

HIOKI

PARTIAL DISCHARGE DETECTOR ST4200 HIGH VOLTAGE MULTIPLEXER SW2001

NEW



**Enhance PD detection,
Elevate your motor inspection**

CE **3 year**
Warranty

Why is partial discharge testing necessary?

In today's motor market, it's no longer enough for R&D and QA teams to simply identify defective motors; they must also detect latent defects. What was once considered "good enough" can now lead to severe consequences. Partial discharge is a key indicator of these latent defects. Traditional motor testing methods, such as hipot, surge, and winding-resistance tests, fail to identify such minuscule defects. As insulation standards advance, previously tolerable weaknesses can now result in partial discharges, leading to short-circuits, insulation failures, and even fires. Fortunately, incorporating a partial discharge testing regimen can be both quick and effective. Hioki provides a range of flexible solutions, from a straightforward, budget-friendly choice to a comprehensive integrated testing station. These solutions not only safeguard against the costly and hazardous effects of undetected partial discharges but also represent a crucial step forward in the evolution of motor manufacturing.

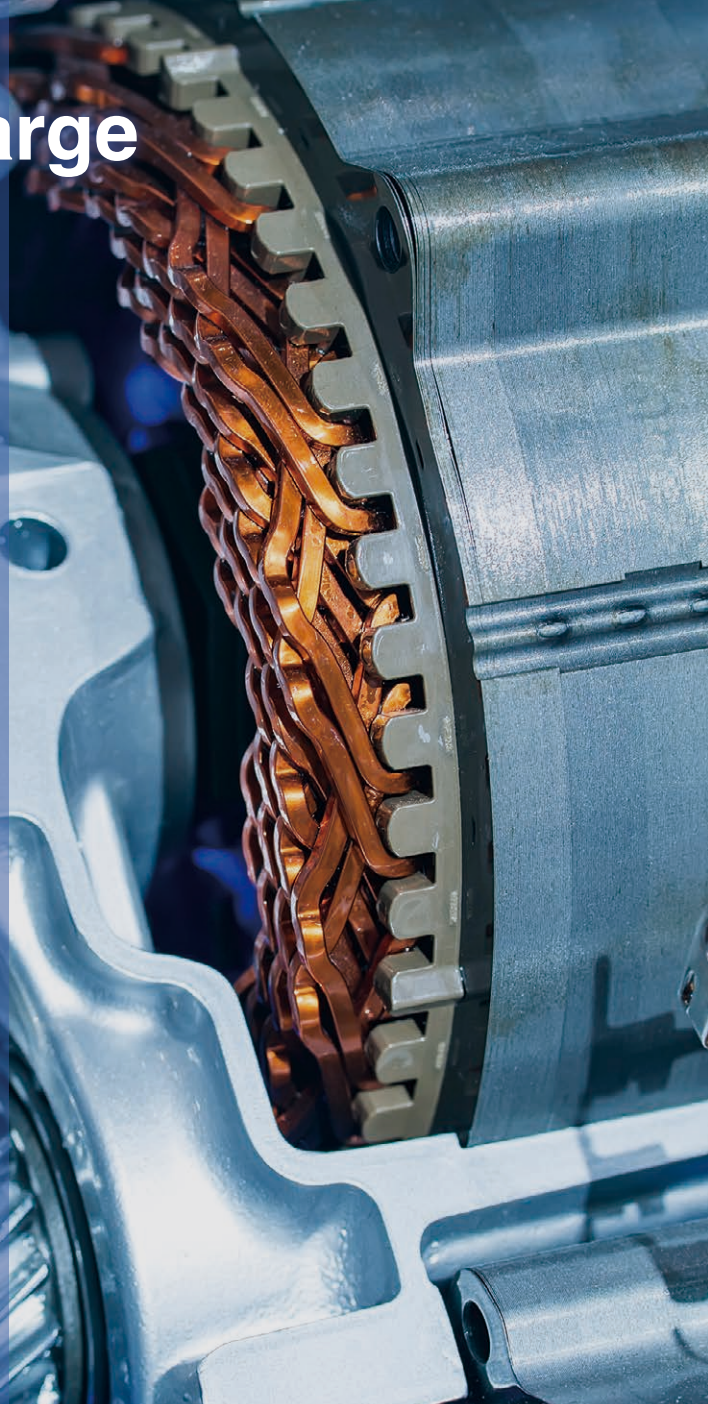

Voltage waveform of the inverter

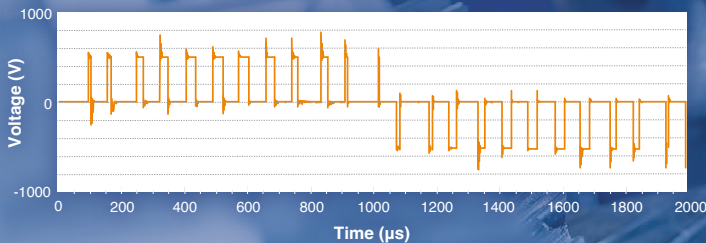

The voltage of the inverter that drives the motor has a waveform that switches rapidly. Each switching operation is accompanied by a surge voltage of approximately twice or more of the switching voltage, causing a momentary high voltage to be applied between the windings inside the motor. Repeated exposure to this inverter surge voltage accelerates the degradation of insulation.

Latent defects that can lead to serious accidents

Partial discharges are thought to happen when a voltage above approximately 350 V is applied to a winding that lacks adequate insulation. These discharges can take place in areas of the winding with insufficient insulation. Over time, they repeatedly occur in the same spot, further deteriorating the insulation, leading to short circuits or insulation breakdowns. Such issues can result in severe incidents, including fires.

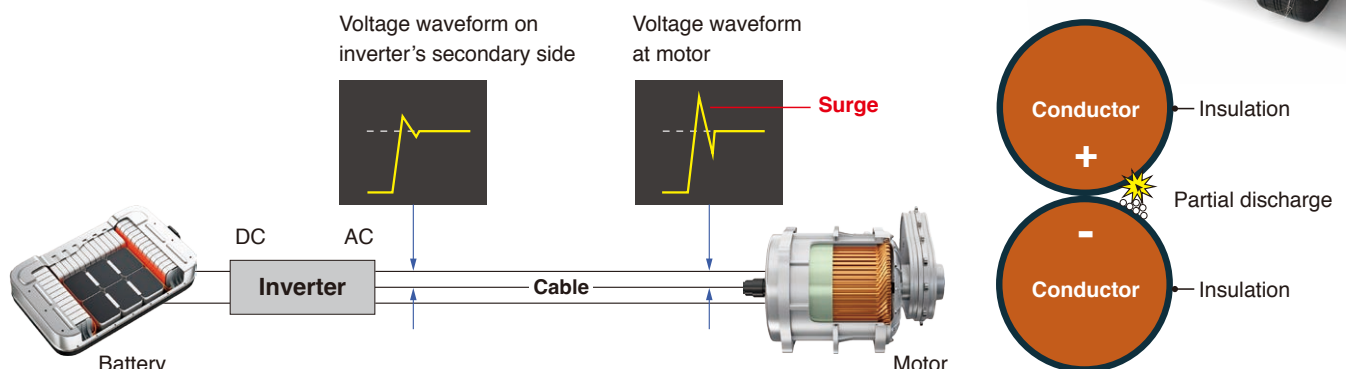
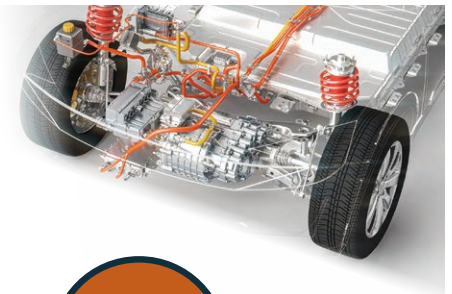

Identifying latent defects before they lead to insulation breakdown

The goal of insulation resistance and hipot testing is to identify motors with already present insulation issues. However, these tests cannot detect latent defects. By identifying partial discharges, latent defects can be uncovered before they result in failures.

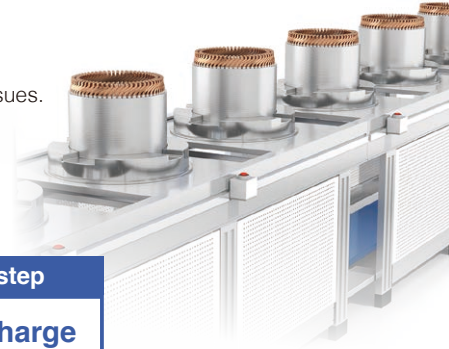

Motor stator inspections

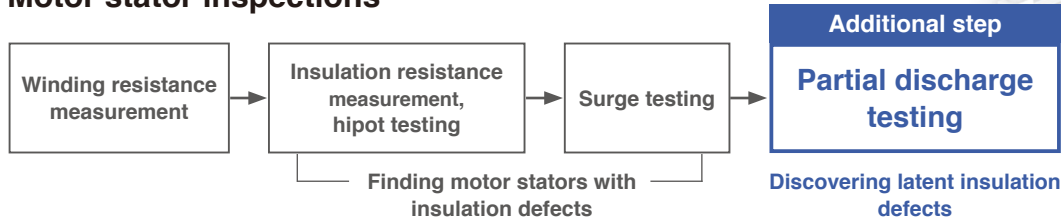

Partial discharge testing in motor stators

In partial discharge testing, partial discharges are detected while applying a high voltage between each phase's windings (turn-to-turn), between phases (phase-to-phase), and between each phase and the stator core (phase-to-core).

Where is partial discharge most likely to occur?

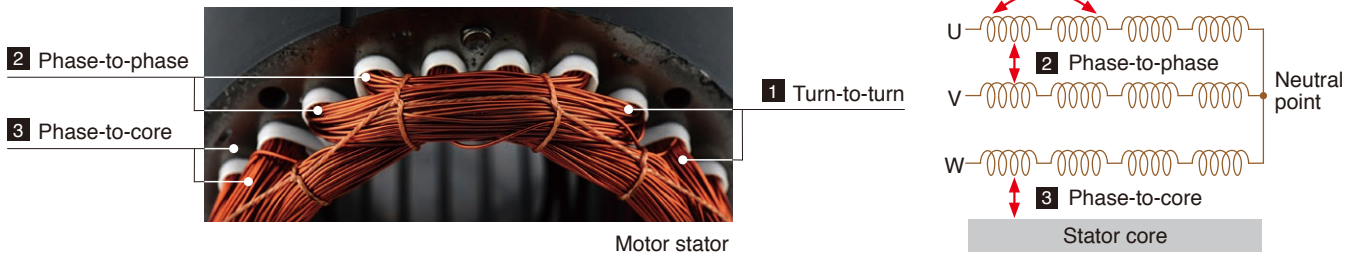

1 Turn-to-turn PD: Discharges caused by voltage differences between wires in the same phase. Surge generator is used for the test.

2 Phase-to-phase PD: Discharges caused by contact between wires in different phases or by misalignment/tearing of insulating paper. Ideally, the test should be performed with the neutral point open and using a high-voltage AC power source for the test.

3 Phase-to-core PD: Discharges caused by contact between wires and the stator core, or by misalignment/tearing of insulating paper. A high-voltage AC power source is used for the test.

Choose the optimal PD testing methods for reliable detection

Since the turn-to-turn PD test checks the ability to resist inverter surges, a surge PD test is performed using an impulse or surge waveform. Ideally, testing between phases and between each phase and the stator core should be done by AC PD testing because the longer voltage application time would increase the likelihood of partial discharge to occur. However, since AC PD testing cannot be performed for phase-to-phase PD tests with a closed neutral point, an impulse waveform is used.



AC PD testing

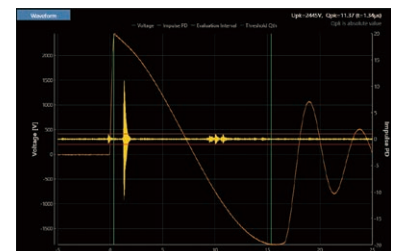

Surge PD testing

Hioki recommends using both AC PD testing and surge PD testing for stator partial discharge testing. The ST4200 Partial Discharge Detector can perform both types of partial discharge detection in a single unit.

Partial Discharge Detector ST4200



Enhanced reliability, Upgraded quality

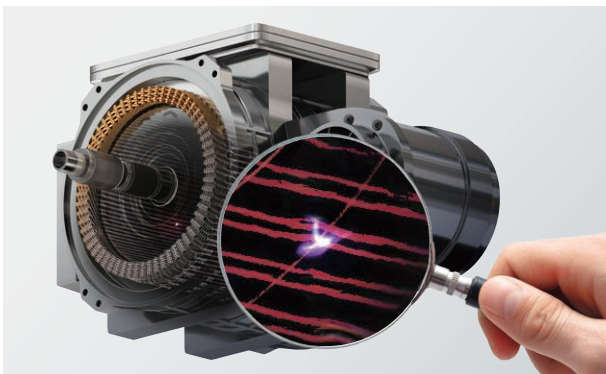

Maximize PD detection to find a variety of latent defects

- Dual-mode PD detection provides reliable inspection with both AC PD and Surge PD testing.

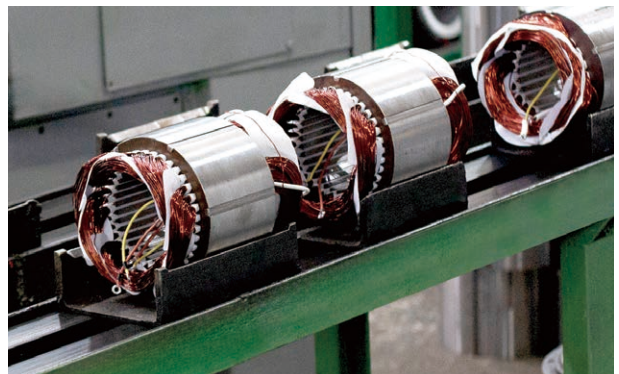

Reliable PD testing even on production lines

- Noise-resistant PD detection with a high-frequency CT.
- Stable partial discharge detection even in complex inspection systems when used in conjunction with SW2001.

High Voltage Multiplexer SW2001

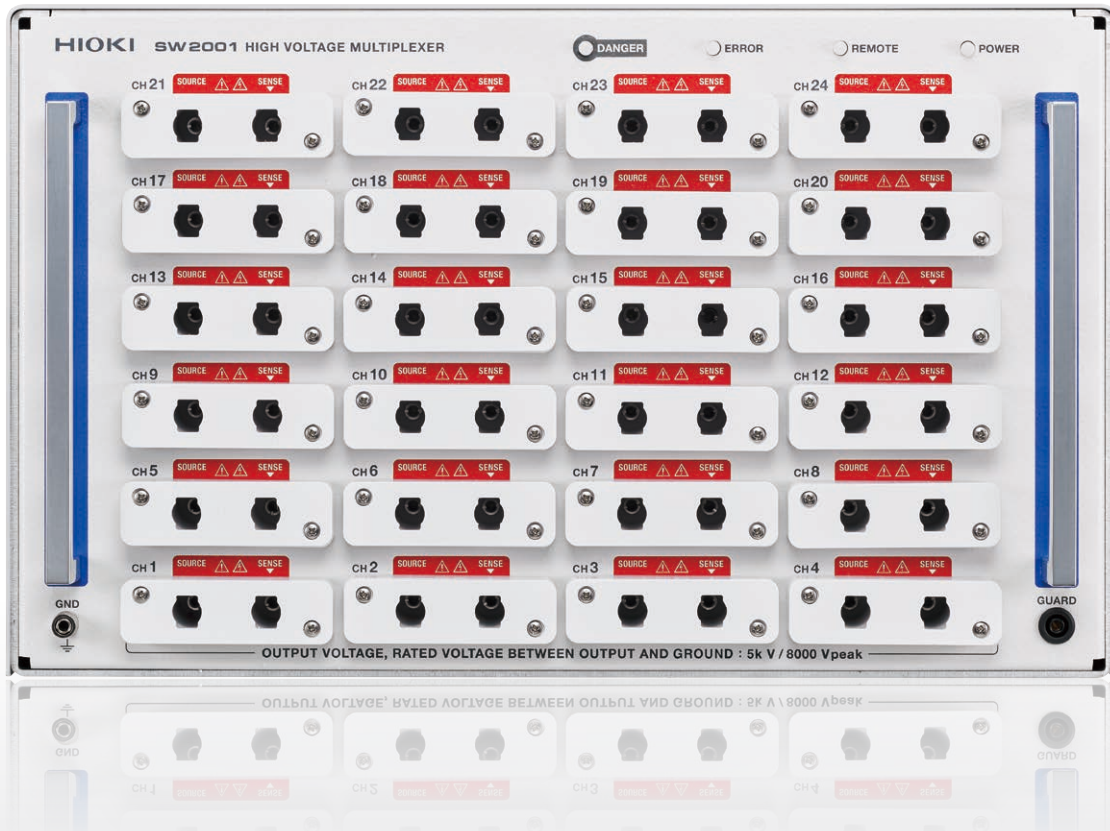

Boosted productivity, Enhanced reliability



Boost productivity with one multiplexer handling six tests

- Selectable number of channels for your test needs:
4, 8, 16, or 24 channels.



Enhance reliability with reduced production line stops, test accuracy, and reproducible results

- Highly reliable multiplexing design with extended
operational lifespan.



Benefit

- 01 Maximize PD detection to find a variety of latent defects
- 02 Streamline your data analysis and accelerate research with diverse analytical functions
- 03 Reliable PD testing even on production lines
- 04 Simplified system design for improved noise resistance
- 05 Boost productivity with one multiplexer handling six tests
- 06 Enhance reliability with reduced production line stops, test accuracy, and reproduceable results

Challenge & Solution

Partial discharge testing on production lines faces challenges with reproducibility due to noise interference. This issue arises from the choice of partial discharge detection methods and the design of the motor inspection systems. While the use of multiplexers is increasing to enhance the efficiency of motor production testing, designing a system that can safely and reliably switch between high-voltage and low-voltage measurements is challenging. It is also challenging to minimize the impact of multiplexers on measurement performance while also improving the system's robustness to minimize maintenance downtime. Balancing these design requirements is a complex task. It is also a strenuous effort to reduce the impact of multiplexers on measurement performance while also enhancing the system's robustness to minimize maintenance downtime.



Benefit 01

Maximize PD detection to find a variety of latent defects

Challenges

Surge PD testing can be used to detect partial discharges at all three points of the stator (turn-to-turn, phase-to-phase, and phase-to-core) regardless of the neutral point connection. Although performing only surge PD testing would be easy, it is not very effective at detecting partial discharges in the following ways.

- ⊗ The test surge often does not give enough time for partial discharge to occur.
- ⊗ The test surge gets attenuated inside the stator.

Solution

Dual-mode partial discharge detection

Find the maximum number of latent defects by utilizing both AC PD and surge PD testing.

You can select the optimal PD testing method based on whether or not the neutral point is connected and the test location.

AC PD testing

A high AC voltage is repeatedly applied while the charge quantity (pC) of the discharge is measured based on the current waveform. Compliance with IEC 60270 and IEC 60034-27-1.

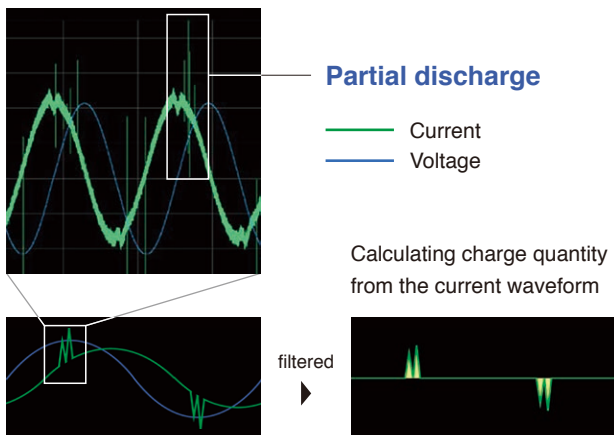

Surge PD testing

An instrument applies a surge while the discharge waveforms appearing in the current waveform are detected. This tests how well the stator can withstand a surge voltage. Compliance with IEC 61934 Edition 2.0 and IEC 60034-27-5.

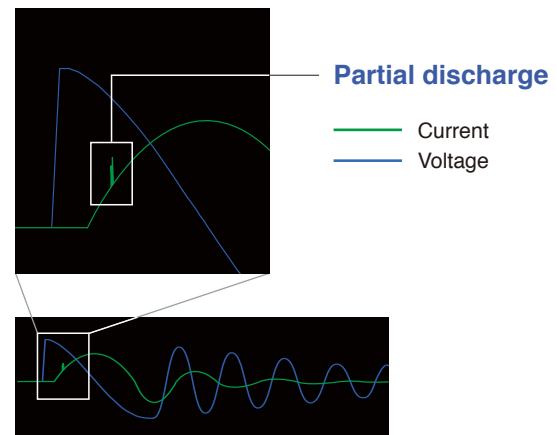

Before neutral-point connection

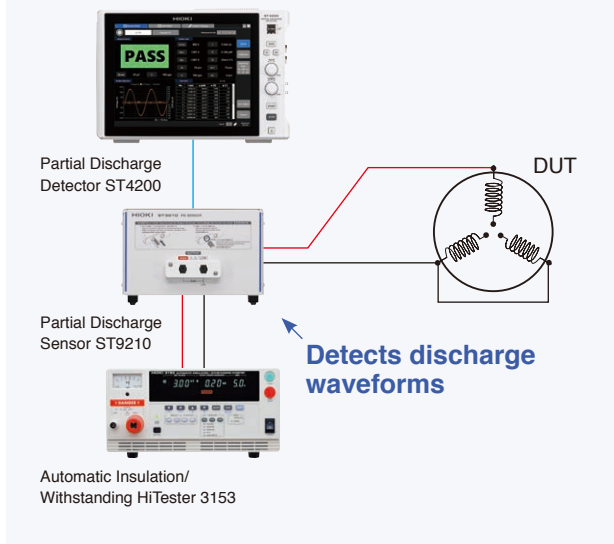

Detects discharge waveforms

After neutral-point connection

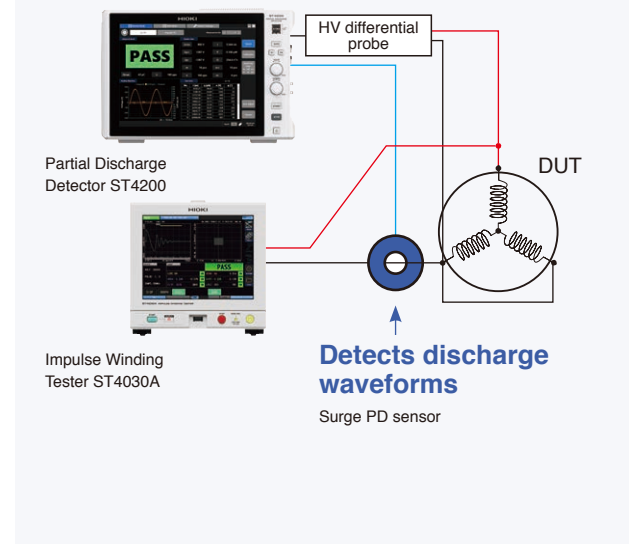

Detects discharge waveforms

Benefit 02

Streamline your data analysis and accelerate research with diverse analytical functions

AC PD testing (Normal Mode)

In Normal Mode, PD testing is conducted at a constant test voltage. The red line labeled *A* in the figure to the right indicates the PD threshold (Qth). Any pulses that surpass this threshold are registered as partial discharges.

The pass/fail criteria for the PD test can be configured based on parameters such as Qmax (maximum PD charge) and n (the number of partial discharge pulses occurring per second).

Besides Phase-Resolved Partial Discharge (PRPD) analysis, the system offers a range of analytical functions, including Qmax-t, Qpk-t, m-t, $\Sigma m-\Phi$, q- Φ , and $\Sigma q-\Phi$.

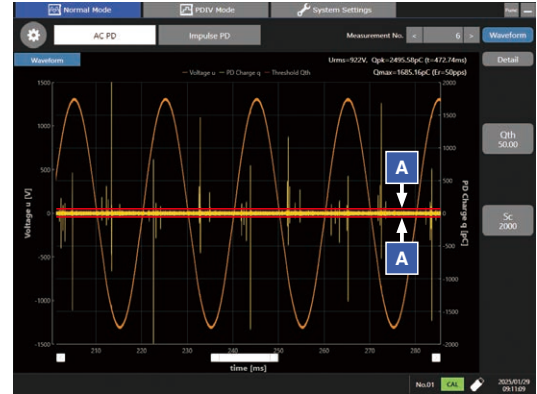

Setting of PD threshold

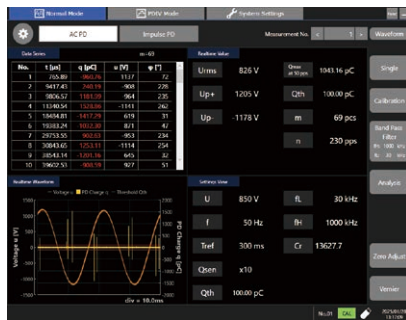

AC PD Normal Mode measurement

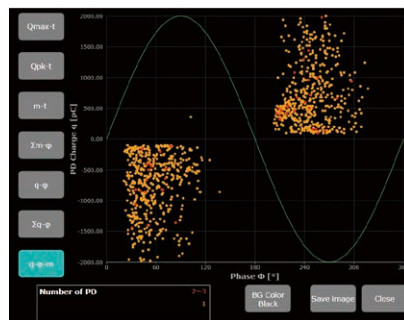

q- Φ -m analysis graph

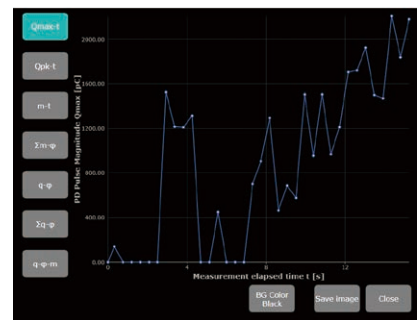

Qmax-t analysis graph

AC PD testing (PDIV Mode)

In PDIV mode, the test voltage is ramped up and down to measure the Partial Discharge Inception Voltage (PDIV) and Partial Discharge Extinction Voltage (PDEV). (*B* in the right figure indicates the PDIV value, and *C* indicates the PDEV value.)

For each measurement cycle, recorded PD data, including time of occurrence, charge magnitude, instantaneous voltage, and voltage phase, can be displayed and recorded. (*D* in the right figure shows the measurement display.)

A graph of voltage versus maximum charge (Qmax) is plotted in real time (*E* in the right figure). The system also offers various other analysis functions, such as pulse-count versus voltage graphs.

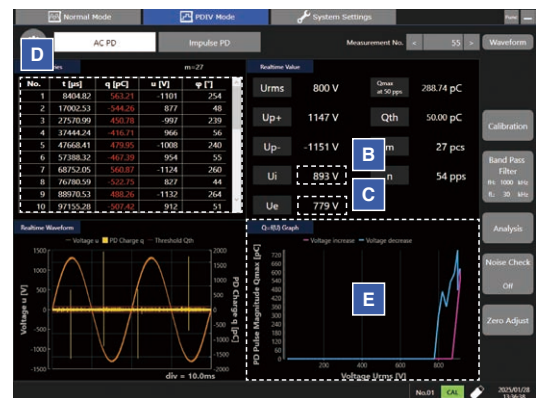

AC PD PDIV Mode measurement

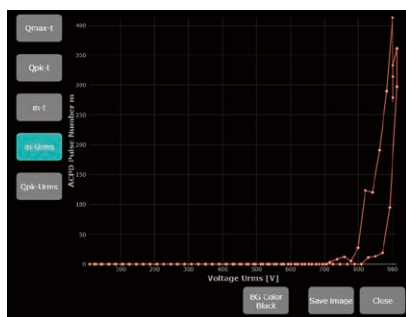

m-Urms analysis graph



Qpk Urms analysis graph

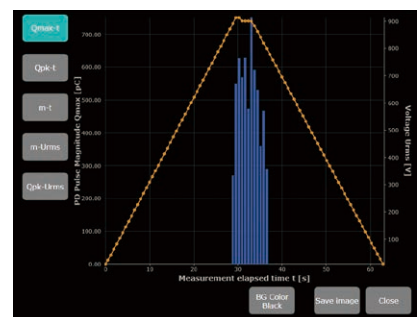

Qmax-t analysis graph

Surge PD testing (Normal Mode)

In normal mode, PD testing is conducted at a fixed test voltage. The red line (F) in the accompanying figure represents the PD threshold (Qth).

Only pulses exceeding this Qth value are considered and recorded as partial discharges. Furthermore, a gating period (G) can be defined to mitigate the effects of non-PD pulses that may occur during the rising edge of the impulse waveform.

Furthermore, in normal mode, the number of test repetitions can be set arbitrarily. Table H on the right presents data acquired from a series of 10 tests. This table displays and records key parameters for each test, including the peak partial discharge magnitude (Qpk), the peak test voltage (Upk), and the time from the trigger point to when a peak partial discharge is detected (tpk).



Setting of the PD threshold and the judgement window

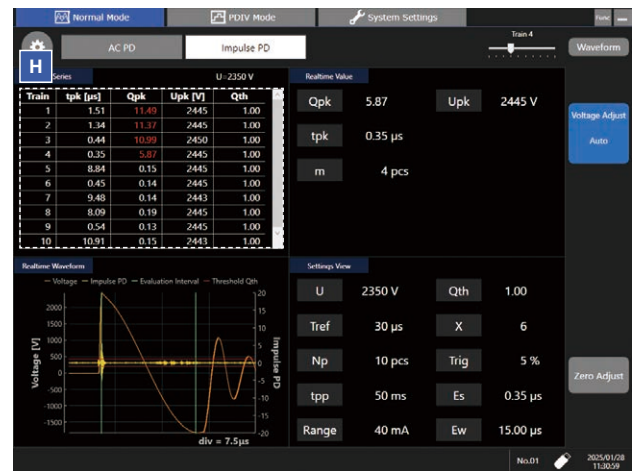

Surge PD Normal Mode measurement

Surge PD testing (PDIV Mode)

PDIV Mode allows users to define the starting voltage, maximum voltage, and voltage step. This mode then displays and records key partial discharge parameters: see Figure I.

- PDIV Partial Discharge Inception Voltage
- RPDIV Repetitive Partial Discharge Inception Voltage
- RPDEV Repetitive Partial Discharge Extinction Voltage
- PDEV Partial Discharge Extinction Voltage

Furthermore, the SBS graph (Graph J) provides real-time monitoring of the applied voltage and the corresponding PD pulse magnitude throughout the test.



Surge PD PDIV Mode measurement

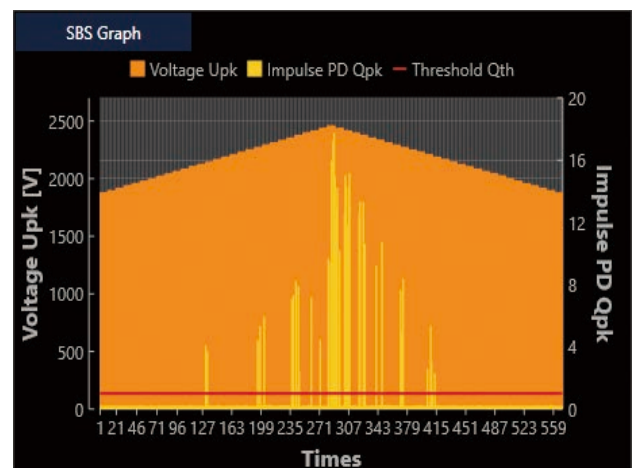

SBS analysis graph

Benefit 03

Reliable partial discharge testing even on production lines

Challenges

Using microwave antennae to detect partial discharge causes the following challenges

- ⊗ It picks up noise from plant equipment and power lines, affecting measured values.
- ⊗ Slight antenna directivity errors result in false PASS/FAIL judgements.
- ⊗ Motor casings can shield partial discharge signals from being detected, as if they were faraday cages.

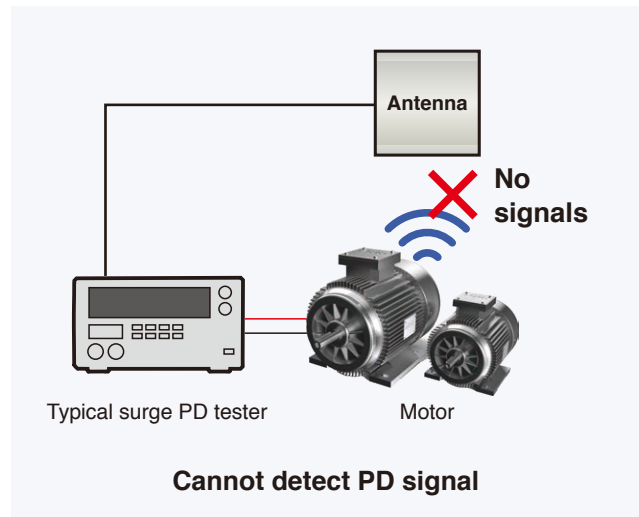
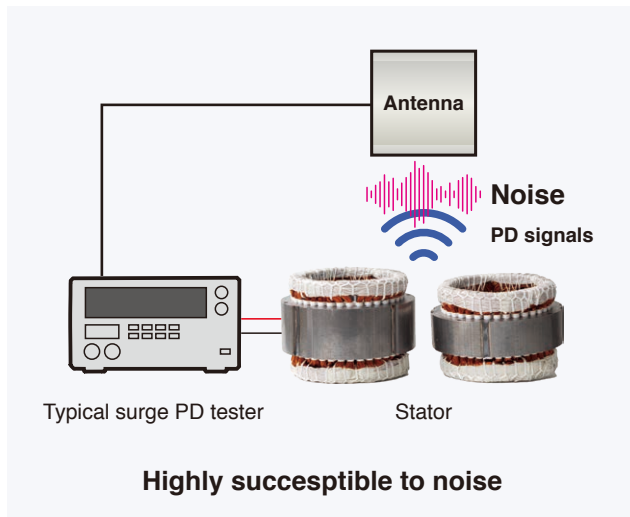

Solution

Noise-resistant partial discharge detection with a high-frequency CT

Partial discharge testing using a high-frequency CT simplifies installation by reducing the need for precise positioning and minimizes noise. Both of these benefits reduce measurement errors when compared to the antenna method. Unlike the antenna method which cannot detect partial discharges through the finished motor casing, this method also allows surge PD testing for finished motors.

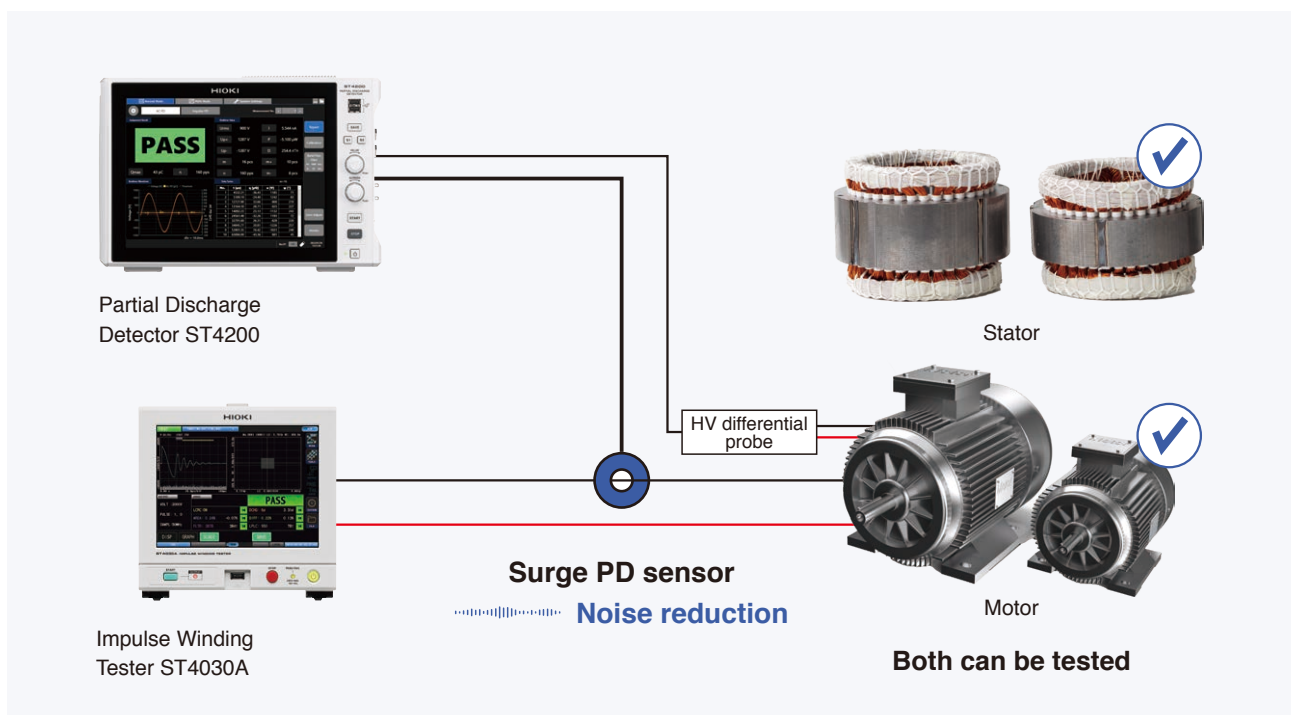

Benefit 04

Simplified system design for improved noise resistance

Challenge

⊘ Noise from complex wiring inside the test system makes PD detection unstable.



Complex wiring



Noise makes detection unstable

Solution

Integration with the SW2001 High Voltage Multiplexer

To minimize the impact of noise in complex testing environments, a partial discharge testing system with the ST4200 can utilize a multiplexer-based architecture, incorporating the SW2001. This design significantly reduces wiring complexity by consolidating multiple input signals, minimizing cable runs and interconnections. This approach effectively reduces potential noise sources such as electromagnetic interference (EMI), ground loops, and capacitive coupling, resulting in more accurate and reliable measurements.

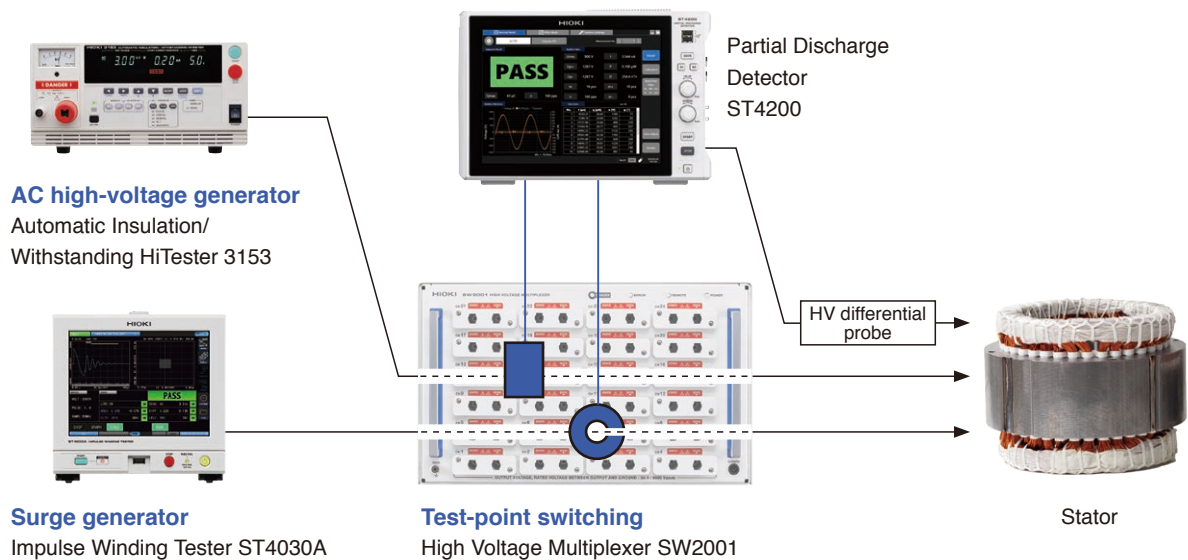

Factory option accessories

Please specify at the time of order as the unit is embedded during the manufacturing process.

 **AC partial discharge detection**
PD Sensor ST9200

 **Surge partial discharge detection**
PD Sensor ST9201

Benefit 05

Boost productivity with one multiplexer handling six tests

Conventional motor test lines often require moving motors from one testing station to another between tests. To enhance efficiency and optimize space utilization, modern lines consolidate multiple tests into a single location.

Challenges

- ⊗ Traditional motor test systems often limit testing to one motor at a time, requiring frequent and time-consuming reconnections of test leads for multi-motor inspections.
- ⊗ Other than 4 connection points, testing finished motors require two more connections for testing thermistor temperature sensors.

Conventional motor test line

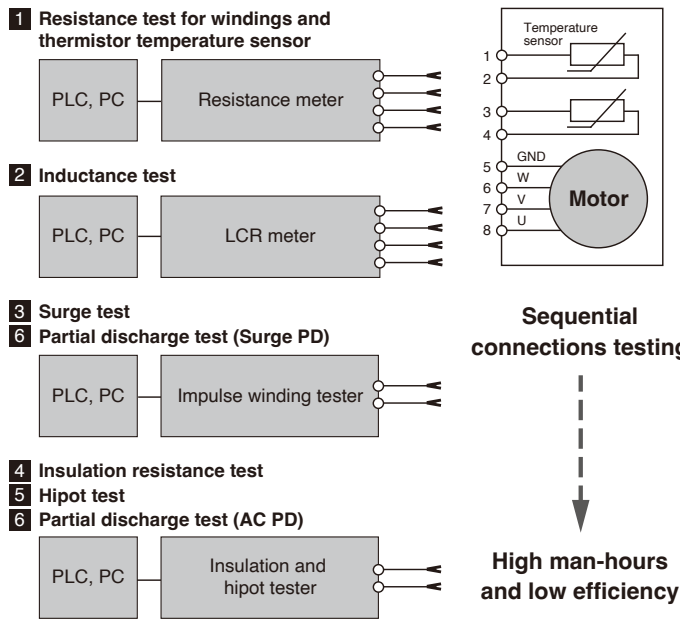

Modern motor test line

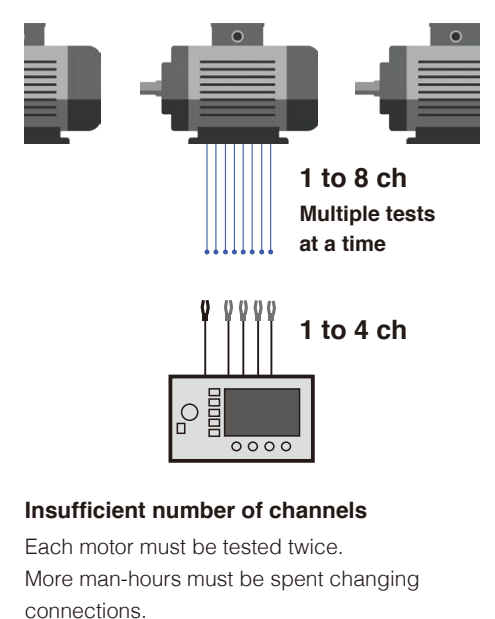

Solution

Select the number of channels based on your testing needs

Streamline your motor inspections by connecting multiple instruments for six different tests: resistance, inductance, surge, hipot, insulation resistance, and partial discharge (ACPD and surge PD). The multiplexer eliminates the need for frequent reconnections, in both serial motor test lines (conventional test lines) and parallel motor test lines. The SW2001 supports simultaneous testing of up to 3 three-phase motors with two built-in thermistor temperature sensors.

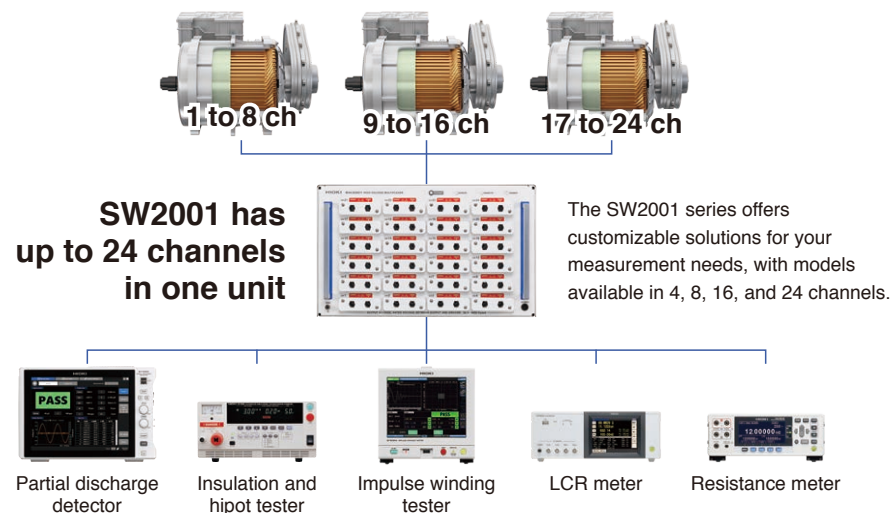

Benefit 06

Enhance reliability with reduced production line stops, test accuracy, and reproducible results

Combined motor/stator testing systems typically involve high-voltage testing such as the hipot test (applying several kV between coil and core) and low-voltage testing such as the winding resistance test. This necessitates switching measurement circuits between the test instrument and the device under test (DUT).

Challenges

1. Impact of multiplexer design on measurement

- ⊘ **Poor insulation performance**
Designs that fail to meet the necessary insulation performance can cause measurement error in insulation resistance and hipot tests (occurring from humidity changes causing leakage current).
- ⊘ **Increase in relay contact resistance**
Typical relays experience an increase in contact resistance due to repeated use, leading to variations in measurement values.
- ⊘ **Hardware design issues**
Suboptimal design causes noise interference and internal discharge, reducing reliability in partial discharge detection and other motor inspections.

2. Sudden failure of measuring instruments

- ⊘ **Failure due to residual energy**
If a low-voltage measuring instrument, such as a resistance meter, is connected to the test object without sufficiently discharging the energy accumulated in the winding during high-voltage testing, the high voltage generated between windings may cause the low-voltage measuring instrument to fail.
- ⊘ **Frequent high-voltage relay replacement**
If the high-voltage relays used in the multiplexer do not fully meet the required voltage specifications, they rapidly deteriorate, leading to frequent relay replacements. This results in production line downtime and reduced productivity.

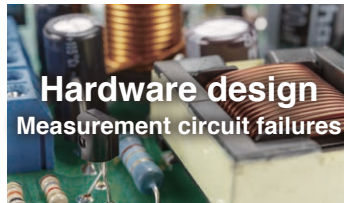
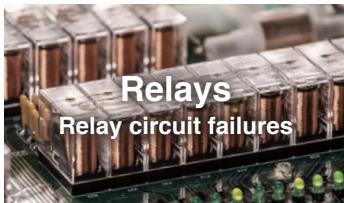

Solution

Highly reliable multiplexing design with extended operational lifespan: SW2001

The SW2001 employs highly durable high-voltage reed relays to reduce maintenance frequency. These relays operate by generating a magnetic field through current flow in an adjacent excitation coil, which switches the contacts inside a glass tube. The multiplexer's high-voltage reed relays with this operating mechanism enable safe switching in high-voltage circuits (with a maximum peak voltage of 8 kV) and help reduce the impact of leakage current on measurements.

In addition to adopting such reed relays, the SW2001 multiplexer utilizes advanced insulation design to ensure more accurate measurements. This includes optimizing the spatial insulation distance between relays, selecting appropriate insulation materials, and using high-voltage printed circuit boards to enhance insulation between relays and grounding. Furthermore, to minimize the risk of damage to the measuring instrument caused by energy accumulated in the measured winding, a protective discharge function is incorporated.

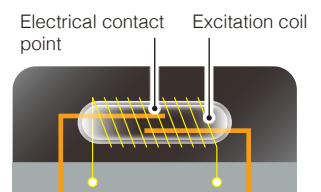

High-voltage reed relays



Optimization of insulation design

Guaranteed measurement performance and high durability

Effect on accuracy

- Insulation resistance measurement accuracy: 2% (1 M to 1 G)
- Magnitude of effect on AC PD measurement: 40 pC or less (during 3 kV application)

Durability

- Maximum allowable impulse current: 100 A peak
- Main circuit relay service life: 5 million or more cycles (reference value, not guaranteed)



SW2001

Reliable switching

The SW2001 facilitates safe and precise measurement for the diverse set of motor tests that demand a wide range of specs from high sensitivity for low voltages (motor winding resistance tests and inductance tests) to high-voltage resistance (max. 5 kV RMS for AC/DC hipot tests and max. 8 kV peak for surge tests).

Protective discharge function

The protective discharge function can ground the output-side's main circuit so that it can discharge residual energy prior to closing the I/O relay's main circuit. This prevents damage to low-voltage meters from stored energy.

System configuration

AC PD testing

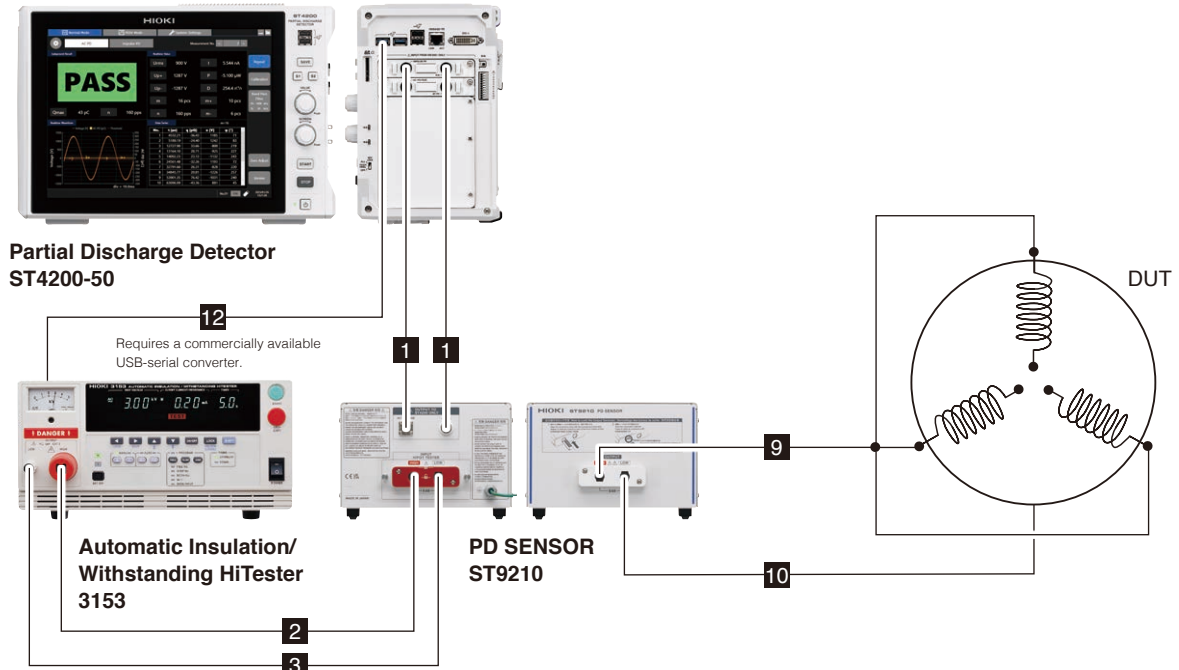

Devices and accessories used

ST4200-50 (×1), 3153 (×1), ST9210 (×1), **1** L9218 (×2), **2** L2270 (×1), **3** L2271 (×1), **9** Clip Type Lead (Red) (×1), **10** Clip Type Lead (Black) (×1), **12** L9637 (×1)

Note: PD calibrator required for PD test system calibration. Please purchase one separately.

Surge PD testing

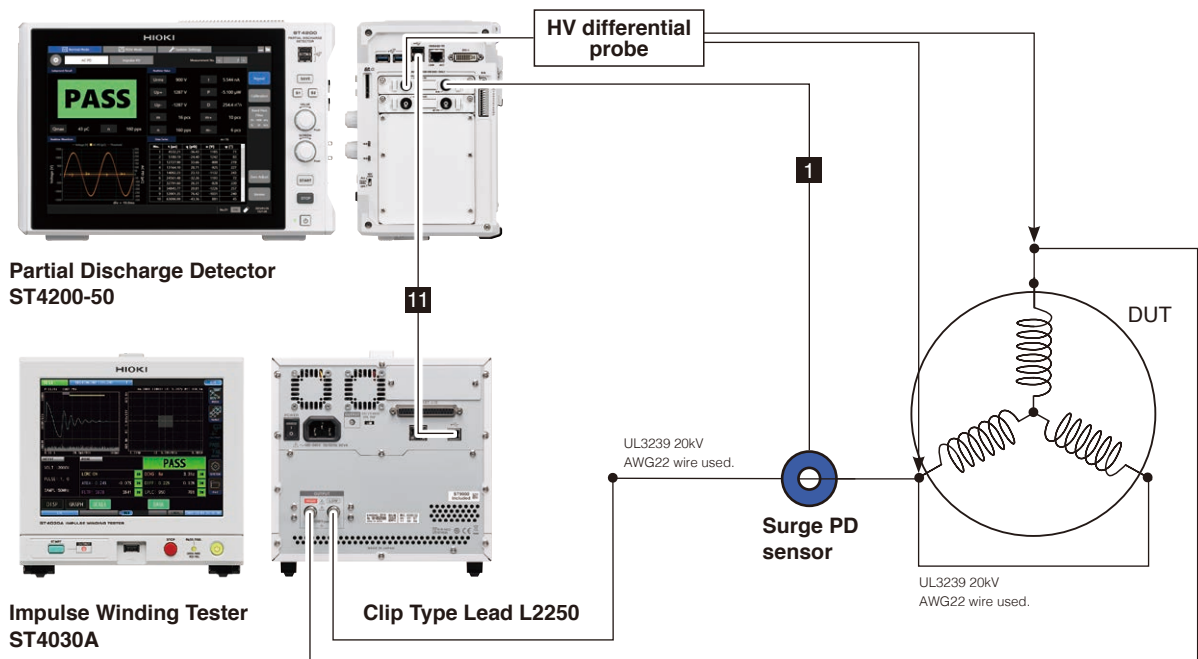

Devices and accessories used

ST4200-50 (×1), ST4030A (×1), Surge PD sensor (×1), L2250 (×1), HV differential probe (×1), PD filter (×1),

1 L9218 (×1), **11** L1002 (×1)

Motor testing system with the SW2001 High Voltage Multiplexer

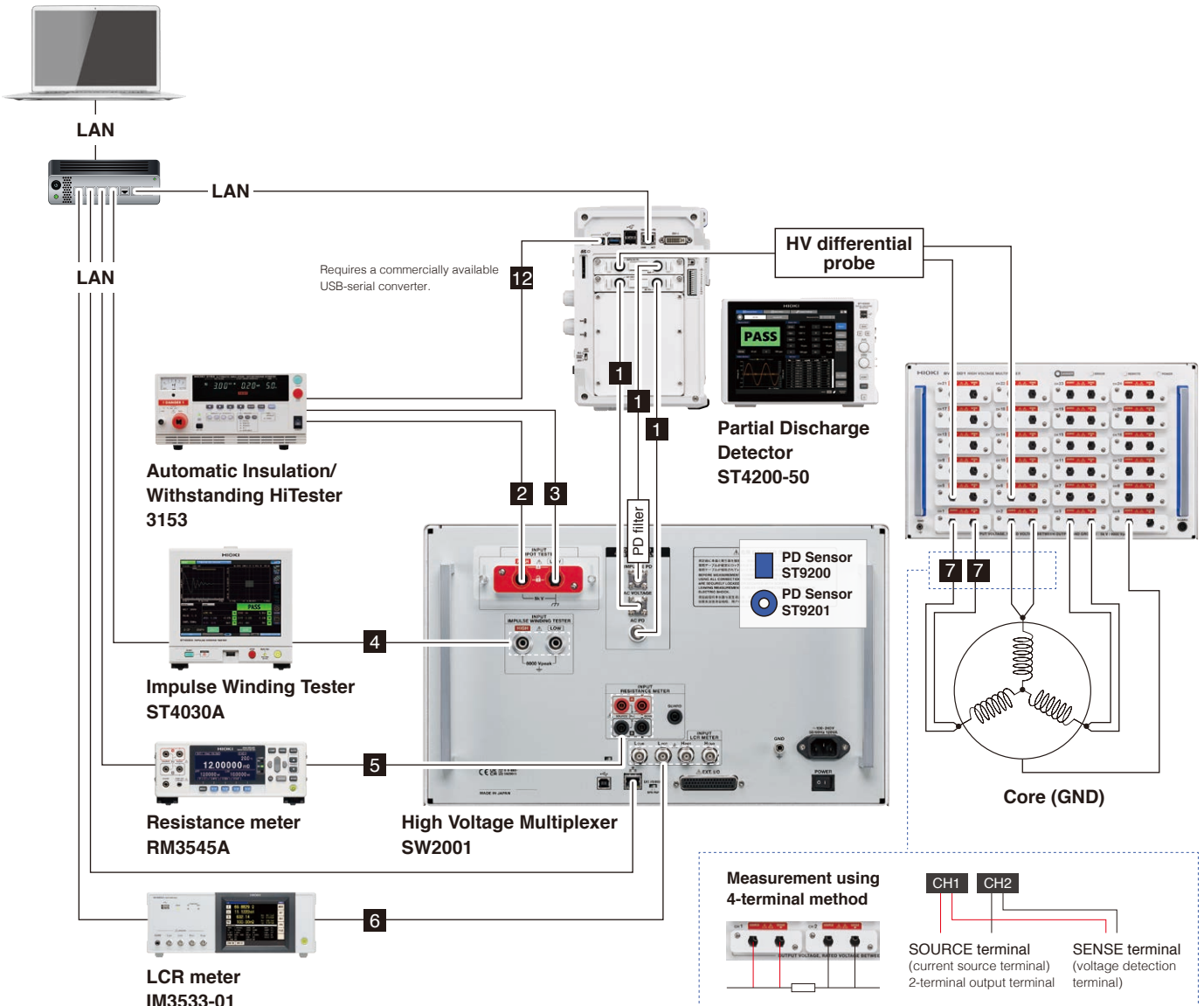

Connection cables & lead cables



1 CONNECTION CABLE L9218
For connecting the ST4200 and SW2001



2 CONNECTION CABLE L2270
Red (high): for connecting the 3153



3 CONNECTION CABLE L2271
Black (low): for connecting the 3153



4 CONNECTION CABLE L2255
Red and black set: for connecting the ST4030A



5 CONNECTION CABLE L2111
4-terminal: for connecting the RM3545A



6 CONNECTION CABLE L2005
4-terminal: for connecting the IM3533-01



7 UNTERMINATED LEAD CABLE L2265
Red, high-voltage connector to bare wire



8 UNTERMINATED LEAD CABLE L2266
Black, high-voltage connector to bare wire

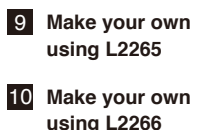

9 Make your own using L2265



10 Make your own using L2266



11 USB CABLE (A-B) L1002



12 RS-232C CABLE L9637
Please use a commercially available USB-serial converter to connect the ST4200 to secondary instruments.

System configuration

Selection guide

Test

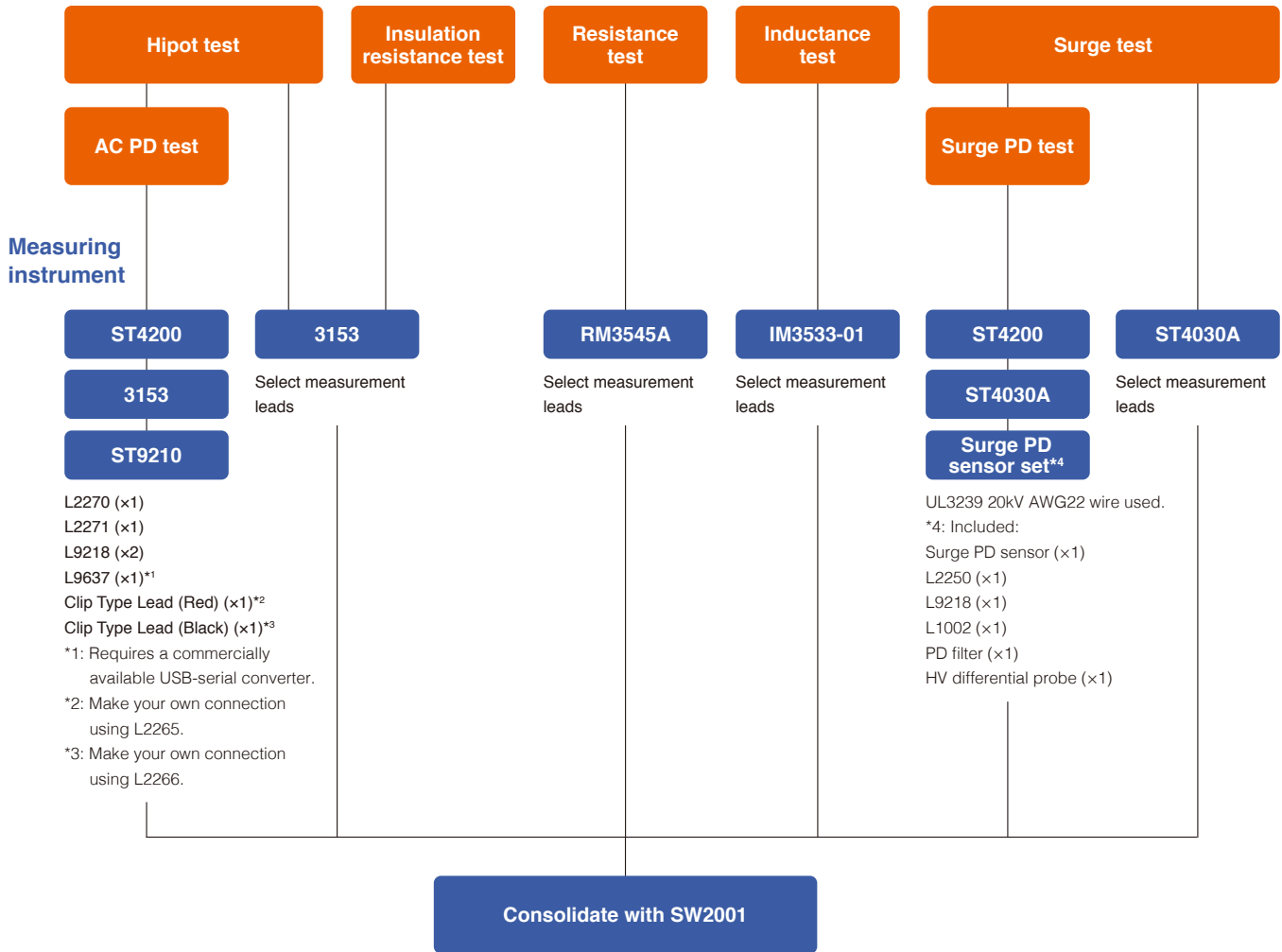

See page 15

Choose your kit

AC PARTIAL DISCHARGE TEST KIT



Included:

- ST4200-50
- 3153
- ST9210
- L2270, L2271
- L2265, L2266
- L9218 (x2), L9637

Please use a commercially available USB-serial converter to connect the ST4200 to secondary instruments.

SURGE PARTIAL DISCHARGE TEST KIT



Included:

- ST4200-50
- ST4030A
- Surge PD sensor set

UL3239 20kV AWG22 wire is required for measurement.

AC/SURGE PARTIAL DISCHARGE TEST KIT



Included:

- ST4200-50
- 3153, ST4030A
- ST9210, Surge PD sensor set
- L2270, L2271
- L2265, L2266
- L9218 (x2), L9637

Please use a commercially available USB-serial converter to connect the ST4200 to secondary instruments.



Product name: Partial Discharge Detector ST4200

Model number (order code) **ST4200-50**

Included accessories: power cord x 1, startup guide x 1

Factory option accessory

SSD UNIT U8332
Internal drive, 256 GB



Please specify at the time of order as the unit is embedded during the manufacturing process.

Options and accessories

Additional storage media

Use only storage media sold by Hioki.



PD SENSOR ST9210

Sensor for AC partial discharge test

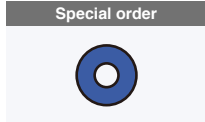

SURGE PD SENSOR SET

Surge PD sensor, L2250, L9218, L1002, PD filter, HV differential probe



USB CABLE (A-B) L1002



RS-232C CABLE L9637

Please use a commercially available USB-serial converter to connect the ST4200 to secondary instruments.



USB DRIVE (16 GB) Z4006



SD MEMORY CARD (2GB) Z4001 (8GB) Z4003



SW2001-24

Product name: High Voltage Multiplexer SW2001

Model number (order code) 4-channel model: **SW2001-04**
 8-channel model: **SW2001-08**
 16-channel model: **SW2001-16**
 24-channel model: **SW2001-24**

Included accessories: power cord x 1, startup guide x 1, support feet for installation x 4, EXT I/O connectors x 2

Factory option accessories

PD SENSOR ST9200
For AC partial discharge detection, embedded into the SW2001

PD SENSOR ST9201
For surge partial discharge detection, embedded into the SW2001

Please specify at time of order as one of these components are embedded during the manufacturing process.

Options and accessories



CONNECTION CABLE L9218

For connecting the ST4200 and SW2001



CONNECTION CABLE L2270

Red (high): for connecting the 3153



CONNECTION CABLE L2271

Black (low): for connecting the 3153



CONNECTION CABLE L2255

Red and black set: for connecting the ST4030A



CONNECTION CABLE L2111

4-terminal: for connecting the RM3545A



CONNECTION CABLE L2005

4-terminal: for connecting the IM3533-01



UNTERMINATED LEAD CABLE L2265

Red, high-voltage connector to bare wire



UNTERMINATED LEAD CABLE L2266

Black, high-voltage connector to bare wire



USB CABLE (A-B) L1002

Related products



Automatic Insulation/Withstanding HiTester 3153



Impulse Winding Tester ST4030A



Resistance Meter RM3545A



LCR Meter IM3533-01

ST4200 specifications

Note: the terminology 'surge' can be replaced with 'impulse'.

AC PD measurement

Detection method	Discharge charge quantity measurement using detected impedance and a band-pass filter in accordance with IEC 60270 and IEC 60034-27-1	
Sampling rate	100 MS/s	
Charge quantity measurement range	Test piece capacitance C	Charge quantity measurement range Q
	200 pF ≤ C < 2 nF	10 pC ≤ Q ≤ 500 pC
	2 nF ≤ C ≤ 10 nF	10 pC ≤ Q ≤ 2500 pC
Sampling window time width	100 to 1000 ms	
Test frequency range (applied voltage)	45 Hz to 1.1 kHz	
Measurement parameters	<p>[Normal mode] Maximum repeating PD strength (Q_{max}), PD pulse count (m, m+, m-), PD pulse incidence (n), voltage RMS value (U_{rms}), voltage crest value (U_{p+}, U_{p-}), average discharge current (I), discharge power (P), second-order rate (D), PD pulse apparent charge (q), PD pulse phase angle (φ)</p> <p>[PDIV mode] (normal mode parameters plus the following) PD inception voltage (U_i), PD extinction voltage (U_e)</p>	

Impulse PD measurement

Detection method	Discharge current detection using a CT and digital filter in accordance with IEC 61934 Edition 2.0 and IEC 60034-27-5	
Sampling rate	200 MS/s	
Waveform recording length	2000 to 200,000 points (varies with sampling window time width)	
Measurement parameters	<p>[Normal mode] PD peak discharge magnitude (Q_{pk}), pulse sequence PD count (m)</p> <p>[PDIV mode] (normal mode parameters plus the following) PD inception voltage (PDIV), repetitive PD inception voltage (RPDIV), repetitive PD extinction voltage (RPDEV), PD extinction voltage (PDEV), repeating PD peak discharge magnitude (RQ_{pk})</p>	

Specifications shared by AC PD and impulse PD measurement

Measurement modes	Normal mode: instrument applies a constant voltage and performs either single or continuous measurement. PDIV mode: instrument performs measurement while varying the applied voltage in compliance with standards.					
Input channels	AC VOLTAGE: voltage monitor signal (BNC terminal) AC PD: AC partial discharge current sensor signal (BNC terminal) IMPULSE PD: impulse partial discharge current sensor signal (BNC terminal)					
Graph display parameters	AC PD	<p>[Voltage waveform, PD pulse monitor] X-axis: time; Y-axis: voltage or PD pulse (each with its own scale) [Voltage and discharge quantity characteristics (Q = f (U) graph)] X-axis: voltage RMS value; Y-axis: maximum repeating PD strength</p>				
	Impulse PD	<p>[Current waveform, PD pulse monitor] X-axis: time; Y-axis: current or PD pulse (each with its own scale) [Impulse voltage or PD pulse trend with repeated impulse application] X-axis: count; Y-axis: impulse voltage or PD pulse (each with its own scale)</p>				
Judgment description	FAIL if: · Measurement result is greater than or equal to judgment value · Judgment value is negative and the measurement result is less than or equal to the judgment value Otherwise, PASS					
	Judgment functionality	Measurement parameters for which judgment can be performed	<table border="1"> <tr> <td>AC PD</td> <td> <p>[Normal mode] Maximum repeating PD strength (Q_{max}), PD pulse count (m, m+, m-), PD pulse incidence (n), average discharge current (I), discharge power (P), second-order rate (D) [PDIV mode] (normal mode parameters plus the following) PD inception voltage (U_i), PD extinction voltage (U_e)</p> </td> </tr> <tr> <td>Impulse PD</td> <td> <p>[Normal mode] PD peak discharge magnitude (Q_{pk}), pulse sequence PD count (m) [PDIV mode] (normal mode parameters plus the following) PD inception voltage (PDIV), repetitive PD inception voltage (RPDIV), repetitive PD extinction voltage (RPDEV), PD extinction voltage (PDEV), repeating PD peak discharge magnitude (RQ_{pk})</p> </td> </tr> </table>	AC PD	<p>[Normal mode] Maximum repeating PD strength (Q_{max}), PD pulse count (m, m+, m-), PD pulse incidence (n), average discharge current (I), discharge power (P), second-order rate (D) [PDIV mode] (normal mode parameters plus the following) PD inception voltage (U_i), PD extinction voltage (U_e)</p>	Impulse PD
AC PD		<p>[Normal mode] Maximum repeating PD strength (Q_{max}), PD pulse count (m, m+, m-), PD pulse incidence (n), average discharge current (I), discharge power (P), second-order rate (D) [PDIV mode] (normal mode parameters plus the following) PD inception voltage (U_i), PD extinction voltage (U_e)</p>				
Impulse PD	<p>[Normal mode] PD peak discharge magnitude (Q_{pk}), pulse sequence PD count (m) [PDIV mode] (normal mode parameters plus the following) PD inception voltage (PDIV), repetitive PD inception voltage (RPDIV), repetitive PD extinction voltage (RPDEV), PD extinction voltage (PDEV), repeating PD peak discharge magnitude (RQ_{pk})</p>					

Accuracy specifications

PD pulse phase angle measurement accuracy (reference value, not guaranteed)	Voltage input frequency	PD pulse phase angle error (°)
	45 Hz ≤ f ≤ 100 Hz	±0.4
	100 Hz < f ≤ 400 Hz	±1.0
	400 Hz < f ≤ 1 kHz	±2.5
Effects of radiative radio frequency electromagnetic fields	50 pC or less (at 10 V/m)	
Effects of conductive radio frequency electromagnetic fields	50 pC or less (at 10 V)	
Effects of pulse noise superposed on power supply	50 pC or less (with pulse noise of 1 kV and pulse width of 50 ns)	

High-voltage source control

Control description	Cooperative control of withstanding voltage tester and impulse winding tester used as high-voltage generators for partial discharge testing
Compatible instruments (February 2025)	Automatic Insulation/Withstanding HiTester 3153, Impulse Winding Tester ST4030A, etc.

General specifications

Location of use	Indoors, Level 2 pollution, maximum elevation of 2000 m
Operating temperature and humidity range	0°C to 40°C (32°F to 104°F), 80% RH or less (non-condensing)
Storage temperature and humidity range	-10°C to 50°C (14°F to 122°F), 80% RH or less (non-condensing)
Standards compliance	Safety: IEC 61010; EMC: EN 61326
Power supply	Rated supply voltage: 100 to 240 V AC; rated power: 300 VA
External dimensions	Approx. 353 mm (13.9 in.) W × 235 mm (9.25 in.) H × 154.8 mm (6.09 in.) D (excluding protruding parts)
Weight	Approx. 7.3 kg (257.5 oz.) (with U8332); approx. 7.1 kg (250.4 oz.) (without U8332)

Data storage functionality

Storage destination	SD memory card	Z4001 (2 GB), Z4003 (8 GB)
	USB drive	Z4006 (16 GB)
	SSD	U8332 SSD Unit (256 GB)
File system	FAT32, NTFS, exFAT	
File name	Alphanumeric character or Japanese input	
Treatment of identical file names	Saved after appending serial numbering to end	
Auto-saving	The following data is automatically saved after measurement: · Data series (impulse PD and AC PD) · SBS graph image · AC PD Q = f (U) graph image	
Manual saving	The following data can be saved by pressing the SAVE key: · Data series (impulse PD and AC PD) · AC PD real-time waveform image · Impulse PD real-time waveform image · SBS graph image · AC PD Q = f (U) graph image	
Saved formats	Display graph images	BMP, PNG, JPEG
	Measurement data	CSV (data is saved in each mode's fixed format)
File selection	New file or existing file: The user can select whether to create a new file or append data to an existing file when measurement starts.	
SAVE key operation	When the SAVE key is pressed, data is saved to the previously set save-destination using the previously set filename in accordance with the save settings.	

Data load functionality

Storage media	SD memory card	Z4001 (2 GB), Z4003 (8 GB)
	USB drive	Z4006 (16 GB)
	SSD	U8332 SSD Unit (256 GB)
Loaded data format	CSV	

Interfaces

Interfaces	LAN, USB, RS-232C* (please use a commercially available USB-serial conversion cable), monitor output, EXT. I/O (measurement start, measurement cancel, overall judgment PASS/ FAIL) *Connect to secondary instruments (e.g., Automatic Insulation/Withstanding HiTester 3153)	
------------	--	--



- 1** Built-in SSD specified at time of order
- 2** USB 2.0 connector × 4
- 3** USB 3.0 connector × 2
- 4** LAN connector (100Base-TX)
- 5** DVI-I terminal
- 6** SD memory card slot
Be sure to use Hioki's approved storage media accessories. The instrument may not be able to save or load data properly if other media are used.
- 7** External control terminals
- 8** Measurement signal input terminal

Test data and waveform images can be saved on the ST4200's internal storage or on external media. This data can be used to validate test results.

SW2001 specifications

Basic specifications

Input channels	2 channels of high-voltage 2-terminal input: for insulation and hipot tester, surge tester 2 channels of low-voltage 4-terminal input: for LCR meter, resistance meter		
Output channels	CH1 to CH4 (SW2001-04), CH1 to CH8 (SW2001-08), CH1 to CH16 (SW2001-16), CH1 to CH24 (SW2001-24) SOURCE terminal (or 2-terminal output terminals) and SENSE terminal for each channel		
Partial discharge sensor output	AC voltage monitoring, AC partial discharge current, impulse partial discharge current (Current output is available only when equipped with current sensor ST9200 or ST9201, which are options that must be specified when ordering.) (Each is output through a BNC terminal.)		
Maximum input voltage	Between high-voltage 2-terminal input and hipot tester input terminal: 5 kV AC, 5 kV DC, 7.07 kV peak Between high-voltage 2-terminal input and impulse input terminal: 8 kV peak (impulse) Between low-voltage 4-terminal input and LCR meter input terminal or resistance meter input terminal: 30 V AC RMS, 60 V DC, 42.4 V peak		
Rated output voltage	5 kV AC RMS, 5 kV DC, 8 kV peak (impulse)		
Maximum rated terminal-to-ground voltage	Between high-voltage 2-terminal input and hipot tester input terminal: 5 kV AC RMS, 5 kV DC, 7.07 kV peak Between high-voltage 2-terminal input and impulse input terminal: 8 kV peak (impulse) Between low-voltage 4-terminal input and LCR meter input terminal or resistance meter input terminal: 30 V AC RMS, 60 V DC, 42.4 V peak Output terminal: 5 kV AC RMS, 5 kV DC, 8 kV peak (impulse)		
Maximum allowable impulse current	100 A peak		
Primary circuit relay service life	Open/close cycles: 5 million or more (reference value, not guaranteed)		
Effects on measurement accuracy (add to measurement accuracy)	<table border="0"> <tr> <td style="vertical-align: top;"> LCR measurement · Measurement frequency of DC or less than 10 kHz: $\pm 3\%$ · Measurement frequency of 10 kHz to 100 kHz: $\pm 5\%$ · Measurement impedance of 1 MΩ or greater: $\pm 5\%$ DC resistance measurement · < 1 Ω: $\pm 5\%$ · $\geq 1 \Omega$: $\pm 2\%$ Insulation resistance measurement · $\geq 1 \text{ M}\Omega < 1 \text{ G}\Omega$: $\pm 2\%$ · $\geq 1 \text{ G}\Omega < 10 \text{ G}\Omega$: $\pm 5\%$ </td> <td style="vertical-align: top; border-left: 1px dashed black; padding-left: 10px;"> Impulse voltage · No effect defined in regulations or standards (internal wiring impedance: max. 150 μH) No-load leakage current · 1.5 mA or less at 5 kV AC (23°C [73°F], 50% RH) (Above effects on accuracy are under conditions of up to 500 pF of parasitic capacitance.) </td> </tr> </table>	LCR measurement · Measurement frequency of DC or less than 10 kHz: $\pm 3\%$ · Measurement frequency of 10 kHz to 100 kHz: $\pm 5\%$ · Measurement impedance of 1 M Ω or greater: $\pm 5\%$ DC resistance measurement · < 1 Ω : $\pm 5\%$ · $\geq 1 \Omega$: $\pm 2\%$ Insulation resistance measurement · $\geq 1 \text{ M}\Omega < 1 \text{ G}\Omega$: $\pm 2\%$ · $\geq 1 \text{ G}\Omega < 10 \text{ G}\Omega$: $\pm 5\%$	Impulse voltage · No effect defined in regulations or standards (internal wiring impedance: max. 150 μH) No-load leakage current · 1.5 mA or less at 5 kV AC (23°C [73°F], 50% RH) (Above effects on accuracy are under conditions of up to 500 pF of parasitic capacitance.)
LCR measurement · Measurement frequency of DC or less than 10 kHz: $\pm 3\%$ · Measurement frequency of 10 kHz to 100 kHz: $\pm 5\%$ · Measurement impedance of 1 M Ω or greater: $\pm 5\%$ DC resistance measurement · < 1 Ω : $\pm 5\%$ · $\geq 1 \Omega$: $\pm 2\%$ Insulation resistance measurement · $\geq 1 \text{ M}\Omega < 1 \text{ G}\Omega$: $\pm 2\%$ · $\geq 1 \text{ G}\Omega < 10 \text{ G}\Omega$: $\pm 5\%$	Impulse voltage · No effect defined in regulations or standards (internal wiring impedance: max. 150 μH) No-load leakage current · 1.5 mA or less at 5 kV AC (23°C [73°F], 50% RH) (Above effects on accuracy are under conditions of up to 500 pF of parasitic capacitance.)		
Magnitude of effect on AC PD measurement (reference value, not guaranteed)	Under conditions of ambient temperature at 23°C (73°F), 50% RH and measurement probe open (no capacitive load): With applied voltage of 3 kV, 40 pC or less With applied voltage of 4 kV, 100 pC or less		
Interfaces	LAN, USB, EXT. I/O		

Function specifications

Channel switching	Input and output channels are connected to the bus specified by EXT. I/O or communications commands.
Interlock	Opens all relays unconditionally and at top priority based on EXT. I/O
Channel delay	User can set a delay time between completion of all relay switching and outputting of the switched signals. Delay time: 0.000 to 9.999 s (default setting: 0.000 s)
Settings backup	Backs up communications settings to nonvolatile memory
Panel function	Saves channel switching settings to nonvolatile memory (up to 1000)
Communications settings mode switching	Selects the LAN communications settings with a slide switch between the fixed-settings mode (DFLT) and user-configured mode (USER) Selection is applied when the instrument is powered on.
Protective discharge function	Grounds the output-side's main circuit prior to closing the I/O relay's main circuit Discharge time (standby time between grounding the output-side's main circuit and closing the input-side's main circuit) setting: 0.000 to 1.000 s (default value: 0.000 s)
Accelerated discharge function	Reduces the discharge time after performing insulation or hipot testing by using an external discharge resistor to discharge the residual charge held by the circuit under test (Two output channels are used to connect the discharge resistor.)

General specifications

Location of use	Indoors, Level 2 pollution, maximum elevation of 2000 m
Operating temperature and humidity range	0°C to 40°C (32°F to 104°F), 80% RH or less (non-condensing)
Storage temperature and humidity range	-10°C to 50°C (14°F to 122°F), 80% RH or less (non-condensing)
Standard compliance	Safety: IEC 61010; EMC: EN 61326
Interfaces	LAN, USB, EXT. I/O
Power supply	Rated supply voltage: 100 to 240 V AC; rated power: 120 VA
External dimensions	Approx. 439.2 mm (17.29 in.) W × 265.9 mm (10.47 in.) H × 770 mm (30.31 in.) D (excluding protruding parts)
Weight	SW2001-04: approx. 20.5 kg (723.1 oz.); SW2001-08: approx. 22.5 kg (793.7 oz.); SW2001-16: approx. 27.0 kg (952.4 oz.); SW2001-24: approx. 31.5 kg (1111.1 oz.) (All figures do not include weight from the ST9200/ST9201 factory options.) With ST9200, add 1.2 kg (42.3 oz.); with ST9201, add 139 g (4.9 oz.).

Note: company names and product names appearing in this brochure are trademarks or registered trademarks of various companies.

HIOKI
HIOKI E. E. CORPORATION

HEADQUARTERS

81 Koizumi,
Ueda, Nagano 386-1192 Japan
<https://www.hioki.com/>



Scan for all regional contact information

DISTRIBUTED BY