

EV MAINTENANCE TEST TOOL

The latest edition of the instruction manual



**Read carefully before use.
Keep for future reference.**

When using the instrument for the first time

- Safety Information ▶ p.8
- Precautions for Use ▶ p.9
- Preparing for Measurement (IR4059, RM3548-50) ▶ p.10

Contents

- Verifying That There Is No Voltage ▶ p.18
- Performing Equipotential Bonding Testing ▶ p.24
- Performing Insulation Resistance Testing ▶ p.27

EN



Introduction

Thank you for choosing Hioki's EV Maintenance Test Tool. To ensure your ability to make full use of the product, please handle this documentation carefully and store it for future reference.

The following documentations are available for reference:

Document	Contents
DT4261 Digital Multimeter Instruction Manual	Provides detailed information, including instructions on how to use the instrument in question as well as descriptions of its functionality and specifications. For more information about each instrument, please refer to its Instruction Manual.
FT3701-20 Infrared Thermometer Instruction Manual	
IR4059 Insulation Tester Instruction Manual	
RM3548-50 Resistance Meter Instruction Manual	
EV Maintenance Manual (this document)	Provides information about EV maintenance methods and information to ensure safe use of each instrument.

The latest edition of the instruction manual

The information in this manual is subject to change for reasons such as product improvements or specification changes.

The latest edition can be downloaded from Hioki's website.

<https://www.hioki.com/global/support/download/>



Target audience

This manual has been written for use by individuals who use the product or provide information about how to use the product.

Work that involves handling high-voltage components should be performed only by qualified personnel who have received specialized training.

Checking Package Contents

When you receive the product, inspect it for damage or other issues prior to use. If you find any damage or discover that the product does not perform as indicated in its specifications, please contact your authorized Hioki distributor or reseller.

C0213 Carrying Case

Options

This section includes only principal products.

For more information about instrument options, please review the applicable Instruction Manual. If you wish to purchase an option, please contact your authorized Hioki distributor or reseller.

Optional equipment is subject to change with no advance notice. Check Hioki's website for the latest information.

Model	Name	Appearance
DT4261	Digital Multimeter	
FT3701-20	Infrared Thermometer	
IR4059	Insulation Tester	
RM3548-50	Resistance Meter	
L2140	Test Leads	
9465-11	Pin Type Lead	
Z5020* ¹	Magnetic Strap	
Z3210* ¹	Wireless Adapter	

*1: Optional equipment common to the DT4261, IR4059, and RM3548-50.

Overview

The voltages present in electric vehicles (EVs) are rising, necessitating caution with regard to numerous aspects of maintenance and inspection work.

The EV Maintenance Test Tool can be used to safely carry out necessary electrical tests from the time the high-voltage bus is disconnected to its restoration.

For more information about disconnecting and restoring an EV's high-voltage bus and related safety precautions, please consult the service manual from the vehicle's manufacturer or contact the vehicle's manufacturer.

EV Maintenance Flow (example)

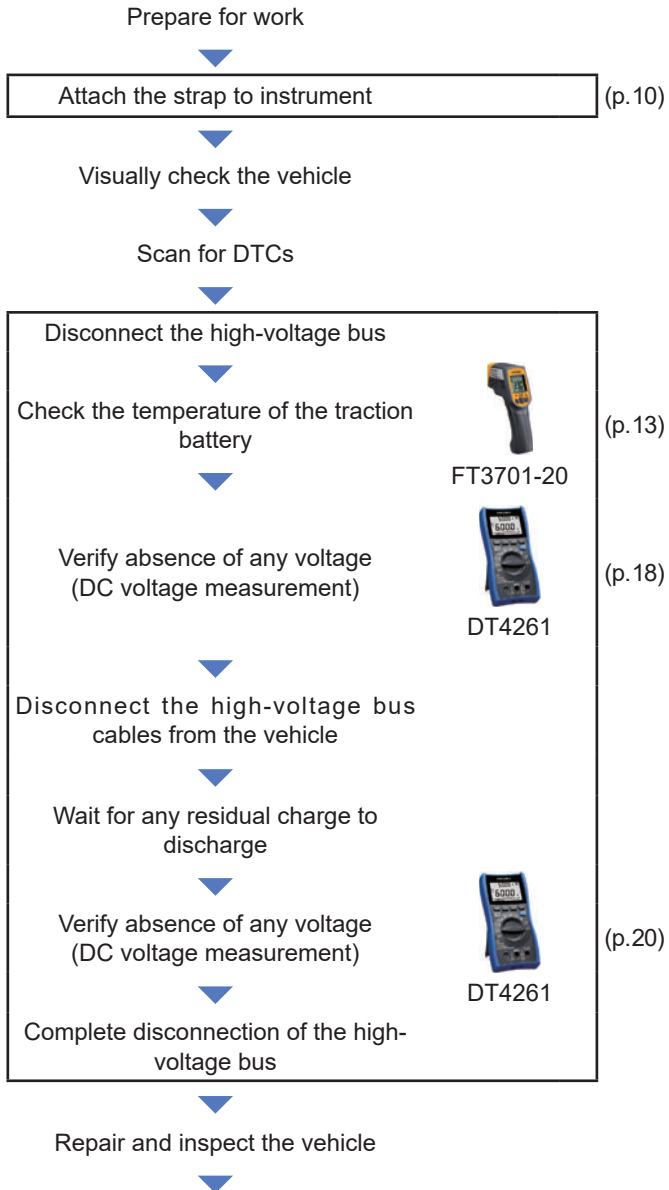

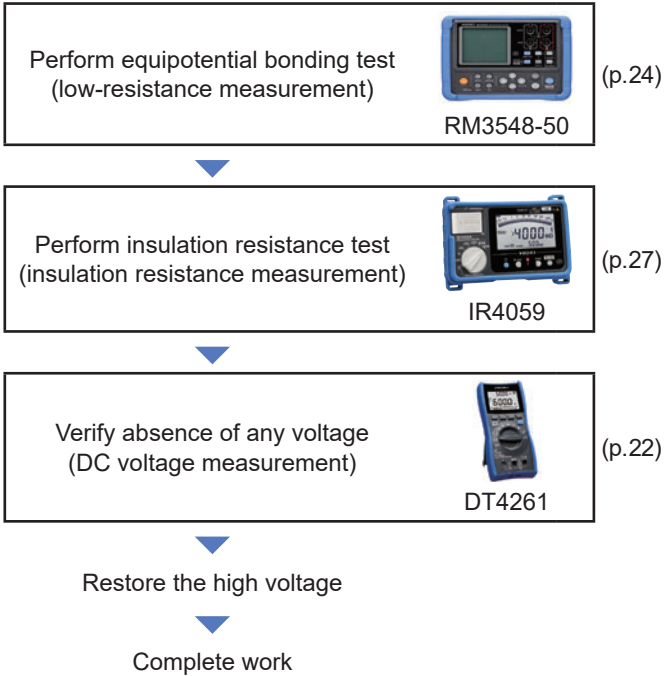







Symbols and Abbreviations

Safety notations

This manual classifies seriousness of risks and hazard levels as described below.

 DANGER	Indicates an imminently hazardous situation that, if not avoided, will result in death or serious injury.
 WARNING	Indicates a potentially hazardous situation that, if not avoided, could result in death or serious injury.
 CAUTION	Indicates a potentially hazardous situation that, if not avoided, could result in minor or moderate injury or potential risks of damage to the supported product (or to other property).
	Indicates a high-voltage hazard. Failure to verify safety or improper handling of the instruments could lead to an electric shock, a burn, an injury, or a death.
	Indicates a prohibited action.
	Indicates a mandatory action.

Other notations

	Indicates useful functions and advice you should know.
--	--

Safety Information

Before using any of the instruments described in this manual, review its Instruction Manual and the service manual published by the vehicle's manufacturer.

Work that involves handling high-voltage components should be performed only by qualified personnel who have received specialized training.

Precautions for Use

To ensure you can safely use the instrument and fully utilize its functionality, be sure to observe the following precautions:

Checking safety before use

Inspect the instrument prior to use to ensure there are no faults or damage and verify proper operation. If you find any damage, contact your Hioki distributor.

Preparing for Measurement (IR4059, RM3548-50)

If hanging the instrument from your neck

You can attach the neck strap to an instrument so that you can hang it from your neck. The strap can be attached as follows: (The strap attaches at four points.)

RM3548-50

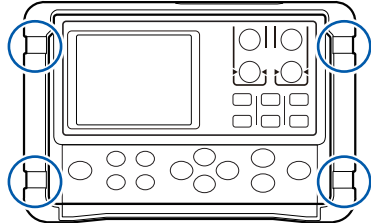
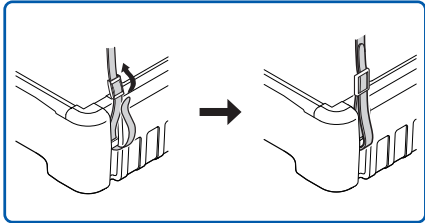

IR4059

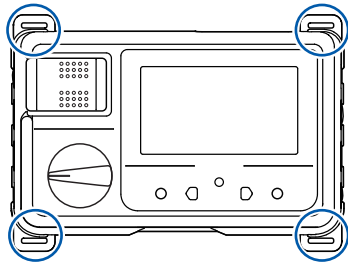
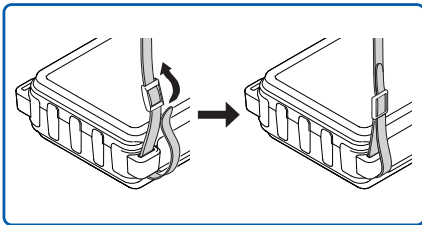

If hanging the instrument from the chassis

- 1 Route the neck strap through two Z5020 Magnetic Straps.

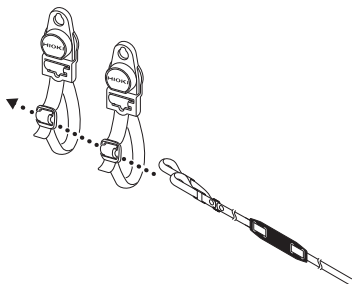

- 2 Then attach the neck strap to the RM3548-50 Resistance Meter or IR4059 Insulation Tester. (The strap attaches at two points.)

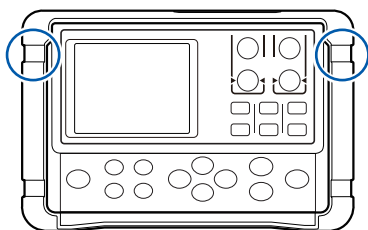
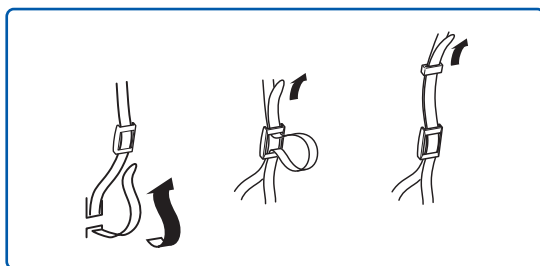

RM3548-50

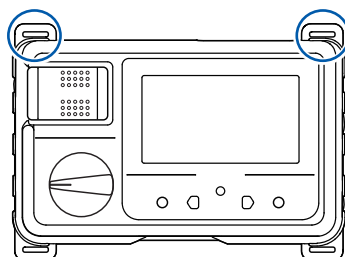

IR4059

3 Affix the magnets so as to position the instrument as desired. (Example with IR4059)

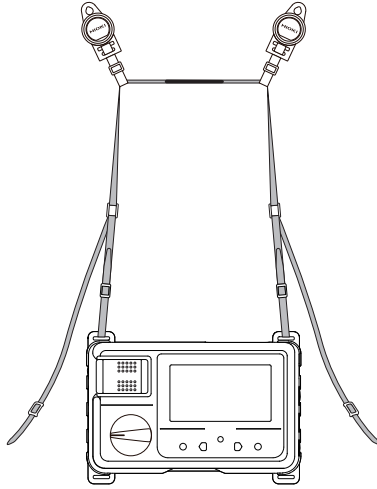

Preparing to Repair or Inspect the Vehicle (Disconnecting the Vehicle's High-voltage Bus)

DANGER

- **Before testing, remove the service plug to disconnect the high-voltage bus.**

Failure to do so could cause electric shock.

- **Verify that there is no voltage both before and after disconnecting the high-voltage bus cables, and before reconnecting them.**

Failure to do so could cause electric shock.

- **Remove the service plug and allow a suitable amount of time to pass for the inverter's capacitors to discharge.**

Failure to do so could cause electric shock. The discharge time varies from manufacturer to manufacturer. For more information, refer to the vehicle manufacturer's service manual.



- **When handling high-voltage components, use high-voltage gloves and other protective gear.**

Failure to do so could cause electric shock. For more information, refer to the vehicle manufacturer's service manual.

- **Use protective gear until you have verified that vehicle parts are safe to touch (are not carrying a voltage).**

Failure to do so could cause electric shock. For more information, refer to the vehicle manufacturer's service manual.

- **If a test indicates an anomaly, halt work.**

Failure to do so could cause electric shock. For more information, refer to the vehicle manufacturer's service manual.

Like gasoline-powered vehicles, EVs require repairs and inspections. However, unlike gasoline-powered vehicles, EVs incorporate high-voltage sources such as traction batteries and inverters, making it essential to ensure worker safety by reliably disconnecting high-voltage components prior to performing repair and inspection work.

To safely repair and inspect an EV, you must perform zero-voltage measurement (p. 18); equipotential bonding testing, for example to verify that locations where electricity could flow, such as the vehicle's chassis, are at the same potential (p. 24); and insulation resistance testing to verify that there are no insulation defects (p. 27).

Measurement locations (example)

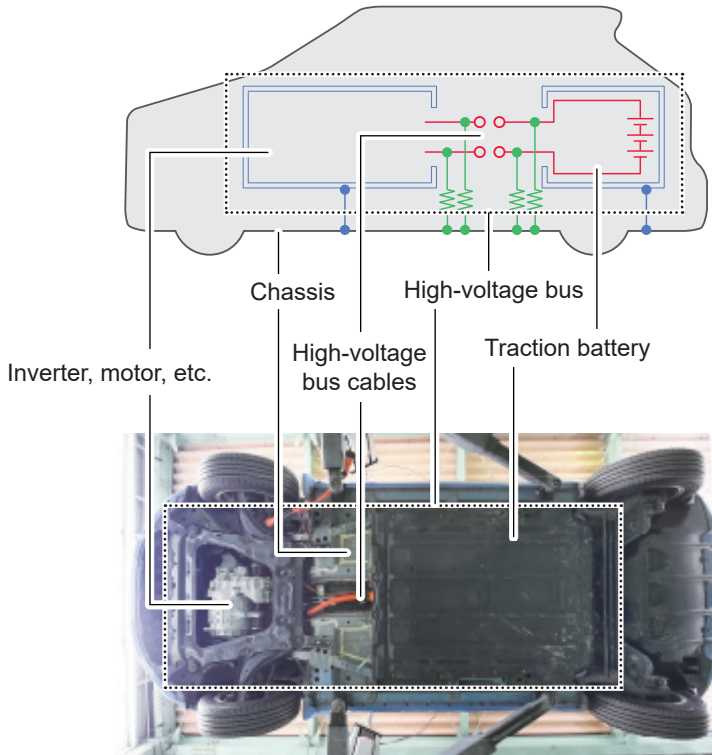

Tips

The high-voltage bus consists of electrical circuitry that operates at a high voltage, including the connection system for REESS charging.

You will need:

FT3701-20 Infrared Thermometer, DT4261 Digital Multimeter, and protective gear

1 Put on the protective gear.

2 Disconnect the vehicle's high-voltage bus.

Follow the instructions in the vehicle manufacturer's service manual.

3 Check the temperature at the traction battery with the FT3701-20.

Measure the surface temperature of the traction battery and verify that there are no variations in temperature or hot areas.

For more information about how to use the FT3701-20, see the FT3701-20's Instruction Manual.

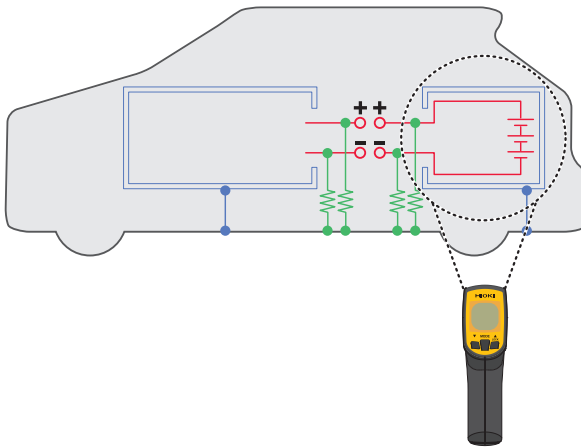

FT3701-20

4 Using the DT4261, verify that there is no voltage across locations with which your hands might come into contact when disconnecting high-voltage bus cables and the vehicle's chassis ground. (p.19)

5 Disconnect the high-voltage bus cables.

6 Wait for the high-voltage bus to discharge.

The discharge time varies from manufacturer to manufacturer.

For more information, refer to the vehicle manufacturer's service manual.

7 Using the DT4261, verify that there is no voltage between the high-voltage bus cable terminals and the vehicle's chassis ground. (p.20)

Once you've verified that there is no voltage, the process of disconnecting the vehicle's high-voltage bus is complete.

8 Repair and inspect the EV.

9 Using the DT4261, verify that there is no voltage between the high-voltage bus cable terminals and the vehicle's chassis ground. (p.22)

Verifying That There Is No Voltage

DANGER



- **Verify that there is no voltage both before and after disconnecting the high-voltage bus cables, and before reconnecting them.**

Failure to do so could cause electric shock.

The purpose of zero-voltage measurement is to prevent electric shock by verifying that the high-voltage bus has been disconnected. You will do so by verifying a 0 V reading at locations that could carry a high voltage. Repeat this test three times: before and after disconnecting the high-voltage bus cables between the traction battery and inverter, and before reconnecting them.

Zero-voltage measurement timing	Objective
Before disconnecting the high-voltage bus cables between the traction battery and inverter	To verify that there is no voltage at locations with which your hands might come into contact when disconnecting the high-voltage bus cables.
After disconnecting the high-voltage bus cables between the traction battery and inverter	To verify that the vehicle is not carrying a dangerous voltage before repairing or inspecting the EV.
Before reconnecting the high-voltage bus cables between the traction battery and inverter	To verify that the high-voltage bus cables can be safely connected after repairing or inspecting the EV.

Before disconnecting the high-voltage bus cables

After disconnecting the high-voltage bus, test locations with which your hands could come into contact when disconnecting the high-voltage bus cables. For more information about how to use the DT4261, see the DT4261's Instruction Manual.

You will need:

DT4261 Digital Multimeter, L9300 Test Lead (included with the DT4261), and protective gear

- 1** Put on the protective gear.
- 2** Select LoZ V with the DT4261's rotary switch.
- 3** Connect the test leads to the DT4261.
- 4** Connect the red test lead to each location with which your hands could come into contact when disconnecting the high-voltage bus cables, and the black lead to the vehicle's chassis ground.
- 5** Verifying that there is no voltage.

For more information, refer to the vehicle manufacturer's service manual.

- 6** Once you've verified that there is no voltage, disconnect the high-voltage bus cables.

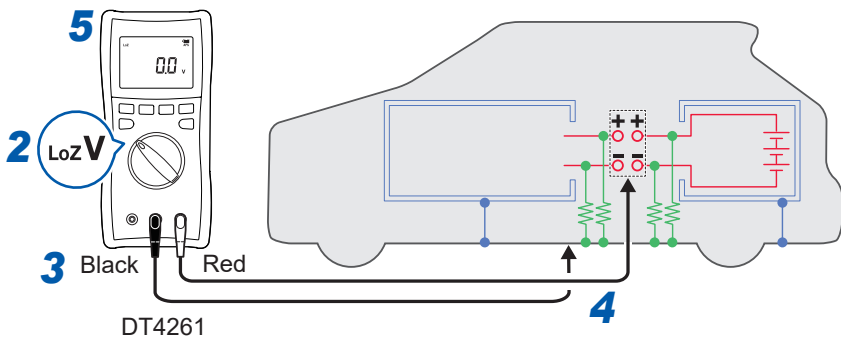

After disconnecting the high-voltage bus cables

DANGER

- **Allow a suitable amount of time to pass for the high-voltage bus to discharge.**



Failure to do so could cause electric shock. The discharge time varies from manufacturer to manufacturer. For more information, refer to the vehicle manufacturer’s service manual.

After disconnecting the high-voltage bus cables, wait for the high-voltage bus to discharge.

The discharge time varies from manufacturer to manufacturer. For more information, refer to the vehicle manufacturer’s service manual.

For more information about how to use the DT4261, see the DT4261’s Instruction Manual.

Once the high-voltage bus has discharged, verify that there is no voltage. The table lists example measurement locations.

Testing locations (example)	DT4261 terminal (+)	DT4261 terminal (-)
Traction battery side	High-voltage bus cable positive electrode (+)	Chassis ground (GND)
	High-voltage bus cable negative electrode (-)	Chassis ground (GND)
	High-voltage bus cable positive electrode (+)	High-voltage bus cable negative electrode (-)
Inverter side	High-voltage bus cable positive electrode (+)	Chassis ground (GND)
	High-voltage bus cable negative electrode (-)	Chassis ground (GND)
	High-voltage bus cable positive electrode (+)	High-voltage bus cable negative electrode (-)

You will need:

DT4261 Digital Multimeter, L9300 Test Lead (included with the DT4261), and protective gear

- 1** Put on the protective gear.
- 2** Select LoZ V with the DT4261's rotary switch.
- 3** Connect the test leads to the DT4261.
- 4** Test the high-voltage bus cables on both the traction battery and inverter side.

Please refer to the table for a list of example test locations. (p.20)

- 5** Verifying that there is no voltage.

For more information, refer to the vehicle manufacturer's service manual.

- 6** Once you've verified that there is no voltage, repair and inspect the EV.

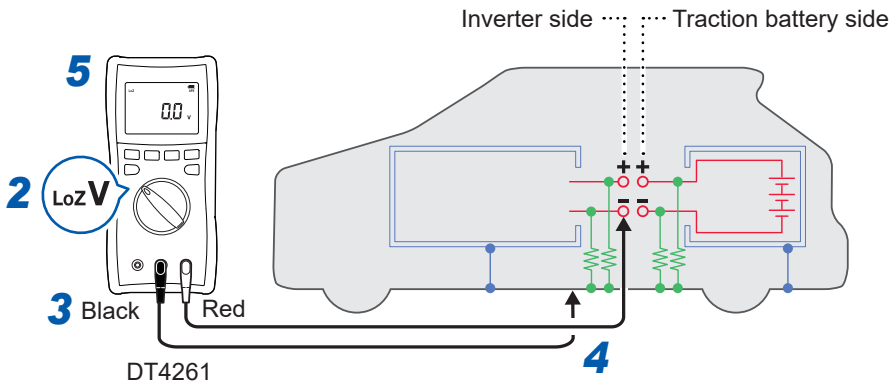

Example: Inverter-side high-voltage bus cable negative electrode and chassis ground (GND)

Before reconnecting the high-voltage bus cables after repairing and inspecting the vehicle

Before reconnecting the high-voltage bus cables, verify that there is no voltage on the traction battery or inverter side. The table lists example measurement locations.

Since the inverter side of the bus includes diodes, switch the DT4261's polarity when performing the test.

For more information about how to use the DT4261, see the DT4261's Instruction Manual.

Testing locations (example)	DT4261 terminal (+)	DT4261 terminal (-)
Traction battery side	High-voltage bus cable positive electrode (+)	Chassis ground (GND)
	High-voltage bus cable negative electrode (-)	Chassis ground (GND)
Inverter side	High-voltage bus cable positive electrode (+)	Chassis ground (GND)
	High-voltage bus cable negative electrode (-)	Chassis ground (GND)
	Chassis ground (GND)	High-voltage bus cable positive electrode (+)
	Chassis ground (GND)	High-voltage bus cable negative electrode (-)

You will need:

DT4261 Digital Multimeter, L9300 Test Lead (included with the DT4261), and protective gear

- 1** Put on the protective gear.
- 2** Select LoZ V with the DT4261's rotary switch.
- 3** Connect the test leads to the DT4261.
- 4** Test the high-voltage bus cables on both the traction battery and inverter side. Please refer to the table for a list of example test locations. (p.22)
- 5** Verifying that there is no voltage.

For more information, refer to the vehicle manufacturer's service manual.

- 6** Once you've verified that there is no voltage, reconnect the high-voltage bus cables.

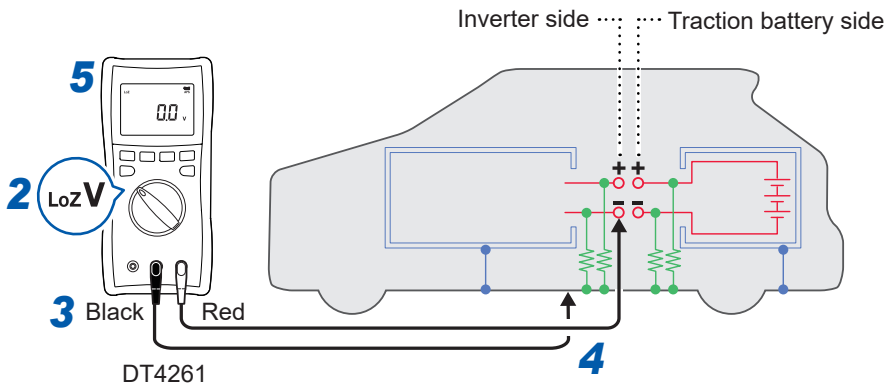

Example: Inverter-side high-voltage bus cable negative electrode and chassis ground (GND)

Performing Equipotential Bonding Testing

Equipotential bonding testing is performed in order to check for problems with connections between components, for example between the vehicle chassis and shielding. It is carried out when installing or replacing high-voltage components. In performing such testing, you will measure the resistance of the ground connections with the vehicle chassis and high-voltage parts. If the resistance value is high or exhibits significant variability, there may be an issue with the high-voltage component's connection or a problem with the component itself. For more information about testing, refer to vehicle manufacturer's service manual.

For more information about how to use the RM3548-50, see the RM3548-50's Instruction Manual.

**You will need: RM3548-50 Resistance Meter
L2140 Test Leads or 9465-11 Pin Type Lead**

- 1** Following the instructions in “Preparing to Repair or Inspect the Vehicle (Disconnecting the Vehicle’s High-voltage Bus)” (p. 13).
- 2** Following the instructions in “Verifying That There Is No Voltage” (p. 18).
- 3** Connect the test leads to the RM3548-50.
- 4** Verify that the tips of the test leads being used with the RM3548-50 are free of dirt and wear.
Remove any dirt since it could affect measured values.
- 5** Turn on the RM3548-50's OVC function.
- 6** Set the measurement range.
The measurement current varies with the vehicle manufacturer. For more information, refer to the vehicle manufacturer's service manual. (To measure a resistance of 0.1 Ω or less at a measurement current of 200 mA or greater, set the RM3548-50's measurement range to 300 mA.)
- 7** Connect the test leads to each measurement location.

- 8** Measure the resistance values between the connecting components' terminals and the vehicle chassis, and between connected components and the vehicle chassis.
- 9** Verify that each measured value is less than 0.1Ω and that there are no significant discrepancies between measurement locations.

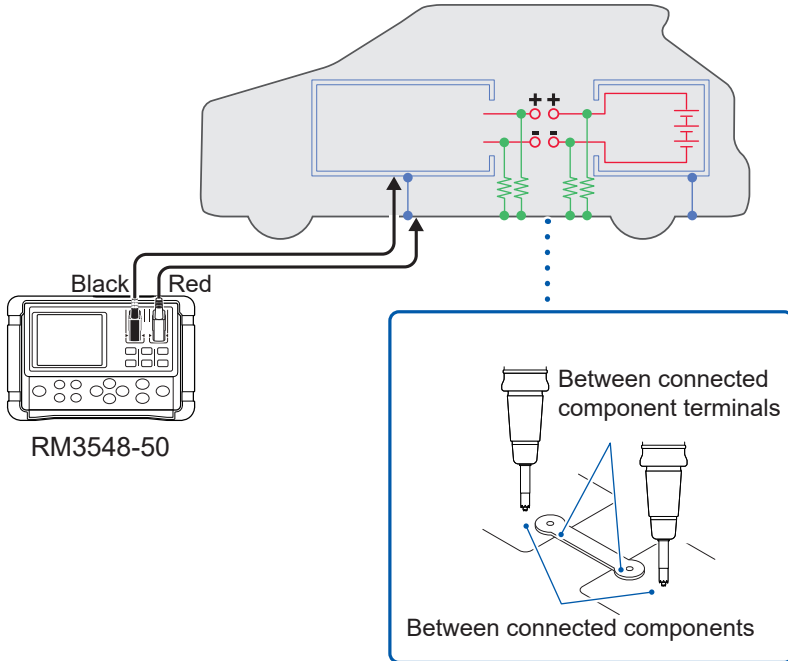

Example: Between connected components

Example test

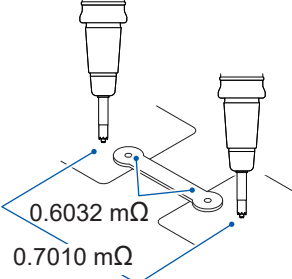
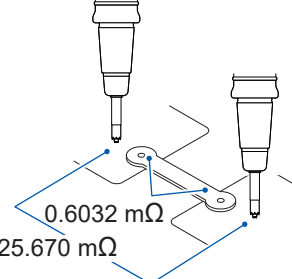
Normal connection	⚠️ Problematic connection
 <p>0.6032 mΩ 0.7010 mΩ</p>	 <p>0.6032 mΩ 25.670 mΩ</p>
<ul style="list-style-type: none"> • Measured value is less than 0.1 Ω. • There is no significant difference between the resistance value of the connecting components' terminals and the resistance value of the connected components. 	<ul style="list-style-type: none"> • The resistance value between the connecting components' terminals or between the connected components is too high. • There is a significant difference between the resistance value of the connecting components' terminals and the resistance value of the connected components.

Performing Insulation Resistance Testing

CAUTION

- Use a voltage range that is higher than the traction battery's voltage.



Failure to do so may prevent measurement. For more information, refer to the vehicle manufacturer's service manual.

Insulation resistance testing is performed to verify that there is no insulation defect between the high-voltage bus and ground. It is performed on the traction battery side of the bus as well as the inverter side. Testing is carried out between the terminals on both sides of the high-voltage bus cables and the vehicle's chassis ground. The test voltage used to make these measurements must be higher than that of the vehicle's traction battery. Since the test voltage varies with the vehicle under test, please refer to vehicle manufacturer's service manual.

For more information about how to use the IR4059, see the IR4059's Instruction Manual.

Testing locations (example)	IR4059 terminal (+)	IR4059 terminal (-)
Traction battery side	High-voltage bus cable positive electrode (+)	Chassis ground (GND)
	High-voltage bus cable negative electrode (-)	Chassis ground (GND)
Inverter side	High-voltage bus cable positive electrode (+)	Chassis ground (GND)
	High-voltage bus cable negative electrode (-)	Chassis ground (GND)
	Chassis ground (GND)	High-voltage bus cable positive electrode (+)
	Chassis ground (GND)	High-voltage bus cable negative electrode (-)

You will need:

IR4059 Insulation Tester and L9788-11 Test Lead Set with Remote Switch (recommended)

- 1** Following the instructions in “Preparing to Repair or Inspect the Vehicle (Disconnecting the Vehicle’s High-voltage Bus)” (p. 13).
- 2** Following the instructions in “Verifying That There Is No Voltage” (p. 18).
- 3** Connect the test leads to the IR4059.
- 4** Select the OFF position with the IR4059’s **MEASURE** key.
- 5** Select a voltage range that is higher than the traction battery’s voltage with the instrument’s rotary switch.

If the vehicle manufacturer species a voltage range, select that range. Please refer to the vehicle manufacturer’s service manual. (If using the 500 V range or 1000 V range, press the RELEASE key to disengage the lock.)
- 6** Connect the test leads to each measurement location.
Please refer to the table for a list of example test locations. (p.27)
(Since the inverter side of the bus includes diodes, swap the red and black test leads when performing this test.)
- 7** Press the **MEASURE** key.
- 8** Once the display stabilizes, check the value.
- 9** Select the OFF position with the **MEASURE** key while leaving the test leads connected to the measurement locations.

10 Verify that the measured value is greater than the insulation resistance value specified by the vehicle manufacturer.

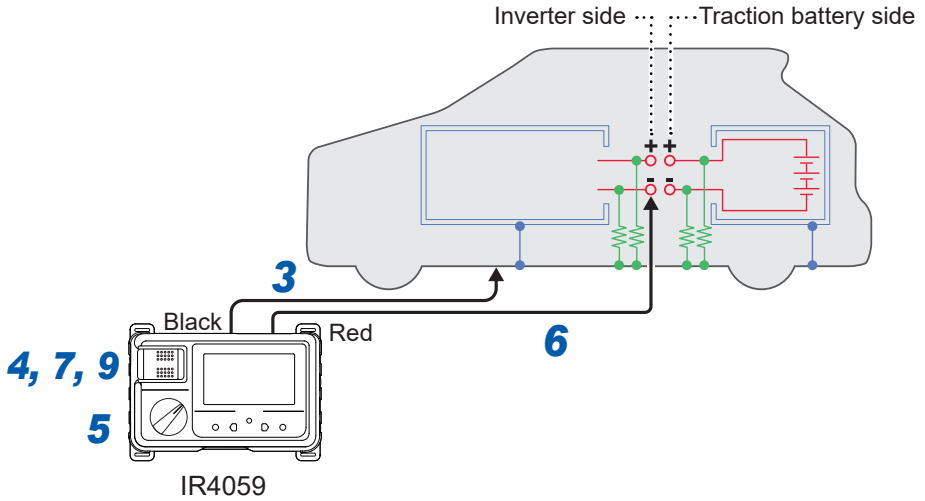

Example: Inverter-side high-voltage bus cable negative electrode and chassis ground (GND)

Re-energize the Vehicle's High-voltage Bus (Restore the High Voltage)

- 1** Verify that there is no voltage between the inverter and traction battery sides of the bus. (p.22)
- 2** Connect the high-voltage bus cables to the inverter and traction battery sides of the bus.
- 3** Reconnect the service plug.
- 4** Re-energize the vehicle's high-voltage bus.

For more information about how to re-energize the vehicle's high-voltage bus, see the vehicle manufacturer's service manual.

Specifications

For more information about an instrument's specifications, refer to its Instruction Manual.

Appendix

EV maintenance report (example)

Basic information			
Test date		Tested by	
Vehicle memo			

Visual inspection		
Item	Judgment/ measured value	Comment
High-voltage warning signs		
System damage		
Orange HV cable damages		
Corrosion on bonding point of HV components		
HV connectors damages or contamination		
DTCs		
All potential equalization (bonding) cables		
Battery temperature	°C	
Other		

Instrument information			
	Model	Serial number	Other
Infrared Thermometer	FT3701-20		
Resistance Meter	RM3548-50		
Insulation Tester	IR4059		
Digital Multimeter	DT4261		
2-pole voltmeter			
Other equipment			

Zero voltage check (DC voltage measurement)			
Before disconnecting the high-voltage bus cables		Measured value	Comment
Between (+) HV+ and (-) HV-		V	
Between (+) HV+ and (-) GND		V	
Between (+) HV- and (-) GND		V	
After disconnecting the high-voltage bus cables		Measured value	Comment
Between (+) HV+ and (-) HV-		V	
Between (+) HV+ and (-) GND		V	
Between (+) HV- and (-) GND		V	
Before reconnecting the high-voltage bus cables		Measured value	Comment
Battery side	Between (+) HV+ and (-) GND	V	
Battery side	Between (+) HV- and (-) GND	V	
Inverter side	Between (+) HV+ and (-) GND	V	
Inverter side	Between (+) HV- and (-) GND	V	
Inverter side	Between (+) HV+ and (-) GND	V	
Inverter side	Between (+) HV- and (-) GND	V	

Memo	
------	--

Potential equalization test (bonding)			
FROM	TO	Measured value	Comment

Insulation resistance test			
		Measured value	Comment
Battery side	Between (+) HV+ and (-) GND		
Battery side	Between (+) HV- and (-) GND		
Inverter side	Between (+) HV+ and (-) GND		
Inverter side	Between (+) HV- and (-) GND		
Inverter side	Between (+) GND and (-) HV+		
Inverter side	Between (+) GND and (-) HV-		

Memo	
------	--

Memo

HIOKI

www.hioki.com/



**All regional
contact
information**

HIOKI E.E. CORPORATION

81 Koizumi, Ueda, Nagano 386-1192 Japan

2402 EN

Edited and published by HIOKI E.E. CORPORATION

Printed in Japan

- Contents subject to change without notice.
- This document contains copyrighted content.
- It is prohibited to copy, reproduce, or modify the content of this document without permission.
- Company names, product names, etc. mentioned in this document are trademarks or registered trademarks of their respective companies.

Europe only

• EU declaration of conformity can be downloaded from our website.

• Contact in Europe: HIOKI EUROPE GmbH
Helfmann-Park 2, 65760 Eschborn, Germany

hioki@hioki.eu