



High-precision Power Analysis Through Sensing Technology

Superior affinity between power analyzers and current sensors

Hioki develops both power analyzers and current sensors. Advanced sensing technology is a prerequisite for accurate power analysis. Given the high affinity between current sensors and power analyzers, precise power analysis is possible.

For high voltage measurements above 1500 V
AC/DC HIGH VOLTAGE DIVIDER VT1005
Divides and outputs voltages of up to 5000 V



The current sensor method is an approach to making measurements that closely resemble the actual operating environment

Measurement example using the current sensor method

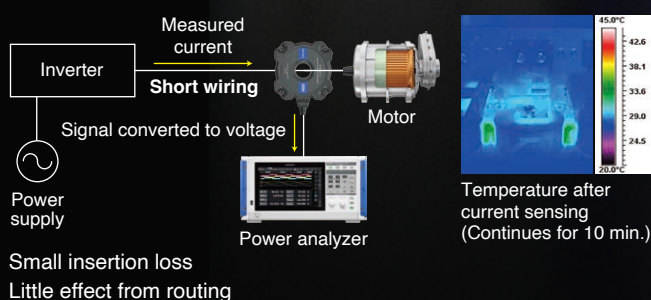

Measurement example using the direct wiring method

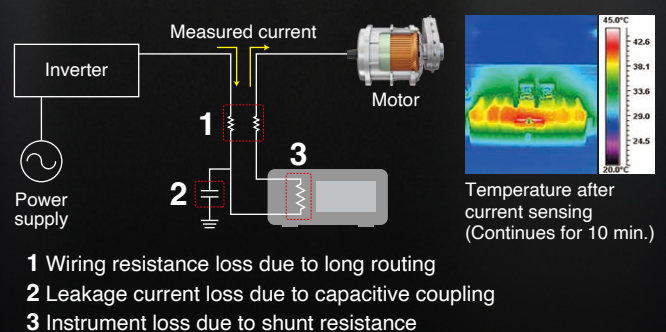

Important points in evaluating high-efficiency inverters

When evaluating the power conversion efficiency of an inverter, the inverter's input and output power are measured, and its efficiency is calculated. PWM (pulse width modulated) inverter output, which has been widely used in recent years, contains the fundamental and its harmonic, the switching frequencies, and its harmonic component. Since switching frequencies are high, current sensors that can measure over a wide bandwidth are needed for the measurement process.

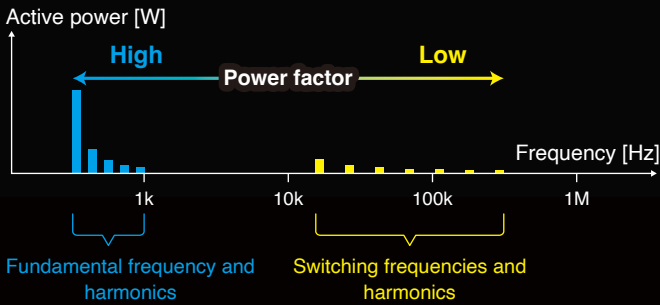

Active power spectrogram for an inverter's output power.
The ability to measure low-powerfactor, high-frequency components is essential.

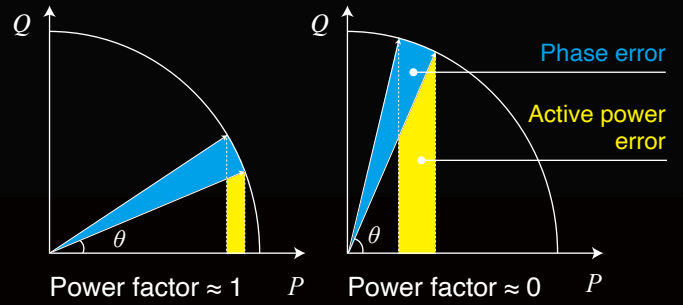

At low power factors, phase error has a significant effect on power error.
Phase accuracy of current sensor is important.

For high current measurements above 2000 A
 SENSOR UNIT CT9557
 The current sensor output is added and output
 Accurately measures large currents up to 8000 A (4 wires)



Current sensor with defined phase accuracy can accurately measure power

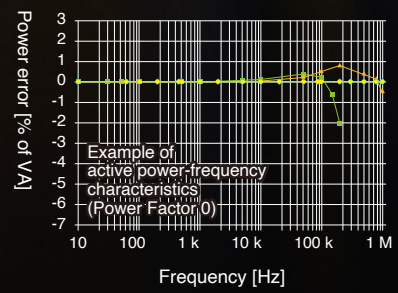
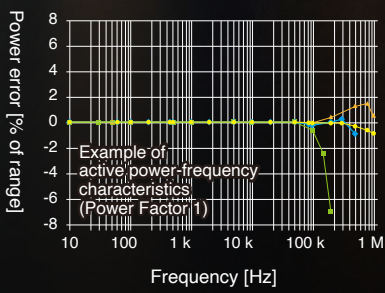

- PW8001+U7005 (1500 V/50 A range)
- ▲ PW6001 (600 V/50 A range)
- ◆ PW8001+U7001 (1500 V/50 A range)
- PW3390 (150 V/50 A range)

Hioki specifies the phase accuracy of current sensors for more accurate power measurement. By correcting the phase characteristics of the current sensor with a power analyzer, low power factor power can be accurately measured down to higher frequencies.

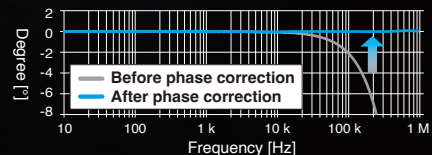

Example of the phase correction for the CT6904A AC/DC current sensor

Power analyzer lineup

Basic accuracy for 50/60 Hz active power

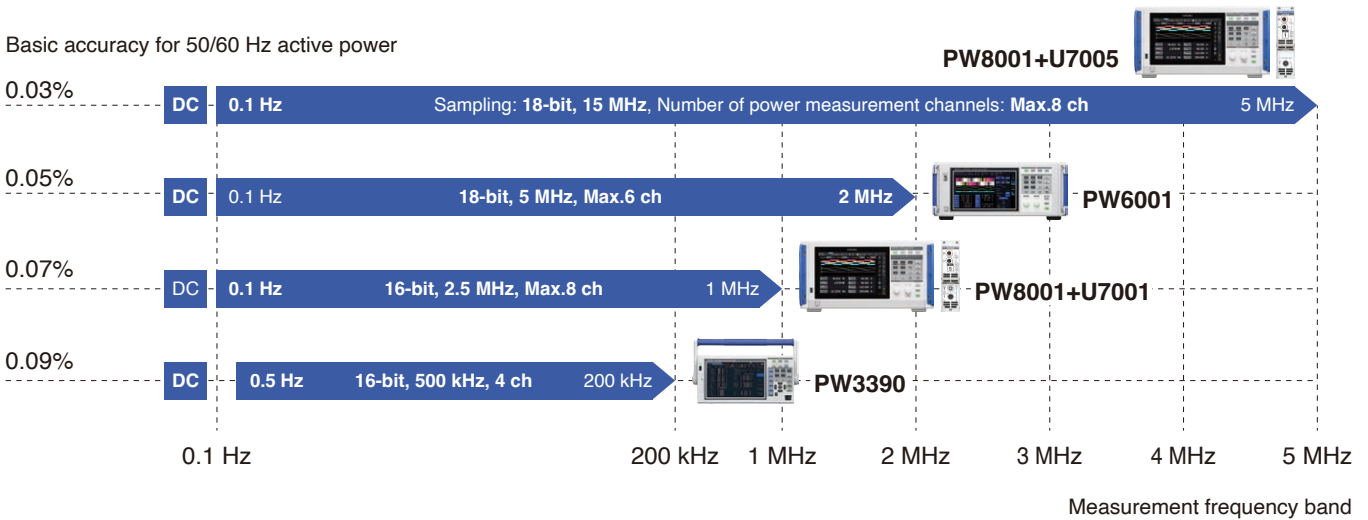

Applications

Power conversion efficiency evaluation of inverters



Measure input and output power for power conversion devices like inverters and calculate efficiency and loss.

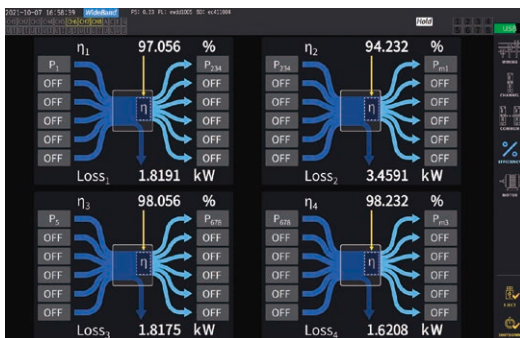
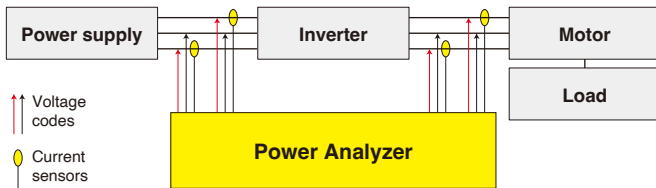

Efficiency and loss calculations (PW8001)

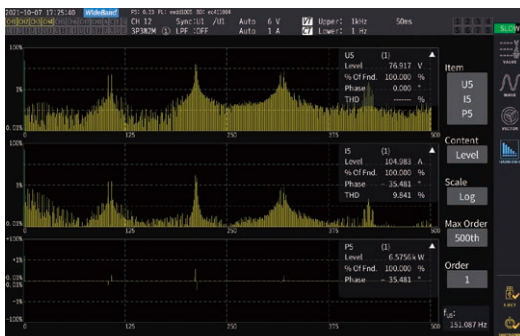

Harmonic analysis of the 500th-order (PW8001)

Detect power conversion efficiency and loss

Number of power measurement channels	
PW8001	Up to 8 channels (specified at time of purchase)
PW6001	Up to 6 channels (specified at time of purchase)
PW3390	4 ch

Efficiency and loss calculations	
PW8001	Max. 4 each for efficiency and loss (with Auto mode)
PW6001	Max. 4 each for efficiency and loss
PW3390	Max. 3 each for efficiency and loss

The PW8001's Auto mode automatically switches calculation formulas depending on the direction of power flow. (Ordinarily, calculation formulas are switched manually depending on the direction of power flow.)

Accuracy for active power*	DC	50 Hz/60 Hz	10 kHz
PW8001+U7005	±(0.02% + 0.03%)	±(0.01% + 0.02%)	±(0.05% + 0.05%)
PW8001+U7001	±(0.02% + 0.05%)	±(0.02% + 0.05%)	±(0.2% + 0.05%)
PW6001	±(0.02% + 0.05%)	±(0.02% + 0.03%)	±(0.15% + 0.1%)
PW3390	±(0.05% + 0.07%)	±(0.04% + 0.05%)	±(0.2% + 0.1%)

*±(% of reading + % of range)

Harmonics measurement

	Synchronization frequency range	Maximum analysis order
PW8001+U7005	0.1 Hz to 1.5 MHz	500th
PW8001+U7001	0.1 Hz to 1 MHz	500th
PW6001	0.1 Hz to 300 kHz	100th
PW3390	0.5 Hz to 5 kHz	100th

The instrument can perform harmonic analysis for each channel's voltage, current, and active power and display the results. The PW8001 and PW6001 can analyze harmonics for individual channels, and they can simultaneously measure harmonics in multiple circuits at different frequencies.

Common-mode rejection ratio (CMRR)

	50 Hz/60 Hz	100 kHz
PW8001+U7005	120 dB or greater	110 dB or greater
PW8001+U7001	100 dB or greater	80 dB typical
PW6001	100 dB or greater	80 dB or greater
PW3390	80 dB or greater	-

When evaluating an equipment that produces noise, such as an inverter, it is essential to consider how effectively the device can withstand noise.

Evaluation of inverters and motors

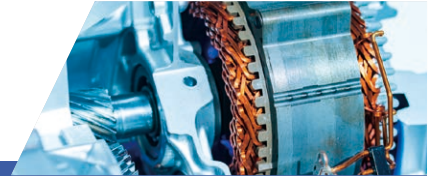

Efficiency and loss can be calculated from the power on the input and output sides of inverters and motors. Torque meter and pulse encoder signals can be input to the power analyzer to simultaneously analyze and record the motor's torque, rotation speed, and mechanical output.

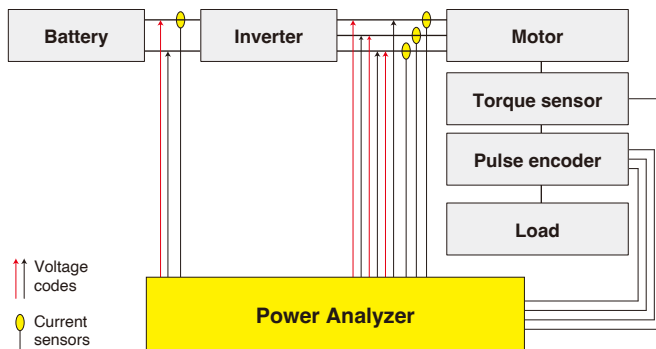

Motor analysis

Number of motors that can be simultaneously analyzed	
PW8001	Max. 4 motors
PW6001	Max. 2 motors
PW3390	1 motor

Input signals from a torque meter and pulse encoder to analyze motor torque, speed, rotational direction, and electrical angle.

user-defined calculations (used when calculating motor parameters)	
PW8001	Up to 20 equations can be set
PW6001	Up to 16 equations can be set
PW3390	-

Set calculation formulas as desired and display the results in real time. Calculate L_d and L_q motor parameters from electrical angle measurements.

Correction of torque meter measurement error	
PW8001	Zero correction, nonlinear correction*, friction correction*
PW6001	Zero correction
PW3390	Zero correction

*Enter the calibration values and points for compensating the sensor's error to calibrate the torque meter's value.

CAN or CAN FD output function

PW8001	Yes
PW6001	-
PW3390	-

The PW8001 can output measurement data to a CAN bus in real time as CAN or CAN FD signals, which can be recorded along with ECU data.

Solar inverter efficiency measurements



Measure a solar inverter's input and output power and calculate efficiency and loss. Evaluate power generation systems that require measuring high voltages and multiple circuits, such as a multi-string solar inverter.

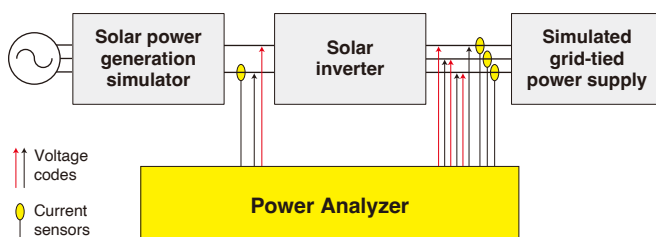

Maximum input voltage

PW8001+U7005	1000 V AC/DC, ± 2000 V peak
PW8001+U7001	1000 V AC, 1500 V DC, ± 2000 V peak
PW6001	1000 V AC/DC, ± 2000 V peak
PW3390	1500 V AC/DC, ± 2000 V peak

Use the VT1005 (option) to measure voltages of up to 5000 V with a power analyzer.

IEC standard compliant harmonic and flicker measurement

	IEC harmonics measurement	IEC Flicker Measurement
PW8001	Yes	Yes
PW6001	Yes	-
PW3390	-	-

Measure harmonics in compliance with the IEC 61000-4-7 standard and flicker in compliance with the IEC 61000-4-15 standard.

Multi-string solar inverters evaluation

Optical link interface	
PW8001	Analysis of up to 16 channels
PW6001	Analysis of up to 12 channels
PW3390	-

Connect two power analyzers with the optical link interface to aggregate and analyze measured data on one instrument.

Power analyzer lineup

Model	PW8001+U7005	PW8001+U7001	PW6001	PW3390		
Applications	For measurement of SiC and GaN inverters and reactor/transformer loss	For measurement of high-efficiency IGBT inverters and solar inverters	For measurement of high-efficiency IGBT inverters	For portability and high accuracy		
Basic accuracy	Basic accuracy for 50/60 Hz power*1	±(0.01% + 0.02%)	±(0.02% + 0.05%)	±(0.02% + 0.03%)	±(0.04% + 0.05%)	
	Accuracy for DC power*1	±(0.02% + 0.03%)	±(0.02% + 0.05%)	±(0.02% + 0.05%)	±(0.05% + 0.07%)	
	Accuracy for 10 kHz power*1	±(0.05% + 0.05%)	±(0.2% + 0.05%)	±(0.15% + 0.1%)	±(0.2% + 0.1%)	
	Accuracy for 50 kHz power*1	±(0.15% + 0.05%)	±(0.4% + 0.1%)	±(0.15% + 0.1%)	±(0.4% + 0.3%)	
Measurement	Measurement frequency band	DC, 0.1 Hz to 5 MHz	DC, 0.1 Hz to 1 MHz	DC, 0.1 Hz to 2 MHz	DC, 0.5 Hz to 200 kHz	
	Number of power measurement channels	1 to 8 channels, specify U7001 or U7005 when placing an order (mixed available)		1 to 6 channels, a specify when ordering	4 channels	
	Voltage, current ADC sampling	18-bit, 15 MHz	16-bit, 2.5 MHz	18-bit, 5 MHz	16-bit, 500 kHz	
	Voltage range	6 V, 15 V, 30 V, 60 V, 150 V, 300 V, 600 V, 1500 V		6 V, 15 V, 30 V, 60 V, 150 V, 300 V, 600 V, 1500 V	15 V, 30 V, 60 V, 150 V, 300 V, 600 V, 1500 V	
	Current range	100 mA to 2000 A*2	probe1: 100 mA to 2000 A*2 probe2: 100 mV, 200 mV, 500 mV, 1 V, 2 V, 5 V	probe1: 100 mA to 2000 A*2 probe2: 100 mV, 200 mV, 500 mV, 1 V, 2 V, 5 V	100 mA to 8000 A*2	
	Data update rate	1 ms, 10 ms, 50 ms, 200 ms		10 ms, 50 ms, 200 ms	50 ms	
	Common-mode rejection ratio (CMRR)	50/60 Hz: 120 dB or greater 100 kHz: 110 dB or greater	50/60 Hz: 100 dB or greater 100 kHz: 80 dB typical	50/60 Hz: 100 dB or greater 100 kHz: 80 dB or greater	50/60 Hz: 80 dB or greater	
	Temperature coefficient	0.01%/°C		0.01%/°C	0.01%/°C	
	Voltage input method	Photoisolated input, resistor voltage division	Isolated input, resistor voltage division	Photoisolated input, resistor voltage division	Isolated input, resistor voltage division	
	Current input method	Isolated input from current sensor		Isolated input from current sensor	Isolated input from current sensor	
	Current input	External current sensor input	Yes (ME15W)	Yes (ME15W, BNC)	Yes (ME15W, BNC)	Yes (ME15W)
		Power supplied to external current sensor	Yes		Yes	Yes
Current sensor phase shift calculation		Yes (auto)		Yes	Yes	
Voltage input	Maximum input voltage	1000 V, ±2000 V peak	1000 V AC, 1500 V DC, ±2000 V peak	1000 V, ±2000 V peak (10 ms)	1500 V, ±2000 V peak	
	Maximum rated line-to-ground voltage	600 V CAT III 1000 V CAT II	600 V AC/1000 V DC CAT III 1000 V AC/1500 V DC CAT II	600 V CAT III 1000 V CAT II	600 V CAT III 1000 V CAT II	
Analysis/calculation	Efficiency and loss calculations	Yes (Max.4 each for efficiency and loss, auto*3)		Yes (Max.4 each for efficiency and loss)	Yes (Max.3 each for efficiency and loss)	
	Motor analysis	Yes*4		Yes*4	Yes*4	
	Number of channels	Max. 4 motors		Max. 2 motors	1 motor	
	Input format	Analog DC, frequency, pulse		Analog DC, frequency, pulse	Analog DC, frequency, pulse	
	Torque meter correction	Zero correction, nonlinear correction, friction correction		Zero correction	Zero correction	
	Harmonics measurement	Yes (8, for each channel)	Yes (8, for each channel)	Yes (6, for each channel)	Yes	
	Max. analysis order	500th	500th	100th	100th	
	Synchronization frequency range	0.1 Hz to 1.5 MHz	0.1 Hz to 1 MHz	0.1 Hz to 300 kHz	0.5 Hz to 5 kHz	
	IEC harmonics measurement	Yes		Yes	-	
	IEC flicker measurement	Yes		-	-	
	FFT spectrum analysis	Yes (DC to 4 MHz)	Yes (DC to 1 MHz)	Yes (DC to 2 MHz)	Yes (DC to 200 kHz)	
	User-defined calculations	Yes		Yes	-	
Delta conversion	Yes (Δ-Y, Y-Δ)		Yes (Δ-Y, Y-Δ)	Yes (Δ-Y)		
D/A output	Yes*4 20 ch (waveform output, analog output)		Yes*4 20 ch (waveform output, analog output)	Yes*4 16 ch (waveform output, analog output)		
Display	Display	10.1" WVGA TFT color LCD		9" WVGA TFT color LCD	9" WVGA TFT color LCD	
	Touch screen	Yes		Yes	-	
Interface	External storage media	USB 3.0		USB 2.0	USB 2.0, CF card	
	LAN (100BASE-TX, 1000BASE-T)	Yes		Yes	Yes (10BASE-T and 100BASE-TX only)	
	GP-IB	Yes		Yes	-	
	RS-232C	Yes (maximum 115,200 bps)		Yes (maximum 230,400 bps)	Yes (maximum 38,400 bps)	
	External control	Yes		Yes	Yes	
	Synchronization of multiple instruments	Yes (up to 4 instruments)		-	Yes (up to 8 instruments)	
	Optical link	Yes*4		Yes	-	
CAN or CAN FD	Yes*4		-	-		
Dimensions, weight (W×H×D)	430 mm × 221 mm × 361 mm (16.93 in. × 8.70 in. × 14.21 in.), 14 kg (493.84 oz.)		430 mm × 177 mm × 450 mm (16.93 in. × 6.97 in. × 17.72 in.), 14 kg (493.84 oz.)	340 mm × 170 mm × 156 mm (13.39 in. × 6.69 in. × 6.14 in.), 4.6 kg (162.26 oz.)		

*1: ±(% of reading + % of range) *2: 6 ranges, based on sensor *3: The position of terms set on the input and output sides is switched depending on the sign of the measured values.

*4: Sold separately

Model No. (Order code)

PW8001

Model	Number of channels	Motor analysis	Waveform and D/A output	CAN or CAN FD interface	Optical link interface	
PW8001-01	1 to 8 channels, specify U7001 or U7005 when placing an order (mixed available)	-	-	-	-	
PW8001-02		-	Yes	-	-	
PW8001-03		-	-	-	Yes	-
PW8001-04		-	-	-	-	Yes
PW8001-05		-	Yes	Yes	-	Yes
PW8001-06		-	-	-	Yes	Yes
PW8001-11		Yes	-	-	-	-
PW8001-12		Yes	Yes	Yes	-	-
PW8001-13		Yes	-	-	Yes	-
PW8001-14		Yes	-	-	-	Yes
PW8001-15		Yes	Yes	Yes	-	Yes
PW8001-16		Yes	-	-	Yes	Yes

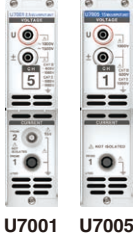

PW6001

Model	Number of channels	Motor analysis	Waveform and D/A output
PW6001-01	1 ch	-	-
PW6001-02	2 ch	-	-
PW6001-03	3 ch	-	-
PW6001-04	4 ch	-	-
PW6001-05	5 ch	-	-
PW6001-06	6 ch	-	-
PW6001-11	1 ch	Yes	Yes
PW6001-12	2 ch	Yes	Yes
PW6001-13	3 ch	Yes	Yes
PW6001-14	4 ch	Yes	Yes
PW6001-15	5 ch	Yes	Yes
PW6001-16	6 ch	Yes	Yes

Scan for more details on each product.



PW8001



PW6001



PW3390



Current Sensors



CT9557



VT1005

PW3390

Model	Number of channels	Motor analysis	Waveform and D/A output
PW3390-01	4 ch	-	-
PW3390-02	4 ch	-	Yes
PW3390-03	4 ch	Yes	Yes

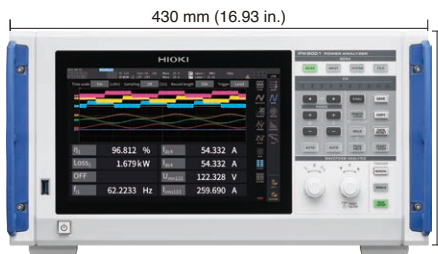

430 mm (16.93 in.)

221 mm (8.70 in.)



430 mm (16.93 in.)

177 mm (6.97 in.)

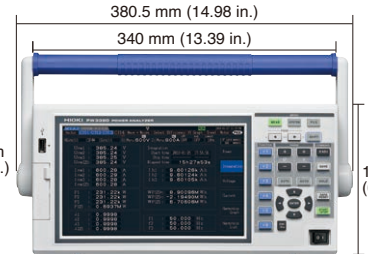

380.5 mm (14.98 in.)

340 mm (13.39 in.)

170 mm (6.69 in.)

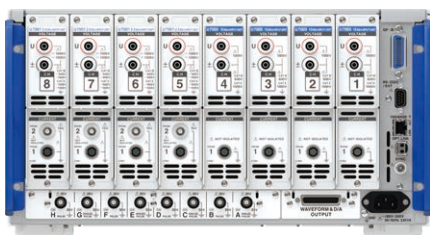



















PW8001-15
Four U7001 units installed
Four U7005 units installed

PW6001-16

PW3390-03

Current sensor lineup

Model	Appearance	Rated current	Maximum peak current	Frequency range	Amplitude accuracy 50 Hz/ 60 Hz	Diameter of measurable conductors	Cable length	Automatic phase correction ^{*1}	Operating temperature
Pass-through types									
CT6862-05		50 Arms	±141 A peak	DC to 1 MHz	±0.05 % rdg ±0.01 % f.s.	φ 24 mm (0.94 in.)	3 m (9.84 ft.)	-	-30°C to 85°C -22°F to 185°F
CT6872		50 Arms	±200 A peak	DC to 10 MHz	±0.03 % rdg ±0.007 % f.s.	φ 24 mm (0.94 in.)	3 m (9.84 ft.)	Yes	-40°C to 85°C -40°F to 185°F
CT6872-01							10 m (32.81 ft.)		
CT6863-05		200 Arms	±565 A peak	DC to 500 kHz	±0.05 % rdg ±0.01 % f.s.	φ 24 mm (0.94 in.)	3 m (9.84 ft.)	-	-30°C to 85°C -22°F to 185°F
CT6873		200 Arms	±350 A peak ²	DC to 10 MHz	±0.03 % rdg ±0.007 % f.s.	φ 24 mm (0.94 in.)	3 m (9.84 ft.)	Yes	-40°C to 85°C -40°F to 185°F
CT6873-01							10 m (32.81 ft.)		
CT6875A		500 Arms	±1500 A peak ²	DC to 2 MHz	0.04 % rdg ±0.008 % f.s.	φ 36 mm (1.42 in.)	3 m (9.84 ft.)	Yes	-40°C to 85°C -40°F to 185°F
CT6875A-1				DC to 1.5 MHz			10 m (32.81 ft.)		
CT6904A		500 Arms	±1000 A peak ²	DC to 4 MHz	±0.02 % rdg ±0.007 % f.s.	φ 32 mm (1.26 in.)	3 m (9.84 ft.)	Yes	-10°C to 50°C 14°F to 122°F
CT6904A-1				DC to 2 MHz			10 m (32.81 ft.)		
CT6904A-2		800 Arms	±1200 A peak ²	DC to 4 MHz	±0.025 % rdg ±0.009 % f.s.	φ 32 mm (1.26 in.)	3 m (9.84 ft.)	Yes	-10°C to 50°C 14°F to 122°F
CT6904A-3				DC to 2 MHz			10 m (32.81 ft.)		
CT6876A		1000 Arms	±1800 A peak ²	DC to 1.5 MHz	0.04 % rdg ±0.008 % f.s.	φ 36 mm (1.42 in.)	3 m (9.84 ft.)	Yes	-40°C to 85°C -40°F to 185°F
CT6876A-1				DC to 1.2 MHz			10 m (32.81 ft.)		
CT6877A		2000 Arms	±3200 A peak ²	DC to 1 MHz	0.04 % rdg ±0.008 % f.s.	φ 80 mm (3.15 in.)	3 m (9.84 ft.)	Yes	-40°C to 85°C -40°F to 185°F
CT6877A-1							10 m (32.81 ft.)		
Clamp types									
CT6830		2 Arms	±4.3 A peak	DC to 100 kHz	±0.3 % rdg ±0.05 % f.s.	φ 5 mm (0.20 in.)	4 m, 20 cm ⁴ (13.12 ft., 7.87 in.)	Yes	-40°C to 85°C (-40°F to 185°F)
CT6831		20 Arms	±43 A peak	DC to 100 kHz	±0.3 % rdg ±0.01 % f.s.	φ 5 mm (0.20 in.)	4 m, 20 cm ⁴ (13.12 ft., 7.87 in.)	Yes	-40°C to 85°C (-40°F to 185°F)
9272-05		20 Arms, 200 Arms	±71 A peak, ±430 A peak	1 Hz to 100 kHz	±0.3 % rdg ±0.01 % f.s.	φ 46 mm (1.81 in.)	3 m (9.84 ft.)	-	0°C to 50°C 32°F to 122°F
CT6841A		20 Arms	±60 A peak ²	DC to 2 MHz	±0.2 % rdg ±0.01 % f.s.	φ 20 mm (0.79 in.)	3 m (9.84 ft.)	Yes	-40°C to 85°C -40°F to 185°F
CT6843A		200 Arms	±600 A peak ²	DC to 700 kHz	±0.2 % rdg ±0.01 % f.s.	φ 20 mm (0.79 in.)	3 m (9.84 ft.)	Yes	-40°C to 85°C -40°F to 185°F
CT6844A		500 Arms	±800 A peak ²	DC to 500 kHz	±0.2 % rdg ±0.01 % f.s.	φ 20 mm (0.79 in.)	3 m (9.84 ft.)	Yes	-40°C to 85°C -40°F to 185°F
CT6845A		500 Arms	±1500 A peak ²	DC to 200 kHz	±0.2 % rdg ±0.01 % f.s.	φ 50 mm (1.97 in.)	3 m (9.84 ft.)	Yes	-40°C to 85°C -40°F to 185°F
CT6846A		1000 Arms	±1900 A peak ²	DC to 100 kHz	±0.2 % rdg ±0.01 % f.s.	φ 50 mm (1.97 in.)	3 m (9.84 ft.)	Yes	-40°C to 85°C -40°F to 185°F
Direct-wired types									
PW9100A-3 ³		50 Arms	±200 A peak ²	DC to 3.5 MHz	±0.02 % rdg ±0.005 % f.s.	M6 screw terminals	3 ch	Yes	0°C to 40°C 32°F to 104°F
PW9100A-4 ³		50 Arms	±200 A peak ²	DC to 3.5 MHz	±0.02 % rdg ±0.005 % f.s.	M6 screw terminals	4 ch	Yes	0°C to 40°C 32°F to 104°F

*1: When using PW8001 *2: Within 20 ms and 40°C (104°F) or less *3: Special specification PW9100A with a rated current of 5A can also be ordered.
*4: Between sensor to multiplexer, Between multiplexer to output connector

Note: Company names and product names appearing in this brochure are trademarks or registered trademarks of various companies.

HIOKI
HIOKI E. E. CORPORATION

HEADQUARTERS
81 Koizumi,
Ueda, Nagano 386-1192 Japan
<https://www.hioki.com/>



Scan for all regional contact information

DISTRIBUTED BY