

CT6877 CT6877-01 AC/DC CURRENT SENSOR

Instruction Manual

EN

Apr. 2019 Edition 1
CT6877A961-00 19-04H



HIOKI

<http://www.hioki.com>



Our regional contact information

HEADQUARTERS
81 Koizumi
Ueda, Nagano 386-1192 Japan

HIOKI EUROPE GmbH
Rudolf-Diesel-Strasse 5
65760 Eschborn, Germany
hioki@hioki.eu

1808EN

Edited and published by HIOKI E.E. CORPORATION

Printed in Japan

- CE declarations of conformity can be downloaded from our website.
- Contents subject to change without notice.
- This document contains copyrighted content.
- It is prohibited to copy, reproduce, or modify the content of this document without permission.
- Company names, product names, etc. mentioned in this document are trademarks or registered trademarks of their respective companies.

Warranty

Warranty malfunctions occurring under conditions of normal use in conformity with the Instruction Manual and Product Precautionary Markings will be repaired free of charge. This warranty is valid for a period of three (3) years from the date of purchase. Please contact the distributor from which you purchased the product for further information on warranty provisions.

Introduction

Thank you for purchasing the HIOKI Model CT6877, CT6877-01 AC/DC Current Sensor. To obtain maximum performance from the product over the long term, be sure to read this manual carefully and keep it handy for future reference. Be sure to also read the accompanying "Operating Precautions" before use.

Target audience

This manual has been written for use by individuals who use the product in question or who teach others to do so. It is assumed that the reader possesses basic electrical knowledge (equivalent to that of someone who graduated from the electrical program at a technical high school).

Troubleshooting

- If the device seems to be malfunctioning, contact your authorized Hioki distributor or reseller.
- Store the packaging materials even after unpacking, because you will need them when you transport the instrument.

Safety Information

Symbols Affixed to the Device

Indicates cautions and hazards. When the symbol is printed on the instrument, be sure to also read the accompanying "Operating Precautions" before use.

DANGER

- If the cable insulator melts, metal parts could be exposed, posing a hazard. Keep the cable away from sources of heat.
- Connect the device to only the secondary side of a distribution panel. Even if a short-circuit occurs on the secondary side of the distribution panel, the distribution panel will interrupt a short-circuit current. Do not connect it to the primary side of the distribution panel because an unrestricted current flow could damage the device and facilities if a short-circuit occurs.

WARNING

- Do not place the cable in contact with the measured line. Any contact can cause the device to malfunction and lead to a short-circuit or electric shock.

CAUTION

- To prevent cable damage, do not step on cables or pinch them between other objects. Do not bend or pull on cables at their base.
- Do not place the device on an unstable table or an inclined place. Dropping or knocking down the device can cause injury or damage to the device.
- The cable is hardened in freezing temperatures. Do not bend or pull it to avoid tearing its shield or cutting cable.
- When the power to lines to be measured is turned on or off, a current flowing through the lines can exceed considerably the maximum allowable current of the device. This could result in damage to the device. Make sure that there is not any over-current.
- Make sure that applying any current could cause damage to the device if it is turned off.

Overview

This pull-through current sensor has excellent frequency characteristics (amplitude, phase) and temperature characteristics (sensitivity, offset), which enables high-precision power measurement as well as current measurement.

Use with Other Hioki Products

This device is used in connection with a dedicated instrument (Hioki product). Refer to "Combined accuracy and conditions" specified in the specifications for details.

Name of Each Part

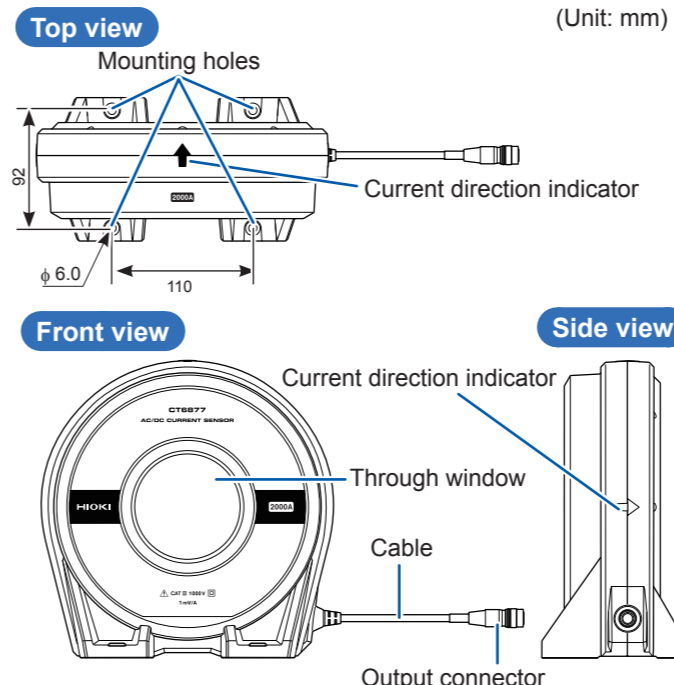

Measurement Procedure

Inspection Before Use

Verify that the device operates normally to ensure that no damage occurred during storage or shipping. If you find any damage, contact your authorized Hioki distributor or reseller.

Check Items	Remedy
Is the device cracked or damaged?	If there is any damage, electric shock may result. Discontinue use and contact your authorized Hioki distributor or reseller.
Is the cable insulation torn?	
Is the cable broken at the base (of the connector or the sensor)?	Broken connections will make proper measurement impossible. Discontinue use and contact your authorized Hioki distributor or reseller.

Mount

CAUTION

- Do not use the device fastened on a wall in locations susceptible to vibration or impact. Failure to observe this can cause damage to the device.
- Use a wall strong enough, such as a metallic wall, to fasten the device. Fastening the device on a low-strength wall may cause damage to the wall.

- Use hexagon socket head cap screws and tighten them with the recommended torque to fasten the device on a wall.
- Install additional supporters when the device is to be fastened for a long time.
- Remove the device from a wall at the time of transportation.

Recommended tightening conditions

Nominal screw size: M5
Screw length: 20 mm or more
Tightening torque: 1.5 N·m to 2.0 N·m

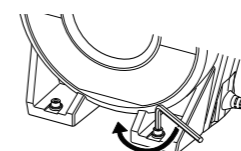

Wiring

Make sure the direction of the arrow on the case matches the direction of the current flow, as shown in the figure below. If they are oriented incorrectly, the output signal from the sensor will be reversed. When using the device in combination with a power meter, conform to the power meter's wiring method.

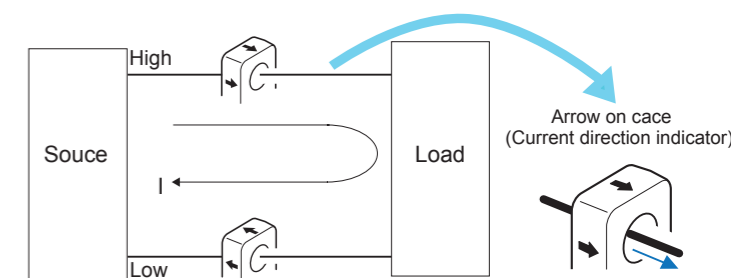

IMPORTANT

Make sure to pass only one conductor through the window.

OK
Whether the power is single-phase or three-phase, the device cannot measure a current if two or more of the conductors pass through the window in a bundle.

NO
The device cannot accurately measure a current that passes through a conductor sheathed with a grounded shield.

- Arrange the conductor as close to the center of the through window as possible. For a current to be measured of frequency 1 kHz or more, the conductor position could cause increase in measured value error or distortion of output-signal waveforms.
- If a conductor not being measured carries a current of frequency 1 kHz or more, keep such conductor at least 100 mm away from the device. Failure to observe this could cause increase in measured value error or distortion of output signal waveforms.
- Use the device with its surface temperature of 105°C or less.

Options

CT9901 Conversion Cable

Connecting the CT9901 enables the device to connect to an instrument that does not support direct connection with the device (No accuracy is affected).

CT9902 Extension Cable

- Connecting a CT9902 enables the device cable to be extended by 5 m (max. 10 m).
- Up to two of the Extension Cable available (If three or more extension cables are connected to the device, its performance is not guaranteed)
- Add the following to the sensor accuracy for each cable used:
Amplitude accuracy: $\pm 0.1\%$ rdg. ($DC \leq f < 1 \text{ kHz}$)
 $\pm (0.1 + 0.01 \times f^*)\%$ rdg. ($1 \text{ kHz} < f^*$)
Phase accuracy: $\pm (0.03 \times f^*)^\circ$ ($1 \text{ kHz} < f^*$)
*: frequency

Specifications

Accuracy

f.s.: Maximum display value or scale length (The rated measurement current)

rdg.: Reading value (The value currently being measured and indicated on the measuring instrument)

1. General Specifications

Operating environment	Indoors, Pollution Degree 2, altitude up to 2000 m (6562 ft.)
Operating temperature and humidity	-40°C to 85°C (-40°F to 185.0°F) 80% RH or less (no condensation)
Storage temperature and humidity	-40°C to 85°C (-40°F to 185.0°F) 80% RH or less (no condensation)
Standards	Safety: EN 61010 EMC: EN 61326
Dielectric strength	7.4 kV AC (sensed current: 1 mA) 50 Hz/60 Hz for 1 minute, between through window and cable output terminal
Power supply	Supplied from PW6001, PW3390, CT9555, CT9556, CT9557, or external DC power supply Rated supply voltage: ±11.5 V to ±15 V (Tracking) Maximum rated current: ±500 mA (2000 A/55 Hz measurement, ±12 V power supply)
Maximum rated power	9.5 VA (2000 A/55 Hz measurement, ±12 V power supply)
Interface	Dedicated interface (ME15W)
Dimensions	Approx. 229W × 232H × 112D mm (9.02"W × 9.13"H × 4.41"D) (excluding protrusions and the cable)
Output cable length	CT6877: Approx. 3 m CT6877-01: Approx. 10 m
Mounting hole diameter	φ6 mm (M5 Hexagon socket head bolts, recommended tightening torque: 1.5 N·m to 2.0 N·m)
Mass	CT6877: Approx. 5 kg (176.4 oz.) CT6877-01: Approx. 5.3 kg (186.9 oz.)
Product warranty period	3 years
Accessories	Mark bands ×6 Instruction Manual (JA, EN, CN) Operating Precautions (0990A907)
Options	CT9901 Conversion Cable CT9902 Extension Cable

2. Input / Output / Measurement Specifications

-1. Basic specifications

Rated current	2000 A AC/DC
Measurable conductor diameter	φ80 mm or less
Maximum input current	Not exceeding derating curve shown in Figure 1 Provided that measurement is performed at 40°C or less and finishes within 20 ms. ±3200 A peak is allowable
Output voltage	1 mV/A
Maximum rated voltage to earth	1000 V (Measurement category III) Anticipated transient overvoltage: 8000 V
Output resistance	50 Ω±10 Ω

-2. Accuracy specifications

Conditions of guaranteed accuracy	Guaranteed accuracy period: 1 year Guaranteed accuracy period after adjustment made by Hioki: 1 year Accuracy guarantee for temperature and humidity: 0°C to 40°C (32°F±104.0°F), 80% RH or less No warm-up required, sine wave inputted, connected with measuring instrument with input resistance 1 MΩ or more, line-to-ground voltage: 0 V, no external magnetic field, conductor arranged at center of window
--	--

Measurement accuracy

Frequency	Amplitude	Phase
DC	±0.04% rdg.±0.008% f.s.	-
DC < f < 16 Hz	±0.1% rdg.±0.02% f.s.	±0.1°
16 Hz ≤ f < 45 Hz	±0.05% rdg.±0.01% f.s.	±0.1°
45 Hz ≤ f ≤ 66 Hz	±0.04% rdg.±0.008% f.s.	±0.1°
66 Hz < f ≤ 100 Hz	±0.05% rdg.±0.01% f.s.	±0.1°
100 Hz < f ≤ 500 Hz	±0.1% rdg.±0.02% f.s.	±0.2°
500 Hz < f ≤ 1 kHz	±0.2% rdg.±0.02% f.s.	±0.4°
1 kHz < f ≤ 5 kHz	±0.5% rdg.±0.02% f.s.	± (0.3 + 0.1 × f)°
5 kHz < f ≤ 10 kHz	±0.5% rdg.±0.02% f.s.	± (0.3 + 0.1 × f)°
10 kHz < f ≤ 50 kHz	±1.5% rdg.±0.05% f.s.	± (0.3 + 0.1 × f)°
50 kHz < f ≤ 100 kHz	±2.5% rdg.±0.05% f.s.	± (0.3 + 0.1 × f)°
100 kHz < f ≤ 700 kHz	± (0.025 × f)% rdg.±0.05% f.s.	± (0.3 + 0.1 × f)°
Frequency range	1 MHz (±3 dB Typical)	-

- Symbols f in accuracy expressions are represented in kHz.
- Accuracy of amplitude and phase is specified with 110% f.s. input or less and not exceeding derating curve in Figure 1. Accuracy in range of DC < f < 10 Hz are design value.
- Add ±0.01% rdg. to amplitude accuracy when input is 100% f.s. to 110% f.s.
- For Model CT6877-01, add the following values to accuracy in the range of 1 kHz < f ≤ 700 kHz.
Amplitude accuracy: ±(0.005×f)% rdg.
Phase accuracy: ±(0.015×f)°

Linearity ^{*1*}	±10 ppm Typical (23°C)
Offset voltage ^{*2}	±10 ppm Typical (23°C, no input)

*1: Output voltages are measured while input currents (DC) are changed in steps of 400 A beginning from +2000 A to -2000 A and then to +2000 A. Defined as the difference between the regression line calculated from the above measurements and the measurement points.
*2: Defined as a percentage of the rated current.

Output noise	300 μV rms or less (≤1 MHz)
Effect of temperature	Within the range of -40°C to 0°C or 40°C to 85°C Amplitude sensitivity: ±15 ppm of rdg./°C Offset voltage: ±0.5 ppm of f.s./°C
Effect of magnetization	10 mA or less (input equivalent, after 2000 A DC is inputted)
Common mode rejection ratio (CMRR)	140 dB or more (50 Hz/60 Hz) 120 dB or more (100 kHz) (Effect on output voltage/common-mode voltage)
Effect of conductor position	DC, 50 Hz/60 Hz: ±0.01% rdg. or less (input current: 100 A) 1 kHz: ±0.05% rdg. or less (input current: 10 A) 10 kHz: ±0.2% rdg. or less (input current: 10 A) 100 kHz: ±0.8% rdg. or less (input current: 10 A) (When wire of outer diameter 10 mm is used)
Effect of radiated radio-frequency electromagnetic field	5% f.s. or less at 10 V/m
Effect of conducted radio-frequency electromagnetic field	1% f.s. or less at 10 V
Effect of external magnetic field	80 mA or less (input equivalent, under a magnetic field of 400 A/m DC or 400 A/m with 60 Hz)

Figure 1. Frequency Derating Curve

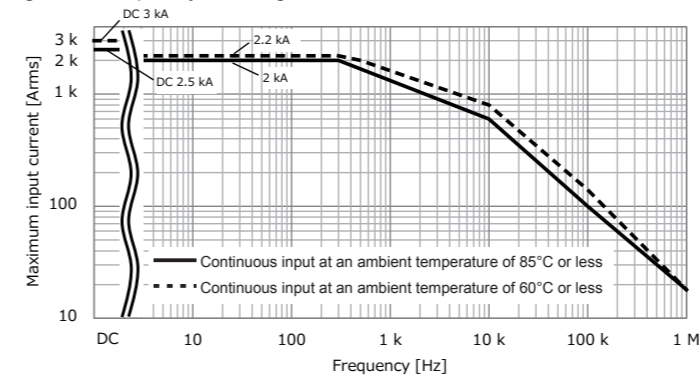

3. Function Specifications

-1. PW6001 Power Analyzer

Combined accuracy

Frequency	Current	Power	Phase
DC	±0.06% rdg. ±0.038% f.s. (f.s.: The measurement range set on the PW6001)	±0.06% rdg. ±0.058% f.s. (f.s.: The measurement range set on the PW6001)	PW6001 accuracy + sensor accuracy
45 Hz ≤ f ≤ 66 Hz	±0.06% rdg. ±0.028% f.s. (f.s.: The measurement range set on the PW6001)	±0.06% rdg. ±0.038% f.s. (f.s.: The measurement range set on the PW6001)	
DC, band other than 45 Hz ≤ f ≤ 66 Hz	PW6001 accuracy + sensor accuracy (Consider sensor rating for f.s. error.)	PW6001 accuracy + sensor accuracy (Consider sensor rating for f.s. error.)	

- For other measurement parameters, add PW6001 accuracy and sensor accuracy together (consider sensor rating for f.s. error).
- For the 40 A range or the 80 A range, add ±0.2% of the measurement range set on the PW6001.
- Add accuracy according to each condition in specifications of the power analyzer and sensor.

-2. PW3390 Power Analyzer

Combined accuracy

Frequency	Current	Power	Phase
DC	±0.09% rdg. ±0.078% f.s. (f.s.: The measurement range set on the PW3390)	±0.09% rdg. ±0.078% f.s. (f.s. The measurement range set on the PW3390)	PW3390 accuracy + sensor accuracy
45 Hz ≤ f ≤ 66 Hz	±0.08% rdg. ±0.058% f.s. (f.s. The measurement range set on the PW3390)	±0.08% rdg. ±0.058% f.s. (f.s. The measurement range set on the PW3390)	
DC, band other than 45 Hz ≤ f ≤ 66 Hz	PW3390 accuracy + sensor accuracy (Consider sensor rating for f.s. error.)	PW3390 accuracy + sensor accuracy (Consider sensor rating for f.s. error.)	

- For other measurement parameters, add PW3390 accuracy and sensor accuracy together (consider sensor rating for f.s. error).
- For the 40 A range or the 80 A range, add ±0.2% f.s. of the measurement range set on the PW3390.
- Add accuracy according to each condition in specifications of the power analyzer and sensor.

-3. CT9555, CT9556, CT9557 Sensor Unit

Combined accuracy

- Sensor accuracy is applicable (with output coaxial cable of length 1.6 m or less).
- Add sensor unit accuracy when RMS output or total output is used.
- Add accuracy according to each condition in specifications of the products to be connected and sensor.

-4. Other connectable products

Connecting CT9901 Conversion Cable enables the device to be used in combination with the following products:

Combined product	Combined accuracy and conditions
9555-10 Sensor Unit	Sensor accuracy (with output coaxial cable of length 1.6 m or less)
3390, 3390-10 Power Analyzer	Recognized as [AC/DC200 A] Set CT ratio to [10]. (Combined accuracy) = (3390 [-10] accuracy) + (sensor accuracy), (power factor: 1)

Characteristics

Frequency characteristics (Typical)

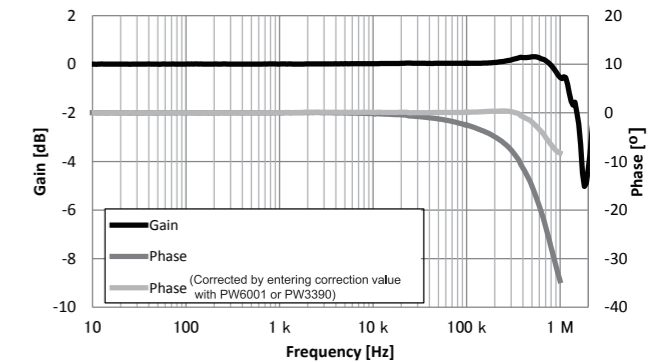

CMRR (Typical)

Effect on output voltage/common-mode voltage

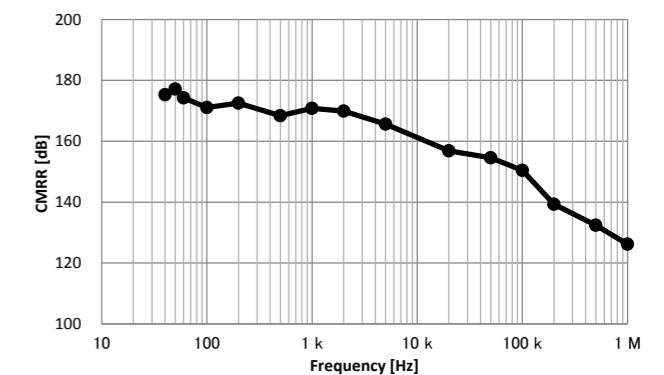

Linearity error (Typical)

Output voltages are measured while input currents (DC) are changed in steps of 400 A beginning from +2000 A to -2000 A and then to +2000 A. Linearity error : Defined as the difference between the regression line calculated from the above measurements and the measurement points.

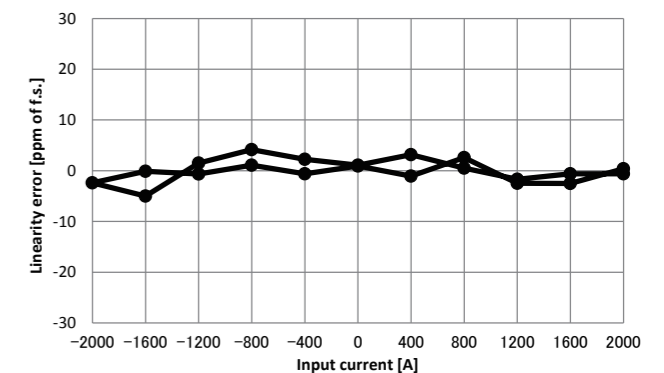

Phase Correction Values

Enter the following correction values (representative values) when performing phase correction on the PW6001 or PW3390.

CT6877:	100 kHz	-2.63°
CT6877-01:	100 kHz	-3.34°