

8910

Instruction Manual

CAN ADAPTER



Contents

Introduction.....	1
Inspection.....	1
Safety Notes.....	4
Notes on Use.....	7

Chapter 1

Product Overview 11

1.1 Overview.....	11
1.2 Major Features.....	12
1.3 Identification of Controls and Indicators.....	13

Chapter 2

Preparation 15

2.1 Installation of the Instrument.....	15
2.2 Power Supply Connections.....	16
2.2.1 Connecting the AC adapter.....	16
2.2.2 Connecting the DC Power Supply.....	17
2.3 Connection Procedure.....	18
2.4 Power On/Off.....	21

Chapter 3

Operation 23

3.1 Modes.....	23
3.2 Conversion Mode.....	23
3.3 Setting Mode.....	24
3.3.1 Activating setting mode.....	25
3.3.2 Contents of display in setting mode.....	26
3.3.3 Selecting a channel number.....	26
3.3.4 Selecting the CAN definition data to be output.....	27
3.3.5 Setting the D/A conversion format/logic bit position.....	28
3.3.6 Returning to conversion mode.....	29
3.4 Calibration Mode.....	30
3.4.1 Activating calibration mode.....	30
3.4.2 Selecting a channel number.....	31
3.4.3 Outputting a calibration signal.....	31
3.4.4 Returning to conversion mode.....	32
3.5 Operation Map.....	33

Chapter 4	
Preparation of the CAN Set Program	37
4.1 Overview	37
4.2 Program Setup	38
4.2.1 System requirements	38
4.2.2 Installation	38
4.2.3 Un-Installation	39
Chapter 5	
Starting the CAN Set Program	41
5.1 Connecting the PC to the 8910	41
5.2 Starting Up the Condition Setting Program	42
5.3 Menu Items in the Setting Window	45
5.4 Operation Flowchart	46
Chapter 6	
Setting the CAN Definition Data	49
6.1 Opening a CAN definition data file	49
6.1.1 Opening a CAN definition data file	49
6.1.2 Creating a new CAN definition data file	50
6.2 Editing the CAN Definition Data	52
6.2.1 Setting the message ID	53
6.2.2 Setting the data length	53
6.2.3 Setting the data start position	54
6.2.4 Setting the data pattern	55
6.2.5 Setting the sign	56
6.2.6 Setting the signal name	57
6.2.7 Setting the label name	57
6.2.8 Setting the unit	57
6.2.9 Setting the scaling	58
6.2.10 Error Message	60
6.3 Deletion of CAN Definition Data	61
6.4 Closing the CAN Definition Data File (Saving the File)	62
6.5 CAN Definition Data List Detail Display	63
6.6 Editing in Another Window	65
6.6.1 Opening a new window	65
6.6.2 Creating a new CAN definition data file	69
6.6.3 Opening a CAN definition data file	69
6.6.4 Editing CAN definition data	69
6.6.5 Saving CAN definition data	69

Chapter 7	
Settings	71
7.1	Registration List Operations 71
7.1.1	Opening a registration list 71
7.1.2	Creating a registration list (registering definition data to a registration list) 72
7.1.3	Deleting data from the registration list 74
7.2	Allocation to Output Channels 75
7.2.1	Setting analog output channels 75
7.2.2	Deleting registered data from the analog output allocation list 76
7.2.3	Setting logic output channels 77
7.2.4	Deleting data from the logic output allocation list 78
7.3	Message ID Trigger 79
7.3.1	Setting the message ID trigger 79
7.3.2	Setting output channels 80
7.4	Setting the ID Filter 81
Chapter 8	
Transfer of Setting Data to the 8910	83
8.1	Setting Communication Parameters 83
8.2	Executing Data Transfer 84
8.3	In Case of Errors 85
8.4	Duplicate Bit Check 86
Chapter 9	
Functions of the Setting Program	87
9.1	Saving the Setting Data 87
9.1.1	Saving data with a new name 87
9.1.2	Overwriting 88
9.2	Setting Data Printout 89
9.2.1	Printing 89
9.2.2	Print preview 89
9.2.3	Setting the printer 90
9.2.4	Examples of printouts 90
9.3	Displaying Windows 92
9.4	Password Setting 93
9.5	Version Check 94

Chapter 10 Connection to Memory HiCorder _____ 95

10.1	Using the 8910 with the 8826 MEMORY HiCORDER	96
10.1.1	Displaying the 8910 setting screen	96
10.1.2	8910 setting screen	98
10.1.3	Setting the block no.	99
10.1.4	Setting analog channel output	100
10.1.5	Setting logic channel output	102
10.1.6	Displaying the registration list	103
10.1.7	Communication between the 8826 and 8910	104
10.1.8	Downloading an setting data file	107
10.2	Using the 8910 with the 8841, 8842 MEMORY HiCORDER.....	109
10.2.1	Displaying the 8910 setting screen	109
10.2.2	8910 setting screen	111
10.2.3	Setting the block no.	112
10.2.4	Setting analog channel output	113
10.2.5	Setting logic channel output	115
10.2.6	Displaying the registration list	116
10.2.7	Communication between the 8841, 8842 and 8910 ...	117
10.2.8	Downloading a setting data file	120

Chapter 11 Specifications _____ 123

11.1	General Specifications.....	123
11.2	Specifications of Functions.....	125
11.3	Specifications of 8910 CAN Set Program (PC Application).....	126
11.4	Specifications of CAN Setting Function (for Memory HiCorder).....	127
11.5	Accessories	128
11.6	Options	128
11.6.1	9713-01 CAN CABLE (one end unprocessed)	129
11.6.2	9713-02 CAN CABLE (For automotive connector)	130
11.6.3	9714-01 LOGIC CABLE (one end unprocessed)	131
11.6.4	9714-02 LOGIC CABLE (for Memory HiCorder)	132
11.7	Specifications of Connectors	133

Chapter 12	
Maintenance and Service	135
12.1 Service and Cleaning	135
12.2 Troubleshooting	135



Introduction

Thank you for purchasing the HIOKI "Model 8910 CAN ADAPTER". To obtain maximum performance from the instrument, please read this manual first, and keep it handy for future reference.

Inspection

When you receive the instrument, inspect it carefully to ensure that no damage occurred during shipping. In particular, check the accessories, panel switches, and connectors. If damage is evident, or if it fails to operate according to the specifications, contact your dealer or Hioki representative.

Accessories

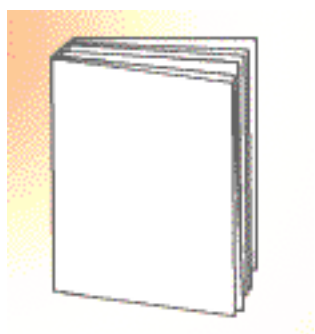

Instruction manual 1



CD-R ("8910 CAN set program" software (Japanese/English 2 files) (for PC), CAN setting function (for Memory HiCorder)) 1

RS-232C cable (D-sub 9-pin, male-female, straight cable) (Approx. 1.8 m) 1

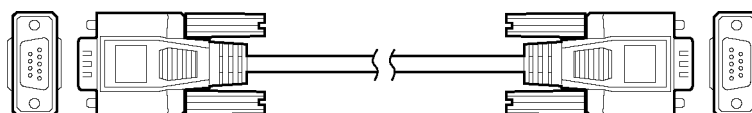

9418-15 AC ADAPTER 1

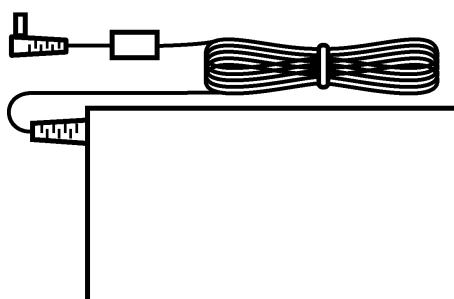

Power cord 1

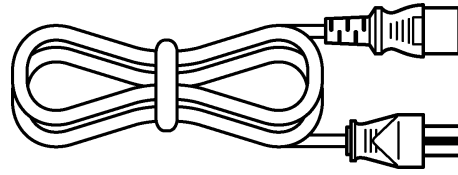

9713-01 CAN CABLE (one end unprocessed) (Approx. 2 m) 1

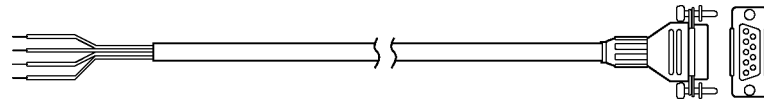

Options

9713-01 CAN CABLE (one end unprocessed) (Approx. 2 m)

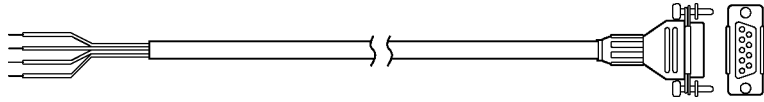

9713-02 CAN CABLE (For automotive connector) (Approx. 2 m)
 (Since this part is made to order, check the specifications document and delivery date.)

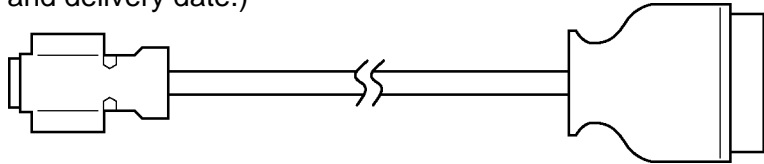

9714-01 LOGIC CABLE (one end unprocessed) (Approx. 1.5 m)

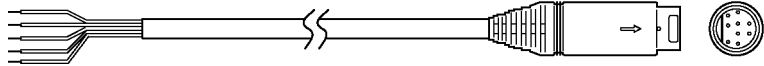

9714-02 LOGIC CABLE (for Memory HiCorder) (Approx. 1.5 m)

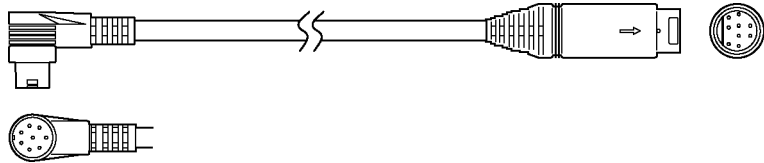

9165 CONNECTION CORD (Metal BNC - Metal BNC) (Approx. 1.5 m)

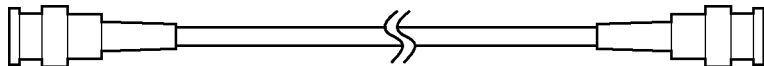

L9217 CONNECTION CORD (Metal BNC - Insulated BNC)
 (Insulated BNC for Memory HiCorder) (Approx. 1.7 m)

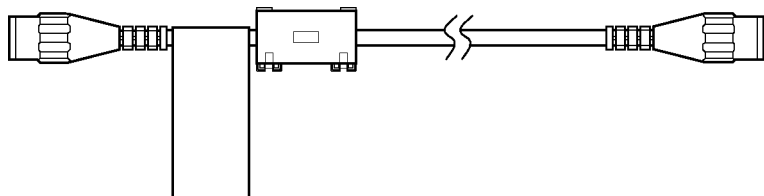

9557 RS-232C CARD (for Memory HiCorder)

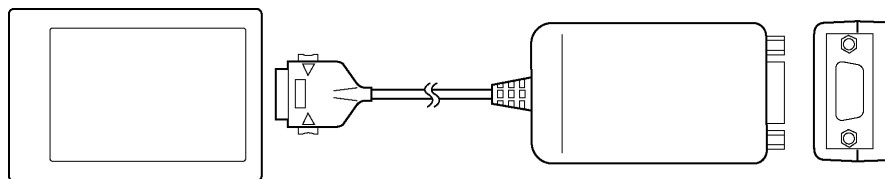

Preliminary Checks

Before using the instrument the first time, verify that it operates normally to ensure that no damage occurred during storage or shipping. If you find any damage, contact your dealer or Hioki representative.

WARNING

Before using the instrument, make sure that the insulation on the cords and cables are undamaged and that no bare conductors are improperly exposed. Using the product in such conditions could cause an electric shock, so contact your dealer or Hioki representative for repair.

Safety Notes



This instrument is designed to comply with IEC 61010 Safety Standards, and has been thoroughly tested for safety prior to shipment. However, mishandling during use could result in injury or death, as well as damage to the instrument. Be certain that you understand the instructions and precautions in the manual before use. We disclaim any responsibility for accidents or injuries not resulting directly from instrument defects.

This manual contains information and warnings essential for safe operation of the instrument and for maintaining it in safe operating condition. Before using it, be sure to carefully read the following safety precautions.

Safety symbols



In the manual, the  symbol indicates particularly important information that the user should read before using the instrument.



Indicates AC (Alternating Current).



Indicates DC (Direct Current).



Indicates the OFF side of the power switch.



Indicates the ON side of the power switch.

The following symbols in this manual indicate the relative importance of cautions and warnings.



Indicates that incorrect operation presents an extreme hazard that could result in serious injury or death to the user.



Indicates that incorrect operation presents a significant hazard that could result in serious injury or death to the user.



Indicates that incorrect operation presents a possibility of injury to the user or damage to the instrument.



Indicates advisory items related to performance or correct operation of the instrument.

Mouse Operation

Click	:	Press and quickly release the left button of the mouse.
Right-click	:	Press and quickly release the right button of the mouse.
Double click	:	Quickly click the left button of the mouse twice.
Drag	:	While holding down the left button of the mouse, move the mouse and then release the left button to deposit the chosen item in the desired position.
Activate	:	Click on a window on the screen to activate that window.

Indications

- Unless otherwise specified, “Windows” represents Windows 95, 98, Me, Windows NT4.0, Windows 2000, or Windows XP.
- Dialogue box represents a Windows dialog box.
- Menus, commands, dialogs, buttons in a dialog, and other names on the screen and the keys are indicated in brackets.

Measurement categories

To ensure safe operation of measurement instruments, IEC 61010 establishes safety standards for various electrical environments, categorized as CAT II to CAT IV, and called measurement categories. These are defined as follows.

CAT II : Primary electrical circuits in equipment connected to an AC electrical outlet by a power cord (portable tools, household appliances, etc.)

CAT II covers directly measuring electrical outlet receptacles.

CAT III : Primary electrical circuits of heavy equipment (fixed installations) connected directly to the distribution panel, and feeders from the distribution panel to outlets.

CAT IV : The circuit from the service drop to the service entrance, and to the power meter and primary overcurrent protection device (distribution panel).

Using a measurement instrument in an environment designated with a higher-numbered category than that for which the instrument is rated could result in a severe accident, and must be carefully avoided. Use of a measurement instrument that is not CAT-rated in CAT II to CAT IV measurement applications could result in a severe accident, and must be carefully avoided.

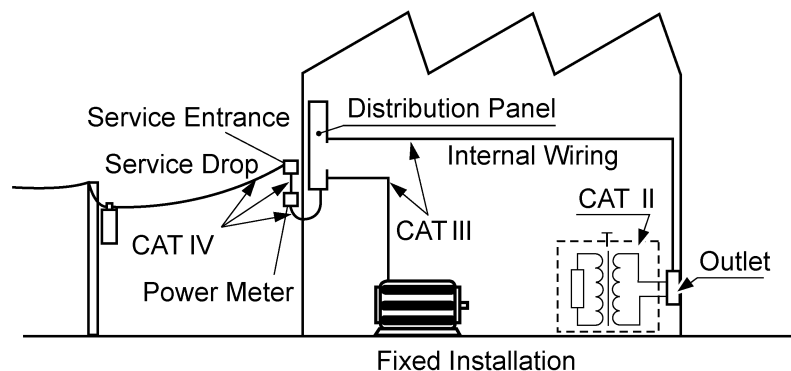

Notes on Use

Follow these precautions to ensure safe operation and to obtain the full benefits of the various functions.



□ Connecting the Cables (RS-232C Cable, CAN Cable, Connection Cord [Analog], Logic Cable)

The ground (GND) conductors of the connecting cables* connect in common to the Model 8910 chassis ground (they are not isolated). Care is therefore necessary to ensure that there is no potential difference between the instrument chassis ground and the ground of any connecting device. Otherwise, the instrument or connecting device could be damaged. Refer to “Power Sources” below.

□ Power Sources

The ground (GND) conductors of connecting cables* connect in common to the Model 8910 chassis ground (they are not isolated). Therefore, supplying power from different sources to the instrument and a connecting device could cause electric shock and equipment damage. To avoid these hazards, power should always be supplied from the same source.

Even when power is supplied from the same source, as a result of wiring, potential difference between grounds can result in current flow through the connecting cables* that could damage the equipment.

To avoid such hazards, we recommend observing the following precautions for power connections:

- (1) When powering the 8910 from the supplied AC adapter, before connecting devices to the 8910, plug the (supplied) grounded power cord of the AC adapter into the same outlet as that used to power the devices to be connected.
 - ❖ 2.2.1 *Connecting the AC adapter (Page 16) and 2.3 Connection Procedure (Page 18)*
- (2) When powering the 8910 from a DC power source, before making other connections, first connect the ground of the 8910 to the grounds of the devices to be connected. In this case, always use the same power source.
 - ❖ 2.2.2 *Connecting the DC Power Supply (Page 17) and 2.3 Connection Procedure (Page 18)*
- (3) When powering the 8910 from the supplied AC adapter and powering connecting devices from a DC source (or when powering the 8910 from DC and connecting devices from AC), before making other connections to the 8910, first connect the ground of the 8910 to the grounds of the devices to be connected. Refer to the following alternatives regarding common ground connection methods.
 - (a) Connect the grounds of devices running on DC power to the AC adapter’s ground.
 - (b) Connect pin 3 (CAN_GND) of the 9713-01 CAN Cable to the ground of the device to be connected.

*Connecting cables: Cables and connection cords being connected to the 8910.



Note: In method (b) above, because of wire length and CAN cable wiring conditions, some potential difference may remain between grounding points, so we recommend (a) as the preferred method.

- ❖ **2.2.1 Connecting the AC adapter (Page 16),**
- 2.2.2 Connecting the DC Power Supply (Page 17) and
- 2.3 Connection Procedure (Page 18)



☐ Power Supply Connections

Before turning the instrument on, make sure the supply voltage matches that indicated on the its power connector. Connection to an improper supply voltage may damage the instrument and present an electrical hazard.

☐ Grounding the Instrument

To avoid electrical accidents and to maintain the safety specifications of this instrument, connect the power cord provided only to a 3-contact (two-conductor + ground) outlet.

- ❖ **2.2 Power Supply Connections (Page 16)**

☐ Before Powering on

Check the power supply is correct for the rating of the unit.



☐ Usage Precautions for the CD-R

- Always hold the disc by the edges, so as not to make fingerprints on the disc or scratch the printing.
- Never touch the recorded side of the disc. Do not place the disc directly on anything hard.
- Do not wet the disc with volatile alcohol or water, as there is a possibility of the label printing disappearing.
- To write on the disc label surface, use a spirit-based felt pen. Do not use a ball-point pen or hard-tipped pen, because there is a danger of scratching the surface and corrupting the data. Do not use adhesive labels.
- Do not expose the disc directly to the sun's rays, or keep it in conditions of high temperature or humidity, as there is a danger of warping, with consequent loss of data.
- To remove dirt, dust, or fingerprints from the disc, wipe with a dry cloth, or use a CD cleaner. Always wipe radially from the inside to the outside, and do no wipe with circular movements. Never use abrasives or solvent cleaners.
- Hioki shall not be held liable for any problems with a computer system that arises from the use of this CD-R, or for any problem related to the purchase of a Hioki product.

CAUTION

Installation Environment

- Do not use the instrument where it may be exposed to corrosive or combustible gases. The instrument may be damaged.
- The instrument should be installed and operated indoors only, between -10 and 55°C and 30 to 80% RH.
- Do not store or use the instrument where it could be exposed to direct sunlight, high temperature or humidity, or condensation. Under such conditions, the instrument may be damaged and insulation may deteriorate so that it no longer meets specifications.

Others

- To prevent an electric shock accident, confirm that the white or red portion (insulation layer) inside the cable is not exposed. If a color inside the cable is exposed, do not use the cable.
- Carefully read and observe all precautions in this manual.

NOTE

- Using a connection cord other than that specified by HIOKI may damage the BNC connector or result in measurement errors due to contact failure.
- Even when using the 8910 within the permitted operating temperature (-10 to 55°C) and humidity ranges, display on the LCD may become difficult to read at very low or high ambient temperatures. (In such case, alter the viewing angle.) Note that this change does not affect instrument operation.
- This instrument may cause interference if used in residential areas. Such use must be avoided unless the user takes special measures to reduce electromagnetic emissions to prevent interference to the reception of radio and television broadcasts.

Product Overview

Chapter 1

1.1 Overview

- 8910 CAN ADAPTER is a signal converter that acquires necessary signals from CAN signals flowing on a CAN bus, converts the signals to analog or logic signals, then generates output.
- The type of data to be acquired is set by using a PC, with settings transferred and saved in internal memory of the 8910 via the RS-232C.
- Internal memory can store up to 50 items of CAN definition data. Since you can change allocated output channels by using the LCD and operation keys on the front panel, the instrument can be used in various applications without a PC.

1.2 Major Features

1. Compact size and lightweight
The main unit is compact and lightweight for easy portability.
2. Ample output channels
The 8910 is equipped with ample output channels - 12 channels for analog signal output and 24 bits for logic signal output.
3. Two independent input ports
Since CAN1 and CAN2 are independent, two networks with different baud rates can be connected.
4. Automatic baud rate setting
Because the 8910 monitors the CAN bus and automatically sets the baud rate, there is no need to manually set the baud rate. (Supported baud rates are 125 kbps, 250 kbps, 500 kbps, and 1 Mbps.)
5. Detailed settings using a PC
Easy-to-use PC application software enables the detailed settings of data to be acquired from a CAN bus.
6. Observation with your existing recorder
The output signal level ranges from -5 to +5 V, and the value is held until subsequent signal output. Therefore, output from the 8910 can be connected to an ordinary recorder. Thus, you can observe CAN signals by connecting the 8910 to your existing recorder.
7. Real-time output
CAN signals are converted into analog/logic signals and output in real time.
8. Mixed recording
By using the 8910 with a recorder such as the Memory HiCorder, "sensor data or control signal on CAN" and "signal that cannot be acquired on CAN" can be recorded together.

1.3 Identification of Controls and Indicators

Front Side

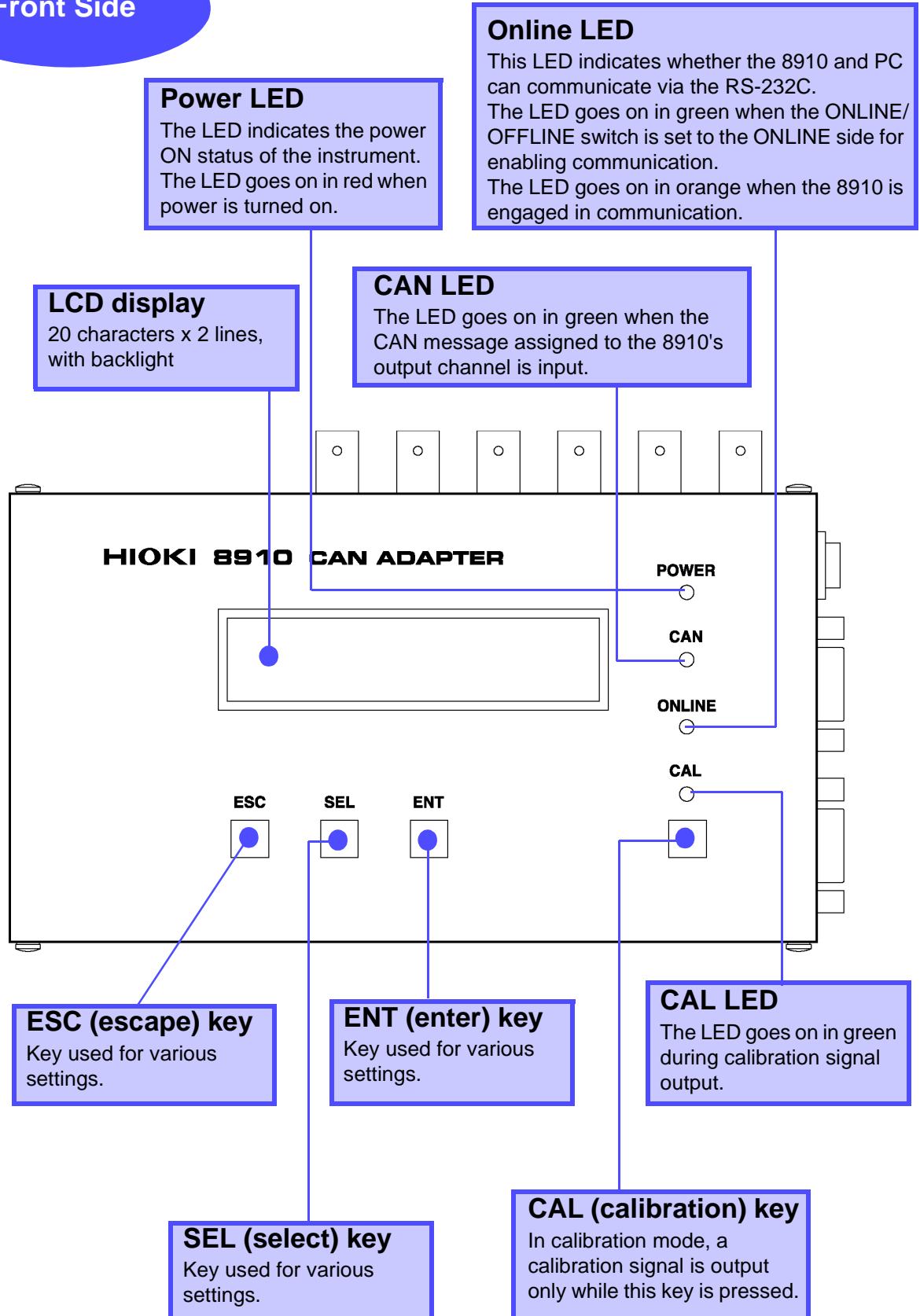

Back Side

Analog Output Terminals

These terminals output analog signals. All 12 channels use BNC connectors.

Logic Output Terminals

These terminals output logic signals. Each terminal outputs 4 bits, for a total of 24 bits.

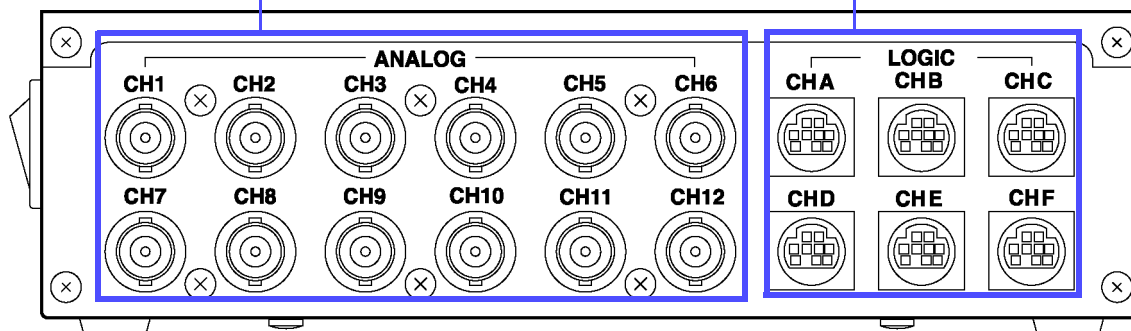

Right Side

RS-232C Terminal

This is a communication connector for connecting a host PC or Memory HiCorder.

CAN Input Ports 1, 2

These ports are CAN signal input terminals. Since CAN1 and CAN2 are independent, two different networks can be connected. These ports can also be used to supply power to the 8910.

Power Switch

This switch turns the power ON and OFF. The switch is effective for power supplied through DCIN, CAN1, and CAN2.

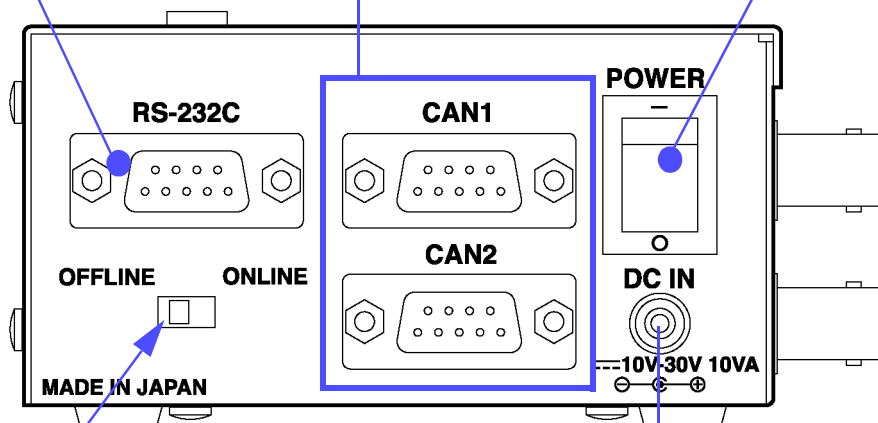

ONLINE/OFFLINE Switch

This switch is used to set the 8910 to ONLINE or OFFLINE mode. Setting this switch to ONLINE enables the 8910 to communicate with the host PC or Memory HiCorder.

AC adapter connection Terminal

This terminal is used to connect the AC ADAPTER. (A DC power supply (10 to 30 V) can also be connected.)

Key lock: Note that the 8910 accepts no key entry when the [ONLINE/OFFLINE] switch is set to the [ONLINE] side.

Preparation

Chapter 2

2.1 Installation of the Instrument

1. Installation orientation
Install the instrument on a flat, level surface.
2. Ambient conditions
 - Temperature : -10 to 55°C
 - Humidity : 30 to 80%RH (with no condensation)
3. Do not use the instrument in the following locations:
 - Subject to direct sunlight.
 - Subject to high levels of dust, steam, or corrosive gases (Avoid using the equipment in an environment containing corrosive gases (e.g., H₂S, SO₂, NI₂, and Cl₂) or substances that generate harmful gasses (e.g., organic silicones, cyanides, and formalins).
 - Subject to vibrations.
 - In the vicinity of equipment generating strong electromagnetic fields.

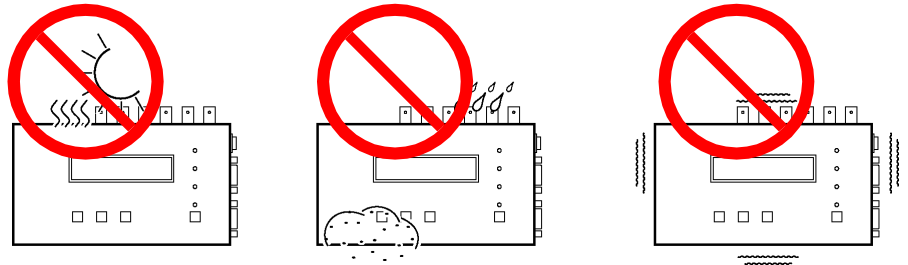

2.2 Power Supply Connections

2.2.1 Connecting the AC adapter



- Use only the supplied Model 9418-15 AC ADAPTER . AC adapter input voltage range is 100 to 240 VAC (with $\pm 10\%$ stability) at 50/60 Hz. To avoid electrical hazards and damage to the instrument, do not apply voltage outside of this range.
- To avoid electrical accidents and to maintain the safety specifications of this instrument, connect the power cord only to a 3-contact (two-conductor + ground) outlet.

1 Connect the AC adapter to the 8910.

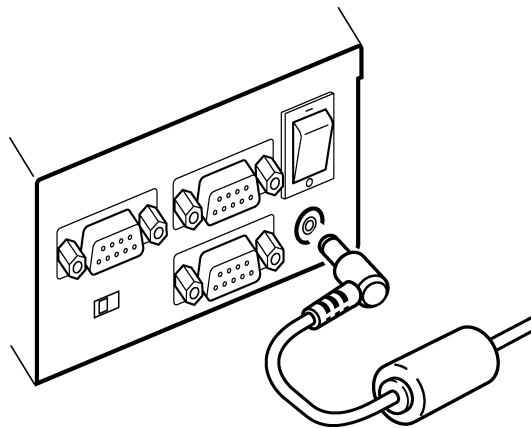

2 Connect the AC adapter plug to an outlet.

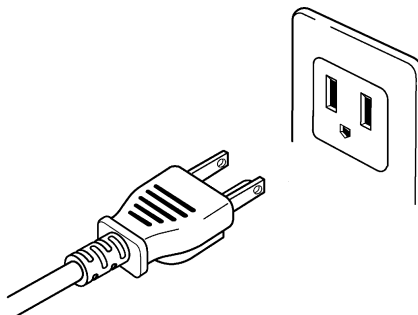

2.2.2 Connecting the DC Power Supply

In addition to the AC adapter, any of the following power sources can be used:

- DC power supply (10 to 30 V) (Voltage fluctuations of $\pm 10\%$ from the rated supply voltage are taken into account.)
- Power supplied from CAN input port (10 to 30 V) (Voltage fluctuations of $\pm 10\%$ from the rated supply voltage are taken into account.)

2.3 Connection Procedure



- To avoid the risk of electric shock, never connect the connecting cables* of energized equipment to the 8910.
- The ground (GND) conductors of connecting cables* connect in common to the Model 8910 chassis ground (they are not isolated). Therefore, supplying power from different sources to the instrument and a connecting device could cause electric shock and equipment damage. **To avoid these hazards, power should always be supplied from the same source.** Even when power is supplied from the same source, as a result of wiring, potential difference between grounds can result in current flow through the connecting cable that could damage the equipment. To avoid such hazards, we recommend observing the following precautions for power connections:

*Connecting cables: Cables and connection cords being connected to the 8910.

Recommended Connection Procedures

- (1) When powering the 8910 from the supplied AC adapter

Before connecting devices to the 8910, plug the (supplied) grounded power cord of the AC adapter into the same outlet as that used to power the devices to be connected.

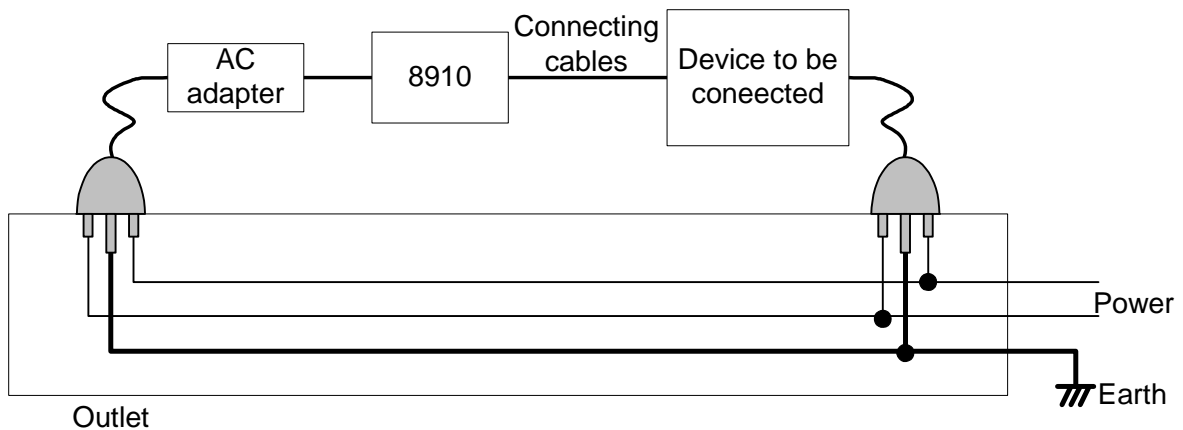

- (2) When powering the 8910 from a DC power source

Before making other connections, first connect the ground of the 8910 to the grounds of the devices to be connected. In this case, always use the same power source.

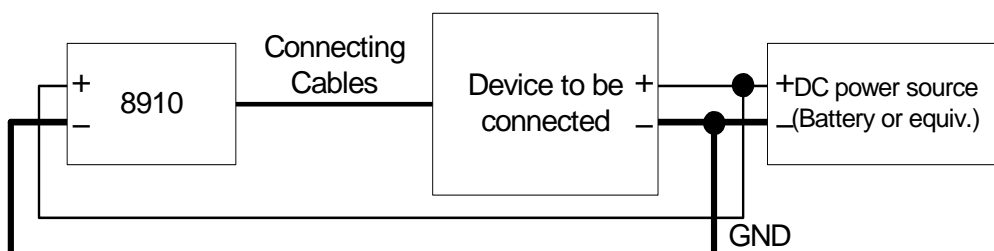

2.3 Connection Procedure

- (3) When powering the 8910 from the supplied AC adapter and powering connecting devices from a DC source (or when powering the 8910 from DC and connecting devices from AC)

Before making other connections to the 8910, first connect the ground of the 8910 to the grounds of the devices to be connected. Refer to the following alternatives regarding common ground connection methods.

- (a) Connect the grounds of devices running on DC power to the AC adapter's ground.
 (b) Connect pin 3 (CAN_GND) of the 9713-01 CAN Cable to the ground of the device to be connected.

Note: In method (b) above, because of wire length and CAN cable wiring conditions, some potential difference may remain between grounding points, so we recommend (a) as the preferred method.

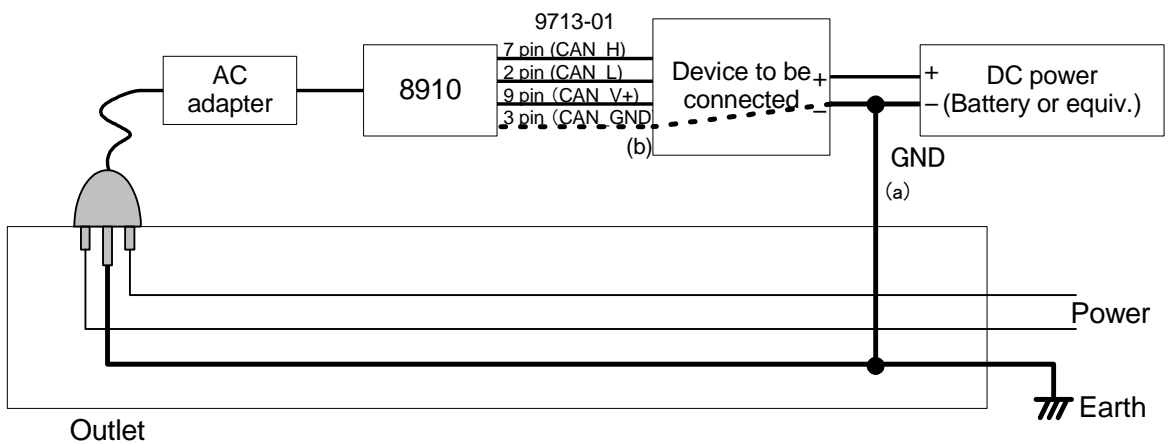

2.3 Connection Procedure

The following diagram shows the connection points of the cables and cords to be connected to the 8910 CAN ADAPTER.

NOTE

The instrument does not output signals (including response bits) to the CAN bus. Therefore, when only one device connected to the bus in addition to the 8910, communication is not possible since response bits cannot be exchanged. Therefore, be sure to connect the bus to which the 8910 is connected with two or more devices to enable communication.

Connection Points

The 9714-01 or 9714-02 LOGIC CABLE (This is the 9714-02)

The 9165 or L9217 CONNECTION CORD

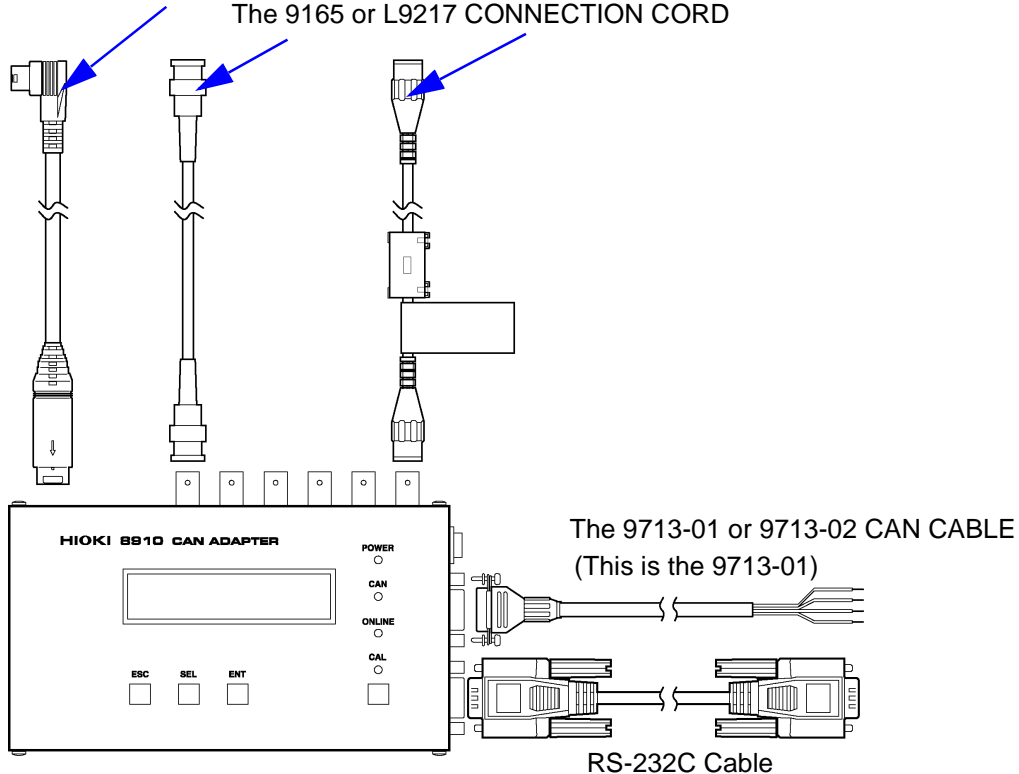

CAUTION

To prevent an electric shock accident, confirm that the white or red portion (insulation layer) inside the cable is not exposed. If a color inside the cable is exposed, do not use the cable.

Connecting to the Analog Output

1. Align the BNC connector with the guide groove of the unit output connector, and turn clock wise while pressing in to lock the connector.



2. To remove from the instrument, turn the BNC connector counterclockwise to release the lock, then pull it.

2.4 Power On/Off



Check the following points before the power switch is turned on.

- When using the AC adapter, make sure that the power supply complies with the rated voltage (100 - 240 VAC) and rated frequency (50/60 Hz) of the 8910.

- The instrument is correctly connected.

❖ (Section 2.1, 15p.)

1 Connect the cables and cords.

Connect cables and cords before turning on the power.

2 Turn on the power.

When the power switch is turned on, the POWER LED goes on.

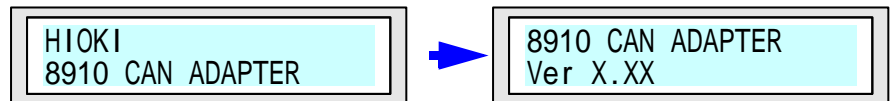

Confirm that the above display appears. (X.XX is the version No.)

3 The 8910 then begins internal initialization.

When initialization is complete, the display below appears and the instrument enters CAN signal conversion mode.

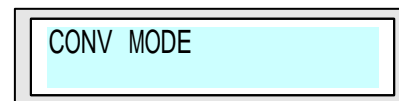

Note that if no CAN data has been registered or assigned to any output channel, the following error message will flash on the display:

Error Messages

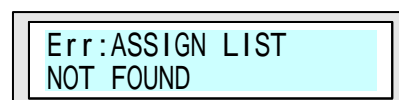

<When no CAN data is registered>

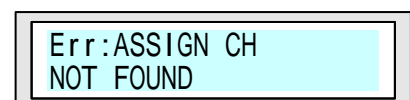

<When no CAN data is assigned to an output channel>

NOTE

- The error message continues flashing until a key is pressed.
- While the error message is displayed, RS communication is disabled. To conduct RS communication, press any key to place the instrument in conversion mode.

Operation

Chapter 3

3.1 Modes

The 8910 has the following three operation modes, which can be switched by using keys on the front panel.

Conversion mode	This mode converts the CAN signal input from the CAN 1 or 2 port according to the set definition data, and outputs the converted signal from the specified analog or logic output terminal.
Setting mode	This mode is used to select data to be acquired from the CAN bus and set the channel for acquired data output.
Calibration mode	This mode outputs a calibration signal.

3.2 Conversion Mode

- Conversion mode is the first mode to become active after power is turned on.
- This mode converts the CAN message supplied to CAN1 or CAN2 port according to internally set definition data, and outputs the converted signal from a specified analog or logic output terminal.

When conversion mode is active, the LCD indicates the following:

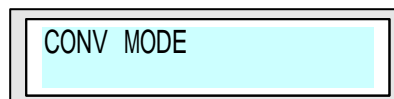

- The 8910 monitors the CAN bus and adjusts the baud rate automatically. Therefore, the instrument has already begun to receive signal input from CAN1 or CAN2 at this point.
- When the CAN message assigned to the output channel enters the CAN port, the CAN LED goes on in green.
- The output voltage level is held until conversion of the next CAN message.
- Four baud rates are supported: 125 kbps, 250 kbps, 500 kbps, and 1 Mbps.

NOTE

3.3 Setting Mode

- This mode is used to set the data to be output from each analog/logic output channel.
- The internal memory of the 8910 can store up to 50 items of CAN definition data.
- The data in memory can be assigned to the 12 analog output channels or six (24 bits) logic output channels for output.

NOTE

- CAN definition data must be set in advance using the PC application.
 - ❖ [Chapter 6, 49p](#)
- The keys on the 8910 enable the following settings:
 - Channel selection
 - Label selection
 - D/A conversion format/logic bit positionBut the setting bellow cannot be made solely by using the 8910.
 - CAN input port selection
 - ID trigger setting
 - ID filter setting

3.3.1 Activating setting mode

1 Position the [ONLINE/OFFLINE] switch to the [OFFLINE] side.

To use the keys on the 8910 for entering settings, position the [ONLINE/OFFLINE] switch to the [OFFLINE] side. Make sure that the ONLINE LED is off

2 Press the [SEL] key.

When the instrument is in conversion mode, pressing the [SEL] key changes the mode in the following sequence:

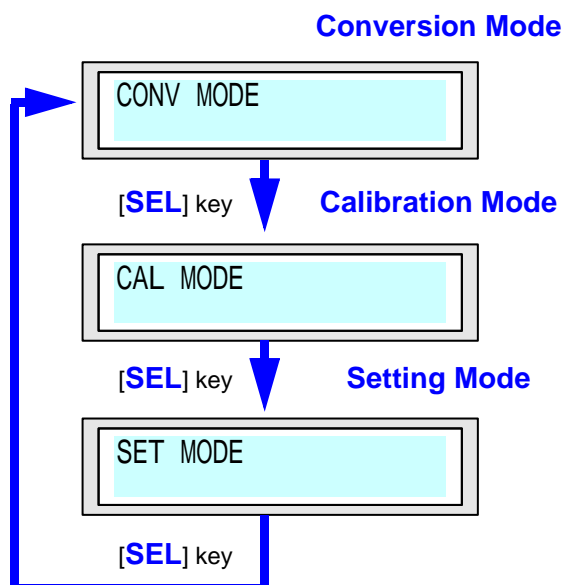

3 In setting mode, press the [ENT] key.

In setting mode, pressing the [ENT] key displays the following indication:

```
Analog 01
*** OFF ***
```

The instrument is now in setting mode. ([*** OFF ***] appears when the channel is not assigned with data for output.)

3.3.2 Contents of display in setting mode

When the data to be output is assigned, the label name and D/A conversion format ([B] or [M]) of CAN definition data are indicated for an analog channel; the label name and bit position are indicated for a logic channel.

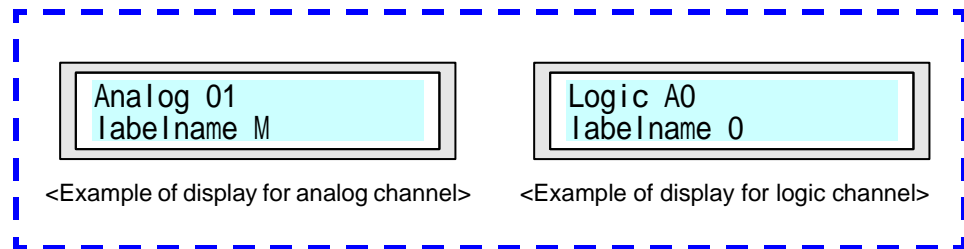

3.3.3 Selecting a channel number

1 Activating setting mode (Section 3.3.1, 25p.)

When setting mode is activated, the channel number on the LCD flashes, indicating that the channel selection can be changed.

2 Push the [SEL] key, and select a channel.

In this condition, each time the [SEL] key is pressed, the channel indicated on the LCD changes sequentially from analog channel 1 to 12. After analog channel 12, logic channels are shown in order of [A0] to [F3], then the indication returns to analog channel 1. Hold down the [SEL] key until the desired channel is shown.

CH

01→02→03...12→A0→A1→A2→A3→B0→B1→B2→B3→C0
→C1→C2→C3→D0→D1→D2→D3→E0→E1→E2→E3→F0
→F1→F2→F3→ (returns to the beginning)

3 Push the [ENT] key.

After selecting a channel, press the [ENT] key. This enters the new setting.

NOTE

Since CAN data conversion and output are in process for all channels during channel number selection, the setting can be changed while observing the output.

3.3.4 Selecting the CAN definition data to be output

1 Enter the channel number. (Section 3.3.3, 26p.)

When the [ENT] key is pressed to enter the channel number, the channel number stops flashing. At the same time, the label name of CAN definition data starts flashing, indicating that CAN definition data assigned to the output channel can be changed.

2 Press the [SEL] key, and select a label name.

In this condition, pressing the [SEL] key changes the indication of the label name. Hold down the [SEL] key until the label name of definition data to be output is shown.

3 Press the [ENT] key.

After selecting the CAN definition data to be output, press the [ENT] key. This enters the setting.

NOTE

- To disable output, use the [SEL] key to select [*** OFF ***], then press the [ENT] key.
- CAN data conversion and output are stopped for all channels while CAN definition data is being selected.

3.3.5 Setting the D/A conversion format/logic bit position

1 Enter the CAN definition data. (Section 3.3.4, 27p.)

When CAN definition data is entered by pressing the [ENT] key, the D/A conversion format ([B] or [M]) flashes for an analog channel; the bit position flashes for a logic channel.

2 Press the [SEL] key, and set the value.

Hold down the [SEL] key until the flashing section shows the desired value.

3 Press the [ENT] key.

To enter the D/A output format or bit position, press the [ENT] key. This enters the new setting.

After the D/A output format or bit position is selected by pressing the [ENT] key, the channel number indication starts flashing again.

NOTE

CAN data conversion and output are stopped for all channels while the D/A conversion format/logic bit position is being set.

D/A conversion format

This format is used to select analog signal output in a range from -5 to +5 V or 0 to +5 V. Selecting Bipolar [B] sets the output range from -5 to +5 V; selecting Monopolar [M] sets the output range from 0 to +5 V.

The D/A resolution is 16 bits in both cases. When the data length is 16 bits, the relationship between input data and output voltage is as follows:(29p.)

(When the data length is N (bits), replace "16" in the factorial of "2" shown in the diagram with "N" in calculation.)

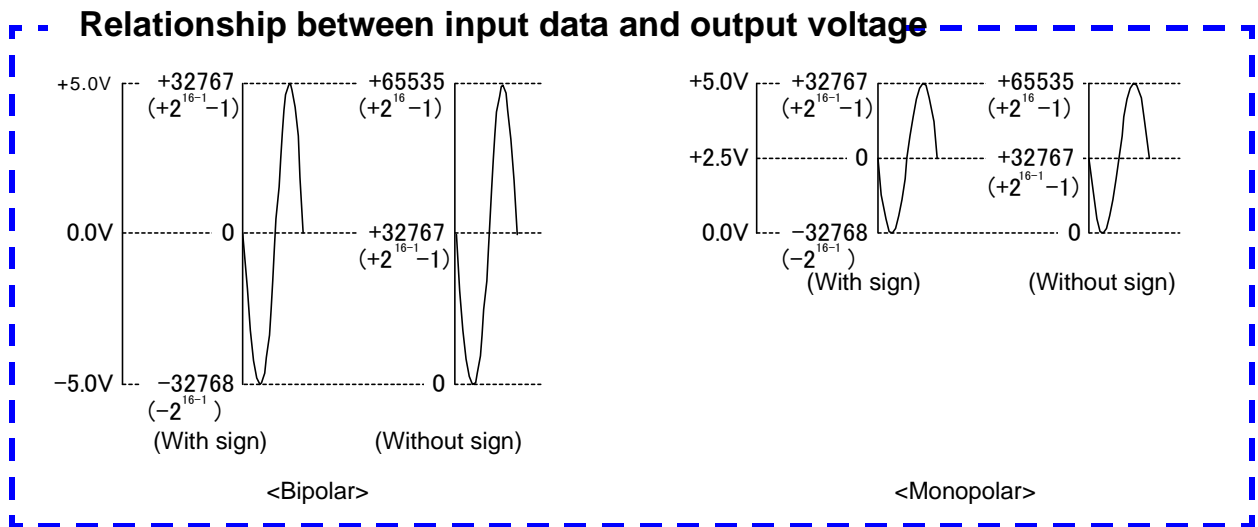
**Bit position**

When the assigned CAN definition data is 2 bits or more, this setting determines the type of bit data that is output.

3.3.6 Returning to conversion mode

After settings are made, press the [ESC] key several times to return to conversion mode.

When no key entry is made for about 30 seconds, the 8910 also returns to conversion mode.

3.4 Calibration Mode

- This mode is used to select an analog/logic output channel and output a calibration signal from the selected channel.
- This mode lets you check for proper connection of the analog connection cords and logic cables.

3.4.1 Activating calibration mode

1 Position the [ONLINE/OFFLINE] switch to the OFF LINE side.

To use the keys on the 8910 for entering settings, position the [ONLINE/OFFLINE] switch to the [OFFLINE] side. Make sure that the ONLINE LED is off.

2 Press the [SEL] key.

When the instrument is in calibration mode, pressing the [SEL] key changes the mode in the following sequence:

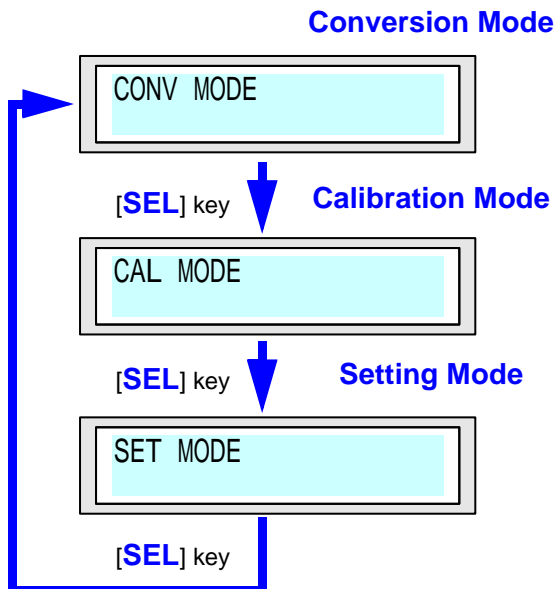

3 In calibration mode, press the [ENT] key

In calibration mode, pressing the [ENT] key displays the following indication:

Calibration A01

3.4.2 Selecting a channel number

1 Activating calibration mode. (Section 3.4.1, 30p.)

When calibration mode is activated, the channel number on the LCD flashes, indicating that channel selection can be changed.

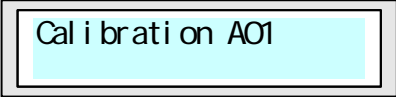

Calibration A01

2 Push the [SEL] key, and select a channel.

In this condition, each time the [SEL] key is pressed, the channel indicated on the LCD changes sequentially from analog channel 1 to 12. After analog channel 12, logic channels are shown in order of A to F, then the indication returns to analog channel 1. Hold down the [SEL] key until the desired channel is shown.

CH

A01→A02→A03....→A12→LA→LB→LC→LD→LE→LF→(returns to the beginning)

3.4.3 Outputting a calibration signal

- After selecting a channel, press the [CAL] key to output a calibration signal. The calibration signal is output from the selected channel only while the [CAL] key is held down.
- CAN data conversion and output are stopped for all channels during calibration signal output.
- For an analog channel, the output alternates between 0 V and 5 V at 100-ms intervals.
- For a logic channel, the output bit pattern alternates between 0Ah (1010) and 05h (0101) at 100-ms intervals.

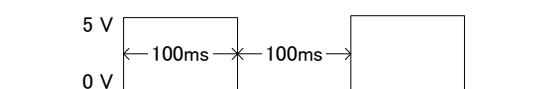

<For analog channel>

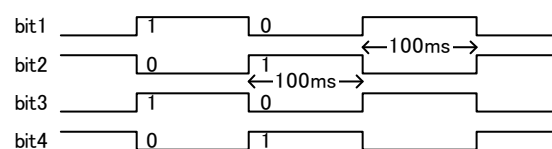

<For Logic Channel>

3.4.4 Returning to conversion mode

- Press the **[ESC]** key to exit from calibration mode and return to conversion mode.
 - When no key entry is made for about 30 seconds, the 8910 also returns to conversion mode.
-

3.5 Operation Map

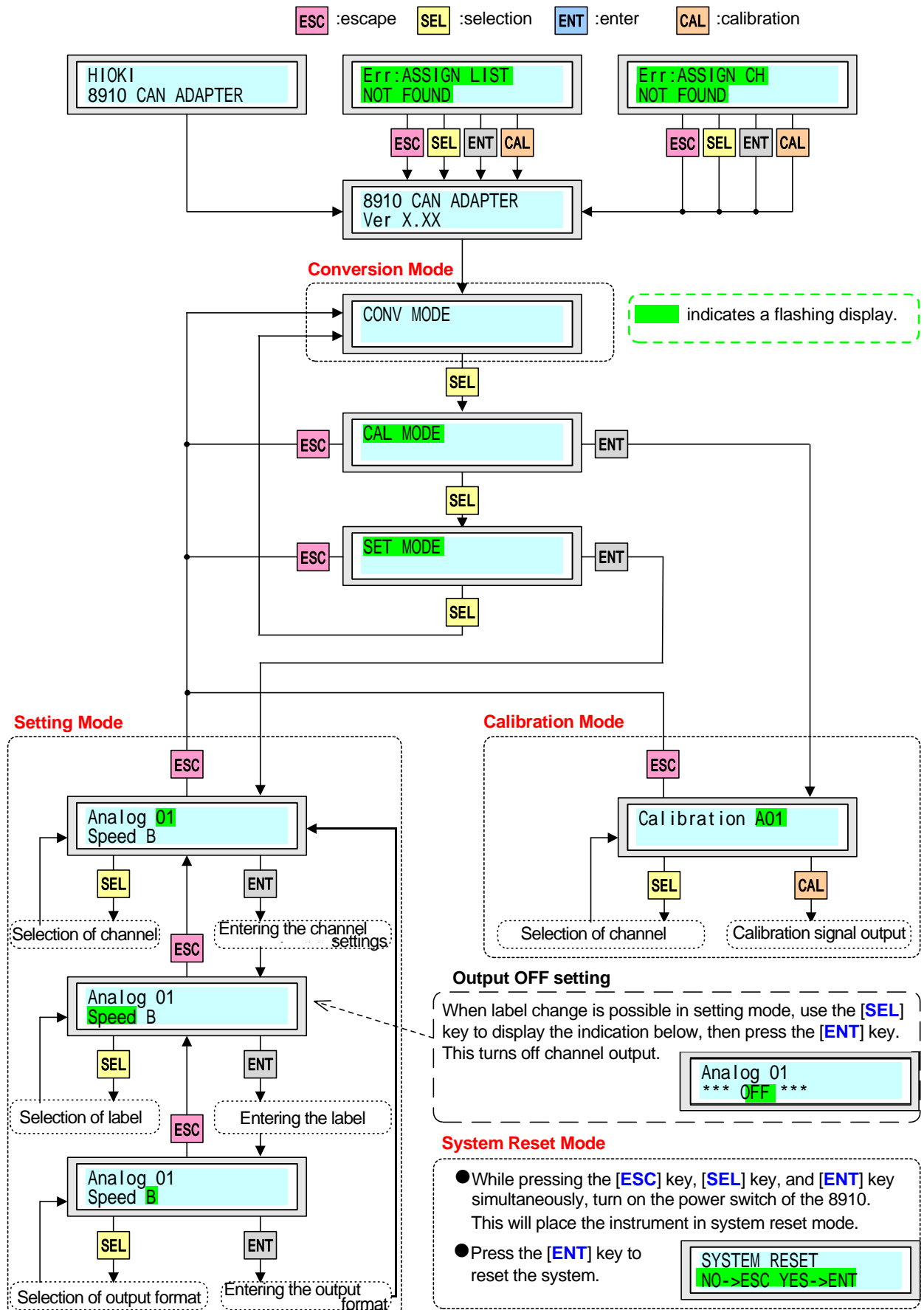

ONLINE mode/OFFLINE mode

- ◆ Operate the switch to toggle between ONLINE mode and OFFLINE mode.
- ◆ In ONLINE mode, RS communication is enabled. The keys are not operable in this mode (key lock).
- ◆ In OFFLINE mode, the 8910 accepts operations. RS communication is not possible in this mode.

RS communication

- ◆ Even when the instrument is in ONLINE mode, the ONLINE LED goes off and RS communication is disabled in the following cases:
 1. When an error message is displayed
 2. When the instrument is in system reset mode

Key operation

- ◆ Keys are not operable when the instrument is in ONLINE mode (key lock).
- ◆ Even in ONLINE mode (key lock), pressing a key turns on the backlight for about 10 seconds.
- ◆ Even in ONLINE mode (key lock), the keys are operable in the following cases:
 1. When an error message is displayed
 2. When the instrument is in system reset mode

Display

- ◆ The backlight turns off when no key entry is made for about 10 seconds.
- ◆ The instrument returns to conversion mode when no key entry is made for about 30 seconds.
- ◆ The display remains on until a key is pressed in the following cases:
 1. When an error message is displayed
 2. When the instrument is in system reset mode

CAN conversion and output

- ◆ CAN conversion and output are in process for all channels in the following cases:
 1. When the instrument is in conversion mode
 2. While the [CAL] key is not pressed in CAL mode
 3. When a channel is being selected in setting mode (with setting changeable while observing the output)

- ◆ CAN conversion and output are stopped for all channels in the following cases:
 1. When the [CAL] key is pressed in CAL mode during CAL signal output
 2. When the label, output format, or bit position is being selected in setting mode
 3. When the instrument is engaged in RS communication
 4. When an error message is displayed
 5. When the instrument is in system reset mode

Setting change

- ◆ When the [SEL] key is used in setting mode to change a setting, pressing the [ENT] key enters the new setting.
- ◆ A new setting will not be effective by simply changing a setting with the [SEL] key in setting mode.
- ◆ The entered setting is written to backup memory immediately before CAN conversion and output.
- ◆ In setting mode, CAN conversion and output are conducted when setting item selection returns to the channel selection. Therefore, the setting is written to backup memory at this time.
- ◆ If 8910 power is turned off before setting item selection returns to the channel selection, the setting change made in setting mode will not be written to backup memory.

Operation tips

- ◆ In CAL mode, pressing the [SEL] key changes the channel indication in the forward direction. Pressing the [SEL] key while holding down the [ENT] key changes the channel indication in the reverse direction.
- ◆ In setting mode, pressing the [SEL] key changes the setting item indication in the forward direction. Pressing the [CAL] key changes the setting item indication in the reverse direction.



Preparation of the CAN Set Program

Chapter 4

4.1 Overview

The 8910 CAN set program is the software used to set recording conditions for the 8910 CAN ADAPTER. The program mainly consists of 8910 setting mode and CAN definition data editing mode.

◆ 8910 setting mode

This mode is used to set the 8910 CAN ADAPTER.

In this mode, up to 50 items of CAN definition data to be registered in the 8910 can be selected, with data to be output from the 8910 output channel selected from the data registered. After setting is completed, the setting data is transferred to the 8910 via the RS-232C.

◆ CAN definition data editing mode

This mode is used to create or edit a CAN definition data file.

4.2 Program Setup

4.2.1 System requirements

To use the program, the following hardware and software are required:

Personal computer

IBM PC/AT compatible

Pentium 133 MHz or higher (recommended)

Min. 64 MB RAM (recommended)

Free hard disk space: 5 MB

RS-232C capability

CD-ROM drive (to install software)

OS

Microsoft Windows 95 (OSR2 or later)

Windows 98

Windows NT4.0 (SP3 or later)

Windows Me

Windows 2000

Windows XP

4.2.2 Installation

Follow the procedure below to install the program.

1. Close all active applications.
2. Insert the CD-R provided into the CD-ROM drive.
3. Execute the Setup file on the CD-R.

Assuming that your CD-ROM drive is drive R

(otherwise, substitute the appropriate drive letter for R)

(1) Click the [Start] button.

(2) Select [Run...] on the Windows Start Menu.

(3) Enter as following in the text box.

Using the English file : R:\8910SET\ENGLISH\SETUP.EXE

Using the Japanese file: R:\8910SET\JAPANESE\SETUP.EXE

(4) Click [OK].

4. The installer starts up. Follow the instructions displayed on the screen to install the program.

4.2.3 Un-Installation

The program can be uninstalled by using one of the following methods:

<Method 1>

1. Click the [**Start**] button to open the Windows Start Menu.
2. Select [**Programs**] - [**HIOKI**] – [**8910 CanSet Program**] - [**Uninstall 8910 CanSet Program**].
3. When a dialog box appears asking about file deletion, select [**Yes**].

<Method 2>

1. Click the [**Start**] button to open the Windows Start Menu.
2. Select [**Settings**] - [**Control Panel**].
3. Click the [**Add/Remove Programs**] icon to open the [**Add/Remove Programs Properties**] dialog box.
4. Select [**8910 CanSet Program**] in the list shown in the [**Add/Remove Programs Properties**] dialog box, then click the [**Add/Remove**].

The uninstaller starts up and deletes the program. Note that setting files remain on the PC. Manually delete any unnecessary files.



Starting the CAN Set Program

Chapter 5

Before initiating the setting procedure, connect the PC to the 8910. After connection is made, start up the setting application software.

5.1 Connecting the PC to the 8910

Follow the procedure below to connect the PC to the 8910.

1. Turn off the power of the 8910.
2. Make sure that no cable is connected to the CAN1 or CAN2 port of the 8910.
3. Connect the RS cable to the RS-232C terminal on the 8910.
4. Connect the other end of the RS cable to the RS-232C terminal on the PC.
5. Turn on the power of the 8910.
6. Position the [ONLINE/OFFLINE] switch to [ONLINE] side.

5.2 Starting Up the Condition Setting Program

1. Click the [Start] button to open the Windows Start Menu, then select [Programs] - [HIOKI] - [8910 CanSet Program] - [8910 CanSet Program].
2. The program starts up and the following 8910 setting window appears on the display.

<To end the program>

Select [Close] or [Exit] on the [File] pull-down menu. Selecting [Close] only closes the 8910 setting window. Selecting [Exit] closes the 8910 setting window and CAN definition data editing window (Section 6.6, 65p.) at the same time.

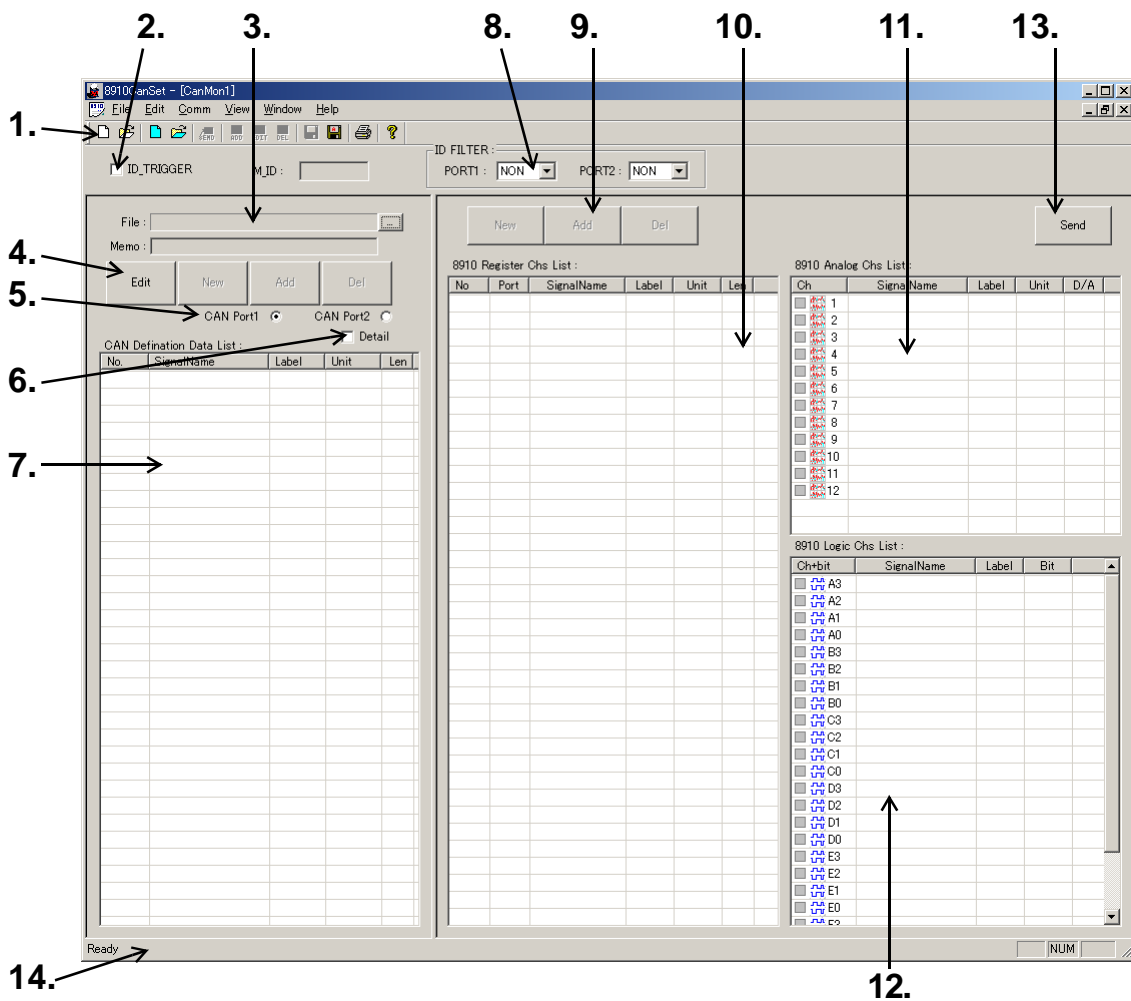

5.2 Starting Up the Condition Setting Program

1. Toolbar	<p>Various operations can be conducted by clicking appropriate icons on the toolbar. The colored icons effective in this window (from the left) are:</p> <ul style="list-style-type: none"> • [New] for the 8910 setting file • [Open] for the 8910 setting file • [New] for the CAN definition data file • [Open] for the CAN definition data file • [Save] for the currently open file • [Save as] for the currently open file • [Print] for setting data <p>Checking [Toolbar] on the [View] pull-down menu displays the toolbar.</p>
2. ID trigger setting	<p>The ID trigger is a function that outputs a pulse wave from a selected logic channel at ID message input. This section is used to enter the ID trigger setting.</p>
3. CAN definition data file selection	<p>This shows the name of the CAN definition data list file currently selected. To change the file, click the [...] button on the right side.</p>
4. CAN definition data edit button	<p>This button is used to edit CAN definition data. It allows the editing of existing data and creation of new data.</p>
5. CAN port selection	<p>This is used to select CAN1 or CAN2 input port of the 8910 for data input.</p>
6. CAN definition data list detail display	<p>Checking this item displays all setting items of definition data in list format. When this setting is off, only the necessary items are displayed.</p>
7. CAN definition data list	<p>This section displays the content of the downloaded CAN definition data file. In the initial state, the content of the previously used file is displayed.</p>
8. ID filter setting	<p>Each input port can be set with a filter to prevent the reception of messages in standard or extended format.</p>
9. 8910 registration list edit button	<p>This button is used for editing an 8910 registration list. It allows the editing of an existing list and creation of a new list.</p>
10. 8910 registration list content	<p>This section displays the CAN definition data to be registered on the 8910 CAN ADAPTER. Up to 50 items of definition data can be registered on the 8910.</p>
11. Analog output allocation list	<p>This list displays the data to be output through analog output channels 1 through 12 of the 8910 CAN ADAPTER.</p>
12. Logic output allocation list	<p>This list displays the data to be output through logic output channels A through F of the 8910 CAN ADAPTER. Each line on the display represents one bit.</p>
13. Send button	<p>This button transmits the settings made in this window to the 8910 CAN ADAPTER.</p>

14. Status bar

This section indicates the current status. Checking **[Status bar]** on the **[View]** pull-down menu displays the status bar.

5.3 Menu Items in the Setting Window

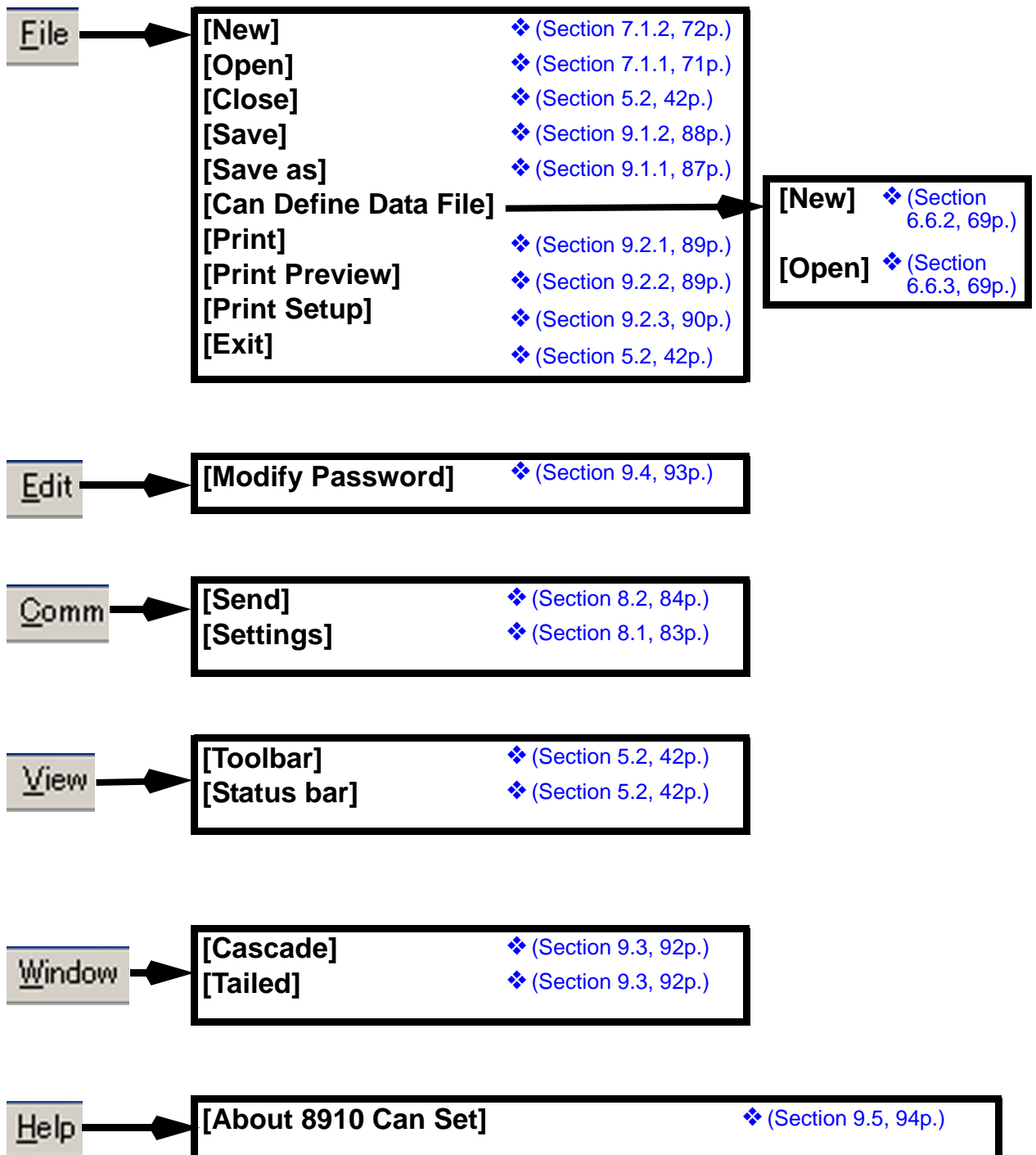

5.4 Operation Flowchart

1. Prepare for setting.

- **Connecting the PC to the 8910**
Connect the PC to the 8910 via the RS-232C.
- **Starting up the 8910 CAN set program**

2. Set the CAN definition data.

- **Setting the message ID**
Set the message ID.
- **Setting the data length**
Set the data size.
- **Setting the data start position**
Set the data location.
- **Setting the data pattern**
Set the data pattern (byte arrangement).
- **Setting the sign**
Set whether the data has a sign.
- **Setting the signal name/label name**
Set the name of the data.
- **Setting the scaling**
Set the physical quantity of data.

3. Register the definition data in the registration list.

- **Loading CAN definition data**
Read the data from the file.
- **Registration of definition data in the registration list**
Select the data from the definition list and register it.

4. Set the ID filter.

- **Setting the ID filter**
Set the filter ON/OFF for each input port.

5. Assign data to output channels.

- **Allocation of data to analog channels**
Set the output analog channels.
- **Allocation of data to logic channels**
Set the output logic channels.

6. Set the ID trigger.

- **Selection of a message ID**
Select an applicable message ID.
- **Selection of output channels**
Select a pulse output channel.

<Go to the next page>

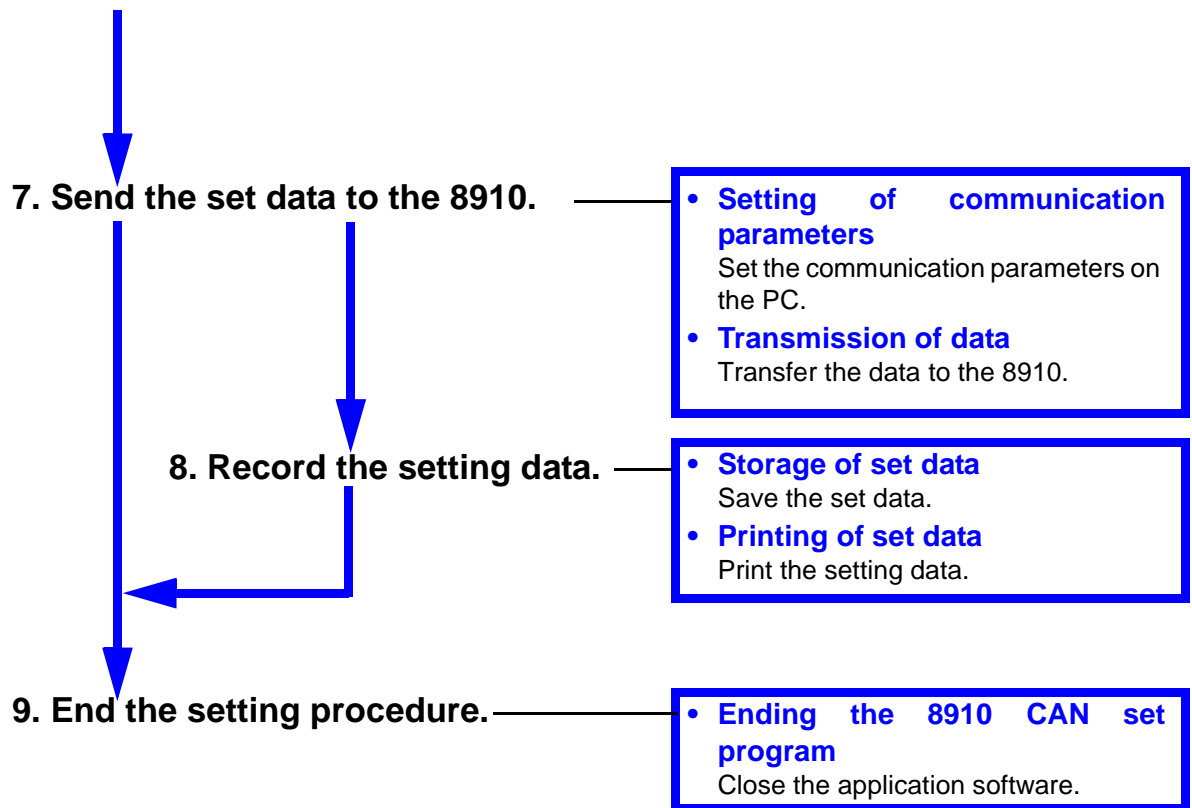



Setting the CAN Definition Data

Chapter 6

- Parameters must be edited or created to acquire data from the CAN bus.
- CAN definition data can be set using the 8910 setting window or by opening the CAN definition data editing window. The following describes how to set data in the 8910 setting window.
❖ [How to use the editing window](#) → (Section 6.6, 65p.)

6.1 Opening a CAN definition data file

6.1.1 Opening a CAN definition data file

The stored CAN definition data file can be read.

1 Click the [...] button.

Click the [...] button located to the right of the CAN definition data file name box to show the file loading dialog box.



2 Select a file.

From the list of CAN definition data files shown in the file loading dialog box, select a file (with extension "cdf") to read.

3 Click the [Start] button.

Clicking the [Start] button on the dialog box updates the CAN definition data list.

6.1.2 Creating a new CAN definition data file

1 Click [Edit] button.

Click the button located above the CAN definition data list to create a new CAN definition data file. To prevent operation errors, only the [Edit] button is operable under normal conditions. First, click this button.

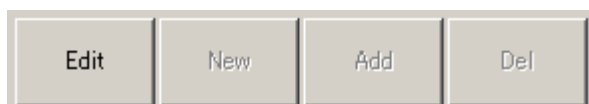

2 Enter the password.

When the password protection function is enabled, the password input dialog box opens. Enter the password.

❖ [Details of the password setting](#) →(Section 9.4, 93p.)

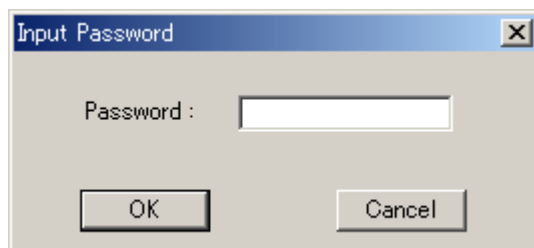

The [Edit] button remains depressed and the [New] button, [Add] button become operable. (The Memo (comment) display (66 p.) also becomes available for use.)



3 Click the [New] button.

Clicking the [New] button opens a confirmation dialog box that asks whether to initialize the CAN definition data file.

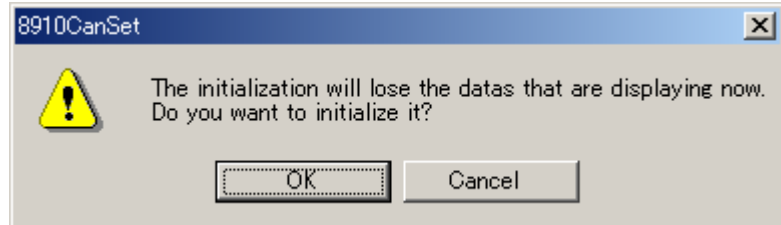

OK	Creates a CAN definition data file.
Cancel	Cancels creation of a CAN definition data file.

Clicking [OK] deletes the content of the currently displayed CAN definition data list and executes initialization.

6.2 Editing the CAN Definition Data

New definition data can be added to the currently open CAN definition data file.

1 Click the [Add] button.

Click the [Add] button located above the CAN definition data list to open the CAN definition data setting window.



2 Set items.

This window is used to set items such as the message ID and start bit.

CAN definition data setting window

The screenshot shows the 'CAN Define Data' dialog box with the following fields and labels:

- Setting of message ID:** Points to the 'ID' text box.
- Setting of data start position:** Points to the 'StartBit' text box.
- Setting of data length:** Points to the 'Length[bit]' text box.
- Setting of data type:** Points to the 'ByteOrder' dropdown menu.
- Setting of sign:** Points to the 'Value Type[Sign]' dropdown menu.
- Setting of signal name:** Points to the 'Signal Name' text box.
- Setting of label name:** Points to the 'Label' text box.
- Setting of unit:** Points to the 'Unit' text box.
- Setting of scaling:** Points to the 'BitRate' radio button and its associated text box.

The dialog box contains the following fields and controls:

- Buttons: Edit, New, Add, Del
- Fields: ID, StartBit, Length[bit], ByteOrder, Value Type[Sign], Signal Name, Label, Unit
- Radio buttons: BitRate (selected), Minimum
- Text boxes: 1.0, 0.000, 0.0, 1.000
- Dropdown menus: U/L(Motorola), Unsigned
- Buttons: OK, Cancel

6.2.1 Setting the message ID

- Set the message ID of the message in which data to be acquired is stored.
- Since this instrument supports extended format, a value of up to 29 bits can be set in the message ID section. Enter numeric values in hexadecimal notation.

ID	0 to 1FFFFFFF
----	---------------

Example: When 64 is entered in the input box, this input is interpreted as 100 in decimal notation since 64 in hexadecimal notation is 100.

6.2.2 Setting the data length

Enter the size (bits) of data to be acquired.

- Since the maximum size of data that can be captured by the 8910 is 2 bytes (16 bits), a value from 1 to 16 can be entered in the input box.
- The data length set here, together with the data start position and data pattern system settings, determines the location of acquisition data in the CAN data frame.

Length [bit]	1 to 16 (bits)
--------------	----------------

6.2.3 Setting the data start position

The least significant bit (LSB) position of acquisition data is used to specify its location in the CAN data frame.

The bit positions are numbered as follows:

1. As the reference position, the least significant bit (LSB) position of the first byte of data in the data frame is given a value of 0. From there, the number is increased by one towards the most significant bit (MSB) position.
2. From the MSB position, it moves to the next byte data, and the number is incremented by one from the LSB toward the MSB.
3. Since the maximum size of the data frame section is 8 bytes (64 bits), the MSB position in the 8th byte from the beginning is numbered 63. Therefore, the bit positions can be expressed with numbers from 0 to 63, as shown below.

		← MSB				LSB →			
		↑ Beginning							
bit byte		7	6	5	4	3	2	1	0
0		7	6	5	4	3	2	1	0
1		15	14	13	12	11	10	9	8
2		23	22	21	20	19	18	17	16
3		31	30	29	28	27	26	25	24
4		39	38	37	36	35	34	33	32
5		47	46	45	44	43	42	41	40
6		55	54	53	52	51	50	49	48
7		63	62	61	60	59	58	57	56
		↓ End							

Example: 8-bit data in the second byte from the beginning is specified.

Message beginning

Message end →

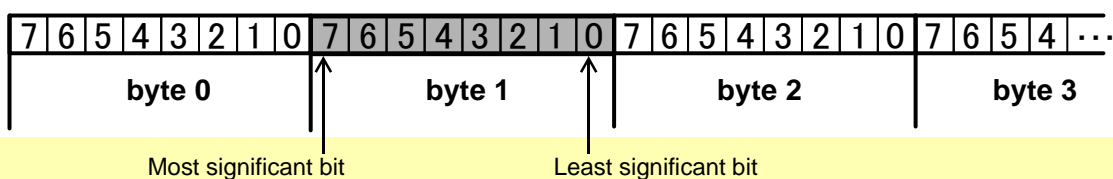

Since its least significant bit (LSB) position is Bit 0 in Byte 1, the bit position is 8.

6.2.4 Setting the data pattern

Here, the data pattern is set. Even if the data start position and data length are the same, the data position (method of data acquisition) varies depending on whether the data pattern is Motorola format or Intel format.

Example: A data whose bit length is 10 bits and data start position (LSB position) is Bit 16.

bit byte	7	6	5	4	3	2	1	0
0	7	6	5	4	3	2	1	0
1	15	14	13	12	11	10	9	8
2	23	22	21	20	19	18	17	16
3	31	30	29	28	27	26	25	24

<Motorola format>



(MSB) 9 8 23 22 21 20 19 18 17 16 (LSB)

The position of Bit 9 is the MSB
(most significant bit) position.

bit byte	7	6	5	4	3	2	1	0
0	7	6	5	4	3	2	1	0
1	15	14	13	12	11	10	9	8
2	23	22	21	20	19	18	17	16
3	31	30	29	28	27	26	25	24

<Intel format>



(MSB) 25 24 23 22 21 20 19 18 17 16 (LSB)

The position of Bit 25 is the MSB
(most significant bit) position.

The data pattern (method of data acquisition) is selected from the following three systems:

U/L (Motorola)	Data is extracted according to Motorola format.
L/U (Motorola)	Data is extracted according to Motorola format, then the high-byte and low-byte positions are switched. This setting is effective when the data length is from 9 to 16 bits. When the data length is 8 bits or shorter, this setting function is the same way as U/L (Motorola).
L/U (Intel)	Data is extracted according to Intel format.

Example: In the 16-bit data shown in the diagram, when the value of Byte 0 is FF and the value of Byte 1 is 00, the following value results according to the method used:

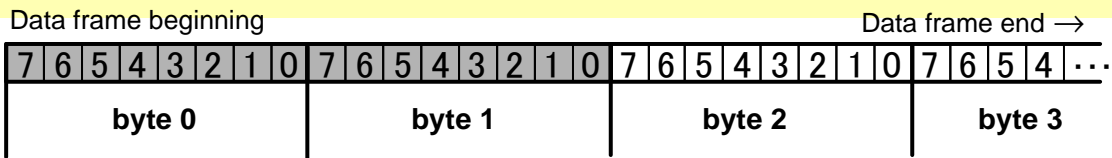

Value based on U/L (Motorola): FF00

Value based on L/U (Motorola): 00FF

Value based on L/U (Intel) : 00FF

(The data start position is 8 in Motorola format, and 0 in Intel format.)

6.2.5 Setting the sign

This is used to set whether the pertinent data has a sign.

Unsigned	Without sign
1-Signed	With sign (with negative number being one's complement)
2-Signed	With sign (with negative number being two's complement)

When "with sign" is set in "positive → negative" sign conversion, one's complement only interchanges 0 and 1 in binary notation, whereas two's complement adds 1 after 0 and 1 are interchanged.

Example: Data with a data length of one byte

Unsigned: 0 to +255 (00h to FFh)

1-Signed: -127 to +127 (80h to 7Fh)

2-Signed: -128 to +127 (80h to 7Fh)

○ -1 in 2-Signed is FFh, but -1 in 1-Signed results in FEh.

NOTE

When the data length is 1 bit, only Unsigned can be selected.

6.2.6 Setting the signal name

A signal name with up to 40 characters can be assigned to data.

- Click the signal name input box, then enter a signal name.
- The signal name is useful for identifying data among other data used in the condition setting program. A comment can be entered as the signal name.
- When the 8910 CAN ADAPTER is used with the HIOKI 8826, 8841, 8842 MEMORY HiCORDER, the signal name can be transferred to the 8826, 8841, 8842 MEMORY HiCORDER as comment data.

NOTE

Spaces or commas cannot be used in a signal name.

6.2.7 Setting the label name

The label name must be set for each item of data since data is distinguished by the label name on the 8910.

- Make sure that the same label name is not used twice.
- Up to 16 characters can be used in the label name. To enter a label name, click the label name input box, then enter a name.

NOTE

Spaces or commas cannot be used in a label name.

6.2.8 Setting the unit

Data can be attached with a unit of physical quantity with up to 8 characters.

- Click the unit input box, then enter a unit.

NOTE

Spaces or commas cannot be used in an unit.

6.2.9 Setting the scaling

- Data can be set with a physical quantity.
- Since the output voltage from the 8910 CAN ADAPTER is determined by the data length setting, sign setting, and D/A output setting, the setting value entered here is not reflected in the actual output value.
- However, this setting is useful for understanding the possible range of physical quantity of actual data.
- When the 8910 CAN ADAPTER is used with the HIOKI 8826, 8841, 8842 MEMORY HiCORDER, the scaling setting on the 8826, 8841, 8842 MEMORY HiCORDER side can be automatically adjusted according to the value set here.

The conversion bit rate/offset value or maximum value/minimum value can be used to specify scaling. Select one of the two methods.

◆ Specifying with conversion bit rate/offset value

1 Select the radio button next to [BitRate].

Select the radio button next to [BitRate] when using the conversion bit rate/offset value to specify the scaling.

BitRate	Physical quantity per 1 bit of acquisition data
Offset	Offset value

2 Set the [BitRate] and [Offset] value.

Based on the physical quantity per bit of acquisition data and the offset value, the physical quantity can be expressed by the following formula:

$$\text{Physical quantity} = \text{BitRate} \times \text{Data value (Bit)} + \text{Offset}$$

Example: When the [BitRate] is set to 0.1 and [Offset] to 100 as shown above, and the acquired data value is 500, the physical quantity
 Physical quantity = $500 \times 0.1 + 100 = 150$

6.2 Editing the CAN Definition Data

When the [BitRate] or [Offset] is set, the [Maximum] and [Minimum] values are automatically set based on the set values, data length setting, and sign setting.

◆ Specifying with maximum and minimum values

1 Select the radio button next to [Minimum].

Select the radio button next to [Minimum] when using the maximum and minimum values to specify the scaling

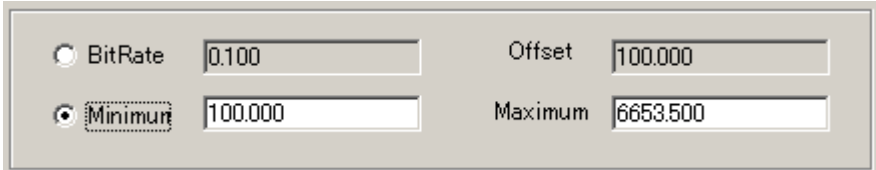

The screenshot shows a dialog box with four input fields and two radio buttons. The 'BitRate' field is set to 0.100, the 'Offset' field is set to 100.000, the 'Minimum' field is set to 100.000, and the 'Maximum' field is set to 6653.500. The 'Minimum' radio button is selected, while the 'BitRate' radio button is unselected.

<input type="radio"/> BitRate	0.100	Offset	100.000
<input checked="" type="radio"/> Minimum	100.000	Maximum	6653.500

2 Set the [Maximum] and [Minimum] value.

Set the [Maximum] and [Minimum] possible values of the data.

When the [Maximum] and [Minimum] value is set, the physical conversion bit rate and offset value are automatically set based on the set values, data length setting, and sign setting.

6.2.10 Error Message

If the CAN definition data settings are incorrect or conflicting, an error message appears when the [OK] button is clicked.

If an error message appears, take the following corrective action:

◆ If error message "Input please" appears



The message ID or label name input box (or both) is blank. Neither the message ID input box nor label name input box can be left blank. Be sure to enter a setting in both boxes.

◆ If error message "Bad Can define data!" appears

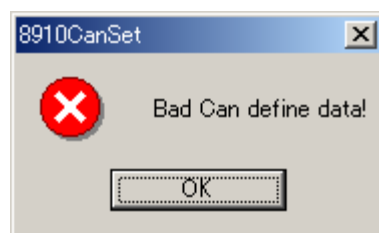

The data length, data start position, and data pattern settings determine the location of acquisition data in the CAN data frame, but current settings deviate from the range of the CAN data frame.

Example:

Data Length : 10 bits

Data start position : 0 (Bit 0 in Byte 0)

Data pattern : U/L (Motorola)

When the settings above are entered, the two high-order bits are outside the CAN data frame, as shown below.

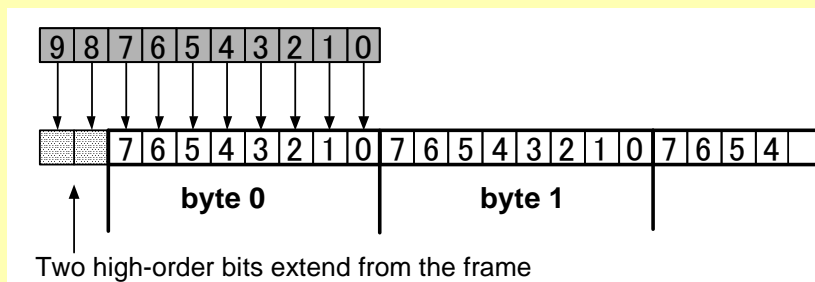

In this case, the problem can be corrected by changing the data length to 8 bits, data start position to 14 (Bit 6 in Byte 1), or data pattern to L/U (Intel).

Confirm that the data length, data start position, and data pattern settings do not cause any conflict.

6.3 Deletion of CAN Definition Data

The definition data in the current CAN definition data file can be deleted as follows:

1 Click the [Del] button.

When the definition data to delete is selected in the CAN definition data list and the [Del] button located above the list clicked, the deletion confirmation dialog box opens.

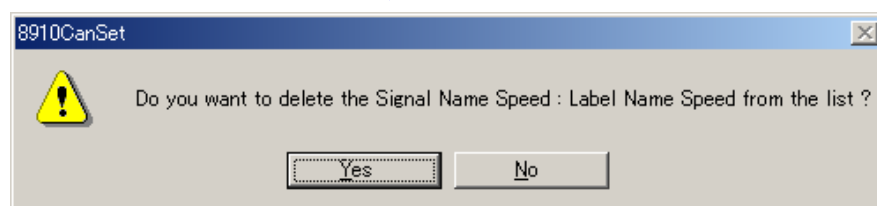
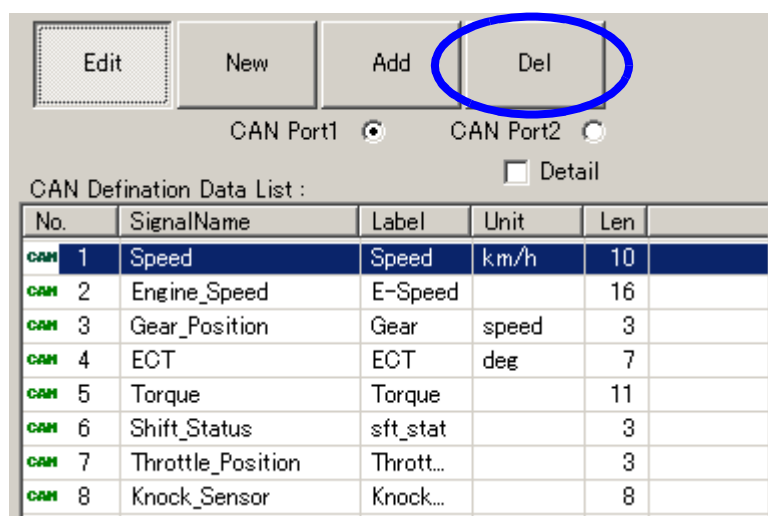

2 Click the [Yes] or [No] button.

- | | |
|------------|---|
| Yes | Deletes the selected definition file. |
| No | Cancels deletion of the selected definition file. |

6.4 Closing the CAN Definition Data File (Saving the File)

1 Click the [Edit] button.

To close the currently open CAN definition data file, click the depressed [Edit] button.



2 Click the [OK] or [Cancel] button.

If the content of the CAN definition data file has been changed, a dialog box appears, asking whether to save the changes you made. Select [OK] or [Cancel].

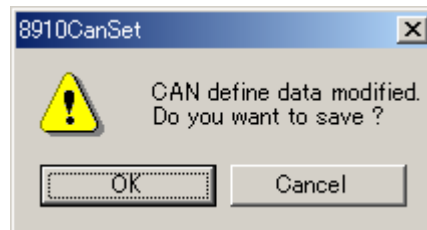

OK	Closes the open definition data file after saving the changes.
Cancel	Closes the open definition data file without saving the changes.

All items of CAN definition data shown in the CAN definition data list are saved, and the file will have extension cdf.

6.5 CAN Definition Data List Detail Display

The CAN definition data list usually shows only five items (as follows) due to limited space:

- Number
- Signal name
- Label name
- Unit
- Data length

However, when the box next to [Detail] is checked, six additional items (as follows) are displayed, so that all setting items of definition data can be checked on the screen:

- ID
- Start bit
- Data pattern
- Sign
- Conversion bit rate
- Offset value

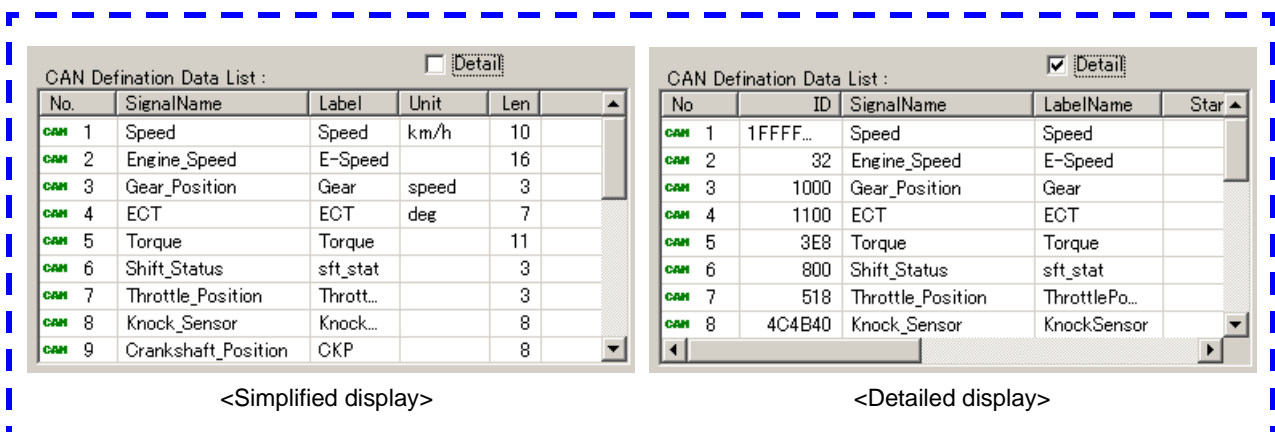

When a detailed display is shown, the display area can be moved by using the scroll bar at the bottom of the list pane to check all items.

<Moving the display area>

The size of the CAN definition data list display area can be changed.

1 Move the cursor, and left-click the mouse.

Position the cursor on the border between the CAN definition data list and 8910 registration list so that the cursor changes into a double arrow pointing left and right. Then, left-click the mouse.

2 Drag the mouse.

Keep clicking the mouse, and drag to the left or right to adjust the size of the display area.

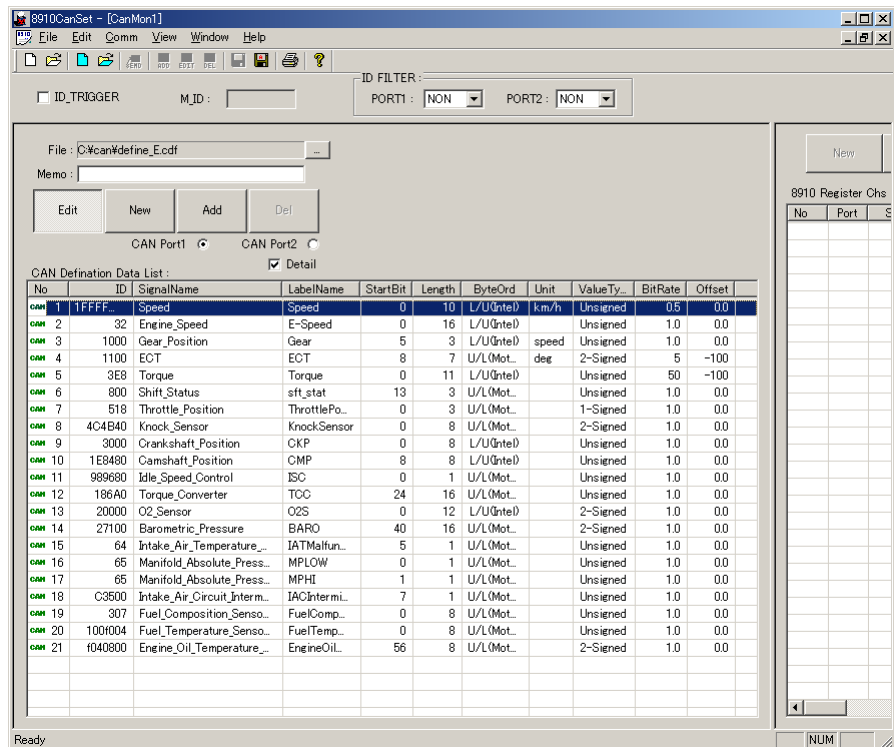

6.6 Editing in Another Window

In addition to the 8910 setting window, the CAN definition data editing window can be used for setting CAN definition data.

6.6.1 Opening a new window

1 Select [File] - [CAN Define Data File].

Select **[CAN Define Data File]** on the **[File]** pull-down menu in the 8910 setting window.

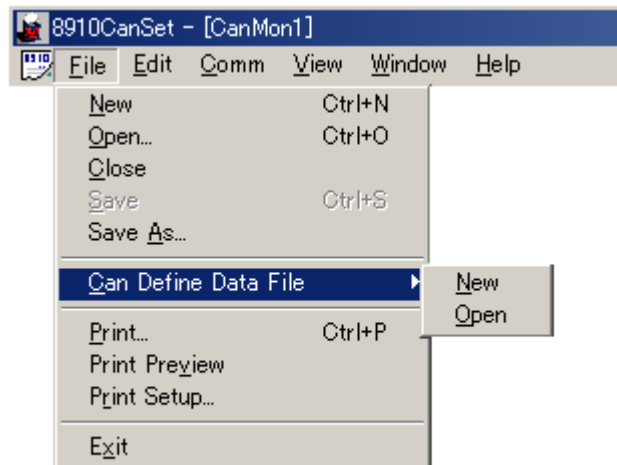

2 Select [New] or [Open].

When a new menu opens, select **[New]** or **[Open]**.

New	Creates a new file.
Open	Opens an existing file.

3 Enter the password.

When the password protection function is enabled, the **[Input Password]** dialog box opens. Enter the password.

❖ Details of the password setting → (Section 9.4, 93p.)

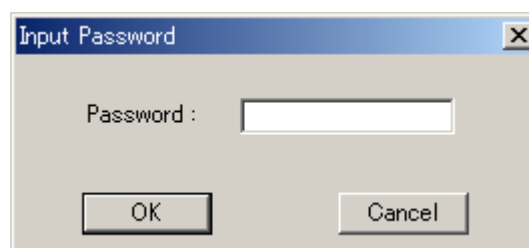

4 A window opens.

A dedicated window for CAN definition data editing opens.

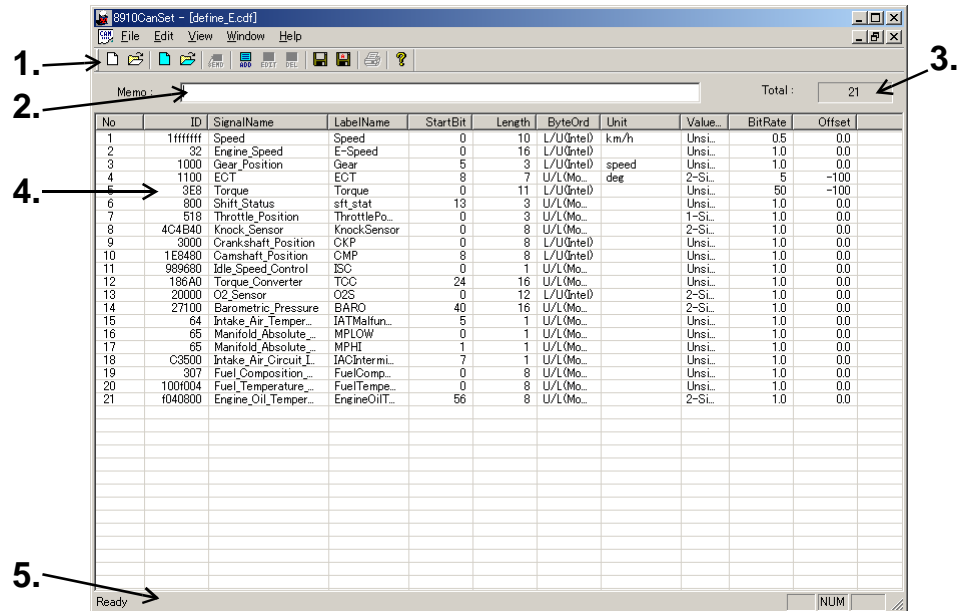

1. Toolbar

Clicking color icons on the toolbar executes the following operations:

The icons effective in this window are (from the left):

- [New] for the 8910 setting file
- [Open] for the 8910 setting file
- [New] for the CAN definition data file
- [Open] for the CAN definition data file
- [New] for the CAN definition data
- [Edit] for the CAN definition data
- [Delete] for the CAN definition data
- [Save] for the currently open file.
- [Save as] for the currently open file.

Checking [Toolbar] on the [View] pull-down menu displays the toolbar.

2. Memo (comment) display

A comment regarding the CAN definition data file can be entered and displayed.

3. Number of registered data items display

The number of CAN definition data items registered in the CAN definition data file is displayed.

4. CAN definition data list display

This section displays the settings of CAN definition data registered in the CAN definition data file. Double-click an item to edit the definition of that item.

5. Status bar

This section shows the current status.

Checking [Status bar] on the [View] pull-down menu displays the status bar.

<To End>

Select [**C**lose] or [**E**xit] on the [**F**ile] pull-down menu. Selecting [**C**lose] only closes the CAN definition data editing window. Selecting [**E**xit] closes the CAN definition data editing window and 8910 setting window (Section 5.2, 42p.) at the same time.

◆ Menu Items in the CAN Definition Data Editing Window

File	<ul style="list-style-type: none"> [New] ❖ (Section 6.6.2, 69p.) [Open] ❖ (Section 6.6.3, 69p.) [Close] ❖ (Section 6.6.1, 65p.) [Save] ❖ (Section 6.6.5, 69p.) [Save as] ❖ (Section 6.6.5, 69p.) [Print] } Cannot be used in CAN definition data editing mode. [Print Preview] } [Print Setup] ❖ (Section 9.2.3, 90p.) [Exit] ❖ (Section 6.6.1, 65p.)
-------------	--

Edit	[Modify Password] ❖ (Section 9.4, 93p.)
-------------	---

View	<ul style="list-style-type: none"> [Toolbar] ❖ (Section 6.6.1, 65p.) [Status bar] ❖ (Section 6.6.1, 65p.)
-------------	---

Window	<ul style="list-style-type: none"> [Cascade] ❖ (Section 9.3, 92p.) [Tailed] ❖ (Section 9.3, 92p.)
---------------	---

Help	[About 8910 Can Set] ❖ (Section 9.5, 94p.)
-------------	--

6.6.2 Creating a new CAN definition data file

Select **[New]** on the **[File]** pull-down menu or click the following icon on the toolbar to create a new CAN definition data file.



6.6.3 Opening a CAN definition data file

Select **[Open]** on the **[File]** pull-down menu or click the following icon on the toolbar to open another CAN definition data file.



6.6.4 Editing CAN definition data

The definition data can be edited by double-clicking an item on the list, by using the pull-down menu, or using the toolbar.

❖ [How to edit the data](#) → (Section 6.2, 52p.)



The three icons above on the toolbar are used for editing: **[Add new data]**, **[Edit selected data]**, and **[Delete selected data]** (from left to right).

6.6.5 Saving CAN definition data

The pull-down menu or toolbar icon can be used to save the currently open file.

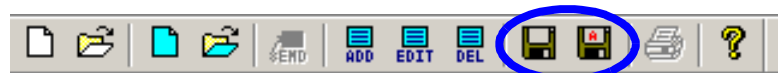

The two icons above on the toolbar are used for saving data: **[Save]** and **[Save data as]** (from left to right).

Settings

Chapter 7

7.1 Registration List Operations

The center pane of the window is a list used for registering CAN definition data to be transferred to the 8910 CAN ADAPTER.

The following items are listed:

No	Port	SignalName	Label	Unit	Len

From the left:

- Item no.
- CAN port no.
- Signal name
- Label name
- Unit
- Data length

Up to 50 items of CAN definition data can be registered on the 8910.

7.1.1 Opening a registration list

1 Select [file] - [Open] or clicking the icon .

Select [Open] on the [File] pull-down menu or click the icon on the toolbar to download a stored 8910 setting file.



2 Select the desired file.

From the 8910 setting files displayed in the file read dialog box, select the desired file (with extension cmu).

Executing the file read command updates the 8910 registration list and analog/logic output allocation list.

7.1.2 Creating a registration list (registering definition data to a registration list)

- To create a new registration list, a definition data list must be read from a stored CAN definition data list file.
 - Then necessary data must be selected from the downloaded definition data and registered in the registration list for data transfer to the 8910.
- ❖ If there is no CAN definition data file, create a file. → (Chapter 6, 49p.).

1 Creating a new document.

1 Select [File] - [New] or click the icon .

Selecting [New] on the [File] pull-down menu or clicking the following icon on the toolbar deletes and initializes the contents of the 8910 registration list and analog/logic output allocation list. When the registered contents already exist, a confirmation dialog box appears prior to deletion.



Clicking the [New] button located above the 8910 registration list produces the same result.



2 Downloading a CAN definition data file

1 Click [...] button.

Click the [...] button located to the right of the CAN definition data file name box to show the file loading dialog box.



2 Select a file.

From the list of CAN definition data files shown in the file loading dialog box, select a file (with extension ".cdf") to read.

3 Click the [Start] button.

Clicking the [Start] button on the dialog box updates the CAN definition data list.

3 Selecting data

Clicking an item in the 8910 registration list selects data to be registered in the list. The line selected is highlighted.

CAN Definition Data List : Detail

No.	SignalName	Label	Unit	Len
CAN 1	Speed	Speed	km/h	10
CAN 2	Engine_Speed	E-Speed		16
CAN 3	Gear_Position	Gear	speed	3
CAN 4	ECT	ECT	deg	7
CAN 5	Torque	Torque		11
CAN 6	Shift_Status	sft_stat		3

Multiple lines in the CAN definition data list can be selected by clicking while holding down the [Shift] or [Ctrl] key.

4 Selecting a CAN port

The CAN port setting section is located above the CAN definition data list pane.

CAN Port1 CAN Port2

Select CAN1 or CAN2 port of the 8910 to input the selected definition data.

5 Registering from the CAN definition list to the 8910 registration list

The highlighted line in the CAN definition list can be added to the 8910 registration list by dragging and dropping, or by clicking the [Add] button above the 8910 registration list.

Edit New Add Del

CAN Port1 CAN Port2

CAN Definition Data List : Detail

No.	SignalName	Label	Unit	Len
CAN 1	Speed	Speed	km/h	10
CAN 2	Engine_Speed	E-Speed		16
CAN 3	Gear_Position	Gear	speed	3
CAN 4	ECT	ECT	deg	7
CAN 5	Torque	Torque		11
CAN 6	Shift_Status	sft_stat		3

8910 Register Chs List :

No	Port	Signal

Register by drag & drop.

OR

New Add Del

7.1 Registration List Operations

If definition data with the same name has already been registered in the registration list, a dialog box appears, asking whether to overwrite the previous data.

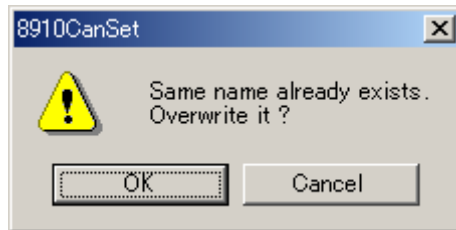

OK	Overwrites existing data and registers new data in the list.
Cancel	Stops the registration of data in the list.

The items (up to 50) registered in the 8910 registration list are sent to the memory of the 8910.

7.1.3 Deleting data from the registration list

1 Click an item.

Clicking an item on the 8910 registration list highlights the line selected.

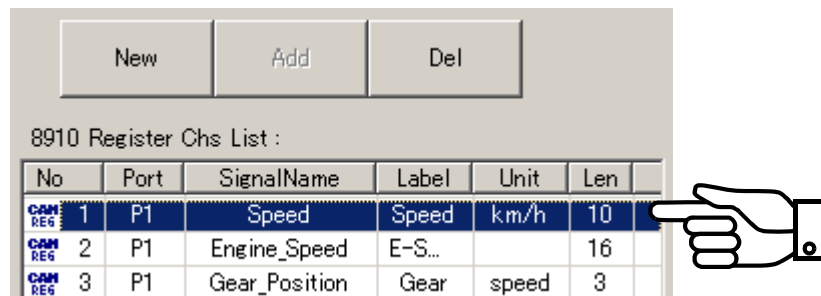

2 Click the [Del] button.

When there is a highlighted line in the 8910 registration list, the [Del] button located above the 8910 registration list becomes operable. Clicking this button deletes the item selected.

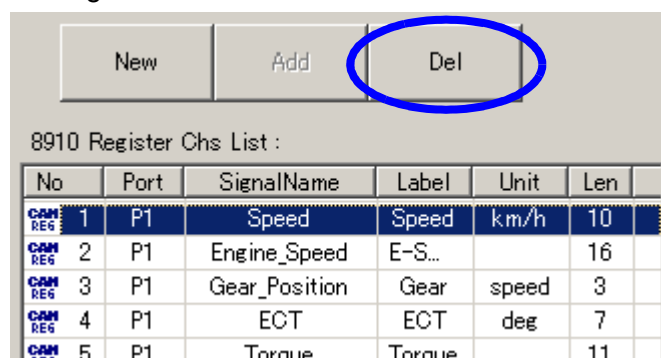

7.2 Allocation to Output Channels

7.2.1 Setting analog output channels

The data to be acquired by the 8910 must be selected from items registered in the 8910 registration list, and a channel must be selected to output that data.

1 Select and click an item on the registration list.

Selecting and clicking an item in the 8910 registration list highlights the line selected.

8910 Register Chs List :						8910 Analog Chs List :	
No	Port	SignalName	Label	Unit	Len	Ch	Signal
CAN REG 1	P1	Speed	Speed	km/h	10		
CAN REG 2	P1	Engine_Speed	E-S...		16		
CAN REG 3	P1	Gear_Position	Gear	speed	3	<input type="checkbox"/>	3
CAN REG 4	P1	ECT	ECT	deg	7	<input type="checkbox"/>	4
CAN REG 5	P1	Torque	Torque		11	<input type="checkbox"/>	5
CAN REG 6	P1	Shift_Status	sft_s...		3	<input type="checkbox"/>	6

2 Drag and drop the item on to a channel section.

When the highlighted line is dragged and dropped onto a channel section in the analog output allocation list, it is assigned to that output channel.

8910 Register Chs List :						8910 Analog Chs List :	
No	Port	SignalName	Label	Unit	Len	Ch	SignalName
CAN REG 1	P1	Speed	Speed	km/h	10	<input checked="" type="checkbox"/>	
CAN REG 2	P1	Engine_Speed	E-S...		16	<input type="checkbox"/>	
CAN REG 3	P1	Gear_Position	Gear	speed	3	<input type="checkbox"/>	3
CAN REG 4	P1	ECT	ECT	deg	7	<input type="checkbox"/>	4
CAN REG 5	P1	Torque	Torque		11	<input type="checkbox"/>	5
CAN REG 6	P1	Shift_Status	sft_s...		3	<input type="checkbox"/>	6
CAN REG 7	P1	Throttle Posit	Thrn		3	<input type="checkbox"/>	7

Register by drag & drop.

3 Select [B(+/-)] or [M(+)].

After allocation is completed, the D/A conversion format setting dialog box opens. Select bipolar or monopolar. This setting determines whether the analog signal is output in a ± 5 V range or 0 to 5 V range.

❖ Section 3.3.5, (28p.)

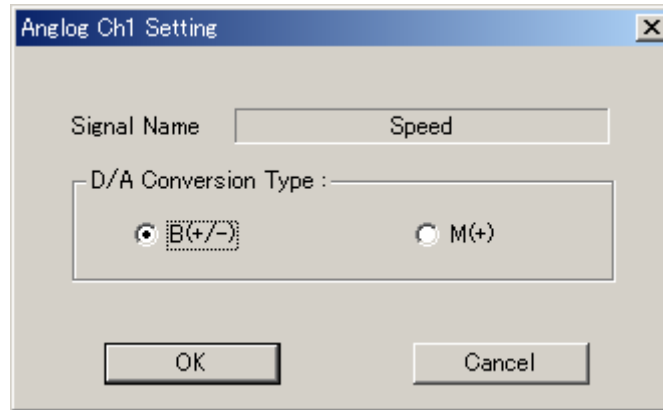

B(+/-)	BipolarAnalog signal is output in ± 5 V range.
M(+)	MonopolarAnalog signal is output in 0 to 5 V range.

NOTE

Double-clicking a registered channel can also set the D/A conversion format. Therefore, the type of D/A conversion can be changed after registering the data in the analog output allocation channel.

7.2.2 Deleting registered data from the analog output allocation list

1 Select an item to be deleted, and right-click.

When an item to be deleted from the analog output allocation list is right-clicked.

2 Click [Yes].

A dialog box appears, asking whether to delete the data. Click [Yes] to delete the selected line

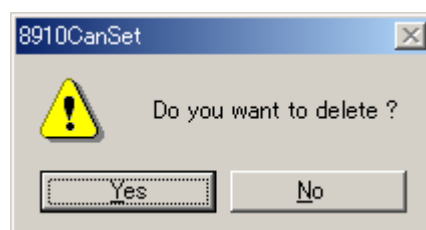

7.2.3 Setting logic output channels

Logic output channels are set the same way as for analog output channels.

❖ Section 7.2.1, (75p.)

When assigned data is 2 bits or larger, the data is automatically allocated so that the most significant bit is assigned to the channel selected, with the rest allocated to the following channel.

Example 1: Data with label name [abc] and a data length of 5 bits assigned to Bit 1 in Ch A is allocated as shown below.

A1 abc bit4
A0 abc bit3
B3 abc bit2
B2 abc bit1
B1 abc bit0

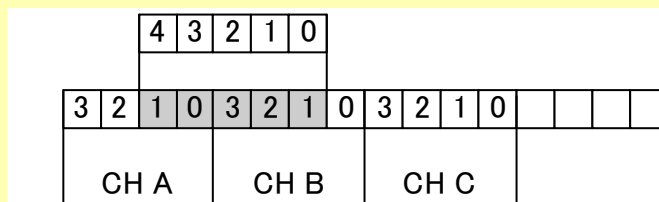

In this example, if another signal is already allocated to 3 bits from Bit 2 to Bit 0 in Ch B, the original signal only remains in Bit 0 in Ch B because overlapping bits are overwritten in one bit units.

Example 2: Dragging and dropping data with a data length of 3 bits to Bit 3 in Ch A.

8910 Register Chs List :						
No	Port	SignalName	Label	Unit	Len	
CAN REG 1	P1	Speed	Speed	km/h	10	
CAN REG 2	P1	Engine_Speed	E-S...		16	
CAN REG 3	P1	Gear_Position	Gear	speed	3	
CAN REG 4	P1	ECT	ECT	deg	7	
CAN REG 5	P1	Torque	Torque		11	

8910 Logic Chs List :				
Ch+bit	SignalName	Label	Bit	
<input type="checkbox"/> A3	Gear_Position	Gear	2	
<input checked="" type="checkbox"/> A2	Gear_Position	Gear	1	
<input checked="" type="checkbox"/> A1	Gear_Position	Gear	0	
<input type="checkbox"/> A0				
<input type="checkbox"/> B3				
<input type="checkbox"/> B2				

7.2.4 Deleting data from the logic output allocation list

1 Select an item to be deleted, and right-click.

When an item to be deleted from the logic output allocation list is right-clicked.

2 Click [Yes].

A dialog box appears, asking whether to delete the data. Click [Yes] to delete the selected line.

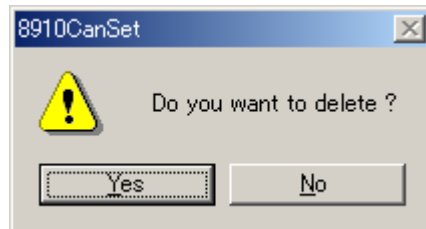

For logic output channel deletion, data can only be specified by line (bit).

7.3 Message ID Trigger

- The message ID trigger outputs a pulse (**H** active) with a width of 100 μ s from the logic channel selected when a specified ID message is input.
- This is effective when using this instrument in combination with a recorder with a trigger function.

NOTE

Analog/logic output is held until the next CAN message is converted. Therefore, setting the ID trigger does not allow you to observe the output pulse even when a logic output is held H. In such case, turn off the power of the 8910, then turn it back on and set the logic output to L before setting the ID trigger.

7.3.1 Setting the message ID trigger

[ID_TRIGGER] located at the left-upper corner of the window is used to set the message ID trigger.

1 Check the [ID_TRIGGER] box.

Checking the check box enables the trigger function.

2 Input the message ID number.

When the trigger function is turned on, the no. of the message ID for triggering signal output must be entered in the [M_ID] input box.

Example: Entering message ID100 outputs a signal from the logic channel selected.



ID_TRIGGER M_ID :

Deselecting the [ID_TRIGGER] check box deactivates the message ID trigger function.

NOTE

If communication with the 8910 is performed with the [ID_TRIGGER] check box selected, but with no number entered in the [M_ID] input box, a transmission error occurs and communication will be aborted.

7.3.2 Setting output channels

Multiple logic channels can be specified for ID trigger output.

1 Double-click a logic channel.

Double-clicking a logic channel to be specified as an output channel changes the corresponding icon to red and sets the channel as an output channel.

Ch+bit	SignalName	Label	Bit
<input checked="" type="checkbox"/> A3	Gear_Position	Gear	2
<input checked="" type="checkbox"/> A2	Gear_Position	Gear	1
<input checked="" type="checkbox"/> A1	ID TRIGGER	100	1
<input type="checkbox"/> A0			
<input type="checkbox"/> B3			
<input type="checkbox"/> B2			
<input type="checkbox"/> B1			

When a channel is set as an output channel, the icon changes to red. Moreover, the signal name column shows [ID TRIGGER] and the label name column indicates the message ID set as a trigger. The Bit will be fixed at 1.

NOTE

- When a channel already assigned with output data is specified, that channel outputs both the assigned data and ID trigger simultaneously. When reliable detection of the ID trigger is important, select a channel without output data assigned.
- When the ID filter is enabled, the ID set with the ID trigger function is filtered, thus disabling the ID trigger. (When the ID set with the ID trigger function is allocated to another channel, i.e., not that of the ID trigger, the ID trigger is enabled.)

7.4 Setting the ID Filter

Individual input ports can be applied with a filter to inhibit the reception of messages other than those assigned to the output channels.

- The filter results in the acquisition of standard format or extended format only.
- The filter can improve acquisition performance.

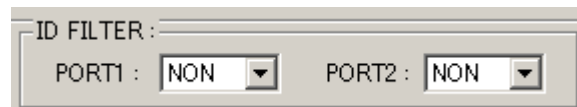

ID FILTER: PORT1 : PORT2 :

STD	ID filter allows the acquisition of standard format only.
EXT	ID filter allows the acquisition of extended format only.
NON	ID filter is disabled, and both standard and extended formats can be acquired.

Transfer of Setting Data to the 8910

Chapter 8

The CAN definition data registered in 8910 registration data, and the analog/logic channel allocation settings can be transferred to the 8910.

8.1 Setting Communication Parameters

1 Select [Comm] - [Settings].

Select [Settings] on the [Comm] pull-down menu, The [Comm Condition] dialog box is opened.

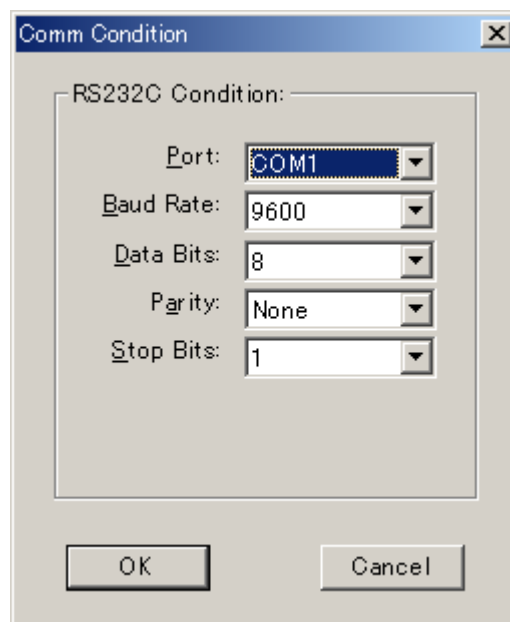

2 Make the RS-232C settings.

Make the following RS-232C settings:

- [Baud Rate] to 19.2 k
- [Data Bits] to 8
- [Parity] to None
- [Stop Bits] to 1.

For [Port], select the RS port used on the PC side.

8.2 Executing Data Transfer

1. Make sure that the 8910 is connected to the PC.
2. Make sure that the CAN1 and CAN2 ports on the 8910 are not connected to any cable.
3. Set the 8910 to ONLINE mode. (Position the [online/offline] switch to [ONLINE] side.)
4. Execute transfer by selecting [Send] on the [Comm] pull-down menu.
5. A progress bar appears during write operation to indicate the status of writing.
6. When transfer operation is completed, a dialog box appears for reporting that the conditions have been set.

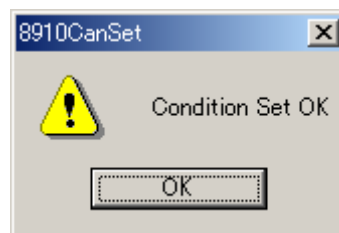
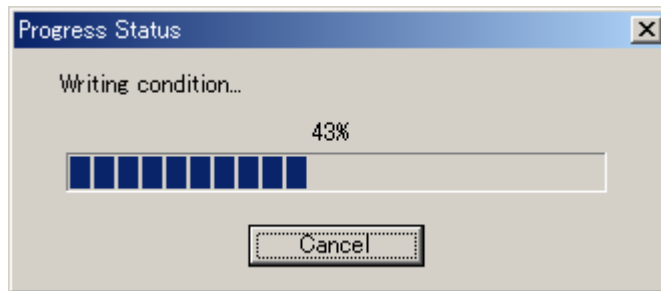

8.3 In Case of Errors

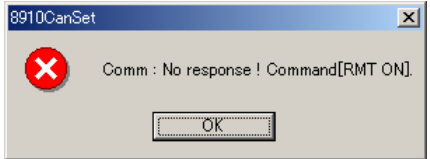
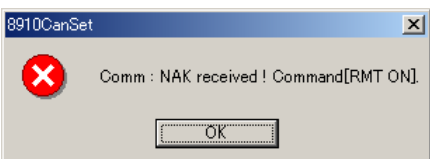
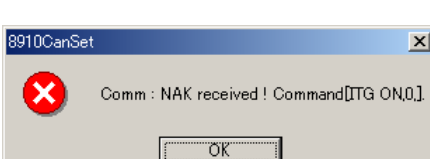
Error Display	Indication	Check items
	<p>Indicates that the 8910 was not found during data transfer.</p>	<ul style="list-style-type: none"> • Are all cables properly connected? • Are the communication settings correct? • Is there no cable connected to the CAN1 or CAN2 port on the 8910?
	<p>Indicates that the 8910 was found, but communication operation failed.</p>	<ul style="list-style-type: none"> • Is the [ONLINE/OFFLINE] switch positioned to [ONLINE] side?
	<p>Indicates that the message ID trigger setting is incomplete.</p>	<p>If the message ID trigger setting is turned ON (with the [ID_TRIGGER] check box selected),</p> <ul style="list-style-type: none"> • Is a trigger ID set (ID no. in [M_ID] input box)? • Is a logic channel set for signal output?

NOTE

If an error occurs, the 8910 may remain in Remote mode (with the ONLINE LED lit in orange). In this case, retransmit the data to exit Remote mode.

8.4 Duplicate Bit Check

The presence of duplicate bits is automatically checked when transferring setting data.

If duplicate bits are found, the following items are displayed.

- Registration list item no.
- Message ID
- Signal name of the duplicate data

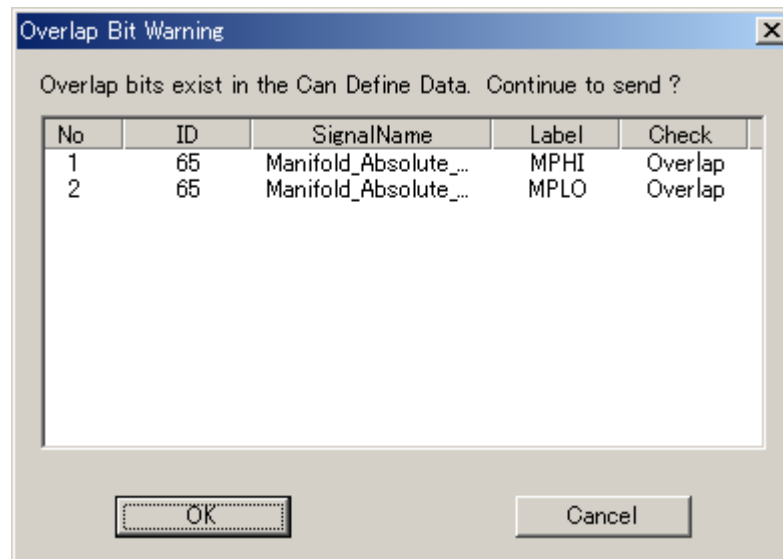

The transfer operation can be resumed or cancelled.

OK	Transfer data to the 8910.
Cancel	Cancels data transfer to the 8910.

Functions of the Setting Program *Chapter 9*

9.1 Saving the Setting Data

The settings can be saved on a specified destination media.

9.1.1 Saving data with a new name

The data edited in 8910 setting mode can be saved with a new name by selecting **[Save as]** on the **[File]** pull-down menu or clicking the icon below on the toolbar.



1. Select **[Save as]** on the **[File]** pull-down menu or clicking the icon below on the toolbar. The file save dialog box is shown.
2. Enter a file name in the file save dialog box.
3. Click the **[OK]** button.
4. The 8910 registration list and analog/digital output allocation list are saved as an 8910 setting file with the specified name.

The file contains:

- List items registered in 8910 registration list (up to 50 items)
- Analog output channel allocation settings (12 channels)
- Logic output channel allocation settings (24 channels)

The file has extension ".cmu."

9.1.2 Overwriting

The current setting data can be written over an existing 8910 setting file by selecting **[Save]** on the **[File]** pull-down menu or clicking the icon below on the toolbar.



If the current list has no file name, such as for a newly created file, executing the **[Save]** command prompts the **[Save as]** command.

NOTE

Executing the **[Save]** command overwrites an existing file with the current list content. Careless use of this command may result in the loss of current list data.

9.2 Setting Data Printout

9.2.1 Printing

The content of 8910 setting data can be printed by selecting [**Print**] on the [**File**] pull-down menu or clicking the icon below on the toolbar.



The printed information includes the contents of the 8910 registration list and analog/logic output allocation list.

The header section indicates model no. 8910 and the date, and print as follows:

- Registration list data (i.e., port, signal name, label name, unit, data length)
- Analog channel settings (i.e., channel no., signal name, label name, unit, D/A)
- Logic channel settings (i.e., channel no. - bit, signal name, label name, assigned bit).

HIOKI 8910					
YYY/MM/DD hh:mm:ss					
CAN ADAPTER DATA LIST					
No.	Port	Name	Label	Unit	Length(bit)
xx	xx	xxxxxxxxx	xxxxxxxxx	xxxxx	xx
ANALOG					
Ch	Name	Label	Unit	D/A	
1	xxxxxxxxx	xxxxxxxxx	xxxxx	x	
LOGIC					
Ch-Pos	Name	Label	Assign bit		
A3	xxxxxxxxx	xxxxxx	x		

❖ Actual printouts→(Section 9.2.4, 90p.)

9.2.2 Print preview

Prior to printing, the print image can be displayed on the screen by selecting [**Print Preview**] on the [**File**] pull-down menu.

9.2.3 Setting the printer

Select [**Printer Setup**] on the [**File**] pull-down menu to set printer conditions.

9.2.4 Examples of printouts

HIOKI 8910
2004/01/01 12:00:00

CAN ADAPTER ASSIGN LIST

ANALOG

Ch.	Name	Label	Unit	D/A
1	Speed	Speed	km/h	M
2	Engine_Speed	E-Speed		M
3	Gear_Position	Gear	speed	M
4	ECT	ECT	deg	B
5	Torque	Torque		M
6	Shift_Status	sft_stat		M
7	Throttle_Position	ThrottlePosition		B
8	Knock_Sensor	KnockSensor		B
9	Torque_Converter	TCC		M
10				
11	Barometric_Pressure	BARO		B
12	EnginOilTemperature	EngineOilTemp		B

LOGIC

Ch_Bit	Name	Label	Assign Bit
A3	ManifoldPressureLO	MPLOW	0
A2	IntakeAirCircuitIntermittent	IACIntermittent	0
A1			
A0	Idle_Speed_Control	ISC	0
B3	ID TRIGGER	ff	1
B2	ID TRIGGER	ff	1
B1	ID TRIGGER	ff	1
B0	ID TRIGGER	ff	1
C3	FuelCompositionSensor	FuelCompsition	5
C2	FuelCompositionSensor	FuelCompsition	4
C1	FuelCompositionSensor	FuelCompsition	3
C0	FuelCompositionSensor	FuelCompsition	2
D3	FuelCompositionSensor	FuelCompsition	1
D2	FuelCompositionSensor	FuelCompsition	0
D1	Fuel_Temperature_Sensor_Malfunction	FuelTemperature	7
D0	Fuel_Temperature_Sensor_Malfunction	FuelTemperature	6
E3	Fuel_Temperature_Sensor_Malfunction	FuelTemperature	5
E2	Fuel_Temperature_Sensor_Malfunction	FuelTemperature	4
E1	Fuel_Temperature_Sensor_Malfunction	FuelTemperature	3
E0	Fuel_Temperature_Sensor_Malfunction	FuelTemperature	2
F3	Fuel_Temperature_Sensor_Malfunction	FuelTemperature	1
F2	Fuel_Temperature_Sensor_Malfunction	FuelTemperature	0
F1			
F0			

9.2 Setting Data Printout

HIOKI 8910
2004/01/01 12:00:00

CAN MONITOR DATA LIST

No.	Port	Name	Label	Unit	Len(bit)
1	P1	Speed	Speed	km/h	10
2	P1	Engine_Speed	E-Speed		16
3	P1	Gear_Position	Gear	speed	3
4	P1	ECT	ECT	deg	7
5	P1	Torque	Torgue		11
6	P1	Shift_Status	sft_stat		3
7	P2	Throttle_Position	ThrottlePosition		3
8	P2	Knock_Sensor	KnockSensor		8
9	P2	Crankshaft_Position	CKP		8
10	P2	Camshaft_Position	CMP		8
11	P2	Idle_Speed_Control	ISC		1
12	P1	Torque_Converter	TCC		16
13	P1	O2_Sensor	O2S		12
14	P1	Barometric_Pressure	BARO		16
15	P1	Intake_Air_Temperature_Malfunction	IATMalfunction		1
16	P1	Manifold_Absolute_Pressure_Circuit_Low	MPLOW		1
17	P2	Manifold_Absolute_Pressure_Circuit_High	MPHI		1
18	P2	Intake_Air_Circuit_Intermittent	IACIntermittent		1
19	P2	Fuel_Composition_Sensor_Malfunction	FuelCompsition		8
20	P2	Fuel_Temperature_Sensor_Malfunction	FuelTemperature		8
21	P2	Engine_Oil_Temperature_Malfunction	EngineOilTemp		8

9.3 Displaying Windows

When the CAN definition data setting window is opened, it appears on top of the 8910 setting window. Both windows can be repositioned for easy viewing by selecting [**Cascade**] or [**Tiled**] on the [**Window**] pull-down menu.

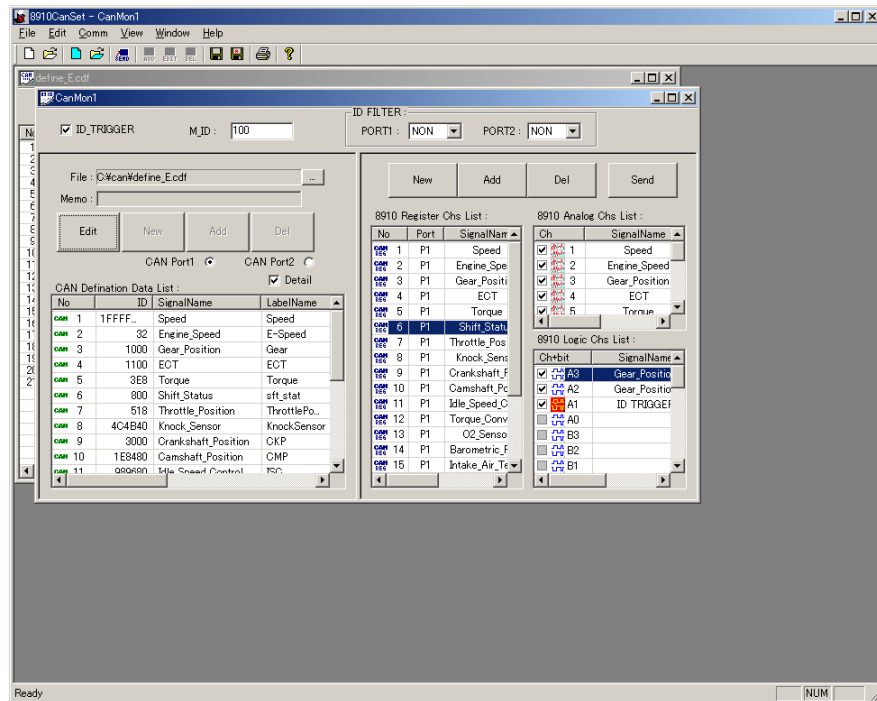

<Cascade arrangement>

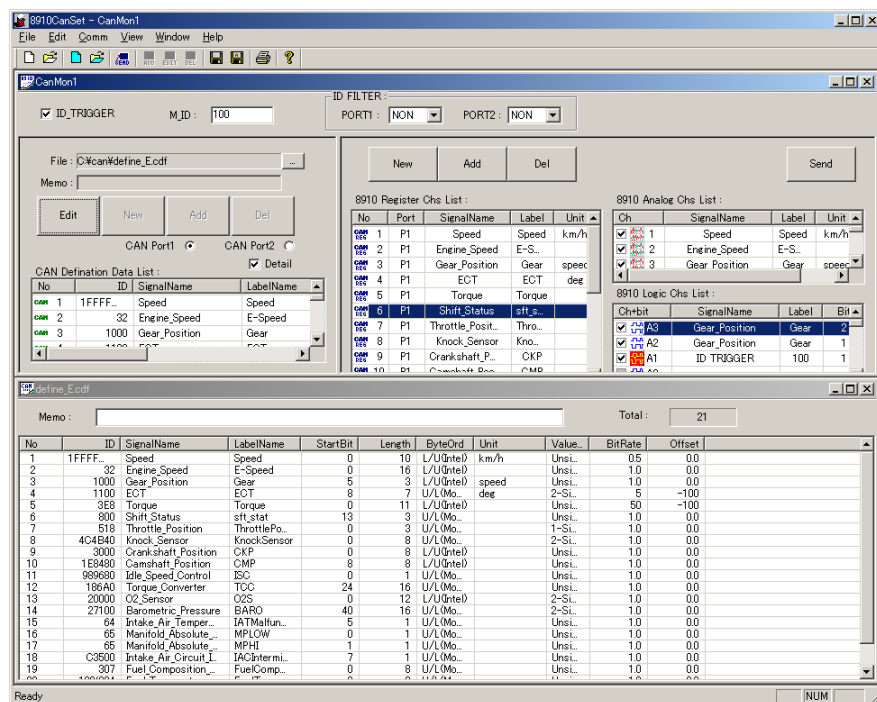

<Tiled arrangement>

9.4 Password Setting

- The password protection function can be activated, requiring the set password to be entered for opening a CAN definition data file.
- This function effectively prevents the inadvertent editing of data.

1 Select [Edit] - [Modify Password].

To set a password, select [**Modify Password**] on the [**Edit**] pull-down menu to open the [**Modify Password**] dialog box.

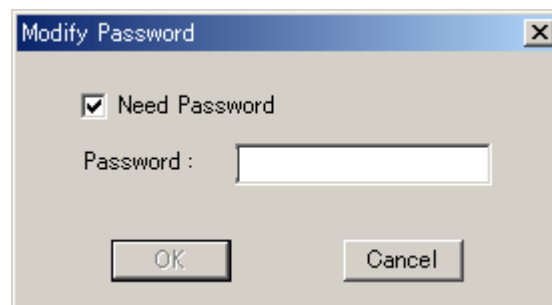

2 Select the [Need Password] check box, and enter a password.

To enable password setting, select the [**Need Password**] check box in the dialog box, enter a password in the [**Password**] input box.

3 Click [OK].

Click [**OK**].

The password must consist of only alphanumeric characters. After this setting is entered, the password must be entered to open a CAN definition data file.

<To disable the password protection function>

Deselect the check box.

- There will be no need to enter the password to open a CAN definition data file after entering the setting.
- The password protection function is disabled in default installation status, with no password required. There is no password protection until a password is set.

NOTE

A password can only be set when the program is in CAN definition data editing mode.

9.5 Version Check

- You will be asked to provide the software version no. when making an inquiry regarding the product.
- To check the software version, select [**About 8910 Can Set**] on the [**Help**] pull-down menu.

Connection to Memory HiCorder

Chapter 10

The 8910 can be connected to the 8826, 8841, or 8842 MEMORY HiCORDER via the RS-232C interface for the transfer of 8910 setting data to and from the Memory HiCorder.

The Memory HiCorder enable as follows:

- Change the 8910 output channel setting.
- Display the setting data list.
- Automatically set the scaling of the Memory HiCorder according to scaling information in the CAN definition data.

Supported models and versions

Memory HiCorder

8826 (Ver. 2.40 or later)

8841 (Ver. 2.50 or later)

8842 (Ver. 2.50 or later)

Communication interface

9557 RS-232C CARD

NOTE

Versions of the Memory HiCorder older than the above must be upgraded.

10.1 Using the 8910 with the 8826 MEMORY HiCORDER

10.1.1 Displaying the 8910 setting screen

1 Display [SYSTEM 4 - INTERFACE] screen on the 8826.

Press the [SYSTEM] key of the 8826 until the [SYSTEM4-INTERFACE] screen is shown.

Screen

[SYSTEM1-INTERFACE]→[SYSTEM2-INTERFACE]→
[SYSTEM3-INTERFACE]→[SYSTEM4-INTERFACE]→
(returns to the beginning)

2 Move the flashing cursor to [INTERFACE] indication.

Move the flashing cursor to the menu selection position ([INTERFSACE] indication at the top of the screen). This displays the [CAN] GUI appears next to the [CH. SET] key.

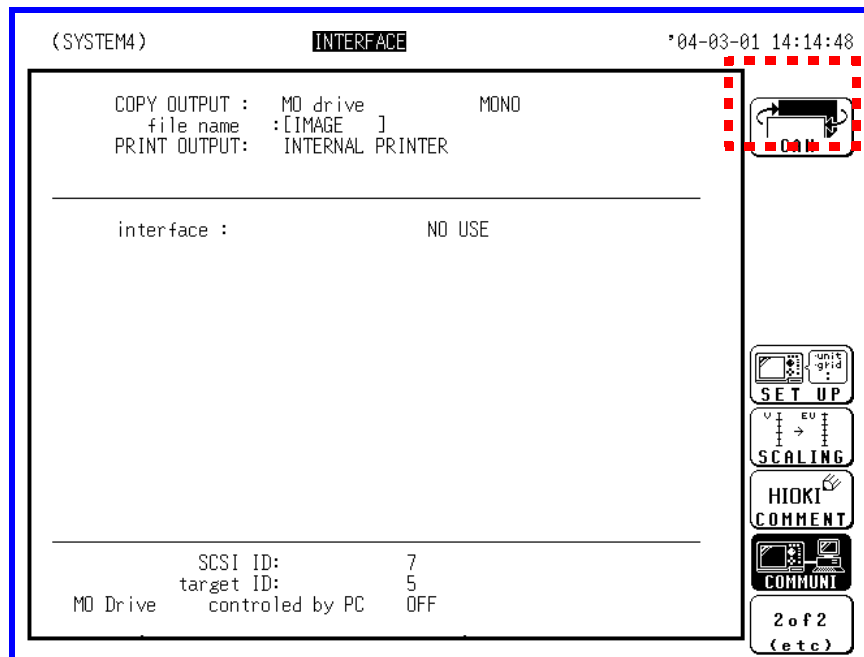

<Interface Setting Screen>

10.1 Using the 8910 with the 8826 MEMORY HiCORDER

3 Click the [CH. SET] key to display the 8910 setting screen.

In this state, clicking the [CH. SET] key switches display from the interface setting screen to the 8910 setting screen.

(SYSTEM4) **INTERFACE** *04-03-01 14:15:04

BLOCK NO. 1	8910 LABEL NAME CH	D/A 8826 TYPE CH	8910 LABEL CH	BP 8826 CH
	1 OFF		A0 OFF	
	2 OFF		A1 OFF	
	3 OFF		A2 OFF	
	4 OFF		A3 OFF	
ID TRIGGER OFF	5 OFF		B0 OFF	
	6 OFF		B1 OFF	
ID FILTER CAN1:NON CAN2:NON	7 OFF		B2 OFF	
	8 OFF		B3 OFF	
	9 OFF		C0 OFF	
	10 OFF		C1 OFF	
	11 OFF		C2 OFF	
	12 OFF		C3 OFF	
			D0 OFF	
			D1 OFF	
			D2 OFF	
			D3 OFF	
			E0 OFF	
			E1 OFF	
			E2 OFF	
			E3 OFF	
			F0 OFF	
			F1 OFF	
			F2 OFF	
			F3 OFF	













2 of 2
(etc)

<8910 Setting Screen>

<To switch the screen>

To switch from the 8910 setting screen to the interface setting screen, click the [CH. SET] key while the [INTERFACE] GUI is displayed next to the [CH. SET] key.

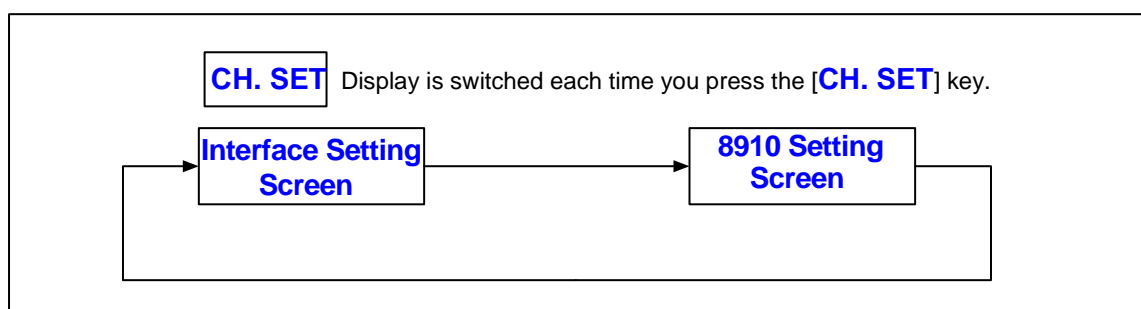

10.1.2 8910 setting screen

(SYSTEM4) INTERFACE *04-03-01 14:16:42

1. →	BLOCK NO. 1	8910 LABEL NAME CH	D/A 8826 TYPE CH	8910 LABEL CH	BP 8826 CH	
		1 Speed	BI 1	A0 IATMalfunc~	0 A1	← 6. INTERFACE
		2 E-Speed	MOND 2	A1 Gear	0 A2	
4. →	ID TRIGGER ON 100	3 Gear	MOND 3	A2 Gear	1 A3	← 7. LIST
	ID FILTER CAN1:NON CAN2:NON	4 ECT	BI 4	A3 Gear	2 A4	
		5 Torque	MOND 5	B0 OFF	0 B3	
		6 sft_stat	MOND 6	B1 OFF	0 B4	
		7 ThrottlePosition	BI 7	B2 MPH I	0 C4	
		8 KnockSensor	BI 8	B3 MPLOW		
		9 CKP	MOND 9	C0 OFF		
		10 CMP	MOND 10	C1 OFF		
5. →		11 ISC	MOND 11	C2 OFF		
		12 TCC	MOND 12	C3 IACIntermit~		
				D0 OFF		
				D1 OFF		
				D2 OFF		
				D3 ID TRIGGER	100	
				E0 EngineOilTe~	4 E1	
				E1 EngineOilTe~	5 E2	← 8. HIOKI COMMENT
				E2 EngineOilTe~	6 E3	
				E3 EngineOilTe~	7 E4	
				F0 EngineOilTe~	0 F1	
				F1 EngineOilTe~	1 F2	
				F2 EngineOilTe~	2 F3	
				F3 EngineOilTe~	3 F4	

2 of 2 (etc)

Item	Description	Reference
1. Block no. setting	Used to select a block for saving setting data.	❖ 10.1.3
2. Analog CH output setting section	Used to set and display CAN definition data to be output from an analog channel of the 8910.	❖ 10.1.4
3. Logic CH output setting section	Used to set and display CAN definition data to be output from a logic channel of the 8910.	❖ 10.1.5
4. ID trigger/ID filter setting display	Displays the ID trigger and ID filter settings.	-
5. Communication message display section	Displays the status of communication between the 8910 and 8826.	❖ 10.1.7
6. Screen selection GUI	Switches display between the interface setting screen and 8910 setting screen.	❖ 10.1.1
7. List display GUI	Displays a list of registered CAN definition data.	❖ 10.1.6
8. Function key GUI	Used to make settings. The function varies depending on the position of the flashing cursor.	-

10.1.3 Setting the block no.

(SYSTEM4) INTERFACE *04-03-01 14:15:12

BLOCK NO.	8910 CH	LABEL NAME	D/A 8826 TYPE	8910 CH	LABEL	BP 8826 CH
	1	OFF		A0	OFF	
	2	OFF		A1	OFF	
ID TRIGGER	3	OFF		A2	OFF	
OFF	4	OFF		A3	OFF	
ID FILTER	5	OFF		B0	OFF	
CAN1:NON	6	OFF		B1	OFF	
CAN2:NON	7	OFF		B2	OFF	
	8	OFF		B3	OFF	
	9	OFF		C0	OFF	
	10	OFF		C1	OFF	
	11	OFF		C2	OFF	
	12	OFF		C3	OFF	
				D0	OFF	
				D1	OFF	
				D2	OFF	
				D3	OFF	
				E0	OFF	
				E1	OFF	
				E2	OFF	
				E3	OFF	
				F0	OFF	
				F1	OFF	
				F2	OFF	
				F3	OFF	













- The 8826 can store the setting data of up to six 8910s. Each setting data storage area is called a block.
- Move the flashing cursor to the [**BLOCK NO.**] indication, then use a function key ([**F1**] or [**F2**]) to increment or decrement the number from [**1**] to [**6**].

NOTE

If there is no data in the selected block, the flashing cursor can only be moved to the block no. selection section.

❖ How to transfer data from the 8910→(Section 10.1.7, 104p.)

10.1.4 Setting analog channel output

8910 CH	LABEL NAME	D/A TYPE	8826 CH
1	Speed	BI	1
2	E-Speed	MONO	2
3	Gear	MONO	3
4	ECT	BI	4
5	Torque	MONO	5
6	sft_stat	MONO	6
7	ThrottlePosition	BI	7
8	KnockSensor	BI	8
9	CKP	MONO	9
10	CMP	MONO	10
11	ISC	MONO	11
12	TCC	MONO	12

↑ 1. ↑ 2. ↑ 3. ↑ 4.

•The cursor keys can be used to move the cursor to any item indication except those in the 8910 CH column.

•The function keys can be used to change the value of a selected item.

Item	Description	Setting range
1. 8910 CH	Analog output channels (fixed) of the 8910	1 to 12
2. Analog CH output data	Used to select CAN definition data to be output from an analog channel of the 8910. The label name is displayed.	OFF, 1 to registered data count
3. D/A conversion setting	Used to set whether to perform D/A conversion based on bipolar (-5 to +5 V) or monopolar (0 to +5 V) inside the 8910.	BI (bipolar) MONO (monopolar)
4. 8826 input channel	Used to set the channel of the 8826 for receiving data input. This is not a setting item for the 8910. This information is required to reflect the scaling value and signal name on the 8826.	1 to 32

NOTE

Setting changes made here are not reflected on the 8910 until data transmission (Section 10.1.7, 104p.) is performed.

10.1 Using the 8910 with the 8826 MEMORY HiCORDER

- The [F3] (Scaling function key) is effective for items 2 to 4 above. Clicking this function key automatically sets the scaling value for the channel specified as the 8826 input channel according to the content of CAN definition data as follows:
 - Data length
 - Sign setting
 - D/A conversion setting
- And at the same time, the signal name contained in CAN definition data as 8826 comment data.
- The scaling conversion bit rate and offset value of the 8826 are obtained by using the following formula with the bit rate and offset value contained in CAN definition data.
- In the following, the length of CAN definition data is n (bits), bit rate is $BitRate$, and offset value is $Offset$.

Without sign

For bipolar

Conversion bit rate: $((2^n - 1) \times BitRate) / 10.0$

Offset : $Offset + ((2^n - 1) \times BitRate) / 2.0$

For monopolar

Conversion bit rate: $((2^n - 1) \times BitRate) / 5.0$

Offset : $Offset$

With sign

For bipolar

Conversion bit rate: $((2^n - 1) \times BitRate) / 10.0$

Offset : $Offset - BitRate / 2.0$

For monopolar

Conversion bit rate: $((2^n - 1) \times BitRate) / 5.0$

Offset : $Offset - 2^{n-1} \times BitRate$

10.1.5 Setting logic channel output

8910 CH	LABEL	BP	8826 CH
A0	IATMal funct~	0	A1
A1	Gear	0	A2
A2	Gear	1	A3
A3	Gear	2	A4
B0	OFF		
B1	OFF		
B2	MPHI	0	B3
B3	MPLDW	0	B4
C0	OFF		
C1	OFF		
C2	OFF		
C3	IACIntermit~	0	C4
D0	OFF		
D1	OFF		
D2	OFF		
D3	ID TRIGGER		D00
E0	EngineOilTe~	4	E1
E1	EngineOilTe~	5	E2
E2	EngineOilTe~	6	E3
E3	EngineOilTe~	7	E4
F0	EngineOilTe~	0	F1
F1	EngineOilTe~	1	F2
F2	EngineOilTe~	2	F3
F3	EngineOilTe~	3	F4

↑ ↑ ↑ ↑
 1. 2. 3. 4.

- The cursor keys can be used to move the cursor to any item indication except those in the 8910 CH column.

- The function keys can be used to change the value of a selected item.

- Clicking the [F3] (COMMENT function key) automatically sets the signal name contained in CAN definition data as 8826 comment data.

Item	Description	Setting range
1. 8910 CH	Logic output channels (fixed) of the 8910	A0 to F3
2. Logic CH output data	<ul style="list-style-type: none"> • Used to select CAN definition data to be output from a logic channel of the 8910. • The label name is displayed. • Each time the [F5] (ID TRIGGER function key) is clicked, selection toggles between the 8910 ID trigger output channel and normal signal output channel. • When the ID trigger output channel is selected, the ID trigger and applicable ID are displayed. 	OFF, 1 to registered data count, ID trigger setting
3. Bit position setting	When the selected CAN definition data is 2 bits or more, this setting is used to select the bits to be output.	0 to data length of applicable CAN definition data - 1
4. 8826 input channel	Used to set the data input channel on the 8826. This is not a setting item for the 8910. This information is required to reflect the scaling value and signal name on the 8826.	A1 to H4

NOTE

Setting changes made here are not reflected on the 8910 until data transmission (Section 10.1.7, 104p.) is performed.

10.1.6 Displaying the registration list

The CAN definition data downloaded into blocks can be displayed. On the 8910 setting screen, the [LIST] GUI is shown next to the [VIEW] key.

In this state, pressing the [VIEW] key switches display in the following sequence:

For up to 25 items of definition data

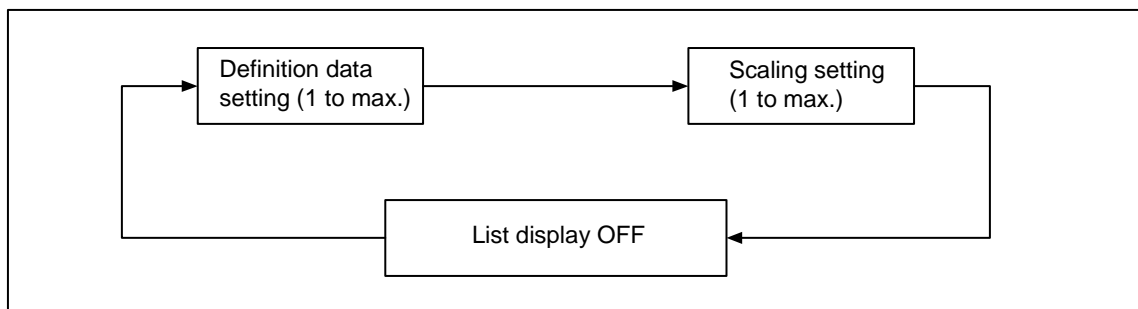

For more than 26 items of definition

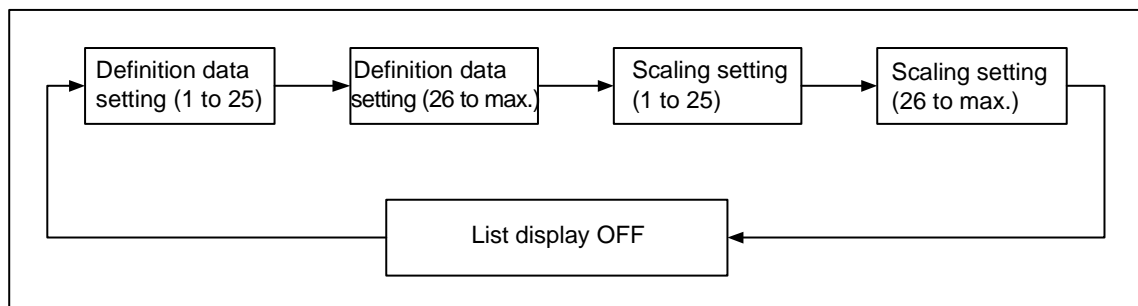

Clicking any key other than the [VIEW] key closes the list display window.

Setting display items of CAN definition data (from left)

Label name	up to 16 alphanumeric characters
Message ID	0 to 1FFFFFFF (hexadecimal notation)
Start position	0 to 63
Data length	1 to 16 (bits)
Byte pattern	U/L (Motorola), L/U (Motorola), L/U (Intel)
Sign	Unsigned (without sign), 1-Signed (one's complement), 2-Signed (two's complement)
Input port	CAN1 or CAN2

Setting display items of scaling (from left)

Label name	up to 16 alphanumeric characters
Bit rate	decimal value (exponential notation)
Offset	decimal value (exponential notation)
Unit	up to 8 characters

(SYSTEM4) INTERFACE *04-03-01 14:17:43

CAN Define Data List(1/2)

No.	Label name	ID(HEX)	Pos.	Size	Order	Sign	Port
1:	Speed	1FFFFFFF	0	10bit	L/U(I)	Unsigned	CAN1
2:	E-Speed	32	0	16bit	L/U(I)	Unsigned	CAN1
3:	Gear	1000	5	3bit	L/U(I)	Unsigned	CAN1
4:	ECT	1100	8	7bit	L/U(M)	2-Signed	CAN1
5:	Torque	3E3	0	11bit	L/U(I)	Unsigned	CAN1
6:	sft_stat	800	13	3bit	L/U(M)	Unsigned	CAN1
7:	ThrottlePosition	518	0	3bit	L/U(M)	1-Signed	CAN1
8:	KnockSensor	4C4B40	0	8bit	L/U(M)	2-Signed	CAN1
9:	CKP	3000	0	8bit	L/U(I)	Unsigned	CAN1
10:	CMP	1E8480	8	8bit	L/U(I)	Unsigned	CAN1
11:	ISC	989680	0	1bit	L/U(M)	Unsigned	CAN1
12:	TDC	186A0	24	16bit	L/U(M)	Unsigned	CAN1
13:	OZS	20000	0	12bit	L/U(I)	2-Signed	CAN1
14:	BARO	27100	40	16bit	L/U(M)	2-Signed	CAN1
15:	IATMalfunction	64	5	1bit	L/U(M)	Unsigned	CAN1
16:	MPLow	65	0	1bit	L/U(M)	Unsigned	CAN1
17:	MPhi	65	1	1bit	L/U(M)	Unsigned	CAN1
18:	IACIntermittent	C3500	7	1bit	L/U(M)	Unsigned	CAN1
19:	FuelComposition	307	0	8bit	L/U(M)	Unsigned	CAN1
20:	FuelTemperature	100F004	0	8bit	L/U(M)	Unsigned	CAN1
21:	EngineOilTemp	F040800	56	8bit	L/U(M)	2-Signed	CAN1

INTERFACE
LIST

(SYSTEM4) INTERFACE *04-03-01 14:17:53

CAN Define Data List(2/2)

No.	Label name	Bitrate	Offset	Unit
1:	Speed	5.000000E-01	0.000000E+00	km/h
2:	E-Speed	1.000000E+00	0.000000E+00	
3:	Gear	1.000000E+00	0.000000E+00	speed
4:	ECT	5.000000E+00	-1.000000E+02	deg
5:	Torque	5.000000E+01	-1.000000E+02	
6:	sft_stat	1.000000E+00	0.000000E+00	
7:	ThrottlePosition	1.000000E+00	0.000000E+00	
8:	KnockSensor	1.000000E+00	0.000000E+00	
9:	CKP	1.000000E+00	0.000000E+00	
10:	CMP	1.000000E+00	0.000000E+00	
11:	ISC	1.000000E+00	0.000000E+00	
12:	TDC	1.000000E+00	0.000000E+00	
13:	OZS	1.000000E+00	0.000000E+00	
14:	BARO	1.000000E+00	0.000000E+00	
15:	IATMalfunction	1.000000E+00	0.000000E+00	
16:	MPLow	1.000000E+00	0.000000E+00	
17:	MPhi	1.000000E+00	0.000000E+00	
18:	IACIntermittent	1.000000E+00	0.000000E+00	
19:	FuelComposition	1.000000E+00	0.000000E+00	
20:	FuelTemperature	1.000000E+00	0.000000E+00	
21:	EngineOilTemp	1.000000E+00	0.000000E+00	

INTERFACE
LIST

<Example of CAN definition data setting list display>
<Example of scaling data setting list display>

10.1.7 Communication between the 8826 and 8910

- The RS-232C interface is used for communication between the 8826 and 8910.
- On the 8826 side, the RS-232C parameters are automatically set upon communication, but the 9557 RS-232C CARD and connection cable must be set and connected so that the RS-232C function of the 8826 is ready for operation.
- In the following, "8826" refers to the "8826 installed with the 9557."
❖ For further details → instruction manuals for the 8826 and 9557.

10.1 Using the 8910 with the 8826 MEMORY HiCORDER

◆ Receiving data from the 8910

Follow the procedure below to receive data.

1. Connect the 8826 to the 8910 with the RS-232C cable.
2. Position the [ONLINE/OFFLINE] switch of the 8910 to [ONLINE] side.
3. On the 8910 setting screen of the 8826, select a block to receive data, then click [F4] (8910 → RECORDER function key).
4. After the self-check function checks connectivity, the 8826 receives data in follows order:
 - (1) The registration list (up to 50 items)
 - (2) Analog CH (12 channels)
 - (3) Logic CH (24 bits)

The data reception status is indicated in the communication message display section at the lower left of the screen.

Block No.

(SYSTEM4) INTERFACE *04-03-01 14:16:42

BLOCK NO.	8910 LABEL NAME	D/A TYPE	8826 CH	8910 LABEL	BP	8826 CH
1	Speed	BI	1	A0 IATMalfunc~	0	A1
2	E-Speed	MONO	2	A1 Gear	0	A2
3	Gear	MONO	3	A2 Gear	1	A3
4	ECT	BI	4	A3 Gear	2	A4
5	Torque	MONO	5	B0 OFF	0	B3
6	sft_stat	MONO	6	B1 OFF	0	B4
7	ThrottlePosition	BI	7	B2 MPH	0	B4
8	KnockSensor	BI	8	B3 MPlow	0	C4
9	CKP	MONO	9	C0 OFF	0	C4
10	CMP	MONO	10	C1 OFF	0	C4
11	ISC	MONO	11	C2 OFF	0	C4
12	TCC	MONO	12	C3 IACIntermit~	0	C4
				D0 OFF		
				D1 OFF		
				D2 OFF		
				D3 ID TRIGGER	100	
				E0 EngineOilTe~	4	E1
				E1 EngineOilTe~	5	E2
				E2 EngineOilTe~	6	E3
				E3 EngineOilTe~	7	E4
				F0 EngineOilTe~	0	F1
				F1 EngineOilTe~	1	F2
				F2 EngineOilTe~	2	F3
				F3 EngineOilTe~	3	F4

Communication message display section

5. Once data is received, it is displayed on the screen and communication terminates.
If data reception fails, the communication message display section indicates "Can not connect."

If the error message appears Check the cable for proper connection, and that the [ONLINE/OFFLINE] switch of the 8910 is positioned to [ONLINE] side.

◆ Sending data to the 8910

Follow the procedure below to send data.

1. Connect the 8826 to the 8910 with the RS-232C cable.
2. Position the [ONLINE/OFFLINE] switch of the 8910 to [ONLINE] side.
3. On the 8910 setting screen of the 8826, select a block to which to send data, then click [F5] (RECORDER → 8910 function key).
4. After the self-check function checks connectivity, the 8826 sends data in following order:
 - (1) The registration list (up to 50 items)
 - (2) Analog CH (12 channels)
 - (3) Logic CH (24 bits)

The data send status is indicated in the communication message display section at the lower left of the screen.

Block No.

(SYSTEM4) INTERFACE *04-03-01 14:15:12

BLOCK NO.	8910 CH	LABEL NAME	D/A 8826 TYPE	8910 CH	LABEL	BP 8826 CH
1	OFF			A0	OFF	
2	OFF			A1	OFF	
3	OFF			A2	OFF	
4	OFF			A3	OFF	
5	OFF			B0	OFF	
6	OFF			B1	OFF	
7	OFF			B2	OFF	
8	OFF			B3	OFF	
9	OFF			C0	OFF	
10	OFF			C1	OFF	
11	OFF			C2	OFF	
12	OFF			C3	OFF	
				D0	OFF	
				D1	OFF	
				D2	OFF	
				D3	OFF	
				E0	OFF	
				E1	OFF	
				E2	OFF	
				E3	OFF	
				F0	OFF	
				F1	OFF	
				F2	OFF	
				F3	OFF	

ID TRIGGER OFF
 ID FILTER CAN1:NON CAN2:NON

INTERFACE
 CAN LIST
 LIST
 ↑
 ↓
 8910 RECORDER
 RECORDER 8910

Communication message display section

5. Once the data is transmitted, the communication message display section is cleared and communication terminates. If data transmission fails, the communication message display section indicates "Can not connect."

If the error message appears

Check the cable for proper connection, and that the [ONLINE/OFFLINE] switch of the 8910 is positioned to [ONLINE] side.

10.1.8 Downloading an setting data file

An 8910 setting data file (with extension "cmu") created with the "8910 CAN set program" software can be downloaded to the 8826.

1 Select a block.

Open the 8910 setting screen and select a block to which to transfer the setting data.

(SYSTEM4) INTERFACE *04-03-01 14:15:23

BLOCK NO.	8910 LABEL NAME CH	D/A 8826 TYPE CH	8910 LABEL CH	BP 8826 CH
	1 OFF		A0 OFF	
	2 OFF		A2 OFF	
ID TRIGGER OFF	3 OFF		A3 OFF	
	4 OFF		B0 OFF	
ID FILTER CAN1:NON CAN2:NON	5 OFF		B1 OFF	
	6 OFF		B2 OFF	
	7 OFF		B3 OFF	
	8 OFF		C0 OFF	
	9 OFF		C1 OFF	
	10 OFF		C2 OFF	
	11 OFF		C3 OFF	
	12 OFF		D0 OFF	
			D1 OFF	
			D2 OFF	
			D3 OFF	
			E0 OFF	
			E1 OFF	
			E2 OFF	
			E3 OFF	
			F0 OFF	
			F1 OFF	
			F2 OFF	
			F3 OFF	

INTERFACE
LIST
↑
↓
8910 RECORDER
RECORDER 8910

2 Download the 8910 setting data file.

Display the file screen and download the desired 8910 setting data file.

(FILE) *04-03-01 14:15:49

(command)	(media)	(Sort)
command_SELECT	MD	FILE NAME
/CANDATA/		
0001	.	04-03-01 14:13:48 <DIR>
0002	.	04-03-01 14:13:48 <DIR>
0003	CANMIN1.CMU	04-03-01 14:07:12 4088







3 files 199.301M bytes free

FILES list print
SAVE
LOAD
FILE → TIME
INCR
FILE → FILE
DELETE
2 of 2
(etc)

3 The setting data is transferred to the selected block.

(SYSTEM4) **INTERFACE** *04-03-01 14:16:05

BLOCK NO.	8910 LABEL CH	NAME	D/A TYPE	8826 CH	8910 LABEL CH	BP 8826 CH
2	1	Speed	BI	1	A0 IATMalfunc~	0 A1
	2	E-Speed	MONO	2	A1 Gear	0 A2
	3	Gear	MONO	3	A2 Gear	1 A3
	4	ECT	BI	4	A3 Gear	2 A4
	5	Torque	MONO	5	B0 OFF	
	6	sft_stat	MONO	6	B1 OFF	
	7	ThrottlePosition	BI	7	B2 MPH1	0 B3
	8	KnockSensor	BI	8	B3 MFLOW	0 B4
	9	CKP	MONO	9	C0 OFF	
	10	CMP	MONO	10	C1 OFF	
	11	ISC	MONO	11	C2 OFF	
	12	TCC	MONO	12	C3 IACIntermit~	0 C4
					D0 OFF	
					D1 OFF	
					D2 OFF	
					D3	100
					ID TRIGGER	
					E0 EngineDilTe~	4 E1
					E1 EngineDilTe~	5 E2
					E2 EngineDilTe~	6 E3
					E3 EngineDilTe~	7 E4
					F0 EngineDilTe~	0 F1
					F1 EngineDilTe~	1 F2
					F2 EngineDilTe~	2 F3
					F3 EngineDilTe~	3 F4

2 of 2
(etc)

NOTE

Note that executing the data read command deletes all existing data in the block.

10.2 Using the 8910 with the 8841, 8842 MEMORY HiCORDER

10.2.1 Displaying the 8910 setting screen

1 Display [SYSTEM 4 - INTERFACE] screen on the 8841, 8842

Press the [SYSTEM] key of the 8841, 8842 until the [SYSTEM4-INTERFACE] screen is shown.

Screen

[SYSTEM1-INTERFACE]→[SYSTEM2-INTERFACE]→
[SYSTEM3-INTERFACE]→[SYSTEM4-INTERFACE]→
(returns to the beginning)

2 Move the flashing cursor to [INTERFACE] indication.

Move the flashing cursor to the menu selection position ([INTERFACE] indication at the top of the screen). This displays the [CAN] GUI next to the [CH. SET] key.

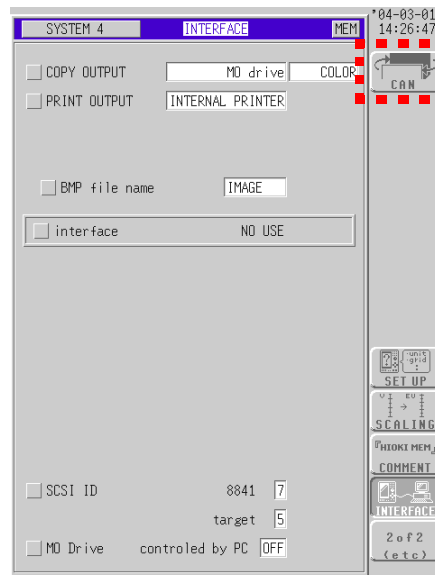

<Interface Setting Screen>

3

Click the [CH. SET] key to display the 8910 setting screen.

In this state, clicking the [CH. SET] key switches display from the interface setting screen to the 8910 setting screen.

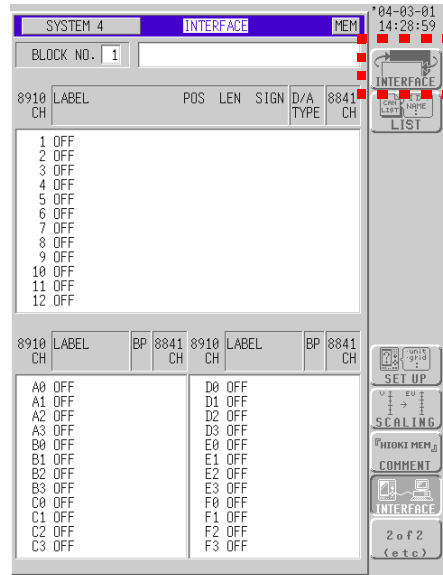

<8910 Setting Screen>

<To switch the screen>

To switch from the 8910 setting screen to the interface setting screen, click the [CH. SET] key shown next to the [INTERFACE] GUI.

Display is switched each time you press the [CH. SET] key.



10.2.2 8910 setting screen

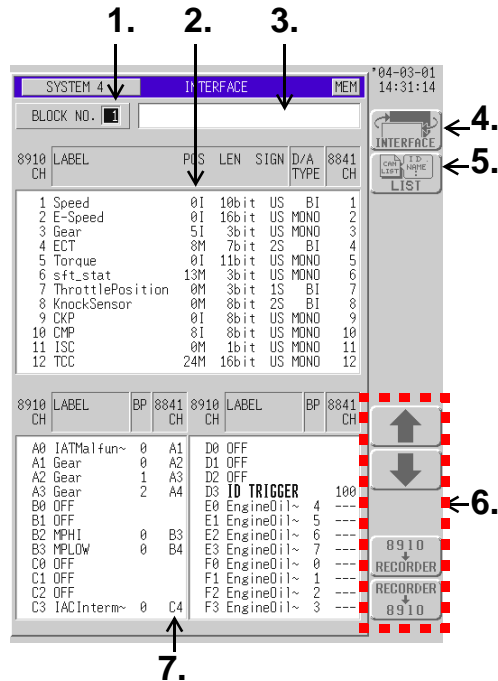

Item	Description	Reference
1. Block no. setting	Used to select a block for saving setting data.	❖ 10.2.3
2. Analog CH output setting section	Used to set and display CAN definition data to be output from an analog channel of the 8910.	❖ 10.2.4
3. Communication message display section	Indicates the status of communication between the 8910 and 8841, 8842.	❖ 10.2.7
4. Screen selection GUI	Switches display between the interface setting screen and 8910 setting screen.	❖ 10.2.1
5. List display GUI	Displays a list of registered CAN definition data.	❖ 10.2.6
6. Function key GUI	Used to make settings. The setting varies depending on the position of the flashing cursor.	-
7. Logic CH output setting section	Used to set and display CAN definition data to be output from a logic channel of the 8910.	❖ 10.2.5

10.2.3 Setting the block no.

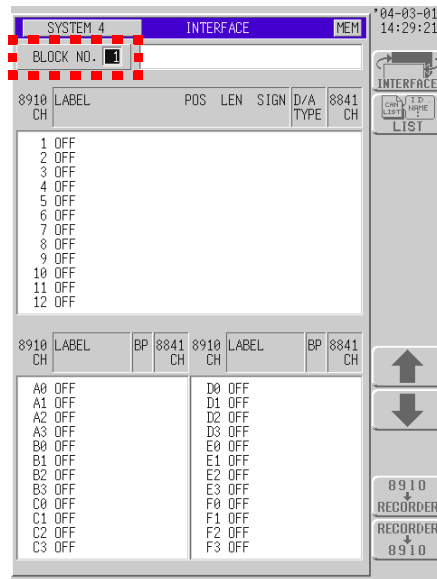

- The 8841, 8842 can store setting data of up to six 8910s. Each setting data storage area is called a block.
- Move the flashing cursor to the **[BLOCK NO.]** indication, then use a function key (**[F1]** or **[F2]**) to increment or decrement the number (from 1 to 6).

NOTE

If there is no data in the selected block, the flashing cursor can only be moved to the block no. selection section.

❖ [How to transfer data from the 8910 → \(Section 10.2.7, 117p.\)](#)

10.2.4 Setting analog channel output

8910 CH	LABEL	POS	LEN	SIGN	D/A TYPE	8841 CH
1	Speed	0I	10bit	US	BI	1
2	E-Speed	0I	16bit	US	MONO	2
3	gear	5I	3bit	US	MONO	3
4	ECT	8M	7bit	2S	BI	4
5	Torque	0I	11bit	US	MONO	5
6	sft_stat	13M	3bit	US	MONO	6
7	ThrottlePosition	0M	3bit	1S	BI	7
8	KnockSensor	0M	8bit	2S	BI	8
9	CKP	0I	8bit	US	MONO	9
10	CMP	8I	8bit	US	MONO	10
11	TSC	0M	1bit	US	MONO	11
12	TCC	24M	16bit	US	MONO	12

↑ ↑ ↑ ↑
1. **2.** **3.** **4.**

- The setting items are shown below.
- The cursor keys can be used to move the cursor to any item indication except those in the 8910 CH column.

Item	Description	Setting range
1. 8910 CH	Analog output channels (fixed) of the 8910	1 to 12
2. Analog CH output data	Used to select CAN definition data to be output from an analog channel of the 8910. The label name, position, byte pattern, data length, and sign are displayed.	OFF, 1 to registered data count
3. D/A conversion setting	Used to set whether to perform D/A conversion based on bipolar (-5 to +5 V) or monopolar (0 to +5 V) inside the 8910.	BI (bipolar) MONO (monopolar)
4. 8841, 8842 input channel	Used to set the channel of the 8841, 8842 for receiving data input. This is not a setting item for the 8910. This information is required to reflect the scaling value and signal name on the 8841, 8842.	1 to 16

- The [F3] (Scaling function key) is effective for items 2 to 4 above. Clicking this function key automatically sets the scaling value for the channel specified as the 8841, 8842 input channel according to the content of CAN definition data as follows:
 - Data length
 - Sign setting
 - D/A conversion setting
- And at the same time, the signal name contained in CAN definition data as 8841, 8842 comment data.
- The scaling conversion bit rate and offset value of the 8841, 8842 are obtained by using the following formula with the bit rate and offset value contained in CAN definition data.

10.2 Using the 8910 with the 8841, 8842 MEMORY HiCORDER

- In the following, the length of CAN definition data is n (bits), bit rate is $BitRate$, and offset value is $Offset$.

Without sign

For bipolar

Conversion bit rate: $((2^n - 1) \times BitRate) / 10.0$

Offset : $Offset + ((2^n - 1) \times BitRate) / 2.0$

For monopolar

Conversion bit rate: $((2^n - 1) \times BitRate) / 5.0$

Offset : $Offset$

With sign

For bipolar

Conversion bit rate: $((2^n - 1) \times BitRate) / 10.0$

Offset : $Offset - BitRate / 2.0$

For monopolar

Conversion bit rate: $((2^n - 1) \times BitRate) / 5.0$

Offset : $Offset - 2^{n-1} \times BitRate$

NOTE

Setting changes made here are not reflected on the 8910 until data transmission (Section 10.2.7, 117p.) is performed.

10.2.5 Setting logic channel output

8910 CH	LABEL	BP	8841 CH	8910 CH	LABEL	BP	8841 CH
A0	IATMal fun~	0	A1	D0	OFF		
A1	Gear	0	A2	D1	OFF		
A2	Gear	1	A3	D2	OFF		
A3	Gear	2	A4	D3	ID TRIGGER	100	
B0	OFF		E0	EngineOil~	4	---	
B1	OFF		E1	EngineOil~	5	---	
B2	MPHI	0	E2	EngineOil~	6	---	
B3	MPLOW	0	E3	EngineOil~	7	---	
C0	OFF		F0	EngineOil~	0	---	
C1	OFF		F1	EngineOil~	1	---	
C2	OFF		F2	EngineOil~	2	---	
C3	IACInterm~	0	C4	F3	EngineOil~	3	---

↑ ↑ ↑ ↑ ↑ ↑ ↑
1. **2.** **3.** **4.** **1.** **2.** **3.** **4.**

- The setting items are shown below.
- The cursor keys can be used to move the cursor to any item indication except those in the 8910 CH column.

Item	Description	Setting range
1. 8910 CH	Logic output channels (fixed) of the 8910	A0 to F3
2. Logic CH output data	<ul style="list-style-type: none"> • Used to select CAN definition data to be output from a logic channel of the 8910. • The label name is displayed. • Each time the [F5] (ID TRIGGER function key) is clicked, selection toggles between the 8910 ID trigger output channel and normal signal output channel. • When the ID trigger output channel is selected, the ID trigger and applicable ID are displayed. 	OFF, 1 to registered data count, ID trigger setting
3. Bit position setting	When the selected CAN definition data is 2 bits or more, this setting is used to select the bits to be output.	0 to data length of applicable CAN definition data - 1
4. 8841, 8842 input channel	Used to set the data input channel on the 8841, 8842. This is not a setting item for the 8910. This information is required to reflect the signal name on the 8841, 8842.	A1 to D4

- The [F3] (COMMENT function key) is effective for items 2 to 4 above. Clicking this function key automatically sets the signal name contained in CAN definition data as 8841, 8842 comment data.

NOTE

Setting changes made here are not reflected on the 8910 until data transmission (Section 10.2.7, 117p.) is performed.

10.2.6 Displaying the registration list

The CAN definition data downloaded into blocks can be displayed. On the 8910 setting screen, the [LIST] GUI is shown next to the [LEVEL MONI] key. In this state, pressing the [LEVEL MONI] key switches display in the following sequence:

For up to 25 items of definition data

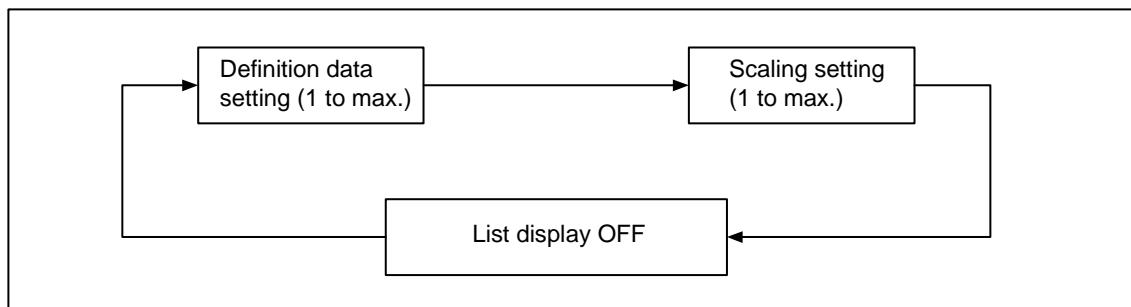

For more than 26 items of definition

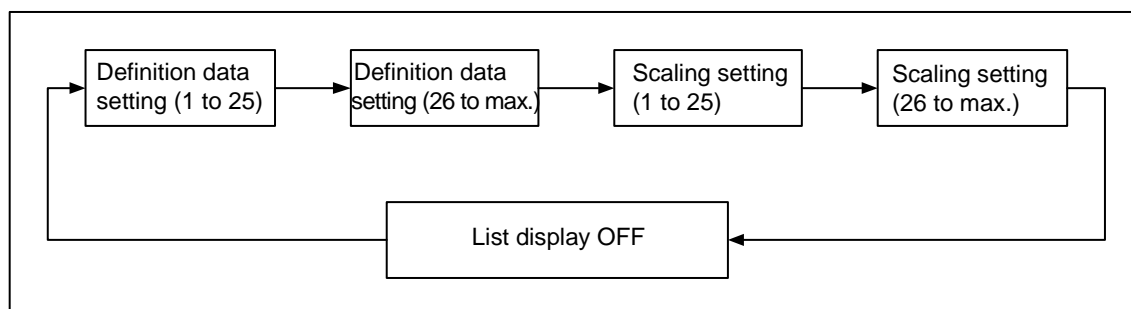

No.	label name, ID(HEX), pos.	size, sign
1:	Speed, 1FFFFFFF, 01,	10bit, US, 1
2:	E-Speed, 32, 01,	16bit, US, 1
3:	Gear, 1000, 51,	3bit, US, 1
4:	ECT, 1100, 0M,	7bit, 2S, 1
5:	Torque, 3E8, 01,	11bit, US, 1
6:	sft_stat, 800, 13M,	3bit, US, 1
7:	ThrottlePosition, 518, 0M,	3bit, 1S, 1
8:	KnockSensor, 4C4B40, 0M,	3bit, 2S, 1
9:	CKP, 3000, 01,	8bit, US, 1
10:	CMP, 1E8480, 31,	8bit, US, 1
11:	ISC, 989680, 0M,	1bit, US, 1
12:	TCC, 186A0, 24M,	16bit, US, 1
13:	O2S, 20000, 01,	12bit, 2S, 1
14:	BARD, 27100, 40M,	16bit, 2S, 1
15:	IATMalfunction, 64, 5M,	1bit, US, 1
16:	MPL0W, 65, 0M,	1bit, US, 1
17:	MPL1, 65, 1M,	1bit, US, 1
18:	IACIntermittent, C3500, 7M,	1bit, US, 1
19:	FuelComposition, 307, 0M,	8bit, US, 1
20:	FuelTemperature, 100F004, 0M,	8bit, US, 1
21:	EngineOilTemp, F040800, 56M,	8bit, 2S, 1

<Example of CAN definition data setting list display>

No.	Bitrate	Offset	Unit
1:	5.000000E-01,	0.000000E+00,	km/h
2:	1.000000E+00,	0.000000E+00,	
3:	1.000000E+00,	0.000000E+00,	speed
4:	5.000000E+00,	-1.000000E+02,	deg
5:	5.000000E+01,	-1.000000E+02,	
6:	1.000000E+00,	0.000000E+00,	
7:	1.000000E+00,	0.000000E+00,	
8:	1.000000E+00,	0.000000E+00,	
9:	1.000000E+00,	0.000000E+00,	
10:	1.000000E+00,	0.000000E+00,	
11:	1.000000E+00,	0.000000E+00,	
12:	1.000000E+00,	0.000000E+00,	
13:	1.000000E+00,	0.000000E+00,	
14:	1.000000E+00,	0.000000E+00,	
15:	1.000000E+00,	0.000000E+00,	
16:	1.000000E+00,	0.000000E+00,	
17:	1.000000E+00,	0.000000E+00,	
18:	1.000000E+00,	0.000000E+00,	
19:	1.000000E+00,	0.000000E+00,	
20:	1.000000E+00,	0.000000E+00,	
21:	1.000000E+00,	0.000000E+00,	

<Example of scaling data setting list display>

10.2 Using the 8910 with the 8841, 8842 MEMORY HiCORDER

Setting display items of CAN definition data (from left)

Label name	up to 16 alphanumeric characters
Message ID	0 to 1FFFFFFF (hexadecimal notation)
Start position	0 to 63
Data length	1 to 16 (bits)
Byte pattern	M (U/L Motorola), L (L/U Motorola), I (L/U Intel)
Sign	US (without sign), 1S (one's complement), 2 S (two's complement)
Input port	1 (CAN1) or 2 (CAN2)

Setting display items of scaling (from left)

Bit rate	decimal value (exponential notation)
Offset	decimal value (exponential notation)
Unit	up to 8 characters

The following information is displayed at the bottom of the list:

ID trigger	ON/OFF setting, and applicable ID (when ON is selected)
ID filter	STD, EXT, NON (for each input channel of the 8910)

Clicking any key other than the [LEVEL MONI] key closes the list display window.

10.2.7 Communication between the 8841, 8842 and 8910

- The RS-232C interface is used for communication between the 8841, 8842 and 8910.
 - On the 8841, 8842 side, the 9557 RS-232C CARD and connection cable must be set and connected so that the RS-232C function of the 8841, 8842 is ready for operation.
 - In the following, the "8841, 8842" refers to the "8841, 8842 installed with the 9557."
- ❖ For further details → [instruction manuals for the 8841, 8842 and 9557.](#)

◆ Receiving data from the 8910

Follow the procedure below to receive data.

1. Connect the 8841, 8842 to the 8910 with the RS-232C cable.
2. Position the [ONLINE/OFFLINE] switch of the 8910 to [ONLINE] side.
3. On the 8910 setting screen of the 8841, 8842, select a block to receive data, then click [F4] (8910 → RECORDER function key).
4. After the self-check function checks connectivity, the 8841, 8842 receives data in follows order:
 - (1) The registration list (up to 50 items)
 - (2) Analog CH (12 channels)
 - (3) Logic CH (24 bits)

The data reception status is indicated in the communication message display section to the right of the block number indication.
5. Once data is received, it is displayed on the screen and communication terminates.
If data reception fails, the communication message display section indicates "**Cannot connect to 8910.**".

If the error message appears Check the cable for proper connection, and that the [ONLINE/OFFLINE] switch of the 8910 is positioned to [ONLINE] side.

NOTE

The RS-232C parameters are automatically set in the 8841, 8842 at data reception.

Block no.

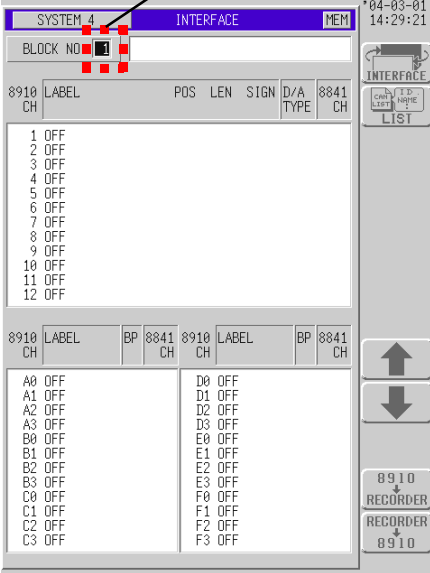

Click [F4] key.



Communication message display

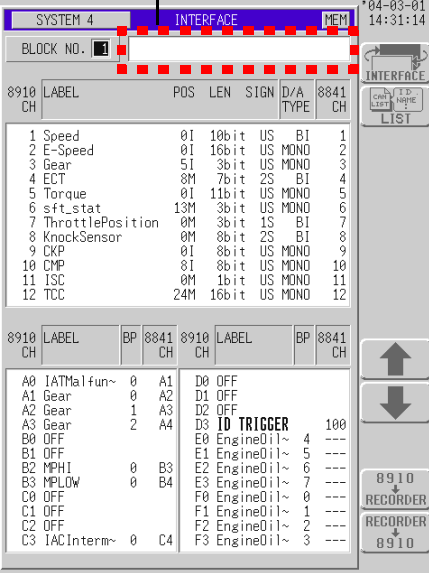

10.2 Using the 8910 with the 8841, 8842 MEMORY HiCORDER

◆ Sending data to the 8910

Follow the procedure below to send 8910 setting data stored in the 8841, 8842 to the 8910.

1. Connect the 8841, 8842 to the 8910 with the RS-232C cable.
2. Position the [ONLINE/OFFLINE] switch of the 8910 to [ONLINE] side..
3. On the 8910 setting screen of the 8841, 8842 select a block to which to send data, then click [F5] (RECORDER → 8910 function key).
4. After the self-check function checks connectivity, the 8841, 8842 sends data in following order:
 - (1) The registration list (up to 50 items)
 - (2) Analog allocations (12 channels)
 - (3) Logic allocations (24 bits)The data send status is indicated in the communication message display section to the right of the block number indication.
5. Once the data is transmitted, the communication message display section is cleared and communication terminates. If data transmission fails, the communication message display section indicates "**Cannot connect to 8910.**".

If the error message appears Check the cable for proper connection, and that the [ONLINE/OFFLINE] switch of the 8910 is positioned to [ONLINE] side.

NOTE

The RS-232C parameters are automatically set in the 8841, 8842 at data transmission.

10.2.8 Downloading a setting data file

An 8910 setting file (with extension "cmu") created with the "8910 CAN set program" software can be downloaded to the 8841, 8842.

1 Select a block.

Open the 8910 setting screen and select a block to which to transfer the setting data.

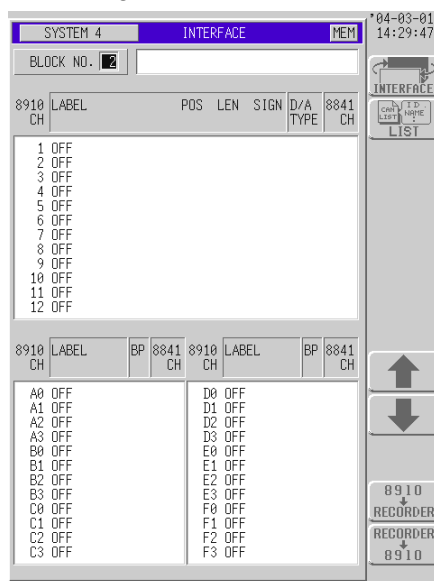

2 Download the 8910 setting data file.

Display the file screen, then download the desired 8910 setting data file.

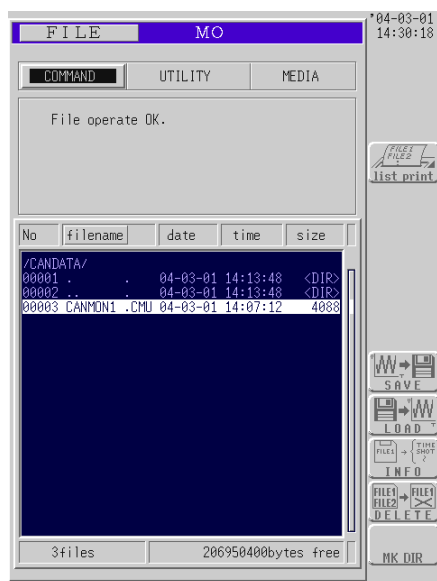

10.2 Using the 8910 with the 8841, 8842 MEMORY HiCORDER

3 The setting data is transferred to the selected block.

SYSTEM 4		INTERFACE		MEM		04-03-01 14:30:47	
BLOCK NO. 2							
8910 CH	LABEL	POS	LEN	SIGN	D/A TYPE	8841 CH	
1	Speed	01	10bit	US	BI	1	
2	E-Speed	01	16bit	US	MONO	2	
3	Gear	51	3bit	US	MONO	3	
4	ECT	8M	7bit	2S	BI	4	
5	Torque	01	11bit	US	MONO	5	
6	sft_stat	13M	3bit	US	MONO	6	
7	ThrottlePosition	0M	3bit	1S	BI	7	
8	KnockSensor	0M	8bit	2S	BI	8	
9	CKP	01	8bit	US	MONO	9	
10	CMP	81	8bit	US	MONO	10	
11	ISC	0M	1bit	US	MONO	11	
12	TCC	24M	16bit	US	MONO	12	

8910 CH	LABEL	BP	8841 CH	8910 CH	LABEL	BP	8841 CH
A0	IATMalfun~	0	A1	D0	OFF		
A1	Gear	0	A2	D1	OFF		
A2	Gear	1	A3	D2	OFF		
A3	Gear	2	A4	D3	ID TRIGGER	4	100
B0	OFF			E0	EngineOil~	5	---
B1	OFF			E1	EngineOil~	6	---
B2	MPHI	0	B3	E2	EngineOil~	7	---
B3	MPLow	0	B4	E3	EngineOil~	8	---
C0	OFF			F0	EngineOil~	9	---
C1	OFF			F1	EngineOil~	10	---
C2	OFF			F2	EngineOil~	11	---
C3	IACInterm~	0	C4	F3	EngineOil~	12	---

NOTE

Executing the data read command deletes all existing data in the block.

Specifications *Chapter 11*

11.1 General Specifications

Basic specifications

Product warranty period: 1 year.

Accuracy at $23 \pm 5^{\circ}\text{C}$ ($73 \pm 8.5^{\circ}\text{F}$), 30 to 80% RH after 30-minute warming-up time.

Period of guaranteed accuracy: 1 year.

Number of CAN input channels	CAN 2 ch
CAN protocol	CAN Ver. 2.0B (standard format, extended format)
CAN communication speed	125 k, 250 k, 500 k, 1 M bps (High-Speed CAN (ISO 11898))
CAN interface	Listen-only
CAN input connector	D-sub 9-pin, male connector (CiA-compliant)
Number of logic output channels	Logic 6 ch - 24 bit (6 ch \times 4 bit / ch = 24 bit)
Logic output format	Unbalanced output (grounded on one side) (GND terminal shared with GND of main instrument)
Logic output voltage	0 to 5 V (LOW level: 0 to 0.5V, HIGH level: 4.5 to 5.0 V)
Logic output connector	MINI DIN Round-type 9-pin connector
Number of analog output channels	Analog 12 ch
Analog output format	Unbalanced output (grounded on one side) (GND terminal shared with GND of main instrument)
Analog output voltage	-5 to +5V
Analog output terminal	BNC connector
Output D/A resolution	16 bit
DC amplitude accuracy	$\pm 0.1\%$ f.s.
Temperature characteristic	$\pm 0.01\%$ f.s./ $^{\circ}\text{C}$ (typ.)
Output resistance	$100\Omega \pm 10\%$ (DC)
Analog output waveform	Staircase output (without smoothing filter)
Response speed	Within 1 ms When one ID (at output interval of 3 ms or more) is acquired and its ID assigned to all analog/logic channels, with the ID filter ON: the response speed is the length of time from CAN message reception to completion of all analog/logic outputs.
Backup	All backup setting data is stored in nonvolatile memory.
Operating environment	Max. 2000 m (6562 feet) height, indoors Pollution degree 2
Operating temperature/humidity range	-10 to 55°C (14 to 131°F), 30 to 80%RH (with no condensation)
Storage temperature/humidity range	-20 to 70°C (-4 to 158°F), 10 to 90%RH (with no condensation)

11.1 General Specifications

9418-15 AC ADAPTER Accessory

Operating temperature/humidity range	0 to 40°C (32 to 104°F), 20 to 80%RH (with no condensation)
Storage temperature/humidity range	-20 to 80°C (-4 to 176°F), 10 to 95%RH (with no condensation)
Power supply	<ol style="list-style-type: none"> 9418-15 AC ADAPTER (Accessory) (Output 12 VDC±5%) AC adapter rated power voltage: 100 to 240 VAC (Voltage fluctuations of ±10% from the rated supply voltage are taken into account.) AC adapter rated power frequency: 50/60 Hz 10 to 30 VDC (Voltage fluctuations of ±10% from the rated supply voltage are taken into account.) Supply from CAN input connector (10 to 30 VDC) (Voltage fluctuations of ±10% from the rated supply voltage are taken into account.)
Maximum rated power	10 VA
Power input terminal	Power supply jack (center: positive) (GND terminal shared with GND of main instrument) CAN input connector (2 channels) (GND terminal shared with GND of main instrument)
Dimensions	Approx. 180W × 50H × 100D mm (7.09W × 1.97 H × 3.94D") (excluding projections)
Mass	Approx. 940 g (33.2 oz.)
Effect of radiated radio-frequency electromagnetic field	±2% f.s. at 3 V/m
Effect of conductive radio-frequency electromagnetic field	±2% f.s. at 3 V
Standards applying	Safety: EN61010 EMC: EN61326 Class A EN61000-3-2 EN61000-3-3

Display section

Screen	LCD (with backlight)
LCD display resolution	20 characters × 2 lines, 5 × 8 dots/characters
LCD display language	English
LCD backlight	Auto OFF
Status display LEDs	4 LEDs (POWER, CAN, ONLINE, CAL)

Operation section

Operation switch	3 setting keys (ESC, SEL, ENT), non-locking pushbutton switches 1 CAL key (CAL), non-locking pushbutton switch ONLINE/OFFLINE selection slide switch Power switch (common for three power supply lines)
------------------	--

External interfaces

RS-232C	EIA RS-232C compliance (for condition setting)
RS input connector	D-sub 9 pin female connector (for straight cable)
Transmission speed	19200 bps fixed
Communication content	Communication of condition setting data with PC or MEMORY HiCORDER

11.2 Specifications of Functions

ONLINE mode	Communication between 8910 and external equipment (PC or Memory HiCorder) connected via RS-232C Keys on the 8910 are disabled.
OFFLINE mode	Stand-alone use of the 8910 <ol style="list-style-type: none"> CAN conversion mode CAN messages transmitted via the CAN bus are converted to analog/logic signals and output from specified channels. CAL mode When an analog channel is specified, the output alternates between 0% and 100% at intervals of about 100 ms. When a logic channel is specified, the output alternates between 0AH (1010B) and 0.5H (0101B) at intervals of about 100 ms. Setting mode The data to be output from analog/logic channels is selected from the 8910 registration list.
Settings	<ol style="list-style-type: none"> CAN definition data (1) CAN definition data setting 8910 setting data (2) CAN input port setting (3) 8910 registration list setting (4) Output channel list setting (5) D/A conversion format setting (analog channels only) (6) Bit position setting (logic channels only) (7) ID trigger setting (8) ID filter setting
Setting method	<ol style="list-style-type: none"> Settings entered by using "8910 CAN set program" on PC (Used for above (1), (2), (3), (7), (8) settings) Settings entered by using "8910 CAN set program" on PC, or Settings entered by using Memory HiCorder, or Settings entered by using the 8910 (Used for above (4), (5), (6) settings)
Setting data transfer	<ol style="list-style-type: none"> Transfer of setting data from PC to the 8910 via RS-232C (The PC cannot read setting data of the 8910.) Transfer of setting data from PC to Memory HiCorder (8841, 8842, 8826) via media (Setting data of the Memory HiCorder cannot be stored on media.) Transfer of setting data from HiCorder to the 8910 via RS-232C (The Memory HiCorder cannot read setting data of the 8910.)
Setting information confirmation	Displayed on PC, Memory HiCorder, and the 8910
Scaling	Supports only linear functions (by Memory HiCorder)
Trigger function	ID trigger (When the set ID is received, an "H" active pulse with a pulse width of 100 μ s is output from a specified logic channel.)
Filter function	ID filter (By screening out IDs other than the one assigned to the output channel, acquisition performance is improved.)

11.3 Specifications of 8910 CAN Set Program (PC Application)

General specifications

Type	CD-R, one disc (Japanese/English 2 files) (including the "CAN setting function")
System requirements	CPU: Pentium 133 MHz or higher RAM: 64 MB or more HDD: 5 MB of free space or more Supported OSs: Windows 95, Windows 98, Windows NT4.0 (SP3 or later), Windows ME, Windows 2000, Windows XP
Supported measuring equipment	8910 CAN ADAPTER

Functions

Settings	<ol style="list-style-type: none"> 1. CAN definition data <ol style="list-style-type: none"> (1) CAN definition data setting <ol style="list-style-type: none"> -1. Item no. (1 to 300) -2. CAN message ID (0 to 1ffffff H) -3. Start bit (0 to 63) -4. Data length (1 to 16) -5. Data pattern (U/L (Motorola), L/U (Motorola), L/U (Intel)) -6. Sign (Unsigned, 1-Signed, 2-Signed) -7. Signal name (up to 40 characters) -8. Label name (up to 16 characters) -9. Scaling unit (up to 8 characters) -10. Scaling value (selected from "bit rate/offset value" and "maximum value/minimum value") 2. 8910 setting data <ol style="list-style-type: none"> (2) CAN input port setting <ol style="list-style-type: none"> -1. Selection of input port no. (1, 2) (3) 8910 registration list setting <ol style="list-style-type: none"> -1. Selection of up to 50 items from CAN definition data (4) Output channel setting <ol style="list-style-type: none"> -1. Allocation of 8910 registration list to analog output channels (12 channels) -2. Allocation of 8910 registration list to logic output channels (24 bits) (5) D/A conversion format setting (analog channels only) <ol style="list-style-type: none"> -1. Selection of bipolar (output of -5 V to 5 V) or monopolar (output of 0 V to 5 V) (6) Bit position setting (logic channels only) (7) ID trigger setting <ol style="list-style-type: none"> -1. Selection of ON (pulse output based on ID trigger) or OFF (data output), input of specified ID, designation of logic output channel (8) ID filter setting (set individually for CAN input port 1 and CAN input 2) <ol style="list-style-type: none"> -1. STD (standard format, ID filter ON), EXT (extended format, ID filter ON), NON (mixed formats, ID filter OFF)
Number of setting items	<ol style="list-style-type: none"> 1. CAN definition data: up to 300 items per file 2. 8910 registration list: up to 50 items 3. Output channel: up to 12 analog channels and 24 logic channel bits

11.4 Specifications of CAN Setting Function (for Memory HiCorder)

Display function	<ol style="list-style-type: none"> CAN definition data list display (of all CAN definition data setting items) 8910 registration list display (item no., input port no., signal name, label name, unit, data length) Analog output list display (ON/OFF, channel no., signal name, label name, unit, D/A conversion format) Logic output list display (ON/OFF, channel no., signal name, label name, bit position, ID trigger setting)
Storage	<ol style="list-style-type: none"> CAN definition data (binary format, with extension "cdf") 8910 setting data (all settings except for CAN definition data) (binary format, with extension "cmu")
Communication function	<p>Transfer of setting data to the 8910 via RS-232C (8910 setting data cannot be read.)</p> <p>Transfer of setting data to Memory HiCorder via media (Memory HiCorder setting data cannot be stored on media.)</p>
Model compatible with communication control	8910 CAN ADAPTER, 1 instrument (effective only when the 8910 is in ONLINE mode)

11.4 Specifications of CAN Setting Function (for Memory HiCorder)

General specifications

Type	CD-R, one disc (including "8910 CAN set program")
Supported measuring equipment	8826, 8841, 8842 (9557 RS-232C CARD required)

Functions

Settings	<ol style="list-style-type: none"> Output channel setting <ol style="list-style-type: none"> Allocation of 8910 registration list to analog output channels (12 channels) Allocation of 8910 registration list to logic output channels (24 bits) D/A conversion format (analog channels only) <ol style="list-style-type: none"> Selection of bipolar (output of -5 V to 5V) or monopolar (output of 0 V to 5 V) Bit position setting (logic channels only) Memory HiCorder channel setting (analog channels, logic channels) <ol style="list-style-type: none"> Correlation between 8910 output channels and Memory HiCorder input channels
Display function	8910 setting data display
Storage	<p>8910 setting data x 6 blocks can be stored in internal backup memory of the Memory HiCorder.</p> <p>Simultaneous storage upon Memory HiCorder channel setting (Data cannot be stored on media.)</p>
Communication function	<p>Transfer of setting data to 8910 via RS-232C (8910 setting data can also be read.)</p> <p>Transfer of setting data from PC via media (Memory HiCorder setting data cannot be stored on media.)</p>
Automatic scaling function	Automatic calculation of Memory HiCorder scaling setting based on 8910 setting data

11.5 Accessories

- Instruction manual 1
- CD-R ("8910 CAN set program" software (Japanese/English 2 files) (for PC), CAN setting function (for Memory HiCorder)) 1
- RS-232C cable (D-sub 9-pin, male-female, straight cable) 1
- 9418-15 AC ADAPTER 1
- Power cord 1
- 9713-01 CAN CABLE (one end unprocessed) 1

11.6 Options

- 9713-01 CAN CABLE (one end unprocessed)
- 9713-02 CAN CABLE (For automotive connector)
(Since this part is made to order, check the specifications document and delivery date.)
- 9714-01 LOGIC CABLE (one end unprocessed)
- 9714-02 LOGIC CABLE (for Memory HiCorder)
- 9165 CONNECTION CORD (Metal BNC - Metal BNC)
- L9217 CONNECTION CORD (Metal BNC - Insulated BNC)
(Insulated BNC for Memory HiCorder)
- 9557 RS-232C CARD (for Memory HiCorder)

11.6.1 9713-01 CAN CABLE (one end unprocessed)

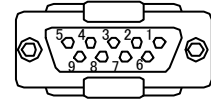
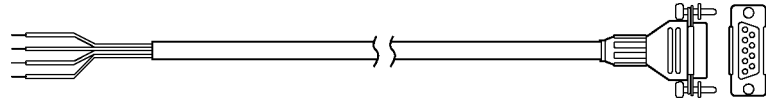

Female connector (9 holes)

Wire color	Pin no.	Name of signal received
-	1	NC
Green	2	CAN_L
Black	3	CAN_GND
-	4	NC
-	5	NC
-	6	NC
Red	7	CAN_H
-	8	NC
White	9	CAN_V+
-	Shielded	GND

Operating temperature/humidity range -10 to 55°C (14 to 131°F), 80%RH max. (with no condensation)

Storage temperature/humidity range -20 to 70°C (-4 to 158°F), 90%RH max. (with no condensation)

Rated voltage 60 VDC

Rated current 2 A

Dimensions Approx. 2000 mm (78.7")

Mass Approx. 110 g (3.5 oz.)

11.6.2 9713-02 CAN CABLE (For automotive connector)

Since this part is made to order, check the specifications document and delivery date.

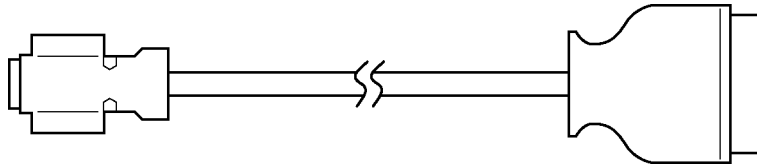

Operating temperature/humidity range -5 to 60°C (23 to 140°F), 90%RH max. (with no condensation)

Storage temperature/humidity range -20 to 80°C (-4 to 176°F), 90%RH max. (with no condensation)

Rated voltage 60 VDC

Rated current 2 A

Dimensions Approx. 2000 mm (78.7")

Mass Approx. 150 g (5.3 oz.)

11.6.3 9714-01 LOGIC CABLE (one end unprocessed)

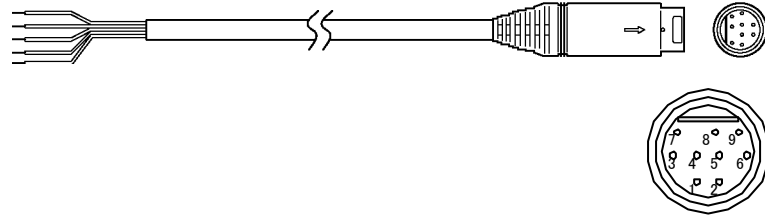

Male connector (9 pins)

Wire color	Pin no.	Name of signal received
Red	1	1 ch
Blue	2	2 ch
Yellow	3	3 ch
Purple	4	4 ch
-	5	NC
Green	6	GND
-	7	GND
-	8	GND
-	9	GND
-	Shielded	GND

Operating temperature/humidity range -10 to 55°C (14 to 131°F), 80%RH max. (with no condensation)

Storage temperature/humidity range -20 to 70°C (-4 to 158°F), 90%RH max. (with no condensation)

Rated voltage 12 VDC

Rated current 1 A

Dimensions Approx. 1500 mm (59.1")

Mass Approx. 60 g (2.1 oz.)

11.6.4 9714-02 LOGIC CABLE (for Memory HiCorder)

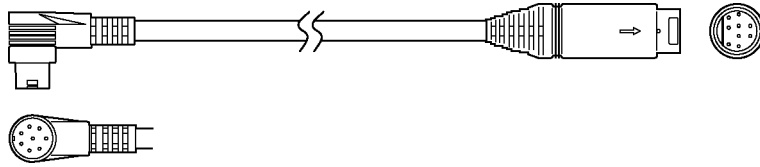

Operating temperature/humidity range -10 to 55°C (14 to 131°F), 80%RH max. (with no condensation)

Storage temperature/humidity range -20 to 70°C (-4 to 158°F), 90%RH max. (with no condensation)

Rated voltage 12 VDC

Rated current 1 A

Dimensions Approx. 1540 mm (60.6")

Mass Approx. 90 g (3.2 oz.)

11.7 Specifications of Connectors

CAN connector D-Sub 17LE23090-27 (manufactured by DDK Ltd.)

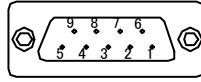

Male connector (9 pins)

No.	Name of signal	No.	Name of signal
1	NC	6	NC
2	CAN L	7	CAN H
3	CAN GND	8	NC
4	NC	9	CAN V+
5	NC	Shielded	GND

RS-232C connector D-Sub 17LE13090-27 (manufactured by DDK Ltd.)

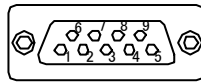

Female connector (9 holes)

No.	Name of signal	No.	Name of signal
1	NC	6	Shorted-circuited with signal No. 4
2	TXD	7	CTS
3	RXD	8	RTS
4	Shorted-circuited with signal No. 6	9	NC
5	GND	Shielded	GND

NOTE

RTS and DTR are set to HI level at the factory.

Logic connector TCS7913-43-201 (manufactured by Hosiden Corp.)

Female connector (9 holes)

No.	Name of signal	No.	Name of signal
1	1 CH	6	GND
2	2 CH	7	GND
3	3 CH	8	GND
4	4 CH	9	GND
5	NC	Shielded	GND

Analog connector BNC BNC-R-PC (manufactured by Hirose Electric Co., Ltd.)

Maintenance and Service

Chapter 12

12.1 Service and Cleaning

Service

- If damage is suspected, check the "Section 12.2 Troubleshooting" before contacting your dealer or Hioki representative.
- When sending the instrument for repair, pack the instrument so that it will not sustain damage during shipping, and include a description of existing damage. We cannot accept responsibility for damage incurred during shipping.

Cleaning

- To clean the instrument, wipe it gently with a soft cloth moistened with water or mild detergent. Never use solvents such as benzene, alcohol, acetone, ether, ketones, thinners or gasoline, as they can deform and discolor the case.
- Wipe the LCD gently with a soft, dry cloth.

12.2 Troubleshooting

If the instrument does not seem to operate normally, check the following points before requesting service.

Problem	Check
LED does not light when the instrument is turned on.	Is the AC adapter connected properly?
Keys on the main instrument are ineffective.	Confirm that the [ONLINE/OFFLINE] switch is set to the [ONLINE] side.
Cannot communicate with the PC.	<ul style="list-style-type: none"> • Check the RS cable for proper connection. • Check the communication settings on the PC. • Confirm that the [ONLINE/OFFLINE] switch is positioned to the [ONLINE] side.
Signal cannot be acquired from the CAN bus.	<ul style="list-style-type: none"> • Check the RS cable for proper connection. • Check the acquisition data settings. • Confirm that the output channel is assigned with acquisition data.

If you cannot determine the cause of a problem, reset the system. This returns all settings to the defaults (factory settings). After resetting the system, transfer the setting data from the PC again.

System reset

1. Hold down the [ESC], [SEL], and [ENT] keys simultaneously, then turn on the power switch.
2. The LCD on the main instrument indicates the following:



SYSTEM RESET
NO->ESC YES->ENT

3. Press the [ENT] key to initialize the settings and return the product to the default condition set at the factory.

Index

Numerics

8910 setting37, 42

A

AC adapter 16
 Accessories1, 128
 Ambient conditions15
 Analog output14, 75

B

Backlight124
 Baud rate12, 83
 Bipolar28, 76
 Bit position28
 Block no.99, 112

C

Calibration mode30
 CAN definition data37, 49
 Cleaning135
 Comment57, 102
 Communication83, 104
 Connection cord20
 Connection procedure18
 Connectors133
 Conversion mode23

D

D/A conversion format28, 76
 Data length53
 Data pattern55
 Detail display63
 Downloading72, 107, 120
 Duplicate bit86

E

Error60, 85

F

File62, 87, 107, 120

G

Grounding 8, 16

I

ID filter 81
 ID trigger 79
 Input ports 14
 Installation 38
 Interface 123

K

Key lock 14

L

Label name 27, 57
 Logic output 14, 77

M

Memo 66
 Memory HiCorder 95
 Message ID 53, 79
 Monopolar 28, 76

O

ONLINE/OFFLINE Switch 14
 Operation map 33
 Options 128
 Output terminals 14
 Output voltage level 23

P

Password 93
 Power Cord 20
 Power supply 16, 124
 Printing 89

R

Rated power frequency 124
 Rated power voltage 124
 Registration list 71
 RS-232C 83

S

Saving	62, 87
Scaling	58, 101, 113
Setting mode	24
Setting screen	96, 109
Sign	56
Signal name	57
Start position	54
System reset	136

V

Version	21, 94, 95
---------------	------------

Warranty Certificate

HIOKI

Model	Serial number	Warranty period One (1) year from date of purchase (___ / ___)
-------	---------------	---

Customer name: _____
Customer address: _____

Important

- Please retain this warranty certificate. Duplicates cannot be reissued.
- Complete the certificate with the model number, serial number, and date of purchase, along with your name and address. The personal information you provide on this form will only be used to provide repair service and information about Hioki products and services.

This document certifies that the product has been inspected and verified to conform to Hioki's standards. Please contact the place of purchase in the event of a malfunction and provide this document, in which case Hioki will repair or replace the product subject to the warranty terms described below.

Warranty terms

1. The product is guaranteed to operate properly during the warranty period (one [1] year from the date of purchase).
If the date of purchase is unknown, the warranty period is defined as one (1) year from the date (month and year) of manufacture (as indicated by the first four digits of the serial number in YYMM format).
2. If the product came with an AC adapter, the adapter is warranted for one (1) year from the date of purchase.
3. The accuracy of measured values and other data generated by the product is guaranteed as described in the product specifications.
4. In the event that the product or AC adapter malfunctions during its respective warranty period due to a defect of workmanship or materials, Hioki will repair or replace the product or AC adapter free of charge.
5. The following malfunctions and issues are not covered by the warranty and as such are not subject to free repair or replacement:
 - 1. Malfunctions or damage of consumables, parts with a defined service life, etc.
 - 2. Malfunctions or damage of connectors, cables, etc.
 - 3. Malfunctions or damage caused by shipment, dropping, relocation, etc., after purchase of the product
 - 4. Malfunctions or damage caused by inappropriate handling that violates information found in the instruction manual or on precautionary labeling on the product itself
 - 5. Malfunctions or damage caused by a failure to perform maintenance or inspections as required by law or recommended in the instruction manual
 - 6. Malfunctions or damage caused by fire, storms or flooding, earthquakes, lightning, power anomalies (involving voltage, frequency, etc.), war or unrest, contamination with radiation, or other acts of God
 - 7. Damage that is limited to the product's appearance (cosmetic blemishes, deformation of enclosure shape, fading of color, etc.)
 - 8. Other malfunctions or damage for which Hioki is not responsible
6. The warranty will be considered invalidated in the following circumstances, in which case Hioki will be unable to perform service such as repair or calibration:
 - 1. If the product has been repaired or modified by a company, entity, or individual other than Hioki
 - 2. If the product has been embedded in another piece of equipment for use in a special application (aerospace, nuclear power, medical use, vehicle control, etc.) without Hioki's having received prior notice
7. If you experience a loss caused by use of the product and Hioki determines that it is responsible for the underlying issue, Hioki will provide compensation in an amount not to exceed the purchase price, with the following exceptions:
 - 1. Secondary damage arising from damage to a measured device or component that was caused by use of the product
 - 2. Damage arising from measurement results provided by the product
 - 3. Damage to a device other than the product that was sustained when connecting the device to the product (including via network connections)
8. Hioki reserves the right to decline to perform repair, calibration, or other service for products for which a certain amount of time has passed since their manufacture, products whose parts have been discontinued, and products that cannot be repaired due to unforeseen circumstances.

HIOKI E.E. CORPORATION

<http://www.hioki.com>

18-07 EN-1

HIOKI

<http://www.hioki.com>



**Our regional
contact
information**

HEADQUARTERS

81 Koizumi
Ueda, Nagano 386-1192 Japan

HIOKI EUROPE GmbH

Rudolf-Diesel-Strasse 5
65760 Eschborn, Germany
hioki@hioki.eu

1808EN

Edited and published by HIOKI E.E. CORPORATION

Printed in Japan

- CE declarations of conformity can be downloaded from our website.
- Contents subject to change without notice.
- This document contains copyrighted content.
- It is prohibited to copy, reproduce, or modify the content of this document without permission.
- Company names, product names, etc. mentioned in this document are trademarks or registered trademarks of their respective companies.