

# HIOKI

---

---

Measurement Guide

## MR8847

# MEMORY HiCORDER

**Read first.**

Offers an introduction to the Memory HiCorder's basic measuring method for first time users.

**HIOKI E. E. CORPORATION**

May 2011 Edition 1 MR8847A983-00 11-05H

---



\*600360690\*



# Introduction

Thank you for purchasing the HIOKI "Model MR8847 Memory HiCorder."  
This Measurement Guide consists of some basic application examples. Before using the instrument, be sure to read the Instruction Manual carefully.

The following documents are provided with this instrument. Refer to them as appropriate for your application.

Document	Description
<b>1 Measurement Guide (This document)</b>	<b>Read first.</b> Offers an introduction to the Memory HiCorder's basic measuring method for first time users.
<b>2 Instruction Manual</b>	Contains explanation and instructions regarding the instrument's operating method and functions.

## Contents

Screen structure and operation overview	The following explains the screen structure and overview of the operation keys of the main instrument. (⇒ p.2)
Measurement Preparations	The following explains the things to be done before carrying out measurement. (⇒ p.4)
Measurement Procedure	The following explains the flow from pre-measurement check to analysis/saving/printing. (⇒ p.6)
Measure the commercial power supply	The following explains how to record waveforms of a commercial power supply of 100 V. (⇒ p.8) The following explains how to save the data.
Monitor abnormal occurrences	The following explains how to record a voltage dip caused by a special occurrence such as a black out. (⇒ p.10) Using the trigger function to carry out constant monitoring, only the abnormal occurrence can be recorded. The following explains the method to automatically save data.
Analyze	Waveform measurement value can be viewed or calculated using the A/B cursor. (⇒ p.12) The following explains how to display the measured waveform without overlapping.
Print	The following explains the printing method. (⇒ p.17)
Convenient functions	The following explains the auto range function, pre-trigger and probe compensation. (⇒ p.19)
Others	The following are explanations for the screen, time axis and sampling, record length setting, voltage axis and optical resolution, and file transfer speed. (⇒ p.21)

# Screen structure and operation overview

Screen structure In the sheet tab screen, the sheet can be changed by pressing the key.

**Waveform screen** DISP

Screen to view waveforms.

**File screen** FILE

Screen to view data files in the media (CF card, HDD, USB, internal memory).

**Settings window** Waveform screen can be displayed.

**Channel settings window** CH. SET

Window to set details for the Analog/Logic Channel.

**Trigger settings window** TRIG. SET

Window to set details for the trigger.

**Status screen** STATUS

Screen to set measurement methods, calculations for waveforms, and etc.

**System screen** SYSTEM

Screen to set environment, save file, set printing, set communication, and initialize data.

**Channel screen** CHAN

The screen to set the various Channel Scaling Comments.

### Operating Keys

**DISP** key  
Displays the Waveform screen.

**SYSTEM** key  
Displays the System screen.

**CH.SET** key  
Displays the channel settings window on the Waveform screen.

**TRIG.SET** key  
Displays the trigger settings window on the Waveform screen.

**F** key  
Select setting items

**ESC** key  
Cancels an operation.  
Removes the displayed dialog and window

**STOP** key  
Stops measurements  
1 press: Measurement stops after the set recording length  
2 presses: Immediate stop

**START** key  
Starts measurements  
The green LED at the upper is lit during measurement.

**STATUS** key  
Displays the Status screen.

**CHAN** key  
Displays the Channel screen.

**FILE** key  
Displays the File screen.

**ABCSR** key  
Displays the A/B cursor settings window.

**WAVE** key  
Assigns the Jog & Shuttle knobs to waveform scrolling.

Inner: **Jog**  
Outer: **Shuttle**  
Scrolls waveforms

**CURSOR** key  
Moves the cursor up, down, left and right on the screen.

**KEY LOCK:**  
Press and hold the right and left **CURSOR** keys for three seconds to disable key operations.  
To cancel key-lock, hold the keys again for three seconds.

**Manual trigger** key  
Issues a manual trigger event.

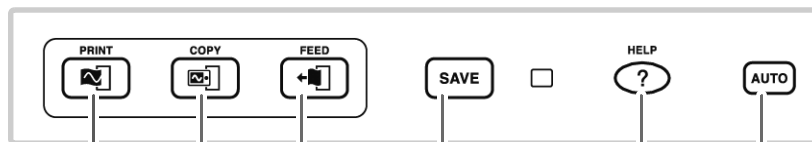

**PRINT** key  
Prints waveforms

**COPY** key  
Prints a hard copy of the display screen

**FEED** key  
Feeds paper

**SAVE** key  
Saves data to storage media.  
The LED to the right of the key lights up in blue.

**HELP** key  
Opens help information

**AUTO** key  
Starts auto-range measurement

#### To change the setting content

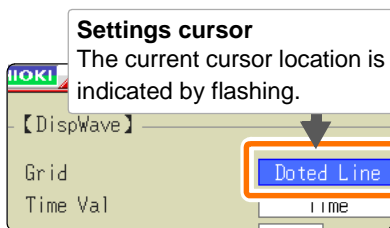

1 Move the setting cursor to the item.

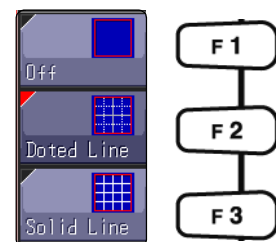
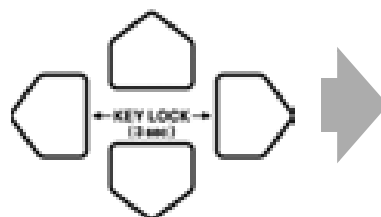

2 Select

# Measurement Preparations

## Install the instrument

**To prevent overheating, be sure to leave the specified clearances around the unit.**

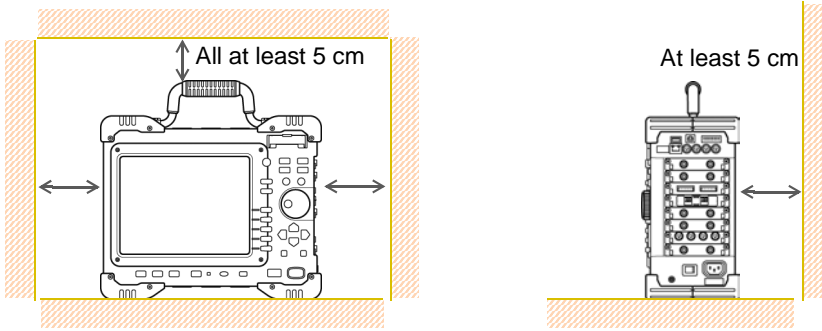

## Set the items necessary to the device

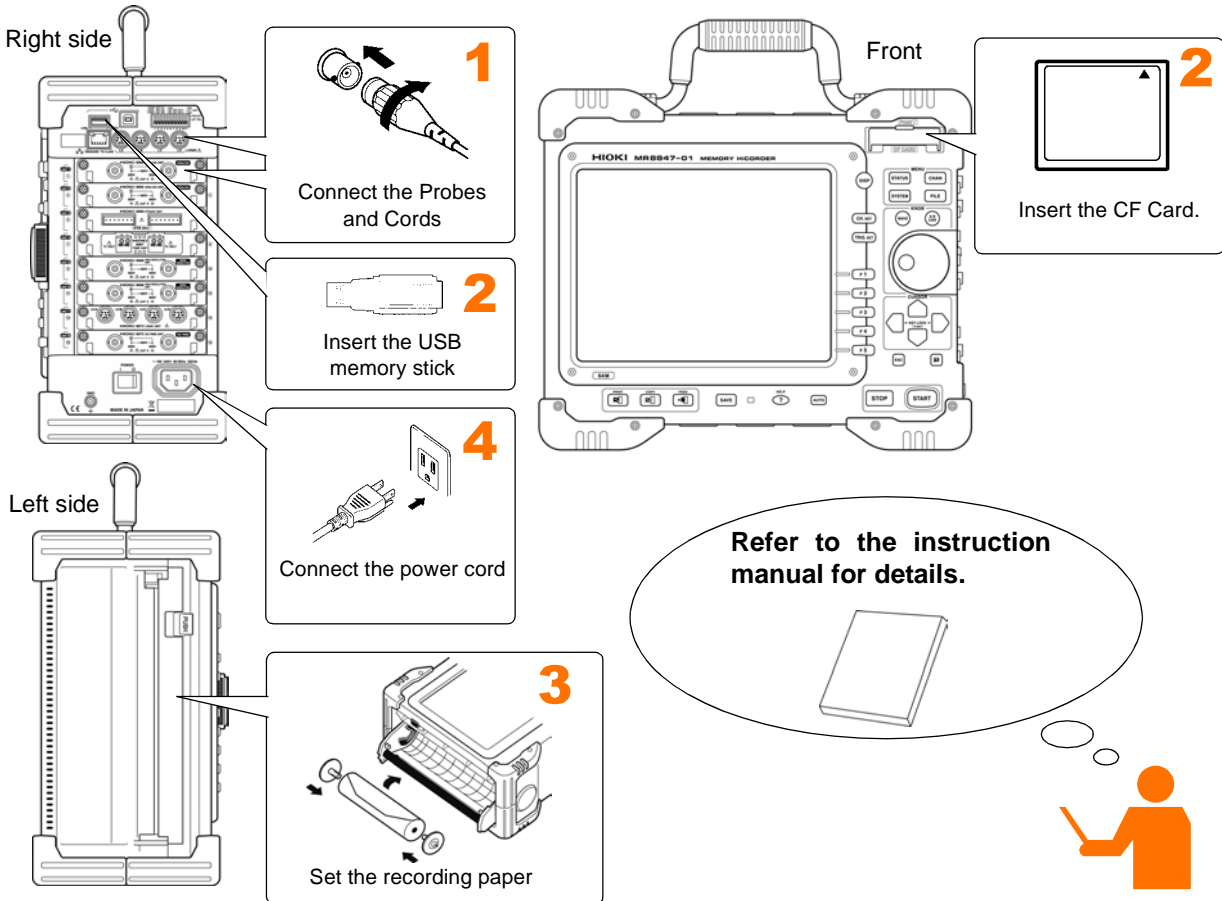

## Supply the power

Right Side

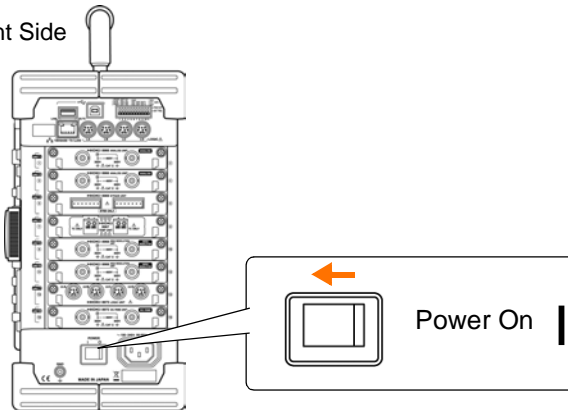

## Setting the clock

SYSTEM

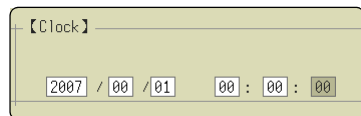

Carry out setting in the [Init] sheet.

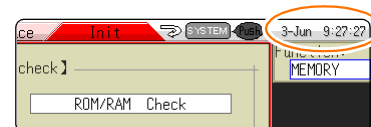

The date and time indication is shown at the top right of the screen.

## Perform zero-adjust

CHAN

This procedure compensates for input module differences and sets the reference potential of the instrument to 0 V.

Carry out setting in the [Unit List] sheet.

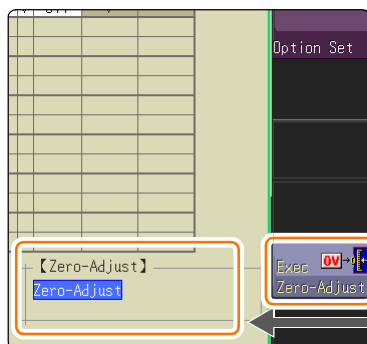

2. Select [Exec Zero-Adjust].

1. Move the cursor to this position.

For best measurement precision, a warm-up period of about 30 minutes after power-on is recommended.



Point

[Exec Zero-Adjust] can still be selected in the channel settings window ([Analog] sheet).

(Press the **DISP** key (Waveform screen) → press the **CH.SET** key (Channel settings window))

## Measurement Procedure

Before measuring, please read "Operating Precautions" in the instruction manual.

### Perform the inspection before measurement

Please read "Pre-Measurement Inspection" in the instruction manual.

### Connect to the measurement point

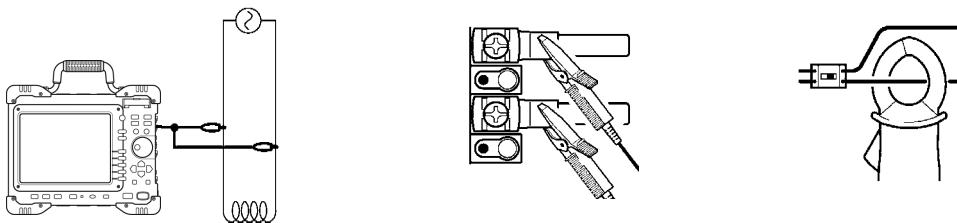

### Set the measurement conditions



Carry out setting in the Waveform screen.

- Measurement function
- Timebase
- Recording length ([Shot])



CH. SET

Carry out settings in the Channel settings window ([Analog] sheet).

- Vertical axis (Voltage axis) range

Carry out settings other than the above mentioned, when necessary.

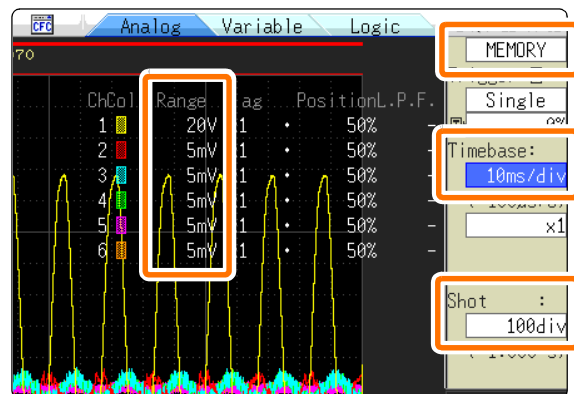

### Start or stop measurement



Start Measurement



STOP

Stop Measurement



Analyze, save and print

Analyze

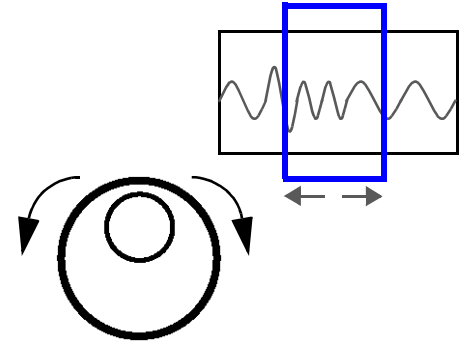
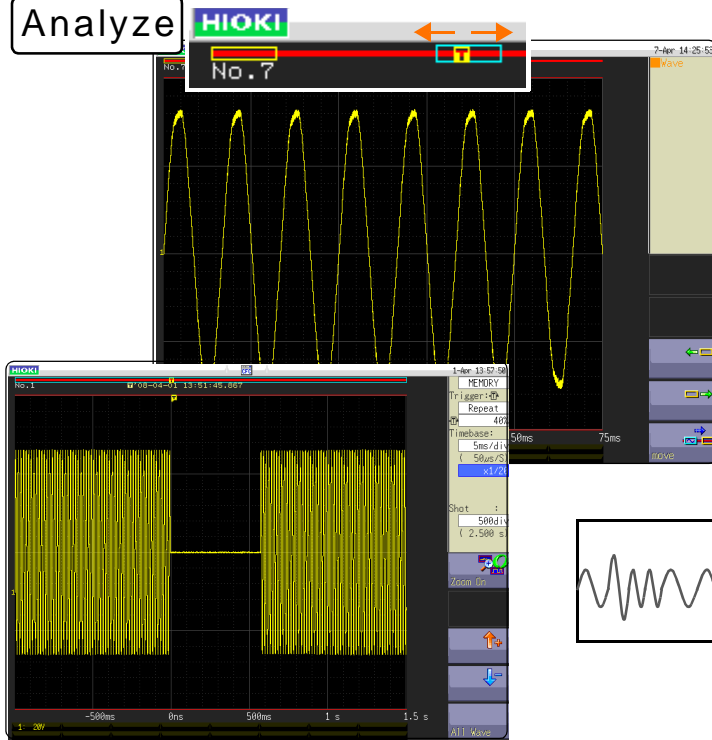

Scroll and view the waveform.

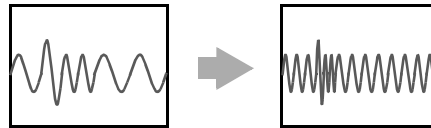

Waveform display can be changed.  
(You can zoom in or out)

Save

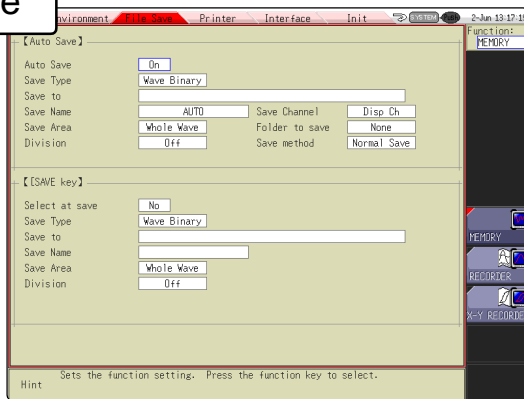

Save data.  
Data can be automatically saved under the pre-set saving conditions.

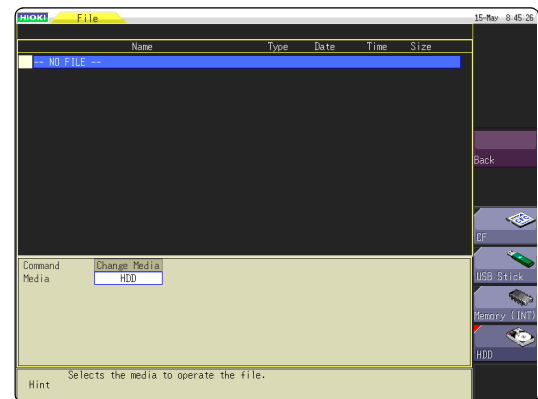

View saved data.  
Data can be loaded, and file can be deleted and copied.

Print



Print the recorded waveform.

# Measure the commercial power supply

The following explains the method of recording voltage waveform for a commercial power supply of AC 100 V (50/60 Hz).

The method of saving the data after measuring will also be explained.

Here the level trigger is used to measure.

To measure repetitive waveforms such as commercial power supply, setting the measurement start point as the standard level trigger level will make it easier to observe the waveforms.

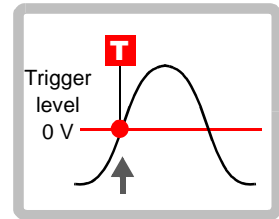

## 1 Prepare for measurement

### Required items:

- MR8847
- 8966 Analog Unit
- L9198 Connection Cord
- CF Card

"Measurement Preparations" (⇒ p.4)

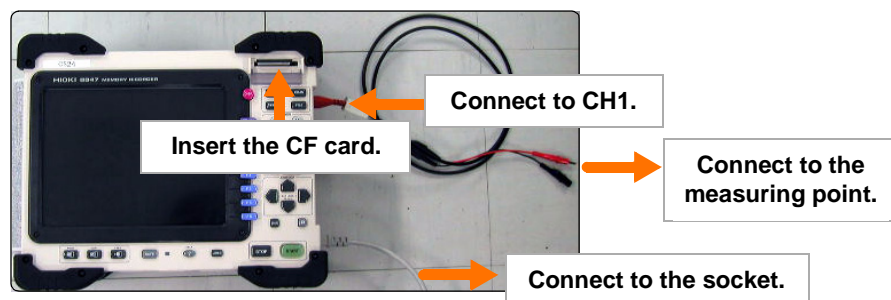

## 2 Set the measurement conditions and trigger conditions

Carry out the following setting on the Waveform screen.

Set the measurement conditions. (Channel settings window)

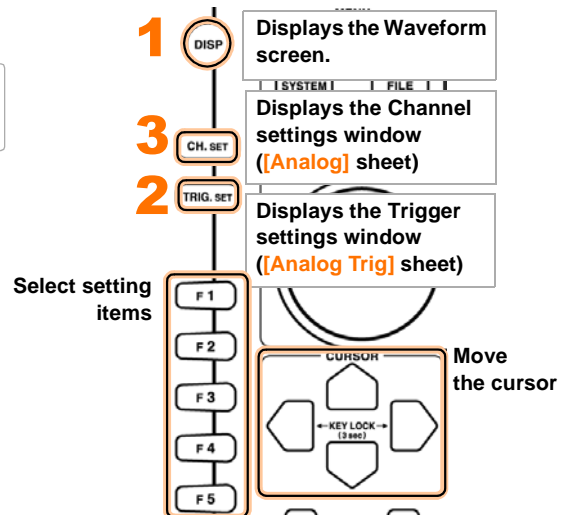
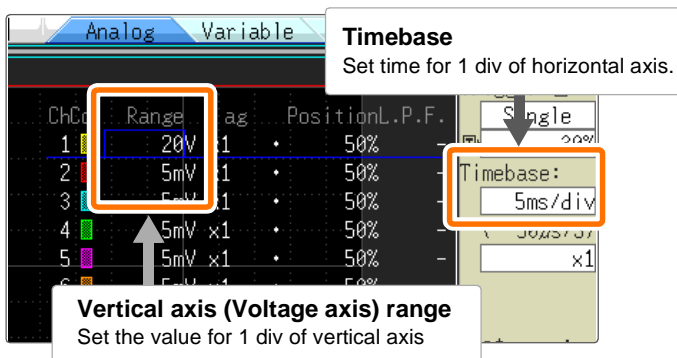

Setting for trigger conditions (Trigger settings window)

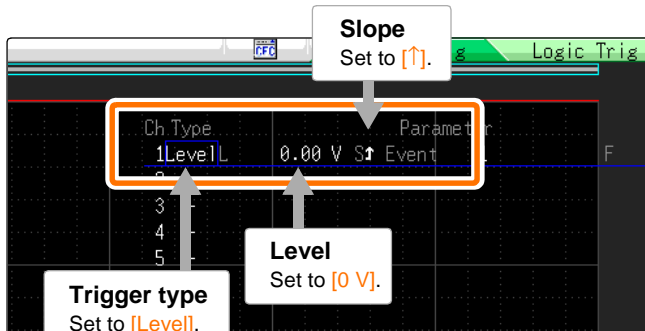

### Deciding on the horizontal axis (time axis) range

The horizontal axis (time axis) range is calculated from the frequency and cycle.

$$f \text{ [Hz]} = 1/t \text{ [s]} \text{ (f: frequency, t: cycle)}$$

Example: When the measurement frequency is 50 Hz. E.g. 1 cycle is  $t = 1/50 \text{ [s]}$ , i.e. 20 ms.

When the horizontal axis (time axis) is set to 20 ms/div, exactly 1 cycle will be displayed in 1 division (1 square).

### Vertical axis (Voltage axis) range

If you change the range during a measurement, the measurement will restart.

### 3 Set the saving conditions

The following explains the setting method to save immediately by pressing the **SAVE** key. Carry out the following setting using the File Save sheet on the System screen.

**Select at save (Selection Save)\***  
Set to [No].  
Pressing the **SAVE** key will allow saving under the saving conditions to be carried out immediately.

**Save conditions**

- Save Type: Wave Binary
- Save to: CF Card
- Save Name: TEST
- Save Area: Whole Wave

The setting will appear as shown on the left screen.

**Displays the File Save sheet.**

**Move the cursor**

**Select setting items**

\*: When [Yes] is set, pressing the **SAVE** key each time will allow users to select the saving conditions.



**Point**

To view the waveform on the instrument, set the [Save Type] to binary and to view the waveform on the computer, set it to text. Data saved as text cannot be viewed on the instrument.

### 4 Start to stop the measurement

[Trigger Wait]

Press the **START** key.

When the trigger conditions are met, the trigger is activated and the waveforms equivalent to the pre-set record length will be recorded.

Measurement data will be recorded until the **STOP** key is pressed.

### 5 Save data

Data will be saved under the pre-set saving conditions when the **SAVE** key is pressed.



**Point**

Saved data can be confirmed on the File screen when the **FILE** key is pressed. (⇒ p.16)

Refer to "Analyze"(⇒ p.12) for the analyzing method.

# Monitor abnormal occurrences

The following explains the recording method in the case of a drop in voltage brought about by a black out, etc.

Keep monitoring and save the measurement data automatically.

In this section, a voltage dip trigger is used to measure. The following explains how to activate the trigger when an input signal from a 50 Hz commercial power falls from approximately 100 Vrms (141.4 Vpeak) to below 90 Vrms (127.2 Vpeak).

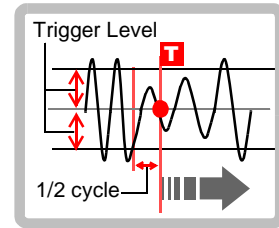

## 1 Prepare for measurement

Required items:

- MR8847
- 8966 Analog Unit
- L9198 Connection Cord
- CF Card

"Measurement Preparations" (⇒ p.4)

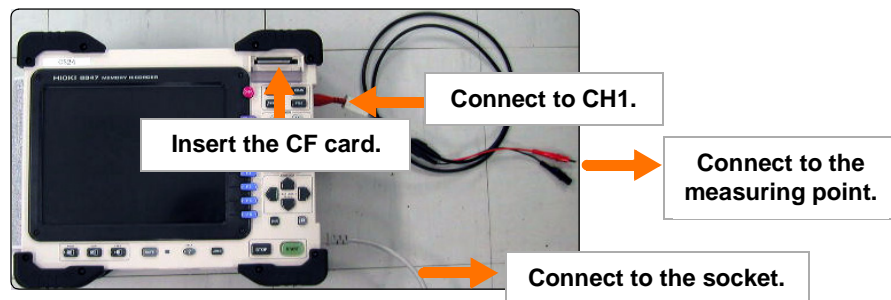

## 2 Set the measurement conditions and trigger conditions

Carry out the following setting on the Waveform screen.

Set the measurement conditions. (Channel settings window)

The screenshot shows the 'Channel settings window' with the following annotations:
 

- Timebase:** Set time for 1 div of horizontal axis. The value is set to 5ms/div.
- Vertical axis (Voltage axis) range:** Set the value for 1 div of vertical axis. The value is set to 20V.

The diagram shows the front panel controls with the following steps:
 

- 1 DISP:** Displays the Waveform screen.
- 2 TRIG. SET:** Displays the Trigger settings window (Analog Trig sheet).
- 3 CH. SET:** Displays the Channel settings window (Analog sheet).

 A 'CURSOR' control is also shown with the instruction 'Move the cursor'.

Setting for trigger conditions (Trigger settings window)

The screenshot shows the 'Trigger settings window' with the following annotations:
 

- Trigger Type:** Set to [Drop].
- Level:** Set to [127 V].
- Frequency:** Set the frequency. The value is 50Hz.
- Pre-Trigger:** Set the %. The value is 40%.
- Trigger:** Set to [Repeat].

The diagram shows a waveform with a red vertical line 'T' indicating the trigger point. The recording length is 25 DIV. The pre-trigger is 40% and the recording length is 60%.

Set the pre-trigger to record waveforms that exist before any abnormal occurrence, such as a spontaneous black out. The pre-trigger sets where the trigger location (trigger point) is located on the record length.

E.g. To record 10 DIV worth of waveform that exist before a spontaneous black out and which corresponds to a record length of 25 DIV, set the pre-trigger to 40%. Calculation method:  $10 [DIV] / 25 [DIV] \times 100\%$

See: "What is a pre-trigger?" (⇒ p.20)

### 3 Set automatic saving

Carry out the following setting using the file saving sheet on the System screen.

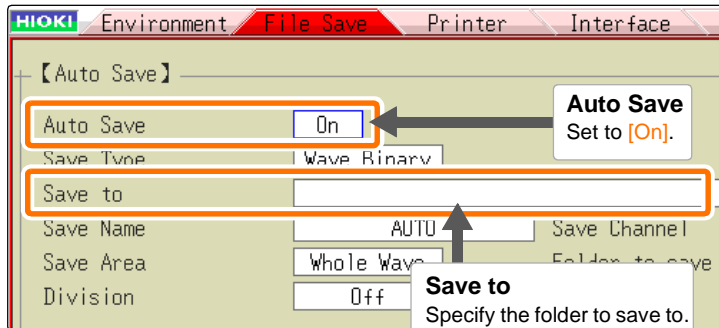

**Savable media is HDD and CF Card only.**

**When saving to the CF Card, please ensure that there is enough capacity and the card is properly inserted.**

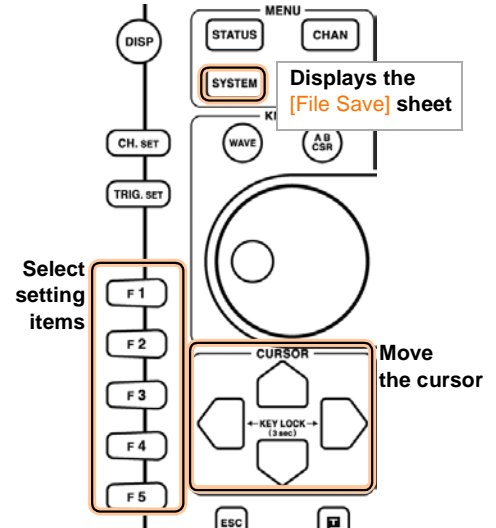

### 4 Start and Stop Measurement

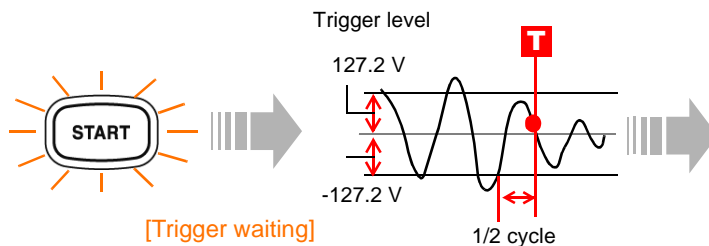

Press the **START** key.

[Trigger waiting] will be displayed until the commercial power voltage satisfies the trigger conditions (in this case, until a spontaneous blackout occurs). When the trigger conditions are met, the trigger is activated and measurement will start.

Data will be saved automatically to the CF card and wait the next spontaneous blackout after finish the measurement.

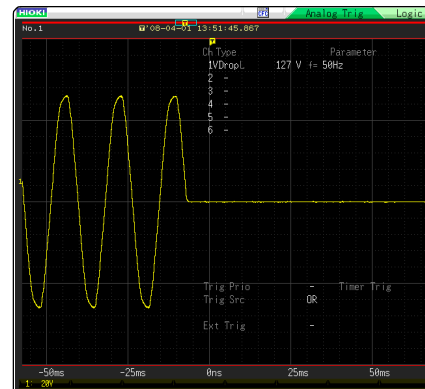

Measurement data will be recorded until the **STOP** key is pressed.

Refer to "Analyze" (⇒ p.12) for analysis methods.

### Analyze

#### Confirm the measurement waveform

##### Scroll the waveform

The location of the waveform on display can be confirmed with the scroll bar. The time (🇩🇪) below shows when the trigger is activated.

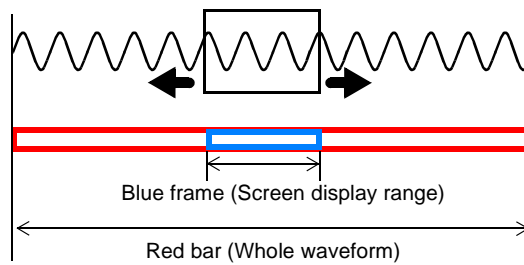
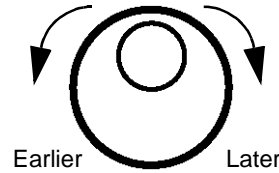
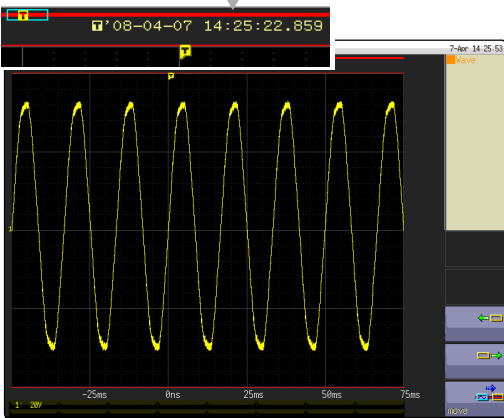

##### Expand or compress the waveform

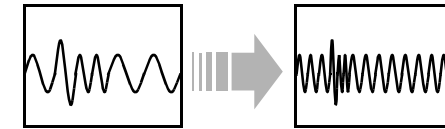
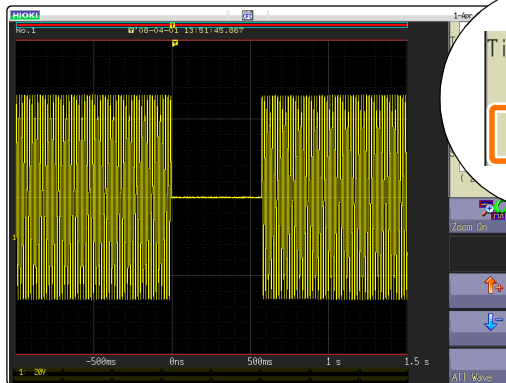

Change the magnification.

When A/B cursor appears on the screen, use the cursor as the standard to expand or compress.

##### Zoom and view the waveform

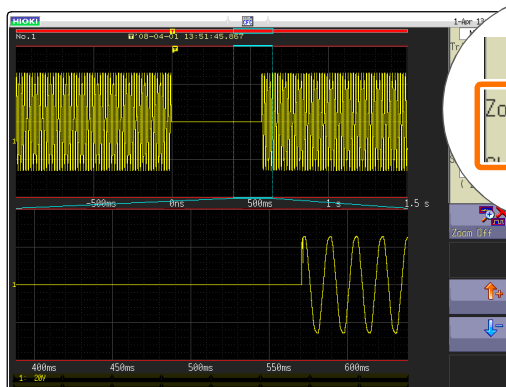

First, move the cursor to the magnification, and select **[Zoom On]**.

Next, move the cursor to the **[Zoom Mag]** item, and set the magnification.

The screen is divided vertically into two.

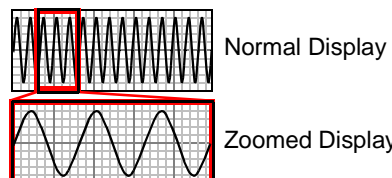

# Read measurement value

## 1. Set the AB cursor.

Carry out the following setting by displaying the waveform screen and using the AB cursor setting window

**AB cursors**  
Set to [Trace].

**Kind**  
Set to [a-B].

**Subject Ch**  
Set to [ALL].

When trace is set, time value and measurement value can be seen.

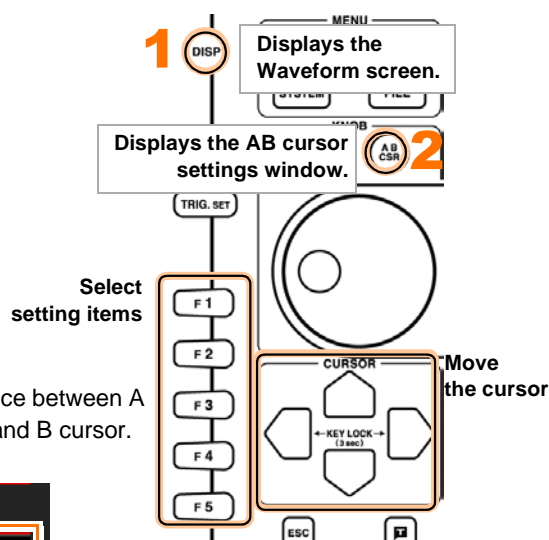

t	-933.40ms	-914.10ms	19.30ms
1	-54.8 V	73.0 V	127.8 V

Change the type of AB cursor to display only the time or measurement values.  
Change the AB cursor type.  
[V Csr]: Time value and Frequency  
[H Csr]: Measurement value

## 2. Move the AB cursor to the point you wish to see.

Move the cursor to the point of the measurement value on the waveform you wish to see with the jog shuttle.

B cursor moves.

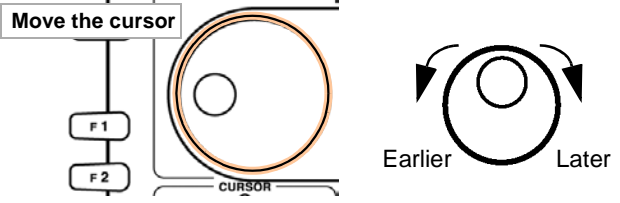

**Change the moving cursor**  
Change moving target ([Kind]) to change the moving cursor.

- [A] : Use and move A cursor only.
- [A-b] : Use the AB cursor to move A only.
- [a-B] : Use the AB cursor to move B only.
- [A&B] : Move both sides simultaneously.

Factory default is set to [A].

### Display the waveforms without overlapping

When measurements on multi phenomenon are carried out, the waveforms may overlap and become difficult to see.

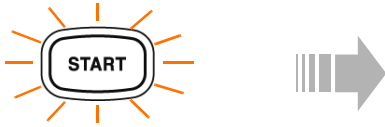

The **START** key is pressed and measurement has started but the waveforms overlap and cannot be seen clearly.

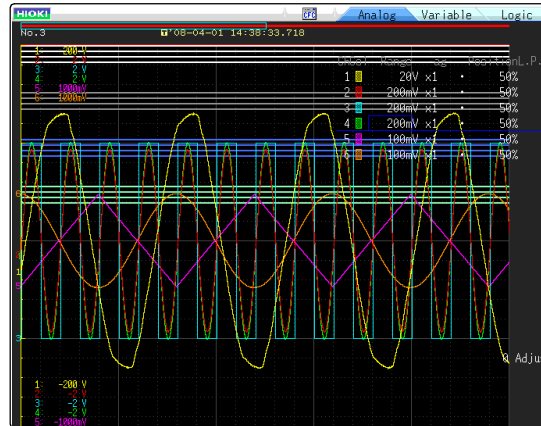

When this happens, change the location of the display, or the width of the vertical axis on display to show the waveforms more clearly.

Carry out the following settings by displaying the channel setting window in the waveform screen.

**Magnification**  
Waveform can be expanded or compressed in the direction of the vertical axis.

**Zero position**  
Location of the waveform can be moved up or down.

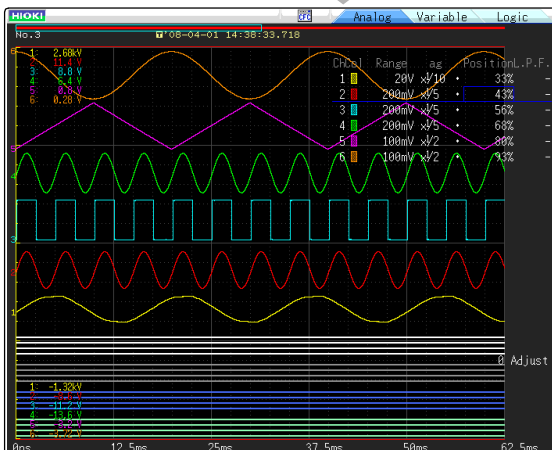
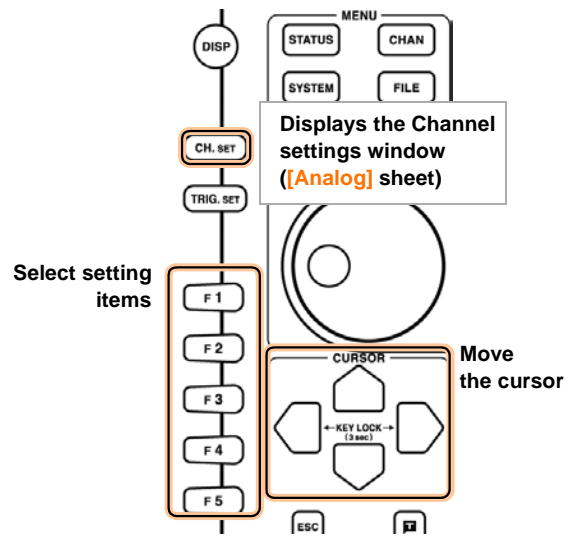

- Can be changed even during measurement.
- Location of logic waveform can also be changed voluntarily. ([Logic] sheet)

**Caution:**  
When direct current components are loaded on the waveform, the waveform appears to fluctuate when the magnification is changed. This is because magnification applied to the direct current component as well.



## Calculate the measurement data

Up to 16 can be calculated at once.

Calculation items: average value, execution value, peak value, maximum value, minimum value, cycle, frequency, etc. The calculation method on the measurement data for all the 20 items will be explained here.

Carry out the following setting using the calculation sheet on the status screen.

No.	Type	Channel	Parameter	Judge
No. 1	Rms	Ch1		Off
No. 2	Peak-Peak	Ch1		Off
No. 3	Maximum	Ch1		Off
No. 4	Minimum	Ch1		Off
No. 5	Period	Ch1	L: 0.0000 F: - S: ↑	Off
No. 6	Off			
No. 7	Off			
No. 8	Off			

Once measurement is completed, calculation automatically starts. The calculation result will be displayed on the top right side of the waveform screen.

In consecutive trigger mode, next measurement will take place after calculation has been executed.

When setting window, etc. is displayed in the waveform screen, pressing the **ESC** key will display the calculation results.

### Viewing Media

Data saved in the main instrument can be confirmed in the file screen.

The first screenshot shows the 'File' screen with a 'Media Change' button highlighted by a red box and the number '2'. A hint at the bottom says: 'First, press the media select function key (CH. SET) to select the media to operate. Then, carry out the save or read commands.'

The second screenshot shows the 'Change Media' dialog box with 'USB Stick' highlighted by a red box and the number '3'. A hint at the bottom says: 'Selects the media to operate the file.'

The third screenshot shows a list of files and folders on a CF card. A red box highlights the 'Media Change' button. A hint at the bottom says: 'For details on the file operating commands, please press HELP to confirm. To operate other media, press the media change key.'

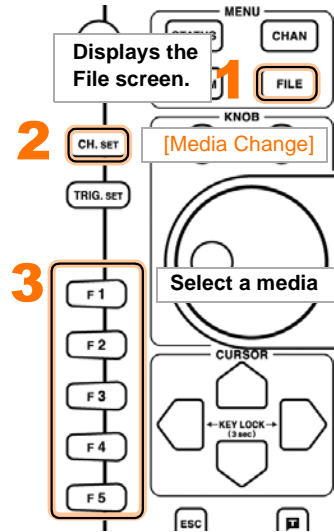

Save the files in the **[HIOKI8847]** folder.

#### Setting data

Multiple data can be saved in the instrument, and loaded selectively. When saved in the CF card **[HIOKI8847]** folder, loading automatically starts when the power is supplied.

#### Waveform data

- To load data in the main instrument, save as "Binary Format".
- To load data in the computer, save as "Text Format".

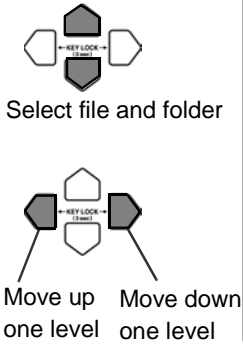

### Data the instrument can save & load

File type	File format	File extension & Description			File type	File format	File extension & Description		
Settings data*	Binary	<b>SET</b>	S, L	Settings data (Measurement Configuration)	Waveform management data (Memory Division / Divided Saving)	(Index file)	<b>IDX</b>	S, L	Index data for divided saving
Waveform data	Binary	<b>MEM</b>	S, L	Memory Function waveform data			<b>SEQ</b>	S, L	Index data for memory division (automatically created during batch saving)
		<b>REC</b>	S, L	Recorder Function waveform data	Display/Waveform screens*	BMP	<b>BMP</b>	S	Image data
		<b>XYC</b>	S, L	X-Y Recorder Function waveform data	Numerical calculation results	Text	<b>CSV</b>	S	Text data
		<b>FFT</b>	S, L	FFT Function data	Comment for printing	Text	<b>TXT</b>	L	Text data
	Text	<b>CSV</b>	S	Text data	Waveform evaluation setting data	Binary	<b>ARE</b>	S, L	Waveform evaluation areas Settings data
				Waveform evaluation area	BMP	<b>BMP</b>	S, L	Image data	

(S: Savable, L: Loadable) However, setting data will not be saved automatically (only manually)

# Print

Print the measurement results.

## 1. Print settings

Print according to conditions set in the system screen printer sheet.

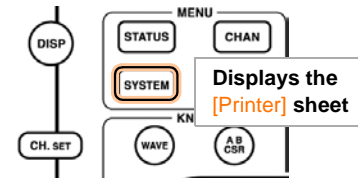
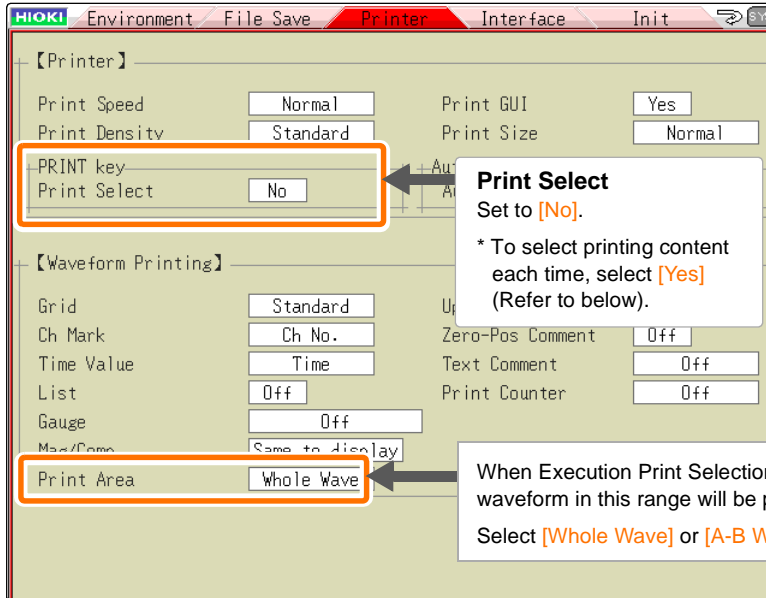

Use this sheet to set other detailed settings related to the printer, such as ink density.  
Setting does not have to be carried out every time.

**Print Select**  
 Set to [No].  
 \* To select printing content each time, select [Yes] (Refer to below).

When Execution Print Selection is set to [No], waveform in this range will be printed.  
 Select [Whole Wave] or [A-B Wave].

## 2. Print

Pressing the **PRINT** key in the waveform screen will print the waveform immediately.

Press the **STOP** key to terminate the printing job.

\*In the case of [Print Select] is set to [Yes]  
 Press the **PRINT** key to display printing content selection GUI.

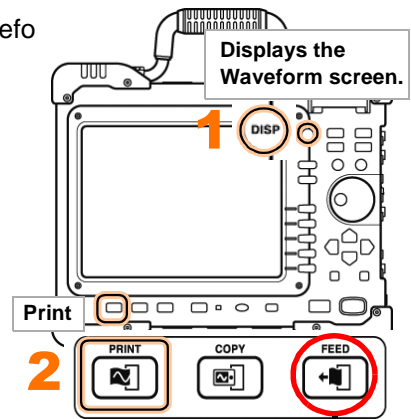

**FEED** key  
 Send paper. Use this to terminate the printing job or to increase the space between printing jobs.

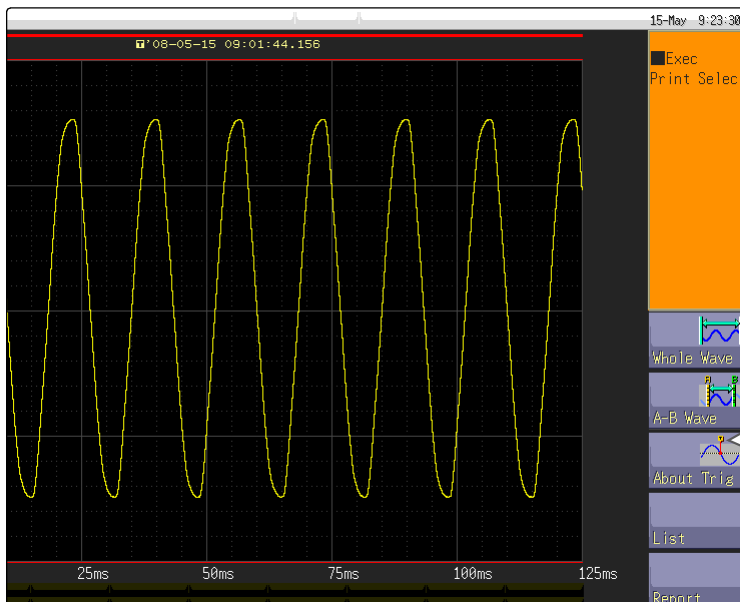

- Select printing content.
- Whole Wave** : Print the whole waveform data range.
  - A-B Wave** : Print the range specified by the AB cursor (AB cursor will not be printed).
  - About Trig** : Print 10 DIV worth of waveform data from both sides of the trigger position.
  - List** : Print major setting items.
  - Report** : Print the report.
- Factory default is set to [Whole Wave].

## Hard copy

When the **COPY** key is pressed, the screen can be printed. The display screen will be printed as it is.

Printing of waveform display only is also possible.  
Use the **SYSTEM** key to display and set the printer sheet.

Print GUI	Yes	<b>Print GUI</b> Set to [No].
Print Size	Normal	

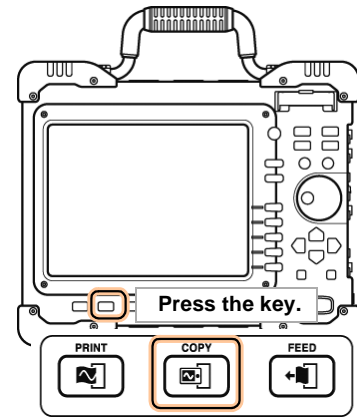

## Report printing

Function to print the waveform appearing on the screen not as hard copy, but as waveform printing together with setting information.

In the waveform screen, press the **FEED** and **COPY** keys simultaneously.  
(Press the **FEED** key slightly faster).

Printing example

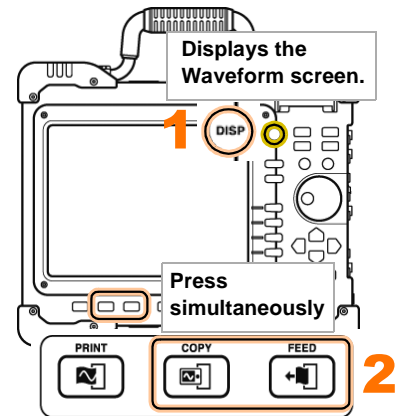
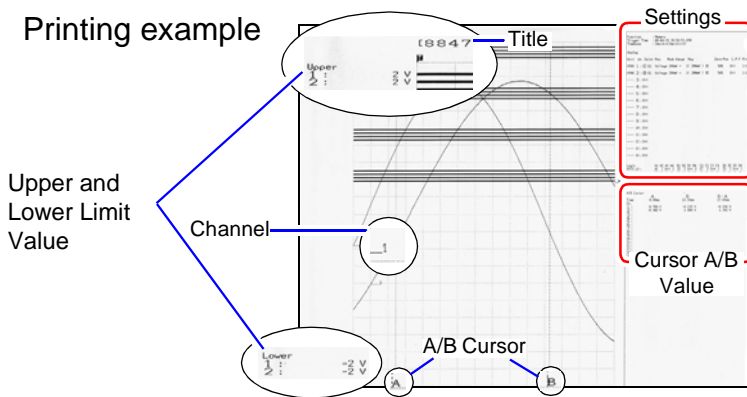

## A4 size printing

When the waveform display width is changed, A4 size printing is possible, with a similar operation as report printing.

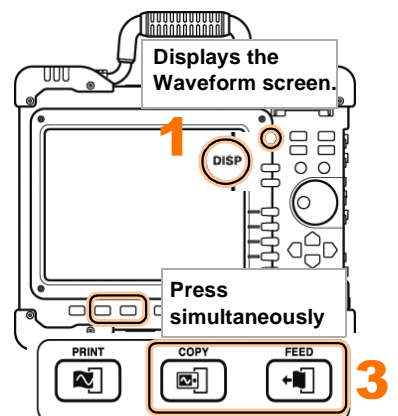
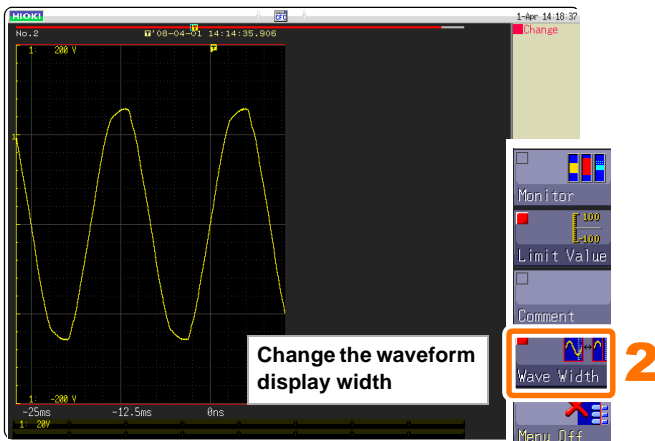

## Convenient functions

In this section, introducing the convenient functions.

### Auto range function

Start the measurement by pressing the **AUTO** key to automatically set the time axis range, voltage axis range, and zero position.

#### 1. Prepare for measurement

##### Required items:

- MR8847
- 8966 Analog Unit
- L9198 Connection Cord
- CF Card

"Measurement Preparations" (⇒ p.4)

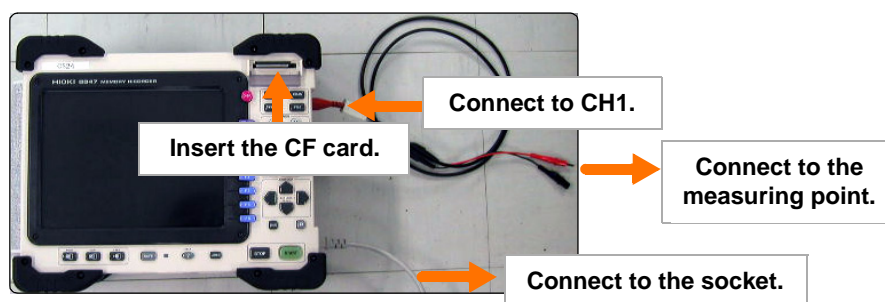

#### 2. Measure with the auto range

Pressing the **AUTO** key, and then **F1** key will automatically start the measurement.

E.g. Using the auto range function and a supply of 100 V 60 Hz of commercial power supply to the Analog unit.

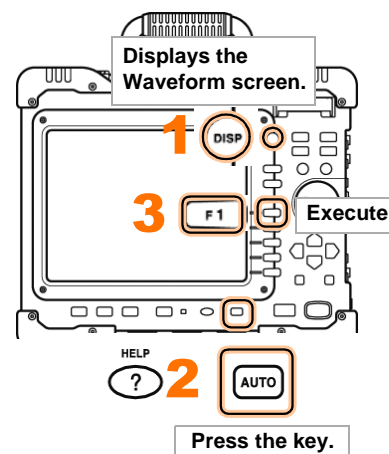
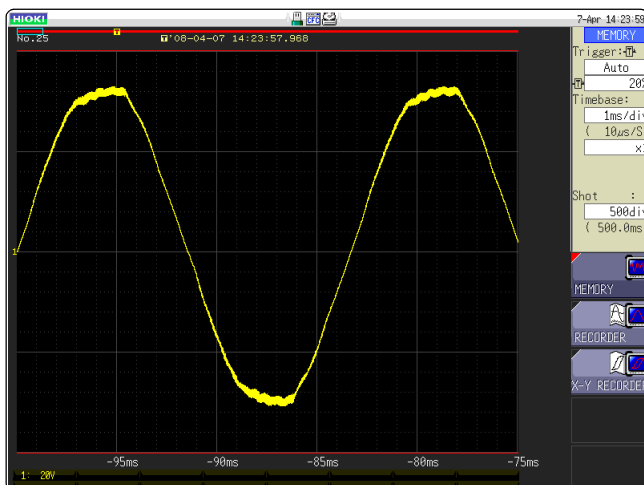

# What is a pre-trigger?

It is a function which allows waveforms before the trigger point to be recorded.

**Merit** Useful to detect signs before abnormal occurrences happen because parts before the trigger point are recorded.

**If the pre-trigger is not used...** If the pre-trigger is not used, only the parts after the trigger point are recorded. User will be able to see the abnormal occurrence but will not be able to detect any signs before that.

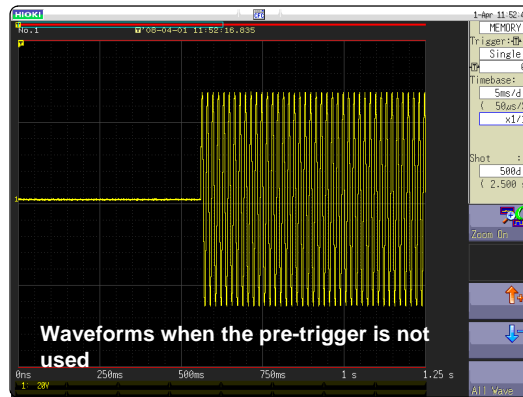

**Using the pre-trigger allows the user to observe the part before the abnormal occurrence.** When the pre-trigger is used, the parts before the trigger point are recorded, allowing the user to detect signs before the abnormal occurrences happen.

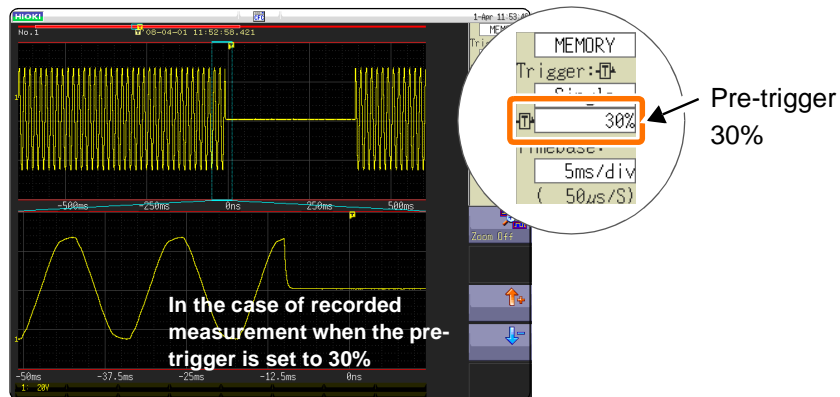

Signs are very likely to be present before any abnormal occurrence or distortion happens.

Using the pre-trigger of the Memory HiCorder, users can observe the parts before any abnormal occurrences, and find out the reason why accidents and production faults happen during which type of waveforms.

The trigger function is recommended to prevent accidents and faults and losses due to such occurrences.

## Probe Compensation

Probe compensation can be carried out by using 9665 10:1 Probe and 9666 100:1 Probe.

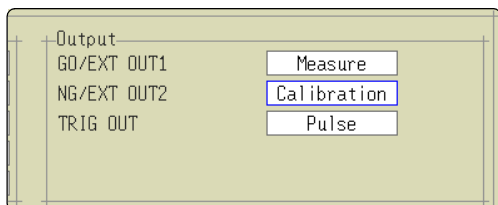

A 1 kHz 5 V square wave is outputted from an external output terminal (NG/EXT.OUT2 Terminal). Probe compensation can be carried out by using this signal.

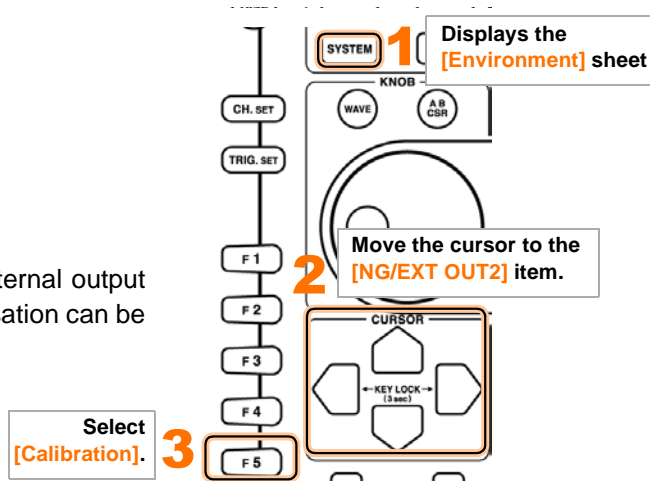

## Others

### About the Screen

The instrument's LCD provides SVGA (800 × 600) resolution. The waveform display area consists of 625 horizontal dots and 500 vertical dots. The waveform display area is divided into 25 divisions horizontally, and 20 divisions vertically, with each division composed of 25 dots horizontally and vertically.

Each data frame (one division) represents 100 samples horizontally, and 80 to 1600 data bits vertically. (depending on the input module)

Each displayed data frame (one division) changes in accordance with expansion and compression of the time and voltage axes.

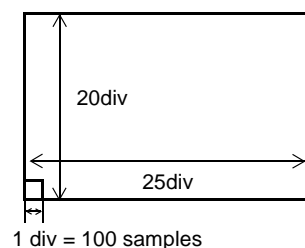

### Timebase and Sampling

#### For the Memory Function (Sampling point recording):

The sampling period is  $1/100^{\text{th}}$  of the timebase. When the timebase is set to 100 ms/div, the sampling period is 1 ms. Changing the timebase setting also changes the sampling period accordingly.

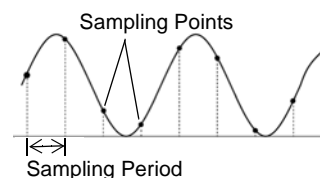

#### For the Recorder Function (Envelope recording):

One data point is recorded every  $1/100^{\text{th}}$  of the timebase as two amplitude values: the maximum and minimum values measured during the specified sampling period.

With the 10 ms/div timebase, one data point is recorded every 100 ms. When the sampling period is set to 1 ms, 100 samples are provided in order to record each data point. The values recorded for each data point are maximum and minimum values among these 100 samples.

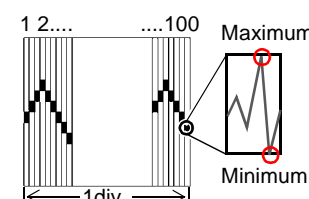

## Recording Length Setting

Set the length (number of divisions) to record each time data is acquired. Each division of the recording length consists of 100 data points. The number of data points of the whole recording length is the specified recording length (divisions)  $\times$  100, + 1.

Example. The number of data points when the specified recording length is 50 divisions:

$50 \text{ div} \times 100 \text{ data points} + 1 = 5001 \text{ data points}$

## Voltage axis and optical resolution

Optical resolution differs with different input units.

The following table shows the full scale optical resolution for all the units.

The smallest optical resolution can be calculated from the screen full scale value and the full scale optical resolution shown in the table below.

E.g. In the case of measurement with the 8966 Analog unit

The smallest optical resolution when the power voltage with vertical axis 20V/div and vertical axis magnification  $\times$  1 is measured is

Screen full scale:  $20 \text{ V/div} \times 20 \text{ div} = 400 \text{ V}$

Full scale optical resolution at vertical axis  $\times$  1: 2000

$400 \text{ V} / 2000 = 0.2 \text{ V}$

Full-scale resolution for input units at various vertical axis zoom factors (LSB)

Input module	Zoom factor									
	$\times 1/10$	$\times 1/5$	$\times 1/2$	$\times 1$	$\times 2$	$\times 5$	$\times 10$	$\times 20$	$\times 50$	$\times 100$
8966 (Analog) 8971 (Current) 8972 (DC/RMS)	20000 (4000)	10000 (4000)	4000	2000	1000	400	200	100	40	20
8967 (Temperature)*	200000	100000	40000	20000	10000	4000	2000	1000	400	200
8968 (High resolution)	320000 (64000)	160000 (64000)	64000	32000	16000	6400	3200	1600	640	320
8969 (Strain)	250000 (64000)	125000 (64000)	50000	25000	12500	5000	2500	1250	500	250
8970 (Power frequency)	20000	10000	4000	2000	1000	400	200	100	40	20
8970 (Count)	400000	200000	80000	40000	20000	8000	4000	2000	800	400
8970 (Excluding power frequency and count)	100000	50000	20000	10000	5000	2000	1000	500	200	100

Brackets indicate valid data range

\*: With the 8967 Temp Unit, the valid range differs depending on the thermocouple. For information on the minimum resolution, see the specifications of the 8967 Temp Unit.

## Data Saving Speed

The following shows the speeds of saving binary data (reference values) using different media and interfaces. Note that the data saving speed varies depending on the saving conditions, device manufacturer, device capacity, communication conditions, and others.

Storage media	Saving speed (reference value)
Save to CF card	500kB/s
Save to HDD	800kB/s
Save to USB	500kB/s
Save to PC with LAN	500kB/s



MEMO

MEMO



# HIOKI

---

HIOKI E. E. CORPORATION

## Headquarters

81 Koizumi, Ueda, Nagano 386-1192, Japan  
TEL +81-268-28-0562 FAX +81-268-28-0568  
E-mail: os-com@hioki.co.jp URL <http://www.hioki.com/>  
(International Sales and Marketing Department)

## HIOKI USA CORPORATION

6 Corporate Drive, Cranbury, NJ 08512, USA  
TEL +1-609-409-9109 FAX +1-609-409-9108  
E-mail: hioki@hiokiusa.com URL <http://www.hiokiusa.com>

## HIOKI (Shanghai) Sales & Trading Co., Ltd.

1608-1610, Shanghai Times Square Office  
93 Huaihai Zhong Road  
Shanghai, P.R.China POSTCODE: 200021  
TEL +86-21-63910090 / 63910092 FAX +86-21-63910360  
E-mail: info@hioki.com.cn URL <http://www.hioki.cn>

### Beijing Representative Office:

TEL +86-10-84418761 / 84418762 FAX +86-10-84418763  
E-mail: info-bj@hioki.com.cn

### Guangzhou Representative Office:

TEL +86-20-38392673 / 38392676 FAX +86-20-38392679  
E-mail: info-gz@hioki.com.cn

## HIOKI INDIA PRIVATE LIMITED

Khandela House, 24 Gulmohar Colony  
Indore 452 018 (M.P.), India  
TEL +91-731-4223901 / 4223902 FAX +91-731-4223903  
E-mail: info@hioki.in URL <http://www.hioki.in>

## HIOKI SINGAPORE PTE. LTD.

33 Ubi Avenue 3, #03-02 Vertex Singapore 408868  
TEL +65-6634-7677 FAX +65-6634-7477  
E-mail: info@hioki.com.sg

1104

---

Edited and published by Hioki E.E. Corporation  
Technical Support Section

- All reasonable care has been taken in the production of this manual, but if you find any points which are unclear or in error, please contact your supplier or the International Sales and Marketing Department at Hioki headquarters.
- In the interests of product development, the contents of this manual are subject to revision without prior notice.
- The content of this manual is protected by copyright. No reproduction, duplication or modification of the content is permitted without the authorization of Hioki E.E. Corporation.

Printed in Japan



Printed on recycled paper