

HIOKI

Instruction Manual

3290

CLAMP ON AC/DC HiTESTER

HIOKI E. E. CORPORATION

July 2012 Revised edition 9 3290A981-09 12-07H



600113919

Contents

Introduction	1
Inspection	2
Safety Notes	3
Usage Notes	6
Organization of This Manual	10

Chapter 1 Overview **13**

1.1 Product Overview	13
1.2 Features	13
1.3 Parts Names and Functions	16
1.3.1 3290 CLAMP ON AC/DC HiTESTER	16
1.3.2 CT9691 , CT9692, CT9693 (9691, 9692, 9693) CLAMP ON AC/DC SENSOR	. 24
1.4 Flowchart Of Key Operations	25
1.4.1 Current Measurements Mode	25
1.4.2 Frequency Mode	28
1.5 Modes	29

Chapter 2

Basic Measurement Procedures **35**

2.1 DC Measurement (DC A)	36
2.2 AC Measurement (AC A)	38
2.3 Peak Measurement In AC+DC A Mode	39

Chapter 3 Measurement Procedures 43

3.1	Preparations	43
3.2	Current Measurement	45
3.2.1	Measuring DC Current (DC A)	46
3.2.2	Measuring AC Current (AC A)	47
3.2.3	Measuring AC + DC Current (AC+DC A)	49
3.2.4	Bar Graph	50
3.2.5	Peak Measurement	51
3.2.6	Output Function (Current Measurement)	53
3.3	Frequency Measurement	57
3.3.1	Frequency Measurement	57
3.3.2	Output Function (Frequency Measurement)	58
3.4	Auto-Zero Adjustment Function	60
3.5	Data Hold Function	61
3.6	Changing the Screen Update Rate	61
3.6.1	SLOW Mode	61
3.6.2	FAST Mode	62
3.7	Recording Function	63
3.7.1	Measurement Reading	63
3.7.2	Display of Elapsed Time	64
3.7.3	Interrupting the Recording Function ...	64
3.7.4	Clearing Recorded Data	64
3.7.5	Disabling the Recording Function	65
3.8	Measurement Method Switching Function	66
3.8.1	RMS Measurement	66
3.8.2	MEAN Measurement	66
3.9	Measurement Response Speed Switching Function	67

3.9.1 NORMAL Mode	67
3.9.2 SLOW Mode	67
3.9.3 FAST Mode	67
3.10 Filter Function	70
3.11 Key Lock Function	71
3.12 Bar Graph Enlargement Function	71
3.13 Battery Check Function	72
3.14 MON Output Filter Function	73
3.15 Auto Power Off Function	74
3.16 Setting the Save Function	75
3.17 Battery-Low Warning	76
3.18 Beep Tone	77
Chapter 4 Batteries Replacement	79
Chapter 5 AC Adapter	81
Chapter 6 Attaching the Strap	83
Chapter 7 Specifications	85
7.1 Measurement Specifications	85
7.2 General Specifications	88

Chapter 8 Clamp Sensor Specifications 93

- 8.1 CT9691 (9691)
CLAMP ON AC/DC SENSOR93
- 8.2 CT9692 (9692)
CLAMP ON AC/DC SENSOR96
- 8.3 CT9693 (9693)
CLAMP ON AC/DC SENSOR99

Chapter 9 Carrying Case 103

Chapter 10 Troubleshooting 105

Chapter 11 After-sale Service 111

- 11.1 Cleaning111
- 11.2 Service111

Chapter 12 Appendix 113

- 12.1 Combined Accuracy113
 - 12.1.1 Accuracy Tables113
 - 12.1.2 Method of Calculation118
- 12.2 Use of Intermediate Cable119

Introduction

Thank you for purchasing the HIOKI "3290 CLAMP ON AC/DC HiTESTER". To obtain maximum performance from the product, please read this manual first, and keep it handy for future reference.

This manual describes the operation of the 3290 when used with the CT9691 (9691), CT9692 (9692), or CT9693 (9693) CLAMP ON AC/DC SENSOR.

Request

We have tried to bring this manual as close to perfection as we could achieve. If perchance you find any unclear portions, mistakes, omissions, or the like, we would be most obliged if you could please notify us of them via any HIOKI agent, or directly.

Inspection

- When you receive the product, inspect it carefully to ensure that no damage occurred during shipping. In particular, check the accessories, panel switches, and connectors. If damage is evident, or if it fails to operate according to the specifications, contact your dealer or Hioki representative.
- Before using the product the first time, verify that it operates normally to ensure that no damage occurred during storage or shipping. If you find any damage, contact your dealer or Hioki representative.

Accessories

Strap	1
LR6 Manganese battery.....	4
Instruction Manual.....	1

Options

9400 CARRYING CASE
9094 OUTPUT CORD
9445-02 AC ADAPTER
9445-03 AC ADAPTER
CT9691 (9691) CLAMP ON AC/DC SENSOR
CT9692 (9692) CLAMP ON AC/DC SENSOR
CT9693 (9693) CLAMP ON AC/DC SENSOR

Safety Notes

This manual contains information and warnings essential for safe operation of the product and for maintaining it in safe operating condition. Before using the product, be sure to carefully read the following safety notes.





This product is designed to conform to IEC 61010 Safety Standards, and has been thoroughly tested for safety prior to shipment. However, mishandling during use could result in injury or death, as well as damage to the product. Be certain that you understand the instructions and precautions in the manual before use. We disclaim any responsibility for accidents or injuries not resulting directly from product defects.

Safety Symbols



In the manual, the  symbol indicates particularly important information that the user should read before using the product.

The  symbol printed on the product indicates that the user should refer to a corresponding topic in the manual (marked with the  symbol) before using the relevant function.



Indicates a double-insulated device.



Indicates DC (Direct Current).



Indicates AC (Alternating Current).





Indicates both DC (Direct Current) and AC (Alternating Current).



Indicates that the instrument may be connected to or disconnected from a live circuit.

The following symbols in this manual indicate the relative importance of cautions and warnings.

 <u>DANGER</u>	Indicates that incorrect operation presents an extreme hazard that could result in serious injury or death to the user.
 <u>WARNING</u>	Indicates that incorrect operation presents a significant hazard that could result in serious injury or death to the user.
 <u>CAUTION</u>	Indicates that incorrect operation presents a possibility of injury to the user or damage to the product.
<u>NOTE</u>	Advisory items related to performance or correct operation of the product.

Other Symbols

	Indicates the prohibited action
---	---------------------------------

Accuracy

We define measurement tolerances in terms of f.s. (full scale), rdg. (reading) and dgt. (digit) values, with the following meanings:

f.s.	(maximum display value or scale length) The maximum displayable value or the full length of the scale. This is usually the maximum value of the currently selected range.
rdg.	(reading or displayed value) The value currently being measured and indicated on the measuring product.
dgt.	(resolution) The smallest displayable unit on a digital measuring product, i.e., the input value that causes the digital display to show a "1".

Measurement categories

This product complies with CAT III (600 V), CAT II (1000 V) safety requirements.

To ensure safe operation of measurement products, IEC 61010 establishes safety standards for various electrical environments, categorized as CAT II to CAT IV, and called measurement categories.

CAT II	Primary electrical circuits in equipment connected to an AC electrical outlet by a power cord (portable tools, household appliances, etc.) CAT II covers directly measuring electrical outlet receptacles.
CAT III	Primary electrical circuits of heavy equipment (fixed installations) connected directly to the distribution panel, and feeders from the distribution panel to outlets.
CAT IV	The circuit from the service drop to the service entrance, and to the power meter and primary overcurrent protection device (distribution panel).

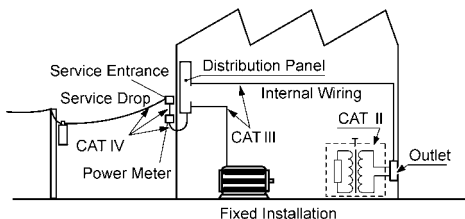

Using a measurement product in an environment designated with a higher-numbered category than that for which the product is rated could result in a severe accident, and must be carefully avoided.

Usage Notes



Follow these precautions to ensure safe operation and to obtain the full benefits of the various functions.

DANGER

- To avoid short circuits and potentially life-threatening hazards, never attach the product to a circuit that operates at more than the 600V, or over bare conductors.
- Clamp sensor should only be connected to the secondary side of a breaker, so the breaker can prevent an accident if a short circuit occurs. Connections should never be made to the primary side of a breaker, because unrestricted current flow could cause a serious accident if a short circuit occurs.
- Use only the specified Model 9445-02 AC ADAPTER or 9445-03 AC ADAPTER. AC adapter input voltage range is 100 to 240 VAC (with $\pm 10\%$ stability) at 50/60 Hz. To avoid electrical hazards and damage to the product, do not apply voltage outside of this range.

WARNING





- To avoid electric shock, do not allow the product to get wet, and do not use it when your hands are wet.
- Do not use the product where it may be exposed to corrosive or combustible gases. The product may be damaged or cause an explosion.

 **WARNING**

- The top part of the clamp sensor above the barrier (including the clamps, but not the lever) is provided with double insulation to ensure safety. Be careful not to drop the sensor or otherwise subject it to impact. A damaged sensor may result in electric shock during measurement. In case of sensor damage, contact us immediately for repair or discard the damaged sensor to avoid subsequent use.
- To avoid damage to the product, do not exceed the maximum input current rating, which depends on the frequency of the current being measured (see "Chapter 8 Clamp Sensor Specifications" (p. 93) - Frequency-dependent deletion characteristics) Be careful about the evolution of heat, when the input frequency is high.
- To avoid electric shock when replacing the batteries, first disconnect the clamp from the object to be measured.
- After replacing the batteries, replace the cover and screws before using the product.
- Do not mix old and new batteries, or different types of batteries. Also, be careful to observe battery polarity during installation. Otherwise, poor performance or damage from battery leakage could result.
- To avoid the possibility of explosion, do not short circuit, disassemble or incinerate batteries.
- Handle and dispose of batteries in accordance with local regulations.

 **CAUTION**

- Do not use the product when the battery is depleted ( lights on the LCD). When  is on, accuracy and other specifications cannot be guaranteed.
- For the inside memory protection, make sure the power is turned off before plugging in or unplugging the AC adapter.
- Adjustments and repairs should be made only by technically qualified personnel.
- If the protective functions of the product are damaged, either remove it from service or mark it clearly so that others do not use it inadvertently.
- To avoid corrosion from battery leakage, remove the batteries from the product if it is to be stored for a long time.

CAUTION

Direct
sunlight

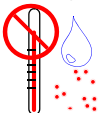

High temper-
ature, high
humidity, dust



Electromag-
netic radiation



Impact,
dropping

Observe the following to avoid damage to the product.

- Installation and Operating Environment Between 0°C and 40°C; 80% RH or less; indoors only.
- Do not store or use the product where it could be exposed to direct sunlight, high temperature or humidity, or condensation. Under such conditions, the product may be damaged and insulation may deteriorate so that it no longer meets specifications.
- This product is not designed to be entirely water- or dust-proof. To avoid damage, do not use it in a wet or dusty environment.
- Do not use the product near a device that generates a strong electromagnetic field or electrostatic charge, as these may cause erroneous measurements.
- To avoid damage to the product, protect it from vibration or shock during transport and handling, and be especially careful to avoid dropping.

NOTE

- Accurate measurement may be impossible in the presence of strong magnetic fields, such as near transformers and high-current conductors, or in the presence of strong electromagnetic fields such as near radio transmitters.
- To clean the product, wipe it gently with a soft cloth moistened with water or mild detergent. Never use solvents such as benzene, alcohol, acetone, ether, ketones, thinners or gasoline, as they can deform and discolor the case.

Organization of This Manual

Chapter 1 Product Overview

Provides an overview of the product and describes the parts and functions.

Chapter 2 Basic Measurement Procedure

Describes the basic measurement procedure for quick reference and the peak measurement procedure in DC current (DC A) mode, AC current (AC A) mode, and AC+DC A mode.

Chapter 3 Measurement Procedure

Describes the measurement procedure for the 3290 CLAMP ON AC/DC HiTESTER when combined with the CT9691 (9691), CT9692 (9692), or CT9693 (9693) CLAMP ON AC/DC SENSOR.

Chapter 4 Battery Replacement

Explains how to replace the battery used for the 3290 Clamp On AC/DC HiTESTER.

Chapter 5 AC Adapter

Explains how to use the 9445-02 AC Adapter (optional).

Chapter 6 Attaching the Strap

Explains how to attach the strap.

Chapter 7 Specifications

Lists the specifications of the 3290 CLAMP ON AC/DC HiTESTER.

Chapter 8 Clamp Sensor Specifications

Lists the specifications of the CT9691 (9691), CT9692 (9692), and CT9693 (9693) CLAMP ON AC/DC SENSORS.

Chapter 9 Carrying Case

Explains how to use the 9400 CARRYING CASE (optional).

Chapter 10 Troubleshooting

Lists common symptoms that may indicate a malfunction. If you encounter a problem, be sure to read this chapter before requesting repair.

Chapter 11 Service

Describes our customer support service.

Chapter 12 Appendix

- Provides the accuracy table and explains how to calculate accuracy for the 3290 CLAMP ON AC/DC Hi-ESTER when combined with the CT9691 (9691), CT9692 (9692), or CT9693 (9693) CLAMP ON AC/DC SENSOR.
- Describes how to use the intermediate cable.

Overview

Chapter 1

1.1 Product Overview

The 3290 CLAMP ON AC/DC HiTESTER is used with the CT9691 (9691), CT9692 (9692), or CT9693 (9693) CLAMP ON AC/DC SENSOR. These sensors are interchangeable and any model can be used with the 3290. The 3290 automatically detects the sensor connected and sets up the appropriate range. When combined with the CT9691 (9691), CT9692 (9692), or CT9693 (9693) Sensor, the 3290 HiTESTER can perform DC, AC, and AC+DC measurement of a live power line. Various functions are available (using the SHIFT key) to make the 3290 suitable for various current measurement applications. The 3290 is also equipped with two output terminals to enable a variety of advanced measurements, such as simultaneous output of both monitor and rms record. Moreover, the 3290 can operate using battery power or the AC adapter (for long-term measurement use).

1.2 Features

The 3290 has the following features:

- ◆ **Multifunction Microcomputer**
The 3290 both compact and multifunctional thanks to the built-in microcomputer and use of the SHIFT key.
- ◆ **Large-Screen LCD**
The large-screen LCD employed is easy to read.
- ◆ **Clamp Sensor**
The 3290 is compatible with three clamp-on AC/DC sensors (CT9691 (9691), CT9692 (9692), and CT9693 (9693) having different ratings. Because the 3290

automatically detects the sensor connected, you need not edit the setting each time you change the sensor.

◆ **Multifunction Microcomputer**

The 3290 both compact and multifunctional thanks to the built-in microcomputer and use of the SHIFT key.

◆ **Large-Screen LCD**

The large-screen LCD employed is easy to read.

◆ **Clamp Sensor**

The 3290 is compatible with three clamp-on AC/DC sensors (CT9691 (9691), CT9692 (9692), and CT9693 (9693)) having different ratings. Because the 3290 automatically detects the sensor connected, you need not edit the setting each time you change the sensor.

◆ **Two Output Terminals**

Two signals are output simultaneously from among the four following: current (REC = record and MON = monitor), current frequency (REC = record), and low battery warning signal.

- Current monitor & low battery warning signal
- Current monitor & current record
- Current record & low battery warning signal
- DC component & AC component (AC/DC separate output)
- Frequency record & current record

◆ **Method of measurement**

In AC A mode, you can select either the true rms (RMS) or average rectified rms indication (MEAN).

◆ **Measurement Response Speed**

For RMS measurement, you can select a response speed from FAST, NORMAL, or SLOW.

◆ **Low-frequency Current Measurement**

In AC+DC A mode, you can measure current from 1 Hz when the measurement response speed is set to SLOW.

◆ **Filter Function**

This function turns on and off a low-pass filter (LPF) of approximately 500 Hz.

◆ **Setting Save Function**

This function saves the current measurement conditions so that settings are retained even after power is turned OFF.

 **Key Lock Function**

This locks all keys including the POWER key (except the keys used to unlock).

 **AC+DC Measurement**

The 3290 measures AC superimposed on DC, half-wave rectified, and full-wave rectified.

 **Peak Measurement**

The peak hold current can also be measured.

 **REC Function**

You can select whether the maximum or minimum measurement value is displayed.

 **Dual-power supply**

The 3290 runs on either battery power or an AC power source.

 **Dustproof Cap**

The dustproof cap is provided for use in a dusty environment.

 **Intermediate Cable**

In case the CT9691 (9691), CT9692 (9692), or CT9693 (9693) sensor cable (about 2 m long) is too short, an intermediate cable can be used to extend connection length. Insert the intermediate cable between the 3290 and the sensor cable.

1.3 Parts Names and Functions

1.3.1 3290 CLAMP ON AC/DC HITESTER

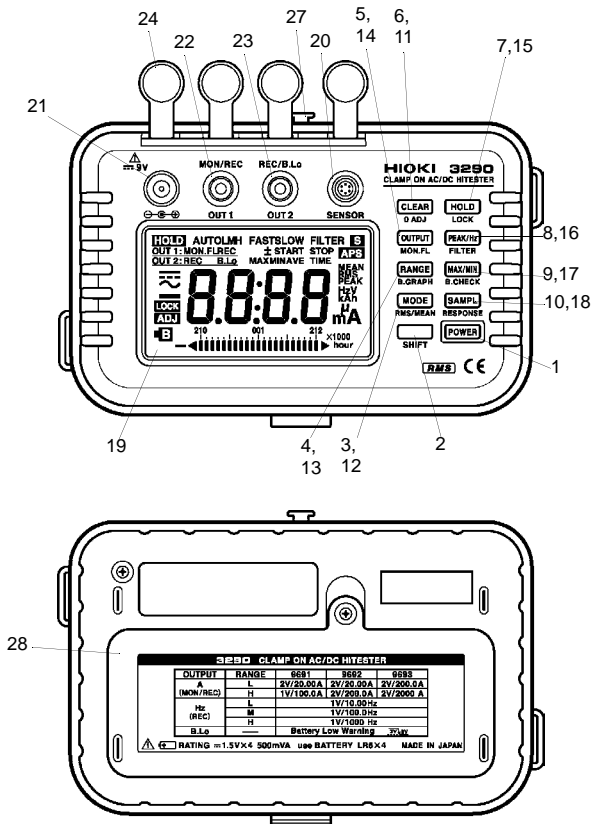

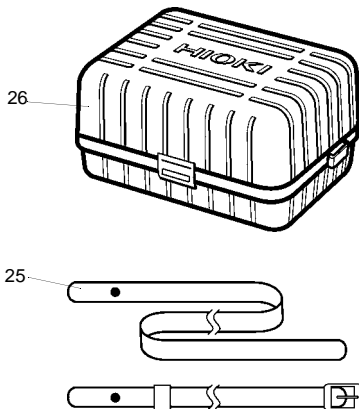

Keys for Basic Measurement

1. POWER Key

- Turns power ON/OFF.
- Holding down the CLEAR key and turning power on initializes the setting save function and restores the default settings.
- Holding down the HOLD key and turning power on disables the auto power-off function.
- Holding down the PEAK/Hz key and turning power on turns off the buzzer.

2. SHIFT Key

- Pressing this key causes **S** to light, indicating that the additional function (in blue letters) allocated to each key is available. To turn **S** off, press the SHIFT key again.
- Some keys may be locked when **S** is on.

3. MODE Key

- Selects the current measurement mode.

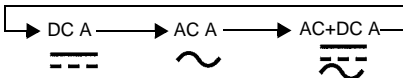

4. RANGE Key

- Selects auto range or manual range.
- Selects a measurement range when manual range is selected.
- The current ranges for the CT9691 (9691) and CT9692 (9692) are 20 A and 200 A; the ranges for the CT9693 (9693) are 200 A and 2000 A. The frequency ranges are 10 Hz, 100 Hz, and 1000 Hz.

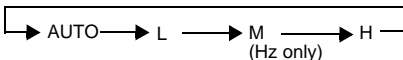

5. OUTPUT Key

- Sets the output (for current and frequency measurement).
Two outputs are available. The settings available for each current measurement mode are fixed.
- Disables the auto power-off function.

6. CLEAR Key

- Clears data to "0" during peak measurement.
- Clears data to "0" during activation of the recording function.
- Holding down the CLEAR key and turning power on initializes the setting save function and restores the default settings.

7. HOLD Key

- Suspends or deactivates the screen-updating function. (See "15. LOCK Key (SHIFT HOLD Keys)" (p.21) for details of the key lock function.)
- Holding down the HOLD key and turning power on disables the auto power-off function.

8. PEAK/Hz Key

- PEAK performs peak measurement of waveforms (peak hold).
- Hz performs frequency measurement (in AC A mode).
- Holding down the PEAK/Hz key and turning power on turns off the buzzer.

9. MAX/MIN Key

- Activates the recording function and displays the maximum value (MAX), minimum value (MIN), mean value of both maximum & minimum values (AVE), and elapsed time (TIME).
- Pressing this key immediately activates the recording function.
- MAX displays the maximum value of measurements taken after the recording function is activated.
- MIN displays the minimum value of measurements taken after the recording function is activated.
- AVE displays the mean value of the maximum and minimum values measured after the recording function is activated.
- TIME displays the time elapsed after the recording function is activated.
- The auto power-off function is deactivated.

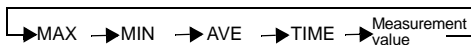

10. SAMPL Key

- Selects a screen-updating rate from NORMAL (twice/sec.), SLOW (once/3 sec.), or FAST (4 times/sec.). Each time this key is pressed, the rate changes in the order above.
- The rate is usually set to NORMAL. (Note that there is no indication for NORMAL.)
- SLOW decelerates the speed of updating on-screen measurement (with SLOW on).
- FAST accelerates the speed of updating on-screen measurement (with FAST on).

- During RMS measurement in AC mode or when in AC+DC mode (with RMS on), the measurement response speed changes according to the screen-updating rate (SLOW, FAST, or NORMAL).
- You can only change the measurement response speed. For details, see 18 under “Keys for Advanced Measurement.”

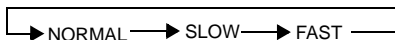

11. 0 ADJ Key (SHIFT CLEAR Keys)

- Performs auto zero adjustment in DC A or AC+DC A mode.

Keys for Advanced Measurement

12. RMS/MEAN Key (SHIFT MODE Keys)

- Selects the true rms measurement (RMS) or average rectified rms indication (MEAN) in AC A mode. RMS provides accurate measurement of distorted waveforms. MEAN only provides accurate measurement of undistorted sine waves.

13. B.GRAPH Key (SHIFT RANGE Keys)

- Enlarges the range of a bar graph.

14. MON.FL Key (SHIFT OUTPUT Keys)

- Turns on a low-pass filter of approx. 1 Hz when MON is selected for OUT1 in DC A mode.
- Turns on a low-pass filter of approx. 1 Hz when MON is selected for OUT1 (REC for OUT2) in AC+DC A mode. This enables separate output of the DC component (OUT1) and AC component (OUT2). (The value of the AC component is indicated on the LCD.)

15. LOCK Key (SHIFT HOLD Keys)

- Locks all keys including the POWER key.
- To unlock, press the same keys again (SHIFT HOLD keys).

16. FILTER Key (SHIFT PEAK/Hz Keys)

- Turns on a low-pass filter of approx. 500 Hz in AC A or AC+DC A mode.
- To turn the filter off, press the same keys again (SHIFT PEAK/Hz keys).

17. B.CHECK Key (SHIFT MAX/MIN Keys)

- Indicates remaining battery power. When power is depleted to 0%, the low battery warning (**B**) goes on.

18. RESPONSE Key (SHIFT SAMPL Keys)



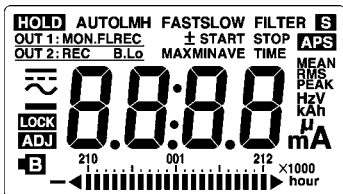

- Selects a measurement response speed independently from the screen-updating rate when RMS is selected in AC A mode or when AC+DC mode is selected.
- Press the SAMPL key to return to the measurement response speed that matches the selected screen-updating rate.

Display

19. LCD



The letter of LCD is clearest, when it sees from the front side.

	Direct Current (DC)
	Alternating Current (AC)
	Alternating Current and Direct Current (AC+DC)
ADJ	Auto zero adjustment is active.
B	Low battery warning
OUT1	Setting of OUT1
OUT2	Setting of OUT2
HOLD	Data hold function
MON	Monitor is active.
MON.FL	1 Hz filter for monitor is active.
REC	Record is active.
APS	Auto power-off is active.
AUTO	Auto-range
L	Current/frequency low range
M	Frequency mid range
H	Current/frequency high range
FAST	Screen-updating 4 times/sec.
SLOW	Screen updating approx. once/3 sec.
FILTER	500 Hz filter is active.
MAX	Maximum value
MIN	Minimum value
AVE	Average value
TIME	Elapsed time
MEAN	Average rectified rms indication
RMS	True root mean square value
PEAK	Wave peak value
Hz	Frequency
LOCK	Key lock is active.P
A	Current
hour	100 hours/segment (bar graph)
	Input over (bar graph)
S	SHIFT

Parts

20. Sensor Connector (SENSOR)

Connect the CT9691 (9691), CT9692 (9692), or CT9693 (9693) CLAMP ON AC/DC SENSOR to this connector.

21. AC Adapter Connection Terminal

Connect the 9445-02 AC ADAPTER (optional) to this terminal when not using the battery or for long-term measurement.

22. Output Terminal 1 (OUT1)

Connect the 9094 OUTPUT CORD (optional) to this terminal to obtain output during current or frequency measurement.

23. Output Terminal 2 (OUT2)

Connect the 9094 OUTPUT CORD (optional) to obtain output during current measurement or at detection of the low battery warning signal.

24. Dustproof Caps (4 pcs.)

Used to protect the terminals in a dusty environment.

25. Strap

Used to hang the 3290 around neck so as not to drop it.

26. Top Case

Cover the 3290 with this case when not in use to protect the LCD, keys and terminals.

27. Top Case Clasp

Insert the clasp into the top case to attach the case. Move the top case to the rear during measurement.

28. Battery Cover

Unfasten the screw, then remove the case to replace the battery.

1.3.2 CT9691 , CT9692, CT9693 (9691, 9692, 9693) CLAMP ON AC/DC SENSOR

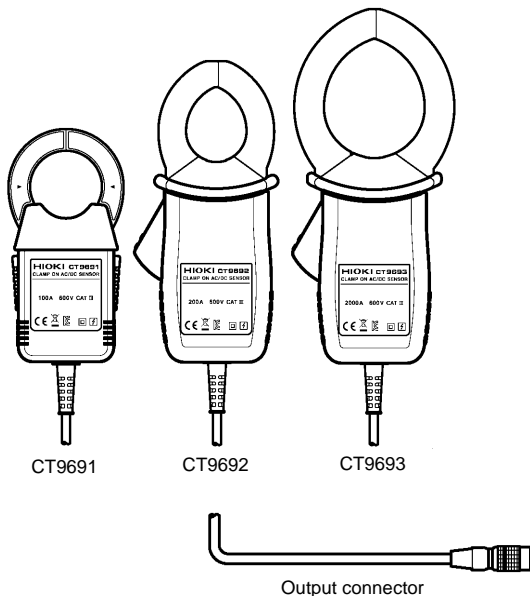

1.4 Flowchart Of Key Operations

1.4.1 Current Measurements Mode

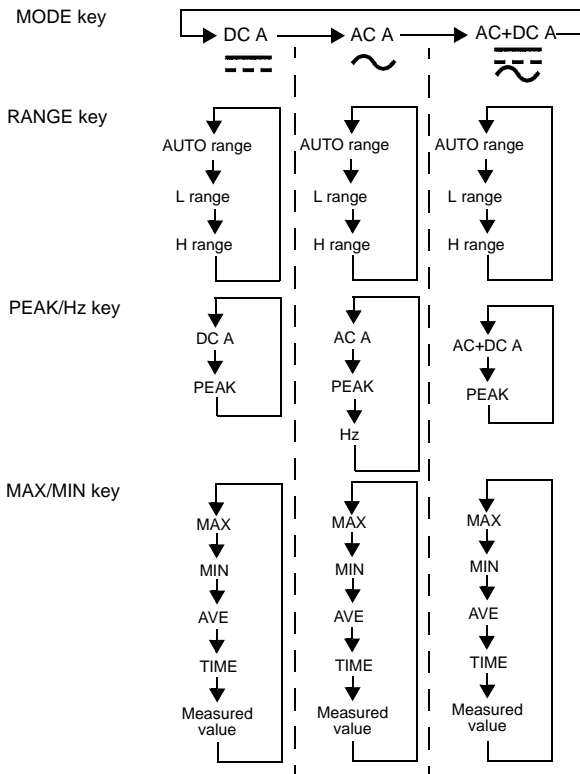

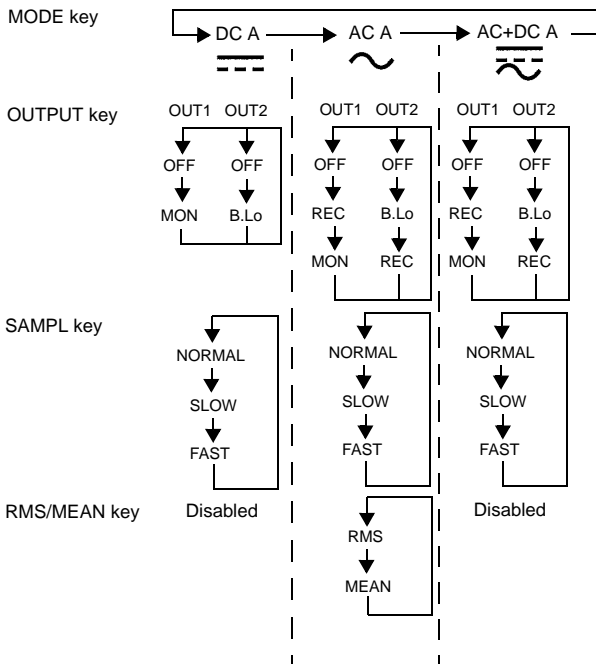

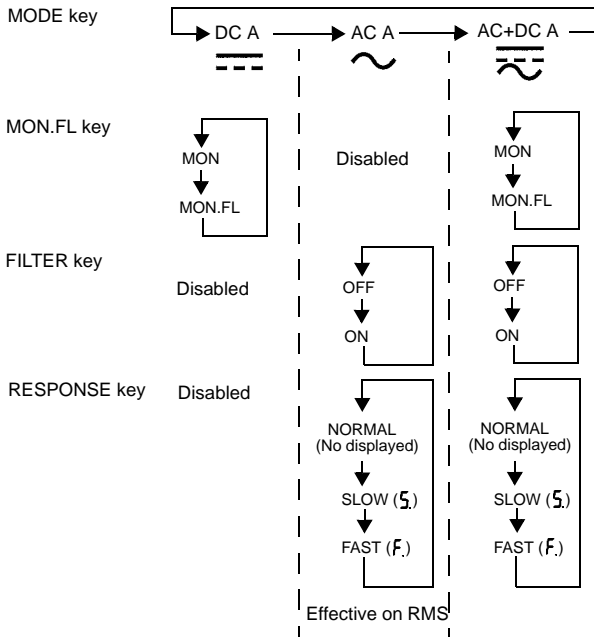



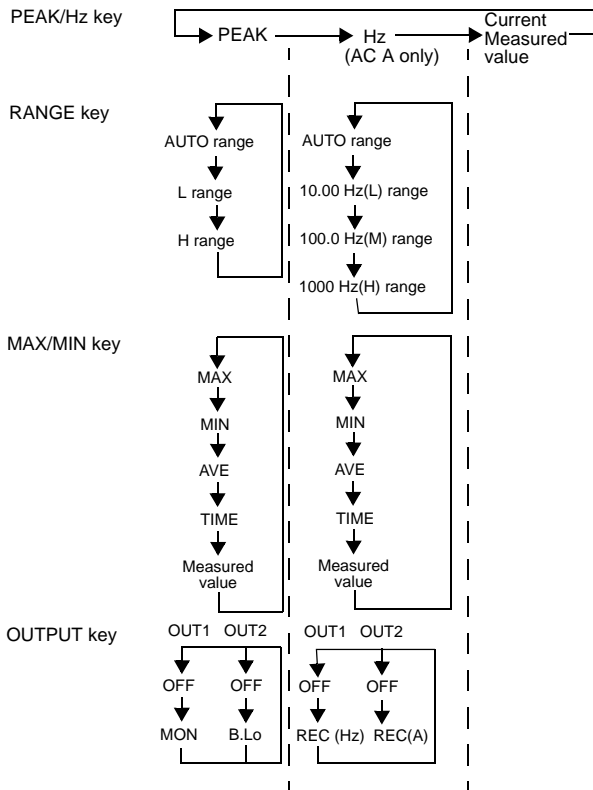



























1.4.2 Frequency Mode



1.5 Modes











For current, three modes are provided: DC (direct current, ), AC (alternating current, ) , and AC+DC (alternating current and direct current, ) modes. Select a proper mode according to the waveform shown below:















Mode	Input waveform	Display	OUTPUT (only for current mode)	
			REC	MON
DC ()		OK (with polarity)	Setting impossible	
		No Not measurable		
		No Not measurable		
AC ()		No Not measurable (zero displayed)		
		OK		
		No Not measurable		
AC+DC ()		OK (without polarity)		
		OK		
		OK		











Quick Reference

Measurements	Operations	(page)
DC A		46
AC A RMS		47
AC A MEAN		47
AC+DC A		49
DC A peak		51
AC A RMS peak		51
AC A MEAN peak		51
AC+DC A peak		51
AC A RMS Hz		57
AC A MEAN Hz		57

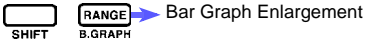
Quick Reference (application)

Operations		(page)
Hold the measured value (Data Hold Function)		
 peak/Hz/ MAX/MIN	Measurement → HOLD 	61
"O.L." is displayed (Overflow Warning Function)		
 peak/Hz/ MAX/MIN	When the measured value exceeds the maximum value, "O.L." is displayed.	-
Change the screen update rate (Changing the Screen Update Rate)		
 peak/Hz	(NORMAL/SLOW/FAST) switch 	61
Measurement speed can be changed (Measurement Response Speed Switching Function)		
 peak/Hz	(NORMAL/SLOW/FAST) switch   AC A mode: RMS AC+DC A mode only	67
Outputs (Output Function)		
 Hz	 → OUT1: OUT2: on	53 58

Operations	(page)
<p>Obtained through a low-pass filter (LPF) set to approximately 1 Hz (MON Output Filter Function)</p> <p></p> <p>OUT1 : MON OUT2 : REC</p> <p>  →</p> <p>OUT1 : MON.FL OUT2 : REC</p> <p>Disable:   Press the key again.</p>	73
<p>Obtained through a low-pass filter (LPF) to measurement value and output. (Filter Function)</p> <p></p> <p>  → FILTER: on</p> <p>Disable:   Press the key again.</p>	70
<p>Disabling the auto power off function (Auto Power Off Function)</p>	74
<p>Disabling the beep tone (Beep Tone)</p>	77
<p>Hold the maximum measurement, minimum measurement, and mean value. (Recording Function)</p> <p> peak/Hz</p> <p>  → </p> <p>The elapsed time is displayed. (MAX/MIN/AVE/TIME/ Instantaneous value switch</p> <p>MAX: maximum value /MIN: minimum value /AVE: average value /TIME: elapsed time</p> <p>Disable:  Press the key.</p>	63

Operations		(page)
Saved the settings (Setting the Save Function)		
 peak/Hz	 (Hold down 2 seconds.) Disable: 	75
Enlarged to the Bar graph. (Bar Graph Enlargement Function)		
 Hz	 Bar Graph Enlargement Disable: 	71
Battery check		
 peak/Hz/ MAX/MIN		72
Key lock		
 peak/Hz	 LOCK on Disable: 	71

Basic Measurement Procedures

Chapter 2



- To avoid short circuits and potentially life-threatening hazards, never attach the product to a circuit that operates at more than the 600V, or over bare conductors.
- Clamp sensor should only be connected to the secondary side of a breaker, so the breaker can prevent an accident if a short circuit occurs. Connections should never be made to the primary side of a breaker, because unrestricted current flow could cause a serious accident if a short circuit occurs.
- Use only the specified Model 9445-02 AC ADAPTER or 9445-03 AC ADAPTER . AC adapter input voltage range is 100 to 240 VAC (with $\pm 10\%$ stability) at 50/60 Hz. To avoid electrical hazards and damage to the product, do not apply voltage outside of this range.

This chapter describes the basic measurement procedure. For details of the measurement procedure, see "Chapter 3 Measurement Procedures" (p. 43).

2.1 DC Measurement (DC A)

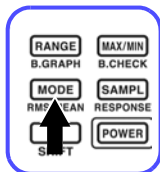

1. Press the **MODE** key to display DC A ($\overline{\text{---}}$).

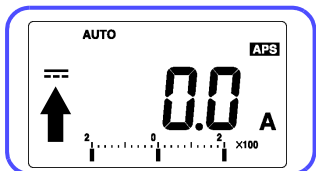

2. Press the **SHIFT** key to display **S**.

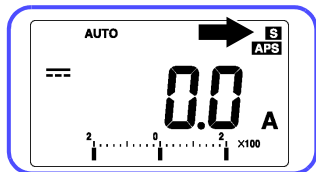
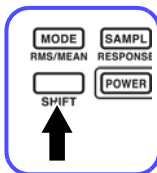

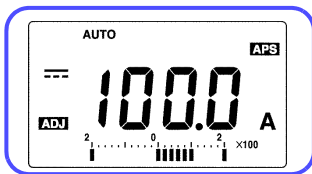
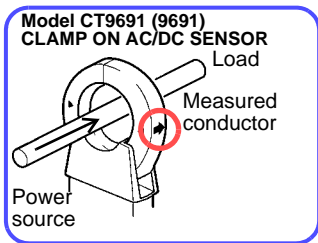
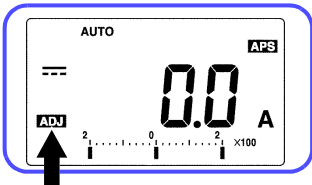

3. Press the **0 ADJ** key (**CLEAR** key) to perform zero adjustment.
4. **ADJ** will appear on the LCD.
5. Align the current direction indicator on the clamp with the current direction of the conductor to be measured, then clamp the conductor so that it passes through the center of the clamp core. The figure shows the CT9691 CLAMP ON AC/DC SENSOR. When using the CT9692 (9692) or CT9693 (9693) CLAMP ON AC/DC SENSOR, note that the current direction indicator is located in a different position.
6. Read the displayed value. Since the measurement range is set to **AUTO**, you need not set the range.

2.2 AC Measurement (AC A)

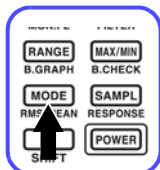

1. Press the **MODE** key to display AC A (\sim).

* When measuring current up to 10 Hz, use AC+DC A mode and select SLOW.

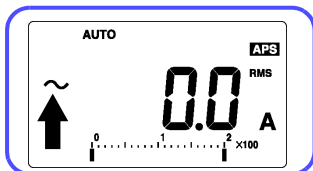

2. Clamp the conductor to be measured so that it passes through the center of the clamp core. You need not align the direction of the clamp.

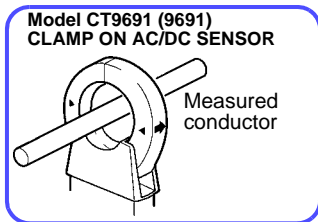

3. Read the displayed value. Since measurement range is set to **AUTO**, you need not set the range.

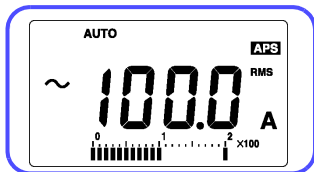

2.3 Peak Measurement In AC+DC A Mode

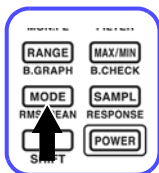

1. Press the **MODE** key to display AC+DC A ()

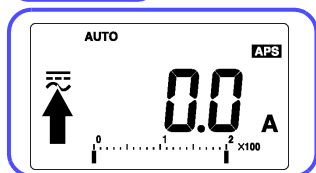

2. Press the **PEAK/Hz** to display **PEAK**.

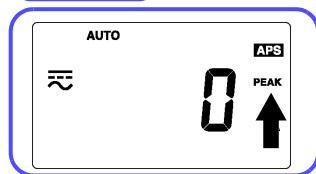
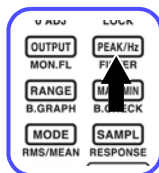

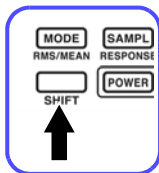

3. Press the **SHIFT** key to display **S**.

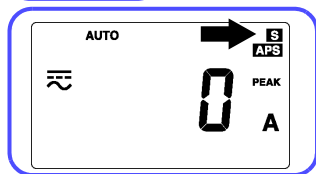

4. Press the **0 ADJ** key (CLEAR key) to perform zero adjustment.



5. **ADJ** will appear on the LCD.

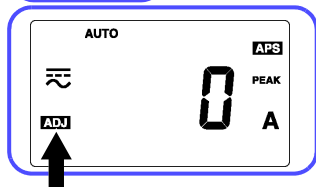

6. Clamp the conductor to be measured so that it passes through the center of the clamp core. You need not align the direction of the clamp.

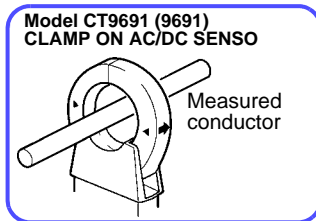



7. Press the **CLEAR** key (0 **ADJ** key) to clear the data.

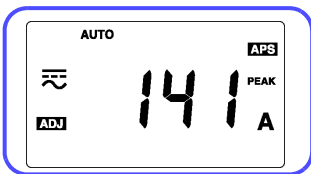

8. Read the displayed value. Since the measurement range is set to **AUTO**, you need not set the range.

Measurement Procedures

Chapter 3

CAUTION

- Do not connect or disconnect the output connector of the clamp-on sensor while power is supplied to the 3290 or the sensor is clamping a conductor to be measured.
- When disconnecting the output connector of the clamp-on sensor from the 3290 sensor connector, be sure to hold it by the metal part and pull it upward. If it is pulled by the cable, the lock will not be released and a broken wire in the cable may result.
- The maximum continuous-input limit is obtained from the temperature increase due to self-heating during measurement. To prevent damage to the clamp-on sensor, do not input a current exceeding this limit.
- The maximum continuous-input limit varies depending on the clamp-on sensor and the frequency of the current to be measured. Please see the dilating-characteristics graph by frequency in "Chapter 8 Clamp Sensor Specifications".

3.1 Preparations

1. Remove the battery cover and insert the battery (see "Chapter 4 Batteries Replacement" (p. 79)).
2. Connect the output connector of the clamp-on sensor to the sensor connector. The type of clamp-on sensor will be detected automatically.

- Press the POWER key to turn on the power. Make sure all segments of the LCD light up. Then, the model No. (3290) is displayed and the charge remaining in the battery is shown by a bar graph.



New battery



50% battery charge remaining

The battery charge is 0.

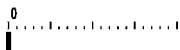

B lights up.

The beep tone sounds three times.

- The 3290 is ready for operation in DC-current measurement mode.

NOTE

- If the setting save function has been used (if the HOLD key is held down for approximately 2 seconds, the current setting is saved), the 3290 will be in the saved measurement mode.
- To cancel the saved setting, turn off the power and then turn it on again while holding down the CLEAR key. The 3290 will return to the default setting (DC current).

Low-Battery-Voltage Detection Function

If the battery voltage falls when **B** is on, the power will be turned off. On the LCD, “bATT” and “Lo” will appear.

Connecting/Disconnecting the Clamp On Sensor

When connecting the clamp-on sensor to the 3290, hold it by the area above the metal part of the output connector when inserting it. If it is held by the metal part, it won't be possible to insert the output connector into the sensor connector. Make sure the wide terminal of the connector is at the top when the connector is inserted. When disconnecting the clamp-on sensor from the 3290, hold the metal part of the connector when pulling it out. If it is held by the area above the metal part, it won't be possible to disconnect the connector.

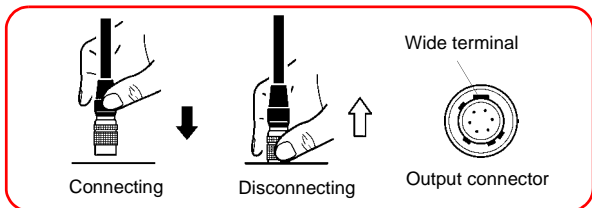

3.2 Current Measurement

CAUTION

- The ends of the clamp sensor are very delicate. Be careful not to drop the sensor or subject it to impact. If the sensor is deformed or the contact surfaces of the clamps are damaged, the measurement may not be accurate.

NOTE

- Be sure to read the instruction manual for the clamp sensor to be used before starting measurement.
- The hall element is used for the detector of the clamp-on sensor. The hall element tends to drift with age or due to the ambient temperature. Keep this fact in mind when performing measurement continuously.
- Accurate measurement may be impossible in the presence of strong magnetic fields, such as near transformers and high-current conductors, or in the presence of strong electromagnetic fields such as near radio transmitters.

NOTE

- The reading may show a measurement greater than the actual value due to magnetic-field interference. The amount of interference varies depending on the sensor. For details, see "Effect of external electromagnetic field" in "Chapter 8 Clamp Sensor Specifications".
- The CT9691 (9691) has a lock mechanism for the clamps so that the clamps will not open due to vibration or other similar causes during measurement. Lock the clamps as necessary. (If the clamps should open even slightly during measurement, the accuracy cannot be guaranteed.)
- Attach the clamp around only one conductor. Single-phase (2-wire) or three-phase (3-wire) cables clamped together will not produce any reading.

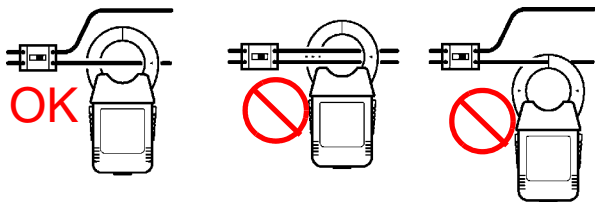

3.2.1 Measuring DC Current (DC A)

1. Press the MODE key to display " — — —".
2. Select a measurement range suitable for the current to be measured.
3. Before clamping the conductor to be measured, press the 0ADJ key (SHIFT CLEAR key) with the clamp sensor fully closed to perform the auto zero adjustment (see "3.4 Auto-Zero Adjustment Function"). Upon completion of the auto zero adjustment, "ADJ" will light up. (When auto range is selected, the auto zero adjustment is made for the two ranges.)

The auto zero adjustment range is ± 450 dgt. for the L range and ± 45 dgt. for the H range. If the sensor's offset exceeds these ranges, the auto zero adjustment cannot be performed.

4. Open the clamps of the sensor. Orient the current direction indicator on the clamps in the current direction of the conductor to be measured, place the conductor in the center of the clamp core, and clamp it.

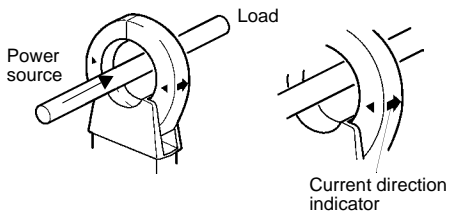
**NOTE**

- In DC A mode, only a DC current that does not contain an AC component can be measured correctly (see "1.5 Modes" (p. 29)).
- When a conductor to be measured is placed in the center of the clamp core, measurement is performed the most accurately, with no effect of the conductor position.
- The measurement may change if the direction of the clamp sensor is changed. However, the measurements are within the guaranteed accuracy range.
- If the reading fluctuates rapidly and is difficult to read, press the SAMPL key to select SLOW.
- The L range displays up to 2500 dgt.

3.2.2 Measuring AC Current (AC A)

1. Press the MODE key to display " \sim ".
2. Select a measurement range suitable for the current to be measured.

3. Open the clamps of the sensor, place the conductor to be measured in the center of the clamp core, and clamp it. In addition, make sure the clamp sensor is perpendicular to the conductor.

NOTE

- When measuring a current of 10 Hz or less, use AC+DC A mode. Press the SAMPL key to set the screen-updating rate to SLOW (the measurement response speed must be SLOW; the unit symbol "A" will blink slowly). If SLOW is selected in AC A mode, the measurements may become smaller than those in AC+DC A mode.
- DC, full-wave rectified waveforms, half-wave rectified waveforms, and DC+AC waveforms cannot be measured in AC A mode (see "1.5 Modes" (p. 29)).
- When a conductor to be measured is placed in the center of the clamp core, measurement is performed the most accurately without effect of the conductor position. If the clamp sensor is not perpendicular to the conductor, there may be a slight effect on the measurement when the measured current frequency is high.
- We recommend that RMS measurement be performed. By switching over to MEAN (SHIFT MODE key), the MEAN value can be compared with the RMS value and a check can be conducted for distortion in the measured current. If the values are nearly the same, the current is close to a sine wave with little distortion (the ratio of the peak to rms is close to 1.4:1).
- When the MEAN and RMS measurements differ, the measured current may be distorted.
- During MEAN measurement, the measurement response speed cannot be changed.
- Select RMS measurement and the FAST screen-updating rate if the rise in the current waveform is sharp (the measurement response speed must be FAST; the unit symbol "A" will blink quickly).
- The L range displays up to 2500 dgt.

3.2.3 Measuring AC + DC Current (AC+DC A)

1. Press the MODE key to display “”.
2. Select a measurement range suitable for the current to be measured.
3. Before clamping the conductor to be measured, press the 0ADJ key (SHIFT CLEAR key) with the clamp sensor fully closed to perform the auto zero adjustment. Upon completion of the auto zero adjustment, “**ADJ**” will light up (see “3.4 Auto-Zero Adjustment Function” (p. 60)).
4. Open the clamps of the sensor, place the conductor to be measured in the center of the clamp core, and clamp it. In addition, make sure the clamp sensor is perpendicular to the conductor.

NOTE

- When measuring a current of 10 Hz or less, press the SAMPL key to set the screen updating rate to SLOW (the measurement response speed must be SLOW; the unit symbol “A” will blink slowly).
- When a conductor to be measured is placed in the center of the clamp core, measurement is performed the most accurately with no effect of the conductor position. If the clamp sensor is not perpendicular to the conductor, there may be a slight effect on the measurement when the measured current frequency is high.
- RMS measurement is performed.
- When DC measurement is performed, the polarity will not be displayed. The measurement may change if the direction of the clamp sensor is changed. However, the measurements are within the guaranteed accuracy range.
- Set the screen-updating rate to FAST if the increase in the current waveform is sharp (the measurement response speed must be FAST; the unit symbol “A” will blink quickly).
- The L range displays up to 2500 dgt.

3.2.4 Bar Graph

The bar graph shows the current measurement range and the measurement.

The blinking segment represents the current measurement range. When AUTO range is selected, it represents the range for internal operation. For example, if the segment at "2" is blinking and the number to the right is "x10," the range is 20 A.

In DC A mode, the negative polarity is shown to the left of "0" and the positive polarity is shown to the right.

Therefore, two segments will blink.

The measurement is represented by the segments that light up. For instance, when the 20-A range is selected in AC A mode, if the segments up to 1 (11 segments) are on, the measurement is 10 A or more but below 11 A.

NOTE

- Because the segment at the number that represents the range blinks, if a measurement is 1900 dgt. or more but below 2100 dgt. (1800 dgt. or more but below 2200 dgt. in DC A mode), the bar graph will not show any change.
- If a measurement is 2100 dgt. or more (2200 dgt. or more in DC A mode), "▶" will appear.
- The numerical reading may differ from the measurement on the bar graph (e.g., "▶" appears even if the numerical reading is 2099 dgt.).
- If the reading shows **O.L.**, "▶" will appear.
- When a measurement is unstable, the segments that represent the measurement may blink.

NOTE

When the CT9691 (9691) clamp on the AC/DC sensor is connected and the H range is selected, the indication will differ from that when other sensors are used as below.

- Because the sensor rating is 100 A, the segment at "1" blinks and the number to the right of the bar graph shows "x100," indicating the 100-A range.
- If a measurement is between 900 dgt. and 1050 dgt., the bar graph will not show any change. (Normally, one segment lights up for every 100 dgt..)
- If a measurement exceeds 1050 dgt., the segment 12th onward will light up and "▶" will appear ("▶" will appear in DC A mode).

3.2.5 Peak Measurement

1. Press the MODE key and select a measurement mode for the circuit to be measured.
2. The measurement mode is changed as shown below each time the PEAK/Hz key is pressed. Select PEAK.

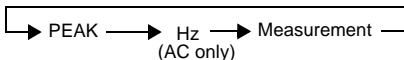

3. In DC A or AC+DC A mode, perform the auto zero adjustment by pressing the 0ADJ key (SHIFT CLEAR key). (See "3.4 Auto-Zero Adjustment Function" (p. 60).)
4. 4. Select a measurement range. (When AUTO range is selected, some time may be required for the 3290 to detect an appropriate range and switch over to the range. This may delay the peak measurement. If it is not possible to estimate the peak current value, use the H range.)

5. Before conducting the measurement, press the CLEAR key to clear (reset) the previous data. In DC A or AC+DC A mode, when there is no input, pressing the 0ADJ key (SHIFT CLEAR key) performs the auto zero adjustment and clears the data at the same time.
6. Open the clamps of the sensor, place the conductor to be measured in the center of the clamp core, and clamp it.

NOTE

- When measuring a current of 10 Hz or less, use AC+DC A mode (it is not necessary to select SLOW when only peak measurement is performed).
- Be careful to prevent the power from being turned off by the auto-power-off function (see "3.15 Auto Power Off Function" (p. 74)). If the measurement exceeds the auto-power-off time, disable the auto power off.
- When peak measurement is performed, the polarity will not be displayed. When the direction of the clamp sensor is changed, the measurement may change within the guaranteed accuracy range.
- Clear the data using the CLEAR key, if necessary, after clamping the conductor.
- There is no difference in peak measurement between RMS and MEAN in AC A mode.
- The output function is not available for peak measurements. If the OUTPUT key is pressed in peak measurement mode, the current measurement will be output.
- To check the transitional peak values, press the MAX/MIN key to display a measurement (no indicator). (The largest value will be displayed each time the screen is updated.)
- The bar graph is not displayed in peak measurement mode.
- During peak measurement, the peak detection circuit performs analog processing (no digital sampling is performed).

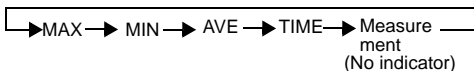

3.2.6 Output Function (Current Measurement)

Fully insert the 9094 output cord (optional) into the output terminal.



To prevent malfunction, be careful not to short-circuit the output terminal or apply a voltage to it.

There are two output terminals, and different signals may be output from these terminals. The current measurement is output at the rate printed on the battery cover of the 3290.

The battery-low warning signal is output at approximately DC 3 V until the warning indicator (■B) appears. After ■B has appeared, it will be reduced to approx. 0 V (see "3.17 Battery-Low Warning" (p. 76)).

- Output 1 (OUT1) is selectable between REC (numerical record output) and MON (waveform output) during current measurement (MON only in DC A mode, see "1.5 Modes" (p. 29)). During frequency measurement, REC (numerical record output) can be selected.
 - Output 2 (OUT2) is selectable between REC (numerical record output) and B.Lo (battery-low warning signal) during current measurement (B.Lo only in DC A mode). During frequency measurement, REC (numerical record output) can be selected.
1. Press the MODE key to select a measurement mode suitable for the circuit to be measured.
 2. Press the RANGE key to fix the measurement range.
 3. Press OUTPUT key, and OUT1 and OUT2 will light up, indicating that the output function is enabled. This automatically disables the auto power off ("APS" goes out).

4. Press the OUTPUT key to edit the output setting.

DC A Mode

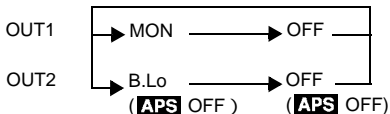

AC A Mode and AC+DC A Mode

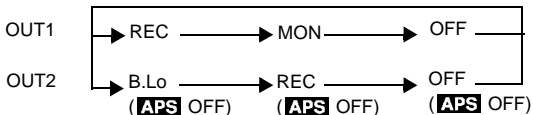

5. Determine the range setting from both the measurement range of the 3290 and that of the instrument used, such as a recorder. See the conversion tables below.

Instrument range /DIV	10 mV	20 mV	50 mV	0.1 V	0.2 V	0.5 V	1 V	2V
200 A range	1 A	2 A	5 A	10 A	20 A	50 A	100 A	200 A
20 A range	0.1 A	0.2 A	0.5 A	1 A	2 A	5 A	10 A	20 A

*The figures above represent the currents per DIV of the measuring instrument.

Instrument range /DIV	10 mV	20 mV	50 mV	0.1 V	0.2 V	0.5 V	1 V	2V
2000 A range	10 A	20 A	50 A	100 A	200 A	500 A	1000 A	2000 A
200 A range	1 A	2 A	5 A	10 A	20 A	50 A	100 A	200 A

*The figures above represent the currents per DIV of the measuring instrument.

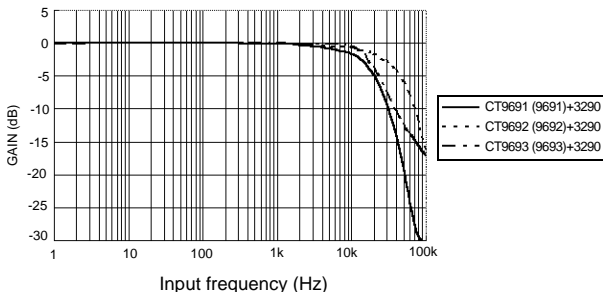
Clamp-On Sensor + 3290 MON Output
Frequency Characteristics**NOTE**

- Make sure measuring instruments connected to the 3290 have input impedance over 1 M Ω . If the impedance is low, the readings will be affected.
- When using the output function, be sure to press the OUTPUT key, and make sure OUT1 is on. Data is output even if OUT1 is not shown on the LCD. However, the auto power off is valid, and the power will be turned off approximately 10 minutes later.
- If the auto zero adjustment is not performed in DC A or AC+DC A mode, errors may occur in the reading and output.
- When measuring a current of 10 Hz or less, use AC+DC A mode. Press the SAMPL key to set the screen updating rate to SLOW (the measurement response speed must be SLOW; the unit symbol "A" will blink slowly). If SLOW is selected in AC A mode, the measurements may become smaller than those in AC+DC A mode.

NOTE

- The guaranteed output accuracy range is that in which the current measurements are not **O.L.** in the L range (MON output may saturate if it exceeds 4 V in the L range). In the H range, the accuracy range is determined by the maximum peak current of the clamp-on sensor.
- There is no difference in MON output between RMS and MEAN in AC A mode.
- If the OUTPUT key is pressed in AUTO range, the measurement range is set to the range in effect when the key is pressed (AUTO goes out).
- The REC output is analog. During RMS measurement, the measurement response speed changes in accordance with the screen updating rate. The measurement response speed may be changed separately by pressing the RESPONSE key (SHIFT → SAMPL key). (See "3.9 Measurement Response Speed Switching Function" (p. 67).)
- During MEAN measurement, the measurement response speed will not change when the screen updating rate is changed.
- While current measurements are being output, peak measurement or frequency measurement can be performed, and the recording function or data hold function can be used (if the screen updating rate, measurement mode, or measurement range is changed, or auto zero adjustment is performed, the output will fluctuate).
- If the HOLD key is pressed during output, the output value will not be held.
- If the MODE key is pressed to switch over to the current measurement mode while frequency measurement records are being output, the 3290 continues to output the frequency records. To output current measurements, press the OUTPUT key to cancel the frequency output and edit the output setting.
- Use the 9445-02 or 9445-03 AC adapter (optional) for long-term recording.
- When the AC adapter is used, if the commercial power line contains a large amount of noise, the display may show several counts or noise may be present in the output. In such a case, connect the ground terminal or the L terminal of the recorder to the ground.

3.3 Frequency Measurement

3.3.1 Frequency Measurement

1. Press the MODE key to display “ \sim ”.
2. When the current range of the circuit to be measured is known, set the current range to the manual range (if the current range is unknown, perform current measurement and then set the range).
3. Each time the PEAK/Hz key is pressed, the indication will change as shown below.

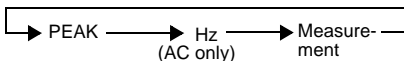

4. Select a frequency range suitable for the frequency to be measured.
5. Open the clamps of the sensor, and clamp the conductor to be measured.

NOTE

- When the 3290 is running on the battery, if frequency measurement is performed with the current showing O.L., the current consumption will be increased and the battery life will be shortened.
- If the input is too small for the range (5% or less), the measurement may not be accurate. The reading may show “----” or O.L., or it may fluctuate.
- The reading will show “----” if the input is below 10 Hz in the 100-Hz or 1000-Hz range, and below 1 Hz in the 10-Hz range.
- If the input exceeds 1 kHz, the reading shows O.L..
- Some time may be required for the reading to stabilize, depending on the frequency range and input frequency.

NOTE

- The 10-Hz range or 100-Hz range will display up to 125% of each range.
- Pressing the MAX/MIN key will not affect the output.
- The bar graph shows the current measurement.
- Zero cross detection of waveforms is used for frequency measurement. In the case of special waveforms, such as those of inverters, the frequencies may not be measured despite the fact that a low-pass filter is used (when the carrier frequencies are as low as several kHz, the carrier component cannot be removed and zero cross detection therefore cannot be performed correctly, thereby increasing the reading).
- If there is a DC waveform including 0 V, zero cross detection cannot be performed correctly and the reading may be increased or become unstable.

3.3.2 Output Function (Frequency Measurement)

Fully insert the 9094 output cord (optional) into the output terminal.

⚠ WARNING

To prevent malfunction, be careful not to short-circuit the output terminal or apply a voltage to it.

An output of DC 1 V is produced for 1000 counts on the full scale of the frequency range. The output is synchronized with the screen updating rate. (The output waveform will be in a stepped shape due to D/A outputs.)

1. Edit the settings while referring to "3.3.1 Frequency Measurement" (p. 57).
2. Press the OUTPUT key; OUT1 and OUT2 will light up, indicating that the output function is enabled. OUT1 outputs the frequency numerical record, and OUT2 outputs the current numerical record.

3. The auto-power-off function will be automatically disabled (**APS** goes out).

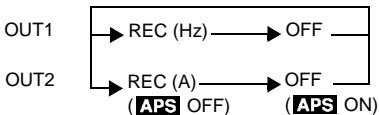

4. Determine the range setting from both the measurement range of the 3290 and that of the instrument used, such as a recorder.

Instrument range /DIV	10 mV	20 mV	50 mV	0.1 V	0.2 V	0.5 V	1 V
1000 Hz range	10 Hz	20 Hz	50 Hz	100 Hz	200 Hz	500 Hz	1000 Hz
100 Hz range	1 Hz	2 Hz	5 Hz	10 Hz	20 Hz	50 Hz	100 Hz
10 Hz range	0.1 Hz	0.2 Hz	0.5 Hz	1 Hz	2 Hz	5 Hz	10 Hz

*The figures above represent the frequencies per DIV of the measuring instrument.

NOTE

- Make sure measuring instruments connected to the 3290 have input impedance over 1 M.
- When using the output function, be sure to press the OUTPUT key and confirm that OUT1 is on. When OUT1 is off, the output will not reflect the value for frequency measurement.
- When the 3290 is running off battery power, performing frequency measurements with the current showing O.L. will increase current consumption and reduce battery life.
- If the OUTPUT key is pressed in the AUTO range, the frequency range is set to the range in effect at the time the key is pressed (AUTO goes out).
- If the HOLD key is pressed, the output value will also be held.
- If the measurement mode is changed to frequency measurement mode while current measurement records are being output, the 3290 will continue to output current records. To output frequency measurements, press the OUTPUT key to cancel current output and edit the output setting.

NOTE

- When “----“ is displayed, the output is 0 V. When **O.L.** is displayed, the output is approx. 1.4 V.
- Use the 9445-02 or 9445-03 AC adapter (optional) for long-term recording.
- When the AC adapter is used, if the commercial power line contains a large amount of noise, the display may show several counts or noise may be present in the output. In such a case, connect the ground terminal or the L terminal of the recorder to the ground.

3.4 Auto-Zero Adjustment Function

The auto-zero adjustment function automatically adjusts the offset in the internal circuit that results from temperature characteristics or clamp-sensor magnetization. This function is used for measurement in DC A mode and AC+DC A mode. The clamp core is magnetized when a large DC current is measured or a powerful magnet is placed close to the clamp core.

1. Fully close the clamps of the sensor and confirm that the reading has stabilized with no input. Press the 0ADJ key (SHIFT CLEAR key). “**ADJ**” blinks during auto-zero adjustment and stops blinking and remains on upon completion.

NOTE

- Perform auto-zero adjustment even if the reading is zero.
- The adjustable range in current measurement mode is ± 450 dgt in the L range and ± 45 dgt. in the H range. If the sensor's offset exceeds these ranges, auto-zero adjustment cannot be performed.
- If auto-zero adjustment is performed during current measurement or while the reading fluctuates, zero adjustment may not be performed correctly.
- If the 0ADJ key (SHIFT CLEAR key) is pressed again during auto-zero adjustment (**ADJ** is blinking), zero adjustment will be canceled.

3.5 Data Hold Function

Use this function to hold the current reading. “**HOLD**” will light up, and the numerical reading and bar graph will be held. The data hold function is available in any measurement mode.

1. Press the HOLD key; the reading and bar graph will be held.
2. To cancel, press the HOLD key again.

NOTE

- If the HOLD key is pressed while current measurements are being output, the output will not be held. While frequency measurements are being output, the output reflects the reading.

3.6 Changing the Screen Update Rate

The screen update rate is set to twice per second when power is turned on. This rate may be changed according to measurement conditions. Every time the SAMPL key is pressed, the indication changes as shown below.

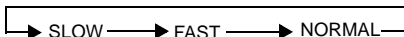

3.6.1 SLOW Mode

If the reading fluctuates rapidly, making it hard to read during current or frequency measurement, select a slower screen update rate (approximately once every 3 seconds).

NOTE

- To measure currents of 10 Hz or less, measurement accuracy is guaranteed only when AC+DC A mode is selected and the measurement response speed is set to SLOW.
- During RMS measurement in AC A mode or in AC+DC A mode, the measurement response speed (RMS measurement conversion speed) changes according to the screen update rate (“5” lights up for approximately 1 second). In SLOW mode, the unit symbol “A” blinks slowly.

NOTE

- During RMS measurement in AC A mode or in AC+DC A mode, measurement response time is approximately 8 seconds. If there is a transient change in measurement, some time will be required for the reading to stabilize.

3.6.2 FAST Mode

This mode sets the screen update rate to approximately 4 times/second during current or frequency measurement. It is suitable for measurement of abrupt changes such as starting currents.

When measuring a starting current, press the MAX/MIN key to use the recording function in order to hold the maximum value (MAX). This will make measurements easier to read.

NOTE

- When the measurement response speed is set to FAST during measurement of currents below 45 Hz, measurement accuracy cannot be guaranteed.
- During RMS measurement in AC A mode or in AC+DC A mode, the measurement response speed (RMS measurement conversion speed) changes according to the screen update rate ("F." lights up for approximately 1 second). In FAST mode, the unit symbol "A" blinks quickly.
- During RMS measurement in AC A mode or in AC+DC A mode, a continuous waveform of more than 200 ms is required to start current measurement. With a shorter waveform, the reading will indicate a value smaller than the actual value.

3.7 Recording Function

Use the recording function to hold the maximum measurement, minimum measurement, and mean value of the maximum & minimum.

3.7.1 Measurement Reading

Pressing the MAX/MIN key during current or frequency measurements activates the recording function. The 3290 saves the maximum measurement (MAX), minimum measurement (MIN), and mean value (AVE) in internal memory when the MAX/MIN key is pressed. If the MAX/MIN key is pressed while the recording function is activated, the indication changes as shown below. When MAX, MIN, AVE, or TIME is not displayed, the reading represents an instantaneous value.

The unit for the bar graph is hours.

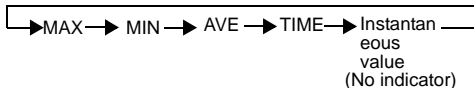

Data (MAX, MIN, AVE) will be held while the display is being switched over. However, if the maximum or minimum data is updated in the meantime, the data values will be updated.

When the recording function is activated, the auto power off function is disabled (**APS** off).

The mean value (AVE) is calculated by the following equation:

$$\text{Mean Value} = [(\text{Maximum} + \text{Minimum})/2]$$

If, after PEAK mode is selected using the PEAK/Hz key, the recording function is activated and an instantaneous value (no indicator) is selected, the transitional peak values can be viewed.

3.7.2 Display of Elapsed Time

When the MAX/MIN key is pressed to activate the recording function, measurement of elapsed time will begin. The elapsed time is displayed when "TIME" is on. The digital readout can display a maximum of 99 hours 59 minutes. Each block of 100 hours is indicated by the illumination of successive bar graph segments. An elapsed time of up to 2099 hours 59 minutes can be so indicated.

When the second segment lights up, 100 hours have elapsed. When the 21st segment lights up, 2000 hours have elapsed.

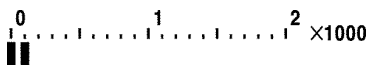

3.7.3 Interrupting the Recording Function

Press the HOLD key to interrupt the recording function.

"**HOLD**" will light up, and the elapsed time will stop incrementing. While the recording function is interrupted, data is not updated even if the clamp sensor is disconnected from the conductor. While the recording function is interrupted, the readings can be changed using the MAX/MIN key. When the HOLD key is pressed again, "**HOLD**" will disappear and recording will resume.

3.7.4 Clearing Recorded Data

To clear data while the recording function is activated, press the CLEAR key.

3.7.5 Disabling the Recording Function

To disable the recording function, press the MODE key during current or frequency measurement. If the recording function is disabled, the auto power off function will be enabled (**APS** lights up). However, if the output function is on, the auto power off function will not be enabled.

NOTE

- When minimum and average data is required, start the recording function during measurement. If the recording function is started when there is no input, the minimum measurements always show zero. To end the recording, press the HOLD key, then end measurement. If the clamp-on sensor is disconnected from the circuit to be measured before the recording function is ended, the minimum measurement will become zero.
- The data will be lost when power is turned off.
- If the recording function is started in the AUTO range, the measurement range will be set to the range in effect at the time the MAX/MIN key is pressed.
- Use the 9445-02 or 9445-03 AC adapter (optional) for long-term recording. If the 3290 is powered by batteries, press the B.CHECK key (SHIFT → MAX/MIN key) and check the remaining battery power before starting measurement.

3.8 Measurement Method Switching Function

In AC A mode, the measurement method is selectable between true rms measurement (RMS) and average rectified rms indication (MEAN). RMS provides accurate measurement of distorted waveforms. MEAN provides accurate measurement of sine waves that are not distorted. Press the RMS/MEAN key (SHIFT → MODE key) to select the measurement method.

3.8.1 RMS Measurement

The true rms measurement uses the rms conversion IC. In addition to distorted waveforms, this method is used for square and triangle waves. In AC+ DC A mode, full-wave rectified and half-wave rectified waveforms are also measured. For this conversion, there is a correlation between frequency characteristics and conversion speed (see "3.9 Measurement Response Speed Switching Function" (p. 67)).

NOTE

- In AC+DC A mode, RMS measurement is performed.

3.8.2 MEAN Measurement

The average rectified rms indication measurement converts the input waveform to a full-wave rectified waveform using the absolute value detection circuit. The converted waveform is then smoothed by LPF and multiplied by 1.11 for conversion to rms. This method provides accurate measurement of only sine waves without distortion. If the measurement is nearly the same as the RMS measurement, the waveform will be similar to a sine wave with little distortion. Furthermore, after peak measurement is performed, the ratio of the peak value to the MEAN measurement is approximately 1.4 ($= \sqrt{2}$), which is even closer to a sine wave.

3.9 Measurement Response Speed Switching Function

When RMS is selected in AC A mode or when measurement is performed in AC+DC A mode, the measurement response speed can be changed. Press the RESPONSE key (SHIFT → SAMPL key) to change the speed.

Pressing the SAMPL key only changes the screen update rate. The measurement response speed will be changed according to the screen update rate.

3.9.1 NORMAL Mode

If the setting is not saved by the setting save function, the 3290 is in NORMAL mode. In NORMAL mode, no indicator is shown on the LCD. The unit symbol "A" remains on without blinking. This mode can be used for almost any measurement.

3.9.2 SLOW Mode

When SLOW mode is selected, "S" lights up for approximately 1 second and the unit "A" blinks slowly. In AC+DC A mode, low frequencies (10 Hz or less) will be measured accurately when SLOW mode is selected. However, due to the slow response speed, the 3290 will be unable to measure sudden changes.

NOTE

- To measure currents of 10 Hz or less, measurement accuracy is guaranteed only when AC+DC A mode is selected and measurement response speed is set to SLOW.

3.9.3 FAST Mode

When FAST mode is selected, "F" lights up for approximately 1 second and the unit "A" blinks quickly. In FAST mode, the 3290 is able to measure sudden changes but cannot measure low frequencies (below 45 Hz) accurately.

NOTE

- Accuracy is not guaranteed for frequencies below 45 Hz.

Output Response Waveform (Rise)

FAST

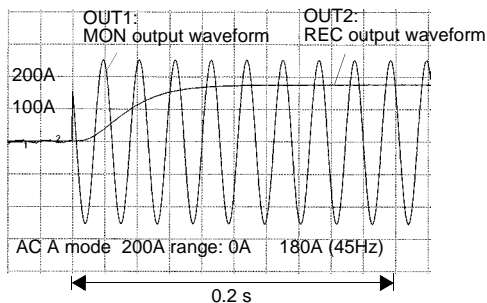

NORMAL

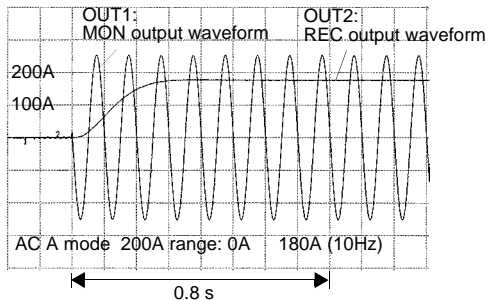

SLOW

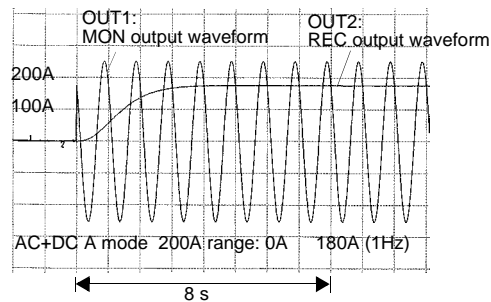

Output Response Waveform (Fall)

FAST

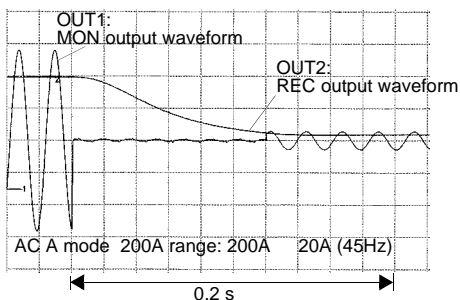

NORMAL

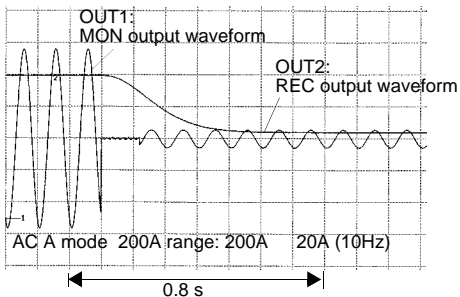

SLOW

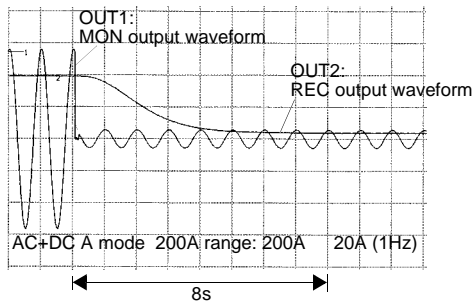

3.10 Filter Function

The filter function is available in AC A and AC+DC A modes. A low-pass filter (LPF) allows low frequencies to pass through while removing high frequencies. The 3290 sets the cut-off frequency (f_c) to approximately 500 Hz. When the filter function is enabled, input current waveforms around 500 Hz can be reduced to -3 dB (attenuation by approx. 30%). ("FILTER" will appear when the filter function is enabled.)

Use this function to remove the carrier component of the secondary side of an inverter, or to reduce noise. Press the FILTER key (SHIFT → PEAK/Hz key) to enable this function.

Fundamental: 50 Hz
Carrier: 2 kHz

Filter OFF
OUT1: MON output

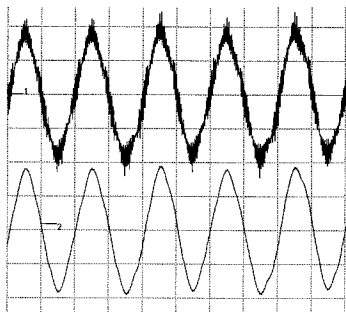

Filter ON
OUT1: MON output

3290 Filter Characteristics

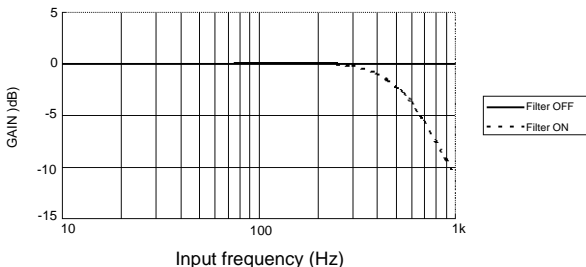

3.11 Key Lock Function

This function locks all keys, including the POWER key, to prevent accidental alteration of the settings. The auto power off function will be disabled.

Press the LOCK key (SHIFT → HOLD key) to lock. Press it again to unlock. "**LOCK**" will appear when the keys are locked.

3.12 Bar Graph Enlargement Function

The bar graph is normally sized according to the measurement range. The bar graph can be enlarged to show 1/10 of the range.

Press the B.GRAPH key (SHIFT → RANGE key) to enlarge. Press it again to cancel. For example, the L range (20.00-A range when the CT9691 (9691) clamp-on sensor is used) can be enlarged to 2-A full scale (f.s.).

3.13 Battery Check Function

This function uses a bar graph to indicate the remaining battery power. Press the B.CHECK key (SHIFT MAX/MIN key) to display the bar graph. The remaining charge will be indicated as 0%, 25%, 50%, 75%, or 100% for approximately 2 seconds. An indication of 100% means sufficient charge remains. An indication of 0% means battery power is exhausted.

When it falls to 0%, the battery-low warning indicator (**B**) will appear.

If the unit runs off the 9445-02 or 9445-03 AC adapter, AC adapter voltage will be indicated instead.



New battery



Reduced to 50%

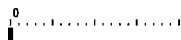

Reduced to 0. **B** lights up. The beep tone sounds 3 times.

NOTE

- After **B** lights up, accuracy cannot be guaranteed. Replace batteries immediately.
- * If the AC adapter voltage is indicated, the indicated value may not reach 100%. However, this does not indicate a problem (when the specified AC adapter 9445-02 or 9445-03 is used).

3.14 MON Output Filter Function

In DC A or AC+DC A mode, when OUT1 is set to MON, output can be obtained through a low-pass filter (LPF) set to approximately 1 Hz. This function will be useful for outputting a DC component only when an AC component or noise is superimposed on the DC component. Press the MON.FL key (SHIFT → OUTPUT key) to enable the function. Press it again to disable the function. If this function is enabled in AC+DC A mode, OUT1 outputs the DC component while OUT2 outputs the AC component (REC). The mode indicator changes from “

NOTE

- When MON.FL is used, the response speed of OUT1 will be reduced.
- OUT1 has a 1-Hz filter. If the AC component included in a waveform has a low frequency and large input, the filter may be unable to completely remove the AC component.
- Peak measurement using this function shows the same result as peak measurement in AC A mode (peak measurement of the waveform with the DC component removed).

3.15 Auto Power Off Function

When approximately 10 minutes have elapsed since the last key operation, the power to the 3290 is automatically turned off. This prevents the 3290 from being left on unintentionally and minimizes battery consumption.

When "**APS**" is displayed, the auto power off function is enabled. "**APS**" will start blinking and the beep tone will sound for approximately 30 seconds just before power is turned off.

Press any key except the POWER key to extend operation by 10 minutes.

Disabling the Auto Power Off Function

- While holding down the HOLD key, press the POWER key to turn on power (to enable the auto power off function, turn power off, then on again).
- When the setting is saved with the auto power off function disabled, to enable the function, restore the default setting (while holding down the CLEAR key, turn on power).

NOTE

In the following cases, the power will not be turned off even if the auto power off function is enabled.

- The MAX/MIN key is pressed and the recording function is used.
- The OUTPUT key has been pressed.
- The LOCK key has been pressed.

3.16 Setting the Save Function

The 3290 is factory-set as shown below. A setting may be edited (for example) by selecting a frequently used mode and saving it. When the setting is saved, the 3290 will be turned on with the saved setting. The saved setting can be changed.

With the power on, set the mode, measurement range and other parameters. Hold down the HOLD key for approximately 2 seconds (“**SAVE**” will appear). To restore the default setting, hold down the CLEAR key and turn on power (press the POWER key). (“**DATA**” and “**CLR**” will appear.)

Mode	Range	Output	Auto power-off	Screen-updating
DC	AUTO	OFF	ON	NORMAL

The following settings cannot be saved.

- Recording function (Set it after measurement has started.)
- Sensor detection (The 3290 detects the sensor connected when power is turned on.)

NOTE

- If the setting is saved following auto-zero adjustment, the auto-zero adjustment data will be saved. However, be sure to perform auto-zero adjustment before starting measurement in DC A or AC+DC A mode.
- The auto power off setting and the beep tone setting can also be saved. To enable the auto power off function or the beep tone, hold down the CLEAR key and turn on power.
- The Record Function is disabled as soon as the instrument's power is turned off. To enable the Record Function, make the appropriate settings again after turning on the power.
- If using the 3290 after it has been repaired or recalibrated, the saved settings may have been deleted. Check that the settings saved prior to repair work are still valid before using the instrument; otherwise reset and re-save the settings as appropriate.

3.17 Battery-Low Warning



If the unit is operated with very low battery power, accuracy cannot be guaranteed. When the battery-low warning indicator (**B**) appears, replace all batteries with fresh batteries.

If the battery-low warning indicator (**B**) appears during long-term current measurement output, it may not be clear which measurements are guaranteed and which are not. If OUT2 is set to B.Lo, around DC 3 V is output if the battery-low warning indicator (**B**) is not on, and 0 V is output when the indicator is on.

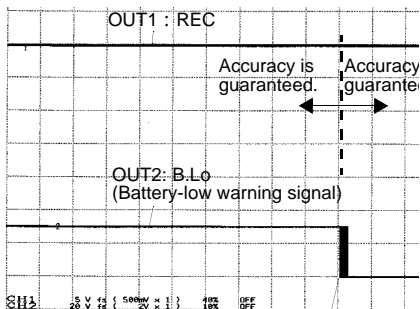

If the paper-feed speed is low, the lines of the graph will be thickened.

NOTE

- When the 3290 is running off battery power, performing frequency measurements with the current showing O.L., will increase current consumption and reduce battery life.
- The charge remaining in the battery can be checked using the bar graph immediately after power is turned on or by pressing the B.CHECK key (SHIFT → MAX/MIN key). Please note that the charge indicated is approximate and should only be used as a guide. Exercise caution when performing long-term measurement or when using the recording function.

NOTE

If the power is turned off with the battery-low warning indicator (**B**) displayed, when power is turned on again, the battery-low warning indicator (**B**) may not light up immediately. This is because voltage often increases slightly if a battery is not used for some time. The battery-low warning indicator (**B**) will soon light up again. Replace the battery as soon as possible (see "Chapter 4 Batteries Replacement" (p. 79)).

3.18 Beep Tone

The beep tone sounds once when any key is pressed. It sounds twice when the key operation is not accepted. The key operation is not accepted in the following cases.

- Invalid operation while the recording function is in use
- Invalid operation while **S** is displayed
- Data clear (CLEAR key) when peak measurement is not selected
- Filter switching (SHIFT → PEAK/Hz key) in DC A mode
- Measurement response speed switching (SHIFT → OUTPUT key) in DC A mode
- Auto-zero adjustment (SHIFT → CLEAR key) in AC A mode

Disabling the Beep Tone

- While holding down the PEAK/Hz key, press the POWER key (turn power off, then on again to cancel).
- If the setting is saved with the beep tone disabled, to enable the beep tone, restore the default setting (hold down the CLEAR key and turn on power).

Batteries Replacement

Chapter 4



- To avoid electric shock when replacing the batteries, first disconnect the clamp from the object to be measured.
 - After replacing the batteries, replace the cover and screws before using the product.
 - Do not mix old and new batteries, or different types of batteries. Also, be careful to observe battery polarity during installation. Otherwise, poor performance or damage from battery leakage could result.
 - To avoid the possibility of explosion, do not short circuit, disassemble or incinerate batteries.
 - Handle and dispose of batteries in accordance with local regulations.
-
1. Use a Phillips screwdriver to unfasten the setscrew on the battery cover.
 2. Remove the battery cover.
 3. Remove the battery.
 4. Insert a new batteries while confirming the correct polarity.
 5. First fit the tab of the cover, then fit the cover. Secure the cover in place by tightening the setscrew.

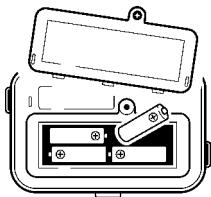

AC Adapter

Chapter 5

Fully insert the optional 9445-02 AC adapter into the AC adapter connection terminal.



- AC adapter input voltage range is 100 to 240 VAC (with $\pm 10\%$ stability) at 50/60 Hz. To avoid electrical hazards and damage to the product, do not apply voltage outside of this range.



- For AC adapter operation, use only the Hioki Model 9445-02 or 9445-03 AC adapter. We cannot accept responsibility for accidents or damage related to the use of any other AC adapter.

The adapter may be used either with or without the batteries.

Use of the batteries enables continuous measurement if the AC power source temporarily becomes unavailable, due to a blackout or some other reason. (The duration of measurement backup depends on the remaining battery power.)

When using the AC adapter, note that the voltage drops to approximately 6 V. When the battery voltage is higher than the internal voltage (i.e., when using a brand new battery), the battery may be drained. When the battery voltage drops below the internal voltage, the power supply is switched over to the AC adapter.

NOTE

- When using the AC adapter, note that current of approximately 3 mA is consumed regardless of whether the power switch of the 3290 is on or off. (Battery power is not consumed, however, when power is turned off.)
- When the power supply is switched over from the battery to the AC adapter or vice versa during peak measurement, an inaccurate measurement result (i.e., value larger than the actual value) may be displayed.
- When using the AC adapter, note that the battery indicator (bar graph) indicates the voltage (approx. 6 V) of the AC adapter. Though the voltage may not reach 100%, this poses no problem for measurement operation.

Attaching the Strap Chapter 6

Using the 3290 with the strap attached improves operability.

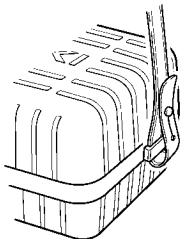

1. Fasten the two straps together into one.
2. Attach each end to the 3290 as shown in the figure above.

Specifications

Chapter 7

7.1 Measurement Specifications

Measurement Mode

 DC A

 AC A (RMS: True RMS, MEAN: Mean Value)

 AC+DC A (RMS: True RMS)

Use with Sensor

(The specifications vary depending on the maximum continuous input range and maximum peak current of the sensor used.)

- The current measurement ranges of the 3290 are auto range and manual range (L range and H range).

The 3290 automatically detects the sensor connected to it.

Connected sensor	Standard Measurement			Peak Measurement			Output rate
	Range	Resolution	Maximum displayed	Range	Resolution	Maximum displayed	
CT9691 (9691)	20 A	0.01 A	25.00 A	20 A	0.1 A	50.0 A	100 mV/A
	200 A	0.1 A	105.0 A	200 A	0.1 A	150.0 A	10 mV/A
CT9692 (9692)	20 A	0.01 A	25.00 A	20 A	0.1 A	50.0 A	100 mV/A
	200 A	0.1 A	210.0 A	200 A	0.1 A	300.0 A	10 mV/A
CT9693 (9693)	200 A	0.1 A	250.0 A	200 A	1 A	500 A	10 mV/A
	2000 A	1 A	2100 A	2000 A	1 A	3000 A	1 mV/A

Measurement Response Speed

The measurement response speed is the time required until the analog output value stabilizes when input is changed from 0% to 90% and from 100% to 10% of the range in true rms measurement (RMS).

- (1) FAST (0.2 sec)
Satisfies the specification at 45 Hz or more.
- (2) NORMAL (0.8 sec)
Satisfies the specification at 10 Hz or more.
- (3) SLOW (8.0 sec)
Satisfies the specification at 1 Hz or more.

Accuracy of the 3290

(23±5°C, 73±9°F, 80%RH or less, no condensation)
Guaranteed accuracy period: 1 year

1. Current Measurement

- In DC or AC+DC mode, the measurement is conducted after zero adjustment has been performed.
- FAST, NORMAL, and SLOW indicate the measurement response speed.
- When a low-pass filter (500 Hz) is used, the specifications shall be satisfied at 60 Hz or less.

(1) Display accuracy

± (rdg. +dgt.)

		DC	1 ≤ f < 10 (Hz)	10 < f < 45 (Hz)	45 ≤ f ≤ 66 (Hz)	66 ≤ f ≤ 1k (Hz)
DC		± (0.3%+5)	-	-	-	-
AC RMS AC+DC	FAST	± (0.3%+7) (AC +DC only)	-	-	± (0.3%+3)	± (0.3%+3)
	NORMAL		± (1.0%+3) (AC +DC only)	± (0.3%+3)		
	SLOW		-	-		
AC MEAN			-	-		

(2) REC output accuracy (2 V/range)

± (rdg. +mV)

		DC	1 ≤ f < 10 (Hz)	10 < f < 45 (Hz)	45 ≤ f ≤ 66 (Hz)	66 ≤ f ≤ 1k (Hz)
AC RMS AC+DC	FAST	± (0.8%+10) (AC +DC only)	-	-	± (0.8%+5)	± (0.8%+5)
	NORMAL		± (1.3%+5) (AC +DC only)	± (0.8%+5)		
	SLOW		-	-		
AC MEAN			-			

(3) MON output accuracy (2 V/range)

± (rdg. +mV)

	DC	1 ≤ f < 10 (Hz)	10 < f < 45 (Hz)	45 ≤ f ≤ 66 (Hz)	66 ≤ f ≤ 1k (Hz)
DC	± (0.3%+5)	± (0.3%+5)	± (0.3%+5)	± (0.3%+5)	± (0.3%+5)
AC+DC					
AC	-	-			

(4) Peak display accuracy (Peak hold function)

When sine waves are continuously input after peak reset

L range

± (rdg. +dgt.)

	DC	1 ≤ f < 10 (Hz)	10 < f < 45 (Hz)	45 ≤ f ≤ 66 (Hz)	66 ≤ f ≤ 1k (Hz)
DC	± (0.5%+2)	± (0.5%+2)	± (0.5%+2)	± (0.5%+2)	± (0.5%+2)
AC+DC					
AC	-	-			

H range

± (rdg. +dgt.)

	DC	1 ≤ f < 10 (Hz)	10 < f < 45 (Hz)	45 ≤ f ≤ 66 (Hz)	66 ≤ f ≤ 1k (Hz)
DC	± (0.5%+5)	± (0.5%+5)	± (0.5%+5)	± (0.5%+5)	± (0.5%+5)
AC+DC					
AC	-	-			

2. Frequency measurement

- When input is 5% or larger of the current range

(1) Display accuracy

\pm (rdg. +dgt.)

Range (Accuracy Range)	Resolution	Maximum display	
10Hz (1.00 to 10.00Hz)	0.01Hz	12.50Hz	\pm (0.3%+1)
100Hz (10.0 to 100.0Hz)	0.1Hz	125.0Hz	
1000Hz (100 to 1000Hz)	1Hz	1000Hz	\pm (1.0%+1)

(2) Output accuracy

\pm (rdg. +mV)

Range (Accuracy Range)	REC	
10Hz (1.00 to 10.00Hz)	DC1V/f.s.	\pm (1.3%+3)
100Hz (10.0 to 100.0Hz)		
1000Hz (100 to 1000Hz)		\pm (2.0%+3)

Output response:

4 seconds or less at 1000 Hz and 100 Hz range

6 seconds or less at 10 Hz

7.2 General Specifications

Functions

Auto zero adjustment	Press the SHIFT and the CLEAR keys to perform auto zero adjustment (in DC A and AC+DC A modes).
Data hold	Press the HOLD key to retain the current value on the screen.

Turning the filter on/off	Press the SHIFT and the PEAK/Hz keys to turn a 500 Hz LPF on and off in AC A and AC+DC A modes. The filter characteristic is -3 dB at 550 Hz $\pm 10\%$.
Recording	Press the MAX/MIN key to select the maximum value (MAX), minimum value (MIN), average (AVE), or elapsed time (TIME) to be displayed.
Setting the save function	Hold down the HOLD key (for more than 2 sec.) to save the current settings. To initialize, hold down the CLEAR key and turn on the POWER key.
Switching the method of measurement	Press the SHIFT and the MODE keys to select the true rms (RMS) or average rectified rms indication (MEAN) (in AC A mode).
Expanding the bar graph range	Press the SHIFT and the RANGE keys to change the bar graph range.
Separate AC/DC output	Press the SHIFT and the OUTPUT keys to output MON (waveform passed through a 1 Hz LPF) from OUT1 and REC (numeric data coupled with AC) from OUT2. The LCD only shows the AC component (in AC+DC A mode).
Low battery warning output	Press the OUTPUT key (when OUT2 is set to B.Lo) to output 0 V for the low battery warning (normally 3.0 V).
Key lock	Press the SHIFT and the HOLD keys to lock the keys. Press the same keys again to unlock the keys.
Battery check	Press the SHIFT MAX/MIN keys to check the remaining battery power.
Switching response (Switching measurement response speed)	Select 0.2 sec. (FAST), 0.8 sec. (NORMAL), or 8 sec. (SLOW) when true rms (RMS) is selected. (Interlocked with screen-updating rate in AC RMS or AC+DC mode. Press the SHIFT SAMPL keys to set the response speed independently.)

Auto power-off	Automatic shutdown occurs after 10.5 ± 1 minutes. A beep tone warning sounds before shutdown. You can extend the time or disable the function (by holding down the HOLD key and turning power on).
Beep tone	ON/OFF (Holding down the PEAK/Hz key and turning power on switches off the beep sound.)
Display	Liquid crystal display (LCD)
Digital counter	Max. 3000 counts (current) Max. 1250 counts (frequency)
Bar graph display	21 segments
Over-range display	O.L. goes on. When input is outside the full-scale range, the ◀▶ bar graph appears.
Low battery warning	B goes on (during which time accuracy cannot be guaranteed).
Data hold indicator	HOLD
Auto power-off active indicator	APS
Units	A, Hz
Zero suppression	5 counts
Screen-updating rate	Digital counter NORMAL (approx. twice/second) SLOW (approx. once/3 seconds) FAST (approx. 4 times/second) Bar graph display Approx. 4 times/second
Display response time (The range can be fixed from 0% to 100%.)	Current: Max. 1 second Frequency: Max. 1 second (1000 Hz, 100 Hz range) Max. 2.5 seconds (10 Hz range)
Switching the range	Selectable from auto range and manual (fixed) range.

Circuit dynamic characteristics (crest factor)	Max. 2.5 (The upper limit of H range is the maximum peak current of the sensor connected. The maximum output voltage of L range is 4 V.)
Output impedance	Max. 100 Ω
Temperature characteristics	0 to 40°C range: 0.1 x accuracy specifications/°C 32 to 104°F range: 0.18 x accuracy specifications/°F
Location for use	Indoor, altitude up to 2000 m (6566 feet)
Operating temperature and humidity range	0 to 40°C, 32 to 104°F, 80% RH or less; no condensation
Storage temperature range	-10 to 50°C, 14 to 122°F; no condensation
Power supply	Four 1.5 V LR6 batteries or the AC adapter (optional)
Maximum rated power	500 mVA (running on battery power with a sensor connected)
Battery life	Approx. 22 hours (continuous, no load, with a sensor connected)
Applicable standards	Safety EN61010 EMC EN61326 EN61000-3-2 EN61000-3-3
Effect of conducted radio-frequency electromagnetic field	Max. 10%f.s. of L range at 3 V
Dimensions	Approx. 155W x 98H x 47D mm Approx. 6.10"W x 3.86"H x 1.85"D (excluding protruding parts)
Mass	Approx. 545 g (19.2 oz.) (including battery)
Accessories	Strap 1 LR6 batteries 4 Instruction manual 1

Options	9445-02 AC ADAPTER
	9445-03 AC ADAPTER
	9094 OUTPUT CORD
	9400 CARRYING CASE
	CT9691 (9691) CLAMP ON AC/DC SENSOR
	CT9692 (9692) CLAMP ON AC/DC SENSOR
	CT9693 (9693) CLAMP ON AC/DC SENSOR

Clamp Sensor Specifications

Chapter 8

8.1 CT9691 (9691) CLAMP ON AC/DC SENSOR

Rated current	AC/DC 100 A
Output voltage	AC/DC 1 V/100 A
Maximum permissible input (rms)	100 A continuous (Derating according to frequency)
Maximum peak current value	150 A peak
Accuracy guarantee for temperature and humidity	23±5°C (73±9°F), 80%RH or less, no condensation
Guaranteed accuracy period	1 year (Opening and closing of the sensor: 10,000 times)

(1) Continuous input

Range	DC	DC < f ≤ 66 (Hz)	66 < f ≤ 500 (Hz)
I ≤ 80 (A)	± 1.0%rdg.± 0.5mV	± 1.0%rdg.± 0.5mV	± 2.0%rdg.± 0.5mV
80 < I ≤ 100 (A)			± 2.5%rdg.± 0.5mV

(2) Peak input (only available for 3290 or 3290-10)

Range	DC	DC < f ≤ 66 (Hz)	66 < f ≤ 500 (Hz)
I _{peak} ≤ 110 (A _{peak})	± 1.0%rdg.± 2mV	± 1.0%rdg.± 2mV	± 2.0%rdg.± 2mV
110 < I _{peak} ≤ 150 (A _{peak})			± 2.5%rdg.± 2mV

Frequency band	DC to 10 kHz (-3dB)
Effect of conductor position	Within $\pm 1.0\%$ (at 80 A (55 Hz))
Effect of external electromagnetic field	0.5 A equivalent or less (in an external electromagnetic field of 400 A/m)
Temperature characteristics	0 to 40°C range: 0.1 x accuracy specifications/°C 32 to 104°F range: 0.18 x accuracy specifications/°F
Operating temperature and humidity range	0 to 40°C, 32 to 104°F, 80% RH or less; no condensation
Storage temperature range	-10 to 50°C, 14 to 122°F, 80% RH or less; no condensation
Location for use	Indoor, altitude up to 2000 m (6566 feet)
Maximum permitted circuit voltage	600 V
Dielectric strength	5.55 kV AC for 1 minute (sensor - case, sensor - circuit)
Maximum rated power	50 mVA
Measurable conductor diameter	$\phi 35$ mm (1.38") or less
Dimensions	Approx. 53W x 129H x 18D mm Approx. 2.09"W x 5.08"H x 0.71"D (excluding protruding parts)
Mass	Approx. 230 g (8.1 oz.) (including batteries)
Cable length	Approx. 2 m (6.5 feet)
Accessory	Instruction manual 1
Applicable standards	Safety EN61010 Measurement categories III (Anticipated Transient Over-voltage: 6000 V), Pollution Degree 2 EMC EN61326

CT9691 (Equivalent to 9691) Frequency characteristics

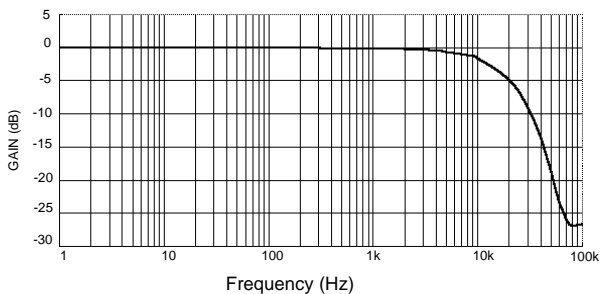

CT9691 (Equivalent to 9691) Derating according to frequency

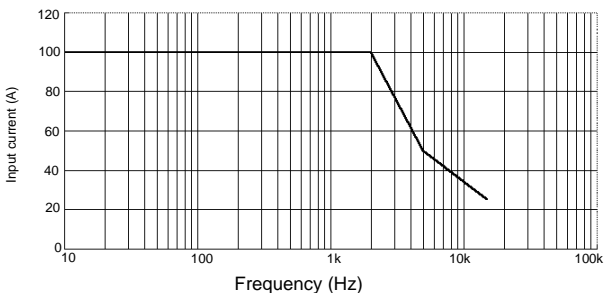

8.2 CT9692 (9692) CLAMP ON AC/DC SENSOR

Rated current	AC/DC 200 A
Output voltage	AC/DC 2 V/200 A
Maximum permissible input (rms)	200 A continuous (Derating according to frequency)
Maximum peak current value	300 A peak
Accuracy guarantee for temperature and humidity	23±5°C(73±9°F), 80%RH or less, no condensation
Guaranteed accuracy period	1 year (Opening and closing of the sensor: 10,000 times)

(1) Continuous input

Range	DC	DC < f ≤ 66 (Hz)	66 < f ≤ 1k(Hz)
I ≤ 200 (A)	± 1.0%rdg.± 0.5mV	± 1.0%rdg.± 0.5mV	± 2.0%rdg.± 0.5mV

(2) Peak input (only available for 3290 or 3290-10)

Range	DC	DC < f ≤ 66 (Hz)	66 < f ≤ 1k(Hz)
I _{peak} ≤ 300 (A _{peak})	± 1.0%rdg.± 2mV	± 1.0%rdg.± 2mV	± 2.0%rdg.± 2mV

Frequency band	DC to 20 kHz (-3dB)
Effect of conductor position	Within ±0.5%
Effect of external electromagnetic field	0.7 A equivalent or less (in an external electromagnetic field of 400 A/m)

Temperature characteristics	0 to 40°C range: 0.1 x accuracy specifications/°C 32 to 104°F range: 0.18 x accuracy specifications/°F
Operating temperature and humidity range	0 to 40°C, 32 to 104°F, 80% RH or less; no condensation
Storage temperature range	-10 to 50°C, 14 to 122°F, 80% RH or less; no condensation
Location for use	Indoor, altitude up to 2000 m (6566 feet)
Maximum permitted circuit voltage	600 V
Dielectric strength	5.55 kV AC for 1 minute (sensor - case, sensor - circuit)
Maximum rated power	50 mVA
Measurable conductor diameter	φ33 mm (1.30") or less
Dimensions	Approx. 62W x 167H x 35D mm Approx. 2.44"W x 6.57"H x 1.38"D (excluding protruding parts)
Mass	Approx. 410 g (14.5 oz.) (including batteries)
Cable length	Approx. 2 m (6.5 feet)
Accessory	Instruction manual 1
Applicable standards	Safety EN61010 Measurement categories III (Anticipated Transient Over-voltage: 6000 V), Pollution Degree 2 EMC EN61326

CT9692 (Equivalent to 9692) Frequency characteristic

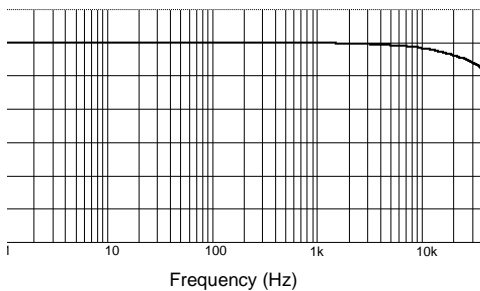

CT9692 (Equivalent to 9692) Derating according to frequency

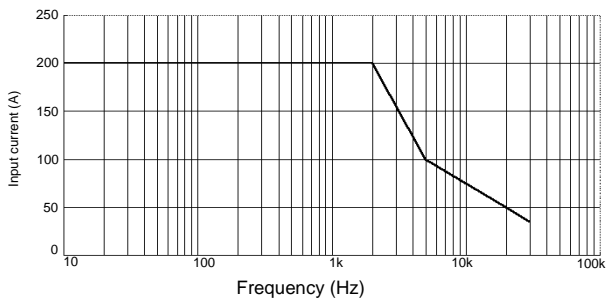

8.3 CT9693 (9693) CLAMP ON AC/DC SENSOR

Rated current	AC/DC 2000 A
Output voltage	AC/DC 2 V/2000 A
Maximum permissible input (rms)	2000 A (Derating according to frequency)
Maximum peak current value	2840 A peak
Accuracy guarantee for temperature and humidity	23±5°C(73±9°F), 80%RH or less, no condensation
Guaranteed accuracy period	1 year (Opening and closing of the sensor: 10,000 times)

(1) Continuous input

Range	DC	45 ≤ f ≤ 66 (Hz)	DC < f < 45, 66 < f ≤ 1k (Hz)
I ≤ 1800 (A)	± 1.5%rdg.± 0.5mV	± 1.0%rdg.± 0.5mV	± 2.0%rdg.± 0.5mV
1800 < I ≤ 2000 (A)		± 2.0%rdg.± 0.5mV	---

(2) Peak input (only available for 3290 or 3290-10)

Range	DC	45 ≤ f ≤ 66 (Hz)	DC < f < 45, 66 < f ≤ 1k (Hz)
I _{peak} ≤ 2300 (A _{peak})	± 1.5%rdg.± 2mV	± 1.0%rdg.± 2mV	± 2.0%rdg.± 2mV
2300 < I _{peak} ≤ 2840 (A _{peak})	± 6.0%rdg.± 2mV	± 6.0%rdg.± 2mV	---

Frequency band	DC to 15 kHz (-3dB)
Effect of conductor position	Within $\pm 0.7\%$
Effect of external electromagnetic field	2.0 A equivalent or less (in an external electromagnetic field of 400 A/m)
Temperature characteristics	0 to 40°C range: 0.1 x accuracy specifications/°C 32 to 104°F range: 0.18 x accuracy specifications/°F
Operating temperature and humidity range	0 to 40°C, 32 to 104°F, 80% RH or less; no condensation
Storage temperature range	-10 to 50°C, 14 to 122°F, 80% RH or less; no condensation
Location for use	Indoor, altitude up to 2000 m (6566 feet)
Maximum permitted circuit voltage	600 V
Dielectric strength	5.55 kV AC for 1 minute (sensor - case, sensor - circuit)
Maximum rated power	50 mVA
Measurable conductor diameter	$\phi 55$ mm (2.17") or less
Dimensions	Approx. 62W x 196H x 35D mm Approx. 2.44"W x 7.72"H x 1.38"D (excluding protruding parts)
Mass	Approx. 500 g (17.6 oz.) (including batteries)
Cable length	Approx. 2 m (6.5 feet)
Accessory	Instruction manual 1
Applicable standards	Safety EN61010 Measurement categories III (Anticipated Transient Over-voltage: 6000 V), Pollution Degree 2 EMC EN61326

CT9693 (Equivalent to 9693) Frequency characteris

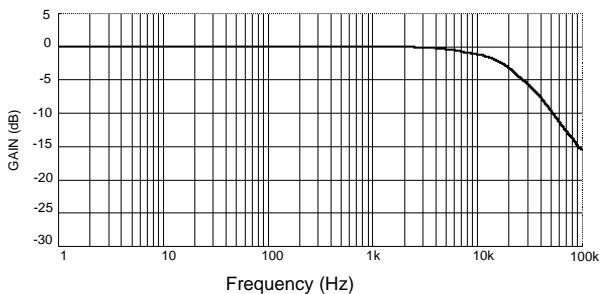

CT9693 (Equivalent to 9693) Derating according to frequency

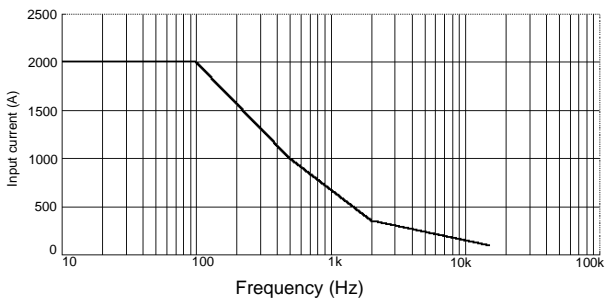

Carrying Case

Chapter 9

The optional 9400 Carrying Case is used to house the products described below.

- 3290 CLAMP ON AC/DC HiTESTER
- CT9691 (9691) CLAMP ON AC/DC SENSOR
- CT9692 (9692) CLAMP ON AC/DC SENSOR
- CT9693 (9693) CLAMP ON AC/DC SENSOR
- 9094 OUTPUT CORD
- 9445-02 AC ADAPTER or 9445-03 AC ADAPTER
- Instruction Manual
- Strap

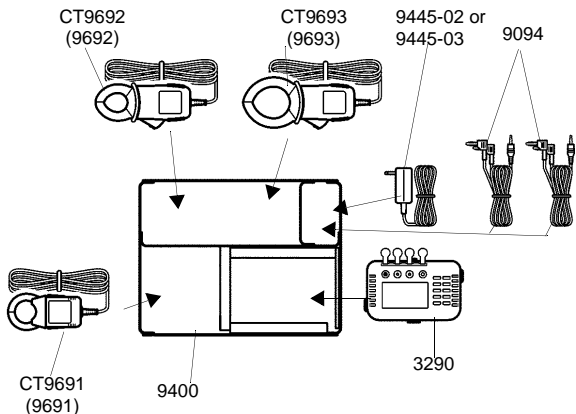

You can use the carrying case as follows:

1. Open the carrying case cover and fold it into the bottom of the case, then connect the sensor to the 3290 in the case.

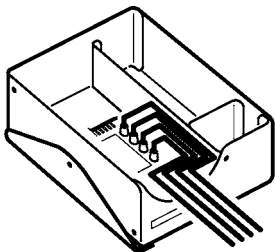

2. Remove the top case of the 3290. With the sensor connected to the 3290, close the carrying case cover and perform measurement. (Make sure that the cables are not compressed by the bulging instruction manual pocket on the rear of the cover when closing the cover.)

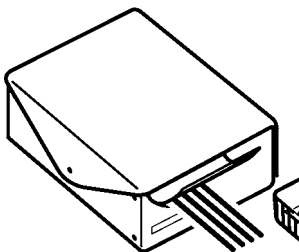

Troubleshooting Chapter 10

If the unit seems not to be working normally, check the following points first before requesting service.

Symptom	Batteries	Battery metal fittings
Unit does not come on.	Yes	Yes
ⓑ indication appears and unit immediately turns off.	Yes	
ⓑ indication appears.	Yes	
Unit turns off during use.*	Yes	Yes
Remedy: If problem persists, request service.	Replace batteries.	Check connection of batteries to metal fittings.

NOTE

- When APS (auto power-off) is effective, the unit is automatically shut down when no key is pressed for about 10 minutes. (See "3.15 Auto Power Off Function" (p. 74).)
- Hold down SHIFT key and turn the power on. The indication "3290" and version of software then appear on the LCD.
- The letter of LCD is clearest, when it sees from the front side. There is rose attachment in the depth of the letter when see LCD from right above, it is not break.

Repair is required if E.001 to E.005 is indicated on the counter, when power is turned on.

○ If no power is supplied:

- If you're using a battery, check that it has sufficient remaining power. (See "3.1 Preparations" (p. 43).) Even when using an unused battery, check the expiration date. A depleted battery may lack sufficient current capacity to drive the 3290.
- If you're using the AC adapter, check that it's fully inserted into the AC adapter terminal and socket.
- If no power is supplied by the AC adapter but the battery works, the adapter may be defective. (Make sure that you're using the 9445-02 or 9445-03 AC ADAPTER.)

○ The counter doesn't become zero:

- If this occurs in DC A or AC+DC A modes, use the auto-zero adjustment function. (See "3.4 Auto-Zero Adjustment Function" (p. 60).)
- The range of zero adjustment is ± 450 dgt. for L range and ± 45 dgt. for H range. Check whether the sensor's offset exceeds the relevant range. If it does, the clamp sensor needs repair.
- In SLOW mode, it may take some time to reset the counter to zero.
- When peak measurement is selected or the range changed, be sure to use the CLEAR key to clear the data.

- **The measured value is less (lower) than the estimate.**

Current Measurement

- Check the ends of the clamp sensor for damage.
- If the clamp sensor clamps are not closed tightly, the measurement value will be less than the actual value.
- Check the frequency of current to be measured to determine whether it is outside the range prescribed in the product specifications. (Note that a high inverter carrier frequency will result in a displayed value less than the total rms.)
- Check whether you are measuring current up to 10 Hz in AC+DC A mode when not using SLOW mode.
- For a current waveform that is not continuous (e.g., starting current), note that the measurement value will be less than the actual value.
- Check whether you are measuring in DC A or AC+DC A mode and whether auto zero adjustment was correctly performed. (See "3.4 Auto-Zero Adjustment Function" (p. 60).) If measurement is performed with the counter showing a negative value, the measurement value will be less than the actual value.
- Check whether you are using the correct mode. (See "1.5 Modes" (p. 29) for details.)
- Check whether you are using MEAN to measure a distorted waveform.
- Check whether you are using filter function. For a component of 500 Hz or more, note that the measurement value will be less than the actual value.
- Check whether the peak value exceeds the crest factor as prescribed in the product specifications. If possible, increase the range. (For transitional peak values, see the Note in "3.2.5 Peak Measurement".)
- Check whether the crest factor (peak/rms) exceeds the product specifications.
- Check the low battery warning indicator.

Frequency Measurement

- Check the waveform. The 3290 may not be able to measure some special waveforms, such as those of an inverter.
- Check the current to determine whether current input amounts are 5% or more of the current range.

○ **The measured value is over than the estimate.**

Current Measurement

- Check the ends of the clamp sensor for damage.
- Check that you're using the proper range.
- Examine the waveform using MON output function to confirm that no components but the estimated frequency are being used.
- Check that the counter has been reset with CREAR before peak measurement.
- Look for magnetic fields, electrical fields or possible noise sources near the product.
- When drive power is switched from the battery to the AC adapter or vice versa during peak current measurement, the measurement value may become greater than the actual value. (See "Chapter 5 AC Adapter" (p. 81) for details.)

Frequency Measurement

- Look for magnetic fields, electrical fields or possible noise sources near the product.
- Check the waveform. The 3290 may not be able to measure some special waveforms, such as those of an inverter. (See the Note in "3.3.1 Frequency Measurement" for details.)
- Measurement indicates twice the frequency when measuring a full-wave rectified waveform.
- Check whether the waveform contains a DC component including 0 A. (See the Note in "3.3.1 Frequency Measurement".)

○ The output value is smaller than the estimated value

- Take the same precautionary steps as for the measured value on the counter.
- Confirm that the 9094 OUTPUT CORD is properly inserted into the output terminal and check for any broken wires.
- Make sure you've selected the proper output mode (REC or MON).
- Make sure the previously selected output mode (current or frequency) is not active.
- Check that the input impedance of the connected measuring instrument is at least 1 M Ω .
- Check that the mode of the connected measuring instrument is not an AC coupling, or that the filter function is disabled.

○ The output value is larger than the estimated value.

- Take the same precautionary steps as for the measured value on the counter.
- Check that you've selected the proper output mode (REC or MON).
- Check that the previously selected output mode (current or frequency) is not active.

○ The measured value fluctuates.

- Check whether the circuit to be measured is stable (with MON output). A non-periodic waveform may cause measurement to fluctuate.
- * Check whether the correct screen-updating rate (measurement response speed) is selected for the frequency of the current. For frequency up to 10 Hz, select AC+DC A mode and SLOW.
- Check that the sensor cable are fully connected.
- Check the waveform. The 3290 may not be able to measure some special waveforms, such as those of an inverter. (see the Note in "3.3.1 Frequency Measurement" for details.)

After-sale Service Chapter 11

11.1 Cleaning

To clean the product, wipe it gently with a soft cloth moistened with water or mild detergent. Never use solvents such as benzene, alcohol, acetone, ether, ketones, thinners or gasoline, as they can deform and discolor the case.

11.2 Service

- If the product seems to be malfunctioning, confirm that the batteries are not discharged before contacting your dealer or Hioki representative.
- To avoid corrosion from battery leakage, remove the batteries from the product if it is to be stored for a long time.
- The minimum stocking period for replacement parts is five years after end of production.
- For information regarding service, please contact your dealer or the nearest Hioki representative.
- If uncertain whether the problem can be attributed to the 3290 or clamp sensor, request that both be repaired.
- Pack the product carefully so that it will not be damaged during shipment, and include a detailed written description of the problem. Hioki cannot be responsible for damage that occurs during shipment.

Appendix

Chapter 12

12.1 Combined Accuracy

12.1.1 Accuracy Tables

This section shows the accuracy tables when the 3290 is combined with the CT9691 (9691), CT9692 (9692), or CT9693 (9693), and describes the method of calculation.

CT9691 (9691) + 3290 Combined Accuracy

(1) Display accuracy

 $\pm(\%rdg. +A)$

		DC	$1 \leq f < 10(\text{Hz})$	$10 \leq f \leq 66(\text{Hz})$	$66 < f \leq 500(\text{Hz})$	
L	DC	1.3%+0.10A	-			
	AC+DC	1.3%+0.12A	2.0%+0.08A	1.3%+0.08A	2.3%+0.08A	
	AC	-				
H	DC	1.3%+0.5A	-			
	AC+DC	to 80A	1.3%+0.7A	2.0%+0.3A	1.3%+0.3A	2.3%+0.3A
		80A to 100A				2.8%+0.3A
	AC	to 80A	-		1.3%+0.3A	2.3%+0.3A
		80A to 100A				2.8%+0.3A

(2) REC output accuracy

 $\pm(\%rdg. +mV)$

		DC	$1 \leq f < 10(\text{Hz})$	$10 \leq f \leq 66(\text{Hz})$	$66 < f \leq 500(\text{Hz})$	
L	AC+DC	1.8%+15mV	2.3%+10mV	1.8%+10mV	2.8%+10mV	
	AC	-				
H	AC+DC	to 80A	1.8%+10.5mV	2.3%+5.5mV	1.8%+5.5mV	2.8%+5.5mV
		80A to 100A				3.3%+5.5mV
	AC	to 80A	-		1.8%+5.5mV	2.8%+5.5mV
		80A to 100A				3.3%+5.5mV

(3) MON output accuracy

 $\pm(\%rdg. +mV)$

		DC	$1 \leq f < 10(\text{Hz})$	$10 \leq f \leq 66(\text{Hz})$	$66 < f \leq 500(\text{Hz})$	
L	DC		-			
	AC+DC		1.3%+10mV		2.3%+10mV	
	AC	-				
H	DC		-			
	AC+DC	to 80A		1.3%+5.5mV		2.3%+5.5mV
		80A to 100A				2.8%+5.5mV
	AC	to 80A	-			2.3%+5.5mV
		80A to 100A				2.8%+5.5mV

(4) Peak display accuracy

 $\pm(\%rdg. +A)$

		DC	$1 \leq f < 10(\text{Hz})$	$10 \leq f \leq 66(\text{Hz})$	$66 < f \leq 500(\text{Hz})$	
L	DC		-			
	AC+DC		1.5%+0.4A		2.5%+0.4A	
	AC	-				
H	DC		-			
	AC+DC	to 110Ap		1.5%+0.7A		2.5%+0.7A
		110 to 150Ap				3.0%+0.7A
	AC	to 110Ap	-			2.5%+0.7A
		110 to 150Ap				3.0%+0.7A

CT9692 (9692) + 3290 Combined Accuracy

(1) Display accuracy

 $\pm(\%rdg. +A)$

		DC	$1 \leq f < 10(\text{Hz})$	$10 \leq f < 66(\text{Hz})$	$66 \leq f < 1\text{k}(\text{Hz})$
L	DC	1.3%+0.10A	-		
	AC+DC	1.3%+0.12A	2.0%+0.08A	1.3%+0.08A	2.3%+0.08A
	AC	-			
H	DC	1.3%+0.5A	-		
	AC+DC	1.3%+0.7A	2.0%+0.3A	1.3%+0.3A	2.3%+0.3A
	AC	-			

(2) REC output accuracy

 $\pm(\%rdg. +mV)$

		DC	$1 \leq f < 10(\text{Hz})$	$10 \leq f < 66(\text{Hz})$	$66 \leq f < 1\text{k}(\text{Hz})$
L	AC+DC	1.8%+15mV	2.3%+10mV		
	AC	-			2.8%+10mV
H	AC+DC	1.8%+10.5mV	2.3%+5.5mV	1.8%+5.5mV	2.8%+5.5mV
	AC	-			

(3) MON output accuracy

 $\pm(\%rdg. +mV)$

		DC	$1 \leq f < 10(\text{Hz})$	$10 \leq f < 66(\text{Hz})$	$66 \leq f < 1\text{k}(\text{Hz})$
L	DC	-			
	AC+DC	1.3%+10mV			
	AC	-			2.3%+10mV
H	DC	-			
	AC+DC	1.3%+5.5mV			
	AC	-			2.3%+5.5mV

(4) Peak display accuracy

 $\pm(\%rdg. +A)$

		DC	$1 \leq f < 10(\text{Hz})$	$10 \leq f < 66(\text{Hz})$	$66 \leq f < 1\text{k}(\text{Hz})$
L	DC	-			
	AC+DC	1.5%+0.4A			
	AC	-			2.5%+0.4A
H	DC	-			
	AC+DC	1.5%+0.7A			
	AC	-			2.5%+0.7A

CT9693 (9693) + 3290 Combined Accuracy

(1) Display accuracy

 $\pm(\%rdg. +A)$

		DC	$1 \leq f < 10(\text{Hz})$	$10 \leq f < 45(\text{Hz})$	$45 \leq f \leq 66(\text{Hz})$	$66 < f \leq 1\text{k}(\text{Hz})$	
L	DC	1.8%+1.0A	-				
	AC+DC	1.8%+1.2A	3.0%+0.8A	2.3%+0.8A	1.3%+0.8A	2.3%+0.8A	
	AC	-					
H	DC	1.8%+0.5A	-				
	AC+DC	to 1800A	1.8%+7A	3.0%+3A	2.3%+3A	1.3%+3A	2.3%+3A
		1800A to 2000A				2.3%+3A	-
	AC	to 1800A	-	2.3%+3A	1.3%+3A	2.3%+3A	
1800A to 2000A				2.3%+3A	-		

(2) REC output accuracy

 $\pm(\%rdg. +mV)$

		DC	$1 \leq f < 10(\text{Hz})$	$10 \leq f < 45(\text{Hz})$	$45 \leq f \leq 66(\text{Hz})$	$66 < f \leq 1\text{k}(\text{Hz})$	
L	AC+DC	2.3%+15mV	3.3%+10mV	2.8%+10mV	1.8%+10mV	2.8%+10mV	
	AC	-					
H	AC+DC	to 1800A	2.3%+10.5mV	3.3%+5.5mV	2.8%+5.5mV	1.8%+5.5mV	2.8%+5.5mV
		1800A to 2000A				2.8%+5.5mV	-
	AC	to 1800A	-	2.8%+5.5mV	1.8%+5.5mV	2.8%+5.5mV	
		1800A to 2000A			2.8%+5.5mV	-	

(3) MON output accuracy

 $\pm(\%rdg. +mV)$

		DC	$1 \leq f < 10(\text{Hz})$	$10 \leq f < 45(\text{Hz})$	$45 \leq f \leq 66(\text{Hz})$	$66 < f \leq 1\text{k}(\text{Hz})$	
L	DC	1.8%+10mV	-				
	AC+DC		2.3%+10mV		1.3%+10mV	2.3%+10mV	
	AC		-		1.3%+10mV	2.3%+10mV	
H	DC	1.8%+5.5mV	-				
	AC+DC		to 1800A	2.3%+5.5mV		1.3%+5.5mV	2.3%+5.5mV
			1800A to 2000A	-		2.3%+5.5mV	-
	AC		to 1800A	-	2.3%+5.5mV	1.3%+5.5mV	2.3%+5.5mV
1800A to 2000A		-		2.3%+5.5mV	-		

(4) Peak display accuracy

 $\pm(\%rdg. +A)$

		DC	$1 \leq f < 10(\text{Hz})$	$10 \leq f < 45(\text{Hz})$	$45 \leq f \leq 66(\text{Hz})$	$66 < f \leq 1\text{k}(\text{Hz})$	
L	DC	2.0%+4A	-				
	AC+DC	2.0%+4A	2.5%+4A	2.5%+4A	2.0%+4A	2.5%+4A	
	AC	-		2.5%+4A	2.0%+4A	2.5%+4A	
H	DC	to 2300Ap	2.0%+7A	-			
		2300Ap to	6.5%+7A	-			
	AC+DC	to 2300Ap	2.0%+7A	2.5%+7A	2.5%+7A	2.0%+7A	2.5%+7A
		2300Ap to	6.5%+7A	-		6.5%+7A	-
	AC	to 2300Ap	-		2.5%+7A	2.0%+7A	2.5%+7A
		2300Ap to	-			6.5%+7A	-

12.1.2 Method of Calculation

This section describes the method of calculation by assuming that measurement is performed in AC A mode using the CT9692 (9692).

Total error when displayed value is 160.0 A (60 Hz)

- Total error = $\pm(1.3\% \text{rdg.} + 0.3 \text{ A})$ *1
= $\pm(2.08 \text{ A} + 0.3 \text{ A})$ *2
= $\pm 2.3 \text{ A}$
- True value when 160.0 A is shown: 157.5 A to 162.3 A

*1 See the accuracy at 10 to 66 Hz in AC mode for H range in the CT9692 (9692)+3290 combined display accuracy table on page 115.

*2 rdg. error = 160 A x 1.3%

Total error when REC output is 1.2 V (60 Hz) (for L range)

- Total error = $\pm(1.8\% \text{rdg.} + 10 \text{ mV})$ *3
= $\pm(21.6 \text{ mV} + 10 \text{ mV})$ *4
= $\pm 31.6 \text{ mV}$
- True value of 1.2 V output: 1.1684 V to 1.2316 V (11.684 A to 12.316 A in terms of current)

*3 See the accuracy at 10 to 66 Hz in AC mode for L range in the CT9692 (9692)+3290 combined REC output accuracy table on page 115.

*4 rdg. error = 1.2 V x 1.8%

12.2 Use of Intermediate Cable

The standard length of the sensor cable is two meters. If the cable is too short, an intermediate cable can be used. Insert the intermediate cable between the clamp sensor cable and the 3290.

The cables are available in lengths of 5 m, 10 m, 20 m, 30 m, 50 m, and 100 m.

NOTE

- Note that a long cable may result in a larger value being displayed when no or low input is made due to noise.
- When using an intermediate cable, note that the accuracy will be within the specifications, but the frequency characteristic may vary. Moreover, the longer the intermediate cable, the greater the variation in accuracy.

The graph below shows frequency characteristic differences among standard equipment, that with a 10 m intermediate cable, and that with a 100 m intermediate cable.

CT9691 (Equivalent to 9691) + intermediate cable + 3290
MON output frequency characteristics

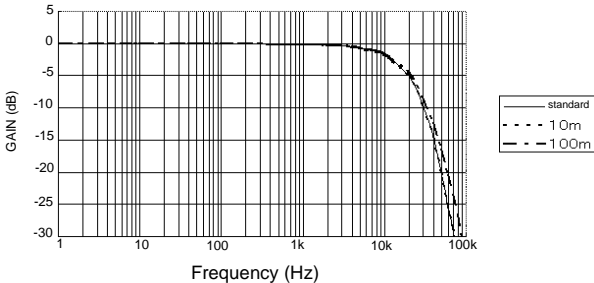

CT9692 (Equivalent to 9692) + intermediate cable + 3290
MON output frequency characteristics

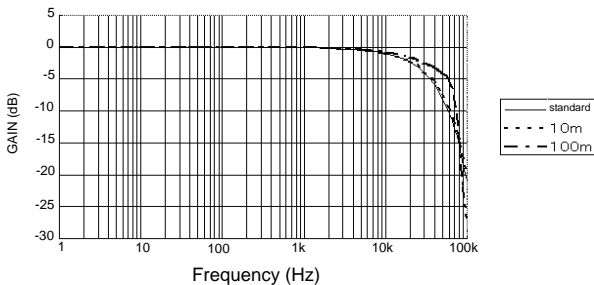

CT9693 (Equivalent to 9693) + intermediate cable + 3290
MON output frequency characteristics

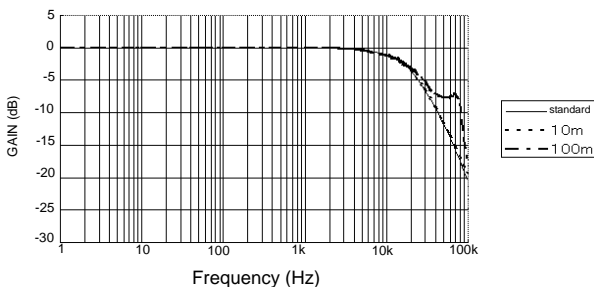

HIOKI

HIOKI E. E. CORPORATION

Headquarters

81 Koizumi, Ueda, Nagano 386-1192, Japan
TEL +81-268-28-0562 FAX +81-268-28-0568 E-mail: os-com@hioki.co.jp
URL <http://www.hioki.com/>
(International Sales and Marketing Department)

HIOKI USA CORPORATION

6 Corporate Drive, Cranbury, NJ 08512, USA
TEL +1-609-409-9109 FAX +1-609-409-9108 E-mail: hioki@hiokiusa.com
URL <http://www.hiokiusa.com>

HIOKI (Shanghai) Sales & Trading Co., Ltd.

1608-1610, Shanghai Times Square Office 93 Huaihai Zhong Road Shanghai,
P.R.China POSTCODE: 200021
TEL +86-21-63910090 FAX +86-21-63910360 E-mail: info@hioki.com.cn
URL <http://www.hioki.cn>

HIOKI INDIA PRIVATE LIMITED

Khandela House, 24 Gulmohar Colony Indore 452 018 (M.P.), India
TEL +91-731-6548081 FAX +91-731-4020083 E-mail: info@hioki.in
URL <http://www.hioki.in>

HIOKI SINGAPORE PTE. LTD.

33 Ubi Avenue 3, #03-02 Vertex Singapore 408868
TEL +65-6634-7677 FAX +65-6634-7477 E-mail: info@hioki.com.sg 1205

-
- For regional contact information, please go to our website at <http://www.hioki.com>.
 - The Declaration of Conformity for instruments that comply to CE mark requirements may be downloaded from the HIOKI website.
 - All reasonable care has been taken in the production of this manual, but if you find any points which are unclear or in error, please contact your supplier or the International Sales and Marketing Department at Hioki headquarters.
 - In the interests of product development, the contents of this manual are subject to revision without prior notice.
 - The content of this manual is protected by copyright. No reproduction, duplication or modification of the content is permitted without the authorization of Hioki E.E. Corporation.