

# **HIOKI**

---

---

Measurement Guide

**LR8400-20**

**LR8401-20**

**LR8402-20**

**MEMORY HiLOGGER**

**HIOKI E. E. CORPORATION**

April 2010 Edition 1 LR8400B981-00 10-04H

---



\*600301720\*



# Introduction

Thank you for purchasing the Hioki Model LR8400-20, LR8401-20, LR8402-20 Memory HiLogger.

**This Measurement Guide consists of some basic application examples. Before using the HiLogger, be sure to read the Instruction Manual carefully.**

The following documents are provided with the HiLogger. Refer to them as appropriate for your application.

Document	Description
<b>1</b> <b>Measurement Guide (This document)</b>	<b>Read first.</b> Offers an introduction to the Memory HiLogger's basic measuring method for first time users.
<b>2</b> <b>Instruction Manual</b>	Contains explanation and instructions regarding the HiLogger's operating method and functions.

## Contents

<b>Operating Outlines and Screen Configurations</b>	Describes the screen types and an overview of the operating keys. (p. 2)
<b>Measurement Preparations</b>	Describes the preparations for measuring. (p. 7)
<b>Measurement Procedure</b>	Describes procedures from pre-measurement inspection to observation. (p. 8)
<b>Measuring</b>	This is an example of simultaneously measuring and automatically saving variations in voltage (CH1) and temperature (CH2) of a 1.5 V battery. (p. 10)
<b>Viewing Waveforms or Numerical Values</b>	Describes using the HiLogger to view waveforms and numerical values. (p. 14)
<b>Observing Data on a Computer</b>	Describes how to observe data with a computer. (p. 18)

# Operating Outlines and Screen Configurations

## Front Panel

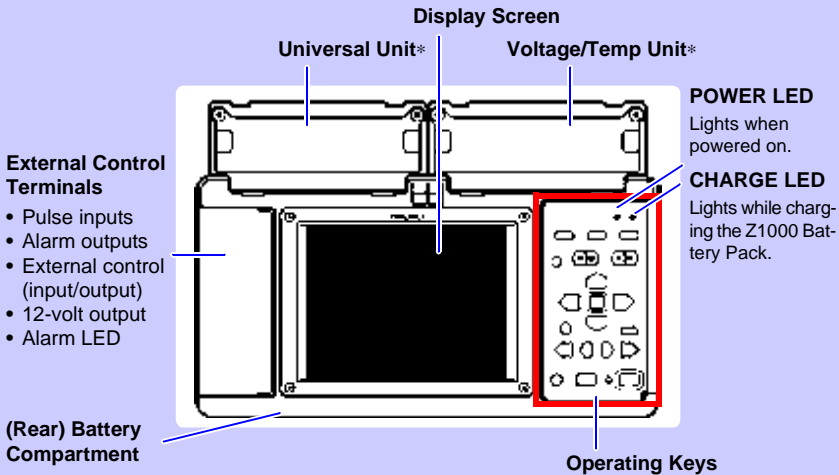

\*: Input units are installed as specified upon factory shipping.

## Right Side

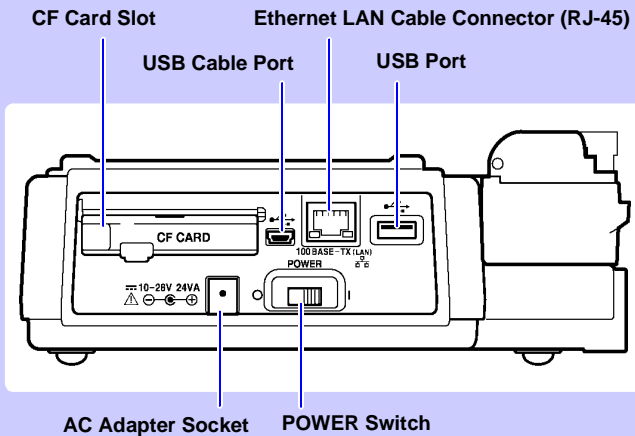

## Operation Keys

### Choose a screen

#### ■ WAVE/DATA

Selects among waveform/numerical screen displays (p. 4).

#### ■ SET

Displays the Settings screens, and switches among the screen tabs with each press (p. 5).

#### ■ FILE

Displays file information (p. 6).

### Scroll waveforms and read cursor values

Use **SCROLL/CURSOR** to select waveform scrolling or A/B cursor motion, and use the arrow keys to scroll or move A/B cursors (p. 15).

### Saving operations

Press to save data manually.

### Start and stop measurement

Start and stop measurement. The LED next to **START** lights green while measuring (p. 9).

### Setup and display

#### ■ CH

Select channels.

#### ■ UNIT

Switches input units.

#### ■ MONIT

Shows the current input waveform and numerical values (data not stored in internal memory, CF card, and USB flash drive).

#### ■ ESC

Cancels changes to settings.

#### ■ Cursor Keys

Moves the position of the cursor (blinking selection) on the screen.

#### ■ ENTER

Accepts displayed settings.

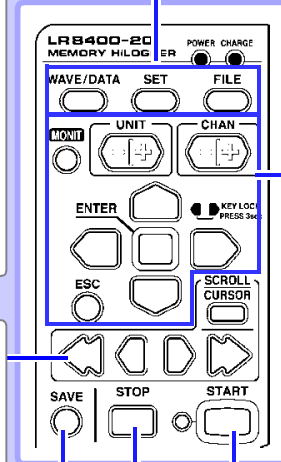

## Basic Key Operations

### Changing screen contents



Select the item to change.

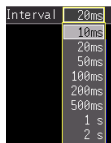

Show available setting options.

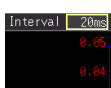

Select the desired setting.

Apply the new setting, or cancel it.



### Disables keypad operations (Key-Lock function)



Hold the left and right keys simultaneously for three seconds to lock and unlock other key operations.

### Zero Adjust



With the Waveform/Value or [CH] screen displayed, press the up and down cursor keys simultaneously.

Waveform/Numerical Screens

WAVE/DATA SET FILE  
 The screen switches each time you press the key. (seven display types)

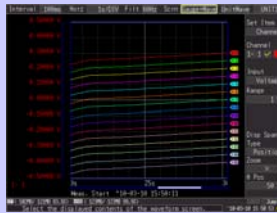
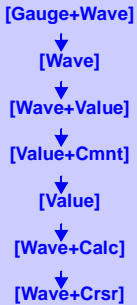

[Gauge+Wave] Screen

Measurement data is displayed as waveforms with gauges.

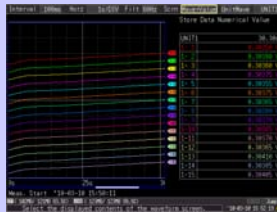

[Wave+Value] Screen

Measurement data is displayed as waveforms and numerical values.

UNIT1	36.30s
1-1	0.26310 V1-9 0.26245 V
1-2	0.26275 V1-10 0.26195 V
1-3	0.26305 V1-11 0.26215 V
1-4	0.26265 V1-12 0.26185 V
1-5	0.26280 V1-13 0.26200 V
1-6	0.26240 V1-14 0.26175 V
1-7	0.26260 V1-15 0.26175 V
1-8	0.26225 V

[Value] Screen

Measurement data is displayed as numerical values.

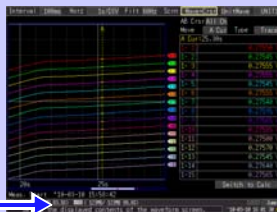

[Wave+Crsr] Screen

Measurement data is displayed as waveforms with cursor values.

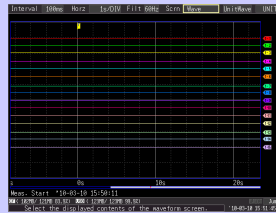

[Wave] Screen

Measurement data is displayed as waveforms.

UNIT1	36.30s Comment
1-1	0.26310 V Pressure 1
1-2	0.26275 V Pressure
1-3	0.26305 V Power
1-4	0.26265 V
1-5	0.26280 V
1-6	0.26240 V
1-7	0.26260 V
1-8	0.26225 V
1-9	0.26195 V
1-10	0.26215 V
1-11	0.26185 V
1-12	0.26200 V
1-13	0.26175 V
1-14	0.26175 V
1-15	0.26175 V
1-16	0.26175 V

[Value+Cmnt] Screen

Measurement data is displayed as numerical values with comments.

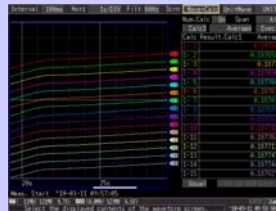

[Wave+Calc] Screen

Measurement data is displayed as waveforms with calculation results.

Operational information is displayed along the bottom of the screen.

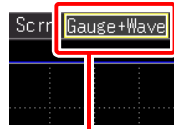

Switches among the above screens.

## Settings Screens

WAVE/DATA SET FILE



The screen switches each time you press the key. (seven display types)



Press the left/right keys to select between the Settings screens.

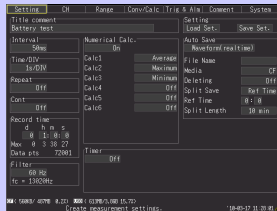

When a tab is selected with the cursor, the left-right cursor keys switch among the setting screens.

**[Setting] Screen**

Make settings for recording. Set numerical calculation, auto-saving and timers.

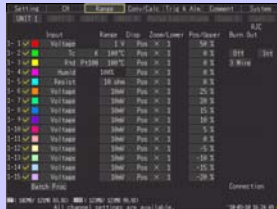
**[Range] Screen**

Make settings while viewing all channel set.

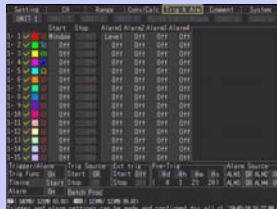
**[Trig & Alm] Screen**

Recording criteria (triggering) and warning sounds can be set for each channel.

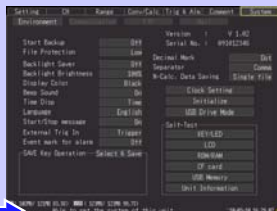
**[System] Screen**

Configure the system environment.

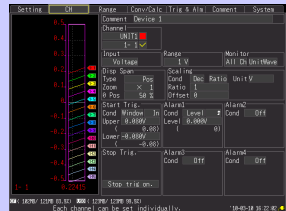
**[CH] Screen**

Make input channel settings while viewing the monitor display.

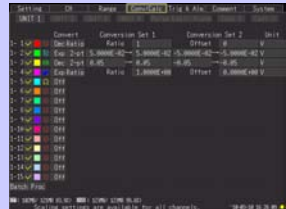
**[Conv/Calc] Screen**

Make these settings to convert measured values to arbitrary units for display.

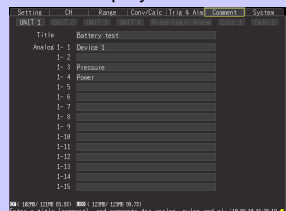
**[Comment] Screen**

Enter channel comments.



Selects a measurement input unit and its settings.

Operational information is displayed along the bottom of the screen.

### File Screen

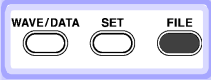

Operational information is displayed along the bottom of the screen.

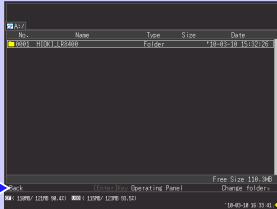

View and manage files on the CF card/USB flash drive.



# Measurement Preparations

Follow these steps to prepare before measuring.

Make the necessary connections to the HiLogger, and turn the power switch on.

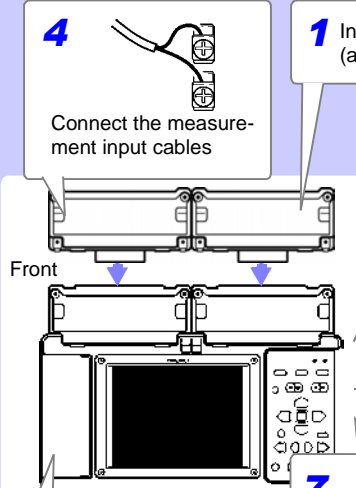

**1** Input Expansion Units (as needed)

**4** Connect the measurement input cables

**5** Connect each pair of input and output terminals (as needed)

**6** Turn the power on.

**3** Connect the AC adapter

**7** Insert an optional CF card or USB flash drive (when saving data)

Front

Right side

Right side

Right side

- If auto-saving to CF card or USB flash drive is disabled, data is only recorded in internal memory, and is lost when measurement starts again, or about 30 minutes after the HiLogger is turned off. We recommend keeping auto-saving to CF card enabled.

**2** Install the battery pack (option) (as needed)

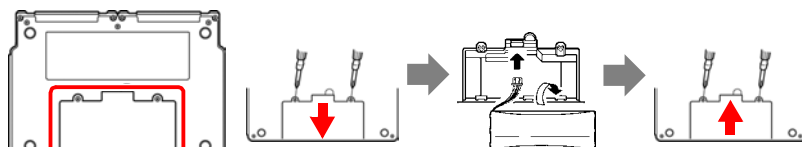

- When the battery pack is installed, operation switches to battery power during power outages so that measurements can continue uninterrupted.

# Measurement Procedure

Before measuring, be sure to read the "Operating Precautions" in the Instruction Manual.

Pre-measurement inspection

Read "Pre-Connection Inspection" in the Instruction Manual.

Connect to the measurement object

Configure settings for measurement



Configure recording settings on the [Setting] screen.

- Recording interval
- Recording time
- Auto-saving (if used)

Make other settings as necessary.

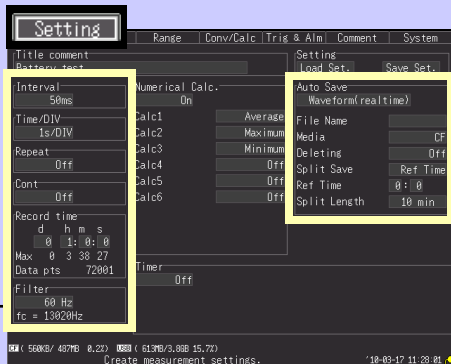

Configure input channel settings on the [CH] screen.

- Channel selection
- Input type
- Measurement range

Make other settings as necessary.

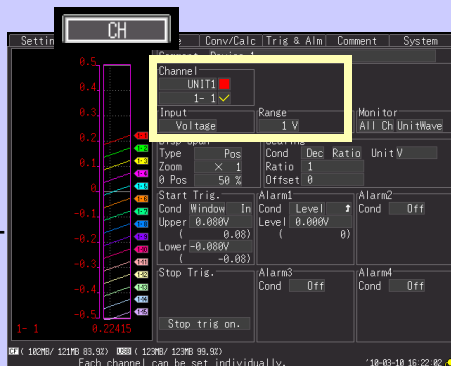

(continues on next page)

## Start and finish measuring\*

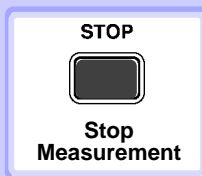
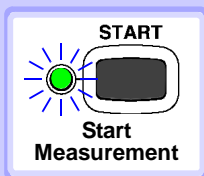

When continuous recording (**[Cont]**) is disabled (**[Off]**), measurement stops automatically after the set recording time (there is no need to press **STOP**).

\* Triggering is used to start and stop measurement by specified criteria, or at specified times.



## Observation

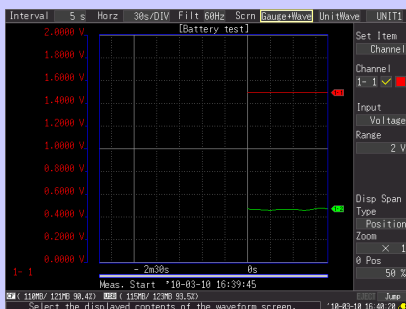

# Measuring

This is an example of simultaneously measuring and automatically saving variations in voltage (CH1) and temperature (CH2) of a 1.5 V battery.

## 1 Prepare the Following Before Measuring

**Items to prepare**

- Model LR8400-20, LR8401-20, LR8402-20 Memory HiLogger
  - AC Adapter (supplied)
  - Measurement (input) leads
  - Thermocouple
  - CF Card \*
- \*: Hioki option

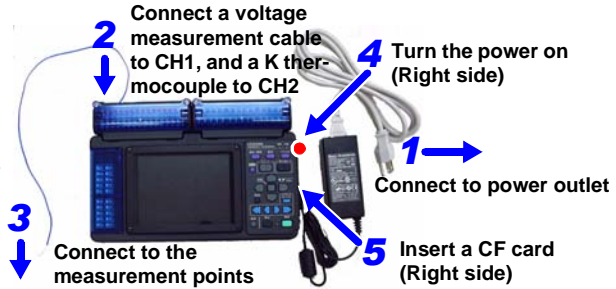

## 2 Configure Measurement Settings

Make recording timing settings on the **[Setting]** screen.

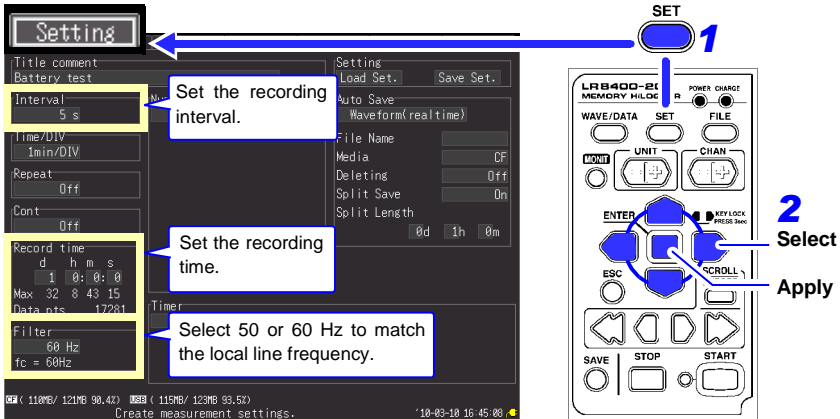

The default settings for the non-framed items can be left as-is. Change as needed.

**Setting Example**

Record at five-second intervals for one day automatically on the CF card (p. 12)

- Interval: 5sec**
- Record time: Cont Off, 1 day**

**Measurement Hints**

**Filter** : When 50 or 60 Hz is selected, longer recording intervals produce lower cut-off frequencies and better noise suppression.

**Recording Time**: To measure continuously until you press **STOP**, enable continuous recording (Cont: On).

Make input channel settings on the [CH] screen.

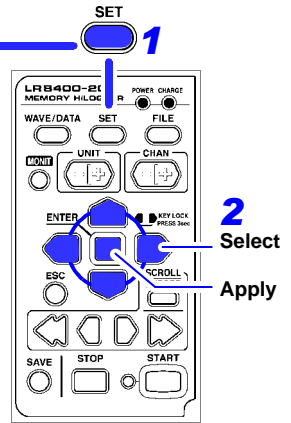
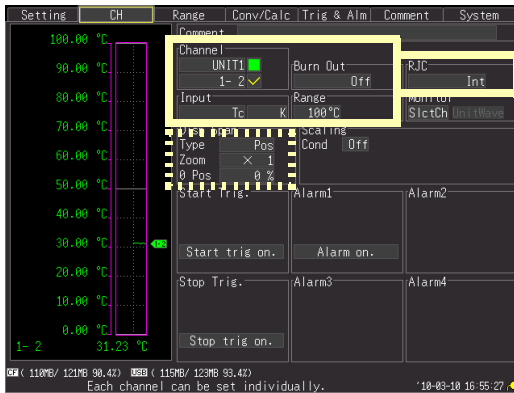
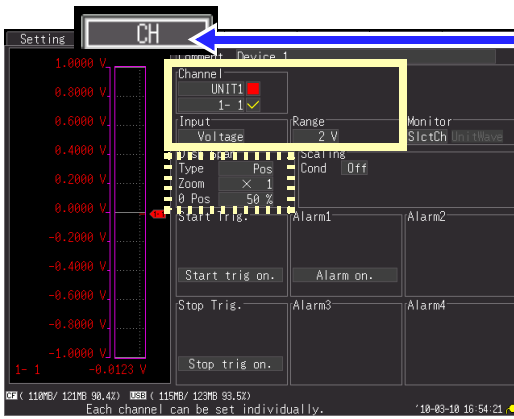

**Setting Example**

Channel: CH1, Input: Voltage, Range: 2V  
 Channel: CH2, Input: TC, K, Range: 100°C,  
 Burn Out: Off, RJC: INT

**Measurement Hints**

For maximum resolution, select the most sensitive range that includes the measured value.

Settings within the dotted frame affect the vertical axis display.

**Disp Span**

Type	Position
0 Pos	0% (appears as 0 V at the bottom of the screen)

When set as shown at the left, the vertical axes appear like this.

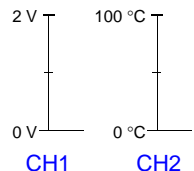

### 3 To Enable Auto-Save (set saving conditions)

If auto-saving to CF card or USB flash drive is not enabled, data is only recorded in internal memory, and is lost when measurement starts again, or about 30 minutes after the HiLogger is turned off. We recommend keeping auto-saving to CF card enabled.

Make these settings on the **[Setting]** screen.

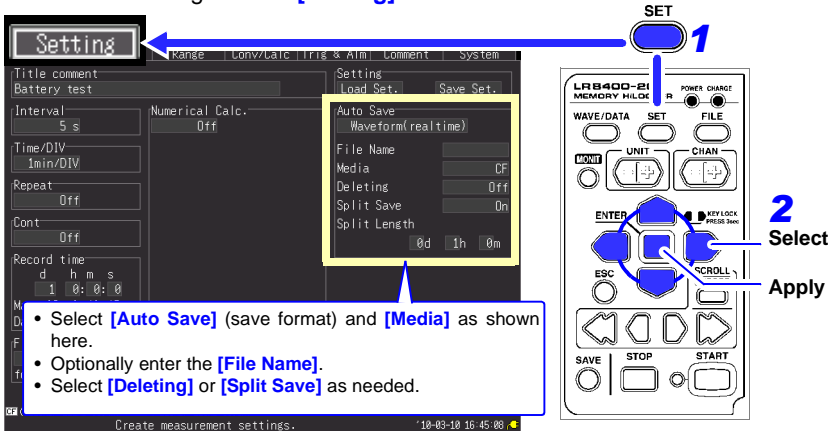

- Select **[Auto Save]** (save format) and **[Media]** as shown here.
- Optionally enter the **[File Name]**.
- Select **[Deleting]** or **[Split Save]** as needed.

- Confirm that there is enough free space on the media, and that it is inserted correctly.
- Although real-time saving to USB flash drive is available, we recommend using a CF card for optimum reliability and data preservation.
- Performance cannot be guaranteed when using storage media other than a Hioki-specified CF card option.

#### Measurement Hints

- **When the CF card or USB flash drive becomes full while saving:**  
 Enable **[Deleting]** (set to On) to delete the oldest files and continue saving.  
 Disable **[Deleting]** (set to Off) to stop saving when the media is full.
- **When partial saving is enabled, files are saved at the specified interval.**  
 Select **[Split Save]** (set to On or Ref time) to set the partition time span.

Observation Method	Setting State
Save measurement data for later analysis with the HiLogger or the Logger Utility.	<b>Auto save: Waveform(realtime)</b>
Retrieve data from the CF card or USB flash drive for analysis with Excel.	<b>Auto save: CSV(realtime)</b>

Conversion to text (CSV) format can be done later, so we suggest selecting **[Waveform(realtime)]** for typical operation.

## 4 Start and finish measuring

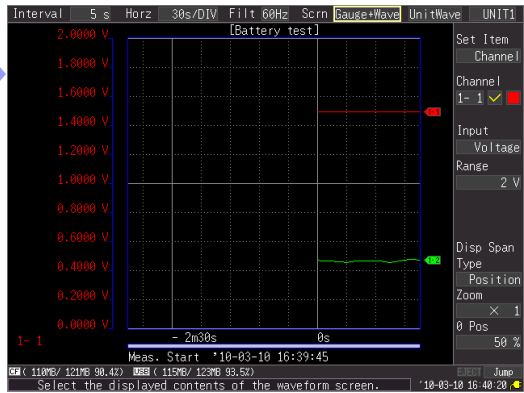
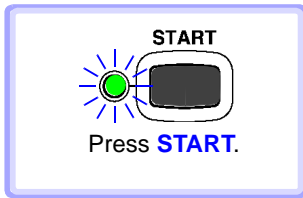

- Data is recorded to HiLogger memory. It is then automatically saved to the CF card. Recording stops one day after starting.
- To stop recording early, press **STOP**.
- To view waveforms or numerical values while measuring, see "Viewing Waveforms or Numerical Values" (p. 14).

# Viewing Waveforms or Numerical Values

This section describes how to view waveforms and numerical values during and after measurement.

## Display Waveforms

Press **WAVE/DATA** to display the Waveform/Value screen. The screens toggle each time the key is pressed. Gauges can be displayed, and numerical values and waveforms can be viewed simultaneously.

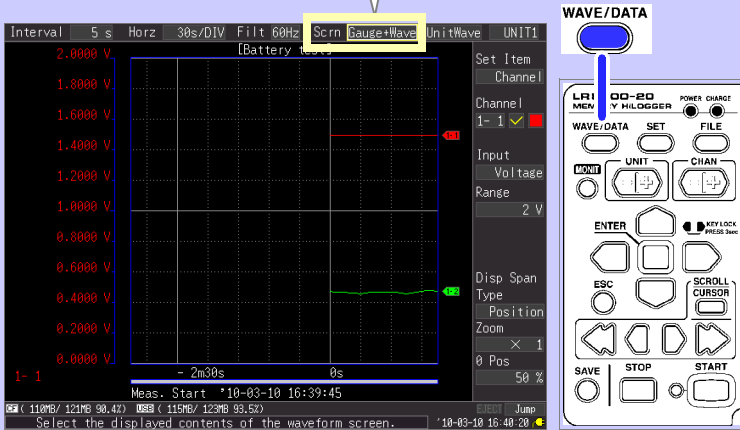
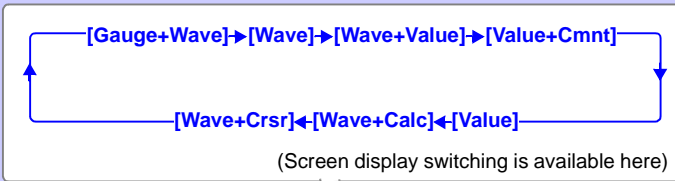



# Viewing a Measurement Waveform

## Scrolling the Waveform

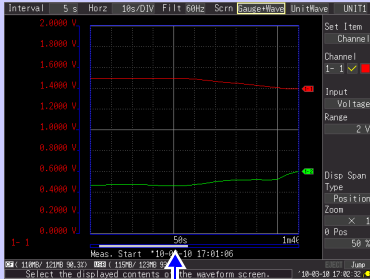

The portion of a waveform that is currently displayed can be confirmed by the position of the scroll bar.

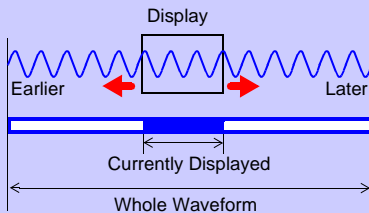

### Scrolling Methods

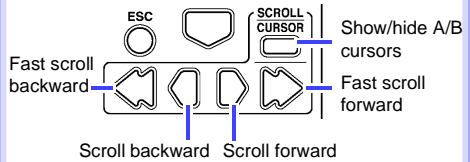

### Jumps to the latest waveform

Press both simultaneously



### Jumps to the waveform beginning

Press both simultaneously



## Zooming the Waveform View

### Zooming (Magnifying and Reducing) the Horizontal Axis



Specify the time per division for the horizontal axis.

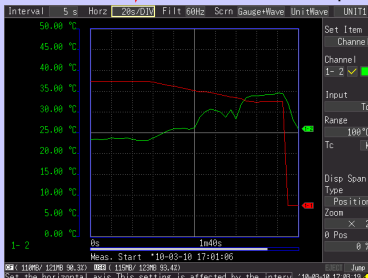
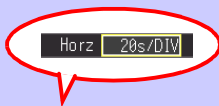

### Zooming the Vertical Axis

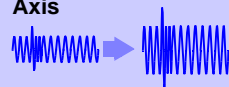

Specify the magnification factor for the vertical axis.



## View Measurement Values

Measured values can be viewed as numerical values, waveforms and numerical values, or as numerical values and comments.

Displayed numerical values are those of the current input signals.

To display waveforms and numerical values

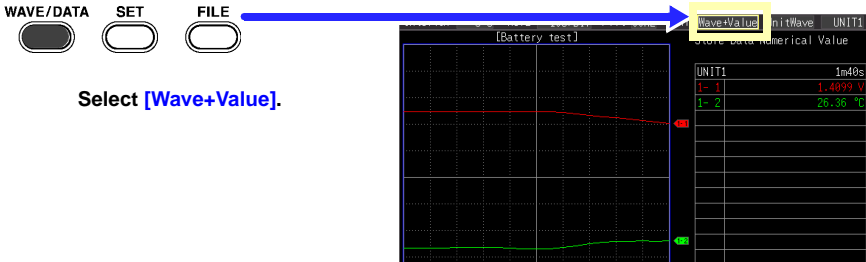

To display numerical values and comments

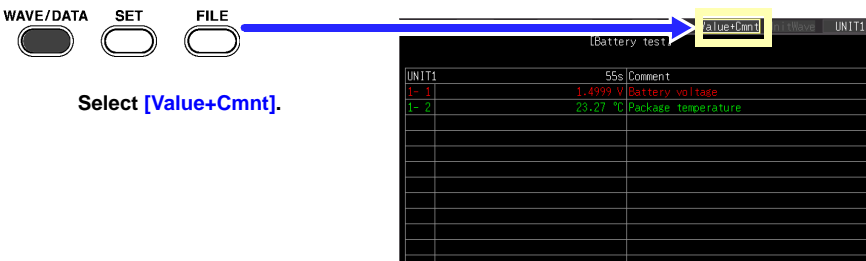

To display numerical values only

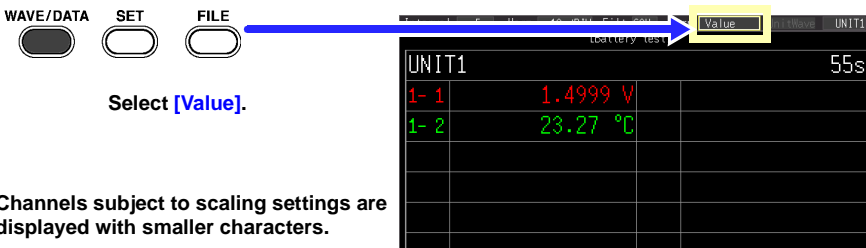

Channels subject to scaling settings are displayed with smaller characters.

### Advice

- Use the A/B cursors to view measured values at particular times. See "Displaying Cursor Values" in the Instruction Manual for details.
- Average, maximum, and minimum values can be calculated and displayed while measuring. See "Numerical Calculations/Waveform Calculations" in the Instruction Manual for details.

## View CF Card / USB Flash Drive Contents

Data saved by the LR8400-20, LR8401-20, LR8402-20 can be confirmed on the File screen. It is stored on the CF Card/USB flash drive as follows. The numbers in the file names are automatically generated sequentially.

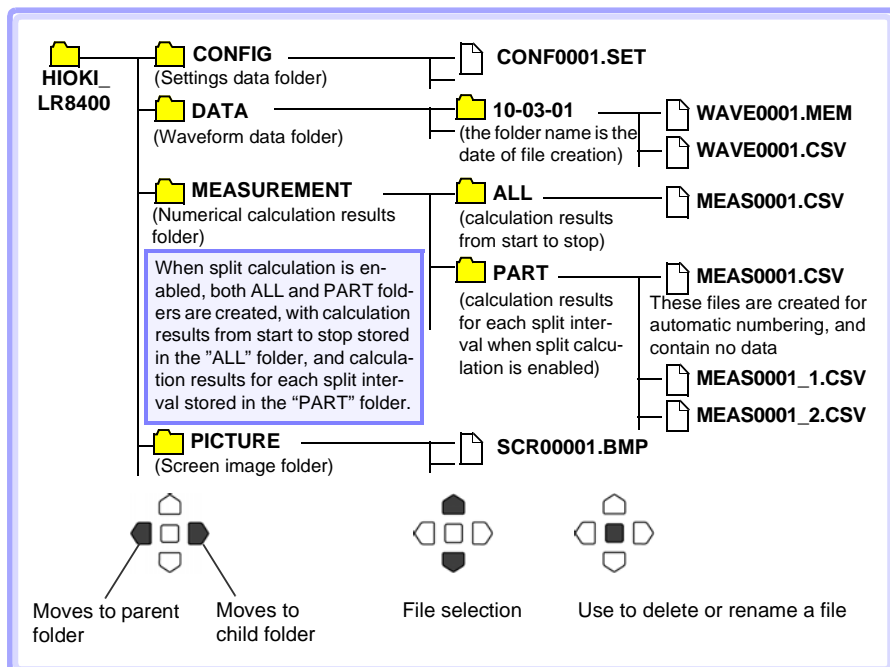
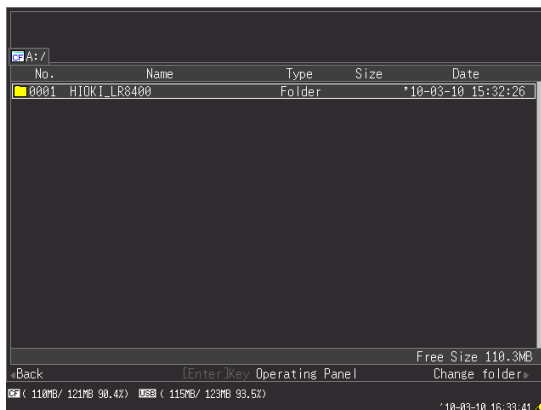

Auto-saved file names are of the form username0001.XXX or AUTO0001.XXX.

# Observing Data on a Computer

## Converting waveform data to text format

To analyze data using a spreadsheet program such as Excel, first convert the waveform (binary) data to text (CSV) format using the HiLogger or Logger Utility program. This procedure describes how to convert to text format using the Logger Utility. See the LR8400 Series Instruction Manual for steps to install and start the Logger Utility.

### 1 Obtain Measurement Data

Load the measurement data file (".MEM" extension) from the HiLogger, as follows.

#### 1 Start the Logger Utility.

See the instruction manual for details.

#### 2 Remove the CF card or USB flash drive with the saved measurement data from the HiLogger, and insert it into the computer.

To load data from CF card to a computer without removing the CF card from the HiLogger, select the HiLogger's USB Drive mode and connect it to a computer with the USB cable. (See the Instruction Manual for USB Drive mode details.)

#### 3 In the menu bar, click [File] - [Open Waveform File].

The [Open Waveform File] dialog appears.

#### 4 Select the file to load, and click the [Open] button.

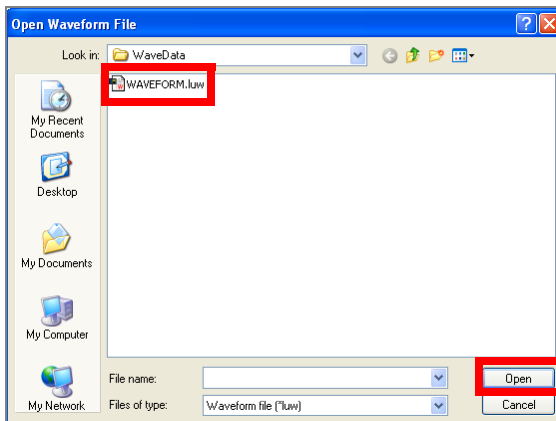

## 2 Save in Text (CSV) Format

- 1 In the menu bar, click **[File] - [Save File in Text Format]**.

The **[Save File in Text Format]** dialog appears.

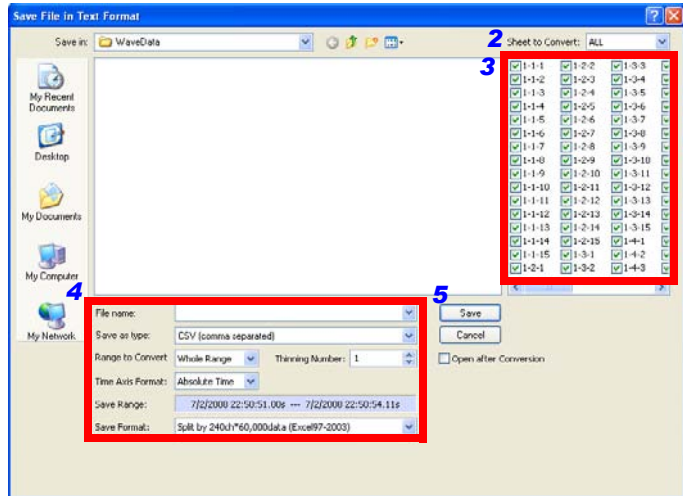

- 2 Select the sheet of measurement data to save.
- 3 Select the check boxes for the channels to save.
- 4 Set the following:

<b>[File name]</b>	Enter any file name.
<b>[Save as type]</b>	<b>CSV (comma separated)</b> (Saves as CSV (text format))
<b>[Range to Convert]</b>	<b>Whole Range</b> (Converts the whole span of waveform data)
<b>[Thinning Number]</b>	<b>1</b> (Saves all data)
<b>[Time Axis Format]</b>	<b>Absolute Time</b> (Saves timing data based on time elapsed from the start of measurement)
<b>[Save Format]</b>	<b>No split</b> (Saves into a single file)

**See:** See the Logger Utility instruction manual for setting details.

- 5 Click the **[Save]** button.

### NOTE

Files saved in text format cannot be opened by the Logger Utility.

## **Computer Connection (for communication)**

Connect a computer to the HiLogger with a LAN or USB cable to view recorded data and make HiLogger settings on the computer.

Use the supplied Logger Utility application program to monitor waveforms, numerical values, and warning output states in real time, and to collect measurement data from up to five HiLoggers on one computer. (Logger Utility version 1.40 and later)

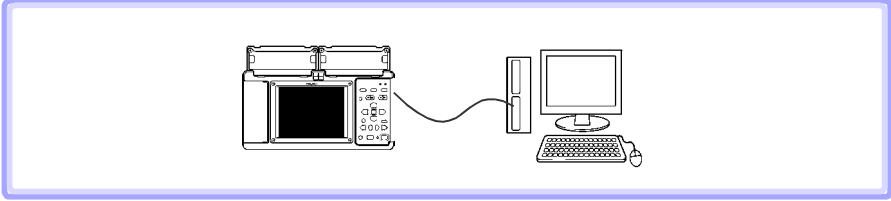

**See the Logger Utility instruction manual for details.**

---



# HIOKI

---

HIOKI E. E. CORPORATION

## HEAD OFFICE

81 Koizumi, Ueda, Nagano 386-1192, Japan  
TEL +81-268-28-0562 FAX +81-268-28-0568  
E-mail: [os-com@hioki.co.jp](mailto:os-com@hioki.co.jp) URL <http://www.hioki.com/>  
(International Sales and Marketing Department)

## HIOKI USA CORPORATION

6 Corporate Drive, Cranbury, NJ 08512, USA  
TEL +1-609-409-9109 FAX +1-609-409-9108

---

Edited and published by Hioki E.E. Corporation

Technical Support Section

- All reasonable care has been taken in the production of this manual, but if you find any points which are unclear or in error, please contact your supplier or the International Sales and Marketing Department at Hioki headquarters.
- In the interests of product development, the contents of this manual are subject to revision without prior notice.
- The content of this manual is protected by copyright. No reproduction, duplication or modification of the content is permitted without the authorization of Hioki E.E. Corporation.



Printed on recycled paper Printed in Japan

---