

CM7290

HIOKI

CM7291

Instruction Manual

DISPLAY UNIT



The latest edition of the instruction manual



EN

Aug. 2024 Revised edition 4
CM7290A961-04



600457194

Contents

Introduction.....	1
Verifying Package Contents	1
Measurement Flowchart	3
■ When performing standalone measurement.....	3
■ When measuring while connected to another device	4
Safety Information.....	6
Operating Precautions	8

1 Overview **11**

1.1 Overview and Features.....	11
1.2 Parts and Functions	12
■ Display	13
■ Warning and battery power displays	14
1.3 Tables of Key Operations	15
■ Measuring	16
■ Display/output/communication	17
■ System operation	18
■ Maintenance operation.....	19
■ Handy functions	20
■ Key configurations.....	22

2 Pre-measurement Preparation **25**

2.1 Installing the Z5004 Magnetic Strap.....	25
2.2 Connecting the Sensor.....	26
2.3 Supplying Power.....	27
■ Installing/replacing the batteries.....	27
■ Connecting the AC adapter (optional).....	28
■ Connecting to an external DC power supply	29
2.4 Turning the Power On/Off.....	30
■ When using battery power	30
■ When using the AC adapter or an external DC power supply.....	30
2.5 Connecting to an External Device.....	31

1

2

3

4

5

Appx.

3	Measurement and Output	33
3.1	Inspection Prior to Use.....	33
3.2	Taking Measurements	34
■	Types of output in the different measurement modes	35
■	Setting measurement range.....	36
3.3	Changing the Display/output update time (rate) (to Faster or Slower)	37
3.4	Examples of Measurement Waveforms	38
3.5	Bluetooth® Communications (only for CM7291).....	39
■	Installing the application software GENNECT Cross	39
■	Pairing the app with the CM7291	40
■	Making measurements with the Bluetooth® function	40
4	Specifications	41
4.1	General Specifications	41
4.2	Input and Output Specifications, and Measurement Specifications	45
4.3	Functional Specifications	51
4.4	Connection Terminal Specifications	55
4.5	External Interface Specifications (only for CM7291).....	55
5	Maintenance and Service	57
5.1	Troubleshooting.....	58
5.2	Error Displays	62
	Appendix	63
Appx. 1	Range Structure, Output rate, and Power Consumption Category with a Sensor Connected	63
Appx. 2	Calculating Accuracy when Used with a Sensor	64
Appx. 3	Combinational Accuracies (Representative values)	68
Appx. 4	Measurement Response Waveforms	76

Introduction

Thank you for purchasing the Hioki CM7290/CM7291 Display Unit. To obtain maximum performance from the unit, please read this manual first, and keep it handy for future reference.

Latest instruction manual



The contents of this manual are subject to change, for example as a result of product improvements or changes to specifications.

The latest edition can be downloaded from Hioki's website.

<https://www.hioki.com/global/support/download>

Verifying Package Contents

When you receive the unit, inspect it carefully to ensure that no damage occurred during shipping. Pay particular attention to the accessories, panel switches, and connectors. If damage is evident, or if it fails to operate according to the specifications, contact your authorized Hioki distributor or reseller.

Confirm that these contents are provided.

CM7290 or CM7291

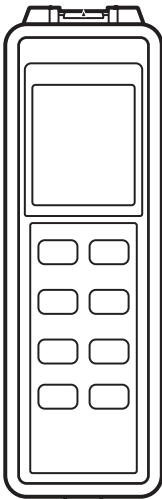

Instruction manual

For the instruction manual in other languages, see the Hioki website.

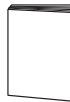

LR6 alkaline battery (AA) × 2



Protector (pre-installed)

Precautions Concerning Use of Equipment that Emits Radio Waves (only for CM7291)



Options

- The options listed below are available for the unit. To order an option, please contact your authorized Hioki distributor or reseller. Options are subject to change. Please check Hioki's website for the latest information.
- Use an optional sensor equipped with a Hioki PL14 output connector.

9445-02	AC Adapter
L9094	Output Cord (for banana terminal, 1.5 m)
L9095	Output Cord (for BNC terminal, 1.5 m)
L9096	Output Cord (for lead terminal, 1.5 m)
C0220	Carrying Case (for sensor and display unit)
C0221	Carrying Case (for 30 m extension cable, sensor and display unit)
L0220-01	Extension Cable (2 m)
L0220-02	Extension Cable (5 m)
L0220-03	Extension Cable (10 m)
L0220-04	Extension Cable (20 m)
L0220-05	Extension Cable (30 m)
L0220-06	Extension Cable (50 m)
L0220-07	Extension Cable (100 m)
Z5004	Magnetic Strap

Measurement Flowchart

When performing standalone measurement

Installation and connection

Inspect prior to use (p.33).

Connect the sensor to the unit (p.26).

You will need:

A sensor equipped with a Hioki PL14 connector (optional)

Supplying power (p.27).

You will need:

Fresh LR6 Alkaline battery ×2, fully charged HR6 Nickel-metal hydride battery ×2, or the AC adapter
See "Options" (p.2).

Turn the power on (p.30).

If being driven by an AC adapter, the unit is automatically powered on.

Measuring

Execute zero adjustment (p.16).

Zero adjustment is unavailable for sensors dedicated for AC measurement.

Connect the sensor to the conductor to be measured (p.34).

Select the measurement mode (p.16).

Check the measured values.

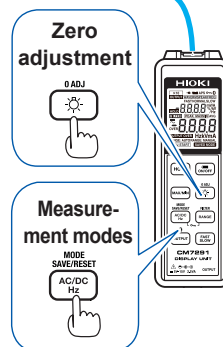
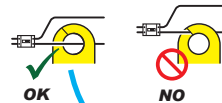

Ending

Disconnect the sensor from the conductor measured, and turn off the unit's power supply.

When measuring while connected to another device

Installation and connection

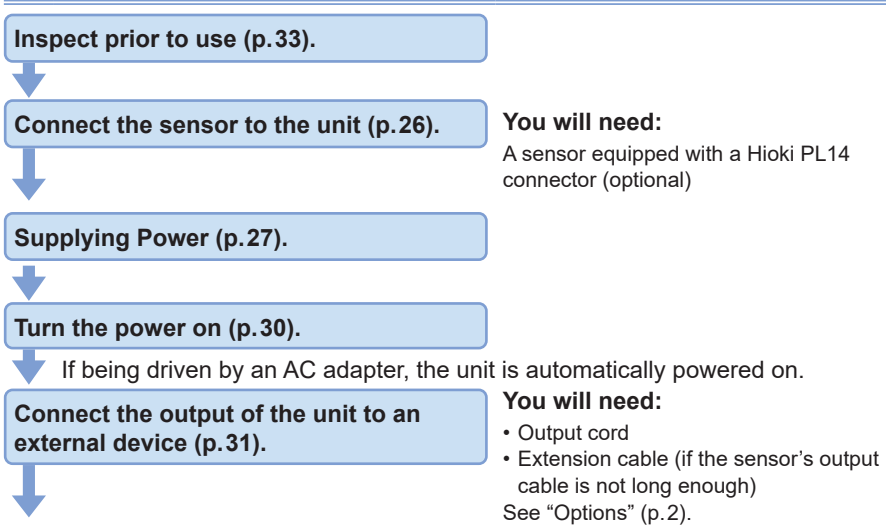

Measuring

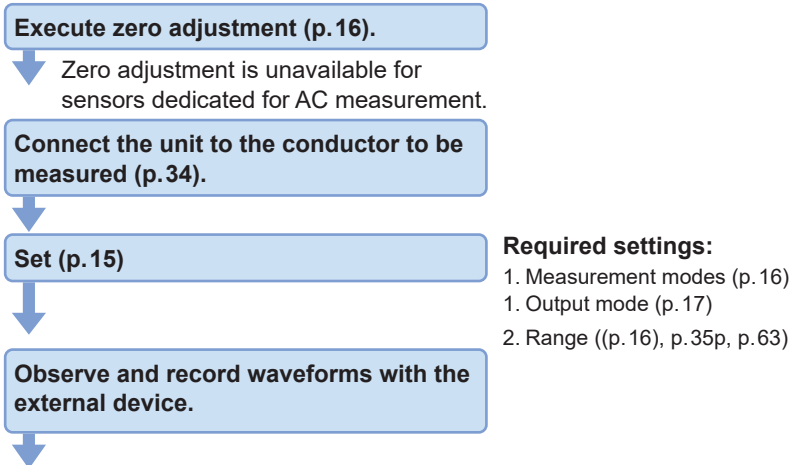

Ending

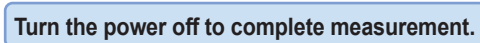

Example of connection to devices installed in a measuring system

With the settings below, the unit will start up in the previously selected output mode and begin generating output whenever the power is supplied through the external power supply jack. This is the recommended way if the unit is connected to devices installed in a measuring system.

See “2.5 Connecting to an External Device” (p.31).

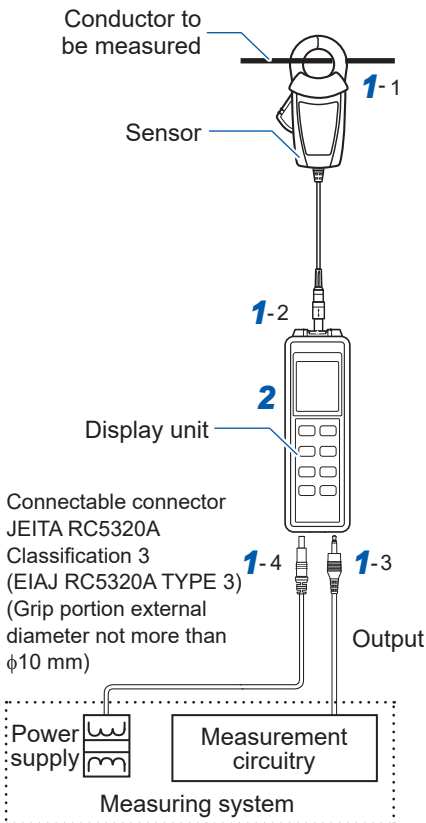

1 Connections

Connect the devices as follows:

1. Sensor – to the conductor to be measured
2. Display unit – to the sensor
3. Display unit – to the output destination
4. Display unit – to the (standalone DC isolated) power supply

2 Setting

Configure the settings in the following order:

1. Set the appropriate measurement mode, output mode, or range
2. Set "Enable" or "Disable" for zero adjustment at power-up
3. Save settings (save the measurement mode settings at power-up)
4. Set the key lock to "Enable" (to avoid operational mistakes)

Measures against power outage

- If batteries have been installed in the unit, it will switch to battery power if power from the AC adapter or external power supply (connected via the external power supply jack) is interrupted and then continue to generate output as long as the battery lasts. Once the external power supply is restored, the unit will switch back to that power source.
- The displayed value or output may be affected by switching noise when the unit switches from battery to AC adapter or vice-versa.

Safety Information

This unit is designed to conform to IEC 61010 Safety Standards, and has been thoroughly tested for safety prior to shipment. However, using the unit in a way not described in this manual may negate the provided safety features. Before using the unit, be certain to carefully read the following safety notes.

WARNING



- **Electricity poses risks of electric shock and arc discharge due to short circuits. Individuals using an electrical measuring instrument for the first time should be supervised by a technician who has experience in electrical measurement.**
- **Protective gear**
This unit measures live lines. To prevent electric shock accidents, wear protective insulation in accordance with laws and regulations.







CAUTION





Mishandling during use could cause damage to the unit. Be certain that you understand the instructions and precautions in the manual before use.

Notation



In this manual, the risk seriousness and the hazard levels are classified as follows.

 DANGER	Indicates an imminent hazard that could lead to serious injury or death.
 WARNING	Indicates a hazard that could lead to serious injury or death.
 CAUTION	Indicates a hazard that could lead to minor injury or that could be expected to result in equipment or other damage.
IMPORTANT	Indicates information related to the operation of the unit or maintenance tasks with which the operators must be fully familiar.
	Indicates a strong magnetic-field hazard. The effects of the magnetic force can cause abnormal operation of heart pacemakers and/or medical electronics.
	Indicates the prohibited action.
	Indicates the action which must be performed.
*	Additional information is presented below.
Bold character	Control operation keys are enclosed in brackets ([]).

Symbols displayed on the unit

	Indicates cautions and hazards. When the symbol is printed on the unit, refer to a corresponding topic in the instruction manual.
	Indicates DC (Direct Current).
	Indicates AC (Alternating Current).

Symbols for various standards

	Indicates the Waste Electrical and Electronic Equipment Directive (WEEE Directive) in EU member states.
	This symbol indicates that the product conforms to regulations set out by the EU Directive.
	Indicates that the product incorporates Bluetooth® wireless technology.

Characters in screen displays

The screen of this unit displays characters in the following manner.

A	B	C	D	E	F	G	H	I	J	K	L	M	N	O	P	Q	R	S	T	U	V	W	X	Y	Z
A	b	C	d	E	F	G	H	,	u	ℓ	ñ	o	P	q	r	S	t	U	u	Y		Y	≡		

1	2	3	4	5	6	7	8	9	0
1	2	3	4	5	6	7	8	9	0

Accuracy



We define measurement tolerances in terms of f.s. (full scale), rdg. (reading) and dgt. (digit) values, with the following meanings:

f.s.	(Maximum display value) Indicates the display unit's maximum display value for the range that is currently in use.
rdg.	(Reading or displayed value) The value currently being measured and indicated on the measuring instrument.
dgt.	dgt. (resolution) The smallest displayable unit on a digital measuring instrument, i.e., the input value that causes the digital display to show a "1" as the least-significant digit.

Operating Precautions

Follow these precautions to ensure safe operation and to obtain the full benefits of the various functions.

DANGER

- 
 - Do not use the unit beyond its rated and specification ranges. Doing so could make the unit break or heat up, possibly resulting in bodily injury.
 - The sensor's maximum measurable current generally varies with the frequency, and this restricts the current that can be measured continuously with derating. Do not use the unit to measure currents that exceed the derating. Doing so could cause heat emission from the sensor, which could result in a malfunction, cause fire or burn injury.
- 
 - Persons wearing electronic medical devices such as a pacemaker should not use the Z5004 Magnetic Strap. The Z5004 Magnetic Strap could interfere with electrical medical devices, and should be kept away. The medical device's operation could be compromised, posing risk to the wearer's life.

CAUTION

- 
 - Do not use an uninterruptible power supply (UPS) or a DC-AC inverter that produces rectangular waves or pseudo-sine-wave output to power the unit. Doing so may damage the unit.

Usage environment

WARNING

Avoid the following locations that could cause an accident or damage to the unit.



- Exposed to direct sunlight or high temperature
- Exposed to corrosive or combustible gases
- Exposed to a strong electromagnetic field or electrostatic charge
- Near induction heating systems (such as high-frequency induction heating systems and IH cooking equipment)
- Susceptible to mechanical vibrations
- Exposed to water, oil, chemicals, or solvents
- Exposed to high humidity or condensation
- Exposed to high quantities of dust particles

Cautions for connecting to terminals

CAUTION

- To prevent damage to the BNC connector (optional L9095), be sure to release its locking mechanism before pulling it out, and grip it by its head (not by the cable).



- When disconnecting a connector from the unit, be sure to grip the part of the connector with the arrows and pull it straight out. Gripping the connector elsewhere or pulling with excessive force may damage the connector.

AC adapter

WARNING



Use only the specified AC adapter. AC adapter input voltage range is 100 to 240 V AC at 50/60 Hz. To avoid electrical hazards and damage to the unit, do not apply voltage outside of this range.

Handling of the cables

WARNING

Damage to the cables or the unit may result in electric shock. Before using the unit, perform the following inspection.



- Before using the unit, make sure that the insulation on the cables are undamaged and that no bare conductors are improperly exposed. If there is any damage to the insulation, have the cable(s) repaired.
- Verify that the unit operates normally to ensure that no damage occurred during storage or shipping. If you find any damage, contact your authorized Hioki distributor or reseller.

Batteries

CAUTION

Heed the following instructions to avoid battery performance drop or leakage.



- Do not mix new and old batteries, or different types of batteries.
- Pay attention to the polarity markings "+-", so that you do not insert the batteries the wrong way around.
- Do not use a battery beyond its recommended use period.
- Do not leave a depleted battery inside the unit.
- Be sure to replace it with a battery of the specified type.
- Remove the batteries and store them if the unit will not be in use for a long time.

IMPORTANT

- Handle and dispose of batteries in accordance with local regulations.
- The  indicator lights up when the batteries have run low. Replace them as soon as possible.
- Do not remove the rubber seal from the battery cover.
- Replace the rubber seal on the battery cover as soon as it deteriorates. When replacing a part, please contact your authorized Hioki distributor or reseller.

1.1 Overview and Features

The CM7290 Display Unit is to be used with a current sensor equipped with a Hioki PL14 output connector. It will automatically recognize the current sensor when it is connected, and the range and output rate will be automatically set. Set the measurement mode to AC or DC so that the unit can display or output values.

The unit supports simultaneous dual displays – for example, of the measured value and output rate during output, or of the current measured value and maximum value. You can clamp the sensor in high or confined locations, and view the display close at hand. And even when you're in low-light conditions, the backlight feature will allow easier reading of displayed values.

With the optional output cord, waveforms, rms values and so forth can be output in analog form to a recorder, logger or power meter for waveform observation, long-term recording, power analysis or similar application.

Supports 2 power sources – AC adapter and batteries – for prolonged measurement. The unit can be turned on by powering an AC adapter, so installation into other devices is made possible.

The CM7291 also provide Bluetooth communications functionality, allowing measurement data to be monitored and logged from a smartphone or tablet.

CAUTION

Because the CM7291 emits radio waves, an approval or a license issued by a country or region where it is used is required to use it. Use in a country or region where it has not been approved may be subject to fines or other penalties as a violation of applicable laws or regulations.

For more information about approved countries/regions for use, see the attached “Precautions Concerning Use of Equipment That Emits Radio Waves” or visit Hioki’s website.

Trademark

- The Bluetooth® word mark and logos are registered trademarks owned by Bluetooth SIG, Inc. and any use of such marks by Hioki E.E. Corporation is under license. Other trademarks and trade names are those of their respective owners.
- Android and Google Play are trademarks of Google, Inc.
- IOS is a registered trademark of Cisco Systems, Inc. and/or its affiliates in the United States and certain other countries.
- iPhone, iPad, iPad mini™, iPad Pro™, and iPod touch are trademarks of Apple Inc.
- The App Store is a service mark of Apple Inc.

1.2 Parts and Functions

CM7291 (Display unit with protector)

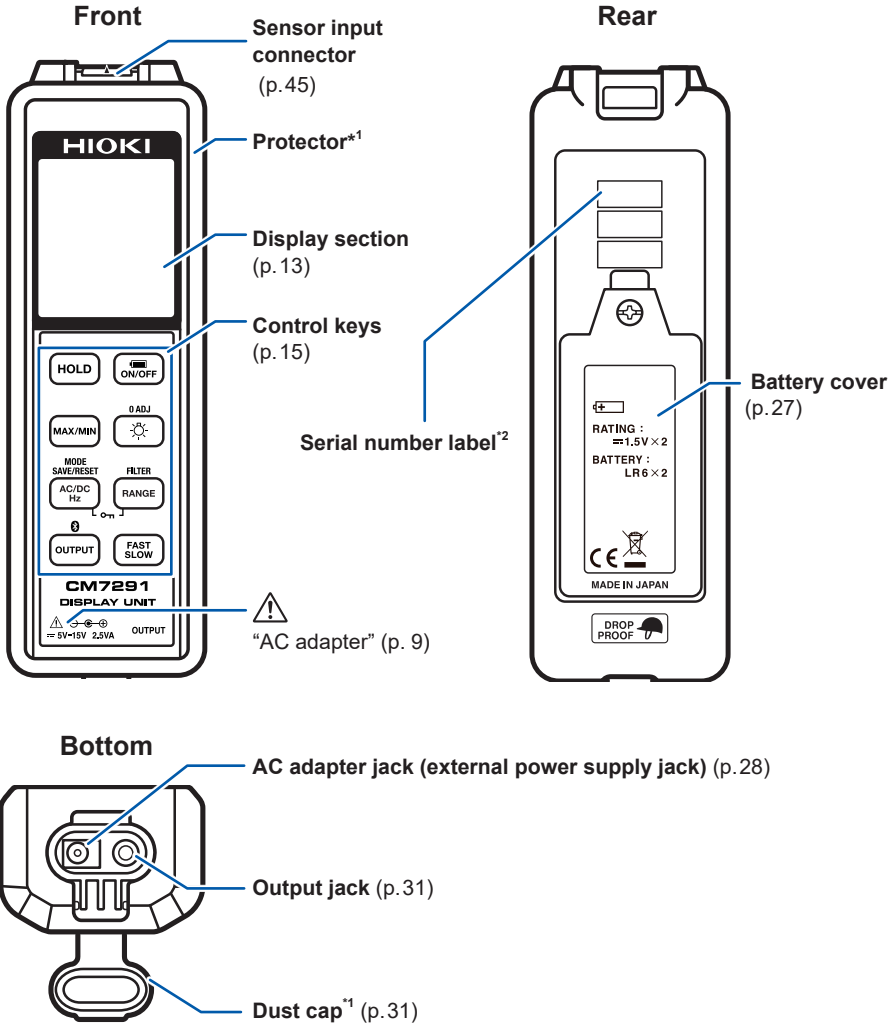

*1: If the protector or dust cap gets dirty or damaged, replace it as necessary. Contact your authorized Hioki distributor or reseller when ordering.

*2: The serial number consists of 9 digits. The first two (from the left) indicate the year of manufacture, and the next two indicate the month of manufacture. Do not remove the label, as it is needed for the product warranty.

Display

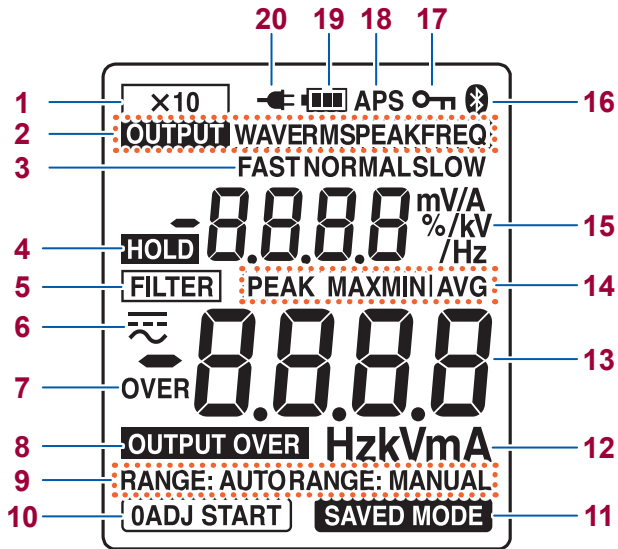

1	Output ×10 function enabled	(p. 17)
2	Output mode enabled	(p. 17)
3	Response speed	(p. 17)
4	Hold function enabled	(p. 16)
5	Filter function is enabled	(p. 22)
6	Measurement modes	(p. 16)
7	Over-range	(p. 14)
8	Over-output	(p. 14)
9	Auto ranging / Manual ranging	(p. 16)
10	Zero adjustment at power-up enabled	(p. 20)





11	Save settings enabled	(p. 20)
12	Unit	
13	Measured value (main display)	
14	Items displayed when analysis display is enabled	(p. 16)
15	(Sub display:)	
	Instantaneous value when analysis display is enabled	(p. 16)
	Output rate when output mode is enabled	(p. 17)
16	Bluetooth® Communications	(p. 18)
17	Key lock function enabled	(p. 18)
18	Auto power-save function enabled	(p. 20)
19	Battery power warning display	(p. 14)
20	AC adapter connected	(p. 28)

Warning and battery power displays

Warning displays

OVER	Appears when the measured value exceeds the maximum input range.
OUTPUT OVER	Appears when the display value exceeds the output range while the output mode is PEAK or FREQ.

Battery power warning display

	Battery full.
	As the battery is discharged, solid black bars disappear from left to right.
	Battery low. Please replace them as soon as possible.
	(flashing) Battery depleted. Replace with new batteries.

Power shut-off

- When battery-powered, power is turned off automatically if the unit is not operated for approx. 10 minutes (p.20).
- The power will also be turned off when the batteries have run low. Replace with new batteries (p.27).

1.3 Tables of Key Operations

This section describes how to access different functions by pressing keys differently.

	Short press	1-second long press	Turn on power while pressing key*
	Execute the operation written on the key	Execute the operation written above the key	Execute a specific command (see the following pages)
Example: 	Switches the range	Filter function enabled/disabled	Displays the model number and software version



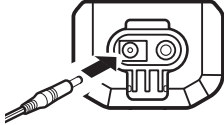





* : Method of turning on the power will differ depending on the power source. See "2.5 Connecting to an External Device" (p.31).

Power source	Turning on the power	Example
Batteries	▶ First turn off the power and then press the [ON/OFF] key while pressing the key	
AC adapter or external DC power supply	▶ With the connector of the AC adapter or power cord disconnected from the unit insert the connector while pressing the key	

For more information, see the appropriate table(s) on the following pages, as set out below.



How to use the unit based on the operation you wish to perform	▶	<ul style="list-style-type: none"> • "Measuring" (p.16) • "Display/output/communication" (p.17) • "System operation" (p.18) • "Maintenance operation" (p.19) • "Handy functions" (p.20)
Roles of individual keys	▶	<ul style="list-style-type: none"> • "Key configurations" (p.22)





Measuring

Desired operation (function)	How to set/ cancel it	Screen display Enabled: Lit Disabled: Unlit	Description
Turn the power on (with battery drive)	 Short press	Display lights up	<ul style="list-style-type: none"> When the unit is driven by power from an AC adapter or external DC power supply, this key is disabled, and in order to turn the power off you must disconnect the connector from the AC adapter's or external DC power supply's terminal (p.30).
Turn the power off (with battery drive)	 1-second long press	Display goes out	<ul style="list-style-type: none"> When power from an AC adapter or external power supply is turned off with batteries installed in the unit, the batteries will begin automatically to power the unit.
Execute zero adjustment	 1-second long press	Example: 	<ul style="list-style-type: none"> Resets the display value to zero, after memorizing it. Disabled if an AC current sensor is connected.
Switch the measurement mode	 Short press	≡ : DC measurement ("DC") ~ : AC measurement ("AC") ≡ : AC + DC measurement ("AC+DC") ~ : Frequency measurement ("Hz")	
Hold display updating (HOLD)	 Short press		<ul style="list-style-type: none"> Halts updating of the display. Can be used for any measurement.
Switch ranging manually (Ranging)	 Short press	RANGE: AUTO: Auto ranging RANGE: MANUAL: Manual ranging	<ul style="list-style-type: none"> Factory settings: Auto ranging (appropriate range is switched to automatically) You can also change the range manually. When output becomes valid during auto-range operation, auto-range operation will be disabled, and the unit will switch to manual range operation using the present range.





Desired operation (function)	How to set/cancel it	Screen display Enabled: Lit Disabled: Unlit	Description
Analyze the measured values (Analysis display)	 Start: Short press Switch: Short press Cancel: 1-second long press	"MAX" : Maximum value "MIN" : Minimum value "AVG" : Average value PEAK MAX : Maximum peak value PEAK MIN : Minimum peak value	<ul style="list-style-type: none"> The unit will display values for the interval starting when the analysis display was activated (in the main display). The current instantaneous values are also displayed (in the sub display). The peak values are 0-to-peak values. (Polarity is indicated.)

Display/output/communication



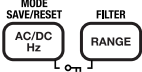

Desired operation (function)	How to set/cancel it	Screen display Enabled: Lit Disabled: Unlit	Description
Switch the response speed	 Short press	Time FAST : NORMAL : SLOW : 	See: <ul style="list-style-type: none"> "Display and output update rate" (p.51) "Appx. 4 Measurement Response Waveforms" (p.76)
Switch the measurement mode	 Short press	WAVE : Waveform RMS : Root mean square PEAK : Max. absolute value at update time interval, with sampling of 2 kS/s FREQ : Frequency	<ul style="list-style-type: none"> Output varies with the output mode. Output rate is displayed in sub display. Output is ground output when the output mode is disabled.

Desired operation (function)	How to set/cancel it	Screen display Enabled: Lit Disabled: Unlit	Description
Make output 10 times higher than normal (output × 10)	<p>Select output mode, then give</p>  <p>a 1-second long press</p>		<p>This function is used when the magnitude of the output is so low that it may be obscured by noise from nearby equipment. Even if you set a range whose output voltage exceeds ±5 V, the 10x output can still be selected. However, the output voltage will be limited to ±5 V.</p> <p>Output ranges: WAVE: ±5 V±0.3 V RMS: 0 V to 5 V±0.3 V PEAK: 0 V to 2.3 V±0.1 V</p>
Enable Bluetooth® communications (only for CM7291)	 <p>a 1-second long press</p>		<p>See: "Making measurements with the Bluetooth® function" (p.40)</p>

System operation

Desired operation (function)	How to set/cancel it	Screen display Enabled: Lit Disabled: Unlit	Description
Turn on the backlight	 <p>Short press</p>	<p>Backlight turns on</p>	-
Turn off the buzzer	 <p>Turn on power while pressing key</p>	-	<ul style="list-style-type: none"> • Factory settings: buzzer turned on • Setting is memorized when power is turned off.
Disable key operation (key lock)	 <p>1-second long press</p>		<p>All key operations except key lock cancellation are disabled. However, the ON/OFF button can be used.</p>

Maintenance operation





Desired operation	How to set/ cancel it	Screen display	Description
Display Serial No.	 Turn on power while pressing key	*1	Used for checking the Serial No. when you are unable to check the No. on the back of the unit because it has been installed into another device.
Display model number and software version	 Turn on power while pressing key	*2	The model number and software version will be displayed.
Check if all LCD segments are displayed	 Turn on power while pressing key	All segments of display will light up	<ul style="list-style-type: none"> • Used for inspection prior to use (p.33).
Revert to factory settings	 Turn on power while pressing key	—	See "4.3 Functional Specifications" (p.51).



*1: The 9-digit serial number will be displayed as a series of three numbers.

*2: The model number is displayed in the sub display, and the software version is displayed in the main display.

Handy functions





You can cancel each function by performing the same operation used to activate it.







Desired operation (function) ☑: Enabled (factory settings)	How to set/ cancel it	Screen display Enabled: Lit Disabled: Unlit	Description
<p>Execute zero adjustment automatically when power is turned on (Zero adjustment at power-up)</p>	 <p>Turn on power while pressing key</p>		<ul style="list-style-type: none"> This function can be used if a no-input state will continue for approximately 1 minute when the unit is turned on. Check the unit if there is any input as the following may occur: <ul style="list-style-type: none"> The screen display may indicate FAIL. Zero-adjustment data may be cleared. A large error component may result. When this function is disabled, press the [0ADJ] key to execute zero adjustment as necessary. Setting is memorized when power is turned off.
<p>Save the settings (Save settings)</p>	 <p>1-second long press</p>		<ul style="list-style-type: none"> Use this to save the current settings (except the auto power-save function setting, which will not be saved). You can then measure using the saved settings right away when you next power up. The unit will detect the sensor type, including whether it is an AC sensor or an AC/DC sensor, its rating, and its output rate. Settings can be saved for each sensor type. So, for example, CT7636 and CT7736 will be identified as the same sensor. Settings saved may be deleted as a result of calibration or repair. Check the setting status before using the unit.

Desired operation (function) ☑: Enabled (factory settings)	How to set/ cancel it	Screen display Enabled: Lit Disabled: Unlit	Description
Have backlight turned off automatically ☑	 Turn on power while pressing key	-	<ul style="list-style-type: none"> • Backlight will be turned off automatically after being lit for approx. 40 seconds. • Setting is memorized when power is turned off.
When the unit is battery-powered, disable the APS (auto power-save).	 Turn on power while pressing key	APS	<ul style="list-style-type: none"> • Disable the APS function. • The battery-powered unit is automatically turned off when the APS function is enabled after approximately 10 minutes of inactivity. (p.53) The APS segment on the screen blinks, and the buzzer sounds before the unit is turned off. • The APS function will be automatically disabled if the output, analysis display or key lock function is enabled. (When that function is disabled, APS will be automatically re-enabled.) • APS is disabled when an AC adapter is used.
Remove noise and other unwanted frequency components (Filter function*¹)	 1-second long press	FILTER	This can only be set in the AC, AC+DC, and Hz modes.

*1: The display value and output value are values that have been passed through a low-pass filter (LPF) with cut-off frequencies (f_c) around 180 Hz. With the filter function enabled, the 180 Hz components can be damped by -3 dB (approx. 30%). Use this function to remove carrier components from the inverter output side (secondary side) or if noise is annoying you, and in similar cases.

Key configurations

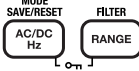
Key	Short press	1-second long press	Turn on power while pressing key
	Sets/cancels HOLD	–	Disables auto power-save
	HOLD Lit / Unlit	–	APS Unlit
	Enables or switches the analysis display function	Cancels the analysis display function	Enables/disables the buzzer sound
	"MAX" : Maximum value "MIN" : Minimum value "AVG" : Average value PEAK MAX : Maximum peak value PEAK MIN : Minimum peak value	–	–
	Switches the measurement mode	Sets/cancels the save settings function	Sets/cancels backlight auto-off
	≡: DC measurement ~: AC measurement ≡~: AC + DC measurement ~: Frequency measurement ("Hz")	SAVED MODE Lit / Unlit	When enabled, the backlight will automatically turn off approximately 40 sec. after the last operation.
	Switches the output mode	Enable/disable Bluetooth® communications (only for CM7291)	Displays the serial No.
	WAVE : Waveform RMS : Root mean square PEAK : Maximum absolute value at update time interval, with sampling of 2 kS/s FREQ : Frequency	 Lit / Unlit (only for CM7291)	–

Key	Short press	1-second long press	Turn on power while pressing key
	When using battery power: <ul style="list-style-type: none"> • Turn the power on • After APS has been disabled, turning on the power again will re-enable APS 	When using battery power: <ul style="list-style-type: none"> • Turn the power off 	-
	<ul style="list-style-type: none"> • Display lights up • APS Lit 	-	-
	Backlight On/Off	Executes zero adjustment (display and output values are set to zero after being memorized)	Enables/disables zero adjustment at power-up
	-	The values in the main display will change to zero	0ADJ START Lit / Unlit
	Switches the range	Filter functions Enabled/ disabled	Displays the model number and software version
	RANGE: AUTO: Auto ranging RANGE: MANUAL: Manual ranging	 Lit / Unlit	-
	Switches the response speed		Revert to factory settings (clears saved settings, etc.)
	FAST: Fast rate NORMAL: Medium rate SLOW: Slow rate	-	-
	-	Sets/cancels key lock	-
	-	 Lit / Unlit	-

Tables of Key Operations

Key	Short press	1-second long press	Turn on power while pressing key
	-	Sets/cancels ×10 output amplification function • This operation can only be performed during output operation.	-
	-	×10 Lit / Unlit	-

2

Pre-measurement Preparation

2.1 Installing the Z5004 Magnetic Strap

Attach the optional Z5004 Magnetic Strap as required.
The magnet can be used to attach to a wall, such as a metal surface.

2

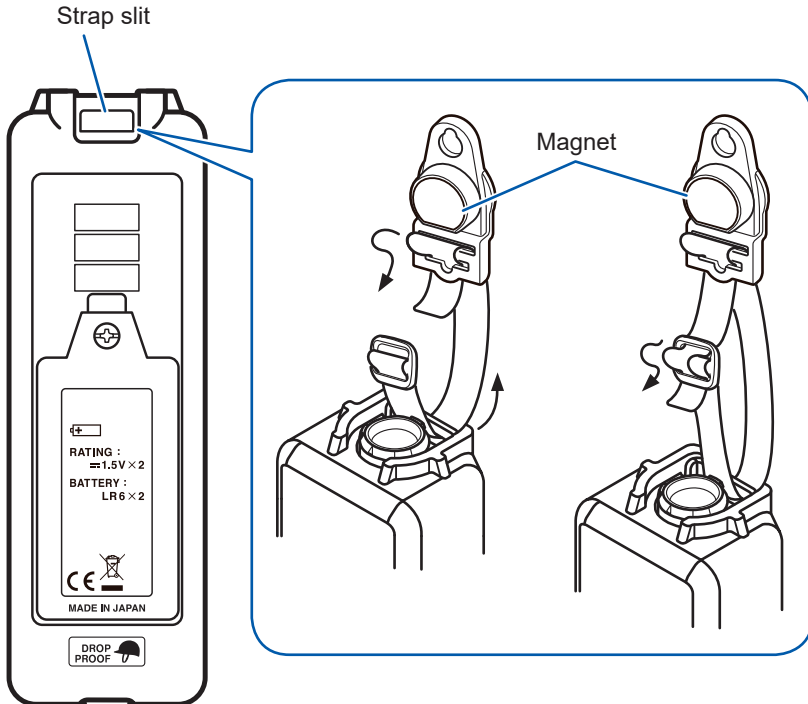

2.2 Connecting the Sensor

When the optional current sensor (output connector: Hioki PL14 Connector) (p.45) is connected, its type will be automatically recognized, and settings that match the sensor will be configured automatically (measurement mode, current rating, output rate).

Insert the output connector of the sensor so that the arrow is aligned with the arrow on the sensor input connector of the unit.

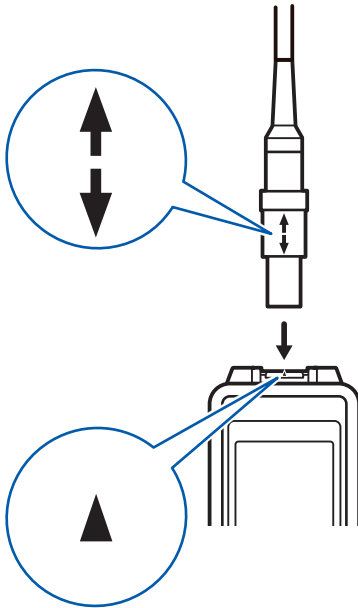

Connecting a sensor consuming a large current while operating the unit on battery power with low battery voltage may cause the unit to shut off due to its inability to supply sufficient power to the sensor.

2.3 Supplying Power

Installing/replacing the batteries

When using the unit for the first time, be sure to install two LR6 alkaline battery (AA) batteries. Also, before measurement, check that there is adequate power in the batteries. If there is not, replace the batteries. Batteries can be replaced with the protector installed. Disconnect the sensor from the conductor to be measured, before replacing the batteries.

See “Batteries” (p.10).

2

IMPORTANT

When  indicator is lit, the batteries are low. Please replace the batteries as soon as possible.

- When batteries are installed, the unit will switch to battery power when the supply of power from the AC adapter is interrupted, allowing continued measurement. (Duration of operation in this state will depend on the sensor connected and the remaining power of the batteries.)
- After use, always turn OFF the power.

You will need: Phillips screwdriver (No. 2), LR6 alkaline battery (AA) ×2 or
HR6 Nickel-metal hydride battery ×2

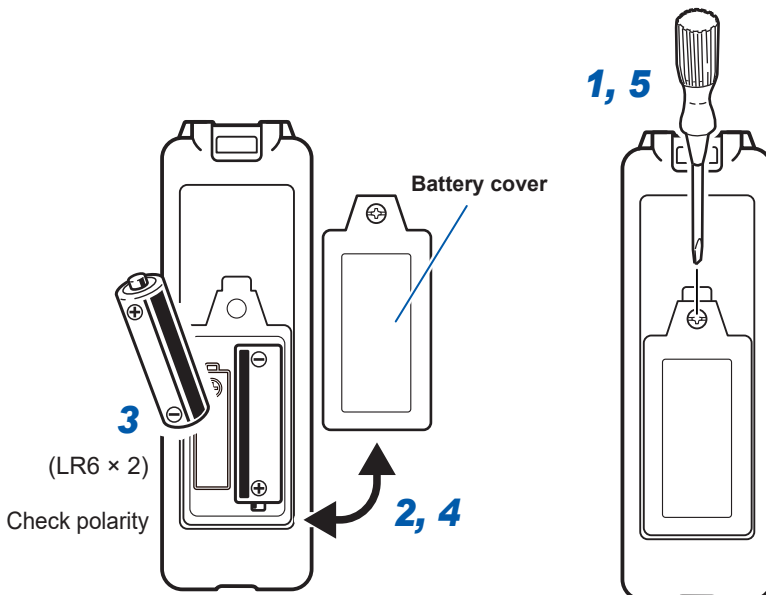

Connecting the AC adapter (optional)

Be sure to read “AC adapter” (p.9) and “Handling of the cables” (p.10) before connecting the AC adapter.

Use the optional AC adapter to supply power from an outlet. When power is supplied via the AC adapter, the unit will run on AC adapter drive even if batteries are installed.

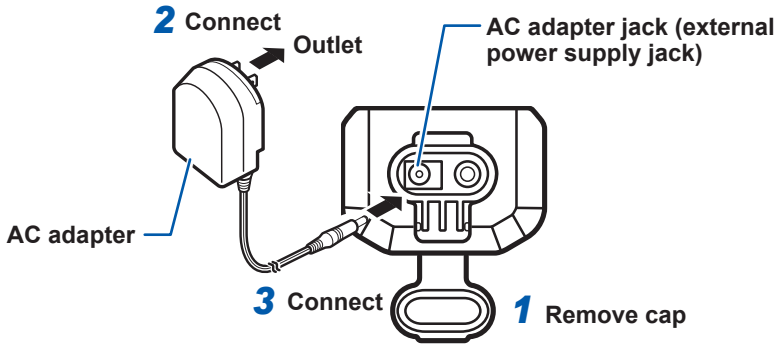

- When batteries are installed, the unit will switch to battery power when the supply of power from the AC adapter is interrupted, allowing continued measurement. (Duration of operation in this state will depend on the sensor connected and the remaining power of the batteries.)
- The displayed value or output may be affected by switching noise when the unit switches from battery to AC adapter or vice-versa.
- To disable battery drive when AC adapter power is shut off, remove the batteries.

Connecting to an external DC power supply

Be sure to read “Handling of the cables” (p. 10) before connecting the power supply.

When connecting to an external DC power supply, make sure that the supply has the correct rating and uses a compatible connector. See “Power supply” (p.41).

When power is supplied from an external DC supply, that power supply will receive priority and the unit will operate on power from the external DC power supply even if batteries have been installed.

2

Connection Example

When using an external DC power supply (other than the optional AC adapter), be sure to use a power supply connector that qualifies as JEITA RC5320A Classification 3 (EIAJ RC5320A TYPE 3) (grip portion external diameter not more than $\phi 10$ mm).

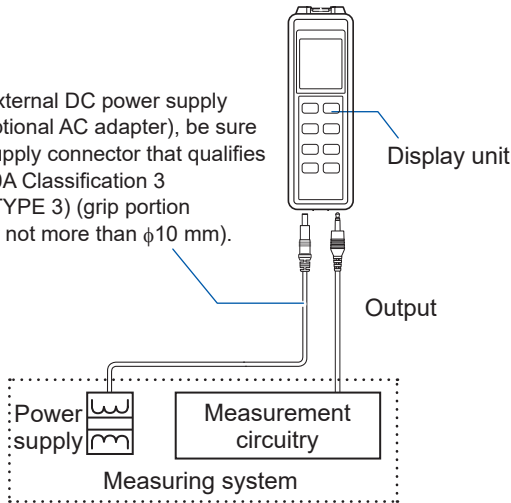

The unit must have an exclusive power supply – the optional AC adapter, or an isolated DC power supply satisfying the power supply specifications – that is used for the unit alone. If the power source is shared with the measurement circuitry, the zero-point for output values will shift when the load on the measurement circuitry fluctuates, making accurate measurement impossible.

2.4 Turning the Power On/Off

When using battery power

Turning the power on/off

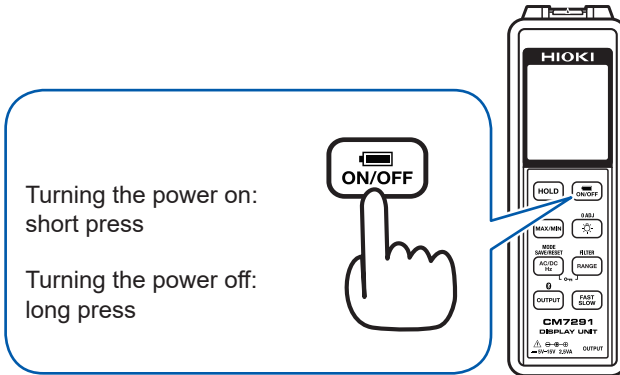

When using the AC adapter or an external DC power supply

The unit will remain on at all times.

Turning the power off

Disconnect the connector from the AC adapter (external power supply) terminal.

2.5 Connecting to an External Device

If the unit is to be used in combination with another device, use the output cord (optional) to connect to the external device.

If the sensor cable is not long enough, use an extension cable (optional).
See "Options" (p.2).

2

Insert the output cord all the way into the unit. Otherwise the contacting will be poor and the measured value will not be output accurately.

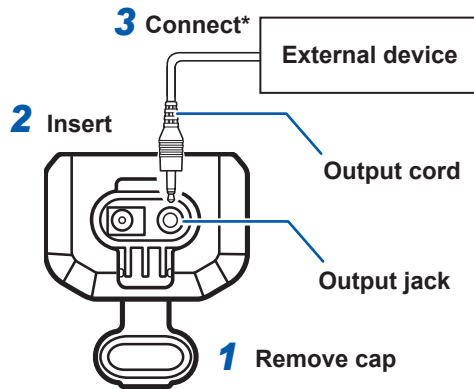

*: The connection method will depend on the option(s) used (see below).

Using an L9095 Output Cord:

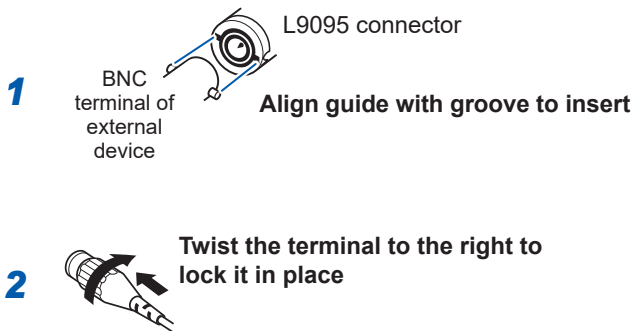

3 Measurement and Output

3.1 Inspection Prior to Use

Inspect the unit and sensor for any damage it may have sustained during storage or shipment and verify that it is operating properly before use. If you find any faults, contact your authorized Hioki distributor or reseller.

Where to check		Check item	Solution
Cables		Any cable's insulation broken?	Do not use the cable. Have it repaired.
Display unit	Batteries	Sufficient battery power remaining?	<ul style="list-style-type: none">• If the indicator shows , the batteries have run low and you should replace them as soon as possible.• If the batteries are low, the unit may switch off when the backlight turns on or when a beep tone sounds.
	Range	Does the range correspond to the current?	Check by switching the range with the [RANGE] key.
	Zero check	With the AC mode selected, does the display read 0 A or close to 0 A?	If it does not, contact your authorized Hioki distributor or reseller.
		With the DC mode selected, does the display read 0 A or close to 0 A?	Perform zero-adjustment with the [0ADJ] key. Verify that the displayed value is close to 0 A while not measuring anything.
	Display	All LCD segments are displayed?	Check that all of the LCD's segments light up (p.30). If any does not, have the unit repaired.

3.2 Taking Measurements

2 Clamp the conductor

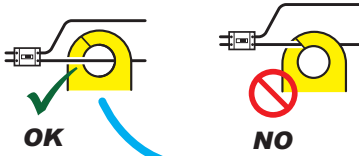

1 Execute zero adjustment.*1

Long press



3 Select the measurement mode*2

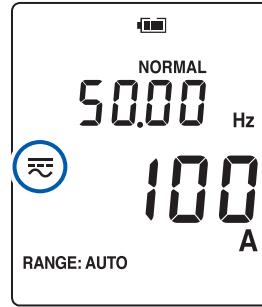
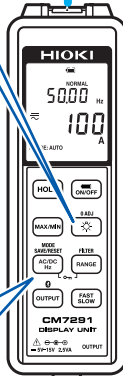

Measurement modes:

- DC
- AC
- AC + DC

- To measure current of not more than 10 Hz, select the AC+DC mode, and use the **[FAST/SLOW]** key to set the response speed to **SLOW**.
- Auto ranging will be set. You can alternatively set manual ranging (p. 16).

*1: Not needed if zero adjustment at power-up is enabled (p. 20).

*2: Not needed if save settings is enabled (p. 20).

- There may be a delay in the display or output during low-input or low-frequency measurement.
- When measuring a DC current or generating waveform output with the output function, align the current direction mark with the direction of current flow in the conductor and clamp the sensor so that the conductor is located roughly in the center of the sensor.

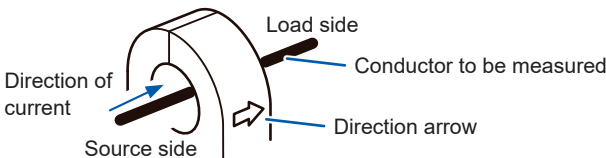

Types of output in the different measurement modes

MODE SAVE/RESET AC/DC Hz		OUTPUT
AC/DC sensor	AC sensor	
AC/DC ⎓		WAVE → RMS → PEAK → OFF
AC ~	AC ~	WAVE → RMS → PEAK → OFF
DC ≡		WAVE → OFF
Hz ~	Hz ~	FREQ → OFF

3

⚠ CAUTION



- AC+DC mode and AC mode have a frequency band of about 30 kHz (-3dB) for the wave outputting (WAVE OUT) function.
- Selecting DC mode enables the low-pass filter with a cut-off frequency of about 1 Hz. Select AC+DC mode to use the wave outputting (WAVE OUT) with a faster response setting.

Setting measurement range

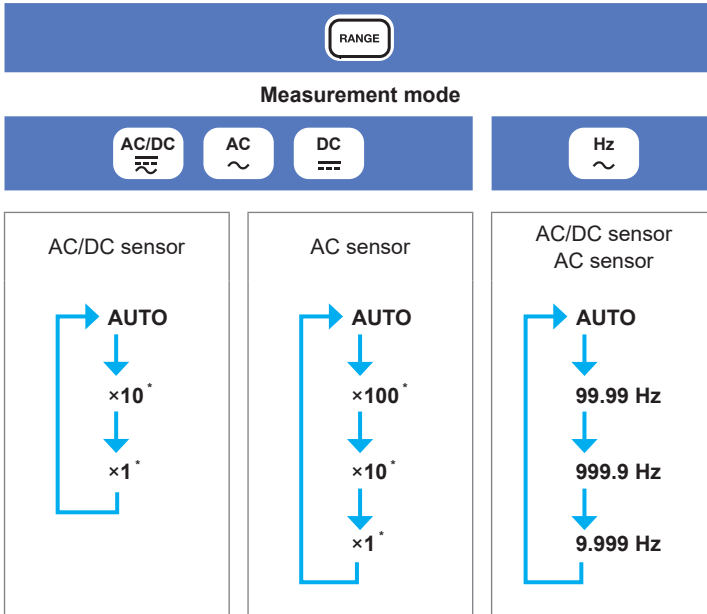

*: The ranges as a whole with a sensor connected

See “Appx. 1 Range Structure, Output rate, and Power Consumption Category with a Sensor Connected” (p.63) for details about the range structure of each of the sensors.

Enabling OUTPUT will switch the measurement range from AUTO to a manual range.

Enabling the analysis display (MAX/MIN) will cause a measurement range to be fixed. To change the measurement range, disable the analysis display (MAX/MIN).

3.3 Changing the Display/output update time (rate) (to Faster or Slower)

You can change the rate at which the display/output is updated.
(factory settings: **NORMAL**)

Response speed	Time
FAST	Fast rate
NORMAL	↕
SLOW	Slow rate

See “Display and output update rate” (p.51).

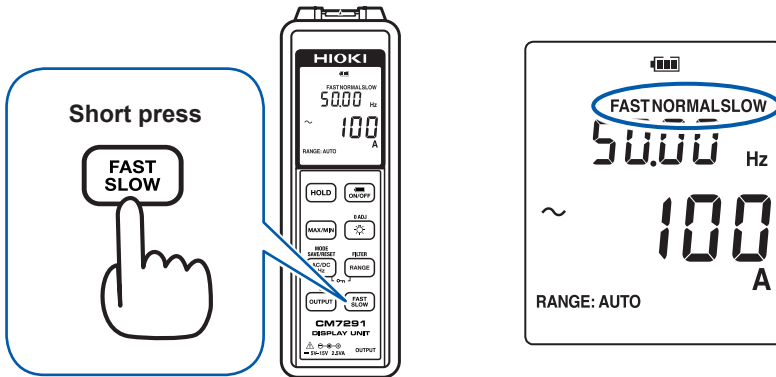

The display or output may indicate an excessively large value immediately after switching to SLOW mode.





















































3.4 Examples of Measurement Waveforms

Table of waveforms

The table below gives examples of the typical waveforms when appropriate settings are made. See “Accuracy specifications (for display unit only)” (p.47) to check the accuracy specifications for the unit.

✓: Available, -: Not suitable

(The waveforms shown in the table are typical examples of when appropriate settings are made.)

Measurement mode and symbol	Measurement waveform (The AC waveforms depict those with a commercial frequency or full-wave rectified.)	Display	Output		
			WAVE (with polarity)	RMS (no polarity)	PEAK (no polarity)
DC 		✓			
		-			
		-			
		-			
AC 		-			
		✓			
		-			
		-			
AC+DC  $\sqrt{DC^2 + AC^2}$		✓			
		✓			
		✓			
		✓			
Frequency Hz		Frequency		Output proportional to frequency (mV/Hz)	

*1: In DC mode, the low-pass filter with a cut-off frequency of approximately 1 Hz is enabled. Select AC+DC mode when an input signal with fast response is output as a waveform output.

3.5 Bluetooth® Communications (only for CM7291)

The CM7291 supports Bluetooth® (Bluetooth® low energy) .

When the Bluetooth® function is enabled, you can review measurement data and create measurement reports

on mobile devices (iPhone, iPad, iPad Mini™, iPad Pro™, iPod touch, and Android™ devices). For more information about this functionality, see the help function in the application software GENNECT Cross.

1 Install the GENNECT Cross on your mobile device. (p.35)



2 Enable the Bluetooth® function on the CM7291.

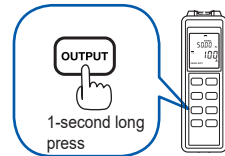

3 Launch the GENNECT Cross and pair it with the CM7291. (p.39)

4 Select the general measurement, logging, or wave graph function.

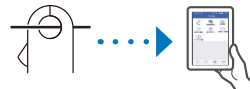

Installing the application software GENNECT Cross

Search for “GENNECT Cross” on the App Store from your iPhone, iPad or other Apple device, or on Google Play™ from your Android™ device. Then download and install the GENNECT Cross. You will need an Apple ID to download the app from the App Store, or a Google account to download the app from Google Play™. For more information about how to register an account, contact the store at which you purchased your device.



- Because the CM7291 emit radio waves, use in a country or region where they have not been approved may be subject to fines or other penalties as a violation of applicable laws or regulations. For more information, see the attached “Precautions Concerning Use of Equipment That Emits Radio Waves” or go to our website.
- The CM7291 availability is limited to certain countries. For more information, contact your authorized Hioki distributor or reseller.
- For more information, see the attached “Precautions Concerning Use of Equipment That Emits Radio Waves.”
- Bluetooth® communications range varies greatly with distance from obstructions (walls, metal obstruction, etc.) as well as distance from the floor or ground. To ensure stable measurement, verify adequate signal strength.
- Although this app is provided free of charge, downloading or use of the app may incur Internet connection charges. Such charges are the sole responsibility of the user.
- This app is not guaranteed to operate on all mobile devices.

Pairing the app with the CM7291

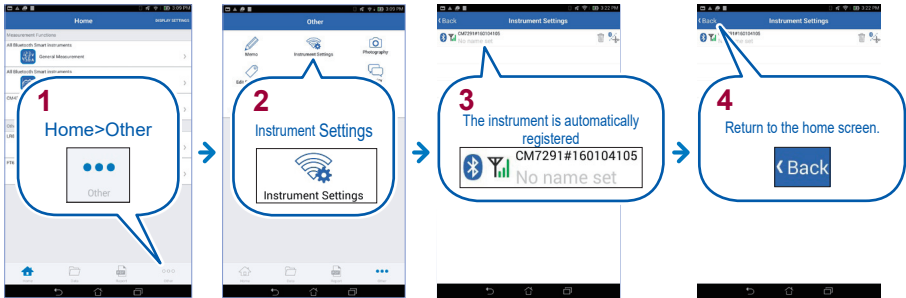

- When the app is launched for the first time (before being paired with any instrument), the instrument settings screen will be displayed.
- While the mobile device is displaying the instrument settings screen, simply move it close to a CM7291 to automatically pair it with the instrument (the app can be paired with up to 8 instruments).
- Allow about 5 to 30 seconds for the instrument to pair with the app after being turned on. If the instrument fails to pair within 1 minute, relaunch GENNECT Cross and cycle the instrument's power.
- For previously registered instruments, the operations described above can be skipped.

Making measurements with the Bluetooth® function

Select the general measurement, logging, or wave graph function on the home screen. For more information about each function, see the help function in the GENNECT Cross.

A value displayed in the app and that displayed on the instrument may differ from each other due to communication delay or discrepancy between display update rates. A statistical value calculated from logged values and an analytical value displayed on the instrument may differ from each other.



General Measurement
Saves measured values from multiple channels

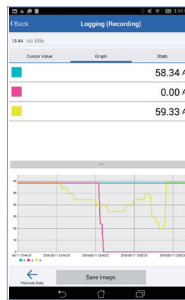

Logging
Simple logging (up to 24 hours)
For CM7291, several keys are disabled while logging is performed.

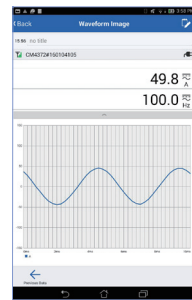

Wave Graph
Simple oscilloscope
No waveforms are displayed during PEAK output or with Hz function set.

4

Specifications

4.1 General Specifications

Operating environment	Indoors, Pollution Degree 2, altitude up to 2000 m (6562 ft.)
Operating temperature and humidity	-25°C to 65°C (-13°F to 149°F), 80% RH or less (non-condensing, except for battery)
Storage temperature and humidity	-25°C to 65°C (-13°F to 149°F), 80% RH or less (non-condensing, except for battery)
Dust-proof, water-proof	IP54 (EN60529) (with AC adapter/power connector cap on and sensor connected)
Standards	Safety EN61010 EMC EN61326
Drop proof	1.5 m when protector is used The instrument with nickel-metal hydride batteries inserted is not drop-proof.
Power supply	<ul style="list-style-type: none">• LR6 Alkaline battery ×2• HR6 Nickel-metal hydride battery ×2• Externally supplied power of 5 V to 15 V Recommended AC adapter 9445-02 AC Adapter Rated power voltage : 100 V to 240 V AC (assuming voltage fluctuation of ±10%) Rated power-supply frequency: 50 Hz/60 Hz Anticipated transient overvoltage: 2500 V
Battery power warning voltage	 flashes prior to power shut-off

**Rated power
(Reference values
for 23°C)**

Sensor power consumption category	In either of the following conditions: - With Bluetooth® turned OFF, the backlight turned off, and the output mode set to WAVE - With Bluetooth® turned OFF, the backlight turned off, and the output mode set to RMS	Maximum rated power
0	0.3 VA	0.8 VA
1	0.5 VA	1.0 VA
2	0.7 VA	1.2 VA
3	1 VA	1.5 VA
4	1.5 VA	2.0 VA

See “Appx. 1 Range Structure, Output rate, and Power Consumption Category with a Sensor Connected” (p.63) for power consumption categories.

Continuous operating time (when batteries used; reference values for 23°C)

When powered by two LR6 Alkaline batteries (reference value at 23°C)

Sensor power consumption category	In either of the following conditions: - With Bluetooth® turned OFF, the backlight turned off, and the output mode set to WAVE - With Bluetooth® turned OFF, the backlight turned off, and the output mode set to RMS	In either of the following conditions: - With Bluetooth® turned ON, the output mode set to OFF, and the backlight turned OFF - With the output mode set to PEAK, Bluetooth® turned OFF, and the backlight turned OFF
0	Approx. 30 hours	Approx. 19 hours
1	Approx. 16 hours	Approx. 11 hours
2	Approx. 8 hours	Approx. 6 hours
3	Approx. 4 hours	Approx. 3 hours
4	Approx. 1.4 hours	Approx. 1 hours

When powered by two HR6 Nickel-metal hydride batteries (reference value at 23°C)

Sensor power consumption category	In either of the following conditions: - With Bluetooth® turned OFF, the backlight turned off, and the output mode set to WAVE - With Bluetooth® turned OFF, the backlight turned off, and the output mode set to RMS	In either of the following conditions: - With Bluetooth® turned ON, the output mode set to OFF, and the backlight turned OFF - With the output mode set to PEAK, Bluetooth® turned OFF, and the backlight turned OFF
0	Approx. 26 hours	Approx. 20 hours
1	Approx. 19 hours	Approx. 16 hours
2	Approx. 14 hours	Approx. 12 hours
3	Approx. 7 hours	Approx. 6 hours
4	Approx. 5 hours	Approx. 5 hours

See "Appx. 1 Range Structure, Output rate, and Power Consumption Category with a Sensor Connected" (p. 63) for power consumption categories.

Dimensions	Approx. 52 mm (2.05") W × 163 mm (6.42") H × 37 mm (1.46") D (with protector) Approx. 48 mm (1.89") W × 159 mm (6.26") H × 33 mm (1.30") D (without protector)
-------------------	---

Mass	Approx. 220 g (7.8 oz.) (with protector, batteries installed) Approx. 185 g (6.5 oz.) (without protector, batteries not installed)
-------------	---

General Specifications

Product warranty period	3 years
Accessories	See "Verifying Package Contents" (p. 1).
Options	See "Options" (p.2).

4.2 Input and Output Specifications, and Measurement Specifications

(1) Measurement functions and measurable waveforms

See “3.4 Examples of Measurement Waveforms” (p. 38).

(2) Basic Specifications

Sensor input connector	Hioki PL14	
AC measurement method	Measurement of true rms	
Output impedance	50 Ω ($\pm 5\%$)	
PEAK sensing duration	2 ms or greater (during PEAK MAX/PEAK MIN and PEAK output)	
Zero-display range	29 count or less for AC and DC+AC RMS values	
Crest factor	AC or DC+AC 3 (5000 counts) or 2.5 (6000 counts)	
Auto ranging transition threshold	Measurement modes	Conditions for transition
	DC, AC, or DC + AC	To higher range: 6001 counts or more To lower range: 539 counts or less
	Frequency	To higher range: 10000 counts or more To lower range: 899 counts or less
Warning displays	OVER	Display value has exceeded the instrument range or the sensor rating
	OUTPUT OVER	When the display value exceeds the output range while the output mode is PEAK or FREQ

(3) Basic conditions for accuracy specifications

Power supply voltage range for guaranteed accuracy	With power ON
Conditions of guaranteed accuracy	Guaranteed accuracy period: 3 years Temperature and humidity for guaranteed accuracy: 23°C \pm 5°C (73°F \pm 9°F), 80% RH or less Zero-adjustment executed

Measurement response time and AC accuracy guaranteed frequency range by response speed	Response speed	Measurement response time ^{*1}	AC accuracy guaranteed frequency range
	FAST	0.3 s	45 Hz ≤ f ≤ 1 kHz ^{*2}
	NORMAL	0.8 s	10 Hz ≤ f ≤ 1 kHz ^{*2}
	SLOW	5.0 s	3 Hz ≤ f ≤ 1 kHz ^{*2}
<p>*1 Time required for the RMS output value to fall within the accuracy specifications range when the input is varied from 10% to 90% with the range fixed</p> <p>*2 For values of f such that 66 Hz ≤ f ≤ 1 kHz, the range is defined only with the filter set to OFF.</p>			
Temperature coefficient	Within the operating temperature range, add measurement accuracy × 0.1/°C (except 23°C ± 5°C).		
Maximum extension length	100 m (but will depend on device connected to)		
Condition for AC guaranteed accuracy	Sine wave input		
Effect of radiated radio-frequency electromagnetic field	15% f.s. at 10 V/m		
Effect of conducted radio-frequency electromagnetic field	10% f.s. at 3 V		

(4) Range breakdown

Range	Resolution (dgt.)	Input voltage range		Peak resolution (dgt.)	Peak input range (AC or DC + AC)	Notes
		DC	AC or DC + AC			
×100	0.001 mV	-	6.000 mV (AC only)	0.01 mV	±15.00 mV (AC only)	FAST and NORMAL only; valid for supported sensors only.
×10	0.01 mV	±60.00 mV	60.00 mV	0.1 mV	±150.0 mV	
×1	0.1 mV	±600.0 mV	600.0 mV	1 mV	±1500 mV	Maximum display range depends on the connected sensor

(5) Accuracy specifications (for display unit only)

1. DC display (Measured value/MAX/MIN/AVG DC value), coupling method: DC coupling

Range	Accuracy guarantee frequency range	Measurement accuracy
×1, ×10	DC	±0.3% rdg. ±8 dgt.

2. AC display, coupling method: AC coupling

• AC rms value (Measured value/MAX/MIN/AVG rms)

Range	Accuracy guarantee frequency range	Measurement accuracy
×100	10 Hz ≤ f < 45 Hz	±1.8% rdg. ±15 dgt. ^{*2*4}
	45 Hz ≤ f ≤ 66 Hz	±1.3% rdg. ±13 dgt. ^{*2*4}
	66 Hz < f ≤ 1 kHz	±2.0% rdg. ±15 dgt. ^{*2*4}
×1, ×10	3 Hz ≤ f < 10 Hz	±1.2% rdg. ±10 dgt. ^{*3*4}
	10 Hz ≤ f < 45 Hz	±0.8% rdg. ±10 dgt. ^{*1*3*4}
	45 Hz ≤ f ≤ 66 Hz	±0.3% rdg. ±8 dgt. ^{*1*3*4}
	66 Hz < f ≤ 1 kHz	±1.0% rdg. ±10 dgt. ^{*1*3*4}

*1: Add ±5 dgt. to this accuracy when operating in SLOW mode.

*2: When the filter is set to ON: Specified with a reading of 300 dgt. or more.
When the filter is set to OFF: Specified with a reading of 400 dgt. or more.

*3: Specified with a reading of 300 dgt. or more.

*4: When the filter is set to ON, add ±0.5% rdg. ±5 dgt. to this accuracy.

• AC peak (PEAK MAX/PEAK MIN Zero-to-Peak)

Range	Accuracy guarantee frequency range	Measurement accuracy
×100	10 Hz ≤ f ≤ 66 Hz	±2.5% rdg. ±12 dgt. ^{*1*2}
×1, ×10	3 Hz ≤ f < 10 Hz	±2.5% rdg. ±7 dgt. ^{*1}
	10 Hz ≤ f ≤ 66 Hz	±2.5% rdg. ±7 dgt. ^{*1}

*1: When the filter is set to ON, add ±0.5% rdg. to this accuracy.

*2: When the filter is set to ON: Specified with a reading of 45 dgt. or more.
When the filter is set to OFF: Specified with a reading of 60 dgt. or more.

3. DC+AC display, coupling method: DC coupling
 • DC+AC rms value (Measured value/MAX/MIN/AVG rms)

Range	Accuracy guarantee frequency range	Measurement accuracy
×1, ×10	DC	±1.5% rdg. ±15 dgt. ^{*1}
	3 Hz ≤ f < 10 Hz	±1.2% rdg. ±12 dgt. ^{*1}
	10 Hz ≤ f < 45 Hz	±0.8% rdg. ±12 dgt. ^{*1}
	45 Hz ≤ f ≤ 66 Hz	±0.3% rdg. ±12 dgt. ^{*1}
	66 Hz < f ≤ 1 kHz	±1.0% rdg. ±12 dgt. ^{*1}

*1: Add ±0.5% rdg. to this accuracy when the filter is set to ON. Specified with a reading of 300 dgt. or more.

- DC+AC peak (PEAK MAX/PEAK MIN Zero-to-Peak)

Range	Accuracy guarantee frequency range	Measurement accuracy
×1, ×10	DC	±2.5% rdg. ±7 dgt. ^{*1}
	3 Hz ≤ f < 10 Hz	±2.5% rdg. ±7 dgt. ^{*1}
	10 Hz ≤ f ≤ 66 Hz	±2.5% rdg. ±7 dgt. ^{*1}

*1: Add ±0.5% rdg. to this accuracy when the filter is set to ON.

4. Frequency display (Measured value/MAX/MIN/AVG), coupling method: AC coupling
 In AC mode: simultaneous display (Factory setting is sub display. Can be switched to main display with **[AC/DC/Hz]** key.)

With the sub display, the frequency range is set automatically. With the main display, the frequency range can be switched using **[RANGE]** key.

Minimum sensitivity: 300 dgt. or more

When the frequency or the AC value is out of the measurement range, "----Hz" is displayed.

Frequency range (Accuracy guarantee range)	Resolution	Measurement accuracy
9.999 Hz (1.000 Hz to 9.999 Hz) ^{*1}	0.001 Hz	±0.2% rdg. ±0.002 Hz
99.99 Hz (9.00 Hz to 99.99 Hz)	0.01 Hz	±0.1% rdg. ±0.01 Hz
999.9 Hz (90.0 Hz to 999.9 Hz)	0.1 Hz	±0.1% rdg. ±0.1 Hz

*1: The display range starts from 0.950 Hz.

5. DC output

Range	Output type	Accuracy guarantee frequency range	Output accuracy
×1, ×10	WAVE	DC	±0.5% rdg. ±0.8 mV ^{*1}

*1: When using the ×10 output amplification function, add ±0.3% rdg. to this accuracy and multiply the error in millivolt by 10. (Also, multiply the f.s. error of the sensor by 10.)

6. AC output

Range	Output type	Accuracy guarantee frequency range	Output accuracy	
×100	WAVE	10 Hz ≤ f < 45 Hz	±2.0% rdg. ±1.5 mV ^{*2 *5}	
		45 Hz ≤ f ≤ 66 Hz	±1.5% rdg. ±1.3 mV, phase ±0.2 deg. ^{*2 *5}	
		66 Hz < f ≤ 1 kHz	±2.2% rdg. ±1.5 mV ^{*2 *5}	
	RMS	10 Hz ≤ f < 45 Hz	±2.0% rdg. ±1.5 mV ^{*2 *5}	
		45 Hz ≤ f ≤ 66 Hz	±1.5% rdg. ±1.3 mV ^{*2 *5}	
		66 Hz < f ≤ 1 kHz	±2.2% rdg. ±1.5 mV ^{*2 *5}	
	PEAK	10 Hz ≤ f ≤ 66 Hz	±2.5% rdg. ±12 mV ^{*2 *4}	
	×1, ×10	WAVE	3 Hz ≤ f < 10 Hz	±1.4% rdg. ±1.2 mV ^{*2 *3}
			10 Hz ≤ f < 45 Hz	±1.0% rdg. ±1.0 mV ^{*2}
45 Hz ≤ f ≤ 66 Hz			±0.5% rdg. ±0.8 mV, phase ±0.2 deg. ^{*2}	
66 Hz < f ≤ 1 kHz			±1.2% rdg. ±1.0 mV ^{*2}	
RMS		3 Hz ≤ f < 10 Hz	±1.4% rdg. ±1.2 mV ^{*1 *2 *3}	
		10 Hz ≤ f < 45 Hz	±1.0% rdg. ±1.0 mV ^{*1 *2}	
		45 Hz ≤ f ≤ 66 Hz	±0.8% rdg. ±0.8 mV ^{*1 *2}	
		66 Hz < f ≤ 1 kHz	±1.2% rdg. ±1.0 mV ^{*1 *2}	
PEAK		3 Hz ≤ f < 10 Hz	±2.5% rdg. ±7 mV ^{*2 *3}	
		10 Hz ≤ f ≤ 66 Hz	±2.5% rdg. ±7 mV ^{*2}	

*1: Add ±2.0 mV to this accuracy when measuring an input below 300 dgt.

*2: Add ±0.5% rdg. ±0.5 mV to this accuracy when the filter is set to ON.

When using the ×10 output amplification function, add ±0.3% rdg. to this accuracy and multiply the error in millivolt by 10. (Also, multiply the f.s. error of the sensor by 10.)
The phase accuracy is specified when the filter is set to OFF, and the response rate is set to FAST or NORMAL.

*3: Accuracy for measurements below 3 mV with frequencies in the range of 3 Hz ≤ f < 10 Hz is designed only.

*4: When the filter is set to ON: Specified with a reading of 45 dgt. or more.

When the filter is set to OFF: Specified with a reading of 60 dgt. or more.

*5: When the filter is set to ON: Specified with a reading of 300 dgt. or more.

When the filter is set to OFF: Specified with a reading of 400 dgt. or more.

7. DC+AC output

Range	Output type	Accuracy guarantee frequency range	Output accuracy
×1, ×10	WAVE	DC	±1.5% rdg. ±1.2 mV ^{*2}
		3 Hz ≤ f < 10 Hz	±1.4% rdg. ±1.2 mV, phase (design value) ±0.2 deg. ^{*2,*3}
		10 Hz ≤ f < 45 Hz	±1.0% rdg. ±1.2 mV, phase ±0.2 deg. ^{*2}
		45 Hz ≤ f ≤ 66 Hz	±0.5% rdg. ±1.2 mV, phase ±0.2 deg. ^{*2}
		66 Hz < f ≤ 1 kHz	±1.2% rdg. ±1.2 mV ^{*2}
	RMS	DC	±1.7% rdg. ±1.2 mV ^{*1,*2}
		3 Hz ≤ f < 10 Hz	±1.4% rdg. ±1.2 mV ^{*1,*2,*3}
		10 Hz ≤ f < 45 Hz	±1.0% rdg. ±1.2 mV ^{*1,*2}
		45 Hz ≤ f ≤ 66 Hz	±0.8% rdg. ±1.2 mV ^{*1,*2}
		66 Hz < f ≤ 1 kHz	±1.2% rdg. ±1.2 mV ^{*1,*2}
	PEAK	DC	±2.5% rdg. ±7 mV ^{*2}
		3 Hz ≤ f < 10 Hz	±2.5% rdg. ±7 mV ^{*2,*3}
		10 Hz ≤ f ≤ 66 Hz	±2.5% rdg. ±7 mV ^{*2}

*1: Add ±2.0 mV to this accuracy when measuring an input of 300 dgt. or below.

*2: Add ±0.5% rdg. ±0.5 mV to this accuracy when the filter is set to ON.

When using the ×10 output amplification function, add ±0.3%rdg. to this accuracy and multiply the error in millivolt by 10.(Also, multiply the f.s. error of the sensor by 10.)
The phase accuracy is specified when the filter is set to OFF.

*3: For values of f such that 3 Hz ≤ f < 10 Hz, the output accuracy for voltages of 3 mV or less is provided as a design value.

8. Frequency output, coupling method: AC coupling

Minimum sensitivity: 300 dgt. or more

Frequency range switchable using RANGE.

Frequency range (Accuracy guarantee range)	Output accuracy	Output rate
9.999 Hz (1.000 Hz to 9.999 Hz)	±0.4% rdg. ±2.3 mV	100 mV/Hz
99.99 Hz (9.00 Hz to 99.99 Hz)	±0.3% rdg. ±2.2 mV	10 mV/Hz
999.9 Hz (90.0 Hz to 999.9 Hz)	±0.3% rdg. ±2.2 mV	1 mV/Hz

4.3 Functional Specifications

(1) Display and output update rate





Output mode	Response speed or frequency range	Display update rate	Output update rate	Notes
Disabled	SLOW	1.0 s (1 time/s) **1	No output	-
	NORMAL	0.2 s (5 times/s)		
	FAST	0.2 s (5 times/s)		
WAVE	SLOW	1.0 s (1 time/s)	(Analog output)	-
	NORMAL	0.2 s (5 times/s)		-
	FAST	0.2 s (5 times/s)		-
RMS	SLOW	1.0 s (1 time/s)	(Analog output)	-
	NORMAL	0.2 s (5 times/s)		-
	FAST	0.2 s (5 times/s)		-
PEAK	SLOW	1 s (1 time/s)	1 s (1 time/s)	With sampling of 2 kS/s, maximum absolute value at update time interval is output.
	NORMAL	0.2 s (5 times/s)	0.2 s (5 times/s)	
	FAST	0.2 s (5 times/s)	0.02 s (50 times/s)	
FREQ	9.999 Hz range	3.0 s (1 time/3 s)	3.0 s (1 time/3 s)	-
	99.99 Hz range	0.2 s (5 times/s)	0.2 s (5 times/s)	-
	999.9 Hz range	0.2 s (5 times/s)	0.2 s (5 times/s)	-

*1: For frequency display only: 3.0 s (1 time/3 s), same as FREQ.

(2) Functions and their factory settings

No.	Functions	Description	Factory settings and notes
1	Measurement modes	DC, AC, DC + AC, or FREQ	DC + AC
2	Display/output update time (rate)	Display and output update time (rate)	NORMAL
3	Ranging	Auto: Optimal range is selected automatically RANGE: AUTO lights up Manual: Range is selected manually RANGE: MANUAL lights up When output becomes valid during auto-range operation, auto-range operation will be disabled and the range will be set to the present range.	Factory settings: RANGE: AUTO
4	Hold	Puts display value updating on hold (manual) HOLD lights up	OFF
5	Zero-adjustment	Resets the display value to zero, after memorizing it	Factory setting value, or last memorized value
6	Analysis display (MAX/MIN/AVG/PEAK MAX/PEAK MIN display)	The following are displayed (in the main display) in the order given from the start of analysis display: Maximum value (MAX) Minimum value (MIN) Average value (AVG) Maximum peak value (PEAK MAX) Minimum peak value (PEAK MIN) Current instantaneous value displayed in sub display *The peak values are 0-to-peak values (displayed with polarity) PEAK MAXMIN AVG lights up While the analysis display is active, PEAK output, auto ranging and range switching cannot be performed. During PEAK output operation, only PEAK MAX and PEAK MIN are displayed. MAX/MIN/AVG cannot be displayed.	Factory setting: OFF
7	Filter (for AC or DC+AC)	Low-pass filter (180 Hz), pass-band setting OFF/ON FILTER lights up	Factory setting is OFF
8	Display backlight	Lit/unlit (manual setting) for white-colored backlight Automatically turns off after approx. 40 seconds after the last operation.	Turned OFF at power-up

No.	Functions	Description	Factory settings and notes
9	Warning displays	If input exceeds the range, the range f.s. value is displayed with OVER segments flashing. When output peak exceeds the range, the OUTPUT OVER lights up	–
10	Auto power save (APS)	Power is switched off if no operation is performed for approx. 10 minutes When this function is enabled, APS lights up The APS becomes disabled in one of the following conditions: Automatically disabled during output or during MAX/MIN/AVG display When being driven by an AC adapter. When the key lock is activated. When the APS is disabled (p.22).	Enabled, but will be disabled by power-on option
11	Battery power warning display	Displays battery remaining power	–
12	External power source	When using power from the AC adapter terminal (external power supply terminal), the unit is always on, and the  lights up.	–
13	Backlight auto-off	Automatically turns off the backlight	Factory setting: enabled
14	Buzzer sound	Buzzer sound	Factory setting: enabled
15	Power-on option	Turn on the power while pressing key See “Tables of Key Operations” (p. 15).	–
16	Save settings	Configures the settings mode at startup. Pressing the [MODE SAVE/RESET] key when SAVED MODE is not lit up will set the current measurement mode to the startup mode. Pressing the [MODE SAVE/RESET] key when SAVED MODE is lit up will cancel the saved setting. SAVED MODE will light up when performing this command or when startup up with it enabled. SAVED MODE will turn off when the mode or setting is changed.	Factory setting: OFF (disabled)
17	Output	Output varies with the designated mode. Can be output simultaneously with the analysis display function (other than PEAK output). Output is ground output when the output mode is disabled.	Factory setting: OFF

No.	Functions	Description	Factory settings and notes
18	Key lock	Disables all key operations (except canceling of key lock) However, turning the power ON/OFF is possible  is displayed	Factory setting: OFF
19	Zero adjustment at power-up	Executes zero adjustment at power-up OADJ START is displayed	Factory setting: OFF
20	Output amplification ×10	Makes output 10 times higher than normal • Output ranges: WAVE: ±5 V ±0.3 V RMS: 0 V to 5 V ±0.3 V PEAK, FREQ: 0 V to 2.3 V ±0.1 V • Screen display: ×10 lights up	Factory setting: OFF (output amplification ×1)
21	Error displays	Displays fault diagnosis results when the power is turned on	–
22	Serial No. display	Displays the serial No.	
23	External communications (only for CM7291)	Bluetooth® function off:  mark turns off Bluetooth® function on:  mark lights up Bluetooth® function on/communications active:  mark flashes	Factory setting: OFF



(3) Key input configuration

See “Tables of Key Operations” (p.15).

(4) LCD display method

FSTN-type liquid crystal display, 1/3 bias, 1/6 duty dynamic drive
See “Display” (p.13).

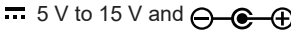
4.4 Connection Terminal Specifications

Item	Symbol	Notes
Output jack	OUTPUT	Diameter 3.5 mm monaural pin-jack
DC external power supply	 5 V to 15 V and 	JEITA RC5320A Classification 3 (EIAJ RC5320A TYPE 3) (Grip portion external diameter not more than $\phi 10$ mm)

4.5 External Interface Specifications (only for CM7291)

4

Display function	Display of measured values on a smartphone or a tablet while using Bluetooth® communications.
Interface	Bluetooth® 4.0LE ( Bluetooth®)
Maximum antenna power	+0 dBm (1 mW)
Communications range	Approx. 10 m (line of sight)
Communications range	GATT (Generic Attribute Profile)
Supported devices	Android 4.3 or later, iOS 10 or later (only for Bluetooth® low energy models)

5 Maintenance and Service

Cleaning

IMPORTANT

Never use solvents such as benzene, alcohol, acetone, ether, ketones, thinners or gasoline, as they can deform and discolor the case.

- Dirt on the mating surfaces of the sensor's jaws will degrade measurement, so keep the surfaces clean by gently wiping with a soft cloth.
- Clean the display area by wiping it gently with a soft dry cloth.

Calibration

How often you should calibrate the unit will depend on the usage conditions and the environment. Determine a calibration interval that is suited to your usage conditions and environment, and request to have calibration done by Hioki.

Precautions when transporting the unit

- To avoid damage to the unit, remove the accessories and optional equipment from the unit. Moreover, be sure to pack in a double carton. Damage occurring during transportation is not covered by the warranty.
- When sending the unit for repair, be sure to include details of the problem.



Disposal

Dispose of the unit in accordance with local regulations.

5.1 Troubleshooting

Troubleshooting checklist

If you feel that the unit may be malfunctioning, contact your authorized Hioki distributor or reseller after carrying out the checks below.

Problem	Check	Solution	See
<ul style="list-style-type: none"> Power will not turn on Power shuts off during operation 	When AC adapter is used:		p.28
	<ul style="list-style-type: none"> Is the AC adapter inserted all the way into the AC adapter jack or outlet? 	<ul style="list-style-type: none"> Insert it all the way in. 	
	<ul style="list-style-type: none"> Does the power supply being used conform to the designated specifications? 	<ul style="list-style-type: none"> Use a power supply of the designated specifications. 	
	<ul style="list-style-type: none"> Does the power turn on with battery power supply (although not with the AC adapter)? 	<ul style="list-style-type: none"> If the power turns on with battery power supply, the AC adapter is probably faulty. Replace it with an AC adapter of the specified type. 	
	When batteries are used:		p.27
	<ul style="list-style-type: none"> Have the batteries run low? 	<ul style="list-style-type: none"> If they have, replace them with new ones. 	
<ul style="list-style-type: none"> Have the batteries passed their expiration date? 	<ul style="list-style-type: none"> If they have, replace them with new ones. Even unused batteries may not provide sufficient power due to current discharge. 		
	<ul style="list-style-type: none"> Are the contacting portions of the battery holder damaged or corroded? 	<ul style="list-style-type: none"> The unit needs to be repaired. Contact your authorized Hioki distributor or reseller for repair. 	
 indicator flashes	-	<ul style="list-style-type: none"> The batteries have run low. Replace with new batteries. 	p.14 p.27
Keys do not work	<ul style="list-style-type: none"> Is  indicator lit? 	<ul style="list-style-type: none"> Key lock function is on. Press and hold [AC/DC Hz] and [RANGE] keys simultaneously for one second to cancel key lock. 	-

Problem	Check	Solution	See				
Display will not reset to zero	<ul style="list-style-type: none"> Has DC or AC+DC measurement mode been selected? 	<ul style="list-style-type: none"> Execute zero adjustment. 	p. 16				
	<ul style="list-style-type: none"> Is the possible range for zero adjustment exceeded? <table border="1" data-bbox="333 331 605 451"> <tr> <td data-bbox="333 331 468 387">×1 range</td> <td data-bbox="468 331 605 387">Approx. ± 80 dgt.</td> </tr> <tr> <td data-bbox="333 387 468 451">×10 range</td> <td data-bbox="468 387 605 451">Approx. ± 800 dgt.</td> </tr> </table>	×1 range	Approx. ± 80 dgt.	×10 range	Approx. ± 800 dgt.	<ul style="list-style-type: none"> If the range is exceeded, the current sensor must be repaired. 	-
	×1 range	Approx. ± 80 dgt.					
×10 range	Approx. ± 800 dgt.						
<ul style="list-style-type: none"> Is the response speed set to SLOW? 	<ul style="list-style-type: none"> If the response speed is set to SLOW, the display may not read zero immediately. 	p. 17					
The display goes off immediately.	<ul style="list-style-type: none"> Is auto-power-save function (APS) enabled? 	<ul style="list-style-type: none"> Disable auto power-save function (APS). 	p. 22				
Display value is lower than expected	Current measurement						
	<ul style="list-style-type: none"> Are the sensor jaw tips damaged? 	<ul style="list-style-type: none"> Is damage is evident, have it repaired. 	-				
	<ul style="list-style-type: none"> Are the sensor jaws tightly closed? 	<ul style="list-style-type: none"> Close them tightly. If they are not properly closed, the value will be low. 	-				
	<ul style="list-style-type: none"> Is the measurement mode suitable? 	<ul style="list-style-type: none"> Select a measurement mode that is suitable for the conductor to be measured. 	p. 16				
	<ul style="list-style-type: none"> The method for executing zero adjustment in the DC or AC+DC measurement mode is correct? 	<ul style="list-style-type: none"> Execute zero adjustment. A lower than expected display value will result if the measurement are made while the unit is displaying a negative value. 	p. 16				
	<ul style="list-style-type: none"> Are you measuring a current of 10 Hz or lower? 	<ul style="list-style-type: none"> To measure current of not more than 10 Hz, select the AC+DC mode, and set the display/output update rate to SLOW. 	p. 16				
	<ul style="list-style-type: none"> Has SLOW been set with auto ranging? 	<ul style="list-style-type: none"> With SLOW, measurement of rapid variation is not possible. Set NORMAL or FAST. 	p. 37				

Problem	Check	Solution	See	
Display value is lower than expected	<ul style="list-style-type: none"> Is the filter function being used 	<ul style="list-style-type: none"> Disable the filter function. If components of 60 Hz or higher are present, the value will be low. 	p.22	
	<ul style="list-style-type: none"> Does the  indicator flash? 	<ul style="list-style-type: none"> The batteries have run low. Replace with new batteries. 	p.27	
	<ul style="list-style-type: none"> Does the frequency of the current being measured fall outside the range defined in the product specifications (for either the unit or the current sensor)? 	<ul style="list-style-type: none"> Use a current sensor that conforms with the specifications. If the inverter's carrier frequency is high, the display value will be lower than the total rms value. 	p.47	
	<ul style="list-style-type: none"> Has the peak value exceeded the product specification? 	<ul style="list-style-type: none"> If possible, use a larger current range. If that is not possible, use a current sensor that conforms with the specifications. 	p.36	
	Frequency measurement			
	<ul style="list-style-type: none"> Are you measuring a special waveform - of an inverter, etc.? 	<ul style="list-style-type: none"> In frequency measurement, a frequency value is calculated from a count of the number of times that a particular threshold value is exceeded. This means that even in the case of a special waveform, it may be possible to measure it by changing the mode – AC or AC+DC, etc. – or changing the range. 	–	
<ul style="list-style-type: none"> Is the current input value 300 dgt. or more of the range? 	<ul style="list-style-type: none"> Use an appropriate range and/or an appropriate current sensor. 	p.36		

Problem	Check	Solution	See
Output value is lower than expected		<ul style="list-style-type: none"> Carry out the same checks as for "Display value is lower than expected." 	-
	<ul style="list-style-type: none"> Is the output cord inserted all the way into the output jack? Has a wire snapped? 	<ul style="list-style-type: none"> Insert it all the way in. If a wire has snapped, replace the cord with a new one. 	p.31
	<ul style="list-style-type: none"> Has the wrong output mode been selected? 	WAVE: Waveform RMS: Root mean square PEAK: Maximum absolute value at update time interval, with sampling of 2 kS/s FREQ: Frequency	p. 17
	<ul style="list-style-type: none"> Does the value show the output for the recently set mode? 		
	Connected instrument <ul style="list-style-type: none"> Is AC coupling being used? 	<ul style="list-style-type: none"> If a DC waveform is being measured, AC coupling will result in almost no output. Select the DC or AC+DC mode. 	-
	<ul style="list-style-type: none"> Is the filter function enabled? 	<ul style="list-style-type: none"> Disable the filter function. 	p.22
Display value is higher than expected	Current measurement		
	<ul style="list-style-type: none"> Are the current sensor tips damaged? 	<ul style="list-style-type: none"> If damage is evident, have it repaired. 	-
	<ul style="list-style-type: none"> The method for executing zero adjustment in the DC or AC+DC measurement mode is correct? 	<ul style="list-style-type: none"> Execute zero adjustment. A higher than expected display value will result if measurement are made while the unit is displaying a positive value. 	p. 16
	<ul style="list-style-type: none"> Does the current contain frequency components other than those expected? 	<ul style="list-style-type: none"> Use waveform output (WAVE) to check the waveform. 	p.38
	<ul style="list-style-type: none"> Is a large magnetic or electric field, or large noise, being generated nearby? 	<ul style="list-style-type: none"> Distance the unit from the noise generation source. 	-
	<ul style="list-style-type: none"> Does the  indicator flash? 	<ul style="list-style-type: none"> The batteries have run low. Replace with new batteries. 	p. 14 p.27
	<ul style="list-style-type: none"> Has the power source been switched from the batteries to an AC adapter or vice-versa during peak current measurement? 	<ul style="list-style-type: none"> Noise may be generated when the power supply is switched. If this noise causes problems during measurement, take steps to ensure that the unit does not switch power supplies. 	p.27

Problem	Check	Solution	See
Display value is higher than expected	Frequency measurement		
	<ul style="list-style-type: none"> Is a large magnetic or electric field, or large noise, being generated nearby? 	<ul style="list-style-type: none"> Distance the unit from the noise generation source. 	-
	<ul style="list-style-type: none"> Is the current input value 300 dgt. or more of the current range? 	<ul style="list-style-type: none"> Use an appropriate range and/or an appropriate current sensor. 	p. 16
	<ul style="list-style-type: none"> Are you measuring a full-wave rectified waveform? 	<ul style="list-style-type: none"> If you are, the frequency will be double its pre-rectification level. 	-
Output value is higher than expected	<ul style="list-style-type: none"> Has the correct output mode been selected? 	WAVE: Waveform RMS: Root mean square PEAK: Maximum absolute value at update time interval, with sampling of 2 kS/s FREQ: Frequency	p. 17
Display value fluctuates	<ul style="list-style-type: none"> Any poor contacting of the sensor cables, etc.? 	<ul style="list-style-type: none"> Have the item(s) repaired if you suspect poor contacting. 	-
	<ul style="list-style-type: none"> Does the display/output update time (rate) selected match the current's frequency? 	<ul style="list-style-type: none"> Change the response speed and set the display/output update time (rate) according to the current's frequency. 	p. 37

5.2 Error Displays

If any of these errors is displayed in the LCD display area, repair is required. Contact your authorized Hioki distributor or reseller for repair.

Error display	Cause	Corrective action/more information
Err 001	ROM error Program	If any of these errors is displayed in the display area, repair is required. Contact your authorized Hioki distributor or reseller for repair.
Err 002	ROM error Adjustment data	
Err 004	EEPROM error Memory data	
Err 005	ADC error Hardware failure	
Err 008	Bluetooth® error Hardware malfunction (only for CM7291)	

Appendix

Appx. 1 Range Structure, Output rate, and Power Consumption Category with a Sensor Connected

Connected sensor	Sensor type	Rated current of sensor	Range Structure	Minimum resolution	Output rate (WAVE, RMS, PEAK)	Range configuration (for calculating accuracy)			Sensor power consumption category*1
						Sensor's output rate	Unit's range	Sensor's range	
CT7631	AC/DC Sensor	100 A	100.0 A	0.1 A	1 mV/A	1 mV/A	x1	x1	1 (CT7631)/ 2 (CT7731)
					10 mV/A	10 mV/A	x10	x1	
CT7636	AC/DC Sensor	600 A	600.0 A	0.1 A	1 mV/A	1 mV/A	x1	x1	1 (CT7636)/ 2 (CT7736)
CT7736	AC/DC Sensor	600 A	600.0 A	0.01 A	10 mV/A	10 mV/A	x10	x1	
CT7642	AC/DC Sensor	2000 A	2000 A	1 A	0.1 mV/A	0.1 mV/A	x1	x1	1 (CT7642)/ 2 (CT7742)
CT7742	AC/DC Sensor	2000 A	600.0 A	0.1 A	1 mV/A	1 mV/A	x10	x1	
CT7044	AC Sensor	6000 A	6000 A	1 A	0.1 mV/A	0.1 mV/A	x1	x1	1
CT7045	AC Sensor	6000 A	600.0 A	0.1 A	1 mV/A	1 mV/A	x10	x10	
CT7046	AC Sensor	6000 A	600.0 A	0.01 A	10 mV/A	10 mV/A	x10	x10	
CT7126	AC Sensor	60 A	6000 A	0.01 A	10 mV/A	10 mV/A	x1	x1	0
					100 mV/A	100 mV/A	x10	x1	
CT7131	AC Sensor	100 A	6000.0 mA	0.1 mA	1 mV/mA	1 mV/mA	x100	x1	0
					10 mV/A	1 mV/A	x1	x1	
CT7136	AC Sensor	600 A	6000 A	0.01 A	10 mV/A	10 mV/A	x10	x1	0
					100 mV/A	100 mV/A	x100	x1	
CT7116	AC Sensor	6 A	6000.0 mA	0.1 mA	1 mV/mA	100 mV/A	x10	x1	0
					10 mV/mA	100 mV/mA	x100	x1	

*1: See "4.1 General Specifications"(p.41) for details about the sensor power consumption category.

Connected sensor	Unit's frequency range	Output rate (FREQ)
Common to all the sensors	9.999 Hz	100 mV/Hz
	99.99 Hz	10 mV/Hz
	999.9 Hz	1 mV/Hz

Appx. 2 Calculating Accuracy when Used with a Sensor

Calculating accuracy of displayed value (calculation procedure)

1 Collect data required to calculate accuracy.

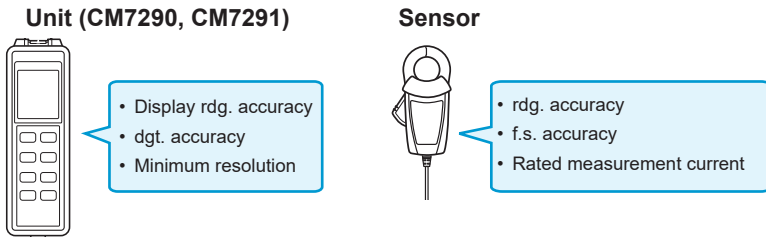

2 Calculate the following accuracy: (1) Combinational rdg. accuracy, and (2) Combinational amperage accuracy.

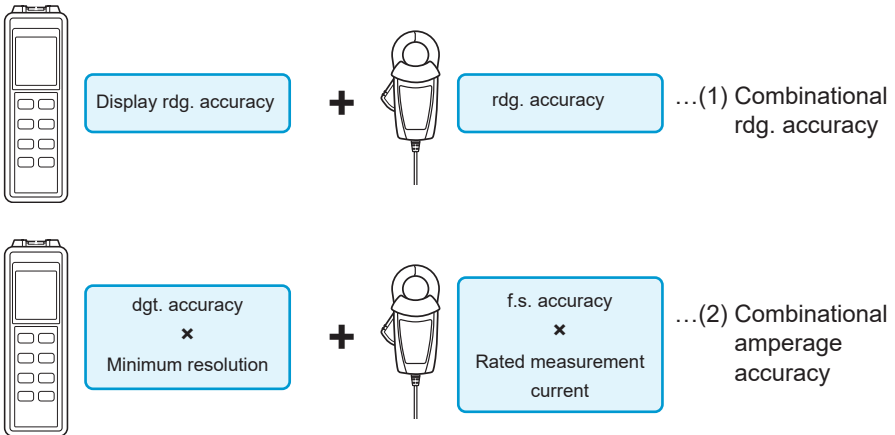

3 Calculate the accuracy of displayed value.

(1) Combinational rdg. accuracy × Displayed value + (2) Combinational amperage accuracy = **Accuracy of displayed value**

Calculation example

Unit's display: 58.00 A (displayed value), 60 Hz (×10 range setting, AC)

Sensor: CT7631 (rated current: 100 A, output rate: 1 mV/A)

1 Collect data required to calculate accuracy. (See p.47, p.63, and Instruction manuals of sensors)

Unit (CM7290, CM7291)

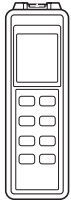

- Display rdg. accuracy
±0.3% rdg.
- dgt. accuracy
±8 dgt.
- Minimum resolution
0.01 A

Sensor (CT7631)



- rdg. accuracy
±1.0% rdg.
- f.s. accuracy
±0.5% f.s.
- Rated measurement current
100 A

2 Calculate the following accuracy: (1) Combinational rdg. accuracy, and (2) Combinational amperage accuracy.

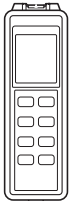

±0.3% rdg.

+



±1.0% rdg.

= ±1.3% rdg.

...(1) Combinational rdg. accuracy



±8 dgt.
×
0.01 A

+



±0.5% f.s.
×
100 A

= ±0.58 A

...(2) Combinational amperage accuracy

3 Calculate the accuracy of displayed value.

$$\begin{array}{l} \text{(1) Combinational} \\ \text{rdg. accuracy} \end{array} \quad \pm 1.3\% \text{ rdg.} \quad \times \quad \begin{array}{l} \text{Displayed} \\ \text{value} \end{array} \quad 58.00 \text{ A} \quad \pm \quad \begin{array}{l} \text{(2) Combinational} \\ \text{amperage accuracy} \end{array} \quad 0.58 \text{ A} \quad = \quad \pm 1.334 \text{ A}$$

The accuracy for an input current of 58.00 A is **±1.334 A**.

Calculating accuracy of wave-output value (calculation procedure)

1 Collect data required to calculate accuracy.

Unit (CM7290, CM7291)

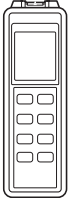

- Output rdg. accuracy
- Millivolt accuracy
- Output rate

Sensor



- rdg. accuracy
- f.s. accuracy
- Rated measurement current

2 Calculate the following accuracy: (1) Combinational rdg. accuracy, and (2) Combinational millivolt accuracy.



Output rdg. accuracy

+



rdg. accuracy

...(1) Combinational rdg. accuracy



Millivolt accuracy

+



Output rate

×



f.s. accuracy
×
Rated measurement current

...(2) Combinational millivolt accuracy

3 Calculate the accuracy of output value.

(1) Combinational rdg. accuracy × Output value + (2) Combinational millivolt accuracy
= **Accuracy of output value**

Calculation example

Output value: 580 mV (output value when 58 A current is measured), 60 Hz (×10 range setting, AC)

Sensor: CT7631 (rated current: 100 A, output rate: 1 mV/A)

1 Collect data required to calculate accuracy. (p.49, p.63, and Instruction manuals of sensors)

Unit (CM7290, CM7291)



- Output rdg. accuracy
±0.5% rdg.
- Millivolt accuracy
±0.8 mV
- Output rate
10 mV/A

Sensor (CT7631)



- rdg. accuracy
±1.0% rdg.
- f.s. accuracy
±0.5% f.s.
- Rated measurement current
100 A

2 Calculate the following accuracy: (1) Combinational rdg. accuracy, and (2) Combinational millivolt accuracy.



±0.5% rdg.

+



±1.0% rdg.

= **±1.5% rdg.**

...(1) Combinational rdg. accuracy



±0.8 mV

+



10 mV/A

×



±0.5% f.s.
×
100 A

= **±5.8 mV**

...(2) Combinational millivolt accuracy

3 Calculate the accuracy of output value.

$$\underline{\pm 1.5\% \text{ rdg.}} \times \underline{580 \text{ mV}} + \underline{\pm 5.8 \text{ mV}} = \underline{\pm 14.5 \text{ mV}}$$

(1) Combinational rdg. accuracy

Output value

(2) Combinational millivolt accuracy

The accuracy for an output voltage of 580 mV is **±14.5 mV**.

Appx. 3 Combinational Accuracies (Representative values)

To see tables listing all the combinational accuracies, visit [Hiiki's website](#).

CM7290 (CM7291) + CT7631/CT7731

Accuracy of displayed value

Instrument range	Accuracy guaranteed range of current measurement		DC function	AC function	AC + DC function	
	DC	AC/AC+DC			45 Hz ≤ f ≤ 66 Hz	DC
60.00 A	0.00 A ≤ I ≤ 60.00 A	3.00A ≤ I ≤ 60.00 A	DC ±1.3% rdg. ±0.58 A	45 Hz ≤ f ≤ 66 Hz ±1.3% rdg. ±0.58 A	DC ±2.5% rdg. ±0.65 A	45 Hz ≤ f ≤ 66 Hz ±1.3% rdg. ±0.62 A
100.0 A	0.0 A ≤ I ≤ 100.0 A	30.0A ≤ I ≤ 100.0 A	±1.3% rdg. ±1.3 A	±1.3% rdg. ±1.3 A	±2.5% rdg. ±2.0 A	±1.3% rdg. ±1.7 A

Accuracy of output value

Instrument range (output rate)	Accuracy guaranteed range of current measurement		DC function		AC function	
	WAVE	RMS	WAVE output		45 Hz ≤ f ≤ 66 Hz	
			WAVE output	DC	WAVE output (phase)	RMS output
60.00 A (10 mV/A)	0.00 A ≤ I ≤ 60.00 A	3.00A ≤ I ≤ 60.00 A	±1.5% rdg. ±5.8 mV	DC	±1.5% rdg. ±5.8 mV (±2.0°)	±1.8% rdg. ±5.8 mV
100.0 A (1 mV/A)	0.0 A ≤ I ≤ 100.0 A	30.0A ≤ I ≤ 100.0 A	±1.5% rdg. ±1.3 mV	DC	±1.5% rdg. ±1.3 mV (±2.0°)	±1.8% rdg. ±1.3 mV

Instrument range (output rate)	Accuracy guaranteed range of current measurement		AC + DC function	
	WAVE	RMS	WAVE output (phase)	
			DC	RMS output
60.00 A (10 mV/A)	0.00 A ≤ I ≤ 60.00 A	3.00 A ≤ I ≤ 60.00 A	±2.5% rdg. ±6.2 mV	45 Hz ≤ f ≤ 66 Hz ±1.5% rdg. ±6.2 mV (±2.0°)
100.0 A (1 mV/A)	0.0 A ≤ I ≤ 100.0 A	30.0A ≤ I ≤ 100.0 A	±2.5% rdg. ±1.7 mV	±1.5% rdg. ±1.7 mV (±2.0°)

CM7290 (CM7291) + CT7636/CT7736

Accuracy of displayed value

Instrument range	Accuracy guaranteed range of current measurement		DC function	AC function	AC + DC function
	DC	AC/AC+DC			
60.00 A	0.00 A ≤ I ≤ 60.00 A	3.00 A ≤ I ≤ 60.00 A	DC ±2.3% rdg. ±3.08 A	45 Hz ≤ f ≤ 66 Hz ±2.3% rdg. ±3.08 A	DC ±3.5% rdg. ±3.15 A
600.0 A	0.0 A ≤ I ≤ 600.0 A	30.0 A ≤ I ≤ 600.0 A	±2.3% rdg. ±3.8 A	±2.3% rdg. ±3.8 A	±3.5% rdg. ±4.5 A

Accuracy of output value

Instrument range (output rate)	Accuracy guaranteed range of current measurement		DC function	AC function	
	WAVE	RMS		WAVE output (phase)	RMS output
			45 Hz ≤ f ≤ 66 Hz		
60.00 A (10 mV/A)	0.00 A ≤ I ≤ 60.00 A	3.00 A ≤ I ≤ 60.00 A	DC ±2.5% rdg. ±30.8 mV	45 Hz ≤ f ≤ 66 Hz ±2.5% rdg. ±30.8 mV (±2.0°)	±2.8% rdg. ±30.8 mV
600.0 A (1 mV/A)	0.0 A ≤ I ≤ 600.0 A	30.0 A ≤ I ≤ 600.0 A	±2.5% rdg. ±3.8 mV	±2.5% rdg. ±3.8 mV (±2.0°)	±2.8% rdg. ±3.8 mV

Instrument range (output rate)	Accuracy guaranteed range of current measurement		DC	AC + DC function	
	WAVE	RMS		WAVE output (phase)	RMS output
			45 Hz ≤ f ≤ 66 Hz		
60.00 A (10 mV/A)	0.00 A ≤ I ≤ 60.00 A	3.00 A ≤ I ≤ 60.00 A	±3.5% rdg. ±31.2 mV	45 Hz ≤ f ≤ 66 Hz ±2.5% rdg. ±31.2 mV (±2.0°)	DC ±3.7% rdg. ±31.2 mV
600.0 A (1 mV/A)	0.0 A ≤ I ≤ 600.0 A	30.0 A ≤ I ≤ 600.0 A	±3.5% rdg. ±4.2 mV	±2.5% rdg. ±4.2 mV (±2.0°)	±3.7% rdg. ±4.2 mV

CM7290 (CM7291) + CT7642/CT7742

Accuracy of displayed value

Instrument range	Accuracy guaranteed range of current measurement		DC function	AC function	AC + DC function
	DC	AC/AC+DC			
600.0 A	0.0 A ≤ I ≤ 600.0 A	30.0 A ≤ I ≤ 600.0 A	DC ±1.8% rdg. ±10.8 A	45 Hz ≤ f ≤ 66 Hz ±1.8% rdg. ±10.8 A	DC ±3.0% rdg. ±11.5 A
2000 A	0 A ≤ I ≤ 2000 A	300 A ≤ I ≤ 1800 A	±1.8% rdg. ±18 A	±1.8% rdg. ±18 A	±1.8% rdg. ±22 A
		1800 A < I ≤ 2000 A			±2.3% rdg. ±22 A

Accuracy of output value

Instrument range (output rate)	Accuracy guaranteed range of current measurement		DC function	AC function	
	WAVE	RMS		WAVE output (phase)	RMS output
600.0 A (1 mV/A)	0.00 A ≤ I ≤ 600.0 A	30.0 A ≤ I ≤ 600.0 A	±2.0% rdg. ±10.8 mV	45 Hz ≤ f ≤ 66 Hz	
				±2.0% rdg. ±10.8 mV (±2.5°)	±2.3% rdg. ±10.8 mV
2000 A (0.1 mV/A)	0 A ≤ I ≤ 1800 A	300 A ≤ I ≤ 1800 A	±2.0% rdg. ±1.8 mV	±2.0% rdg. ±1.8 mV (±2.5°)	
				±2.5% rdg. ±1.8 mV (±2.5°)	±2.8% rdg. ±1.8 mV

Instrument range (output rate)	Accuracy guaranteed range of current measurement		DC	AC + DC function	
	WAVE	RMS		WAVE output (phase)	RMS output
600.0 A (1 mV/A)	0.00 A ≤ I ≤ 600.0 A	30.0 A ≤ I ≤ 600.0 A	±3.0% rdg. ±11.2 mV	45 Hz ≤ f ≤ 66 Hz	
				±2.0% rdg. ±11.2 mV (±2.5°)	±3.2% rdg. ±11.2 mV
2000 A (0.1 mV/A)	0 A ≤ I ≤ 1800 A	300 A ≤ I ≤ 1800 A	±3.0% rdg. ±2.2 mV	±2.0% rdg. ±2.2 mV (±2.5°)	
				±2.5% rdg. ±2.2 mV (±2.5°)	±3.2% rdg. ±2.2 mV

CM7290 (CM7291) + CT7044/CT7045/CT7046

Accuracy of displayed value

Instrument range	Accuracy guaranteed range of current measurement	AC function	
		45 Hz ≤ f ≤ 66 Hz	
60.00 A	3.00 A ≤ I ≤ 60.00 A	±1.8% rdg. ±1.58 A	
600.0 A	30.0 A ≤ I ≤ 600.0 A	±1.8% rdg. ±2.3 A	
6000 A	300 A ≤ I ≤ 6000 A	±1.8% rdg. ±23 A	

Accuracy of output value

Instrument range (output rate)	Accuracy guaranteed range of current measurement		AC function	
	WAVE	RMS	WAVE output (phase)	RMS output
			45 Hz ≤ f ≤ 66 Hz	
60.00 A (10 mV/A)	0.00 A ≤ I ≤ 60.00 A	0.00 A ≤ I ≤ 60.00 A	±2.0% rdg. ±15.8 mV (±1.2°)	±2.3% rdg. ±15.8 mV
600.0 A (1 mV/A)	0.0 A ≤ I ≤ 600.0 A	0.0 A ≤ I ≤ 600.0 A	±2.0% rdg. ±2.3 mV (±1.2°)	±2.3% rdg. ±2.3 mV
6000 A (0.1 mV/A)	0 A ≤ I ≤ 6000 A	0 A < I ≤ 6000 A	±2.0% rdg. ±2.3 mV (±1.2°)	±2.3% rdg. ±2.3 mV

CM7290 (CM7291) + CT7126

Accuracy of displayed value

Instrument range	Accuracy guaranteed range of current measurement	AC function
		45 Hz ≤ f ≤ 66 Hz
600.0 mA	40.0 mA ≤ I ≤ 600.0 mA	±1.6% rdg. ±7.3 mA
6.000 A	0.300 A ≤ I ≤ 6.000 A	±0.6%r dg. ±0.014 A
60.00 A	3.00 A ≤ I ≤ 60.00 A	±0.6% rdg. ±0.09 A

Accuracy of output value

Instrument range (output rate)	Accuracy guaranteed range of current measurement		AC function	
	WAVE	RMS	WAVE output (phase)	RMS output
			45 Hz ≤ f ≤ 66 Hz	
600.0 mA (1 mV/mA)	40.0 mA ≤ I ≤ 600.0 mA	40.0 mA ≤ I ≤ 600.0 mA	±1.8%r dg. ±7.3 mV (±2.2°)	±1.8% rdg. ±7.3 mV
6.000 A (100 mV/A)	0.000 A ≤ I ≤ 6.000 A	0.300 A ≤ I ≤ 6.000 A	±0.8% rdg. ±1.4 mV (±2.2°)	±1.1% rdg. ±1.4 mV
60.00 A (10 mV/A)	0.00 A ≤ I ≤ 60.00 A	3.00 A ≤ I ≤ 60.00 A	±0.8% rdg. ±0.86 mV (±2.2°)	±1.1% rdg. ±0.86 mV

CM7290 (CM7291) + CT7131

Accuracy of displayed value

Instrument range	Accuracy guaranteed range of current measurement	AC function
		45 Hz ≤ f ≤ 66 Hz
60.00 A	3.00 A ≤ I ≤ 60.00 A	±0.6% rdg. ±0.10 A
100.0 A	30.0 A < I ≤ 100.0 A	±0.6% rdg. ±0.8 A

Accuracy of output value

Instrument range (output rate)	Accuracy guaranteed range of current measurement		AC function	
	WAVE	RMS	WAVE output (phase)	RMS output
60.00 A (10 mV/A)	0.00 A ≤ I ≤ 60.00 A	3.00 A ≤ I ≤ 60.00 A	45 Hz ≤ f ≤ 66 Hz	±1.1% rdg. ±1.0 mV
100.0A (1 mV/A)	0.0 A ≤ I ≤ 100.0 A	30.0 A ≤ I ≤ 100.0 A		±0.8% rdg. ±0.82 mV (±1.2°)

CM7290 (CM7291) + CT7136

Accuracy of displayed value

Instrument range	Accuracy guaranteed range of current measurement	AC function
		45 Hz ≤ f ≤ 66 Hz
6.000 A	0.400 A ≤ I ≤ 6.000 A	±1.6% rdg. ±0.073 A
60.00 A	3.00 A ≤ I ≤ 60.00 A	±0.6% rdg. ±0.14 A
600.0 A	30.0 A ≤ I ≤ 600.0 A	±0.6% rdg. ±0.86 A

Accuracy of output value

Instrument range (output rate)	Accuracy guaranteed range of current measurement		AC function	
	WAVE	RMS	WAVE output (phase)	RMS output
			45 Hz ≤ f ≤ 66 Hz	
6.000 A (100 mV/A)	0.400 A ≤ I ≤ 6.000 A	0.400 A ≤ I ≤ 6.000 A	±1.8% rdg. ±7.3 mV (±0.7°)	±1.8% rdg. ±7.3 mV
60.00 A (10 mV/A)	0.00 A ≤ I ≤ 60.00 A	3.00 A ≤ I ≤ 60.00 A	±0.8% rdg. ±1.4 mV (±0.7°)	±1.1% rdg. ±1.4 mV
600.0 A (1 mV/A)	0.0 A ≤ I ≤ 600.0 A	30.0 A ≤ I ≤ 600.0 A	±0.8% rdg. ±0.86 mV (±0.7°)	±1.1% rdg. ±0.86 mV

CM7290 (CM7291) + CT7116

Accuracy of displayed value

Instrument range	Accuracy guaranteed range of current measurement	AC function	
		45 Hz ≤ f ≤ 66 Hz	
60.00 mA	4.00 mA ≤ I ≤ 60.00 mA	±2.3% rdg. ±3.13 mA	
600.0 mA	30.0 mA ≤ I ≤ 600.0 mA	±1.3% rdg. ±3.8 mA	
6.000 A	0.300 A ≤ I ≤ 6.000 A	±1.3% rdg. ±0.011 A	

Accuracy of output value

Instrument range (output rate)	Accuracy guaranteed range of current measurement		AC function	
	WAVE	RMS	WAVE output (phase)	RMS output
			45Hz ≤ f ≤ 66Hz	
60.00 mA (10 mV/mA)	4.00 mA ≤ I ≤ 60.00 mA	4.00 mA ≤ I ≤ 60.00 mA	±2.5% rdg. ±31.3 mV (±3.2°)	±2.5% rdg. ±31.3 mV
600.0mA (1mV/mA)	0.0 mA ≤ I ≤ 600.0 mA	30.0 mA ≤ I ≤ 600.0 mA	±1.5% rdg. ±3.8mV (±3.2°)	±1.8% rdg. ±3.8 mV
6.000A (100 mV/A)	0.000 A ≤ I ≤ 6.000 A	0.300 A ≤ I ≤ 6.000 A	±1.5% rdg. ±1.1 mV (±3.2°)	±1.8% rdg. ±1.1 mV

Appx. 4 Measurement Response Waveforms

When generating RMS or PEAK output, select an appropriate measurement response time based on the following waveform response information:

RMS output (input: 3 Hz)

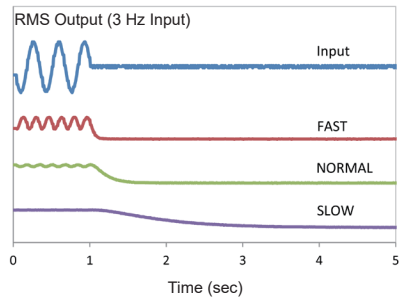
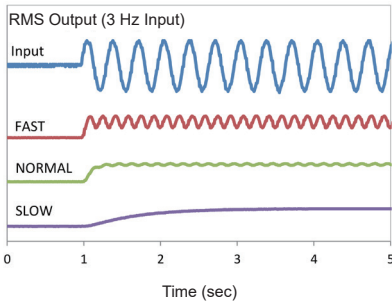

RMS output (input: 10 Hz)

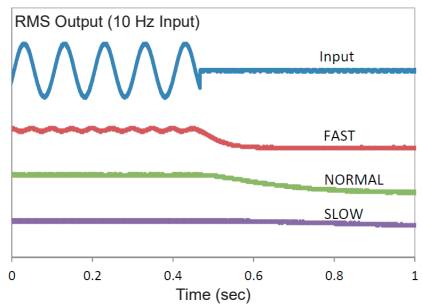
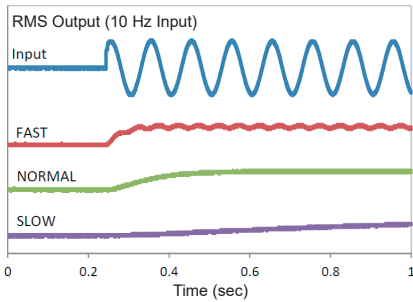

RMS output (input: 45 Hz)

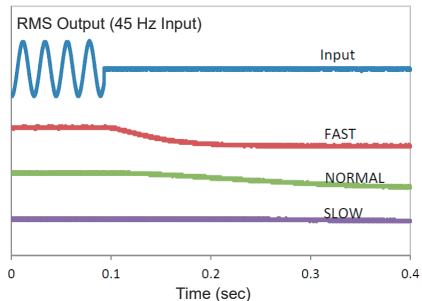
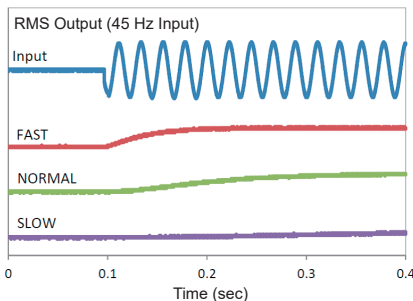

PEAK output (input: 10 Hz)

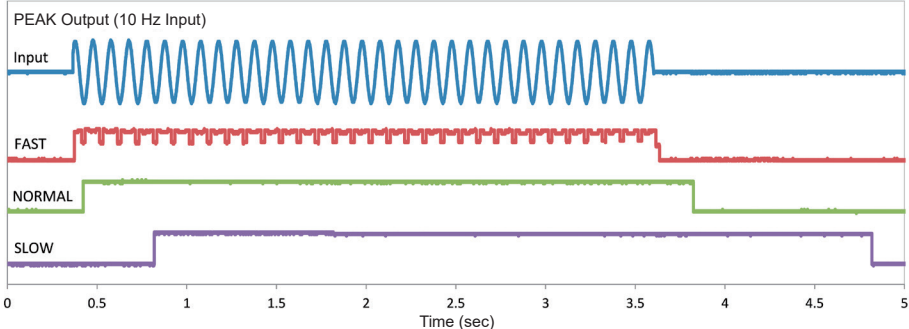

PEAK output (input: 50 Hz)

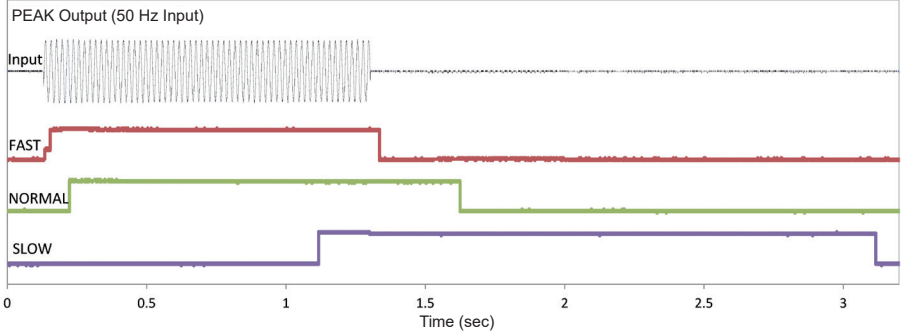

Warranty Certificate

HIOKI

Model	Serial number	Warranty period Three (3) years from date of purchase (___ / ___)
-------	---------------	--

Customer name: _____

Customer address: _____

Important

- Please retain this warranty certificate. Duplicates cannot be reissued.
- Complete the certificate with the model number, serial number, and date of purchase, along with your name and address. The personal information you provide on this form will only be used to provide repair service and information about Hioki products and services.

This document certifies that the product has been inspected and verified to conform to Hioki's standards. Please contact the place of purchase in the event of a malfunction and provide this document, in which case Hioki will repair or replace the product subject to the warranty terms described below.

Warranty terms

1. The product is guaranteed to operate properly during the warranty period (three [3] years from the date of purchase).
If the date of purchase is unknown, the warranty period is defined as three (3) years from the date (month and year) of manufacture (as indicated by the first four digits of the serial number in YYYY format).
2. If the product came with an AC adapter, the adapter is warranted for one (1) year from the date of purchase.
3. The accuracy of measured values and other data generated by the product is guaranteed as described in the product specifications.
4. In the event that the product or AC adapter malfunctions during its respective warranty period due to a defect of workmanship or materials, Hioki will repair or replace the product or AC adapter free of charge.
5. The following malfunctions and issues are not covered by the warranty and as such are not subject to free repair or replacement:
 - 1. Malfunctions or damage of consumables, parts with a defined service life, etc.
 - 2. Malfunctions or damage of connectors, cables, etc.
 - 3. Malfunctions or damage caused by shipment, dropping, relocation, etc., after purchase of the product
 - 4. Malfunctions or damage caused by inappropriate handling that violates information found in the instruction manual or on precautionary labeling on the product itself
 - 5. Malfunctions or damage caused by a failure to perform maintenance or inspections as required by law or recommended in the instruction manual
 - 6. Malfunctions or damage caused by fire, storms or flooding, earthquakes, lightning, power anomalies (involving voltage, frequency, etc.), war or unrest, contamination with radiation, or other acts of God
 - 7. Damage that is limited to the product's appearance (cosmetic blemishes, deformation of enclosure shape, fading of color, etc.)
 - 8. Other malfunctions or damage for which Hioki is not responsible
6. The warranty will be considered invalidated in the following circumstances, in which case Hioki will be unable to perform service such as repair or calibration:
 - 1. If the product has been repaired or modified by a company, entity, or individual other than Hioki
 - 2. If the product has been embedded in another piece of equipment for use in a special application (aerospace, nuclear power, medical use, vehicle control, etc.) without Hioki's having received prior notice
7. If you experience a loss caused by use of the product and Hioki determines that it is responsible for the underlying issue, Hioki will provide compensation in an amount not to exceed the purchase price, with the following exceptions:
 - 1. Secondary damage arising from damage to a measured device or component that was caused by use of the product
 - 2. Damage arising from measurement results provided by the product
 - 3. Damage to a device other than the product that was sustained when connecting the device to the product (including via network connections)
8. Hioki reserves the right to decline to perform repair, calibration, or other service for products for which a certain amount of time has passed since their manufacture, products whose parts have been discontinued, and products that cannot be repaired due to unforeseen circumstances.

HIOKI E.E. CORPORATION

<http://www.hioki.com>

18-07 EN-3

HIOKI

www.hioki.com/



**All regional
contact
information**

HIOKI E.E. CORPORATION

81 Koizumi, Ueda, Nagano 386-1192 Japan

2402 EN

Edited and published by HIOKI E.E. CORPORATION

Printed in Japan

- Contents subject to change without notice.
- This document contains copyrighted content.
- It is prohibited to copy, reproduce, or modify the content of this document without permission.
- Company names, product names, etc. mentioned in this document are trademarks or registered trademarks of their respective companies.

Europe only

•EU declaration of conformity can be downloaded from our website.

•Contact in Europe: HIOKI EUROPE GmbH
Helfmann-Park 2, 65760 Eschborn, Germany

hioki@hioki.eu