

Solution for charge/discharge testing of batteries



## Introducing a data logger that's ideal for evaluating high-voltage battery packs

### Product Concept

Battery packs consist of many battery cells that are connected in series. Since variability in cell characteristics can lead to a decline in the battery pack's overall performance, it's critical to ascertain voltage and temperature behavior at the cell level. Furthermore, it's necessary to make a comprehensive evaluation of the battery pack's overall characteristics during charge/discharge testing. This can be done by measuring individual cells' voltage and temperature at the same time as total voltage and total current. Manufacturers are designing batteries of increasingly high voltage for use in electric vehicles (EVs). As battery voltages rise from 400 V to 800 V, it becomes harder to measure battery cells' voltage and temperature safely. Instruments used to conduct charge/discharge testing of these high-voltage battery packs must now have higher terminal-to-ground and module-to-module voltage than before.



### Product features

- Maximum rated terminal-to-ground voltage **1500 V DC** (CAT II) insulation
- 10 ms sampling with **1500 channels** (20 ms sampling with 3000 channels)
- HIL support with a data output interval as short as **5 ms**

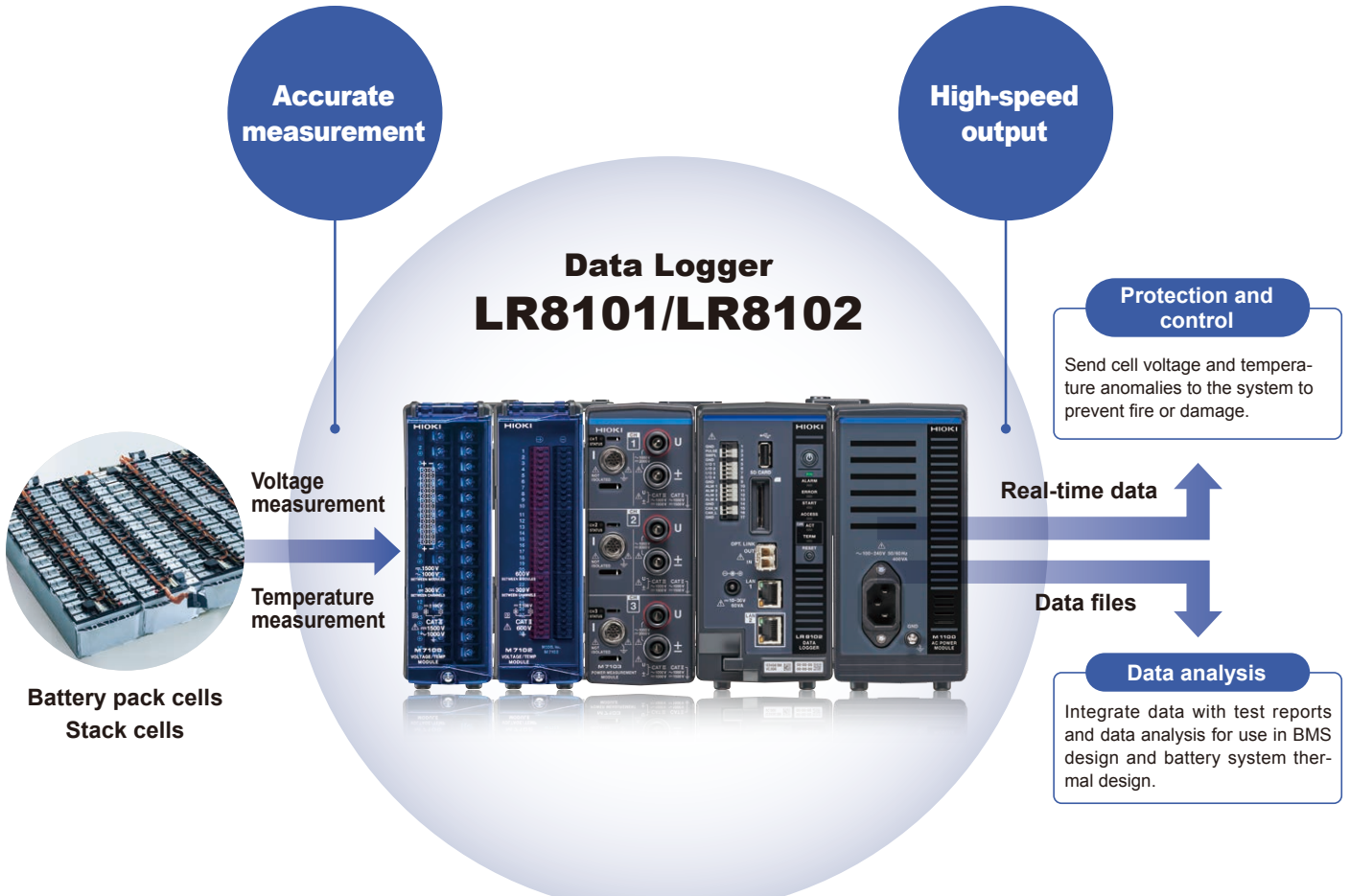

**Advantages**

- 1**



**Safely measure cell voltage and total voltage of high-voltage batteries**

1500 V DC CAT II insulation performance that complies with the EN IEC 61010 safety standard
- 2**



**Expand to as many as 3000 channels as the system grows**

Support for 15 to 3000 channels by adding modules
- 3**



**Realize real-time data output at an interval as short as 5 ms with UDP output**

Use live data for battery cells as a trigger for HIL systems or protective functions.

**Product Components**

The product makes measurements by combining a data logger with one or more measurement modules.

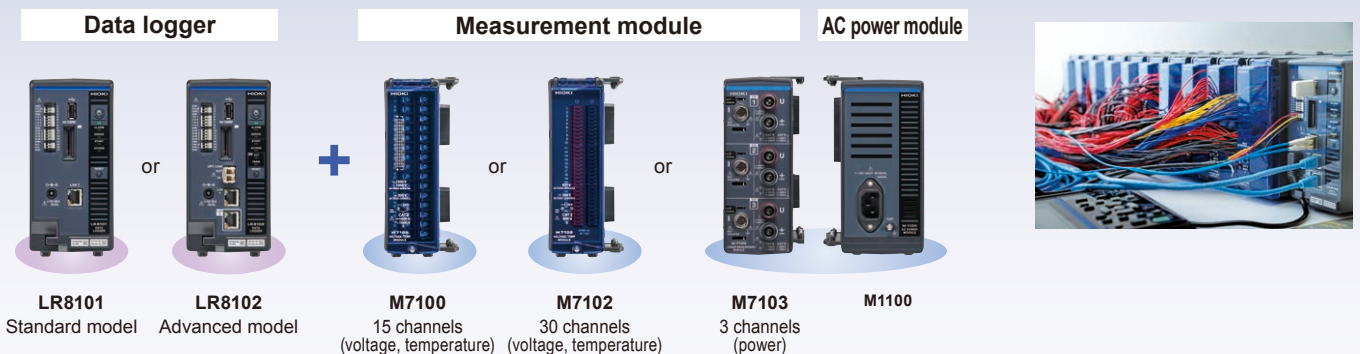

The M1100 is required if using the M7103.

# Product line

## Data Loggers

Select from two logger models. If you wish to synchronize sampling and use more than measurement modules, you'll need at least two LR8102 loggers.



### Standard model

## Data Logger LR8101

Basic functionality needed to collect general-purpose data

Connect up to 10 measurement modules per logger

Send data to a computer via LAN



### Advanced model

## Data Logger LR8102

Support for large-scale systems and real-time simulations

Synchronize sampling across up to 10 main units

Extensive communications interfaces for high-speed data transfers

Connect up to 10 measurement modules per logger

Send data to a computer via LAN

Maximum number of connectable modules (measurement modules)	10 (M7100, M7102, M7103)	10 (M7100, M7102, M7103)
Maximum number of synchronizable loggers	-	10 (requires optical connection cables)
Maximum number of measurable channels (data refresh interval)	<ul style="list-style-type: none"> <li>80 channels (5 ms)</li> <li>150 channels (10 ms)</li> <li>300 channels (20 ms)</li> </ul>	<ul style="list-style-type: none"> <li>800 channels (5 ms)</li> <li>1500 channels (10 ms)</li> <li>3000 channels (20 ms)</li> </ul>
Communications interface(s)	LAN1	LAN1, LAN2, CAN
LAN 1 (communications commands, data download)	Data collection and recording condition configuration via Logger Utility; setting configuration, recording control, FTP server function, FTP client function, HTTP server function, and XCP on Ethernet (TCP) via communications commands	
LAN 2 (real-time data output)	-	<ul style="list-style-type: none"> <li>Data output with refresh interval as short as 5 ms via UDP</li> <li>XCP on Ethernet (UDP)</li> </ul>
CAN (real-time data output)	-	Data output with refresh interval as short as 5 ms via CAN or CAN FD
External control terminals	Pulse/logic input, external sampling input, external I/O (4), alert output (4), CAN interface (LR8102 only)	

## Measurement modules

Choose measurement modules based on the number of channels and the required maximum rated module-to-module and terminal-to-ground voltages.



1500 V DC  
terminal-to-ground voltage

### Voltage/Temp Module M7100

- For systems ranging from 600 V to 1500 V
- Measure up to 15 channels with one module at a maximum sampling rate of 5 ms.

Voltage  
Temperature



600 V DC  
terminal-to-ground voltage

### Voltage/Temp Module M7102

- For systems of 600 V or less
- Measure up to 30 channels with one module at a maximum sampling rate of 10 ms.

Voltage  
Temperature



1500 V DC  
terminal-to-ground voltage

### Power Measurement Module M7103

- For measuring a system's total voltage and total current
- Measure up to 3 channels at as fast as 5 ms sampling with a single instrument.

Voltage  
Current  
Power

Number of measurable channels	15 channels	30 channels	3 channels
Minimum data refresh interval (number of usable channels)	5 ms (1 to 8 channels) (voltage only) 10 ms to 10 sec (9 to 15 channels)	10 ms (1 to 15 channels) 20 ms to 10 sec (16 to 30 channels)	Select from 5 ms, 50 ms, and 200 ms
Measurement parameters	Voltage, temperature (thermocouple)	Voltage, temperature (thermocouple)	Voltage, current (current sensor), power
Measurement range (voltage)	Voltage: 10 mV f.s. to 100 V f.s.	Voltage: 10 mV f.s. to 100 V f.s.	Voltage: 6 V f.s. to 1500 V f.s. Current: 0.04 A to 20 kA (depends on the sensor used)
Resolution and precision when using the 6 V range	60 $\mu$ V resolution, $\pm 3$ mV accuracy	60 $\mu$ V resolution, $\pm 3$ mV accuracy	Voltage or current (45 Hz $\leq f \leq$ 440 Hz): $\pm(0.02\%$ of reading + 0.03% of range)
Input resistance	100 M $\Omega$ or greater (10 mV to 6 V range) 1 M $\Omega$ $\pm 5\%$ (10 V to 100 V range)	100 M $\Omega$ or greater (10 mV to 6 V range) 1 M $\Omega$ $\pm 5\%$ (10 V to 100 V range)	Voltage inputs: 3 M $\Omega$ $\pm 30$ k $\Omega$ , 1.5 pF typical Current sensor inputs: 1 M $\Omega$ $\pm 50$ k $\Omega$
Maximum input voltage	$\pm 100$ V DC	$\pm 100$ V DC	Voltage inputs: 1000 V AC, 2000 V DC Current sensor inputs: 8 V, $\pm 12$ V peak
Maximum channel-to-channel voltage	300 V DC	300 V DC	-
Maximum rated module-to-module voltage	1500 V DC, 1000 V AC	600 V DC, 600 V AC	-
Maximum rated terminal-to-ground voltage	1500 V DC, 1000 V AC (CAT II)	600 V DC, 600 V AC (CAT II)	1000 V DC, 1000 V AC (CAT III) 1500 V DC, 1000 V AC (CAT II)



## Example setup

This section introduces a setup capable of measuring standard 400 V battery packs as well as 800 V battery packs, which are already being commercialized.

## Applications

Assessing cell charge/discharge characteristics  
 Verifying cell balance  
 Evaluating thermal management  
 Evaluating performance with an HIL system  
 Detecting test system errors

### Example of interoperation with a charge/discharge tester

### Capturing data for all cells in a 400 V battery pack

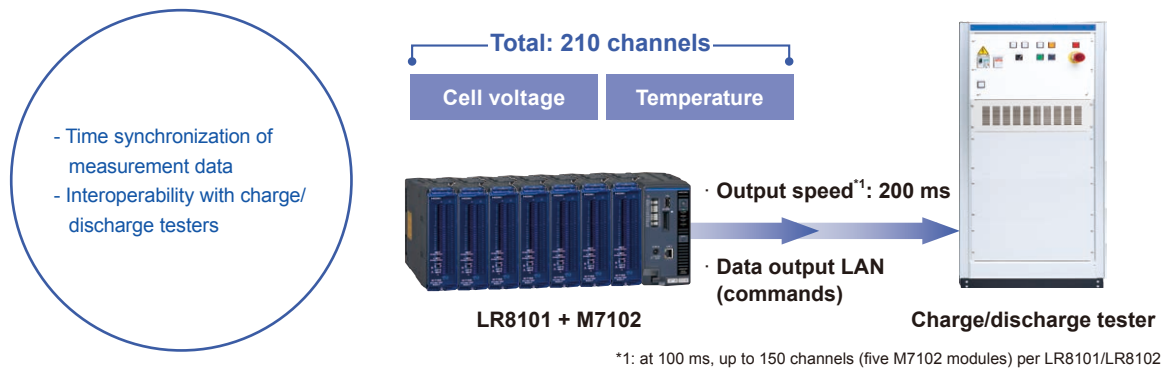

Measurement conditions	Setup
<ul style="list-style-type: none"> <li>· 210 channels (30 channels × 7 modules)</li> <li>· Sampling interval: 200 ms</li> <li>· Communication interface: LAN1</li> <li>· Communication protocol: TCP (communication commands)</li> </ul>	<ul style="list-style-type: none"> <li>· Data Logger LR8101 × 1</li> <li>· Voltage/Temp Module M7102 × 7</li> <li>· LAN Cable 9642 × 1</li> </ul>

### Example of interoperation with a next-generation high-voltage battery testing systems

### Building a system for testing battery packs that exceed 800 V

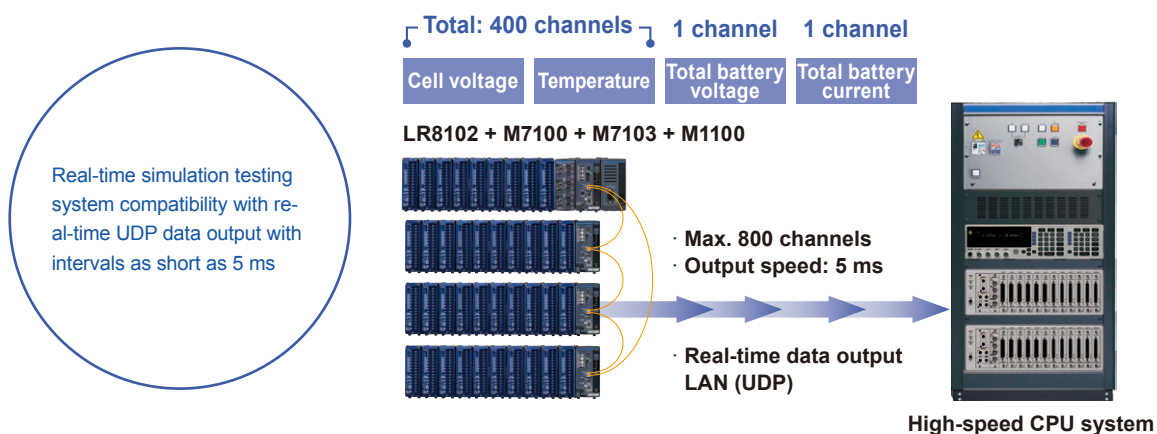

Measurement conditions	Setup
<ul style="list-style-type: none"> <li>· Cell voltage and temperature: total of 400 channels</li> <li>· Total battery voltage: 1 channel</li> <li>· Total battery current: 1 channel</li> <li>· Sampling interval: 5 ms (voltage), 10 ms (temperature)</li> <li>· Communication interface: LAN2</li> <li>· Communication protocol: UDP</li> </ul>	<ul style="list-style-type: none"> <li>· Data Logger LR8102 × 4</li> <li>· Voltage/Temp Module M7100 × 39</li> <li>· 200 voltage channels: M7100 × 25 (8 channels per module)</li> <li>· 200 temperature channels: M7100 × 14 (15 channels per module)</li> <li>· Power Measurement Module M7103 × 1</li> <li>· AC Power Module M1100 × 1</li> <li>· Optical Connection Cable L6101 (1 m) × 3</li> <li>· Optical Connection Cable L6102 (10 m) × 1</li> <li>· Current sensor × 1</li> </ul> <p><sup>*</sup> A hub and one LAN cable for each logger are needed in order to simultaneously configure multiple devices. Use of Cat 7 cabling is recommended since large amounts of data will be transferred at high speed.</p>



| Advantage 1 |

## Safely measure voltage at all cells of high-voltage batteries

The LR8101 and LR8102 data loggers are ideal for embedding in battery testing systems.

In battery pack charge/discharge testing, technicians acquire voltage and temperature data for each cell, allowing them to assess battery characteristics in a comprehensive manner.

### Maximum rated module-to-module and terminal-to-ground voltages

#### 1500 V DC (CAT II) insulation

Although the voltage of individual cells in a battery may be low at about 4 V, safely measuring the voltage at each cell in an 800 V battery pack, a type that is already being commercialized, requires an instrument with a maximum rated terminal-to-ground voltage of at least 800 V DC.

Since the Voltage/Temp Module M7100 and Power Measurement Module M7103 has a maximum rated terminal-to-ground voltage of 1500 V, it can accommodate testing of 800 V batteries with an ample margin of safety. It can also be used to measure cell voltage and temperature in next-generation battery packs that exceed 800 V and power storage systems such as energy storage systems (ESSs) that exceed 1000 V.

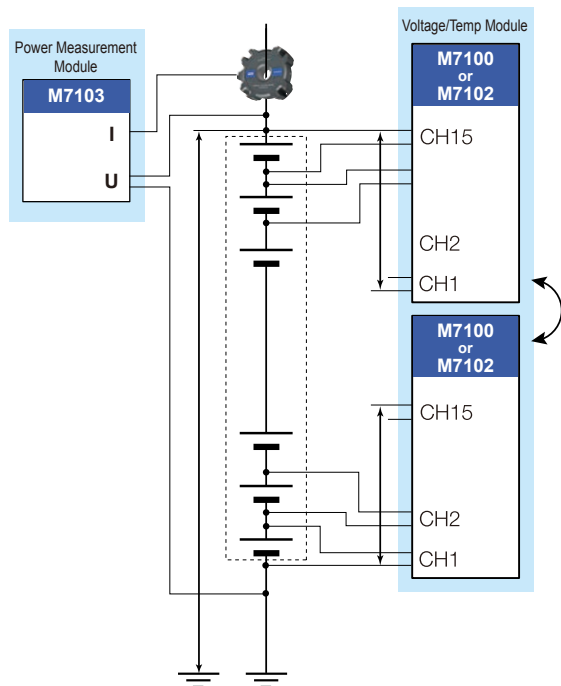

**Maximum rated terminal-to-ground voltage**  
**M7100: 1500 V DC, 1000 V AC (CAT II)**  
**M7102: 600 V DC, 600 V AC (CAT II)**  
**M7103: 1500 V DC, 1000 V AC (CAT II)**

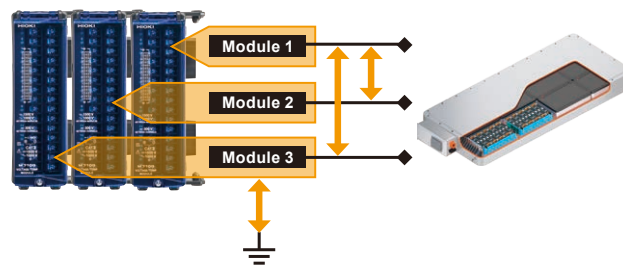

**Maximum rated module-to-module voltage**

**M7100: 1500 V DC, 1000 V AC**  
**M7102: 600 V DC, 600 V AC**

**Maximum rated channel-to-channel voltage in module**

**M7100, M7102: 300 V DC**

#### Caution: mixing of modules

When using a mix of different measurement modules to measure targets such as battery packs that are connected in series, the lower of the two maximum rated module-to-module voltage specifications applies.

### Safe, EN IEC 61010-compliant design



When measuring voltage or electrode temperature at cells that make up a battery pack, high voltages will be applied between terminals and ground (between input channels and ground) and between measurement modules.

The Voltage/Temp Module M7100 uses a newly designed isolation transformer to realize 1500 V DC insulation between input channels and ground. Safety and reliability are assured thanks to the device's ability to withstand not only steady high voltages, but also transitory voltage surges. The module complies with the EN IEC 61010 international standard, ensuring that it meets safety requirements for battery measurement.

## | Advantage 2 |

## Expand to as many as 3000 channels as the system grows

The LR8101/LR8102 can be expanded in a flexible manner based on the necessary number of measurement channels. The expandable nature of the logger (starting at one logger and module) also means that it will take only as much space as is necessary. Space no longer needs to be wasted on large loggers that take up more space than the application requires.

### Support for multi-channel measurement

## Synchronized measurement of up to 3000 channels

The Data Logger LR8101/LR8102 is used in combination with one or more measurement modules. If 10 M7102 modules, which can each measure 30 channels, are connected, a single instrument can measure up to 300 channels. Furthermore, if up to 10 of the LR8102 advanced models are connected with optical cabling, their sampling can be synchronized, allowing the number of measurement channels to be increased to a maximum of 3000.

### Add channels with a space-saving design

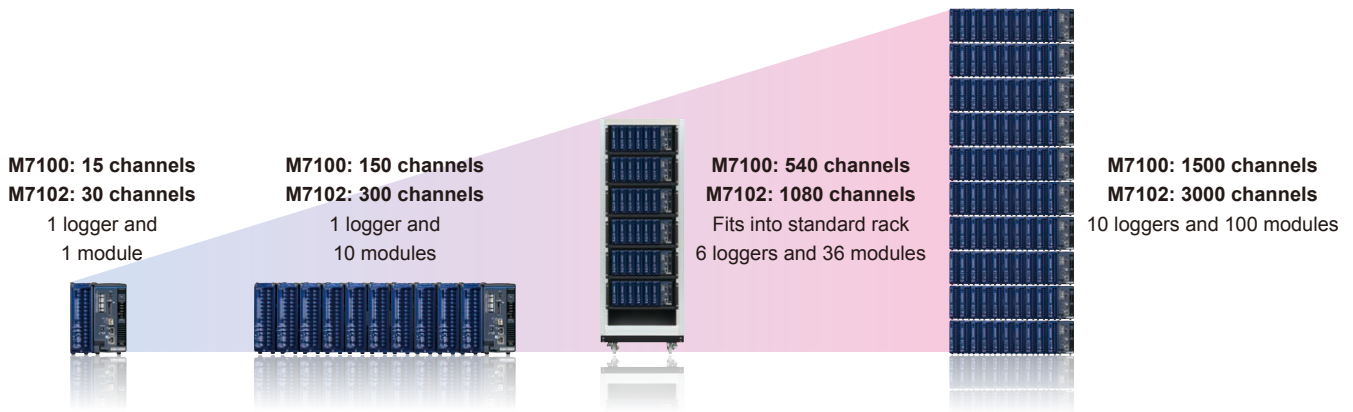

### Synchronized sampling with multiple loggers

#### LR8102 only

By daisy-chaining loggers together with the L6101 or L6102 optical connection cables, sampling-synchronized measurement can be performed for up to 10 loggers. An optical connection cable is required for each logger.



Example of synchronized measurement with 3 loggers

### LAN conceptual connection diagram

Data can be acquired and settings configured from multiple devices by using a hub and LAN cables.

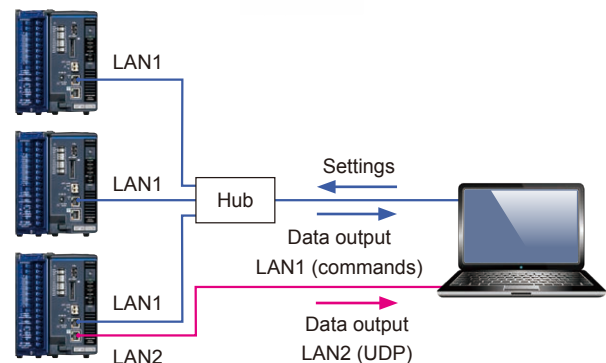

#### The LR8102's LAN connection for UDP output

- Data is output from the LAN2 port. Use of Cat 7 cabling is recommended since large amounts of data will be transferred at high-speed.
- The loggers' settings are configured from the LAN1 port of each logger via hub when using UDP output.

## Realize real-time data output at an interval as short as 5 ms with UDP output

### LR8102 only

The LR8102 can be embedded in testing systems such as HIL systems, which perform simulations while transferring measurement data at high speeds.

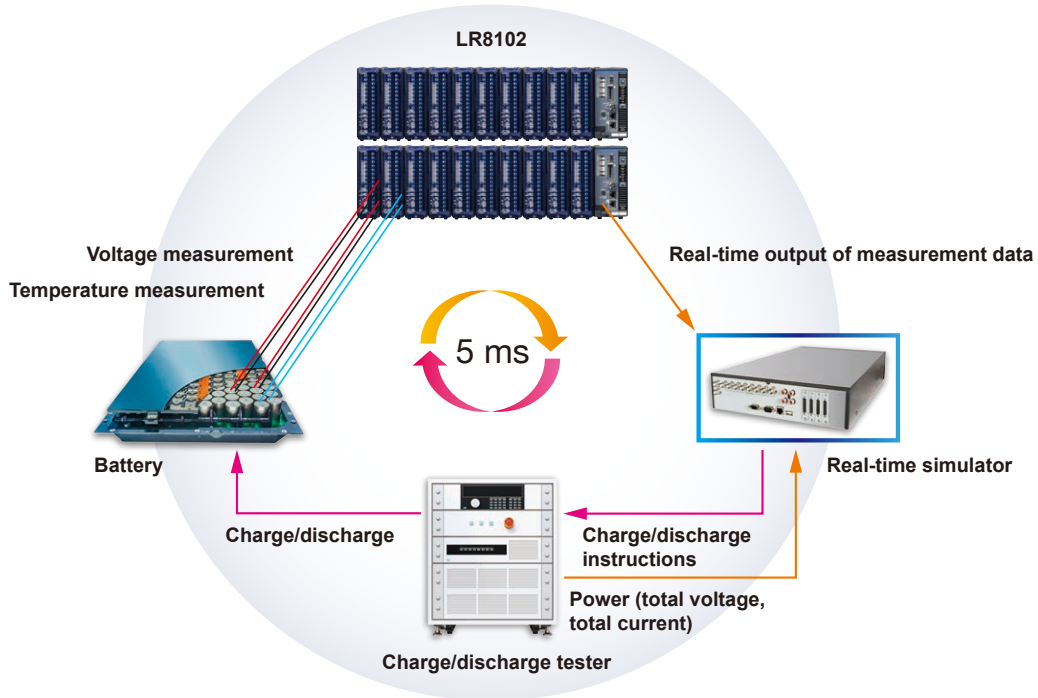

### Support for HIL system-linked simulation testing

When using measured data to develop a battery-related control simulation, it's necessary to transfer measurement data to the system at high-speed.

Since the LR8102 uses UDP to output one datapoint at a time at an interval as short as 5 ms, it's ideal for interoperability with HIL systems.

### Synchronization with charge/discharge tester data

Since the LR8102 is so fast that it can keep up with the fast charge/discharge and measurement performed by the charge/discharge tester. This time-precision can drastically improve the overall detail and accuracy of the simulation.

## Data output

Data can be output at an interval as short as 5 ms by using UDP output, CAN output, or XCP via Ethernet (all of which are supported exclusively by the LR8102). Operating conditions may be subject to limitations depending on the usage environment. For detailed conditions, please see the instruction manual found on Hioki's website.

	Logger Utility	GENNECT One	Communication command	UDP output	CAN output	XCP on Ethernet
Shortest sampling period	5 ms	1 s	100 ms	5 ms	5 ms	5 ms
Number of operable instruments (Number of instruments that can be synchronized for sampling)	5 units	10 units	10 units	10 units	10 units	10 units
Maximum number of operable channels (Number of channels synchronized for sampling)	600 channels (For M7103, up to 30 channels per module)	512 channels	1500 channel (100 ms) Up to 150 channels (5 modules) per unit 3000 channels (200 ms) Up to 300 channels (10 modules) per unit	5000 channels Up to 500 channels per unit if the synchronization setting is enabled while using the primary unit to generate output.	100 channels (5 ms) 450 channels (10 ms) 1000 channels (20 ms) (Reference value when data are received using the CAN FD port only)	500 channels (5 ms to 100 ms) (For LAN1) No limit on number of channels (For LAN 2)
Output port						
	LAN1	✓	✓	-	-	✓
	LAN2	-	-	✓	-	✓
	CAN	-	-	-	✓	-
How to obtain sample program	<ul style="list-style-type: none"> <li>Included on the provided DVD</li> <li>The latest version can be obtained from the Hioki website.*1</li> </ul>		<ul style="list-style-type: none"> <li>Sample program is included in the Instruction Manual (included on the provided DVD)</li> <li>Sequence Maker*2</li> </ul>	<ul style="list-style-type: none"> <li>Sample program is included on the provided DVD</li> </ul>	-	-

\*1: MATLAB sample scripts and LabVIEW drivers can be downloaded from Hioki's website. MATLAB and LabVIEW can be used to control instruments and analyze data. (MATLAB and LabVIEW are registered trademarks of MathWorks and NI, respectively.) <https://www.hioki.co.jp/support/softwaredownload/>

\*2: Sequence Maker is here. <https://sequencemaker.hioki.com/en/>



## Easy data collection using Hioki software

### Logger Utility (included accessory)

Hioki's Logger Utility can collect data on a computer in real time with a sampling rate as fast as 5 ms. In addition to controlling measurement and displaying waveforms, it provides various functions such as data conversion (between waveform and text formats), calculation, search, and printing.

Recording interval	Simultaneous recording	Connectable instruments	Connection method
5 ms	600 channels	Up to 5 loggers	LAN1 port

Each M7103 unit offers up to 30 channels.

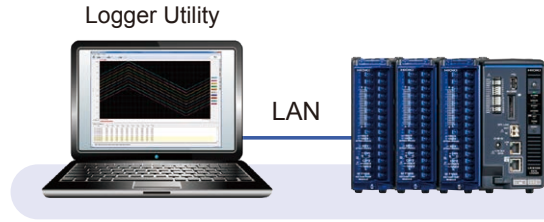

### Analyze measured values as waveforms

You can check charge/discharge characteristics with the Logger Utility.

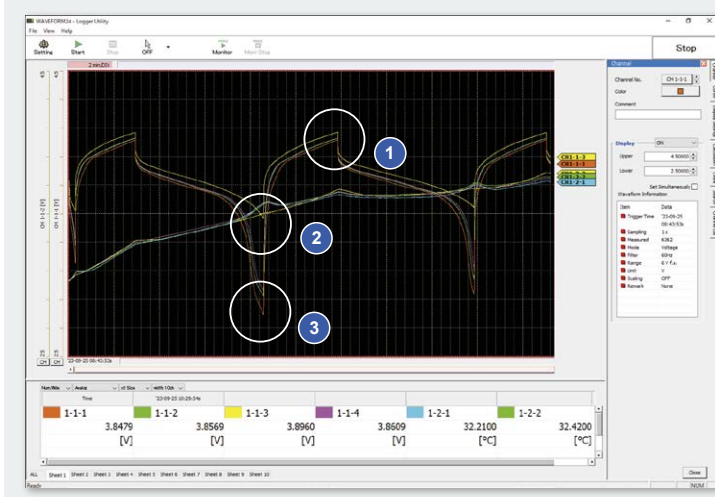

#### Example charge/discharge characteristics waveform

Variability among cells can be seen at the following points:

- 1 The time required to reach the charging upper-limit voltage varies from cell to cell.
- 2 The package temperature varies from cell to cell.
- 3 The time required to reach the discharge final voltage varies from cell to cell.

### GENNECT One (free Windows application, included accessory)

Connect instruments to a computer via LAN and collect data in real time at an interval as short as 1 sec. GENNECT One supports multiple instruments on the same LAN and allows instruments to be controlled from the computer.

Recording interval	Simultaneous recording	Connectable instruments	Connection method
1 s	512 channels	Up to 10 loggers	LAN1 port



## Interfaces

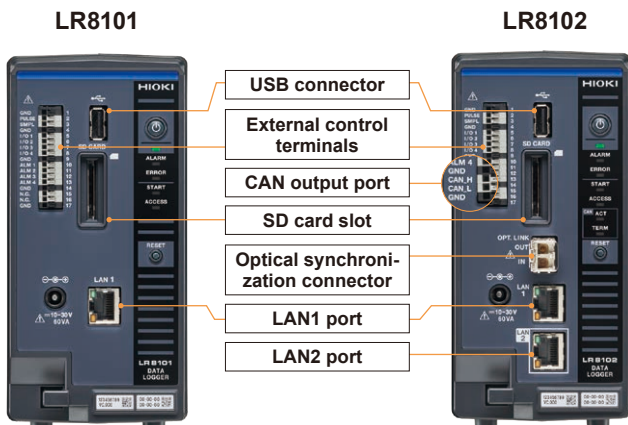

#### LAN1 port

LAN1 can be used to configure settings using communications commands and to collect data. LAN2 (LR8102 only) can be used to output measurement data in real time using the UDP protocol.

#### CAN output port (LR8102 only)

This port can be used to output measured values to a CAN bus in real time while measurement is in progress.

#### Optical synchronization connector (LR8102 only)

Increase the LR8102's maximum channel to 3000 by connecting multiple LR8102s with optical connection cables (sold separately).

#### External control terminals

##### Alarm functionality

You can have the logger sound a tone or output an alarm signal to an external device when the measurement data satisfies the set condition.

##### External sampling

Data can be sampled and recorded in synchronization with an external clock.



## Specifications

Data Logger LR8101/LR8102 specifications	
Maximum number of connectable modules	10
Measurement modules	M7100 Voltage/Temp Module (15 channels) M7102 Voltage/Temp Module (30 channels) M7103 Power Measurement Module (3 channels)
Operating temperature and humidity range	-10°C to 50°C (14°F to 122°F), 80% RH or less (non-condensing)
Storage temperature and humidity range	-20°C to 60°C (-4°F to 140°F), 80% RH or less (non-condensing)
External dimensions	Approx. 80W × 166H × 238D mm (3.1W × 6.5H × 9.4D in.) (excluding protruding parts)
Weight	Approx. 1.5 kg (3.3 lb.)
Included accessories	Operating Precautions ×1, Startup Guide ×1, DVD ×1
Power supply	
AC adapter	Z1016 AC Adapter (drives instrument at 12 V DC ±10%)
External power supply	10 V to 30 V DC
Interfaces	
Number of LAN ports	1 (LR8101), 2 (LR8102)
LAN1 functionality	Collecting data and setting recording conditions using Logger Utility Setting IP address initial settings using Logger Utility Configuring settings and controlling recording using communication commands Manually acquiring data using the FTP server Automatically sending data via FTP (FTP client) HTTP server function XCP on Ethernet (TCP) NTP client function
LAN2 functionality (LR8102 only)	Measurement data can be output by UDP XCP via Ethernet (UDP)
USB interface (host)	USB drive, Guaranteed operation: Z4006 (16 GB)
SD card slot	SD memory card/SDHC memory card support Guaranteed operation: Z4001 (2 GB), Z4003 (8 GB)
External control terminals	Pulse/logic input, external sampling input, external I/O (4), alarm output (4), CAN interface (LR8102 only), GND terminals (5)

### Synchronized operation (multiple loggers can operate in a synchronized manner; LR8102 only)

Maximum number of synchronizable instruments	10
--	----

### Voltage/Temp Module M7100 specifications

Operating temperature and humidity range	-10°C to 50°C (14°F to 122°F), 80% RH or less (no condensation)
Withstand voltage	7.4 kW AC, for 1 minute between input channels (+/-, 1 mA of sensed current) and LR8101/LR8102 or between modules 350 V AC, 1 min. (sensed current, 1 mA) between input channels (+, -)
External dimensions	Approx. 53W × 166H × 263D mm (2.1W × 6.5H × 10.4D in.) (excluding protruding parts)
Weight	Approx. 1.3 kg (2.9 lb.)
Number of input channels	15 channels
Input terminal	M3 screw-type terminal block (2 terminals per channel), terminal block cover
Measurement targets	Voltage/Temperature (thermocouples, K, J, E, T, N, R, S, B, C)
Input type	Scanning by semiconductor relay, floating unbalanced input, all channels isolated
A/D resolution	18 bits
Maximum input voltage	±100 V DC
Max. channel-to-channel voltage	300 V DC
Maximum rated terminal-to-ground voltage	1500 V DC, measurement category III, anticipated transient overvoltage of 8000 V 1000 V AC, measurement category III, anticipated transient overvoltage of 6000 V
Maximum rated module-to-module voltage	1500 V DC, 1000 V AC
Input resistance	100 MΩ or greater for voltage ranges of 10 mV f.s. to 6 V f.s. (including "1-5 V f.s. range"); for all thermocouple ranges 1 MΩ ±5% (for voltage ranges 10 V f.s. to 100 V f.s.)
Data refresh interval	5 ms <sup>1</sup> , 10 ms <sup>2</sup> , 20 ms, 50 ms, 100 ms, 200 ms, 500 ms, 1 s, 2 s, 5 s, 10 s *1: when all the module's measurement channels are set to a voltage range and one to eight channels are being used *2: when thermocouple wire break detection is disabled
Measurement ranges	Voltage: 10 mV f.s., 20 mV f.s., 100 mV f.s., 200 mV f.s., 1 V f.s., 2 V f.s., 6 V f.s., 10 V f.s., 20 V f.s., 60 V f.s., 100 V f.s., 1 to 5 V f.s. Thermocouple: 100°C f.s., 500°C f.s., 2000°C f.s.

### Voltage/Temp Module M7102 specifications

Operating temperature and humidity range	-10°C to 50°C (14°F to 122°F), 80% RH or less (no condensation)
Withstand voltage	Between input channels (+, -) and the LR8101/ LR8102: 3.6 kV AC, for 1 minute (sensed current, 1 mA) Between each module: 3.6 kV AC, for 1 minute (sensed current, 1 mA) Between each input channel (+, -): 350 V AC, for 1 minute (sensed current, 1 mA)

External dimensions	Approx. 53W × 166H × 263D mm (2.1W × 6.5H × 10.4D in.) (excluding protruding parts)
Weight	Approx. 1.2 kg (2.6 lb.)
Number of input channels	30 (configure voltage or thermocouple for each channel)
Input terminal	Push-button type terminal block (2 terminals per channel), terminal block cover
Measurement parameters	Voltage/Thermocouple (K, J, E, T, N, R, S, B, C)
Input type	Scanning by semiconductor relay, floating unbalanced input All channels isolated
A/D resolution	18 bits
Max. input voltage	±100 V DC
Max. channel-to-channel voltage	300 V DC
Max. rated terminal-to-ground voltage	600 V AC/DC, measurement category III, anticipated transient overvoltage of 4000 V
Max. rated module-to-module voltage	600 V AC/DC
Input resistance	100 MΩ or greater for voltage ranges 10 mV f.s. to 6 V f.s. (including "1-5 V f.s. range") and for all thermocouple ranges 1 MΩ ±5% for voltage ranges 10 V f.s. to 100 V f.s.
Data refresh interval	10 ms <sup>1</sup> , 20 ms <sup>2</sup> , 50 ms, 100 ms, 200 ms, 500 ms, 1 s, 2 s, 5 s, 10 s *1: when thermocouple wire break detection is disabled and the number of channels in use ranges from 1 to 15. *2: when thermocouple wire break detection is disabled, or when thermocouple wire break detection is enabled and the number of channels in use ranges from 1 to 15.
Measurement ranges	Voltage: 10 mV f.s., 20 mV f.s., 100 mV f.s., 200 mV f.s., 1 V f.s., 2 V f.s., 6 V f.s., 10 V f.s., 20 V f.s., 60 V f.s., 100 V f.s., "1-5 V f.s. range" Thermocouple: 100°C f.s., 500°C f.s., 2000°C f.s.

### Power Measurement Module M7103 specifications

Temperature and humidity range	Operating: 0°C to 40°C, 80% RH or less (no condensation) Storage: -10°C to 50°C, 80% RH or less (no condensation)
Standard compliance	Safety: EN61010, EMC: EN61326 Class A
External dimensions	Approx. 65W × 170H × 255D mm (2.6W × 6.7H × 10.0D in.) (excluding protruding parts)
Weight	Approx. 1.5 kg (3.3 lb.)

### Power measurement input specifications

Measurement lines	1-phase/2-wire (1P2W) 1-phase/3-wire (1P3W) 3-phase/3-wire (3P3W2M, 3V3A, 3P3W3M) 3-phase/4-wire (3P4W)
Number of power channels	3 (voltage: 3 terminals, U1 to U3; current: 3 terminals, I1 to I3)
Input terminal	Voltage: plug-in terminals (safety terminals) Current: dedicated connectors (ME15W)
Input type	Voltage: isolated, resistive potential divider Current: isolated input via current sensors (voltage output)
Voltage ranges	6 V, 15 V, 30 V, 60 V, 150 V, 300 V, 600 V, 1500 V
Current ranges	0.04 A range to 20 kA range (depends on the current sensor used)
Crest factor	3 (relative to voltage and current range ratings), but 1.35 for 1500 V range
Input resistance, input capacitance	Voltage inputs: 3 MΩ±30 kΩ, 1.5 pF typical Current sensor inputs: 1 MΩ±50 kΩ
Maximum input voltage	Voltage inputs: 1000 V AC, 2000 V DC Current sensor inputs: 8 V, ±12 V peak
Maximum rated terminal-to-ground voltage	1000 V AC/DC, CAT III, anticipated transient overvoltage of 8000 V 1000 V AC, 1500 V DC, CAT II, anticipated transient overvoltage of 8000 V
Measurement method	Simultaneous voltage and current digital sampling with zero-cross synchronization calculations
Sampling	500 kHz, 16 bit
Frequency band	DC, 0.1 Hz to 100 kHz
Effective measurement range	1% of range to 110% of range
LPF (Low pass filter)	Select from OFF, 500 Hz, and 5 kHz
Measurement parameters	Voltage (U), current (I), active power (P), apparent power (S), reactive power (Q), power factor (PF), phase angle (φ), voltage frequency (f), current frequency (fi), voltage ripple ratio (Urf), current ripple ratio (Irf), current integration (Ih), power integration (WP), voltage peak (Upk), current peak (Ipk)
Other measurements	Frequency, integration, harmonic (IEC measurement mode, wide-band measurement mode)
Functions	AUTO range, calculation, synchronization source sharing

### AC Power Module M1100 specifications

Temperature and humidity range	Operating: 0°C to 40°C, 80% RH or less (no condensation) Storage: -10°C to 50°C, 80% RH or less (no condensation)
Standard compliance	Safety: EN61010, EMC: EN61326 Class A
Power supply	•Grid power Rated supply voltage: 100 to 240 V AC (assuming voltage fluctuations of ±10% of the rated supply voltage) Rated power supply frequency: 50, 60 Hz Anticipated transient overvoltage: 2500 V Maximum rated power: 400 VA (at the M1100's maximum rated current and power) 300 VA (with 4 M7103 modules and 6 M7100 modules connected) Normal power consumption: 55 W (with 2 M7103 modules connected and CT6872 sensors connected to all current channels while measuring 20 A AC with 1000 V input for all voltage channels)
External dimensions	Approx. 80W × 166H × 238D mm (3.1W × 6.5H × 9.4D in.) (excluding protruding parts)
Weight	Approx. 2.0 kg (4.4 lb.)

## External dimensions

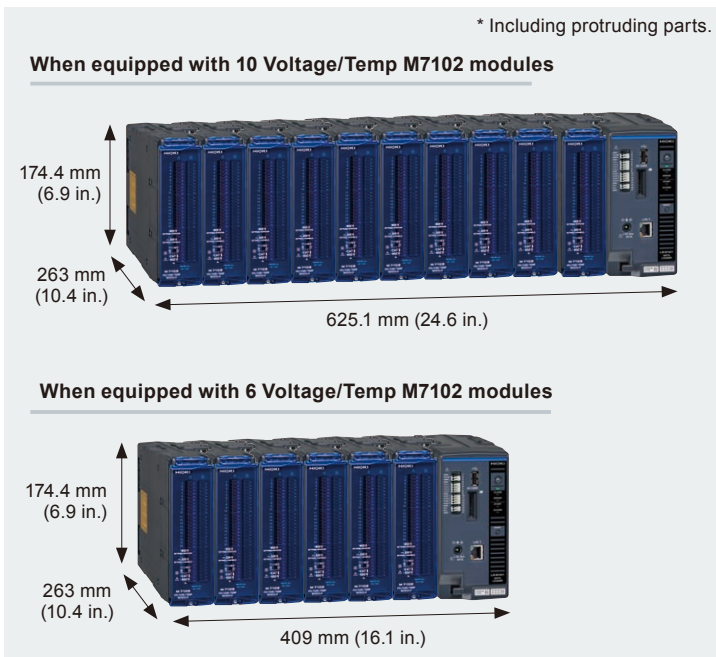
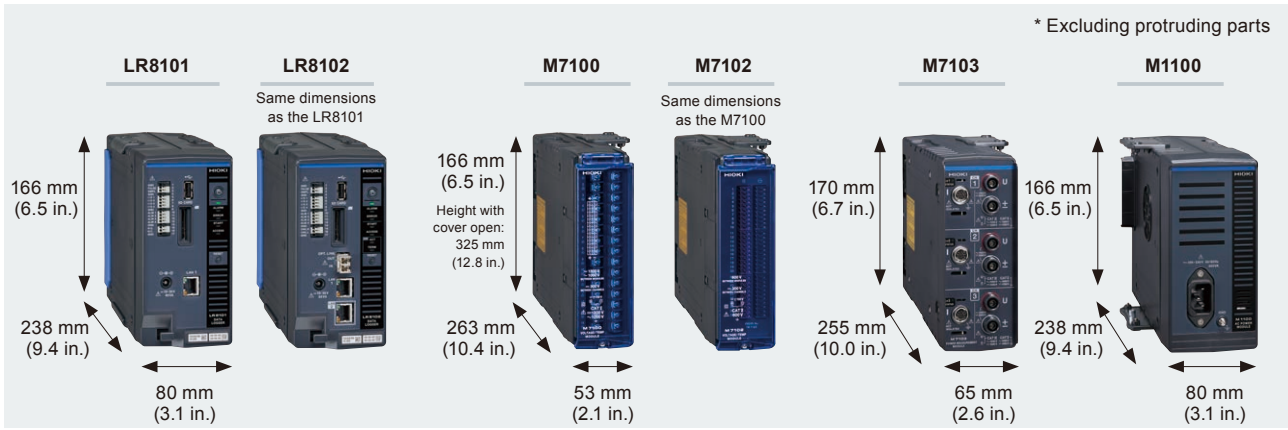

### Illustration of rack-mounted installation

One logger and six modules can be installed in each row of a 19-inch rack.



## Options

### Logger options: power supply, synchronization cable



**AC Adapter Z1016**  
Powers the logger using commercial power (AC power)



**Power Cable L1012**  
With one end terminating in bare wires, approx. 2 m (6.6 ft.)  
Powers the logger using an external power supply (DC)



For synchronizing measurement of multiple loggers

LR8102 only

**Optical Connection Cable L6101**  
Length: 1 m (3.3 ft.)  
**Optical Connection Cable L6102**  
Length: 10 m (32.8 ft.)



For CAN output

LR8102 only

**CAN Cable 9713-01**  
With one end terminating in bare wires; length: 1.8 m (5.9 ft.)



**LAN Cable 9642**  
Straight-through LAN with crossover conversion connector, 5 m (16.4 ft.)

### Logger options: sStorage media

Be sure to use storage media supplied by Hioki. Instruments may not be able to write to or read from storage media other than Hioki media; proper operation not guaranteed.



**SD Memory Card Z4001**



**SD Memory Card Z4003**  
8 GB



**USB Drive Z4006**  
16 GB

### Sensors

For reference only. Please purchase locally.



**K Thermocouple T Thermocouple**

### Power Measurement Module options: voltage input cord, etc



**VOLTAGE CORD L1025**  
1500 V DC CAT II, 1 A, 1000 V CAT III, 1 A, banana - banana (red, black each), alligator clip, approx. 3 m (9.84 ft) length



**VOLTAGE CORD L9438-50**  
1000 V specifications, Black/ Red, 3 m (9.84 ft) length, Alligator clip x2



**VOLTAGE CORD L1000**  
Red/Yellow/ Blue/ Gray each 1. Black 4, 3 m (9.84ft) length, Alligator clip x 8



**PATCH CORD L1021-01**  
Banana branch-banana, Red: 1, 0.5 m (1.64 ft) length, for branching from the L9438s or L1000s, CAT IV 600 V, CAT III 1000 V



**PATCH CORD L1021-02**  
Banana branch-banana, Black: 1, 0.5 m (1.64 ft) length, for branching from the L9438s or L1000s, CAT IV 600 V, CAT III 1000 V



**GRABBER CLIP L9243**  
Attaches to the tip of the banana plug cable, Red/ Black: 1 each, 185 mm (7.28 in.) length, CAT II 1000 V



**WIRING ADAPTER PW9000**  
When three-phase 3-wire connection, the voltage cable to be connected can be reduced from 6 to 3



**WIRING ADAPTER PW9001**  
When three-phase 4-wire connection, the voltage cable to be connected can be reduced from 6 to 4



**AC/DC HIGH VOLTAGE DIVIDER VT1005**  
Divides voltage of up to 5000 V and outputs Measurement band: DC to 4 MHz (-3 dB) Measurement accuracy: ±0.08% (DC), ±0.04% (50/60 Hz), ±0.17% (50 kHz)

## Power Measurement Module options: current sensor

### Pass-through type, HIOKI ME15W terminal



**AC/DC CURRENT SENSOR  
CT6862-05**

Rated 50 A AC/DC  
DC to 1 MHz  
φ 24 mm (0.94 in)  
Cable length: 3 m (9.84 ft)



**AC/DC CURRENT SENSOR  
CT6872**

Rated 50 A AC/DC  
DC to 10 MHz  
φ 24 mm (0.94 in)  
Cable length: 3 m (9.84 ft)



**AC/DC CURRENT SENSOR  
CT6872-01**

Rated 50 A AC/DC  
DC to 10 MHz  
φ 24 mm (0.94 in)  
Cable length: 10 m (32.81 ft)



**AC/DC CURRENT SENSOR  
CT6863-05**

Rated 200 A AC/DC  
DC to 500 kHz  
φ 24 mm (0.94 in)  
Cable length: 3 m (9.84 ft)



**AC/DC CURRENT SENSOR  
CT6873**

Rated 200 A AC/DC  
DC to 10 MHz  
φ 24 mm (0.94 in)  
Cable length: 3 m (9.84 ft)



**AC/DC CURRENT SENSOR  
CT6873-01**

Rated 200 A AC/DC  
DC to 10 MHz  
φ 24 mm (0.94 in)  
Cable length: 10 m (32.81 ft)



**AC/DC CURRENT SENSOR  
CT6875 A**

Rated 500 A AC/DC  
DC to 2 MHz  
φ 36 mm (1.42 in)  
Cable length: 3 m (9.84 ft)



**AC/DC CURRENT SENSOR  
CT6875A-1**

Rated 500 A AC/DC  
DC to 2 MHz  
φ 36 mm (1.42 in)  
Cable length: 10 m (32.81 ft)



**AC/DC CURRENT SENSOR  
CT6876A**

Rated 1000 A AC/DC  
DC to 1.5 MHz  
φ 36 mm (1.42 in)  
Cable length: 3 m (9.84 ft)



**AC/DC CURRENT SENSOR  
CT6876A-1**

Rated 1000 A AC/DC  
DC to 1.5 MHz  
φ 36 mm (1.42 in)  
Cable length: 10 m (32.81 ft)



**AC/DC CURRENT SENSOR  
CT6877A**

Rated 2000 A AC/DC  
DC to 1 MHz  
φ 80 mm (3.15 in)  
Cable length: 3 m (9.84 ft)



**AC/DC CURRENT SENSOR  
CT6877A-1**

Rated 2000 A AC/DC  
DC to 1 MHz  
φ 80 mm (3.15 in)  
Cable length: 10 m (32.81 ft)



**AC/DC CURRENT SENSOR  
CT6904A**

Rated 500 A AC/DC  
DC to 4 MHz  
φ 32 mm (1.26 in)  
Cable length: 3 m (9.84 ft)

### Clamp type, HIOKI ME15W terminal



**CLAMP ON SENSOR  
9272-05**

Rated 20 A/200 A AC  
DC to 100 kHz  
φ 46 mm (1.81 in)  
Cord length: 3 m (9.84 ft)



**AC/DC CURRENT PROBE  
CT6841A**

Rated 20 A AC/DC  
DC to 2 MHz  
φ 20 mm (0.79 in.)  
Cable length: 3 m (9.84 ft)



**AC/DC CURRENT PROBE  
CT6843A**

Rated 200 A AC/DC  
DC to 700 kHz  
φ 20 mm (0.79 in.)  
Cable length: 3 m (9.84 ft)



**AC/DC CURRENT PROBE  
CT6844A**

Rated 500 A AC/DC  
DC to 500 kHz  
φ 20 mm (0.79 in.)  
Cable length: 3 m (9.84 ft)



**AC/DC CURRENT PROBE  
CT6845A**

Rated 500 A AC/DC  
DC to 200 kHz  
φ 50 mm (1.97 in.)  
Cable length: 3 m (9.84 ft)



**AC/DC CURRENT PROBE  
CT6846A**

Rated 1000 A AC/DC  
DC to 100 kHz  
φ 50 mm (1.97 in.)  
Cable length: 3 m (9.84 ft)



**NEW**  
**AC/DC CURRENT PROBE  
CT6830**

Rated 2 A AC/DC  
DC to 100 kHz  
φ 5 mm or less  
Cable length: 4 m (13.12 ft)



**NEW**  
**AC/DC CURRENT PROBE  
CT6831**

Rated 20 A AC/DC  
DC to 100 kHz  
φ 5 mm or less  
Cable length: 4 m (13.12 ft)



**NEW**  
**AC/DC CURRENT PROBE  
CT6833**

Rated 200 A AC/DC  
DC to 50 kHz  
φ 20 mm or less  
Cable length: 5 m (16.4 ft)



**NEW**  
**AC/DC CURRENT PROBE  
CT6833-01**

Rated 200 A AC/DC  
DC to 50 kHz  
φ 20 mm or less  
Cable length: 10 m (32.81 ft)



**NEW**  
**AC/DC CURRENT PROBE  
CT6834**

Rated 200 A AC/DC  
DC to 50 kHz  
φ 20 mm or less  
Cable length: 5 m (16.4 ft)



**NEW**  
**AC/DC CURRENT PROBE  
CT6834-01**

Rated 200 A AC/DC  
DC to 50 kHz  
φ 20 mm or less  
Cable length: 10 m (32.81 ft)

### Sensor unit, etc.



**SENSOR UNIT  
CT9557**

Power supply for current sensors (4 ch, with Waveform/Total Waveform/Total RMS output)



**CONNECTION CABLE  
CT9904**

ME15W (12 pin) terminal to ME15W (12 pin) terminal, 1 m (3.28 ft) length (for connecting CT9557 total output)



**AC/DC CURRENT BOX  
PW9100A-3**

3 channels  
50 A AC/DC input  
DC to 3.5 MHz



**AC/DC CURRENT BOX  
PW9100A-4**

4 channels  
50 A AC/DC input  
DC to 3.5 MHz

### Direct wire type, HIOKI ME15W terminal

### Standard current sensors, HIOKI PL14 terminal



**AC/DC AUTO-ZERO CURRENT SENSOR  
CT7742**

Rated 2000 A AC/DC  
DC to 5 kHz  
φ 55 mm (2.17 in)  
2.5 m (8.20 ft)



**AC/DC CURRENT SENSOR  
CT7642**

Rated 2000 A AC/DC  
DC to 10 kHz  
φ 55 mm (2.17 in)  
2.5 m (8.20 ft)



**AC FLEXIBLE CURRENT SENSOR  
CT7044**

Rated 6000 A AC  
10 Hz to 15 kHz  
φ 100 mm (3.94 in)  
Cable length: 2.5 m (8.20 ft)



**AC FLEXIBLE CURRENT SENSOR  
CT7045**

Rated 6000 A AC  
10 Hz to 15 kHz  
φ 180 mm (7.09 in)  
Cable length: 2.5 m (8.20 ft)



**AC FLEXIBLE CURRENT SENSOR  
CT7046**

Rated 6000 A AC  
10 Hz to 15 kHz  
φ 254 mm (10.00 in)  
Cable length: 2.5 m (8.20 ft)



**CONVERSION CABLE  
CT9920**

Required to connect a current sensor with HIOKI PL14 terminal output connector to M7103



# Selection Guide

STEP 1

## Choose a data logger

Choose a logger based on the number of channels and data output method.



**Data Logger LR8101**  
Standard model

OR



**Data Logger LR8102**  
Advanced model

STEP 2

## Choose measurement modules



**Voltage/Temp Module M7100**  
15 channels

1500 V DC terminal-to-ground voltage

OR



**Voltage/Temp Module M7102**  
30 channels

600 V DC terminal-to-ground voltage

OR



**Power Module M7103**  
3 channels

1500 V DC terminal-to-ground voltage

STEP 3

## Choose a power supply

\*An AC adapter or power cable must be purchased separately.  
No AC adapter or power cable required when using a Power Supply Module.



**AC Adapter Z1016**  
Powers the logger using grid power (AC)

OR



**Power Cable L1012**  
Powers the logger using an external power supply (DC)

OR



**AC Power Module M1100**  
Required when using the M7103

STEP 4

## Prepare a LAN cable

Connect the computer to the logger (LAN1 port).

A hub and one LAN cable to each logger are needed in order to simultaneously configure multiple devices. (The LAN1 port is used for configuring the instrument's settings, even when using UDP output.)



**LAN Cable 9642**

Straight-through LAN with crossover conversion connector, 5 m (16.4 ft.)

STEP 5

## Choose how to output data

### Output data from LAN1

There's no need to provide additional LAN cables as described in Step 4.

### Output data from LAN2

**LR8102 only**

An additional LAN cable is required if you wish to output data from the LAN2 port. Use of Cat 7 cabling is recommended since large amounts of data will be transferred at high speed.

### Output data from CAN

**LR8102 only**

One CAN cable is required for each logger.



**CAN Cable 9713-01**

With one end terminating in bare wires; length: 1.8 m (5.9 ft.)

STEP 6

## Synchronize measurement

**LR8102 only**

If you wish to synchronize measurement of multiple loggers, you'll need one optical connection cable for each logger. Choose either the L6101 or the L6102 based on the required length.



**Optical Connection Cable L6101**  
Length: 1 m (3.3 ft.)

**Optical Connection Cable L6102**  
Length: 10 m (32.8 ft.)

Note: Company names and product names appearing in this brochure are trademarks or registered trademarks of various companies.

**HIOKI**  
HIOKI E. E. CORPORATION

DISTRIBUTED BY

### HEADQUARTERS

81 Koizumi,  
Ueda, Nagano 386-1192 Japan  
<https://www.hioki.com/>



Scan for all regional contact information