

Application Note

Evaluation of the Efficiency of Inverters That Use SiC Power Devices in Electrical Railways

The VT1005 can be used with a power analyzer PW8001 to measure the efficiency of inverters that use SiC power devices.

Target

High-Efficiency Inverter for High-Voltage Input/Output

Issues

Inverters used in applications such as railways and other transportation convert high-voltage power, and it's necessary to measure high voltages to measure the efficiency of those devices. Silicon carbide (SiC) is attracting attention as a next-generation material that could take the place of conventional silicon (Si). The use of SiC power devices in inverters makes it possible to balance high-speed switching control with high-efficiency power conversion. Developers and manufacturers need to be able to measure efficiency accurately on the order of 0.1% to verify the effects of efficiency improvements in such inverters. So, the ability to measure the high-frequency components of the output power is essential.

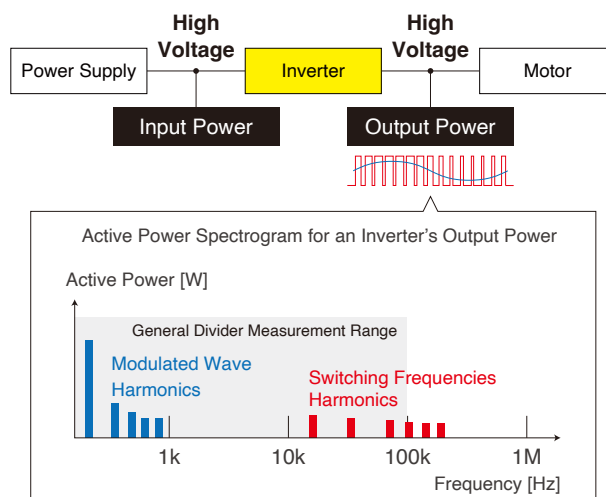

Solutions: High-Voltage Measurements

The VT1005 allows power analyzers to measure voltages of up to 5000 V.

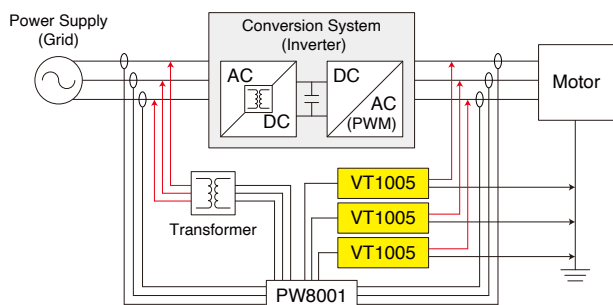

(Measurement Example) Efficiency Measurement of Railways Inverters

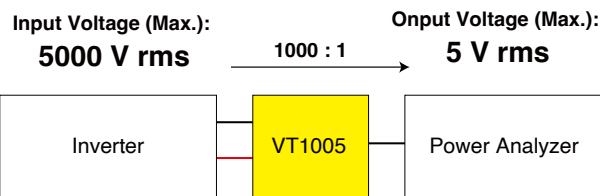

Measurement Category

- 5000 Vrms (± 7100 Vpeak) No measurement category
- 2000 Vrms CAT II
- 1500 Vrms CAT III

Equipment used

POWER ANALYZER	PW8001	HIOKI
AC/DC HIGH VOLTAGE DIVIDER	VT1005	HIOKI
AC/DC CURRENT SENSOR	CT6877A	HIOKI

Application Note

Solutions: Measurement of High-Frequency Components

The VT1005's measurement band is DC to 4 MHz, allowing it to measure voltage from DC to high frequencies. In addition, the excellent flatness of the amplitude and phase characteristics in the measurement band enables highly accurate power measurement.

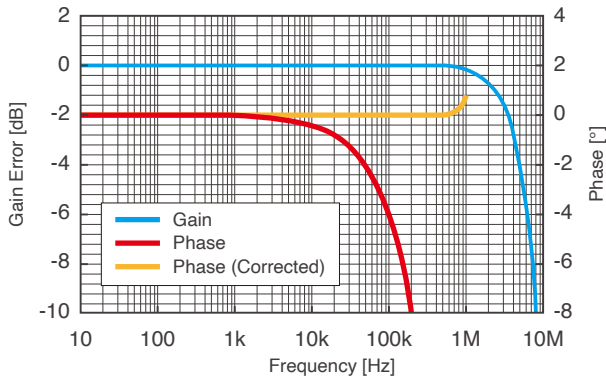

VT1005 Frequency Characteristics (Typical Value)

Key in efficiency and loss measurement: The flatness of amplitude characteristics and phase characteristics

Even if an instrument has a wide measurement band, it will be unable to accurately measure the efficiency of high-efficiency inverters or loss in reactors if it has high amplitude error and phase error within that band. The VT1005 delivers amplitude error of within $\pm 0.1\%$ (from DC to 200 kHz) and phase error of within $\pm 0.1^\circ$ (*1) (from DC to 500 kHz). The flatness of its amplitude characteristics and phase characteristics is excellent throughout the measurement band, allowing the device to accurately measure inverter efficiency on the order of 0.1%. In addition, it can measure loss in reactors that have a voltage and current phase difference of 88° with an error of $\pm 5\%$. (*1: After phase correction by the power analyzer)

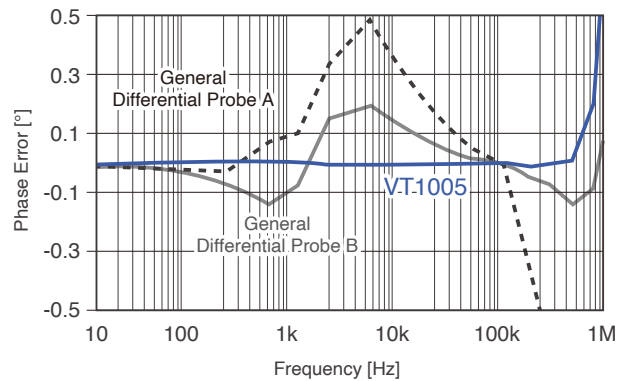
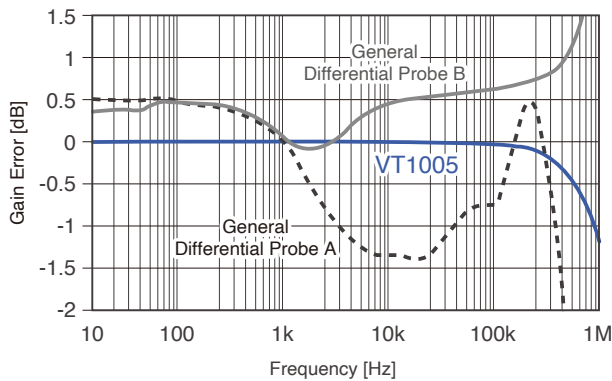

Phase correction with power analyzer

The VT1005 has defined phase correction values. These correction values can be entered into Hioki power analyzers to allow correction of phase error, which makes it possible to accurately measure voltage in the high-frequency band.

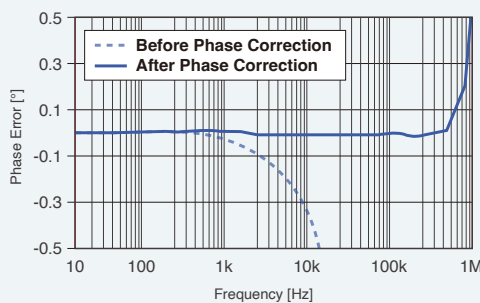

At Low Power Factors, Phase Error Has a Substantial Impact on Power Error

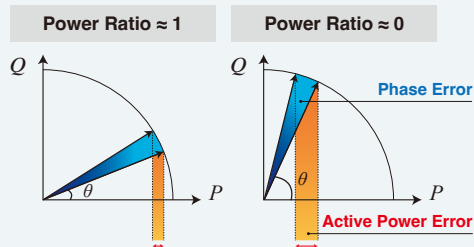

Application Note

Noise resistance

The VT1005 is highly resistant to both common-mode and high-frequency noise, allowing it to measure voltage accurately even in noisy environments. Since conversion devices like inverters are sources of noise, noise resistance is important in efficiency evaluation.

Differential Input Method:
Outputs Potential Difference Between (+) And (-) Signals
Common-Mode Noise Is Canceled

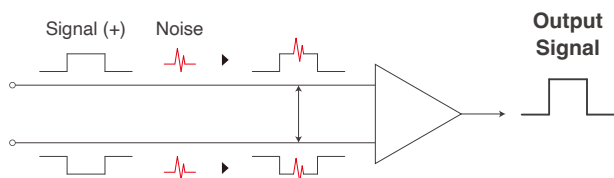

Output voltage waveform during 50 kHz switching from an Inverter that uses SiC power devices

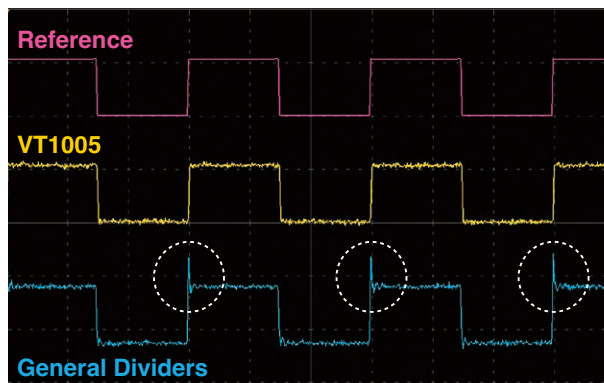

Observation of a voltage that does not exist,

Comparing the noise resistance measurement result of an inverter's secondary side.

SiC power devices are characterized by fast voltage rising and falling response, and their output waveforms contain numerous high-frequency components. Some companies' dividers are prone to the effects of high-frequency noise outside the band. Use of such dividers can lead to erroneous observation of significant ringing that is not actually occurring, resulting in large measurement errors.