

⚡ CT6875A / CT6875A-1

AC/DC CURRENT SENSOR

Maximum rating 500A, high-stability, high-accuracy, wideband DC to 2 MHz /1.5 MHz, high-CMRR, high-performance fluxgate technology, pass-through type



Features

- 5 ppm linearity
- 5 ppm offset
- Voltage output
- CT coil structure for broadband and superior frequency characteristics
- Built-in plated shield for excellent noise resistance (high CMRR)
- Aperture $\phi 36\text{mm}$ for cables and bus-bars
- The Power Analyzer PW8001 automatically recognizes the current sensor's information (phase shift data, sensor model name, rated current, serial number) when connected.

Applications

- Automotive (e.g. xEV R&D and manufacturing)
- Renewable energy (power conditioner R&D and manufacturing)
- Efficiency measurement of high-efficiency energy converters
- Analysis of industrial inverter motors
- Calibration of shunt resistors
- Measurement of minute superimposed current in battery systems
- Industrial drones
- For feedback control in medical devices (MRI,CT, X-ray)

Specification highlights	Symbol	Unit	Min.	Typ.	Max.
Nominal primary DC current	IPN DC	A	-500		500
Nominal primary AC current	IPN AC	Arms			500
Measurement range	IPM	A	-550		550
Nominal output voltage	V _{out}	V	-2		2
Primary / secondary ratio	Ratio	V/A	0.004	0.004	0.004
Linearity error	ϵ_L	ppm		± 5	
Offset error	ϵ_O	ppm		± 5	
DC amplitude error	ϵ_G	ppm		± 10	
Bandwidth ($\pm 3\text{dB}$)	f	MHz		CT6875A : 2 CT6875A-1: 1.5	
Withstand voltage (1mA, 50 /60Hz for 1minute)	U _d	kV			7.4
Power supply voltages	U _c	V	± 11.5		± 15
Operating temperature range	T _A	$^{\circ}\text{C}$	-40		85
Output cable length	L _{cab}	m		CT6875A : 3m CT6875A-1: 10m	

⚡ CT6875A / CT6875A-1

AC/DC CURRENT SENSOR

⚡ **Electrical specifications at T_A = 23°C ±5°C, supply voltage (by using external PSU) = ±12V unless otherwise stated**

Parameter	Symbol	Unit	Min.	Typ.	Max.	Comment
Nominal primary DC current	I _{PN DC}	A	-500		500	Refer to "Figure 1. Frequency derating"
Nominal primary AC current	I _{PN AC}	Arms			500	Refer to "Figure 1. Frequency derating"
Measurement range	I _{PM}	A	-550		550	Refer to "Figure 1. Frequency derating"
Maximum input current	I _{MAX}	A _{peak}	-1500		1500	Not exceeding derating curve shown in Figure 1 However, it is allowable for up to 20 ms at 40°C or less
Nominal output voltage	V _{out}	V	-2		2	
Primary/secondary ratio	Ratio	V/A	0.004	0.004	0.004	
Bandwidth (-3dB) CT6875A CT6875A-1	f	MHz		2 1.5		Refer to "Figure 2. Frequency characteristics"
Output resistance			40	50	60	
Linearity error	ε _L	ppm		±5		Refer to "Figure 3. Linearity error characteristics"
Offset error	ε _O	ppm		±5		
DC amplitude error	ε _G	ppm		±10		
AC amplitude error 10 Hz - 100 Hz 100 Hz - 1 kHz 1 kHz - 20 kHz 20 kHz - 100 kHz 100 kHz - 300 kHz 300 kHz - 1 MHz	ε _G	%		±0.005 ±0.02 ±0.08 ±0.5 ±1 ±5		
Output noise	noise	μVrms			300	Measurement bandwidth: DC to 1MHz
Effects of temperature Amplitude sensitivity Offset voltage		ppm of reading/°C ppm of full scale/°C	-20 -1		20 1	Within the range of -40°C to 0°C or 40°C to 85°C
Effects of magnetization		mA			10	Input equivalent, after 500 A DC is inputted
Common mode rejection ratio 50/60 Hz 100 kHz	CMRR	dB	140 120			(Effect on output voltage/common-mode voltage) Refer to "Figure 4. CMRR characteristics"
Effects of conductor position DC 50/60 Hz 10 kHz 100 kHz		% of reading	-0.01 -0.01 -0.4 -2.5		0.01 0.01 0.4 2.5	When wire of outer diameter 10 mm is used
Effects of external magnetic field		mA			20 20	Input equivalent, under a magnetic field of 400 A/m, DC Input equivalent, under a magnetic field of 400 A/m, 60 Hz
Effects of radiated radio-frequency electromagnetic field		% of full scale			0.5	10 V/m
Effects of conducted radio-frequency electromagnetic field		% of full scale			0.2	10 V
Fluxgate excitation frequency	f _{Exc}	kHz		10.4		
Power supply voltages	U _c	V	±11.5		±15	
Positive current consumption	I _{ps}	mA			400	DC + 500 A with ±12V
Negative current consumption	I _{ns}	mA			-400	DC - 500 A with ±12V

⚡ **Isolation specifications**

Parameter	Unit	Value	Comment
Rated insulation RMS voltage, basic insulation	V	1000	IEC 61010-1 conditions • over voltage cat III • pollution degree 2
Rated insulation RMS voltage, reinforced insulation	V	1000	
RMS voltage for AC isolation test, 50/60 Hz, 1minute	kV	7.4	Between primary and secondary (and shield) Sensed current: 1 mA
Clearance	mm	23.2	Shortest distance through air
Creepage distance	mm	23.2	Shortest path along device body
Comparative tracking index (CTI)	V	< 250	Performance level category (PLC)= 3
Standards			Safety: EN 61010 EMC: EN 61326

⚡ CT6875A / CT6875A-1

AC/DC CURRENT SENSOR

⚡ Environmental and mechanical characteristics

Parameter	Symbol	Unit	Min.	Typ.	Max.	Comment
Operating environment (altitude)		m			2000	Indoor use, pollution degree 2
Ambient operating temperature range	T _A	°C	-40		85	
Ambient storage temperature range	T _{Ast}	°C	-40		85	
Relative humidity	RH	%			80	Non-condensing
Measurable conductor diameter	D _{meas}	mm			36	
Dimensions	W H D	mm		160 112 50		Refer to "Figure 5. Dimensions"
Output cable length CT6875A CT6875A-1	L _{cable}	m		3 10		
Mounting hole diameter	D _{mout}	mm		φ5.2		M5 screws, recommended tightening torque: 1.5 Nm to 2.0 Nm
Weight CT6875A CT6875A-1	m	g		820 1150		

⚡ Measurement accuracy (total accuracy including uncertainty in calibration system etc.)

Frequency [Hz]	Amplitude		Phase [°]
	[±% of reading]	[±% of full scale]	
DC	0.04	0.008	-
DC < f < 16	0.1	0.02	0.1
16 ≤ f < 45	0.05	0.01	0.1
45 ≤ f ≤ 66	0.04	0.008	0.08
66 < f ≤ 100	0.05	0.01	0.1
100 < f ≤ 500	0.1	0.02	0.2
500 < f ≤ 1 k	0.2	0.02	0.4
1 k < f ≤ 5 k	0.4	0.02	0.5
5 k < f ≤ 10 k	0.4	0.02	0.1 × f
10 k < f ≤ 50 k	1.5	0.05	0.1 × f
50 k < f ≤ 100 k	2.5	0.05	0.1 × f
100 k < f ≤ 1 M	0.025 × f	0.05	0.1 × f
Frequency range	2 MHz/1.5 MHz (CT6875A-1) (±3 dB typical)		-

Electrical specifications at T_A = 0°C to 40°C, supply voltage (by using external PSU) = ±12 V unless otherwise stated

- The variable f in accuracy equations is expressed in kHz.
- Accuracy of amplitude and phase is specified with 110% of full scale input or less and not exceeding derating curve in Figure 1. Accuracy in range of DC < f < 10 Hz are design values.
- Add ±0.01% of reading to amplitude accuracy when input is 100% to 110% of full scale.
- For the CT6875A-1, add the following values to accuracy in the range of 1 kHz < f ≤ 1 MHz.
Amplitude accuracy: ±(0.005 × f [kHz])% of reading
Phase accuracy: ±(0.015 × f [kHz])°
- Combined accuracy with HIOKI power analyzer PW8001, PW6001 and PW3390 is specified (DC, 45 Hz ≤ f ≤ 66 Hz).
For details of combined accuracy, refer to the instruction manual (<https://www.hioki.com/download/38368>).

⚡ Definition of on accuracy

(total accuracy including uncertainty in calibration system etc.)

Reading (displayed value) error:

Indicates the value displayed by the instrument. Limit values for reading errors are expressed as a percentage of the reading ("%" of reading" or "% rdg").

Range error:

Indicates the instrument's range. Limit values for range errors are expressed as a percentage of the range ("%" of range").

Full scale (rated current) error:

Indicates the rated current. Limit values for full-scale errors are expressed as a percentage of full scale ("%" of full scale" or "% f.s.").

Calibration:

The accuracy of HIOKI products includes all factors that affect the measurement results, such as calibration system errors, ambient temperature, and secular change, as "uncertainty".

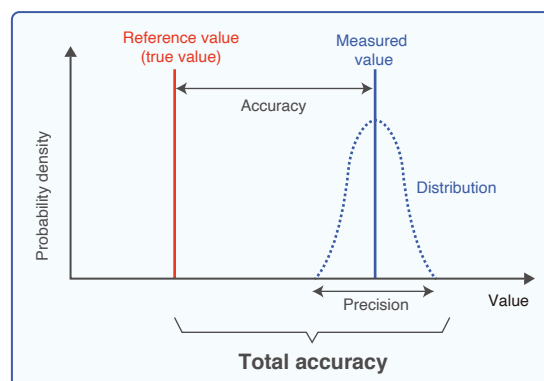





HIOKI is accredited as an official ISO/IEC 17025 calibrator.

⚡ CT6875A / CT6875A-1

AC/DC CURRENT SENSOR

⚡ Specific accuracy calculation example

How to measure the current of **DC 300A** of a conductor with a diameter of $\phi 30$ mm or less with high accuracy.
Guaranteed specifications at $T_A = 23^\circ\text{C} \pm 5^\circ\text{C}$

Measuring instrument configuration	CT6875A,CT6875A-1	CT9555	L9217 + 9704	DM7276
External view				
Range (connection)	500 A (2 V)	Front OUTPUT terminal (BNC terminal)	✓	10V
Output voltage	$300\text{ A} \times 2\text{ V} / 500\text{ A} = 1.2\text{ V}$			-
Error (reading)	0.04%	-	-	0.0009%
Error (full scale)	0.008%	-	-	12 μV
Total error	$1.2\text{ V} \times (0.04 + 0.0009)\% + 2\text{ V} \times 0.008\% + (12\ \mu\text{V} \times 10^{-6})\text{ V} = 0.0006628\text{ V}$			
Total error (input equivalent)	$0.0006628\text{ V} / 2\text{ V} \times 500\text{ A} = 0.1657\text{ A}$			
Error range	$300\text{ A} \pm 0.1657\text{ A} \rightarrow 299.8343\text{ A to } 300.1657\text{ A}$			

⚡ Definition of linearity error

Linearity error ϵ_L :

Indicates that the output (current or voltage) changes linearly in response to the input current.

A regression line is attained by measuring the output voltage in the sequence below in 100 A intervals:

+500 A \rightarrow 0 A \rightarrow -500 A \rightarrow 0 A \rightarrow +500 A

It is defined as the difference between the regression line calculated from the above measurements and the measurement points.

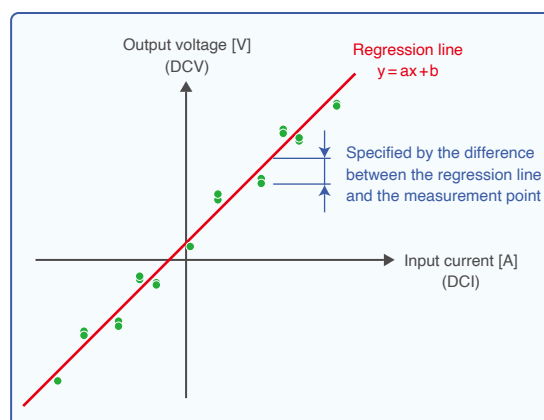

⚡ Definition of offset error

Offset error ϵ_O :

Specified by the ratio of the average value (μ) of the measured values of the offset voltage and the rated current (I_{max}) of each current sensor.

$$\epsilon_O = \mu / I_{max} \text{ [ppm]}$$

⚡ Definition of amplitude error

Amplitude error ϵ_G :

An index showing the degree of flatness of the frequency characteristics of gain.

DC error is defined as (linearity error + offset error).

AC error is defined as deviation from the 55 Hz measurement point.

$$\epsilon_{DC} = \epsilon_L + \epsilon_O \text{ [ppm]}$$

$$\epsilon_{GAC} = \frac{\text{Gain}(f) - \text{Gain}(55\text{ Hz})}{\text{Gain}(55\text{ Hz})} \times 100 \text{ [%]}$$

CT6875A / CT6875A-1

AC/DC CURRENT SENSOR

Figure 1. Frequency derating

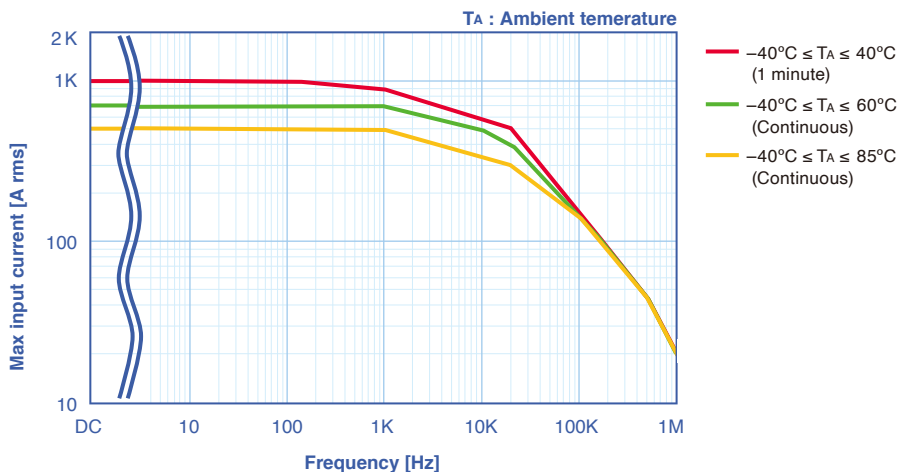

Figure 2. Frequency characteristics

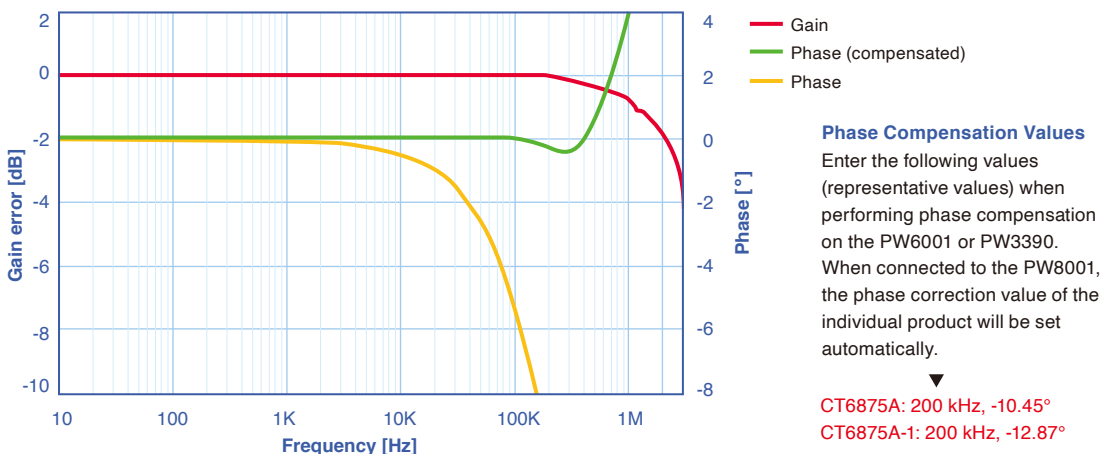
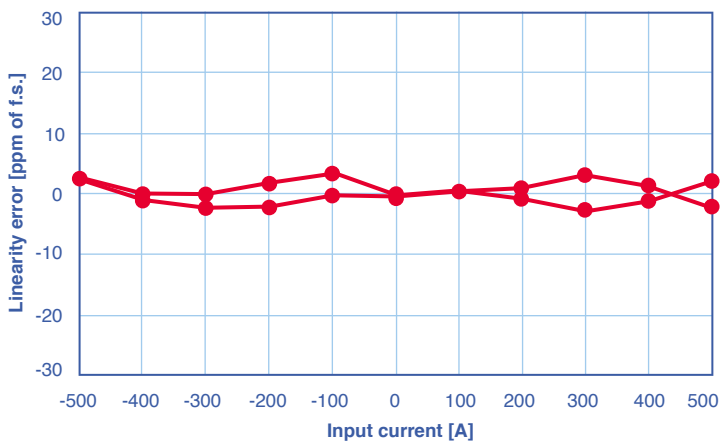

Figure 3. Linearity error characteristics



⚡ CT6875A / CT6875A-1

AC/DC CURRENT SENSOR

⚡ Figure 4. CMRR characteristics

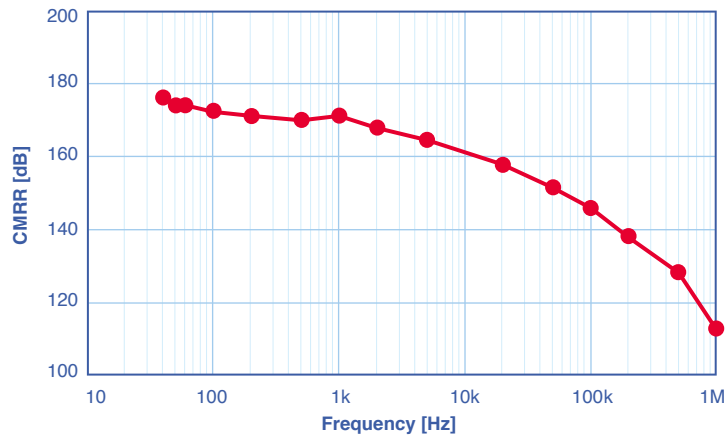

⚡ CT6875A / CT6875A-1

AC/DC CURRENT SENSOR

⚡ Figure 5. Dimensions

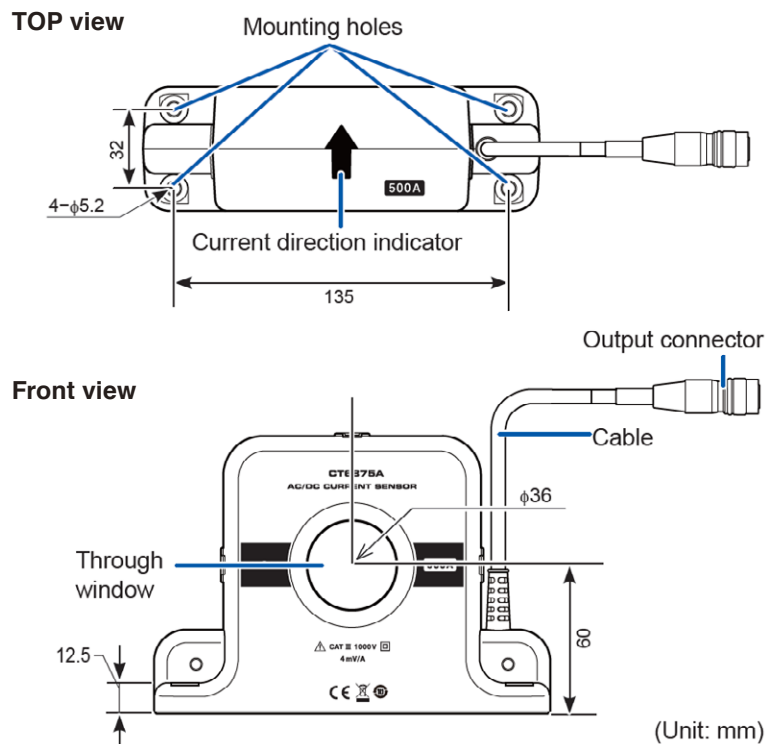

⚡ Figure 6. Pin assignment (when not using the sensor units CT9555, CT9556, or CT9557)

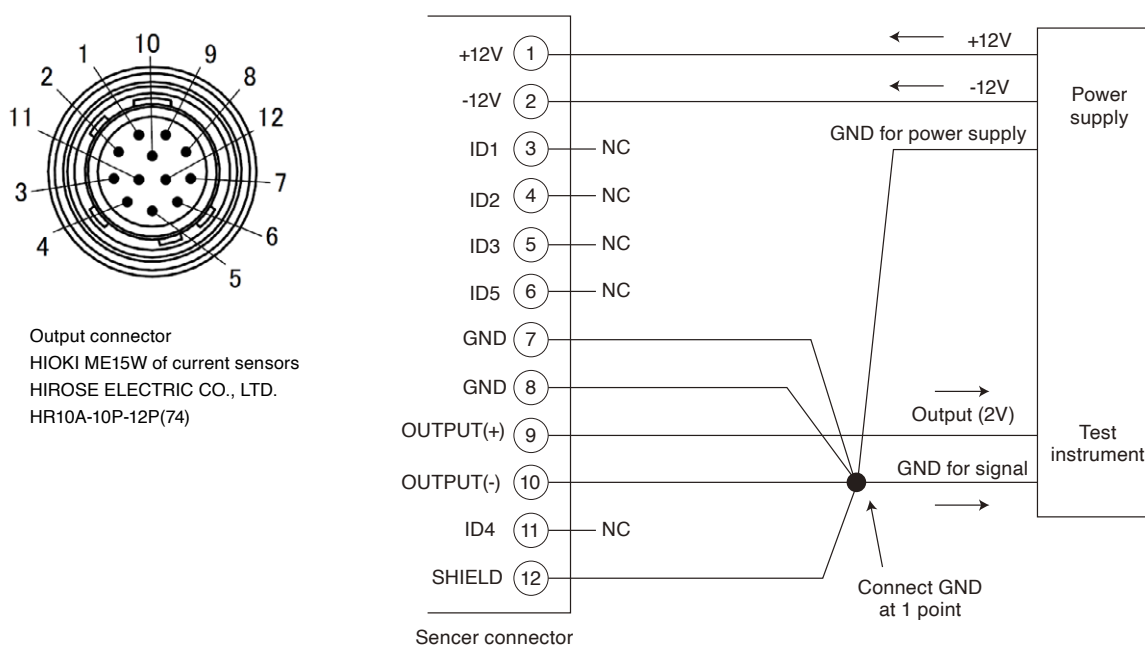

⚡ CT6875A / CT6875A-1

AC/DC CURRENT SENSOR

⚡ Figure 7. Options and main combination

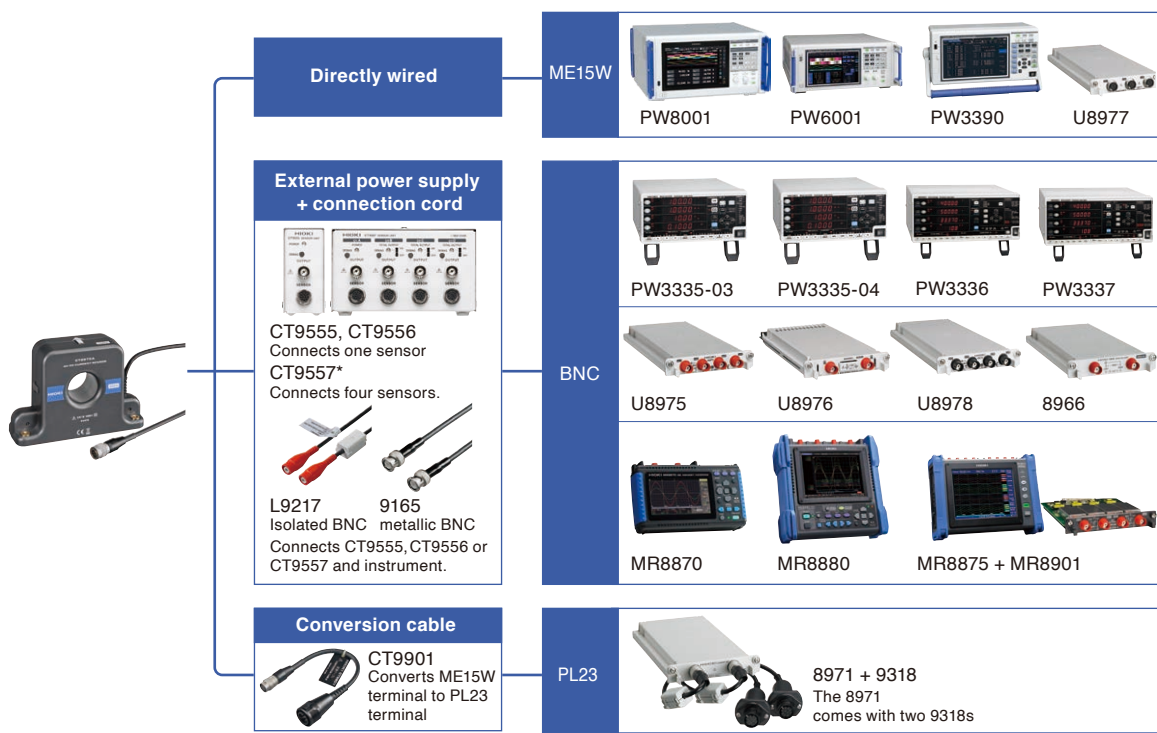

The CT9557 not only functions as a 4-channel power supply, but can also output additive waveform and RMS output from up to four input waveforms.

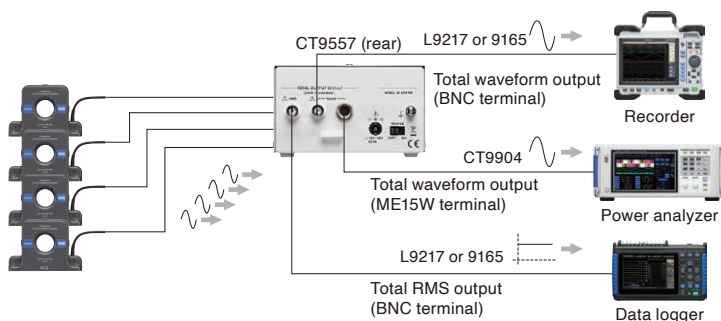

CT9904 CONNECTION CABLE
ME15W (12 pin) terminal - ME15W (12 pin) terminal
The CT9904 is the cable for the CT9557 addition output and POWER ANALYZER PW8001/PW6001/PW3390 connection.



CT9902 EXTENSION CABLE
ME15W (12 pin) terminal - ME15W (12 pin) terminal
The CT9902 can be used to extend a current sensor's cable by 5m. Up two of these cables can be used for a maximum extension of 10 m.
*When using the CT9902, an additional accuracy needs to be added. For details, see the sensor's user manual.

⚡ Links

1. Web site https://www.hioki.com/global/products/current-probes/high-precision/id_345446
2. Accuracy calculation tools
PW8001, PW6001, PW3390: <https://hioki-cierto.com/gl/fm50bha8wk/>

Files and information such as the Power Analyzer accuracy calculation tools are updated regularly. Instead of downloading them once and using them for a long time, download them from the download link just before using them.