

CM4371-50

CM4373-50

CM4375-50

AC/DC CLAMP METER

HIOKI

Instruction Manual



Read carefully before use.

Keep for future reference.



EN

Nov. 2023 Revised edition 2
CM4371C961-02



Contents

Introduction.....	1
Notations	3
Checking Package Contents	7
Options	8
Safety Information	11
Operating Precautions	12
1 Overview	19
1.1 Product Overview and Features	19
1.2 Part Names	20
2 Making Measurements	21
2.1 Inspection Before Measurement.....	21
2.2 Installing Batteries and the Z3210 Wireless Adapter	22
Installation procedure	26
2.3 Use of Test Leads.....	28
L9300 Test Lead (accessory).....	30

2.4	Current Measurement	33
	Manual hold, automatic hold	35
	Switching the ranges	39
	Filter function	40
	Maximum value, minimum value, average, and peak value	41
	Inrush current (inrush)	42
2.5	Various Other Measurement Functions	43
2.6	LCD Backlight, Automatic Power Save (APS)	47
2.7	DC High V Probe Mode	48
2.8	Wireless communications function.....	52
	Using GENNECT Cross.....	52
	Z3210-to-Excel direct data entry function (Excel direct input function, HID function).....	55
2.9	Rotary Switch Combinations	59
3	Specifications	61
3.1	General Specifications	61
3.2	Input Specifications, Measurement Specifications	65
3.3	Accuracy table.....	75

4	Maintenance and Service	107
4.1	Troubleshooting	107
4.2	Error and Operation Displays	109
4.3	Cleaning	110
5	Appendix	111
5.1	Voltage Detection Function	111
5.2	Example of Use	113
	Index	115
	Warranty Certificate	119

Introduction

Thank you for choosing the Hioki CM4371-50/CM4373-50/CM4375-50 AC/DC Clamp Meter. To ensure your ability to get the most out of this instrument over the long term, please read this manual carefully and keep it available for future reference.

Read the separate document “Operating Precautions” carefully before using the instrument.

Latest edition of instruction manual

The contents of this manual are subject to change, for example as a result of product improvements or changes to specifications.

The latest edition as well as multilingual editions of the manual (in Chinese, French, German, Italian Korean, and Spanish) can be downloaded from Hioki’s website.

<https://www.hioki.com/global/support/download>



Product registration

Register your product in order to receive important product information.

<https://www.hioki.com/global/support/myhioki/registration>



Target audience

This manual has been written for use by individuals who use the product in question or who teach others to do so. It is assumed that the reader possesses basic electrical knowledge (equivalent to that of someone who graduated from the electrical program at a technical high school).







Trademarks

- Excel is a trademark of the Microsoft group of companies.
- The Bluetooth[®] word mark and logos are registered trademarks owned by Bluetooth SIG, Inc. and any use of such marks by Hioki E.E. Corporation is under license. Other trademarks and trade names are those of their respective owners.







Notations

Safety notations



In this document, the severity levels of risk and hazard are classified as follows.

 DANGER	<p>Indicates an imminently hazardous situation that, if not avoided, will result in death or serious injury.</p>		<p>Indicates an action that must not be performed.</p>
 WARNING	<p>Indicates a potentially hazardous situation that, if not avoided, could result in death or serious injury.</p>		<p>Indicates an action that must be performed.</p>
 CAUTION	<p>Indicates a potentially hazardous situation that, if not avoided, could result in minor or moderate injury or potential risks of damage to the supported product (or to other property).</p>		<p>Indicates a high-voltage hazard. Failure to verify safety or improper handling of the instrument could lead to electric shock, burn injury, or death.</p>
IMPORTANT	<p>Indicates information or content that is particularly important from the stand point of operating or maintaining the instrument.</p>		<p>Indicates the presence of a hazard caused by a strong magnet. The product could interfere with the proper operation of electronic medical devices such as pacemakers.</p>

Symbols shown on the instrument

	<p>Indicates the presence of a potential hazard. For more information about locations where this symbol appears on instrument components, see the "Operating Precautions" (p. 12) and the accompanying document entitled "Operating Precautions."</p>
	<p>Indicates that a dangerous voltage is generated from this terminal.</p>
	<p>Indicates that the product can be attached or detached while the circuit is live.</p>
	<p>Indicates the instrument is protected throughout by double insulation or reinforced insulation.</p>
	<p>Indicates alternating current (AC).</p>
	<p>Indicates direct current (DC).</p>
	<p>Indicates the grounding terminal.</p>

Symbols for various standards

	<p>Indicates that the product is subject to the Waste Electrical and Electronic Equipment (WEEE) Directive in EU member nations.</p>
	<p>Indicates that the product complies with standards imposed by EU directives.</p>

Screen display

The instrument screen displays the alphanumeric characters as follows.

A	B	C	D	E	F	G	H	I	J	K	L	M	N	O	P	Q	R	S	T	U	V	W	X	Y	Z
A	b	C	d	E	F	G	H	,	J	K	L	ñ	n	o	P	q	r	S	t	U	u	y	1	4	≡

Exception

OPEN : Wire break detected

1	2	3	4	5	6	7	8	9	0
1	2	3	4	5	6	7	8	9	0

Notations

Accuracy labeling

Instrument accuracy is expressed by defining a percentage of the reading, a percentage of full scale, a percentage of the setting, or a limit value for errors in terms of digits.

Reading (display value)	Indicates the value displayed by the instrument. Limit values for reading errors are expressed as a percentage of the reading (“% rdg”).
Full scale (maximum display value)	Indicates the maximum display value for each measurement range. Measurement range values for the instrument indicates that maximum display value. Limit values for full-scale errors are expressed as a percentage of full scale (“% f.s.”).

Other notations

(p.)	Indicates the page number to reference.
*	Indicates additional information is described below.
CM4371-50	Indicates that the item is applicable to the CM4371-50 only.

Checking Package Contents

When you receive the instrument, inspect it to ensure that no damage occurred during shipment. Pay particular attention to included accessories, panel keys, and terminals. If you find any damage or discover that the instrument does not perform as indicated in its specifications, please contact your authorized Hioki distributor or reseller.

AC/DC Clamp Meter



L9300 Test Lead
(p.28)



C0203 Carrying Case



LR03 Alkaline batteries ×2



Instruction Manual
(this manual)

Please visit Hioki's website to download other language versions in PDF format.



Operating Precautions
(0990A907)



Options

The options listed below are available for the instrument. To order an option, please contact your authorized Hioki distributor or reseller.

Options are subject to change. Check Hioki's website for the latest information.

Connection cables

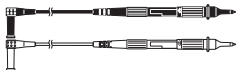

L9300 Test Lead*1



L9207-10 Test Lead*1

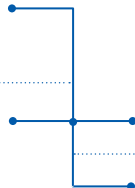

When attaching the L4933 or L4934 to test leads, set the test leads to the measurement category II configuration (for the L9207-10, remove the sleeves).

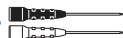

L4933 Contact Pin Set*3



L4934 Small Alligator Clip Set**4



L4930 Connection Cable Set^{*2}
(length: 1.2 m)



L4931 Extension Cable Set^{*2}
(length: 1.5 m,
with the coupling connector)

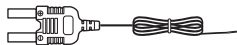

DT4910 Thermocouples (K)

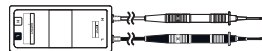

P2000 DC High Voltage Probe^{*11}



L4935 Alligator Clip Set^{*2}

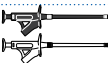

L9243 Grabber Clip^{*5}

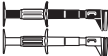

L4936 Bus Bar Clip Set^{*6}



L4937 Magnetic Adapter Set^{*7}



9804 Magnetic Adapter^{*10}



L4932 Test Pin Set^{*1}



L4938 Test Pin Set^{*8}



L4939 Breaker Pin Set^{*9}

*1: CAT IV 600 V, CAT III 1000 V, CAT II 1000 V, 10 A

*2: CAT IV 600 V, CAT III 1000 V, 10 A

*3: 30 V AC, 60 V DC, 3 A

*4: CAT III 300 V, CAT II 600 V, 3 A

*5: CAT II 1000 V, 1 A

*6: CAT III 600 V, 5 A

*7: CAT III 1000 V, 2 A

*8: CAT III 600 V, CAT II 600 V, 10 A

*9: CAT III 600 V, 10 A

*10: CAT IV 1000 V, 2 A

*11: CAT IV 1000 V, CAT III 2000 V

Options

Carrying cases

The instrument, test leads, and the instruction manuals can be accommodated.

C0203 Carrying Case



C0207 Carrying Case



Z3210 Wireless Adapter



Connecting the Z3210 to the instrument enables the wireless communication function.

See "2.8 Wireless communications function" (p.52).

Safety Information

Measurement categories

The instrument conforms to the safety requirements for CAT III 1000 V and CAT IV 600 V measuring instruments.

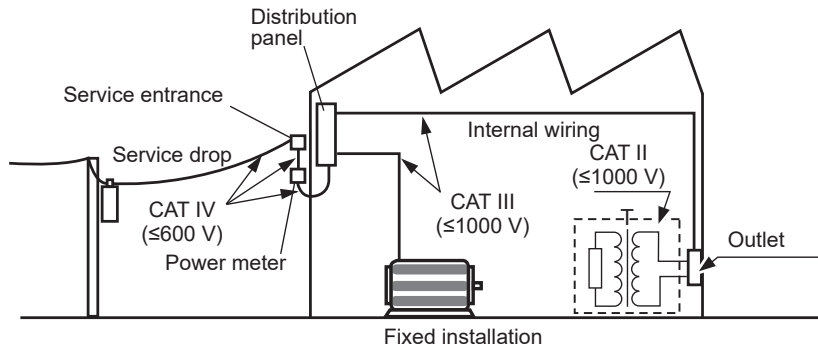

Operating Precautions

Observe the following precautionary information to ensure that the instrument can be used safely and in a manner that allows it to perform as described in its specifications. Carefully read the separate document entitled “Operating Precautions” before use. Use of the instrument should conform not only to its specifications, but also to the specifications of all accessories, options, and other equipment in use.

DANGER

■ **Do not touch the section beyond the barrier during operation.**

Failure to do so could cause the operator to experience an electric shock.
See “1.2 Part Names” (p.20).



■ **Do not measure any current in excess of the derating curve.**

Doing so can cause overheating of the sensor, resulting in bodily injury, fire, or damage to the instrument.

See “Frequency derating characteristics” (p.68).

The maximum measurement current varies with the frequency, and the current that can be measured continuously is limited. Operating the instrument at less than this limitation is referred to as derating.

 **DANGER**

- **Inspect the instrument and verify proper operation before use.**

Use of the instrument while malfunctioning could result in serious bodily injury. If you find any damage, contact your authorized Hioki distributor or reseller. See “2.1 Inspection Before Measurement” (p.21).



- **Confirm that the white portion (insulation layer) inside the cable is not exposed.**

Using the instrument with a color inside its cable exposed could cause the operator to experience an electric shock.

 **WARNING**

- **Do not allow the instrument to get wet.**
- **Do not take measurements with wet hands.**

Failure to do so could cause the operator to experience an electric shock.



- **When using the instrument while connected to test leads, do not make measurements that exceed either of the ratings indicated on the instrument or on the test leads, whichever is lower.**

Using the instrument to make measurements that exceed either rating could cause the operator to experience an electric shock.

IMPORTANT

■ Do not allow any foreign object to be caught between the facing core surfaces of the jaws.



■ Do not scratch the facing core surfaces of the jaws.

■ Do not touch the facing core surfaces of the jaws with your fingers.



■ Do not insert any foreign object into the gap of the jaws.

■ Do not drop the instrument.

■ Do not subject the instrument to any shock.

Doing so may adversely affect the measurement accuracy and open/close operation.

Clamp the instrument around only one conductor. Clamping the instrument around two or more of conductors in a bundle prevents the instrument from measuring any current regardless of whether the measurement target is a single-phase or three-phase circuit.

L4937 Magnetic Adapter Set / 9804 Magnetic Adapter (optional)

 **DANGER**



- **People with electronic medical devices such as pacemakers should not use the magnetic adapter.**
- **Keep the magnetic adapter away from the body.**

Failure to do so may affect proper operation of the electric medical devices, presenting a hazard to human life.

 **CAUTION**

- **Do not drop the magnetic adapter.**
- **Do not subject the magnetic adapter to mechanical shock.**

Doing so could damage the magnetic adapter.
- **Do not use the magnetic adapter in locations where it may be exposed to rainwater, dust, or condensation.**

Doing so could decompose or deteriorate the magnetic adapter. In addition, diminished magnetic adhesion cause the instrument to drop, resulting in damage to the instrument.
- **Do not bring the magnetic adapter near magnetic storage devices, such as floppy disks, magnetic cards, prepaid cards, or magnetized tickets.**
- **Do not bring the magnetic adapter near precision electronic equipment, such as computers, TV screens, or electronic wrist watches.**





Doing so could damage such devices or data stored in them.



1.1 Product Overview and Features

This instrument is a clamp meter that can perform true RMS measurement of current simply by clamping it around a circuit. In addition to current, it can measure voltage, frequency, rush current, resistance, diode, capacitance, temperature, and AC power. Installing the Z3210 Wireless Adapter (optional) to the instrument allows your mobile device to display waveforms and measure harmonics.

Measurement function list

	DC current and DC voltage, DC power
NCV	Electric charge detection CM4371-50 CM4373-50
TEMP 	Capacitance, temperature
	Continuity check, resistance, diode
	Automatic AC/DC, AC voltage, DC voltage, AC+DC voltage, frequency
	Automatic AC/DC, AC current, DC current, AC+DC current, frequency

1.2 Part Names

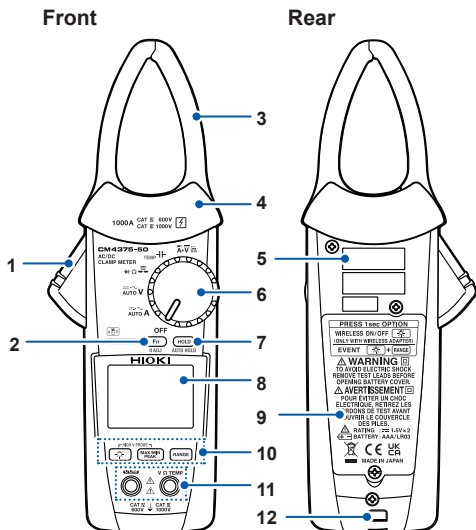

(The illustration shows the CM4375-50.)

1	Operation grip
2	Fn key (allows you to choose a function)
3	Jaws
4	Barrier
5	Serial number (The serial number consists of 9 digits. The first two (from the left) indicate the year of manufacture, and the next two indicate the month of manufacture.)
6	Rotary switch See "Measurement function list" (p. 19).
7	HOLD key
8	LCD
9	Battery cover
10	Operation keys
11	Measurement terminals
12	Strap hole

2

Making Measurements

2.1 Inspection Before Measurement

2

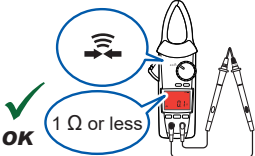
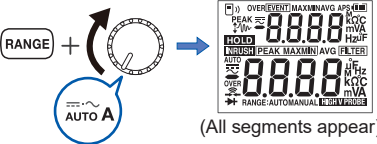
Check	Inspection details	Check	Inspection details
<input type="checkbox"/>	The battery cover is closed and its screw has been securely tightened.	<input type="checkbox"/>	There is no damage to the test lead insulation, and neither the white sheathing nor metal conductor inside the wire are exposed.
<input type="checkbox"/>	There is no foreign matter on the measurement terminals (p.20).	<input type="checkbox"/>	The instrument is neither damaged nor cracked.
<input type="checkbox"/>	The test leads are not broken (p.44). 	<input type="checkbox"/>	No segments are missing.  (All segments appear)

2.2 Installing Batteries and the Z3210 Wireless Adapter

Installing the Z3210 to the instrument enables the wireless communications function. (p.52)
Before using the instrument for the first time, insert two LR6 Alkaline batteries or two fully charged HR6 Nickel-metal hydride batteries.

WARNING

- **Before removing the battery cover, remove the instrument from an object under measurement and set the rotary switch to the OFF position.**



Failure to do so could cause the operator to experience an electric shock. When the instrument is clamped around the object under measurement, the battery contact terminals are regarded as high-voltage parts.

 **WARNING**

- **After replacing the batteries or installing/removing the Z3210 Wireless Adapter, install the battery cover and tighten the screw, then use the instrument.**



Use of the instrument with the battery cover removed could result in bodily injury.

- **Secure the battery cover with the screw attached to the instrument at the time of shipment.**

If you have lost the screw or find that the screw is damaged, please contact your authorized Hioki distributor or reseller.

CAUTION



- Do not mix batteries of different ages or types.
- Do not use a battery whose recommended service life has expired.
- Do not reverse the battery polarity.
- Do not leave the exhausted batteries in the instrument.

Doing so may cause the batteries to leak, damaging the instrument.



- Use the specified type of batteries only (LR03 Alkaline batteries or HR03 Nickel-metal hydride batteries).
 - Remove the batteries when the instrument is not in use for an extended period of time.
- Doing so may cause the batteries to leak, damaging the instrument.
- Before handling the Z3210, eliminate static electricity on your body by touching any metallic part, such as a doorknob.

Failure to do so may cause static electricity to damage the Z3210.

- When the  mark blinks, the batteries will be exhausted. Replace the batteries with new ones in good time. The instrument may be turned off when the display is backlit or the buzzer sounds. After use, be sure to turn off the instrument.
- Dispose of the batteries in accordance with local regulations.

Nickel-metal hydride batteries

CAUTION



- **When using the instrument, insert two LR6 Alkaline batteries or two fully charged HR6 Nickel-metal hydride batteries.**

2

The instrument powered by nickel-metal batteries will indicate an inaccurate remaining-battery level; however, it can be used without any trouble even with such batteries inserted. See the continuous operating time below.

For CM4371-50

- When two LR03 Alkaline batteries are used
Approx. 40 hours (without the Z3210 installed)
Approx. 20 hours (with the Z3210 installed, in wireless communication)
- When two LR03 nickel-metal hydride batteries (750 mAh capacity each) are used
Approx. 40 hours (without the Z3210 installed)
Approx. 25 hours (with the Z3210 installed, in wireless communication)

Visit an FAQ page on Hioki's global website for more information about nickel-metal hydride batteries that Hioki has guaranteed to work.

Installation procedure

Read the precautions before performing the procedure. (p.22)

You will need:

Phillips screwdriver (No. 2)

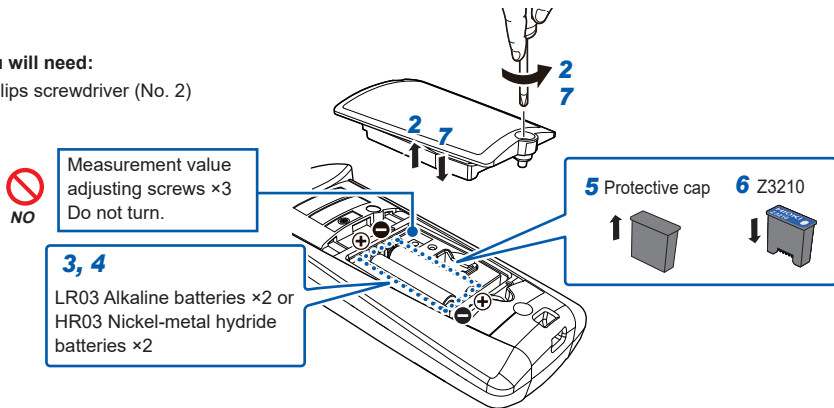

Do not turn any screws except the battery cover screw.

After removing the battery cover, you will find three screws, which are used to adjust measured values. Do not turn them because the instrument will not be able to perform measurement accurately.

- 1** Remove the instrument from an object under measurement and set the rotary switch to the OFF position.
- 2** Loosen the screw and remove the battery cover.
- 3** Remove the old batteries (when replacing the batteries).
- 4** Install fresh batteries, observing the correct polarity.
When installing the Z3210 Wireless Adapter, go on to step **5**.
When not installing the Z3210 Wireless Adapter, go on to step **7**.
- 5** Remove the protective cap from the instrument.
- 6** Install the Z3210 Wireless Adapter, observing the correct orientation.
- 7** Reattach the battery cover and tighten the screw.

2.3 Use of Test Leads

The L9300 Test Lead (accessory) or the L9207-10 Test Lead (optional) is used for measurement. Depending on measurement locations, use Hioki's optional measurement cables. See "Options" (p.8)

WARNING



■ **When using the instrument, use the test leads and options specified by Hioki.**

Using test leads and options other than those specified could cause bodily injury or short circuit accidents.



■ **When measuring the power line voltage, use test leads that satisfy the following conditions.**

- IEC 61010 or EN 61010 safety standard-compliant
- Rated for measurement category III or IV
- With the rated voltage higher than voltage being measured

Failure to do so could cause the operator to experience an electric shock. The optional test leads for this instrument comply with the EN 61010 safety standard. Observe the measurement category and rated voltage indicated on the test leads during use.

 **CAUTION**

- **Do not bend the cables at temperatures of 0°C or lower. Do not pull on the cables.**



The cables can become rigid. Doing so could damage the insulation or cause a wire break, resulting in an electric shock.

L9300 Test Lead (accessory)

See the precautions in “Use of Test Leads” (p.28) as well.

WARNING

- **Use the test leads with the correct measurement category displayed.**
- **Do not use the test leads if the metal pin is bent or the protective finger guard does not slide properly.**



Doing so could cause short circuit accidents.

Switching the measurement category

1 Unlock the protective finger guard.

Rotate the grip to unlock, moving the ▷ mark along the guide line.

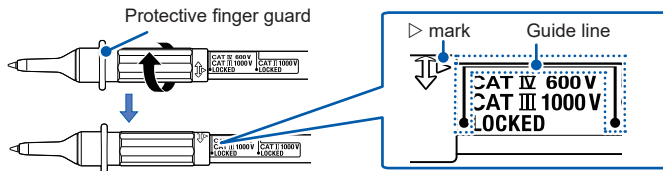

2

2 Slide the protective finger guard.

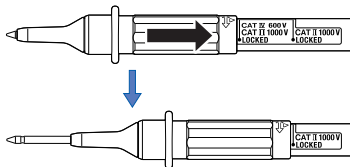

Slide the ▷ mark along the guide line.

Use of Test Leads

3 Lock the protective finger guard.

Rotate the grip to lock, moving the ▷ mark along the guide line.

Rotate the grip until it clicks, and make sure that the ▷ mark indicates **[LOCKED]**.

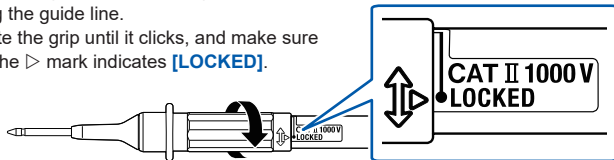

Perform the above steps to switch over from measurement category II to measurement category III or IV as well.

2.4 Current Measurement

- 1 Rotate the rotary switch.



- 2 Hold down for 1 s.



IMPORTANT

Always perform zero adjustment to perform accurate measurement.

- 3 Clamp the instrument around the wire.

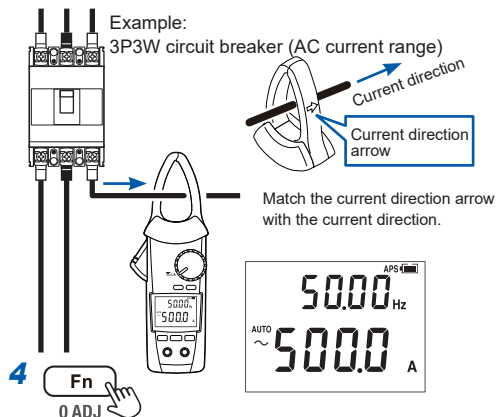

4

AUTO → \sim → \equiv → \equiv → Hz
(Auto AC/DC) (AC A) (DC A) (AC+DC A) (Frequency)

2

Current Measurement

Frequency detection range for AC current

CM4371-50	20.00 A range	4.00 A or more
	600.0 A range	20.0 A or more
CM4373-50	600.0 A range	40.0 A or more
	2000 A range	200 A or more
CM4375-50	—	5.0 A or more

DC voltage polarity check (p.59)

If the measured value is negative, the buzzer will sound and the display will be backlighted in red.
(threshold: -10 A)

Manual hold, automatic hold

Manual hold

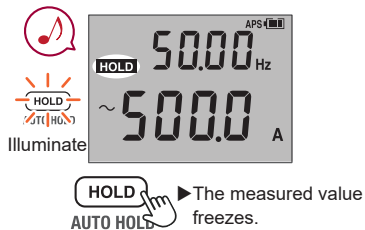

Press the **HOLD** key again to disable the hold function.

Automatic hold

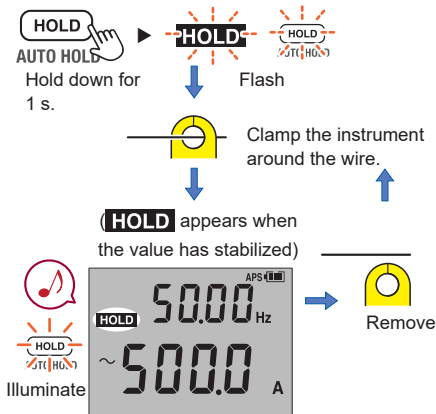

The measured value freezes automatically.

Holding down the **HOLD** key for 1 s to disable the automatic hold function.

Automatic hold conditions

Displayed value will freeze when the following two conditions are satisfied at the same time:

- When the measured value fluctuation stabilizes within the fluctuation range described in the table on the next page.
- When the measured value exceeds the threshold value described in the table on the next page (voltage, current).

When the measured value is less than the threshold value described in the table on the next page (resistance, continuity check, diode).

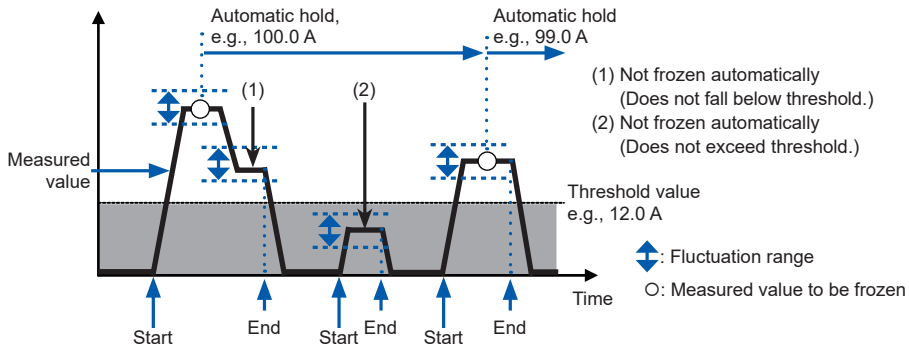

Suppose that the measured value has fallen below (voltage, current) or exceeded the threshold value (resistance, continuity, diode) after the displayed value froze. When the two auto-hold conditions are met again after that, refreshing measured values will stop.

Measurement function*1	Measurement range	Fluctuation range	Threshold value
Auto A AC current DC current AC+DC current	20.00 A range (CM4371-50)	Within 1.00 A	1.00 A
	600.0 A range (CM4371-50, CM4373-50)	Within 12.0 A	12.0 A
	1000 A range (CM4375-50)	Within 12.0 A (When inputting more than 12.0 A) Within 1.0 A (When inputting more than 12.0 A)	12.0 A (When inputting more than 12.0 A) 0.9 A (When inputting more than 12.0 A)
	2000 A range (CM4373-50)	Within 40 A	40 A

Current Measurement

Measurement function*1	Measurement range	Fluctuation range	Threshold value
Auto V*2 AC voltage DC voltage*2 AC+DC voltage	6.000 V, 60.00 V, 600.0 V range	Within 120 counts	120 counts
	1000 V range	Within 20 V	20 V
DC High V Probe Mode	600.0 V range	Within 12.0 V	80.0 V
	2000 V range	Within 20 V	80 V
Continuity check Resistance	600.0 Ω range, 6.000 k Ω range, 60.00 k Ω range, 600.0 k Ω range, 6.000 M Ω range	Within 100 counts	4900 counts
Diode	1.800 V range	Within 0.040 V	1.460 V

*1: The automatic hold function does not support measurement functions not listed in this row.

*2: Except the 600.0 mV range (only when the range is set manually)

Switching the ranges

When the CM4373-50 measures current

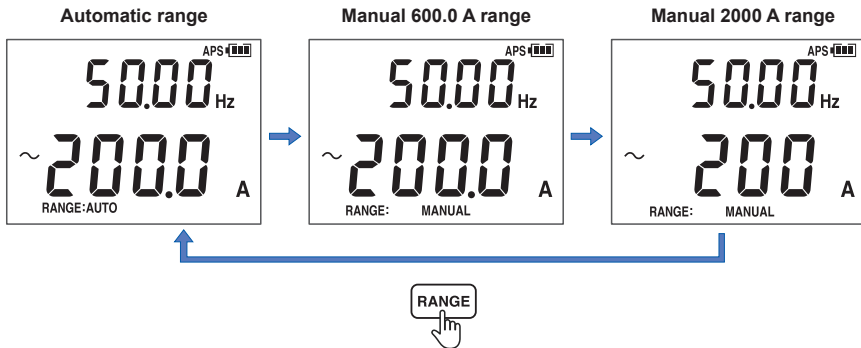

2

When the CM4371-50 measures current



The CM4375-50 provides the 1000 A range only.

Filter function

Filter off

Measured value including noise

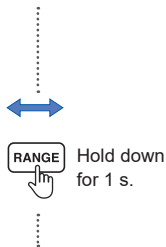
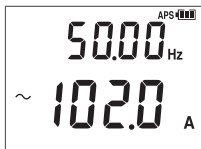

Filter on

Measured value with reduced noise



Frequency characteristics when the filter function is enabled

(100 A input)

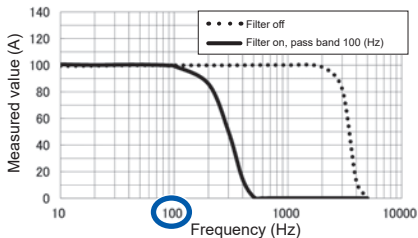

Disable the filter function when performing measurement of power supply frequencies in excess of 100 Hz, for example, on an aircraft or ship.

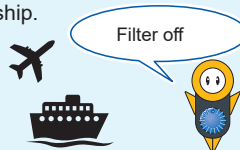

Maximum value, minimum value, average, and peak value

- 1 Clamp the instrument around the wire.



- 2 **Fn**
0 ADJ



AUTO

(Auto AC/DC)



(AC A)



(DC A)



(AC+DC A)

Hz

(Frequency)

MAX, MIN, AVG,
and PEAK are
unavailable in Auto
AC/DC mode.

- 3 **MAX/MIN**
PEAK
INRUSH

MAX → MIN → AVG → **PEAK MAX** → **PEAK** → MIN

- 4 **HOLD**
AUTO HOLD

► The measured value
freezes.

MAX/MIN
PEAK
INRUSH

Hold down for 1 s.
► Cancel

The instrument
measures RMS
values.



AVG indicates
the average of all
measured values.

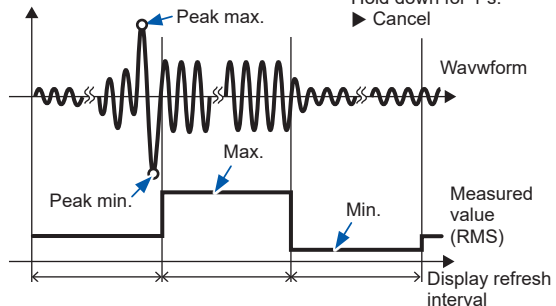

Inrush current (inrush)

- 1 Turn off the motor.
- 2 Rotate the rotary switch.



- 3 Hold down for 1 s.

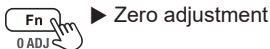

- 4 Clamp the instrument around the wire.

See "Inrush trigger level" (p.67).

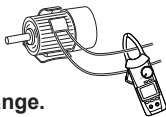

- 5 Set the range.

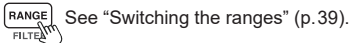

In automatic ranging mode, the instrument will be automatically set to the 600.0 A range (CM4371-50), 2000 A range (CM4373-50).

- 6 Hold down for 1 s.



- 7 Turn the motor on.

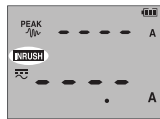
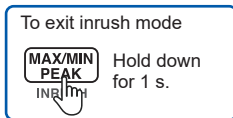

(Inrush current occurs)

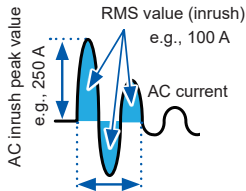
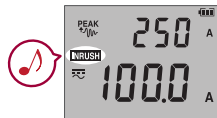

Inrush current occurrence period (about 10 ms to 999 ms)

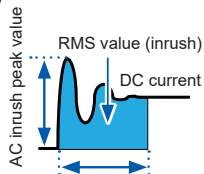

Inrush current occurrence period (about 10 ms to 999 ms)

2.5 Various Other Measurement Functions

Voltage measurement

e.g., Commercial power supply (AC voltage)

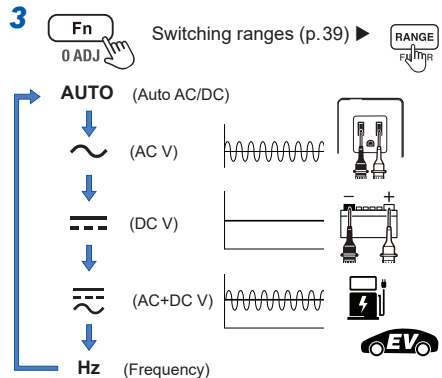
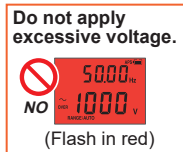
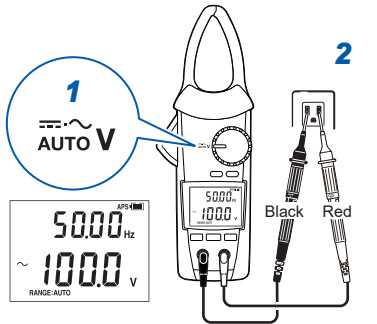

2

DC voltage polarity check (p.59)
 If the measured value is negative, the buzzer will sound and the display will be backlighted in red. (threshold: -10 V)

Continuity check

2 Zero adjustment

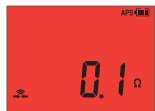
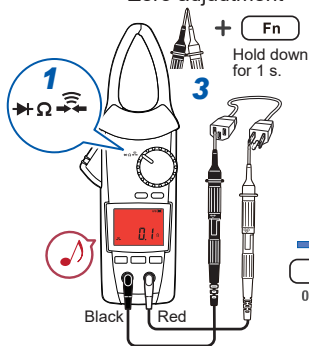

(Backlighted in red)

See the specifications for the short-circuit and open-circuit detecting thresholds (p. 72).

Resistance measurement

2 Zero adjustment

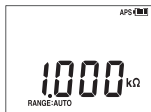
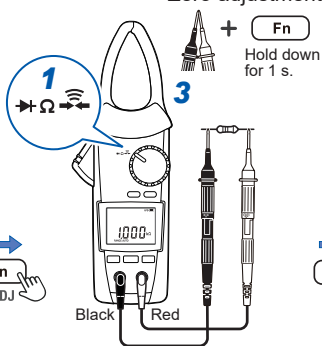

If resistance values of coils, including motors and transformers, measured with the auto-ranging fluctuate, select the range manually.

Diode measurement

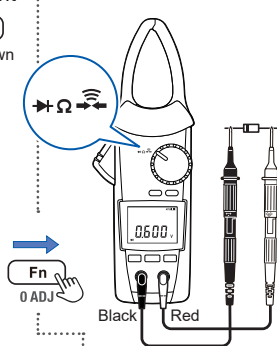

Fn
0 ADJ

Capacitance measurement

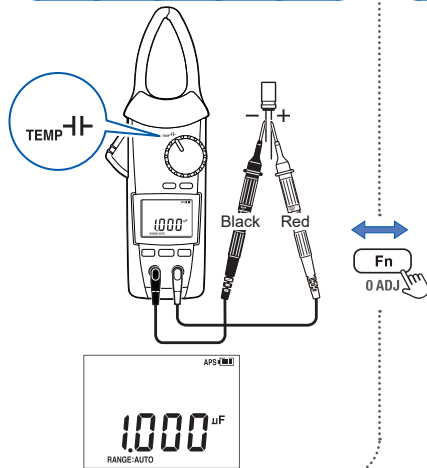

Type K thermocouples exhibit a physical phenomenon known as short range ordering, which can cause inaccurate measurements in the range of 250°C to 600°C.

Temperature measurement

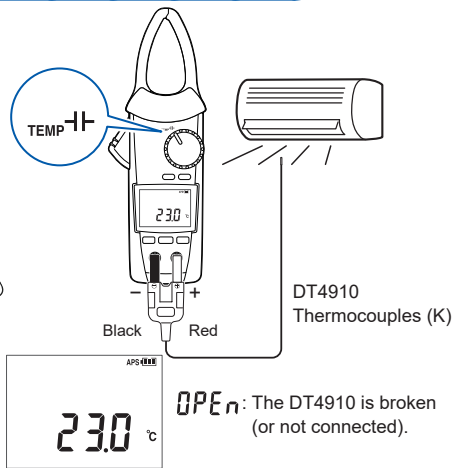

To switch the temperature units, see p. 60.

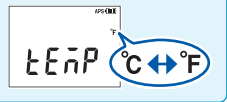

Various Other Measurement Functions

Electric charge detection

CM4371-50 CM4373-50

See "5.1 Voltage Detection Function" (p. 111)

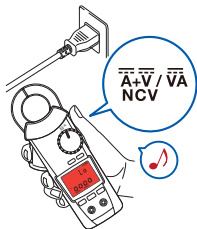

Bring the jaw close a power line.

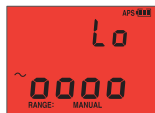

(Illuminate in red)

To switch the sensitivity. (Hi/Lo) (p. 101)



Simultaneous display of DC current and DC voltage

e.g., Checking a car battery
Switch the ranges using the **RANGE** key.

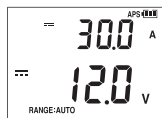
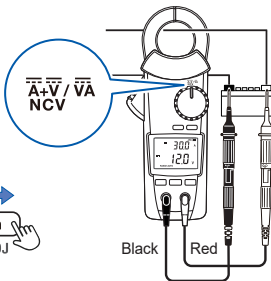

DC power measurement

CM4375-50

e.g., Maintenance for a solar power system

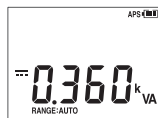
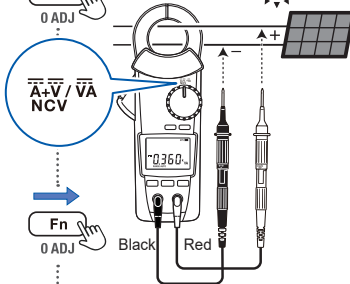
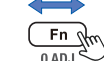

2.6 LCD Backlight, Automatic Power Save (APS)

LCD backlight

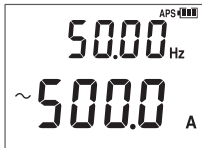

Backlight off

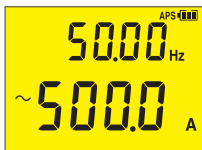

Backlight on
Automatically shut off after 40 s
of inactivity

Automatic power save

(Always on)

How to cancel: p.59

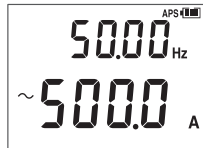

After 15 minutes
of inactivity

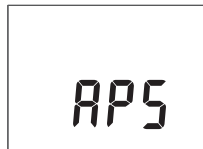

After 45 minutes of inactivity

The instrument is automatically turned off.
Set the rotary switch to the OFF position to restart.

2.7 DC High V Probe Mode

Use of the P2000 DC High Voltage Probe (optional) allows you to measure DC voltage of up to 2000 V (CAT III 2000 V, CAT IV 1000 V), such as open voltage of solar panels.

WARNING

■ **Do not use the P2000 to measure AC voltage.**



The probe cannot accurately measure AC voltage. Improper measurement could lead to electric shock. You can use the P2000 for DC voltage measurement only.

■ **Do not measure voltage that exceeds 2000 V DC.**

Doing so could damage the instrument and the P2000, causing bodily injury.



■ **Use the P2000 to measure voltage that exceeds 1000 V.**

Use of other probes could cause the operator to experience an electric shock.

CAUTION



■ **Connect the instrument and the P2000 together with the strap when using the L4943.**

The cables and plugs will be subjected to stress, damaging them.

When using the L4943 Connection Cable Set*

- 1** Disconnect the clip* from the strap buckle* as shown in the figure.



- 2** Attach the strap* to the P2000.
For details, see the P2000 Instruction manual.

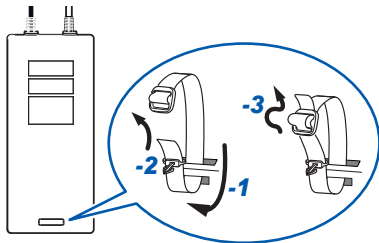
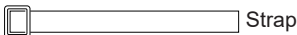

- 3** Attach the strap buckle to the instrument and connect it to the clip that you attached to the P2000 with the strap.

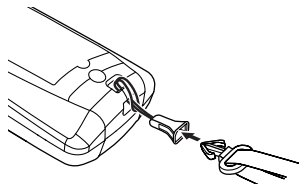

*: Supplied with the P2000.

When using the L4930 Connection Cable Set or the L4931 Extension Cable Set (optional)

Hang the P2000 in some way, such as using a magnetic strap, not to subject the cables and the plugs to stress.

Making Measurements

- 1** Rotate the rotary switch.



- 2** Hold down the two keys for 1 s as described below.



► DC High V Probe mode On

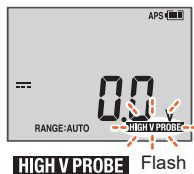

- 3** Connect the P2000 DC High Voltage Probe to the measurement terminals of the instrument.

- 4** Set the range.



See "Switching the ranges" (p.39).

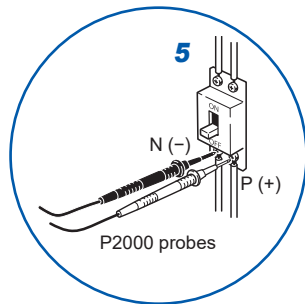
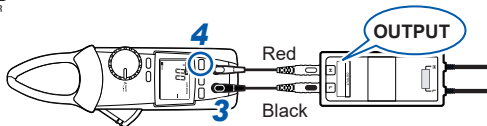

- 5** Bring the probes into contact with an object to be measured.

Saving the DC High V Probe mode settings

Turn off the instrument, and then set the rotary switch to other than the OFF position while holding down the two operation keys as described below.



- The DC High V Probe mode start-up setting can be toggled between on and off. (p.59)
- When the DC High V Probe mode start-up is enabled, the instrument will start in the mode you last used.

2.8 Wireless communications function

Installing the Z3210 Wireless Adapter (optional) is required.
Concurrent use of GENNECT Cross and HID function (p.55) is not available.

Using GENNECT Cross

Enabling the wireless communications function allows you to check and record the measured data of the instrument, and create measurement reports using your mobile device. For details, visit the GENNECT website

Using the wireless communications function

- 1 Connect the Z3210 Wireless Adapter (option) into the instrument. (p.22)
- 2 Install GENNECT Cross on your mobile device.
- 3 Turn on the instrument.
- 4 Enable the wireless communications function.

When the instrument is turned on for the first time after the Z3210 has been installed, the wireless communications function will be enabled.

Off
(Default
setting)



Hold down for 1 s.

 appears:

Wireless communications function enabled

Off: Wireless communications function disabled

Blinks: During wireless communications

5 Start GENNECT Cross and register the connection of the instrument.

- When GENNECT Cross is started for the first time (when there is no registered instrument), the Instrument Settings screen appears.
- When the instrument is placed near your mobile device, its connection is registered automatically on the Instrument Settings screen of GENNECT Cross (up to eight instruments).
- Wait for 5 to 30 s until the connection of the instrument is registered after turning on the instrument. If the connection of the instrument is not registered after 1 minute has elapsed, restart GENNECT Cross and the instrument.

6 Select a measurement function to perform measurement.

- The communication distance is about 10 m with a clear line of sight. The communicable distance may vary greatly depending on the presence of an obstruction (wall or metallic shielding object) and the distance between the floor (ground) and instrument. To ensure the stable communication, make sure that the radio wave intensity is sufficient.
- GENNECT Cross is free of charge. However, the customer is responsible for the cost to download the application software and connect to the Internet when using the software.
- GENNECT Cross may not operate properly depending on the mobile device.
- The Z3210 uses the 2.4 GHz band wireless technology.

When there is a device that uses the same frequency band such as a wireless LAN (IEEE 802.11.b/g/n) near your mobile device, the communication may not be established.

When the instrument is placed on the floor or ground, the communication distance becomes shorter. It is recommended that you move the instrument away from the floor or ground and place it on a desk or table or hold it by hand.

Event recording function

The event recording function logs the data when a measured value exceeds a desired threshold value, which can be set with GENNECT Cross. For details, see the operation guide for the GENNECT Cross app (free of charge). The number of recorded events can be checked using the instrument.

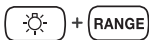

Hold down the two keys for 1 s as described above.



Event count display

- Up to 99 events can be recorded. If events has reached 99, the event recording will stops. When another event recording starts, previously recorded data will be deleted.
 - Some events with a duration time of less than 400 ms may not be accurately measured, failing to detect them.*
- * Current frequency, voltage frequency, capacitance (400 ms to 4000 ms, depending on measured value), temperature (type K thermocouple) 2000 ms

Z3210-to-Excel direct data entry function (Excel direct input function, HID function)

Concurrent use of GENNECT Cross and HID function is not available.

The human interface device (HID) profile, with which the Z3210 Wireless Adapter is equipped, is a profile same as that wireless keyboards use.

2

HID ON	Preparatory to data entry, open an Excel file on your mobile device or computer and choose a cell. When the instrument's display freezes, the measured values will be entered on the cells. The use of this function with the automatic hold function enabled comes in handy. (p.35)
HID OFF	When you wish to use GENNECT Cross, disable the HID function.

The setting whether the HID function has been enabled or disabled will not be saved in the instrument but in the Z3210.

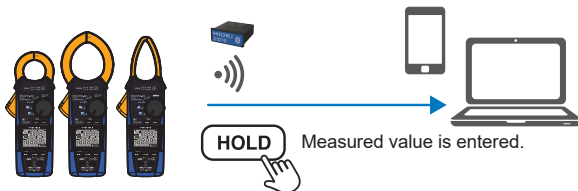

Confirming the HID setting

- 1** Remove the test leads from the object under measurement.
- 2** Set the rotary switch to the OFF position.
- 3** Connect the Z3210 Wireless Adapter (option) into the instrument. (p.22)
- 4** Confirm the HID setting.

Make sure that the instrument is turned off, and then set the rotary switch to the TEMP position while holding down the **RANGE** key.

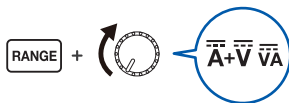

The settings stored in the Z3210 will be displayed.

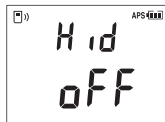

or

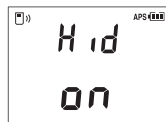



When [----] appears

Update the Z3210 firmware to the latest version using GENNECT Cross (version 1.8 or later)..

To change the HID setting, use the procedure on the following page.

Changing the HID setting

- 1 Turn off the instrument.
- 2 Change the HID setting.

Make sure that the instrument is turned off, and then set the rotary switch to any position while holding down both the  key and the  key.



After exhibiting the following displays, the instrument is automatically turned off.

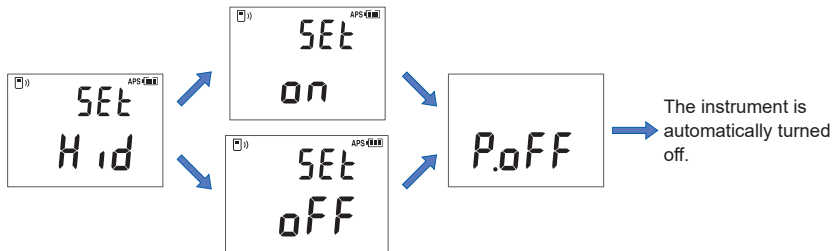

- 3 Turn on the instrument again.
The HID setting will be toggled.

IMPORTANT

To switch over from the HID function to GENNECT Cross

If you start GENNECT Cross without canceling the pairing between the mobile device and the instrument, GENNECT Cross may not be able to recognize the instrument as a connectible device. Follow the procedure below to reconnect the instrument to GENNECT Cross. Use the **Bluetooth**[®] setting of your mobile device to delete the instrument.

1. Disable the Z3210's HID function. (p.57)
2. Use the Instrument Setting of GENNECT Cross to reconnect the instrument.

Check Hioki's website for the latest information.

<https://z3210.gennect.net>



▲
Learn more here !

2.9 Rotary Switch Combinations













Turn off the instrument, and then turn it on again while holding down one or two operation keys.

(Set the rotary switch to other than the OFF position)

Setting	Procedure	Factory-shipped setting	Saving of setting
Auto-power save (APS) function cancel	+ Any position	On	Not saved
DC current/voltage, polarity check on/off	+ Any position	Off	Saved
LCD all segments display* ¹ , firmware version number* ¹ , model number (only last four digit)* ¹ , serial number* ¹ , HID setting check (Z3210 required)* ¹	+ Any position	-	-
Buzzer (on/off)	+ Any position	On	Saved
Automatic backlight shutoff (on/ off)	+ Any position	On	Saved
DC High V Probe mode setting saving (on/off)	+ + Any position	Off	Saved

Rotary Switch Combinations

Setting	Procedure	Factory-shipped setting	Saving of setting
Toggling the HID setting (on/off) (Z3210 required)	 +  + 	-	_*2
Switching between the two temperature units: degrees Celsius and degrees Fahrenheit	 +  +  ↓  +  Hold down for 1 s. ↓ To switch the temperature units  ↓ To save the setting  Hold down for 1 s.	Degrees Celsius	Saved

*1: The screen display depends on the rotary switch position.

*2: The setting whether the HID function has been enabled or disabled will not be saved in the instrument but in the Z3210.

3

Specifications

3.1 General Specifications

Operating environment	Indoor use, pollution degree 2, altitude up to 2000 m (6562 ft.)
Operating temperature and humidity range	-25°C to 65°C (-13°F to 149°F), 90% RH or less (non-condensing)
Storage temperature and humidity range	-30°C to 70°C (-22°F to 158°F), 90% RH or less (non-condensing, with batteries removed)

General Specifications

Dust resistance and water resistance	<p>IP20 (EN 60529) (when measuring voltage with the instrument completely dried and the jaws closed)</p> <p>IP50 (EN 60529) (when measuring resistance under completely dry conditions)</p> <p>IP54 (EN 60529) (in storage)</p> <p>The protection rating for the enclosure of this instrument (based on EN60529) is IP20*, IP50*, or IP54*.</p> <p>* IP20, IP50, IP54:</p> <p>This indicates the degree of protection provided by the enclosure of the device for use in hazardous locations, entry of solid foreign objects, and the ingress of water.</p> <p>2: Protected against access to hazardous parts with a fingers. The equipment inside the enclosure is protected against entry by solid foreign objects larger than 12.5 mm in diameter.</p> <p>5: Protected against access to hazardous parts with wire measuring 1.0 mm in diameter. Dustproof type (The penetration of dust cannot be prevented completely, but quantities of dust that may hinder the stated operation of equipment or safety cannot penetrate the enclosure.)</p> <p>0: The equipment inside the enclosure is not protected against the harmful effects of water.</p> <p>4: The equipment inside the enclosure is protected against the harmful effects of water splashed against the enclosure from any direction.</p>
Standards	Safety EN 61010 EMC EN 61326

Power supply	<ul style="list-style-type: none"> • LR03 Alkaline batteries ×2 Rated supply voltage: 1.5 V DC × 2 • HR03 Nickel-metal hydride battery ×2 Rated supply voltage 1.2 V DC × 2 	
Continuous operating time (when two LR03 Alkaline batteries are used)	CM4371-50* ¹	About 40 hours (without the Z3210) About 20 hours (with the Z3210 installed and wirelessly communicating)
	CM4373-50* ²	About 40 hours (without the Z3210) About 24 hours (with the Z3210 installed and wirelessly communicating)
	CM4375-50* ²	About 40 hours (without the Z3210) About 20 hours (with the Z3210 installed and wirelessly communicating)
Dimensions*³	CM4371-50	Approx. 65W × 216H × 35D mm (2.56"W × 8.50"H × 1.38"D)
	CM4373-50	Approx. 65W × 250H × 35D mm (2.56"W × 9.84"H × 1.38"D)
	CM4375-50	Approx. 65W × 242H × 35D mm (2.56"W × 9.53"H × 1.38"D)
Jaw dimensions	CM4371-50	Approx. 69Wj × 14Dj mm (2.72"W × 0.55"D)
	CM4373-50	Approx. 92Wj × 18Dj mm (3.62"W × 0.71"D)
	CM4375-50	Approx. 53Wj × 20Dj mm (2.09"W × 0.79"D)
Jaw cross-sectional minimum dimension	CM4375-50	Approx. 9.5 mm (0.37")

General Specifications

Maximum measurable conductor diameter	CM4371-50	φ33 mm
	CM4373-50	φ55 mm
	CM4375-50	φ34 mm
Weight	CM4371-50	Approx. 340 g (12.0 oz., including batteries)
	CM4373-50	Approx. 530 g (18.7 oz., including batteries)
	CM4375-50	Approx. 350 g (12.3 oz., including batteries)
Product warranty duration	3 years or until the jaw open/close cycles reaches 30,000, whichever comes first	
Accessories	p.7	
Options	p.8	

*1: Other prescribed conditions

When measuring 10 A AC, with the LCD not backlighted, values for reference purposes at 23°C

*2: Other prescribed conditions

When measuring 100 A AC, with the LCD not backlighted, values for reference purposes at 23°C

*3: The Jaw is not included in the dimensions of width and depth but in that of height.

3.2 Input Specifications, Measurement Specifications

(1) Basic specifications

Measurable range	See “3.3 Accuracy table” (p.75).
Maximum rated voltage between terminals	1000 V AC (up to 1 kHz) 1000 V DC
Maximum rated line-to-ground voltage	600 V (measurement category IV) 1000 V (measurement category III) Anticipated transient overvoltage: 8000 V
Measurement method	True RMS measurement
Measurement terminals	COM terminal, V terminal

(2) Current measurement specifications

Maximum input current	As per the frequency derating characteristics (p.68)	
Coupling type	AC current**1	AC coupling
	Other current measurement parameters	DC coupling

Input Specifications, Measurement Specifications

Display update rate *2	Auto A, AC current, DC current, AC+DC current	5 times/s	
	Current frequency	0.3 to 5.0 times/s (depending on the frequency)	
	DC power	1 time/s	
	DC current + DC voltage	2.5 times/s	
Zero-display range	Auto A, AC current, DC current, AC+DC current	5 counts or less	
Crest factor	Auto A, AC current, AC+DC current, inrush current		
	CM4371-50	20.00 A range	7.5
		600.0 A range	3 (500.0 A or less) 2.5 (more than 500.0 A but 600.0 A or less)
	CM4373-50	600.0 A range	3 (500.0 A or less) 2.5 (more than 500.0 A but 600.0 A or less)
		2000 A range	2.84 (1000 A or less) 1.42 (more than 1000 A but 2000 A or less)
CM4375-50	1000 A range	1.5 (1000 A or less)	

Input Specifications, Measurement Specifications

Frequency detection input level	CM4371-50	20.00 A range	4.00 A or more* ³
		600.0 A range	20.0 A or more
	CM4373-50	600.0 A range	40.0 A or more
		2000 A range	200 A or more
	CM4375-50	1000 A range	5.0 A or more* ⁴
	Inrush trigger level	CM4371-50	20.00 A range
600.0 A range			+10 A or more Otherwise, -10 A or less
CM4373-50		600.0 A range	+10 A or more Otherwise, -10 A or less
		2000 A range	+100 A or more Otherwise, -100 A or less
CM4375-50		1000 A range	+10 A or more Otherwise, -10 A or less
Peak detection time width		1 ms or more (with filter disabled)	

*1: Does not apply to AC detection in Auto A mode.

*2: Does not include range switching time.

*3: 8.00 A or more for $1 \text{ Hz} \leq f \leq 5 \text{ Hz}$

*4: 10.0 A or more for $1 \text{ Hz} \leq f \leq 5 \text{ Hz}$

Frequency derating characteristics

CM4371-50

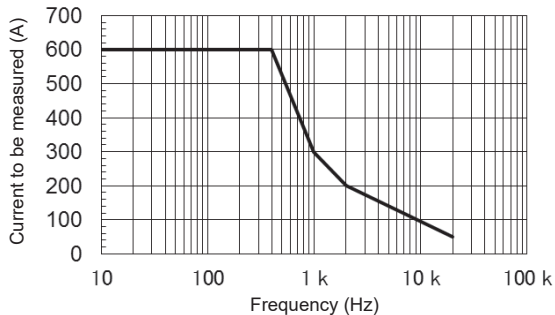

Inputting up to 1061 A of current is allowable for 1 minute or less.
(66 Hz or less)

Input Specifications, Measurement Specifications

CM4373-50

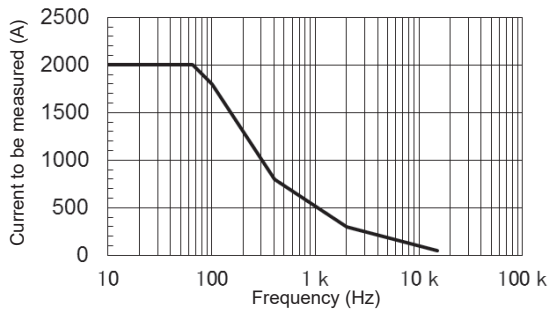

CM4375-50

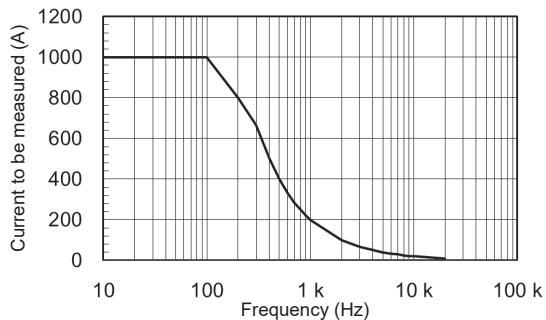

3

Input Specifications, Measurement Specifications

(3) Voltage measurement specifications

Overload protection	1100 V DC, 1100 V AC, or 2×10^7 V·Hz, whichever is lower (Up to 1 minute of continuous application)	
Coupling type	AC voltage* ¹	AC coupling
	Other voltage measurement parameters	DC coupling
Input impedance	See “3.3 Accuracy table” (p. 75).	
Display update rate*²	Auto V, AC voltage, DC voltage, AC + DC voltage	5 times/s
	Voltage frequency	0.3 to 5.0 times/s (depending on frequency)
	DC power	1 time/s
	DC current + DC voltage	2.5 times/s
Zero-display range	Auto V, AC voltage, AC voltage + DC voltage	5 counts or less
Crest factor	Auto V, AC voltage, AC voltage + DC voltage	6.000 V range, 60.00 V range, 600.0 V range: 3 (4000 counts or less) 2 (more than 4000 counts but 6000 counts or less)
		1000 V range: 2 (750 counts or less) 1.5 (more than 750 counts but 1000 counts or less)

Peak detection time width	1 ms or more (with filter disabled)	
Frequency detection input level	10% or more of each range's f.s.	
CMRR^{*3}	AC voltage, AC+DC voltage	60 dB or more
	DC voltage	100 dB or more
NMRR^{*4}	DC voltage	60 dB or more

*1: Does not apply to AC detection in Auto V mode.

*2: Does not include range switching time.

*3: Defined for 1 k Ω unbalance assuming that the input frequency is 0 Hz, 50 Hz, or 60 Hz.

*4: Defined assuming that the input frequency is 50 Hz or 60 Hz.

(4) Other measurement parameters

Overload protection	1000 V DC, 1000 V AC, or 2×10^7 V·Hz, whichever is lower (Up to 1 minute of continuous application)	
Overload current	At steady state: 30 mA or less At transient state: 1.5 A or less	
Display update rate*	Capacitance	0.5 to 5 times/s (depending on the capacitance)
	Temperature (Type K thermocouple)	1 time/s (including thermocouple wiring break check)
Response time	Continuity check	Open or short-circuit condition lasting for 0.5 ms or more can be detected.
Open terminal voltage	Continuity check, resistance, diode	2.0 V DC or less
Short-circuit detecting threshold	25 Ω \pm 10 Ω (continuous beep, LCD backlit in red)	
Open-circuit detecting threshold	250 Ω \pm 10 Ω	
Stabilization time for reference junction compensation of instrument	Up to 120 minutes (Reference: when the instrument having a temperature of 23°C is left to stand in ambient environments of 65°C for 60 minutes)	

*: Does not include range switching time.

(5) DC High V Probe mode (in combination with the P2000)*¹

Maximum rated line-to-ground voltage	Conform to the specifications of the P2000.
Maximum rated voltage between terminals	Conform to the specifications of the P2000.
Overload protection	Conform to the specifications of the P2000.
Coupling type	DC coupling
Combinatorial measurement accuracy	<ul style="list-style-type: none"> • DC high voltage See “(11) DC high voltage (DC High V Probe mode)” (p.98) in “3.3 Accuracy table.” • DC power See “(18) DC power ” (p.102) in “3.3 Accuracy table.”

*1: The specifications above apply when both of the following two conditions are satisfied only: (1) the P2000 is connected, and (2) the instrument is in DC High V Prove mode.

Input Specifications, Measurement Specifications

(6) Accuracy specifications

Accuracy guarantee conditions	Accuracy guarantee duration	1 year (duration for which accuracy shown in the accuracy table is guaranteed) 3 years (duration for which 1.5 times accuracy shown in the accuracy table is guaranteed), value for reference purposes
	Accuracy guarantee temperature and humidity range	23°C ±5°C (73°F ±9°F), 90% RH or less (non-condensing)
	Accuracy guarantee of current measurement, continuity check, and resistance measurement assumes that zero adjustment has been performed. Temperature (Type K thermocouple) measurement requires use of the DT4910.	
Input condition for accuracy table	Sine wave input	
Measurement accuracy	See “3.3 Accuracy table” (p.75).	
Effects of conductor position*	CM4371-50	Within ±1.5% rdg
	CM4373-50	Within ±1.0% rdg
	CM4375-50	Within ±1.5% rdg (for cables of ϕ 11 mm or more)
Temperature coefficient	Add [(measurement accuracy × 0.1)/°C] to measurement accuracy (outside the temperature range of 23°C ±5°C).	

*: At any position with respect to the jaw's center-point.

3.3 Accuracy table

(1) Auto A (AC/DC current automatic detection)

When AC is detected:

Conforms to the accuracy specifications described in "(4) AC+DC voltage" (p.82).

When DC is detected:

Conforms to the accuracy specifications described in "(3) DC current" (p.80).

(2) AC current

Measured value/MAX/MIN/AVG (CM4371-50)

Range (automatic ranging threshold)	Accuracy guarantee range (resolution)	Accuracy guarantee frequency range	Measurement accuracy	
			Filter disabled	Filter enabled
20.00 A (more than 2000 counts)	1.00 A to 20.00 A (0.01 A)	10 Hz ≤ f < 45 Hz	±1.8% rdg ±0.10 A	±2.3% rdg ±0.10 A
		45 Hz ≤ f ≤ 66 Hz	±1.3% rdg ±0.08 A	±1.8% rdg ±0.08 A
		66 Hz < f < 1 kHz	±2.0% rdg ±0.10 A	–
600.0 A (less than 180 counts)	1.0 A to 600.0 A (0.1 A)	10 Hz ≤ f < 45 Hz	±1.8% rdg ±0.5 A	±2.3% rdg ±0.5 A
		45 Hz ≤ f ≤ 66 Hz	±1.3% rdg ±0.3 A	±1.8% rdg ±0.3 A
		66 Hz < f < 1 kHz	±2.0% rdg ±0.5 A	–

Accuracy table

Measured value/MAX/MIN/AVG (CM4373-50)

Range (automatic ranging threshold)	Accuracy guarantee range (resolution)	Accuracy guarantee frequency range	Measurement accuracy	
			Filter disabled	Filter enabled
600.0 A (more than 6000 counts)	1.0 A to 30.0 A (0.1 A)	10 Hz ≤ f < 45 Hz	±1.8% rdg ±1.0 A	±2.3% rdg ±1.0 A
		45 Hz ≤ f ≤ 66 Hz	±1.3% rdg ±0.8 A	±1.8% rdg ±0.8 A
		66 Hz < f < 1 kHz	±2.0% rdg ±1.0 A	–
	30.1 A to 600.0 A (0.1 A)	10 Hz ≤ f < 45 Hz	±1.8% rdg ±0.5 A	±2.3% rdg ±0.5 A
		45 Hz ≤ f ≤ 66 Hz	±1.3% rdg ±0.3 A	±1.8% rdg ±0.3 A
		66 Hz < f < 1 kHz	±2.0% rdg ±0.5 A	–
2000 A (less than 540 counts)	10 A to 1800 A (1 A)	10 Hz ≤ f < 45 Hz	±1.8% rdg ±5 A	±2.3% rdg ±5 A
		45 Hz ≤ f ≤ 66 Hz	±1.3% rdg ±3 A	±1.8% rdg ±3 A
		66 Hz < f < 1 kHz	±2.0% rdg ±5 A	–
	1801 A to 2000 A (1 A)	10 Hz ≤ f < 45 Hz	±2.8% rdg ±5 A	±3.3% rdg ±5 A
		45 Hz ≤ f ≤ 66 Hz	±2.3% rdg ±3 A	±2.8% rdg ±3 A
		66 Hz < f < 1 kHz	–	–

Measured value/MAX/MIN/AVG (CM4375-50)

Range	Accuracy guarantee range (resolution)	Accuracy guarantee frequency range	Measurement accuracy	
			Filter disabled	Filter enabled
1000 A	1.0 A to 30.0 A (0.1 A)	10 Hz ≤ f < 45 Hz	±1.8% rdg ±1.0 A	±2.3% rdg ±1.0 A
		45 Hz ≤ f ≤ 66 Hz	±1.3% rdg ±0.8 A	±1.8% rdg ±0.8 A
		66 Hz < f < 1 kHz	±2.0% rdg ±1.0 A	–
	30.1 A to 900.0 A (0.1 A)	10 Hz ≤ f < 45 Hz	±1.8% rdg ±0.5 A	±2.3% rdg ±0.5 A
		45 Hz ≤ f ≤ 66 Hz	±1.3% rdg ±0.3 A	±1.8% rdg ±0.3 A
		66 Hz < f < 1 kHz	±2.0% rdg ±0.5 A	–
	900.1 A to 999.9 A (0.1 A)	10 Hz ≤ f < 45 Hz	±2.3% rdg ±0.5 A	±2.8% rdg ±0.5 A
		45 Hz ≤ f ≤ 66 Hz	±1.8% rdg ±0.3 A	±2.3% rdg ±0.3 A
		66 Hz < f < 1 kHz	±2.5% rdg ±0.5 A	–

Accuracy table

PEAK MAX/ PEAK MIN (CM4371-50)

Range	Accuracy guarantee range (resolution)	Accuracy guarantee frequency range	Measurement accuracy
20.00 A	±1.0 A to ±150.0 A (0.1 A)	10 Hz ≤ f < 45 Hz	±1.8% rdg ±0.7 A
		45 Hz ≤ f ≤ 66 Hz	±1.3% rdg ±0.7 A
		66 Hz < f < 1 kHz	±2.0% rdg ±0.7 A
600.0 A	±10 A to ±900 A (1 A)	10 Hz ≤ f < 45 Hz	±1.8% rdg ±7 A
		45 Hz ≤ f ≤ 66 Hz	±1.3% rdg ±7 A
		66 Hz < f < 1 kHz	±2.0% rdg ±7 A
	±901 A to ±1500 A (1 A)	10 Hz ≤ f < 45 Hz	±5.5% rdg ±7 A
		45 Hz ≤ f ≤ 66 Hz	±5.0% rdg ±7 A
		66 Hz < f < 1 kHz	±5.7% rdg ±7 A

PEAK MAX/ PEAK MIN (CM4373-50)

Range	Accuracy guarantee range (resolution)	Accuracy guarantee frequency range	Measurement accuracy
600.0 A	±10 A to ±1500 A (1 A)	10 Hz ≤ f < 45 Hz	±1.8% rdg ±7 A
		45 Hz ≤ f ≤ 66 Hz	±1.3% rdg ±7 A
		66 Hz < f < 1 kHz	±2.0% rdg ±7 A
2000 A	±10 A to ±2300 A (1 A)	10 Hz ≤ f < 45 Hz	±1.8% rdg ±7 A
		45 Hz ≤ f ≤ 66 Hz	±1.3% rdg ±7 A
		66 Hz < f < 1 kHz	±2.0% rdg ±7 A
	±2301 A to ±2840 A (1 A)	10 Hz ≤ f < 45 Hz	±6.5% rdg ±7 A
		45 Hz ≤ f ≤ 66 Hz	±6.0% rdg ±7 A
		66 Hz < f < 1 kHz	–

PEAK MAX/ PEAK MIN (CM4375-50)

Range	Accuracy guarantee range (resolution)	Accuracy guarantee frequency range	Measurement accuracy
1000 A	±10 A to ±1000 A (1 A)	10 Hz ≤ f < 45 Hz	±1.8% rdg ±7 A
		45 Hz ≤ f ≤ 66 Hz	±1.3% rdg ±7 A
		66 Hz < f < 1 kHz	±2.0% rdg ±7 A
	±1001 A to ±1500 A (1 A)	10 Hz ≤ f < 45 Hz	±2.3% rdg ±7 A
		45 Hz ≤ f ≤ 66 Hz	±1.8% rdg ±7 A
		66 Hz < f < 1 kHz	±2.5% rdg ±7 A

Accuracy table

(3) DC current

Measured value/MAX/MIN/AVG (CM4371-50)

Range (automatic ranging threshold)	Accuracy guarantee range (resolution)	Measurement accuracy
20.00 A (more than 2000 counts)	± 1.00 A to ± 20.00 A (0.01 A)	$\pm 1.3\%$ rdg ± 0.08 A
600.0 A (less than 180 counts)	± 1.0 A to ± 600.0 A (0.1 A)	$\pm 1.3\%$ rdg ± 0.3 A

Measured value/MAX/MIN/AVG (CM4373-50)

Range (automatic ranging threshold)	Accuracy guarantee range (resolution)	Measurement accuracy
600.0 A (more than 6000 counts)	± 1.0 A to ± 30.0 A (0.1 A)	$\pm 1.3\%$ rdg ± 0.8 A
	± 30.1 A to ± 600.0 A (0.1 A)	$\pm 1.3\%$ rdg ± 0.3 A
2000 A (less than 540 counts)	± 10 A to ± 2000 A (1 A)	$\pm 1.3\%$ rdg ± 3 A

Measured value/MAX/MIN/AVG (CM4375-50)

Range	Accuracy guarantee range (resolution)	Measurement accuracy
1000 A	± 1.0 A to ± 30.0 A (0.1 A)	$\pm 1.3\%$ rdg ± 0.8 A
	± 30.1 A to ± 999.9 A (0.1 A)	$\pm 1.3\%$ rdg ± 0.3 A

PEAK MAX/ PEAK MIN (CM4371-50)

Range	Accuracy guarantee range (resolution)	Measurement accuracy
20.00 A	± 1.0 A to ± 150.0 A (0.1 A)	$\pm 1.3\%$ rdg ± 0.7 A
600.0 A	± 10 A to ± 900 A (1 A)	$\pm 1.3\%$ rdg ± 7 A
	± 901 A to ± 1500 A (1 A)	$\pm 5.0\%$ rdg ± 7 A

PEAK MAX/ PEAK MIN (CM4373-50)

Range	Accuracy guarantee range (resolution)	Measurement accuracy
600.0 A	± 10 A to ± 1500 A (1 A)	$\pm 1.3\%$ rdg ± 7 A
2000 A	± 10 A to ± 2300 A (1 A)	$\pm 1.3\%$ rdg ± 7 A
	± 2301 A to ± 2840 A (1 A)	$\pm 6.0\%$ rdg ± 7 A

PEAK MAX/ PEAK MIN (CM4375-50)

Range	Accuracy guarantee range (resolution)	Measurement accuracy
1000 A	± 10 A to ± 1000 A (1 A)	$\pm 1.3\%$ rdg ± 7 A
	± 1001 A to ± 1500 A (1 A)	$\pm 1.8\%$ rdg ± 7 A

Accuracy table

(4) AC+DC voltage

Measured value/MAX/MIN/AVG (CM4371-50)

Range (automatic ranging threshold)	Accuracy guarantee range (resolution)	Accuracy guarantee frequency range	Measurement accuracy	
			Filter disabled	Filter enabled
20.00 A (more than 2000 counts)	1.00 A to 20.00 A (0.01 A)	10 Hz ≤ f < 45 Hz	±1.8% rdg ±0.10 A	±2.3% rdg ±0.10 A
		DC, 45 Hz ≤ f ≤ 66 Hz	±1.3% rdg ±0.13 A	±1.8% rdg ±0.13 A
		66 Hz < f < 1 kHz	±2.0% rdg ±0.10 A	–
600.0 A (less than 180 counts)	1.0 A to 600.0 A (0.1 A)	10 Hz ≤ f < 45 Hz	±1.8% rdg ±0.7 A	±2.3% rdg ±0.7 A
		DC, 45 Hz ≤ f ≤ 66 Hz	±1.3% rdg ±1.3 A	±1.8% rdg ±1.3 A
		66 Hz < f < 1 kHz	±2.0% rdg ±0.7 A	–

Measured value/MAX/MIN/AVG (CM4373-50)

Range (automatic ranging threshold)	Accuracy guarantee range (resolution)	Accuracy guarantee frequency range	Measurement accuracy	
			Filter disabled	Filter enabled
600.0 A (more than 6000 counts)	1.0 A to 30.0 A (0.1 A)	10 Hz \leq f < 45 Hz	$\pm 1.8\%$ rdg ± 1.2 A	$\pm 2.3\%$ rdg ± 1.2 A
		DC, 45 Hz \leq f \leq 66 Hz	$\pm 1.3\%$ rdg ± 1.8 A	$\pm 1.8\%$ rdg ± 1.8 A
		66 Hz < f < 1 kHz	$\pm 2.0\%$ rdg ± 1.2 A	–
	30.1 A to 600.0 A (0.1 A)	10 Hz \leq f < 45 Hz	$\pm 1.8\%$ rdg ± 0.7 A	$\pm 2.3\%$ rdg ± 0.7 A
		DC, 45 Hz \leq f \leq 66 Hz	$\pm 1.3\%$ rdg ± 1.3 A	$\pm 1.8\%$ rdg ± 1.3 A
		66 Hz < f < 1 kHz	$\pm 2.0\%$ rdg ± 0.7 A	–
2000 A (less than 540 counts)	10 A to 1800 A (1 A)	10 Hz \leq f < 45 Hz	$\pm 1.8\%$ rdg ± 7 A	$\pm 2.3\%$ rdg ± 7 A
		DC, 45 Hz \leq f \leq 66 Hz	$\pm 1.3\%$ rdg ± 13 A	$\pm 1.8\%$ rdg ± 13 A
		66 Hz < f < 1 kHz	$\pm 2.0\%$ rdg ± 7 A	–
	1801 A to 2000 A (1 A)	10 Hz \leq f < 45 Hz	$\pm 2.8\%$ rdg ± 7 A	$\pm 3.3\%$ rdg ± 7 A
		DC, 45 Hz \leq f \leq 66 Hz	$\pm 2.3\%$ rdg ± 13 A	$\pm 2.8\%$ rdg ± 13 A
		66 Hz < f < 1 kHz	–	–

Accuracy table

Measured value/MAX/MIN/AVG (CM4375-50)

Range	Accuracy guarantee range (resolution)	Accuracy guarantee frequency range	Measurement accuracy	
			Filter disabled	Filter enabled
1000 A	1.0 A to 30.0 A (0.1 A)	10 Hz ≤ f < 45 Hz	±1.8% rdg ±1.2 A	±2.3% rdg ±1.2 A
		DC, 45 Hz ≤ f ≤ 66 Hz	±1.3% rdg ±1.8 A	±1.8% rdg ±1.8 A
		66 Hz < f ≤ 1 kHz	±2.0% rdg ±1.2 A	–
	30.1 A to 900.0 A (0.1 A)	10 Hz ≤ f < 45 Hz	±1.8% rdg ±0.7 A	±2.3% rdg ±0.7 A
		DC, 45 Hz ≤ f ≤ 66 Hz	±1.3% rdg ±1.3 A	±1.8% rdg ±1.3 A
		66 Hz < f ≤ 1 kHz	±2.0% rdg ±0.7 A	–
	900.1 A to 999.9 A (0.1 A)	10 Hz ≤ f < 45 Hz	±2.3% rdg ±0.7 A	±2.8% rdg ±0.7 A
		DC, 45 Hz ≤ f ≤ 66 Hz	±1.8% rdg ±1.3 A	±2.3% rdg ±1.3 A
		66 Hz < f ≤ 1 kHz	±2.5% rdg ±0.7 A	–

PEAK MAX/ PEAK MIN (CM4371-50)

Range	Accuracy guarantee range (resolution)	Accuracy guarantee frequency range	Measurement accuracy
20.00 A	±1.0 A to ±150.0 A (0.1 A)	10 Hz ≤ f < 45 Hz	±1.8% rdg ±0.7 A
		DC, 45 Hz ≤ f ≤ 66 Hz	±1.3% rdg ±0.7 A
		66 Hz < f < 1 kHz	±2.0% rdg ±0.7 A
600.0 A	±10 A to ±900 A (1 A)	10 Hz ≤ f < 45 Hz	±1.8% rdg ±7 A
		DC, 45 Hz ≤ f ≤ 66 Hz	±1.3% rdg ±7 A
		66 Hz < f < 1 kHz	±2.0% rdg ±7 A
	±901 A to ±1500 A (1 A)	10 Hz ≤ f < 45 Hz	±5.5% rdg ±7 A
		DC, 45 Hz ≤ f ≤ 66 Hz	±5.0% rdg ±7 A
		66 Hz < f < 1 kHz	±5.7% rdg ±7 A

Accuracy table

PEAK MAX/ PEAK MIN (CM4373-50)

Range	Accuracy guarantee range (resolution)	Accuracy guarantee frequency range	Measurement accuracy
600.0 A	±10 A to ±1500 A (1 A)	10 Hz ≤ f < 45 Hz	±1.8% rdg ±7 A
		DC, 45 Hz ≤ f ≤ 66 Hz	±1.3% rdg ±7 A
		66 Hz < f < 1 kHz	±2.0% rdg ±7 A
2000 A	±10 A to ±2300 A (1 A)	10 Hz ≤ f < 45 Hz	±1.8% rdg ±7 A
		DC, 45 Hz ≤ f ≤ 66 Hz	±1.3% rdg ±7 A
		66 Hz < f < 1 kHz	±2.0% rdg ±7 A
	±2301 A to ±2840 A (1 A)	10 Hz ≤ f < 45 Hz	±6.5% rdg ±7 A
		DC, 45 Hz ≤ f ≤ 66 Hz	±6.0% rdg ±7 A
		66 Hz < f < 1 kHz	–

PEAK MAX/ PEAK MIN (CM4375-50)

Range	Accuracy guarantee range (resolution)	Accuracy guarantee frequency range	Measurement accuracy
1000 A	±10 A to ±1000 A (1 A)	10 Hz ≤ f < 45 Hz	±1.8% rdg ±7 A
		DC, 45 Hz ≤ f ≤ 66 Hz	±1.3% rdg ±7 A
		66 Hz < f < 1 kHz	±2.0% rdg ±7 A
	±1001 A to ±1500 A (1 A)	10 Hz ≤ f < 45 Hz	±2.3% rdg ±7 A
		DC, 45 Hz ≤ f ≤ 66 Hz	±1.8% rdg ±7 A
		66 Hz < f < 1 kHz	±2.5% rdg ±7 A

(5) Current frequency, voltage frequency

Range (automatic ranging threshold)	Accuracy guarantee range (resolution)	Measurement accuracy
9.999 Hz (more than 9999 counts)	1.000 Hz to 9.999 Hz (0.001 Hz)	$\pm 0.1\%$ rdg ± 0.003 Hz
99.99 Hz (more than 9999 counts, less than 900 counts)	1.00 Hz to 99.99 Hz (0.01 Hz)	$\pm 0.1\%$ rdg ± 0.01 Hz
999.9 Hz (less than 900 counts)	1.0 Hz to 999.9 Hz (0.1 Hz)	$\pm 0.1\%$ rdg ± 0.1 Hz

(6) Inrush current**Measured inrush value (CM4371-50)**

Range	Accuracy guarantee range (resolution)	Accuracy guarantee frequency range	Measurement accuracy
20.00 A	3.00 A to 20.00 A (0.01 A)	DC, 20 Hz $\leq f \leq$ 500 Hz	$\pm 5.0\%$ rdg ± 0.13 A
600.0 A	10.0 A to 600.0 A (0.1 A)	DC, 20 Hz $\leq f \leq$ 500 Hz	$\pm 5.0\%$ rdg ± 1.3 A

Accuracy table

Measured inrush value (CM4373-50)

Range	Accuracy guarantee range (resolution)	Accuracy guarantee frequency range	Measurement accuracy
600.0 A	10.0 A to 600.0 A (0.1 A)	DC, 20 Hz \leq f \leq 500 Hz	$\pm 5.0\%$ rdg ± 1.3 A
2000 A	100 A to 1800 A (1 A)	DC, 20 Hz \leq f \leq 500 Hz	$\pm 3.3\%$ rdg ± 13 A
	1801 A to 2000 A (1 A)	DC, 20 Hz \leq f \leq 66 Hz	$\pm 5.0\%$ rdg ± 13 A

Measured inrush value (CM4375-50)

Range	Accuracy guarantee range (resolution)	Accuracy guarantee frequency range	Measurement accuracy
1000 A	10.0 A to 999.9 A (0.1 A)	DC, 20 Hz \leq f \leq 500 Hz	$\pm 5.0\%$ rdg ± 1.3 A

Inrush peak value (CM4371-50)

Range	Accuracy guarantee range (resolution)	Accuracy guarantee frequency range	Measurement accuracy
20.00 A	± 3.0 A to ± 150.0 A (0.1 A)	DC, $20 \text{ Hz} \leq f \leq 500 \text{ Hz}$	$\pm 6.0\%$ rdg ± 1.0 A
600.0 A	± 10 A to ± 900 A (1 A)	DC, $20 \text{ Hz} \leq f \leq 500 \text{ Hz}$	$\pm 6.0\%$ rdg ± 10 A
	± 901 A to ± 1500 A (1 A)	DC, $20 \text{ Hz} \leq f \leq 500 \text{ Hz}$	$\pm 9.7\%$ rdg ± 10 A

Inrush peak value (CM4373-50)

Range	Accuracy guarantee range (resolution)	Accuracy guarantee frequency range	Measurement accuracy
600.0 A	± 10 A to ± 1500 A (1 A)	DC, $20 \text{ Hz} \leq f \leq 500 \text{ Hz}$	$\pm 6.0\%$ rdg ± 10 A
2000 A	± 100 A to ± 2300 A (10 A)	DC, $20 \text{ Hz} \leq f \leq 500 \text{ Hz}$	$\pm 6.0\%$ rdg ± 100 A
	± 2310 A to ± 2840 A (10 A)	DC, $20 \text{ Hz} \leq f \leq 66 \text{ Hz}$	$\pm 8.0\%$ rdg ± 100 A

Inrush peak value (CM4375-50)

Range	Accuracy guarantee range (resolution)	Accuracy guarantee frequency range	Measurement accuracy
1000 A	± 10 A to ± 1000 A (1 A)	DC, $20 \text{ Hz} \leq f \leq 500 \text{ Hz}$	$\pm 6.0\%$ rdg ± 10 A
	± 1001 A to ± 1500 A (1 A)	DC, $20 \text{ Hz} \leq f \leq 500 \text{ Hz}$	$\pm 8.0\%$ rdg ± 10 A

Accuracy table

(7) Auto V (AC/DC voltage automatic detection)

When AC is detected: Conforms to the accuracy specifications described in “(10) AC+DC voltage” (p.95).

When DC is detected: Conforms to the accuracy specifications described in “(9) DC voltage” (p.93).

(8) AC voltage

Measured value/MAX/MIN/AVG

Range (automatic ranging threshold)	Accuracy guarantee range (resolution)	Accuracy guarantee frequency range* ¹ * ²	Measurement accuracy		Input impedance* ³
			Filter disabled	Filter enabled	
6.000 V (more than 6000 counts)	0.000 V to 0.299 V (0.001 V)	15 Hz ≤ f < 45 Hz	±1.5% rdg ±0.015 V	±2.0% rdg ±0.015 V	3.2 MΩ ±5%
		45 Hz ≤ f ≤ 66 Hz	±0.9% rdg ±0.013 V	±1.4% rdg ±0.013 V	
		66 Hz < f < 1 kHz	±1.5% rdg ±0.015 V	–	
	0.300 V to 6.000 V (0.001 V)	15 Hz ≤ f < 45 Hz	±1.5% rdg ±0.005 V	±2.0% rdg ±0.005 V	3.2 MΩ ±5%
		45 Hz ≤ f ≤ 66 Hz	±0.9% rdg ±0.003 V	±1.4% rdg ±0.003 V	
		66 Hz < f < 1 kHz	±1.5% rdg ±0.005 V	–	

Range (automatic ranging threshold)	Accuracy guarantee range (resolution)	Accuracy guarantee frequency range* ¹ * ²	Measurement accuracy		Input impedance* ³
			Filter disabled	Filter enabled	
60.00 V (more than 6000 counts, less than 540 counts)	3.00 V to 60.00 V (0.01 V)	15 Hz ≤ f < 45 Hz	±1.5% rdg ±0.05 V	±2.0% rdg ±0.05 V	3.1 MΩ ±5%
		45 Hz ≤ f ≤ 66 Hz	±0.9% rdg ±0.03 V	±1.4% rdg ±0.03 V	
		66 Hz < f < 1 kHz	±1.5% rdg ±0.05 V	–	
600.0 V (more than 6000 counts, less than 540 counts)	30.0 V to 600.0 V (0.1 V)	15 Hz ≤ f < 45 Hz	±1.5% rdg ±0.5 V	±2.0% rdg ±0.5 V	3.0 MΩ ±5%
		45 Hz ≤ f ≤ 66 Hz	±0.9% rdg ±0.3 V	±1.4% rdg ±0.3 V	
		66 Hz < f < 1 kHz	±1.5% rdg ±0.5 V	–	
1000 V (less than 540 counts)	50 V to 1000 V (1 V)	15 Hz ≤ f < 45 Hz	±1.5% rdg ±5 V	±2.0% rdg ±5 V	3.0 MΩ ±5%
		45 Hz ≤ f ≤ 66 Hz	±0.9% rdg ±3 V	±1.4% rdg ±3 V	
		66 Hz < f < 1 kHz	±1.5% rdg ±5 V	–	

*1: Accuracy within the frequency range of 15 Hz (inclusive) to 20 Hz (exclusive) is designed values.

*2: Within the frequency range of less than 45 Hz, the accuracy guarantee assumes a superposed DC voltage of less than 500 V.

*3: Defined assuming that the 50 Hz AC is input.

Accuracy table

PEAK MAX/ PEAK MIN

Range	Accuracy guarantee range (resolution)	Accuracy guarantee frequency range* ¹ * ²	Measurement accuracy
6.000 V	0 V to ± 12.00 V (0.01 V)	15 Hz \leq f < 45 Hz	$\pm 1.8\%$ rdg ± 0.07 V
		45 Hz \leq f \leq 66 Hz	$\pm 1.5\%$ rdg ± 0.07 V
		66 Hz < f < 1 kHz	$\pm 1.8\%$ rdg ± 0.07 V
60.00 V	± 3.0 V to ± 120.0 V (0.1 V)	15 Hz \leq f < 45 Hz	$\pm 1.8\%$ rdg ± 0.7 V
		45 Hz \leq f \leq 66 Hz	$\pm 1.5\%$ rdg ± 0.7 V
		66 Hz < f < 1 kHz	$\pm 1.8\%$ rdg ± 0.7 V
600.0 V	± 30 V to ± 1000 V* ³ (1 V)	15 Hz \leq f < 45 Hz	$\pm 1.8\%$ rdg ± 7 V
		45 Hz \leq f \leq 66 Hz	$\pm 1.5\%$ rdg ± 7 V
		66 Hz < f < 1 kHz	$\pm 1.8\%$ rdg ± 7 V
1000 V	± 50 V to ± 1000 V* ⁴ (1 V)	15 Hz \leq f < 45 Hz	$\pm 1.8\%$ rdg ± 7 V
		45 Hz \leq f \leq 66 Hz	$\pm 1.5\%$ rdg ± 7 V
		66 Hz < f < 1 kHz	$\pm 1.8\%$ rdg ± 7 V

*1: Accuracy within the frequency range of 15 Hz (inclusive) to 20 Hz (exclusive) is designed values.

*2: Within the frequency range of less than 45 Hz, the accuracy guarantee assumes a superposed DC voltage of less than 500 V.

*3: Values of up to ± 1200 V are displayed, but accuracy is not defined for display values in excess of 1000 V (values for reference purposes).

*4: Values of up to ± 1500 V are displayed, but accuracy is not defined for display values in excess of 1000 V (values for reference purposes).

(9) DC voltage**Measured value/MAX/MIN/AVG**

Range (automatic ranging threshold)	Accuracy guarantee range (resolution)	Measurement accuracy	Input impedance (DC input)
600.0 mV (more than 6000 counts)	0.0 mV to ± 600.0 mV (0.1 mV)	$\pm 0.5\%$ rdg ± 0.5 mV	6.7 M Ω $\pm 5\%$
6.000 V (more than 6000 counts, less than 540 counts)	0.000 V to ± 6.000 V (0.001 V)	$\pm 0.5\%$ rdg ± 0.003 V	6.7 M Ω $\pm 5\%$
60.00 V (more than 6000 counts, less than 540 counts)	0.00 V to ± 60.00 V (0.01 V)	$\pm 0.5\%$ rdg ± 0.03 V	6.1 M Ω $\pm 5\%$
600.0 V (more than 6000 counts, less than 540 counts)	0.0 V to ± 600.0 V (0.1 V)	$\pm 0.5\%$ rdg ± 0.3 V	6.0 M Ω $\pm 5\%$
1000 V (less than 540 counts)	0 V to ± 1000 V (1 V)	$\pm 0.5\%$ rdg ± 3 V	6.0 M Ω $\pm 5\%$

Accuracy table

PEAK MAX/ PEAK MIN

Range	Accuracy guarantee range (resolution)	Measurement accuracy
600.0 mV	0 mV to ± 1200 mV (1 mV)	$\pm 1.0\%$ rdg ± 7 mV
6.000 V	0.00 V to ± 12.00 V (0.01 V)	$\pm 1.0\%$ rdg ± 0.07 V
60.00 V	0.0 V to ± 120.0 V (0.1 V)	$\pm 1.0\%$ rdg ± 0.7 V
600.0 V	0 V to ± 1000 V (1 V)	$\pm 1.0\%$ rdg ± 7 V
1000 V	0 V to ± 1000 V (1 V)	$\pm 1.0\%$ rdg ± 7 V

(10) AC+DC voltage

Measured value/MAX/MIN/AVG

Range (automatic ranging threshold)	Accuracy guarantee range (resolution)	Accuracy guarantee frequency range ^{*1}	Measurement accuracy		Input impedance ^{*2}	
			Filter disabled	Filter enabled		
6.000 V (more than 6000 counts)	0.000 V to 0.299 V (0.001 V)	10 Hz ≤ f < 45 Hz	±1.5% rdg ±0.023 V	±2.0% rdg ±0.023 V	DC: 6.7 MΩ ±5% AC: 3.2 MΩ ±5%	
		DC, 45 Hz ≤ f ≤ 66 Hz	±1.0% rdg ±0.023 V	±1.5% rdg ±0.023 V		
		66 Hz < f < 1 kHz	±1.5% rdg ±0.023 V	–		
	0.300 V to 6.000 V (0.001 V)	10 Hz ≤ f < 45 Hz	±1.5% rdg ±0.013 V	±2.0% rdg ±0.013 V		DC: 6.7 MΩ ±5% AC: 3.2 MΩ ±5%
		DC, 45 Hz ≤ f ≤ 66 Hz	±1.0% rdg ±0.013 V	±1.5% rdg ±0.013 V		
		66 Hz < f < 1 kHz	±1.5% rdg ±0.013 V	–		
60.00 V (more than 6000 counts, less than 540 counts)	3.00 V to 60.00 V (0.01 V)	10 Hz ≤ f < 45 Hz	±1.5% rdg ±0.13 V	±2.0% rdg ±0.13 V	DC: 6.1 MΩ ±5% AC: 3.1 MΩ ±5%	
		DC, 45 Hz ≤ f ≤ 66 Hz	±1.0% rdg ±0.13 V	±1.5% rdg ±0.13 V		
		66 Hz < f < 1 kHz	±1.5% rdg ±0.13 V	–		

Accuracy table

Range (automatic ranging threshold)	Accuracy guarantee range (resolution)	Accuracy guarantee frequency range* ¹	Measurement accuracy		Input impedance* ²
			Filter disabled	Filter enabled	
600.0 V (more than 6000 counts, less than 540 counts)	30.0 V to 600.0 V (0.1 V)	10 Hz ≤ f < 45 Hz	±1.5% rdg ±0.7 V	±2.0% rdg ±0.7 V	DC: 6.0 MΩ ±5% AC: 3.0 MΩ ±5%
		DC, 45 Hz ≤ f ≤ 66 Hz	±1.0% rdg ±0.7 V	±1.5% rdg ±0.7 V	
		66 Hz < f < 1 kHz	±1.5% rdg ±0.7 V	–	
1000 V (less than 540 counts)	50 V to 1000 V (1 V)	10 Hz ≤ f < 45 Hz	±1.5% rdg ±7 V	±2.0% rdg ±7 V	DC: 6.0 MΩ ±5% AC: 3.0 MΩ ±5%
		DC, 45 Hz ≤ f ≤ 66 Hz	±1.0% rdg ±7 V	±1.5% rdg ±7 V	
		66 Hz < f < 1 kHz	±1.5% rdg ±7 V	–	

*1: Accuracy within the frequency range of 10 Hz (inclusive) to 20 Hz (exclusive) is designed values.

*2: Defined assuming that the DC or 50 Hz AC is input.

PEAK MAX/ PEAK MIN

Range	Accuracy guarantee range (resolution)	Accuracy guarantee frequency range* ¹	Measurement accuracy
6.000 V	0.00 V to ± 12.00 V (0.01 V)	10 Hz \leq f < 45 Hz	$\pm 1.5\%$ rdg ± 0.07 V
		DC, 45 Hz \leq f \leq 66 Hz	$\pm 1.0\%$ rdg ± 0.07 V
		66 Hz < f < 1 kHz	$\pm 1.5\%$ rdg ± 0.07 V
60.00 V	± 3.0 V to ± 120.0 V (0.1 V)	10 Hz \leq f < 45 Hz	$\pm 1.5\%$ rdg ± 0.7 V
		DC, 45 Hz \leq f \leq 66 Hz	$\pm 1.0\%$ rdg ± 0.7 V
		66 Hz < f < 1 kHz	$\pm 1.5\%$ rdg ± 0.7 V
600.0 V	± 30 V to ± 1000 V* ² (1 V)	10 Hz \leq f < 45 Hz	$\pm 1.5\%$ rdg ± 7 V
		DC, 45 Hz \leq f \leq 66 Hz	$\pm 1.0\%$ rdg ± 7 V
		66 Hz < f < 1 kHz	$\pm 1.5\%$ rdg ± 7 V
1000 V	± 50 V to ± 1000 V* ³ (1 V)	10 Hz \leq f < 45 Hz	$\pm 1.5\%$ rdg ± 7 V
		DC, 45 Hz \leq f \leq 66 Hz	$\pm 1.0\%$ rdg ± 7 V
		66 Hz < f < 1 kHz	$\pm 1.5\%$ rdg ± 7 V

*1: Accuracy within the frequency range of 10 Hz (inclusive) to 20 Hz (exclusive) is designed values.

*2: Values of up to ± 1200 V are displayed, but accuracy is not defined for display values in excess of 1000 V (values for reference purposes).

*3: Values of up to ± 1500 V are displayed, but accuracy is not defined for display values in excess of 1000 V (values for reference purposes).

Accuracy table

(11) DC high voltage (DC High V Probe mode)

Measured value/MAX/MIN/AVG

Range (automatic ranging threshold)	Accuracy guarantee range (resolution)	Measurement accuracy (In combination with the P2000)	Input impedance (In combination with the P2000)
600.0 V (more than 6000 counts)	80.0 V to ± 600.0 V (0.1 V)	$\pm 1.0\%$ rdg ± 0.3 V	19.3 M Ω $\pm 2\%$
2000 V (less than 540 counts)	80 V to ± 2000 V (1 V)	$\pm 1.0\%$ rdg ± 3 V	19.3 M Ω $\pm 2\%$

(12) Continuity check

Range	Accuracy guarantee range (resolution)	Measurement current	Measurement accuracy
600.0 Ω	0.0 Ω to 600.0 Ω (0.1 Ω)	200 μ A $\pm 20\%$	$\pm 0.7\%$ rdg ± 0.5 Ω

(13) Resistance

Range (automatic ranging threshold)	Accuracy guarantee range (resolution)	Measurement current	Measurement accuracy
600.0 Ω (more than 6000 counts)	0.0 Ω to 600.0 Ω (0.1 Ω)	200 $\mu\text{A} \pm 20\%$	$\pm 0.7\%$ rdg $\pm 0.5 \Omega$
6.000 k Ω (more than 6000 counts, less than 540 counts)	0.000 k Ω to 6.000 k Ω (0.001 k Ω)	100 $\mu\text{A} \pm 20\%$	$\pm 0.7\%$ rdg $\pm 0.005 \text{ k}\Omega$
60.00 k Ω (more than 6000 counts, less than 540 counts)	0.00 k Ω to 60.00 k Ω (0.01 k Ω)	10 $\mu\text{A} \pm 20\%$	$\pm 0.7\%$ rdg $\pm 0.05 \text{ k}\Omega$
600.0 k Ω (more than 6000 counts, less than 540 counts)	0.0 k Ω to 600.0 k Ω (0.1 k Ω)	1 $\mu\text{A} \pm 20\%$	$\pm 0.7\%$ rdg $\pm 0.5 \text{ k}\Omega$
6.000 M Ω (less than 540 counts)	0.000 M Ω to 6.000 M Ω (0.001 M Ω)	100 nA $\pm 20\%$	$\pm 1.0\%$ rdg $\pm 0.005 \text{ M}\Omega$

(14) Diode

Range	Accuracy guarantee range (resolution)	Short-circuit current	Measurement accuracy
1.800 V	0.000 V to 1.800 V* ¹ (0.001 V)	200 $\mu\text{A} \pm 20\%$	$\pm 0.7\%$ rdg $\pm 0.005 \text{ V}$

*1: A series of beeps indicates forward connection (0.15 V to 1.8 V). A continuous beep is emitted and the LCD is backlit in red if the voltage is less than 0.15 V.

Accuracy table

(15) Capacitance

Range (automatic ranging threshold)	Accuracy guarantee range (resolution)	Charging current	Measurement accuracy
1.000 μF (more than 1100 counts)	0.000 μF to 1.100 μF (0.001 μF)	10 nA $\pm 20\%$ 100 nA $\pm 20\%$ 1 μA $\pm 20\%$	$\pm 1.9\%$ rdg ± 0.005 μF
10.00 μF (more than 1100 counts, less than 100 counts)	0.00 μF to 11.00 μF (0.01 μF)	100 nA $\pm 20\%$ 1 μA $\pm 20\%$ 10 μA $\pm 20\%$	$\pm 1.9\%$ rdg ± 0.05 μF
100.0 μF (more than 1100 counts, less than 100 counts)	0.0 μF to 110.0 μF (0.1 μF)	1 μA $\pm 20\%$ 10 μA $\pm 20\%$ 100 μA $\pm 20\%$	$\pm 1.9\%$ rdg ± 0.5 μF
1000 μF (less than 100 counts)	0 μF to 1100 μF (1 μF)	10 μA $\pm 20\%$ 100 μA $\pm 20\%$ 200 μA $\pm 20\%$	$\pm 1.9\%$ rdg ± 5 μF

(16) Temperature (Type K thermocouple)

Thermocouple type	Unit	Accuracy guarantee range (resolution)	Measurement accuracy*1
K	$^{\circ}\text{C}$	-40.0°C to 400.0°C (0.1 $^{\circ}\text{C}$)	$\pm 0.5\%$ rdg $\pm 3.0^{\circ}\text{C}$
K	$^{\circ}\text{F}^{*2}$	-40.0°F to 752.0°F (0.1 $^{\circ}\text{F}$)	$\pm 0.5\%$ rdg $\pm 5.4^{\circ}\text{F}$

*1: Prescribed conditions (assuming that an ambient temperature where the instrument is left to stand stabilizes in the range of $\pm 1^{\circ}\text{C}$)

*2: The temperature unit can be switched over to Fahrenheit by a special operation on the instrument.

(17) Electric charge detection (CM4371-50, CM4373-50)

Range (detection sensitivity)	Detectable voltage range* ¹	Detectable frequency
Hi	Line-to-earth voltage: 40 V AC to 600 V AC	50 Hz/60 Hz
Lo	Line-to-earth voltage: 80 V AC to 600 V AC	50 Hz/60 Hz

*1: Prescribed condition

Assuming that the instrument is brought into contact with a 2 mm² 600 V polyvinyl chloride insulated wire or equivalent

Accuracy table

(18) DC power (CM4371-50)

Current range	Voltage range* ¹ (input voltage range)	Accuracy guarantee range (resolution)	Measurement accuracy	
20 A	600.0 mV (0.0 mV to ± 600.0 mV)	0.00 VA to ± 12.00 VA (0.01 VA)	$\pm 2.0\%$ rdg ± 0.20 VA	
	6.000 V (± 0.540 V to ± 6.000 V)	0.0 VA to ± 120.0 VA (0.1 VA)	$\pm 2.0\%$ rdg ± 2.0 VA	
	60.00 V (± 5.40 V to ± 60.00 V)	0.000 kVA to ± 1.200 kVA (0.001 kVA)	$\pm 2.0\%$ rdg ± 0.020 kVA	
	600.0 V (± 54.0 V to ± 600.0 V)	0.00 kVA to ± 12.00 kVA (0.01 kVA)	$\pm 2.0\%$ rdg ± 0.20 kVA	
	1000 V (± 540 V to ± 1000 V)	0.00 kVA to ± 20.00 kVA (0.01 kVA)	$\pm 2.0\%$ rdg ± 0.20 kVA	
	DC High V Probe mode	600.0 V (± 80.0 V to ± 600.0 V)	0.00 kVA to ± 12.00 kVA* ² (0.01 kVA)	$\pm 3.0\%$ rdg ± 0.20 kVA
		2000 V (± 540 V to ± 2000 V)	0.00 kVA to ± 40.00 kVA (0.01 kVA)	$\pm 3.0\%$ rdg ± 0.20 kVA

Current range	Voltage range* ¹ (input voltage range)	Accuracy guarantee range (resolution)	Measurement accuracy	
600 A	600.0 mV (0.0 mV to ± 600.0 mV)	0.0 VA to ± 360.0 VA (0.1 VA)	$\pm 2.0\%$ rdg ± 2.0 VA	
	6.000 V (± 0.540 V to ± 6.000 V)	0.000 kVA to ± 3.600 kVA (0.001 kVA)	$\pm 2.0\%$ rdg ± 0.020 kVA	
	60.00 V (± 5.40 V to ± 60.00 V)	0.00 kVA to ± 36.00 kVA (0.01 kVA)	$\pm 2.0\%$ rdg ± 0.20 kVA	
	600.0 V (± 54.0 V to ± 600.0 V)	0.0 kVA to ± 360.0 kVA (0.1 kVA)	$\pm 2.0\%$ rdg ± 2.0 kVA	
	1000 V (± 540 V to ± 1000 V)	0 kVA to ± 600 kVA (1 kVA)	$\pm 2.0\%$ rdg ± 20 kVA	
	DC High V Probe mode	600.0 V (± 80.0 V to ± 600.0 V)	0.00 kVA to ± 360.0 kVA* ² (0.1 kVA)	$\pm 3.0\%$ rdg ± 2.0 kVA
		2000 V (± 540 V to ± 2000 V)	0.00 kVA to ± 1200 kVA (1 kVA)	$\pm 3.0\%$ rdg ± 20 kVA

Accuracy table

DC power (CM4373-50)

Current range	Voltage range* ¹ (input voltage range)	Accuracy guarantee range (resolution)	Measurement accuracy
600 A	600.0 mV (0.0 mV to ±600.0 mV)	0.0 VA to ±360.0 VA (0.1 VA)	±2.0% rdg ±2.0 VA
	6.000 V (±0.540 V to ±6.000 V)	0.000 kVA to ±3.600 kVA (0.001 kVA)	±2.0% rdg ±0.020 kVA
	60.00 V (±5.40 V to ±60.00 V)	0.00 kVA to ±36.00 kVA (0.01 kVA)	±2.0% rdg ±0.20 kVA
	600.0 V (±54.0 V to ±600.0 V)	0.0 kVA to ±360.0 kVA (0.1 kVA)	±2.0% rdg ±2.0 kVA
	1000 V (±540 V to ±1000 V)	0 kVA to ±600 kVA (1 kVA)	±2.0% rdg ±20 kVA
	DC High V Probe mode	600.0 V (±80.0 V to ±600.0 V)	0.00 kVA to ±360.0 kVA* ² (0.1 kVA)
2000 V (±540 V to ±2000 V)		0.00 kVA to ±1200 kVA (1 kVA)	±3.0% rdg ±20 kVA

Current range	Voltage range* ¹ (input voltage range)	Accuracy guarantee range (resolution)	Measurement accuracy
2000 A	600.0 mV (0.0 mV to ± 600.0 mV)	0.000 kVA to ± 1.200 kVA (0.001 kVA)	$\pm 2.0\%$ rdg ± 0.020 kVA
	6.000 V (± 0.540 V to ± 6.000 V)	0.00 kVA to ± 12.00 kVA (0.01 kVA)	$\pm 2.0\%$ rdg ± 0.20 kVA
	60.00 V (± 5.40 V to ± 60.00 V)	0.0 kVA to ± 120.0 kVA (0.1 kVA)	$\pm 2.0\%$ rdg ± 2.0 kVA
	600.0 V (± 54.0 V to ± 600.0 V)	0 kVA to ± 1200 kVA (1 kVA)	$\pm 2.0\%$ rdg ± 20 kVA
	1000 V (± 540 V to ± 1000 V)	0 kVA to ± 2000 kVA (1 kVA)	$\pm 2.0\%$ rdg ± 20 kVA
	DC High V Probe mode	600.0 V (± 80.0 V to ± 600.0 V)	0.00 kVA to ± 1200 kVA* ² (1 kVA)
2000 V (± 540 V to ± 2000 V)		0.00 kVA to ± 4000 kVA (1 kVA)	$\pm 3.0\%$ rdg ± 20 kVA

Accuracy table

DC power (CM4375-50)

Current range	Voltage range* ¹ (input voltage range)	Accuracy guarantee range (resolution)	Measurement accuracy
1000 A	600.0 mV (0.0 mV to ±600.0 mV)	0.000 kVA to ±0.600 kVA (0.001 kVA)	±2.0% rdg ±0.020 kVA
	6.000 V (±0.540 V to ±6.000 V)	0.00 kVA to ±6.00 kVA (0.01 kVA)	±2.0% rdg ±0.20 kVA
	60.00 V (±5.40 V to ±60.00 V)	0.0 kVA to ±60.0 kVA (0.1 kVA)	±2.0% rdg ±2.0 kVA
	600.0 V (±54.0 V to ±600.0 V)	0 kVA to ±600 kVA (1 kVA)	±2.0% rdg ±20 kVA
	1000 V (±540 V to ±1000 V)	0 kVA to ±1000 kVA (1 kVA)	±2.0% rdg ±20 kVA
	DC High V Probe mode	600.0 V (±80.0 V to ±600.0 V)	0 kVA to ±600 kVA* ² (1 kVA)
2000 V (±540 V to ±2000 V)		0 kVA to ±2000 kVA (10 kVA)	±3.0% rdg ±20 kVA

*1: DC power ranges will be automatically switched in sync with the voltage range.

*2: When a voltage of less than 80.0 V is input, the LCD shows **[---kVA]**.

4

Maintenance and Service

4.1 Troubleshooting

Problem	Cause	Remedy
The instrument is indicating an abnormal measured value.	The measured value is lower than the lower limit value of the measuring range.	Wrap the wire around the jaw one or more times. Wrapping the wire n times can increase the displayed value by $(n + 1)$ times.
	The tips of the jaw open.	Close the jaw tips.
	The jaw is damaged.	The instrument with its jaw damaged cannot measure current accurately. Have the instrument repaired.
	Displayed values can frequently fluctuate due to induction potential even with no input. This, however, is not a malfunction.	
Measured value differ from those of another clamp-on current meter.	Measured waveforms contain a component that falls outside the frequency characteristics range.	The instrument cannot accurately measure waveforms that contain a component that falls outside the frequency characteristics range.
	The instrument, which uses the true RMS method, can accurately measure distorted waveforms. When measuring a distorted waveform, the measured value will differ from a clamp-on current meter that uses the averaging method.	

Troubleshooting

Problem	Cause	Remedy
The current value is larger than expected. A current value is displayed even with no input.	There is a transformer or high-current circuit that emits a strong magnetic field near the instrument. Otherwise, there is a wireless device that emits a strong electric field.	Perform measurement keeping the instrument away from such equipment.
The instrument's jaw emits sound (vibration).	Greater than or equal to 500 A of AC current is being measured.	The jaw may emit sound (vibration); however, there is no effect on the measurement.
The measured value does not appear.	The test leads have a break.	Check the continuity of the test leads. (p.44) If a break is found, replace the test leads.
No measured value is displayed even when the test lead tips are shorted.	The test leads are not inserted all the way.	Insert the test leads all the way.
Zero adjustment is impossible.	Zero adjustment was performed leaving the instrument clamped around a measurement target.	If you wish to measure current, remove the instrument from a measurement target to perform zero adjustment.

If problems cannot be resolved even after you have implemented such remedies, have the instrument repaired.

4.2 Error and Operation Displays

Error display	Description	Remedy
v.UP	The instrument's firmware is being upgraded.	Do not remove the batteries until the upgrade completes.
Err 001	ROM error (program)	When the error appears on the display, it is necessary to repair the instrument. Please contact your authorized Hioki distributor or reseller.
Err 002	ROM error (adjustment data)	
Err 004	Memory error	
Err 005	ADC error (hardware malfunction)	
Err 008	Z3210 communication error (the Z3210 is malfunctioning or is not properly connected)	Perform the following steps. (p.26) Disconnect and then reconnect the Z3210. If you have another Z3210, replace the unit in question with that one. If the error continues to be displayed, the instrument needs to be repaired. Please contact your authorized Hioki distributor or reseller.

4.3 Cleaning

CAUTION



- **If the instrument becomes dirty, wipe the instrument clean with a soft cloth moistened with water or a neutral detergent.**

Never use solvents such as benzene, alcohol, acetone, ether, ketone, thinners or gasoline. Doing so could deform and discolor the instrument.

IMPORTANT

- **Keep the facing core surfaces of the jaws clean by gently wiping them with a soft dry cloth.**

Dirt on the facing core surfaces of the jaws can adversely affect the measurement accuracy.

Wipe the LCD gently with a soft, dry cloth.

5.1 Voltage Detection Function

Check the instrument for proper operation by measuring a power supply with a known voltage, such as a commercial power supply, before use.

The voltage detection function cannot operate correctly for the following circuits and wires:

- Non-grounded circuits, of which the line-to-earth voltage is not fixed, such as the secondary side of transformers
- DC circuits
- Grounded wires
- Shielded wires

It is recommended that you set the voltage detection function to Hi. If the voltage detection function malfunctions due to the effect of a nearby wire, set the sensitivity to Lo. However, depending on the use environment, the instrument with the sensitivity set to Lo may not be able to detect even a voltage within the detection range.

Voltage Detection Function

Measurement principle

The instrument employs a voltage-detecting method using electrostatic coupling to determine the live condition of objects under test.

See "(17) Electric charge detection (CM4371-50, CM4373-50)" (p. 101) for information about the detectable voltage range and detectable frequency.

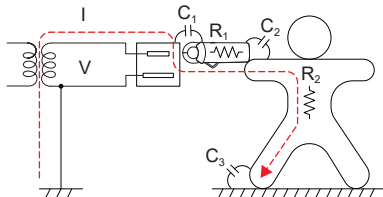

Measuring principle diagram

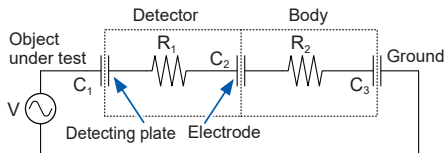

Equivalent circuit diagram

Although a detected current will flow to the ground through your body, the current, less than $1 \mu\text{A}$, will not adversely affect you.

IMPORTANT

If it is difficult to judge with the voltage detection function, check the voltage using the voltage measuring function.

5.2 Example of Use

Checking for noise superimposed on DC voltage and current

Measure voltage/current values and voltage/current peak values of each DC component, AC component, and AC+DC resultant component.

Example: A DC voltage of 100 V with an AC voltage of 10 V superimposed

See page 41 for information about how to use the **MAX/MIN** **PEAK** and **Fn** keys.

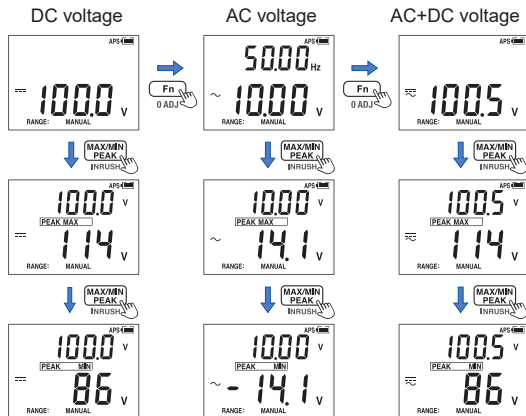
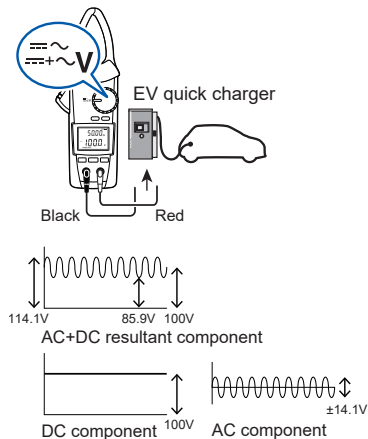

Example of Use

A

AC+DC current	37
AC+DC voltage	38, 95
AC current	37, 75
AC voltage	38, 90
Automatic hold	35, 36
Automatic power save	47, 59
Average	41

B

Backlight	24, 47, 59
Flashing	43
Illuminate in red	34, 44
Buzzer	24, 34, 43, 59

C

Capacitance	45, 100
Continuity check	38, 44, 98, 108
Current	33, 65

D

DC current	37, 46
DC High V Probe mode	48
DC power	46
DC voltage	38, 46, 59, 93
Degrees Fahrenheit	60
Diode	38, 44, 99
Displayed value fluctuation	107
DT4910 Thermocouples (K)	45

E

Error and Operation Display	109
Event recording function	54
Excel direct entry function	55

F

Filter	40
Frequency	33, 41, 43, 87

G

GENNECT Cross..... 52

H

HID 55

I

Inrush current 42, 87

J

Jaws 15, 20

L

L9300..... 30

M

Manual hold 35

Maximum value 41

Measurement function 19, 37, 43

Minimum value 41

N

Noise 40

P

Peak value 41

Polarity check 34, 43, 59

R

Range 39

Resistance 38, 44, 99

Rotary switch combinations 59

S

Serial number 20, 59

Switching the temperature units 60

T

Temperature 45, 100

Test leads 8, 28, 108

V

Voltage..... 43, 70

W

Wire break 5, 21, 45, 108

Wireless Adapter 22, 52

Wireless communications function 52

Z

Z3210 22, 52

Zero adjustment..... 33, 42, 44, 108

Warranty Certificate

HIOKI

Model	Serial number	Warranty period Three (3) years from date of purchase (___ / ___ / ___)
-------	---------------	--

Customer name: _____
Customer address: _____

Important

- Please retain this warranty certificate. Duplicates cannot be reissued.
- Complete the certificate with the model number, serial number, and date of purchase, along with your name and address. The personal information you provide on this form will only be used to provide repair service and information about Hiko products and services.

This document certifies that the product has been inspected and verified to conform to Hiko's standards. Please contact the place of purchase in the event of a malfunction and provide this document, in which case Hiko will repair or replace the product subject to the warranty terms described below.

Warranty terms

1. The product is guaranteed to operate properly during the warranty period (three [3] years from the date of purchase). If the date of purchase is unknown, the warranty period is defined as three (3) years from the date (month and year) of manufacture (as indicated by the first four digits of the serial number in YYYYMM format).
2. If the product came with an AC adapter, the adapter is warranted for one (1) year from the date of purchase.
3. The accuracy of measured values and other data generated by the product is guaranteed as described in the product specifications.
4. In the event that the product or AC adapter malfunctions during its respective warranty period due to a defect of workmanship or materials, Hiko will repair or replace the product or AC adapter free of charge.
5. The following malfunctions and issues are not covered by the warranty and as such are not subject to free repair or replacement:
 - 1. Malfunctions or damage of consumables, parts with a defined service life, etc.
 - 2. Malfunctions or damage of connectors, cables, etc.
 - 3. Malfunctions or damage caused by shipment, dropping, relocation, etc., after purchase of the product
 - 4. Malfunctions or damage caused by inappropriate handling that violates information found in the instruction manual or on precautionary labeling on the product itself
 - 5. Malfunctions or damage caused by a failure to perform maintenance or inspections as required by law or recommended in the instruction manual
 - 6. Malfunctions or damage caused by fire, storms or flooding, earthquakes, lightning, power anomalies (involving voltage, frequency, etc.), war or unrest, contamination with radiation, or other acts of God
 - 7. Damage that is limited to the product's appearance (cosmetic blemishes, deformation of enclosure shape, fading of color, etc.)
 - 8. Other malfunctions or damage for which Hiko is not responsible
6. The warranty will be considered invalidated in the following circumstances, in which case Hiko will be unable to perform service such as repair or calibration:
 - 1. If the product has been repaired or modified by a company, entity, or individual other than Hiko
 - 2. If the product has been embedded in another piece of equipment for use in a special application (aerospace, nuclear power, medical use, vehicle control, etc.) without Hiko's having received prior notice
7. If you experience a loss caused by use of the product and Hiko determines that it is responsible for the underlying issue, Hiko will provide compensation in an amount not to exceed the purchase price, with the following exceptions:
 - 1. Secondary damage arising from damage to a measured device or component that was caused by use of the product
 - 2. Damage arising from measurement results provided by the product
 - 3. Damage to a device other than the product that was sustained when connecting the device to the product (including via network connections)
8. Hiko reserves the right to decline to perform repair, calibration, or other service for products for which a certain amount of time has passed since their manufacture, products whose parts have been discontinued, and products that cannot be repaired due to unforeseen circumstances.

HIOKI E.E. CORPORATION

<http://www.hioki.com>

18-07 EN-3

HIOKI

www.hioki.com/



**All regional
contact
information**

HIOKI E.E. CORPORATION

81 Koizumi, Ueda, Nagano 386-1192 Japan

2309 EN

Edited and published by HIOKI E.E. CORPORATION

Printed in Japan

- Contents subject to change without notice.
- This document contains copyrighted content.
- It is prohibited to copy, reproduce, or modify the content of this document without permission.
- Company names, product names, etc. mentioned in this document are trademarks or registered trademarks of their respective companies.

Europe only

• EU declaration of conformity can be downloaded from our website.

• Contact in Europe: HIOKI EUROPE GmbH
Helfmann-Park 2, 65760 Eschborn, Germany

hioki@hioki.eu