

PW3390

HIOKI

PW3390-01
PW3390-02
PW3390-03

Instruction Manual

POWER ANALYZER



Video

Scan this code to watch the instructional video(s).

Carrier charges may apply.



The latest edition of the instruction manual



**Read carefully before use.
Keep for future reference.**

Names and Functions of Parts ▶ p.17
Basic Operations ▶ p.20
Measurement Preparations ▶ p.27

Troubleshooting ▶ p.223
Error Indication ▶ p.226

EN

Mar. 2024 Revised edition 7
PW3390A961-07



Contents

Introduction.....	1
Confirming Package Contents.....	2
Safety Notes.....	5
Usage Notes.....	8
Chapter 1	
Overview	13
1.1 Product Overview.....	13
1.2 Features.....	14
1.3 Operating Overview	16
Chapter 2	
Names and Functions of Parts, Basic Operations & Screens	17
2.1 Names and Functions of Parts.....	17
2.2 Basic Operations.....	20
2.3 Display Items and Screen Types	21
2.3.1 Common Display Items	21
2.3.2 Measurement Screen	22
2.3.3 Screen Types	23
Chapter 3	
Measurement Preparations	27
3.1 Operations in general.....	27
3.2 Initial Instrument Preparations	28
3.3 Pre-Operation Inspection	30
3.4 Connecting the Power Cord.....	31
3.5 Grounding the Instrument's Functional Earth (when measuring in noisy environments)	31
3.6 Connecting the Voltage Measurement Cables	32
3.7 Connecting the Current Sensors.....	33
3.8 Turning the Power On and Off.....	36
3.9 Selecting the Wiring Mode	37
3.10 Setting the Current Sensors.....	41

3.11	Attaching to the Lines to be Measured and Zero Adjustment	44
3.12	Verifying Correct Wiring (Connection Check)	46

Chapter 4

Viewing Measurement Values _____ 47

4.1	Measurement Value Display Procedure	47
4.2	Viewing Power Measurements, and Changing the Measurement Configuration	51
4.2.1	Displaying Power Measurements	51
4.2.2	Selecting Ranges.....	53
4.2.3	Selecting the Sync Source.....	58
4.2.4	Frequency Measurement Settings.....	60
4.2.5	Selecting the Rectification Method.....	62
4.2.6	Setting Scaling (when using VT(PT) or CT).....	63
4.2.7	Setting the Low-Pass Filter	64
4.3	Integration Value Observation	65
4.3.1	Displaying Integration Values	65
4.3.2	Setting the Integration Mode.....	68
4.3.3	Manual Integration Method	69
4.3.4	Integration Combined with Timing Control.....	71
4.4	Viewing Harmonic Measurement Values	74
4.4.1	Displaying the Harmonic Bar Graph	74
4.4.2	Displaying the Harmonic List	76
4.4.3	Displaying Harmonic Vectors.....	77
4.4.4	Selecting the Harmonic Sync Source	79
4.4.5	Selecting the THD Calculation Method	80
4.5	Viewing Waveforms	81
4.5.1	Displaying Waveforms	81
4.5.2	Resizing Waveforms.....	84
4.6	Viewing Noise Measurement Values (FFT Function)	85
4.6.1	Displaying Noise Voltage and Current.....	85
4.6.2	Setting the Sampling Frequency and Points.....	87
4.6.3	Setting the Minimum Noise Frequency	88
4.6.4	Measurement Channel and Window Function Settings	90
4.7	Viewing Efficiency and Loss Measurement Values	91
4.7.1	Displaying Efficiency and Loss	91
4.7.2	Selecting the Calculation Formula	92
4.7.3	Measurement Examples	93
4.8	Viewing Motor Measurement Values (Model PW3390-03 only)	96

4.8.1	Motor Input Settings	98
4.8.2	Measuring Motor Electrical Angle.....	104
4.8.3	Detecting the Motor Rotation Direction.....	107

Chapter 5 **Operating Functions** _____ **109**

5.1	Timing Control Functions	109
5.2	Averaging Function	112
5.3	Data Hold and Peak Hold Functions.....	114
5.3.1	Data Hold Function.....	114
5.3.2	Peak Hold Function	115
5.4	X-Y Plot Function	117
5.5	Delta Star (Δ -Y) Transform Function	118
5.6	Selecting the Calculation Method	120
5.7	Trend Function.....	121

Chapter 6 **Changing System Settings** _____ **129**

6.1	Initializing the Instrument (System Reset)	132
6.2	Factory Default Settings.....	133

Chapter 7 **Data Saving and File Operations** _____ **135**

7.1	Inserting and Removing Storage Media.....	136
7.2	The File Operation Screen.....	138
7.3	Media Formatting	139
7.4	Saving Operations	140
7.5	Measurement Data Saving	141
7.5.1	Manually Saving Measurement Data.....	141
7.5.2	Auto-Saving Measurement Data	143
7.5.3	Selecting Measurement Items to Save.....	145
7.6	Saving Noise Data and Waveform Data	147
7.6.1	Saving Noise Data.....	147
7.6.2	Saving Wave Data.....	148
7.7	Saving Screen Capture Images	149
7.8	Loading Screenshots	150
7.9	Saving Setting Configurations.....	151

7.10	Reloading Setting Configurations	152
7.11	File and Folder Operations	153
7.11.1	Creating Folders	153
7.11.2	Copying Files and Folders	154
7.11.3	Deleting Files and Folders	156
7.11.4	Renaming Files and Folders	157

Chapter 8

Connecting External Devices _____ 159

8.1	Connecting Multiple PW3390 (Synchronized Measurements)	159
8.2	Controlling Integration with External Signals	163
8.3	Using Analog and Waveform D/A Output	166
8.3.1	Connecting Application-Specific Devices to the Instrument.	166
8.3.2	Output Item Selection	168
8.3.3	Output Level	171
8.3.4	D/A Output Examples	172
8.4	Connecting the Instrument to a LR8410 Link-compatible Logger	174
8.4.1	Configuring and Connecting the Adapter.....	175
8.5	Using the Motor Testing.....	176
8.6	Connecting VT1005	178

Chapter 9

Operation with a Computer _____ 181

9.1	Control and Measurement via Ethernet ("LAN") Interface	182
9.1.1	LAN Settings and Network Environment Configuration	182
9.1.2	Instrument Connection.....	184
9.2	Remote Control of the Instrument by Internet Browser ..	186
9.2.1	Connecting to the Instrument.....	186
9.2.2	Operating Procedure	187
9.3	Control and Measurement via USB Interface	188
9.3.1	Connecting to the Instrument.....	188
9.3.2	After Connecting	188
9.4	Control and Measurement via RS-232C Interface	189
9.4.1	Connecting to the Instrument.....	189
9.4.2	Setting the RS-232C Communications Speed.....	190

Chapter 10	
Specifications	193
10.1 General Specifications	193
10.2 Basic Specifications	194
10.3 Functions Specifications	203
10.4 Setting Specifications.....	208
10.5 Measurement Item Details	211
10.6 Calculation Formula Specifications.....	214
10.7 Wiring System Diagram Specifications	221
Chapter 11	
Maintenance and Service	223
11.1 Cleaning.....	223
11.2 Troubleshooting	223
11.3 Error Indication.....	226
11.4 Disposing of the Instrument	230
Appendix	A1
Appendix 1Block Diagram	A1
Appendix 2Measurement Data Saving Format.....	A2
Appendix 3Physical Illustration.....	A5
Appendix 4Rack Mounting.....	A6
Index	i

Introduction

Thank you for purchasing the Hioki PW3390 Power Analyzer. To obtain maximum performance from the product, please read this manual first, and keep it handy for future reference.

To measure current, the power analyzer requires clamp-on current probes or AC/DC current probes (Options, (p. 3), afterwards referred to generically as “current sensors”). See your current sensor’s instruction manual for details.



Product registration

Register this product in order to receive important product information.

<https://www.hioki.com/global/support/myhioki/registration/>

Trademarks

- CompactFlash is a registered trademark of Sandisk Corporation (USA).
- Excel and Windows are trademarks of the Microsoft group of companies.
- Adobe and Adobe Reader are either trademarks or registered trademarks of Adobe in the United States and other countries.
- The Bluetooth® word mark and logos are registered trademarks owned by Bluetooth SIG, Inc. and any use of such marks by Hioki E.E. Corporation is under license. Other trademarks and trade names are those of their respective owners.

Product model numbers

Rear side

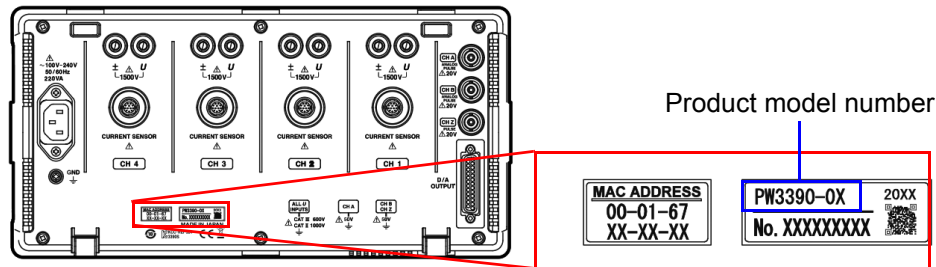

The product model number is indicated as below depending on a manufacturing date.

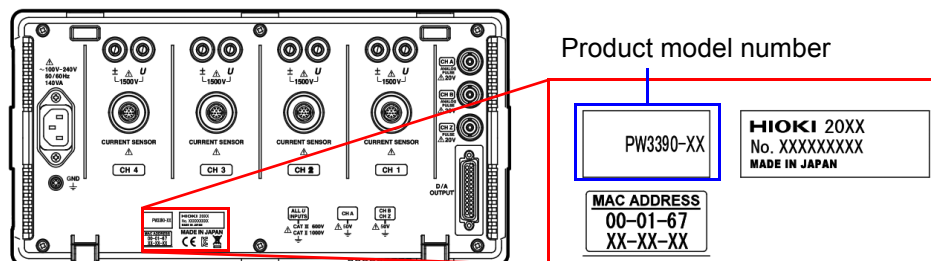

Product model number	Feature
PW3390-01	Basic model (model without motor analysis and D/A output)
PW3390-02	Model with D/A output
PW3390-03	Model with motor analysis and D/A output

In this document, the terms “master” and “slave” used in the earlier editions have been replaced with “primary” and “secondary,” respectively.

Confirming Package Contents

When you receive the instrument, inspect it carefully to ensure that no damage occurred during shipping. In particular, check the accessories, panel switches, and connectors. If damage is evident, or if it fails to operate according to the specifications, contact your authorized Hioki distributor or reseller.

Confirm that these contents are provided.

Main instrument

- PW3390 Power Analyzer ×1

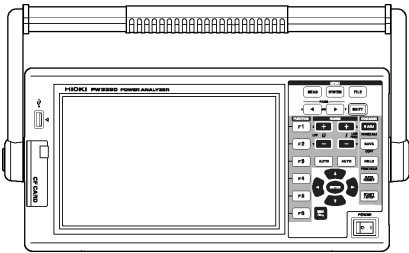

Accessories

- Grounded power cord ×1

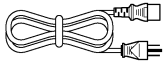

- USB cable ×1

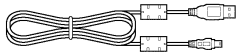

- D-Sub connector ×1
(used only with the D/A output function-equipped
PW3390-02 or PW3390-03)



- Instruction manual (This document) ×1



- Measurement guide ×1



- Input cable labels (to identify voltage cords and
current sensor channels) ×2



Please attach to the instrument before use. (p. 28)

Options

The following options are available for the product. Contact your authorized Hioki distributor or reseller when ordering. The options are subject to change. Visit our website for updated information.

Voltage measurement options

- L9438-50 Voltage Cord (banana/banana; 1 each red and black; with alligator clips/approx. 3 m)
CAT III 1000 V, 10 A / CAT IV 600 V, 10 A
- L1000 Voltage Cord (banana/banana; 1 each red, yellow, blue, and gray; 4 black; with alligator clips/
approx. 3 m) CAT III 1000 V, 10 A / CAT IV 600 V, 10 A
- L4931 Extension Cable Set (banana/banana; 1 each red and black/approx. 1.5 m, for extending the
L9438-50 or L1000) CAT III 1000 V, 10 A / CAT IV 600 V, 10 A
- L1021-01 Patch Cord (branched bananas/banana; 1 red/approx. 0.5 m, for branching the L9438-50 or L1000)
CAT III 1000 V, 10 A / CAT IV 600 V, 10 A
- L1021-02 Patch Cord (branched bananas/banana; 1 black/approx. 0.5 m, for branching the L9438-50 or L1000)
CAT III 1000 V, 10 A / CAT IV 600 V, 10 A
- L9243 Grabber Clip (1 each red and black) CAT II 1000 V, 1 A
- PW9000 Wiring Adapter (for three-phase 3-wire) CAT III 1000 V, 1 A / CAT IV 600 V, 1 A (p. 32)
- PW9001 Wiring Adapter (for three-phase 4-wire) CAT III 1000 V, 1 A / CAT IV 600 V, 1 A (p. 32)
- VT1005 AC/DC High Voltage Divider

Current measurement options

- CT6830 AC/DC Current Probe (2 A)
- CT6831 AC/DC Current Probe (20 A)
- CT6841 AC/DC Current Probe (20 A)
- CT6843 AC/DC Current Probe (200 A)
- CT6844 AC/DC Current Probe (500 A)
- CT6845 AC/DC Current Probe (500 A)
- CT6846 AC/DC Current Probe (1000 A)
- CT6841-05 AC/DC Current Probe (20 A)
- CT6843-05 AC/DC Current Probe (200 A)
- CT6844-05 AC/DC Current Probe (500 A)
- CT6845-05 AC/DC Current Probe (500 A)
- CT6846-05 AC/DC Current Probe (1000 A)
- CT6841A AC/DC Current Probe (20 A)
- CT6843A AC/DC Current Probe (200 A)
- CT6844A AC/DC Current Probe (500 A)
- CT6845A AC/DC Current Probe (500 A)
- CT6846A AC/DC Current Probe (1000 A)
- 9272-05 Clamp On Sensor (20 A/200 A AC)
- 9709-05 AC/DC Current Sensor (500 A)
- CT6862 AC/DC Current Sensor (50 A)
- CT6863 AC/DC Current Sensor (200 A)
- CT6865 AC/DC Current Sensor (1000 A)
- CT6872 AC/DC Current Sensor (50 A, cable length 3 m)
- CT6872-01 AC/DC Current Sensor (50 A, cable length 10 m)
- CT6873 AC/DC Current Sensor (200 A, cable length 3 m)
- CT6873-01 AC/DC Current Sensor (200 A, cable length 10 m)
- CT6862-05 AC/DC Current Sensor (50 A)
- CT6863-05 AC/DC Current Sensor (200 A)
- CT6865-05 AC/DC Current Sensor (1000 A)
- CT6875 AC/DC Current Sensor (500 A, cable length 3 m)
- CT6875-01 AC/DC Current Sensor (500 A, cable length 10 m)
- CT6876 AC/DC Current Sensor (1000 A, cable length 3 m)
- CT6876-01 AC/DC Current Sensor (1000 A, cable length 10 m)
- CT6877 AC/DC Current Sensor (2000 A, cable length 3 m)

Confirming Package Contents

- CT6877-01 AC/DC Current Sensor (2000 A, cable length 10 m)
- CT6904 AC/DC Current Sensor (500 A)
- CT6875A AC/DC Current Sensor (500 A, cable length 3 m)
- CT6875A-1 AC/DC Current Sensor (500 A, cable length 10 m)
- CT6876A AC/DC Current Sensor (1000 A, cable length 3 m)
- CT6876A-1 AC/DC Current Sensor (1000 A, cable length 10 m)
- CT6877A AC/DC Current Sensor (2000 A, cable length 3 m)
- CT6877A-1 AC/DC Current Sensor (2000 A, cable length 10 m)
- CT6904A AC/DC Current Sensor (500 A)
- PW9100-03 AC/DC Current Box (50 A, 3 channels)
- PW9100-04 AC/DC Current Box (50 A, 4 channels)
- PW9100A-3 AC/DC Current Box (50 A, 3 channels)
- PW9100A-4 AC/DC Current Box (50 A, 4 channels)
- CT9557 Sensor Unit (sensor power supply with 4-channel addition function)
- CT9904 Connection Cable (for connecting the CT9557)
- CT9900 Conversion Cable (PL23 receptacle-ME15W plug)
- CT9920 Conversion Cable (PL14 receptacle-ME15W plug)
- Special-order: 5 A rated version of the PW9100 AC/DC Current Box
- Special-order: High-accuracy version of the 9709-05 AC/DC Current Sensor
- Special-order: High-accuracy version of the CT6862-05 AC/DC Current Sensor
- Special-order: High-accuracy version of the CT6863-05 AC/DC Current Sensor
- Special-order: CT6904-01 AC/DC Current Sensor (500 A, cable length 10 m)
- Special-order: CT6904-60 AC/DC Current Sensor (800 A, cable length 3 m)
- Special-order: CT6904-61 AC/DC Current Sensor (800 A, cable length 10 m)
- Special-order: CT6904A-1 AC/DC Current Sensor (500 A, cable length 10 m)
- Special-order: CT6904A-2 AC/DC Current Sensor (800 A, cable length 3 m)
- Special-order: CT6904A-3 AC/DC Current Sensor (800 A, cable length 10 m)
- CT7742 AC/DC Auto-Zero Current Sensor (2000 A)
- CT7642 AC/DC Current Sensor (2000 A)
- CT7044 AC Flexible Current Sensor (6000 A, ϕ 100 mm)
- CT7045 AC Flexible Current Sensor (6000 A, ϕ 180 mm)
- CT7046 AC Flexible Current Sensor (6000 A, ϕ 254 mm)

Connection options

- L9217 Connection Cord (isolated BNC/isolated BNC; 1.6 m; for motor analysis input)
CAT II 600 V, 0.2 A / CAT III 300 V, 0.2 A
[See "8.5 Using the Motor Testing" \(p. 176\)](#)
- Special-order: D/A Output Cable (25-pin D-sub/male BNC; 16-channel conversion/2.5 m)
- 9683 Connection Cable (for synchronization /1.5 m)
[See "Connecting Multiple PW3390 \(Synchronized Measurements\)" \(p. 159\)](#)
- 9642 LAN Cable (5 m, with straight/cross conversion connector)
- 9637 RS-232C Cable (9pin-9pin/1.8 m, crossing cable)

Other options

- 9728 PC Card 512M (512 MB CF Card + Adapter)
 - 9729 PC Card 1G (1 GB CF Card + Adapter)
 - 9830 PC Card 2G (2 GB CF Card + Adapter)
 - 9794 Carrying Case (PW3390 dedicated hard type)
 - Special-order: Rack mounting hardware (EIA/JIS)
-

Safety Notes

WARNING

This instrument is designed to comply with IEC 61010 Safety Standards, and has been thoroughly tested for safety prior to shipment. However, mishandling during use could result in injury or death, as well as damage to the instrument. However, using the instrument in a way not described in this manual may negate the provided safety features.

Be certain that you understand the instructions and precautions in the manual before use. We disclaim any responsibility for accidents or injuries not resulting directly from instrument defects.

This manual contains information and warnings essential for safe operation of the product and for maintaining it in safe operating condition. Before using the product, be sure to carefully read the following safety notes.

Safety symbols



Indicates cautions and hazards. When the symbol is printed on the instrument, refer to a corresponding topic in the Instruction Manual.



Indicates a grounding terminal.



Indicates the ON side of the power switch.



Indicates the OFF side of the power switch.

The following symbols in this manual indicate the relative importance of cautions and warnings.



DANGER

Indicates that incorrect operation presents a significant hazard that could result in serious injury or death to the user.



WARNING

Indicates that incorrect operation presents a significant hazard that could result in serious injury or death to the user.



CAUTION

Indicates that incorrect operation presents a possibility of injury to the user or damage to the product.

NOTE

Advisory items related to performance or correct operation of the product.

Symbols for various standards





Indicates the Waste Electrical and Electronic Equipment Directive (WEEE Directive) in EU member states.



Indicates that the product conforms to regulations set out by the EU Directive.

Other symbols

Symbols in this manual

	Indicates the prohibited action.
(p.)	Indicates the location of reference information.
	Indicates quick references for operation and remedies for troubleshooting.
*	Indicates that descriptive information is provided below.
[]	Menus, commands, dialogs, buttons in a dialog, and other names on the screen and the keys are indicated in brackets.
CURSOR (Bold character)	Bold characters within the text indicate operating key labels.
Windows	Unless otherwise specified, "Windows" represents Windows 7, Windows 8, or Windows 10.
Dialog	Dialog box represents a Windows dialog box.

Mouse action terminology

Click:	Press and quickly release the left button of the mouse.
Right-click:	Press and quickly release the right button of the mouse.
Double click:	Quickly click the left button of the mouse twice.
Drag:	While holding down the left button of the mouse, move the mouse and then release the left button to deposit the chosen item in the desired position.
Activate:	Click on a window on the screen to activate that window.

Accuracy

We define measurement tolerances in terms of f.s. (full scale), rdg. (reading) and dgt. (digit) values, with the following meanings:

f.s.	(maximum display value or scale length) The maximum displayable value or scale length. This is usually the name of the currently selected range.
rdg.	(reading or displayed value) The value currently being measured and indicated on the measuring instrument.
dgt.	(resolution) The smallest displayable unit on a digital measuring instrument, i.e., the input value that causes the digital display to show a "1" as the least-significant digit.

Measurement categories

This instrument complies with CAT II (1000 V) and CAT III (600 V) safety requirements. To ensure safe operation of measurement instruments, IEC 61010 establishes safety standards for various electrical environments, categorized as CAT II to CAT IV, and called measurement categories.

CAT II	Primary electrical circuits in equipment connected to an AC electrical outlet by a power cord (portable tools, household appliances, etc.) CAT II covers directly measuring electrical outlet receptacles. CAT II covers directly measuring electrical outlet receptacles.
CAT III	Primary electrical circuits of heavy equipment (fixed installations) connected directly to the distribution panel, and feeders from the distribution panel to outlets.
CAT IV	The circuit from the service drop to the service entrance, and to the power meter and primary overcurrent protection device (distribution panel).

Using a measurement instrument in an environment designated with a higher-numbered category than that for which the instrument is rated could result in a severe accident, and must be carefully avoided. Use of a measurement instrument that is not CAT-rated in CAT II to CAT IV measurement applications could result in a severe accident, and must be carefully avoided.

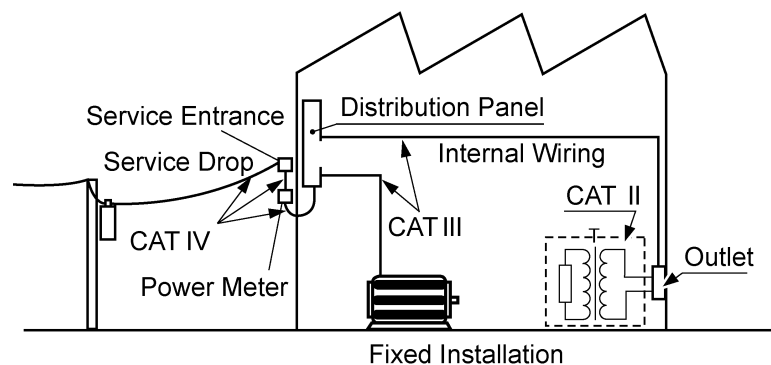

Usage Notes

Follow these precautions to ensure safe operation and to obtain the full benefits of the various functions.

Before use

Before using the instrument the first time, verify that it operates normally to ensure that no damage occurred during storage or shipping. If you find any damage, contact your authorized Hioki distributor or reseller.



DANGER

Before using the instrument, make sure that the insulation on the voltage cords is undamaged and that no bare conductors are improperly exposed. Using the instrument in such conditions could cause an electric shock, so contact your authorized Hioki distributor or reseller for replacements.

Instrument installation

Avoid the following locations that could cause an accident or damage to the instrument.



Exposed to direct sunlight
Exposed to high temperature



In the presence of corrosive or explosive gases



Exposed to liquids
Exposed to high humidity or condensation



Exposed to strong electromagnetic fields
Near electromagnetic radiators



Exposed to high levels of particulate dust



Near induction heating systems (e.g., high-frequency induction heating systems and IH cooking utensils)



Subject to vibration

Installing

- The instrument should be operated only with the bottom or rear side downwards.
- Vents (on the right side of the instrument) must not be obstructed.

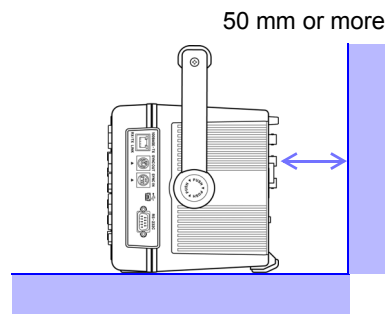
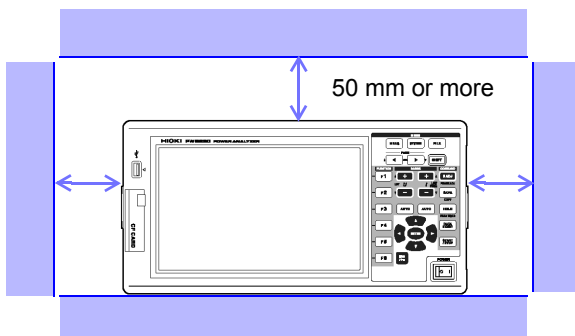

Handling the instrument

DANGER

To avoid electric shock, do not remove the instrument's case. The internal components of the instrument carry high voltages and may become very hot during operation.

CAUTION

- If the instrument exhibits abnormal operation or display during use, review the information in Troubleshooting section "11.2 Troubleshooting" (p. 223) and Error Indications section "11.3 Error Indication" (p. 226) before contacting your authorized Hioki distributor or reseller.
- To avoid damage to the instrument, protect it from physical shock when transporting and handling. Be especially careful to avoid physical shock from dropping.
- To move the instrument, first disconnect all cables, remove any CF card and USB memory, and carry it by the handle.
- Do not apply heavy downward pressure with the stand extended. The stand could be damaged.
[See "Using the Handle as a Stand" \(p. 17\)](#)
- Use a common ground for both the instrument and any devices to be connected. Using different ground circuits will result in a potential difference between the instrument's ground and the computer's ground. If the communications cable is connected while such a potential difference exists, it may result in equipment malfunction or failure.
- Before connecting or disconnecting the communications cable, always turn off the instrument and any devices to be connected. Failure to do so could result in equipment malfunction or damage.
- After connecting the communications cable, tighten the screws on the connector securely. Failure to secure the connector could result in equipment malfunction or damage.

NOTE

This instrument may cause interference if used in residential areas. Such use must be avoided unless the user takes special measures to reduce electromagnetic emissions to prevent interference to the reception of radio and television broadcasts.

Handling the cords and current sensors

DANGER

Connect the current sensors or voltage cords to the instrument first, and then to the active lines to be measured. Observe the following to avoid electric shock and short circuits.

- Do not allow the voltage cord clips to touch two wires at the same time. Never touch the edge of the metal clips.
- When the current sensor is opened, do not allow the metal part of the clamp to touch any exposed metal, or to short between two lines, and do not use over bare conductors.
- To avoid short circuits and potentially life-threatening hazards, never attach the current sensor to a circuit that operates at more than the maximum rated voltage to earth (See your current sensor's instruction manual for its maximum ratings.)
- Current sensor and voltage cables should only be connected to the secondary side of a breaker, so the breaker can prevent an accident if a short circuit occurs. Connections should never be made to the primary side of a breaker, because unrestricted current flow could cause a serious accident if a short circuit occurs.
- Connect only those voltage cables necessary for measurement.
- To prevent an electric shock accident, confirm that the white or red portion (insulation layer) inside the cable is not exposed. If a color inside the cable is exposed, do not use the cable.

WARNING

- In order to use the CT6862 AC/DC Current Sensor, the line to be measured must be temporarily disconnected. To avoid shock and short circuits, turn off the power to lines to be measured before making connections to terminals to be measured and turning on the instrument.
- To avoid electric shock, do not exceed the lower of the ratings shown on the instrument and test leads.

CAUTION

- To avoid electric shock and short-circuit accidents, use only the specified voltage cord to connect the instrument input terminals to the circuit to be tested.
- For safety reasons, when taking measurements, only use the optional voltage cord. Avoid stepping on or pinching cables, which could damage the cable insulation.
- To avoid breaking the cables, do not bend or pull them.
- To avoid damaging the power cord, grasp the plug, not the cord, when unplugging it from the power outlet.
- Keep the cables well away from heat sources, as bare conductors could be exposed if the insulation melts.
- Be careful to avoid dropping the current sensors or otherwise subjecting them to mechanical shock, which could damage the mating surfaces of the core and adversely affect measurement.
- Be careful when handling the cords, since the conductor being measured may become very hot.
- When disconnecting the connector, be sure to release the lock before pulling off the connector. Forcibly pulling the connector without releasing the lock, or pulling on the cable, can damage the connector.
- To prevent damage to the instrument and current sensors, never connect or disconnect a sensor while the power is on, or while the sensor is clamped around a conductor.

Before connecting measurement cables

DANGER

- Do not use the instrument with circuits that exceed its ratings or specifications. Doing so may damage the instrument or cause it to become hot, resulting in bodily injury.
- Never exceed a current sensor's input current rating. Doing so could destroy the instrument and cause personal injury.

WARNING

- Before turning the instrument on, make sure the source voltage matches that indicated on the instrument's power connector. Connection to an improper supply voltage may damage the product and present an electrical hazard.
- To avoid electrical accidents and to maintain the safety specifications of this instrument, connect the power cord provided only to an outlet.

CAUTION

For safety reasons, disconnect the power cord when the instrument is not used.

Before connecting to the lines to be measured

DANGER

To avoid electrical hazards and damage to the instrument, do not apply voltage exceeding the rated maximum to the external input terminals.

WARNING

- To avoid electrical accidents, confirm that all connections are secure. The increased resistance of loose connections can lead to overheating and fire.
- Ensure that the input does not exceed the maximum input voltage or current to avoid instrument damage, short-circuiting and electric shock resulting from heat building.

CAUTION

- When the power is turned off, do not apply voltage or current to the voltage input terminals, current input terminals, or current sensors. Doing so may damage the instrument.
- Note that the instrument may be damaged if the applied voltage or current exceeds the measurement range.

While measuring

WARNING

If an abnormality such as smoke, strange sound or offensive smell occurs, stop measuring immediately, disconnect from the measurement lines, turn off the instrument, unplug the power cord from the outlet, and undo any changes to the wiring. Contact your authorized Hioki distributor or reseller as soon as possible. Continuing to use the instrument may result in fire or electric shock.

Overview

Chapter 1

1

1.1 Product Overview

The Hioki PW3390 Power Analyzer is a high-precision, broad-range instrument for measuring electrical power from DC to inverter frequencies. Four input channels are provided to support single- and three-phase inverter motor system measurements.

For developing and evaluating high efficiency inverter motors

- High precision and stability ensure highly reproducible power measurements
- Electrical phase angle measurements necessary for motor analysis
- Measure motor efficiency by connecting with a high precision torque meter or encoder.

For developing and evaluating alternative energy sources such as solar, wind power, and fuel cells

- Simultaneously measure AC and DC power.
- Separately measure power input, sold, consumed, and regenerated using the DC mode and the current and integrated power (electrical energy) in RMS mode.
- Save long-term measurement data to high-capacity storage media.

For inverter motor maintenance

- Easily measure inverter secondary power on site.
- Simultaneously measure primary and secondary inverter power.
- Measure inverter noise.

1.2 Features

◆ Supports multiple power system configurations

- Four isolated voltage and current input channels are provided to support simultaneous multi-system measurements such as inverter primary and secondary power.
- Measure power system wiring configurations from single-phase to three-phase, four-wire.
- Broad frequency range (0.5 Hz to 5 kHz fundamental) supports DC to inverter frequencies.

◆ High accuracy over a broad range

- Basic accuracy is $\pm 0.04\%$ rdg. $\pm 0.05\%$ f.s. at DC and from 0.5 Hz to 200 kHz.
- Precise measurements over a broad range of inverter carrier frequencies: $\pm 0.2\%$ rdg. $\pm 0.1\%$ f.s. at 10 kHz, and $\pm 1.5\%$ rdg. $\pm 0.5\%$ f.s. at 100 kHz.

◆ Current sensor phase correction function (standard feature)

- This function utilizes virtual oversampling, a new technology, to correct current sensor phase errors at a resolution of 0.01° , allowing accurate measurement of the high-frequency, low-power-factor power components contained in inverter output switching frequencies.

◆ Provides both fast data processing and high accuracy

- While maintaining high accuracy, power measurements and harmonic analysis updates every 50 ms.
- During low-frequency measurements, data is automatically updated in sync with frequency, so no refresh (data update rate) switching is needed when changing from low to high rotation rates.

◆ Extensive data analysis functions are included as standard features

- Simultaneously measure RMS, MEAN, AC and DC components, and fundamental waveforms.
- Perform harmonic analysis up to the 100th order and inverter noise (FFT) analysis up to 200 kHz.
- Display high-speed waveforms sampled at up to 500 kS/s.
- Perform multifaceted analysis with X-Y graph functions.

◆ Simultaneous analysis of all parameters

- Simultaneously analyzes harmonics, noise while performing integration, displaying waveforms and trend graph.

◆ Supports measurements with both easy-to-use clamp probes and high-precision penetrating probes

- Select from various AC and AC/DC clamp-on current probes with ranges from 2 A to 1000 A.
 - Measure high currents with high precision using clamp-on current sensor probes.
 - Clamp-on current probes eliminate the need for problematic direct contact with wiring.
 - In-phase effects on inverter measurements are greatly reduced by isolating current sensors from the measurement objects.
-

- ◆ **Single-unit instrument ideal for portable as well as rack-mount applications**
 - Small and light weight (approx. 4.6 kg), with a convenient carrying handle (p. 17).
 - Rack mountable in 170 mm (EIA 4U) vertical space.

 - ◆ **Variety of interfaces are equipped in standard**
 - Includes 100 Mbps Ethernet and USB 2.0 High Speed communications interfaces.
 - Supports high-speed data communication systems.
 - Provides a dedicated front-panel USB port and CF card slot for removable storage devices.
 - Supports high-capacity media for high-speed data storage.

 - ◆ **PC application program provides remote control and data acquisition (p. 181)**
 - With the instrument connected to a computer by LAN, USB cable, or RS-232C, use the PC application program to acquire data on the computer and control the instrument remotely. Download the PC application program from Hioki's website. (<https://www.hioki.com>)
 - Even without the PC application program, the same operations can be performed using a browser to access the HTTP server function.

 - ◆ **Wiring confirmation function avoids wiring mistakes (p. 46)**
 - The vector display avoids wiring mistakes by confirming even complicated three-phase wiring.

 - ◆ **Multi-instrument synchronization capability supports additional measurement channels (p. 159)**
 - Measure with up to 8 instruments simultaneously.
 - Secondary (slave) instruments measure and record data in synchronization with the primary (master) instrument.
 - Using the PC application program, synchronously acquire and record data on up to 8 instruments.

 - ◆ **Prepared for motor evaluation options (p. 176)**
 - Motor power can be determined by measuring torque meter output and rotation rate.
 - Supports both analog DC and frequency-output-type torque measurement inputs.
 - Supports both analog DC and rotation pulse outputs for measurement inputs.
 - Supports encoder Z-phase signals for phase measurements with standard encoder pulses.

 - ◆ **D/A output option for waveform output (p. 166)**
 - Outputs up to 16 analog measurement parameters on 16 D/A output channels.
 - Voltage and current waveforms sampled at 500 kHz in the waveform output mode provide safely isolated voltage and current waveforms for other waveform measuring instruments.

 - ◆ **Easy-to-see color LCD (p. 17)**
 - Includes a 9-inch color TFT LCD.
 - Easily view waveforms and graphs on the wide-screen 800 × 480 dot display.
-

1.3 Operating Overview

Be sure to read "Usage Notes" (p. 8) before measuring.

Follow the procedures below to perform measurements. Data saving and analysis on the computer can be performed as necessary.

Initial Instrument Preparations

See 3.2 (p.28)

Pre-Operation Inspection

See 3.3 (p.30)

Always perform these checks before connecting, and when turning the power on.

Installing the Instrument

See "Instrument installation" (p. 8)

Connecting Cables and Probes, and Turning Power On

See 3.4 (p.31) to 3.8 (p.36)

For high-precision measurements, allow at least 30 minutes warm-up after power-on before executing zero adjustment.

Configuring wiring settings and sensor settings, and checking the wiring

See 3.9 (p.37) to 3.12 (p.46)

Configure current sensor phase correction to facilitate more precise measurement. Always execute zero adjustment before connecting to measurement objects.

Viewing Measurement Values

See Chapter 4 (p.47)

Press the **MEAS** key, and select display contents with the **◀** **▶** and **F** keys.
See "2.2 Basic Operations" (p. 20)

Saving

Manual saving

Press the **SAVE** key.

See Chapter 7 (p.135)

Save in realtimecontrol

After pressing **START/STOP** saving starts at the specified start time.

Stops automatically at the specified stop time.
Press the **START/STOP** key to force stop.

Save timer control

Press **START/STOP** to save for a specified time span.

Stops automatically when the specified time has elapsed.
Press the **START/STOP** key to force stop.

Save interval control

Press **START/STOP** to start. Save the specified time span.

Press **START/STOP** to stop. When the timer and real-time control are set, stops at the specified time.

Analyzing Saved Data on a Computer

See Chapter 9 (p.181)

Connect the instrument to a computer with the supplied USB cable or an Ethernet cable and use the dedicated PC application program to transfer data to the computer for analysis. This also enables remote operation and control of the instrument.

Turning Power Off

See 3.8 (p.36)

Names and Functions of Parts, Basic Operations & Screens

Chapter 2

2.1 Names and Functions of Parts

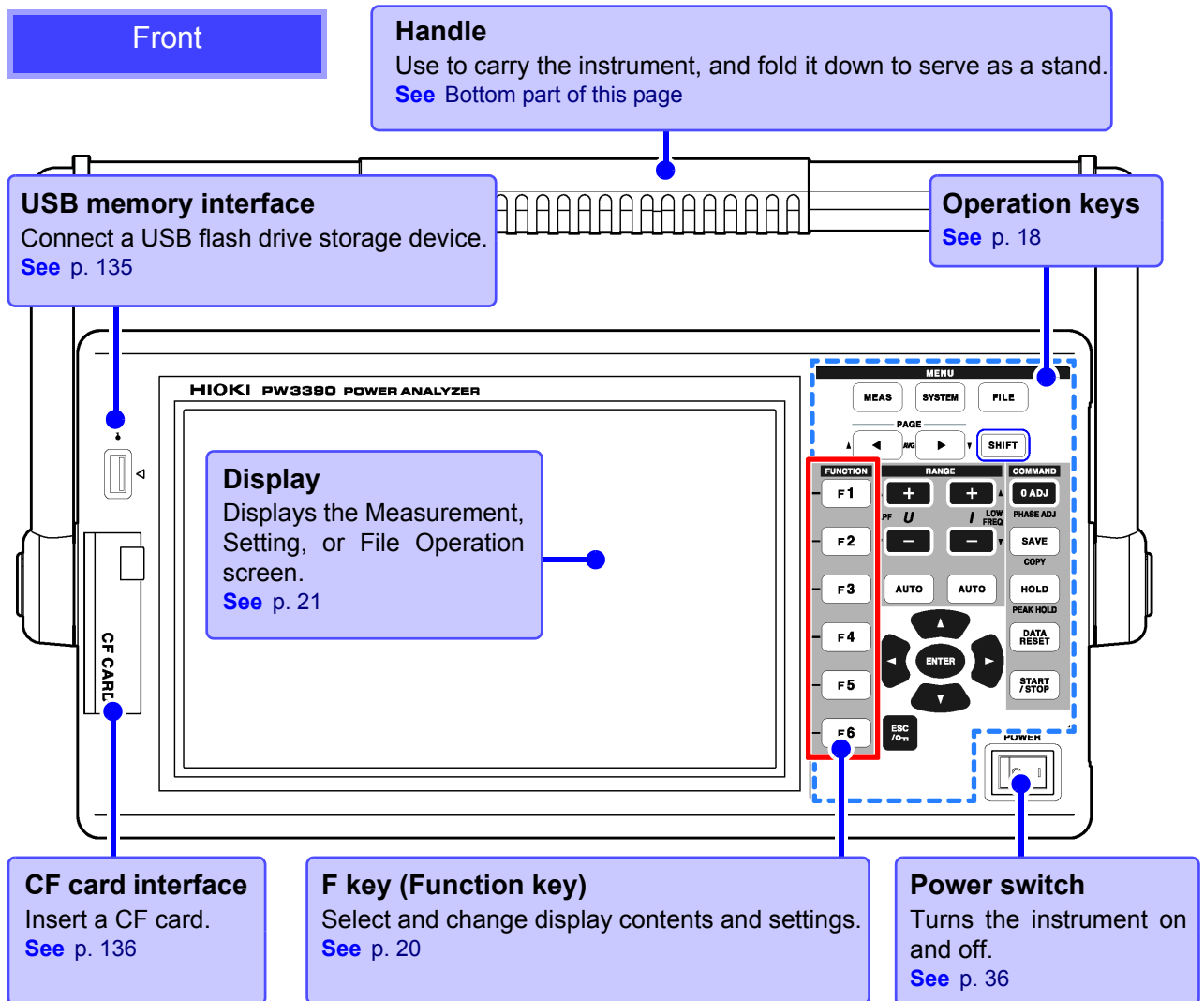

Using the Handle as a Stand

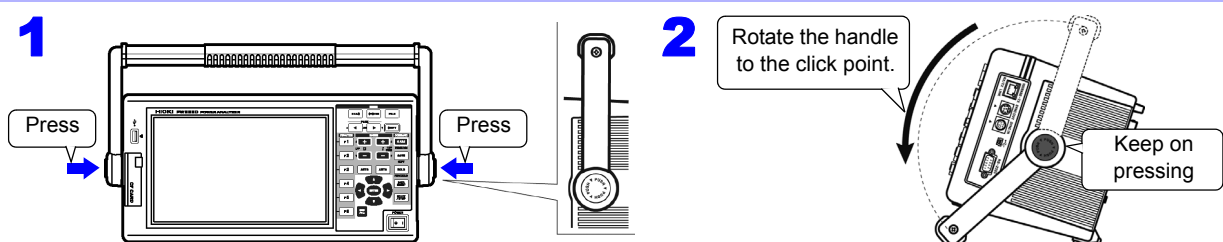

Operation keys

MENU keys (Screen selection)

Press a key to select a screen (the lit key indicates the current selection).

MEAS	Displays the Measurement screen for viewing measurement values. Voltage and current ranges can be selected, and low-pass filter settings can be changed.(p. 23)
SYSTEM	Displays the Setting screen for setting measurement criteria, wiring mode (phase systems), wiring check and system environment configuration.(p. 24)
FILE	Displays the File Operation screen for performing file operations on data saved to storage media, and selecting data file formats.(p. 25)

PAGE keys

- Changes the screen page.
- Allows you to configure averaging (p. 112).

RANGE keys

- The *U* + and – keys change the voltage measurement range, and the *I* + and – keys change the current measurement range.
- Pressing the **AUTO** key activates Auto Ranging (p. 54).
- These keys also set the low-pass filter (p. 64) and the lower measurement limit setting (p. 60).

ENTER key

Accepts selections and changes to settings.

CURSOR keys

Move the cursors.

ESC key

Cancels the last change to a setting, and returns it to its original state.

(Key-lock)

Hold for three seconds to toggle the key lock. The key lock state is indicated at the top of the screen (p. 21).

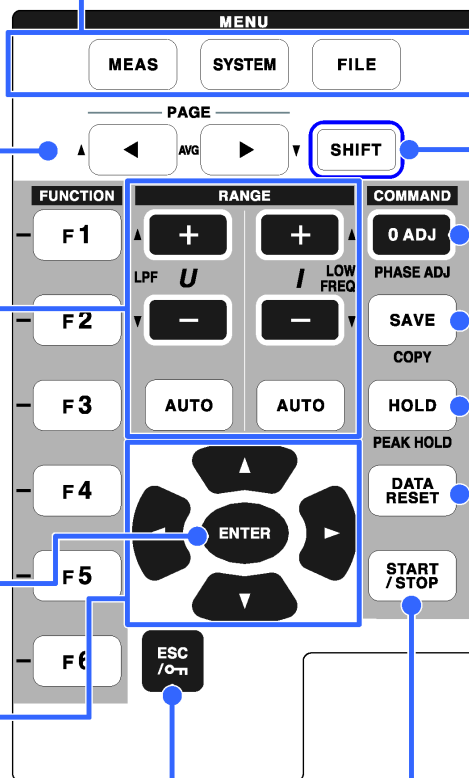

SHIFT key

(Lit when running)
Activates alternate key functions.

0 ADJ key

Performs zero adjustment and current sensor degaussing.
[See 3.11 \(p.44\)](#)

SAVE key

Saves data to the storage media.
[See 7.5.2 \(p.143\)](#)
(Screen Capture)
Press the **SAVE** key while holding the **SHIFT** key to capture a screen image to the specified storage media.
(p. 149)

HOLD key

(Lit when running)
Toggles the peak-hold function.
[See 5.3 \(p.114\)](#)

DATA RESET key

Resets the integration values.
[See 4.3.1 \(p.65\)](#)

START/STOP key

(Lit when running)
Starts and stops integration and saving operations.
To restart integration and saving: Press the **DATA RESET** key to reset integration values, then press this key. (Press the **START/STOP** key without resetting the integrated value if you wish to add the integration result to the previous one.)

NOTE

- When the key lock function is enabled, all other key operations are disabled.
- The key lock state is retained even when power is off.

Right side

Ethernet interface jack
For LAN connection with an Ethernet cable.
See p. 184

Sync interface
For synchronizing cables, as needed.
See p. 159

USB port
For the supplied USB cable, as needed.
See p. 188

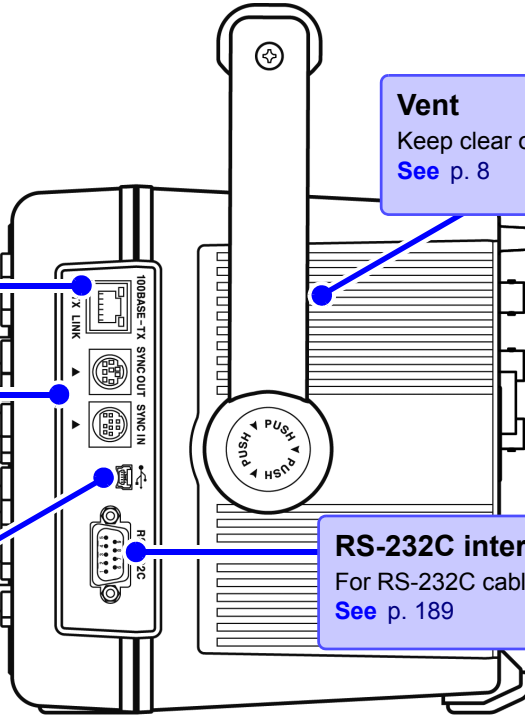

Vent
Keep clear of obstructions.
See p. 8

RS-232C interface
For RS-232C cable connection, as needed.
See p. 189

Rear side

Power inlet
Connect the supplied power cord.
See p. 31,
"Usage Notes" (p. 8) ⚠

Voltage input terminals
Connect Hioki-specified voltage measurement cables.
See p. 32,
"Usage Notes" (p. 8) ⚠

CH A torque signal input BNC jack
Connect the Hioki L9217 BNC connection cable to this terminal (PW3390-03 [model with motor analysis and D/A output] only).
See p. 176,
"Usage Notes" (p. 8) ⚠

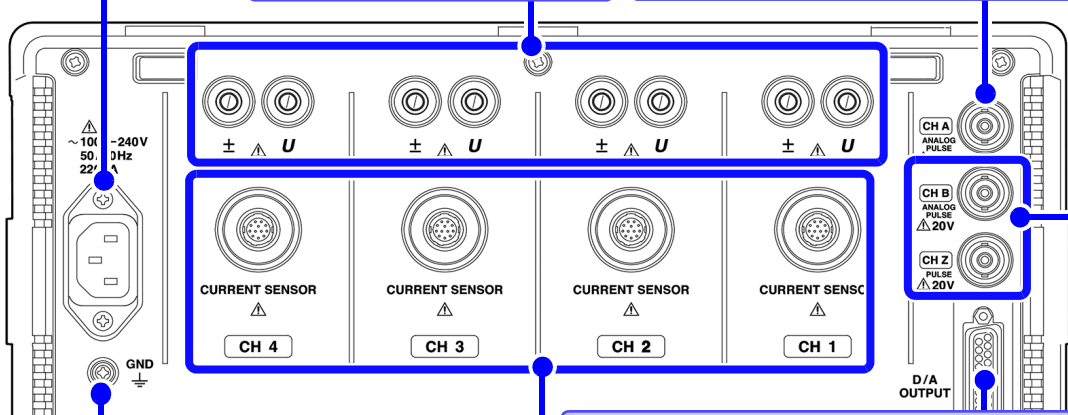

~10K
~240V
50, 60 Hz
22A

Serial number*
This is the instrument's serial number.

Output terminal
Connect the supplied D-sub plug (PW3390-02 [model with D/A output] and PW3390-03 [model with motor analysis and D/A output] only).
See p. 166

Functional ground terminal
Connect this terminal to a clean common ground to suppress electrical noise when measuring in an electrically noisy environment.
See p. 31

Current input terminals
Connect an Hioki-specified current sensor.
See p. 32,
"Usage Notes" (p. 8) ⚠

CH B and CH Z rotation signal input BNC jacks
Connect the Hioki L9217 Connection Cord to these terminals (PW3390-03 [model with motor analysis and D/A output] only).
See p. 176,
"Usage Notes" (p. 8) ⚠

* The serial number consists of 9 digits. The first two (from the left) indicate the year of manufacture, and the next two indicate the month of manufacture. Required for product control. Do not peel off the label.

2.2 Basic Operations

To select a display screen

Press **MEAS**, **SYSTEM**, or **FILE** to display the corresponding screen.
See p. 23 to p. 25

To select the displayed screen page

Press the **◀** **▶** keys to change.
See p. 23, p. 25



Help comment

Describes the object at the current cursor position (only on Setting and File Operations screens).

To select and change display contents and settings

Press one of the **F** keys to select and change display contents and settings. The displayed function labels depend on the currently displayed screen.

Special Setting Items

All CH Set	Select to apply the same setting to all channels.
Next	This appears when more than six setting items are available. Press F6 to display the function labels of the additional items.

Using [All CH Set]

(For example, to enable auto-ranging on all channels.)

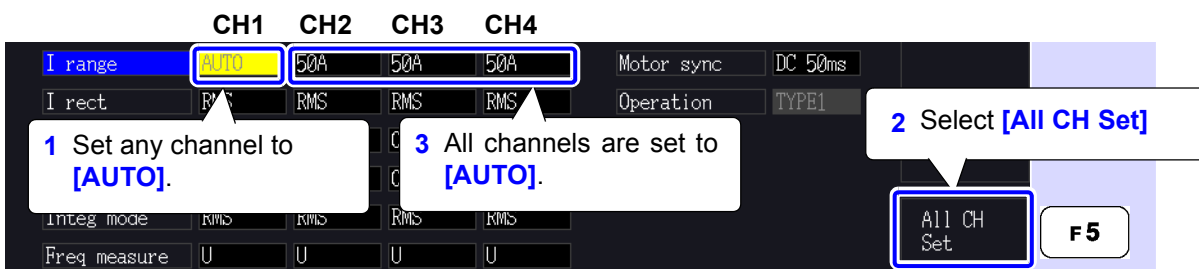

2.3 Display Items and Screen Types

2.3.1 Common Display Items

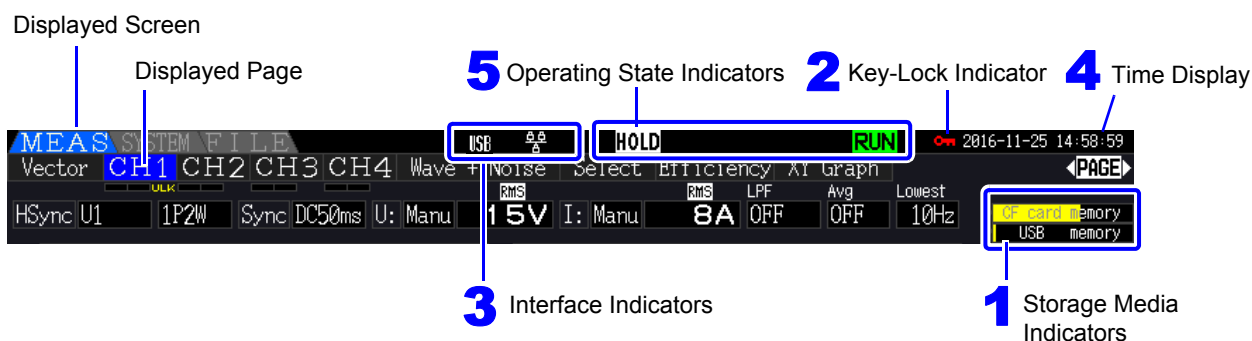

These items are displayed on every screen.





1 Storage Media Indicators

Level indicators for the CF card and USB memory stick. The used storage space is indicated in yellow, and it turns to red when the media is 95% full.

2 Key-Lock Indicator

	Lights to indicate Key Lock is active (keys are locked), after holding the  for three seconds.
---	---





3 Interface Indicators

	Lights when the instrument is connected to a computer by USB cable (and the computer is on).
	Lights when the instrument is connected to a LAN.

4 Time Display

Displays the current date and time.
To set the Clock: (p. 131)

5 Operating State Indicators

	Indicates that the instrument is in the integration standby state.
	Indicates integration is in progress.
	Indicates integration is stopped.
	Indicates Data Hold is active.
	Indicates Peak Hold is active.

2.3.2 Measurement Screen

These display items appear only on the Measurement screen.

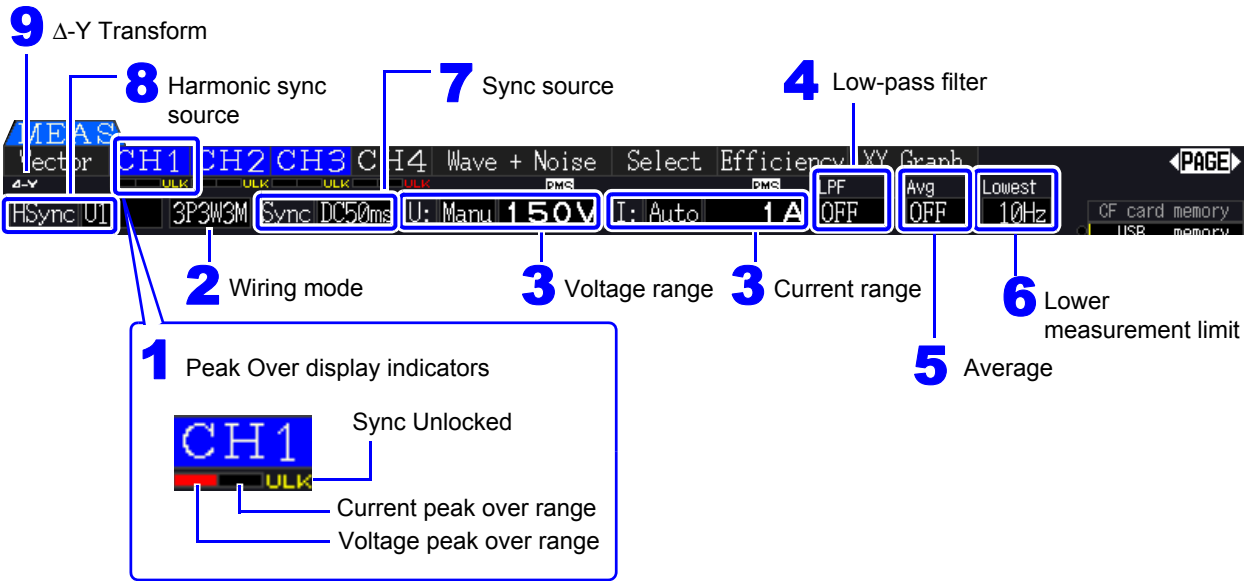

1 Peak Over display indicators

These indicators appear in red at the bottom of each channel page tab (CH1 to CH4). These indicate (from the left) when voltage and current peaks ranges are exceeded (p. 50), and when synchronization is unlocked (p. 59).

2 Wiring mode

Indicates the selected wiring mode (p. 37). The wiring mode (phase system selection) must be set to match actual measurement connections.

3 Voltage range/Current range

- Indicate the voltage and current range settings.
- The settings are made by the **RANGE** keys (p. 54).
- When the range has been set manually, **[MANU]** appears.
- When the auto-ranging is enabled, **[AUTO]** appears (p. 53).

4 Low-pass filter

Indicates the low-pass filter setting (p. 64).

To change the setting, hold the **[SHIFT]** key while pressing an **LPF** key (one of the left-most **[+]** or **[-]** **RANGE** keys).

5

Average

Indicates the averaging setting state (p. 112).

To change the setting, hold the **[SHIFT]** key while pressing the **AVG** key either **[←]** or **[→]** of the **PAGE** key.

6 Lower measurement limit

Displays the lower measurement limit setting (p. 60).

To change the setting, hold the **[SHIFT]** key while pressing a **LOW FREQ** key (one of the right-most **[+]** or **[-]** **RANGE** keys).

7 Sync source

Indicates the synchronization source signal that determines the period (between zero crossings) used as the basis for all calculations (p. 58). The setting is made on the Input Settings page of the Settings screen.

8 Harmonic sync source

Indicates the synchronization signal source used for harmonic measurements (p. 79). The setting is made on the Input Settings page of the Settings screen.

9 Δ-Y Transform

Indicates whether Δ-Y transform is enabled or disabled (ON/OFF)(p. 118). The setting is made on the Input Settings page of the Settings screen.

2.3.3 Screen Types

Measurement Screen (Press the **MEAS** key to display) This screen displays measurement values.

Press the keys to change the screen page as follows.

[Vector]

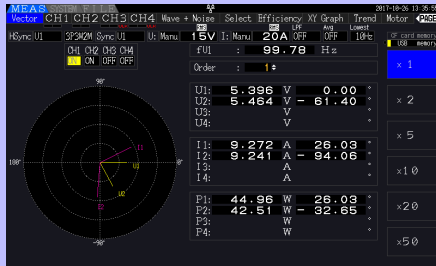

This page displays measured harmonic voltage, harmonic current, and harmonic power on channels 1 to 4 as numerical values and as vectors.

[CH1 to CH4]

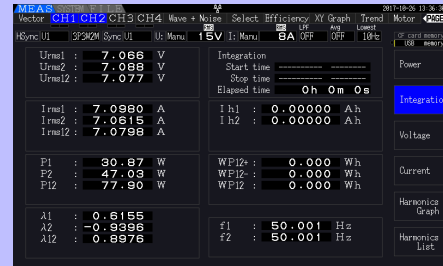

This page displays measured power, voltage and current values, integration values, and provides access to harmonic graphs and lists for each channel.

[Motor]



Displayed only on the PW3390-03 (model with motor analysis and D/A output).

This page displays measured values for the motor analysis.

[Wave + Noise]

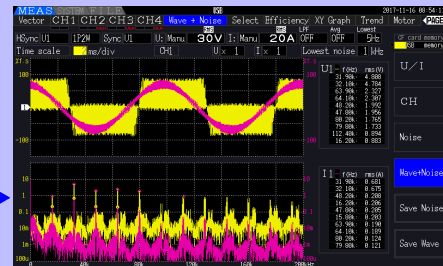

This page displays voltage, current, and noise waveforms. The data can be saved.

[Trend]

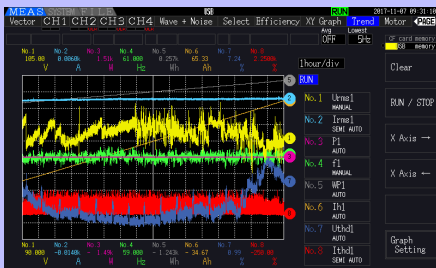

This page displays measurement item fluctuations.

[Select]

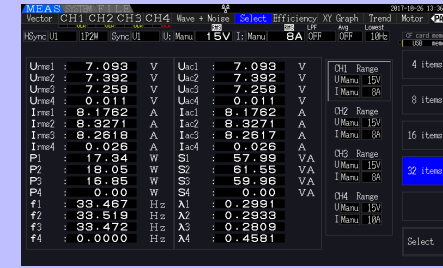

Select any parameter on this page for display.

[XY Graph]

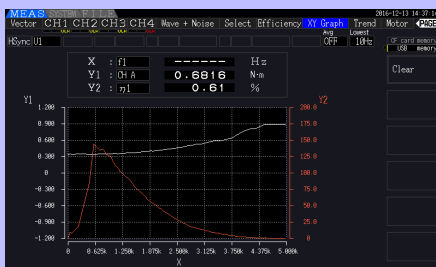

This page displays an X-Y graph of measurement parameters selected for horizontal and vertical axes.

[Efficiency]

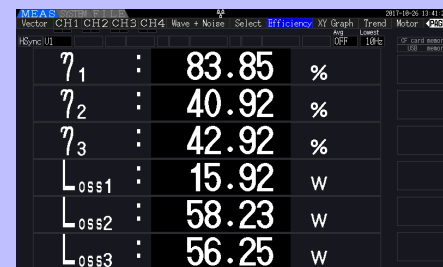

This page displays the numerical values of efficiency and loss determined by calculation formulas.

2.3 Display Items and Screen Types

Setting Screen (Press the **SYSTEM** key to display) Use this screen to view and change settings for measurement criteria, wiring mode, wiring check and system environment configuration.

Press the keys to change the screen page as follows.

[Wiring]

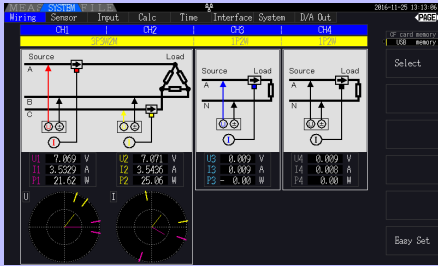

Select the appropriate wiring mode (phase system configurations) and execute quick setup on this page. Wiring diagrams for each mode depict the appropriate measurement cable connections.

[Sensor]

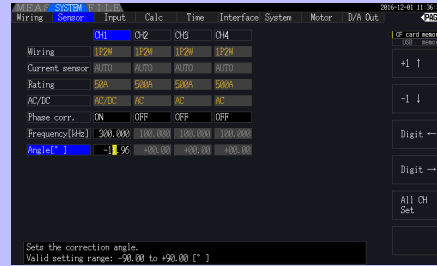

[D/A Out]

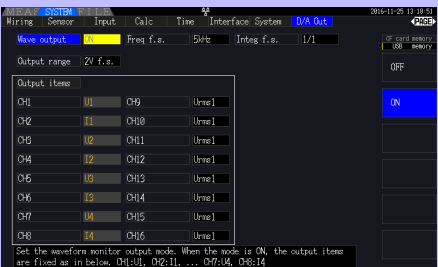

Make D/A output-related settings on this page.

[Input]

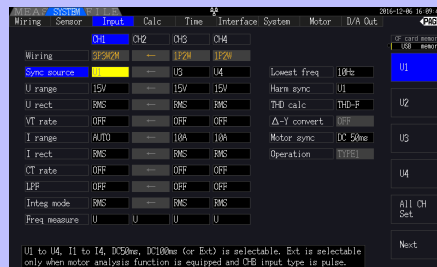

Make detailed measurement criteria settings on this page.

[Motor]

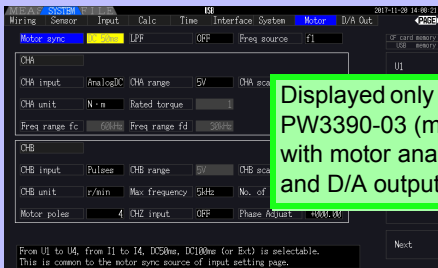

Displayed only on the PW3390-03 (model with motor analysis and D/A output).

Make motor measurement-related settings on this page.

[Calc]

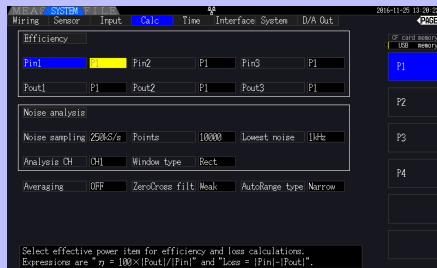

Make calculation-related settings on this page.

To next page

Press the ◀ ▶ keys to change the screen page as follows.

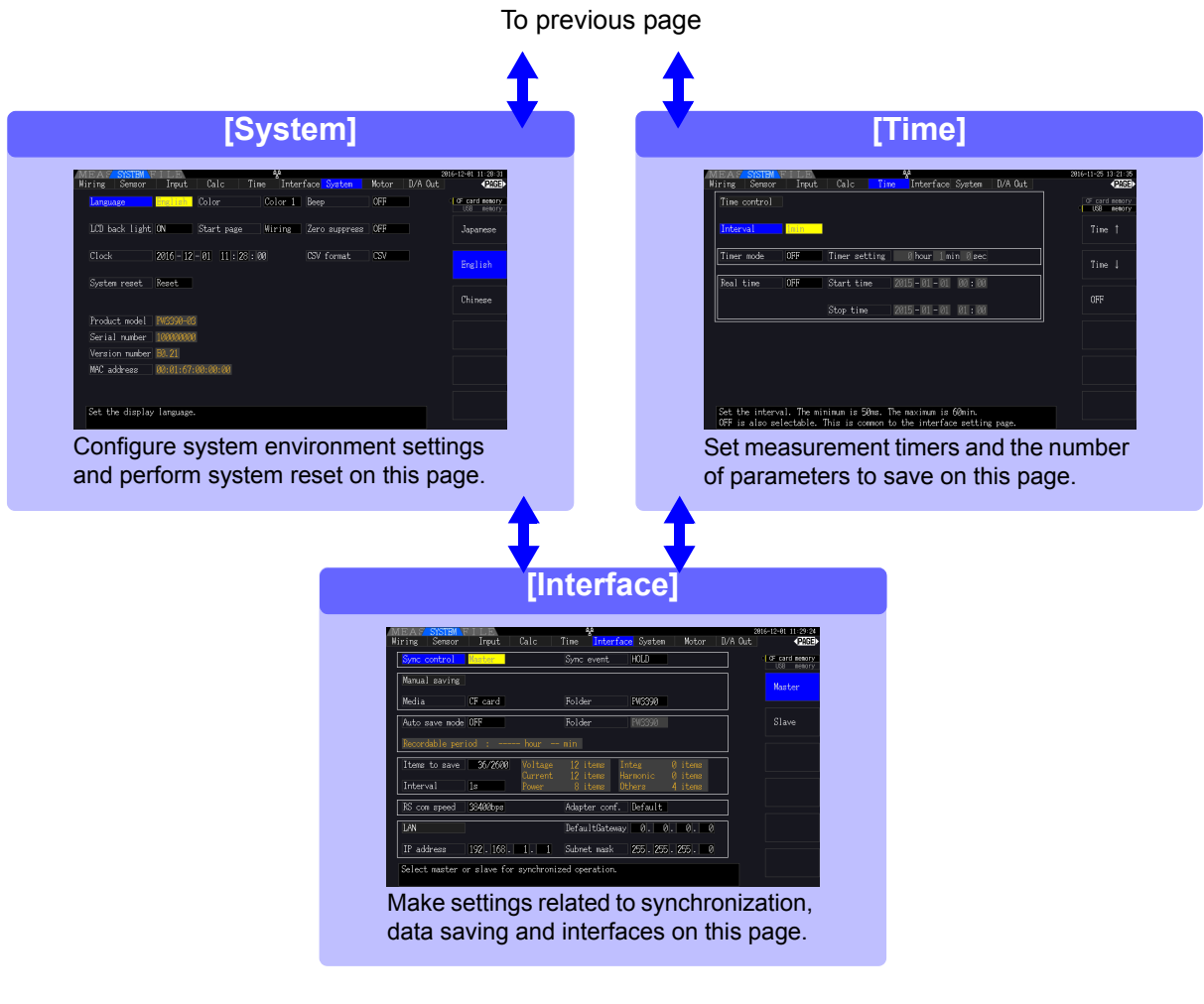

File Operations Screen (Press the **FILE** key to display) Use this screen to configure saving of data files to removable storage media, and to save and reload settings files.

Press the ◀ ▶ keys to change the screen page as follows.

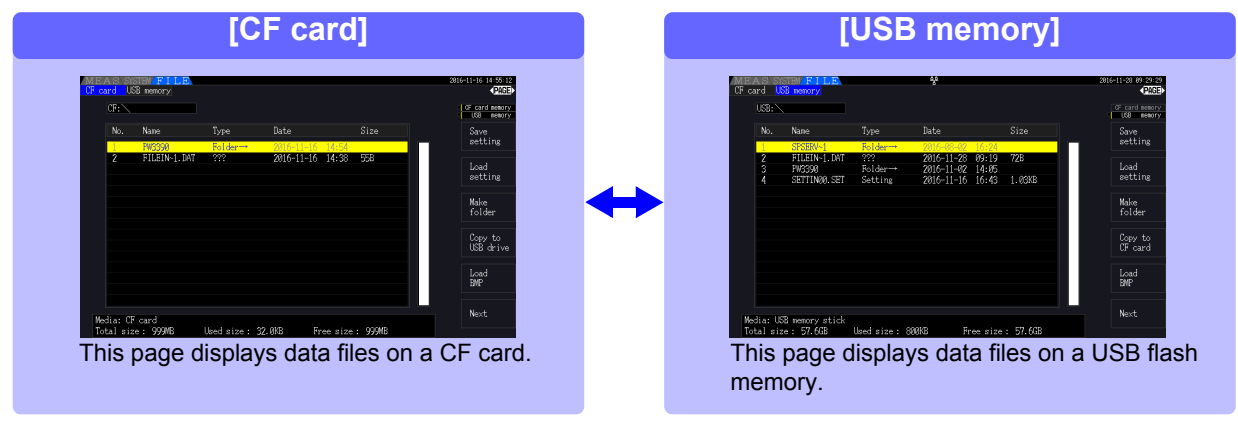

Measurement Preparations

Chapter 3

3.1 Operations in general

3

Chapter 3 Measurement Preparations

Initial Instrument Preparations

See 3.2 (p.28)

Apply the appropriate adhesive labels to the voltage cords and current sensors. Then bundle the voltage cables together with the spiral tubes.

Pre-Operation Inspection

See 3.3 (p.30)

Always perform these checks before connecting, and when turning the power on.

Installing the Instrument

See "Instrument installation" (p. 8)

Connecting the Power Cord

See 3.4 (p.31)

Connecting the Voltage Measurement Cables

See 3.6 (p.32)

Connecting the Current Sensors

See 3.7 (p.33)

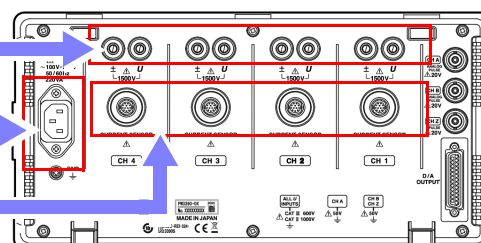

Rear side

Turning Power On

See 3.8 (p.36)

For best precision, allow at least 30 minutes warm-up before executing zero adjustment and measuring.

Setting the wiring mode and current sensors

See 3.9 (p.37) to 3.10 (p.41)

Configure current sensor phase correction to facilitate more precise measurement.

Connecting to the Lines to be Measured

See 3.11 (p.44)

Always execute zero adjustment before connecting to measurement objects. (p. 44)

Verifying Correct Wiring

See 3.12 (p.46)

3.2 Initial Instrument Preparations

Perform the following before starting measurement the first time.

Put the provided input cord labels for each voltage cord and current sensor

The labels are provided to clearly indicate which cable connects to each input jack.

Before applying the labels
Wipe any dust from the surface of the voltage measurement cables and current sensors, and ensure that it is dry.

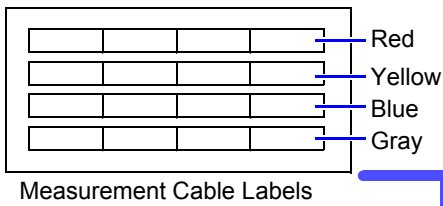

For each input jack, apply labels with the same color near the jack and to its corresponding voltage measurement cable lead or clamp sensor cable.

Apply labels to both ends of the voltage measurement cables.

Apply labels to both ends of the current sensor cables.

Bundle the voltage measurement cable leads with the spiral tubes

Five spiral tubes are supplied with the Model L9438-50 Voltage Cord. Use the spiral tubes as needed to wrap red and black leads together.

Preparation items

L9438-50 Voltage Cord

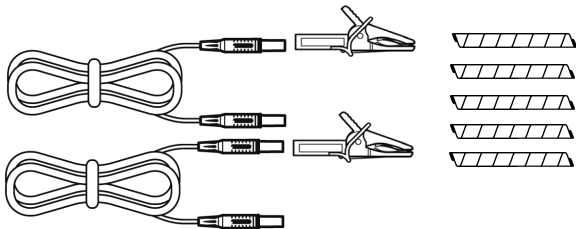

- Alligator Clips ×2 (one each red and black)
- Banana Plug Leads ×2 (one each red and black)
- Spiral Tubes ×5 (for cable bundling)

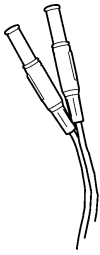
Procedure

- 1.** Hold two cable leads (one each red and black) side-by-side. Start bundling from one end of the leads.

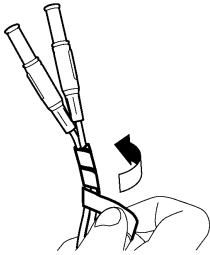

- 2.** Wind the spiral tube around the leads.

Wrap the two leads together with the spiral tube. The five supplied spiral tubes should be applied with suitable spacing.

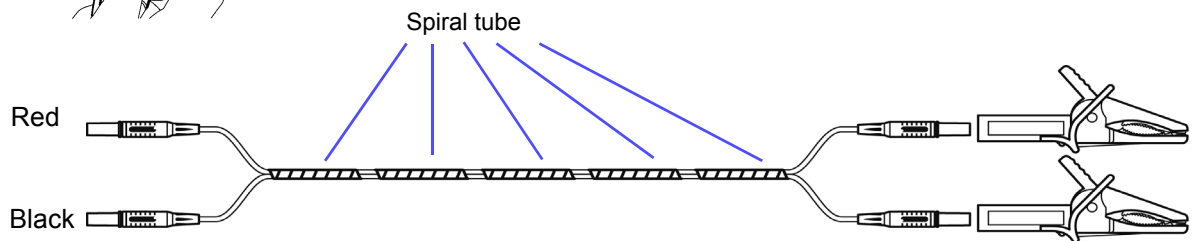

3.3 Pre-Operation Inspection

Before using the instrument the first time, verify that it operates normally to ensure that no damage occurred during storage or shipping. If you find any damage, contact your authorized Hioki distributor or reseller.

1 Pre-connection inspection

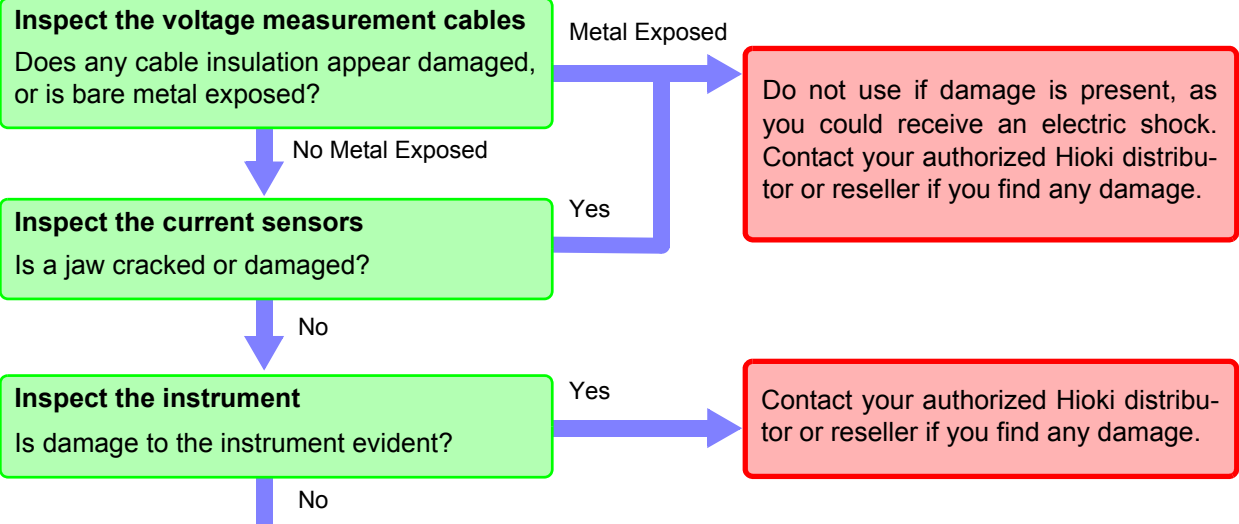

2 Power-on confirmation

See "3.8 Turning the Power On and Off" (p. 36)

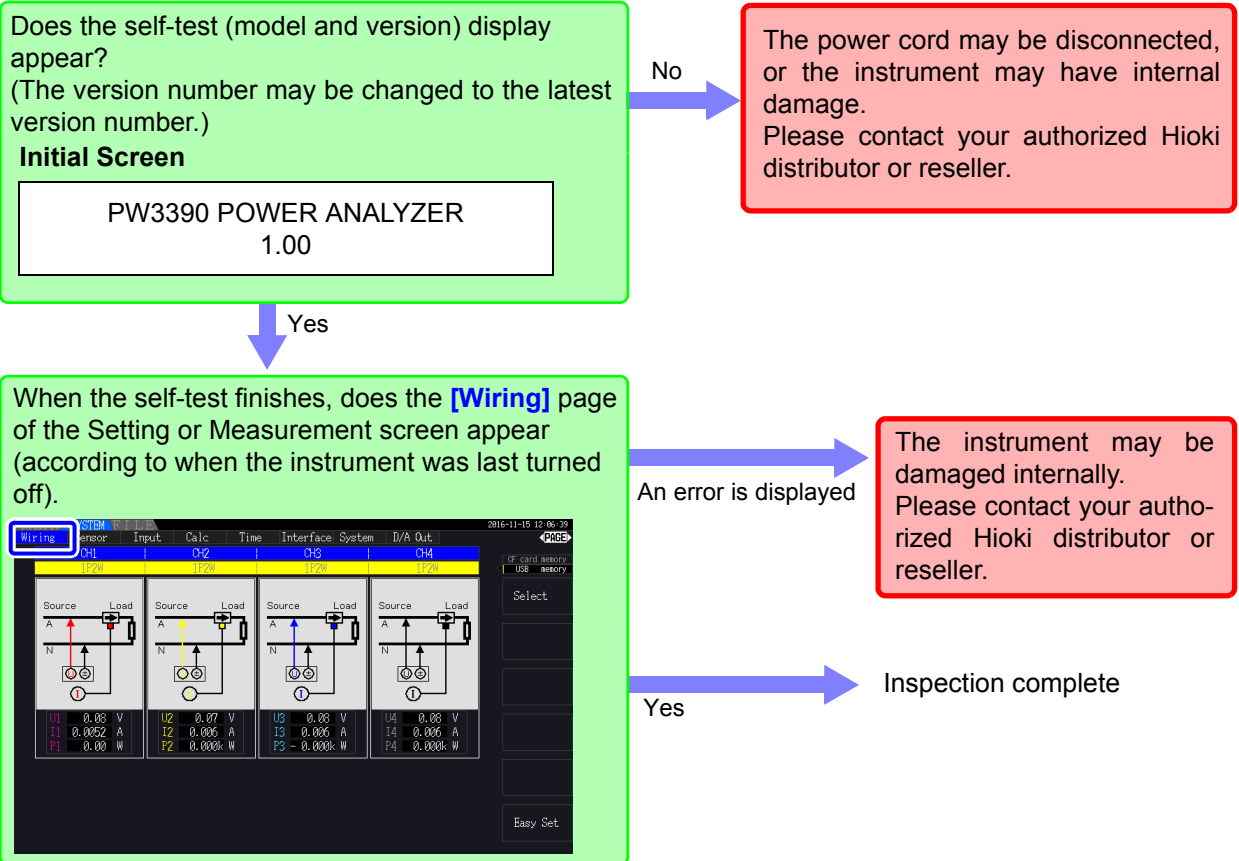

3.4 Connecting the Power Cord

Be sure to read the "Usage Notes" (p. 8) before connecting power.
Connect the power cord to the power inlet on the instrument, and plug it into an outlet.

Connection Procedure

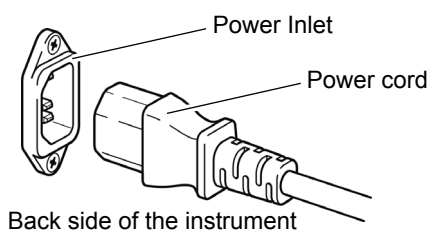

Turn off the power before disconnecting the power cord.

1. Check that the instrument's power switch is turned off.
2. Confirm that the line voltage matches instrument requirements, and plug the power cord into the power inlet on the instrument.
3. Plug the other end of the power cord into an outlet.

3.5 Grounding the Instrument's Functional Earth (when measuring in noisy environments)

Ground the instrument's functional earth.
Connect the functional ground terminal to a clean common ground to suppress noise effects when measuring in an electrically noisy environment.

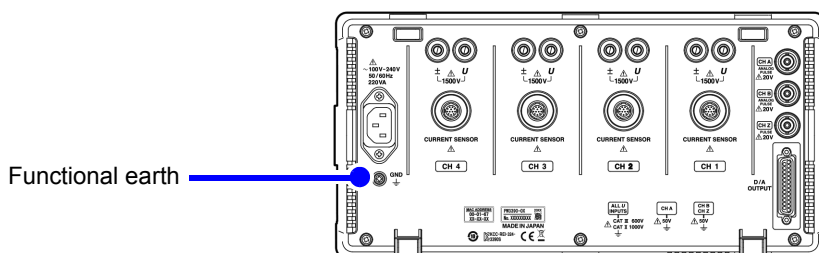

3.6 Connecting the Voltage Measurement Cables

Be sure to read the "Usage Notes" (p. 8) before connecting measurement cables. Plug the voltage measurement cable leads into the voltage measurement jacks on the instrument (the number of connections depends on the lines to be measured and selected wiring mode).

Connection Procedure

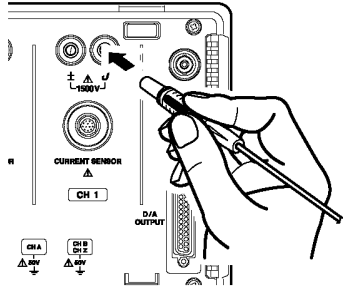

Insert each voltage cable into the jack with the same color as the indicated channel. Insert the plugs into the terminals as far as they will go.

Connecting the Wiring Adapter

Using the PW9000/PW9001 Wiring Adapter can reduce the number of the voltage cords used for measurement wiring.

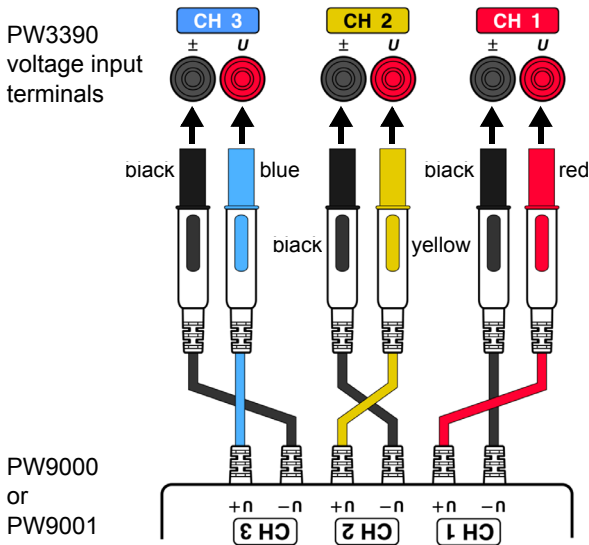

For measurement of the three-phase three-wire system (3P3W3M), using the PW9000 can reduce the number of voltage cords from six to three.

For measurement of the three-phase four-wire system (3P4W), using the PW9001 can reduce the number of voltage cords from six to four.

Connecting the Patch Cord

Using the L1021 Patch Cord can distribute an inputted voltage to multiple channels.

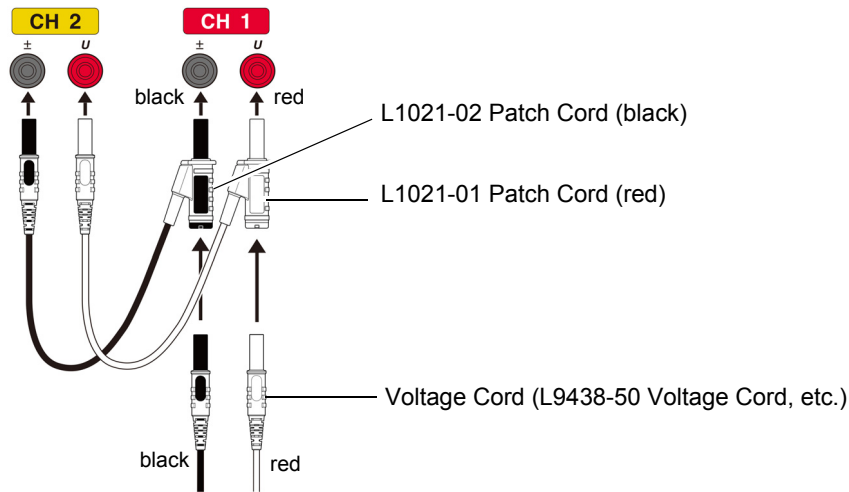

3.7 Connecting the Current Sensors

Be sure to read the "Usage Notes" (p. 8) before connecting measurement cables.

Plug the current sensor cables into the current measurement jacks on the instrument (the number of connections depends on the lines to be measured and selected wiring mode). See the instruction manual supplied with the current sensor for specification details and usage procedures.

Connection Procedure

Align so that the thick band is positioned at the top of the instrument (facing up).

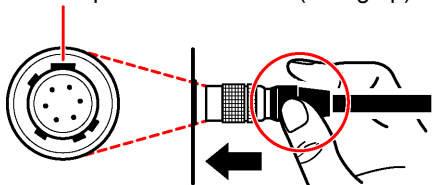

Grip the top of the metal portion.

- 1** Align the guide position of the connector.
 - 2** Push the connector straight in until it locks in place.
- The instrument will automatically recognize the current sensor type.

Disconnecting the current sensors

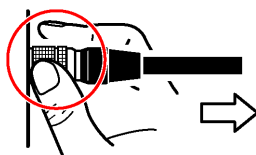

Grip the metal portion.

- 1** Grip the metal portion of the connector and slide it toward you to disengage the lock.
- 2** Pull out the connector.

3.7 Connecting the Current Sensors

Current sensors in the 9709, 9272, CT6860, and CT6840 series are available in two variants: one version with a metal connector, in which case the model number ends in -05, and another with a black plastic connector, in which case the -05 is omitted. Sensors with a metal connector can be connected directly to the instrument's current input terminal.

Current sensors with a black plastic connector (whose model numbers lack the -05) can be connected to the instrument's current input terminal by using the optional CT9900 Conversion Cable.

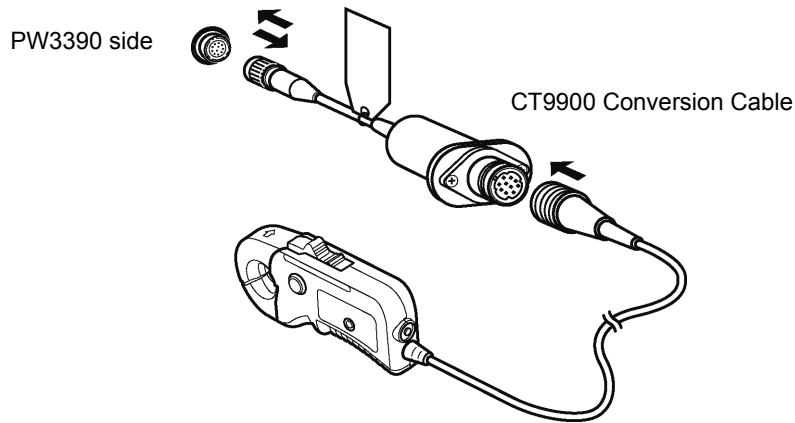

When connecting the CT6865 (rated for 1000 A) or CT6846 (rated for 1000 A) with the CT9900 Conversion Cable, the sensor will be recognized as a 500 A AC/DC sensor. Use a CT ratio setting of 2.00.

Connecting the CT7000 series sensors

The CT7642, CT7742, CT7044, CT7045, and CT7046 Current Sensors can be used to measure large currents of 1000 A and greater. When using these current sensors, connect them to the instrument via the CT9920 Conversion Cable.

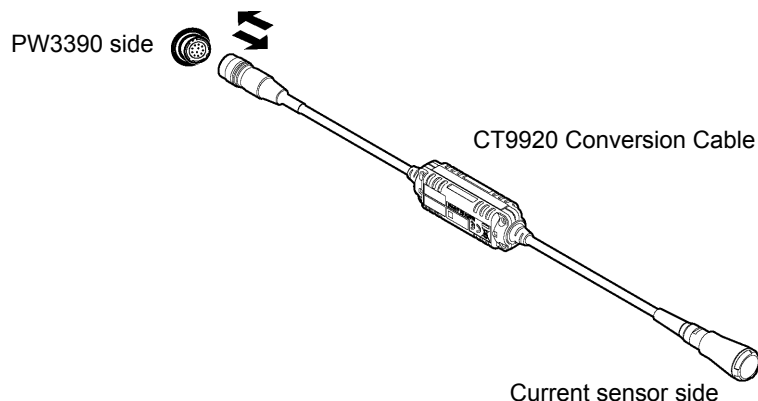

When connecting a sensor via the CT9920 Conversion Cable, it is necessary to configure a setting to select the current sensor being used.

See "3.10 Setting the Current Sensors" (p. 41)

To measure voltage and current beyond the range of the instrument or current sensor

Use an external VT (PT) or CT. By specifying the VT or CT winding ratio on the instrument, the input level at the primary side can be read directly.

See "4.2.6 Setting Scaling (when using VT(PT) or CT)" (p. 63)

⚠ DANGER

During wiring, avoid touching the VT (PT), CT or input terminals. Exposed live contacts can cause electric shock or other accident resulting in personal injury or death.

⚠ WARNING

- When using an external VT (PT), avoid short-circuiting the secondary winding. If voltage is applied to the primary when the secondary is shorted, high current flow in the secondary could burn it out and cause a fire.
- When using an external CT, avoid open-circuiting the secondary winding. If current flows through the primary when the secondary is open, high voltage across the secondary could present a dangerous hazard.

NOTE

- Phase difference in an external VT (PT) or CT can cause power measurement errors. For optimum power measurement accuracy, use a VT (PT) or CT that exhibits minimal phase difference at the operating frequency.
- To ensure safety when using a VT (PT) or CT, one side of the secondary should be grounded.

3.8 Turning the Power On and Off

Be sure to read the "Usage Notes" (p. 8) before turning the instrument on.
Connect the power cord and voltage and current measurement cables before turning the instrument on.

Turning the power on

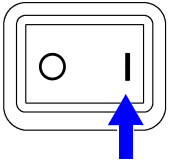

Turn the power switch on ().

The instrument performs a 10-second power-on self test.

See 3.3 (p.30)

The instrument performs a 10-second power-on self test.

When the self test finishes, the [\[Wiring\]](#) page of the Setting screen appears (initial screen). If [\[Start page\]](#) is set to [\[Last Screen\]](#) (p. 131), the last displayed Measurement screen appears.

NOTE

If the self-test fails, operation stops at the self-test screen. If the fault recurs after turning the power off and on, the instrument may be damaged. Perform the following procedure:

1. Stop measuring, disconnect the measurement cables from the object being measured, and turn the instrument off.
2. Disconnect the power cord and all cables from the instrument.
3. Contact your authorized Hioki distributor or reseller.

For best precision, after turning on the instrument, allow a warm-up period of at least 30 minutes to elapse before performing zero-adjustment. (p. 44)

Turning the power off

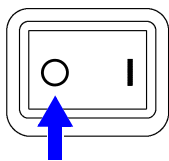

Turn the power switch off ().

3.9 Selecting the Wiring Mode

Select the wiring mode to match the phase system(s) to be measured. Eight wiring modes are available.

To open the [Wiring] page

Press the **SYSTEM** key and select the **[Wiring]** page with the  .

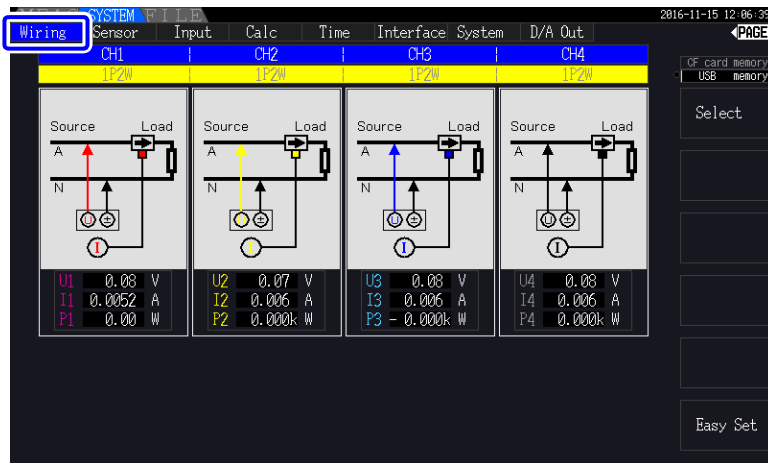

To select the wiring mode

1 Press the **F1** key to select **[Select]** (or press the **ENTER** key) to display the pull-down menu.

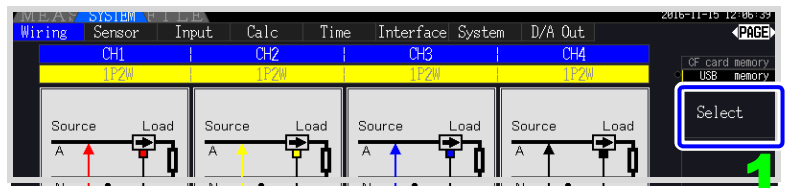

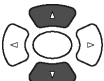
2  Select the wiring mode



3 To accept the selection:
Press **F1** (or the **ENTER** key)
To cancel the selection:
Press **F6** (or the **ESC/On** key)

Accepting the selection displays the wiring diagram of the selected wiring mode.(p. 38)

NOTE

- To measure multiphase power, use the same type of current sensor on each phase line. For example, to measure 3-phase 4-wire power, use the same model current sensors on channels 1 to 3.
- When using a current sensor with switchable sensor rating (such as Model 9272-05), set the sensor rating to match the rating of the line.
- When the selected wiring mode uses multiple channels, channel-specific settings (such as voltage range) are linked to the first channel's settings.

Wiring configuration diagram

Wiring Mode 1. Single-phase, 2-wire (1P2W) × 4

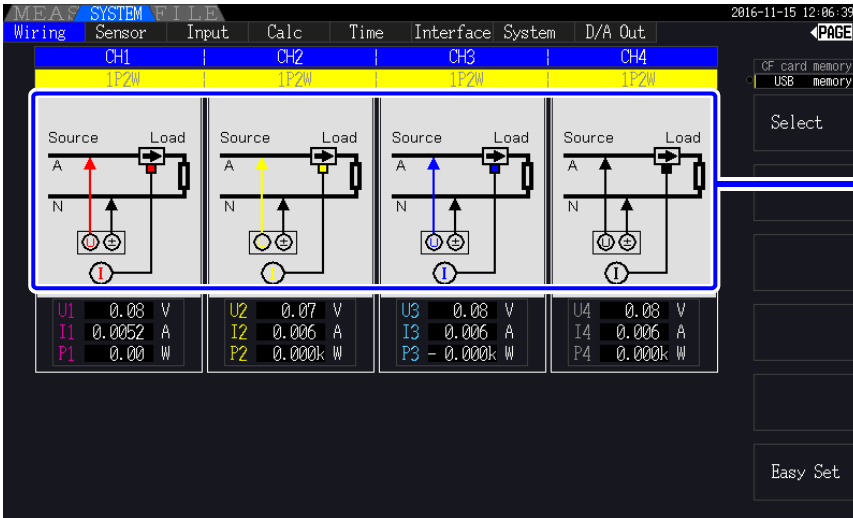

Wiring configuration diagram

See Pages p. 221 and p. 222 for additional wiring diagrams.

Wiring Mode 2. Single-phase, 3-wire (1P3W) + single-phase, 2-wire (1P2W) × 2

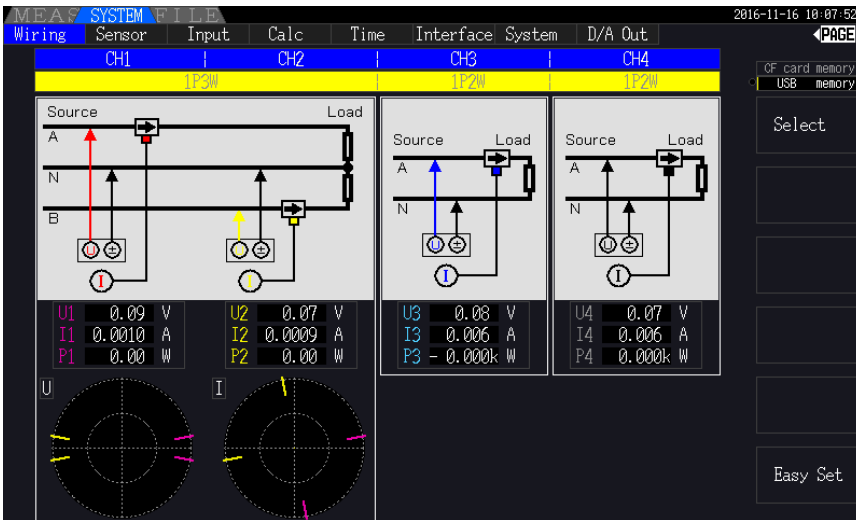

Wiring Mode 3. 3-phase, 3-wire (3P3W2M) + single-phase, 2-wire (1P2W) × 2

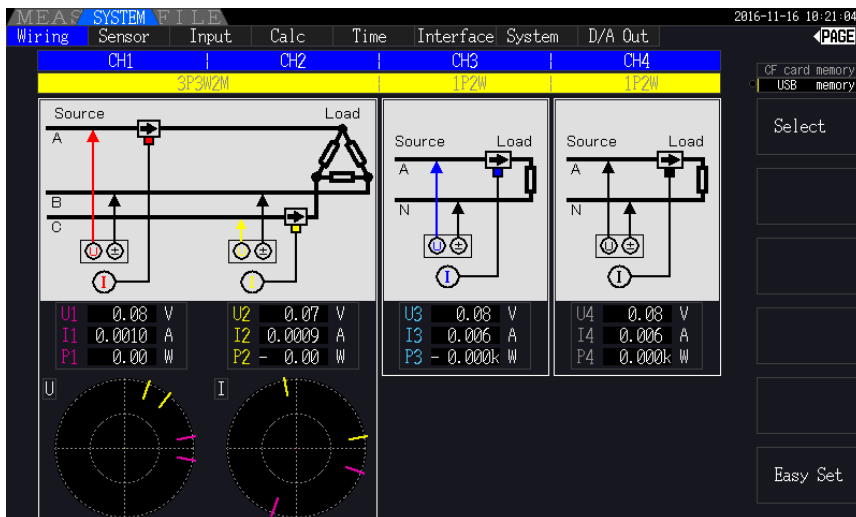

Wiring Mode 4. Single-phase, 3-wire (1P3W) × 2

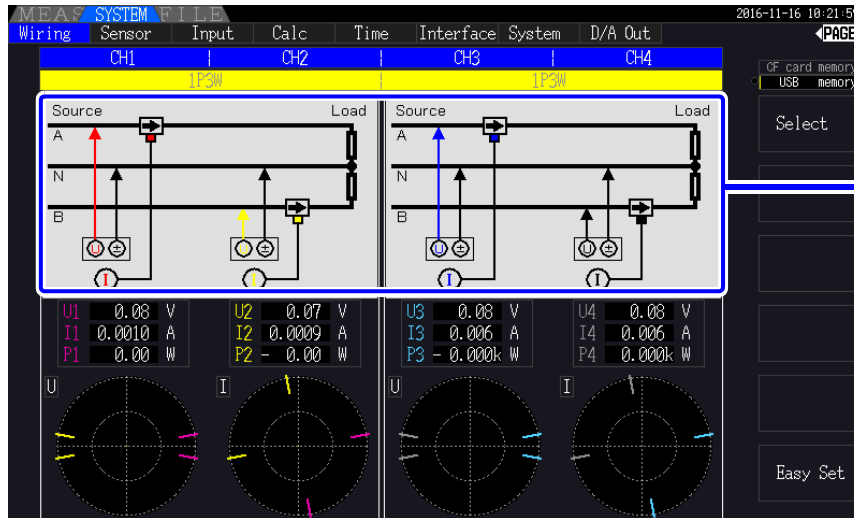

Connection diagrams

See
Connection diagrams can also be found on p. 221 and p. 222.

Wiring Mode 5. 3-phase, 3-wire (3P3W2M) + single-phase, 3-wire (1P3W)

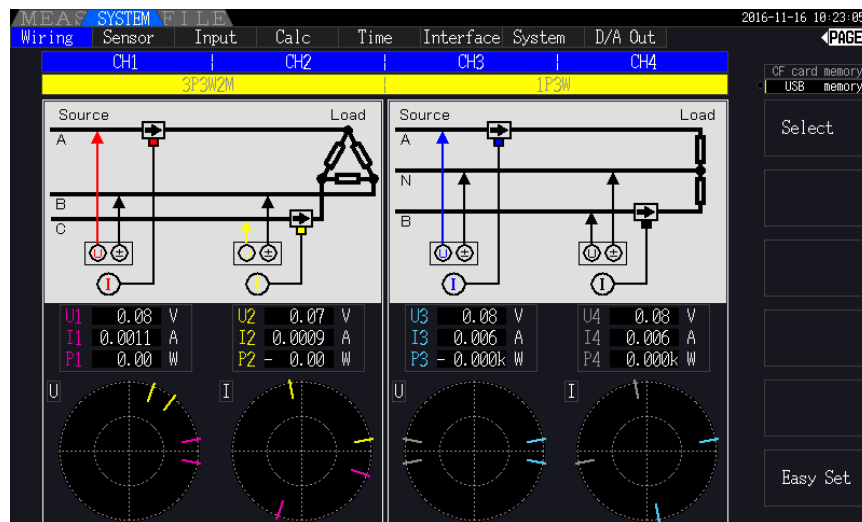

Wiring Mode 6. 3-phase, 3-wire (3P3W2M) × 2

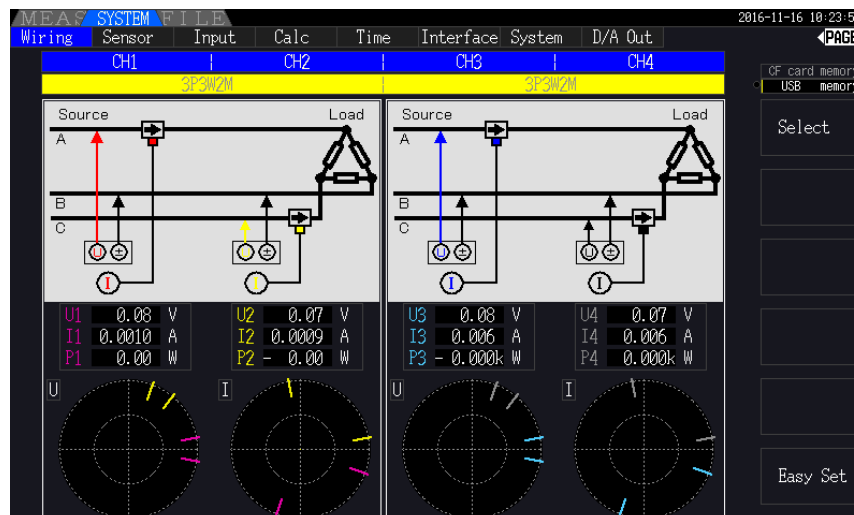

Wiring Mode 7. 3-phase, 3-wire (3P3W3M) + single-phase, 2-wire (1P2W)

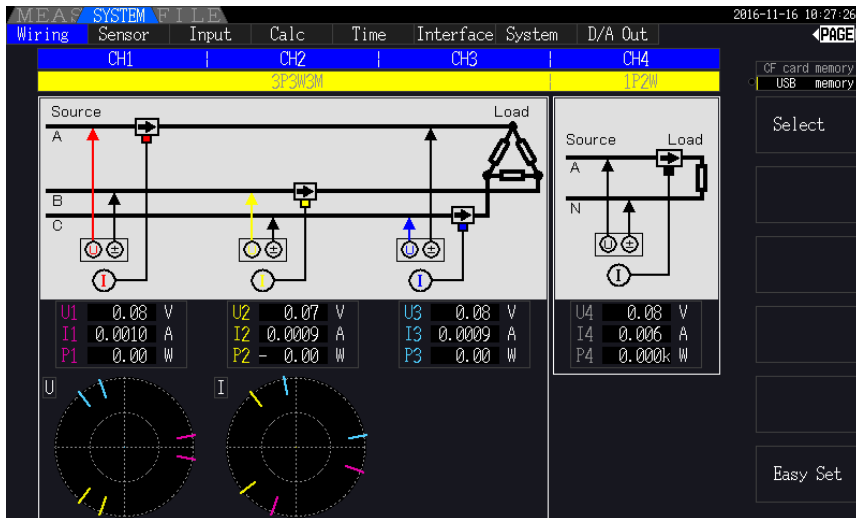

Wiring Mode 8. 3-phase, 4-wire (3P4W) + single-phase, 2-wire (1P2W)

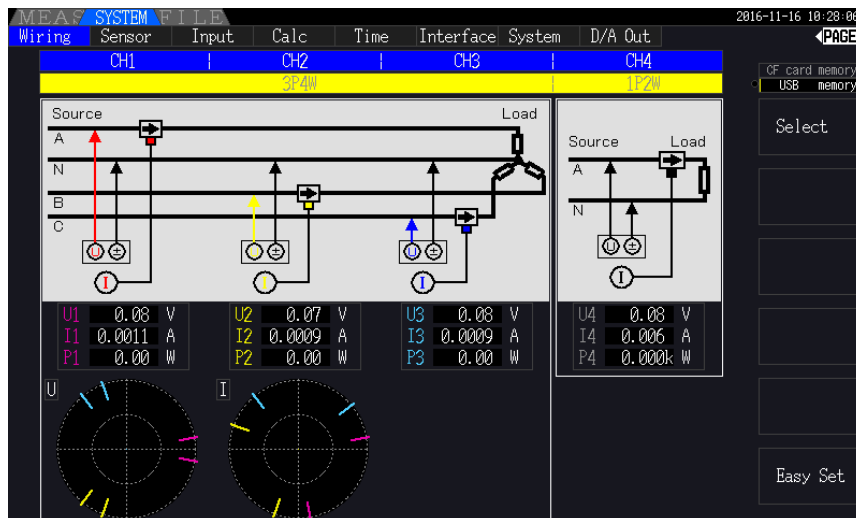

Wiring	Description
1P2W	Single-phase, 2-wire Select this wiring mode when measuring DC lines.
1P3W	Single-phase, 3-wire A
3P3W2M	3-phase, 3-wire This wiring mode is used for 2-meter measurement to measure 3-phase delta lines with two channels. It allows accurate measurement of active power, even with unbalanced and distorted waveforms. Apparent power, reactive power, and power factor values for unbalanced lines may differ from values obtained with other instruments. In that case, use the 3P3W3M wiring mode.
3P3W3M	3-phase, 3-wire This wiring mode is used for 3-meter measurement to measure 3-phase delta lines with three channels.
3P4W	3-phase, 4-wire This wiring mode is used for 3-meter measurement to measure 3-phase Y (star) lines with three channels.

3.10 Setting the Current Sensors

Selecting the current sensors in use

If a CT7044, CT7045, CT7046, CT7642, or CT7742 large current sensor has been connected to the instrument's current input terminal via the CT9920 Conversion Cable, set the model or output rate of the current sensor in use.

SYSTEM

Display the [Sensor] page

Select the item to display

Select a [Current sensor] for the channel being set.

Select with the F keys

Wiring	Input	Calc	Time	Interface	System	Motor	D/A Out
CH1	CH2	CH3	CH4				
1P2W	2P2W	1P2W	1P2W				
Current sensor	CTO	AUTO	AUTO				
Rating	500A	500A	500A				
AC/DC	AC	AC	AC				
Phase corr.	OFF	OFF	OFF				
Frequency[Hz]	10.000	100.000	100.000				
Angle[°]	+1.00	+00.00	+00.00				

CT7642	F1
CT7742	F2
CT7044	F3
CT7045	F4
All CH Set	F5
Next	F6

Sets the type of sensor when connected to the CT9920.
Set to AUTO when not connected to the CT9920.

NOTE

If a high-precision sensor that does not require the CT9920 Conversion Cable has been connected directly to one of the instrument's current input terminals, there is no need to select the current sensor since the instrument will detect it automatically.

Configuring current sensor phase correction

Generally speaking, phase error tends to increase gradually for current sensors in the high-frequency domain of the frequency band (see illustrative figure below).

Power measurement error in the high-frequency domain can be reduced by using information about the sensor's unique phase characteristics to correct phase error.

Illustrative figure

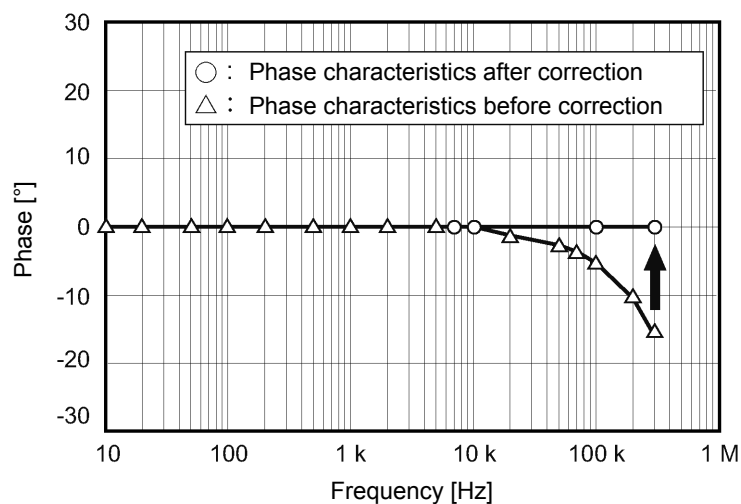

3.10 Setting the Current Sensors

Current sensor phase characteristics typical values

Check Hioki's website for the typical values of the phase characteristics for the current sensors that are not listed in the table.

Search "Typical Values of Current Sensor's Phase Characteristics" at <https://www.hioki.com/>

Model	Frequency (kHz)	Typical values of phase difference between input and output (°)
CT6830	10	-6.90
CT6831	10	-4.40
CT6841, CT6841-05	100	-1.82
CT6841A	100	-3.59
CT6843, CT6843-05	100	-1.68
CT6843A	100	-3.96
CT6844, CT6844-05	50	-1.29
CT6844A	100	-3.92
CT6845, CT6845-05	20	-0.62
CT6845A	10	-0.94
CT6846, CT6846-05	20	-1.89
CT6846A	10	-1.05
CT6862, CT6862-05	300	-10.96
CT6863, CT6863-05	100	-4.60
CT6865, CT6865-05	1	-1.21
CT6872	100	-1.28
CT6872-01	100	-2.63
CT6873	100	-0.75
CT6873-01	100	-2.10
CT6875, CT6875A	200	-10.45
CT6875-01, CT6875A-1	200	-12.87
CT6876, CT6876A	200	-12.96
CT6876-01, CT6876A-1	200	-14.34
CT6877, CT6877A	100	-2.63
CT6877-01, CT6877A-1	100	-3.34
CT6904 Series* ¹	300	-9.82
9709-05	20	-1.11
PW9100 Series* ²	300	-2.80
9272-05 (20 A)	50	-3.34
9272-05 (200 A)	50	-4.18
CT7044	5	-11.18
CT7045	5	-11.90
CT7046	5	-13.02
CT7642	1	-8.17
CT7742	1	-18.62

*1. CT6904, CT6904-01, CT6904-60, CT6904-61, CT6904A, CT6904A-1, CT6904A-2, CT6904A-3

*2. PW9100-03, PW9100-04, PW9100A-3, PW9100A-4

Typical values for all sensors reflect the following conditions:

- Standard cable length (not using an extended cable)
- Conductor under measurement positioned in the center of the sensor

If the VT1005 is used, different typical values of the phase difference are used for the setting.

See "8.6 Connecting VT1005" (p. 178)

Determine the frequency and phase difference for the sensor to which correction is being applied based on the table of current sensor phase characteristics (Reference: "Configuring current sensor phase correction" (p. 41)). (Refer to the "Frequency" column for the frequency and the "Typical values of phase difference between input and output" column for the phase difference.)

Example for CT6862:

To set a frequency of 300.000 kHz and a phase difference of -10.96°

Display the **[Sensor]** page

Select the item to display

Select a **[Phase corr.]** for the channel being set.

Select **[ON]** with the **F2** key

Select the item to display

Select a **[Frequency[kHz]]** for the channel being set.

Select **[300.000]** with the **F** keys

Select a **[Angle[°]]** for the channel being set.

Select **[-10.96]** with the **F** keys

Method for inputting values using **F** keys
 Select which digit to input with the **F3** and **F4** keys.
 Then increment or decrement the value as desired with the **F1** (+1) and **F2** (-1) keys (to select a value from 0 to 9).

NOTE

- The valid setting range for the angle [°] setting is -90° to +90°. However, the time difference calculated from the frequency and phase difference is limited to the range of -200 μs to 200 μs, and phase correction calculations are performed at a resolution of 5 ns.
- Set the frequency and phase difference as appropriate for the current sensor in use.
- Use of an improper setting may result in erroneous correction, which may in turn cause the measurement error to increase. Be sure to enter the settings accurately.

3.11 Attaching to the Lines to be Measured and Zero Adjustment

Be sure to read the "Usage Notes" (p. 8) before attaching to the lines. Always perform zero adjustment before attaching to the lines.

Then attach the voltage measurement clips and current sensors to the measurement lines according to the on-screen wiring diagrams. For proper accuracy, attach to the lines exactly as shown.*

* The diagram appears when the wiring mode is selected.(p. 37)



Although the instrument can measure multiple lines at the same time, to avoid electric shock and short-circuit accidents, do not attach any unnecessary cables.

NOTE

The phases are named A, B, and C on the wiring diagram display. Substitute with equivalent names such as R,S, and T or U,V, and W, as appropriate.

Zero Adjustment and Degaussing

To obtain the specified accuracy, after 30 minutes warm-up, perform zero-adjustment on both voltage and current measurement channels.

When using an AC/DC current sensor, perform degaussing along with zero adjustment.

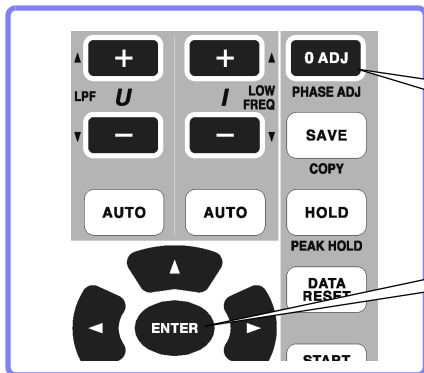

1. Press the **MEAS** key.

2. Press the key. **[Execute Zero Adjust.]** is displayed.

3. Press the key. (**ESC** to cancel.) **[Executing zero adjustment]** is displayed for 30 seconds, until finished.

NOTE

- Perform zero adjustment only after plugging the current sensor into the instrument (proper adjustment requires that the current sensor be connected).
- Perform zero adjustment before attaching to the lines to be measured (proper adjustment requires the absence of any input voltage or current).
- For optimum measurement accuracy, zero adjustment should be performed within the specified ambient temperature range.
- The operating keys are disabled during zero adjustment.
- If the instrument is equipped with motor analysis functionality, zero adjustment is not applicable for analog DC input on channels A and B. Perform the special zero adjustment from the Motor screen.

See "4.8 Viewing Motor Measurement Values (Model PW3390-03 only)" (p. 96)

Attach voltage measurement cables to measurement lines

Example: Secondary side of breaker

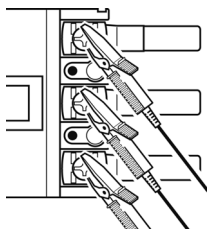

Securely clip the leads to metal parts such as load-side screw terminals or bus bars.

L9438-50 Voltage Cord

Attach current sensors to measurement lines

(Example: 9272-05)

Be sure to attach each clamp around only one conductor.

Correct measurement cannot be obtained if a clamp is attached around more than one conductor.

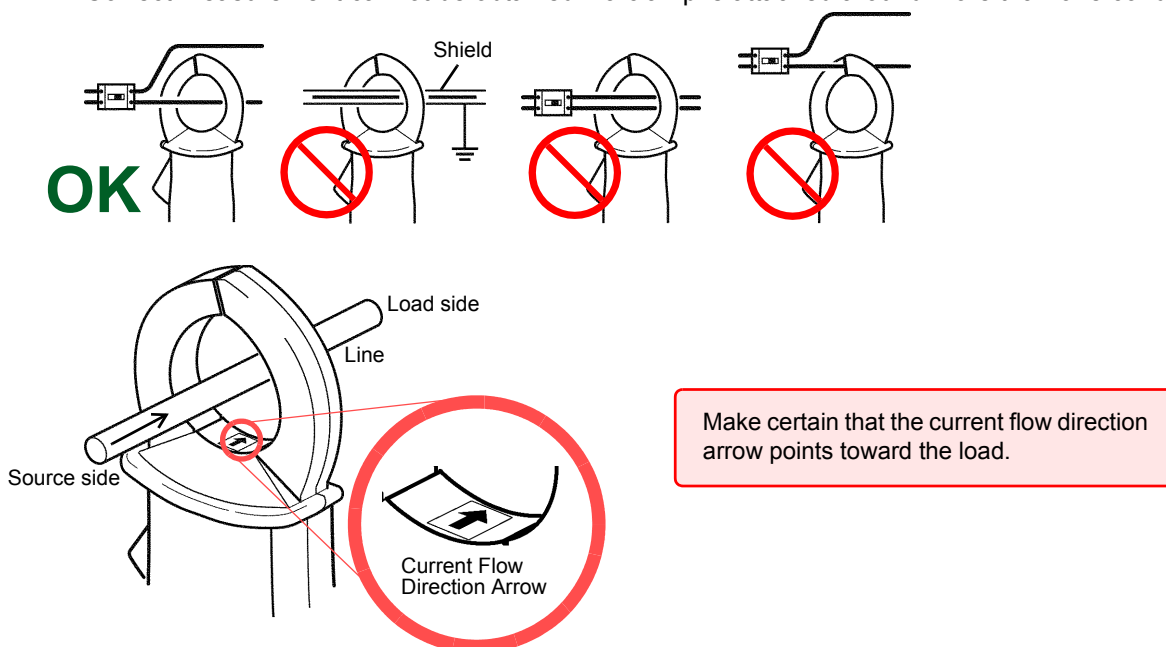

Easy set

NOTE If measurement line power is off, turn it on before performing quick setup.

- 1** Select **[Easy Set]** with the **F6** key.
A confirmation dialog box appears.
- 2** To execute: Press **ENTER**.
To cancel: Press **ESC**.

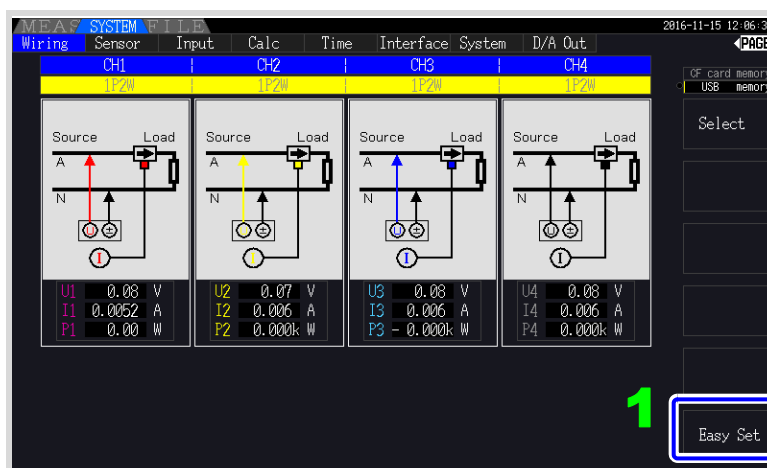

What settings are affected by quick setup?

For accurate measurements, settings such as range and sync source must be properly configured. Executing quick setup automatically configures the following settings to the Hioki-recommended values for the selected wiring mode (phase system): voltage and current ranges, sync source, lower measurement frequency limit, integration mode, harmonic sync source and rectification system.

NOTE

Execute quick setup when using the instrument the first time, and when changing to a different line configuration.

3.12 Verifying Correct Wiring (Connection Check)

Correct attachment to the lines is necessary for accurate measurements.

Refer to the measured values and vector displays to verify that the measurement cables are correctly attached.

For 1P2W systems

Verify that an appropriate measurement value is displayed.

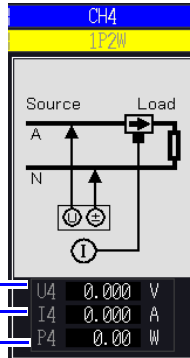

Measured voltage value
Measured current value
Measured active power value

For systems other than 1P2W

- Verify that an appropriate measurement value is displayed.
- Verify that the vectors are displayed with the appropriate range.

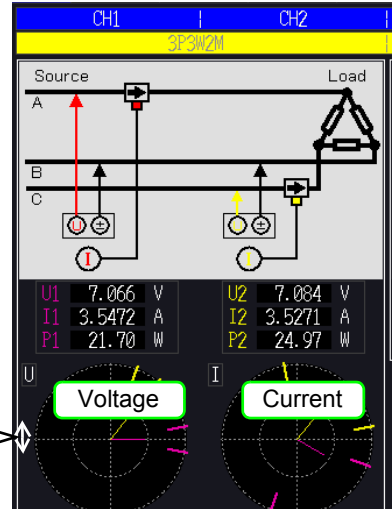

Vector line range
Colors match the corresponding lines in the wiring diagram.

In this case

If the measured voltage value is too high or too low

If the measured current value is not correct

If the measured active power value is negative

If vectors are too short, or unequal

If vector direction (phase) or color is incorrect

Check

- Are the cables securely plugged into the voltage measurement jacks on the instrument? (p. 32)
- Are the voltage measurement cables properly attached to the lines? (p. 44)
- Are the cables securely plugged into the current measurement jacks on the instrument? (p. 33)
- Are the current sensors properly attached to the lines? (p. 45)
- Are the current sensors appropriate for the line current to be measured?
- If using the 9272-05 Clamp On Sensor is the sensor range set correctly?
- Are the voltage measurement cables properly attached to the lines? (p. 44)
- Is the arrow marker on the current sensors pointing toward the load?

Voltage vectors:

- Are the cables securely plugged into voltage measurement jacks on the instrument? (p. 32)
- Are the voltage measurement cable clips properly attached to the lines? (p. 44)

Current vectors:

- Are the cables securely plugged into the current measurement jacks on the instrument? (p. 33)
- Are the current sensors properly attached to the lines? (p. 45)
- Are the current sensors appropriate for the line current to be measured?
- If using the 9272-05 Clamp On Sensor, is the sensor range set correctly?

Voltage vectors:

- Check that the voltage measurement clips are attached to the lines according to the wiring diagram.

Current vectors:

- Check that the current sensors are attached to the lines according to the wiring diagram.

NOTE

- The display range of the vector diagrams assumes inductive loads (such as with a motor). The vectors may appear out of range when measuring near-zero power factor, or capacitive loads.
- When measuring multiple 1P3W or 3-phase lines at the same time, vectors are not displayed correctly when the harmonic sync source frequency is different from that of the lines to be measured.
- When measuring 3P3W2M systems, the active power (P) measured on each channel may be negative.

Viewing Measurement Values

Chapter 4

4.1 Measurement Value Display Procedure

The following procedure displays measurement values.

Display Procedure (the following shows 1P2W wiring mode)

The diagram illustrates the procedure to view measurement values. It starts with a 'MEAS' button, which leads to a screen with left and right arrow buttons. The instruction 'Display the [CH] page' points to the right arrow. Below this, the instruction 'Use the F keys to select display contents' points to a screenshot of the device's measurement screen.

The screenshot shows a measurement screen with the following data:

Channel	Value	Unit
CH1	7.069	V
S1	24.948	VA
I _{rms1}	3.5291	A
Q1	12.482	var
P1	21.602	W
φ1	30.02	°
λ1	0.8659	
f1	50.001	Hz

On the right side of the screen, there is a vertical menu of function keys (F1-F6):

- Power (F1)
- Integration (F2)
- Voltage (F3)
- Current (F4)
- Harmonics Graph (F5)
- Harmonics List (F6)

Annotations in the diagram include:

- A box around 'CH1 CH2 CH3 CH4' at the top of the screen.
- An arrow pointing from the right arrow button to the 'CH1' label.
- An arrow pointing from the 'F' keys instruction to the function key menu.
- An arrow pointing from the 'See' text below to the 'Harmonics Graph' and 'Harmonics List' options.



See Displays the Harmonic Graph or Harmonic List.
"4.4 Viewing Harmonic Measurement Values" (p. 74)

The above screen is specific to the wiring mode (here showing four 1P2W systems) the number of measurement items displayed depends on the selected wiring mode. See Section "3.9 Selecting the Wiring Mode" (p. 37) to set the wiring mode.

4.1 Measurement Value Display Procedure

Selecting Measured Items for Display

From all measured items, select those you want to display on one screen.

Press   to display the **[Select]** page.

First press an **F** key to select the number of items to be displayed.

4 Items Display



8 Items Display

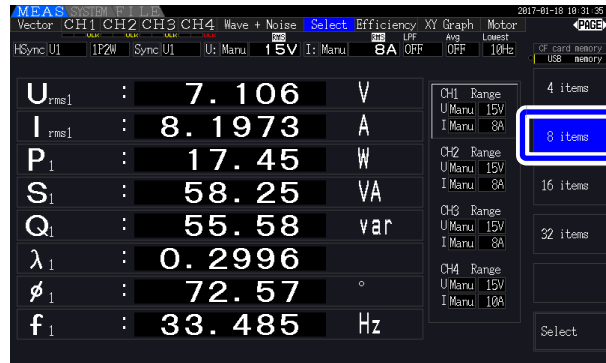

16 Items Display



32 Items Display

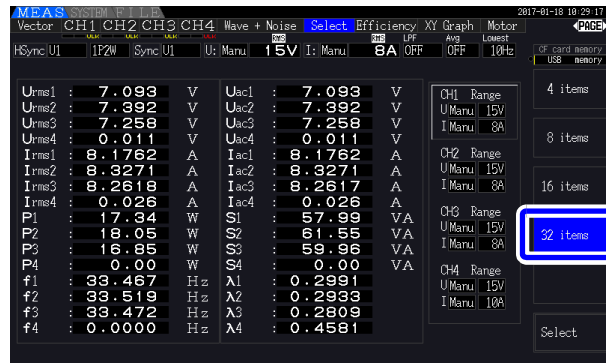

Display Item Selection Procedure

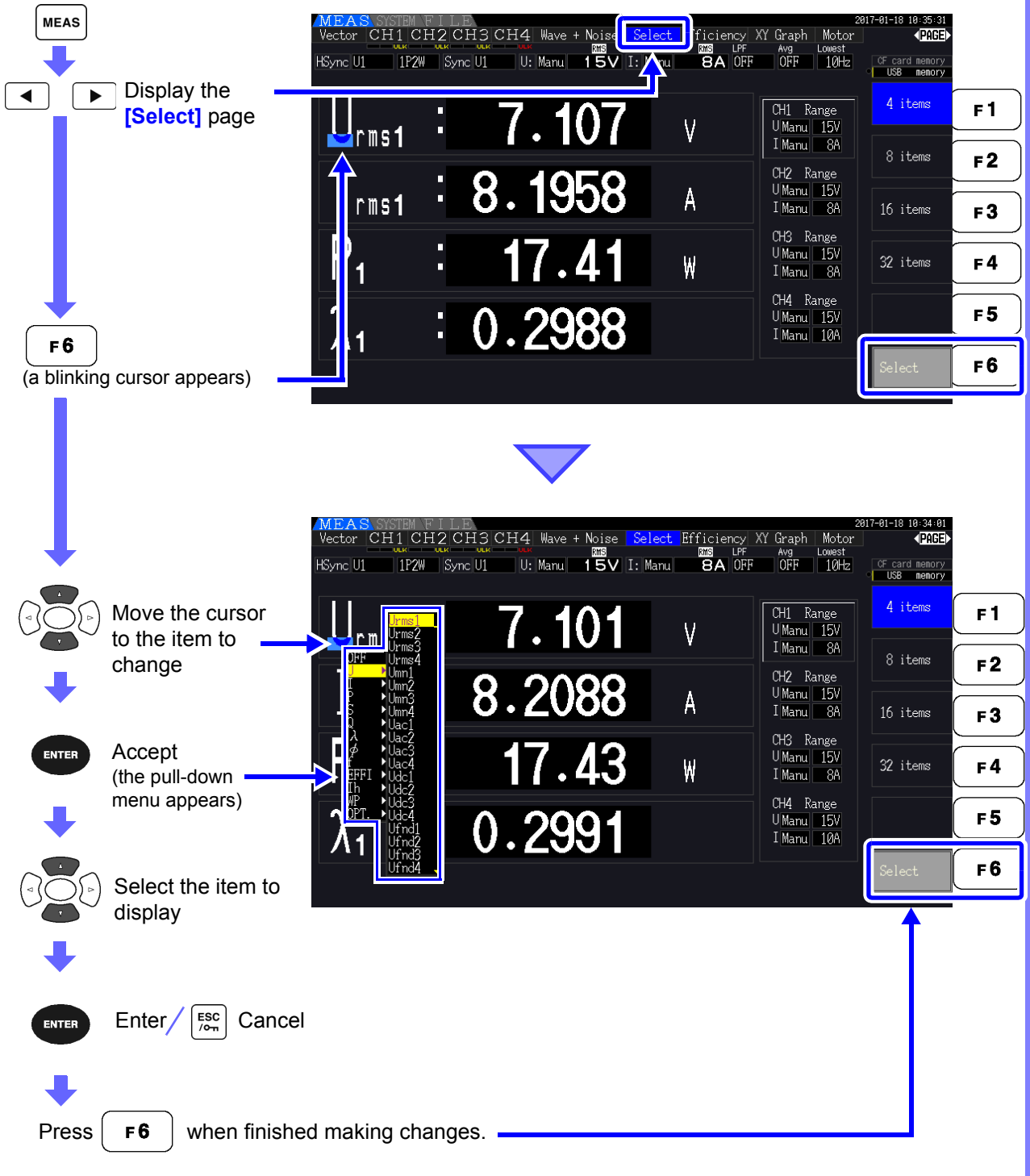

4.1 Measurement Value Display Procedure

About Valid and Displayable Ranges

The valid measurement range (the range of guaranteed accuracy) is 1% to 110% of the full-scale range (except that valid voltage is limited to 1000 V in the 1500 V scale).

The display range of this unit is between the zero suppress level to 120% of the measurement range.

The following display indicates over-range measurement.

The data from over-range measurements are saved as "+9999.9E+99"* and not added to the integrated value.

See Measurement Value Data Format (p. A4)

If input at or below the zero suppress setting for the measurement range is measured, the measured value will not change from zero. To display even low input levels, turn off the zero suppress setting or set it to 0.1%.

See Zero suppress level: OFF (initial setting), 0.1%f.s., 0.5%f.s. (p. 131)

* When the data are opened with spreadsheet software such as Excel, the over-range measurements may be displayed as "9.9999E+102", for example.

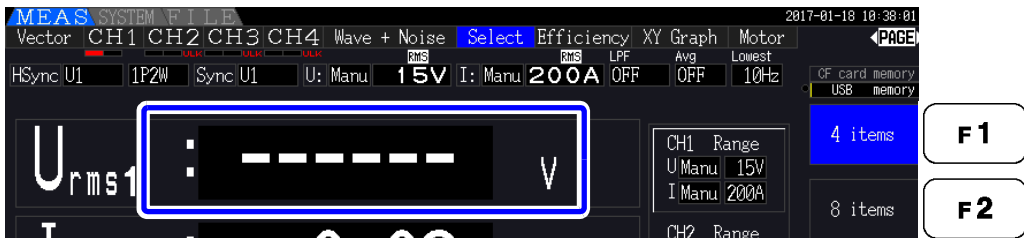

About Peak Over Indicators

Peak Over indicators light when an input voltage or current waveform peak value exceeds three times the full-scale range (except the 1500 V range, when the voltage exceeds ± 2000 V, see the figure below). The indicators are shown on all screens, so that Peak Over can be seen even on channels not currently selected.

Example: The following display indicates that the CH 1 voltage and CH 3 current are at Peak Over levels.

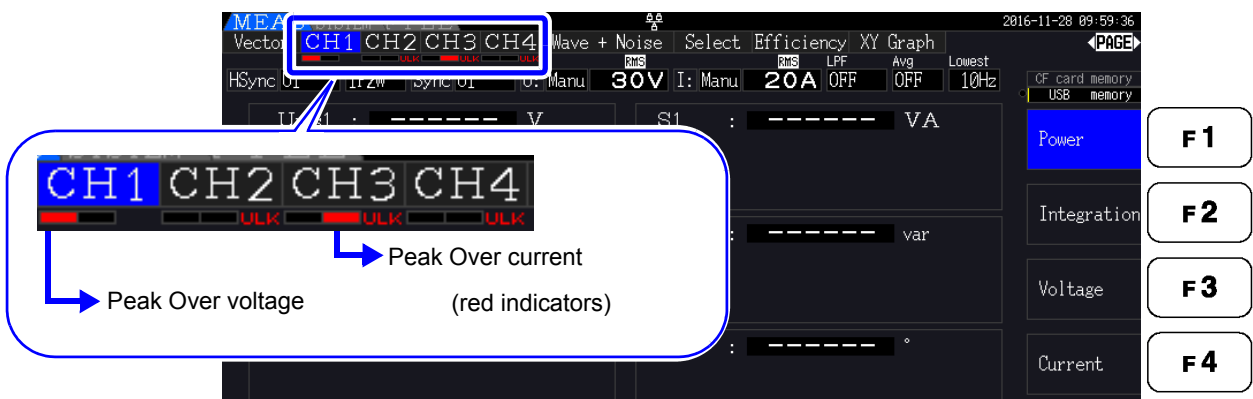

4.2 Viewing Power Measurements, and Changing the Measurement Configuration

4.2.1 Displaying Power Measurements

When viewing power measurements, **[Power]**, **[Voltage]**, and **[Current]** are displayed so that measured values can be confirmed. Press **[MEAS]** to display the Measurement screen, and select the desired **[CH]** page with the **[◀]** **[▶]** keys. Power measurements can be displayed in a list, and detailed voltage and current values can be displayed.

Displaying Power

Press **[F1]**. (The screen shows values for Wiring mode 1, four 1P2W systems.)

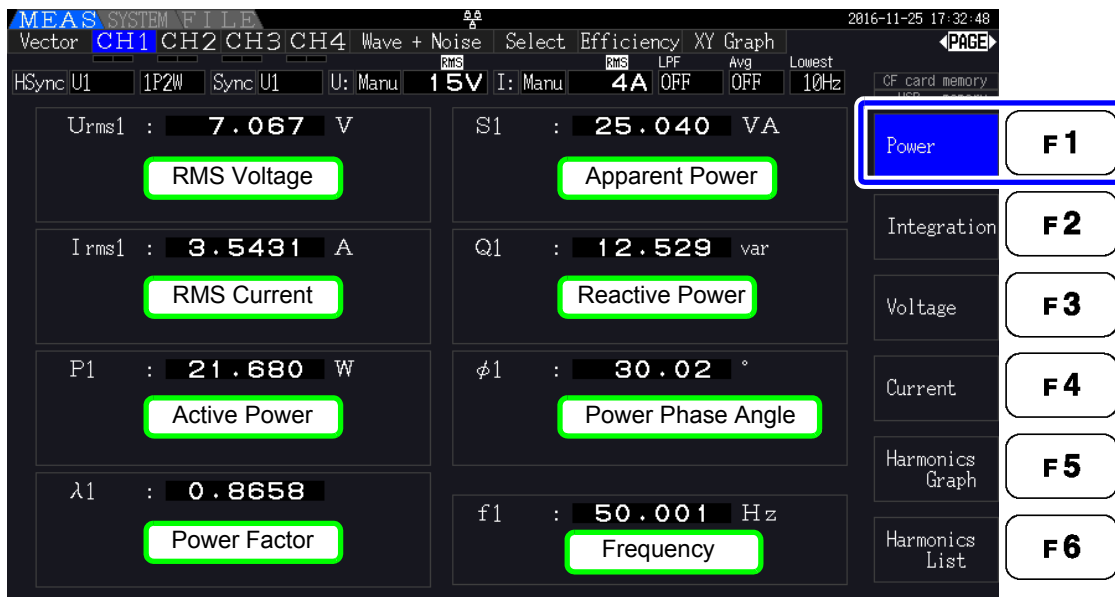

NOTE

- Average rectified RMS converted value is displayed for Urms or Irms according to the rectification setting.
[See "4.2.5 Selecting the Rectification Method" \(p. 62\)](#)
- Polarity of power factor (λ), Reactive power (Q), and power phase angle (ϕ) shows the LEAD or LAG. "No polarity sign" means "LAG" and "-" means "LEAD".
- The polarity of power factor, reactive power and power phase angle may not be stable when the voltage and current has big level difference or power phase angle is around zero.
- During 3P3W2M measurement, the active power (P), reactive power (Q), apparent power (S), power factor (λ), and power phase angle (ϕ) for each channel indicate intermediate measurement results. Use the total values (P12, P34, etc.) for final evaluation purposes.

Displaying Voltage

Press **F3**. The screen shows settings for Wiring mode 7, (3 phase 3 wire (3P3W3M)+1 phase 2 wire (1P2W)).

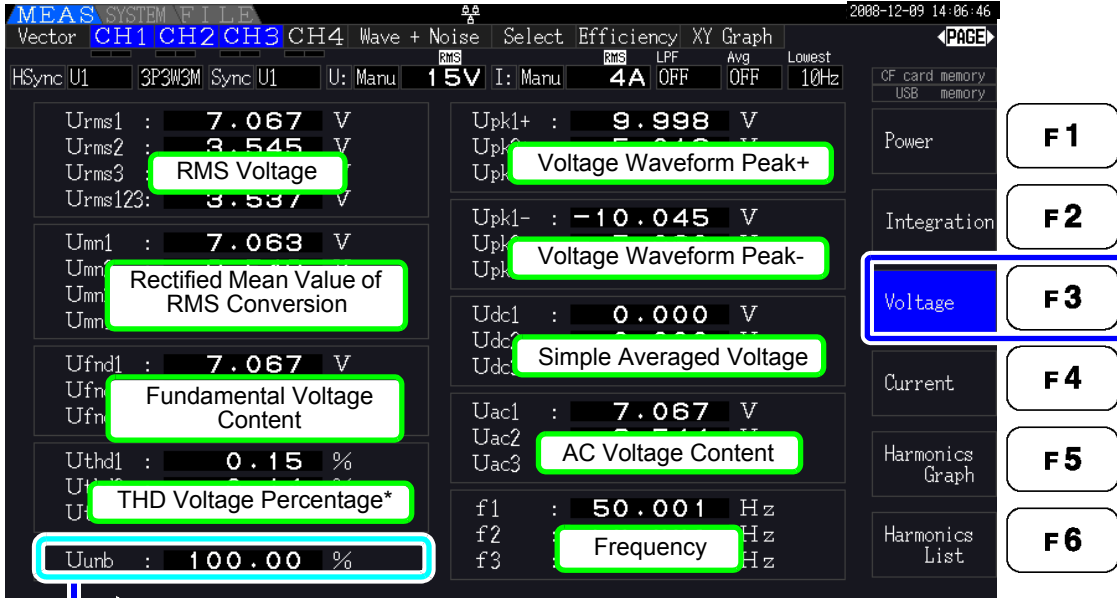

When the Wiring mode is 3P3W3M or 3P4W, voltage unbalance Uunb [%] is displayed.
 * When the integration mode is set to DC, the voltage ripple rate Urf [%] will be displayed instead of the voltage total harmonic distortion.

Displaying Current

Press **F4**. The screen shows settings for Wiring mode 7, (3 phase 3 wire (3P3W3M)+1 phase 2 wire (1P2W)).

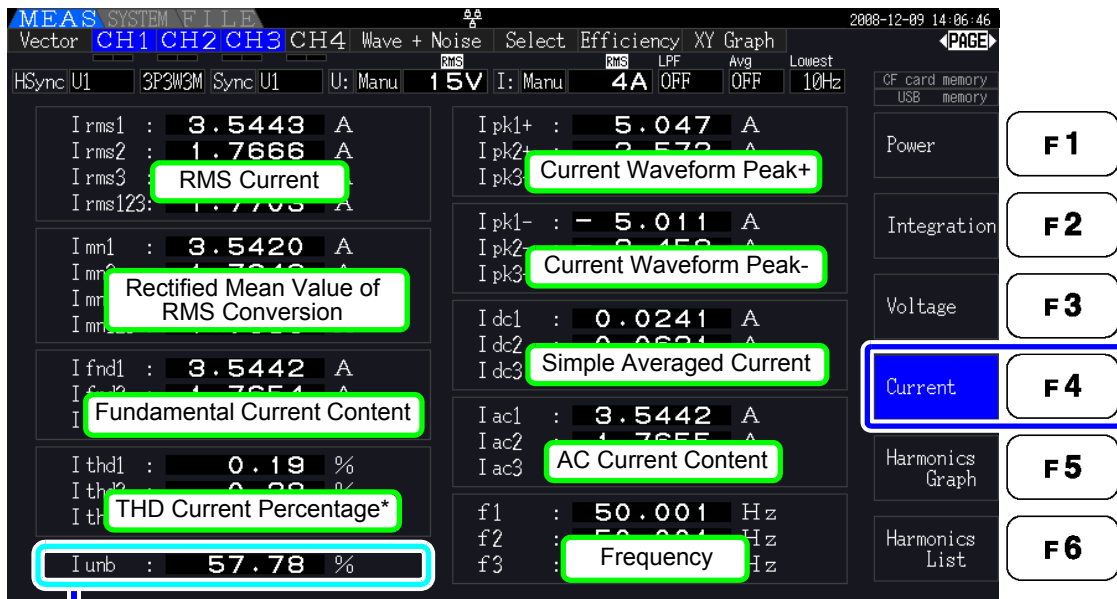

When the Wiring mode is 3P3W3M or 3P4W, current unbalance Iunb [%] is displayed.
 * When the integration mode is set to DC, the current ripple rate Irf [%] will be displayed instead of the current total harmonic distortion.

4.2.2 Selecting Ranges

Measurement ranges are selected as described below.

⚠ DANGER

- If the maximum voltage or current rating is exceeded, immediately stop measuring, shut off power to the measurement lines, and disconnect from the measurement object.
- Continuing to measure when maximum ratings are exceeded may damage the instrument and result in injury or death.

⚠ WARNING

- The maximum input voltage is 1500 V, ±2000 V peak. Do not use the voltage exceeding it to avoid damaging the unit or injury.
- Never exceed the maximum rated input current to the current sensor, as damage to the instrument or injury or death can result.

Types of Range Setting

Measurement ranges can be selected in two ways:

Manual range setting	Select the range manually (Press + or - key of the RANGE keys to select the desired range.)
Auto-Ranging	Each voltage and current range is set automatically according to the measurement inputs for each wiring system. (Press the AUTO key of the RANGE keys.)

Range Display

The active range selection is displayed at the locations on the Measurement screen shown below (except on the **[Efficiency]**, **[XY Graph]**, and **[Motor]** pages). Manual range selections are indicated by **[Manu]**, and Auto-ranging selections by **[Auto]**.

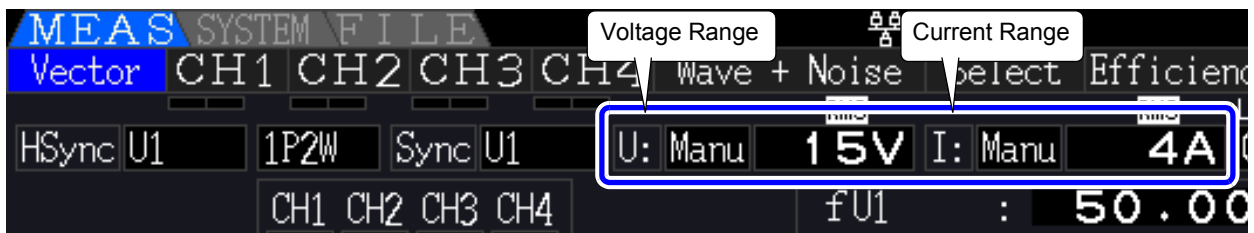

Range Setting Procedure

Ranges can be set on the following Measurement screen pages: **[Vector]**, **[CH]** (any), **[Wave + Noise]**, **[Select]**, and **[Input]**. Change the range with the **RANGE** keys.

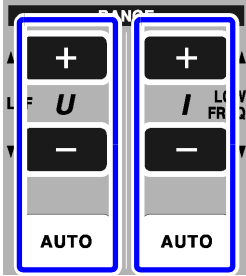

Voltage Range Current Range

For Manual range selection, press the **+** / **-** key of the **RANGE** keys to select the desired range.

For Auto range selection, Press the **AUTO** key of the **RANGE** keys.

Setting from the [Vector] Page of the Measurement Screen

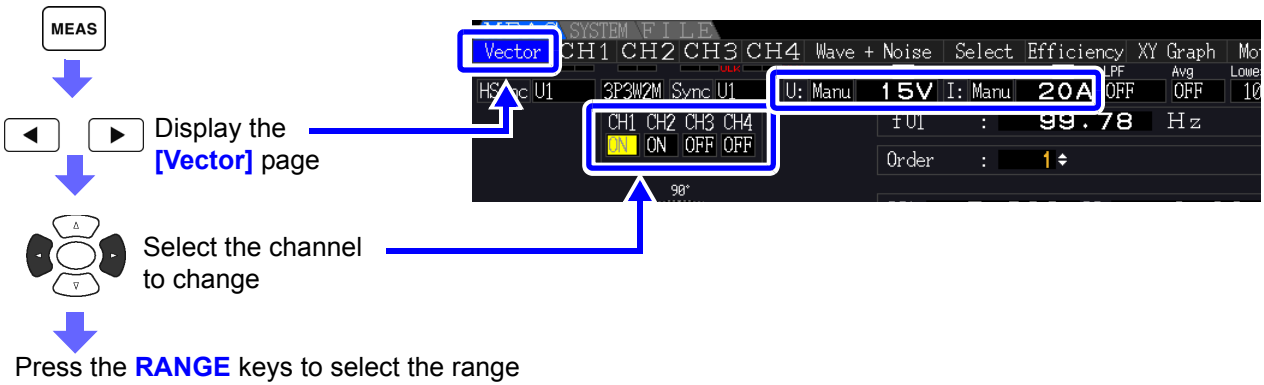

Setting from the [CH] Pages of the Measurement Screen

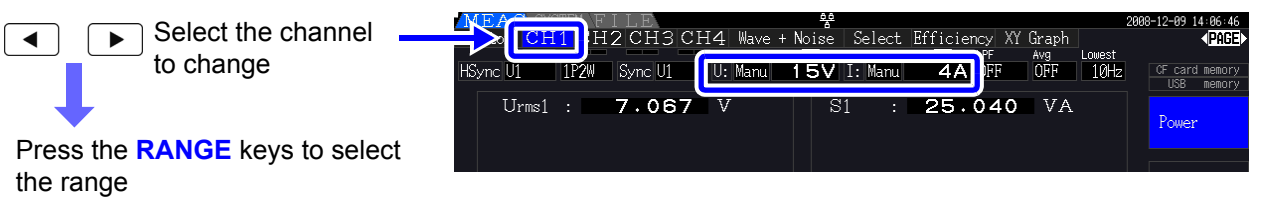

Setting from the [Wave + Noise] Page of the Measurement Screen

Display the [Wave + Noise] page

F1 Select [U/I]*

Select the channel to change

Press the RANGE keys to select the range

* Press F2 to display [CH] for changing.

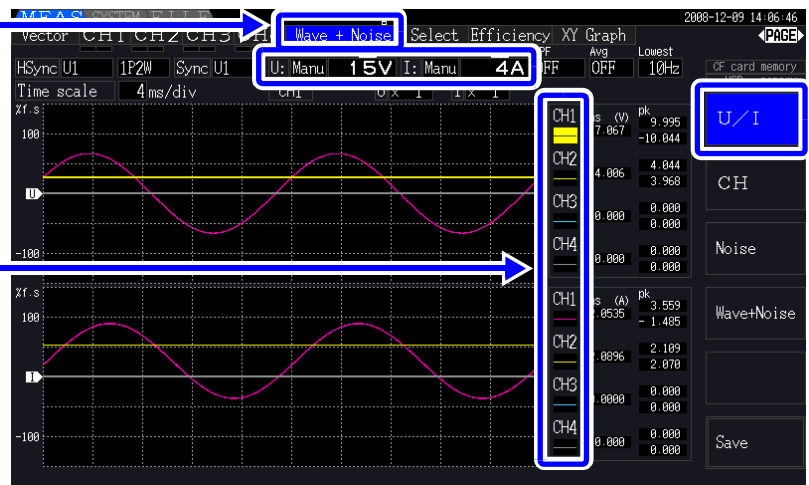

4

Setting from the [Select] Page of the Measurement Screen

Display the [Select] page

Select the channel to change

Press the RANGE keys to select the range

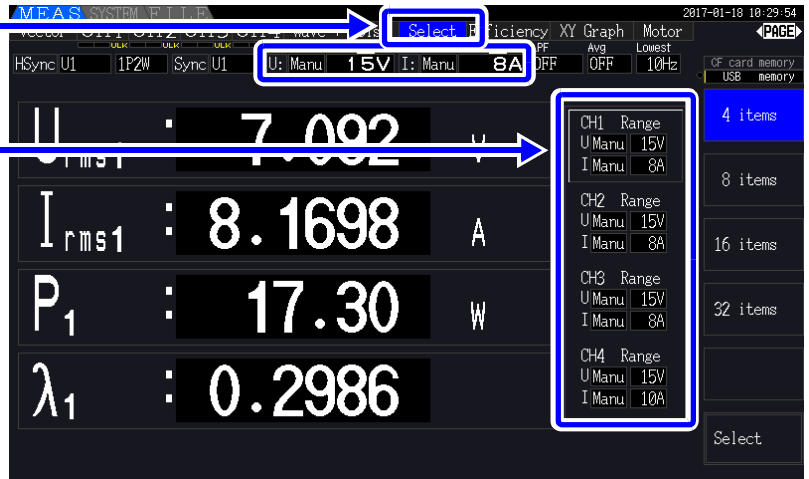

Setting from the [Input] Page of the Setting Screen

The screenshot shows the 'MEAS SYSTEM' menu with the 'Input' page selected. The 'U range' for CH1 is highlighted in yellow and set to 15V. The 'I range' for CH1 is set to 40A. The 'Wiring' is set to 1P2W for all channels. The 'Sync source' is U1. The 'U rect' is RMS for all channels. The 'VT rate' is OFF for all channels. The 'I rect' is OFF for all channels. The 'CT rate' is OFF for all channels. The 'LPP' is OFF for all channels. The 'Integ mode' is DC for all channels. The 'Freq measure' is U for all channels. The 'Lowest freq' is 10Hz. The 'Harm sync' is U1. The 'THD calc' is THD-F. The 'Δ-Y convert' is OFF. The 'Motor sync' is DC 50ms. The 'Operation' is TYPE1.

Annotations and instructions:

- Display the [Input] page (indicated by a right arrow key icon).
- Select the channel to change (indicated by a circular arrow icon).
- Press the RANGE keys to select the range (Changes the selected [U range] or [I range]).

Function key actions:

- F1: Range ↑
- F2: Range ↓
- F3: (Unlabeled)
- F4: (Unlabeled)
- F5: All CH Set
- F6: AUTO

To change the [U range] or [I range], select it with the cursor and press **F1**, **F2**, or **F6** to change the range.

About [All CH Set], see "2.2 Basic Operations" (p. 20).

NOTE

When measuring multiple channels with a Wiring mode other than 1P2W, all channels are forced to the same range. In this case, the range of each channel is set to match the channel set to the lowest range.

Auto-Ranging Span

This setting determines auto-ranging behavior, and can be specified for each wiring system. Select **[Wide]** if the range changes frequently due to large fluctuations.

Narrow	<ul style="list-style-type: none"> The measurement range increments by one when a Peak Over state occurs or when any RMS value exceeds 105% f.s. The measurement range decrements by one when all RMS values fall below 40% f.s. (unless a Peak Over state would result in the lower range). This is the default setting.
Wide	<ul style="list-style-type: none"> The measurement range increments by one when a Peak Over state occurs or when any RMS value exceeds 110% f.s. The measurement range decrements by two when all RMS values fall below 10% f.s. (unless a Peak Over state would result in the lower range).

NOTE When Δ -Y transform is enabled (p. 118), the range-decrementing voltage is $1/\sqrt{2}$ (approximately 0.57735) f.s.

Setting Procedure

SYSTEM
 ← → Display the **[Calc]** page
 Select **[AutoRange type]**
 Select with the **F** keys

MEAS SYSTEM FILE 2016-11-28 18:37:16
 Wiring Sensor Input **Calc** Time Interface System D/A Out
 Efficiency
 P1 Pin3 P1
 Pout1 P1 Pout2 P1 Pout3 P1
 Noise analysis
 Noise sampling 250kS/s Points 10000 Lowest noise 1kHz
 Analysis CH CH1 Window type Hanning
 AutoRange type **Narrow**
 F1
 F2
 F3
 F4
 F5
 F6
 Set the ranging pattern of AUTO range.
 Use "Wide" when the range is not stable in AUTO range.

NOTE

- If the range switches frequently even when the **[Wide]** setting for **[AutoRange type]** is selected, Manual range setting is recommended. See "4.2.2 Selecting Ranges" (p. 53)
- When integration starts, the range selected at that time becomes fixed, and auto-ranging is disabled.

4.2.3 Selecting the Sync Source

Select the source to determine the fundamental cycle (between zero crossings) on which various calculations are to be based.

As a general usage, for each wiring, select the voltage of the measurement channel for the channel measuring the alternating current, and 50 msDC for the channel measuring the direct current.

When measuring distorted alternating waveforms with a lot of noise, such as PWM waveforms, accurate measurements can be achieved by suitably combining the settings in "Setting the Zero-Crossing Filter" (p. 59).

Select from the following 11 items for each Wiring mode. Press **SYSTEM** to make the setting on the Setting screen.

U1 to U4 (Default setting), I1 to I4, DC 50 ms, DC 100 ms, Ext*

The selected synchronization source is displayed as **[Sync]** on the Measurement screen.

Use the **[Ext]** setting when performing pulse-based measurement during motor analysis or when measuring electrical angle.

* Motor Testing is installed and CH B is set only for pulse input.

Sync Source Setting Procedure

[All CH Set] and **[Next]**:
See "2.2 Basic Operations" (p. 20)

NOTE

- When measuring AC input with **[DC 50 ms]** and **[DC 100 ms]** settings, displayed values fluctuate and proper measurement is not possible. Select any of **[U1]** to **[U4]** or **[I1]** to **[I4]**.
- Voltage and current share the same sync source on each channel.
- **[DC 50 ms]** is the fastest calculation interval for DC measurements. However, if input interference (50/60-Hz power line noise) causes measurement values to fluctuate, select **[DC 100 ms]**.
- When U or I is selected as a sync source, amplitude should remain at least 30% f.s.
- Also when U or I is selected as a sync source, if a frequency is applied above 5 kHz or below the minimum measurement frequency, the displayed frequency may differ from the input frequency.
For the sync source, select an input with a fundamental frequency of 0.5 Hz to 5 kHz, and specify the corresponding minimum measurement frequency.
- The measurement values may get unstable at the frequency around the lowest measurable frequency, because the synchronization is unlocked.

Setting the Zero-Crossing Filter

When U or I is selected, set the level of the zero-crossing filter.

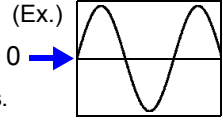
OFF	Set to display waveforms from "0". NOTE When [OFF] is selected, accuracy is undetermined, so always select the Weak or Strong setting when viewing measurement values.	(Ex.) 
Weak	The filter should usually be set to either [Weak] or [Strong].	
Strong	Select this setting if synchronization is lost because the input fundamental and the carrier frequency are too close together, such as when measuring an inverter secondary (default setting).	

Zero-Crossing Filter Setting Procedure

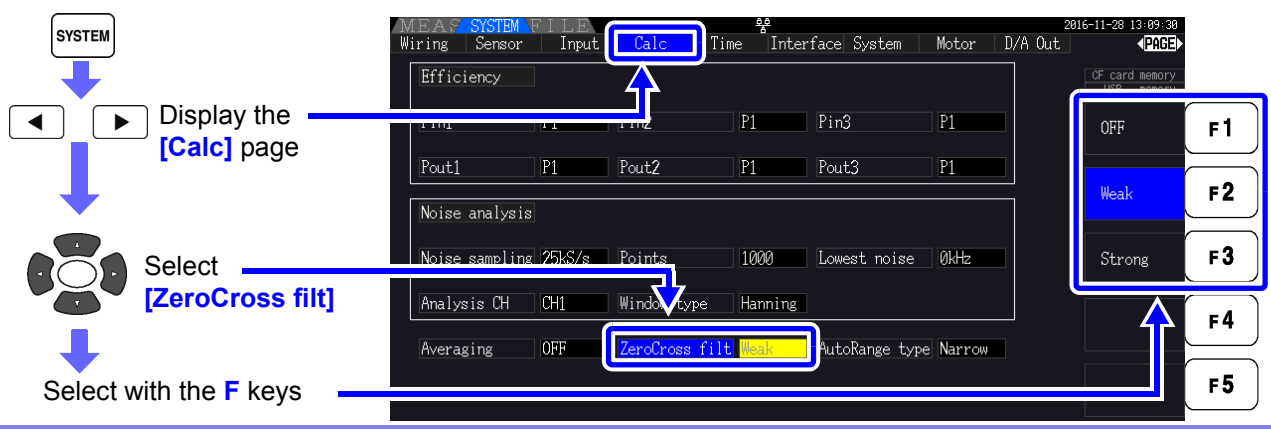

About the Sync Unlock Indicators

When a sync signal cannot be acquired,* its Sync Unlock indicator appears (see figure below). The indicators for all channels are displayed on all screens, so sync unlock events are visible even when they occur on channels that are not currently selected for display.

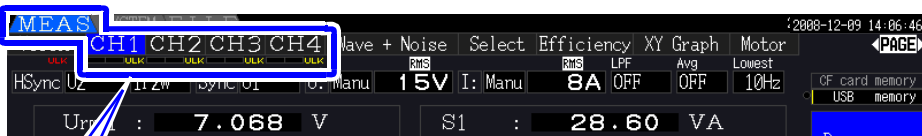

Red	Indicates sync is unlocked. The channel cannot be measured accurately.
Yellow	"ULK" lights yellow when the frequency of any sync source channel is at or below 99% (or at or above 101%) of the harmonic sync source. In this case, the harmonics of each measured value, the fundamental content (U _{fn} and I _{fn}), and the total harmonic distortion (U _{thd} and I _{thd}) cannot be measured correctly. Example: When the frequency of the harmonic sync source is 50 Hz and the frequency of the sync source channel is 49.5 Hz or less, or 50.5 Hz or more. Harmonic sync source unlocked

Harmonic sync source unlocked
See "4.4.4 Selecting the Harmonic Sync Source" (p. 79)

* If the frequency of the selected sync source (input) is not between 0.5 Hz and 5 kHz, or if there is no sync source input signal, or if the input amplitude is too low (below 30% f.s.)

4.2.4 Frequency Measurement Settings

By configuring U or I settings for each input channel, the instrument can simultaneously measure multiple frequencies in different wiring systems.

Frequency Measurement Display System

- 0.5000 Hz → 9.9999 Hz → 10.000 Hz → 99.999 Hz → 100.00 Hz → 999.99 Hz → 1.0000 kHz → 5.0000 kHz
- 0.5000 Hz ← 9.8999 Hz ← 9.900 Hz ← 98.999 Hz ← 99.00 Hz ← 989.99 Hz ← 0.9900 kHz ← 5.0000 kHz
- For other measurement input frequencies (not between 0.5 Hz and 5 kHz): "0.0000 Hz" is displayed for frequencies below 0.5 Hz, and "----- Hz" for 5 kHz and above.

Frequency Measurement Source Setting Procedure

Diagram illustrating the steps to reach the Frequency Measurement Source Setting screen:

- Display the **[Input]** page
- Select **[Freq measure]**
- Select with the **F** keys

The screenshot shows the **MEAS SYSTEM** screen with the **Input** tab selected. The **Freq measure** is set to **U**. The **F** keys (F1-F6) are shown on the right side of the screen.

About **[All CH Set]**, see "2.2 Basic Operations" (p. 20).

Specify the lowest (limit) measurement frequency for frequency measurements.
Set the lowest measurement frequency according to the input frequency.
The setting is displayed as the **[Lowest]** value on the Measurement screen.

Setting the lowest measurement frequency on the Measurement screen

This setting is available on all Measurement screen pages.

Diagram illustrating the steps to set the lowest measurement frequency on the Measurement screen:

- Press the **LOW FREQ** **[+]** or **[-]** key to make the setting

The screenshot shows the **MEAS** screen with the **Lowest** value set to **10Hz**. The **SHIFT** key and the **LOW FREQ** key (with **+** and **-** sides) are shown below the screen.

Setting the Lowest Measurement Frequency on the Setting Screen

SYSTEM

Display the [Input] page

Select [Lowest freq]

Select with the F keys

Wiring	CH1	CH2	CH3	CH4	Lowest freq
1P2W	1P2W	1P2W	1P2W	1P2W	10Hz
Sync source	U1	U1	U1	U1	
U range	60V	60V	60V	60V	
U rect	RMS	RMS	RMS	RMS	
VT rate	OFF	OFF	OFF	OFF	
I range	20A	20A	20A	20A	
I rect	RMS	RMS	RMS	RMS	
CT rate	OFF	OFF	OFF	OFF	
LPF	OFF	OFF	OFF	OFF	

0.5Hz F1

1Hz F2

2Hz F3

5Hz F4

10Hz F5

20Hz F6

Set the lowest frequency for measurement.
0.5Hz, 1Hz, 2Hz, 5Hz, 10Hz or 20Hz is selectable.

NOTE

- The frequency measurement range is 0.5 Hz to 5 kHz (within the sync frequency range). Input frequencies outside of this range cannot be measured.
- The guaranteed accuracy of frequency measurement stipulates sine wave input of at least 30% of the measurement range of the frequency measurement source. Frequency measurement may not be possible with other input signals.
- For input signals of 45 Hz and below, the data update rate depends on the input frequency.
- If a frequency is applied above 5 kHz or below the minimum measurement frequency, the displayed frequency may differ from the input frequency.

4.2.5 Selecting the Rectification Method

Select the voltage or current rectification method to be used for calculating apparent power, reactive power, and power factor. Two rectification methods are selectable for each voltage and current input. Make this selection before measurement.

RMS	True root mean square value. Ordinarily, this setting should be used. (default setting)
MEAN	Rectified mean value of RMS conversion. In general, select this only when measuring the line voltage of an inverter's secondary-side PWM waveform.

[MEAN] and [RMS] settings for each range are made on the [CH] pages.

Setting Procedure

SYSTEM

Display the [Input] page

Select a [U rect] and [I rect] for the channel being set.

Select with the F keys

About [All CH Set], see "2.2 Basic Operations" (p. 20).

The screenshot shows the 'MEAS SYSTEM' menu with the 'Input' page selected. The table below shows the configuration for four channels (CH1-CH4):

Wiring	Sensor	Input	CH1	CH2	CH3	CH4
Wiring			1P2W	1P2W	1P2W	1P2W
U rect			RMS	RMS	RMS	RMS
I rect			RMS	RMS	RMS	RMS

On the right side of the screen, function keys are visible: F1 (RMS), F2 (MEAN), F3, F4, and F5 (All CH Set).

4.2.6 Setting Scaling (when using VT(PT) or CT)

Set the VT or CT ratio when using an external VT(PT) or CT.
When a ratio has been set, **[VT]** or **[CT]** is displayed above each range setting on the **[CH]** pages.



The settable range is as follows.

VT rate	OFF/0.01 to 9999.99 (Setting is not available when VT × CT exceeds 1.0E+06.)
CT rate	OFF/0.01 to 9999.99 (Setting is not available when VT × CT exceeds 1.0E+06.)

NOTE When **[OFF]** is selected, VT and CT ratios are both 1.00.

Setting Procedure

SYSTEM
 ← → Display the **[Input]** page
 Select a **[VT rate]** and **[CT rate]** for the channel being set.
 Select with the **F** keys

About **[All CH Set]**, see "2.2 Basic Operations" (p. 20).

4.2.7 Setting the Low-Pass Filter

The instrument includes a low-pass filter function to limit the measurement frequency range. Enable the filter to remove harmonic components or extraneous noise when measuring. Filter cut-off frequency can be selected from the following four settings, and can be set differently for each wiring system.

OFF	Specified accuracy applies only at 200 kHz and below. (Default setting)
100 kHz	Specified accuracy applies only at 20 kHz and below, except 10 kHz to 20 kHz, add $\pm 1\%$ rdg.
5 kHz	Specified accuracy applies only at 500 kHz and below.
500 Hz	Specified accuracy applies only at 60 kHz and below, add $\pm 0.1\%$ f.s.

The low-pass filter setting appears below **[LPF]** on the Measurement screen.

NOTE The low pass filter rejects harmonic components and may impede accurate measurement of power, efficiency, and loss. It is recommended to set the low-pass filter to **[OFF]** to allow accurate measurement unless you wish to reject harmonic components.

Setting the Cut-Off Frequency on the Measurement Screen

The setting can be made from the **[Vector]**, each **[CH]**, **[Wave + Noise]**, and **[Select]** page on the Measurement screen.

MEAS

Display any of these pages

Press the **LPF** **+** or **-** key to make the setting

Use this sides key. (**LPF** key)

Selecting the Cut-Off Frequency on the Setting screen.

SYSTEM

Display the **[Input]** page

Select a **[LPF]** for the channel being set.

Select with the **F** keys

About **[All CH Set]**, see "2.2 Basic Operations" (p. 20).

4.3 Integration Value Observation

4.3.1 Displaying Integration Values

Current (I) and active power (P) are integrated on all channels simultaneously. Positive, negative and total values are displayed.

Displaying Integration Contents

Press **MEAS**, select a channel **[CH]** with **◀** **▶**, then press **F2**.

RUN	Integration in progress
STOP	Integration stopped
WAIT	Waiting for integration to start by real-time clock control

Example: With 1P2W Wiring mode selected, and DC integration mode

Ih1+	CH1 positive current integration value*
Ih1-	CH1 negative current integration value*
Ih1	CH1 total current integration value

WP1+	CH1 positive active power integration value
WP1-	CH1 negative active power integration value
WP1	CH1 total active power integration value

* Displayed only for DC integration mode

NOTE Items that can be integrated depend on the selected wiring and integration mode. See "3.9 Selecting the Wiring Mode" (p. 37), "4.3.2 Setting the Integration Mode" (p. 68) These items can be selected and displayed on the Selection Display screen.

Before Starting Integration

1. Verify that the clock is set correctly.
See "Clock" (p. 131)
2. Select the integration mode.
See 4.3.2 (p.68)
3. Set the desired time control functions (interval, timer, and clock controls).
See 4.3.4 (p.71)
Set "OFF" for time settings when integrating manually.
4. Make appropriate settings for saving to CF card, and when using the D/A output, as needed.
See "7.3 Media Formatting" (p. 139), "8.3 Using Analog and Waveform D/A Output" (p. 166)

Starting, Stopping, and Resetting Integration

These functions can be controlled by key operations or by communication commands.

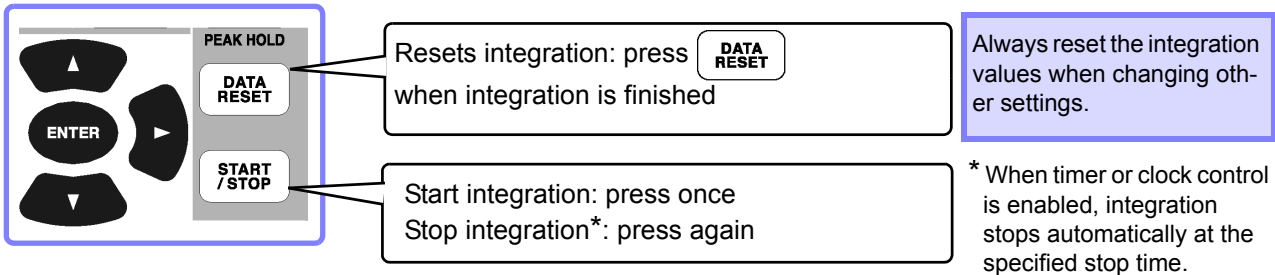

NOTE

- Integration start, stop and value reset cannot be performed on the Setting or File Operation screens. These functions are available only on the Measurement screen.
- Remote control by LAN communications can be performed using the same operations on the remote control from the Internet browser.
See "9.2 Remote Control of the Instrument by Internet Browser" (p. 186)

NOTE

- Maximum integration time is 9999 hours, 59 minutes and 59 seconds, after which integration automatically stops.
- Integration start, stop and reset by the operating keys and external control act on all integration items simultaneously.
- The following physical quantities can be measured by integration for each wiring system and DC integration mode.

Mode Name	Physical Quantities
1P2W, DC Mode	Ih+, Alh-, Ih, WP+, WP-, WP
1P2W	Ih, WP+, WP-, WP
1P3W, 3P3W2M (using CH 1 and CH 2)	Ih1, Ih2, WP12+, WP12-, WP12
3P3W3M, 3P4W (using CH 1, CH 2 and CH 3)	Ih1, Ih2, Ih3, WP123+, WP123-, WP123

- Calculation results for each channel are integrated at 20 times per second, so integration values may differ for measurement devices with different response or sampling rates, and for different calculation methods.
- When auto-ranging is enabled for any item, the actual measurement range becomes fixed at its current setting the moment integration starts, so set the range beforehand to avoid over-range input.
- For current integration, the DC mode integrates instantaneous current, and the RMS mode integrates RMS current.
- For power integration, the DC mode integrates instantaneous power, and the RMS mode integrates active power.
- When integration is enabled (including “Wait” for clock control), settings cannot be changed other than switching screens and the Data and Peak Hold functions.
- When Data or Peak Hold is active, integration continues internally even when displayed values are fixed. Even so, it is the displayed data that is output to CF card and D/A outputs.
- Integration display values are unaffected by the Peak Hold state.
- If a power outage occurs during integration, integration restarts when power is restored.

4.3.2 Setting the Integration Mode

Select the integration mode for each channel.
Two choices are available for each wiring system.

RMS Mode	<ul style="list-style-type: none"> Integrates RMS current and active power during every measurement interval (50 ms). Each polarity is integrated only for active power.
DC Mode	<ul style="list-style-type: none"> Integrates instantaneous current and power values for each polarity during every sampling interval (at 500 kHz sampling frequency) Only selectable for 1P2W wiring with AC/DC current sensors Integration is performed simultaneously on three current values (Ih+, Ih-, and Ih) and three active power values (WP+, WP-, and WP)

Setting Procedure

Display the **[Input]** page

Select the channel to change

Select with the **F** keys

About **[All CH Set]**, see "2.2 Basic Operations" (p. 20).

NOTE Display of THD (total harmonic distortion) or RF (ripple factor) of the measurement value is determined according to the integration mode setting. When the RMS integration mode is selected, THD is displayed, and when the DC mode is selected, RF is displayed.

4.3.3 Manual Integration Method

This method starts and stops integration by manual operation.

Procedure

Displayed Integration Value

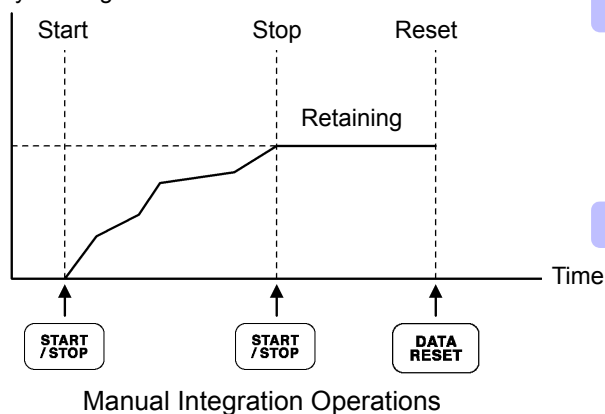

Before starting integration

Disable (set to **[OFF]**) the timer and clock timing control settings.

See "Integration Combined with Timing Control" (p. 71)

Start

Press **START / STOP**.

(The **START / STOP** key lights green, and **RUN** is displayed to indicate the operating state.)

Stop

Press **START / STOP** key again.

(The **START / STOP** key lights red, and **STOP** is displayed.)

Reset the integration value

Press **DATA RESET** when finished integration.

Displayed Integration Value

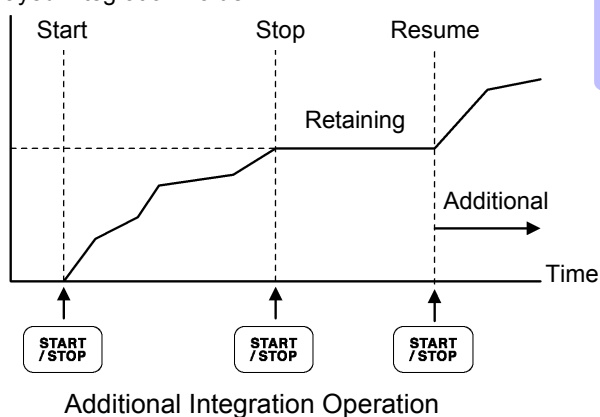

Additional integration

(resumes integration with the values acquired previously)

Press **START / STOP** again.

(The **START / STOP** key lights green, and **RUN** is displayed to indicate the operating state.)

Saving Integration Data at Each Interval

During manual integration, integration values can be saved in combination with interval time. Measurement items selected as described in section "7.5.3 Selecting Measurement Items to Save" (p. 145) can be saved to CF card at the specified interval.

See Can be set in "Interface" page of setting screen.

Procedure

1. Select the integration data to be saved at each interval.
See 7.5.3 (p.145) (Press **F4** [Integ] to select the integration recording parameters to save.)
2. Set saving (ON/OFF), and specify the folder, if needed.
See "7.5.2 Auto-Saving Measurement Data" (p. 143), "7.11.1 Creating Folders" (p. 153)
3. Select the interval time.
See 5.1 (p.109)
4. Press **START/STOP** to start saving at the selected intervals. (Press **START/STOP** again to stop.)

NOTE

- The maximum integration time is 9999 hours, 59 minutes, and 59 seconds.
- When Data or Peak Hold is active, integration continues internally even when displayed values are fixed. Even so, it is the displayed data that is output to CF card and D/A outputs.

4.3.4 Integration Combined with Timing Control

After specifying timer and clock settings, press **START/STOP** to cause integration to start and stop at the specified times. Integration can be controlled by the following three timing methods.

Manually Controlled Integration

Press **START/STOP** to start integration.

Press **START/STOP** again to stop integration.

See "4.3.3 Manual Integration Method" (p. 69)

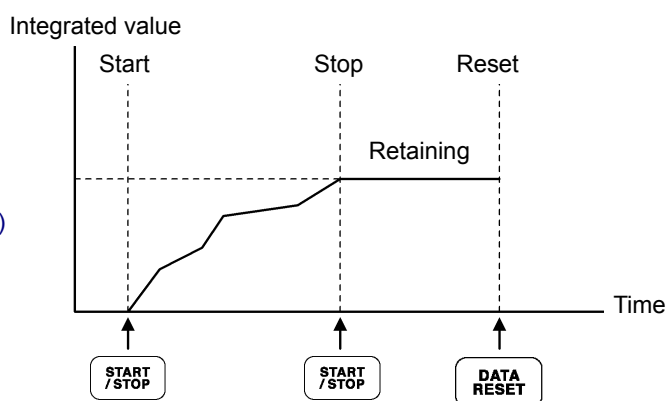

Timer-Controlled Integration

Press **START/STOP** to start integration.

Integration stops automatically when the timer expires.

See "Timer-Controlled Integration" (p. 72)

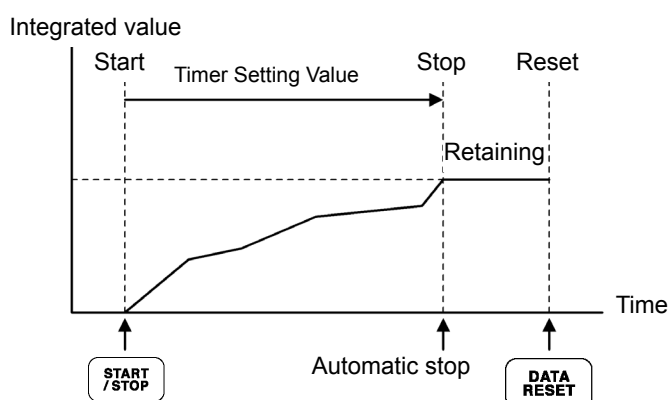

Clock-Controlled Integration

Press **START/STOP**.

Integration starts and stops at the specified times.

See "Clock-Controlled Integration" (p. 73)

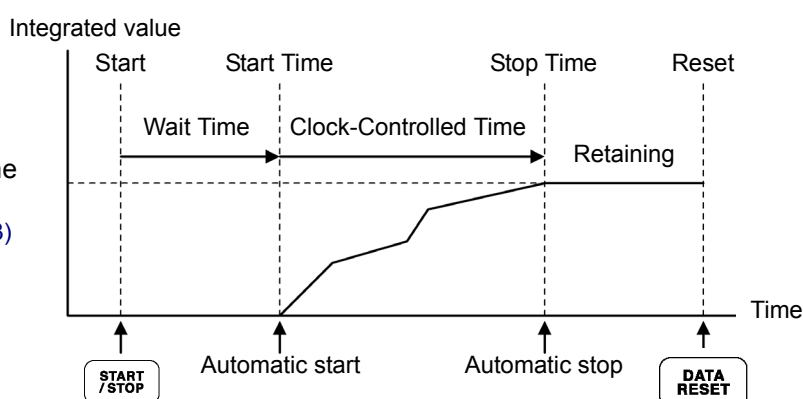

NOTE

When an interval time is enabled, activating Data or Peak Hold by pressing the **HOLD** key causes the display to update at each interval.

Also, when timer or clock control is enabled, the final measurement data is displayed at the specified stop time.

Timer-Controlled Integration

Integration is performed for the specified duration, and stops when the timer expires. Calculation results are held constant when the timer stops.

If auto-saving is enabled, integration values are saved to CF card when integration starts and stops. If an interval time is also specified, total integration values up to that point are saved at each interval.

See "7.5.2 Auto-Saving Measurement Data" (p. 143)

Setting Procedure

SYSTEM

Display the [Time] page

Select [Timer mode]

F2 to enable (set to [ON])

Select a [Timer setting] digit

Use the F keys to set the timer

Press **START/STOP** to start integration, which stops automatically after the set time elapses.

To interrupt integration:
Press **START/STOP** again.

MEAS SYSTEM FILE 2016-11-28 13:49:53
Wiring Sensor Input Calc Time interface System Motor D/A Out
Time control
Interval 1min
Timer mode ON Timer setting 999 hour 59 min 59 sec
Start time 15-01-01 00:00
Stop time 15-01-01 01:00
Set the value of timer.
Allowable setting is from 10sec to 9999hr 59min 59sec.

+1 ↑ F1
-1 ↓ F2
Digit ← F3
Digit → F4
F5
F6

ENTER DATA RESET
START/STOP Lights green

NOTE

- Integration stops when the timer expires (or the clock stop time occurs). When this occurs before the end of an interval, the last interval is ignored.
- Setting range is 10 seconds ("0 hour 0 min 10 sec") to "9999 hour, 59 min 59 sec".
- If clock timing control is set longer than the timer setting, integration starts at the clock start time and stops when the timer has expired (the clock stop time is ignored).
- Pressing **START/STOP** before the timer expires during timer controlled integration stops integration and retains the integration values. In this instance, pressing **START/STOP** again resumes integration and continues for the set timer duration (additional integration).

Clock-Controlled Integration

After pressing **START/STOP**, the instrument waits until the specified clock start time. Integration then begins and continues until the specified clock stop time.

If auto-saving is enabled, integration values are saved to CF card at the specified start and stop times. If an interval time is also specified, total integration values up to that point are saved after each interval.

Setting Procedure

SYSTEM

Display the [Time] page

Select [Real time] →

F2 to enable (set to [ON])

Select a [Start time] and [Stop time] digit

Use the F keys to set the timer

START/STOP (automatically starts and stops at the specified clock times)

To abort automatic control (while waiting):
Press **START/STOP** again.

MEAS SYSTEM FILE 2016-11-28 13:51:02
Wiring Sensor Input Calc Time Interface System Motor D/A Out
Time control
Interval 1min
Timer mode OFF Timer setting 0 hour 1 min 0 sec
Real time ON Start time -01-01 00:00
Stop time 2015-01-01 01:00
CF card memory
+1 ↑ F1
-1 ↓ F2
+10 ↑ F3
-10 ↓ F4
F5
F6

DATA RESET
ENTER
START/STOP

During wait: lights yellow
At the start time: lights green

NOTE

- Clock control settings are in 1-minute units.
- Clock setting years are AD (Christian Era), and 24-hour time (e.g., December 6th 2017, 10:16 PM appears as 2017-12-06 22:16)
- If a specified clock time has already passed, clock control is considered to be disabled (OFF).
- When integration is interrupted during clock timing control, clock control is disabled (OFF).
- If clock timing control is set longer than the timer setting, integration starts at the clock start time and stops when the timer has expired (the clock stop time is ignored).
- Integration stops after 9999 hours, 59 minutes, and 59 seconds if the time between clock start and stop times is set longer than that.

4.4 Viewing Harmonic Measurement Values

4.4.1 Displaying the Harmonic Bar Graph

The results of harmonic analysis of voltage, current and active power on the same channel can be displayed as a bar graph. Numerical data for the cursor-selected order is also displayed.

Press **MEAS** to display the Measurement screen.

Press **←** **→** to select the desired **[CH]** page, and press **F5**.

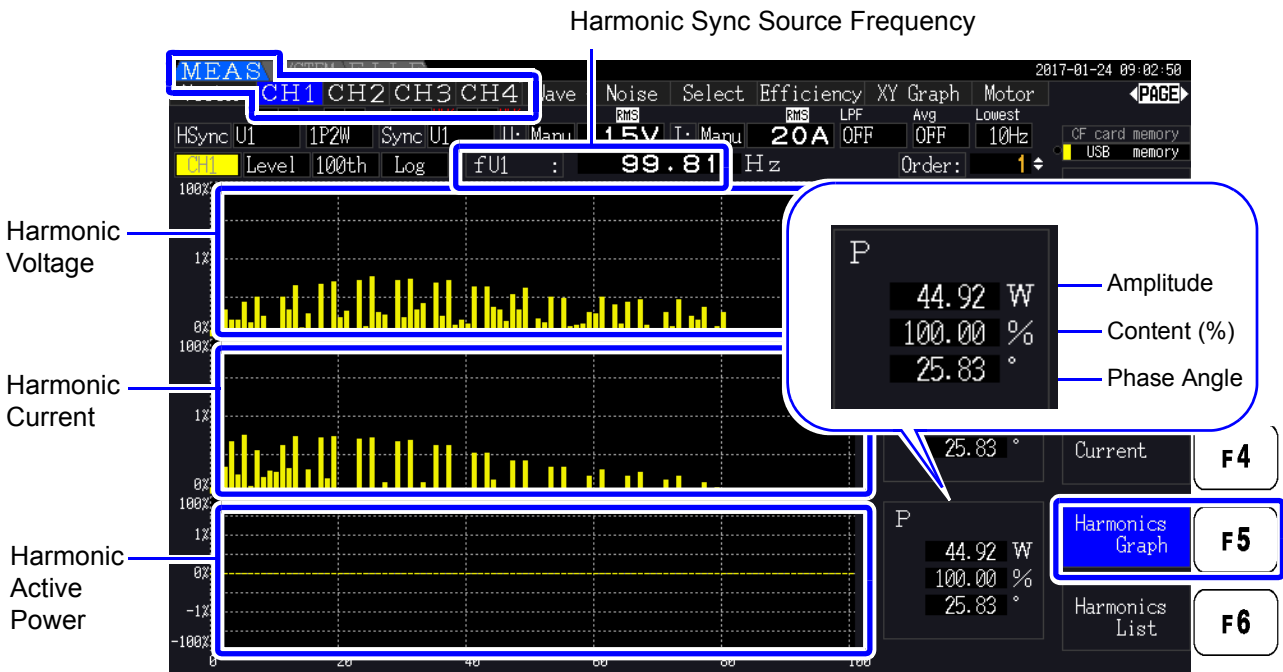

Changing the Displayed Order

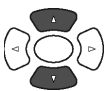

Change the selected order.

These selections correspond to the orders on the Harmonic Vector screen.

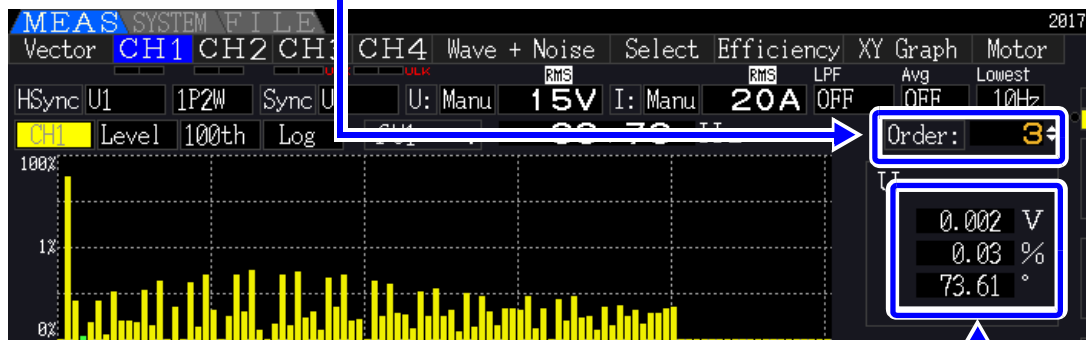

The green bar indicates the selected order.

Shows the measured values of the cursor-selected order.

Changing Display Settings

Select the item

Displays the pull-down menu

Selects from the pull-down menu

Enter / Cancel

Channels in the same wiring

Displayed item

Maximum harmonic order to display

Vertical axis display

Channel Changes channels in the same wiring system.

(Example) In the 3P4W wiring

CH1, CH2, CH3, CH123

Display Contents Changes the display contents

Level (amplitude), %ofFnd (content percentage), Phase (phase angle)

- The phase angle of harmonic active power is equivalent to the harmonic voltage-current phase difference.
- The scale of the vertical axis is a percentage of the range of the selected amplitude.
- This selection is the same as on the Harmonic List screen.

NOTE A gray bar may be displayed when phase angle is selected, indicating that the corresponding amplitude is very low (less than 0.01% f.s.).

Highest Order Display Changes the highest order displayed

100th, 50th, 20th

This selection is the same as on the Harmonic List screen.

NOTE Depending on the sync frequency used for measurement, the specified maximum order may not be displayable.

See "Highest order analysis and window waveforms" (p. 198)

Vertical Axis Display Type Changes the vertical axis display type.

Linear	Linear display
Log	Logarithmic display (allows easier viewing of small values)

NOTE When the display content is phase angle, the **[Linear]** setting is fixed and cannot be changed.

4.4.2 Displaying the Harmonic List

The results of harmonic analysis of voltage, current and active power on the same channel can be displayed as a list.

Press **MEAS** to display the Measurement screen.

Press **◀ ▶** to select the desired **[CH]** page, and press **F6**.

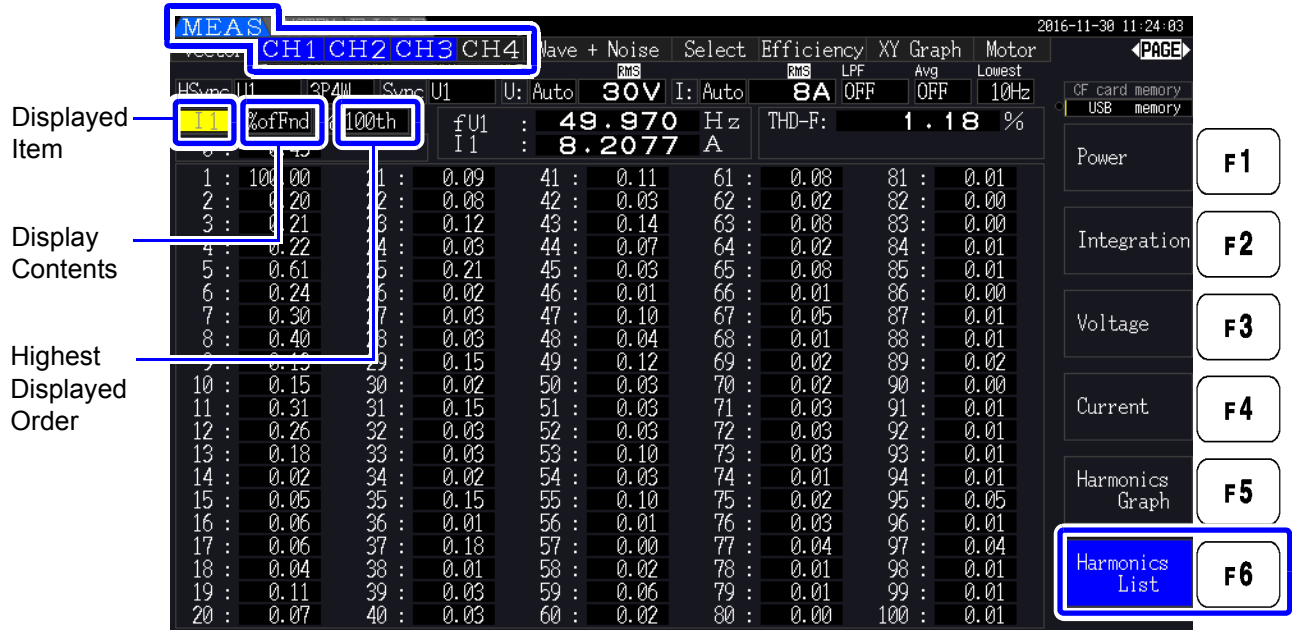

Changing Display Settings

See p. 75 for the procedures to change the display settings.

Displayed Item Changes item (physical quantity) to be displayed.
(Example) In the 3P4W wiring
U1, I1, P1, U2, I2, P2, U3, I3, P3, P123

Display Contents Changes the highest order displayed
Level (amplitude), %ofFnd (content percentage), Phase (phase angle)

- The phase angle of harmonic active power is equivalent to the harmonic voltage-current phase difference.
- This selection is the same as on the Harmonic Bar Graph screen.

Highest Displayed Order Changes the highest order displayed
100th, 50th, 20th

This selection is the same as on the Harmonic Bar Graph screen.

NOTE Depending on the sync frequency used for measurement, the specified maximum order may not be displayable.
 See "Highest order analysis and window waveforms" (p. 198)

4.4.3 Displaying Harmonic Vectors

The voltage, current, and phase angle of each harmonic order are displayed in a vector plot showing the phase relationship between voltage and current. Numerical values for the selected order are also displayed.

Press **MEAS** and then **◀ ▶** to select the **[Vector]** page.

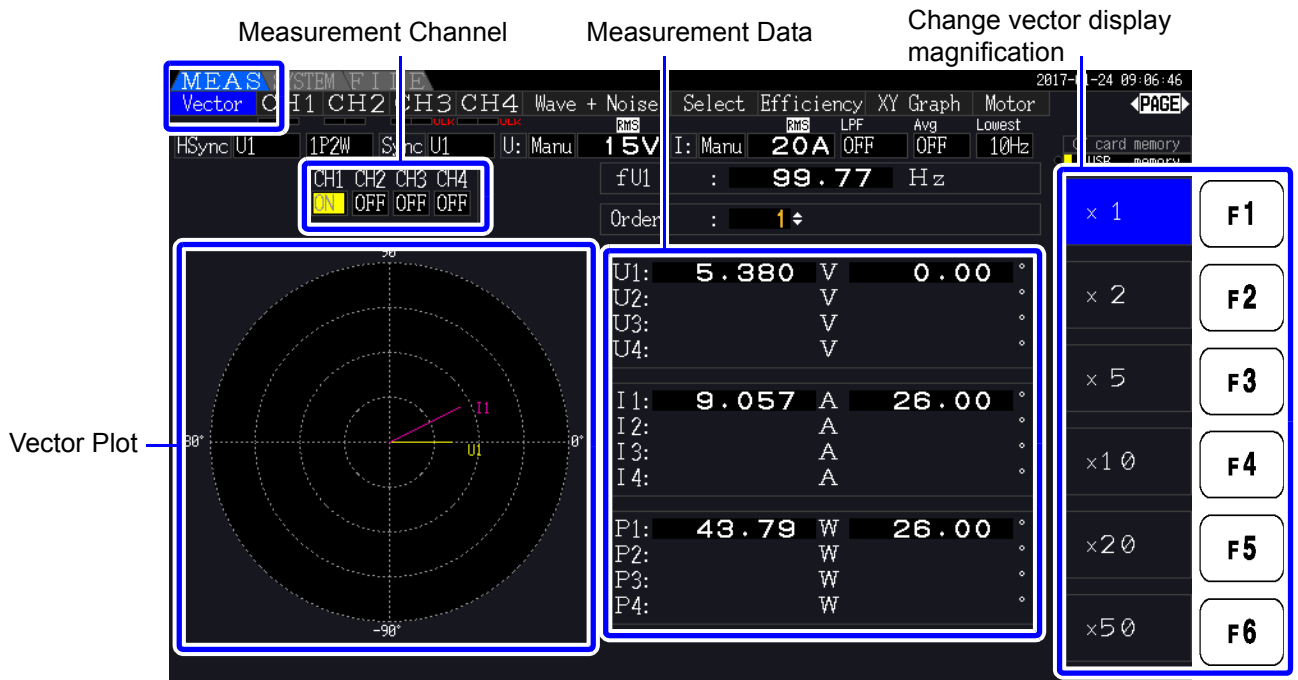

- NOTE**
- Voltage and current for all channels are displayed on one screen.
 - Voltage-current phase angles are determined relative to the (0°) standard of the fundamental waveform used as the harmonic sync source.
 - The phase angle of harmonic active power is equivalent to the harmonic voltage-current phase difference of the same order on the same channel.

Changing the Displayed Order

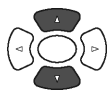

Changes the order.

This selection is the same as on the Harmonic Bar Graph screen.

Changes to the measurement values of the cursor order.

Displays the vectors for the selected order.

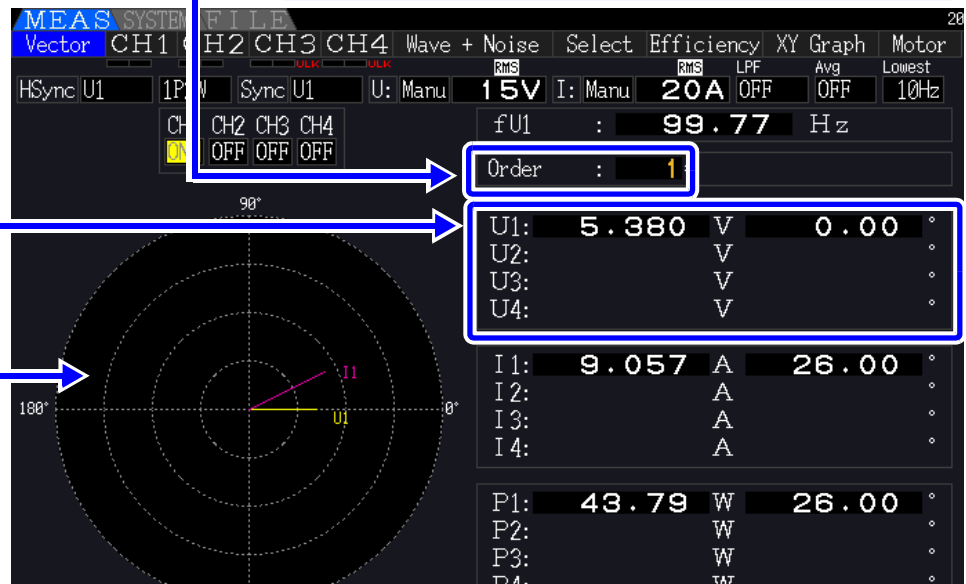

Changing Display Settings

Select the item (channel)

ENTER Displays the pull-down menu

Selects from the pull-down menu

ENTER / Cancel

MEAS SYSTEM FILE

Vector CH1 CH2 CH3 CH4 Wave + Noise Select Effici

HSync U1 1P2W Sync U1 U: Manu 15V I: Manu 20A

CH1 CH2 CH3 CH4

ON OFF OFF OFF

ON OFF

Measurement Channel

fU1 : 99.

Order : 1

U1: 5.387

U2:

U3:

U4:

I1: 9.155

I2:

Measurement Channel

Change the channels to be displayed. Setting channels that are not used to **[OFF]** can simplify the display.

ON	Vector and numerical values are displayed
OFF	Vector and numerical values are not displayed

4.4.4 Selecting the Harmonic Sync Source

The **[Harm sync src]** has to be selected for harmonic analysis. Available selections depend on the input source.

- Using a measurement voltage or current input as the sync source

U1 to U4, I1 to I4

The frequency of the measurement voltage or current waveform is sampled for harmonic analysis synchronization.

For all channels, the (0°) reference point for all phase angle measurements is the fundamental waveform of the harmonic sync source.

- Using the instrument's internal fixed clock as the sync source

DC50 ms, DC100 ms

Waveforms are sampled in synchronization with the 50 ms timing used by the instrument for data update and for harmonic analysis. Use this source when no input is stable enough for synchronization. When DC100 ms is selected, 50 Hz is measured as the fifth-order harmonic, and 60 Hz as the sixth-order harmonic.

- Using an external signal as the sync source (PW3390-03)

Ext

This setting is available only when Motor analysis function is installed and CH B is set for pulse input. Waveforms are sampled in synchronization with the rising edges of the pulses input on CH B to perform harmonic analysis.

See "4.8.1 Motor Input Settings" (p. 98)

Diagram illustrating the steps to select the harmonic sync source:

- Display the **[Input]** page
- Select the item
- Select with the **F** keys

About **[Next]**,
See "2.2 Basic Operations" (p. 20)

Wiring	Sensor	CH1	CH2	CH3	CH4
Wiring		1P2W	1P2W	1P2W	1P2W
Sync source		U1	U1	U1	U1
U range		60V	60V	60V	60V
U rect		RMS	RMS	RMS	RMS
VT rate		OFF	OFF	OFF	OFF
I range		20A	20A	20A	20A
I rect		RMS	RMS	RMS	RMS
CT rate		OFF	OFF	OFF	OFF
Integ mode		RMS	RMS	RMS	RMS
Freq measure		U	U	U	U

U1 to U4, I1 to I4, DC50ms, DC100ms (or Ext) is selectable. Ext is selectable only when motor analysis function is equipped and CHB input type is pulse.

NOTE

- The same harmonic sync source is shared by all channels. Harmonic analysis cannot be performed correctly on channels with input frequency different from the selected harmonic sync source.
- The harmonic sync source selected here is also used as the sync source for waveform displays.
- Correct analysis is not possible in the following situations:
 - If the sync source signal is very distorted
 - If the sync source signal frequency is below the lower limit of the valid range
 - If the sync source frequency is unstable

4.4.5 Selecting the THD Calculation Method

Select whether to use THD-F or THD-R method to calculate total harmonic distortion. The selected calculation method is applicable to both harmonic voltage and current.

THD-F	The percentage of total harmonics relative to the fundamental waveform This setting is generally used in testing that conforms to IEC and other standards. (Default setting)
THD-R	The percentage of total harmonics relative to the sum of the total harmonics and the fundamental waveform This setting will yield a lower value than THD-F for highly distorted waveforms.

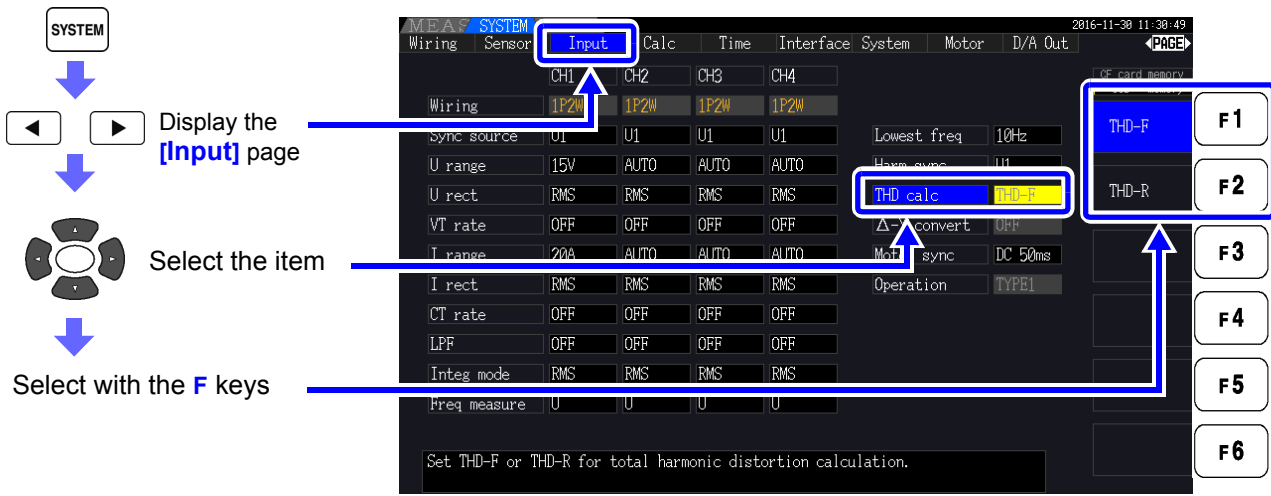

What is THD?
 THD is an abbreviation for total harmonic distortion: the total amount of signal distortion caused by all harmonics.

4.5 Viewing Waveforms

4.5.1 Displaying Waveforms

Waveforms of voltage and current measured on up to four channels can be displayed separately according to voltage, current, or channel.

Waveforms are sampled at 500 kS/s, with the displayed time span per screen determined by the timing of the harmonic sync source.

The waveform span displayed on one screen is determined by the [Time scale] setting.

Displaying Voltage and Current Waveforms Separately

Waveform Display Enable/Disable (p. 83)

Waveform color appears when enabled (ON).

CH1 rms (V)	pk
99.27	140.02
	-139.89
	RMS (rms)

Positive Peak Value (pk+)

Negative Peak Value (pk-)

RMS (rms)

MEAS

MEAS

Wave + Noise

U/I F1

CH F2

Noise F3

Wave+Noise F4

F5

F6

Display the [Wave + Noise] page

F1 Select [U/I] (Current/Voltage)

Displays four overlapping voltage waveforms

Displays four overlapping current waveforms

CH1 rms (V)	pk
99.27	140.02
	-139.89
CH2	
3.547	5.024
	-5.057
CH3	
7.067	9.990
	-10.045
CH4	
1.770	2.524
	-2.531

CH1 rms (A)	pk
8.663	14.365
	-14.328
CH2	
8.000	14.336
	-14.299
CH3	
5.34m	0.0091
	0.0015
CH4	
0.009	0.039
	-0.034

Displaying Separate Channel Waveforms

F2 Select **[CH]** (Separate Channel)

Voltage Scale (Positive-only display)

Current Scale (Negative-only display)

Waveform Display Enable/Disable (p. 83)

Waveform color appears when enabled (ON).

U	rms (V)	pk
U	3.546	5.021
I	8.758	14.315
U	9.992	14.196
I	8.8642	-14.338
U	7.065	5.023
I	8.009	5.031
U	97.28	137.27
I	8.637	-137.14
U	3.546	-5.058
I	8.758	-14.241

Positive Peak Value (pk+)

Negative Peak Value (pk-)

RMS (rms)

U/I F1

CH F2

Noise F3

Wave+Noise F4

F5

Save F6

- NOTE**
- Waveforms and numerical measurement values displayed at the right are not synchronized with measurement timing.
 - Displayed waveform values are not the calculated RMS and peak numerical values.
 - The vertical axis of the waveform is displayed as a percentage of the full-scale range of each channel, so the amplitudes of different channels are not directly comparable.
 - To display waveforms starting from zero amplitude, see "Zero-Crossing Filter Setting Procedure" (p. 59).
 - Pressing the **HOLD** key will trigger the HOLD state. However, display data updates will not function for the waveform display. See "5.3.1 Data Hold Function" (p. 114).

Hiding and Displaying Waveforms

Select whether to display or not display waveforms.
Available settings are [U/I] and [CH].

ON	Display waveforms
OFF	Do not display waveforms

Select the channel to change

ENTER Displays the pull-down menu

Selects from the pull-down menu

ENTER / ESC Cancel

Sampling value for 500 kS/s

Maximum value

Minimum value

Waveform for 50 kS/s

Maximum value

Minimum value

Waveform data for 50 kS/s

The waveform displayed on the screen or the waveform data saved in "Saving Noise Data and Waveform Data" (p. 147) always uses the Peak-Peak compressed waveform data sampled at 500 kS/s. Therefore, even if the sampling speed is set low, it will be an accurate waveform with peak information of the waveform before compression. The data of saved waveform data is linked to the same number of points for noise analysis, and for each point, the maximum value and minimum value in the figure on the right are both saved.

- NOTE**
- To shorten the time it takes to renew the waveform display, decrease the number of points for noise analysis. The quickest display renewal is 1000 points. See "4.6.2 Setting the Sampling Frequency and Points" (p. 87)
 - Changing the settings for waveform display and noise analysis do not affect the electric power or the sampling for harmonic measurement.

4.5.2 Resizing Waveforms

Waveforms can be reduced and enlarged for convenient viewing, and to confirm details. Make this setting using the cursor keys on the [Wave + Noise] page.

See "4.5.1 Displaying Waveforms" (p. 81)

Changing Vertical Axis Magnification

Voltage and current waveforms can be vertically resized (magnification is the same for all channels).

Press **F1** or **F2**

Select U (voltage) or I (current) for resizing

ENTER Displays the pull-down menu

Selects from the pull-down menu

ENTER Enter / **ESC / On** Cancel

Changing Horizontal Axis Magnification (Timebase)

Select [Time scale]

ENTER Displays the pull-down menu

Selects from the pull-down menu
See Chart in below.

ENTER Enter / **ESC / On** Cancel

NOTE

- The waveform sampling rate is fixed at 500 kS/s.
- Available timebase selections depend on the selected number of noise analysis points, as follows.

Selected No. of Points	Timebase Selections					
1000	0.2 ms/div	0.4 ms/div	1 ms/div	2 ms/div	4 ms/div	10 ms/div
5000	1 ms/div	2 ms/div	5 ms/div	10 ms/div	20 ms/div	50 ms/div
10000	2 ms/div	4 ms/div	10 ms/div	20 ms/div	40 ms/div	100 ms/div
50000	10 ms/div	20 ms/div	50 ms/div	100 ms/div	200 ms/div	500 ms/div

4.6 Viewing Noise Measurement Values (FFT Function)

Perform FFT analysis on a selected channel's voltage and current to display noise up to 200 kHz as a graph and as numerical values. This function is convenient for monitoring an inverter's carrier frequency, harmonic noise ingress on commercial power lines, or DC power.

For more information about how to change the function's settings, see "4.6.2 Setting the Sampling Frequency and Points" (p. 87).

The numerical noise values can be saved to storage media.

See "7.5.3 Selecting Measurement Items to Save" (p. 145)

(Select **[Other]** with the **F6** key and set the noise peak value.)

4.6.1 Displaying Noise Voltage and Current

Noise voltage and current can be displayed in separate graphs along with numerical values. Numerical noise voltage and current values at ten frequencies are displayed in order of decreasing amplitude.

Horizontal Axis	Linear frequency scale
Vertical Axis	Logarithmic noise amplitude scale

Displaying Noise

The screenshot shows the MEAS system interface with the following components:

- Navigation Instructions:**
 - MEAS
 - Display the **[Wave + Noise]** page
 - Select **[Noise]** (F3)
- Wave + Noise Page:**
 - Top status bar: MEAS SYSTEM FILE, Vector: CH1 CH2 CH3 CH4, 2017-11-20 14:26:09
 - Parameters: HSync U1, 1P2W, Sync U1, U: Manu, 30V, I: Ma
 - Sampling: 1kS/s, CH1, Lowest noise, 1 kHz, 38 memory
 - Noise Voltage Graph:** A yellow FFT plot showing noise voltage amplitude vs. frequency (0 to 200 kHz).
 - Noise Current Graph:** A pink FFT plot showing noise current amplitude vs. frequency (0 to 200 kHz).
 - Noise Voltage Numerical Value Table:**

U1	f (Hz)	rms (V)
31.98k	4.822	
32.18k	4.797	
63.98k	2.320	
64.18k	2.300	
48.28k	1.998	
47.88k	1.957	
80.28k	1.767	
79.88k	1.724	
112.48k	0.905	
16.28k	0.883	
 - Noise Current Numerical Value Table:**

I1	f (Hz)	rms (A)
31.98k	0.886	
32.18k	0.679	
48.28k	0.208	
16.28k	0.208	
47.88k	0.205	
15.88k	0.203	
63.98k	0.191	
64.18k	0.189	
80.28k	0.124	
79.88k	0.120	
 - Function Keys:**
 - F1: U/I
 - F2: CH
 - F3: Noise
 - F4: Wave+Noise
 - F5: Save Noise
 - F6: Save Wave

Displaying Waveforms and Noise

The waveform to be analyzed and its noise analysis results can be displayed at the same time.

The screenshot shows the MEAS software interface with the following elements:

- Navigation Diagram:**
 - MEAS button
 - Left and right arrow buttons
 - Display the [Wave + Noise] page
 - F4 button: Select [Wave + Noise]
- Waveform Colors Table:**

Waveform Colors	
Voltage	Yellow
Current	Red
- Main Interface:**
 - Top bar: MEAS SYSTEM FILE, Vector: CH1 CH2 CH3 CH4, Select: Efficiency XY Graph Trend, Motor, PAGE
 - Parameters: HSync U1, IP2W, Sync U1, U: Manu 30V, Time scale: ms/div, CH1, Ux 1, Ix 1, Lowest noise 1kHz, USB memory
 - Voltage and Current Waveforms:** Two waveforms, one yellow (Voltage) and one red (Current), overlaid on a black background.
 - Voltage and Current Noise Graphs:** Two noise spectra, one yellow (Voltage) and one red (Current), overlaid on a black background.
 - Noise Voltage Numerical Value Table:**

U1 - f (Hz)	rms(V)
31.98k	4.797
32.18k	4.775
63.98k	2.331
64.18k	2.317
48.28k	1.991
47.88k	1.955
88.28k	1.773
79.88k	1.736
112.48k	0.982
16.28k	0.888
 - Noise Current Numerical Value Table:**

I1 - f (Hz)	rms(A)
31.98k	0.682
32.18k	0.676
48.28k	0.287
16.28k	0.285
47.88k	0.284
15.88k	0.283
63.98k	0.192
64.18k	0.191
88.28k	0.124
79.88k	0.121
 - Function Keys:** F1 (U/I), F2 (CH), F3 (Noise), F4 (Wave+Noise), F5 (Save Noise), F6 (Save Wave)

NOTE Pressing the **HOLD** key will trigger the HOLD state. However, display data updates will not function for the waveform display.
 See "5.3.1 Data Hold Function" (p. 114)

4.6.2 Setting the Sampling Frequency and Points

Set the FFT sampling rate and number of points according to the frequency of the noise to be analyzed. These settings are on the **[Calc]** page of the Setting screen.

SYSTEM
 ← → Display the **[Calc]** page
 Select the item
 Select with the **F** keys

MEAS SYSTEM FILE
 Wiring Sensor Input **Calc** Time Interface System Motor D/A Out
 Efficiency
 Pout1 P1 Pout2 P1 Pout3 P1
 Noise analysis
 Noise sampling 250kS/s Points 10000 Lowest noise 0kHz
 Analysis CH CH1 Window type Hanning
 Averaging OFF ZeroCross filt Weak AutoRange type Narrow
 Set the sampling speed of noise analysis. Setting is limited by the lowest freq of noise. This affects freq resolution, freq range and time scale.

500kS/s F1
 250kS/s F2
 100kS/s F3
 50kS/s F4
 25kS/s F5
 10kS/s F6

Sampling can be selected at the **[Noise]** setting on the **[Wave + Noise]** page of the Measurement screen. How to display, see "Displaying Noise" (p. 85).

Changing Sampling on the Measurement Screen See Screen display procedure: "Displaying Noise" (p. 85)

Select the item
 ENTER Displays the pull-down menu
 Selects from the pull-down menu
 ENTER / ESC / On Cancel

MEAS SYSTEM FILE
 Vector CH1 CH2 CH3 CH4 Wave + Noise Select Efficiency
 HSyn U1 1P2W Syn U1 U: Manu 30V I: Manu 20A
 Sampling 250 kS/s
 CH1
 10
 1
 0.1
 10m
 1m

4.6 Viewing Noise Measurement Values (FFT Function)

The highest frequency that can be analyzed depends on the sampling setting as follows.

Sampling Rate	500 kS/s	250 kS/s	100 kS/s	50 kS/s	25 kS/s	10 kS/s
Highest Frequency	200 kHz	50 kHz	20 kHz	10 kHz	5 kHz	2 kHz

Also, the frequency resolution of noise analysis depends on the sampling rate setting and the number of points.

Sampling Rate	500 kS/s	250 kS/s	100 kS/s	50 kS/s	25 kS/s	10 kS/s							
Points	1000	5000	10000	50000	100 Hz	50 Hz	25 Hz	10 Hz	5 Hz	2 Hz	1 Hz	0.5 Hz	0.2 Hz

NOTE

- The instrument's internal anti-aliasing filter is set automatically according to the sampling setting, so that aliasing effects are suppressed even at slow sampling rates.
- Changing the sampling rate does not affect power measurements or the measurement frequency range of harmonic measurements.
- Noise analysis display updating is not linked to other measurement data such as power or harmonics.
Data saving is not synchronized with saving of power or harmonic data.
- The number of points determines the amount of time required for analysis, so larger numbers of points result in slower update times. Updating 1,000 points takes approximately 400 ms, 5,000 points approximately 1 s, 10,000 points approximately 2 s, and 50,000 points approximately 15 s.
- To analyze noise frequency details, select fast sampling or a large number of points (e.g., to analyze the difference between 50 Hz and 60 Hz, select a frequency resolution of 10 Hz or less).
- The sampling rate setting is linked to the waveform timebase display setting.

4.6.3 Setting the Minimum Noise Frequency

Set the minimum acquisition frequency for numerical noise values according to the noise frequency to be analyzed. The lower limit can be set from 0 Hz to 10 kHz in 1-kHz steps. The setting applies to both [Noise] and [Wave + Noise]. Make this setting on the [Calc] page of the Setting screen.

Setting on the Measurement Screen

Screen display procedure:
See "4.6.1 Displaying Noise Voltage and Current" (p. 85)

Navigation steps:

- Select **[Lowest Noise]** (using the four-way directional pad)
- Press **ENTER**
- Select the numerical value (using the four-way directional pad)
- Press **ENTER** or **ESC** (Cancel)

Settings on the Setting Screen

SYSTEM

MEAS SYSTEM FILE

Wiring Sensor Input **Calc** Time Interface System Motor D/A Out

Efficiency

P1 Pin3 P1

Pout1 P1 Pout2 P1 Pout3 P1

Noise analysis

Noise sampling: 300ms 10ms

Analysis CH: CH1 Window type: Hanning

Averaging: OFF ZeroCross filt: Weak AutoRange type: Narrow

f ↑ F1

f ↓ F2

F3

F4

F5

F6

Set the lowest frequency of noise peak search between 0kHz and 10kHz. This setting is limited by the sampling speed of noise.

Display the [Calc] page

Select the item

Select with the F keys

A numerical noise value is recognized as a peak value when its amplitude is greater than the levels of the next lower- and higher-frequency points in voltage and current FFT calculation results, and the ten highest peak values are acquired.

In this case, frequencies below the set minimum noise frequency are ignored.

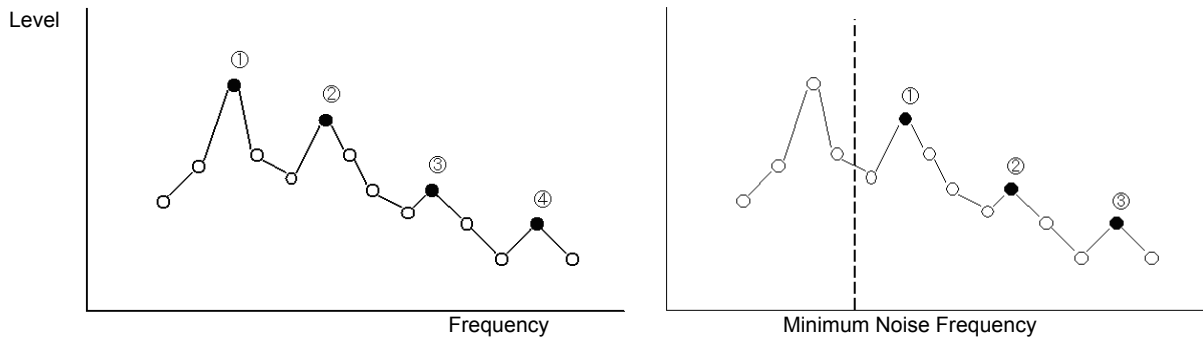

NOTE The range of available settings for the minimum noise frequency depends on the noise sampling rate setting.

Noise Sampling Rate	500 kS/s	250 kS/s	100 kS/s	50 kS/s	25 kS/s	10 kS/s
Minimum Noise Frequency	0 to 10 kHz			0 to 9 kHz	0 to 4 kHz	0 to 1 kHz

4.6.4 Measurement Channel and Window Function Settings

Select the measurement channels and Window function for noise analysis calculations.

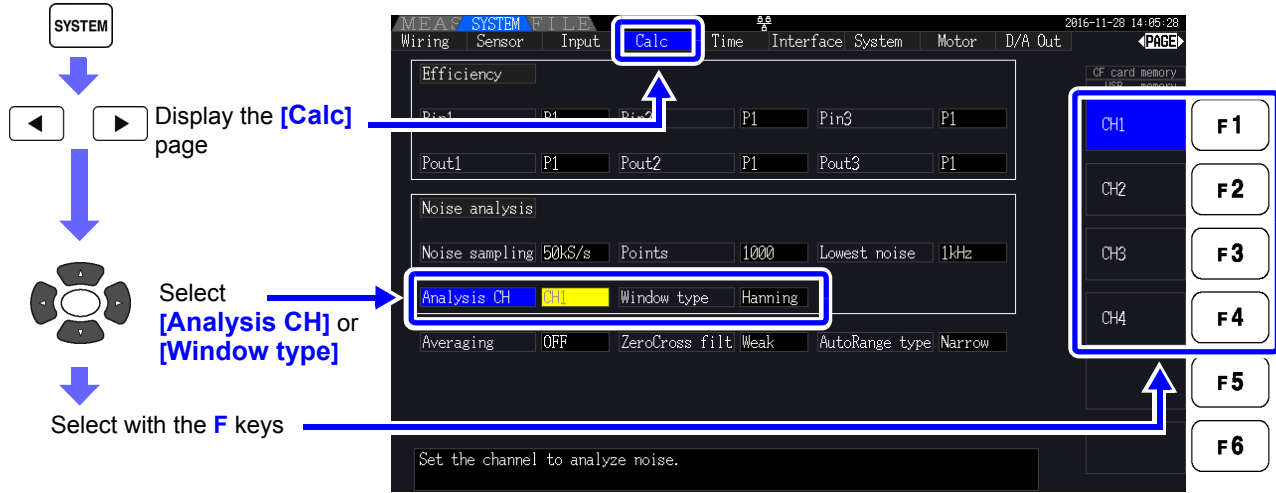

What is a Window type?

Noise analysis is performed by applying FFT calculations to a specific interval of a waveform defined by the specified number of points at the specified sampling rate. The processing of an extracted interval of a waveform is called "Window processing." The FFT calculation of the specified waveform interval is supposed to be repeated periodically. On this instrument, the displayed waveform is shown with the defined window.

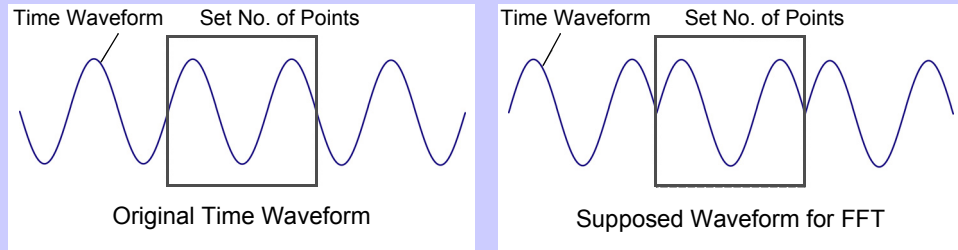

When the number of points specified for FFT calculation does not coincide with the measurement waveform period, the edges of the waveform within the window become discontinuous (called "leakage errors"), and non-existent noise is detected. The Window type provide means of suppressing leakage errors by smoothly connecting the edges of the waveforms.

Measurement Ch Select the measurement channel for noise analysis calculations.

CH1, CH2, CH3, CH4

Window type Select a Window type.

Rect (Rectangular)	This type of window function is effective when the measurement waveform period is an integer multiple of the FFT calculation interval.
Hanning	This type of window function is effective when the rectangular window is not, and when frequency resolution is the primary concern. (Default setting)
Flat top	This type of window function is effective when the rectangular window is not, and when amplitude resolution is the primary concern.

4.7 Viewing Efficiency and Loss Measurement Values

This instrument uses active power and motor power values to calculate and display efficiency (η [%]) and loss [W]. For example, inverter input-output efficiency and internal loss, and motor input-output efficiency and loss, as well as total efficiency, can be calculated by a single instrument.

NOTE

- Motor power (P_m) measurement can only be selected on models equipped with motor analysis functionality.
- Measurement values may be scattered when measuring severely fluctuating or transient loads. In that case, use the averaging function.
- On wiring systems with different power ranges, calculations use the data from the highest power range.
- On wiring system with different sync sources, calculations use the most recent data at calculation time.
- When either one of the output power is a direct current (DC), making the synchronized source setting for the channel to measure DC the same as the alternating current side can suppress the unevenness of the efficient measurement value. E.g., in the following connection example (p. 93) on "Measuring Efficiency and Loss of a Switching Power Supply" in general the CH1 synchronization source is set to U1, while the CH2 synchronization source is set to 50 msDC, but when the fluctuation is great and there is unevenness in the efficient measurement value, set the CH2 synchronization source to U1 same as CH1.

4.7.1 Displaying Efficiency and Loss

Press **MEAS** and then **◀** **▶** to select the **[Efficiency]** page.

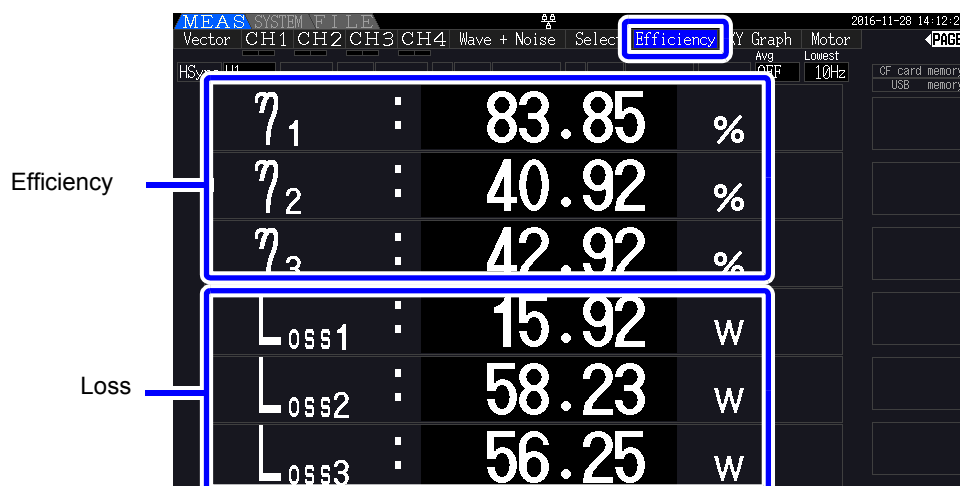

NOTE

- The display range for Efficiency (η [%]) is 0.00% to 200.00%.
- The display range for Loss [W] is 0% to $\pm 120\%$ of the power range.

4.7.2 Selecting the Calculation Formula

Up to three formulas (η_1 to η_3 , and Loss1 to Loss3) can be selected for Efficiency (η) and Loss calculations. Select the calculation items from all Pin and Pout active power values to be applied to the following formulas.

$$\eta = 100 \times |P_{out}| / |P_{in}|$$

$$Loss = |P_{in}| - |P_{out}|$$

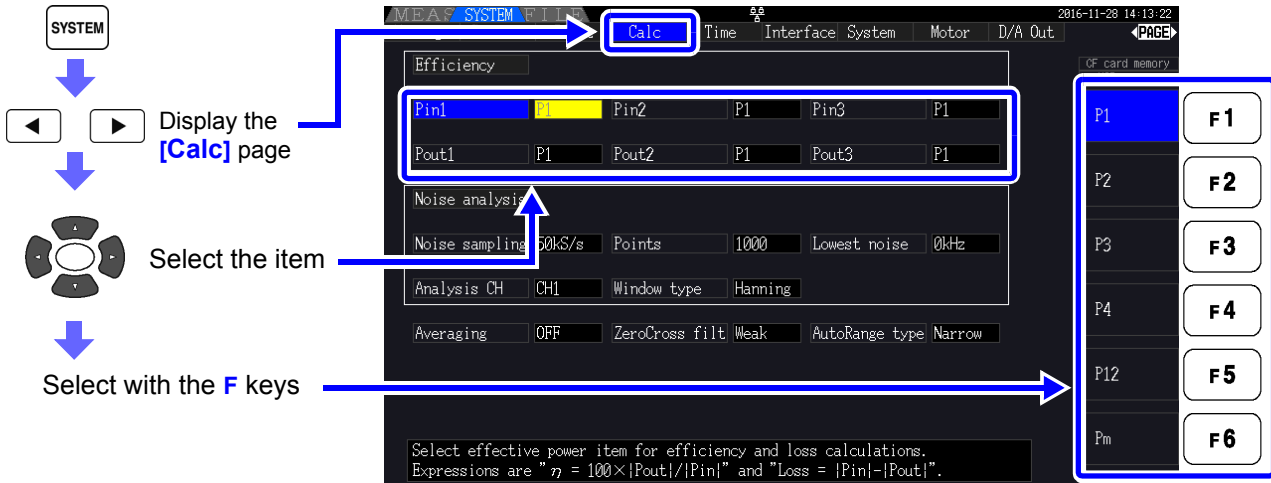

NOTE [Pm] can be selected on models equipped with motor analysis functionality while using the following settings:

CHA units	mN·m, N·m, kN·m
CHB units	r/min

4.7.3 Measurement Examples

Here is an efficiency and loss measurement example.
 Before measuring, perform the preparations in "Chapter 3 Measurement Preparations" (p. 27)), and make the appropriate connections and settings.

Measuring Efficiency and Loss of a Switching Power Supply

Example: The input and output sides of the switching power supply are connected to CH 1 and CH 2 of the instrument, respectively.

Connection Example

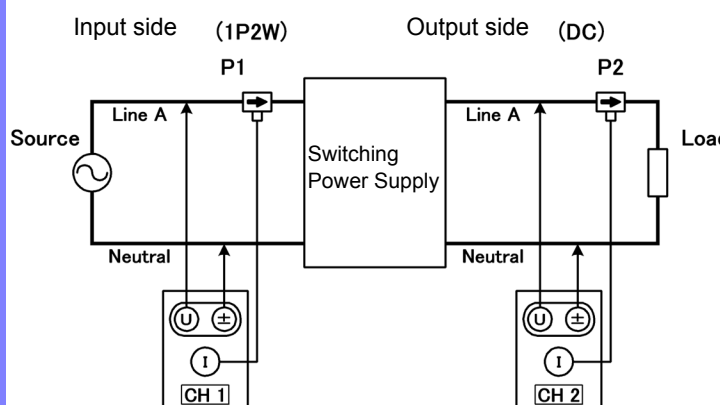

Required items:

- L9438-50 Voltage Cord ×2
 - 9272-05 Clamp On Sensor ×1
 - CT6841-05 AC/DC Current Probe ×1
-input side
output side

Wiring Mode Setting

Wiring Mode 1
 [1P2W] × 4 systems

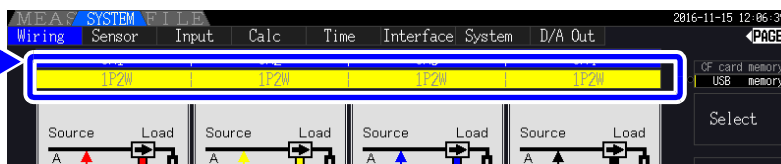

Calculation Formula Setting

Calculation Formula

$$\eta = 100 \times |P2| / |P1|$$

$$\text{Loss1} = |P1| - |P2|$$

Set Pin1 to P1,
 and Pout1 to P2

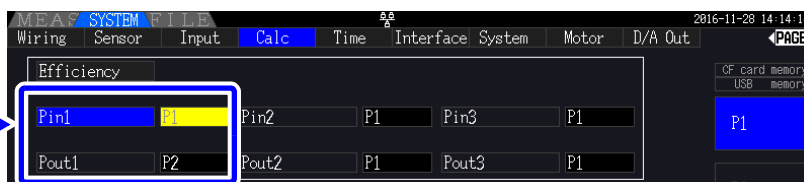

4.7 Viewing Efficiency and Loss Measurement Values

Measuring Efficiency and Loss of an Inverter

Example: Inverter input is connected to CH 3, and the outputs are connected to CH 1 and CH 2 of the instrument.

Connection Example

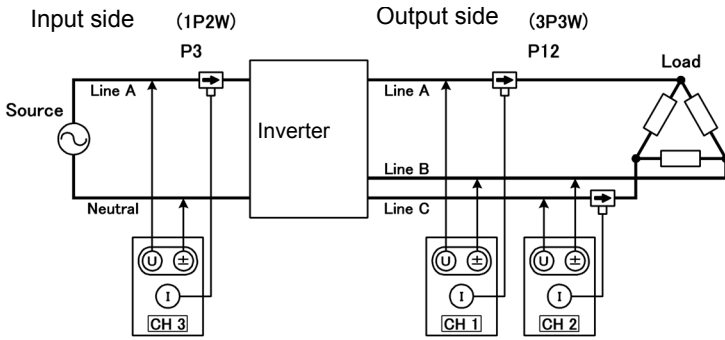

- Required items:
- L9438-50 Voltage Cord ×3
 - 9272-05 Clamp On Sensor ×1
 -input side
 - CT6843-05 AC/DC Current Probe ×2
 -output side

Wiring Mode Setting

Wiring Mode 3
[3P3W2M] + [1P2W] × 2 systems

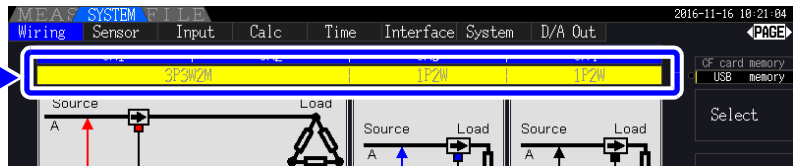

Calculation Formula Setting

Calculation Formula

$$\eta = 100 \times |P12| / |P3|$$

$$\text{Loss1} = |P3| - |P12|$$

Set Pin1 to P3,
and Pout1 to P12

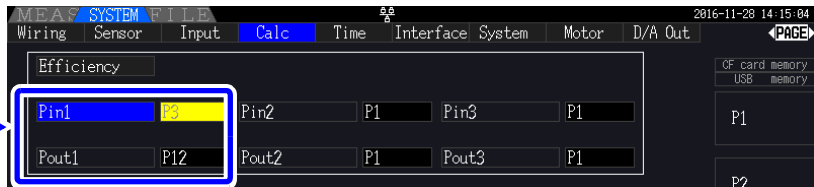

Measuring Efficiency and Loss of an Inverter and Motor

Example: Inverter inputs are connected to CH 1 and CH 2, inverter outputs to CH 3 and CH 4 of the instrument, analog output from the tachometer to rotation signal input CH B, and analog output from the torque meter to torque signal input CH A.
 How to connect torque meter or tachometer, see 8.5 (p.176).

Connection Example

Required items: Requires the PW3390-03 (model with motor analysis and D/A output).

- L9438-50 Voltage Cord ×4
- 9272-05 Clamp On Sensor ×2.....input side
- CT6843-05 AC/DC Current Probe ×2.....output side
- Tachometer ×1With pulse output capability
- Torque Meter ×1
- L9217 Connection Cord ×2

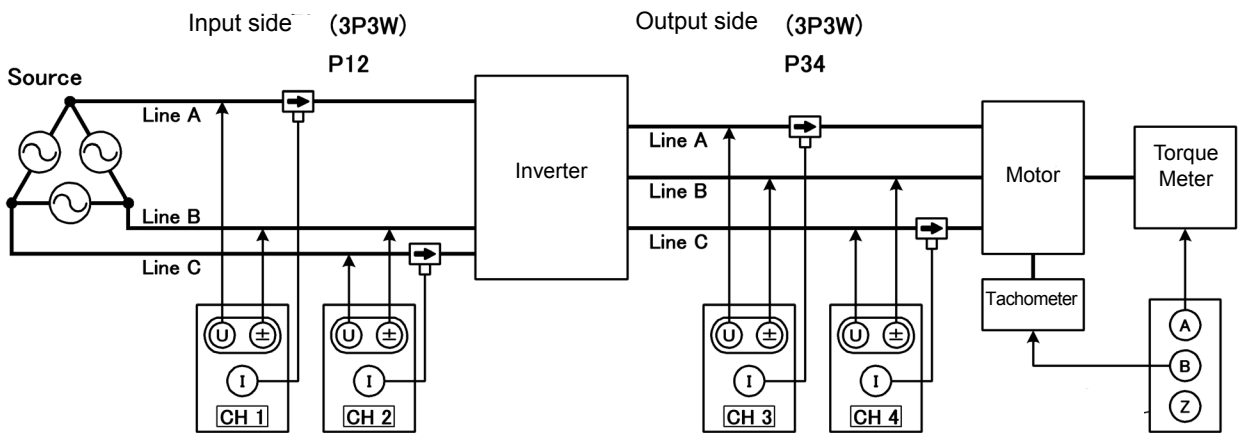

Wiring Mode Setting

Wiring Mode 6
 [3P3W2M] × 2 systems

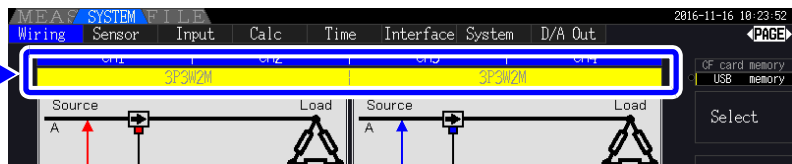

Calculation Formula Setting

Calculation Formula

Inverter $\eta = 100 \times |P34| / |P12|$, Loss1 = $|P12| - |P34|$
 Motor $\eta = 100 \times |Pm| / |P34|$, Loss2 = $|P34| - |Pm|$
 Total $\eta = 100 \times |Pm| / |P12|$, Loss3 = $|P12| - |Pm|$

Set Pin1 to P12,
 and Pout1 to P34

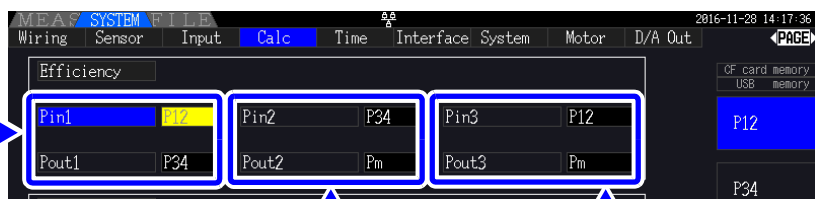

Set Pin2 to P34,
 and Pout2 to Pm

Set Pin3 to P12,
 and Pout3 to Pm

NOTE The torque meter and tachometer should have the fastest possible output response time.

4.8 Viewing Motor Measurement Values (Model PW3390-03 only)

Motor analysis can be performed using the PW3390-03 (model with motor analysis and D/A output). When the motor analysis function is installed, the **[Motor]** page appears on the Measurement and Setting screens.

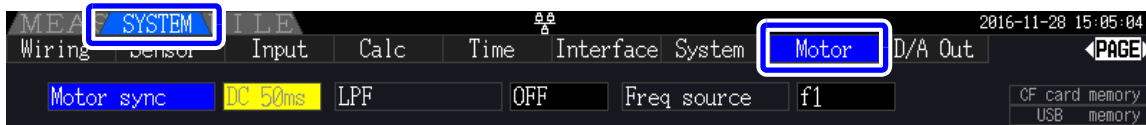
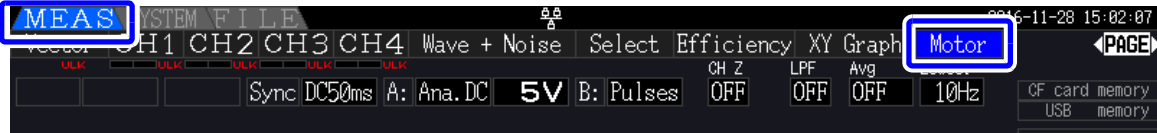

The motor analysis function acquires signals from rotation-sensing devices such as a torque sensor and rotary encoder and measures motor analysis items (torque, rotation rate, motor power and slip). Motor efficiency, total efficiency and loss can be calculated when combined with the "4.7 Viewing Efficiency and Loss Measurement Values" (p. 91) functions.

Setting the Motor Sync Source

Press **[MEAS]** and then **[Left Arrow]** **[Right Arrow]** to select the **[Motor]** page.

Motor Sync Source Setting CH A Range Setting CH B Range Setting

A screenshot of the Motor measurement screen. The 'Motor' option is highlighted in the top menu. Below the menu, there are settings for 'Sync DC50ms', 'A: Ana. DC 5V', and 'B: Pulses'. The main display area shows four rows of data: 'CH A : -0.0001 N·m' (Torque), 'CH B : 0.00k r/min' (Rotation Rate), 'Pm : - 0.000k W' (Motor Power), and 'Slip : - - - - - %' (Slip). A 'Correct' button is visible at the bottom right.

Motor measurements can be displayed simultaneously with motor input voltage and current, power measurements and motor efficiency.

See "Selecting Measured Items for Display" (p. 48)

- NOTE**
- When **[CH A]** measurement units are set to **[V]** and **[Hz]**, or **[CH B]** units are set to other than **[r/min]**, motor power **[Pm]** display is always disabled ("OFF").
 - When **[CH B]** measurement units are set to **[V]**, slip cannot be calculated, and **[- - - - -]** is displayed.

Executing Zero Adjustment

Execute zero adjustment to compensate for input signal bias before measuring analog DC voltage on CH A or CH B.

If a non-zero value is displayed for torque or rotation rate when no torque or rotation is occurring, execute zero adjustment before applying any torque or rotation input.

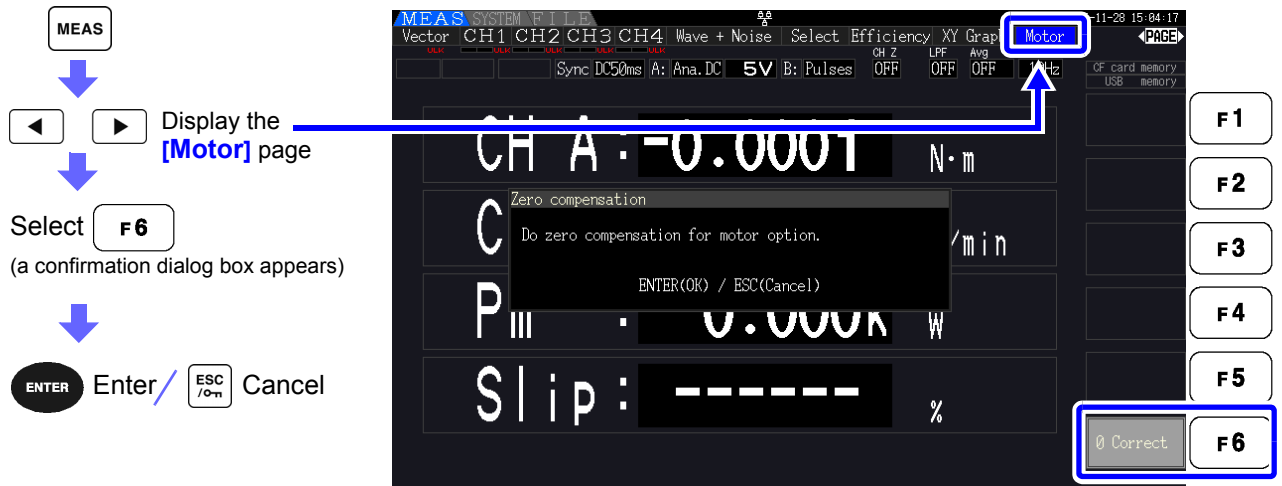

NOTE

- This particular zero adjustment function applies only to the motor analysis function, so the other input channels (CH 1 to CH 4) are unaffected. To execute zero adjustment on those channels, see section "3.11 Attaching to the Lines to be Measured and Zero Adjustment" (p. 44).
- Zero adjustment is only applicable to analog DC input channels.
- The maximum zero adjustment span is $\pm 10\%$ of the full-scale range, outside of which no adjustment occurs.

4.8.1 Motor Input Settings

Set to suit the motor to be measured, or the connected torque sensor or tachometer.
 See "8.5 Using the Motor Testing" (p. 176)

Basic Operating Procedure

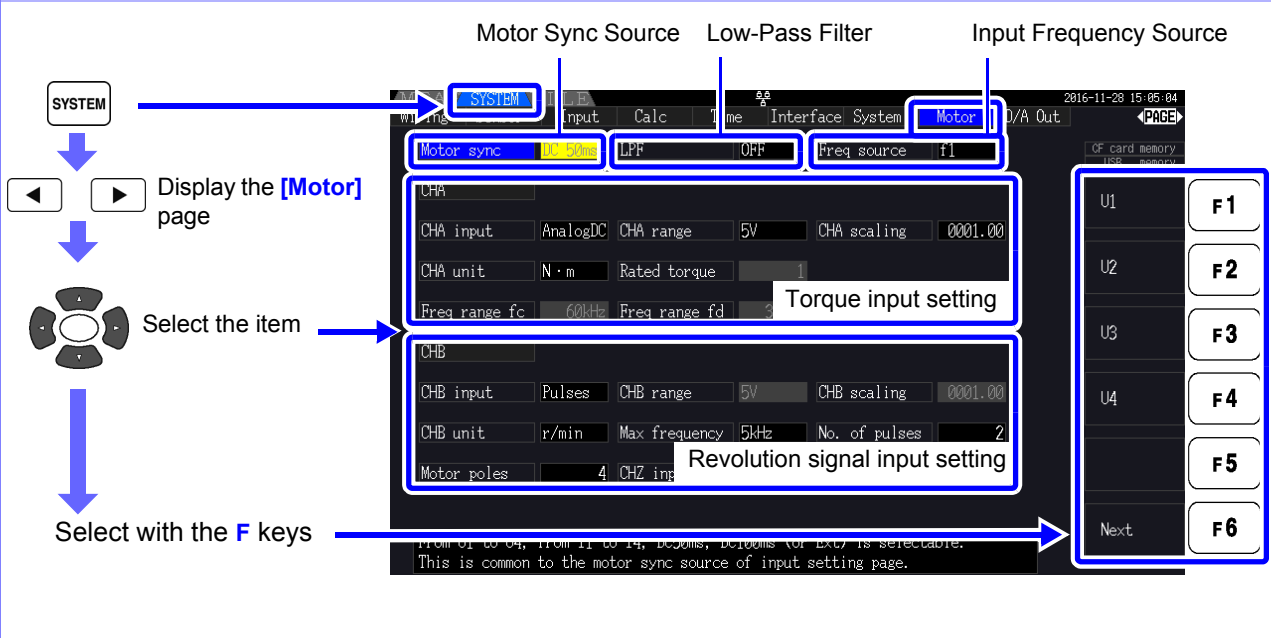

Selecting the Motor Sync Source

Select the source of the signal that determines the period to serve as the basis for motor analysis calculations. Motor analysis items are measured according to the period of the source selected here.

U1 to U4, I1 to I4, DC50 ms (Default setting), DC100 ms, Ext

See "4.2.3 Selecting the Sync Source" (p. 58)

The selected motor sync source is displayed as [Sync] on the Motor screen.

NOTE

- All motor analysis items depend on the same sync source.
- When measuring motor efficiency in combination with the functions of section "4.7 Viewing Efficiency and Loss Measurement Values" (p. 91), select the same sync source as that of the motor voltage and current input channels. Optimum measurement accuracy is possible when the calculation periods are the same.
- [Ext] is only selectable when CH B is set for pulse input.

Low-Pass Filter (LPF) Settings

When CH A or CH B is set for Analog DC input, enable the filter to suppress harmonic noise. Measurements should normally be made with the filter disabled (OFF), but it should be enabled (ON) when measurement values are destabilized by the effects of external electrical noise.

ON, OFF (Default setting)

NOTE

- The LPF setting is the same for CH A and CH B. Independent setting is not available.
- When CH A is set for frequency input and CH B is set for pulse input, the LPF setting has no effect.

Selecting the Input Frequency Reference Source

To calculate motor slip, select a reference source for measuring the motor input frequency.

f1, f2, f3, f4

See "4.2.4 Frequency Measurement Settings" (p. 60)

Slip Calculation Formula

CH B Measurement Units	Calculation Formula
When [Hz]	$100 \times \frac{\text{Input Frequency} - \text{CH B Display Value} }{\text{Input Frequency}}$
When [r/min]	$100 \times \frac{2 \times 60 \times \text{Input Frequency} - \text{CH B Display Value} \times \text{Set No. of Poles}}{2 \times 60 \times \text{Input Frequency}}$

NOTE

- To calculate slip, set CH B to suit the rotation input signal.
- As the input frequency, select the most stable signal from the voltage and current supplied to the motor.

Setting Torque Input (CH A)

Select the type of input signal from the torque sensor connected to CH A.

CHA input

AnalogDC	When the sensor outputs a DC voltage proportional to the torque
Freq	When the sensor outputs a frequency proportional to the torque

Available setting items depend on the state of the following settings.

When [AnalogDC] is selected

When [CHA input] is set to [AnalogDC], set these three items to suit the sensor: [CHA range], [CHA scaling], and [CHA unit].

Example: When the rated torque is 500N·m and the torque sensor's output range is ±10 V.

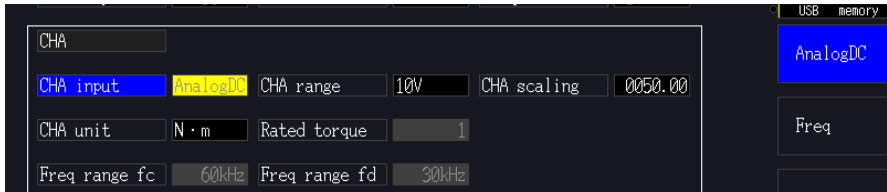

The screenshot shows the motor measurement interface with the following settings:

- CHA input: AnalogDC
- CHA range: 10V
- CHA scaling: 0050.00
- CHA unit: N·m
- Rated torque: 1
- Freq range fc: 60kHz
- Freq range fd: 30kHz

CHA range	10 V
CHA scaling	50
CHA unit	N·m

CHA range Select to suit the output voltage of the torque sensor.

1 V, 5 V, 10 V

NOTE The CH A range can be selected with the voltage range keys from the Motor page of the Measurement screen.

CHA scaling Settable from 0.01 to 9999.99.

The measurement value displayed for CH A = CH A input voltage × CH A scaling value. Set [CHA unit] according to the torque value that corresponds to one volt of torque sensor output.

(Scaling value = max. rated torque of sensor ÷ output scale voltage value)

In this example, the scaling value is 50.

(50 = 500 N·m ÷ 10)

CHA unit Set to suit the torque sensor.

V	Select to display raw input voltage.
mN·m	Select this for torque sensors rated at 1 mN·m to 999 mN·m per volt output.
N·m	Select this for torque sensors rated at 1 N·m to 999 N·m per volt output.
kN·m	Select this for torque sensors rated at 1 kN·m to 999 kN·m per volt output.

NOTE When CH A units are set to [V], motor power [Pm] is not displayed.

When [Freq] is selected

When [CHA input] is set to [Freq], make these four settings to suit the sensor: [CHA unit], [Rated torque], [Freq range fc], and [Freq range fd].

Example 1: Using a torque sensor rated at 500 N·m for an output span of 60 kHz \pm 20 kHz

CHA unit	N·m
Rated torque	500
Freq range fc	60 kHz
Freq range fd	20 kHz

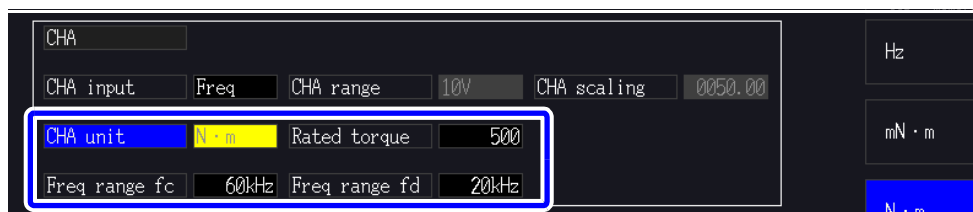

Example 2: Using a torque sensor rated at 2 kN·m, with maximum positive rated torque providing 15 kHz output, and maximum negative rated torque providing 5 kHz output

CHA unit	kN·m
Rated torque	2
Freq range fc	10 kHz
Freq range fd	5 kHz

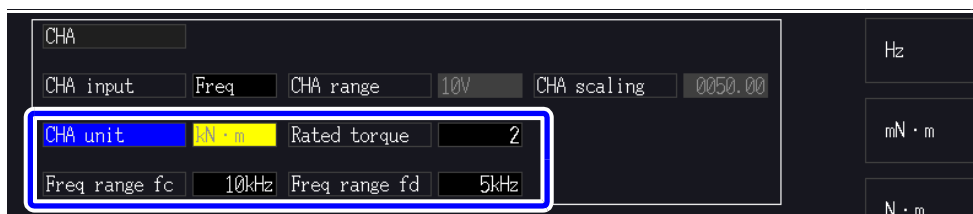

CHA unit Set to suit the connected torque sensor.

Hz, mN·m, N·m, kN·m

- NOTE**
- When CH A units are set to [Hz], motor power (Pm) is not displayed.
 - Select fc+fd for frequencies below 100 kHz, and fc-fd for frequencies above 1 kHz. Setting beyond the numerical value limits is not possible.

Rated torque Enter an integer from 1 to 999. Set the maximum rated torque of the torque sensor in the corresponding CH A units.

Freq range fc Set a value between 1 kHz to 100 kHz in 1 kHz steps.

Freq range fd Set fc to the center frequency corresponding to zero torque, and set fd to the frequency corresponding to maximum rated torque.

Setting the Rotation Signal Input (CH B)

Select the type of rotation signal to be applied to CH B

CHB input

Analog DC	For DC voltage proportional to the rotation rate
Pulses	For pulse signals proportional to the rotation rate

Available setting items depend on the state of the following settings.

When [Analog DC] is selected

When [CHB input] is set to [AnalogDC], set these three items to suit the rotation signal: [CHB range], [CHB scaling], and [CHB unit].

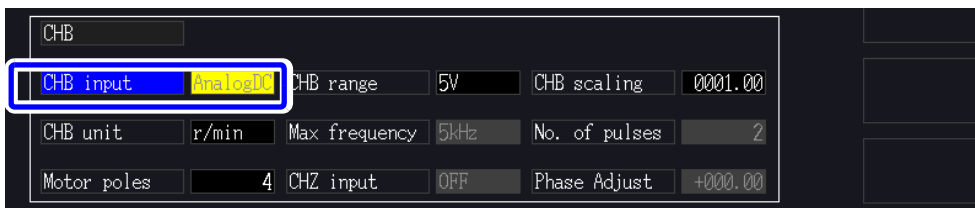

CHB range Select to suit the applied rotation signal voltage input.

1 V, 5 V, 10 V

CHB scaling Settable from 0.01 to 9999.99. The measurement value displayed for CH B = CH B input voltage × CH B scaling value. Set [CH B Units] according to the rotation rate that corresponds to one volt of rotation signal.

CHB unit Always select r/min when measuring motor power (Pm).

V, Hz, r/min

- NOTE**
- The CH B range can be selected with the current range keys from the Motor page of the Measurement screen.
 - Set the number of motor poles when measuring the slip. (p. 103)

When [Pulses] is selected

When [CHB input] is set to [Pulses], make these six settings to suit the rotation signal: [CHB unit], [Max frequency], [No. of pulses], [Motor poles], [CHZ input] and [Phase Adjust].

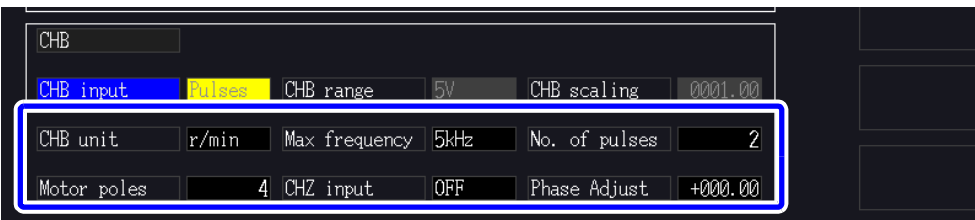

CHB unit Always select [r/min] when measuring motor power (Pm).

Hz, r/min

4.8 Viewing Motor Measurement Values (Model PW3390-03 only)

NOTE The measurement range when CH B units are set to Hz is 0.5 Hz to 5 kHz.

Measurement values are calculated as
$$\frac{\text{No. of Poles} \times \text{Pulse Input Frequency}}{2 \times \text{Pulse Count Setting}}$$

When the pulse signal input frequency is higher than the measurement range, set the appropriate pulse count.

Max frequency

Determine the full-scale measurement value for CH B.
For the digits displayed for rotation and motor power, the value calculated under the frequency set here is determined as full-scale.
Select a higher value closest to the maximum value of the voltage frequency inputted in the motor.

E.g., when a maximum voltage of 133 Hz inputs in the motor, select 500 Hz.
(When CH B is set for D/A Output, this setting is the full-scale value.)

100 Hz, 500 Hz, 1 kHz, 5 kHz

No. of pulses

Set the number of pulses per mechanical rotation, from 1 to 60,000.
Available setting values are multiples of half the number of motor poles.
(For an incremental type rotary encoder that provides 1000 pulses per rotation, set to 1000.)

+1/2 the number of motor poles, -1/2 the number of motor poles	Increment or decrement by 1/2 the number of motor poles.
+1/2 × 10 times the number of motor poles, -1/2 × 10 times the number of motor poles	Increment or decrement by 1/2 × 10 times the number of motor poles.
+1/2 × 100 times the number of motor poles, -1/2 × 100 times the number of motor poles	Increment or decrement by 1/2 × 100 times the number of motor poles.

Motor Poles

Set the number of motor poles as an even number between 2 and 98.
(The slip calculation and the rotation signal input as the frequency corresponding to the mechanical rotation angle are converted to the frequency corresponding to the electrical angle.)

+2, -2	Increment or decrement by 2.
+10, -10	Increment or decrement by 10.

NOTE The motor pole setting is enabled by pressing **F5** (Set). Be sure to press **F5** (Set) after changing the setting.

CHZ Input

Select the signal to input in CH Z

OFF	Ignore CH Z (no connection to CH Z jack).
Z Phase	Select this when inputting the original signal (generally known as Z Phase) pulse of the rotating angle. Used in "4.8.2 Measuring Motor Electrical Angle" and zero-clear the pulse counts of the CHB with this pulse when using multiple pulses of the CHB.
B Phase	Select this when inputting the B Phase pulse of the rotary encoder. Used in "4.8.3 Detecting the Motor Rotation Direction"

Phase Adjust

Set the phase zero adjustment correction value as desired. To set the correction value based on signal input, use the phase zero adjustment function on the Measurement screen (**SHIFT** + **0 ADJ**).

See "Setting the phase zero adjustment correction value manually" (p. 106)

4.8.2 Measuring Motor Electrical Angle

If the [Harm sync src] is set to [Ext] when pulses are input to CH B for the rotation signal, voltage and current phase shift based on the pulses can be seen.

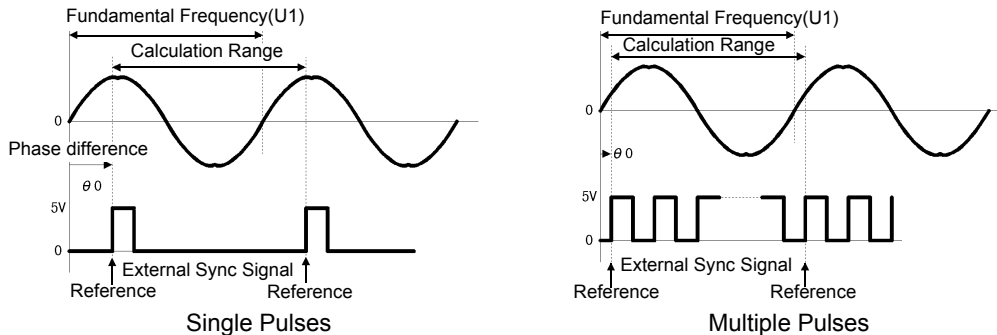

Measuring Electrical Angle with Multiple Pulses

- Use of the original signal (Z phase) is recommended. The original (Z phase) signal serves as a reference pulse for consistent phase measurements.
- When multiple pulses are used as the rotation signal input without the original (Z phase) signal, the reference pulse is determined upon synchronization, so upon resynchronization after sync unlock occurs, a different pulse may become the reference standard.

NOTE

- Harmonic analysis by synchronization with the rotation signal input pulse requires that the pulse count be an integer multiple of the input frequency. For example, a 4-pole motor requires a pulse count that is an integer multiple of two, and a 6-pole motor requires a pulse count that is an integer multiple of three.
- When a motor with internal wiring is measured as a 3P3W3M wiring system, the voltage and current phase angles can be measured using the Δ -Y transform function.

Phase Zero Adjustment (PHASE ADJ)

Press **SHIFT** and then **0 ADJ** to correct (zero) any phase difference between the rotation signal input pulse and U1 fundamental content.

- NOTE**
- Phase zero adjustment is available only when CH B is set for pulse input and **[Harm sync src]** is set to **[Ext]**. Otherwise, performing this key operation has no effect.
 - When harmonic synchronization is unlocked, this key operation has no effect.
 - Press **SHIFT** and then **DATA RESET** to clear the correction value.

Electrical Angle Measurement Example

- 1.** Without providing current to a motor, rotate it from the load side while measuring the voltage induced at its input terminals.
- 2.** Perform phase zero adjustment.
(Zero out any phase difference between the fundamental waveform of the induced voltage input as U1 and the pulse signal.)
- 3.** Apply current to rotate the motor.
(The voltage-current phase angle measured by the instrument is the electrical angle based on the induced voltage phase.)

- NOTE** Phase difference is affected by the rotation input signal pulse waveform and the instrument's internal circuit delay, which cause measurement errors when measuring frequencies much different from that at which phase zero adjustment was performed.

Setting the phase zero adjustment correction value manually

You can set the phase zero adjustment correction value as desired.

The phase zero adjustment correction value can be set as desired within the range of -180.00° to $+180.00^\circ$. Enter the phase difference between the rotation input signal pulse and the U1 fundamental component.

If using the instrument in an environment in which the phase angle is expressed as a value from 0° to 360° , enter after converting to a value from -180° to $+180^\circ$.

NOTE

- Phase zero adjustment is valid only when CH B is set to pulse input and the **[Harmonic sync source]** is set to **[Ext]**. No setting can be entered if CH B is not set to pulse input.
- The screen displays the present phase zero adjustment correction value. Consequently, pressing the **[0 ADJ]** key while holding down the **[SHIFT]** key on the Measurement screen to perform zero adjustment will cause the correction value to be overwritten. In addition, resetting the correction value by pressing the **[DATA RESET]** key on the Measurement screen while holding down the **[SHIFT]** key will revert the correction value to 0.
- The set phase zero adjustment correction value will be subtracted from pulse-based voltage and current phase measured values.

Setting Procedure

Press **[SYSTEM]**

↓

[◀] [▶] Display the **[Motor]** page

↓

[F1-F5] Select **[Phase Adjust]**

↓

Select with the **F** keys

F1	Increase/reduce value
F2	value
F3	Select digit to change
F4	change
F5	Change sign

4.8.3 Detecting the Motor Rotation Direction

When the A phase pulse and the B phase pulse of the incremental-type rotary encoder are input in the CH B and CH Z rotation signal input jacks, the rotation direction of the axis can be detected and polar code can be assigned to the number of rotations.

When the setting [B Phase] for CH Z input is selected, the rotation direction is detected. Rotation direction is determined by another directional level (High/Low) in the detection timing of rise/fall of A Phase pulse and B Phase pulse.

Normal rotation

Polar code for number of rotation is +

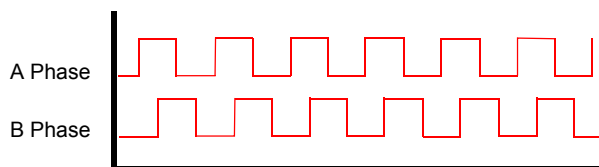

Counter rotation

Polar code for number of rotation is -

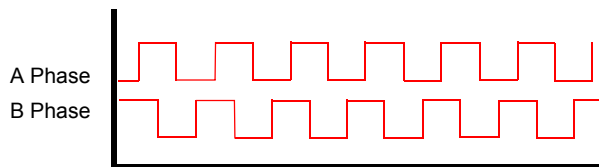

The rotation direction detected is assigned as a polar code to the measurement value of the number of rotations, and also reflected in the motor power [Pm] measurement value.

NOTE

Rotation direction detection and acquisition of original signal (Z Phase pulse) cannot be performed simultaneously.

Use the original signal (Z Phase pulse) when measuring the motor electrical angle using multiple pulses.

Operating Functions

Chapter 5



5.1 Timing Control Functions

Three types of timing controls are available: interval, count-down timer, and real-time clock settings. Timing control can be applied to CF card saving and integration operations.

See "4.3 Integration Value Observation" (p.65), "7.5.2 Auto-Saving Measurement Data" (p.143)

Interval timing control	Controls repeating operations at a specific interval.
Timer timing control	Controls operation for a specific count-down time. Combine with interval timing to specify the duration of interval timing operation.
Real-time clock timing control	Controls operation between specific real-time start and stop times. Combined with interval timing to specify when interval timing operation begins and ends.



NOTE**Before starting integration and saving using timing control functions**

- Before using automatic saving or integration, ensure that the real-time clock is correctly set (p.131).
- The timing control cannot be set to CF card saving and integration independently.
- Integration is always active, so when a timing control function is active, **RUN** appears on the display. When timing control has stopped, press  to reset integration and clear the **STOP** indicator.
- Even when a timing control function is enabled, you must press  to begin operation.

About interval timing control

- If the timer or clock control is not active, integration automatically stops at 9999 hours, 59 minutes, and 59 seconds. In this case, press  to reset the integration value and restart integration.
- Interval timing is not available when the interval time setting is longer than the timer or clock (start/stop) settings.
- When the ending time of the timer or clock settings is different from the ending time of the last interval, the timer or clock setting has priority.
- When changing the interval setting, the number of recordable data items (p.145) also changes (longer intervals allow more data items to be recorded).

About timer timing control

- When clock control settings define a time span longer than the timer setting, integration starts at the specified clock start time, and stops when the timer setting has elapsed (any clock control stop time is ignored).
- During integration and before the timer stops, pressing  interrupts integration but retains the integration value. In this case, pressing  again resumes integration until the timer stops ("additional integration").

About clock timing control

- When clock control is enabled for a time span longer than the timer setting, integration begins at the specified clock start time, and stops when the timer setting has elapsed (any clock control stop time is ignored).
- When the set time has elapsed, real-time control is considered disabled **[OFF]**.
- When integration is interrupted during the clock control period, clock control is disabled **[OFF]**.

See the graph in "4.3.4 Integration Combined with Timing Control" (p.71) for integration operations.

Setting Method

Press **SYSTEM** and the **◀** **▶** keys to display the **[Time]** page.

1  Select the item

2 Use **F** keys to set.

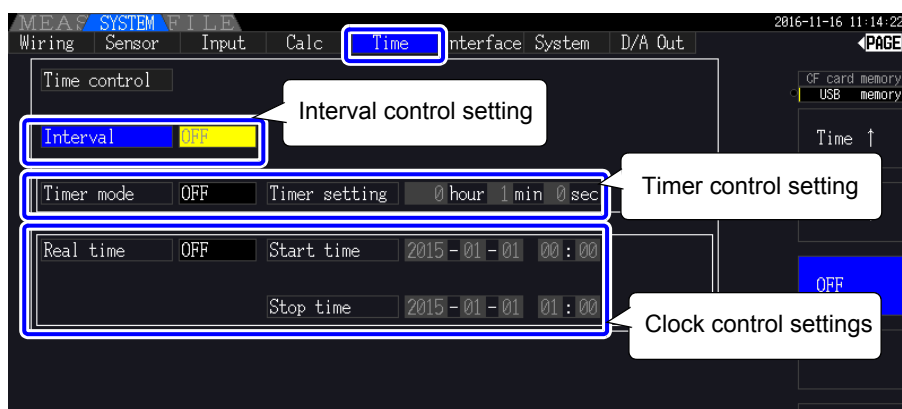
**Interval**

(The interval setting is also available on the **[Interface]** page.)

Time↑ /Time↓	Select an interval time from 50, 100, 200, or 500 ms; or 1, 5, 10, 15, or 30 s; or 1, 5, 10, 15, 30, or 60 min.
OFF	Interval time control is disabled.

**Timer mode/
Real time**

ON	Timer control/clock control is enabled.
OFF	Timer control/clock control is disabled.

Timer setting

Set the count-down timer. Settable range is 10 s to 9999 h 59 m 59 s.

+1↑ /-1↓	Increments/decrements by 1.
+10↑ /-10↓	Increments/decrements by 10.
Digit←/Digit→	Moves to the [hour] digits.

**Start time
Stop time**

Set start and stop times for clock timing. Select the year and the 24-hour time (e.g., 16 December, 2017 10:16 PM →**[2017/12/06 22:16]**)

+1↑ /-1↓	Increments/decrements by 1.
+10↑ /-10↓	Increments/decrements by 10.

5.2 Averaging Function

The averaging function averages measured values and displays the result. This function can be used to obtain more stable display values when measured values fluctuate and cause large variations in the display.

Performs averaging on all instantaneous measurement values, including harmonics and motor sync source.

Averaging setting can be selected from the following.

OFF	Averaging is disabled.
FAST	Averaging is enabled. Response time* is 0.2 s.
MID	Averaging is enabled. Response time is 1.0 s.
SLOW	Averaging is enabled. Response time is 5 s.
SLOW2	Averaging is enabled. Response time is 25 s.
SLOW3	Averaging is enabled. Response time is 100 s.

* Period to be within the accuracy when the input changes from 0% to 100% f.s.

Averaging Method

- Index averaging (applicable to 50 ms data update rate)
- Averaging is applied to voltage (U), current (I), and power (P), before performing calculations.
- For the harmonics, RMS values and percentage are calculated in average to instantaneous values, and the phase angle is calculated in average of real part and imaginary part after FFT calculation.
- Phase differences, distortion ratios and unbalance ratios are calculated from the data averaged as above.

NOTE

- Peak, integration, and noise values are excluded.
- When averaging is enabled, averaging is applied to all data being saved.

Configuring averaging on the Measurement screen

The averaging setting is displayed under **[Avg]** at the top of the Measurement screen.

1 **MEAS**

2 Press the **SHIFT** key and then use the **◀** and **▶** keys to select the desired setting. Press the keys repeatedly to vary the setting among the following values:
OFF ↔ FAST ↔ MID ↔ SLOW ↔ SLOW2 ↔ SLOW3.

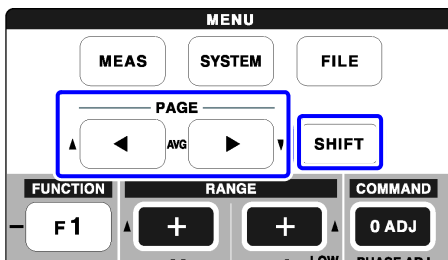
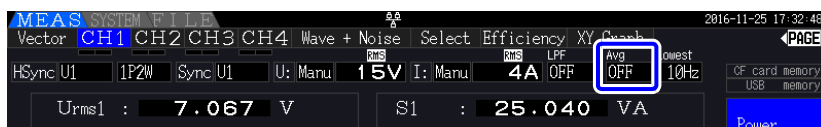

Configuring averaging on the Settings screen

Press **SYSTEM** and the **◀** **▶** keys to display the **[Calc]** page.

1  Select the item

2 Use **F** keys to set.

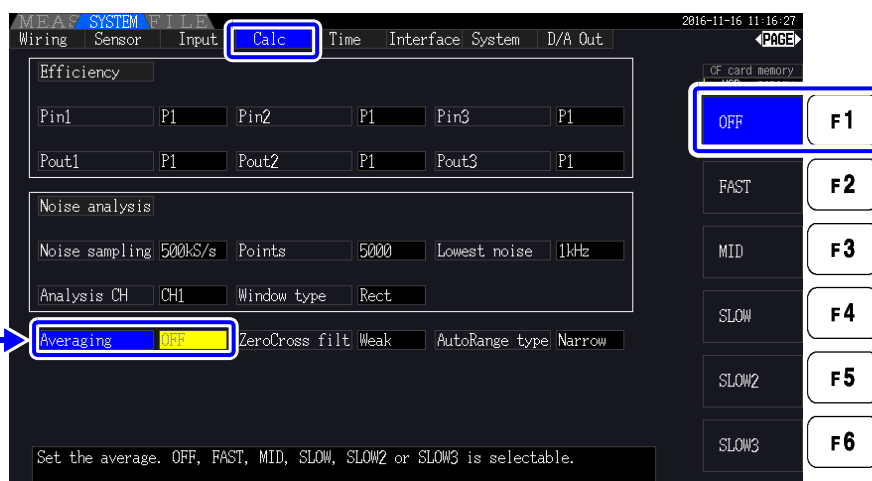

5.3 Data Hold and Peak Hold Functions

5.3.1 Data Hold Function

Pressing **HOLD** disables updating of all displayed measurement values and waveforms. In this state, data on other screens can be viewed as it was when **HOLD** was pressed.

The data update of internal measurement values is not synchronized to the display update. The internal measurement values are updated in 50 ms (internal data update rate). The waveform and noise data is updated at the calculation completion. However, the waveform and noise display is not updated.

While data hold is active, **HOLD** is displayed and the **HOLD** key lights red.

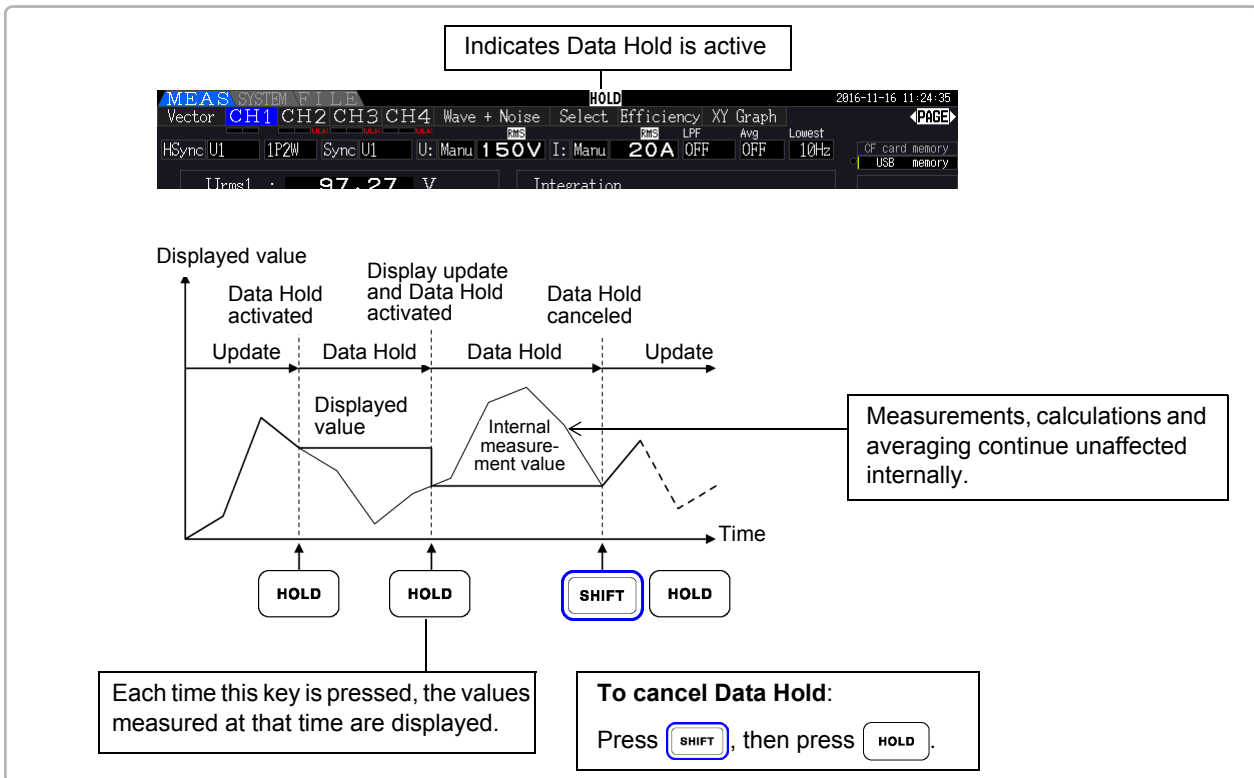

Display data update

After pressing **HOLD**, the display data is next updated at the end of the measurement interval or when an external sync signal is received.

Output data

When the display is HOLD, the HOLD value is keep on outputting for the D/A output, CF card save and communication. However, the waveform output continues to output the instantaneous value regardless to the HOLD status.

NOTE

- Clock and integration times and Peak Over display are unaffected by the Data Hold function.
- Data Hold and Peak Hold functions cannot be activated simultaneously.
- Settings cannot be changed while Hold is active.
- When AUTO ranging is enabled, the range is fixed at that used when **HOLD** is pressed.
- **HOLD** key operation is recognized before and during use of the timer control functions.
 - When an interval time is set: the display updates at each interval, and display data is held for the duration of the interval.
 - When the timer or clock control is set: the display updates and holds the values at the stop time.
- When auto-saving at a specified interval, data is saved immediately before display update.

5.3.2 Peak Hold Function

Pressing **SHIFT** after pressing **HOLD** activates the Peak Hold state, in which only those items that exceed their previous maximum values are updated. This is convenient, for example, to measure motor inrush current.

When Peak Hold is active, **PEAK** is displayed and the **HOLD** key lights red.

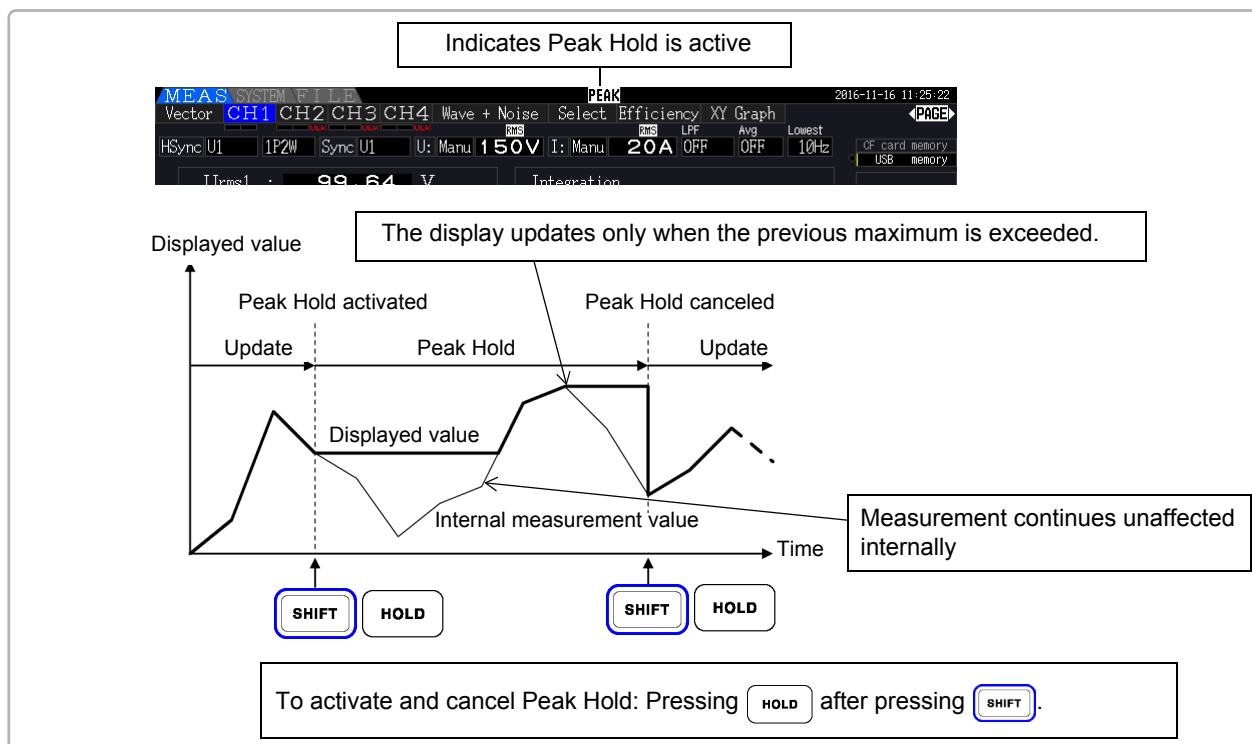

Pressing **HOLD** when Peak Hold is active resets the peak values and resumes with new peaks from that point.

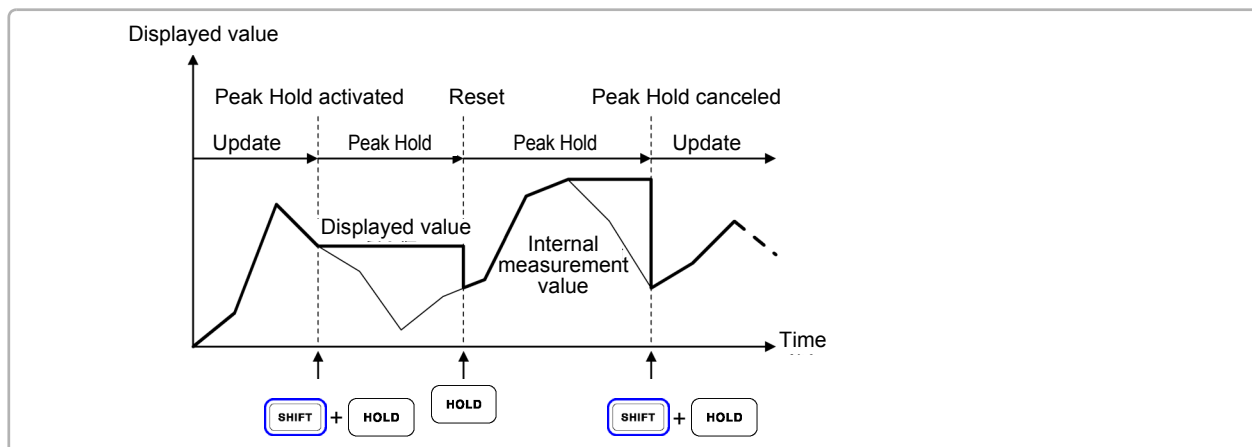

Display data update

After pressing **HOLD**, the display data is next updated at the end of the measurement interval or when an external sync signal is received.

(Updating of internal measurement values is not synchronized with display data update, but at the 50-ms internal data update rate, and waveform and noise data are updated when calculation finishes.)

Output data

When the display is HOLD, the HOLD value is keep on outputting for the D/A output, CF card save and communication. However, the waveform output continues to output the instantaneous value regardless to the HOLD status.

NOTE

- Waveform displays and integration values are unaffected by Peak Hold.
- When averaging is enabled, the maximum value is recognized only after measured values have been averaged.
- Data Hold and Peak Hold functions cannot be activated simultaneously.
- The display shows [- - - - -] for over-range values. In this case, temporarily cancel Peak Hold and switch to the appropriate range.
- Maximum values for Peak Hold are absolute values, so if -60 W is measured after +50 W, the absolute value of -60 W is larger, and the display shows [-60W].
- Settings cannot be changed while Peak Hold is active.
- When auto-saving at a specified interval, data is saved immediately before the display update.

Using Peak Hold with Timing Control Functions

When the **interval timer** is used, the maximum value within each interval is displayed.

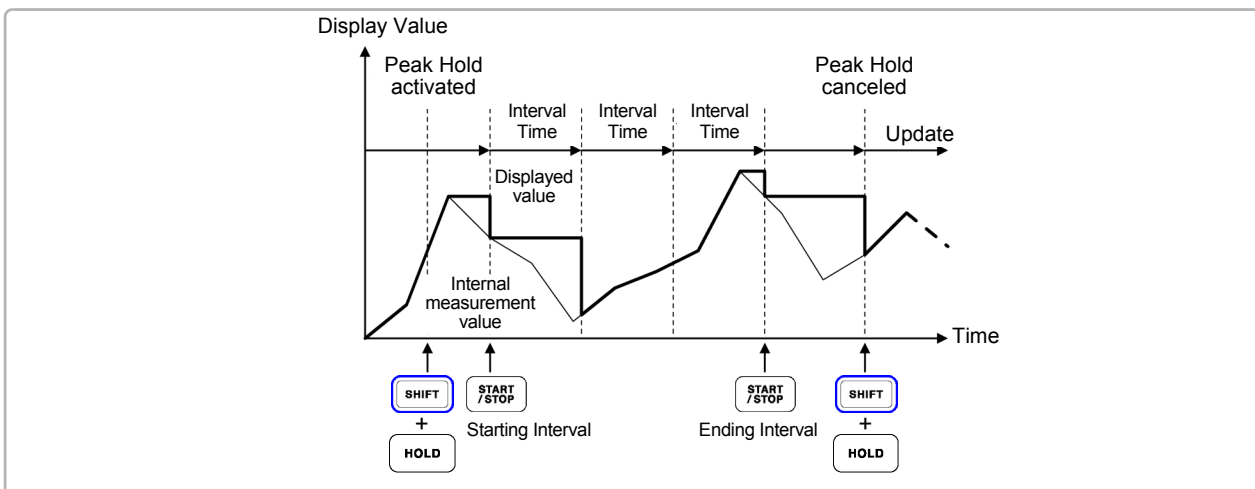

When the **timer or clock control** is enabled, the maximum value between starting and stopping times is displayed (and held).

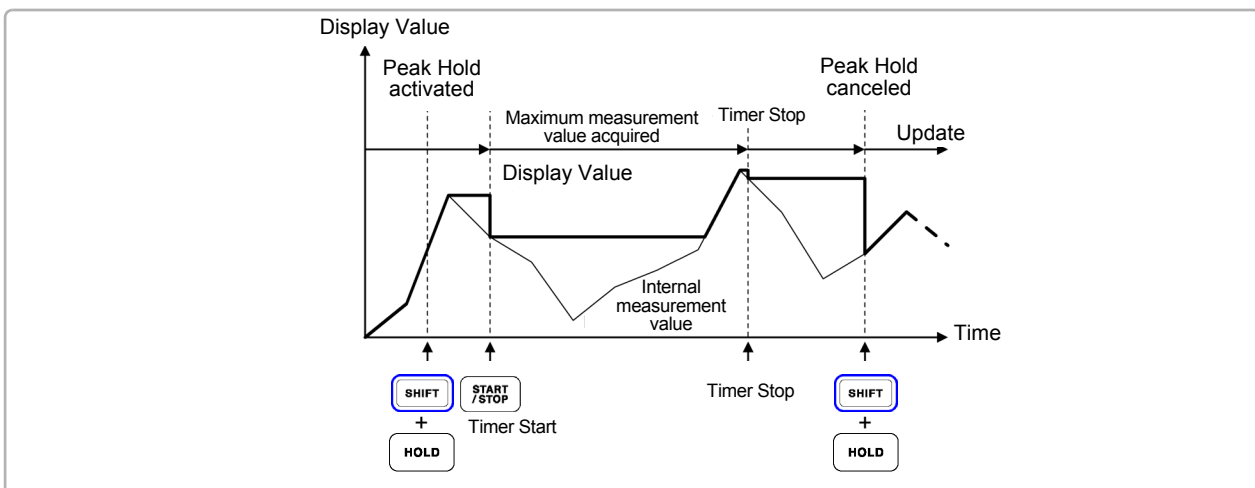

NOTE

- The Peak Hold function can be enabled either before or during timing control operation. However, when timing control is active, the maximum value is obtained only after the time the Peak Hold function is enabled.
- The time of maximum input occurrence is not displayed.
- See "5.1 Timing Control Functions" (p.109) for details about settings for the interval, timer and clock timing controls.

5.4 X-Y Plot Function

Select parameters for x and y (horizontal and vertical) axes in the basic measurement items to create simple X-Y graphs. Plot screens can be saved and printed as screen capture images.

XY Graph Display

Press **MEAS** and **◀ ▶** key to display the **[XY Graph]** page.

X-Y graph plotting starts, and proceeds at the display update rate.

Press **F1** to clear and restart plotting.

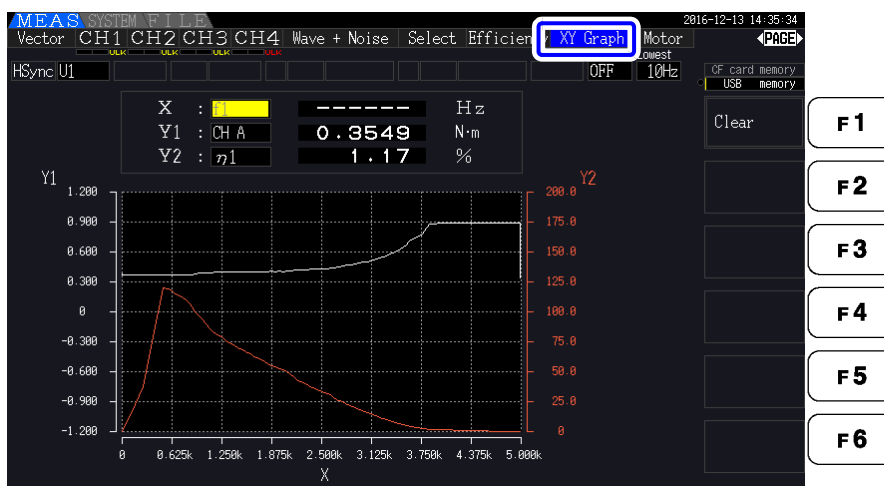

NOTE

- Plotted data is not stored in memory, so it is lost when the screen is changed.
- When the items with AUTO ranging is selected, the data is cleared when the internal range is switched in AUTO ranging.

Display Setting Procedure

Move the highlight cursor the display item (parameter) to change.

ENTER Enter
(Displays the pull-down menu)

Select a parameter for display.

ENTER Enter / **ESC** / **On** Cancel

Displayed data is cleared, and plotting restarts.

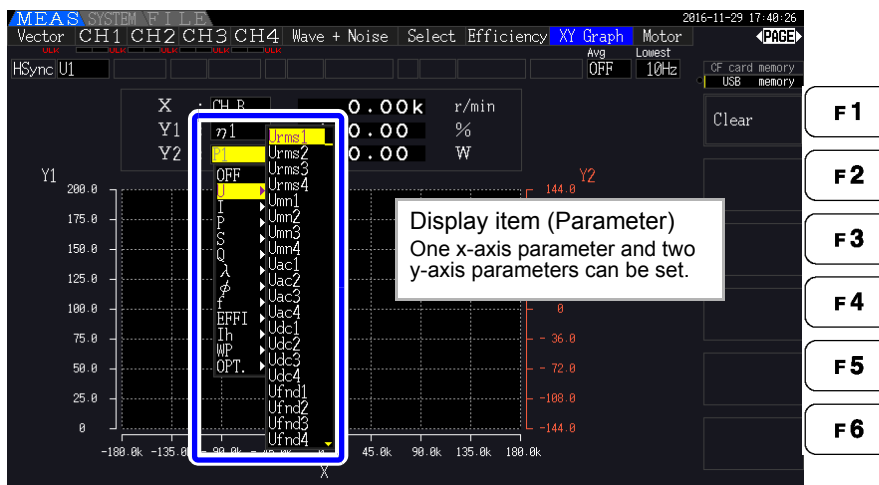

5.5 Delta Star (Δ -Y) Transform Function

For 3P3W3M wiring systems (wiring mode 7 on p.40), Δ (Delta) wiring configuration values are converted to Y (Wye) wiring values ('star' configuration) so that measured values are equivalent to those of 3P4W lines.

When this function is enabled, even when a motor has internal Wye wiring and the central (neutral) point is inaccessible, it can be measured using phase voltage to emulate the Wye configuration.

Δ -Y transform analyzes voltage waveforms after performing vector conversion using a virtual neutral. Although voltage waveforms, voltage measurement values, and harmonic voltages are all input as line voltages, they are calculated as phase voltages.

Illustration of Δ -Y transform

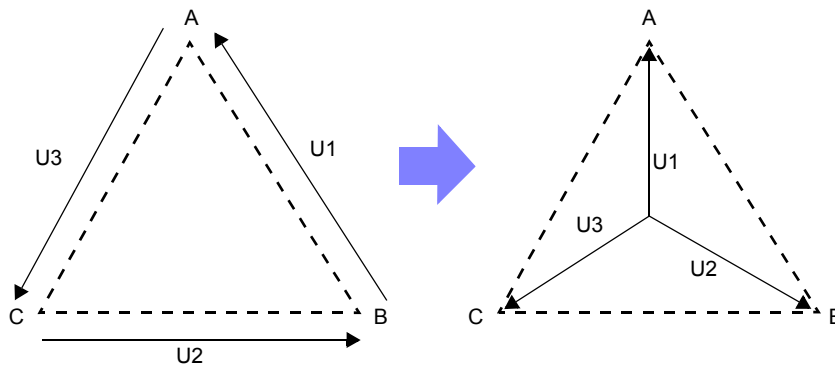

Setting Procedure

SYSTEM

Display the [Input] page

Select [Δ -Y convert]

Use F keys to select

The Measurement screen appears as follows.

MEAS SYSTEM FILE
Vector CH1 CH2 CH3 C
 Δ -Y ULK ULK ULK

NOTE

- Δ -Y transform is only selectable for 3P3W3M wiring.
- When Δ -Y transform is enabled, the vector diagram on the Wiring screen is the same as that for 3P4W (instead of the 3P3W3M vector diagram).
- When auto-ranging voltage and Δ -Y transform are enabled, the range-switching level for the next lower range is calculated to be $1/\sqrt{3}$ times (approx. 0.57735 times) the full-scale range value.

See "Auto-Ranging Span" (p. 57)

5.6 Selecting the Calculation Method

A function to change the calculation methods of apparent power and reactive power when the wiring is 3P3W3M (refer to "Wiring Mode 7. 3-phase, 3-wire (3P3W3M) + single-phase, 2-wire (1P2W)" (p. 40)). When measuring the PWM waveform using the setting for rectification method "MEAN", it can improve the mutual compatibility with measurement values of other wattmeter.

There are two types of settings, TYPE1 and TYPE2, and both are only valid during 3P3W3M wiring.

TYPE 1	The standard 3P3W3M calculation method.
TYPE 2	Calculation method to improve the mutual compatibility with 3V3A wiring of other power meter. Under sine wave input, there is no difference from the calculation results of TYPE1, but when the PWM waveform is measured using the setting for rectification method "MEAN", the values of S123, Q123, ϕ 123, and λ 123 is closer to the power meter for 3V3A wiring than TYPE1.

Setting Procedure

The screenshot shows the MEAS SYSTEM menu with the following settings:

Wiring	CH1	CH2	CH3	CH4	Sync source	U range	U rect	VT rate	I range	CT rate	LPF	Lowest freq	Harm sync	THD calc	Δ -Y convert	Motor sync
3P3W3M				1P2W	U1	150V	RMS	OFF	20A	OFF	OFF	10Hz	U1	THD-F	ON	DC 50ms

On the right side of the screen, the following options are visible:

- TYPE1 (F1)
- TYPE2 (F2)
- F3
- F4
- F5
- F6

The 'Operation' menu is highlighted with 'TYPE1' selected.

Setting Procedure:

- Display the [Input] page
- Select [Operation]
- Use F keys to select

NOTE

- Use TYPE1 for general use. Use TYPE2 when mutual compatibility is necessary, such as when changing from the device currently in use.
- All measurement values are not affected except for values of S123, Q123, ϕ 123, and λ 123.
- When the Δ -Y transform function is ON, there is no difference between the calculation results of TYPE1 and TYPE2 even with PWM waveform.

5.7 Trend Function

You can select up to eight basic measurement parameters and display fluctuations in their respective measured values as a graph. The generated screens can be saved as screenshots.

Displaying the Trend screen

Press **MEAS** and **◀** **▶** key to display the **[Trend]** page.

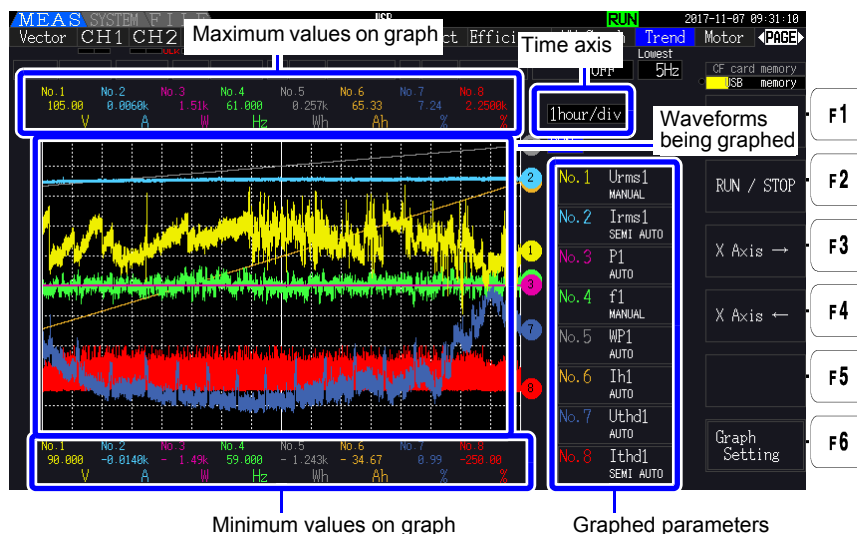

Graphed parameters The graph number, graphed parameter, and scale setting are shown. **[SEMI AUTO]** is shown if a scale factor has been set, while **[AUTO]** or **[MANUAL]** is shown if using the AUTO or MANUAL setting, respectively.

Graph display method The displayed graph waveforms are generated by graphing virtual D/A output waveforms on the screen. Consequently, some combinations of display parameters may result in unusually shaped graphs based on the D/A output rules.

- D/A output rules
See: "8.3.3 Output Level" (p.171), "8.3.4 D/A Output Examples" (p.172)
- Integration scale and frequency full scale settings
See: "8.3.2 Output Item Selection" (p.168)

NOTE

On the Trend screen, measured values that fall outside the display range (see "10.5 Measurement Item Details" (p.211)) are clipped in principle to the maximum display value.

This functionality applies to the following displays:

- Graph waveforms
- Icons that indicate present measured values

To save fluctuations in measured values, use the auto-saving function (p.143) together.

Starting and stopping graphing and clearing the graph display

The instrument will start graphing the selected parameters when it is turned on.

Use **F** keys to select

F1	Clears the graph display.
F2	<ul style="list-style-type: none"> While graphing is ongoing: Stops graphing. When graphing is stopped: Clears the graph display and starts graphing.

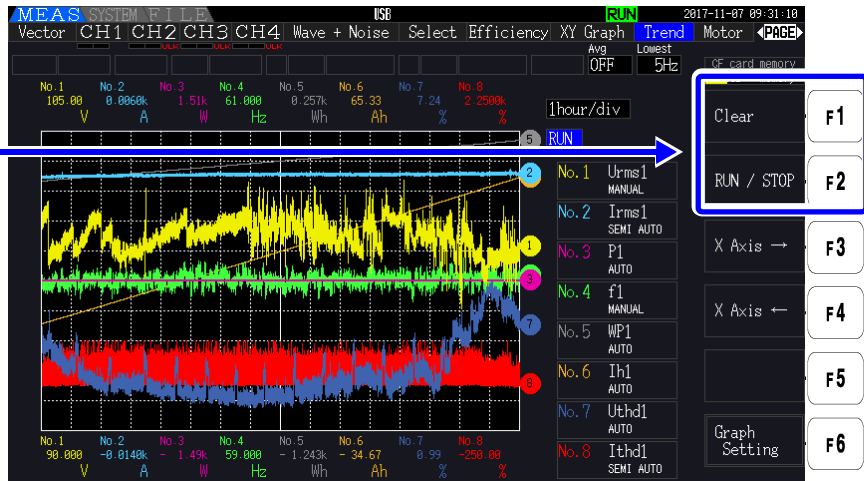

NOTE

In addition to the above, the graph display will be cleared in the following circumstances:

- When the trend graph time axis or graph parameter settings are changed
- When a setting related to measured values, for example the range, is changed
- When a setting on the System screen is changed
- When integration is started or when the integration value is reset
- When the instrument is turned on
- When a control operation that results in one of the above circumstances is performed using the communications interface*

Using buttons or performing integration on the System screen may result in the graph display being cleared inadvertently. Hioki recommends avoiding opening the System screen if you wish to not clear the graph display.

*For more information about the communications interface, see "Chapter 9 Operation with a Computer" (p.181).

Setting the time axis

Use **F** keys to setting



The graph display will be cleared.

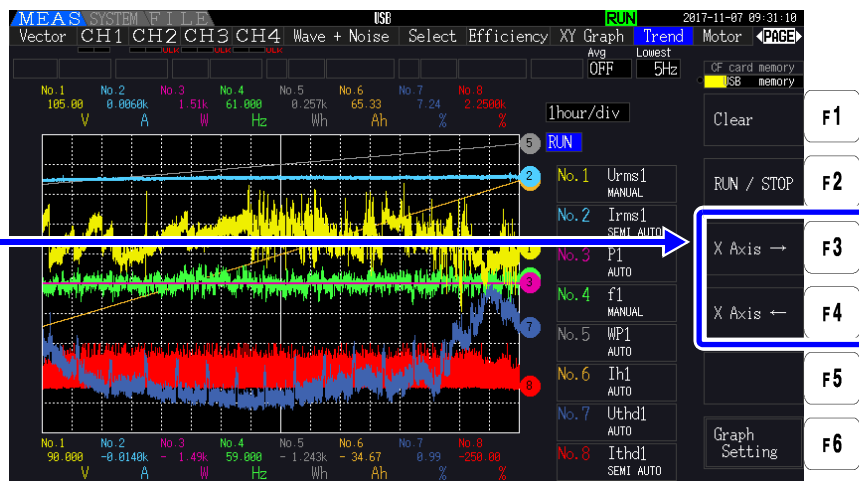

Time axis

1.5s/div, 3s/div, 6s/div, 12s/div, 30s/div
 1min/div, 3min/div, 6min/div, 10min/div, 30min/div
 1hour/div, 3hour/div, 6hour/div, 12hour/div, 1day/div

NOTE

Using a large time axis setting may result in a delay before graphing begins. In this case, the instrument will display **[NOW WAITING]** until graphing starts.

Configuring trend graphs

Pressing the **F6** key will display the Trend Graph Setting screen. Pressing the **F6** key again or **ESC** key will return to the Trend screen.

Setting graphed parameters

Select the measurement parameter for the graph number you wish to change.

ENTER Enter

(Displays the pull-down menu)

Selects from the pulldown menu

ENTER Enter / **ESC** Cancel

The graph display will be cleared.

Item	Scale	Base div	Base %	MAX	MIN
No. 1 Urms1	×100	+3	+123.45%	+1000.0	-1000.0
No. 2 Irms1	×100	+2	+000.00%	+1000.0	-1000.0

- F1
- F2
- F3
- F4
- F5
- F6

Setting the scale

Select **[Scale]** for the graph number you wish to change.

Press the **F1** key or the **F2** key to select the scale.

Press the **F3** key for the AUTO setting.

Press the **F4** key for the MANUAL setting.

Item	Scale	Base div	Base %	MAX	MIN
No. 1 Urms1	×500	+3	+123.45%	+1000.0	-1000.0
No. 2 Irms1	×100	+2	+000.00%	+1000.0	-1000.0
No. 3 P1	×1	+1	+000.00%	+1000.0	-1000.0
No. 4 Q1	1/4	0	+000.00%	+1000.0	-1000.0
No. 5 λ1	AUTO	-1	+000.00%	+1000.0	-1000.0
No. 6 f1	AUTO	-2	+000.00%	+1000.0	-1000.0
No. 7 Uthd1	MANUAL	0	+000.00%	+1234.0	-5678.0
No. 8 Ithd1	MANUAL	0	+000.00%	+1000.0	-1000.0

Scale 1/8, 1/4, 1/2, ×1, ×2, ×5, ×10, ×20, ×50, ×100, ×200, ×500

NOTE

- Setting the scale to **[×1]** causes the value per division on the vertical axis to be 25% of the full-scale value of each plotted item.
- For more information about the relationship between graphed parameters and referenced full-scale values, see "8.3.3 Output Level" (p.171).
- When the scale is set to **[AUTO]**, the scale value will be set such that the maximum and minimum values for the waveform being graphed fit in the available space.
- When the scale is set to **[MANUAL]**, you can set the maximum and minimum values that will be displayed on the trend graph.

Setting the trend graph reference position

Select **[Base Div]** for the graph number you wish to change.

Use **F** keys to select

Base Div: -4 to +4

Item	Scale	Base div	Base %	MAX	MIN
No. 1 Urms1	×500	+3	+123.45%	+1000.0	-1000.0
No. 2 Irms1	×100	+2	+000.00%	+1000.0	-1000.0
No. 3 P1	×1	+1	+000.00%	+1000.0	-1000.0
No. 4 Q1	1/4	0	+000.00%	+1000.0	-1000.0
No. 5 λ1	AUTO	-1	+000.00%	+1000.0	-1000.0
No. 6 f1	AUTO	-2	+000.00%	+1000.0	-1000.0
No. 7 Uthd1	MANUAL	0	+000.00%	+1234.0	-5678.0
No. 8 Ithd1	MANUAL	0	+000.00%	+1000.0	-1000.0

NOTE

- Changing the reference position while using the **[AUTO]** scale setting may cause a scale value that differs from the scale value selected for the initial position (reference position 0) to be selected due to a change in the domain that can be graphed.
- The **[Base Div]** setting is not available while using the **[MANUAL]** scale setting. Only values between the set maximum and minimum values are graphed.

Setting the value that corresponds to the reference position (percent of full scale)

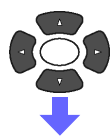

Select **[Base %]** for the graph number you wish to change.

Use **F** keys to set.

Base%:

-300.00% to +300.00%

Item	Scale	Base div	Base %	MAX	MIN
No. 1 Urms1	×500	+3	+123.45%	+1000.0	-1000.0
No. 2 Irms1	×100	+2	+000.00%	+1000.0	-1000.0
No. 3 P1	×1	+1	+000.00%	+1000.0	-1000.0
No. 4 Q1	1/4	0	+000.00%	+1000.0	-1000.0
No. 5 λ1	AUTO	-1	+000.00%	+1000.0	-1000.0
No. 6 f1	AUTO	-2	+000.00%	+1000.0	-1000.0
No. 7 Uthd1	MANUAL	0	+000.00%	+1234.0	-5678.0
No. 8 Ithd1	MANUAL	0	+000.00%	+1000.0	-1000.0

NOTE

- The formula displayed above allows you to check the value of the plotted item that corresponds to the reference position.
- The **[Base %]** setting is not available while using the **[AUTO]** scale setting. The value that corresponds to the reference position is determined automatically based on the maximum and minimum values for the waveform being graphed.
- The **[Base %]** setting is not available while using the **[MANUAL]** scale setting. Only values between the set maximum and minimum values are graphed.

Setting the trend graph maximum and minimum values

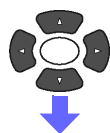

Select **[MAX]** or **[MIN]** for the graph number you wish to change.

Open a value entry dialog box with the **F1** key or **ENTER** key.

Item	Scale	Base div	Base %	MAX	MIN
No. 1 Urms1	×500	+3	+123.45%	+1000.0	-1000.0
No. 2 Irms1	×100	+2	+000.00%	+1000.0	-1000.0
No. 3 P1	×1	+1	+000.00%	+1000.0	-1000.0
No. 4 Q1	1/4	0	+000.00%	+1000.0	-1000.0
No. 5 λ1	AUTO	-1	+000.00%	+1000.0	-1000.0
No. 6 f1	AUTO	-2	+000.00%	+1000.0	-1000.0
No. 7 Uthd1	MANUAL	0	+000.00%	+1234.0	-5678.0
No. 8 Ithd1	MANUAL	0	+000.00%	+1000.0	-1000.0

NOTE

- The **[MAX]** and **[MIN]** settings are not available when using a scale setting other than **[MANUAL]**.
- No trend graph will be generated if the **[MAX]** value is less than the **[MIN]** value, or if the **[MIN]** value is greater than the **[MAX]** value.

Value entry dialog box

Entering values



Select the value you wish to enter.

Enter the selected value at the input cursor position with the **ENTER** key.

Accept: Accept the entered value by pressing the **F5** or the **ENTER** key while **OK** is selected.



NOTE The value of the minimum digit is fixed to 0. If the input cursor is at the minimum digit, you will not be able to enter any value.

Entering the decimal point



Select the [.]

Move the decimal point to the input cursor position with the **ENTER** key.

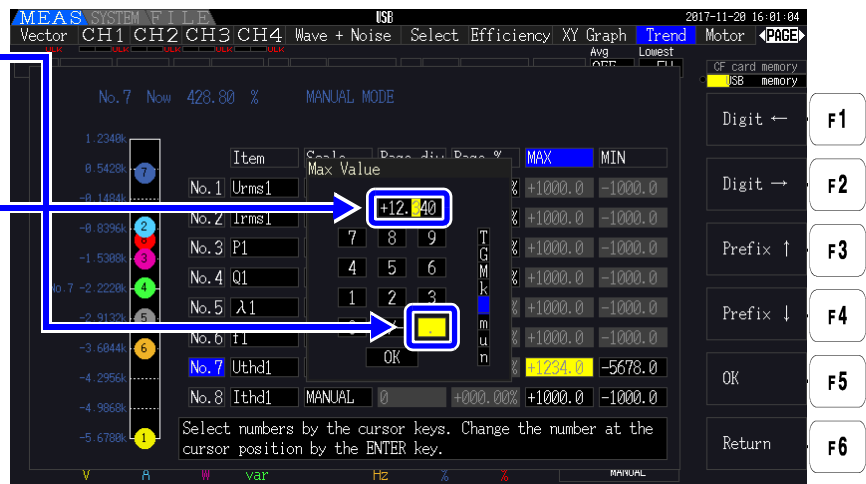

NOTE

- No decimal point can be entered if the input cursor is located at the maximum digit.
- The input cursor will skip the decimal point position. If you wish to set a whole number, move the input cursor to the minimum digit and enter the decimal point.

Changing the sign



Select the [+/-]

Change the sign of the entered value with the **ENTER** key.



MEAS SYSTEM FILE USB 2017-11-20 16:01:25

Vector CH1 CH2 CH3 CH4 Wave + Noise Select Efficiency XY Graph Trend Motor <PAGE>

No. 7 Now 426.80 % MANUAL MODE

Item	Scale	Max Value	Unit	MAX	MIN
No. 1 Urms1		2.340	%	+1000.0	-1000.0
No. 2 Irms1			%	+1000.0	-1000.0
No. 3 P1			%	+1000.0	-1000.0
No. 4 Q1			%	+1000.0	-1000.0
No. 5 λ1			%	+1000.0	-1000.0
No. 6 f1			%	+1000.0	-1000.0
No. 7 Uthd1			%	+1294.0	-5678.0
No. 8 Ithd1	MANUAL	0	+000.00%	+1000.0	-1000.0

Select numbers by the cursor keys. Change the number at the cursor position by the ENTER key.

Digit ← F1
Digit → F2
Prefix ↑ F3
Prefix ↓ F4
OK F5
Return F6

Move the input cursor

Move the cursor left or right with the **F1** key or **F2** key, respectively.

NOTE The input cursor only appears at value digits. It will skip the decimal point.

Selecting the unit prefix

Select the unit prefix with the **F** key.

Prefixes:
T, G, M, k, None, m, u, n

MEAS SYSTEM FILE USB 2017-11-20 16:01:44

Vector CH1 CH2 CH3 CH4 Wave + Noise Select Efficiency XY Graph Trend Motor <PAGE>

No. 7 Now 426.80 % MANUAL MODE

Item	Scale	Max Value	Unit	MAX	MIN
No. 1 Urms1		2.340M	%	+1000.0	-1000.0
No. 2 Irms1			%	+1000.0	-1000.0
No. 3 P1			%	+1000.0	-1000.0
No. 4 Q1			%	+1000.0	-1000.0
No. 5 λ1			%	+1000.0	-1000.0
No. 6 f1			%	+1000.0	-1000.0
No. 7 Uthd1			%	+1294.0	-5678.0
No. 8 Ithd1	MANUAL	0	+000.00%	+1000.0	-1000.0

Select numbers by the cursor keys. Change the number at the cursor position by the ENTER key.

Digit ← F1
Digit → F2
Prefix ↑ F3
Prefix ↓ F4
OK F5
Return F6

NOTE Values shown on the trend graph are displayed after being adjusted for the appropriate decimal point position and unit prefix. Consequently, the decimal point positions and prefixes for values shown on the trend graph and entered values may not agree.

Changing System Settings

Chapter 6

On the [\[System\]](#) page, view the instrument's version information and change settings such as display language, beep sounds, and screen colors.

[System] Page Display

Press **SYSTEM** followed by **◀** **▶** to display the [\[System\]](#) page.

Select the display language. (p. 130)

Select screen colors. (p. 130)

Enable/disable beep sounds. (p. 130)

Set LCD backlighting. (p. 130)

Set the system's real-time clock. (p. 131)

Execute system reset. (p. 132)

Check the instrument model.

View the instrument's serial number.

View the instrument's firmware version number.

Check the instrument's MAC address.

Select the startup (initial) screen. (p. 131)

Configure zero suppression. (p. 131)

Set the CSV file format.

Setting Item Descriptions

Use the  keys to select an item, and the **F** keys to change its setting.

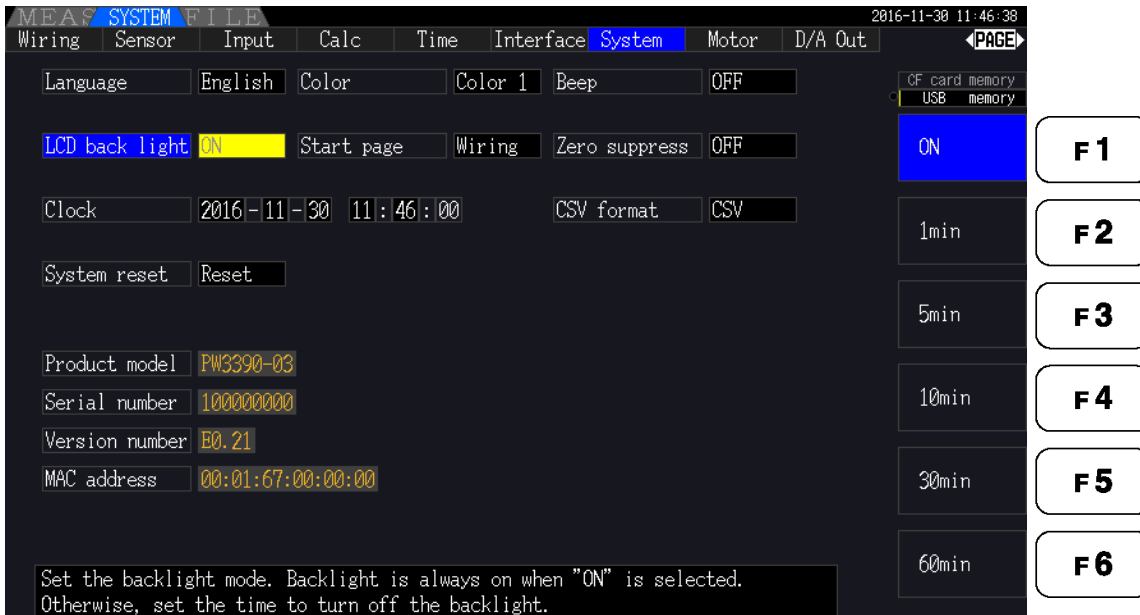

The screenshot shows the 'MEAS SYSTEM FILE' menu with the 'System' tab selected. The 'LCD back light' setting is currently set to 'ON'. A list of options is displayed on the right, with function keys F1 through F6 corresponding to each option: F1 for ON, F2 for 1min, F3 for 5min, F4 for 10min, F5 for 30min, and F6 for 60min. A note at the bottom of the screen reads: 'Set the backlight mode. Backlight is always on when "ON" is selected. Otherwise, set the time to turn off the backlight.'

Language Select the language for the display.

English	English
Japanese	Japanese
Chinese	Chinese

Color Select the screen color scheme.

Color1	Black
Color2	Green
Color3	Blue
Color4	Gray
Color5	Purple

Beep Set to enable or disable key-press beep sounds.

ON	Beeps are enabled.
OFF	Beeps are disabled.

LCD back light The backlight can be set to turn off after a period of key inactivity. The screen reappears upon pressing any key.

ON	The screen backlight remains on.
1min/5min/10min/ 30min/60min	The screen blanks after the selected period of inactivity.

Start page

Select the screen to appear when the instrument is turned on.

Wiring	Initially display the wiring screen.
Last scr	Initially displays the Measurement screen that was displayed when the instrument was turned off.

Zero suppress

This setting establishes a level below which values are treated as zero for data acquisition purposes.

OFF	Zero suppression is disabled. To display small values, disable zero suppression.
0.1% f.s./0.5% f.s.	Measured values below the selected level are treated as zero.

Clock

Sets the internal real-time clock. Data is saved and managed according to this setting.

+1↑ /-1↓	Increments/decrements by 1.
+10↑ /-10↓	Increments/decrements by 10.
Set	Press to apply setting changes (resets seconds to 00).

CSV file format

Sets the CSV file format. This setting applies to measurement data saved manually as well as all measurement data and waveform data saved automatically.

CSV	Use commas (",") as delimiters in measurement data. Use periods (".") as decimal points.
SSV	Use semicolons (";") as delimiters in measurement data. Use commas (",") as decimal points.

6.1 Initializing the Instrument (System Reset)

If the instrument operates abnormally, see "Before returning for repair" (p. 224).
If the cause cannot be determined, perform a system reset.

1  Select the item

2 Press  [Reset].
(A dialog box appears.)

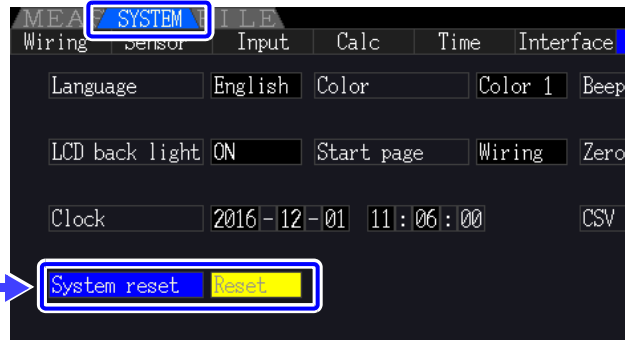

3  Enter /  Cancel



NOTE

System reset returns all except the display language and communication settings to their factory defaults. All measurement data is erased from the screen and from internal memory.
See "6.2 Factory Default Settings" (p. 133)

Power-On Reset

To return all instrument settings to their factory defaults, hold the  key while turning the power on. This is called a 'power-on reset'. All settings including the display language and communication settings are initialized.

1 Turn off the instrument power.
See "3.8 Turning the Power On and Off" (p. 36)

2 Press the  key while turning the power on, and hold the  key until the message "BOOT-KEY-RESET READY. Please release the SHIFT key." appears.

6.2 Factory Default Settings

The factory default settings are as follows.

Setting Item		Default Setting	Setting Item	Default Setting
Wiring		Mode 1 (1P2W x 4)	Folder	PW3390
Phase correction		OFF	RS com speed*	38400 bps
Sync source		U1, U2, U3, U4	IP address*	192.168.1.1
U range		600 V	Subnet mask*	255.255.255.0
U rect		RMS	Default Gateway*	0.0.0.0
VT rate		OFF	Language*	English
I range		Sensor Rating	Color	Color1
I rect		RMS	Beep	ON
CT rate		OFF	LCD back light	ON
LPF (Input)		OFF	Start page	Wiring
Integ mode		RMS	Zero suppress	OFF
Freq measure		U	CSV file format	CSV
Lowest freq		5 Hz	Motor Sync	DC 50 ms
Harm sync src		U1	LPF (Motor analysis options)	OFF
THD calc		THD-F	Freq source	f1
Δ -Y convert		OFF	CHA input	AnalogDC
Calculation method		TYPE1	CHA range	5 V
Efficiency	Pin1 to Pin3	P1	CHA scaling	1.0
	Pout1 to Pout3	P1	CHA unit	N•m
Noise	Sampling	100 kS/s	Rated torque	1
	Points	5000	Freq range fc	60 kHz
	Lowest noise	1 kHz	Freq range fd	30 kHz
	Analysis CH	CH1	CHB input	Pulses
	Window type	Hanning	CHB range	5 V
Averaging		OFF	CHB scaling	1.0
ZeroCross filt		Strong	CHB unit	r/min
AutoRange type		Narrow	Max frequency	5 kHz
Interval		1 min	No. of pulses	2
Timer mode		OFF	Motor poles	4
Timer setting		1 min	CHZ	OFF
Real time		OFF	Wave output	ON
Sync control		Master	Freq f.s.	5 kHz
Sync event		HOLD	Integ f.s.	1/1
Media (Manual saving)		CF Card	Output range	2 V f.s.
Folder (Manual saving)		PW3390	Output items CH1 to CH16	Urms1
Auto save		OFF		

* Items not initialized by System Reset (initialized only by Power-On Reset, p.132).

NOTE

Settings for measurement display and recording data are also initialized.

Data Saving and File Operations

Chapter 7

The instrument supports saving of setting configurations, measurement data, waveform data, and screen images to CF card or USB flash drive (only setting configurations can be reloaded).

USB Flash Drive

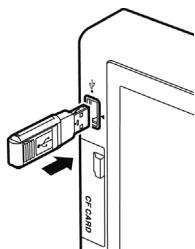

Connector	USB type A
Electrical specification	USB2.0
Power supply	500 mA maximum
No. of ports	1
Compatible USB device	USB Mass Storage Class

CF Card

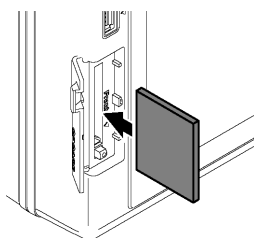

Slot	TYPE1 × 1
Supported card	Compact Flash memory card (at least 32 MB)
Max. supported capacity	Up to 2 GB
Data format	MS-DOS (FAT16/FAT32) format

P: supported ÷ not supported

Storable Content	CF card	USB flash drive	See
Manual save measurement data	P	P	p. 141
Auto-save measurement data	P	–	p. 143
Save waveforms	P	P	p. 147
Save screen image	P	P	p. 149
Save setting configuration	P	P	p. 151
Load setting configuration	P	P	p. 151
Copy files and folders	P	P	p. 154

Important

- Use only PC Cards sold by Hioki. Compatibility and performance are not guaranteed for PC cards made by other manufacturers. You may be unable to read from or save data to such cards.

Hioki options

PC cards (CF card and adapter)

9728 PC CARD 512M

9729 PC CARD 1G

9830 PC CARD 2G

(adapter is not used with this Analyzer)

- Format new CF cards before use.
[See "7.3 Media Formatting" \(p. 139\)](#)

7.1 Inserting and Removing Storage Media

Insert and remove CF cards and USB flash drives as follows.

CF card

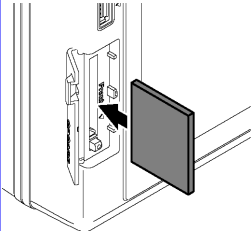

To insert a CF card

Open the CF card slot cover, and with the ▲ mark pointing toward the screen, insert the card in the direction shown by the arrow as far as it will go.

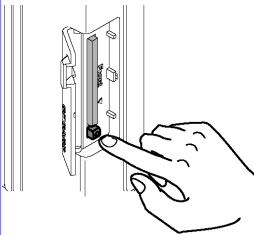

To remove a CF card

Open the CF card slot cover, press the eject button so that it pops out, then press it again to eject the CF card.

USB flash drive

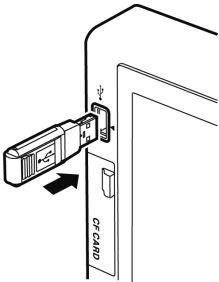

Insert a USB flash drive in the USB port on the front of the instrument (and just pull it out to remove).

- Do not insert any device other than a USB flash drive.
- Not all commercially available USB flash drives are compatible.

⚠ CAUTION

- Hioki cannot recover data from damaged or faulty storage media resulting from abnormalities. We are also unable to provide compensation for such data loss, regardless of the contents or cause of the failure or damage. We recommend making backups of all important data.
- Avoid forcing insertion of storage media backwards or in the wrong orientation, as this could damage the media or instrument.
- If the eject button is sticking out too far, push it in and then insert the CF card all the way into the slot. Inserting the CF card while the eject button is sticking out may damage the instrument. If unable to insert the CF card all the way, do not force it. Instead, press the eject button so that the CF card is ejected. Then press the eject button again and insert the CF card all the way into the slot.
- Exercise care when using such products because static electricity could damage the CF card or cause a malfunction of the instrument.
- The Media-Busy indicators (p. 21) light green when storage media is being accessed. Do not turn the instrument off while an indicator is lit. Also avoid removing storage media while it is being accessed, as that may corrupt stored data.
- Remove the storage media when transporting the instrument. Otherwise, the instrument or media could be damaged.
- Do not move the instrument with a USB flash drive installed. Otherwise, the instrument or media could be damaged.
- Some USB flash drives are easily affected by static electricity. Be careful handling the USB flash drive to avoid damage to the drive or instrument malfunctions due to static electricity.
- Some USB flash drives may prevent the instrument from turning on or recognizing the drive when inserted. In this case, turn the instrument on before inserting the USB flash drive. We recommend testing a USB flash drive before use.

NOTE

Storage media have a limited usable lifetime. After long-term use, data reading and writing will fail, at which time the media must be replaced.

7.2 The File Operation Screen

The File Operation screen is described below.

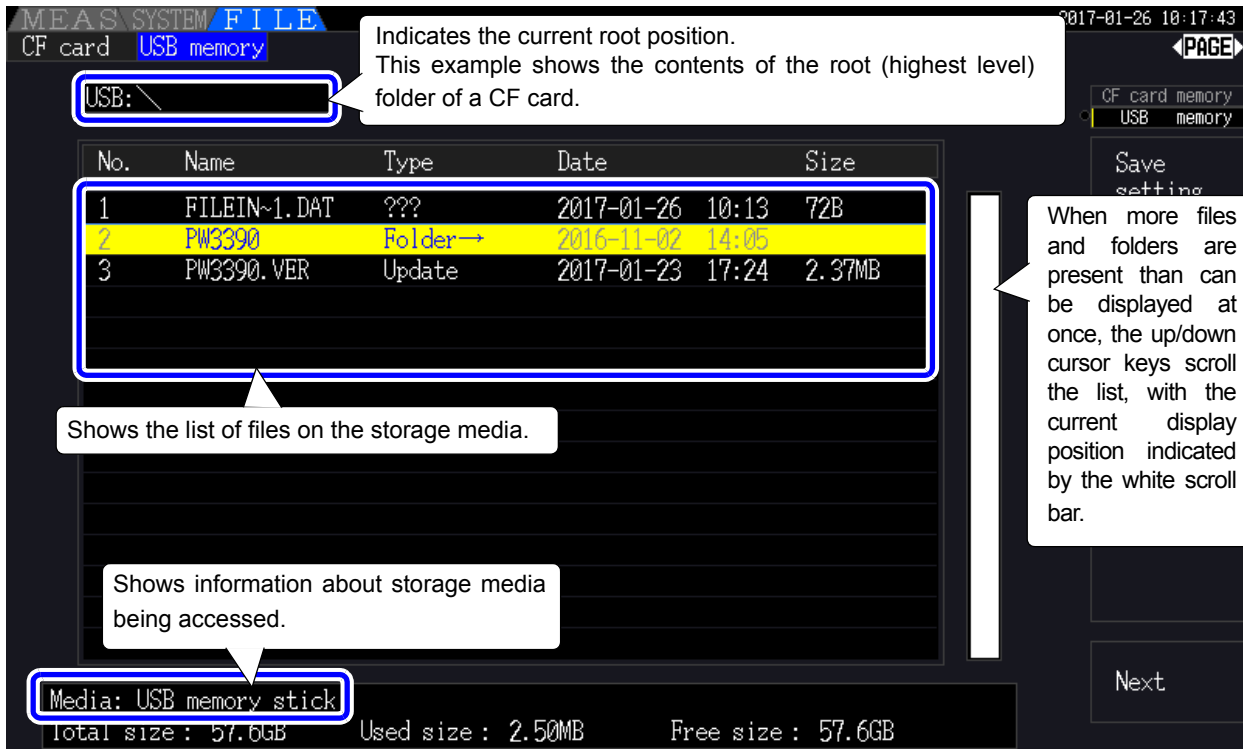

NOTE The File Operation screen is not available during auto-saving.

About File Types

The following file data types may be stored.

Name	Type (file extension)	Description
M3390nnn.CSV	CSV	Manually saved measurement data
MMDDnnkk.CSV	CSV	Auto-saved measurement data
W3390nnn.CSV	CSV	Waveform data
H3390nnn.BMP	BMP	Screen capture image data
xxxxxxx.SET	SET	Setting configuration data
F3390nnn.CSV	CSV	Noise data
xxxxxxx	Folder →	Folder (no extension)
xxxxxxx	???	Files cannot be used and saved on this unit.

- In this table, 'nnn' and 'nn' indicate a serial number (000 to 999 or 00 to 99) within the same folder, and 'kk' is a serial number of a split file when the file size exceeds 100 MB. MMDD indicate month and day.
- Setting configuration files can be optionally assigned names (up to eight characters)

Changing Folders, Selecting the Root Folder

- From the root, press **ENTER** or the right cursor key to display the contents of the currently selected folder.
- Press the left cursor key to return to the root folder.
- Folders within folders other than the root are not accessible.

7.3 Media Formatting

Format a media if it is not already formatted (initialized).
Insert the media to be formatted (p. 136), and start formatting.

Formatting procedure

FILE

← →

Display the page for the media you wish to format.

F6

F3

(The format confirmation dialog appears.)

To execute: **ENTER**

To cancel: **ESC / On**

A dialog appears when formatting is finished.

No.	Name	Type	Date	Size
1	PWG3590	Folder→	2016-11-16 14:54	
2	FILEIN-1.DAT	???	2016-11-16 14:38	55B

Media: CF card
Total size: 999MB Used size: 32.0KB Free size: 999MB

Next **F6**

No.	Name	Type	Date	Size
1	PWG3590	Folder→	2016-11-16 14:54	
2	FILEIN-1.DAT	???	2016-11-16 14:38	55B

Media: CF card
Total size: 999MB Used size: 32.0KB Free size: 999MB

Format **F3**

NOTE

Formatting erases any data stored on the media so that it cannot be recovered. Execute only after confirming that no important files will be lost. We recommend keeping a backup of any precious data stored on a media.

Upgrade **F4**

This key is not used other than when upgrading the firmware.

7.4 Saving Operations

Manual Saving (p. 141)

Save destination	CF card USB flash drive
Saving method	Press SAVE

- When the storage media is full, saving stops.

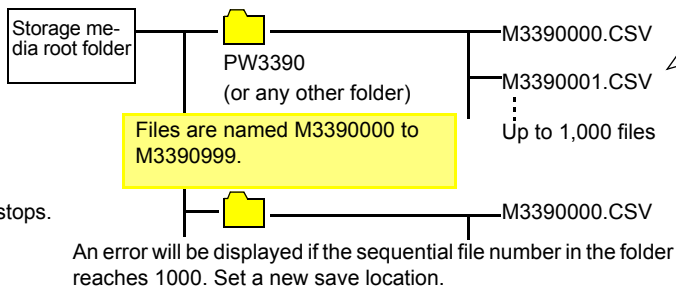

A new file is created when any of the following are changed:
Save destination folder
Wiring mode
Measurement objects to be saved

Auto-saving (p. 143)

Save destination	CF card
Saving method	Automatically, according to timing control settings

- When an auto-saved file exceeds 100 MB, a new file is created and saving continues.
- Up to 100 files per day can also be saved to the root folder.
- When the storage media is full, saving stops.

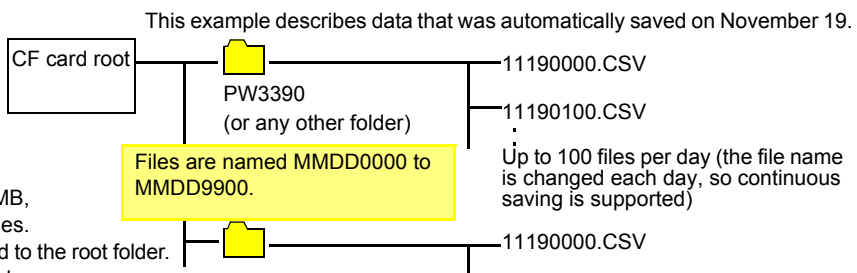

Waveform Data Saving (p. 147)

Save destination	CF card USB flash drive
Saving method	Press F6 on the [Wave + Noise] page of the Measurement screen

- When the storage media is full, saving stops.

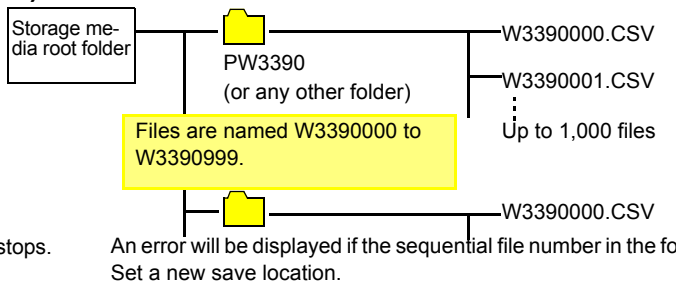

Screen Capture Image Saving (p. 149)

Save destination	CF card USB flash drive
Saving method	Display the screen to save, and press SHIFT and SAVE

- When the storage media is full, saving stops.

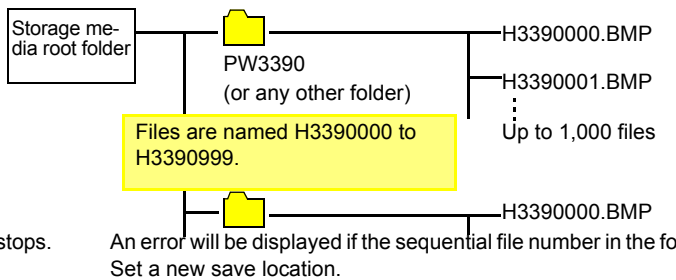

Saving Setting Configurations (p. 151)

Save destination	CF card USB flash drive
Saving method	Move to a folder on the File Operations screen, and press F1

- Files can also be saved to the root folder.
- When the storage media is full, saving stops.

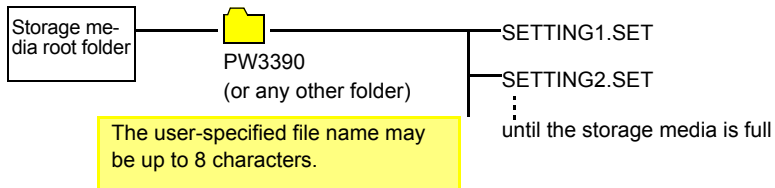

NOTE

- The maximum number of files to save in the root for manual save, waveform and screen copy is up to 512 files in FAT16 format.
- Changing the save destination or cycling the instrument resets the sequential numbers. Once the sequential numbers have been reset, newly created files are numbered sequentially skipping the existing numbers.

7.5 Measurement Data Saving

Measurement data can be saved either manually or automatically.
All measurement values including harmonics and peak values of FFT functions can be selected for saving.
Files are saved in CSV format.

NOTE Both manual and auto-saving are disabled while accessing storage media (Media-Busy indicator lights green, (p. 21)).

7.5.1 Manually Saving Measurement Data

Press **SAVE** to save values measured at the time the key is pressed.
Specify the items to save beforehand.

- Saving Procedure**
1. Select the measurement items to save.
(See 7.5.3 (p.145))
 2. Select the save destination media and folder.
 3. Press **SAVE** when you want to save.
(The specified folder is automatically created and data saved.)

Save destination:	CF card or USB flash drive
File names:	Auto-generated, with CSV extensions M3390nnn.CSV ('nnn' is a serial number from 000 to 999 in the same folder) Example: M3390000.CSV
Remarks:	A new file is created the first time, after which data is added to the same file. However, when the save destination, wiring mode, or measurement items to save is changed, a new file is created and subsequent data saved to that.

NOTE

- Saved CSV files are only intended to be reloaded.
- The displayed data and saved data may not be equivalent due to the timing difference when saving the data by pressing the **SAVE** key. Use the HOLD function to save the same data.

Selecting the Save Destination

The diagram illustrates the process of selecting the save destination. It starts with the **SYSTEM** menu, which leads to the **[Interface]** page. From there, the user selects **[Media]** using the **F** keys. The screenshot shows the **Media** selection screen with **CF card** highlighted. The interface also displays various settings such as **Folder** (PW3390), **Auto save file** (OFF), **Recordable period**, **Items to save** (36/5000), **Interval** (1min), **RS com speed** (38400bps), and **LAN** settings (IP address: 192.168.1.1, Subnet mask: 255.255.255.0). The **SAVE** key is highlighted in the bottom right corner of the interface.

Selecting the Destination Folder and Measurement Items to Save

SYSTEM

Display the **[Interface]** page

For manual saving: **[Folder]**

For auto-saving: **[Folder]**
(Can be set when the auto save mode is ON.)

F1

(A dialog appears)

keys to select characters

Enter characters with the **F** keys

Enter: **F6**

Cancel: **ESC / ⏏**

MEAS SYSTEM FILE 2016-12-01 11:16:36

Wiring Sensor Input Calc Time **Interface** System Motor D/A Out

Sync control Master Sync event HOLD

manual saving

Media CF card

Folder PW3390

Folder PW3390

Recordable period : --- hour -- min

Items to save 36/2000 Voltage 12 items Integ 0 items
Current 12 items Harmonic 0 items
Power 8 items Others 4 items

Interval 1s

RS com speed 38400bps Adapter conf. Default

LAN DefaultGateway 0. 0. 0. 0

IP address 192.168. 1. 1 Subnet mask 255. 255. 255. 0

Set the folder for manual saving. Folder name is 8 characters in maximum.
Open name input dialog by F1 key.

Name Input **F1**

F2

F3

F4

F5

F6

MEAS SYSTEM FILE 2016-12-01 11:17:07

Wiring Sensor Input Calc Time **Interface** System Motor D/A Out

Sync control Master Sync event HOLD

Manual saving

Media CF card Manual saving

Folder PW3390

Recordable period : --- hour -- min

Items to save 36/2000 Voltage 12 items Integ 0 items
Current 12 items Harmonic 0 items
Power 8 items Others 4 items

Interval 1s

RS com speed 38400bps Adapter conf. Default

LAN DefaultGateway 0. 0. 0. 0

IP address 192.168. 1. 1 Subnet mask 255. 255. 255. 0

Select characters by cursor keys. Enter a character at cursor position by F1 or ENTER. Change the character position by F4 and F5.

Input **F1**

BS **F2**

Del **F3**

Pos ← **F4**

Pos → **F5**

OK **F6**

Dialog box setting items

Input	Enters the character at the cursor position. (The same as ENTER .)
BS	Deletes the character before the cursor position.
Del	Deletes the character at the cursor position.
Pos←/Pos→	Moves the cursor position.
OK	Accepts the entered folder name. After accepting, closes the dialog.

NOTE

Folder names can be up to eight characters.

7.5.2 Auto-Saving Measurement Data

Each measurement value can be automatically saved at the specified time. Items that have been specified beforehand are saved.

- Saving Procedure**
1. Select the measurement items to be saved.
(See 7.5.3 (p.145))
 2. Enable auto-saving and select the destination folder (as necessary).
(See Setting Auto-Saving below, and "Selecting the Destination Folder and Measurement Items to Save" (p. 142).)
 3. Set the save time.
(See 5.1 (p.109))
 4. Press **START/STOP** to start auto-saving (and press **START/STOP** again to stop).
(The specified folder is automatically created, and data saved therein.)

Save destination:	CF card only (Any USB memories are unavailable for the auto-save.)
File names:	Automatically generated from the starting date, with CSV extension. MMDDnnkk.CSV (MM: year, DD: day, nn: serial number from 00 to 99 in same folder, kk: consecutive number of file division when file size exceeds 100 MB) Example: 11040000.CSV (for the first file saved on November 4)

NOTE

- Interval-saved CSV files are only for reloading.
- While auto-saving is enabled, manual saving and waveform saving are not available.
- If the auto save is started while saving in manual, waveform, or screen copy, the several data may be missed.

Setting Auto-Saving

Display the **[Interface]** page

Select **[Auto save mode]**

The data save destination can be specified only when auto-saving is enabled.

NOTE

- The maximum number of data points that can be recorded (p. 145) depends in the interval time (longer intervals allow recording more data points).
- When auto-saving is disabled (**[OFF]**), the **[Folder]** cannot be set.
- Folder names can be up to eight characters.



Remaining available recording time

When **[Auto save mode]** is enabled, the remaining available recording time on the selected media is displayed. The displayed remaining time is an approximation calculated from the storage media capacity, number of recording items, and interval time.

Auto-Saving Operations

Timing controls available for auto-saving are as follows.

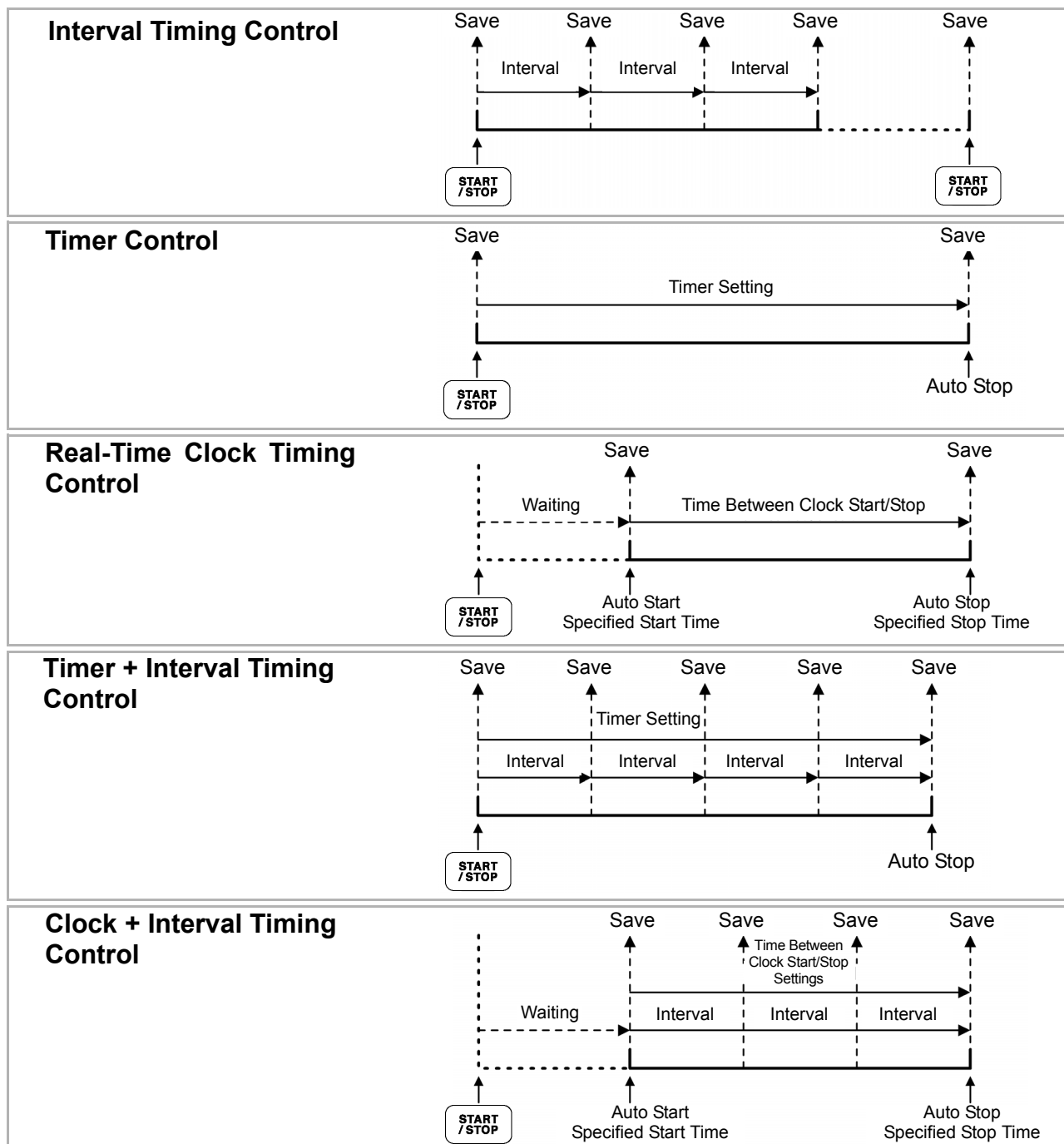

NOTE

- Settings cannot be changed while timing controls are enabled. Also, when auto-ranging is enabled along with timing control, the range that is active when **START/STOP** is pressed remains fixed.
- The all data is saved in the same file under timing control. When integration is reset, data is saved to a new file at the next start time.
- When the timer stop time and the interval ending time do not match, the timer stop time has priority, and the last interval is truncated.
- When the clock control stop time and the interval ending time do not match, the clock control stop time has priority, and the last interval is truncated.
- When the storage media becomes full during auto-saving, an error is displayed and saving stops. In that case, auto-saving can be resumed (using an automatically named file with the same name) by replacing the CF card with another (formatted) CF card. To OFF the interval, see (p. 111)

7.5.3 Selecting Measurement Items to Save

The items to be saved to storage media can be selected.

The number of items that can be recorded depends on the interval timing setting.

Interval	50ms	100ms	200ms	500ms	1s	Other
Maximum recordable items	130	260	520	1300	2600	5000

Setting Procedure

Setting Procedure

- Display the **[Interface]** page
- Select **[Items to save]**
- Select measurement contents with the **F** keys.
 - Press **F6** to select Noise peak, CH A, CH B, Pm, Slip and elapsed time.
- Select the items to be saved.
- Set by **F** keys* (Press **ENTER** to toggle off/on.)

Press **F6** (or **ESC/On**) to return to the previous page.
"O" indicates ON, blank indicates OFF, and "-" indicates not selectable.

No. of items to record
Indicates the number of data items enabled (set to "ON")

Maximum recording quantity
determined by the interval setting

Item name: Frequency
Set recording items of power. "O" means item to record. "-" means do not record the item. "-" is not selectable.

* Setting Contents

OFF	Saving disabled
ON	Saving enabled
All CH set	Sets all channels ON or OFF (not displayed when [Others] is selected). See "Using [All CH Set]" (p. 20)
All OFF	Sets all selected items OFF.
All ON	Sets all selected items ON.

When [Harmonic] is Selected

When **[Harmonic]** is selected for measurement contents to be saved, the output, highest, and lowest orders can be selected in addition to the items to be saved.

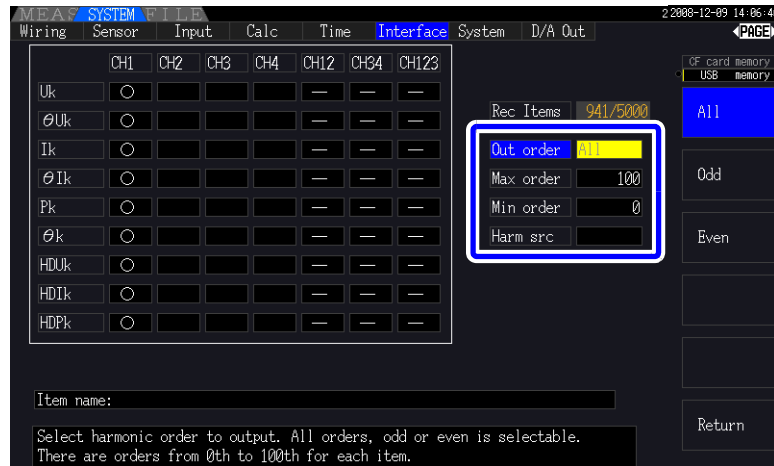

Out order

Select the orders for output.

All	Selects all harmonic orders.
Odd	Selects only odd harmonic orders.
Even	Selects only even harmonic orders.
Return	Returns to previous page.

Max order

Set the highest order to be output. Settable range is 0 to 100. This setting must be higher than the lowest order setting.

+1↑ /-1↓	Increment or decrement by 1.
+10↑ /-10↓	Increment or decrement by 10.
100th	Sets to the 100th order.

Min order

Set the lowest order to be output. Settable range is 0 to 100. This setting must be lower than the highest order setting.

+1↑ /-1↓	Increment or decrement by 1.
+10↑ /-10↓	Increment or decrement by 10.
0th	Sets the zero order (DC component).

Harm src (Harmonic source)

This setting stores the measured frequency of the harmonic sync source.

7.6 Saving Noise Data and Waveform Data

7.6.1 Saving Noise Data

This operation saves the waveform displayed on the [\[Wave + Noise\]](#) page as a CSV file.

Saving Procedure

The screenshot shows the MEAS SYSTEM interface with the 'Wave + Noise' page selected. The interface displays two frequency spectra plots (yellow and pink) and a table of noise analysis results. A diagram on the left shows the procedure: MEAS -> Display the [Wave + Noise] page -> F5 (Saves the noise waveform at this moment). The 'Save Noise' button (F5) is highlighted in the screenshot.

U1 - f (Hz)	rms (V)
31.90k	4.822
32.10k	4.797
63.90k	2.320
64.10k	2.300
48.20k	1.598
47.80k	1.957
80.20k	1.757
79.80k	1.724
112.40k	0.995
16.20k	0.883

I1 - f (Hz)	rms (A)
31.90k	0.656
32.10k	0.679
48.20k	0.208
16.20k	0.208
47.80k	0.205
15.80k	0.203
63.90k	0.191
64.10k	0.189
80.20k	0.124
79.80k	0.120

Save destination: CF card, USB flash drive
(Save destination setting is the same as for Manual saving (p. 141))

File names: Auto generated, with CSV extension
F3390nnn.CSV ("nnn" is serial number 000 to 999 within the same folder)
Example: F3390000.CSV

NOTE

- Data is saved for channels for which noise analysis calculations have been enabled.
- Noise waveforms cannot be saved during auto-saving operation.
- Voltage noise and current noise are saved together as noise waveform data for each frequency being analyzed.

See "4.6 Viewing Noise Measurement Values (FFT Function)" (p. 85)

7.6.2 Saving Wave Data

This operation saves the waveform displayed on the **[Wave + Noise]** page as a CSV file.

Saving Procedure

MEAS

Vector CH1 CH2 CH3 CH4 **Wave + Noise** Select Efficiency XY Graph Trend Motor **PAGE**

HSync U1 1P2W Sync U1 U: Manu **30V** I: Manu **20A** OFF OFF 5Hz

Time scale ms/div CH1 U_x 1 I_x 1 Lowest noise 1 kHz

U1 - f (Hz) rms (V)

31.90k	4.797
32.10k	4.775
63.90k	2.331
64.10k	2.317
48.20k	1.991
47.80k	1.955
80.20k	1.773
79.80k	1.736
112.40k	0.902
16.20k	0.680

I1 - f (Hz) rms (A)

31.90k	0.682
32.10k	0.676
48.20k	0.207
16.20k	0.205
47.80k	0.204
15.80k	0.203
63.90k	0.192
64.10k	0.191
80.20k	0.124
79.80k	0.121

U/I **F1**

CH **F2**

Noise **F3**

Wave+Noise **F4**

Save Noise **F5**

Save Wave **F6**

Display the **[Wave + Noise]** page

F6

(Saves the waveform at this moment)

Save destination: CF card, USB flash drive
(Save destination setting is the same as for Manual saving (p. 141))

File names: Auto generated, with CSV extension
W3390nnn.CSV ("nnn" is serial number 000 to 999 within the same folder)
Example: W3390000.CSV

NOTE

- Items with screen display turned off will not be saved.
- Waveforms cannot be saved during auto-saving operation.
- Waveform data is saved as Peak-Peak compressed Max/Min data set.
[See "4.5.1 Displaying Waveforms" \(p. 81\)](#)
- In saved files that contain waveform data, headers will precede values as listed below:
For maximum values of voltage waveforms, WAVE_U1(MAX) to WAVE_U4(MAX)
For minimum values of voltage waveforms, WAVE_U1(MIN) to WAVE_U4(MIN)
For maximum values of current waveforms, WAVE_I1(MAX) to WAVE_I4(MAX)
For minimum values of current waveforms, WAVE_I1(MIN) to WAVE_I4(MIN)

7.7 Saving Screen Capture Images

The currently displayed screen can be saved as a 256-color bmp bitmap file (BMP file name extension).

Press **SHIFT** and **SAVE** to save a bitmap image of the current screen to the specified media.

Save destination:	CF card, USB flash drive (Save destination setting is the same as for Manual saving, (p. 141))
File names:	Auto generated, with CSV extension H3390nnn.BMP ("nnn" is serial number 000 to 999 within the same folder) Example: H3390000.BMP

NOTE You can also save screen capture images while auto-saving is in progress. However, auto-save operation takes precedence, and the screen capture operation will not be performed if the interval is 1 s or less.

7.8 Loading Screenshots

You can load previously saved screenshot files and display their contents on the screen.

Loading screenshots (example illustrating how to load an image file inside a folder on the CF card)

Display the [CF card] page

keys to select a screenshot file

F5 OR ENTER

Press any key to return to the previous screen.

No.	Name	Type	Date	Size
16	F3390003.CSV	CSV	2017-07-24 16:43	5.55KB
17	W3390001.CSV	CSV	2017-07-24 16:43	184KB
18	W3390002.CSV	CSV	2017-07-24 16:43	184KB
19	F3390004.CSV	CSV	2017-07-24 17:53	54.3KB
20	M3390002.CSV	CSV	2017-07-26 14:03	582B
21	H3390006.BMP	BMP	2017-07-26 14:04	63.7KB
22	F3390005.CSV	CSV	2017-08-03 09:35	31.8KB
23	F3390006.CSV	CSV	2017-08-08 10:47	32.3KB
24	F3390007.CSV	CSV	2017-08-08 16:43	30.8KB
25	W3390003.CSV	CSV	2017-08-08 16:43	923KB
26	M3390003.CSV	CSV	2017-08-23 17:11	624B
27	08230000.CSV	CSV	2017-08-23 17:15	2.58KB
28	M3390004.CSV	CSV	2017-09-07 17:01	588B
29	F3390008.CSV	CSV	2017-09-29 16:15	28.9KB
30	H3390007.BMP	BMP	2017-11-02 11:43	47.7KB

Media: CF card
Total size: 492MB Used size: 14.3MB Free size: 478MB

Save setting F1
Load setting F2
Make folder F3
Copy to USB drive F4
Load BMP F5
Next F6

NOTE

- Do not open images that were not saved by the PW3390.
- For more information about how to load a file inside a folder, see "7.2 The File Operation Screen" (p. 138).

7.9 Saving Setting Configurations

Various instrument settings can be saved to storage media as settings files.

Save Procedure (Example: saving to a CF card folder)

The diagram illustrates the save procedure for setting configurations to a CF card folder. It consists of two screenshots of the instrument's file manager interface and a series of instructions with corresponding button presses.

First Screenshot: The file manager shows the CF card memory. The file list is as follows:

No.	Name	Type	Date	Size
1	PW3390	Folder	2016-11-16 14:54	
2	FILEIN-1.DAT	???	2016-11-16 14:38	55B

The status bar at the bottom indicates: Media: CF card, Total size: 999MB, Used size: 32.0KB, Free size: 999MB.

Second Screenshot: The file manager shows the CF card memory with the folder selected. The file list is as follows:

No.	Name	Type	Date	Size
	Make setting file			
	File name	SETTING		

The status bar at the bottom indicates: Media: CF card, Total size: 999MB, Used size: 32.0KB, Free size: 999MB.

Instructions:

- Display the [CF card] page. (Press FILE)
- Use the left and right arrow keys to select a folder.
- Press the left arrow key or ENTER to open a folder.
- Press F1 (A dialog appears.)
- Use the left and right arrow keys to select a character.
- Enter characters with the F keys. Enter: F6. Cancel: ESC (F6).

Dialog Box Setting Items

Input	Enter the character at the cursor position. (Same as ENTER)
BS	Deletes the character to the left.
Del	Deletes the character at the cursor position.
Pos ←/Pos→	Moves the cursor position.
OK	Accepts the entered file name. The dialog closes when accepted.

Save destination: CF card, USB flash drive
(Save destination setting is the same as for Manual saving, (p. 141))

File names: User-named (up to eight characters), file name extension is SET
Example: SETTING1.SET

NOTE

- Language and communications settings are not saved.
- Setting configuration saving is not available during auto-saving.
- Folders within folders cannot be selected.

7.10 Reloading Setting Configurations

Previously saved settings can be reloaded from setting configuration files.

Loading Procedure (Example: loading a setting configuration file from a CF card folder)

The diagram illustrates the loading procedure through two screenshots of the instrument's file browser interface and a series of instructions:

- Step 1:** Press the **FILE** button to display the **[CF card]** page. The screenshot shows the file browser with the **CF card** selected. The file list includes:

No.	Name	Type	Date	Size
1	PWG390	Folder	2016-11-16 14:54	
2	FILEIN-1.DAT	???	2016-11-16 14:38	55B
- Step 2:** Use the left and right arrow keys to select a folder. In the screenshot, the **PWG390** folder is selected.
- Step 3:** Press the **ENTER** or **ENTER** key to open a folder. The screenshot shows the file browser displaying the contents of the **PWG390** folder:

No.	Name	Type	Date	Size
1	SETTING.SET	Setting	2016-11-16 15:02	1.05KB
- Step 4:** Use the left and right arrow keys to select a setting configuration file. In the screenshot, the **SETTING.SET** file is selected.
- Step 5:** Press the **F2** (or **ENTER**) key. A dialog appears. The screenshot shows the **Load setting** option highlighted on the right-hand side of the interface.
- Step 6:** Press **ENTER** to confirm the selection.
- Step 7:** Press **ESC / On** to cancel the operation.

NOTE

- In order to restore settings, the instrument model and sensor setup must be the same. Otherwise, the settings will not be restored. For example, the settings file for a PW3390-01 cannot be loaded by a PW3390-02.
- Loading a settings file saved by an instrument running firmware older than Version 2.00 on an instrument running Version 2.00 or newer firmware may cause the Measurement screen being displayed to change.
- With the exception of backing up settings before and after upgrading an instrument, it is not recommended to load settings files saved by an instrument running a different version of the firmware.

7.11 File and Folder Operations

7.11.1 Creating Folders

Both auto-saving and manual saving require that a save destination folder be created.
 Insert storage media before creating folders. (p. 136)

Creation Procedure

FILE

Display the [CF card] page

F3
(A dialog appears.)

keys to select a character

Enter characters with the F keys.

Enter: F6

Cancel: ESC / on

MEAS SYSTEM FILE 2016-11-16 14:55:12

CF card USB memory

CF card memory
USB memory

Save setting F1

Load setting F2

Make folder F3

Copy to USB drive F4

F5

F6

Media: CF card
Total size: 999MB Used size: 32.0KB Free size: 999MB

MEAS SYSTEM FILE 2016-11-16 15:05:26

CF card USB memory

CF card memory
USB memory

Input F1

BS F2

Del F3

Pos ← F4

Pos → F5

OK F6

Media: CF card
Total size: 999MB Used size: 48.0KB Free size: 999MB

Dialog Box Setting Items

Input	Enter the character at the cursor position. (Same as ENTER)
BS	Deletes the character to the left.
Del	Deletes the character at the cursor position.
Pos ←/Pos→	Moves the cursor position.
OK	Accepts the entered folder name. The dialog closes when accepted.

NOTE

- Folder names may be up to eight characters.
- Folders can only be created in the root folder.

7.11.2 Copying Files and Folders

Files can be copied between a CF card and USB flash drive.
 Insert the CF card and USB flash drive before copying. (p. 136)

File Copying Procedure (Example: copying the root files from a CF card to a folder on a USB flash drive)

FILE

Display the **[CF card]** page

keys to select the file

F4
 (The USB flash drive root folder contents appear in the dialog)

Press **ENTER** to accept

keys to select the folder to copy

or **ENTER** to open a folder

Copy: **F1**

Cancel Copy: **F6** (or **ESC / ⏎**)
 (A dialog appears when copying is finished.)

ENTER

CF card

No.	Name	Type	Date	Size
1	SETTING.SET	Setting	2016-11-16 15:02	1.03KB

Media: CF card
 Total size: 999MB Used size: 48.0KB Free size: 999MB

USB memory

No.	Name	Type	Date	Size
1	SPSERV-1	Folder→	2016-03-02 16:24	
2	FILEIN-1.DAT	???	2016-11-16 14:26	71B
3	H3390.VER	Version up	2016-10-07 09:59	2.23MB
4	PW3390	Folder→	2016-11-02 14:00	

Media: USB memory stick
 Total size: 57.6GB Used size: 3.90MB Free size: 57.6GB

If a duplicate file name exists:
 A dialog appears to confirm overwriting.
 To overwrite: **ENTER**
 To cancel copying: **ESC / ⏎**
 However, cannot overwrite the read only files.

NOTE

- Files can be copied from folders on the source storage media.
- Files and folders can be copied to the root folder on the destination storage media.
- If a duplicate file exists at the destination, an error is displayed. Change the folder name and try again.
 See "7.11.4 Renaming Files and Folders" (p. 157)

Folder Copying Procedure (Example: copying a folder from a CF card to a USB flash drive)

FILE

Display the **[CF card]** page

keys to select the folder

F4
(A dialog appears.)

Copy: **ENTER**

Cancel Copy: **ESC / On**

(A dialog appears when copying is finished.)

ENTER

CF card

No.	Name	Type	Date	Size
1	PW3390	Folder	2016-11-16 14:54	
2	FILEIN-1.DAT	???	2016-11-16 14:38	55B

Media: CF card
Total size : 999MB Used size : 32.0KB Free size : 999MB

Save setting **F1**

Load setting **F2**

Make folder **F3**

Copy to USB drive **F4**

F5

F6

Next

If a duplicate folder exists :

If a duplicate folder exists at the destination, an error is displayed. Change the folder name and try again.
See "7.11.4 Renaming Files and Folders" (p. 157)

NOTE

Folders can only be copied to the root folder.

7.11.3 Deleting Files and Folders

Files can be deleted from storage media.
Insert the storage media before deleting files. (p. 136)

Deleting Procedure (Example: deleting a file (or folder) from a CF card)

FILE

Display the [CF card] page

keys to select the file/folder to delete

F2
(A dialog appears.)

Delete: **ENTER**

Cancel Deletion: **ESC / ⏏**

(The selected file or folder is deleted. Deleting a folder also deletes any files within it.)

No.	Name	Type	Date	Size
1	PW3390	Folder	2016-11-16 14:54	
2	FILEIN-1.DAT	???	2016-11-16 14:38	55B

Media: CF card
 Total size : 999MB Used size : 48.0KB Free size : 999MB

Function keys: **F1** (Rename), **F2** (Delete), **F3** (Format), **F4** (Update), **F5**, **F6** (Next)

NOTE

To delete a file within a folder, open the folder and select the file.
 See "Changing Folders, Selecting the Root Folder" (p. 138)

7.11.4 Renaming Files and Folders

Files on storage media can be renamed.

Insert the storage media before renaming a file. (p. 136)

Renaming Procedure (Example: renaming a file (or folder) in the CF card)

FILE

Display the [CF card] page

keys to select the file or folder to rename

F1
(A dialog appears)

keys to select a character

Enter characters with the **F** keys.

Enter: **F6**

Cancel: **ESC / ⏏**

Media: CF card
Total size : 999MB
Used size : 32.0KB
Free size : 999MB

Media: CF card
Total size : 999MB
Used size : 48.0KB
Free size : 999MB

Dialog Box Setting Items

Input	Enter the character at the cursor position. (Same as ENTER)
BS	Deletes the character to the left.
Del	Deletes the character at the cursor position.
Pos ←/Pos →	Moves the cursor position.
OK	Accepts the entered file/folder name. The dialog closes when accepted.

NOTE

- Folder names may be up to eight characters.
- To rename a file within a folder, open the folder and select the file.
See "Changing Folders, Selecting the Root Folder" (p. 138)

Connecting External Devices Chapter 8

8.1 Connecting Multiple PW3390 (Synchronized Measurements)

Up to eight PW3390 can be connected with optional Hioki 9683 Connection Cable (for synchronous measurements).

When so connected, one PW3390 operates as primary (master) instrument over the others set as secondary (slave) instruments providing multi-instrument synchronous measurements.

The maximum delay of synchronization is 5 μ s/connection and is 5 μ s+50 ms for synchronization event.

The timing control functions can be applied to synchronous measurements.

See "5.1 Timing Control Functions" (p. 109)

The secondary (slave) PW3390s are synchronized by the primary (master) PW3390 for the following operations.

- Clock and data update timing (clock and data update timing of the secondary [slave] instruments are the same as those of the primary [master] instruments.)
- Timing control, integration start/stop and data reset (the **START/STOP** and **DATA RESET** keys on the primary [master] instrument also control the secondary [slave] instruments)
- Events (select from data hold, data saving, or screen capture)

CAUTION

- To avoid damaging the instrument, do not insert or remove connectors while the power is on.
- Establish a one-point common earth ground point for all instruments in the measurement system. Different grounding points could allow dangerous potential differences between the GND terminals of the primary (master) instrument and secondary (slave) instruments. If sync cables are connected under such conditions, malfunctions or damage could occur.

NOTE

Display the MEAS screen on both primary (master) instrument and secondary (slave) instruments, when executing time control, integration start/stop, data reset, and HOLDING event.

Connecting Multiple PW3390 with Sync Cables

This description uses an example of three PW3390.

Required items: Three PW3390s, two Model 9683 Connection Cables

- Procedure**
1. Verify that all PW3390s are turned off.
 2. As shown below, connect the sync cables between the OUT and IN terminals of the primary (master) instrument and each secondary (slave) instrument.
 3. Turn each instrument on in the following order: primary (master) instrument, secondary (slave) instrument 1, secondary (slave) instrument 2 (turn the instruments off in the reverse order).

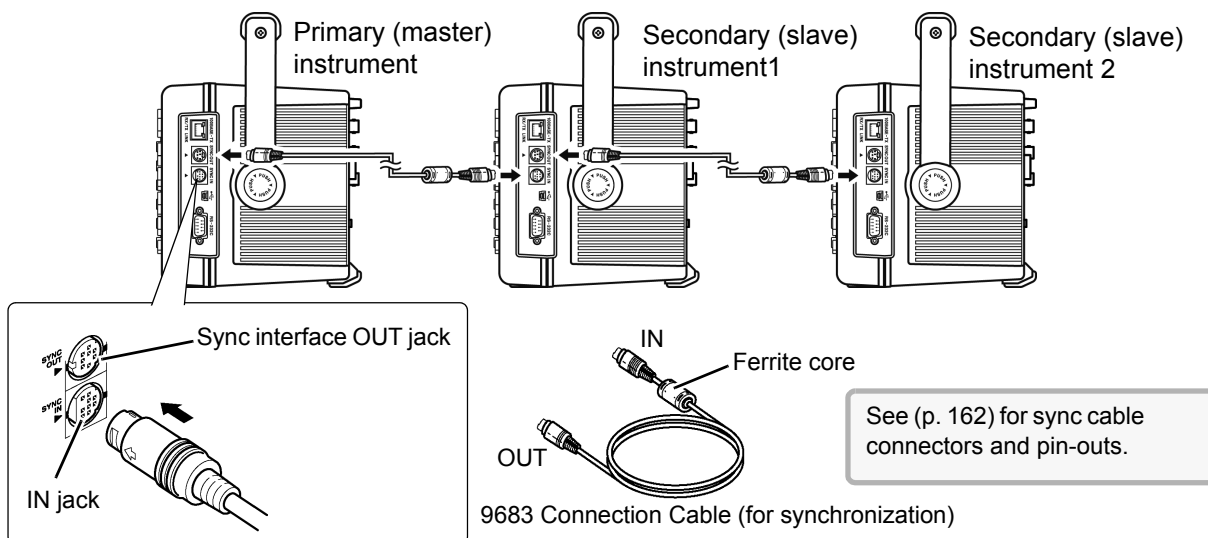

NOTE

- As a single measurement system, settings are made only on the primary (master) instrument.
- During synchronous control, the 9683 Connection Cable conduct control signals. Never disconnect a sync cable during synchronous control, as the control signals would be interrupted.
- The IN and OUT ends of the 9683 Connection Cable are different. Do not apply excessive insertion force.
- Turning secondary (slave) instruments on first may result in synchronization errors.

Instrument Settings for Synchronous Measurement

Set each instrument to be either the primary (master) instrument or a secondary (slave) instrument. These settings are made on the **[Interface]** page of the Setting screen.

Setting Procedure

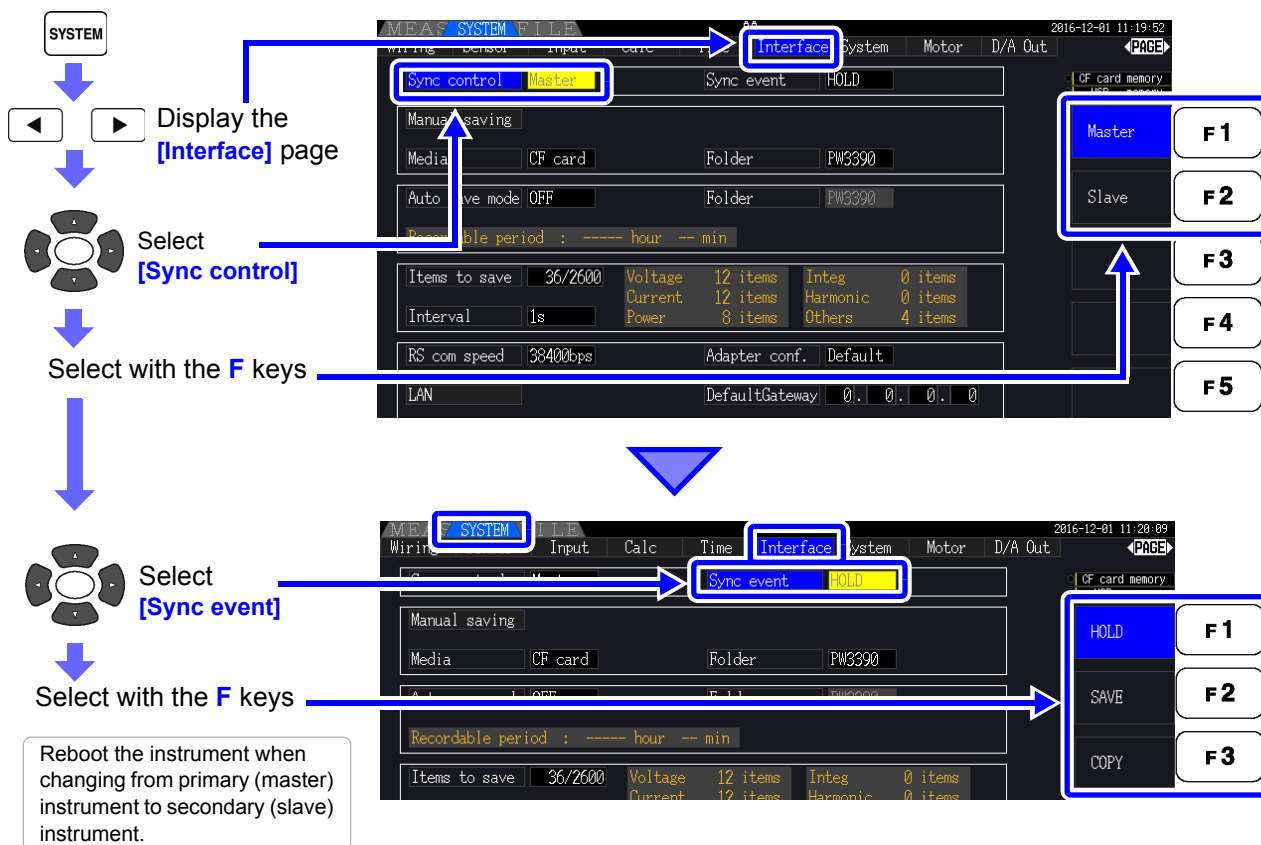

Sync event

Select the events to be synchronized (Settings of primary [master] instrument are reflected on the secondary [slave] instruments)

HOLD	Pressing HOLD on the primary (master) instrument activates Data Hold on all instruments.
SAVE	Pressing SAVE on the primary (master) instrument executes manual saving on all instruments.
COPY	Pressing SHIFT + SAVE on the primary (master) instrument captures the screen image on all instruments.

NOTE

- The RTC clock time, timer, and clock control start and stop times cannot be set on the secondary (slave) instruments.
- Selecting **[SAVE]** or **[COPY]** as a synchronized event sets the manual save destination folder appropriately and records data on each PW3390. See "7.5.1 Manually Saving Measurement Data" (p. 141), "7.7 Saving Screen Capture Images" (p. 149)
- To save measurement data to storage media with an interval time control combination, set the same interval setting on the primary (master) instrument and all secondary (slave) instruments, and enable auto-saving (set to ON). In this case, selecting **[SAVE]** as a synchronous event has no effect. See "5.1 Timing Control Functions" (p. 109), "7.5.2 Auto-Saving Measurement Data" (p. 143)
- Confirm no error display on the secondary (slave) instrument's screen when executing the synchronization event.

Sync Cable Pin-Outs

Sync Output (OUT): 8-pin mini-DIN plug pin configuration

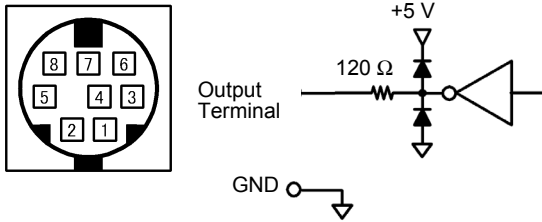

Pin No.	I/O	Function
1	O	Data Reset 0 for data reset
2	O	Start/Stop Integration 0: Start, 1: Stop
3	O	1-s clock
4	O	Event 0 for valid event
5	I	Primary (master) instrument/secondary (slave) instrument setting
6	-	Unused
7	I/O	GND
8	I/O	GND

Sync Input (IN): 9-pin mini-DIN plug pin configuration

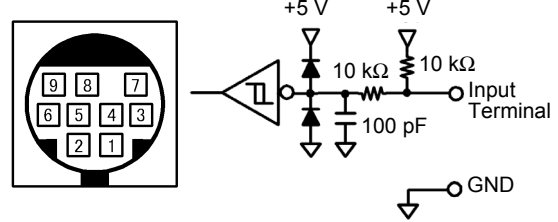

Pin No.	I/O	Function
1	I	Data Reset 0 for data reset
2	I	Start/Stop Integration 0: Start, 1: Stop
3	I	1-s clock
4	I	Event 0 for valid event
5	O	Primary (master) instrument/secondary (slave) instrument setting
6	-	Unused
7	I/O	GND
8	I/O	GND
9	-	Unused

8.2 Controlling Integration with External Signals

The synchronization interface provided by the instrument's SYNC IN terminal can be used to start, stop, reset integration, and event via 0 V/5 V logic signals or short/open contact signals.

Synchronization input (IN) 9-pin round connector pin layout and internal circuit diagram

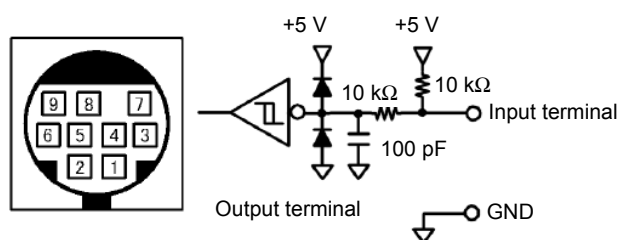

Provide a device that allocates functionality to pin numbers as follows to control the instrument. To connect the device to the instrument, cut off the 9683 Connection Cable's OUT connector and connect its internal wires to the control device, referring to their colors.

Pin number	Wire color	Functionality
1	Brown	Data reset The integration value is reset when this pin is low for an interval of at least 40 ms. This operation is valid only while integration is stopped.
2	Red	Integration start/stop Integration starts when this pin changes from high (5 V or open) to low (0V or shorted). Integration stops when this pin changes from low to high.
3	Orange	Unused
4	Yellow	Event When this pin is kept low for an interval of at least 40 ms, it operates in the same manner as the event set as the synchronization control function's synchronization event. See "Instrument Settings for Synchronous Measurement" (p. 161)
5	Green	Unused
6	Blue	Unused
7	Purple	Connect to ground (GND).
8	Gray	Connect to ground (GND).
9	-	Not present

NOTE

- Pin 5 (wire color: green) carries an output signal. Never short it with the other pins.
- Be sure to leave all unused pins open.
- Use this functionality with the instrument's synchronization control setting set to "Master."
- To start or stop integration, reset integration data, or perform event hold operation, display the Measurement screen. These operations cannot be performed on the Settings screen or the File Operation screen.

Connecting the cable

Required items: 9683 Connection Cable and external device that will be used to control the instrument. Connect the cable to the SYNC IN terminal on the right side of the instrument. The end of the cable with the ferrite clamp is the IN end.

SYNC interface

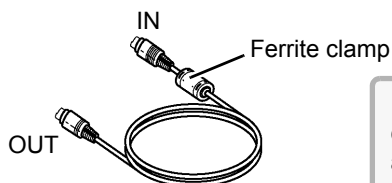
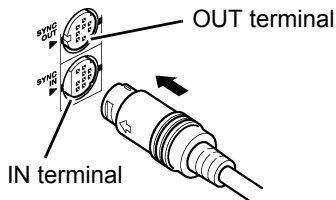

For more information about the connection cable's connector and pin layout, see p. 162.

9683 Connection Cable (For synchronization)

Control signal timing

External control signals are detected at the intervals shown in the timing charts below.

Integration start/stop (pin No. 2)

This signal controls when integration starts and stops. It has the same effect as pressing the **START/STOP** key on the instrument's control panel.

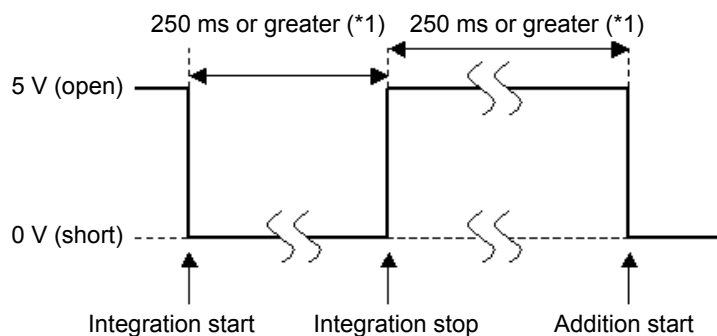

*1. When auto-saving is on, 1 s or more.

Integration value reset (pin No. 1)

This control signal resets the integration value to zero.

It has the same effect as pressing the **DATA RESET** key on the instrument's control panel.

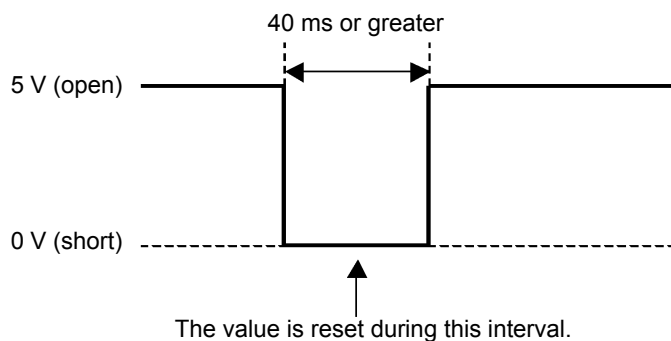
**NOTE**

- This signal is ignored if it is input while integration is ongoing.
- Input this signal after allowing an interval of at least 250 ms (or when auto-saving is on, at least 1 s) to elapse after integration stops.

Event (pin No. 4)

This signal controls hold, manual save, or screen capture operation. It operates in the same manner as the event set as the synchronization control function's synchronization event.

See "7.5.1 Manually Saving Measurement Data" (p. 141) and "7.7 Saving Screen Capture Images" (p. 149).

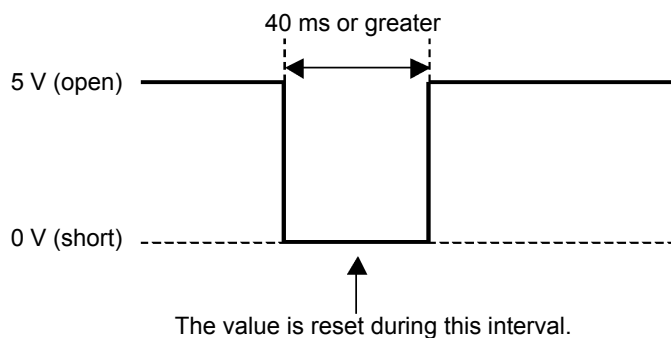
**NOTE**

- This signal is ignored if it is input while integration is ongoing.
- Input this signal after allowing an interval of at least 250 ms (or when auto-saving is on, at least 1 s) to elapse after integration stops.

CAUTION

- To avoid damaging the instrument, do not input a voltage of 5.5 V or greater.
- Input chatter-free signals as control signals.

8.3 Using Analog and Waveform D/A Output

Analog (p. 169) or waveform output (p. 170) is possible for PW3390-02 and PW3390-03.

- PW3390-02 Model with D/A output
- PW3390-03 Model with motor analysis and D/A output

Both D/A output provides 16 output channels, and is selectable from the basic measurement items.

! WARNING

To avoid electric shock and short circuits, turn the instrument and measurement line power off before connecting or disconnecting D/A outputs.

! CAUTION

- To avoid damage to the instrument, do not short-circuit or apply voltage between outputs.
- The outputs are not isolated from one another.

8.3.1 Connecting Application-Specific Devices to the Instrument

Use a mating D-sub connector to connect the D/A outputs to the desired device (oscilloscope, data logger/recorder).

To be safe, always turn off the instrument and devices before making connections. Turn the instrument and devices on after confirming the connections.

Output Circuit

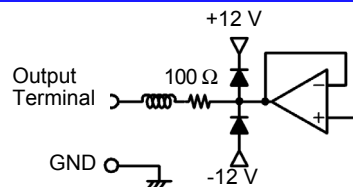

NOTE

The impedance of each output is approximately 100 Ω , so the inputs of the recording, DMM or other device to be connected should be high impedance (at least 1 M Ω).

See "Chapter 10 Specifications" (p. 193)

D/A Output Connector Pin-Out

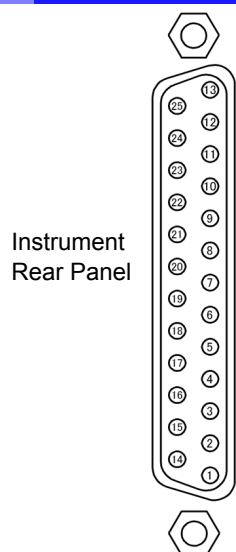

Pin No.	Output () waveform output content	Pin No.	Output
1	GND	14	GND
2	D/A1 (U1)	15	D/A9
3	D/A2 (I1)	16	D/A10
4	D/A3 (U2)	17	D/A11
5	D/A4 (I2)	18	D/A12
6	D/A5 (U3)	19	D/A13
7	D/A6 (I3)	20	D/A14
8	D/A7 (U4)	21	D/A15
9	D/A8 (I4)	22	D/A16
10	GND	23	GND
11	GND	24	GND
12	GND	25	GND
13	GND		

How to connect D/A output terminals

Use the supplied connector (DB-25P-NR, D819678-2R Japan Aviation Electronics Industry, Ltd.) or equivalent connector to connect to the D/A output terminal.

Rear panel

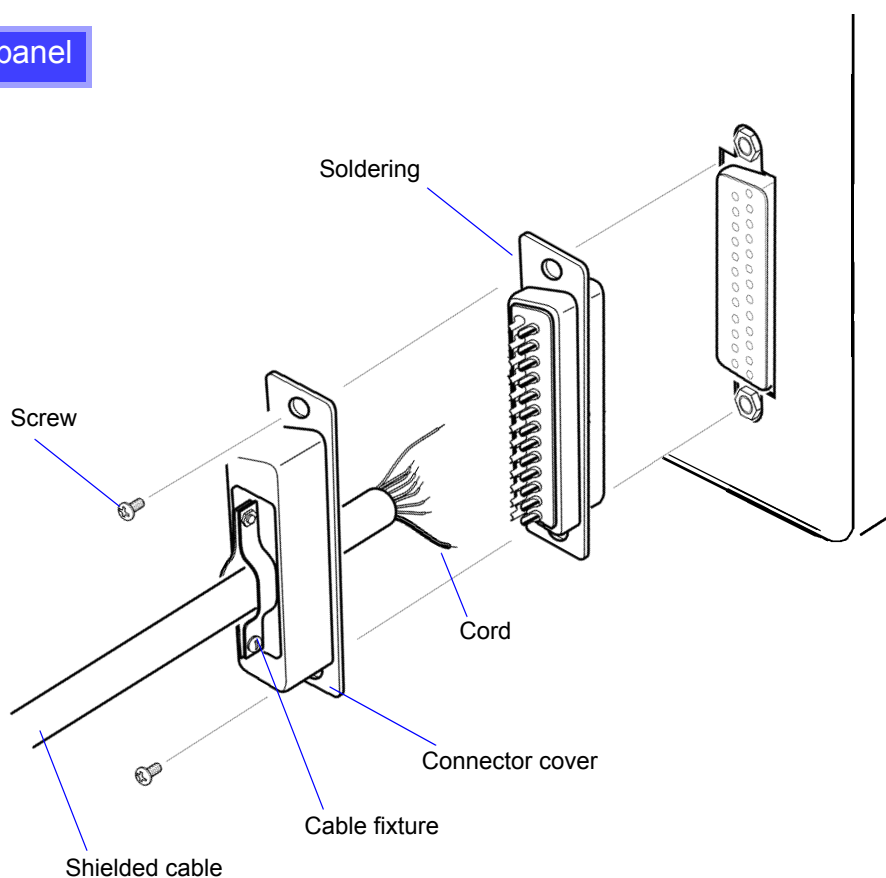

NOTE

- Solder the cord securely.
- Fix the connector and connector cover by the supplied screws (M2.6 × 6).
- Hold the connector cover when connecting or disconnecting the connector.
- Use the shielded cable for D/A output.
- Connect to the connector cover or cable fixture if the cable's shield is not grounded.

8.3.2 Output Item Selection

Select the items for D/A output. Up to 16 items can be selected.
Make the settings on the **[D/A Out]** page of the Setting screen.

Setting Procedure

SYSTEM

Display the **[D/A Out]** page

Select **[Wave output]**

Select with the **F** keys

ON: Enable waveform output
OFF: Disable waveform output

Select a channel to be set.

F1
(the pull-down menu appears)

Select parameter items
(sub parameter last)

Enter: **F1** or **ENTER**

Cancel: **F6** or **ESC/On**

Wave output ON

Output range 2V f.s.

CH1	U1	CH9	Urms1
CH2	I1	CH10	Urms1
CH3	U2	CH11	Urms1
CH4	I2	CH12	Urms1
CH5	U3	CH13	Urms1
CH6	I3	CH14	Urms1
CH7	U4	CH15	Urms1
CH8	I4	CH16	Urms1

Set the waveform monitor output mode. When the mode is ON, the output items are fixed as in below. CH1:U1, CH2:I1, ... CH7:U4, CH8:I4

MEAS SYSTEM FILE

Wave output ON

Output range 2V f.s.

Freq f.s. 5kHz

Integ f.s. 1/1

CH1	U1	CH9	Urms1
CH2	I1	CH10	Urms1
CH3	U2	CH11	Urms1
CH4	I2	CH12	Urms1
CH5	U3	CH13	Urms1
CH6	I3	CH14	Urms1
CH7	U4	CH15	Urms1
CH8	I4	CH16	Urms1

Move to a list of sub parameters by →. Return to parameters from the sub parameters by ←. Select a

Main parameter

Sub parameter

Pull-Down Menu
Select the main and sub parameter.

OFF F1
ON F2
F3
F4
F5
F6

OK F1
F2
F3
F4
F5
F6

Freq f.s.

Set this to output frequency in the analog output.

100 Hz, 500 Hz, 1 kHz, 5 kHz

For models equipped with motor analysis functionality, this is the same as the maximum motor measurement frequency setting. ("Max frequency" (p. 103))

Integ f.s.

Set for analog outputs. ("About Full-Scale Integration" (p. 169))

1/10, 1/2, 1/1, 5, 10, 50, 100, 500, 1000, 5000, 10000

Output range

Set the output voltage value for full scale input when waveform is output.

1 V f.s., 2 V f.s.

NOTE

- Waveform output can be selected only for channels 1 through 8 (D/A1 to D/A8). Channels 9 through 16 (D/A9 to D/A16) are for analog output only.
- The output parameters for LR8410 Link-compatible loggers are the same as the output parameters for channels 9 through 16 (D/A9 to D/A16).
See "8.4 Connecting the Instrument to a LR8410 Link-compatible Logger" (p. 174)
- Items selected on the MEAS, SYSTEM or FILE screen are always output.

About Analog Outputs

- Instrument measurement values are output as level-converted DC voltages.
- Voltage and current (sensor) inputs are isolated from the outputs.
- Select a basic measurement item for each of up to 16 outputs, or for up to eight waveform outputs.
- Long-term trend recording is available by connecting a data logger or recorder.

Specifications	
Output voltage	± 5 V DC (approx. ± 12 V max. See "Output Level" (p. 171) for the output ratings of each item)
Output impedance	$100 \Omega \pm 5 \Omega$
Output update rate	50 ms (depending on data update rate of selected item)
Full-scale frequency	100 Hz, 500 Hz, 1 kHz, 5 kHz (same as the maximum motor measurement frequency setting)
Full-scale integration	(1/10, 1/2, 1/1, 5, 10, 50, 100, 500, 1000, 5000, 10000) \times range

NOTE

- Positive and negative over-range voltages are approximately +6 and -6 V, respectively. (For voltage and current peaks are about 5.3 V.)
- Maximum output voltage that can possibly be output from malfunction, etc. is approximately ± 12 V.
- When using VT or CT ratio, the output is ± 5 V DC at the "VT/CT ratio \times range".
- When HOLDing, peak HOLDing or averaging, the output value is the result of these functions.
- During data hold when an interval time is set, outputs are updated at each interval after starting integration.
- When auto-ranging is enabled, the analog output levels change with auto-ranging. Be careful to avoid range conversion mistakes when measuring rapidly fluctuating values. Such mistakes can be avoided by using a fixed, manually selected range.
- Harmonic analysis data other than the basic measurement items is not available for output.

About Full-Scale Integration

The full-scale value is set for the analog output in integration.

For example, when the integration value is less than the full scale value, the time for the integration value to reach full-scale is long, so D/A output voltage changes slowly.

Conversely, when the integration value is larger than the full-scale value, the time to reaching the full-scale value becomes short, and D/A output voltage changes quickly.

The full scale value of integrated power can be changed for the D/A output by setting the integration full scale.

About Waveform Outputs

- Output signals are waveforms of the instantaneous values of input voltages and currents.
- Voltage inputs and current sensor inputs are mutually isolated.
- Combine with an oscilloscope to observe waveforms of phenomena such as device inrush current.

Specifications	
Output voltage	Select from either ± 1 V or ± 2 V, crest Factor 2.5 or higher
Output impedance	$100 \Omega \pm 5 \Omega$
Output update rate	500 kHz

NOTE

- D/A1: U1, D/A2: I1, D/A3: U2, D/A4: I2, D/A5: U3, D/A6: I3, D/A7: U4, D/A8: I4
- Waveform clipping occurs at approximately ± 7 V.
- Maximum output voltage that can possibly be output from malfunction, etc. is approximately ± 12 V.
- When using VT or CT ratio, the instrument outputs a voltage that is obtained by multiplying the range by the VT or CT ratio.
- Waveform output consists of uninterrupted instantaneous values, regardless of data hold, peak hold, or averaging operations.
- When auto-ranging is enabled, the analog output levels change with auto-ranging. Be careful to avoid range conversion mistakes when measuring rapidly fluctuating values. Such mistakes can be avoided by using a fixed range. It is recommended to use a fixed range for this type of measurement.

8.3.3 Output Level

Full-scale D/A output span is ± 5 V DC. This corresponds to the full-scale measurement input spans as follows.

Selected Output Item	Full Scale
Voltage and current of each channel. Sum of voltage and current (dc, pk+ and pk- for each U1 to U4, I1 to I4, U12, U34, U123, I12, I34, or I123) Motor analysis options (CH A, CH B, Pm, Slip)	dc, CH A, CH B, Pm, Slip: Measurement range (with polarity) pk+, pk-: Measurement range (with polarity) $\times 3$ D/A output value -100% f.s. to 0 to +100% f.s. \rightarrow -5 V to 0 to +5 V
Voltage and current of each channel. Sum of voltage and current (rms, mn, ac and rnd of each U1 to U4, I1 to I4, U12, U34, U123, U12, I34 or I123)	Measurement range (without polarity) D/A output value 0 to +100% f.s. \rightarrow 0 to +5 V
Active, reactive, and apparent power on each channel (P1 to P4, Q1 to Q4, S1 to S4) Apparent power has no polarity	(voltage range) \times (current range) For example, measuring in the 300 V and 10 A ranges supports 3 kW full-scale active power measurements. Active power D/A output value -3 kW to 0 to +3 kW \rightarrow -5 V to 0 to +5 V Apparent power D/A output value 0 to +3 kVA \rightarrow 0 to +5 V
Sum of active power, reactive power and apparent power in the 1P3W, 3P3W2M or 3P3W3M measurement. (P12, P34, Q12, Q34, S12, S34, P123, Q123, S123) Apparent power has no polarity	(voltage range) \times (current range) $\times 2$ For example, measuring in the 300 V and 10 A ranges supports 6 kW full-scale active power measurement. Active power D/A output value -6 kW to 0 to +6 kW \rightarrow -5 V to 0 to +5 V Apparent power D/A output value 0 to +6 kVA \rightarrow 0 to +5 V
Sum of active power, reactive power and apparent power in the 3P4W measurement. (P123, Q123, S123) Power factor has no polarity	(voltage range) \times (current range) $\times 3$ For example, measuring in the 300 V and 10 A ranges supports 9 kW full-scale active power measurement. Active power D/A output value -9 kW to 0 to +9 kW \rightarrow -5 V to 0 to +5 V Apparent power D/A output value 0 to +9 kVA \rightarrow 0 to +5 V
Power factor (λ)	Power factor D/A output value -1 to 0 to +1 \rightarrow -5 V to 0 to +5 V
Power phase angle (ϕ)	Power phase angle D/A output value -180° to 0 to +180° \rightarrow -5 V to 0 to +5 V
Efficiency (η)	Efficiency D/A output value 0 to 200% \rightarrow 0 to +5 V
Current integration (Ih)	(current range) \times (full-scale integration) For example, integrating for one hour in the 10 A range supports 10 Ah full-scale current integration measurement. Current integration D/A output value -10 Ah to 0 to +10 Ah \rightarrow -5 V to 0 to +5 V
Active power integration (WP) in 1P2W	(voltage range) \times (current range) \times (full-scale integration) For example, integrating for one hour in the 300 V and 10 A ranges supports 3 kW full-scale active power integration measurements. Active power integration D/A output value -3 kWh to 0 to +3 kWh \rightarrow -5 V to 0 to +5 V
Active power integration (WP) in 1P3W, 3P3W2M, and 3P3W3M	(voltage range) \times (current range) \times (full-scale integration) $\times 2$ For example, integrating for one hour in the 300 V and 10 A ranges supports 6 kWh full-scale active power integration measurements. Active power integration D/A output value -6 kWh to 0 to +6 kWh \rightarrow -5 V to 0 to +5 V
Active power integration (WP) in 3P4W	(voltage range) \times (current range) \times (full-scale integration) $\times 3$ For example, integrating for one hour in the 300 V and 10 A ranges supports 9 kWh full-scale active power integration measurements. Active power integration D/A output value -9 kWh to 0 to +9 kWh \rightarrow -5 V to 0 to +5 V
Frequency (f1 to f4)	Full-scale frequency is full scale.

NOTE Refer to Section 10.5 “1. Basic Measurement Items” for items not listed in the above.

8.3.4 D/A Output Examples

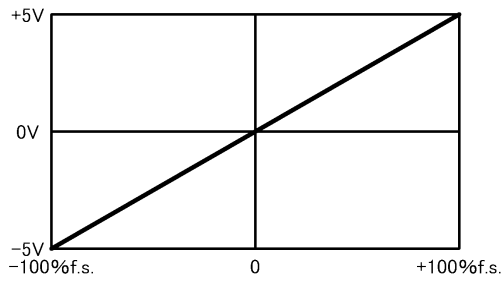

Voltage and current (dc, pk+, pk-),
active power, reactive power

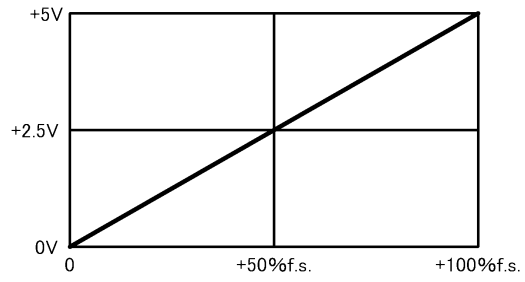

Voltage and current (rms, mn, ac, fnd, thd),
apparent power

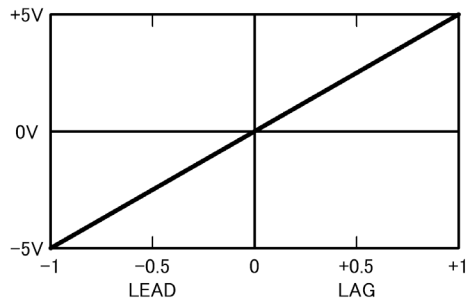

Power factor

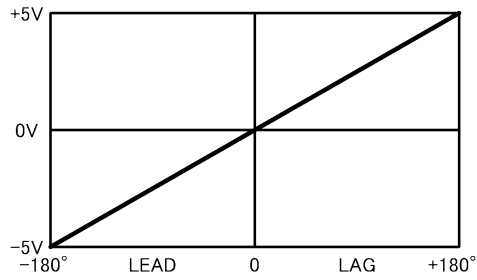

Power phase angle

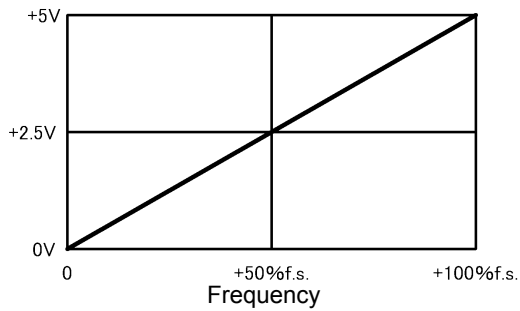

Frequency

Outputs 0 V when the frequency is less than the measurement lower limit frequency (the display will indicate 0.0000 Hz).

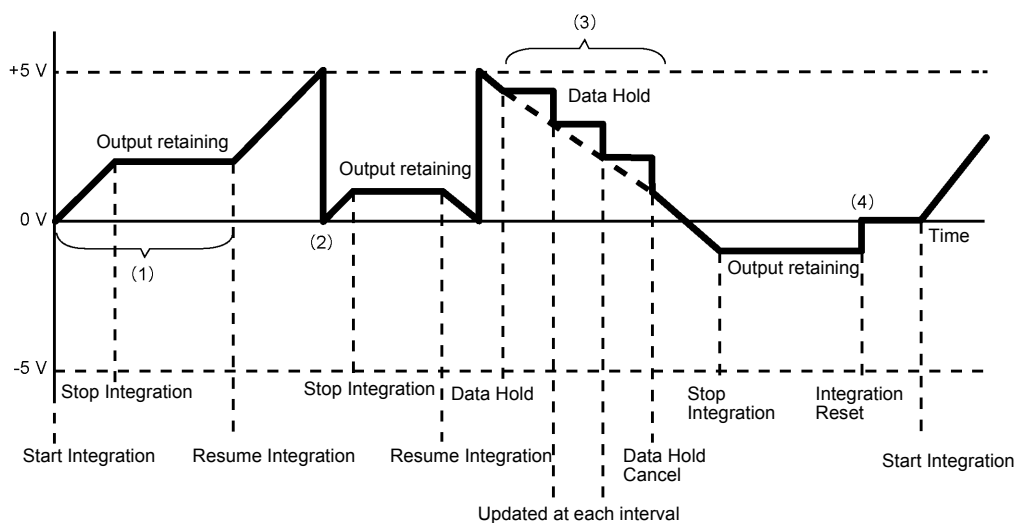

- (1) Analog output changes when integration starts, and is held constant after integration stops.
- (2) When the integration value exceeds ± 5 V, analog output becomes 0 V and changes proceed from there.
- (3) When the data hold is activated during integration, analog output is held constant. However, when data hold is canceled, analog output returns to the actual integration value.
- (4) The integration value is reset, and analog output becomes 0 V.

8.4 Connecting the Instrument to a LR8410 Link-compatible Logger

The instrument can be connected to Hioki model LR8410 Link-compatible logger (LR8410-20 Wireless Logging Station) via Bluetooth[®], enabling it to send measured values for D/A output parameters wirelessly to the logger (D/A9 to D/A16, up to 8 parameters). Establishing such a connection will enable the LR8410 Link-compatible logger to observe and record measured values from the instrument along with measurement targets such as voltage, temperature, and humidity across multiple channels.

To connect the instrument to an LR8410 Link-compatible logger, you will need the following Bluetooth[®] serial conversion adapter and power adapter:

- Bluetooth[®] serial conversion adapter: Parani* -SD1000 (from SENA Technologies Co., Ltd.)
Bluetooth[®] Class 1
* Trademark of another company
- AC/DC power adapter: OPA-G01 (from SENA Technologies Co., Ltd.)

Operating precautions

- To ensure safety, be sure to turn off the instrument before connecting it to the adapter. Turn on the instrument after connecting the adapter.
- Refer to the Parani-SD1000 operating precautions for more information about Bluetooth[®] use.
- Because values are displayed at the resolution of the logger being used, they will differ slightly from the measured values that are displayed by the instrument. To record values that are closer to the instrument's measured values, choose a range that is appropriate for the input.

8.4.1 Configuring and Connecting the Adapter

1. Set the Bluetooth[®] serial conversion adapter's communications speed.
The speed is set with DIP switches.
2. Affix the Bluetooth[®] serial conversion adapter to the instrument's D-sub 9-pin connector.

Setting procedure

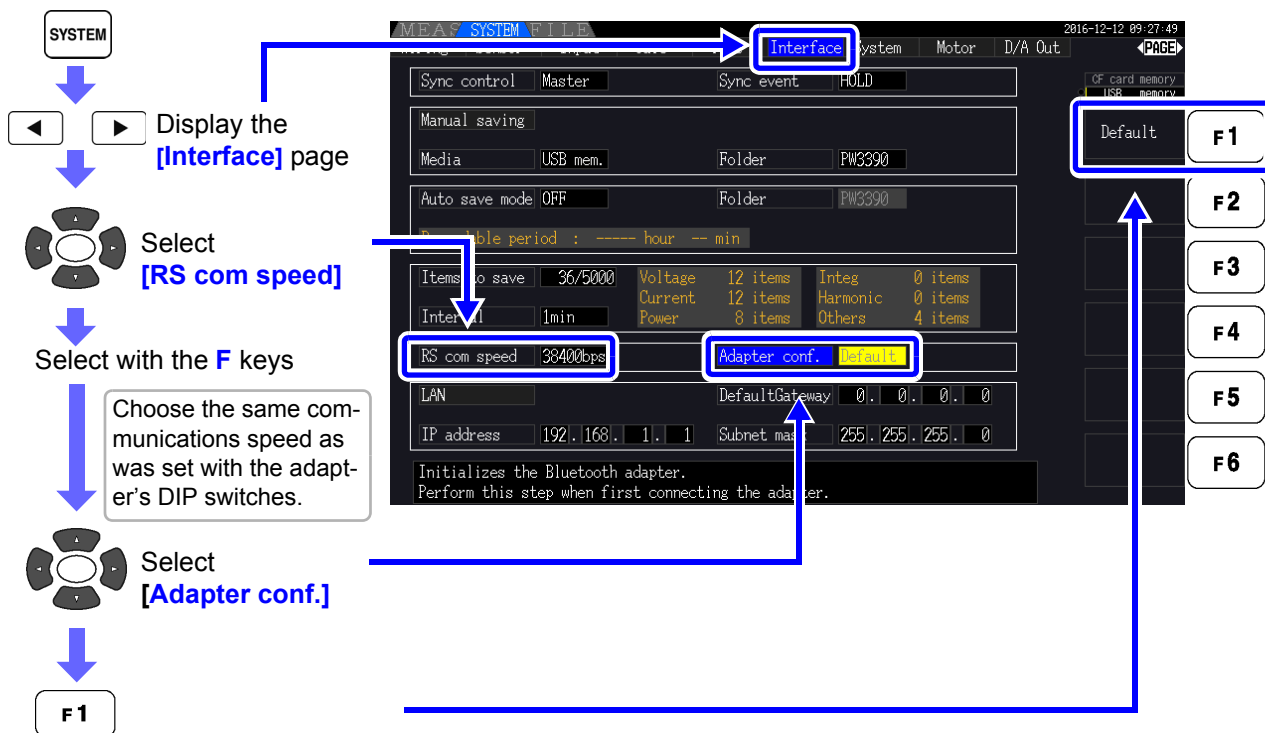

Initialize the adapter (see chart below).

Perform this step when connecting the adapter for the first time after purchase.

Device name	PW3390#nnnnnnnnn:HIOKI (where n indicates the 9-digit serial number)
Operation mode	Mode3 (Causes the adapter to stand by for connections from all Bluetooth [®] devices.)
Pin code	0000
Response	Unused
Escape sequence characters	Not permitted

NOTE

- For more information about how to configure Hioki LR8410 Link-compatible loggers such as the LR8410, see the instruction manual for the logger with which you wish to use the instrument.
- Changing the instrument's measurement range while its measured values are being automatically saved by an LR8410 Link-compatible logger will prevent the logger from saving the values properly. Set the measurement range on the instrument with the manual range setting before initiating auto-saving. When auto-saving is started, the auto-range settings for all channels will turn off.
- The output parameters for LR8410 Link-compatible loggers are the same as the output parameters for D/A output channels 9 through 16 (D/A9 to D/A16).
See "8.3.2 Output Item Selection" (p. 168).

8.5 Using the Motor Testing

Motor analysis can be performed for PW3390-03.

Use the motor analysis function to measure torque, rotation rate, motor power and slip by acquiring signals from a tachometer, torque sensor or (incremental) revolution encoder.

Connecting a Torque Meter and Tachometer

When the motor analysis function is installed, apply torque signals to the CH A jack, and rotary encoder signals to CH B and CH Z jacks (isolated BNC jacks are on the rear of the instrument).

CH A, CH B and CH Z jacks are isolated to support torque meters and tachometers with different ground potentials.

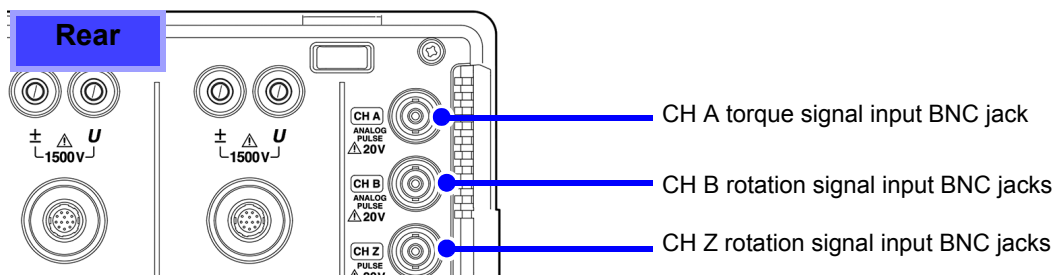

! WARNING

To avoid electric shock and damage to the instrument, observe the following when connecting to the CH A torque signal input BNC jack and the CH B and CH Z rotary signal input BNC jacks.

- Before connecting, turn off the instrument and any devices to be connected.
- Do not exceed the maximum input signal ratings.
- A serious accident could result if a plug falls out and contacts another conductor during operation. Ensure that all connections are secure.

! CAUTION

When disconnecting a BNC plug, always grip the plug and release the lock before pulling it out. Attempting to pull out a plug without releasing the lock, or pulling hard on the cable, will damage the connectors.

Connect the instrument and input devices using Hioki L9217 Connection Cords.

Guide pins on instrument jack

Notches on BNC plug

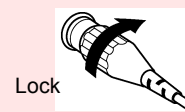

Required items: Hioki L9217 Connection Cords (as needed), input devices

Procedure

1. Confirm that the instrument and input devices are turned off.
2. As shown in the examples on the next page, connect the output jacks on the input devices to the instrument using the connection cords.
3. Turn the instrument on.
4. Turn the connected devices on.

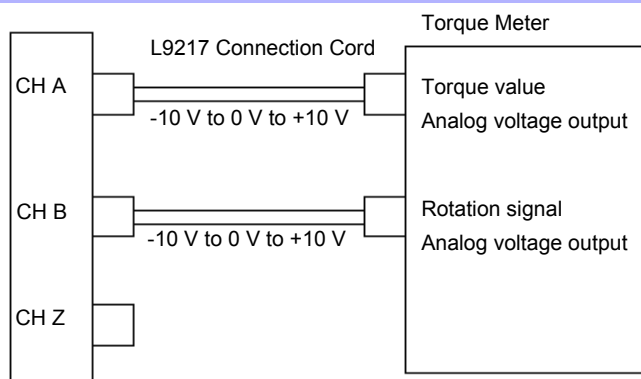
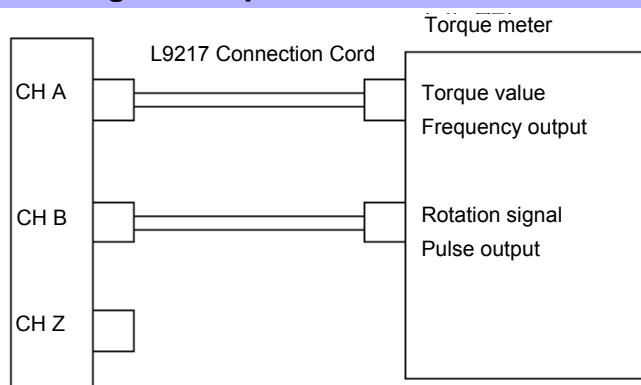
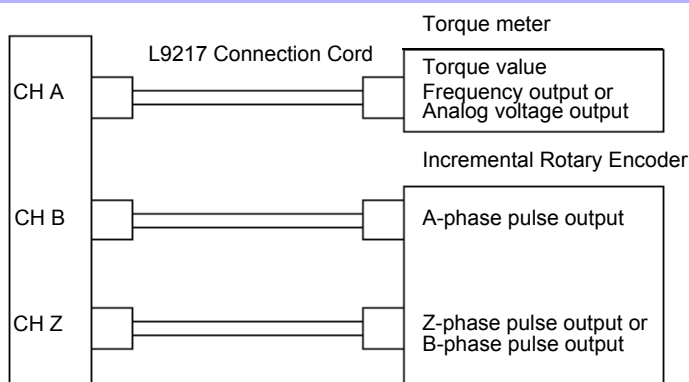
Example 1: Connecting a torque meter that provides analog torque values and rotation signals**Example 2: Connecting a torque meter that provides torque values as frequency and rotation signals as pulses****Example 3: Connecting the torque meter that provides torque values and the incremental rotary encoder****NOTE**

- CHPulse measurement is not available with CH Z only. Always use pulse input to CH B in combination with CH Z.
- When using CH Z (original position signal or Z-phase), apply a train of at least four pulses to CH B.

Motor Analysis Settings on the Instrument, Displaying Measured Values

See section "4.8 Viewing Motor Measurement Values (Model PW3390-03 only)" (p. 96) for measurement displays and instrument setting procedures.

8.6 Connecting VT1005

The VT1005 is an AC/DC divider that converts the input voltage of 5 kV at maximum (no measurement category) and output the voltage at the ratio of 1000:1 with high precision.

The VT1005 has frequency characteristics with excellent flatness as well as stable temperature characteristics. In addition to voltage measurements, the divider can be used for high-precision power measurements when combined with a power analyzer.

Setting the scaling (VT)

Press **SYSTEM** and the **◀** **▶** keys to display the **[Input]** page.

1  Select the items

2 Select **[VT rate]**
Enter **[1000]** with the **F** key

The VT1005 ratio (division ratio) can be set on the instrument to allow input values to be read directly.

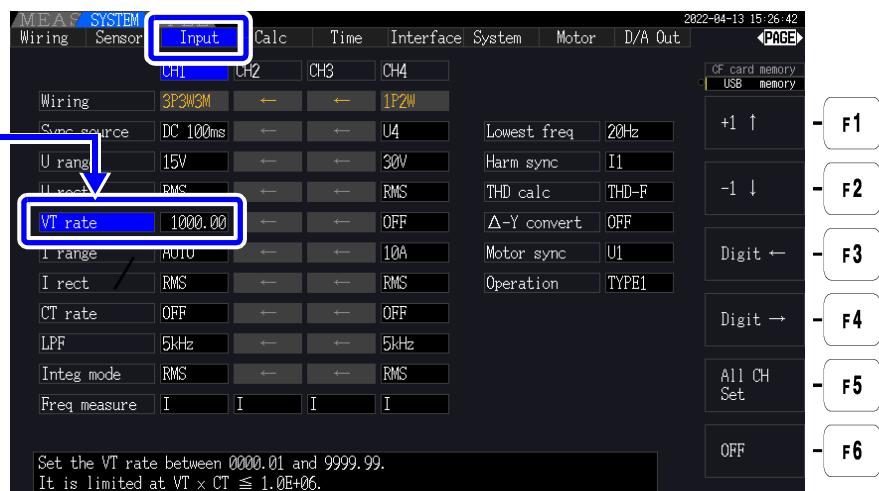

The screenshot shows the 'Input' menu on the instrument's display. The 'VT rate' is set to 1000.00. The menu includes options for Wiring, Current source, U range, U react, I range, I rect, CT rate, LPF, Integ mode, and Freq measure. The right side of the screen shows function keys F1 through F6.

Item	CH1	CH2	CH3	CH4
Wiring	3P3W3M	←	←	1P2W
Current source	DC 100ms	←	←	U4
U range	15V	←	←	30V
U react	RMS	←	←	RMS
I range	AUTO	←	←	10A
I rect	RMS	←	←	RMS
CT rate	OFF	←	←	OFF
LPF	5kHz	←	←	5kHz
Integ mode	RMS	←	←	RMS
Freq measure	I	I	I	I

Set the VT rate between 0000.01 and 9999.99.
It is limited at $VT \times CT \leq 1.0E+06$.

Setting the phase compensation value

By setting the phase compensation value on the instrument, the phase compensation can be performed including the divider, the connection cord, and the current sensor to reduce the error component in power measurements made in high-frequency regions.

NOTE Enter the phase compensation value accurately.
Mistaken settings can cause the compensation process to increase measurement error.

1   Display the **[Sensor]** page

2  Select the items

Enter the compensation value on "Phase compensation values (typical values)" (p. 179)

The phase compensation is performed for the VT1005 and the current sensor by using the phase compensation function of the current sensor. The phase compensation values depend on the length of the L9217 Connection Cord used for the VT1005 as well as the type of the current sensor to be used.

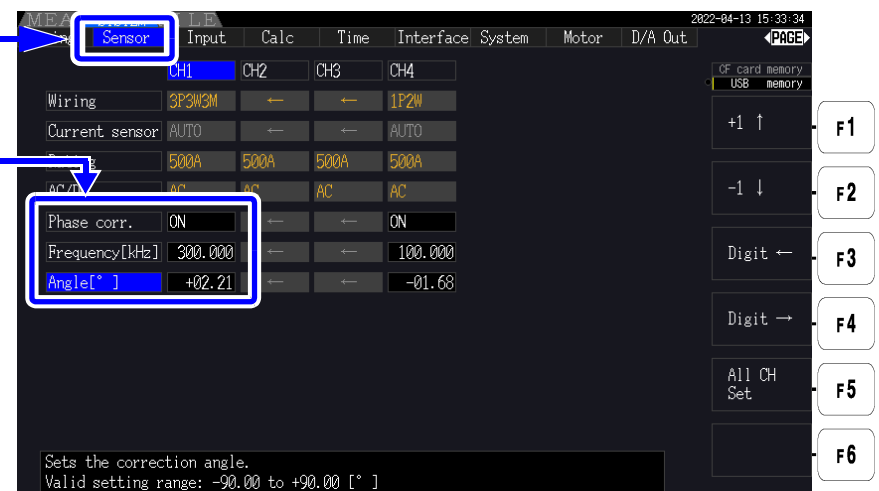

The screenshot shows the 'Sensor' menu on the instrument's display. The 'Phase corr.' is set to ON, and the 'Angle[°]' is set to +02.21. The menu includes options for Wiring, Current sensor, AC type, Phase corr., Frequency[kHz], and Angle[°]. The right side of the screen shows function keys F1 through F6.

Item	CH1	CH2	CH3	CH4
Wiring	3P3W3M	←	←	1P2W
Current sensor	AUTO	←	←	AUTO
AC type	500A	500A	500A	500A
Phase corr.	ON	←	←	ON
Frequency[kHz]	300.000	←	←	100.000
Angle[°]	+02.21	←	←	-01.68

Sets the correction angle.
Valid setting range: -90.00 to +90.00 [°]

Phase compensation values (typical values)

Model	Frequency (kHz)	Typical values of phase difference between input and output (°)		
		L9217	L9217-01	L9217-02
		Connection Cord (1.6 m)	Connection Cord (3.0 m)	Connection Cord (10 m)
CT6830	10	-6.50	-6.47	-6.35
CT6831	10	-4.00	-3.97	-3.85
CT6841, CT6841-05	100	+2.19	+2.44	+3.70
CT6841A	100	+0.42	+0.67	+1.93
CT6843, CT6843-05	100	+2.33	+2.58	+3.84
CT6843A	100	+0.05	+0.30	+1.56
CT6844, CT6844-05	50	+0.72	+0.84	+1.47
CT6844A	100	+0.09	+0.34	+1.60
CT6845, CT6845-05	20	+0.18	+0.23	+0.48
CT6845A	10	-0.54	-0.51	-0.39
CT6846, CT6846-05	20	-1.09	-1.04	-0.79
CT6846A	10	-0.65	-0.62	-0.50
CT6862, CT6862-05	300	+1.07	+1.81	+5.60
CT6863, CT6863-05	100	-0.59	-0.34	+0.92
CT6865, CT6865-05	1	-1.17	-1.17	-1.15
CT6872	100	+2.73	+2.98	+4.24
CT6872-01	100	+1.38	+1.63	+2.89
CT6873	100	+3.26	+3.51	+4.77
CT6873-01	100	+1.91	+2.16	+3.42
CT6875, CT6875A	200	-2.43	-1.93	+0.59
CT6875-01, CT6875A-1	200	-4.85	-4.35	-1.83
CT6876, CT6876A	200	-4.94	-4.44	-1.92
CT6876-01, CT6876A-1	200	-6.32	-5.82	-3.30
CT6877, CT6877A	100	+1.38	+1.63	+2.89
CT6877-01, CT6877A-1	100	+0.67	+0.92	+2.18
CT6904 series*1	300	+2.21	+2.95	+6.74
9709-05	20	-0.31	-0.26	-0.01
PW9100 series*2	300	+9.23	+9.97	+13.76
9272-05 (20 A)	50	-1.33	-1.21	-0.58
9272-05 (200 A)	50	-2.17	-2.05	-1.42
CT7044	5	-10.98	-10.97	-10.90
CT7045	5	-11.70	-11.69	-11.62
CT7046	5	-12.82	-12.81	-12.74
CT7642	1	-8.13	-8.13	-8.11
CT7742	1	-18.58	-18.58	-18.56

The standard cable length is used for the current sensor. The conductor is positioned in the center of the sensor.

*1 : CT6904, CT6904-01, CT6904-60, CT6904-61, CT6904A, CT6904A-1, CT6904A-2, CT6904A-3

*2 : PW9100-03, PW9100-04, PW9100A-3, PW9100A-4

Operation with a Computer

Chapter 9

The instrument includes standard USB and Ethernet interfaces to connect a computer for remote control. The instrument can be controlled by communication commands, and measurement data can be transferred to the computer using the dedicated application program.

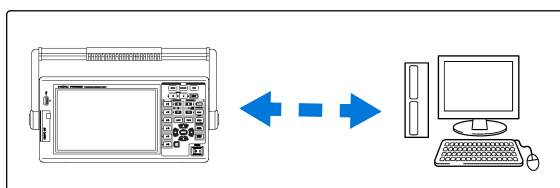

Operating precautions:

Use only one interface at a time (USB, LAN, or RS-232C). Attempting to use multiple interfaces at the same time will cause the instrument to malfunction, for example by interrupting communications.

Ethernet ("LAN") Connection Capabilities

- **Control the instrument remotely by internet browser.** (p. 186)
- **Control the instrument remotely with communication commands**
(by creating a program and connecting to the TCP/IP communication command port. The port number of TCP/IP is fixed to 3390).
- **Set the instrument using the dedicated application program to transfer measurement data to the computer.**

USB Connection Capabilities

- **Set the instrument using the dedicated application program to transfer measurement data to the computer**
(the program's USB driver must be installed on the computer).

RS-232C Connection Capabilities

- **Controlling the instrument with communication commands.**
- **Configuring the instrument's settings and sending measurement data to a computer with a dedicated application.**

- NOTE**
- The dedicated application, USB driver, and the Communication Command Instruction Manual can be downloaded from our website (<https://www.hioki.com>).
 - To communicate with the instrument, use only one of the following: remote control, the dedicated application, or communication commands. Simultaneous use of multiple communication methods will cause the instrument to malfunction, for example by interrupting communication with the computer.
 - Do not operate the instrument both remotely and manually at once.

9.1 Control and Measurement via Ethernet ("LAN") Interface

Remote control is available by internet browser. Measurement data is transferred to the computer by using the dedicated software.

Before communicating, configure the instrument's LAN settings for the network environment, and connect the instrument to a computer with the Ethernet cable.

- NOTE**
- See the application program's operating manual for operating procedures.
 - See the Communication Command Instruction Manual for command communication procedures.
(Both are downloadable from <https://www.hioki.com>).

9.1.1 LAN Settings and Network Environment Configuration

Configure the Instrument's LAN Settings

- NOTE**
- Make these settings before connecting to a network. Changing settings while connected can duplicate IP addresses of other network devices, and incorrect address information may otherwise be presented to the network.
 - The instrument does not support DHCP (automatic IP address assignment) on a network.

Making Network Settings

SYSTEM

Display the [Interface] page

select a setting item

Select with the F keys

MEAS SYSTEM FILE 2016-12-01 11:22:29

Wiring Sensor Input Calc Time Interface system Motor D/A Out

Sync control Master Sync event HOLD

Media CF card Folder PW3390

Auto save mode OFF Folder PW3390

Recordable period : ---- hour -- min

Items to save 36/2600 Voltage 12 items Integ 0 items

Interval 1s Current 12 items Harmonic 0 items

Power 8 items Others 4 items

RS com speed 38400bps Adapter conf. Default

LAN DefaultGateway 0. 0. 0. 0

IP address 172. 168. 1. 1 Subnet mask 255. 255. 255. 0

Set IP address.

+1 ↑ F1

-1 ↓ F2

+10 ↑ F3

-10 ↓ F4

+100 ↑ F5

-100 ↓ F6

+1↑ /-1↓	Increment/decrement by 1
+10↑ /-10↓	Increment/decrement by 10
+100↑ /-100↓	Increment/decrement by 100

Setting Items

- IP address** Identifies each device connected on a network.
Each network device must be set to a unique address.
The instrument supports IP version 4, with IP addresses indicated as four decimal octets, e.g., "192.168.0.1".
- Subnet mask** This setting is used to distinguish the address of the network from the addresses of individual network devices.
The normal value for this setting is the four decimal octets "255.255.255.0".
- Default Gateway** When the computer and instrument are on different but overlapping networks (subnets), this IP address specifies the device to serve as the gateway between the networks.
If the computer and instrument are connected one-to-one, no gateway is used, and the instrument's default setting "0.0.0.0" can be kept as is.

Network Environment Configuration

Example 1: Connecting the instrument to an existing network

To connect to an existing network, the network system administrator (IT department) has to assign settings beforehand.

Some network device settings must not be duplicated.

Obtain the administrator's assignments for the following items, and write them down.

IP Address	_____
Subnet Mask	_____
Default Gateway	_____

Example 2: Connecting multiple instruments to a single computer using a hub

When building a local network with no outside connection, the following private IP addresses are recommended.

Configure the network using addresses 192.168.1.0 to 192.168.1.24

IP Address	Computer:192.168.1.1	
	Power Analyzers: assign to each instrument in order	192.168.1.2, 192.168.1.3, 192.168.1.4, ...
Subnet Mask	255.255.255.0	
Default Gateway	0.0.0.0	

Example 3: Connecting one instrument to a single computer using the 9642 LAN Cable

The 9642 LAN Cable can be used with its supplied connection adapter to connect one instrument to one computer, in which case the IP address is freely settable. Use the recommended private IP addresses.

IP Address	Computer:192.168.1.1	
	Power Analyzers:192.168.1.2 (Set to a different IP address than the computer.)	
Subnet Mask	255.255.255.0	
Default Gateway	0.0.0.0	

9.1.2 Instrument Connection

Connect the instrument to the computer using an Ethernet LAN cable.

CAUTION When connecting the instrument to your LAN using a LAN cable of more than 30 m or with a cable laid outdoors, take appropriate countermeasures that include installing a surge protector for LANs. Such signal wiring is susceptible to induced lighting, which can cause damage to the instrument.

Required items: When connecting the instrument to an existing network

(prepare any of the following):

- Straight-through Cat 5, 100BASE-TX-compliant Ethernet cable (commercially available). For 10BASE communication, a 10BASE-T-compliant cable may also be used.
- Hioki 9642 LAN Cable (option)

When connecting one instrument to a single computer

(prepare one of the following):

- 100BASE-TX-compliant cross-over cable
- 100BASE-TX-compliant straight-through cable with cross-over adapter
- Hioki 9642 LAN Cable (option)

Instrument Ethernet ("LAN") interface

The Ethernet interface jack is on the right side.

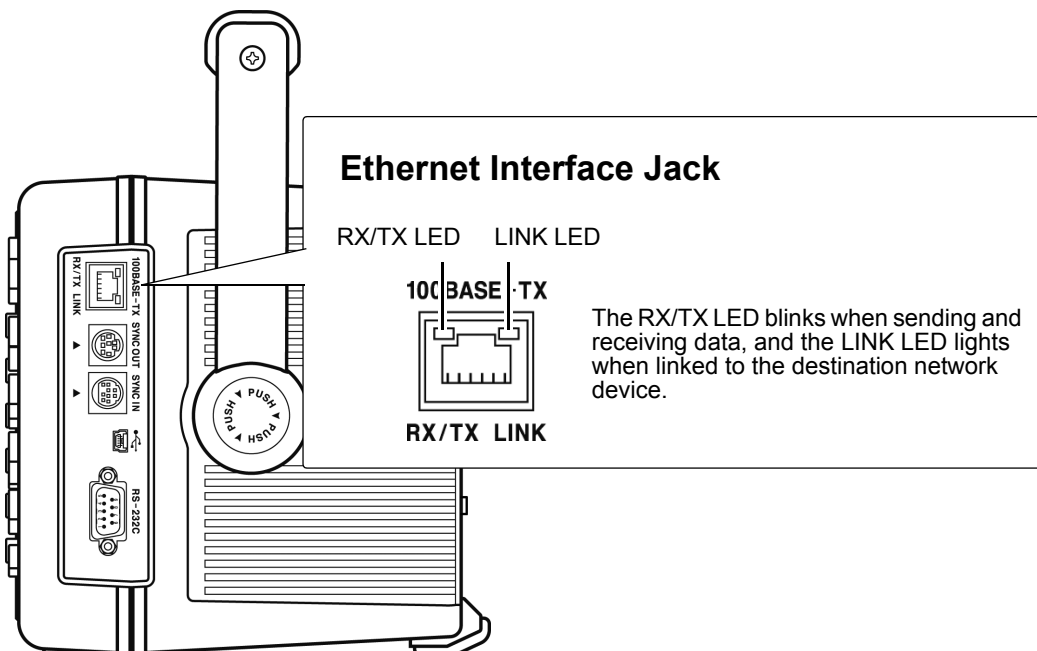

Connecting the Instrument to a Computer with an Ethernet ("LAN") Cable

Connect by the following procedure.

When connecting the instrument to an existing network (connect the instrument to a hub)

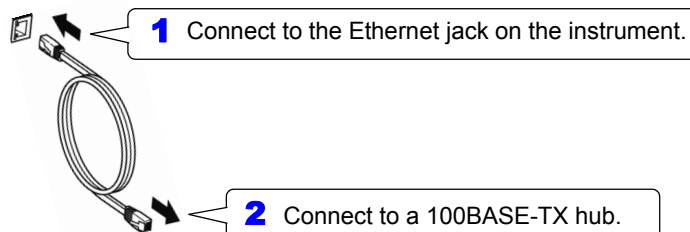

When connecting the instrument to a single computer (connect the instrument to the computer)

Use the Hioki 9642 LAN Cable and cross-over adapter (9642 accessory)

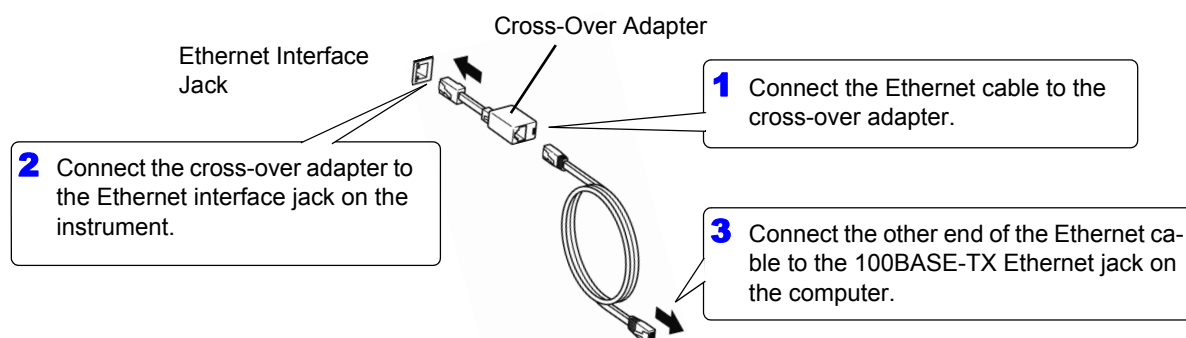

When the Ethernet connection is established, the LAN indicator appears at the top of the screen, as shown below.

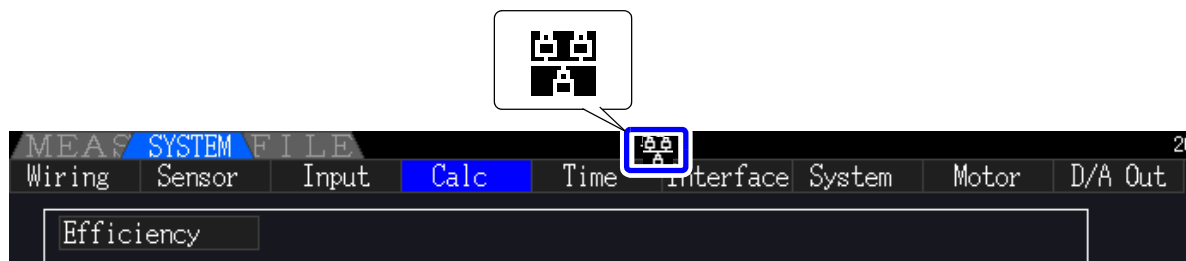

9.2 Remote Control of the Instrument by Internet Browser

The instrument includes a standard HTTP server function that supports remote control by an internet browser on a computer. The instrument's display screen and control panel keys are emulated in the browser. Operating procedures are the same as on the instrument.

- NOTE**
- Internet browser security level should be set to Medium or Medium-high.
 - Unintended operations may occur if remote control is attempted from multiple computers simultaneously. Use one computer at a time for remote control.

9.2.1 Connecting to the Instrument

Launch the Internet browser, and enter "http://" followed by the IP address assigned to the instrument in the browser's address bar.

For example, if the instrument's IP address is 192.168.0.1, enter as follows.

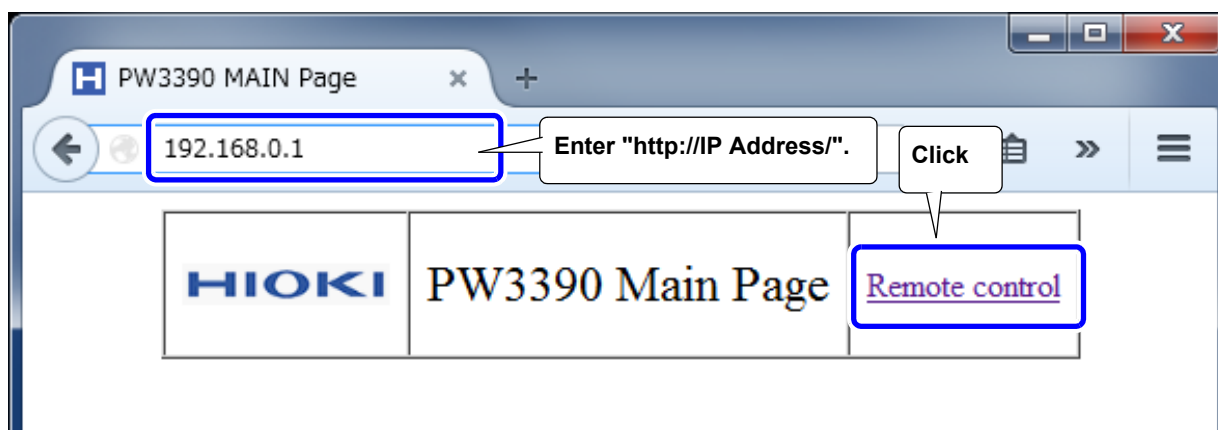

When the Main page appears as illustrated, the connection to the instrument has been established. Click the [\[Remote control\]](#) link to jump to the Remote Control page.



What if the Main Page does not display?

- Check the network settings on the instrument and the IP address of the computer.
[See "9.1.1 LAN Settings and Network Environment Configuration" \(p. 182\)](#)
- Check that the LINK LED in the Ethernet internet jack is lit, and that  (the LAN indicator) is displayed on the instrument's screen.
[See "9.1.2 Instrument Connection" \(p. 184\)](#)

9.2.2 Operating Procedure

The instrument's screen and control panel emulations appear in the browser. Click on the control panel keys to perform the same operations as the instrument keys. To enable automatic browser screen updating, set the Update Time in the Auto Update menu.

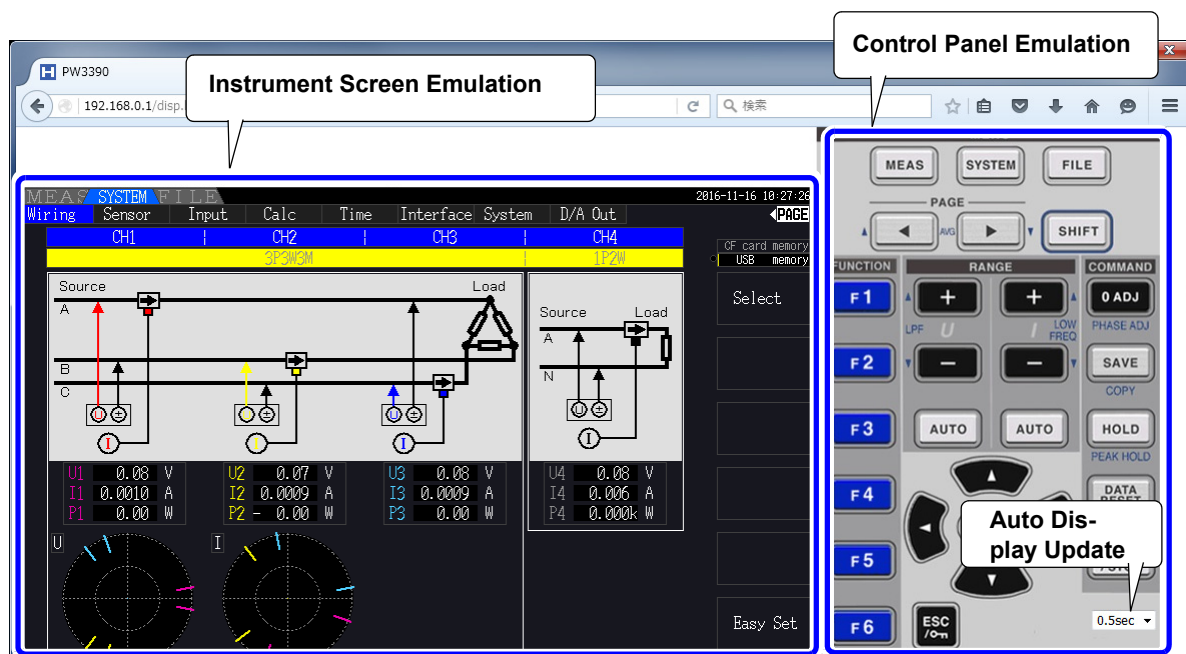

Auto Display Update Settings

The instrument screen emulation updates at the specified interval.

OFF, 0.5s, 1s, 2s, 5s, 10s

NOTE

- The enlarged or reduced browser may cause an unusual action. Use the browser displayed at the same magnification.
- When the auto-display-update is not used, or the auto-display-updating rate setting is relatively long, operating the instrument may cause the display to be abnormal; however, this is not a malfunction of the instrument. Specify the auto-display-update rate appropriately.
- You may not be able to operate the instrument as intended through some Internet browsers.

9.3 Control and Measurement via USB Interface

The instrument can be set and measurement data transferred to a computer using a standard USB connection.

NOTE

- Install the dedicated software to a computer before connecting this instrument to a computer.
- See the application program's manual for operating procedures.
- To connect the instrument to a computer, a dedicated USB driver must be installed. The dedicated USB driver is attached to the dedicated software. (Compatible to the Windows 7 (32-bit, 64-bit), Windows 8 (32-bit, 64-bit), Windows 10 (32-bit, 64-bit).)
The dedicated application and USB driver can be downloaded from our website (<https://www.hioki.com>).

9.3.1 Connecting to the Instrument

Connect the instrument to the computer with a USB cable. No instrument settings are necessary to establish the USB connection.

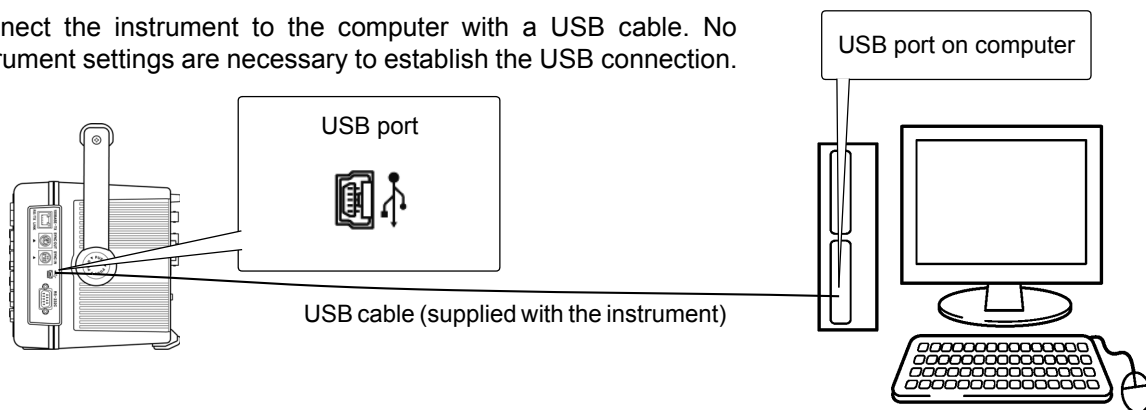

The USB indicator is displayed when the connection to the computer is established.



CAUTION

- To avoid faults, do not disconnect or reconnect the USB cable during instrument operation.
- Connect the instrument and the computer to a common earth ground. Using different grounds could result in potential difference between the instrument and the computer. Potential difference on the USB cable can result in malfunctions and faults.

NOTE

If both the instrument and computer are turned off the power while connected by the USB cable, turn on the power of the computer first. It is not able to communicate if the instrument is turned on the power first.

9.3.2 After Connecting

Install the USB driver on the computer before running the dedicated application program.

9.4 Control and Measurement via RS-232C Interface

The instrument ships standard with a RS-232C interface, which makes it possible to control the instrument and send measurement data to a computer using communication commands after connecting the instrument to a computer with an RS-232C cable.

CAUTION Use only one interface at a time (LAN, USB, or RS-232C). Using multiple interfaces at the same time will cause the instrument to malfunction, for example by interrupting communications.

NOTE

- See the application program's operating manual for operating procedures.
- See the Communication Command Instruction Manual for command communication procedures. (Both are downloadable from <https://www.hioki.com>).

9.4.1 Connecting to the Instrument

Recommended cable: 9637 RS-232C Cable (9pin-9pin/1.8 m, crossing cable)

Connect the instrument to a computer with a RS-232C cable.

- Be sure to secure the connector in place with screws.

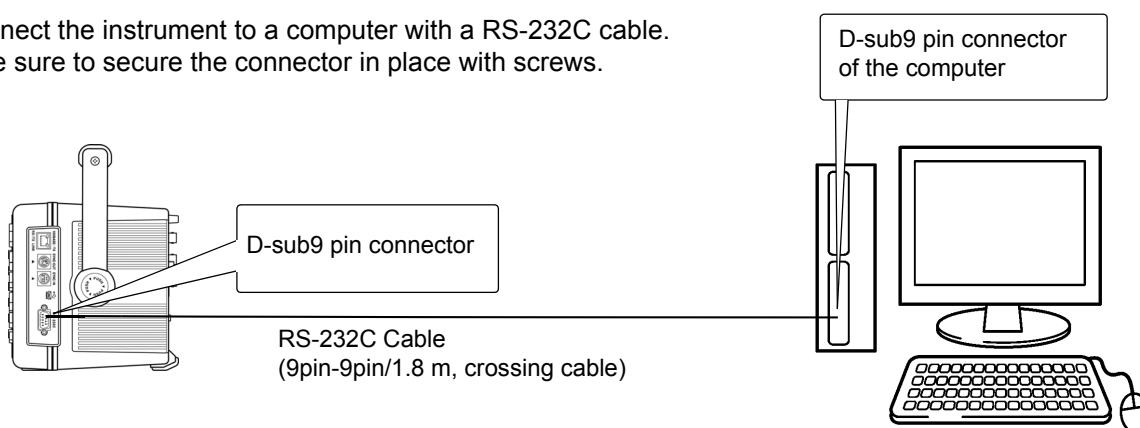

9.4.2 Setting the RS-232C Communications Speed

SYSTEM
 Display the [Interface] page
 Select a setting item [RS com speed]
 Select with the F keys
 Reboot the instrument when changing the settings.

Setting the PC's communications speed

Use the same communications protocol settings as are being used by the instrument.

- Asynchronous
- Communications speed: 9600/19200/38400 bps (use same setting as instrument)
- Stop bits: 1
- Data length: 8 bits
- Parity check: None
- Flow control: None

NOTE

- When connecting the instrument to a controller (DTE), provide a cross cable that satisfies the specifications of both the instrument's connector and the controller's connector.
- If using a USB-serial cable, you may need a gender changer or straight/cross converter. Provide a gender changer or straight/cross converter that satisfies the specifications of both the instrument's connector and the USB/serial cable's connector.

The instrument's I/O connectors implement terminal (DTE) specifications. The instrument uses pin numbers 2, 3, 5, 7, and 8. Other pins are unused.

Pin number	Compatible connection circuit name		CCIT circuit number	EIA code	JIS code	Common code
1	Data channel receive	Carrier Detect	109	CF	CD	DCD
	Carrier detect					
2	Receive data	Receive Data	104	BB	RD	RxD
3	Transmit data	Send Data	103	BA	SD	TxD
4	Data terminal ready	Data Terminal Ready	108/2	CD	ER	DTR
5	Signal ground	Signal Ground	102	AB	SG	GND
6	Data set ready	Data Set Ready	107	CC	DR	DSR
7	Request to send	Request to Send	105	CA	RS	RTS
8	Clear to send	Clear to Send	106	CB	CS	CTS
9	Ring indicator	Ring Indicator	125	CE	CI	RI

Cross wiring

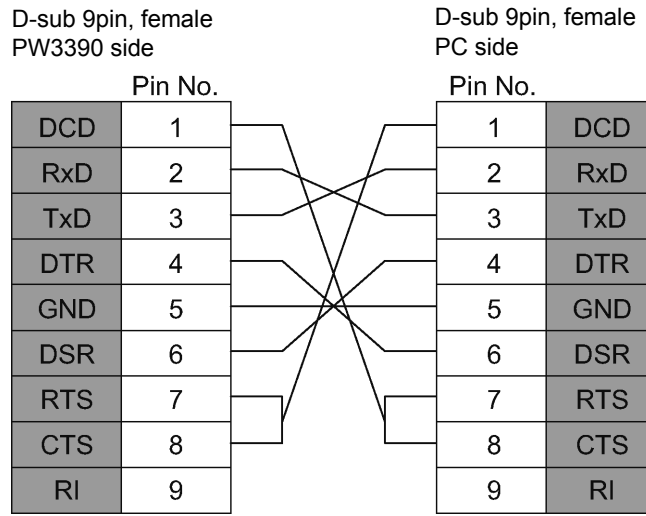

Specifications Chapter 10

10.1 General Specifications

Operating environment	Indoors, Pollution Degree 2, altitude up to 2000 m (6562 ft.)
Operating temperature and humidity	-10°C to 40°C (14°F to 104°F), 80% RH or less (no condensation)
Storage temperature and humidity	-10°C to 50°C (14°F to 122°F), 80% RH or less (no condensation)
Dustproof and waterproof	IP20 (EN60529)
Applicable standards	Safety: EN61010 EMC: EN61326 Class A
Power supply	Rated supply voltage: 100 V to 240 V AC (Voltage fluctuations of $\pm 10\%$ for the rated supply voltage are taken into account.) Rated supply frequency: 50 Hz/60 Hz Anticipated transient overvoltage: 2500 V Maximum rated power: 220 VA
Backup battery life	Clock, settings and integration values for backup (Lithium battery), Approx. 10 years (at 23°C, as a referential)
Interface	USB (function), USB memory, LAN, CF card, RS-232C, Synchronous control
Dimensions	Approx. 340 W \times 170 H \times 156 D mm (13.39" W \times 6.69" H \times 6.14" D) (excluding protrusions)
Mass	Approx. 4.6 kg (162.3 oz.) when PW3390-03
Product warranty period	3 years
Accessories	See "Confirming Package Contents"(p.2)
Options	See "Options"(p.3)

10.2 Basic Specifications

1. Power Measurement Input Specifications

Measurement line type	Single-phase 2-wire (1P2W), Single-phase 3-wire (1P3W), 3-phase 3-wire (3P3W2M, 3P3W3M), 3-phase 4-wire (3P4W)			
	CH1	CH2	CH3	CH4
Pattern 1	1P2W	1P2W	1P2W	1P2W
Pattern 2	1P3W		1P2W	1P2W
Pattern 3	3P3W2M		1P2W	1P2W
Pattern 4	1P3W		1P3W	
Pattern 5	3P3W2M		1P3W	
Pattern 6	3P3W2M		3P3W2M	
Pattern 7	3P3W3M			1P2W
Pattern 8	3P4W			1P2W
Number of input channels	Voltage: 4 channels U1 to U4 Current: 4 channels I1 to I4			
Measurement input terminal type	Voltage: Plug-in jacks (safety terminal) Current: Dedicated custom connectors (ME15W)			
Input methods	Voltage: Isolated inputs, resistive dividers Current: Isolated input through current sensors (voltage output)			
Voltage range	15 V/30 V/60 V/150 V/300 V/600 V/1500 V, selectable for each measured wiring system			
Current range	When not using the CT9920 Conversion Cable: Sensor rating is automatically detected. 2 A/4 A/8 A/20 A (with the 9272-05, 20 A) 0.04 A/0.08 A/0.2 A/0.4 A/0.8 A/2 A (2 A sensor) 0.4 A/0.8 A/2 A/4 A/8 A/20 A (20 A sensor) 4 A/8 A/20 A/40 A/80 A/200 A (200 A sensor) 40 A/80 A/200 A/400 A/800 A/2 kA (2000 A sensor) 0.1 A/0.2 A/0.5 A/1 A/2 A/5 A (5 A sensor) 1 A/2 A/5 A/10 A/20 A/50 A (50 A sensor) 10 A/20 A/50 A/100 A/200 A/500 A (500 A sensor) 20 A/40 A/100 A/200 A/400 A/1 kA (1000 A sensor) When using the CT9920 Conversion Cable: User must select sensor output rate or sensor model. 400 A/800 A/2 kA (CT7642 and CT7742) 400 A/800 A/2 kA/4 kA/8 kA (CT7044, CT7045, and CT7046) 400 A/800 A/2 kA/4 kA/8 kA/20 kA (100 μ V/A) 40 A/80 A/200 A/400 A/800 A/2 kA (1 mV/A) 4 A/8 A/20 A/40 A/80 A/200 A (10 mV/A) 0.4 A/0.8 A/2 A/4 A/8 A/20 A (100 mV/A) Selectable for each measurement channel (however, the same sensor type must be used for each of the same wire connection channels)			
Crest factor	300 (relative to minimum effective voltage/current input) (for 1500 V range: 133) 3 (relative to voltage/current range rating) (for 1500 V range: 133)			
Input resistance (50 Hz/60 Hz)	Voltage input section:	2 M Ω \pm 40 k Ω (differential input and isolated input)		
	Current sensor input section:	1 M Ω \pm 50 k Ω		
Maximum input voltage	Voltage input section:	1500 V, \pm 2000 V peak		
	Current sensor input section:	5 V, \pm 10 V peak		
Maximum rated voltage to earth	Voltage input terminal	1000 V (50 Hz/60 Hz)		
	Measurement categories III	600 V (anticipated transient overvoltage 6000 V)		
	Measurement categories II	1000 V (anticipated transient overvoltage 6000 V)		
Measurement method	Simultaneous digital sampling of voltage and current, synchronous zero-crossing calculation method			
Sampling	500 kHz/16 bit			
Measurement frequency range	DC, 0.5 Hz to 200 kHz			
Synchronization frequency range	0.5 Hz to 5 kHz Selectable lower limit measurement frequency (0.5 Hz/1 Hz/2 Hz/5 Hz/10 Hz/20 Hz)			

1. Power Measurement Input Specifications

Synchronization source	U1 to U4, I1 to I4, Ext (with the motor evaluation installed model and CH B set for pulse input), DC (50 ms or 100 ms fixed) Selectable for each measurement channel (U/I for each channel measured using the same synchronization source) The zero-crossing filter automatically follows due to the digital LPF when U or I is selected. Two filter levels for zero-crossing filter (strong or weak) Operation and accuracy are undetermined when the zero-crossing filter is disabled (off). Operation and accuracy are undetermined when U or I is selected and measured input is below 30% f.s.
Data update interval	50 ms
LPF	OFF/500 Hz/5 kHz/100 kHz (selectable for each wiring system) 500 Hz Accuracy defined under 60 Hz, add $\pm 0.1\%$ f.s. 5 kHz Accuracy defined under 500 Hz 100 kHz Accuracy defined under 20 kHz, add 1% rdg. from 10 kHz to 20 kHz
Polarity discrimination	Voltage/current zero-crossing timing comparison method Zero-crossing filter provided by digital LPF
Measurement items	Voltage (U), Current (I), active power (P), apparent power (S), reactive power (Q), power factor (λ), phase angle (ϕ), frequency (f), efficiency (η), loss (Loss), voltage ripple factor (Urf), current ripple factor (Irf), current integration (Ih), power integration (WP), peak voltage (Upk), peak current (Ipk)

1. Power Measurement Input Specifications

Accuracy

	Voltage (U)	Current (I)
DC	$\pm 0.05\% \text{ rdg.} \pm 0.07\% \text{ f.s.}$	$\pm 0.05\% \text{ rdg.} \pm 0.07\% \text{ f.s.}$
$0.5 \text{ Hz} \leq f < 30 \text{ Hz}$	$\pm 0.05\% \text{ rdg.} \pm 0.1\% \text{ f.s.}$	$\pm 0.05\% \text{ rdg.} \pm 0.1\% \text{ f.s.}$
$30 \text{ Hz} \leq f < 45 \text{ Hz}$	$\pm 0.05\% \text{ rdg.} \pm 0.1\% \text{ f.s.}$	$\pm 0.05\% \text{ rdg.} \pm 0.1\% \text{ f.s.}$
$45 \text{ Hz} \leq f \leq 66 \text{ Hz}$	$\pm 0.04\% \text{ rdg.} \pm 0.05\% \text{ f.s.}$	$\pm 0.04\% \text{ rdg.} \pm 0.05\% \text{ f.s.}$
$66 \text{ Hz} < f \leq 1 \text{ kHz}$	$\pm 0.1\% \text{ rdg.} \pm 0.1\% \text{ f.s.}$	$\pm 0.1\% \text{ rdg.} \pm 0.1\% \text{ f.s.}$
$1 \text{ kHz} < f \leq 10 \text{ kHz}$	$\pm 0.2\% \text{ rdg.} \pm 0.1\% \text{ f.s.}$	$\pm 0.2\% \text{ rdg.} \pm 0.1\% \text{ f.s.}$
$10 \text{ kHz} < f \leq 50 \text{ kHz}$	$\pm 0.3\% \text{ rdg.} \pm 0.2\% \text{ f.s.}$	$\pm 0.3\% \text{ rdg.} \pm 0.2\% \text{ f.s.}$
$50 \text{ kHz} < f \leq 100 \text{ kHz}$	$\pm 1.0\% \text{ rdg.} \pm 0.3\% \text{ f.s.}$	$\pm 1.0\% \text{ rdg.} \pm 0.3\% \text{ f.s.}$
$100 \text{ kHz} < f \leq 200 \text{ kHz}$	$\pm 20\% \text{ f.s.}$	$\pm 20\% \text{ f.s.}$

	Active power (P)	Phase difference
DC	$\pm 0.05\% \text{ rdg.} \pm 0.07\% \text{ f.s.}$	–
$0.5 \text{ Hz} \leq f < 30 \text{ Hz}$	$\pm 0.05\% \text{ rdg.} \pm 0.1\% \text{ f.s.}$	$\pm 0.08^\circ$
$30 \text{ Hz} \leq f < 45 \text{ Hz}$	$\pm 0.05\% \text{ rdg.} \pm 0.1\% \text{ f.s.}$	$\pm 0.08^\circ$
$45 \text{ Hz} \leq f \leq 66 \text{ Hz}$	$\pm 0.04\% \text{ rdg.} \pm 0.05\% \text{ f.s.}$	$\pm 0.08^\circ$
$66 \text{ Hz} < f \leq 1 \text{ kHz}$	$\pm 0.1\% \text{ rdg.} \pm 0.1\% \text{ f.s.}$	$\pm 0.08^\circ$
$1 \text{ kHz} < f \leq 10 \text{ kHz}$	$\pm 0.2\% \text{ rdg.} \pm 0.1\% \text{ f.s.}$	$\pm (0.06 * f + 0.02)^\circ$
$10 \text{ kHz} < f \leq 50 \text{ kHz}$	$\pm 0.4\% \text{ rdg.} \pm 0.3\% \text{ f.s.}$	$\pm 0.62^\circ$
$50 \text{ kHz} < f \leq 100 \text{ kHz}$	$\pm 1.5\% \text{ rdg.} \pm 0.5\% \text{ f.s.}$	$\pm (0.005 * f + 0.4)^\circ$
$100 \text{ kHz} < f \leq 200 \text{ kHz}$	$\pm 20\% \text{ f.s.}$	$\pm (0.022 * f - 1.3)^\circ$

Values of f in above tables are given in kHz.

Accuracy figures for DC voltage and current are defined for U_{dc} and I_{dc} , while accuracy figures for frequencies other than DC are defined for U_{rms} and I_{rms} .

Accuracy figures for phase difference values are defined for full-scale input with a power factor of zero and the LPF disabled.

Accuracy figures for voltage, current, and active power values in the frequency range of 0.5 Hz to 10 Hz are provided as reference values.

Accuracy figures for voltage and active power values in excess of 220 V in the frequency range of 10 Hz to 16 Hz are provided as reference values.

Accuracy figures for voltage and active power values in excess of 750 V in the frequency range of 30 kHz to 100 kHz are provided as reference values.

Accuracy figures for voltage and active power values in excess of $(22000/f [\text{kHz}]) \text{ V}$ in the frequency range of 100 kHz to 200 kHz are provided as reference values.

Accuracy figures for voltage and active power values in excess of 1000 V are provided as reference values.

Accuracy figures for phase difference values outside the frequency range of 45 Hz to 66 Hz are provided as reference values.

For voltages in excess of 600 V, add the following to the phase difference accuracy:

$$500 \text{ Hz} < f \leq 5 \text{ kHz}: \pm 0.3^\circ$$

$$5 \text{ kHz} < f \leq 20 \text{ kHz}: \pm 0.5^\circ$$

$$20 \text{ kHz} < f \leq 200 \text{ kHz}: \pm 1^\circ$$

Add $\pm 20 \mu\text{V}$ to the DC current and active power accuracy (at 2 V f.s.)

Add the current sensor accuracy to the above accuracy figures for current, active power, and phase difference.

However, the combined accuracy is defined separately for the current measurement options listed below.

Combined accuracy when used with current measurement options PW9100-03 or PW9100-04 (with PW3390 range as f.s.)

	Current (I)	Active power (P)
DC	$\pm 0.07\% \text{ rdg.} \pm 0.077\% \text{ f.s.}$	$\pm 0.07\% \text{ rdg.} \pm 0.077\% \text{ f.s.}$
$45 \text{ Hz} \leq f \leq 66 \text{ Hz}$	$\pm 0.06\% \text{ rdg.} \pm 0.055\% \text{ f.s.}$	$\pm 0.06\% \text{ rdg.} \pm 0.055\% \text{ f.s.}$

Add $\pm 0.12\% \text{ f.s.}$ (f.s. = PW3390 range) when using 1 A or 2 A range.

Combined accuracy when used with any of the following current measurement options: special-order high-accuracy 9709-05, high-accuracy CT6862-05, or high-accuracy CT6863-05 (with PW3390 range as f.s.)

	Current (I)	Active power (P)
DC	$\pm 0.095\% \text{ rdg.} \pm 0.08\% \text{ f.s.}$	$\pm 0.095\% \text{ rdg.} \pm 0.08\% \text{ f.s.}$
$45 \text{ Hz} \leq f \leq 66 \text{ Hz}$	$\pm 0.085\% \text{ rdg.} \pm 0.06\% \text{ f.s.}$	$\pm 0.085\% \text{ rdg.} \pm 0.06\% \text{ f.s.}$

Apply LPF accuracy definitions to the above accuracy figures when using the LPF.

1. Power Measurement Input Specifications

Guaranteed accuracy period	6 months (and 1.25 times specified accuracy for one year)
Conditions of guaranteed accuracy	Temperature and humidity for guaranteed accuracy: 23°C±3°C, 80% RH or less Warm-up time: 30 minutes or more Input: Sine wave input, power factor of one, or DC input, zero ground voltage, within effective measurement range after zero-adjustment and within the specified range in which the fundamental wave satisfies the synchronization source conditions.
Temperature coefficient	±0.01% rdg./°C (for DC, add ±0.01% f.s./°C)
Effect of common mode voltage	±0.01% f.s. or less (with 1000 V (50 Hz/60 Hz) applied between voltage measurement jacks and chassis)
Magnetic field interference	±1% f.s. or less (in 400 A/m magnetic field, DC and 50 Hz/60 Hz)
Power factor influence	Other than $\phi = \pm 90^\circ$ $\pm(1 - \cos(\phi + \text{Phase difference accuracy}) / \cos(\phi)) \times 100\% \text{ rdg.}$ When $\phi = \pm 90^\circ$ $\pm \cos(\phi + \text{Phase difference accuracy}) \times 100\% \text{ f.s.}$
Effect of conducted radio-frequency electromagnetic field	@3 V, current and active power not more than ±6% f.s., where f.s. current is the rated primary-side current of the current sensor f.s. active power equals the voltage range × the rated primary-side current of the current sensor
Effect of radiated radio-frequency electromagnetic field	@10 V/m, current and active power not more than ±6% f.s., where f.s. current is the rated primary-side current of the current sensor, and f.s. active power equals the voltage range × the rated primary-side current of the current sensor
Effective measuring range	Voltage, Current, Power: 1% to 110% of the range
Total display area	Voltage, Current, Power: from zero-suppression range setting to 120%
Zero-suppression ranges	Selectable OFF, 0.1 or 0.5% f.s. When OFF, non-zero values may be displayed even with no measurement input
Zero adjustment	Voltage: Zero-adjustment compensation of internal offset at or below ±10% f.s. Current: Zero-adjustment compensation of input offset at or below ±10% f.s. ±4 mV
Waveform peak measurement range	Within ±300% of each voltage and current range
Waveform peak measurement accuracy	Within ±2% f.s. of voltage and current display accuracy

2. Frequency Measurement Specifications

Measurement channels	Four (f1 to f4)
Measurement source	Select U/I for each measurement channel
Measurement method	Reciprocal method + zero-crossing sample value correction
Measuring range	Synchronous range from 0.5 Hz to 5 kHz (with "0.0000 Hz" or "----- Hz" unmeasurable time) Selectable lower limit measurement frequency (0.5 Hz/1 Hz/2 Hz/5 Hz/10 Hz/20 Hz)
Data update interval	50 ms (measurement-frequency-dependent at 45 Hz and below)
Accuracy	±0.01 Hz (during voltage frequency measurement, with sine wave input of at least 30% of the voltage measurement range and while measuring within the range of 45 Hz to 66 Hz) Under other conditions, ±0.05% rdg. ±1 dgt. (with sine wave of at least 30% of the measurement source's measurement range)
Numerical display format	0.5000 Hz to 9.9999 Hz, 9.900 Hz to 99.999 Hz, 99.00 Hz to 999.99 Hz, 0.9900 kHz to 5.0000 kHz

3. Integration Measurement Specifications

Measurement mode	Selectable RMS or DC for each wiring mode (DC is selectable only for 1P2W wiring and AC/DC sensors)
Measurement items	Current integration (Ih+, Ih-, and Ih), active power integration (WP+, WP-, and WP) Ih+ and Ih- only for DC mode measurements, and Ih only for RMS mode measurements
Measurement method	Digital calculation from each current and active power phase (when averaging, calculates with previous average value) In DC mode: calculates current value at every sample, and integrates instantaneous power independent of polarity In RMS mode: Integrates current effective values between measurement intervals, and polarity-independent active power value
Measurement interval	50 ms data update interval
Display resolution	999999 (6 digits + decimal), starting from resolution at which 1% of each range constitutes f.s.
Measuring range	0 to ±9999.99 TAh/TWh (however, with integration time of no greater than 9999 hours and 59 minutes) Integration stops when either maximum integration value or time is exceeded.
Integration time accuracy	±50ppm±1dgt. (-10°C to 40°C)
Integration accuracy	± (current and active power accuracy) ± integration time accuracy
Backup function	Integration automatically resumes after power outages.

4. Harmonic Measurement Specifications

Number of measurement channels	4 Channels Harmonic measurements not available for multiple systems with different frequencies.		
Measurement items	Harmonic rms voltage, harmonic voltage percentage, harmonic voltage phase angle, harmonic rms current, harmonic current percentage, harmonic current phase angle, harmonic active power, harmonic power percentage, harmonic voltage-current phase difference, total harmonic voltage distortion, total harmonic current distortion, voltage imbalance, current imbalance		
Measurement method	Zero-crossing synchronous calculation (all channels in same window), with gap Fixed 500 kS/s sampling, after digital anti-aliasing filter Equal thinning between zero crossings (with interpolation calculation)		
Synchronization source	U1 to U4, I1 to I4, External (with motor analysis and CH B set for pulse input), DC selectable (50 ms or 100 ms)		
FFT calculation word length	32 bits		
Anti-aliasing filter	Digital filter (automatically set based on synchronization frequency)		
Windows	Rectangular		
Synchronization frequency range	As specified for power measurements		
Data update interval	50 ms (measurement-frequency-dependent at 45 Hz and below)		
Phase zero adjustment	Provided by key operation or external control command (only with external sync source) The phase zero adjustment value can be set automatically or manually. Phase zero adjustment setting range: 0.00° to ±180.00° (in 0.01° increments)		
Highest order analysis and window waveforms	Synchronization frequency range	Window waveforms	Analysis order
	0.5 Hz ≤ f < 40 Hz	1	100 th
	40 Hz ≤ f < 80 Hz	1	100 th
	80 Hz ≤ f < 160 Hz	2	80 th
	160 Hz ≤ f < 320 Hz	4	40 th
	320 Hz ≤ f < 640 Hz	8	20 th
	640 Hz ≤ f < 1.2 kHz	16	10 th
	1.2 kHz ≤ f < 2.5 kHz	32	5 th
2.5 kHz ≤ f < 5.0 kHz	64	3 th	
Accuracy	Frequency	Voltage(U), Current(I), Active Power(P)	
	0.5 Hz ≤ f < 30 Hz	±0.4% rdg. ±0.2% f.s.	
	30 Hz ≤ f ≤ 400 Hz	±0.3% rdg. ±0.1% f.s.	
	400 Hz < f ≤ 1 kHz	±0.4% rdg. ±0.2% f.s.	
	1 kHz < f ≤ 5 kHz	±1.0% rdg. ±0.5% f.s.	
	5 kHz < f ≤ 10 kHz	±2.0% rdg. ±1.0% f.s.	
	10 kHz < f ≤ 13 kHz	±5.0% rdg. ±1.0% f.s.	
Not specified for sync frequencies of 4.3 kHz and higher Add the LPF accuracy to the above when using LPF.			

5. Noise Measurement Specifications

Calculation channels	1(Select one from CH1 to CH4)
Calculation parameters	Voltage/Current
Calculation type	RMS spectrum
Calculation method	Fixed 500 kS/s sampling, thinning after digital anti-aliasing filter
FFT calculation word length	32 bits
FFT data points	1,000/5,000/10,000/50,000 (according to displayed waveform recording length)
Anti-aliasing filter	Automatic digital filter (varies with maximum analysis frequency)
Windows	Rectangular, Hanning, flat-top
Data update interval	Determined by FFT points within approx. 400 ms, 1s, 2s, or 15 s, with gap
Highest analysis frequency	200 kHz/50 kHz/20 kHz/10 kHz/5 kHz/2 kHz
Frequency resolution	0.2 Hz to 500 Hz (Determined by FFT points and maximum analysis frequency)
Noise amplitude measurement	Calculates the ten highest level and frequency voltage and current FFT peak values (local maxima). In FFT calculation results, peak values are recognized when data levels on either side are lower. The lower noise frequency limit can be specified.

6. Motor Analysis Specifications (Model PW3390-03 only)

Number of input channels	3 channels CH A: Analog DC input, Frequency input CH B: Analog DC input, Pulse input CH Z: Pulse input
Measurement input jacks	Insulated BNC jacks
Input impedance (DC)	1 M Ω \pm 100 k Ω
Input methods	Isolated and differential inputs (not isolated between channels B and Z)
Measurement parameters	Voltage, torque, rotation rate, frequency, slip, and motor power
Maximum input voltage	\pm 20 V (during analog, frequency, and pulse input)
Maximum rated voltage to earth	50 V (50 Hz/60 Hz)
Period of guaranteed accuracy	6 months (and 1.25 times specified accuracy for one year)
Conditions of guaranteed accuracy	Temperature and humidity for guaranteed accuracy: 23 $^{\circ}$ C \pm 3 $^{\circ}$ C (73 $^{\circ}$ F \pm 5 $^{\circ}$ F), 80% RH or less Warm-up time: 30 minutes or more Input: With 0 V to ground, after zero adjustment

(1) Analog DC Input (CH A/CH B)

Measurement range	\pm 1 V, \pm 5 V, \pm 10 V (when inputting analog DC)
Valid input range	1% to 110% f.s.
Sampling	10 kHz/16bits
Response time	1 ms (measuring zero to full scale, with LPF off)
Measurement method	Simultaneous digital sampling and zero-crossing synchronous calculation system (cumulative average of intervals between zero crossings)
Synchronization source	Same as power measurement input specification (common to CH A and CH B)
Measurement accuracy	\pm 0.08% rdg. \pm 0.1% f.s.
Temperature coefficient	\pm 0.03% f.s./ $^{\circ}$ C
Effect of common mode voltage	Not more than \pm 0.01% f.s. (with 50 V [DC or 50 Hz/60 Hz] between measurement jacks and PW3390 chassis)
Effect of external magnetic field	Not more than \pm 0.1% f.s. (at 400 A/m DC and 50 Hz/60 Hz magnetic fields)
LPF	OFF/ON (OFF: 4 kHz, ON: 1 kHz)
Total display area	Zero-suppression range setting \pm 120%
Zero adjustment	Zero-corrected input offset of voltage \pm 10% f.s. or less

(2) Frequency Input (CH A only)

Valid amplitude range	\pm 5 V peak (5 V symmetrical, equivalent to RS-422 complementary signal)
Max. measurement frequency	100 kHz
Measurement range	1 kHz to 100 kHz
Synchronization source	Same as power measurement input specification
Data output interval	According to synchronization source
Measurement accuracy	\pm 0.05% rdg. \pm 3 dgt.
Total display area	1.000 kHz to 99.999 kHz

10.2 Basic Specifications

(3) Pulse Input (CH B only)

Detection level	Low: 0.5 V or less, High: 2.0 V or more
Measurement range	1 Hz to 200 kHz (at 50% duty)
Division setting range	1 to 60000
Measurement frequency range	0.5 Hz to 5.0 kHz (limited to measured pulse frequency divided by selected no. of divisions)
Minimum detectable pulse width	2.5 μ s or better
Measurement accuracy	$\pm 0.05\%$ rdg. ± 3 dgt.

(4) Pulse Input (CH Z only)

Detection level	Low: 0.5 V or less, High: 2.0 V or more
Measurement range	0.1 Hz to 200 kHz (at 50% duty)
Minimum detectable pulse width	2.5 μ s or better
Settings	OFF/Z Phase/B Phase (clear counts of CHB in rising edge during Z Phase, detect polar code for number of rotations during B Phase)

7. D/A Output Option Specifications (Models PW3390-02 and PW3390-03)

Number of output channels	16 channels
Output contents	Selectable waveform/analog outputs (from basic measurement parameters) Waveform output only on Channels 1 to 8
Output connector	One 25-pin female D-sub
D/A conversion resolution	16 bits (polarity + 15 bits)
Output accuracy	Analog output: Measurement accuracy $\pm 0.2\%$ f.s. (DC level) Waveform output: Measurement accuracy $\pm 0.5\%$ f.s. (at ± 2 V f.s.), $\pm 1.0\%$ f.s. (at ± 1 V f.s.) (rms level within synchronous frequency range)
Output update interval	Analog output: 50 ms (according to input data update interval of selected parameter) Waveform output: 500 kHz
Output voltage	Analog output: ± 5 V DC nom. (approx. ± 12 V DC max.) Waveform output: ± 2 V/ ± 1 V switchable, crest factor of 2.5 or greater Setting applies to all channels.
Output impedance	100 Ω ± 5 Ω
Period of guaranteed accuracy	6 months (For 1 year accuracy, calculate the specified accuracy for 6 months $\times 1.25$)
Conditions of guaranteed accuracy	Temperature and humidity: 23°C ± 3 °C (73°F ± 5 °F), 80% RH or less Warm-up time: 30 minutes or more, After zero adjustment of the PW3390
Temperature coefficient	$\pm 0.05\%$ f.s./°C

Pinout

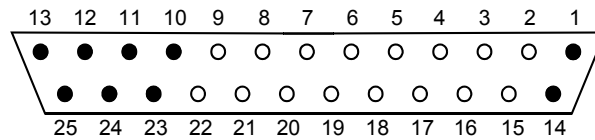

Pin No.	Output (Waveform)	Pin No.	Output
1	GND	14	GND
2	D/A1 (U1)	15	D/A9
3	D/A2 (I1)	16	D/A10
4	D/A3 (U2)	17	D/A11
5	D/A4 (I2)	18	D/A12
6	D/A5 (U3)	19	D/A13
7	D/A6 (I3)	20	D/A14
8	D/A7 (U4)	21	D/A15
9	D/A8 (I4)	22	D/A16
10	GND	23	GND
11	GND	24	GND
12	GND	25	GND
13	GND	—	—

8. Display Specifications

Languages	Japanese, English, Simplified Chinese
Display type	9-inch TFT color LCD (800×480 dots)
Dot pitch	0.246(V) mm ×0.246(H) mm
LCD backlight	Always ON, Auto OFF (after 1/5/10/30/60 minutes)
Display numerical resolution	99999 counts (other than the integrated value) 999999 counts (Integrated value)
Display refresh interval	Measurement values: 200 ms (independent of internal data update interval) Waveforms, FFT: Screen-dependent
Screens	Measurement, Setting, and File Operation screens

9. External Interface Specifications

(1) USB Interface (Functions)

Connector	Mini-B receptacle
Compliance standard	USB2.0 (Full Speed/High Speed)
No. of ports	1
Class	Individual (USB488h)
Connection destination	Computer Windows 7 (32-bit, 64-bit)/Windows 8 (32-bit, 64-bit)/Windows 10 (32-bit, 64-bit)
Function	Data transfer and command control Not for simultaneous use with Ethernet: USB has priority when both interfaces used

(2) USB Memory Interface

Connector	USB type A connector
Compliance standard	USB2.0
USB power supply	500 mA maximum
No. of ports	1
USB storage device support	USB Mass Storage Class
Recordable content	Save and load settings files Save measurement values (CSV format) Copy measurement values and recorded data (from CF card) Save waveform data Save FFT spectrum for noise measurement Save and load screen captures

(3) LAN Interface

Connector	RJ-45 connector × 1
Compliance standard	IEEE802.3 compliant
Transmission method	10BASE-T/100BASE-TX Auto detected
Protocol	TCP/IP
Function	HTTP server (remote operation), Dedicated port (data transfer and command control) Not for simultaneous use with USB (functions): USB has priority when both interfaces used

(4) CF Card Interface

Slot	One Type 1
Compatible card	Compact Flash memory card (32 MB or higher)
Supported memory capacity	Up to 2 GB
Data format	MS-DOS format (FAT16/FAT32)
Recordable content	Save and load settings files Save measurement voltage and auto-recorded data (CSV format) Copy measurements/recorded data (from USB storage) Save waveform data Save FFT spectrum for noise measurement Save and load screen captures

(5) RS-232C Interface

Method	RS-232C [EIA RS-232D], [CCITT V.24], [JIS X5101] compliant
Connector	D-sub9 pin connector ×1
Connection destination	PC (simultaneous use of USB and LAN not supported; order of precedence with simultaneous connection: USB > LAN > RS-232C.)
Communication format	Full duplex, start-stop synchronization, 8-bit data, no parity, one stop bit, hardware flow control, CR+LF delimiter
Communication speeds	9600 bps, 19200 bps, 38400 bps
Function	Command control, Bluetooth [®] logger connectivity (simultaneous use not supported)

(6) Synchronization Control Interface

Signal contents	One-second clock, integration START/STOP, DATA RESET, EVENT
Connector types	IN: 9-pin round connector ×1 OUT: 8-pin round connector ×1
Signal	5 V CMOS
Max. input	±20 V
Max. signal delay	2 μs (rising edge)

(7) External Control Interface

Connector types	9-pin round connector ×1 ; also used as synchronization control interface
Pin assignments	Pin 1: Data reset Pin 2: Integration start/stop Pin 4: Event Pin 7: Ground
Electrical specifications	0 V/5 V (2.5 V to 5 V) logic signal, or contact signal with contacts shorted/open
Function	Data reset: Same operation as the DATA RESET key on the control panel Integration start/stop: Same operation as the START/STOP key on the control panel Event: Same operation as the event set as the synchronization control function's synchronization event (Cannot be used at the same time as synchronization control.)

10.3 Functions Specifications

1. AUTO range Function

Function	Automatically selects voltage and current ranges according to measured amplitude on each phase.
Operating states	Selectable on or off for each phase system
Auto-ranging span	Wide/Narrow (common to all wiring systems) Wide: When a phase system's peak-over or rms value is above 110% f.s., increments one range, and, when all rms values within the phase system are below 10% f.s., decrements two ranges (except when peak-over occurs in the lower range, in which case no range decrementing occurs). Narrow: When a wiring system peak over or rms value is above 105% f.s., increments one range, and, when all rms values within the wiring system are below 40% f.s., decrements one range (except when peak-over occurs in the lower range, in which case no range decrementing occurs). When Δ -Y transform is enabled, the range-decrementing voltage is $1/\sqrt{3}$ (approximately 0.57735) f.s.

2. Timing Control Functions

Interval	OFF/50 ms/100 ms/200 ms/500 ms/1 s/5 s/10 s/15 s/30 s /1 min/5 min/10 min/15 min/30 min/60 min Setting determines the maximum data-saving capacity
Timing controls	OFF /Timer /RTC Timer: 10 s to 9999:59:59 [h:m:s] (in seconds) Real-Time Clock: Start and stop times (in minutes)

3. Hold Functions

(1) Hold

Function	Stops all updating of displayed measurement values and waveforms, and holds display. However, the clock and peak-over display continue to be updated. Disabled when the peak-hold function is enabled.
Data updating	The next display data update occurs when the HOLD key is pressed again, at the end of the measurement interval, or when an external sync signal is detected. Internal data is updated every 50 ms (independent of the display data update interval). Waveform and noise data are updated when calculation finishes.
Output data	Held values are present at D/A output and are saved to CF card (although waveform output continues). With auto-saving enabled, data is saved immediately before it is updated.
Display	The HOLD indicator appears when Hold is active.
Backup	Not applicable (the function is deactivated upon recovery from power outages.)

(2) Peak Hold

Function	All measurement values are updated to display the maximum value for each measurement. However, displayed waveforms and integration values continue to be updated with instantaneous values. When averaging is enabled, maximum values are displayed after averaging. Cannot be used together with the display-hold function. Signed items are compared for absolute values.
Data updating	Displayed data is cleared when the HOLD key is pressed again, at the end of the measurement interval, or when an external sync signal is detected. Internal data is updated every 50 ms (independent of the display refresh interval).
Output data	Held values are present at D/A output and are saved to CF card (although waveform output continues). With auto-saving enabled, data is saved immediately before it is updated.
Display	The PEAK HOLD indicator appears when Peak Hold is active.
Backup	Not applicable (the function is deactivated upon recovery from power outages.)

10.3 Functions Specifications

4. Calculation Functions

(1) Rectification System

Function	Select which voltage and current values to used for calculating apparent and reactive power, and power factor
Method	rms/mean (voltage and current in each phase system)

(2) Scaling

VT (PT) ratio	OFF/0.01 to 9999.99 (Settings for which VT×CT exceeds 1.0E+06 are disallowed.)
CT ratio	OFF/0.01 to 9999.99 (Settings for which VT×CT exceeds 1.0E+06 are disallowed.)
Display	VT or CT indicator is displayed when scaling.

(3) Average

Function	Averages all instantaneous measurement values including harmonics (but not peak, integration, or FFT noise values). When averaging is enabled, the averaged data is saved.
Method	Indexed average (applied at 50 ms data update intervals) Averaged voltage (U), current (I), and power (P) values are used for calculations. rms values are averaged for harmonic amplitude, and instantaneous values are averaged for relative harmonic content. Phase angle is calculated from the average real and imaginary components after FFT. Phase difference, distortion and imbalance are calculated from the above data after averaging. Ripple factor is calculated from averaging the differences in peak values.
Response speed	OFF/FAST/MID/SLOW/SLOW2/SLOW3 (time remains within specified accuracy when input changes from 0 to 100% f.s.) Corresponding response times are 0.2 s/1.0 s/5 s/25 s/100 s
Display	The AVG indicator is displayed when averaging is enabled.

(4) Efficiency and Loss Calculations

Function	Efficiency η [%] and Loss [W] are calculated from active power values measured on each phase and system.
Calculation items	Active power (P) of each phase and system Motor power (Pm) when motor evaluation model PW3390-03 is installed
Calculation accuracy	Measurements applied to formulas are handled as 32-bit floating point values. When calculating parameters between wiring systems with different power ranges, the higher range is used.
Calculation rate	At every 50 ms data update interval When calculating between wiring systems having different sync sources, the most recent data is used at calculation time.
Maximum no. of simultaneous calculations	Efficiency and loss, by three formulas
Calculation method	Parameters specified for P_{in} and P_{out} are applied as follows $\eta = 100 \times P_{out} / P_{in} $, Loss = $ P_{in} - P_{out} $

(5) Δ - Y Calculation

Function	For 3P3W3M systems, converts line voltage waveforms into phase voltage waveforms using the virtual neutral point. All voltage parameters including harmonics such as true rms voltage are calculated as phase voltage waveforms.
Calculation method	$U1s = (u1s-u3s)/3$, $U2s = (u2s-u1s)/3$, $U3s = (u3s-u2s)/3$ u1s to u3s: Line voltage values sampled across channels 1 to 3 U1s to U3s: Phase voltage values calculated for channels 1 to 3

(6) Selecting the Calculation Method

Function	Select the calculation method used to calculate the apparent power and reactive power during 3P3W3M wiring. Only affect measurement values S123, Q123, ϕ 123, λ 123
Calculation method	TYPE1/TYPE 2 (only valid when wiring is 3P3W3M)

(7) Current sensor phase correction calculations

Function	Compensation by calculating the current sensor's harmonic phase characteristics
Operating modes	OFF/ON (set separately for each wiring mode)
Configuration of corrected values	Correction points are set using frequency and phase difference (set separately for each wiring mode). Frequency: 0.001 kHz to 999.999 kHz (in 0.001 kHz increments) Phase difference: 0.00° to $\pm 90.00^\circ$ (in 0.01° increments) However, the time difference calculated from the frequency phase difference is limited to a maximum of 200 μ s in 5 ns increments.

5. Display Functions

(1) Wiring Check screen

Function	The wiring diagram and voltage/current vectors are displayed for the selected wiring system(s). The correct range for the wiring system is shown on the vector display, to confirm proper measurement cable connections.
Start-up mode	The Wiring Check screen can be set to always appear upon start-up (Start-Up Screen setting).
Basic settings	Selects auto-ranging for voltage and current on each wiring system, and sets each value to its default. Not available when integration or the Hold function is enabled.

(2) Independent wiring system display mode

Function	Displays power and harmonic measurement values for channels 1 to 4. A composite measurement line pattern is displayed for each system.
DMM	Basic, voltage, current, and power measurement parameter screens
Harmonics	Bar Graph, List or Vector screen

(3) Display Selections

Function	Select to display any 4, 8, 16, or 32 of the basic measurement parameters.
Display layout	4, 8, 16, or 32 parameters, Independently set for each screen

(4) Efficiency and Loss Screen

Function	The efficiency and loss obtained by the specified calculation formulas are displayed numerically.
Display layout	Three efficiency and three loss values.

(5) Waveform & Noise Screen

Function	Voltage and current waveforms sampled at 500 kHz and noise measurements are displayed compressed on one screen.
Trigger	Synchronized with the harmonic sync source
Recording length	1000/5000/10000/50000 × All voltage and current channels
Compression ratio	1/1, 1/2, 1/5, 1/10, 1/20, 1/50 (peak-to-peak compression) Also, peak-to-peak compression enables drawing 500-dot (vertical) screen images
Noise sampling	500 kS/s, 250 kS/s, 100 kS/s, 50 kS/s, 25 kS/s, 10 kS/s (according to compression ratio)
Recording time	

Sampling	Recording length			
	1000	5000	10000	50000
500 kS/s	2 ms	10 ms	20 ms	100 ms
250 kS/s	4 ms	20 ms	40 ms	200 ms
100 kS/s	10 ms	50 ms	100 ms	500 ms
50 kS/s	20 ms	100 ms	200 ms	1000 ms
25 kS/s	40 ms	200 ms	400 ms	2000 ms
10 kS/s	100 ms	500 ms	1000 ms	5000 ms

6. Graph Display Functions

(1) X-Y Plot Screen

Function	Select horizontal and vertical axes from the basic measurement items to display on the X-Y graphs. Dots are plotted at the data update interval, and is not saved. Drawing data can be cleared.
Horizontal axis	1 data item (gauge display available)
Vertical axis	2 data items (gauge display available)

(2) Trend screen

Function	Measured values selected as trend display parameters from all basic measurement parameters are graphed as a time sequence. Waveforms are graphed by subjecting data refresh rate data to peak-peak compression based on the time axis setting. Data is not stored.
Operation	Graphing can be started and stopped using the RUN and STOP commands, respectively. During hold and peak hold operation, the display value is graphed. Graph data is cleared when a trend display parameter is changed; when a setting related to measured values, for example the range, is changed; when a setting on the System screen is changed; or when graphing is restarted after clearing the data or stopping graphing.
Number of graphed parameters	Up to 8
Graphed parameters	All basic measurement parameters can be selected as trend display parameters.

10.3 Functions Specifications

(2) Trend screen

Time axis	1.5 / 3 / 6 / 12 / 30 s/div , 1 / 3 / 6 / 10 / 30 min/div, 1 / 3 / 6 / 12 hour/div, 1 day/div
Vertical axis	Auto (The vertical axis is configured so that data in the screen display range fits on the screen.) Semi-auto (The zoom factor is set from the following values relative to the full-scale value for graphed parameters: 1/8, 1/4, 1/2, ×1, ×2, ×5, ×10, ×20, ×50, ×100, ×200, ×500) Manual (The user sets the display maximum and minimum values.)

7. Auto-Save Functions

Function	Each value is stored to CF card during every measurement interval. Can be controlled by timer or real-time clock
Save destinations	Off, CF card (not available for USB storage) The destination folder can be specified.
Saved items	Any measured values including harmonics and noise value data of the FFT function
Max. no. of saved items	Interval-setting-dependent <ul style="list-style-type: none"> • 50 ms: 130 items • 100 ms: 260 items • 200 ms: 520 items • 500 ms: 1300 items • 1 s: 2600 items • 5 s to 60 min: 5000 items
Data format	CSV file format (with read-only attribute) With functionality for switching the delimiter based on the selected file format CSV: Comma (",") as measurement data delimiter and period (".") as decimal point SSV: Semicolon (";") as measurement data delimiter and comma (",") as decimal point
File name	Automatically generated using starting date and time, with CSV extension

8. Manual Saving Functions

(1) Measurement Data

Function	Pressing the SAVE key saves each measurement value at that moment to the save destination. A new file is created the first time data is saved, and subsequent saves are made to that file.
Save destinations	USB memory/CF card Able to specify the folder to save.
Saving items	Saved items: any measured values including harmonics and noise value data of the FFT function
Screen capture	CSV file format (with read-only attribute) With functionality for switching the delimiter based on the selected file format CSV: Comma (",") as measurement data delimiter and period (".") as decimal point SSV: Semicolon (";") as measurement data delimiter and comma (",") as decimal point
File name	Automatically created with CSV extension

(2) Screen Capture

Function	The COPY key (SHIFT+SAVE) captures and saves a bitmap image of the display to the save destination
Save destinations	USB memory/CF card Able to specify the folder to save.
Data format	Compressed BMP format (256-color)
File name	Automatically created with BMP file name extension
Constraints	Function available while auto-save operation is in progress, but auto-save operation takes precedence. Unavailable if interval is less than 5 s.

(3) Settings Data

Function	Settings specified on the FILE screen are saved as a file on the save destination. Saved settings files can then be reloaded to restore a previous setting configuration (except for language and communications settings).
Save destinations	USB memory/CF card Able to specify the folder to save.
File name	Automatically created with SET file name extension

(4) Waveform Data

Function	Saves the waveform being displayed by means of [Wave/Noise] display.
Save destinations	USB memory/CF card Able to specify the folder to save.
Data format	CSV file format (with read-only attribute) With functionality for switching the delimiter based on the selected file format CSV: Comma (",") as measurement data delimiter and period (".") as decimal point SSV: Semicolon (";") as measurement data delimiter and comma (",") as decimal point
File name	Automatically generated; extension: CSV
Constraints	Cannot be saved while auto-save operation is in progress.

(5) FFT data

Function	Saves the noise measurement FFT spectrum that is currently displayed on the Waveform/Noise screen
Save destinations	USB memory/CF card Able to specify the folder to save.
Data format	CSV file format (with read-only attribute) With functionality for switching the delimiter based on the selected file format CSV: Comma (",") as measurement data delimiter and period (".") as decimal point SSV: Semicolon (";") as measurement data delimiter and comma (",") as decimal point
File name	Automatically generated; extension: CSV
Constraints	Cannot be saved while auto-save operation is in progress.

9. Synchronous Control Function

Function	Synchronous measurements are available by using sync cables to connect one Model PW3390 as a primary (master) instrument and one or more as secondary (slave) instruments. Clocks and data updates are synchronized when the secondary (slave) instrument is turned on. Afterwards, resynchronization is performed at each second of the clock (disabled when the secondary [slave] instrument is started while the primary [master] instrument is off). When internal settings match, auto-save is available while synchronized.
Synchronized items	Clock, data update interval (except for FFT calculations), integration START/STOP, DATA RESET, certain events
Event items	Hold, manual save, screen capture
Synchronization timing	Clock, data update interval: within 10 s after power-on by a secondary (slave) PW3390 START/STOP, DATA RESET, event: Upon key-press and communications operations on the primary (master) PW3390
Synchronization delay	Maximum 5 μ s per connection. Maximum synchronization delay of an event is +50 ms

10. Bluetooth® logger connectivity

Function	Sends measured values wirelessly to logger by using a Bluetooth® serial conversion adapter.
Supported devices	Hioki LR8410 Link-compatible loggers (LR8410-20)
Sent data	Measured values assigned to the D/A CH9 to CH16 analog output parameters

11. Other functions

Real-time clock function	Auto-calendar, leap-year correcting 24-hour clock
RTC accuracy	± 3 s per day (25°C)
Sensor recognition	Current sensors are automatically recognized when connected Sensor range and connection state are detected, and warning indicators displayed as needed Excluding the CT7000 series sensors
Warning indicators	When peak over occurs on voltage and current measurement channels When no sync source is detected Warning indicators for all channels are displayed on all pages of the MEAS screen.
Key-lock	Toggles on/off by holding the ESC key for three seconds. A key-lock indicator is displayed when the keys are locked.
System reset	Returns all settings to factory defaults However, language and communications settings are unaffected.
Power-on reset	Holding the SHIFT key when turning the power on returns all settings including language and communications settings, to factory defaults.
File operations	Media content list display, format media, create folders, delete files and folders, copy between storage media

10.4 Setting Specifications

1. Input Settings

Wiring modes	CH1	CH2	CH3	CH4
Pattern 1	1P2W	1P2W	1P2W	1P2W
Pattern 2	1P3W		1P2W	1P2W
Pattern 3	3P3W2M		1P2W	1P2W
Pattern 4	1P3W		1P3W	
Pattern 5	3P3W2M		1P3W	
Pattern 6	3P3W2M		3P3W2M	
Pattern 7	3P3W3M			1P2W
Pattern 8	3P4W			1P2W

Synchronization source	U1 to U4, I1 to I4, Ext (when channel B is set for pulse input with a model with motor analysis) DC (50 ms/100 ms) @Selectable on all wiring systems
Voltage range	AUTO/1500 V/600 V/300 V/150 V/60 V/30 V/15 V
Voltage rectification method	RMS/MEAN (voltage value used to calculate apparent and reactive power, and power factor)
Current range	When not using the CT9920 Conversion Cable: AUTO/20 A/8 A/4 A/2 A (20 A with model 9272-05) AUTO/2 A/0.8 A/0.4 A/0.2 A/0.08 A/0.04 A (with 2 A sensor) AUTO/20 A/8 A/4 A/2 A/0.8 A/0.4 A (with 20 A sensor) AUTO/200 A/80 A/40 A/20 A/8 A/4 A (with 200 A sensor) AUTO/2 kA/800 A/400 A/200 A/80 A/40 A (with 2000 A sensor) AUTO/5 A/2 A/1 A/0.5 A/0.2 A/0.1 A (with 5 A sensor) AUTO/50 A/20 A/10 A/5 A/2 A/1 A (with 50 A sensor) AUTO/500 A/200 A/100 A/50 A/20 A/10 A (with 500 A sensor) AUTO/1 kA/400 A/200 A/100 A/40 A/20 A (with 1000 A sensor) When using the CT9920 conversion cable: Depends on selected sensor output rate or sensor model. AUTO/2 kA/800 A/400 A (with models CT7642 and CT7742) AUTO/8 kA/4 kA/2 kA/800 A/400 A (with models CT7044, CT7045, and CT7046) AUTO/20 kA/8 kA/4 kA/2 kA/800 A/400 A (100 μ V/A) AUTO/2 kA/800 A/400 A/200 A/80 A/40 A (1 mV/A) AUTO/200 A/80 A/40 A/20 A/8 A/4 A (10 mV/A) AUTO/20 A/8 A/4 A/2 A/0.8 A/0.4 A (100 mV/A)
Current rectification method	RMS/MEAN (current value used to calculate apparent and reactive power, and power factor)
VT(PT) ratio	OFF/0.01 to 9999.99 (setting not available if VT \times CT ratio exceeds 1.0E+06)
CT ratio	OFF/0.01 to 9999.99 (setting not available if VT \times CT ratio exceeds 1.0E+06)
LPF	OFF, 500 Hz, 5 kHz, 100 kHz
Lower limit measurement frequency	0.5 Hz, 1 Hz, 2 Hz, 5 Hz, 10 Hz, 20 Hz
Frequency measurement	Select U or I for f1, f2, f3, and f4
Integration mode	RMS/DC

2. Current sensor phase correction settings

Operating states	OFF/ON
Frequency	0.001 kHz to 999.999 kHz
Phase difference	0.00° to \pm 90.00°

3. Calculation and Recording Settings

Average	OFF/FAST/MID/SLOW/SLOW2/SLOW3
Interval	OFF, 50 ms, 100 ms, 200 ms, 500 ms, 1 s, 5 s, 10 s, 15 s, 30 s, 1 min, 5 min, 10 min, 15 min, 30 min, 60 min
Timer control	Elapsed time/Real-time clock Timer: OFF, 10 s to 9999:59:59 [hhhh:mm:ss] (in 1 s units) Real-time clock: OFF, start and stop times (YMD-hms, in 1 min units)
Zero suppression	OFF, 0.1% f.s./0.5% f.s.
Zero-crossing filter	OFF, weak or strong
Auto-ranging span	Wide or narrow
Efficiency calculations	Three items (select from all active power values) $\eta = 100 \times P_{out} / P_{in} $
Loss calculations	Three items (select from all active power values) $Loss = P_{in} - P_{out} $
Δ -Y transform	OFF/ON
Calculation method	TYPE1/TYPER2

4. Harmonic Settings

Harmonic	U1 to U4, I1 to I4, Ext (when channel B is set for pulse input with a model with motor analysis) DC (50 ms/100 ms) Settings common to all channels
TTHD calculation	THD-F/THD-R

5. Noise Analysis Settings

Measurement channels	Select one of channels 1 to 4
Windows	Rectangular, Hanning, flat-top
Lower limit noise frequency	0 kHz to 10 kHz

6. D/A Output Settings (with D/A output option model)

Waveform output	OFF/ON
Output items	Select one basic measurement item for each output channel. Only selectable for channels 9 to 16 when waveform output is enabled [ON] (Channels 1 to 8 provide waveform output only)
Full-scale frequency	100 Hz, 500 Hz, 1 kHz, 5 kHz (same as max. measurement frequency setting for motor)
Full-scale integration	1/10, 1/2, 1/1, 5, 10, 50, 100, 500, 1000, 5000, 10000 \times range

7. Motor Measurement Settings (with motor evaluation model)

Synchronization source	U1 to U4, I1 to I4, Ext (with channel B set for pulse input), DC (50 ms/100 ms) Common to channels A and B
CHA input	Analog DC or frequency
CHA range	± 1 V, ± 5 V, ± 10 V (for analog DC only)
Frequency range	Select f_c and f_d for frequency range $f_c \pm f_d$ [Hz] (frequency measurement only) 1 kHz to 98 kHz in 1 kHz units, where $f_c + f_d < 100$ kHz and $f_c - f_d > 1$ kHz)
CHA scaling	0.01 to 9999.99 (for analog DC only)
Rated torque	1 to 999 (frequency measurement only)
CHA unit	Analog DC: V, N \cdot m, mN \cdot m, kN \cdot m Frequency: Hz, N \cdot m, mN \cdot m, kN \cdot m
CHB input	Analog DC or pulse
CHB range	± 1 V, ± 5 V, ± 10 V (for analog DC only)
Motor poles	2 to 98
Max. measurement frequency	100 Hz, 500 Hz, 1 kHz, 5 kHz (pulse input only) Same as full-scale D/A output frequency setting
CHB scaling	0.01 to 9999.99 (for analog DC only)
Pulse count	Integer multiple of half the number of motor poles, from 1 to 60000 (pulse input only)
CHB	Analog DC: V, Hz, r/min Pulse: Hz, r/min
CHZ	OFF/Z-phase/B-phase (pulse input only)
Measurement frequency source	f1 to f4 (for slip calculations)
Phase zero adjustment	0.00 $^\circ$ to $\pm 180.00^\circ$ (Pulse only)
LPF	OFF/ON

8. Interface Settings

Synchronization control	Primary (master) instrument/secondary (slave) instrument
Synchronous event items	HOLD, SAVE, COPY
Saving data	Select the items to record (Max. number of items is limited according to the interval setting.)
Auto-save	OFF/ON (CF card)
Data save destination	Destination folder
Manual save destination	USB memory, CF card (Specify the folder to save.)
RS-232C communications speed	9600bps/19200bps/38400bps
Adapter configuration	Initialization of Bluetooth® serial conversion adapter
IP address	Four 3-digit octets (0 to 255)
Subnet mask	Four 3-digit octets (0 to 255)
Default gateway	Four 3-digit octets (0 to 255)

9. System Settings

Display language	JAPANESE/ENGLISH/CHINESE
Beep sound	OFF/ON
Screen color schemes	COLOR1/COLOR2/COLOR3/COLOR4/COLOR5
Start-up screen selection	Wiring or Last-displayed screen (Measurement screens only)
LCD backlight	ON/1 min/5 min/10 min/30 min/60 min
Clock setting	Year, month, day, hour and minute setting, and zero-second adjustment
CSV file format	CSV/SSV
System reset	Reset
Model number indication	Displayed
Serial number indication	Displayed
Version indication	Software version displayed
MAC address	Displays the MAC address.

10.5 Measurement Item Details

1. Basic Measurement Items

Measurement items	Symbol	Unit	Pattern 1 1P2W+1P2W +1P2W+1P2W	Pattern 2,3 1P3W/3P3W2M +1P2W+1P2W	Pattern 4,5,6 1P3W/3P3W2M +1P3W/3P3W2M	Pattern 7,8 3P3W3M/3P4W +1P2W	Display range	Polarity (+/-)		
Frequency	f	Hz	1, 2, 3, 4	1, 2, 3, 4	1, 2, 3, 4	1, 2, 3, 4		0.5000 to 5.0000k		
Voltage	RMS	Urms	V	1, 2, 3, 4	1, 2, 3, 4, 12	1, 2, 3, 4, 12, 34	1, 2, 3, 4, 123	U Range	zero to 120%	
	Voltage MEAN	Umn	V	1, 2, 3, 4	1, 2, 3, 4, 12	1, 2, 3, 4, 12, 34	1, 2, 3, 4, 123	↓	zero to 120%	
	AC component	Uac	V	1, 2, 3, 4	1, 2, 3, 4	1, 2, 3, 4	1, 2, 3, 4	↓	zero to 120%	
	Simple average	Udc	V	1, 2, 3, 4	1, 2, 3, 4	1, 2, 3, 4	1, 2, 3, 4	↓	zero to 120%	●
	Fundamental wave component	Ufnd	V	1, 2, 3, 4	1, 2, 3, 4	1, 2, 3, 4	1, 2, 3, 4	↓	zero to 120%	
	Wave peak +	Upk+	V	1, 2, 3, 4	1, 2, 3, 4	1, 2, 3, 4	1, 2, 3, 4	↓	zero to 300%	●
	Wave peak -	Upk-	V	1, 2, 3, 4	1, 2, 3, 4	1, 2, 3, 4	1, 2, 3, 4	↓	zero to 300%	●
	THD/ripple rate*5	Uthd Urf	%	1, 2, 3, 4	1, 2, 3, 4	1, 2, 3, 4	1, 2, 3, 4		0.00 to 500.00	
Unbalance factor	Uunb	%				123		0.00 to 100.00		
Current	RMS	Irms	A	1, 2, 3, 4	1, 2, 3, 4, 12	1, 2, 3, 4, 12, 34	1, 2, 3, 4, 123	I Range	zero to 120%	
	Current MEAN	Imn	A	1, 2, 3, 4	1, 2, 3, 4, 12	1, 2, 3, 4, 12, 34	1, 2, 3, 4, 123	↓	zero to 120%	
	AC component	Iac	A	1, 2, 3, 4	1, 2, 3, 4	1, 2, 3, 4	1, 2, 3, 4	↓	zero to 120%	
	Simple average	Idc	A	1, 2, 3, 4	1, 2, 3, 4	1, 2, 3, 4	1, 2, 3, 4	↓	zero to 120%	●
	Fundamental wave component	Ifnd	A	1, 2, 3, 4	1, 2, 3, 4	1, 2, 3, 4	1, 2, 3, 4	↓	zero to 120%	
	Wave peak+	Ipk+	A	1, 2, 3, 4	1, 2, 3, 4	1, 2, 3, 4	1, 2, 3, 4	↓	zero to 300%	●
	Wave peak-	Ipk-	A	1, 2, 3, 4	1, 2, 3, 4	1, 2, 3, 4	1, 2, 3, 4	↓	zero to 300%	●
	THD/ripple rate*5	Ithd Irf	%	1, 2, 3, 4	1, 2, 3, 4	1, 2, 3, 4	1, 2, 3, 4		0.00 to 500.00	
Unbalance factor	Iunb	%				123		0.00 to 100.00		
Effective power	P	W	1, 2, 3, 4	1, 2, 3, 4, 12	1, 2, 3, 4, 12, 34	1, 2, 3, 4, 123	P Range	zero to 120%	●	
Apparent power	S	VA	1, 2, 3, 4	1, 2, 3, 4, 12	1, 2, 3, 4, 12, 34	1, 2, 3, 4, 123	↓	zero to 120%		
Reactive power	Q	var	1, 2, 3, 4	1, 2, 3, 4, 12	1, 2, 3, 4, 12, 34	1, 2, 3, 4, 123	↓	zero to 120%	●	
Power factor	λ		1, 2, 3, 4	1, 2, 3, 4, 12	1, 2, 3, 4, 12, 34	1, 2, 3, 4, 123		0.0000 to 1.0000	●	
Phase angle	Voltage phase angle	θU	°	1, 2, 3, 4	1, 2, 3, 4	1, 2, 3, 4	1, 2, 3, 4		0.00 to 180.00	●
	Current phase angle	θI	°	1, 2, 3, 4	1, 2, 3, 4	1, 2, 3, 4	1, 2, 3, 4		0.00 to 180.00	●
	Power phase angle	φ	°	1, 2, 3, 4	1, 2, 3, 4, 12	1, 2, 3, 4, 12, 34	1, 2, 3, 4, 123		0.00 to 180.00	●
Inte- gration	Integ. current in positive direction*1	Ih+	Ah	1, 2, 3, 4	3, 4		4	I Range	zero to 1% to *4	
	Integ. current in negative direction*1	Ih-	Ah	1, 2, 3, 4	3, 4		4	↓	zero to 1% to *4	△
	Sum of integ. current	Ih	Ah	1, 2, 3, 4	1, 2, 3, 4	1, 2, 3, 4	1, 2, 3, 4	↓	zero to 1% to *4	●
	Energy in positive direction	WP+	Wh	1, 2, 3, 4	3, 4, 12	12, 34	4, 123	P Range	zero to 1% to *4	
	Energy in negative direction	WP-	Wh	1, 2, 3, 4	3, 4, 12	12, 34	4, 123	↓	zero to 1% to *4	△
Sum of energy	WP	Wh	1, 2, 3, 4	3, 4, 12	12, 34	4, 123	↓	zero to 1% to *4	●	
Efficiency	η	%	1, 2, 3	1, 2, 3	1, 2, 3	1, 2, 3		0.00 to 200.00		
Loss	Loss	W	1, 2, 3	1, 2, 3	1, 2, 3	1, 2, 3	P Range	zero to 120%	●	
Motor *2	Torque	CH A	*3	—	—	—	—	A Range	zero to 120%	●
	Rotation speed	CH B	*3	—	—	—	—	B Range	zero to 120%	●
	Motor power	Pm	W	—	—	—	—	Pm Range	zero to 120%	●
	Slip	Slip	%	—	—	—	—		0.00 to 100.00	●

*1. DC integration mode

*2. Models with motor analysis only

*3. Can be changed with unit selection. No zero suppression when the frequency or pulse is set.

*4. Forward, reverse and combined values should be same range, and are displayed with the number of digits available for any maximum value

*5. THD when the integration mode is RMS, and rf when the integration mode is DC,
zero indicates zero-suppression setting, and values less than zero are zero suppressed

For the P range, see 4. Power range configuration.

In the Pm range, calculated by entering the rated torque as the torque and the rated RPM as the RPM in the motor power calculation formula.

Range A when CH A measures frequency at rated torque setting value

Range B when CH B measures pulses at maximum measurement frequency setting value [Hz]

2. Harmonic Measurement Items

Measurement items	Symbol	Unit	Pattern 1 1P2W+1P2W +1P2W+1P2W	Pattern 2,3 1P3W/3P3W2M +1P2W+1P2W	Pattern 4,5,6 1P3W/3P3W2M +1P3W/3P3W2M	Pattern 7,8 3P3W3M/3P4W +1P2W	Display range		Polarity (+/-)
Harmonic voltage	Uk	V	1, 2, 3, 4	1, 2, 3, 4	1, 2, 3, 4	1, 2, 3, 4	U Range	0 to 120%	
Harmonic voltage phase angle	θUk	°	1, 2, 3, 4	1, 2, 3, 4	1, 2, 3, 4	1, 2, 3, 4		0.00 to 180.00	●
Harmonic current	Ik	A	1, 2, 3, 4	1, 2, 3, 4	1, 2, 3, 4	1, 2, 3, 4	I Range	0 to 120%	
Harmonic current phase angle	θIk	°	1, 2, 3, 4	1, 2, 3, 4	1, 2, 3, 4	1, 2, 3, 4		0.00 to 180.00	●
Harmonic active power	Pk	W	1, 2, 3, 4	1, 2, 3, 4, 12	1, 2, 3, 4, 12, 34	1, 2, 3, 4, 123	P Range	0 to 120%	●
Phase difference of harmonic voltage and harmonic current	θk	°	1, 2, 3, 4	1, 2, 3, 4, 12	1, 2, 3, 4, 12, 34	1, 2, 3, 4, 123		0.00 to 180.00	●
Harmonic voltage content	HDUk	%	1, 2, 3, 4	1, 2, 3, 4	1, 2, 3, 4	1, 2, 3, 4		0.00 to 500.00	
Harmonic current content	HDIk	%	1, 2, 3, 4	1, 2, 3, 4	1, 2, 3, 4	1, 2, 3, 4		0.00 to 500.00	
Harmonic power content	HDPk	%	1, 2, 3, 4	1, 2, 3, 4, 12	1, 2, 3, 4, 12, 34	1, 2, 3, 4, 123		0.00 to 500.00	●

3.Noise Measurement Items

Measurement items	Symbol	Unit	Display range	
Voltage noise	U _{nf}	Hz	0 to Maximum frequency setting	Ten measurements in descending order of U _N
	U _N	V	0 to 120% of U range	
Current noise	I _{nf}	Hz	0 to Maximum frequency setting	Ten measurements in descending order of I _N
	I _N	A	0 to 120% of I range	

4.Power Range Configurations

(1) With 20 A sensors

Current/Phase (Wiring) System/ Voltage		15.000 V	30.000 V	60.000 V	150.00 V	300.00 V	600.00 V	1.5000 kV
400.00 mA	1P2W	6.0000	12.000	24.000	60.000	120.00	240.00	600.00
	1P3W 3P3W(2M/3M)	12.000	24.000	48.000	120.00	240.00	480.00	1.2000k
	3P4W	18.000	36.000	72.000	180.00	360.00	720.00	1.8000k
800.00 mA	1P2W	12.000	24.000	48.000	120.00	240.00	480.00	1.2000k
	1P3W 3P3W(2M/3M)	24.000	48.000	96.00	240.00	480.00	0.9600k	2.4000k
	3P4W	36.000	72.000	144.00	360.00	720.00	1.4400k	3.6000k
2.0000 A	1P2W	30.000	60.000	120.00	300.00	600.00	1.2000k	3.0000k
	1P3W 3P3W(2M/3M)	60.000	120.00	240.00	600.00	1.2000k	2.4000k	6.0000k
	3P4W	90.00	180.00	360.00	0.9000k	1.8000k	3.6000k	9.000k
4.0000 A	1P2W	60.000	120.00	240.00	600.00	1.2000k	2.4000k	6.0000k
	1P3W 3P3W(2M/3M)	120.00	240.00	480.00	1.2000k	2.4000k	4.8000k	12.000k
	3P4W	180.00	360.00	720.00	1.8000k	3.6000k	7.2000k	18.000k
8.0000 A	1P2W	120.00	240.00	480.00	1.2000k	2.4000k	4.8000k	12.000k
	1P3W 3P3W(2M/3M)	240.00	480.00	0.9600k	2.4000k	4.8000k	9.600k	24.000k
	3P4W	360.00	720.00	1.4400k	3.6000k	7.2000k	14.400k	36.000k
20.000 A	1P2W	300.00	600.00	1.2000k	3.0000k	6.0000k	12.000k	30.000k
	1P3W 3P3W(2M/3M)	600.00	1.2000k	2.4000k	6.0000k	12.000k	24.000k	60.000k
	3P4W	0.9000k	1.8000k	3.6000k	9.000k	18.000k	36.000k	90.00k

Active power (P) units are [W], apparent power (S) units are [VA], and reactive power (Q) units are [VAR]

Multiply the range configurations in this table by a factor of 1/10 when using a 2 A sensor, by a factor of 10 when using a 200 A sensor, by a factor of 100 when using a 2 kA sensor, or by a factor of 1000 when using a 20 kA sensor.

(2) With 50 A sensors

Current/Phase (Wiring) System/ Voltage		15.000 V	30.000 V	60.000 V	150.00 V	300.00 V	600.00 V	1.5000 kV
1.0000 A	1P2W	15.000	30.000	60.000	150.00	300.00	600.00	1.5000k
	1P3W 3P3W(2M/3M)	30.000	60.000	120.00	300.00	600.00	1.2000k	3.0000k
	3P4W	45.000	90.00	180.00	450.00	0.9000k	1.8000k	4.5000k
2.0000 A	1P2W	30.000	60.000	120.00	300.00	600.00	1.2000k	3.0000k
	1P3W 3P3W(2M/3M)	60.000	120.00	240.00	600.00	1.2000k	2.4000k	6.0000k
	3P4W	90.00	180.00	360.00	0.9000k	1.8000k	3.6000k	9.000k
5.0000 A	1P2W	75.000	150.00	300.00	750.00	1.5000k	3.0000k	7.5000k
	1P3W 3P3W(2M/3M)	150.00	300.00	600.00	1.5000k	3.0000k	6.0000k	15.000k
	3P4W	225.00	450.00	0.9000k	2.2500k	4.5000k	9.000k	22.500k
10.000 A	1P2W	150.00	300.00	600.00	1.5000k	3.0000k	6.0000k	15.000k
	1P3W 3P3W(2M/3M)	300.00	600.00	1.2000k	3.0000k	6.0000k	12.000k	30.000k
	3P4W	450.00	0.9000k	1.8000k	4.5000k	9.000k	18.000k	45.000k
20.000 A	1P2W	300.00	600.00	1.2000k	3.0000k	6.0000k	12.000k	30.000k
	1P3W 3P3W(2M/3M)	600.00	1.2000k	2.4000k	6.0000k	12.000k	24.000k	60.000k
	3P4W	0.9000k	1.8000k	3.6000k	9.000k	18.000k	36.000k	90.00k
50.000 A	1P2W	750.00	1.5000k	3.0000k	7.5000k	15.000k	30.000k	75.000k
	1P3W 3P3W(2M/3M)	1.5000k	3.0000k	6.0000k	15.000k	30.000k	60.000k	150.00k
	3P4W	2.2500k	4.5000k	9.000k	22.500k	45.000k	90.00k	225.00k

Active power (P) units are [W], apparent power (S) units are [VA], and reactive power (Q) units are [VAR]

Multiply the range configurations in this table by a factor of 1/10 when using a 5 A sensor or by a factor of 10 when using a 500 A sensor.

(3) With 1000 A sensors

Current/Phase (Wiring) System/ Voltage		15.000 V	30.000 V	60.000 V	150.00 V	300.00 V	600.00 V	1.5000 kV
20.000 A	1P2W	300.00	600.00	1.2000k	3.0000k	6.0000k	12.000k	30.000k
	1P3W 3P3W (2M/3M)	600.00	1.2000k	2.4000k	6.0000k	12.000k	24.000k	60.000k
	3P4W	0.9000k	1.8000k	3.6000k	9.000k	18.000k	36.000k	90.00k
40.000 A	1P2W	600.00	1.2000k	2.4000k	6.0000k	12.000k	24.000k	60.000k
	1P3W 3P3W (2M/3M)	1.2000k	2.4000k	4.8000k	12.000k	24.000k	48.000k	120.00k
	3P4W	1.8000k	3.6000k	7.2000k	18.000k	36.000k	72.000k	180.00k
100.00 A	1P2W	1.5000k	3.0000k	6.0000k	15.000k	30.000k	60.000k	150.00k
	1P3W 3P3W (2M/3M)	3.0000k	6.0000k	12.000k	30.000k	60.000k	120.00k	300.00k
	3P4W	4.5000k	9.000k	18.000k	45.000k	90.00k	180.00k	450.00k
200.00 A	1P2W	3.0000k	6.0000k	12.000k	30.000k	60.000k	120.00k	300.00k
	1P3W 3P3W (2M/3M)	6.0000k	12.000k	24.000k	60.000k	120.00k	240.00k	600.00k
	3P4W	9.000k	18.000k	36.000k	90.00k	180.00k	360.00k	0.9000M
400.00 A	1P2W	6.0000k	12.000k	24.000k	60.000k	120.00k	240.00k	600.00k
	1P3W 3P3W (2M/3M)	12.000k	24.000k	48.000k	120.00k	240.00k	480.00k	1.2000M
	3P4W	18.000k	36.000k	72.000k	180.00k	360.00k	720.00k	1.8000M
1.0000 kA	1P2W	15.000k	30.000k	60.000k	150.00k	300.00k	600.00k	1.5000M
	1P3W 3P3W (2M/3M)	30.000k	60.000k	120.00k	300.00k	600.00k	1.2000M	3.0000M
	3P4W	45.000k	90.00k	180.00k	450.00k	0.9000M	2.4000M	4.5000M

Active power (P) units are [W], apparent power (S) units are [VA], and reactive power (Q) units are [VAR]

10.6 Calculation Formula Specifications

1. Calculation Formulas for Basic Measurement Items

Phase System Items	1P2W	1P3W	3P3W2M	3P3W3M	3P4W
Voltage RMS	$Urms(i) = \sqrt{\frac{1}{M} \sum_{s=0}^{M-1} (U(i)s)^2}$	$Urms_{12} = \frac{1}{2}(Urms_1 + Urms_2)$ $Urms_{34} = \frac{1}{2}(Urms_3 + Urms_4)$		$Urms_{123} = \frac{1}{3}(Urms_1 + Urms_2 + Urms_3)$	
Voltage MEAN	$Umn(i) = \frac{\pi}{2\sqrt{2}M} \sum_{s=0}^{M-1} U(i)s $	$Umn_{12} = \frac{1}{2}(Umn_1 + Umn_2)$ $Umn_{34} = \frac{1}{2}(Umn_3 + Umn_4)$		$Umn_{123} = \frac{1}{3}(Umn_1 + Umn_2 + Umn_3)$	
Voltage AC component	$Uac(i) = \sqrt{(Urms(i))^2 - (Udc(i))^2}$				
Voltage simple average	$Udc(i) = \frac{1}{M} \sum_{s=0}^{M-1} U(i)s$				
Voltage fundamental wave component	Harmonic voltage $U1(i)$ for harmonic calculation formulas				
Peak voltage	$U_{pk(i)+} = U(i)_s$ Maximum M value $U_{pk(i)-} = U(i)_s$ Minimum M value				
THD Voltage Percentage	$Uthd(i)$ in harmonic calculation formulas				
Voltage ripple rate	$\frac{ (U_{pk(i)+} - U_{pk(i)-}) }{(2 \times Udc(i))} \times 100$				
Voltage unbalance factor	—	—	—	$Uunb_{123} = \sqrt{\frac{1 - \sqrt{3} - 6\beta}{1 + \sqrt{3} - 6\beta}} \times 100$ $\beta = \frac{U_{12}^4 + U_{23}^4 + U_{31}^4}{(U_{12}^2 + U_{23}^2 + U_{31}^2)^2}$ <small>U_{12}, U_{23}, and U_{31} are fundamental rms voltages (between lines) obtained from harmonic calculations. For 3P4W systems, voltage balance is detected from phase voltage, but is converted to voltage between lines for calculations.</small>	

(i) : Measurement channel
 M : Number of synchronous samples
 s : Sample (data point) number

Phase System Items	1P2W	1P3W	3P3W2M	3P3W3M	3P4W
Current RMS	$I_{rms(i)} = \sqrt{\frac{1}{M} \sum_{s=0}^{M-1} (I(i)_s)^2}$	$I_{rms12} = \frac{1}{2}(I_{rms1} + I_{rms2})$ $I_{rms34} = \frac{1}{2}(I_{rms3} + I_{rms4})$		$I_{rms123} = \frac{1}{3}(I_{rms1} + I_{rms2} + I_{rms3})$	
Current MEAN	$I_{mn(i)} = \frac{\pi}{2\sqrt{2}M} \sum_{s=0}^{M-1} I(i)_s $	$I_{mn12} = \frac{1}{2}(I_{mn1} + I_{mn2})$ $I_{mn34} = \frac{1}{2}(I_{mn3} + I_{mn4})$		$I_{mn123} = \frac{1}{3}(I_{mn1} + I_{mn2} + I_{mn3})$	
Current AC component	$I_{ac(i)} = \sqrt{(I_{rms(i)})^2 - (I_{dc(i)})^2}$				
Current simple average	$I_{dc(i)} = \frac{1}{M} \sum_{s=0}^{M-1} I(i)_s$				
Current fundamental wave component	Harmonic current $I(i)$ in harmonic calculation formulas				
Peak current	$I_{pk(i)+} = I(i)_s \quad \text{Maximum } M \text{ value}$ $I_{pk(i)-} = I(i)_s \quad \text{Minimum } M \text{ value}$				
THD Current Percentage	$I_{thd(i)} \text{ in harmonic calculation formulas}$				
Current ripple rate	$\frac{ (I_{pk(i)+} - I_{pk(i)-}) }{(2 \times I_{dc(i)})} \times 100$				
Current unbalance factor	-	-	-	$I_{unb123} = \frac{\sqrt{1 - \sqrt{3 - 6\beta}}}{\sqrt{1 + \sqrt{3 - 6\beta}}} \times 100$ $\beta = \frac{I_{12}^4 + I_{23}^4 + I_{31}^4}{(I_{12}^2 + I_{23}^2 + I_{31}^2)^2}$	$I_{12}, I_{23}, \text{ and } I_{31} \text{ are fundamental rms currents (between lines) obtain from harmonic calculations. For 3P3W3M and 3P4W systems, these are converted to current between lines for calculations.}$

(i) : Measurement channel
M : Number of synchronous samples
s : Sample (data point) number

Phase System Items	1P2W	1P3W	3P3W2M	3P3W3M	3P4W
Active power	$P_{(i)} = \frac{1}{M} \sum_{s=0}^{M-1} (U_{(i)s} \times I_{(i)s})$	$P_{12} = P_1 + P_2$ $P_{34} = P_3 + P_4$		$P_{123} = P_1 + P_2 + P_3$	
	<ul style="list-style-type: none"> For 3P3W3M and 3P4W systems, phase voltage is used for waveform voltage $U_{(i)s}$. For 3P3W3M system, voltages sampled as line voltage are converted into phase voltage. $U_{1s}=(u_{1s}-u_{3s})/3$, $U_{2s}=(u_{2s}-u_{1s})/3$, $U_{3s}=(u_{3s}-u_{2s})/3$ u_{1s} to u_{3s}: Line voltage values sampled across channels 1 to 3 U_{1s} to U_{3s}: Phase voltage values calculated for channels 1 to 3 For 3P4W system, voltages, sampled as phase voltages, are used without being converted. The polarity sign for active power indicates power flow direction: positive (+P) for forward power (consumption), and negative (-P) for reverse power (regeneration), and indicates net current flow for power. 				
Apparent power	$S_{(i)} = U_{(i)} \times I_{(i)}$	$S_{12} = S_1 + S_2$ $S_{34} = S_3 + S_4$	$S_{12} = \frac{\sqrt{3}}{2}(S_1 + S_2)$ $S_{34} = \frac{\sqrt{3}}{2}(S_3 + S_4)$	When calculation method TYPE1 is selected $S_{123} = S_1 + S_2 + S_3$ When calculation method TYPE2 is selected $S_{123} = \frac{\sqrt{3}}{3}(U_1 \times I_1 + U_2 \times I_2 + U_3 \times I_3)$	$S_{123} = S_1 + S_2 + S_3$
	<ul style="list-style-type: none"> Select $U_{(i)}$ and $i_{(i)}$ from rms/mn. Use phase voltage for voltage $U_{(i)}$ during 3P3W3M and 3P4W wirings for calculation method TYPE1. 				
Reactive power	$Q_{(i)} = si_{(i)} \sqrt{S_{(i)}^2 - P_{(i)}^2}$	$Q_{12} = Q_1 + Q_2$ $Q_{34} = Q_3 + Q_4$		When calculation method TYPE1 is selected $Q_{123} = Q_1 + Q_2 + Q_3$ When calculation method TYPE2 is selected $Q_{123} = si_{123} \sqrt{S_{123}^2 - P_{123}^2}$	$Q_{123} = Q_1 + Q_2 + Q_3$
	<ul style="list-style-type: none"> The polarity sign (si) for reactive power (Q) is indicated by [no sign] for lag or [-] for lead. The polarity sign ($si(i)$) for each channel (i) is acquired from lag or lead of the voltage waveform $U_{(i)s}$ and current waveform $I_{(i)s}$. Use phase voltage for voltage waveform $U_{(i)s}$ during 3P3W3M and 3P4W wirings for calculation method TYPE1. For 3P3W3M system, voltages sampled as line voltage are converted into phase voltage. $U_{1s}=(u_{1s}-u_{3s})/3$, $U_{2s}=(u_{2s}-u_{1s})/3$, $U_{3s}=(u_{3s}-u_{2s})/3$ u_{1s} to u_{3s}: Line voltage values sampled across channels 1 to 3 U_{1s} to U_{3s}: Phase voltage values calculated for channels 1 to 3 For 3P4W system, voltages, sampled as phase voltages, are used without being converted. Use calculation method TYPE2's S_{123} for S_{123} under 3P3W3M wiring for calculation method TYPE2, and obtain the polarity sign si_{123} from the sign for Q_{123} of calculation method TYPE1. 				
Power factor	$\lambda_{(i)} = si_{(i)} \left \frac{P_{(i)}}{S_{(i)}} \right $	$\lambda_{12} = si_{12} \left \frac{P_{12}}{S_{12}} \right $ $\lambda_{34} = si_{34} \left \frac{P_{34}}{S_{34}} \right $		$\lambda_{123} = si_{123} \left \frac{P_{123}}{S_{123}} \right $	
	<ul style="list-style-type: none"> The polarity (si) for power factor (λ) is indicated by [no sign] for lag or [-] for lead. The polarity sign ($si(i)$) for each channel (i) is acquired from lag or lead of the voltage waveform $U_{(i)s}$ and current waveform $I_{(i)s}$. Polarities si_{12}, si_{34}, and si_{123} are acquired from reactive power values Q_{12}, Q_{34}, and Q_{123}, respectively. 				
Power phase angle	$\phi_{(i)} = si_{(i)} \cos^{-1} \lambda_{(i)} $	$\phi_{12} = si_{12} \cos^{-1} \lambda_{12} $ $\phi_{34} = si_{34} \cos^{-1} \lambda_{34} $		$\phi_{123} = si_{123} \cos^{-1} \lambda_{123} $	
	<ul style="list-style-type: none"> The polarity sign ($si(i)$) for each channel (i) is acquired from lag or lead of the voltage waveform $U_{(i)s}$ and current waveform $I_{(i)s}$. Polarities si_{12}, si_{34}, and si_{123} are acquired from reactive power values Q_{12}, Q_{34}, and Q_{123}, respectively. In the formula, $\cos^{-1} \lambda$ is used when $P \geq 0$. When $P < 0$, $180 - \cos^{-1} \lambda$ is used. 				

(i) : Measurement channel
M : Number of synchronous samples
s : Sample (data point) number

2. Motor analysis measurement items calculation formulas

Items	Setting Units	Calculation Formulas	
CH A	V (DC Voltage)	$\frac{1}{M} \sum_{s=0}^{M-1} A_s$	
	N• m, mN• m, or kN• m common to all measurements (torque)	For Analog DC	A [V] × CH A scaling setting
		For Frequency	$\frac{(\text{Measurement freq.} - fc \text{ setting value}) \times \text{rated torque setting value}}{fd \text{ setting value}}$
<i>M</i> :Number of synchronous samples, <i>S</i> :Sample (data point) number			
CH B	V (DC Voltage)	$\frac{1}{M} \sum_{s=0}^{M-1} B_s$	
	Hz (Frequency)	For Analog DC	B [V] × CH B scaling setting
		Pulse input	$s_i \frac{\text{set no. of poles} \times \text{pulse frequency}}{2 \times \text{set no. of pulses}} *1$ Polarity sign <i>s_i</i> is obtained from the rise/fall edge and logic level (High/Low) of A Phase pulse and B Phase pulse.
	r/min (rotation rate)	For Analog DC	B [V] × CH B scaling setting
Pulse input		$\frac{2 \times 60 \times \text{frequency [Hz]} (\text{calculated from above Pulse Input value} *1)}{\text{set no. of poles}}$	
Pm	N• m (CH A units)	$(\text{CH A display value}) \times \frac{2 \times \pi \times (\text{CH B display value})}{60}$	
	mN• m (CH A units)	$(\text{CH A display value}) \times \frac{2 \times \pi \times (\text{CH B display value})}{60 \times 1000}$	
	kN• m (CH A units)	$(\text{CH A display value}) \times \frac{2 \times \pi \times (\text{CH B display value}) \times 1000}{60}$	
	Calculation is disabled when CH A units are not those specified above, and when CH B units are set to other than r/min.		
Slip	Hz (CH B units)	$100 \times \frac{ \text{Input frequency} - \text{CH B display value} }{\text{Input frequency}}$	
	r/min (CH B units)	$100 \times \frac{2 \times 60 \times \text{Input frequency} - \text{CH B display value} \times \text{set no. of poles}}{2 \times 60 \times \text{Input frequency}}$	
	Select an input frequency (<i>f</i> ₁ to <i>f</i> ₄)		

3. Harmonic Measurement Calculation Formulas

Phase System Items	1P2W	1P3W	3P3W2M	3P3W3M	3P4W
Harmonic voltage	$U_{k(i)} = \sqrt{(U_{kr(i)})^2 + (U_{ki(i)})^2}$				
Harmonic voltage Phase angle	$\theta U_{k(i)} = \tan^{-1} \left(\frac{U_{kr(i)}}{-U_{ki(i)}} \right)$				
Harmonic current	$I_{k(i)} = \sqrt{(I_{kr(i)})^2 + (I_{ki(i)})^2}$				
Harmonic current Phase angle	$\theta I_{k(i)} = \tan^{-1} \left(\frac{I_{kr(i)}}{-I_{ki(i)}} \right)$				
Harmonic effective power	$P_{k(i)} = U_{kr(i)} \times I_{kr(i)} + U_{ki(i)} \times I_{ki(i)}$		$P_{k1} = \frac{1}{3}(U_{kr1} - U_{kr3}) \times I_{kr1} + \frac{1}{3}(U_{ki1} - U_{ki3}) \times I_{ki1}$ $P_{k2} = \frac{1}{3}(U_{kr2} - U_{kr1}) \times I_{kr2} + \frac{1}{3}(U_{ki2} - U_{ki1}) \times I_{ki2}$ $P_{k3} = \frac{1}{3}(U_{kr3} - U_{kr2}) \times I_{kr3} + \frac{1}{3}(U_{ki3} - U_{ki2}) \times I_{ki3}$ $P_{k4} = U_{kr4} \times I_{kr4} + U_{ki4} \times I_{ki4}$		Same as 1P2W
	-	$P_{k12} = P_{k1} + P_{k2}$ $P_{k34} = P_{k3} + P_{k4}$		$P_{k123} = P_{k1} + P_{k2} + P_{k3}$	
Harmonic reactive power (only used internally)	$Q_{k(i)} = U_{kr(i)} \times I_{ki(i)} - U_{ki(i)} \times I_{kr(i)}$		$Q_{k1} = \frac{1}{3}(U_{kr1} - U_{kr3}) \times I_{ki1} - \frac{1}{3}(U_{ki1} - U_{ki3}) \times I_{kr1}$ $Q_{k2} = \frac{1}{3}(U_{kr2} - U_{kr1}) \times I_{ki2} - \frac{1}{3}(U_{ki2} - U_{ki1}) \times I_{kr2}$ $Q_{k3} = \frac{1}{3}(U_{kr3} - U_{kr2}) \times I_{ki3} - \frac{1}{3}(U_{ki3} - U_{ki2}) \times I_{kr3}$ $Q_{k4} = U_{kr4} \times I_{ki4} - U_{ki4} \times I_{kr4}$		Same as 1P2W
	-	$Q_{k12} = Q_{k1} + Q_{k2}$ $Q_{k34} = Q_{k3} + Q_{k4}$		$Q_{k123} = Q_{k1} + Q_{k2} + Q_{k3}$	
Harmonic voltage Current phase angle	$\theta_{k(i)} = \theta I_{k(i)} - \theta U_{k(i)}$				
	-	$\theta_{k12} = \tan^{-1} \left(\frac{Q_{k12}}{P_{k12}} \right)$ $\theta_{k34} = \tan^{-1} \left(\frac{Q_{k34}}{P_{k34}} \right)$		$\theta_{k123} = \tan^{-1} \left(\frac{Q_{k123}}{P_{k123}} \right)$	

(i) : Measurement channel

k : Order of analysis

r : Real part of complex result of FFT

i : Imaginary part of complex result of FFT

Harmonic voltage phase angle and harmonic current phase angle are corrected to the fundamental waveform of the harmonic sync source that serves as a phase reference point of 0° (except when an external harmonic sync source is used).

Phase System	1P2W	1P3W	3P3W2M	3P3W3M	3P4W
Items					
Harmonic voltage content	$Uhd_{k(i)} = \frac{U_k}{U_1} \times 100$				
Harmonic current content	$Ihd_{k(i)} = \frac{I_k}{I_1} \times 100$				
Harmonic power content	$Phd_{k(i)} = \frac{P_k}{P_1} \times 100$				
THD Voltage Percentage	$Uthd_{(i)} = \frac{\sqrt{\sum_{k=2}^K (U_k)^2}}{U_1} \times 100 \quad (\text{with THD-F setting}), \text{ or } \frac{\sqrt{\sum_{k=2}^K (U_k)^2}}{\sqrt{\sum_{k=1}^K (U_k)^2}} \times 100 \quad (\text{with THD-R setting})$				
THD Current Percentage	$Ithd_{(i)} = \frac{\sqrt{\sum_{k=2}^K (I_k)^2}}{I_1} \times 100 \quad (\text{with THD-F setting}), \text{ or } \frac{\sqrt{\sum_{k=2}^K (I_k)^2}}{\sqrt{\sum_{k=1}^K (I_k)^2}} \times 100 \quad (\text{with THD-R setting})$				

(i) : Measurement channel
 k : Order of analysis
 K : Maximum analysis order (depending on sync frequency)

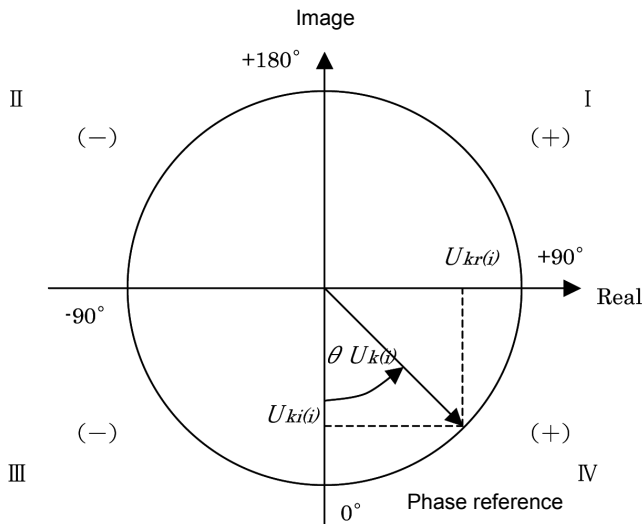

I	$\tan^{-1} \left(\frac{U_{kr(i)}}{-U_{ki(i)}} \right) + 180^\circ$
III, IV	$\tan^{-1} \left(\frac{U_{kr(i)}}{-U_{ki(i)}} \right)$
II	$\tan^{-1} \left(\frac{U_{kr(i)}}{-U_{ki(i)}} \right) - 180^\circ$
$U_{ki(i)} = 0, U_{kr(i)} < 0$	-90°
$U_{ki(i)} = 0, U_{kr(i)} > 0$	$+90^\circ$
$U_{ki(i)} < 0, U_{kr(i)} = 0$	0°
$U_{ki(i)} > 0, U_{kr(i)} = 0$	$+180^\circ$
$U_{ki(i)} = 0, U_{kr(i)} = 0$	0°

4. Noise measurement parameter calculation formulas

Items	Calculation Formulas
Voltage noise	$U_n = \sqrt{(U_{kr})^2 + (U_{ki})^2}$
Current noise	$I_n = \sqrt{(I_{kr})^2 + (I_{ki})^2}$

r : Post-FFT real part

i : Post-FFT imaginary part

10.7 Wiring System Diagram Specifications

Single Phase 2-wire (1P2W)

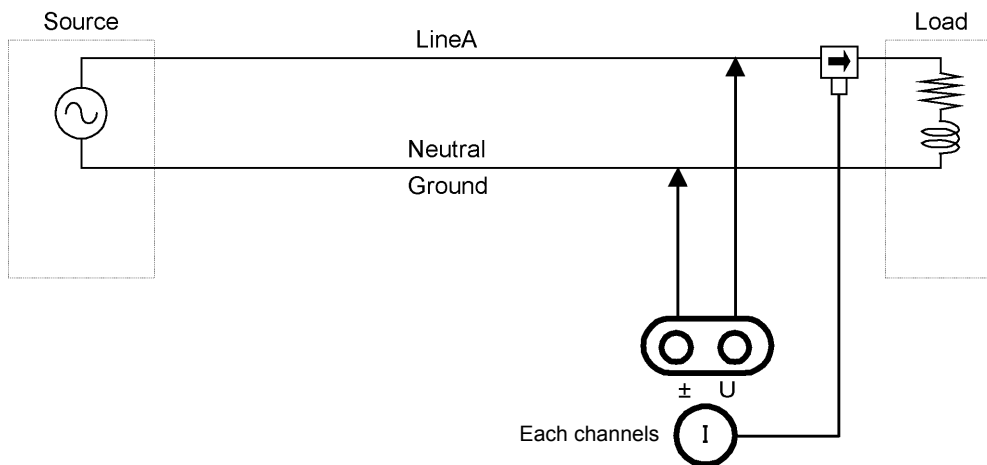

Single Phase 3-wire (1P3W)

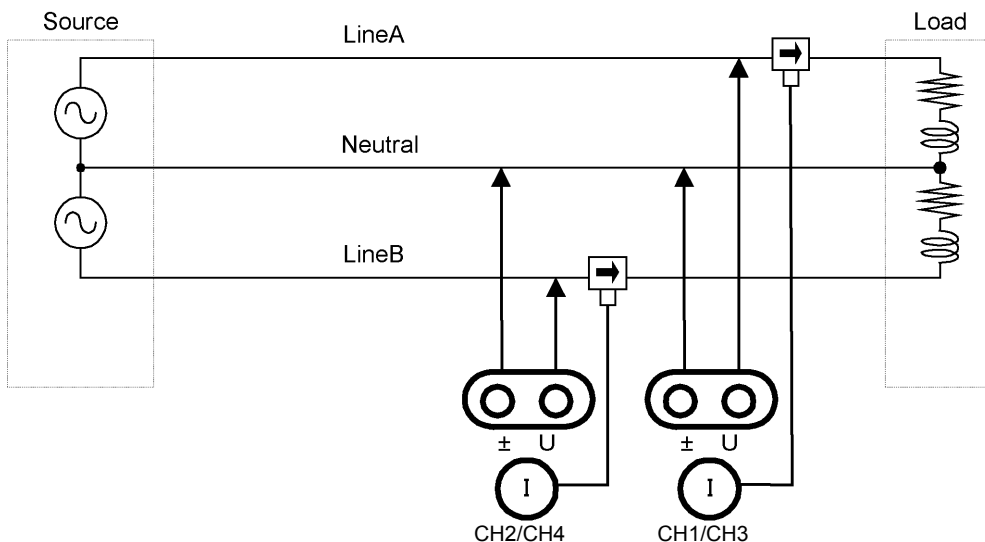

3-Phase 3-Wire 2-Measurement (3P3W2M)

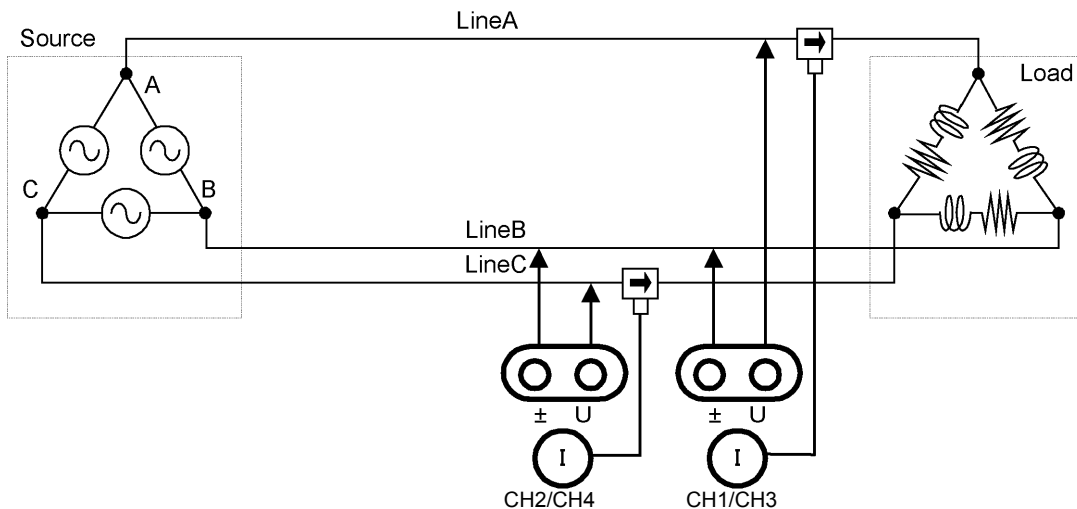

10.7 Wiring System Diagram Specifications

3-Phase 3-Wire 3-Measurement (3P3W3M)

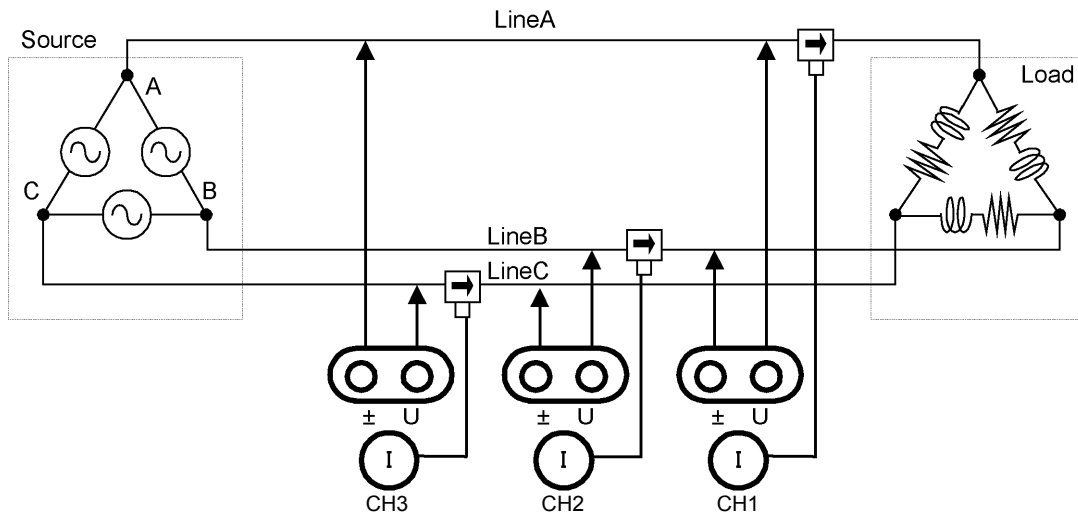

3-Phase 4-Wire (3P4W)

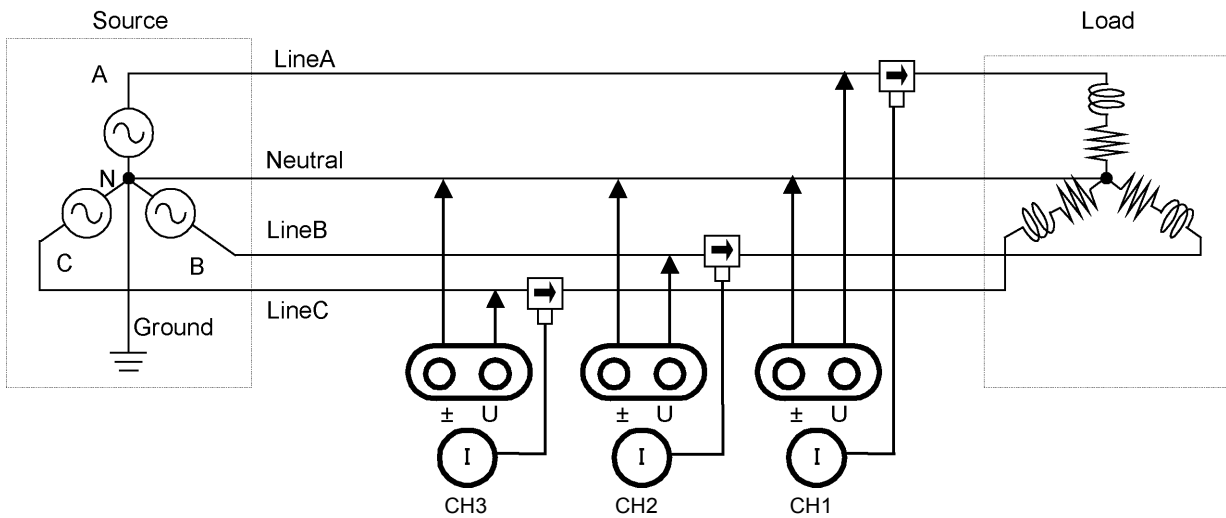

Maintenance and Service

Chapter 11

11.1 Cleaning

- NOTE**
- To clean the instrument, wipe it gently with a soft cloth moistened with water or mild detergent. Never use solvents such as benzene, alcohol, acetone, ether, ketones, thinners or gasoline, as they can deform and discolor the case.
 - Wipe the LCD gently with a soft, dry cloth.

11.2 Troubleshooting

Before requesting instrument repair or inspection, please read "Before returning for repair" (p. 224) and Section "11.3 Error Indication" (p. 226).

Inspection and repair



WARNING

Touching any of the high-voltage points inside the instrument is very dangerous. Do not attempt to modify, disassemble or repair the instrument; as fire, electric shock and injury could result.



CAUTION

If the protective functions of the instrument are damaged, either remove it from service or mark it clearly so that others do not use it inadvertently. The instrument contains a built-in backup lithium battery, which offers a service life of about ten years. If the date and time deviate substantially when the instrument is switched on, it is the time to replace that battery. Contact your authorized Hioki distributor or reseller.

NOTE

- If damage is suspected, check the "Before returning for repair" (p. 224) section before contacting your authorized Hioki distributor or reseller. However, in the following cases, immediately stop using the instrument, unplug the power cord and contact your authorized Hioki distributor or reseller.
 - When the nature of the damage is clearly evident
 - When measurement is impossible
 - After long-term storage in adverse conditions such as high temperature or humidity
 - After being subject to severe shock during transport
 - After severe exposure to water, oil, or dust (internal insulation can be degraded by oil or water, causing increase hazard of electric shock or fire)
- If measurement settings cannot be saved, contact Hioki for repair.

Transporting the instrument



Pack the instrument so that it will not sustain damage during shipping, and include a description of existing damage. We do not take any responsibility for damage incurred during shipping.

Replaceable parts and useful life

Certain parts require replacement periodically and at the end of their useful life: (Useful life depends on the operating environment and frequency of use. Operation cannot be guaranteed beyond the following periods)

Part	Useful Life	Remarks
Electrolytic Capacitors	Approx. 10 years	The useful life of electrolytic capacitors depends on the operating environment. The board(s) on which these components are mounted must be replaced.
Lithium battery	Approx. 10 years	The instrument contains a built-in backup lithium battery, which offers a service life of about ten years. If the date and time deviate substantially when the instrument is switched on, or backup error is returned in self-test, it is the time to replace that battery. Contact your authorized Hioki distributor or reseller.
Fan motor	Approx. 6 years	Assuming 24 hours of use per day
LCD backlight (to half brightness)	Approx. 8 years	Assuming 24 hours of use per day

Before returning for repair

Symptom	Check Item, or Cause	Remedy and Reference
The display does not appear when you turn the power on.	Is the power cord unplugged? Is it properly connected?	Confirm that the power cord is properly connected. See "3.4 Connecting the Power Cord" (p. 31)
Keys do not work.	Are the keys locked?	Hold  for three seconds to disable the key-lock function.
The MENU key is lit, but the screen is blank	The LCD backlight is set to turn off after a specified interval.	Press any key. See "LCD back light" (p. 130)
Voltage or current measurement values are not displayed	Are the voltage measurement and current sensor cables connected properly?	Check connections and wiring. See "3.6 Connecting the Voltage Measurement Cables" (p. 32), "3.12 Verifying Correct Wiring (Connection Check)" (p. 46)
	Is the proper input channel displayed (e.g., when measuring input on CH1, is the [CH1] page displayed)?	Press   to change the input channel page. See "4.2 Viewing Power Measurements, and Changing the Measurement Configuration" (p. 51)
Effective power is not displayed.	Are the settings for voltage range/current range, and zero-suppression correct?	Set appropriate values for voltage range/current range. When the input is too small in relation to the range, set the zero-suppression to 0.1% or OFF. See "4.2.2 Selecting Ranges" (p. 53) See "Chapter 6 Changing System Settings" (p. 129)
Frequency measurement is impossible, measured values are unstable	Is the input frequency within the range 0.5 Hz to 5 kHz?	Verify the input frequency using the noise measurement function. See "4.6 Viewing Noise Measurement Values (FFT Function)" (p. 85)
	Is the input frequency below the lower limit setting?	Set the lower limit frequency for measurement. See "4.2.4 Frequency Measurement Settings" (p. 60)
	Is the sync source input correct? Is the range of the sync source input too high?	Check the sync source settings. See "4.2.3 Selecting the Sync Source" (p. 58), "4.2.2 Selecting Ranges" (p. 53)
	Is the measurement target a largely distorted waveform such as PWM?	Set the zero-crossing filter to "Strong". See 4.2.3 "Setting the Zero-Crossing Filter" (p. 59)

Symptom	Check Item, or Cause	Remedy and Reference
3-phase voltage is measured low	Is the phase voltage measured under the Δ -Y transform function?	Turn OFF the Δ -Y transform function. See "5.5 Delta Star (Δ -Y) Transform Function" (p. 118)
Power measurement value is strange.	Is the wiring correct?	Check that the wiring is correct. See "3.12 Verifying Correct Wiring (Connection Check)" (p. 46)
	Is the rectification method and LPF correct?	Set the correct rectification method. Try turning OFF the LPF if the LPF is set. See "4.2.5 Selecting the Rectification Method" (p. 62) See "4.2.7 Setting the Low-Pass Filter" (p. 64)
Current does not show 0 even with no input	Is a low current range used under the universal Clamp-on CT? Could be due to high frequency noise of current sensor.	Set the LPF to 100kHz and then carry out zero adjust. See "4.2.7 Setting the Low-Pass Filter" (p. 64) See "3.11 Attaching to the Lines to be Measured and Zero Adjustment" (p. 44)
Apparent power and reactive power of the inverter's secondary side are different from other measuring devices Voltage value is displayed high	Is the rectification method the same as other measuring devices?	Set the rectification method same as other measuring devices. See "4.2.5 Selecting the Rectification Method" (p. 62)
	Calculation method may be different.	Set the calculation method to TYPE2. See "5.6 Selecting the Calculation Method" (p. 120)
Number of motor rotations cannot be measured	Is the pulse output the voltage output? Pulse of the open collector output cannot be detected.	Select a voltage output suitable for the setting of the CH B pulse input. See 10.2 "6. Motor Analysis Specifications (Model PW3390-03 only)" (p. 199)
	Is there noise in the pulse output?	Confirm the cable wiring. Ground the encoder providing the pulse output. Condition may improve when the common side of the signal is grounded.
Torque frequency input cannot be measured.	Are the frequency input voltage level and frequency within the instrument's valid input range?	Use a torque gauge that generates 1 kHz to 100 Hz frequency output in the form of an RS-422 complementary signal. See 10.2 "(1) Analog DC Input (CH A/CH B)" (p. 199)
An unusually big value is recorded in the saved data	Is the range exceeded?	Select an appropriate range setting. See "4.2.2 Selecting Ranges" (p. 53) See "Appendix 2 Measurement Data Saving Format" (p. A2)

When no apparent cause can be established

Perform a system reset.

This will return all settings to their factory defaults.

[See](#) "6.1 Initializing the Instrument (System Reset)" (p. 132)

11.3 Error Indication

An error indicator appears when an error occurs. Refer to the corresponding countermeasure for each case. Press  to clear the error indicator.

Error display	Cause	Remedy
FPGA initializing error	FPGA boot error.	Repair is required. Contact your authorized Hioki distributor or reseller.
Sub CPU initializing error.	Sub CPU boot error.	
DRAM error.	DRAM error.	
SRAM error.	SRAM error.	
Invalid FLASH SUM.	Firmware checksum error.	
Invalid Adjustment SUM.	Adjusted value checksum error.	
Invalid Backup values.	Backed up system variable invalid.	
Sub CPU DRAM error.	Sub CPU DRAM error.	
Integrating.	Attempted to change settings while integrating.	Stop integration, and change the setting after resetting the integration value. See "4.3 Integration Value Observation" (p. 65)
Waiting or halting for integration.	Attempted to change settings while awaiting (or stopping) integration.	
Holding.	Attempted to change settings during Data Hold.	Change the setting after canceling Data or Peak Hold. See "5.3 Data Hold and Peak Hold Functions" (p. 114)
Peak holding.	Attempted to change settings during Peak Hold.	
This operation is effective in [MEAS] tab only.	Attempted to start/stop integration or saving, perform data reset, or activate Data or Peak Hold from the Setting or File Operation screen.	Change to the Measurement screen, and try again.
Failed to load the program.	Firmware update file not found, or bad checksum.	The firmware update file may be corrupted. Obtain another copy of the file, and try again.
Cannot change wiring. Different current sensors are in same system.	Wiring mode selection is inhibited by incorrect sensor combination.	Check current sensor connections. See "3.9 Selecting the Wiring Mode" (p. 37)
Some CH could not be changed in one lump.	Channel setting changes inhibited in the [All Ch] batch setting.	Select the current range, VT ratio, CT ratio and integration mode for each channel.
Cannot change the VT value. VT × CT exceeds the full scale (1.0E+06).	Attempted VT ratio setting would cause over-range VT× CT value.	Set values that do not exceed the VT× CT limit (1.0E+06). See "4.2.6 Setting Scaling (when using VT(PT) or CT)" (p. 63)
Cannot change the CT value. VT × CT exceeds the full scale (1.0E+06).	Attempted CT ratio setting would cause over-range VT× CT value.	
Cannot add any recording item. Exceeding the maximum number of recording items.	Too many items selected for recording within the selected interval setting.	Set a longer interval. See "5.1 Timing Control Functions" (p. 109)
Cannot change the output orders. Exceeding the maximum number of orders.	Harmonic orders selected for output (including highest and lowest order settings) would produce too many items.	
Cannot change the interval. Too many recording items are selected. Reduce the items to change interval.	Attempted to set the interval too short for the currently selected recording items.	Select fewer recording items. See "7.5.3 Selecting Measurement Items to Save" (p. 145)

Error display	Cause	Remedy
Cannot change the lowest noise frequency. Change the noise sampling speed.	Attempted to set the minimum noise frequency at or above the maximum frequency (determined by the noise sampling rate).	Increase the noise sampling rate setting, or set the minimum noise frequency setting below the maximum frequency. See "4.6.2 Setting the Sampling Frequency and Points" (p. 87) "4.6.3 Setting the Minimum Noise Frequency" (p. 88)
Cannot change the noise sampling speed. Change the lowest noise frequency.	Attempted to set the maximum frequency (determined by the noise sampling rate) below the minimum noise frequency.	Decrease the minimum noise frequency setting. See "4.6.3 Setting the Minimum Noise Frequency" (p. 88)
Cannot change the setting under secondary (slave) instrument mode.	Attempted to set the clock, timer or clock control settings with secondary (slave) instrument mode enabled.	Clock, timer, and clock start/stop settings cannot be changed while secondary (slave) instrument mode is enabled. See "8.1 Connecting Multiple PW3390 (Synchronized Measurements)" (p. 159)
Cannot change the setting in 3-phase measurement.	Attempted to select DC integration on a non-1P2W channel.	DC integration is only available with 1P2W wiring systems with an AC/DC current sensor connected.
Cannot set DC when AC sensor is connected.	Attempted to select DC integration on a channel with an AC current sensor.	See "4.3.2 Setting the Integration Mode" (p. 68)
Not enough free capacity in CF card.	Not enough space on CF card.	Delete unneeded files, or replace storage media (new CF card must be formatted).
Not enough free capacity in USB memory stick.	Not enough space on USB drive.	
Cannot create a file or folder. Too many files or folders in root.	Possibly too many file or folders in the root folder.	Delete unneeded files and folders, or specify another folder as the file copy destination. See "7.4 Saving Operations" (p. 140) "7.11 File and Folder Operations" (p. 153)
CF card is not inserted. Press the ENTER key to reload.	CF card not found.	Check that a CF card or USB drive is inserted. If so, press the ENTER key to reload. See "7.1 Inserting and Removing Storage Media" (p. 136)
USB memory stick is not connected. Press the ENTER key to reload.	USB drive not found.	
invalid character is used in the folder name.	Attempted an operation with folder name contains an invalid character, entered by computer or malfunction.	Try again from the computer.
invalid character is used in the file name.	Attempted an operation with file name contains an invalid character, entered by computer or malfunction.	
Skip copying file named with the invalid character.	A file name within the folder contains an invalid character.	File(s) not copied. Perform the copy operation from the computer.
Failed to access to the folder.	Cannot access non-existent folder.	-
Failed to access to the file.	Cannot access non-existent file.	-
Cannot create a file name automatically.	Automatic file name creation stopped.	Specify a different destination folder, or create a new folder for saving, or delete unneeded files, or replace storage media (new CF card must be formatted). See "7.11 File and Folder Operations" (p. 153)
Skip copying file named with the invalid character.	Attempted to open a computer-created folder that is not within the root folder.	Try again from the computer.
Skip copying folder not under the root folder.	During folder copy, attempted to copy a folder containing another folder.	File(s) not copied. Perform the copy operation from the computer.
Cannot create a folder not under the root folder.	Attempted to create a folder not in the root folder.	Create a folder directly in the root folder. See "7.11.1 Creating Folders" (p. 153)

Error display	Cause	Remedy
Cannot copy a folder not under the root folder.	Attempted to copy a folder within a non-root folder.	Try again from the computer.
Cannot delete a folder not under the root folder.	Attempted to delete a non-root folder.	
Cannot delete a folder having another folder.	Attempted to delete a folder containing another folder.	
Skip copying a file having invalid character and folder not under the root folder.	During folder copy, attempted to copy a file or folder with an invalid name.	File or folder not copied. Perform the copy operation from the computer.
Input the name.	No file or folder name has been specified.	Enter a file or folder name. See "Chapter 7 Data Saving and File Operations" (p. 135)
Invalid setting file.	"Load Setting File" attempted without a valid setting configuration file selected (wrong file type, or corrupted or incompatible content).	Select a valid setting configuration file. Settings cannot be loaded unless instrument options and save settings are the same as when saved. See "7.10 Reloading Setting Configurations" (p. 152)
Cannot find the firmware update file in the root.	Attempted firmware update without an update file.	Copy the update file to the root folder of the storage media, and try again.
Cannot find either CF card or USB memory stick.	CF card or USB drive not found when copying files and folders.	Confirm that the storage media is inserted. See "7.1 Inserting and Removing Storage Media" (p. 136)
Cannot copy the folder. Same file name already exists.	When copying a folder, a duplicate file name was found on the destination.	Select a different name for the file or folder. See "7.11.4 Renaming Files and Folders" (p. 157)
Cannot delete the file having invalid character file name in this folder.	Attempted to delete a folder containing a file with an invalid character in its name, entered by computer or malfunction.	Try again from the computer.
Cannot copy the file. Same folder name already exists.	The name of a file to be copied or created as a setting configuration file duplicates an existing folder name.	Select a different name for the file or folder. See "7.11.4 Renaming Files and Folders" (p. 157)
Copy after changing the folder name. Same folder name already exists.	The name of a folder to be copied duplicates an existing folder name in the root folder of the storage media.	Select a different folder name. See "7.11.4 Renaming Files and Folders" (p. 157)
CF card is not ready. Failed to save.	Cannot save because CF card not found.	Check that a CF card or USB drive is inserted. See "7.1 Inserting and Removing Storage Media" (p. 136)
USB memory stick is not ready. Failed to save.	Cannot save because USB drive not found.	
Cannot move to [FILE] TAB during auto saving.	Attempted to open the File Operation screen during auto-saving.	The File Operation screen cannot be opened during auto-saving. Wait until auto-saving is finished.
Cannot execute during auto saving.	Attempted manual saving and waveform saving during auto-saving.	Manual saving and waveform saving are not available during auto-saving. Wait until auto-saving is finished.
Screenshots are not available due to automatic save operation when the interval is 1 s or less.	Attempted to save a screen capture while auto-save operation with an interval of 1 s or less is being used.	Save the screen capture after auto-save operation is complete. To use this feature while auto-save operation is in progress, set the interval to at least 5 s.
Failed to copy. Or, there is a file cannot be copied.	A problem occurred while copying.	Try again from the computer.

Error display	Cause	Remedy
Different sensors! Cannot change the wiring in the setting file.	Attempted to load an incompatible setting configuration file.	Settings cannot be loaded unless instrument options and saved items are the same as those installed and selected when saved. See "7.10 Reloading Setting Configurations" (p. 152)
D/A output function is different.	Attempted to load an incompatible setting configuration file.	
Motor analyzing function is different.	Attempted to load an incompatible setting configuration file.	
Inconsistent items to save	Attempted to load an incompatible setting configuration file.	
CF card error! This card is not supported.	Incompatible CF card found.	Use a Hioki CF card option. See "Chapter 7 Data Saving and File Operations" (p. 135)
USB memory stick error! This memory stick is not supported.	Incompatible CF card found.	Use a Hioki CF card option. See "Chapter 7 Data Saving and File Operations" (p. 135)
Failed to write.	Writing to storage media failed.	Try again.
Failed to read.	Reading from storage media failed.	
Failed to save while calculating the waveform data	Attempted to save a waveform while it is being created.	Try again after the waveform is created (when the timer mark disappears).
Failed to create a file.	File creation failed for unknown reason.	Try again.
Failed to create a folder.	Folder creation failed for unknown reason.	
Synchronized signals cannot be detected.	Synchronized signals cannot be detected from the primary (master) instrument when setting the secondary (slave) instrument.	Confirm that the primary (master) instrument is connected with synchronized cable and that the primary (master) instrument is turned ON. See "8.1 Connecting Multiple PW3390 (Synchronized Measurements)" (p. 159) When not using the synchronization function, set the synchronization control setting to [Master].
Unknown error!	An unknown error has occurred.	Clear this error by pressing any key except  or  once. If the error recurs, contact your authorized Hioki distributor or reseller.

Contact your authorized Hioki distributor or reseller, if a repair should become necessary.

NOTE

If the measurement lines are energized when the instrument is turned on, the instrument may be damaged or an error message may appear, so before energizing the lines, turn the instrument on and confirm that no error message is displayed.

11.4 Disposing of the Instrument

When disposing of this instrument, remove the lithium battery and dispose of battery and instrument in accordance with local regulations.

Dispose the other options appropriately.

WARNING

- To avoid electric shock, turn off the power switch and disconnect the power cord and measurement cables before removing the lithium battery.
- Battery may explode if mistreated. Do not short-circuit, recharge, disassemble or dispose of in fire.
- Keep batteries away from children to prevent accidental swallowing.

Tools required: One No. 2 Phillips screw-driver, tweezers

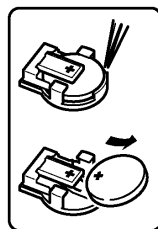
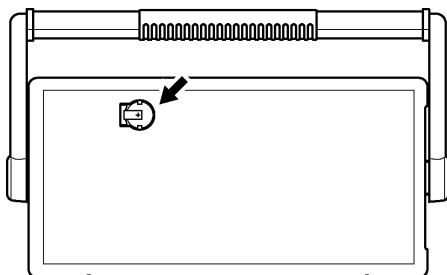
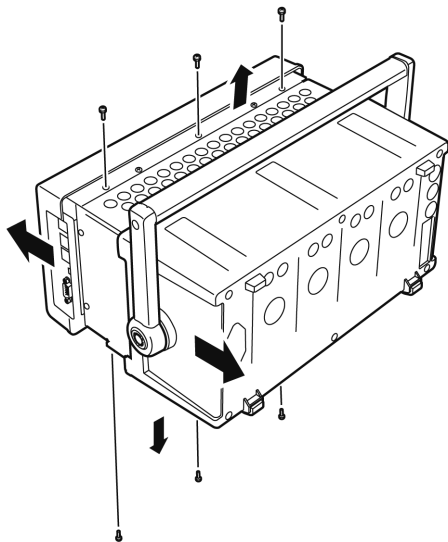
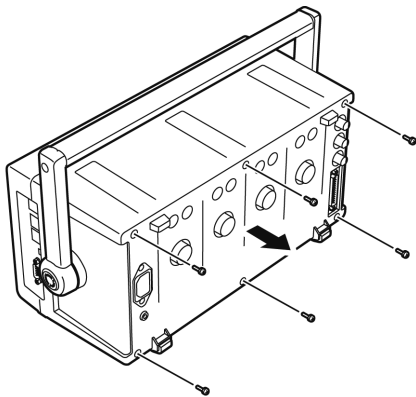

1. Turn the instrument's power switch off.
2. Disconnect the power cord and all cables.
3. Remove the six Phillips head screws in the rear cover, and remove the cover by sliding it back.
4. Remove the six Phillips head screws around the front panel, and remove the panel.
5. Insert the tweezers between the battery and its holder on the internal board, and lift the battery to remove it.

CALIFORNIA, USA ONLY

Perchlorate Material - special handling may apply.
See <https://dtsc.ca.gov/perchlorate/>

Appendix

Appendix 1 Block Diagram

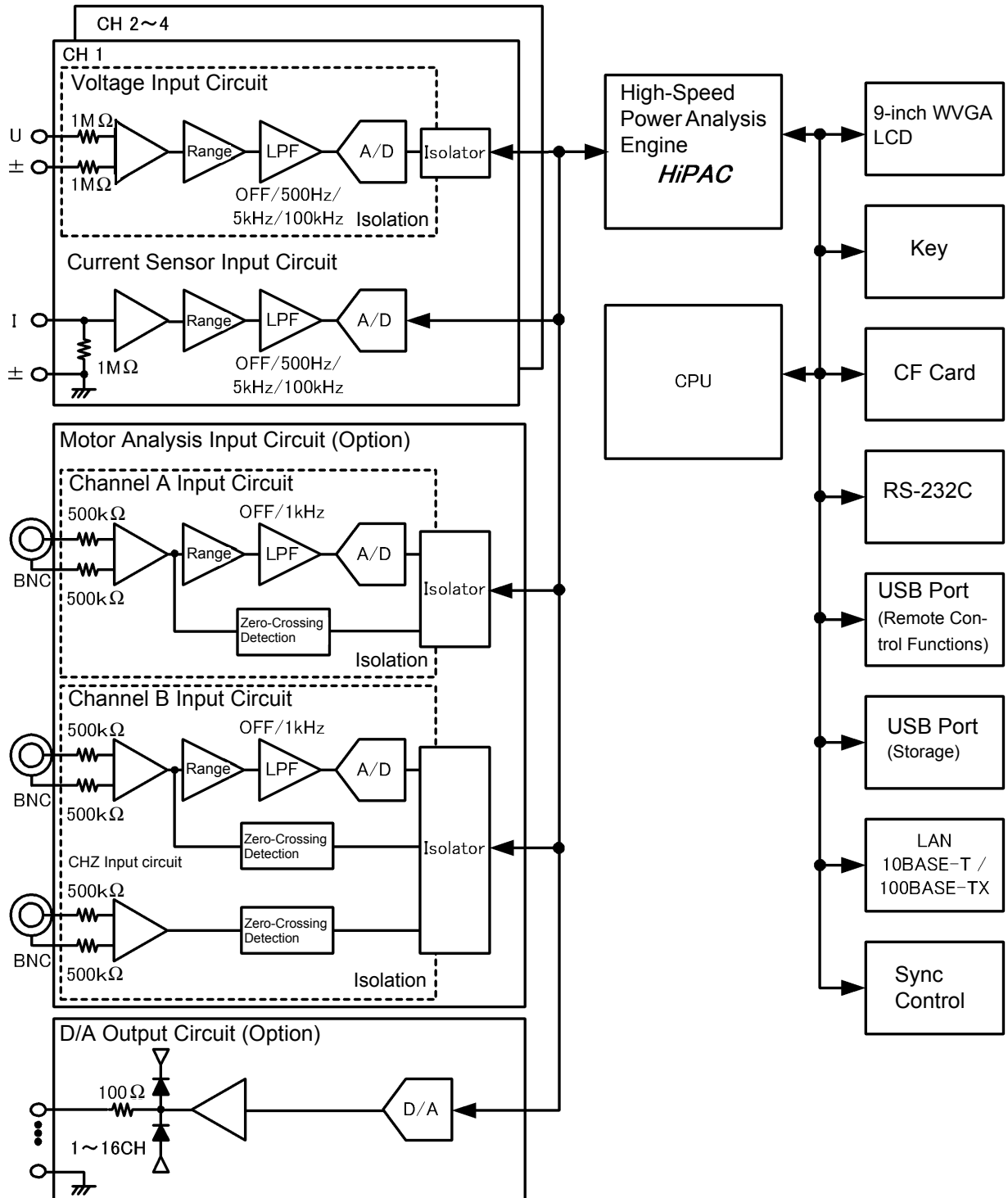

Appendix 2 Measurement Data Saving Format

Header Structure

Headers (item names saved at the head of the file) when measurement data is saved by manual or auto-saving are as follows.

- Selected items are output in order from the top of the table, and from left to right.
- Measurement data is output after the last line of the header, in the same sequence as the header.
- The first three items (Data, Time, and Status) are always output regardless of selected items.

Output Item		Header Item and Alignment			
Year, Month, and Day		Date			
Time		Time			
Status		Status			
Elapsed Time		Laptime			
Elapsed Time (ms)		Laptime (ms)			
Voltage	RMS	Urms1 to Urms4	Urms12	Urms34	Urms123
	Voltage MEAN	Umn1 to Umn4	Umn12	Umn34	Umn123
	AC component	Uac1 to Uac4			
	Simple average	Udc1 to Udc4			
	Fundamental wave component	Ufnd1 to Ufnd4			
	wave peak +	PUpk1 to PUpk4			
	wave peak -	MUpk1 to MUpk4			
	THD/ripple rate	Uthd1 to Uthd4/Urf1 to Urf4			
	Unbalance factor	Uunb123			
Current	RMS	Irms1 to Irms4	Irms12	Irms34	Irms123
	Current MEAN	Imn1 to Imn4	Imn12	Imn34	Imn123
	AC component	Iac1 to Iac4			
	Simple average	Idc1 to Idc4			
	Fundamental wave component	Ifnd1 to Ifnd4			
	wave peak +	PIpk1 to PIpk4			
	wave peak -	Mlpk1 to Mlpk4			
	THD/ripple rate	lthd1 to lthd4/lrf1 to lrf4			
	Unbalance factor	lunb123			
Effective power	P1 to P4	P12	P34	P123	
Apparent power	S1 to S4	S12	S34	S123	
Reactive power	Q1 to Q4	Q12	Q34	Q123	
Power factor	PF1 to PF4	PF12	PF34	PF123	
Phase angle	DEG1 to DEG4	DEG12	DEG34	DEG123	
Frequency	FREQ1 to FREQ4				
Integration	Integ. current in positive direction	PIH1 to PIH4			
	Integ. current in negative direction	MIH1 to MIH4			
	Sum of integ. Current	IH1 to IH4			
	Energy in positive direction	PWP1 to PWP4	PWP12	PWP34	PWP123
	Energy in negative direction	MWP1 to MWP4	MWP12	MWP34	MWP123
Sum of energy	WP1 to WP4	WP12	WP34	WP123	
Efficiency	Eff1 to Eff3				
Loss	Loss1 to Loss3				
Motor	ExtA	ExtB	Pm	Slip	

Harmonic Measurement Items						
Harmonic Frequency		HFREQ				
(n=0)	nth order voltage	Level	HU1Ln		(n: order)	
		Content	HU1Dn			
		Phase angle	HU1Pn			
		...	to			
		Level	HU4Ln			
		Content	HU4Dn			
	Phase angle	HU4Pn				
	nth order current	Level	HI1Ln			
		Content	HI1Dn			
		Phase angle	HI1Pn			
		...	to			
		Level	HI4Ln			
		Content	HI4Dn			
	Phase angle	HI4Pn				
	nth order power	Level	HP1Ln			
		Content	HP1Dn			
		Phase angle	HP1Pn			
		...	to			
		Level	HP4Ln			
		Content	HP4Dn			
		Phase angle	HP4Pn			
Level		HP12Ln				
Content		HP12Dn				
Phase angle		HP12Pn				
Level		HP34Ln				
Content		HP34Dn				
Phase angle		HP34Pn				
Level		HP123Ln				
Content		HP123Dn				
Phase angle	HP123Pn					
(n=1 to 100)	(n: order)		
Noise Measurement Items						
Noise	Voltage	UNf01	UN01	to	UNf10	UN10
	Current	INf01	IN01	to	INf10	IN10

About Status Data

The status data indicates the measurement state when the data was saved, and is displayed as a 32-bit hexadecimal digit, as follows.

bit 31	bit 30	bit 29	bit 28	bit 27	bit 26	bit 25	bit 24
HM4	HM3	HM2	HM1	MRB	MRA	MPB	MPA
bit 23	bit 22	bit 21	bit 20	bit 19	bit 18	bit 17	bit 16
ULM	UDP	UCU	HUL	UL4	UL3	UL2	UL1
bit 15	bit 14	bit 13	bit 12	bit 11	bit 10	bit 9	bit 8
RI4	RI3	RI2	RI1	RU4	RU3	RU2	RU1
bit 7	bit 6	bit 5	bit 4	bit 3	bit 2	bit 1	bit 0
PI4	PI3	PI2	PI1	PU4	PU3	PU2	PU1

HMx : Invalid harmonic parameter (no harmonic sync)

MRx : Motor analysis options A and/or B over range

MPx : Motor analysis options A and/or B peak over

ULM : Motor analysis options A and/or B sync unlocked

UDP: Display impossible (for example, when the measurement data is clearly invalid immediately after the range is changed)

A4

Appendix 2 Measurement Data Saving Format

- UCU : Calculation Impossible (e.g., measurement data is invalid immediately after changing ranges)
- HUL : Harmonic sync unlocked
- ULx : Channel x sync unlocked
- RIx : Channel x current over range
- RUx : Channel x voltage over range
- PIx : Channel x current peak over
- PUx : Channel x voltage peak over
- (x is a channel number)

Example: for the status information "00000007"

Each character of status information, which contains information for four bits, represents the following information.

1st character "0"	2nd character "0"	3rd character "0"	4th character "0"	5th character "0"	6th character "0"	7th character "0"	8th character "7"
bit 31 to bit 28	bit 27 to bit 24	bit 23 to bit 20	bit 19 to bit 16	bit 15 to bit 12	bit 11 to bit 8	bit 7 to bit 4	bit 3 to bit 0

In addition, bits and characters are related as follows:

	bit 31	bit 30	bit 29	bit 28
	bit 27	bit 26	bit 25	bit 24
	bit 23	bit 22	bit 21	bit 20
	bit 19	bit 18	bit 17	bit 16
	bit 15	bit 14	bit 13	bit 12
	bit 11	bit 10	bit 9	bit 8
	bit 7	bit 6	bit 5	bit 4
	bit 3	bit 2	bit 1	bit 0
"F"	1	1	1	1
"E"	1	1	1	0
"D"	1	1	0	1
"C"	1	1	0	0
"B"	1	0	1	1
"A"	1	0	1	0
"9"	1	0	0	1
"8"	1	0	0	0
"7"	0	1	1	1
"6"	0	1	1	0
"5"	0	1	0	1
"4"	0	1	0	0
"3"	0	0	1	1
"2"	0	0	1	0
"1"	0	0	0	1
"0"	0	0	0	0

In this example, characters 1st through 7th are all "0", while the 8th character is "7". Consequently, bits 2, 1, and 0 have the value 1, while all other bits have the value 0.

The status of bit 2, bit 1, and bit 0 represent PU3, PU2, and PU1, respectively, which means that voltages acquired across CH1 CH2, and CH3 exceed the peak.

Measurement Value Data Format

General Measurement Values	±□□□□□□E±□□ 6-digit mantissa including the decimal point and 2-digit exponent ("+" sign and leading zero are omitted for mantissa.)
Integration Value	±□□□□□□□E±□□ 7-digit mantissa including the decimal point and 2-digit exponent ("+" sign and leading zero are omitted for mantissa.)
Time	YYYY/MM/DD □□□□/□□/□□ HH:MM:SS □□:□□:□□ Elapsed Time □□□□:□□:□□ Elapsed Time (ms) □□□
Error state	Input out of range +9999.9E+99

Appendix 3 Physical Illustration

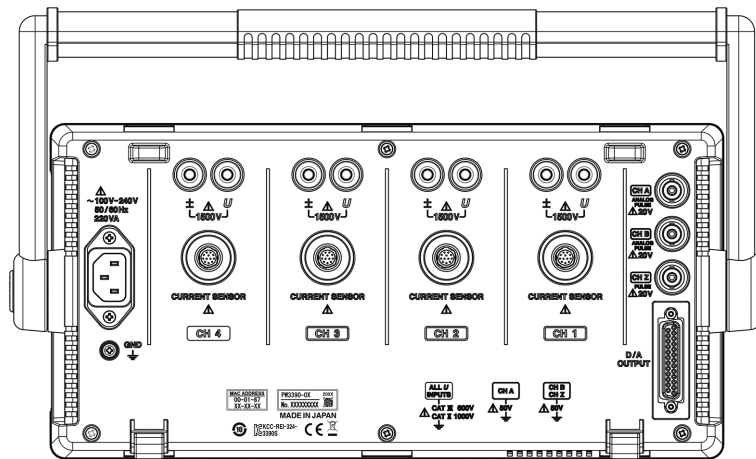
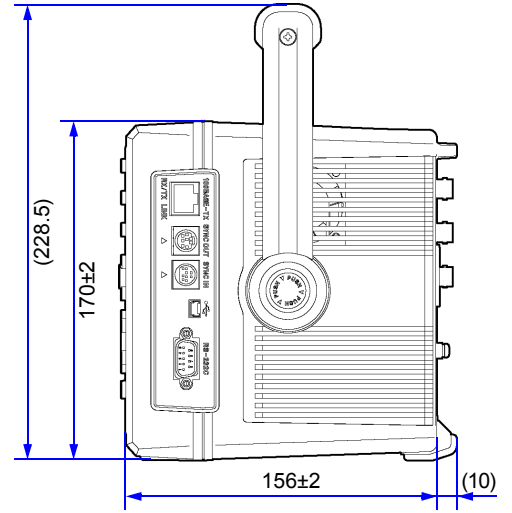
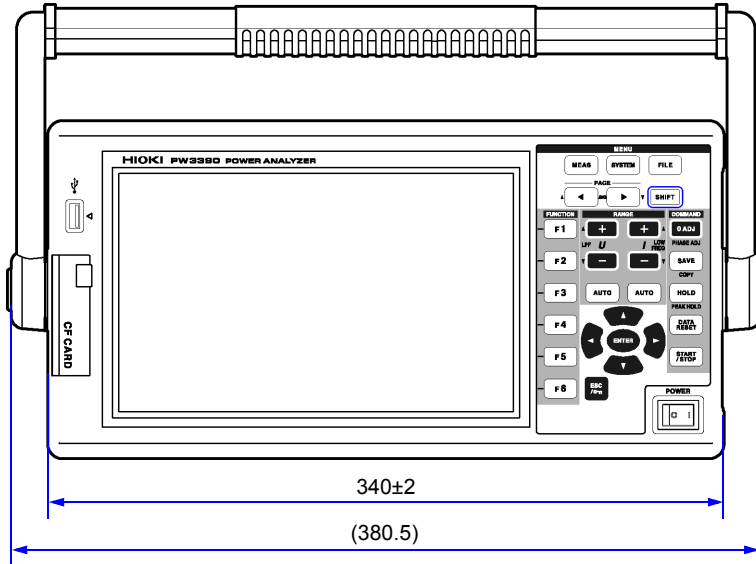

(Unit: mm)

A6

Appendix 4 Rack Mounting

Appendix 4 Rack Mounting

The illustrated rack mounting brackets are available. For more information, contact your authorized Hioki distributor or reseller.

Front View

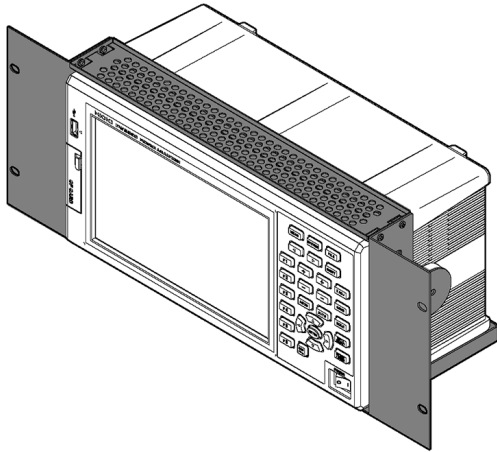

Rear View

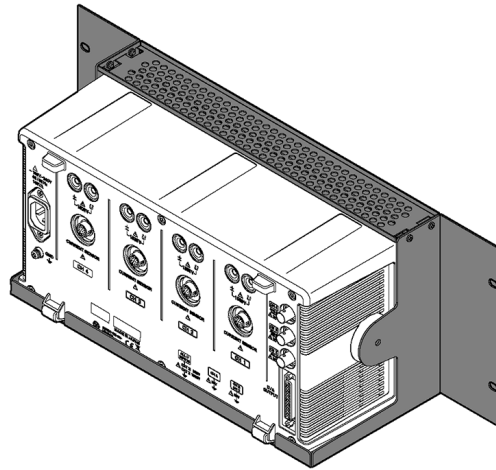

Index

A

Active Power	51, 65, 68, 74, 76
All CH Set	20
Analog DC	99, 102
Phase Zero Adjustment	105
Analog output	169, 170
Apparent Power	51, 62
Auto display update settings	187
AUTO range	53
Auto-Saving	143, 144
Averaging	113

B

Before Connecting	11
Bluetooth	174

C

Calculation Formula Specifications	214, 221
CF card	135, 136
CH A	99
input	99
range	100
scaling	100
unit	101
CH B	102
input	102
range	102
scaling	102
unit	102
CH Z	176
Cleaning	223
Clock	71, 73, 114, 116, 131
Clock control	67, 73
Color	130
Connection Check	46
Content	76
content	75
Conversion cable	34
CSV file format	131
CT	63
Current sensor	
Connecting	33
Labels	28
Options	3
Setting	41

D

D/A output	168
Output examples	172
Data format	135
Data Hold	161
Data Saving	140
DC	
100 ms	58, 79, 98
50 ms	58, 79, 98
DC Integration Mode	68
Dedicated application program	181
Default Gateway	183
Delta-star transfer function	118
Display Contents (Harmonic)	76
Displayed Item	76
Displayed item (Harmonic)	75
Disposing	230
Distortion ratios	112

E

Easy set	45
Efficiency	91, 92
Electrical Angle	104, 105
Error Indication	226
η	91, 171
Ethernet	
connection	185
Interface	184
LAN cable	184, 185
Ext	58, 79, 98, 104, 105
External controlling	163
External signal as the sync source	79

F

Factory Default Settings	133
ϕ	171
FAST	112
File	25, 135, 138, 153, 154, 156, 157
FILE key	18
Flat top	90
Folder	153, 154, 155, 156
Formatting	139
Freq range fc	101
Frequency Measurement Source	60
Full-scale frequency	169, 209
Full-scale integration	169

Fundamental Current Content	52
Fundamental Voltage Content	52
Fundamental wave component	211

G

Grounding	31
-----------------	----

H

Handle	17
Hanning	90
Harmonic Bar Graph	74
Harmonic List	76
Harmonic Sync Source	79, 104, 105
Harmonic Vectors	77
Hiding and Displaying Waveforms	83
Highest Displayed Order	76
Highest order	146
HOLD	21
Hold	114
Horizontal Axis Magnification (Waveform)	84
HTTP server	186

I

Incremental rotary encoder	177
Index averaging	112
Initializing	132
Input Cable Labels	2
Input Frequency Source	98
Inspection	223
Instantaneous values	114, 170
Integration Value	65, 203, 204
Interface	21
Internal fixed clock	79
Interval	70, 109, 144, 145
Interval timing control	109
IP address	183
Items to save	145

K

Key-Lock	21
----------------	----

L

Labels	28
LAN Interface	182, 201
Language	130
LCD back light	130
Linear	75
Log	75, 85
Loss	91, 92, 91
LOW FREQ key	60
Lower measurement limit	22, 60, 61

Lowest order	146
Low-pass filter	22, 64
Motor	98

M

Main page	186
Manual Integration	69, 70
MANUAL range	53, 54
Manual Save	135, 138, 140, 141
Master	159
Max frequency (Motor)	102
Maximum recordable items	145
MEAN	62
MEAS key	18
Measured Items for Display	48
Measurement Ch (Noise analysis)	90
Measurement Channel (Harmonic)	77
Measurement Configuration	51
Measurement Screen	22
MID	112
Minimum Noise Frequency	88
Motor	
Poles	102
Sync source	98
Zero adjustment	97
Motor Power	91, 96, 101, 176

N

No. of pulses	102
Noise	85
Noise sampling	89
Noise saving	147

O

Output Level	171
Output order	146

P

Peak Hold	21, 115, 116
Peak Over	50
PHASE ADJ	105
Phase angle	172
phase angle	75, 76
Phase correction	41
Pm	96, 101, 102
Points	84, 88, 90
Power Factor	51, 65
Power-On Reset	132
Primary (master) instrument	159
PT	63
Pulse count	104

R

Rated torque	100, 101
Reactive Power	51, 62
Real time	73, 111, 133, 203, 207, 209
Realtime	16, 65, 66, 69, 71, 72
Real-Time Clock	144
Real-time clock timing control	109
Rectangular	90
Rectification Method	62
Remaining available recording time	143
Repair	223
Replaceable parts and useful life	224
Resetting Integration	66
Response time	112
RF	68
Ripple factor	68
RMS	62
RMS Integration Mode	68
Rotation rate	96, 102
rotation rate	96
Rotation Signal Input	102
RS-232C	
Connection	181
Interface	189
RTC clock	161
RUN mark	21

S

Sampling Frequency	68, 87
Saving Operations	140
Saving Screen Capture Images	149
Scale of the vertical axis	75
Scaling	63
Secondary (slave) instrument	159
Self test	30
Settings file	151, 152
SHIFT key	18
Slave	159
Slip	96, 99
SLOW	112
Specifications	208
Start page	131
START/STOP key	18
Starting, Stopping, and Resetting Integration	66
STOP mark	21
Subnet mask	183
Sync cable	160
Sync event	161
Sync Source	58, 79
Sync Unlock	59
Synchronized Measurement	159
SYSTEM	24
SYSTEM key	18

System reset	132, 225
--------------------	----------

T

THD	80
THD Voltage Percentage	52, 80
THD-F	80
THD-R	80
θ	211
Timer	72, 144
Timer timing control	109
Timing Control Functions	109, 110, 116
Timing control functions	
Interval timing control	109
Real-time clock timing control	109
Timer timing control	109
Torque	96, 99
Torque meter	177
Trend	121

U

Unbalance ratios	112
Upgrade	139
USB	
Connection	181
flash drive	135, 136
Interface	188
Uunb	52

V

Vector	46, 54, 77, 118
VT(PT)	63

W

Warm-up	44
Wave + Noise	55, 81, 147, 148
Waveform	88, 199, 203
Waveform display	79, 116
Waveform outputs	169
Window Function	90
Wiring Mode	37

X

X-Y graphs	117
X-Y Plot	117

Z

Zero Adjustment	44, 97, 105, 199
Motor	97
Zero suppress	131
Zero-Crossing Filter	59



Warranty Certificate

HIOKI

Model	Serial number	Warranty period Three (3) years from date of purchase (___ / ___)
-------	---------------	--

Customer name: _____

Customer address: _____

Important

- Please retain this warranty certificate. Duplicates cannot be reissued.
- Complete the certificate with the model number, serial number, and date of purchase, along with your name and address. The personal information you provide on this form will only be used to provide repair service and information about Hioki products and services.

This document certifies that the product has been inspected and verified to conform to Hioki's standards.

Please contact the place of purchase in the event of a malfunction and provide this document, in which case Hioki will repair or replace the product subject to the warranty terms described below.

Warranty terms

1. The product is guaranteed to operate properly during the warranty period (three [3] years from the date of purchase).
If the date of purchase is unknown, the warranty period is defined as three (3) years from the date (month and year) of manufacture (as indicated by the first four digits of the serial number in YYMM format).
2. If the product came with an AC adapter, the adapter is warranted for one (1) year from the date of purchase.
3. The accuracy of measured values and other data generated by the product is guaranteed as described in the product specifications.
4. In the event that the product or AC adapter malfunctions during its respective warranty period due to a defect of workmanship or materials, Hioki will repair or replace the product or AC adapter free of charge.
5. The following malfunctions and issues are not covered by the warranty and as such are not subject to free repair or replacement:
 - 1. Malfunctions or damage of consumables, parts with a defined service life, etc.
 - 2. Malfunctions or damage of connectors, cables, etc.
 - 3. Malfunctions or damage caused by shipment, dropping, relocation, etc., after purchase of the product
 - 4. Malfunctions or damage caused by inappropriate handling that violates information found in the instruction manual or on precautionary labeling on the product itself
 - 5. Malfunctions or damage caused by a failure to perform maintenance or inspections as required by law or recommended in the instruction manual
 - 6. Malfunctions or damage caused by fire, storms or flooding, earthquakes, lightning, power anomalies (involving voltage, frequency, etc.), war or unrest, contamination with radiation, or other acts of God
 - 7. Damage that is limited to the product's appearance (cosmetic blemishes, deformation of enclosure shape, fading of color, etc.)
 - 8. Other malfunctions or damage for which Hioki is not responsible
6. The warranty will be considered invalidated in the following circumstances, in which case Hioki will be unable to perform service such as repair or calibration:
 - 1. If the product has been repaired or modified by a company, entity, or individual other than Hioki
 - 2. If the product has been embedded in another piece of equipment for use in a special application (aerospace, nuclear power, medical use, vehicle control, etc.) without Hioki's having received prior notice
7. If you experience a loss caused by use of the product and Hioki determines that it is responsible for the underlying issue, Hioki will provide compensation in an amount not to exceed the purchase price, with the following exceptions:
 - 1. Secondary damage arising from damage to a measured device or component that was caused by use of the product
 - 2. Damage arising from measurement results provided by the product
 - 3. Damage to a device other than the product that was sustained when connecting the device to the product (including via network connections)
8. Hioki reserves the right to decline to perform repair, calibration, or other service for products for which a certain amount of time has passed since their manufacture, products whose parts have been discontinued, and products that cannot be repaired due to unforeseen circumstances.

HIOKI E.E. CORPORATION

<http://www.hioki.com>

18-07 EN-3

HIOKI
www.hioki.com/



**All regional
contact
information**

HIOKI E.E. CORPORATION

81 Koizumi, Ueda, Nagano 386-1192 Japan

2402 EN

Edited and published by HIOKI E.E. CORPORATION

Printed in Japan

- Contents subject to change without notice.
- This document contains copyrighted content.
- It is prohibited to copy, reproduce, or modify the content of this document without permission.
- Company names, product names, etc. mentioned in this document are trademarks or registered trademarks of their respective companies.

Europe only

• EU declaration of conformity can be downloaded from our website.

• Contact in Europe: HIOKI EUROPE GmbH
Helfmann-Park 2, 65760 Eschborn, Germany

hioki@hioki.eu