

# MR8740

# MR8741

# HIOKI

Instruction Manual

# MEMORY HiCORDER

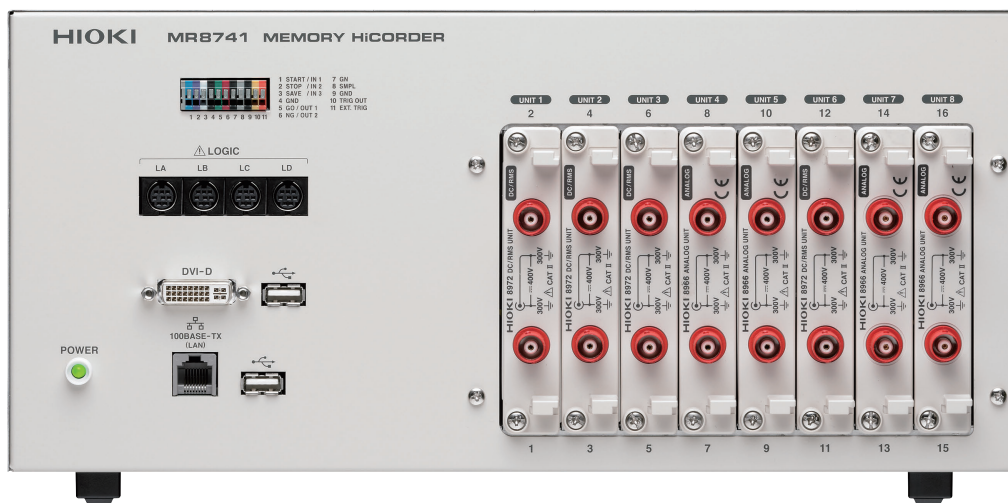
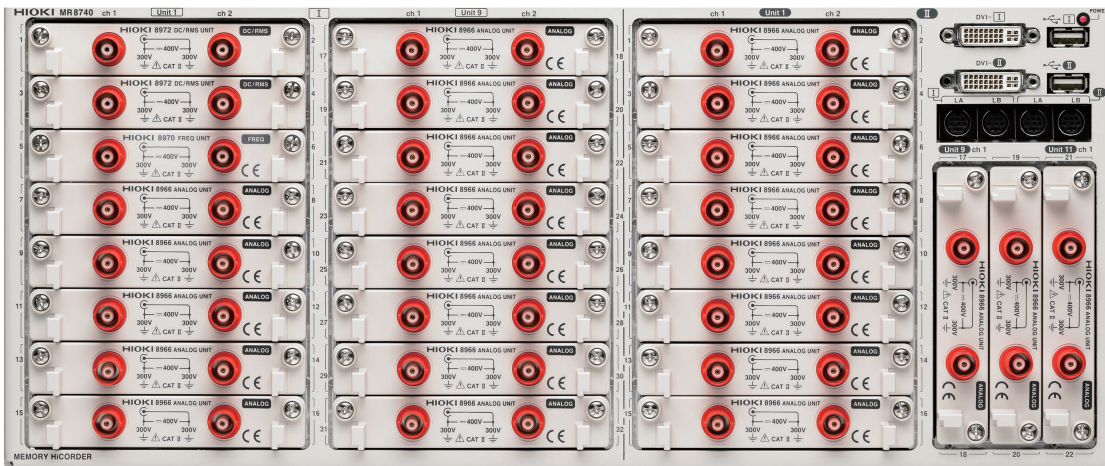

EN

Oct. 2022 Revised edition 10  
MR8740A982-10 22-10H



# Contents

Usage Index .....	1
Introduction.....	2
Confirming Package Contents.....	3
Safety Information .....	4
Operating Precautions.....	8

## **Chapter 1** **Overview** 15

1.1 Product Overview .....	15
1.2 Names and Functions of Parts .....	16
1.3 Display .....	18
1.4 Screen Configuration .....	19
1.5 Basic Operations .....	22
1.5.1 Mouse Operations .....	22
1.5.2 Mouse Right-click Menu .....	23
1.5.3 Mouse Left-click Operations .....	29
1.5.4 Mouse Wheel Operations .....	31
1.5.5 Waveform Operations .....	32
1.5.6 Measurement Operations .....	33
1.5.7 File Operations .....	34

## **Chapter 2** **Measurement Preparations** 35

2.1 Installing and Removing Modules .....	36
2.2 Connecting Cords .....	39
2.3 Recording Media Preparation .....	54
2.3.1 Storage Media (Inserting a USB Memory Stick) .....	54
2.3.2 Formatting Storage Media .....	55
2.4 Supplying Power .....	56
2.4.1 Connecting the Power Cord .....	56
2.4.2 Turning the Power On and Off .....	57
2.5 Setting the Clocks .....	58
2.6 Adjusting the Zero Position (Zero-Adjust) .....	59
2.7 Performing Calibration (When Mounting MR8990) .....	60

## **Chapter 3**

### **Measurement Procedure 61**

3.1	Measurement Workflow .....	61
3.2	Pre-Measurement Inspection .....	63
3.3	Setting Measurement Configuration .....	64
3.3.1	Measurement Function .....	64
3.3.2	Time Axis Range and Sampling Rate .....	66
3.3.3	Recording Length (number of divisions) 69	
3.3.4	Screen Layout .....	71
3.4	Input Channel Setting .....	72
3.4.1	Channel Setting Workflow .....	73
3.4.2	Analog Channel .....	75
3.4.3	Logic Channel .....	78
3.4.4	Display Sheet .....	79
3.5	Starting and Stopping Measurement .....	80

## **Chapter 4**

### **Saving/Loading Data & Managing Files 83**

4.1	Data capable of Being Saved & Loaded .....	85
4.2	Saving Data .....	87
4.2.1	Save Types and Workflow .....	87
4.2.2	Automatically Saving Waveforms .....	88
4.2.3	Saving Data Selectively (SAVE) .....	93
4.2.4	Saving Example (Saving for Memory Division) .....	96
4.2.5	Save Waveform Output Data to the Media .....	98
4.3	Loading Data .....	99
4.4	Managing Files .....	102
4.4.1	Saving .....	103
4.4.2	Checking the Contents of a Folder (Open a Folder) 105	
4.4.3	Creating New Folders .....	105
4.4.4	Deleting Files & Folders .....	106
4.4.5	Sorting Files .....	107
4.4.6	Renaming Files & Folders .....	107
4.4.7	Copying a File Into a Specified Folder .....	108

## **Chapter 5**

### **Printing 109**

5.1	Printing Type and Workflow .....	110
5.2	Making Auto Print Settings .....	111

---

5.3	Send PRINT key .....	112
5.4	Set the print contents .....	113
5.5	Miscellaneous Printing Functions .....	116
5.5.1	Screen Hard Copy .....	116
5.5.2	Report Print (A4 Size Print) .....	116
5.5.3	List Print .....	117
5.5.4	Text Comment Printing .....	117

## **Chapter 6**

### **Waveform Screen Monitoring and Analysis \_\_\_\_\_ 119**

6.1	Reading Measurement Values (Using the A/B Cursors) .	120
6.2	Specifying a Waveform Range (A/B Cursor) .....	124
6.3	Moving the Waveform Display Position .....	125
6.3.1	About Display Position .....	125
6.3.2	Scrolling the Measurement Waveform .....	125
6.3.3	Moving the Position .....	126
6.4	Performing Waveform X-Y Synthesis .....	127
6.5	Magnifying and Compressing Waveforms .....	129
6.5.1	Magnifying and Compressing Horizontal Axis (Time Axis) ...	129
6.5.2	Zoom Function (Magnifying a Section of the Horizontal Axis (Time Axis)) .....	130
6.5.3	Magnifying and Compressing Vertical Axis (Voltage Axis) ...	131
6.6	Monitoring Input Levels (Level Monitor) .....	132
6.6.1	Level Monitor .....	132
6.6.2	Numerical Value Monitoring (DMM Display) .....	133
6.7	Switching the Waveform Screen Display (Display Menu) 134	
6.7.1	Showing Upper/Lower Limit On Waveform Screen .....	134
6.7.2	Showing Comments On Waveform Screen .....	134
6.7.3	Switching the Waveform Display Width .....	135
6.7.4	Switching the Format (MR8741 Only) .....	135
6.7.5	Changing the Monitor Values (MR8740 Only) .....	135
6.7.6	Switch the Displayed Sheet .....	135
6.8	Seeing Block Waveforms .....	136

## **Chapter 7**

### **Utility Functions \_\_\_\_\_ 137**

7.1	Adding Comments .....	138
7.1.1	Adding a Title Comment .....	138
7.1.2	Adding a Channel Comment .....	139
7.1.3	Alphanumeric Input .....	141
7.2	Displaying Waveforms During Recording (Roll Mode) ....	145

7.3	Displaying New Waveforms Over Past Waveforms (Overlay) .....	146
7.4	Converting Input Values (Scaling Function) .....	148
7.4.1	Scaling Setting Examples .....	150
7.5	Variable Function (Setting the Waveform Display Freely) ..	155
7.6	Fine Adjustment of Input Values (Vernier Function) .....	158
7.7	Inverting the Waveform (Invert Function) .....	159
7.8	Copying settings to other channels (calculation No.) (Copy function) .....	160
7.9	Setting Details of Modules .....	161
7.9.1	Setting the Anti-aliasing Filter (A.A.F) .....	162
7.9.2	Probe Attenuation Selection .....	162
7.9.3	Setting Model 8967 TEMP Unit .....	163
7.9.4	Setting Model 8969 and U8969 Strain Unit .....	165
7.9.5	Setting Model 8970 Freq Unit .....	166
7.9.6	Setting Model 8971 Current Unit .....	169
7.9.7	Setting Model 8972 DC/RMS Unit .....	170
7.9.8	Setting Model MR8990 Digital Voltmeter Unit .....	171
7.9.9	Setting Model Model U8974 High Voltage Unit .....	173
7.9.10	Setting Model U8979 Charge Unit .....	174
7.9.11	Setting Model MR8790 Waveform Generator Unit .....	177
7.9.12	Setting Model MR 8971 Pulse Generator Unit .....	179
7.9.13	Setting Model U8793 Arbitrary Waveform Generator Unit ...	181
7.10	Register the Waveform in the U8793 Arbitrary Waveform Generator Unit .....	184
7.11	Saving Waveforms Registered in Model U8793 onto a Storage Device .....	188
7.12	Setting Output Waveform Parameters on the Waveform Screen .....	188

## **Chapter 8**

### **Trigger Settings** \_\_\_\_\_ **189**

8.1	Setting Workflow .....	190
8.2	Setting the Trigger Mode .....	191
8.3	Triggering by Analog Signals .....	192
8.3.1	Analog Trigger Settings and Types .....	192
8.4	Triggering by Logic Signals (Logic Trigger) .....	197
8.5	Trigger by Timer or Time Intervals (Timer Trigger) .....	199
8.6	Synchronizing Between Blocks (MR8740 Only) .....	202

8.7	Applying an External Trigger (MR8741 Only) .....	203
8.8	Triggering Manually (Manual Trigger) .....	203
8.9	Pre-Trigger Settings .....	204
8.9.1	Setting the Trigger Start Point (Pre-Trigger) .....	204
8.9.2	Setting Trigger Acceptance (Trigger Priority) .....	206
8.10	Setting Trigger Timing .....	207
8.11	Setting Combining Logic (AND/OR) for Multiple Trigger Sources .....	208
8.12	Using trigger settings to search measurement data .....	209

## **Chapter 9**

### **Numerical Calculation Functions \_\_\_\_\_ 211**

9.1	Numerical Calculation Workflow .....	212
9.2	Settings for Numerical Value Calculation .....	214
9.2.1	Displaying Numerical Calculation Results .....	217
9.3	Judging Calculation Results .....	218
9.3.1	Display of Judgment Results and Signal Output .....	220
9.4	Saving Numerical Calculation Results .....	221
9.5	Numerical Calculation Type and Description .....	223

## **Chapter 10**

### **Waveform Calculation Functions \_\_\_\_\_ 227**

10.1	Waveform Calculation Workflow .....	228
10.2	Settings for Waveform Calculation .....	231
10.2.1	Displaying the waveform calculation results .....	232
10.2.2	Setting constants .....	234
10.2.3	Changing the display method for calculated waveforms .....	235
10.3	Waveform Calculation Operators and Results .....	237

## **Chapter 11**

### **Memory Division Function \_\_\_\_\_ 241**

11.1	Recording Settings .....	243
11.2	Display Settings .....	244

---

## **Chapter 12**

### **FFT Function \_\_\_\_\_ 247**

12.1	Overview and Features .....	247
12.2	Operation Workflow .....	248
12.3	Setting FFT Analysis Conditions .....	249
12.3.1	Selecting the FFT Function .....	249
12.3.2	Selecting the Data Source for Analysis .....	250
12.3.3	Setting the Frequency Range and Number of Analysis Points .....	251
12.3.4	Thinning Out and Calculating Data .....	253
12.3.5	Setting the Window Function .....	254
12.3.6	Setting Peak Values of Analysis Results .....	255
12.3.7	Averaging Waveforms .....	256
12.3.8	Emphasizing Analysis Results (phase spectra only) .....	259
12.3.9	Analysis Mode Settings .....	260
12.3.10	Setting the Display Range of the Vertical Axis (Scaling) .....	264
12.3.11	Setting and Changing Analysis Conditions on the Waveform Screen .....	265
12.4	Selecting Channels .....	266
12.5	Setting Screen Displays .....	267
12.5.1	Displaying running spectrums .....	269
12.6	Saving Analysis Results .....	272
12.7	Analysis with the Waveform Screen .....	273
12.7.1	Analyzing after Specifying an Analysis Starting Point .....	273
12.8	FFT Analysis Modes .....	275
12.8.1	Analysis Modes and Display Examples .....	275
12.8.2	Analysis Mode Functions .....	293

## **Chapter 13**

### **Waveform Evaluation Function(MR8741 Only) \_\_ 295**

13.1	Waveform GO/NG Evaluation (MEM, FFT Function) .....	295
13.2	Setting the Waveform Area .....	298
13.3	Setting the Waveform Evaluation Mode .....	300
13.4	Setting the GO/NG Stop Mode .....	301
13.5	Creating the Evaluation Area .....	303
13.6	Editor Command Details .....	304

## **Chapter 14**

### **System Environment Settings \_\_\_\_\_ 309**

## **Chapter 15**

### **Connection to a Computer** \_\_\_\_\_ **313**

15.1 LAN Settings and Connection (Before Using FTP/ Internet Browser/Command Communications) .....	314
15.1.1 Making LAN Settings at the Instrument .....	314
15.1.2 Connecting Instrument and PC With LAN Cable .....	318
15.2 Performing Remote Operations on the Instrument (Use an Internet Browser) .....	320
15.2.1 Making HTTP Settings on the Instrument .....	320
15.2.2 Connecting to the Instrument With an Internet Browser .....	321
15.2.3 Operating the Instrument With an Internet Browser .....	322
15.3 Accessing the Files on the Instrument From a Computer (Using FTP) .....	327
15.3.1 Making FTP Settings at the Instrument .....	328
15.3.2 Using FTP to Connect to the Instrument .....	329
15.3.3 Using FTP for File Operations .....	330
15.4 Wave Viewer (Wv) .....	331
15.5 Controlling the Instrument with Command Communications (LAN) .....	332
15.5.1 Making Settings on the Instrument .....	333
15.6 Operating the instrument remotely and acquiring data by using Model 9333 LAN Communicator .....	334

## **Chapter 16**

### **External Control (MR8741 Only)** \_\_\_\_\_ **335**

16.1 Connecting External Control Terminals (MR8741 Only) .....	336
16.2 External I/O (MR8741 Only) .....	337
16.2.1 External Input (START/IN1) (STOP/IN2) (SAVE/IN3) .....	337
16.2.2 External Output (GO/OUT1) (NG/OUT2) .....	338
16.2.3 External Sampling (SMPL) .....	340
16.2.4 Trigger Output (TRIG OUT) .....	341
16.2.5 External Trigger terminal (EXT.TRIG) .....	342

## **Chapter 17**

### **Specifications** \_\_\_\_\_ **343**

17.1 General Specifications of the Instrument .....	343
17.2 Measurement Functions .....	346
17.2.1 Memory Function .....	346
17.2.2 Recorder Function .....	346
17.2.3 FFT Function .....	346



17.3	Trigger Section .....	347
17.4	File Specifications .....	348
17.5	Built-In Functions .....	349
17.6	Specifications of Modules .....	352
17.6.1	8966 Analog Unit .....	352
17.6.2	8967 TEMP Unit .....	353
17.6.3	8968 High Resolution Unit .....	354
17.6.4	8969 Strain Unit / U8969 Strain Unit .....	355
17.6.5	8970 Freq Unit .....	356
17.6.6	8971 Current Unit .....	358
17.6.7	8972 DC/RMS Unit .....	359
17.6.8	8973 Logic Unit .....	360
17.6.9	MR8990 Digital Voltmeter Unit .....	361
17.6.10	U8974 High Voltage Unit .....	362
17.6.11	U8979 Charge Unit .....	364
17.6.12	U8793 Arbitrary Waveform Generator Unit .....	367
17.6.13	MR8790 Waveform Generator Unit .....	369
17.6.14	MR8791 Pulse Generator Unit .....	370

## **Chapter 18**

### **Maintenance and Service** 373

18.1	Troubleshooting .....	374
18.2	Initializing the Instrument .....	376
18.2.1	Initializing System Settings (System Reset) .....	376
18.2.2	Initializing Waveform Data .....	376
18.3	Error Messages .....	377
18.4	Self-Test (Self Diagnostics) .....	380
18.4.1	ROM/RAM Check .....	380
18.4.2	Display Check .....	381
18.4.3	System Configuration Check .....	381
18.5	Updating the Instrument .....	382
18.6	Cleaning .....	384
18.7	Disposing of the Instrument (Lithium Battery Removal) .....	385

## **Appendix** A 1

Appendix 1	Default Values for Major Settings.....	A 1
Appendix 2	Reference.....	A 2
Appendix 2.1	Waveform File Sizes .....	A 2
Appendix 2.2	Setting Configuration and Image Data File Sizes .....	A 5
Appendix 2.3	Timebase and Maximum Recordable Time .....	A 6

Appendix 2.4 Maximum record length and number of divisions  
(Memory division function) ..... A 7

Appendix 2.5 Time Axis Range and Sampling Rate of  
MR8990 Digital Voltmeter Unit ..... A 8

Appendix 2.6 Scaling Method When Using Strain Gauges ..... A 9

Appendix 3 About Options..... A 10

    Appendix 3.1 Options ..... A 10

Appendix 4 FFT Definitions ..... A 14

**Index** \_\_\_\_\_ **Index 1**

**X**

***Contents***

---

---

# Usage Index

## Basic Workflow

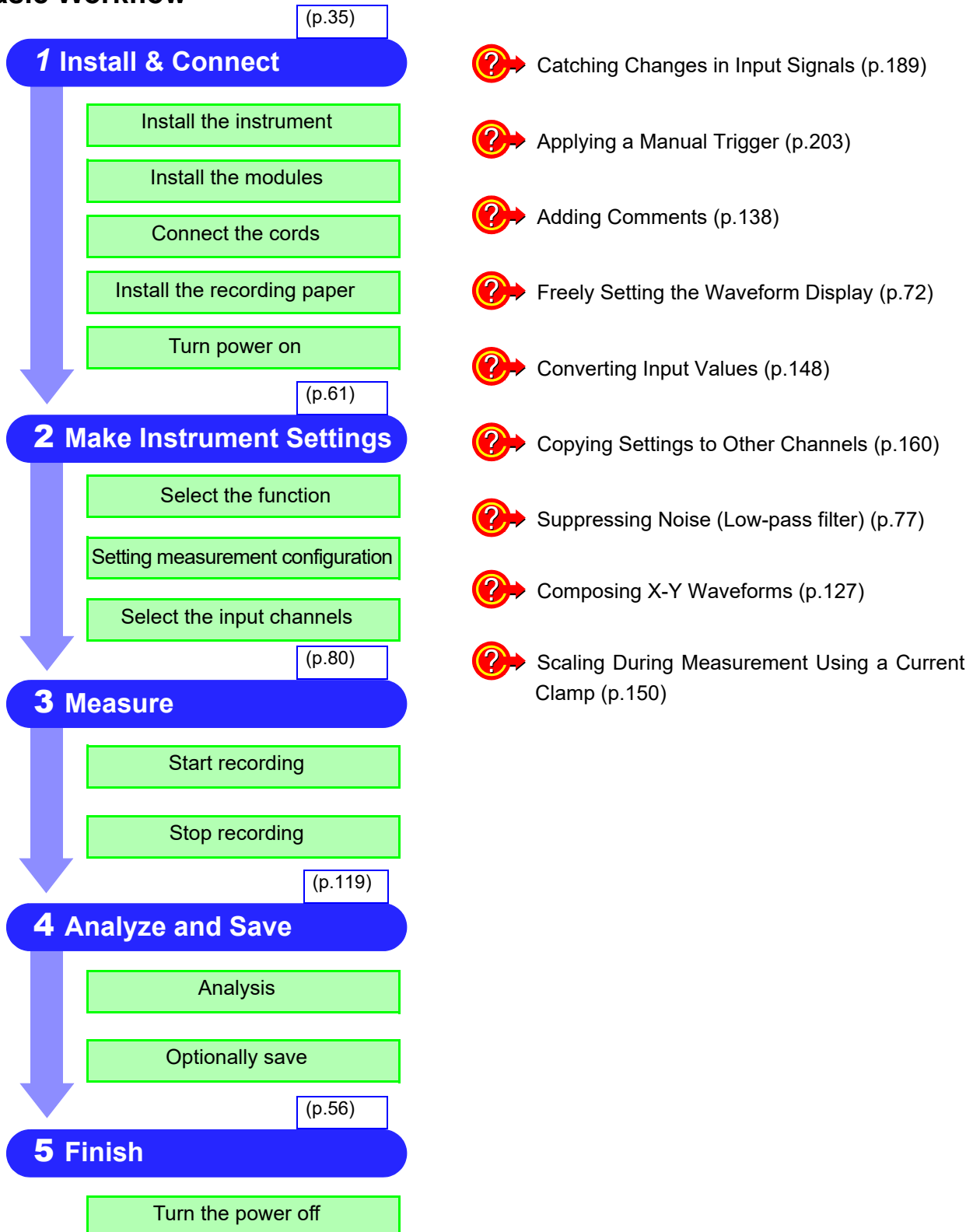

## Introduction

Thank you for purchasing the HIOKI "Model MR8740/MR8741 Memory HiCorder". To obtain maximum performance from the instrument, please read this manual carefully, and keep it handy for future reference.

The optional clamps ( p. A 10) collectively mean "clamp sensors."

The following instruction manuals are available for this instrument. Refer to the relevant manual as usage.

Type	Contents	Print	CD
Instruction Manual (this document)	Contains details and specifications regarding the functions and operations of this instrument.	✓	—
Communication Command Instruction Manual	Contains a list of the communication commands and their explanations to control the instrument with a computer.	—	✓
U8793, MR8790, MR8791 Instruction Manual	Contains specifications and explanations of functions/operations of Models U8793 Arbitrary Waveform Generator Unit, MR8790 Waveform Generator Unit, MR8791 Pulse Generator Unit, and SF8000 Waveform Maker.	—	✓

- Trademarks**
- Microsoft, Windows, Excel, and Internet Explorer are either registered trademarks or trademarks of Microsoft Corporation in the United States and other countries.
  - CompactFlash is a registered trademark of SanDisk Corporation (USA).
  - Sun, Sun Microsystems, Java, and any logos containing Sun or Java are trademarks or registered trademarks of Oracle Corporation in the United States and other countries.

## Confirming Package Contents

When you receive the instrument, inspect it carefully to ensure that no damage occurred during shipping. In particular, check the accessories, panel switches, and connectors. If damage is evident, or if it fails to operate according to the specifications, contact your dealer or Hioki representative.

### Confirm that these contents are provided. (One each)

- MR8740 or MR8741 Memory HiCorder

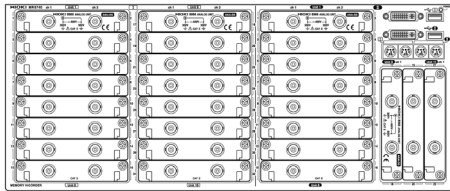

MR8740

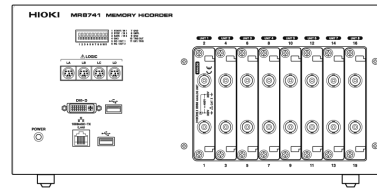

MR8741

### Accessories

- Instruction Manual (this document)



- Power Cord

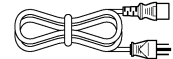

- Application disc \*1 (p.331)

- SF8000 Waveform Maker
- Wave Viewer (WV)
- Communication Command Instruction Manual
- U8793, MR8790, MR8791 Instruction Manual\*2



- Rack mounting brackets (for EIA standard)  
(Model MR8740 only)

Other options specified when ordered  
Options List ( p. A 10)

\*1: The latest version can be downloaded from our website.

\*2: If one or more Model 8967 Temp Units are installed in the instrument, two ferrite clamp-on chokes (small) will be supplied per module.

### **NOTE**

If the 8967 TEMP Unit is installed in the MR8740/MR8741, two ferrite clamp-on chokes (small) will be supplied per unit.

## Safety Information

This instrument and modules are designed to conform to IEC 61010 Safety Standards, and has been thoroughly tested for safety prior to shipment. However, using the instrument in a way not described in this manual may negate the provided safety features.

Before using the instrument, be certain to carefully read the following safety notes:



Mishandling during use could result in injury or death, as well as damage to the instrument. Be certain that you understand the instructions and precautions in the manual before use.



With regard to the electricity supply, there are risks of electric shock, heat generation, fire, and arc discharge due to short circuits. If anyone who is unfamiliar with electrical measuring instruments will use the instrument, a person familiar with such instruments must supervise operations.

## Protective Gear









This instrument is measured on a live line. Wear the insulating protective gear according to the regulation to avoid electric shocks.

## Notation

In this document, the risk seriousness and the hazard levels are classified as follows.



<b>DANGER</b>	Indicates that incorrect operation presents an extreme hazard that could result in serious injury or death to the user.
<b>WARNING</b>	Indicates that incorrect operation presents a significant hazard that could result in serious injury or death to the user.
<b>CAUTION</b>	Indicates that incorrect operation presents a possibility of injury to the user or damage to the instrument.
<b>NOTE</b>	Indicates advisory items related to performance or correct operation of the instrument.
	Indicates a high voltage hazard. If a particular safety check is not performed or the instrument is mishandled, this may give rise to a hazardous situation; the operator may receive an electric shock, be burnt or even be fatally injured.
*	Indicates that descriptive information is provided below.

## Symbols Affixed to the Instrument

	Indicates cautions and hazards. When this symbol is printed on the instrument, refer to the corresponding topic in this Instruction Manual.
	Indicates the ON side of the power switch.
	Indicates the OFF side of the power switch.
	Indicates DC (Direct Current).
	Indicates AC (Alternating Current).
	Indicates a grounding terminal.
	Indicates a fuse.

## Other Symbols

### Symbols in This Manual

	Indicates the prohibited action.
(p. )	Indicates the location of reference information.
	Indicates quick references for operation and remedies for troubleshooting.
*	Indicates that descriptive information is provided below.
[ ]	Menus, commands, dialogs, buttons in a dialog, and other names on the screen and the keys are indicated in brackets. Unless otherwise specified, "Windows" represents Windows 7, Windows 8, and Windows 10.
<b>MEM</b>	Indicates Memory function support.
<b>FFT</b>	Indicates FFT Recorder function support.



# 6

## Safety Information

---

---

### Mouse Operations

Click:	Press and quickly release the left button of the mouse.
Right-click:	Press and quickly release the right button of the mouse.
Double-click:	Quickly click the left button of the mouse twice.
Drag:	Move the mouse while holding down the left button of the mouse, and then release the button at the desired position.
Activate:	Click on a screen to activate that screen.

### Accuracy

We define measurement tolerances in terms of f.s. (full scale) values, with the following meanings:

**f.s. (maximum display value or scale length)**

The maximum displayable value or scale length. In this instrument, the maximum displayable value is the range (V/div) times the number of divisions (20) on the vertical axis.

Example: For the 1 V/div range, f.s. = 20 V

**rdg. (reading value, displayed value, or indicated value)**

The value currently being measured and indicated on the measuring instrument.

---

## Measurement categories

To ensure safe operation of measuring instruments, IEC 61010 establishes safety standards for various electrical environments, categorized as CAT II to CAT IV, called measurement categories.



- Using a measuring instrument in an environment designated with a higher-numbered category than that for which the instrument is rated could result in severe accidents, and must be carefully avoided.
- Using a measuring instrument that has no category rating in an environment designated with the CAT II to CAT IV category could result in severe accidents, and must be carefully avoided.

**CAT II** When directly measuring the electrical outlet receptacles of the primary electrical circuits in equipment connected to an AC electrical outlet by a power cord (portable tools, household appliances, etc.)

**CAT III** When measuring the primary electrical circuits of heavy equipment (fixed installations) connected directly to the distribution panel, and feeders from the distribution panel to outlets

**CAT IV** When measuring the circuit from the service drop to the service entrance, and to the power meter and primary overcurrent protection device (distribution panel)

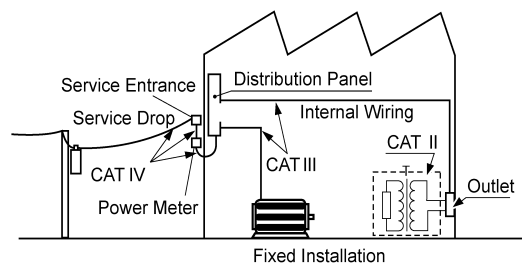

### **NOTE**

The applicable measurement category is determined by the module being used. Refer to "17.6 Specifications of Modules" (p.352).

## Operating Precautions

### Before Use

Follow these precautions to ensure safe operation and to obtain the full benefits of the various functions.

#### **⚠ DANGER**

If connection cables or instrument are damaged, there is a risk of electric shock. Before using the instrument, perform the following inspection.

- Before using the instrument, check that the insulation of the connection cables is not damaged and that no metal parts are exposed. Using the instrument under such conditions could result in electric shock. Replace the connection cable with those specified by our company.
- Verify that it operates normally to ensure that no damage occurred during storage or shipping. If you find any damage, contact your authorized Hioki distributor or reseller.

### Installing the instrument and modules

#### **⚠ WARNING**

Installing the instrument and modules in inappropriate locations may cause a malfunction of instrument or may give rise to an accident. Avoid the following locations:

- Exposed to direct sunlight or high temperatures
- Exposed to corrosive or combustible gases
- Exposed to a strong electromagnetic field or electrostatic charge
- Near induction heating systems (such as high-frequency induction heating systems and IH cooking equipment)
- Susceptible to vibration
- Exposed to water, oil, chemicals, or solvents
- Exposed to high humidity or condensation
- Exposed to high quantities of dust particles

#### **⚠ CAUTION**

Do not place the instrument on an unstable table or an inclined place. Knocking over or dropping the instrument can damage the instrument.

### Installing

To prevent overheating, be sure to leave the specified clearances around the unit.

- The instrument should be operated only with the bottom side downwards.
- Vents must not be obstructed.
- Do not install the instrument at a slanted angle.

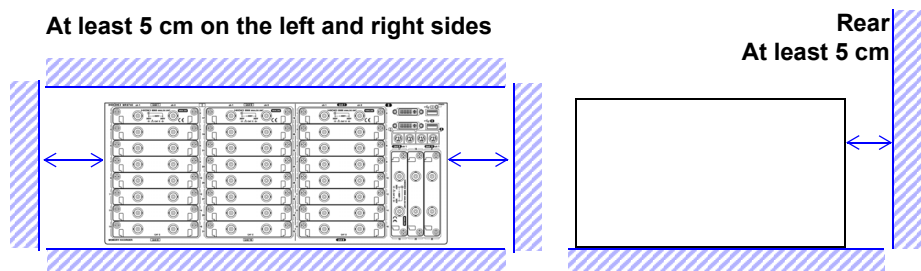

When mounting the instrument in a system rack, make sure the operating temperature range of the instrument will not be exceeded.

## Handling the Instrument and Modules

### **DANGER**

- Do not exceed the range of the specifications and the rated value of the cable or the module. Otherwise, the instrument may be damaged or may produce heat, resulting in personal injury.  
The maximum rated voltage to earth does not change when an attenuator or similar is used at the input. Take the connection method into consideration and make sure that the rating is not exceeded.
- To avoid electric shock, do not remove the instrument's cover and the module case.  
The internal components of the instrument carry high voltages and may become very hot during operation.
- It is recommended to measure the secondary side of a distribution panel with the U8974 High Voltage Unit. Do not connect the connection cords on the primary side of the distribution panel because an unrestricted current flow can damage the connection cords and facilities if a short-circuit occurs.

### **WARNING**

- Each channel of Model U8979 Charge Unit has the BNC terminal and miniature connector terminal with the common ground. Do not connect cords with each of the terminals simultaneously to avoid a short-circuit.
- Setting the measurement mode to **[PreAmp]** allows Model U8979 Charge Unit to constantly provide power (3.0 mA, 22 V) to sensors. Set any measurement mode other than **[PreAmp]** or turn off the instrument before connecting a sensor or probe with a BNC terminal to avoid an electric shock or damage to the measurement target.
- To avoid electric shocks, confirm that the instrument is turned off and the connection cables are disconnected before removing or replacing a module.
- To avoid electric shocks, do not operate the instrument with a module removed.  
To use the instrument after removing a module, install a blank panel over the opening of the removed module.
- To prevent instrument damage or electric shocks, use only the screws for securing the module in place that shipped with the instrument.  
If you lose any screw or find that any screws are damaged, please contact your Hioki distributor for a replacement.

### **CAUTION**

- Model U8979 Charge Unit has miniature connectors with the maximum input charge of  $\pm 500$  pC (for six higher-sensitivity range) or  $\pm 50,000$  pC (for six lower-sensitivity range). Inputting a charge that exceeds these value causes damage to the instrument.
- Use an acceleration sensor with a built-in pre-amplifier that conforms to the specification of Model U8979 (3.0 mA, 22 V). Using an inapplicable sensor may cause damaging itself.
- To avoid damage to the instrument, protect it from physical shock when transporting and handling. Be especially careful to avoid physical shock from dropping.
- The mounting screws must be firmly tightened or the module may not perform as specified or may fail.
- To avoid damaging modules, do not touch the module connectors on this instrument.

**NOTE**

- Before transporting the instrument, disconnect all cables and USB memory sticks.
- When there is no input, the waveform might be unstable due to the induced voltage, but this is not an error.
- This instrument may cause interference if used in residential areas. Such use must be avoided unless the user takes special measures to reduce electromagnetic emissions to prevent interference to the reception of radio and television broadcasts.

**Handling Media****CAUTION**

- Do not remove the media while it is being accessed by the instrument. Data on the media could be lost.
- Do not turn off the power to the instrument while the media is being accessed by the instrument. Data on the media could be lost.
- Do not transport the instrument while a USB flash drive is connected. Damage could result.
- If damage occurs to the data on the media, we cannot restore or analyze the lost data. No compensation will be provided, regardless of the type or cause of the problem or damage. We therefore recommend maintaining a backup of any important data.
- Be careful to avoid inserting a media backwards or upside-down. The media or the instrument could be damaged.
- Never insert or eject a media while it is being accessed by the instrument. Data on the media could be lost.
- Do not operate the instrument at a slanted angle. It may not work properly.
- Do not transport the instrument while a USB memory stick is connected. Damage could result.
- Some USB memory sticks are susceptible to static electricity. Exercise care when using such products because static electricity could damage the USB memory stick or cause malfunction of the instrument.
- With some USB devices, the instrument may not start up if power is turned on while the device is inserted to the USB port. In such a case, turn power on first, and then insert the USB device. It is recommended to try out operation with a USB memory stick before starting to use it for actual measurements.
- Peculiar USB memory requiring fingerprint authentication or password cannot be used.

**NOTE**

- When saving or loading data, insert the storage media before selecting it. If the media is not inserted, the file list display will not appear.
  - All media (USB memory) have a limited service life. After extensive use over a long period, data retention and readout may become stop working. In that case, replace the card with a new one.
  - Automatic saving of data is possible only on USB memory stick media.
  - Use only Model Z4006 USB Drive sold by Hioki. Compatibility and performance are not guaranteed for USB flash drive made by other manufacturers.
-

## Before Connecting Cables

### **DANGER**

#### **When measuring power line voltage**

- Connecting cables should only be connected to the secondary side of a breaker. Even if there is a short circuit on the secondary side of the breaker, the breaker cuts off the electric supply. Do not connect to the primary side of a breaker because unrestricted current flow could damage the instrument and facilities if a short circuit occurs.
- To prevent electrical shocks and personal injury, do not touch any input terminals on the VT (PT), CT or the instrument when they are in operation.
- Do not permanently connect the instrument in an environment where voltage surges exceeding the maximum input voltage may occur. Applying voltage may result in damage to the instrument, or a serious accident.
- Do not short-circuit two wires to be measured by bringing the connection cables into contact with them. Arcs or such grave accidents are likely to occur.
- To avoid short circuit or electric shock, do not touch the metal parts of the connecting cable clips.
- To avoid electrical shocks, be careful to avoid shorting live lines with the connection cable clips.

### **WARNING**

- To avoid electric shock and short-circuit accidents, use only the specified test leads to connect the instrument input terminals to the circuit to be tested.
- To prevent an electric shock, confirm that the white or red portion (insulation layer) inside the cable is not exposed. If a color inside the cable is exposed, do not use the cable.

### **CAUTION**

- The cable is hardened under the 0°C (32°F) or colder environment. Do not bend or pull cables in such environments to avoid tearing insulation or breaking the cable.
- **Connecting to the BNC jacks on modules**  
Do not use a metal BNC connector. If you connect a metal BNC cable to an insulated BNC connector, the insulated BNC connector can be damaged and the instrument may be damaged.
- To prevent cable damage, do not step on the cable or pinch them between other objects. Do not bend or pull cables at their base.

### **NOTE**

- Use only the specified connection cables. Using a non-specified cable may satisfy the specification requirements due to poor connection or other reasons.
- For detailed precautions and instructions regarding connections, refer to the instruction manuals for your modules, connection cables, etc.

## Before Connecting a Logic Probe to the Measurement Object

### **⚠ DANGER**

To avoid electric shock and short circuit accidents or damage to the instrument, pay attention to the following:

- The ground pin in the LOGIC connector (plug) of the Model 9320-01 and 9327 Logic Probes (and legacy Models 9306 and 9320) is not isolated from this instrument's ground (common ground).

Use grounding-type polarized power cords for the measurement object and this instrument, and obtain power from the same mains circuit.

Connecting to different mains circuits or using a non-grounding power cord may cause damage to the measurement object or this instrument because of current flow through the logic probes resulting from potential difference between the grounds of the different wiring systems.

To avoid these problems, we recommend the following connection procedure:

Connect this instrument to the same outlet as the measurement object using the (supplied) grounding polarized power cord.

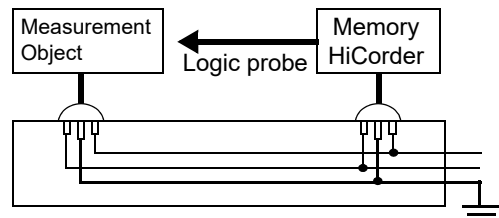

ground to the GND terminal (functional earth terminal) of this instrument. (Always obtain power from the same mains circuit.)

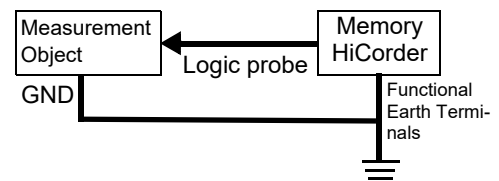

## Before Turning the Power Supply On

### **⚠ WARNING**

- To avoid electrical accidents and to maintain the safety specifications of this instrument, connect the power cord provided only to an outlet.ii
- Before turning the instrument on, make sure the supply voltage matches that indicated on its power connector. Connection to an improper supply voltage may damage the instrument and present an electrical hazard.

### **⚠ CAUTION**

- Avoid using an uninterruptible power supply (UPS), DC/AC inverter with rectangular wave or pseudo-sine-wave output to power the instrument. Doing so may damage the instrument.
- To avoid damaging the power cord, grasp the plug, not the cord, when unplugging it from the power outlet.

### **NOTE**

Turn off the power before disconnecting the power cord.

## Before Connecting to an External Device (model MR8741 only)

### **DANGER**

To avoid electrical hazards and damage to the instrument, do not apply voltage exceeding the rated maximum to the input terminals.

I/O terminals	Maximum input voltage
START/IN1	-0.5 V to 7 V DC
STOP/IN2	-0.5 V to 7 V DC
SAVE/IN3	-0.5 V to 7 V DC
GO/OUT1	50 V DC 50 mA 200 mW
NG/OUT2	50 V DC 50 mA 200 mW
SMPL	-0.5 V to 7V DC
TRIG OUT	50 V DC 50 mA 200 mW
EXT.TRIG	-0.5 to 7 V DC

### **WARNING**

To avoid electric shock or damage to the equipment, always observe the following precautions when connecting to external control terminals.

- Always turn off the power to the instrument and to any devices to be connected before making connections.
- Be careful to avoid exceeding the ratings of external terminals and connectors.
- The external control terminal shares the ground with the chassis. As required, isolate the devices and systems to be connected to the external control terminals from one another.

### **CAUTION**

- The ground pins of external control connectors are not isolated from the instrument's ground. Connect so that no potential difference arise between external control connector ground and the ground of the connection object. Failure to observe this precaution can result in damage to the connection object and the instrument.
- To avoid damage, do not disconnect the communications cable while the instrument is sending or receiving data.
- Use a common ground to both the instrument and the connected equipment. Using different ground circuits will result in a ground potential difference between the instrument and the connected equipment. If the cable is connected while such a potential difference exists, it may result in equipment malfunction or failure.
- Before connecting or disconnecting any cable, always turn off the instrument and your device to be connected. Failure to do so could result in an equipment malfunction or damage to the equipment.
- After connecting the communications cable, tighten the screws on the connector securely. Failure to secure the connector could result in equipment malfunction or damage.

### **NOTE**

MR8740 does not support external control.



### Disc precautions

#### **NOTE**

- Keep the recorded side of discs free of dirt and scratches. When writing text on a disc's label, use a pen or marker with a soft tip.
- Keep discs inside a protective case and do not expose to direct sunlight, high temperatures, or high humidity.
- Hioki is not liable for any issues your computer system experiences in the course of using this disc.

### Precautions During Shipment

#### **NOTE**

Keep the packing material that was used for shipping this instrument because you may need to use it when transporting the instrument in the future.

---

# Overview

# Chapter 1

1

Chapter 1 Overview

## 1.1 Product Overview

The Memory HiCorder is easy to operate and allows quick and efficient measurement and analysis. Major applications include error monitoring and inspection lines. The product offers the following features.

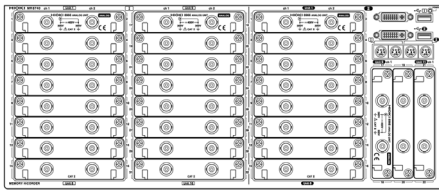

MR8740

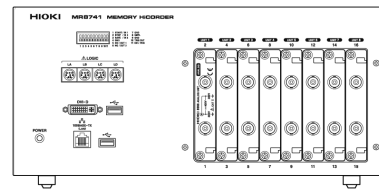

MR8741

### Simultaneous multi-channel measurement

Measure up to 54 analog channels.

### All channels isolated

### High-speed sampling: 20 MS/s

Enables responsive evaluation and analysis.

### Ideal for mounting in a rack

Height: 4U (178 mm) or less

### Multi-channel waveform generation

# 1.2 Names and Functions of Parts

## MR8740

### Front

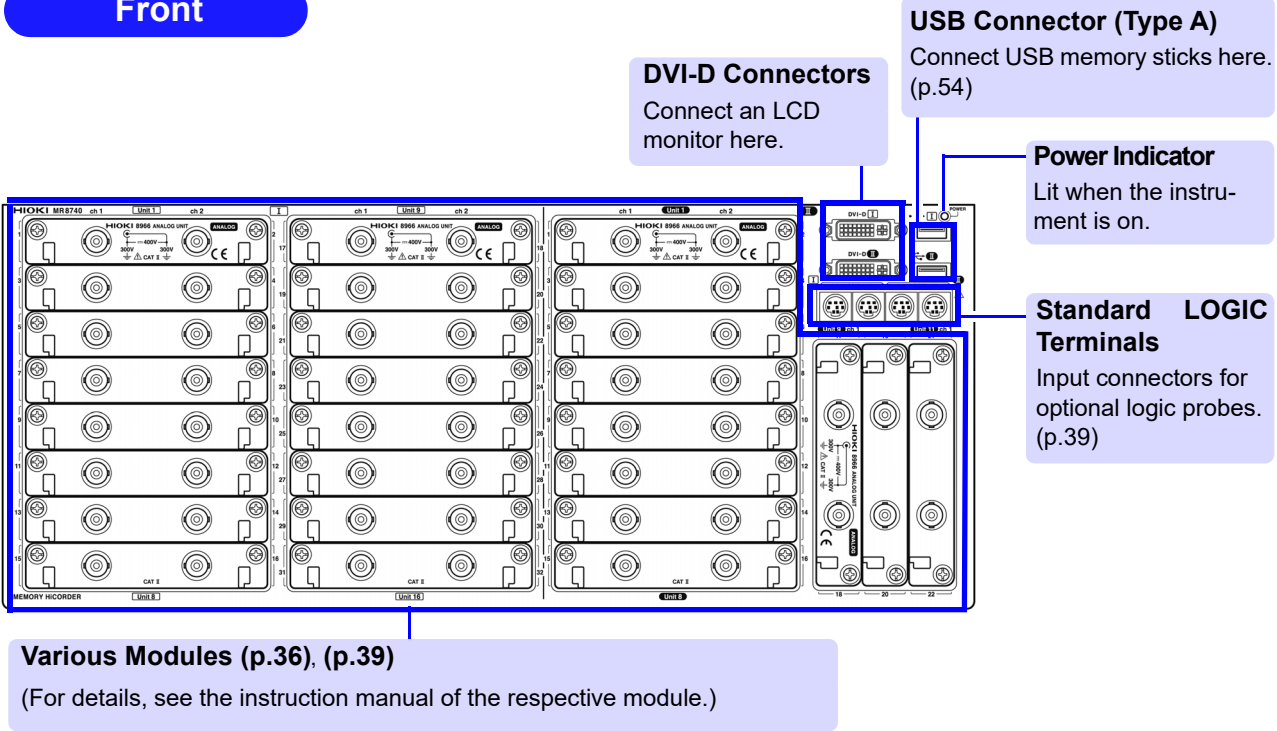

### Rear

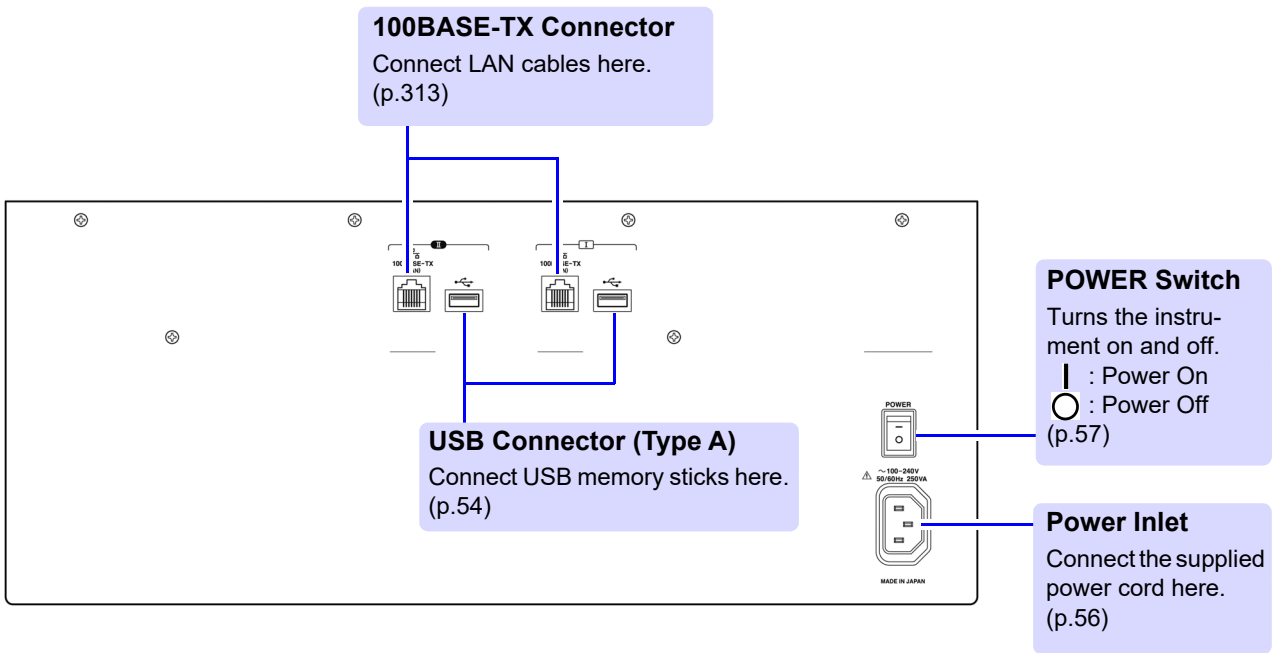

MR8741

Front

Standard LOGIC Terminals

Input connectors for optional logic probes. (p.39)

DVI-D Connector

Connect an LCD monitor here.

Power Indicator

Lit when the instrument is on.

External control terminals

Input any external sampling signal here. (p.336)  
Allows control of the instrument.

100BASE-TX Connector

Connect a LAN cable here. (p.313)

USB Connector (Type A)

Connect USB memory sticks here. (p.54)

Various Modules

(p.36), (p.39)  
(For details, see the instruction manual of the respective module.)

Rear

Ventilation Holes (Fan)

Make sure the ventilation holes are not obstructed.

POWER Switch

Turns the instrument on and off.  
 | : Power On  
 ○ : Power Off (p.57)

Power Inlet

Connect the supplied power cord here. (p.56)

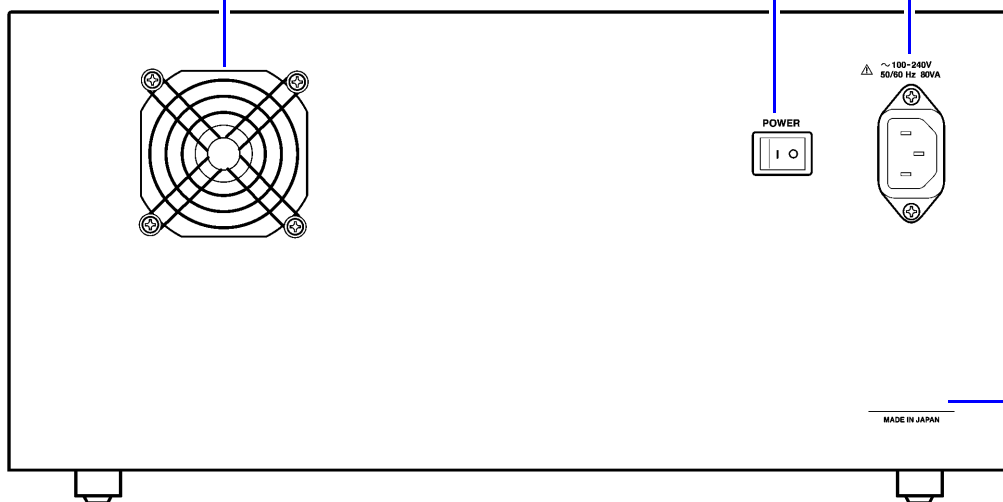

\*: The serial number consists of 9 digits. The first two (from the left) indicate the year of manufacture, and the next two indicate the month of manufacture.

Manufacturer's Serial No.\*

Shows the serial number.  
Required for production control. Do not peel off the label.

## 1.3 Display

This instrument allows you to use a commercially available LCD monitor for displaying waveforms and various settings.

Connect the LCD monitor to a DVI-D connector on the front of the instrument.

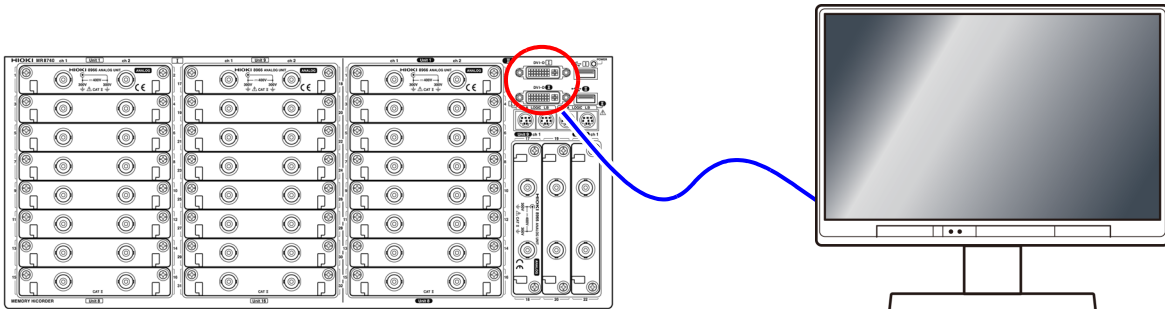

### **NOTE**

- The instrument's DVI connectors are designed exclusively for digital. They cannot be used for analog. A VGA-DVI adapter also cannot be used.
- There are a variety of LCD monitors available, and not all LCD monitors will work with the instrument.
- The display aspect ratio for DVI output with this instrument is 4:3. If you use a wide LCD (16:9), display will be stretched in the horizontal direction.
- External interference may cause display to be distorted. Keep the LCD and LCD cable as far away as possible from sources of interference.
- MR8740 displays the waveforms of the block I side (32 analog channels + 8 logic channels) with DVI-I, and the waveforms of the block II side (22 analog channels + 8 logic channels) with DVI-II. The waveforms of block I and block II cannot be displayed at the same time.

## 1.4 Screen Configuration

The screen configuration is shown below. Click an item with the mouse to display the corresponding screen.

On the Waveform screen, the trigger settings window and channel settings window can be displayed.

### Waveform Screen

**DISP** This screen is for observing waveforms.  
The settings window on the right shows the measurement parameters.

### Trigger Settings Window/Channel Settings Window

**TRIG.SET** This window is for making the advanced settings for triggers.  
**CH.SET** This window is for making the advanced settings for analog channels and logic channels.

### Status Screen

**STATUS** This screen is for making settings for the measurement method and numerical calculation of waveform data.  
There are the following sheets: [\[Status\]](#) sheet, [\[Num Calc\]](#) sheet, [\[Memory Div\]](#) sheet, [\[Wave Calc\]](#) sheet

### Channel Screen

**CHAN** This screen is for making channel settings, scaling settings, and comment settings.  
There are the following sheets: [\[Unit List\]](#) sheet, [\[Each Ch\]](#) sheet, [\[Scaling\]](#) sheet, [\[Comment\]](#) sheet

### System Screen

**SYSTEM** This screen is for making settings for the environment, file saving, and communication, and for performing data initialization.  
There are the following sheets: [\[Environment\]](#) sheet, [\[File Save\]](#) sheet, [\[Printer\]](#) sheet, [\[Interface\]](#) sheet, [\[Init\]](#) sheet

### File Screen

**FILE** This screen is for viewing the data files on media (USB memory stick and internal memory).

# Explanation of Screen Contents

## Waveform Screen

### Title comment

Shows the set title comment. (p.138)

### Trigger time

Shows the date and time of the last trigger event. (p.189)

### Media icon

Shows the media status. (p.54)

### Operation icons

Left-click to scroll the waveform or operate the A/B cursors.

### Current date and time

Shows the set date and time. (p.58)

**Trigger marker**  
Shows the point where the trigger event occurred. (p.189)

**Storage counter**  
Shows how many trigger events occurred. (p.81)

**Logic waveform (p.78)**

**Analog waveform (p.75)**

**Upper and lower limits**  
The upper and lower limit values for each channel are shown here. (p.134)

**Vertical axis display**  
Shows the value per increment for each channel. This is linked to the vertical axis (voltage axis) range setting. (p.75)

**Scroll bar**  
The stored waveform is indicated by a red bar, and the displayed waveform by a blue frame. (p.125)

**Settings cursor**  
The current cursor location is indicated by flashing.

**Settings window**  
Set the measurement parameters here. (p.64)

**Display and setting icons**  
Left-click to display the waveforms and numerical values or make channel settings.

Elements common to the Status screen, Channel screen, System screen, and File screen

Sheet tabs

Shows the names of sheets that can be selected.

Click a tab to switch to the corresponding sheet.

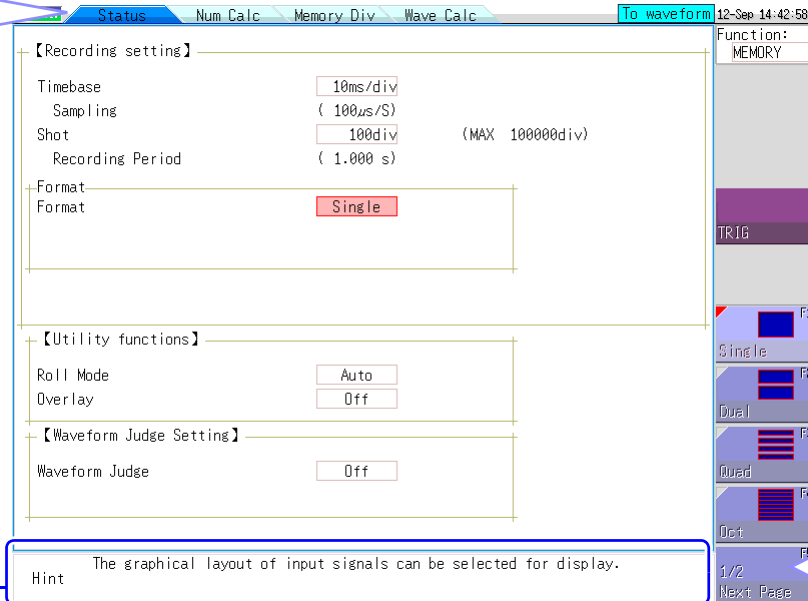

Hint

Shows an explanation about the item where the settings cursor is currently located. Messages such as "Online" and error messages are also shown here.

Next Page

This is shown if there are more than six selection items.

Selecting this button displays the other items.



## 1.5 Basic Operations

You can use a mouse to make various settings on the instrument. This section explains how to perform mouse operations.

### 1.5.1 Mouse Operations

Use a commercially available USB mouse to operate the instrument.

#### **NOTE**

- There are a variety of mice available, and not all mice will work with the instrument.
- The instrument's USB ports are designed exclusively for use with mice and USB memory sticks. Do not connect any other type of device.
- With some USB devices, the instrument may not start up if the power is turned on while the USB device is connected to a USB connector. If that happens, connect the USB device after turning on the power.
- When the instrument is operated with a mouse, some screens may not display properly.
- External interference may cause the mouse to malfunction. Keep the mouse and mouse cable as far away as possible from sources of interference.
- Do not use a USB hub because mouse operation may not be possible. Also, do not connect two mice.

The following describes how to operate the instrument with a mouse:

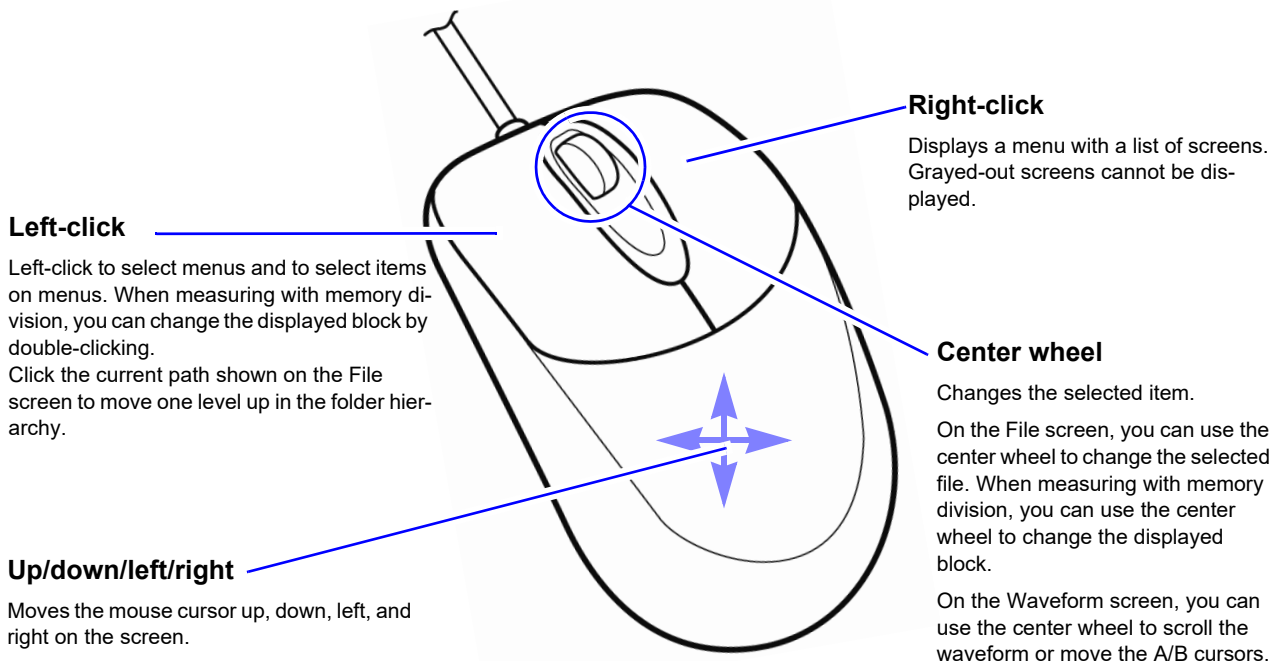

#### **Convenient features: Shortcut operations**

Drag the mouse in any of the following directions while the right mouse button is held down to perform the corresponding shortcut operation.

- Drag right: START operation
- Drag left: STOP operation
- Drag up: ESC operation

## 1.5.2 Mouse Right-click Menu

Right-clicking with the mouse displays a list of screens. This section describes the menu and the screens that can be displayed.

### DISP

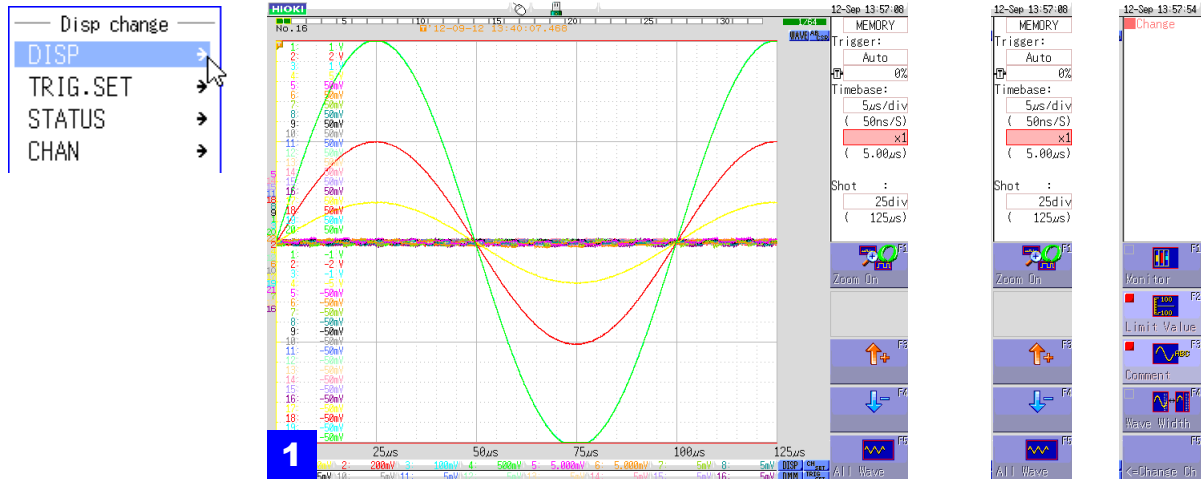

### 1 Waveform screen

Click **[DISP]** to display the Waveform screen. If the Waveform screen is already displayed, the GUI menu on the right of the screen changes each time you click this item. Alternatively, you can change the GUI menu on the right of the screen when the Waveform screen is displayed by clicking the **[DISP]** icon on the bottom right.

### CH.SET

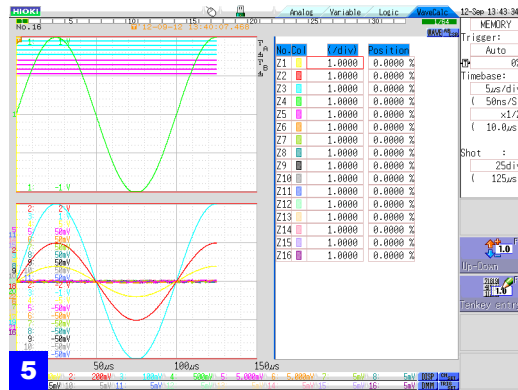
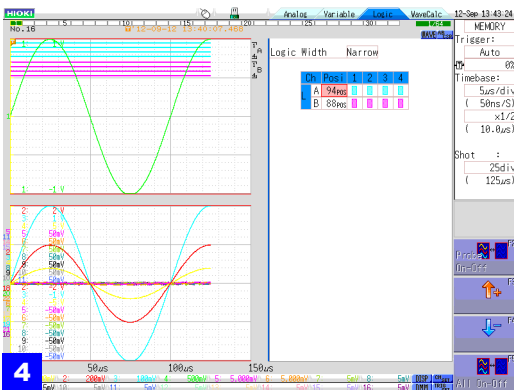
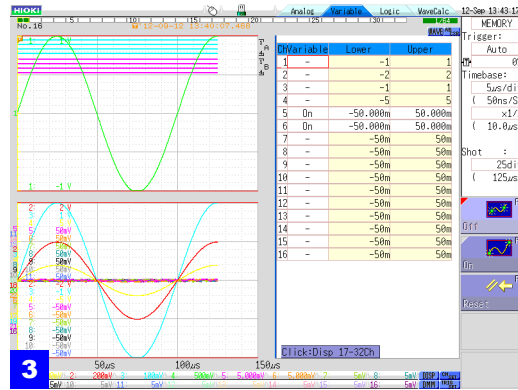
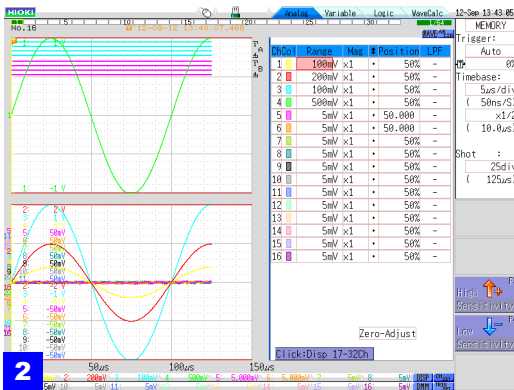
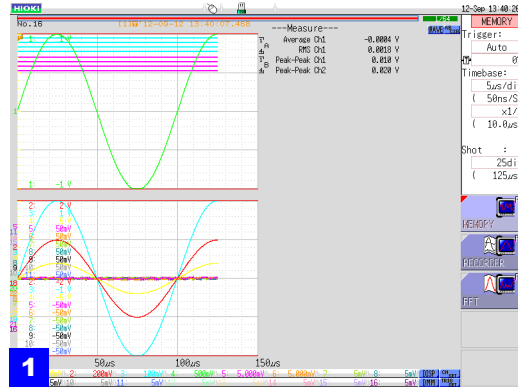
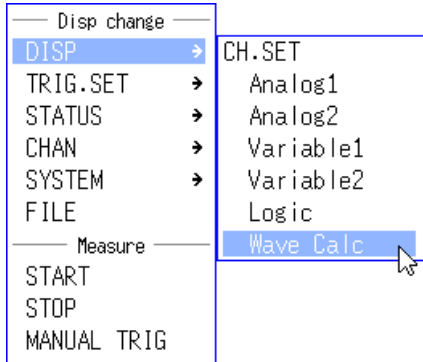

#### 1 Waveform display

This is the normal waveform display state. Move the cursor to **[DISP]** and then click any of the menu items under **[CH.SET]** to switch to one of the screens 2 to 5. Alternatively, you can click the **[CH.SET]** icon on the bottom right of the Waveform display screen to switch screens.

#### 2 Analog channel 1/2

Displays the screen for setting the display position, etc. by setting the range for the analog unit.

#### 3 Display range 1/2

Displays the screen for setting the waveform display range of the analog unit.

#### 4 Logic

Displays the screen for changing the display position or color of the logic waveform.

#### 5 Waveform calculation

Displays the screen for changing the display position or color of the calculation waveform when waveform calculation is set to ON.

TRIG.SET

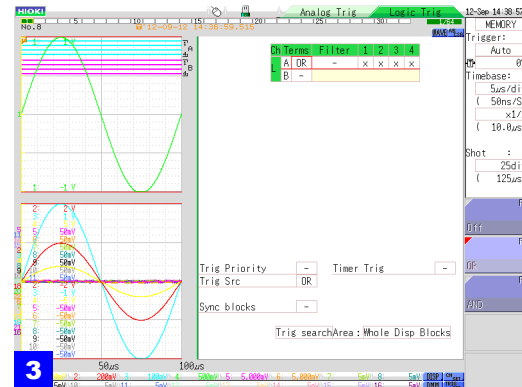
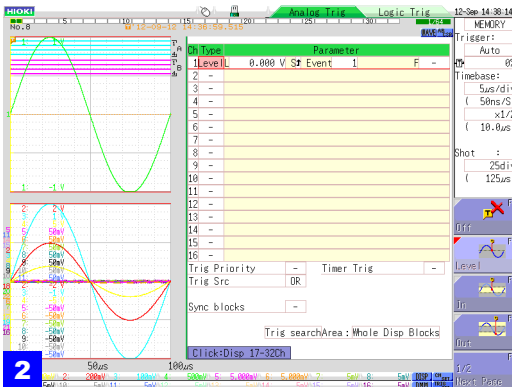
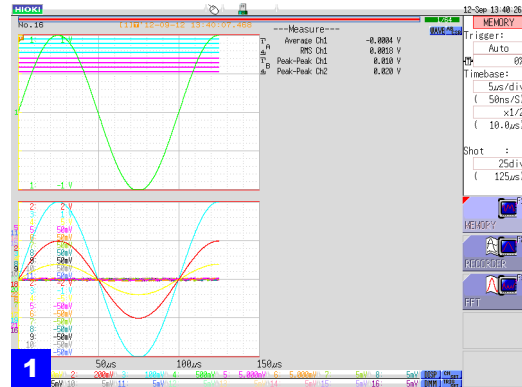
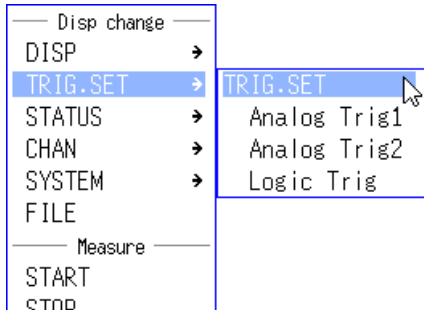

**2** Analog trigger 1/2

Displays the screen for setting the trigger criteria of the analog unit.

**1** Waveform display

This is the normal waveform display state. Clicking **[TRIG.SET]** switches between screens 1 to 3. Alternatively, you can click the **[TRIG.SET]** icon on the bottom right of the Waveform display screen to switch screens.

**3** Logic trigger

Displays the screen for setting the waveform display range of the logic channel.

### STATUS

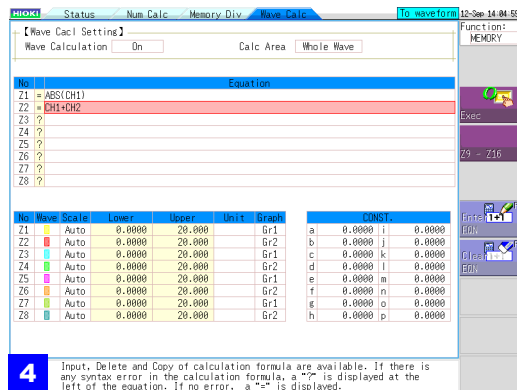
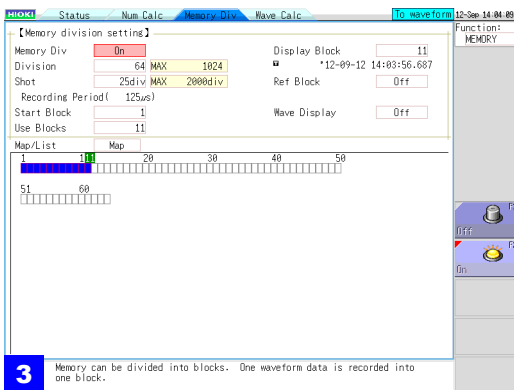
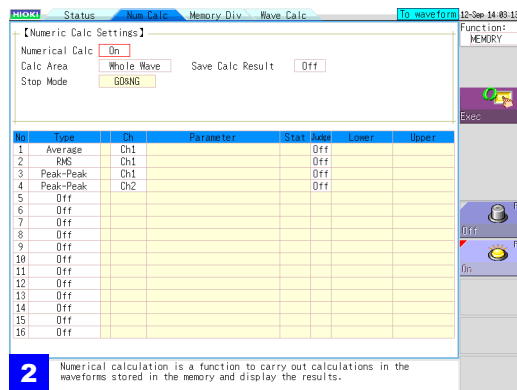
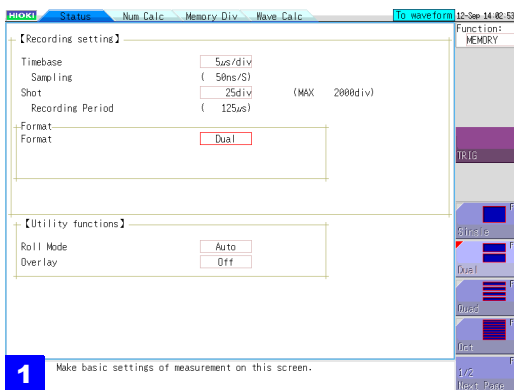
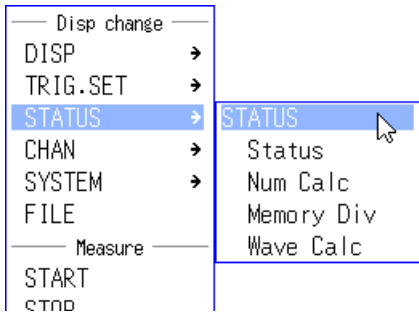

### 1 Status

Displays the screen for setting the basic items for measurement such as the time axis range.

### 3 Memory division

Displays the screen for setting the measurement of waveform data using the internal memory of the instrument divided.

### 2 Numerical calculation

Displays the screen for setting the analysis of measured waveform data.

### 4 Waveform calculation

Displays the screen for setting the application and analysis of addition, subtraction, multiplication, division, and other numerical calculations for waveform data.

## CHAN

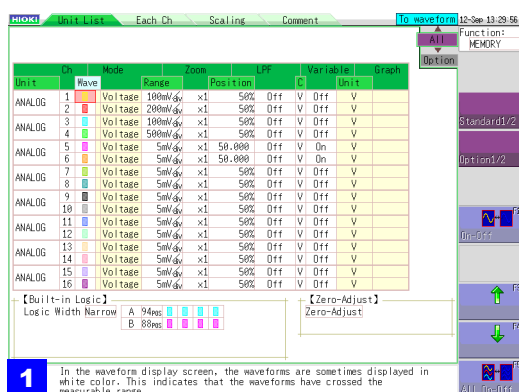
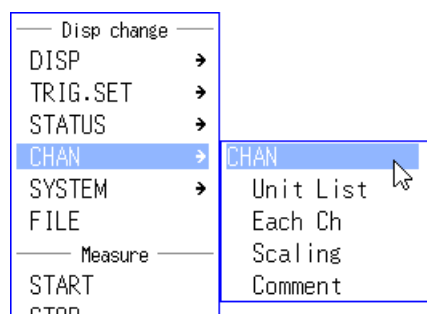

1 In the waveform display screen, the waveforms are sometimes displayed in white color. This indicates that the waveforms have crossed the measurable range.

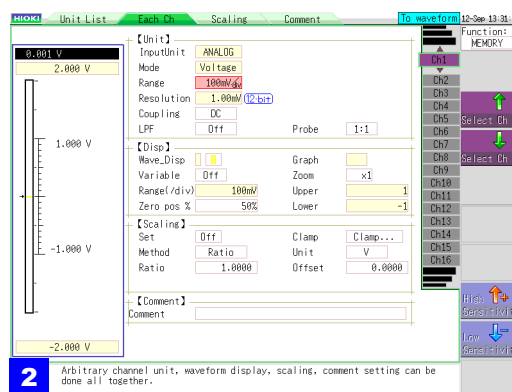

2 Arbitrary channel unit, waveform display, scaling, comment setting can be done all together.

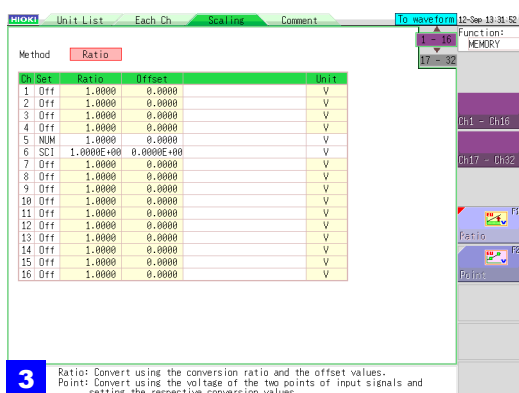

3 Ratio: Convert using the conversion ratio and the offset values.  
Point: Convert using the voltage of the two points of input signals and setting the respective conversion values.

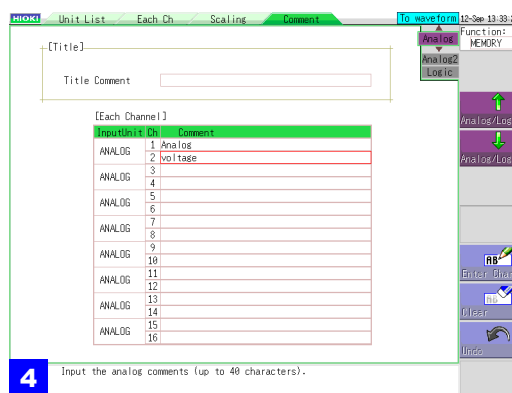

4 Input the analog comments (up to 40 characters).

## 1 Unit list

Displays a list of plug-in units inserted into the instrument and their settings.

## 3 Scaling

Displays the screen for setting the conversion of measurement values using linear functions.

## 2 Each channel

Displays the settings for each unit.

## 4 Comments

Displays the screen for setting a comment for each measurement channel.

**SYSTEM**

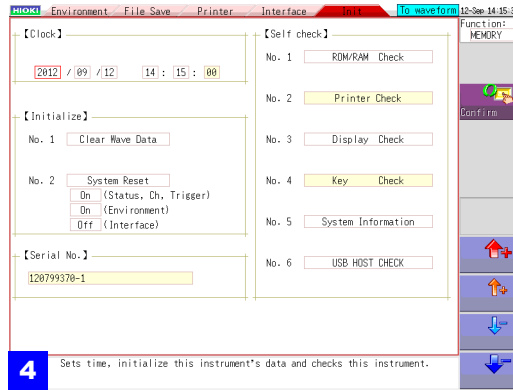
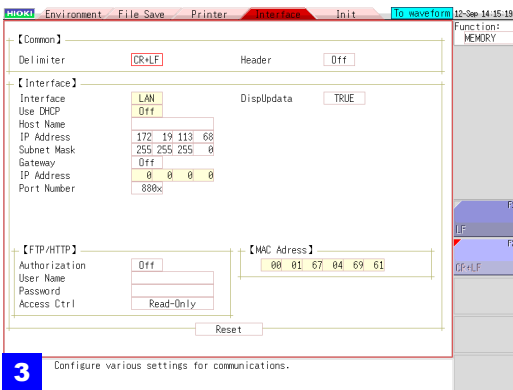
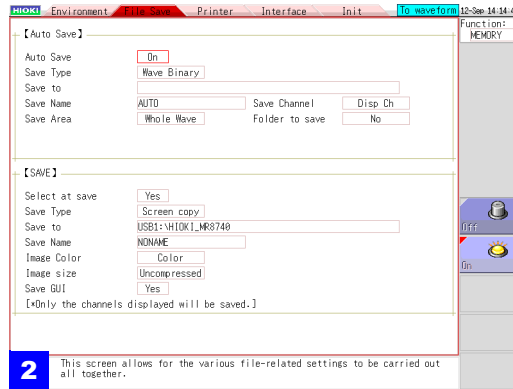
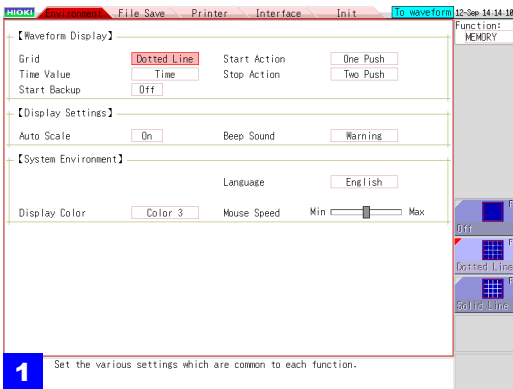
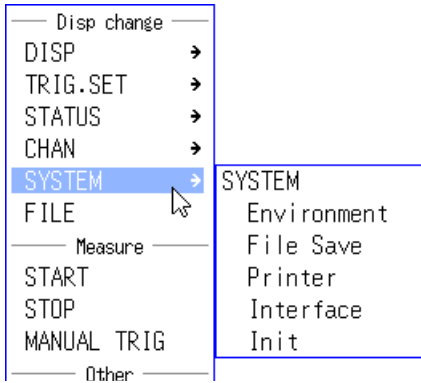

**1 Environment**

Displays the screen for setting the operating environment of the instrument.

**2 File save**

Displays the screen for setting the method for saving measurement data.

**3 Interface**

Displays the screen for the LAN communication setting conditions.

**4 Initialization**

Displays the screen for clearing the settings of the instrument, setting the time, etc.

## 1.5.3 Mouse Left-click Operations

You can select menus and confirm items by left-clicking with the mouse. This section describes left-click operations for menu selection and settings.

### Operations on a Settings Screen

#### Clicking a setting

When clicked, the setting becomes selected, the frame changes color, and the setting flashes.

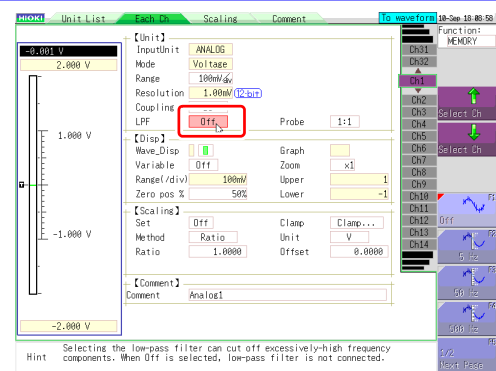

#### Selecting a setting value from the GUI on the right of the screen

You can change the setting by moving the mouse cursor to a selection item on the right of the screen and then clicking. The number of selection items differs depending on the setting.

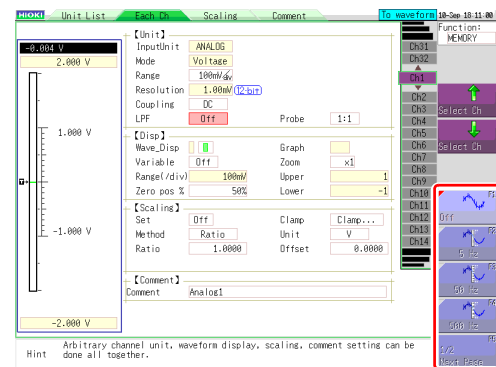



### Changing Pages on a Settings Screen

When settings are split into multiple pages, you can change the settings screen directly by clicking the displayed tabs.

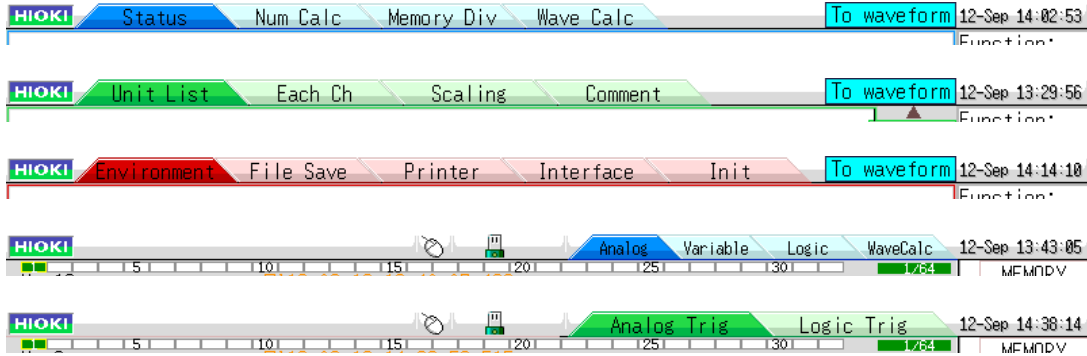

With the tabs of the Waveform screen, clicking the currently selected tab again changes the displayed channel.

### Character Input

The menus displayed when inputting comments and calculation equations allow direct character input with click operations.

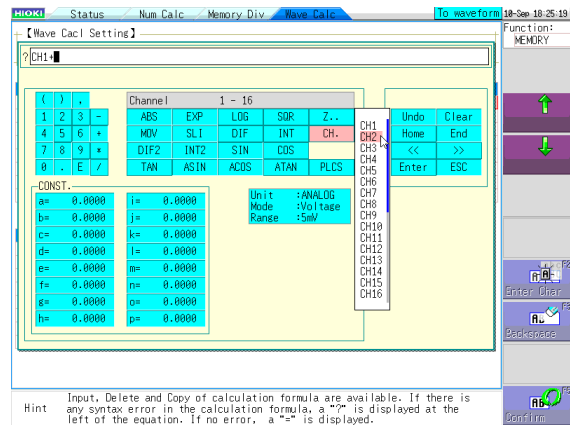
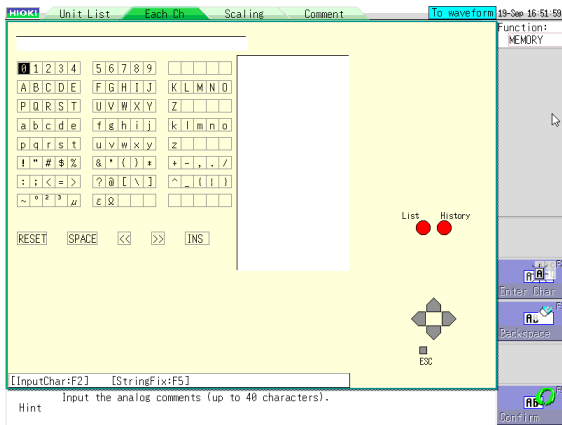

## 1.5.4 Mouse Wheel Operations

For an item with a list menu, you can change the setting item with the mouse wheel. You can also use the mouse wheel to scroll the display of a menu that has a scroll bar displayed.

### Selecting from a list menu

For a setting with a selection item list displayed on the top right of the screen, you can use the wheel to change the setting item.

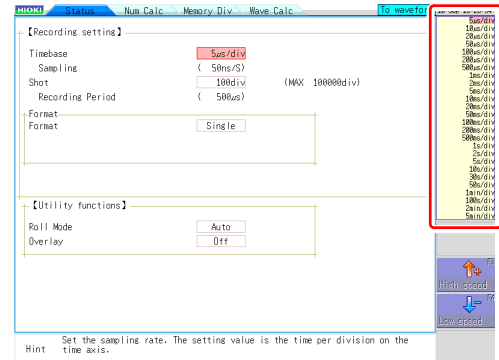

### Scrolling a displayed list

You can use the wheel to scroll up and down a list.

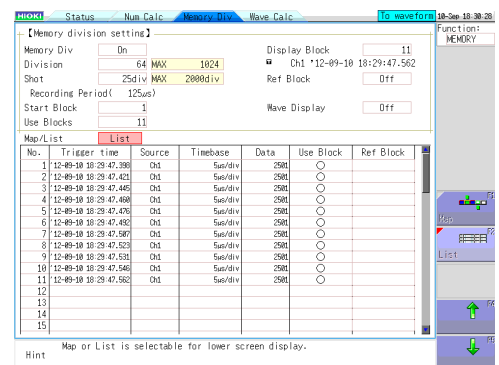

For details on wheel operation on the Waveform screen, refer to the next page.

## 1.5.5 Waveform Operations

You can scroll a waveform and change the cursor position on the Waveform screen.

### Scrolling measured waveforms left or right

When the mouse cursor is in the Waveform screen, you can scroll the waveform by moving the mouse left or right while holding down the left mouse button (dragging).

You can rotate the wheel button forward or backward to make fine scrolling adjustments.

(If the waveform is not scrollable, click the **[WAVE]** icon on the top right of the Waveform display screen.)

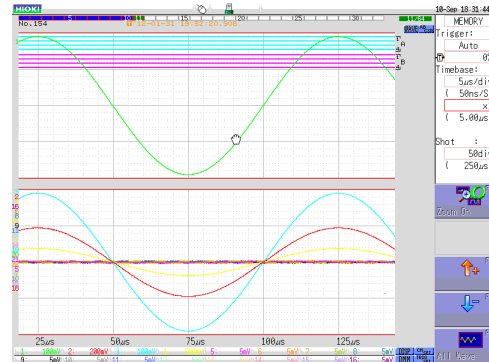

### Moving the A/B cursors

When the mouse cursor is in the Waveform screen, you can move the cursors by moving the mouse left or right while holding down the left mouse button (dragging). You can rotate the wheel button forward or backward to move the A/B cursors one sample at a time.

(Click the **[AB CSR]** icon on the top right of the Waveform display screen beforehand.)

When the A/B cursors are in the Waveform screen, you can move the A or B cursor if you left-click the A or B mark.

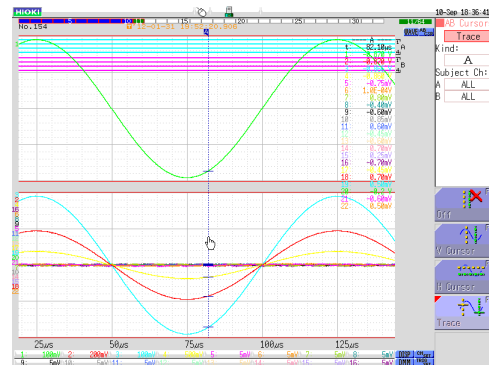

### Changing the displayed block

When the memory is divided, you can change the measurement block if you double-click the block number on the top of the screen. When the mouse cursor is in the block number, you can also change the measurement block number by rotating the mouse wheel button forward or backward.

(If the displayed block is not displayed on the Waveform screen, click the **[WAVE]** icon on the top right of the Waveform display screen, and click **[pos<->block]** from the GUI menu on the right side of the screen.)

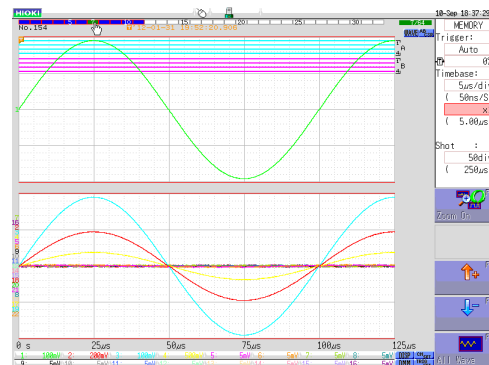

## 1.5.6 Measurement Operations

You can control the starting and stopping of measurement from the menu that is displayed by right-clicking.

### Starting measurement

Click **[START]** to start measurement.

### Stopping measurement

Click **[STOP]** to stop measurement.

### Triggering manually

When the instrument is in a measuring state, you can click **[MANUAL TRIG]** to apply a trigger manually.

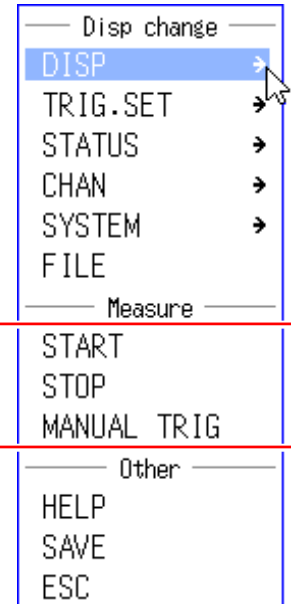

### **NOTE**

You can also start and stop measurement as described below.

**[START]** Press the right mouse button, drag right, and then release the button.

**[STOP]** Press the right mouse button, drag left, and then release the button.

### 1.5.7 File Operations

You can change the displayed folder, load files, and perform other file operations on the File screen.

#### Moving to a folder

To move to a folder, double-click the folder to which you want to move. To move to the folder one layer up, click the folder path part.

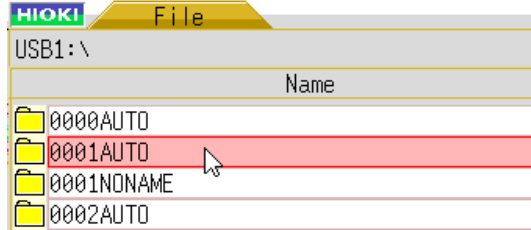

#### Scrolling a file list

Click the bar on the right side of the screen to scroll a list. You can also scroll the list one item at a time by rotating the wheel button forward or backward.

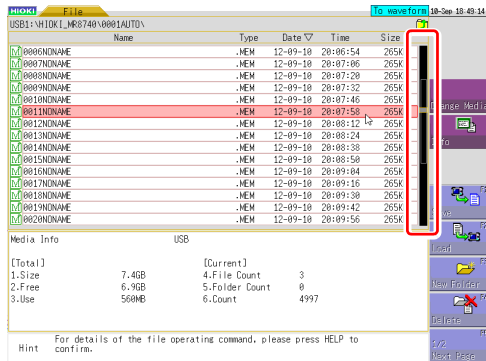

#### Selecting the file to load

If you double-click the list, you can select the file to load.

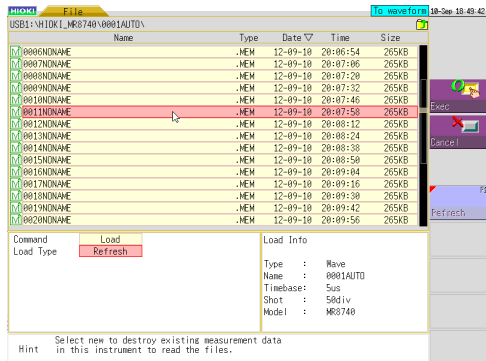

# Measurement Preparations

## Chapter 2

2

Chapter 2 Measurement Preparations

### Work Flow

- 1** Install this instrument (p.8)
- 2** Install or remove modules.  
(When adding or replacing modules) (p.36)
- 3** Connect a logic probe to the Standard LOGIC terminals  
(When measuring logic signals) (p.49)
- 4** Connect the input cable(s) to the input module  
(When measuring analog signals) (p.39)  
Probes and cables will differ depending on the measurement purpose.
- 5** Connect an LCD monitor (p.18)
- 6** Insert media (USB memory stick) (p.54)
- 7** Connect the power cord (p.56)
- 8** Turn the power on (p.57)
- 9** Setting the clock (p.58)
- 10** Perform zero-adjust (p.59)

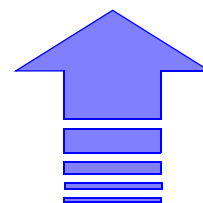
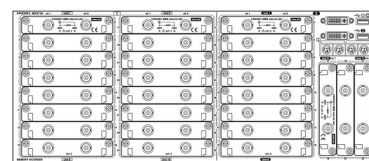

**When preparations are complete, let's start a measurement (p.61)**



#### Using communication functions

See: "Chapter 15 Connection to a Computer" (p.313)

#### Using external control functions

See: "Chapter 16 External Control (MR8741 Only)" (p.335)

## 2.1 Installing and Removing Modules

Read "Handling the Instrument and Modules" ( p.9) carefully.

Modules specified at the time the instrument is ordered are supplied preinstalled. Use the following procedures to add or replace modules, or to remove them from the instrument.

**NOTE**

- Up to three logic units can be installed as units 1 to 8. Logic units installed as the other units cannot be used. Other 8973 Logic Unit being installed will be disabled.
- For information on the analog channel resolution when logic channels are used, see "7.9 Setting Details of Modules" (p.161).

### Installing a module

Front Side

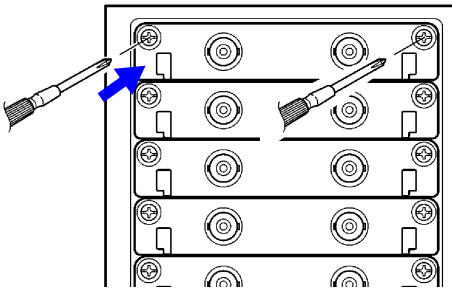

Required item: One Phillips-head screwdriver

- 1 Turn the instrument's **POWER** switch Off.
- 2 With attention to the orientation of the module, insert it firmly all the way in. Make certain that the labels on the module's panel face the same direction as the labels on the right side of the instrument.
- 3 Using the Phillips screwdriver, tighten the two module mounting screws.

### Removing an module

Front Side

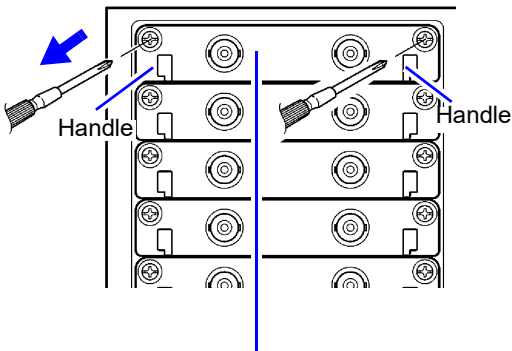

Required item: One Phillips-head screwdriver

- 1 Turn the instrument's **POWER** switch Off.
- 2 Remove any cables or thermocouples connected to the module.
- 3 Remove the power cord.
- 4 Using the Phillips screwdriver, loosen the two module mounting screws.
- 5 Grasp the handle and pull the module out.

(Example:8966)

### If not installing another module after removal

Front Side

Blank panel

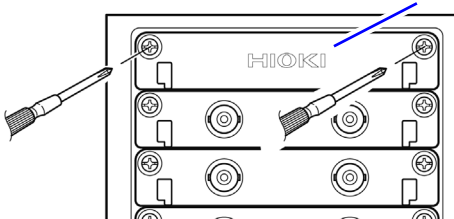

Using the Phillips screwdriver, tighten the two mounting screws.

Measurements made without a blank panel installed may fail to meet specifications because of temperature instability within the instrument.

About channel allocation

Information about the modules installed the instrument can be verified in the System Configuration list (p.346).

MR8740

The instrument has a two-block configuration consisting of Block I and Block II. For each block, the module numbers are in order starting with one at the top, and the channel numbers are in order starting with one on the left of the module at the very top.

Analog channels only

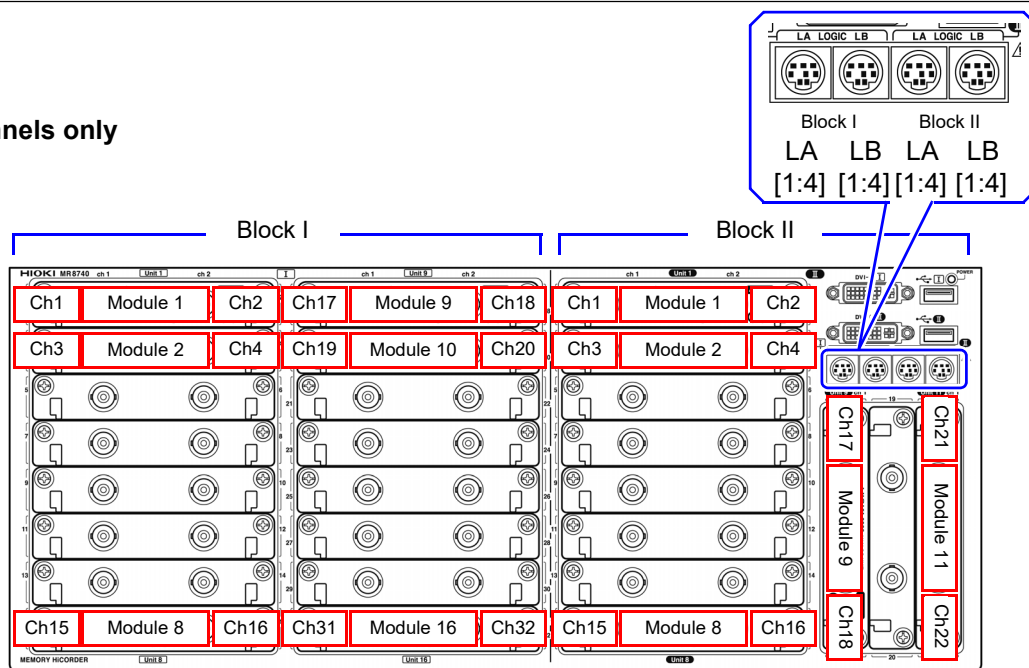

Mix including logic units

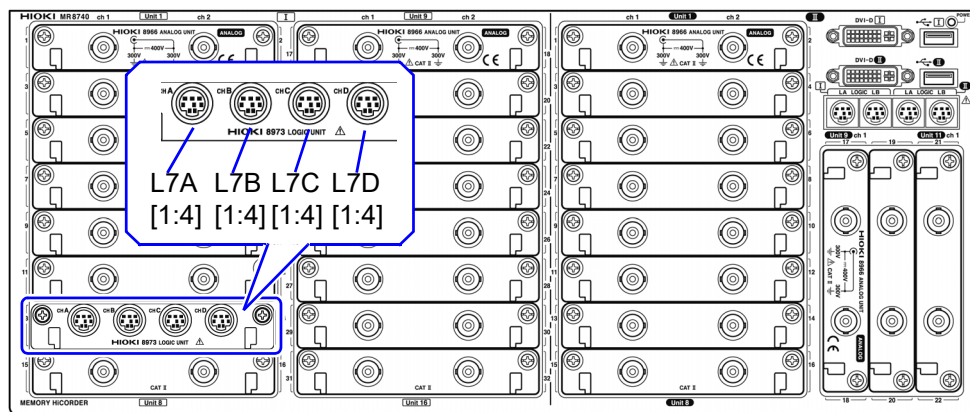

**NOTE** Install the logic units at the module 1 to module 8 positions on both blocks. Even if you install logic units for module 9 and after, they will be invalid.



## 2.1 Installing and Removing Modules

### MR8741

The module numbers are in order starting with one at the left, and the channel numbers are in order starting with one at the bottom of the module at the very left.

#### Analog channels only

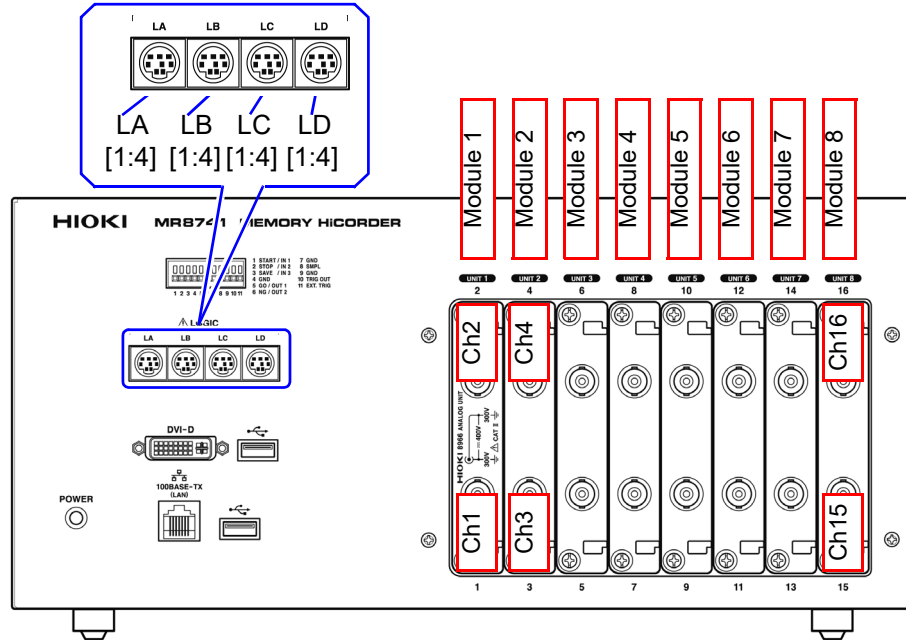

#### Mix including logic units

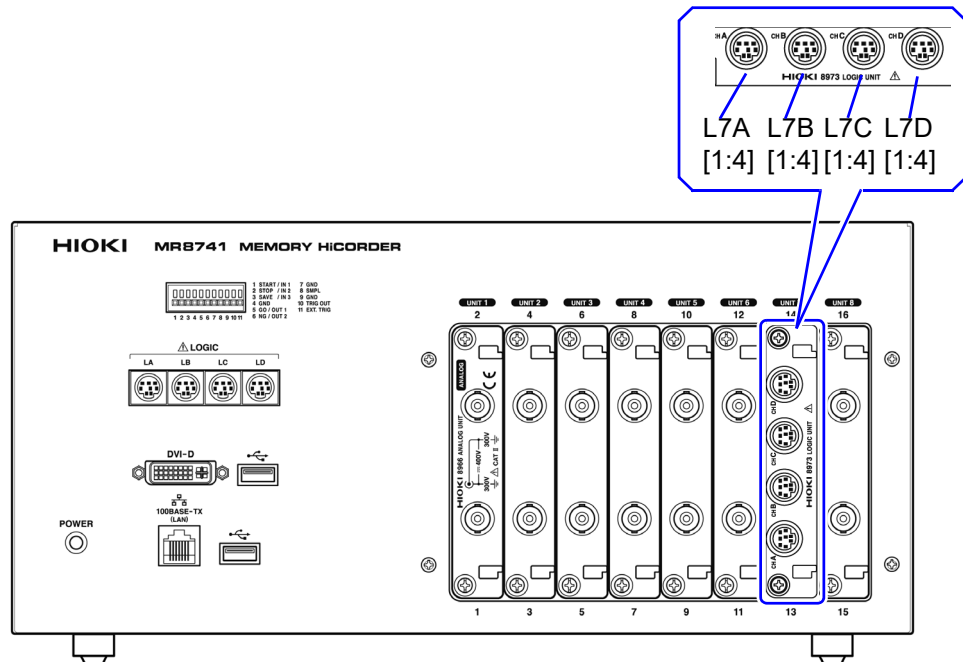

## 2.2 Connecting Cords

Read "Before Connecting Cables" ( p.11) carefully.  
 For detailed precautions and instructions regarding connections, refer to the instruction manuals for your modules, connection cables, etc.

### Measuring Voltage

**Applicable Modules**

- 8966 Analog Unit
- 8968 High Resolution Unit
- 8972 DC/RMS Unit
- U8979 Charge Unit

Connect to the BNC jack on a module.

**Use to connect: Connection cords**

- Model L9197 Connection Cord  
 (Maximum input voltage: 600 V)  
 Large alligator clip type

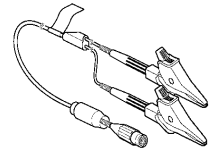

- Model L9198 Connection Cord  
 (Maximum input voltage: 300 V)  
 Small alligator clip type

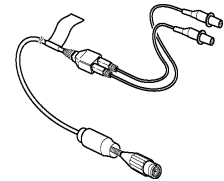

- Model L9217 Connection Cord  
 (Maximum input voltage: 300 V)  
 For measuring BNC output

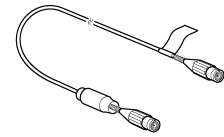

- L9790 Connection Cord  
 (Maximum input voltage: 600 V)  
 Terminal type: Alligator, contact, grabber

Example: Terminal type: Alligator

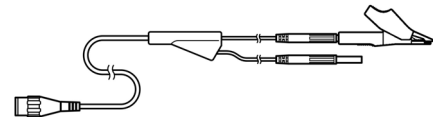

- Model 9166 Connection Cord  
 (Maximum input voltage: 30 V AC, 60 V DC)  
 Electrical clips

When a voltage to be measured exceeds a maximum input rating of a module being used

- Model 9322 Differential Probe \*1
- Model 9665 10:1 Probe
- Model 9666 100:1 Probe
- Model P9000-01/-02 Differential Probe \*2

Example: Model P9000-02 Differential Probe

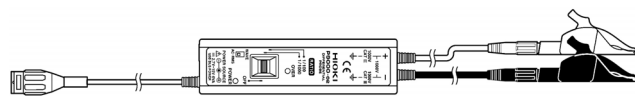

\*1 An optional power cord or AC adapter is required.

\*2 An optional AC adapter or a commercially available USB cable is required.

**Connect to BNC jack**

Example: Model 8966 Analog Unit

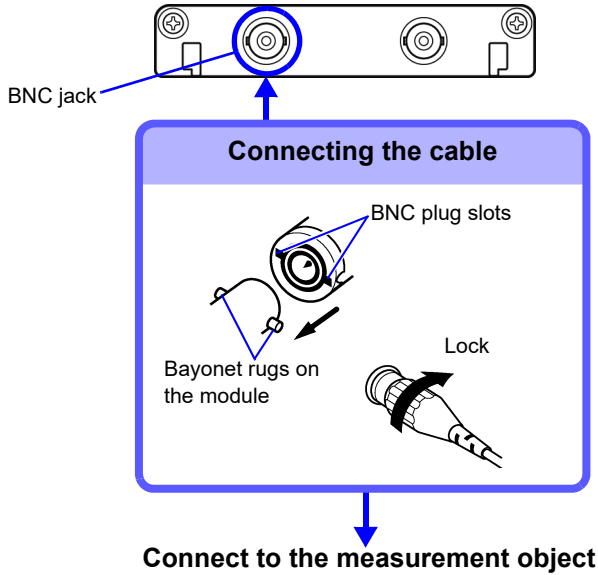

Required item: One of the above cables

- 1** Connect the BNC plug on the cable to a BNC jack on the module.
- 2** Align the slots in the BNC plug with the guide pins on the jack on the module, then push and twist the plug clockwise until it locks.
- 3** Connect the cable clips to the measurement object.  
Disconnecting BNC connectors  
Push the BNC plug, twist it counter-clockwise, and pull it out.

## Measuring Frequency, Number of Rotations and Count

Refer to (p.40) for details about connecting to BNC terminals.

### Applicable Modules

- Model 8970 Freq Unit

Connect to the BNC jack on a module.

### Use to connect: Connection cords

- Model L9197 Connection Cord  
(Maximum input voltage: 600 V)  
Large alligator clip type

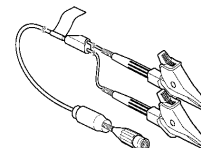

- Model L9198 Connection Cord  
(Maximum input voltage: 300 V)  
Small alligator clip type

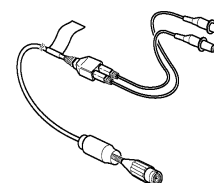

- Model L9217 Connection Cord  
(Maximum input voltage: 300 V)  
For measuring BNC output

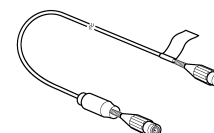

- Model L9790 Connection Cord  
(Maximum input voltage: 600 V)  
Terminal type: Alligator, contact, grabber

Example: Terminal type: Alligator

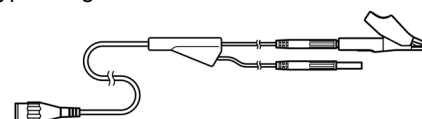

If the voltage to be measured exceeds the maximum input rating of the module being used

- Model 9322 Differential Probe<sup>\*1</sup>
- Model 9665 10:1 Probe
- Model 9666 100:1 Probe
- Model P9000-01/-02 Differential Probe<sup>\*2</sup>

Example: Model P9000-02 Differential Probe

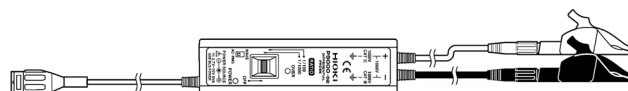

\*1 An optional power cord or AC adapter is required.

\*2 An optional AC adapter or a commercially available USB cable is required.

### Measuring Temperature

#### Applicable Modules

- Model 8967 TEMP Unit

Connect to the terminal block on the input module.

#### Use to connect: Thermocouple

(Compatible wire: AWG 16 to 26, 0.4 to 1.2 mm diameter)

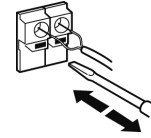

Connect to terminal block

#### Insert to terminal block

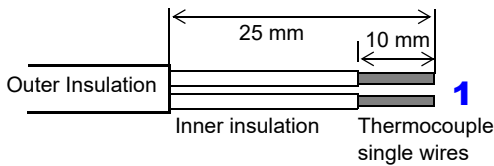

#### Required item:

Thermocouple, Ferrite clamp-on choke (8967's option), flat-blade screwdriver (2.6-mm blade)

#### Recommended wire:

Compatible wire: Single-strand thermocouple wire, 0.4 to 1.2-mm diameter  
Stripping length: 10 mm

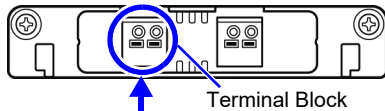

#### Inserting a Thermocouple

##### Connection Holes

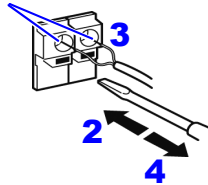

**5** Attach to the measurement object

- Strip insulation from the thermocouple wires as shown at the left.  
Stripping length: approx. 10 mm
- Push the blade of a flat screwdriver into the button on the terminal block of the module.
- Insert each thermocouple wire into the appropriate terminal hole while pressing the button.  
Confirm proper polarity.
- Release the button.  
The thermocouple is connected.
- Attach to the measurement object.  
  
To remove the thermocouple  
Hold the button while pulling the thermocouple wire out.

#### **NOTE**

If surrounding equipment is affected by noise, coil the thermocouple several times and then attach the included ferrite clamp-on choke (as seen in the diagram to the right).

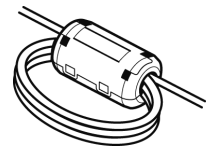

## Measuring vibration or displacement with a strain gauge transducer

### Applicable Modules

- Model U8969 Strain Unit
- Model 8969 Strain Unit

The following device can be connected to the module.

- Strain Gauge Transducer (Not available from Hioki)
- Connect L9769 or 9769 Conversion Cable to the strain gauge

Connect a strain gauge transducer to a connector on Model U8969 Strain Unit via Model L9769 Conversion Cable; Model 8969 Strain Unit via Model 9769 Conversion Cable.

### NOTE

The instrument describes Model U8969 as "8969".

### Connect to module's terminal

Example: Connecting the strain gauge transducer to Model U8969 Strain Unit via Model L9769 Conversion Cable

#### Connecting the Model L9769

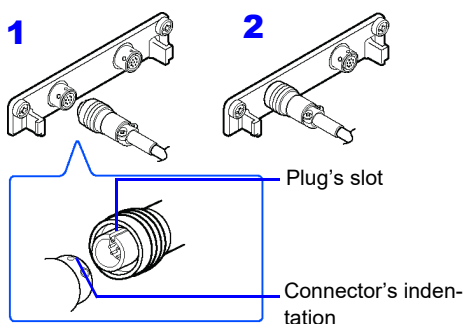

**3** Connect Model L9769 to the strain gauge transducer.

**4** Connect the strain gauge transducer to a measurement object.

#### Required items:

Model L9769 Conversion Cable, strain gauge transducer

- 1** Insert Model L9769 into a connector of Model U8969 with the slot of the plug aligned with the outward indentation of the connector.
- 2** Insert the plug into the connector until they are locked together.
- 3** Connect Model L9769 to the strain gauge transducer.
- 4** Connect the strain gauge transducer to a measurement object.

#### How to disconnect Model L9769

Pull the sleeve of the plug gently, releasing the plug, and disconnect the cable.

#### Connector pin-out of the U8969

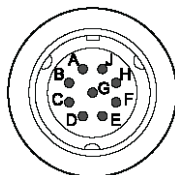

The metal shell is connected to the GND of the instrument.

Pin Mark	Description
A	BRIDGE+
B	INPUT+
C	BRIDGE-
D	INPUT+
E	FLOATING COMMON
F	SENSE+
G	SENSE-
H, J	N.C.

#### Connector pin-out of the L9769 Conversion Cable on strain gauge transducer side

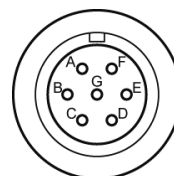

Applied voltage: bridge voltage of 2 V

The metal shell is connected to the GND of the instrument.

Pin Mark	Description
A	BRIDGE+, SENSE+
B	INPUT-
C	BRIDGE-, SENSE-
D	INPUT+
E	FLOATING COMMON
F, G	N.C.

### Connection of Model L9769

- Pin F of the module end is connected with Pin A of the strain gauge transducer end.
- Pin G of the module end is connected with Pin C of the strain gauge transducer end.

#### Connect to module's terminal

Example: Connecting the 9769 Conversion Cable with the supplied conversion cable

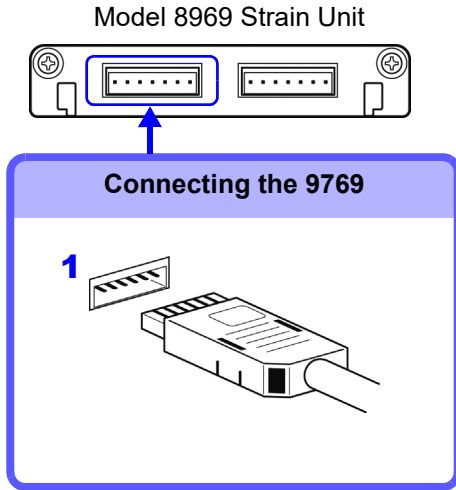

**2** Connect to the strain gauge transducer

**3** Attach to the measurement object

Required item:  
9769 Conversion Cable, strain gauge transducer

**1** Connect the 9769 to a terminal on the module.

The orange section of the 9769 must face up.

**2** Connect the strain gauge transducer to the conversion cable.

**3** Attach to the measurement object.

Connector pin-out of the 8969  
(1 is on left when unit top side is facing up)

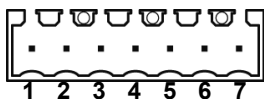

Pin No.	Description
1	BRIDGE+
2	SENSE+
3	INPUT+
4	INPUT-
5	BRIDGE-
6	SENSE-
7	FLOATING COMMON

Connector pin-out of the 9769 on strain gauge transducer side

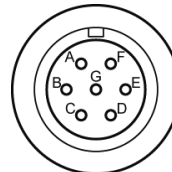

Applied voltage:  
bridge voltage of 2 V

The metal shell is connected to the GND of Model 8969.

Pin Mark	Description
A	BRIDGE+
B	INPUT-
C	BRIDGE-
D	INPUT+
E	FLOATING COMMON
F, G	N.C.

### NOTE

- Performing measurement with a strain gauge requires a bridge box. Use a strain gauge and bridge box both of which are commercially available.
- The bridge box may be susceptible to the effect of noise. For more information about how to ground the bridge box, refer to its instruction manual or contact the manufacturer of the bridge box.
- Do not excessively bend the cable and the base between cable and connector, pull on them, nor twist them. Doing so may cause the conversion cable to break.

## Measuring Current

### **NOTE**

- 8971 Current Unit cannot be used with MR8741.
- With MR8740, up to four 8971 Current Units can be used.

### Current sensors that can be connected to the Model 8971 Current Unit

The following current sensors can be connected to the Model 8971 Current Unit. Connecting these current sensors requires one or two conversion cables.

Model number	Model name	Maximum input current / Frequency	Conversion cable for 8971	Connector*1
9709	AC/DC Current Sensor	500 A	9318	Plastic
9709-05		DC to 100 kHz	CT9901 + 9318	Metal
9272-05	Clamp on Sensor	20 A/200 A	CT9901 + 9318	Metal
9272-10		1 Hz to 100 kHz	9318	Plastic
CT6841	AC/DC Current Probe	20 A	9318	Plastic
CT6841-05		DC to 1 MHz	CT9901 + 9318	Metal
CT6843	AC/DC Current Probe	200 A	9318	Plastic
CT6843-05		DC to 500 kHz	CT9901 + 9318	Metal
CT6844	AC/DC Current Probe	500 A	9318	Plastic
CT6844-05		DC to 200 kHz	CT9901 + 9318	Metal
CT6845	AC/DC Current Probe	500 A	9318	Plastic
CT6845-05		DC to 100 kHz	CT9901 + 9318	Metal
CT6846	AC/DC Current Probe	1000 A	9318	Plastic
CT6846-05		DC to 20 kHz	CT9901 + 9318	Metal
CT6862	AC/DC Current Sensor	50 A	9318	Plastic
CT6862-05		DC to 1 MHz	CT9901 + 9318	Metal
CT6863	AC/DC Current Sensor	200 A	9318	Plastic
CT6863-05		DC to 500 kHz	CT9901 + 9318	Metal
CT6865	AC/DC Current Sensor	1000 A	9318	Plastic
CT6865-05		DC to 20 kHz	CT9901 + 9318	Metal
CT6875	AC/DC Current Sensor	500 A DC to 2 MHz	CT9901 + 9318	Metal
CT6876	AC/DC Current Sensor	1000 A DC to 1.5 MHz	CT9901 + 9318	Metal

\*1: Metal connector (ME15W), plastic connector (PL23)



### Connecting a current sensor with Model 8971 Current Unit

Current sensors whose model number is without the suffix -05, which have a plastic connector (PL23), can be connected with Model 8971 Current Unit in combination with Model 9318 Conversion Cable\*.

Those whose model number is with the suffix -05, which have a metallic connector, can be connected to Model 8971 Current Unit in combination with both the 9318 Conversion Cable\* and the CT9901 Conversion Cable.

\*1: Model 9318 Conversion Cable is an accessory of Model 8971 Current Unit.

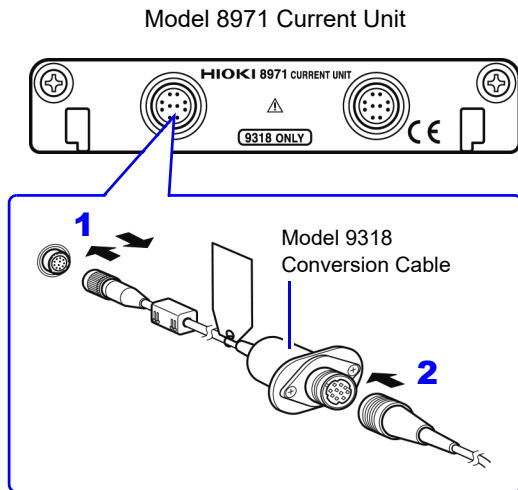

- 1** Align the guides of the conversion cable with those of the sensor connector on the module, and straightly insert the plug until it locks.
- 2** Align the guides of the current sensor to be used with those of the conversion cable connector, and straightly insert the plug until it locks.  
The instrument automatically recognizes the model of the current sensor.
- 3** Clamp the current sensor around a line of a measuring object.

#### How to connect the cable and a sensor

- 1** Hold and pull the plastic collar of the conversion cable, which releases the lock, and then remove the connector.
- 2** Hold and pull the plastic collar of the current sensor, which releases the lock, and then remove the connector.

### When measuring current with a 9018-50 Clamp On Probe

You can use a voltage measurement unit such as the 8966 Analog Unit to make measurements. For more information about how to configure the instrument for use in this type of application, see the example settings in "7.4.1 Scaling Setting Examples" (p.150).

## Measuring acceleration

Familiarize yourself with "Handling the Instrument and Modules" ( p.9) before connecting a current sensor.

### Applicable Modules

- Model U8979 Charge Unit

The following device can be connected to the module.

- Acceleration sensor (Not available from Hioki)

Connect a acceleration sensor to Model U8979 Charge Unit.

### Acceleration sensor connectable with Model U8979



Use an acceleration sensor with a built-in pre-amplifier that conforms to the specification of Model U8979 Charge Unit. Using an inapplicable sensor may cause damaging itself.

Acceleration sensor type	Terminal the sensor is connected to	Note
With a built-in pre-amplifier	BNC connector	Drive power: 3.0 mA, 22 V
Charge output	Miniature connector (#10-32)	–

### Connecting an acceleration sensor with a built-in pre-amplifier

#### Connecting a BNC-output acceleration sensor with a built-in pre-amplifier

Model U8979 Charge Unit

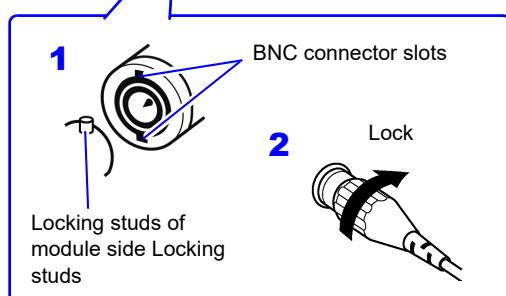
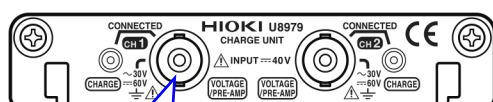

- 1 Align the slots in the BNC connector of an acceleration sensor with the locking studs of a BNC connector on the module, and insert the connector.
- 2 Turn the BNC connector of the acceleration sensor clockwise until it locks.
- 3 Attach the acceleration sensor with the built-in pre-amplifier to a measurement target.

#### How to remove the acceleration sensor

Turn the BNC connector of the acceleration sensor counter-clockwise to release the lock and remove the connector.

#### Connecting an acceleration sensor other than a sensor with a built-in pre-amplifier

Convert the output connector into the BNC connector using a commercially available conversion connector or conversion cable to connect the sensor.

### Connecting a charge-output acceleration sensor

#### Connecting a charge-output acceleration sensor equipped with the miniature connector (#10-32)

Model U8979 Charge Unit

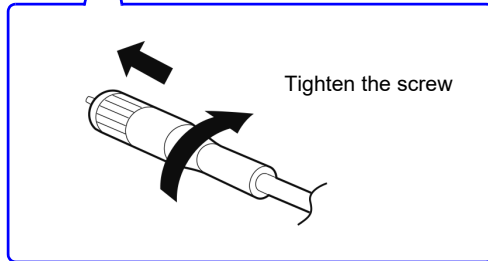
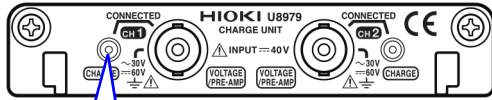

- 1 Align the screw of the miniature connector, and turn the connector clockwise to tighten it.
- 2 Attach the charge-output acceleration sensor to a measurement target.

#### How to disconnect the current sensor

Turn the miniature connector counterclockwise, and then pull out the connector.

#### Connecting a charge-output acceleration sensor equipped with a connector other than a miniature connector (#10-32)

Convert the output connector into the miniature connector (#10-32) using a commercially available conversion connector or conversion cable to connect the sensor.

## Measuring Logic Signals

Read "Before Connecting a Logic Probe to the Measurement Object" ( p.12) carefully.

For more information about logic probe specifications, see the instruction manual that came with the logic probe you plan to use

### Applicable Modules

- Model 8973 Logic Unit

LA to LB (MR8740) and LA to LD (MR8741) are supplied as standard equipment with the instrument.

### Use to connect: Logic Probe

- MR9321-01 Logic Probe
- 9320-01 Logic Probe
- 9327 Logic Probe

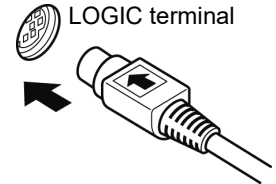

### Connect to LOGIC Terminals

Example: Connecting the 9327 Logic Probe

#### MR8740 Front Side

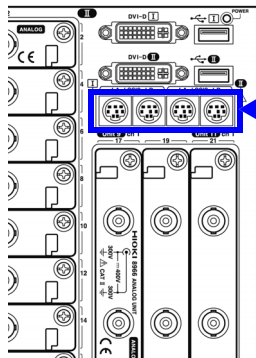

#### LOGIC terminals

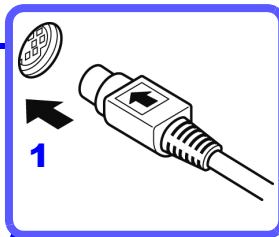

Required item: Model 9327 Logic Probe

- 1 Connect the logic probe by aligning the grooves on the plug and a LOGIC terminal.
- 2 Connect to the measurement object.

**2** Connect to the measurement object

#### MR8741 Front Side

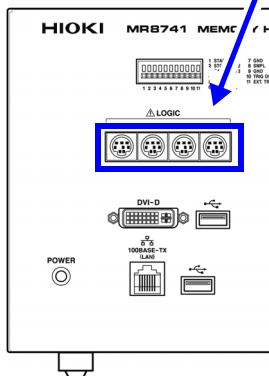

**Measuring Voltage with High Accuracy (Digital Voltmeter)**

Applicable Modules  
• Model MR8990 Digital Voltmeter Unit

Connect to the banana jacks on a module.

Cables to connect: L2200 Test Lead

- L2200 Test Leads (Maximum input voltage: 1000 V)

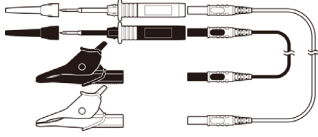
A diagram showing two L2200 test leads. One is a standard two-wire lead with red and black insulated wires and metal probes. The other is a more complex lead with a central shielded wire and two outer wires, also with red and black insulation and metal probes.

**Connect to banana jacks**

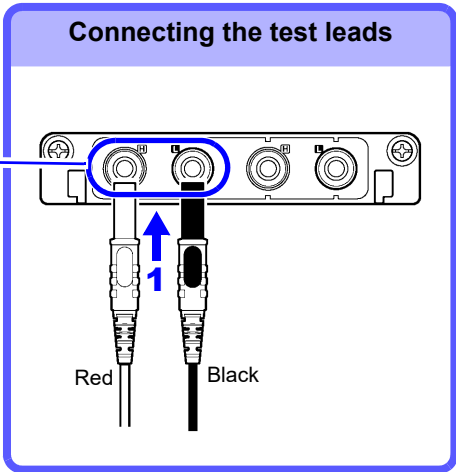

Banana jack

Red

Black

Required item: Test leads above

- 1** Connect the test leads to the banana jacks on the module. Connect the black lead to the L jack, and the red lead to the H jack. Make sure the test lead plugs are fully inserted into the jacks.
- 2** Connect the test leads to the object to be measured.

**2** Connect the leads to the object to be measured

## High Voltage Measurement

**Applicable Modules**

- Model U8974 High Voltage Unit

Connect to the banana jacks on a module.

Required item: Model L4940 Connection Cable Set

- Model L4940 Connection Cable Set: (Maximum input voltage: 1000 V)



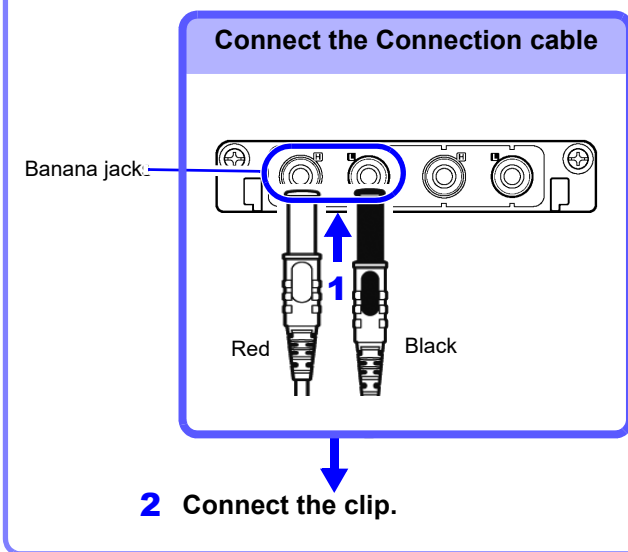

### To Connect to banana jacks

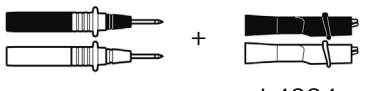

Required item: Model L4940 Connection Cable Set

- 1** Connect the plug of the connection cable to the banana jacks on the module. Connect the terminal and the plug of the same color.
- 2** Insert the accessory clip into cable clips.
- 3** Connect the cable clips to the measurement object.

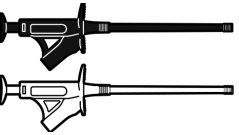
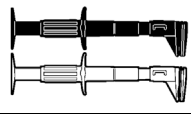
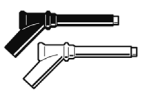
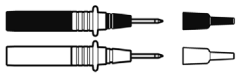
Accessory clips	
 <p style="text-align: center;">L4934</p>	Model L4934 Small Alligator Clip Set * Model L4932 is required when using Model L4934.
	Model L4935 Alligator Clip Set
	Model L9243 Grabber Clip
	Model L4936 Bus Bar Clip Set
	Model L4937 Magnetic Adapter Set
	Model L4932 Test Pin Set

**3** Connect to the measurement object.



### Output Waveform

#### Applicable Modules

- Model U8793 Arbitrary Waveform Generator Unit
- Model MR8790 Waveform Generator Unit

Connect to the SMB jack on a module.

Required item: Model L9795-01 /L9795-02 Connection Cableconnect: L2200 Test Lead

- Model L9795-01 Connection Cable (Electrical clips)



- Model L9795-02 Connection Cable (BNC output)

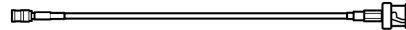

### To Connect to Output Terminals

Example: Model U8793



Output terminal

#### Connect the Connection cable

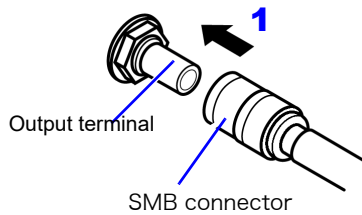

- 2 Connect to the object to which the waveform is being applied.

Required items: Connection cable mentioned above

- 1 Insert the SMB connector of connection cable in the output terminal of the module until you hear a click.
- 2 Connect the cable clips to the object to which the waveform is being applied.

#### To disconnect output connectors

Grip the head of the SMB connector (not the cable), and pull it out.

## Output Pulse Waveform

### Applicable Module

- Model MR8791 Pulse Generator Unit

Required items: Commercially available cable  
(Half-pitch 50 pins)

Connect to the banana jacks on a module.

### To Connect to Output Connector

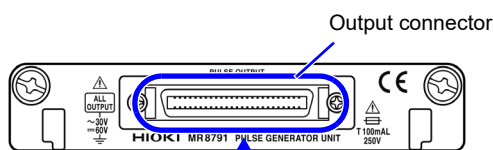

Required items: Commercially available cable

- 1 Connect the connection cable to Output Connector of module.
- 2 Connect the connection cable to the object to which the waveform is being applied.

#### Connect the Connection cable

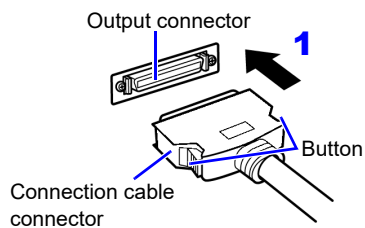

- 2 Connect to the object to which the waveform is being applied.

#### To disconnect output connectors

Hold the button of connection cable while pulling the connector.

### Output connector

10250-52A2PL: Sumitomo 3M products (SCSI-2 connector), (Centronics half-pitch 50 pin socket-contact)  
Refer to "Output Connector Specifications" ( p.371).

- Metal shell of the connector 10250-52A2PL is the same as GND of the instrument (frame GND).
- Use lock type connectors for connecting the harness and the connector.



## 2.3 Recording Media Preparation

Read "Handling Media" ( p.10) carefully.

### 2.3.1 Storage Media (Inserting a USB Memory Stick)

Media icons    Icons indicating the status of storage media are always shown at the top of the screen.

  
USB  
memory  
stick



: Media is inserted





: Media is inserted and selected as save target (Icon color is red)



: Media is not inserted but selected as save target (Icon color is black)

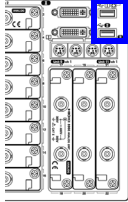
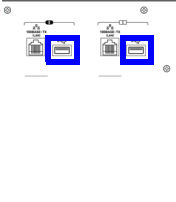
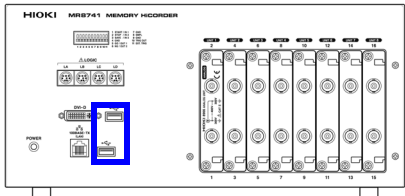

: The center part of the icon appears yellow while the USB memory stick is being accessed.

Storage Media	Inserting procedure, Remarks, and Notes
<p>RAM (Internal memory)</p> 	<ul style="list-style-type: none"> <li>• Memory integrated in the unit is used. Only settings can be stored.</li> <li>• Automatic saving of data is not possible.</li> </ul>
<p>USB memory stick</p> 	<ul style="list-style-type: none"> <li>• Do not connect any devices other than USB memory stick.</li> <li>• Not all commonly available USB memory sticks are supported.</li> <li>• To use a USB memory stick, suitable unit settings must be made, as described below.</li> </ul> <p><b>Inserting a USB memory stick</b> Ensure correct orientation of the USB memory stick and push it all the way into the connector.</p> <p><b>Remove a USB memory stick</b> Verify that the unit is not accessing the USB memory stick (for saving or loading data, etc.). Then pull the USB memory stick out. (No special steps are required at the instrument.)</p> <div style="text-align: center;"> <p>USB Connector (Type A)</p> <p>MR8740 Front Side</p>  <p>Back Side</p>  <p>MR8741 Front Side</p>  </div>

## 2.3.2 Formatting Storage Media

Possible targets for formatting are USB memory stick, and internal memory. During the formatting process, a folder named "HIOKI\_MR8740" or "HIOKI\_MR8741" will be created.

### **NOTE**

Note that formatting used storage media deletes all the information on the storage media and that deleted information is unrecoverable.

### Procedure

To open the screen: Right-click and select **[FILE]** → File screen

**1** Insert the storage media.

**2** Select **[Next Page]**.  
Select **[Format]**.

The flashing cursor moves to the **[Format Target]** item.

**3** Select the storage media to format, and select **[Exec]**.  
The specified storage media is formatted.

A confirmation window will be displayed.  
Select **[Yes]** to proceed, or **[No]** to cancel.

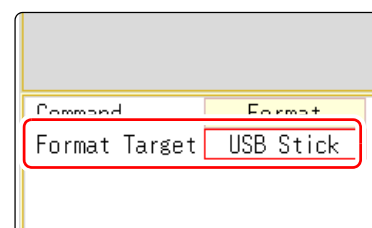

## 2.4 Supplying Power

Read "Before Turning the Power Supply On" ( p.12) carefully.

### 2.4.1 Connecting the Power Cord

Connect the power cord to MR8740/MR8741 and plug it into an AC outlet.

#### Connection Procedure

Back Side

MR8740

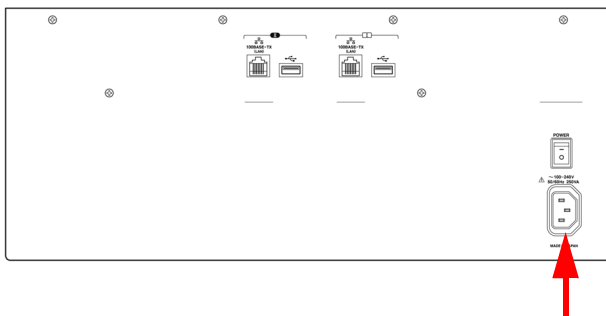

MR8741

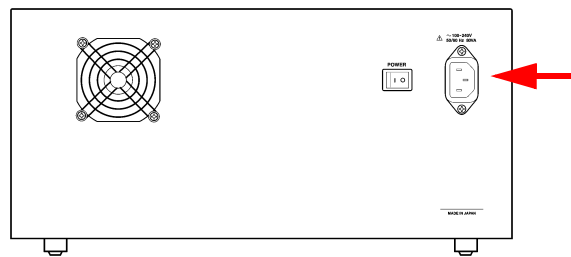

- 1.** Connect the power cord to the power inlet on the instrument.
- 2.** Plug the power cord into the mains outlet.

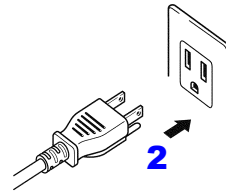

## 2.4.2 Turning the Power On and Off

This section explains the correct procedure for powering the unit up or down.

### Turning Power On

Back Side

MR8740

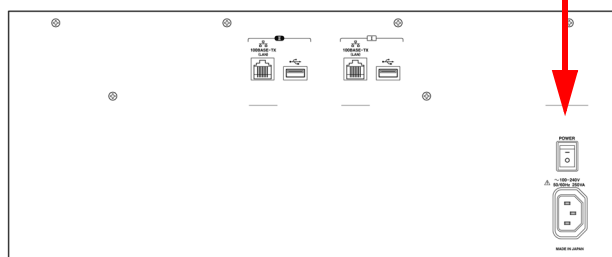

Power On |

MR8741

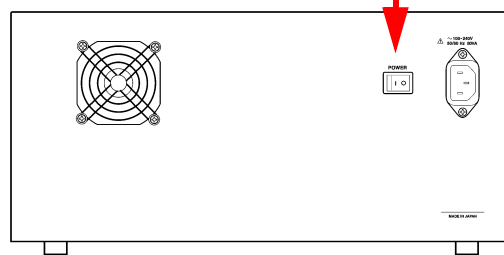

Power On |

Turn the **POWER** switch on ( | ).

The startup screen appears first, and then the Waveform screen is shown.

### **NOTE**

#### Before Starting Measurement

To obtain precise measurements, provide about 30 minutes warm-up after turning power on to allow the internal temperature of the modules to stabilize. After that, perform zero adjustment before taking measurements.

### Turning Power Off

Before Turning  
Power Off

#### Recording Data

When the **POWER** switch is turned off, internal recorded data is erased. If you don't want to lose recorded data, save it first to a USB memory stick.

See: "Chapter 4 Saving/Loading Data & Managing Files" (p.83)

Power Off ○

Turn the **POWER** switch off (○).

When power is turned on again, the display appears with the settings that existed when power was last turned off.

## 2.5 Setting the Clocks

Set date and time for the built-in clock as follows.

The clock has an automatic calendar with leap year correction and 24-hour format.

The functions listed below make use of the clock. Ensure that the clock is set correctly before using these functions.

- Measurement with timer-based trigger
- Saving measurement data

### Procedure

To open the screen: Right-click and select [SYSTEM] → [Init] sheet

- 1 Move the flashing cursor to the [Clock] item.
- 2 Select the digit to change and set the numeric value.
- 3 When you select [Apply] while the flashing cursor is on the [Clock] item, the clock is set to the current date and time values.

The date and time indication is shown at the top right of the screen.

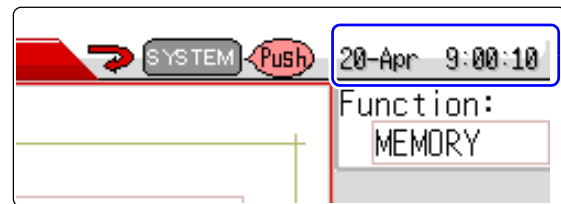
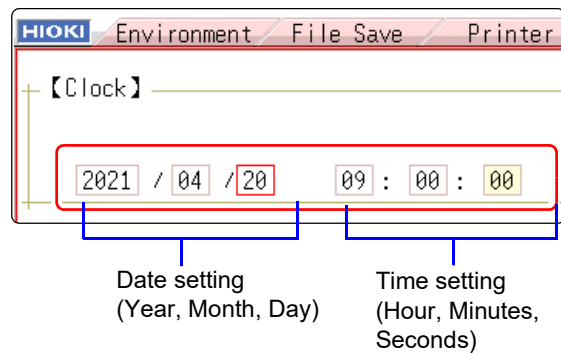

### **NOTE**

The instrument contains a built-in backup lithium battery, which offers a service life of about ten years. If the date and time deviate substantially when the instrument is switched on, it is the time to replace that battery. Contact your dealer or Hioki representative.

## 2.6 Adjusting the Zero Position (Zero-Adjust)

This procedure compensates for module differences and sets the reference potential of the instrument to 0 V.

The compensation procedure is performed for all channels and ranges.

### Before starting zero-adjust

- To obtain precise measurements, provide about 30 minutes warm-up after turning power on to allow the internal temperature of the modules to stabilize.
- Note that zero-adjust cannot be performed during a measurement.
- During zero-adjust, the mouse operation is disabled. (The procedure may take several seconds.)

### Procedure

To open the screen: Right-click and select [CHAN] → [Unit List] sheet

**1** Move the flashing cursor to the [Zero-Adjust] item.

**2** Select [Exec Zero-Adjust].

The zero-adjust procedure is carried out.

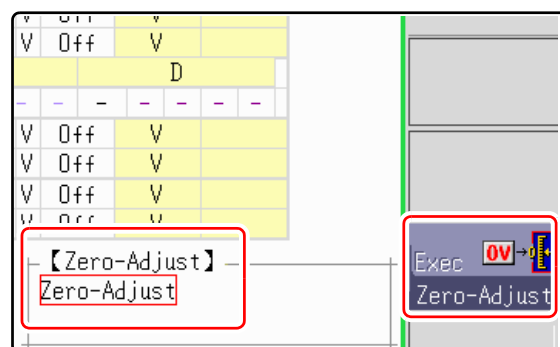

### NOTE

- Zero-adjust has no effect on the 8969 and U8969 Strain Unit. (Perform zero-adjust using Auto Balance.)  
See: "7.9.4 Setting Model 8969 and U8969 Strain Unit" (p.165)
- MR8990 Digital Voltmeter Unit performs calibration when zero adjustment is performed.  
See: "2.7 Performing Calibration (When Mounting MR8990)" (p.60)

### Perform zero-adjust in the following cases.

- When an module was changed.
- When power was turned off and on again.
- When settings were initialized (system reset).
- When DC/RMS is switched at the 8971 Current Unit (model MR8740 only), 8972 DC/RMS Unit, or U8974 High Voltage Unit
- When measurement mode has been switched on Model U8979 Charge Unit.
- When the ambient temperature has changed significantly.  
Zero-position drift\* may occur.

\* Drift: This refers to spurious output caused by a shift in the operating point of an operational amplifier. Drift can occur due to changes in temperature and due to component aging over a period of use.

## 2.7 Performing Calibration (When Mounting MR8990)

This procedure compensates for MR8990 Digital Voltmeter Unit differences. The compensation procedure is performed for all channels and ranges.

### Before starting calibration

- Before performing this procedure, allow the equipment to warm up for about 30 minutes after the power is turned on to enable the internal temperature of the modules to stabilize.
- Note that calibration cannot be performed during measurement. However, if the calibration setting is set to ON, calibration is performed at the start of measurement.
- Mouse operations are not accepted during calibration. (The procedure may take several seconds.)

### Procedure

To open the screen: Right-click and select [CHAN] → [Unit List] sheet

**1** Move the flashing cursor to the [Zero-Adjust].

**2** Select [Execute Zero-Adjust].

Calibration is executed.

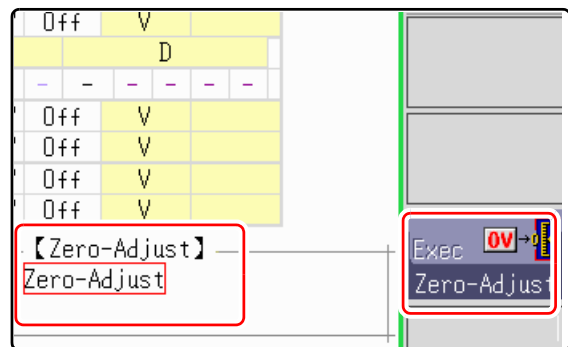

**In the following cases, calibration should be executed again.**

- When a module was changed.
- When power was turned off and on again.
- When settings were initialized (system reset).
- When the ambient temperature has changed significantly.

# Measurement Procedure

## Chapter 3

### 3.1 Measurement Workflow

3

Chapter 3 Measurement Procedure

#### 1 Pre-Measurement Inspection

See:

"3.2 Pre-Measurement Inspection" (p.63)

#### 2 Make basic settings for measurement

Select suitable recording method for measurement target

See:

"3.3.1 Measurement Function" (p.64)

Set data acquisition speed

"3.3.2 Time Axis Range and Sampling Rate" (p.66)

Set waveform length

"3.3.3 Recording Length (number of divisions)" (p.69)

Set waveform display format

"3.3.4 Screen Layout" (p.71)

##### Application examples

See:

"6.4 Performing Waveform X-Y Synthesis" (p.127)

"7.2 Displaying Waveforms During Recording (Roll Mode)" (p.145)

"7.3 Displaying New Waveforms Over Past Waveforms (Overlay)" (p.146)

"Chapter 9 Numerical Calculation Functions" (p.211)

#### 3 Input Channel Settings

Make analog channel settings

See:

"3.4.2 Analog Channel" (p.75)

Make logic channel settings

"3.4.3 Logic Channel" (p.78)

##### Application examples

See:

"7.1 Adding Comments" (p.138)

"7.4 Converting Input Values (Scaling Function)" (p.148)

"7.5 Variable Function (Setting the Waveform Display Freely)" (p.155)

"7.6 Fine Adjustment of Input Values (Vernier Function)" (p.158)

"7.7 Inverting the Waveform (Invert Function)" (p.159)



**4 Make trigger settings**



See:  
"Chapter 8 Trigger Settings" (p.189)

**5 Starting Measurement**

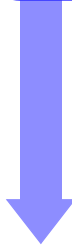

See:  
"3.5 Starting and Stopping Measurement" (p.80)  
"Chapter 4 Saving/Loading Data & Managing Files" (p.83)  
"6.1 Reading Measurement Values (Using the A/B Cursors)" (p.120)  
"6.3.2 Scrolling the Measurement Waveform" (p.125)  
"6.5 Magnifying and Compressing Waveforms" (p.129)

**6 Stopping Measurement**

See:  
"3.5 Starting and Stopping Measurement" (p.80)



**To reuse previously stored settings**

Load the settings file from the File screen.  
Saving the settings for different measurement targets or applications enhances operation convenience.

See: "4.3 Loading Data" (p.99)



**To return settings to the original (basic default) condition**

From the System screen, select the **[Init]** sheet to return the unit to the factory default settings. In this condition, the unit is set up to easily perform simple measurements. If operation of the unit seems unusual or overly complex, perform the initialization procedure.

See: "18.2 Initializing the Instrument" (p.376)

---

## 3.2 Pre-Measurement Inspection

The following steps should be performed before measurement.

Before using the instrument the first time, verify that it operates normally to ensure that the no damage occurred during storage or shipping. If you find any damage, contact your dealer or Hioki representative.

### 1 Peripheral Device Inspection

When using probes and connection cables

Is the insulation of the probe or connection cable to be used damaged, or is bare metal exposed?

Metal Exposed

No Metal Exposed

When using a clamp

Is the clamp cracked or damaged?

Go to **2**

Yes

No

Go to **2**

Do not use if damage is present, as you could receive an electric shock. Replace the damaged items.

### 2 Instrument and Module Inspection

Is damage to the instrument or modules evident?

Yes

No

If damage is evident, request repairs.

When turning power on

Do the fans rotate and the Hioki logo appear on the screen?

No

Yes

The power cord may be damaged, or the instrument may be damaged internally. Request repairs.

Does the Waveform screen appear?

Nothing appears, or the display is abnormal

Yes

The instrument may be damaged internally. Request repairs.

Inspection complete

## 3.3 Setting Measurement Configuration

Set measurement conditions as follows.

By calling up the Waveform screen and then using the Settings window to make basic settings, you can immediately verify the effect of settings on the waveform. Basic settings can also be made by calling up the Status screen and selecting the **[Status]** sheet.

### Opening the Settings window

Click **[DISP]** in the right-click menu.

The screenshot shows the oscilloscope's main display with a waveform and a 'Settings window' on the right. A right-click menu is open on the left, with 'DISP' highlighted. The Settings window has a red box around it, with arrows pointing to specific settings: 'MEMORY' (p.64), 'Timebase setting (Sampling rate)' (p.66), and 'Recording Length (Number of divisions)' (p.69).

### 3.3.1 Measurement Function

Select the function according to the measurement and recording target.



#### Procedure

To open the screen: Right-click and select **[DISP]** → Waveform screen

Move the flashing cursor to the function item (topmost field in the settings window).

Select

MEMORY (default setting)/RECORDER/FFT

 <p>MEMORY</p>	<p><b>This function is most suitable for oscilloscope-type measurements, such as instantaneous waveforms and transient phenomena.</b></p> <p>Trigger functions and calculation functions can be used.</p>
 <p>RECORDER</p>	<p><b>This function is suitable for use instead of pen recorders and pen oscilloscopes, to record long-term fluctuations and create records for observing slow phenomena.</b></p> <p>Real-time printing of data is possible.</p>
 <p>FFT</p>	<p><b>Analyze the frequency.</b></p> <p><b>Various types of spectrum and octave analysis can be performed.</b></p> <p>See: "Chapter 12 FFT Function" (p.247)</p>

Description Recorder Function Values

With the Recorder function, each data sample consists of the maximum and minimum values acquired in the specified sampling period. So each data sample has its own amplitude breadth.

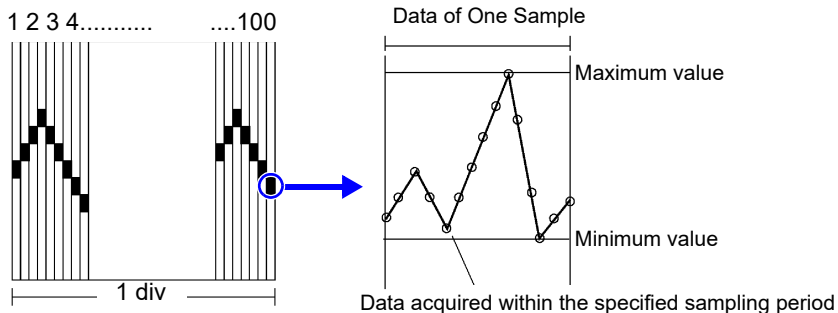

When input waveform variation is slight, the difference between maximum and minimum values (breadth, or width) can be inordinately large if the sampling period is short and if severe fluctuations are present due to noise. This phenomena may be prevented by setting a longer sampling period.

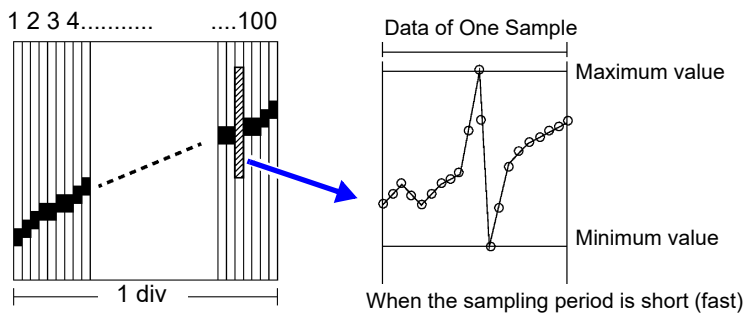

## 3.3.2 Time Axis Range and Sampling Rate

MEM REC

The timebase setting establishes the rate of input signal waveform acquisition, specified as time-per-division on the horizontal axis (time/div).

The sampling setting specifies the interval from one sample to the next.

(The setting is shown in brackets under the time axis range for the Memory function (see illustration at right). The indication changes with the time axis range.)

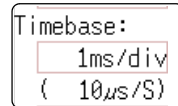

### Procedure

To open the screen: Right-click and select **[DISP]** → **Waveform screen**

#### Memory Function case

- 1 Move the flashing cursor to the **[Timebase]** item, and then left-click.
- 2 Set the time per division (timebase) on the horizontal axis.

Select

5 (default setting), 10, 20, 50, 100, 200, 500  $\mu$ s/div  
 1, 2, 5, 10, 20, 50, 100, 200, 500 ms/div  
 1, 2, 5, 10, 30, 50 s/div, 1 min/div, 100 s/div  
 2, 5 min/div

To control sampling by an external signal, select **[External]**. (MR8741 only)

When external sampling is selected, the number of samples per division can be set in the range from 10 - 10000 S/div.

See: "16.2.3 External Sampling (SMPL)" (p.340)

#### Recorder Function case

- 1 Move the flashing cursor to the **[Timebase]** item.
- 2 Set the time per division (timebase) on the horizontal axis.

Select

10 (default setting), 20, 50, 100, 200, 500 ms/div  
 1, 2, 5, 10, 30, 50 s/div, 1 min/div, 100 s/div  
 2, 5, 10, 30 min/div, 1 h/div

- 3 Move the flashing cursor to the **[Sampling]** item.
- 4 Set the sampling rate.

Select

1 (default setting), 10, 100  $\mu$ s  
 1, 10, 100 ms  
 (Select a sampling rate less than 1/100 of the time axis)

The range of choices depends on the selected timebase.

The higher the sampling rate, the more detailed changes can be observed.

## Description

Selecting the time axis range

**MEM**

Refer to the table below when setting the time axis range. For example, to measure a 100 kHz waveform, the maximum display frequency setting range according to the table is 200 kHz - 800 kHz. If the maximum display frequency is set to 400 kHz, setting the time axis range to 10  $\mu$ s/div is recommended.

Timebase	Sampling Rate (Speed)	Maximum display frequency
5 $\mu$ s/div	50 ns (20 MS/s)	800 kHz
10 $\mu$ s/div	100 ns (10 MS/s)	400 kHz
20 $\mu$ s/div	200 ns (5 MS/s)	200 kHz
50 $\mu$ s/div	500 ns (2 MS/s)	80 kHz
100 $\mu$ s/div	1 $\mu$ s (1 MS/s)	40 kHz
200 $\mu$ s/div	2 $\mu$ s (500 kS/s)	20 kHz
500 $\mu$ s/div	5 $\mu$ s (200 kS/s)	8 kHz
1 ms/div	10 $\mu$ s (100 kS/s)	4 kHz
2 ms/div	20 $\mu$ s (50 kS/s)	2 kHz
5 ms/div	50 $\mu$ s (20 kS/s)	800 Hz
10 ms/div	100 $\mu$ s (10 kS/s)	400 Hz
20 ms/div	200 $\mu$ s (5 kS/s)	200 Hz
50 ms/div	500 $\mu$ s (2 kS/s)	80 Hz
100 ms/div	1 ms (1 kS/s)	40 Hz
200 ms/div	2 ms (500 S/s)	20 Hz
500 ms/div	5 ms (200 S/s)	8 Hz
1 s/div	10 ms (100 S/s)	4 Hz
2 s/div	20 ms (50 S/s)	2 Hz
5 s/div	50 ms (20 S/s)	0.8 Hz
10 s/div	100 ms (10 S/s)	0.4 Hz
30 s/div	300 ms (3.33 S/s)	0.13 Hz
50 s/div	500 ms (2 S/s)	0.08 Hz
1 min/div	600 ms (1.67 S/s)	0.04 Hz
100 s/div	1 s (1 S/s)	0.067 Hz
2 min/div	1.2 s (0.83 S/s)	0.033 Hz
5 min/div	3 s (0.33 S/s)	0.013 Hz

**What is the maximum display frequency?**

Displaying waveforms by their sampled values with adequate resolution of characteristics such as sine wave peaks requires a minimum of about 25 samples per waveform period. Maximum display frequency is determined by the timebase.

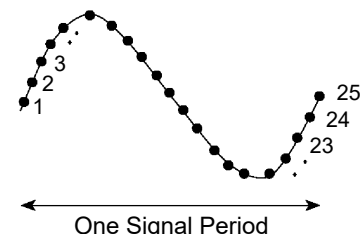
**What is aliasing (recording of non-existent waveforms)?**

If the signal to be measured changes too fast relative to the sampling rate, beginning at a certain frequency, non-existent slow signal fluctuations are recorded. This phenomena is aliasing.

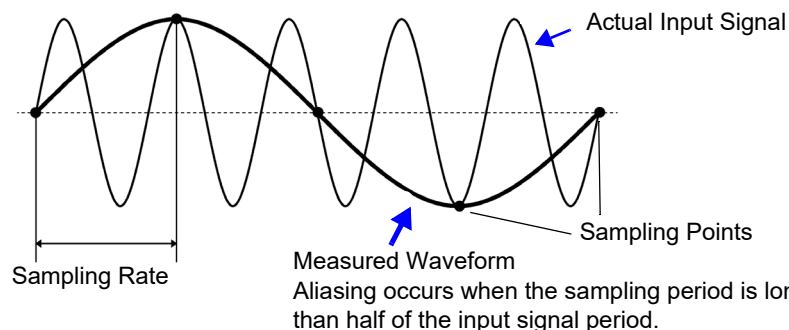

With the Memory function, the sampling rate can be significantly affected by the timebase setting, so care is necessary to avoid aliasing when selecting the timebase. Because the timebase determines the maximum display frequency, the fastest possible timebase setting should be used.

The sampling rate is automatically set to 1/100 of the selected time axis range.

If MR8990 Digital Voltmeter Unit is installed, the sampling rate for the channels of that unit is set to 1/50.

Example: When 8966 is installed on unit 1 (channels 1 and 2) and MR8990 on unit 2 (channels 3 and 4), and the time axis is set to 1 s/div

Sampling rate of unit 1 (8966): 10 ms

Sampling rate of unit 2 (MR8990): 20 ms

#### REC

- The timebase and sampling rate can be set independently. The sampling rate is selected depending on the timebase setting.
- When the following timebase values are selected, displayed waveforms are compressed in the horizontal (time axis) direction as shown.

20 ms/div → x1/2

10 ms/div → x1/5



#### To minimize noise during measurement

If the sampling rate is set too fast, when the input waveform amplitude is small, the difference between maximum and minimum values may become quite large as a result of sudden impulses such as noise. To prevent such phenomena, select a slower sampling rate or enable the module's lowpass filter (p.75).

#### MEM REC Common

### NOTE

The data refresh rate is not allowed to exceed the maximum sampling rate of the module.

During the period when data are not updated, the same data are measured, resulting in a stair-shaped waveform. Even when the same signal is input simultaneously by two units, the data may differ due to differences in sampling rate, frequency bandwidth, and frequency response.

#### Data refresh rate for various units

Module	Max. timebase	Max. sampling rate or data refresh rate	Reference information
8966	5 $\mu$ s/div	50 ns (20 MS/s)	-
8967	Dependent on data refresh setting	Dependent on data refresh setting	See: "7.9.3"(p.163)
8968	100 $\mu$ s/div	1 $\mu$ s (1 MS/s)	-
8969, U8969, U8979	500 $\mu$ s/div	5 $\mu$ s (200 ks/s)	-
8970	Dependent on setting	Dependent on setting	See: "7.9.5"(p.166)
8971	100 $\mu$ s/div	1 $\mu$ s (1 MS/s)	See: "7.9.6"(p.169)
8972	Dependent on response setting	Dependent on response setting	See: "7.9.7"(p.170)
8973	5 $\mu$ s/div	50 ns (20 MS/s)	-
MR8990	Dependent on NPLC setting	Dependent on NPLC setting	-
U8974	Dependent on NPLC setting	Depends on response setting	See: "7.9.9"(p.173)

### 3.3.3 Recording Length (number of divisions)

MEM REC

Set the length (number of divisions) to record each time data is acquired.

#### Procedure

To open the screen: Right-click and select [DISP] → Waveform screen

#### Memory Function case

1 Move the flashing cursor to the [Shot] item, and then left-click.

2 Select the type.

Select

Fixd Shot Select from a a range of preset values.

User Shot Freely specify any value in 1-division units.

3 Set the recording length.

Select

(Fixed Shot)

25, 50, 100, 200, 500, 1000, 2000, 5000, 10000, 20000, 50000, 100000 div

(User Shot)

1 to 160000 div

Can be inputted by the numeric keypad on the STATUS screen.

See: "7.1.3 Alphanumeric Input" (p.141)

#### Recorder Function case

1 Move the flashing cursor to the [Shot] item.

2 Select the type.

Select

Fixd Shot Select from a a range of preset values.

User Shot Freely specify any value in 1-division units.

3 Set the recording length.

Select

(Fixed Shot)

Cont. When [On] is selected, measurement is carried out while continuously overwriting data in memory. Data from the point at which measurement was stopped to the maximum recording length can be saved or printed again.

25, 50, 100, 200, 500, 1000, 2000, 5000, 10000, 20000, 50000 div

(User Shot)

1 to 80,000 div

Can be inputted by the numeric keypad.

See: "7.1.3 Alphanumeric Input" (p.141)



## Description

**MEM****Recording Length and Data Samples**

Each division of the recording length consists of 100 data samples. The total number of data samples for a specified recording length = set recording length (divisions)  $\times$  100 + 1.

However, if MR8990 Digital Voltmeter Unit is installed, the number of data samples is as follows.

- When only MR8990 is installed  
 Number of data samples for each division: 50 data samples  
 Total number of data samples for recording length: Set recording length (divisions)  $\times$  50 + 1
- When a mix of MR8990 and another units is installed  
 Channel of MR8990  
 Number of data samples for each division: 50 data samples  
 Total number of data samples for recording length: Set recording length (divisions)  $\times$  50 + 1  
 Channel of other units  
 Number of data samples for each division: 100 data samples  
 Total number of data samples for recording length: Set recording length (divisions)  $\times$  100 + 2

**REC**

- Each recording length division = 100 pairs of data points, with each pair composed of two values: the maximum and minimum measured values within each sampling period. The resolution of the data measured by the recorder function is 16bit.

**When recording length is set to [Cont.]**

- Data for up to 80,000 divisions from the end of measurement can be recorded in the internal memory of the unit.  
 The instrument stores the maximum recording length of data back from the point at which measurement was stopped in its internal memory (80,000 divisions).
- When Auto-saving is On, the saving is not performed during the measurement. At the forced shutdown point, the remaining data in memory will be saved.

**To change recording length while measuring**

Recording length can be changed on the Waveform screen.  
 The measurement will restart with the newly set recording length.

### 3.3.4 Screen Layout

**MEM** **REC**

You can specify the format in which the input signal is shown on the Waveform screen.

**NOTE** Selecting X-Y1 screen or X-Y4 screen allows waveform X-Y synthesis. (This applies to the Memory function.)

See: "6.4 Performing Waveform X-Y Synthesis" (p.127)

#### Procedure

To open the screen: Right-click and select **[STATUS]** → **[Status]** sheet

#### Memory Function case

Move the flashing cursor to the **[Format]** item.

Select	
Single	Display and record using 1 graph. (default setting)
Dual	Display and record using 2 graphs.
Quad	Display and record using 4 graphs.
Oct	Display and record using 8 graphs.
Hex	Display and record using 16 graphs.
XYSingle	Set input signal to X-Y and display and record the correlation using 1 graph.
XYQuad	Set input signal to X-Y and display and record the correlation using 4 graphs.

### Analog Channel Assignment

With 2, 4, 8, or 16 screens, analog channels can be freely assigned to the respective graphs.

#### Procedure

To open the screen: Right-click and select **[CHAN]** → **[Unit List]** sheet

**1** Move the flashing cursor to the **[Graph]** item.

**2** Select the display screen for each channel.

The sequence is Gr1, Gr2, Gr3... from the top.

<Sample screen after setting>

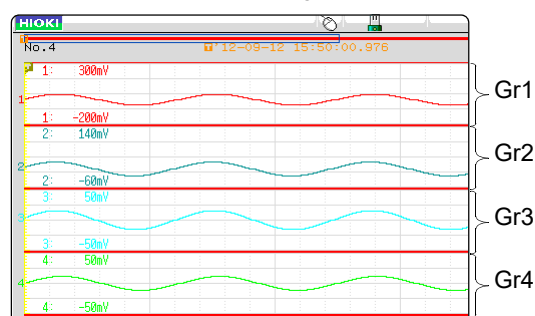

## 3.4 Input Channel Setting

Set the analog channel and logic channel.

### Opening the Channel settings window

See: "Displaying All Channels for Making the Variable Function Setting" (p.157)

Click **[DISP]** → **[CH.SET]** in the right-click menu.

You can switch setting screens by clicking a tab.

Ch	Col	Range	Mag	Position	LPF
1		100mV	x1	50%	-
2		200mV	x1	50%	-
3		100mV	x1	50%	-
4		500mV	x1	50%	-
5		5mV	x1	50.000	-
6		5mV	x1	50.000	-
7		5mV	x1	50%	-
8		5mV	x1	50%	-
9		5mV	x1	50%	-
10		5mV	x1	50%	-
11		5mV	x1	50%	-
12		5mV	x1	50%	-
13		5mV	x1	50%	-
14		5mV	x1	50%	-
15		5mV	x1	50%	-
16		5mV	x1	50%	-



#### To hide waveform interpolation

Set the waveform display color in the channel setting window to Off.

See: "1. Waveform Display Color" (p.75)



#### To copy the settings of one channel to another

See: "7.8 Copying settings to other channels (calculation No.) (Copy function)" (p.160)

## 3.4.1 Channel Setting Workflow

Explains the workflow to make settings for the analog channels (MR8740: Ch1 - Ch32, MR8741:Ch1 - Ch16).

### 1 Select the channels to use (Memory function) only

### 2 Make input and screen display related settings

Select input coupling	See: "3. Coupling" (p.75)
Match range to measurement target input value (as necessary)	"2. Vertical axis (Voltage axis) Range" (p.75)
Convert input value (as necessary)	"7.4 Converting Input Values (Scaling Function)" (p.148)
Make filter settings (if noise occurs)	"7. Low-pass filtering" (p.77)
Fine-tune waveform amplitude (as necessary)	"5. Vernier" (p.76)
Set zoom on vertical axis (voltage axis) direction (as necessary)	"4. Vertical axis (Voltage axis) Zoom" (p.76)

### 3 Make trigger settings (as necessary)

See:  
"Chapter 8 Trigger Settings" (p.189)

### 4 Make display color and display position settings

Set waveform display color	See: "1. Waveform Display Color" (p.75)
Set display position and scaling (as necessary)	"7.5 Variable Function (Setting the Waveform Display Freely)" (p.155)

### 4 Make graph display settings

For 1, 2, 4, 8, 16 screens	See: "Analog Channel Assignment" (p.71)
For X-Y1, X-Y4 screens	Procedures "4" and "5" of "6.4 Performing Waveform X-Y Synthesis" (p.128)

**NOTE**

- When input coupling is set to GND, the waveform will have no amplitude and range setting is not possible.
- Due to the influence of filter attenuation, correct range setting may sometimes not be possible.
- When making trigger settings, set the vertical axis (voltage axis) range first. If the range is changed after specifying the trigger, the trigger setting may change.
- When using the Variable function, set the vertical axis (voltage axis) range first. If the range is changed after specifying the Variable setting, observation with sufficient precision may not be possible.
- When using the Variable and Scaling functions together, make the Scaling settings first. If Scaling settings are made after selecting the Variable function, the intended display result may not be achieved.

The setting workflow for logic channels (standard LOGIC terminals LA - LB (MR8740), LA -LD (MR8741), expansion LOGIC terminals L1A - L8D) is explained below.

**1 Make screen display related settings**

Setting logic recording width

See:  
"1. Logic Width" (p.78)

**2 Make display color and display position settings**

Set waveform display position

See:  
"2. Waveform Display Position" (p.78)

Set waveform display color

"3. Waveform Display Color" (p.78)

**NOTE**

- Waveform display position can be specified in 1% increments.
- Not displayed for X-Y1 and X-Y4 screens.
- With MR8740, install the logic units on unit 1 to unit 8. Any logic units installed on units 9 and after will be invalid.

### 3.4.2 Analog Channel

Set the analog channel.

For information about specific settings for each module, see "7.9"(p.161).

**Procedure**

To open the screen: Right-click and select [DISP] →Waveform screen →Right-click and select [CH.SET] →Channel settings window ([Analog] sheet)

- 1 Move the flashing cursor to the channel for which to make settings.
- 2 Select the settings by clicking the mouse.

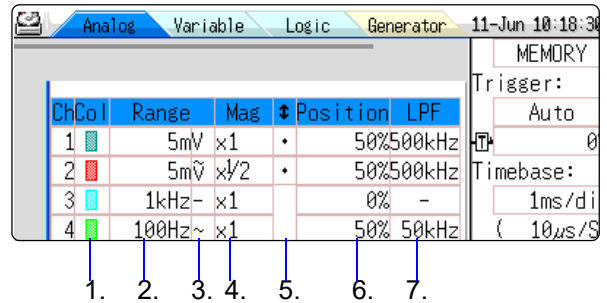

**To copy the settings of one channel to another**

See: "7.8 Copying settings to other channels (calculation No.) (Copy function)" (p.160)

#### 1. Waveform Display Color

Specifies the color in which the waveform of the selected channel is displayed. You can also select the same color as another channel.

Select

Off	The waveform is not displayed. If the Auto Save setting for [Save Channel] is [Disp Ch], data for the channel will also not be saved. See: "Select the channel to save." (p.90)
On	The waveform is displayed. Set the display color by clicking [↑] or [↓].
All On-Off	Switches the waveform display of all channels to all ON or all OFF

#### 2. Vertical axis (Voltage axis) Range

Sets the vertical axis (voltage axis) range for each channel. The value set here is the voltage of one increment on the vertical axis.

For information on the full-scale value for the respective modules, see the table in the section "6. Zero Position" (p.76).

When the Variable function is on but Variable Auto Adjustment is off, the size of the waveform on the screen will not change even if the vertical axis (voltage) range is changed.



**An over-range condition has occurred**

Change the vertical axis (voltage axis) range to a lower sensitivity setting.

#### 3. Coupling

Set the input signal coupling method. Normally, DC coupling should be selected.

Select

DC (V, -)	Both DC components and AC components of the input signal will be measured. (default setting)
AC (V̂, ~)	Only AC components of the input signal will be measured. DC components are blocked.
GND (⏏)	Input is shorted to ground. (Allows checking the zero position.)

### 4. Vertical axis (Voltage axis) Zoom

Vertical axis (voltage axis) zoom-up or zoom-down settings can be made separately for each channel. The settings will be used for display.

Zooming is carried out using the zero position as reference. The measurement resolution does not change.

See: "6.5.3 Magnifying and Compressing Vertical Axis (Voltage Axis)" (p.131)

To achieve a user-specified zoom setting, the Variable function is used. By reversing plus/minus, the waveform can be inverted.

See: "7.5 Variable Function (Setting the Waveform Display Freely)" (p.155)  
"7.7 Inverting the Waveform (Invert Function)" (p.159)

### 5. Vernier

Fine adjustment of input voltage can be performed arbitrarily on the Waveform screen (display only). When recording physical values such as noise, temperature and acceleration using sensors, amplitude can be adjusted to facilitate calibration.

See: "7.6 Fine Adjustment of Input Values (Vernier Function)" (p.158)

### 6. Zero Position

Sets the 0 V level display position. If the 0 V input level has shifted, perform zero-adjust.

See: "2.6 Adjusting the Zero Position (Zero-Adjust)" (p.59)

See: "2.7 Performing Calibration (When Mounting MR8990)" (p.60)

If the zero position of the 8969 and U8969 Strain Unit is out of alignment, perform auto balance.

See: "7.9.4 Setting Model 8969 and U8969 Strain Unit" (p.165)

### **NOTE**

- Simply moving the display position will not apply an offset to the input.
- Zoom of the vertical axis direction (voltage axis) is based on the zero position.
- The voltage range displayed in the waveform screen changes with zero position and zoom of the vertical axis (voltage axis) but the measurable range does not change.

The zero position is as shown in the illustration below.  
(Example: 8966 Analog Unit)

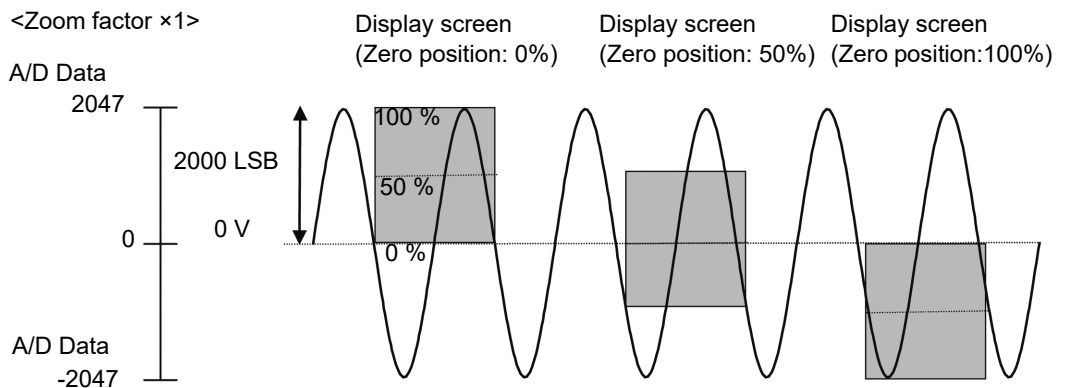

Full-scale resolution for input units at various vertical axis zoom factors (LSB)

Module	Zoom factor									
	×1/10	×1/5	×1/2	×1	×2	×5	×10	×20	×50	×100
8966 (Analog) 8971 (Current) 8972 (DC/RMS)	20000 (4000)	10000 (4000)	4000	2000	1000	400	200	100	40	20
8967 (Temperature)*	200000	100000	40000	20000	10000	4000	2000	1000	400	200
8968 (High resolution) U8974 (High voltage)	320000 (64000)	160000 (64000)	64000	32000	16000	6400	3200	1600	640	320
8969, U8969 (Strain) U8979 (Charge)	250000 (64000)	125000 (64000)	50000	25000	12500	5000	2500	1250	500	250
8970 (Power frequency)	20000	10000	4000	2000	1000	400	200	100	40	20
8970 (Count)	400000	200000	80000	40000	20000	8000	4000	2000	800	400
8970 (Excluding power frequency and count)	100000	50000	20000	10000	5000	2000	1000	500	200	100
MR8990 (DVM)	1200000	1200000	1200000	1000000	500000	200000	100000	50000	20000	10000

Brackets indicate valid data range

\*: With the 8967 TEMP Unit, the valid range differs depending on the thermocouple. For information on the minimum resolution, see the specifications of the 8967 TEMP Unit.

Full-scale value = Vertical-axis (voltage-axis) range × 20 divisions

Example: When the vertical-axis (voltage-axis) range is set to 1 V/div

1 V/div × 20 = 20 V

The 1 V/div range has a full-scale value of 20 V.

## 7. Low-pass filtering

Make settings for the low-pass filter of the module. This is useful for eliminating unwanted high-frequency components. The filter type depends on the module. Make the setting according to the input characteristics.



### 3.4.3 Logic Channel

Make settings for the logic channels. The channel settings window (Logic sheet) is shown when the display format is 1, 2, 4, 8 or 16 screens.

#### Procedure

To open the screen: Right-click and select [DISP] → Waveform screen → Right-click and select [CH.SET] → Channel settings window ([Logic] sheet)

- 1 Move the flashing cursor to the channel for which to make settings.
- 2 Select the settings by clicking the mouse.

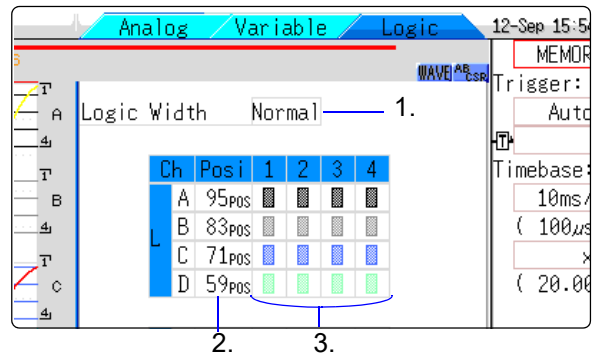

#### To copy the settings of one channel to another

See: "7.8 Copying settings to other channels (calculation No.) (Copy function)" (p.160)

#### 1. Logic Width

Allows changing the display width of the logic waveform.

Making waveforms more narrow can enhance the readability of the display when there are a high number of waveforms.

Select

<b>Wide</b>	Make the waveform wider.
<b>Normal</b>	Display the waveform at normal width.
<b>Narrow</b>	Make the waveform more narrow. (default setting)

#### 2. Waveform Display Position

Determines where on the screen the logic waveform is displayed.

The position can be freely moved within the range of the display.

#### 3. Waveform Display Color

Specifies the color in which the waveform of the selected channel is displayed. You can also select the same color as another channel.

For logic modules, the color can be specified for each module and each channel separately.

Select

<b>Off</b>	The waveform is not displayed. If the [Save Channel] setting is [Disp Ch], data for the channel will not be automatically saved. See: "4.2.2 Automatically Saving Waveforms" (p.88)
<b>On</b>	The waveform is displayed. Set the display color by clicking [↑] or [↓].
<b>Probe On-Off</b>	Switches the waveform display of the same probes to all ON or all OFF.
<b>All On-Off</b>	Switches the display of all logic waveforms to all ON or all OFF. This can be selected when the cursor at in the waveform display position item.

**NOTE**

- When the standard logic display is on, the 8970 Freq Unit installed on unit 1 or 2 can no longer be used. Furthermore, the 16-bit resolution 8967 TEMP Unit, 8968 High Resolution Unit, 8969 Strain Unit, U8969 Strain Unit, U8974 High Voltage Unit, and U8979 Charge Unit have a resolution of 12 bits. Also, when MR8990 Digital Voltmeter Unit is installed on unit 1 (unit 1 or unit 2 in the case of MR8741), the standard logic can no longer be used.
- With MR8740, install the logic units on unit 1 to unit 8. Even if you install logic units on units 9 and after, they will be invalid.

**3.4.4 Display Sheet**

The input channel settings can be set differently for each displayed sheet. Up to four sheets can be set. You can set desired waveforms for displaying to different sheets and switch them.

Sheet switching (1 to 4)

Unit	Ch	Mode	Range	Zoom	Position	LPF	Variable	Graph
ANALOG	1	Voltage	100mV/div	x10	65%	Off	V Off	V
	2	Voltage	5mV/div	x1/5	55%	Off	V Off	V
TEMP	3	Temp-K	10°C/div	x1	0%		Off	°C
	4	Temp-K	10°C/div	x1	0%		Off	°C
STRAIN	5		20µε/div	x1	50%	Off	Off	µε
	6		20µε/div	x1	50%	Off	Off	µε
HIGH RES	7	Voltage	5mV/div	x1	50%	Off	V Off	V
	8	Voltage	5mV/div	x1	50%	Off	V Off	V
FREQ	9	Freq	1Hz/div	x1	0%	Off	- Off	Hz
	10	Freq	1Hz/div	x1	0%	Off	- Off	Hz
CURRENT	11	20A/2V	100mA/div	x1	50%	Off	A Off	A
	12	20A/2V	100mA/div	x1	50%	Off	A Off	A
LOGIC	L7							
DC/RMS	15	DC	5mV/div	x1	50%	OFF	V Off	V
	16	DC	5mV/div	x1	50%	OFF	V Off	V

Hint Display/setting screen of list of channel settings. Use the MENU key on the top right of this instrument to move to other setting screens, CH.SET key to move to general settings, and the TRIG.SET key to move to the optional.

**NOTE**

- Only the following display-related settings can be set to each displayed sheet.
  - Analog waveform: Display ON/OFF, waveform color, ratio, zero position, graph variable (ON/OFF, upper and lower limit)
  - Logic waveform: Display ON/OFF, waveform color, display position, and logic width
  - X-Y waveform: Display ON/OFF, waveform color, X ch, Y ch, waveform calculation (X ch, Y ch)
  - Common setting: Display format
- The measurement-related settings other than above will be common to all displayed sheets.
  - When range is changed, the range of all display sheets is changed.
- When a settings file is saved, the settings of all displayed sheets are saved.
- A waveform file is saved based on the setting of the sheet displayed at the time of saving. When a waveform file is loaded, only the sheet displayed at the time of saving can be loaded because other sheets were not saved.

You can configure the waveform calculation settings using the channel setting window.

See: "3.4 Input Channel Setting" (p.72)

## 3.5 Starting and Stopping Measurement

This section explains how to initiate and terminate a measurement.

### Procedure

To open the screen: Right-click and select **[DISP]** →Waveform screen

### Starting Measurement

Click **[START]** to start measuring.

#### **NOTE**

- When a measurement is started, waveform data that were displayed on the screen are cleared. However, when the measurement conditions are the same, the waveform data for up to 16 past measurements is retained as history.
- Measurement can also be started by inputting a signal at the external control terminal.

See: "Chapter 16 External Control (MR8741 Only)" (p.335)



#### **To prevent inadvertent measurement start**

To reduce the risk of accidentally starting a measurement through an operation error, operation conditions can be set for **[START]**.

See: "Start Action" (p.311)

#### **To automatically save data during measurement**

See: "4.2.2 Automatically Saving Waveforms" (p.88)

### Stopping Measurement

Click **[STOP]** to stop recording at the end of the specified recording length.  
Click **[STOP]** again so stop recording immediately.

The operation conditions for **[START]** and **[STOP]** can be changed.

See: "Chapter 14 System Environment Settings" (p.309)

**Note** When **[STOP]** is clicked, the following indication may appear on the screen.



The measurement will stop at the point where the mouse is clicked.

The stopping procedure is canceled and measurement continues.

**Measurement and Internal Operations**

Measurement methods are normal measurement (start recording when measurement starts) and trigger measurement (start recording when trigger criteria are satisfied). In this manual, "Measurement start" means the instant when you click **[START]**, and "Recording start" means the instant when recording begins on the waveform screen.

- Select the Trigger mode **to record upon either single or repeating trigger events**.(p.191)
- Enable pre-triggering if you want **to capture data measured prior to trigger events**.(p.204)

**Normal Measurement**

**Without triggering**

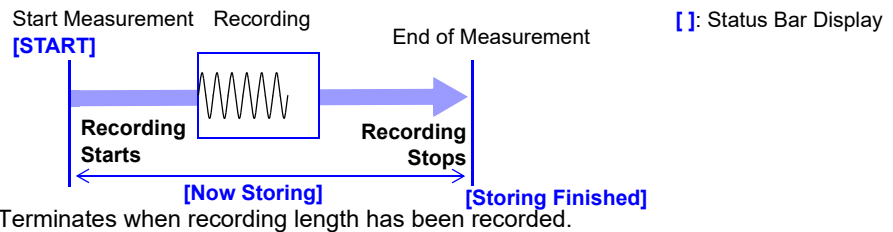

Terminates when recording length has been recorded.

**Trigger Measurement**

Trigger mode: **[Single]**  
Pre-triggering not enabled

**Single triggering**

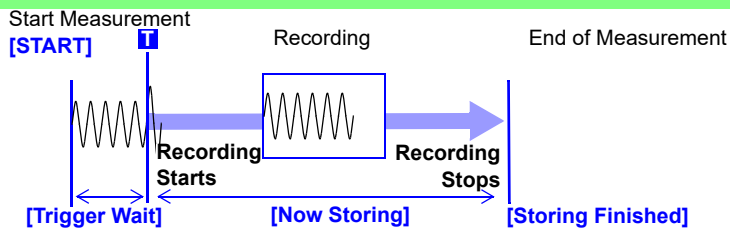

Recording starts when a trigger event occurs and continues for the specified recording length.

Trigger mode: **[Repeat]**  
Pre-triggering not enabled

**Repeated triggering**

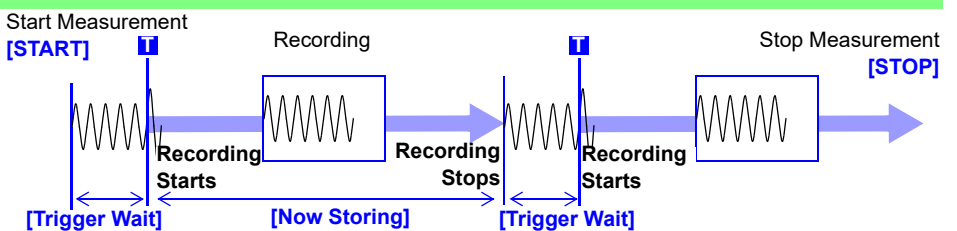

Recording starts when a trigger event occurs, continues for the specified recording length, and returns to the Trigger Wait state.

**Repeated triggering and recording of phenomena before each event**

Trigger mode: **[Repeat]**  
Pre-triggering enabled

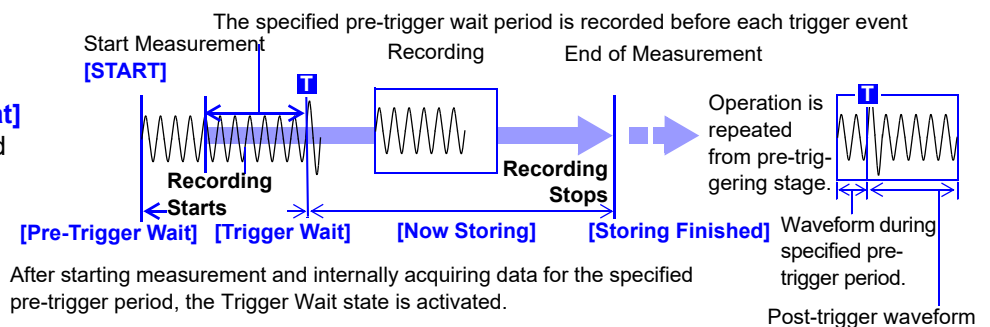

After starting measurement and internally acquiring data for the specified pre-trigger period, the Trigger Wait state is activated.

The data before a trigger event (for the pre-trigger period) is recorded.

When the trigger mode is set to **[Repeat]** or **[Auto]** (Memory function only), the number of trigger events is shown in the top part of the screen (Storage Counter).

See: "Explanation of Screen Contents" (p.20)



# Saving/Loading Data & Managing Files Chapter 4

Data can be saved and loaded and files can be managed.

Before saving data, configure the save settings on the **[File Save]** sheet.

Load data and manage files from the File screen.

4

Chapter 4 Saving/Loading Data &amp; Managing Files

## Opening the **[File Save]** sheet

Click **[SYSTEM]** in the right-click menu.

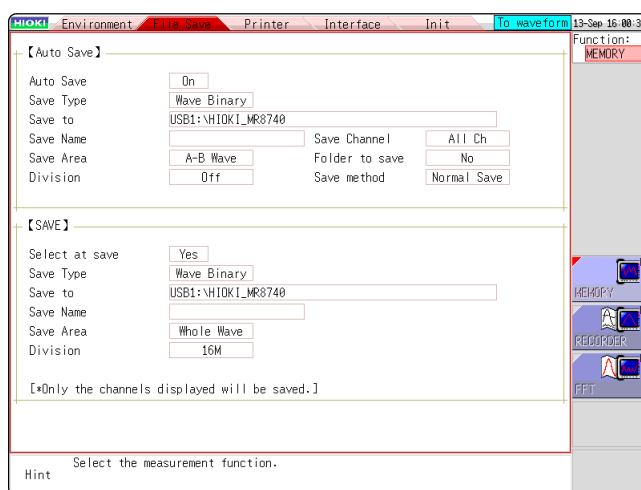
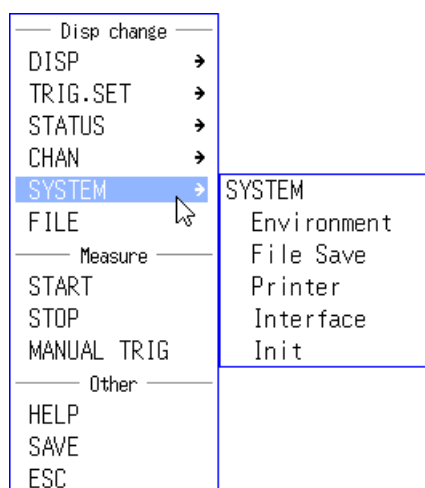

You can switch setting screens by clicking a tab.

## Operations available from the **[File Save]** sheet

### Saving Data (p.87)

#### Save Method

- Auto save
- Manual save by clicking **[SAVE]** (Selection save, Quick save)

#### Save Types

- (Auto Save) (Manual save by clicking **[SAVE]**)
- Waveform data
    - Settings data
    - Waveform data
    - Display screens
    - Waveform screen
    - Numerical calculation results (p.221)
    - Waveform evaluation area

## Opening the File screen

Click **[FILE]** in the right-click menu.

The file order will be displayed.

- △: Ascending order
- ▽: Descending order

The selected file is indicated by a flashing cursor.

Read-only files and folders are shown in blue. Deleting or re-naming such files is not possible.

Media information

Shows information about the selected media.

File Count : Shows the number of saved files in the selected folder level.

Folder Count: Shows the number of folders in the selected folder level.

Count : Shows the number of files and folders that can be created in the selected folder level.

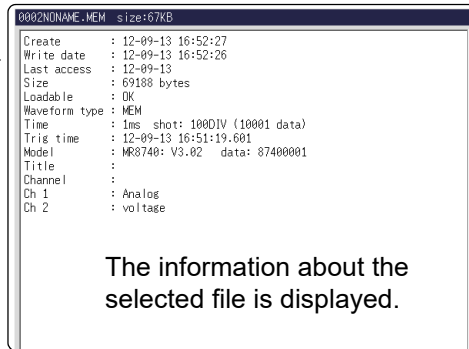
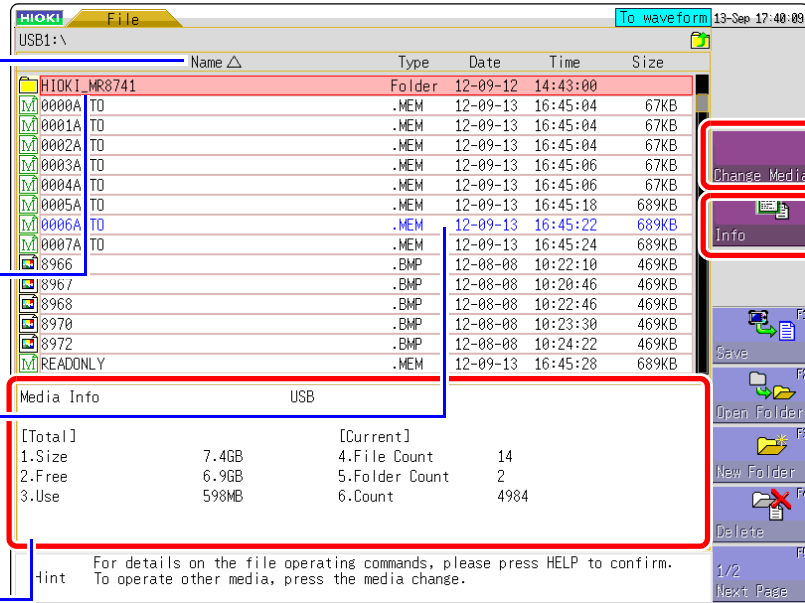

The information about the selected file is displayed.

## To change the media

- 1 Verify that a storage media is inserted.  
See: "2.3 Recording Media Preparation" (p.54)
- 2 Select **[Change Media]** and select a storage media.  
The files on the selected storage media are shown in the file list.



## Operations available from the File screen

**Formatting Storage Media** (p.55)

**Loading Data** (p.99)

**Managing Files** (p.87)















- Saving data(p.103)
- Creating new folders (p.105)
- Copying files (p.108)
- Sorting files (p.107)
- Deleting files (p.106)
- Renaming files (p.107)

## 4.1 Data capable of Being Saved & Loaded

The following kinds of data can be saved by and loaded into the instrument.

### Data the Instrument Can Save & Load

O: Possible/ -: Not Possible

File Type	File Format	Indication	File Extension & Description	Save		Load	PC Readable
				Auto	Manual		
Settings Data * <sup>1</sup>	Binary		SET Settings data (Measurement Configuration)	-	O	O	-
Waveform Data * <sup>2</sup> Whole of the waveform acquired by the instrument or a section of the waveform specified with the A and B cursors.	Binary		MEM Memory Function waveform data	O	O	O	- * <sup>4</sup>
			REC Recorder Function waveform data	O	O	O	- * <sup>4</sup>
			FFT FFT Function data	O	O	O	-
	Text		CSV Text Data	O	O	-	O
Waveform Management Data * <sup>3</sup> (Divided Saving)	(Index file)		IDX Index data for divided saving	O	O	O	-
			SEQ Index data for memory division (automatically created during batch saving)	O	O	O	-
Captured Screen Image (Display/Waveform screens)	BMP* <sup>5</sup>		BMP Image Data	-	O	-	O
Numerical Calculation Results	Text		CSV Text Data	O	O	-	O
Waveform evaluation settings Data	Binary		ARE Settings data (MR8741 only) (measurement conditions + waveform evaluation areas)	-	O	O	-
Waveform evaluation area	BMP		BMP Waveform evaluation area image data (MR8741 only)	-	O	O	O
Arbitrary waveform data	Binary		WFG Arbitrary waveform data (For U8793)	-	O	O	-
	Text		TFG Arbitrary waveform data (For U8793)	-	-	O	O
Arbitrary waveform data	Binary		PLS Pulse pattern data (For MR8791)	-	O	O	-
Generation program data	Program		FGP Generation program data (For U8793)	-	O	O	-

\*1: Multiple data can be saved in the instrument, and loaded selectively. Automatic loading at power-on is also possible.

\*2: When the data is to be reloaded on the instrument, save it in binary format. Waveforms and some measurement settings are saved.

When the data is to be loaded on a PC, save it in text format. (p.87)

When saving a section of a waveform, use the A and B cursors to set the section. (p.120), (p.124)

\*3: When you want to use memory division and load all blocks at the same time:

Save measurement data using **[All blocks]**. A directory is automatically created and waveform data for each block and index data (SEQ) is created. When loading, load this index data.

When loading waveform data of divided saving: Import the IDX index data.

\*4: Loading is possible with the Wave Viewer (Wv).

\*5: This is a standard Windows® graphics format. File in this format can be handled by many graphics programs.



 : File type cannot be handled by MR8740/MR8741.



### **NOTE**

Files larger than 2 GB cannot be saved.

### **Data Not Loadable on the Instrument**

- Data saved on devices other than the MR8740/MR8741 Memory HiCorder, MR8847s Memory HiCorder, and MR8827 Memory HiCorder.
- Image files other than waveform evaluation areas ()
-  file

## 4.2 Saving Data

### 4.2.1 Save Types and Workflow

There are basically three types of save operations.

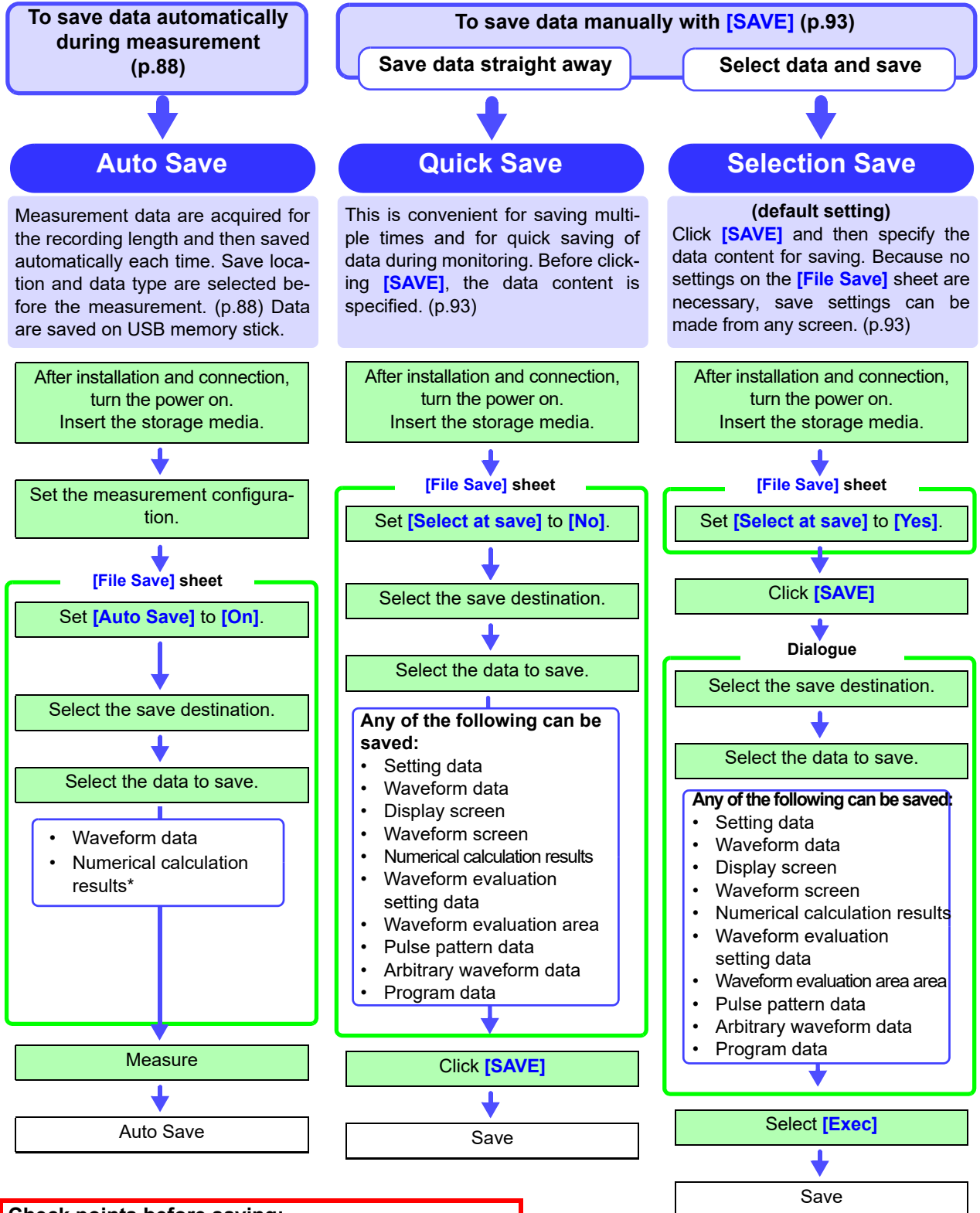

**Check points before saving:**

- Media inserted and initialized? (p.54), (p.55)
- Save target specified correctly?
- Auto Save set to **[On]**? (For auto-saving)

**\*: To save numerical calculation results**  
See: "9.4 Saving Numerical Calculation Results" (p.221)

## 4.2.2 Automatically Saving Waveforms

Measurement data are acquired for the recording length and then saved automatically each time. Save location and data type are selected before the measurement. Waveform data can be saved.

### Procedure

To open the screen: Right-click and select [SYSTEM] → [File Save] sheet

- 1 Enable auto save.**  
Move the flashing cursor to the [Auto Save] item, and select [On].  
Default setting: Off (automatic saving is not performed)

- 2 Set the save type.**  
Move the flashing cursor to the [Save Type] item.

Select

<b>Wave Binary</b>	Save the waveform data in binary format. (Data saved in binary format can only be loaded to this instrument.)
<b>Wave Text</b>	Save the waveform data in text format. The data can be thinned out and then saved. (This data can be opened by a computer editor or spreadsheet software, but it cannot be loaded to this unit.)

- 3 Set the save destination.**  
Move the flashing cursor to the [Save To], and select [Edit].  
The Browse folders dialog box appears (at bottom right).

Move the flashing cursor to the save target media\* and confirm the setting with [Confirm].

Select

<b>USB1</b>	Automatically save the waveform data on the USB memory stick.
<b>LAN</b>	Automatically save the waveform data on the PC connected via LAN. Model 9333 LAN Communicator is required to be installed.

When the root directory (topmost folder on media) was selected, a folder named "HIOKI\_MR8740" or "HIOKI\_MR8741" is created automatically. (If the media was initialized in the instrument, the folder will already have been created.) This folder is then used as save target.

To create a new folder, select [New Folder]. When [LAN] is set as the save destination, [New Folder] setting is ignored and the folder named with the current date is created.

- 4 Set the file name.**  
Move the flashing cursor to the [Save Name], and enter the save name.

See: "7.1.3 Alphanumeric Input" (p.141)

When [LAN] is set as the save destination, [Save Name] setting is ignored and the files to be saved are named in the previously-determined format.

See: "Save Operations (When setting the save destination to [LAN])"(p.92)

### NOTE

#### File name

The maximum number of characters for the [Save Name] string is 123. The maximum path length including file name is 255 characters.

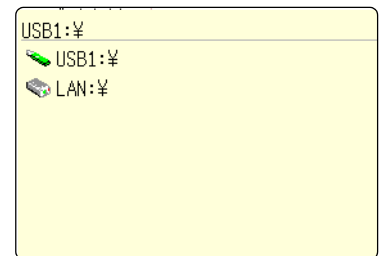
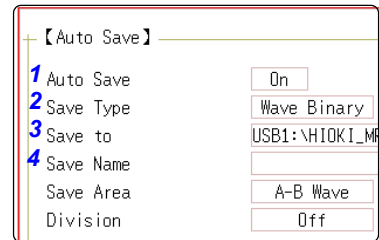

**5 Select the save area.**

Move the flashing cursor to the **[Save Area]** item.

Select

<b>Whole Wave</b>	Save all recorded data. (default setting)
<b>A-B Wave</b>	Save the data between the A and B cursors. If only the A cursor is used, the range from the A cursor position to the end of the data is saved. A/B cursor Specification Method (p.120)

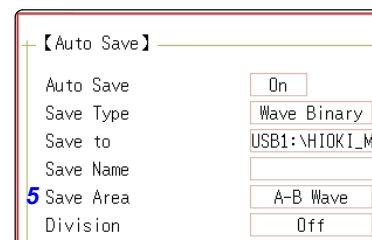
**6 (When [Wave Binary] is the selected save type)**

**Select whether to save divided files**

Move the flashing cursor to the **[Division]** item.

Select

<b>Off</b>	Files are not divided when saved.
<b>16M, 32M 64M</b>	Select the size for divided save.

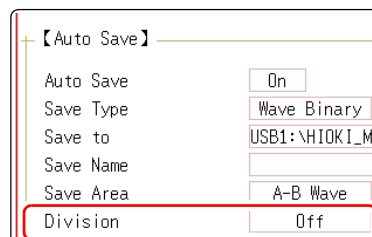

**(When [Wave Text] is selected as the save type)**

**Set the data thinning number.**

Move the flashing cursor to the **[Save Thin]** item.

Select

<b>Off</b>	Data thinning (sub-sampling) is not carried out.
<b>1/2 to 1/1000</b>	Set the thinning number (out of how many data items to leave one data item remaining).

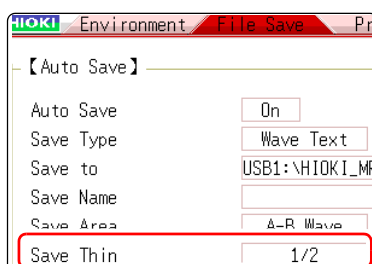
**NOTE****About the save area**

- If the MR8990 is installed, one data item more than the number of data items specified with the A and B cursors may be saved.
- The data that is measured and saved with the MR8990 will be the same data twice in a row.

**About divided saving**

- Large quantities of waveform data can be divided and saved as multiple files.
- Saving divided data makes a folder automatically, and creates one or more waveform files and an index (IDX) file in the folder.
- Then by loading the IDX file, the data in the waveform file(s) is loaded as a batch.
- When divided saving is selected, delete save is not available.
- When using the memory division function, divided saving cannot be performed automatically.

See: "Batch load of waveform data"(p.101)  
"Memory Division Function"(p.241)

**Thinning**

A large amount of space is required for saving files in text format. Data thinning enables a reduction in file size.

Example: When **[1/2]** is set, every second data item is saved. The number of data items is reduced to a 1/2.

**7 Select the channel to save.**

Move the flashing cursor to the **[Save Channel]** item.

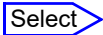

<b>Disp Ch</b>	Saves the channels of all sheets for which waveform display is set to <b>[On]</b> . (default setting)
<b>All Ch</b>	Saves all measured channels (in the case of the memory function, channels has been set as <b>[Used Ch]</b> on the Status settings screen).

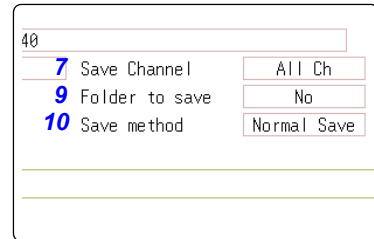

**8 Specify the action if a file with the same name exists in the target folder.**

Move the cursor to **[Same Name]**.

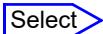

<b>Auto</b>	If no files with the same name exist, saves the file with the designated name. Otherwise, a 4-digit number is automatically added to the beginning of the file name (default setting). If the first character of the file name is a numeral, the added number will continue sequentially from that number.
<b>Serial</b>	Unconditionally, a 4-digit number is automatically added to the beginning of the file name. If a file with the same name exists, saves the file, adding the 4-digit number that is increased by 1.

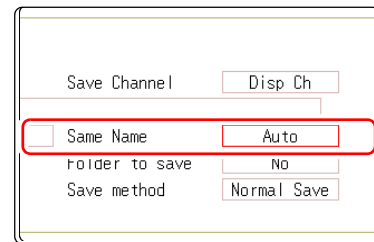

**9 Set whether to create folders.**

Move the flashing cursor to the **[Folder to save]** item.

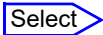

<b>No</b>	A folder is not created when measurement starts.
<b>Yes</b>	A folder is created automatically when measurement starts and files are saved in the folder.

When **[LAN]** is set as the save destination, **[New Folder]** setting is ignored and the folder named with the current date is created.

**10 Set the save method for when the storage media runs out of space.**

Move the flashing cursor to the **[Save method]** item.

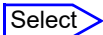

<b>Normal Save</b>	Automatic saving stops when the storage media becomes full.
<b>Delete Save</b>	Old files are deleted and automatic saving is performed when the storage media becomes full. (Waveform files only.) The <b>[Folder to save]</b> setting is set automatically to <b>[Yes]</b> .

When **[LAN]** is set as the save destination, **[Save Name]** setting is ignored and the files to be saved are named in the previously-determined format.

See: "Save Operations (When setting the save destination to [LAN])"(p.92)

**11 Confirm the measurement configuration and other settings, then start measurement (**[START]**).**

After the data is acquired, the screen image is saved automatically to the specified storage media.

**NOTE**

**Maximum number of files per folder**

The combined maximum for files and folders created in one folder is 5,000.

See: "Save Operations (When setting the save destination to [LAN])"(p.92)



**To clear the Auto Save dialog box**

Click **[SAVE]** to turn the dialog box display on and off.

**Auto Save Operations (When setting the save destination to the recording media)**

**Example 1: Saving Files to the Topmost Directory of the Storage Media**  
(A folder named "HIOKI\_MR8740 " is created and file is saved there)

Save To:	USB:HIOKI_MR8740
Save method:	Normal Save
Folder to save:	No

**When the storage media becomes full:**  
Automatic saving stops.

**Example 2: Saving Files to a Folder on Storage Media**

Save To:	USB:HIOKI_MR8740 \TEST
Save method:	Normal Save
Folder to save:	No

Create a folder named "TEST" on the USB memory stick beforehand.)

**When the storage media becomes full: Automatic saving stops.**

**Example 3: Create folder on media automatically and save data there**

Save To:	USB:HIOKI_MR8740
Save method:	Normal Save
Folder to save:	Yes

**When the storage media becomes full:**  
Automatic saving stop.

**Example 4: Using Delete/Save to Automatically Save Data**

Save To:	USB:HIOKI_MR8740 or specified folder in "HIOKI_MR8740" folder
Save method:	Delete Save
Folder to save:	No

When the number of files in the folder has reached 5,000, or when the storage media has become full, files in the AUTO014530 folder (or specified folder) will automatically be deleted in sequence, starting from the oldest file, and replaced by new files. (Only waveform files are deleted.)

**Example 5: Saving data in an existing folder on the media using divided saving**

Save To: USB:\HIOKI\_MR8740\TEST  
 Save method: Normal Save  
 Folder to save: No

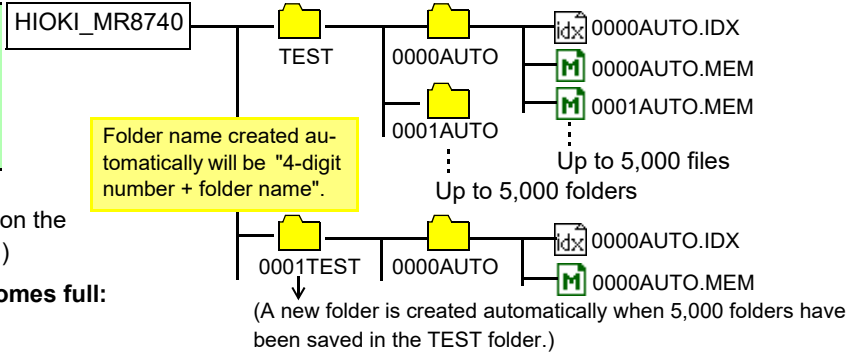

Create a folder named "TEST" on the USB memory stick beforehand.)

**When the storage media becomes full: Automatic saving stops.**

**Example 6: Saving data in an automatically created folder on the media using divided saving**

Save To: USB:\HIOKI\_MR8740  
 Save method: Normal Save  
 Folder to save: Yes

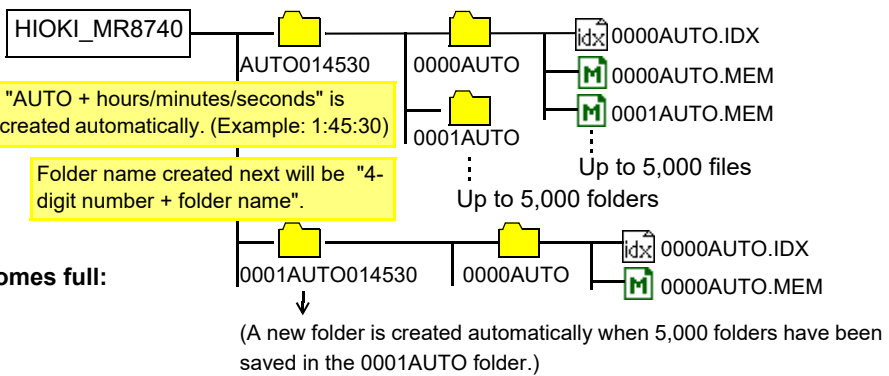

**When the storage media becomes full: Automatic saving stop.**

**Save Operations (When setting the save destination to [LAN])**

The file is saved according to the method (on the right figure) specified under [Save Settings] by using Model 9333 LAN Communicator.

For more information about how to configure the save settings, see the instruction manual of Model 9333 LAN Communicator.

The destination folders and files are named in the previously-determined formats as follows:

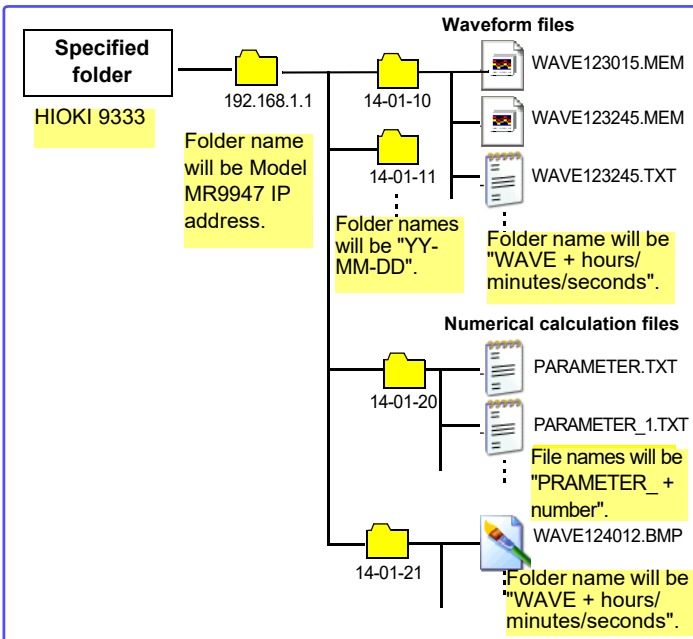
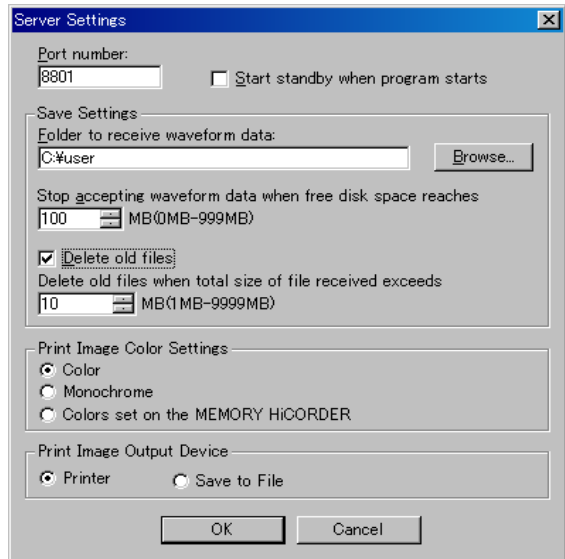

## 4.2.3 Saving Data Selectively (SAVE)

To perform quick saving by clicking **[SAVE]** in the right-click menu, you need to set the saving conditions beforehand. The type of data to be saved are as following. (Settings data, waveform data, display screens, waveform screen, numerical calculation results)

### Procedure

To open the screen: Right-click and select **[SYSTEM]** → **[File Save]** sheet

#### 1 Set the save method for when **[SAVE]** is clicked.

Move the flashing cursor to the **[Select at save]** item, and select **[No]**.

Select

**Yes** After clicking **[SAVE]**, set the data to save in the dialog box, then save the data. (default setting)  
See: "Selection Save"(p.87)

**No** The preset data is saved upon clicking **[SAVE]**.  
See: "Quick Save"(p.87)

When **[Yes]** is selected, the following setting determines which dialog box appears when clicking **[SAVE]**. (Middle screen at right)

However, this is not applicable when other dialogs such as "Folder Reference Dialog" are shown on the screen.

#### 2 Set the save destination.

Move the flashing cursor to the **[Save To]**, and select **[Edit]**.

The Browse folders dialog box appears (at bottom right).

Move the flashing cursor to the save target media\* and confirm the setting with **[Confirm]**.

Select

**USB1** Automatically save the waveform data on the USB memory stick.

**LAN** Automatically save the waveform data on the PC connected via LAN. Model 9333 LAN Communicator is required to be installed.

When the root directory (topmost folder on media) was selected, a folder named "HIOKI\_MR8740" or "HIOKI\_MR8741" is created automatically. (If the media was initialized in the instrument, the folder will already have been created.) This folder is then used as save target.

To create a new folder, select **[New Folder]**. When **[LAN]** is set as the save destination, **[New Folder]** setting is ignored and the folder named with the current date is created.

#### 3 Set the file name.

Move the flashing cursor to the **[Save Name]**, and enter a save name.

See: "7.1.3 Alphanumeric Input" (□ p.141)

When **[LAN]** is set as the save destination, **[Save Name]** setting is ignored and the files to be saved are named in the previously-determined format.

See: "Save Operations (When setting the save destination to [LAN])"(p.92)

### NOTE

#### File Name

The maximum number of characters for the **[Save Name]** string is 123. The maximum path length including file name is 255 characters.



**4 Specify the action if a file with the same name exists in the target folder.**

Move the cursor to **[Same Name]**.

Select

<b>Auto</b>	If no files with the same name exist, saves the file with the designated name. Otherwise, a 4-digit number is automatically added to the beginning of the file name (default setting). If the first character of the file name is a numeral, the added number will continue sequentially from that number.
<b>Serial</b>	Unconditionally, a 4-digit number is automatically added to the beginning of the file name. If a file with the same name exists, saves the file, adding the 4-digit number that is increased by 1.

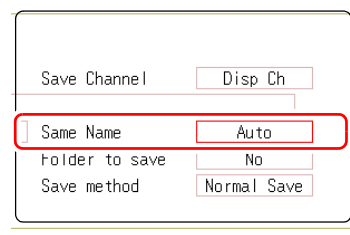

**5 Set the data to save.**

Move the flashing cursor to the **[Save Type]** item.

Select

<b>Set</b>	Save the settings data.
<b>Wave Binary</b>	Save waveform data in binary format. Select this to reload the waveform into the instrument.
<b>Wave Text</b>	Save waveform data in text format. Select this to use the waveform in a PC. (Memory/Recorder/FFT Function only)
<b>ALL-Wave Bin</b>	Data of all blocks is saved in binary format. (Only when the memory division setting is On.)
<b>ALL-Wave Txt</b>	Data of all blocks is saved in text format. (When the memory division setting is On)
<b>Screen Copy</b>	Save screen display data as a BMP file. Data saved in BMP format can be displayed on a PC with image viewing software.
<b>Wave Image</b>	Convert the waveform data to a paper image and save it in BMP format. Data saved in BMP format can be displayed on a PC with image viewing software.
<b>Calc Result</b>	Save the numerical calculation results. (Memory Function only)
<b>Waveform evaluation setting</b>	Save settings data and waveform evaluation areas. (MR8741 only)
<b>Waveform evaluation area</b>	Save evaluation areas created with the waveform evaluation function as black-and-white BMP files. Saved data can be edited on a computer and loaded back into the instrument. (MR8741 only) Edit images in black and white only.
<b>Pulse pattern</b>	Saves pulse patterns registered in the MR8791.
<b>Arbitrary waveform</b>	Saves arbitrary waveforms registered in the U8793.
<b>Program</b>	Saves program data registered in the U8793.

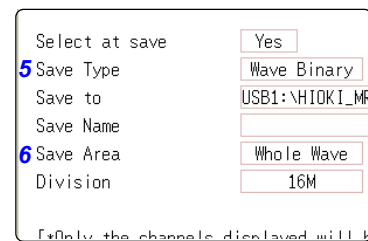

**6 (When Wave Binary or Wave Text was selected) Set the save area.**

Move the flashing cursor to the **[Save Area]** item.

Select

<b>Whole Wave</b>	Save all recorded data.(default setting)
<b>A-B Wave</b>	Data between the A/B cursor pair are saved. If only cursor A is used, all data after the cursor are saved. (A/B Cursor Specification Method (p.124))

The channel displayed on the screen will be saved.

**NOTE**

- If the MR8990 is installed, one data item more than the number of data items specified with the A and B cursors may be saved.
- The data that is measured and saved with the MR8990 will be the same data twice in a row.

**7 Making advanced settings**

Available settings will differ, depending on the save type. Refer to the table below.

Save Type	Settings	Description
<b>Setting</b>	-	-
<b>Wave Binary</b>	<b>Division</b> (Off, 16 M, 32 M, 64 M)	Select this to divide a large file into several files for saving. A folder with the specified name is created and data are saved as multiple files in that folder.
<b>Wave Text</b>	<b>Save Thin</b> (Off, 1/2 to 1/1000)	Select this to use thinning (sub-sampling) when saving data. Only a specified subset (one out of several data) is retained.
<b>Screen Copy (Hard copy of the display)</b>	<b>Image Color</b> (Color, Gray, Mono, Mono (Rev))	Specifies the color for the created image file.
	<b>Image size</b> (UnCompressed, Compressed)	Determines whether the image file is compressed.
	<b>Save GUI</b> (Yes, No)	Determines whether the GUI section is also saved.
<b>Wave Image (Print Image)</b>	<b>Output File</b> (All, 1 to 250)	Specifies the number of files to save. (Memory Function and Recorder Function)
	<b>Wave Image Shot</b> (1 to 60 div)	Specifies the data volume per file. If the number of measurement data is lower than the number of selected divisions, only the number of measurement data will be saved. (Memory Function and Recorder Function)
<b>Calc Result</b>	<b>Folder to save</b> (New File, Existing File)	Determines whether data are saved under a new file name every time (with automatically incremented number if the same file name exists), or appended to the same file.

**8 (For memory function)**

**When using the memory division function**

**Select the blocks to be saved**

Move the flashing cursor to the **[Save Block]**.

Select

<b>All Blks</b>	Blocks with waveforms are all saved.
<b>Start-End</b>	All used blocks from the start block are saved.

This completes the data save settings. When **[SAVE]** is clicked, the saving operation will use these settings.

**NOTE**

If **[Image size]** is used when saving a display image file, the image may not be viewable with some image viewer applications.

## 4.2.4 Saving Example (Saving for Memory Division)

For details on mouse operations for basic file screens, see "1.5.7 File Operations" (p.34).

### Saving a Memory Division Waveform File

- 1 Configure the memory division settings, and then perform measurement.**  
See: "Chapter 11 Memory Division Function" (p.241)

- 2 Right-click to display the list menu, and then click [SAVE].**

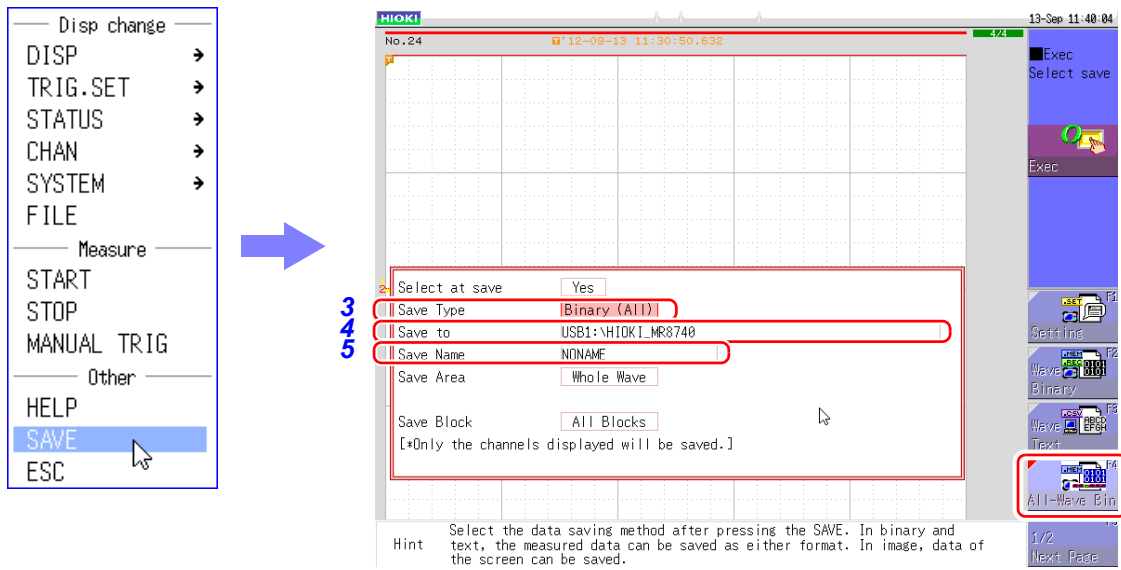

- 3 Set [Save Type] to [ALL-Wave Bin].**  
(The setting item indication is "ALL Bin".)

If you select [Wave Binary] instead of [ALL-Wave Bin] here, the data of the currently displayed block is saved.

- 4 Set [Save To].**  
See: "4.2.3 Saving Data Selectively (SAVE)" (p.93)
- 5 Set [Save Name].**  
See: "4.2.3 Saving Data Selectively (SAVE)" (p.93)

**6** Set [Save Area].  
(All waveforms or waveforms between A and B)

**7** Set [Save Block].

[All Blks]

Saves all blocks with waveforms.

[Start-End]

Saves all blocks from the start block to the end block.

**8** Configure each setting, and then click [Exec].

When the data is saved, a folder is created under the name set as the save name, and the waveform data of each block and the SEQ file (memory block integration file) are saved in that folder.

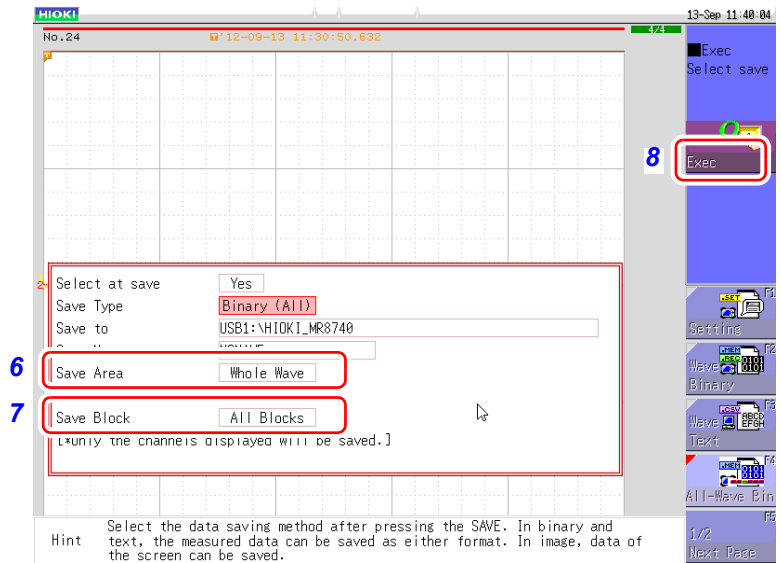

## 4.2.5 Save Waveform Output Data to the Media

The pulse pattern data registered in Model MR8791, arbitrary waveform data registered in Model U8793, or program data is saved in the media.

Before attempting to save the data, make sure that the storage media is inserted and the loading target is correctly specified.

**Procedure:**

To open the screen: press the FILE key to display the [File] sheet.

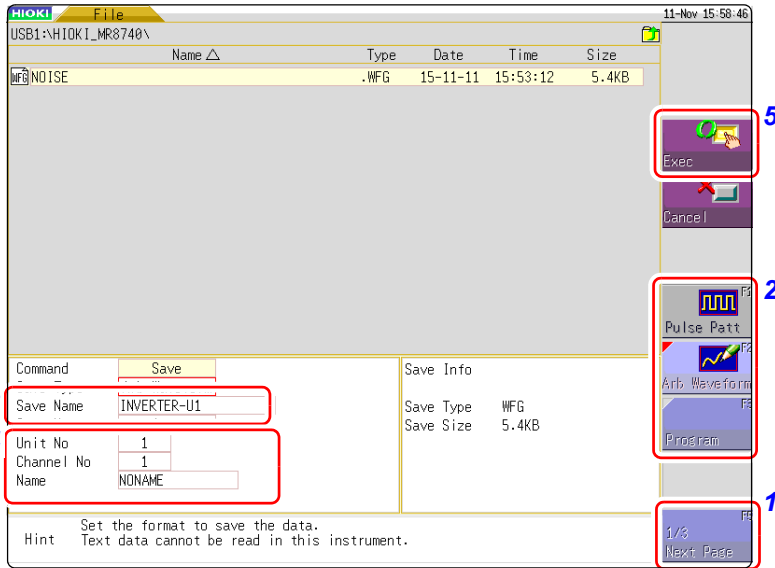

- 1** Press [Next Page].
- 2** Select [Pulse Patt], [Arb Waveform], or [Program].
- 3** Enter a [Save Name].
- 4** Register a [Unit No], a [Channel No], and a [Name] of the MR8791 or the U8793.
- 5** Press [Exec].  
The data registered in the module is saved to the media.

Refer to the instruction manual of Models U8793, MR8790, and MR8791 regarding each detailed save settings.

## 4.3 Loading Data

Data saved on media or in the internal memory of the instrument can be reloaded.

### Data Loading Workflow

Before attempting to load data, make sure that the storage media is inserted and the loading target is correctly specified.

Only settings and measurement data saved in binary format can be loaded into the instrument.

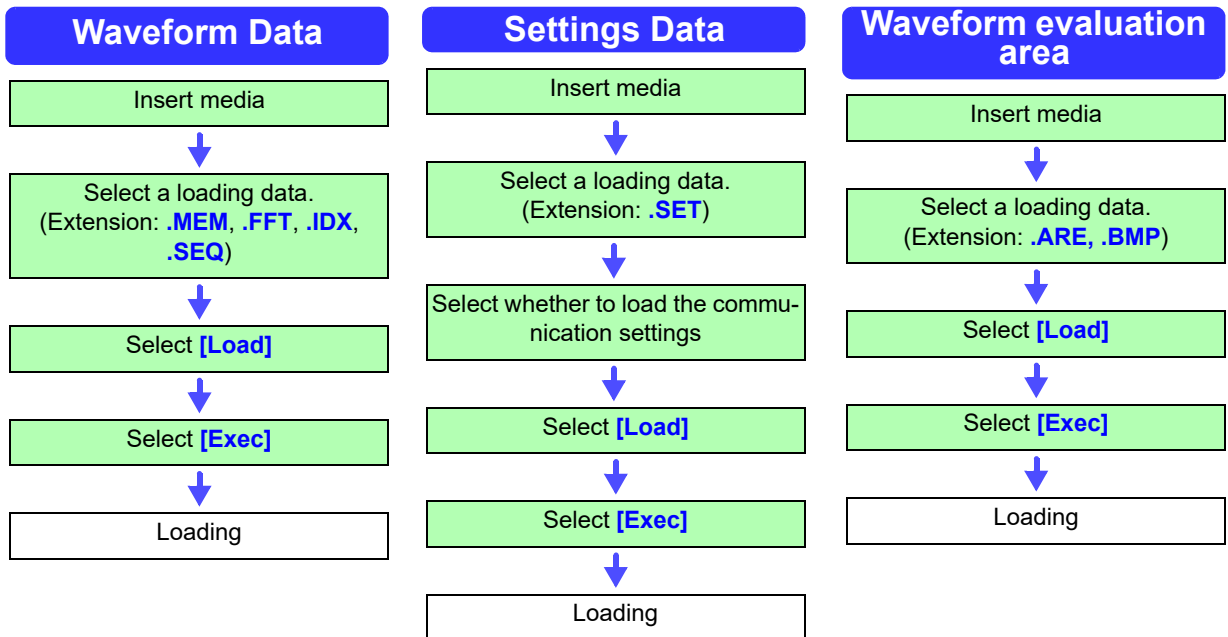

Refer to "7.10 Register the Waveform in the U8793 Arbitrary Waveform Generator Unit" (p.184), or the instruction manual of Models U8793, MR8790, and MR8791 regarding the detailed settings for loading (registration) of pulse pattern data, arbitrary waveform data, program data.

### Loading the Communication Settings

When loading settings data, you can select whether to load communication settings such as the IP address of the LAN.

No: Does not load the communication settings.  
(Default setting)

Yes: Loads the communication settings.

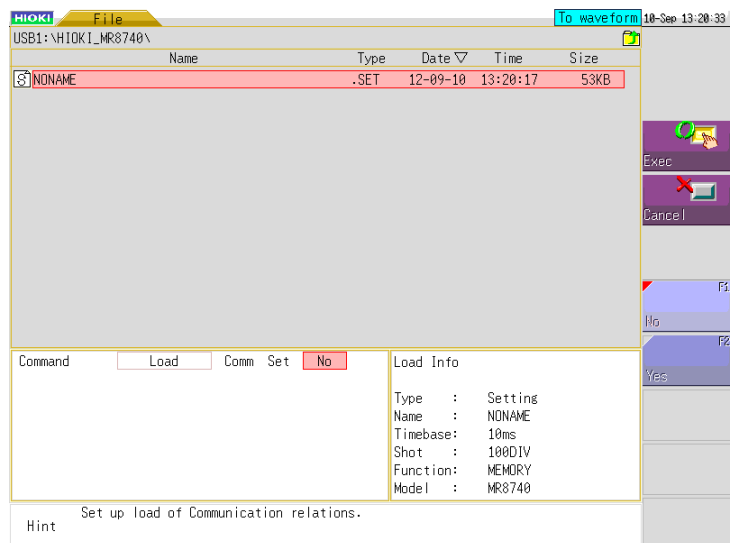

**NOTE**

Please note that the currently set IP address and other communication settings will be overwritten if the loading of the communication settings is set to [Yes] and a setting file is loaded.

**Loading Example (Loading a Memory Division File)**

**1** Right-click to display the list menu, and then click **[FILE]**.

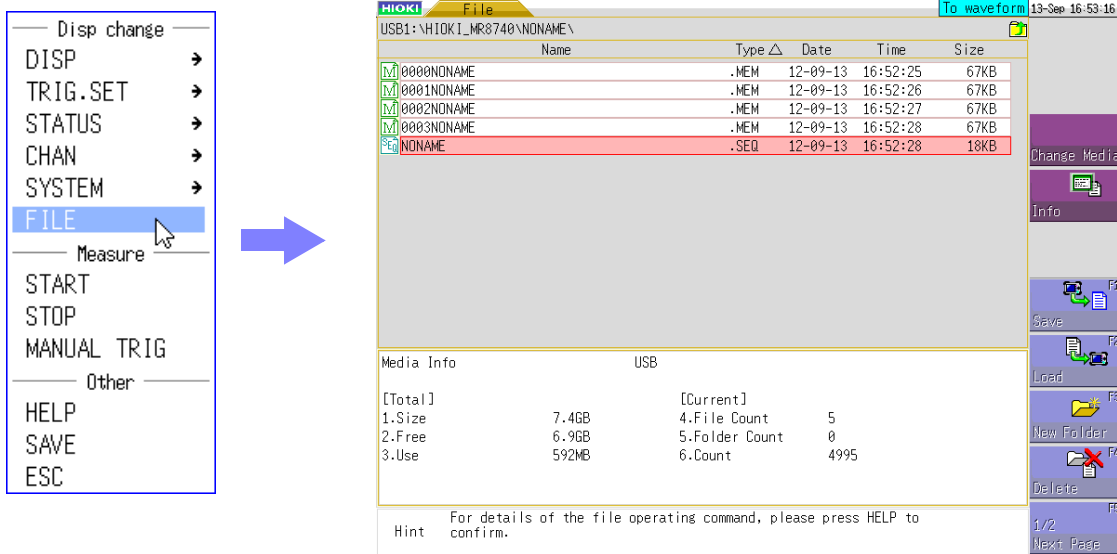

**2** Double-click the SEQ file in the folder created in **step 8** of "Saving a Memory Division Waveform File", and then click **[Exec]** to load the waveform data on the instrument so that it becomes the same as when each memory block was saved.

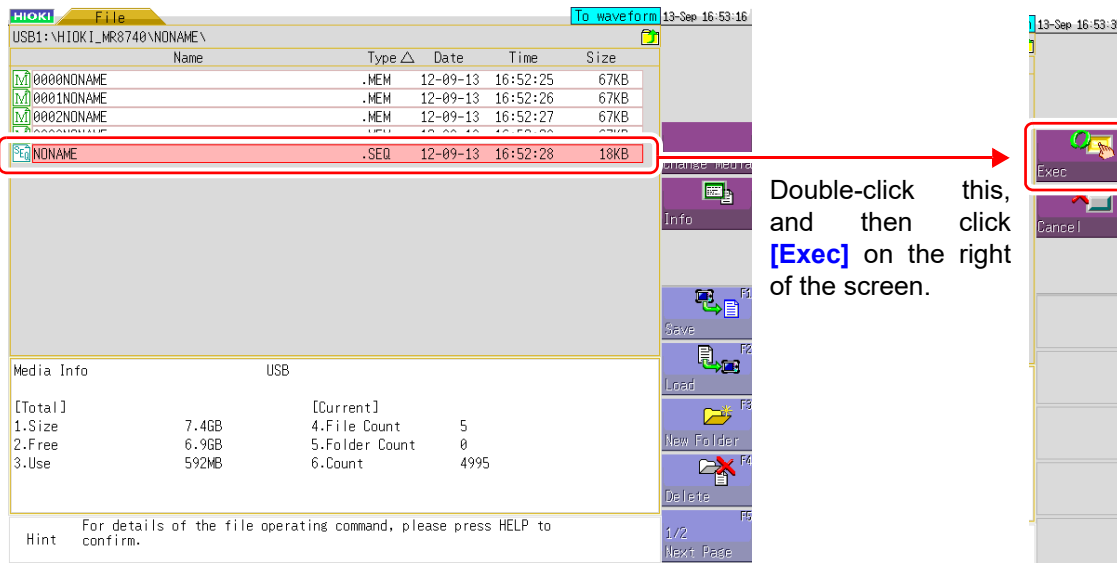

**3** Double-click a MEM file in the folder created in **step 8** of "Saving a Memory Division Waveform File", and then click **[Exec]** to load only the waveform data of that block to the instrument.

**NOTE**

When loading from a source other than the internal memory Insert the storage media before making the media selection.

**Other limitations**

- Data saved with Memory HiCorders other than the MR8740/MR8741, MR8847s and MR8827 cannot be loaded.
- When loading waveform data, the settings for the instrument are the same settings as when the data is saved. To reset to the instrument settings, carry out **[Clear Wave Data]** (p.376) or start the measurement.

## Batch load of waveform data

When the following index files are loaded, waveform data can be loaded as a batch. With the following settings, index files are created along with waveform files.

Extension	Explanation
<b>IDX</b>	Divided files are loaded together. (To create index files: Use <b>[Division]</b> at the <b>[File Save]</b> sheet of the System screen to set the dividing size and then save. Note: If <b>[Save type]</b> is not <b>[Wave Binary]</b> , index files are not created) See: "4.2.2 Automatically Saving Waveforms" (p.88) "4.2.3 Saving Data Selectively (SAVE)" (p.93)
<b>SEQ</b>	(When using the memory division function of the memory function) Waveform data of all blocks is loaded together. (To create index files: At the <b>[Memory Div]</b> sheet of the Status Screen, set <b>[Memory Div]</b> to <b>[On]</b> . At the <b>[File Save]</b> sheet of the System Screen, set <b>[Save Type]</b> to <b>[ALL-Wave Bin]</b> .) See: "11.1 Recording Settings" (p.243) "4.2.3 Saving Data Selectively (SAVE)" (p.93)

## Loading a waveform evaluation area (MR8741 only)

Files with the following two extensions can be loaded:

Extension	Explanation
<b>ARE</b>	<b>Loads waveform evaluation areas and settings data (files saved by selecting "Area settings" when saving the data).</b>
<b>BMP</b>	<b>Loads waveform evaluation areas. (Files saved by selecting "Area image" when saving the data can be edited on a computer and then loaded back into the instrument.)</b>

## Data Loading for Waveform Generation (Registration)

You can load data for generated modules.

Data loading is performed on Signal generator sheet of Channel screen (**CHAN** key) or FILE screen (**FILE** key). For details, see the instruction manual of Models U8793, MR8790, and MR8791.

Extension	Explanation
<b>WFG, TFG</b>	<b>The data for waveform generation is loaded in channels of a specified arbitrary waveform generator module. The waveform data loaded (registered) is output from Model U8793 Arbitrary Waveform Generator Unit. Refer to "7.10 Register the Waveform in the U8793 Arbitrary Waveform Generator Unit" (p.184)</b>
<b>PLS</b>	<b>The data for pulse pattern generation is loaded in channels of a specified arbitrary wave generator module. The pulse pattern waveform loaded (registered) is output from Model MR8791 Pulse Generator Unit.</b>
<b>FGP</b>	<b>The waveform generation program file is loaded in channels of a specified arbitrary waveform generator module.</b>



## 4.4 Managing Files

Click **[FILE]** to display the File screen. Data saved to storage media can be managed on the File screen.

Select a file from the file list.

### **NOTE**

Before performing an operation, insert the storage media. When no storage media is inserted, "NO FILE" appears in the file list of the File screen.

### List of File Operations

Function indication (GUI)	Description	Reference page
<b>Media Change</b>	Change media.	(p.84)
<b>Save</b>	Select channels and save settings data and waveform data as files.	(p.103)
<b>Sort</b>	Sort files on file list in selected order.	(p.107)
<b>Open Folder</b>	Open the selected folder.	(p.105)
<b>Load</b>	Load settings data or waveform data from a file.	(p.99)
<b>Copy</b>	Copy a file to a specified folder. If selected item is a folder, move to that folder.	(p.108)
<b>New Folder</b>	Create a new folder.	(p.105)
<b>Rename</b>	Change a file name or folder name.	(p.107)
<b>Delete</b>	Delete a file or folder.	(p.106)
<b>Format</b>	Format selected storage media.	(p.55)
<b>Next Page</b>	Switch operation indication (GUI).	

## 4.4.1 Saving

You can save settings data or waveform data on storage media. Data will be saved in the folder indicated by the cursor. By using the A/B cursor pair, waveform data can be saved partially.

### Procedure

To open the screen: Right-click and select **[FILE]** → File screen

To change the media: (p.84)

- 1 **Select storage media for saving.**  
See: "To change the media"(p.84)
- 2 **Move the flashing cursor into the folder to save.**
- 3 **Set the data to save.**  
Select **[Save]** and then select **[Save Type]**.

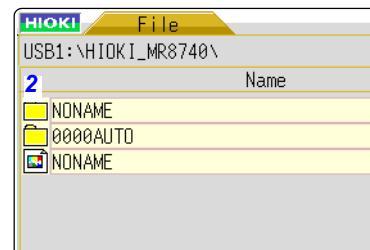

\*Refer to Appendix 2.4 Save Waveform Output Data to the Media.

<b>Setting</b>	Settings data
<b>Wave Binary</b>	Waveform data (Binary)
<b>Wave Text</b>	Waveform data (Text) (Memory/FFT Function)
<b>Numeric value calculation results</b>	Numeric value calculation results (Text)
<b>Waveform evaluation settings</b>	Settings data and evaluation area (MR8741 only)
<b>Waveform evaluation area</b>	Evaluation area (MR8741 only)
<b>Pulse pattern</b>	Pulse pattern data registered in the MR8791*
<b>Arbitrary waveform</b>	Arbitrary waveform data registered in the U8793*
<b>Program</b>	Program data registered in the U8793*

\*Refer to "4.2.5 Save Waveform Output Data to the Media" (p.98) for more information about how to save data.

- 4 **Set the file name.**  
Move the flashing cursor to the **[Save Name]** item.  
Enter the save name.  
See: "7.1.3 Alphanumeric Input" (p.141)
- 5 **Specify the action if a file with the same name exists in the target folder.**  
Move the flashing cursor to the **[Same Name]** item.

Select

<b>Auto</b>	If no files with the same name exist, saves the file with the designated name. Otherwise, a 4-digit number is automatically added to the beginning of the file name (default setting). If the first character of the file name is a numeral, the added number will continue sequentially from that number.
<b>Serial</b>	Unconditionally, a 4-digit number is automatically added to the beginning of the file name. If a file with the same name exists, saves the file, adding the 4-digit number that is increased by 1.
<b>Overwrite</b>	Saves the file with the designated name.
<b>Error</b>	If a file with the same name exists, an error message will be displayed.

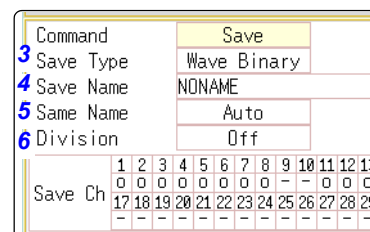

- Data saved with the "Text" option is only for loading to a PC and cannot be loaded back into the instrument. To reload the data later into the instrument, use the "Binary" option.
- When **[Memory (Int)]** is selected as storage media, only settings data can be saved.
- The waveform evaluation area you have created can be saved as a black-and-white BMP file. Saved data can be edited on a computer and loaded back into the instrument. Edit images in black and white only.

### 6 (When [Wave Binary] is the selected save type) Select whether to save divided files.

Move the flashing cursor to the [Division] item.

Select	
Off	Files are not divided when saved.
16M, 32M, 64M	Select the size for Divided Save.

See: "About divided saving"(p.104)

### (When [Text] is the selected save type) Set the data thinning number.

Set the data thinning number.

Move the flashing cursor to the [Save Thin] item.

Select	
Off	Data thinning (sub-sampling) is not carried out.
1/2 to 1/1000	Set the thinning number (out of how many data items to leave one data item remaining).

Command	Save
Save Type	Wave Text
Save Name	NONAME
Save Name	Auto
Save Thin	Off
Save Ch	1 2 3 4 5 6 7 8 9 10 11 12 13 14 15 16 17 18 19 20 21 22 23 24 25 26 27 28 29 30

### 7 Select the channels to save.

Move the flashing cursor to the save channel item.

	Analog Channels																Logic Channels		Waveform Calculation (When [Wave Calculation] is [On])	
Save Ch	1	2	3	4	5	6	7	8	9	10	11	12	13	14	15	16	Save L	Z		
	0	0	0	0	0	0	0	0	0	0	0	0	0	0	0	0	L	ALL		
	-	-	-	-	-	-	-	-	-	-	-	-	-	-	-	-	o	o		

Select	
-	Channel will not be saved.
o	Channel will be saved.
All Ch	Saves waveforms acquired across all channels (analog, logic, calculated waveforms).
Reset	Return to previous settings.

### 8 Execute the save operation.

Select [Exec].

#### **NOTE**

#### File name

The maximum number of characters for the [Save Name] string is 123. The maximum path length including file name is 255 characters.

#### About divided saving

Large quantities of waveform data can be divided and saved as multiple files. Saving divided data creates one or more waveform files and an index (IDX) file. Then by loading the IDX file, the data in the waveform file(s) is loaded as a batch.

See: "Batch load of waveform data"(p.101)

#### Other limitations

Text format data cannot be loaded into the instrument.

## 4.4.2 Checking the Contents of a Folder (Open a Folder)

See the contents of a selected folder (by opening that folder).

### Procedure

To open the screen: Right-click and select **[FILE]** → File screen

To change the media: (p.84)

- 1 Move the flashing cursor to the folder whose contents you want to see.
- 2 Click **[Open Folder]**.  
A list with the folder contents appears.

## 4.4.3 Creating New Folders

You can create a new folder in the currently displayed folder level.

### Procedure

To open the screen: Right-click and select **[FILE]** → File screen

To change the media: (p.84)

- 1 Display a screen with the folder level where you want to create a new folder.
- 2 Select **[New Folder]**.
- 3 Enter **[Folder Name]**.  
*See: "7.1 Adding Comments" (p.138)*
- 4 Select **[Exec]**.  
A new folder is created.  
To cancel creating:  
Select **[Cancel]**.

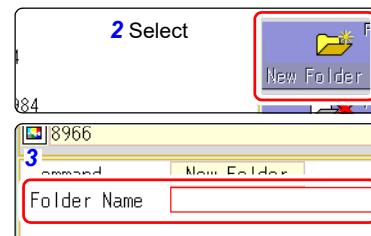

### NOTE

#### Folder name

The maximum number of characters for the **[Save Name]** string is 127. The maximum path length including folder name is 255 characters.

### 4.4.4 Deleting Files & Folders

Delete a file or folder.

#### Procedure

To open the screen: Right-click and select **[FILE]** → File screen

To change the media: (p.84)

**1** Select the file or folder you want to delete.

**2** Select **[Delete]**.  
**[DeleteOne]** is shown as **[DeleteTarget]**.

**3** (When multiple files are to be deleted)  
 Select **[Multi Files]**.  
**[DeletePlural]** is shown as deletion target.

#### Select

<b>Slct/Deslct</b>	Select the individual file or folder at the cursor. If something is currently selected, the selection is cleared.
<b>Slct/Deslct All</b>	Select all files or folders. If something is currently selected, the selection is cleared.
<b>Rev Slct</b>	Currently selected files or folders are deselected, and currently not selected files or folders are selected.

Selected files or folders are shown in red (see illustration at right).

**4** Select **[Exec]**.  
 The selected files or folders are deleted.

To cancel deleting:  
 Select **[Cancel]**.

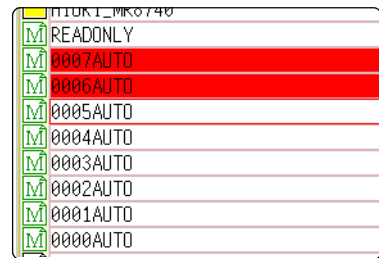
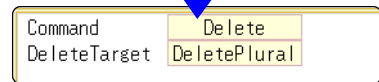
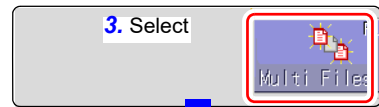
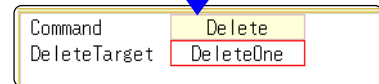
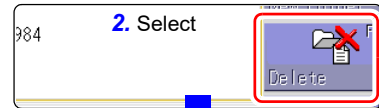

## 4.4.5 Sorting Files

Sort files in the file list into a specified order.

### Procedure

To open the screen: Right-click and select **[FILE]** → File screen

To change the media: (p.84)

- 1 Select **[Sort]**, and select **[Type]**.

Off	No sorting.
Name	Sorts files by file name characters.
Type	Sorts files by type (file format) of data (settings, MEM waveforms, etc.)
Date	Sorts files by time and date of creation.
Size	Sorts files by size.

Folders/files are sorted by specified item.

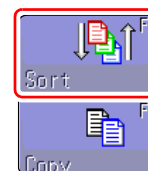

1. Select

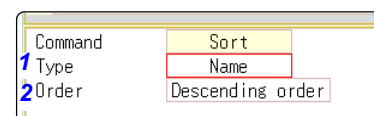

- 2 Move the flashing cursor to the **[Order]**.

Select

Ascending order	A → Z → , Old → New, Small → Large
Descending order	Reverse sort order

Folders/files are sorted in specified order.

- 3 Select **[OK]**.

The sort screen closes.

You can also sort files by clicking an item name in the file list with the mouse.

### NOTE

The order format will be displayed in the file list (with  $\Delta$ : Ascending order  $\nabla$ : Descending order mark) and marked by the GUI.

When there are both files and folders, folders are listed at the top and files at the bottom.

## 4.4.6 Renaming Files & Folders

Rename a file or folder.

### Procedure

To open the screen: Right-click and select **[FILE]** → File screen

To change the media: (p.84)

- 1 Select the file or folder you want to rename.



2. Select

- 2 Select **[Rename]**.



- 3 Select **[Enter Char]**, and enter **[Save Name]**.

See: "7.1 Adding Comments" (p.138)

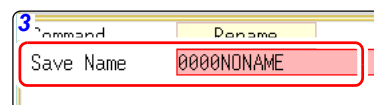

- 4 Select **[Exec]**.

The file or folder is renamed.

To cancel renaming:

Select **[Cancel]**.

### 4.4.7 Copying a File Into a Specified Folder

You can copy a file into a specified folder.

#### Procedure

To open the screen: Right-click and select **[FILE]** → File screen

To change the media: (p.84)

**1** Move the flashing cursor to the file you want to copy.

**2** Select **[Copy]**.  
Move the flashing cursor to the **[Copy Place]** item.

**3** Select **[Edit]**.  
The Browse folders dialog box appears (at bottom right).

**4** Move the flashing cursor to the copy target folder and confirm the setting with **[Confirm]**.

**5** (When there are multiple copy targets)  
Select **[Multi Files]**.

Select

<b>Slct/Deslct</b>	Select the individual file or folder at the cursor. If something is currently selected, the selection is cleared.
<b>Slct/Deslct All</b>	Select all files or folders. If something is currently selected, the selection is cleared.
<b>Rev Slct</b>	Currently selected files or folders are deselected, and currently not selected files or folders are selected.

Selected files or folders are shown in red (see illustration at right).

Select **[Select End]**.

**6** Select **[Exec]**.  
The file is copied to the specified target location.

To cancel copying:  
Select **[Cancel]**.

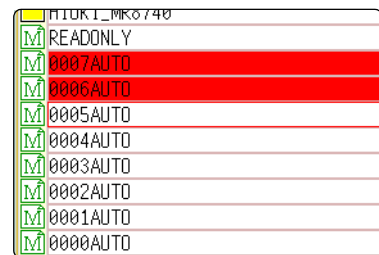
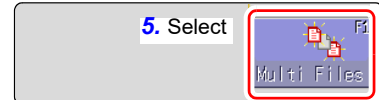
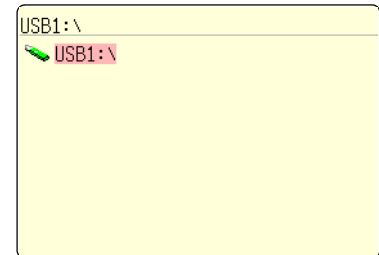
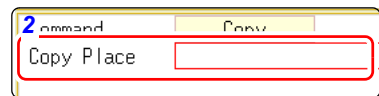
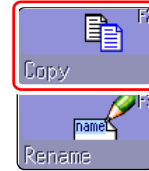

# Printing

# Chapter 5

The **[Printer]** sheet lets you specify the print method and make other printing related settings. The data to be printed are transferred to the PC connected via LAN and printed by using the printer connected to the PC.

## Opening the **[Printer]** sheet



Pressing this key repeatedly displays the various sheets.

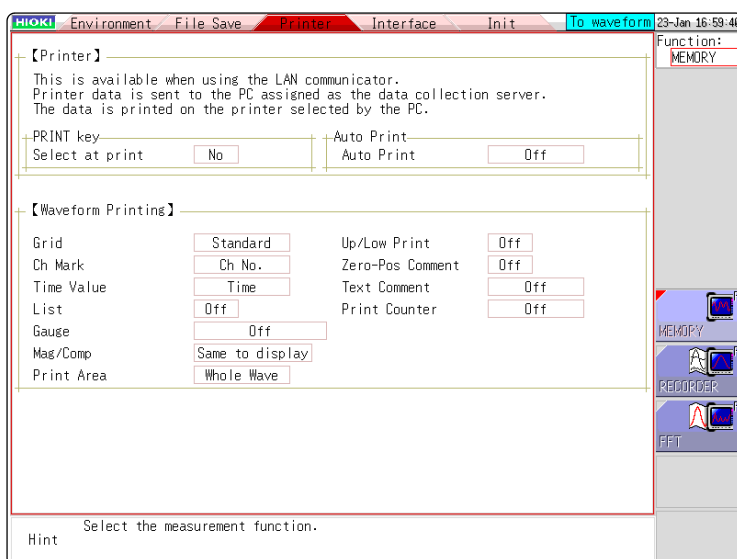
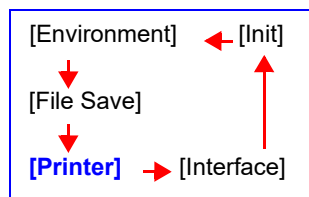

## Operations available from the **[Printer]** sheet

### Selecting the print method

- See: "5.1 Printing Type and Workflow" ( p.110)
- Auto Print ( p.111)
  - Manual Print ( p.112)
- See: "5.5.1 Screen Hard Copy" ( p.116)
- See: "5.5.2 Report Print (A4 Size Print)" ( p.116)
- See: "5.5.3 List Print" ( p.117)
- See: "5.5.4 Text Comment Printing" ( p.117)

### Making printer settings

- Grid Type ( p.113)
- Channel Marker Type ( p.113)
- List ( p.114)
- Gauge ( p.114)
- Horizontal axis (Time axis) Zoom (Mag/Comp) ( p.114)
- Upper/Lower Limit Print ( p.115)
- Zero Position Comment Print ( p.115)
- Print Counter ( p.115)



# 5.1 Printing Type and Workflow

There are basically three types of printing operations.

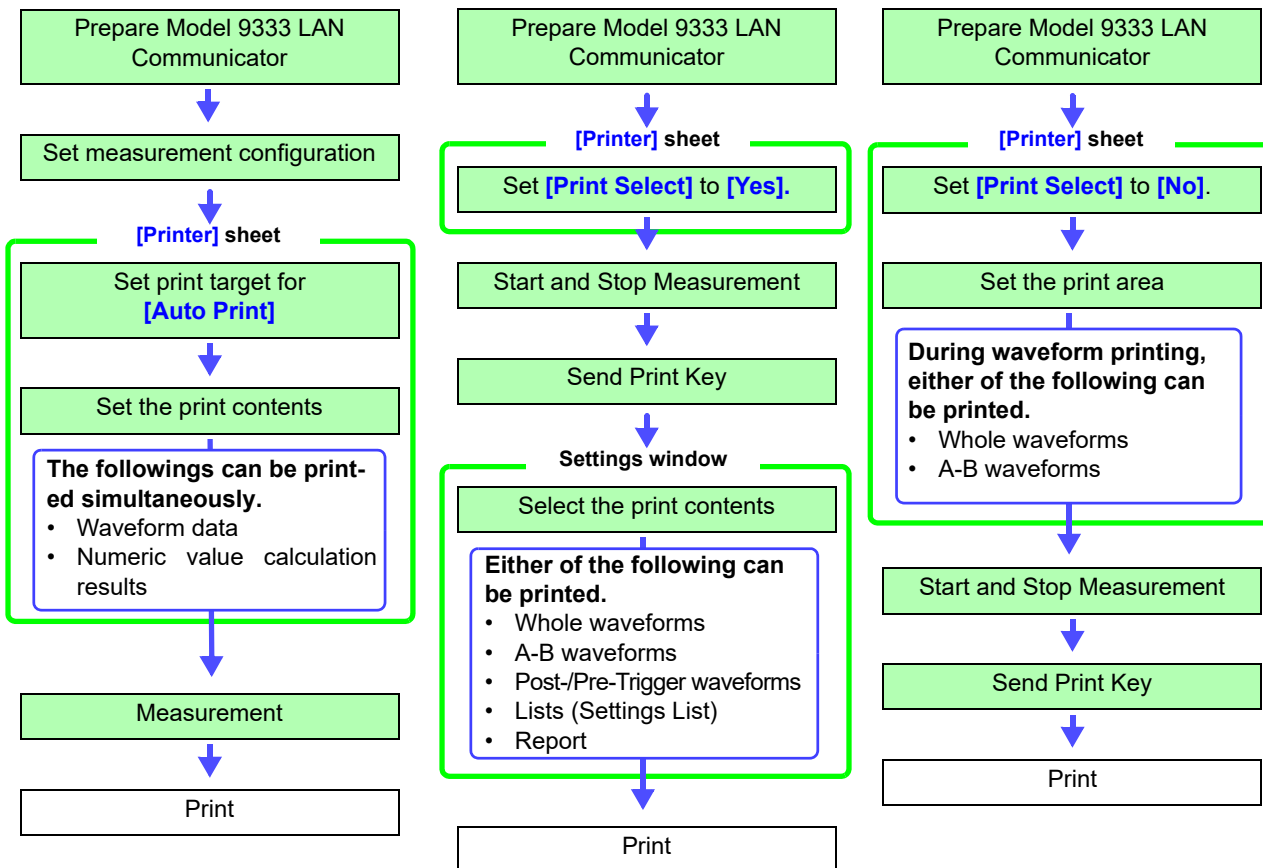
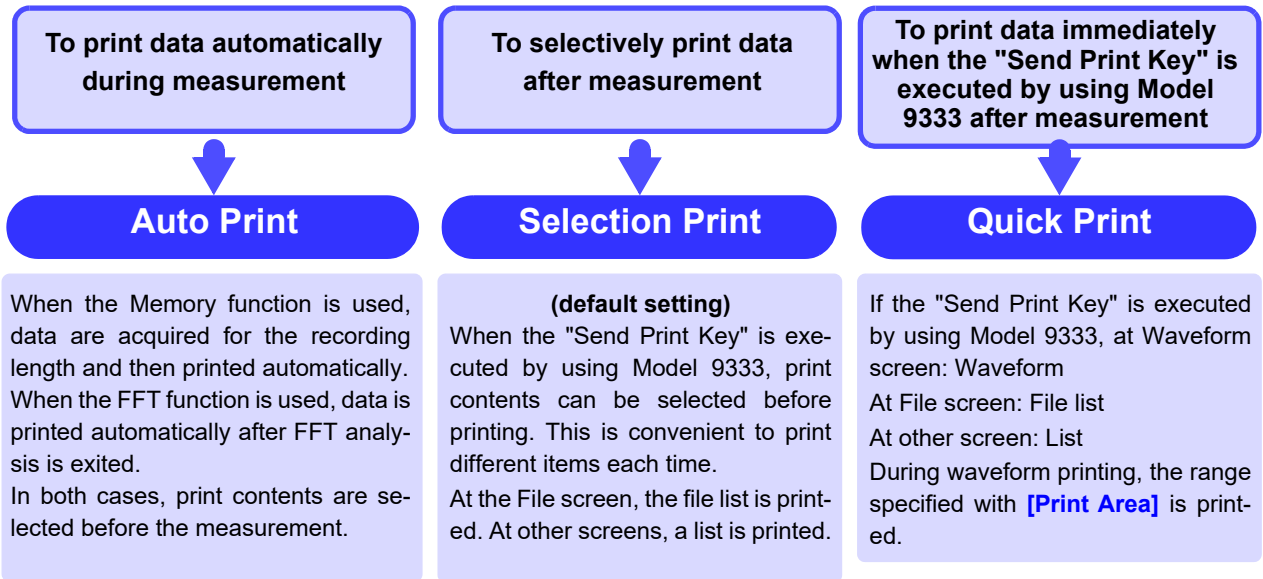

**NOTE**

When both Auto Print and Auto Save are enabled, Auto Save is executed first. However, when the Roll Mode function (default setting: Auto) is used with the Memory function, Auto Print has priority.

## 5.2 Making Auto Print Settings

**MEM** **FFT**

This applies to the Memory function, Recorder function, and FFT function.

Make these settings before measurement.

Measurement data is printed automatically when you press the **START** key to start measurement.

Make sure that the PC connected via LAN is prepared.

### Procedure

To open the screen: Press the **SYSTEM** key → **[Printer]** sheet

#### 1 Enable Auto Print.

(Memory Function, FFT Function case:)

Move the cursor to the **[Auto Print]** item.

Select **[On]**.

Default setting: Off (Auto Print is not carried out)

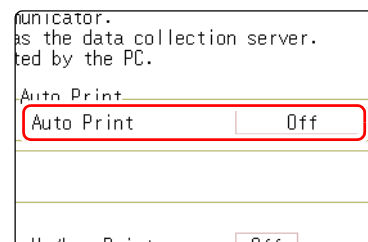

#### 2 (Memory Function case:)

Make print area settings as required.

Move the cursor to the **[Print Area]** item.

**Select** →

<b>Whole Wave</b>	Print all waveform data in internal memory of instrument. (default setting)
<b>A-B Wave</b>	Print only A/B cursor defined range of waveform data in internal memory of instrument.

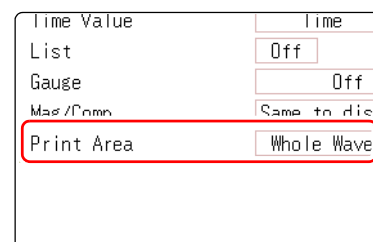

#### 3 Check the measurement conditions and start the measurement. (Press the **START** key.)

Memory Function case:

Data are acquired for the recording length and then printed automatically.

FFT Function case:

Data is printed automatically after FFT analysis is exited.

When printing is carried out again after stopping, the range selection will be used.

#### • To output the waveform data to the PC connected via LAN

Model 9333 LAN Communicator is required to be installed on the PC to which the data is to be output. For more information about how to operate and configure Model 9333 LAN Communicator, in addition to install it on the PC, see the instruction manual of Model 9333 LAN Communicator.

### NOTE

- When both Auto Print and Auto Save are enabled, Auto Save is executed first.
- However, when the Roll Mode function (default setting: Auto) is used with the Memory function, Auto Print has priority.
- If A/B cursor is On during manual printing after acquiring waveform data, the range will be printed.

When performing waveform evaluation, the evaluation area will be printed at the same time. To disable printing of the evaluation area, set waveform evaluation to **[OFF]**. ( p.300)

### 5.3 Send PRINT key

If the "Send Print Key" is executed by using Model 9333, the data are printed after the print range and types are selected.

This is also useful to prevent inadvertent printing due to operation errors.

#### Procedure

To open the screen: Press the **SYSTEM** key → [Printer] sheet

#### 1 Enable data selection at time of printing

Move the cursor to the **[Select at print]** item.  
Select **[Yes]**.

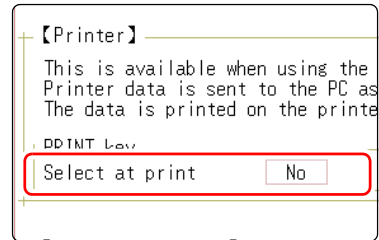

#### Procedure

To open the screen: Press the **DISP** key → File screen

#### 2 Start and stop the measurement.

Press the **START** key to start the measurement.  
Press the **STOP** key to finish the measurement.

During measurement, printing is not possible. Measurement must be stopped before starting to print.

#### 3 Select print contents and execute printing

If the "Send Print Key" is executed by using Model 9333, the GUI **[Select at print]** is displayed at the right on the screen.

Select

<b>Whole Wave</b>	Print all waveform data in internal memory of instrument. (default setting)
<b>A-B Wave</b>	Print only A/B cursor defined range of waveform data in internal memory of instrument. (Memory Function and Recorder Function only)
<b>About Trig</b>	Print waveform data for 10 divisions before and after trigger position. (Memory Function only)
<b>List</b>	Print main settings.
<b>Report</b>	Print the report. See: "5.5.2 Report Print (A4 Size Print)" ( p.116)

When the selection (except for **[Cancel]**) has been made, printing starts.

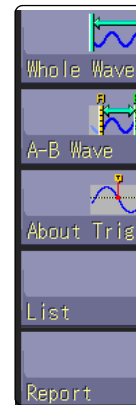

#### • To output the waveform data to the PC connected via LAN

Model 9333 LAN Communicator is required to be installed on the PC to which the data is to be output. For more information about how to operate and configure Model 9333 LAN Communicator, in addition to install it on the PC, see the instruction manual of Model 9333 LAN Communicator.

**When performing waveform evaluation, the evaluation area will be printed at the same time. To disable printing of the evaluation area, set waveform evaluation to [OFF]. ( p.300)**

## 5.4 Set the print contents

Set the print contents on the **[Printer]** sheet of the System screen.

### Print contents setting

To open the screen: Press the **SYSTEM** key → **[Printer]** sheet

This is available when using the LAN communicator. ( p.116)  
 Printer data is sent to the PC assigned as the data collection server.  
 The data is printed on the printer selected by the PC.

PRINT key Select at print  Auto Print

【Waveform Printing】

1 Grid  Up/Low Print   
 2 Ch Mark  Zero-Pos Comment   
 Time Value  Text Comment  ( p.117)  
 List  Print Counter   
 Gauge   
 Mag/Comp   
 Print Area

- 1 **Select the grid type.**  
Move the cursor to the **[Grid]** item.

Select

Off, Standard (default setting), Fine, Std Dark, Fine Dark

- 2 **Select the channel marker type.**  
Move the cursor to the **[Ch Mark]** item.

Select

Off	Do not print the channel number or comments.
Ch No.	Print the channel number . (default setting)
Comment	Print the comments entered in the Channel Settings screen over the waveform. A comment setting must have been made. See: "7.1 Adding Comments" ( p.138)

<Print Example>

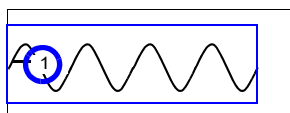

Channel number.

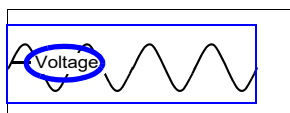

Comment

**NOTE**

#### Grid Type

Grids displayed on the screen are not reflected in the printout.

### Print contents setting

To open the screen: Press the **SYSTEM** key → [Printer] sheet

This is available when using the LAN communicator.  
Printer data is sent to the PC assigned as the data collection server.  
The data is printed on the printer selected by the PC. (p.116)

PRINT key Select at print  Auto Print

【Waveform Printing】

Grid  7 Up/Low Print

Ch Mark  8 Zero-Pos Comment

3 Time Value  9 Text Comment  (p.117)

4 List  Print Counter

5 Gauge

9 Mag/Comp

Print Area

### 3 Select the horizontal axis (time axis) display value. Select

Move the cursor to the [Time Value] item.

<Print Example>

-2.000000 s	5	500
Time	div	Sample Num
1m40 s	'04-10-30 10:20:30	
Time (60)	Date	

Time*	Print the time from trigger event (unit is fixed). (default setting)
Time (60)*	Print the time from trigger event (unit is modulo 60).
div	Print the number of divisions from trigger event.
Date*	Print the date and time when waveform was acquired.
Sample Num	Print the number of samples from trigger event.

\* Printing for external sampling is done according to the [Sample] setting.

### 4 Print a list of settings Select

Move the cursor to the [List] item.

Off	Do not print a list. (default setting)
On	Print list after waveform.

### 5 Select the type of gauge. Select

Move the cursor to the [Gauge] item.

<Print Example>

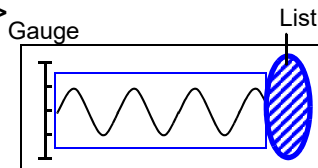

Off	Do not print a gauge. (default setting)
Before Wave	Print gauge before waveform.
After Wave	Print gauge after waveform.
Before&Aft Wave	Print gauge before and after waveform.

### 6 Set the horizontal axis (time axis) magnification and compression. Select

Move the cursor to the [Mag/Comp] item.

Select

x10 to x1/200000 (Memory Function case)	Print using the magnification or compression ratio set here.
x1 to x1/50000 (Recorder Function case)	
Same to display	Print using the magnification or compression ratio set for the waveform screen. (default setting)

### NOTE

#### Horizontal axis (Time axis) zoom

When time axis zoom has been set, printing will be carried out using this zoom setting, regardless of the zoom setting on the Waveform screen.

**7 Set the upper and lower limit value**

Move the cursor to the **[Up/Low Print]** item.

<Print Example>

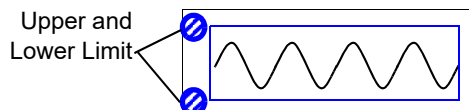
**8 Set the zero-position comment**

Move the cursor to the **[Zero-Pos Comment]** item.

<Print Example>

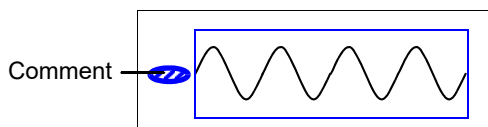
**9 Select the counter print.**

Move the cursor to the **[Print Counter]** item.

(When **[Date]** or **[Name]** is selected)

**If you want to begin from an arbitrary count**

Move the cursor to the **[Counter Num]**, and set an arbitrary count.

See: "7.1.3 Alphanumeric Input" ( p.141)

The count is automatically cleared to zero when the instrument is powered on.

The count is increased by 1 each time a waveform is acquired. (Maximum count 9999)

(When **[Name]** is selected)

**Enter a counter name.**

Move the cursor to the **[Counter Name]**, and enter a counter name (up to 10 characters).

See: "7.1.3 Alphanumeric Input" ( p.141)

<Print Example of Data and Counter>

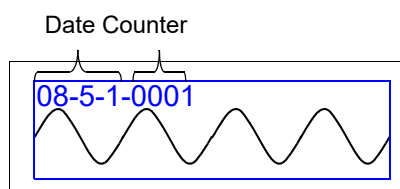

Select

Off	Do not print upper and lower limits. (default setting)
On	Print upper and lower limits.

Select

Off	Print the channel number. (default setting)
On	Print zero position comment.

The zero position comment is not printed in the following case:

- When the waveform screen format has been set to X-Y, or FFT display
- When no comment has been set for a channel

See: "7.1 Adding Comments" ( p.138)

Select

Off	Do not print a counter. (default setting)
Date	Print the date of printing and a waveform acquisition count. (Example: 04-8-1-0001)
Name	Print a counter name and a waveform acquisition count. (Example: DeviceA-0001)

<Print Example of Counter name and Counter>

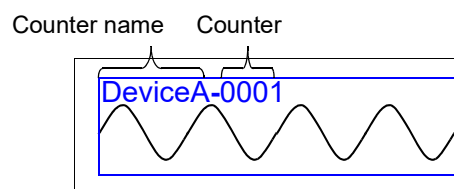

## 5.5 Miscellaneous Printing Functions

You can produce a hard copy of the screen display, perform report printing or list printing.

### 5.5.1 Screen Hard Copy

To print the hardcopy of the screen, display the screen to be printed, and then execute the "Print Screen" by using Model 9333.

#### GUI print setting

To open the screen: Press the **SYSTEM** key → **[Printer]** sheet

<Print Example>

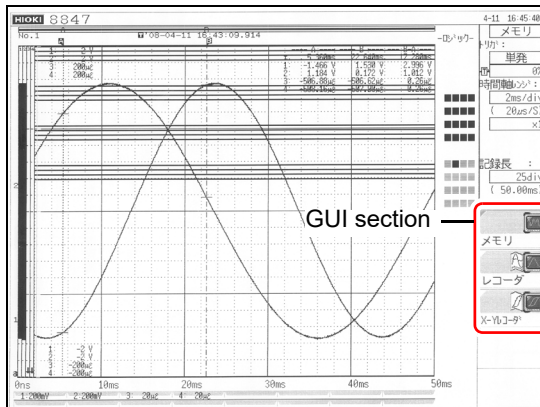

### 5.5.2 Report Print (A4 Size Print)

The waveform range as displayed on the Waveform screen, upper and lower limit values, and channel settings are printed in A4 size. When zoom display is enabled, two zoom display screens are printed.

The A/B cursor pair shown on the Waveform screen is also printed.

If the comment type is set to **[Comment]** or **[Set&Com]** on the Comment sheet of the Channel screen, the title comment can also be printed. ( See: "7.1.1 Adding a Title Comment" ( p.138) )

#### Procedure

To open the screen: Press the **DISP** key → File screen, Press the **DISP** key → Select the **[WAVE WIDTH]** menu

Execute the "Get/Print Report Image" by using Model 9333.

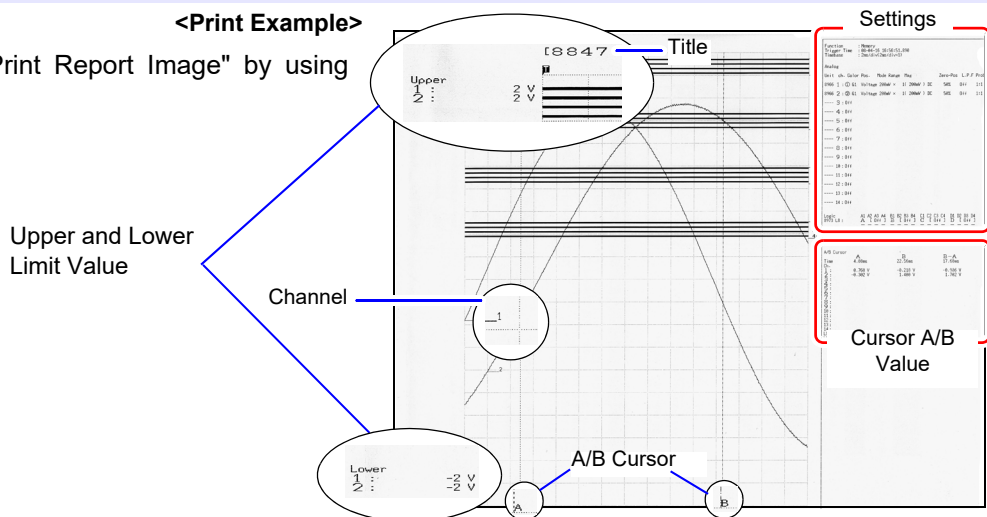

### 5.5.3 List Print

This function prints out function status information and channel setting information in list format. The list settings are the same as for the List function. ( See: "Print a list of settings" ( p.114 ) )

Execute the "Send Print Key" by using Model 9333.

#### **NOTE**

The printed list contains the setting parameters for the acquired waveform data. The list content will not change even if the settings were changed after the waveform data were acquired.

### 5.5.4 Text Comment Printing

A text document edited on a PC can be printed together with a waveform.

1. Create a text file using [Notepad] or another suitable application on the PC.

The maximum size of the text comment that can be imported to the MR8847 is 104 x 200. Print width will be adjusted to the widest line.

2. Press the **SYSTEM** key and set [Text Comment] on the [Printer] sheet.

Select

Off	Text comment is not printed. (default setting)
Before Wave	Text comment is printed before waveform.
After Wave	Text comment is printed after waveform.

3. Press the **FILE** key and use the File screen to import the text file created on the PC into the MR8847.

See: "4.3 Loading Data" ( p.99 )

The text file content will be printed along with the waveform when printing.

Print Example \_ Positioning with regard to other print items

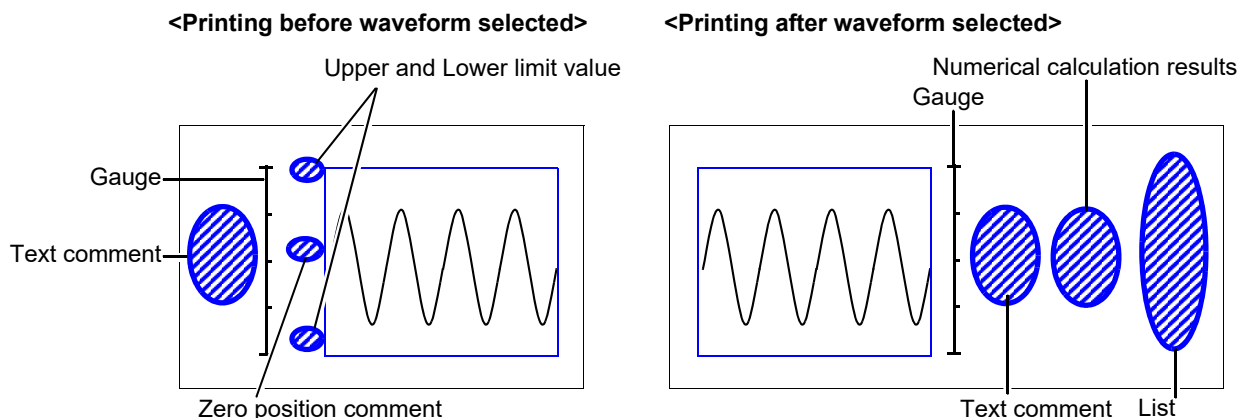





# Waveform Screen Monitoring and Analysis

## Chapter 6

Analytical operations such as display magnification, compression, and search are available on the Waveform screen.

### Opening the Waveform screen

Click **[DISP]** in the right-click menu.

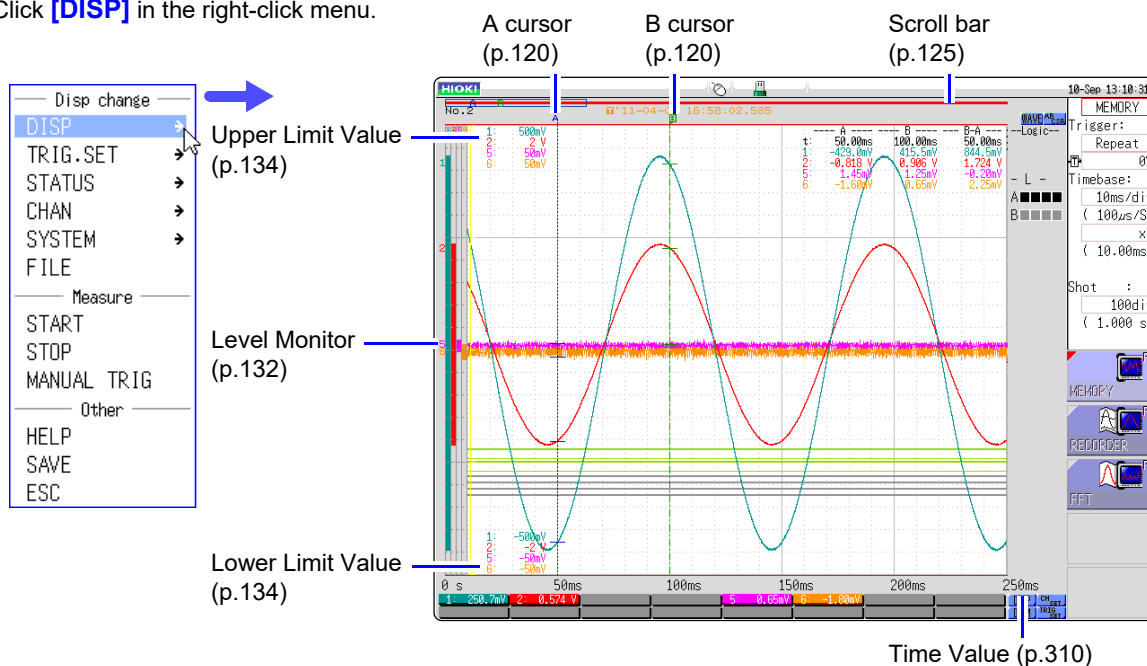

### Operations available from the Waveform screen

#### A/B Cursor

- Read measurement value (p.120)
- Specifying a Waveform Range (p.124)

#### Moving the Waveform Display Position

- Moving the waveform (p.125)
- Moving the position (p.126)

#### Performing X-Y Synthesis (p.127)

#### Magnifying and Compressing Waveforms

- Magnifying and Compressing Horizontal Axis (Time Axis) (p.129)
- Zoom Function (Magnifying a Section of the Horizontal Axis (Time Axis) )(p.130)
- Magnifying and Compressing Vertical Axis (Voltage Axis) (p.131)

#### Monitoring Input Levels (p.132)

#### Switching the Waveform Screen (p.134)

- Displaying upper and lower limit values
- Displaying comments
- Switching the waveform display width

### 6.1 Reading Measurement Values (Using the A/B Cursors)

- Time difference, frequency and potential difference (and when scaling is enabled, scaling values) can be read as numerical values using the A/B cursors on the Waveform screen. The cursors also allow specifying the calculation and X-Y synthesis range.
- When displaying the X-Y waveform, the A/B cursors can be used to read the measurement values. Also with a split screen, A/B cursors can be used separately in the graphs to read the potential difference between the A and B points.

#### A/B Cursor Settings

To open the screen: Right-click and select [DISP] → Waveform screen → Left-click [AB CSR] → A/B cursors settings window

#### 1 Left-click the [AB CSR] icon.



Left-click the [AB CSR] icon on the top right of the Waveform screen.

#### 2 Select the Cursor Type.

Move the flashing cursor to the [A/B Cursors] item and select it.

Select	
Off	A/B cursors are not used.
div	Move in horizontal axis (time axis) direction (X axis for X-Y synthesis)
Range	Move in vertical axis (voltage axis) direction (Y axis for X-Y synthesis)
Trace	Trace waveform data.

#### 3 Select the movement target for the A/B cursors

Move the flashing cursor to the [Kind] item and select it.

Select	
A	Use only cursor A.
A-b	Use A/B cursors but move only cursor A.
a-B	Use A/B cursors but move only cursor B.
A&B	Move both cursor A and cursor B together.

#### 4 Select the measurement target channel ([Subject CH]) for A and B

Move the flashing cursor to the [A] or [B] item and select it.

Select	
ALL	Shows measurement values for all channels. (When cursor type is [Trace] or [Range])
Ch1 to Ch16	Show measurement values in selected channels out of Ch1 - Ch16 (for 1, 2, 4, 8, 16 screens).
Gr1 to Gr8	Specify X-Y synthesis for Gr1 to Gr8 (for X-Y screen)
Analog Ch↔Calc Ch	When there is data on which waveform calculation has been performed, the cursor target is switched by analog channel and waveform calculation data.

#### 5 Move the A/B cursors

If you click while the mouse cursor is in the Waveform screen, the A/B cursors move to that position. Furthermore, you can also move the A or B cursor by dragging the A or B cursor mark on the Waveform screen while holding down the left button of the mouse.

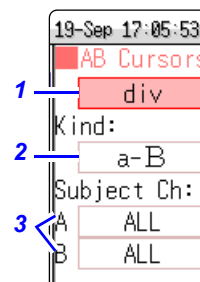

**If numerical values are hard to read**

Right-click and select **[DISP]** to enable display selection. You can display the waveform and numerical values separately.

**See:** "6.7.3 Switching the Waveform Display Width" (p.135)

**If A/B cursors are activated but do not show up on screen**

The position of the A/B cursors can be checked on the scroll bar.(p.125)

If the cursor type is **[div]** or **[Trace]** cursors, cursor measurements can be made even if the A or B cursor is off-screen.

**To view the waveform before or after the A/B cursors when these are off the screen**

When using the A/B cursors, the waveform at an off-screen cursor location can be displayed using the Jump function.

**See:** "6.3.3 Moving the Position" (p.126)

## 6.1 Reading Measurement Values (Using the A/B Cursors)

### Reading Measurement Values on Waveform Screen (for 1, 2, 4, 8, 16 screens)

To open the screen: Right-click and select [DISP] → Waveform screen

#### <Screen display (time axis cursor)>

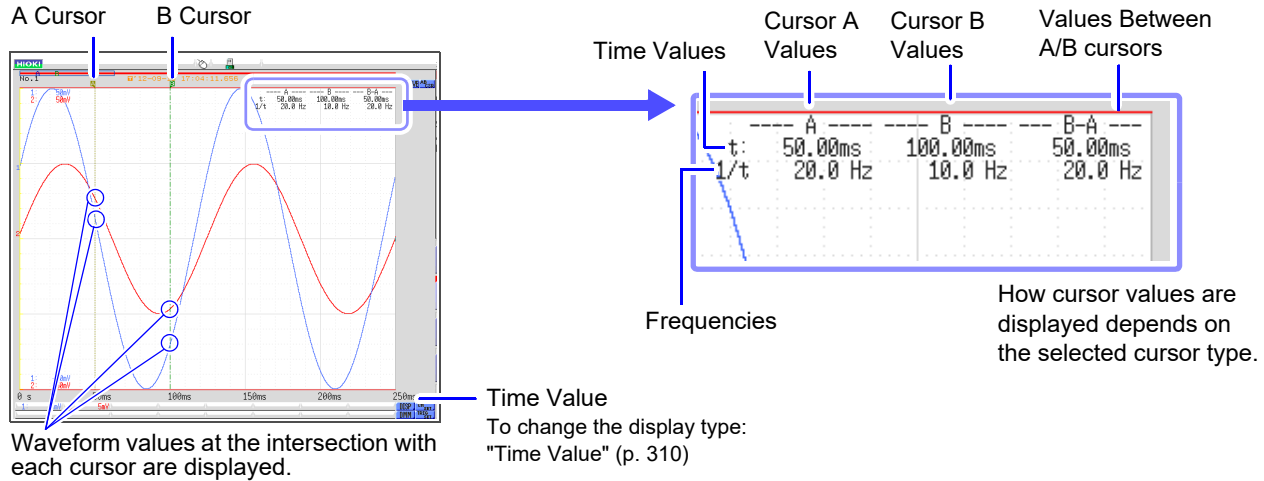

#### <Cursor Value>

Cursor Type	Cursor Value	Cursor Value Display Example (with two cursors)
<b>div</b> (Time Value and Frequency)	<p>t: A, B each cursor value: Time from trigger point or recording start B-A value: Time difference between A/B cursors</p> <p>1/t: Frequency for which t is 1 cycle</p>	See "Screen display" above
<b>Range</b> (Measurement Values)	<p>A, B each cursor value: Measured value of channel B-A value: Difference between measured values at A/B cursors</p>	
<b>Trace</b> (Time and Measurement Values)	<p>Time Values A, B each cursor value: Time from trigger point or recording start B-A value: Time difference between A/B cursors</p> <p><b>Measurement Values</b> A, B each cursor value: (Memory function) measurement value (Recorder function) maximum, minimum values B-A value: Difference between measured values at A/B cursors</p>	<p>Time Values</p> <p>Measurement Values</p>

You can click [DISP] to display the waveform and cursor values separately.  
See: "6.7.3 Switching the Waveform Display Width" (p.135)

### **NOTE**

- When Using External Sampling: Value t is the number of samples.
- The data measured with MR8990 Digital Voltmeter Unit is updated at each of the two movement points of the A and B cursors.
- When the voltage range is changed during measurement by the recorder function: Trace measurement values are acquired at the range settings when measurement was stopped.

**Reading Measurement Values on Waveform Screen (for X-Y1, 4 screens)**

To open the screen: Right-click and select [DISP] → Waveform screen

<Screen display (X axis measurement value)>

X-Y synthesis of channel 1 and channel 2 waveform

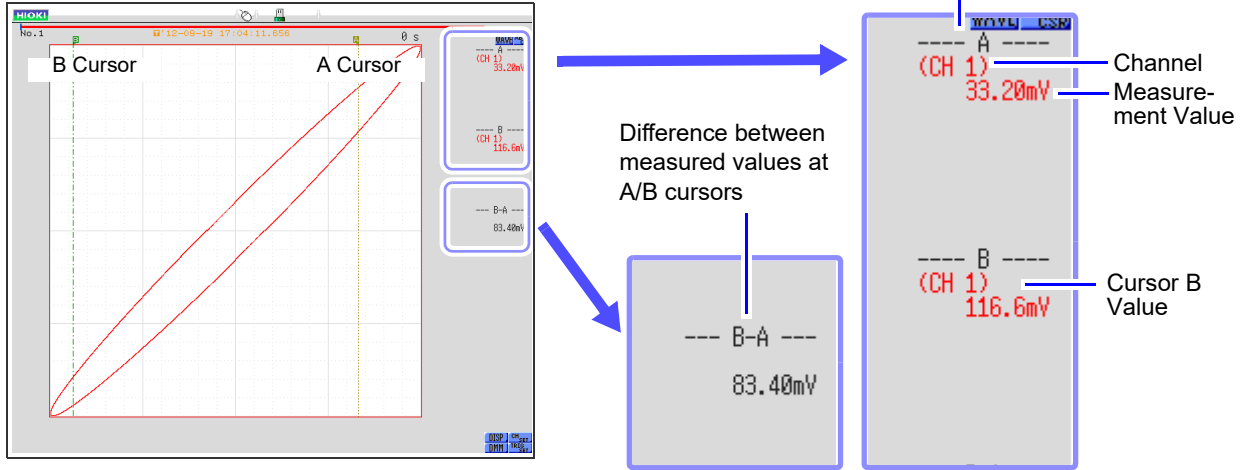

<Cursor Value>

Cursor Type	Cursor Value	Cursor Value Display Example (with two cursors)
<b>X</b> (X axis measurement value)		See "Screen display" above
<b>Y</b> (Y axis measurement value)		<p>(Y axis channels)</p> <ul style="list-style-type: none"> <li>Cursor A measurement value</li> <li>Cursor B measurement value</li> <li>Difference between measured values at A/B cursors</li> </ul>
<b>Trace</b> (Time and X axis, Y axis measurement value)		<p>(X axis and Y axis channels)</p> <ul style="list-style-type: none"> <li>Cursor A time and measurement value</li> <li>Cursor B time and measurement value</li> <li>Time and measurement value differential between cursor A and B</li> </ul>

## 6.2 Specifying a Waveform Range (A/B Cursor)

When the waveform is shown as a time display, the range can be specified with the div cursor or Trace cursor.

The specified range will be used for file saving, X-Y synthesis, and numerical calculation. The range selection will be retained also when the waveform display format is changed.

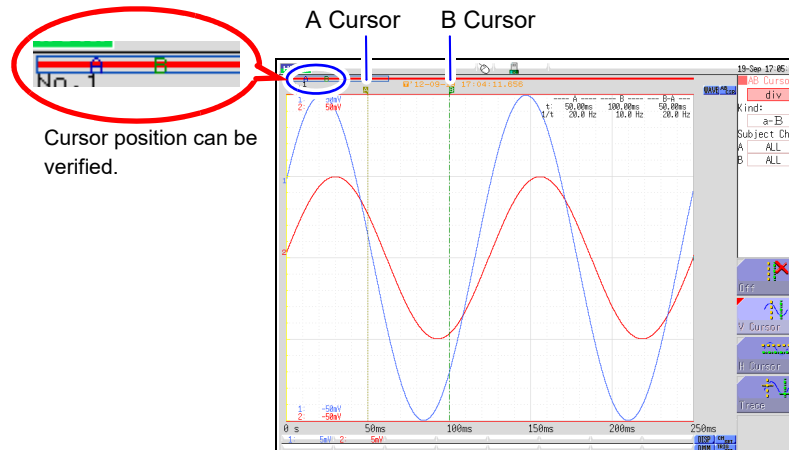

The general procedure is as follows.

1. Set A/B cursors  
See: "A/B Cursor Settings" (p. 120)
2. Specify a range
  - **For file saving:**  
System screen - [File Save] sheet - [Save Area] item: Select [A-B Wave].  
See: "4.2.2 Automatically Saving Waveforms" (p.88)  
"4.2.3 Saving Data Selectively (SAVE)" (p.93)
  - **For X-Y synthesis:**  
Status screen - [Status] sheet - [Combo Area] item: Select [A-B Wave].  
See: "6.4 Performing Waveform X-Y Synthesis" (p.127)
  - **For numerical calculation:**  
Status screen - [Num Calc] sheet - [Calc Area] item: Select [A-B Wave].  
See: "9.2 Settings for Numerical Value Calculation" (p.214)

### NOTE

#### About reading measurement values and cursor types:

See: "6.1 Reading Measurement Values (Using the A/B Cursors)" (p.120)

#### Available range for A/B cursor

The available range depends on the function.

- Memory function: Recorded measurement data for one measurement
- Recorder function: Up to the range of measurement data recorded during one measurement, or up to the range of measurement data that can be recorded internally, starting at the point at which measurement ended and going backwards in time.  
The following measurement data can be recorded internally: max. 80,000div

#### When the MR8990 Digital Voltmeter Unit is installed

There may be one data item more than the range (number of data items) specified with the A/B cursors.

## 6.3 Moving the Waveform Display Position

MEM REC

This applies to the Memory function and Recorder Function.

### 6.3.1 About Display Position

From the scroll bar you can verify the relative position and size of the displayed portion of a waveform within the overall recorded waveform.

Trigger time, trigger position and A/B cursor positions (when using voltage axis cursor or trace cursors) are also displayed.

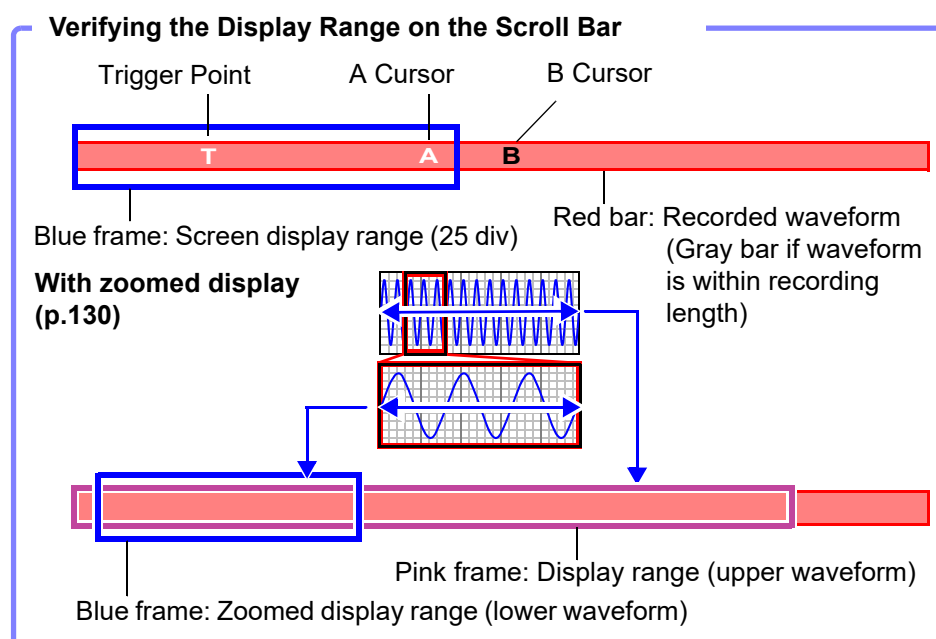

### 6.3.2 Scrolling the Measurement Waveform

When measuring or displaying an existing waveform, use the mouse to scroll.

#### Scrolling measured waveforms left or right

To open the screen: Left-click the **[WAVE]** icon.

- 1 Left-click the **[WAVE]** icon.



Left-click the **[WAVE]** icon on the top right of the Waveform screen.

- 2 Move the mouse left or right while holding down the left mouse button (dragging) when the mouse cursor is in the Waveform screen.

The waveform is scrolled.

You can rotate the wheel button forward or backward to make fine scrolling adjustments.



#### To see past waveforms in Roll Mode

You can view past waveforms during measurement by scrolling the waveforms with the mouse. To redisplay a waveform, select **[Scroll]**.



### 6.3.3 Moving the Position

You can display the waveform position you wish to view immediately by specifying it with the mouse.

#### Procedure

To open the screen: Right-click and select **[DISP]** → Waveform screen → Left-click the **[WAVE]** icon → **WAVE** settings GUI display

- 1 Left-click the **[WAVE]** icon.



Left-click the **[WAVE]** icon on the top right of the Waveform screen.

- 2 Use the mouse to specify a position on the scroll bar of the screen.

- 3 Left-click the mouse.

The selected display position appears on the screen.



#### Moving the position when **[Memory Div: On]** with the Memory function:

Click the **[WAVE]** icon. With no block displayed in the upper part of the screen, move the position.

(When a block is displayed in the upper part of the screen, the desired block can be selected and the recorded waveform can be displayed. (p.136))

## 6.4 Performing Waveform X-Y Synthesis

MEM

This applies to the Memory function.

- To perform **waveform X-Y synthesis**, go to the Status screen, select the **[Status]** sheet, and set **[Format]** to X-Y1 screen or X-Y4 screen. By assigning any analog channel to the X axis and Y axis, up to 8 X-Y combo displays can be generated.
- Vertical axis (voltage axis) zoom also applies to X-Y synthesis.

### Procedure

To open the screen: Right-click and select **[STATUS]** → **[Status]** sheet

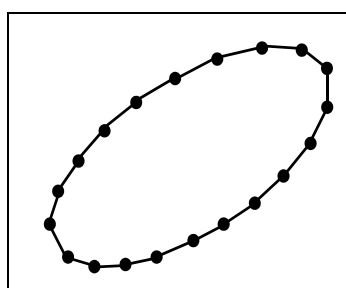
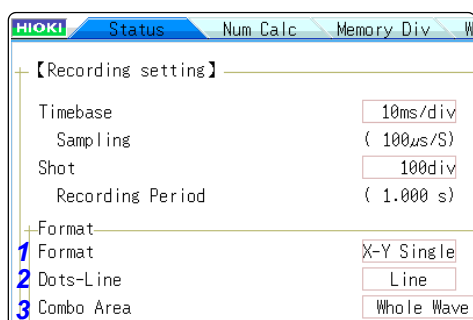

Line

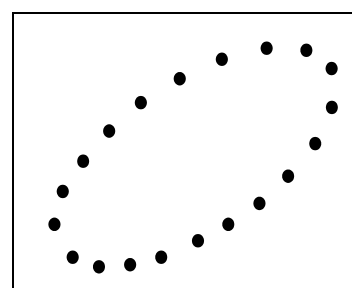

Dot

- 1 Move the flashing cursor to the **[Format]** item, **Select** and then click.

**X-Y Single** The waveforms of graphs 1 - 8 are shown and recorded on a single screen.

**X-Y Quad** The waveforms of graphs 1 - 8 are shown and recorded on a quadruplet screens.

- 2 Move the flashing cursor to the **[Dots-Line]** item, **Select** and then click.

**Dots** Measurement data only are shown as dots. Order stored in memory will no longer be known.

**Line** Measurement data are linked by a line in the order stored in memory and shown as a waveform. (default setting)

- 3 Move the flashing cursor to the **[Combo Area]** item, **Select** and then click.

See: "6.2 Specifying a Waveform Range (A/B Cursor)" (p.124)

**Whole Wave** All data are used for X-Y synthesis.

**A-B Wave** Only data range marked by A/B cursors is used for X-Y synthesis.



#### To speed up the time between measurement and waveform display

- When **[Dots]** is selected for the Dot-Line interpolation setting, the waveform will be displayed faster.
- Specify a range using the A/B cursors. (Memory Function only)

### Procedure

To open the screen: Right-click and select **[DISP]** → Waveform screen → Right-click and select **[CH.SET]** → X-Y settings window

#### 4 Set the waveform color in the graph display.

Move the flashing cursor to the graph color item to set, and click it.  
Set the waveform display color.

You can also select the same color as for another channel.

Select	
Off	Waveform display is off. If <b>[Save Channel]</b> is set to <b>[Disp Ch]</b> in the Auto Save settings, the data will not be saved. <b>See:</b> "Select the channels to save." (p. 104)
On	The waveform is displayed. Set the display color by clicking <b>[↑]</b> or <b>[↓]</b> .

#### 5 Select the channels for X-Y synthesis.

Move the flashing cursor to the items for the X (time axis) and Y (voltage axis) and assign a channel.

The same channel can also be assigned multiple times.

Col	X	Y
Gr1	Ch1	Ch2
Gr2	Ch1	Ch3
Gr3	Ch1	Ch4
Gr4	Ch1	Ch5
Gr5	Ch1	Ch6
Gr6	Ch1	Ch7
Gr7	Ch1	Ch8
Gr8	Ch1	Ch9



#### Synthesis for A/B section of a waveform

Perform the following steps.

1. Right-click and select **[STATUS]** to bring up the Status screen, and select the **[Status]** sheet.
2. Select 1, 2, 4, 8 or 16 screens as **[Format]**.
3. Right-click and select **[DISP]** to display the waveform.
4. Use the A/B cursors to specify the range for synthesis. See the following pages. (p.120), (p.124)
5. Right-click and select **[STATUS]** to bring up the Status screen, and select the **[Status]** sheet.
6. Select **[X-Y Single]** or **[X-Y Quad]** for **[Format]**.



#### To move pen on synthesized waveform

You can move the pen over the entire waveform by rotating the mouse wheel button. (Click the **[WAVE]** icon while AB CSR is displayed.)  
The time at the pen position is shown at the top right of the screen.

## 6.5 Magnifying and Compressing Waveforms

### 6.5.1 Magnifying and Compressing Horizontal Axis (Time Axis)

MEM

This applies to the Memory function and Recorder function. (However, with the Recorder function, waveform magnification is not available.)

Data details can be observed by magnifying the waveform along the horizontal axis (time axis). Also, by compressing the time axis, overall waveform fluctuations can be readily seen.

On-screen magnification and compression is based on the left edge of the screen. However, when A/B cursor appears on the screen, use the cursor as the standard to expand or compress.

The amount of magnification/compression can be changed after measurement.

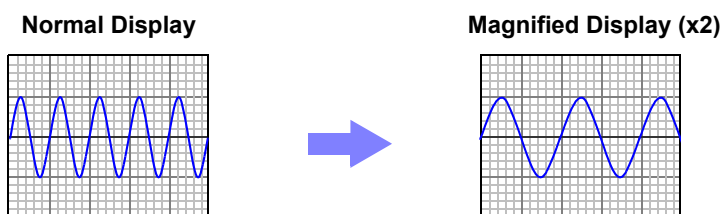

#### Procedure

To open the screen: Right-click and select [DISP] → Waveform screen

- 1 Move the flashing cursor to the magnification item, and click it.
- 2 Select display magnification.

Memory Function

Select

x10, x5, x2, x1, x1/2, x1/5, x1/10, x1/20, x1/50, x1/100, x1/200, 1/500, x1/1000, x1/2000, x1/5000, x1/10000, x1/20000, 1/50000, x1/100000, x1/200000

When [Zoom On] is selected, a section of the time axis will be magnified.

See: "6.5.2 Zoom Function (Magnifying a Section of the Horizontal Axis (Time Axis))" (p.130)

When [All Wave] is selected, the entire recording length waveform will be displayed.

Recorder Function

Select

x1, x1/2, x1/5, x1/10, x1/20, x1/50, x1/100, x1/200, x1/500, x1/1000, x1/2000, x1/5000, x1/10000, x1/20000, x1/50000

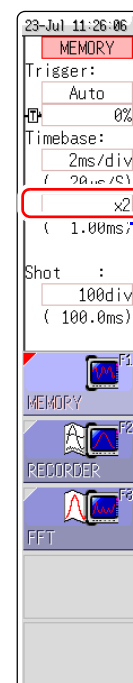

Time per division of the displayed time axis

#### NOTE

When a waveform loaded from media is displayed at a high compression ratio, the display may be slow to update.

## 6.5.2 Zoom Function (Magnifying a Section of the Horizontal Axis (Time Axis))

MEM

This applies to the Memory function only.

A magnified section of a waveform can be displayed together with the unmagnified view by splitting the screen horizontally.

With the waveform displayed normally on the upper half of the screen, a section magnified along the time axis can be displayed on the lower half.

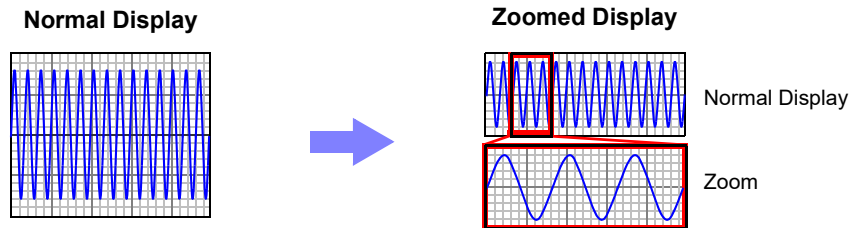

### Procedure

To open the screen: Right-click and select [DISP] → Waveform screen

- 1 Move the mouse cursor to the magnification setting field under the time axis range, and click it to display [Zoom On].

- 2 Select [Zoom On].

The Zoom function is enabled and the screen is split into upper and lower halves.

(Upper: waveform to be magnified, Lower: magnified (zoomed) section of waveform)

- 3 Select display magnification for the zoomed waveform section.

Move the flashing cursor to the [Zoom Mag], and set the magnification.

The zoomed waveform section at the lower half of the screen is magnified. When the same value or a smaller value than the magnification/compression ratio is specified, the ratio is automatically set to a setting one step higher than the [Zoom Mag] setting.

- 4 Scrolls the zoomed section of the waveform.

See: "6.3.2 Scrolling the Measurement Waveform" (p.125)

To cancel Zoom:

Click the magnification, and select [Zoom Off]. (The condition is canceled while keeping the inherited zoom ratio.)

Example: When the zoom ratio was set to x5 and zoom is canceled, the ratio setting will be [x5].

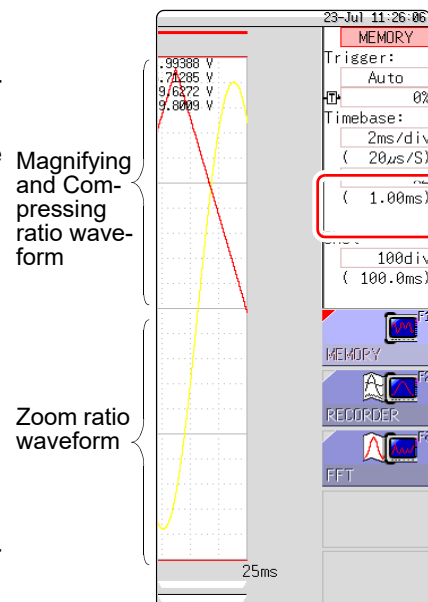
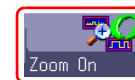

 **To view the entire waveform (Memory function only)**  
 Move the flashing cursor to the ratio item in the settings window and select **[All Wave]**.  
 The waveform information for the entire recording length is displayed.

**Description About logic waveform display**

When the Zoom function is enabled, and the logic waveform display position is at less than **[50pos]**, the logic waveform will not be displayed.

Example: Display position **[30pos]**

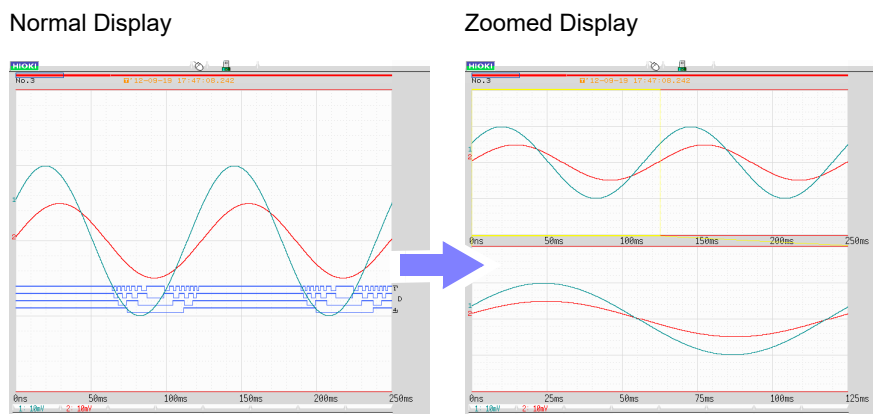

**6.5.3 Magnifying and Compressing Vertical Axis (Voltage Axis)** **MEM REC**

**This applies to the Memory function and Recorder Function.**

Waveforms on each channel can be magnified or compressed along the vertical axis (voltage axis) for display.

Magnification and compression based on zero position.

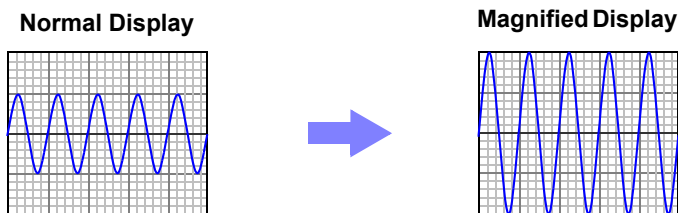

**Procedure**

To open the screen: Right-click and select **[DISP]** → Waveform screen → Right-click and select **[CH.SET]** → Channel settings window (**[Analog]** sheet)

Move the flashing cursor to the **[Mag]** item of the channel to adjust, and click it.

Select x1  
 x1/10, x1/5, x1/2, x1, x2, x5, x10, x20, x50, x100

Analog		Variable		Logic	
ChCol	Range	Mag	Position	LPF	WAVE
1	5mV	x1	50%	-	
2	5mV	x1	50%	-	
3	5mV	x1	50%	-	
4	5mV	x1	50%	-	

Selecting **[Invert]** will invert plus and minus in the waveform.

See: "7.7 Inverting the Waveform (Invert Function)" (p.159)

 **To display at an arbitrary ratio**  
 See: "7.5 Variable Function (Setting the Waveform Display Freely)" (p.155)

# 6.6 Monitoring Input Levels (Level Monitor)

All input waveform levels can be monitored in real time.  
Analog channels and logic channels can be displayed at the same time.

## 6.6.1 Level Monitor

### Procedure

To open the menu: Right-click and select [DISP] → Display Menu

Selecting [Monitor] displays the analog channel level on the left of the Waveform screen, the logic channel level on the right of the Waveform screen, and the monitor numerical values at the bottom of the Waveform screen.

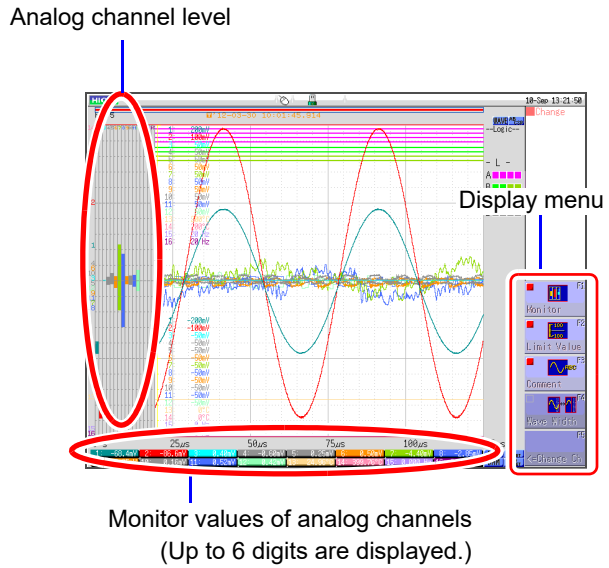

**To hide the level monitor**  
Select [Monitor] again.

Display format 2 - 16 screens (p.71)  
Level monitors are displayed for each graph.

Upper and lower limit indication is combined with level monitor.

See: "6.7.1 Showing Upper/Lower Limit On Waveform Screen" (p.134)

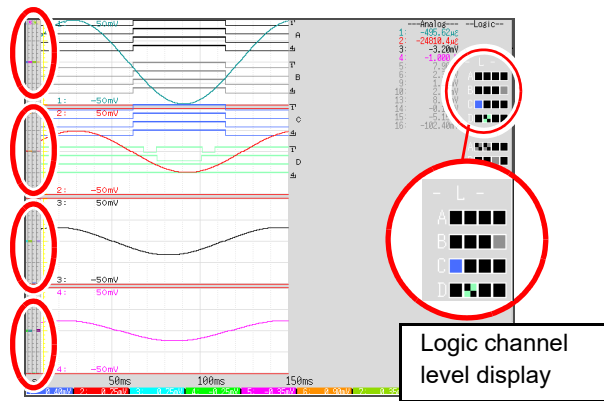

#### How to View a Level Monitor

**Level display of an analog channel**

Input Level

Waveform Display Range Full Span

#### Level display of logic channels

□	— High	When the display setting is On, the part indicated in white takes the color specified for the waveform display. When the setting is Off, the part becomes gray. The part indicated in black takes the background color.
◻	— High & Low	
■	— Low	

**NOTE**

Input levels are not displayed for channels having no corresponding module installed.

## 6.6.2 Numerical Value Monitoring (DMM Display)

Input values can be monitored as numerical values in the same way as with a DMM (digital multimeter).

### Procedure

To open the screen: Right-click and select **[DISP]** → Left-click the **[DMM]** icon

Left-click the **[DMM]** icon.



Left-click the **[DMM]** icon on the top right of the Waveform screen.

The display changes to numerical value (DMM) display.

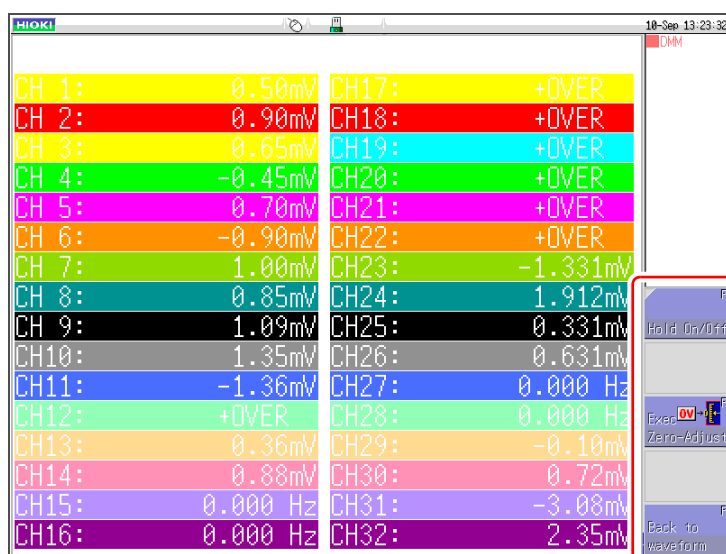

Display menu

To return to the Waveform screen

Left-click **[Back to waveform]** in the display menu on the right of the screen.

To pause (hold) display

Left-click **[HOLD ON/OFF]** in the display menu on the right of the screen. The HOLD mark appears at the top of the screen to indicate that the screen is in the HOLD state.

Click **[HOLD ON/OFF]** in the HOLD state to cancel hold.

Zero adjust

Zero adjustment (calibration for MR8990) can also be performed in the numerical value (DMM) display screen. Left-click **[Exec Zero-Adjust]** in the display menu on the right of the screen.



## 6.7 Switching the Waveform Screen Display (Display Menu)

The display menu allows you to bring up additional information such as upper/lower limit value indication and comment display. It also allows you to set the waveform display width.

See: About level monitor (p.132)

### Procedure

To open the menu: Right-click and select **[DISP]** → Display Menu

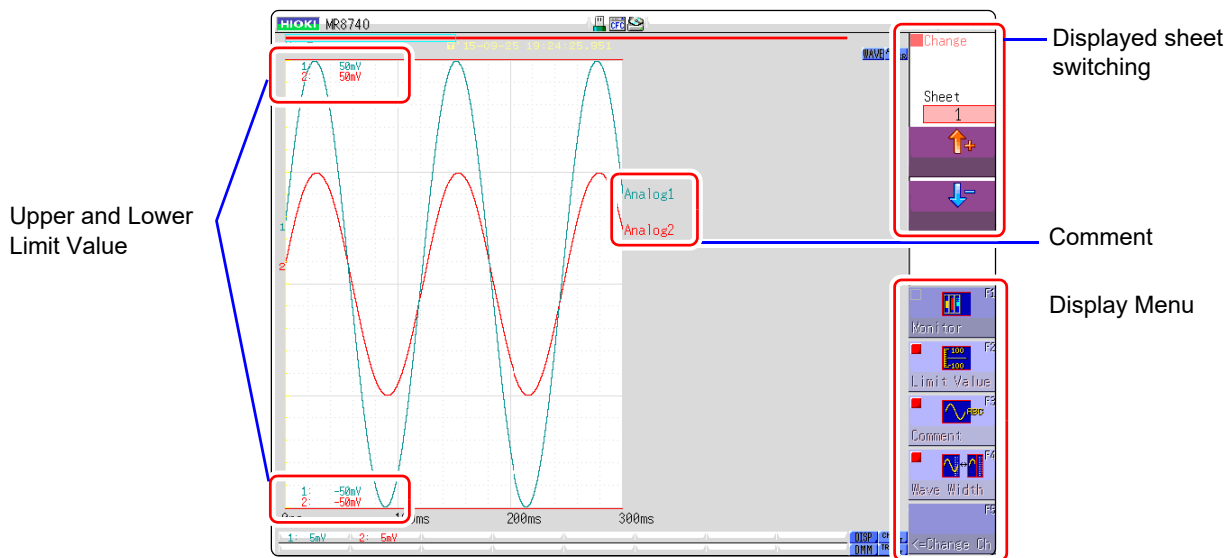

**To hide the menu:**  
Select the same menu again.

### 6.7.1 Showing Upper/Lower Limit On Waveform Screen

Select **[Limit Value]** to show the upper/lower limit value indication on the Waveform screen.

### 6.7.2 Showing Comments On Waveform Screen

Select **[Comment]** to show the comment indication on the Waveform screen.

- Comment information must have been entered via the **[Comment]** sheet on the Channel screen.  
See: "7.1 Adding Comments" (p.138)
- When overlapped with other displayed elements, the comments may not display properly. Hide the Channel Settings Window, Trigger Settings Window, Level Monitor, etc., or decrease the **[Wave Width]**.

### 6.7.3 Switching the Waveform Display Width

Select **[Wave Width]** to change the display width of the Waveform screen.

If a waveform is hard to see because of numeric value and settings information, this function can be used to separate the waveform and other information.

The function is also active for the Channel settings window and Trigger settings window.

### 6.7.4 Switching the Format (MR8741 Only)

The screen changes each time you click **[Format]**.

### 6.7.5 Changing the Monitor Values (MR8740 Only)

Click **[Change Ch]** to change the channels displayed at the bottom of the screen (CH1 to CH16 and CH17 to CH32).

When level monitoring is ON: The channel displayed for analog monitoring changes.

When level monitoring is OFF: The channel displayed for the range setting changes.

### 6.7.6 Switch the Displayed Sheet

Select **[↑]/[↓]** to switch the displayed sheet.

The settings of each displayed sheet can be specified on the Unit List tab of the Channel settings window.

**See:** Refer to "3.4.4 Display Sheet" (p.79)

## 6.8 Seeing Block Waveforms

MEM

**This applies to the Memory function only.**

If recorded by memory division, the usage status of blocks can be checked. Furthermore, the desired block can be selected and the recorded waveform can be displayed.

When memory division is not used, depending on the record length, it is possible to display the last 16 measured waveforms.

See: "6.3 Moving the Waveform Display Position" (p.125)

Blue blocks:  
Saved blocks (blocks in use)

Data trigger time of the selected block

Green blocks: Currently selected displayed block  
Blocks with light blue frame: Referenced blocks

- 1 Right-click and select **[DISP]** to display the Waveform screen.
- 2 When the waveform display position is displayed, left-click the **WAVE** button on the top right of the screen to switch to block display.
- 3 Left-click the rectangle of the block to display. When there are more than 32 blocks, click to the right side of the last block to display the next 32 blocks, and click to the left side of the first block to display the previous 32 blocks.



### When you want to overlap with other blocks (reference blocks)

Open the Status screen to the **[Memory Div]** sheet and set **[Ref Block]** to **[On]** and select **[All Blks On]**.

See: "11.2 Display Settings" (p.244)

# Utility Functions Chapter 7

Various utility functions are described in the section.

## Utility Functions

**Adding Comments (p.138)**

**Converting input values (Scaling) (p.148)**

**Setting the waveform display freely(p.155)**

**Fine Adjustment of Input Values (p.158)**

**Inverting a waveform (p.159)**

**Copying a setting to another channel(p.160)**

### Applicable measurements and settings

- Displaying Waveforms During Recording (p.145)
- Overlaying with past recorded waveforms (p.146)

### Detailed module settings (p.161)

- Making anti-aliasing filter settings
- Selecting the thermocouple type
- Making reference point compensation settings
- Making wire break detection settings
- Making data updating settings
- Executing auto balance
- Making probe attenuation settings
- Making response settings
- Making measurement mode settings

## 7.1 Adding Comments

This section explains how to enter title comments and channel comments. Information about alphanumeric input is also provided.

### 7.1.1 Adding a Title Comment

When you enter a title comment, it can be displayed at the top of the Waveform screen. (Allowed number of characters: up to 40)

#### Procedure

To open the screen: Right-click and select [CHAN] → [Comment] sheet

InputUnit	Ch	Comment
ANALOG	1	
	2	
TEMP	3	
	4	

#### 1 Enter a title comment.

Move the flashing cursor to the **[Title Comment]** item, and then click.

#### Select

<b>Input</b>	Enter comment text. See: "Entering Text" (p.141)
<b>Clear</b>	Clear entered information
<b>Undo</b>	Return to condition of preceding step



#### To select from preset terms

Clicking **[PRESET]** after activating text input brings up a list of preset terms. It is also possible to select words from previously entered titles (History function).

See: "Entering Text From a Term List Or History List" (p.142)

## 7.1.2 Adding a Channel Comment

Comments added for each channel can be displayed on-screen. (Allowed number of characters: up to 40)



### To display a comment on the screen

Right-click and select **[DISP]**, and then select a comment.

See: "6.7.2 Showing Comments On Waveform Screen" (p.134)

### To copy a comment to another channel

The **[Comment]** sheet can be used to copy a comment.

See: "7.8 Copying settings to other channels (calculation No.) (Copy function)" (p.160)

### Procedure

To open the screen: Right-click and select **[CHAN]** → **[Comment]** sheet

[Each Channel]		
InputUnit	Ch	Comment
ANALOG	1	
	2	
TEMP	3	
	4	
DC/RMS	5	
	6	
ANALOG	7	
	8	
ANALOG	9	
	10	
LOGIC	11	Enter on LogicPage

### 1 Enter the comment for each analog channel.

Move the flashing cursor to the **[Comment]** item, and then click.

Select

<b>Input</b>	Enter comment text. See: "Entering Text" (p.141)
<b>Clear</b>	Clear entered information
<b>Undo</b>	Return to condition of preceding step



### To select from preset terms

Clicking **[PRESET]** after activating text input brings up a list of preset terms. It is also possible to select words from previously entered titles (History function).

See: "Entering Text From a Term List Or History List" (p.142)

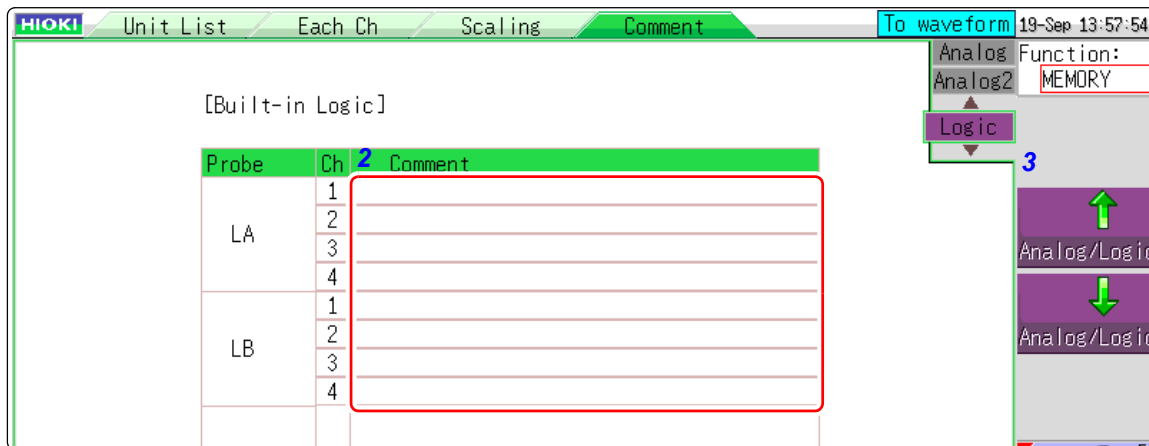

### 2 Enter the comment for each logic channel. Select

Move the flashing cursor to the **[Comment]** item, and then click.

<b>Input</b>	Enter comment text. <a href="#">See: "Entering Text" (p.141)</a>
<b>Clear</b>	Clear entered information
<b>Undo</b>	Return to condition of preceding step



#### To select from preset terms

Clicking **[PRESET]** after activating text input brings up a list of preset terms. It is also possible to select words from previously entered titles (History function).

[See: "Entering Text From a Term List Or History List" \(p.142\)](#)

## 7.1.3 Alphanumeric Input

Move the flashing cursor to the setting item for which to make the input, and choose the content with the mouse.

### Entering Text

1. Move the flashing cursor to the field for entering text with the mouse, and then click **[Enter Char]**.

A virtual keyboard appears.

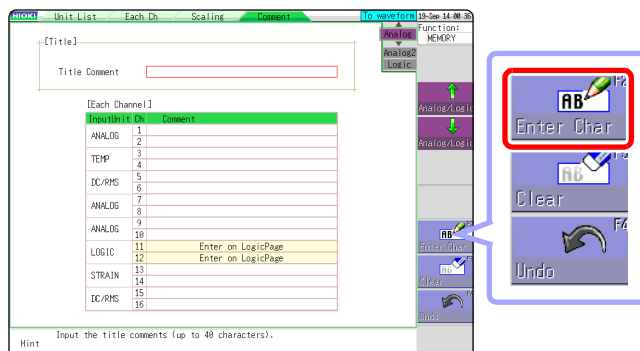

2. Select a character from the virtual keyboard to enter it.

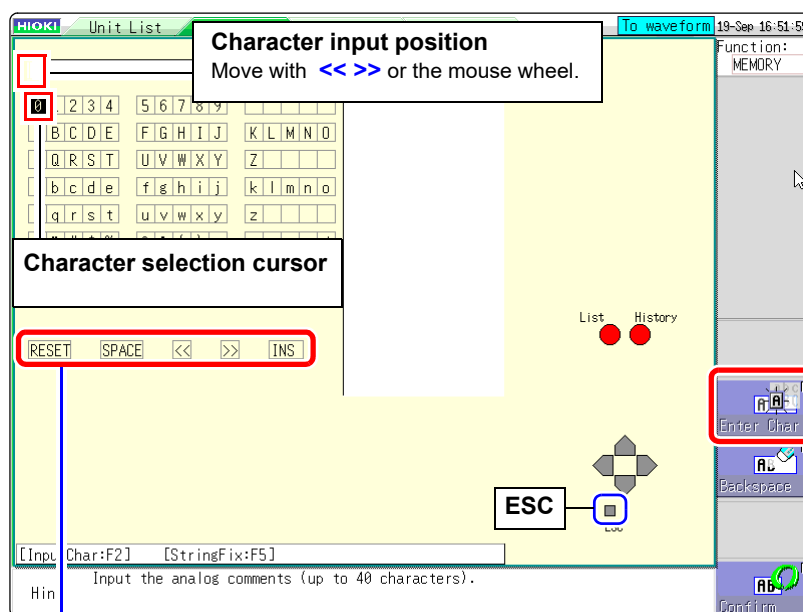

**RESET:** Deletes all entered characters.

**SPACE:** Inserts a space.

**OVWR/INS:** Toggles between Overwrite (OVWR) and Insert (INS) mode.

**<<:** Move the character input position left.

**>>:** Move the character input position right.

3. Select **[Confirm]** to accept the entry.  
Click **[ESC]** to cancel the input.  
(Clicking **[ESC]** again closes the virtual keyboard)

### NOTE

#### Entering units and symbols

Characters entered at the unit may be saved differently.

Save (saving of numerical calculation results or text format information)

$2 \rightarrow \wedge 2$ ,  $3 \rightarrow \wedge 3$ ,  $\mu \rightarrow \sim u$ ,  $\Omega \rightarrow \sim o$ ,  $\varepsilon \rightarrow \sim e$ ,  $^{\circ} \rightarrow \sim c$ ,  
 $\pm \rightarrow \sim +$ ,  $\mu\text{E}$  (display only)  $\rightarrow u\text{E}$ ,  $^{\circ}\text{C}$  (display only)  $\rightarrow \text{C}$

Characters not allowed in the file name have been detected. (Please use only uppercase letters.)



### Entering Text From a Term List Or History List

While the virtual keyboard is displayed, clicking **[Term List]** displays preregistered words.

Also, clicking **[History List]** displays words entered in the past.

1. Move the flashing cursor to the comment field and select **[Enter Char]**. The virtual keyboard appears.

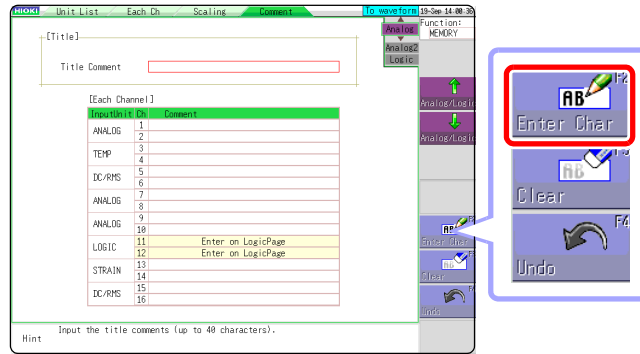

2. (To select from preset terms)

Click **[Term List]**.

A list of preset terms appears.

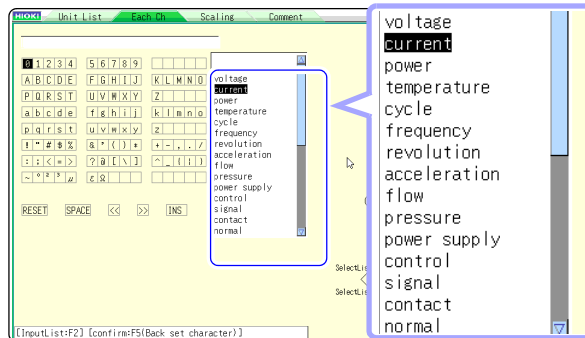

(To select from past input)

Click **[History List]**.

A History list appears.

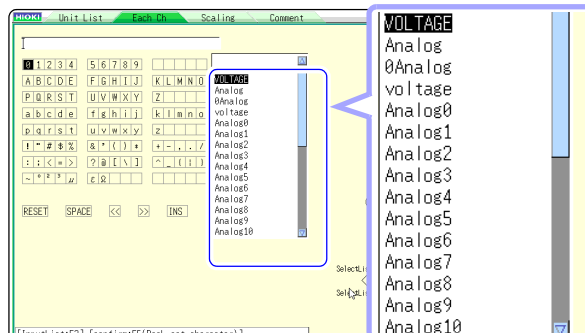

Click **[ESC]** to cancel selection from the history list.

3. Select the word to enter from the list. You can also select the word to enter by double-clicking it.
4. Select **[Confirm]** to accept the entry. The virtual keyboard disappears. To return the edited field to the original condition, select **[Undo]**.

## Entering Numerals By Up/Down Action

1. Move the flashing cursor to the numeric input field and select [Up-Down]. A virtual keyboard for digit input appears.

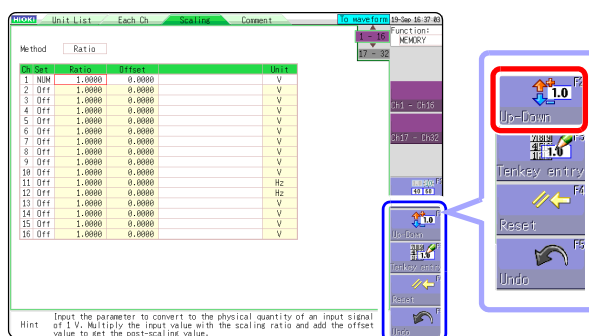

2.
  - Click  $\triangle\triangledown$  in the displayed up-down input window. This allows you to change the value of the corresponding digit.
  - Click a digit that can be changed. The selection cursor moves to that location.
  - Rotate the mouse wheel. This allows you to increase or decrease the value of the digit where the selection cursor is located.

If the value is changed in the  $\triangle$  (up) direction, the current numeral itself increases.

(If there is a minus sign at the beginning, the numerical value of the digit decreases [the set value increases].)

3. Click [Confirm].  
The currently set value is entered.
- Click [ESC] to cancel the input.

## Entering Numerals With a Numeric Keypad

1. Move the flashing cursor to the numeric input field and select **[Tenkey Entry]**. A virtual keyboard for numeric keypad input appears.

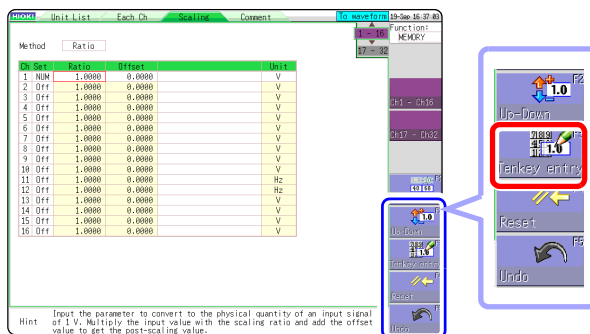

2. Use the virtual keyboard for numeric keypad input.

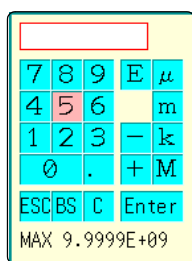

**BS:** Delete 1 character  
**C:** Delete all characters  
**E:** Exponent entry  
**μ, m, k, M:** Unit prefix

3. Click **[Enter]**.  
The entered value is confirmed.

Click **[ESC]** to cancel the input.

## 7.2 Displaying Waveforms During Recording (Roll Mode)

MEM

This applies to the Memory function only.

You can display the waveform at the same time as the data are acquired.

- If measurement is carried out at low sampling speed settings using the Memory function, a long time will be required until data for the entire recording length have been collected. In such cases, the Roll Mode function is convenient.
- The new waveform scrolls automatically.

### Procedure

To open the screen: Right-click and select **[STATUS]** → **[Status]** sheet

Move the flashing cursor to the **[Roll Mode]** item.

Select

<b>Off</b>	Normal recording. Data is displayed only after acquiring the specified recording length.
<b>On</b>	Waveforms are displayed while recording (with 10 ms and slower settings). When the timebase is set to 5 ms/div or faster, waveforms are not displayed until after acquisition has finished.
<b>Auto</b>	Regardless of the timebase setting, whether or not the waveform is displayed depends on the waveform display magnification settings while the data is being recorded. However, when the waveform is displayed using a time axis slower than 100 ms per division, or when the time axis range is 5 $\mu$ s/div, the waveform will be displayed after it has been captured.

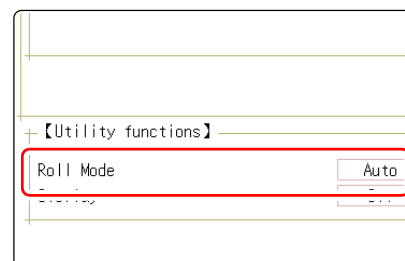

### NOTE

During longer recording operations, the waveform will scroll, so that you can always observe the latest signal.

### Description

#### When the Roll mode function is [On]

The roll mode cannot be used simultaneously with the following functions.

- Overlay (p.146)
- Memory division (p.241)
- Waveform calculation (p.227)

When the functions above are set to **[On]**, the roll mode function is automatically set to **[Auto]**.

#### When the Roll Mode function is Off

Waveforms are displayed after the data has been acquired for the entire recording length, so with slow sampling there may be a long wait after starting measurement before the waveform is displayed.

# 7.3 Displaying New Waveforms Over Past Waveforms (Overlay) MEM

This applies to the Memory function only.

Displayed waveforms are retained on-screen and overlaid with new waveforms.

- Use this to compare new waveforms with those recorded immediately before. (When the trigger mode is **[Repeat]** or **[Auto]** (p.191)
- There are two overlay methods: automatic overlay during measurement and manual overlay.

Normal Display

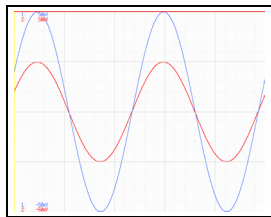

Waveforms with the Overlay Function

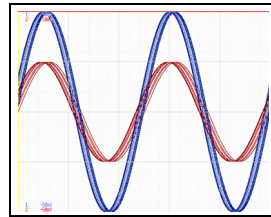

### Procedure

To open the screen: Right-click and select **[STATUS]** → **[Status]** sheet

Move the flashing cursor to the **[Overlay]** item.

Select

<b>Off</b>	Overlay disabled.(default setting)
<b>Auto</b>	Each time a waveform is acquired, it is automatically displayed as an overlay. When the trigger mode is <b>[Cont.]</b> or <b>[Auto]</b> , waveforms will be overlaid from start until stop.
<b>Manual</b>	Overlay waveforms on the screen manually. Regardless of the trigger mode, the waveform is left on the screen (p.146).

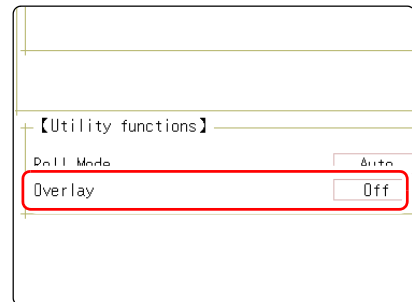

This mode cannot be used simultaneously with the Roll Mode.  
"When the Overlay function is enabled ([Auto] or [Manual])." (□ p.147)

### Manual Overlay (Any waveform can be retained on-screen)

To open the screen: Right-click and select **[DISP]** → **Waveform** screen

Move the flashing cursor to the **[Overlay]**.

Select

<b>Overlay</b>	Clicking <b>[Overlay]</b> leaves the loaded waveform on the screen. The overlay is displayed until the waveform is cleared.
<b>Clear</b>	Clears the screen of all overlaid waveforms. Cleared waveforms cannot be displayed again.

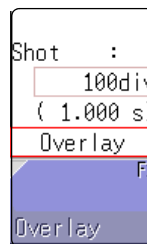

- Description** When the Overlay function is enabled ([Auto] or [Manual]).
- The Roll Mode function (p.145) and Overlay functions (p.146) cannot both be enabled at the same time. When the Roll Mode is enabled, the Overlay function is automatically set [Off]. And when Overlay function is enabled, automatically turns the Roll Mode [Auto].
  - The following operations are not available on the Waveform screen. Waveform scrolling, Zoom function On/Off, Changing horizontal axis (time axis) magnification/compression, Changing zero position
  - In the following cases, overlaid waveforms are cleared and only the most recent waveform is displayed.
    - When [Format] was changed on the [Status] sheet
    - When the [Combo Area] setting has been changed ([Format] set to [X-Y Single] or [X-Y Quad])
    - Waveform display setting was changed on [Unit List] sheet or [Each Ch] sheet (Display magnification, zero position, variable, display on/off, waveform color)

# 7.4 Converting Input Values (Scaling Function)

## About the Scaling Function

Use the scaling function to convert the measured voltage units output from a sensor to the physical units of the parameter being measurement.

Hereafter, "scaling" refers to the process of numerical value conversion using the Scaling function.

Gauge scales, scale values (upper and lower limits of the vertical axis (voltage axis)) and A/B cursor measurement values can be displayed in scaled units. Scaling is available for each channel.

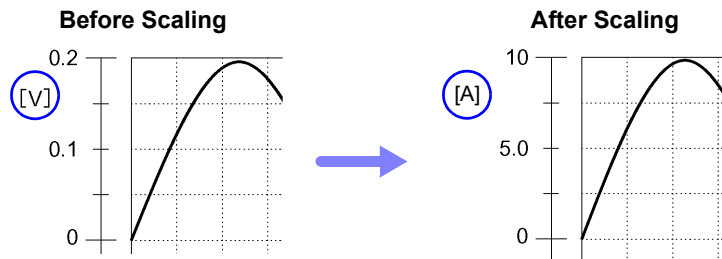

### Scaling Setting Example

See: When using a clamp sensor (p.150) (Example: Converting [ V ] → [ A ])  
 When using the Strain Unit (p.151) (Example: Converting [  $\mu\epsilon$  ] → [ G ])

## Scaling Methods

Two scaling methods are available:

- Conversion Ratio Setting
- Two-Point Setting

(:Example: Converting [V] → [A])

### Conversion Ratio Setting

Set the physical value per volt (conversion ratio: eu/V) of the input signal, an offset value and measurement unit name (eu: engineering units) for conversion, so measurement values acquired as voltage are converted to the specified units.

Example:

Conversion ratio: A value per volt, Offset value: B, Unit name: A

Convert from slope (conversion ratio) and offset value

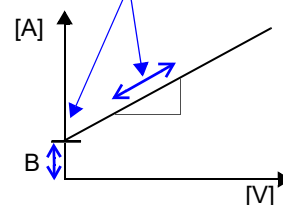

### Two-Point Setting

Set the voltage values of two points of the input signal, the converted unit value of these two points and the name of the converted measurement units, so measurement values acquired as voltage are converted to the specified units.

Example:

Voltage value at 2 points	Voltage of units to convert
$V_H$ : Higher potential point	$A_H$ : Value for higher potential point
$V_L$ : Lower potential point	$A_L$ : Value for lower potential point

Unit name: A

Conversion ratio and offset value are calculated from the two points and converted

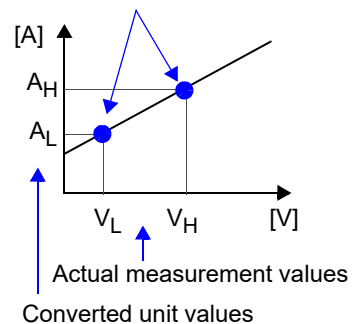

## Procedure

To open the screen: Right-click and select [CHAN] → [Each Ch] sheet

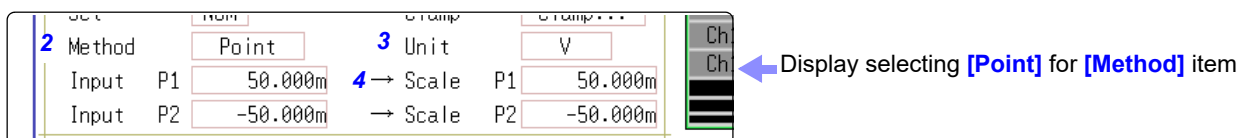
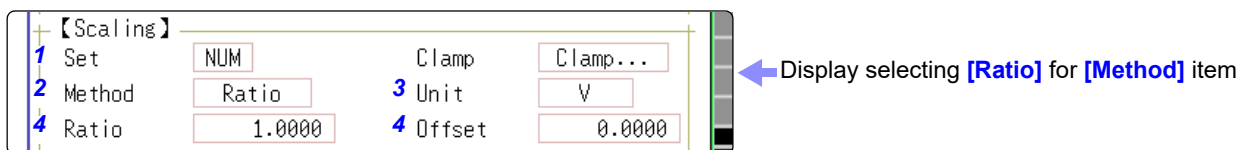

### 1 Enable the Scaling function.

Move the flashing cursor to the [Disp] item.

Select

Off	No scaling.
NUM	Displayed as a decimal and includes a unit (m, k, etc.).
SCI	Displayed as an exponent (the power of ten)

### 2 Select the scaling conversion method.

Move the flashing cursor to the [Method] item.

Select

Ratio	Specify by conversion ratio.
Point	Specify by two points.

### 3 Specify the physical units.

Move the flashing cursor to the [Unit], and enter the physical unit name. (Up to 7 characters)

See: "Entering Text" (p.141)

**Input example:**  
 Decimal 1.2345 mV  
 Exponent 1.2345E-03V

### 4 Enter the numerical values for conversion.

**When you have selected [Ratio] (set conversion ratio and offset)**

Enter numerical values in each field.

Move the flashing cursor to the [Ratio] and [Offset] items.

-9.9999E+9 to 9.9999E+9

**When you have selected [2-Point] (set input values for two points and the values after conversion)**

Enter numerical values in each field.

Move the flashing cursor to the [Input P1], [Scale P1], [Input P2], and [Scale P2].

-9.9999E+9 to 9.9999E+9

## NOTE

- When saving text or results of numerical calculation, some characters and symbols used for display on the instrument will be converted as follows. (MR8740/MR8741 display → saved string)
- $^2 \rightarrow \wedge 2$ ,  $^3 \rightarrow \wedge 3$ ,  $\mu \rightarrow \sim u$ ,  $\Omega \rightarrow \sim o$ ,  $\varepsilon \rightarrow \sim e$ ,  $^\circ \rightarrow \sim c$ ,  $\pm \rightarrow \sim +$ ,  $\mu\varepsilon$  (display only)  $\rightarrow uE$ ,  $^\circ C$  (display only)  $\rightarrow C$



To enter the current input value as is for P1 or P2  
 Select [Monitor Val].



**To reset Scaling settings:**

Move the flashing cursor to the **[Setting]**, and select **[Reset]**.

**To copy the scaling setting to another channel**

The Channel screen - **[Scaling]** sheet can be used to copy a setting.

See: "7.8 Copying settings to other channels (calculation No.) (Copy function)" (p.160)

**Using the Scaling and Variable functions (p.155) in combination:**

The full span of output from a sensor can be displayed. (p.157)

**NOTE**

At factory shipping, automatic correction of the variable function (p.311) is set to **[On]**.

At this time, the Variable setting is altered so that it is linked to (dependent upon) the vertical axis (voltage axis) range and scaling settings. If you want the Variable function setting to take priority, use either of the following procedures:

- Set Scaling first, and then set the Variable function
- Set a Variable value before Scaling, and then set Scaling.

When automatic correction of the Variable function (Variable Auto Adjustment) is disabled (**[Off]**), the Scaling and Variable settings are unlinked (independent of one another).

## 7.4.1 Scaling Setting Examples

### Using a Clamp-On Probe

#### Example 1 Measure with the 10 A range of the Model 9018-50 Clamp On Probe and display the measured data in units of [A] (Amperes)

The 9018-50 Clamp On Probe provides 0.2 V output when measuring 10 A. So Scaling should be set to display 10 A with 0.2 V input (and 0 A with 0 V input).

[Scaling]		Clamp	Clamp...
Set	Off	Model	9000~
Method	Ratio	Clamp	9018-50
Ratio	1.0000	Range	10A

Setting Items	Setting Choice
Disp	NUM or SCI
Clamp	9018-50
Unit*	A
Method*	Ratio
Ratio*	50.000

\*: Set automatically when clamp is selected.

#### Selecting a Clamp Type

1. Move the flashing cursor to the **[Clamp]** item, and select **[Select]**.  
The flashing cursor moves to the **[Model]** item.
2. Select **[9000 ~ ]**.  
The flashing cursor moves to the **[Clamp]**.
3. Select **[9018-50]** from the clamp list and select **[Confirm]**.  
Units, scaling method, and ratio are set automatically.
4. Select the same range of the clamp when using the range selection type.  
Select **[10A]** here.

## 7.4 Converting Input Values (Scaling Function)

However, you may need to switch the vertical axis (voltage axis) range to suit actual input values.

For example, to display  $\pm 0.2$  V at full scale, set the vertical display to 20 mV per division (the instrument's 20 mV/div range)

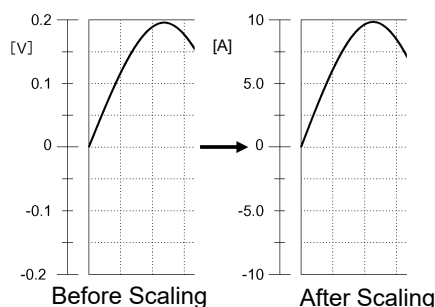

With scaling, signals from the sensor are acquired as current values.

A/B cursors and gauges are displayed with current (Ampere) values.

See: Upper/lower limit: (p.134)

Cursor A/B value: (p.120)

### Using Model 8969 or U8969 Strain Unit

#### Example 2 Using the 20 G rated capacity and a strain gauge transducer with 1000 $\mu\text{V/V}$ rated output, display measured data in units of [G]

For the rated capacity and rated output, consult the calibration record of the strain gauge transducer to be used. Set as follows:

【Scaling】			
Set	NUM		
Rated Cap	20.000	Unit	G
RatedOutput	1.0000k $\mu\text{V/V}$		

Setting Items	Setting Choice
Disp	NUM
Unit	G
Rated Cap (Rated capacity)	20 [G]
Rated Output	1k

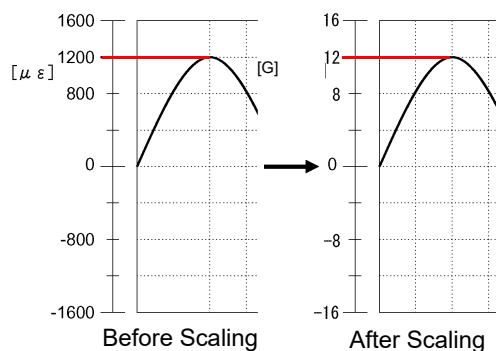

By using the Scaling function, signals from the strain gauge transducer are acquired as physical values.

A/B cursors and gauges are displayed as physical (G) values.

See: Upper/lower limit: (p.134)

Cursor A/B value: (p.120)

#### **NOTE**

Set the parameters such that the rated capacity divided by two times the rated output is less than or equal to  $9.9999 \times 10^9$ .

### When a calibration factor is stated in the strain gauge transducer inspection records

Set the [Method] item on the [Scaling] sheet to [Ratio].

**Example 3 Measure using a strain gauge transducer with a calibration factor of 0.001442 G / 1 x 10<sup>-6</sup> strain\*, and display the measured data in [G] units.**

The value of the calibration factor (0.001442 [G]) is set as the conversion ratio.  
(\* 10<sup>-6</sup> strain = με)

Move the flashing cursor to the channel to set, and making settings as follows.

Setting Items	Setting Choice
Disp	NUM
Unit	G
Ratio	0.001442 [G] (Conversion ratio) (displays as 1.4420m)

Ch	Set	Ratio	Offset	Unit
1	NUM	1.4420m	0.0000	G
2	Off	1.0000	0.0000	V
3	Off	1.0000	0.0000	V
4	Off	1.0000	0.0000	V
5	Off	1.0000	0.0000	V
6	Off	1.0000	0.0000	V
7	Off	1.0000	0.0000	V
8	Off	1.0000	0.0000	V
9	Off	1.0000	0.0000	A
10	Off	1.0000	0.0000	A
11	Off	1.0000	0.0000	Hz
12	Off	1.0000	0.0000	Hz
13	Off	1.0000	0.0000	V

### Using a strain gauge with a Gauge Factor other than 2.0

The 8969 or U8969 Strain Unit measures the Gauge Rate as 2.0.

When using the other strain gauge, the Gauge Factor needs to be set as the conversion ratio. For example, if the Gauge Factor is 2.1, the conversion ratio is 0.952 (2÷2.1).

Gauge Rate 2.00

This value cannot be changed.

**Example 4 Measure using a strain gauge (2.1 Gauge Factor), and display the measured data in [G] units.**

The scaling (conversion ratio) needs to be calculated to include both Gauge Factor and physical value conversions. In this case, the conversion ratio setting is the product of the conversion ratios of the Gauge Factor and measurement unit scaling.

The Gauge Factor component of the conversion ratio is 0.952, and the physical value component is 0.001442\*

$$\text{Conversion Ratio} = 0.952 \times 0.001442 = 0.0013728$$

As in Example 3, enter [0.0013728] as the conversion ratio.

\* To convert measurement values to physical values when using a strain gauge, calculate using the Young's modulus or Poisson's ratio of the measurement

#### 7.4 *Converting Input Values (Scaling Function)*

---

---

object. The conversion method depends on the conditions in which the strain gauge is used.

[See:](#) "Appendix 2.6 Scaling Method When Using Strain Gauges"(p.A9)

### Using the dB value

#### Example 5 Acquiring the conversion rate to convert 40 dB input to 60 dB

1. For scaling, set the [Method] to [Ratio].
2. Point the flashing cursor to the conversion rate setting and select [dB Scaling].

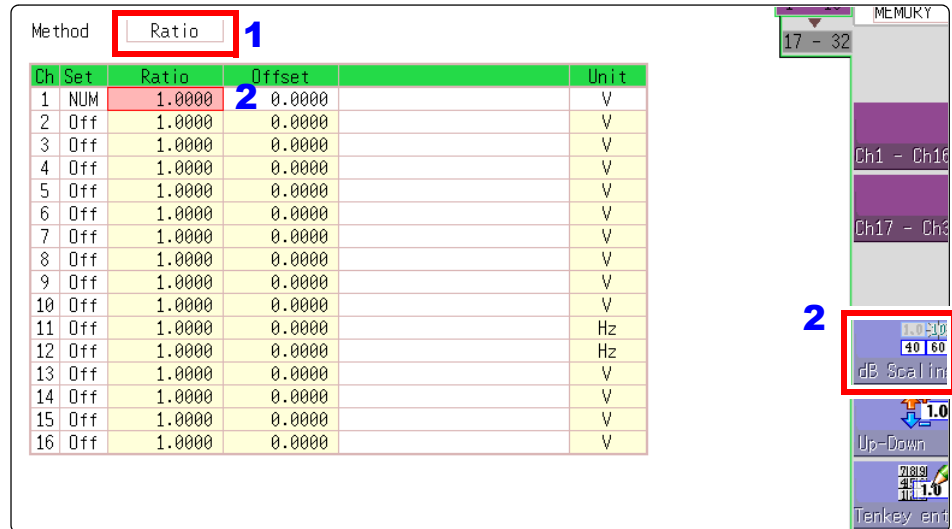

3. In the displayed entry field and physical quantity field, enter 40 dB and 60 dB, respectively.  
After entering the values, select [Confirm].

See: "7.1.3 Alphanumeric Input" (p.141)

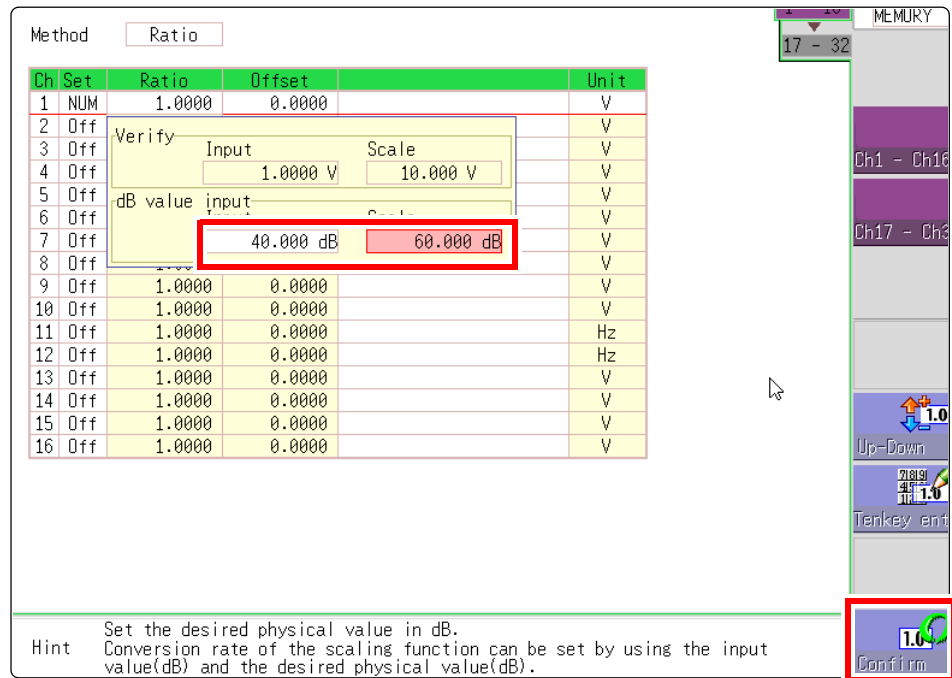

The conversion rate for the entered dB value is entered. (The offset becomes 0.)

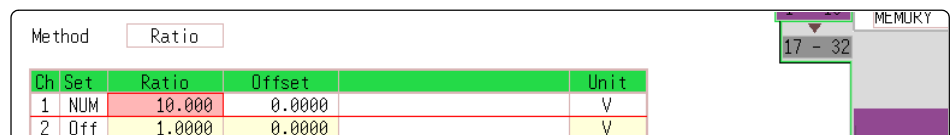

## 7.5 Variable Function (Setting the Waveform Display Freely)

The waveform height and display position can be arbitrarily set along the vertical axis (voltage axis).

### NOTE

#### Precautions for using the Variable Function

- Verify that the vertical axis (voltage axis) range is set properly for the input signal.
- The vertical axis (voltage axis) range is unaffected by changes to the upper and lower limits made by the Variable setting.

The following two setting methods are available:

- Set the displayed amplitude per division (1div setting)  
Set the amplitude to be displayed per vertical division and the zero position of the waveform on the vertical axis (voltage axis).

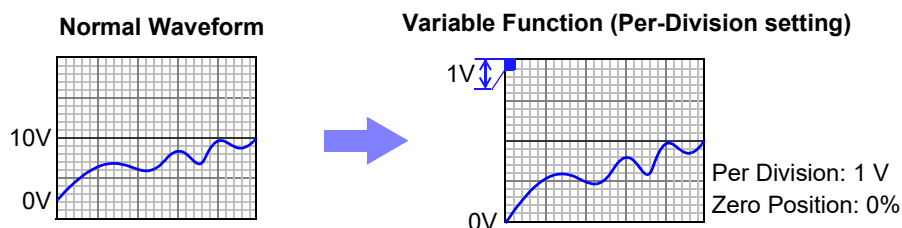

- Set the Upper and Lower Limits (Upper-Lower setting)  
The upper and lower limits on the vertical axis (voltage axis) can be set to display the waveform amplitude full-screen.

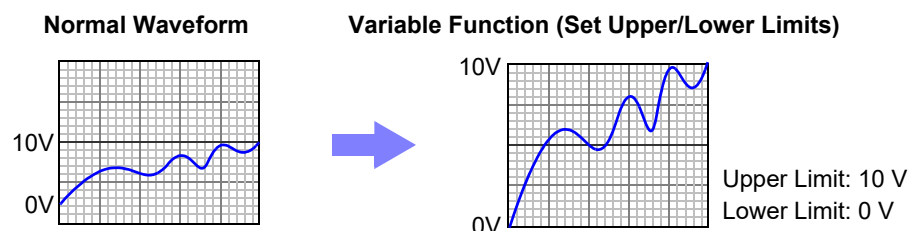

Settings for the Variable function can be made for each individual channel, using the **[Each Ch]** sheet accessed from the Channel screen (p.156), or for all channels using the Display range window (p.157).

## Make the Variable Function Setting per channel

### Procedure

To open the screen: Right-click and select [CHAN] → [Each Ch] sheet

#### 1 Enable the Variable function.

Move the flashing cursor to the [Variable], and select [On].

#### 2 Set the display range per division

Move the flashing cursor to the [Range(div)], and enter numerical value.

(Measurement units depend on the measurement mode of the module.)

(When this is changed, the upper/lower limit values for the display also change accordingly.)

#### 3 Set the waveform zero position to display on the vertical axis (vertical axis).

Move the flashing cursor to the [Zero pos%], and enter numerical % value.

(When this is changed, the upper/lower limit values for the display also change accordingly.)

#### 4 (When setting upper and lower values)

Move the flashing cursor to the [Upper] and [Lower], and specify the values.

- When upper and lower values are set, waveforms can be displayed at full span on the screen.
- Depending on the scaling setting, the upper and lower display values may be less than 1. In such cases, set [Variable] to [On] and then select [Auto Set]. Easy-to-read upper and lower limit values are set based on the currently set values.

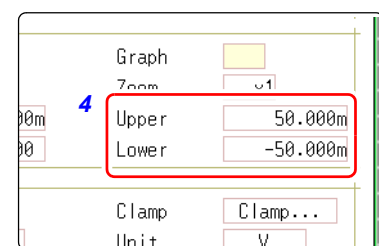
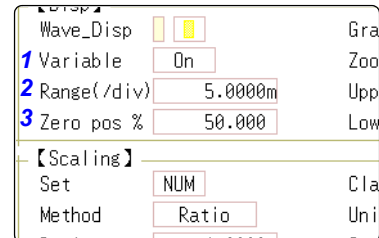

#### To reset the settings

Select [Reset] to return the settings to the default values.

### NOTE

- For information on numeric input, see "7.1.3 Alphanumeric Input" (p.141).
- The [Unit List] sheet accessed from the Channel screen also lets you turn the Variable function On or Off individually for each channel.
- By using the Scaling and Variable functions together, the full span of a sensor's output can be displayed. (p.157)
- When Scaling is enabled, values are displayed in scaling units. When these settings are changed, the numerical values indicating the display range on the level monitor are changed accordingly.

## Displaying All Channels for Making the Variable Function Setting

### Procedure

To open the screen: Right-click and select [DISP] → Waveform screen → Right-click and select [CH.SET] → Display range window

#### 1 Enable the Variable function.

Move the flashing cursor to the [Variable], and select [On].

#### 2 Set the upper and lower limits.

Move the flashing cursor to the [Upper] and [Lower], and enter numerical value.

Ch	Variable	Lower	Upper
1	On	-50.000m	50.000m
2	-	-50m	50m
3	-	-50m	50m
4	-	-50m	50m
5	-	-50m	50m

### Description When setting combined use of the Scaling and Variable functions

#### When Auto-Correction of the Variable function is enabled (On, default setting) (p.311)

The Variable function settings change according to Scaling and vertical axis (voltage axis) range settings. Set Scaling before setting the Variable function.

If you change Scaling settings after enabling the Variable function, the Variable setting voltage is automatically corrected so that the displayed size of waveforms is unchanged.

When Auto-Correction of the Variable function is disabled (Off)

Set the Variable function after setting Scaling.

If setting the Variable function first, enter post-scaling values (converted physical values).

#### To display the full span of output from a sensor

By using the Scaling function in combination, voltage from a sensor can be converted to the physical units of the measurement object.

Example:

Set Scaling as follows:

Scaling: Decimal or exponent, Two-Point Setting

Units: A

Sensor Output (Input 1): 1.23 [V] → (Scale 1): 0 [A]

Sensor Output (Input 2): 5.78 [V] → (Scale 2): 10 [A]

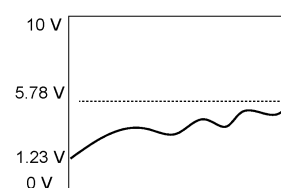

(with Variable function Off)

Voltage from the sensor is displayed as voltage.

It is displayed with the vertical axis (voltage axis) range and at the zero position set on the Channel settings window ([Analog] sheet).

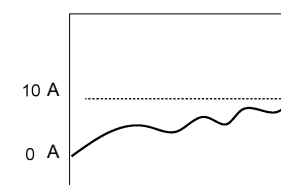

The Variable function is set as follows:

Variable: On, Set Upper/Lower Limits

Lower Limit: 0 [A] Upper Limit: 10 [A]

The full span of output from the sensor is displayed.

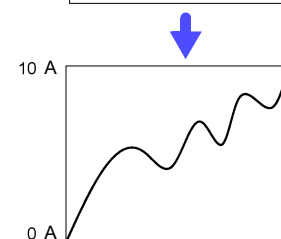



## 7.6 Fine Adjustment of Input Values (Vernier Function)

Fine adjustment of input voltage can be performed arbitrarily on the Waveform screen. When recording physical values such as noise, temperature and acceleration using sensors, amplitude can be adjusted to facilitate calibration.

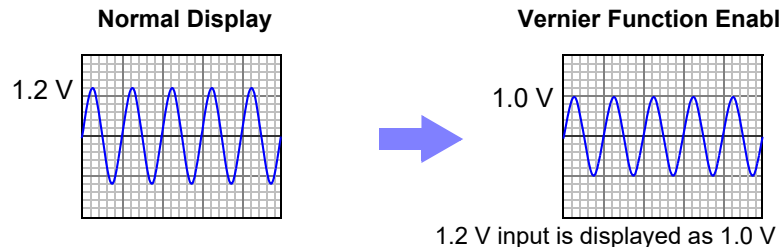

### Procedure

To open the screen: Right-click and select [DISP] → Waveform screen → Right-click and select [CH.SET] → Channel settings window ([Analog] sheet)

- 1 Move the flashing cursor to the [↕] vernier setting item of the channel to adjust.

- 2 Make the adjustment while watching the waveform.

Vernier ↑	Magnify waveform
Vernier ↓	Compress waveform
Vernier Reset	Return waveform to original position

Analog		Variable		Logic	
Ch	Col	Range	Mag	Position	LPF
1	█	100mV	x1	50%	-
2	█	200mV	x1	50%	-
3	-	100mV	x1	50%	-
4	-	500mV	x1	50%	-

### NOTE

- The adjustment range is 50 - 200% of the original waveform. The magnification/compression ratio is not displayed.
- Vernier adjustments cannot be verified on waveforms.
- The waveform data (saved file data) is adjusted by the Vernier function.

## 7.7 Inverting the Waveform (Invert Function)

This applies to the analog channels only. You can invert the plus and minus sides of the waveform.

- Example:
- When a current sensor is clamped around a wire with its current direction mark mistakenly in the direction opposite to the current flow
  - When a signal is inputted with spring-pulling force negative and spring-compressing force positive; however, you would like to display the results with spring-pulling force positive and spring-compressing force negative

### Procedure

To open the screen: Right-click and select [DISP] → Waveform screen → Right-click and select [CH.SET] → Channel settings window ([Analog] sheet)

- 1 Move the flashing cursor to the [Mag] item for the channel whose waveform you want to invert.
- 2 Select [Invert].

ChCo1	Range	Mag	Position	LPF
1	5mV	x1	50%	-
2	5mV	x-1	50%	-
3	20V	x1	50%	-
4	5V	x1	50%	-

### NOTE

The waveform data (saved file data) is adjusted by the Invert function.

## 7.8 Copying settings to other channels (calculation No.) (Copy function)

At the following screens, settings can be copied to other channels and calculation No. (When the FFT function is used).

- Channel settings window
- Display range window
- Trigger settings window
- Status screen-[Status] sheet- [Analysis] list and [Scale] list (with FFT function only)
- Status screen - [Num Calc] sheet
- Status screen-[Wave Calc] sheet
- Channel screen - [Unit List] sheet
- Channel screen - [Scaling] sheet
- Channel screen - [Comment] sheet

The procedure is explained for the Display range window.

### Procedure

To open the screen: Right-click and select [DISP] →Waveform screen→Right-click and select [CH.SET]→Display range window

- 1 Click the copy source channel number (calculation No.).
- 2 Select [Copy].
- 3 Click the channel number (calculation No.) where you want to paste the settings.
- 4 Select [Paste].

To copy to all channels (calculations), select a channel number (calculation No.) other than the copy source and select [All Paste].

When you want to copy all the settings on the Unit list/Scaling/Variable sheets, select the [All setting Paste] button or [All setting All paste] button.

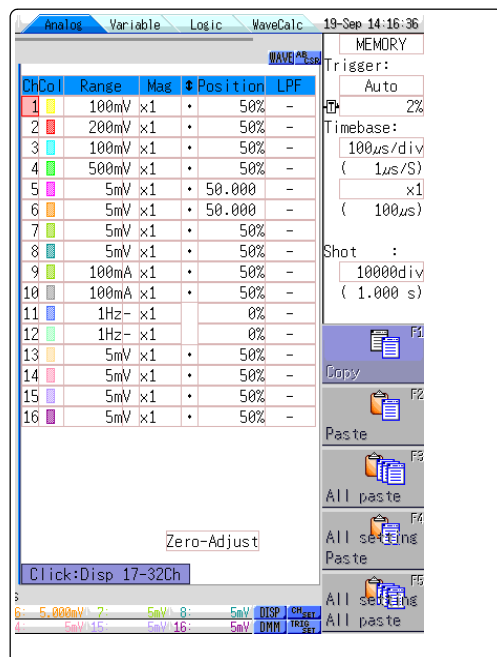

### NOTE

When channel settings are copied among different model units, the settings other than scaling cannot be performed. (Scaling copy is available.)

## 7.9 Setting Details of Modules

Using the [Each Ch] sheet accessed from the Channel screen, you can make detailed settings.

### Opening the [Each Ch] sheet, Making a Channel Selection

Click [CHAN] in the right-click menu.

Shows the channel number and channel position.

Select the channel.

### Logic channel allocation when using Standard LOGIC terminals

	Module	Memory for each channel (16 bits)			
		4 bits	4 bits	4 bits	4 bits
Ch1*	Analog	Analog Ch1			LA
Ch2*		Analog Ch2			LB
Ch3*	Logic	L2A	L2B	-	
Ch4*		L2C	L2D		
Ch5	Analog	Analog Ch5			
Ch6		Analog Ch6			
Ch7	Logic	L4A	L4B	-	
Ch8		L4C	L4D		
Ch9	Analog	Analog Ch9			
Ch10		Analog Ch10			
Ch11	Analog	Analog Ch11			
Ch12		Analog Ch12			
Ch13	Analog	Analog Ch13			
Ch14		Analog Ch14			
Ch15	Analog	Analog Ch15			
Ch16		Analog Ch16			

\*: Ch1 - Ch2 provide 12-bit precision when logic channels LA - LB are used.  
 When Ch1 to Ch2 are 8970 Freq Unit and standard logic channels LA to LB are used, the units of corresponding channels can no longer be used.  
 When the MR8990 Digital Voltmeter Unit is installed on unit 1 (unit 1 or unit 2 in the case of MR8741), the standard logic can no longer be used.

## 7.9.1 Setting the Anti-aliasing Filter (A.A.F)

MEM

The anti-aliasing filter (A.A.F) setting is configurable for Model 8968 High Resolution Unit and Model U8979 Charge Unit only.

See: Opening the [\[Each Ch\]](#) sheet, Making a Channel Selection (p.161)

【Unit】		
InputUnit	HIGH RES	
Mode	Voltage	A.A.F <input type="checkbox"/> Off
Range	5mV	

### A.A.F

Enable the anti-aliasing filter to remove aliasing distortion.

The cutoff frequency automatically changes according to the time axis range or (when the FFT function is used) the frequency range setting.

Select

Selections	Description
Off	The anti-aliasing filter is disabled. (default setting)
On	The anti-aliasing filter is enabled. (When the External sampling is used, the antialiasing filter (AAF) is not available.)

## 7.9.2 Probe Attenuation Selection

See: Opening the [\[Each Ch\]](#) sheet, Making a Channel Selection (p.161)

Range	5mV	
Resolution	3.125 $\mu$ V	16-bit
Coupling	DC	
LPF	Off	Probe <input type="checkbox"/> 1:1

### Probe

Make the setting when performing measurement with a connection cable or probe.

Select

Selections	Description
1:1	Model L9197, L9198 or L9217 Connection Cable connected to the module. (default setting)
10:1	Model 9665 10:1 Probe connected to the module.
100:1	9666 100:1 Probe, P9000-01/-02 Differential Probe connected to the module.
1000:1	Model 9322 Differential Probe, P9000-01/-02 Differential Probe connected to the module.

## 7.9.3 Setting Model 8967 TEMP Unit

See: Opening the [\[Each Ch\]](#) sheet, Making a Channel Selection (p.161)

InputUnit	TEMP	RJC	INT
Mode	Temp-K	Burn Out	Off
Range	10°C	Renew Data	Normal
Resolution	0.01°C (16-bit)		

### Mode

Set to match the type of thermocouple being used.

Select

Selections	Measurement Range	Selections	Measurement Range
<b>Temp- K</b>	-200 to 1350°C	<b>Temp- R</b>	0 to 1700°C
<b>Temp- J</b>	-200 to 1100°C	<b>Temp- S</b>	0 to 1700°C
<b>Temp- E</b>	-200 to 800°C	<b>Temp- B</b>	400 to 1800°C
<b>Temp- T</b>	-200 to 400°C	<b>Temp- W</b>	0 to 2000°C
<b>Temp- N</b>	-200 to 1300°C		

### RJC (Reference Junction Compensation)

When connecting a thermocouple directly to the module, select [\[Int\]](#).

Reference junction compensation is performed within the module. When connecting through a reference junction device (e.g., a 0°C control tank), select [\[Ext\]](#).

Select

Selections	Description
<b>INT</b>	Reference junction compensation is provided within the module. (default setting) (Measurement Accuracy: The sum of the accuracies of the temperature measurement and the reference junction compensation.)
<b>EXT</b>	Reference junction compensation is not provided within the module. (Measurement Accuracy: The accuracy of temperature measurement only)

### Burn Out

A broken thermocouple wire can be detected during temperature measurement. Normally when a thermocouple wire breaks, measured values exhibit random instability.

Select

Selections	Description
<b>Off</b>	Broken wires are not detected.
<b>On</b>	Broken wires are detected. Wire breakage is detected by sensing a miniscule current flow (about 100 nA) through the thermocouple. If the thermocouple wires are long or composed of a high-resistance material, set <a href="#">[Burn Out]</a> to <a href="#">[Off]</a> to avoid measurement errors.

### Renew Data (Data Refresh)

The data refresh rate can be set to Fast, Normal, or Slow.

The default setting is **[Normal]**. This allows stable measurement while removing noise. For quicker response, select **[Fast]**, but note that this will make the measurement more susceptible to noise. For further improved measurement stability, select **[Slow]**.

Select 

Selections	Description
<b>Fast</b>	Data are updated approximately every 1.2 ms.
<b>Normal</b>	Data are updated approximately every 100 ms. (default setting)
<b>Slow</b>	Data are updated approximately every 500 ms.

---

## 7.9.4 Setting Model 8969 and U8969 Strain Unit

The 8969 Strain Unit and U8969 Strain Unit can perform auto balance. When auto balance is performed, the reference output level of the conversion unit can be matched with the specified zero position. It is applicable only to a 8969 Strain Unit and U8969 Strain Unit.

### **NOTE**

The instrument describes Model U8969 as "8969".

### Before executing auto-balance

- Turn power on and wait 30 minutes to allow the internal temperature of the module to stabilize.
- After connecting a strain gauge transducer to the module and a measuring target, execute the autobalance without any input including distortion.
- Auto-balance cannot execute during measurement.
- Mouse operations are not accepted while auto-balance is executing.

### To execute auto-balance

See: Opening the [\[Each Ch\]](#) sheet, Making a Channel Selection (p.161)

InputUnit	STRAIN		
Range	20 $\mu$ E		
Resolution	0.0160 $\mu$ E	16-bit	Gauge Rate 2.00

Setting Item: [\[Range\]](#)

Selections	Description
<b>Auto Bal All Chs</b>	Auto-balance will be executed for all channels where a Model 8969 or U8969 Strain Unit is installed.
<b>Auto Bal Ch 1</b>	Auto-balance will be executed for the currently selected channel.

Auto Balance can also be executed from the Channel settings window (Analog sheet) (if the range of a channel with installed strain unit is selected).

See: Opening the Channel settings window ([\[Analog\]](#) sheet): (p.75)

### In the following cases, auto-balance should be executed again.

- After changing the vertical axis (strain axis) range
- After a module has been removed or inserted
- After the strain gauge transducer has been replaced
- After power has been turned off and on
- After performing a system reset
- When ambient temperature has changed significantly (the zero position may drift)



### If "Warning: Auto balance failed." appears:

The channel on which auto-balance failed is displayed.

Verify the following, and execute again:

- Is the strain gauge transducer in a discharged state? (Make sure that it is not being subject to vibration, etc.)
- Is the strain gauge transducer correctly connected to a measuring target?



## 7.9.5 Setting Model 8970 Freq Unit

**NOTE**

When the display of standard logic channels (LA and LB) is on, the 8970 Freq Unit installed on unit 1 can no longer be used.

See: Opening the [Each Ch] sheet, Making a Channel Selection (p.161)

【Unit】			
InputUnit	FREQ	VRange	±10V
Mode	Count	Threshold	+2.5V
Range	2k	Timing	Start
Resolution	1.00 (16-bit)	Count Over	Hold
Coupling	DC	Slope	↑
LPF	Off	Divide	1

Mode

Changes the measurement mode.

Select

Selections	Description
Frequency	Measure the frequency of the measurement waveform (Hz hertz) (default setting)
RPM	Measure the number of rotations of the measurement target (r/min rotations/minutes)
P-Freq	Measure the power frequency variation (Hz hertz)
Count	Add up the number of input pulses
Duty	Measure the duty rate of the measurement waveform (% percent)
Pulse Width	Measure the pulse width (s second)

**NOTE**

Pulses with rises during dead time (calculation) (25 kHz or higher) cannot be measured.

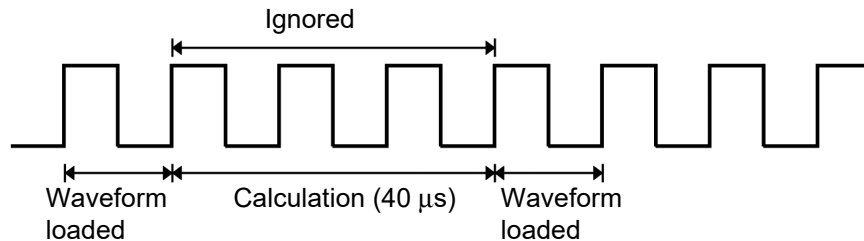

VRange (Input voltage)

Set the maximum level for the input signal.

Select

±10 V (default setting), ±20 V, ±50 V, ±100 V, ±200 V, ±400 V

Threshold

- When the measurement waveform exceeds the threshold value, the measurement value is acquired based on the time interval and the number of times the threshold was exceeded.
- The threshold value upper and lower limits and increases and decreases in width depend on the input voltage ([VRange]) setting.
- While setting the threshold, the voltage level is displayed on the level monitor.

**NOTE**

To prevent measurement errors due to noise, the threshold has a hysteresis of approximately 3% versus the input voltage. (When [VRange] is [±10 V], it is around ±0.3 V.)

Set a threshold in excess of the hysteresis width versus the voltage peak.

## Slope

For each measurement mode, set the direction the specified level is exceeded.

Select

Selections	Description
↑	Rises above the specified level are detected. (default setting)
↓	Drops below the specified level are detected.

## Devide

Determines the frequency for each set pulse.

Select

1(default setting) to 4096

Example: When the encoder is at 360 pulses per rotation, the frequency of each rotation can be measured by setting the number of divisions to 360. When frequency dividing is not used, set to 1.

## Timing

This is enabled only when [Mode] is [Count].

Sets the start timing for the sum count.

Select

Selections	Description
Start	When [START] is clicked, summing is started. (default setting)
Trig	When a trigger is applied, summing is started.

**NOTE**

- When the [Start] is set, there is some internal processing time between clicking [START] and the start of measurement. Therefore, the count value is not zero at the start point.
- When the [Start] is set and the trigger level is exceeded while waiting for the pre-trigger, the trigger is not enacted. Furthermore, the time for internal processing at start and the trigger priority setting may cause the trigger not to be enacted at the specified trigger level.
- When memory division is used, there are cases when the last data in the previous block remains in the first part of the block.

## Count Over

This is enabled only when [Mode] is [Count].

Select

Selections	Description
Hold	Counting is performed to the maximum (at 2 k range, 65535) and no higher.
Back	If counting is performed up to 25 times the range (at 2 k range, up to 50000) the count value returns to 0.

See: Opening the [Each Ch] sheet, Making a Channel Selection (p.161)

InputUnit	FREQ	VRange	±10V
Mode	Duty	Threshold	+2.5V
Range	5%		
Resolution	0.01% (16-bit)		
Coupling	DC	Level	High

### Level

This is enabled only when [Mode] is [Pulse Width] or [Duty].

In pulse width/ duty rate measurements, set which level is detected when the threshold is exceeded.

Select

Selections	Description
High	Measures above the threshold value. (default setting)
Low	Measures below the threshold value.

See: Opening the [Each Ch] sheet, Making a Channel Selection (p.161)

InputUnit	FREQ	VRange	±10V
Mode	Freq	Threshold	+2.5V
Range	1kHz	Smoothing	Off
Resolution	2.00 Hz (16-bit)	Hold	Off(0.5Hz)

### Smoothing

This is enabled only when [Mode] is [Frequency] or [RPM].

Set smoothing.

Select

Selections	Description
Off	The measured data is recorded as is. (A step waveform.) (default setting)
On	The measured data is interpolated so that the waveform is smooth and then it is output. (Further delayed from upper limit 10 kHz and Off.)

### Hold

This is enabled only when [Mode] is [Frequency] or [RPM].

Set hold for the frequency and summing.

Select

Selections	Description
Off (1Hz/0.5Hz/ 0.2Hz/0.1Hz)	When the frequency in the brackets is reached but not determined, it is defined as a stopped item and the measurement value becomes 0 Hz (0 rpm). (default setting)
On	The value defined last time is retained.

## 7.9.6 Setting Model 8971 Current Unit

See: Opening the **[Each Ch]** sheet, Making a Channel Selection (p.161)

InputUnit	CURRENT
Mode	20A/2V
Range	100mA/div

### Mode

There is no need to change the setting since it is set when the clamp sensor is automatically recognized.

Select

Selections	Description
<b>20A/2V</b>	Sets this option when Model 9272 (20 A range), 9277, or CT6841 Clamp Sensor is connected. (default setting)
<b>200A/2V</b>	Sets this option when Model 9272 (200 A range), 9278, CT6863, or CT6843 Clamp Sensor is connected.
<b>50A/2V</b>	Sets this option when Model CT6862 Clamp Sensor is connected.
<b>500A/2V</b>	Sets this option when Model 9279, 9709, CT6844, CT6845, CT6846*, CT6865*, CT6875, or CT6876* Clamp Sensor is connected.

\*: When Model CT6846, CT6865, or CT6876 is connected to Model 8971 Current Unit through Model 9318 Conversion Cable, the instrument recognizes that as an 500 A AC/DC sensor is connected; set the scaling ratio to 2.00.

### Range

Select

Selections	Description
<b>DC</b>	Current measurement (Default setting)
<b>RMS</b>	RMS current measurement

- NOTE**
- 8971 Current Unit cannot be used with MR8741.
  - With MR8740, up to four 8971 Current Units can be used.

## 7.9.7 Setting Model 8972 DC/RMS Unit

See: Opening the [\[Each Ch\]](#) sheet, Making a Channel Selection (p.161)

InputUnit	DC/RMS		
Mode	DC	Response	Normal
Range	5mV		

### Mode

Switches between voltage measurement and RMS measurement.

Select

Selections	Description
<b>DC</b>	Voltage measurement (default setting)
<b>RMS</b>	RMS measurement

### Response

Response can be set to three speeds: Fast, Normal and Slow.

Normally set to [\[Fast\]](#), this can be changed to [\[Normal\]](#) or [\[Slow\]](#) to stabilize the display when measuring low frequencies, or when severe fluctuations are present.

Select

Selections	Description
<b>Fast</b>	Sets the response time to about 100 ms. (default setting)
<b>Normal</b>	Sets the response time to about 800 ms.
<b>Slow</b>	Sets the response time to about 5 s.

## 7.9.8 Setting Model MR8990 Digital Voltmeter Unit

### NOTE

- When the MR8990 Digital Voltmeter Unit is installed on unit 1 (unit 1 or unit 2 in the case of MR8741), the standard logic can no longer be used.
- The resolution of the data measured by the recorder function is 16bit.

【Unit】			
InputUnit	DVM		
Mode	Voltage	Freq	60Hz
Range	5mV/div	NPLC	10
Resolution	24.41nV	Response	Off
	24-bit	CAL	Off

### Frequency

Set the power frequency.

Set 50 Hz or 60 Hz according to the power frequency for the region of use.

Select

Selections	Description
50Hz	Cycle 20 ms (default setting)
60Hz	Cycle 16.67 ms

### NOTE

If the power frequency setting is not configured correctly, measurement values will be unstable.

### NPLC

PLC (Power Line Cycle) is the time equivalent to one cycle of the power frequency.

Set the integration time based on one PLC.

Select

0.1 to 0.9, 1 (default setting) to 10, 20, 30, 40, 50, 60, 70, 80, 90, 100

Example: When the power frequency is 50 Hz, and NPLC is set to 10,  $20 \text{ ms} \times 10 = 200 \text{ ms}$ .

The measurement data refresh rate becomes 200 ms.

### Fast response

Data can be refreshed at high speed.

Select

Selections	Description
Off	Refreshes data at the integration time set for NPLC. (default setting)
On	Calculates the moving average and refreshes the data at high speed. Refreshes the data at 0.1 PLC when NPLC is up to 9. Refreshes the data at 1 PLC when NPLC is 10 or above.

### Calibration

This setting is for performing calibration or synchronization between channels automatically when measurement is started. Performing synchronization between channels enables matching the timing for the start of integration.

Select

Selections	Description
<b>Off</b>	Calibration and synchronization are not performed.
<b>On</b>	Performs calibration and synchronization.
<b>Synchroniza- tion</b>	Performs only synchronization between channels.

**NOTE**

- The calibration time is approximately 150 ms. That period becomes a waiting time in which measurement is not performed.
- If synchronization between channels is performed, a signal to stop integration is sent to each unit when measurement is started and the wait process is performed until the first integration finishes. The wait time required for this process is (10 ms + integration time<sup>\*</sup>).

<sup>\*</sup>The integration time varies depending on the NPLC setting.

If synchronization is not performed, the above wait time will also be required for measurement performed immediately after the settings of the Digital Voltmeter Unit are changed. However, there will be no wait time when measurement is performed with the same settings.

- When this is set to OFF (default setting), perform calibration manually.

[See:](#) "2.7 Performing Calibration (When Mounting MR8990)" (p.60)

## 7.9.9 Setting Model U8974 High Voltage Unit

See: "Opening the [Each Ch] sheet, Making a Channel Selection" (p.161)

InputUnit	HI VOLT		
Mode	RMS	Response	Normal
Range	RMS200mV		

### Mode

Switches between voltage measurement and RMS measurement.

Select

Selections	Description
<b>DC</b>	Voltage measurement (Default setting)
<b>RMS</b>	RMS measurement

### Response

The response time for RMS measurement can be set to three speeds: Fast, Normal and Slow.

The response time can be set to **[Slow]** to stabilize the measured value when the frequency is low or when severe fluctuations are present.

Select

Selections	Description
<b>Fast</b>	Response time is set to 150 ms.
<b>Normal</b>	Response time is set to 500 ms. (Default setting)
<b>Slow</b>	Response time is set to 2.5 s.



### 7.9.10 Setting Model U8979 Charge Unit

This setting allows you to choose between voltage measurement and acceleration measurement (chargeoutput or built-in pre-amplifier) for a channel. A channel can measure either one of them.

[Voltage] mode and [PreAmp] mode use BNC connectors, whereas [Charge] mode uses miniature connectors.

Model U8979 can automatically recognize TEDS-compliant\* sensors.

\*: Transducer electronic data sheet



Setting the measurement mode to [PreAmp] allows Model U8979 Charge Unit to constantly provide power (3.0 mA, 22 V) to sensors. Set any measurement mode other than [PreAmp] or turn off the instrument before connecting a sensor or probe with a BNC terminal to avoid an electric shock or damage to the measurement target.

See: "Opening the [Each Ch] sheet, Making a Channel Selection" (p.161)

InputUnit	CHARGE	A.A.F	Off
Mode	Charge	Sens.	1.000
Range	500mV/s <sup>2</sup> /div		

#### Mode

Switches the measurement mode.

Select

Mode	Measurement target	Measurement sensitivity
<b>Voltage</b>	Voltage	—
<b>Charge (Default setting)</b>	Charge-output acceleration sensor	0.1 pC/(m/s <sup>2</sup> ) to 10 pC/(m/s <sup>2</sup> )
<b>PreAmp</b>	Acceleration sensor with a built-in preamplifier	0.1 mV/(m/s <sup>2</sup> ) to 10 mV/(m/s <sup>2</sup> )

(When setting mode to [PreAmp])

Move the cursor to the [Sens.] box and execute [TEDS Load].

Acquires sensitivity of a connected sensor. However, the instrument can acquire sensitivity of TEDS-compliant acceleration sensors with a built-in pre-amplifier only.

When sensor sensitivity has been acquired, it is automatically set.

#### A.A.F

The anti-aliasing filter can prevent aliasing distortion that may be produced during FFT calculation. The cutoff frequency automatically changes according to the sampling rates or frequency range (for the FFT function) settings.

Select

Selections	Description
<b>OFF</b>	Disables the anti-aliasing filter. (Default setting)
<b>ON</b>	Enables the anti-aliasing filter. (Disabled when the external sampling is used, or the sampling rate is set at 100 kS/s or faster)

## Sensitivity

You can enter sensor sensitivity to two decimal places. For a charge-output acceleration sensor or non-TEDS-compliant sensor, enter its sensitivity marked on the sensor, which represents sensitivity per meter per second squared.

### Setting example for sensor sensitivity

#### Example 1 For a sensor with its sensor sensitivity per meter per second squared marked

Sensor sensitivity	(setting value)
1.08 pC/(m/s <sup>2</sup> )	1.08

#### Example 2 For a sensor with its sensor sensitivity per gee (G) marked.

For a sensor with its sensitivity marked, enter a quotient of the marked sensitivity divided by 9.8 m/s<sup>2</sup>.

Sensor sensitivity	(setting value)
For sensor sensitivity of 64 pC/G 64.0 / 9.8 = 6.53061... pC/(m/s <sup>2</sup> )	6.531 (to two decimal places)

### To convert a unit from meter per second squared into gee (G)

The instrument measure charge quantities per meter per second squared. You can convert such charge quantities into those per gee (G) using the scaling function.

See: "7.4 Converting Input Values (Scaling Function)" (p.148)

Configure the scaling setting as follows;

#### Example 1 Specifying a conversion ratio

Ratio	0.1020E+00 (= 1/9.8)
Offset	0.0000E+00
Units	G

#### Example 2 Specifying two points

Input1	9.8000E+00	Scale1	1.0000E+00
Input2	0.0000E+00	Scale2	0.0000E+00
Units	G		

## When using an out-of-setting-range current sensor

You can use an out-of-setting-range current sensor using the scaling function.

See: "4.2.2 Automatically Saving Waveforms" (p.88)

**Sensitivity** Multiply the sensor sensitivity of a sensor to be used by a certain value to allow a product to fall within the setting range (0.1 to 10), and enter the product.

**Scaling** Configure the scaling setting so that a scaling ratio is the same value as the number you multiplied the sensor sensitivity by.

### Example 1 For sensor sensitivity of 23.4 pC/(m/s<sup>2</sup>)

Specify 10 pC/(m/s<sup>2</sup>), which results from multiplying the sensor sensitivity by 1/2.34, as the sensor sensitivity.

To display measured values after multiplying them by 1/2.34, configure the scaling setting as follows:

To configure the scaling setting using the conversion ratio method

Ratio	0.4274E+00 (= 10/23.4)		
Offset	0.0000E+00		
Units	m/s <sup>2</sup>		

To configure the scaling setting using the 2-point method

Input1	2.3400E+00	Scale1	1.0000E+00
Input2	0.0000E+00	Scale2	0.0000E+00
Units	m/s <sup>2</sup>		

### Example 2 For sensor sensitivity of 0.05 pC/(m/s<sup>2</sup>)

Specify 0.1 pC/(m/s<sup>2</sup>), which results from multiplying the sensor sensitivity by two, as the sensor sensitivity.

To display measured values after multiplying them by two, configure the scaling setting as follows:

To configure the scaling setting using the conversion ratio method

Ratio	2.0000E+00 (= 0.1/0.05)		
Offset	0.0000E+00		
Units	m/s <sup>2</sup>		

To configure the scaling setting using the 2-point method

Input1	0.0500E+00	Scale1	1.0000E+00
Input2	0.0000E+00	Scale2	0.0000E+00
Units	m/s <sup>2</sup>		

## 7.9.11 Setting Model MR8790 Waveform Generator Unit

Channels installed with Model MR8790 cannot be measured.

See: "Opening the [Each Ch] sheet, Making a Channel Selection" (p.161)

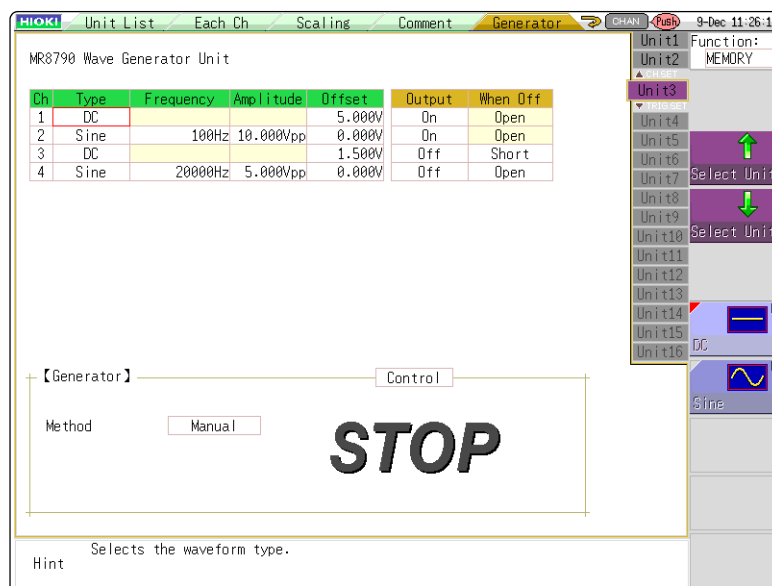

Type

Selects the waveform type.

Select

Selections	Description
DC	DC output (Default setting)
Sine	Sine wave output

Frequency

Sets the frequency of output signal.

0 Hz to 20000 Hz

Amplitude

Sets the amplitude of output signal.

The output voltage with guaranteed accuracy is the sum of the amplitude and the offset, between -10 V and +10 V. If the sum of the amplitude and the offset is set outside the guaranteed accuracy range, parts of the waveform will be clamped to the upper limit, approximately +14 V and the lower limit, approximately -14 V.

0.000 V p-p to 20.000 V p-p

Offset

For DC output: Sets DC voltage.

For sine wave output: Sets the offset voltage.

The output voltage with guaranteed accuracy is the sum of the amplitude and the offset, between -10 V and +10 V. If the sum of the amplitude and the offset is set outside the guaranteed accuracy range, parts of the waveform will be clamped to the upper limit, approximately +14 V and the lower limit, approximately -14 V.

-10 V to +10 V

## When Off

Sets the output terminal status when the output is OFF.

Select

Selections	Description
<b>Open</b>	Opens the output terminals, separating them from internal circuits.
<b>Short</b>	Short-circuits the output terminals, separating them from internal circuits.

## Output

Turns waveform output On/Off.

Select

Selections	Description
<b>On</b>	Outputs waveform.
<b>Off</b>	Does not output the waveform.

## Control

Sets the waveform output.

Select

Selections	Description
<b>RUN</b>	Starts output.
<b>PAUSE</b>	Pauses output. While output is paused, the output at the time [PAUSE] was pressed will be output.
<b>STOP</b>	Stops output.

## Method

Selects the control method for waveform output.

Select

Selections	Description
<b>Manual</b>	Restricts control of signal output to Signal Generation screen.
<b>Sync.</b>	Augments manual control with signal output in synchronization with the start and end of measurement. <b>START</b> key: Starts output when measurement starts. <b>STOP</b> key: Stops output when measurement stops
<b>Keys</b>	Augments manual control by allowing signal output to be manipulated using the instrument's keys. <b>START</b> key: Starts output. <b>STOP</b> key: Stops output. Manual Trigger key: Pauses output.

For details, see the instruction manual of Models U8793, MR8790, and MR8791.

## 7.9.12 Setting Model MR 8971 Pulse Generator Unit

Channels installed with Model MR8791 cannot be measured.

See: "Opening the [Each Ch] sheet, Making a Channel Selection" (p.161)

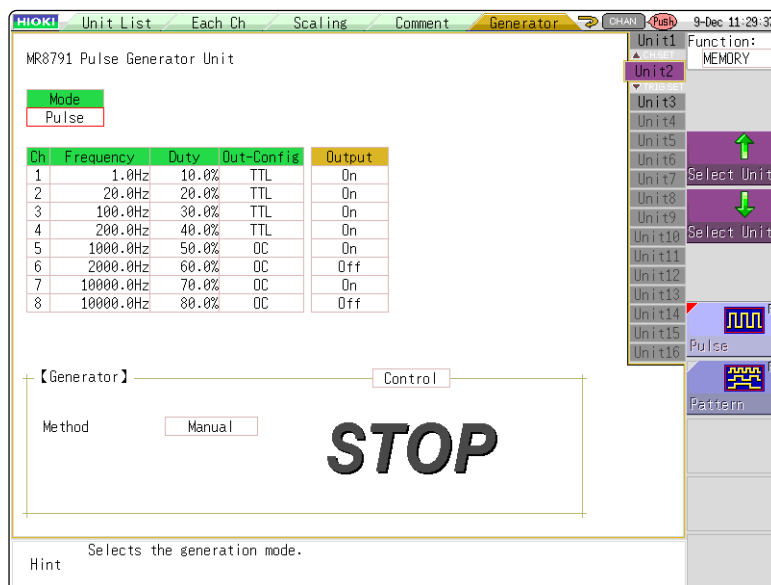

### Mode

Select the type of output.

Select

Selections	Description
<b>Pulse</b>	Pulse output (Default settings)
<b>Pattern</b>	Pattern output

Refer to the instruction manual of Models U8793, MR8790, and MR8791 regarding the detailed settings for pattern output.

### Frequency

Sets the frequency for pulse output.

0 Hz to 20000 Hz

### Duty

Sets the pulse duty.

0% to 100%

### Out-Config

Sets the output status.

Select

Selections	Description
<b>TTL</b>	TTL output
<b>OC</b>	Open collector output

**Output**

Turns waveform output On/Off.

Select

Selections	Description
<b>On</b>	Outputs waveform.
<b>Off</b>	Does not output the waveform.

**Control**

Sets the waveform output.

Select

Selections	Description
<b>RUN</b>	Starts output.
<b>PAUSE</b>	Pauses output. While output is paused, the output at the time [PAUSE] was pressed will be output.
<b>STOP</b>	Stops output.

**Method**

Selects the control method for waveform output.

Select

Selections	Description
<b>Manual</b>	Restricts control of signal output to Signal Generation screen.
<b>Sync.</b>	Augments manual control with signal output in synchronization with the start and end of measurement. <b>START</b> key: Starts output when measurement starts. <b>STOP</b> key: Stops output when measurement stops.
<b>Sync.</b>	Augments manual control by allowing signal output to be manipulated using the instrument's keys. <b>START</b> key: Starts output. <b>STOP</b> key: Stops output. Manual Trigger key: Pauses output.

For details, see the instruction manual of Models U8793, MR8790, and MR8791.

## 7.9.13 Setting Model U8793 Arbitrary Waveform Generator Unit

Channels installed with U8793 cannot be measured.

See: "Opening the [Each Ch] sheet, Making a Channel Selection" (p.161)

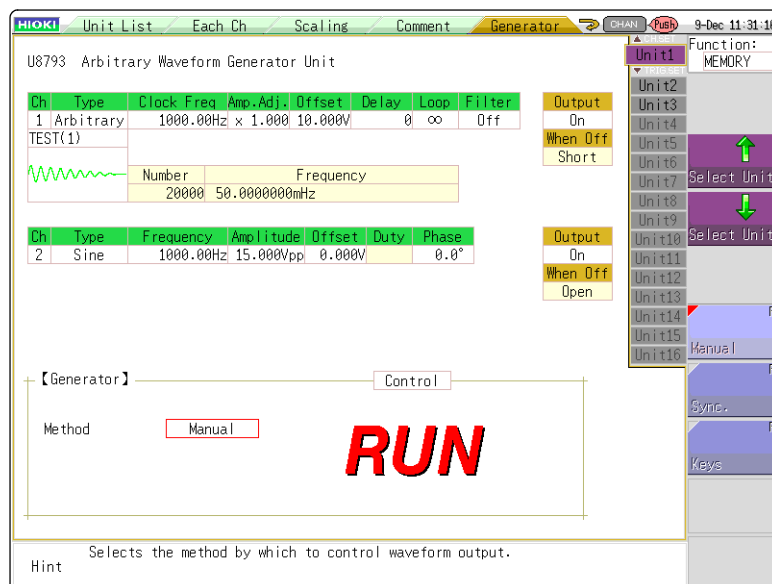

Type

Selects the waveform type.

Select

Selections	Description
<b>DC</b>	DC output (Default setting)
<b>Sine</b>	Sine wave output
<b>Square</b>	Rectangular wave output
<b>Pulse</b>	Pulse wave output
<b>Triangle</b>	Triangular wave output
<b>Ramp-up</b>	Ramp-up wave output
<b>Ramp-down</b>	Ramp-up wave output
<b>Arbitrary</b>	Outputs the created waveform
<b>Program</b>	Outputs the waveform set in the program

Refer the instruction manuals of Model U8793, MR8790, and MR8791 for the settings at the time of program selection.

Frequency

Sets the frequency of output signal.

0 Hz to 100000 Hz

Amplitude

Sets the amplitude of output signal.

The output voltage with guaranteed accuracy is the sum of the amplitude and the offset, between -10 V and +10 V. If the sum of the amplitude and the offset is set outside the guaranteed accuracy range, parts of the waveform will be clamped to the upper limit, approximately +16 V and the lower limit, approximately -11 V.

0.000 V p-p to 20.000 V p-p



### Offset

For DC output: Sets DC voltage.  
 For sine wave output: Sets the offset voltage.  
 The output voltage with guaranteed accuracy is the sum of the amplitude and the offset, between -10 V and +10 V. If the sum of the amplitude and the offset is set outside the guaranteed accuracy range, parts of the waveform will be clamped to the upper limit, approximately +16 V and the lower limit, approximately -11 V.

-10 V to +15 V

### Phase

Sets the phase.

-360° to 360°

### Duty

Sets the duty when selecting pulse wave.

0.1% to 99.9%

### When Off

Sets the output terminal status when the output is off.

Select

Selections	Description
<b>Open</b>	Opens the output terminals, separating them from internal circuits.
<b>Short</b>	Short-circuits the output terminals, separating them from internal circuits.

### Output

Turns waveform output On/Off.

Select

Selections	Description
<b>On</b>	Outputs waveform.
<b>Off</b>	Does not output the waveform.

### Control

Sets the waveform output.

Select

Selections	Description
<b>RUN</b>	Starts output. (Output indicator: Red)
<b>PAUSE</b>	Pauses output. While output is paused, the output at the time [PAUSE] was pressed will be output. (Output indicator: Red)
<b>STOP</b>	Stops output. (Output indicator: Off)

Method	<p>Selects the control method for waveform output.</p> <p>Select</p> <table border="1"> <thead> <tr> <th>Selections</th> <th>Description</th> </tr> </thead> <tbody> <tr> <td><b>Manual</b></td> <td>Restricts control of signal output to Signal Generation screen.</td> </tr> <tr> <td><b>Sync.</b></td> <td>Augments manual control with signal output in synchronization with the start and end of measurement. <b>START</b> key: Starts output when measurement starts. <b>STOP</b> key: Stops output when measurement stops.</td> </tr> <tr> <td><b>Keys</b></td> <td>Augments manual control by allowing signal output to be manipulated using the instrument's keys. <b>START</b> key: Starts output. <b>STOP</b> key: Stops output. Manual Trigger key: Pauses output.</td> </tr> </tbody> </table>	Selections	Description	<b>Manual</b>	Restricts control of signal output to Signal Generation screen.	<b>Sync.</b>	Augments manual control with signal output in synchronization with the start and end of measurement. <b>START</b> key: Starts output when measurement starts. <b>STOP</b> key: Stops output when measurement stops.	<b>Keys</b>	Augments manual control by allowing signal output to be manipulated using the instrument's keys. <b>START</b> key: Starts output. <b>STOP</b> key: Stops output. Manual Trigger key: Pauses output.
Selections	Description								
<b>Manual</b>	Restricts control of signal output to Signal Generation screen.								
<b>Sync.</b>	Augments manual control with signal output in synchronization with the start and end of measurement. <b>START</b> key: Starts output when measurement starts. <b>STOP</b> key: Stops output when measurement stops.								
<b>Keys</b>	Augments manual control by allowing signal output to be manipulated using the instrument's keys. <b>START</b> key: Starts output. <b>STOP</b> key: Stops output. Manual Trigger key: Pauses output.								
<h3>Settings when selecting arbitrary waveform</h3>									
Data name	Register/delete the data of the outputted waveform. Maximum eight waveforms can be registered.								
Filter	Filter the output waveform.  Off (Default setting) to 1 MHz								
Clock Freq	Set the clock frequency of the D/A converter that generates waveforms. The period and frequency of the output waveform are displayed on the lower level.								
Delay	Set the delay for waveform generation. When the delay value is positive, the phase is progressive.  -250,000 data to 250,000 data (Default settings: 0)								
Loop	Set the repetition count for generating waveforms.  1 to 50,000,∞ (Default setting: ∞)								
Amp Adj	Set the amplitude level for waveform output.								
Offset	Set the offset voltage for waveform.								

# 7.10 Register the Waveform in the U8793 Arbitrary Waveform Generator Unit

You can register waveform in the Model U8793. Registered waveforms can be output from the Model U8793.

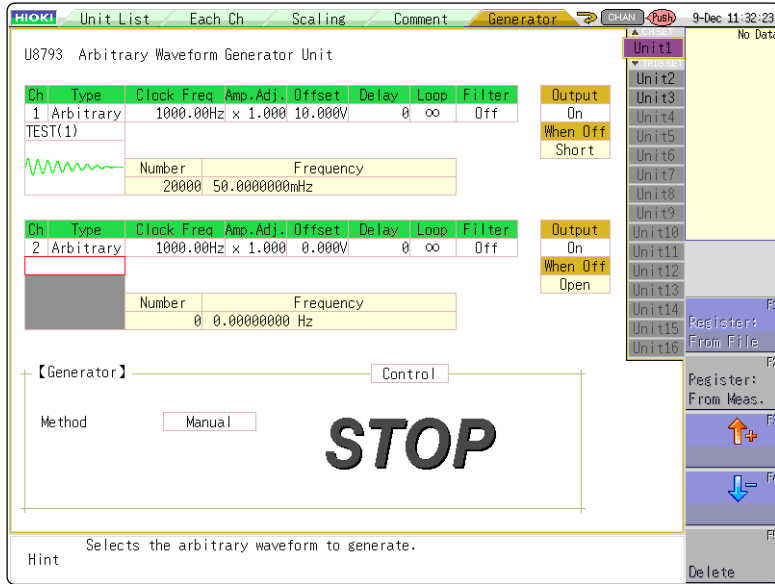

## Procedure

To open the screen: press the **CHAN** key to open the Channel screen, and then select **[Generator]** sheet

**1 Set the type to arbitrary waveform.**

Move the cursor to **[Type]** on the settings screen, and select **[Arbitrary]** using the **F** keys.

**2 Register the waveform.**

Move the cursor to the item listed below **[Arbitrary]** on the settings screen.

**3 Select a reading source of the waveform.**

Select

Selections	Description
<b>Register: From File</b>	Registers from data saved in the media.
<b>Register: From Meas.</b>	Registers the data measured using memory function. You can also register after reading the MEM files from media to the instrument.
↑ or ↓	Select arbitrary waveform data registered in the Model U8793. (Use when selecting/deleting output waveforms.)
<b>Delete</b>	Deletes the data registered in the U8793 memory. If eight waveforms are already registered in the memory, delete any of them and then register.

## Register From Files

### 1 Select [Register..from file] using F keys

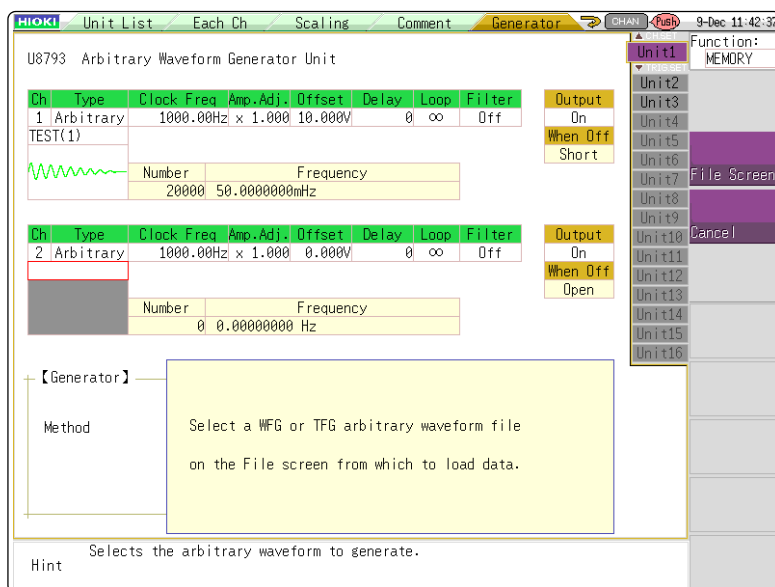

### 2 Select [to File scrn] using the CH.SET key.

Move to the file screen.

### 3 Select arbitrary waveform file WFG or TFG on the file screen and then register.

### Register From Measured Data

**1** Select [Register..from measurement data] using F keys

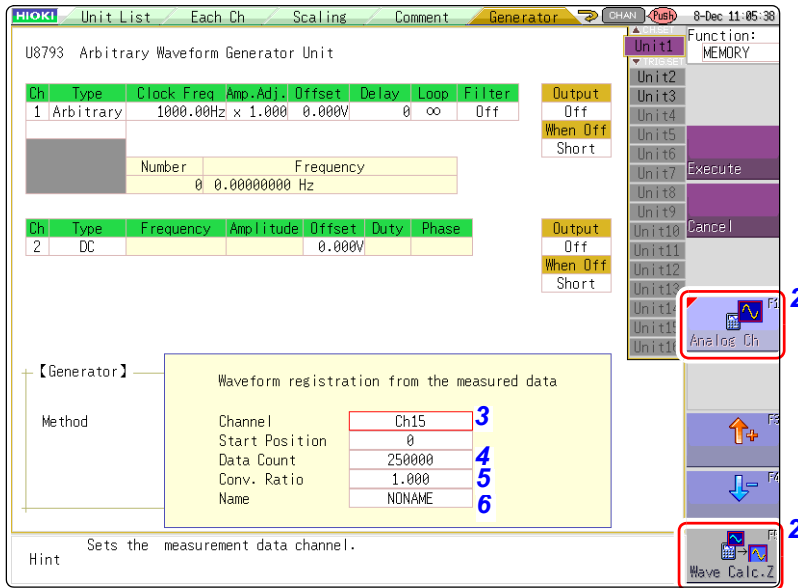

**2** Select the waveform to be registered using F keys.

Select

Selections	Description
<b>Analog Ch</b>	Registers the waveform of the measured analog channel.
<b>Wave Calc. Z</b>	Registers the waveforms with waveform calculation result.

**3** Select the waveform channels to register.

Analog waveform

Ch1 to Ch32

Waveform calculations

Z1 to Z16

**4** Set the data count to be registered.

Select

Selections	Description
<b>Whole wave-forms</b>	Registers the whole wave.*
<b>A-B waveforms</b>	Registers the waveforms between AB cursors.*
<b>Tenkey input</b>	Randomly sets data lead position and data count in the numeric keypad input.

\* Data count more than 250,000 (maximum registerable data count) cannot be registered.

### 7.10 Register the Waveform in the U8793 Arbitrary Waveform Generator Unit

---

---

#### 5 Set the conversion ratio.

Amplify or attenuate a voltage value of the measured data to register it.

0.001 times to 100 times

---

#### 6 Enter a data name.

Register as an arbitrary waveform data in the U8793 memory.

Enter a **[Name]**.

When a data name is not entered, the data will be registered as **[NONAME]**.

## 7.11 Saving Waveforms Registered in Model U8793 onto a Storage Device

You can save the arbitrary waveform data registered in U8793 in the media. For saving methods, refer to "4.2.5 Save Waveform Output Data to the Media" (p.98).

## 7.12 Setting Output Waveform Parameters on the Waveform Screen

Parameters (frequency, amplitude, and offset) for the output waveform that was configured on the Generator screen (signal generation setting screen) can be changed on the Waveform screen. The ability to configure and change these settings while outputting and measuring the resulting waveform provides a convenient way to measure a waveform while varying its parameters.

- 1 Display the Waveform screen (if viewing another screen, press **DISP** to display the Waveform screen).

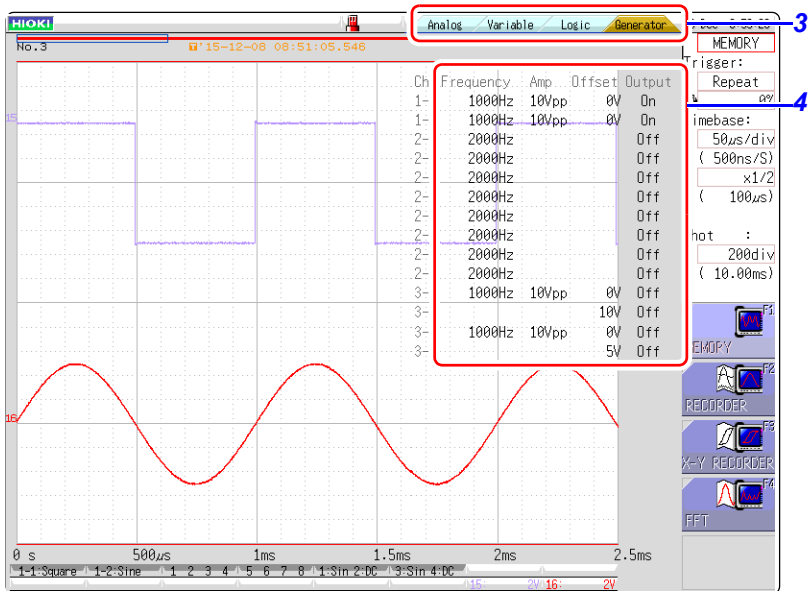

- 2 Press **CH.SET** (to display the tabs).
- 3 Press **CH.SET** or select the [Generator] tab with the mouse.
- 4 Set the following parameters as desired.

Select

Selections	Description
<b>Frequency</b>	Sets the frequency.
<b>Amp</b>	Sets the amplitude.
<b>Offset</b>	Sets the offset.
<b>Output</b>	Turns output on or off.

**NOTE**

For details, see the instruction manual of Models U8793, MR8790, and MR8791.

# Trigger Settings Chapter 8

Triggering is the process of controlling the start and stop of recording by specific signals or conditions (criteria). When recording is started or stopped by a specific signal, we say the trigger is "applied" or "triggering occurs".

Trigger settings are made in the Trigger settings window of the Waveform screen.

## Opening the Trigger settings window

Click **[TRIG.SET]** in the right-click menu.

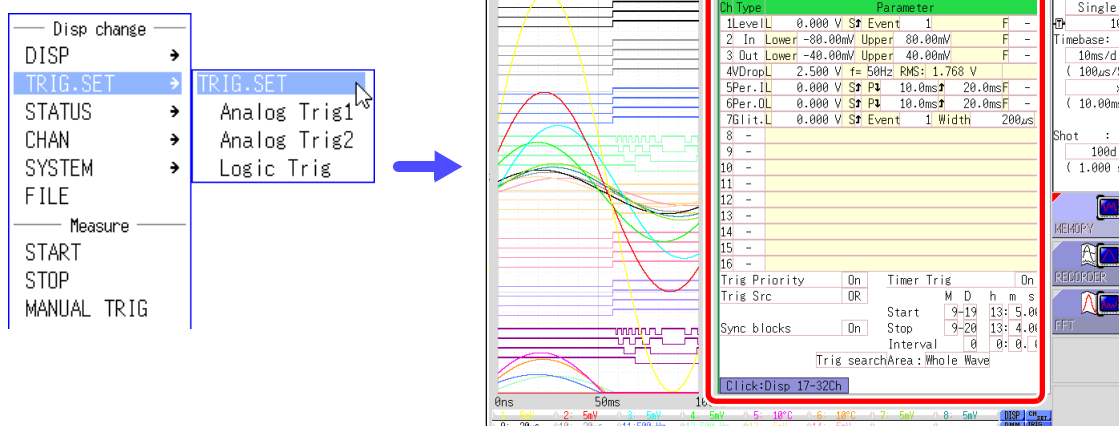

If the trigger setting screen is hard to see due to waveform overlap, narrow the waveform display width to divide the waveform display screen and trigger settings screen. Refer to "6.7.3 Switching the Waveform Display Width" (p.135).

## Operations available from the Trigger settings window

### Trigger Settings

- Trigger mode setting (p.191)
- Combining logic (AND/OR) for multiple trigger sources (p.208)
- Pre-trigger settings (p.204)

### Trigger Source Settings

#### Analog Trigger Settings (p.192)

- Level trigger
- Window trigger
- Period trigger
- Glitch trigger
- Slope trigger

#### Logic Trigger Settings (p.197)

- Setting combining logic for logic triggers
- Trigger filter settings
- Trigger pattern settings

#### Timer Trigger Settings (p.199)

#### External Trigger Settings (p.203)

#### Manual Trigger Settings (p.203)

#### Trigger Output (MR8741) (p.341)

#### Searching for trigger positions (p.209)



## 8.1 Setting Workflow

The procedure for making trigger settings is as follows.

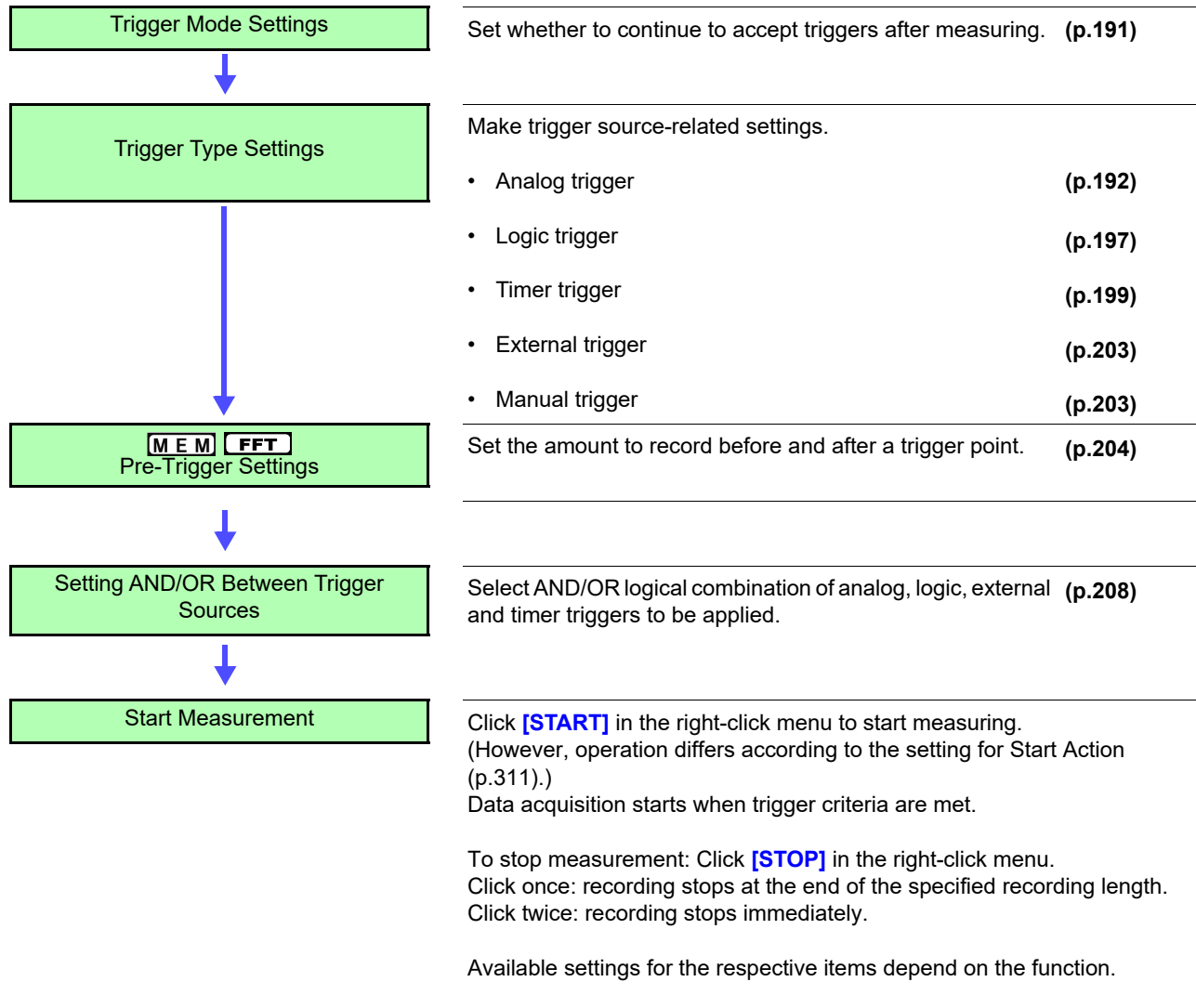

### **NOTE**

- Except for manual trigger, triggering is based on the AND/OR combination of trigger sources. (p.208)
- When triggering occurs, the TRIG OUT terminal for control of external devices carries an output signal. (p.341) (MR8741 only)
- Settings for the analog trigger are restricted for the channel of the MR8990 Digital Voltmeter Unit.
- When MR8990 Digital Voltmeter Unit is installed, the trigger position may be offset by 1 point.

## 8.2 Setting the Trigger Mode

Set whether to continue to accept triggers after measuring.  
If all trigger sources are disabled (Off, with no trigger setting), measurement starts immediately (free-running).

### Procedure

To open the screen: Right-click and select **[DISP]** → Waveform screen

- 1 Move the flashing cursor to the **[Trigger]** item.
- 2 Select the trigger mode.

Select

<b>Single</b>	Only one trigger is recognized. After measurement is started, once a trigger is applied, a waveform is recorded for the specified recording length, and measurement then stops.
<b>Repeat</b>	Triggers are accepted continuously. When no trigger is applied, the instrument enters the Trigger Wait state. Click <b>[STOP]</b> to stop measuring. (See below)
<b>Auto</b>	<div style="border: 1px solid black; padding: 2px; display: inline-block;">MEM</div> <div style="border: 1px solid black; padding: 2px; display: inline-block; margin-left: 10px;">FFT</div> Triggers are accepted continuously. If no trigger is applied within about one second, a waveform of the specified recording length is automatically recorded. Click <b>[STOP]</b> to stop measuring.

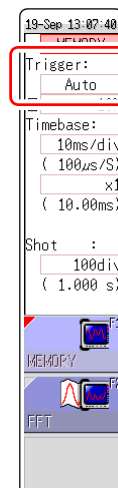

**Description** Available selections depend on the function.

Trigger Mode	Function	
	<div style="border: 1px solid black; padding: 2px; display: inline-block;">MEM</div> <div style="border: 1px solid black; padding: 2px; display: inline-block; margin-left: 10px;">FFT</div>	<div style="border: 1px solid black; padding: 2px; display: inline-block;">REC</div>
<b>Single</b>	○	○ (default setting)
<b>Repeat</b>	○	○
<b>Auto</b>	○ (default setting)	×

To Stop Measuring:

Click **[STOP]** in the right-click menu.

Click once: recording stops at the end of the specified recording length.

Click twice: recording stops immediately.

**When the trigger mode is set to [Repeat]**

During the processing interval from the end of recording until entering the next trigger standby condition (Auto Save, waveform display processing, numerical calculation), triggering will not be accepted.

## 8.3 Triggering by Analog Signals

### 8.3.1 Analog Trigger Settings and Types

The steps for making settings and selecting the type of analog trigger are described below. The Trigger settings window ([\[Analog Trg.\]](#) sheet) is used. An analog trigger cannot be set for the channel of MR8990 Digital Voltmeter Unit.

#### Procedure

To open the screen: Right-click and select [\[DISP\]](#) → Waveform screen → Right-click and select [\[TRIG.SET\]](#) → Trigger settings window ([\[Analog Trg.\]](#) sheet)

	Ch	Type	Parameter						
1. Level Trigger (p.193)	1	Level	L	0.000 V	S	Event	1	F	-
2. In-Window Trigger	2	In	Lower	-80.00mV	Upper	80.00mV	F	-	
Out-of-Window Trigger (p.193)	3	Out	Lower	-40.00mV	Upper	40.00mV	F	-	
3. Voltage Sag Trigger (p.194)	4	VDrop	L	2.500 V	f = 50Hz	RMS: 1.768 V			
4. In-Period Trigger	5	Per.	IL	0.000 V	S	P	5.00μs	10.00μs	F -
Out-of-Period Trigger (p.194)	6	Per.	OL	0.000 V	S	P	5.00μs	10.00μs	F -
5. Glitch Trigger (p.195)	7	Glit.	L	0.000 V	S	Event	1	Width	100ns

- 1 Move the flashing cursor to the [\[Type\]](#) item of the channel for which to make the setting.
- 2 Select the trigger type from the GUI displayed on the screen.
- 3 Use the mouse to move the flashing cursor to the parameter item.
- 4 Set the parameter value from the GUI displayed on the screen.



#### To copy the setting to another channel

The Trigger settings window ([\[Analog Trg.\]](#) sheet) can be used to copy a setting.  
See: "7.8 Copying settings to other channels (calculation No.) (Copy function)" (p.160)

#### **NOTE**

- When the FFT function is used and [\[Reference\]](#) item on the [\[Status\]](#) sheet is set to [\[From Memory\]](#), an analog trigger cannot be set.
- Only the level trigger and window trigger can be set for the channel of the MR8990 Digital Voltmeter Unit. The voltage drop trigger, periodic trigger and glitch trigger cannot be set.

## 1. Level Trigger

A trigger is applied when an input signal crosses the specified trigger level (threshold voltage).

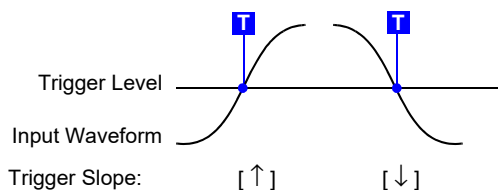

### **NOTE**

In this manual, **T** indicates a "trigger point", as the time at which a trigger is applied.

Type	Parameters	
[Level]	[L] (Level)	Sets the level (voltage value) for the trigger. (The setting can be made in 1/50 increments.)
	[S] (Slope)	Determines whether triggering occurs when the signal crosses the threshold (trigger level) on the upslope (rising edge) or on the downslope (falling edge). With the [↕] setting, triggering occurs in either direction. (↑, ↓, ↕)
	[Event]	The number of signal rising edge (or falling edge) events is counted, and triggering occurs when the Event number set here is exceeded. (1 to 4000)
	[F] (Filter)	Triggering occurs when the trigger criteria are met within the specified filter width. This is useful to prevent spurious triggering due to noise. (MEM FFT: Off, 0.1 - 10 div)

## 2. In-Window Trigger, Out-of-Window Trigger

Upper and lower limit values are set for the trigger level, and triggering occurs when the input signal enters this range (In) or leaves this range (Out).

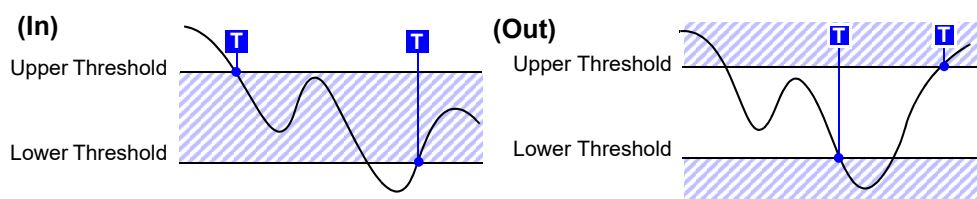

Type	Parameters	
[In] or [Out]	[Lower]	Set the lower limit value. (The setting can be made in 1/50 increments.)
	[Upper]	Set the upper limit value. (The setting can be made in 1/50 increments.)
	[F] (Filter)	Triggering occurs when the trigger criteria are met within the specified filter width. This is useful to prevent spurious triggering due to noise. (MEM FFT: Off, 0.1 - 10 div)

### 3. Voltage Sag Trigger (MEM FFT only)

Triggering occurs when the voltage peak drops below a preset level for more than half a cycle. The allowable time axis range is 20  $\mu$ s - 50 ms/div.

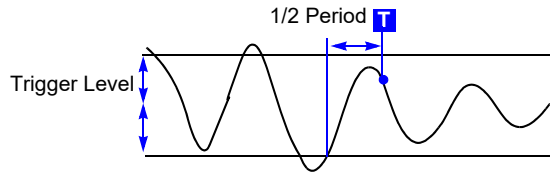

Type	Parameters	
[VDrop]	[L] (Level)	Sets the level (voltage value) for the trigger. (The setting can be made in 1/50 increments.)
	[f=] (Frequency)	Select 50 or 60 Hz.
	RMS: (actual value)	It is an aim of the actual value. Changes in sync with the level setting.

### 4. In-Period Trigger, Out-of-Period Trigger

The rising edge and falling edge cycle of the reference voltage is measured, and triggering occurs when the cycle enters the preset range (In) or leaves the preset range (Out).

See: "Description" (p.196)

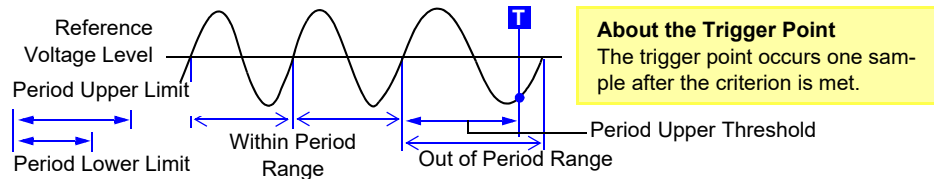

Type	Parameters	
[Per.I] or [Per.O]	[L] (Level)	Sets the level (voltage value) for the trigger. (The setting can be made in 1/50 increments.)
	[S] (Slope)	Determines whether triggering occurs when the signal crosses the threshold (trigger level) on the upslope (rising edge) or on the downslope (falling edge). ( $\uparrow$ , $\downarrow$ )
	[P $\downarrow$ ] (Period lower limit) <sup>*1</sup>	Available settings are 0 and more than 5 times the sampling frequency. Settings higher than the upper limit value are not accepted. (When the setting is 0, the lower limit is disregarded, and triggering occurs only on the upper limit.)
	[P $\uparrow$ ] (Period upper limit) <sup>*1</sup>	The setting range extends to 20,000 times the sampling frequency. Lower settings than the lower limit value are not accepted.
	[F] (Filter)	Triggering occurs when the trigger criteria are met within the specified filter width. This is useful to prevent spurious triggering due to noise. (MEM FFT): Off, 0.1 - 10 div)

\*1: Changes in sync with the time axis range.

## 5. Glitch Trigger (MEM FFT only)

Triggering occurs when the input signal crosses the trigger level (threshold voltage) if its pulse width is shorter than the specified width.

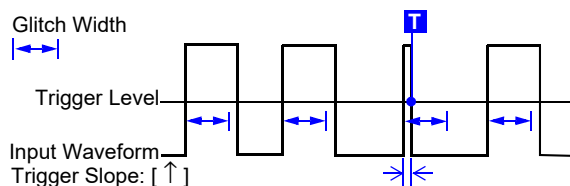

Type	Parameters	
[Grit.]	[L] (Level)	Sets the level (voltage value) for the trigger. (The setting can be made in 1/50 increments.)
	[S] (Slope)	Determines whether triggering occurs when the signal crosses the threshold (trigger level) on the upslope (rising edge) or on the downslope (falling edge). (↑, ↓)
	[Event]	The number of signal rising edge (or falling edge) events is counted, and triggering occurs when the Event number set here is exceeded. (1 to 4000)
	[Width]	Sets the pulse width (time) that is used to determine a glitch. Triggering occurs when the width is lower than this value. (The available setting range depends on the sampling frequency. Lower limit: sampling frequency x 2, upper limit: sampling frequency x 4000)



### When Using Noisy Signals for Triggering

#### Method 1: Enable the trigger filter

By setting the filter width to prevent triggering on noise, triggering occurs only when the trigger criteria continue to be met for at least the specified width (interval).

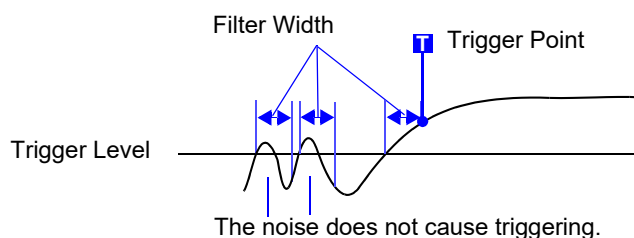

#### Method 2: Setting an Event Count

If triggering occurs too frequently, an event count can be specified so that a trigger is accepted only after the specified number of trigger events has occurred.

Example: When the event count is set to [4] (Slope: ↑)

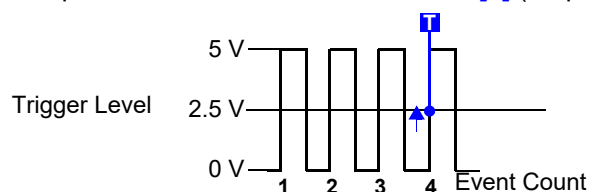

### Suppressing Noise Effect

Noise near the trigger level can erroneously increment the event count. Set the trigger filter to avoid such effects.

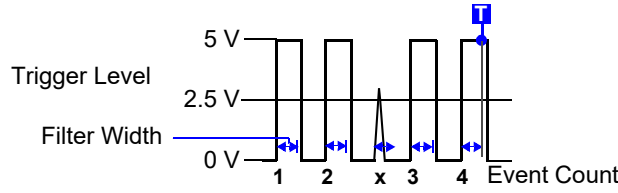

**Description About period range settings**

The period range settings for period triggering depend on the sampling period (sampling rate). (Changing the timebase also changes the period setting range.) The sampling rate setting can be verified on the Status screen - Status sheet. The upper threshold of the period range cannot be set below the lower threshold, and vice-versa.

Lower threshold: can be set either to zero, or to at least five times the sampling period.

Upper threshold: can be set to no more than 2,000 times the sampling period.

To apply a trigger when the frequency increases (shorter period) above the upper threshold:

Set the period trigger type to [Per.I], and the lower threshold to [0]. The lower threshold is ignored, and triggering occurs when the frequency exceeds that corresponding to the upper threshold.

To apply a trigger when the frequency decreases (longer period) below the upper threshold:

Set the period trigger type to [Per.O], and the lower threshold to [0]. The lower threshold is ignored, and triggering occurs when the frequency drops below that corresponding to the upper threshold.

**About the trigger point of the Out-of-Period trigger**

Triggering occurs when the period of sequential crossings of the specified reference voltage exceeds the period range.

The point at which triggering occurs depends on the specified period range and the period of the measured signal.

When the input signal period is shorter than the specified lower threshold (Trigger Slope: ↑)

Triggering occurs when the rising edge (↑ trigger slope) of the input signal crosses the reference voltage level, before reaching the lower period threshold.

When the input signal period is longer than the specified upper threshold (Trigger Slope: ↑)

Triggering occurs when the upper threshold period is reached, before the rising edge (↑ trigger slope) of the input signal crosses the reference voltage level. Therefore, the trigger point is determined by the upper threshold of the period range.

## 8.4 Triggering by Logic Signals (Logic Trigger)

The steps for making settings and selecting the type of logic trigger are described below. The Trigger settings window ([Logic Trig] sheet) is used.

- Input signals on logic channels serve as the trigger source. Triggering occurs when the specified trigger pattern and logical probe combining criteria (AND/OR) are met.
- The trigger detection method can be selected according to whether a trigger is applied or not when the criteria are already met at the start of measurement.
- By using the trigger filter, triggering can be limited so as to occur only when trigger criteria are met for at least the specified filter width.

### Procedure

To open the screen: Right-click and select [DISP] → Waveform screen → Right-click and select [TRIG.SET] → Trigger settings window ([Logic Trig] sheet)

- 1 Move the flashing cursor to the channel you want to set.
- 2 Make the setting from the GUI displayed on the screen.

Logic Channels		1.	2.	3.			
Ch	Terms	Filter	1	2	3	4	
L	A	OR	-	x	x	x	x
	B	And	-	x	x	x	x
	C	-					
	D	-					
L6	A	-					
	B	-					
	C	-					
	D	-					

### 1. Trigger

Sets the trigger probe combining logic (AND/OR).

Select

Off	Logic triggering is disabled. (default setting)
OR	Triggering occurs when input signal logic matches any setting in the trigger pattern.
AND	Triggering occurs only when input signal logic matches all settings in the trigger pattern.

### 2. Filter

Sets the filter width (trigger filter) for triggering. (as occasion demands)  
Suppresses triggering from noise.(p.195)

Select

Off	Trigger filtering is disabled. (default setting)
0.1 to 10	Trigger filtering is enabled. The filter width is set as a number of divisions.



### 3. Trigger Pattern

Make the settings of the logic trigger pattern.

Select	
X	Ignore signal. (default setting)
0	Trigger at LOW signal level.
1	Trigger at HIGH signal level.



#### To copy the setting to another channel

The Trigger settings window ([\[Logic Trig\]](#) sheet) can be used to copy a setting.

See: "7.8 Copying settings to other channels (calculation No.) (Copy function)" (p.160)

### Setting Example

**Example 1: Trigger when the input signal matches any of the following criteria:**

Channel 1 (LA1): HIGH level  
 Channel 2 (LA2): LOW level  
 Trigger: OR  
 LA [1, 2, 3, 4]: [1 0 X X]

Triggering occurs when the LA1 or LA2 trigger criteria are met.

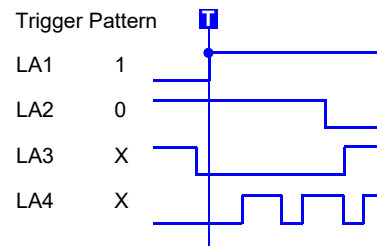

**Example 2: Triggering occurs when the input signal matches both of the following criteria:**

Channel 1 (LA1): HIGH level  
 Channel 2 (LA2): LOW level  
 Trigger: AND  
 LA [1, 2, 3, 4]: [1 0 X X]

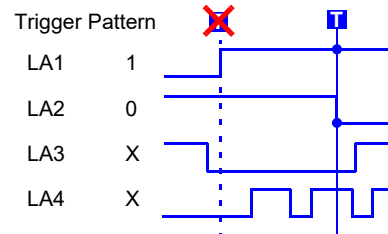

### NOTE

- If the conditions are met already when measurement is started (AND: all trigger patterns are met, OR: one trigger pattern is met), triggering does not occur. Triggering only occurs if the conditions are removed and then met again.
- Triggers for standard logic channels (LA and LB) are enabled regardless of the logic waveform display or unit type.

## 8.5 Trigger by Timer or Time Intervals (Timer Trigger)

Set this to record at fixed times.

- Triggering occurs at the specified interval from the specified Start time until the Stop time.
- Before setting, verify that the clock is set to the correct time. If not, set the clock on the System screen - Init sheet. (p.58)

### Procedure

To open the screen: Right-click and select [DISP] → Waveform screen → Right-click and select [TRIG.SET] → Trigger settings window

#### 1 Enable or disable the timer trigger.

Move the flashing cursor to the [Timer Trig] item.

Select

Off	Timer triggering is disabled.
On	Timer triggering is enabled.

Records the specified recording length

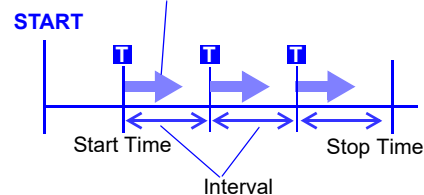

#### 2 (When [On] is selected)

Set Start and Stop times.

Move to cursor to the [M], [D], [h] and [m] items to set recording Start and Stop times.

Set the date and time.

To set the current date and time:

Select [Present Time].

#### 3 (To apply a trigger through the specified interval, from Start to Stop)

Set the Interval.

Move to cursor to the [D], [h], [m] and [s] items of [Interval].

Set the recording interval.

Recording starts at the specified Start time.

To stop recording early:

Click [STOP] in the right-click menu.

**When the specified interval is shorter than the specified recording length:**  
Records the specified recording length

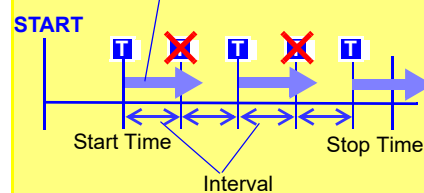

**When the recording length exceeds the specified interval**  
The next trigger is not applied until the data for the specified recording length has been acquired.

**When the recording length exceeds the stop time**  
Recording time depends on the operating function.  
"About Stop Time and Recording Length" (p.200)

**When the interval is set to zero**  
If the [Repeat] trigger mode is selected, or REC&MEM function is used, recording is repeated from Start to Stop times.

### NOTE

The timer trigger time and the time at which the trigger is actually fired may differ by up to 3 sample times.

### Description **About start and stop times**

- Start and Stop times should be set as times elapsed since the measurement was started.
- When the trigger mode is **[Single]** and the timer trigger is **[On]**, only one timer trigger specified as the Start trigger is recognized. Interval and Stop time triggers are ignored.

### To record an interval with specified Start and Stop times

Set the trigger mode to **[Repeat]**, and set all other trigger sources **[Off]**. However, triggering is disabled during processing (auto save, waveform display processing and calculation) from the end of recording to the next Trigger Wait state, so depending on measurement settings, recording may not occur within the specified interval.

### About Stop Time and Recording Length

The stop time is function-dependent:

Memory function: Measurement data is acquired for the specified recording length, then recording stops.

Recorder function: Measurement data continues to be acquired until the specified Stop time.

Relationship Between Last Recording Length and Stop Time

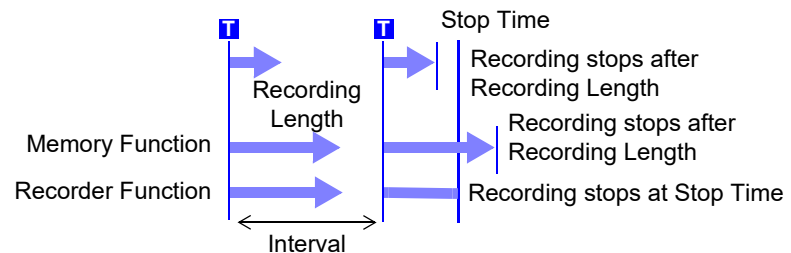

**When a trigger is applied from a trigger source other than a timer trigger**

Trigger sources set to On are all enabled.

However, trigger timing depends on the trigger source settings.

- When trigger criteria are ORed together (Trigger Source: OR)  
Depending on the other trigger sources, triggering can occur before the specified trigger Start time, after the specified Stop time, or outside of the specified Interval.
- When trigger criteria are ANDed together (Trigger Source: AND)  
Triggering occurs between the specified Start and Stop times when criteria for all trigger sources set within the specified interval are satisfied.  
If the interval is set to zero, triggering occurs when criteria for all trigger sources set between specified Start and Stop times are satisfied.

Example: measuring when both timer trigger and level triggers (Slope:  $\uparrow$ ) are enabled.

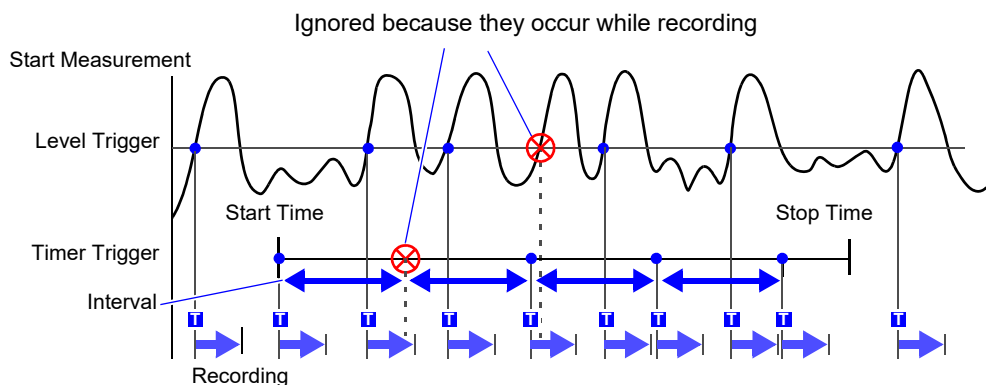
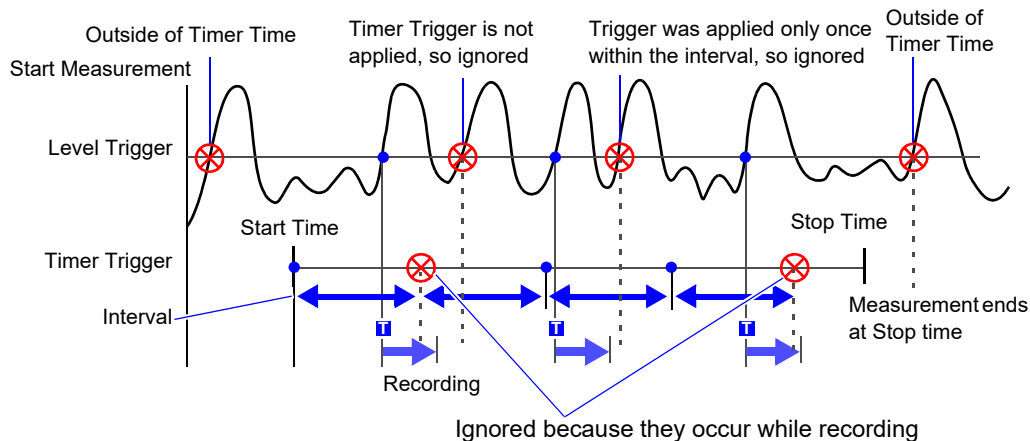
**When trigger criteria are ORed together (Trigger Source: OR)****When trigger criteria are ANDed together (Trigger Source: AND)**

## 8.6 Synchronizing Between Blocks (MR8740 Only)

The input signal from another block can be used as a trigger source. Use this to synchronize between block I and block II of MR8740 Memory HiCorder.

### Procedure

To open the screen: Right-click and select [DISP] → Waveform screen → Right-click and select [TRIG.SET] → Trigger settings window

#### 1 Enable synchronization between blocks.

Move the flashing cursor to the [Sync blocks] item.

Select

Off	Synchronization between blocks is not performed. (default setting)
On	Synchronization between blocks is performed.

Trig Priority	-	Time
Trig Src	OR	
Sync blocks	On	
		Trig searchArea

### NOTE

- To synchronize block I and block II, trigger synchronization needs to be set for both blocks.
- The sampling offset between blocks is within 3 samples or 1 us. If the sampling differs between both blocks, the offset will be for the slow sampling side.
- Synchronizing between blocks of the U8793, MR8790, or MR8791 cannot be enabled.

## 8.7 Applying an External Trigger (MR8741 Only)

An external signal applied to the External Control terminal can serve as a trigger source (External Trigger). It can also be used to synchronously drive parallel triggering of multiple MR8741s.

### Procedure

To open the screen: Right-click and select **[DISP]** → Waveform screen → Right-click and select **[TRIG.SET]** → Trigger settings window

#### 1 Enable external triggering.

Move the flashing cursor to the **[Ext Trig]** item.

Select

Off	Disables external triggering.(default setting)
On	Enables external triggering.

Timing	Start	Timer
Trig Src	OR	
Ext Trig	On	

#### 2 Apply the input signal to the external trigger (EXT.TRIG) terminal.

See: "16.2.5 External Trigger terminal (EXT.TRIG)" (p.342)

## 8.8 Triggering Manually (Manual Trigger)

Triggers can be applied manually by clicking **[MANUAL TRIG]** in the right-click menu. Manual triggering takes priority over all other trigger sources, regardless of settings.

To stop recording:

Click **[STOP]** in the right-click menu.

Click once	Recording is carried out for one recording length and then stops.
Click twice	Recording stops when <b>[STOP]</b> is clicked.

### **NOTE**

As for other trigger types, triggering does not occur during pre-trigger standby. Set the trigger priority function to **[On]**.

See: "8.9.2 Setting Trigger Acceptance (Trigger Priority)" (p.206)

# 8.9 Pre-Trigger Settings

MEM FFT

This applies to the Memory function, and FFT function only. By setting a portion (number of divisions or percentage) of the recording length to occur before triggering, the waveform is recorded before as well as after the trigger point. You can also set the duration of a waveform to be recorded after a trigger point.

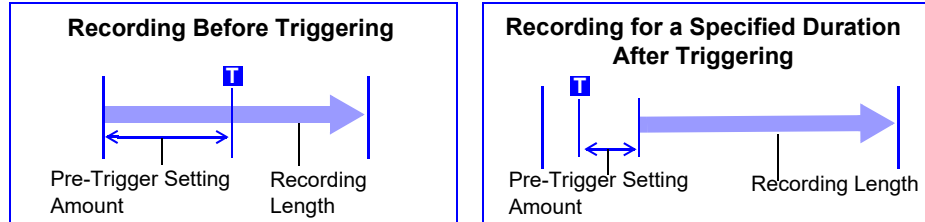

**NOTE**

- When all trigger sources (analog, timer trigger, etc.) are disabled (Off), pre-trigger settings are ignored.
- Pre-triggers cannot be set by div with the FFT function.

## 8.9.1 Setting the Trigger Start Point (Pre-Trigger)

Set the position of the trigger point relative to the specified recording length. There are two setting methods. (Setting by percent and setting by div)

**Procedure**

To open the screen: Right-click and select [DISP] → Waveform screen

- 1 Select the unit to set the pre-trigger.**  
Move the flashing cursor to the Pre-trigger.

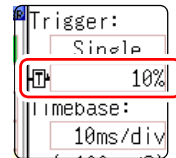

Select

%	Settings are by percent. (default setting)
div	Settings are by number of div. For external sampling, set by number of samples.

- 2 Enter the numerical value.**

**(When [%] is selected)**

With the recording start point as 0% and the recording end point as 100%, set the % for the trigger point.

Select

-95%, 100%, 95%, 90%, 80%, 70%, 60%, 50%, 40%, 30%, 20%, 10%, 5%, 2%, 0%
--

**(When [div] is selected)**

With the recording start point as 0div and the recording end point as the set recording length, set the number of div for the trigger point.

Select

-Recording length (div) to +Recording length (div)
--

## Description About pre-triggering and the recording period (recording length)

### Pre-Trigger setting examples

- 95% 95% of the recording length is recorded before the trigger point
- 50% 50% of the recording length is recorded before and 50% after the trigger point
- 95% 95% of the recording length is recorded after the trigger point

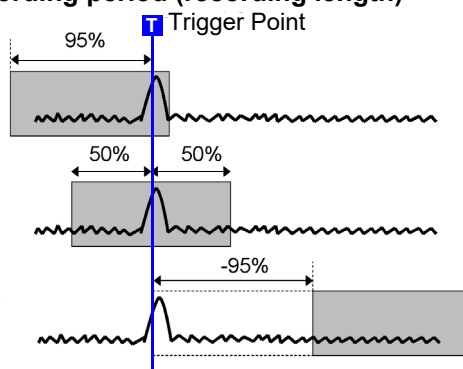

### **NOTE**

- Trigger events during the specified pre-trigger recording period are ignored. To enable recognition of such triggers, set Trigger Priority to **[On]**.

See: "8.9.2 Setting Trigger Acceptance (Trigger Priority)" (p.206)

### Difference between **[Pre-Trigger wait]** and **[Trigger wait]**

When measurement is started, the specified pre-trigger length is recorded. This period is indicated as the **[Pre-Trigger wait]**.

After the specified pre-trigger length has been recorded, the period indicated as **[Trigger wait]** continues until a trigger occurs.

See: "Measurement and Internal Operations" (p.81)



## 8.9.2 Setting Trigger Acceptance (Trigger Priority)

MEM

This applies to the Memory function only.

You can set whether a trigger is recognized (accepted) if trigger criteria are met during this period.

- When pre-triggering is enabled, trigger events are normally ignored for a certain period after measurement starts (while recording the specified pre-trigger period).
- This period is indicated on the Status bar as [Pre-Trigger wait].

### Procedure

To open the screen: Right-click and select [DISP] → Waveform screen → Right-click and select [TRIG.SET] → Trigger settings window

Move the flashing cursor to the [Trig Prio] item.

Select	
Off	Trigger events are ignored during [Pre-Trigger wait] (default setting)
On	Trigger events are recognized (accepted) during [Pre-Trigger wait].



### Description When trigger criteria are met during [Pre-Trigger wait]

Example: When the pre-trigger period is set to 50%

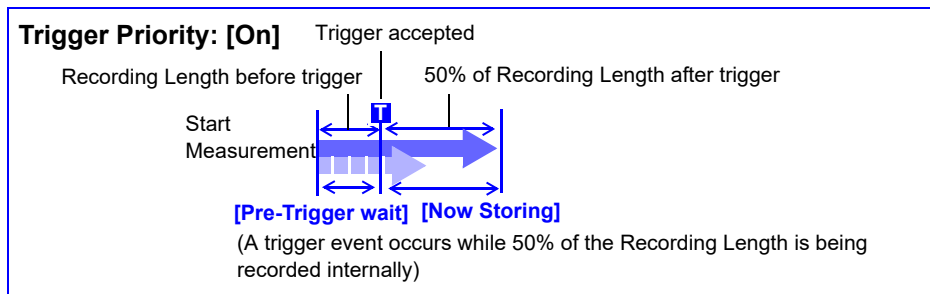
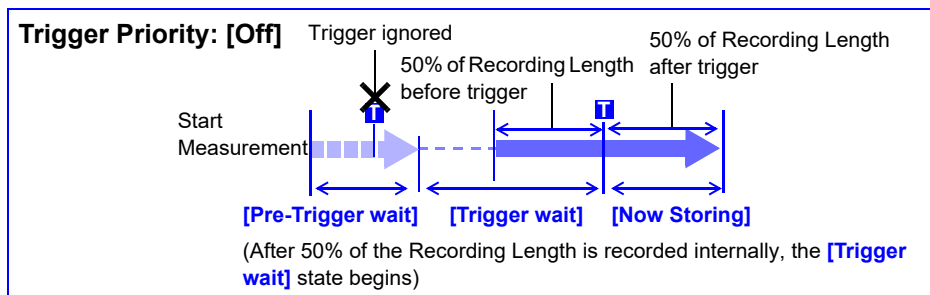

When a trigger event occurs during pre-trigger recording, the data actually recorded may be shorter than the specified recording length. (In this case, the pre-trigger recording length is shortened. The recording length after the trigger event is the specified recording length minus the specified pre-trigger period.)

# 8.10 Setting Trigger Timing

REC

This applies to the Memory function only.  
Set waveform recording operation when a trigger event occurs.

## Procedure

To open the screen: Press the **DISP** key → Waveform screen → Press the **TRIG.SET** key → Trigger settings window

Move the flashing cursor to the **[Timing]** item.

Select

<b>Start</b>	Start recording when a trigger event occurs, and stop after the specified recording length.(default setting)
<b>Stop</b>	Start recording when the <b>START</b> key is pressed, and stop when a trigger event occurs.
<b>Start &amp; Stop</b>	Record the interval from one trigger event until the next trigger event.

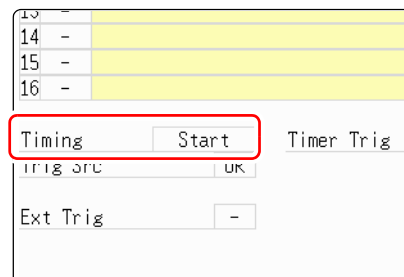

## Description About trigger timing

The selected trigger mode determines how recording stops.

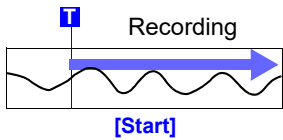
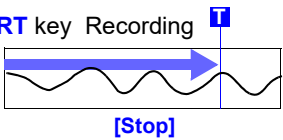
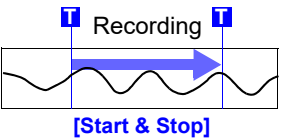
			
Recording Starts	Recording starts when a trigger event occurs	Recording starts when you press the <b>START</b> key	Recording starts when a Start trigger event occurs
Recording Stops	Recording stops after data has been acquired for the specified recording length	Recording stops when a trigger event occurs	Recording stops when a Stop trigger event occurs
With <b>[Single]</b> trigger mode			
With <b>[Repeat]</b> trigger mode	The Trigger Wait state begins after data has been acquired for the specified recording length. When another trigger event occurs, data is again acquired for the specified recording length, then Trigger Wait resumes (repeats)	When a trigger event occurs, recording stops and then starts again (repeats)	When a trigger event occurs, recording stops and the Trigger Wait state resumes. When another trigger event occurs, recording continues until the next trigger occurs (repeats)

**If no trigger event occurs before the specified recording length elapses:**  
**[Stop]** or **[Start & Stop]**: Recording stops after data has been acquired for the specified recording length

**If no trigger event occurs before the specified recording length elapses:**  
**[Start]** : After data is acquired for the specified recording length, recording restarts. This repeats until a trigger event occurs.  
**[Start & Stop]**: The Trigger Wait state begins after data has been acquired for the specified recording length (Start Trigger)

**Example: When the trigger type is Level Trigger, Level = 0.000 V, and Slope = ↑(rising)**

Setting of **[Timing]**

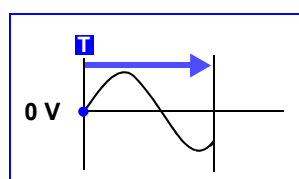

Records for specified recording length

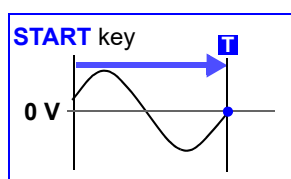

Press **START** key to record. Records until a trigger occurs

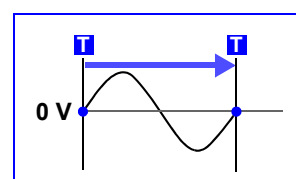

Recording starts when a Start trigger event occurs. Records until a Stop trigger occurs

The above sequences repeat when the trigger mode is **[Repeat]**.

# 8.11 Setting Combining Logic (AND/OR) for Multiple Trigger Sources

Analog, logic, external and timer trigger criteria can be combined by AND/OR logic to define complex trigger criteria.

## Procedure

To open the screen: Right-click and select [DISP] → Waveform screen → Right-click and select [TRIG.SET] → Trigger settings window

Move the flashing cursor to the [Trig Src] item.

Select

<b>OR</b>	Triggering occurs when any one of the specified trigger source criteria is met. (default setting)
<b>AND</b>	Triggering occurs only when all of the specified trigger source criteria are met.

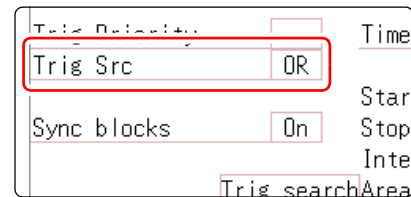

(Memory Function case)

## Description When the trigger combining logic (Source (AND/OR)) is set to [AND]

If trigger criteria are already met when measurement is started, no triggering occurs. Triggering occurs only after all trigger sources have ceased to meet the criteria at once, and are subsequently met again.

Setting Example:

To apply a trigger when the upslope (↑) of the waveform crosses zero volts  
Triggering occurs as follows in the AND and OR cases.

Channel	Trigger	Trigger Level	Slope	Filter
Ch1, Ch2	Level	0.00 V	↑	Off

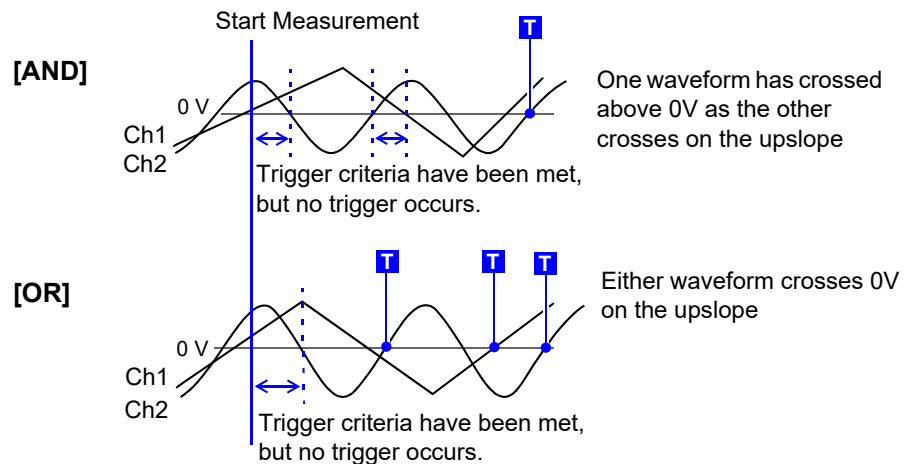

## 8.12 Using trigger settings to search measurement data

MEM

Trigger settings can be used to search measurement data.

Locations that match the set trigger criteria in the measurement data are searched for and displayed sequentially.

Using the same method to set triggers, it is possible to search for criteria different to those at the time of measurement.

Example 1: The measurement trigger criteria is trigger level 0 V and the data search condition is level 100 V.

Example 2: After measurement with a free run without a trigger, locations that exceed 100 V are searched for.

### Procedure

To open the screen: Right-click and select [DISP] → Waveform screen → Right-click and select [TRIG.SET] → Trigger settings window ([Analog Trig], or [Logic Trig] sheet)

#### 1 After measurement is finished, set the search criteria.

The setting method is the same as described in "8.3 Triggering by Analog Signals" (p.192) and "8.4 Triggering by Logic Signals (Logic Trigger)" (p.197).

#### 2 Specify the search range.

Move the flashing cursor to the [Area] item.

Select

Whole Wave	Search all measured data. (default setting)
A-B Wave	Search in the range between A/B cursor.

(When using memory division)

Select

Whole Display Blocks	Applies search to the whole display blocks.
A/B Display Blocks	When setting the A/B cursors on the display blocks, applies search to the range between the A and B cursors on the display blocks.
Whole Blocks	Applies search to the data in the whole blocks.
A/B Whole Blocks	When setting the A/B cursors for the whole blocks, applies search to the range between the A and B cursors for the whole blocks.

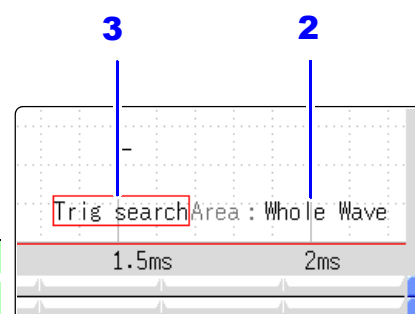

- When selecting A/B range and only A cursor is shown on the screen, search will be performed on the data after A cursor.
- The search range for [Whole Blocks] and [A/B Whole Blocks] will be defined according to the start block and the number of blocks to be measured.

#### 3 Execute search.

Move the flashing cursor to the [Trig search] item.

Select

Execute search	Start the search from the beginning of the measurement data.
Search next	Searches for the next search condition at the most recent search position.
Move A cursor	Move A cursor to the searched position.
Move B cursor	Move B cursor to the searched position.
Clear	Clear the searched position.

**Description**    **Search results**

Locations that match the criteria are displayed in the center of the screen and an S mark is displayed in this position.

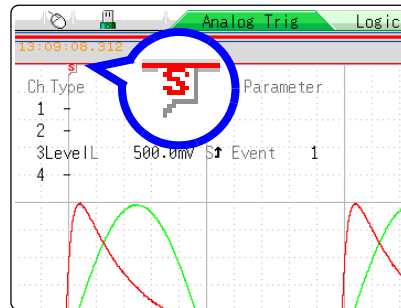

When no matches are found, a message stating that no matches were found is displayed.

**NOTE**

- Pre-triggers, trigger priorities, external triggers and timer triggers cannot be used as search conditions.
- The trigger position and search results may not match.
- Data measured with MR8990 Digital Voltmeter Unit cannot be searched.

# Numerical Calculation Functions

## Chapter 9

Numerical calculations can only be used with the Memory function.

Results calculated from the acquired waveform are displayed as numerical values on the Waveform screen. Numerical calculation settings are made on the Status screen - **[Num Calc]** sheet.

### Opening the **[Num Calc]** sheet

Select **[STATUS]** and then **[Num Calc]** from the right-click menu.

No	Type	Ch	Parameter	Stat	Unit	Lower	Upper
1	Average	Ch1		Off			
2	RMS	Ch1		On		-1.0000	1.0000
3	Peak-Peak	Ch1		Off			
4	Pulse Width	Ch1	L 0.0000 F - S	First Off			
5	Duty Ratio	L A 1	F -	First Off			
6	Off						
7	Off						
8	Off						
9	Off						
10	Off						
11	Off						
12	Off						
13	Off						
14	Off						
15	Off						
16	Off						

Hint: Select the measurement function.

### Operations available from the **[Num Calc]** sheet

#### Numerical Calculations

- Average
  - RMS (Root-Mean-Square) value \*
  - Peak-to-Peak Value
  - Maximum Value
  - Time to Maximum Value
  - Minimum Value
  - Time to Minimum Value
  - Period
  - Frequency
  - Rise Time \*
  - Fall Time \*
  - Standard Deviation \*
  - Area \*
  - X-Y Area \*
  - Time to Level
  - Level at Time
  - Pulse Width
  - Duty Ratio(%)
  - Pulse Count
  - Four Arithmetic Operations
  - Time difference calculation
  - Phase contrast calculation
  - High level calculation \*
  - Low level calculation \*
- (Total of 24 types)
- Specified calculation between A/B cursors
- Waveform calculations can be limited to data within the range specified by A/B cursors.
- \*: Calculation performed with MR8990 Digital Voltmeter Unit is invalid.
- Calculation operator details:  
"9.5 Numerical Calculation Type and Description" (p.223)

#### Numerical Calculation Judgment (p.218)

The result of a numerical calculation can be compared to a preset reference range, for GO/NG (Pass/Fail) evaluation.

#### Save Numerical Calculation Results

- Auto Save numerical calculation results
  - Save specified existing numerical calculation result
- See: "9.4 Saving Numerical Calculation Results" (p.221)

There are a total of 24 types of numerical calculations, 16 of which can be performed simultaneously.

When the Scaling function is used, numerical calculation is performed on the scaled value.

## 9.1 Numerical Calculation Workflow

There are two different ways of performing calculation.

- Calculating the data automatically after the measurement: Settings for numerical calculation must be made before the measurement.
- Calculating the existing data: Calculation is possible for waveform data after measurement is completed, and for data saved on media.

### Calculating While Measuring

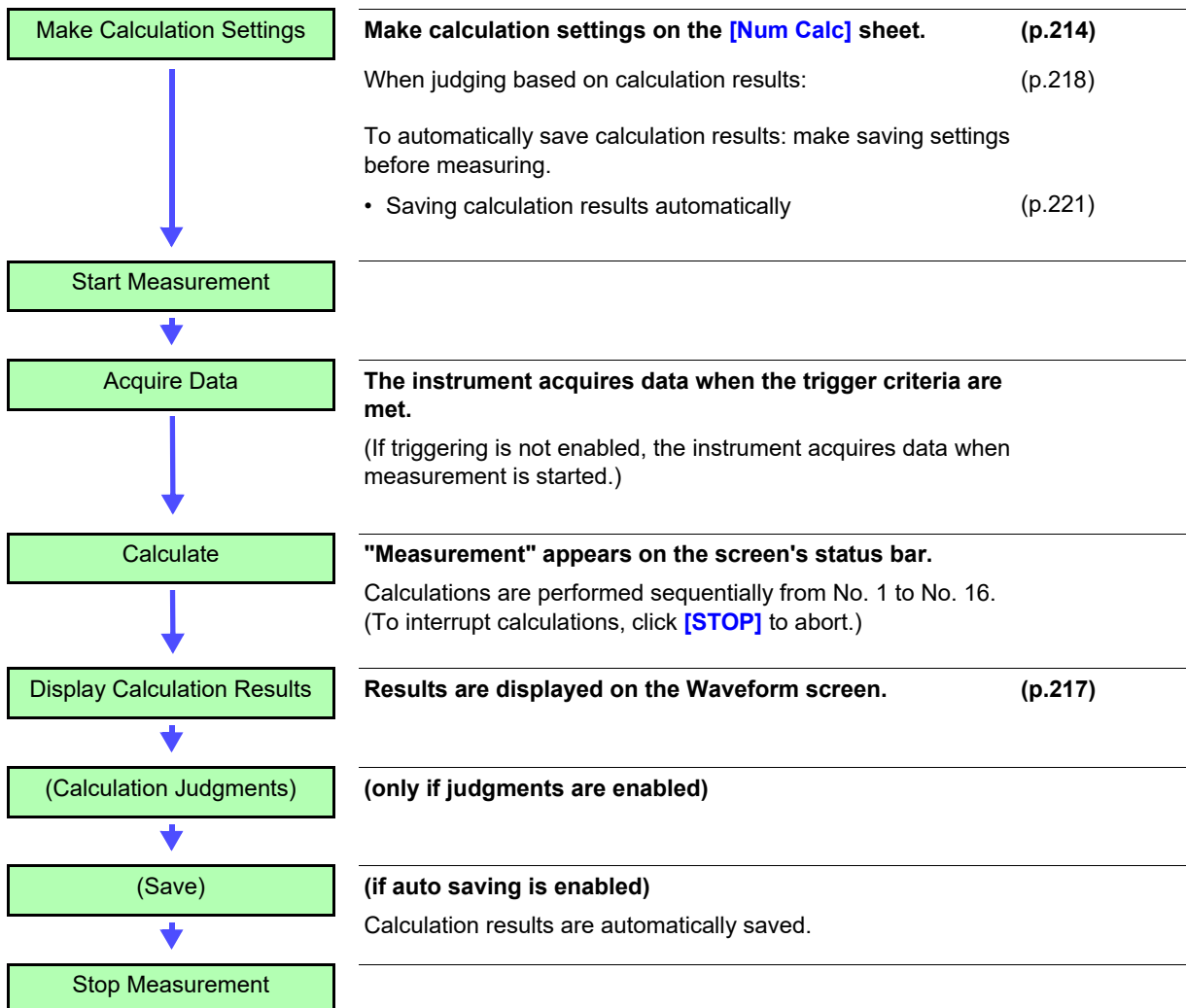

## Applying Calculations to Existing Data

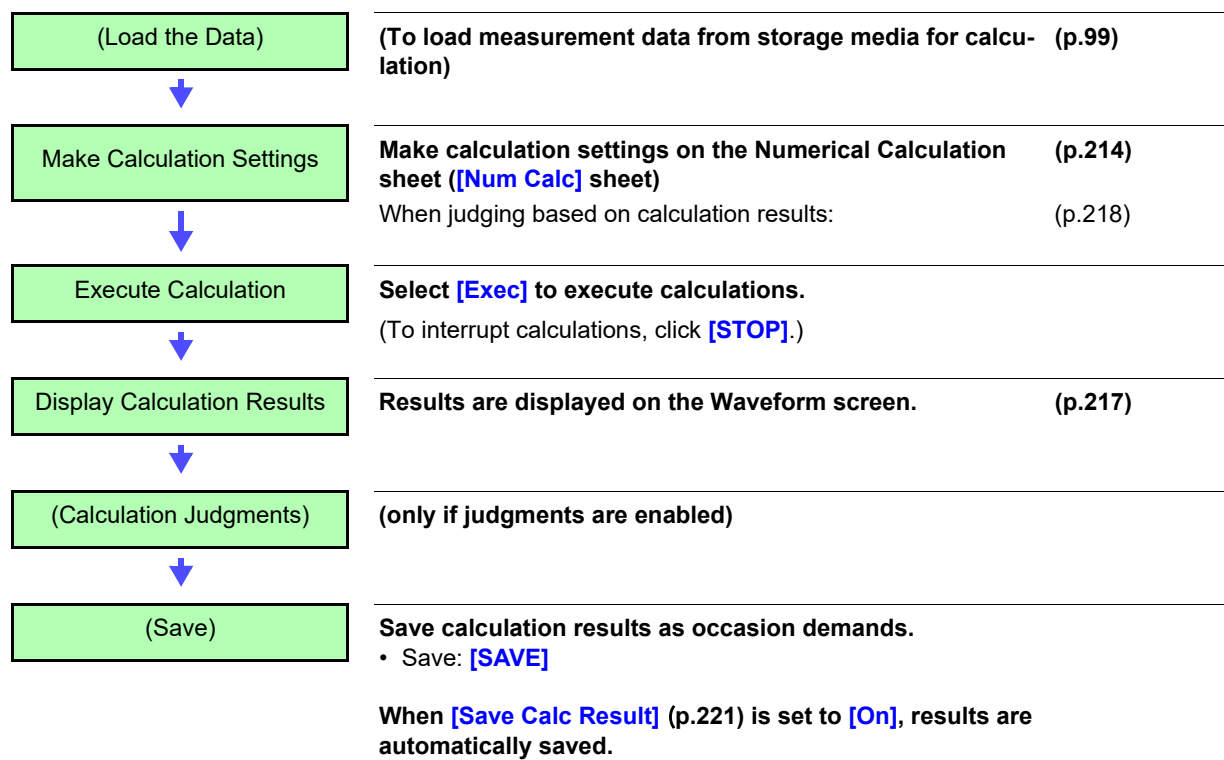

### When specifying a waveform range for calculation:

Before executing a calculation, specify the calculation range using the A/B cursors (div or Trace cursors) on the Waveform screen. Set the calculation range on the [Num Calc] sheet to [A-B Wave].

- Range cursors cannot be used to specify the range.
- When one cursor is used, the calculation range is from the cursor to the end of the data.

See: "6.2 Specifying a Waveform Range (A/B Cursor)" (p.124)  
"9.2 Settings for Numerical Value Calculation" (p.214)



# 9.2 Settings for Numerical Value Calculation

## Procedure

To open the screen: Right-click and select [STATUS] → [Num Calc] sheet

**1 Enable the Numerical Calculation function.**

Move the flashing cursor to the [Numerical Calc] item.  
Select [On].

**2 Specify the Numerical Calculation range.**

Move the flashing cursor to the [Calc Area] item.

Select

<b>WholeWave</b>	Applies calculations to the whole waveform. (default setting)
<b>A-B Wave</b>	Applies calculations to the data between A/B cursors.
<b>AfterTrigger</b>	Applies calculations to the waveform after a trigger.

See: "6.2 Specifying a Waveform Range (A/B Cursor)" (p.124)

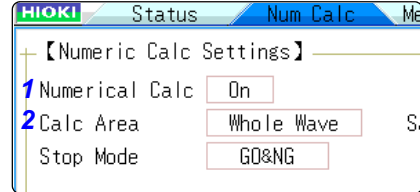

When selecting [A-B Wave], specify the calculation range using the A/B cursors on the Waveform screen.  
If no measurement data has been acquired by the instrument, first measure once so that the range can be specified for calculations to be applied to subsequent measurements.

**3 Perform calculation settings.**

No	Type	Ch	Parameter	Stat	Judge	Lower	Upper
1	Average	Ch1			Off		
2	RMS	Ch1			On	-1.0000	1.0000
3	Pulse Width	Ch1	L 0.0000 F - S ↑	Ave	Off		
4	Time Diff	A Ch2	L 1.0000 F 0.1div S ↑	First	Off		

(1) Calculation Type    (2) Channel for Calculation    (3) Parameters\*    (4) Statistical calculation    \*: Setting choices depend on the calculation type.

**(1) Select the calculation type.**

Move the flashing cursor to the number of the calculation type for which to make settings, and select the calculation type.

Also select [Judge] if you require judgment of calculation results.(p.218)

(When you select [List] a list of calculation types appears.)

<b>Off</b>	No calculation. (default setting)	<b>X-Y Area*<sup>1</sup></b>	Area of X-Y composite waveform
<b>Average</b>	Average value of waveform data	<b>Time to Lev*<sup>2</sup></b>	Time from trigger to specified level
<b>Rms*<sup>1</sup></b>	RMS value of waveform data	<b>Lev-time</b>	Measurement value at a specified time point after triggering
<b>Peak-Peak</b>	Peak-to-peak value of waveform data	<b>Pulse Width*<sup>2</sup></b>	Pulse width of waveform data
<b>Maximum</b>	Maximum value of waveform data	<b>Duty Ratio*<sup>2</sup></b>	Duty of waveform data
<b>Max-Time</b>	Time from trigger to maximum value	<b>Pulses*<sup>2</sup></b>	Pulse count of waveform data
<b>Minimum</b>	Minimum value of waveform data	<b>Calculation</b>	Four arithmetic operations on numerical calculation results
<b>Min-Time</b>	Time from trigger to minimum value	<b>Time Diff*<sup>2</sup></b>	Time difference between phenomenon A and B.
<b>Period*<sup>2</sup></b>	Period of signal waveform	<b>Phase Diff*<sup>2</sup></b>	Time difference between phenomenon A and B displayed as a phase contrast.
<b>Frequency*<sup>2</sup></b>	Frequency of signal waveform	<b>High Level*<sup>1</sup></b>	High level value for waveform data
<b>RiseTime*<sup>1</sup></b>	Rise time of waveform data	<b>Low Level*<sup>1</sup></b>	Low level value for waveform data
<b>FallTime*<sup>1</sup></b>	Fall time of waveform data		
<b>Std Dev*<sup>1</sup></b>	Standard deviation of waveform data		
<b>Area*<sup>1</sup></b>	Area enclosed by zero position and signal waveform		

\*1: Calculation performed with MR8990 Digital Voltmeter Unit is invalid. The indication of the calculation result becomes "\*\*\*\*\*".

\*2: Setting can also be made for logic channels

**(2) Select the channel for calculations.**

Move the flashing cursor to the item for the calculation target, and select the channel.

(A logic channel can also be selected for Time to Level, Pulse Width, Duty Cycle, and Pulse Count.)

**(3) Set parameters.**

Settings may not be necessary for some calculation types. When calculating time differences and phase contrast, make settings for A and B channels.

Move the flashing cursor to the parameter items, and make appropriate parameter settings.

See: "Parameter table" (p.216)

See: "7.1.3 Alphanumeric Input" (p.141)

**(4) Set the statistical calculation.**

Move the flashing cursor to the [Stat] column.

Select

<b>First</b>	Calculate at the first condition of the measurement data.
<b>Average</b>	Acquire the average value of the calculation result in the measurement data.
<b>Max</b>	Acquire the maximum value from the calculation result in the measurement data.
<b>Min</b>	Acquire the minimum value from the calculation result in the measurement data.

**(5) When time difference calculation or phase contrast calculation has been selected, set Ch (channel) and parameters for A and B.****4 Execute the calculations. (when judging calculations (p.218))**

Applying Calculations to Existing Data

Select [Exec].

When calculating automatically after measurement

Click [START] to start measurement.

**When saving calculation results during measurement**

Settings must be made before the measurement.

See: "9.4 Saving Numerical Calculation Results" (p.221)

**When saving existing data**

Click [SAVE].

See: "4.2.3 Saving Data Selectively (SAVE)" (p.93)

**To copy a calculation setting to another calculation number**

Use the [Num Calc] sheet.

See: "7.8 Copying settings to other channels (calculation No.) (Copy function)" (p.160)

## Parameter table

Calculation Type	Parameter	Parameter description
<b>Period</b> <b>Frequency</b> <b>Pulse Width</b> <b>Pulses</b> <b>Duty Ratio*</b> <b>Time Diff</b> <b>Phase Diff</b>  *: Level and Filter only	<b>L (Level)</b>	Calculation is based on the interval (time) when this level is crossed.
	<b>F (Filter)</b>	Only when the measurement signal has crossed the level and has not crossed the level again within the specified filter width, it is taken as a valid event. This is useful to exclude level crossing events due to noise.
	<b>S (Slope(↑, ↓))</b>	Calculation is based on the interval (time) when the level is crossed. Depending on this setting, either crossing on the upward slope (↑) or downward slope (↓) is used for calculation.
<b>Risetime</b> <b>Falltime</b>	<b>P (%)</b>	Determines which section of the waveform between the upper and lower limits is used for risetime (or falltime) calculation. The range is narrowed from the upper and lower limit values by the percentage set here.
<b>Time to Lev</b>	<b>L (Level)</b>	Calculates the time specified level is crossed.
	<b>F (Filter)</b>	Only when the measurement signal has crossed the level and has not crossed the level again within the specified filter width, it is taken as a valid event. This is useful to exclude level crossing events due to noise.
	<b>S (Slope(↑, ↓))</b>	Determines whether the time is calculated until the signal crosses the specified level on the upward slope or on the downward slope.
<b>Lev-Time</b>	<b>Time or Measure (Calculation results)</b>	Specifies the time for calculating the measurement value, using the trigger position as zero. To use the numerical calculation result, specify the numerical calculation number. The range specified by A/B cursors is not available.
<b>Calculation</b>	<b>Numerical Calculation No.</b>	Sets the numerical calculation number.
	<b>+, -, ×, ÷</b>	Sets the operators for the four arithmetic operations.

### **NOTE**

- Depending on the signal waveform, calculation values for the Period, Frequency, Risetime, and Falltime parameters may not be displayed.
- When Scaling is enabled, the waveform data are scaled before numerical calculation. The units for parameter values are derived from the units set for the Scaling function.

See: About Scaling: "7.4 Converting Input Values (Scaling Function)" (p.148)

## 9.2.1 Displaying Numerical Calculation Results

Numerical calculation results are displayed on the Waveform screen

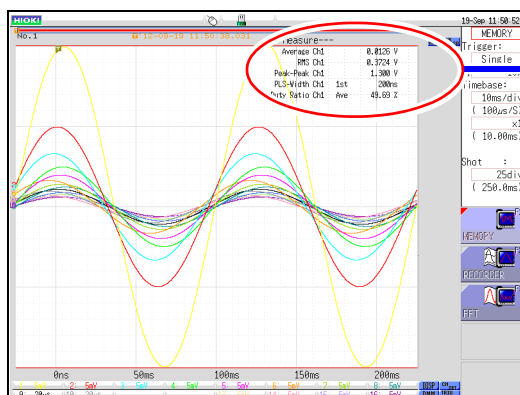

Calculation Results

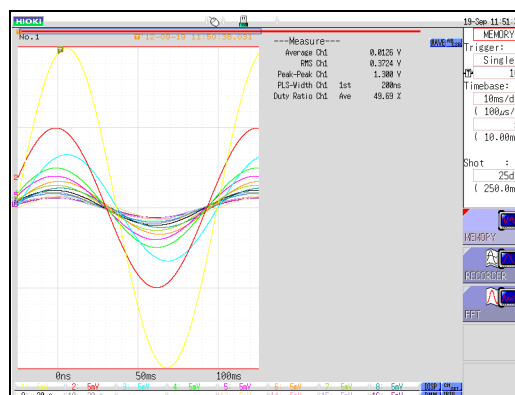

If the display is hard to view because of overlapping numerical values and waveforms

Switch the waveform display width in the **[DISP]** menu.

Numerical values and waveforms are displayed separately.

See: "6.7.3 Switching the Waveform Display Width" (p.135)



**To save calculation results after measuring:**

Set the **[Select at save]** item to **[Yes]**. When you click **[SAVE]** after measurement, you can select the content to be saved. (Select **[Calc Result]**.)

See: "4.2.3 Saving Data Selectively (SAVE)" (p.93)

**NOTE**

If a numerical calculation that becomes invalid is performed using the data measured with MR8990 Digital Voltmeter Unit, the calculation result is displayed as "\*\*\*\*\*".

## 9.3 Judging Calculation Results

Set the judgment criteria (upper and lower threshold values) by which to judge numerical calculation results. Judgment criteria can be set for every numerical calculation.

Waveform acquisition processing depends on the trigger mode setting (Single or Repeat) and the criteria specified to stop measuring upon judgment (GO, NG or GO & NG).

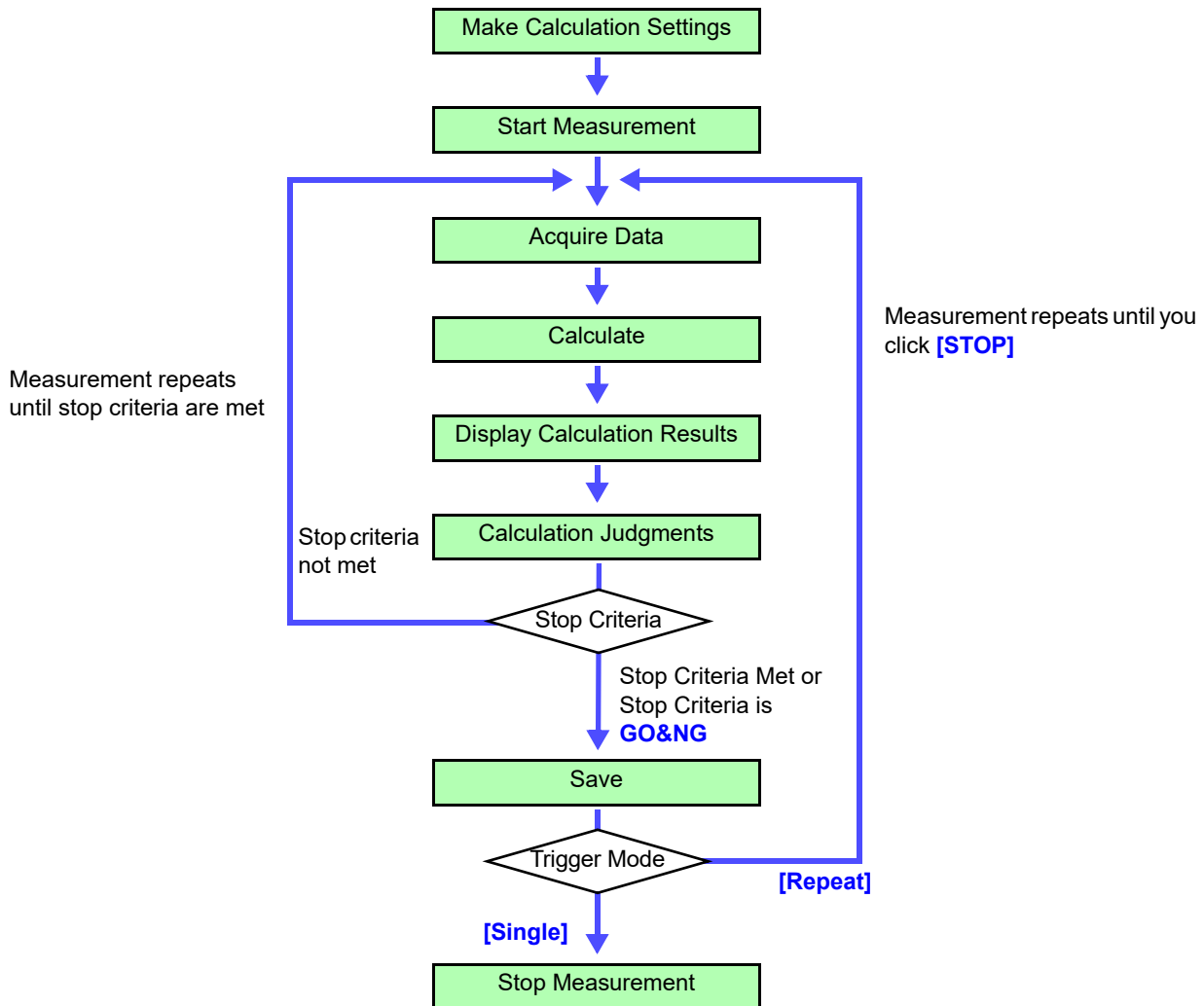

### **NOTE**

Automatic saving will not be carried out before termination conditions are fulfilled at the end of the calculation evaluation.

## Procedure

To open the screen: Right-click and select **[STATUS]** → **[Num Calc]** sheet

### 1 Make calculation settings. (p.214)

### 2 Enable the judgment function.

Move the flashing cursor to the **[Judge]** setting for Calculation No. to judge, and select **[On]**.

Select

Off	Judgment is not carried out.
On	Result will be NG (Fail) if judgment range is exceeded. Any channel in which result was NG is shown in red.

Stat	Judge	Lower	Upper
	Off		
2	On	-1.0000	1.0000
S ↑	First Off		
	First Off	3 Lower limit value	Upper limit value

### 3 Specify the judgment thresholds.

Move the flashing cursor to the **[Lower]** and **[Upper]** items.

Select an entry method and enter the threshold values.

Input range:-9.9999E+29 to +9.9999E+29

See: "7.1.3 Alphanumeric Input" (p.141)

### 4 Select the Stop Criteria upon judgment.

Move the flashing cursor to the **[Stop Mode]** item.

Select

GO	Continue to the next process when within the threshold range (PASS judgment)
NG	Continue to the next process when outside of the threshold range (FAIL judgment)
GO&NG	Continue to the next process regardless of judgment result.



### Execute the calculations.

Applying Calculations to Existing Data

Select **[Exec]**.

When judging automatically after measurement

Click **[START]** to start measurement.

## NOTE

### About upper and lower threshold

The upper threshold of the period range cannot be set below the lower threshold, and vice-versa.

### About executing the calculation

Processing depends on the Trigger Mode setting.

If calculating while acquiring waveforms, measurement is repeated until the Stop Criteria are met. (p.218)



### To record all calculation results

Set the Stop Mode item to **[GO&NG]**.

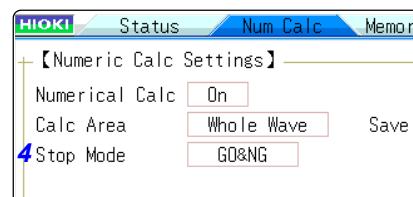

## 9.3.1 Display of Judgment Results and Signal Output

Judgment results of numerical calculations are displayed on the Waveform screen.

Within the judgment threshold range: GO judgment

Out of the judgment threshold range: NG judgment (displayed in red)

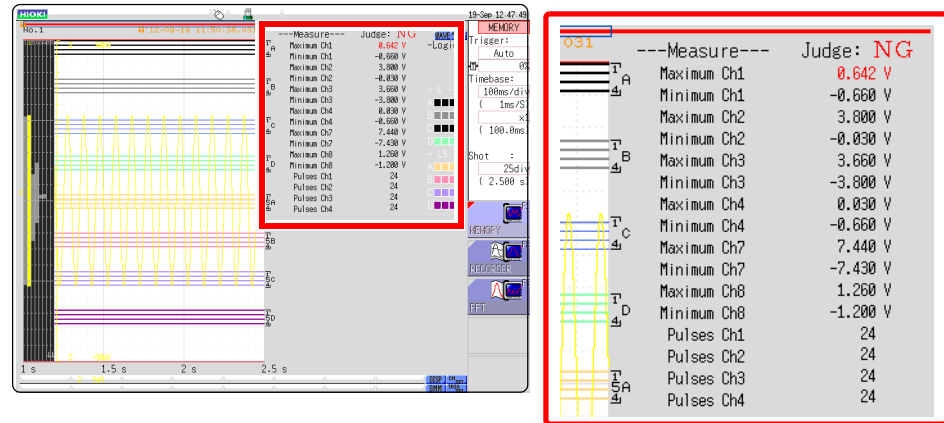

### When the judgment result is GO

- The GO signal is output at the GO/EXT.OUT.1 external I/O terminal. (MR8741 only)

### When the judgment result is NG

- The NG signal is output at the NG/EXT.OUT.2 external I/O terminal. (MR8741 only) The NG judgment is asserted when any channel is judged as NG.
- When the beeper is enabled, a beep sounds when a result is out of the threshold range.

## 9.4 Saving Numerical Calculation Results

Calculate and automatically save during data acquisition. Before measurement begins, the calculation settings need to be set.



**CAUTION** When using auto save during measurement, do not remove the storage media specified as the save destination until the measurement operation is completely finished. Doing so may damage data on the storage media.

### Procedure

To open the screen: Right-click and select **[STATUS]** → **[Num Calc]** sheet

#### 1 Enable the saving of numerical calculation results.

Move the flashing cursor to the **[Save Calc Result]** item.

Select **[On]**. (default setting: Off)

1	Save Calc Result	<input type="checkbox"/> On
2	Folder to save	<input type="text"/> New File
3	Save to	<input type="text"/> USB1:\HIOKI_MRS
4	Save Name	<input type="text"/> MEAS

#### 2 Select the file creation method.

Move the flashing cursor to the **[Folder to save]** item.

Select

<b>New File</b>	Creates a new file for each measurement.
<b>Existing File</b>	Adds calculation results to one file.

#### 3 Set the save target

Move the flashing cursor to the **[Save To]** item.

Select **[Edit]**.

The Browse folders dialog box appears. (See illustration at right.)

Move the flashing cursor to the save target media.

Select **[Confirm]** to confirm the selection.

Select

<b>USB1</b>	Automatically save the waveform data on the USB memory stick.
<b>LAN</b>	Automatically save the waveform data on the PC connected via LAN. Model 9333 LAN Communicator is required to be installed.

To create a new folder to use as target, select **[New Folder]**. When **[LAN]** is set as the save destination, **[New Folder]** setting is ignored and the folder named with the current date is created.

#### 4 Enter a save name (if you want to use a different name).

Move the flashing cursor to the **[Save Name]** item.

Enter the save name. (default setting: MEAS)

See: "7.1 Adding Comments" (p.138)

When **[LAN]** is set as the save destination, **[Save Name]** setting is ignored and the files to be saved are named in the previously-determined format.

See: "Save Operations (When setting the save destination to [LAN])" (p.92)

#### Save Name

- The maximum length of the Save Name string is 123 characters. The maximum path length is 255 characters.
- A sequential number starting from 0001 is automatically appended to the Save Name (when **[New File]** is selected).

**Confirm the measurement configuration and numerical calculation result settings, then start measurement.**



## Example for saving numerical calculation results

### **NOTE**

If you save numerical calculation results, characters or display items used on the instrument are converted as shown below.

Characters used on the instrument	Saved characters
2	^2
3	^3
$\mu$	~u
$\Omega$	~o
e	~e
°	~c
$\pm$	~+
$\mu\text{E}$ (display only)	uE
°C (display only)	C

<When calculation settings are as follows>

Calculation No. 1: Maximum value of analog channel 1

Calculation No. 2: Maximum value of analog channel 1

Calculation No. 3: Maximum value of analog channel 2

Calculation No. 4: Maximum value of analog channel 2

```
"Trig Time", "No1 Maximum Ch1", "No2 Minimum Ch1", "No3 Maximum Ch2", "No4 Minimum Ch2"
";", "V", "V", "V", "V"
"08-04-11 17:40:33.351", "+3.00078E-05", "+2.12000E-04", "+2.00000E-03", "+1.30000E-03"
"08-04-11 17:44:25.976", "+3.06078E-05", "+2.39996E-04", "+2.00000E-03", "+1.10000E-03"
```

Recorded in the order of the calculation settings of line 1.

Line 1: Calculation Settings  
 Line 2: Calculation Result Unit  
 From Line 3: Calculation Results

## 9.5 Numerical Calculation Type and Description

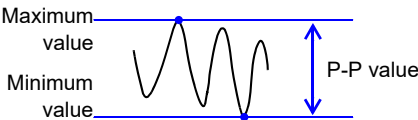
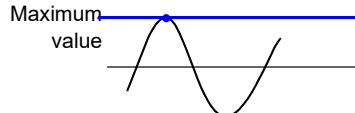
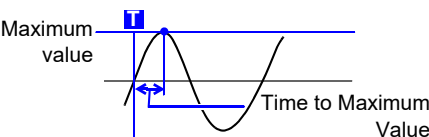
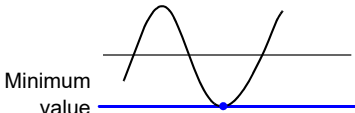
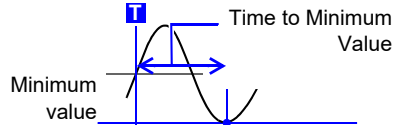
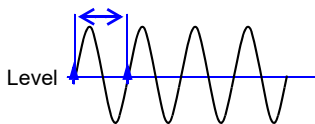
Numerical Calculation Type	Description
<b>Average</b>	<p>Obtains the average value of waveform data.</p> $AVE = \frac{1}{n} \sum_{i=1}^n di$ <p>AVE: Average value n: Data count di: Data on channel number i</p>
<b>RMS (Root-Mean-Square) value (Rms)</b>	<p>Obtains the RMS value of waveform data. If Scaling is enabled, calculations are applied to the waveform after scaling.</p> $RMS = \sqrt{\frac{1}{n} \sum_{i=1}^n di^2}$ <p>RMS: RMS value n: Data count di: Data on channel number i</p>
<b>Peak-to-Peak value (Peak-Peak)</b>	<p>Obtains the value of the difference (peak-to-peak value) between maximum and minimum values of waveform data.</p>  <p>Maximum value Minimum value P-P value</p>
<b>Maximum Value (Maximum)</b>	<p>Obtains the maximum value of waveform data.</p>  <p>Maximum value</p>
<b>Time to Maximum Value (Max-Time)</b>	<p>Obtains the time (in seconds) from the last trigger point to the maximum value. If the maximum value occurs in two or more instances, the first instance is treated as the maximum value.</p>  <p>Maximum value Time to Maximum Value</p>
<b>Minimum Value (Minimum)</b>	<p>Obtains the minimum value of waveform data.</p>  <p>Minimum value</p>
<b>Time to Minimum Value (Min-Time)</b>	<p>Obtains the time (s) from the trigger point to the minimum value. When there are two or more minimum value points, the first point of the first waveform for which calculation was carried out is taken as the minimum value.</p>  <p>Minimum value Time to Minimum Value</p>
<b>Period/Frequency</b>	<p>Obtains the time (in seconds) from the last trigger point to the minimum value. Calculates the period/frequency based on the time difference from the point when a specified level is crossed in the rising or falling direction to the point when it is next crossed.</p>  <p>Level</p>

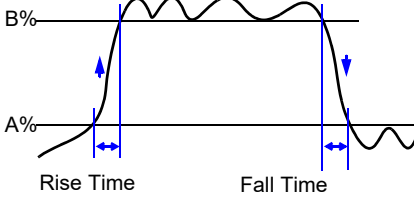
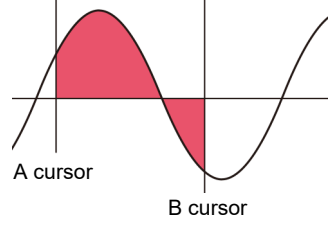
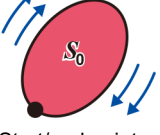
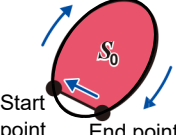
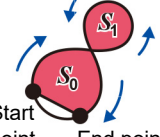
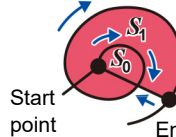
Numerical Calculation Type	Description
<p><b>Rise Time and Fall Time</b></p>	<p>The rise time of the acquired waveform from A% to B% (or fall time from B% to A%) is obtained by calculation using a histogram (frequency distribution) of the 0 and 100% levels of the acquired waveform. As waveform data is acquired, the rise time (or fall time) is obtained from the first rising (or falling) edge.</p> <p>When calculation of the range specified by the A/B cursors is selected, the obtained rise time (or fall time) is the first rising (or falling) edge between the cursors.</p>  <p>A: 5 to 30% B: 95 to 70%</p>
<p><b>Standard Deviation (Std Dev)</b></p>	<p>Obtains the standard deviation of the waveform data.</p> $\sigma = \sqrt{\frac{1}{n} \sum_{i=1}^n (di - AVE)^2}$ <p>σ: Standard Deviation AVE: Average n: Data count di: Data on channel number i</p>
<p><b>Area</b></p>	<p>Obtains the area value (V•s) enclosed by the zero position (point of zero potential) and the signal waveform.</p> <p>When calculation of the range specified by the A/B cursors is selected, the calculated area is constrained to the waveform between the cursors.</p>  $S = \sum_{i=1}^n  di  \cdot h$ <p>S: Area n: Data count di: Data on channel number i h=Δt: Sampling rate</p>
<p><b>X-Y Area</b></p>	<p>Obtains the area (V<sup>2</sup>) of an X-Y composite waveform. In the following figures, the areas within the lines are calculated. The calculation is available even if the X-Y composite waveform is not intended for display.</p> <p>To enable area calculation, specify the calculation range using the A/B cursors (Voltage axis or Trace) on the waveform of each channel for X-Y composition. (The area cannot be specified directly by A/B cursors on the X-Y waveform.)</p> <p><a href="#">See:</a> About A/B Cursor: "6.1 Reading Measurement Values (Using the A/B Cursors)" ( p.120)</p> <div style="display: flex; justify-content: space-around;"> <div data-bbox="438 1456 853 1691"> <p><b>When the trace consists of multiple loops</b></p>  <p><math>S = n \times S_0</math> S: Area n: Number of loops</p> </div> <div data-bbox="853 1456 1377 1691"> <p><b>When the trace is an open curve</b></p>  <p><math>S = S_0</math> S: Area (Area enclosed by the curve and line connecting start and end points)</p> </div> </div> <div style="display: flex; justify-content: space-around; margin-top: 20px;"> <div data-bbox="438 1713 853 1937"> <p><b>When the trace is a figure-8</b></p>  <p><math>S =  S_0 - S_1 </math> S: Area</p> </div> <div data-bbox="853 1713 1377 1937"> <p><b>When the trace is an open curve</b></p>  <p><math>S = S_0 \times 2 + S_1</math> S: Area (The number of overlapping regions increases with the number of loops)</p> </div> </div> <p><b>Setting Choices: Set the X- and Y-axis channels.</b></p>

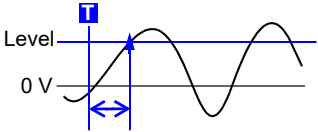
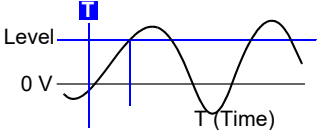
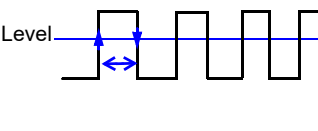
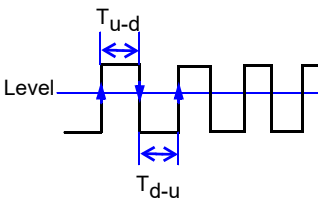
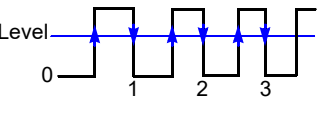
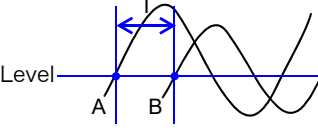
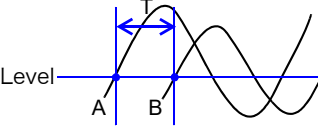
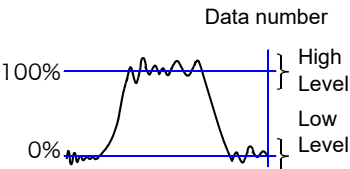
Numerical Calculation Type	Description
<b>Time to Level (Time-Lev)</b>	<p>Finds the point where the signal crosses a specified level from the start of the calculation range, and obtains the time elapsed from the last trigger event.</p> 
<b>Specified Time Level (Lev-Time)</b>	<p>Obtains the level at a specified time point after the trigger event. The time can also be specified using other calculation results obtained earlier.</p> 
<b>Pulse Width</b>	<p>Obtains pulse width as the time difference between one rising or falling intersection of the waveform through a specified level to the next intersection (with opposite slope).</p> 
<b>Duty Ratio (%)</b>	<p>Obtains the duty percentage based upon the ratio of the time from a rising intersection to the next falling intersection at a specified level, to the time from the same falling intersection to the next rising intersection at the same level.</p> $\text{Duty (\%)} = \frac{T_{u-d}}{T_{u-d} + T_{d-u}} \times 100 (\%)$ <p><math>T_{u-d}</math>: Time (seconds) after rising intersection to falling intersection  <math>T_{d-u}</math>: (s) Time (seconds) after falling intersection to the next rising intersection</p> 
<b>Pulses</b>	<p>Obtains the count of pulses from the number of rising or falling intersections with a specified level. One pulse is counted when the signal falls back below the specified level after rising through it (or vice versa)</p> 
<b>Four Arithmetic Operations (Calculation)</b>	<p>Performs arithmetic operations (+, -, ×, ÷) upon arbitrarily selected results of numerical calculations.</p>
<b>Time difference calculation (Time Diff)</b>	<p>Obtain T[s], the time difference that passes between rises above or drops below the level specified for A and B waveforms. Time difference T = B waveform (time where the level was exceeded) - A waveform (time where the level was exceeded).</p> 
<b>Phase contrast calculation (Phase Diff)</b>	<p>Obtain the time difference that passes between rises above or drops below the level specified for A and B waveforms and then obtain the phase contrast [°], based on A waveform.</p> $\text{Phase contrast} = \frac{\text{Time difference of A and B waveform [T]}}{\text{Cycle of A waveform}} \times 360^\circ$ 
<b>High Level Low Level</b>	<p>With 0% of the loaded waveform data as the Low level and 100% as the High level, a histogram (frequency distribution) is used for calculation.</p> 



# Waveform Calculation Functions **MEM** Chapter 10

10

Chapter 10 Waveform Calculation Functions

Waveform calculations can only be used with the Memory function.

A pre-specified calculation equation is applied to acquired waveform data, and the calculation results are displayed as a waveform on the Waveform screen.

Waveform calculation settings are made on the Status screen - **[Wave Calc]** sheet.

## Opening the **[Wave Calc]** sheet

Select **[STATUS]** and then **[Wave Calc]** from the right-click menu.

No.	Wave	Scale	Lower	Upper	Unit	Graph	CONST.
Z1	Auto	0.0000	20.000				a 0.0000 i 0.0000
Z2	Auto	0.0000	20.000				b 0.0000 j 0.0000
Z3	Auto	0.0000	20.000				c 0.0000 k 0.0000
Z4	Auto	0.0000	20.000				d 0.0000 l 0.0000
Z5	Auto	0.0000	20.000				e 0.0000 m 0.0000
Z6	Auto	0.0000	20.000				f 0.0000 n 0.0000
Z7	Auto	0.0000	20.000				g 0.0000 o 0.0000
Z8	Auto	0.0000	20.000				h 0.0000 p 0.0000

Hint: Waveform calculation is a function to carry out calculations on the waveform data in the memory and display the waveform results on the screen.

## Operations available from the **[Wave Calc]** sheet

### Waveform Calculations

- Four Arithmetic Operators (+, -, \*, /)
  - Absolute Value (ABS)
  - Exponent (EXP)
  - Common Logarithm (LOG)
  - Square Root (SQR)
  - Moving Average (MOV)
  - Slide along the time axis
  - Differential Calculus: 1<sup>st</sup> derivative (DIF), 2<sup>nd</sup> derivative (DIF2)
  - Integral Calculus: 1<sup>st</sup> integral (INT), 2<sup>nd</sup> integral (INT2)
  - Trigonometric functions (SIN, COS TAN)
  - Inverse Trigonometric functions (ASIN, ACOS ATAN)
  - Digital Voltmeter Unit PLC delay time shift (PLCS)
- (Total 12 types)
- Specified calculation between A/B cursors
- Waveform calculations can be limited to data within the range specified by A/B cursors.
- Calculation operator details:  
"10.3 Waveform Calculation Operators and Results" (p.237)

In addition to the four arithmetic operators, 10 types of functions can be used. It is possible to set up to 16 calculation formulas.

When Scaling is enabled, numerical calculations are performed on scaled values.

# 10.1 Waveform Calculation Workflow

There are two different ways of performing calculation.

- Calculating the data automatically after the measurement: Settings for waveform calculation must be made before the measurement.
- Calculating the existing data: Calculation is possible for waveform data after measurement is completed, and for data saved on media.

## Calculating While Measuring

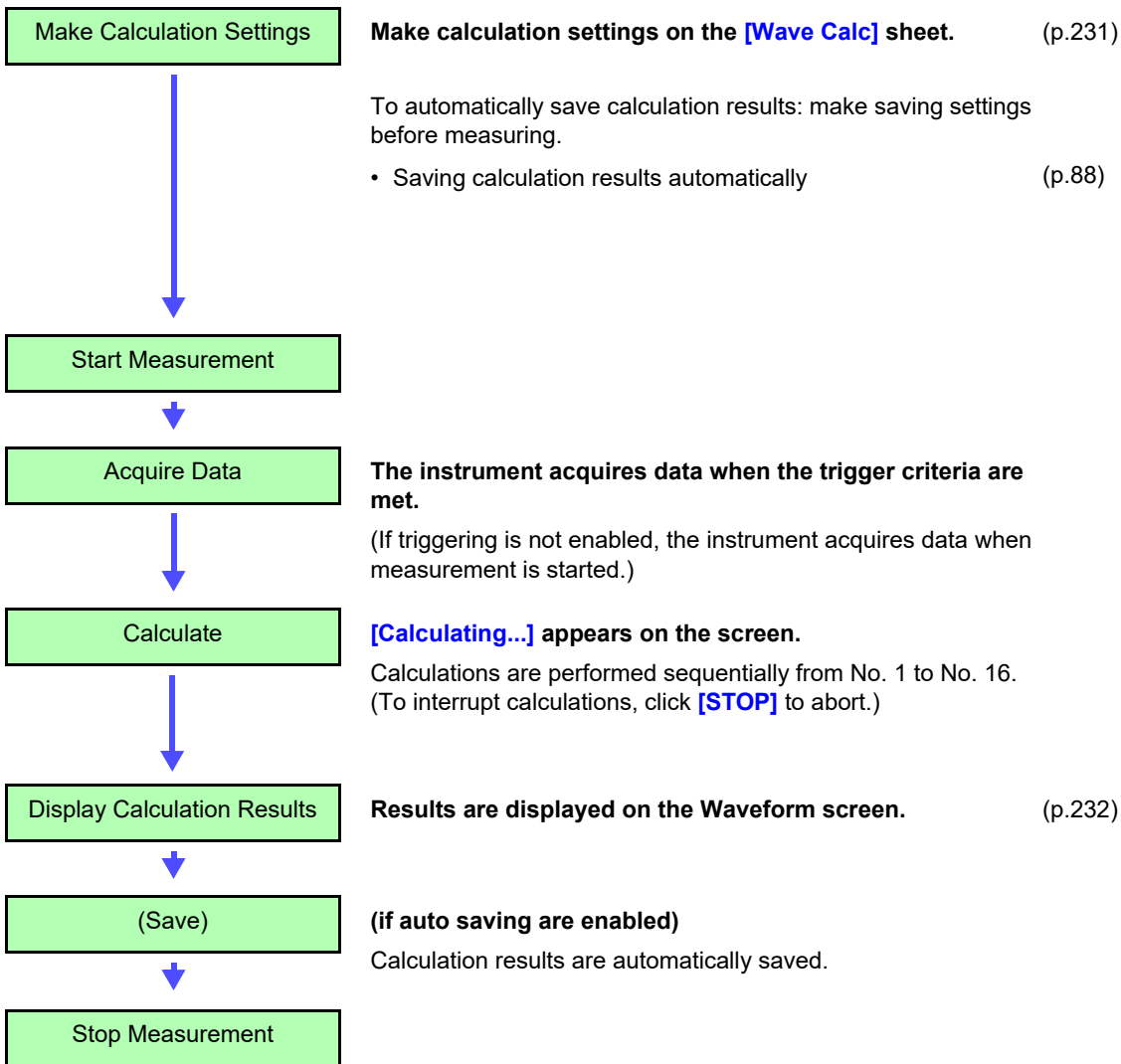

**NOTE**

- Waveform calculation is not available when using Roll Mode.
- If waveform calculation is performed while measuring and is forcibly exited during calculation, the result at that time of exit is displayed. To re-calculate, select the [Exec] button at the waveform calculation sheet.

## Applying Calculations to Existing Data

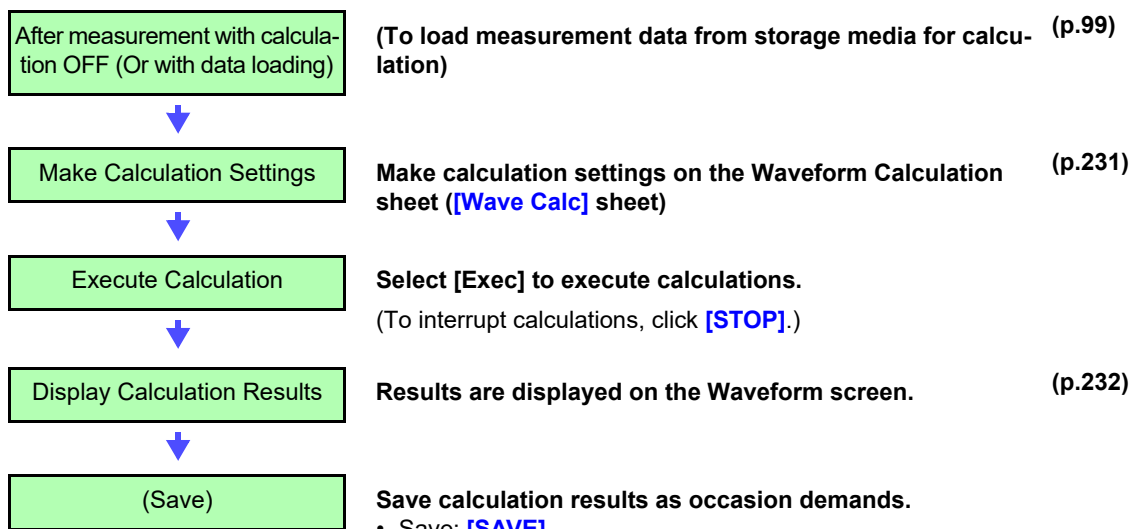

### NOTE

- The maximum record length that can be calculated is as follows.

MR8740	2,000div
MR8741	

To perform calculation for waveforms measured at longer record lengths, save to files in sections at a range shorter than maximum record length, reload to this instrument and then calculate.

- When memory division is not used, it is possible to reference the last 16 measured waveforms. However, when waveform calculation is performed for this waveform, waveform data other than that of the currently referenced blocks (the blocks in the data to be calculated) is deleted.



**When specifying a waveform range for calculation:**

Before executing a calculation, specify the calculation range using the A/B cursors (div or Trace cursors) on the Waveform screen. Set the calculation range on the **[Wave Calc]** sheet to **[A-B Wave]**.

- Range cursors cannot be used to specify the range.
- When one cursor is used, the calculation range is from the cursor to the end of the data.

Post-measurement waveform calculation cannot be performed for waveforms measured in excess of the maximum recording length, even if a range is specified with the A and B cursors. To perform waveform calculation for a waveform with a longer recording length, save a subset of the waveform that is shorter than the maximum recording length to a separate file, load that file back into the instrument, and then perform the calculation.

**See:** "6.2 Specifying a Waveform Range (A/B Cursor)" (p.124)  
"10.2 Settings for Waveform Calculation" (p.231)

**Changing calculation settings while measuring:**

Changes made to calculation settings while measuring are applied after measurement is finished.

**To change calculation settings and recalculate:**

Make changes to calculation contents on the **[Wave Calc]** sheet, and execute the calculation.

**See:** "10.2 Settings for Waveform Calculation" (p.231)

**To not display a calculation waveform, or to display only the desired waveform:**

The displayed sheet and calculation waveform to be displayed can be selected on the **[Wave Calc]** sheet.

**See:** "10.2.3 Changing the display method for calculated waveforms" (p.235)

## 10.2 Settings for Waveform Calculation

### Procedure

To open the screen: Right-click and select [STATUS] → [Wave Calc] sheet

#### 1 Enable the Waveform Calculation function.

Move the flashing cursor to the [Wave Calculation] item, and select [On].

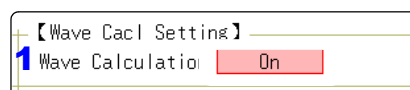

#### 2 Specify the waveform calculation range.

Move the flashing cursor to the [Calc Area] item.

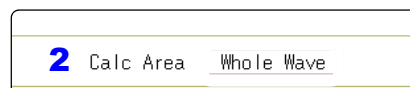

Select

<b>Whole Wave</b>	Applies calculations to the whole waveform. (default setting)
<b>A-B Wave</b>	Applies calculations to the data between A/B cursors.

See: "6.2 Specifying a Waveform Range (A/B Cursor)" (p.124)

When selecting [A-B Wave], specify the calculation range using the A/B cursors on the Waveform screen.

If no measurement data has been acquired by the instrument, first measure once so that the range can be specified for calculations to be applied to subsequent measurements.

#### 3 Perform calculation settings.

Move the flashing cursor to the [Equation] column of the calculation to be set and select [Enter EQN].

A dialog is displayed for entering a calculation equation.

.Calculation No.

No.	Equation
Z1 ?	
Z2 ?	
Z3 ?	

Enter EQN

Enter calculation operators

( ) + -	ABS EXP LOG SQRT Z..
1 2 3 *	MOV SLI DIF INT CH.
4 5 6 +	DIF2 INT2 SIN COS
7 8 9 *	TAN ASIN ACOS ATAN PLCS
0 . E /	

Enter numerical values and symbols

a= 0.0000	i= 0.0000
b= 0.0000	j= 0.0000
c= 0.0000	k= 0.0000
d= 0.0000	l= 0.0000
e= 0.0000	m= 0.0000
f= 0.0000	n= 0.0000
g= 0.0000	o= 0.0000
h= 0.0000	p= 0.0000

Enter constants  
Constants must have been previously entered on the [CONST.] (p.234)

Undo	Clear
Home	End
<<	>>
Enter	ESC

#### 4 Select a calculation equation.

See: "Waveform Calculation Example" (p.236)

#### If "=" is displayed

The entered calculation equation is syntactically correct.

#### If "?" is displayed

The equation has a syntax error.

The cursor is placed at the location of the error to facilitate correction.

- Are parentheses correctly matched?
- Has a multiplication operator "\*" been omitted?

10.2 Settings for Waveform Calculation

- 5 When finished entry, select **[Confirm]**.  
The entered equation is displayed in the **[Equation]** field.  
The scale (maximum and minimum vales) of the calculation results has a default setting of **[Auto]**. If you want to scale the results, set the maximum and minimum values under **[Manual]**.  
**See:** "Changing the display method for calculated waveforms" (p.235)
- 6 (As occasion demands)  
Set auto saving (p.88).
- 7 Execute the calculations.

Applying Calculations to Existing Data

At the **[Wave Calc]** sheet, select **[Exec]**.

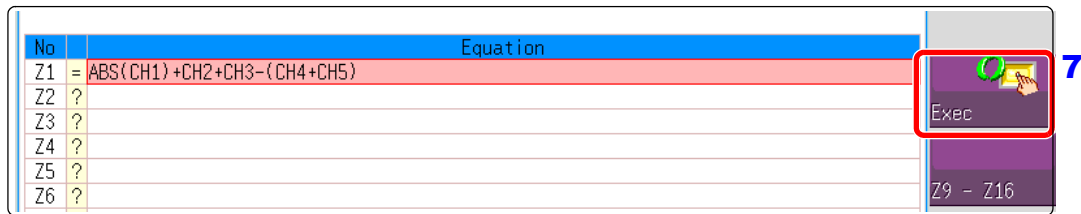

To calculate while measuring

Click **[START]** to start measurement.  
Calculation waveforms are displayed after loading waveforms.

10.2.1 Displaying the waveform calculation results

Waveform calculation results are displayed on the Waveform screen.

Example: Waveform of the calculated absolute value of the waveform of CH1. Calculation equation = ABS(CH1)

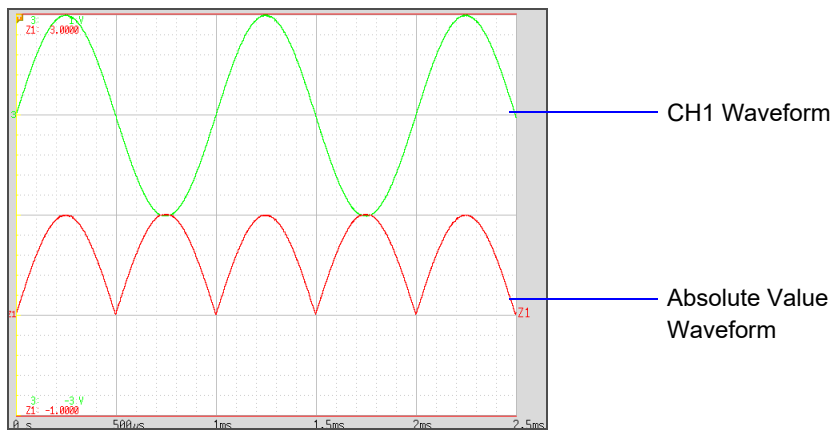

To copy settings from one calculation to another:

Settings can be copied at the **[Wave Calc]** sheet.

**See:** "7.8 Copying settings to other channels (calculation No.) (Copy function)" (p.160)

## About calculation equations

### Operators

Operator	Name	Operator	Name
ABS	Absolute Value	DIF2	2 <sup>nd</sup> Derivative
EXP	Exponent	INT2	2 <sup>nd</sup> Integral
LOG	Common Logarithm	SIN	Sine
SQR	Square Root	COS	Cosine
MOV	Moving Average	TAN	Tangent
SLI	Movement parallel to the time axis	ASIN	Inverse Sine
DIF	1 <sup>st</sup> Derivative	ACOS	Inverse Cosine
INT	1 <sup>st</sup> Integral	ATAN	Inverse Tangent
		PLCS	Digital Voltmeter Unit PLC delay time shift

See: "10.3 Waveform Calculation Operators and Results" (p.237)

### Entering Calculation Equations

- Each entered calculation equation may contain up to 80 characters.
- Each constant in a calculation equation may contain up to 30 digits.
- For multiplication, use [\*]. For division, use [/].
- Entering a long, complex formula such as that shown below will cause "?" to be displayed. Separate the formula into two shorter formulas.

$$\frac{\text{ABS}(\text{CH1}) + \text{CH2} \times \text{CH3} - (\text{CH4} + \text{CH5}) \times \text{ABS}(\text{CH4})}{\text{DIF}(\text{CH1}, 1)}$$

1
2
3

- When dividing by 0, an overflow value is output.  
(For positive values, +9.9999E+29. For negative values, -9.9999E+29.)
- The result of calculation Z<sub>i</sub> can be used in other calculation equations. However, the Z<sub>n</sub>th equation can only refer to the results of equations up to Z<sub>n-1</sub>.  
(Example: Equation Z<sub>4</sub> can include the results of equations Z<sub>1</sub> through Z<sub>3</sub>.)

### Using the MOV, SLI, DIF and DIF2 operators in an equation

The number # after a comma within parenthesis (\_, #) for each operation is set to the calculation operator.

Operator	Setting Choice	Setting Examples
<b>MOV</b> (Moving Average) <b>SLI</b> (Parallel Movement)	Set the number of points to move. Setting Range MOV (Moving Average): 1 to 5000 SLI: -5000 to 5000	Calculate the 10-point moving average of CH1: MOV(CH1,10)
<b>DIF</b> (Derivative) <b>DIF2</b> (2nd Derivative)	Specify the sampling interval for differentiation. "1" is normally acceptable, but this should be set larger to capture fluctuation values of slowly changing waveforms. DIF and DIF2 Setting Range: 1 to 5000	Differentiate CH2 using a 20-point sampling interval: DIF(CH2,20)

### When calculation results overflow (OVER)

- The value that indicated by the A/B cursor is not a correct value.
- When [Scale] is set to [Auto], waveforms appear at the top or bottom edge of the screen. This makes calculation result overflow obvious.

## 10.2.2 Setting constants

### Procedure

To open the screen: Right-click and select [STATUS] → [Wave Calc] sheet

**1** Move the flashing cursor to the No. to be set as [CONST.].

**2** Select an entry method, and enter the constant.

Setting range:  $-9.9999\text{E}+29$  to  $+9.9999\text{E}+29$

See: "7.1.3 Alphanumeric Input" (p.141)

Defined constants are shown in the constant display of the calculation equation setting dialog.

**1**

CONST.	
a	0.0000
b	0.0000
c	0.0000
d	0.0000
e	0.0000
f	0.0000
g	0.0000
h	0.0000
i	0.0000
j	0.0000
k	0.0000
l	0.0000
m	0.0000
n	0.0000
o	0.0000
p	0.0000

## 10.2.3 Changing the display method for calculated waveforms

MEM

### Procedure

To open the screen: Right-click and select **[STATUS]** → **[Wave Calc]** sheet

Calculation No.	Nr	Wave	Scale	Lower	Upper	Unit	Graph
	Z1		Auto	0.0000	20.000		Gr1
	Z2		Auto	0.0000	20.000		Gr2
	Z3		Auto	0.0000	20.000		Gr1
	Z4		Auto	0.0000	20.000		Gr2
	Z5		Auto	0.0000	20.000		Gr1

1 Waveform color    2 Display range setting method    3 Upper and lower limits    4 Displayed measurement units    6 Graph to display

### 1 Enable waveform display, and display color

Move the flashing cursor to the **[Wave]** column.

Select	
On-Off	Set On to display the waveform of the flashing cursor column (default setting). Set to Off to hide display.
↕	Select the waveform color.
All On-Off	Select On to display all waveforms. Select Off to hide all waveforms.

### 2 Select a method to set scaling

Move the flashing cursor to the **[Scale]** column for the Calculation No. to be set.

Select	
Auto	Automatically sets the display range of the vertical axis. (After calculation, the upper and lower limits are obtained from the results, and set automatically.)
Manual	Upper and lower limits of the vertical axis display range are entered manually. A shorter calculation time than with Auto is possible.

Depending on calculation results, automatic scaling settings may be unsatisfactory, in which case the limits must be entered manually.

### 3 Set the upper and lower limits of the display range (when **[Manual]** is selected)

Select **[Lower]** and **[Upper]**.

Select an entry method and enter the limit values.

Entry range: -9.9999E+29 to +9.9999E+29

See: "7.1.3 Alphanumeric Input" (p.141)

### 4 Specify the physical units

Move the flashing cursor to the **[Unit]** column.

Select an entry method and enter the physical units.

See: "7.1.3 Alphanumeric Input" (p.141)

### 5 Select the graph to be displayed.

(When split screen (**[Format]** item on the **[Status]** sheet) is **[Dual]** or higher)

Move the flashing cursor to the **[Graph]** column and select the graph

### Waveform Calculation Example

#### Calculate the RMS waveform from the instantaneous waveform

The RMS values of the waveform input on Channel 1 are calculated and displayed. This example describes the calculation of waveform data measured for one cycle over two divisions.

#### 1 Enable the Waveform Calculation function.

Move the flashing cursor to the **[Wave Calculation]** item, and select **[On]**.

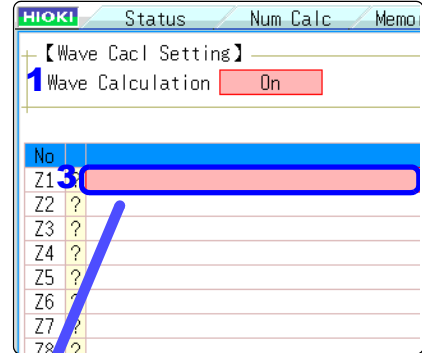

#### 2 Specify the waveform calculation range.

Move the flashing cursor to the **[Calc Area]** item, and select **[Whole Area]**.

#### 3 Perform calculation settings.

Move the flashing cursor to the **[Equation]** column of No. Z1 and then select **[Enter EQN]**.

A dialog is displayed for entering a calculation equation.

After selecting the channel number, select the **[Enter Char]** button.

#### Entering the calculation equation

$SQR(MOV(CH1*CH1,200))$

The number of samples per cycle (1 division = 100 samples) Here, one cycle is two divisions (200 samples)

Enter numerical values and symbols

It is convenient to set constants beforehand on the **[CONST.]** (p.234)

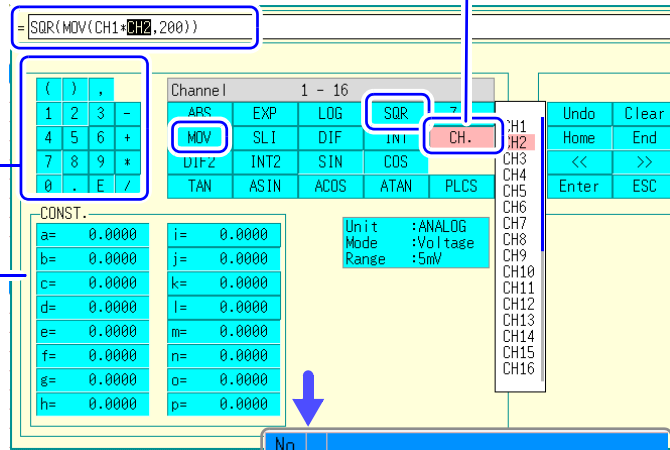

#### 4 When finished entry, select **[Confirm]**.

The entered equation is displayed in the **[Equation]** field.

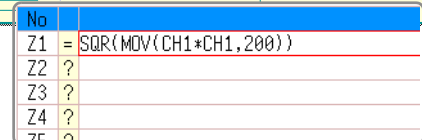

#### 5 Execute the calculations.

Click **[START]** to start measurement.

The calculation waveform is displayed after acquiring the input waveform.

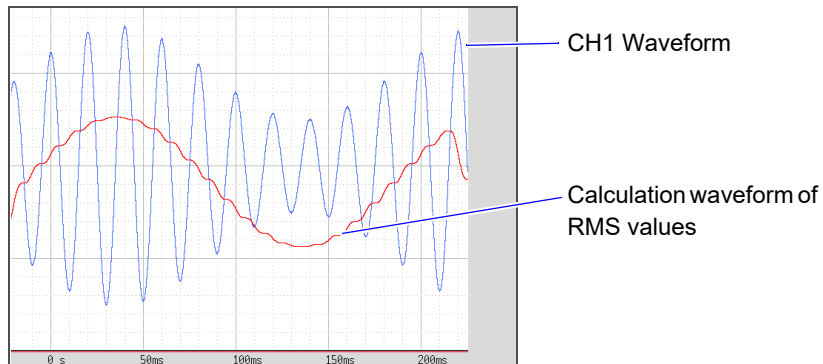

To view calculated waveforms of loaded data, move to the **[Wave Calc]** sheet and select **[Exec]**.

## 10.3 Waveform Calculation Operators and Results

$b_i$ :  $i$ th member of calculation result data,  $d_i$ :  $i$ th member of source channel data

Waveform Calculation Type	Description
<b>Four Arithmetic Operators (+, -, *, /)</b>	Executes the corresponding arithmetic operation.
<b>Absolute Value (ABS)</b>	$b_i =  d_i $ ( $i = 1, 2, \dots, n$ )
<b>Exponent (EXP)</b>	$b_i = \exp(d_i)$ ( $i = 1, 2, \dots, n$ )
<b>Common Logarithm (LOG)</b>	<p>When <math>d_i &gt; 0</math>, <math>b_i = \log_{10} d_i</math>            When <math>d_i = 0</math>, <math>b_i = -\infty</math> (overflow value output)            When <math>d_i &lt; 0</math>, <math>b_i = \log_{10}  d_i </math> (<math>i = 1, 2, \dots, n</math>)            Note: Use the following equation to convert to natural logarithm calculations.  <math>\ln X = \log_e X = \log_{10} X / \log_{10} e</math>  <math>1 / \log_{10} e \approx 2.30</math></p>
<b>Square Root (SQR)</b>	<p>When <math>d_i \geq 0</math>, <math>b_i = \sqrt{d_i}</math>            When <math>d_i &lt; 0</math>, <math>b_i = -\sqrt{ d_i }</math> (<math>i = 1, 2, \dots, n</math>)</p>
<b>Moving Average (MOV)</b>	<p>When <math>k</math> is odd number: <math>b_i = \frac{1}{k} \sum_{t=i-\frac{k}{2}}^{i+\frac{k}{2}} d_t</math> (<math>i = 1, 2, \dots, n</math>)            When <math>k</math> is even number: <math>b_i = \frac{1}{k} \sum_{t=i-\frac{k}{2}+1}^{i+\frac{k}{2}} d_t</math> (<math>i = 1, 2, \dots, n</math>)</p> <p><math>d_t</math>: <math>t^{\text{th}}</math> member of source channel data  <math>k</math>: number of points to move (1 to 5000)            1 div = 100 points.</p> <p><math>k</math> is specified after a comma.            (Ex.) To make Z1 the moving average of 100 points: MOV(Z1,100)</p>
<b>Slides waveform data along the time axis (SLI)</b>	<p>Moves along the time axis by the specified distance.  <math>b_i = d_i - k</math> (<math>i = 1, 2, \dots, n</math>)  <math>k</math>: number of points to move (-5000 to 5000)</p> <p><math>k</math> is specified after a comma.            (Ex.) To slide Z1 by 100 points along the time axis: SLI(Z1,100)            Note: When sliding a waveform, if there is no data at the beginning or end of the calculation result, the voltage value becomes zero. 1 div = 100 points.</p>
<b>Sine (SIN)</b>	<p><math>b_i = \sin(d_i)</math> (<math>i = 1, 2, \dots, n</math>)            Trigonometric functions employ radian (rad) units.</p>
<b>Cosine (COS)</b>	<p><math>b_i = \cos(d_i)</math> (<math>i = 1, 2, \dots, n</math>)            Trigonometric functions employ radian (rad) units.</p>
<b>Tangent (TAN)</b>	<p><math>b_i = \tan(d_i)</math> (<math>i = 1, 2, \dots, n</math>)            where <math>-10 \leq b_i \leq 10</math>            Trigonometric functions employ radian (rad) units.</p>
<b>Arcsine (ASIN)</b>	<p>When <math>d_i &gt; 1</math>, <math>b_i = \pi / 2</math>            When <math>-1 \leq d_i \leq 1</math>, <math>b_i = \text{asin}(d_i)</math>            When <math>d_i &lt; -1</math>, <math>b_i = -\pi / 2</math>            Trigonometric functions employ radian (rad) units.</p>



$b_i$ :  $i$ th member of calculation result data,  $d_i$ :  $i$ th member of source channel data

Waveform Calculation Type	Description
<b>Arccosine (ACOS)</b>	When $d_i > 1$ , $b_i = 0$ When $-1 \leq d_i \leq 1$ , $b_i = \text{acos}(d_i)$ When $d_i < -1$ , $b_i = \pi$ ( $i = 1, 2, \dots, n$ ) Trigonometric functions employ radian (rad) units.
<b>Arctangent (ATAN)</b>	$b_i = \text{atan}(d_i)$ ( $i = 1, 2, \dots, n$ ) Trigonometric functions employ radian (rad) units.
<b>First derivative (DIF) Second derivative (DIF2)</b>	<p>The first and second derivative calculations use a fifth-order Lagrange interpolation polynomial to obtain a point data value from five sequential points.  <math>d_1</math> to <math>d_n</math> are the derivatives calculated for sample times <math>t_1</math> to <math>t_n</math>.                      Note: Scattering of calculation results increases as input voltage level decreases. If scattering is excessive, apply the moving average (MOV).</p> <p><b>Calculation formulas for the first derivative</b></p> Point $t_1$ $b_1 = (-25d_1 + 48d_2 - 36d_3 + 16d_4 - 3d_5)/12h$ Point $t_2$ $b_2 = (-3d_1 - 10d_2 + 18d_3 - 6d_4 + d_5)/12h$ Point $t_3$ $b_3 = (d_1 - 8d_2 + 8d_4 - d_5)/12h$ ↓ Point $t_i$ $b_i = (d_{i-2} - 8d_{i-1} + 8d_{i+1} - d_{i+2})/12h$ ↓ Point $t_{n-2}$ $b_{n-2} = (d_{n-4} - 8d_{n-3} + 8d_{n-1} - d_n)/12h$ Point $t_{n-1}$ $b_{n-1} = (-d_{n-4} + 6d_{n-3} - 18d_{n-2} + 10d_{n-1} + 3d_n)/12h$ Point $t_n$ $b_n = (3d_{n-4} - 16d_{n-3} + 36d_{n-2} - 48d_{n-1} + 25d_n)/12h$
	$b_1$ to $b_n$ : calculation results $h = \Delta t$ : Sampling Period
	<p><b>Calculation formulas for the second derivative</b></p> Point $t_1$ $b_1 = (35d_1 - 104d_2 + 114d_3 - 56d_4 + 11d_5)/12h^2$ Point $t_2$ $b_2 = (11d_1 - 20d_2 + 6d_3 + 4d_4 - d_5)/12h^2$ Point $t_3$ $b_3 = (-d_1 + 16d_2 - 30d_3 + 16d_4 - d_5)/12h^2$ ↓ Point $t_i$ $b_i = (-d_{i-2} + 16d_{i-1} - 30d_i + 16d_{i+1} - d_{i+2})/12h^2$ ↓ Point $t_{n-2}$ $b_{n-2} = (-d_{n-4} + 16d_{n-3} - 30d_{n-2} + 16d_{n-1} - d_n)/12h^2$ Point $t_{n-1}$ $b_{n-1} = (-d_{n-4} + 4d_{n-3} + 6d_{n-2} - 20d_{n-1} + 11d_n)/12h^2$ Point $t_n$ $b_n = (11d_{n-4} - 56d_{n-3} + 114d_{n-2} - 104d_{n-1} + 35d_n)/12h^2$

$b_i$ :  $i$ th member of calculation result data,  $d_i$ :  $i$ th member of source channel data

Waveform Calculation Type	Description
<b>First integral (INT)</b> <b>Second integral (INT2)</b>	<p>First and second integrals are calculated using the trapezoidal rule.  <math>d_1</math> to <math>d_n</math> are the integrals calculated for sample times <math>t_1</math> to <math>t_n</math>.</p> <p>Calculation formulas for the first integral            Point <math>t_1 I_1 = 0</math>            Point <math>t_2 I_2 = (d_1 + d_2)h/2</math>            Point <math>t_3 I_3 = (d_1 + d_2)h/2 + (d_2 + d_3)h/2 = I_2 + (d_2 + d_3)h/2</math>            ↓            Point <math>t_n I_n = I_{n-1} + (d_{n-1} + d_n)h/2</math></p> <p><math>I_1</math> to <math>I_n</math>: calculation results  <math>h = \Delta t</math>: Sampling Period</p> <p>Calculation formulas for the second integral            Point <math>t_1 II_1 = 0</math>            Point <math>t_2 II_2 = (I_1 + I_2)h/2</math>            Point <math>t_3 II_3 = (I_1 + I_2)h/2 + (I_2 + I_3)h/2 = II_2 + (I_2 + I_3)h/2</math>            ↓            Point <math>t_n II_n = II_{n-1} + (I_{n-1} + I_n)h/2</math></p> <p><math>II_1</math> to <math>II_n</math>: calculation results</p>
<b>Digital Voltmeter Unit            PLC delay time shift            (PLCS)</b>	<p>Shifts the time by the amount of delay for the frequency (PLC) and NPLC set on MR8990 Digital Voltmeter Unit.</p> <p>Since the Digital Voltmeter Unit obtains the average of the amount of time set for NPLC, a waveform that is delayed by just a time that is 1/2 of the NPLC is observed, compared to 8966 Analog Unit. The PLCS calculation shifts this amount of delay time to correct the offset with the analog unit.</p> <p>Reference: If there is no data at the end of the calculation result, the voltage becomes 0 V.</p>



# Memory Division Function **MEM** Chapter 11

Memory division function can only be used with the Memory function.  
Memory division settings are made on the Status screen - **[Memory Div]** sheet.  
Blocks to be displayed can also be selected on the Waveform screen (p.136).

11

Chapter 11 Memory Division Function

## Opening the **[Memory Div]** sheet

Select **[STATUS]** and then **[Memory Div]** from the right-click menu.

**NOTE** When using memory division, synchronization between blocks may not be possible in the following conditions.  
(MR8740 only)

When using memory division, the trigger output (TRIG\_OUT terminal output) may output the Low level or output erratically in the following conditions.  
(MR8741 only)

- The time axis range is 5  $\mu\text{s}/\text{div}$  to 100  $\mu\text{s}/\text{div}$
- The record (measurement) time is 5 ms or less
- Tracking wave display is **[OFF]**.

Operations available from the [Memory Div] sheet

- Waveforms can be recorded into individual blocks by dividing memory space into multiple blocks.
- You can record waveforms beginning at any block (Start Block), choose which blocks to display (Display Block), or display multiple overlaid blocks (Reference Block).
- The maximum number of blocks for memory division depends on the installed memory board and recording length (up to 1024 divisions).
- Triggered waveform data can be acquired continuously and recorded sequentially in specified blocks (at the Start Block, for the specified Used Blocks). Dead time while displaying (during which triggers are ignored) can be minimized.
- Even if the Memory Division function is not used, up to 16 blocks of data (depending on the specified recording length) can be saved to each block, so that previously recorded data can be selected for display on the Waveform Screen.

See: "6.8 Seeing Block Waveforms" (p.136)

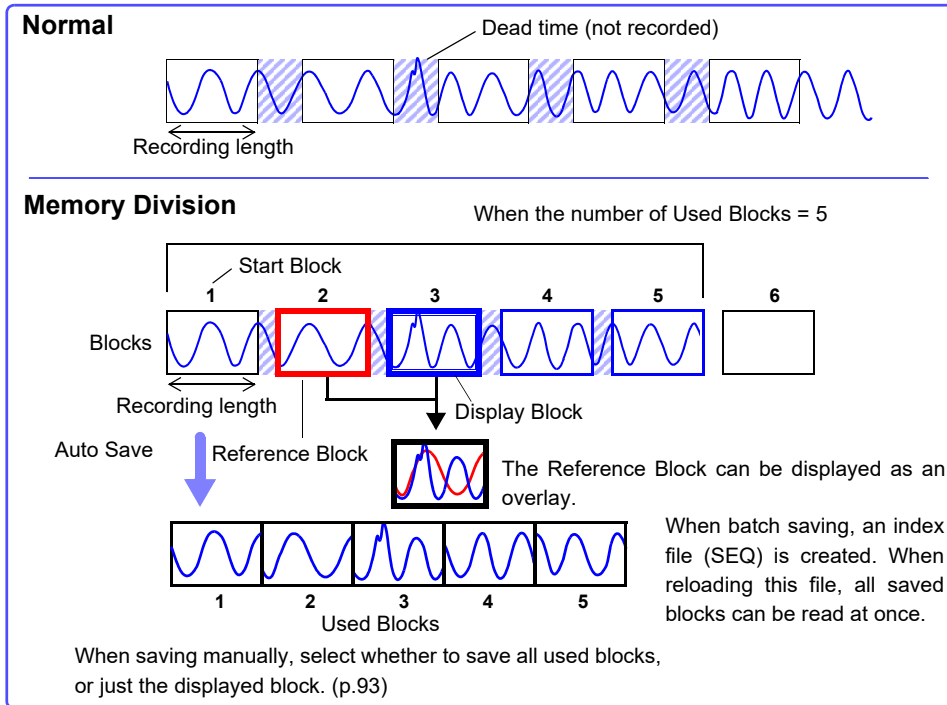

## 11.1 Recording Settings

### Procedure

To open the screen: Right-click and select [STATUS] → [Memory Div] sheet

#### 1 Enable the Memory Division function.

Move the flashing cursor to the [Memory Div] item.

Select [On].

Off	Memory Division is disabled.(default setting)
On	Memory Division is enabled.

#### 2 Set the number of divisions.

Move the flashing cursor to the [Division] item.

Set the number of blocks for division.

Default setting: 4

#### 3 Set the recording length.

(This is linked to the recording length setting on the [Status] sheet.)

Move the flashing cursor to the [Shot] item.

Set the recording length.

The maximum recording length and number of divisions are determined automatically according to memory capacity and the number of channels used.

Setting range: "Appendix 2.4 Maximum record length and number of divisions (Memory division function)"(p.A7)

#### 4 Set the start block.

Move the flashing cursor to the [Start Block] item.

Set the block number at which to start recording.

Default setting: 1

#### 5 Set the Used Block number.

Move the flashing cursor to the [Use Blocks] item.

Set the number of blocks to use.

Default setting: 1

【Memory division setting】

1	Memory Div	On
2	Division	4
3	Shot	25div
	Recording Period	2.500ms
4	Start Block	1
5	Use Blocks	1

Memory Division, Waveform Calculation, and Roll Mode cannot be enabled at the same time.

When the number of divisions is 32, the Start Block is 5 and the Used Block number (number of blocks to use) is 20

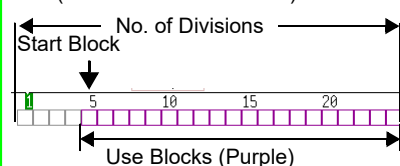

#### About Recording

When a fast timebase is selected, displaying and saving operation are not available while measuring.

Selecting the display screen for auto saving lengthens dead time.



#### To display any block on the waveform screen when finished measuring:

Set the number of blocks to display (p.244).  
(This can also be set on the Waveform screen (p.136).)

#### To display overlaid waveforms:

Set the number of blocks for reference (p.244).

# 11.2 Display Settings

## Procedure

To open the screen: Right-click and select [STATUS] → [Memory Div] sheet

### 1 To display any block on the Waveform screen

#### Set the display blocks

Set after measurement is complete. (This can also be set on the Waveform screen (p.136).)

Move the flashing cursor to the [Display Block] item.

Set the number of blocks to display on the Waveform screen.

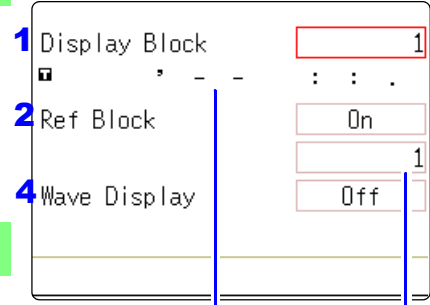

Trigger time Reference Block No.

### 2 To display multiple blocks as overlaid waveforms

#### Enable the Reference Block function

Move the flashing cursor to the [Ref Block] item.

Select [On].

Off	Reference Blocks are not displayed (default setting)
On	Reference Blocks overlay Display blocks on the display.

### 3 (When Reference Blocks are enabled [On]) Select whether to reference every block

To overlay all waveforms, select [All Blks On].

All Blks Off	Set reference to all blocks to Off.
All Blks On	Set reference to all blocks to On.

To overlay selected waveforms, move the flashing cursor to the number column of the reference block and select the block number.

Select

Ref On-Off	Set On or Off. If [On] is selected, the block frame of the selected block number is displayed as a green square.
↑↓	Select a block.

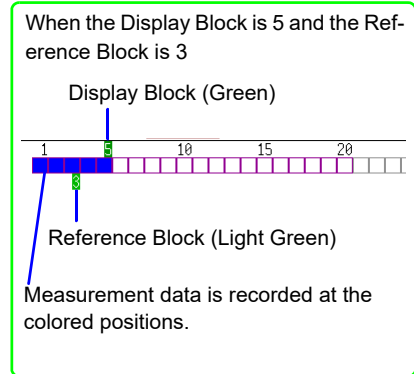

#### Reference Block Selection

Reference Blocks can also be selected and deselected in the [Ref Block] item on the [List] display.

See: "Getting Details on Each Block:" (p.245)

### 4 To display every block as its waveform is acquired

#### Enable tracking waveform display.

Move the flashing cursor to the [Wave Display] item.

Select [On].

Off	The waveform of only the last block is displayed after recording up to the number of used blocks. (default setting)
On	Waveforms are displayed one block at a time as they are acquired at each trigger event.

#### Enabling the Trace Waveform display lengthens dead time.

About Dead Time:

See: "Difference Between Dead Times During Normal and Memory Division Recording" (p.246)

Even if the Roll Mode is enabled (other than Off), it is not usable when the Trace Waveform display is disabled.

### Viewing Memory Division waveforms on the Waveform screen

See: "6.8 Seeing Block Waveforms" (p.136)



### Getting Details on Each Block:

The trigger time and measurement status of each block can be viewed on the list.

Move the flashing cursor to the **[Map/List]**, and select **[List]**.

Map/List		List					
No.	Trigger time	Source	Timebase	Data	Use Block	Ref Block	
1	09-06-23 16:40:33.093	Ch1	10 $\mu$ s/div	2501	<input type="radio"/>		
2	09-06-23 16:40:34.968	Ch1	10 $\mu$ s/div	2501	<input type="radio"/>		
3	09-06-23 16:40:36.023	Ch1	10 $\mu$ s/div	2501	<input type="radio"/>		

Block No.

A block can be selected with the mouse.

You can move the flashing cursor to the Reference Block column to set a block's on/off state as a Reference Block.



### To switch block waveforms on the Waveform screen:

To be able to select the block you want to see, click **[WAVE]** in the right-click menu at the Waveform screen and switch Pos to Block.

See: "6.8 Seeing Block Waveforms" (p.136)

### NOTE

- When displaying memory division blocks as a list, blocks may have the same trigger times. This occurs because the minimum resolution of the clock used by this unit is 1/128th of a second (7.8125 ms) and measurement occurs during this interval.

**Example:**  
The recording time is 1.25 ms and the trigger times of No. 3 and No. 4 blocks may be the same.

No.	Trigger time	Source	Timebase	Data	Use Block	Ref Block
1	09-06-23 16:40:33.093	Ch1	10 $\mu$ s		<input type="radio"/>	
2	09-06-23 16:40:34.968	Ch1	10 $\mu$ s		<input type="radio"/>	
3	09-06-23 16:40:36.023	Ch1	10 $\mu$ s		<input type="radio"/>	
4	09-06-23 16:40:36.023	Ch1	10 $\mu$ s/div	2501	<input type="radio"/>	
5	09-06-23 16:40:38.132	Ch1	10 $\mu$ s/div	2501	<input type="radio"/>	

- If triggers occur continuously within an interval shorter than 500  $\mu$ s, the displayed trigger time may indicate a time slower than reality.



**Difference Between Dead Times During Normal and Memory Division Recording**

When Auto Save is set for continuous triggering [Repeat]

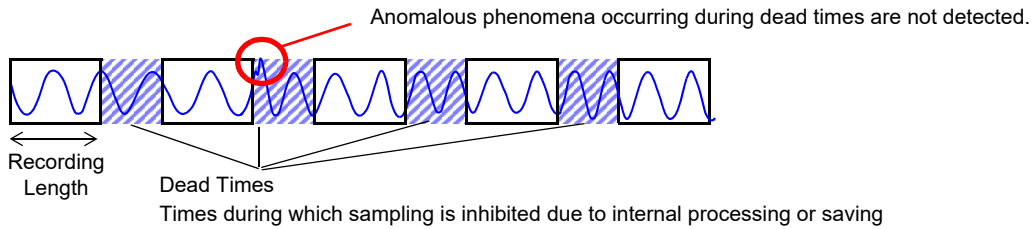

When the Trace Waveform Display is disabled (Off) during Memory Division recording

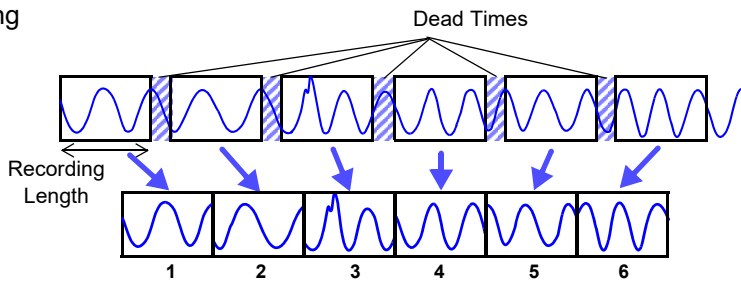

The waveform data of each recording length is recorded in one block.

When recording with Memory Division, dead time is shorter than with normal recording.

**NOTE**

- The dead time (time where no sampling occurs between blocks) of memory division is as follows.  
 5  $\mu$ s/div to 20  $\mu$ s/div: 1 to 8 samples  
 Time axis slower than 50  $\mu$ s/div: 1 samples  
 Note: Dead time lengthens during numerical calculation or waveform calculation, or when the time axis is 5 to 20  $\mu$ s/div and tracking waveform display is [On].
- When measuring with an 8970 Freq Unit, dead time is approximately 230 ms. When measuring in integral value ([Count]) mode, there are cases when the last data in the previous block remains in the first part of the block.
- When tracking waveform display is [Off], the roll mode function cannot be used, even when roll mode is enabled (not Off).
- When triggering occurs very often, clicking [STOP] may not stop measurement until enough data has been acquired to fill the blocks specified for use.

**Auto Save for Memory Division Recording**

Measuring conditions	Auto Save
With Numerical calculation ON	Auto Save is performed every time one block is measured. When Tracking wave display is ON, Waveform is also displayed.
When time axis is 5 to 20 $\mu$ s/div with Tracking wave display ON.	Auto Save and Waveform Display are performed every time one block is measured.
When time axis is 5 to 20 $\mu$ s/div with Tracking wave display OFF.	Auto Save is performed after all blocks are measured.
Other than above	Auto Save is performed simultaneously with measuring. When Tracking wave display is ON, Waveform is also displayed.

# FFT Function

**FFT**

## Chapter 12

### 12.1 Overview and Features

FFT analysis can only be used with the FFT function.

The FFT (Fast-Fourier Transform) functions provide frequency analysis of input signal data.

Use these functions for frequency analysis of rotating objects, vibrations, sounds and etc.

For details, refer to "Appendix 4 FFT Definitions" (p.A14).

Analysis can be performed on data as it is being measured, on pre-existing analog waveform data previously acquired with the Memory function, and on data output from waveform calculations.

When Model 8968 High Resolution Unit or Model U8979 Charge Unit, each of which is equipped with the anti-aliasing filter, is used, the cut-off frequency can be set automatically by linking with the frequency range setting.

#### Major Features

- FFT analysis frequency range: 133 mHz to 8 MHz
- FFT Analysis Modes (16 types)
  - Storage Waveform
  - Histogram
  - Linear Spectrum
  - RMS Spectrum
  - Power Spectrum
  - Power Spectrum Density\*
  - LPC analysis (Power Spectrum Density)\*
  - Transfer Function
  - Cross-power Spectrum
  - Impulse Response
  - Coherence Function
  - Phase Spectrum
  - Auto-correlation Function
  - Cross-correlation Function
  - 1/1 Octave Analysis\*
  - 1/3 Octave Analysis\*

\* Not available when using external sampling.

For phase spectra, only the required phase information is highlighted and displayed.

[See:](#)"12.3.8 Emphasizing Analysis Results (phase spectra only)" (p.259)

so, when performing FFT analysis with the instrument connected to a sound level or vibration meter, scaling by dB can be set from the Channel Settings screen if you want to read values directly in calibrated units of measurement.

[See:](#)"Scaling" (p.266)

#### **NOTE** To suppress the effects of aliasing distortion

- We recommend using Model 8968 High Resolution Unit that are equipped with anti-aliasing filtering to suppress the effects of aliasing distortion when sampling.
- FFT analysis cannot be performed for MR8990 Digital Voltmeter Unit.

[See:](#) [Aliasing Distortion and Anti-Aliasing Filters](#)

"Appendix 4 FFT Definitions" (p.A14)

Refer to the "17.2.3 FFT Function" (p.346) for FFT function specifications.

# 12.2 Operation Workflow

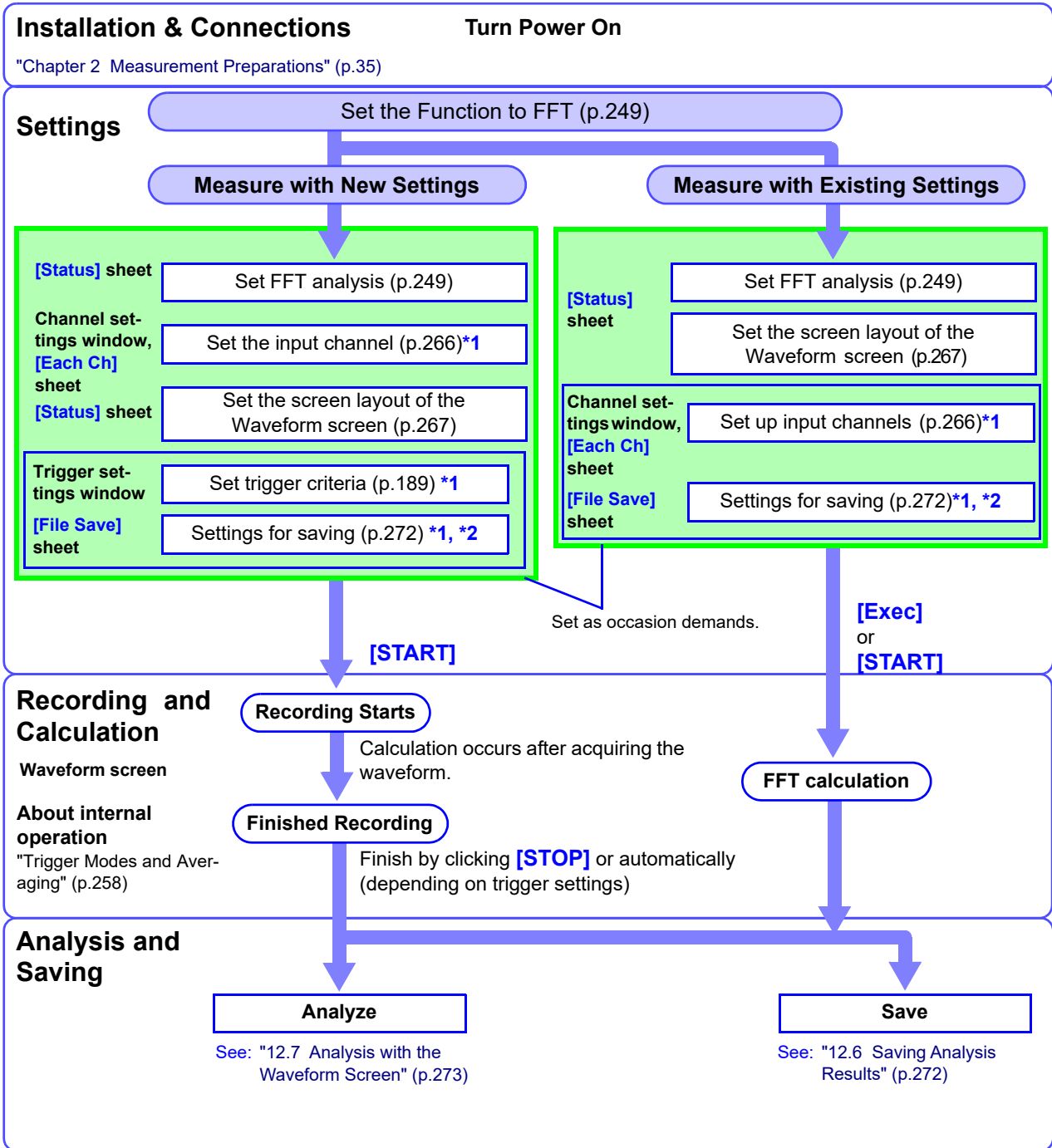

\*1: Settings are the same as for the Memory function.

\*2: Even after analysis, save settings can be set manually.

## 12.3 Setting FFT Analysis Conditions

Basic measurement configuration settings are performed on the Status screen-[Status] sheet. Measurement configuration can be performed from the Waveform screen (p.265).

### Opening the [Status] sheet

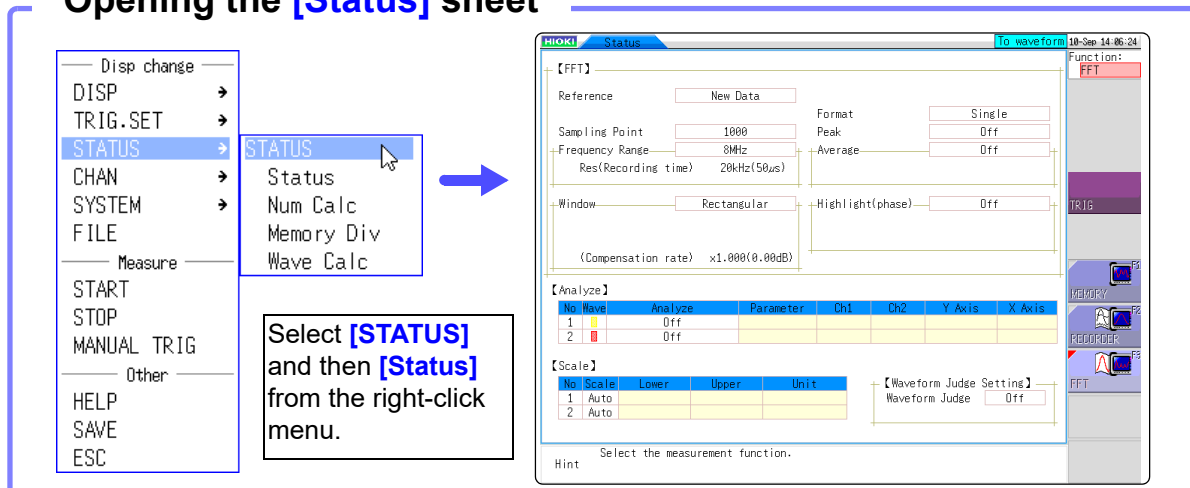

### 12.3.1 Selecting the FFT Function

The FFT function can be selected at screens other than the file screen.

#### Procedure

- 1 Move the flashing cursor to the function item (the upper most column of the Settings window).
- 2 Select [FFT].

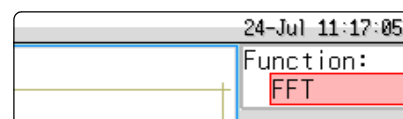

## 12.3.2 Selecting the Data Source for Analysis

Select the data to be used for FFT analysis.

There are two analysis methods: analysis using new measurements and analysis of data measured using the memory function.

### Procedure

To open the screen: Right-click and select **[STATUS]** → **[Status]** sheet

See: To set from the Waveform screen (p.265)

#### 1 Select the input data source.

Move the flashing cursor to the **[Reference]** item.

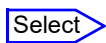

<b>New Data</b>	Acquire a new waveform for analysis.
<b>From Memory</b>	Calculates data measured using the memory function.

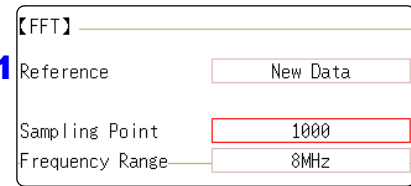

#### 2 When finished making settings, click **[START]**.

##### For the **[New Data]** case

Measurement starts to acquire data for the number of analysis points specified as the **[Sampling Point]**, and FFT analysis is performed.

##### For the **[From Memory]** case

Analysis is performed on the number of specified points from data previously recorded in memory (Memory function data).

The analysis starting point can also be specified.

See: "12.7.1 Analyzing after Specifying an Analysis Starting Point" (p.273)

The frequency range is selected automatically.

See: "Relationship Between Frequency Range, Resolution and Number of Analysis Points" (p.252)

#### When the input data **[Reference]** is **[From Memory]**

Analysis is performed until the specified number of FFT analysis points have been processed, then the data is shifted by that amount and analysis repeats until all of the previously acquired data has been processed. (If the amount of data is less than the specified number of FFT analysis points, no analysis occurs.)

#### When no trace is displayed after starting measurement

Analysis is impossible if **[From Memory]** is selected as the input data source and no recorded data exists in the instrument's memory.

Either select **[New Data]** as the input data source, or load the data to be analyzed before clicking **[START]** again.

### NOTE

When the **[Reference]** is set to **[From Memory]**, the frequency is automatically set.  
The setting cannot be changed.

## 12.3.3 Setting the Frequency Range and Number of Analysis Points

### About the frequency range and number of analysis points

- The settings for the frequency range and number of analysis points determine the input signal acquisition time and frequency resolution.
- The frequency range setting for the FFT function corresponds to the timebase setting of the Memory function. Changing the frequency range also changes the data sampling period.

See: "Relationship Between Frequency Range, Resolution and Number of Analysis Points" (p.252)

- The cut-off frequency of the anti-aliasing filter is the same as the frequency range setting.

See: "Relationship Between Frequency Range, Resolution and Number of Analysis Points" (p.252)

- The set number of analysis points specifies the amount of data to be analyzed with each measurement. Increasing the number of analysis points increases the frequency resolution, but also increases the time required for calculations.

See: "Number of Analysis Points" (p.A16)

### **NOTE**

**When the [Reference] is [From Memory], the frequency is automatically set.**

**The setting cannot be changed.**

### Procedure

To open the screen: Right-click and select [STATUS] → [Status] sheet

See: To set from the Waveform screen (p.265)

#### 1 Set the number of FFT analysis points.

Move the flashing cursor to the [Sampling Point] item.

Select

1000 (default setting), 2000, 5000, 10000

See: "Number of Analysis Points" (p.A16)

#### 2 Select the frequency range.

Move the flashing cursor to the [Frequency Range] item.

Select

8 MHz(default setting), 4 MHz, 2 MHz, 800 kHz, 400 kHz, 200 kHz, 80 kHz, 40 kHz, 20 kHz, 8 kHz, 4 kHz, 2 kHz, 800 Hz, 400 Hz, 200 Hz, 80 Hz, 40 Hz, 20 Hz, 8 Hz, 4 Hz, 1.33 Hz, 800 mHz, 667 mHz, 400 mHz, 333 mHz, 133 mHz, External

See: "Relationship Between Frequency Range, Resolution and Number of Analysis Points" (p.252)

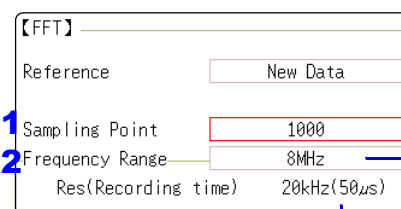

#### Frequency Resolution (during acquisition)

The resolution is affected by settings of frequency range and the number of analysis points. Not displayed for external sampling.

To control sampling by an external signal, select [External]

**When the input data [Reference] is [From Memory]**

The frequency range is set automatically when analysis is started.

## Relationship Between Frequency Range, Resolution and Number of Analysis Points

Range [Hz]	Sampling frequency [Hz]	Timebase [div] (MEM)	Sampling period	Number of FFT Analysis Points							
				1,000		2,000		5,000		10,000	
				Resolution [Hz]	Acquisition interval	Resolution [Hz]	Acquisition interval	Resolution [Hz]	Acquisition interval	Resolution [Hz]	Acquisition interval
8 M *1	20 M	5 μs	50 ns	20 k	50 μs	10 k	100 μs	4 k	250 μs	2 k	500 μs
4 M *1	10 M	10 μs	100 ns	10 k	100 μs	5 k	200 μs	2 k	500 μs	1 k	1 ms
2 M *1	5 M	20 μs	200 ns	5 k	200 μs	2.5 k	400 μs	1 k	1 ms	500	2 ms
800 k *1	2 M	50 μs	500 ns	2 k	500 μs	1 k	1 ms	400	2.5 ms	200	5 ms
400 k *1	1 M	100 μs	1 μs	1 k	1 ms	500	2 ms	200	5 ms	100	10 ms
200 k *1	500 k	200 μs	2 μs	500	2 ms	250	4 ms	100	10 ms	50	20 ms
80 k *1	200 k	500 μs	5 μs	200	5 ms	100	10 ms	40	25 ms	20	50 ms
40 k	100 k	1 ms	10 μs	100	10 ms	50	20 ms	20	50 ms	10	100 ms
20 k	50 k	2 ms	20 μs	50	20 ms	25	50 ms	10	100 ms	5	200 ms
8 k	20 k	5 ms	50 μs	20	50 ms	10	100 ms	4	250 ms	2	500 ms
4 k	10 k	10 ms	100 μs	10	100 ms	5	200 ms	2	500 ms	1	1 s
2 k	5 k	20 ms	200 μs	5	200 ms	2.5	400 ms	1	250 ms	500 m	2 s
800	2 k	50 ms	500 μs	2	500 ms	1	1 s	400 m	2.5 s	200 m	5 s
400	1 k	100 ms	1 ms	1	1 s	500 m	2 s	200 m	5 s	100 m	10 s
200	500	200 ms	2 ms	500 m	2 s	250 m	4 s	100 m	10 s	50 m	20 s
80	200	500 ms	5 ms	200 m	5 s	100 m	10 s	40 m	25 s	20 m	50 s
40	100	1 s	10 ms	100 m	10 s	50 m	20 s	20 m	50 s	10 m	100 s
20	50	2 s	20 ms	50 m	20 s	25 m	40 s	10 m	100 s	5 m	200 s
8 *2	20	5 s	50 ms	20 m	50 s	10 m	100 s	4 m	250 s	2 m	500s
4 *2	10	10 s	100 ms	10 m	100 s	5 m	200s	2 m	500 s	1 m	1 ks
1.33 *2	3.33	30 s	300 ms	3.33 m	300 s	1.66 m	600s	666 μ	1.5 ks	333 μ	3 ks
800 m *2	2	50 s	500 ms	2 m	500 s	1 m	1 ks	400 μ	2.5 ks	200 μ	5 ks
667 m *2	1.67	60 s	600 ms	1.66 m	600 s	833 μ	1.2 ks	333 μ	3 ks	166 μ	6 ks
400 m *2	1	100 s	1 s	1 m	1 ks	500 μ	2 ks	200 μ	5 ks	100 μ	10 ks
333 m *2	833 m	120 s	1.2 s	833 μ	1.2 ks	416 μ	2.4 ks	166 μ	6 ks	83.3 μ	12 ks
133 m *2	333 m	300 s	3 s	333 μ	3 ks	166 μ	6 ks	66.6 μ	15 ks	33.3 μ	30 ks

The cut-off frequency of the anti-aliasing filter is the same as the frequency range.

\*1. The anti-aliasing filter is turned off.

\*2. Cut-off frequency is 20 Hz.

## 12.3.4 Thinning Out and Calculating Data

When performing FFT analysis of data measured using the memory function, the measurement data can be thinned before calculation. If the sampling frequency is too high and the expected results are not obtained, thin the data before calculation to increase the frequency resolution.

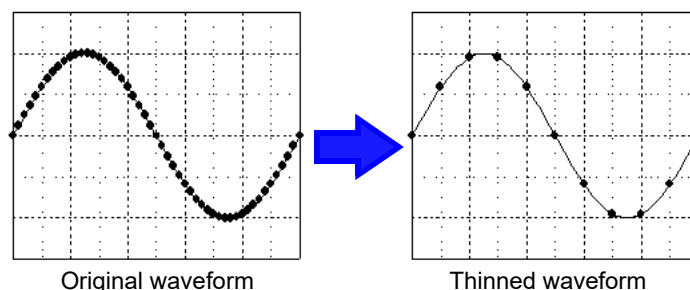

### Procedure

To open the screen: Right-click and select **[STATUS]** → **[Status]** sheet

#### 1 Select the reference data.

Move the flashing cursor to the **[Reference]** item, and select **[From Memory]**.

Reference	From Memory
Save Thin	OFF
Sampling Point	1000
Frequency Range	4MHz
Res(Recording time)	10kHz(100μs)

#### 2 Select the thinning amount.

Move the flashing cursor to the **[Save Thin]** item.

Select

Off	Do not thin out.. (default setting)
1/10	Skip every 10 data points.
1/100	Skip every 100 data points.
1/1000	Skip every 1000 data points.

### NOTE

- The **[Save Thin]** setting can only be set when the **[Reference]** is set to **[From Memory]**.
- The range that can be set for thinning changes depending on the time axis range measured by the memory function.
- The frequency range is automatically determined. This setting cannot be changed.
- When thinning, aliasing occurs and waveforms that did not originally exist may be observed. Make settings after sufficient consideration of the frequencies included in waveforms.



## 12.3.5 Setting the Window Function

The window function defines the segment of the input signal to be analyzed. Use the window function to minimize leakage errors. There are three general types of window functions:

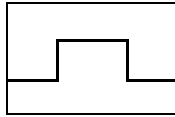

• Rectangular Window

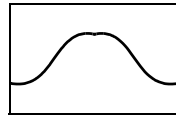

- Hann window
- Hamming window
- Blackman window
- Blackman-Harris window
- Flat top window

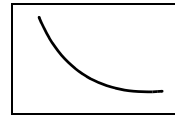

• Exponential window

The non-rectangular window functions generally produce lower-level analysis results. By applying attenuation correction, the attenuation introduced by the non-rectangular window functions can be corrected to bring analysis results back to similar levels.

### Procedure

To open the screen: Right-click and select [STATUS] → [Status] sheet

See: To set from the Waveform screen (p.265)

#### 1 Select the window function.

Move the flashing cursor to the [Window] item.

Select

Rectangular (default setting), Hanning, Hamming, Blackman, Blackman Harris, Flat-top, Exponential

See: "Window Function" (p.A22)

1 Window	Exponential
2 Attenuation rate	1%
3 Compensation	None
	(Compensation rate) x1.000(0.00dB)
[Analyze]	

Correction value

#### 2 If [Exponential] is the selected type

Set the attenuation coefficient (percentage).

Move the flashing cursor to the [Attenuation rate] item.

Set the attenuation coefficient as a percentage.

Noise is suppressed in the attenuated waveform.

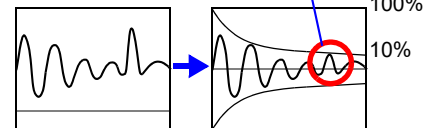

When the attenuation rate is 10%

#### 3 Set attenuation correction.

Move the flashing cursor to the [Compensation] item.

Select

None	Attenuated window function values are not corrected. (default setting)
Power	The window function multiplies the power levels of the time-domain waveform so that output levels are comparable to those of a rectangular window.
Average	The window function multiplies the average value of the time-domain waveform so that output levels are comparable to those of a rectangular window.

For the rectangular window function: The correction value is always 1 (0 dB).

## 12.3.6 Setting Peak Values of Analysis Results

Either local or global maxima ([maximal]/ [maximum]) of the input signal and analysis results can be displayed on the Waveform screen. However, if Nyquist display is selected on the Status screen-[Status] sheet, no peak values are displayed.

### Procedure

To open the screen: Right-click and select [STATUS] → [Status] sheet

#### Selecting peak value display.

Move the flashing cursor to the [Peak] item.

Select	
Off	Not displayed. (default setting)
Maximal	(local maxima) When the value of data at a point is greater than that of the adjacent points, that data is considered a local maxima. The ten largest local maxima are displayed.
Maximam	(global maxima) Among all data values, the ten points with the greatest values are displayed.

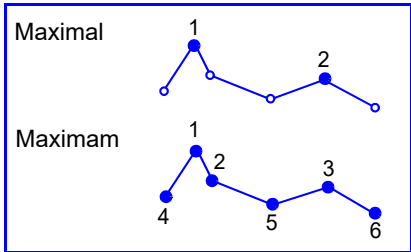
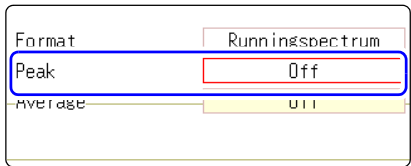

### NOTE

- No display occurs if peak values cannot be detected.
- Peak values on the Waveform screen can be displayed, but cannot be saved as peak values in text files.
- Depending on the split screen status, display ten peak values may not be possible. In such cases, only the displayable number is displayed, starting from large items.

Example: When the reference data setting is [From Memory]

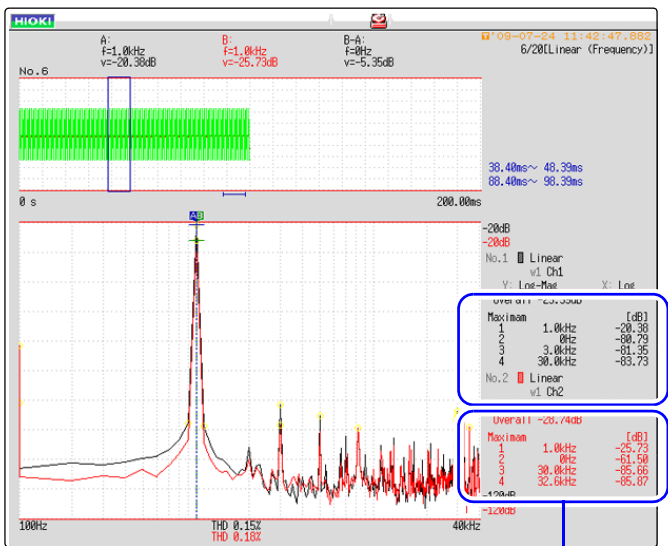

Peak value display From 1 to 4

## 12.3.7 Averaging Waveforms

The averaging function calculates the average of the values obtained from multiple measurements of a periodic waveform. This can reduce noise and other non-periodic signal components. Averaging can be applied to a time-domain waveform or to a spectrum.

### Procedure

To open the screen: Right-click and select **[STATUS]** → **[Status]** sheet

#### 1 Enable averaging.

Move the flashing cursor to the **[Average]** item.

<b>Select</b>	
<b>Off</b>	Averaging is disabled. (default setting)
<b>Linear (Time axis)</b>	Time-domain waveforms are summed and averaged and then calculation is performed.
<b>Expo. (Time axis)</b>	The exponential mean of time-domain waveforms is determined and then calculation is performed.
<b>Linear (Frequency)</b>	Frequency-domain waveforms are summed and averaged and then the calculation result is output.
<b>Expo. (Frequency)</b>	The exponential mean of frequency-domain waveforms is determined and then the calculation result is output.
<b>Peak (Frequency)</b>	The maximum value of frequency-domain waveforms is retained.

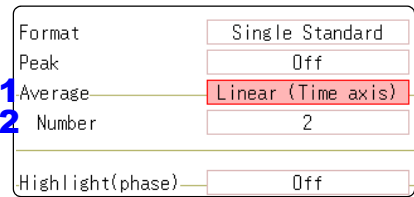

**About averaging calculation formulas**  
 See: "Averaging" (p.A20)

**When averaging and auto saving are enabled at the same time**  
 Data is saved after the specified count of values have been averaged.

See: "Trigger Modes and Averaging" (p.258)

#### 2 Select the count for averaging.

Move the flashing cursor to the **[Number]** item.

Select the number of measurements to be averaged.  
 Setting range: 2 to 10,000

### NOTE

- After measuring with averaging enabled, display is not available when the channel is changed. Also, when the analysis mode is changed, the analysis modes that can be displayed are limited.
- When averaging is performed with the analysis mode disabled (Off), no trace is displayed when the analysis mode is changed after measurement.
- When **[Format]** is set to **[Running spectrum]**, **[Average]** cannot be set.



### When averaging time-domain waveform values:

Waveforms are acquired and averaged within the time domain. After averaging, FFT calculation is performed.

When the trigger mode is **[Auto]**: Data is acquired when measurement is started, even if trigger criteria are not met after a certain interval. So if averaging is applied to an asynchronous signal, the resulting data is meaningless.

Synchronous signals have better SNR (signal-to-noise ratio) and are more suitable for analysis.

### When averaging spectrum values:

Acquired data is first subject to FFT analysis. After analysis, averaging is performed within the frequency range, and the result is displayed. This differs from time-domain averaging in that averaging can be performed without trigger synchronization. However, if the characteristics of the input waveform allow triggering, using the trigger for synchronization is recommended.

### Spectrum peak hold:

After performing FFT calculations on the acquired waveform, peak values are retained (held) and displayed within the frequency range.

## ■ FFT Analysis Modes and Averaging

●: Settable, ×: Cannot be set, ○: Partially settable

Analysis Mode	Averaging				
	Waveform Averaging		Spectrum Averaging		
	Simple	Exponential	Simple	Exponential	Peak Hold
OFF	×	×	×	×	×
Storage Waveform	●	●	×	×	×
Histogram	●	●	×	×	×
Linear Spectrum	●	●	○ *2	○ *2	○ *2
RMS Spectrum	●	●	○ *2	○ *2	○ *2
Power Spectrum	●	●	●	●	●
Power Spectrum Density *1	●	●	●	●	●
LPC analysis(Power Spectrum Density) *1	●	●	×	×	×
Transfer Function	●	●	○ *2	○ *2	○ *2
Cross Power Spectrum	●	●	○ *2	○ *2	○ *2
Impulse Response	●	●	●	●	●
Coherence Function	×	×	●	●	×
Phase Spectrum	●	●	×	×	×
Auto-correlation Function	●	●	●	●	●
Cross-correlation Function	●	●	●	●	●
1/1 Octave Analysis *1	●	●	●	●	●
1/3 Octave Analysis *1	●	●	●	●	●

\*1. Not available for external sampling

\*2. Not available when the y axis is real (linear) or imaginary (linear), or for Nyquist plots

■ Trigger Modes and Averaging

If the trigger mode is **[Single]** or the calculation setting is **[Once]**

Measurements continue until the specified number of averaging points is acquired.

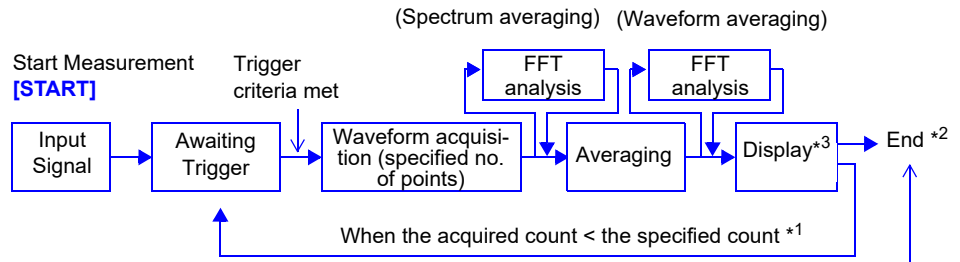

- \*1. Awaiting trigger continues until the specified count is reached.
- \*2. Measurement stops automatically when the specified count is reached. If measurement was interrupted by clicking **[STOP]**, the averaging result up to that point is displayed.
- \*3 If **[Reference]** is **[New Data]** and the automatic saving setting is ON, data is saved when the specified number of times is reached.

If the trigger mode is **[Continue]** or the calculation setting is **[Repeat]**

Measurement continues after the specified averaging count has been acquired.

When the specified averaging count is exceeded, averaging is repeated and measurement continues until **[STOP]** is clicked.

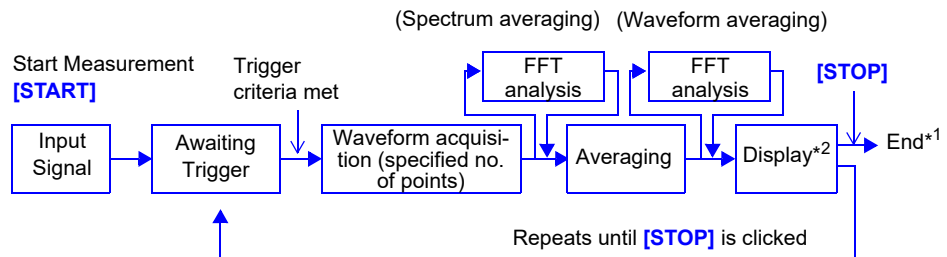

- \*1 When stopped before the specified count, the average up to that point is displayed.
- \*2 If **[Reference]** is **[New Data]** and the automatic saving setting is On, data is saved when the specified number of times is reached.

When the trigger mode is **[Auto]**

•For time-domain waveforms:

Data is acquired when **[START]** is clicked, even if trigger criteria are not met after a certain interval. So if averaging is applied to an asynchronous signal, the resulting data is meaningless.

•For spectrum values:

When **[START]** is clicked, measurement starts. Even if the trigger criteria are not met, the specified amount of data is acquired, and after FFT analysis, the results are averaged.

When the specified averaging count is exceeded, averaging is repeated and measurement continues until **[STOP]** is clicked.

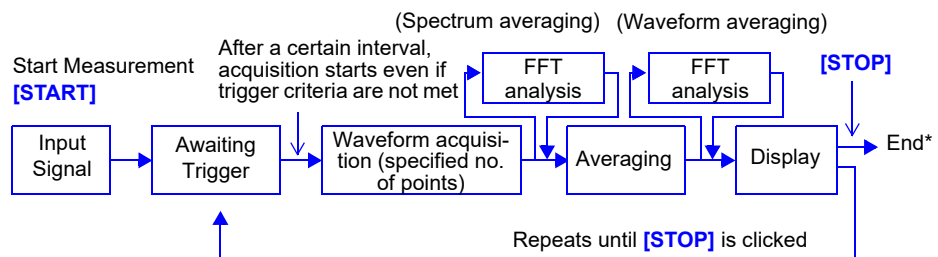

- \* When stopped before the specified count, the average up to that point is clicked.

## 12.3.8 Emphasizing Analysis Results (phase spectra only)

By specifying a setting factor (rate) to be applied to the input signal, the display of data exceeding the resulting threshold can be emphasized. This feature is useful for viewing waveforms that may otherwise be obscured by noise.

The reliability of phase spectrum values is poor when discrete Fourier transform values are extremely small. For example, in the case of a pure sine wave, almost all phase values at frequencies other than the input frequency result from calculation errors. By treating the maximum value of the power (or cross-power) spectrum of the input signal,  $P_{max}$ , as a reference value, data that exceeds that value multiplied by rate  $R$  can be displayed with emphasis.

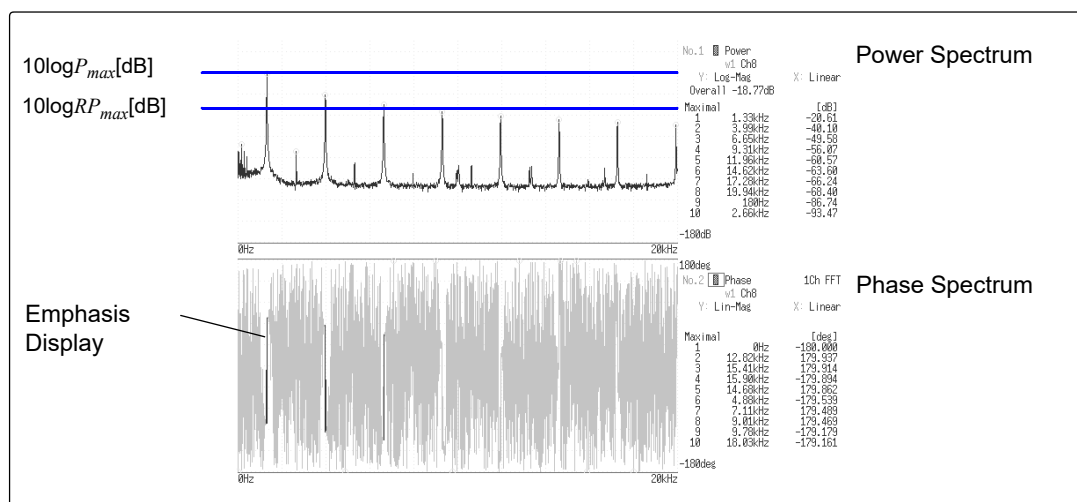

### Procedure

To open the screen: Right-click and select [STATUS] → [Status] sheet

#### 1 Enable the highlighting function.

Move the flashing cursor to the [Highlight(phase)] item.

Select

Off Emphasis display disabled. (default setting)

On Emphasis display enabled.

1	Highlight(phase)	On
2	Attenuation rate	1
3	(dB)	0dB

#### 2 Set the attenuation rate or attenuation value.

##### To set an attenuation rate

Move the flashing cursor to the [Attenuation rate] item.

Enter the attenuation rate.

See: "7.1.3 Alphanumeric Input" (p.141)

##### To set an attenuation value [dB]

Move the flashing cursor to the [(dB)] item.

Enter the attenuation value.

See: "7.1.3 Alphanumeric Input" (p.141)

##### Attenuation Rate and Value

Attenuation value: A [dB]

Attenuation rate: R

$$-A = 10\log_{10}R$$

$$1 \times 10^{-6} \leq R \leq 1$$

$$0 \leq A \leq 60$$

## 12.3.9 Analysis Mode Settings

Select the type of FFT analysis, channel(s), waveform display color and x and y axes.

### Procedure

To open the screen: Right-click and select **[STATUS]** → **[Status]** sheet

See: To set from the Waveform screen (p.265)

Analysis Setting Contents

Analysis No. Settings can be made from the dialogs, or copied from another Analysis No. (p.160)

No	Wave	Analyze	Parameter	Ch1	Ch2	Y Axis	X Axis
1	Yellow	Storage Waveform		Ch1		Lin-Mag	Linear
2	Red	Histogram		Ch1		Lin-Mag	Linear

2 Display Color

1 Analysis Type

3 Parameter

4 Channel for Analysis

5 X/Y Axes Display

### 1 Select the FFT analysis mode.

Move the flashing cursor to the **[Analyze]** column of the Analysis No. to set.

Select

<b>Off</b>	No analysis. (default setting)	<b>Transfer Function</b>	(p.282)
<b>Storage Waveform</b>	(p.275)	<b>Cross Power Spectrum</b>	(p.283)
<b>Histogram</b>	(p.275)	<b>Impulse Response</b>	(p.284)
<b>Linear Spectrum</b>	(p.276)	<b>Coherence Function</b>	(p.285)
<b>RMS Spectrum</b>	(p.277)	<b>Phase Spectrum</b>	(p.286)
<b>Powre Spectrum</b>	(p.279)	<b>Auto-Correlation</b>	(p.287)
<b>Powre Spectrum density*</b>	(p.280)	<b>Cross-correlation</b>	(p.288)
<b>LPC (density)*</b>	(p.281)	<b>1/1 Octave*</b>	(p.288)
		<b>1/3 Octave*</b>	(p.288)

\*Not available with external sampling enabled.

See: "12.8.2 Analysis Mode Functions" (p.293)

(When [List] is selected, a list of calculation types appears.)

### 2 Select whether to display the waveform, and its color.

Move the flashing cursor to the **[Wave]** column.

Select whether the waveform is to be displayed (On) or not, and its color if displayed.

### 3 When [Parameter] setting contents are displayed

#### Set the parameter.

Move the flashing cursor to the **[Parameter]** column of the Analysis No. to set.

Select

Analyze	Parameter	Setting Contents
1/1 Octave, 1/3 Octave	<b>Filter: Normal</b>	enables the octave filter.
	<b>Filter: Sharp</b>	See: "Octave Filter Setting" (p.262)
Phase Spectrum	<b>1ch FFT</b>	Calculates the phase of <b>[Ch1]</b> .
	<b>2ch FFT</b>	Calculates the phase difference between <b>[Ch1]</b> and <b>[Ch2]</b> .
LPC (density)	<b>Order :2 to 64</b>	Larger numerical values make finer spectrum components visible.

### 4 Select the channel for analysis.

Move the flashing cursor to the **[Ch1]** item.

Select which channel number to use. However, the channel of MR8990 Digital Voltmeter Unit cannot be set.

### 5 Set the horizontal and vertical axes displaying the calculation results.

Move the flashing cursor to the **[X Axis]** or **[Y Axis]**.

Set the contents of the calculation results to be displayed on the horizontal and vertical axes.

(Selectable display contents vary by analysis mode.)

See: "Analysis Modes and X/Y Axis Display" (p.262)

#### Y-axis display

<b>Lin-Mag</b>	Analysis results are displayed as amplitude values.
<b>Log-Mag</b>	Analysis results are displayed as dB values. The dB reference is 1 eu. (As a voltage example, 1 V is 0 dB.)
<b>Lin-Real</b>	The real-number component of analysis results are displayed.
<b>Lin-Imag</b>	The imaginary component of analysis results are displayed.

#### X-axis display

<b>Linear</b>	Frequency-axis is displayed linearly.
<b>Log</b>	Frequency-axis is displayed logarithmically. This is convenient when the data of interest is at the lower end of the frequency range, such as for sound and vibration.

#### Analysis channel setting

For any of the following analysis modes, set both channels 1 and 2.

Transfer Function, Impulse Response, Cross-correlation Function, Cross Power Spectrum, Coherence Function, Phase Spectrum (2ch FFT)

#### To analyze using external sampling

The horizontal axis ( x-axis) displays the number of data points.



#### How do I copy settings to other calculation No.?

See: "7.8 Copying settings to other channels (calculation No.) (Copy function)" (p.160)



■ Octave Filter Setting

Filter features are based on JIS C1513-2002 class 1, class 2 (IEC61260).

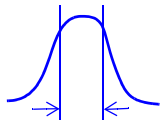
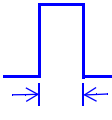
 <p>Normal</p> <p>Filter characteristics approximate those of an analog filter.</p>	 <p>Sharp</p> <p>Only those spectral component within the octave band are used for analysis. Spectral components outside of the octave band are totally ignored.</p>
--	--

After determining the entire power spectrum, the instrument performs octave analysis defined by the above filter characteristics.

See: "Octave Filter Characteristics" (p.A26)

■ Analysis Modes and X/Y Axis Display

●: Settable, ×: Unsettable

Analysis Mode	X axis		Y axis				Nyquist display
	Linear	Log	Lin-Mag	Log-Mag	Lin-Real	Lin-Imag	
OFF	×	×	×	×	×	×	×
Storage Waveform	●	×	●	×	×	×	×
Histogram	●	×	●	×	×	×	×
Linear Spectrum	●	●	●	●	●	●	●
RMS Spectrum	●	●	●	●	●	●	×
Power Spectrum	●	●	●	●	×	×	×
Power Spectrum Density	●	●	●	●	×	×	×
LPC analysis (Power Spectrum Density)	●	●	●	●	×	×	×
Transfer Function	●	●	●	●	●	●	●
Cross Power Spectrum	●	●	●	●	●	●	●
Impulse Response	●	×	●	×	×	×	×
Coherence Function	●	●	●	×	×	×	×
Phase Spectrum	●	●	●	×	×	×	×
Auto-correlation Function	●	×	●	×	×	×	×
Cross-correlation Function	●	×	●	×	×	×	×
1/1 Octave	×	●	●	●	×	×	×
1/3 Octave	×	●	●	●	×	×	×

The x/y axes cannot be set when Nyquist Display is selected.

### ■ Total harmonic distortion (THD)

When the analysis mode is one of the following, the cursor appears and the distortion rate is calculated.  
(Linear spectrum, RMS spectrum, power spectrum)

The distortion rate calculates the cursor position as the fundamental wave. When 2 cursors appear, the A cursor becomes the fundamental wave.

When calculation results cannot be obtained, [---%] is displayed.

Note that distortion rate values may become higher depending on the window function settings.

$$\text{THD} = \sqrt{\frac{\sum(f_n)^2}{(f_0)^2}} \times 100 \quad [\%]$$

$f_0$  = fundamental wave

$f_n$  =  $n$  next higher harmonic

### 12.3.10 Setting the Display Range of the Vertical Axis (Scaling)

The display range of the vertical (y) axis can be set to automatically suit analysis results, and can be freely expanded and compressed.

#### Procedure

To open the screen: Right-click and select **[STATUS]** → **[Status]** sheet

#### 1 Select automatic or manual scaling of the y-axis display.

Move the flashing cursor to the **[Scale]** column of the Analysis No. to set.

Select

<b>Auto</b>	Scaling of the vertical (y) axis is automatically set according to analysis results. (default setting)
<b>Manual</b>	Scaling of the vertical (y) axis can be set as desired, to suit the purpose of the measurement. This is useful for magnifying or reducing the displayed amplitude, and for shifting the displayed waveform up or down.

No	Scale	Lower	Upper
1	Manual	-1.0000	1.0000
2	Auto		

#### 2 When [Manu] is selected

##### Set the upper and lower limits to display.

Move the flashing cursor to the **[Lower]** or **[Upper]** item.

Set the upper and lower limits to display the analysis results.

Setting range:  $-9.9999E+29$  to  $+9.9999E+29$   
(with exponent from E-29 to E+29)

See: "7.1.3 Alphanumeric Input" (p.141)



#### How do I copy settings to other calculation No.?

See: "7.8 Copying settings to other channels (calculation No.) (Copy function)" (p.160)

## 12.3.11 Setting and Changing Analysis Conditions on the Waveform Screen

The following settings can be made on the Waveform screen. Changes to the displayed analysis results become effective when the settings are changed.

- Available settings are frequency range, number of analysis points, type of window function, trigger mode and pre-triggering
- Available settings are analysis number, analysis mode, waveform color, analysis channel and x/y axis display type
- Trigger settings (p.192)  
(Note: If [Reference] is [From Memory], triggers cannot be set.)

### Setting details

To open the screen: Right-click and select [DISP] → Waveform screen

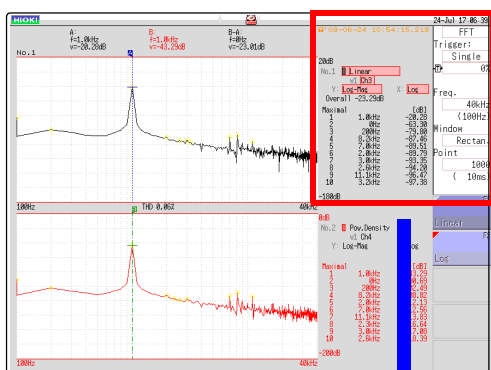

#### Setting method

Use the mouse to move the flashing cursor to each item, and select a setting from the GUI displayed on the bottom right of the screen.

#### Trigger mode and Pre-trigger

Select the trigger mode and pre-triggering (same as for the Memory function).

Trigger Mode: Single, Repeat, Auto  
Pre-trigger: Select from list

See: "8.2 Setting the Trigger Mode" (p.191)  
"8.9 Pre-Trigger Settings" (p.204)

**Analysis Mode** → FFT

**Waveform Color** → 20dB

**Analysis Number\*** (p.260) → No.1

**Analysis Channel** → w1 Ch3

**Display types of X-axis (horizontal axis) and Y-axis (vertical axis)**

3	200Hz	-79.80
4	8.2kHz	-87.46
5	7.0kHz	-89.51
6	2.0kHz	-89.79
7	3.0kHz	-93.35
8	2.6kHz	-94.20
9	11.1kHz	-96.47
10	3.2kHz	-97.38

**Trigger:** Single

**Freq.:** 40kHz (100Hz)

**Window:** Rectan.

**Point:** 1000 (10ms)

\*Coupled with the [Analysis] list at the [Status] sheet of the Status screen.

# 12.4 Selecting Channels

Channel selection is the same for all functions.

For the setting method, refer to "3.4 Input Channel Setting" (p.72) and "7.9 Setting Details of Modules" (p.161).

## Scaling

The scaling setting allows values displayed on this instrument to match the actual values read directly on a sound level meter or vibration meter.

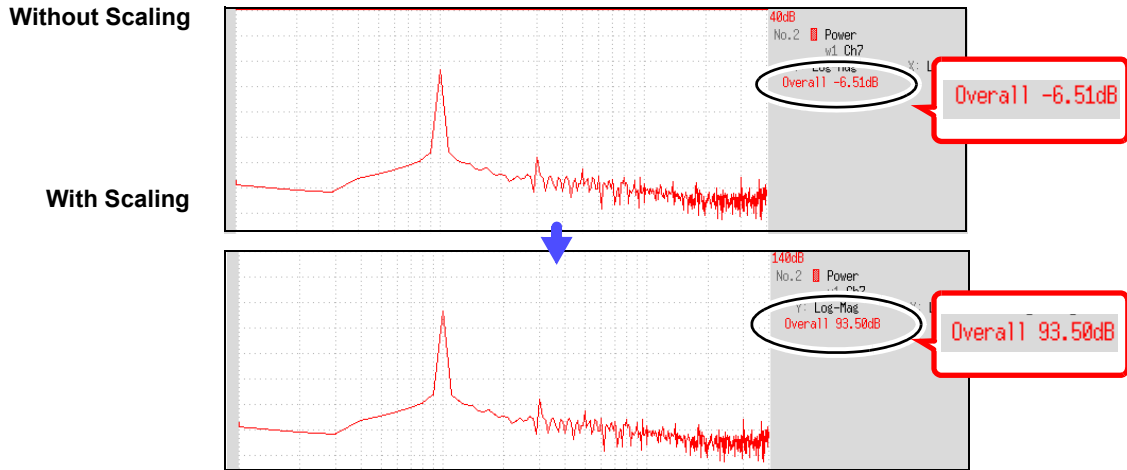

Setting example: To display measurement data on this instrument so that it corresponds to that on a sound level meter.

In a case where a sound level meter displays 93.5 dB and the overall value displayed on the Waveform screen of this instrument is -6-51 dB.

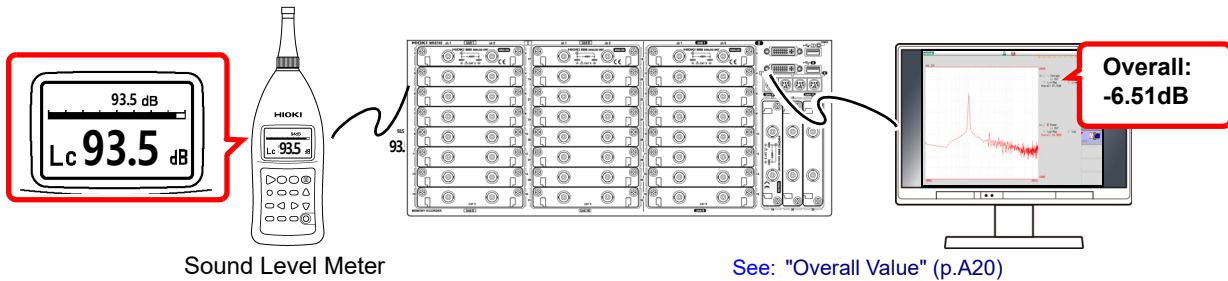

【Scaling】			
Set	1 NUM	Clamp	Clamp...
Method	2 Ratio	Unit	V
Ratio	3 1.0000	Offset	0.0000
Verify			
	Input	Scale	
	1.0000 V	100.12kV	
【Comment】			
Comment	dB value input	Scale	
	4 -6.5100 dB	5 93.500 dB	

- 1 Select [Num].
- 2 Select [Ratio].
- 3 Move the flashing cursor to [Ratio], and click [dB Scaling].  
The dB Scaling dialog appears.
- 4 Enter the (overall) value "-6.51" displayed on the instrument.
- 5 Enter the value "93.5" (from the sound level meter) that you want to read directly.
- 6 Click [Confirm] to perform scaling.  
Scaling is performed automatically and the conversion value is set in the conversion rate column.

0 dB reference differs depends on the physical quantity. As an example for sound pressure, 20 μPa is 0 dB. In dB scaling, the dB value can be directly read; however, it may not be possible to directly read instantaneous values. Read the written standards and other materials regarding 0 dB references.

## 12.5 Setting Screen Displays

Set the display method for FFT calculation results.

### Procedure

To open the screen: Right-click and select **[STATUS]** → **[Status]** sheet

#### 1 Select the display format.

Move the flashing cursor to the **[Format]** item.

Select the format of data to be displayed.

The display format depends on the input data selected for analysis.

<b>Single Standard</b>	The FFT calculation results are displayed in one screen. If the calculations have multiple settings, waveforms are overlaid. Note: Depending on the analysis mode settings, analysis No1 only may be preferentially displayed.
<b>Dual Standard</b>	The FFT calculation results are displayed in two screens. If the calculations have multiple settings, waveforms are displayed for each specified calculation.
<b>Single Nyquist</b>	If the analysis mode is linear spectrum, transfer function or cross power spectrum, the FFT calculation result is displayed in Nyquist display on one screen. If the calculations have multiple settings, waveforms are overlaid.
<b>Dual Nyquist</b>	If the analysis mode is linear spectrum, transfer function or cross power spectrum, the FFT calculation result is displayed in Nyquist display on two screens. If the calculations have multiple settings, waveforms are displayed for each specified calculation.
<b>Running spectrum</b>	If the analysis mode is one of the following, analysis results are displayed three-dimensions: frequency, oscillation and time. (Linear spectrum, RMS spectrum, power spectrum, power spectrum density, LPC analysis, transfer function, cross power spectrum, 1/1 octave analysis, 1/3 octave analysis) If the calculations have multiple settings, No1 is preferentially displayed.

\*: The horizontal axis and vertical axis display the real parts and the imaginary parts of calculation results, respectively.

#### 2 Click **[DISP]** in the right-click menu to display the Waveform screen.

1

Format	Single Standard
Peak	Off
Average	Linear (Time axis)
Number	2

#### To use an existing memory waveform for analysis

Select **[From Memory]** as the input data source **[Reference]**.

See: "12.3.2 Selecting the Data Source for Analysis" (p.250)

#### To specify the analysis starting point

Specify the starting point on the memory waveform.

See: "12.7.1 Analyzing after Specifying an Analysis Starting Point" (p.273)



**When “Drawing failed”:**

- **NG: Nyquist, Running Spectrum**  
The display format settings and analysis mode do not match.
- **NG: X-Axis**  
Either change the **[Format]** setting and increase the number of screen divisions or change the display setting of the X-axis.  
Linear and logarithm X-axes cannot exist in one graph.
- **NG:X-unit**  
Set **[Format]** and increase the number of screen divisions. Different horizontal axis units cannot coexist in 1 graph.
- **NG: EXT**  
Analysis mode cannot perform external sampling.

**■ Display Types and Split-Screen Settings**

Nine display arrangements are available.

	Standard		Nyquist		Running Spectrum
	Single Standard	Dual Standard	Single Nyquist	Dual Nyquist	Running spectrum
<b>[Reference] setting</b>	<b>[New Data]</b>	<b>[From Memory]</b>	<b>[New Data]</b>	<b>[From Memory]</b>	<b>[New Data]</b>
One division					
Two divisions					

## 12.5.1 Displaying running spectrums

If [Format] is set to [Running spectrum], changes in frequency over time can be observed.

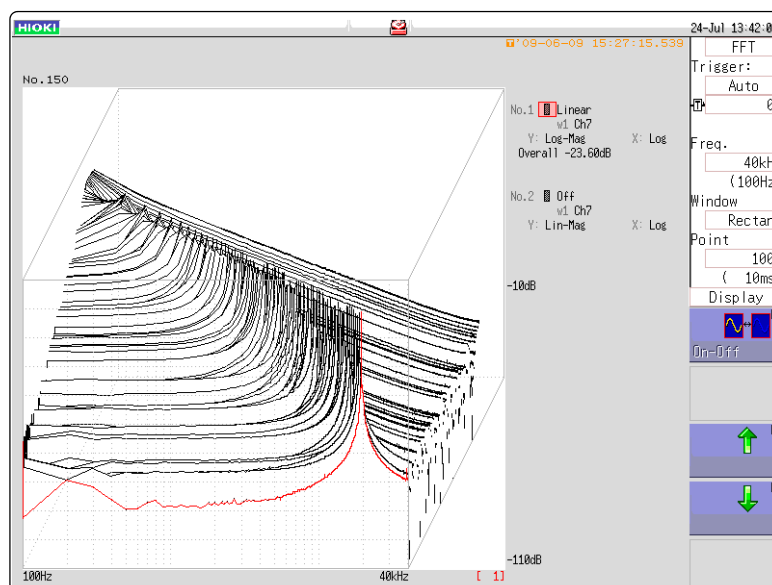

### Procedure

To open the screen: Right-click and select [STATUS] → [Status] sheet

#### 1 Select the reference data.

Move the flashing cursor to the [Reference], and select **1** [New Data].

Reference	New Data
Sampling Point	1000
Frequency Range	8MHz
Res(Recording time)	20kHz(50μs)

#### 2 Select the display format.

Move the flashing cursor to the [Format], and select [Running spectrum].

Format	Running spectrum
Peak	Off
Average	Off

### NOTE

- [Running spectrum] can only be set when the [Reference] is [New Data].
- The calculation interval (time interval of the running spectrum waveform and the waveform) is not regulated.
- Averaging cannot be used.
- Calculations that can be analyzed by running spectrum are limited to the following. When other calculations are selected or calculation settings are changed after measurement stops, waveforms are not displayed.  
(Linear spectrum, RMS spectrum, power spectrum, power spectrum density, LPC analysis, transfer function, cross power spectrum, 1/1 octave analysis, 1/3 octave analysis)



## Procedure

To open the screen: Right-click and select [DISP] → Waveform screen

### Reading measurement values of past waveforms by cursor

After measurement is finished, read the values of each waveform by cursor.

**1** Click [WAVE] in the right-click menu.

**2** Select a waveform.

Rotate the mouse wheel to select the waveform.  
(The waveform number is displayed in the lower right of the screen.)

**3** Move the cursor.

Click [AB CSR] in the right-click menu, and rotate the mouse wheel to read the cursor value.

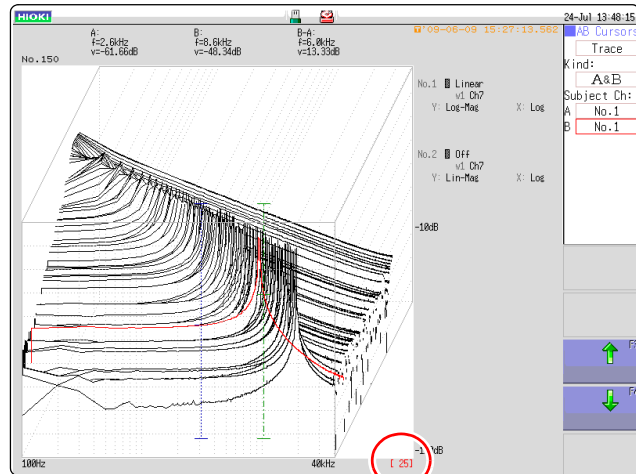

The older the waveform,  
the larger the number.

**Changing the grid display**

The display format of the grid can be switched.

- 1** Click **[WAVE]** in the right-click menu.
- 2** Move the flashing cursor to the **[Display]**.
- 3** Change the grid display  
Click **[Change Grid]** and change the grid display.  
Each click changes the display format.

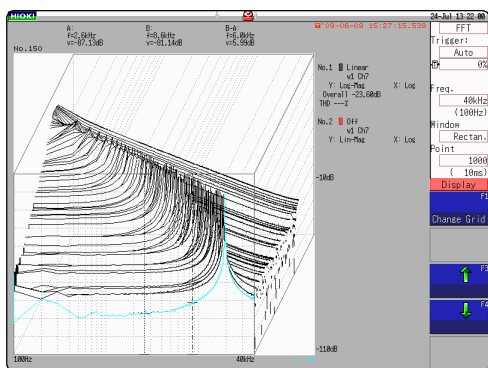

Grid Type 1

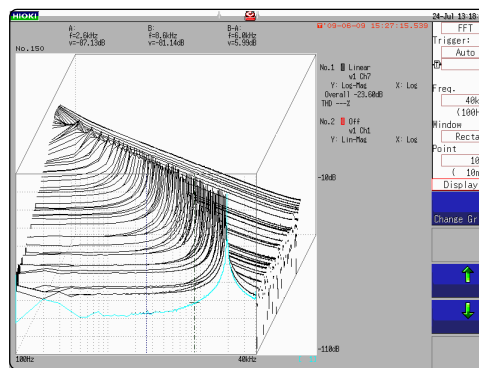

Grid Type 2

**Changing the number of waveforms to be displayed**

The number of waveforms to be displayed can be changed.  
The following number of waveforms can be selected: 10, 20, 50, 100, and 200.

- 1** Click **[WAVE]** in the right-click menu.
- 2** Move the flashing cursor to the **[Display]**.
- 3** Change the number of waveforms to be displayed.  
Clicking either **[↑]** or **[↓]**, adjust the number of waveforms to be displayed.

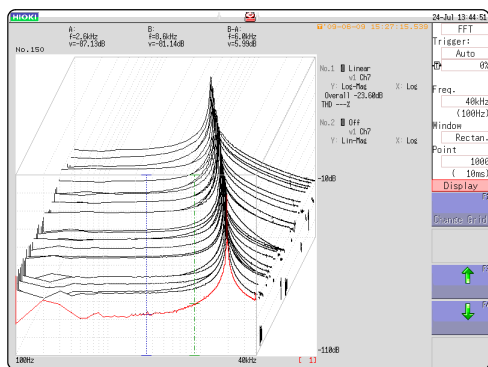

50 waveforms displayed

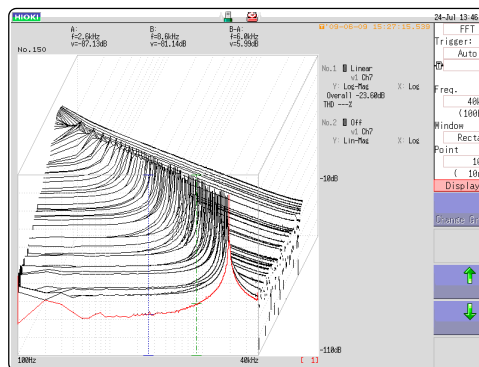

100 waveforms displayed

## 12.6 Saving Analysis Results

The saving procedure is the same as for the Memory function.

See: "Chapter 4 Saving/Loading Data & Managing Files" (p.83)

The size of saved files depends on the save format and analysis method.

See: "Appendix 2.1 Waveform File Sizes" (p.A2)

### ■ When FFT Analysis Results are Saved as Text

Divide files by calculation item and then save.

#### Text Saving Example

```

"MR8746"
"FFT number of points","Frequency range","Trigger date","Trigger time","Overall","THD"
"1000","400kHz","09-06-04","10:47:29.601","61.528m","0.18%"
"No","Analysis method","Analysis Channel 1","Units"
"2","Linear spectrum","Ch8","[V]"
"Frequency [Hz]","[V]"
+0.000000E+00,+7.174499E-04
+1.000000E+03,+1.663352E-05
+2.000000E+03,+5.939297E-06
+3.000000E+03,+2.212059E-05
+4.000000E+03,+2.946144E-05
+5.000000E+03,+4.513562E-05
+6.000000E+03,+6.034131E-05
+7.000000E+03,+6.403472E-05
+8.000000E+03,+8.428788E-05
+9.000000E+03,+9.635616E-05
+1.000000E+04,+1.529819E-04
+1.100000E+04,+1.443363E-04
+1.200000E+04,+1.687671E-04
+1.300000E+04,+1.921578E-04
+1.400000E+04,+2.516198E-04
+1.500000E+04,+3.108865E-04
+1.600000E+04,+3.912515E-04
+1.700000E+04,+5.484038E-04
+1.800000E+04,+8.432313E-04
+1.900000E+04,+1.709446E-03
+2.000000E+04,+8.694760E-02
+2.100000E+04,+1.874374E-03

```

Line 1: Title comment  
Lines 2 to 3: Trigger Time  
Calculation information  
X-axis data    Y-axis data

## 12.7 Analysis with the Waveform Screen

### 12.7.1 Analyzing after Specifying an Analysis Starting Point

The FFT function can specify the calculation start position for waveforms measured by the memory function before calculation.

Operation differs by calculation execution settings.

See: "Trigger Modes and Averaging" (p.258)

•Calculation execution: **[Single]**

Analysis is performed once on the specified number of analysis points beginning with the specified starting point, and analysis results are displayed.

This is convenient for analyzing only a specific range. However, if averaging is enabled, analysis repeats for the specified averaging count.

•Calculation execution: **[Repeat]**

Analysis is performed repeatedly on the specified number of analysis points beginning with the specified starting point and ending with end of waveform data, and final analysis results are displayed (Calculation is performed for the number of specified points so a good end point becomes the final analysis result.)

#### Verifying the analysis starting point while viewing analysis data

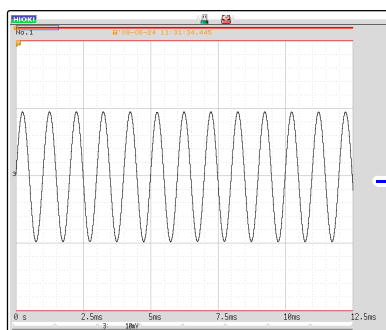

**1** Display the waveform with the Memory function.

**2** Switch to FFT function.



**3** Click **[STATUS]** in the right-click menu to display the **[Status]** sheet of the Status screen.

**4** Set the **[Reference]** item to **[From Memory]**.  
Set analysis conditions such as the analysis mode and number of analysis points (these can also be set on the Waveform screen).

No.	Wave	Analyze	Parameter	Ch1	Ch2	Y Axis	X Axis
1	0	Off					
2	1	Off					

No.	Scale	Lower	Upper	Unit
1	Auto			
2	Auto			

Hint Select the measurement function by pressing F1-3 key.

**5** Click **[DISP]** in the right-click menu to display the **Waveform** screen.

The one-time calculation range is displayed for the memory waveform.

**6** Use the mouse to move the memory waveform portion in order to specify the calculation range, and then rotate the mouse wheel to move the calculation range in order to specify the calculation position.

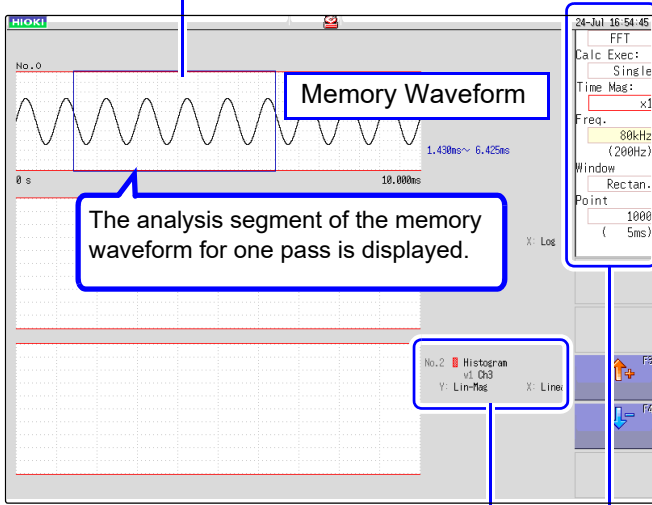

**7** Select analysis conditions as occasion demands.

**To change the number of analysis points**

The setting can be changed at the top of the Waveform screen. The range is determined by the number of analysis points. If the analysis range (number of points) is larger than the memory waveform as shown below, analysis is not performed.

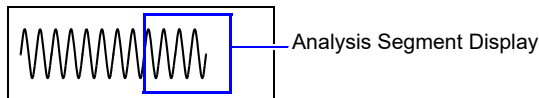

**To analyze only a certain portion**

If [Exec] is [Single] in the setting items at the right side of the screen, only the calculation range currently displayed can be calculated. For settings other [Single], calculation points are calculated until the final data. To stop mid-way, click [STOP].

**8** Click [Exec] or [START] to perform analysis.

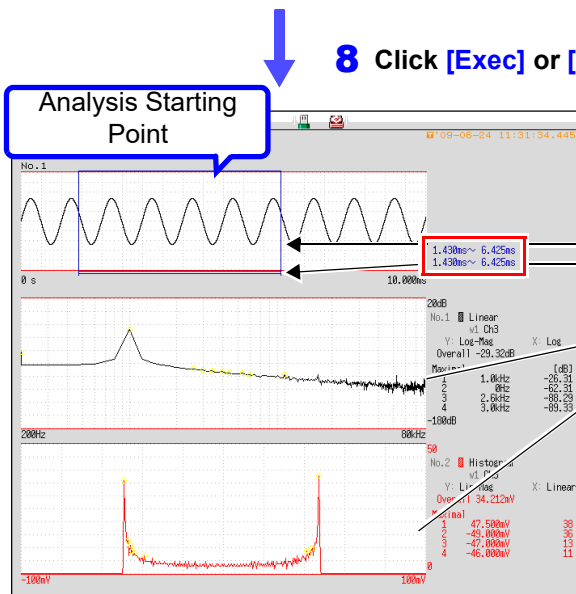

Calculation range (portion in square)  
Last range calculated (line portion)

Analysis results are displayed on the lower graphs.

When the trigger mode is [Auto] or [Repeat], the number of analysis points up to the end of the waveform data is analyzed, and the last data is displayed.

## 12.8 FFT Analysis Modes

### 12.8.1 Analysis Modes and Display Examples

For the functions of each analysis mode, see "12.8.2 Analysis Mode Functions" (p.293).

#### Storage

Displays the time axis waveform of the input signal.

When the window function setting is other than rectangular, the window function is applied to the waveform and displayed.

Axis	Display Type	Description
X axis	Linear	Time-domain display Displays the value of the time-domain waveform corresponding to the set frequency range. <a href="#">See: "Relationship Between Frequency Range, Resolution and Number of Analysis Points" (p.252)</a>
Y axis	Lin-Mag	Displays the module waveform

#### Waveform Example

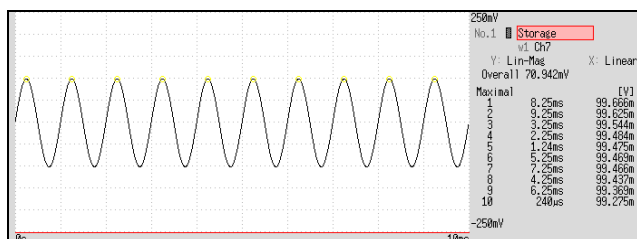

Window: Rectangular  
X axis: Linear  
Y axis: Lin-Mag

#### Histogram

Acquires the amplitude distribution of the input signal.

Main uses:

- To inspect deviations in the amplitude range of a waveform
- With analysis point distribution, to ascertain whether a waveform is artificial or natural (natural forms exhibiting regular distribution)

[See: About the Functions](#) "12.8.2 Analysis Mode Functions" (p.293)

Axis	Display Type	Description
X axis	Linear	Displays input level of the input signal.
Y axis	Lin-Mag	Displays analysis data distribution.

#### Waveform Example

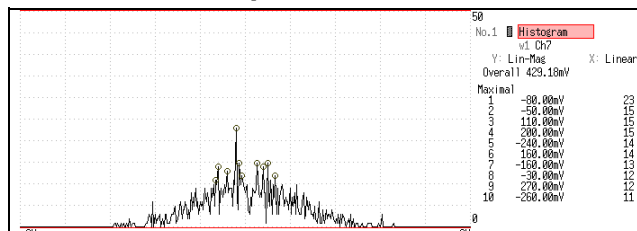

Normal display  
X axis: Linear  
Y axis: Lin-Mag

**Linear Spectrum**

The linear spectrum plots the input signal frequency. It can be displayed as a Nyquist plot.

Main uses:

- To inspect the peak frequency contents of a waveform
- To inspect signal amplitudes at each frequency

See: About the Functions"12.8.2 Analysis Mode Functions" (p.293)

Axis	Display Type	Description
X axis	Linear	Frequency is displayed with equal spacing
	Log	Frequency display of logarithm interval
	Nyquist display	The real-number component of analysis values are displayed linearly.
Y axis	Lin-Mag	Analysis values are displayed linearly.
	Log-Mag	Analysis values are displayed as dB values. (0 dB reference value: 1 eu)*
	Lin-Real	The real-number component of analysis values are displayed.
	Lin-Imag	The imaginary component of analysis values are displayed.
	Nyquist display	The imaginary component of analysis values are displayed.

\* eu: engineering units that are currently set are the standard (e.g., when the unit settings is volts, 0 dB = 1 V)

**Waveform Example**

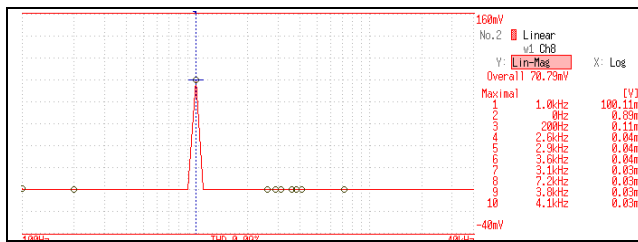

**Normal display**

X axis: Log

Y axis: Lin-Mag

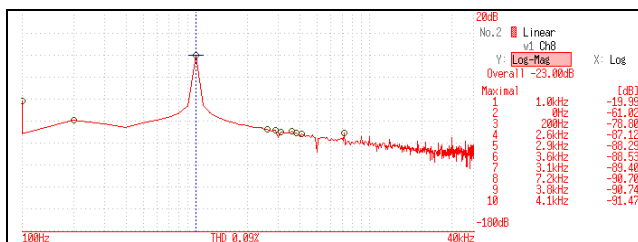

**Normal display**

X axis: Log

Y axis: Log-Mag

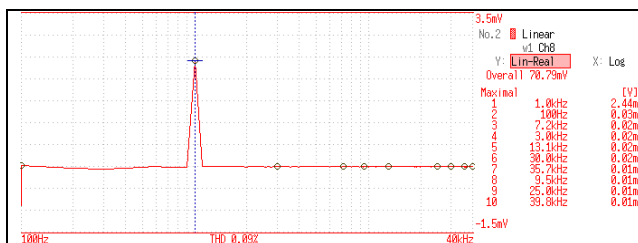

**Normal display**

X axis: Log

Y axis: Lin-Real

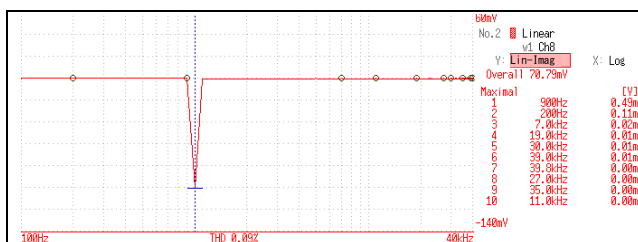

**Normal display**

X axis: Log

Y axis: Lin-Imag

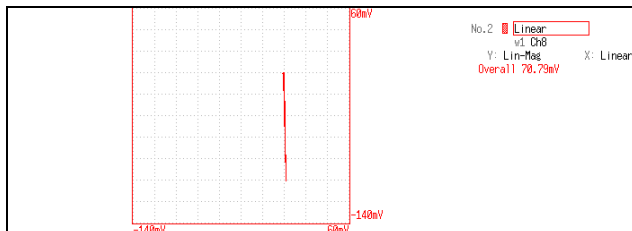

Nyquist display

**NOTE**

- If the cursor is displayed, the total harmonic distortion (THD), which sets the fundamental wave as the cursor position, is displayed. When two cursors appear, A cursor is the fundamental wave. When results cannot be obtained, [---%] is displayed.
- When only sine waves are input, the level of this component becomes approximately 1.4 times (3 dB) larger than the overall value. To measure at a reference the same as the overall value, analyze using RMS spectrum or power spectrum.

See: RMS Spectrum (p.277), Power Spectrum (p.279)

**RMS Spectrum**

The oscillation component (actual value) is calculated by the frequency axis waveform of the input signal. RMS and power spectra displays use the same analysis results displayed logarithmically (amplitude in dB).

**Main uses:**

- To inspect the execution value of the frequency component of the waveform
- To inspect the RMS value at each frequency

See: About the Functions"12.8.2 Analysis Mode Functions" (p.293)

Axis	Display Type	Description
X axis	Linear	Frequency is displayed with equal spacing
	Log	Frequency display of logarithm interval
Y axis	Lin-Mag	Analysis values are displayed linearly.
	Log-Mag	Analysis values are displayed as dB values. (0 dB reference value: 1eu)*
	Lin-Real	The real-number component of analysis values are displayed.
	Lin-Imag	The imaginary component of analysis values are displayed.

\* eu: engineering units that are currently set are the standard (e.g., when the unit settings is volts, 0 dB = 1 V)

**Waveform Example**

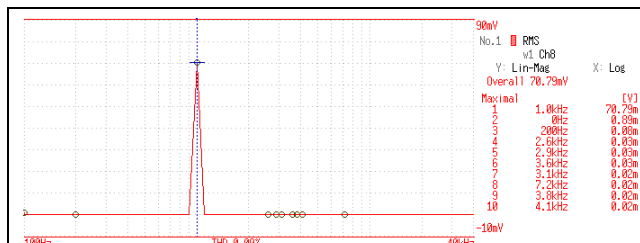

Normal display

X axis: Log  
Y axis: Lin-Mag



12.8 FFT Analysis Modes

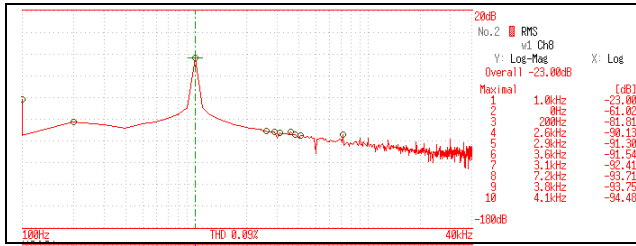

**Normal display**  
 X axis: Log  
 Y axis: Log-Mag

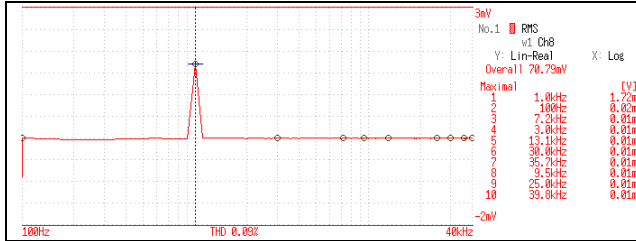

**Normal display**  
 X axis: Log  
 Y axis: Lin-Real

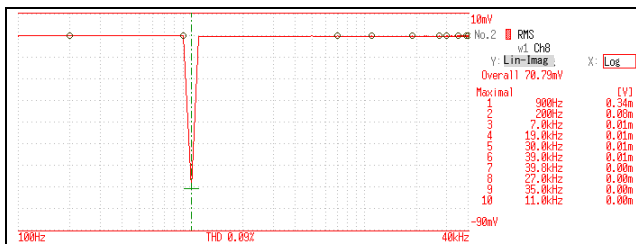

**Normal display**  
 X axis: Log  
 Y axis: Lin-Imag

**NOTE**

If the cursor is displayed, the total harmonic distortion (THD), which sets the fundamental wave as the cursor position, is displayed.  
 When two cursors appear, A cursor is the fundamental wave.  
 When results cannot be obtained, [---%] is displayed.

**Power Spectrum**

Displays input signal power as the amplitude component.

Main uses:

- To inspect the peak frequency contents of a waveform
- To inspect the power level at each frequency

See: About the Functions"12.8.2 Analysis Mode Functions" (p.293)

Axis	Display Type	Description
X axis	Linear	Frequency is displayed with equal spacing
	Log	Frequency display of logarithm interval
Y axis	Lin-Mag	Analysis data is displayed linearly as squared values. Indicates the power component.
	Log-Mag(logarithm)	Analysis values are displayed as dB values. (0 dB reference value: 1eu <sup>2</sup> )*

\* eu: engineering units that are currently set are the standard (e.g., when the unit settings is volts, 0 dB = 1 V<sup>2</sup>)

**Waveform Example**

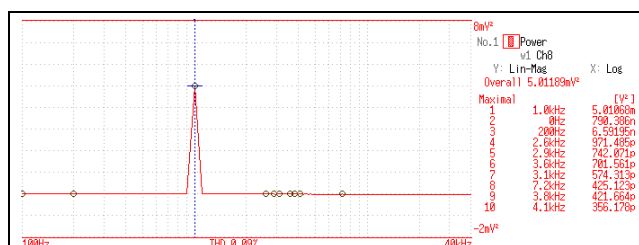

**Normal display**

X axis: Log  
Y axis: Lin-Mag

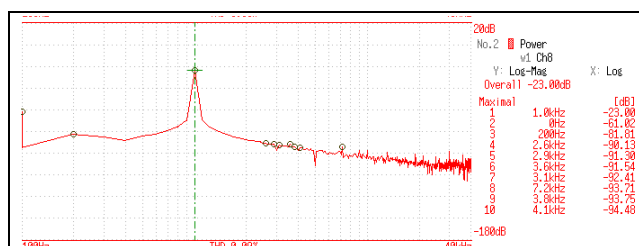

**Normal display**

X axis: Log  
Y axis: Log-Mag

**NOTE**

If the cursor is displayed, the total harmonic distortion (THD), which sets the fundamental wave as the cursor position, is displayed.  
When two cursors appear, A cursor is the fundamental wave.  
When results cannot be obtained, [---%] is displayed.

### Power Spectrum Density

Indicates the power spectrum density of the input signal with only the amplitude component included. This is the power spectrum divided by the frequency resolution.

**Main uses:**

To acquire a power spectrum with 1-Hz resolution for highly irregular waveforms such as white noise

See: About the Functions"12.8.2 Analysis Mode Functions" (p.293)

Axis	Display Type	Description
X axis	Linear	Frequency is displayed with equal spacing
	Log	Frequency display of logarithm interval
Y axis	Lin-Mag	Analysis values are displayed linearly.
	Log-Mag(logarithm)	Analysis values are displayed as dB values. (0 dB reference value: 1eu <sup>2</sup> /Hz)*

\* eu: engineering units that are currently set are the standard (e.g., when the unit settings is volts, 0 dB = 1 V<sup>2</sup>/Hz)

### Waveform Example

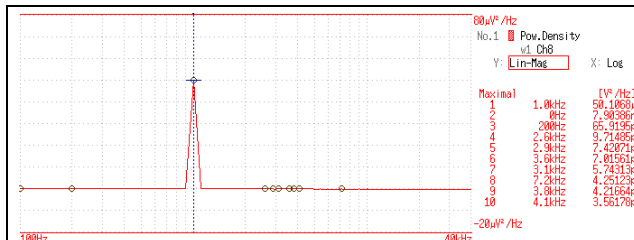

**Normal display**

X axis: Log

Y axis: Lin-Mag

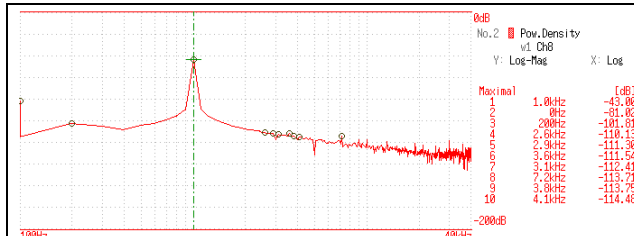

**Normal display**

X axis: Log

Y axis: Log-Mag

**NOTE**

Not available with external sampling enabled.

**LPC (Power Spectrum Density)**

When the spectrum shape is complex and hard to comprehend with either linear or power spectra, a rough spectrum structure can be obtained. Main uses:

To obtain a spectral envelope using statistical methods

See: About the Functions "12.8.2 Analysis Mode Functions" (p.293)

Axis	Display Type	Description
X axis	Linear	Frequency is displayed with equal spacing
	Log	Frequency display of logarithm interval
Y axis	Lin-Mag	The analysis data is displayed linearly.
	Log-Mag(logarithm)	Analysis values are displayed as dB values. (0 dB reference value: 1eu <sup>2</sup> /Hz)*

\* eu: engineering units that are currently set are the standard (e.g., when the unit settings is volts, 0 dB = 1 V<sup>2</sup>/Hz)

**Waveform Example**

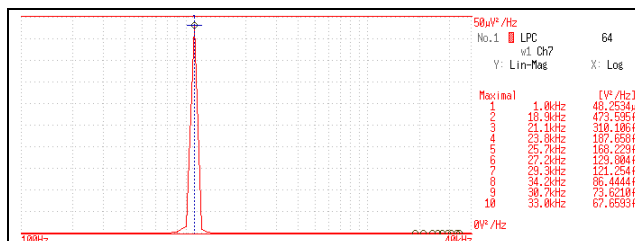

X axis: Log  
Y axis: Lin-Mag

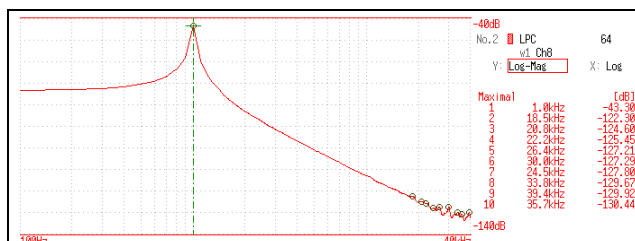

X axis: Log  
Y axis: Log-Mag

- NOTE**
- Always specify the order (from 2 to 64). Higher orders can expose finer spectral details.
  - Amplitude values provided by LPC are not always the same as the power spectrum density.
  - If an error occurs during analysis, no waveform is displayed.
  - Noise-like phenomena can strongly affect the spectrum shape.

**Transfer Function**

From the input and output signals, the transfer function (frequency characteristic) of a measurement system can be obtained. It can also be displayed as a Nyquist plot.

Main uses:

- To inspect a filter's frequency characteristic
- To inspect the stability of a feedback control system (using the Nyquist plot)
- To inspect the resonance characteristic of an object using an impulse hammer and pick-up sensor

See: About the Functions"12.8.2 Analysis Mode Functions" (p.293), "Linear Time-Invariant Systems" (p.A15)

Axis	Display Type	Description
X axis	Linear	Frequency is displayed with equal spacing
	Log	Frequency display of logarithm interval
	Nyquist display	Displays the real-number component of the input-output ratio.
Y axis	Lin-Mag	Displays the input-output ratio linearly (dimensionless units).
	Log-Mag(logarithm)	Displays the input-output ratio as dB values.
	Lin-Real	Displays the real-number component of the input-output ratio (dimensionless units).
	Lin-Imag	Displays the imaginary component of the input-output ratio (dimensionless units).
	Nyquist display	Displays the imaginary component of the input-output ratio.

**Waveform Example**

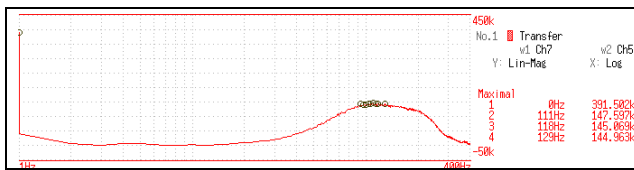

**Normal display**  
X axis: Log  
Y axis: Lin-Mag

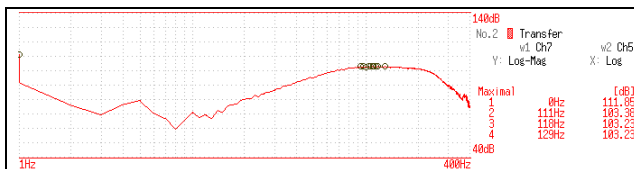

**Normal display**  
X axis: Log  
Y axis: Log-Mag

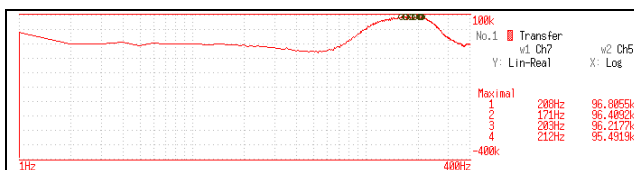

**Normal display**  
X axis: Log  
Y axis: Lin-Real

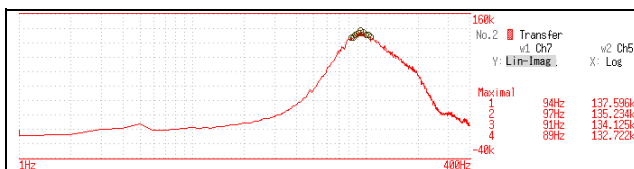

**Normal display**  
X axis: Log  
Y axis: Lin-Imag

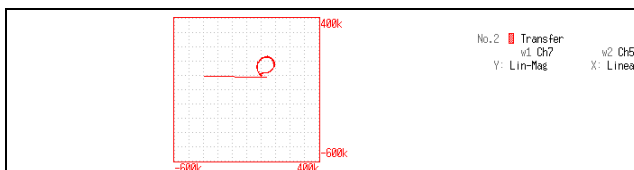

**Nyquist display**

## Cross Power Spectrum

The product of the spectra of two input signals can be obtained. The common frequency components of two signals can be obtained.

Using the voltage and current waveforms as input signals, active power, reactive power and apparent power can be obtained at each frequency.

### Main uses:

To inspect common frequency components of two signals

See: About the Functions"12.8.2 Analysis Mode Functions" (p.293)

Axis	Display Type	Description
X axis	Linear	Frequency is displayed with equal spacing
	Log	Frequency display of logarithm interval
	Nyquist display	Displays the real-number component of the input-output ratio linearly.
Y axis	Lin-Mag	Displays the squared value of amplitude contents of analysis data linearly.
	Log-Mag(logarithm)	Displays the amplitude contents of analysis data as dB values. (0 dB reference value: $1e^{-2}$ )*
	Lin-Real	Displays the squared values of the real component of analysis data linearly.
	Lin-Imag	Displays the squared values of the imaginary component of analysis data linearly.
	Nyquist display	Displays the imaginary component of analysis data linearly.

\* eu: engineering units that are currently set are the standard (e.g., when the unit settings is volts,  $0\text{ dB} = 1\text{ V}^2$ )

### Waveform Example

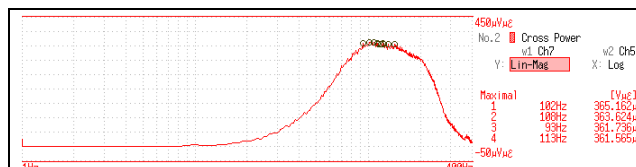

**Normal display**  
X axis: Log  
Y axis: Lin-Mag

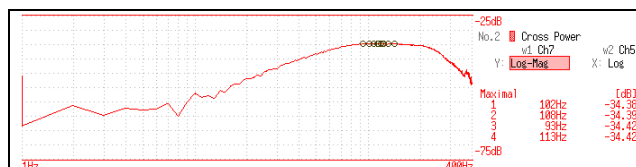

**Normal display**  
X axis: Log  
Y axis: Log-Mag

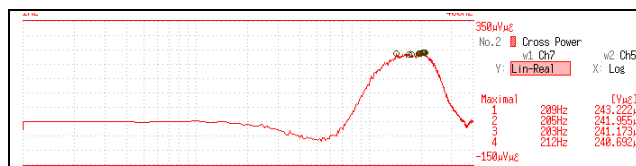

**Normal display**  
X axis: Log  
Y axis: Lin-Real

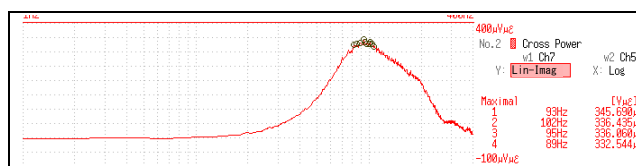

**Normal display**  
X axis: Log  
Y axis: Lin-Imag

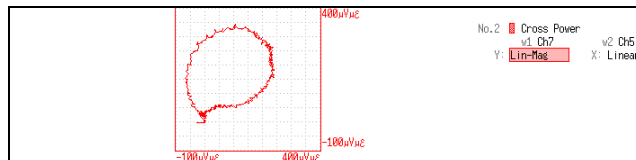

**Nyquist display**

## Impulse Response

The transfer characteristic of a system is obtained as a time-domain waveform. Utilizing both output and input signals of the measurement system, a unit impulse is applied to the system and the corresponding response waveform is obtained.

**Main uses:**

To inspect circuit time constants

See: [About the Functions](#)"12.8.2 Analysis Mode Functions" (p.293), "Linear Time-Invariant Systems" (p.A15)

Axis	Display Type	Description
X axis	Linear	Time display The center ( $t = 0$ ) is the reference. To the right is lag time (+ $t$ ), and to the left is lead time (- $t$ )
Y axis	Lin-Mag	This value is the transfer function provided by inverse Fourier transformation.

### Waveform Example

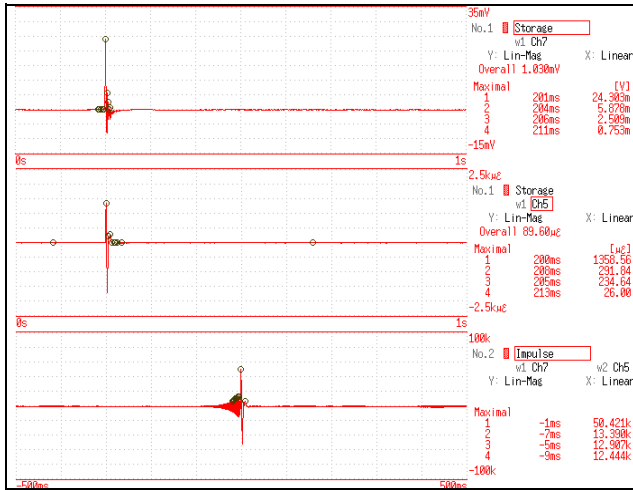

Normal display  
X axis: Linear  
Y axis: Lin-Mag

Input signal 1

Input signal 2

Impulse response

## Coherence Function

This function gives a measure of the correlation (coherence) between input and output signals. Values obtained are between 0 and 1.

### Main uses:

- To evaluate transfer functions
- In a system with multiple inputs, to inspect the effect of each input on the output

See: "12.8.2 Analysis Mode Functions" (p.293)

Axis	Display Type	Description
X axis	Linear	Frequency is displayed with equal spacing
	Log	Frequency display of logarithm interval
Y axis	Lin-Mag	Displays the causal relationship and degree of relationship between two input signals, as a value between 0 and 1 (dimensionless units).

### Waveform Example

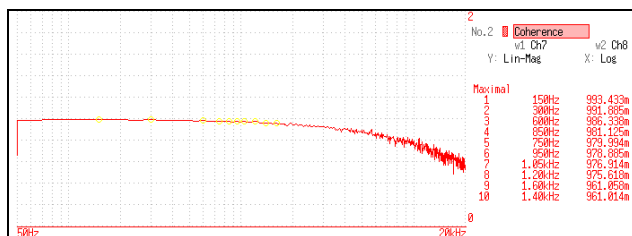

Normal display  
X axis: Log  
Y axis: Lin-Mag

### **NOTE**

- With a single measurement, the coherence function gives a value of one for all frequencies. Spectrum (frequency-domain) averaging should always be performed before measurement (analysis is not available with time-domain averaging).
- The coherence function has two general definition formulas. For the definition formulas, see "12.8.2 Analysis Mode Functions" (p.293).



### Phase Spectrum

Shows the phase characteristics of the input signal.

Main uses:

- To inspect the phase spectrum of channel 1. Displays the phase of a cosine waveform as a reference (0°).
- To inspect the phase difference between channels 1 and 2.

See: About the Functions"12.8.2 Analysis Mode Functions" (p.293)

1 Ch FFT: Displays the phase of the signal on channel 1. Displays the phase of a cosine waveform as a reference (0°). Unless the waveform is synchronous, phase values are unstable.

2 Ch FFT: Displays the phase difference between channels 1 and 2. Positive values indicate that the phase of channel 2 is leading.

Axis	Display Type	Description
X axis	Linear	Frequency is displayed with equal spacing
	Log	Frequency display of logarithm interval
Y axis	Lin-Mag	Analysis values are displayed linearly.

### Waveform Example

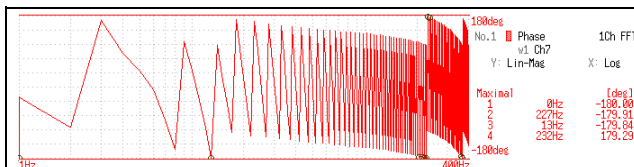

1chFFT  
X axis: Log  
Y axis: Lin-Mag

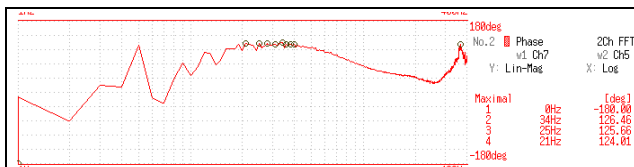

2chFFT  
X axis: Log  
Y axis: Lin-Mag

### ■ Emphasizing only a Specific Portion (Highlighted Display)

A specific portion of a phase spectrum can be emphasized and displayed.

See: "12.3.8 Emphasizing Analysis Results (phase spectra only)" (p.259)

## Auto Correlation Function

Shows the correlation of two points on the input signal at time differential  $t$ .

### Main uses:

- To detect periodicity in irregular signals (improving and detecting SNR)
- To inspect periodic components in a noisy waveform.

See: About the Functions"12.8.2 Analysis Mode Functions" (p.293)

Axis	Display Type	Description
X axis	Linear	Time display The center ( $t = 0$ ) is the reference. To the right is lag time ( $+t$ ), and to the left is lead time ( $-t$ )
Y axis	Lin-Mag	+1 to -1 (dimensionless units) The closest correlation at time differential $t$ is +1, and the least correlation is 0. -1 indicates completely reversed polarity. Because of the characteristics of the function, $t = 0$ becomes +1.

### Waveform Example

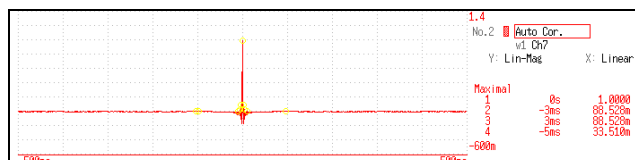

X axis: Linear  
Y axis: Lin-Mag

### **NOTE**

This instrument provides a circular auto-correlation function. Analysis results are normalized to the maximum value.

**Cross-Correlation Function**

Using two input signals, shows the correlation of two points on the input signal at time differential  $t$ . Output is displayed as a function of differential time  $t$ .

Main uses:

- To determine the phase shift of two signals per unit of time
- To determine the speed and distance of time lag between two signals

See: About the Functions"12.8.2 Analysis Mode Functions" (p.293)

Axis	Display Type	Description
X axis	Linear	Time display The center ( $t = 0$ ) is the reference. To the right is lag time ( $+t$ ), and to the left is lead time ( $-t$ )
Y axis	Lin-Mag	+1 to -1 is displayed in dimensionless units. At time differential $t$ , this value is +1 when the correlation of input and output signals is the closest, and 0 when correlation is the least. -1 indicates completely reversed polarity.

**Waveform Example**

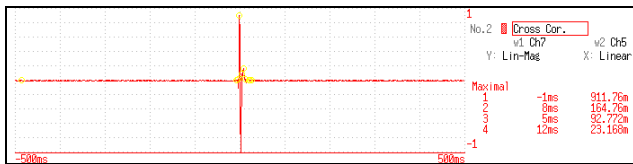

X axis: Linear  
Y axis: Lin-Mag

**NOTE**

This instrument provides a circular cross-correlation function. Analysis results are normalized to the maximum value.

**1/1 and 1/3 Octave Analysis**

Analyze spectrums such as noise using fixed rate spectrum filters of 1/1 octave band or 1/3 octave band.

Main uses:

To analyze noise frequency

See: About the Functions"12.8.2 Analysis Mode Functions" (p.293), "Octave Filter Characteristics" (p.26)

Axis	Display Type	Description
X axis	Log	Displays the center frequency of each band.
Y axis	Lin-Mag	Octave analysis values are displayed linearly.
	Log-Mag	Octave analysis values are displayed as dB values. (0 dB reference value: 1eu)*

\* eu: engineering units that are currently set are the standard (e.g., when the unit settings is volts, 0 dB = 1 V)

**Waveform Example**

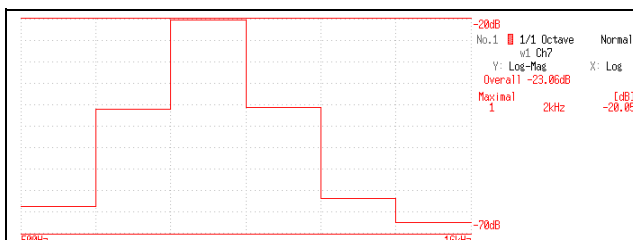

1/1 Octave  
X axis: Log  
Y axis: Log-Mag  
Filter: Normal

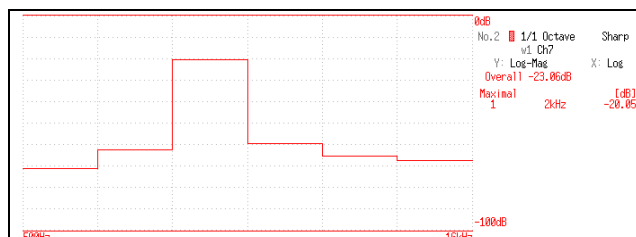

**1/1 Octave**  
 X axis: Log  
 Y axis: Log-Mag  
 Filter: Sharp

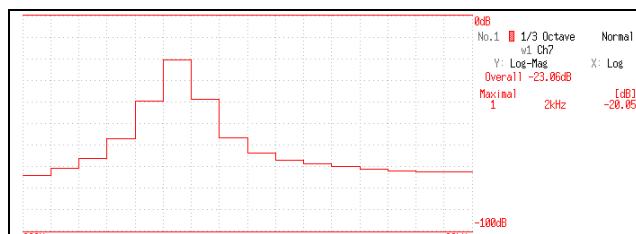

**1/3 Octave**  
 X axis: Log  
 Y axis: Log-Mag  
 Filter: Normal

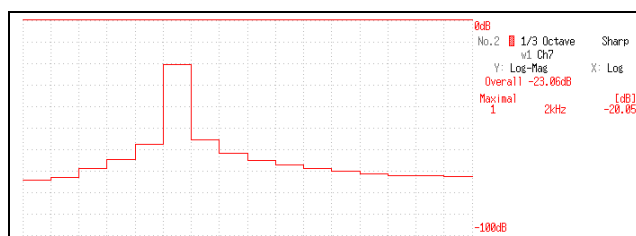

**1/3 Octave**  
 X axis: Log  
 Y axis: Log-Mag  
 Filter: Sharp

**NOTE** Not available with external sampling enabled.

## ■ Octave Analysis

Octave analysis consists of frequency analysis of the signal passed through a constant-width band-pass filter. The power spectrum displays the power level in each subband after dividing the spectrum into fixed-width segments (subbands), while octave analysis scales the spectrum logarithmically and displays each octave (subband) as a bar graph.

The center frequency of the octave bands and filter characteristics are determined according to IEC61260 standards. With this instrument, 1/1- and 1/3-octave analyses are calculated using power spectrum Analysis results.

1/1 Octave Analysis: 6 subbands

1/3 Octave Analysis: 16 subbands

The octave analysis results of this unit are displayed based on the oscillation level as a reference. Therefore, when only sine waves are input, the value doubles (3.01 dB) versus the overall value. To directly read by energy base, adjust the level by the setting scaling in advance.

See: "7.4 Converting Input Values (Scaling Function)" (p.148)



(●: 1/1 OCT, ○: 1/3 OCT)

Timebase	5 μ	10 μ	20 μ	50 μ	100 μ	200 μ	500 μ	1m	2m	5m	10m	20m	50m	100m	200m	500m	1	2	5	10	30	50	60	100	120	300	
Period [s]	50h	100h	200h	500h	1μ	2μ	5μ	10μ	20μ	50μ	100μ	200μ	500μ	1m	2m	5m	10m	20m	50m	100m	300m	500m	600m	100	120	300	
Sampling frequency [Hz]	20M	10M	5M	2M	1M	500k	200k	100k	50k	20k	10k	5k	2k	1k	500	200	100	50	20	10	3.33	1.66	1	1	1.2	3	
Frequency range [Hz]	8H	4H	2H	800k	400k	200k	80k	40k	20k	8k	4k	2k	800	400	200	80	40	20	8	4	1.33	800m	667m	400m	333m	133m	
1/1 OCT	0	1	2	3	4	5	6	7	8	9	10	11	12	13	14	15	16	17	18	19	20	21	22	23	24	25	
1/3 OCT																											
7											●	○	○	○	○	○											
8										●	○	○	○	○	○	○											
9									●	○	○	○	○	○	○	○											
10								●	○	○	○	○	○	○	○	○											
11							●	○	○	○	○	○	○	○	○	○											
12							●	○	○	○	○	○	○	○	○	○											
13							●	○	○	○	○	○	○	○	○	○											
14							○	○	○	○	○	○	○	○	○	○											
15							○	○	○	○	○	○	○	○	○	○											
16							○	○	○	○	○	○	○	○	○	○											
17							○	○	○	○	○	○	○	○	○	○											
18							○	○	○	○	○	○	○	○	○	○											
19							○	○	○	○	○	○	○	○	○	○											
20							○	○	○	○	○	○	○	○	○	○											
21							○	○	○	○	○	○	○	○	○	○											



## 12.8.2 Analysis Mode Functions

Analysis Mode	Internal analysis formula (linear, real, imag [imaginary], log [logarithm])
OFF	No analysis.
Storage Waveform	A waveform obtained by applying the window function to a time-domain waveform.
Histogram	Counts amplitude data.
Linear Spectrum	$X(k) = \sum_{n=0}^{N-1} x(n)W^{kn} \quad F(k) = CX(k) \quad C = \begin{cases} 1/N(DC) \\ 2/N(AC) \end{cases}$ $linear =  F(k)  \quad real = \text{Re}\{F(k)\} \quad imag = \text{Im}\{F(k)\} \quad log = 20 \log  F(k) $
RMS Spectrum	$F'(k) = C'F(k) \quad C' = \begin{cases} 1 (DC) \\ 1/\sqrt{2} (AC) \end{cases}$ $linear =  F'(k)  \quad real = \text{Re}\{F'(k)\} \quad imag = \text{Im}\{F'(k)\} \quad log = 20 \log  F'(k) $
Power Spectrum	$P(k) = a F(k) ^2 \quad a = \begin{cases} 1 (DC) \\ 1/2 (AC) \end{cases}$ $linear = P(k) \quad log = 10 \log  P(k) $
Power Spectrum Density	$P'(k) = P(k)/\delta f \quad \delta f: \text{Frequency resolution}$ $linear = P'(k) \quad log = 10 \log  P'(k) $
LPC analysis(Power Spectrum Density)	(Abbr.) Spectrum approximation from Linear Predictive Coding. See: "Linear Predictive Coding (LPC)" (p.A27)
Transfer Function	$H(k) = Y(k)/X(k)$ $linear =  H(k)  \quad real = \text{Re}\{H(k)\} \quad imag = \text{Im}\{H(k)\} \quad log = 20 \log  H(k) $
Cross Power Spectrum	$S_{yx}(k) = X^*(k)Y(k) : \text{Cross Spectrum}$ $X_{power}(k) = AS_{yx}(k) \quad A = \begin{cases} 1/N^2 \\ 2/N^2 \end{cases}$ $linear =  X_{power}(k)  \quad real = \text{Re}\{X_{power}(k)\}$ $mag = \text{Im}\{X_{power}(k)\} \quad log = 10 \log  X_{power}(k) $
Impulse Response	$h(n) = \frac{1}{N} \sum_{k=0}^{N-1} \frac{Y(k)}{X(k)} W^{-kn}$
Coherence Function	$coh(k) = \frac{\sqrt{S_{yx}(k)S_{yx}^*(k)}}{\sqrt{S_{xx}(k)S_{yy}(k)}}$
Phase Spectrum	$\theta(k) = 180/\pi \times \tan^{-1}(\text{Im}(F'(k))/\text{Re}(F'(k)))$ $\theta(k) = 180/\pi \times \tan^{-1}(\text{Im}(S_{yx}(k))/\text{Re}(S_{yx}(k)))$
Auto-correlation Function	$R_{xx}(n) = \frac{1}{N} \sum_{k=0}^{N-1}  X(k) ^2 W^{-kn} \quad (\text{recursive convolution})$
Cross-correlation Function	$R_{yx}(n) = \frac{1}{N} \sum_{k=0}^{N-1} S_{yx}(k) W^{-kn} \quad (\text{recursive convolution})$
1/1 Ovtave Analysis	(Abbr.)
1/3 Ovtave Analysis	(Abbr.)





# Waveform Evaluation Function (MR8741 Only) Chapter 13

## 13.1 Waveform GO/NG Evaluation (MEM, FFT Function)

Only MR8741 supports the waveform evaluation function.

- The waveform evaluation function can be used from the Memory function (single screen, X-Y single screen), FFT function (1 screen standard, 1 screen Nyquist).
- GO (pass) or NG (fail) evaluation of the input signal waveform can be performed using an evaluation area specified by the user.
- This can serve to detect irregular waveforms.
- Depend on evaluation result, GO and NG terminal output the signal.
- All displayed channels can be used for GO/NG evaluation.

13

Chapter 13 Waveform Evaluation Function (MR8741 Only)

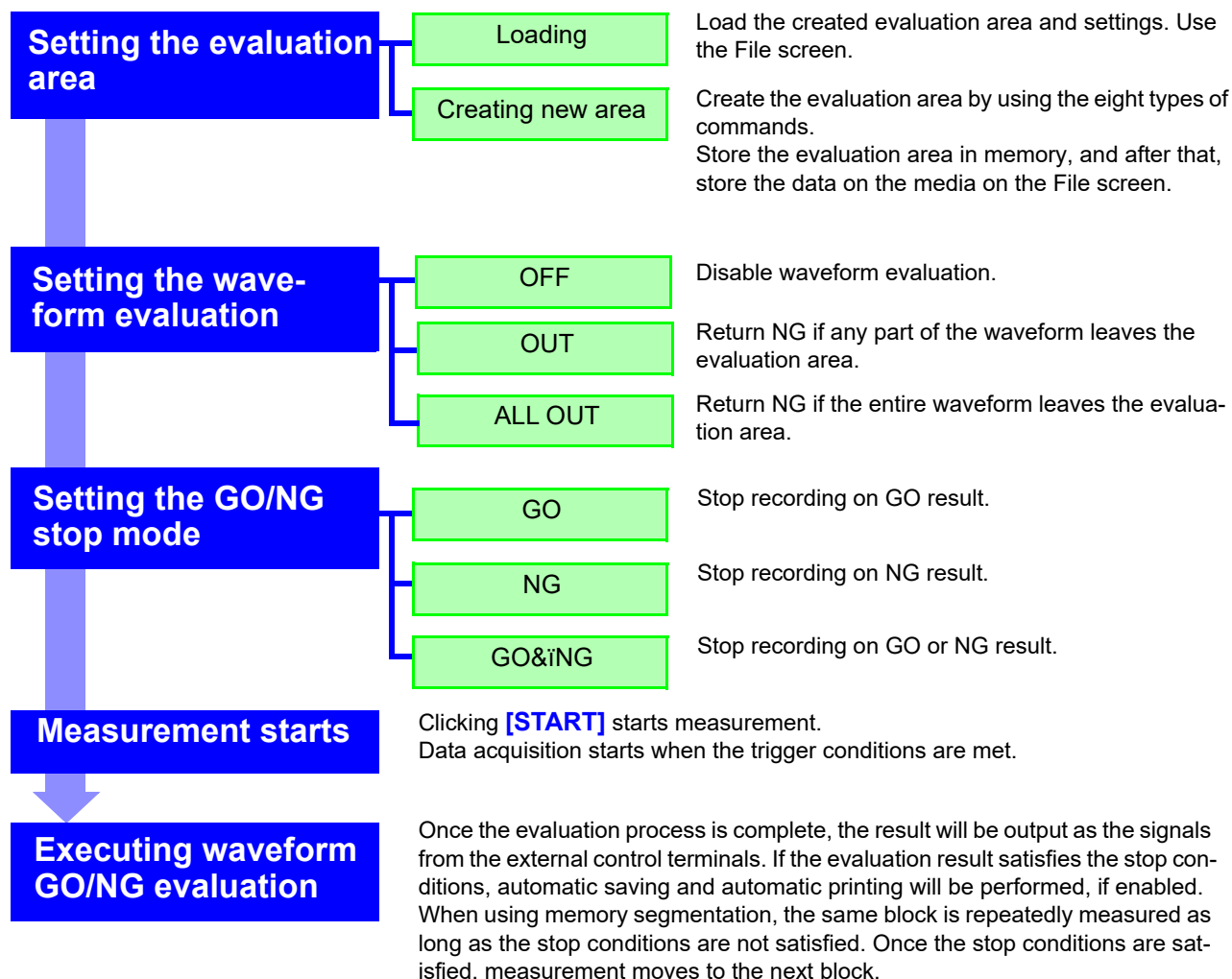

**NOTE**

- Trigger mode: SINGLE Measurement continues until stop mode conditions are fulfilled and then stops.
  - Trigger mode REPEAT, AUTO Recording and waveform evaluation is carried out continuously. Click **[STOP]** to terminate the measurement.
  - When "auto save" is set to ON, data are stored on media when the stop conditions are satisfied.
  - When memory segmentation is ON, data is recorded to the memory block only when the stop conditions are satisfied.
  - During waveform evaluation, evaluation is performed concurrently with measurement when the time axis range is 1 ms/div or less with the roll mode setting ON or during automatic operation with the display at 100 ms/div or less as a result of the time axis magnification factor. At all other times, evaluation is performed after measurement is complete.
  - When performing evaluation after measurement is complete, this sequence of two alternating operations (capturing data and performing the evaluation) is performed repeatedly, so that data is not captured while the evaluation is in progress. Therefore data are not captured while the evaluation is in progress, which means that the input signal is not being continuously monitored. The time required for evaluation is on the order of 100 ms.
  - When performing evaluation and measurement concurrently, the waveform is displayed and evaluated while measurement continues. However, please note that processing is not necessarily conducted in real time.
  - If a high setting is chosen for recording length or if compression is used, the evaluation cycle becomes slower.
  - Waveform scrolling is not available while waveform evaluation is ON. To use waveform scrolling, you should first turn waveform evaluation OFF.
  - Although the waveform display will change if you change display-related settings after measurement completes, the waveform evaluation results from when the measurement was made are retained. To repeat the evaluation process for the waveform after the new settings have been applied, perform waveform evaluation on the Status basic settings screen.  
[See: "6.5.1 Magnifying and Compressing Horizontal Axis \(Time Axis\)" \(p.129\)](#)
  - When using the highlight function with the FFT function, only the highlighted data is evaluated.
-

## Waveform evaluation mode and stop mode

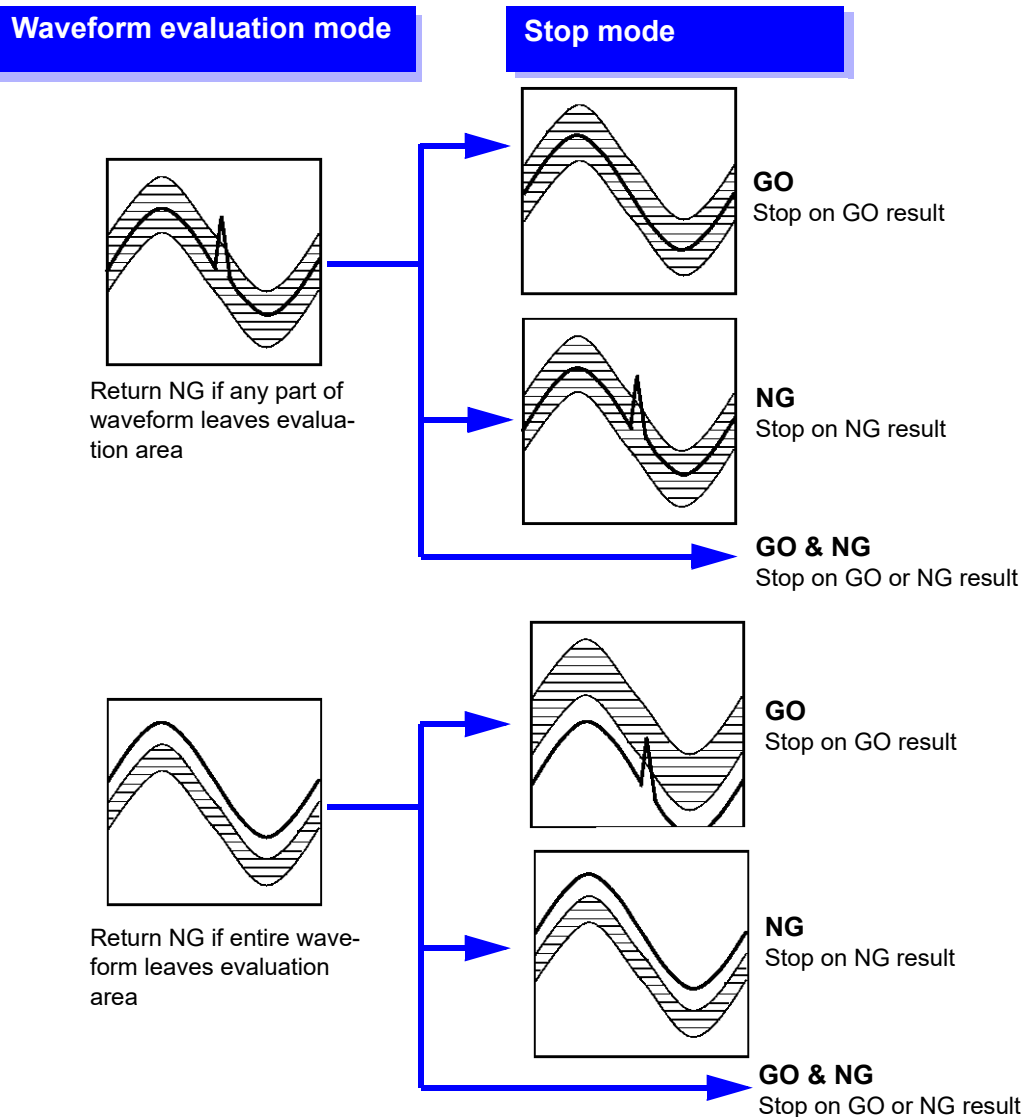

# 13.2 Setting the Waveform Area

To evaluate the waveforms, a evaluation area is required. Two methods are available: one is to load the already created evaluation area and settings, and the other is to create a new evaluation area.

## Loading the already created evaluation area

### Setting method

#### Procedure Screen: FILE

- 1 Click **[FILE]** to call the File screen.
- 2 Select the media for loading.
- 3 Use the bar cursor to select the desired file.
- 4 Select **[Load]**.
- 5 Select **[Exec]**.
- 6 When no more changes need be made to the loaded settings, press the **DISP** key to make the Waveform screen appear, and then press the **START** key to initiate measurement.  
 To change the settings, first change the contents, then press the **DISP** key to make the Waveform screen appear, and then press the **START** key to initiate measurement.  
 See: "4.3 Loading Data" (p.99)

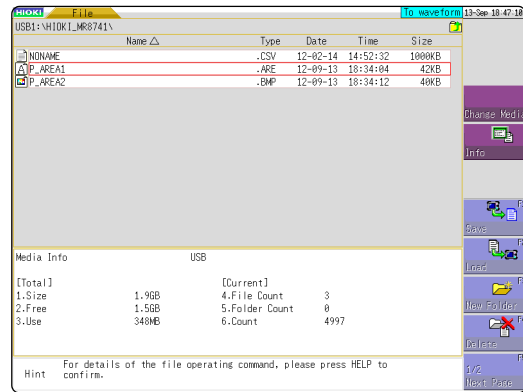

### Requirements for loading waveform evaluation area BMP files

Observe the following requirements when creating waveform evaluation areas on a computer and when loading waveform evaluation areas created on other equipment:

item	Condition	Loading operation
Color	White and black	White pixels are treated as background, and black pixels are treated as the evaluation area.
Size	501 horizontal pixels × 626 vertical pixels	The file will be used as the evaluation area for the Memory Function 1 screen.
	501 horizontal pixels × 501 vertical pixels	When using the FFT function, the file will be used as the FFT evaluation area. When using other functionality, the file will be used as the memory function XY evaluation area.

Files that do not satisfy these requirements cannot be loaded properly.

## Creating a new evaluation area

### Setting method

#### Procedure Screen: STATUS

- 1 Click **[STATUS]** to call the Status screen.
- 2 Move the flashing cursor to Waveform Judge.
- 3 Select **[Edit]** from the GUI displayed on the screen.
- 4 Make the new evaluation area.  
See: "13.5 Creating the Evaluation Area" (p.303)
- 5 Store the new evaluation area in the internal memory.
- 6 After setting the parameters for "Waveform Judge setting" and "Stop Mode," click **[DISP]** to make the Waveform display screen appear, and then click **[START]** to initiate measurement.
- 7 Save the evaluation area on the File screen, if it s necessary.  
See: "4.2 Saving Data" (p.87)

#### Function:MEMORY

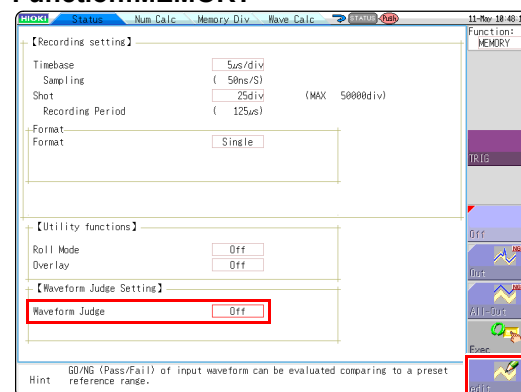

#### Function:FFT

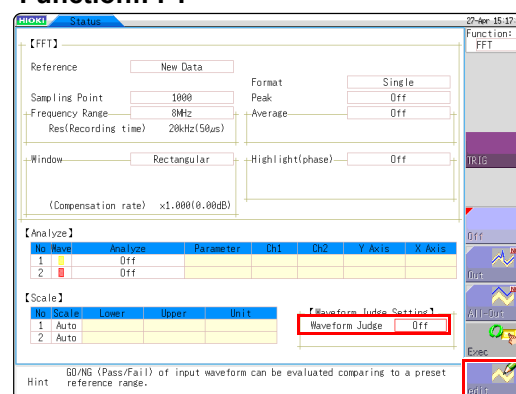

### **NOTE**

Only one waveform evaluation area is stored in internal memory. For example, when operation is changed from the Memory function screen to the X-Y screen and the X-Y screen waveform evaluation area is stored, the waveform evaluation area created for the Memory function is lost.

# 13.3 Setting the Waveform Evaluation Mode

## Setting method

### Procedure Screen: STATUS

- 1 Move the flashing cursor to Waveform Judge.
- 2 Select the setting from the GUI displayed on the screen.

Select

<b>Off</b>	Disable waveform evaluation.
<b>Out</b>	Return NG if any part of the waveform leaves the evaluation area.
<b>All out</b>	Return NG if the entire waveform leaves the evaluation area.
<b>exec</b>	Enable waveform evaluation.
<b>edit</b>	Activate editor for setting up evaluation area.

### Function:MEMORY

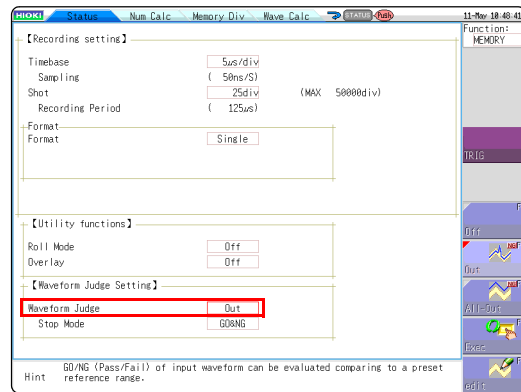

### Function:FFT

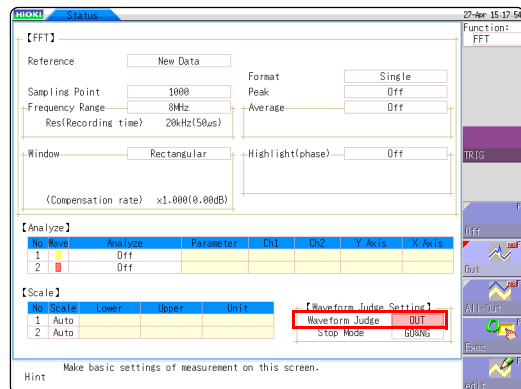

## 13.4 Setting the GO/NG Stop Mode

When waveform evaluation is enabled (OUT or ALL OUT is selected), the "Stop mode" menu appears. Specify which evaluation option, GO or NG, should be used to stop the recording. The Auto Save function is only executed when interruption conditions are satisfied.

### Setting method

#### Procedure Screen: STATUS

- 1 Move the flashing cursor to the position Stop Mode.
- 2 Select the setting from the GUI displayed on the screen.

Select

GO	Stop recording on GO result.
NG	Stop recording on NG result.
GO or NG	Stop recording on GO or NG result.

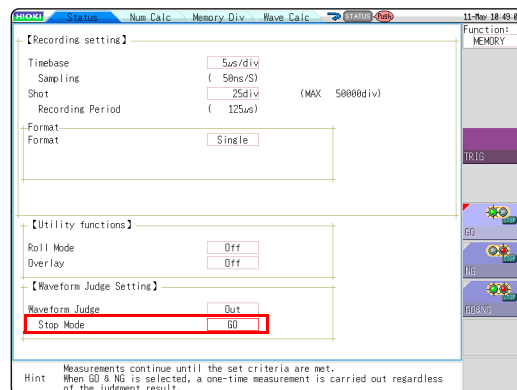



### Relationship between stop conditions and the trigger mode

- There are three trigger modes: Single, Repeat, and Auto.
- See: "8.2 Setting the Trigger Mode" (p.191)
- There are three stop conditions: PASS, FAIL, and PASS & FAIL.
- By combining a trigger mode and a stop condition, you can halt measurement when a desired comparison result is achieved. You can also automatically save, or superimpose the waveform for the desired evaluation results. Automatic saving, and superimposition are performed when the stop conditions are met.

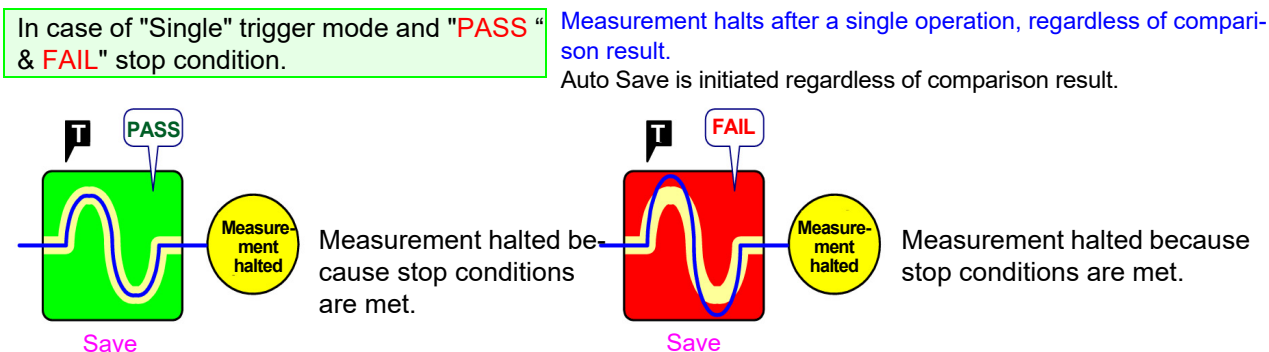
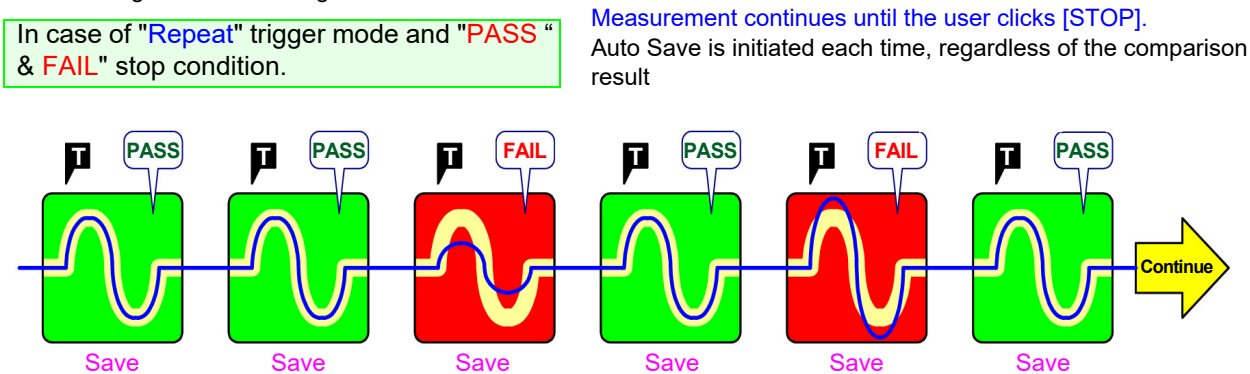
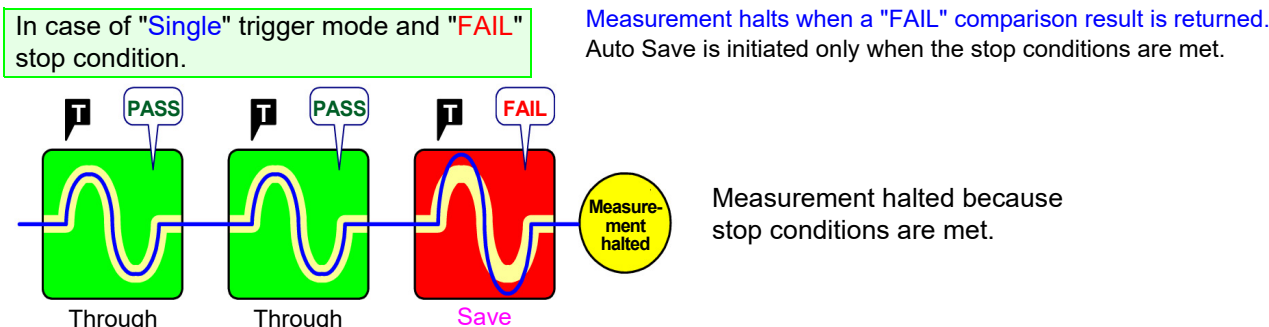
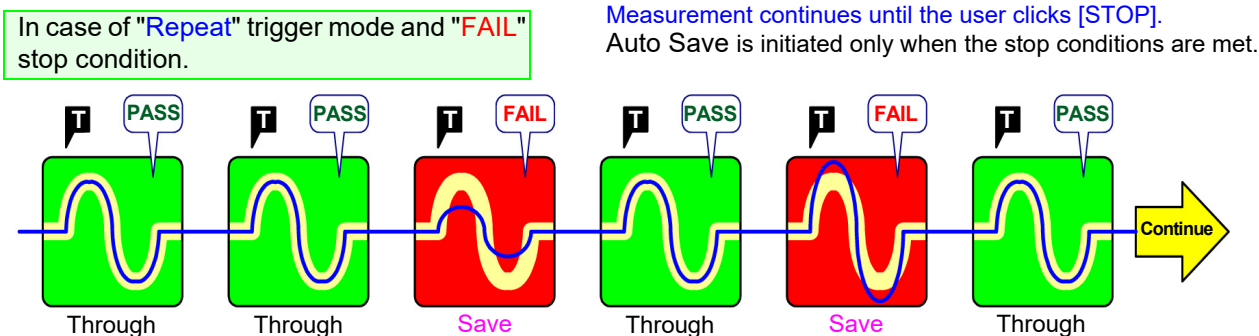

- When the "Single" trigger mode is set, measurement is stopped if the stop conditions are met. Measurement continues until the stop conditions are met.
- When the "Repeat" or "Auto" trigger mode is set, measurement continues until [STOP] is clicked (or a STOP signal is input), whether or not the stop conditions are met.

## 13.5 Creating the Evaluation Area

### Setting method

#### Procedure Screen: Waveform display

- 1 Move the flashing cursor to the **[Waveform Judge]** item and select **[Edit]** from the GUI displayed on the screen.
- 2 Select an editor from the GUI displayed on the screen, and create the area that will be the reference for waveform judgment. You can also use the mouse to create an area.  
See: "1.5.1 Mouse Operations" (p.22)
- 3 Click **[Exit]** to terminate the editor.
- 4 Serves to store the created area in memory.
 

<b>Save and End</b>	Saves the created evaluation area in the instrument's internal memory and exits.
<b>Discard Changes and End</b>	Discards the created evaluation area and exits.
- 5 Save the evaluation area through the File screen or **[SAVE]**, if necessary.  
See: "4.2 Saving Data" (p.87)

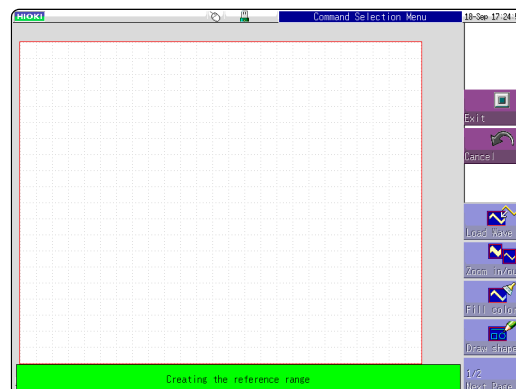

## 13.6 Editor Command Details



### Load Wave

The waveform shown on the Waveform screen is loaded into the editor and displayed.

#### Instructions

- 1 Select **[Load Wave]**.
- 2 Select the type of waveform capture to perform. The waveform displayed on the Waveform screen will be loaded into the editor.

Select	
Waveform capture	Captures the storage waveform displayed on the Waveform screen.
Overlay capture	Captures overlay waveforms shown on the Waveform screen after connecting the uppermost and lowermost positions with the same display color and filling in the resulting enclosed space. When the waveforms are overlapping, undisplayed portions of the waveforms cannot be recognized. This option can be selected when an overlay has been drawn on the screen.
Memory segmentation reference waveform	Captures the memory segmentation reference waveform shown on the Waveform screen after connecting the uppermost and lowermost positions with the same display color and filling in the resulting enclosed space. When the waveforms are overlapping, undisplayed portions of the waveforms cannot be recognized. This option can be selected when an overlay has been drawn on the screen.

- 3 Select **[Load Wave]** to exit waveform capture mode.



### Zoom in/out

Magnifies or compresses the waveform shown on the screen in the horizontal and vertical directions.

#### Instructions

- 1 Select **[Zoom in/out]**.
- 2 Select whether to magnify or compress the waveform.
- 3 Set the amount of magnification or compression.
  - You can set values with the mouse.
  - The amount of movement can be set in 0.04/div steps.

Execute	Performs magnification or compression processing based on the settings and creates an evaluation area.
Exit magnification/compression	Exits magnification/compression mode.

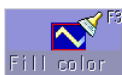

## Fill color

Fills in an enclosed area.

### Instructions

- 1 Select **[Fill color]**.
- 2 Use the mouse to move the paintbrush mark  to the area to be filled in. If the area is not completely enclosed, adjacent areas will also be filled in.



Execute	The area completely enclosed by lines is filled in.
Exit paint	Terminate the paint mode.



## Draw shape

Serves to draw a straight, square or a circle.

### Instructions

- 1 Select **[Draw shape]**.
- 2 Select the figure you wish to draw.
- 3 Using the mouse, move the  mark to the origin of the figure.
- 4 Selecting **[Set]** sets the current position as the origin.
- 5 Moving the  mark draws a figure between the origin and the  mark.
- 6 Selecting **[Set]** again accepts the figure and causes its color to change. For straight lines, the origin is set at the accepted position. For other types of figure, accepting the figure has the same effect as selecting **[Cancel]**.
- 7 To draw another figure, click **[Select]** and selecting the figure type.
- 8 You can repeat steps (3) through (7) to draw figures as desired.
- 9 Click **[Exit Draw shape]** to exit figure mode.





## Eraser

Serves to erase unwanted sections.

Move the  mark with the mouse to erase parts of the image.

### Instructions

- 1 Select **[Eraser]**.
- 2 Use the mouse to move the eraser mark  to the start point of the section to be erased.
- 3 Clicking **[Set]** allows you to erase figures while moving the eraser. Clicking **[Cancel]** allows you to move the eraser without erasing the figures.
- 4 Move the  mark in the **[Set]** state to erase the parts of figures you don't need.
- 5 Click **[Exit Erase]** to terminate the erase mode.



## Clear all

Clears the entire editor screen.



Select **[Clear all]** to clear the editor screen.



## Clear select area

Clears a specified rectangular area of the editor screen.

### Instructions

- 1 Select **[Clear select area]**.
- 2 Using the mouse, move the  mark to the origin of the area to be erased.
- 3 Clicking **[Set]** sets the position as the origin.
- 4 Moving the  mark displays a rectangle drawn between the origin and the  mark.
- 5 Clicking **[Set]** again erases the area inside the rectangle. Clicking **[Cancel]** cancels the position of the origin.
- 6 Click **[Exit Area Clear]** to exit area clear mode.



## Invert colors

Reverses the colors of a filled-in area and the surrounding area.

Select **[Invert colors]** to display filled-in area in reverse.



## Cancel

Serves to undo the immediately preceding command.

It can be used with commands other than [Save and End] and [Discard and End].

Select **[Cancel]** to cancel the editor screen.



## Exit

Terminates the editor.

Select **[Exit]** to select storing evaluation area in memory and quit editor or quitting editor without storing evaluation area in memory. If **[Exit]** is clicked without having done any editing or immediately after using the store command, the editor is terminated without confirmation.

**Note** :The waveform loaded into the editor will be displayed in a different color than was set with the original settings.

Save and End	Store evaluation area in memory and quit editor. <a href="#">See:"4.2 Saving Data" (p.87)</a>
Discard and End	Quit editor without storing evaluation area in memory. The created area is discarded.



# System Environment Settings

## Chapter 14

Use the System screen - **[Environment]** sheet to make system-related settings.

### Opening the **[Environment]** sheet

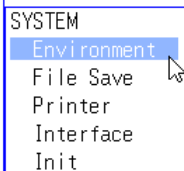
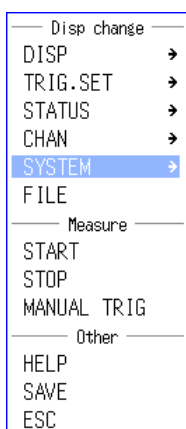

Select **[SYSTEM]** and then **[Environment]** from the right-click menu.

### MR8740

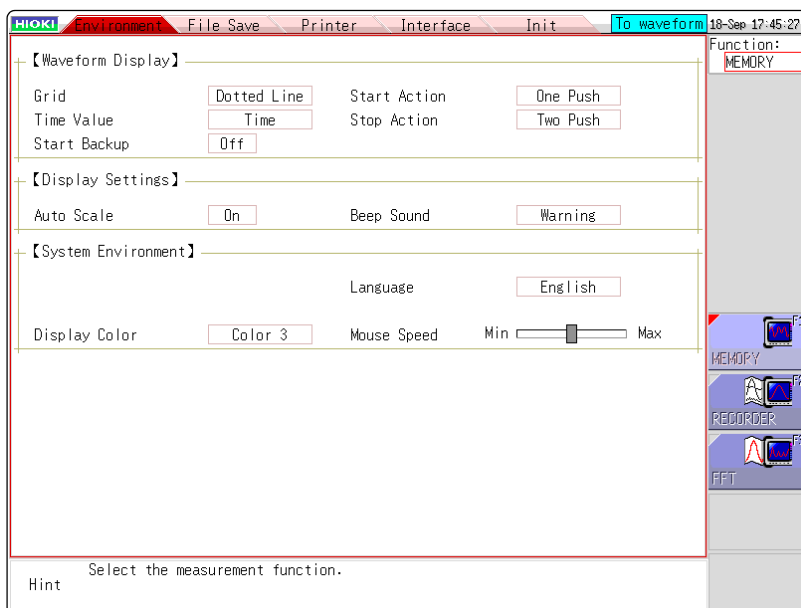

### MR8741

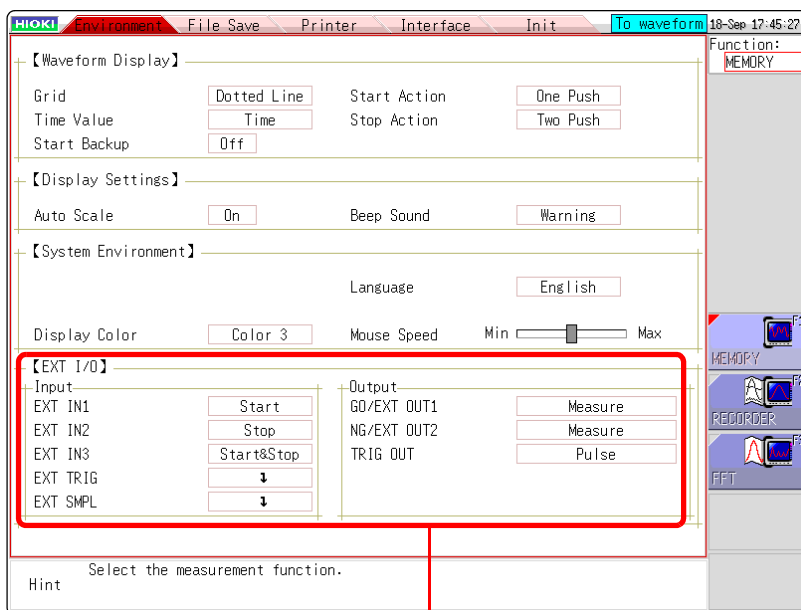

See: "Chapter 16 External Control (MR8741 Only)" (p.335)



## Setting Descriptions

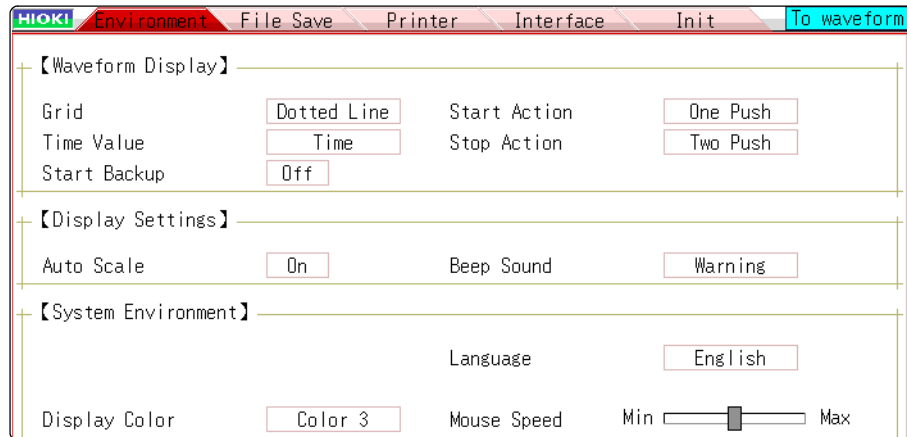

### Grid

Select the grid (graticule) type for the waveform screen.

<b>Off</b>	No grid displayed.
<b>Dotted Line</b>	Display a dotted-line grid. (default setting)
<b>Solid Line</b>	Display a solid-line grid.

### Time Value

Display the time from the trigger point on the display.

<b>Time</b>	Display the time from the trigger point (fixed units). (default setting)
<b>Time (60)</b>	Display the time from the trigger point (sexagesimal (base-60) system).
<b>div</b>	Display the number of divisions (div) from the trigger point.
<b>Date</b>	Display time of waveform acquisition.
<b>Sample Num</b>	Display the number of data points from the trigger point.

- During external sampling, the number of points is fixed.
- These settings affect the values read at the A/B cursors.

### Start Backup

Preserves measurement condition settings. If a power outage occurs while recording, it resumes automatically when power is restored. When triggering is enabled, the awaiting-trigger state is activated.

**Off (default setting) / On**

- Valid only during recording.
- This function does not start automatically when the instrument is turned on.

### Display Color

Screen background and character colors on the Waveform screen can be set as desired. Select **[Color Edit]** change the **[R]** (red), **[G]** (green) and **[B]** (blue) values of each item to change its color. ( p.312)

**Color 1 / Color 2 / Color 3 / Color Edit**

### Beep Sound

This function audibly indicates warnings and operating conditions by beep sounds.

<b>Off</b>	Beep sounds are disabled.
<b>Warning</b>	Beeps sound for error messages (warning displays) and upon NG (fail) judgments. (default setting)
<b>Warn+Act</b>	In addition to the warning beeps above, beeps sound to indicate start, trigger, stop and auto-save-finish.

Language	Selects the display language.
<b>English (default setting) / Japanese / Korean / Chinese</b>	
Auto Scale	Variable values are automatically changed according to changes in scaling and voltage range.
<a href="#">See: "7.5 Variable Function (Setting the Waveform Display Freely)" (p.155)</a>	
<b>Off / On (default setting)</b>	
Start Action	To prevent operating mistakes from unintentionally starting measurement, the <b>[START]</b> operation method can be changed. This setting does not affect external control terminal functions.
<b>Click Once</b> Click once with the mouse to start measurement. (default setting)	
<b>Click Twice</b> Click twice with the mouse to start measurement.	
Stop Action	Normally, clicking <b>[STOP]</b> once causes measurement to stop after the specified recording length is completed, and clicking it twice stops measurement immediately. However, this setting is provided to allow a single click of <b>[STOP]</b> to stop measurement.
<b>Click Twice</b> Click twice with the mouse to stop measurement. (default setting)	
<b>Click Once</b> Click once with the mouse to stop measurement.	
Mouse Speed	Sets the mouse movement speed. Use the mouse to move the square while holding down the left button. Moving it towards "Min" makes the mouse pointer move more slowly, while moving it towards "Max" makes the pointer move more quickly.

Mouse Speed      Min  Max

## Additional Description

Selecting a  
Screen Color

Select **[Color Edit]** to display the **[Custom Color]** screen.  
Change the **[R]** (red), **[G]** (green) and **[B]** (blue) values of each item to change its color.

See: "7.1.3 Alphanumeric Input" (p.141)

**[Custom Color]** screen

The screenshot shows the 'Custom Color' screen with a waveform display on the left and a list of color settings on the right. The waveform display shows several colored waves with numerical values like 2.5400mV and 3.2800mV. The list of settings includes Wave 1 through Wave 16, Grid, Cursor A, Cursor B, Number, AllBack, WaveBack, SetBack, and Waveform, each with R, G, and B values.

	R	G	B
Wave 1	7	7	0
Wave 2	7	0	0
Wave 3	0	7	7
Wave 4	0	7	0
Wave 5	7	0	7
Wave 6	7	4	0
Wave 7	4	6	0
Wave 8	0	4	4
Wave 9	0	0	0
Wave 10	4	4	4
Wave 11	2	3	7
Wave 12	4	7	5
Wave 13	7	6	4
Wave 14	7	4	5
Wave 15	5	4	7
Wave 16	4	0	4
Grid	5	5	5
Cursor A	0	0	5
Cursor B	0	4	0
Number	0	0	0
AllBack	6	6	6
WaveBack	7	7	7
SetBack	7	7	7
Waveform	3	6	6

Color setting for each waveform

Grid (graticule) color

Colors of cursor A and B lines

Color of numerical values

Background color

Background color of the Waveform screen

Background color of the setting screen

Evaluation area color

Select

Done

Applies the settings.

Reset

Reverts to the default settings.

# Connection to a Computer

## Chapter 15

This instrument is equipped with an Ethernet 100BASE-TX interface for LAN communications. You can control the instrument from PCs and other devices by connecting it to a network with 10BASE-T or 100BASE-TX cable (maximum length 100 m).

### Opening the [Interface] sheet

The screenshot shows the instrument's menu system. On the left, a 'Disp change' menu lists options: DISP, TRIG.SET, STATUS, CHAN, SYSTEM, FILE, Measure, START, STOP, MANUAL TRIG, Other, HELP, SAVE, and ESC. The 'SYSTEM' option is highlighted, and a sub-menu is shown with options: SYSTEM, Environment, File Save, Printer, Interface, and Init. An arrow points from the 'Interface' option to the main configuration window.

The main configuration window is titled 'HIOLKI Environment File Save Printer Interface Init To waveform 5-Feb 9:12:58'. It contains several sections:
 

- 【Common】**: Delimiter (CR+LF), Header (Off).
- 【Interface】**: Interface (LAN), Disp Update (TRUE), Host Name, IP Address (192.168.0.2), Subnet Mask (255.255.255.0), Gateway (Off), IP Address (0.0.0.0), Port Number (880x).
- 【FTP/HTTP】**: Authorization (Off), User Name, Password, Access Ctrl, Read-Only, Reset.
- 【MAC Address】**: 00 01 67 00 00 00.

 A red box highlights the MAC Address field, and a callout box explains: 'MAC Address This is a unique number that is used to identify devices in a network.'

A text box at the bottom left of the screenshot states: 'Select [SYSTEM] and then [Interface] from the right-click menu.'

### Operations available from the [Interface] sheet

#### LAN connections and settings (p.314)

- Connecting the instrument and a PC over a network
- Making 1:1 Connections between the instrument and a PC

#### Accessing files on the instrument via FTP (p.327)

The instrument is equipped with an FTP (File Transfer Protocol, compliant with RFC959) server. You can use a PC FTP client to transfer files to instrument media and perform other file operations.

#### Remote control of the instrument using an Internet browser (p.320)

#### Controlling the instrument by command communications (p.332)

You can control the instrument by creating programs and connecting to the command communications port by TCP.

#### Operating the instrument remotely and acquiring data by using Model 9333 LAN Communicator (p.334)

For more information about commands, refer to the communications operation manual on the supplied application disk.

### NOTE

The settings of both block I and block II need to be made for MR8740.

# 15.1 LAN Settings and Connection (Before Using FTP/Internet Browser/Command Communications)

The required settings are different, depending on whether the instrument is to be connected to an existing network or directly to a PC.

### **CAUTION**

When connecting the instrument to your LAN using a LAN cable of more than 30 m or with a cable laid outdoors, take appropriate countermeasures that include installing a surge protector for LANs. Such signal wiring is susceptible to induced lighting, which can cause damage to the instrument.

### **NOTE**

Always configure the LAN settings before connecting the instrument to the network. When you change the settings while connected to the network, the IP addresses may not be unique or invalid address data may be transmitted over the network.

## 15.1.1 Making LAN Settings at the Instrument

### Things to Check Before Making Settings

The required settings are different, depending on whether the instrument is to be connected to an existing network or whether a new network consisting only of the instrument and one computer is to be configured.

#### When Connecting the instrument to an Existing Network

The following items must be assigned in advance by your network administrator. Be sure that there is no conflict with other devices.

- **The host name and address of the instrument**  
Host name (up to 12 characters): \_\_\_\_\_  
IP address: ..... : ..... : ..... : .....  
Subnet mask: ..... : ..... : ..... : .....
- **Gateway**  
Whether to use a gateway: Yes/No  
IP address (when used): ..... : ..... : ..... : .....
- **The TCP/IP port number to use:** \_\_\_X (default 880x)  
(Specify the most significant 3 digits of the 4-digit number. The least significant digit (0 to 9) is reserved for use by the instrument. Specify when the default 8800 to 8809 cannot be used.)

#### When Configuring a New Network with a PC and This Instrument

(Using as Local Network Without External Connections)  
If there is not administrator for your network, or if you have been entrusted with settings, the following addresses are recommended.

(Settings example)

```

IP address
PC: 192.168.0.1
First recorder: 192.168.0.2
Second recorder: 192.168.0.3 and so on, in sequence.
      ↓                ↓
Host name ..... Any name (However, must be unique)
Subnet mask ..... 255.255.255.0
Gateway ..... Off
Port number ..... 880X

```

## Setting Items

<b>Interface</b>	LAN
<b>Host Name</b>	This is a name that identifies the instrument on the network. Assign a host name that is different from the names of all other devices. This instrument does not support dynamic DNS, the name that you set is not registered with a DNS server.
<b>IP Address</b>	This is an address that identifies an individual device on a network. Assign an address that is different from the addresses of all other devices.
<b>Subnet Mask</b>	This is a setting used to divide an IP address shown to the network into a network address and a host address. Use the same subnet mask for all devices in the same network.
<b>Gateway IP Address</b>	<b>For network connections:</b> When your PC (or the communicating device) is on another network than this instrument, set this to <b>[On]</b> and specify the gateway device. When the PC is on the same network, this is usually set to the same address as the default gateway in the PC communications settings.

## Authorization User Name and Password

These are used when you login to the instrument by FTP, or use a PC browser (with the authorization setting set to on).

When authorization is enabled, login is not possible unless a correct user name and password are entered. This setting is recommended if you wish to restrict the users who can access the instrument.

The "Password" item is displayed as "\*\*\*\*\*".

Valid characters: Alphabetic characters and symbols (however, ":" (colon) cannot be used)

If you want to allow anyone to access, or you wish to login as "anonymous" with a FTP client, leave the user name and password fields blank.

## 15.1 LAN Settings and Connection (Before Using FTP/Internet Browser/Command Communications)

MR8740/MR8741 is not equipped with a DHCP function.

There are two methods to install the instrument (MR8740/MR8741) to a network using a DHCP server to assign IP addresses.

- (1) Ask your network system administrator to provide an available IP address, which is out of the range of the IP addresses the DHCP server leases, and assign it as the static IP address to the instrument.
- (2) Forward incoming traffic addressed to the IP address assigned by the DHCP server via a router.

It is recommended to employ the former method (1) to assign the static IP address to the instrument because the latter method (2) will make the setting configuration complicated and require additional work to verify the IP address assigned by the DHCP server.

As the figure below indicates, install the router between the DHCP server and the instrument. Contact your dealer or Hioki representative for more information.

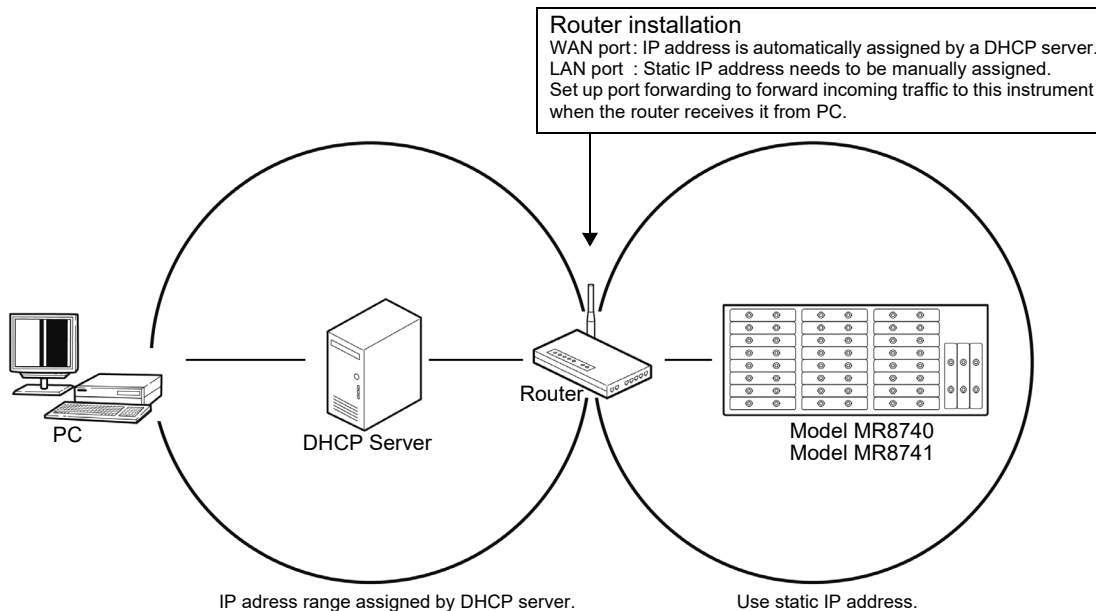

**LAN Setup Workflow**

Click **[SYSTEM]** in the right-click menu to display the Communications sheet. According to the intended use, make settings as outlined below.

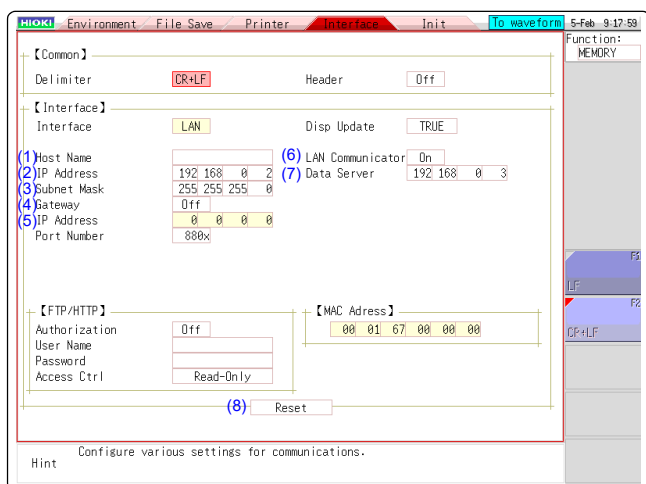

Use the mouse to move the flashing cursor and select a setting item.

See: "7.1.3 Alphanumeric Input" (p.141)

For details on each setting, see "Setting Items" (p.315).

**About the network**  
For IP address information and other details about the network you are using, contact your network administrator.

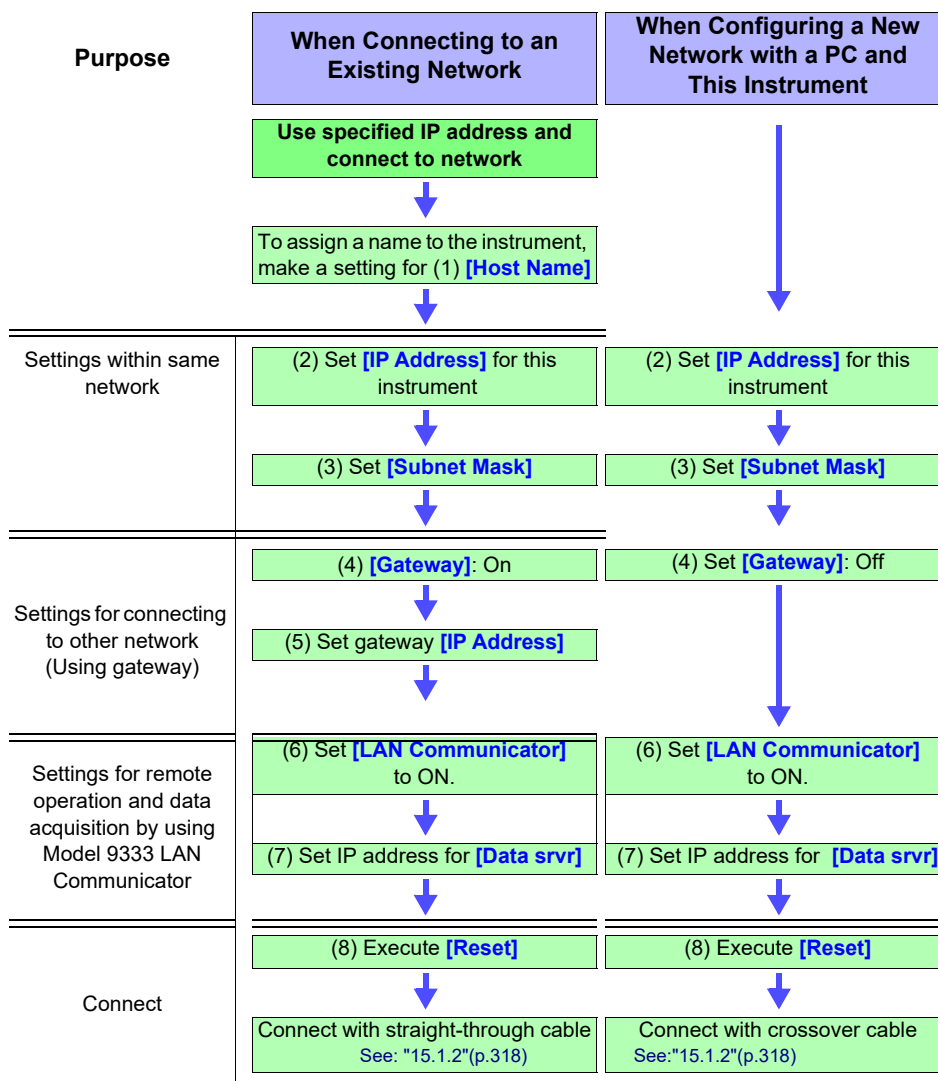



### 15.1.2 Connecting Instrument and PC With LAN Cable

Connect the instrument to a PC with a LAN cable as follows.

1. Plug the LAN cable (100BASE-TX compliant) into the 100BASE-TX connector on the rear of the instrument in the case of the MR8740 and on the front of the instrument in the case of the MR8741.

MR8740: Rear

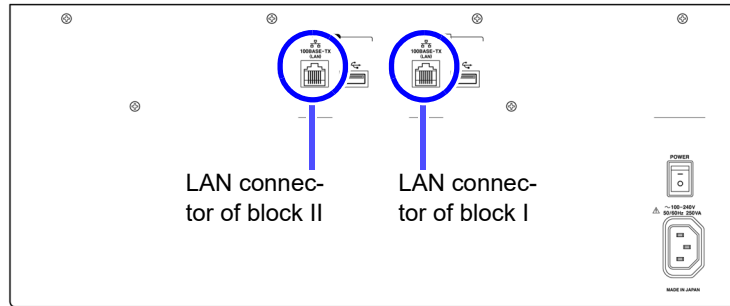

MR8741: Front

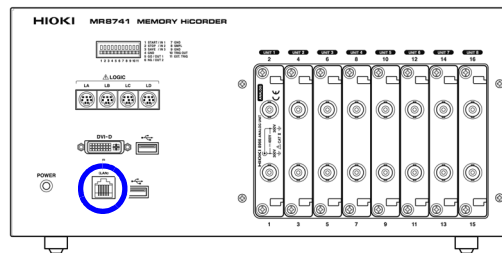

2. Connect the above LAN cable to the PC. There are two ways to do this.

#### 1. Connecting the Instrument to a Network (Connecting the Instrument to a Hub)

You can monitor and control the instrument from a PC by connecting the instrument to a hub with LAN cable (100BASE-TX cable).

Connection cable: Use one of the following.

- 100BASE-TX straight-through cable (maximum length 100 m, commercially available)  
(10BASE-T cable may also be used for 10BASE communications)
- 9642 LAN Cable (option)

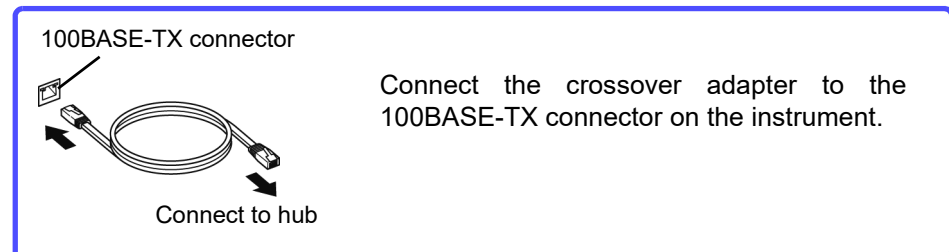

#### **NOTE**

In the case of MR8740, control is required for each block.

## 2. Making 1:1 Connections Between the Instrument and a PC (Connecting the Instrument to a PC)

You can monitor and control the instrument from a PC by connecting the instrument to the PC with LAN cable (100BASE-TX cable)

Connection cable: Use one of the following.

- 100BASE-TX crossover cable (maximum length 100 m)
- 100BASE-TX straight-through cable with crossover adapter (maximum length 100 m)
- 9642 LAN Cable (option, supplied with crossover adapter)

### Connecting with the 9642 LAN Cable and crossover adapter (supplied)

100BASE-TX connector

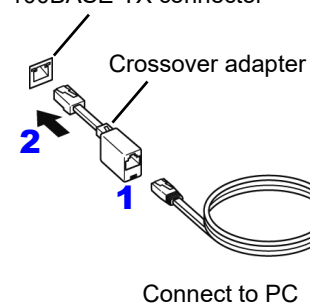

- 1 Connect the 9642 LAN Cable to the supplied crossover adapter.
- 2 Connect the crossover adapter to the 100BASE-TX connector on the instrument.
- 3 Connect the 9642 LAN Cable to the 100BASE-TX connector on the PC.

This completes the connection procedure.

Files on the instrument can now be accessed from the PC.

See: "15.2 Performing Remote Operations on the Instrument (Use an Internet Browser)" (p.320)

"15.3 Accessing the Files on the Instrument From a Computer (Using FTP)" (p.327)

"15.5 Controlling the Instrument with Command Communications (LAN)" (p.332)

## 15.2 Performing Remote Operations on the Instrument (Use an Internet Browser)

You can perform remote operations on the instrument from a PC by using an Internet browser.

### **NOTE**

Attempting to control the instrument simultaneously from multiple computers may result in unintended operation. Use only one computer to perform remote operations.

To use an Internet browser, the instrument must be properly set up and connected via LAN cable to the PC. (p.314), (p.318)

Microsoft® Internet Explorer® 8 or later is recommended as the browser. Set the security level to "Medium". If [REMOTE CONTROL] and [MEMORY DATA GET] do not work, install JRE from the application disc. And invalidate the pop-up blok.

### Installing JRE

1. When you insert the supplied application disc (CD-R) into the CD-ROM drive of the PC, the top page will automatically be displayed. If the page does not appear, open the file "index.htm" with your web browser.
2. Select the display language to use. Click on the [English] icon.
3. Click on the [JRE installation] icon.
4. Click on the [Install] icon. Then follow the prompts that appear to complete the installation.

## 15.2.1 Making HTTP Settings on the Instrument

### Procedure

To open the screen: Right-click and select [SYSTEM] → [Interface] sheet

#### 1 Make authorization settings.

Move the flashing cursor to the [Authorization] item.

Select

Off	Use the Web server without authorization. (default setting)
On	Use the Web server with authorization.

[FTP/HTTP]

1 Authorization

2 User Name

2 Password

Access Ctrl

#### 2 (When [On] is selected)

##### Set the user name and password for authentication.

Move the flashing cursor to the [User Name] and [Password] items and enter suitable information.

See: "7.1.3 Alphanumeric Input" (p.141)

"Authorization User Name and Password" (p.315)

The user name and password for authentication are used both for access via an Internet browser and FTP.

#### 3 Apply the setting.

Move the flashing cursor to the [Reset] item.

Select [Reflect Set].

The indication "LAN was reconnected" appears at the bottom of the screen.

## 15.2.2 Connecting to the Instrument With an Internet Browser

The following example shows how to use the Internet Explorer® browser on Windows 7.

Launch Internet Explorer® on the PC and enter "http://" plus the IP address of the instrument in the address bar.

If the IP address of the instrument is "192.168.0.2"

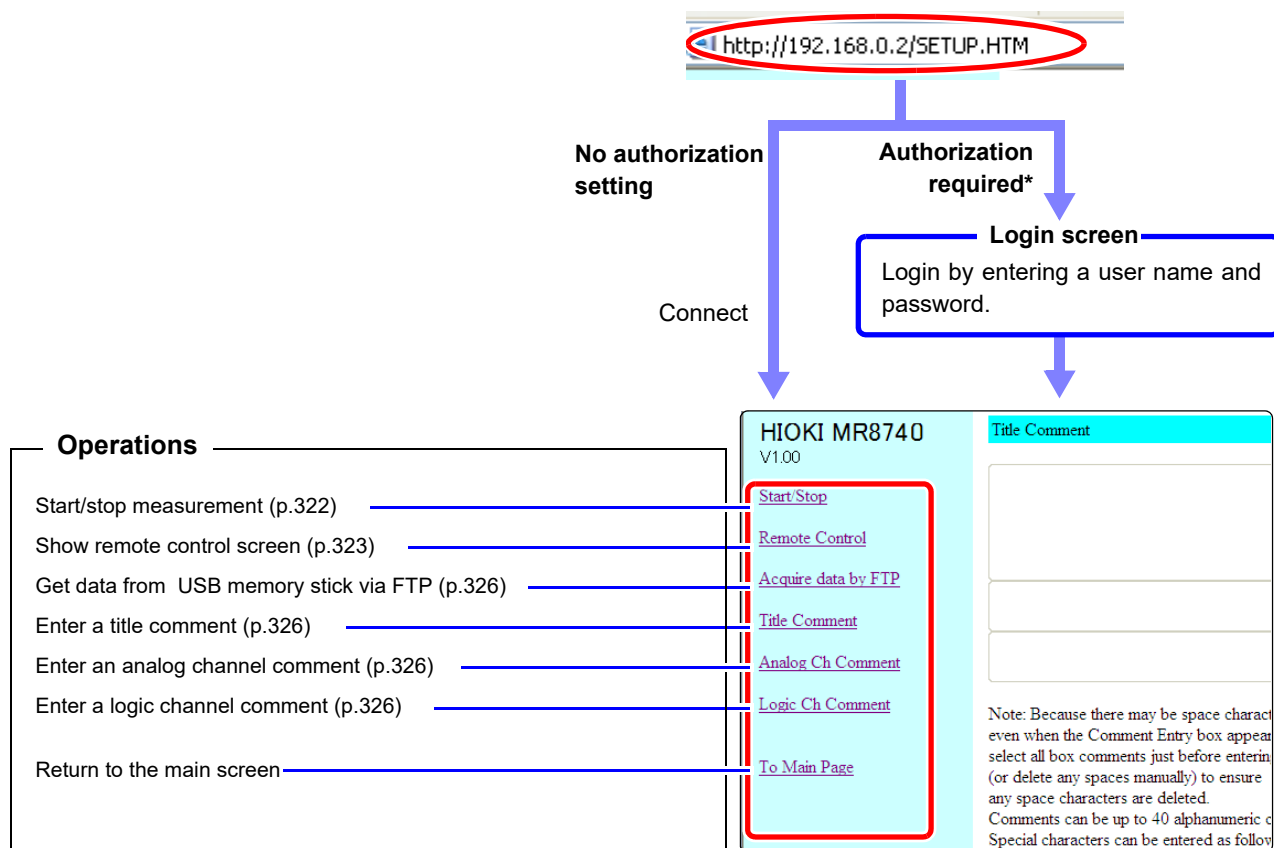

\*: When user name and password for authentication were set via System screen - **[Interface]** sheet  
See: "15.2.1 Making HTTP Settings on the Instrument" (p.320)

# 15.2.3 Operating the Instrument With an Internet Browser

## Start/Stop Measurement, acquire measurement data

You can start and stop a measurement.

### Start/stop measurement, acquire measurement data screen

To open the screen: Click **[Start/Stop]** on list of operations.

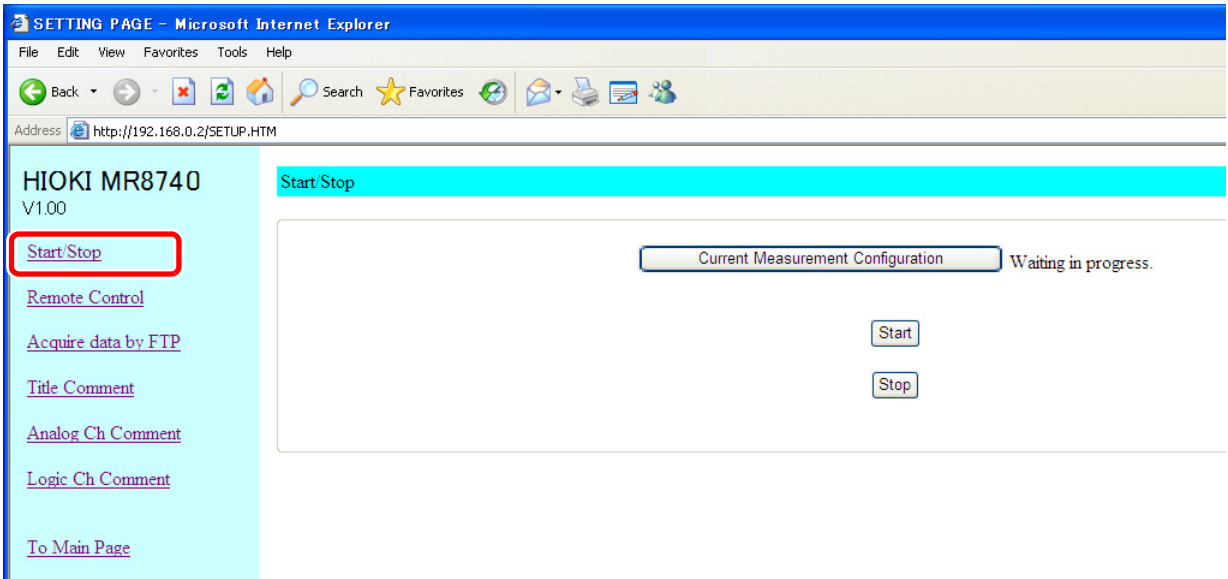

### Procedure

- Click **[Start]** to start the measurement.
- Click **[Stop]** to stop the measurement.
- Click **[Current Measurement Configuration]** to bring up information about the current measurement configuration on the screen.

To acquire measurement data:

Click on **[Acquire binary]**, **[Acquire text]** or **[To MSEXCEL]** under **[Acquire Measurement Data]**.

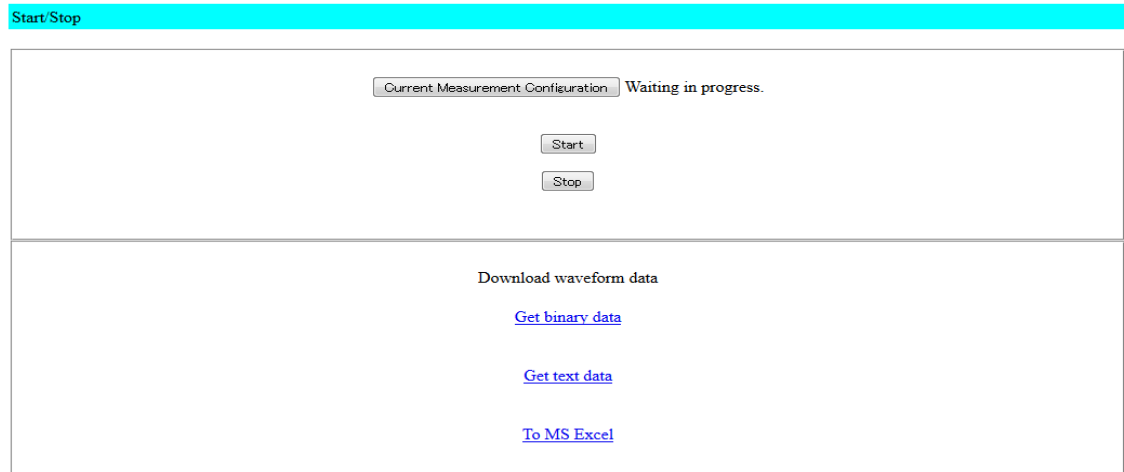

- Get binary data : Acquire data in binary format.
  - Get text data : Acquire data in text format.
  - To MS Excel : Forward data to Excel in MS-EXCEL. Able to create graphs, etc.
- When there is no measurement data, **[No measurement data]** will be displayed.

## Remote Operation

The instrument can be controlled from a remote location. (This remote operation is mainly intended for monitoring the screen. If you want more nimble remote operation, use Model 9333 LAN Communicator.)

### Remote Control Screen

To open the screen: Click [\[Remote Control\]](#) on list of operations.

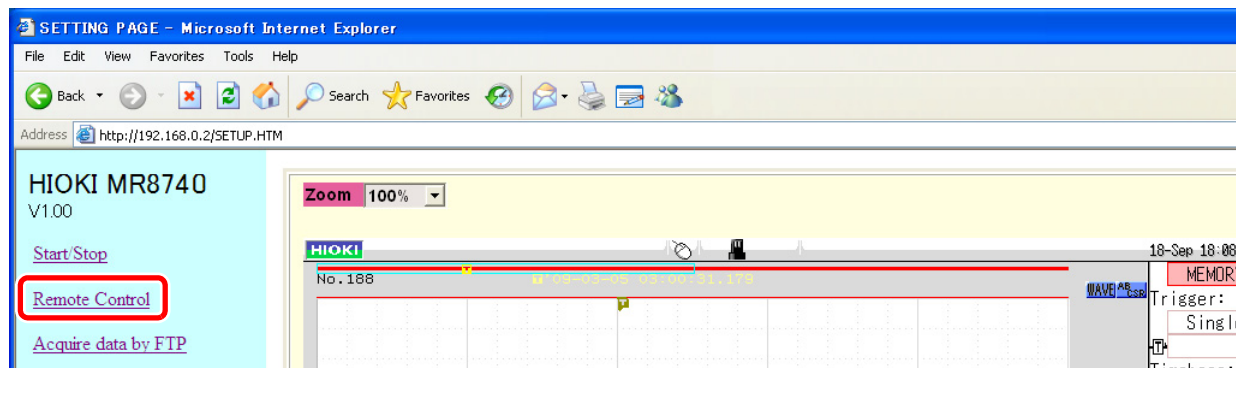

The remote control screen is divided into the instrument display section and operation panel.

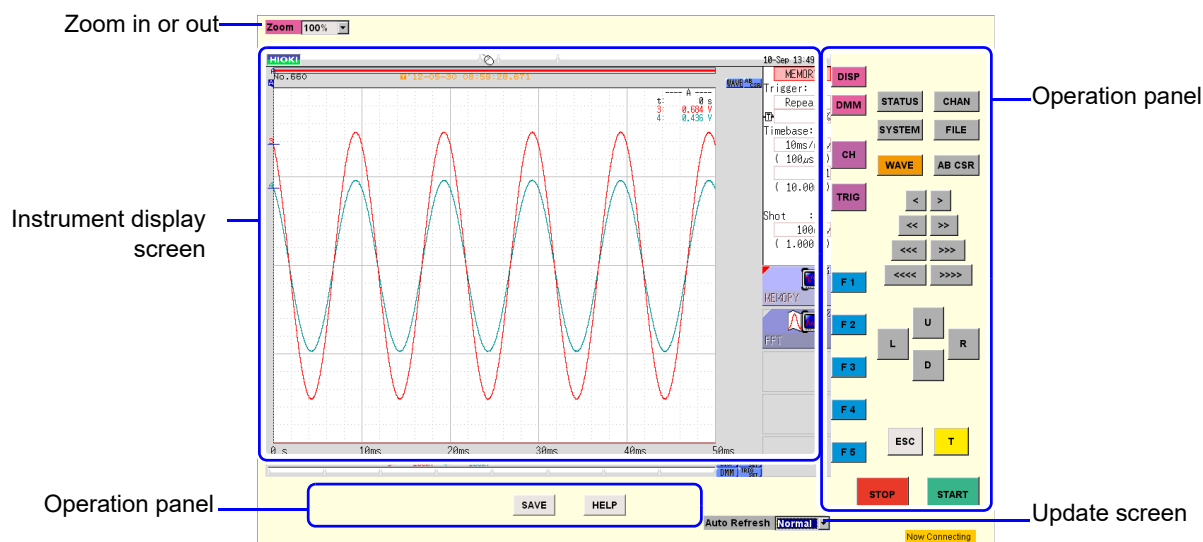

When Auto Update is enabled, screen information is sent from the instrument to the PC in regular intervals to keep the display updated.

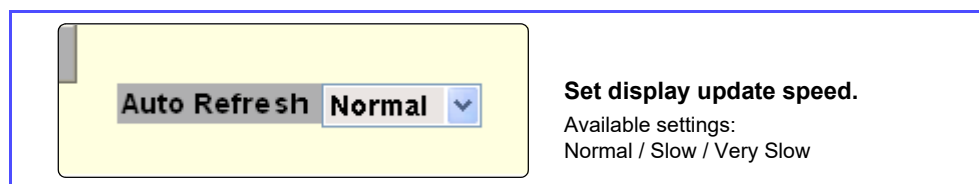

### Basic Operations

When you click a button on the operation panel, MR8740/MR8741 Memory HiCorder performs the same action as if the corresponding key on the unit was pressed. However, simultaneously activating more than one button is not possible. The keys and controls on the instrument are active also during remote operation.

#### **NOTE**

Remote control may not be possible when JRE has not been installed. (p.320)  
If you will be using key operation, we recommend setting the refresh speed to [Slow] or [Very Slow].

### Acquiring Instrument Memory Data from a Computer

Use any of the following operating procedures to acquire the data.

- Use the FTP function
- Use communication commands

#### **NOTE**

For details on each of the commands, refer to the Instrument Communication Command Instruction Manual on the application CD.

### Acquiring data by FTP

- 1 Save the data you want to acquire to a USB memory stick.  
See: "4.2 Saving Data" (p.87)
- 2 Use the FTP function to move the saved data to a computer.

#### Screen for Acquiring Data by FTP

To open the screen: Click **[Acquire data by FTP]** in the list of operations.

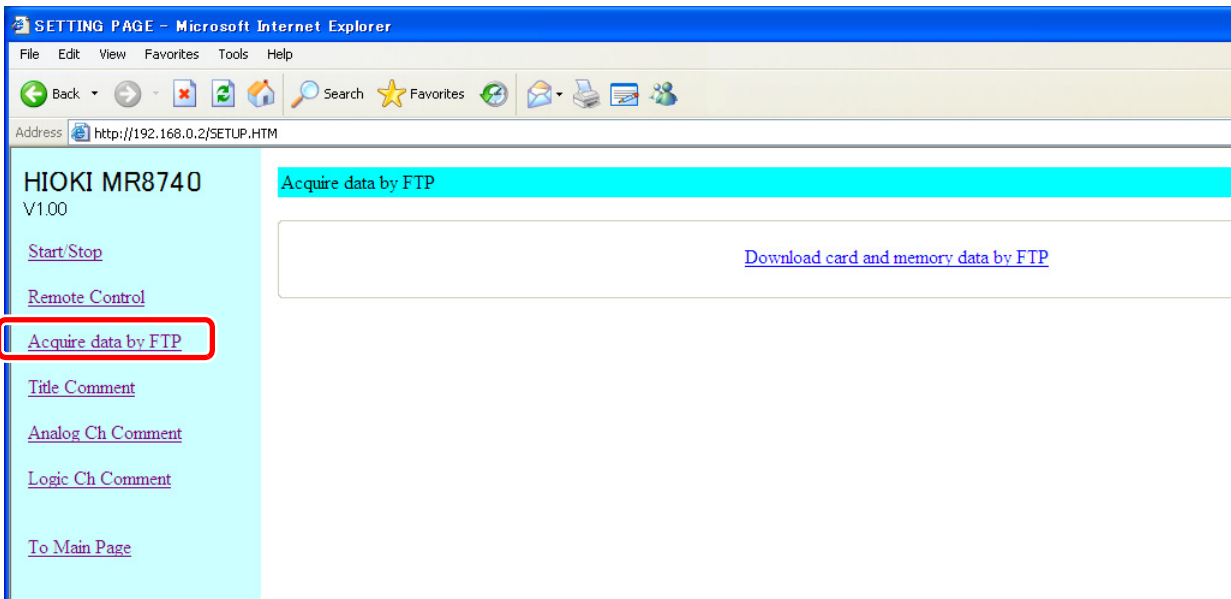

#### Procedure

Click **[Download card and memory data by FTP]**.  
A list of folders is displayed.

For details on how to perform file operations, see "15.3.3 Using FTP for File Operations" (p.330).

## Acquiring data by communication commands

### Transferring storage data (measurement values)

Use :MEMory:VDTA? A.

#### Procedure

**1** :MEMory:MAXPoint?

The number of data samples stored in the memory of the instrument is acquired. Check that storage data exists.

**2.** :MEMory:POINT CH\$,A

The output point of the storage data is specified.  
(If you want to acquire the data from the beginning, change the value of A to 0.)

**3.** :MEMory:VDTA? A

Just the number of data samples of the storage data (measurement values) specified with A is transferred from the instrument to the computer. The output point is also incremented by the number of data samples.

#### **NOTE**

- From 1 to 80 values can be acquired at one time with the VDTA command. If you want to acquire more values than that, send the command in step **3** repeatedly.
- The maximum number of data samples that can be acquired is the value acquired with the MAXPoint command.

### Transferring storage data in binary format

Use :MEMory:BDATA? A.

#### Procedure

**1** :MEMory:MAXPoint?

The number of data samples stored in the memory of the instrument is acquired. Check that storage data exists.

**2.** :MEMory:POINT CH\$,A

The output point of the storage data is specified.  
(If you want to acquire the data from the beginning, change the value of A to 0.)

**3.** :MEMory: BDATA? A

Just the number of data samples of the storage data (binary) specified with A is transferred from the instrument to the computer. The output point is also incremented by the number of data samples.

#### **NOTE**

- From 1 to 400 values can be acquired at one time with the BDATA command. If you want to acquire more values than that, send the command in step **3** repeatedly.
- The maximum number of data samples that can be acquired is the value acquired with the MAXPoint command.
- #0 (indicates binary format) is added to the beginning of the output data.
- After #0, the storage data is transmitted two bytes at a time.



### Entering a Comment

You can specify strings to be used as title comment, logic channel comment, and analog channel comment.

Information about the module type and channel (installation location in the instrument) can be obtained and used only for the respective channel.

#### Comment Setting Screen

To open the screen: Click **[Title Comment]**, **[Analog Ch Comment]**, or **[Logic Ch Comment]** on list of operations.

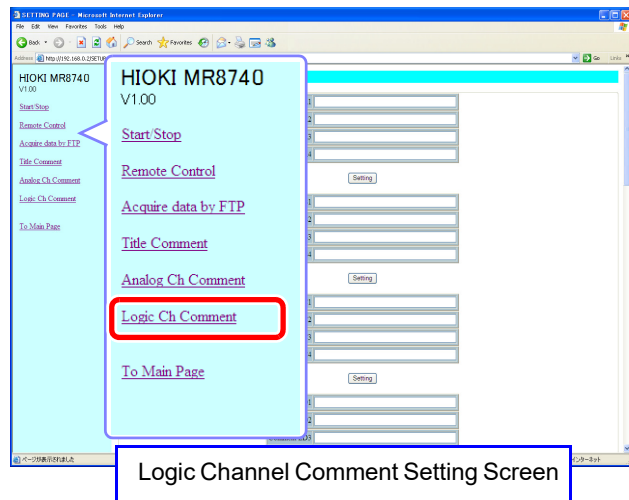
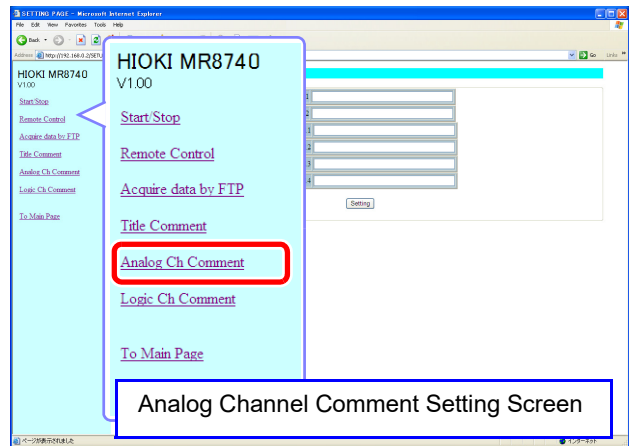
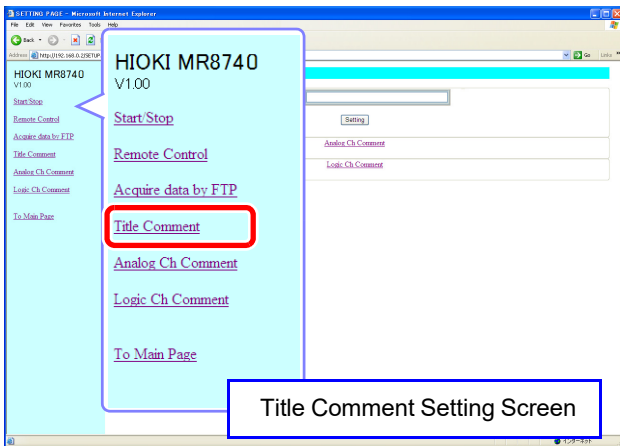

#### Procedure

Enter a string in the comment input field and click the **[Setting]** button. The comment string can be up to 40 characters long.

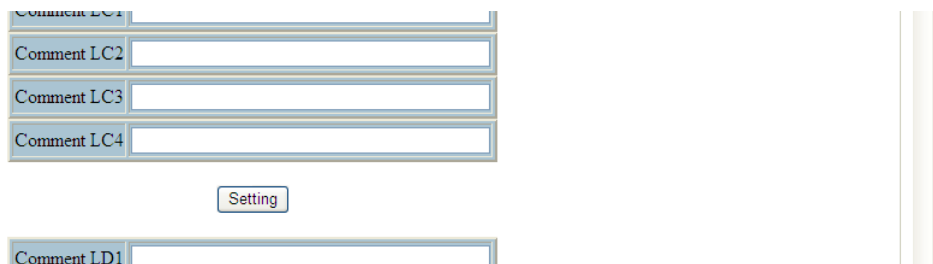

## 15.3 Accessing the Files on the Instrument From a Computer (Using FTP)

By using a PC FTP client, you can transfer files from the instrument's media to the PC and perform other file operations.

- This instrument is equipped with an FTP (File-Transfer-Protocol, RFC959 compliant) server.
- You can use Internet Explorer® or other popular FTP clients.

### **NOTE**

- The FTP server of the instrument allows only one connection at a time. More than one PC cannot access the server simultaneously.
- If no command is sent from a PC for more than one minute after connecting to the FTP server, the FTP may disconnect the PC. Reconnect the FTP.
- FTP operation will be interrupted when measurement is started.
- Before inserting or removing a USB memory stick, terminate the FTP connection.
- Do not perform file operations while FTP is being used.
- With Internet Explorer®, the refresh date of files may not match those of the main instrument.
- With Internet Explorer®, temporary internet files may retain data from their previous access, so the previous data may be obtained instead of the newest data.

**To use FTP, the instrument must be properly set up and connected via LAN cable to the PC.**

See: "15.1.1 Making LAN Settings at the Instrument" (p.314)  
"15.1.2 Connecting Instrument and PC With LAN Cable" (p.318)

### **NOTE**

Be careful when moving files by FTP, as some FTP client/browser programs may delete all selected files or folders from the source if you cancel a transfer before completion. Rather than moving files in one step, we recommend copying (downloading) and then manually deleting from the source.

### Things to Check Before Using FTP

Relationship Between Storage Media and Directories	Each of the various types of storage media appears as a directory on the FTP server.  /RAM ..... Internal memory /USB1 ..... USB memory stick /STORAGE ..... Storage memory
Limitations	<ul style="list-style-type: none"> <li>• During measurement, file access is not possible.</li> <li>• Storage data can be forwarded directly to the PC.</li> </ul>

### About the Storage Folder

The STORAGE folder will be displayed when there is a storage waveform. After storage, the following files can be stored in the STORAGE folder:

- Setting file
- Waveform binary file (data.xxx extension, based on the function, are mem, rec, xyc, and fft)
- Waveform text file(data.csv)

### **NOTE**

- IData between the AB cursors will be saved when the time axis/trace cursor is displayed.
- IData for the channel which is ON will be saved.
- IWaveform for the block which is displayed during memory division will be displayed.
- IThinning setting will not be considered during text saving. All data is saved at all times.

## 15.3.1 Making FTP Settings at the Instrument

### Procedure

To open the screen: Right-click and select [SYSTEM] → [Interface] sheet

**1 Set the access restrictions.**

Move the flashing cursor to the [Access Ctrl] item.

Select

<b>Read/Write</b>	File deletion and renaming are permitted.
<b>Read-Only</b>	File reading only is permitted. This prevents files from being deleted or changed from outside the instrument.

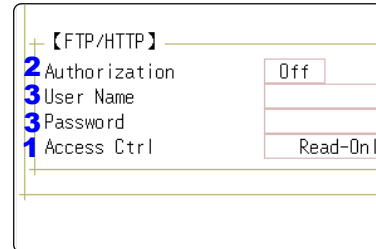

**2 Make authorization settings.**

Move the flashing cursor to the [Authorization] item.

Select

<b>Off</b>	Web server authentication is not used. (default setting)
<b>On</b>	Web server authentication is used.

The user name and password for authentication are the same for the Internet browser and for FTP.

**3 When [On] is selected**

**Set up a user name and password.**

Move the flashing cursor to the [User Name] and [Password] items and enter suitable information.

See: "7.1.3 Alphanumeric Input" (p.141)  
 "Authorization User Name and Password" (p.315)

**4 Apply the settings.**

Move the flashing cursor to the [Reset] item.

Select [Reflect Set].

The indication "LAN was reconnected" appears at the bottom of the screen.

## 15.3.2 Using FTP to Connect to the Instrument

The following example shows how to use the Internet Explorer® browser on Windows 7.

Launch Internet Explorer® on the PC and enter "ftp://" plus the IP address of the instrument in the address bar.

If the IP address of the instrument is "192.168.0.2":

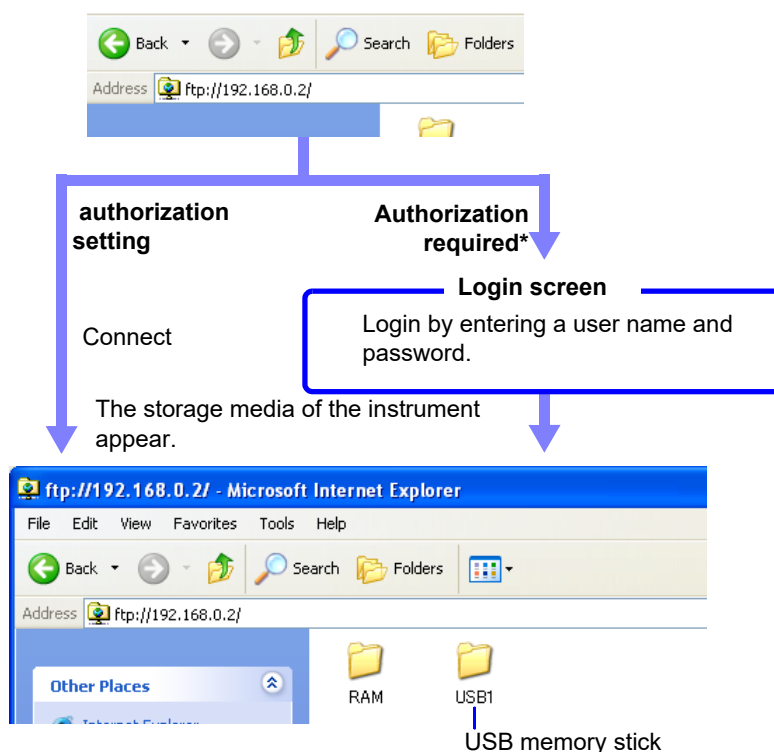

Click to display the file stored on the media.

\* An authorization user name and password have been set in the System screen - **[Interface]** sheet.

See: "15.3.1 Making FTP Settings at the Instrument" (p.328)

You can also enter the user name and password, delimited by ':' and '@', in front of the normal IP address.

**[ftp:// Username:Password@ instrument IP address]**

Example: When the user name is "hioki" and the password is "1234":  
Enter `[ftp://hioki:1234@192.168.0.2]`.



### If the connection fails

Check the communications settings of the instrument.

See: "LAN Setup Workflow" (p.317)

### 15.3.3 Using FTP for File Operations

#### Downloading Files

Select the file to download from the folder list and drag and drop\* it on the download destination (the desktop or a folder outside the Internet Explorer® window).  
\*: Click the file and hold the button down. Move the mouse pointer to the target destination, and then release the button

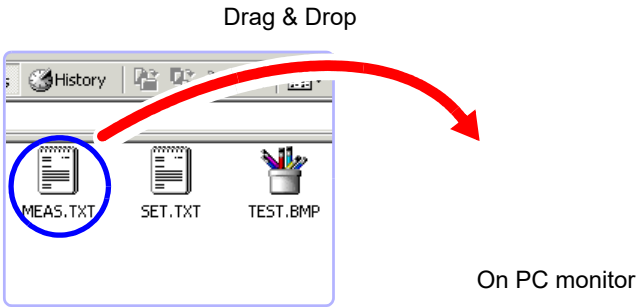

Minutes and seconds may not be reflected on the file stamp (date) of the file.

#### Deleting and Renaming Files

Right click a file in the FTP folder list, and select **[Delete]** or **[Rename]** from the pull-down menu.

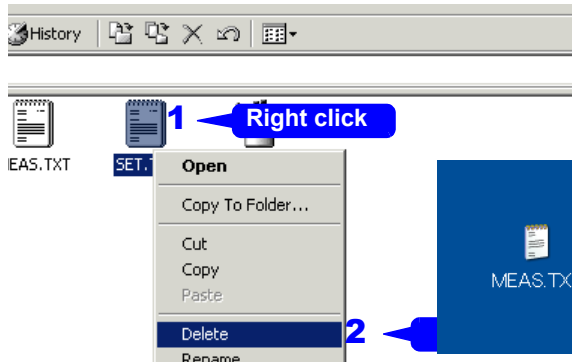

**NOTE** Files cannot be uploaded to the instrument from the computer.

## 15.4 Wave Viewer (Wv)

The viewer has a CSV conversion function. Converted files may be read by a spreadsheet program.

This section explains how to install and uninstall and how to start and quit the Wave Viewer.

### System requirements

System requirements: PC running Windows 7, Windows 8, or Windows 10.

### Installation (Windows 7)

1. When you insert the Application Disk (CD-R) into the CD-ROM drive, the opening page should appear automatically.  
If it does not appear, open the "index.htm" file with your Web browser.
2. Select the language to display (click the English icon).
3. Click the **[Wave viewer (Wv)]** icon to view Wv specifications and revision history.
4. Click the **[Install]** icon at the top right of the page to open the **[File Download]** dialog.
5. Click **[Open]** to display the confirmation dialog to proceed with installation. And go on the procedure.
6. Click **[Next]** to open the installation destination selection window. Click the **[Browse]** button to change the installation folder.
7. Click **[Next]** to start installation.  
The program is now installed.

### Startup

Before using the program, review the "READ ME" text file.

In the Windows® Start menu, select **[Programs] - [HIOKI] - [Wv.]** This starts the Wave Viewer application.

### Shutdown

Access the menus of the Wave Viewer application and select **[File] - [Exit]** to shut down the program. Alternatively, you can click the Close button at the top right of the screen.

### Uninstallation

1. Click the Windows® Start button, click **[Control Panel]**, and then click **[Uninstall a program]**.  
The list of the installed programs appears.
2. Select **[HIOKI Wave Viewer (Wv)]** and uninstall the application.  
To upgrade to a newer version, uninstall the old version first and then install the new version.

# 15.5 Controlling the Instrument with Command Communications (LAN)

You can control the instrument remotely over the communications interface (LAN).

- For details, see the communications related documentation on the supplied application disc.
- Before using command communications, the LAN settings and connection must have been established properly.

See: LAN"15.1"(p.314)



In an environment where noise from inverters or similar devices is present, errors may occur when controlling the instrument remotely. Take care to ensure that the environment is not subject to excessive noise.

## About Setting Items

<b>Delimiter</b>	The Delimiter item specifies LF or CR+LF as the newline delimiter in command response messages. The instrument understands all three settings: LF or CR+LF.
<b>Header</b>	Use for control of communications commands. The Header item specifies whether to prefix headers to command response messages. For more information about commands, refer to the Communications operation manual on the supplied CD.
<b>Command Port (Port number)</b>	The instrument uses the TCP/IP protocol for communications. TCP/IP allows communicating devices to establish multiple connections, which are distinguished by port numbers. By default the instrument uses port numbers 8800 to 8809. •8800 to 8801 reserved •8802 (instrument is server): For communications command control •8803 to 8809 reserved Normally these ports do not need to be changed. You can change them if certain ports cannot be used for security reasons, or if certain ports are not available on the communicating PC. Set only the most significant three digits. The least significant digit (0 to 9) is used by the instrument, or reserved for use by the instrument.

## 15.5.1 Making Settings on the Instrument

Set items related to command communications.

### Procedure

To open the screen: Right-click and select **[SYSTEM]** → **[Interface]** sheet

#### 1 Set the delimiter.

Move the flashing cursor to the **[Delimiter]** item.

Select

<b>LF</b>	Send character code 0x0a.
<b>CR+LF</b>	Send character codes 0x0d and 0x0a.

#### 2 Make header settings.

Move the flashing cursor to the **[Header]** item.

Select

<b>Off</b>	Do not add a header to response data.
<b>On</b>	Add a header to response data.

#### 3 Set the communications command port.

Move the flashing cursor to the **[Port Number]** item, and enter the port number.

##### About headers

The response to a :FUNCTION? query command from the PC differs according to the header setting.

On .....:FUNCTION MEM  
Off ..... MEM

##### About port numbers

Specify only the most significant 3 digits of the 4-digit port number.

If you specify "880x", port number 8802 is used.

"Command Port (Port number)"  
(p.332)

1 Delimiter	CR+LF
2 Header	Off
3 Port Number	880x



# 15.6 Operating the instrument remotely and acquiring data by using Model 9333 LAN Communicator

Model 9333 LAN Communicator, which is the optional communication program for PCs, enables the PC to control the instrument remotely and to store data directly. Additionally, Model 9333 enables waveforms to be printed from a printer connected to the PC.

## Procedure

### 1 Setting the LAN Communicator

Select

On	LAN Communicator is enabled.
Off	LAN Communicator is disabled.

### 2 Setting the data collection server

Specify the IP address of the PC on which Model 9333 LAN Communicator is running to communicate with the instrument. The IP address is required to acquire data by using Model 9333 LAN communicator. As necessary, set "LAN:\\" as the save destination on the [File Save] sheet.

### 3 Apply the settings.

Move the flashing cursor to the [Reset] item. Select [Reflect Set].

The indication "LAN was reconnected" appears at the bottom of the screen.

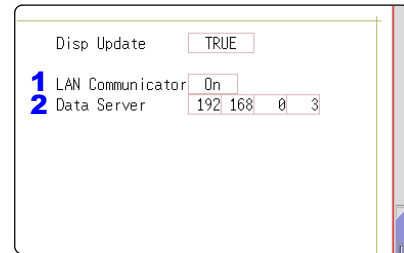

Setting the [LAN Cpmunicator] to [On] disables internet browsers to operate the instrument.

On: Using Model 9333 LAN communicator allows you to remotely control the instrument.

Off: Using a web browser allows you to remotely control the instrument.

# External Control (MR8741 Only) Chapter 16

This chapter describes how to operate MR8741 using the external control terminals.

We use the term external control terminals generically to refer to all of the terminals.

## Opening the [Environment] sheet

The screenshot illustrates the process of opening the [Environment] sheet. On the left, a menu tree is shown with 'SYSTEM' selected. A right-click menu is open over 'SYSTEM', with 'Environment' highlighted. A blue arrow points from this menu to the 'Environment' sheet on the right. The 'Environment' sheet contains various settings for waveform display, display settings, system environment, and external I/O. A red box highlights the [EXT I/O] section, which includes input and output controls. A hint at the bottom of the sheet reads: 'Hint Select the measurement function.'

Select **[SYSTEM]** and then **[Environment]** from the right-click menu.

# 16.1 Connecting External Control Terminals (MR8741 Only)

The method for connecting to the external control terminals is as follows.

## Connecting External I/O Terminals (Connector Blocks)

### Cables to connect

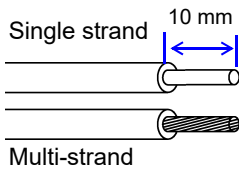

Recommended cables:  
 single strand diameter:  $\phi$  0.65 mm (AWG22)  
 multi-strand: 0.32 mm<sup>2</sup> (AWG22)

Usable cables:  
 Single strand diameter:  $\phi$  0.32 - 0.65 mm (AWG28 to 22)  
 Multi-strand: 0.08 - 0.32 mm<sup>2</sup> (AWG28 - 22)  
 Strand diameter:  $\phi$  0.12 mm or greater (per wire)  
 Standard insulation stripping length: 9 - 10 mm  
 Button operation specified tool: Flat-blade screwdriver ( $\phi$  3 mm shaft diameter, 2.6 mm tip width)

### Connection procedure

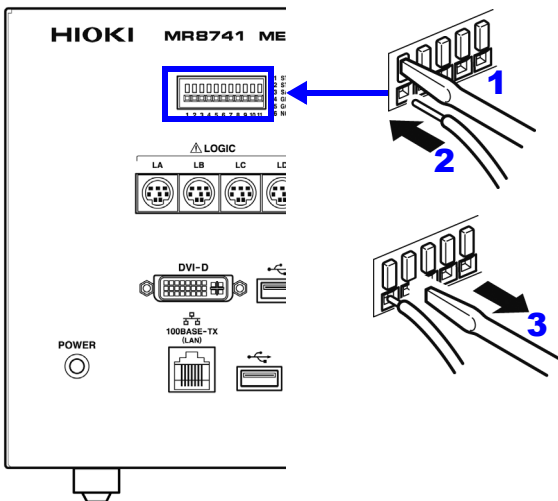

1. Push in the button on the connector with a flat-blade screwdriver or other tool.
2. With the button held in, insert the cable into the cable connection hole.
3. Release the button.  
The cable is locked.

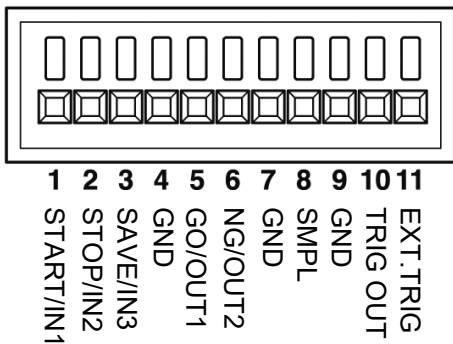

Terminal No.	Operation
1	Input external signal and execute the following
2	• Start/end measurement
3	• Save data
4	Ground (shared with the chassis)
5	Output instrument status as a signal
6	Output instrument status as a signal
7	Ground (shared with the chassis)
8	Input external signal and set sampling rate
9	Ground (shared with the chassis)
10	Output signal when triggering occurs
11	Input external signal as trigger source

## 16.2 External I/O (MR8741 Only)

### 16.2.1 External Input (START/IN1) (STOP/IN2) (SAVE/IN3)

External control signals can be applied to start and stop measurement, and to save data. The factory-default settings are to **[START]**, **[STOP]**, and **[SAVE]**.

#### Signal Input Procedure

1. Connect the cables for the corresponding external input signals to START/ IN1, STOP/IN2, SAVE/IN3, and GND terminals.  
See: "16.1 Connecting External Control Terminals (MR8741 Only)" (p.336)
2. On the **SYSTEM** screen, open the **[Environment]** sheet and move the cursor to the **[START/EXT.IN1]**, **[STOP/EXT.IN2]**, or **[SAVE/EXT.IN3]** item.
3. Select the operation performed by the instrument in response to external signal input.

Select	
Start	Start measurement. (Is not affected by <b>[Start Action]</b> (p.311))
Stop	Stop measurement. (Operations after measurement, such as numerical calculations and automatic saving will be carried out)
Start/Stop	Start measurement on LOW level, and stop measurement on HIGH level.
Abort	Stop measurement immediately. (Operations after measurement, such as numerical calculations and automatic saving will not be carried out)
Save	Save the data according to the saving conditions specified on the <b>[File Save]</b> sheet of the System screen. (Not valid during Selective Saving (p.93))
RUN/STOP	Runs/stops waveform output. (RUN at LOW level, STOP at HIGH level).
PAUSE	Stops waveform output temporarily.

#### NOTE

- For STOP operation, follow **[Stop Action]** (p.311).
  - External input is not available when the HELP screen or a dialog window is being displayed.
4. Short circuit the terminal and GND, or input a HIGH level (3.0 to 5.0 V) or LOW level (0 to 0.8 V) pulse wave or rectangular wave to the terminal.

Control with the LOW level of the input waveform.

<b>Voltage range</b>	HIGH level: 3.0 to 5.0 V , LOW level: 0 to 0.8 V
<b>Pulse width</b>	HIGH level: 20 ms or greater, LOW level: 30 ms or greater
<b>Maximum input voltage</b>	-0.5 to 7 V

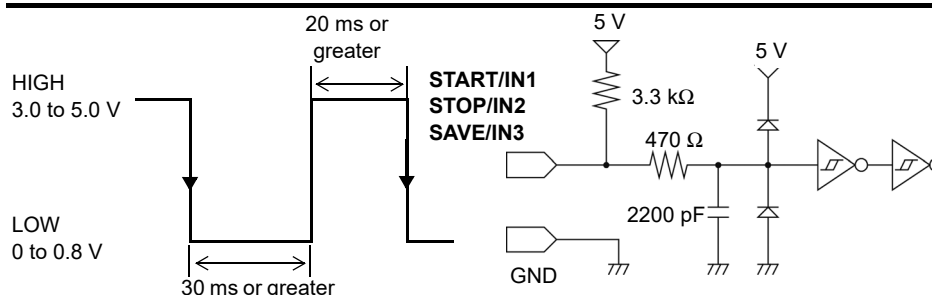

## 16.2.2 External Output (GO/OUT1) (NG/OUT2)

Signals can be output that indicate the MR8741 judgment state.

### Signal Output Procedure

1. Connect the GO/OUT1, NG/OUT2, and GND terminals to the device(s) to be controlled by single wires.  
See: "16.1 Connecting External Control Terminals (MR8741 Only)" (p.336)
2. On the **SYSTEM** screen, open the **[Environment]** sheet and move the cursor to the **[GO/EXT.OUT1]** or **[NG/EXT.OUT2]** item.
3. Select the conditions under which the instrument outputs a signal.  
(when the **[GO/EXT OUT1]** item is selected)

Select

<b>Measure</b>	A LOW signal is output when the judgment result is GO (pass).
<b>Waveform Evaluation</b>	A LOW signal is output when the waveform evaluation result is GO (pass).
<b>Value Evaluation or Waveform Evaluation</b>	A LOW signal is output when either the value calculation or waveform calculation evaluation result is GO (pass).
<b>Value Evaluation and Waveform Evaluation</b>	A LOW signal is output when both the value calculation and waveform evaluation result are GO (pass).
<b>Error</b>	Output a LOW level signal when an error occurs.
<b>Busy</b>	A LOW signal is output when external start operation is disabled, such as during startup and saving.
<b>Trigger</b>	Output a LOW level signal while instrument is waiting for a trigger.

GO evaluation result output (low level output) is held until the next measurement starts.

(when the **[NG/EXT OUT2]** item is selected)

Select

<b>Measure</b>	A LOW signal is output when the judgment result is NG (fail).
<b>Waveform Evaluation</b>	A LOW signal is output when the waveform evaluation result is NG (fail).
<b>Value Evaluation or Waveform Evaluation</b>	A LOW signal is output when either the value calculation or waveform calculation evaluation result is NG (fail).
<b>Value Evaluation and Waveform Evaluation</b>	A LOW signal is output when both the value calculation and waveform evaluation result are NG (fail).
<b>Error</b>	Output a LOW level signal when an error occurs.
<b>Busy</b>	A LOW signal is output during measurement and saving, and when it's finished, a HIGH signal is output.
<b>Trigger</b>	Output a LOW level signal while instrument is waiting for a trigger.
<b>Calibration</b>	1 kHz output for calibrating Model 9665 10:1 Probe and the 9666 100:1 Probe.

NG evaluation result output (low level output) is held until the next measurement starts.

**4.** The signal for the specified state is output.

<b>Output signal</b>	Open drain output (with voltage output) active LOW
<b>Output voltage range</b>	HIGH level: 4.0 to 5.0 V, LOW level: 0 to 0.5 V (current value: 15 mA)
<b>Maximum input voltage</b>	50 VDC, 50 mA, 200 mW

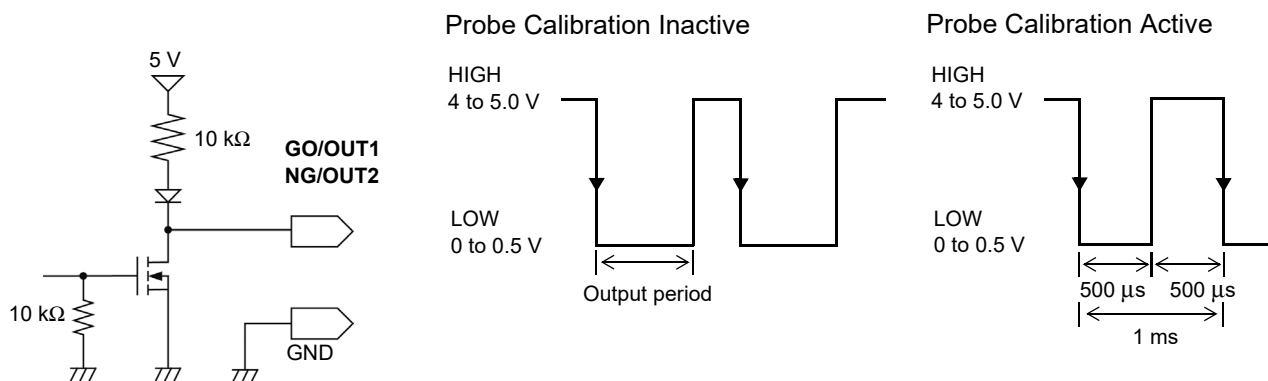

## 16.2.3 External Sampling (SMPL)

MEM

This applies to only the Memory function of MR8741.  
The sampling speed can be controlled by applying an external signal.

### Signal Input Procedure

1. Connect the cables for the corresponding output signals to SMPL and GND terminals.
2. On the **SYSTEM** screen, open the **[Environment]** sheet and move the cursor to the **[EXT.SMPL]** item.
3. Select whether the sampling event occurs on the rising edge (↑) of the waveform or the falling edge (↓).
4. Input HIGH level (3.0 to 5.0 V) and LOW level (0 to 0.8 V) pulse waves or rectangular waves to the EXT.SMPL terminal.  
Data is sampled on the rising edge or falling edge of the input waveform. Note that the sampling frequency is limited by the selected edge.  
For proper operation, pulse width must be at least as shown in the following table.

#### Minimum external sampling pulse width

Setting (EXT.SMPL)	Pulse width					
	When the Roll Mode is set to <b>[On]</b>			When the Roll Mode is set to <b>[Off]</b>		
	$t_H$	$t_L$	$t$	$t_H$	$t_L$	$t$
↑	> 5 $\mu$ s	> 5 $\mu$ s	> 10 $\mu$ s	> 50 ns	> 50 ns	> 100 ns
↓	> 5 $\mu$ s	> 5 $\mu$ s	> 10 $\mu$ s	> 50 ns	> 50 ns	> 100 ns

<b>Voltage range</b>	HIGH level: 3.0 to 5.0 V, LOW level: 0 to 0.8 V
<b>Pulse width</b>	HIGH, LOW level: 50 ns or greater
<b>Response frequency</b>	10 MHz or lower
<b>Maximum input voltage</b>	-0.5 to 7 V

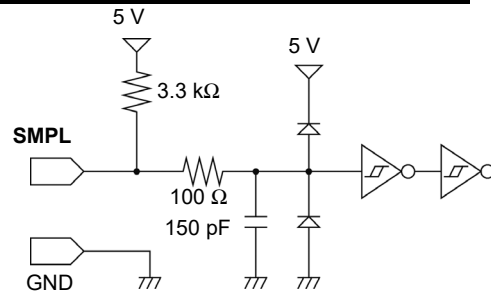
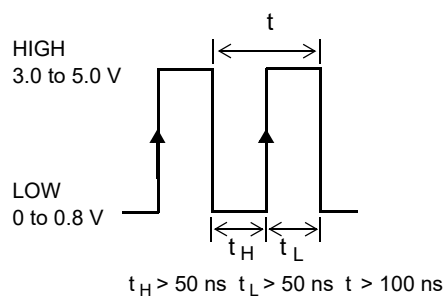

### NOTE

- When a sampling signal of 5 MHz or greater is input, trigger points are delayed by 1 sample.
- When set to **[Auto]** or **[On]**, the Roll Mode can be used with external sampling. However, it is disabled if the external sampling input is faster than 100 kHz, to avoid degraded sampling accuracy.
- The anti-aliasing filter (A.A.F) is disabled regardless of its setting.  
[See:"7.9.1 Setting the Anti-aliasing Filter \(A.A.F\)" \(p.162\)](#)
- When Roll Mode is set to ON, externally sampled signals will not be accepted for the following periods:
  - (1) 150  $\mu$ s to 200  $\mu$ s after the first sampling clock has been entered, and
  - (2) Clock 2 when no signals are detected in the period (1) above.
- When external sampling is valid, the output settings of Models MR8790, MR8791, and U8793 can not be updated.

## 16.2.4 Trigger Output (TRIG OUT)

You can output a signal when a trigger event occurs. In addition, multiple MR8741s can be used for parallel synchronous operation.

### Signal Output Procedure

1. Connect the cables for the output signals to TRIGOUT and GND terminals.  
See: "16.1 Connecting External Control Terminals (MR8741 Only)" (p.336)
2. On the **SYSTEM** screen, open the **[Environment]** sheet and move the cursor to the **[TRIG.OUT]** item.
3. Select the output signal type for the trigger output terminal.

Select

<b>Pulse</b>	After LOW level output, the signal goes HIGH after a specified interval.
<b>Level</b>	After the trigger is established, a LOW level signal will be outputted during the waveform retrieval.

4. When trigger event occurs, a pulse wave changing from the HIGH level (4.0 to 5.0 V) to the LOW level (0 to 0.5 V) is output from the TRIG OUT terminal.

<b>Output signal</b>	Open drain output (with voltage output), active LOW*
<b>Output voltage range</b>	HIGH level: 4.0 to 5.0 V, LOW level: 0 to 0.5 V (current value:15 mA)
<b>Pulse width</b>	Pulse width at pulse setting time : 2 ms $\pm$ 1 ms Pulse width at level setting time: (sampling rate $\times$ no. of data points after trigger) or more
<b>Maximum input voltage</b>	50 VDC, 50 mA, 200 mW

\*: Triggering should occur when the signal voltage level changes from HIGH to LOW.

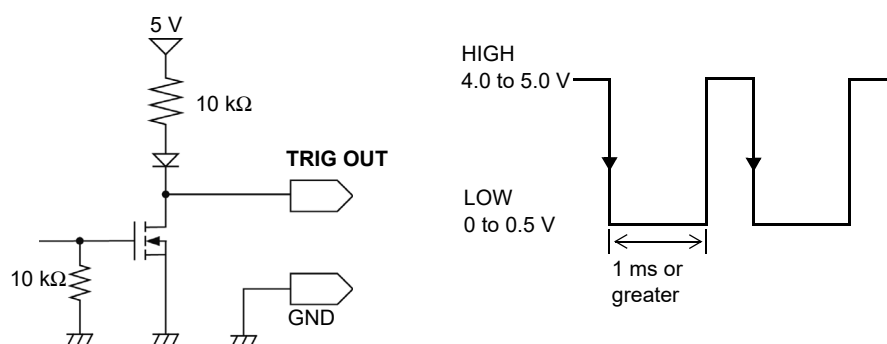

### NOTE

When using memory division, the trigger output (TRIG\_OUT terminal output) may output the Low level or output erratically in the following conditions.

- The time axis range is 5  $\mu$ s/div to 100  $\mu$ s/div
- The record (measurement) time is 5 ms or less
- Tracking wave display is [OFF].



## 16.2.5 External Trigger terminal (EXT.TRIG)

You can input external signals as trigger sources. In addition, multiple MR8741s can be used for parallel synchronous operation.

### Signal Input Procedure

1. Connect the cables for the corresponding external input signals to the EXT.TRIG and GND terminals.  
See: "16.1 Connecting External Control Terminals (MR8741 Only)" (p.336)
2. In the Trigger Settings window, set External trigger to **[On]**.
3. On the **SYSTEM** screen, open the **[Environment]** sheet and move the cursor to the **[EXT.TRIG]** item.
4. Select whether the trigger event occurs on the rising edge (↑) of the waveform or the falling edge (↓).
5. Short-circuit the EXT.TRIG terminal and GND, or input a HIGH level (3.0 to 5.0 V) or LOW level (0 to 0.8 V) pulse wave or rectangular wave to the EXT.TRIG terminal.  
A trigger event occurs on the rising or falling edge of the input waveform.

<b>Output signal</b>	HIGH level: 3.0 to 5.0 V, LOW level: 0 to 0.8 V
<b>Pulse width</b>	HIGH level: 50 ns or greater, LOW level: 50 ns or greater
<b>Maximum input voltage</b>	-0.5 to 7 V

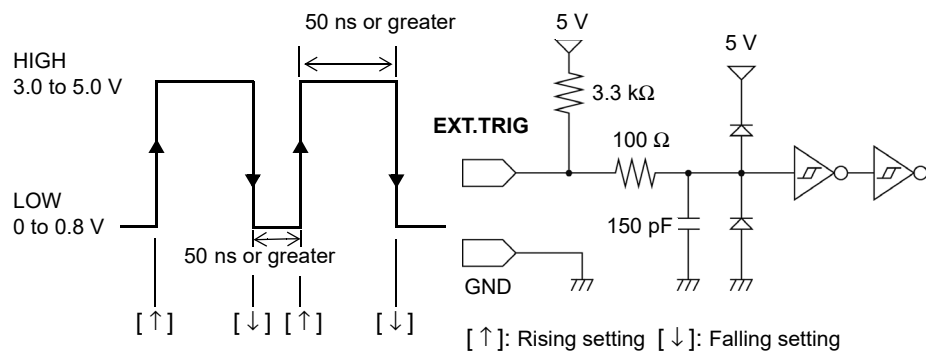

# Specifications Chapter 17

## 17.1 General Specifications of the Instrument

### Basic Specifications

<b>Measurement functions</b>		<ul style="list-style-type: none"> <li>• Memory Function (high-speed data saving)</li> <li>• Recorder Function (real time recording)</li> <li>• FFT Function (frequency analysis)</li> </ul>
<b>Maximum number of channels</b>	MR8740: Block I	32 analog channels + 8 logic channels, or 26 analog channels + 56 logic channels at a maximum (Together with the logic channels the instrument provides, when 3 modules of Model 8973 Logic Unit are installed)
	Block II	22 analog channels + 8 logic channels, or 16 analog channels + 56 logic channels at a maximum (Together with the logic channels the instrument provides, when 3 modules of Model 8973 Logic Unit are installed)
	MR8741:	16 analog channels + 16 logic channels, or 10 analog channels + 64 logic channels at a maximum (Together with the logic channels the instrument provides, when 3 modules of Model 8973 Logic Unit are installed)
<b>Number of modules</b>	MR8740: Block I	Up to 16 modules
	Block II	Up to 11 modules
		Restrictions
		<ul style="list-style-type: none"> <li>• Up to 4 modules of Model 8971 Current Unit can be installed.</li> <li>• Block I: Up to 3 modules of Model 8973 Logic Unit can be installed in every slot except those for Unit 9 through Unit 16.</li> <li>• Block II: Up to 3 modules of Model 8973 Logic Unit can be installed in every slot except those for Unit 9 through Unit 11.</li> </ul>
	MR8741:	Up to 8 modules
		Restrictions
		<ul style="list-style-type: none"> <li>• Model 8971 Current Unit cannot be used.</li> <li>• Up to 3 modules of Model 8973 Logic Unit can be installed.</li> </ul>
<b>Number of the instrument logic channels</b>	MR8740: Block I	8 (The input connectors of logic probes share the ground with the instrument.)
	Block II	8 (The input connectors of logic probes share the ground with the instrument.)
		Restrictions imposed when the instrument logic channels are used (common to block I and II)
		<ul style="list-style-type: none"> <li>• Measurement resolution of each measuring module decreases to 12 bits when the module is installed in a slot for Unit 1 or Unit 2.</li> <li>• No frequency measuring modules are available when the module is installed in the slots for Unit 1 or Unit 2.</li> <li>• Installing Model MR8990 Digital Voltmeter Unit in both slots for Unit 1 and Unit 2 disables the instrument logic channels.</li> </ul>
	MR8741:	16 (The input connectors of logic probes share the ground with the instrument.)
		<ul style="list-style-type: none"> <li>• Installing Model MR8990 Digital Voltmeter Unit in both slots for Unit 1 and Unit 2 disables the instrument logic channels.</li> <li>• Restrictions imposed when the logic instrument channels are used (when the logic measurement is set to on)</li> </ul>
		Measurement resolution of each measuring module decreases to 12 bits when the module is installed in a slot for Unit 1 or Unit 2.
		No frequency measuring modules are available when the module is installed in the slots for Unit 1 or Unit 2.
<b>Memory capacity</b>		16MW /channel
<b>Maximum sampling rate</b>		20 MS / s (All channels simultaneously)
<b>Timebase accuracy</b>		± 0.01% (Relative error between grid and time)
<b>Clock functions</b>		Automatic calendar, automatic leap year adjustment, 24-hour clock Accuracy: ± 100 ppm (Operated within the operating temperature range) Reference value: ± 10 ppm (at 25°C)
<b>Backup battery life</b>		Approx. 10 years (reference duration at 25°C) for clock and settings
<b>Operating environment</b>		Indoors, Pollution degree 2, up to 2000 m (6562-ft.) ASL
<b>Operating temperature and humidity</b>		0°C to 40°C (32°F to 104°F), 20 to 80% RH (non-condensation)

## 17.1 General Specifications of the Instrument

<b>Storage temperature and humidity</b>	-10°C to 50°C (14°F to 122°F), 90% RH or less (non-condensation)
<b>Temperature and humidity range for guaranteed accuracy</b>	23°C ± 5°C (73.4°F ± 9.0°F), 20 to 80% RH (non-condensation)
<b>Period of guaranteed accuracy</b>	1 year
<b>Product warranty period</b>	3 year
<b>Isolation resistance and withstand voltage</b>	Between chassis and power line :1.69 kV AC for 1 min at least 50 MΩ at 500 V DC (MR8740) 1.69 kV AC for 1 min at least 20 MΩ at 500 V DC (MR8741) Between module and chassis: 3 kV AC for 1 min at least 100 MΩ at 500 V DC
<b>Power source</b>	Rated power supply voltage: 100 to 240 VAC (continuous input) (Voltage fluctuations of ±10% from the rated supply voltage are taken into account.) Rated power supply frequency: 50 Hz/60 Hz Overvoltage category II (anticipated transient overvoltage 2500 V)
<b>Maximum rated power</b>	MR8740: 250 VA max. MR8741: 120 VA max.
<b>Dimensions</b>	MR8740: Approx. 426W × 177H × 505D mm (sans protrusions) (Approx. 16.77"W × 6.97"H × 19.88"D) MR8741: Approx. 350W × 160H × 320D mm (sans protrusions) (Approx. 13.78"W × 6.30"H × 12.60"D) Approx. 350W × 175H × 320D mm (within protrusions) (Approx. 13.78"W × 6.89"H × 12.60"D)
<b>Mass</b>	MR8740: Approx. 10.8 kg (Approx. 381.0 oz.) (Instrument) MR8741: Approx. 5.4 kg (Approx. 190.5 oz.) (Instrument)
<b>Applicable standards</b>	Safety EN61010 EMC EN61326 Class A

## External Interfaces

### LAN

<b>No. of ports</b>	MR8740: 2 (1 port for each block) MR8741: 1
<b>Compliant standards</b>	IEEE802.3 Ethernet 100BASE-TX, FTP server, HTTP server
<b>Connector</b>	RJ-45
<b>Maximum cable length</b>	100 m

### USB

<b>No. of ports</b>	MR8740: 4 (2 ports for each block) MR8741: 2
<b>Compliant standards</b>	USB2.0compliant
<b>Host</b>	Connector: Series-A receptacle Connecting device: USB memory stick, Mouse

### DVI Interfaces

<b>No. of ports</b>	MR8740: 2 (1 port for each block) MR8741: 1
<b>Resolution</b>	SVGA (800 × 600)
<b>Connector</b>	DVI-D (for digital)

## Modules/Waveform Display

<b>Measurement mode</b>	Module model-dependent
<b>Measurement range</b>	Module model-dependent
<b>Input coupling</b>	Module model-dependent
<b>Low-pass filter</b>	Module model-dependent
<b>Displayed graphs*<sup>1</sup></b>	On-screen settings for displayed graphs and multi-graph printing (up to 16 graphs)
<b>Waveform display*<sup>1</sup></b>	Select Off, or from 16 colors
<b>Waveform display position*<sup>1</sup></b>	in increments of 1% Preset (ascending, descending, 0%, 50%)
<b>Zero adjust</b>	All channels and ranges together
<b>Waveform display magnification*<sup>1</sup></b>	Horizontal axis (Time axis): ×10, ×5, ×2, ×1, ×1/2, ×1/5, ×1/10, ×1/20, ×1/50, ×1/100, ×1/200, ×1/500, ×1/1000, ×1/2000, ×1/5000, ×1/10000, ×1/20000 Vertical axis (Voltage axis): ×100, ×50, ×20, ×10, ×5, ×2, ×1, ×1/2, ×1/5, ×1/10
<b>Variable display function*<sup>1</sup></b>	Specified by upper and lower limit values, by displayed amplitude per division
<b>Scaling</b>	Automatic scrolling (10:1, 100:1, 1000:1, selectable for different attenuating probes) Manual scrolling (conversion ratio setting, two-point setting and unit settings)
<b>Invert function</b>	Polarity reversal
<b>Vernier function</b>	Included
<b>Commenting</b>	Alphanumeric and Japanese characters (title, each analog channel, and each logic channel)
<b>Comment entry method</b>	Single character, stored string and historical string entry (pre-stored and previously used strings can be recalled, inserted and edited)
<b>Copy channel settings</b>	Copy and paste, or paste all
<b>Logic setting*<sup>1</sup></b>	Width: Selectable from three types: wide, standard, and narrow Display position: Freely settable in increments of 1% Display bits: Off or selectable from among 16 colors, settable individually for each bit
<b>Zoom function*<sup>1</sup></b>	The waveform screen is divided vertically in two, and the lower portion displays zoomed waveforms.

\*1:When an LCD monitor is connected or when displaying the Waveform screen via a computer using the HTTP function

## Accessories/Options

<b>Accessories</b>	Instruction Manual ..... 1 Application CD ..... 1 Power Cord ..... 1 Rack mounting brackets (for EIA standard) ..... 1 set (MR8740 only)
<b>Options</b>	<b>For information about options: (p. A10)</b>

## 17.2 Measurement Functions

### 17.2.1 Memory Function

<b>Timebase</b>	5, 10, 20, 50, 100, 200, 500 $\mu$ s/div 1, 2, 5, 10, 20, 50, 100, 200, 500 ms/div 1, 2, 5, 10, 30, 50, 100 s/div 1, 2, 5 min/div
<b>Time axis resolution</b>	100 points/div
<b>Sampling period</b>	1/100th of timebase
<b>Recording length</b>	Fixed recording length: 25, 50, 100, 200, 500, 1000, 2000, 5000, 10000, 20000, 50000, 100000 div Arbitrary recording length: Can be set in units of divisions (up to 160,000 div)
<b>Screen Settings</b>	1 screen, 2 screens, 4 screens, 8 screens, 16 screens, X-Y 1 screen, or X-Y 4 screens
<b>Interpolation function</b>	Line, line and dot (with X-Y)
<b>Waveform scrolling</b>	Left-right scrolling is available, Backward scrolling is available during Roll Mode display
<b>Overlay function</b>	Automatic: Always overlays when starting, and clears by restarting Manual: Overlays only necessary waveforms, and clears them as needed
<b>Automatic saving</b>	Automatically saves data on USB memory stick after measuring (binary or text) When sampling is slow, saving starts during recording.
<b>Automatic print</b>	Automatically prints data after measurement (Sends print data to PC connected via LAN, Model 9333 LAN communicator is required.)
<b>Manual print</b>	The "Send Print Key" function of Model 9333 LAN communicator is utilized
<b>Report print</b>	The "Send Print Key" function of Model 9333 LAN communicator is utilized

### 17.2.2 Recorder Function

<b>Timebase</b>	10, 20, 50, 100, 200, 500 ms/div 1, 2, 5, 10, 30, 50, 100 s/div 1, 2, 5, 10, 30 min/div, 1 h/div
<b>Time axis resolution</b>	100 points/div
<b>Sampling period</b>	1, 10, 100 $\mu$ s 1, 10, 100 ms (not more than 1/100th of the selected timebase)
<b>Recording length</b>	Fixed recording length: 25, 50, 100, 200, 500, 1000, 2000, 5000, 10000, 20000, 50000 div Adjustable recording length: Can be set in units of divisions (up to 80,000 div) Continuous
<b>Screen and Printing Settings</b>	1, 2, 4, 8 or 16 screens
<b>Waveform Storage</b>	The most recent 80,000 divisions of measurement data is retained in internal memory
<b>Waveform Scrolling</b>	Left-right scrolling by Jog and Shuttle knobs. Including backward scrolling during measurement
<b>Automatic saving</b>	Automatically saves data on USB memory stick after measuring (binary or text) When sampling is slow, saving starts during recording.
<b>Manual print</b>	The "Send Print Key" function of Model 9333 LAN communicator is utilized
<b>Report print</b>	The "Send Print Key" function of Model 9333 LAN communicator is utilized

### 17.2.3 FFT Function

<b>Frequency range</b>	133 mHz to 8 MHz, external
<b>Dynamic range</b>	72 dB (Theoretical value ), 96dB (Theoretical value)(When the 8968 High Resolution Unit is used)
<b>Number of sampling points</b>	1000 points, 2000 points, 5000 points, 10000 points
<b>Frequency resolution</b>	1/400, 1/800, 1/2000, 1/4000
<b>Anti-aliasing filter</b>	Coupled with the frequency range, the cutoff frequency is automatically set. (Only when using the Model 8968 High Resolution Unit or Model U8979 Charge Unit)
<b>Analysis channel setting</b>	Can be selected from desired channels
<b>FFT analysis modes</b>	Storage waveform, linear spectrum*, RMS spectrum*, power spectrum*, cross power spectrum, auto-correlation function, histogram, transfer function, cross-correlation function, impulse response, coherence function, 1/1 octave analysis, 1/3 octave analysis, LPC analysis, phase spectrum * The total harmonic distortion (THD) is displayed when the cursor display is ON.
<b>Display formats</b>	Single, Dual, Nyquist display, running spectrum display
<b>Window</b>	Rectangular window, Hanning, Hamming, Blackman, Blackman Harris, Flat top, Exponential
<b>Display scale</b>	Linear, log

<b>Peak hold</b>	Included
<b>Averaging</b>	Time axis, simple average of frequency axis, indexed average, peak hold (frequency axis), number of times (2, 4, 8, ... 10,000)
<b>Automatic print</b>	Automatically prints data after measurement (Sends print data to PC connected via LAN, Model 9333 LAN communicator is required.)
<b>Manual print</b>	The "Send Print Key" function of Model 9333 LAN communicator is utilized
<b>Report print</b>	The "Send Print Key" function of Model 9333 LAN communicator is utilized

## 17.3 Trigger Section

<b>Trigger method</b>	Digital comparison
<b>Trigger modes</b>	<ul style="list-style-type: none"> <li>• Single, Repeat, Automatic (Memory function, FFT function)</li> <li>• Single, Repeat (Recorder function)</li> </ul>
<b>Trigger source</b>	MR8740: Block I Analog Unit (Ch1 to Ch32), 8 Standard Logic Channels Block II Analog Unit (Ch1 to Ch22), 8 Standard Logic Channels MR8741: Analog Unit (Ch1 to Ch16), 16 Standard Logic Channels Independent trigger criteria settable for each channel Free-run operation occurs when all trigger types are off.
<b>Manual trigger</b>	Trigger operated by the manual trigger key of the Memory HiCorder
<b>Timer trigger</b>	Trigger depending on the time and interval settings
<b>External trigger (MR8741 only)</b>	External signal is used as trigger.
<b>Trigger criteria</b>	AND or OR of each trigger source
<b>Trigger types (analog)</b>	<ul style="list-style-type: none"> <li>• Level Trigger Set digitally as a voltage value below full-scale</li> <li>• Voltage Sag Trigger (Drop) Triggering occurs when peak voltage falls below the specified level (for commercial power). (for 50/60 Hz commercial power)</li> <li>• Window Trigger Upper and lower trigger threshold levels are specified Triggering occurs when the signal enters or exits the defined threshold range.</li> <li>• Period Trigger A trigger period reference voltage level and period range are specified The period of the signal rising (or falling) through the specified level is measured, and triggering occurs when the period is outside of the specified range.</li> <li>• Glitch Trigger Set voltage level and pulse width (glitch width) Triggering occurs when the signal pulse width is narrower than the specified pulse width defined as rising (or falling) through a specified voltage level.</li> <li>• Event Trigger Triggering occurs when the event values specified for the level or glitch trigger are exceeded. Triggering occurs when the input rises above (or falls below) the specified trigger voltage level.</li> </ul>
<b>Trigger types (logic)</b>	Pattern (mask) trigger by 1, 0, or x (x: don't care)
<b>External trigger (MR8741 only)</b>	External signal is used as trigger.
<b>Trigger filter</b>	OFF, 0.1, 0.2, 0.5, 1.0, 1.5, 2.0, 2.5, 5.0, 10.0 div (Memory function, FFT function) OFF, ON: 10 ms fixed (Recorder function)
<b>Trigger level resolution</b>	0.1% f.s. (f.s. = 20 div)
<b>Pre-trigger</b>	Applicable to memory function or FFT function % setting: 0, 2, 5, 10, 20, 30, 40, 50, 60, 70, 80, 90, 95, 100, -95% div setting: Setting by units of 1 div
<b>Trigger priority</b>	Off/On
<b>Trigger synchronization (MR8740)</b>	Synchronization between block I and block II (by using external trigger) Offset between blocks of the larger value of 1 $\mu$ s or 3 samples or less
<b>Trigger marker</b>	Trigger marks indicate positions of trigger events
<b>Trigger timing</b>	Start (All functions), stop (Recorder function), Start & stop (Recorder function)
<b>Trigger Output (MR8741 only)</b>	Open collector output With 5 V voltage output, active low, low output level 0 V to 0.5 V (current of 15 mA) Pulse width for level setting: (sampling rate $\times$ number of data points after trigger) or more Pulse width for pulse setting: 2 ms $\pm$ 1 ms

## 17.4 File Specifications

### Data Saving

<b>Supported storage media</b>	USB memory stick, Internal RAM, LAN (Model 9333 LAN Communicator)
<b>Saved data</b>	MR8740: Setting data, measurement data, screen image, print image MR8741: Setting data, measurement data, screen image, print image, waveform evaluation conditions, waveform evaluation areas
<b>Saving types</b>	<ul style="list-style-type: none"> <li>• Setting data (.SET) (Only setting configurations can be saved to internal RAM)</li> <li>• Measurement data Binary format (.MEM, .REC, .FFT), Text format (.TXT)</li> <li>• Index, Memory division (.SEQ), division save (.IDX)</li> <li>• Screen image (.BMP)</li> <li>• Print image (.BMP)</li> <li>• Waveform evaluation conditions (.ARE) *Evaluation area + Saving settings (MR8741 only)</li> <li>• Waveform evaluation area (.BMP) *Saving of evaluation area (MR8741 only)</li> <li>• Arbitrary waveform data (.WFG) (when Model U8793 is installed)</li> <li>• Generation program data (.FGP) (when Model U8793 is installed)</li> <li>• Pulse pattern data (.PLS) (when Model MR8791 is installed)</li> </ul>
<b>File name entry</b>	Alphanumerics and Japanese
<b>Saving range</b>	Whole range, or between A/B cursors
<b>Data thinning save</b>	When saved in text format OFF, 1/2, 1/5, 1/10, 1/20, 1/50, 1/100, 1/200, 1/500, 1/1000
<b>Division save</b>	When saved in binary format 16 MB, 32 MB, 64 MB
<b>Duplicate file name handling</b>	Auto: If a file with the same name exists, saves the file, adding a 4-digit number at the beginning of the file name. Serial: Saves the file, adding a 4-digit number at the beginning of the file name. Overwrite: If a file with the same name exists, overwrites the file. Error: If a file with the same name exists, an error message will be displayed.
<b>Selection of blocks to be saved</b>	Saves the selected blocks when dividing the memory
<b>Selection of channels to be saved</b>	Selects the channels to save (measurement data, calculation data), all channels

### Data Loading

<b>Supported storage media</b>	USB memory stick, Internal RAM
<b>Loadable data types</b>	MR8740: Setting data, measurement data, analysis data MR8741: Setting data, measurement data, analysis data, waveform evaluation conditions, waveform evaluation area
<b>Loadable data formats</b>	<ul style="list-style-type: none"> <li>• Setting data (.SET) (Setting configurations can only be saved to internal RAM)</li> <li>• Measurement data Binary format (.MEM, .REC, .FFT)</li> <li>• Index memory division (.SEQ), division save (.IDX)</li> <li>• Waveform evaluation conditions (.ARE) Evaluation area + Loading a setting configurations (MR8741 only)</li> <li>• Evaluation area (.BMP) Loading a evaluation area (MR8741 only)</li> <li>• Arbitrary waveform data (when Model U8793 is installed)</li> <li>• Generation program data (.FGP) (when Model U8793 is installed)</li> <li>• Pulse pattern data (.PLS) (when Model MR8791 is installed)</li> </ul>
<b>Loading method</b>	New

### Others

<b>Display file information</b>	Included
<b>Delete data</b>	Single or multiple file selections
<b>Sort files</b>	By name, date, size, extension Ascending order, descending order
<b>Rename file</b>	Included
<b>Directory</b>	Create, rename and delete
<b>Copy file</b>	Copy to other media
<b>One-Touch saving</b>	The saving format and data specified in advance can be saved with a single action (One-Touch saving via <b>SAVE</b> key or a mouse click).

## 17.5 Built-In Functions

### Calculation-related functions

<b>Calculation functions</b>	Memory Function supported
<b>Number of calculations</b>	Up to 16 calculations can be applied to any channel
<b>Calculation range</b>	Whole range, between A/B cursors or after trigger
<b>Calculation types</b>	Average, RMS value, P-P value, maximum value, time to maximum value, minimum value, time to minimum value, period, frequency, rise time, fall time, standard deviation, squared value, X-Y squared value, time to level, level at time, pulse width, duty ratio, pulse count, four basic arithmetic operations, time difference, phase difference, High level, Low level
<b>Auto-save calculation results</b>	After measuring, automatically saves to USB memory stick (text format)
<b>Statistical calculation</b>	First, average, maximum, or minimum
<b>Judgment of calculation results</b>	Calculation results can be judged based on the specified maximum/minimum value Stop condition: GO, NG, GO&NG
<b>Evaluation output</b>	Outputs GO or NG judgment signal via external control terminals Open collector output With 5 V voltage output, active low, Low output level 0 V to 0.5 V (current of 15 mA) Pulse width: 1.8 ms or more

### Waveform calculation function

<b>Calculation support function</b>	Memory Function
<b>Number of calculations</b>	Up to a maximum of 16 calculations for desired channels
<b>Calculation range</b>	All range, between A/B cursor selections
<b>Calculation record length</b>	Up to 2,000 div
<b>Operators</b>	Four arithmetic operations, absolute values, indexes, common logarithms, square root, moving average, differential (primary, secondary) Integral (primary, secondary), parallel displacement of time axis direction, trigonometric function, reverse trigonometric function, integration time correction based on NPLC setting
<b>Automatic saving of calculation results</b>	After measurement, automatic saving to USB memory stick (binary, .txt file)

### Memory division function

<b>Division support function</b>	Memory Function
<b>Number of memory divisions</b>	2 to 1024
<b>Divided record length</b>	Can be set as desired (but depends on the number of divisions)
<b>Sequential saving</b>	Possible by specifying start and end blocks
<b>Sequential saving dead time</b>	When block display is OFF: 1 to 8 samples (time axis 5 $\mu$ s/div to 20 $\mu$ s/div) 1 sample (time axis 50 $\mu$ s/div or more)
<b>Multi-block saving</b>	Saving of waveforms is possible by specifying the desired blocks of divisions
<b>Block display</b>	Display can be set to ON or OFF
<b>Block overlaying</b>	Desired blocks or all blocks

### Cursor measurement functions

<b>Cursor supporting Functions</b>	Memory function, recorder function, FFT function
<b>Number of cursors</b>	Two (Cursors A and B)
<b>Cursor types</b>	Line (vertical or horizontal) and Trace
<b>Cursor movements</b>	A Cursor, B Cursor, A&B Cursors
<b>Measurement function</b>	A Cursor : Amplitude at each cursor, time from trigger event AB Cursor: Time, amplitude and frequency (period) differences between cursors
<b>Cursor-supported channels</b>	All channels (default), or any specified channel
<b>Included functions</b>	Partial saving (specified time span)



## Monitor functions

<b>Monitor display*<sup>1</sup></b>	Level monitor: Display the level and numerical value by selecting the level monitor with the <b>DISP</b> key DMM display: Display the numerical values by pressing the <b>DISP</b> key
<b>Numerical value display*<sup>1</sup></b>	Instantaneous value display, with hold function
<b>Level monitor sampling</b>	10 kS/s (fixed)
<b>Refresh rate</b>	0.5 s or more, depends on the NPLC settings when using the Model MR8990 Digital Voltmeter Unit

\*1: When an LCD monitor is connected or when displaying the Waveform screen via a computer using the HTTP function

## Position Display (VIEW) Functions

<b>Display function*<sup>1</sup></b>	Position: Displays the current position with respect to the entire recording length Blocks: Memory division blocks (When memory division is ON)
<b>Position display*<sup>1</sup></b>	Currently displayed position (linked to scroll), positions of A and B cursors, trigger position, waveform search results position
<b>Block display*<sup>1</sup> (only when using memory division)</b>	Block usage status (When memory division is ON) Past waveform history status (When memory division is OFF) Display of display block for all blocks
<b>Jump function</b>	Jump to trigger position/cursor position Jump to desired block (When memory division is ON) Jump to past waveform (When memory division is OFF) Jump to waveform search position

\*1: When an LCD monitor is connected or when displaying the Waveform screen via a computer using the HTTP function

## Waveform Evaluation Function (MR8741 Only)

<b>Waveform evaluation functionality</b>	Compares memory (Y-T waveform, X-Y waveform) and FFT-created waveform area with captured waveforms and determines whether the captured waveform falls inside or outside the corresponding area.
<b>Evaluation modes</b>	Out: NG (fail) if any part of the waveform falls outside the area. All out: NG (fail) if the entire waveform falls outside the area.
<b>Evaluation stop conditions</b>	GO, NG, GO&NG Printer output can be generated or the waveform can be saved when evaluation stops. (Using the automatic print function built into Model 9333 LAN Communicator.)
<b>Evaluation output</b>	GO/NG evaluation output from terminal block: Open collector output (with 5 V voltage output, active low, low output level of 0 to 0.5 V, current value of 15 mA) Pulse width: 1.8 ms or more
<b>Waveform evaluation time</b>	Evaluation time: 100 ms or less; evaluation period: 250 ms or less* *1 channel, time axis of 5 $\mu$ s/div, recording length of 25 div, magnification factor of 1, 2 input waveform periods When sampling is slow, waveforms can be evaluated during measurement.
<b>Graphic editor</b>	Instrument: Includes an editor for creating waveform evaluation reference areas. External: Waveform evaluation reference areas (BMP data) created with third-party software on a computer can be loaded into the instrument.
<b>Editor commands</b>	Waveform capture, magnify/compress, paint, draw, erase, all clear, clear, reverse, undo, end

## Waveform Generation Function

The detailed hardware functions conform to the generator module specifications of Models MR8790, MR8791, and U8793

<b>Waveform generation mode</b>	Depends on generator modules of Models MR8790, MR8791, and U8793
<b>Waveform output control</b>	Output control RUN (generation), STOP (stop), PAUSE (suspension) Output control method Manual: Controls output by using the F key on the settings screen. Measurement and synchronization: Keys: <b>START</b> key, <b>STOP</b> key for output control (disable measurement)
<b>Output waveform</b>	Model MR8790 Waveform Generator Unit: DC, Sine waves Model MR8791 Pulse Generator Unit: Pulse, pattern Model U8793 Arbitrary Waveform Generator Unit: DC, sine waves, triangular waves, rectangular waves, pulse, ramp up, ramp down, arbitrary waveform, program
<b>Waveform compatible for output (Only U8793)</b>	Refer to "Arbitrary waveform generation function specifications" ( p.368)

## Others

<b>On-line help function*1</b>	Clicking <b>[HELP]</b> displays help for the item at the currently selected (blinking) item (the whole screen is not used) Basic help (when making settings, displays a brief description of the selected (blinking) item along the bottom of the screen)
<b>Grid types*1</b>	Display only: Off, normal or normal (dark)
<b>Comment display*1</b>	Comments are displayed with channel numbers on the screen (channel markers)
<b>Time scale display*1</b>	Time, time (base-60), scale, date, sample numbers
<b>Variable auto-compensation*1</b>	OFF, ON
<b>Start backup function</b>	OFF, ON
<b>Display color*1</b>	Color 1 to 3, or user-defined
<b>Beep sound</b>	Off, warnings, or warnings and operations
<b>Language*1</b>	Japanese/ English/ Korean/ Chinese
<b>Start action</b>	Click once, or twice
<b>Stop action</b>	Click once, or twice
<b>GUI section saving</b>	Off / On
<b>External control terminals*2</b>	Trigger control terminals (EXT.TRIG, TRIG OUT), External sampling input terminal (EXT.SMPL) Remote control input terminal (START/IN1, STOP/IN2, SAVE/IN3), Evaluation output terminals (GO/OUT1, NG/OUT2)
<b>Remote control*2</b>	Select from among terminals for remote input (START/IN1, STOP/IN2, SAVE/IN3): <b>[START] [STOP] [START/STOP] [ABORT] [PRINT] [SAVE] [Pen Up/Down] [RUN/STOP] [PAUSE]</b>
<b>Internal status output*2</b>	Select from among evaluation output terminals (GO/OUT1, NG/OUT2): <b>[Error], [BUSY], [Trigger]</b>
<b>Probe calibration output*2</b>	Select evaluation output terminal (NG/OUT2): <b>[Probe Calibration]</b>
<b>Evaluation output*2</b>	Select from among evaluation output terminals (GO/OUT1, NG/OUT2): <b>[Measure], [Waveform Evaluation], [Value Evaluation or Waveform Evaluation], [Value Evaluation and Waveform Evaluation]</b>
<b>Time setting</b>	Included (settable with mouse or communication command)
<b>Initialization</b>	Clear waveform data System reset (Settings/System settings 1 <b>[Environment]</b> /System settings 2 <b>[Interface]</b> )
<b>Self-Test function</b>	ROM/RAM, Display, System information, USB host

\*1: When an LCD monitor is connected or when displaying the Waveform screen via a computer using the HTTP function

\*2: Model MR741 only

## 17.6 Specifications of Modules

### 17.6.1 8966 Analog Unit

<b>Temperature and humidity range for guaranteed accuracy</b>	23°C ± 5°C (73.4°F ± 9.0°F), 20 to 80% RH (when zero adjustment is executed 30 minutes after power on)	
<b>Product warranty period</b>	3 years	
<b>Period of guaranteed accuracy</b>	1 year	
<b>No. of input channels</b>	2 channels	
<b>Measurement range</b>	5, 10, 20, 50, 100, 200, 500 mV, 1, 2, 5, 10, 20 V/div	
<b>Measurement accuracy</b>	± 0.5% f.s.(Filter 5 Hz On)	
<b>Temperature characteristic</b>	± 0.06% f.s./°C	
<b>Frequency characteristic</b>	DC Coupling: DC to 5 MHz -3 dB AC Coupling: 7 Hz to 5 MHz -3 dB (low cut-off frequency 7 Hz ± 50%)	
<b>Noise</b>	1.5 mVp-p (typ), 2 mVp-p (max) (sensitivity range, with input shorted)	
<b>Common mode rejection ratio</b>	80 dB minimum (at 50 Hz/60 Hz and with signal source resistance 100 Ω maximum)	
<b>Low-pass filter</b>	OFF, 5 ± 50%, 50 ± 50%, 500 ± 50%, 5k ± 50%, 50 k ± 50%, 500 k ± 50%(Hz)-3dB	
<b>Input type</b>	Unbalanced (floating)	
<b>Input coupling</b>	AC/ DC/ GND	
<b>Input resistance</b>	1 MΩ ± 1%	
<b>Input capacitance</b>	30 pF ± 10 pF (at 100 kHz)	
<b>A/D resolution</b>	12 bit	
<b>Maximum sampling rate</b>	20 MS/s	
<b>Input terminals</b>	Insulated BNC terminal	
<b>Maximum input voltage</b>	400 VDC	
<b>Maximum rated voltage to earth</b>	300 V AC/DC (between input channels and chassis, and between input channels), Measurement category II (anticipated transient overvoltage 2500 V)	
<b>Operating temperature and humidity</b>	Same as the host Memory HiCorder	
<b>Operating environment</b>	Same as the host Memory HiCorder	
<b>Storage temperature and humidity</b>	Temperature -10°C to 50°C (14°F to 122°F) Humidity 80% RH or less (non-condensating)	
<b>Dimensions</b>	Approx. 106 mmW × 19.8 mmH × 207.5 mmD (4.17"W × 0.78"H × 8.17"D)	
<b>Mass</b>	Approx. 250 g (8.8 oz)	
<b>Effect of radiated radio-frequency electromagnetic field</b>	± 15% f.s. (max) at 3 V/m	
<b>Effect of conducted radio-frequency electromagnetic field</b>	±45% f.s. (max) at 3 V (100 mV/div range, with 1 VDC input)	
<b>Applicable standards</b>	Safety	EN61010
	EMC	EN61326 Class A
<b>Options</b>	Model L9197 Connection Cord (300 V CAT IV, 600 V CAT III, 1 A) Model L9198 Connection Cord (300 V CAT III, 600 V CAT II, 0.2 A) Model L9217 Connection Cord (300 V CAT III, 600 V CAT II, 0.2 A) Model L9790 Connection Cord (With Model L9790-01 or Model 9790-03 attached: 300 V CAT III, 600 V CAT II, 1 A) (With Model 9790-02 attached: 150 V CAT III, 300 V CAT II, 1 A) Model 9322 Differential Probe (With grabber clips attached: 1000 V CAT II) (With alligator clips attached: 600 V CAT III, 1000 V CAT II) Model P9000-01 Differential Probe (1000 V CAT III) Model P9000-02 Differential Probe (1000 V CAT III) Model 9665 10:1 Probe (300 V CAT II) Model 9666 100:1 Probe (300 V CAT II)	

## 17.6.2 8967 TEMP Unit

Temperature and humidity range for guaranteed accuracy	23°C ± 5°C (73.4°F ± 9.0°F), 20 to 80% RH (when zero adjustment is executed 30 minutes after power on)
Product warranty period	3 years
Period of guaranteed accuracy	1 year
No. of input channels	2 channels
Input terminals	Pushbutton-type terminal block (2 terminals/ch)
Sensor	Thermocouple (K, J, E, T, N, R, S, B, W)

Measurement ranges  
Measurable range  
Resolution  
Measurement accuracy  
(f.s.=20 div)

Sensor	Range	Measurable range	Resolution	Measurement accuracy		
Thermocouple (not including standard junction compensation accuracy)	K <sup>*1</sup>	10°C/div	-100°C to 200°C	0.01°C	±0.1% f.s. ± 1°C ± 0.1% f.s. ± 2°C (-200°C to 0°C)	
		50°C/div	-200°C to 1000°C	0.05°C		
		100°C/div	-200°C to 1350°C	0.1°C		
	J <sup>*1</sup>	10°C/div	-100°C to 200°C	0.01°C		
		50°C/div	-200°C to 1000°C	0.05°C		
		100°C/div	-200°C to 1100°C	0.1°C		
	E <sup>*1</sup>	10°C/div	-100°C to 200°C	0.01°C		
		50°C/div	-200°C to 800°C	0.05°C		
		100°C/div	-200°C to 800°C	0.1°C		
	T <sup>*1</sup>	10°C/div	-100°C to 200°C	0.01°C		
		50°C/div	-200°C to 400°C	0.05°C		
		100°C/div	-200°C to 400°C	0.1°C		
	N <sup>*1</sup>	10°C/div	-100°C to 200°C	0.01°C		
		50°C/div	-200°C to 1000°C	0.05°C		
		100°C/div	-200°C to 1300°C	0.1°C		
	R <sup>*1</sup>	10°C/div	0°C to 200°C	0.01°C		±0.1% f.s. ± 3.5°C (0°C to 400°C) (except B, for which accuracy is not guaranteed below 400°C)
		50°C/div	0°C to 1000°C	0.05°C		
		100°C/div	0°C to 1700°C	0.1°C		
S <sup>*1</sup>	10°C/div	0°C to 200°C	0.01°C			
	50°C/div	0°C to 1000°C	0.05°C			
	100°C/div	0°C to 1700°C	0.1°C			
B <sup>*1</sup>	50°C/div	400°C to 1000°C	0.05°C	± 0.1% f.s. ± 3°C (400°C and higher)		
	100°C/div	400°C to 1800°C	0.1°C			
W <sup>*2</sup> (WRe5-26)	10°C/div	0°C to 200°C	0.01°C			
	50°C/div	0°C to 1000°C	0.05°C			
	100°C/div	0°C to 2000°C	0.1°C			

\*1: JIS C 1602-1995, \*2: ASTM E-988-96

Reference junction compensation accuracy ± 1.5°C (Reference junction compensation: When internal, add to thermocouple measurement accuracy)

Reference junction compensation Selectable internal or external (during thermocouple measurement)

Temperature characteristic Add (meas. accuracy × 0.1)°C to meas. accuracy

Data refresh Selectable from normal, fast or slow

Selection	Fast	Normal	Slow
Data Refresh Rate	1.2 ms	100 ms	500 ms

Open-circuit detection Selectable On or Off

Input resistance ≥ 100MΩ (with open-circuit detection Off) or 5.1 MΩ ± 5% with open-circuit detection On)

Common mode rejection ratio 80 dB minimum (at 50 Hz/60 Hz, with signal source ≥ 100Ω, and Fast data refresh setting)  
100 dB minimum (at 50 Hz/60Hz, with signal source ≥ 100Ω, and Normal data refresh setting)

Input type Unbalanced (floating)

Maximum rated voltage to earth 300 V AC/DC (between input channels and chassis, and between input channels)  
Measurement category II, (anticipated transient overvoltage 2500 V)

Operating temperature and humidity Same as the host Memory HiCorder

Storage temperature and humidity Temperature -20°C to 50°C (-4°F to 122°F), Humidity 90% RH or less (non-condensating)

Operating environment Same as the host Memory HiCorder

Dimensions Approx. 106 mmW × 19.8 mmH × 204.5mmD (4.17"W × 0.78"H × 8.05"D)

Mass Approx. 240 g (8.8 oz)

Option Ferrite clamp-on choke ..... 2

Effect of radiated radio-frequency electromagnetic field ± 2% f.s. (max) at 3 V/m

Effect of conducted radio-frequency electromagnetic field ± 2% f.s. (max) at 3 V

Applicable standards Safety EN61010  
EMC EN61326 Class A

Options (sold separately) Model 9810 Thermocouples (K)

### 17.6.3 8968 High Resolution Unit

<b>Temperature and humidity range for guaranteed accuracy</b>	23 °C ± 5°C (73.4°F ± 9.0°F), 20 to 80% RH (when zero adjustment is executed 30 minutes after power on)
<b>Product warranty period</b>	3 years
<b>Period of guaranteed accuracy</b>	1 year
<b>No. of input channels</b>	2 channels
<b>Measurement ranges</b>	5, 10, 20, 50, 100, 200, 500 mV, 1, 2, 5, 10, 20 V/div
<b>Measurement accuracy</b>	±0.3% f.s. (Filter 5 Hz On, after zero adjustment)
<b>Temperature characteristic</b>	±0.045% f.s./°C
<b>Frequency characteristic</b>	DC coupling: DC to 100 kHz -3 dB AC coupling: 7 Hz to 100 kHz -3 dB (low-cut frequency: 7 Hz±50%)
<b>Noise</b>	500 μVp-p (typ), 1 mVp-p (max) (sensitivity range, with input shorted)
<b>Common mode rejection ratio</b>	80 dB minimum (at 50 Hz/60 Hz and with signal source resistance 100 Ω maximum)
<b>Low-pass filter</b>	Off, 5±50%, 50±50%, 500±50%, 5 k±50%, 50k±50%(Hz)-3 dB
<b>Anti-aliasing filter</b>	Cutoff frequency (fc) 20, 40, 80, 200, 400, 800, 2k, 4k, 8k, 20k, 40k (Hz) (Automatic setting when the anti-aliasing filter is ON) Attenuation property at 1.5 fc, -66 dB or higher
<b>Input type</b>	Unbalanced (floating)
<b>Input coupling</b>	AC/DC/GND
<b>Input resistance</b>	1 MΩ±1%
<b>Input capacitance</b>	30 pF±10 pF (at 100 kHz)
<b>A/D resolution</b>	16 bit
<b>Maximum sampling rate</b>	1 MS/s
<b>Input terminals</b>	Insulated BNC terminal
<b>Maximum input voltage</b>	400 V DC
<b>Maximum rated voltage to earth</b>	300 V AC/DC (between input channels and chassis, and between input channels) Measurement category II (anticipated transient overvoltage 2500 V)
<b>Operating temperature and humidity</b>	Same as the host Memory HiCorder
<b>Operating environment</b>	Same as the host Memory HiCorder
<b>Storage temperature and humidity</b>	Temperature -10°C to 50°C (14°F to 122°F) Humidity 80% RH or less (non-condensating)
<b>Dimensions</b>	Approx. 106 mmW × 19.8 mmH × 207.5 mmD (4.17"W × 0.78"H × 8.17"D)
<b>Mass</b>	Approx. 250 g (8.8 oz)
<b>Effect of radiated radio-frequency electromagnetic field</b>	±15% f.s. (max) at 3 V/m
<b>Effect of conducted radio-frequency electromagnetic field</b>	±20% f.s. (max) at 3 V (at 100 mV/div range, 1 VDC input)
<b>Applicable standards</b>	Safety EN61010 EMC EN61326 Class A
<b>Options</b>	Model L9197 Connection Cord (300 V CAT IV, 600 V CAT III, 1 A) Model L9198 Connection Cord (300 V CAT III, 600 V CAT II, 0.2 A) Model L9217 Connection Cord (300 V CAT III, 600 V CAT II, 0.2 A) Model L9790 Connection Cord (With Model L9790-01 or Model 9790-03 attached: 300 V CAT III, 600 V CAT II, 1 A) (With Model 9790-02 attached: 150 V CAT III, 300 V CAT II, 1 A) Model 9322 Differential Probe (With grabber clips attached: 1000 V CAT II) (With alligator clips attached: 600 V CAT III, 1000 V CAT II) Model P9000-01 Differential Probe (1000 V CAT III) Model P9000-02 Differential Probe (1000 V CAT III) Model 9665 10:1 Probe (300 V CAT II) Model 9666 100:1 Probe (300 V CAT II)

## 17.6.4 8969 Strain Unit / U8969 Strain Unit

	8969	U8969
<b>Product warranty period</b>	1 year	3 years
<b>Conditions of guaranteed accuracy</b>	<b>Guaranteed accuracy period:</b> 1 year  <b>Temperature and humidity for guaranteed accuracy:</b> 23°C ± 5°C (73.4°F ± 9.0°F), 20% to 80% RH <b>Warm-up time:</b> At least 30 minutes <b>Specified after performing the auto-balance</b>	<b>Guaranteed accuracy period:</b> 1 year <b>Guaranteed accuracy period from adjustment made by Hioki:</b> 1 year <b>Temperature and humidity for guaranteed accuracy:</b> 23°C ± 5°C (73.4°F ± 9.0°F), 80% RH or less <b>Warm-up time:</b> At least 30 minutes <b>Specified after performing the auto-balance</b>
<b>No. of input channels</b>	2 channels	
<b>Input terminals</b>	Weidmüller SL3.5/7/90G	NDIS connector EPRC07-R9FNDIS
<b>Measurement Object</b>	Strain gauge transducer	
<b>Gauge ratio</b>	2.0	
<b>Bridge voltage</b>	2 V±0.05 V	
<b>Bridge resistance</b>	120 Ω to 1 kΩ	
<b>Balance adjustment range</b>	±10000 με or less	
<b>Balancing</b>	Electronic auto-balancing	
<b>Measurement ranges</b>	20, 50, 100, 200, 500, 1000 με/div	
<b>Measurement accuracy</b>	±0.5% f.s.±4 με (with the low-pass filter set to 5 Hz)	
<b>Temperature characteristic</b>	Gain: ±0.05% f.s./°C Zero position: ±2.5 με/°C	
<b>Frequency characteristic</b>	DC to 20 kHz +1/-3 dB	
<b>Low-pass filter</b>	Off, 5±30%, 10±30%, 100±30%, 1k±30%(Hz) -3 dB	
<b>A/D resolution</b>	16 bits (±f.s. equals ±25000 pieces of data)	
<b>Maximum sampling rate</b>	200 kS/s	
<b>Maximum rated voltage to earth</b>	33 Vrms AC or 70 V DC (between each input channel and enclosure, between any two of input channels) Anticipated transient overvoltage: 330 V (Based on EN61010-2-030:2010)	30 Vrms AC or 60 V DC (between each input channel and enclosure, between any two of input channels) Anticipated transient overvoltage: 330 V
<b>Operating temperature and humidity</b>	In accordance with the specifications of Memory HiCorder in which Model 8969 is installed	Temperature -10°C to 40°C (-14°F to 104°F), Humidity 80% RH or less (non-condensating)
<b>Storage temperature and humidity</b>	In accordance with the specifications of Memory HiCorder in which Model 8969 is installed	Temperature -20°C to 50°C (-4°F to 122°F), Humidity 90% RH or less (non-condensating)
<b>Operating environment</b>	In accordance with the specifications of Memory HiCorder in which Model 8969 is installed	Indoors, Pollution Degree 2, altitude up to 2000 m (6562 ft.)
<b>Dimensions</b>	Approx. 106 mmW × 19.8 mmH × 196.5 mmD (4.17"W × 0.78"H × 7.74"D)	
<b>Mass</b>	Approx. 220 g (7.8 oz)	Approx. 245 g (8.6 oz)
<b>Accessories</b>	Model 9769 Conversion Cable × 2 (Compatible connector: NDIS connector PRC03-12A10-7M10.5)	Model L9769 Conversion Cable × 2 (Compatible connector: NDIS connector PRC03-12A10-7M10.5)
<b>Effect of radiated radio-frequency electromagnetic field</b>	± 10% f.s. (at a maximum) at 3 V/m (with the low-pass filter set to 5 Hz)	
<b>Effect of conducted radio-frequency electromagnetic field</b>	± 10% f.s. (at a maximum) at 3 V (with the low-pass filter set to 5 Hz)	
<b>Applicable standards</b>	Safety EN61010 EMC EN61326 Class A	

## 17.6.5 8970 Freq Unit

<b>Temperature and humidity range for guaranteed accuracy</b>	23°C ± 5°C (73.4 ± 9.0°F), 20% RH to 80% RH
<b>Measurement functions</b>	Based on voltage input, measures frequency, rotation speed, power frequency, integral values, pulse duty ratio, and pulse width.
<b>Connection terminal</b>	Insulated BNC terminal
<b>Input resistance</b>	1 MΩ±1%
<b>Input capacitance</b>	30pF±10pF
<b>Maximum input voltage</b>	400 VDC
<b>Maximum rated voltage to earth</b>	300 V AC/DC (Measurement category II), anticipated transient overvoltage 2500 V (between each input channel and main unit, and between input channels)
<b>Input type</b>	Unbalanced (input isolated from output)
<b>Product warranty period</b>	3 years
<b>Guaranteed accuracy period</b>	1 year
<b>Frequency mode</b>	
<b>Measurement ranges</b>	1, 5, 10, 50, 100, 500, 1k, 5 kHz/div (f.s.=20div)
<b>Measurement accuracy</b>	±0.1%f.s. (except for 5 kHz/div range) ±0.7%f.s.(5 kHz/div range)
<b>Measurement ranges</b>	DC to 100 kHz (min. pulse width 2 μs)
<b>Rotation speed mode</b>	
<b>Measurement ranges</b>	100, 500, 1k, 5k, 10k, 50k, 100 kr/min /div (f.s.=20div)
<b>Measurement accuracy</b>	±0.1%f.s. (except for 100 kr/min range) ±0.7%f.s.(100 kr/min range)
<b>Measurement ranges</b>	0 to 2 kr/min (min. pulse width 2 μs)
<b>Power frequency mode</b>	
<b>Measurement ranges</b>	50 Hz (40 Hz to 60 Hz), 60 Hz (50 Hz to 70 Hz), 400 Hz (390 Hz to 410 Hz) (f.s.=20div)
<b>Measurement accuracy</b>	±0.03 Hz (50 Hz, 60 Hz) ±0.1 Hz (400 Hz)
<b>Integral values mode</b>	
<b>Measurement ranges</b>	2 k, 10 k, 20 k, 100 k, 200 k, 1 M counts/div
<b>Measurement accuracy</b>	±range/2000
<b>Measurement ranges</b>	DC to 100 kHz (min. pulse width 2 μs)
<b>Pulse duty ratio mode</b>	
<b>Measurement ranges</b>	5%/div (f.s.=20div)
<b>Measurement accuracy</b>	±1% (10 kHz to 10 kHz) ±4% (10 kHz to 100 kHz)
<b>Measurement ranges</b>	10 Hz to 100 kHz (min. pulse width 2 μs)
<b>Pulse width mode</b>	
<b>Measurement ranges</b>	500 μ, 1 m, 5 m, 10 m, 50 m, 100 ms/div (f.s.=20div)
<b>Measurement accuracy</b>	±0.1%f.s.
<b>Measurement ranges</b>	2 μs to 2 s
<b>Measurement resolution</b>	Integral values mode: 2000LSB/DIV (f.s.=20 DIV) Power frequency mode: 100LSB/DIV (f.s.=20 DIV) Except for Integral values mode and Power frequency mode: 500LSB/DIV (f.s.=20 DIV)
<b>Response time</b>	Less than 40 μs + sampling interval of instrument in which the device is installed.
<b>Input voltage range</b>	±10 V, ±20 V, ±50 V, ±100 V, ±200 V, ±400 V
<b>Threshold value</b>	±10 V range: -10 to +10 V variable (0.1 V steps), ±20 V range: -20 to +20 V variable (0.2 V steps), ±50 V range: -50 to +50 V variable (0.5 V steps), ±100 V range: -100 to +100 V variable (1 V steps), ±200 V range: -200 to +200 V variable (2 V steps), ±400 V range: -400 to +400 V variable (5 V steps)
<b>Slope</b>	Rising, falling (Frequency, Rotation speed, Power frequency, Integral values mode)
<b>Level</b>	High, Low (Duty ratio, Pulse width mode)
<b>Hold</b>	Frequency mode/ Rotation speed mode: ON/OFF (1 Hz, 0.5 Hz, 0.2 Hz, 0.1 Hz) :When OFF is selected and the next measurement value is not determined within the waiting time period, the frequency or the rotation speed will be determined using the value which is calculated based on the time period between the timing of the last measurement and the timing of the sampling. Put it to 0 when the measurement value is below the fixed value.
<b>Smoothing</b>	OFF, ON* (Frequency mode, Rotation speed mode) *:The permissible smoothing frequency is up to 10 kHz.
<b>Low-pass filter</b>	OFF, 5, 50, 500, 5k, 50 kHz
<b>Input Coupling</b>	DC, AC (Low frequency cut-off in AC-coupled mode: 7 Hz)
<b>Frequency dividing function</b>	Setting range: 1 to 4096, by one step (Frequency, Rotation speed, Integral values mode)
<b>Integration start timing</b>	Start, Trigger (Integral values mode)
<b>Integration limit</b>	Hold, Loop (Integral values mode)
<b>Operating temperature and humidity ranges</b>	Same as the Memory HiCorder in which the 8970 is installed

<b>Storage temperature and humidity ranges</b>	Same as the Memory HiCorder in which the 8970 is installed
<b>Operating environment</b>	Same as the Memory HiCorder in which the 8970 is installed
<b>Applicable standards</b>	Safety EN 61010, EMC EN 61326 Class A
<b>Dimensions</b>	Approx. 106W x 19.8H x 196.5D mm (4.17"W x 0.78"H x 7.74"D) (excluding projections),
<b>Mass</b>	Approx. 250 g (8.8 oz.)
<b>Options</b>	<p>Model L9197 Connection Cord (300 V CAT IV, 600 V CAT III, 1 A)</p> <p>Model L9198 Connection Cord (300 V CAT III, 600 V CAT II, 0.2 A)</p> <p>Model L9217 Connection Cord (300 V CAT III, 600 V CAT II, 0.2 A)</p> <p>Model L9790 Connection Cord          (With Model L9790-01 or Model 9790-03 attached: 300 V CAT III, 600 V CAT II, 1 A)          (With Model 9790-02 attached: 150 V CAT III, 300 V CAT II, 1 A)</p> <p>Model 9322 Differential Probe          (With grabber clips attached: 1000 V CAT II)          (With alligator clips attached: 600 V CAT III, 1000 V CAT II)</p> <p>Model P9000-01 Differential Probe (1000 V CAT III)</p> <p>Model P9000-02 Differential Probe (1000 V CAT III)</p> <p>Model 9665 10:1 Probe (300 V CAT II)</p> <p>Model 9666 100:1 Probe (300 V CAT II)</p>



## 17.6.6 8971 Current Unit

<b>Temperature and humidity range for guaranteed accuracy</b>	23°C ± 5°C (73.4 ± 9.0°F), 20% RH to 80% RH (when zero adjustment is executed 30 minutes after power on)
<b>Product warranty period</b>	3 years
<b>Guaranteed accuracy period</b>	1 year
<b>Number of input channels</b>	2 channels
<b>Applicable current sensors</b>	<ul style="list-style-type: none"> <li>Models 9272-10, 9277, 9278, 9279, 9709, CT6841, CT6843, CT6844, CT6845, CT6846*<sup>2</sup>, CT6862, CT6863, CT6865*<sup>2</sup> (Each sensor requires Model 9318 Conversion Cable to connect with Model 8971 Current Unit)</li> <li>Models 9272-05, 9709-05, CT6862-05, CT6863-05, CT6865-05*<sup>2</sup>, CT6841-05, CT6843-05, CT6844-05, CT6845-05, CT6846-05*<sup>2</sup>, CT6875, CT6876*<sup>2</sup> (Each sensor requires both Model 9318 Conversion Cable and Model CT9901 Conversion Cable to connect with Model 8971 Current Unit)</li> <li>Hioki current sensors with RM515EPA-10PC (Hirose) installed (Supported conversion ratios: 2 V/20 A, 2 V/50 A, 2 V/200 A, 2 V/500 A, 2 V/1000 A*<sup>2</sup>)</li> </ul>
<b>Measurement ranges</b>	<ul style="list-style-type: none"> <li>When Model 9272-10 (20 A), Model 9272-05 (20 A), Model 9277, Model CT6841, or Model CT6841-05 is used: 100 m, 200 m, 500 m, 1, 2, 5 A/div</li> <li>When Model CT6862 or Model CT6862-05 is used 200 m, 500 m, 1, 2, 5, 10 A/div</li> <li>When Model 9272-10 (200 A), Model 9272-05 (200 A), Model 9278, Model CT6843, Model CT6843-05, Model CT6863, or Model CT6863-05 is used: 1, 2, 5, 10, 20, 50 A/div</li> <li>When Model 9279, Model 9709, Model 9709-05, Model CT6844, Model CT6844-05, Model CT6845, Model CT6845-05, Model CT6846*<sup>2</sup>, Model CT6846-05*<sup>2</sup>, Model CT6865*<sup>2</sup>, Model CT6865-05*<sup>2</sup>, Model CT6875, or Model CT6876*<sup>2</sup> is used: 2, 5, 10, 20, 50, 100 A/div</li> </ul>
<b>Measurement accuracy*<sup>1</sup></b>	±0.65%f.s. (filter 5 Hz ON) ±0.85%f.s. (filter 5 Hz ON, for using with Model 9278 or 9279)
<b>RMS accuracy*<sup>1</sup></b>	±1%f.s. (DC, 30 to 1 kHz), ±3%f.s. (1 kHz to 10 kHz), (Sine wave input, filter 5 Hz ON)
<b>Response time*<sup>1</sup></b>	100 ms (rise 0→90%f.s.)
<b>Crest factor</b>	2
<b>Temperature characteristic*<sup>1</sup></b>	±0.075%f.s./°C
<b>Frequency characteristic*<sup>1</sup></b>	DC Coupling: DC to 100 kHz ±3 dB AC Coupling: 7 Hz to 100 kHz ±3 dB (low cut-off frequency 7 Hz±50%)
<b>Noise*<sup>1</sup></b>	10 mAp-pmax (sensitivity range, with input shorted) (for 20 A/2V range)
<b>Low-pass filter</b>	OFF, 5, 50, 500, 5k, 50 k±50%(Hz)-3 dB
<b>Input type</b>	Unbalanced (Not insulated)
<b>Input coupling</b>	AC/DC/GND
<b>Input resistance</b>	1MΩ±1%
<b>A/D resolution</b>	12 bit
<b>Maximum sampling rate</b>	1 MS/s
<b>Input terminals</b>	Sensor connector HR10A-10R-S (HIROSE)
<b>Operating temperature and humidity ranges</b>	Same as the Memory HiCorder in which the 8971 is installed
<b>Operating environment</b>	Same as the Memory HiCorder in which the 8971 is installed
<b>Storage temperature and humidity ranges</b>	-10 to 50°C (14 to 122°F), 80% RH or less (no condensation)
<b>Dimensions</b>	Approx. 106W x 19.8H x 196.5D mm (4.17"W x 0.78"H x 7.74"D) (excluding projections)
<b>Mass</b>	Approx. 250 g (8.8 oz.)
<b>Applicable Standards</b>	Safety EN 61010 EMC EN 61326 Class A
<b>Accessories</b>	For connecting the clamp sensor: Model 9318 Conversion Cable x 2, Instruction Manual
<b>Options</b>	Model 9318 Conversion Cable Model CT9901 Conversion Cable
<b>Number of the 8971 available for Memory HiCorder</b>	Max. 4 unit (for Model MR8740) (cannot be used with MR8741)

\*1: For current measurement, add accuracy and characteristics of a current sensor used.

\*2: Since the instrument recognizes these sensors as a sensor that has a conversion ratio of 2 V/500 A, the scaling conversion ratio shall be set at 2.

## 17.6.7 8972 DC/RMS Unit

<b>Temperature and humidity range for guaranteed accuracy</b>	23 ± 5°C (73.4 ± 9.0°F), 20 to 80% RH (when zero adjustment is executed 30 minutes after power on)
<b>Product warranty period</b>	3 years
<b>Period of guaranteed accuracy</b>	1 year
<b>No. of input channels</b>	2 channels
<b>Measurement ranges</b>	5, 10, 20, 50, 100, 200, 500 mV, 1, 2, 5, 10, 20 V/div
<b>Measurement accuracy</b>	±0.5% f.s. (Filter 5 Hz On)
<b>RMS accuracy</b>	±1% f.s. (DC, 30 Hz to 1 kHz), ±3% f.s. (1 kHz to 100 kHz) (Sine wave input, response time: SLOW)
<b>Response time</b>	Slow 5 s (during rise 0 to 90% f.s.), Mid 800 ms (during rise 0 to 90% f.s.), Fast 100 ms (during rise 0 to 90% f.s.)
<b>Crest factor</b>	2
<b>Temperature characteristic</b>	±0.045% f.s./°C
<b>Frequency characteristic</b>	DC coupling: DC to 400 kHz ±3 dB AC coupling: 7 Hz to 400 kHz ±3 dB (low cut-off frequency: 7 Hz±50%)
<b>Noise</b>	500 µVp-p (typ), 750 µVp-p (max) (sensitivity range, with input shorted)
<b>Common mode rejection ratio</b>	80 dB minimum (at 50 Hz/60 Hz and with signal source resistance 100 Ω maximum)
<b>Low-pass filter</b>	Off, 5±50%, 50±50%, 500±50%, 5k±50%, 100k±50%(Hz)-3 dB
<b>Input type</b>	Unbalanced (floating)
<b>Input coupling</b>	AC/DC/GND
<b>Input resistance</b>	1 MΩ±1%
<b>Input capacitance</b>	30 pF±10 pF (at 100 kHz)
<b>A/D resolution</b>	12 bits
<b>Maximum sampling rate</b>	1 MS/s
<b>Input terminals</b>	Insulated BNC terminal
<b>Maximum input voltage</b>	400 VDC
<b>Maximum rated voltage to earth</b>	300 V AC/DC (between input channels and chassis, and between input channels) Measurement category II (anticipated transient overvoltage 2500 V)
<b>Operating temperature and humidity</b>	Same as the host Memory HiCorder
<b>Operating environment</b>	Same as the host Memory HiCorder
<b>Storage temperature and humidity</b>	Temperature -10 to 50°C (14 to 122°F), Humidity 80% RH or less (non-condensating)
<b>Dimensions</b>	Approx. 106 mmW × 19.8 mmH × 207.5 mmD (4.17"W × 0.78"H × 8.17"D)
<b>Mass</b>	Approx. 250 g (8.8 oz)
<b>Effect of radiated radio-frequency electromagnetic field</b>	±15% f.s. (max) at 3 V/m
<b>Effect of conducted radio-frequency electromagnetic field</b>	±20% f.s. (max) at 3 V (100 mV/div range, with 1 VDC input)
<b>Applicable standards</b>	Safety EN61010 EMC EN61326 Class A
<b>Options</b>	Model L9197 Connection Cord (300 V CAT IV, 600 V CAT III, 1 A) Model L9198 Connection Cord (300 V CAT III, 600 V CAT II, 0.2 A) Model L9217 Connection Cord (300 V CAT III, 600 V CAT II, 0.2 A) Model L9790 Connection Cord (With Model L9790-01 or Model 9790-03 attached: 300 V CAT III, 600 V CAT II, 1 A) (With Model 9790-02 attached: 150 V CAT III, 300 V CAT II, 1 A) Model 9322 Differential Probe (With grabber clips attached: 1000 V CAT II) (With alligator clips attached: 600 V CAT III, 1000 V CAT II) Model P9000-01 Differential Probe (1000 V CAT III) Model P9000-02 Differential Probe (1000 V CAT III) Model 9665 10:1 Probe (300 V CAT II) Model 9666 100:1 Probe (300 V CAT II)

## 17.6.8 8973 Logic Unit

<b>Product warranty period</b>	3 years
<b>Period of guaranteed accuracy</b>	1 year
<b>No. of input channels</b>	4 Probes (16channels)
<b>Input terminals</b>	Mini DIN
<b>Applicable probes</b>	9320-01 Logic Probe, MR9321-01 Logic Probe, 9327 Logic Probe
<b>Operating temperature and humidity</b>	Same as the host Memory HiCorder
<b>Operating environment</b>	Same as the host Memory HiCorder
<b>Storage temperature and humidity</b>	Temperature -10°C to 50°C (14°F to 122°F) Humidity 80% RH or less (non-condensating)
<b>Dimensions</b>	Approx. 106 mmW × 19.8 mmH × 204.5 mmD (4.17"W × 0.78"H × 8.05"D)
<b>Mass</b>	Approx. 190 g (6.7 oz)
<b>Applicable standards</b>	Safety EN61010 EMC EN61326 Class A

## 17.6.9 MR8990 Digital Voltmeter Unit

<b>Temperature and humidity range for guaranteed accuracy</b>	23 ± 5°C (73.4 ± 9.0°F), 20 to 80% RH (when calibration is executed 30 minutes after power on)																							
<b>Product warranty period</b>	3 years																							
<b>Period of guaranteed accuracy</b>	1 year																							
<b>No. of input channels</b>	2 channels																							
<b>Measurement item</b>	DC voltage																							
<b>Measurement ranges</b>	<table border="1"> <thead> <tr> <th>Measurement Range</th> <th>Effective Input Range*</th> <th>Maximum Resolution</th> <th>Input Resistance</th> </tr> </thead> <tbody> <tr> <td>5 mV/div (f.s. = 100 mV)</td> <td>-120 mV to 120 mV</td> <td>0.1 μV</td> <td rowspan="3">100 MΩ or more</td> </tr> <tr> <td>50 mV/div (f.s. = 1000 mV)</td> <td>-1200 mV to 1200 mV</td> <td>1 μV</td> </tr> <tr> <td>500 mV/div (f.s. = 10 V)</td> <td>-12 V to 12 V</td> <td>10 μV</td> </tr> <tr> <td>5 V/div (f.s. = 100 V)</td> <td>-120 V to 120 V</td> <td>100 μV</td> <td rowspan="2">10 MΩ ±5%</td> </tr> <tr> <td>50 V/div (f.s. = 1000 V)</td> <td>-500 V to 500 V</td> <td>1 mV</td> </tr> </tbody> </table>			Measurement Range	Effective Input Range*	Maximum Resolution	Input Resistance	5 mV/div (f.s. = 100 mV)	-120 mV to 120 mV	0.1 μV	100 MΩ or more	50 mV/div (f.s. = 1000 mV)	-1200 mV to 1200 mV	1 μV	500 mV/div (f.s. = 10 V)	-12 V to 12 V	10 μV	5 V/div (f.s. = 100 V)	-120 V to 120 V	100 μV	10 MΩ ±5%	50 V/div (f.s. = 1000 V)	-500 V to 500 V	1 mV
Measurement Range	Effective Input Range*	Maximum Resolution	Input Resistance																					
5 mV/div (f.s. = 100 mV)	-120 mV to 120 mV	0.1 μV	100 MΩ or more																					
50 mV/div (f.s. = 1000 mV)	-1200 mV to 1200 mV	1 μV																						
500 mV/div (f.s. = 10 V)	-12 V to 12 V	10 μV																						
5 V/div (f.s. = 100 V)	-120 V to 120 V	100 μV	10 MΩ ±5%																					
50 V/div (f.s. = 1000 V)	-500 V to 500 V	1 mV																						
	* Guaranteed range of measurement accuracy																							
<b>Measurement accuracy</b>	<table border="1"> <thead> <tr> <th>Measurement Range</th> <th>NPLC: Less Than 1</th> <th>NPLC: 1 or More</th> </tr> </thead> <tbody> <tr> <td>5 mV/div (f.s. = 100 mV)</td> <td>±0.01% rdg. ±0.015% f.s.</td> <td>±0.01% rdg. ±0.01% f.s.</td> </tr> <tr> <td>50 mV/div (f.s. = 1000 mV)</td> <td colspan="2" rowspan="2">±0.01% rdg. ±0.0025% f.s.</td> </tr> <tr> <td>500 mV/div (f.s. = 10 V)</td> </tr> <tr> <td>5 V/div (f.s. = 100 V)</td> <td colspan="2" rowspan="2">±0.025% rdg. ±0.0025% f.s.</td> </tr> <tr> <td>50 V/div (f.s. = 1000 V)</td> </tr> </tbody> </table>			Measurement Range	NPLC: Less Than 1	NPLC: 1 or More	5 mV/div (f.s. = 100 mV)	±0.01% rdg. ±0.015% f.s.	±0.01% rdg. ±0.01% f.s.	50 mV/div (f.s. = 1000 mV)	±0.01% rdg. ±0.0025% f.s.		500 mV/div (f.s. = 10 V)	5 V/div (f.s. = 100 V)	±0.025% rdg. ±0.0025% f.s.		50 V/div (f.s. = 1000 V)							
Measurement Range	NPLC: Less Than 1	NPLC: 1 or More																						
5 mV/div (f.s. = 100 mV)	±0.01% rdg. ±0.015% f.s.	±0.01% rdg. ±0.01% f.s.																						
50 mV/div (f.s. = 1000 mV)	±0.01% rdg. ±0.0025% f.s.																							
500 mV/div (f.s. = 10 V)																								
5 V/div (f.s. = 100 V)	±0.025% rdg. ±0.0025% f.s.																							
50 V/div (f.s. = 1000 V)																								
<b>Temperature characteristic</b>	±(0.002% rdg. + 0.00025% f.s.)/°C																							
<b>A/D conversion measurement method</b>	ΔΣ modulation method																							
<b>Integration time</b>	<table border="1"> <thead> <tr> <th>Power Frequency</th> <th>Integration Time</th> </tr> </thead> <tbody> <tr> <td>50 Hz</td> <td>20 ms x NPLC</td> </tr> <tr> <td>60 Hz</td> <td>16.67 ms x NPLC</td> </tr> </tbody> </table>			Power Frequency	Integration Time	50 Hz	20 ms x NPLC	60 Hz	16.67 ms x NPLC															
Power Frequency	Integration Time																							
50 Hz	20 ms x NPLC																							
60 Hz	16.67 ms x NPLC																							
	NPLC: Settable from 0.1 to 0.9 (in increments of 0.1), 1 to 9 (in increments of 1), and 10 to 100 (in increments of 10)																							
<b>Response time</b>	Within 2 ms + 2 x integration time (rising: -f.s. to +f.s., falling: +f.s. to -f.s.)																							
<b>Fast response</b>	ON/OFF																							
<b>Common mode rejection ratio</b>	100 dB minimum (at 50 Hz/60 Hz and with signal source resistance of 100 Ω maximum)																							
<b>Input type</b>	Unbalanced (floating)																							
<b>Input terminals</b>	Banana jacks																							
<b>Maximum input voltage</b>	500 VDC																							
<b>Maximum rated voltage to earth</b>	300 V AC/DC (between input channels and chassis, and between input channels) Measurement category II (anticipated transient overvoltage 2500 V)																							
<b>Operating temperature and humidity ranges</b>	Same as the host Memory HiCorder																							
<b>Operating environment</b>	Same as the host Memory HiCorder																							
<b>Storage temperature and humidity ranges</b>	-10°C to 50°C (14°F to 122°F), 80% RH or less (no condensation)																							
<b>Dimensions</b>	Approx. 106 mmW × 19.8 mmH × 196.5 mmD (Approx. 4.17"W × 0.78"H × 7.74"D)																							
<b>Weight</b>	Approx. 260 g (Approx. 9.2 oz.)																							
<b>Accessories</b>	Instruction manual (when shipped alone)																							
<b>Effect of radiated radio-frequency electromagnetic field</b>	±0.1% f.s. (max) at 3 V/m (in 5 mV/div range)																							
<b>Applicable standards</b>	Safety EN 61010 EMC EN61326 Class A																							
<b>Option</b>	L2200 Test Lead (600 V CAT IV, 1000 V CAT III, 10 A)																							

## 17.6.10 U8974 High Voltage Unit

Accuracy figures assume installation in a Memory HiCorder and operation after a 30-minute warm-up period at 23°C±5°C (73°F±9°F) and 80% RH (no condensation).

<b>Product warranty period</b>	3 years	
<b>Guaranteed accuracy period</b>	1 year	
<b>Number of input channels</b>	2 channels	
<b>Measurement functions</b>	Instantaneous value, r.m.s. value (can be changed for each channel)	
<b>Measurement range</b>	200 mV, 500 mV, 1 V, 2 V, 5 V, 10 V, 20 V, 50 V/div (mode DC) 500 mV, 1 V, 2 V, 5 V, 10 V, 20 V, 50 V/div (mode RMS)	
<b>Measurement accuracy</b>	±0.25% f.s. (Filter 5 Hz On)	
<b>RMS measurement accuracy</b>	±1.5% f.s. (DC, not lower than 30 Hz but lower than 1 kHz, sine waves, response time: slow) ±3% f.s. (not lower than 1 kHz but not higher than 10 kHz, sine waves) Crest factor: 2 (sine waves, the peak voltage is up to 1000 V)	
<b>RMS measurement response time</b>	Fast: 150 ms (rising from 0% f.s. to 90% f.s.) Normal: 500 ms (rising from 0% f.s. to 90% f.s.) Slow: 2.5 s (rising from 0% f.s. to 90% f.s.)	
<b>Temperature characteristic</b>	±0.05% f.s./°C	
<b>Frequency characteristic</b>	DC to 100 kHz -3 dB	
<b>Noise</b>	30 mV p-p (typ.), 50 mV p-p (max.) (highest sensitivity range, with input shorted)	
<b>Common mode rejection ratio</b>	80 dB or more (50 Hz/60 Hz input short-circuited)	
<b>Low-pass filter</b>	OFF, 5±50%, 50±50%, 500±50%, 5 k±50%, 50 k±50% (Hz) -3 dB	
<b>Input type</b>	Unbalanced input (floating)	
<b>Input coupling</b>	DC/GND	
<b>Input resistance</b>	4 MΩ±1%	
<b>Input capacitance</b>	5 pF or less (at 100 kHz)	
<b>A/D resolution</b>	16 bits	
<b>Maximum sampling rate</b>	1 MS/s	
<b>Input terminals</b>	Banana jacks	
<b>Maximum input voltage</b>	1000 V DC, 700 V AC	
<b>Maximum rated voltage to earth</b>	1000 V AC/DC measurement category III, 600 V AC/DC measurement category IV (between individual input channels and enclosure as well as between individual input channels) Anticipated transient overvoltage: 8000 V	
<b>Operating temperature and humidity</b>	As per Memory HiCorder in which Model U8974 is installed	
<b>Operating environment</b>	As per Memory HiCorder in which Model U8974 is installed	
<b>Storage temperature and humidity</b>	Temperature	-20°C to 50°C (-4°F to 122°F)
	Humidity	not lower than -20°C but lower than 40°C (not lower than -4°F but lower than 104°F) 80% RH or less (no condensation) not lower than 40°C but lower than 45°C 60% RH or less (not lower than 104°F but lower than 113°F) (no condensation) not lower than 45°C but not higher than 50°C 50% RH or less (not lower than 113°F but not higher than 122°F) (no condensation)
<b>Dimensions</b>	Approx. 106W × 19.8H × 196.5D mm (4.17"W × 0.78"H × 7.74"D)	
<b>Mass</b>	Approx. 230 g (8.1 oz.)	
<b>Effect of radiated radio-frequency electromagnetic field</b>	±5% f.s. (max.) at 3 V/m	
<b>Effect of conducted radio-frequency electromagnetic field</b>	±5% f.s. (max.) at 3 V (500 mV/div range, with 1 V DC input)	
<b>Standards</b>	Safety	EN61010
	EMC	EN61326 Class A

<b>Options</b>	Model L4940 Connection Cable Set (1.5 m)
	Model L4935 Alligator Clip Set (attached to the tips of Model L4940, 600 V CAT IV, 1000 V CAT III, 10 A)
	Model L9243 Grabber Clip (attached to the tips of Model L4940, 1000 V CAT II, 1 A)
	Model L4936 Bus Bar Clip Set (attached to the tips of Model L4940, 600 V CAT III, 5 A)
	Model L4937 Magnetic Adapter Set (attached to the tips of Model L4940, 1000 V CAT III, 2 A)
	Model L4931 Extension Cable Set (to extend the length of Model L4940, 1.5 m, 600 V CAT IV, 1000 V CAT III, 10 A)
	Model L4932 Test Pin Set (attached to the tips of Model L4940, 600 V CAT IV, 1000 V CAT III, 10 A)
	Model L4934* Small Alligator Clip Set (300 V CAT III, 600 V CAT II, 3 A)
	*: Model L4932 is required when Model L4934 is used.

## 17.6.11 U8979 Charge Unit

### General Specifications

<b>Operating environment</b>	Indoors, Pollution Degree 2, Operating altitude: up to 2000 m (6562 ft.)
<b>Operating temperature and humidity</b>	0°C to 40°C (32°F to 104°F), 80% RH or less (no condensation)
<b>Storage temperature and humidity</b>	-10°C to 50°C (14°F to 122°F) For -10°C or higher but lower than 40°C (14°F or higher but lower than 104°F), 80% RH or less (no condensation) For 40°C or higher but lower than 45°C (104°F or higher but lower than 113°F), 60% RH or less (no condensation) For 45°C to 50°C (113°F to 122°F), 50% RH or less (no condensation)
<b>Standards</b>	Safety: EN61010 EMC: EN61326 Class A
<b>Dimensions</b>	Approx. 106W × 19.8H × 196.5D mm (4.17"W × 0.78"H × 7.74"D)
<b>Mass</b>	Approx. 250 g (8.8 oz.)
<b>Product warranty period</b>	3 years
<b>Guaranteed accuracy period</b>	1 year
<b>Option</b>	Model 9166 Connection Cord (for voltage measurement)

### Specifications of input, output, and measurement

#### Common specifications

<b>Number of output channels</b>	2 channels
<b>Measurement mode</b>	Charge, pre-amplifier, voltage (selectable for each channel)
<b>Input type</b>	Unbalanced input (floating) In each channel, the voltage input terminal has the same-potential ground as the charge input terminal.
<b>Common-mode rejection ratio</b>	80 dB or more (at 50 Hz / 60 Hz, a signal source resistance of 100 Ω)
<b>Anti-aliasing filters</b>	Cutoff frequency (fc): 20, 40, 80, 200, 400, 800, 2 k, 4 k, 8 k, 20 k, 40 k (Hz) Switchable between on and off; the instrument automatically chooses a cutoff frequency along with the sampling rate. Attenuation property: -66 dB or higher at a cutoff frequency of 1.5 fc
<b>Maximum sampling rate</b>	200 kS/s
<b>A/D resolution</b>	16 bits (± f.s. = ±25,000 data points)
<b>Maximum rated voltage to earth</b>	30 V AC, 60 V DC (between each input channel and the enclosure, between any two of input channels) Anticipated transient overvoltage: 330 V

#### Voltage input

<b>Measurement range</b>	10, 20, 40, 100, 200, 400 mV f.s., 1, 2, 4, 10, 20, 40 V f.s.
<b>Maximum input voltage</b>	40 V DC
<b>Frequency characteristics</b>	DC to 50 kHz -3 dB (DC-coupled) 1 Hz to 50 kHz -3 dB (AC-coupled, lower cutoff frequency: 1 Hz ±50%)
<b>Noise</b>	80 μV p-p (typ.), 120 μV p-p (max.), with the highest sensitivity range and the terminals of each input connector connected with each other
<b>Input resistance</b>	1 MΩ ±1%
<b>Input capacitance</b>	200 pF or less (at 100 kHz)
<b>Input coupling</b>	AC/DC/GND
<b>Input terminals</b>	Metallic BNC terminal

## Charge input

<b>Supported detector</b>	Charge-output acceleration detector
<b>Measurement sensitivity</b>	0.1 pC/(m/s <sup>2</sup> ) to 10 pC/(m/s <sup>2</sup> )
<b>Measurement range</b>	40, 100, 200, 400, 1 k, 2 k, 4 k, 10 k, 20 k, 40 k, 100 k, 200 k m/s <sup>2</sup> f.s. Measurement sensitivity: 0.1 pC/(m/s <sup>2</sup> ) to 0.25 pC/(m/s <sup>2</sup> ) 20, 40, 100, 200, 400, 1 k, 2 k, 4 k, 10 k, 20 k, 40 k, 100 k m/s <sup>2</sup> f.s. Measurement sensitivity: 0.251 pC/(m/s <sup>2</sup> ) to 0.5 pC/(m/s <sup>2</sup> ) 10, 20, 40, 100, 200, 400, 1 k, 2 k, 4 k, 10 k, 20 k, 40 k m/s <sup>2</sup> f.s. Measurement sensitivity: 0.501 pC/(m/s <sup>2</sup> ) to 1.0 pC/(m/s <sup>2</sup> ) 4, 10, 20, 40, 100, 200, 400, 1 k, 2 k, 4 k, 10 k, 20 k m/s <sup>2</sup> f.s. Measurement sensitivity: 1.001 pC/(m/s <sup>2</sup> ) to 2.5 pC/(m/s <sup>2</sup> ) 2, 4, 10, 20, 40, 100, 200, 400, 1 k, 2 k, 4 k, 10 k m/s <sup>2</sup> f.s. Measurement sensitivity: 2.501 pC/(m/s <sup>2</sup> ) to 5.0 pC/(m/s <sup>2</sup> ) 1, 2, 4, 10, 20, 40, 100, 200, 400, 1 k, 2 k, 4 k m/s <sup>2</sup> f.s. Measurement sensitivity: 5.001 pC/(m/s <sup>2</sup> ) to 10.0 pC/(m/s <sup>2</sup> )
<b>Frequency characteristics</b>	1.5 Hz to 50 kHz -3 dB
<b>Maximum input charge</b>	±500 pC (when one of the higher six ranges is chosen) ±50,000 pC (when one of the lower six ranges is chosen)
<b>Input coupling</b>	AC/GND
<b>Input terminals</b>	Miniature connector (#10-32UNF)

## Input from acceleration sensor with the built-in pre-amplifier

<b>Supported detector</b>	Acceleration detector with built-in pre-amplifier
<b>Measurement sensitivity</b>	0.1 mV/(m/s <sup>2</sup> ) to 10 mV/(m/s <sup>2</sup> )
<b>Measurement range</b>	40, 100, 200, 400, 1 k, 2 k, 4 k, 10 k, 20 k, 40 k, 100 k, 200 k m/s <sup>2</sup> f.s. Measurement sensitivity: 0.1 mV/(m/s <sup>2</sup> ) to 0.25 mV/(m/s <sup>2</sup> ) 20, 40, 100, 200, 400, 1 k, 2 k, 4 k, 10 k, 20 k, 40 k, 100 k m/s <sup>2</sup> f.s. Measurement sensitivity: 0.251 mV/(m/s <sup>2</sup> ) to 0.5 mV/(m/s <sup>2</sup> ) 10, 20, 40, 100, 200, 400, 1 k, 2 k, 4 k, 10 k, 20 k, 40 k m/s <sup>2</sup> f.s. Measurement sensitivity: 0.501 mV/(m/s <sup>2</sup> ) to 1.0 mV/(m/s <sup>2</sup> ) 4, 10, 20, 40, 100, 200, 400, 1 k, 2 k, 4 k, 10 k, 20 k m/s <sup>2</sup> f.s. Measurement sensitivity: 1.001 mV/(m/s <sup>2</sup> ) to 2.5 mV/(m/s <sup>2</sup> ) 2, 4, 10, 20, 40, 100, 200, 400, 1 k, 2 k, 4 k, 10 k m/s <sup>2</sup> f.s. Measurement sensitivity: 2.501 mV/(m/s <sup>2</sup> ) to 5.0 mV/(m/s <sup>2</sup> ) 1, 2, 4, 10, 20, 40, 100, 200, 400, 1 k, 2 k, 4 k m/s <sup>2</sup> f.s. Measurement sensitivity: 5.001 mV/(m/s <sup>2</sup> ) to 10.0 mV/(m/s <sup>2</sup> )
<b>Power supply for detector</b>	1 Hz to 50 kHz -3 dB
<b>Maximum input charge</b>	3.0 mA ±20%, 22 V ±5%
<b>Input coupling</b>	AC/GND
<b>Input terminals</b>	Metallic BNC terminal

## Specifications for accuracy

<b>Conditions of guaranteed accuracy</b>	Guaranteed accuracy period: 1 year Guaranteed accuracy period after adjustment made by Hioki: 1 year Temperature and humidity for guaranteed accuracy: 23°C ±5°C (73°F ±9°F), 80% RH or less Warm-up time: 30 minutes or more Specified after execution of zero-adjustment
<b>Accuracy of voltage measurement</b>	±0.5% f.s. (with the filter set at 5 Hz)
<b>Temperature characteristic of voltage measurement</b>	±0.05% f.s./°C
<b>Accuracy of amplitude with charge inputted</b>	±2% f.s.
<b>Temperature characteristic with charge inputted</b>	±0.2% f.s./°C
<b>Accuracy of amplitude inputted from acceleration detector with built-in pre-amplifier</b>	±2% f.s.
<b>Temperature characteristics of input from acceleration sensor with the built-in preamplifier</b>	±0.2% f.s./°C



## 17.6 Specifications of Modules

---

---

<b>Effect of radiated radio-frequency electromagnetic field</b>	±10% f.s. (max.) at 3 V/m (with the filter set at 5 Hz)
<b>Effect of conducted radio-frequency electromagnetic field</b>	±10% f.s. (max.) at 3 V (with the filter set at 5 Hz)
<b>Low-pass filter</b>	Off, 5 ±50% (voltage input only), 500 ±50%, 5k ±50% (Hz) -3 dB
<b>TEDS</b>	IEEE1451.1.4 Class 1 compliant The instrument reads out sensor information to automatically configure the sensitivity setting.

---

## 17.6.12 U8793 Arbitrary Waveform Generator Unit

### General Specifications

<b>Operating environment</b>	As per Memory HiCorder in which Model U8793 is installed
<b>Operating temperature and humidity</b>	As per Memory HiCorder in which Model U8793 is installed
<b>Storage temperature and humidity</b>	-20°C to 50°C (-4°F to 122°F), 80% RH or less (no condensation)
<b>Standards</b>	Safety EN61010 EMC EN61326 Class A
<b>Dimensions</b>	Approx. 106W × 19.8H × 196.5D mm (4.17"W × 0.78"H × 7.74"D) (excluding protrusions)
<b>Mass</b>	Approx. 250 g (8.8 oz.)
<b>Product warranty period</b>	3 years
<b>Options</b>	Model L9795-01 Connection Cable (terminal type: SMB terminal/mini-alligator clip) Model L9795-02 Connection Cable (terminal type: SMB terminal/BNC terminal)

### Output Specifications

#### Basic Specifications (common for FG function and arbitrary waveform generation function)

<b>Conditions of guaranteed accuracy</b>	Guaranteed accuracy period: 1 year Guaranteed accuracy period from adjustment made by Hioki: 1 year Temperature and humidity for guaranteed accuracy: 23°C±5°C (73°F±9°F), 80% RH or less Warm-up time: at least 30 min. Power supply frequency range for Memory HiCorder in which Model U8793 is installed: 50 Hz/60 Hz ± 2 Hz
<b>Number of output channels</b>	2 channels
<b>Output terminals</b>	SMB terminals
<b>Output type</b>	Unbalanced output (floating)
<b>Maximum rated voltage to earth</b>	30 V AC rms or 60 V DC (between individual output channels and enclosure/external I/O terminals as well as between individual output channels) Anticipated transient overvoltage: 330 V
<b>Maximum output voltage</b>	-10 V to 15 V
<b>Amplitude setting range</b>	0 V p-p to 20 V p-p (setting resolution: 1 mV)
<b>DC offset setting range</b>	-10 V to 15 V (setting resolution: 1 mV)
<b>Output impedance</b>	1 Ω or less
<b>Maximum output current</b>	±10 mA (per channel)
<b>Allowable load resistance</b>	1.5 kΩ or greater
<b>Output format</b>	Waveform output/open/short

#### FG Function Specifications

<b>Output waveform</b>	Sine wave, rectangular wave, pulse wave (variable duty ratio), triangular wave, ramp wave, DC
<b>Output frequency range</b>	0 Hz to 100 kHz (setting resolution: 10 mHz)
<b>Output frequency accuracy</b>	±0.015% of setting
<b>DC output accuracy</b>	±0.05% of setting±10 mV
<b>DC output temperature characteristic</b>	(±0.005% of setting±1 mV)/°C
<b>Amplitude accuracy</b>	±0.5% of setting±10 mV p-p (not lower than 10 mHz but not higher 10 kHz) ±0.8% of setting±10 mV p-p (higher than 10 kHz but not higher than 50 kHz) ±1.0% of setting±10 mV p-p (higher than 50 kHz but not higher than 100 kHz)
<b>Amplitude temperature characteristic</b>	(±0.05% of setting±1 mV p-p)/°C
<b>DC offset accuracy</b>	±0.5% of setting±10 mV
<b>DC offset Temperature characteristic</b>	(±0.05% of setting±1 mV)/°C
<b>Phase difference setting range</b>	-360° to 360° (setting resolution: 0.1°)
<b>Jitter</b>	Within 50 ns p-p (rectangular waves, pulse waves, triangular waves, ramp waves)
<b>Pulse waves duty ratio setting range</b>	0.1% to 99.9% (setting resolution: 0.1%) Valid with a pulse width of 500 ns or greater

<b>Pulse waves duty ratio accuracy</b>	±0.1% of period (not lower than 10 mHz but not higher than 5 kHz) ±0.5% of period (higher than 5 kHz but not higher than 20 kHz) ±1.0% of period (higher than 20 kHz but not higher than 100 kHz)
--	---

### Arbitrary waveform generation function specifications

<b>Output waveform</b>	Waveforms measured with the 8847, MR8847, MR8847A, MR8827, MR8740, or MR8741 Memory HiCorder (Logic waveforms are not supported.) Waveforms measured with the PW3198 Power Quality Analyzer (via SF8000) Waveforms saved by the 7075 Waveform Generator (via SF8000) Waveforms created in CSV format (via SF8000) Waveforms created with the SF8000 Waveform Maker
<b>Voltage axis resolution</b>	16 bits
<b>Waveform memory capacity</b>	256 kW/channel × 8 blocks
<b>Low-pass filter</b>	2nd-order LPF, 50 Hz to 1 MHz (14 steps in 1-2-5 progression)
<b>D/A refresh rate</b>	Max. 2 MHz (setting resolution: 10 mHz)
<b>Clock frequency accuracy</b>	±150 ppm
<b>Clock frequency jitter</b>	Within 50 ns p-p
<b>Delay</b>	-250,000 to 250,000 (settable in increments of 1 data point)
<b>Loop count</b>	1 to 50,000 or ∞

### Sweep Functional Specifications

<b>Sweep waveforms</b>	Non-DC FG waveforms, arbitrary waveforms	
<b>Sweep form</b>	Linear	
<b>Sweep target</b>	FG waveforms:	Frequency, amplitude, offset, duty ratio (pulse waves only) (Simultaneous sweeping of frequency, amplitude, and offset)
	Arbitrary waveforms:	Clock frequency, amplitude, offset (Simultaneous sweeping of clock frequency, amplitude, and offset)
<b>Sweep time setting range</b>	10 μs to 1000 s (setting resolution: 10 μs)	

### Program Function Specifications

<b>Sequence length</b>	Output by connecting up to 128 steps
<b>Step control</b>	Ability to set an FG waveform, sweep waveform, or user waveform for each step Ability to set the number of loops (for sweep waveforms) or output time (for FG and arbitrary waveforms) for each step
<b>Hold settings</b>	ON/OFF setting for each step
<b>Output time setting range</b>	10 μs to 1000 s (for FG and arbitrary waveforms)
<b>Step loop count setting range</b>	1 to 1,000 (for sweep waveforms)
<b>Overall loop count setting range</b>	1 to 50,000 or ∞
<b>Monitor functions</b>	Display of step number being executed, step loop count, and overall loop count

### Other Specifications

<b>Channel synchronization</b>	Ability to set the phase between channels on the same module and between modules
<b>Self-test function</b>	Ability to monitor output voltage value Monitor resolution: 10 mV Monitor accuracy: ±3.0% f.s. (f.s.=15 V)
<b>Output start/stop</b>	By operating key on the Memory HiCorder or applying a signal to the unit's external control terminal
<b>External input</b>	Cancel hold and transition to next step on low-level signal input from an external source while using the program function. Control voltage level: 3.5 V to 5.0 V (high level), 0 V to 0.8 V (low level) Response pulse width: 100 μs or greater (low level)
<b>External output</b>	Output during waveform output Output format: Open-drain output (with 5 V voltage output, active low) Output voltage level: 4.0 V to 5.0 V (high level), 0 V to 0.5 V (low level) Maximum switching capacity: 5 V to 30 V DC, 50 mA
<b>External I/O terminals</b>	Push-button type terminal block
<b>Waveform output indicator</b>	Red LED on during waveform output and off when output is off

## 17.6.13 MR8790 Waveform Generator Unit

Accuracy figures assume installation in a Memory HiCorder and operation after a 30-minute warm-up period at 23°C±5°C (73°F±9°F) and 80% RH (no condensation).

### General Specifications

<b>Product warranty period</b>	3 years
<b>Guaranteed accuracy period</b>	1 year
<b>Guaranteed accuracy period after adjustment made by Hio-ki</b>	1 year
<b>Number of output channels</b>	4 channels (all channels isolated from each other and from the enclosure and outputs)
<b>Self-test function</b>	Included (with voltage and current monitor)
<b>Voltage and current monitor function (switchable)</b>	Resolution: 5 $\mu$ A (current monitor) 10 mV (voltage monitor) Monitor accuracy: $\pm$ 3.0% f.s. (f.s. = 10 V [voltage monitor] or 5 mA [current monitor])
<b>Maximum output current</b>	$\pm$ 5 mA
<b>Allowable load resistance</b>	2 k $\Omega$ or greater
<b>Output terminals</b>	SMB terminals
<b>Output configuration</b>	Waveform output/open/short circuit
<b>Output relay switching time</b>	5 ms or less
<b>Output protection</b>	Output current limited to 40 mA (when output is shorted)
<b>Maximum rated voltage to earth</b>	30 V AC rms or 60 V DC (between individual output channels and enclosure as well as between individual output channels) Anticipated transient overvoltage: 330 V
<b>Operating temperature and humidity</b>	As per Memory HiCorder into which the MR8790 is installed
<b>Operating environment</b>	As per Memory HiCorder into which the MR8790 is installed
<b>Storage temperature and humidity</b>	-20°C to 50°C (-4°F to 122°F), 90% RH or less (no condensation)
<b>Dimensions</b>	Approx. 106W $\times$ 19.8H $\times$ 196.5D mm (4.17"W $\times$ 0.78"H $\times$ 7.74"D) (excluding protrusions)
<b>Mass</b>	Approx. 230 g (8.1 oz.)
<b>Standards</b>	Safety EN61010 EMC EN61326 Class A
<b>Effect of radiated radio-frequency electromagnetic field</b>	$\pm$ 3% f.s. (max.) at 3 V/m (f.s.=10 V)
<b>Effect of conducted radio-frequency electromagnetic field</b>	$\pm$ 1% f.s. (max.) at 3 V (f.s.=10 V)
<b>Options</b>	Model L9795-01 Connection Cable (terminal type: SMB terminal/mini-alligator clip) Model L9795-02 Connection Cable (terminal type: SMB terminal/BNC terminal)

### Voltage Output Specifications

<b>Maximum output voltage</b>	$\pm$ 10 V
<b>Resolution</b>	16 bits
<b>Output frequencies</b>	Output frequencies: DC, 0 Hz to 20 kHz (sine waves) Setting resolution: 1 Hz Frequency accuracy: $\pm$ 0.01% of setting
<b>Amplitude</b>	Setting range: 0 V p-p to 20 V p-p Setting resolution: 1 mV Amplitude accuracy: $\pm$ 0.25% of setting $\pm$ 2 mV p-p (not lower than 1 Hz but not higher than 10 kHz) $\pm$ 0.6% of setting $\pm$ 2 mV p-p (higher than 10 kHz but not higher than 20 kHz)
<b>DC offset</b>	Setting range: -10 V to 10 V Peak value including amplitude and DC offset is limited to $\pm$ 10 V. Setting resolution: 1 mV Offset accuracy: $\pm$ 3 mV
<b>DC output</b>	Output accuracy: $\pm$ 0.6 mV

## 17.6.14 MR8791 Pulse Generator Unit

### General Specifications

<b>Temperature and humidity for guaranteed accuracy</b>	23°C±5°C (73°F±9°F), 80% RH or less (no condensation) (When installed in the Memory HiCorder)
<b>Guaranteed accuracy period</b>	1 year
<b>Product warranty period</b>	3 years
<b>Operating temperature and humidity</b>	As per Memory HiCorder in which Model MR8791 is installed
<b>Operating environment</b>	As per Memory HiCorder in which Model MR8791 is installed
<b>Storage temperature and humidity</b>	-20°C to 50°C (-4°F to 122°F), 90% RH or less (no condensation)
<b>Maximum rated voltage to earth</b>	30 V AC rms or 60 V DC (between output channels and enclosure) Anticipated transient overvoltage: 330 V
<b>Dimensions</b>	Approx. 106W × 19.8H × 196.5D mm (4.17"W × 0.78"H × 7.74"D) (excluding protrusions)
<b>Mass</b>	Approx. 230 g (8.1 oz.)
<b>Number of output channels</b>	8 (output channels and enclosure isolated; output units isolated) (channels not isolated from each other [common GND]) (channels not isolated from output connector frame [common GND])
<b>Output mode 1</b>	Pattern output/pulse output (switched for all 8 channels at once)
<b>Output mode 2</b>	Logic output/open-collector output (set separately for each of 8 channels)
<b>Logic output:</b>	Output voltage level: 0 V to 5 V (high level 3.8 V or greater, low level 0.8 V or less) Rated current: ±5 mA
<b>Open collector Output:</b>	Collector/emitter absolute maximum rated voltage: 50 V Over-current protection: 100 mA
<b>Output mode 3</b>	Output/open (= self-test) (switched for all 8 channels at once)
<b>Open-collector output definition (rising time [10% to 90%])</b>	5 μs (max.) (load capacity of 1000 pF, pull-up resistance of 1 kΩ)
<b>Self-test function</b>	Detected voltages: High level 3.4 V or greater, low level 1.6 V or less
<b>Relay switching time</b>	5 ms or less (logic/open collector switching, output/open [self-test] switching)
<b>Standards</b>	Safety EN61010 EMC EN61326 Class A

### Pulse Output Specifications

<b>Output frequency</b>	Setting range: 0 Hz to 20 kHz (set separately for each of 8 channels) Setting resolution: 0.1 Hz Frequency accuracy: ±100 ppm
<b>Duty ratio</b>	Setting range: 0.1% to 99.9%, 0, 100% (DC) Setting resolution: 0.1% Duty ratio accuracy: {±100 ppm (setting period) ±150 ns} of setting Priority to the "Minimum pulse width" and "Open collector output regulation" specifications
<b>Minimum pulse width</b>	1 μs

### Pattern Output Specifications

<b>Clock frequency</b>	Range: 0 Hz to 120 kHz (Common for 8 channels) Setting resolution: 10 Hz Frequency accuracy: ±100 ppm of setting
<b>Memory (Pattern)</b>	2,048 words (16,384 bits = 2,048 words × 8 bits/word)

## Output Connector Specifications

10250-52A2PL: Sumitomo 3M products (SCSI-2 connector), (Centronics half-pitch 50 pins socket-contact)

Pin	Signal name	Pin	Signal name
1	I_GND	26	I_GND
2	CH1	7	I_GND
3	CH2	28	I_GND
4	CH3	29	I_GND
5	CH4	30	I_GND
6	I_GND	31	I_GND
7	CH5	32	I_GND
8	CH6	33	I_GND
9	CH7	34	I_GND
10	CH8	35	I_GND
11	I_GND	36	I_GND
12	NC	37	I_GND
13	NC	38	I_GND
14	NC	39	I_GND
15	NC	40	I_GND
16	I_GND	41	I_GND
17	NC	42	I_GND
18	NC	43	I_GND
19	NC	44	I_GND
20	NC	45	I_GND
21	I_GND	46	I_GND
22	TEST2 (DIN03)	47	I_GND
23	TEST3 (DIN02)	48	I_GND
24	NC	49	I_GND
25	NC	50	I_GND
Frame	F_GND		

CH1 to CH8: Pulse output

I\_GND: Isolation GND (insulated GND)

F\_GND: Non-Isolation GND (main instrument GND)

NC: No Connect

TESTn: Test pin DO NOT CONNECT

Recommended connection cable: KB-SHH2: Sanwa Supply (SCSI-2 connector) (Centronics half 50-pin male)



# Maintenance and Service

## Chapter 18

### Transporting

Pack the instrument so that it will not sustain damage during shipping, and include a description of existing damage. We cannot accept responsibility for damage incurred during shipping.

Use the original packing materials when transporting the instrument, if possible.



To avoid damage to the instrument, remove the USB memory stick before shipping the instrument.

### Replaceable Parts

Certain parts require replacement periodically and at the end of their useful life: (Useful life depends on the operating environment and frequency of use. Operation cannot be guaranteed beyond the following periods)

Part	Life
<b>Fan Motor</b>	Approx. 60,000 hours
<b>Power Source</b>	Approx. 50,000 hours
<b>Electrolytic Capacitors</b>	Approx. 45,000 hours (The useful life of electrolytic capacitors varies greatly according to the operating environment. In severe operating environments (40°C ambient temperature), degradation occurs in about four years, so they should be replaced periodically.)
<b>Lithium Battery</b>	Approx. 10 years This instrument contains a built-in lithium battery to back up settings and the real-time clock. Have the battery replaced if the date and time are found to lag substantially or if settings are not retained when power is turned off and back on. Contact your dealer or Hioki representative.

The fuse is housed in the power unit of the instrument. If the power does not turn on, the fuse may be blown. If this occurs, a replacement or repair cannot be performed by customers. Please contact your dealer or Hioki representative.



## 18.1 Troubleshooting

If damage is suspected, check the "Troubleshooting" section before contacting your dealer or Hioki representative.

### If Power and Operating Mouse Malfunction

Symptom	Check Item, or Cause	Remedy and Reference
The display does not appear when you turn the power on.	Is the power cord disconnected? Are connections made correctly?	Verify that the power cord is connected properly. <b>"2.4 Supplying Power" ( p.56)</b>
Cannot operate the instrument with a mouse.	<ul style="list-style-type: none"> <li>Is the USB mouse connected?</li> <li>Are you using a hub or special mouse?</li> <li>Is there a source of interference nearby?</li> </ul>	<ul style="list-style-type: none"> <li>Check the USB connector.</li> <li>If you are using a hub, connect the mouse directly to the instrument. Use an ordinary mouse.</li> <li>Move the mouse away from the source of interference.</li> </ul>

### If the Display or Operations Malfunction

Symptom	Check Item, or Cause	Remedy and Reference
Data is not displayed on an external LCD monitor.	<ul style="list-style-type: none"> <li>Is it connected properly?</li> <li>Is it a digital LCD monitor?</li> <li>Are you using a VGA-DVI adapter cable?</li> </ul>	<ul style="list-style-type: none"> <li>Check the connections and power of the instrument and LCD monitor.</li> <li>An analog monitor (VGA output) cannot be used. Use an LCD monitor with a DVI-D (digital output) connector.</li> </ul>
The monitor flickers.	<ul style="list-style-type: none"> <li>Is there a source of interference nearby?</li> <li>Are you using a special LCD monitor? (Although extremely uncommon, flickering may be caused by incompatibility with the LCD monitor.)</li> </ul>	<ul style="list-style-type: none"> <li>Move the cable away from the source of interference.</li> <li>Use an ordinary LCD monitor.</li> </ul>
A waveform does not appear when measurement is started	<ul style="list-style-type: none"> <li>Is the "Pre-Trigger wait" message displayed?</li> <li>Is the "Trigger wait" message displayed?</li> </ul>	When pre-triggering is enabled, triggering is ignored until the pre-trigger portion of the waveform has been acquired. Recording starts when a trigger occurs.
No changes occur in the displayed waveform.	<ul style="list-style-type: none"> <li>Is the clamp sensor or connection cable connected correctly?</li> <li>Is the vertical axis (voltage axis) range set properly?</li> <li>Is the low-pass filter enabled?</li> </ul>	Verify that the clamp sensor or connection cable is connected correctly. Verify the input channel settings.
While measuring with the memory function, the displayed frequency is much lower than the actual frequency.	Aliasing may be occurring.	Change the timebase to use a faster sampling rate. <b>"3.3.2 Time Axis Range and Sampling Rate" ( p.66)</b>

## If the Display or Operations Malfunction

Symptom	Check Item, or Cause	Remedy and Reference
The displayed waveform size does not change when the input range is changed.	Is the Variable function enabled?	Turn the Variable function off. <b>"7.5 Variable Function (Setting the Waveform Display Freely)" ( p.155)</b>

## If Saving is Not Possible

Symptom	Check Item, or Cause	Remedy and Reference
If saving is not possible to the USB memory stick	<ul style="list-style-type: none"> <li>• Is the storage media inserted properly?</li> <li>• Is the storage media formatted?</li> <li>• Is the remaining capacity of the storage media too low?</li> <li>• Has the number of files in the folder reached the limit?</li> </ul>	<b>"2.3 Recording Media Preparation" ( p.54)</b>  <b>"Media information" (p.84)</b>

## Others

Symptom	Check Item, or Cause	Remedy and Reference
The response of remote control is very slow.	Check the java settings.	About the java settings, see the application disk supplied with the instrument.

## If the cause is unknown

Perform a system reset. All settings are returned to their factory defaults.

See: "18.2 Initializing the Instrument" ( p.376)

## 18.2 Initializing the Instrument

### 18.2.1 Initializing System Settings (System Reset)

Select groups of settings currently in force on the instrument, and initialize the settings. Initialization returns the instrument to the factory default state. By default, the setting of [Setting (Stat, Ch, Trig)] and [Setting (Env)] are selected for initialization in this screen.

#### Procedure

To open the screen: Right-click and select **[SYSTEM]** → **[Init]** sheet

- 1** Move the flashing cursor to the item you want to initialize.
- 2** Select **[On]**.  
Select **[Off]** for the groups of settings that you do not want to initialize.

<b>(Status, Ch, Trigger)</b>	Current settings in Status screen, Channel screen, and Trigger setting window (Default setting: On)
<b>(Environment)</b>	Current settings in the Environment sheet and File Save sheet (Default setting: On)
<b>(Interface)</b>	Current settings in the Interface sheet (Default setting: Off)

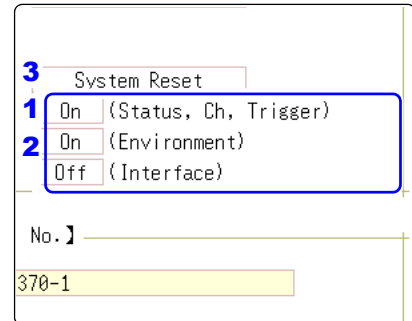

- 3** Move the flashing cursor to the **[System Reset]**.
- 4** Select **[Exec]**.

A confirmation dialog box appears.

- 5** Select **[Yes]**.

To cancel initializing:  
Select **[No]**.  
Initialization is complete when "System initialized" appears.

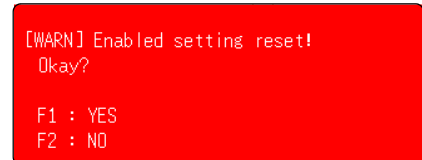

### 18.2.2 Initializing Waveform Data

Discard the waveform data saved in memory and initialize the data.

#### Procedure

To open the screen: Right-click and select **[SYSTEM]** → **[Init]** sheet

- 1** Move the flashing cursor to the **[Clear Wave Data]**.
- 2** Select **[Exec]**.

Initialization is complete when "Waveform data erased." appears.

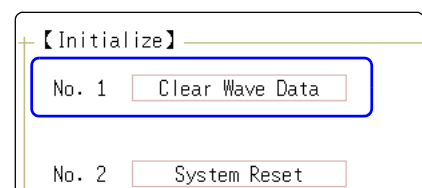

## 18.3 Error Messages

A screen message appears whenever an error occurs. In either case, take the remedial action indicated.

A beep may sound if the beeper setting on the **[Environment]** sheet is **[Warn]** or **[Warn+Action]**.

See: "Chapter 14 System Environment Settings" ( p.309)

### Warning Display

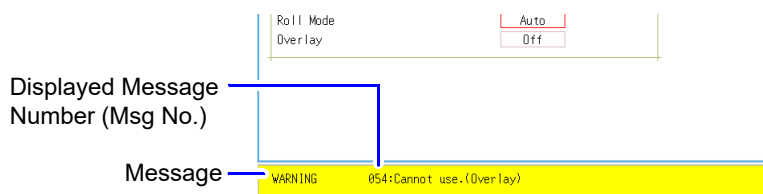

Appears just once when an error occurs. Disappears within a few seconds.

Also disappears when clicking the mouse.

### Displayed Warnings

Msg No.	Message	Remedial Action	Reference
10	Mount media.	Set the recording media.	"2.3 Recording Media Preparation" ( p.54)
11	Illegal format.	Wrong recording format. Reformat the media.	"2.3.2 Formatting Storage Media" ( p.55)
12	Can not write.	Write-protection is enabled on the storage media. Disable it.	-
13	Disk full while accessing the file.	Saving is not possible because of insufficient space on the storage media. Delete files or replace the storage media. If measuring, Stop measurement, then replace the storage media.	"4.4.4 Deleting Files & Folders" ( p.106)
14	File is read only.	File is read only. Deletion is not permitted.	-
15	Access to the file was denied.	An internal fault may have occurred in the instrument. Turn the instrument off and back on	-
16	The file name already exists: cannot save.	Change the file name.	"4.4.6 Renaming Files & Folders" ( p.107)
17	The folder name already exists.	Change the folder name.	-
18	Not enough free space in the folder to create file.	Either delete files in the saving destination folder, or change to another saving destination.	-
19	Folder not empty.	The folder is not empty, be sure you want to delete.	-
20	The maximum length of a file name, including its path, is 255 characters.	File names including the path must not exceed 255 characters.	-
21	Internal error.	An internal error occurred. Check the storage media.	-
22	No waveform data to save.	Acquire waveform data.	-
24	There is no calculation result.	There is no calculation result. Save results after performing calculation.	"Chapter 9 Numerical Calculation Functions" ( p.211)
26	Invalid folder path.	Route cannot be specified.	-
27	When executing, select <b>[No]</b> as the save property.	As other dialogs are displayed, selective saving cannot be carried out. Either set the selective saving during execution to <b>[No]</b> or close the dialog and re-save.	"4.2.3 Saving Data Selectively (SAVE)" ( p.93)
28	Pressed key invalid (waveform evaluation).	Unable to perform operation because waveform evaluation is enabled. Turn off waveform evaluation.	"13.3 Setting the Waveform Evaluation Mode" ( p.300)
29	The record length was restricted.	-	-
31	A/B cursor positions invalid.	The A/B cursors overlap. Check the cursor positions.	"6.2 Specifying a Waveform Range (A/B Cursor)" ( p.124)

## Displayed Warnings

Msg No.	Message	Remedial Action	Reference
32	Zero-adjustment needed.	Perform zero-adjustment.	"2.6 Adjusting the Zero Position (Zero-Adjust)" ( p.59)
33	Disabled key.	Close the dialog.	-
34	Invalid key pressed (Overlay)	The key operation is prohibited because Overlay is enabled.	"7.3 Displaying New Waveforms Over Past Waveforms (Overlay)" ( p.146)
36	No trigger has been set.	Set trigger criteria.	"Chapter 8 Trigger Settings" ( p.189)
38	Use of logic channels has reduced analog waveform resolution from 16 to 12 bits.	Using channels LA - LB reduces resolution of Ch1 - Ch2 to 12 bits.	"7.9 Setting Details of Modules" ( p.161)
39	Auto balance failed.	Check if no load is applied to the strain gauge transducer and the strain gauge transducer is correctly connected to a measuring object.	"7.9.4 Setting Model 8969 and U8969 Strain Unit" ( p.165)
40	Voltage Sag triggering is disabled. (Valid time base range: 20 $\mu$ s/div to 50 ms/div)	Voltage Sag triggering can be used only when the time base is between 20 $\mu$ s/div to 50 ms/div	"8.3.1 Analog Trigger Settings and Types" ( p.192)
42	There is not enough data in the memory.	Measure the data portion required for calculation.	"10.1 Waveform Calculation Workflow" ( p.228)
43	Stopped.	-	-
46	Channels may no longer be able to be used by frequency units due to logic use.	If logic channels A and B of the machine are used, the respective frequency units at channels 1 and 2 cannot be used.	"3.4.3 Logic Channel" ( p.78)
47	:This unit cannot be used because it is not AAF aligned.	Display the [Init] sheet on the SYSTEM screen.	-
48	There are units on which AAF cannot be set to On because of lack of adjustment.	Execute the [System Information] and check the software items. If [Not AAF aligned] is displayed, send the unit for repairs.	-
50	Roll Mode is not available.	The Roll Mode cannot be used when Overlay is enabled.	"7.2 Displaying Waveforms During Recording (Roll Mode)" ( p.145)
51	Cannot use. (Pre Trigger)	The pre-trigger function is not available when using external sampling.	"Chapter 16 External Control (MR8741 Only)" ( p.335)
52	Cannot use. (Roll Mode, Memory Division)	If the waveform calculation function is used, these functions cannot be used.	"10.1 Waveform Calculation Workflow" ( p.228)
53	Cannot use. (Roll Mode, Memory Division, Wave Calculation)	If one function is used, the other functions cannot be used.	"7.2 Displaying Waveforms During Recording (Roll Mode)" ( p.145)
54	Cannot use. (Overlay)	The overlay function is not available when using the Roll mode.	"7.3 Displaying New Waveforms Over Past Waveforms (Overlay)" ( p.146)
55	Cannot use. (Overlay, Memory Division, Wave Calculation)	If roll mode is used, these functions cannot be used.	"7.2 Displaying Waveforms During Recording (Roll Mode)" ( p.145)
57	Cannot set. (External sampling)	Cannot use roll mode when using external sampling.	"7.2 Displaying Waveforms During Recording (Roll Mode)" ( p.145)
58	Rated capacity/rated output error.	Rated capacity/Rated output has exceeded selected range. Input correct value.	Note (p.151)
59	Cannot use. (Roll Mode, Wave Calculation)	If the memory division function is used, these functions cannot be used.	"11.1 Recording Settings" ( p.243)
60	No waveform data.	Acquire waveform data.	-
68	Recording length is too long.	Shorten the measurement record length. The maximum record length that can be calculated is 2,000 div.	"3.3.3 Recording Length (number of divisions)" ( p.69)
91	LAN: Bad IP address.	Check the IP address.	"15.1 LAN Settings and Connection (Before Using FTP/Internet Browser/Command Communications)" ( p.314)
95	LAN: Connection timed out.	Check the transmission setting.	
97	LAN: Network error.	Check the connections between the instrument and connection destination.	

## Displayed Warnings

Msg No.	Message	Remedial Action	Reference
100	Inappropriate setting of time axis for waveform data.	Return the time axis to the time axis setting when the waveform was measured.	"3.3.2 Time Axis Range and Sampling Rate" ( p.66)
101	Some blocks are different in time axis setting from the others.	Set the same time axis setting for all search target blocks. If they cannot be the same, set the search range to display blocks only.	"8.12 Using trigger settings to search measurement data" ( p.209)
102	Some blocks are different in units configuration from the others.	Unify the unit configuration of search target blocks. If they cannot be the same, set the search range to display blocks only.	
103	No data matching your search condition.	Check the trigger setting.	"8.12 Using trigger settings to search measurement data" ( p.209)
104	There is no data in the search target channel.	Select channels with measurement data in the search target.	
105	There is a block with no data in the search target channel.	Select blocks with measurement data in the search target.	
106	Some blocks are different in measurement mode of unit from the others.	Blocks different in measurement mode cannot be searched.	-
108	Some blocks are different in measurement mode of unit from the others.	Set the search range within the display blocks.	"8.12 Using trigger settings to search measurement data" ( p.209)
110	No space to store waveform data at copy location.	Create empty space by deleting waveform data from copy location	"7.10 Register the Waveform in the U8793 Arbitrary Waveform Generator Unit" ( p.184)
111	No space to register arbitrary waveform data.	Create empty space by deleting waveform data from registration location.	"7.10 Register the Waveform in the U8793 Arbitrary Waveform Generator Unit" ( p.184)

# 18.4 Self-Test (Self Diagnostics)

The following self-test checks are available.

## Procedure

To open the screen: Right-click and select [SYSTEM] → [Init] sheet

No. 1	ROM/RAM Check	Check the instrument's internal memory (ROM and RAM). The results are displayed on the screen. (p.380)
No. 2	Printer Check	The instrument does not support the use of a printer. Clicking this has no effect.
No. 3	Display Check	Check the screen display (color check, gradation check). (p.381)
No. 4	Key Check	The instrument does not support the use of keys. Clicking this has no effect.
No. 5	System Information	Check the system configuration. (p.381)

## 18.4.1 ROM/RAM Check

This check tests the instrument's internal memory (ROM and RAM).

- 1 Move the flashing cursor to the [ROM/RAM Check] item.
- 2 Select [Exec].

The ROM/RAM check starts.

The following checks are performed in the sequence shown.  
 Program ROM→Address bus→Backup RAM→ Work RAM→  
 Video RAM→Storage RAM

**Do not turn the power off during the check.**

The judgment results appear when the check finishes.

**OK:** Normal  
**NG:** Error

**If "NG" appears, ask to have the instrument repaired.**

Click the mouse to return to the previous screen.

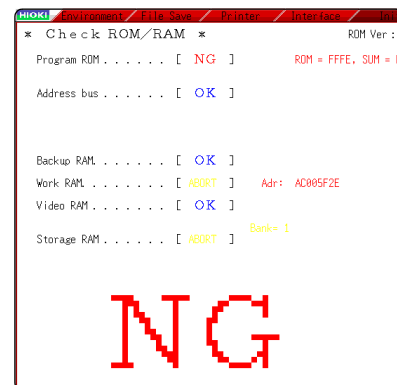

### **NOTE**

- Performing a ROM/RAM check will cause measurement data to be erased. Save the measurement data to other media before performing the ROM/RAM check.
- A ROM/RAM check cannot be stopped part way through.

### Procedure (Common for Display Check, System Configuration Check)

To open the screen: Right-click and select [SYSTEM] → [Init] sheet

## 18.4.2 Display Check

This check tests the condition of the display screen.

- 1 Move the flashing cursor to the [Display Check] item.
- 2 Select [Exec].  
A red screen appears.
- 3 Check the condition of the display.  
Left-click the mouse to change the screen.  
  
The original screen reappears

#### Screen Changes

Color check (Red, Green, Blue, Black, White)→ Gradation check (Red, Green, Blue, Black, White)→ Color pattern→Original screen.

If the display screen seems abnormal, request repairs.

## 18.4.3 System Configuration Check

The list of installed options and other system information appears in a separate window.

- 1 Move the flashing cursor to the [System Information] item.
- 2 Select [Exec].  
The System Configuration List appears.

To reappear the original screen:  
Left-click the mouse.

System Information  
[MR8740 MEMORY HiCORDER]

Ch	Model	Name	Resolution	Sampling	Firmware
Ch1	8966	ANALOG	12-bit	20MS/s	
Ch2	8966	ANALOG	12-bit	20MS/s	
Ch3	8966	ANALOG	12-bit	20MS/s	
Ch4	8966	ANALOG	12-bit	20MS/s	
Ch5	8967	TEMP	16-bit		1.00
Ch6	8967	TEMP	16-bit		1.00
Ch7	8967	TEMP	16-bit		1.00
Ch8	8967	TEMP	16-bit		1.00
Ch9	8972	DC/RMS	12-bit	1MS/s	
Ch10	8972	DC/RMS	12-bit	1MS/s	
Ch11	8972	DC/RMS	12-bit	1MS/s	
Ch12	8972	DC/RMS	12-bit	1MS/s	
Ch13	8966	ANALOG	12-bit	20MS/s	
Ch14	8966	ANALOG	12-bit	20MS/s	
Ch15	8970	FREQ	16-bit		
Ch16	8970	FREQ	16-bit		

Storage RAM: : 512MMord      Firmware Version: V3.02  
 Board Revision: 1001  
 [FPGA Version]  
 Storage Version: 0073:0103  
 IO Version: 0202  
 LCDC Version: 0052

[Communication] Interface : LAN

PUSH ANY KEY

Model number, name, resolution and sampling rate of each installed module (unit)

Currently selected interface

Internal memory capacity

Firmware version no.

Board revision no.

FPGA version no.



# 18.5 Updating the Instrument

Each of block I and block II need to be updated for MR8740. The version update file is the same for both block I and block II.

- 1 Right-click to display the list menu, and then click [FILE] to open the File screen.

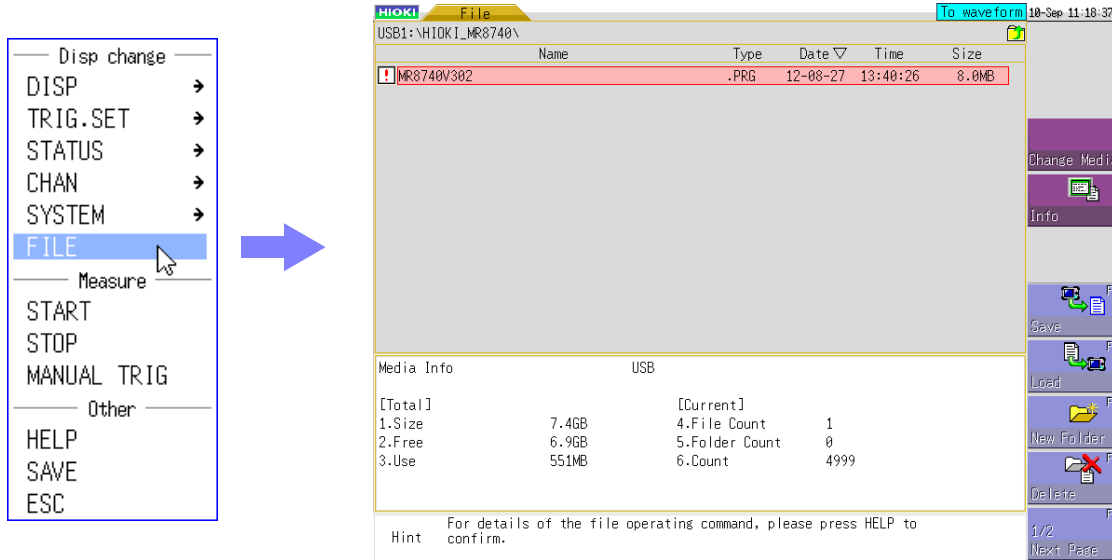

- 2 Double-click the MR8740/MR8741 version update file in the list.

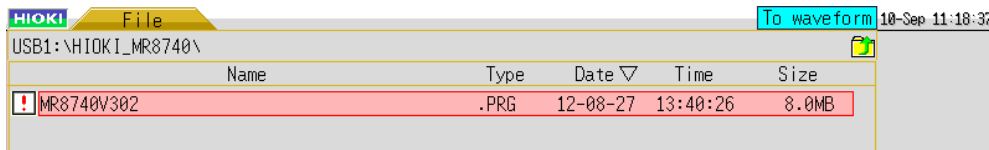

- \* A version update file is indicated with the icon.
- \* If you cannot find a version update file, refer to the next page.

- 3 When the file information appears, check the information and then click [Exec] to start the version update.

**Once you start the update, do not turn the power off until it is finished.**

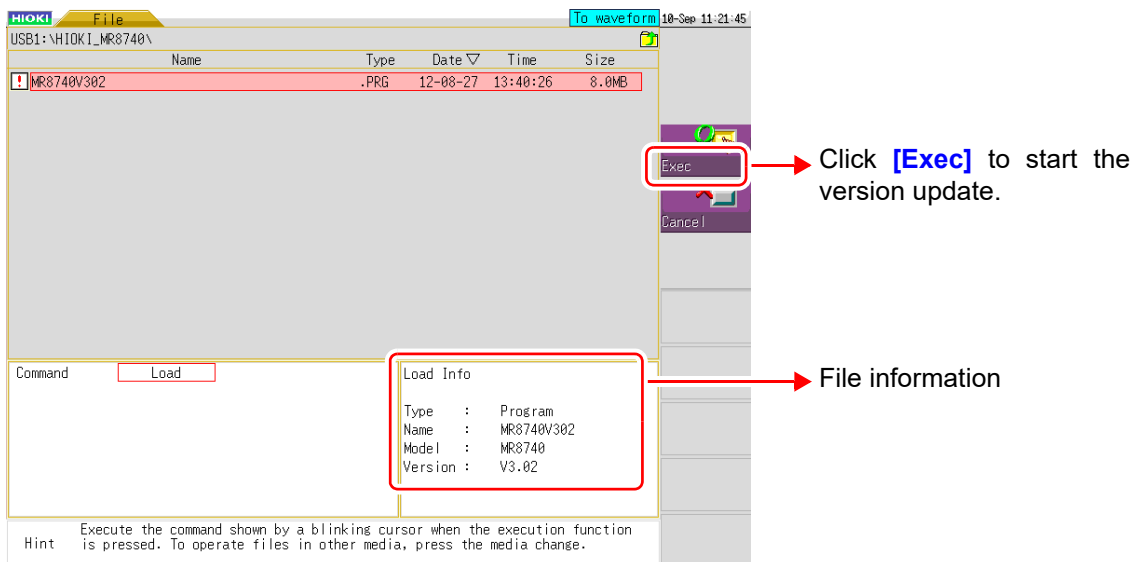



### If the version update file is not displayed on the File screen

The possible causes are as follows.

(Example: When the version update file is saved in the "HIOKI\_MR8740" folder of the USB memory stick)

#### ■ Wrong media is selected

Check the address displayed at the top of the screen. There is no problem if the address begins with "USB1".

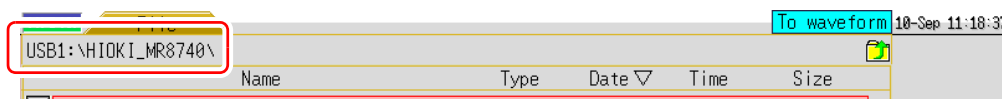

#### • If the address does not begin with "USB1":

Click **[Change Media]** on the right of the File screen and then click [USB Stick] in the displayed list.

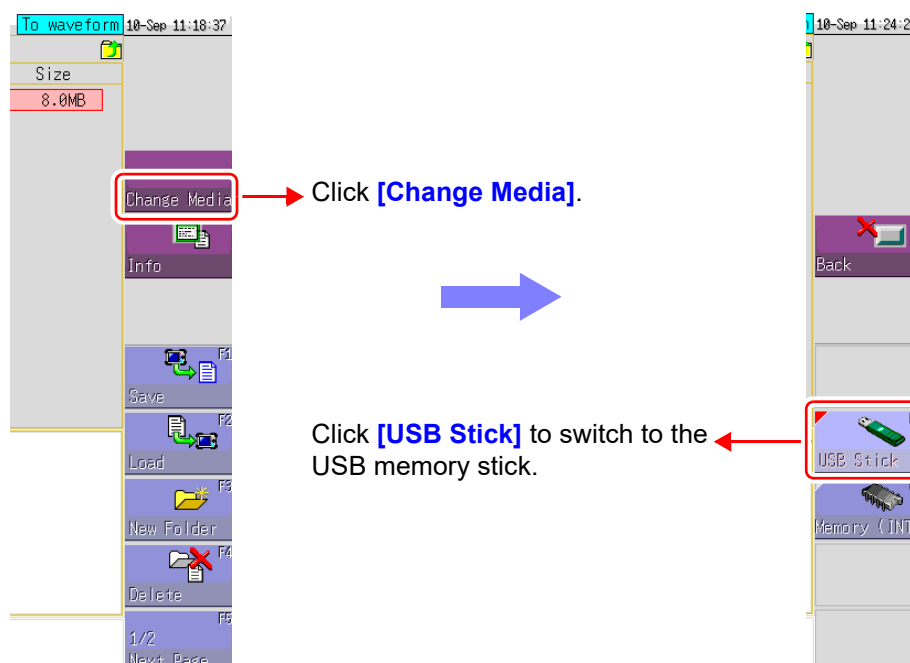

#### ■ Wrong folder is selected

Check the address displayed at the top of the screen. There is no problem if the address is "USB1:\HIOKI\_MR8740\".

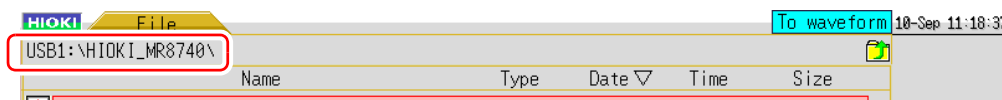

#### • If the address does not begin with "USB1:\HIOKI\_MR8740":

Left-click the part enclosed by a red line in the figure below until "USB1:\\" is displayed for the address. When it is displayed, double-click the HIOKI\_MR8740 folder in the list.

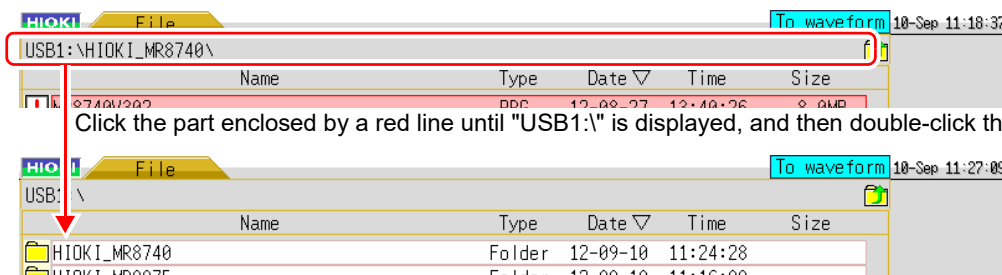

## 18.6 Cleaning

### Cleaning the Instrument and Modules

To clean the instrument and modules wipe it gently with a soft cloth moistened with water or mild detergent.

**NOTE**

Never use solvents such as benzene, alcohol, acetone, ether, ketones, thinners or gasoline, as they can deform and discolor the case.

## 18.7 Disposing of the Instrument (Lithium Battery Removal)

The instrument contains a lithium battery for memory backup. Remove this battery before disposing of the instrument.

### **WARNING**

- To avoid electric shock, turn off the power switch and disconnect the power cord and connection cords before removing the lithium battery.
- Keep batteries away from children to prevent accidental swallowing.
- Battery may explode if mistreated. Do not short-circuit, recharge, disassemble or dispose of in fire.

### **CAUTION**

When disposing of this instrument, remove the lithium battery and dispose of battery and instrument in accordance with local regulations.

CALIFORNIA, USA ONLY  
Perchlorate Material - special handling may apply.  
See [www.dtsc.ca.gov/hazardouswaste/perchlorate](http://www.dtsc.ca.gov/hazardouswaste/perchlorate)

## Procedure

Required tools:

Phillips screwdriver, wire cutter: One each

Box wrench or long-nosed pliers

- 1.** Verify that the power is off, and remove the connection cables and power cord.
- 2.** Remove the screws and each parts as indicated in the next page diagram.
- 3.** Pull the lithium battery up from the circuit board, and cut the two leads with a wire cutter.
- 4.** Remove the battery from the board.

Lithium Battery Removal

MR8740

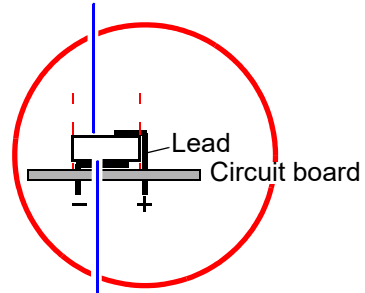
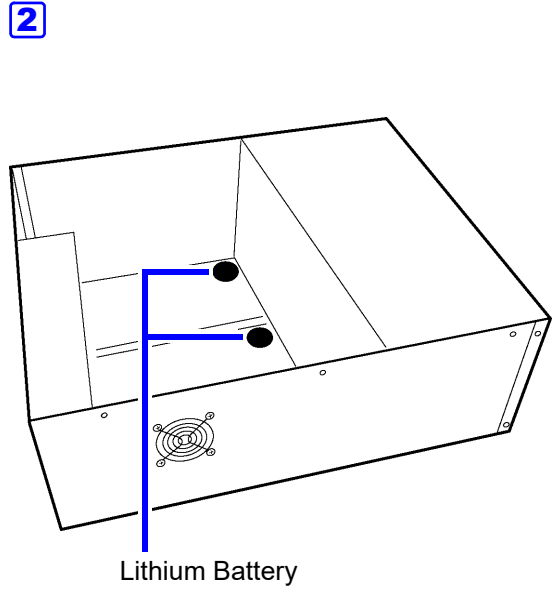
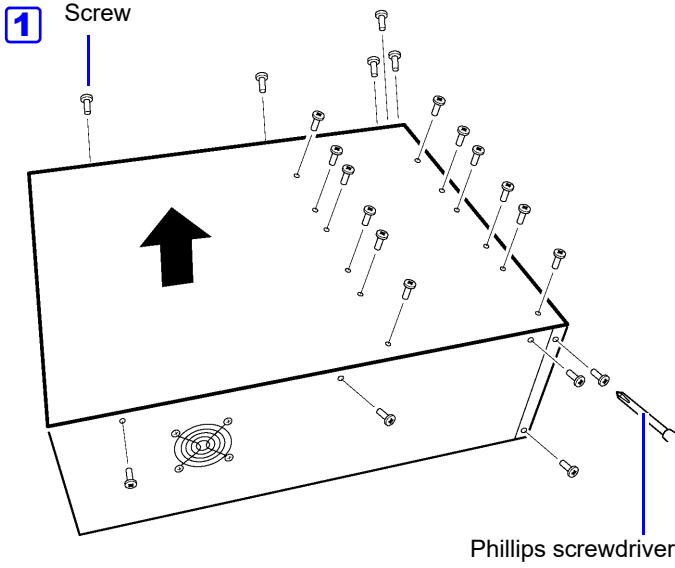

MR8741

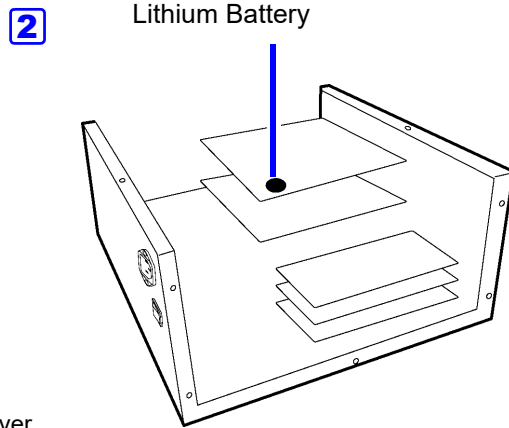
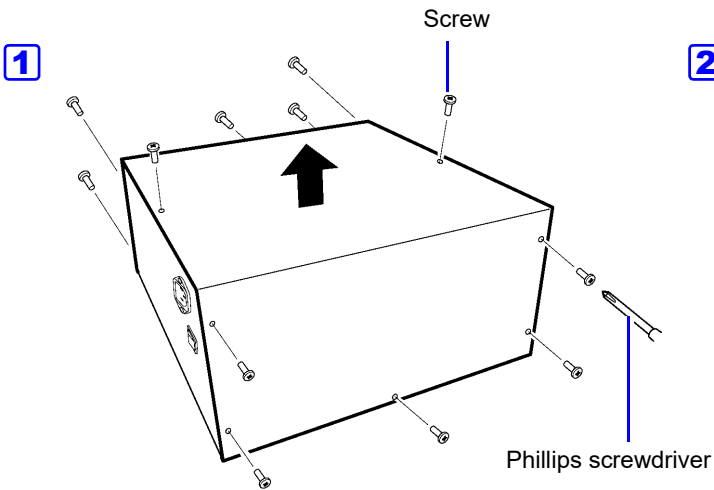

# Appendix

## Appendix 1 Default Values for Major Settings

Default values for major settings are listed below.

Screen	Sheet / Window	Items	Settings
Status	Status	Timebase	
		Memory	5 $\mu$ s/div
		Recorder	10ms
		Shot	25 div
		Format	
		Memory/Recorder	Single
		Roll Mode (Memory)	Auto
	Num Calc.	Numerical Calc	Off
System	Environment	Grid	Dotted Line
		Time Val	Time
		Beep Sound	Warn
		Auto Scal	On
	File Save	Auto Save	Off
	Interface	Interface	LAN
IP Address		192.168.0.2	
Channel	Unit List	Wave_Disp (analog)	Color 1 - 16
		Wave_Disp (Logic)	Off
		Logic Width	Normal
		Range	Maximum sensitivity
		Coupling	DC
	Scaling	Disp	Ratio
		Each channel	Off
Waveform	Trigger settings window	Trigger Mode	
		Memory	Auto
		Recorder	Single
		PreTrigger (Memory)	0%
		Trigger Source	OR
		Timing (Recorder)	Start
		Trigger for each module	Off
		Timer Trigger	Off
		Trigger synchronization (MR8740)	Off
		External Trigger (MR8741)	Off

## Appendix 2 Reference

### Appendix 2.1 Waveform File Sizes

Refer to the following table for information about the waveform file sizes.

#### References

File Type	Function	Sizes	Calculation method
MEM File	Memory Function	(p.A2)	(p.A4)
REC File	Recorder Function	(p.A2)	(p.A4)
FFT File	FFT Function	(p.A3)	(p.A4)
CSV (Text) File	Memory Function	(p.A3)	(p.A4)

#### References of the file size

##### MEM File Size (Memory Function)

File size = setting size + data size  
Calculation method: "MEM File" (p.A4)

Recording length (div)	Data Quantity	Saved Channels					
		1	2	4	8	16	32
100	10,001	48 KB	68 KB	108 KB	1883 KB	349 KB	669 KB
1,000	100,001	224 KB	420 KB	811 KB	1.6 MB	3.1 MB	6.1 MB
10,000	1,000,001	1.9 MB	3.8 MB	7.7 MB	15 MB	31 MB	61 MB
100,000	10,000,001	19 MB	38 MB	76 MB	153 MB	305 MB	610 MB
1,000,000	100,000,001	191 MB	381MB	762 MB	-	-	-

##### REC File Size (Recorder Function)

Filesize = setting size + data size  
Calculation method: "REC File" (p.A4)

Recording length (div)	Data Quantity	Saved Channels					
		1	2	4	8	16	32
100	10,001	68 KB	107 KB	186 KB	345 KB	661 KB	1.3 MB
1,000	100,001	419 KB	105 KB	1.6 MB	3.1 MB	6.1 MB	12 MB
10,000	1,000,001	3.8 MB	7.7MB	15 MB	31 MB	61 MB	122 MB
20,000	2,000,001	7.7 MB	15MB	31 MB	61 MB	122 MB	244 MB
50,000	5,000,001	19 MB	38 MB	76 MB	153 MB	305 MB	610 MB

**FFT File Size (FFT Function)**

File size = header size + The size of the time axis data + the size of the mid-term data  
 Calculation method: "FFT File" (p.A4)

Data Quantity	Number of calculations	
	1	2
1,000	388 KB	729 KB
2,000	728 KB	1.4 MB
5,000	1.7 MB	3.4 MB
10,000	3.4 MB	6.7 MB

**CSV (Text) File Size (Memory Function)**

File size = header size + data size  
 Calculation method: "CSV (Text) File" (p.A4)

Recording length (div)	Data Quantity	Saved Channels					
		1	2	4	8	16	32
100	10,001	313 KB	450 KB	723 KB	1.2 MB	2.3 MB	4.4 MB
1,000	100,001	3.1 MB	4.4 MB	7.1 MB	12 MB	23 MB	44 MB
10,000	1,000,001	31 MB	44 MB	71 MB	124 MB	231 MB	444 MB
100,000	10,000,001	305 MB	439 MB	706 MB	1.2 GB	2.3 GB	4.3 GB
1,000,000	100,000,001	3.0 GB	4.3 GB	6.9 GB	-	-	-

**CSV (Text) File Size (Recorder Function)**

**Note:**

When saving, CSV (text) files longer than 2 GB are segmented into files of 2 GB each.

File size = header size + data size  
 Calculation method: "Recorder Function" (p.A4)

Recording length (div)	Data Quantity	Saved Channels					
		1	2	4	8	16	32
100	10,001	450 KB	723 KB	1.2 MB	2.3 MB	4.4 MB	8.7 MB
1,000	100,001	4.4 MB	7.1 MB	12 MB	23 MB	44 MB	87 MB
10,000	1,000,001	44 MB	71 MB	124 MB	231 MB	444 MB	872 MB
50,000	5,000,001	219 MB	353 MB	620 MB	1.1 GB	2.2 GB	4.3 GB



### Waveform File Size Calculation Method

---

#### MEM File

**File size (bytes) = setting size<sup>\*1</sup> + data size<sup>\*2</sup>**

\*1: Setting size = 28672 + 512 (analog channel portion + 4 x logic channel portion + Number of waveform calculation channels )

\*2: Data size = 2 x (analog channel portion + logic channel portion + 2 x Number of waveform calculation channels) x number of data

#### REC File

**File size (bytes) = setting size<sup>\*1</sup> + data size<sup>\*2</sup>**

\*1: Setting size = 28672 + 512 (analog channel portion + 4 x logic channel portion)

\*2: Data size = 4 x (analog channel portion + logic channel portion ) x number of data

#### FFT File

**File size (bytes) = header size<sup>\*1</sup> + the size of the time axis data<sup>\*2</sup> + the size of the mid-term data<sup>\*3</sup>**

\*1: Header size = 30720 + 512(analog channel portion + Number of waveform calculation channels + Number of FFT calculation channels + 1)

\*2: the size of the time axis data = (analog channel portion + 2 x Number of waveform calculation channels) x data (\*4)

\*3: the size of the mid-term data = (346 x Number of FFT points + 836) x Number of FFT calculation channels(\*4)

(Depending on the measurement conditions, the file size may also increase or decrease from calculation formula result)

#### CSV (Text) File

##### Memory Function

**File size (bytes) = header size<sup>\*1</sup> + data size<sup>\*2</sup>**

\*1: Header size = 194 + 103 x (saved analog channels + saved logic channels)

\*2: Data size = (18 + 14 x saved analog channels + 2 x logic channels) x number of data

##### Recorder Function

**File size (bytes) = header size<sup>\*1</sup> + data size<sup>\*2</sup>**

\*1: Header size = 194 + 130 x (saved analog channels + saved logic channels)

\*2: Data size = (18 + 28 x saved analog channels + 4 x logic channels) x number of data

## Appendix 2.2 Setting Configuration and Image Data File Sizes

For information on the size of setting and image data files, see the table below.

File	Size
Setting file	33 KB
BMP (No color compression)	470 KB
BMP (Gray scale/No compression)	470 KB
BMP (B/W/No compression)	59 KB
BMP (B/W Reverse/No compression)	59 KB

## Appendix 2.3 Timebase and Maximum Recordable Time

The maximum available recording time depends on the selected timebase. The maximum recording time can be obtained by the following formula.

$$\text{Recordable Time} = \text{Timebase} \times \text{Recording Length}$$

Recordable time can be verified on the Status screen - [\[Status\]](#) sheet. ([\[Recording period\]](#))

### **NOTE**

Setting a slow timebase may result in a very long recording time (over a year) which may exceed the guarantee period or product life, in which case we cannot guarantee operation.

Refer to the following tables for the information about recordable time.

### Memory Function

Timebase (Time/div)	Sampling Rate	Maximum Recording Length
		160,000 div
5 μs	50 ns	0.8 s
10 μs	100 ns	1.6 s
20 μs	200 ns	3.2 s
50 μs	500 ns	8 s
100 μs	1 μs	16 s
200 μs	2 μs	32 s
500 μs	5 μs	1 min 20 s
1 ms	10 μs	2 min 40 s
2 ms	20 μs	5 min 20 s
5 ms	50 μs	13 min 20 s
10 ms	100 μs	26 min 40 s
20 ms	200 μs	53 min 20 s
50 ms	500 μs	2h 13 min 20 s
100 ms	1 ms	4 h 26 min 40 s
200 ms	2 ms	8 h 53 min 20 s
500 ms	5 ms	22 h 13 min 20 s
1 s	10 ms	1 d 20 h 26 min 40 s
2 s	20 ms	3 d 16 h 53 min 20 s
5 s	50 ms	9 d 6 h 13 min 20 s
10 s	100 ms	18 d 12 h 26 min 40 s
30 s	300 ms	55 d 13 h 20 min 0 s
50 s	500 ms	92 d 14 h 13 min 20 s
1 min	600 ms	111 d 2 h 40 min 0 s
100 s	1 s	185 d 4 h 26 min 40 s
2 min	1.2 s	222 d 5 h 20 min 0 s
5 min	3 s	

(d: days/ h: hours/ min: minutes/ s: seconds)

## Recorder Function

Timebase/div	Maximum Recording Length: 80,000 div *
10 ms	13 min 20 s
20 ms	26 min 40 s
50 ms	1 h 6 min 40 s
100 ms	2 h 13 min 20 s
200 ms	4 h 26 min 40 s
500 ms	11 h 6 min 40 s
1 s	22 h 13 min 20 s
2 s	1 d 20 h 26 min 40 s
5 s	4 d 15 h 6 min 40 s
10 s	9 d 6 h 13 min 20 s
30 s	27 d 18 h 40 min 0 s
50 s	46 d 7 h 6 min 40 s
1 min	55 d 13 h 20 min 0 s
100 s	92 d 14 h 13 min 20 s
2 min	111 d 2 h 40 min 0 s
5 min	277 d 18 h 40 min 0 s
10 min	
30 min	
1 h	

(d: days/ h: hours/ min: minutes/ s: seconds)

\*: Also when recording length is set to **[Cont.]**, the maximum recording length is 80,000div.

## Appendix 2.4 Maximum record length and number of divisions (Memory division function)

The maximum record length is automatically determined by settings for the number of channels used and the number of divisions.

### Desired record length

The number of divisions (blocks)	Maximum record length (div)
2	80,000
4	40,000
8	20,000
16	10,000
32	5,000
64	2,500
128	1,200
256	600
512	300
1024	150

### Fixed record length

The number of divisions (blocks)	Maximum record length (div)
2	50,000
4	20,000
8	20,000
16	10,000
32	5,000
64	2,000
128	1,000
256	500
512	200
1024	100

### Appendix 2.5 Time Axis Range and Sampling Rate of MR8990 Digital Voltmeter Unit

Timebase/div	Sampling Rate
100 ms	2 ms
200 ms	4 ms
500 ms	10 ms
1 s	20 ms
2 s	40 ms
5 s	100 ms
10 s	200 ms
30 s	600 ms
50 s	1 s
1 min	1.2 s
10 s	2 s
2 min	2.4 s
5 min	6 s

\*: If the data update rate specified at NPLC is longer than the sampling rate indicated in the table above, one of data is measured repeatedly during the data update rate period.

See: "7.9.8 Setting Model MR8990 Digital Voltmeter Unit" (p.171)

\*: If the time axis range is set to one faster than 100 ms/div, one of data is measured repeatedly during the data update rate period specified at NPLC.

See: "7.9.8 Setting Model MR8990 Digital Voltmeter Unit" (p.171)

---

## Appendix 2.6 Scaling Method When Using Strain Gauges

This section describes how to determine the scaling conversion ratio when measuring with strain gauges and the Model 8969 and U8969 Strain Unit.

The appropriate conversion formula for stress depends on how the strain gauges are used.

Three methods are available depending on whether one, two or four strain gauges are used for measurement. The two-gauge method is used for temperature compensation.

E: Young modulus,  $\nu$ : Poisson ratio,  $\epsilon$ : Distortion measurement value

Tensile and Compressive Stress Measurement: Stress ( $\sigma$ ) = E  $\times$   $\epsilon$

For temperature compensation with two or four gauges, position the gauges perpendicularly.

Stress ( $\sigma$ ) is obtained by  $1 / (1 + \nu)$  for two gauges, and by  $1 / \{2 (1 + \nu)\}$  for four gauges.

Bending Stress Measurement: Stress ( $\sigma$ ) = E  $\times$   $\epsilon$

For temperature compensation with two or four gauges, stress ( $\sigma$ ) is obtained as a multiple of  $1/2$  or  $1/4$ , respectively.

Torsional Stress Measurement: Stress ( $\sigma$ ) = E /  $\{2 (1 + \nu)\} \times \epsilon$  (two-gauge case)

For the four-gauge case, it is half of that.

Refer to the strain gauge instruction manual for combinations of strain gauges for each measurement.

Example. Measuring Compressive Stress

Using the one-gauge method for an aluminum measurement object having a Young's modulus of 73 (GPa) according to the following Table,

$$\begin{aligned} \sigma &= 73 \times 10^9 \times \text{Measurement Value (in } \mu\epsilon \text{ units)} \times 10^{-6} \text{ (in } \mu\epsilon \text{ units)} \\ &= 73 \times \text{Measurement Value (in kPa units)} \\ &= 7.44^* \times \text{Measurement Value (in gf/mm}^2 \text{ units)} \\ &^*: 1 \text{ Pa} = 1.01971621 \times 10^{-7} \text{ kgf/mm}^2 \end{aligned}$$

Unit: gf/mm<sup>2</sup>, Conversion Ratio = 7.44 gf/mm<sup>2</sup>

Enter this value as the scaling conversion ratio

### Mechanical properties of industrial materials

Material	Modulus of Elasticity (Young's Modulus)	Poisson's Ratio
	E (GPa)	$\nu$
Carbon Steel (0.1 to 0.25% C)	205	0.28 to 0.3
Carbon Steel (> 0.25% C)	206	0.28 to 0.3
Spring Steel (Quenched)	206 to 211	0.28 to 0.3
Nickel Steel	205	0.28 to 0.3
Cast Iron	98	0.2 to 0.29
Brass (Cast)	78	0.34
Phosphor Bronze	118	0.38
Aluminum	73	0.34
Concrete	20 to 29	0.1

See: "7.4 Converting Input Values (Scaling Function)" (p.148)

# A10

## Appendix 3 About Options

### Appendix 3 About Options

#### Appendix 3.1 Options

The following options are available for the instrument. Contact your authorized Hioki distributor or reseller when ordering. The options are subject to change. Visit our website for updated information. For details of cables and clamps for connecting to the modules and the instrument, refer to manual supplied with them.

Items indicated "specify when ordering" are not user-installable. For new purchases, contact your Hioki distributor.

#### Modules (Measurement amplifiers)

These are installed by insertion into the compartments on the right side of the instrument. Modules can be swapped out as needed.

Application	Model	Channels	Max Sampling Rate	A/D Resolution	Maximum input voltage	Maximum rated voltage to earth
Voltage measurements	Model 8966 Analog Unit	2	20 MS/s	12 bits	400 V DC	300 V AC/DC (CAT II)
	Model 8968 High Resolution Unit	2	1 MS/s	16 bits	400 V DC	300 V AC/DC (CAT II)
	Model MR8990 Digital Voltmeter Unit	2	500 S/s	24 bits	500 V DC	300 V AC/DC (CAT II)
RMS voltage measurements	Model 8972 DC/RMS Unit	2	1 MS/s	12 bits	400 V DC	300 V AC/DC (CAT II)
	Model U8974 High Voltage Unit	2	1 MS/s	16 bits	1000 V DC 700 V AC	1000 V AC/DC (CAT III) 600 V AC/DC (CAT IV)
Temperature (Thermocouple) measurements	Model 8967 TEMP Unit	2	-	16 bits	-	300 V AC/DC (CAT II)
Frequency, count, pulse duty, and pulse width measurements	Model 8970 Freq Unit	2	-	16 bits	400 V DC	300 V AC/DC (CAT II)
Current Measurement (model 8741 only)	Model 8971 Current Unit	2	1 MS/s	12 bits	-	Not insulated
Strain (Strain gauge type converter) measurements	Model 8969 Strain Unit	2	200 kS/s	16 bits	-	33 V rms AC or 70 V DC
	Model U8969 Strain Unit					30 V rms AC or 60 V DC
Digital signals and contact signal measurement	Model 8973 Logic Unit	16	20 MS/s	-	-	Not insulated
Acceleration measurement (sensor with built-in preamplifier, charge-output sensor)	Model U8979 Charge Unit	2	200 kS/s	16 bits	40 V DC	30 V AC, 60 V DC

See: "17.6 Specifications of Modules" (p.352)

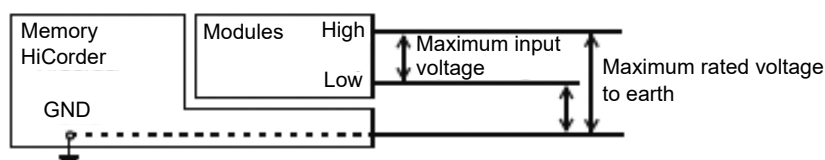

**Module (for generation)**

These modules can be installed along with a measurement module.

Application	Model	Number of channels	Maximum output frequency	Output voltage
Arbitrary waveform generation	U8793 Arbitrary Waveform Generator Unit	2	100 kHz	-10 V to 15 V
Sine wave and DC generation	MR8790 Waveform Generator Unit	4	20 kHz	±10 V
Pulse generation	MR8791 Pulse Generator Unit	8	100 kHz	0 to 5 V

**Measurement probes, cords, and clamps**

Application	Model	Description	Maximum input voltage	Maximum rated voltage to earth
Voltage measurement	Model L9197 Connection Cord	For high voltage	600 V AC/DC	600 V AC/DC (CAT III) 300 V AC/DC (CAT IV)
	Model L9198 Connection Cord	For low voltage	300 V AC/DC	600 V AC/DC (CAT II) 300 V AC/DC (CAT III)
	Model L9790 Connection Cord		600 V AC/DC	With Model L9790-01 Alligator Clip or Model 9790-03 Contact Pin attached 600 V AC/DC (CAT II) 300 V AC/DC (CAT III) With Model 9790-02 Grabber Clip attached 300 V AC/DC (CAT II) 150 V AC/DC (CAT III)
	Model L9217 Connection Cord	Isolated BNC-BNC	300 V AC/DC	600 V AC/DC (CAT II) 300 V AC/DC (CAT III)
	Model 9322 Differential Probe	For high voltage • Model 9418-15 AC Adapter is required when connecting to the module for voltage measurement.	2000 V DC, 1000 V AC	With grabber clips attached 1000 V AC/DC (CAT II) With alligator clips attached 1000 V AC/DC (CAT II) 600 V AC/DC (CAT III)
	Model L4940 Connection Cord	For Model U8974 High Voltage Unit	1000 V DC	With Model L4935 Alligator Clip Set or Model L4932 Test Pin Set attached 600 V AC/DC (CAT IV) 1000 V AC/DC (CAT III, CAT II)
				With Model L9243 Grabber Clip attached 1000 V AC (CAT II)
				With Model L4936 Bus Bar Clip Set attached 600 V AC/DC (CAT III)
				With Model L4937 Magnetic Adapter Set attached 1000 V AC/DC (CAT III)
	Model P9000-01 Differential Probe	The Model Z1008 AC Adapter or a commercially available USB cable is required.	1000 V AC/DC	1000 V AC/DC (CAT III)
	Model P9000-02 Differential Probe			
	Model 9665 10:1 Probe	Maximum rate voltage above ground is that of the module.	1 kV rms (up to 500 kHz)	-
	Model 9666 100:1 Probe		5 kVpeak (up to 1 MHz)	-
Model 9166 Connection Cord	For inputting voltage to Model U8979	30 V AC, 60 V DC	-	



# A12

## Appendix 3 About Options

Application	Model	Description	Maximum input voltage	Maximum rated voltage to earth
Logic signal input	Model 9320-01 Logic Probe	Four channels, for detecting voltage and closed/open contact points	-	-
	Model MR9321-01 Logic Probe	Four isolated channels, for detecting AC/DC voltage on/off (for small terminal types and for lines)	High range 250 V rms Low range 150 V rms	250 V rms (CAT II)
	Model 9327 Logic Probe	Four channels, for detecting voltage and closed/open contact points (high-speed type)	-	-
Voltage generation	Model L9795-01 Connection Cable	Alligator clip	±30 V	30 V rms AC, 42.4 V peak AC, or 60 V DC
	Model L9795-01 Connection Cable	BNC output		
AC/DC Model CT955X or 9318+CT9901 are required for connection.	Model 9709-05 AC/DC Current Sensor	500 A, DC to 100 kHz	-	-
	Model CT6841-05 AC/DC Current Probe	20 A, DC to 1 MHz	-	-
	Model CT6843-05 AC/DC Current Probe	200 A, DC to 500 kHz	-	-
	Model CT6844-05 AC/DC Current Probe	500 A, DC to 200 kHz	-	-
	Model CT6845-05 AC/DC Current Probe	500 A, DC to 100 kHz	-	-
	Model CT6846-05 AC/DC Current Probe	1000 A, DC to 20 kHz	-	-
	Model CT6862-05 AC/DC Current Sensor	50 A, DC to 1 MHz	-	-
	Model CT6863-05 AC/DC Current Sensor	200 A, DC to 500 kHz	-	-
Dedicated for AC Model CT955X or 9318+CT9901 are required for connection.	Model 9272-05 Clamp On Sensor	20 A/200 A, 1 Hz to 100 kHz	-	-
Dedicated for AC	Model 9018-50 Clamp On Probe	10 A to 500 A, 40 Hz to 3 kHz	-	-
	Model 9132-50 Clamp On Probe	20 A to 1000 A, 40 Hz to 1 kHz	-	-
Leakage current	Model 9657-10 Clamp On Leak Sensor	10 A AC (Leakage current, 50 Hz/60 Hz)	-	-
Others For connecting to a module for voltage measurement	Model CT9555, CT9556, and CT9557 Sensor Unit	For Model 9272-05, 9709-05, CT6841-05, CT6843-05, CT6844-05, CT6845-05, CT6846-05, CT6862-05, CT6863-05, CT6875, CT6876, CT6877	-	-
For connecting to the Model 8971 Current Unit	Model 9318 Conversion Cable	For Model 9272-10, 9709, CT6841, CT6843, CT6844, CT6845, CT6846, CT6862, CT6863, CT6865	-	-
	Model 9318 Conversion Cable + Model CT9901 Conversion Cable (both required)	For Model 9272-05, 9709-05, CT6841-05, CT6843-05, CT6844-05, CT6845-05, CT6846-05, CT6862-05, CT6863-05, CT6875, CT6876	-	-

For more information on the output rate of a clamp sensor, see the indication on each clamp sensor or the instruction manual.

### Software

Application Software	Model 9333 LAN Communicator
	Model 9335 Wave Processor

### Storage Devices (Recording Media)

USB flash drive	Model Z4006 USB Drive	16 GB
-----------------	-----------------------	-------

## Appendix 4 FFT Definitions

### What is FFT?

FFT is the abbreviation for Fast Fourier Transform, an efficient method to calculate the DFT (Discrete Fourier Transform) from a time-domain waveform. Also, the reverse process of transforming frequency data obtained by the FFT back into its original time-domain waveform is called the IFFT (Inverse FFT). The FFT functions perform various types of analysis using FFT and IFFT.

### Time and Frequency Domain Considerations

All signals are input to the instrument as a function of the time domain. This function can be considered as a combination of sine waves at various frequencies, such as in the following diagram. The characteristics of a signal that may be difficult to analyze when viewed only as a waveform in the time domain can be easier to understand by transforming it into a spectrum (the frequency domain).

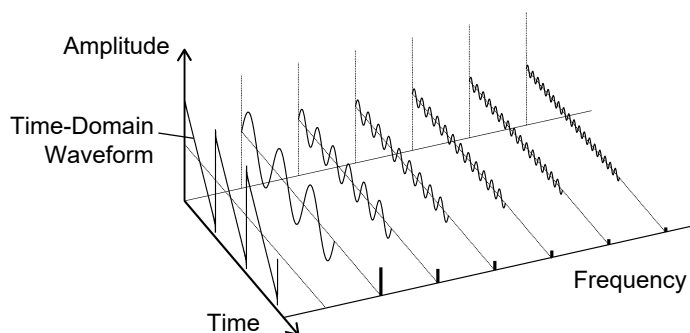

### Discrete Fourier Transforms and Inverse FFT

For a discrete signal  $x(n)$ , the DFT is  $X(k)$  and the number of Analysis points is  $N$ , which relate as follows:

$$X(k) = DFT\{x(n)\} = \sum_{n=0}^{N-1} x(n)W_N^{kn} \dots \dots \dots (1)$$

$$x(n) = IDFT\{X(k)\} = \frac{1}{N} \sum_{k=0}^{N-1} X(k)W_N^{-kn} \dots \dots \dots (2)$$

$$W_N = \exp\left(-j\frac{2\pi}{N}\right) \dots \dots \dots (3)$$

$X(k)$  is typically a complex number, so expression (1) can be transformed again and written as follows:

$$F(k) = |F(k)|\exp\{j\phi(k)\} = |F(k)|\angle\phi(k) \dots \dots \dots (4)$$

$$\phi(k) = \tan^{-1} \frac{\text{Im}\{X(k)\}}{\text{Re}\{X(k)\}} \dots \dots \dots (5)$$

$|F(k)|$  : Amplitude spectrum,  $\phi(k)$  : Phase spectrum

Representing the above relationship on a complex flat surface produces the following figure.

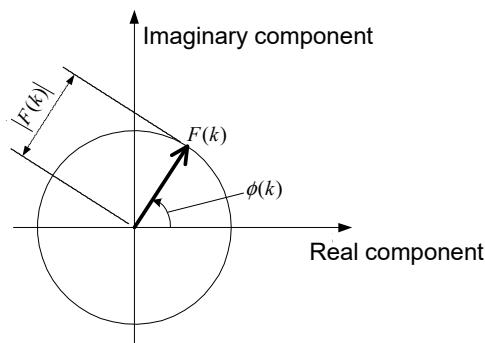

## Linear Time-Invariant Systems

Consider a linear time-invariant (LTI) system  $y(n)$  that is a response to discrete time-domain signal  $x(n)$ .

In such an LTI system, the following expression applies to any integer  $A_i$  when the response to  $x_i(n)$  is  $y_i(n) = L[x_i(n)]$ .

$$L[A_1x_1(n) + A_2x_2(n)] = A_1y_1(n) + A_2y_2(n) \dots \dots \dots (6)$$

If the system function of an LTI system is  $h(n)$ , the input/output relationship can be obtained by the next expression.

$$y(n) = \sum_{m=0}^{\infty} h(n)x(n-m) = \sum_{m=-\infty}^{\infty} h(n-m)x(m) \dots \dots \dots (7)$$

Therefore, when a unit impulse  $\delta(n)$  (which is 1 when  $n = 0$ , and 0 when  $n \neq 0$ ) is applied to  $x(n)$ , the input/output relationship is:

$$y(n) = h(n) \dots \dots \dots (8)$$

This means that when the input signal is given as a unit impulse, the output is the LTI system characteristic itself.

The response waveform of a system to a unit impulse is called the **impulse response**.

On the other hand, when the discrete Fourier transforms of  $x(n)$ ,  $y(n)$  and  $h(n)$  are  $X(k)$ ,  $Y(k)$  and  $H(k)$ , respectively, expression (7) gives the following:

$$Y(k) = X(k)H(k) \dots \dots \dots (9)$$

$H(k)$  is also called the transfer function, calculated from  $X(k)$  and  $Y(k)$ . Also, the inverse discrete Fourier transform function of  $H(k)$  is the unit impulse response  $h(n)$  of the LTI system. The impulse response and transfer function of this instrument are calculated using the relationships of expression (9).

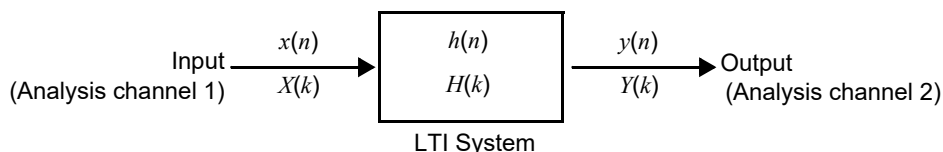

# A16

## Appendix 4 FFT Definitions

---

### Number of Analysis Points

---

The FFT functions of this instrument can perform frequency analysis of time-domain waveforms consisting of 1000, 2000, 5000, or 10,000 points. However, when the following conditions are satisfied, previously analyzed data can be reanalyzed with a different number of analysis points.

- A. When measurements are made with the averaging function disabled (Off)
- B. When measurements are made with the averaging function enabled for time-domain averaging (simple or exponential).

When the number of analysis points at measurement time is  $N_1$  and the number of analysis points is changed to  $N_2$  after measurement, the instrument performs as follows.

#### (1) When $N_1 < N_2$

- Because not enough data has been collected, zero is inserted for time after the end of the measured waveform.
- The window function applies only to the  $N_1$  segment.
- Frequency resolution is increased. For example, if  $N_1 = 1000$  and  $N_2 = 2000$ , frequency resolution is doubled.
- The average energy of the time-domain waveform is reduced, so the amplitude of the linear spectrum is also reduced.

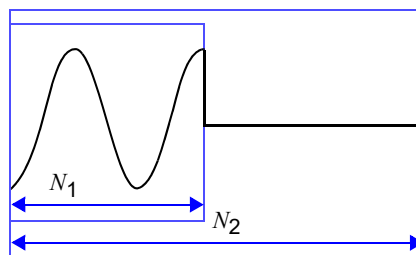

#### (2) When $N_1 > N_2$

- The specified ( $N_2$ ) segment is extracted from the head of the ( $N_1$ ) data.
- The window function applies only to the  $N_2$  segment.
- Frequency resolution is decreased. For example, if  $N_1 = 2000$  and  $N_2 = 1000$ , frequency resolution is halved.
- The average energy of the time-domain waveform is unchanged, so the amplitude of the linear spectrum is not significantly affected.

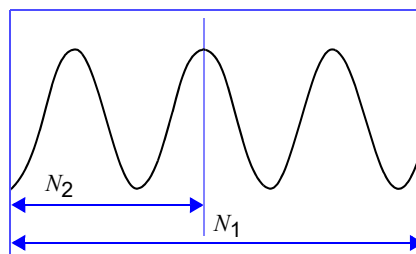

## Aliasing

When the frequency of a signal to be measured is higher than the sampling rate, the observed frequency is lower than that of the actual signal, with certain frequency limitations. This phenomena occurs when sampling occurs at a lower frequency than that defined by the Nyquist-Shannon sampling theorem, and is called **aliasing**.

If the highest frequency component of the input signal is  $f_{\max}$  and the sampling frequency is  $f_s$ , the following expression must be satisfied:

$$f_s = 2f_{\max} \dots\dots\dots (10)$$

Therefore, if the input includes a frequency component higher than  $f_s/2$ , it is observed as a lower frequency (alias) that does not really exist.

The following diagrams show the results of spectrum analysis of composite waveforms having components of 1 kHz and 3 kHz, and of 1 kHz and 7 kHz. If sampling frequency  $f_s$  is 10 kHz, the spectral component of an input frequency above 5 kHz (in this case, 7 kHz) is observed as an alias at 5 kHz or below. In this example the difference between the 3 and 7 kHz components is indiscernible.

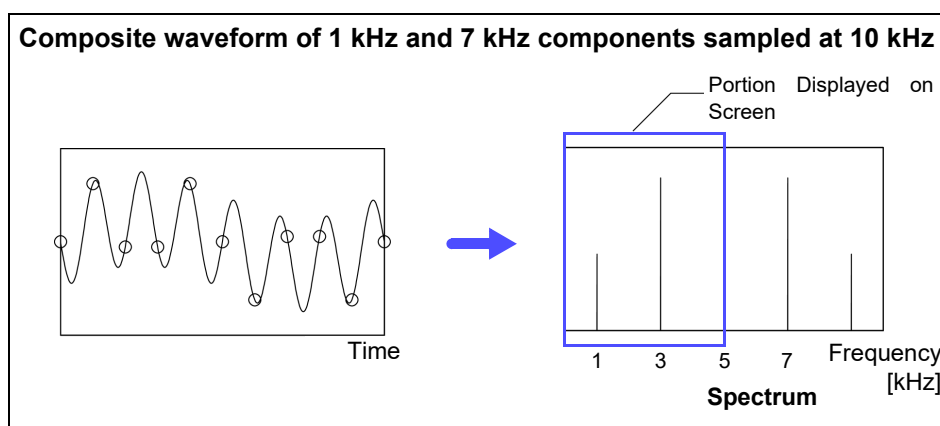
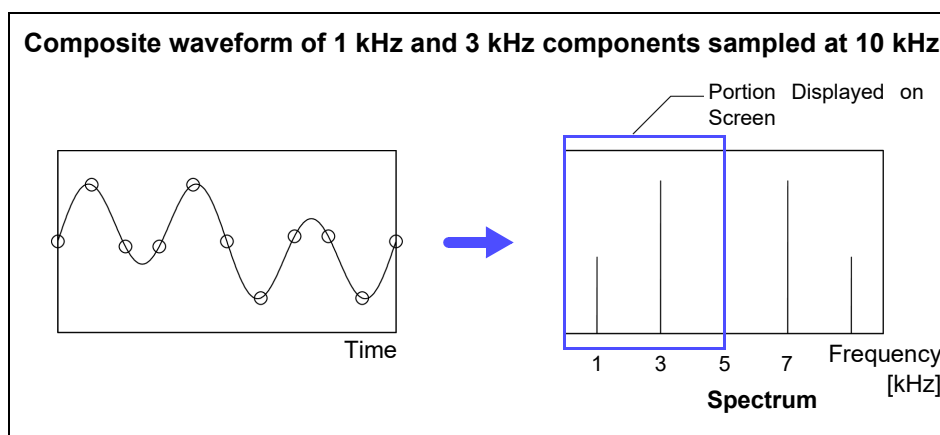

# A18

## Appendix 4 FFT Definitions

### Anti-Aliasing Filters

When the maximum frequency component of the input signal is higher than one-half of the sampling frequency, aliasing distortion occurs. To eliminate aliasing distortion, a low-pass filter can be used that cuts frequencies higher than one-half of the sampling frequency. Such a low-pass filter is called an anti-aliasing filter.

The following figures show the effect of application of an anti-aliasing filter on a square wave input waveform.

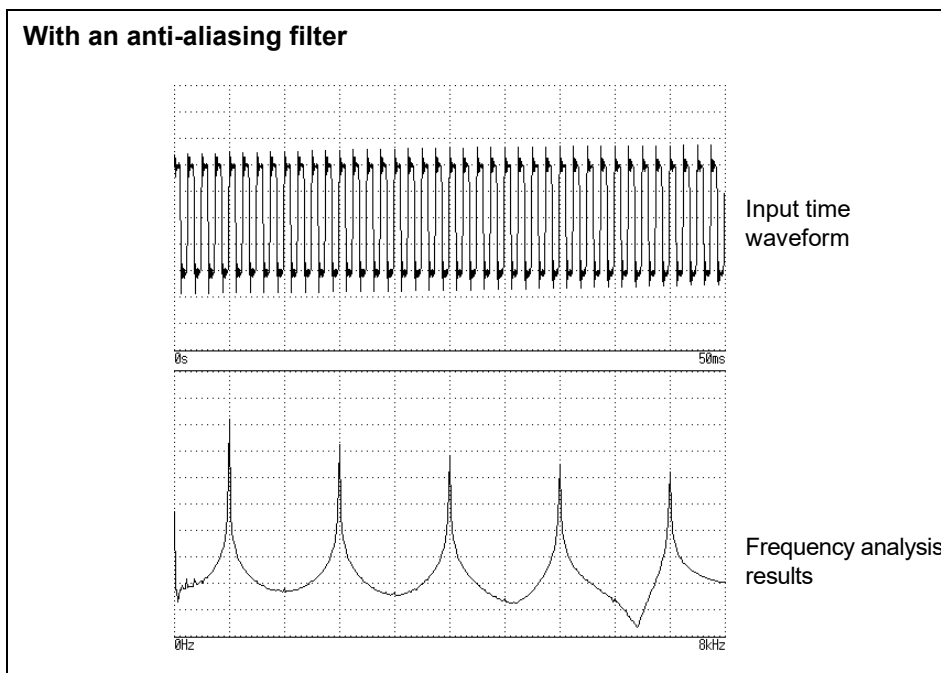
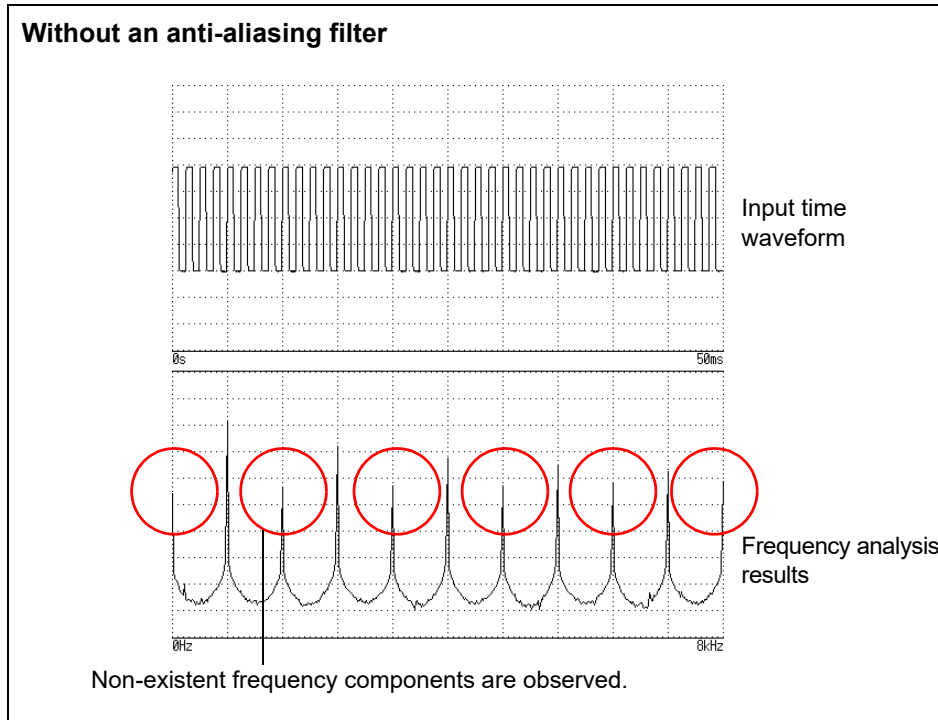

## Imaging

When the instrument is set to a measurement frequency range that requires a higher sampling rate than the maximum capability of the module, intermediate data points are interpolated between successive data samples. In this case, the time-domain waveform exhibits a stair-step shape. When FFT analysis is performed in this situation, non-existent high frequency spectral components appear. This phenomena is called zero-order hold characteristic **imaging**.

The following figures show the time-domain waveform and spectrum of a sine wave applied to the Model 8968 High Resolution Unit.

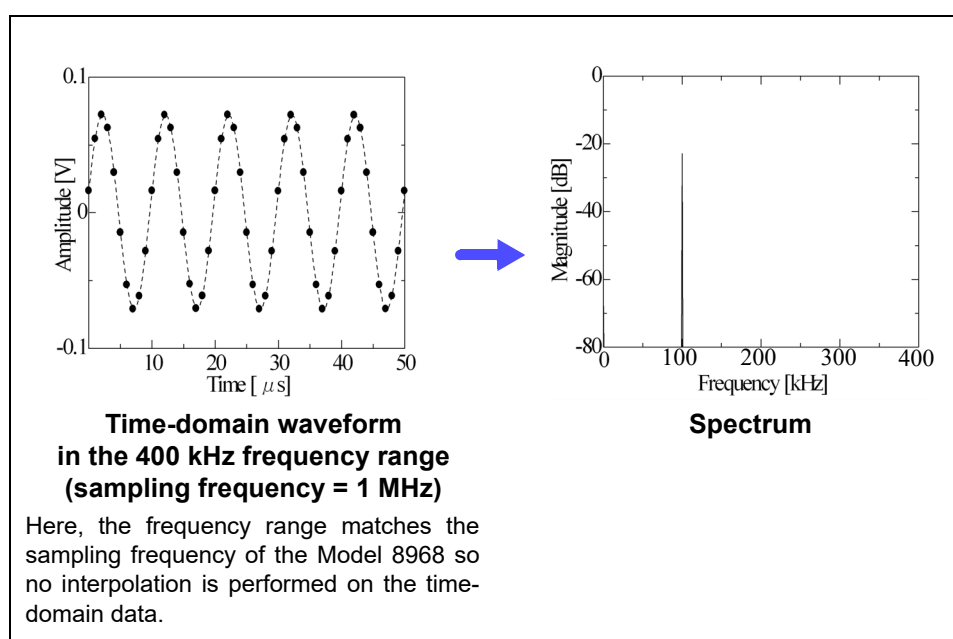
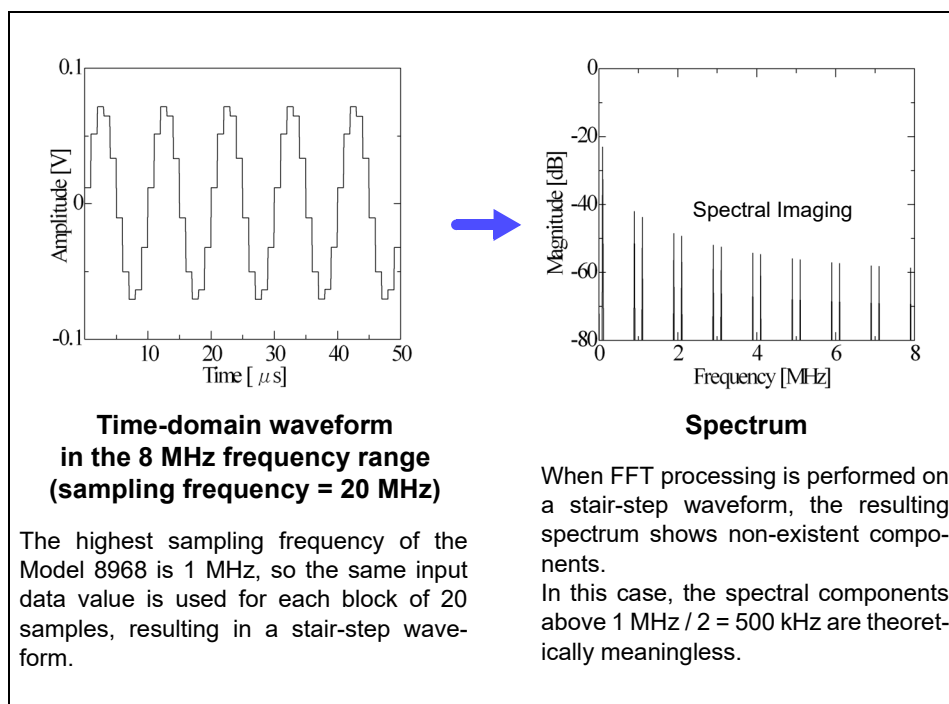

To avoid imaging phenomena when analyzing waveforms with the FFT function, verify the maximum sampling frequency of the module before measuring.



### Averaging

---

With the FFT function, averaging is performed according to the following analytical expressions. Averaging in the time domain produces meaningless data if performed with inconsistent trigger criteria.

#### 1. Simple Averaging (Time and Frequency Domains)

Sequences of acquired data are summed and divided by the number of acquisitions.

$$A_n = \frac{(n-1)A_{n-1} + Z_n}{n} \dots\dots\dots (11)$$

*n*: count of measurements to average

*A<sub>n</sub>*: averaging results of *n* counts

*Z<sub>n</sub>*: measurement data of *n* counts

#### 2. Exponential Averaging (Time and Frequency Domains)

Before averaging, newer data is given exponentially greater significance than older data.

$$A_n = \frac{(N-1)A_{n-1} + Z_n}{N} \dots\dots\dots (12)$$

*N*: Specified number of counts to average

*n*: count of measurements to average

*A<sub>n</sub>*: averaging results of *n* counts

*Z<sub>n</sub>*: measurement data of *n* counts

### Overall Value

---

The overall value is the sum of the power spectrum at each frequency. This value is equal to the positive sum of the squares of the (RMS) input signals, except when frequency averaging is performed. The FFT function of this instrument calculates and displays the RMS values for stored waveforms and the overall value from the sum of the power spectrum for the frequency domain. Any FFT analysis modes other than the power spectrum, however, take the root square of the overall value to match the unit.

With the FFT analysis mode set to the power spectrum

$$(Over\ all) = \sum_{i=0} P_i \dots\dots\dots (13-1)$$

With the FFT analysis mode set to the histogram, linear spectrum, RMS spectrum, impulse response, 1/1 octave analysis, or 1/3 octave analysis

$$(Over\ all) = \sqrt{\sum_{i=0} P_i} \dots\dots\dots (13-2)$$

*P<sub>i</sub>*: power spectrum of value *i*

## Total harmonic distortion (THD)

---

Total harmonic distortion (THD) indicates the proportion of the higher harmonics to the fundamental harmonic

This means that the larger the value, the more distorted the waveform.

$$\text{THD} = \frac{\sqrt{\sum (f_n)^2}}{(f_0)^2} \times 100 \text{ [%]} \dots\dots\dots (14)$$

$f_0$  = fundamental wave

$f_n$  =  $n$  next higher harmonic

### Window Function

The Fourier transform of a continuous system is defined by the integral Calculus in expression (15) for the time range from minus infinity to plus infinity.

$$X(f) = \int_{-\infty}^{\infty} x(t)\mathcal{E}^{-2\pi ft} dt \dots\dots\dots (15)$$

However, because expression (15) cannot be calculated with actual measurements, the Analysis is performed on a segment between finite limits. Processing the waveform segment within these limits is called window processing. For FFT analysis, the waveform segment within these limits is assumed to repeat periodically (as shown below).

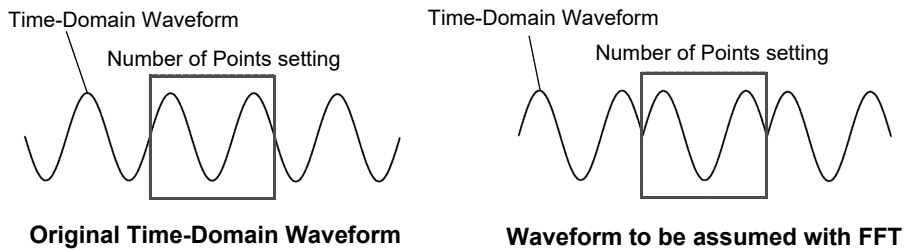

When the number of points for FFT analysis is an integer multiple of the input signal frequency, a single-line spectrum is obtained. However, if it is not an integer multiple of the frequency (when the waveform assumed with FFT includes discontinuous points), the spectrum is scattered, and a line spectrum cannot be obtained. This phenomena is called leakage error (as shown below).

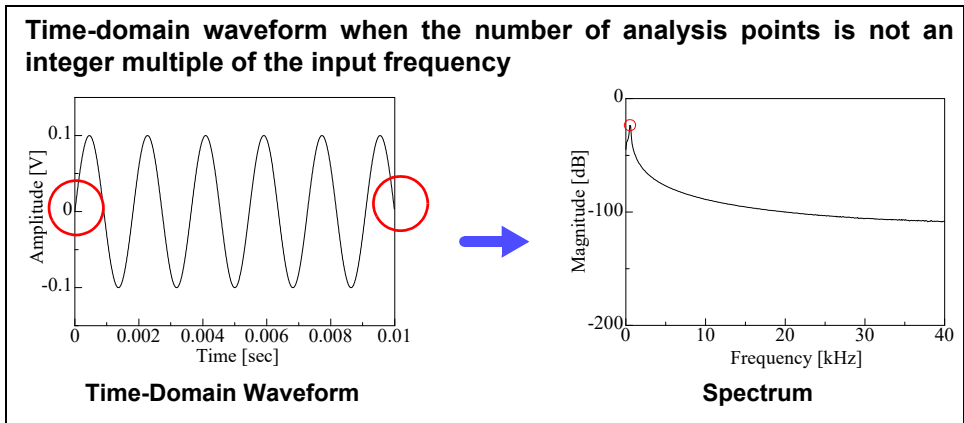
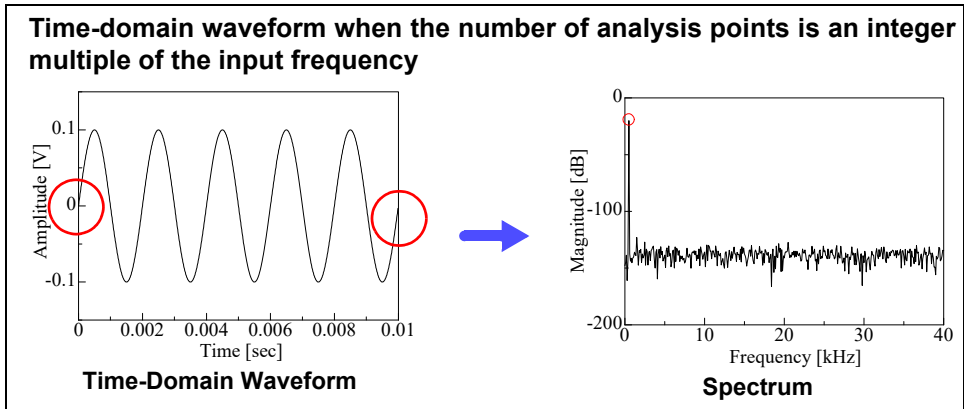

The window function was created to suppress such leakage errors. The window function smoothly connects each end of the time-domain waveform where it is cut off.

The following figure presents an example of spectral analysis by applying a window function to a time-domain waveform. Using the window function, discontinuous points on the time-domain waveform are eliminated, so the wave shape approaches a line spectrum.

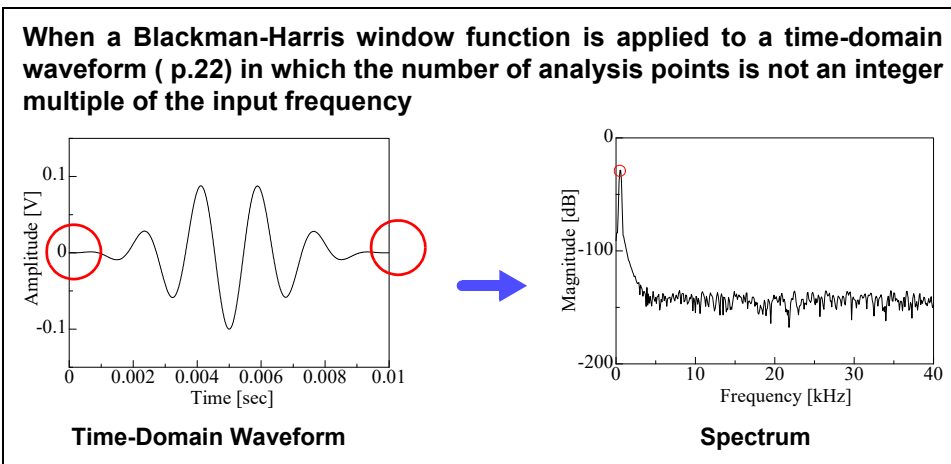

The following figure shows the time-domain waveform of the window function and its spectrum.

Each spectrum shows a large peak at a low frequency, and many smaller peaks at higher frequencies. The largest peak is called the **main lobe**, and the smaller peaks are the **side lobes**.

The most accurate results of the FFT function are obtained when the width of the main lobe and the amplitude of the side lobes are minimized, although both conditions cannot be satisfied at the same time.

Therefore, a window function having a wide main lobe is used when amplitude values are important, while a window function having a small main lobe is used to observe fine spectral details, and a window function having small side lobe amplitudes is used to exclude the effects of the surrounding spectrum.

However, because the main lobe width is proportional to the width (1/W) of the window, increasing the number of analysis points increases the frequency resolution.

**Rectangular window**

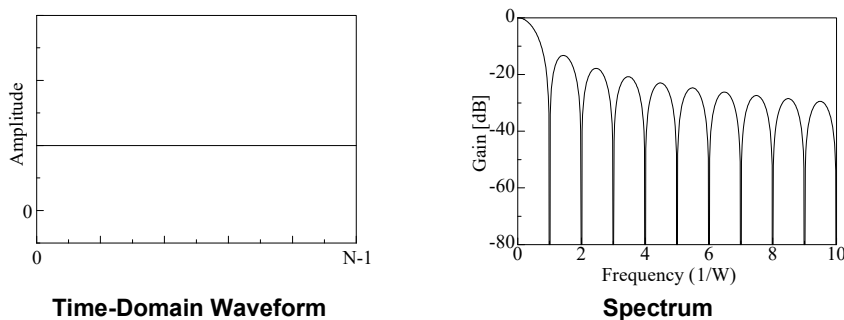

**Hann window**

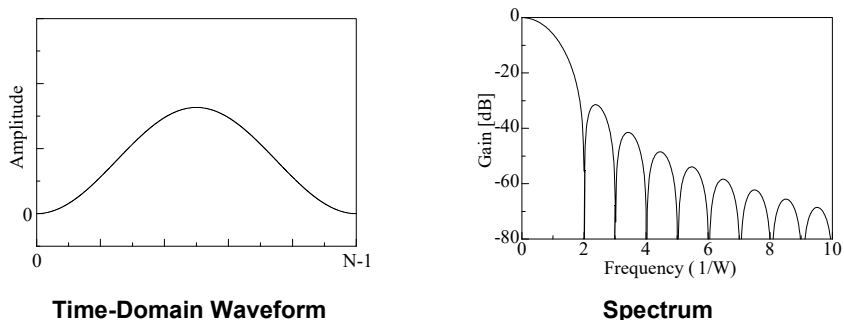

### Exponential window

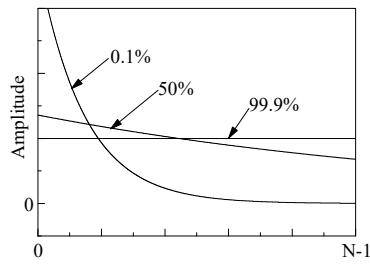

Time-Domain Waveform

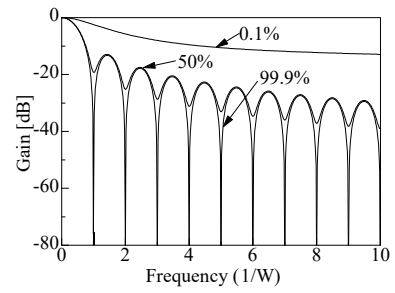

Spectrum

### Hamming window

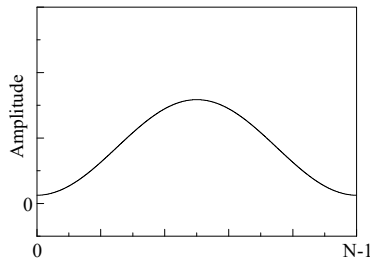

Time-Domain Waveform

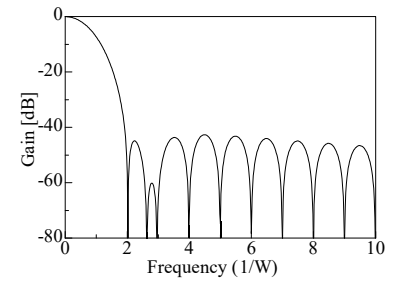

Spectrum

### Blackman window

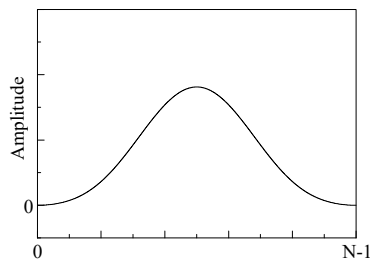

Time-Domain Waveform

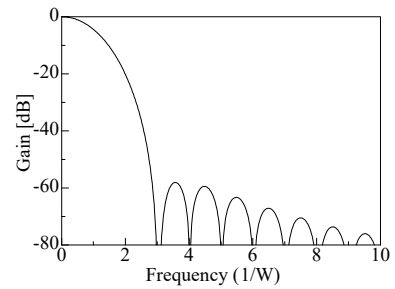

Spectrum

### Blackman-Harris window

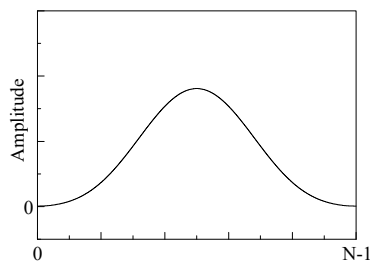

Time-Domain Waveform

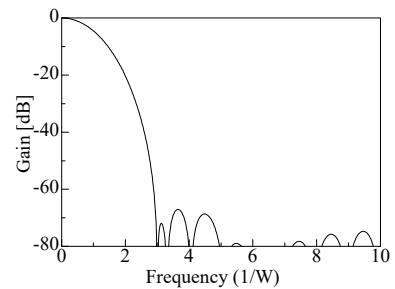

Spectrum

### Flat top window

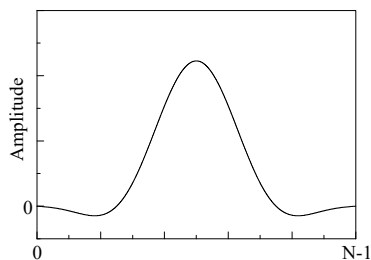

**Time-Domain Waveform**

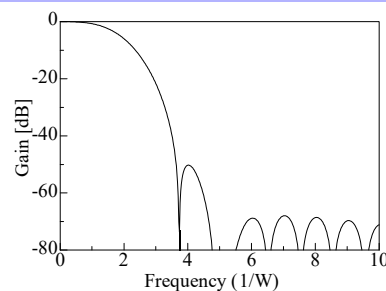

**Spectrum**

The following example shows input sine waves of 1050 and 1150 Hz analyzed with different window functions. Because the frequencies in this example are close to one another, a rectangular window with a narrow main lobe is able to separate and display both frequencies, but a Hann window with a wide main lobe displays the two as a single spectral component.

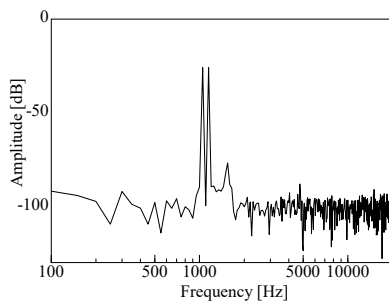

**Analysis Using a Rectangular Window**

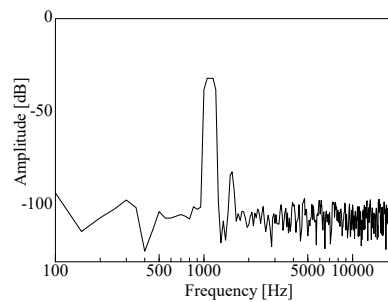

**Analysis Using a Hann Window**

# A26

## Appendix 4 FFT Definitions

### Octave Filter Characteristics

Octave filter characteristics are determined according to IEC61260 standards. The figures below show these standards and the filter characteristics of this instrument.

#### 1/1 Octave Filter Characteristic

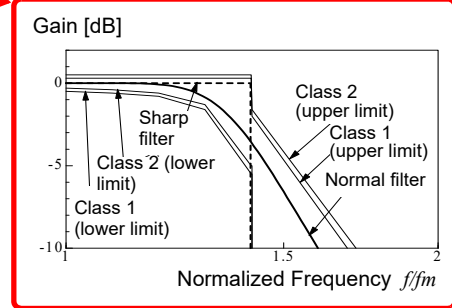
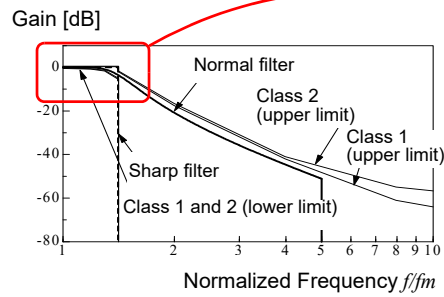

#### 1/3 Octave Filter Characteristic

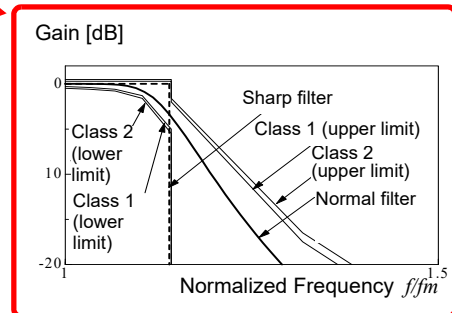
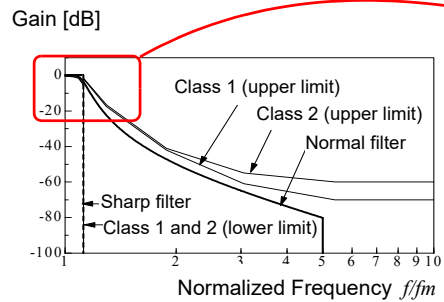

## Linear Predictive Coding (LPC)

In the following figure, linear predictive coding is implemented by passing a sample of the input signal through the prediction filter while altering the filter so as to minimize errors in the original signal.

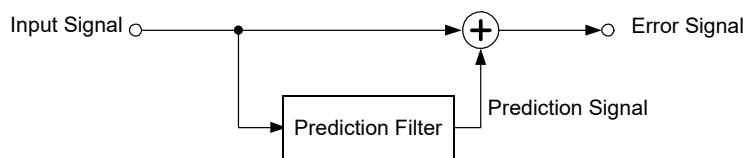

Given a time-discrete signal  $\{x_t\}$  ( $t$  is an integer) where the input signal is sampled at interval  $\Delta T$ , LPC analysis presumes the following relationship between current sample value  $x_t$  and the value of previous sample  $p$ .

$$x_t + \alpha_1 x_{t-1} + \alpha_2 x_{t-2} + \dots + \alpha_p x_{t-p} = \varepsilon_t \quad \text{----- (16)}$$

However,  $\{\varepsilon_t\}$  is an uncorrelated random variable with average value 0 and the dispersion  $\sigma^2$ .

Expression (16) shows how current sample value  $x_t$  can be “linearly predicted” from previous sample values. If the predicted value of  $x_t$  is actually  $\hat{x}_t$ , expression (16) can be transformed as follows.

$$x_t = \hat{x}_t + \varepsilon_t = -\sum_{i=1}^p \alpha_i x_{t-i} + \varepsilon_t \quad \text{----- (17)}$$

Here,  $\alpha_i$  is called the **linear predictor coefficient**.

For LPC analysis, this coefficient is calculated using the Levinson-Durbin algorithm, and a spectrum is obtained. In this instrument, the order of the coefficient can be set from 2 to 64. Larger orders reveal fine spectral components, while small orders reveal the overall spectrum shape.



# A28

## *Appendix 4 FFT Definitions*

---

---

# Index

## Numerics

100BASE-TX .....	318
2-Point .....	149
9333 LAN Communicator .....	334

## A

A.A.F .....	174
A/B cursors .....	120
Acquisition interval .....	252
Aliasing .....	A17
Analog Trigger .....	192
Analysis Modes .....	262, 293
Analysis modes .....	257, 262, 293
Analysis Starting Point .....	273
Anti-aliasing filter .....	A18
Area .....	224
Attenuation rate .....	254
Auto correlation function .....	287
Auto Print .....	111
Auto Save .....	87
Average .....	223
Averaging .....	256, A20

## B

Beep Sound .....	310
Blackman .....	A24
Blackman Harris .....	A24
Blackman Harris Window .....	254
Blackman Window .....	254
Blank Panel .....	36
Blocks in use .....	136

## C

Calculation No. ....	260
Captured Screen Image .....	85
Change Media .....	84
Coherence function .....	285
Comment	
Print (Channel marker) .....	113
Communications .....	313
Access .....	328
Command Communications .....	332
Delimiter .....	333
Header .....	333
Command Port (Port number) .....	332

Deleting and Renaming Files .....	330
Delimiter .....	332
Downloading .....	330
Gateway .....	315
Header .....	332
Host Name .....	315
IP Address .....	315
Network .....	314
Subnet Mask .....	315
Connection	
Current Measurement .....	45
Frequency, number of rotations, and count	
Measurement .....	41
Temperature Measurement .....	42
Voltage Measurement .....	39
Connection cord .....	41
Connection Cords .....	39
Conversion Ratio .....	148
Coupling .....	75
Cross power spectrum .....	283
Cross-correlation function .....	288
Cursor Value .....	120
XY Synthetic Waveform .....	123

## D

Damage .....	374
Delete .....	106
Display color	
Calculation waveforms .....	235
Display Types and Split-Screen Settings .....	268
Disposing	
Lithium Battery .....	386
Downloading .....	330
Duty Ratio .....	225

## E

Entering Numerals .....	144
Entering Text .....	141
Event Count .....	195
Exponential .....	A24
Exponential averaging .....	A20
Exponential window .....	254
external .....	66
External Control .....	335
External Sampling .....	340
External sampling .....	66

# 2

## Index

---

---

<b>F</b>	
Fall Time .....	224
FFT .....	247, A14
File	
Entering units and symbols .....	141
File operation	
Creating New Folders (New Folder) .....	105
Opening a folder (Open Folder) .....	105
Renaming Files & Folders (Rename) .....	107
Sorting Files (Sort) .....	107
File Size	
CSV File .....	A3, A4
FFT File .....	A3, A4
MEM File .....	A2, A4
REC File .....	A2, A4
Filter width .....	195
Flat top window .....	254
Flat-Top .....	A25
Folder	
Creating New Folders (Folder to save) .....	90
Creating New Folders (New Folder) .....	105
Opening a folder (Open Folder) .....	105
Format .....	55, 267
Four Arithmetic Operations (Calculation) .....	225
Fourier transforms .....	A14
Frequency .....	223
Frequency Range .....	251
Frequency range .....	251
Frequency Resolution .....	252
<b>G</b>	
Graph .....	71
Gritch Trigger .....	195
<b>H</b>	
Hamming .....	A24
Hamming Window .....	254
Hanning .....	A23
Hanning Window .....	254
High Level .....	225
Highlight .....	259
Highlight (phase)	
(db) .....	259
Attenuation rate .....	259
Histogram .....	275, 293
<b>I</b>	
Imaging .....	A19
Impulse response .....	284, A15
Input Levels .....	132
Installation .....	8
Installing .....	8
Internal memory .....	54
Internet Browser .....	320
Invert .....	159
<b>J</b>	
Judge .....	219
Calculation Results (Numerical Value) .....	218
<b>L</b>	
L9197 Connection Cord .....	39, 41
L9217 Connection Cord .....	39, 41
LAN .....	314
Level monitor .....	132
Level Trigger .....	193
Linear predictive coding .....	A27
Linear predictive coding (Power spectrum density) .....	281
Linear spectrum .....	276
Linear time-invariant systems .....	A15
Load	
File type .....	85
Logic Channel .....	78
Logic Probe .....	49
Logic Trigger .....	197
Low Level .....	225
Low-pass filtering .....	77
LPC .....	A27
LTI system .....	A15
<b>M</b>	
Magnifying and Compressing .....	129
Zoom Function .....	130
Manual Trigger .....	203
Maximal .....	255
Maximam .....	255
Maximum Value (Maximum) .....	223
Measurable ranges .....	290
Measurable ranges with octave analysis .....	290
Memory Capacity .....	343
Memory Division .....	241
Minimum Value (Minimum) .....	223
Mode .....	163
Module .....	36, 161, 352, A10
Mouse	
malfunction .....	374
<b>N</b>	
NG	
EXT .....	268
Nyquist, Running Spectrum .....	268
X-Axis .....	268
X-unit .....	268
NPLC .....	171, 8
Number of analysis points .....	251, 265, A16

---



# 4

## Index

---

---

<b>T</b>	
Text Comment .....	117
Thermocouple .....	42
Time Axis Range .....	8
Time difference calculation (Time Diff) .....	225
Time to Level (Time-Lev) .....	225
Time to Maximum Value (Max-Time) .....	223
Time to Minimum Value (Min-Time) .....	223
Timebase .....	252, 6
Timer Trigger .....	199
To change the media .....	84
Transfer function .....	282
Trig search .....	209
Trigger .....	189
Glit. ....	195
In .....	193
Level .....	193
Mode .....	191
Out .....	193
Per.I .....	194
Per.O .....	194
Timing .....	207
VDrop .....	194
Trigger Filter .....	195
Trigger mode .....	258, 265
Trigger Modes .....	258
Trigger Output .....	341
Trigger Priority .....	206
Trigger Setting	
Trigger setting workflow .....	190
Trigger Source (AND/OR) .....	208
Two-Point Setting .....	148
<b>U</b>	
upper .....	115
Upper/Lower limit .....	134
USB .....	54
Use Blocks .....	243
Used Block number (number of blocks to use) .....	243
<b>V</b>	
Variable Auto Adjustment .....	150
Variable function	
When setting combined use of	
scaling function .....	157
When setting scaling .....	150
Vernier .....	158
Voltage Sag Trigger .....	194
<b>W</b>	
Wave Binary .....	88, 103
Wave color .....	260
Wave Display .....	244
Wave Text .....	88, 103
Waveform	
Magnifying and Compressing .....	129
Specifying Range .....	124
Waveform Calculation .....	227
Waveform calculation	
Operators .....	237
Waveform Calculations	
Settings .....	231
Waveform Color .....	235
Waveform color .....	265
Waveform Evaluation .....	295
Waveform File Sizes .....	A2
Waveform Screen .....	273
Window	
Compensation .....	254
Window Function .....	254
Window function .....	254, 265, A22
Window trigger .....	193
<b>X</b>	
X Axis .....	261
X-Y Area .....	214, 224
<b>Y</b>	
Y Axis .....	261
<b>Z</b>	
Zero Position .....	59, 76
Zero-Adjust .....	59

---

# Warranty Certificate

# HIOKI

Model	Serial number	Warranty period Three (3) years from date of purchase ( ___ / ___ )
-------	---------------	--

Customer name: \_\_\_\_\_

Customer address: \_\_\_\_\_

## Important

- Please retain this warranty certificate. Duplicates cannot be reissued.
- Complete the certificate with the model number, serial number, and date of purchase, along with your name and address. The personal information you provide on this form will only be used to provide repair service and information about Hioki products and services.

This document certifies that the product has been inspected and verified to conform to Hioki's standards.

Please contact the place of purchase in the event of a malfunction and provide this document, in which case Hioki will repair or replace the product subject to the warranty terms described below.

## Warranty terms

1. The product is guaranteed to operate properly during the warranty period (three [3] years from the date of purchase).  
If the date of purchase is unknown, the warranty period is defined as three (3) years from the date (month and year) of manufacture (as indicated by the first four digits of the serial number in YYMM format).
2. If the product came with an AC adapter, the adapter is warranted for one (1) year from the date of purchase.
3. The accuracy of measured values and other data generated by the product is guaranteed as described in the product specifications.
4. In the event that the product or AC adapter malfunctions during its respective warranty period due to a defect of workmanship or materials, Hioki will repair or replace the product or AC adapter free of charge.
5. The following malfunctions and issues are not covered by the warranty and as such are not subject to free repair or replacement:
  - 1. Malfunctions or damage of consumables, parts with a defined service life, etc.
  - 2. Malfunctions or damage of connectors, cables, etc.
  - 3. Malfunctions or damage caused by shipment, dropping, relocation, etc., after purchase of the product
  - 4. Malfunctions or damage caused by inappropriate handling that violates information found in the instruction manual or on precautionary labeling on the product itself
  - 5. Malfunctions or damage caused by a failure to perform maintenance or inspections as required by law or recommended in the instruction manual
  - 6. Malfunctions or damage caused by fire, storms or flooding, earthquakes, lightning, power anomalies (involving voltage, frequency, etc.), war or unrest, contamination with radiation, or other acts of God
  - 7. Damage that is limited to the product's appearance (cosmetic blemishes, deformation of enclosure shape, fading of color, etc.)
  - 8. Other malfunctions or damage for which Hioki is not responsible
6. The warranty will be considered invalidated in the following circumstances, in which case Hioki will be unable to perform service such as repair or calibration:
  - 1. If the product has been repaired or modified by a company, entity, or individual other than Hioki
  - 2. If the product has been embedded in another piece of equipment for use in a special application (aerospace, nuclear power, medical use, vehicle control, etc.) without Hioki's having received prior notice
7. If you experience a loss caused by use of the product and Hioki determines that it is responsible for the underlying issue, Hioki will provide compensation in an amount not to exceed the purchase price, with the following exceptions:
  - 1. Secondary damage arising from damage to a measured device or component that was caused by use of the product
  - 2. Damage arising from measurement results provided by the product
  - 3. Damage to a device other than the product that was sustained when connecting the device to the product (including via network connections)
8. Hioki reserves the right to decline to perform repair, calibration, or other service for products for which a certain amount of time has passed since their manufacture, products whose parts have been discontinued, and products that cannot be repaired due to unforeseen circumstances.

**HIOKI E.E. CORPORATION**

<http://www.hioki.com>

18-07 EN-3

**HIOKI**  
**www.hioki.com/**



**All regional  
contact  
information**

**HEADQUARTERS**

81 Koizumi  
Ueda, Nagano 386-1192 Japan

**HIOKI EUROPE GmbH**

Helfmann-Park 2  
65760 Eschborn, Germany  
hioki@hioki.eu

2111 EN

Edited and published by HIOKI E.E. CORPORATION

Printed in Japan

- CE declarations of conformity can be downloaded from our website.
- Contents subject to change without notice.
- This document contains copyrighted content.
- It is prohibited to copy, reproduce, or modify the content of this document without permission.
- Company names, product names, etc. mentioned in this document are trademarks or registered trademarks of their respective companies.