

LR5041 LR5042 LR5043

Instruction Manual

VOLTAGE LOGGER



Read carefully before use.
Keep for future reference.

✓ **When using the instrument for the first time**

Part Names/Functions and Display Indicators ▶ p.12
Settings List ▶ p.29

📖 **Troubleshooting**

Maintenance and Service ▶ p.91
Troubleshooting ▶ p.92
Error Displays ▶ p.94

EN

Contents

Introduction	1
Verifying Package Contents	3
Safety Information	5
Operating Precautions	6
Measurement Preparation to Data Analysis	8
Chapter 1	
Overview	11
1.1 Product Overview and Features	11
1.2 Part Names/Functions and Display Indicators	12
1.3 Display Organization	14
Chapter 2	
Measurement Preparations	17
2.1 Installing (or Replacing) the Battery	17
2.2 Connecting a Connection Cable	20
2.3 Installing the PC Application Program	23
Chapter 3	
Settings	29
3.1 Settings List	29
3.2 Making Settings on the Logger	31
3.3 Making Settings from the LR5000 Utility Program	36
Chapter 4	
Measurement and Analysis	43
4.1 Pre-Measurement Inspection	43
4.2 Installing the Logger	44
4.3 Starting and Stopping Recording	46
4.4 Confirming Currently Measured Values and Data Recording	49

4.5	Automatically Importing (Saving) Recorded Data to a Computer, and Graph Display	49
4.6	Manually Importing (Saving) Recorded Data to a Computer, and Graph Display	59
4.7	Displaying a Graph of Saved Recording Data	62
4.8	Printing Recorded Data	64

Chapter 5

Processing Recorded Data _____ 65

5.1	Scaling	67
5.2	Calculating Electric Power	68
5.3	Calculating Energy Cost	69
5.4	Calculating Operating Rate	70
5.5	Integration	71
5.6	Calculating Dew-Point Temperature	72
5.7	Two-Data-Item Arithmetic Calculations	73
5.8	Converting Over-Threshold Data Values	74

Chapter 6

Organizing Data _____ 75

6.1	Copying and Moving Data	76
6.2	Deleting Data	77
6.3	Combining Data	78
6.4	Extracting Data	79

Chapter 7

Options Settings (LR5000 Utility Program) _____ 81

7.1	Changing the Saving Method for Imported Data ...	82
7.2	Changing the Connection Monitoring Method, and Logger Settings Displays	83

Chapter 8

Specifications _____ 85

8.1	Measurement Specifications	85
8.2	Functional Specifications	86

8.3 Miscellaneous87

8.4 LR5091 Communication Adapter Specifications ...88

Chapter 9

Maintenance and Service _____ **91**

9.1 Cleaning92

9.2 Disposing of the Logger92

9.3 Troubleshooting92

9.4 Error Displays94

Appendix _____ **A 1**

Appendix 1 About Recording Modes..... A 1

Appendix 2 Recording Intervals and Maximum
Recording Times A 2

Appendix 3 Battery Life Approximation A 2

Index _____ **Index 1**

Introduction

Thank you for purchasing the HIOKI Model LR5041, LR5042, LR5043 Voltage Logger. To obtain maximum performance from the logger, please read this manual first, and keep it handy for future reference.

The latest edition of the instruction manual



The contents of this manual are subject to change, for example as a result of product improvements or changes to specifications. The latest edition can be downloaded from Hioki's website.
<https://www.hioki.com/global/support/download>



Trademarks

Microsoft and Excel are either registered trademarks or trademarks of Microsoft Corporation in the United States and other countries.

Notation

	Indicates a prohibited action.
(p.)	Indicates the location of reference information.
	Indicates the location of reference information.
*	Indicates that descriptive information is provided below.
[]	Menus, commands, dialogs, buttons in a dialog, and other names on the screen and the keys are indicated in brackets.
SET (Bold characters)	Bold characters within the text indicate operating button labels.
Windows	Unless otherwise specified, "Windows" represents Windows 7 or Windows 10.

2

Introduction

The screen of this logger displays characters in the following manner.

A	B	C	D	E	F	G	H	I	J	K	L	M	N	O	P	Q	R	S	T	U	V	W	X	Y	Z
A	b	C	d	E	F	G	H	I	J	K	L	M	N	O	P	Q	R	S	T	U	V	W	X	Y	Z
1	2	3	4	5	6	7	8	9	0																
1	2	3	4	5	6	7	8	9	0																

◆ Accuracy

We define measurement tolerances in terms of rdg. (reading) and dgt. (digit) values, with the following meanings:

rdg. (reading or displayed value)	The value currently being measured and indicated on the measuring instrument.
dgt. (resolution)	The smallest displayable unit on a digital measuring instrument, i.e., the input value that causes the digital display to show a "1" as the least-significant digit.







◆ Mouse Operation

Click	Press and quickly release the left button of the mouse.
Right-click	Press and quickly release the right button of the mouse.
Double click	Quickly click the left button of the mouse twice.
Drag	While holding down the left button of the mouse, move the mouse and then release the left button to deposit the chosen item in the desired position.
Activate	Click on a window on the screen to activate that window.

Verifying Package Contents

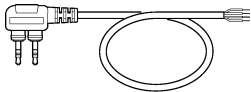
When you receive the logger, inspect it carefully to ensure that no damage occurred during shipping. In particular, check the accessories, panel switches, and connectors. If damage is evident, or if it fails to operate according to the specifications, contact your dealer or Hioki representative.

Quantities in parentheses ().

<input type="checkbox"/> Logger (1)	<u>Accessories</u>
	<input type="checkbox"/> LR6 alkaline battery (1) (Pre-installed in the logger.)
	
	<input type="checkbox"/> LR9802 Connection Cable (1)
	
	<input type="checkbox"/> Operation Manual (1)
	
	<input type="checkbox"/> Instruction Manual (1)
	
	<input type="checkbox"/> Stand (1)
	
	See: Other specified options: "Options" (p.4)

Options

The options listed below are available for the instrument. To order an option, please contact your authorized Hioki distributor or reseller. Options are subject to change. Please check Hioki's website for the latest information.

- LR5091 Communication Adapter(1)**
(Includes LR5000 Utility Program* CD [PC application software] and USB Cable)

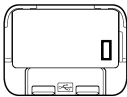

See: LR5091 specification: (p.88)

- LR5092-20 Data Collector**
(Includes LR5000 Utility Program* CD [PC application software], LR03 alkaline battery x2, Instruction manual, Operation manual, and USB Cable)



* :The latest version can be downloaded from our web site.

- LR9802 Connection Cable**
(Cable length: Approx. 1 m)

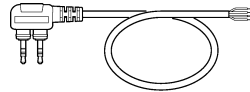

- LR9901 Wall-Mounted Holder**

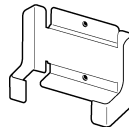

See: Method of mounting: (p.45)

- Z5004 Magnetic Strap**



See: Method of mounting: (p.45)

Transporting Precautions

Use the original packing materials when transporting the logger, if possible. Pack the logger so that it will not sustain damage during shipping, and include a description of existing damage. We do not take any responsibility for damage incurred during shipping.

Safety Information

This manual contains information and warnings essential for safe operation of the logger and for maintaining it in safe operating condition. Before using it, be sure to carefully read the following safety precautions.



This logger is designed to comply with IEC 61010 Safety Standards, and has been thoroughly tested for safety prior to shipment. However, mishandling during use could result in injury or death, as well as damage to the logger. However, using the logger in a way not described in this manual may negate the provided safety features.

Be certain that you understand the instructions and precautions in the manual before use. We disclaim any responsibility for accidents or injuries not resulting directly from logger defects.

Safety Symbols

Markings on the logger have the following meanings.

	In the manual, the symbol indicates particularly important information that the user should read before using the logger.
	The symbol printed on the logger indicates that the user should refer to a corresponding topic in the manual (marked with the symbol) before using the relevant function.
	Indicates DC (Direct Current).

Symbols for Various Standards

Markings on the logger have the following meanings.

	Indicates that the product conforms to regulations set out by the EU Directive.
	This symbol indicates that the product conforms to safety regulations set out by the EC Directive.

Danger Levels

The following symbols in this manual indicate the relative importance of cautions and warnings.

	Indicates that incorrect operation presents an extreme hazard that could result in serious injury or death to the user.
	Indicates that incorrect operation presents a significant hazard that could result in serious injury or death to the user.
	Indicates that incorrect operation presents a possibility of injury to the user or damage to the logger.
	Indicates advisory items related to performance or correct operation of the logger.

Operating Precautions







Follow these precautions to ensure safe operation and to obtain the full benefits of the various functions.

Installation Precautions

Operating temperature and humidity: -20 to 70°C (-4.0 to 158.0°F), 80%RH or less (non-condensating)

Storage temperature and humidity : -20 to 70°C (-4.0 to 158.0°F), 80%RH or less (non-condensating)

Avoid the following locations that could cause an accident or damage to the logger.

	Exposed to direct sunlight Exposed to high temperature		In the presence of corrosive or explosive gases
	Exposed to oil, other chemicals, or solvents Exposed to high humidity or condensation		Exposed to strong electromagnetic fields Near electromagnetic radiators
	Subject to vibration		Near induction heating systems (e.g., high-frequency induction heating systems and IH cooking utensils)

CAUTION

- The protection rating for the enclosure of this device (based on EN60529) is *IP54.
- Although this logger is designed to resist the ingress of dust and water, it is not entirely water- or dust-proof, so to avoid shock or damage, do not use it in a wet or dusty environment.

*IP54 : This indicates the degree of protection provided by the enclosure of the device against use in hazardous locations, entry of solid foreign objects, and the ingress of water.

- 5 : Protected against access to hazardous parts with wire measuring 1.0 mm in diameter. Dust-proof type (The penetration of dust cannot be prevented completely, but quantities of dust that may hinder the stated operation of equipment or safety cannot penetrate the enclosure.)
- 4 : The equipment inside the enclosure is protected against the harmful effects of water splashed against the enclosure from any direction.

Avoiding Logger Damage

CAUTION

To avoid damage to the logger, protect it from physical shock when transporting and handling. Be especially careful to avoid physical shock from dropping.

CD Handling

CAUTION

- Always hold the disc by the edges, so as not to make fingerprints on the disc or scratch the printing. Never touch the recorded side of the disc. Do not place the disc directly on anything hard.
- Do not wet the disc with volatile alcohol or water, as there is a possibility of the label printing disappearing.
- To write on the disc label surface, use a spirit-based felt pen. Do not use a ball-point pen or hard-tipped pen, because there is a danger of scratching the surface and corrupting the data. Do not use adhesive labels.
- Do not expose the disc directly to the sun's rays, or keep it in conditions of high temperature or humidity, as there is a danger of warping, with consequent loss of data.
- To remove dirt, dust, or fingerprints from the disc, wipe with a dry cloth, or use a CD cleaner. Always wipe from the inside to the outside, and do no wipe with circular movements. Never use abrasives or solvent cleaners.
- Hioki shall not be held liable for any problems with a computer system that arises from the use of this CD, or for any problem related to the purchase of a Hioki product.

Preliminary Checks

Before using the logger the first time, verify that it operates normally to ensure that the no damage occurred during storage or shipping. If you find any damage, contact your dealer or Hioki representative.

WARNING

Before using the logger, make sure that the insulation on the connection cables is undamaged and that no bare conductors are improperly exposed. Using the logger in such conditions could cause an electric shock, so contact your dealer or Hioki representative for replacements.

Measurement Preparation to Data Analysis

The steps from measurement preparation to data analysis are illustrated with a typical measurement example.

Example Case: Record a factory flow sensor output signal (1-5 V) at one-minute intervals for one month, and store the data on a computer.

Required Items:

Quantities in parentheses ().

Logger (1)



LR6 alkaline battery (1)



LR9802 Connection Cable (1)

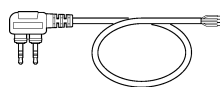

LR5091 Communication Adapter (1)
(LR5000 Utility Program* CD [PC application software] and USB Cable)



Computer (1)

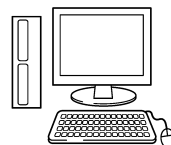

Procedure:

1

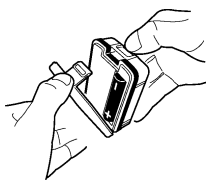

1

Install the battery in the logger.

See: "2.1" (p.17)

2

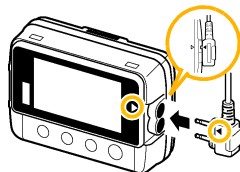

2

Connect the LR9802 Connection Cable to the logger.

See: "2.2" (p.20)

3

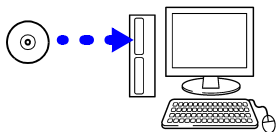

3 Install the LR5000 Utility Program on the computer.

See: "2.3" (p.23)

4

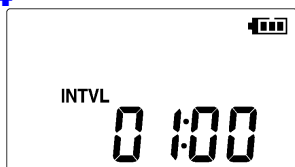

4 Select the recording interval for the logger (in this case, 1 minute).

See: "Recording Interval Setting" (p.31)

(The setting can be made also from the LR5000 Utility Program.) (p.39)

5

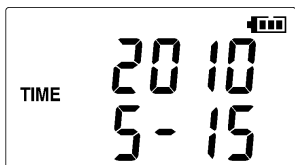

5 Set the logger to the correct date and time (in this case, 15 May 2010, 13:00).

See: "Real-Time Clock Setting" (p.32)

(With the LR5000 Utility Program, the logger can be set to the computer time.) (p.42)



6 Set the stop method to **[OFF]**.

(This setting provides one-time measurement: recording stops when memory becomes full.)

See: "Stop Method Setting (for when memory becomes full)" (p.33)

6



(The setting can be made also from the LR5000 Utility Program.) (p.39)

7

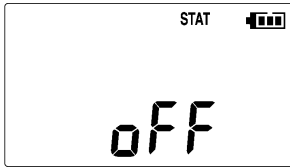

8



11

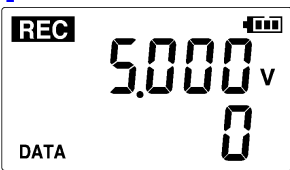

12

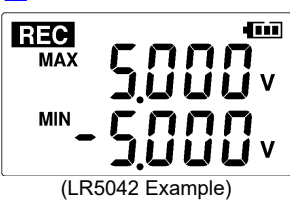

15

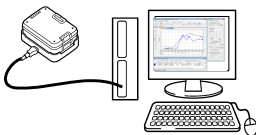

7

Set the recording mode to **[OFF]**.

(This setting provides instantaneous measurement.)

See: "Recording Mode Setting" (p.34)
(The setting can be made also from the LR5000 Utility Program.) (p.39)

8

Set the power save setting to **[ON]**.

(The on (enabled) setting is recommended for long-term recording.)

See: "Power Save Setting" (p.34)
(The setting can be made also from the LR5000 Utility Program.) (p.38)

9

Pre-measurement inspection (p.43)

10

Install the logger at the measurement site in the factory.

See: "4.2" (p.44)
(It can be wall-mounted.)

11

Hold **REC/STOP** on the logger for two seconds to start recording.

(Confirm that the recording data count is incrementing and that recording is actually occurring.)

See: "4.3" (p.46)

12

Switch the logger display by pressing the (+) and (-) buttons to check maximum and minimum recorded values.

(Confirm that recording is actually occurring.)

See: "4.4" (p.49)

13

After a month, hold **REC/STOP** on the logger again for two seconds to stop recording.

See: "4.3" (p.46)

14

Retrieve the logger from the measurement site.

15

Import recorded data from the logger to a connected computer. For analysis, display the data in a graph.

See: "4.5" (p.49)

(The data is automatically saved when imported to the computer. By default, it is also automatically displayed in a graph.)

16

Print recorded data as needed.

See: "4.8" (p.64)

Overview

Chapter 1

1

1.1 Product Overview and Features

This instrument is a compact portable data logger for measuring, displaying, and recording DC voltage.

- Data can be imported while recording.
- Records up to 60,000 measurements

Splash-proof ingress protection (IP54)

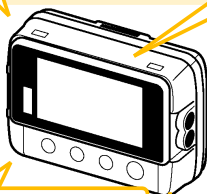

Large display shows measured DC voltage value and recorded data count

Measures DC voltage (one channel).

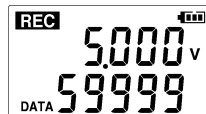

Browse and manage data with LR5000 Utility Program on a PC.

The LR5000 Utility Program PC application is very easy to install. After installation, data management and browsing is easy with auto-start, data display and saving.



- Data is preserved independently of battery state
- Recording continues (for approx. 30 s) during battery replacement

Advanced functions included

- Record statistical values (p.33), (p.39)
- Scaling (p.40), (p.67)
- Alarm display (p.41)
- Preheat output (p.35)

Measures the output of various sensors in the factory

Suitable for ESCO, ISO, and similar measurement applications.

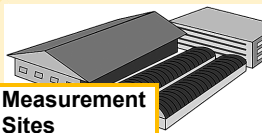

Analysis Site

Measurement Sites



1.2 Part Names/Functions and Display Indicators

Front

LCD (p.13)

The display blanks after 30 seconds of operator inactivity (auto power save). The display reappears by pressing a button. When the display is visible, it refreshes about once per second.

IR Port (p.49)

Communicates with the LR5091 Communication Adapter or LR5092-20 Data Collector

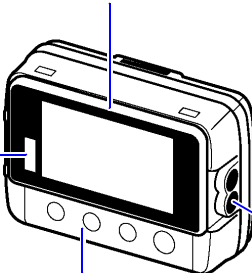

Operation buttons

Battery Cover (p.17)

Connection cable Jacks (p.20)

Connect a connection cable.

Back

Stand/Strap Attachment Hole (p.44)

Attach the logger to a wall or other surface by hanging it on a screw. (Supported screw head dimensions: up to approx. 6.8 mm in diameter and approx. 2.5 mm in thickness)

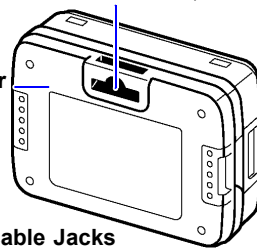

Operation Buttons

SET button

Displays settings.

REC/STOP button

Hold for two seconds to start/stop recording. From a setting display, switches to measurement display.

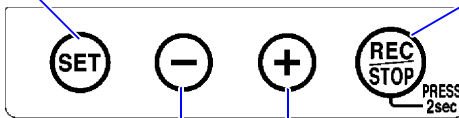

(-) button, (+) button

Changes Measurement display contents.
Changes setting values on the Settings display.

LR5091 Communication Adapter

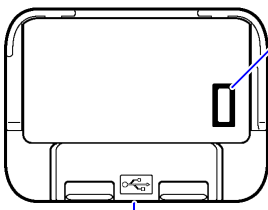

IR Port (p.49)

Communicates with the logger.

USB Port (p.36)

Connect a USB cable here to communicate with a computer. (Mini-B receptacle)

Display Indicators

The display indicators provide the following information.

REC Indicator

Indicates recording in progress. (Blinks when waiting to record.)

AL indicator

When the alarm* function is enabled, this indicates when a measured value is outside of the specified (upper/lower value*) range.

ENDLESS indicator

Indicates the Stop Method Setting display. Also appears on the Measurement display to indicate endless recording (p.33) is enabled.

Battery Status Indicator

Indicates the battery charge status. (p.18)

MAX indicator

Indicates that the value displayed at the right is the maximum.

Measurement Channel

MIN indicator

Indicates that the value displayed at the right is the minimum.

DATA indicator

Indicates that the value displayed at the right is the data count.

TIME indicator

Indicates the Date-Time Setting display.

INTVL indicator

Indicates the Recording Interval Setting display.

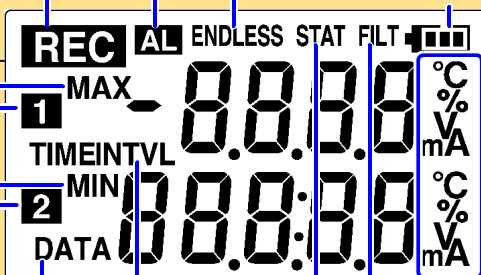

Units

Indicates the unit of measurement on each channel. (not displayed when scaling* is enabled)

Not used by the logger.

STAT indicator

Indicates the Recording Mode Setting display. Also appears on the Measurement display to indicate statistic recording (p.34) is enabled.

* Setting is available from the LR5000 Utility Program or via the LR5092-20 Data Collector.

See: "3.3 Making Settings from the LR5000 Utility Program" (p.36), LR5092-20 Data Collector Instruction Manual

1.3 Display Organization

The logger has two general display types: Measurement and Settings.

Measuring display

The (+) and (-) buttons switch the display type.

(LR5042 Display Example)

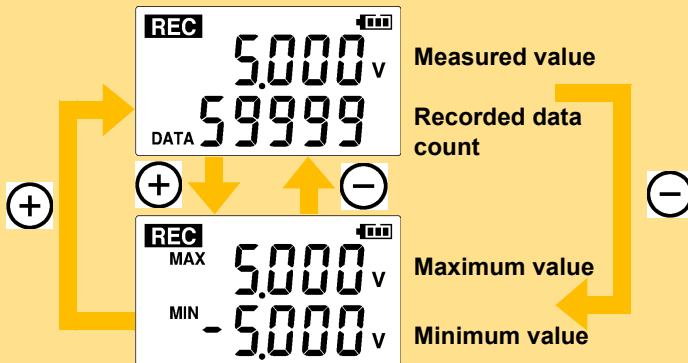

NOTE

- For instantaneous recording, the maximum and minimum values are obtained from all the data measured at each recording interval.
- For statistical recording, the maximum and minimum values are obtained from all the data measured every second.
- The maximum and minimum values are not displayed when the recorded data count is 0.

Setting display

Select the display with the **SET** button. Press **(+)** and **(-)** to change a setting.
Press the **REC/STOP** button to switch to the Measurement display from any other.

(LR5042 Display Example)

Measuring display



Preheat Time Setting (p.35)



Recording Interval Setting (p.31)

Battery life is extended when on (enabled). (Default is on.)
See: "Appendix 3 Battery Life Approximation" (p.A2)



Power Save Setting (p.34)



Year Setting (p.32)

When on (statistical recording), instantaneous, maximum, minimum, and average values are recorded at each interval. Battery life is shorter. (Default is off.) (Record instantaneous values)
See: "Appendix 3 Battery Life Approximation" (p.A2)



Recording Mode Setting (p.34)



Month Setting (p.32)

Select what happens when memory becomes full. When on, the oldest data is overwritten, and when off, recording stops. (Default is on.)



Stop Method Setting (p.33)



Day Setting (p.32)



Hour Setting (p.32)



Minute Setting (p.32)

NOTE

- When no operation occurs for 30 seconds with the Settings display, automatically switches to Measurement display.
 - When the  battery indicator appears, settings cannot be changed (although they can still be displayed).
 - Settings cannot be changed while recording. However, settings can still be displayed by pressing the **SET** button from the Measurement display.
-

Measurement Preparations

Chapter 2

2

2.1 Installing (or Replacing) the Battery



WARNING

- After replacing the battery, replace the cover before using the logger.
- Be sure to insert them with the correct polarity. Otherwise, poor performance or damage from battery leakage could result. Replace batteries only with the specified type.
- Battery may explode if mistreated. Do not short-circuit, recharge, disassemble or dispose of in fire.
- Handle and dispose of batteries in accordance with local regulations.

NOTE

- Data and settings stored in the logger are retained even when the battery is depleted, and during battery replacement.
- The clock can keep good time for several minutes even when the battery is removed during a battery change.
- Once the  battery indicator appears, operation can still continue for about 30 seconds when the battery is removed during recording.
- Testing monitor batteries installed in the unit may possibly be weak. Replace batteries before extended measurement usage.
- Use only LR03 Alkaline batteries. Using manganese batteries may not result in accurate measurements or proper communication with the LR5091 Communication Adapter and LR5092-20 Data Collector.
- After installing the batteries, the following displays appear, and the date and time need to be set. (p.32)

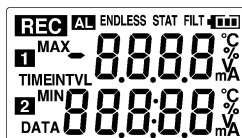

1. All segments

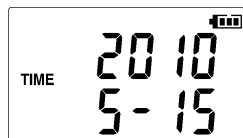

4. Year Setting display



2. Model name



3. Firmware version

2.1 *Installing (or Replacing) the Battery*

NOTE

- When the  battery indicator appears, settings cannot be changed (although they can still be displayed).
- When battery voltage is too low to operate the logger, the following appears. Replace the battery to restore normal operation.



Battery Status Indicator

This indicator is displayed at the top right corner.



Battery charge remains. Fewer blocks within the indicator signify weaker battery charge.



Replace the discharged battery as soon as possible. (Even when the battery is removed during recording, operation can continue for about 30 seconds.)



In this state, recording and communication with the LR5091 Communication Adapter and LR5092-20 Data Collector are not possible.

Using a NiMH Battery

The battery status indicator does not accurately show the remaining battery capacity when using a NiMH battery. Moreover, the battery life will vary greatly with the capacity, charging conditions and repeated uses. Please take note of these points when using it.

The device's battery status display and battery life are based on the usage of a brand-new alkaline battery.

When the logger will not be used for long time



CAUTION

To avoid corrosion and damage to this instrument from battery leakage, remove the batteries from the instrument if it is to be stored for a long time (1 week).

Battery Replacement

Required Items: LR6 alkaline battery (1)

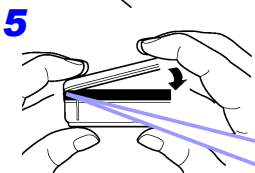
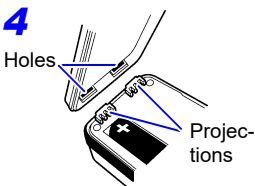
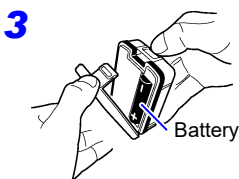
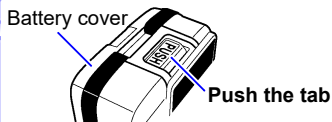
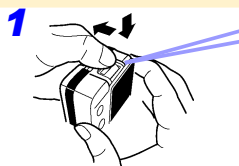

- 1** Press the PUSH tab as shown, and pull the battery cover back.
- 2** Hold the battery cover while separating it from the logger.
- 3** Install the battery as shown.
- 4** Align the holes in the battery cover with the projections on the back of the logger.
- 5** While confirming that there are no gaps, press with your fingers to close the battery cover.

When the battery is installed, the logger turns on.
(there is no power switch)

NOTE Note that the battery cover is designed to seal tightly to preserve dust- and drip-resistance. When the holes in the battery cover are properly aligned with the projections, the battery cover should close smoothly.



The cover will not close correctly if there are any gaps.

NG

Never attempt to force the battery cover closed when not aligned properly. Doing so could cause damage.

OK

2.2 Connecting a Connection Cable



Connect a connection cable to the logger's connection cable jacks.

CAUTION

- To avoid breaking the cable, do not bend or pull it.
- Avoid stepping on or pinching cables, which could damage the cable insulation.

Connection Method

Required Items: Hioki LR9802 Connection Cable

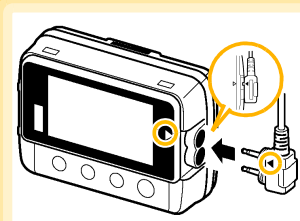

Align the triangles on the plug body and in front of the connection cable jacks, and insert the plug securely.

Correct values are not displayed unless the plug is inserted all the way in.



(LR5043 Example)

If values are not displayed correctly even when the plug is inserted properly, the logger or cable may be damaged. Repair may be necessary.

See: "Requesting repairs" (p.91)

Connection Cable

LR9802 Connection Cable

Cable length: Approx. 1000 mm

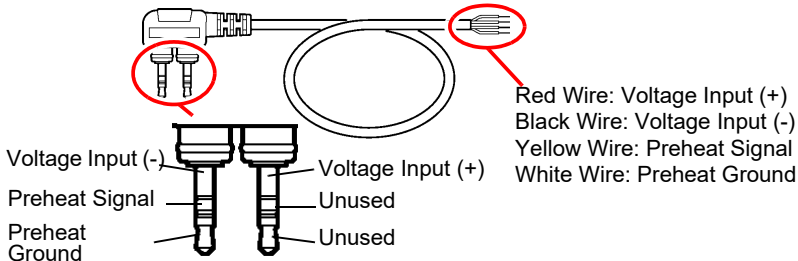

NOTE

When the preheat signal is not used, insulate the preheat signal wire (yellow) and the preheat ground wire (white) with an insulating tape not to touch mistakenly each other.

About the Preheat Signal

Internal Preheat Signal Circuit

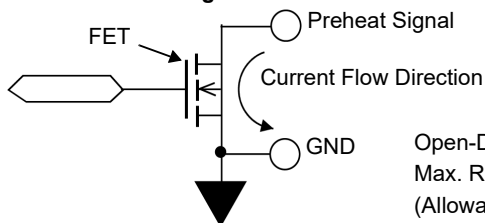

Open-Drain Output*

Max. Rating: 30 V @50 mA

(Allowable Power Dissipation: 200 mW)

* The FET switch between the preheat signal and ground is turned on during preheating. Connect to allow preheat signal current flow to ground.

Preheat Signal Connection Circuit Example

The preheat signal switches power to the sensor on and off. Connect the logger, sensor, power supply, and relay as shown below.

< Typical Circuit >

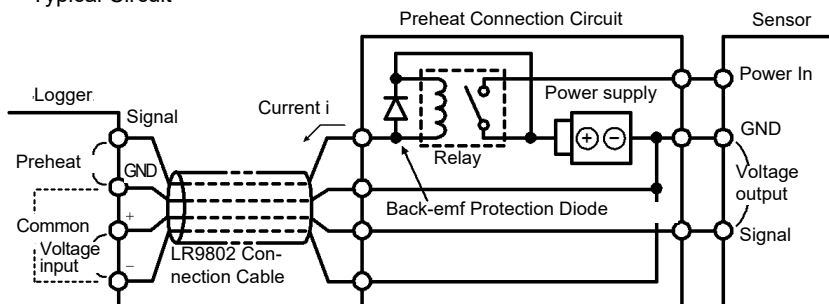

< When Sensor Output Voltage Is Low >

In the above circuit, if relay current (i) is large and sensor output voltage is low, measurement values may be affected by current flow in the connection cable. The amplitude of the effect is determined by cable resistance (about 0.2Ω) and relay current (i). For example, if the relay current is 10 mA, the effect is $10\text{ mA} \times 0.2\ \Omega = 2\text{ mV}$. When the sensor output voltage is low, this 2 mV results in erroneous measurements. In such cases, the effect can be minimized using the circuit on the next page.

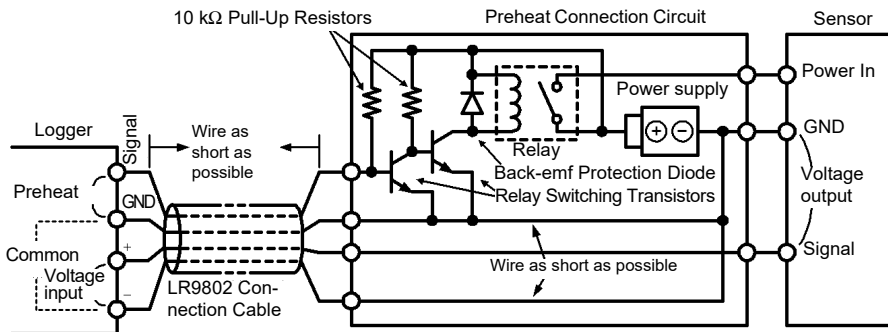

2.2 Connecting a Connection Cable

< Isolating the Preheat Signal >

If the ground side of the power supply cannot be connected to measurement signal ground, isolate the preheat signal as shown in the following circuit diagram. However, in this case, a separate photocoupler power supply is required.

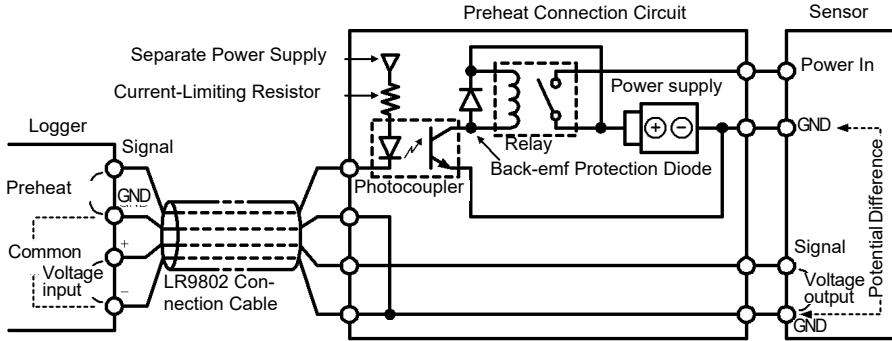

NOTE

- When connecting a relay, transistors, and a photocoupler to the preheat signal line, be sure that the connected supply voltage and drive current do not exceed the maximum preheat signal ratings (30 V, 50 mA).
- When using a relay, be sure to include a back-emf protection diode to prevent damage from counter-emf when relay coil power is removed.

2.3 Installing the PC Application Program

To save, browse, or print data, or to make logger settings from a computer, first install the "LR5000 Utility Program".

LR5000 Utility Program Operating Requirements

CPU	1 GHz or faster processor clock
RAM	1 GB or more (32-bit), 2 GB or more (64-bit)
OS	Windows 7 or Windows 10
Library	.NET Framework 4.5.2 or later
Interface	USB
Monitor Resolution	1024×768 or higher
Hard Disk	At least 30 MB free space (Additional space is required for storing recorded data.)

Installation Procedure

1. Start the computer.
Administrator authority may be required for the installation.
2. Set the included CD to the CD-ROM drive.
3. Click **[Start]** to display the application list.
Click **[Windows System] - [File Explorer]** to start Explorer.

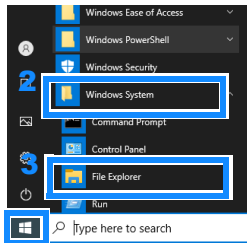

4. Click **[This PC]**, and then, double-click **[CD Drive (D)]** drive.

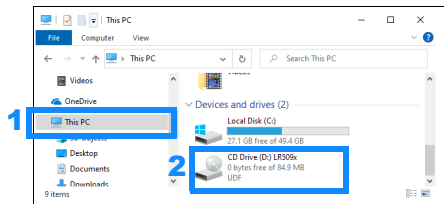

2.3 Installing the PC Application Program

5. Double-click the **[english]** folder.

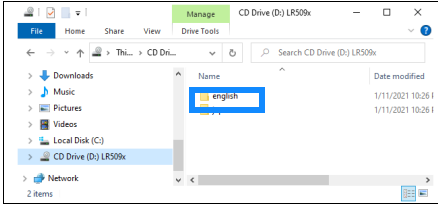

6. Double-click **[setup.exe]** (SET UP file).

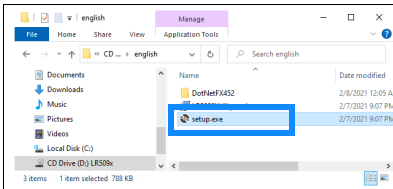

(The extension may not be displayed.) After the installer starts, follow the instruction to proceed with the installation.



If the computer fails in the installation

Some computers, depending on system environments including OS and security, can fail in the installation using the CD-R.

In such a case, download the executable program from the "Drivers, Firmware, Software" page of Hioki's website, and then install it again.

The data logger series LR5000 programs consists of LR5000 Utility Program and LR5091/LR5092 Device Driver, both of which need to be installed.

If the earlier version of LR5091/LR5092 Device Driver has been installed, uninstall it before installing the latest version of program.

Ask your system administrator if installing application programs or changing system environments is prohibited for security reasons.



How to start the program?

The program starts automatically from the next Windows logon. (The icon appears in the task tray (notification area) (p.36).)

Click the icon and click **[Show Main Screen]**.

NOTE

For setting and importing recorded data from loggers other than the LR5000 series, use the Communication Utility program supplied with the model 3911 or 3912 Communication Base. You can browse the recorded data by using LR5000 Utility Program also.

NOTE

Settings and recorded data are not deleted when uninstalling or upgrading the program.

Uninstall Procedure

Follow this procedure to uninstall the LR5000 Utility Program.

- 1 Click **[Start]-[Settings]**.
(The **[Windows Settings]** dialog box appears.)
- 2 Click **[Apps]**.
(The **[Apps & features]** screen appears.)
- 3 Select the **[LR5000 Utility Program]**, and click the **[Uninstall]** button.
- 4 Click **[Uninstall]**.
(The program is uninstalled.)

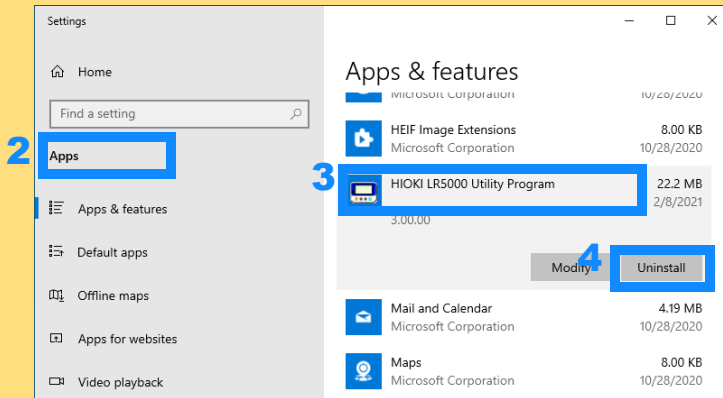
**Version Upgrading**

Download the latest version of the LR5000 Utility Program from our website (<http://www.hioki.com>).

Follow the procedure on the download page to install the latest version.
(The old version is uninstalled automatically.)

Data Import Screens (p.59)

Import data from the logger with these screens.

Example: Logger import screen

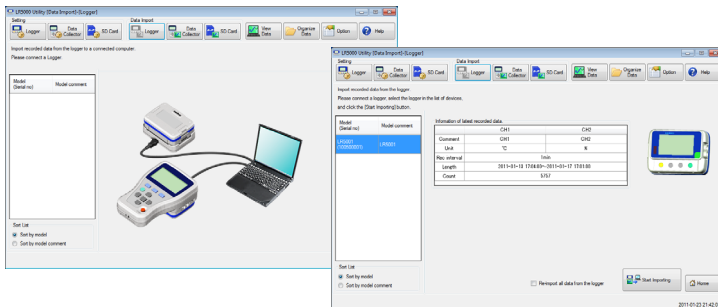

Data Viewing Screens (p.62)

View imported data on these screens.
Select a file to view, as a graph or table.

Example: Screens for viewing the latest data

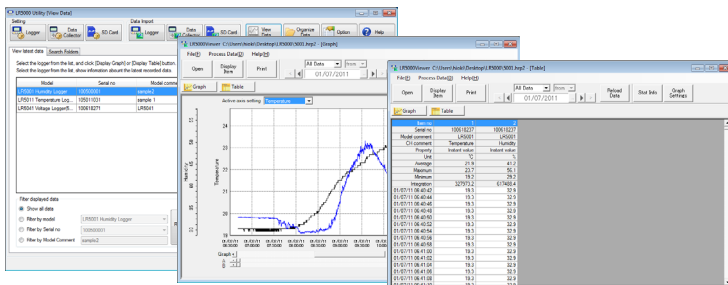

Data Sorting Screens (p.75)

Sort imported data on these screens.
You can copy, delete, move, combine, and extract data.

Example: Data Copy screen

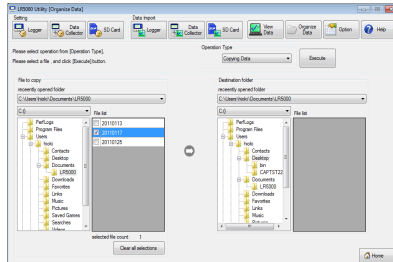

Option Screens (p.81)

Make advanced settings on these screens.
You can specify the data importing method.

Example: Import Method Setting screen

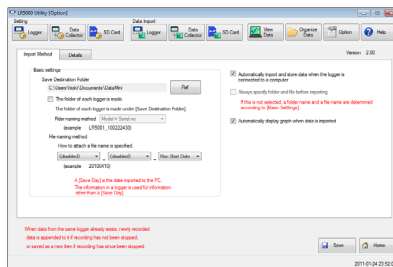

Settings

Chapter 3

Configure measurement settings before starting to record.

Logger settings can also be made from a PC running the LR5000 Utility Program. (p.36)

3.1 Settings List

Following is a list of all settings.

Although all settings are available from the LR5000 Utility Program, some settings are limited when made from the logger.

Setting Item	Setting Options	Logger	Refer To	LR5000 Utility Program	Refer To
Recording Interval	Sets the recording interval.	Yes	(p.31)	Yes	(p.39)
Current Date and Time	Set the current year, month, day, hour, and minute. (The LR5000 Utility Program can set the logger's clock to match the computer's.)	Yes	(p.32)	Yes	(p.42)
Stop Method	Select the processing method when memory becomes full.	Yes	(p.33)	Yes	Included in the recording stop method
Recording Mode	Selects instantaneous or statistical value recording (measurements are taken once per second, and instantaneous, maximum, minimum, and average values are saved at each recording interval).	Yes	(p.34)	Yes	(p.39)
Power Save	Battery life is extended when on (enabled).	Yes	(p.34)	Yes	(p.38)
Preheat Time	Select the ON time for external sensor power control.	Yes	(p.35)	Yes	(p.40)
Model Comment	Enter a comment for the specified logger.	No	-	Yes	(p.38)
Channel Comment	Enter a comment for the specified measurement channel.	No	-	Yes	(p.38)
Recording Start Method	Select the recording start method. (The start time can be specified.)	No	-	Yes	(p.39)

3.1 Settings List

Setting Item	Setting Options	Logger	Refer To	LR5000 Utility Program	Refer To
Recording Stop Method	Select the recording stop method. (The stop time can be specified.)	No	-	Yes	(p.39)
Scaling	Use to scale measured values to display as adjusted values.	No	-	Yes	(p.40)
Alarm Thresholds	Set upper and lower threshold values to display the alarm indicator [AL] on the logger.	No	-	Yes	(p.41)

3.2 Making Settings on the Logger

To return to the Measurement display from any Settings display, press the **REC/STOP** button.

NOTE

- When the  battery indicator appears, settings cannot be changed (although they can still be displayed).
- When no operation occurs for 30 seconds with Settings displayed, automatically switches to Measurement display.
- Settings cannot be changed while recording. However, settings can still be displayed by pressing the **SET** button from the Measurement display.

Recording Interval Setting



- 1 Press the **SET** button to display the interval setting. (The **[INTVL]** indicator appears, and the setting blinks.)
- 2 Press the **(+)** and **(-)** buttons to change the recording interval.
Example of configuration:
1sec 00:01, 1 minute 01:00
- 3 Press the **SET** button to accept the setting.
(The year setting is displayed.)

Recording Interval 1(Default)/2/5/10/15/20/30 sec., 1/2 /5/10/15/20/30/60 min

Real-Time Clock Setting**Year Setting display**

- 1** Press the **SET** button to display the time settings. ([TIME] is displayed, and the year setting blinks.)
- 2** Press the (+) and (-) buttons to change the year.
- 3** Press the **SET** button to accept the year setting.
(The month setting starts blinking.)
- 4** Repeat this procedure to set the month, day, hour, and minute.
- 5** Press the **SET** button to accept the setting.
(The stop method setting is displayed.)

Setting Range 01/01/2010, 00:00 to 12/31/2039, 23:59

Note: Seconds are not settable. However, seconds are set to zero at the instant the display is switched away from the minute setting.

NOTE

After the battery has been removed for a long time, or if the clock is incorrect, reset it.

Stop Method Setting (for when memory becomes full)

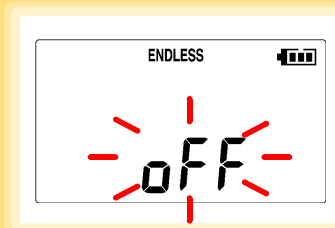

- 1 Press the **SET** button to display the stop method setting. (The **[ENDLESS]** indicator appears, and the setting blinks.)
- 2 Press the **(+)** and **(-)** buttons to select **[ON]** or **[OFF]**.
- 3 Press the **SET** button to accept the setting. (The recording mode setting is displayed.)

Setting Options	Description
OFF	Recording stops when memory becomes full (One-Time Recording).
ON(Default)	The oldest data is overwritten when memory is full (Endless Recording).

NOTE

When memory becomes full during one-time recording, the recorded data count appears as follows.

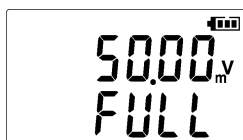

(the Measurement display shows channel measurement value and recorded data count)

When memory becomes full during endless recording, the recorded data count (equal to the memory capacity) remains constant.

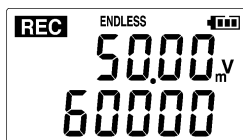

(instantaneous value recording display)

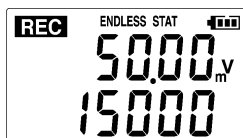

(statistical value recording display)

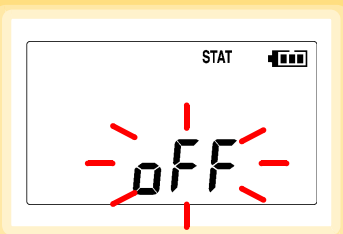
Recording Mode Setting

- 1** Press the **SET** button to display the recording mode setting. (The **[STAT]** indicator appears, and the setting blinks.)
- 2** Press the **(+)** and **(-)** buttons to select **[ON]** or **[OFF]**.
- 3** Press the **SET** button to accept the setting.
(The power save setting is displayed.)

Setting Options	Description
OFF (Default)	The instantaneous value is recorded at each recording interval (instantaneous recording).
ON	When on, measurements are taken once per second, and instantaneous, maximum, minimum, and average values are recorded at each recording interval. (statistical recording). (Up to 15,000 data values can be recorded.)

NOTE

Statistical recording cannot be selected when the recording interval is set to one second.

Power Save Setting

The power save function turns off the display 30 seconds after the last button is pressed. The display reappears upon the next button press.

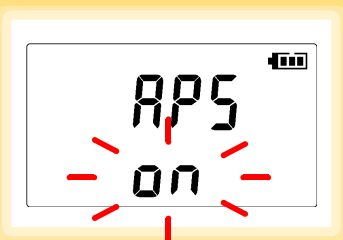

- 1** Press the **SET** button to display the power save setting (**[APS]** appears, and the setting blinks).
- 2** Press the **(+)** and **(-)** buttons to select **[ON]** or **[OFF]**.
- 3** Press the **SET** button to accept the setting.
(The measurement display appears.)

Setting Options	Description
ON (Default)	Power save is enabled.
OFF	Power save is disabled (the display remains visible).

NOTE

The Auto Power Save feature consumes a small amount of current

See: "Appendix 3 Battery Life Approximation" (p.A2)

Setting the Preheat Time

The preheat function provides an output signal synchronized to the logger's measurement timing, to control power supplied to each sensor.

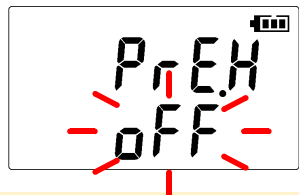

The display changes as follows.

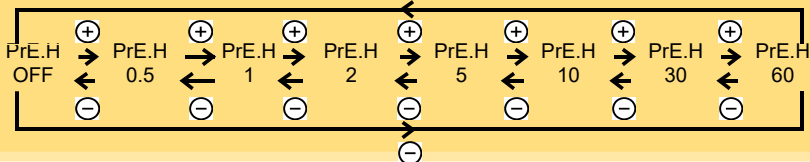

1 Press the **SET** button to display the preheat time setting. (The display indicates "Pr.E.H".)

2 Press the **(+)** and **(-)** buttons to change the preheat time.

3 Press the **SET** button to accept the setting.

(The measurement display appears.)

Setting Options	Description
Preheat Time	OFF(Default)/0.5/1/2/5/10/30/60 sec.

NOTE

The preheat time cannot be set longer than the recording interval. It must be set shorter than the recording interval (longer preheat times are not available). Also, if the recording interval is set shorter than the preheat time setting, the preheat setting is automatically changed to **[OFF]**.

Preheat Signal Output Timing (when Preheat is enabled)

1. During measurement display: The Preheat signal is output continuously.
2. When a measurement is not displayed: Measurement (recording) occurs after the specified preheat time.

Hold the **REC/STOP** button for two seconds

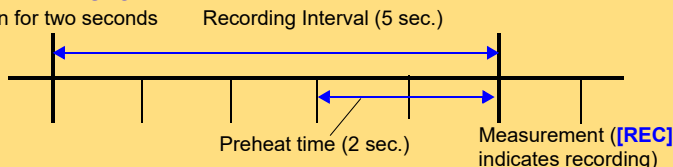

NOTE

- When power save is enabled and a button is pressed to display the measured value, some time may be required for the measured value to stabilize, according to the response time (from power-up to stable output) of the sensor.
- When the preheat time setting is not OFF, and during statistical value recording, the preheat signal is output continuously.

3.3 Making Settings from the LR5000 Utility Program

Logger settings can be made with the LR5000 Utility Program supplied with the LR5091 Communication Adapter and the LR5092-20 Data Collector.

Install the LR5000 Utility Program on the computer before connecting. (p.23)

Connecting the Logger, LR5091, and Computer

Connect to the computer using the supplied USB cable.

Required Items: Logger, LR5091 Communication Adapter, USB cable, Computer

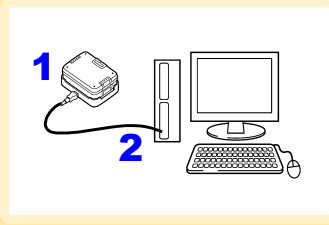

1 Plug the USB cable into the USB port on the LR5091 (or LR5092-20), and into a USB port on the computer.

2 Dock the logger in the LR5091 (or LR5092-20).

(When docking, be sure that the infrared ports are aligned.)

The main display appears automatically (by default).

When the logger contains recorded data, the import confirmation dialog appears. Click **[Yes]** to import the data automatically. (p.49)

Logger Settings

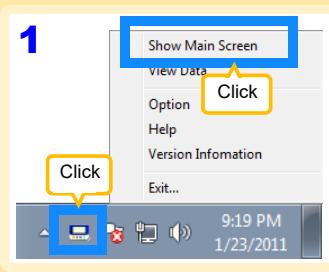

1 If the main screen is not displayed on the computer, click the icon in the task tray (notification area), and click **[Show Main Screen]**.

The main screen appears.

2

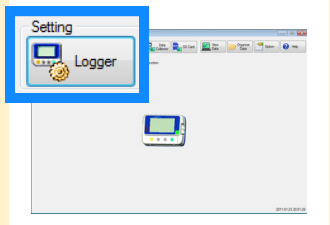

2 For the [Setting], click the [Logger] button.

The Logger Settings screen appears. (If the logger is not connected, you are prompted to connect it. Connect the logger.)

3 Select the logger from the device list*, and edit the settings. (p.38)

4 Click the [Send Settings] button.

Setting Options
Note: The displayed settings are those previously made from the LR5000 Utility Program, which may be different from the current settings within the logger itself.

3 Click to select.
The currently selected logger's background is a different color.

4 Returns to the main screen.

Settings from other loggers can be applied. (p.38)

* About the Device List

- Up to ten loggers can be displayed when connected to the computer.
- When [Show disconnected loggers] is selected, disconnected loggers that had settings previously saved appear in the list.
- The list can be sorted in ascending order ([Sort List]).



How can current settings be imported from the connected logger?

1. Click the [Import Settings] button at the upper right of screen. (A dialog appears.)
2. Click the [Import Settings to Computer] button. (The logger's settings are now reflected in the program.)

3.3 Making Settings from the LR5000 Utility Program



How can the settings from one logger be copied to another?

1. From the device list, select a logger with settings to be copied, and click the **[Copy Settings]** button.
2. From the device list, select a logger as the destination for the settings, and click the **[Paste Settings]** button. (A dialog appears.)
3. Click the **[Paste]** button in the dialog box. (The settings are copied.)



How can I learn more about changing settings?

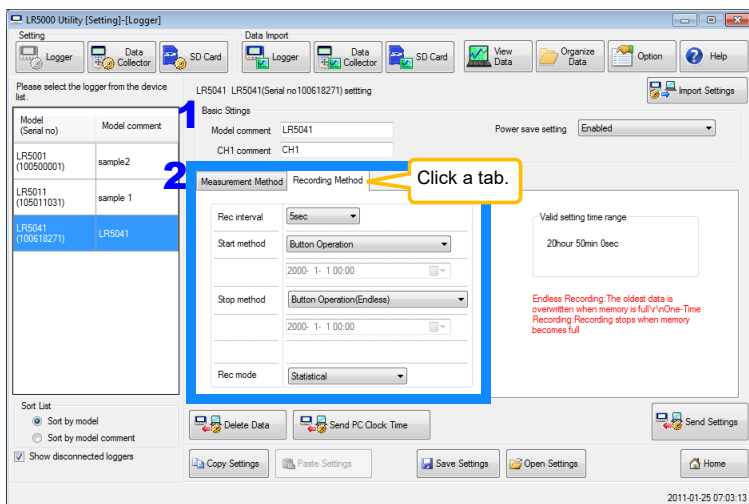

1 Setting the **[Basic Settings]**.

Model comment	Enter a comment to describe the logger as needed.
Power save setting	Enable or disable the power save setting (p. 30). See: "Appendix 3 Battery Life Approximation" (p.A2)
CH1 comment	Enter a comment to describe the measurement channel as needed.

Note: Comments may consist of up to 20 characters.

The following characters are not allowed: \, /, :, *, ?, ", <, >, and |.

2 Settings on the **[Recording Method]** tab.

NOTE

The Auto Power Save feature consumes a small amount of current

Rec interval

Sets the recording interval.

1/2/5/10/15/20/30 sec., 1/2 /5/10/15/20/30/60 min

Start Method

Select the recording start method.

When **[Scheduled Time]** is selected, specify the start date and time.

Setting Options	Description
Button Operation	Starts recording by pressing the button on the logger.
Start After Sent	Starts recording by pressing the [Send Settings] button.
Scheduled Time	Starts recording at the scheduled time after pressing the [Send Settings] button.
Valid setting time range	01/01/2010, 00:00 to 12/31/2039, 23:59

NOTE

When the **[Scheduled Time]** start method is enabled, the **[REC]** indicator on the logger display blinks until the specified start time.

Stop Method

Select the recording stop method.

When **[Scheduled Time (Endless)]** or **[Scheduled Time (One-Time)]** is selected, the date and time need to be set.

Setting Options	Description
Button Operation (endless)	Stops recording by pressing the button on the logger. The oldest data is overwritten when memory is full.
Button Operation (one-time)	Stops recording by pressing the button on the logger. Recording also stops when memory becomes full.
Scheduled Time (Endless)	Stops recording at the scheduled time. The oldest data is overwritten when memory is full.
Scheduled Time (One-Time)	Stops recording at the scheduled time. Recording also stops when memory becomes full.
Hold Data at Scheduled Time	Specify when setting [Scheduled Time (Endless)] . Select this check box to record the data at the scheduled time and stop recording.

Rec Mode

Select the recording mode.

Setting Options	Description
Instantaneous	The instantaneous value is recorded at each recording interval.
Statistical	Measurements are taken once per second, and instantaneous, maximum, minimum, and average values are recorded at each recording interval. (Up to 15,000 data values can be recorded.)

See: Statistical recording results in shorter battery life. "Appendix 3 Battery Life Approximation" (p.A2)

NOTE

Statistical recording cannot be selected when the recording interval is set to one second.

3.3 Making Settings from the LR5000 Utility Program

3 Settings on the [Measurement Method] tab

Click the [Edit] button to display the setting dialog box.

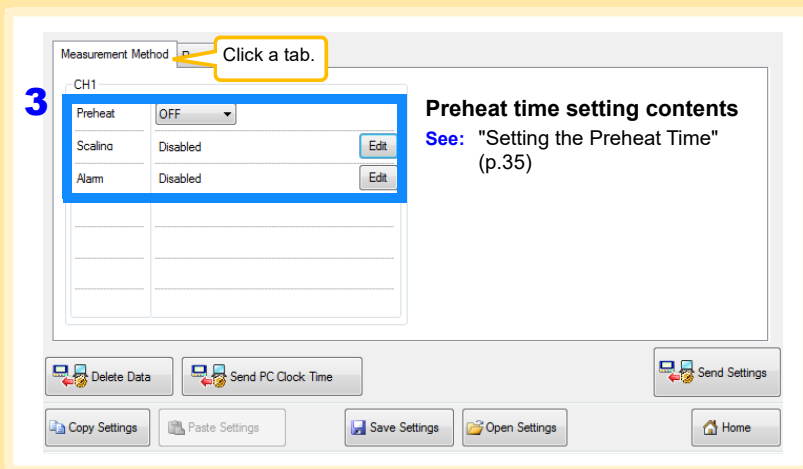

Scaling (set as needed) See: "What is Scaling?" (p.42)

The following scaling calculation is applied to measured values.

$$\text{Scaled Result} = \text{Raw data (measured value)} \times A + B \times \text{SI prefix (multiplier)}$$

The scaled result is displayed on the logger.

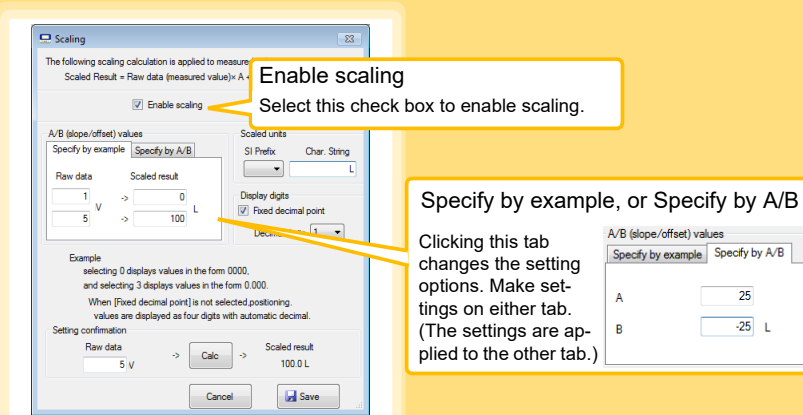

1. Set the following options.

Setting Options	Description
Specify by example	Enter two known conversion points (up to ten digits each).
Specify by A/B	Enter the scaling coefficients (A and B, up to ten digits each).
Scaled units	<ul style="list-style-type: none"> Select the [SI Prefix]. ([p]=1E-12, [n]=1E-9, [μ]=1E-6, [m]=1E-3, blank =1E0, [k]=1E3, [M]=1E6, [G]=1E9, [T]=1E12) Enter the [Char. String] to identify the scaled units. (Up to five characters, except \, /, :, *, ?, ", <, >, and .)
Display digits	<ul style="list-style-type: none"> Select [Fixed decimal point] and specify the [Decimal digits] to be displayed to the right of the decimal point. Valid settings are 0 to 3. (Examples: selecting 0 displays values in the form 0000, and selecting 3 displays values in the form 0.000) When [Fixed decimal point] is not selected, values are displayed as four digits (0.000 to ±9999) with automatic decimal positioning.

2. Confirm settings.

Setting confirmation	Confirm that scaling is performed properly. Enter any numerical value as raw data, and click the [Calc] button to display the scaled result.
-----------------------------	--

3. Click the **[Save]** button.

(Scaling settings are saved, and the display returns to the Logger Settings screen.)

Note: If you click the **[Cancel]** button without saving the settings, the display still returns to the Logger Settings screen.

Alarm Thresholds (set as needed)

Set the upper and lower alarm threshold values. When a measurement is outside of the specified area, the **[AL]** (alarm) indicator is displayed on the logger.

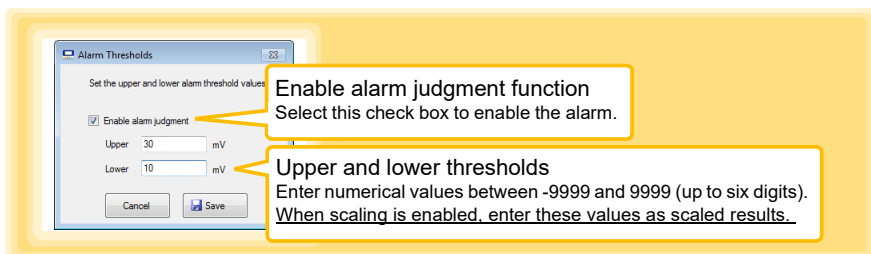

Click the **[Save]** button to save your settings.

(The display returns to the Logger Settings screen.)

Note: If you click the **[Cancel]** button without saving the settings, the display still returns to the Logger Settings screen.

Note: Alarm judgment is performed at every recording interval during instantaneous recording, and once per second during statistical recording.

Note: Alarm judgment is performed using measurement values with a larger number of digits than the values (4 digits) indicated in the LR5041, LR5042, LR5043 display.

Note: The **[AL]** indicator appears when the measured value is out of range (OF/UF displayed), and when a sensor anomaly occurs (- - - displayed).

Other Settings on the Logger Settings Screen

Delete Data
Deletes recorded data in the selected logger (only while connected).

Send PC Clock Time
Set the logger's clock to match the computer's clock (after confirming the computer's clock is correct).

Copy and Paste Settings
Settings can be copied from another logger. (p.38)

Save Settings *
Saves settings to a computer file. In the dialog box that appears, specify the location and name of the destination file (extension .conf).

Open Settings *
Loads settings from a computer file. In the dialog box that appears, specify the location and name of the saved settings file (extension .conf).

* Appears only when [Show the settings of the [Save Settings] and [Open Settings] buttons.] is selected on the Options screen.

What is Scaling?

Scaling converts actual measurement values to their corresponding values in arbitrarily determined units for display. This is convenient for converting the voltage values provided by the logger for display as the corresponding physical values the sensor is intended to measure.

For example, if a flow sensor provides a 1 to 5 V output signal corresponding to 0 to 100 liters flow measurement, set as follows.

To specify by conversion example

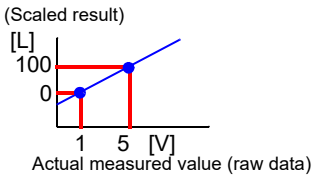

A/B (slope/offset) values		Scaled units	
Specify by example		SI Prefix	Char. String
Specify by A/B			L
Raw data	Scaled result		
1	0	Display digits	
5 V	100 L	<input checked="" type="checkbox"/> Fixed decimal point	
		Decimal digits 1	

To specify by A/B slope/offset

Slope = increase in scaled result / increase in measured value
For the example case, (100 L - 0 L) / (5 V - 1 V) = 25

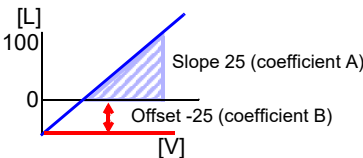

A/B (slope/offset) values		Scaled units	
Specify by example		SI Prefix	Char. String
Specify by A/B			L
A	25	Display digits	
B	-25 L	<input checked="" type="checkbox"/> Fixed decimal point	
		Decimal digits 1	

Measurement and Analysis

Chapter 4

4.1 Pre-Measurement Inspection

Inspect the following items before starting measurement.

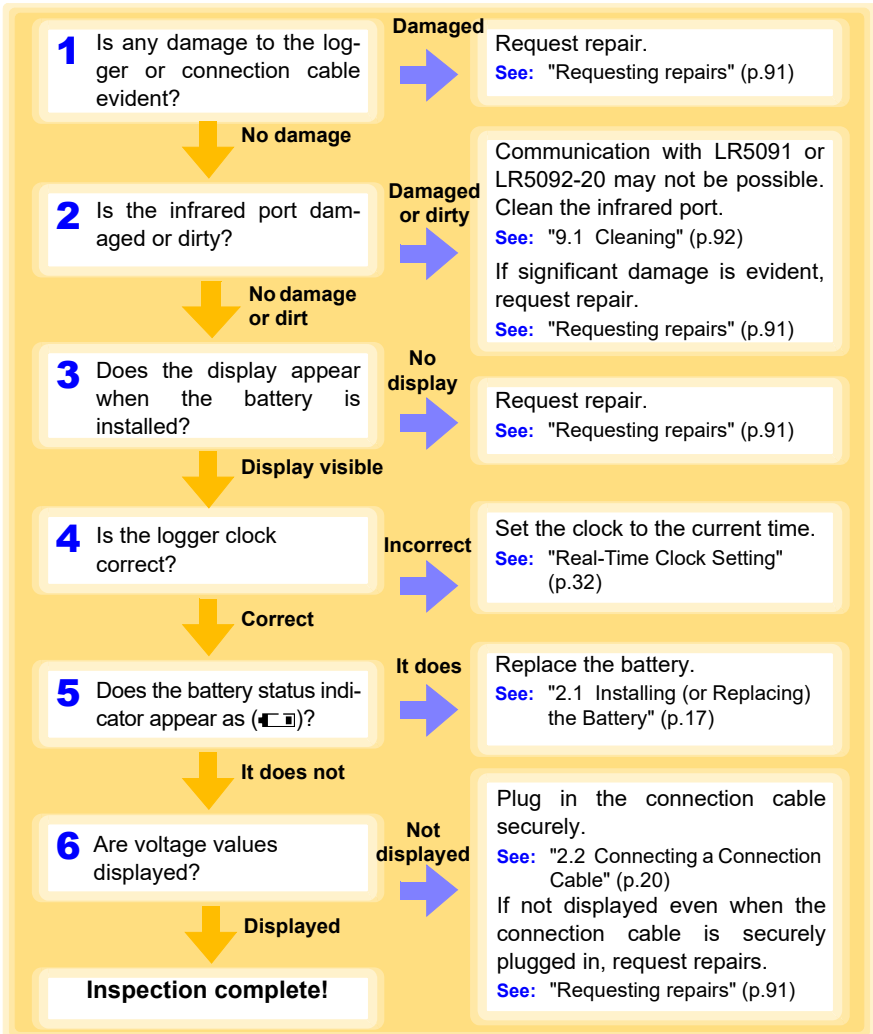

4.2 Installing the Logger

After inspection, install the logger at the measurement site.

Be sure to read the "Installation Precautions" (p.6) before installing.

Install the logger as necessary according to the following procedure.

! WARNING

Persons wearing electronic medical devices such as a pacemaker should not use the Z5004 strap with magnet. Such persons should avoid even proximity to the Z5004, as it may be dangerous. Medical device operation could be compromised, presenting a hazard to human life.

! CAUTION

Do not apply heavy downward pressure with the stand extended. The stand could be damaged.

NOTE

- Avoid shocking the Z5004, such as by dropping. Shock can cause it to be chipped or cracked.
- Do not use the Z5004 where it may be subject to rain, dust, or condensation. Use in such conditions may cause corrosion or deterioration of the magnet.
- If the Z5004 is brought near a magnetic memory device such as a floppy disk, credit/debit card, or pre-paid card or ticket, the device may become unusable due to data corruption. It can also cause damage if brought near a precision electronic device such as a computer, TV, or electronic wristwatch.

Using the Stand

Required Items: Stand (Accessory)

- 1** Strap/stand attachment hole

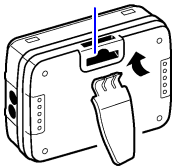

2

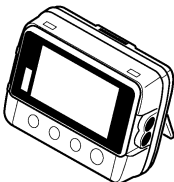

- 1** Attach the stand to the strap/stand attachment hole.

- 2** Stand up the logger.

Wall Mounting with the LR9901 Wall-Mounted Holder

Required Items: LR9901 (Option), 2 screws (supplied with the LR9901), screwdriver, etc. (as needed)

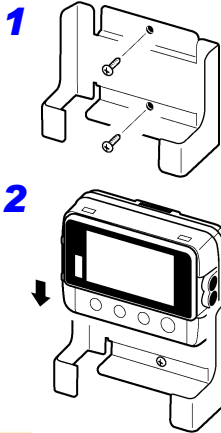

1 Mount the LR9901 to the wall using the two screws.

2 Insert the logger into the LR9901.

 The logger can also be attached to a wall or other surface by hanging the strap or attachment hole on a screw. (Supported screw head dimensions: up to approx. 6.8 mm in diameter and approx. 2.5 mm in thickness)

Wall Mounting with the Z5004 Magnetic Strap

Required Items: Z5004 (Option)

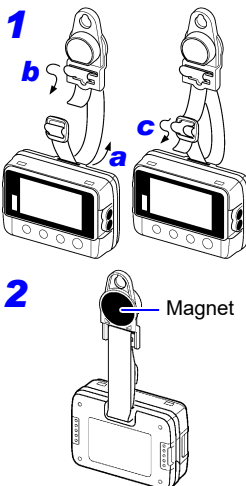

1 Attach the Z5004 to the strap/stand attachment hole.

(feed the strap through a, b, and c)

2 Attach the magnet to the wall (ferrous material).

4.3 Starting and Stopping Recording

Install the logger, connect the leads to the measurement object, and start recording.



To avoid electrical shock, be careful to avoid shorting live lines with the connection cable.



- In order to prevent electric shock and short-circuit accidents, shut off the power to the line to be measured before connecting the connection cable.
- Ensure that the input does not exceed the maximum rated voltage or current to avoid logger damage, short-circuiting and electric shock resulting from heat building.
- The maximum rated voltage between input terminals and ground is 60 VDC. Attempting to measure voltages exceeding 60 V with respect to ground could damage the logger and result in personal injury.

NOTE

Recording cannot start when the battery is depleted. When the battery becomes exhausted during recording, recording stops.

See: "2.1 Installing (or Replacing) the Battery" (p.17)

Start

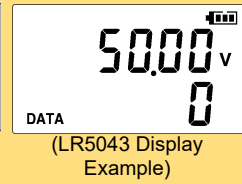
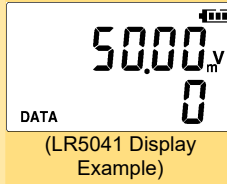
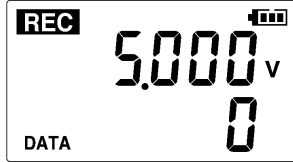
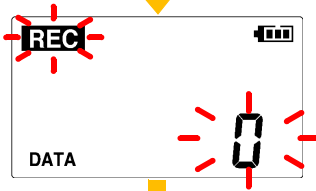
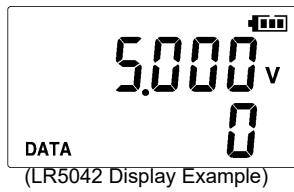

Start From the Measurement display, hold the **REC/STOP** button for two seconds.

The **[REC]** indicator and the data count blink. Note: Continue pressing the button until the **[REC]** indicator changes from a blinking to on state.

When the blinking stops and the data count is zeroed, recording starts.

Logger memory contains the data for two recording sessions. (Be aware that old data is erased when starting recording after two recording sessions.)

After one second, the measurement display reappears.

Stop

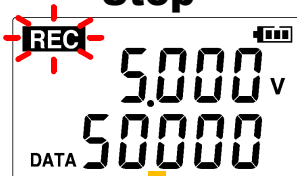

Stop Hold the **REC/STOP** button for two seconds while recording (while **[REC]** is displayed).

[REC] blinks.

Note: Continue pressing the button until the **[REC]** indicator changes from a blinking to off state.

Data can be imported to a computer without stopping recording.

See: "4.5 Automatically Importing (Saving) Recorded Data to a Computer, and Graph Display" (p.49)

[REC] disappears when recording stops.

If the stop method is set to [OFF] (one-time recording), recording stops automatically when memory becomes full.(p.33)

4.3 Starting and Stopping Recording

Automatic Recording Start at Convenient Times

Depending on the selected recording interval, recording start is automatically delayed until the next convenient clock time.

Recording Interval	Recording Start Time
1 sec.	00 to 59 s (1-second interval)
2 sec.	00 to 58 s (2-seconds interval)
5 sec.	00 to 55 s (5-seconds interval)
10 sec.	00 to 50 s (10-seconds interval)
15 sec.	00 to 45 s (15-seconds interval)
20 sec.	00 to 40 s (20-seconds interval)
30 sec.	00 to 30 s (30-seconds interval)
1 min	00 min, 00 s to 59 min, 00 s (1-minute interval)
2 min	00 min, 00 s to 58 min, 00 s (2-minutes interval)
5 min	00 min, 00 s to 55 min, 00 s (5-minutes interval)
10 min	00 min, 00 s to 50 min, 00 s (10-minutes interval)
15 min	00 min, 00 s to 45 min, 00 s (15-minutes interval)
20 min	00 min, 00 s to 40 min, 00 s (20-minutes interval)
30 min	00 min, 00 s to 30 min, 00 s (30-minutes interval)
60 min	00 h, 00 min, 00 s to 23 h, 00 min, 00 s (1-hour interval)

Example: When the button is pushed to start recording at 12:01:00, and the recording interval is 10 minutes

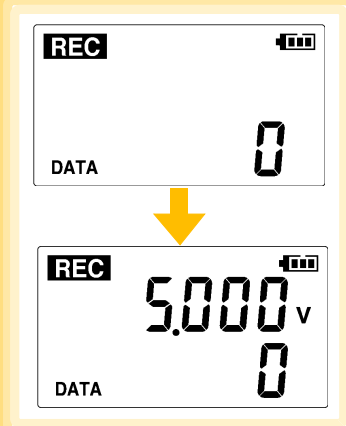

At 12:01:00, you press the **REC/STOP** button.

The **[REC]** indicator in the display turns on, but recording does not start yet.

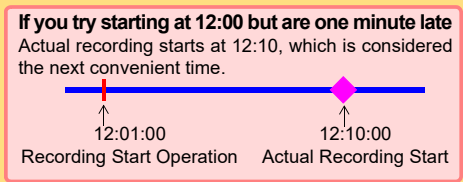

At 12:10:00
Recording starts.

In the case of instantaneous value recording, the number of data soon becomes 1.
 In the case of statistical value recording, the number of data becomes 1 at 12:20:00.

4.4 Confirming Currently Measured Values and Data Recording

Confirm data recording on the Measurement display (p.14).

You can browse current measurement values (instantaneous), the count of recorded data items, and maximum and minimum values.

The (+) and (-) buttons select the type of value displayed.



How to switch from a Setting display to Measurement display?

To switch to the Measurement display from any other display, press **REC/STOP**.

NOTE

- When power saving (p.34) is enabled, the display blanks after no operation occurs for 30 seconds. To browse measurement values (instantaneous) and verify each recorded data value, press any button to turn on the Measurement display.
- The currently displayed instantaneous measurement value is refreshed about once per second, regardless of the recording interval setting.

4.5 Automatically Importing (Saving) Recorded Data to a Computer, and Graph Display

Data recorded in the logger can be imported to the computer. Install the LR5000 Utility Program on the computer beforehand. (p.23)

Required Items: Logger, LR5091 Communication Adapter (or LR5092-20 Data Collector), USB cable, and Computer

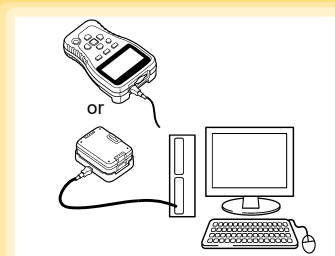

1 Plug the USB cable into the USB port on the LR5091 (or LR5092-20), and into a USB port on the computer.

2 Dock the logger in the LR5091 (or LR5092-20).

(When docking, be sure that the infrared ports are aligned.)

4.5 Automatically Importing (Saving) Recorded Data to a Computer, and Graph Display

The main screen appears automatically.

If newly recorded data exists, the import confirmation dialog appears.

If the data import screen is displayed before connecting the logger, the import confirmation dialog does not appear. Import manually. (p.59)

3 Click [Yes].

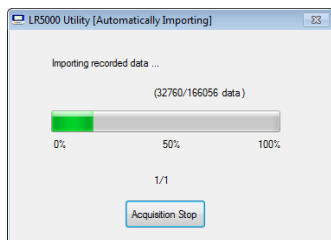
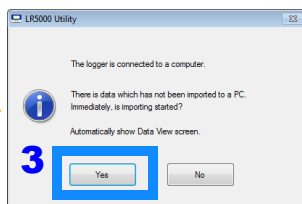

The data recorded in the logger is imported to the computer automatically.

Imported data is saved to a file (Auto Import).

Note: By default, **[Automatically import and store data when the logger is connected to a computer]** (on the Options screen) is enabled. (p.82)

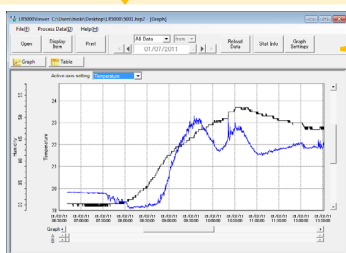

The viewer opens to display the graph (Auto Graph Display).

Note: By default, **[Automatically display graph when data is imported]** (on the Options screen) is enabled. (p.82)



How is recorded data saved?

Recorded data is automatically saved when imported to a computer.

The save destination and file name are specified as a basic setting on the Options screen.

4.5 Automatically Importing (Saving) Recorded Data to a Computer, and Graph Display

Viewer Screen

The viewer screen appears as follows.

See: "Menu Bar Items" (p.52)

Opens a file containing recorded data.

Items to be displayed are selectable. (p.58)

Displayed graphs and tables can be printed. (p.64)

The displayed time span can be specified.

Reloads and refreshes recorded data from a file.

Displays the [Statistical Information and Item Settings] dialog box when a graph is displayed. (p.56)

Click the buttons to switch between graph and table displays.

Displays the [Graph Settings] dialog box when a graph is displayed. (p.54)

The graph or table is displayed.

The screenshot shows the LR5000Viewer application window. The title bar reads "LR5000Viewer (Users\hioki\Desktop\LR5000\5001.hrp2 - [Graph...". The menu bar contains "File(F)", "Process Data(D)", and "Help(H)". Below the menu bar are buttons for "Open", "Display Item", "Print", "Reload Data", "Stat Info", and "Graph Settings". A date selector shows "01/07/2011". Below these are "Graph" and "Table" buttons. The main area displays a graph with "Temperature" on the y-axis (ranging from 19 to 23) and "Humidity" on the left y-axis (ranging from 30 to 45). The x-axis shows time from 01/07/11 06:30:00 to 12:30:00. Two data series are plotted: a blue line for Humidity and a black line for Temperature. A legend at the bottom left shows "Graph x" and "A -" and "B -".

Menu Bar Items

Menu	Item	Contents
File	Open	Opens a file containing recorded data.
	Recently opened recording files	Opens recently used files.
	Save recording file as	Currently displayed recording data is saved as a new file.
	Print graph	Prints data in graphic format. (p.64)
	Paste to Microsoft Excel®	Pastes displayed data into Microsoft Excel®.
	Export CSV file	Exports displayed data as a CSV file.
	Exit	Closes the program.
Data Processing	Scaling	Applies scaling to data on one channel. (p.67)
	Power Calculation	Performs approximate electric power calculation. (p.68)
	Energy Cost	Performs approximate energy cost calculation. (p.69)
	Operating Rate	Performs approximate operating rate calculation. (p.70)
	Integration	Performs data integration. (p.71)
	Dew Point	Performs dew-point temperature calculation. (p.72)
	Two-Data-Item Arithmetic	Performs approximate two-data-item arithmetic calculation. (p.73)
OVER Data Revision	Converts data outside of the upper and lower threshold settings to specified values, and saves as new data. (p.74)	
Help	Help	Displays the help file.
	Version	Displays LR5000 Utility Program version information.

4.5 Automatically Importing (Saving) Recorded Data to a Computer, and Graph Display

Main Graph Features

The main graph features are shown below.

Displays the **[Statistical Information and Item Settings]** dialog box. (p.56)

Click the buttons to switch between graph and table displays.

Displays the **[Graph Settings]** dialog box. (p.54)

When there are two or more axes, select the one displayed closest to the graph.

Scroll Bar (scrolls the graph)

A/B cursors

Item	Serial no.	CH	CH comment	Property	Cursor A	Cursor B	Maximum	Minimum
1	100618237	1	Temperature	Instant value	19.3	22.9	01/07/11 10:30:36	23.7
2	100618237	2	Humidity	Instant value	31.8	45.2	01/07/11 14:58:58	56.1



How can the displayed area be magnified?

- 1 Drag over the area to be enlarged to enclose it in a dotted box.
- 2 Right click to open the pop-up menu, and click **[Magnify selected area]**.

Dotted Box

2 Click

Magnify selected area

Return to previous picture

Save scale(No.1) 1/7/2011 6:37:31

Save scale(No.2)



How can graph line color and display be switched?

Change settings on the **[Item Settings]** tab in the **[Statistical Information and Item Settings]** dialog box (p.56)



How can graph details be set?

Detailed settings are available in the **[Graph Settings]** dialog box. (p.54)

[Graph Settings] dialog box

Graph details can be set as follows. Click each tab to access various settings.

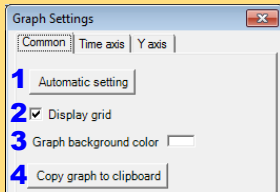
[Common] tab

- 1 Automatically sets the time axis and Y-axis to the optimum scale.
- 2 Select to display the grid.
- 3 Changes the graph background color.
- 4 Copies the graph to the clipboard. The graph can then be pasted into Microsoft Word etc.

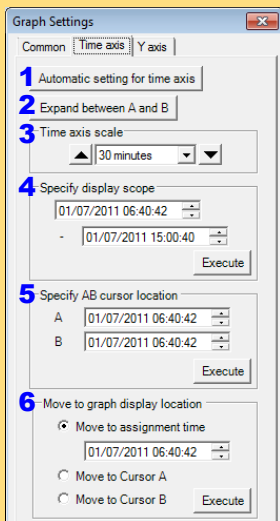
[Time axis] tab

- 1 Automatically sets the time axis to the optimum scale.
- 2 Zooms the display to show only the time span between A/B cursors.
- 3 Changes the time base scale.
- 4 Specifies the displayed time span on the time axis. Click **[Execute]** to apply the settings.
- 5 Specifies cursor positions. Click **[Execute]** to apply the settings.
- 6 Specifies the graph start position (time). Click **[Execute]** to apply the settings.

4.5 Automatically Importing (Saving) Recorded Data to a Computer, and Graph Display

[Y axis] tab

Graph Settings

Common | Time axis | **Y axis**

1 Automatic setting for all Y axis

2 Number of axis: 2 **3** All axial displays

4 Axis comment: Temperature

5 Display item

<input checked="" type="checkbox"/> 1	<input type="checkbox"/> 2	<input type="checkbox"/> 3	<input type="checkbox"/> 4
<input type="checkbox"/> 5	<input type="checkbox"/> 6	<input type="checkbox"/> 7	<input type="checkbox"/> 8
<input type="checkbox"/> 9	<input type="checkbox"/> 10	<input type="checkbox"/> 11	<input type="checkbox"/> 12
<input type="checkbox"/> 13	<input type="checkbox"/> 14	<input type="checkbox"/> 15	<input type="checkbox"/> 16

6 Y axis scale: 1

7 Automatic setting for Y axis

8 Specify display scope: [] Execute

9 Y axis grid: Fine [] Rough [] Standard []

10 Display integrated graph

11 Display upper and lower limits

Display boundary lines of limits

Maximum: [] Minimum: [] Execute

Shade to display area outside scope

Draw lines to indicate limits

- 1** Automatically sets all Y-axes to the optimum scale.
- 2** When the Y-axis is different for each item, set the number of axes to a value other than one. The axes can be set to the number of displayed items (up to 16).
- 3** Displays all axes.
- 4** A comment can be entered for each axis.
- 5** Select the item assigned to each axis.
- 6** Sets the Y-axis scale for each axis.
- 7** Automatically sets the currently selected Y-axis to the optimum scale.
- 8** Specifies the display span on the Y-axis. Click **[Execute]** to apply the settings.
- 9** Sets the Y-axis grid spacing.
- 10** Display the items selected in **[Display item]** on an integrated graph.
- 11** Upper and lower thresholds can be displayed as solid lines on the graph, or out-of-range areas can be filled with a solid color.

4.5 Automatically Importing (Saving) Recorded Data to a Computer, and Graph Display

[Statistical Information and Item Settings] dialog box

The following items appear on the [Statistical information] tab.

- Item no.
- Serial no.
- Channel no.
- Channel comments
- Property (Type of measurement value)
- Measured values at A/B cursors
- Statistical data
- Units

[Statistics] tab

Times at A/B cursors

Select to calculate and display maximum, minimum, average, and integration values between A/B cursors. Integration values are displayed only for integrable items.

Item	Serial no	CH	CH comment	Property	Cursor A	Cursor B	Maximum	Minimum
1	100618237	1	Temperature	Instant value	19.3	22.9	01/07/11 10:30:36 23.7	01/07/11 06:49:18 19.2
2	100618237	2	Humidity	Instant value	31.8	45.2	01/07/11 14:58:58 56.1	01/07/11 08:06:04 29.2

The following items appear on the [Item settings] tab.

- Display on/off
- Graph line colors and thickness
- Bar graph display on/off

[Item settings] tab

Display On/Off	Color	Thickness	Item	Measurement item	Bar graph
<input checked="" type="checkbox"/>	Black	1	1	Temperature	<input type="checkbox"/>
<input checked="" type="checkbox"/>	Blue	1	2	Humidity	<input type="checkbox"/>

4.5 Automatically Importing (Saving) Recorded Data to a Computer, and Graph Display

Main Table Features

The main table features are shown below.

Shows the item no., serial no., model comment, channel comment, property, measurement units, and average, maximum, minimum, and integration values of all data.

Double click a maximum or minimum numerical value to jump to the relevant cell (or to the first if there are multiple relevant cells).

Time of Recording

Recorded Values
Blue indicates minimum values, and red indicates maximum values.

Item no.	1	2
Serial no	100618237	100618237
Model comment	LR5001	LR5001
CH comment	Temperature	Humidity
Property	Instant value	Instant value
Unit	°C	%
Average	21.9	41.2
Maximum	23.7	56.1
Minimum	19.2	29.2
Integration	327973.2	617488.4
01/07/11 06:40:44	19.3	32.9
01/07/11 06:40:46	19.3	32.9
01/07/11 06:40:48	19.3	32.9
01/07/11 06:40:50	19.3	32.9
01/07/11 06:40:52	19.3	32.9
01/07/11 06:40:54	19.3	32.9
01/07/11 06:40:56	19.3	32.9
01/07/11 06:40:58	19.3	32.9
01/07/11 06:41:00	19.3	32.9
01/07/11 06:41:02	19.3	32.9
01/07/11 06:41:04	19.3	32.9
01/07/11 06:41:06	19.3	32.9
01/07/11 06:41:08	19.3	32.9
01/07/11 06:41:10	19.3	32.9

Convenient Table Functions

Use the following operations to scroll the table and copy data to the clipboard.

Item	Contents
Press Ctrl and Home keys simultaneously	Moves to the upper left corner of the table.
Press Ctrl and End keys simultaneously	Moves to the lower right corner of the table.
Home key	Scrolls to display the left edge of the table.
End key	Scrolls to the right edge of the table.
Press Ctrl and C keys simultaneously	Copies the value of the currently selected cell to the clipboard.

4.5 Automatically Importing (Saving) Recorded Data to a Computer, and Graph Display

Selecting Items for Display

Click the **[Display Item]** button in the viewer to display the **[Select Items for Display]** screen.

1 Select up to 600 items for display.

2 Click the **[OK]** button.

1 Check

2 Click

Menu Bar Items

Menu	Items	Contents
Select Items	Check selection range	Add and clear selection of multiple items (display in blue) selected with the mouse.
	Clear check of selection range	
	Select all selections	When there are 600 item in the above list, click to select or clear all items.
	Clear all selections	
	Select all instant values	
	Select all maximum values	
	Select all minimum values	
Select all average values	Select all items (up to 600) of the same property.	
Sort Items	Sort by model name	Sort by model name, serial no., or model comment.
	Sort by serial no	
	Sort by model comment	
	Move selected item up	Move blue mouse-selected items up or down.
	Move selected item down	
Restore original order	Restore original order.	

4.6 Manually Importing (Saving) Recorded Data to a Computer, and Graph Display

You can manually import (save) recorded data to a computer, and display it in a graph.

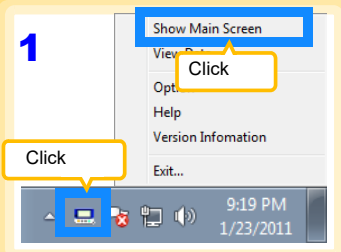
1 

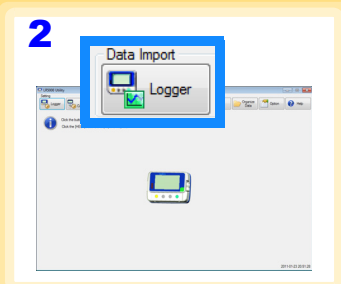
2 

1 If the LR5000 Utility Program is not running on the computer, click the icon in the task tray (notification area), and click **[Show Main Screen]**.

The main screen appears.

2 For the **[Data Import]** device, click the **[Logger]** button.

The Data Import screen appears. If the logger is not connected, you are prompted to connect it. Connect the logger.

3 Select the logger in the list of devices, and click the **[Start Importing]** or **[Next]*** button.

* If **[Always specify folder and file before importing]** on the Options screen is enabled (p.82).

If you click the **[Start Importing]** button, data importing starts ("Screen after importing data" (p.61)).
If you click **[Next]**, the Save Method screen appears (p.60).

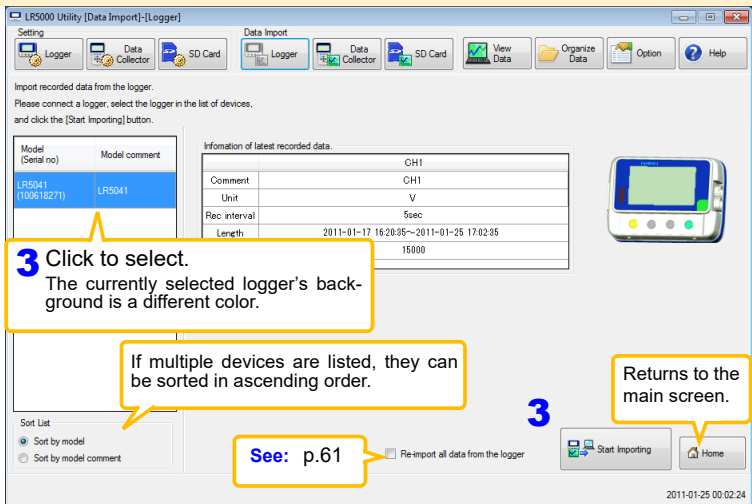

3 Click to select.
The currently selected logger's background is a different color.

If multiple devices are listed, they can be sorted in ascending order.

3 Returns to the main screen.

See: p.61

4.6 Manually Importing (Saving) Recorded Data to a Computer, and Graph Display

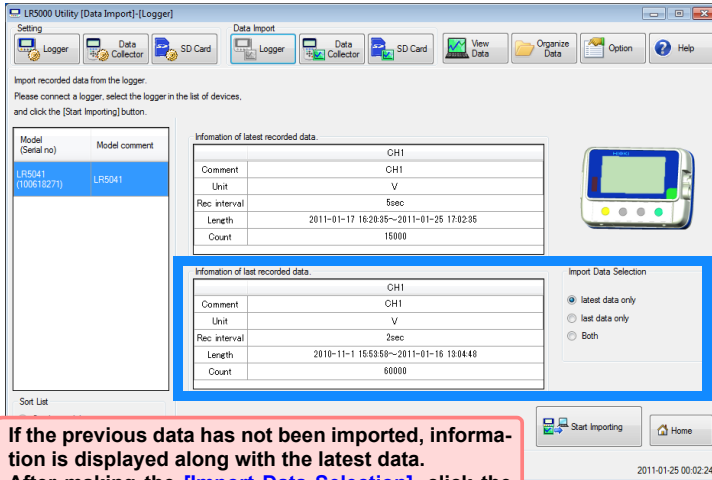

If the previous data has not been imported, information is displayed along with the latest data. After making the [Import Data Selection], click the [Start Importing] or [Next] button.

Save Method Screen

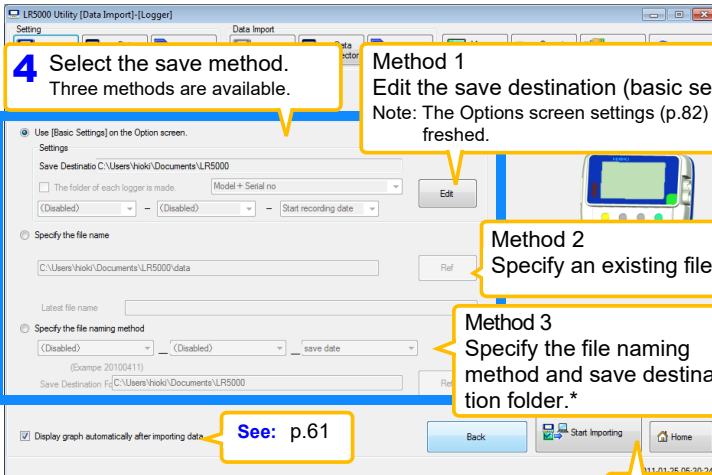

* When data from the same logger already exists, newly recorded data is appended to it if recording has not been stopped, or saved as a new item if recording has since been stopped.

The Save Method screen will appear when the [Always specify folder and file before importing] checkbox on the optional screen is selected.

See: "7.1 Changing the Saving Method for Imported Data" (p.82)



How is automatic importing performed?

On the Options screen, enable **[Automatically import and store data when the logger is connected to a computer]**. (p.82)



How can all data be imported from the logger?

Select **[Re-import all data from the logger]**.

(All data in the logger (including any previously imported) is imported to the computer, and duplicated data is overwritten.)

Data Import screen(p.59)

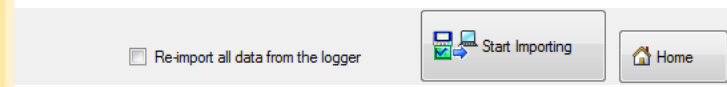

How is the graph automatically displayed after importing data?

Select **[Display graph automatically after importing data]**. (When not selected, the file list is saved and displayed when importing is finished.)

Save Method Screen(p.60)

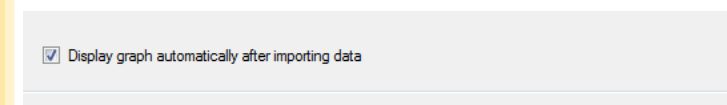

Screen after importing data

The record data has been acquired and it has been saved at the file...

Show recorded data
Destination folder: C:\Users\Yioki\Documents\LR5000
File name: 20110117

Information of recorded data	
CH1	CH1
CH2	CH1
Unit	V
Rec interval	5sec
Time span	2011-01-17 18:20:35~2011-01-17 18:20:35
Count	446

Change logger settings
When a logger settings is changed, please click a [Change Settings] button.

Buttons and Callouts:

- Click the button to display the graph.** (Points to the 'Display Graph' button)
- If there are more than 16 items to display, the display item selection screen appears. Select the items to be displayed in the graph. (p.58)** (Points to the 'Display Graph' button)
- Click the button to display the table.** (Points to the 'Display Table' button)
- The Logger Settings screen appears.** (Points to the 'Change Settings' button)
- Returns to the main screen.** (Points to the 'Home' button)
- Displays the Data Import screen (p.59).** (Points to the 'Back' button)

4.7 Displaying a Graph of Saved Recording Data

Use the LR5000 Utility Program to display saved recording data as a graph.

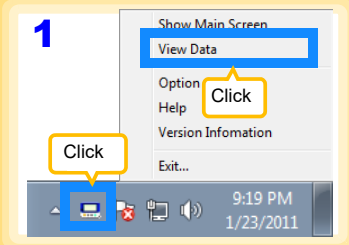

Note: If the LR5000 Utility Program is running, click **[View Data]** on the main screen.

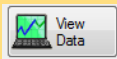

- 1 If the LR5000 Utility Program is not running on the computer, click the icon in the task tray (notification area), and click **[View Data]**.

The Data View screen appears.

The **[View latest data]** tab shows a list of the loggers with data saved on the computer.

- 2 Select the logger from the list.

Information about the latest data appears.

- 3 Click the **[Display Graph]** button.

The viewer opens to display the graph (p.51).

If there are more than 16 items to display, the display item selection screen appears. Select the items to be displayed in the graph (p.58).

Information about the latest data

Information about the latest data

Folder
C:\Users\hiki\Documents\LR5000

File name
20110125

Information of recorded data

	1	2
Model	LR5011	LR5001
Name	Temperature Logger	Humidity Logger
Serial no	105011031	100500001
Model comment	sample 1	sample2
Rec start date	2011-01-25	2011-01-25

2 Click to select.
The currently selected logger's background is a different color.

3 **[Display Graph]**

Other Data Viewing Screen Functions

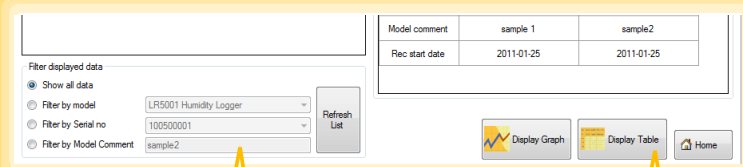

Filter displayed data

You can filter which loggers appear in the list. Specify the desired filtering criteria, and click the **[Refresh List]** button.

Note: You can enter up to 20 characters for **[Filter by Model Comment]**.

Display Table

Opens the viewer to display the table of imported (or selected) data.



How can past data be viewed?

On the **[Search Folders]** tab, select the folder and file name to display.

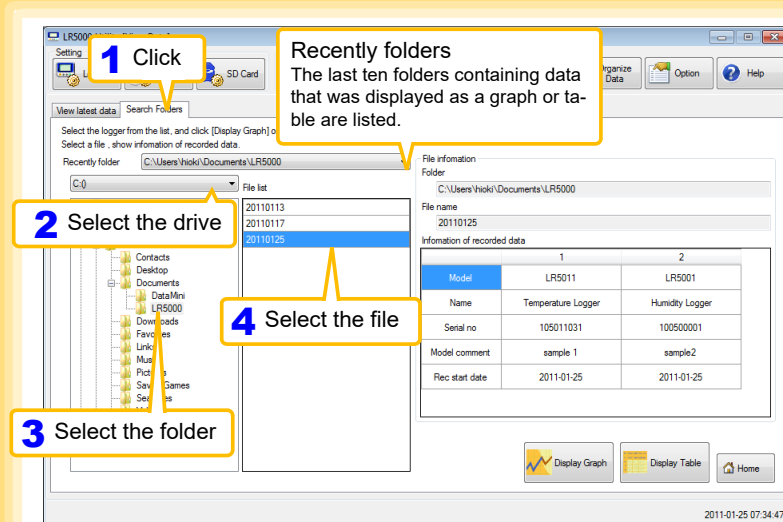

4.8 Printing Recorded Data

Saved recording data can be printed as a graph. Graphs displayed in the LR5000 Utility Program can be printed on A3, A4, or B4-size paper.

With the desired graph displayed, click the **[Print]** button.

See: Graph Display Methods: "4.5" (p.49), "4.6" (p.59), and "4.7" (p.62)

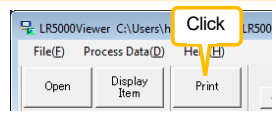

How can I print only part of a graph?

Specify the time span to print, and click **[Print]** button. Times that are not displayed are not printed.

See: "Viewer Screen" (p.51)

Example Graph Printout

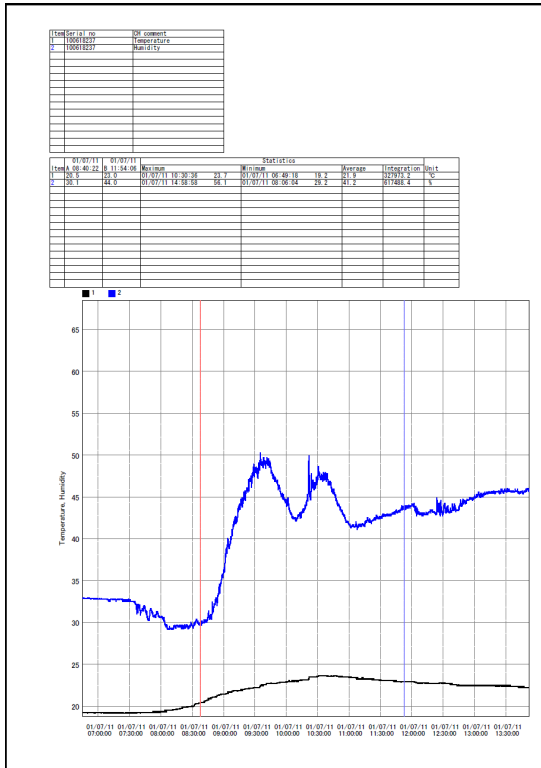

Processing Recorded Data

Chapter 5

Recorded data saved on the computer can be processed by scaling, electric power calculation, energy cost calculation, operating rate calculation, integration, dew-point temperature calculation, two-item arithmetic calculation, and out-of-range data revision. The LR5000 Utility Program performs the calculations.

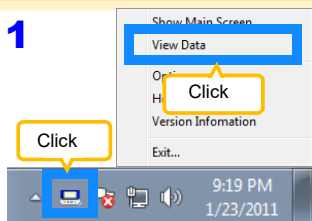

- 1 If the LR5000 Utility Program is not running on the computer, click the icon in the task tray (notification area), and click **[View Data]**.

The Data View screen appears. The **[View latest data]** tab shows a list of the loggers with data saved on the computer.

- 2 Select the logger from the list.

Information about the latest data appears.

- 3 Click the **[Display Graph]** button.

The viewer opens to display the graph (If there are 16 or more items to display, the display item selection screen appears. Select the data items for processing.) (p.58).

Note: If the LR5000 Utility Program is running, click **[View Data]** on the main screen.

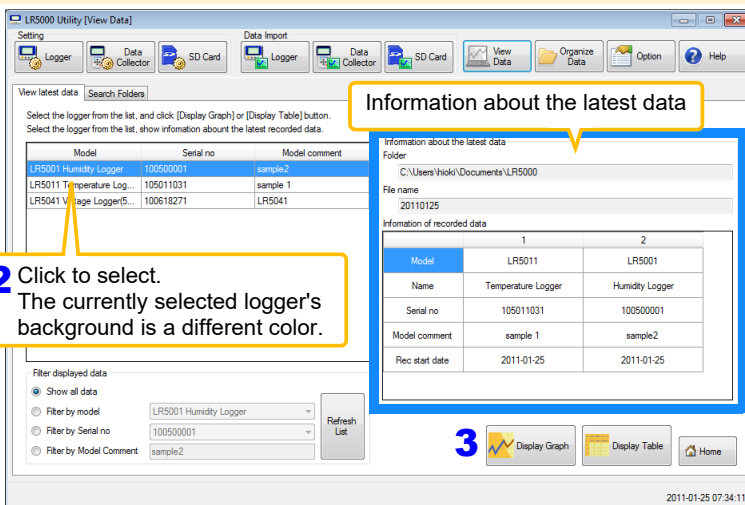

- 4 Click **[Process Data]** in the menu bar, and select the desired items.

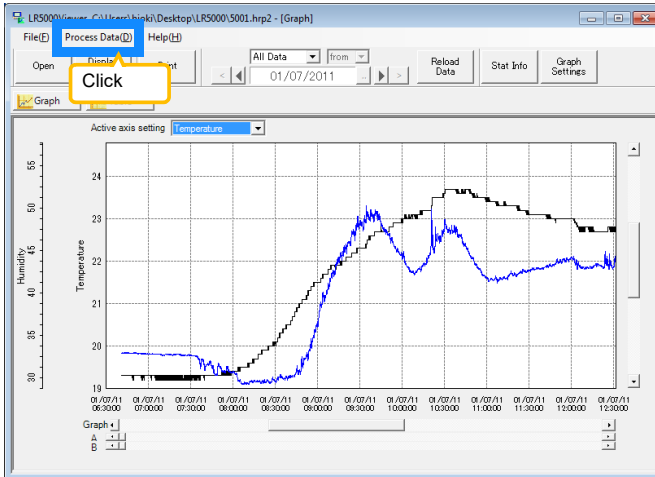

[Process Data] Items

Items	Contents	See
Scaling	Performs scaling on the data of one channel.	(p.67)
Power Calculation	Performs approximate electric power calculation.	(p.68)
Energy Cost	Performs approximate energy cost calculation.	(p.69)
Operating Rate	Performs approximate operating rate calculation.	(p.70)
Integration	Integrates displayed data.	(p.71)
Dew Point	Performs dew-point temperature calculation.	(p.72)
Two-Data-Item Arithmetic	Performs approximate two-data-item arithmetic calculation.	(p.73)
OVER Data Revision	Converts data outside of the upper and lower threshold settings to specified values, and saves as new data items.	(p.74)

5.1 Scaling

The following scaling calculation is applied to measured values.

Scaled Result = Raw data (measured value) × A + B × SI prefix (multiplier)

Scaled results are saved as a new item in the recording file.

The screenshot shows the 'Scaling' dialog box with the following sections and callouts:

- Item and range settings:** A callout points to the 'Item for calculation' dropdown (set to 'LR5001 - Temperature') and the 'Time span for calculation' (set to '2011-01-07' to '2011-01-07').
- A/B (slope/offset) values:** A callout points to the 'Specify by A/B' tab, which shows a table with 'Raw data' (0.2, 50.6 °C) and 'Scaled Result' (0, 50 °C). Another callout points to the 'SI Prefix' dropdown (set to 'C') and the 'units' field (set to '°C').
- Setting confirmation:** A callout points to the 'Raw data' field (0.2 °C) and the 'Calculate' button.
- Execute/Finish:** A callout points to the 'Execute' and 'Finish' buttons.

Additional callout text: 'Clicking this tab changes the setting options. Make settings on either tab. (The settings are applied to the other tab.)'

1. Select the items, time span, and the following options.

Setting Options	Description
Specify by example *	Enter two known conversion points (up to ten digits each).
Specify by A/B *	Enter the scaling coefficients (A and B, up to ten digits each).
Scaled units	<ul style="list-style-type: none"> • Select the [SI Prefix]. ([p]=1E-12, [n]=1E-9, [u]=1E-6, [m]=1E-3, blank =1E0, [k]=1E3, [M]=1E6, [G]=1E9, [T]=1E12) • Enter a character string to identify the scaled units. • (Up to five characters, except \, /, :, *, ?, ", <, >, and .)

* Set either one.

2. Confirm settings.

Setting confirmation	Confirm that scaling is performed properly. Enter any numerical value as raw data, and click the [Calculate] button to display the scaled result.
-----------------------------	--

3. Click the **[Execute]** button.

(The scaled results are saved.)

Note: Click the **[Finish]** button to close the **[Scaling]** dialog box.

5.2 Calculating Electric Power

Approximate electric power is calculated using current measurement data from a clamp logger.

Calculation results are saved as a new item in the recording file.

NOTE

- Electric power calculations are only approximate, so results do not always equal the true electric power value. Use a wattmeter if accurate power measurements are required.
- There is no way to confirm that a specified data item is really a current value. Calculation occurs regardless of data type.

The screenshot shows the 'Power Calculation' dialog box with the following sections and callouts:

- Item and range settings:** Callout: 'Item and range settings. Specify two measured current values and the time span for calculation.' This section includes dropdowns for 'Current1' (Test machine - Current1) and 'Current2' (Test machine - Current1), and date pickers for 'Time span for calculation' (2011-01-07 ~ 2011-01-07) and 'Time span of the recording file' (2011-01-07 - 2011-01-07).
- Calculation formula:** Callout: 'Calculation formula. [Electric Power Type]. Choose [1P2W], [1P3W] or [3P3W] to select the appropriate calculation formula.' This section has a dropdown for 'Electric Power Type' set to '1P2W' and a formula display showing 'Current1 * Voltage1 * PowerFactor'.
- Settings of voltage, power factor, and unit:** This section includes input fields for 'Voltage1' (100) and 'Voltage2' (100), a dropdown for 'Power factor' (0.8), and a dropdown for 'Unit' (W). It also has a 'Registered settings' table with one entry 'Setting1' and buttons for 'Register' and 'Delete'.
- Execute/Finish:** At the bottom, there are buttons for 'Execute' and 'Finish'.

1. Select the items, time span, and calculation formula to be used.
2. Specify the voltage, power factor, and units.
 - To save the settings, click the **[Register]** button.
 - To apply a registered setting, double click it ("Setting1" in the above screenshot).
 - To delete a setting, click it then click the **[Delete]** button.
3. Click the **[Execute]** button.
(Calculation results are saved.)
Note: Click the **[Finish]** button to close the **[Power Calculation]** dialog box.

5.3 Calculating Energy Cost

Approximate energy cost is calculated using current measurement data from a clamp logger.

NOTE

- Energy cost calculations are only approximate, so results do not always equal the true energy cost.
- There is no way to confirm that a specified data item is really an electric power value. Calculation occurs regardless of data type.

The screenshot shows the 'Energy Cost' dialog box. It has a title bar with 'Energy Cost' and standard window controls. Below the title bar, it says 'Approximate energy cost is calculated using current measurement data.' The dialog is divided into several sections:

- 1 Item and range settings:** This section contains a dropdown menu for 'Item for calculation' (set to 'Test machine - Current 1'), a date range for 'Time span for calculation' (from '2011-01-07' to '2011-01-07'), and a 'Select all span' button. Below this is a 'Time span of the recording file' field set to '2011-01-07 - 2011-01-07'.
- 2 Settings:** This section contains input fields for 'Energy cost' (set to '23'), 'Cost/kWh', 'Voltage' (set to '100.0'), and 'Power factor' (set to '0.8').
- 3 Calculation result:** This section contains input fields for 'Electric energy' (set to 'kWh') and 'Energy cost' (set to 'Cost'). A 'Calculate' button is located to the right of the 'Energy cost' field.

A yellow callout box points to the 'Item and range settings' section with the text: 'Item and range settings. Specify the measured current value and the time span for calculation. The time span can also be specified by setting the A/B cursors (p.53) on a graph and selecting [Calculate between A/B cursors].'

1. Select the item and time span.
2. Specify the cost per kWh, voltage, and power factor.
3. Click the **[Calculate]** button.
(Electric power consumption and energy cost values are calculated and displayed.)
Note: Click the **[Finish]** button to close the **[Energy Cost]** dialog box.

5.4 Calculating Operating Rate

The approximate operating rate of the measured value is calculated.

The total amount of time during which data exceeds the **[Upper threshold]** is considered operating time, and the operating rate is calculated as the ratio of the operating time to the total calculation time span.

Example: The time during which a device consumes 20 A or more is considered the operating time.

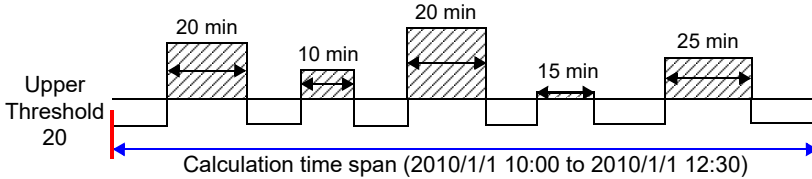

The sum of the times depicted by () is the operating time. (In the above diagram, operating time is 1.5 hours.)

Operating time (1.5 h) ÷ calculation time span (2.5 h) × 100 = 60% operating rate

1 Item and range settings
 Item for calculation: Test machine - Current1
 Time span for calculation: Calculate between A/B cursors
 2011-01-07 ~ 2011-01-07 Select all span
 Time span of the recording file: 2011-01-07 - 2011-01-07

2 Settings
 Upper threshold: 22 A

Calculation result
 operating time: 5.7h operating rate: 68.0 % **3** Calculate

Finish

Item and range settings

Select the item for operating rate calculation, and the time span.

The time span can also be specified by setting the A/B cursors (p.53) on a graph and selecting **[Calculate between A/B cursors]**.

1. Select the item and time span.
2. Set the upper threshold.
3. Click the **[Calculate]** button.
 (Operating hours and operating rate values are calculated and displayed.)
 Note: Click the **[Finish]** button to close the **[Operating Rate]** dialog box.

5.5 Integration

Measurement data can be integrated over a specified time span. Integration results are saved as a new item in the recording file.

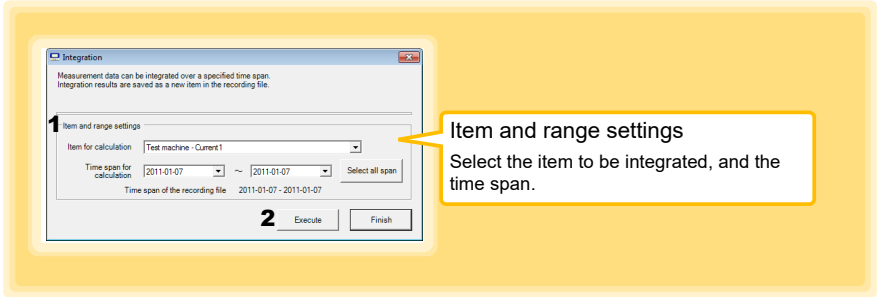

1. Select the item and time span.
2. Click the **[Execute]** button.
(Integration results are saved.)
Note: Click the **[Finish]** button to close the **[Integration]** dialog box.

5.6 Calculating Dew-Point Temperature

Dew-point temperature is calculated from the temperature and humidity measurement data from the logger.

Calculation results are saved as a new item in the recording file.

NOTE

- There is no way to confirm that a specified data item is really a temperature or humidity value. Dew-point calculation occurs regardless of data type.
- Only the specified temperature and humidity data measured during the specified recording time span is applied to calculations and saved.
- The valid range for calculation input measurement data is -100 to 100 degrees, and 0 to 100% humidity. Values outside of these ranges are replaced with the maximum or minimum value within the valid range.

Item and range settings
Specify the temperature and humidity values,
and the time span for calculation.

1. Select the items and time span.

2. Click the **[Execute]** button.
(Calculation results are saved.)

Note: Click the **[Finish]** button to close the **[Dew Point]** dialog box.

5.7 Two-Data-Item Arithmetic Calculations

Simple arithmetic operations (+, -, *, and /) can be applied to two data items. Calculation results are saved as a new item in the recording file.

NOTE

Only the values of data items measured during the specified recording time span are applied to calculations and saved.

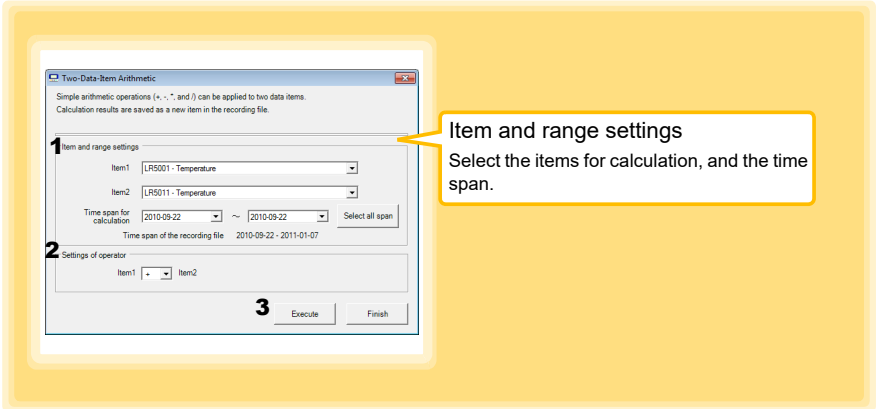

1. Select the items and time span.
2. Select the calculation operator.
3. Click the **[Execute]** button.
(Calculation results are saved.)
Note: Click the **[Finish]** button to close the **[Two-Data-Item Arithmetic]** dialog box.

5.8 Converting Over-Threshold Data Values

Data values larger than the upper threshold and smaller than the lower threshold can be converted to specified values.

Converted results are saved as new data items in the recording file.

OVER Data Revision

Over-threshold data values can be converted to specified values.
Converted results are saved as new data items in the recording file.

1 Item and range settings

Item for calculation: [LR5001 - Humidity]

Time span for calculation: [2011-01-07] ~ [2011-01-07] [Select all span]

Time span of the recording file: 2011-01-07 - 2011-01-07

2 Settings

Upper threshold [90] % > Conversion value [100] %

Lower threshold [10] % > Conversion value [0] %

3 [Execute] [Finish]

Item and range settings

Select the items for conversion, and the time span.

1. Select the items and time span.
2. Set the upper and lower threshold values, and their corresponding conversion values.
3. Click the **[Execute]** button.
(Conversion results are saved.)
Note: Click the **[Finish]** button to close the **[OVER Data Revision]** dialog box.

Organizing Data

Chapter 6

The LR5000 Utility Program can reorganize (copy, delete, move, combine, and extract) imported data.

- If the LR5000 Utility Program is not running on the computer, click the icon in the task tray (notification area), and click **[Show Main Screen]**.

The main screen appears.
- Click the **[Organize Data]** button.

The data reorganization screen appears.
- Select the **[Operation Type]**.

See: "6.1 Copying and Moving Data" (p.76)
 "6.2 Deleting Data" (p.77)
 "6.3 Combining Data" (p.78)
 "6.4 Extracting Data" (p.79)
- Select the working folder or recording file, and click the **[Execute]** button.

Recently opened folder
 The last ten folders containing data that was displayed as a graph or table are listed.

3 Select

4 Click

4 Select the desired file.

4 Select

Returns to the main screen.

Clears all selections (removes check marks).

6.1 Copying and Moving Data

The selected logger recording files can be copied or moved to any folder.

Example: Copy a file from the folder C:\Users\hioki\Documents\LR5000 to C:\Users\hioki\Desktop.

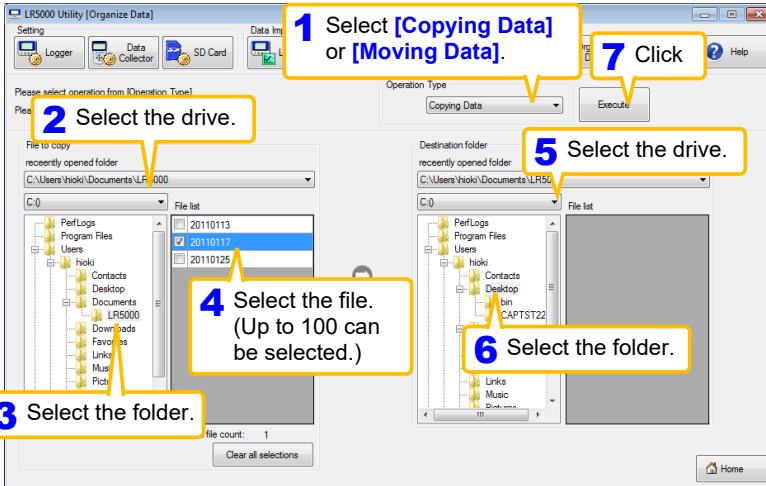

6.2 Deleting Data

Select and delete logger recording files as follows.

Example: Delete a file from the folder C:\Users\hioki\Documents\LR5000.

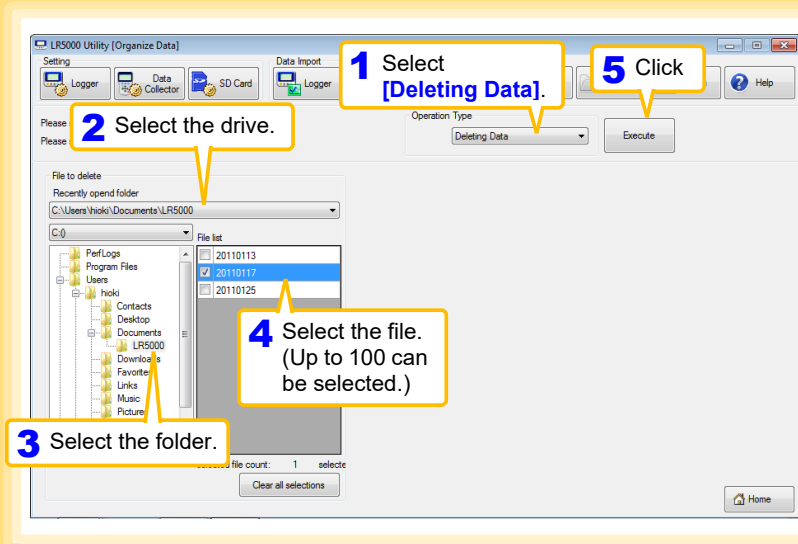

How can I delete data from the logger's memory?

See: "Delete Data" (p.42)

6.3 Combining Data

Separate logger recording files can be combined into one set of recording data.

Example: Combine file 20110117 with other files in C:\Users\hioki\Documents\LR5000, and save the combined data file in C:\Users\hioki\Desktop.

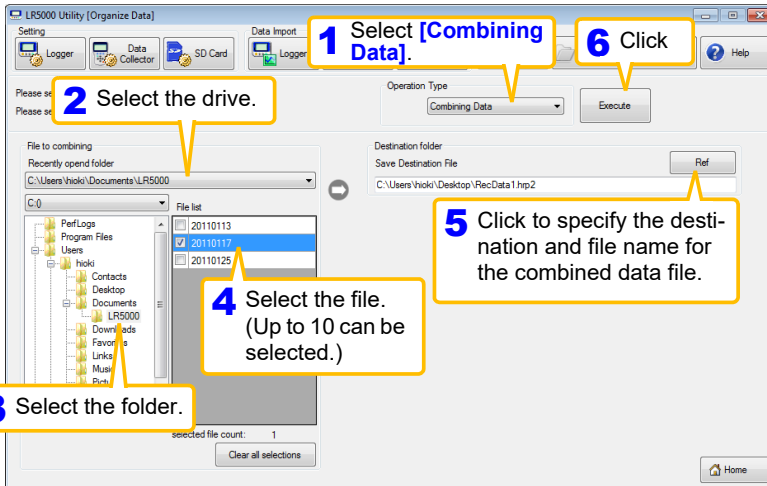

6.4 Extracting Data

Data in a logger recording file can be extracted to a specified time span and saved with a different file name.

Example: Extract the data of January 25th from the file 20110117, and save to a different file.

The screenshot shows the LRS5000 Utility (Organize Data) window. The interface includes a menu bar (Setting, Logger, Data Collector, SD), a toolbar (New Data, Execute, Ref, Help), and a main workspace. The workspace is divided into several sections: 'File to extracting' (showing 'C:\Users\hioiki\Documents\LRS5000'), 'File list' (showing files 20110113, 20110117, and 20110125), 'Destination folder' (set to 'C:\Users\hioiki\Documents\ExtractData\hwp2'), 'Extracting time span' (set to '2011-01-25 00:00:00' to '~ (2011-01-25 00:00:00)'), and 'Extracting data' (a table of data to be extracted).

Numbered callouts describe the steps:

- 1 Select [Extracting Data].
- 2 Select the drive.
- 3 Select the folder.
- 4 Select the file. (one only)
- 5 Specify the extracting time span and extracted data (model).
- 6 Click to specify the destination and file name for the extracted data file.
- 7 Click [Execute].

	Model	Model comment	Serial no	CH1 comment
<input checked="" type="checkbox"/>	LR5011	"sample 1"	105011031	floor 5
<input checked="" type="checkbox"/>	LR5001	"sample 2"	100500001	2nd floor TEM
*				

Options Settings (LR5000 Utility Program) Chapter 7

These settings determine the saving method for imported logger data, device connection monitoring, and logger setting display functions.

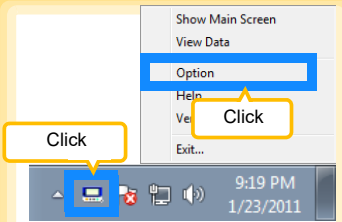

Note: If the LR5000 Utility Program is running, click **[Option]** on the main screen.

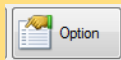

- 1 If the LR5000 Utility Program is not running on the computer, click the icon in the task tray (notification area), and click **[Option]**.

The Options screen appears.

- 2 Change the settings as needed.
See: "7.1 Changing the Saving Method for Imported Data" (p.82)
"7.2 Changing the Connection Monitoring Method, and Logger Settings Displays" (p.83)

- 3 Click the **[Save]** button.

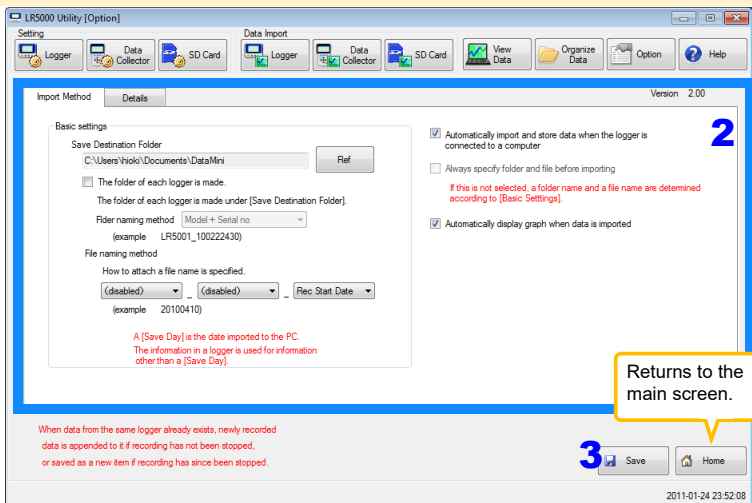

Select the **[Automatically import and store data when the logger is connected to a computer]** checkbox and clear the **[Always specify folder and file before importing]** check box to display the Data Import screen (p.60).

7.1 Changing the Saving Method for Imported Data

The saving method for imported logger data can be changed as follows.

? How can the save destination folder be changed?

1 Click the **[Import Method]** tab.

2 Click to specify the save destination folder.

3 If you select the check box, select the folder name.

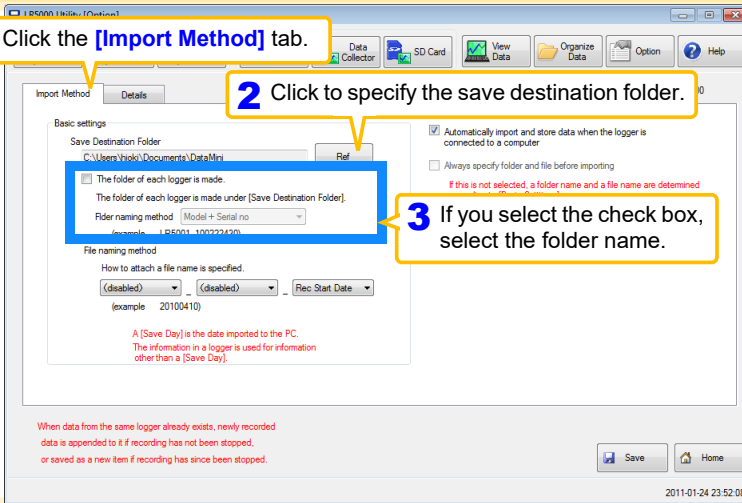

? How can the file naming method be changed?

Set Auto Import and Auto Graph Display functions, if desired.
See: "4.5" (p.49)

File names can be specified as a combination of up to three of these components:
model name, model comment, serial no., recording start day, recording start date and time, and save day

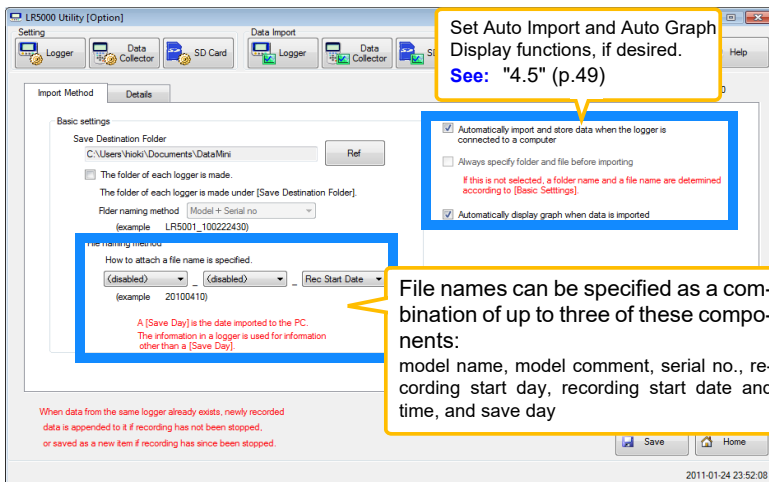

7.2 Changing the Connection Monitoring Method, and Logger Settings Displays

Change the device connection monitoring settings and the functions on the logger settings displays as follows.

 How can the device connection monitoring setting be changed?

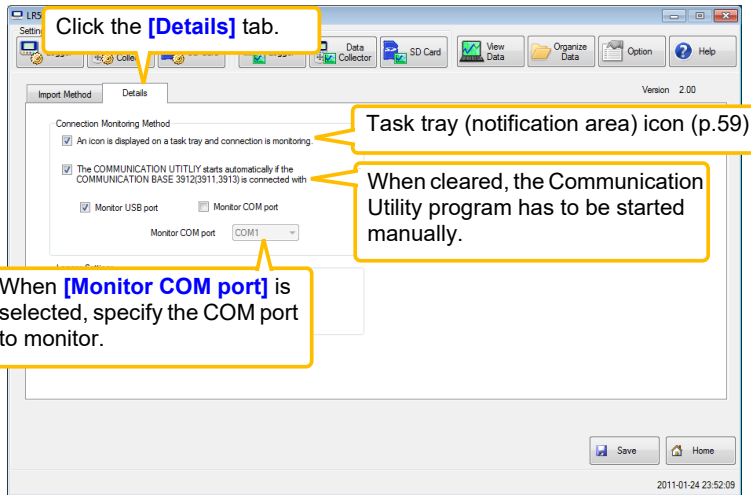

 How can the function settings of the logger's settings displays be changed?

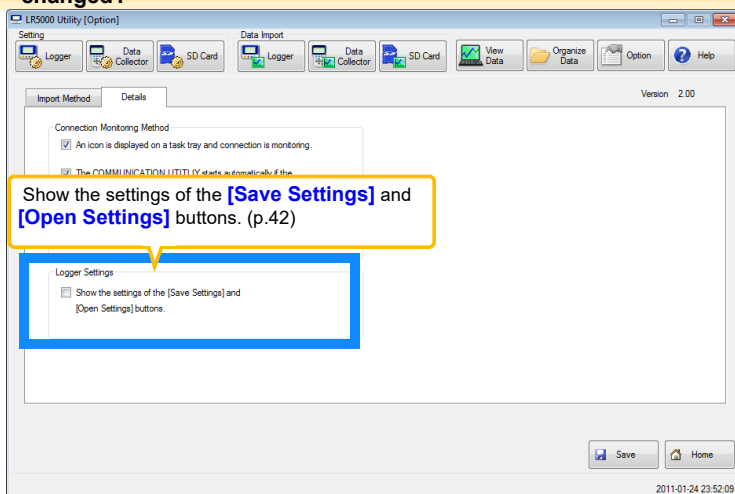

Specifications

Chapter 8

8.1 Measurement Specifications

Input	DC voltage (1 channel)
Input impedance	LR5041: 4 M Ω ±10% LR5042: 2.2 M Ω ±10% LR5043: 2 M Ω ±10%
Measurement ranges	±50.00 mV (LR5041) ±5.000 V (LR5042) ±50.00 V (LR5043) "UF" or "OF" indicates out-of-range measurement
Measurement accuracy	±0.5%rdg. ±5dgt.
Accuracy guarantee for temperature and humidity	<ul style="list-style-type: none"> • Temperature: 23°C±5°C (73°F±9°F) • Humidity: 80%RH or less (non-condensating)
Temperature coefficient	Measurement accuracy × 0.05/°C Note: Add to measurement accuracy when outside of the range 23°C±5°C (73°F±9°F)
Guaranteed accuracy period	1 year
Product warranty period	3 years
Maximum ratings	Max. rated voltage between terminals: ±60 mV (LR5041), ±6 V (LR5042), ±60 V (LR5043) Max. rated voltage to ground: 60 V DC

8.2 Functional Specifications

Display type	LCD
Display contents	Measured value, units (mV, V), recording (REC), endless recording (ENDLESS), statistical recording (STAT), recording interval (INTVL), pre-heat time (PrE.H), date and time (TIME), alarm (AL), battery status, recorded data count (DATA), maximum value (MAX), minimum value (MIN), auto power saving (APS)
Operation button	Four ("SET", "REC/STOP", "+", "-")
Recording interval	1/2/5/10/15/20/30 sec., 1/2/5/10/15/20/30/60 min.
Recording modes	<ul style="list-style-type: none"> Instantaneous recording: The instantaneous value is recorded at each recording interval Statistical recording: Measurements are taken once per second, and instantaneous, maximum, minimum, and average values are saved at each recording interval (cannot be selected when the recording interval is set to one second).
Recording capacity	<ul style="list-style-type: none"> Instantaneous recording: 60,000 values Statistical recording: 15,000 instantaneous, maximum, minimum, and average values
Recording start method	<ul style="list-style-type: none"> Logger button operation Instant or scheduled time (set by computer/Data Collector)
Recording stop method	<ul style="list-style-type: none"> Logger button operation (endless recording) Logger button operation (one-time recording) Scheduled time (endless recording) Scheduled time (one-time recording) Scheduled time is set by computer/Data Collector
Retained recording sessions	Two sessions (each from recording start to stop)
Alarm	Indicates when measured values are outside of the range defined by upper and lower thresholds set from a computer or the Data Collector
Scaling	Scales and displays measured values according to settings made from a computer or the Data Collector (measurement units are not displayed for scaled values)
Preheat output	OFF/0.5/1/2/5/10/30/60 sec.
Power save setting	The measurement data display turns off about 30 seconds after the last button operation (cancel power save for continuous display)
Real-time clock	Provided

8.3 Miscellaneous	
Clock accuracy	±50ppm (@25°C (@77°F)) ±4.32 s/day
Backup	Recorded data and settings (independent of battery)
Interface	Half-duplex start/stop synchronous infrared serial communication between the logger and Communication Adapter or Data Collector
Power supply	<ul style="list-style-type: none"> Rated supply voltage: 1.5 V DC One AA-size alkaline battery (LR6) Recording and clock operation, and maximum and minimum values are retained for about 30 seconds during battery replacement
Maximum rated power	0.1 VA
Battery life	<ul style="list-style-type: none"> Approx. 2 year (instantaneous recording, with 1-minute recording interval and auto power saving, @20°C (@68°F)) Approx. 2 month (with 1-second recording interval, @20°C (@68°F))
Dimensions	Approx. 79W×57H×28D mm (3.11"W×2.24"H×1.10"D)
Mass	Approx. 105 g (3.7 oz.) (w/battery)
Dust and water protection rating	IP54 (EN60529) (with connection cable connected, but not including cable tip)
Accessories	<ul style="list-style-type: none"> LR6 alkaline battery 1 (Internal in the logger) LR9802 Connection Cable 1 Instruction Manual..... 1 Operation Manual..... 1 Stand..... 1
Options	<ul style="list-style-type: none"> LR5091 Communication Adapter LR5092-20 Data Collector LR9802 Connection Cable LR9901 Wall-Mounted Holder Z5004 Magnetic Strap
Environmental conditions	<ul style="list-style-type: none"> Operating environment: indoors, pollution degree 2, up to 2000 m ASL Operating temperature and humidity: -20°C to 70°C (-68°F to 158°F), 80%RH or less (non-condensating) Storage temperature and humidity: -20°C to 70°C (-68°F to 158°F), 80%RH or less (non-condensating)
Applicable Standards	<ul style="list-style-type: none"> Safety: EN61010 EMC : EN61326

8.4 LR5091 Communication Adapter Specifications

Main Unit General Specifications

Functions	Converts between the logger's infrared signals and USB signals to support communications between the logger and a computer (USB port).
Compatible loggers	LR5001 Humidity Logger, LR5011 Temperature Logger, LR5031 Instrumentation Logger, LR5041, LR5042, LR5043 Voltage Logger, LR5051 Clamp Logger Note: Communication with models LR5031 is supported by PC Utility version 1.05 and later. LR5051 is supported by PC Utility version 1.01 and later.
Operating temperature and humidity	Temperature: 0°C to 40°C (32°F to 104°F), Humidity: 80%RH or less (non-condensating)
Storage temperature and humidity	Temperature: -10°C to 50°C (14°F to 122°F), Humidity: 80%RH or less (non-condensating)
Operating environment	Indoors, pollution degree 2, up to 2000 m ASL
Power supply	DC5 V (USB bus-powered)
Maximum rated power	0.5 VA
Dimensions	Approx. 83W×61H×19D mm (3.27"W×2.40"H×0.75"D) (without projections)
Mass	Approx. 43 g (1.5 oz.) (without USB cable)
Applicable Standards	<ul style="list-style-type: none"> • Safety: EN61010 • EMC : EN61326
Product warranty period	3 years
USB standard	USB 2.0 compliant, Full Speed support
Connector	Mini B series receptacle
Connectable device	Computer
Communication speed	115,200bps
Communication method	Half-duplex start/stop synchronous infrared serial communication
Communication speed	115,200bps

Accessories

USB cable (1 m)	1
LR5000 Utility Program (CD)	1

Supplied LR5000 Utility Program Specifications

Supplied medium	CD..... 1
Operating environment	<p>Personal computer meeting the following specifications</p> <ul style="list-style-type: none"> • CPU: 1 GHz or faster processor clock • RAM: 1 GB or more (32-bit), 2 GB or more (64-bit) • Operating system: Windows 7 or Windows 10 • Library: .NET Framework 4.5.2 or later • Interface: USB (or COM port for models 3910, 3911, or 9612) • Monitor resolution: 1024 x 768 or higher • Hard disk: At least 30 MB free space (Additional space is required for storing recorded data.)
Model communication support	<p>All LR5000-series loggers</p> <p>Note1: Communication with models LR5031 is supported by PC Utility version 1.05 and later. LR5051 is supported by PC Utility version 1.01 and later.</p> <p>Note2: The COMMUNICATION UTILITY program supports the following models' settings and data import functions. A computer COM port and 9612 RS-232C cable are required when using the model 3910 or 3911 Communication Base.</p> <ul style="list-style-type: none"> • All "Data Logger" models 363x to 364x • Communication Base models 3910, 3911, and 3912
Communication connections	<p>Communication with LR5000-series loggers:</p> <ul style="list-style-type: none"> • Computer, USB cable, LR5091 Communication Adapter, and LR5000-series logger • Computer, USB cable, LR5092-20 Data Collector, and LR5000-series logger <p>Communication with the LR5092-20 Data Collector: Computer, USB cable, and LR5092-20 Data Collector</p>
Setting functions	<ul style="list-style-type: none"> • Export/import settings by communication with the LR5000 series • Settings exported from each LR5000 are stored on the computer (the following functions are supported by the supplied PC Utility version 2.00, or later) • Export/import settings by communication using the LR5092-20 Data Collector • Import and save logger settings using the LR5092-20 Data Collector via communication or SD memory card • Settings exported to the LR5092-20 Data Collector are stored on the computer
Auto-start function	<p>A small resident program (icon in the task tray/notification area) detects when a logger or the Data Collector is connected to the computer, and automatically starts the LR5000 Utility Program.</p>

8.4 LR5091 Communication Adapter Specifications

Data import functions	<ul style="list-style-type: none"> Communicates with the LR5000-series loggers, and imports recorded data Combines recorded data Incorporates new data when an LR5000-series logger holds data not previously imported <p>(the following functions are supported by the supplied PC Utility version 2.00, or later)</p> <ul style="list-style-type: none"> Communicates with the LR5092-20 Data Collector, and imports recorded data saved in the Data Collector Imports data saved to an SD memory card in the LR5092-20 Data Collector
Graph display functions	<ul style="list-style-type: none"> Displays up to 16 channels in a graph Displays up to 16 Y-axes Displays one time base axis Set line colors for each channel, and display/hide lines and bar graphs for each channel Auto setting of time base and vertical axis Display/hide Y-axis grid lines, and set grid display density Select display background color Copy graph images to the clipboard A/B cursor functions Displays statistical data (maximum, minimum, and average)
Data list display functions	<ul style="list-style-type: none"> Browse recorded data in tabular format Displays up to 600 channels Displays statistical data (maximum, minimum, and average)
Export functions	<ul style="list-style-type: none"> Export all recorded data displayed in a table in CSV format Paste to Excel® all recorded data displayed in a data table Export all recorded data between A/B cursors in CSV format Paste to Excel® all recorded data between A/B cursors
Import functions	<p>Import text files from the 3169 Clamp-On Power HiTester</p> <p>Note: Only electric energy data recorded at one-second or longer interval can be imported</p>
Printing functions	<ul style="list-style-type: none"> Prints graphs and statistical data Supports A3, A4, and B4 paper sizes
Data processing functions	<p>Scaling ($y=ax+b$), electric power calculation, energy cost calculation, operating rate calculation, integration, dew-point temperature calculation, arithmetic calculations, out-of-range data revision</p>
File management functions	<ul style="list-style-type: none"> Copy and delete data saved on the computer <p>(the following functions are supported by the supplied PC Utility version 2.00, or later)</p> <ul style="list-style-type: none"> Delete data saved to an SD memory card in the LR5092-20 Data Collector
Help function	Displays helpful operating instructions

Maintenance and Service

Chapter 9

Requesting repairs

- Use the original packing materials when transporting the instrument, if possible.
- Pack the instrument so that it will not sustain damage during shipping, and include a description of existing damage. We do not take any responsibility for damage incurred during shipping.
- Please contact your dealer or Hioki representative for information on where to submit products for repair.

When the logger will not be used for long time



CAUTION To avoid corrosion and damage to this instrument from battery leakage, remove the batteries from the instrument if it is to be stored for a long time (1 week).

Replaceable part and service life

A part used in the instrument is characterized by performance that degrades over years of use. It is recommended to replace this part regularly to ensure instrument functionality over the long term. To order a replacement, please contact your Hioki distributor. Part service life varies with the operating environment and frequency of use.

Part	Service life
Electric double-layer capacitor	The instrument uses an electric double-layer capacitor to back up internal components, including the clock. Even if it takes only a short time (about 30 s or less) to replace the batteries, the internal clock may not be backed up, with the result that all segments of the screen may be displayed when the instrument is started. In this case, the life of the capacitor has expired. Especially in high-temperature environments, the life of the capacitor may be significantly shortened.

9.1 Cleaning

Wipe the LCD gently with a soft, dry cloth.

To clean the instrument, wipe it gently with a soft cloth moistened with water or mild detergent.

IMPORTANT

Never use solvents such as benzene, alcohol, acetone, ether, ketones, thinners or gasoline, as they can deform and discolor the case.

9.2 Disposing of the Logger

Obey local regulations for disposal of electronic equipment.

9.3 Troubleshooting

If damage is suspected, check the "Before requesting repairs" section before contacting your dealer or Hioki representative.

Before requesting repairs

Problem Symptom	Probable Causes	Remedies and References
The LR5000 Utility Program cannot be installed.	<ul style="list-style-type: none"> The computer operating environment may be incompatible. The installation procedure may be incorrect. 	<p>Check the operating environment requirements, and try installing in (another) compatible computer.</p> <p>See: "LR5000 Utility Program Operating Requirements" (p.23)</p> <p>Refer to the installation procedure, and try again.</p> <p>Pay particular attention to the following:</p> <ul style="list-style-type: none"> Be sure to log in with an Administrator account. Before installing, be sure to close any applications running on the computer. If the installation screen does not appear, execute X:\English\Setup.exe. <p>See: "Installation Procedure" (p.23)</p>
<p>No measured value is displayed.</p>  <p>DATA 0.00 v 0 (LR5043 Example)</p>	<p>The connection cable plug is not inserted all the way in.</p> <p>NOTE The maximum and minimum values are not displayed when the recorded data count is 0.</p>	<p>Verify the correct plug orientation, and insert it as far as possible.</p> <p>If the values are not displayed despite these measures, the connection cable and logger need to be inspected and repaired. Please contact your dealer or Hioki representative.</p> <p>See: "Requesting repairs" (p.91)</p>

Before requesting repairs

Problem Symptom	Probable Causes	Remedies and References
The display is blank.	Power save is enabled.	Press any button or send a communication signal to turn on the display. See: "Part Names/Functions and Display Indicators" (p.12)
The battery is depleted too quickly.	<ul style="list-style-type: none"> The battery supplied with the logger is still being used. A zinc-manganese battery is being used. 	Install a new AA-size (LR6) alkaline battery. See: "2.1 Installing (or Replacing) the Battery" (p.17)
Logger settings cannot be changed.	Dead battery.	When the  battery indicator appears, settings cannot be changed (but only displayed). Replace the battery. See: "2.1 Installing (or Replacing) the Battery" (p.17)
How can the logger's memory be erased?	-	Logger memory can be erased using the LR5000 Utility Program. See: "Other Settings on the Logger Settings Screen" (p.42) Note that data recorded prior to the last recording is automatically erased whenever recording starts. (The logger retains the data from both current and most recent prior recording operation.) See: "4.3 Starting and Stopping Recording" (p.46)
How can recorded values be reorganized?	-	Enable scaling. See: "5.1 Scaling" (p.67) Scaling settings can be made before recording. See: "Scaling (set as needed)" (p.40)
Recorded data has disappeared.	Recording was restarted after stopping.	Note that if recording is accidentally restarted after stopping, data recorded prior to the last recording is automatically erased. (The logger retains the data from both current and most recent prior recording operations.)

Before requesting repairs

Problem Symptom	Probable Causes	Remedies and References
<p>The [REC] indicator disappears even though recording has not been stopped.</p> 	The one-time recording stop method is selected.	<p>With one-time recording, recording stops automatically when memory becomes full. Change the stop method to endless recording.</p> <p>See: Making Settings on the Logger: "Stop Method Setting (for when memory becomes full)" (p.33)</p> <p>See: Making Settings from the LR5000 Utility Program: "Stop Method" (p.39)</p> <p>(With endless recording, the oldest data is overwritten when memory is full, so be sure to save data to a computer periodically during long-term recording. Data can be saved to a computer without stopping recording.)</p> <p>See: "4.5 Automatically Importing (Saving) Recorded Data to a Computer, and Graph Display" (p.49)</p>
The logger cannot communicate with the new LR5091 (LR5092).	The installation of the device driver to the LR5091 (LR5092) failed.	For Window XP, the driver may be required to be installed to each LR5091 (LR5092). Open Windows Device Manager and re-install the driver.
The [Failed to read data partially.] message appears.	The instrument can display up to 84000 data sets per measurement parameter.	The LR5000 viewer places a limit on the number of data sets displayed on graphs and tables. Change the duration to be displayed. Change from [All Data] to [1day] .

9.4 Error Displays

The display appears as follows when an error occurs on the logger.

Logger Error Displays

Error Displays	Meaning	Remedies and References
Err.1	Calibration data error: A fault occurred with the internal calibration data.	<p>Inspection and repair is required. Please contact your dealer or Hioki representative.</p> <p>See: "Requesting repairs" (p.91)</p>
Err.2	Microcomputer error: A fault occurred in microcomputer ROM/RAM.	
Err.3	Data recording error: A fault occurred in recording data or accessing settings.	
bAtE	Battery voltage is too low for normal logger operation.	<p>Replace the battery.</p> <p>See: "2.1 Installing (or Replacing) the Battery" (p.17)</p>

Logger Error Displays

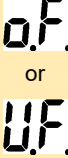
Error Displays	Meaning	Remedies and References
	A measured value is out of range.	Out-of-range values cannot be displayed. [OF] or [UF] is displayed when this data is imported by the LR5000 Utility Program.

LR5000 Utility Program Error Displays

Error Displays	Meaning	Remedies and References
OF	A measured value is out of range.	Out-of-range values cannot be displayed.
UF		

Appendix

Appendix 1 About Recording Modes

The recording method depends on the selected recording mode. The recording modes are as follows.

Instantaneous Recording

Measurements are recorded in internal memory at each recording interval.

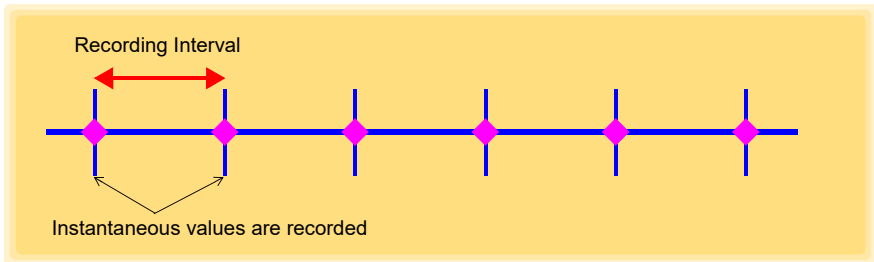

Statistical Recording

Measurements are taken once per second, and instantaneous, maximum, minimum, and average values are saved to internal memory at each recording interval.

Data at the recording start time is not recorded (in the following case, data at 10:00:00 is not recorded).

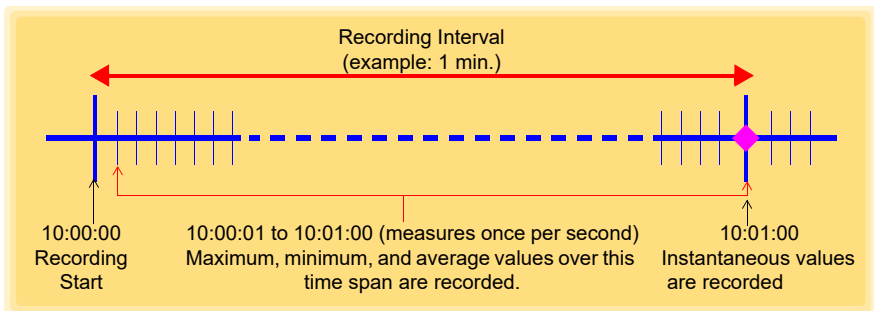

NOTE

Statistical recording cannot be selected when the recording interval is set to one second.

Appendix 2 Recording Intervals and Maximum Recording Times

The maximum recording time is calculated according to the recording capacity.

NOTE

The maximum recording time is limited by the remaining battery capacity.

Instantaneous Recording

Up to 60,000 values can be recorded.

Recording Interval	Maximum Recording Time	Recording Interval	Maximum Recording Time
1 sec.	16 h, 40 min	1 min	41 d, 16 h
2 sec.	1 d, 9 h, 20 min	2 min	83 d, 8 h
5 sec.	3 d, 11 h, 20 min	5 min	208 d, 8 h
10 sec.	6 d, 22 h, 40 min	10 min	416 d, 16 h
15 sec.	10 d, 10 h	15 min	625 d
20 sec.	13 d, 21 h, 20 min	20 min	833 d, 8 h
30 sec.	20 d, 20 h	30 min	1250 d
		60 min	2500 d

Statistical Recording

Up to 15,000 values can be recorded.

Recording Interval	Maximum Recording Time	Recording Interval	Maximum Recording Time
1 sec. (Cannot be set)	-	1 min	10 d, 10 h
2 sec.	8 h, 20 min	2 min	20 d, 20 h
5 sec.	20 h, 50 min	5 min	52 d, 2 h
10 sec.	1 d, 17 h, 40 min	10 min	104 d, 4 h
15 sec.	2 d, 14 h, 30 min	15 min	156 d, 6 h
20 sec.	3 d, 11 h, 20 min	20 min	208 d, 8 h
30 sec.	5 d, 5 h	30 min	312 d, 12 h
		60 min	625 d

Appendix 3 Battery Life Approximation

Battery life depends on the recording interval.

The following table shows battery life when power saving (p.34) is enabled. Battery life is approximately two months when power saving is disabled or when the statistical recording mode is enabled.

Recording Interval	Battery Life	Recording Interval	Battery Life
1 sec.	Approx. 60 days	30 sec.	Approx. 1.5 year
10 sec.	Approx. 1 year	1 min or more	Approx. 2 year

Index

Symbols

(-) button	12
(+) button	12

A

AL indicator	13, 41
Alarm thresholds	13, 41
APS	34
Auto graph display	50
Auto import	50, 82
Auto power save	12

B

Battery is depleted too quickly	93
Battery life approximation	A2
Battery status indicator	13, 18

C

CD Handling	7
Changing the saving method	82
Cleaning	92
Clock setting	15, 32, 42
Combining	78
Connect to the computer	36
Connection cable	20

D

Damage	92
Data	
Combine	78
Copy	76
Delete	42, 77
Extract	79
Move	76
Data import screen (PC application)	59
DATA indicator	13
Data view screen (PC application)	62, 65
Delete	42, 77
Device connection monitoring setting	83
Dew-point temperature calculation	72
Display graph automatically	61

Display indicators	13
Display the graph	61, 65
Display value refresh time	12
Displaying a graph of saved recording data	62
Disposing	92

E

Electric power calculations	68
ENDLESS indicator	13, 33
Endless recording	33, 39
Energy cost calculations	69, 70
Error displays	94
Extracting	79

F

Features	11
----------------	----

G

Graph display	49, 62
Graph Settings	54

H

How can past data be viewed?	63
How can the displayed area be magnified?	53
How can the file naming method be changed?	82
How can the function settings of the logger's settings displays be changed?	83
How can the logger's memory be erased?	93
How can the save destination folder be changed?	82
How can the settings from one logger be copied to another?	38
How to switch from a setting display to measurement display?	49

I

Importing recorded data to a computer	49
---	----

Index 2

Index

Installation	23
Installation precautions	6
Installing the battery	17
Installing the Logger	44
Instantaneous Recording	39
Instantaneous recording	34, A1
Integration	71
Integration values	56, 57
INTVL indicator	13, 31

L

Logger settings screen (PC application)	37
Lower threshold	41
LR5091 Communication Adapter	12
Specifications	88

M

Magnet	45
Main screen	26
Maintenance	91
Markings on the logger	5
MAX indicator	13
Maximum recording times	A2
Maximum value	14
Measurement	43
Measurement channel	13
Measurement preparations	17
Measuring display (Logger)	14
MIN indicator	13
Minimum value	14
Model comment	38
Moving	76

N

No measured value is displayed	92
--------------------------------------	----

O

One-time recording	33, 39, 47
Operation buttons	12
Operation flow	8
Options	4, 45, 87
Options settings (PC application program)	81
Organizing data	75
Overview	11

P

Package contents	3
Part names/functions	12
PC application Installing	23
Operating requirements	23
Screens	26
Version upgrading	25
PC application program Uninstall	25
Power save setting	15, 34, 38
Battery life	A2
Power saving setting	49
Preheat signal	21
Preheat time	15, 35
Preliminary checks	7
Pre-measurement inspection	43
Printing	64
Product overview	11

R

Real-time clock setting	32
REC indicator	13, 47
REC indicator disappears	94
REC/STOP button	12
Recorded data count	14
Recording interval	15, 31, 39, 48
Recording mode	15, 34, 39, A1
Recording Start Method	39
Recording Stop Method	39
Recording times	A2
Repairs	91, 92

S

Safety symbols	5
Save method screen (PC application)	60, 61
Saving recorded data to a computer	49
Scaling	40, 42, 67
Scheduled Time	39
Service	91
SET button	12
Setting (PC application)	37
Setting display (Logger)	15
Settings list	29
Show Main Screen	59, 75
Specifications	85
Stand	44
Starting and stopping recording	46

STAT indicator	13, 34
Statistical recording	34, 39, A1
Stop method	15
Stop method setting	33
Stop method setting (for when memory becomes full)	33

T

TIME indicator	13, 32
Time setting	15, 32, 42
Transporting precautions	4
Troubleshooting	92

U

Uninstall	25
Upper threshold	41

V

Version Upgrading	25
View Data	62, 65
View latest data	62, 65
Viewer	50, 51, 62, 63, 65

W

Wall mounting	45
Wall-mounted holder	45
When the logger will not be used for long time	18, 91

Warranty Certificate

HIOKI

Model	Serial number	Warranty period Three (3) years from date of purchase (___ / ___)
-------	---------------	--

Customer name: _____

Customer address: _____

Important

- Please retain this warranty certificate. Duplicates cannot be reissued.
- Complete the certificate with the model number, serial number, and date of purchase, along with your name and address. The personal information you provide on this form will only be used to provide repair service and information about Hioki products and services.

This document certifies that the product has been inspected and verified to conform to Hioki's standards.

Please contact the place of purchase in the event of a malfunction and provide this document, in which case Hioki will repair or replace the product subject to the warranty terms described below.

Warranty terms

1. The product is guaranteed to operate properly during the warranty period (three [3] years from the date of purchase).
If the date of purchase is unknown, the warranty period is defined as three (3) years from the date (month and year) of manufacture (as indicated by the first four digits of the serial number in YYYY format).
2. If the product came with an AC adapter, the adapter is warranted for one (1) year from the date of purchase.
3. The accuracy of measured values and other data generated by the product is guaranteed as described in the product specifications.
4. In the event that the product or AC adapter malfunctions during its respective warranty period due to a defect of workmanship or materials, Hioki will repair or replace the product or AC adapter free of charge.
5. The following malfunctions and issues are not covered by the warranty and as such are not subject to free repair or replacement:
 - 1. Malfunctions or damage of consumables, parts with a defined service life, etc.
 - 2. Malfunctions or damage of connectors, cables, etc.
 - 3. Malfunctions or damage caused by shipment, dropping, relocation, etc., after purchase of the product
 - 4. Malfunctions or damage caused by inappropriate handling that violates information found in the instruction manual or on precautionary labeling on the product itself
 - 5. Malfunctions or damage caused by a failure to perform maintenance or inspections as required by law or recommended in the instruction manual
 - 6. Malfunctions or damage caused by fire, storms or flooding, earthquakes, lightning, power anomalies (involving voltage, frequency, etc.), war or unrest, contamination with radiation, or other acts of God
 - 7. Damage that is limited to the product's appearance (cosmetic blemishes, deformation of enclosure shape, fading of color, etc.)
 - 8. Other malfunctions or damage for which Hioki is not responsible
6. The warranty will be considered invalidated in the following circumstances, in which case Hioki will be unable to perform service such as repair or calibration:
 - 1. If the product has been repaired or modified by a company, entity, or individual other than Hioki
 - 2. If the product has been embedded in another piece of equipment for use in a special application (aerospace, nuclear power, medical use, vehicle control, etc.) without Hioki's having received prior notice
7. If you experience a loss caused by use of the product and Hioki determines that it is responsible for the underlying issue, Hioki will provide compensation in an amount not to exceed the purchase price, with the following exceptions:
 - 1. Secondary damage arising from damage to a measured device or component that was caused by use of the product
 - 2. Damage arising from measurement results provided by the product
 - 3. Damage to a device other than the product that was sustained when connecting the device to the product (including via network connections)
8. Hioki reserves the right to decline to perform repair, calibration, or other service for products for which a certain amount of time has passed since their manufacture, products whose parts have been discontinued, and products that cannot be repaired due to unforeseen circumstances.

HIOKI E.E. CORPORATION

<http://www.hioki.com>

18-07 EN-3

HIOKI

www.hioki.com/



**All regional
contact
information**

HEADQUARTERS

81 Koizumi
Ueda, Nagano 386-1192 Japan

HIOKI EUROPE GmbH

Helfmann-Park 2
65760 Eschborn, Germany
hioki@hioki.eu

2111 EN

Edited and published by HIOKI E.E. CORPORATION

Printed in Japan

- CE declarations of conformity can be downloaded from our website.
- Contents subject to change without notice.
- This document contains copyrighted content.
- It is prohibited to copy, reproduce, or modify the content of this document without permission.
- Company names, product names, etc. mentioned in this document are trademarks or registered trademarks of their respective companies.