

Maximum accuracy of $\pm 0.16\%$ achieved with current sensors!

- Measure the primary and secondary sides of inverters
- Advanced motor analysis functions
- Measure inverter noise



V

A

kW

Large Assortment of Wide-band, High-Precision Feed-Through Current Sensors

4 Models

Effect of conductor position
Effect of external electromagnetic field

Completely Minimized

50A



CT6862

200A



CT6863

500A



9709

1000A



CT6865

Current Sensor Method

Surpasses the Accuracy of Direct Connection Method

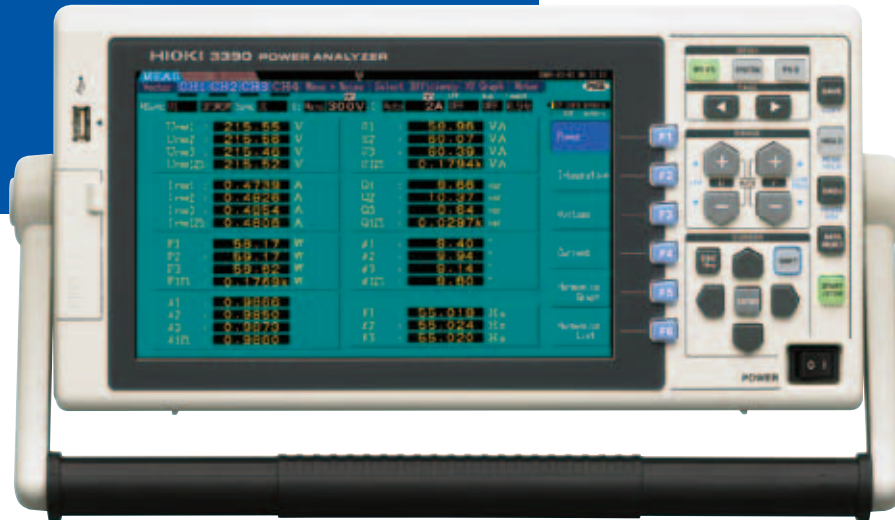

Power Analyzer 3390

When combined with the feed-through current sensors

Maximum accuracy of **$\pm 0.16\%$**

$\pm 0.1\%$

$\pm 0.06\%$



For Current Sensor specifications, please go to

page 15

Power Analyzing Control Engine Technology processes

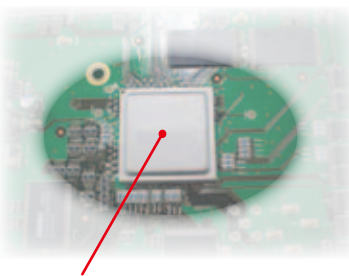

Measurement data at high speeds and with excellent accuracy

50ms

Weight & Volume

1/3

A HIOKI proprietary engine that takes advantage of the latest semi-conductor technologies enables a much smaller footprint than ever before (in comparison with other HIOKI high performance power meters)

Feed-through current sensors

Clamp-on sensors



9709



CT6862



CT6841



9272-10

Current sensor design allows for safe and efficient testing

- Choice of sensors include easy-to-measure AC and AC/DC clamp-on sensors and feed-through current sensors for high-accuracy measurements
- Immune to in-phase noise effects when measuring inverters

Basic accuracy of Model 3390: $\pm 0.1\%$

Basic measurement range: DC, 0.5 Hz to 5 kHz
(Frequency bandwidth: DC, 0.5 Hz to 150 kHz)

Effective input range: 1% to 110%

- High accuracy, wide band, and wide dynamic range
- Also measure the secondary side of DC inverters in conjunction with a variety of HIOKI current sensors

All data updated at 50ms*

- 50ms data refresh rate for all measurements unaffected by settings restraints
- Synchronize the measurements of multiple 3390s
Automatic update rate eliminates the need of switching for low-frequency measurements

* 50ms data refresh rate does not apply to waveform and noise analysis

Meet the Needs of Alternative Energy and Inverter or Motor Evaluations

4-channel isolated input

Measure the primary and secondary sides of inverters simultaneously

- Choose wiring from single-phase two-wire to three-phase four-wire
- Synchronize the measurements of multiple 3390s



Even More!

- Connect up to four 3390s and synchronize their clocks and measurement timing for multiple-channel measurements (using the SYNC terminal and Connection Cable 9683)
- Use dedicated application software to conduct synchronized operations for up to 4 units and obtain all the measurement data

CF card interface

& USB memory interface

Automatically save interval measurement data to a CF card (When saving manually, measured data and waveform data can be saved directly to the CF card and USB memory)

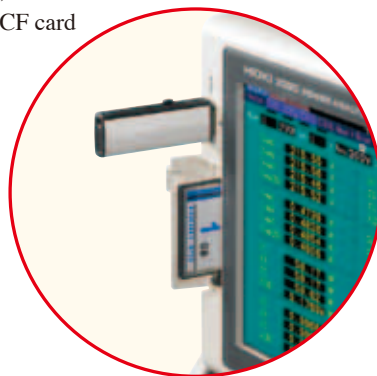

Waveform Output and 16 Channel D/A output

- Use the **D/A OUTPUT OPTION 9792** to update data every 50ms and output up to 16 items in analog format
- Also output the voltage and current waveforms for each channel (using 1 to 8 channels)
(Waveforms are output at 500 kS/s and sinusoidal waveforms can be represented accurately at up to 20 kHz)

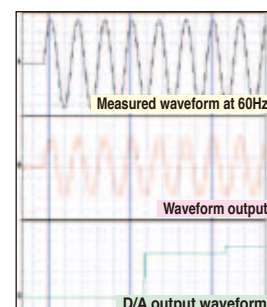

Ideal for Motor Evaluation and Analysis

- Use of the **MOTOR TESTING OPTION 9791 (or 9793)** allows torque meter output and rotation input, and facilitates motor power measurement

For motor evaluation and analysis specifications, please go to **pages 8 & 9**

A Variety of Interfaces Standardly Equipped

Includes 100Mbps Ethernet and USB 2.0 High Speed communications interfaces.

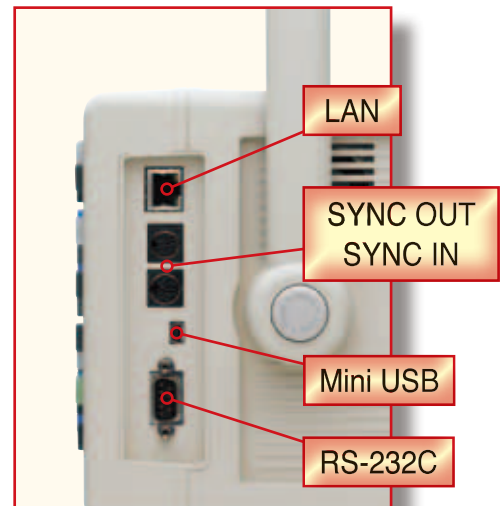

HTTP server function available with free dedicated PC software

- HTTP server function through web browser enables easy remote operation
- **Free dedicated PC application can be downloaded from the HIOKI website**

Collect data and operate the 3390 remotely by connecting it to a PC via LAN or USB

▶ page 11



Extra-Large Screen Expands Possibilities

Capture measured data and waveforms at a glance utilizing a variety of display options

The 9" color LCD can display up to 32 data parameters

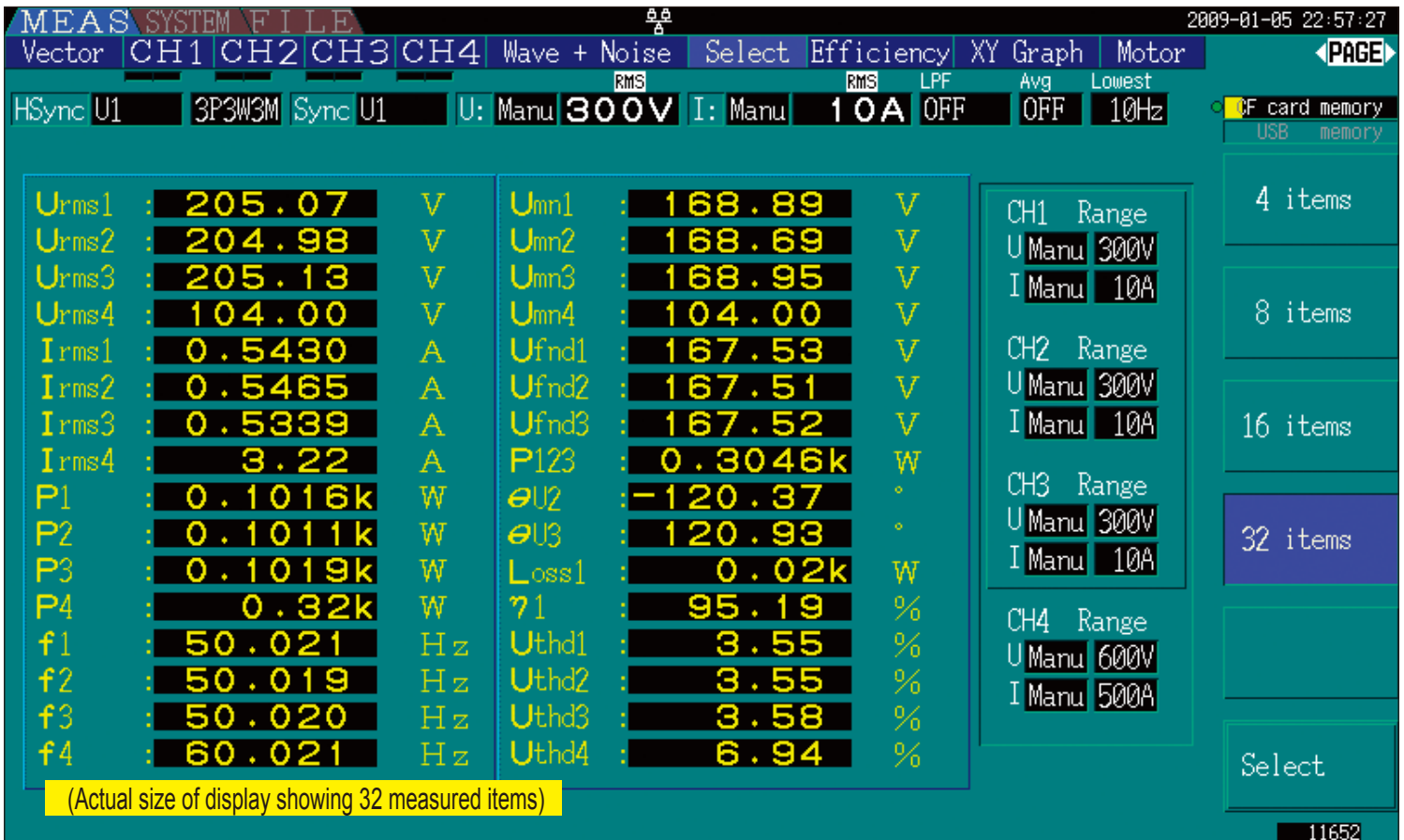

All measurements start with just a connection

Wiring check function prevents connection errors

Display connection and vector diagrams on the Wiring screen

Improve efficiency and reliability while saving time in wiring even for three-phase measurements

Display just the required data in an easy-to-read graphic interface on the Select screen

Screen displaying 32, 16, 8, or 4 items

Display items can be set individually for each selected screen

Read data quickly and easily by just switching between the screens

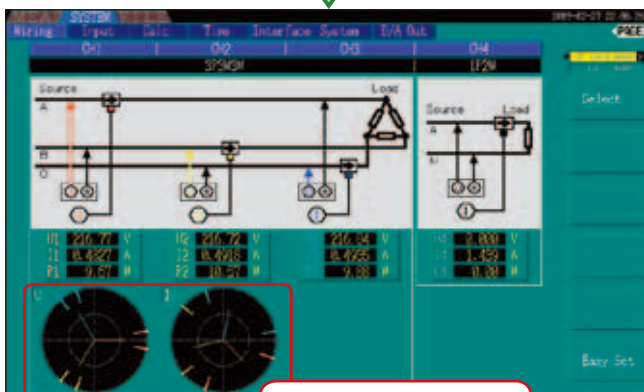

Check Vector Direction

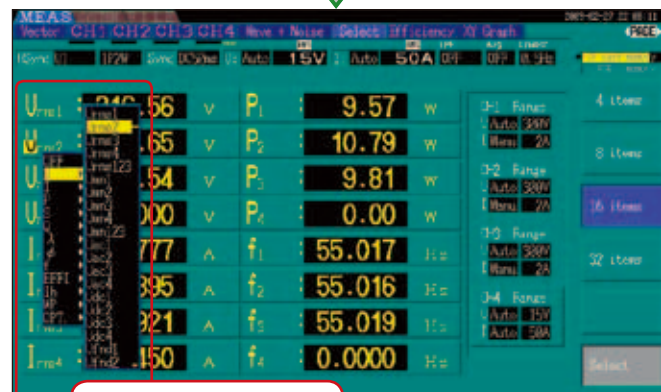

Intuitive Interface

All data is processed in parallel simultaneously.

A wealth of data analysis functions all built-in and ready to use.

Channel display

RMS and MEAN values, and AC, DC, and fundamental waveform components can be measured and displayed simultaneously

V rms value		V mean value	
U _{rms1}	205.07 V	U _{mn1}	168.89 V
U _{rms2}	204.98 V	U _{mn2}	168.69 V
U _{rms3}	205.13 V	U _{mn3}	168.95 V
U _{rms4}	104.00 V	U _{mn4}	104.00 V
I _{rms1}	0.5430 A	U _{fnd1}	167.53 V
I _{rms2}	0.5465 A	U _{fnd2}	167.51 V
I _{rms3}	0.5339 A	U _{fnd3}	167.52 V

Channel Display

One-touch Switching

Harmonic analysis display

Harmonics graph display



Harmonics list display

Harmonic Analysis to the 100th Order

◀ ▶ **Switch screens at the touch of a button**

Verify All Data At a Glance



Vectors display

Measured voltage, current, and power on channels 1 to 4 as numerical values and as vectors



Channel display

Measured power, voltage and current values, integration values, with access to harmonic graphs and lists for each channel.



Fast 500k/s

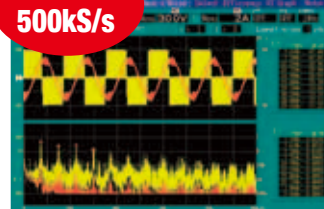

Wave+Noise display

Ideal for frequency analysis of inverter noise (FFT analysis)

Efficiency display

Simultaneously display efficiency and power loss



XY graph display

Power and torque display makes it easy to understand the motor I/O characteristics

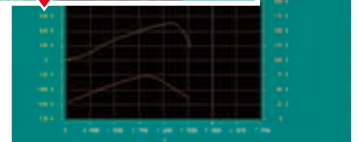

Feed-through Current Sensor Enable Extremely Accurate Measurements

HIOKI's high-performance feed-through current sensors absolutely minimizes the effects of conductor position and external fields, making them exceptionally precise. Repeatability and stability are absolutely unmatched!

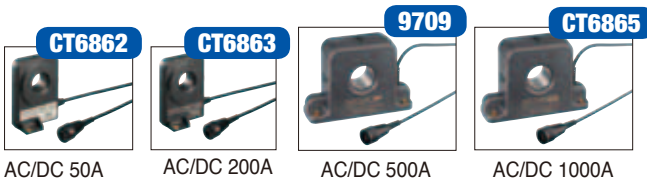

Feed-through current sensors meet a large variety of applications from electric or hybrid vehicle testing, inverter motor evaluations and solar power devices and fuel cell analysis to individual testing of electrical appliances and facilities equipment.

*For further information and specifications, please refer to page 15.

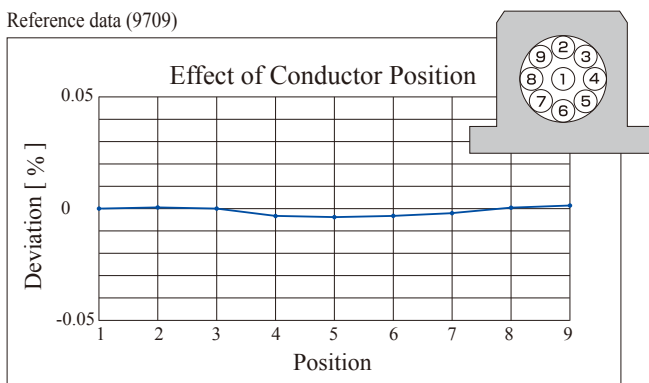

at 100ADC input, when measuring a 10mm diameter wire

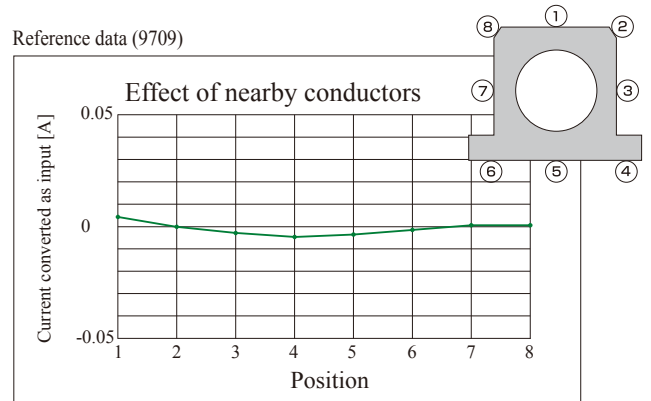

at 100ADC input, when measuring a 10mm diameter wire

Measure the primary and secondary sides of inverters (Performance evaluation of motors and inverters)

Accurately and easily measure the power of inverters and motors for a wide range of applications, from research and development to field tests

Advantages

1. Isolated input of voltage and current lets you measure the power on the primary and secondary sides of inverters simultaneously.
2. Using a non-invasive current sensor makes the connection simple and easy. A vector diagram display ensures connections are checked.

Proprietary HIOKI Technology

3. Accurately measure the fundamental wave voltage and current values related to the motor axis output with confidence
4. All data is measured simultaneously and updated every 50 ms.
5. In addition to the harmonic analysis required to evaluate the inverter control, noise components can also be measured at the same time - ideal for determining the leakage of inverter noise
6. Use of a current sensor reduces the effect of in-phase noise from inverters when measuring the power

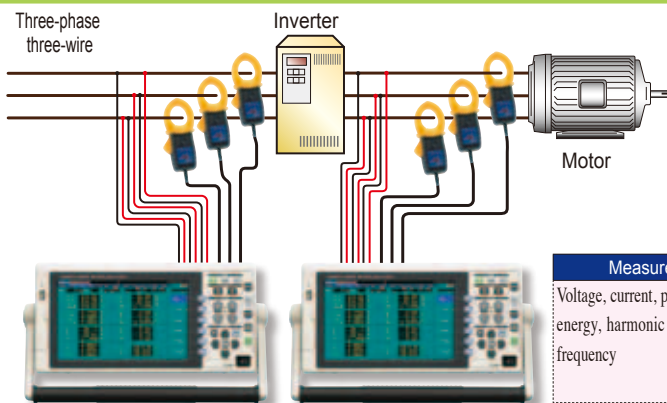

Measure the primary side of inverters
(Using channels 1, 2, and 3)

Measure the secondary side of inverters
(Using channels 1, 2, and 3)

Measurement parameters
Voltage, current, power, power factor, electrical energy, harmonic analysis, noise measurement, frequency

1 To ensure accurate measurements:

- Understand the connections and input states while looking at the connection diagram screen
- Checking unsure connections allows you to perform measurements without worry

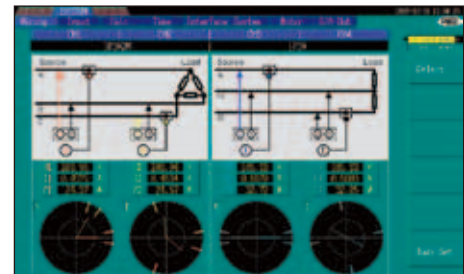

2 PC measurements and synchronizing multiple devices

- Dedicated application software allows you to perform PC measurements right out of the box
- LAN and USB compatibility facilitates efficient data collection and remote operation. Bundled application software allows you to control up to 4 units.

- Acquire all data even when multi-unit measurements are performed
- Two units can be connected using the CONNECTION CABLE 9683 (option) to synchronize the internal clocks and control signals. Interval measurements with the two units allow the acquisition of perfectly synchronized data, making it easy to collect completely harmonized data with a CF card without using a PC.

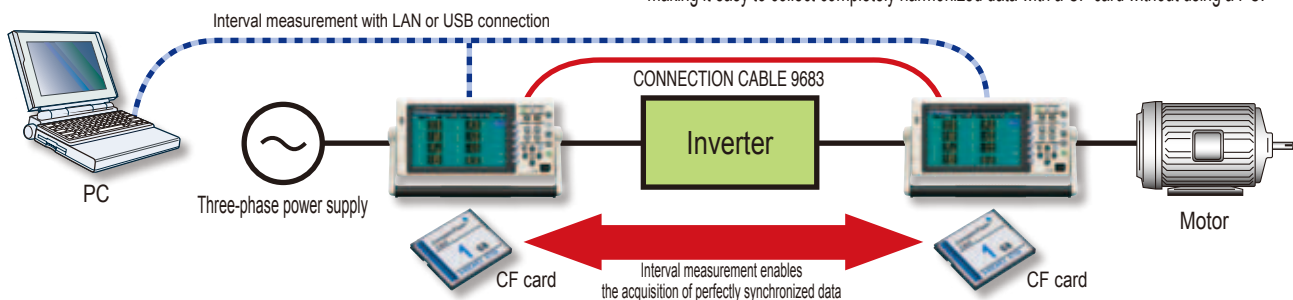

■ What's so special about inverter motors?

Inverter motors are indispensable as the power source of industrial equipment. The rotation of an induction motor depends on the input frequency, so if this input frequency can be made variable, the rotation can be controlled freely. Development of a frequency conversion technology called an inverter has made it possible to freely control the rotation of motors.

In recent years, the mainstream inverter control method is the **PWM (Pulse-width Modulation) method**.

● What is the PWM method?

A pseudo sinusoidal waveform (fundamental wave) resulting from the conversion of the fundamental wave frequency that determines the rotation of a motor to a pulse train called a carrier frequency (at about several kHz to 15 kHz) is effected, controlling the number of rotations.

● Performance evaluation and electrical measurement of motor

The axis output of a motor is closely related to the fundamental wave frequency to be input, so an accurate measurement of this fundamental wave component is required to evaluate the input characteristics.

● Conventional measurement method

Traditional methods use the average rectified RMS indication (Mean) in order to obtain a component value close to the fundamental wave frequency from a pseudo sinusoidal waveform (fundamental wave + carrier wave) to be input. To measure an accurate fundamental component, frequency analysis was required; however, the conventional processing method was not practical because it could barely perform real-time measurements with FFT as a result of the limited computing power.

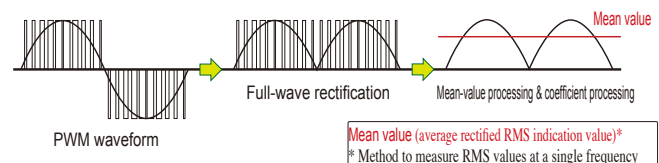

- The 3390 is capable of measuring the fundamental wave component accurately. The 3390 performs this frequency analysis using high-speed harmonic computation processing at an interval of 50 ms and displays the true fundamental wave component.

3 To make the best of inverter motor measurements:

- Parameters critical to the measurement of motor inputs (outputs on the secondary side of inverters) can be measured and displayed simultaneously.

Display item	Measurement details
rms value	RMS value of fundamental wave + carrier wave components
mn value	RMS value (mean value) close to the fundamental wave component
fnf value	True fundamental wave component
thd value	Displays the distortion factor of measured waveform
unb value	Displays the balance between phases
±pk value	Maximum positive/negative values of waveform that is being measured
dc value	Displays a DC component harmful to the motor
ac value	RMS value obtained by removing the DC component from the RMS value
f value	Frequency of each phase

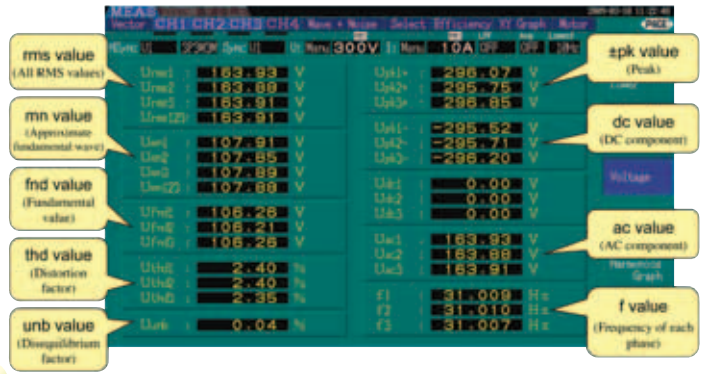

4 Clearly display efficiency and loss of inverters

- Efficiency and loss measurement function built-in

The operating efficiency and power loss of an inverter can be displayed when measuring the inputs and outputs of the inverter simultaneously.



5 X-Y graph display lets you check the dynamic characteristics of inverters

- X-Y graph display function built-in (X-axis: 1 item, Y-axis: 2 items)

By simply specifying the voltage for the X-axis and the power consumption and efficiency for the Y-axis, you can display the dynamic characteristics of a motor in real time.

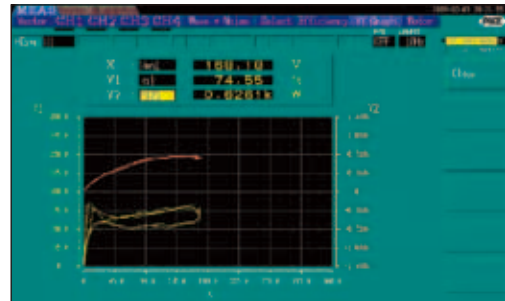

6 Harmonic measurement indispensable for inverter evaluation

- 4-channel simultaneous harmonic analysis function built-in (Performed simultaneously with power measurement)

Harmonic analysis is essential for the development and evaluation of inverters Synchronized to the fundamental wave frequency from 0.5 Hz to 5 kHz Harmonic analysis up to the 100th order can be performed simultaneously with power measurement.



7 Evaluate of the troublesome noise of inverters

- Noise measurement function built-in (1-channel measurement: Performed simultaneously with power measurement and harmonic analysis)

Noise components at up to 100 kHz can be read while looking at the measured waveforms Simultaneously display the top 10 point frequency and voltage/current levels

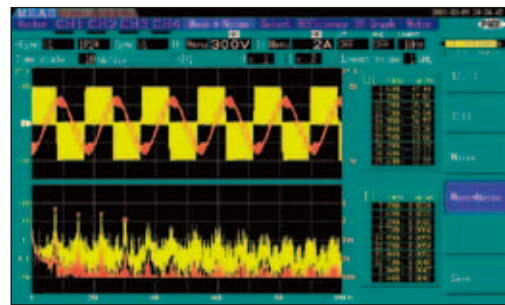

8 Waveforms can be observed at 500 kS/s, and fundamental waves can also be checked

- Waveform monitoring function fully supported

Display the voltage and current waveforms being measured The carrier frequency components of an inverter are also displayed in real time

- Filter function

A filter function is used to remove the carrier frequency components from the inverter, and fundamental wave frequency waveforms can be checked in the waveform display.

* The filter function is reflected in the measured values. Please be careful when you switch to the function during measurement.

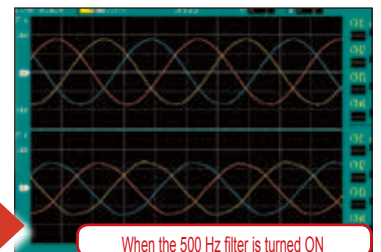
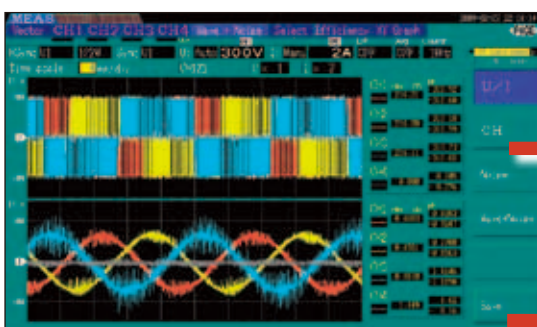

Waveform monitoring of carrier frequency

When the 500 Hz filter is turned ON

Geared for the latest motor evaluation and analysis of Hybrid Electric Vehicles, Electric Vehicles and the like

Drive the research and development of three-phase inverter motors with high accuracy and high-speed measurements

Advantages

1. Use of the MOTOR TESTING OPTION 9791 (9793) lets you perform a total evaluation of inverter motors
2. The voltage, torque, rotation, frequency, slip, and motor power required for motor analysis can be measured with one unit
3. Current sensors make the connection simple. In addition, use of the AC/DC CURRENT SENSOR enables measurements with superior accuracy

Proprietary HIOKI Technology

4. All data is measured simultaneously and updated every 50 ms. Data collection and characteristics tests can be performed at the industry's fastest speed
5. Evolution of electrical angle measurements critical to motor analysis has made it possible to perform more accurate measurements using an incremental encoder
6. Harmonic analysis at 0.5 Hz to 5 kHz without the need for an external timing mechanism
7. Built-in digital anti-aliasing filter (AAF) lets you measure the broadband power on the secondary side of inverters to make accurate harmonic analyses

Example of HEV and EV measurement systems

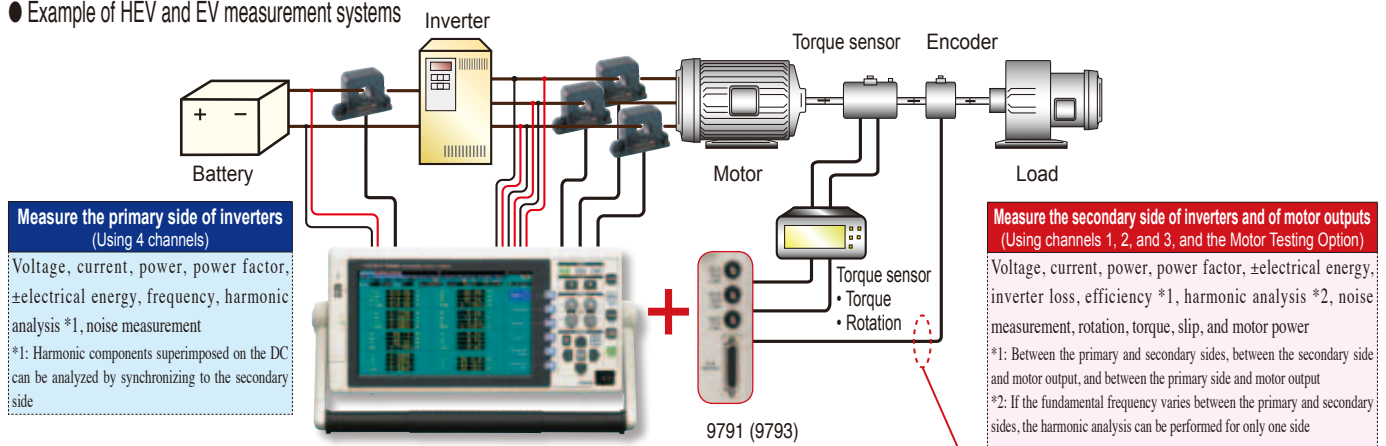

1 Evaluate high-performance vector control inverters:

- Measurements of fundamental wave voltage and current and their phases based on an accurate harmonic analysis are indispensable to motor analysis
- Support of an incremental encoder allows detecting synchronization signals from a motor easily and accurately

Electrical angle measurements are indispensable for dynamic characteristics analysis of motors. The 3390 can conduct FFT analyses synchronized to rotation pulses from the tachometer and the motor induced voltage, and the A-phase and Z-phase pulse inputs that allow measuring and detecting the origin of the motor more simply and accurately – fully meeting the needs of the latest motor analysis tests.

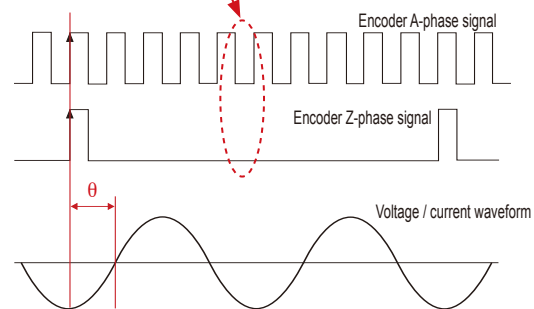
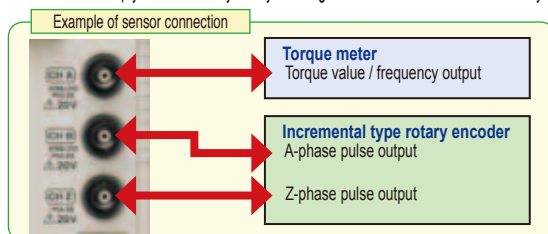

Application 1: "Electrical angle measurement"

- The voltage / current fundamental wave component " θ " from the machine angle origin can be calculated by performing harmonic analysis of motor input voltage / current by synchronizing to the A-phase signal and z-phase signal of an encoder.
- A function to perform zero compensation for this phase angle when a motor induced voltage is generated can be used to measure the voltage and current phase (electrical angle) in real time based on the induced voltage when the motor is started.

The importance of measuring the electrical angle of synchronous motors

The key to the performance of high-performance low-fuel consumption vehicles represented by HEV and EV is the synchronous motor that is used as the power source. The synchronous motor is finely controlled by alternating signals generated by an inverter device (DC to AC conversion) using the electricity from batteries.

What is a synchronous motor?

A synchronous motor rotates in synchronization with the AC frequency. Structurally, the motor is turned by the rotating force at the magnetic pole of the rotator (rotator magnetic pole), which is generated by the rotating magnetic field generated by applying an alternating current to the magnetic field (stator magnetic pole). The rotation speed is synchronized to the speed of the rotating magnetic field, so the

speed can be controlled by changing the speed of the rotating magnetic field (power supply frequency). In addition, high operating efficiency is one of the advantages of the synchronous motor.

Why is electrical angle measurement necessary?

In the case of a synchronous motor, a phase shifting occurs between the stator magnetic pole and the rotator magnetic pole due to a change in the load torque. This shifted angle and the torque force that can be generated by a motor have a close relationship, so it is important to understand this shifted angle (electrical angle) in order to achieve high-efficiency motor control.

The 3390 provides a more accurate measurement method

The 3390 supports the incremental encoder output in addition to the measurement methods of the HIOKI 3194 Power HiTESTER – enabling you to measure this electrical angle more easily and accurately.

2 Analyze harmonic signals from the low-speed rotation range of motors

- Harmonic analysis from a synchronization frequency of 0.5 Hz

Accurate measurements can be performed in the low-speed rotation range of motors without the need of an external clock.

If the synchronization frequency is 45 Hz or more, analysis results are updated every 50 ms, so data analysis can be performed in real time.

Synchronization frequency range	Window wave number	Analysis order
0.5Hz to 40Hz	1	100th order
40Hz to 80Hz	1	100th order
80Hz to 160Hz	2	80th order
160Hz to 320Hz	4	40th order
320Hz to 640Hz	8	20th order
640Hz to 1.2kHz	16	10th order
1.2kHz to 2.5kHz	32	5th order
2.5kHz to 5.0kHz	64	3rd order

- Analyze up to the 100th order

Synchronized to the fundamental wave frequency of 0.5 Hz to 5 kHz

Simultaneously perform analysis up to the 100th order harmonic along with power measurement

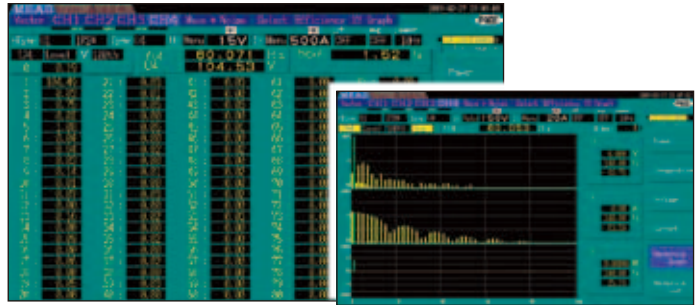

3 Vector display of electrical angles of motors

- Display vectors including that of the phase angle and electrical angle ($\Delta\theta$) of fundamental wave voltage and current. The measured data can be used as parameters to calculate the L_d and L_q values.



4 Clearly view the inverter efficiency/loss and motor power

- Output, efficiency, and loss of inverter motors can be measured with one single unit

Operating efficiency and power loss of the inverter and motor can be displayed when the inputs and outputs of the inverter are measured simultaneously.



5 X-Y graph display lets you check the dynamic characteristics of inverters

- X-Y graph display function built-in (X-axis: 1 item, Y-axis: 2 items)

By simply setting 2 items to the Y-axis as with a 6-axis graph used to evaluate motors, you can display the characteristics of a motor and similar devices in real time.

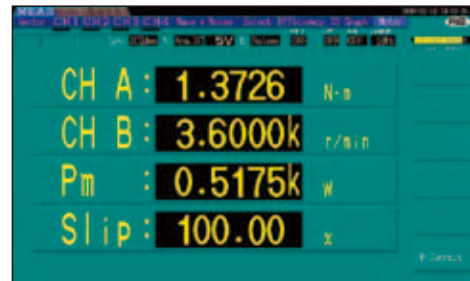
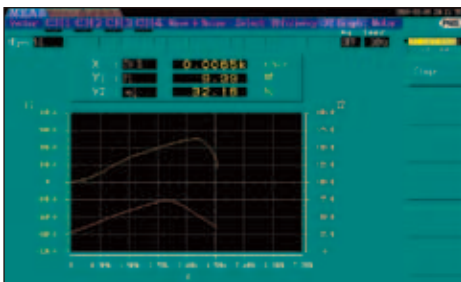

Application 2: Electrical angle measurement using induced voltage of motors (The same measurements conducted with the HIOKI 3194 can also be performed)

Correct the rotation synchronization signal and induced voltage phase of motors as well as measure the phase of voltage and current for the induced voltage of a running motor as an electrical angle.

Step 1: Turn the motor from the load side, and measure the induced voltage of the motor

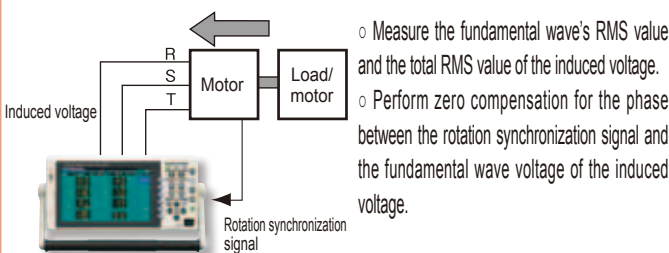

Step 2: Measurement of a running motor

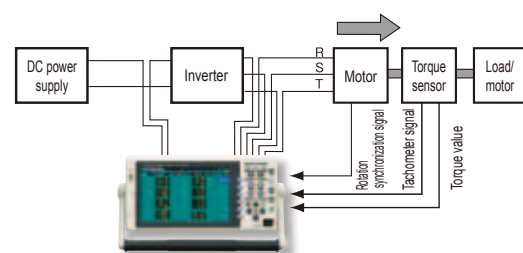

Other Advance Functionsmotor

- Frequency divider circuit (up to 1/60000 frequency dividing) – helpful when the rotation synchronization signal consists of multiple pulses for one cycle of induced voltage.
- Δ -to-Y conversation function - convert the line voltage to a phase voltage (virtual neutral reference) when three-phase three-wire (3P3W3M connection) measurements are performed.

- Measure the fundamental wave component, harmonic component, and electrical angle of line voltage and current of a line to the motor. (The measured data can also be used as parameters for calculation of L_d/L_q)
- Simultaneously measure motor efficiency, inverter efficiency, total efficiency, and inverter loss while observing the motor control.

Evaluate new energies such as solar power, wind power, and fuel cells

Assess power conditioners that are indispensable for converting new energies to electrical power

Advantages

1. The input and output characteristics of a power conditioner can be measured simultaneously in combination with an AC/DC current sensor
2. Use of a current sensor makes the connection simple. Make accurate measurements in combination with the AC/DC CURRENT SENSOR
3. The sale and purchase of electrical energy of a power line connected to a power conditioner can also be measured with one unit

Proprietary HIOKI Technology

4. Measure DC mode integration, which responds quickly to changes in the input of sunlight and the like, and RMS mode integration, which handles the separate integration of the sale and purchase of electric energy, all at the same time
5. Ripple factor, efficiency and loss, which are required to evaluate power conditioners for solar power generation, can be measured with one single unit.

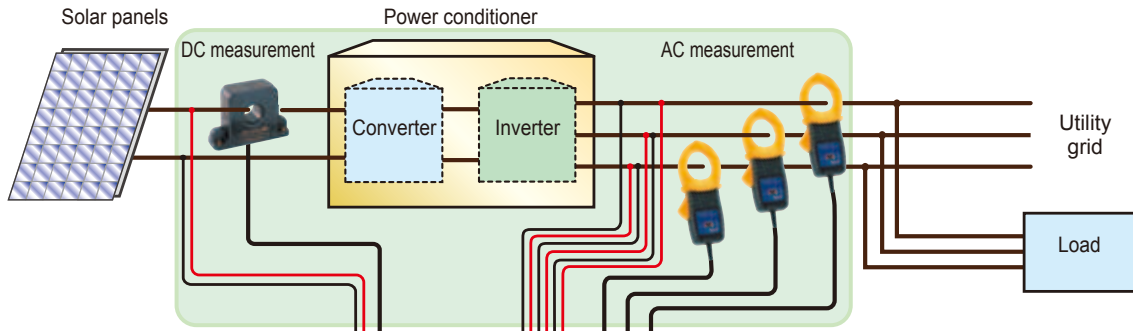

Solar panel output measurement (using the 4th channel)

Voltage, current, power, power factor, ±electrical energy, current waveform

Power conditioner output measurement (using the 1st, 2nd and 3rd channel)

Voltage, current, power, power factor, frequency, ±electrical energy, efficiency, loss, voltage/current waveform, harmonic analysis, voltage ripple factor, voltage disequilibrium factor (when measuring 3 voltages and 3 currents), voltage/current distortion factor

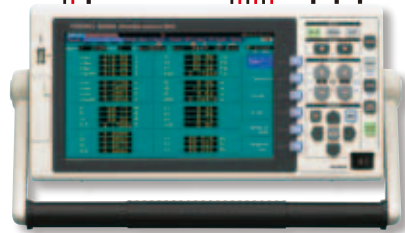

1 Conditioner-specific measurement items all measurable

• Power conditioner measurement-specific ripple factor and disequilibrium factor can also be measured and displayed simultaneously (up to 32 items can be displayed simultaneously), resulting in enhanced test efficiency

Display item	Measurement item
rms value	RMS (DC/AC voltage/current of input and output)
P, Q, S, λ values	Active power, reactive power, apparent power, power factor
Loss value	Input and output loss
η value	Efficiency
thd value	Distortion factor (voltage/current)
rf value	Ripple factor (for DC)
unb value	Disequilibrium
f value	Output frequency



Current trends in solar power generation

• Interconnected system of solar power generation and power conditioner
Electrical energy generated from the solar power generation is DC electrical energy, so it needs to be converted to AC electrical energy to be used by connecting to the utility grid. The device to convert direct current to alternating current is the power conditioner. In particular, to sell electrical energy by connecting to the utility grid, the performance of the power conditioner is important, so the method to evaluate the performance is specified by the national standards.

IEC standard

IEC 61683:1999, Photovoltaic systems -Power conditioners- Procedure for measuring efficiency

Evaluation and measurement of power conditioners

The IEC standard stipulates detailed measurement items to evaluate the input and output characteristics of power conditioners such as harmonic level, ripple factor, voltage disequilibrium factor, and voltage/current waveform.

• The 3390 supports a long list of measurement items including the specific ones required.

The 3390 can measure ripple factor and evaluate and analyze through simultaneous measurements.

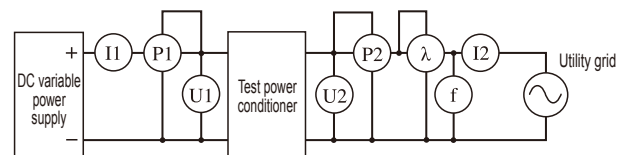

2 The efficiency (loss) and the amount of electrical energy sold and purchased can be displayed clearly

• Not only the amount of electricity generated with solar cells and the efficiency (loss) of a conditioner but also the amount of electrical energy sold and purchased by connecting to the utility grid can be measured simultaneously with one single unit



4 Accurately measure harmonics that are important for connecting to the utility grid

• The harmonic component and distortion factor important for connecting a power conditioner to the utility grid can be measured simultaneously. Synchronized to the fundamental frequency of 0.5 Hz to 5 kHz. Analyze up to the 100th order of voltage, current, and voltage harmonic, and display the current direction

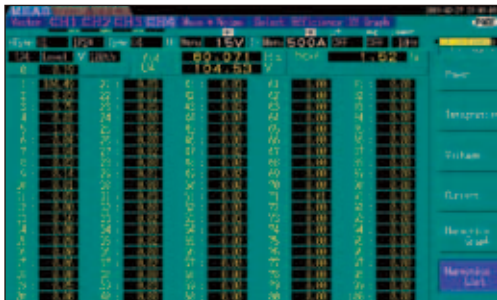

3 Check the input and output waveforms of a conditioner

• Simultaneously check the input and output waveforms of a conditioner at 500 kS/s. The input and output waveforms required to evaluate power conditioners can be checked simultaneously with one unit.

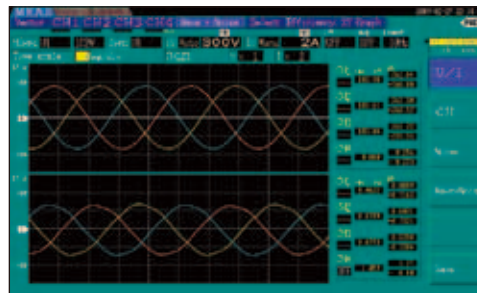

5 Also measure the noise flow of a connected utility grid

• Noise measurement function (1-channel measurement: Performed simultaneously with power measurement and harmonic analysis). Noise components at up to 100 kHz can be read while looking at the measured waveforms. Frequency and voltage/current levels for the top 10 points can be displayed simultaneously.

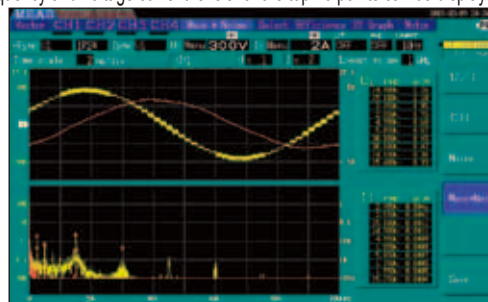

Bundled software dedicated to the 3390 (free download from the HIOKI website)

◆ Features

- Connect the 3390 to a PC via LAN or USB for completely remote operation
- Save measured data to the PC in real time (interval saving is also available)
- Download data stored in the USB memory or CF card
- Connect up to four 3390 Power Analyzers using the free software for remote operation and simultaneous data collection

■ General specifications	
Delivery media	Download from the HIOKI website
Operating environment	Windows 2000, XP, Vista, 7 PC Pentium III 500 MHz or higher CPU, 128 MB or more RAM, and LAN or USB interface Java Runtime Environment (JRE) 1.5.0 or later required
Communication method	Ethernet (TCP/IP), USB 1.1/2.0 For a USB connection, use the supplied dedicated driver (included with the software)
Number of simultaneously-connected units	4
■ Functions	
Remote operation function	Key operation and screen display on a PC
Download function	Downloads data stored on the media (Files in the USB memory or CF card)
Display function	Displays instantaneously measured values of the 3390 on the PC monitor Numerical display: Basic measurement items Waveform display: Instantaneous waveform data Bar graph: Harmonic Vector: Fundamental wave vector
Measured value save function	Saves the specified instantaneous value data to the PC Selects the item to save from the numerical value display items in the display function
Interval save function	Saves instantaneous value data to the PC at the specified interval
CSV conversion function	Saves the displayed waveform data in CSV format to the PC
BMP save function	Saves the displayed waveform and graph data in image format to the PC or copy images to the clipboard
Setting function	Sends the settings of the 3390 made on a PC to the 3390 Setting contents can be saved and loaded to and from a file

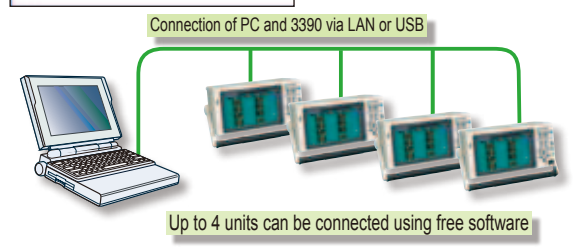

3390 Specifications

(Accuracy guarantee conditions: 23°C ±3°C, 80%RH or less, warm-up time 30 minutes or more, sinusoidal wave input, power factor 1, voltage to ground 0 V, in the range where the fundamental wave meets the conditions of the synchronization source after zero adjustment)

Input				
Measurement line	Single-phase two-wire (1P2W), single-phase three-wire (1P3W), three-phase three-wire (3P3W2M, 3P3W3M), three-phase four-wire (3P4W)			
Connection setting	CH1	CH2	CH3	CH4
Pattern 1	1P2W	1P2W	1P2W	1P2W
Pattern 2	1P3W		1P2W	1P2W
Pattern 3	3P3W2M		1P2W	1P2W
Pattern 4	1P3W		1P3W	
Pattern 5	3P3W2M		1P3W	
Pattern 6	3P3W2M		3P3W2M	
Pattern 7	3P3W3M			1P2W
Pattern 8	3P4W			1P2W
Number of input channels	Voltage: 4 channels U1 to U4 Current: 4 channels I1 to I4			
Input terminals	Voltage: Plug-in terminal (safety terminal) Current: Dedicated connector			
Input method	Voltage: Isolated input, resistance voltage dividing method Current: Isolated input using current sensor (voltage output)			
Measurement range	(Selectable for each connection, auto range available)			
Voltage range	15.000V / 30.000V / 60.000V / 150.00V / 300.00V / 600.00V / 1500.0V			
Current range	*400.00mA / *800.00mA / 2.0000A / 4.0000A / 8.0000A / 20.000A (20 A rating) 4.0000A / 8.0000A / 20.000A / 40.000A / 80.000A / 200.00A (200 A rating) 1.0000A / 2.0000A / 5.0000A / 10.000A / 20.000A / 50.000A (50 A rating) 10.000A / 20.000A / 50.000A / 100.00A / 200.00A / 500.00A (500 A rating) * Only UNIVERSAL CLAMP ON CT CT6841 is applicable			
Power range	Depends on combination of voltage and current range (6.0000 W to 2.2500 MW)			
Crest factor	3 (voltage/current), 1.33 for 1500 V			
Input method (50/60Hz)	Voltage input part: 2 MΩ ±40 kΩ (Differential input and isolated input) Current sensor input part: 1 MΩ ±50 kΩ			
Maximum input voltage	Voltage input part: 1500 V ±2000 V peak Current sensor input part: 5 V ±10 V peak			
Maximum rated voltage to ground	Voltage input terminal 1000 V (50/60 Hz) Measurement category III 600 V (Expected transient overvoltage 6000 V) Measurement category II 1000 V (Expected transient overvoltage 6000 V)			
Measurement method	Voltage and current simultaneous digital sampling and zero cross synchronization calculation method			
Sampling	500kHz / 16bit			
Frequency band	DC, 0.5 Hz to 150 kHz			
Synchronization frequency range	0.5Hz to 5kHz			
Synchronization source	U1 to U4 / I1 to I4 / Ext (with motor analysis option, CH B: when pulse is set) / DC (50 ms, 100 ms fixed) * Selectable for each connection (Zero cross auto follow-up by digital LPF when U / I), Filter resistance two-stage switching (high / low), source input 30% f.s. or more when U / I			
Data update rate	50ms			
LPF	OFF / 500 Hz / 5 kHz / 100 kHz (Selectable for each connection) When 500 Hz: Accuracy ±0.1% f.s. specified at 60 Hz or less When 5 kHz: Accuracy specified at 500 Hz or less When 100 kHz: Accuracy specified at 20 kHz or less (1%rdg. is added at 10k Hz to 20 kHz)			
Polarity determination	Voltage/current zero cross timing comparison method			
Polarity determination Measurement parameters	Voltage (U), current (I), active power (P), apparent power (S), reactive power (Q), power factor (λ), phase angle (φ), frequency (f), efficiency (η), loss (Loss), voltage ripple factor (Ufr), current ripple factor (Ifrr), current integration (Ih), power integration (WP), voltage peak (Upk), current peak (Ipk)			

Accurate Voltage, current, and active power measurements

Accuracy	Voltage (U)	Current (I)	Active power (P)
DC	±0.1%rdg±0.1% f.s.	±0.1%rdg±0.1% f.s.	±0.1%rdg±0.1% f.s.
0.5Hz to 30Hz	±0.1%rdg±0.2% f.s.	±0.1%rdg±0.2% f.s.	±0.1%rdg±0.2% f.s.
30Hz to 45Hz	±0.1%rdg±0.1% f.s.	±0.1%rdg±0.1% f.s.	±0.1%rdg±0.1% f.s.
45Hz to 66Hz	±0.05%rdg±0.05% f.s.	±0.05%rdg±0.05% f.s.	±0.05%rdg±0.05% f.s.
66Hz to 1kHz	±0.1%rdg±0.1% f.s.	±0.1%rdg±0.1% f.s.	±0.1%rdg±0.1% f.s.
1kHz to 10kHz	±0.2%rdg±0.1% f.s.	±0.2%rdg±0.1% f.s.	±0.2%rdg±0.1% f.s.
10kHz to 50kHz	±0.3%rdg±0.2% f.s.	±0.3%rdg±0.2% f.s.	±0.4%rdg±0.3% f.s.
50kHz to 100kHz	±1.0%rdg±0.3% f.s.	±1.0%rdg±0.3% f.s.	±1.5%rdg±0.5% f.s.
100kHz to 150kHz	±20% f.s.	±20% f.s.	±20% f.s.

* Voltage, current, and active power values at 0.5 Hz to 10 Hz are reference values
* Voltage and active power values more than 220 V at 10 Hz to 16 Hz are reference values
* Voltage and active power values more than 750 V at 30 kHz to 100 kHz are reference values
* Voltage and active power values more than (2200f/[kHz]) V at 100 kHz to 150 kHz are reference values
* Voltage and active power values more than 1000 V are reference values
* As for the current and active power values, add the accuracy of the current sensor to the above accuracy

Accuracy guarantee period	6 months (One-year accuracy is the above accuracy × 1.5) (Post-adjustment accuracy guaranteed for 6 months)
Temperature coefficient	±0.01% f.s. / °C (When DC: Add ±0.01% f.s./°C)
Effect of common mode voltage	±0.01% f.s. or less (When applying 1000 V (50/60 Hz) between the voltage input terminal and the case)
Effect of external magnetic field	±1.0% f.s. or less (in a magnetic field at 400 A/m, DC, and 50/60 Hz)

Effect of power factor	±0.15% f.s. or less (When power factor = 0.0 at 45 Hz to 66 Hz), add ±0.45% f.s. when LPF is 500 Hz
Effective measurement range	Voltage, current, and power: 1% to 110% of range
Display range	Voltage, current, and power: Range's zero suppress range setting to ±120%
Zero suppress range	Selects from OFF, 0.1% f.s., and 0.5% f.s. * When OFF is selected, a numerical value may be displayed even if zero is input
Zero adjustment	Voltage: ±10% f.s. Current: ±10% f.s. zero correction is performed for an input offset less than ±4 mV
Waveform peak measurement	Range: Within ±300% of respective voltage and current range Accuracy: Voltage and current respective display accuracy ±2% f.s.

Frequency measurement

Number of measurement channels	4 channels (f1, f2, f3, f4)
Measurement source	Selects from U / I for each input channel
Measurement method	Reciprocal method + zero cross sampling value correction
Measurement range	Within synchronization frequency range between 0.5 Hz and 5 kHz
Data update rate	50 ms (Depends on the frequency when 45 Hz or less)
Accuracy	±0.05%rdg, ±1dgt. (When sinusoidal waveform is 30% or more relative to the measurement range of measurement source)
Display range	0.5000Hz to 9.9999Hz / 9.900Hz to 99.999Hz / 99.00Hz to 999.99Hz / 0.9900kHz to 5.0000kHz

Integration measurement

Measurement mode	RMS / DC (Selectable for each connection, DC is only available when AC/DC sensor is used for 1P2W connections) RMS: Integrates the current RMS values and active power values, only the active values are integrated for each polarity DC: Integrates the current values and instantaneous power values for each polarity
Measurement item	Current integration (Ih+, Ih-, Ih), active power integration (WP+, WP-, WP) Ih+ and Ih- are available only in DC mode, and only Ih is available in RMS mode.
Measurement method	Digital calculation from each current and active power
Measurement interval	Data update rate of 50 ms
Display resolution	999999 (6 digits + decimal point)
Measurement range	0 to ±9999.99 TAh / TWh (Integration time is within 9999 h 59 m) If any integration value or integration time exceeds the above limit, integration stops.
Integration time accuracy	±50 ppm ±1 dgt. (0°C to 40°C)
Integration accuracy	±(Accuracy of current and active power) ± integration time accuracy
Backup function	If power fails during integration, integration resumes after power is restored

Harmonic measurement

Integration time accuracy	4 channels (Harmonic measurement for another line at a different frequency cannot be performed)		
Measurement item	Harmonic voltage RMS value, harmonic voltage percentage, harmonic voltage phase angle, harmonic current RMS value, harmonic current percentage, harmonic current phase angle, harmonic active power, harmonic power percentage, harmonic voltage/current phase difference, total harmonic voltage distortion factor, total harmonic current distortion factor, voltage disequilibrium factor, current disequilibrium factor		
Measurement method	Zero cross synchronous calculation method (All channels same window) with gap		
Synchronization source	U1 to U4 / I1 to I4 / Ext (Motor analysis option included, CHB: when pulse is set) / DC (50 ms/100 ms)		
FFT processing word length	32-bit		
Anti-aliasing filter	Digital filter (Variable by the synchronization frequency)		
Window function	Rectangular		
Synchronization frequency range	0.5 Hz to 5 kHz		
Data update rate	50 ms (Depends on the synchronization frequency when less than 45 Hz)		
Phase zero adjustment	Phase zero adjustment is possible by key / communication command (only when the synchronization source is Ext)		
Maximum analysis order	Synchronization frequency range	Window wave number	Analysis order
	0.5Hz to 40Hz	1	100th order
	40Hz to 80Hz	1	100th order
	80Hz to 160Hz	2	80th order
	160Hz to 320Hz	4	40th order
	320Hz to 640Hz	8	20th order
	640Hz to 1.2kHz	16	10th order
1.2kHz to 2.5kHz	32	5th order	
2.5kHz to 5.0kHz	64	3rd order	

Accuracy	Frequency	Voltage (U) / current (I) / active power(P)
	0.5Hz to 30Hz	$\pm 0.4\% \text{rdg} \pm 0.2\% \text{f.s.}$
	30Hz to 400Hz	$\pm 0.3\% \text{rdg} \pm 0.1\% \text{f.s.}$
	400Hz to 1kHz	$\pm 0.4\% \text{rdg} \pm 0.2\% \text{f.s.}$
	1kHz to 5kHz	$\pm 1.0\% \text{rdg} \pm 0.5\% \text{f.s.}$
	5kHz to 10kHz	$\pm 2.0\% \text{rdg} \pm 1.0\% \text{f.s.}$
	10kHz to 13kHz	$\pm 5.0\% \text{rdg} \pm 1.0\% \text{f.s.}$

* Not specified when the synchronization frequency is 4.3 kHz or more

Noise measurement (FFT processing)

Number of channels	1 channel (Selects one channel from CH1 to CH4)
Measurement item	Voltage/current
Calculation type	RMS spectrum
Measurement method	500 kHz/s sampling (Decimation after digital anti-aliasing filtering)
FFT processing word length	32-bit
Number of FFT points	1,000 points / 5,000 points / 10,000 points / 50,000 points (Linked to the waveform display record length)
Anti-aliasing filter	Digital filter auto (Variable by the maximum analysis frequency)
Window function	Rectangular / Hanning / flat top
Data update rate	Within about 400 ms to 15 s depending on the number of FFT points, with gap
Maximum analysis frequency	100kHz / 50kHz / 20kHz / 10kHz / 5kHz / 2kHz
Frequency resolution	0.2 Hz to 500 Hz (Determined by the number of FFT points and the maximum analysis frequency)
Noise value measurement	Calculates the levels and frequencies of voltage and current peaks (maximum values) for the top 10 points

MOTOR TESTING OPTION (Applicable to the 9791 and 9793)

Number of input channels	3 channels CH A: Analog DC input / frequency input (torque signal input) CH B: Analog DC input / pulse input (rotation signal input) CH Z: Pulse input (Z-phase signal input)
Input terminal form	Isolation type BNC connector
Input resistance (DC)	1 M Ω \pm 100 k Ω
Input method	Isolated input and differential input (No isolation between CH B and CH Z)
Measurement item	Voltage, torque, rotation, frequency, slip, motor output
Maximum input voltage	± 20 V (When analog / frequency / pulse)
Maximum rated voltage to ground	50 V (50/60 Hz)
Accuracy guarantee period	6 months (One-year accuracy is the accuracy below x 1.5) (Post-adjustment accuracy guaranteed for 6 months)
1. Analog DC input (CH A / CH B)	
Measurement range	± 1 V / ± 5 V / ± 10 V (When analog DC input)
Effective input range	1% to 110% f.s.
Sampling	10 kHz / 16-bit
Measurement method	Simultaneous digital sampling and zero cross synchronization calculation method (zero cross averaging)
Synchronization source	Same as the 3390 power measurement input specification (Common for CH A and CH B)
Accuracy	$\pm 0.1\% \text{rdg} \pm 0.1\% \text{f.s.}$
Temperature coefficient	$\pm 0.03\% \text{f.s.}/^\circ\text{C}$
Effect of common mode voltage	$\pm 0.01\% \text{f.s.}$ or less when applying 50 V (DC 50/60 Hz) between the input terminal and the 3390 case
Display range	Range's zero suppress range setting to $\pm 120\%$
Zero adjustment	Voltage $\pm 10\% \text{f.s.}$
2. Frequency input (only for CH A)	
Effective amplitude range	± 5 V peak
Measurement range	100kHz
Band width	1kHz to 100kHz
Accuracy	$\pm 0.05\% \text{rdg} \pm 3 \text{dgt.}$
Display range	1.000kHz to 99.999kHz
3. Pulse input (only for CH B)	
Detection level	Low: 0.5 V or less, High: 2.0 V or more
Measurement band	1 Hz to 200 kHz (When duty ratio is 50%)
Frequency divider setting range	1 to 60000
Measurement frequency range	0.5 Hz to 5.0 kHz (Specified by the frequency at which the measurement pulse is divided by the set frequency dividing number)
Minimum detection width	2.5 μs or more
Accuracy	$\pm 0.05\% \text{rdg} \pm 3 \text{dgt.}$
4. Pulse input (only for CH Z)	
Detection level	Low: 0.5 V or less, High: 2.0 V or more
Measurement band	0.1 Hz to 1 kHz
Minimum detection width	2.5 μs or more
Setting	OFF / ON (When ON, a frequency divider circuit of CH B is cleared by a rising edge)

D/A OUTPUT OPTION (Applicable to the 9792 and 9793)

Number of output channels	16 channels
---------------------------	-------------

Output content	Switchable between Waveform output / Analog output (selects from the measurement items) * Waveform output is only for CH 1 to CH 8
Output terminal form	D-sub 25-pin connector x 1
D/A conversion resolution	16-bit (Polarity + 15-bit)
Output voltage	Analog: DC ± 5 V f.s. (Max. about DC ± 12 V) Waveform output: 2 Vrms f.s., crest factor: 2.5 or more
Accuracy	Analog output: Measurement accuracy $\pm 0.2\% \text{f.s.}$ (DC level) Waveform output: Measurement accuracy $\pm 0.5\% \text{f.s.}$ (at RMS level, in synchronization frequency range)
Accuracy guarantee period	6 months (one-year accuracy is the above accuracy $\times 1.5$) (Post-adjustment accuracy guaranteed for 6 months)
Output update rate	Analog output: 50 ms (As per the data update rate of the selected item) Waveform output: 500 kHz
Output resistance	100 Ω ± 5 Ω
Temperature coefficient	$\pm 0.05\% \text{f.s.}/^\circ\text{C}$

Display

Display character	English / Japanese / Chinese (simplified characters)
Display	9-inch TFT color LCD display (800 \times 480 pixels)
LCD backlight	ON / Auto OFF (1min / 5min / 10min / 30min / 60min)
Display resolution	99999 counts (Integrated value: 999999 counts)
Display refresh rate	200 ms (Independent of internal data update rate; waveform and FFT depend on the screen)
Display screen	Measurement, Setting, File Manipulation screens

External interfaces

1. USB Interface (Function)

Connector	Series Mini-B receptacle
Electrical specification	USB2.0 (Full Speed / High Speed)
Number of ports	1
Class	Vendor specific (USB488h)
Destination	PC (Windows XP / Vista (32-bit version) / 7 (32-bit, 64-bit version))
Function	Data transfer, remote operation, command control

2. USB memory interface

Connector	USB type A connector
Electrical specification	USB2.0
Power supply	Up to 500 mA
Number of ports	1
Applicable USB memory	USB Mass Storage Class
Recordable items	Setting file: Save/Load Measured value/recorded data: Copy (from the CF card data) Waveform data: Save, screen hard copy

3. LAN interface

Connector	RJ-45 connector \times 1
Electrical specification	IEEE802.3 compliant
Transmission method	10BASE-T / 100BASE-TX auto recognition
Protocol	TCP/IP
Function	HTTP server (remote operation), dedicated port (port transfer, command control)

4. CF card interface

Slot	TYPE I \times 1
Usable card	Compact flash memory card (32 MB or more)
Applicable memory capacity	Up to 2 GB
Data format	MS-DOS format (FAT16 / FAT32)
Recordable items	Setting file: Save / Load Measured value / automatically recorded data: Save (in CSV format) Waveform data: Save, screen hard copy

5. RS-232C interface

Method	RS-232C, EIA RS-232D, CCITT V.24, JIS X5101 compliant
Connector	D-sub 9-pin connector \times 1
Recordable items	Full duplex asynchronous method Data length: 8, parity: none, stop bit: 1, Flow control: Hard flow, delimiter: CR+LF
Baud rate	9600, 19200, 38400 bps

6. Synchronization control interface

Terminal form	IN-side 9-pin round connector \times 1, OUT-side 8-pin round connector \times 1
Signal	5 V (CMOS level)
Maximum allowable input	± 20 V
Signal delay	Up to 2 μs (Specified by the rising edge)

Functions

1. Setting

Rectification switching	rms / mean (Selectable for the voltage/current of each connection) rms: Displays the true RMS value (True RMS) mean: Displays the average-value rectified RMS value
Auto range	OFF / ON (Voltage and current range is selectable for each connection)

Data save interval	OFF / 50 ms / 100 ms / 200 ms / 500 ms / 1 s / 5 s / 10 s / 15 s / 30 s / 1 min / 5 min / 10 min / 15 min / 30 min / 60 min * Maximum number of items to save can be specified by the setting (130 items/50 ms, up to 5000 items)				
	Interval time and maximum number of items to be saved		Auto-save (When using a 512 MB card)		
	Interval	Number of items	Number of items to save	Maximum period	
	50ms	130 (When 200 ms: 520)	10 40	About 2 days About 14 hours	
1s	2600 (5 s or more: 5000)	10 1000	About 42 days About 11 hours		
				1min	5000
Time control	OFF / Timer / Actual time When using Timer: 10 s to 9999 h 59 m 59 s (unit: 1 s) When using Actual Time: Start time / stop time (unit: 1 min)				
Scaling	VT ratio: OFF / 0.01 to 9999.99 CT ratio: OFF / 0.01 to 9999.99				
Averaging	Displays the averaged values of all instantaneously measured values including harmonic value (Excluding the peak value, integrated value, and noise value) * Averaged data applies to all data including the saved data during averaging				
Method	Exponential averaging (Applies to the data update rate of 50 ms)				
Response time	OFF / 0.2s (FAST) / 1.0s (MID) / 5.0s (SLOW) (Time within which to fall in the accuracy range when the input changes to 0% f.s. to 100% f.s.)				
Efficiency/loss calculation	Calculates the efficiency η [%] and loss [W] of active power for each connection and channel.				
Calculated item	Active power value (P) for each channel and connection Motor power (Pm) when the 9791 and 9793 Motor Analysis Option is included				
Calculation rate	Calculates and updates at a data update rate of 50 ms * The latest data of calculation is used for a calculation between connections whose synchronization sources are different				
Calculable factors	3 formats for the efficiency and loss, respectively				
Calculation algorithm	Calculated item is specified for Pin and Pout in the format below $\eta = 100 \times Pout / Pin $, $Loss = Pin - Pout $				
$\Delta - Y$ calculation	Converts line voltage waveform to phase voltage waveform using the virtual neutral point for 3P3W3M connection Uses a phase voltage to calculate all voltage parameters including harmonic or voltage RMS value				
Display hold	Stops and displays all displayed measured values and display update of waveforms				
Data update	Updates data when the hold key is manipulated, when the interval is reached, and when an external synchronization signal is detected				
Output data	D/A output, CF data save: Outputs the hold data (The waveform output continues, and the interval auto-save outputs data immediately before it is updated)				
Peak hold	Displays and updates the maximum value for each of all measured data (without waveform display and integrated value) (While averaging is performed, the maximum value is applied to the measured value after averaging. This cannot be used in conjunction with the Hold function)				
Data update	Data is cleared when the hold key is manipulated, when the interval is reached, and when an external synchronization signal is detected (Data is updated at an internal data update rate of 50 ms)				
Output data	D/A output, CF data save: Outputs the peak hold data (The waveform output continues, and the interval auto-save outputs data immediately before it is cleared)				
2. Display					
Connection check screen	Displays the connection diagram and the voltage/current vector diagram * The right connection range is displayed in the vector diagram, so the connection can be checked.				
Connection display screen	Displays measured power and harmonic values on channels 1 to 4 * The values are displayed for each measurement line pattern of combined connections				
DMM screen	Basic Measurement screen, Voltage Measurement screen, Current Measurement screen, Power Measurement screen				
Harmonic screen	Bar Graph screen, List screen, Vector screen				
Select/Display screen	Selects and displays any 4, 8, 16, or 32 measurement items from all basic measurement items Display pattern: 4 items, 8 items, 16 items, or 32 items (4 pattern switching)				
Efficiency/Loss screen	Displays the numerical values of efficient and loss set in the calculation algorithm Display pattern: 3 efficiency items, 3 loss items.				
Waveform & Noise Measurement screen	Displays the voltage/current waveforms sampled at 500 kHz in a compressed screen * Displays the waveform and noise measurement (FFT calculation) result when noise measurement is performed				
Trigger	Synchronization timing of harmonic synchronization source				
Record Length	1,000 points / 5,000 points / 10,000 points / 50,000 points x all voltage/current channels				
Compression Ratio	1/1, 1/2, 1/5, 1/10, 1/25, 1/50 (Peak-Peak compression)				
Recording time	Recording speed / Recording length	1,000 points	5,000 points	10,000 points	50,000 points
	500kS/s	2ms	10ms	20ms	100ms
	250kS/s	4ms	20ms	40ms	200ms
	100kS/s	10ms	50ms	100ms	500ms
	50kS/s	20ms	100ms	200ms	1000ms
	25kS/s	40ms	200ms	400ms	2000ms
	10kS/s	100ms	500ms	1000ms	5000ms
X-Y Plot screen	Selects items on the horizontal and vertical axes from the basic measurement items and displays them in the X-Y graph * The graph is drawn at the data update rate, data is not recorded, and drawing data is cleared				
Option	Horizontal axis: 1 item (with gauge display) Vertical axis: 2 items (with gauge display)				

Motor screen	Displays the measured values of the MOTOR TESTING OPTION 9791 (9793). Display pattern: Displays the numerical values of 4 items	
3. Data save		
Auto data save	Saves each measured value to the CF card at each interval	
Save destination	OFF / CF card (cannot be saved to the USB memory), the save destination folder can be specified	
Save itemAuto	Any item can be selected from all measured data, including harmonic value, and peak value of the noise measurement function	
Data format	CSV file format	
Manual data Save	Saves each measured value to each save destination when the SAVE key is pressed USB memory / CF card, the save destination folder can be specified	
Save destination	Any item can be selected from all measured data, including harmonic value, and peak value of the noise measurement function	
Save itemSave	Any item can be selected from all measured data, including harmonic value, and peak value of the noise measurement function	
Data format	CSV file format	
Screen hard copy	Saves the display screen to the save destination when the COPY key is pressed	
Save destination	USB memory / CF card * The save destination folder can be specified when USB memory or CF card is specified.	
Data format	Compressed BMP format (256 colors)	
Setting data save	Setting information can be saved and loaded to and from the save destination as a setting file (With the exception of language setting and communication setting)	
Save destination	USB memory / CF card (the save destination folder can be specified)	
4. External connected equipment		
Synchronized measurement	The 3390 master and 3390 slaves can be connected with synchronization cables to perform synchronized measurements * If the interval setting is identical, synchronized measurements can be saved automatically	
Synchronized item	Clock, data update rate (excl. noise measurement), integration start/stop, data reset, event	
Event item	Hold, manual save, screen copy	
Synchronization timing	Clock, data update rate, start/stop, data reset, event (During operation of the master by the key or via communication)	
Synchronization delay	Up to 5 μ s per connection, up to +50 ms per event	
5. System		
Display language	English / Japanese / Chinese	
Clock function	Auto Calendar, Auto Leap Year Adjustment, 24 Hour Meter	
Clock setting	Year, Month, Day, Hour, Minute Setting, Zero Second Adjustment	
Real time accuracy	Within ± 3 s / day (25°C)	
Beep tone	OFF / ON	
Screen color	COLOR1 / COLOR2 / COLOR3 / COLOR4 / MONO	
Start screen select	Connection screen / screen closed in the previous session (Measurement screen only)	
LCD backlight	ON / 1min / 5min / 10min / 30min / 60min	
Sensor recognition	Automatically recognizes the current sensor connected	
Alarm display	Voltage/current peak over threshold detection, synchronization source non-detection (Alarm mark on)	
Key lock	ESC key: ON/OFF by holding down the key for 3 seconds (Key lock mark on)	
System reset	Sets the equipment to the default (factory) settings (Communication settings are not changed)	
File manipulation	Media data list display, media formatting, new folder creation, folder file deletion, file copy between media	

General specifications

Operating location	Indoors, altitude up to 2000 m, contamination class 2
Storage temperature and humidity ranges	-10°C to 50°C, 80%RH or less (No dew condensation)
Operating temperature and humidity ranges	0°C to 40°C, 80%RH or less (No dew condensation)
Withstand voltage	For 1 minutes at 50/60 Hz AC5.312 kVrms: Between the voltage input terminal and the unit case AC3.32 kVrms: Between the voltage input terminal and the current input terminal / interface
	AC370 Vrms: Between the 9791 and 9793 input terminals (CH A, CH B, CH Z) and the unit case
	Between CH A and CH B / CH Z
Applicable standard	Safety: EN61010 EMC: EN61326, EN61000-3-2, EN61000-3-3
Rated power supply voltage	100 to 240 VAC (expected transient overvoltage of 2500 V), 50/60 Hz
Maximum rated power	140VA
Dimensions	340 W x 170 H x 157 D mm (13.39" W x 6.69" H x 6.18" D) (excluding protrusions)
Weight	4.8 kg (10.6 lb) (including the 9793)
Backup battery life	About 10 years (a reference value of a lithium ion battery used at 23°C to back up the clock, setting conditions, and integrated values)
Product warranty period	1 year

Basic calculation algorithms

Connection	1P2W	1P3W	3P3W2M	3P3W3M	3P4W
Voltage and current RMS value (True RMS value)	$X_{rms}(i) = \sqrt{\frac{1}{M} \sum_{s=0}^{M-1} X_{(i)s}^2}$	$X_{rms12} \text{ or } X_{rms34} = \frac{1}{2}(X_{rms(i)} + X_{rms(i+1)})$	$X_{rms123} = \frac{1}{3}(X_{rms1} + X_{rms2} + X_{rms3})$		
Voltage and current average rectified RMS indication value	$X_{mn}(i) = \frac{p}{2\sqrt{2}} \frac{1}{M} \sum_{s=0}^{M-1} X_{(i)s} $	$X_{mn12} \text{ or } X_{mn34} = \frac{1}{2}(X_{mn(i)} + X_{mn(i+1)})$	$X_{mn123} = \frac{1}{3}(X_{mn1} + X_{mn2} + X_{mn3})$		
Voltage and current alternating-current component	$X_{ac}(i) = \sqrt{(X_{rms}(i))^2 - (X_{dc}(i))^2}$				
Voltage and current mean value	$X_{dc}(i) = \frac{1}{M} \sum_{s=0}^{M-1} X_{(i)s}$				
Voltage and current fundamental wave component	Fundamental wave value X1(i) based on the harmonic calculation result				
Voltage and current peak value	Maximum value among X pk+(i) = X (i)s M Minimum value among X pk-(i) = X (i)s M				
Active power	$P(i) = \frac{1}{M} \sum_{s=0}^{M-1} (U_{(i)s} \times I_{(i)s})$	$P12 = P1+P2$ $P34 = P3+P4$	$P123 = P1+P2+P3$		
<p>* In the cases of 3P3W3M and 3P4W connections, phase voltage is used for the voltage waveform U (i)s.</p> <p>(3P3W3M: U1s = (U1s-U3s)/3, U2s = (U2s-U1s)/3, U3s = (U3s-U2s)/3)</p> <p>* The polarity symbols of active power P indicate the power direction when power is consumed (+P) and when power is regenerated (-P).</p>					
Apparent power	$S(i) = U(i)sI(i)$	$S12 = S1+S2$ $S34 = S3+S4$	$S_{12} = \frac{\sqrt{3}}{2}(S_1 + S_2)$ $S_{34} = \frac{\sqrt{3}}{2}(S_3 + S_4)$	$S123 = S1+S2+S3$	
<p>* Selects rms or mn for U(i) and I(i)</p> <p>* In the cases of 3P3W3M and 3P4W connections, phase voltage is used for the voltage U (i)</p>					
Reactive power	$Q(i) = \frac{1}{M} \sum_{s=0}^{M-1} (U_{(i)s} \times I_{(i)s} \sin(\theta))$	$Q12 = Q1+Q2$ $Q34 = Q3+Q4$	$Q123 = Q1+Q2+Q3$		
<p>* The polarity symbol si of reactive power Q indicates symbol [none], lag and symbol [-]: lead.</p> <p>* The polarity symbol si(i) is determined by lag or lead of voltage waveform U (i)s and current waveform I (i)s for each measurement channel (i), and in the cases of 3P3W3M and 3P4W connections, phase voltage is used for the voltage waveform U (i)s.</p>					
Power factor	$\lambda(i) = \frac{P(i)}{S(i)}$	$I_{12} = si12 \left \frac{P_{12}}{S_{12}} \right $	$I_{34} = si34 \left \frac{P_{34}}{S_{34}} \right $	$I_{123} = si123 \left \frac{P_{123}}{S_{123}} \right $	
<p>* The polarity symbol si of power factor λ indicates symbol [none], lag and symbol [-]: lead.</p> <p>* The polarity symbol si(i) is determined by lead or lag of voltage waveform U (i)s and current waveform I (i)s for each measurement channel (i), and si12, si34, and si123 are determined by the symbol of Q12, Q34, and Q123, respectively.</p>					

Connection	1P2W	1P3W	3P3W2M	3P3W3M	3P4W
Phase angle	$\varphi(i) = \arcsin \left(\frac{P(i)}{S(i)} \right)$	$f_{12} = si12 \cos^{-1} \left \frac{P_{12}}{S_{12}} \right $	$f_{34} = si34 \cos^{-1} \left \frac{P_{34}}{S_{34}} \right $	$f_{123} = si123 \cos^{-1} \left \frac{P_{123}}{S_{123}} \right $	
<p>The polarity symbol si(i) is determined by lead or lag of voltage waveform U (i)s and current waveform I (i)s for each measurement channel.</p> <p>si12, si34, and si123 are determined by the symbol of Q12, Q34, and Q123, respectively.</p>					
(i): Measurement channel, M: Number of samples between synchronization timings, s: Sample point number					

Motor analysis calculation algorithm

Item	Setting unit	Calculation algorithm
chA	V (DV voltage)	$\frac{1}{M} \sum_{s=0}^{M-1} A_s$
	N•m / mN•m / kN•m	When analog DC: A [V] × chA scaling setpoint
	common (torque)	When frequency: (Measurement frequency - fc setpoint) × rated torque setpoint / fd setpoint
M: Number of samples between synchronization timings, s: Sample point number		
chB	V (DC voltage)	$\frac{1}{M} \sum_{s=0}^{M-1} B_s$
	Hz (frequency)	When analog DC: B[V] × chB scaling setpoint
	r/min (rotation)	When pulse input: Pole number setpoint x pulse frequency / 2 × pulse number setpoint
Pm	N•m (unit of chA)	(Indicated value of chA) × 2 × π × (indicated value of chB) / 60
	mN•m (unit of chA)	(Indicated value of chA) × 2 × π × (indicated value of chB) / 60 / 1000
	kN•m (unit of chA)	(Indicated value of chA) × 2 × π × (indicated value of chB) × 1000 / 60
Calculation cannot be performed when the unit of chA is other than the above, or the unit of chB is other than r/min.		
Slip	Hz (unit of chB)	100 × input frequency - indicated value of chB / input frequency
	r/min (unit of chB)	100 × 2 × 60 × input frequency - indicated value of chB × pole number setpoint / 2 × π × input frequency
Selects the input frequency from f1 to f4		

Current sensors specifications

Model	9272-10	CT6841	CT6843	9279-01
Rated current	AC 20A/200A	AC/DC 20A	AC/DC 200A	AC/DC 500A
Maximum continuous input range	50A/300A rms	40A rms	400A rms	650A rms
Accuracy (45 to 66 Hz, DC: DC compatible sensor)	±0.3%rdg, ±0.01%f.s., ±0.2°	±0.3%rdg, ±0.01%f.s., ±0.1°		±0.5%rdg, ±0.05%f.s., ±0.2° (30 minutes after power is turned on and after magnetization)
Frequency characteristic	1Hz to 5Hz: ±2%rdg, ±0.1%f.s. 1kHz to 5kHz: ±1%rdg, ±0.05%f.s. 10kHz to 50kHz: ±5%rdg, ±0.1%f.s.	DC to 500Hz: ±0.3%max. 500Hz to 10kHz: ±1.5%max. 10kHz to 100kHz: ±5.0%max.	DC to 500Hz: ±0.3%max. 500 to 10kHz: ±1.5%max. 10kHz to 50kHz: ±5.0%max.	DC to 1kHz: ±1.0% (±0.5°) 1 k to 10 kHz: ±2.5% (±2.5°) 10 k to 20 kHz: ±5.0% (±5.0°)
Effect of conductor position	±0.2%rdg, or less (at 100A/55Hz input, using with the wire 10mm diameter)	Within ±0.1%rdg. (deviation from center)		±1.5%rdg, or less (DC, 55Hz)
Effect of external electromagnetic field	100mA or less (in an AC electromagnetic field of 400 A/m, 60Hz)	50mA equivalent or less (400A/m, 60Hz)		Max. 2A (400 A/m, 55Hz and DC)
Operating temperature and humidity	0°C to 50°C (-32°F to 122°F) 80%RH or less (No condensation)	-40°C to 85°C (-40°F to 185°F) 80%RH or less (No condensation)		0°C to 40°C (-32°F to 104°F) 80%RH or less (No condensation)
Measurable conductor diameter	φ 46mm (1.81")	φ 20mm (0.79")		φ 40mm (1.57")
Dimensions, mass	78W×188H×35Dmm(3.07"W×7.40"H×1.38"D), 430g(15.2 oz.)	153W(6.02")×67H(2.64")×25.5D(0.98")mm, 370g(12.3 oz.)		220W×103H×43.5Dmm(8.66"W×4.06"H×1.71"D), 470g(16.6 oz.)

Model	CT6862	CT6863	9709	CT6865
Rated current	AC/DC 50A	AC/DC 200A	AC/DC 500A	AC/DC 1000A
Maximum continuous input range	100A rms	400Arms	700A rms	1200A rms
Accuracy (45 to 66 Hz, DC: DC compatible sensor)	±0.05 %rdg, ±0.01 % f.s., ±0.2° (Right after power is turned on at DC and 16Hz to 400Hz)		±0.05 %rdg, ±0.01 % f.s., ±0.2° (10 minutes after power is turned on)	±0.05 %rdg, ±0.01 % f.s., ±0.2°
Frequency characteristic	DC to 16 Hz: ±0.1%rdg, ±0.02%f.s. (±0.3°) 5kHz to 10kHz: ±1%rdg, ±0.02%f.s. (±1.0°)		DC to 45Hz: ±0.2%rdg, ±0.02%f.s. (±0.3°) 5kHz to 10kHz: ±2%rdg, ±0.1%f.s. (±2.0°) 20kHz to 100kHz: ±30%rdg, ±0.1%f.s. (±30°)	DC to 16Hz: ±0.1%rdg, ±0.02%f.s. (±0.3°) 500Hz to 10kHz: ±5%rdg, ±0.05%f.s. 10kHz to 20kHz: ±30%rdg, ±0.1%f.s.
Effect to conductor position	±0.01%rdg, or less (50A input, DC to 100Hz, using with the wire 5mm diameter)	±0.01%rdg, or less (100A input, DC to 100Hz, using with the wire 10mm diameter)	±0.05%rdg, or less (at 100ADC input, using with the wire 10mm diameter)	±0.05%rdg, or less (1000A input, 50/60Hz, using with the wire 20mm diameter)
Effect of external electromagnetic field	10mA or less	50mA or less	50mA or less	200mA or less
Operating temperature and humidity	CT6862/CT6863/CT6865: -30°C to 85°C (-22°F to 185°F), 9709: 0°C to 50°C (-32°F to 122°F) 80%RH or less (No condensation)			
Measurable conductor diameter	φ 24mm (0.94")	φ 24mm (0.94")	φ 36mm (1.42")	φ 36mm (1.42")
Dimensions, mass	70W×100H×53Dmm (2.76"W×3.94"H×2.09"D), CT6862: 340g(12.0 oz.), CT6863: 350g(12.3oz.)		160W×112H×50Dmm (6.30"W×4.41"H×1.97"D), 9709: 850g(30.0oz.) CT9895: 1000g(35.3oz.)	

Note 1: Includes derating characteristics

Note 2: No phase precision regulations

POWER ANALYZER



POWER ANALYZER

Order Code: **3390**

Accessories: Instruction Manual x 1, Measurement Guide x 1, Power cord x 1, USB cable x 1, D-sub connector x 1 (when 9792 or 9793 is installed), Color label x 2

Ordering Information

Please purchase separately-sold voltage cord and current sensor for measurements. A HIOKI-issued PC card is also necessary in order to save measured data. Factory options cannot be installed after delivery.

Factory options (please specify at the time of order)



- MOTOR TESTING OPTION 9791
- D/A OUTPUT OPTION 9792
- MOTOR TESTING & D/A OUTPUT OPTION 9793

Options for voltage measurements



CAT III 1000V
CAT IV 600V

Voltage Cord L1000

Length : 3m (9.84ft); Red x 1, yellow x 1, blue x 1, gray x 1, and black x 4

Usage:

Indoor wiring in buildings and factories for measurements up to 1000 V; can also be used for internal voltage measurements of equipment up to 1000 V.

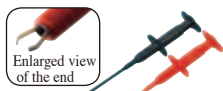

Enlarged view of the end

CAT III 1000V

Grabber Clip 9243

Red x 1, black x 1

Usage:

Attaches to the end of the Voltage Cord L1000 or L9438-50.



CAT III 1000V
CAT IV 600V

Voltage Cord L9438-50

Length : 3m (9.84ft); Red x 1, black x 1



WIRING ADAPTER PW9000

For 3P3W WIRING



WIRING ADAPTER PW9001

For 3P4W WIRING

Usage:

Reduce voltage cords for easy wiring.



3390Rear-view Voltage input terminals

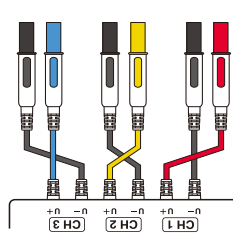

PW9000 or PW9001



PW9001 connection example When used with Model L1000

Note:

Dedicated PC application software and communication command manual are available for the 3390. Please download them from the HIOKI website.

Rack mounts available on special order. Please contact your local HIOKI office or distributor.

When using the 3390 with a DC power supply as in the case of on-vehicle measurements, a separate DC-AC converter is required.

Required DC-AC converter output specification
Output type : Sinusoid wave type, 50/60 Hz (60 Hz recommended)
Output capacity: The maximum power consumption of the 3390 is 140VA. Select a rating more than the capacity.

Options for current measurements

● AC/DC CURRENT SENSOR



CT6862 (AC/DC 50A)



CT6863 (AC/DC 200A)



9709 (AC/DC 500A)



CT6865 (AC/DC 1000A)

● CLAMP ON SENSOR



9272-10 (AC20/200A)

● AC/DC CURRENT PROBE



CT6841 (AC/DC 20A)

● AC/DC CURRENT PROBE



CT6843 (AC/DC 200A)

● UNIVERSAL CLAMP ON CT



9279-01 (AC/DC 500A)

PC Card



9729

Supplied with PC Card adapter

PC Card Precaution

Use only PC Cards sold by HIOKI. Compatibility and performance are not guaranteed for PC cards made by other manufacturers. You may be unable to read from or save data to such cards.

PC Card 512M 9728 (Capacity: 512 MB)

PC Card 1G 9729 (Capacity: 1 GB)

PC Card 2G 9830 (Capacity: 2 GB)

CARRYING CASE



CARRYING CASE 9794

Hard case dedicated to the 3390

448 W x 618 H x 295 D mm (17.64" W x 24.33" H x 11.61" D) (excluding protrusions)

Connection cables



CONNECTION CORD L9217

Length : 1.6 m (5.25 ft) length

Usage : For input of the 9791 and 9793



CONNECTION CABLE 9683

Length : 1.5 m (4.92 ft)

Usage : For synchronized measurement



LAN CABLE 9642

Length : 5 m (16.41 ft)

supplied with straight to cross conversion cable

Combination example

1. General measurements (Three-phase three-wire (3P3W3M) single-circuit)



POWER ANALYZER 3390 x 1



VOLTAGE CODE L9438-50 x 3



200A SENSOR 9272-10 x 3



PC CARD 1G (1GB) 9729 x 1



CARRYING CASE 9794 x 1

2. Inverter input and output evaluation and measurements (Three-phase three-wire (3P3W2M) two-circuit)



POWER ANALYZER 3390 x 1



VOLTAGE CODE L1000 x 1



500A SENSOR 9709 x 4



PC CARD 1G (1GB) 9729 x 1



CARRYING CASE 9794 x 1

3. Motor evaluation and measurements (DC input / three-phase motor evaluation (DC, 3P3W3M measurements))



POWER ANALYZER 3390 x 1



VOLTAGE CODE L1000 x 1



500A SENSOR 9709 x 4



PC CARD 1G (1GB) 9729 x 1



MOTOR TESTING & D/A OUTPUT OPTION 9793 x 1

Note: Company names and Product names appearing in this catalog are trademarks or registered trademarks of various companies.

HIOKI

HIOKI E. E. CORPORATION

HEADQUARTERS

81 Koizumi, Ueda, Nagano, 386-1192, Japan
TEL +81-268-28-0562 FAX +81-268-28-0568
http://www.hioki.com / E-mail: os-com@hioki.co.jp

HIOKI USA CORPORATION

TEL +1-609-409-9109 FAX +1-609-409-9108
http://www.hioki.com / E-mail: hioki@hioki.com

HIOKI (Shanghai) SALES & TRADING CO., LTD.
TEL +86-21-63910090 FAX +86-21-63910360
http://www.hioki.cn / E-mail: info@hioki.com.cn

HIOKI INDIA PRIVATE LIMITED
TEL +91-124-6590210
E-mail: hioki@hioki.in

HIOKI SINGAPORE PTE. LTD.
TEL +65-6634-7677 FAX +65-6634-7477
E-mail: info-sg@hioki.com.sg

HIOKI KOREA CO., LTD.
TEL +82-2-2183-8847 FAX +82-2-2183-3360
E-mail: info-kr@hioki.co.jp

DISTRIBUTED BY