

**HIOKI**

# MR8740T

MR8740-50

Instruction Manual

# MEMORY HiCORDER

Oct. 2021 Revised edition 4  
MR8740C964-04 21-10H

**EN**





# Contents

Introduction.....	1	Configuring Model 8968 High Resolution Unit settings.....	48
How to Refer to This Document .....	3	Configuring Model 8967 Temp Unit settings.....	49
<b>1 Measurement Method</b> .....	<b>5</b>	Configuring Model U8969 Strain Unit settings.....	51
1.1 Measurement Procedure.....	5	Configuring Model 8970 Freq Unit settings.....	53
1.2 Setting Measurement Conditions.....	7	Configuring Model 8971 Current Unit settings.....	56
Sampling rate setting guideline.....	9	Configuring Model 8972 DC/RMS Unit settings.....	57
1.3 Configuring the Input Channel settings.....	11	Configuring Model MR8990 Digital Voltmeter Unit settings .....	58
Analog channels .....	13	Configuring Model U8974 High Voltage Unit settings.....	60
Logic channels.....	17	Configuring Model U8977 3CH Current Unit Settings .....	61
1.4 Configuring the Sheet Settings.....	18	Configuring Model U8979 Charge Unit Settings .....	63
Switching sheets on the waveform screen .....	19	Configuring Model U8991 Digital Voltmeter Unit settings .....	66
1.5 Starting/Stopping Measurement.....	20	<b>3.7 Configuring Generator-Module-Specific Settings .....</b>	<b>67</b>
<b>2 Operating the Waveform Screen and Analyzing Data</b> .....	<b>21</b>	Generating signals from Model MR8790 Waveform Generator Unit.....	67
2.1 Reading Measured Values (Trace Cursors, Horizontal cursor).....	22	Configuring Model MR8790 Waveform Generator Unit setting.....	69
2.2 Displaying Vertical Scales (Gauge Function).....	27	Generating signals from Model MR8791 Pulse Generator Unit .....	71
2.3 Scrolling Through Waveforms .....	29	Configuring Model MR8791 Pulse Generator Unit settings .....	73
Scrolling through waveforms .....	29	Generating signals from Model U8793 Arbitrary Waveform Generator Unit.....	78
Checking a position of waveforms with the scroll bar.....	30	Configuring Model U8793 Arbitrary Waveform Generator Unit.....	80
2.4 Changing the Display Position and Display Magnification of Waveforms .....	31	Registering arbitrary waveforms in the U8793 Arbitrary Waveform Generator Unit.....	83
Differentiating the waveform display position and display magnification of each analog channel.....	32	Editing programs of the U8793 Arbitrary Waveform Generator Unit.....	88
2.5 Enlarging a Part of the Waveform (Zoom Function) .....	35	Configuring Model U8794 VIR Generator Unit settings .....	91
<b>3 Advanced Functions</b> .....	<b>37</b>	<b>4 Saving/Loading Data and Managing Files</b> .....	<b>99</b>
3.1 Overlaying New Waveforms With Previously Acquired Waveforms.....	38	4.1 Data That Can Be Saved and Loaded .....	100
3.2 Converting Input Values (Scaling Function) .....	40	4.2 Saving Data.....	101
When using Model U8969 Strain Unit.....	44	Saving types and setting procedure.....	101
3.3 Fine-Adjusting Input Values (Vernier Function).....	45	Automatically saving waveform data .....	102
3.4 Inverting a Waveform (Invert Function).....	46	Real-time save.....	106
3.5 Copying Settings (Copy Function).....	47	Freely selecting data items to be saved and save files (save icon).....	108
3.6 Configuring Measuring-Module-Specific Settings .....	48		

4.3	Loading Data.....	112
	Data loading procedure.....	112
	Automatically loading the settings (Auto-setup function).....	113
4.4	Managing Files .....	114

## **5 Configuring the Trigger Settings** 115

5.1	Trigger Setting Procedure .....	116
5.2	Enabling the Trigger Function.....	117
5.3	Trigger timing .....	118
5.4	Configuring the Pre-trigger settings..	120
5.5	Setting the Trigger Satisfaction Conditions (AND/OR Operation) Among Trigger Sources.....	123
5.6	Triggering the Instrument Using Analog Signals (Analog Trigger) .....	124
5.7	Triggering the Instrument With Logic Signals (Logic Trigger) .....	131
5.8	Triggering the Instrument at Regular Intervals (Interval Trigger) ..	133
5.9	Externally Triggering the Instrument (External Trigger).....	135
5.10	Manually Triggering the Instrument (Forcible Trigger) .....	135
5.11	Issuing an Alert Using Triggers (Alert Function) .....	136
5.12	Automatically Specifying the Trigger Level (Auto-trigger Level) ....	138

## **6 Search Function** 139

6.1	Searching For Peak Values .....	140
6.2	Searching For Positions Where a Trigger Condition Is Satisfied.....	142
6.3	Searching For Differences from a Fundamental Wave (Memory HiConcierge).....	146
6.4	Jump to the Specified Position .....	148

## **7 Numerical Calculation Function** 149

7.1	Numerical Calculation Procedure ....	150
7.2	Configuring the Numerical Calculation Settings .....	152
	Displaying numerical calculation results .....	163
7.3	Evaluating Calculation Results on a Pass/Fail Basis.....	164

	Displaying evaluation results and externally outputting signals .....	166
7.4	Numerical Calculation Types and Descriptions.....	167

## **8 Waveform Calculation Function** 175

8.1	Waveform Calculation Procedure ....	176
8.2	Configuring Waveform Calculation Settings .....	178
8.3	Operators of Waveform Calculation and Calculation Results	186

## **9 Memory Dividing Function** 191

9.1	Configuring the memory division settings.....	192
9.2	Displaying Waveforms .....	193

## **10 Configuring the System Environment Settings** 195

## **11 Connecting the Instrument to Computers** 199

11.1	Configuring the LAN Settings and Connecting the Instrument to the Network.....	200
	Configuring the LAN settings with the instrument .....	200
11.2	Managing Data in the Instrument With the FTP Server Function .....	204
	Configuring the FTP sever setting with the instrument.....	204
	Operating the instrument with your computer (FTP server function) .....	207
11.3	Sending Data to a Computer With the FTP Client Function.....	208
	Configuring an FTP server setting on a computer .....	209
	Configuring the FTP client setting with the instrument.....	213
11.4	Sending Email messages.....	214
	Configuring the basic setting for sending email messages.....	215
	Configuring the email contents settings ..	216



Configuring the authentication, compression, and encryption settings for email messages to be sent.....217

11.5 Controlling the Instrument with Command Communications (LAN) ..219

11.6 Operating the Instrument With a Browser Installed in a Computer .....221

**12 Externally Controlling the Instrument** 223

12.1 External Input and Output .....224

External input (IN1), (IN2) .....224

External output (OUT1), (OUT2).....225

Trigger output (TRIG.OUT).....227

External trigger terminal (EXT.TRIG) .....229

12.2 External Sampling (EXT.SMPL) .....231

**13 Appendix** 233

13.1 Information for Reference

Purposes.....233

Waveform file size (values for reference purposes) .....233

Maximum recordable time when the real-time save is enabled (values for reference purposes).....235

Scaling method for strain gauges .....237

Example of a waveform text file .....239

**Index** 241





# Introduction

Thank you for choosing the Hioki MR8740T Memory HiCorder (Model MR8740-50). Preserve this manual carefully and keep it handy to make full use of this instrument for a long time.

Following manuals are provided along with these models. Refer to manuals relevant to your purpose.

Type	Contents	Printed	PDF
<b>Operating Precautions</b>	Information on the instrument for safe operation	✓	–
<b>Quick Start Manual</b>	Basic instructions and specifications of the instrument	✓	–
<b>Instruction Manual (this document)</b>	Functions and instructions for the instrument	–	✓
<b>Instruction Manual U8793, MR8790, MR8791</b>	Functions, specifications, and instructions of Models U8793, MR8790, and MR8791.	–	✓

## Latest edition of instruction manual

The contents of this manual are subject to change, for example as a result of product improvements or changes to specifications.

The latest edition can be downloaded from Hioki's website.

<https://www.hioki.com/global/support/download>



## Intended audience

This manual has been written for use by individuals who use the product or provide information about how to use the product.

In explaining how to use the product, it assumes electrical knowledge (equivalent of the knowledge possessed by a graduate of an electrical program at a technical high school).

## Trademarks

- Microsoft, Windows, and Internet Explorer are either registered trademarks or trademarks of Microsoft Corporation in the United States and other countries.
- Other products and company names are trade names, registered trademarks, or trademarks of their respective owners.

## Notations

*	Additional information is presented below.
☑	Indicates the initial setting values of the items. Initializing the instrument restores settings to each of these values.
(p. )	Indicates the location of reference information.
<b>START</b> (Bold-faced)	Names and keys on the screen are shown in boldface.
[ ]	Menus, dialog boxes, buttons in a dialog box, and other names on the screen are indicated in brackets ([ ]).
Windows	Unless otherwise specified, "Windows" represents Windows 7, Windows 8, and Windows 10.
Current sensor	Sensors measuring current are referred to as "current sensor."
S/s	The number of times per second the analog input signals are digitized by the instrument is represented in "samples per second (S/s)." Example: "20 MS/s" (20 megasamples per second) indicates that the signal is digitized $20 \times 10^6$ times per second.

## Accuracy

We define measurement tolerances in terms of f.s. (full scale) and rdg. (reading) values, with the following meanings:

f.s.	(maximum display value or scale length) The maximum displayable value or scale length.
rdg.	(displayed value) The value currently being measured and displayed on the measuring instrument.
setting	(setting value) Indicates the value set as the output voltage, current, or other quantity.

# How to Refer to This Document

## How to open a screen

Indicates the order of clicking the screens.

The button  represents the setting key.

## Procedure numbers

Numbered same as a corresponding step-by-step instruction.

## Options and explanations

Describes options available when an item is clicked.

The icon  indicates the default setting of the item.

 > [Channel] > [UNIT]

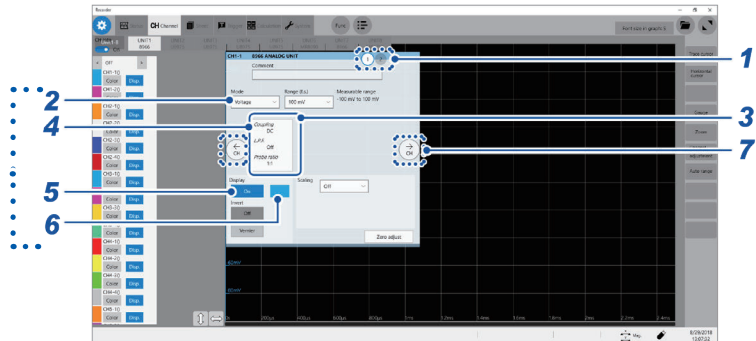

### 1 Type a comment in [Comment].

Number of characters that can be entered: up to 40

### 2 Select a measurement mode in [Mode].

<input checked="" type="checkbox"/> Voltage	Measures a waveform in voltage mode.
<input type="checkbox"/> Temperature	Measures a waveform in temperature mode.

The settings of these modes vary depending on the installed modules. Refer to "3.6 Specifying Module-Specific Settings" of Instruction Manual.

### 3 Select a measurement range in [Range (f.s.)] of each channel.

The measurement ranges that can be set varies depending on modules. If an input voltage exceeds the measurable range (overrange), change the measurement range to one with a lower sensitivity.



## 1.1 Measurement Procedure

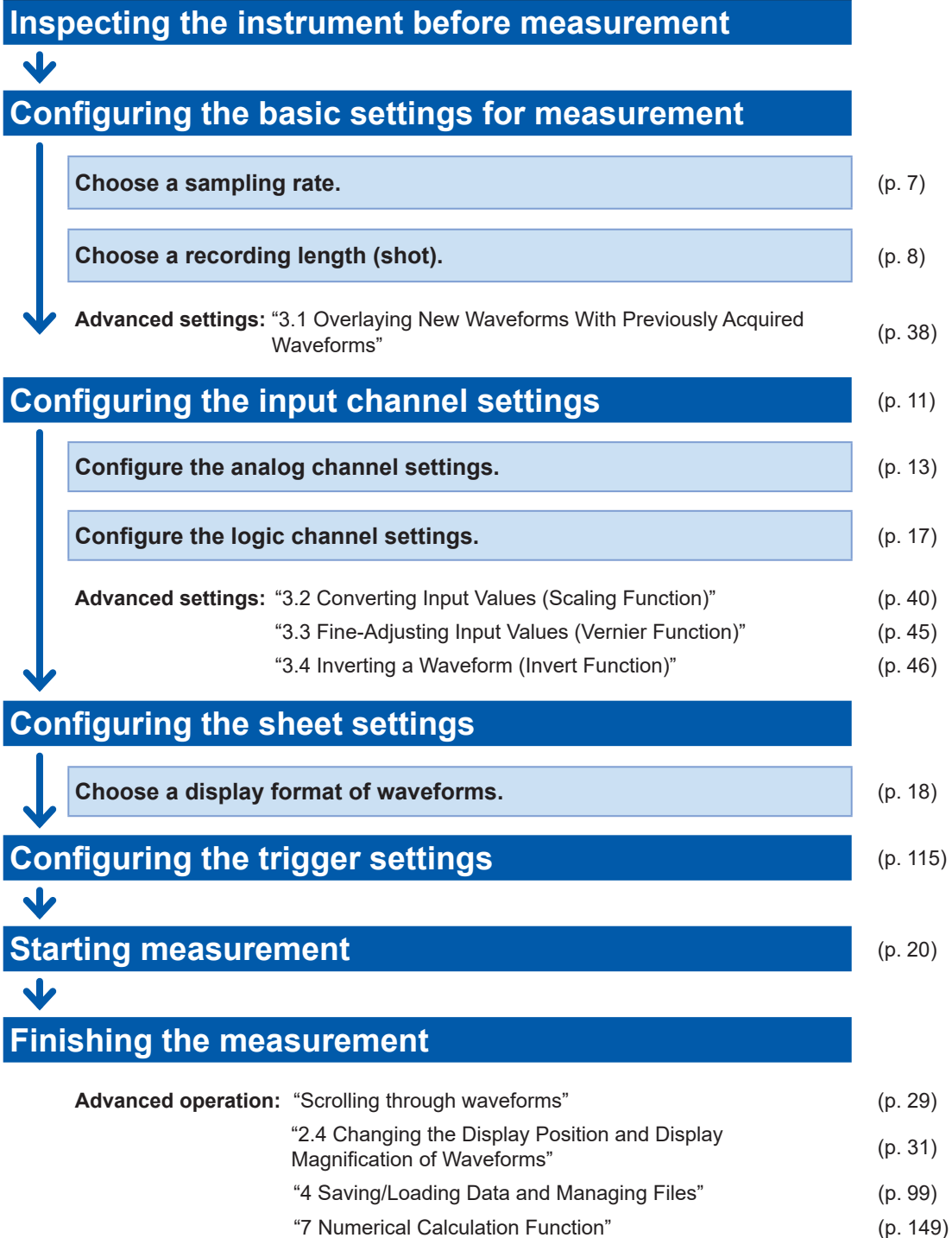

### **To configuring measurement settings automatically**

Clicking **[Auto range]** on the waveform screen automatically specifies the sampling rate, measurement range, and zero position of the input waveform and start a measurement. Refer to “3.7 Measuring Signals With the Auto-range Setting” of Quick Start Manual.

### **To load settings previously registered**

Load the settings file on the file screen.  
Refer to “4.3 Loading Data” (p. 112).

### **To automatically load saved settings at the time of startup**

Configure the setting for the instrument so as to load the file containing the instrument settings at the time of startup.  
Refer to “Automatically loading the settings (Auto-setup function)” (p. 113).

### **Initializing the instrument (Restoring the basic settings)**

Select  > **[System]** > **[Initialize]** to restore the instrument settings to the factory default.  
The setting after the initialization is suitable for simple measurement.  
If any unexpected or complicated behavior is observed, initialize the instrument.  
Refer to “6.2 Initializing the Instrument” in Quick Start Manual.



## 1.2 Setting Measurement Conditions

You have to set conditions required for measurement, such as the sampling rate ([Sampling]) and recording length ([Shot]).

 > [Status] > [Condition]

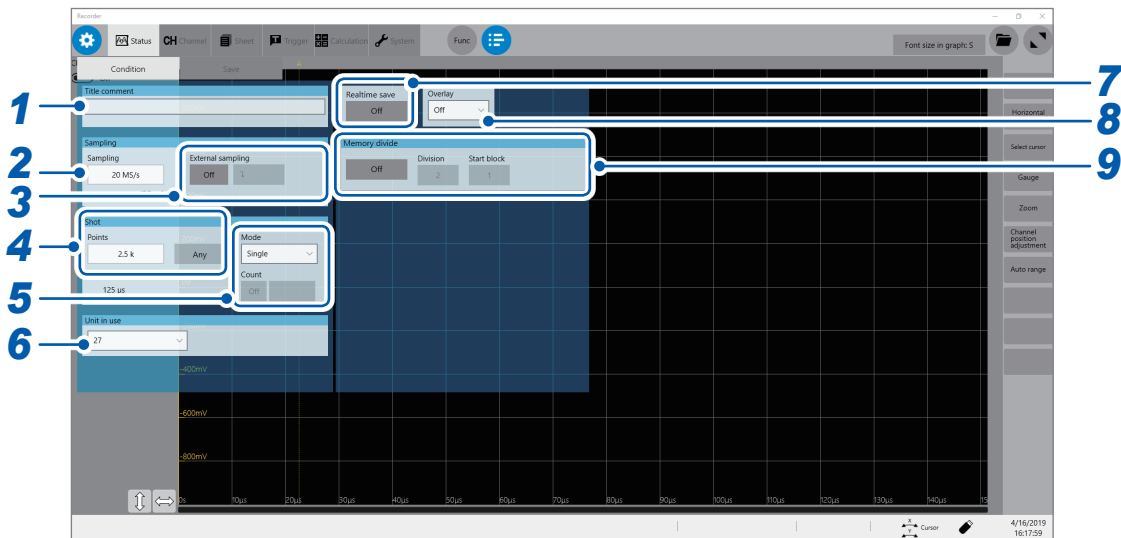

**1** Enter a comment in the [Title comment] box.

Number of characters that can be entered: up to 40

**2** Click the [Sampling] box, and then choose a sampling rate from the list.

Refer to “Sampling rate setting guideline” (p. 9).

20 MS/s, 10 MS/s, 5 MS/s, 2 MS/s, 1 MS/s,  
 500 kS/s, 200 kS/s, 100 kS/s, 50 kS/s, 20 kS/s, 10 kS/s, 5 kS/s, 2 kS/s, 1 kS/s,  
 500 S/s, 200 S/s, 100 S/s, 50 S/s, 20 S/s, 10 S/s, 5 S/s, 2 S/s, 1 S/s

When the real-time save is set to [On], due to the combination of the number of channels to be saved and save destinations, the maximum sampling rate that can be set varies as follows:

Maximum sampling rate that can be chosen	Destination to save	
	Built-in SSD	USB flash drive*
Number of channels to be saved		
12 channels or less	5 MS/s	1 MS/s
33 to 64 channels (SSD) 25 to 64 channels (USB flash drive)	2 MS/s	500 kS/s
13 to 32 channels (SSD) 13 to 24 channels (USB flash drive)	1 MS/s	200 kS/s
65 channels or more	500 kS/s	100 kS/s

(When Model U8991 is installed, double the number of its channels and find the maximum sampling rate.)

\*: Only if Model Z4006 USB Drive, a Hioki-designated option, is used, the real-time save operation with the instrument is guaranteed

**3** Click the **[External sampling]** button to set it to **[On]** or **[Off]**.

<b>Off</b> <input type="checkbox"/>	Disables the external sampling function.
<b>On</b>	Choose this option to sample data at a sampling rate defined by a signal inputted into the external control terminal (EXT.SMPL).

<b>↑</b>	Samples data at rising edges of the input signal.
<b>↓</b> <input type="checkbox"/>	Samples data at falling edges of the input signal.

**4** In the **[Shot]** area, click the **[Points]** box, and then choose an option for the number of points to be measured from the list.

<b>2.5 k</b> <input type="checkbox"/> , <b>5 k</b> , <b>10 k</b> , <b>20 k</b> , <b>50 k</b> , <b>100 k</b> , <b>200 k</b> , <b>500 k</b> , <b>1 M</b> , <b>2 M</b> , <b>5 M</b> , <b>10 M</b> , <b>20 M</b> , <b>50 M</b> , <b>100 M</b>
---

Enabling **[Any]** and clicking **[Points]** allows you to enter the number of points in 100 increments. When the real-time save is set to **[On]**, you cannot specify the recording length in the **[Points]** box. Choose **[Save]**, and enter the recording length in the **[Recording time]** box. (p. 107)  
 The maximum recording length you can specify varies depending on the number of modules to be used, the number of divided memories, and module types to be used.

**5** Click the **[Mode]** box, and then choose a recording mode from the list.

<b>Single</b>	Measures waveforms only once. Clicking the start icon starts recording waveforms, and then stops when recording-length waveforms have been acquired.
<b>Repeat</b> <input type="checkbox"/>	Measures waveforms repeatedly. Clicking the stop icon stops the measurement.

When you choose **[Repeat]** and set **[Count]** to **[On]**, measurements repeat the number of times entered in the **[Count]** box.  
 When **[Realtime save]** is set to **[On]**, you can choose **[Single]** mode only.

**6** Click the **[Unit in use]** box, and then choose the number of modules to be used for measurement from the list.

<b>27</b> <input type="checkbox"/>	Measures waveforms through all modules.
<b>16</b>	Measures waveforms through module 1 through module 16.
<b>8</b>	Measures waveforms through module 1 through module 8.
<b>4</b>	Measures waveforms through module 1 through module 4.

You cannot perform measurement across invalid units. Generator modules, however, can be used. Logic modules can be used only if the number of modules is set to **[27]**.

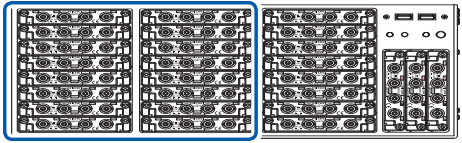
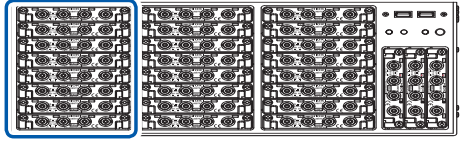
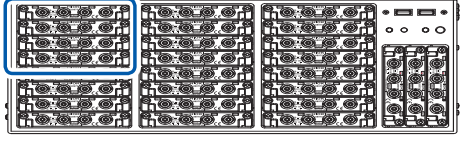
<p><b>16 modules</b></p> <p>Enables module 1 through module 16 installed in the slots shown in the right.</p>	
<p><b>8 modules</b></p> <p>Enables module 1 through module 8 installed in the slots shown in the right.</p>	
<p><b>4 modules</b></p> <p>Enables module 1 through module 4 installed in the slots shown in the right.</p>	

**7** Click the **[Realtime save]** button to set it to **[On]**.

The instrument can record data in the built-in SSD and a storage device while measuring waveforms. Refer to “Real-time save” (p. 106).

**8** Configure the overlaying setting.

Refer to “3.1 Overlaying New Waveforms With Previously Acquired Waveforms” (p. 38).

**9** Configuring the memory division settings

Refer to “Memory Dividing Function” (p. 191).

## Sampling rate setting guideline

Choose a sampling rate using the following table as a guideline.

Maximum display frequency	Sampling rate	Maximum display frequency	Sampling rate
800 kHz	20 MS/s	80 Hz	2 kS/s
400 kHz	10 MS/s	40 Hz	1 kS/s
200 kHz	5 MS/s	20 Hz	500 S/s
80 kHz	2 MS/s	8 Hz	200 S/s
40 kHz	1 MS/s	4 Hz	100 S/s
20 kHz	500 kS/s	2 Hz	50 S/s
8 kHz	200 kS/s	0.8 Hz	20 S/s
4 kHz	100 kS/s	0.4 Hz	10 S/s
2 kHz	50 kS/s	0.2 Hz	5 S/s
800 Hz	20 kS/s	0.08 Hz	2 S/s
400 Hz	10 kS/s	0.04 Hz	1 S/s
200 Hz	5 kS/s		

### If the instrument plots false waveforms (aliasing)

If a measured signal oscillates at a higher frequency compared to the sampling rate you choose, the instrument may plot a false waveform oscillating at a frequency lower than that of the actual signal once the signal frequency reaches a certain level. This phenomenon is called aliasing.

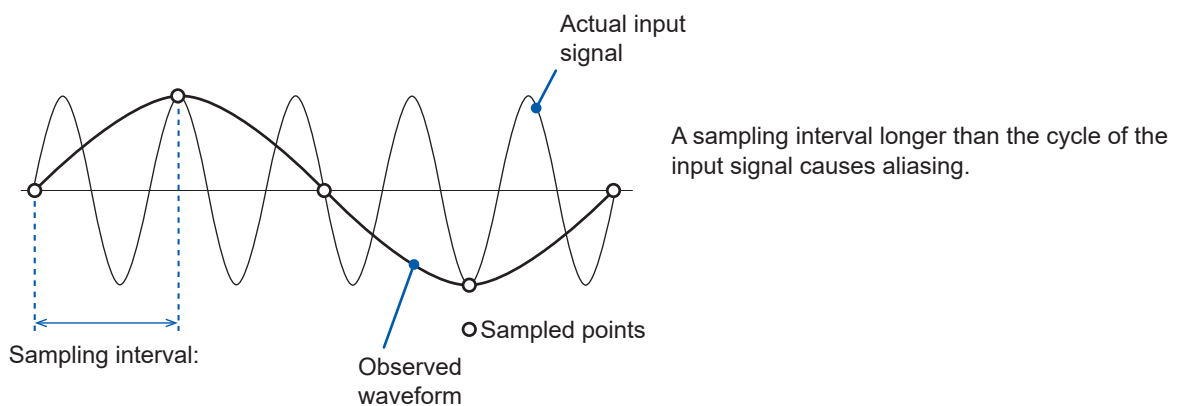

To plot a sign wave that allows you to observe the peaks without any aliasing, the instrument needs to sample the waveform at a minimum of 25 points per cycle.

## To set the sampling rate automatically

Refer to “3.7 Measuring Signals With the Auto-range Setting” of Quick Start Manual.

## Update rate of each module

The data refresh rate is not allowed to exceed the maximum sampling rate of each module.

The instrument measures the same data until the data gets updated, causing the instrument to plot a stair-step waveform.

In addition, even though the instrument measures the same signal simultaneously, values may vary due to differences in the sampling rate, frequency range, and frequency characteristics of modules.

Modules	Maximum sampling rate of module or data refresh rate	Reference page
Model 8966 Analog Unit	20 MS/s (50 ns)	–
Model 8967 Temp Unit	Depends on the data refresh setting.	p. 49
Model 8968 High Resolution Unit	1 MS/s (1 $\mu$ s)	–
Model U8969 Strain Unit	200 kS/s (5 $\mu$ s)	–
Model 8970 Freq Unit	Depends on the setting.	p. 53
Model 8971 Current Unit	1 MS/s (1 $\mu$ s)	–
Model 8972 DC/RMS Unit	Depends on the response setting.	p. 57
Model 8973 Logic Unit	20 MS/s (50 ns)	–
Model MR8990 Digital Voltmeter Unit	Depends on the NPLC setting.	p. 58
Model U8974 High Voltage Unit	Depends on the response setting.	p. 60
Model U8975 4ch Analog Unit	5 MS/s (200 ns)	–
Model U8977 3CH Current Unit	5 MS/s (200 ns)	–
Model U8978 4CH Analog Unit	5 MS/s (200 ns)	–
Model U8979 Charge Unit	200 kS/s (5 $\mu$ s)	–
Model U8991 Digital Voltmeter Unit	Depends on the NPLC setting.	p. 66

## 1.3 Configuring the Input Channel settings

Configure the settings of the analog and logic channels.

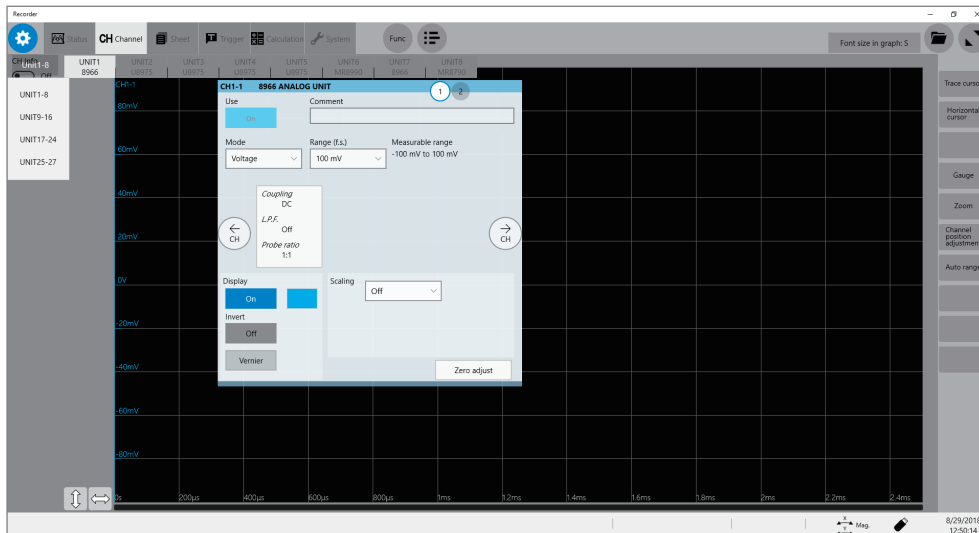

### Operation available on the [Channel] screen

- Adding a comment to each channel
- Setting measurement conditions for each channel
- Configuring the display method setting for waveforms
- Converting measured values into physical quantities and displaying them

## Channel setting procedure

### Analog channels (CH1 through CH108) setting procedure

#### Configuring the input settings

- 
- Choose a measurement mode. (p. 13)
  - Choose a measurement range for each measurement target. (p. 14)
  - Convert input values (scaling function). (p. 16)
  - Choose an input coupling method. (p. 15)
  - Choose a low-pass filter cutoff frequency (if noise is present). (p. 15)

#### Configuring the display settings

- 
- Select a waveform color. (p. 16)
  - Convert input values (scaling function). (p. 16)

### Logic channels (Model 8973 Logic Unit) setting procedure

#### Configuring the display settings

- 
- Choose a logic recording width. (p. 17)
  - Specify the display position of the waveform. (p. 17)
  - Select a waveform color. (p. 17)

## Analog channels

For details on configuring each module setting, refer to “3.6 Configuring Measuring-Module-Specific Settings” (p. 48).

 > [Channel] > each module (UNIT)

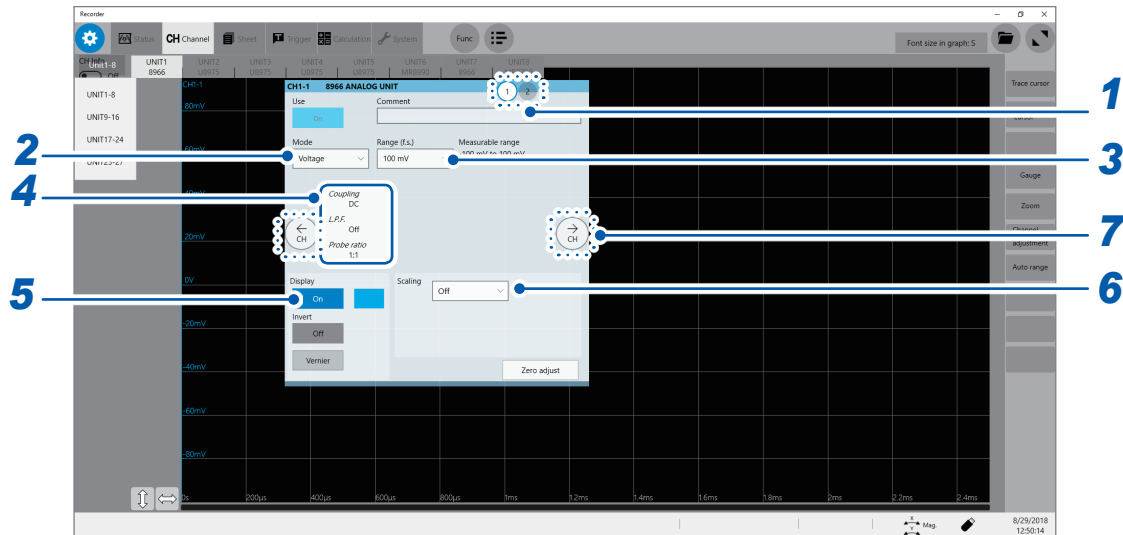

**1** Enter a comment in the [Comment] box.  
Number of characters that can be entered: up to 40

**2** Click the [Mode] box, and then choose a measurement mode from the list.

Voltage 	Measures a waveform in voltage mode.
Temperature	Measures a waveform in temperature mode.

Selectable modes vary depending on the installed modules.  
Refer to “3.6 Configuring Measuring-Module-Specific Settings” (p. 48).

**3 Click the [Range (f.s.)] box, and then choose a measurement range from the list.**

Select a measurement range for each channel. The value of the range represents its maximum displayable value (f.s.).

See the following table for the full-scale resolution of each module.

If the input voltage exceeds the measurable range (overrange occurs), change the measurement range to one with a lower sensitivity.

For Model MR8990 and Model U8991, starting a measurement using a high-sensitivity range with the input terminal open causes an input signal to be overrange.

After changing the measurement range, check values of the level, upper limit, lower limit, and other values of the trigger, search, and numerical calculation functions.

Module	Resolution (LSB)
Model 8966 Analog Unit Model 8971 Current Unit Model 8972 DC/RMS Unit	2,000
Model 8967 Temp Unit*	20,000
Model 8968 High Resolution Unit Model U8974 High Voltage Unit Model U8975 4ch Analog Unit Model U8977 3CH Current Unit Model U8978 4CH Analog Unit	32,000
Model U8969 Strain Unit Model U8979 Charge Unit	25,000
Model 8970 Freq Unit (Power frequency mode)	2,000
Model 8970 Freq Unit (Count mode)	40,000
Model 8970 Freq Unit (Frequency mode, rotation speed mode, duty ratio mode, pulse width mode)	10,000
Model MR8990 Digital Voltmeter Unit Model U8991 Digital Voltmeter Unit	1,000,000

\*: For the Model 8967 Temp Unit, the valid range varies depending on the thermocouples. For more information about resolution, refer to “Model 8967 Temp Unit” in “5.2 Specifications of the Options” in Quick Start Manual.



#### 4 Configure the input coupling, low-pass filter, and probe ratio settings.

Click the area that includes **[Coupling]** allows the setting dialog box to appear.

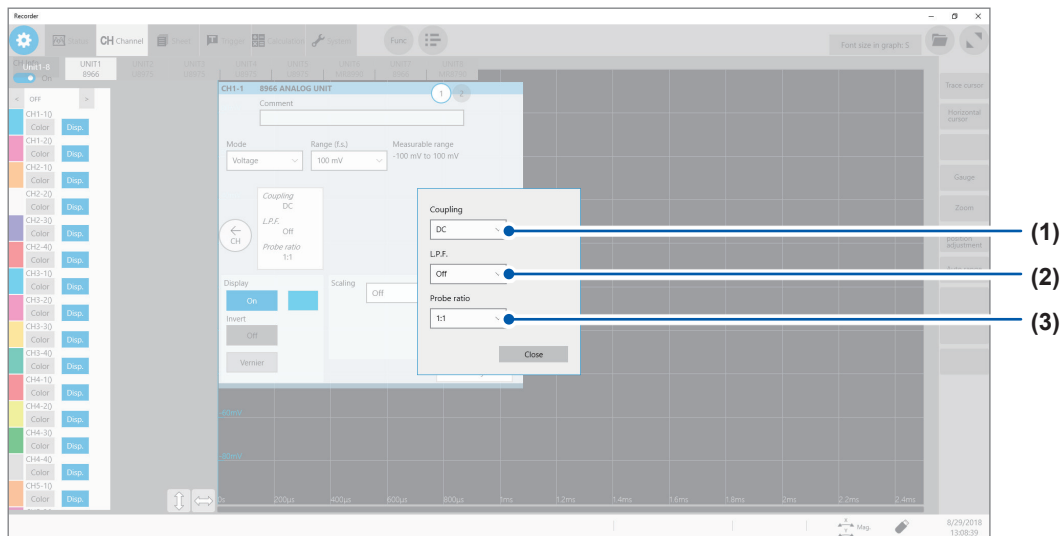

(1) Click the **[Coupling]** box, and then choose a coupling method for an input signal from the list.

Choose a coupling method for an input signal. In general, use the DC coupling.

<b>DC</b> <input checked="" type="checkbox"/>	Measures both DC and AC components of an input signal.
<b>AC</b>	Measures an AC component only of an input signal. A DC component can be eliminated.
<b>GND</b>	Connects the input terminal to the ground, which allows you to check the zero position.

(2) (1) Click the **[L.P.F.]** box, and then choose a cutoff frequency of the low-pass filter from the list.

Enabling the low-pass filter installed in the module can eliminate unwanted high-frequency components. The filters available vary depending on the module types. Use an adequate filter in accordance with the characteristics of an input signal.

Example: Model 8966 Analog Unit

<b>OFF</b> <input checked="" type="checkbox"/> , 5 Hz, 50 Hz, 500 Hz, 5 kHz, 50 kHz, 500 kHz
--

(3) Click the **[Probe ratio]** box, and then choose a probe ratio from the list.

Choose any of the ratios when the measurement involves use of a connection cord or probe.

<b>1:1</b> <input checked="" type="checkbox"/>	Choose this ratio when using Model L9197, Model L9198, Model L9790, or Model L9217 Connection Cord.
<b>1:10</b>	Choose this ratio when using Model 9665 10:1 Probe.
<b>1:100</b>	Choose this ratio when using Model 9666 100:1 Probe, Model P9000-01 Differential Probe, or Model P9000-02 Differential Probe.
<b>1:1000</b>	Choose this ratio when using Model 9322, Model P9000-01, or Model P9000-02 Differential Probe.

**5** Click the **[Display]** button to set it to **[On]** or **[Off]**.

<b>On</b> <sup>☑</sup>	Displays the waveform on the waveform screen.	
	Color	Allows you to choose a waveform display color. You can also choose the same color as lines acquired across other channels.
	<b>Invert</b> ( <b>Off</b> <sup>☑</sup> , <b>On</b> )	When the signs of displayed waveforms are reversed, the waveforms can be inverted. Refer to “3.4 Inverting a Waveform (Invert Function)” (p. 46).
	<b>Vernier</b>	Allows you to freely fine-adjust the input voltage on the waveform screen (display adjustment only). When recording physical values such as noise, temperature, and acceleration with sensors, you can adjust those amplitudes, facilitating calibration. Refer to “3.3 Fine-Adjusting Input Values (Vernier Function)” (p. 45).
<b>Off</b>	Does not display any waveform.	

**6** Configure the scaling settings.

Refer to “3.2 Converting Input Values (Scaling Function)” (p. 40).

**7** Switch the channels.

Click the corresponding location to switch the channels, and then set the measurement conditions by following the procedure above.

## Logic channels

The logic sheet appears when the screen is in Single, Dual, Quad, Octa, or Hexadeca mode.

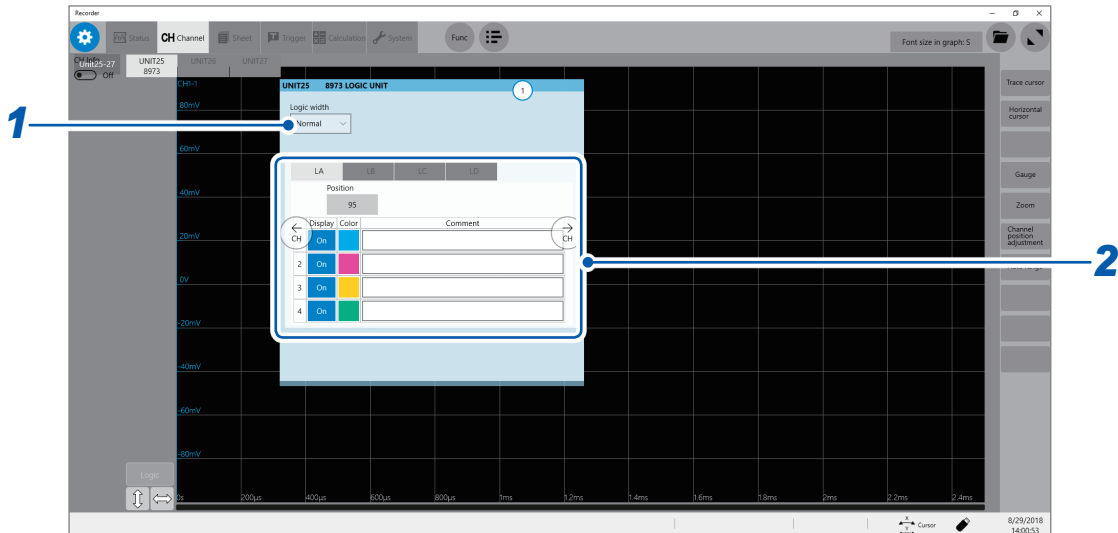

1

Measurement Method

- 1 Click the **[Logic width]** box, and then choose a display width for logic waveforms from the list.

Making waveforms narrower can enhance the readability of a display that contains a large number of waveforms.

This setting is a cross-module for all logic modules installed in the instrument.

<b>Wide</b>	Increases the width of the waveforms.
<b>Normal</b> <input checked="" type="checkbox"/>	Displays the waveforms in normal width.
<b>Narrow</b>	Reduces the width of the waveforms.

- 2 Choose a display method for each probe (LA through LD).

<b>Position</b>	Allows you to specify a numeral that represents a logic waveform position on the screen in one percent point increments. This setting is cross-probe for all probes (LA through LD). You can freely move display positions of the logic waveforms on the display.
<b>Display</b>	Allows you to choose whether to display logic waveform.
<b>Color</b>	Allows you to choose a waveform display color. You can also choose the same color as lines acquired across other channels.
<b>Comment</b>	Allows you to type a comment for each channel. Number of characters that can be entered: up to 40

# 1.4 Configuring the Sheet Settings

You can define the display format of waveforms on the sheet. You can define different display formats for each of the 16 sheets. You can also switch sheets to be displayed on the waveform screen.

 > [Sheet]

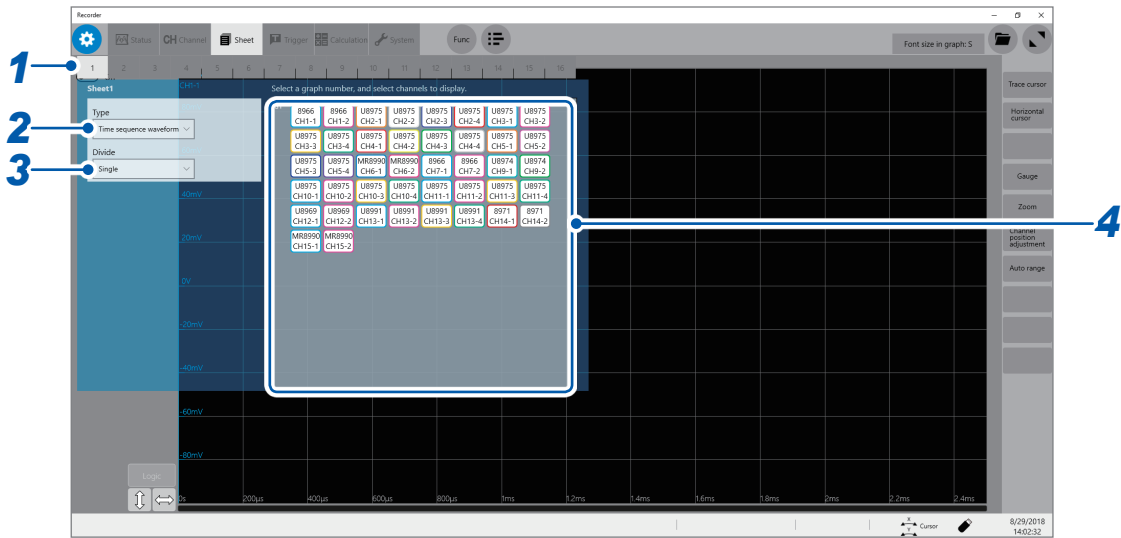

- 1 Choose a sheet.
- 2 Click the [Type] box, and then choose a display format from the list.

Time series waveform <input checked="" type="checkbox"/>	Displays time-domain waveforms.
Time series waveform <input type="checkbox"/>	Displays time-domain waveforms.
XY composite waveform <input type="checkbox"/>	Displays XY composite waveforms.

- 3 Click the [Divide] box, and then choose an option for the number of screens to be divided from the list.

You can split the screen into multiple screens (graphs).

Single , Dual, Quad, Octa, Hexadeca

- 4 Assign channels to the graph. Click the display panel of each graph to open the [Select the channel] dialog box.

**5 Choose channels to be displayed on the graph.**

All channels are chosen in the default setting. Click a button to deselect a channel (Click it again to select it).

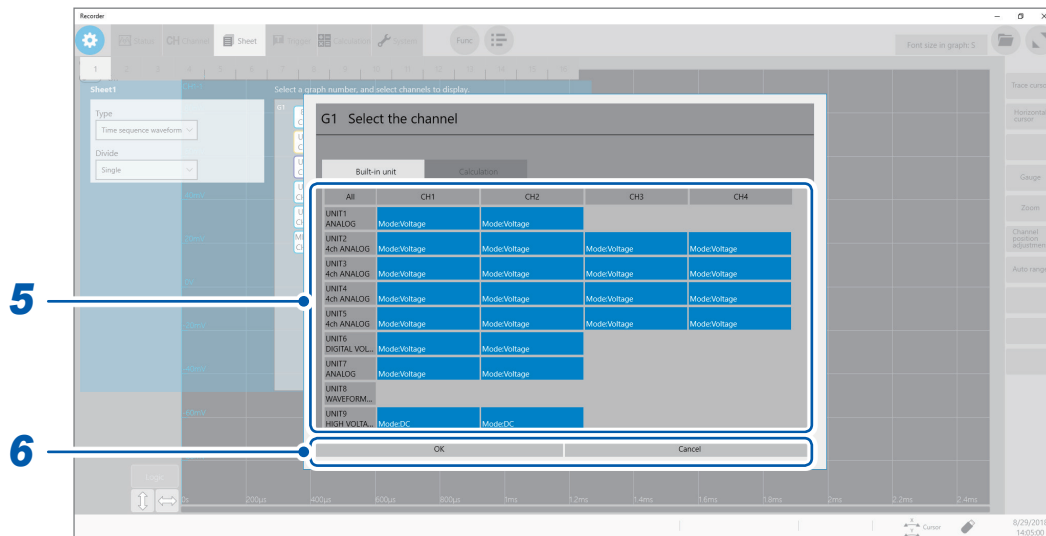

**6 Click [OK].**

Your selection is confirmed.

Clicking [Cancel] closes the dialog box without your selection confirmed.

**Switching sheets on the waveform screen**

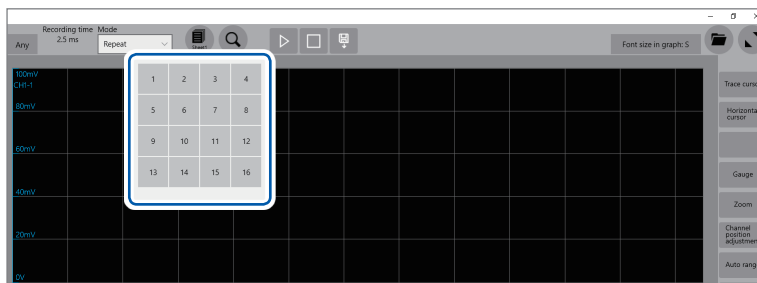

Choose sheet numbers to be displayed.

## 1.5 Starting/Stopping Measurement

### Starting a measurement

When you click the start icon, the instrument starts a measurement.

- Waveform data shown on the screen is cleared once the measurement starts.
- You can also start a measurement by inputting a signal into the external control terminal.

Refer to “12 Externally Controlling the Instrument” (p. 223).

### Waveform display during measurement

In general, the waveforms appear after data with the specified recording length has been acquired. When the measurement speed is relatively slow, the instrument displays waveforms while it is acquiring the data.

However, even if a slow-speed range is set, the instrument may display waveforms after it has been acquired the data of the whole waveform, depending on the overlaying or magnification setting.

### To automatically save data during measurement

Refer to “Automatically saving waveform data” (p. 102).

### Stopping the measurement

Clicking the stop icon once stops the measurement after the instrument has acquired the waveforms with the specified recording length.

Click the stop icon once and click **[OK]** on the dialog box displayed to stop the measurement.

# 2

# Operating the Waveform Screen and Analyzing Data

You can analyze measured data with various functions including cursor measurement of input waveforms and searches on the waveform screen. You can also change measurement conditions or other settings on this screen.

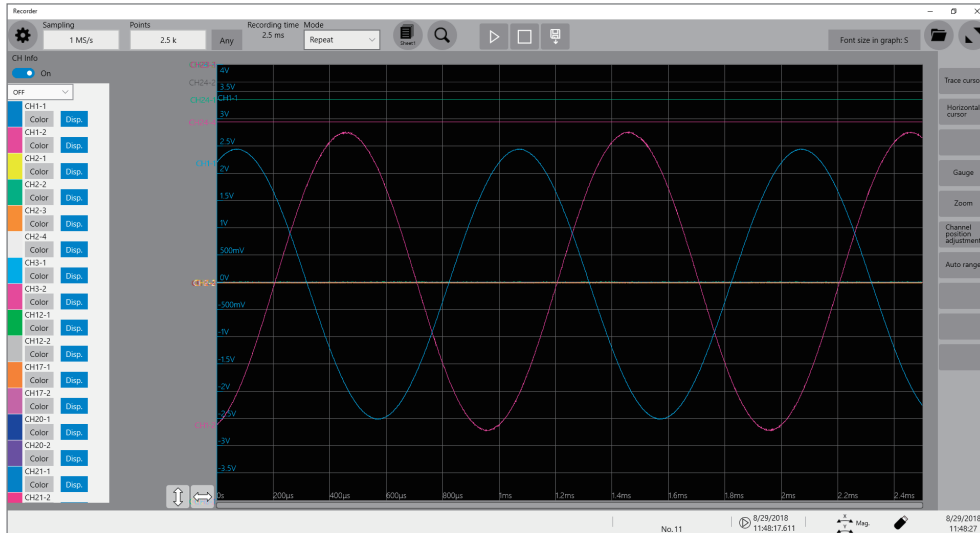

## Operation available on the waveform screen

### Using the trace cursors and horizontal cursors

- Reading measured values (p. 22)

### Changing the display magnification of waveforms

- Magnifying/demagnifying waveforms (p. 31)
- Magnifying a part of waveforms horizontally (p. 35)

### Moving the waveform display position

- Moving waveforms by dragging them
- Moving waveforms with the scroll bar

You can display or hide waveforms with **[CH Info]** set to **[On]**.

You can also change waveform color.

- Clicking **[Color]** allows you to change the waveform display color.
- Clicking **[Disp.]** toggles between showing and hiding a waveform.
- Right-clicking **[Disp.]** toggles between showing and hiding waveforms acquired across all channels.

Setting **[CH Info]** to **[Level Monitor]** allows display values of signals being inputted into measuring modules.

# 2



## 2.1 Reading Measured Values (Trace Cursors, Horizontal cursor)

You can read measured values (scaled values when the scaling is used) using cursors on the waveform screen.

The instrument can simultaneously display up to eight cursors, which contains the trace cursors and horizontal cursors.

You can read differences in measured values and time values between any two cursors you choose from among all cursors.

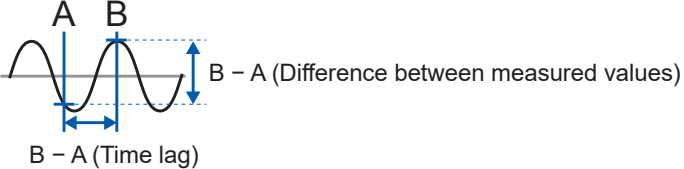
The display way of the cursor values varies depending on the chosen cursor type.

Cursor type	Cursor value
<b>Trace cursor</b>	<p>When you select trace cursor A and trace cursor B</p> <p>Time: Time between the trigger point or recording starting point and the trace cursor</p> <p>Measured value: The measured value at the point where a waveform crosses a trace cursor</p> <p>B-A: Difference in measured values between trace cursor B and trace cursor A</p> 
<b>Horizontal cursor</b>	<p>When you choose horizontal cursor A and horizontal cursor B</p> <p>Measured value: The vertical axis value at a horizontal cursor</p> <p>B - A: Difference in measured value along with vertical value between horizontal cursor A and horizontal cursor B</p> 

When the external sampling is used, the time is represented in the number of samples.



**For the trace cursors**

**1** Set [CH Info] toggle switch to [On].

Click [CH Info] toggle switch to switch between [On] and [Off] for the information display setting of each channel.

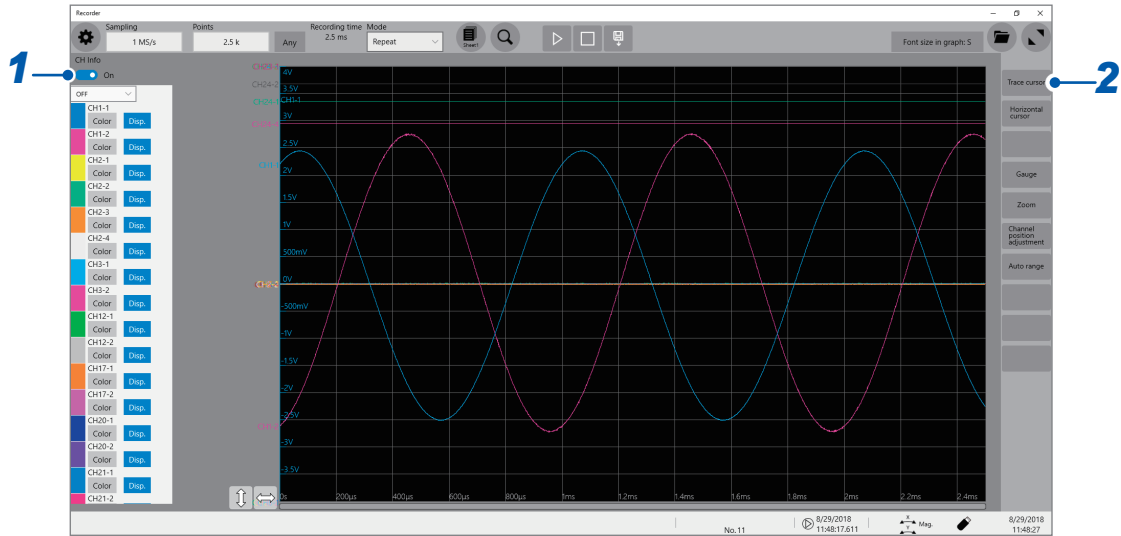

**2** Click [Trace cursor].

**3** Choose two cursors to be used from among [Trace cursor A] through [Trace cursor H].

You can simultaneously use up to eight cursors.  
The chosen trace cursors are displayed on the waveform screen.  
Drag the trace cursors on the waveform screen to move them.

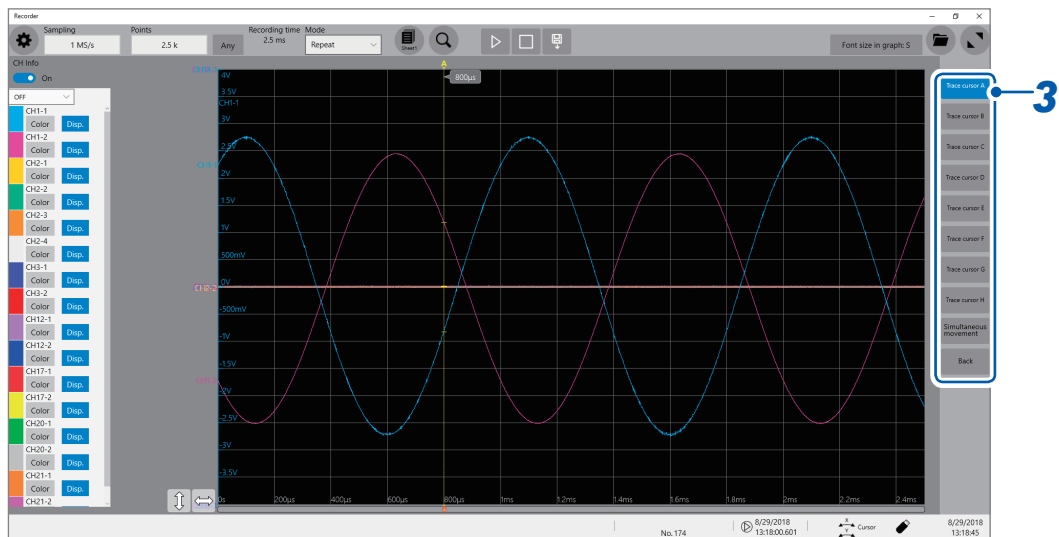

**2**

Operating the Waveform Screen and Analyzing Data

4 Click  under the [CH Info] toggle switch, and then choose [Trace Cur.] from the list.

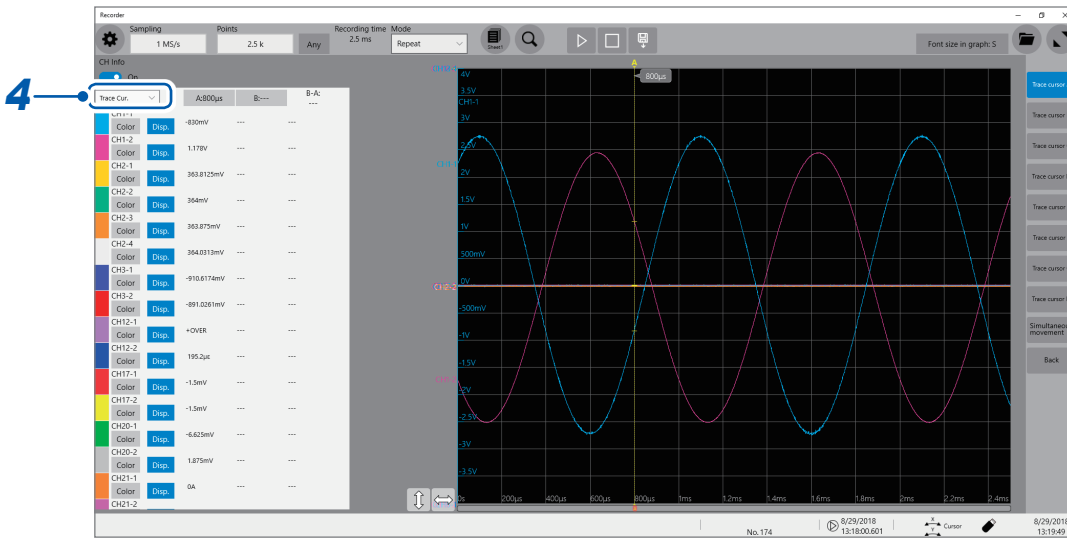

5 Click a trace cursor of which you want to display the value.

You can choose up to two cursors from among trace cursor A ([Trace cursor A]) and trace cursor H ([Trace cursor H]).

(Default setting: [Trace cursor A], [Trace cursor B])

The instrument displays differences between cursors you choose in **a**.

If you choose a trace cursor other than the one chosen in step 3, the instrument displays the strings [---] in the difference field.

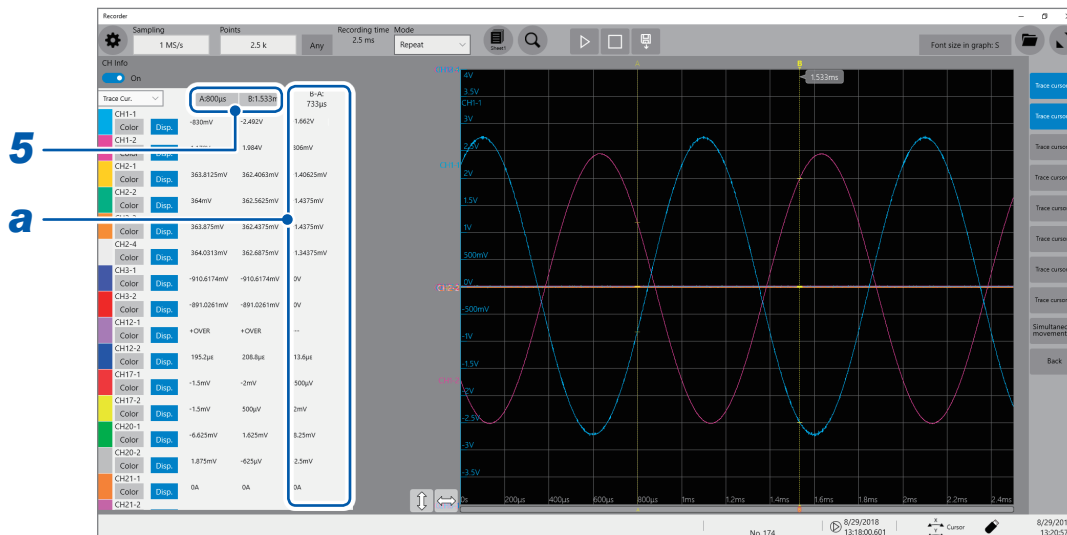

## Changing the display magnification of waveforms while moving the trace cursor

Sliding the mouse upward on the screen while dragging the trace cursor enlarges the waveform display centered around the trace cursor in proportion to the dragging distance.

Sliding the mouse downward compresses the waveform display.

Once you have the magnification to a suitable size, horizontally moving the trace cursor changes the the cursors display position.

Stopping dragging the trace cursor reverts the display to the original magnification.

## To move the cursors precisely

Choose a cursor and rotate the wheel button upward or downward to move the cursor in one sample increments.

## If no trace cursors appear on the screen even though the trace cursors are enabled

You can check the trace cursors positions on the scroll bar. (p. 30)

### For the horizontal cursors

Configure the setting in the same way as the trace cursor.

- 1** Set **[CH Info]** toggle switch to **[On]**.
- 2** Click **[horizontal cursor]**.
- 3** Choose two cursors to be used from among **[Horizontal cursor A]** through **[Horizontal cursor H]**.
- 4** Choose **[Horizontal Cur.]** from the drop-down list.

After that, configure the horizontal cursor setting by following the procedure of the trace cursor setting beginning from step **5**.

## How to read cursor values

### For the trace cursors

- Choose trace cursors the value of which is to be displayed at **1** and **2**.  
The time values of chosen trace cursors are displayed on the waveform screen.
- The difference in time values of chosen trace cursors (the time at **2** minus that at **1**) is displayed at **3**.

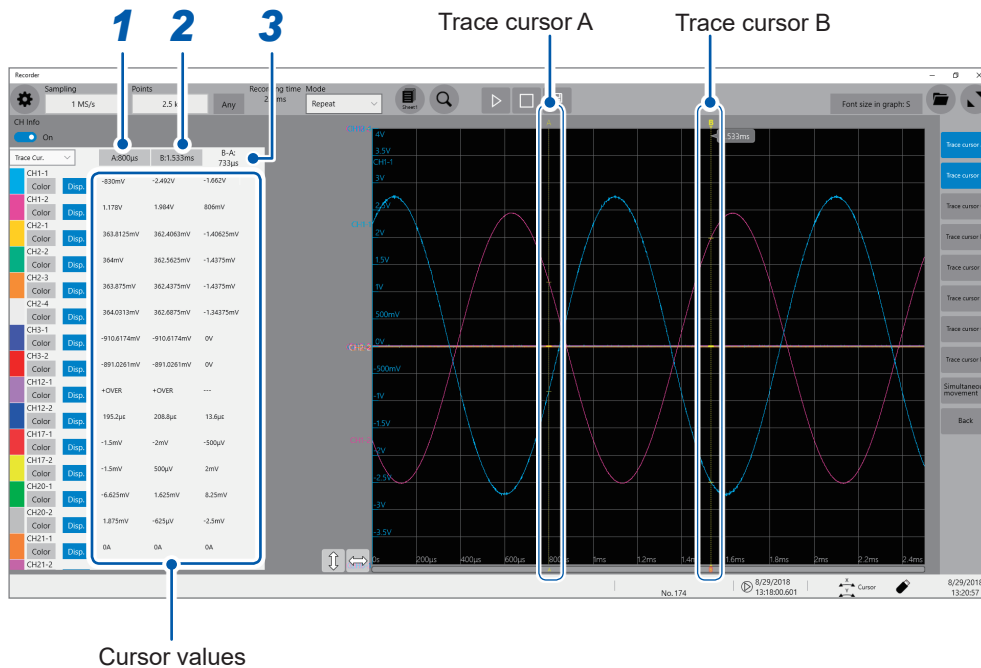

### For the horizontal cursors

- Choose horizontal cursors the values of which are to be displayed at **1** and **2**.
- The difference in measured values of chosen horizontal cursors (the value at **2** minus that at **1**) is displayed at **3**.

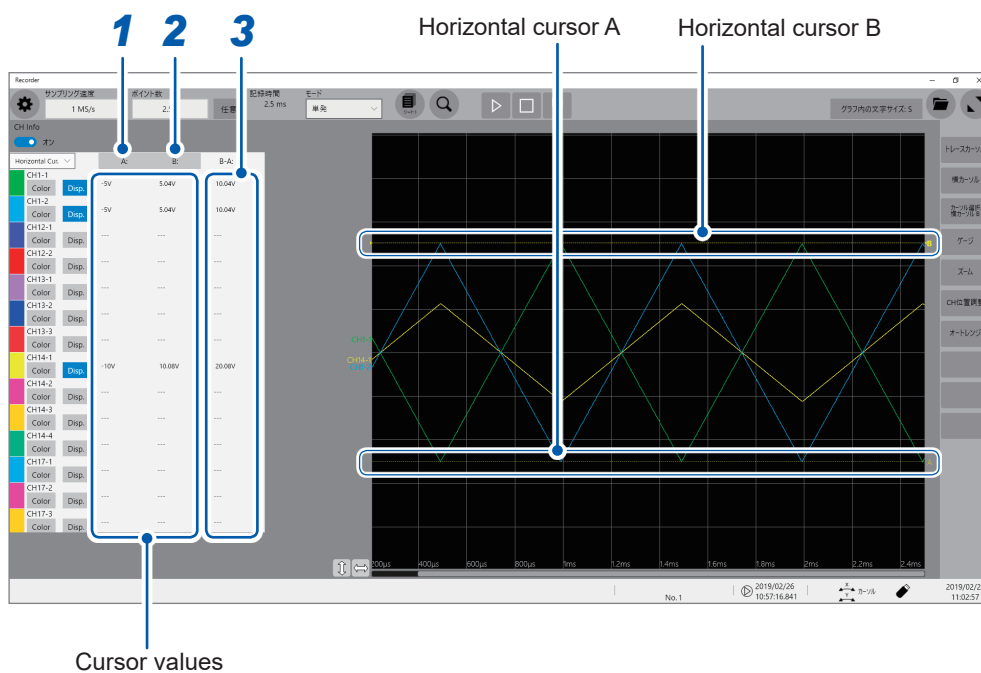

## 2.2 Displaying Vertical Scales (Gauge Function)

Using the gauge function enables the vertical scales (for convenience, hereafter referred to as “gauges”) to be displayed overlapping waveforms.

- 1 Click [Gauge].

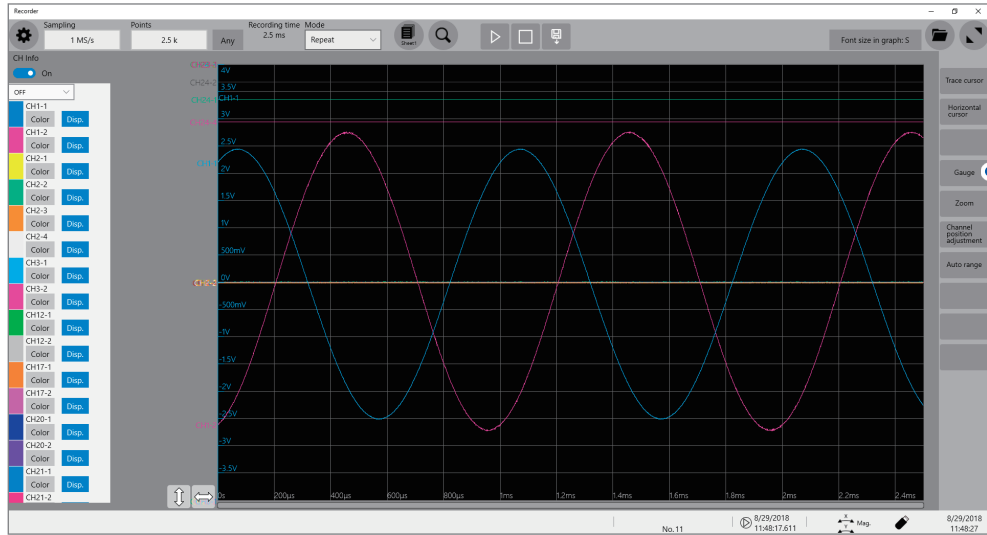

- 2 Choose gauges to be displayed from among [Gauge A] through [Gauge H].

The screen display the gauges at the left.  
You can move a gauge after click it to select.

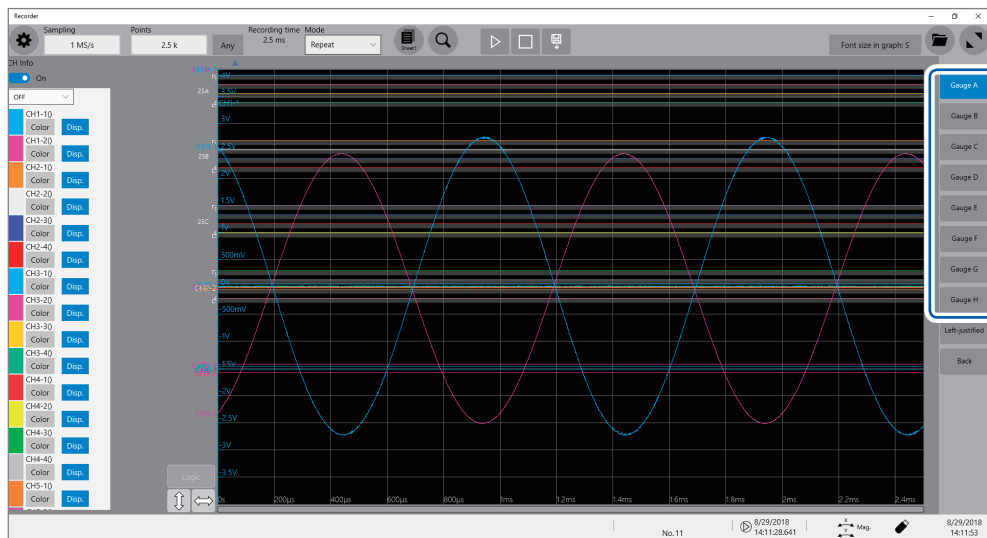

Click [Left-justified] aligns the gauges to the left.

## 2

Operating the Waveform Screen and Analyzing Data

**3** Click **[CH ▲]** or **[CH ▼]** to choose a channel to be displayed.

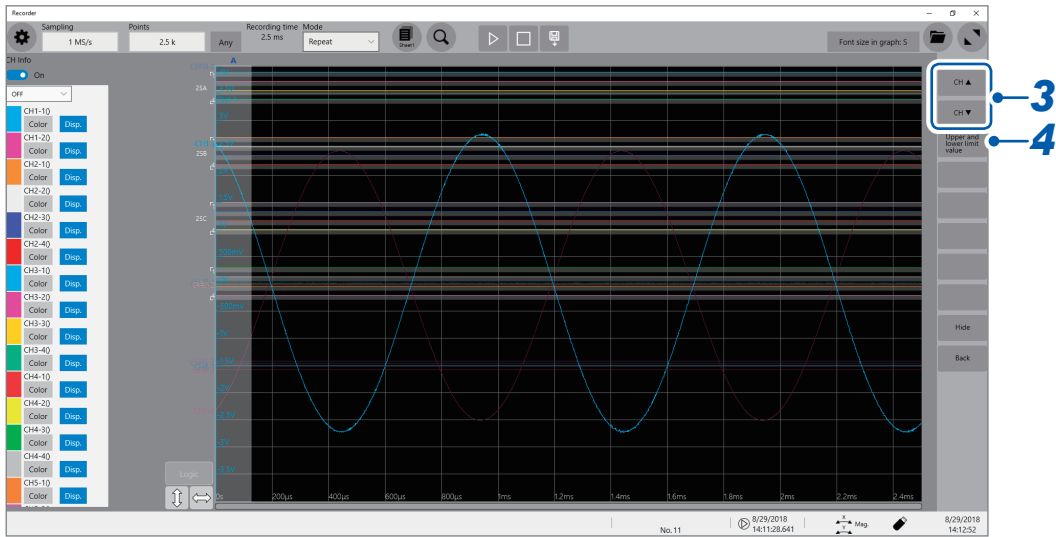

Clicking **[Hide]** hides the gauges.

**4** Click **[Upper and lower limit value]**.

The setting dialog box appears. You can specify the display range of each channel. Enter an upper and lower values in the **[Upper]** and **[Lower]** boxes, respectively, and then click **[OK]**.

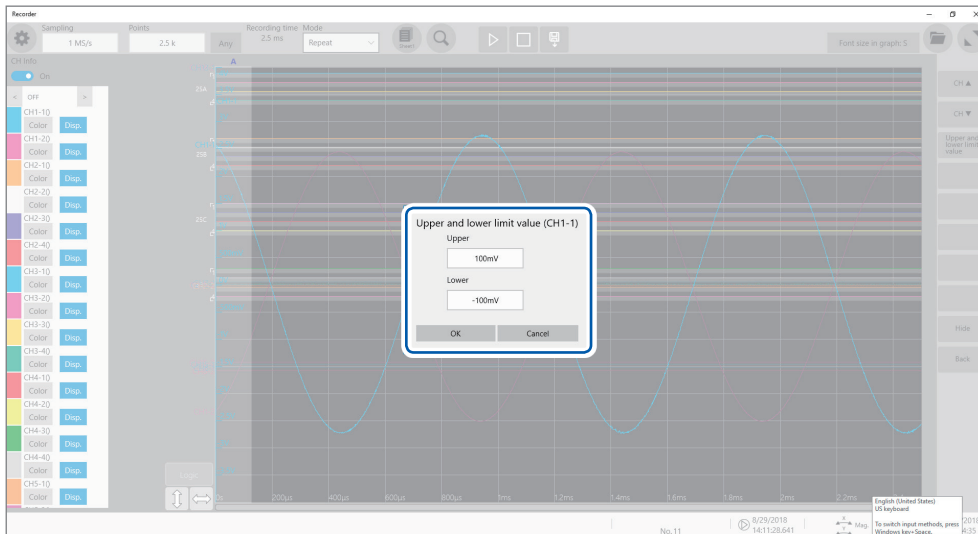

## 2.3 Scrolling Through Waveforms

### Scrolling through waveforms

Dragging the waveform screen scrolls through waveforms that are being measured or existing waveforms.

#### Scrolling direction

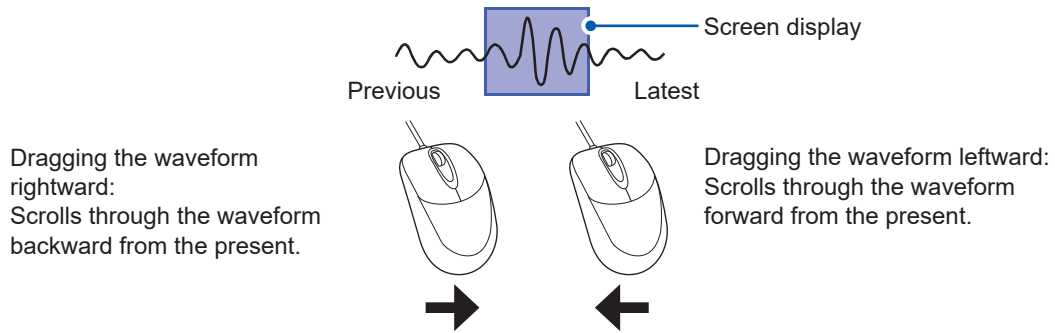

#### To anchor the waveforms vertically

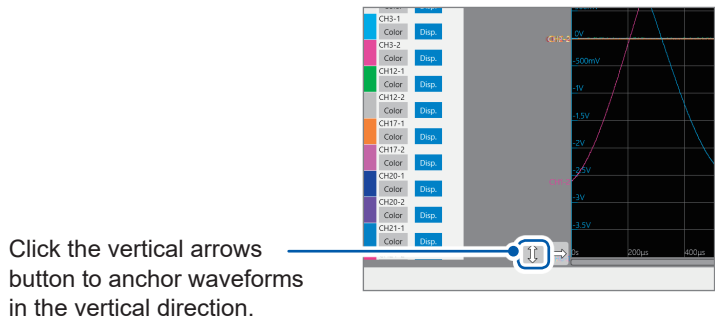

#### To anchor the waveforms horizontally

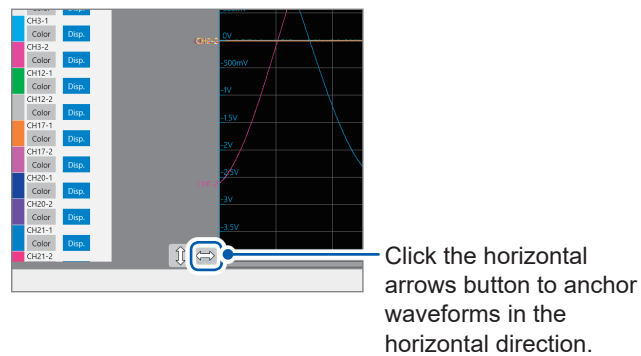

#### To observe waveforms previously obtained during slow-speed measurement

When the waveforms are being displayed during a slow-speed measurement, dragging the waveform screen allows you to observe waveforms previously obtained. To observe the waveforms that are presently measured again, click **[▶▶▶]** on the screen.

## Checking a position of waveforms with the scroll bar

The scroll bar provides the position and size of the displayed part of the waveforms relative to the entire recording-length waveforms. It also shows the positions of the trigger point and trace cursors.

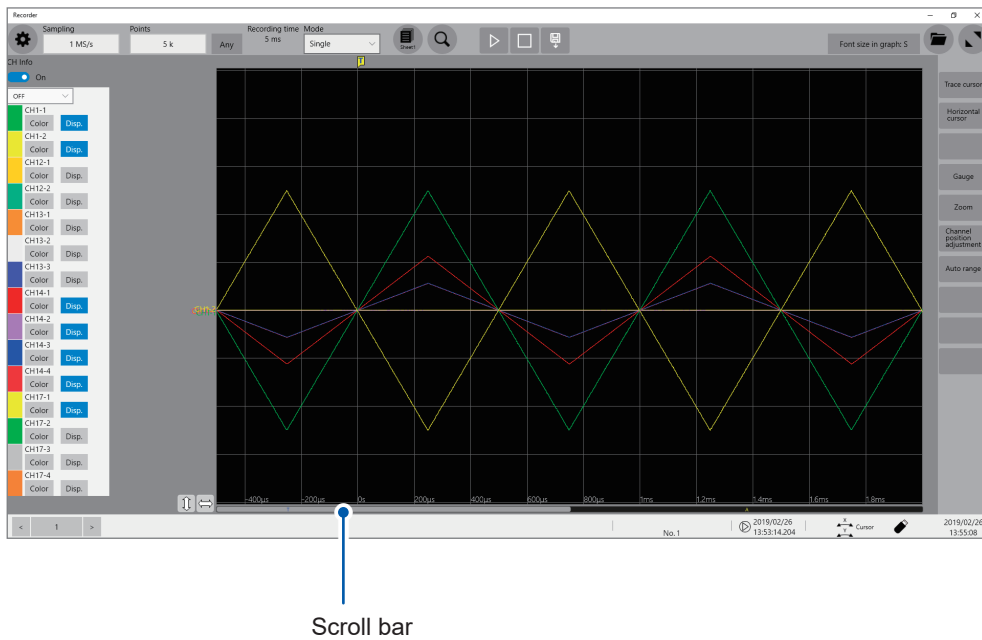

## Verifying the position of the trigger point and cursors on the scroll bar

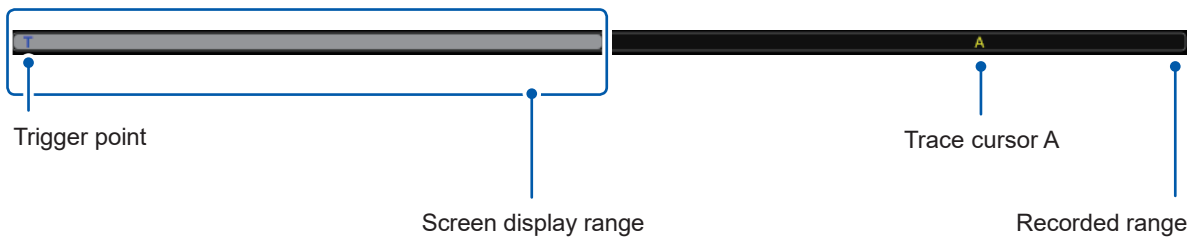

With the display zoomed in, the scroll bars are displayed at both the top and bottom.

## To switch over to another block when [Memory divide] is set to [On]

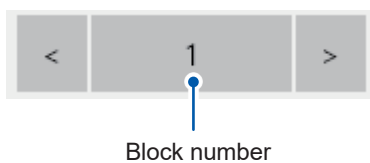

You can move a block by specifying a block number to be displayed.





## 2.4 Changing the Display Position and Display Magnification of Waveforms

You can change the display magnification of waveforms by pointing to the time axis on the waveform screen and rotating the wheel button.

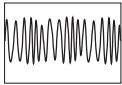
	<p><b>Rotating the wheel button upward</b></p>		<p>Zooms in the waveforms.</p>
	<p><b>Rotating the wheel button downward</b></p>		<p>Zooms out the waveforms.</p>

### To change the display position of logic channels in a batch

You can move logic channels only after click **[Logic]** to choose.  
When **[Logic]** is not chosen, you can move analog channels only.

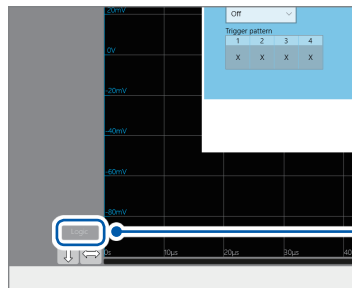

Click the button to select or deselect it.

## Differentiating the waveform display position and display magnification of each analog channel

1 Click [Channel position adjustment].

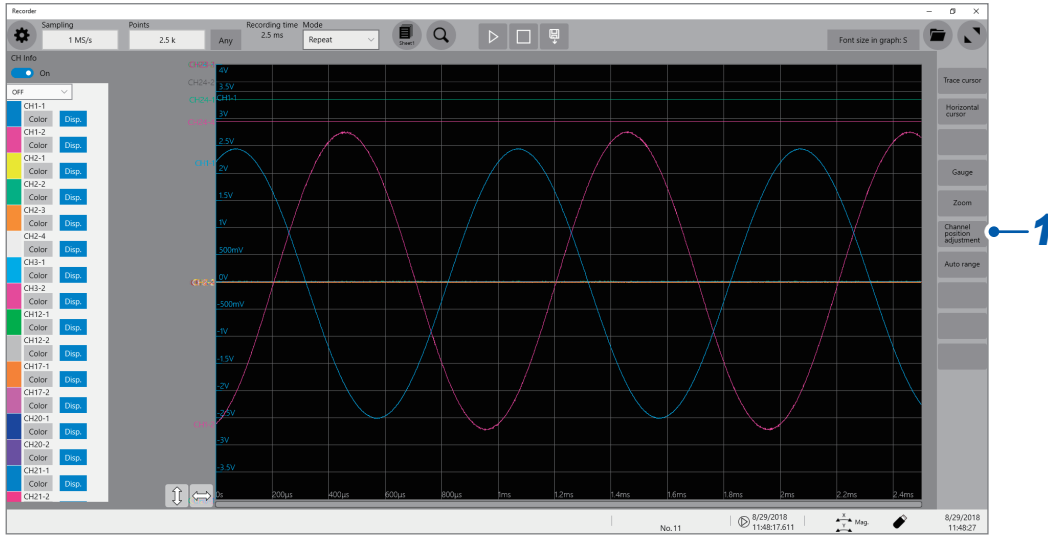

The channel position adjustment screen appears.

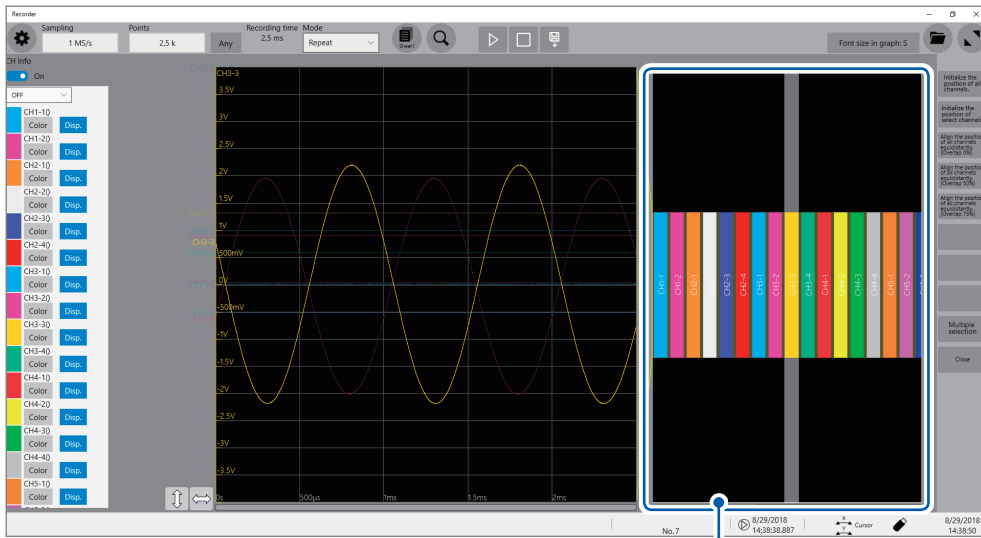

The display range of the waveform screen.

- 2 Click a channel number you want to move to choose and drag the chosen area.**  
The display position of the channel is moved.

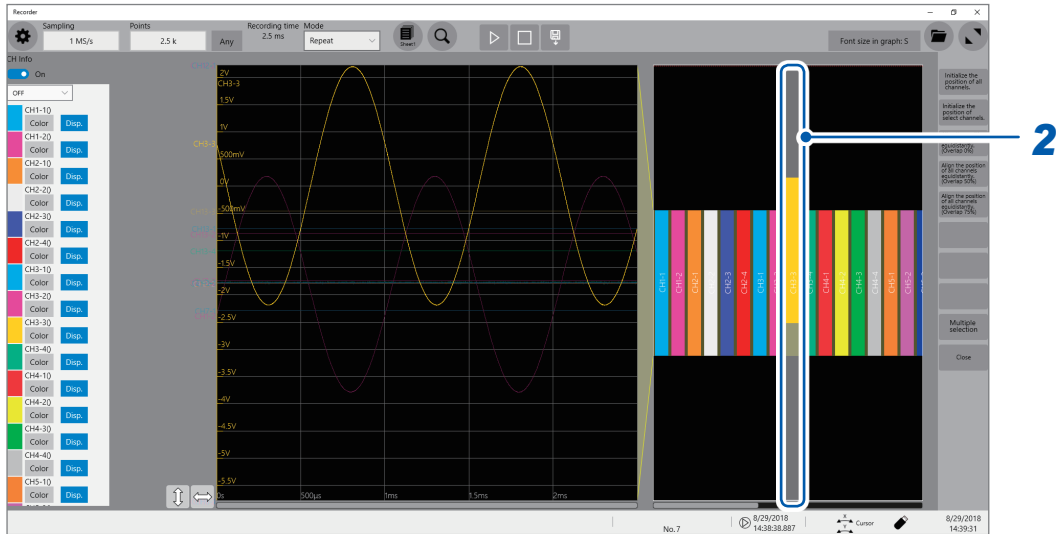

- 3 Click a channel number the display position you want to change.**  
Rotating the wheel button while pointing to the selected area changes the display magnification.

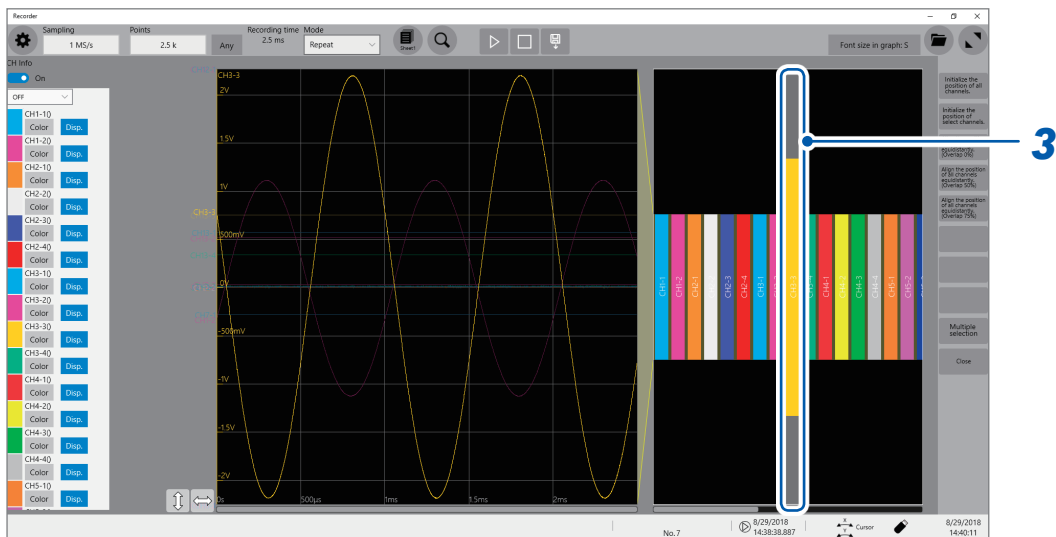

#### 4 Adjust the display position and magnification.

The display can be adjusted as follows depending on the selected state.

<b>Initialize the position of all channels.</b>	Restores all the channels to the initial positions and displays them at the default magnifications.
<b>Initialize the position of select channels.</b>	Restores selected channels only to the initial positions and displays them at the default magnification.
<b>Align the position of all channels equidistantly.</b>	Adjusts the display positions and magnifications of all channels such that they are aligned at the same intervals. Adjust the display position and magnification.
<b>Multiple selection</b>	Allows you to select the channels the displays of which are to be adjusted.

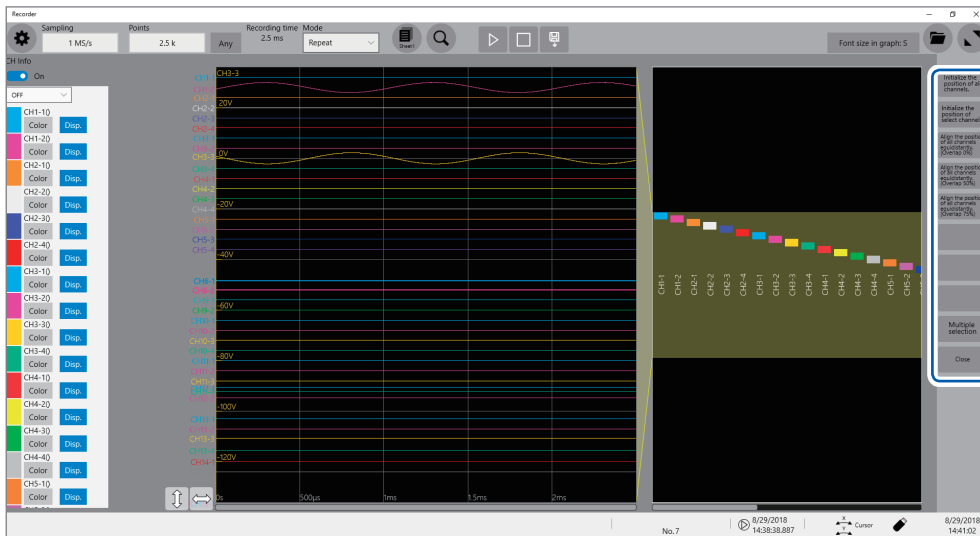

## 2.5 Enlarging a Part of the Waveform (Zoom Function)

Using the zoom function allows you to enlarge a part of waveforms.

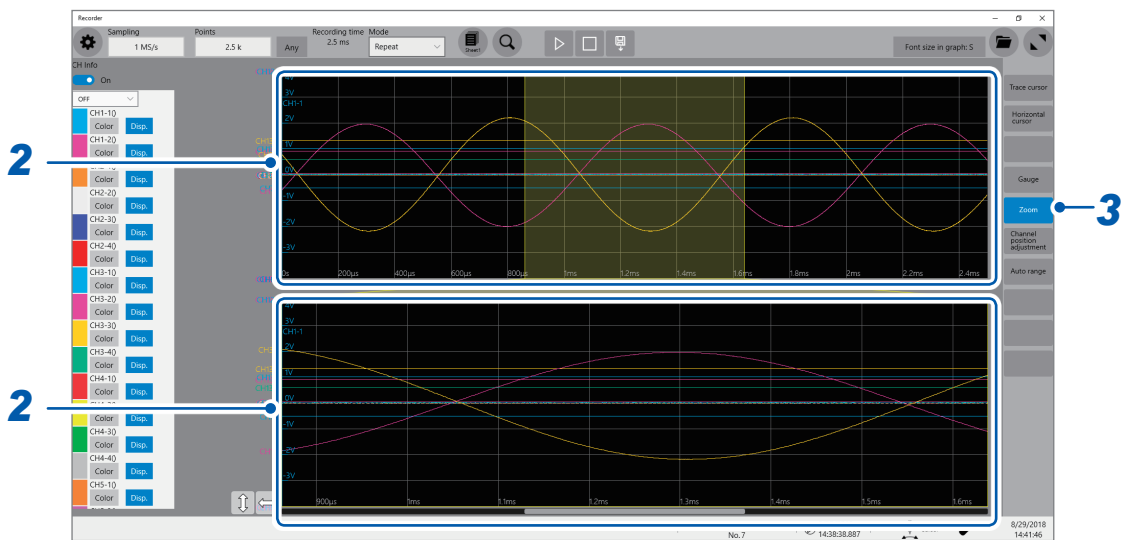
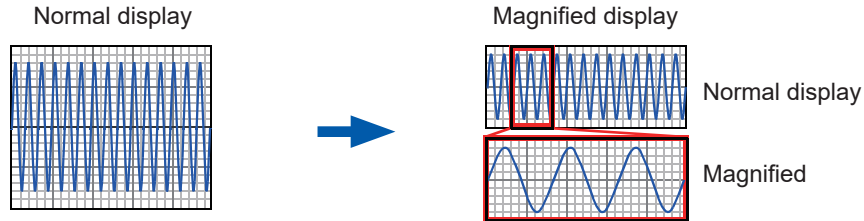

### 1 Click [Zoom].

The screen splits into two, upper and lower, which enable the zoom function.

Upper screen: Displays waveforms in the magnification specified before the zoom function was applied.

The part of the waveforms enclosed by the yellow frame represents the zoomed display range shown in the lower screen.

Lower screen: Displays magnified waveforms.

### 2 Changing the display magnification of waveforms

You can change the display magnification on each screen.

### 3 Drag waveforms to scroll through them on each screen.

### To cancel the magnified display

Click [Zoom] on the screen to cancel the magnified display. When you cancel the magnified display, the display (the upper screen) restores that with the normal magnification.



**Converting input values (scaling) (p. 40)**

**Fine-adjusting input values (p. 45)**

**Inverting a waveform (p. 46)**

**Copying a setting to another channel (p. 47)**

**Advanced measurement and settings**

- Overlaying new waveforms with previously acquired waveforms (p. 38)

**Detailed module settings (p. 48)**

- Anti-aliasing filter
- Thermocouple type
- Reference junction compensation
- Wire break detection
- Data refresh
- Executing auto-balance
- Probe division ratio
- Response time
- Measurement mode

# 3.1 Overlaying New Waveforms With Previously Acquired Waveforms

New waveforms can be overlaid with the presently displayed waveforms.

- You can compare the new waveforms with those recorded before. (When **[Mode]** is set to **[Repeat]**) (p. 8)
- Two methods are available to overlay waveforms: the automatic overlaying during measurement and the manual overlaying.

 > **[Status]** > **[Condition]**

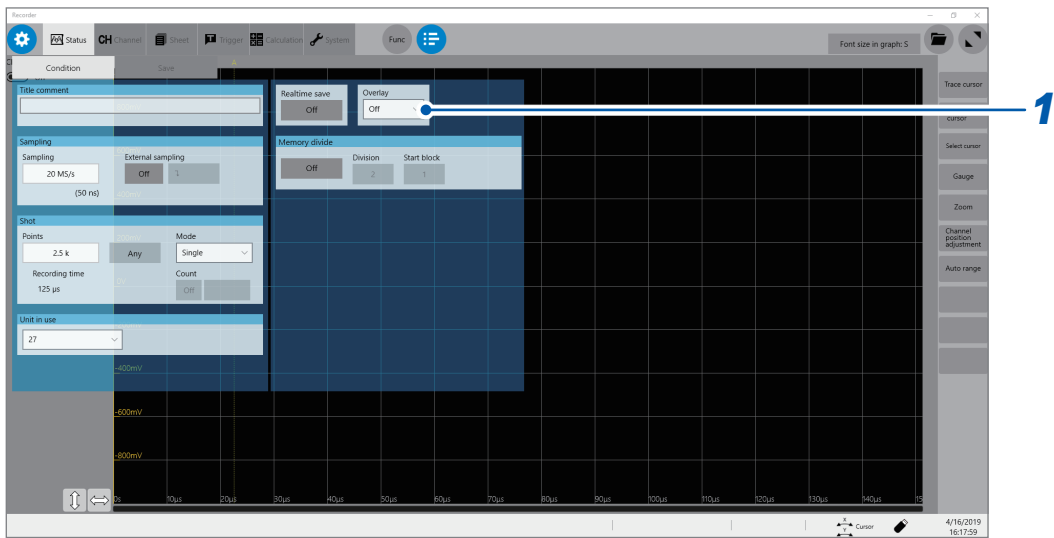

**1** Click the **[Overlay]** box, and then choose an overlaying method from the list.

<b>Off</b> <input checked="" type="checkbox"/>	Does not overlay any waveforms.
<b>Auto</b>	Overlays waveforms newly acquired with the presently displayed waveforms every time the instrument acquires new ones. When <b>[Mode]</b> is set to <b>[Repeat]</b> , the instrument overlays the new waveforms with the presently displayed waveforms beginning from the start until the stop of the measurement.
<b>Manual</b>	Manually overlays the new waveforms with the presently displayed waveforms. Refer to Step 3 "Overlay the waveforms manually (leaving any waveforms to be displayed on the screen)." (p. 39).

Refer to "When the overlay function is enabled (When **[Overlay]** is set to **[Auto]** or **[Manual]**)" (p. 39).



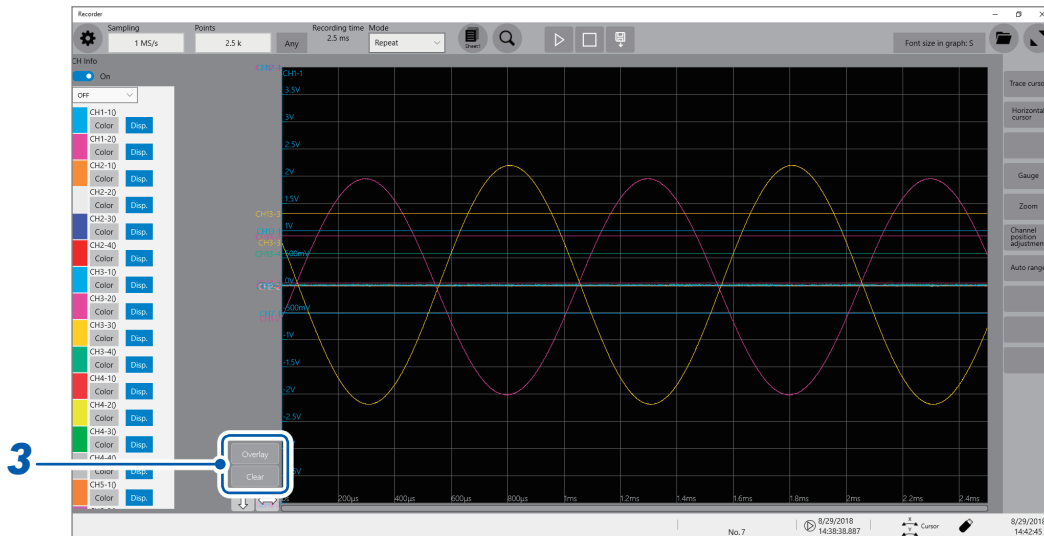

2 Click the button  to display the waveform screen.



3 Overlay the waveforms manually (leaving any waveforms to be displayed on the screen).

<b>Overlay</b>	Leaves the acquired waveforms displayed on the screen. The overlay setting continues to be available until the waveforms are cleared.
<b>Clear</b>	Clears all the overlaid waveforms displayed on the screen. No cleared waveforms can be displayed again.

**When the overlay function is enabled (When [Overlay] is set to [Auto] or [Manual])**

- The instrument displays the waveforms always after the data has been acquired.
- The trace cursors show the measured values of the waveforms most recently acquired.
- The following operation is not available on the waveform screen:  
Scrolling through waveforms, switching the zoom function between on and off, changing the magnification, and changing the zero position.
- The instrument leaves the waveforms most recently displayed only and clears the others in the following cases:
  - After selecting  > [Sheet] and changing its setting
  - After selecting  > [Channel] and changing the waveform display settings (switching between on and off for the display setting or changing a waveform color)
  - After executing the search.
  - After changing the waveform display settings (switching between on and off for the display setting or changing waveform color) in [CH info] on the waveform screen.

## 3.2 Converting Input Values (Scaling Function)

### About the scaling function

The scaling function enables you to convert voltage outputted from measuring devices such as sensors into physical quantities of measuring objects.

Hereafter, the term “scale” refers to converting numerical values using the scaling function.

Gauge scales, scaled values (upper and lower limits of the vertical axis or voltage axis), and measured values using trace cursors are represented as scaled values in the specified units. You can configure different scale settings for each channel.

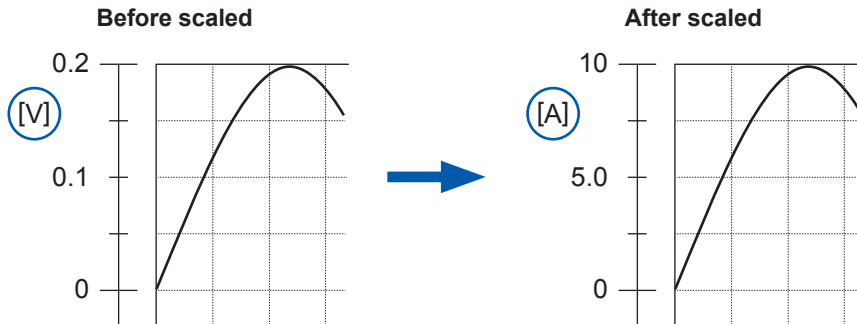

### Scaling methods

The following six methods are available:

- Specifying a conversion ratio and offset
- Specifying two points
- Choosing a model name of a connected current sensor or differential probe
- Choosing an output rate
- Specifying an input value in decibels and value after scaled
- Specifying a rated capacity and rated output according to an inspection record of a strain gauge converter (for Model U8969 Strain Unit only)

> [Channel]

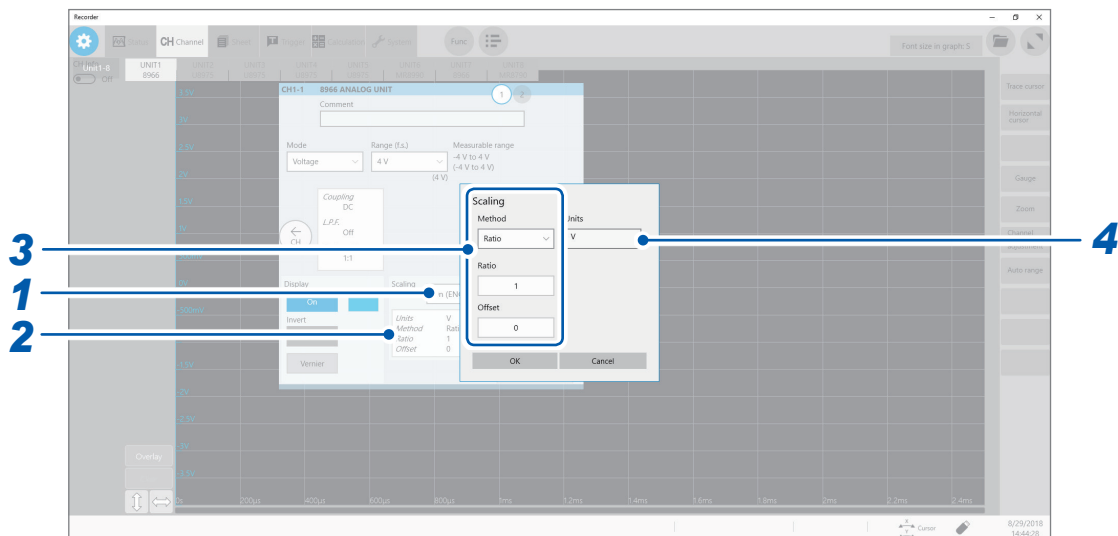

**1** Click the **[Scaling]** box, and then choose a scaling setting from the list.

<b>Off</b> <input type="checkbox"/>	Does not scale any values.
<b>On (ENG)</b>	Displays values in decimal notation with a unit prefix (such as m and k).
<b>On (SCI)</b>	Displays values in scientific notation (as a power of 10).

**2** Click the **setting items area**.

The setting dialog box appears.

**3** Click the **[Method]** box, and then choose a setting method from the list.

<b>Ratio</b> <input checked="" type="checkbox"/>	Allows you to specify conversion ratio and an offset.
<b>2-Point</b>	Allows you to specify two points
<b>Sensor</b>	Allows you to choose a model name and measurement range of a connected current sensor or differential probe.
<b>Output rate</b>	Allows you to choose an output rate (ratio) of a current sensor or a division ratio of a voltage dividing probe.
<b>dB</b>	Allows you to specify an input value in decibels and value after scaled.
<b>Rating</b>	Allows you to specify a rated capacity and rated output according to an inspection record of a strain gauge converter to be used. (For Model U8969 Strain Unit only)

**When using [Ratio]**

Enter a conversion ratio in the **[Ratio]** box.

**-9.9999E+9 to 9.9999E+9**

Enter an offset value in the **[Offset]** box.

**-9.9999E+19 to 9.9999E+19**

**To inputted voltage values into current values**

Specify a physical quantity per one volt of an inputted signal (conversion ratio: eu/V), an offset value, and a measurement unit to be used. The instrument converts (scales) measured values acquired in volts into that in the specified measurement unit. (eu: engineering unit)

Example:  
 Ratio: Change in amperes per volt; offset value: B  
 Unit: A

Scaling values using a slope (conversion ratio) and offset value

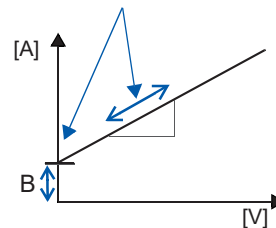

**When using [2-Point]: Specify two input values and those after scaling.**

Enter two voltage values of an inputted signal in the [Input1] and [Input2] boxes.  
 Enter each of two scaled value in the [Scale1] and [Scale2] boxes.

-9.9999E+29 to 9.9999E+29

The instrument converts (scales) measured values in volts into values in the specified measurement unit.

Example:

2 points of values in volts	Values after scaled
V <sub>H</sub> : Higher potential point	A <sub>H</sub> : Value for the higher potential point
V <sub>L</sub> : Lower potential point	A <sub>L</sub> : Value for the lower potential point

Unit: A

Scaling values using a conversion ratio and offset value, both of which are calculated using two points

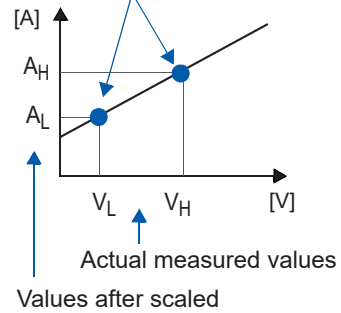

When changing the value with the [Ratio] setting, the instrument does not change the values for V<sub>L</sub> or V<sub>H</sub>, but the values for A<sub>L</sub> and A<sub>H</sub>, all of which have been specified with [Method] set to [2-Point].

**When using [Sensor]**

- Click the [Sensor] box, and then choose a model name of a current sensor or differential probe from the list.
- Click the [Range] box, and then choose a measurement range from the list.

Sensor	Range
Model 3273-50	30 A
Model 3274	150 A
Model 3275	500 A
Model 3276	30 A
Model 3283 <sup>□</sup>	10 mA <sup>□</sup> , 100 mA, 1 A, 10 A, 200 A
Model 3284	20 A <sup>□</sup> , 200 A
Model 3285	200 A <sup>□</sup> , 2000 A
Model 9010-50	10 A <sup>□</sup> , 20 A, 50 A, 100 A, 200 A, 500 A
Model 9018-50	10 A <sup>□</sup> , 20 A, 50 A, 100 A, 200 A, 500 A
Model 9132-50	20 A <sup>□</sup> , 50 A, 100 A, 200 A, 500 A, 1000 A
Model 9322	—
Model 9657-10	10 A
Model 9675	10 A
CT6700, CT6701	5 A
CT6710, CT6711	500 mA, 5 A, 30 A

**Setting example:**

To display values measured with Model 9018-50 Clamp on Probe using the 10 A range as values in amperes (A)

**Sensor:** Model 9018-50

**Range:** 10 A

**Unit:** A

**When using [Output rate]: Choose an output rate (ratio) of a current sensor or a division ratio of a voltage dividing probe.**

Click the [Output rate] box, and then from the list, choose a current value per one volt the current sensor outputs.  
 Otherwise, choose a voltage value per a one volt the differential probe outputs.

10 mA<sup>□</sup>, 100 mA, 1 A, 10 A, 20 A, 50 A, 100 A, 200 A, 250 A, 500 A, 1000 A, 2000 A, 2500 A, 5000 A, 1000 V

**When using [dB]: Specify a physical quantity per input signal (ratio) in decibels.**

- Click the [Input dB] box, and then enter an inputted signal value in decibels.
- Click the [Output dB] box, and then enter an scaled value in decibels.

-200 to +200

You can specify values to five or less significant figures.

Setting example:

Converting (scaling) an input value of 40 dB into 60 dB

**Input dB:** 40

**Output dB:** 60

The conversion ratio corresponding to values entered in decibels is specified. (The offset becomes zero.)

**When using [Rating]**

(For Model U8969 Strain Unit only)

- Click the [Capacity] box, and then enter the rated capacity of a strain gauge converter to be used.
- Click the [Output] box, and then enter a rated output of a strain gauge converter to be used.

+1.0000E-9 to +9.9999E+9

You can specify values to five or less significant figures.

Specify the parameters such that the quotient of the rated capacity divided by two times the rated output is less than or equal to 9.9999E+9.

For the rated capacity and rated output, see an inspection record of a strain gauge converter to be used.

Setting example: To display results measured with a strain gauge converter that has a rated capacity of 20 G and rated output of 1000  $\mu\text{V/V}$  as figures in gravities (G)

Unit: G

Rated capacity: 20

Rated output: 1000

The upper and lower display values of a waveform also automatically change according to the changes made in the scaling settings.

**4 Click the [Units] box, and then enter a unit used for scaled values.**

Enter the unit into which you wish to convert the values. (Number of characters: up to 7)

**To copy the scaling setting to another channel**

Refer to “3.5 Copying Settings (Copy Function)” (p. 47).

## When using Model U8969 Strain Unit

### When an inspection record of a strain gauge converter provides a calibration factor

**Example: To display data measured with the strain gauge converter having a calibration factor of  $0.001442 \text{ G}/1 \times 10^{-6} \text{ strain}^*$  as values in terms of gravities (G)**

(\*:  $10^{-6} \text{ strain} = \mu\epsilon$ )

<b>Scaling</b>	On (ENG)
<b>Method</b>	Ratio
<b>Units</b>	G
<b>Ratio</b>	0.001442 [G] (Displayed as "1.4420 m")

### When an inspection record of a strain gauge converter provides the rated capacity and rated output

Refer to "When using the **[Rating]** setting" in "3.2 Converting Input Values (Scaling Function)"(p. 43).

### When using a strain gauge that has a gauge factor of other than 2.0

Model U8969 Strain Unit measures outputs of the gauge supposing that the gauge factor stands at 2.0.

When a strain gauge that has a gauge factor of other than 2.0 is used, you need to convert its gauge factor into a conversion ratio.

For example, if the gauge factor stands at 2.1, the conversion ratio will be  $0.952 (\approx 2 / 2.1)$ .

**Example: To display data measured with a strain gauge (gauge factor: 2.1) as values in terms of gravities (G)**

Two scaling (conversion ratio) calculations are required: a gauge ratio and conversion ratio that converts output into physical quantities. In this case, enter the product of the conversion ratios of the gauge factor and the scaling conversion ratio as the conversion ratio.

Where the conversion ratio of the gauge factor is 0.952, and the conversion ratio to convert data into physical quantities is  $0.001442^*$ .

Conversion ratio =  $0.952 \times 0.001442 = 0.0013728$

Enter **[0.0013728]** as the conversion ratio.

\*: To convert values measured with a strain gauge into physical quantities, calculate the conversion ratio based on Young's modulus or Poisson's ratio of a measuring object. The conversion method varies depending on the conditions the strain gauge is used in.

Refer to "Scaling method for strain gauges" (p. 237).

## 3.3 Fine-Adjusting Input Values (Vernier Function)

You can freely fine-adjust input voltage on the waveform screen. When recording physical values, such as noise, temperature, and acceleration, with sensors, you can adjust those amplitudes, which facilitates calibration.

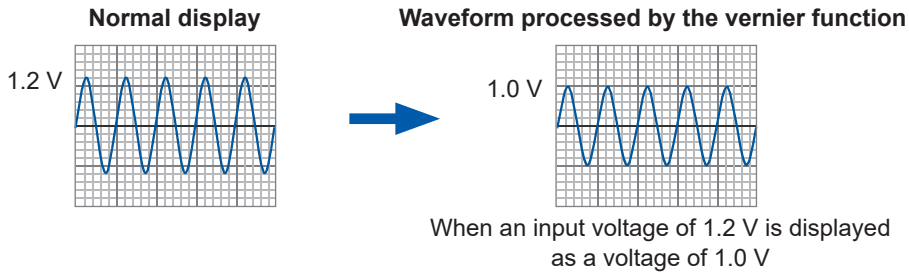

> [Channel]

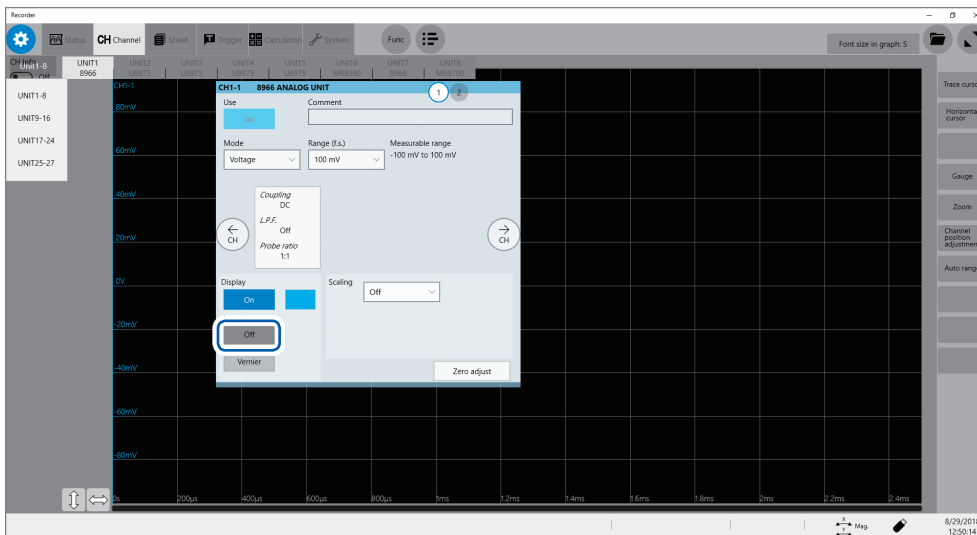

**1** Click [Vernier].

The adjustment keypad appears.

**2** While observing the waveform, you can fine-adjust its amplitude by clicking [--], [-], [+], and [++].

Click [C] to revert the fine-adjusted amplitude to its original.

- The adjustable range is from 50% to 200% of an original waveform.
- You cannot check if waveforms are adjusted by the vernier function by observing waveforms only.
- Waveform data (data saved as files) is that adjusted by the vernier function.

## 3.4 Inverting a Waveform (Invert Function)

You can invert a waveform relative to the X axis. This function can be used for analog channels only.

Measured data saved in files is that inverted by the invert function.

Example:

- When a current sensor is clamped around a wire with its current direction mark mistakenly in the direction opposite to the current flow
- When a signal is inputted with spring-pulling force negative and spring-compressing force positive; however, you would like to display the results with spring-pulling force positive and spring-compressing force negative

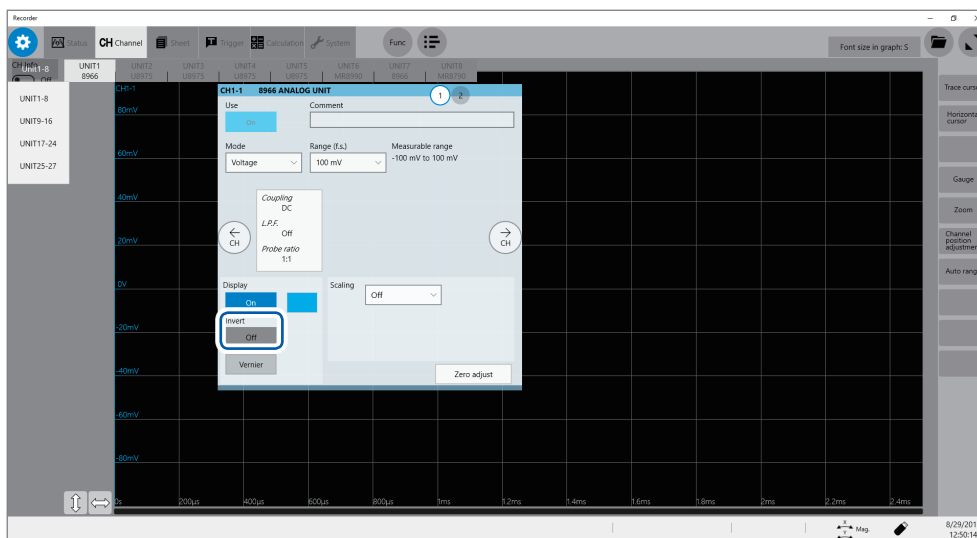

Click the **[Invert]** button to set it to **[On]**.

This setting is not available for Model 8967 Temp Unit, Model 8970 Freq Unit, and Model 8973 Logic Unit.



# 3.5 Copying Settings (Copy Function)

You can copy settings of other channels, as well as the trigger settings.

The following procedure explains how to copy settings of another input channel.

 > [Func] > [Copy] > [Input Channel]

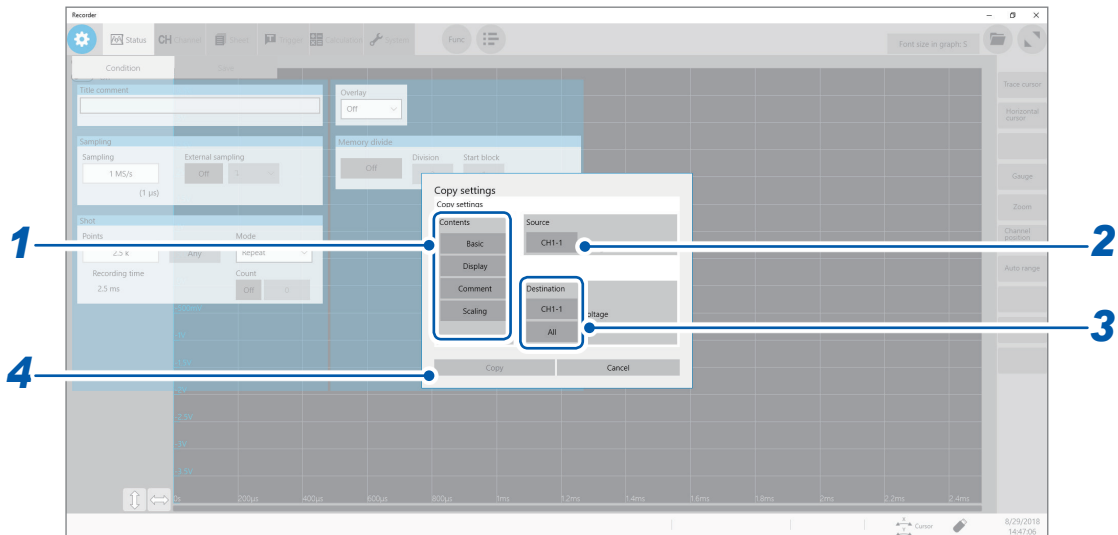

3  
Advanced Functions

**1** In the [Contents] area, click one or more of items that you want to copy.

Depending on module types, some items may not be able to be copied.

<b>Basic</b>	Copies the mode, measurement range, coupling, L.P.F., division ratio, and module-specific settings.
<b>Display</b>	Copies the display setting (excluding comments).
<b>Comment</b>	Copies a comment.
<b>Scaling</b>	Copies the scaling setting.

**2** Click the [Source] box, and then choose a source channel from the list.

**3** Click the [Destination] box, and then choose a destination channel from the list.

Otherwise, click [All].

<b>CH1-1</b> <input checked="" type="checkbox"/> (Channel selection)	Click this option when you would like to copy the settings to any one of the channels. Select a destination channel from the list.
<b>All</b>	Copies settings to all channels of UNIT 1 through UNIT 27.

**4** Click [Copy].

After copying the settings, check that levels and setting values, which includes upper and lower values, and the measurement range are appropriately set.

## 3.6 Configuring Measuring-Module-Specific Settings

You can configure advanced settings for each module.

### Configuring Model 8968 High Resolution Unit settings

 > [Channel] > [8968]

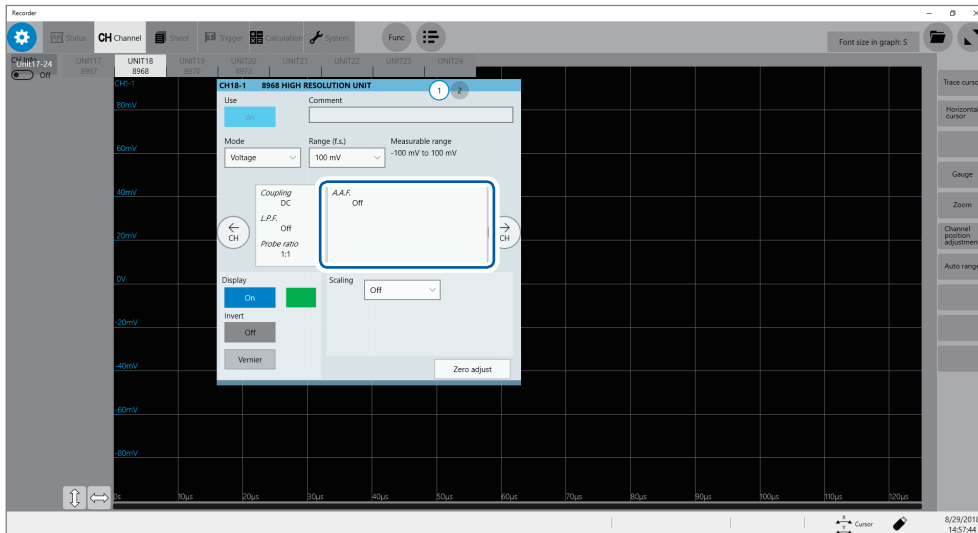

- 1** Click the area that includes **[A.A.F.]**.  
The **[A.A.F.]** setting dialog box appears.
- 2** Click the **[A.A.F.]** box, and then choose **[On]** or **[Off]** from the list for the anti-aliasing filter setting.

Enabling the anti-aliasing filter prevents aliasing distortion from influencing FFT calculations.

The cutoff frequency changes automatically according to the sampling rate setting.

<b>Off</b> <input checked="" type="checkbox"/>	Disables the anti-aliasing filter.
<b>On</b> <input type="checkbox"/>	Enables the anti-aliasing filter. (Disabled when the external sampling is used, or the sampling rate is set at 100 kS/s or faster)

- 3** Click **[Close]**.  
The setting dialog box closes.

# Configuring Model 8967 Temp Unit settings

 > [Channel] > [8967]

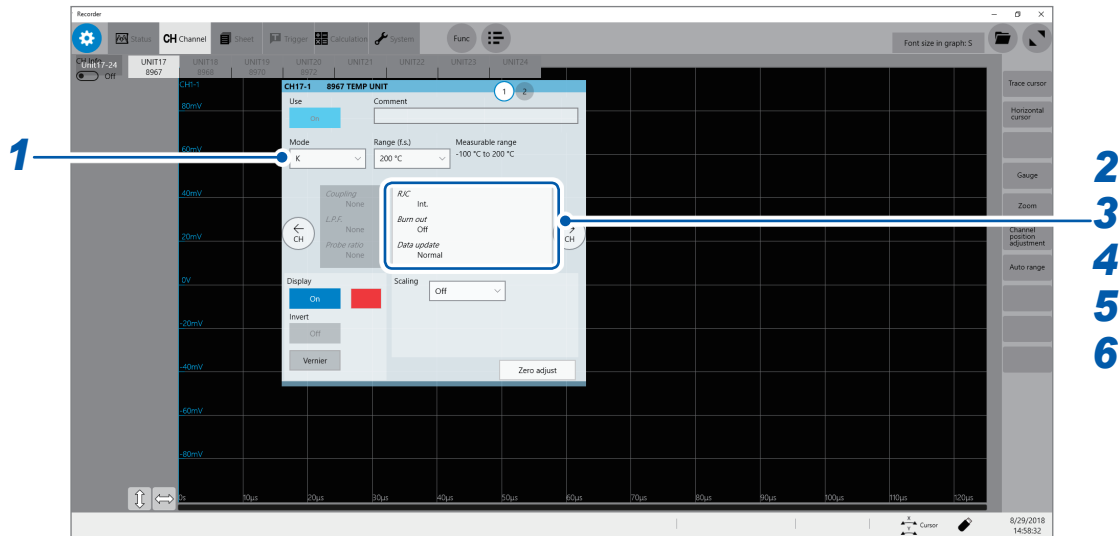

**1** Click the **[Mode]** box, and then choose a thermocouple type from the list.

Choose an option depending on the type of a thermocouple to be used.

Mode	Measurable range	Mode	Measurable range
<b>K</b> <input checked="" type="checkbox"/>	-200°C to 1350°C	<b>R</b>	0°C to 1700°C
<b>J</b>	-200°C to 1100°C	<b>S</b>	0°C to 1700°C
<b>E</b>	-200°C to 800°C	<b>B</b>	400°C to 1800°C
<b>T</b>	-200°C to 400°C	<b>W</b>	0°C to 2000°C
<b>N</b>	-200°C to 1300°C		

**2** Click the area that includes **[RJC]**.

The setting dialog box appears.

**3** Click the **[RJC]** box, and then choose between **[Int.]** and **[Ext.]** from the list for reference junction compensation.

<b>Int.</b> <input checked="" type="checkbox"/>	Executes the reference junction compensation inside the module. (Measurement accuracy: The sum of the accuracy of the temperature measurement and that of the reference junction compensation)
<b>Ext.</b>	Does not execute the reference junction compensation inside the module. (Measurement accuracy: The accuracy of the temperature measurement only)

When connecting a thermocouple directly to the module, choose **[Int.]**.

When connecting a thermocouple via a reference junction device that includes a zero-point bath, choose **[Ext.]**.

**4** Click the **[Burn out]** box, and then choose between **[On]** and **[Off]** from the list for the wire break detection setting.

You can detect a broken thermocouple wire during temperature measurement. If a thermocouple wire breaks, measured values will fluctuate.

<b>Off</b> <sup>☒</sup>	Does not check wires for a break.
<b>On</b>	Check wires for a break by flowing about a minuscule current of 100 nA through the thermocouple.

If the thermocouple wires are long or have a relatively high resistance, set **[Burn out]** to **[Off]** to avoid measurement errors.

**5** Click the **[Data update]** box, and then choose a data update interval from the list.

<b>Fast</b>	Updates data about every 1.2 ms. Choose this option for a quicker response. However, choosing this option causes some increase in noise superimposed on input signals.
<b>Normal</b> <sup>☒</sup>	Updates data about every 100 ms. Choosing this option eliminates noise, leading to stable measurement.
<b>Slow</b>	Updates data about every 500 ms. Choosing this option leads to stabler measurement.

**6** Click **[Close]**.

The setting dialog box closes.

## Configuring Model U8969 Strain Unit settings

Model U8969 Strain Unit can execute auto-balance.

Executing auto-balance regulates the reference output level of a transducer at the specified zero position. Auto-balance is available for Model U8969 Strain Unit only.

You can use Model 8969 Strain Unit you own with this instrument. The instrument displays the model name of Model 8969 Strain Unit as **[U8969]**.

### Before executing auto-balance

- Turn on the instrument and leave it for 30 minutes to allow the internal temperature of the module to stabilize.
- After connecting a strain gauge converter to the module, execute auto-balance without any input including distortion.
- You cannot execute auto-balance during measurement.
- No operation is accepted during auto-balance.

### To execute auto-balance on the channel screen of each channel

 > **[Channel]** > **[U8969]**

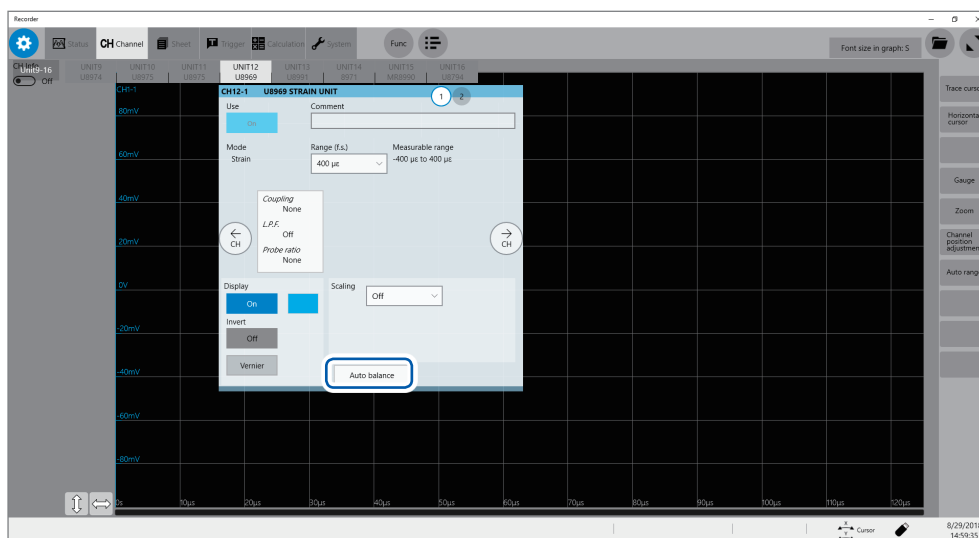

Click **[Auto balance]**, and then choose an auto-balance setting from the list.

<b>One channel only</b>	Executes auto-balance for only a channel displayed on the channel screen.
<b>All</b>	Executes auto-balance for all of the channels Model U8969 is installed in.

## To execute auto-balance on the list screen

 > [Channel] >  > [Operate] > [Auto balance]

Executes auto-balance for all channels of the strain modules installed in the instrument.

In the following cases, execute auto-balance again.

- After changing the vertical axis (strain axis) range
- After replacing any modules
- After replacing the strain gauge converter
- After cycling the instrument
- After initializing the instrument
- When the ambient temperature has significantly changed (the zero position may drift)

## If auto-balance fails

Check the following items, and re-execute auto-balance.

- Is the strain gauge converter not subjected to any load?  
(Make sure that the strain gauge converter is not subjected to vibration or any other loads.)
- Is the strain gauge converter properly connected measuring object?
- Is the measuring object not subjected to any load?

# Configuring Model 8970 Freq Unit settings

> [Channel] > [8970]

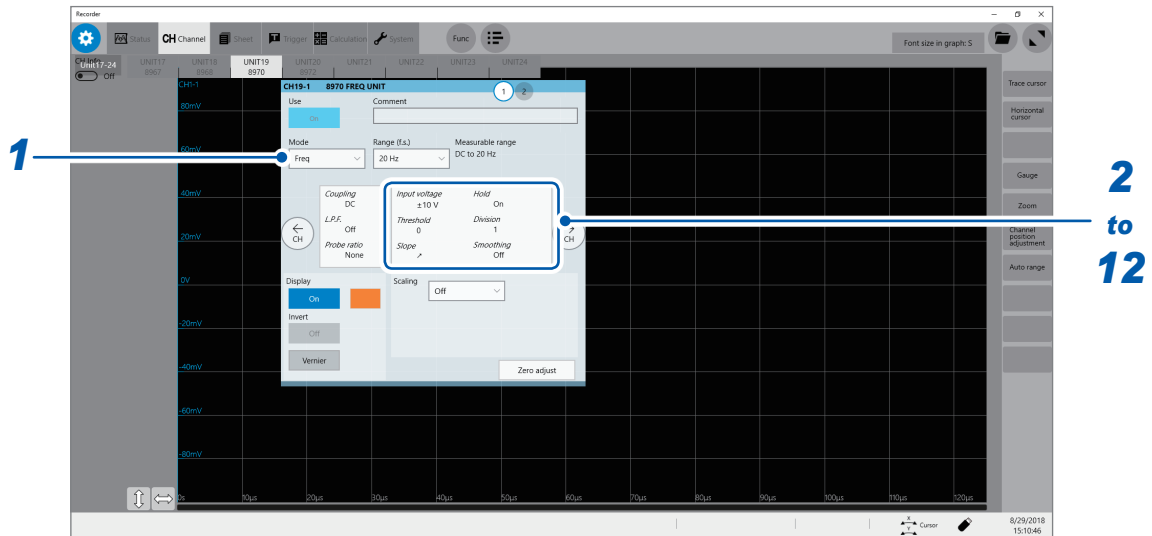

**1** Click the [Mode] box, and then choose a measurement mode from the list.

<b>Frequency</b>	Measures frequency of a waveform (in hertz [Hz]).
<b>Rotation speed</b>	Measures the number of rotations of a measuring object (in rotations per minute [r/min]).
<b>Power frequency</b>	Measures power frequency fluctuation (in hertz [Hz]).
<b>Count</b>	Accumulates the number of input pulses.
<b>Duty ratio</b>	Measures duty ratios of a waveform to be measured (in percent [%]).
<b>Pulse width</b>	Measures pulse widths (in second [s]).

Pulses that rise during the dead time (during a calculation) cannot be measured (with a frequency of 25 kHz or higher).

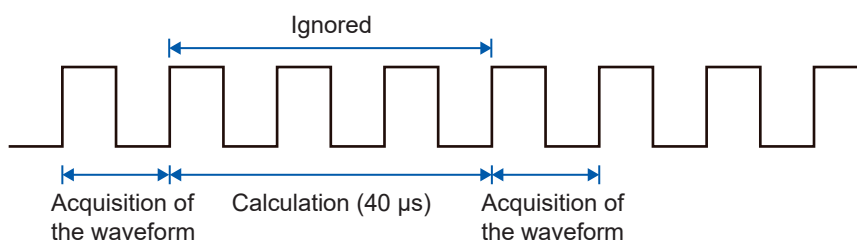

**2** Click the area that includes [Input voltage].

The setting dialog box appears.

**3** Click the [Input voltage] box, and then choose an option for the maximum level of an input signal from the list.

**±10 V**, ±20 V, ±50 V, ±100 V, ±200 V, ±400 V

**4 Click the [Threshold] box, and then enter a threshold value.**



- Measured values are acquired based on the following: the interval between the subsequent two points when measured waveform exceeds (or falls below) the threshold value, and the number of times when the waveform exceeds (or falls below) the threshold value.
- The upper and lower limits of the threshold value and the increment in the threshold value vary depending on the input voltage setting.

To prevent measurement errors due to noise, a hysteresis width of about 3% of the input voltage is tolerated for the threshold.

(When [Input voltage] is set to [±10 V], it stands at about ±0.3 V.)

Specify a threshold allowing for tolerance that exceeds the hysteresis width relative to a peak voltage.

**5 Click the [Slope] box, and then from the list, choose a signal direction to be detected.**

	Detects a waveform when it exceeds the specified threshold value (in the positive direction).
	Detects a waveform when it falls below the specified threshold value (in the negative direction).

**6 Click the [Division], and then enter a pulse count used for calculating frequency.**

1 to 4,096

Example: For an encoder that outputs 360 pulses per rotation, set [Division] at [360] to measure a frequency each rotation. When [Division] is not used, set it at [1].

**7 Click the [Timing] box, and then from the list, choose a condition used for starting a count.**

Only when [Mode] is set to [Count], this setting is available.

<b>Start</b>	Clicking the start icon starts accumulating.
<b>Trigger</b>	Starts a count when the instrument is triggered.

- When [Timing] is set to [Start], some internal processing time is required between the time when the start icon is clicked and the start of a measurement. Thus, the count value is not zero at the start point.
- When the [Timing] is set to [Start], an input that exceeds the trigger level does not trigger the instrument while the instrument is filling the pre-trigger memory. Furthermore, the time for internal processing at the start and the trigger priority setting may not cause the instrument to trigger even when the input signal exceeds the specified trigger level.
- The memory division may cause the last data of the previous block to remain in the top of the block.

**8 Click the [Count over] box, and then from the list, choose an action to be performed when a count number is saturated.**

Only when [Mode] is set to [Count], this setting is available.

<b>Hold</b>	Counts pulses and stops counting when the pulse count reaches the upper limit (65535 for the 40 k range).
<b>Undo</b>	Starts counting pulses and brings the count back to zero when the pulse count reaches 25 times of the range figure (50000 for the 40 k range).



**9** Click the **[Level]** box, and then from the list, choose a side of the threshold level to be detected for pulse width measurement and duty ratio measurement.

Only when **[Mode]** is set to **[Pulse width]** or **[Duty ratio]**, this setting is available.

<b>High</b> <input type="checkbox"/>	Measures waveforms on the upper side of the threshold level.
<b>Low</b>	Measures waveforms on the lower side of the threshold level.

**10** Click the **[Smoothing]** box, and then choose a scaling setting from the list.

Only when **[Mode]** is set to **[Freq]** or **[Revolution]**, this setting is available.

<b>Off</b> <input type="checkbox"/>	Records measured data without smoothing (resulting in a step-like waveform).
<b>On</b>	Interpolates measured data to smooth a waveform and outputs it. (Upper limit: 10 kHz; outputting data with this setting set to on lags behind that with this setting set to off)

**11** Click the **[Hold]** box, and then choose a measured-value retaining setting from the list.

Only when **[Mode]** is set to **[Freq]** or **[Revolution]**, this setting is available.

<b>Off (1 Hz), Off (0.5 Hz), Off (0.2 Hz), Off (0.1 Hz)</b>	When the instrument does not determine the measured value even after the frequency reaches a value in the brackets, the measurement is defined to stop and regards the measured value to be 0 Hz (0 rpm).
<b>On</b> <input type="checkbox"/>	Retains the value confirmed the last time.

**12** Click **[Close]**.

The setting dialog box closes.

## Configuring Model 8971 Current Unit settings

 > [Channel] > [8971]

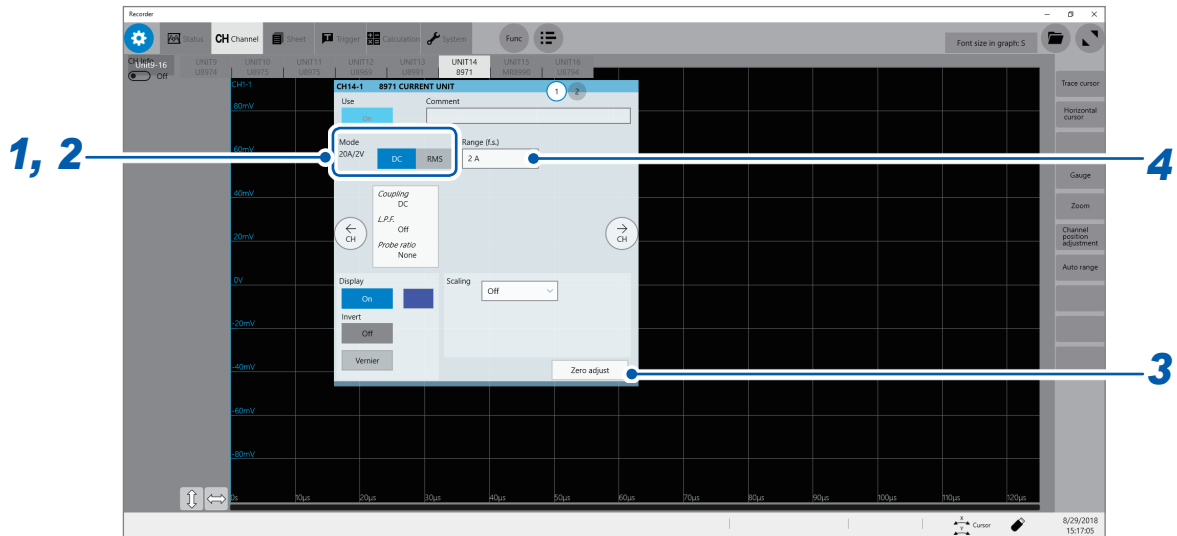

### 1 Confirm the output rate displayed in the [Mode] area.

The instrument automatically recognizes a current sensor connected to Model 8971 Current Unit and displays it as follows:

<b>20A/2V</b>	When one of the following current sensors is connected: Model 9272-10 (20 A range) and Model CT6841.
<b>200A/2V</b>	When one of the following current sensors is connected: Model 9272-10 (200 A range), Model CT6843, and CT6863.
<b>50A/2V</b>	When Model CT6862 AC/DC Current Sensor is connected
<b>500A/2V</b>	When one of the following current sensors is connected: Models 9709, CT6844, CT6845, CT6846*, and CT6865*.
<b>None</b>	When no current sensor is connected.

#### IMPORTANT

\*: When Model CT6846 or Model CT6865 connects to Model 8971 Current Unit via Model 9318 Conversion Cable, the instrument recognizes the sensor as a 500 A AC/DC sensor. Set the conversion ratio at 2.00 in the scaling setting to obtain correct current values.

### 2 In the [Mode] area, click the [DC] or [RMS] to choose a measurement mode.

<b>DC</b> <input checked="" type="checkbox"/>	For current measurement
<b>RMS</b>	For RMS measurement

### 3 (When you have changed the measurement mode) Click [Zero adjust].

The instrument performs zero-adjustment. Execute zero-adjustment without any input.

### 4 Click the [Range (f.s.)] box, and then choose a measurement range from the list.

#### IMPORTANT

The figure of each measurement range name represents the maximum current Model 8971 can measure using the range. However, the instrument cannot measure currents that exceed the rated current of a connected current sensor. Check the specifications of the current sensor used.

# Configuring Model 8972 DC/RMS Unit settings

> [Channel] > [8972]

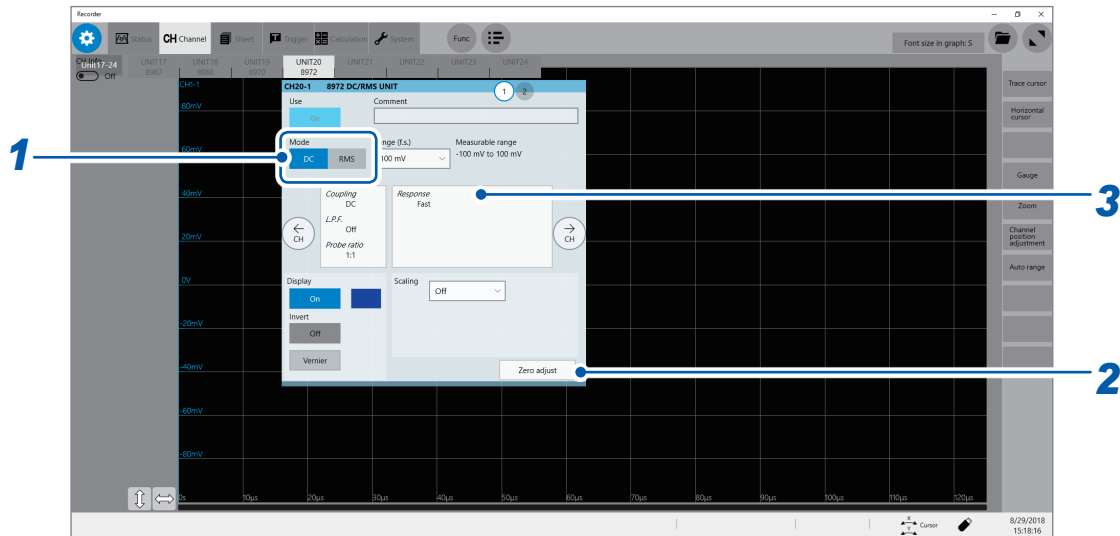

**1** In the [Mode] area, click the [DC] or [RMS] to choose a measurement mode.

<b>DC</b> <input checked="" type="checkbox"/>	For voltage measurement
<b>RMS</b>	For RMS measurement

**2** (When you have changed the measurement mode) Click [Zero adjust].  
The instrument performs zero-adjustment. Execute zero-adjustment without any input.

**3** Click the area that includes [Response].  
The setting dialog box appears.

**4** Click the [Response] box, and then from the list, choose a response time for RMS measurement.

<b>Fast</b> <input checked="" type="checkbox"/>	Sets the response time to about 100 ms.
<b>Normal</b>	Sets the response time to about 800 ms.
<b>Slow</b>	Sets the response time to about 5 seconds.

Usually, use [Fast]. Setting the response time to [Normal] or [Slow] can stabilize the measured values if the frequency is relatively low or the voltage fluctuates severely.

**5** Click [Close].  
The setting dialog box closes.

## Configuring Model MR8990 Digital Voltmeter Unit settings

 > [Channel] > [MR8990]

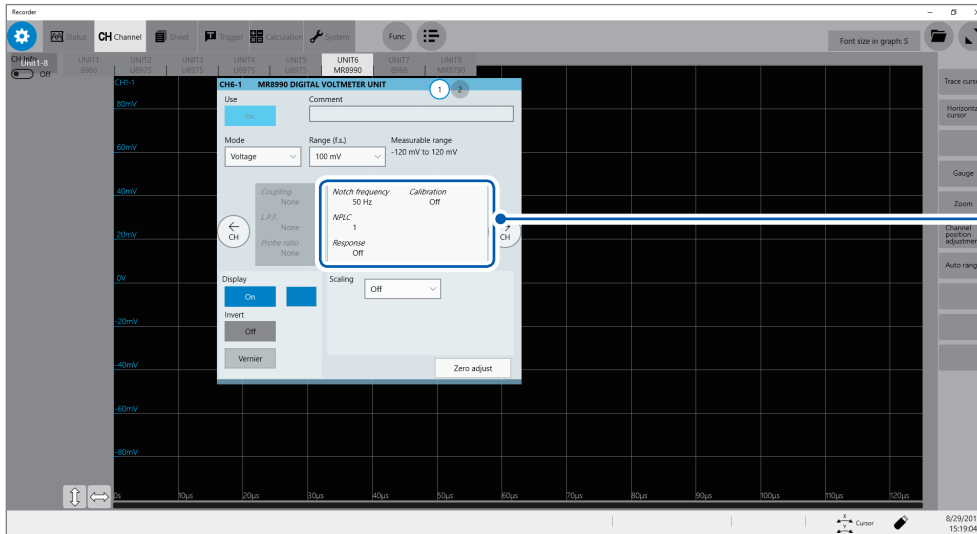

1  
to  
5

**1** Click the area that includes [Notch frequency].

The setting dialog box appears.

**2** Click the [Notch frequency] box, and then choose a power frequency from the list.

Choose a power frequency of your region.

50 Hz <input checked="" type="checkbox"/>	Sets the period at 20 ms.
60 Hz	Sets the period at 16.67 ms.

An incorrect power frequency setting causes measured values to be unstable.

**3** Click the [NPLC] box, and then enter an integration time.

Define an integration time based on the power line cycle (PLC), which is the time equivalent to one period of the power frequency.

0.1 to 0.9, 1  to 10, 20, 30, 40, 50, 60, 70, 80, 90, 100

Example: When the power frequency is 50 Hz and NPLC is set at 10, then 20 ms × 10 = 200 ms is obtained. The instrument updates measured data every 200 ms.

(Increasing NPLC may reduce fluctuation in measured values caused due to exogenous noise or an EMC environment.)

**4** Click the [Response] box, and then choose a data update interval from the list.

Data can be updated at high speed.

Off <input checked="" type="checkbox"/>	Updates data at intervals or input the integration time entered in the [NPLC] box.
On	Updates the data at high speed by calculating moving averages. <ul style="list-style-type: none"> <li>• Updates data at intervals of 0.1 PLC when NPLC is set at 9 or less.</li> <li>• Updates data at intervals of 1 PLC when NPLC is set at 10 or more.</li> </ul>

**5** Click the **[Calibration]** box, and then choose a calibration setting from the list.

Enabling this setting automatically calibrates the module or synchronizes the channels at the start of measurement. The synchronization between channels allows integration calculations to synchronize with each other.

<b>Off</b> <sup>□</sup>	Does not calibrate the module nor synchronize the channels.
<b>On</b>	Calibrates the instrument and synchronizes the channels.
<b>Synchronization</b>	Synchronizes between channels only.

- It takes about 150 ms to calibrate the module. During this period of time, no measurement is performed.
- If the channels are synchronized with each other, the instrument sends a signal that interrupts the integration to each module at the start of measurement; thus, the instrument has to wait until the first integration finishes.

The wait time required for this process stands at the sum of 10 ms and integration time\*.

\*: The integration time varies depending on the NPLC setting.

Even when synchronization is not performed, the wait time described above is required for measurement performed immediately after the settings of Model MR8990 Digital Voltmeter Unit has been changed. No wait time is required when the measurement is performed without any setting changes

- When **[Calibration]** is set to **[Off]** (default setting), execute calibration manually.  
Refer to “2.9 Executing Calibration (For the Instrument With Model MR8990 Installed)” in Quick Start Manual.

**6** Click **[Close]**.

The setting dialog box closes.

## Configuring Model U8974 High Voltage Unit settings

 > [Channel] > [U8974]

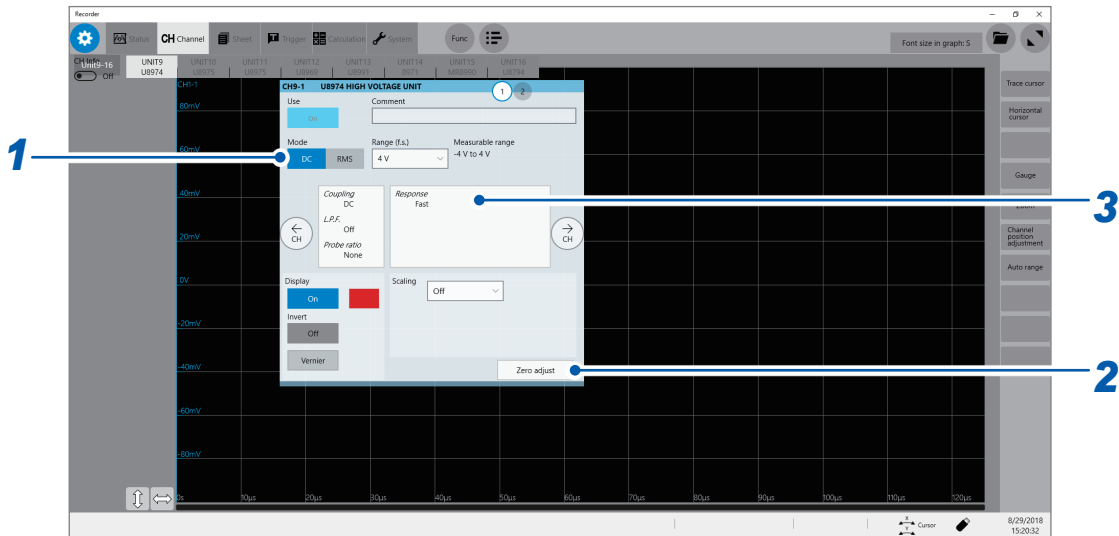

**1** In the [Mode] area, click the [DC] or [RMS] to choose a measurement mode.

<b>DC</b> <input checked="" type="checkbox"/>	For voltage measurement
<b>RMS</b>	For RMS measurement

**2** (When you have changed the measurement mode) Click [Zero adjust].

The instrument performs zero-adjustment. Execute zero-adjustment without any input.

**3** Click the area that includes [Response].

The setting dialog box appears.

**4** Click the [Response] box, and then from the list, choose a response time for RMS measurement.

<b>Fast</b> <input checked="" type="checkbox"/>	Sets the response time at 150 ms.
<b>Normal</b>	Sets the response time at 500 ms.
<b>Slow</b>	Sets the response time at 2.5 seconds.

Setting the response time to [Slow] can stabilize measured values if frequency is relatively low or voltage fluctuates severely.

**5** Click [Close].

The setting dialog box closes.

## Configuring Model U8977 3CH Current Unit Settings

Each of Model 9709, Model CT6860 series, and Model CT6840 series consists of a current sensor with the sub model-number “-05,” which has a metal connector, and that without the sub model-number “-05,” which has a black plastic connector.

You can directly connect a current sensor that has the sub model-number “-05,” which has a metal connector, with Model U8977 U8977 3CH Current Unit. Using Model CT9900 Conversion Cable, you can connect a current sensor without the sub model-number “-05,” which has a plastic connector (PL23), with Model U8977 3CH Current Unit.

 > [Channel] > [U8977]

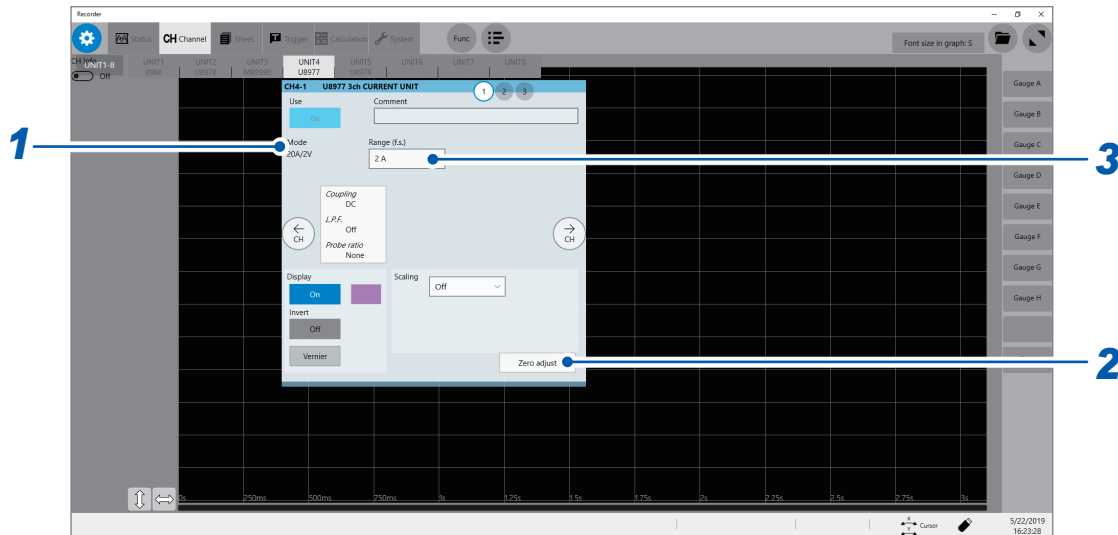

Current sensors to be connected determine whether the instrument automatically recognizes mode or whether you have to choose a current sensor setting.

### 1 (When the instrument automatically recognizes mode) Confirm the output rate displayed in the [Mode] area.

Available measurement ranges, which depend on automatically recognized output rates, are as follows:

<b>20A/2V</b>	2 A, 4 A, 10 A, 20 A, 40 A, 100 A
<b>50A/2V</b>	4 A, 10 A, 20 A, 40 A, 100 A, 200 A
<b>200A/2V</b>	20 A, 40 A, 100 A, 200 A, 400 A, 1 kA
<b>500A/2V</b>	40 A, 100 A, 200 A, 400 A, 1 kA, 2 kA
<b>1000A/2V</b>	100 A, 200 A, 400 A, 1 kA, 2 kA, 4 kA
<b>2000A/2V</b>	200 A, 400 A, 1 kA, 2 kA, 4 kA, 10 kA
<b>None</b>	When no current sensor is connected.

**(When you have to choose a current sensor setting) Click the [Mode] box, and then choose a connected current sensor.**

Available measurement ranges, which depend on chosen current sensors, are as follows:

<b>CT7631/CT7731</b>	200 A
<b>CT7636/CT7736</b>	200 A, 400 A, 1 kA
<b>CT7642/CT7742</b>	2 kA, 4 kA
<b>CT7044/CT7045/ CT7046</b>	2 kA, 4 kA, 10 kA
<b>0.1mV/A</b>	2 kA, 4 kA, 10 kA, 20 kA, 40 kA, 100 kA
<b>1mV/A</b>	200 A, 400 A, 1 kA, 2 kA, 4 kA, 10 kA
<b>10mV/A</b>	20 A, 40 A, 100 A, 200 A, 400 A, 1 kA
<b>100mV/A</b>	2 A, 4 A, 10 A, 20 A, 40 A, 100 A
<b>1000mV/A</b>	0.2 A, 0.4 A, 1 A, 2 A, 4 A, 10 A

**IMPORTANT**

- When Model CT6846 or Model CT6865 connects via Model CT9900 Conversion Cable, the instrument recognizes the sensor as a 500 AAC/DC sensor. Set the conversion ratio at 2.00 in the scaling setting.
- When a current sensor included in Model CT6700 series is connected via Model CT9920 Conversion Cable, set a current sensor model name or its output rate.
- Make sure to execute zero-adjustment after you change the setting. Execute zero-adjustment without any input.

**2 (When you have changed the measurement mode) Click [Zero adjust].**

The instrument performs zero-adjustment. Execute zero-adjustment without any input.

**3 Click the [Range (f.s.)] box, and then choose a measurement range from the list.**

The instrument automatically configures the scaling setting for a measurement range according to a recognized current sensor.

**IMPORTANT**

The figure of each measurement range name represents the maximum current that Model U8977 can measure using the range. However, the instrument cannot measure currents that exceed the rated current of a connected current sensor. Check the specifications of the current sensor used.



## Configuring Model U8979 Charge Unit Settings

This setting allows you to choose between voltage measurement and acceleration measurement (charge-output or built-in pre-amplifier) for an input channel.

A channel can measure either one of them.

Voltage mode and Preamp mode use BNC connectors, whereas Charge mode uses miniature connectors.

Model U8979 can automatically recognize TEDS-compliant\* sensors.

\*: Transducer electronic data sheet

### ⚠ WARNING



Setting the measurement mode to **[Preamp]** allows Model U8979 Charge Unit to constantly provide power (3.5 mA, 22 V) to sensors. Set any measurement mode other than **[Preamp]** or turn off the instrument before connecting a sensor or probe with a BNC terminal to avoid an electric shock or damage to the measurement target.

3

Advanced Functions

⚙ > [Channel] > [U8979]

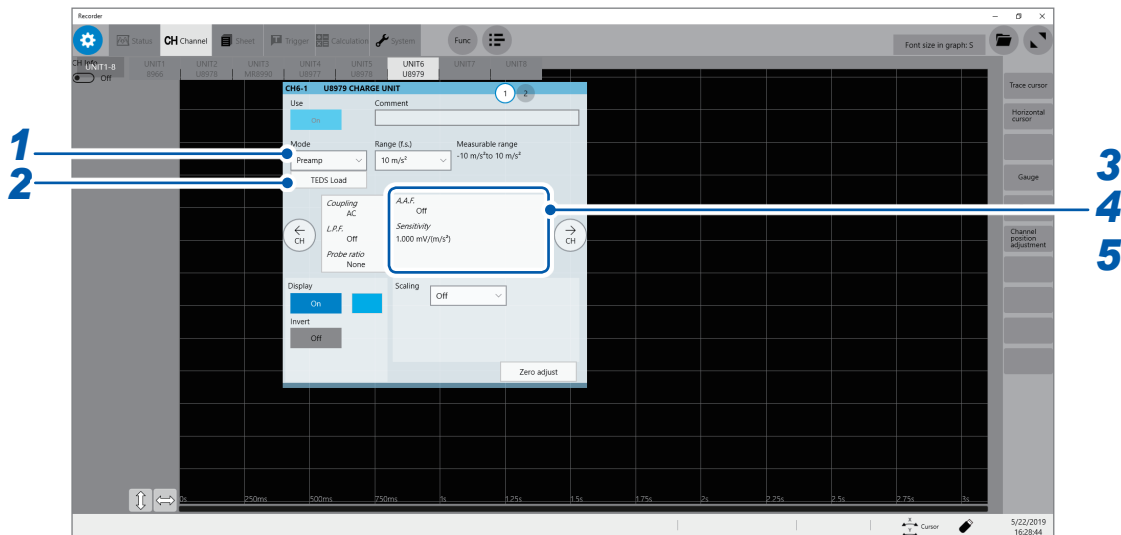

**1** Click the **[Mode]** box, and then choose a measurement mode from the list.

Mode	Measurement target	Measurement sensitivity
Voltage	Voltage	—
Charge <sup>Ⓜ</sup>	Charge-output acceleration sensor	0.1 pC/(m/s <sup>2</sup> ) to 10 pC/(m/s <sup>2</sup> )
Preamp	Acceleration sensor with a built-in pre-amplifier	0.1 mV/(m/s <sup>2</sup> ) to 10 mV/(m/s <sup>2</sup> )

**2** (When setting mode to **[Preamp]**) Click **[TEDS Load]**.

Acquires sensitivity of a connected sensor. However, the instrument can acquire sensitivity of TEDS-compliant acceleration sensors with a built-in pre-amplifier only.

When sensor sensitivity has been acquired, it is automatically set.

**3** Click the area that includes **[A.A.F.]**.

The setting dialog box appears.

**4 Click the [A.A.F.] box, and then choose a anti-aliasing filter setting from a list.**

The anti-aliasing filter can prevent aliasing distortion that may be produced during FFT calculation. The cutoff frequency automatically changes according to the sampling rates or frequency range (for the FFT function) settings.

<b>Off</b> <input checked="" type="checkbox"/>	Disables the anti-aliasing filter.
<b>On</b>	Enables the anti-aliasing filter. (Disabled when the external sampling is used, or the sampling rate is set at 100 kS/s or faster)

**5 Click [Sensitivity] box, and then enter sensor sensitivity.**

You can enter sensor sensitivity to two decimal places. For a charge-output acceleration sensor or non-TEDS-compliant sensor, enter its sensitivity marked on the sensor, which represents sensitivity per meter per second squared.

**6 Click [Close].**

The setting dialog box closes.

**Setting example for sensor sensitivity**

**Example 1**

For a sensor with its sensor sensitivity per meter per second squared marked

Sensor sensitivity	Setting value
1.08 pC/(m/s <sup>2</sup> )	1.08

**Example 2**

For a sensor with its sensor sensitivity per gravity (G) marked.

For a sensor with its sensitivity per gravity (G) marked, enter a quotient of the marked sensitivity divided by 9.8 m/s<sup>2</sup>.

Sensor sensitivity	Setting value
For sensor sensitivity of 64 pC/G 64.0 / 9.8 = 6.53061... pC/(m/s <sup>2</sup> )	6.531 (to two decimal places)

**To convert a unit from meter per second squared into gravity (G)**

The instrument measures charge quantities per meter per second squared. You can convert such charge quantities into those per gravity (G) using the scaling function.

Refer to “3.2 Converting Input Values (Scaling Function)” (p. 40).

Configure the scaling setting as follows;

**Example 1**

**Specifying a conversion ratio**

<b>Ratio</b>	0.1020E+00 (= 1/9.8)
<b>Offset</b>	0.0000E+00
<b>Units</b>	G

**Example 2**

**Specifying two points**

<b>Input1</b>	9.8000E+00	<b>Scale1</b>	1.0000E+00
<b>Input2</b>	0.0000E+00	<b>Scale2</b>	0.0000E+00
<b>Units</b>	G		

## When using an out-of-setting-range current sensor

You can use an out-of-setting-range current sensor using the scaling function.  
Refer to “Automatically saving waveform data” (p. 102).

### 1 Click the area that includes [Sensitivity].

The setting dialog box appears.

### 2 Click [Sensitivity] box, and then enter sensor sensitivity.

Multiply the sensor sensitivity of a sensor to be used by a certain value to allow a product to fall within the setting range (0.1 to 10), and enter the product.

### 3 Click [Close].

The setting dialog box closes.

### 4 Click the [Scaling] box, and then configure the scaling setting.

Configure the scaling setting so that a scaling ratio is the same value as the number you multiplied the sensor sensitivity by.

#### Example 1

##### For sensor sensitivity of 23.4 pC/(m/s<sup>2</sup>)

Specify 10 pC/(m/s<sup>2</sup>), which results from multiplying the sensor sensitivity by 1/2.34, as the sensor sensitivity. To display measured values after multiplying them by 1/2.34, configure the scaling setting as follows:

To configure the scaling setting using the conversion ratio method

Ratio	0.4274E+00 (= 10/23.4)		
Offset	0.0000E+00		
Units	m/s <sup>2</sup>		

To configure the scaling setting using the 2-point method

Input1	2.3400E+00	Scale1	1.0000E+00
Input2	0.0000E+00	Scale2	0.0000E+00
Units	m/s <sup>2</sup>		

#### Example 2

##### For sensor sensitivity of 0.05 pC/(m/s<sup>2</sup>)

Specify 0.1 pC/(m/s<sup>2</sup>), which results from multiplying the sensor sensitivity by two, as the sensor sensitivity. To display measured values after multiplying them by two, configure the scaling setting as follows:

To configure the scaling setting using the conversion ratio method

Ratio	2.0000E+00 (= 0.1/0.05)		
Offset	0.0000E+00		
Units	m/s <sup>2</sup>		

To configure the scaling setting using the 2-point method

Input1	0.0500E+00	Scale1	1.0000E+00
Input2	0.0000E+00	Scale2	0.0000E+00
Units	m/s <sup>2</sup>		

## Configuring Model U8991 Digital Voltmeter Unit settings

 > [Channel] > [U8991]

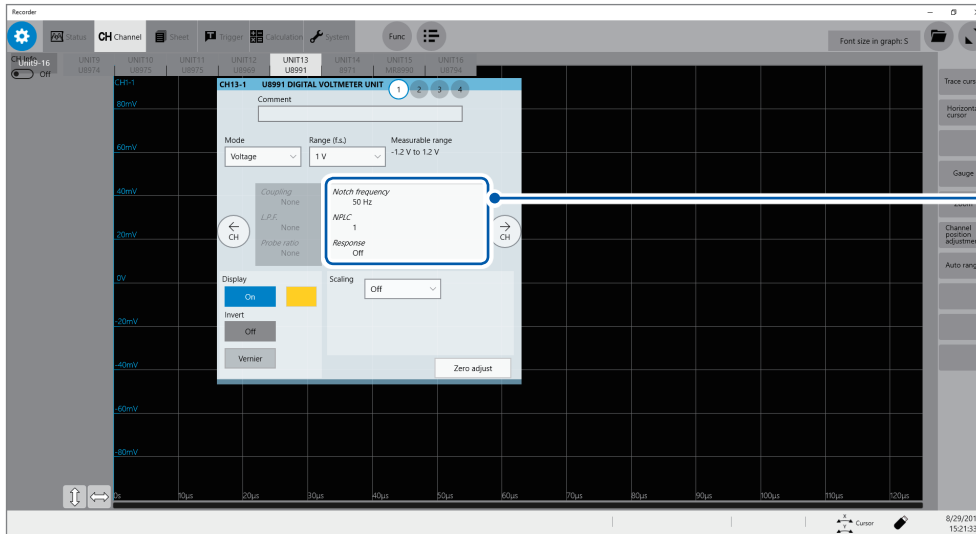

1  
to  
4

**1** Click the area that includes [Notch frequency].

The setting dialog box appears.

**2** Click the [Notch frequency] box, and then choose a power frequency from the list.

Choose a power frequency of your region.

50 Hz <input checked="" type="checkbox"/>	Sets the period at 20 ms.
60 Hz	Sets the period at 16.67 ms.

An incorrect power frequency setting causes measured values to be unstable.

**3** Click the [NPLC] box, and then enter an integration time.

Define an integration time based on the power line cycle (PLC), which is the time equivalent to one period of the power frequency.

1 <input checked="" type="checkbox"/> , 10, 100
---

Example: When the power frequency is 50 Hz and NPLC is set at 10, then  $20 \text{ ms} \times 10 = 200 \text{ ms}$  is obtained. The instrument updates measured data every 200 ms.

(Increasing NPLC may reduce fluctuation in measured values caused due to exogenous noise or an EMC environment.

**4** Click the [Response] box, and then choose a data update interval from the list.

Off <input checked="" type="checkbox"/>	Updates data at intervals the time entered in the [NPLC] box.
On	Calculates moving averages every 1 PLC and updates the data.

**5** Click [Close].

The setting dialog box closes.

# 3.7 Configuring Generator-Module-Specific Settings

You can configure settings of MR8790 Waveform Generator Unit, MR8791 Pulse Generator Unit, and U8793 Arbitrary Waveform Generator Unit on the channel screen. You can configure U8794 VIR Generator Unit settings on the dedicated setting screen.

## Generating signals from Model MR8790 Waveform Generator Unit

For details, see the U8793, MR8790, and MR8791's Instruction Manual.

This section describes how to select the Waveform Generator Unit's output synchronization control and setting method.

 > [Channel] > [MR8790]

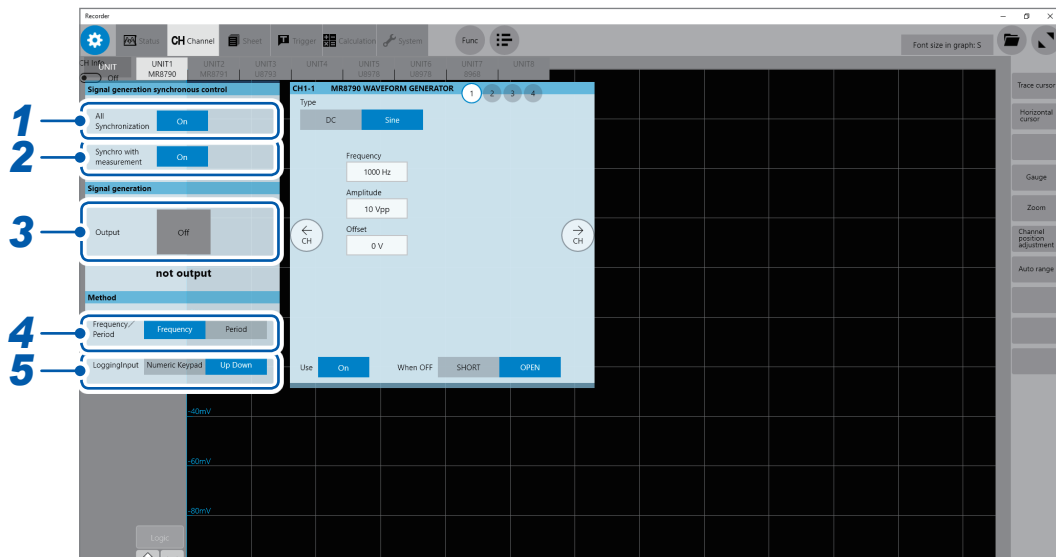

**1** Click the **[All Synchronization]** button, and then choose the synchronization method of channels.

<b>On</b>	Controls the signal generation of all modules' all channels simultaneously.
<b>Off</b> 	Controls the signal generation of the channels only set on this screen.

**2** Click the **[Synchro with measurement]** button, and then choose the synchronization method of signal outputting with measurements.

<b>On</b>	Synchronizes signal outputting with the start/stop of measurements. The signals outputs and stops respectively in sync with the start and stop of measurements.
<b>Off</b> 	Does not synchronize signal outputting with the start/stop of measurements. You can manually control signal outputting.

**3** Click the **[Output]** button, and then choose whether to output the signals.

<b>On</b>	Outputs the signals.
<b>Off</b> 	Stops outputting the signals.

**4** Click **[Frequency]** or **[Period]** button, and then choose the setting method of the signals.

<b>Frequency</b> 	Uses the frequency.
<b>Period</b>	Uses the period.

**5** Click **[Numeric Keypad]** or **[Up Down]**, and then choose a way of entering values.

<b>Numeric Keypad</b> 	Uses the numerical key pad.
<b>Up Down</b>	Uses the Up Arrow and Down Arrow keys.

Key pad

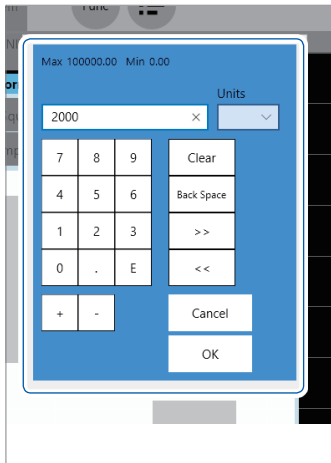

Up Arrow and Down Arrow keys

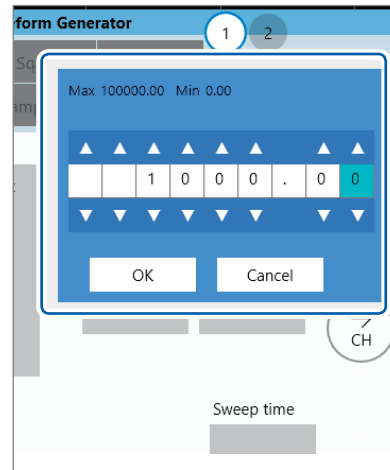

## Configuring Model MR8790 Waveform Generator Unit setting

This section describes how to configure the settings specific to the MR8790 Waveform Generator Unit.

 > [Channel] > [MR8790]

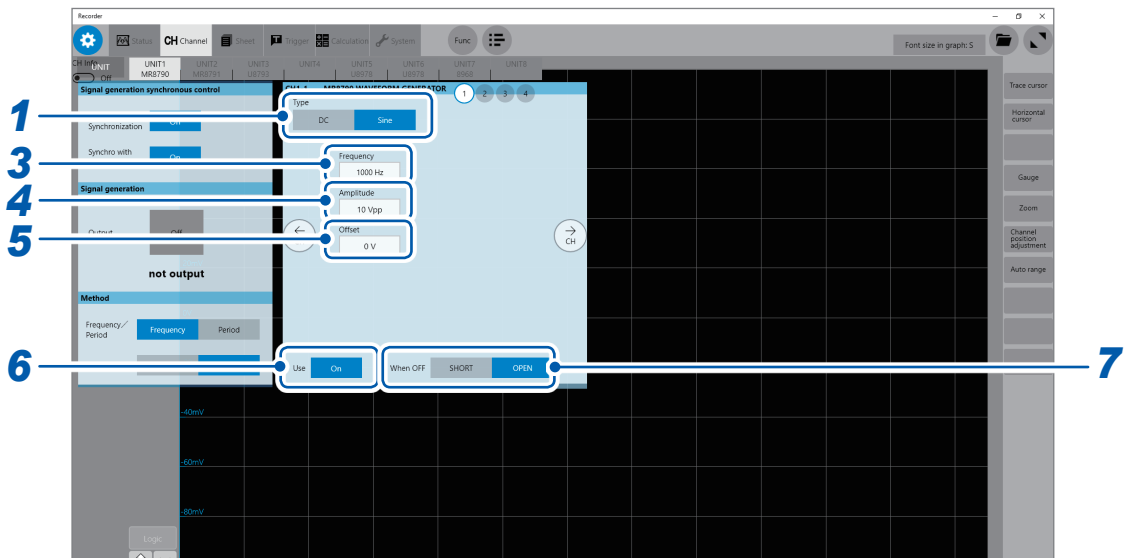
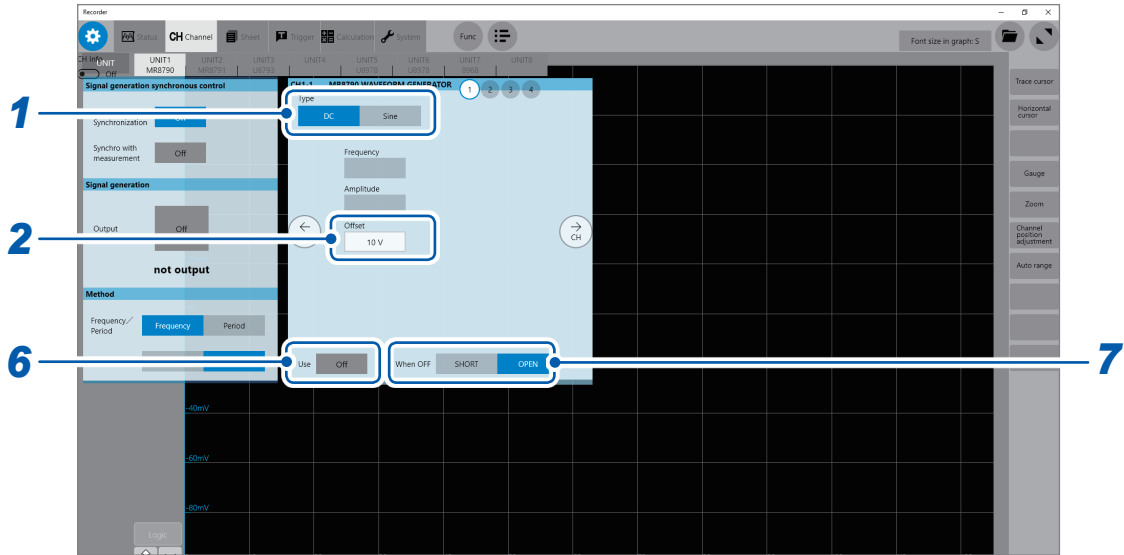

3  
Advanced Functions

### 1 Choose a waveform type

DC	Outputs a DC signal.
Sine 	Outputs a sine wave signal.

### 2 (When [DC] is selected) Enter a DC voltage.

-10.000 V to +10.000 V

**3** (When **[Sine]** is selected) Enter a frequency.

0 Hz to 20000 Hz

**4** (When **[Sine]** is selected) Enter an amplitude.

Accuracy of the output voltage, which consists of amplitude and an offset value, is guaranteed in the range of -10 V to +10 V.

An output waveform will appear with its upper parts limited to about +14 V and lower about -14 V when the sum of the amplitude and offset value is set to out of the accuracy-guaranteed range.

0.000 V p-p to 20.000 V p-p

**5** (When **[Sine]** is selected) Enter an offset voltage.

Accuracy of the output voltage, which consists of amplitude and an offset value, is guaranteed in the range of -10 V to +10 V.

An output waveform will appear with its upper parts limited to about +14 V and lower about -14 V when the sum of the amplitude and offset value is set to out of the accuracy-guaranteed range.

-10.000 V to +10.000 V

**6** (When **[All Synchronization]** is set to **[On]**) Select the output setting for each channel.

<b>On</b>	Uses the channel as the output target.
<b>Off</b> <input checked="" type="checkbox"/>	Does not use the channel as the output target.

**7** Choose a state at the time when no waveform is outputted.

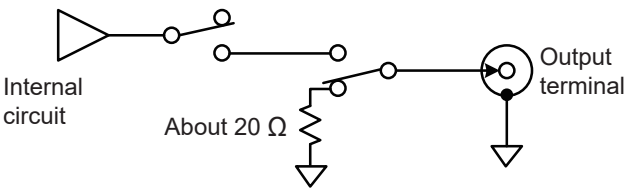
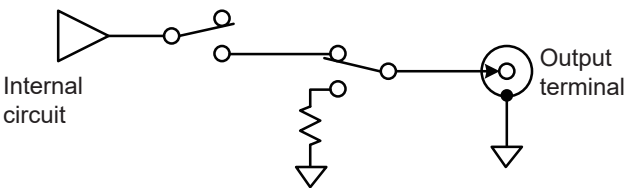
<b>SHORT</b> <input checked="" type="checkbox"/>	Places the output terminal in a short-circuited state by introducing resistance. 
<b>OPEN</b>	Places the output terminal in an open state. 



## Generating signals from Model MR8791 Pulse Generator Unit

For details, see the U8793, MR8791 and MR8791's Instruction Manual.

This section describes how to select the Pulse Generator Unit's output synchronization control and setting method.

 > [Channel] > [MR8791]

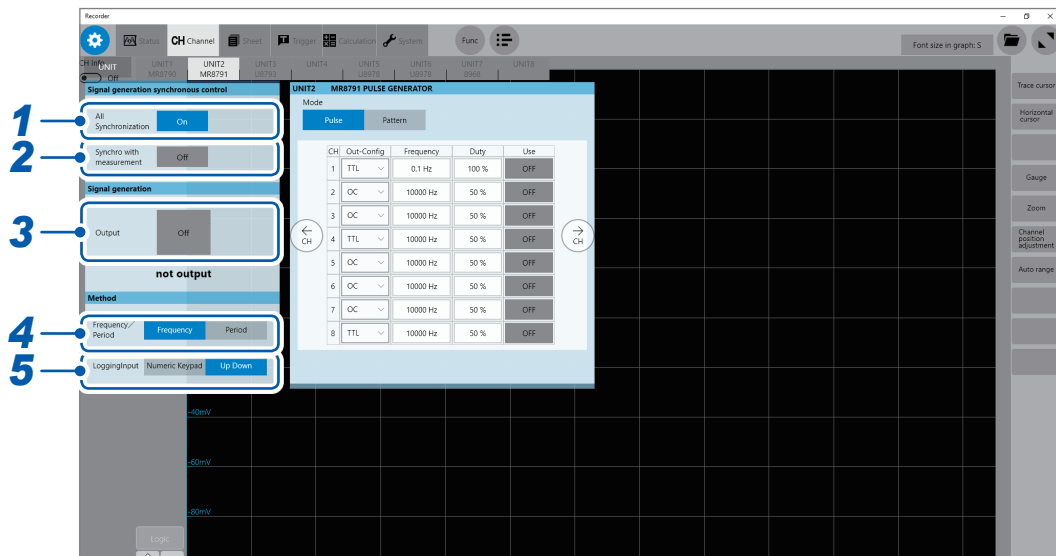

- 1 Click the **[All Synchronization]** button, and then choose the synchronization method of channels.

The MR8791 Pulse Generator Unit can only be used when the **[All Synchronization]** is set to **[On]**.

<b>On</b>	Controls the signal generation of all modules' all channels simultaneously.
<b>Off</b> <input type="checkbox"/>	Controls the signal generation of the channels only set on this screen.

- 2 Click the **[Synchro with measurement]** button, and then choose the synchronization method of signal outputting with measurements.

<b>On</b>	Synchronizes signal outputting with the start/stop of measurements. The signals outputs and stops respectively in sync with the start and stop of measurements.
<b>Off</b> <input type="checkbox"/>	Does not synchronize signal outputting with the start/stop of measurements. You can manually control signal outputting.

- 3 Click the **[Output]** button, and then choose whether to output signals.

<b>On</b>	Outputs the signals.
<b>Off</b> <input type="checkbox"/>	Stops outputting the signals.

**4** Click **[Frequency]** or **[Period]** button, and then choose the setting method of signals.

<b>Frequency</b> 	Uses the frequency.
<b>Period</b>	Uses the period.

**5** Click **[Numeric Keypad]** or **[Up Down]**, and then choose a way of entering values.

<b>Numeric Keypad</b> 	Uses the numerical key pad.
<b>Up Down</b>	Uses the Up Arrow and Down Arrow keys.

Key pad

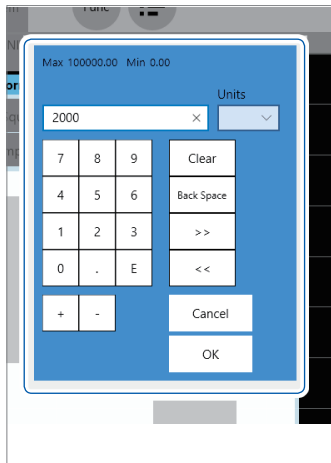

Up Arrow and Down Arrow keys

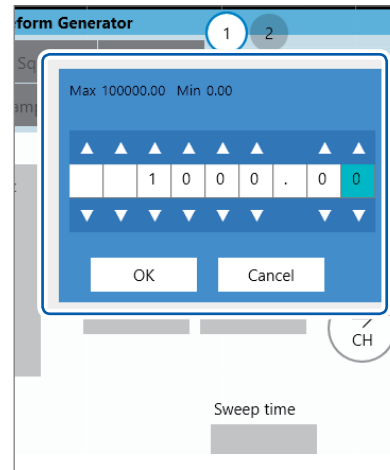

## Configuring Model MR8791 Pulse Generator Unit settings

This section describes how to configure the settings specific to the MR8791 Pulse Generator Unit.

 > [Channel] > [MR8791]

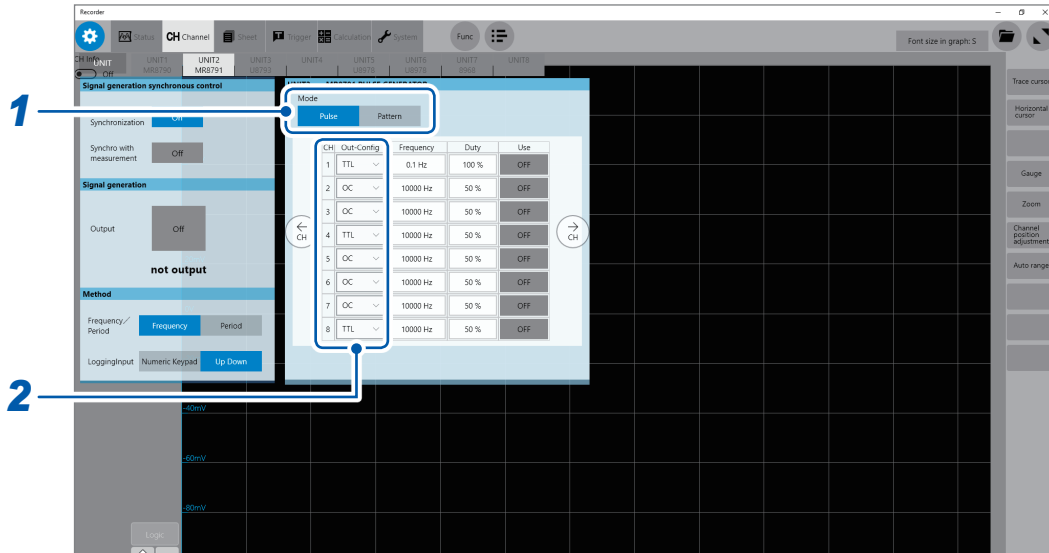

3

Advanced Functions

### 1 Choose an output waveform type.

<b>Pulse</b> <input checked="" type="checkbox"/>	Outputs a pulse waveform.
<b>Pattern</b>	Outputs a pattern waveform.

### 2 Choose the output configuration.

<b>TTL</b> <input checked="" type="checkbox"/>	TTL-level output (amplitude: 0-5 V)
<b>OC</b>	Open-collector output

The ground potential is cross-channel and not insulated.

With the open-collector output setting

- Limit the collector-emitter voltage to 50 V.
- The maximum response time (10% to 90%) is approximately 5  $\mu$ s (with a load capacitance of 1000 pF and a pull-up resistance of 1 k $\Omega$ ) (reference value).

## Configuring the pulse output settings

When **[Pulse]** is selected, configure the settings as follows.

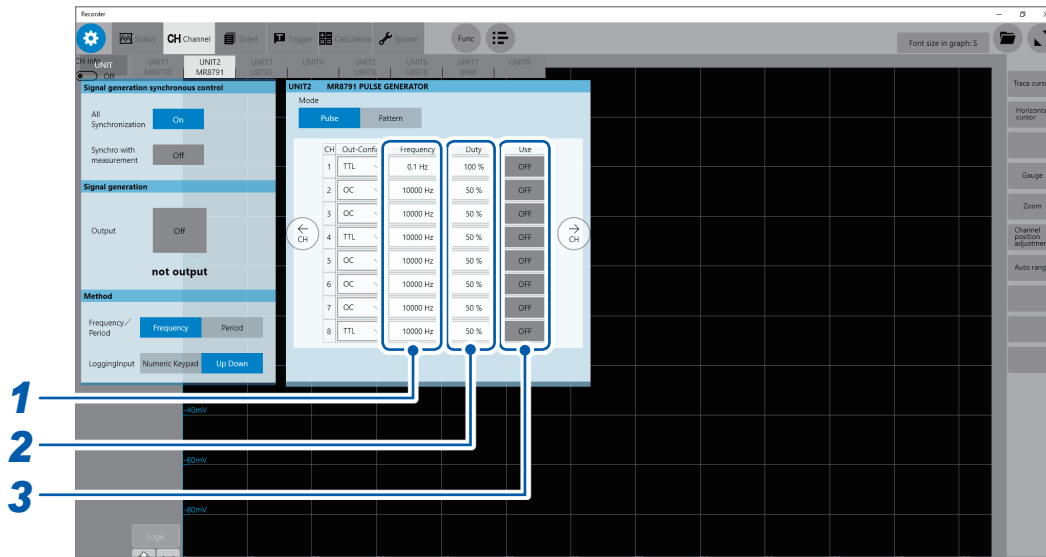

### 1 Enter a frequency (in 0.1 Hz increments).

0.0 Hz to 20000.0 Hz

### 2 Enter a pulse duty ratio (in 0.1 percent point increments).

0.0% to 100.0%

- With the 0% setting, the low-level signal is outputted; with the 100% setting, the high-level signal is outputted. No pulse is outputted.
- With the 100% setting, the low-level signal is outputted even if the output setting is disabled.
- The output pulse width of less than 1  $\mu$ s, which can be derived from the frequency and duty ratio settings, may cause the output pulse to disappear.

### 3 Select the pulse output settings.

<b>On</b>	Outputs a pulse waveform.
<b>Off</b> <input type="checkbox"/>	Does not output any pulse waveform.

## Configuring the pattern output settings

When **[Pattern]** is selected, configure the settings as follows.

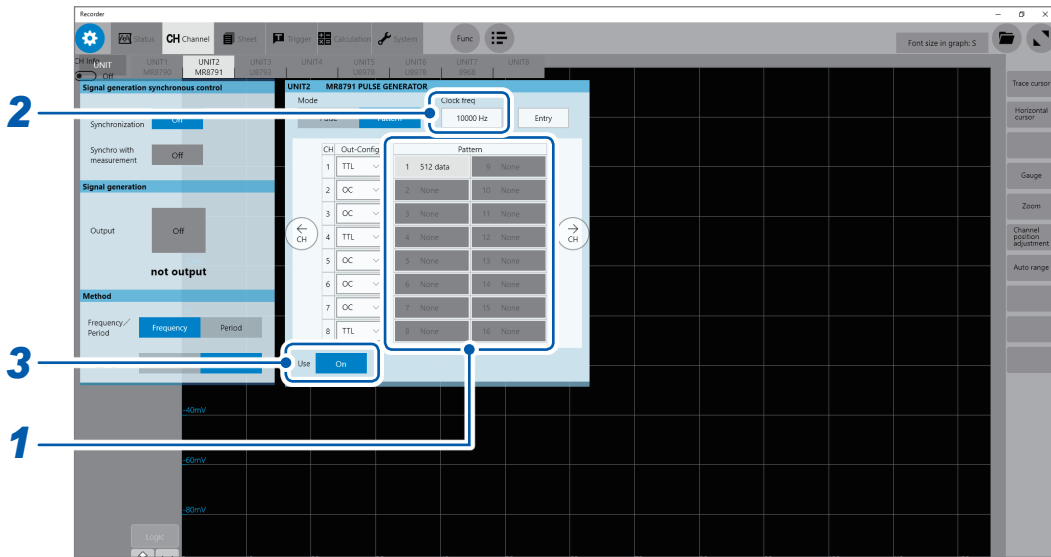

### 1 Select and click the pattern to use.

When output is in the stopped state, the first registered pattern will be output. Pattern data will be erased if the instrument is turned off. Register pattern data again after turning the instrument back on.

### 2 Enter a clock frequency (in 10 Hz increments).

0 Hz to 120000 Hz

### 3 (When the **[All Synchronization]** is set to **[On]**) Select the output setting for each channel.

<b>On</b>	Uses the channel as the output target.
<b>Off</b> <input checked="" type="checkbox"/>	Does not use the channel as the output target.

### Registering a pattern

Insert a storage device with pattern data stored (the extension is “.pls”) before performing any operations. Up to 16 pattern files can be registered.

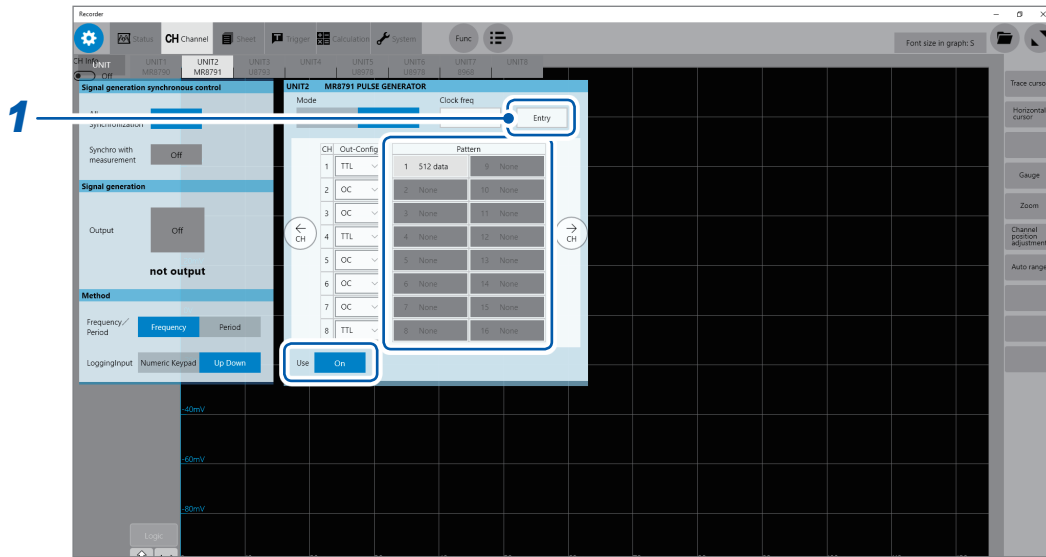

- 1 Click the **[Entry]** button.  
The file selection screen appears.

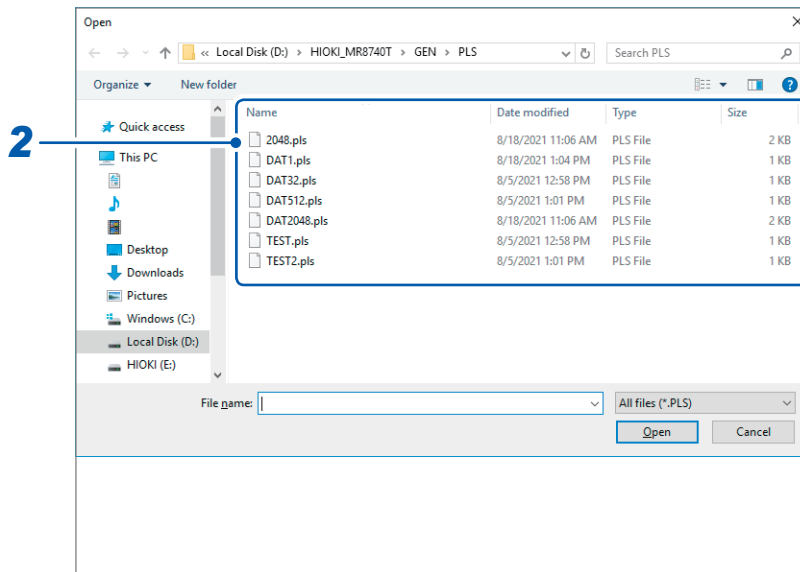

**2 Choose a file you wish to register.**

The **[Entry from File]** dialog box appears.

Entry from File

File name  
DAT512.pls

3 Pattern No.  
Pattern1 None

Samples  
512

4 OK Cancel

**3 Click the [Pattern No.] box, and then choose a pattern.****4 Click the [OK] button, and then register the pattern.**

When you click the **[Cancel]** button, the dialog box is closed without registering.

## Generating signals from Model U8793 Arbitrary Waveform Generator Unit

For details, see the U8793, MR8790, and MR8791's Instruction Manual.

This section describes how to select the Arbitrary Waveform Generator Unit's output synchronization control and setting method.

 > [Channel] > [U8793]

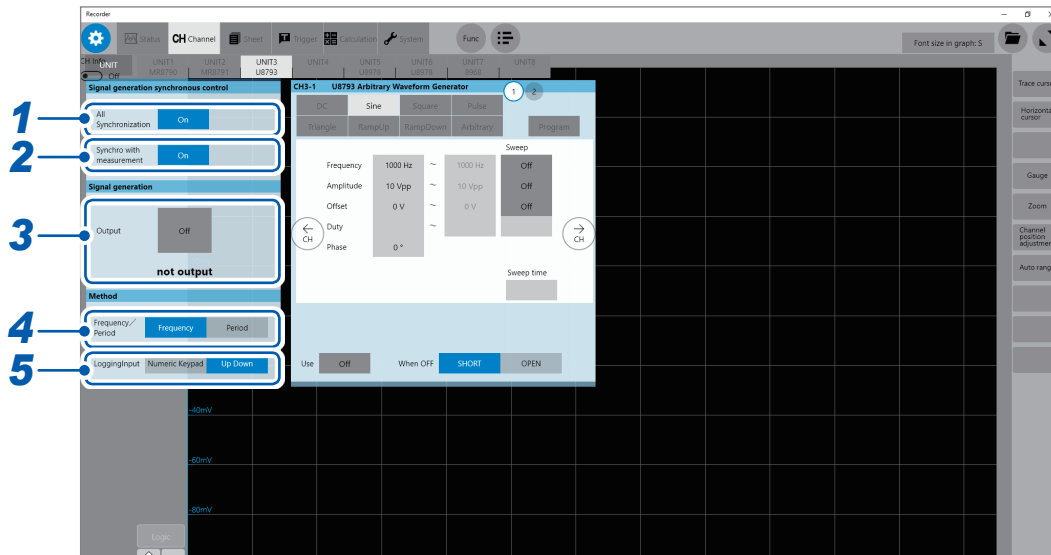

**1** Click the **[All Synchronization]** button, and then choose the synchronization method of channels.

<b>On</b>	Controls the signal generation of all modules' all channels simultaneously.
<b>Off</b> <input checked="" type="checkbox"/>	Controls the signal generation of the channels only set on this screen.

**2** Click the **[Synchro with measurement]** button, and then choose the synchronization method of signal outputting with measurements.

<b>On</b>	Synchronizes signal outputting with the start/stop of measurements. The signals outputs and stops respectively in sync with the the start and stop of measurements.
<b>Off</b> <input checked="" type="checkbox"/>	Does not synchronize signal outputting with the start/stop of measurements. You can manually control signal outputting.

**3** Click the **[Output]** button, and then choose whether to output signals.

<b>On</b>	Outputs the signals.
<b>Off</b> <input checked="" type="checkbox"/>	Stops outputting the signals.



**4** Click **[Frequency]** or **[Period]** button, and choose the setting method of signals.

<b>Frequency</b> 	Uses the frequency.
<b>Period</b>	Uses the period.

**5** Click **[Numeric Keypad]** or **[Up Down]**, and choose a way of entering values.

<b>Numeric Keypad</b> 	Uses the numerical key pad.
<b>Up Down</b>	Uses the Up Arrow and Down Arrow keys.

Key pad

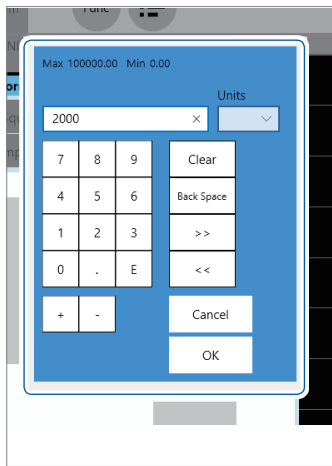

Up Arrow and Down Arrow keys

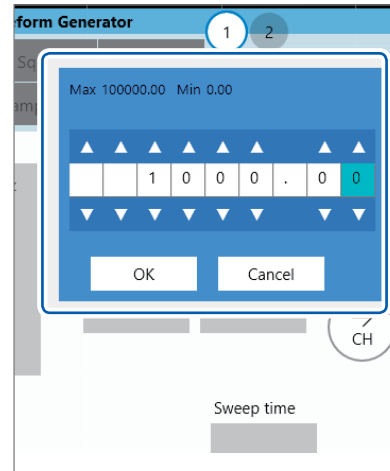

## Configuring Model U8793 Arbitrary Waveform Generator Unit

This section describes how to configure the settings specific to the U8793 Arbitrary Waveform Generator Unit.

 > [Channel] > [U8793]

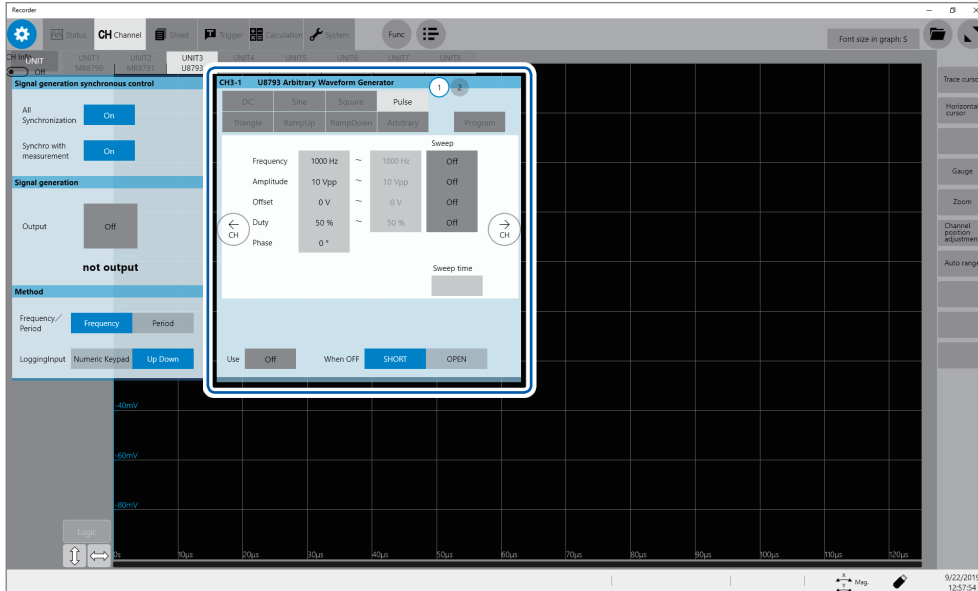

List of parameters than can be displayed and set.

✓: Displayed, –: Not displayed

Type	DC	Sine	Square	Pulse	Triangle	Ramp-Up	Ramp-Down	Arbitrary
<b>Frequency or Period</b> 0.00 to 100,000.00 (Hz) 0.00 to 100.00 (s)	–	✓	✓	✓	✓	✓	✓	–
<b>Clock frequency or Clock period</b> 0.00 to 20,000,000.00 (Hz) 0.00 to 100.00 (s)	–	–	–	–	–	–	–	✓
<b>Amplitude</b> 0.000 to 20.000 (Vpp)	–	✓	✓	✓	✓	✓	✓	–
<b>Amp. Adjust.</b> 0.000× to 2.000×	–	–	–	–	–	–	–	✓
<b>Offset</b> –10.000 to 15.000 (V)	✓	✓	✓	✓	✓	✓	✓	✓
<b>Duty</b> 0.1 to 99.9 (%)	–	–	–	✓	–	–	–	–
<b>Phase</b> –360.0 to 360.0 (°)	–	✓	✓	✓	✓	✓	✓	–
<b>Delay</b> –250000 to 250000 (Can be set in the number of samples)	–	–	–	–	–	–	–	✓

✓: Displayed, -: Not displayed

Type	DC	Sine	Square	Pulse	Triangle	Ramp-Up	Ramp-Down	Arbitrary
<b>Loop times</b> 1 to 50000 (Infinity when set to zero)	-	-	-	-	-	-	-	✓
<b>Filter</b>	-	-	-	-	-	-	-	✓
<b>Sweep</b> (On/Off)	-	✓	✓	✓	✓	✓	✓	✓
<b>Sweep time</b> 10 μ to 1000 (s)	-	✓	✓	✓	✓	✓	✓	✓

- See “Editing programs of the U8793 Arbitrary Waveform Generator Unit” (p. 88) for the **[Program]** settings.
- The least significant digit displayed in the valid setting range indicates the setting resolution.

Type	Function
<b>DC</b>	Outputs a DC signal.
<b>Sine</b>	Outputs a sine wave.
<b>Square</b>	Outputs a square wave with a duty ratio of 50%.
<b>Pulse</b>	Outputs a pulse wave with a previously set duty ratio.
<b>Triangle</b>	Outputs a triangular wave.
<b>RampUp</b>	Outputs a ramp-up wave.
<b>RampDown</b>	Outputs a ramp-down wave.
<b>Arbitrary</b>	Outputs a created arbitrary wave. See “Registering arbitrary waveforms in the U8793 Arbitrary Waveform Generator Unit” (p. 83).
<b>Program</b>	Outputs a waveform according to a previously edited program. See “Editing programs of the U8793 Arbitrary Waveform Generator Unit” (p. 88).
<b>Frequency</b>	Allows you to enter the frequency or period of the output waveform.
<b>Clock frequency</b>	Allows you to enter the frequency or period if you chose the arbitrary waveform setting.
<b>Amplitude</b>	Allows you to enter the amplitude of the output waveform.
<b>Amp. Adjust.</b>	Allows you to adjust the amplitude if you chose the arbitrary waveform setting.
<b>Offset</b>	Allows you to enter the offset voltage of the output waveform. Allows you to enter the DC voltage if you chose the DC voltage setting.
<b>Duty</b>	Allows you to enter the duty ratio if you chose the pulse wave setting.
<b>Phase</b>	Allows you to enter the phase.
<b>Delay</b>	Allows you to enter the delay time if you chose the arbitrary waveform setting.
<b>Loop times</b>	Allows you to enter the number of looping times if you chose the arbitrary waveform setting. If you enter zero, the instrument displays the sign [∞] and continues outputting the signal repeatedly until you stop the output. The <b>[Loop times]</b> setting cannot be configured if the <b>[Sweep]</b> is set to <b>[On]</b> .
<b>Filter</b>	Allows you to choose the frequency used to filter the arbitrary waveform. <b>OFF</b>  , 50, 100, 200, 500, 1 k, 2 k, 5 k, 10 k, 20 k, 50 k, 100 k, 200 k, 500 k, 1M [Hz]

Type	Function				
<b>Sweep</b>	Allows you to set the sweep function to on or off. You can set multiple parameters to on. However, either the frequency sweep or the duty ratio sweep, but not both, can be set to on.				
<b>Sweep time</b>	Allows you to set the sweeping time. Every parameter uses the common sweeping time.				
<b>Use</b>	<p>This setting will appear when the <b>[All Synchronization]</b> has been set to <b>[On]</b>.</p> <table border="1" data-bbox="469 448 1390 539"> <tr> <td data-bbox="469 448 697 492"><b>On</b></td> <td data-bbox="697 448 1390 492">Uses the channel as the output target.</td> </tr> <tr> <td data-bbox="469 492 697 539"><b>Off</b><sup>☒</sup></td> <td data-bbox="697 492 1390 539">Does not use the channel as the output target.</td> </tr> </table>	<b>On</b>	Uses the channel as the output target.	<b>Off</b> <sup>☒</sup>	Does not use the channel as the output target.
<b>On</b>	Uses the channel as the output target.				
<b>Off</b> <sup>☒</sup>	Does not use the channel as the output target.				
<b>When OFF</b>	<p>Allows you to choose an option used when the output is set to off.</p> <table border="1" data-bbox="469 604 1390 696"> <tr> <td data-bbox="469 604 697 649"><b>SHORT</b><sup>☒</sup></td> <td data-bbox="697 604 1390 649">Short-circuits the output terminal.</td> </tr> <tr> <td data-bbox="469 649 697 696"><b>OPEN</b></td> <td data-bbox="697 649 1390 696">Opens the output terminal.</td> </tr> </table>	<b>SHORT</b> <sup>☒</sup>	Short-circuits the output terminal.	<b>OPEN</b>	Opens the output terminal.
<b>SHORT</b> <sup>☒</sup>	Short-circuits the output terminal.				
<b>OPEN</b>	Opens the output terminal.				



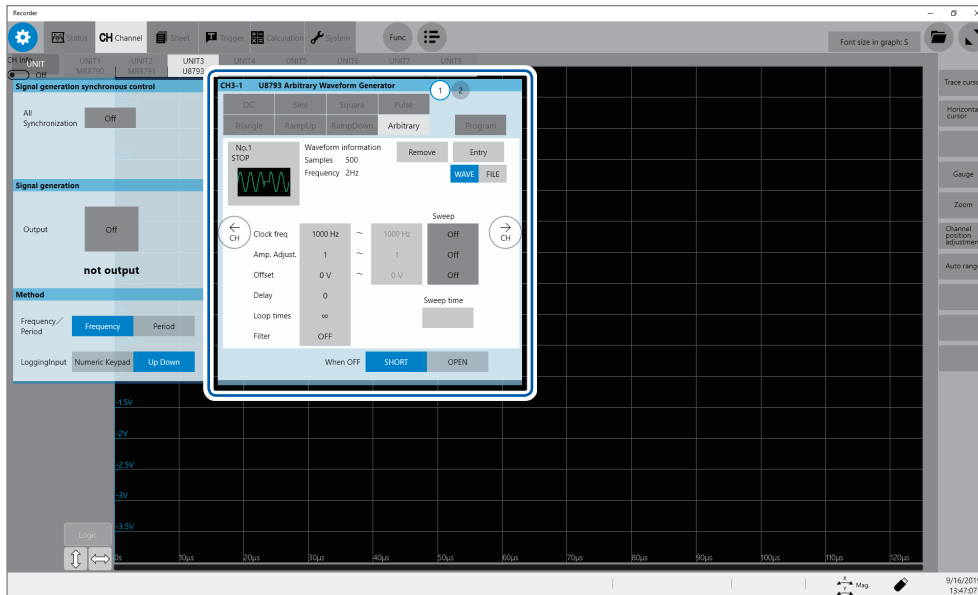

# Registering arbitrary waveforms in the U8793 Arbitrary Waveform Generator Unit

This section describes how to register, display, or delete arbitrary waveform data.

 > [Channel] > [U8793]



3  
Advanced Functions

Display	<p>Displays the arbitrary waveform data set chosen from among registered data sets.</p> <p>Tap  to choose or check the registered arbitrary waveform data sets.</p>				
Remove	<p>Deletes the chosen arbitrary waveform data set.</p> <p>When the U8793 contains eight registered waveforms, delete any one of them before registering a waveform.</p>				
Entry	<p>Registers the arbitrary waveform in a vacant number (up to eight waveforms). It will take about 40 s to register a waveform consisting of 250,000 samples.</p> <table border="1" style="width: 100%;"> <tr> <td style="background-color: #e0f2f1;"><b>WAVE</b> </td> <td>Registers the waveform data the instrument has acquired. See “To register the arbitrary waveform using measured data” (p. 84).</td> </tr> <tr> <td style="background-color: #e0f2f1;"><b>FILE</b></td> <td>Reads the waveform data from a file and registers it. See “To register the arbitrary waveform using a file” (p. 86).</td> </tr> </table>	<b>WAVE</b> 	Registers the waveform data the instrument has acquired. See “To register the arbitrary waveform using measured data” (p. 84).	<b>FILE</b>	Reads the waveform data from a file and registers it. See “To register the arbitrary waveform using a file” (p. 86).
<b>WAVE</b> 	Registers the waveform data the instrument has acquired. See “To register the arbitrary waveform using measured data” (p. 84).				
<b>FILE</b>	Reads the waveform data from a file and registers it. See “To register the arbitrary waveform using a file” (p. 86).				
Save	<p>Press the save icon to save arbitrary waveform data registered in the U8793 as files. See “Freely selecting data items to be saved and save files (save icon)” (p. 108)</p>				

Initializing the instrument will not cause loss of registered waveform data.

## To register the arbitrary waveform using measured data

 > [Channel] > [U8793]

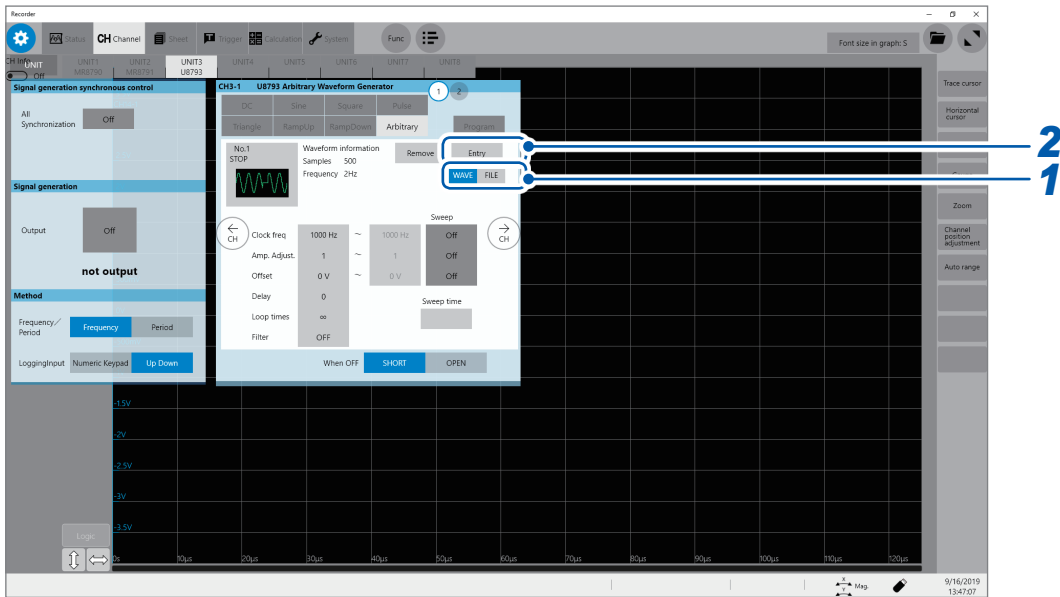

**1** Click the **[WAVE]** button.

**2** Click the **[Entry]** button.

The **[Entry from Measured]** dialog box appears.

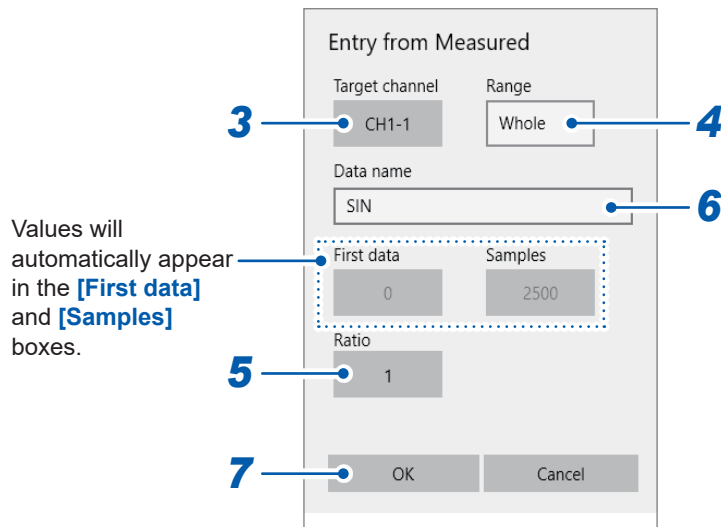

**3** Click **[Target channel]** to choose a channel you wish to register.

Built-in unit, Waveform calculation

**4** Click **[Range]**, and then from the list, choose a registration range option.

<b>Whole</b> <sup>☒</sup>	Registers all data written in the memory.
<b>A_B</b>	Registers the data in the range between trace cursor <b>[A]</b> and trace cursor <b>[B]</b> .
<b>C_D</b>	Registers the data in the range between trace cursor <b>[C]</b> and trace cursor <b>[D]</b> .

When no trace cursors are set, the instrument registers data of the whole range even if you choose **[A\_B]** or **[C\_D]**.

**5** Click the **[Ratio]** button to enter the conversion ratio.

Measured data will be registered after amplifying/attenuating its voltage.

0.001 to 100.000 times (1.000 <sup>☒</sup> time)

**6** Enter a data name in the **[Data name]** box.

Up to 16 single-byte characters or 8 double-byte characters can be entered.

If you enter the name same as a registered data, the existing data will be overwritten.

**7** Click **[OK]**.

## To register the arbitrary waveform using a file

 > [Channel] > [U8793]

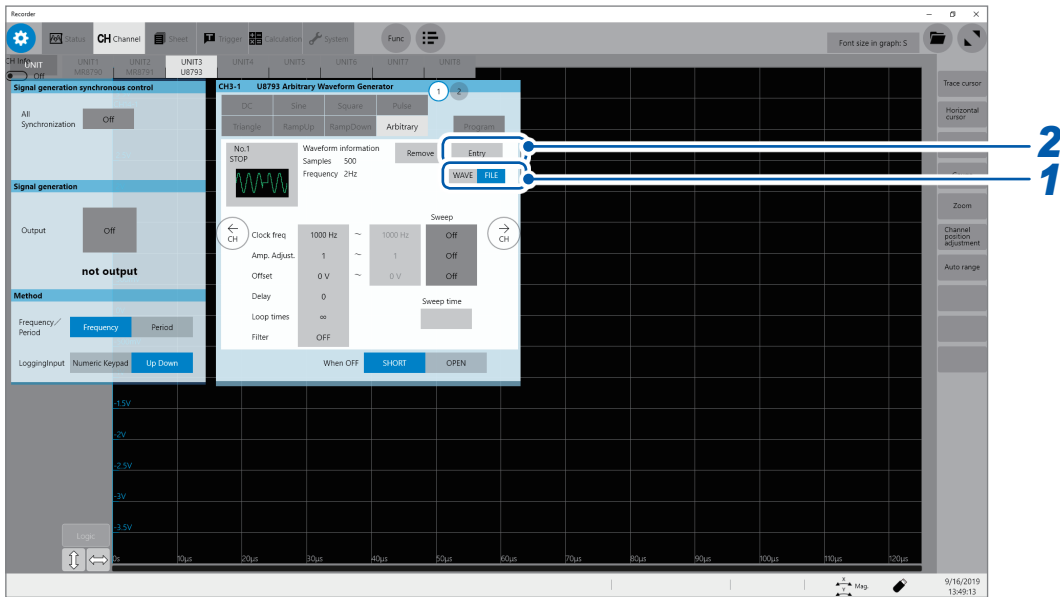

**1** Click the **[FILE]** button.

**2** Click the **[Entry]** button.

The file selection screen appears.

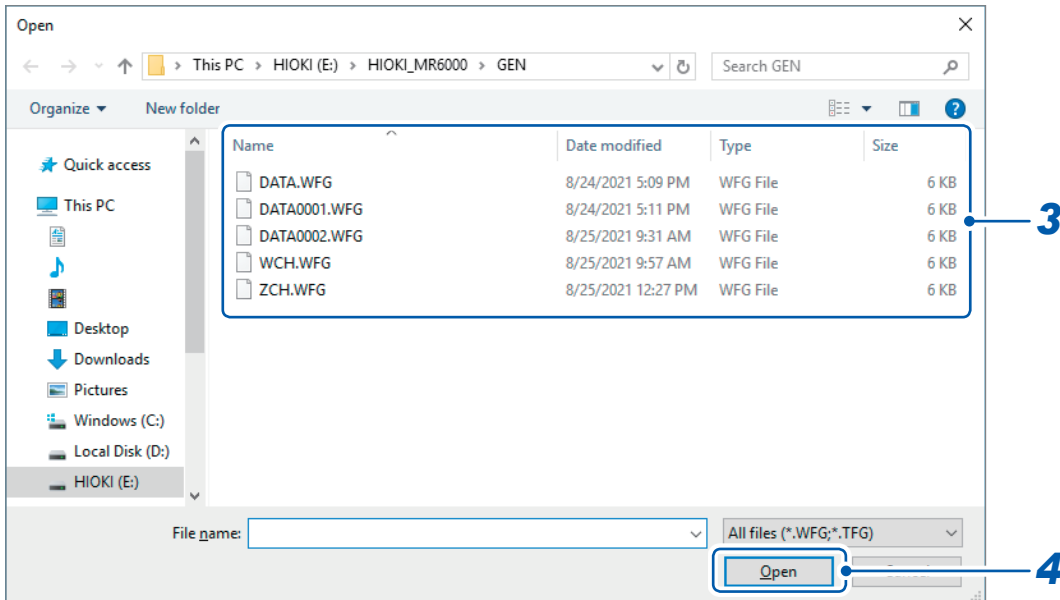

**3** Choose a file you wish to register (.WFG or .TFG).

**4** Click **[Open]**.

The **[Enter from File]** dialog box appears.



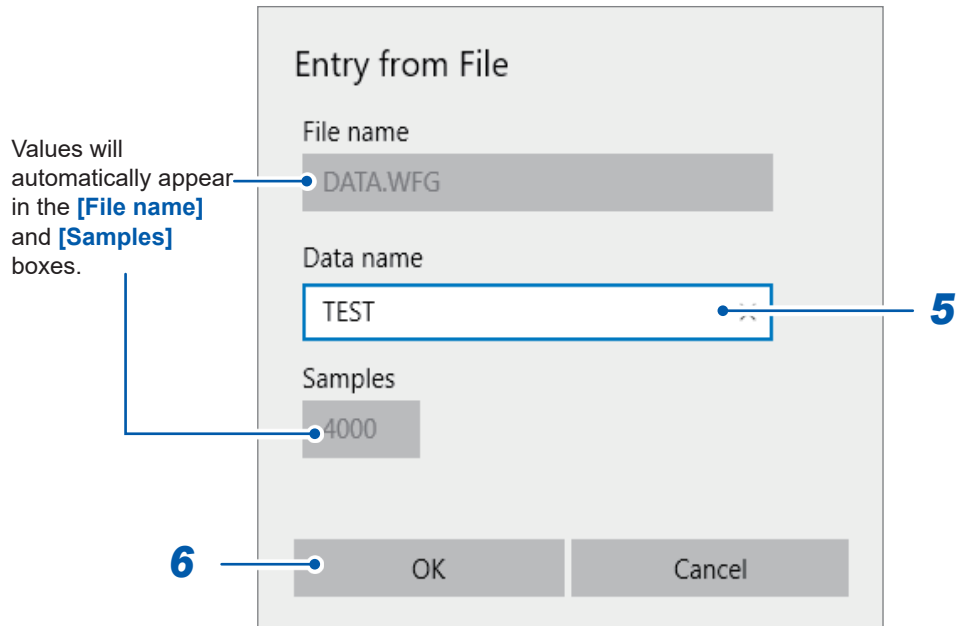

**5** Enter a data name in the [Data name] box.

Up to 16 single-byte characters or 8 double-byte characters can be entered. If you enter the name same as a registered data, the existing data will be overwritten.

**6** Click [OK].

## Editing programs of the U8793 Arbitrary Waveform Generator Unit

You can use the program function to output a waveform generated by piecing up to 128 steps together.

### Setting up the whole program list

This section describes how to load and edit a program list and configure the whole program list.

 > [Channel] > [U8793]

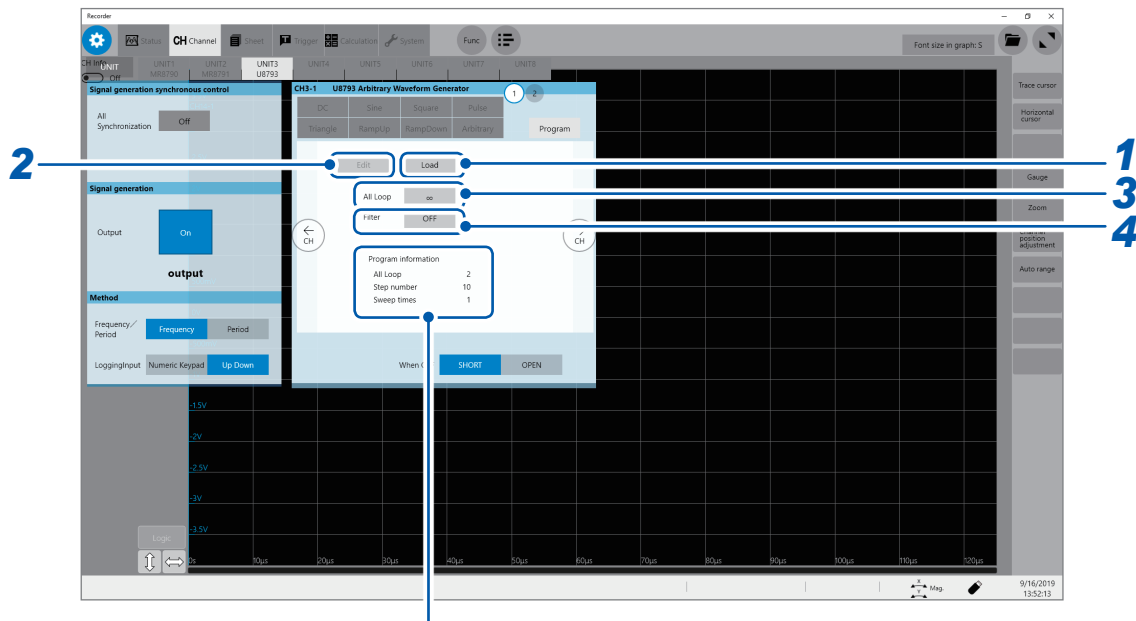

Displays the looping count, step number, and sweeping count of the still-in-progress process.

When you have set the whole looping times to infinity, the instrument will show [∞] as the entire looping count of the still-in-progress process repeating more than 50,000 times.

- 1** Click the **[Load]** button to load a program list into the instrument ( .FGP).
- 2** Click the **[Edit]** button to edit the program list with the instrument.  
See “Editing the program list” (p. 89).
- 3** Click the **[All Loop]** button to enter the number of repetitions the whole program is executed.  
If you enter zero, the instrument displays the sign [∞] and continues outputting the signal repeatedly until you stop the output.

1 to 50000, ∞

- 4** Click the **[Filter]** button to specify a filter frequency commonly used for every step.

OFF, 50, 100, 200, 500, 1 k, 2 k, 5 k, 10 k, 20 k, 50 k, 100 k, 200 k, 500 k, 1M [Hz]

### Editing the program list

You can edit and display programs with up to 128 steps.  
 Even if resetting the instrument, you cannot delete the program list.

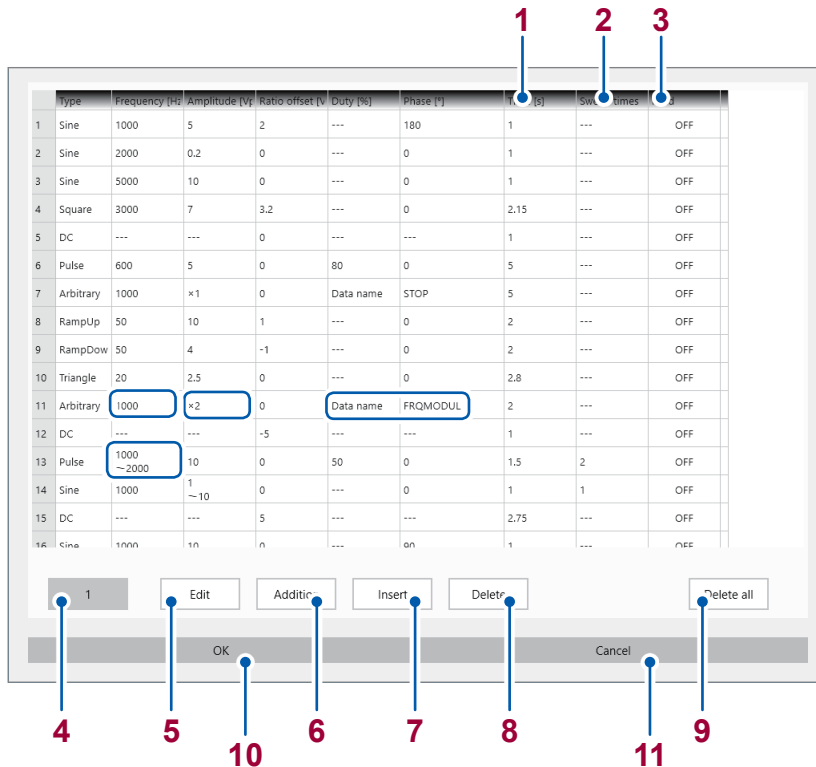

- When the [Type] is set to [Arbitrary], the clock frequency (Hz) will be displayed in the [Frequency [Hz]] column.
- When the [Type] is set to [Arbitrary], the amplitude adjustment factor, such as [x2], will be displayed in the [Amplitude [Vpp]] column.
- When the [Type] is set to [Arbitrary], [Data name] will be displayed in the [Duty [%]] column and data name such as [FRQMODUL] will be displayed in the [Phase [°]] columns.
- Parameters whose sweep setting is set to [On] will be spread over two lines as follows:

[1000  
to 2000]

No.	Element	Function
1	Time [s]	Allows you to set the generating time when the sweep is set to [Off]. <input type="text" value="1"/> to 1000 Allows you to set the sweeping time when the sweep is set to [On]. <input type="text" value="1"/> to 1000
2	Sweep times	Allows you to set the sweeping count when the sweep is set to [On]. <input type="text" value="1"/> to 1000
3	Hold	When you set this column to [Off], the instrument moves on to the next step after the time specified in the [Time [s]] column has elapsed. When you set this column to [On], after the time specified in the [Time [s]] column has elapsed, the instrument continues outputting the signal while an IN signal of high level is being input into the U8793's external control terminal. It will move on to the next step when the IN signal of low level is input.

No.	Element	Function
4	Select number	Displays the number you chose. The step will be used as the reference step to execute steps 5 through 8.
5	Edit	<p>Allows you to edit the chosen step.</p> <p>Use the <b>[Setting program step]</b> dialog to enter parameters you wish to edit. Click <b>[OK]</b> to confirm your entries by overwriting the existing step.</p> <div data-bbox="810 472 1232 920" data-label="Image"> </div> <ul style="list-style-type: none"> <li>• When you set the <b>[Sweep]</b> column to <b>[On]</b>, the dialog will display the string <b>[Sweep time]</b>; when <b>[Off]</b>, the string <b>[Generat. Time]</b> will be displayed instead.</li> <li>• The <b>[Sweep times]</b> setting cannot be configured if the <b>[Sweep]</b> column is set to <b>[Off]</b>.</li> </ul>
6	Addition	Adds a step after the last step.
7	Insert	Inserts a step before the chosen step.
8	Delete	Deletes the chosen step.
9	Delete all	Deletes all steps.
10	OK	Registers the program list.
11	Cancel	Does not update the program list. Your entry will be discarded.
—	Save	Press the save icon to save the program list. See “Freely selecting data items to be saved and save files (save icon)” (p. 108)

For information on other user-interface elements and their functions, see “Configuring Model U8793 Arbitrary Waveform Generator Unit” (p. 80).

## Configuring Model U8794 VIR Generator Unit settings

You can configure U8794 VIR Generator Unit settings on the dedicated setting screen.

 > [Func] > [Generator Setting]

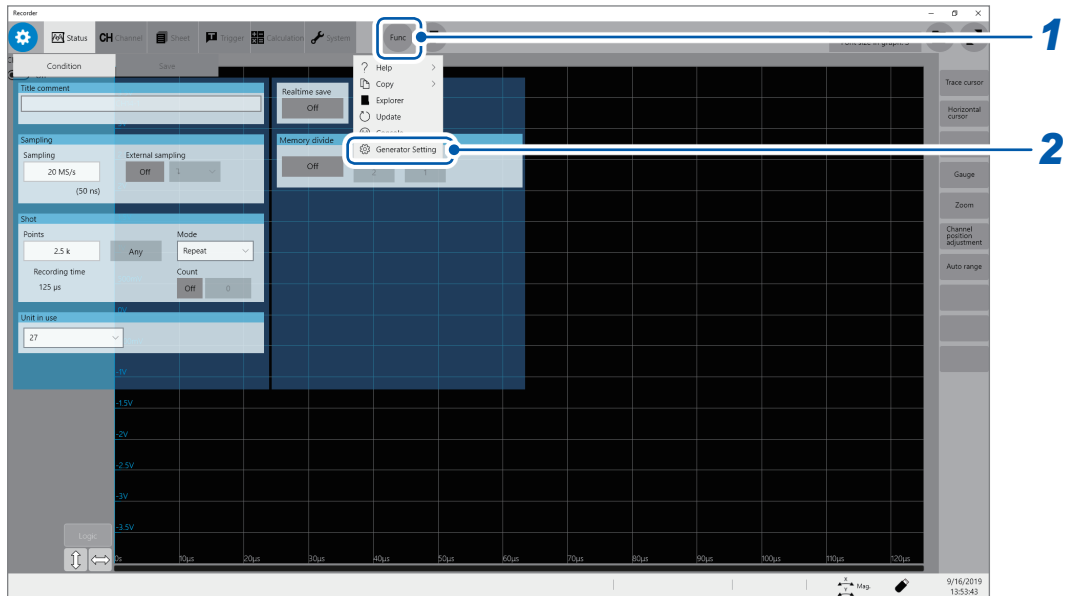

- 1 Click [Func].
- 2 Click [Generator Setting].

The setting screen dedicated for the U8794 appears.

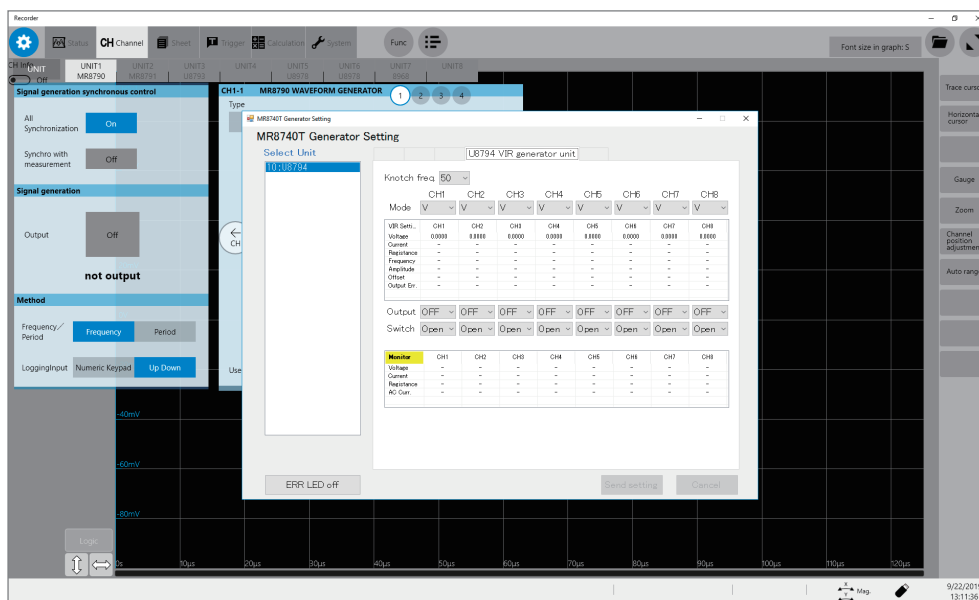

### 3 Choose the U8794 to configure settings.

You can configure U8794 settings.

The module number where U8794 is installed in is indicated at the left side of the model number. Refer to “2.1 Installing and Removing Modules” in Quick Start Manual.

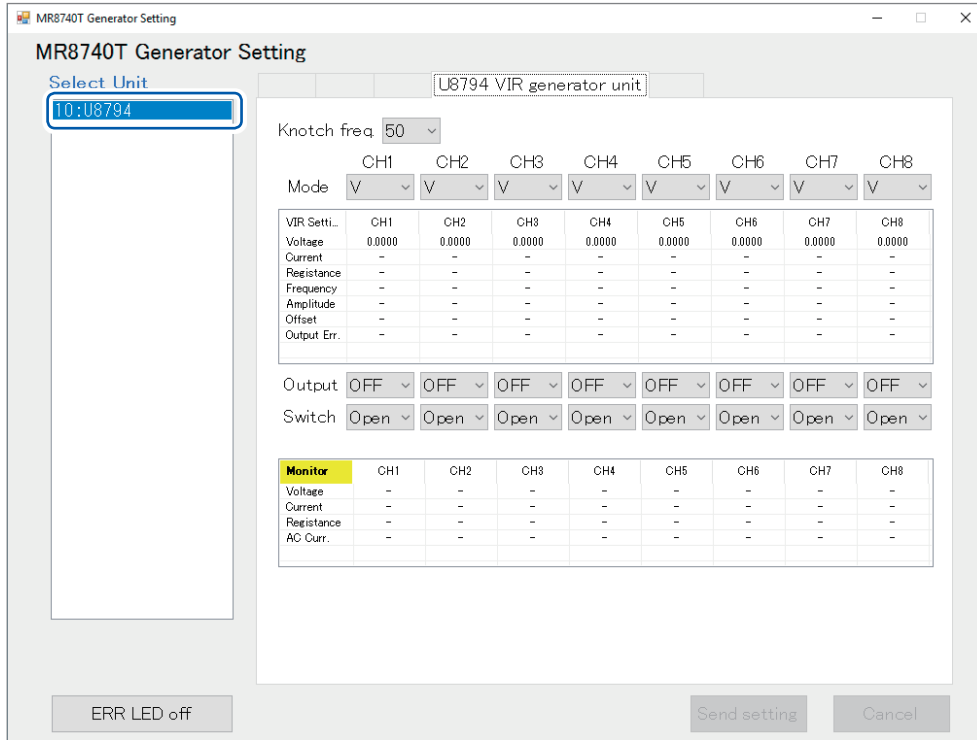

#### Notch frequency

Choose a power frequency according to the power frequency in your region. A correct power frequency setting leads measured values to be stable.

<b>50</b> <input checked="" type="checkbox"/>	Allows you to set the notch frequency at 50 Hz.
<b>60</b>	Allows you to set the notch frequency at 60 Hz.

#### Mode

Allows you to choose an output type.

<b>V</b> <input checked="" type="checkbox"/>	DC voltage
<b>I</b>	DC current
<b>R</b>	Resistance (simulated)
<b>AC</b>	AC voltage

#### Specifying voltage values

Enter an output DC voltage value.

**-0.1 V to 5.3 V**

The output current range is from -5 mA to +5 mA.

### CAUTION



The instrument accepts a load resistance of 1 kΩ or more. Do not connect a load resistance lower than the permissible value or short-circuit an output terminal. Damage to the instrument could result.

## Specifying a current value

The instrument outputs a DC current.

**-5 mA to +5 mA**

The output voltage range is from -0.1 V to +5.3 V.

The instrument switches generation ranges to an appropriate range based on the specified current value.

<b>-5 mA to -1 mA, 1 mA to 5 mA</b>	5 mA range
<b>-1 mA to -250 <math>\mu</math>A, 250 <math>\mu</math>A to 1 mA</b>	1 mA range
<b>-250 <math>\mu</math>A to -50 <math>\mu</math>A, 50 <math>\mu</math>A to 250 mA</b>	250 $\mu$ A range
<b>-50 <math>\mu</math>A to 50 <math>\mu</math>A</b>	50 $\mu$ A range

## Generating resistance

### Resistance generation method

The instrument uses an electric circuit to generate resistance on a simulated manner.

The instrument generates a current  $I_{out} = V_{meas} / R_{set}$  based on the voltage outputted from the OUTPUT terminal  $V_{meas}$  and a specified resistance value  $R_{set}$ .

**10  $\Omega$  to 1 M $\Omega$**

### IMPORTANT

The instrument cannot generate a set resistance value under any one of the following conditions:

- If the instrument is connected to a measuring instrument that outputs a constant current to measure the resistance of a measuring object based on the voltage across both ends of the object  
(Example: workbench-type digital multi-meter)
- If the voltage of the OUTPUT terminal exceeds the range of 0 V to 5 V
- If the current outputted from the instrument exceeds the range of -5 mA to 5 mA

## Optimizing a resistance generation response

### Presuming the characteristic of a measuring object

The resistance generation function of the instrument can presume the characteristic of a measuring object and optimize a resistance generation response based on the presumed result.

### IMPORTANT

- When a connected target has an output resistance of less than 1 k $\Omega$ , a current that exceeds the specification will flow, resulting in damage to the instrument and the connected object.
- A time required for presumption varies depending on the characteristic of a connected object. It must take 1.6 seconds at a maximum.
- When you exchange connected objects, execute presumption of the connected object or restore the presumption result of the connected object to the default.

### Manually optimizing a resistance generation response

You can use the response coefficient command to regulate a response.

Lowering the response coefficient causes a slower response; however, it can prevent oscillations and overshoots.

### IMPORTANT

When you adjust a response coefficient manually, specify an appropriate response coefficient while observing waveforms with another instrument such as an oscilloscope.

## Voltage generation and measurement function

### Outputting an AC voltage

The instrument can output a sine wave with a DC voltage superimposed.

<b>DC offset voltage</b>	0.0 V to 2.5 V
<b>Amplitude</b>	0.0 V p-p to 5.0 V p-p
<b>Frequency</b>	10 Hz, 20 Hz, 50 Hz, 100 Hz

The output voltage range is from -0.1 V to 5.3 V.

### CAUTION



The instrument accepts a load resistance of 1 k $\Omega$  or more. Do not connect a load resistance lower than the permissible value or short-circuit an output terminal. Damage to the instrument could result.

### Output

Switch each output on and off.

<b>OFF</b> <input type="checkbox"/>	Does not output any waveform.
<b>ON</b> <input type="checkbox"/>	Outputs a waveform.

### Switch

You can switch between the short-circuited state and open state for the OUTPUT terminal.

<b>Open</b>	Disconnects the OUTPUT terminal from the output circuit and the GND terminal.
<b>Short</b>	Connects the OUTPUT terminal with the GND terminal.
<b>Normal</b>	Connects the OUTPUT terminal with the internal output circuit.

### Confirmation of the setting

After finishing the setting, click **[Apply]**.

The instrument confirms the settings and outputs a waveform.



### Switching OUTPUT terminals

Terminal setting	Internal circuit
Open	
Short	
Normal	

**IMPORTANT**

Do not set the OUTPUT terminal status to **[Short]** when a power supply device connects with the OUTPUT terminal. A short-circuit current will flow, resulting in damage to the instrument or power supply device.

### Self-diagnosis function

**Simple test**

At the time when you send a query for testing, the instrument measures an output value of the instrument with the internal measuring circuit and return the specified value and a measured value. For the voltage output setting, the instrument sends back the specified voltage and a measured voltage value.

For the current output setting, the instrument sends back the specified current and a measured current value.

### Comprehensive test

The instrument outputs the following voltages and currents of each output function and each generation range, measuring them with the internal measurement circuit. Then, the instrument sends back measured values of each output value.

Output item	Generation range	Measurement range	Output testing point
Voltage	5 V	0.5 V	0 V
			0.5 V
		5 V	0 V
			5 V
Current	5 mA	5 mA	5 mA
			1.1 mA
	1 mA	1 mA	1 mA
			275 $\mu$ A
	250 $\mu$ A	250 $\mu$ A	250 $\mu$ A
			55 $\mu$ A
	50 $\mu$ A	50 $\mu$ A	50 $\mu$ A
			0 $\mu$ A

### CAUTION



Do not connect anything with the OUTPUT terminal during comprehensive tests. The instrument outputs a zero-volt signal and connects the OUTPUT terminal with the GND terminal (in the short-circuit state) during comprehensive tests. If a power supply device connects with the instrument, a short-circuit current will flow, resulting in damage to the instrument or power supply device. The comprehensive test results may be affected depending on devices connected.

### Offset canceling function

#### Regulating the zero point of the output circuit

The instrument measures an output circuit offset with the internal measurement circuit and outputs a value the offset value is subtracted from.

### CAUTION



Do not connect anything with the OUTPUT terminal during an offset measurement. The instrument outputs a zero-volt signal and connects the OUTPUT terminal with the GND terminal (in the short-circuit state) during the offset measurement. If a power supply device connects with the instrument, a short-circuit current will flow, resulting in damage to the instrument or power supply device. The results (zero-point regulation) may be affected depending on devices connected.

## To perform precise measurement

### IMPORTANT

Be careful of the following points when the instrument outputs a current of 100  $\mu\text{A}$  or less with the current output function, when it generates a resistance of 50  $\text{k}\Omega$  or more with the resistance generation function, or when a device connected with the instrument has an output resistance of 50  $\text{k}\Omega$ .

- We recommend you to use measurement cables with an insulating sheath made of polyethylene (PE) or polytetrafluoroethylene (TFE). Using measurement cables with a low-resistance insulating sheath will increase leak currents, with the result that accuracy is significantly affected.
- The instrument will become susceptible to exogenous noise. We recommend you to use shielded measurement cables or connect a capacitor between the OUTPUT terminal and GND terminal.



# 4

# Saving/Loading Data and Managing Files

This chapter explains how to save and load data and manage files.

Before saving data, select **[Status] > [Save]**, and configure the save setting.

The file screen allows you to load data.

The explorer allows you to manage files.

Refer to “4.4 Managing Files” (p. 114).

 **> [Status] > [Save]**

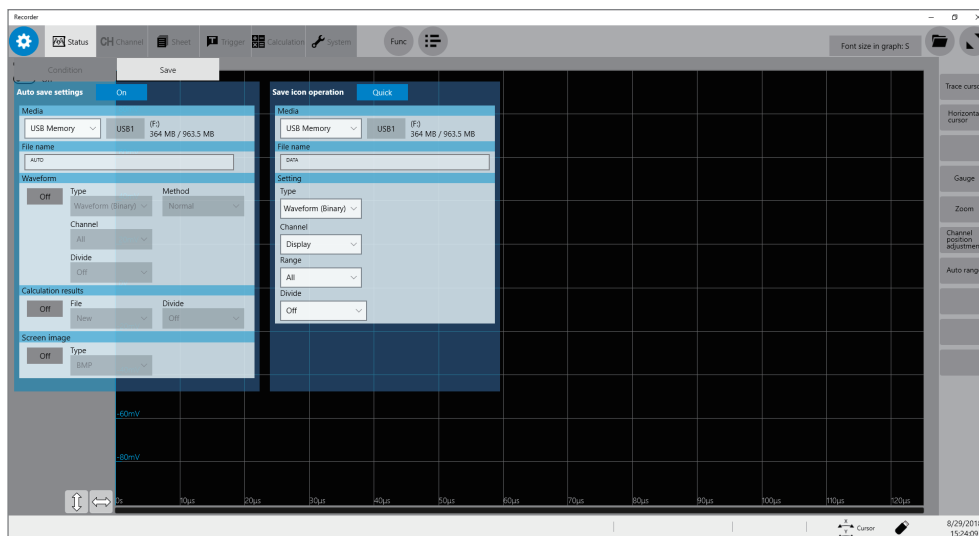

## Operation available on the **[Save]** screen

### Auto-save

Specifying the auto-save method settings for measured data (p. 102)

### Real-time save

Setting the method of saving waveform data in real time (p. 106)

### Save icon operation

- Allows you to select an action to be taken when you click the save icon. (p. 108)
- Specifying contents to be saved when **[Quick]** is selected (p. 108)

## 4.1 Data That Can Be Saved and Loaded

Files that exceed 2 GB cannot be saved.

Data saved with another instrument cannot be loaded onto the instrument.

✓: Enable, –: Disable

File type	File format	File extension and description		Saving		Loading	Loading on a computer
				Auto	Manual		
Setting data* <sup>1</sup>	Binary	.SET	Setting data (measurement conditions)	–	✓	✓	–
Waveform data* <sup>2</sup> The data of whole waveforms or a part of waveforms within the range between the trace cursors (acquired in the instrument)	Binary	MEM	Binary data	✓	✓	✓	– * <sup>3</sup>
		FLT	Waveform data in floating-point format	✓	✓	–	–
	Text	CSV, TXT* <sup>6</sup>	Text data	✓	✓	–	✓
Waveform managing data* <sup>4</sup> (Division save)	(Index file)	IDX	Index data of the division save	✓	✓	✓	–
Screenshot, waveform image	BMP* <sup>5</sup>	BMP	Image data	✓	✓	–	✓
	PNG* <sup>5</sup>	PNG	Image data (PNG format)	✓	✓	–	✓
	JPEG* <sup>5</sup>	JPEG	Image data (JPEG format)	✓	✓	–	✓
Numerical calculation result	Text	CSV, TXT* <sup>6</sup>	Text data	✓	✓	–	✓
Waveform generation data	Binary	WFG	Arbitrary waveform data (for U8973)	–	✓	✓	–
	Text	TFG	Arbitrary waveform data (for U8973)	–	–	✓	✓
	Program	FGP	Generation program data (for U8973)	–	✓	✓	–

\*1: The instrument automatically loads data at the time of startup. (p. 102)

\*2: To load data with the instrument: Save the data in binary format. Waveform data and a part of measurement settings data are saved.

Save the data in binary format. Waveform data and a part of measurement settings data are saved.

To load data with a computer: Save the data in text format. (p. 101)

To save a part of waveforms: Specify a saving range with trace cursors. (p. 22)

\*3: Data can be loaded with Wave Viewer (Wv).

\*4: To load divided waveform data, load the index data (IDX).

\*5: BMP format: This is one of the standard Windows® image file format. Various graphics programs can open these files.

PNG format: Internationally standardized image file format conforming to ISO/IEC15948

JPEG format: Internationally standardized image format conforming to ISO/IEC10918

\*6: When you choose a separator other than **[Comma ,]** in **[Region]**, files are saved with the .TXT extension. (p. 197)

## 4.2 Saving Data

### Saving types and setting procedure

Three ways are available to save data.

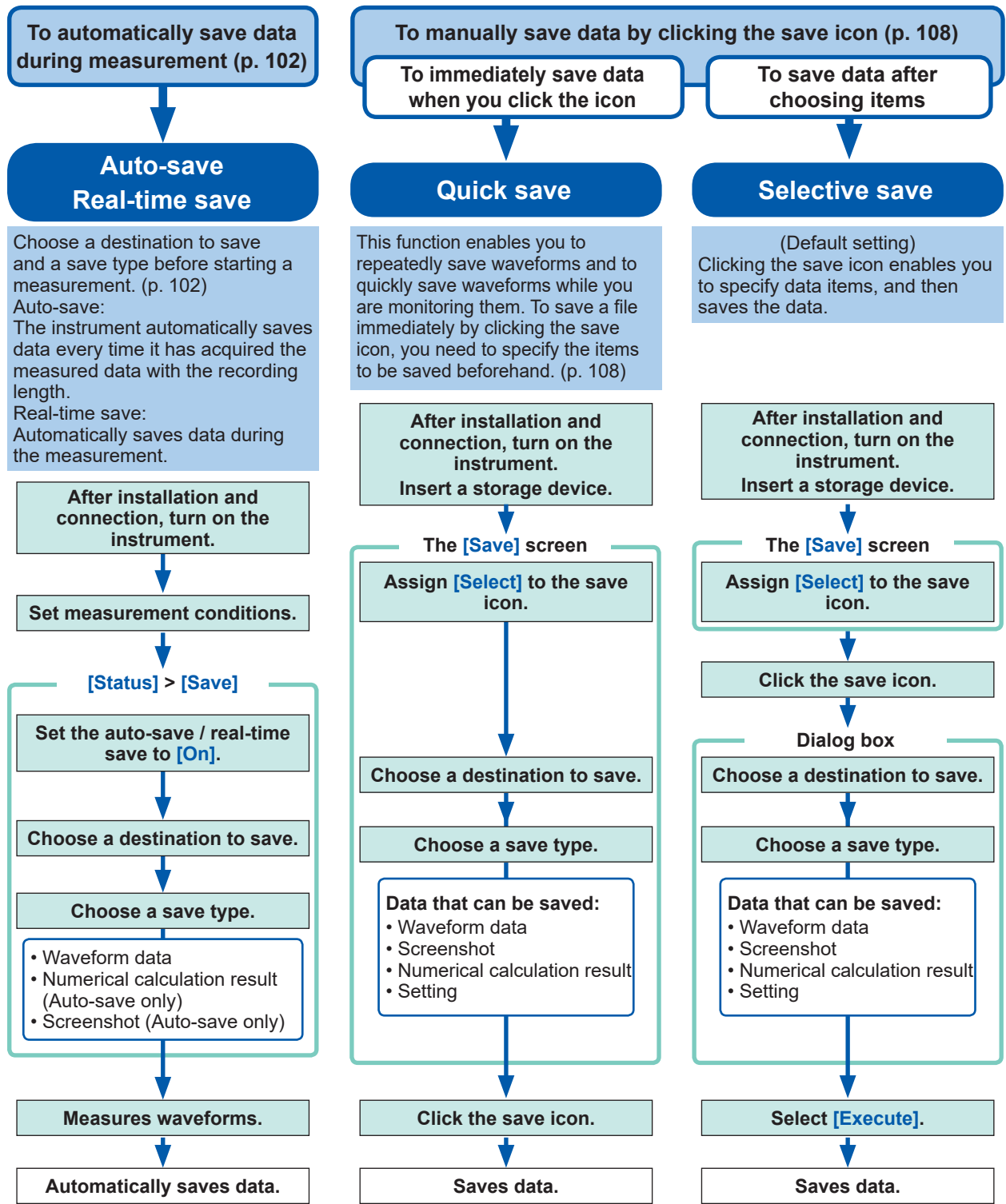

**Check the following before saving data:**

- Have you already inserted and initialized a storage device?  
 Refer to "Formatting storage devices" in "2.5 Preparing Storage Devices (Recording Media)" in Quick Start Manual.
- Is the save destination specified correctly?
- When the auto-save is used, is [Auto save settings] set to [On]?

## Automatically saving waveform data

The instrument automatically saves data every time it has acquired the measured data with the recording length. Specify a save destination and items to be saved before starting a measurement.

 > [Status] > [Save]

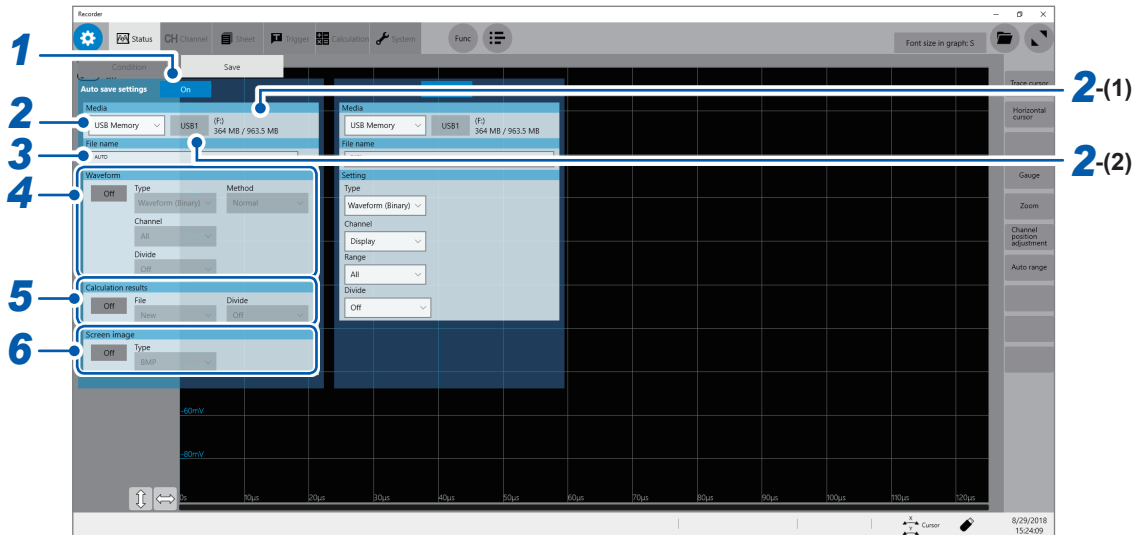

**1** Click the **[Auto save settings]** button to set it to **[On]**.

**2** Click the **[Media]** box, and then choose a destination to save from the list.

<b>SSD/HDD</b> <input checked="" type="checkbox"/>	Built-in SSD
<b>USB flash drive</b>	USB flash drive
<b>Mail</b>	Sends measured data to a computer in the network or to a remote computer as an email attachment.
<b>FTP transfer:</b>	Sends waveform data to a computer connected to your network.

- (1) When you choose a save destination, the state of the storage device such as its drive letter and capacity appears on the right of the **[Media]** box. If no storage device is inserted, the string **[None]** appears.
- (2) When you choose **[USB Memory]** as the save destination, choose a USB flash drive you would like to use as a save destination from among all attached USB flash drives.

- The **[HIOKI\_MR8740T]** folder is automatically created in the specified save destination, and sub-folders are automatically created in the folder according to the **[Type]** setting.

Waveform (Binary), Waveform (Text), Waveform (Float): WAVE  
 Setting: CONFIG  
 Numerical calculation result: MEASURE  
 Screenshot: PICT

When you choose **[FTP]**, configure the LAN and FTP client function settings.

Refer to “Configuring the LAN settings with the instrument” (p. 200) and “11.3 Sending Data to a Computer With the FTP Client Function” (p. 208).

- Use Model Z4006 USB Drive (Hioki’s option) for protecting data.

**3** Enter the file name in the **[File name]** box.

- Number of characters for a file name: Up to 100 characters
- The maximum length of a file name that includes its path: Up to 255 characters



#### 4 In the **[Waveform]** area, click **[On]** or **[Off]** to configure the waveform save setting.

<b>Off</b> <sup>☑</sup>	Does not save any waveforms.
<b>On</b>	Saves waveforms.

Click the **[Type]** box, and then choose a save format of data from the list.

<b>Waveform (Binary)</b> <sup>☑</sup>	Saves waveform data in binary format. (Only data saved in binary format can be loaded onto the instrument)
<b>Waveform (Text)</b>	Saves waveform data in text format. (The instrument decimates the data and saves the remaining data as a file. The files can be opened with editors and spreadsheet software installed in computers; however, they cannot be loaded onto the instrument.)

Click the **[Method]** box, and then from the list, choose an action to be taken if the size of waveform data to be saved exceeds the capacity of the storage device.

<b>Normal</b> <sup>☑</sup>	Stops the auto-save if the storage device is full.
<b>Delete</b>	Deletes older files and continues the auto-save even when the storage device is full (waveform files only). The instrument deletes files only created after the measurement has started. It does not delete previously existing files.

Click the **[Channel]** box, and then choose an option for channels to be saved.

<b>All</b> <sup>☑</sup>	Saves measured data of all channels. The instrument also saves data acquired across channels with the waveform display set to <b>[Off]</b> .
<b>Display</b>	Saves data acquired across channels with the waveform display set to <b>[On]</b> on all sheets.

(When you choose **[Waveform (Binary)]** in the **[Divide]** box)

Click the **[Divide]** box, and then from the list, choose a size of each file.

<b>Off</b> <sup>☑</sup>	Saves a file without dividing it.
<b>16 MB, 32 MB, 64 MB</b>	Choose this option to divide a large file into several files and save them. A file is divided into several files each of which has the specified size. The instrument creates a folder with the specified name, divides a file into several files, and then saves them in the folder.

The instrument automatically creates a folder, and then creates waveform files and an index file (extension: .IDX) in the folder. Loading the IDX file allows the waveform files to be loaded in a batch.

(When you choose **[Waveform (Text)]** in the **[Type]** box)

Click the **[Divide]** box, and then from the list, choose an option for the number of lines of each file.

<b>Off</b> <sup>☑</sup>	Saves a file without dividing it.
<b>60,000 data, 1,000,000 Data</b>	Divides a file according to data points (row) you specify.

When using the memory division function, you cannot use the division save function.

(When you choose **[Waveform (Text)]** in the **[Type]** box)

Click the **[Thin out]** button to set it to **[On]** or **[Off]**.

When you choose **[On]**, click the number box on the right, and then enter the number of data points out of which a data point is retained.

Storing files in text format requires a lot of storage space. Data decimation can reduce file sizes.

<b>Off</b>	No data is decimated.
<b>On (2 to 1,000)</b>	Allows you to enter the decimation number. The instrument retains one data point out of the specified number of data points.

**Example**

When you enter **[3]**, the instrument retains one data point out of three consecutive data points: it decimates the two other points.

The number of data points is reduced by one third of the original number.

**5** In the **[Calculation result]** area, click **[On]** or **[Off]** to configure the saving setting of the numerical calculation result .

<b>Off</b>	Does not save any numerical calculation results.
<b>On</b>	Saves numerical calculation results.

Click the **[File]** box, and then from the list, choose an option for saving data to files.

<b>New</b>	Creates a new file for each measurement and saves it.
<b>Append</b>	Appends data to an existing file and saves it.

Click the **[Divide]** box, and then choose a file division setting from the list.

<b>Off</b>	Does not divide any files.
<b>Split by Calc. No.</b>	Creates a file for each calculation number.

**6** In the **[Screen image]** area, click **[On]** or **[Off]** to configure the saving setting of display images.

<b>Off</b>	Does not save any screenshot.
<b>On</b>	Saves a screenshot.

Click the **[Type]** box, and then choose a save format of images from the list.

**BMP**, **PNG**, **JPEG**

**When you choose data in text format or numerical calculation results to be saved**

Characters or display items used on the instrument are converted as follows:

Character used on the instrument	Saved character
<sup>2</sup>	^2
<sup>3</sup>	^3
μ	~u
Ω	~o
ε	~e
°	~c
±	~+

## Structure of the save destination folders

The instrument saves folders under the “HIOKI\_MR8740T” folder as follows. Every folder can collectively retain up to 5000 files and folders.

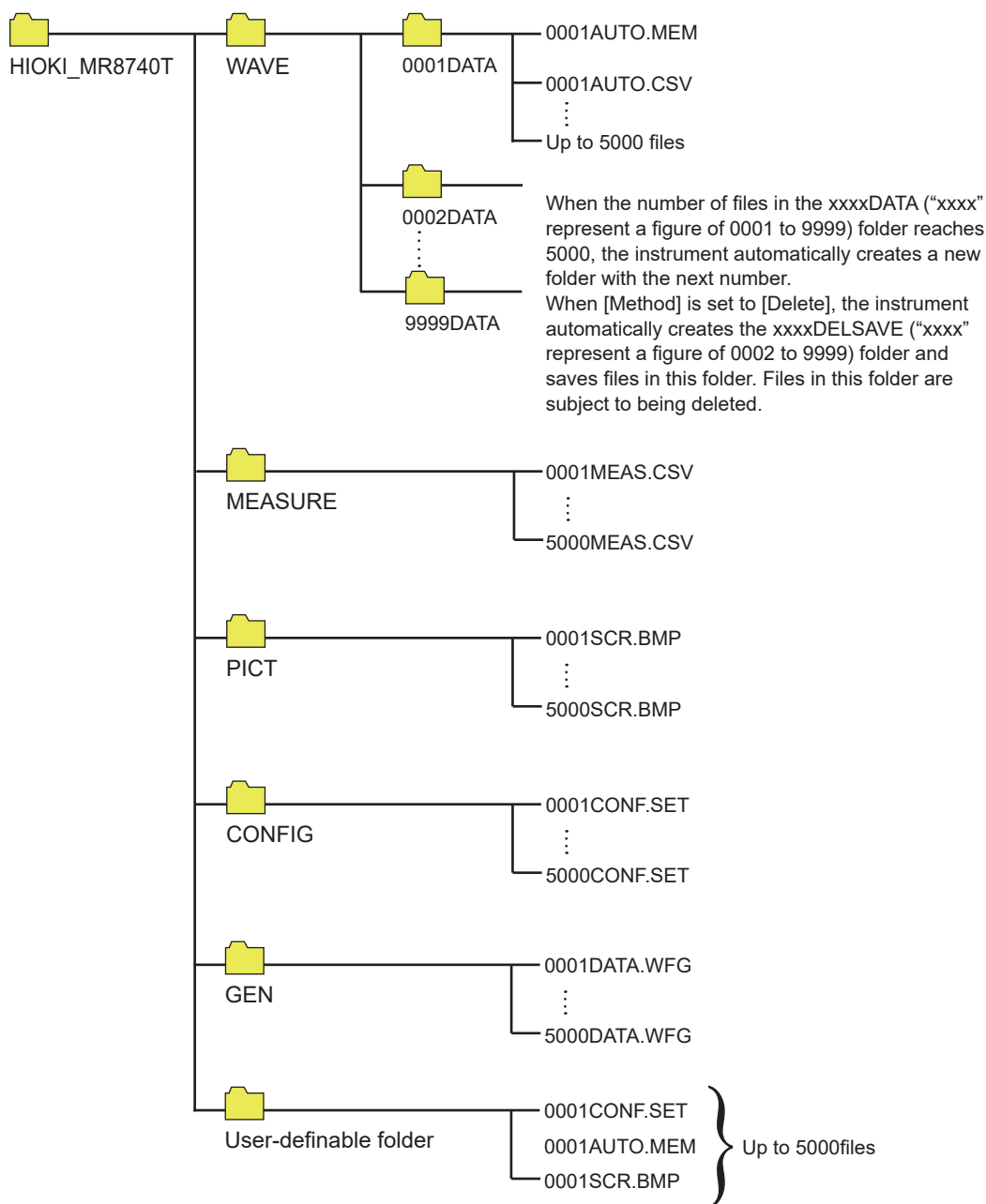

## Real-time save

Since setting the real-time save to **[On]** allows data to be saved in a storage device simultaneously with measurement, the instrument can perform measurement for a long period of time regardless of the capacity of the internal memory.

The measurement condition settings are different between setting the real-time save to **[On]** and **[Off]**.

- When setting the real-time save to **[On]**, you cannot use the following functions:  
Auto-save, trigger function, waveform calculation function, and memory division function.
- No storage device can be removed or replaced during the real-time save.
- If displaying the message, Warning No. 235 **[Real-time save could not be completed within available time.]**, the instrument may record abnormal data in a waveform file saved in a storage device.
- The operation may be automatically restricted or the magnification may be changed if there is a risk that saving data cannot be completed in time during the real-time save.
- When any numerical calculation is set, only manual calculation can be executed.

After the measurement has been complete, select  > **[Calculation]** > **[Numerical calculation]**, and then click **[Execute]**.

- When using a USB flash drive for real-time save, select Model Z4006 USB Drive (option).
- When using a flash drive for real-time save, connect it to the USB 3.0 connector on the rear side of the instrument. Connecting the drive to the USB 2.0 connector cannot deliver the real-time save speed specified in the product specifications.

## Maximum recording time

- When the real-time save is set to **[On]**, the maximum recording time is determined based on the recording interval, the remaining capacity of a storage device, and the number of channels to be used.
- When the sampling rate is set at a slow rate, the recording time is set to a long period of time (one year or more) depending on a condition. The operation cannot be guaranteed because the warranty period or product life may disturb it.
- When the external sampling is used, the instrument calculates the maximum recording time assuming a recording interval of 500 MS/s.

Refer to "Maximum recordable time when the real-time save is enabled (values for reference purposes)" (p. 235).

## Waveform data

When recording waveforms with the real-time save set to **[On]**, the instrument directly saves measured waveform data (.MEM) onto a storage device. If the file size is large, the instrument automatically divides the file into several files each of which has 512 MB and saves them.

## Deleting and saving files when saving data in real time

- If the capacity of the storage device becomes full while the instrument is storing files, it automatically deletes waveform files created after the measurement has started beginning from the oldest, securing free space in the storage device. When free space in a storage device is less than the sum of the created file size and 512 MB before starting a measurement, however, the instrument cannot overwrite any new files over the older files. Use a storage device with as much free space as possible.
- The instrument does not delete waveform files saved in the past.
- When **[Method]** is set to **[Delete]**, the recording length can be set at 10000 days at a maximum; however, data the instrument retains after the measurement is limited to a free space size of a storage device at the start of recording (recording time of the normal saving).

 > [Status] > [Save]

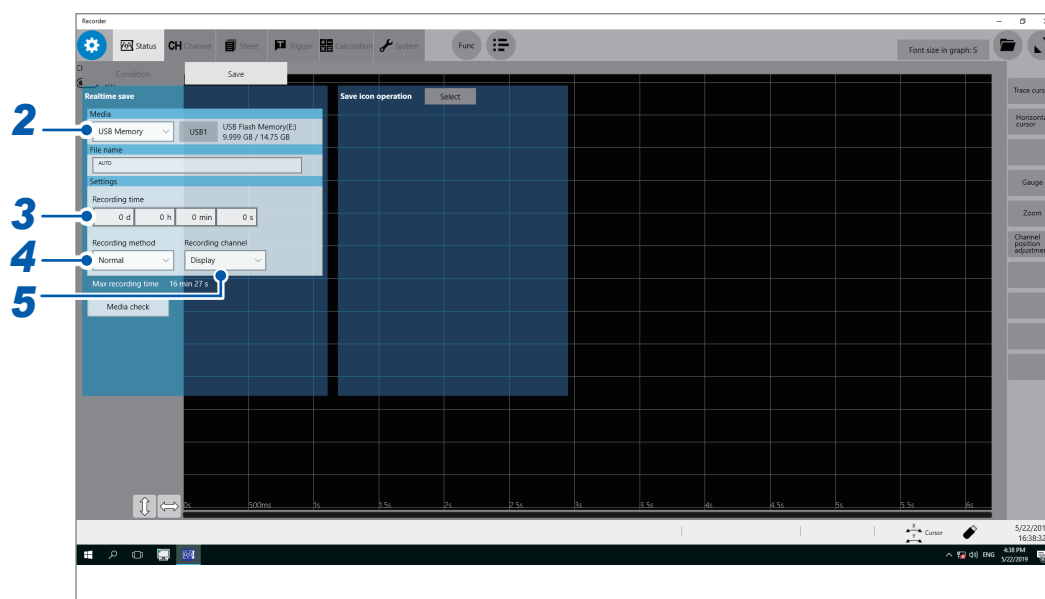

**1** Configure the real-time save and sampling rate settings on the [Condition] screen. Refer to “1.2 Setting Measurement Conditions” (p. 7).

**2** Click the [Media] box, and then choose a destination to save from the list.

**3** Click the [Recording time] box, and then enter a recording time.

<b>d</b>	0 to 10000 (days)
<b>h</b>	0 to 23 (hours)
<b>min</b>	0 to 59 (minutes)
<b>s</b>	0 to 59 (seconds)

**4** Click the [Method] box, and then from the list, choose a saving way if a space of a storage device is insufficient.

<b>Normal</b> <input checked="" type="checkbox"/>	Stops the real-time save and measurement if the storage device is full.
<b>Delete</b>	Deletes older files and saves files in real time if the storage device is full (waveform files only). The instrument deletes files only created after the measurement has started. It does not delete previously existing files.

Setting [Media] to [FTP] forces this setting into [Normal].

**5** Click the [Channel] box, and then choose an option for channels to be recorded.

<b>Display</b>	The instrument records data acquired across channels with the waveform display set to [On].
<b>All</b> <input checked="" type="checkbox"/>	Records data acquired across all measured channels. The instrument also records data acquired across channels with the waveform display set to [Off].

**6** Check settings that include the input channel settings, and then click the start icon.

The instrument saves data onto a storage device in real time during measurement.

## Freely selecting data items to be saved and save files (save icon)

To save a file immediately by clicking the save icon, you need to specify items to be saved beforehand.

You can save the following types of data: (Setting data, waveform data, screenshot, and numerical calculation results)

 > [Status] > [Save]

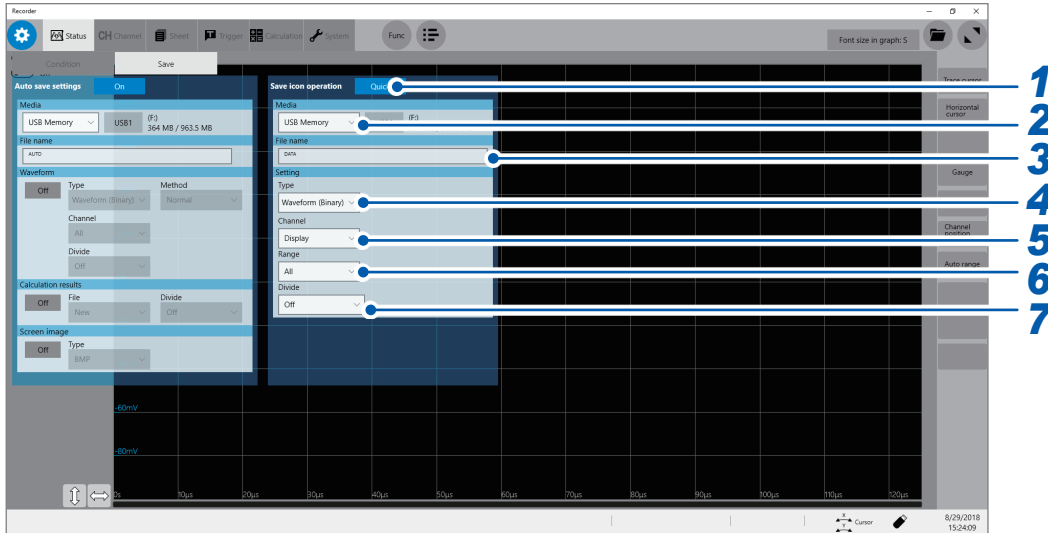

**1** Click the **[Save icon operation]** button, and then choose a save method adopted when you click the save icon.

<p><b>Select</b> <input checked="" type="checkbox"/></p>	<p>Displays the dialog box to allow you to choose items to be saved and saves them. You can specify the subsequent settings in the dialog box that appears when you click the save icon at the start of measurement. This operation cannot be executed if another dialog box is open. Refer to “Selective save” (p. 101).</p>
<p><b>Quick save</b></p>	<p>Immediately saves data consisting of pre-specified items. Refer to “Quick save” (p. 101).</p>

**2** Click the **[Media]** box, and then choose a destination to save from the list (Refer to p. 102).

**3** Click the **[File name]** box, and then enter a file name.

- Number of characters for a file name: Up to 100 characters
- The maximum length of a file name that includes its path: Up to 255 characters

#### 4 Click the **[Type]** box, and then choose a save format of data from the list.

<b>Waveform (Binary)</b> <sup>□</sup>	Saves waveform data in binary format. Choose this option to reload the waveforms into the instrument.
<b>Waveform (Text)</b>	Saves waveform data in text format. Choose this option to load the waveforms with a computer.
<b>Waveform (Float)</b>	Saves waveform data in binary format (32-bit floating point). Choose this option to load the waveforms with a computer.
<b>Screenshot</b>	Saves screenshots. You can display the saved data on a computer with image viewing software.
<b>Numerical calculation result</b>	Saves numerical calculation results.
<b>Waveform (Binary)</b>	Saves data of all blocks in binary format. (When the memory division set to <b>[On]</b> )
<b>Waveform (Text)</b>	Saves data of all blocks in text format. (When the memory division set to <b>[On]</b> )
<b>Setting</b>	Saves the present measurement conditions.
<b>Arbitrary waveform</b>	Saves arbitrary waveform data.
<b>Program</b>	Saves a waveform generation program data.

#### 5 Click the **[Channel]** box, and then choose an option for channels to be saved.

When **[Type]** is set to **[Waveform (Binary)]** or **[Waveform (Text)]**

<b>All</b>	Saves measured data of all channels. Saves the data acquired across the channels with the display setting set to <b>[Off]</b> .
<b>Display</b> <sup>□</sup>	Saves data of all sheets with the display setting set to <b>[On]</b> .

#### 6 Click the **[Range]** box, and then choose an option for save range from the list.

When **[Type]** is set to **[Waveform (Binary)]** or **[Waveform (Text)]**

<b>All</b> <sup>□</sup>	Saves all data written in the memory.
<b>A_B</b>	Saves the data in the range between trace cursor <b>[A]</b> and trace cursor <b>[B]</b> .
<b>C_D</b>	Saves the data in the range between trace cursor <b>[C]</b> and trace cursor <b>[D]</b> .

The instrument saves data acquired across the channels displayed on the screen.

When no trace cursors are set, the instrument saves data of the whole range even if you choose **[A\_B]** or **[C\_D]**.

#### 7 Click the **[Divide]** box, and then from the list, choose a size of each file.

When **[Type]** is set to **[Waveform (Binary)]**

<b>Off</b> <sup>□</sup>	Saves a file without dividing it.
<b>16 MB</b>	Choose this option to divide a large file into several files and save them. A file is divided into several files each of which has the specified size. The instrument creates a folder with the specified name, divides a file into several files, and then saves them in the folder.
<b>32 MB</b>	

The instrument automatically creates a folder, and then creates waveform files and an index file (extension: .IDX) in the folder. Loading the IDX file allows the waveform files to be loaded in a batch.

When using the memory division function, you cannot use the division save function.

When **[Type]** is set to **[Waveform (Text)]**.

<b>Off</b> <sup>□</sup>	Saves a file without dividing it.
<b>60,000 Data</b>	The instrument divides a file into several files each of which contains the specified number of data points.
<b>1,000,000 Data</b>	

When using the memory division function, you cannot use the division save function.

Refer to “Memory Dividing Function” (p. 191).

## 8 Configure advanced save settings according to the [Type] box setting.

Saving format	Setting		Description
Waveform (Text)	Thin out	Off <sup>☑</sup> , On (2 to 1,000)	A large amount of space is required to save files in text format. Decimating data before saving a file can reduce the file size. This setting allows you to specify the decimation number (the instrument retains a data point out of the decimation number of data points). Example When you enter [3], the instrument retains one data point out of three consecutive data points: it decimates the two other points. The number of data points is reduced by half of the original amount.
	Data	All users <sup>☑</sup>	Saves whole data.
		Event	Saves only the data points at event marks.
Screen image	Type	BMP <sup>☑</sup> , PNG, JPEG	Allows you to choose a type for saving image files (screenshot).
Numerical calculation result	File designation	New <sup>☑</sup>	Saves files with a new file name each time. The instrument allocates sequence numbers when the same name is given.
		Append	Appends data to the same file and saves it.
	File division	Off <sup>☑</sup>	Saves all calculations in a single file.
Split by Calc. No.		Creates a new folder, divides a file into several files according to calculation number, and save them in the folder. The instrument appends the string "_K + sequential number" following each file name.	
Arbitrary	Channel		Allows you to choose the channel number of the U8793 where the arbitrary waveform you wish to save has been registered.
	Data name		Allows you to enter the data name of the arbitrary waveform you wish to save. (Up to 16 single-byte characters or 8 double-byte characters)
Program	Channel		Allows you to choose the channel number of the U8793 where the program you wish to save has been registered.



## 9 (When using the memory division function)

Choose an option for blocks to be saved.

<b>Display block</b> <input checked="" type="checkbox"/>	Saves waveforms included in displayed blocks.
<b>All block</b>	Saves waveforms included in the specified number of blocks being used counting from the start block.

Whenever you click the save icon, the instrument saves data in the setting specified.

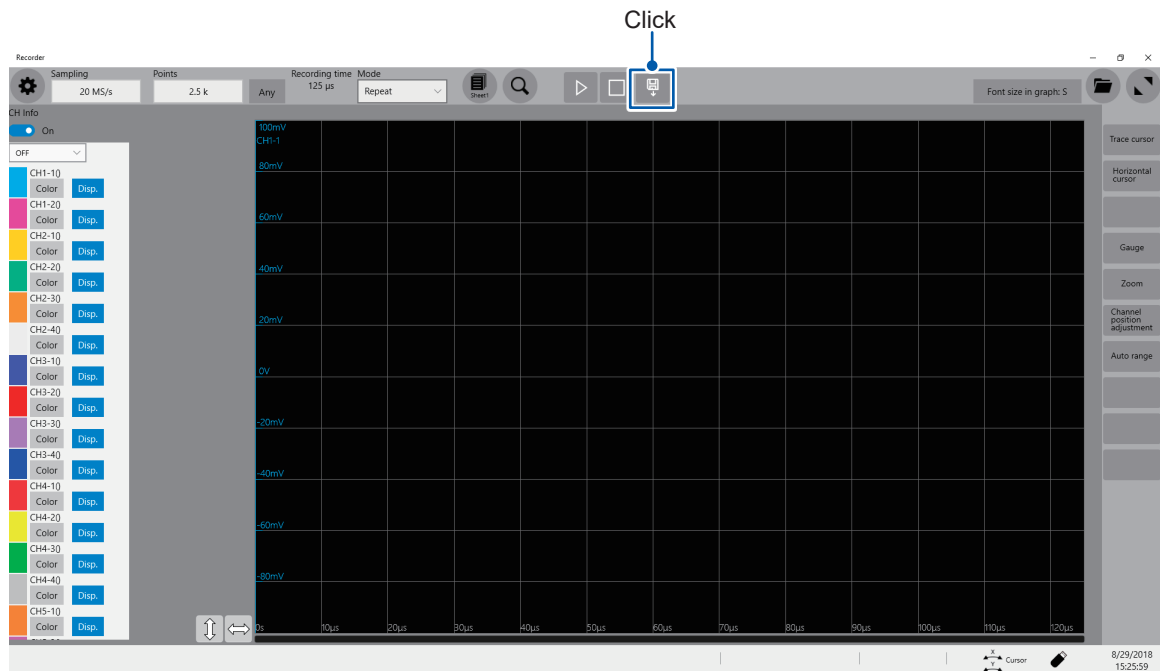

## 4.3 Loading Data

You can load data saved in a storage device or written in the internal memory of the instrument.

### Data loading procedure

Before attempting to load the data, make sure that a storage device is inserted, and the save destination is correctly specified.

Open the file screen, select a storage device, and double-click the file to be loaded.

Waveform and settings files saved in waveform (binary) format can be loaded on the instrument.

The instrument displays only loadable files on the file screen.

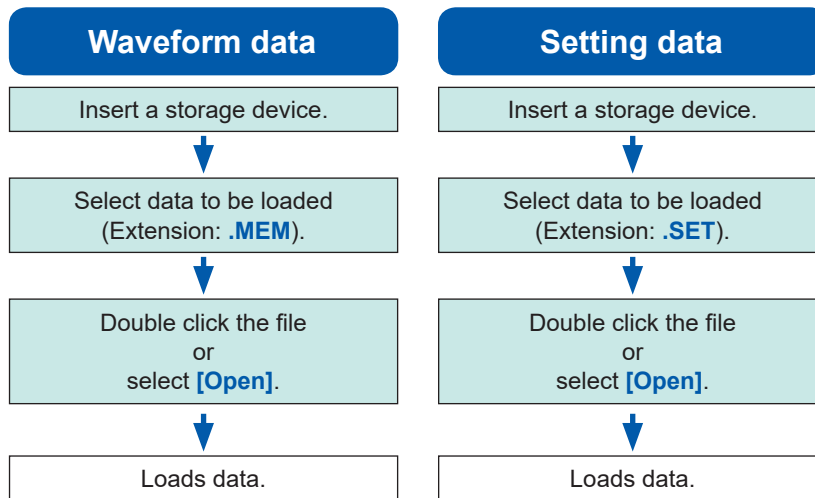

## To display the file screen

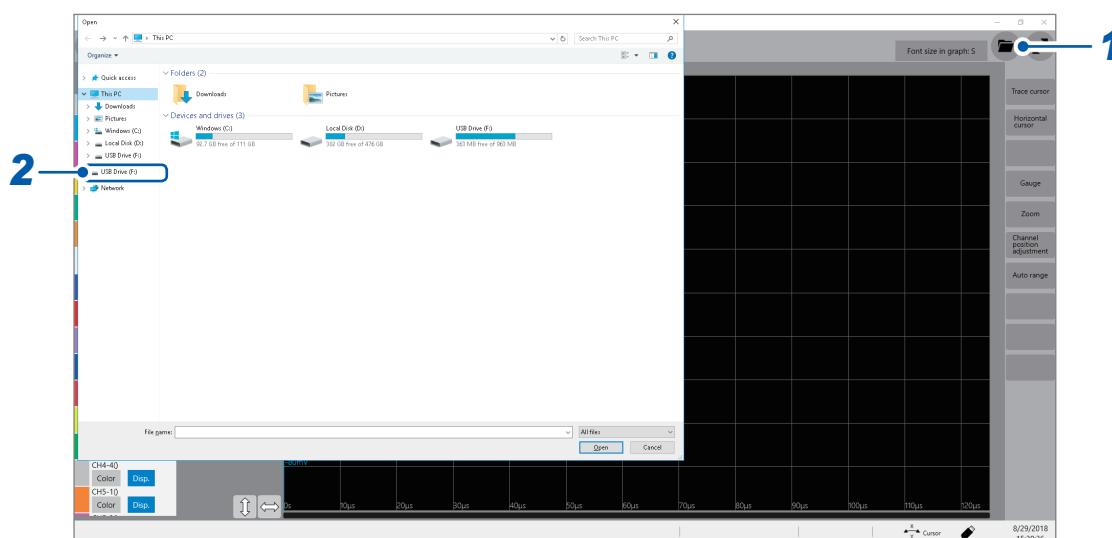

- 1 Open the file screen.
- 2 Choose a storage device to be operated.

## When loading data from a storage device

Insert a storage device before choosing it.

### Others

- The instrument can load data saved with Model MR8740T Memory HiCorder only.
- Loading a waveform file changes the settings of the instrument to those when the waveform file was saved. When you start a measurement in this state, the instrument measures waveforms with the settings of the loaded waveform file; however, the settings of the modules are restored to those set before the waveform file was loaded. To discard the module settings of the loaded waveform file, execute [\[Initialize waveform data\]](#) (Refer to “6.2 Initializing the Instrument” in Quick Start Manual.).

## Automatically loading the settings (Auto-setup function)

The instrument automatically loads the setting data with the file name “STARTUP” stored in the [\[CONFIG\]](#) folder in the [\[HIOKI\\_MR8740T\]](#) folder from a storage device at the time of startup. The instrument searches the drives beginning from drive D in alphabetical order for the file “STARTUP.SET,” loading the file found first.

## 4.4 Managing Files

Opening the explorer allows you to manage data saved in storage devices.

### Operation available on the explorer

Changing storage devices	Storage devices can be changed.
Sorting files	Files on a file list can be sorted based on the chosen basis.
Moving files to a folder	Files can be moved to a folder of your choice.
Copying files or folders	Files can be copied to a specified folder. When you choose folders to be copied, the chosen folders are copied into the specified folder.
Creating a folder	A new folder can be created.
Renaming a file or folder	A file or folder can be renamed.
Deleting files or folders	Files and folders can be deleted.
Format	A storage device can be formatted.

### To open the explorer

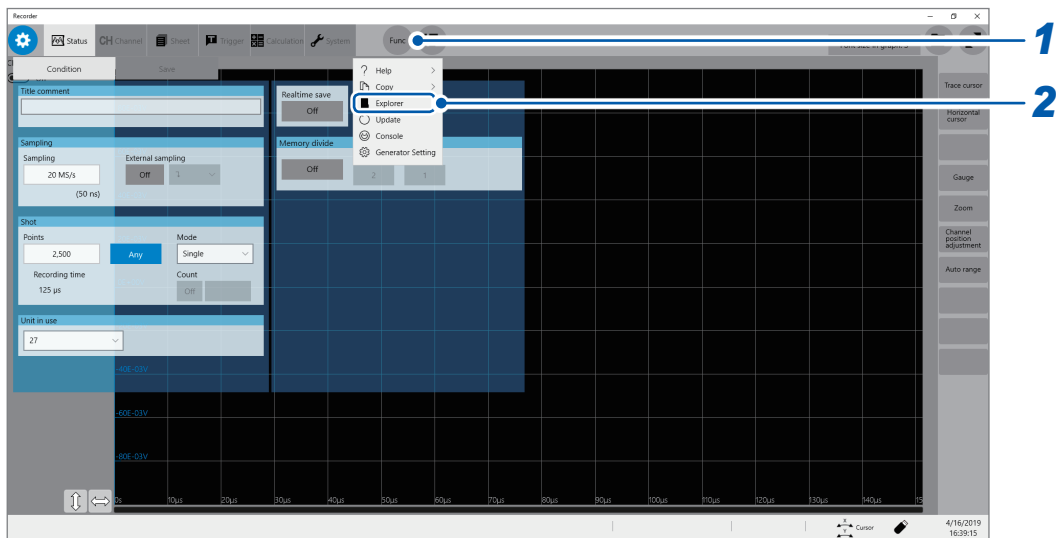

**1** Click **[Func]**.

**2** Choose **[Explorer]**.

Explorer appears.

Choose a storage device to be operated.

# 5

# Configuring the Trigger Settings

The trigger function allows you to start and stop measurements using specific signals. When recording is started by specific signals, it is called “The instrument is triggered.”

In this chapter, the mark **T** represents the point the start trigger is activated.

In the descriptions of each trigger source, the mark **T** represents a point each trigger condition is satisfied and a point each trigger is generated.

When the real-time save is set to **[On]**, you cannot use the trigger function.

 > **[Trigger]** > **[Common]**

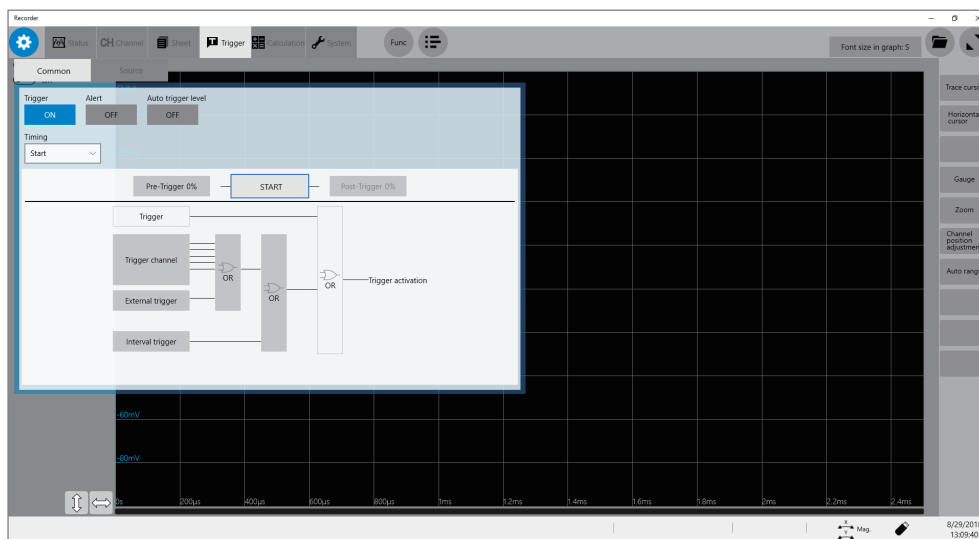

## Operation available on the **[Trigger]** screen

### Configuring the trigger setting

- Trigger timing (p. 118)
- Pre-Trigger (p. 120)
- Trigger satisfaction condition (logical AND or OR operation) among the trigger sources (p. 123)

### Configuring the trigger source settings

#### Configuring the analog trigger settings (p. 124)

- Level trigger
- Window trigger
- Period trigger
- Glitch trigger
- Voltage drop trigger

#### Configuring the interval trigger settings (p. 133)

#### Configuring the external trigger settings (p. 135)

#### Forcible trigger (p. 135)

#### Configuring the logic trigger settings (p. 131)

- Logic-trigger satisfaction conditions
- Trigger filter
- Trigger pattern

#### Trigger output (p. 227)

# 5.1 Trigger Setting Procedure

- The instrument is triggered based on trigger logical-conditions (logical AND or OR operation) among trigger sources except for the forcible trigger. (p. 123)
- When triggered, the instrument outputs the TRIG OUT signal from the external control terminal. (p. 227)

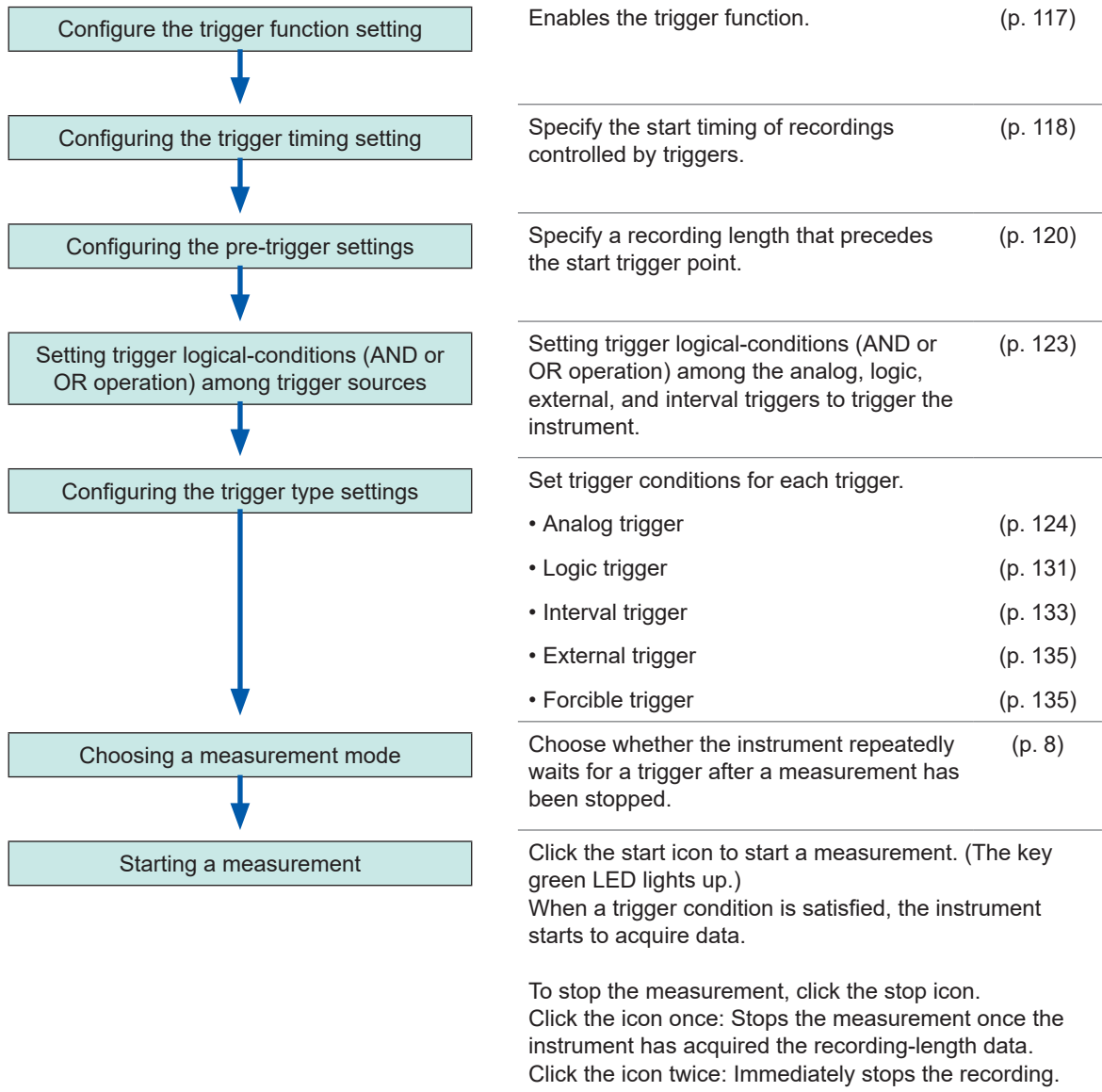

## 5.2 Enabling the Trigger Function

 > [Trigger] > [Common]

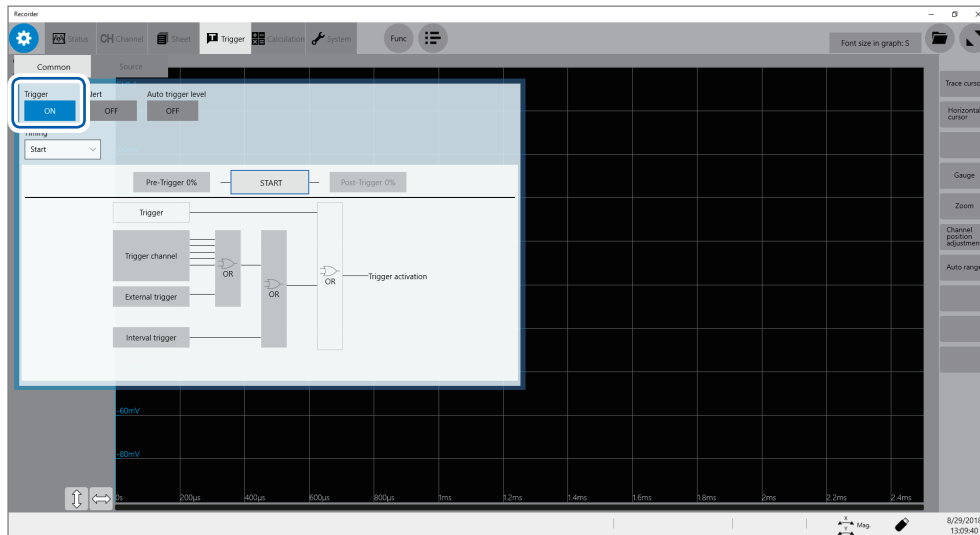

Click the **[Trigger]** button to set it to **[On]**.

<b>On</b> <input checked="" type="checkbox"/>	Enables the trigger function.
<b>Off</b> <input type="checkbox"/>	Disables the trigger function.

### To copy settings to other channels

You can copy settings on the analog trigger setting screen. Refer to “3.5 Copying Settings (Copy Function)” (p. 47).

## 5.3 Trigger timing

 > [Trigger] > [Common]

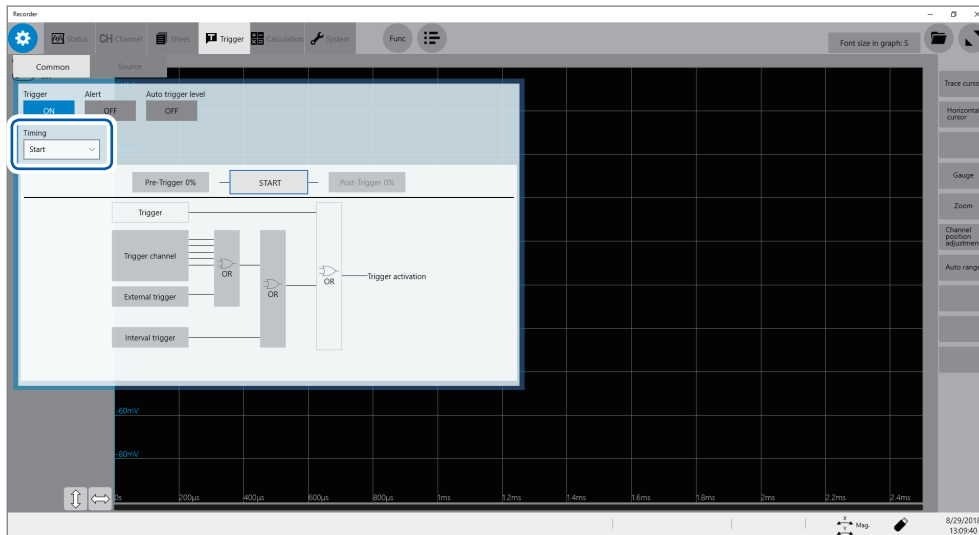

**START**

Starts recording when the instrument is triggered, and stops the recording after the instrument has acquired the recording-length waveforms.

A displayed trigger point may lag behind the actual trigger point by some samples between one and four when measuring modules include any one of the following modules: Model U8975 4ch Analog Unit, Model MR8990 Digital Voltmeter, and Model U8991 Digital Voltmeter Unit.



## Trigger timing

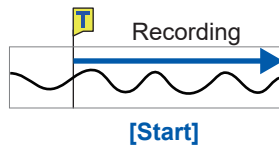

### Starts recording

Starts recording when the instrument is triggered.

### Stops the recording



When the mode is set to **[Single]**

Stops the recording after the instrument has acquired the recording-length data.

When the mode is set to **[Repeat]**

Starts recording, stops the recording after the instrument has acquired the recording-length data, and then waits for a trigger. When triggered again, starts recording, stops the recording after the instrument has acquired the recording-length data, and then waits for a trigger (repeats this sequence).

### Example of trigger timing

When the trigger type is set to the level trigger; level, at 0.000 V; and slope, to positive [↗]

Setting of **[Timing]**

**[Start]**

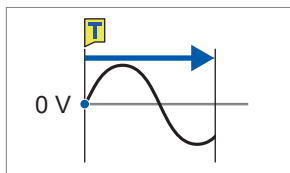

Records recording-length data.

The above processes are repeated when the trigger mode is set to **[Repeat]**.

## 5.4 Configuring the Pre-trigger settings

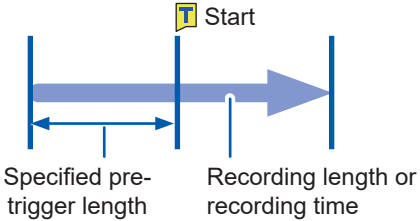
<p><b>Pre-trigger</b></p>	<p>You can record not only waveforms that appear after a start trigger has been activated, but also those that appear before the trigger is activated.</p>	<p><b>Also records data before the start trigger.</b></p> 
---------------------------	--	--

The pre-trigger is set in percent (%) of the recording length.  
 Setting all the trigger sources (analog, interval triggers, etc.) to **[Off]** disables pre-trigger setting.

 > **[Trigger]** > **[Common]**

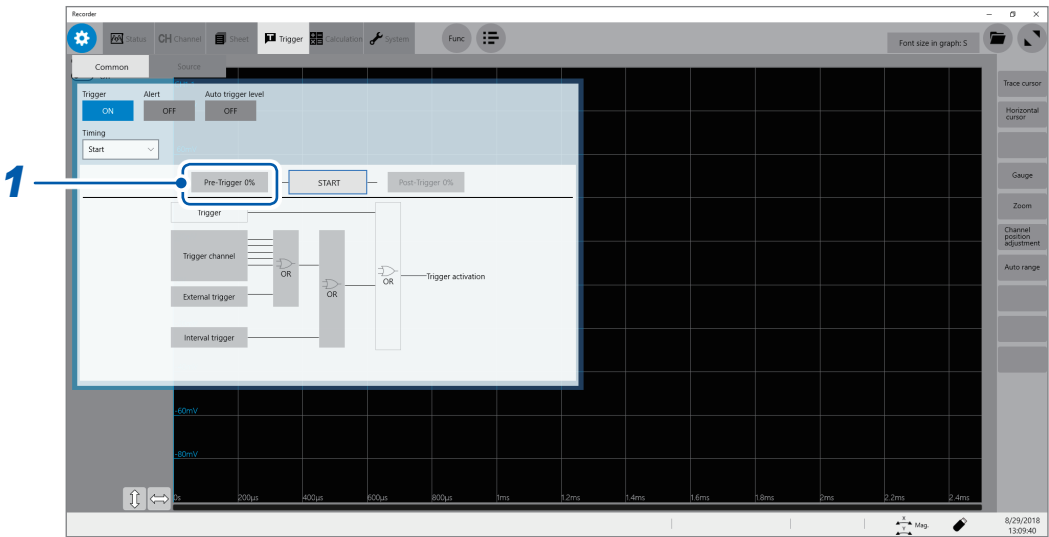

**1** Click **[Pre-Trigger 0%]**.

The setting dialog box appears.

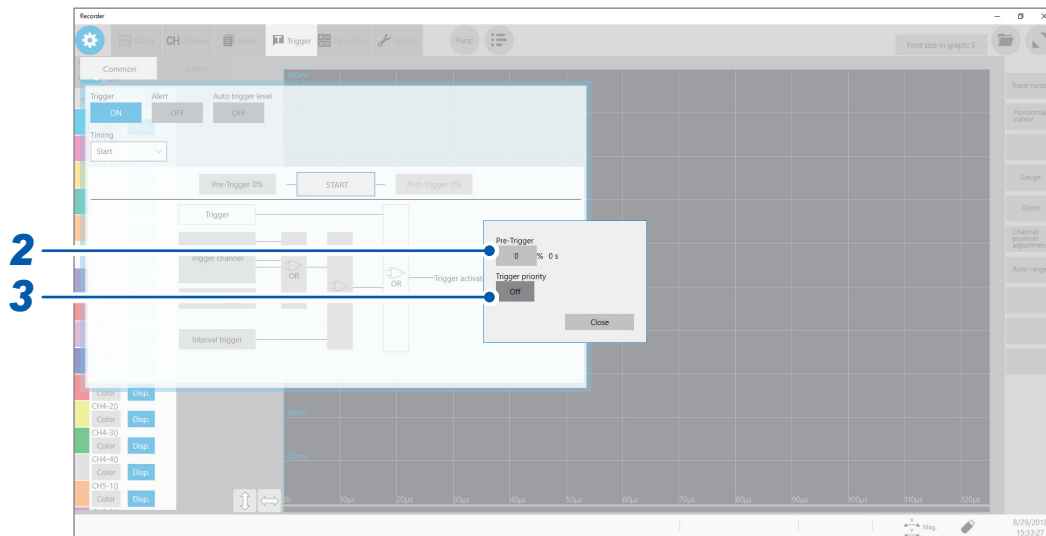

**2** Click the **[Pre-trigger]** box, and then enter a pre-trigger length.

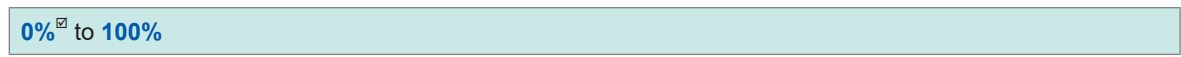

**Difference between [Waiting for Pre-Trigger] and [Waiting for Trigger]**

When starting a measurement, the instrument starts filling the pre-trigger memory. During this period, the instrument displays the message **[Waiting for Pre-Trigger]**. After having filled the pre-trigger memory, the instrument displays the message **[Waiting for Trigger]** until it is triggered. While displaying **[Waiting for Pre-Trigger]**, the instrument is not triggered even when a trigger condition is satisfied.

**Pre-trigger and recording range**

- Using the pre-trigger along with the start trigger setting

When the pre-trigger length is set at 95%:  
Records the waveforms with the recording length, 95% of which appear before the start trigger point.

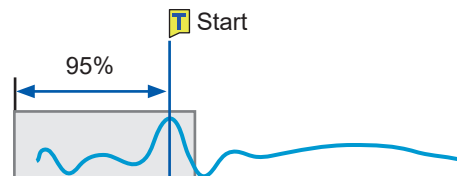

When the pre-trigger length is set at 50%:  
Records recording-length waveforms, 50% of which appear before the start trigger point.

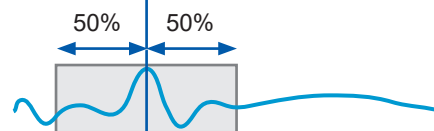

**3** Click the **[Trigger priority]** button to choose a way to handle triggers activated while the instrument is filling the pre-trigger memory.

You can choose whether the instrument is triggered when the trigger condition is satisfied while the instrument is filling the pre-trigger memory.

- When the pre-trigger is enabled, the instrument is not triggered once the measurement has started until a certain period has elapsed (while the instrument is filling the pre-trigger memory).
- The message **[Waiting for Pre-Trigger]** appears on the screen.

<b>Off</b> 	Ignores triggers while filling the pre-trigger memory.
<b>On</b>	Accepts a trigger while filling the pre-trigger memory.

**When the trigger condition is satisfied while the message **[Waiting for Pre-Trigger]** is being displayed**

Example: When the pre-trigger length is set at 50%

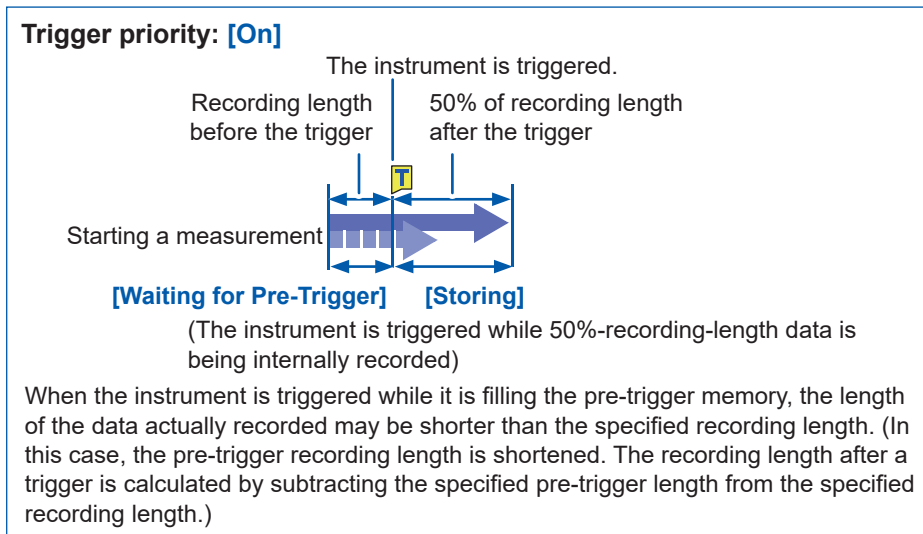
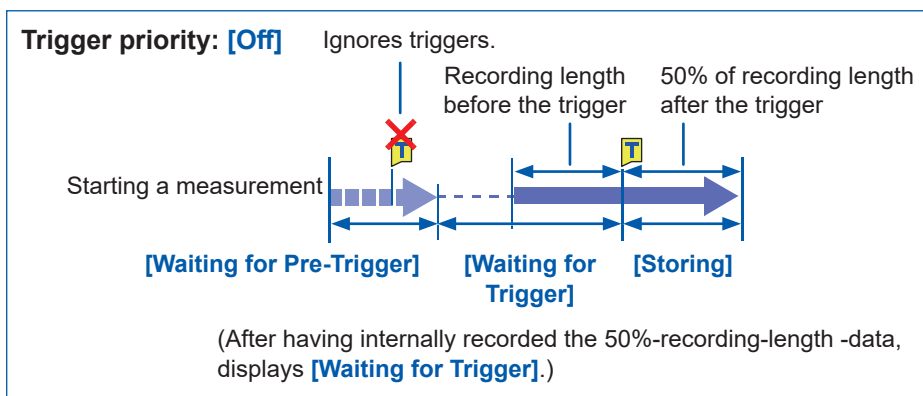

## 5.5 Setting the Trigger Satisfaction Conditions (AND/OR Operation) Among Trigger Sources

Set the trigger logical-conditions among the analog, logic, external, and interval triggers by choosing between logical AND or OR operation.

The forcible trigger triggers the instrument regardless of the trigger logical-conditions setting. If all trigger sources are set to off (i.e., with no trigger setting), recording starts immediately (free run).

 > [Trigger] > [Common]

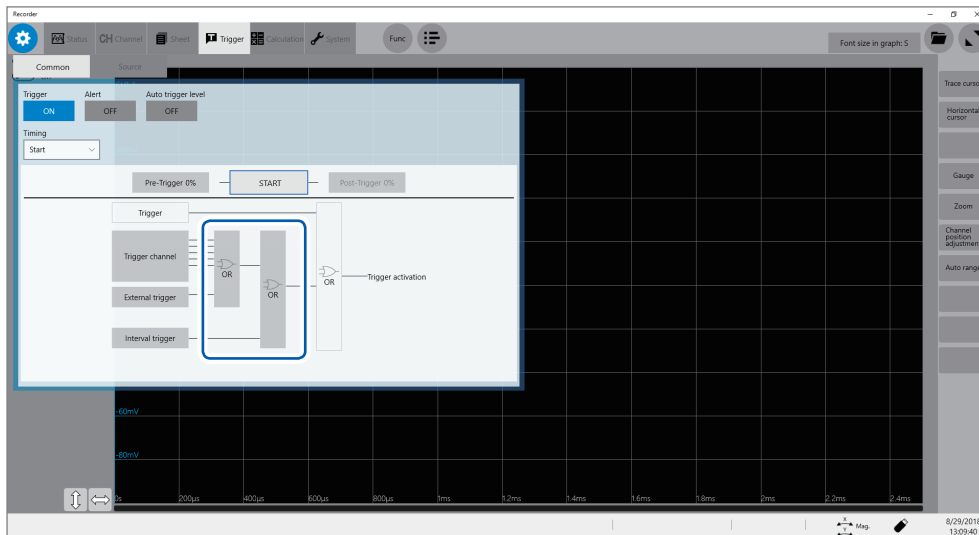

Click **[AND]** or **[OR]**, whichever is displayed, to switch to the other.

<b>OR</b> <input checked="" type="checkbox"/>	When any one of the specified trigger conditions changes from not being satisfied to being satisfied (at a changing point), the instrument is triggered. Thus, even though a trigger condition has been already satisfied at the start of waiting for a trigger, the instrument is not triggered until a changing point is detected.
<b>AND</b>	Only when all of the specified trigger conditions are satisfied, the instrument is triggered. Thus, if all the specified trigger conditions have been already satisfied at the start of waiting for a trigger, the instrument is immediately triggered.

**Setting example: To trigger the instrument when a waveform crosses the zero-volt level in the positive direction (\*)**

The instrument is triggered based on whether the trigger satisfaction condition is set to AND or OR operation in the following ways:

Channel	Trigger	Level at time	Slope	Filter
CH1, CH2	Level	0.00 V	 *	Off

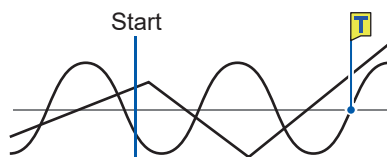

**[AND]**

One waveform is above 0 V, and the other is also above 0 V.

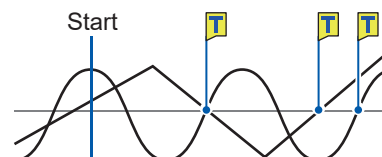

**[OR]**

Either waveform crosses 0 V upwards.

\*: With the **[AND]** setting, the slope setting item appears as **[HIGH]**.

# 5.6 Triggering the Instrument Using Analog Signals (Analog Trigger)

This section explains how to configure the analog trigger settings and types of the analog triggers.

 > [Trigger] > [Source]

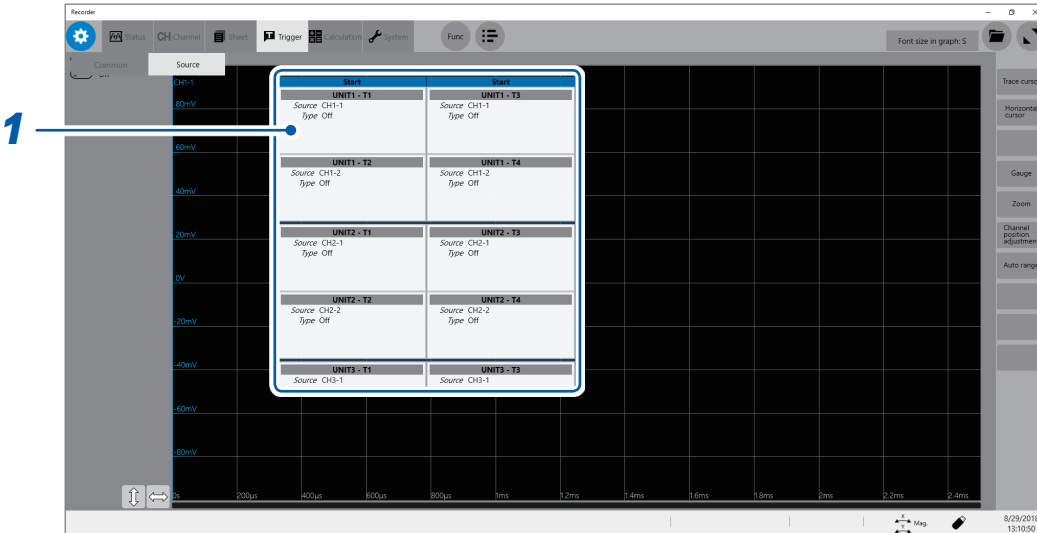

**1** Click a trigger source you want to specify.

The setting dialog box appears.

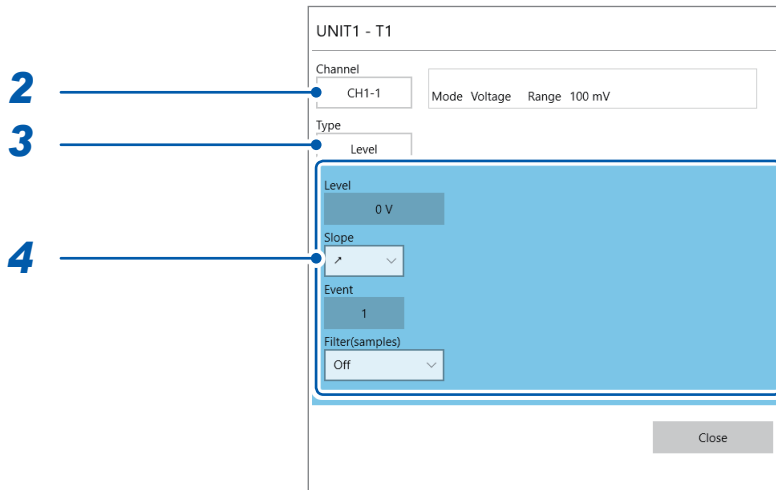

**2** Click the [Channel] box, and then from the list, choose a channel you want to set a trigger condition for.

**3** Click the [Type] box, and then choose a trigger type from the list.

Off, Level, In, Out, Voltage drop, Period-in, Period-out, Glitch

**4** Configure each trigger-type-specific setting.

### 1. [Level] trigger

When an input signal crosses the specified level in the positive or negative direction, an analog trigger is generated.

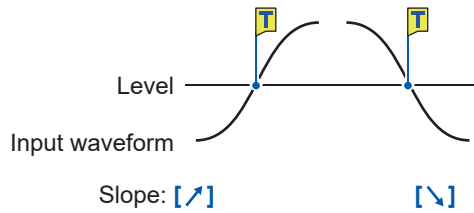

Setting		Description	
<b>Level</b>	-f.s. to +f.s. Default: 0 <input type="checkbox"/>	Allows you to enter a level of the level trigger.	
<b>Slope</b>	<b>With OR</b>	<input type="checkbox"/>	The level-trigger condition is satisfied when a waveform crosses the threshold value (level) in the positive direction.
		<input type="checkbox"/>	The level-trigger condition is satisfied when a waveform crosses the threshold value (level) in the negative direction.
	<b>With AND</b>	<b>HIGH</b> <input type="checkbox"/>	The level-trigger condition is satisfied when a waveform is higher than the threshold value (level).
		<b>LOW</b>	The level-trigger condition is satisfied when a waveform is lower than the threshold value (level).
<b>Event</b>	<b>With OR</b>	1 <input type="checkbox"/> to 4,000	Allows you to enter the number of events. The instrument counts the number of times the level-trigger condition is satisfied. An analog trigger is generated when the count reaches the specified number of events.
	<b>With AND</b>		Not available
<b>Filter</b>	<b>Off</b> <input type="checkbox"/> , 10 to 10,000		Allows you to enter a filter width in the number of samples. Only after the level-trigger condition is continuously satisfied during the specified period, an analog trigger is generated. Specifying this option prevents the instrument from being unintentionally triggered due to noise.

#### With the [Filter] setting

Specifying the filter duration prevents the analog trigger from being unintentionally generated due to noise, allowing it to be generated only after the level-trigger condition continues to be satisfied during the specified duration (period) or longer.

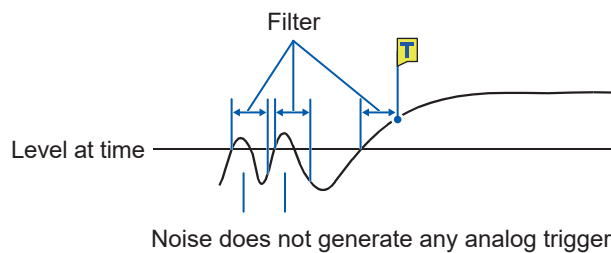

#### With the [Event] setting

If the trigger condition is repeatedly satisfied, setting the number of events prevents an analog trigger from being generated until the number of times the level-trigger condition is satisfied reaches the specified number of counts.

Example: When the number of events is set at [4] (Slope: [ / ]).

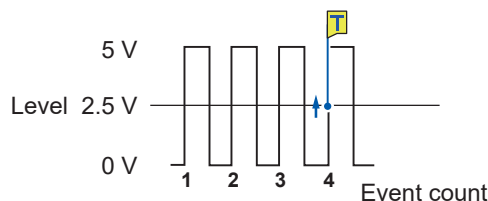

## 2. [In] trigger, [Out] trigger

When an input signal falls within ([In]) or gets out of a range ([Out]), which is determined by specifying upper and lower values, an analog trigger is generated.

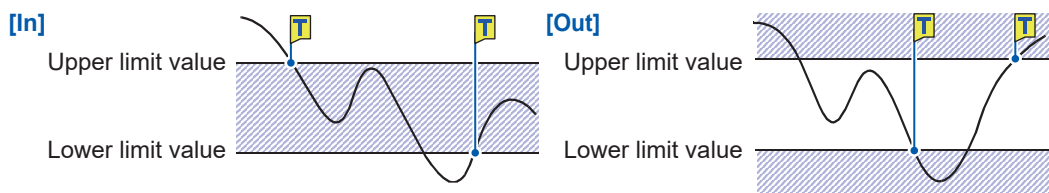

Setting		Description
Event	With OR	1 <sup>□</sup> to 4,000
	With AND	Not available
Filter	Off <sup>□</sup> , 10 to 10,000	Allows you to enter a filter width in the number of samples. Only after the window-trigger condition continues to be satisfied during the specified period, an analog trigger is generated. Specifying this option prevents the instrument from being unintentionally triggered due to noise.
Upper	-f.s. to +f.s.	Allows you to enter an upper limit value.
Lower	-f.s. to +f.s.	Allows you to enter a lower limit value.
Auto-trigger level*	Off <sup>□</sup> , On	With the [On] setting, the instrument automatically specifies a reference level and is triggered when an input signal exceeds the range between the lower value, the sum of the reference level and the lower limit value, and the higher value, the sum of the reference level and the upper limit value. (p. 138) In [Level of the last time], the reference level used in the previous measurement appears.

\*: Available for the out trigger function only

The operation related to the in and out triggers varies depending on the trigger logical-conditions (AND and OR).

With OR	In	The window-trigger condition is satisfied when an input signal crosses the upper or lower limit value of the threshold (level) and thereby falls within the range.
	Out	The window-trigger condition is satisfied when an input signal crosses the upper or lower limit value of the threshold (level) and thereby gets out of the range.
With AND	In	The window-trigger condition is satisfied when an input signal is inside the range, which is specified by the upper and lower limit values of the threshold (level).
	Out	The window-trigger condition is satisfied when an input signal is outside the range, which is specified by the upper and lower limit values of the threshold (level).



### 3. [Voltage drop] trigger

When a voltage peak is continuously lower than a specified level for a time of half a period or more, the voltage-drop-trigger condition is satisfied. The sampling rate can be set at a figure in the range of 2 kS/s to 20 MS/s.

These triggers cannot be specified either when Model 8970, Model MR8990, or Model U8991 is used.

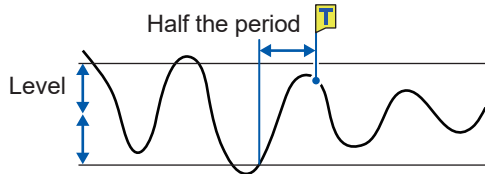

Setting		Description
<b>Level</b>	0 to +f.s. (100 V <sup>□</sup> )	Allows you to enter a level to be used to check for voltage drops.
<b>Frequency</b>	50 Hz <sup>□</sup> , 60 Hz	Allows you to specify a power frequency.
<b>RMS (root-mean-square value)</b>	Varies in conjunction with the level settings	Displays a rough indication of the RMS value.
<b>Event</b>	<b>With OR</b> 1 <sup>□</sup> to 4,000	Allows you to enter the number of events. The instrument counts the number of times the voltage-drop-trigger condition is satisfied. Only after the count reaches the specified number of events, an analog trigger is generated.
	<b>With AND</b>	Not available

Operations of the voltage drop trigger varies depending on the trigger logical-conditions (AND and OR operations).

<b>With OR</b>	As soon as the instrument determines that a voltage peak is falling below a specified level for a time of half a period or more, the voltage-drop-trigger condition is satisfied.
<b>With AND</b>	While a voltage peak is lower than a specified level for a time of half a period or longer, the voltage-drop-trigger condition is continuously satisfied.

#### 4. [Period-in] trigger and [Period-out] trigger

The instrument measures periods of an input waveform, which are time lags between consecutive two points at which an input voltage crosses the specified level in the positive or negative direction. The period-trigger condition is satisfied when a period is inside the specified range (In) or outside the specified range (Out).

An trigger point lags behind the actual trigger point by one sample.

These triggers cannot be specified either when Model 8970, Model MR8990, or Model U8991 is used.

Refer to “Setting of the period range” (p. 129) and “[Period-out] trigger” (p. 129).

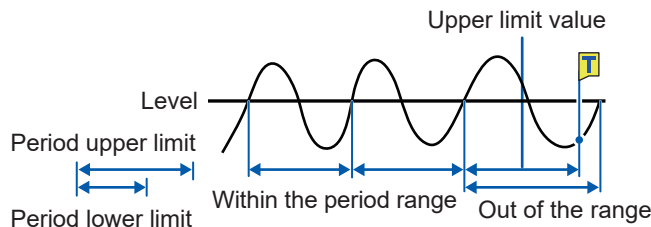

Setting		Description
Level	-f.s. to +f.s. Default: 0	Allows you to enter a level for detecting the rising or falling slopes of a signal.
Slope	↗, ↘	Allows you to choose which of the following points to use to calculate periods: two consecutive points at which a signal crosses the specified level in the positive direction; or those in the negative direction.
Period lower limit*	Zero or 5 times the sampling period or longer	The lower limit of periods cannot be set to a value higher than that in the [Period upper limit] box. When the lower limit of periods is set at [0], the instrument ignores the value in the [Period lower limit] box, and the period-trigger condition is satisfied using the value in the [Period upper limit] box only.
Period upper limit*	20,000 times or less of the sampling period	The higher limit of periods cannot be set to a value lower than that in the [Period lower limit] box.
Event	With OR	1 to 4,000
	With AND	
Filter	Off, 10 to 10,000	Allows you to enter a filter width in the number of samples. Only after the period-trigger condition is continuously satisfied during the specified period, an analog trigger is generated. Specifying this option prevents the instrument from being unintentionally triggered due to noise.

\*: Ranges of values that can be set in the period lower limit and period upper limit boxes varies in conjunction with the sampling rates (periods).

## Setting of the period range

The period range settings of the period trigger vary depending on the sampling periods (sampling rates).

(The setting value of the period range also changes in conjunction with the sampling period [sampling rate] setting.)

Select **[Status] > [Condition] > [Sampling]** and check the sampling rate setting.

### To set the period-trigger condition such that it is satisfied when an input frequency exceeds the upper limit value (when the period becomes shorter)

Set **[Type]** to **[Period-in]** and set **[Period lower limit]** at **[0]**. The instrument ignores a value in the **[Period lower limit]** box, and the period-trigger condition is satisfied when an input frequency exceeds a value in the **[Period upper limit]** box.

### To set the period-trigger condition such that only when an input frequency falls below the upper limit value (when the period becomes longer):

Set **[Type]** to **[Period-out]** and set **[Period lower limit]** at **[0]**. The instrument ignores a value in the **[Period lower limit]** box, and the period-trigger condition is satisfied when an input frequency falls below a value in the **[Period upper limit]** box.

## [Period-out] trigger

The instrument calculates periods by monitoring times when an input signal crosses the specified level in the positive or negative direction, and the period-trigger condition is satisfied when a period gets out of the specified period range.

Points at which the period-trigger condition is satisfied varies depending on the specified period range and the period of a measuring object.

### When an input signal period is shorter than the specified lower limit of periods (with the slope set to positive [↗]).

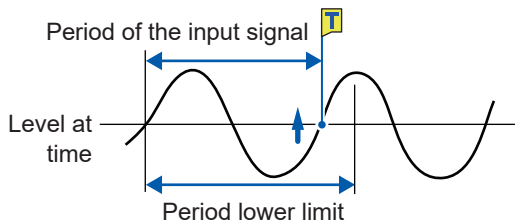

The period-trigger condition is satisfied when a rising slope of an input signal crosses the specified level before the lower limit of periods elapses.

### When an input signal period is longer than the specified upper limit of periods (with the slope set to positive [↗]).

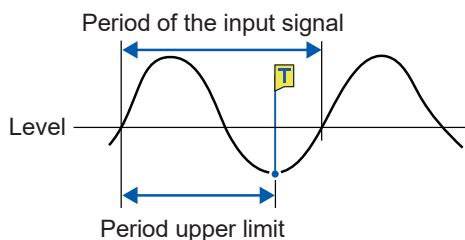

The period-trigger condition is satisfied when the upper limit of periods elapses before a rising slope of an input signal crosses the reference voltage level.

Thus, points at which the period-out-trigger condition is satisfied varies depending on the upper limit of a period range.

## 5. [Glitch] trigger

The glitch-trigger condition is satisfied when a pulse width of an input signal that has crossed the specified level is shorter than the specified duration.

These triggers cannot be set either when Model MR8990 or Model U8991 is used.

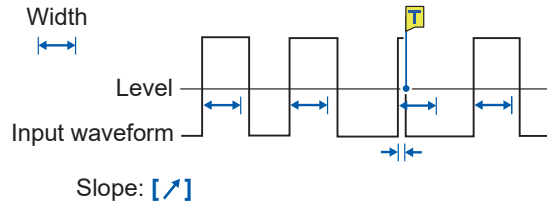

Setting		Description
Level	-f.s. to +f.s. Default: 0	Allows you to specify the level for detecting glitches.
Slope	↗, ↘	Allows you to choose which of the following points to use to detect glitches: two consecutive points at which a signal crosses the specified level in the positive direction; or those in the negative direction.
Event	With OR	Allows you to enter the number of events. The instrument counts the number of times the glitch-trigger condition is satisfied. An analog trigger is generated only after the count reaches the specified number of events.
	1 to 4,000	
	With AND	Not available
Width	2 times to 4000 times of the sampling period	Allows you to enter a pulse width (time), which is used to determine a glitch. The glitch-trigger condition is satisfied when a pulse width is shorter than the specified width. (The available setting range varies depending on the sampling periods. Lower limit: 2 times sampling period or longer; Upper limit: 4000 times sampling period or shorter)

## 5.7 Triggering the Instrument With Logic Signals (Logic Trigger)

This section explains how to configure the logic trigger settings.

- Input signals acquired across the logic channels serve as a trigger source.
- You can set a trigger pattern and trigger logical-condition by choosing between logical AND and OR operations. When the logic-trigger conditions are satisfied, a logic trigger is generated.
- With the trigger filter setting, no logic triggers are generated until the logic-trigger condition is continuously satisfied during the specified filter width or more.

 > [Trigger] > [Source]

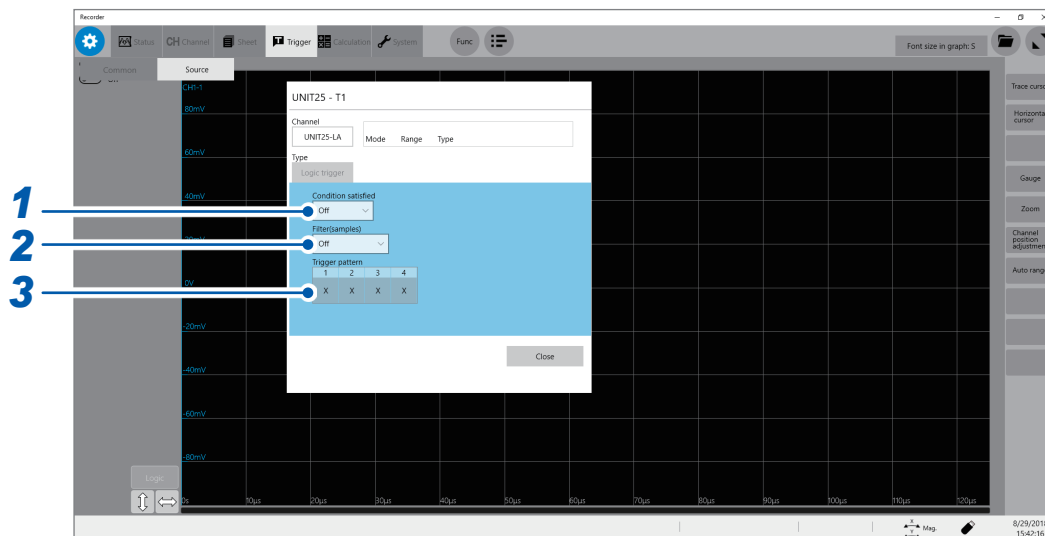

- 1 Click the **[Condition satisfied]** box, and then choose a logic-trigger satisfaction condition from the list.

<b>Off</b>	Disables the logic trigger.
<b>OR</b>	The logic-trigger condition is satisfied when any one of logic input signals matches the trigger pattern.
<b>AND</b>	The logic-trigger condition is satisfied when all logic input signals match the trigger pattern.

- 2 Click the **[Filter]** box, and then choose a sampling count of the filter from the list.

Only after the level-trigger condition is continuously satisfied during the specified period, an analog trigger is generated. Configuring the trigger filter setting prevents a logic trigger from being unintentionally generated due to noise. (p. 125)

<b>Off</b>	Disables the trigger filter.
<b>10 to 10000</b>	Enables the trigger filter. Allows you to enter a filter width in the number of samples.

**3** Click each of the signals under **[Trigger pattern]** to set a logic-trigger pattern.

The logic-trigger pattern can be set.

<b>X</b>	Ignores a signal.
<b>0</b>	The logic-trigger condition of each logic signal is satisfied when the signal is at a low level.
<b>1</b>	The logic-trigger condition of each logic signal is satisfied when the signal is at a high level.

**Setting example**

The logic-trigger conditions differ depending on the combination of the **[Condition satisfied]** setting (logical OR or AND operation) and the **[Trigger pattern]** setting as follows:

**OR**

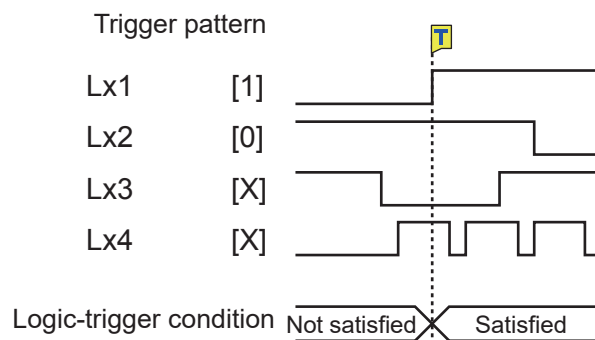

**AND**

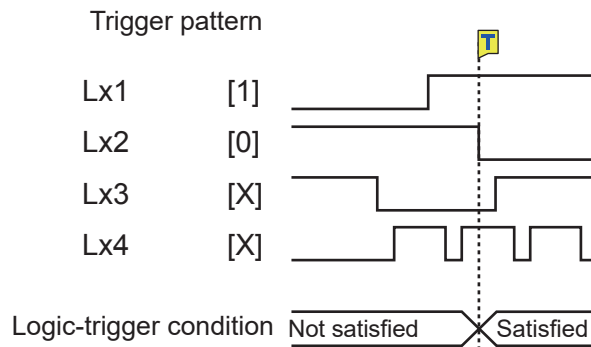

## 5.8 Triggering the Instrument at Regular Intervals (Interval Trigger)

Start triggers can be activated at specified intervals. Setting the recording mode to **[Repeat]** allows the instrument to record waveforms at regular intervals.

- When using the pre-trigger, the instrument starts monitoring interval-trigger times after the first pre-trigger time elapses since the start of measurement.
- No start triggers are activated by any interval triggers while the instrument is filling the pre-trigger memory. An interval trigger triggers the instrument while the instrument is waiting for a trigger after the instrument has filled the pre-trigger memory.
- Since the clock is internally corrected, displayed trigger times may not synchronize with the intervals of the interval trigger.

 > **[Trigger]** > **[Common]**

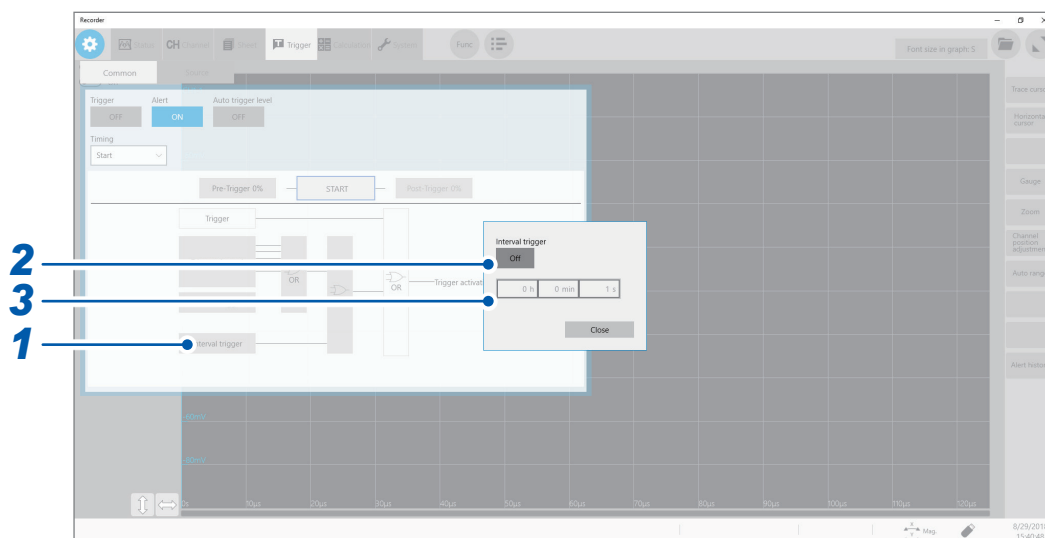

### 1 Click **[Interval trigger]**.

The interval trigger setting dialog box will appear.

### 2 Click **[Interval trigger]** to set it to **[On]**.

### 3 Click the **[h]**, **[min]**, and **[s]** boxes, and then enter a period of time for interval triggers.

An internal trigger is generated at the start of measurement, and triggers are repeatedly generated at the specified intervals.

### Acquiring data at regular intervals (relation between a time interval and a recording length or recording time)

The instrument is not triggered until having acquired data that has the specified recording length or recording interval.

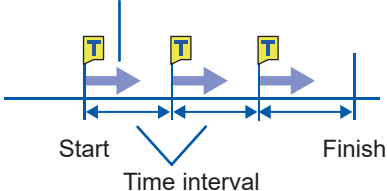
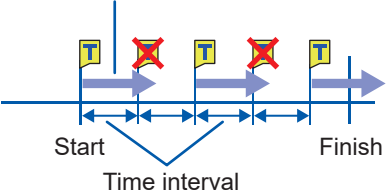
When a recording length or recording time is shorter than a time interval	When a recording length or recording time is longer than a time interval
<p>The instrument records the specified recording length or recording time of the data.</p>  <p>The diagram shows a horizontal timeline from 'Start' to 'Finish'. A bracket below the timeline is labeled 'Time interval'. Three yellow boxes with a 'T' are placed on the timeline, each with a blue arrow pointing right. The arrows represent recording events. The first arrow starts at the 'Start' point and ends before the 'Time interval' bracket. The second arrow starts after the first ends and also ends before the 'Time interval' bracket. The third arrow starts after the second ends and ends exactly at the 'Finish' point, which is also the end of the 'Time interval' bracket.</p>	<p>The instrument records the specified recording length or recording time of the data.</p>  <p>The diagram shows a horizontal timeline from 'Start' to 'Finish'. A bracket below the timeline is labeled 'Time interval'. There are four yellow boxes with a 'T' on the timeline. The first box has a blue arrow pointing right, starting at 'Start' and ending before the 'Time interval' bracket. The second box has a red 'X' over it and no arrow. The third box has a blue arrow pointing right, starting after the first arrow ends and ending before the 'Time interval' bracket. The fourth box has a red 'X' over it and no arrow. The fifth box has a blue arrow pointing right, starting after the third arrow ends and ending at the 'Finish' point, which is also the end of the 'Time interval' bracket.</p>



## 5.9 Externally Triggering the Instrument (External Trigger)

External signals applied to the external control terminals can serve as trigger sources. External signals can also be used to operate multiple instruments in synchronization with each other.

Refer to “External trigger terminal (EXT.TRIG)” (p. 229).

## 5.10 Manually Triggering the Instrument (Forcible Trigger)

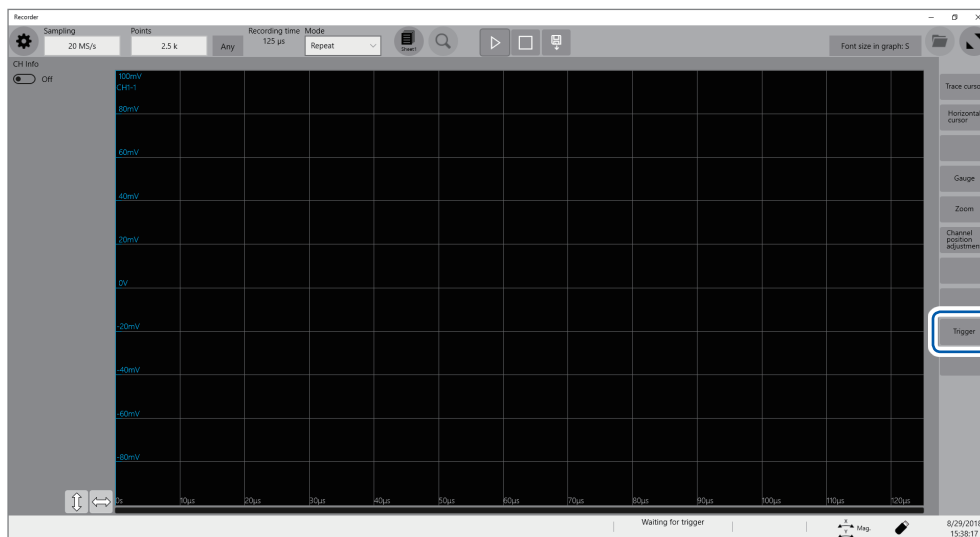

Clicking **[Trigger]** on the right side of the waveform screen allows you to manually trigger the instrument while the instrument is waiting time for a trigger.

The forcible trigger triggers the instrument regardless of the other trigger source settings.

To stop the measurement, click the stop icon.

- Clicking the stop icon once stops the measurement after the instrument has acquired recording-length waveforms.
- Click the stop icon once and click **[OK]** on the dialog box displayed to stop the measurement.

## 5.11 Issuing an Alert Using Triggers (Alert Function)

The alert function detects trigger-condition satisfying points based on trigger settings. When **[Beep sound]** is set to **[Alert]** or **[Alert+Action]**, the instrument continues to beep while the trigger condition is being satisfied. Also, the CMD ERR red LED lights up when the instrument alerts you. The LED goes off when the instrument lifts the alert.

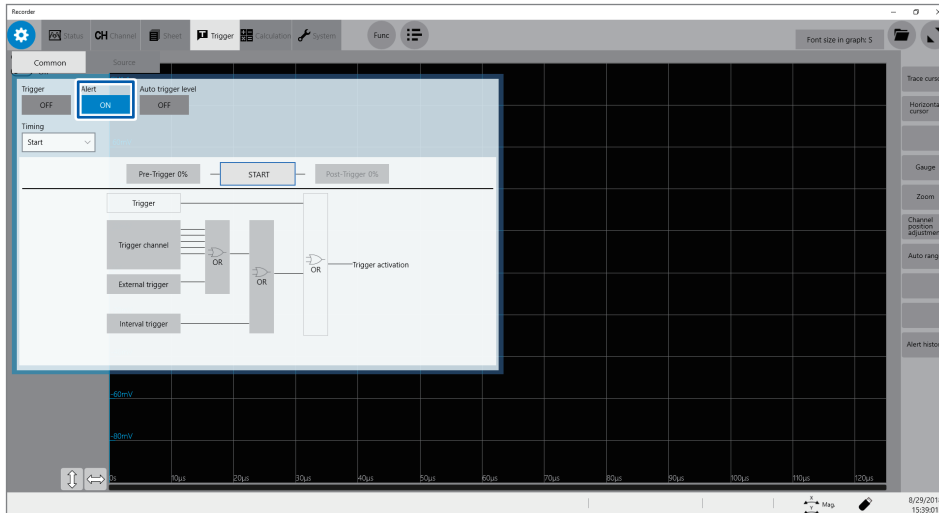

Setting **[Alert]** to **[On]** limits the sampling rate to 100 kS/s or lower. The event count of the trigger setting is fixed at **1**.

 > **[Trigger]** > **[Common]**

**1** Click the **[Trigger]** to set it to **[On]** or **[Off]**.

<b>Off</b> <input type="checkbox"/>	Does not alert you.
<b>On</b> <input type="checkbox"/>	Alerts you.

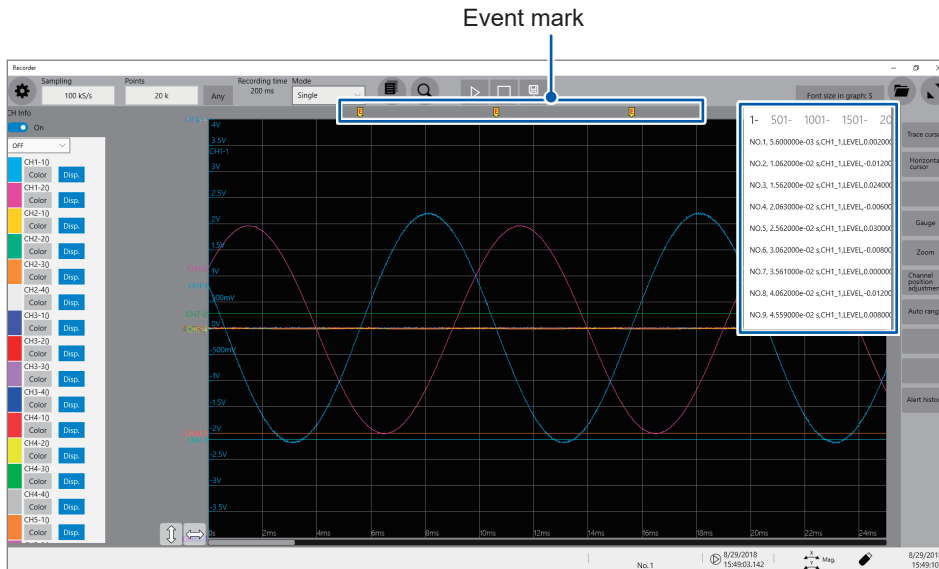

The instrument puts event marks (E) at the positions when the specified trigger condition is satisfied (alert issued) and when the condition fails to be satisfied (alert terminated). At the upper right of the screen, the instrument displays the time when the condition is satisfied, channel number, trigger type, measured value and a character string [Out] or [In]. The string [Out] or [In] is intended for use with the out trigger setting; however, with another trigger setting, the instrument displays [Out] when the condition is satisfied and [In] when the condition fails to be satisfied.

<b>Out</b>	When a condition is satisfied (for the out trigger setting, when a signal gets out of the specified range)
<b>In</b>	When a condition is not satisfied (for the out trigger setting, when a signal falls within the specified range)

If the condition is satisfied and fails to be satisfied repeatedly within 100 ms, the instrument may group this condition changes into one and display it as the following.

<b>Out_In</b>	When a condition is first not satisfied, then the status repeatedly changes, and finally fails to be satisfied
<b>Out_In_Out</b>	When a condition is first not satisfied, then the status repeatedly changes, and is finally satisfied
<b>In_Out</b>	When a condition is first satisfied, then the status repeatedly changes, and is finally satisfied
<b>In_Out_In</b>	When a condition is first satisfied, then the status repeatedly changes, and finally fails to be satisfied

When an alert condition specified for a channel has been already satisfied, the instrument with the alert settings specified for multiple channels displays the first alert at the same position as a position a condition for another channel is next satisfied at.

## 5.12 Automatically Specifying the Trigger Level (Auto-trigger Level)

When you enable this setting, the instrument performs a preliminary measurement before an actual measurement.

In the preliminary measurement, the instrument acquires the specified number of data points and calculates the average value of them. Then, the instrument specifies the average value as the reference of the out trigger and performs the actual measurement using this trigger.

This function is useful when you use the out trigger setting with the trigger and alert functions.

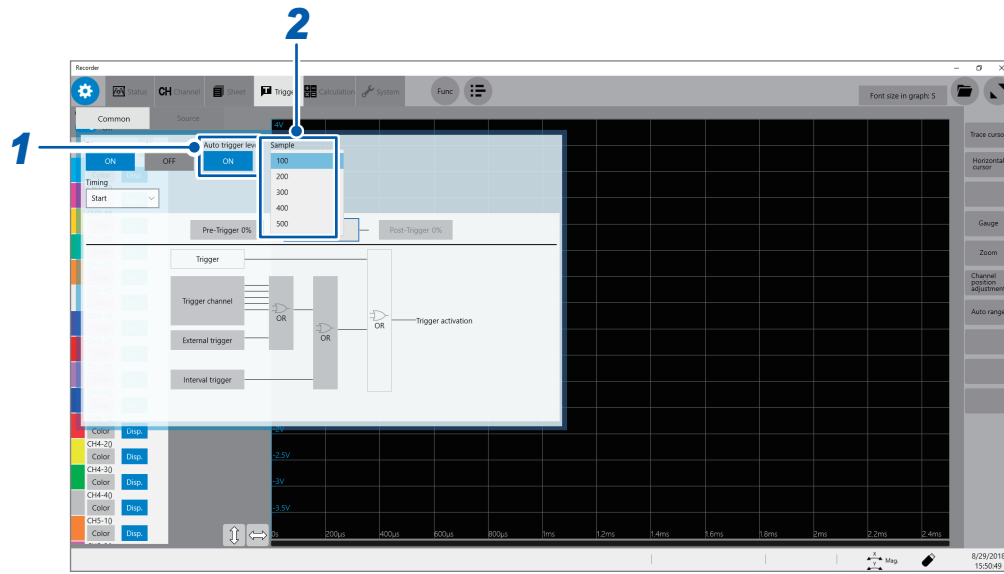

 > [Trigger] > [Common]

**1** Click the [Trigger] to set it to [On] or [Off].

Off <input checked="" type="checkbox"/>	Disables the auto-trigger level function.
On <input type="checkbox"/>	Automatically specifies the reference level of the out trigger.

**2** Click the [Samples] box, and then choose an option for the number of sampling points from the list.

100 <input checked="" type="checkbox"/> , 200, 300, 400, 500
--

**3** Configure the trigger setting for each channel.

On the trigger source setting screen, set the trigger type of a channel to be used to the out trigger, and set [Auto-trigger level] to [On]. (p. 126)

# 6

# Search Function

Using the search function allows you to search measured waveform data for positions where user-defined search criteria have been satisfied.

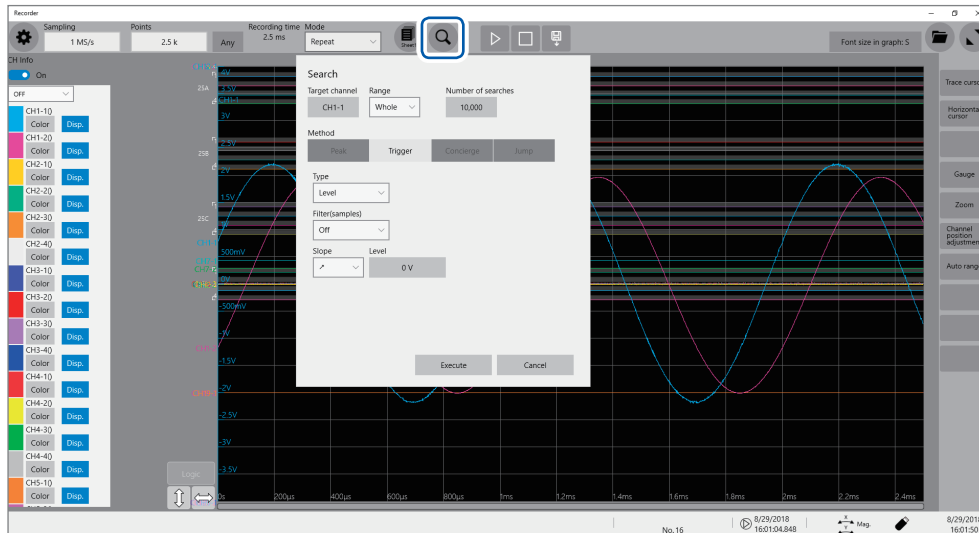

## Operation available on the search screen

### Peak search

You can search for the maximum, minimum, local maximum (maximal), or local minimum (minimal) value. Select one of them. (p. 140)

### Trigger search

You can search for the position where the specified trigger condition is satisfied. Specify the trigger condition. (p. 142)

### Memory HiConcierge

You can automatically detect differences from the fundamental wave based on the histogram or standard deviation. Specify the fundamental wave. (p. 146)

### Jump

The display can jump to the specified time, trace cursor position, event number, trigger point, or search mark. (p. 148)

# 6.1 Searching For Peak Values

You can choose any one of the maximum, minimum, maximal, and minimal values and search measured data for it.

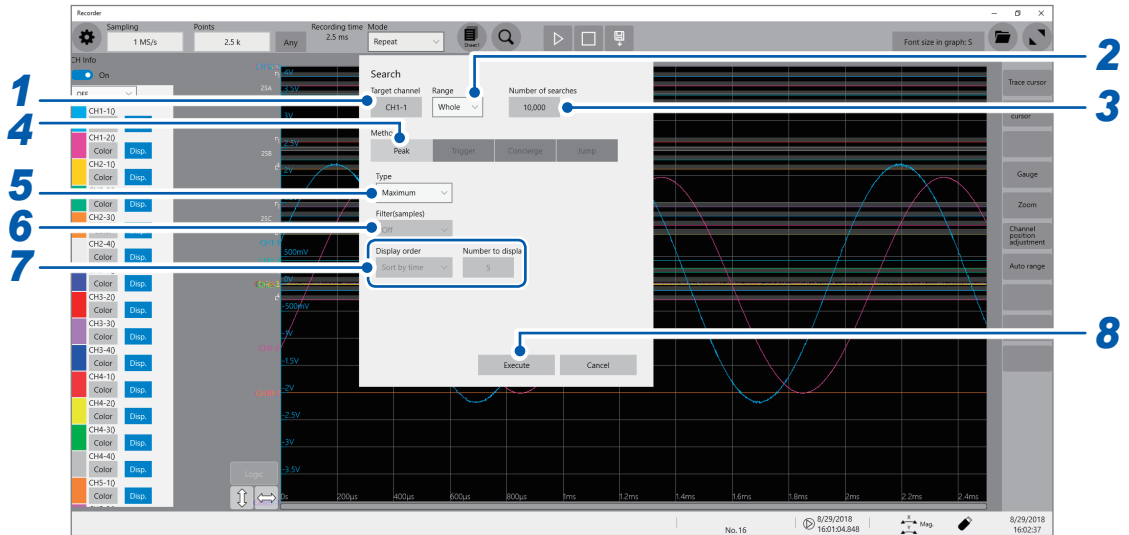

**1** Click the **[Target channel]** box, and then from the channel setting dialog box, choose a channels to be searched for values.

**2** Click the **[Range]** box, then choose an option for the search scope from the list.

<b>Whole</b> <input checked="" type="checkbox"/>	Allows you to search whole waveform.
<b>A_B, C_D</b>	Searches the scope specified with trace cursors A and B or trace cursors C and D.

**3** Click the **[Number of searches]** box, and then enter the number of search results.

**4** In the **[Method]** area, click **[Peak]** to choose a search method for searching for peak values.

**5** Click the **[Type]** box, and then from the list, choose a value type to be searched for.

<b>Maximum</b> <input checked="" type="checkbox"/>	Allows you to search for the maximum value.
<b>Minimum</b>	Allows you to search for the minimum value.
<b>Maximal</b>	Allows you to search for maximal values.
<b>Minimal</b>	Allows you to search for minimal values.

- If search results have two or more maximum or minimum values, the instrument displays any one of them as a representative value among the search results.
- Search results have multiple maximal or minimal values

**6** (When you choose **[Maximal]** or **[Minimal]** in the **[Type]** box)

Click the **[Filter(samples)]** box, and then from the list, choose a decision criterion for maximal or minimal values.

<b>Off</b>	Regards a value as a maximal value when it is larger than the values found one point before and after, and a minimal value when it is smaller.
<b>10 to 10,000</b>	Regards a value as a maximal value when it is larger than all the values found the specified number of points before and after, and a minimal value when it is smaller.

**7** (When you choose **[Maximal]** or **[Minimal]** in the **[Type]** box)

Click the **[Display order]** box, and then from the list, choose a sort criterion for search results.

<b>Sort by time</b>	Displays retrieved positions in chronological order. You cannot enter the number in the <b>[Number to display]</b> box. The instrument handles up to 10,000 search results. The instrument stops the search if it retrieves more than 10,000 results.
<b>Sort by data</b>	With the <b>[Maximal]</b> setting, displays the number, which is specified by <b>[Number to display]</b> , of retrieved positions in descending order. With the <b>[Minimal]</b> setting, displays them in ascending order.

(When you choose **[Sort by data]** in the **[Display order]** box)

Click the **[Number to display]** box, and then enter the number of search results to be displayed.

**8** Click **[Execute]**.

The instrument puts search marks (S) on positions where the search criteria are satisfied.

The **[Search Pos.]** switching panel appears on the waveform screen.

**To stop the search**

Click the stop icon.

**9** Switch retrieved positions using the **[Search Pos.]** switching panel and check the search results.

You can switch the retrieved positions by clicking **[<]** or **[>]**.  
The display order follows the setting in the **[Display order]** box.

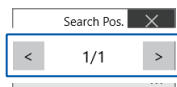

Clicking **[Next]** executes another search beginning from the next point of the retrieved position presently displayed.

The instrument discards a previous search result.

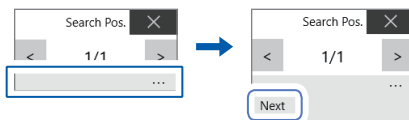

**To specify a retrieved position and jump there**

As described in "6.4 Jump to the Specified Position" (p. 148), choose **[Search number]** in the **[Type]** box, and then click **[Execute]**.

## 6.2 Searching For Positions Where a Trigger Condition Is Satisfied

Setting a trigger condition allows you to search measured data for positions where the trigger condition is satisfied.



- 1 Click the **[Target channel]** box, and then from the channel setting dialog box, choose a channel to be searched for positions where a trigger condition is satisfied.

When you choose an analog channel

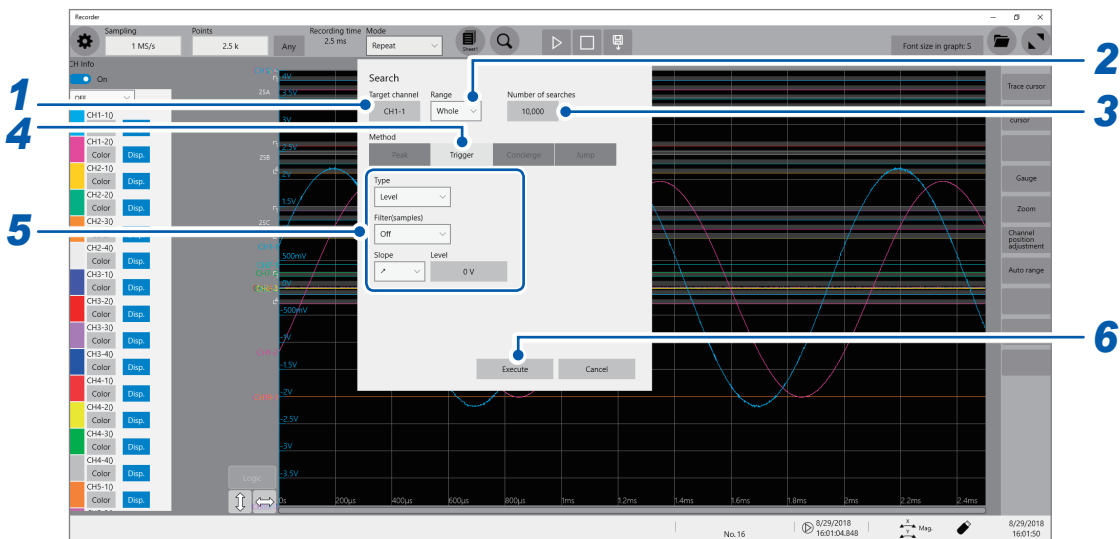

When you choose a logic channel

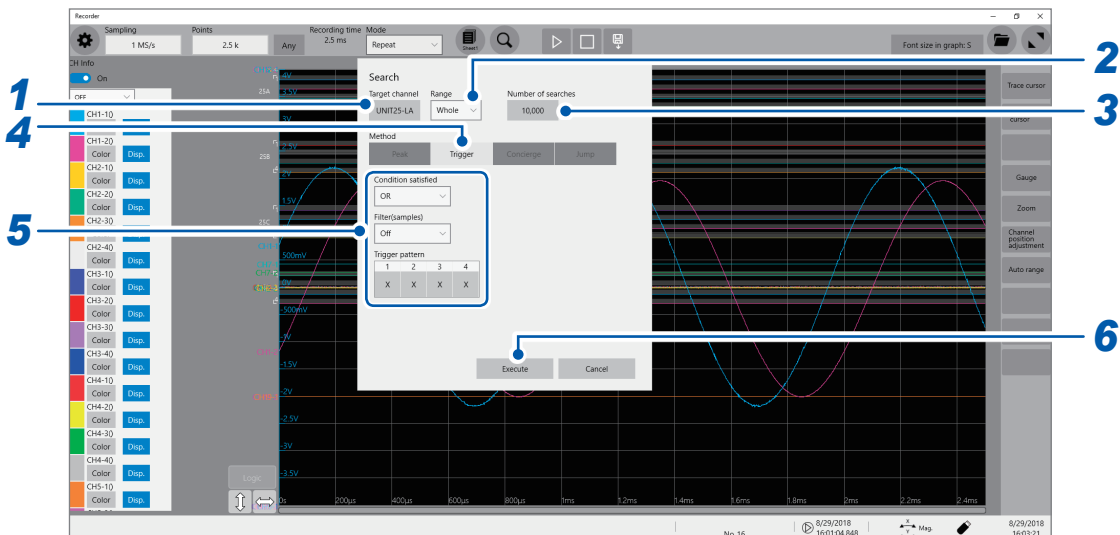

- 2 Click the **[Range]** box, and then from the list, choose an option for a scope to be searched for positions where a trigger condition is satisfied

<b>Whole</b>	Allows you to search whole waveform.
<b>A_B, C_D</b>	Searches the scope specified with trace cursors A and B or trace cursors C and D.



- 3** Click the **[Number of searches]** box, and then enter the number of search results.
- 4** In the **[Method]** area, click **[Trigger]** to choose a search method for searching for triggers.
- 5** Set search criteria.
  - 1. When you choose an analog channel under [Target channel]**  
Click the **[Type]** box, and then from the list, choose a trigger type to be searched for.

<b>Level</b> <input type="checkbox"/>	Allows you to enter a level and search for positions where a waveform crosses the level.
<b>In</b>	Allows you to enter an upper and lower limit values to specify a range and search for positions where a waveform falls within the range.
<b>Out</b>	Allows you to enter an upper and lower limit values to specify a range and search for positions where a waveform gets out of the range.

**Set the search criterion.**

Items to be set may vary depending on trigger types.

**(1) When you choose [Level]**

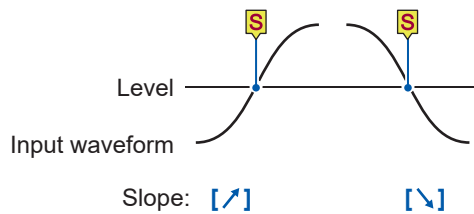

Setting		Description
<b>Filter</b>	<b>Off</b> <input type="checkbox"/> , <b>10 to 10,000</b>	Allows you to enter a filter width in the number of samples. Positions where a search criterion is continuously satisfied during the specified period are determined to be the retrieved positions.
<b>Slope</b>	<input type="checkbox"/> <input type="checkbox"/>	Allows you to choose which of the following points to search for, points at which a signal crosses the specified level in the positive direction or those in the negative direction.
<b>Level</b>	<b>-3.4028E+38 to 3.4028E+38</b> <b>Default: 0</b> <input type="checkbox"/>	Allows you to enter a threshold (level) to be searched for.

(2) With the [In] or [Out] setting

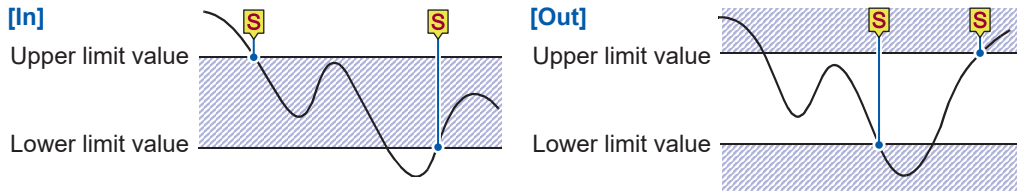

Setting		Description
<b>Filter</b>	Off <sup>☑</sup> , 10 to 10,000	Allows you to enter a filter width in the number of samples. Positions where a search criterion is continuously satisfied during the specified period are determined to be the retrieved positions.
<b>Upper limit value</b>	-3.4028E+38 to 3.4028E+38 Default: 0.2 <sup>☑</sup>	Allows you to enter an upper limit value.
<b>Lower limit value</b>	-3.4028E+38 to 3.4028E+38 Default: 0.2 <sup>☑</sup>	Allows you to enter a lower limit value.

-2. When a logic channel is selected under [Target channel]

You can search for a position that matches the specified pattern.

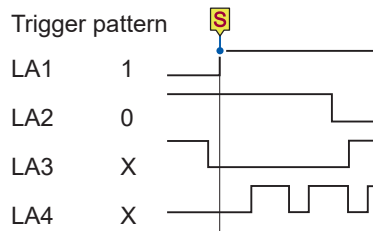

Setting		Description
<b>Satisfied</b>	OR <sup>☑</sup>	The positions where any one of the specified search patterns is satisfied are determined to be the retrieved positions.
	AND	The positions where all the specified patterns are satisfied are determined to be the retrieved positions.
<b>Filter</b>	Off <sup>☑</sup> , 10 to 10,000	Allows you to enter a filter width in the number of samples. Positions where a search condition is continuously satisfied during the specified period are determined to be the retrieved positions.
<b>Trigger pattern</b>	X <sup>☑</sup>	Ignored data.
	0	Searches for low-level positions.
	1	Searches for high-level positions.

In the logic search, the retrieved position is the point where the condition that has not been satisfied changes to being satisfied. Thus, even if signals match a search pattern at the start of a search, it is not regarded as a retrieved position.

## 6 Click **[Execute]**.

The instrument puts search marks (S) on positions where the search criterion is satisfied. You can search for up to 10,000 points. The instrument stops the search if it finds more than 10,000 positions. The retrieved position switching panel appears on the waveform screen.

### To stop the search

Click the stop icon.

## 7 Switch retrieved positions using the **[Search Pos.]** switching panel and check the search results.

You can switch the retrieved positions by clicking **[<]** or **[>]**. The display order follows the setting in **[Display order]**.

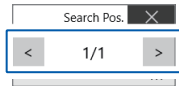

Clicking **[Next]** executes another search beginning from the next point of the retrieved position presently displayed. The instrument discards a previous search result.

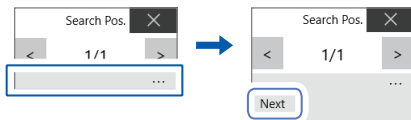

### To specify a retrieved position and jump there

As described in “6.4 Jump to the Specified Position” (p. 148), choose **[Search number]** in the **[Type]** box, and then click **[Execute]**.

## 6.3 Searching For Differences from a Fundamental Wave (Memory HiConcierge)

Using Memory HiConcierge allows you to detect differences from the specified fundamental waveform based on a histogram or standard deviation.

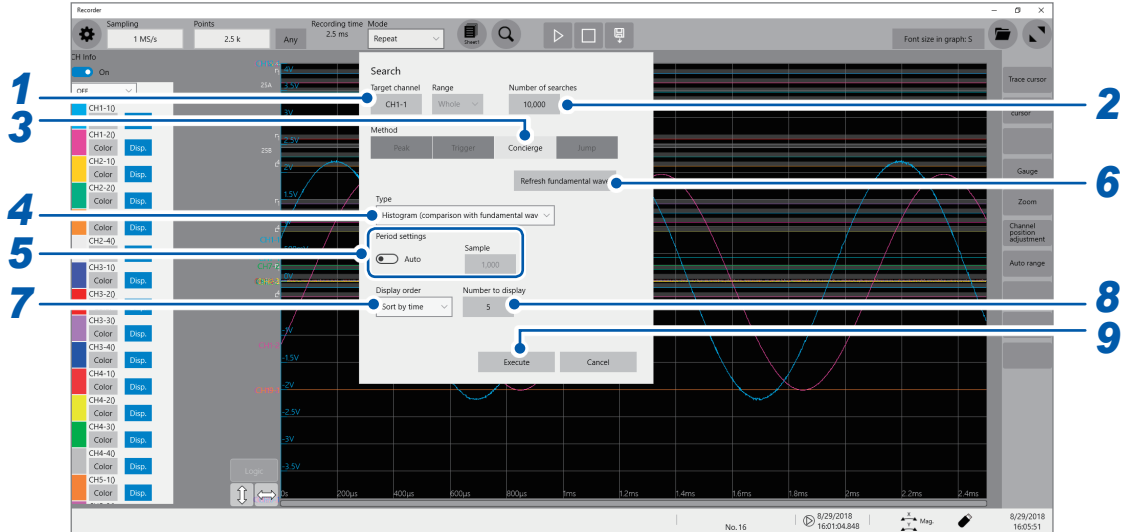

- 1 Click the **[Target channel]** box, and then from the channel setting dialog box, choose a channel to be searched for differences.
- 2 Click the **[Number of searches]** box, and then enter the number of search results.
- 3 In the **[Method]** area, click **[Concierge]** to set the search method to Concierge.
- 4 Click the **[Type]** box, and then from the list, choose a value type to be searched for.

<b>Histogram (comparison with fundamental wave)</b> <sup>□</sup>	Searches for differences from the specified fundamental wave based on a histogram.
<b>Histogram (comparison with previous waveform)</b>	Searches for differences from the previous waveform based on a histogram.
<b>Standard deviation (comparison with fundamental wave)</b>	Searches for differences from the specified fundamental wave based on a standard deviation.
<b>Standard deviation (comparison with previous waveform)</b>	Search for differences from the previous waveform based on a standard deviation.

The instrument searches whole measured waveforms. You cannot specify a segment to be searched.

**5 Use the [Period setting] toggle switch to choose a period setting used for searches.**

The instrument searches for differences from the fundamental wave (or the previous waveform) in the specified intervals.

<b>Auto</b> 	The instrument automatically saves calculation results.
<b>Any</b>	Allows you to click the [Sample] box to enter the number of samples, which specifies a period.

With the [Auto] setting, the instrument may not be able to determine a period depending on measured waveforms. If a fundamental wave have an unintended form, change this setting to [Any] and specify a period in the number of samples in the [Sample] box.

**6 Click [Refresh fundamental wave] to display the fundamental wave.**

The instrument extracts a fundamental wave from the specified period and displays the wave on the screen.

**7 Click the [Display order] box, and then from the list, choose a sort criterion for search results.**

<b>Sort by time</b> 	Displays retrieved positions in chronological order.
<b>Sort by data</b>	Displays retrieved positions in order of decreasing difference from a comparison target (fundamental wave or previous waveform).

**8 Click the [Number to display] box, and then enter the number of search results to be displayed.**

**9 Click [Execute].**

The instrument puts search marks (S) on positions where the search criterion is satisfied.

The retrieved position switching panel appears on the waveform screen.

**To stop the search**

Click the stop icon.

**10 Switch retrieved positions using the [Search Pos.] switching panel and check the search results.**

You can switch the retrieved positions by clicking [<] or [>].

The display order follows the setting in [Display order].

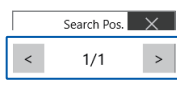

Clicking [Next] executes another search beginning from the next point of the retrieved position presently displayed. The instrument discards a previous search result.

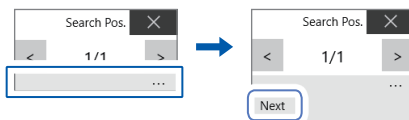

**To specify a retrieved position and jump there**

As described in "6.4 Jump to the Specified Position" (p. 148), set [Type] to [Search number], and then click [Execute].

## 6.4 Jump to the Specified Position

The display can jump to the specified time, trace cursor position, event number, trigger point, or search mark.

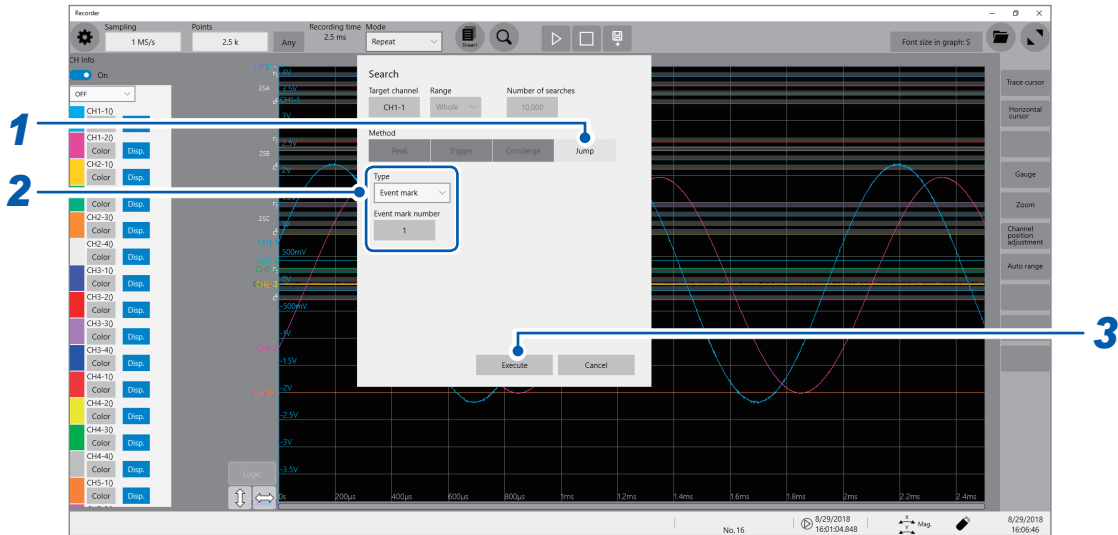

**1** In the **[Method]** area, click **[Jump]** to set the search method to the jump method.

**2** Click the **[Type]** box, and then from the list, choose a type to jump to.

<b>Event mark</b>	Allows you to enter an event number to jump to in the <b>[Event mark number]</b> box.	
<b>Cursor</b>	Allows you to select a position, at which a trace cursor is specified, the display is to jump to.	
<b>Time</b>	<b>Time</b>	Allows you to enter an absolute time to jump to when ( <b>[System]</b> > <b>[Env.]</b> >) <b>[Time value display]</b> is set to <b>[Date]</b> .
	<b>Time from trigger point</b>	Allows you to enter a time relative to the trigger point to jump to when ( <b>[System]</b> > <b>[Env.]</b> >) <b>[Time value display]</b> is set to <b>[Time]</b> or <b>[Mod 60]</b> .
	<b>Points</b>	Allows you to enter the number of points to jump to in the <b>[Points]</b> box when measurement is performed using the external sampling or when ( <b>[System]</b> > <b>[Env.]</b> >) <b>[Time value display]</b> is set to <b>[Samples]</b> .
<b>Trigger</b>	The display jumps to the start trigger point.	
<b>Search number</b>	Allows you to enter a search number to jump to in the <b>[Search number]</b> box.	

**3** Click **[Execute]**.

The instrument put search marks (S) at positions where the search condition is satisfied.

When **[Type]** is set to **[Event mark]**, you can jump to an event mark (E) position.

When **[Type]** is set to **[Search number]**, you can jump to a search mark (S) position.

The jump-destination switching panel appears on the waveform screen.

**4** Switch jump destinations using the **[Search Pos.]** switching panel to check jump results.

You can switch the retrieved positions by clicking **[<]** or **[>]**.



# 7

# Numerical Calculation Function

The instrument makes calculations using acquired waveform data to numerically displays calculation results on the waveform screen. The instrument can evaluate these calculation results on a pass/fail basis.

 > [Calculation] > [Numerical calculation]

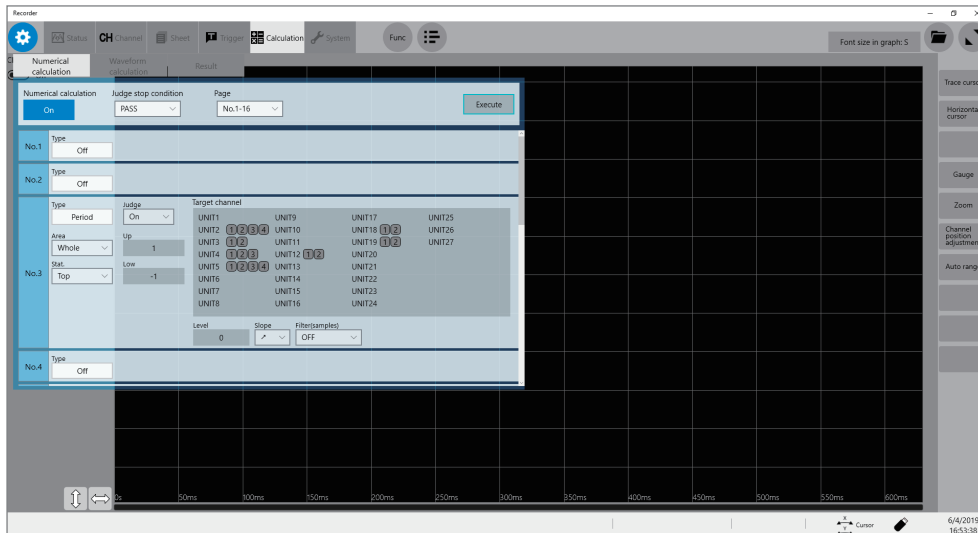

## Operation available on the [Numerical calculation] screen

### Numerical Calculation

- Average value
- RMS
- P-P
- Maximum
- Time to maximum
- Minimum
- Time to minimum
- Period
- Frequency
- Rise time
- Fall time
- Standard deviation
- Area
- X-Y area
- Time to level
- Level at time
- Pulse width
- Duty ratio
- Pulse count
- Arithmetic operations
- Time difference
- Phase contrast
- High level
- Low level
- Intermediate value
- Amplitude
- Overshoot
- Undershoot
- +Width
- -Width
- Burst width
- Accumulation
- Angle of XY waveform (33 types in total)
- Calculation using the data between the cursors  
Numerical calculations can be performed using data within the range specified with the trace cursors.

For details on arithmetic expressions, refer to “Calculation target channels and setting contents of calculation conditions for each calculation type” (p. 155).

### Evaluating numerical calculation results on a pass/fail basis (p. 164)

Evaluating numerical calculation results by comparing them with specified reference ranges, giving pass or fail judgments.

The instrument can simultaneously execute up to 108 types of numerical calculations. When the scaling function is enabled, the instrument makes calculations using scaled values.

# 7.1 Numerical Calculation Procedure

The following two methods are available:

Automatically making calculations after measurement	You have to configure the FFT calculation settings before starting measurement. (not available when the real-time save is set to on)
Making calculations using existing data	The instrument can make calculations using waveform data that has already been acquired or that saved on storage devices.

## Performing calculation during measurement

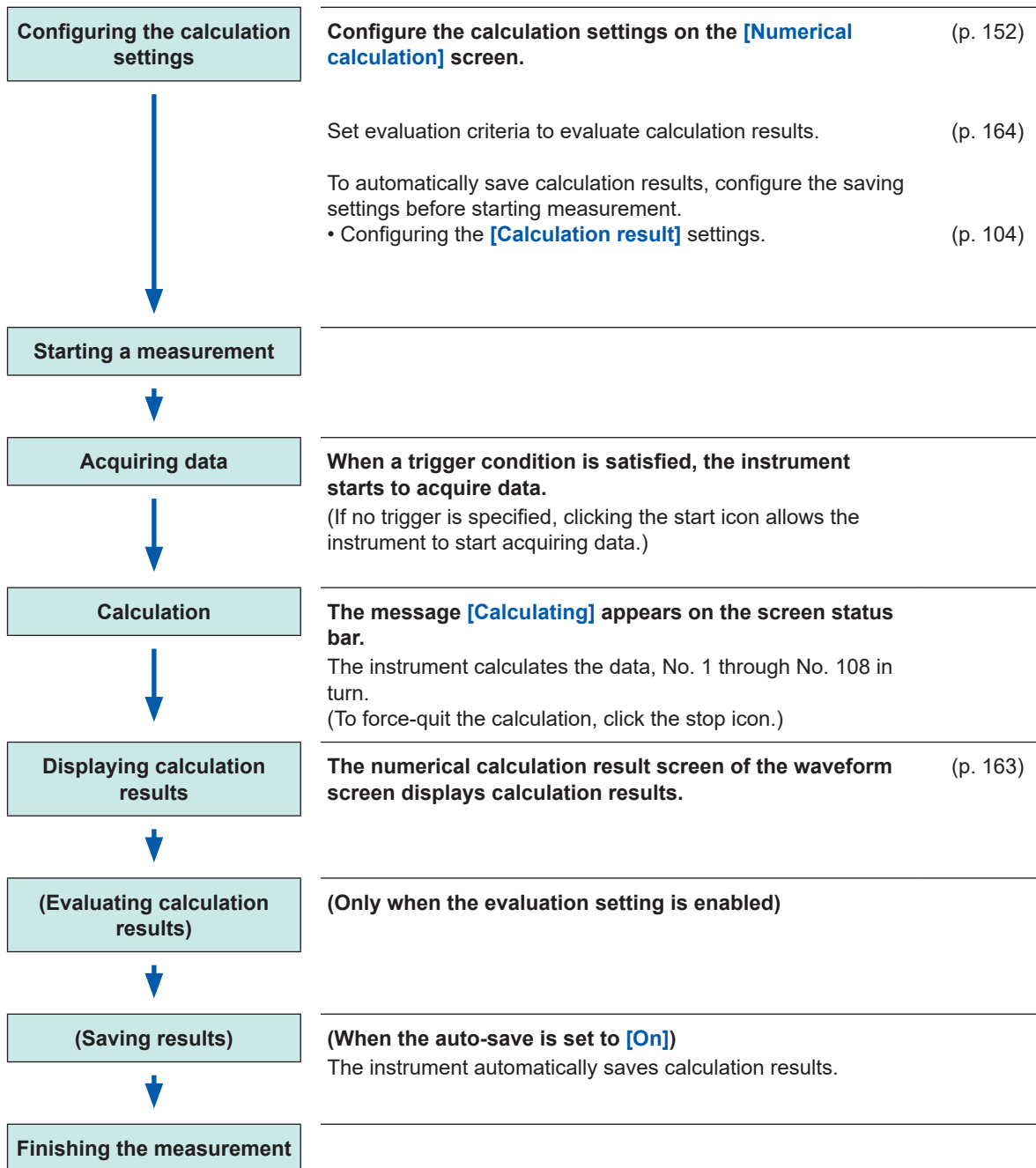



## Making calculations using existing data

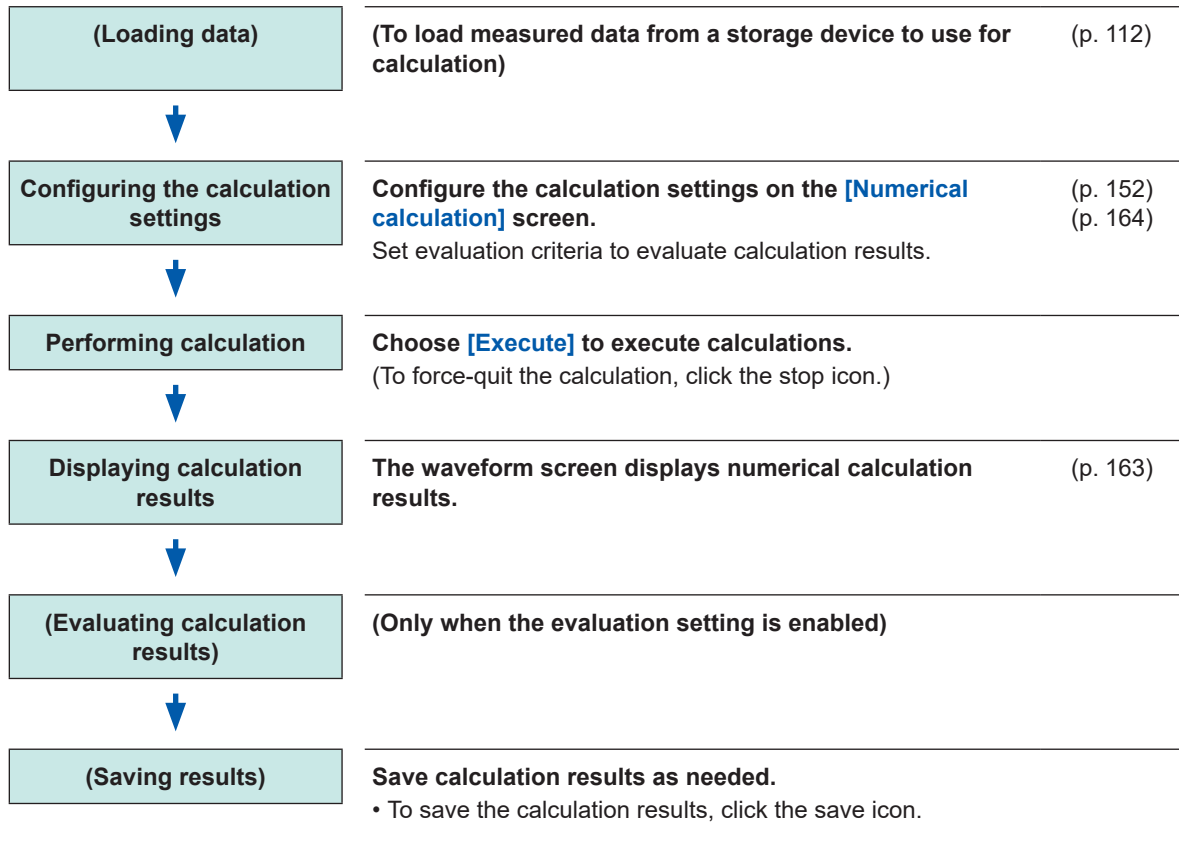

## To specify a range for calculation

Before executing the calculation, specify a calculation range with the trace cursors on the waveform screen. Set **[Area]** to **[A\_B]** or **[C\_D]** on the **[Numeric calculation]** screen. Refer to “7.2 Configuring the Numerical Calculation Settings” (p. 152).

## 7.2 Configuring the Numerical Calculation Settings

 > [Calculation] > [Numerical calculation]

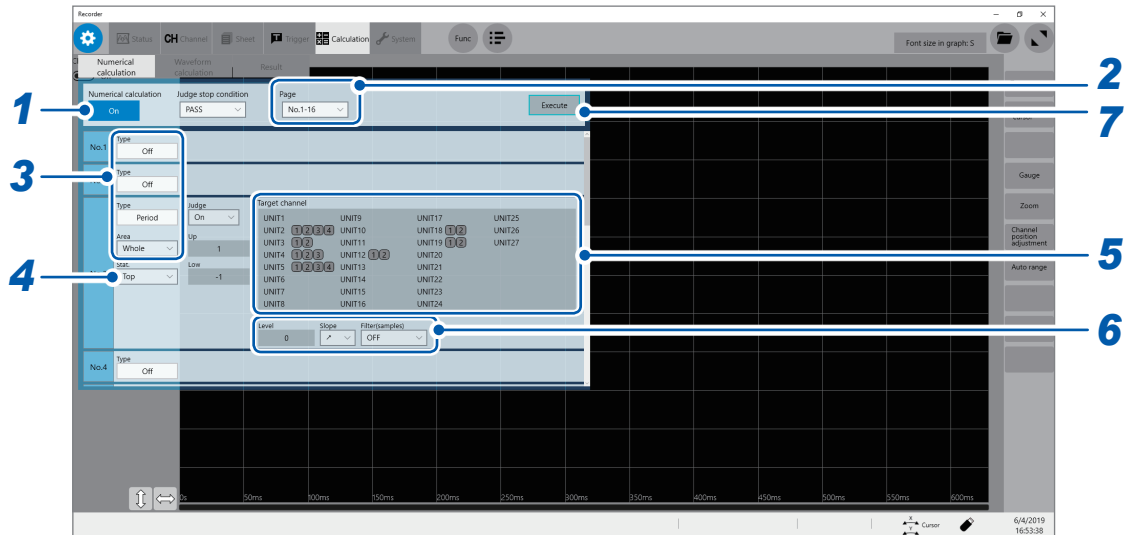

- 1 Click the [Numerical calculation] button to set it to [On].
- 2 Click the [Page] box, and then choose calculation numbers.  
You can specify up to 108 numerical calculations.

### 3 Click the [Calculation Type] box, and then choose a calculation type from the list.

Off <sup>☐</sup>	The instrument does not perform any calculation.
Average value	Average value of waveform data
RMS	RMS value of waveform data
P-P	Peak-to-peak value of waveform data
Maximum	Maximum value of waveform data
Time to maximum	Period of time elapsed from a trigger point to the time of the maximum value
Minimum	Minimum value of waveform data
Time to minimum	Period of time elapsed from a trigger point to the time of the minimum value
Period <sup>*2</sup>	Period of waveform data
Frequency <sup>*2</sup>	Frequency of waveform data
Rise time <sup>*1</sup>	Rise time of waveform data
Fall time <sup>*1</sup>	Fall time of waveform data
Standard deviation	Standard deviation of waveform data
Area	Area enclosed by the horizontal axis and waveform data
X-Y area	Area enclosed by an X-Y composite curve
Time to level <sup>*2</sup>	Period of time elapsed from a trigger point to the time when waveform data reached the specified level
Level at time <sup>*2</sup>	Measured value when the specified time has elapsed from a trigger point
Pulse width <sup>*2</sup>	Pulse width of waveform data
Duty ratio <sup>*2</sup>	Duty ratio of waveform data
Pulse count <sup>*2</sup>	Pulse count of waveform data
Arithmetic operations	Four arithmetic operations of numerical calculation results
Time difference <sup>*2</sup>	Time lag between phenomena A and B
Phase contrast <sup>*2</sup>	Time lag between phenomena A and B represented as a phase difference
High level <sup>*1</sup>	High level of waveform data
Low level <sup>*1</sup>	Low level of waveform data
Intermediate value	Intermediate value of waveform data
Amplitude <sup>*1</sup>	Amplitude value of waveform data
Overshoot <sup>*1</sup>	Overshoot value of waveform data
Undershoot <sup>*1</sup>	Undershoot value of waveform data
+Width <sup>*1</sup>	Time value above the intermediate level
-Width <sup>*1</sup>	Time value below the intermediate level
Burst width <sup>*2</sup>	Burst width of waveform data
Accumulation	Accumulated value of waveform data
Angle of XY waveform	Slope angle of a regression line on an X-Y composite curve

\*1: Unable to make any calculations using data acquired across the measurement channels of Model MR8990 and Model MR8990 Digital Voltmeter Unit.

\*2: The settings can also be configured for the logic channels.

Refer to “Calculation target channels and setting contents of calculation conditions for each calculation type” (p. 155).

**4 Click the [Area] box, and then choose an option for a calculation range.**

You can specify a calculation range for each calculation.

<b>Whole</b> <sup>□</sup>	Makes calculations using whole waveforms.
<b>A_B</b>	Makes calculations using waveforms between trace cursors A and B.
<b>C_D</b>	Makes calculations using waveforms between trace cursors C and D.

Choosing **[A\_B]** or **[C\_D]** allows you to specify the calculation range with the trace cursors on the waveform screen. When the instrument does not acquire any waveforms, perform another measurement and specify a range. Doing so allows you to make calculations using data acquired within the specified range from the next measurement.

**5 Click a calculation target channel.**

The channel selection screen appears.

Refer to “Calculation target channels and setting contents of calculation conditions for each calculation type” (p. 155).

**6 Set calculation conditions.**

Refer to “Calculation target channels and setting contents of calculation conditions for each calculation type” (p. 155).

**7 Execute calculation.**

**(To calculate existing data)**



Click **[Execute]**.

**(To automatically make calculation after measurement)**

Click the start icon.

### Calculation target channels and setting contents of calculation conditions for each calculation type

Calculation type	Setting	Description	Example of screen
Average value RMS P-P Maximum Time to maximum Minimum Time to minimum Standard deviation Area High level Low level Intermediate value Amplitude Overshoot Undershoot Accumulation	<b>Target channel</b> (Analog, waveform calculation)	Allows you to specify calculation target channels.	
	With the <b>[Area]</b> or <b>[Accumulation]</b> setting, set <b>[Method]</b> . ( <b>Total</b> , <b>Absolute value</b> , <b>Positive</b> , <b>Negative</b> )	Calculates an area or accumulation according to the method you specify here.	

Calculation type	Setting	Description	Example of screen	
<b>Period</b> <b>Frequency</b> <b>Pulse width</b> <b>Duty ratio</b>	<b>Target channel</b> (Analog, logic, waveform calculation)	Allows you to specify calculation target channels.		
	<b>Level*</b>	The instrument makes calculations using values based on a period of time when a waveform crossed the level specified here. No setting is available for logic channels.		
	<b>Slope</b>  No slope can be specified for calculating the duty ratio.			Makes calculations using values based on a period of time when a waveform crossed the specified level in the positive direction.
				Makes calculations using values based on a period of time when a waveform crossed the specified level in the negative direction.
	<b>Filter(samples)</b> (Off <sup>□</sup> , 10 to 10,000)			Allows you to enter duration used to determine that a waveform crosses the specified level. Only if a waveform does not cross the level again within the specified filter duration after it has crossed the level, the waveform is considered to have crossed the level. This is useful to eliminate false level-crossing events caused by noise.
	<b>Stat.</b>	<b>Top</b> <sup>□</sup>		Calculates the value of the top parameter in the set calculation range.
<b>Average</b>		Calculates the average, maximum, or minimum value for each parameter within the specified range.		
<b>Max</b>				
	<b>Min</b>			

\*: The range you can specify are between  $-9.9999E+29$  and  $-1.0000E-29$ , 0, and between  $+1.0000E-29$  and  $+9.9999E+29$ . A value to five significant figures can be set (a value to 10 significant figures can be set for a time of the level at time setting).

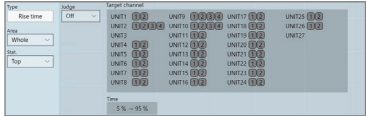
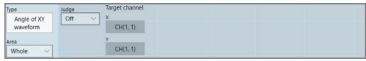
Calculation type	Setting	Description	Example of screen
<b>Rise time</b> <b>Fall time</b>	<b>Target channel</b> (Analog, waveform calculation)	Allows you to specify calculation target channels.	
	<b>Time (%)</b> (5%→95% to 30% → 70% or 95% → 5% to 70%→30%)	Allows you to specify which part of a waveform between the upper and lower limits is used for calculating the rise time (or fall time). A rise time (or fall time) is calculated based on the percentage, which is specified here, of the range between the upper and lower limit values.	
	<b>Stat.</b>	<b>Top</b> Calculates the value of the top parameter in the set calculation range.	
	<b>Average</b> <b>Max</b> <b>Min</b>	Calculates the average, maximum, or minimum value for each parameter within the specified range.	
<b>X-Y area</b> <b>Angle of XY waveform</b>	<b>Target channel</b> (X, Y) (Analog, waveform calculation)	Allows you to assign channels to the X- and Y-axis.	
	With the <b>[X-Y area]</b> setting, set <b>[Method]</b> . ( <b>Coordinate method</b> , <b>Trapezoidal approximation</b> )	Calculates an X-Y area according to a calculation method.	

Calculation type	Setting	Description	Example of screen	
Time to level Pulse count	<b>Target channel</b> (Analog, logic, waveform calculation)	Allows you to specify calculation target channels.		
	<b>Level*</b>	Detects the time when a waveform crossed the level specified here or a pulse count that crossed the level. No setting is available for logic channels.		
	<b>Slope</b>			Detects the time when a waveform crossed the level specified here in the positive direction or a pulse count that crossed the level in the positive direction.
				Detects the time when a waveform crossed the level specified here in the negative direction or a pulse count that crossed the level in the negative direction.
<b>Filter(samples)</b> (Off <sup>□</sup> , 10 to 10,000)	Allows you to enter duration used to determine that a waveform crosses the specified level. Only if a waveform does not cross the level again within the specified filter duration after it has crossed the level, the waveform is considered to have crossed the level. This is useful to eliminate false level-crossing events caused by noise.			

\*: The range that can be set are between  $-9.9999E+29$  and  $-1.0000E-29$ , 0, and between  $+1.0000E-29$  and  $+9.9999E+29$ . A value to five significant figures can be set (a value to 10 significant figures can be set for a time of the level at time setting).



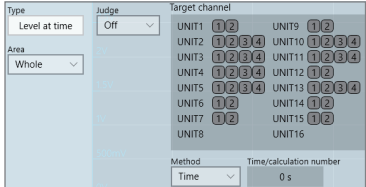
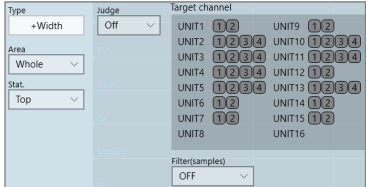

Calculation type	Setting	Description	Example of screen				
Level at time	<b>Target channel</b> (Analog, logic, waveform calculation)	Allows you to specify calculation target channels.					
	<b>Method: Negative</b>	Allows you to set the time-specifying method.					
	<table border="1"> <tr> <td><b>Time</b><sup>☑</sup></td> <td><b>Time</b></td> <td>Allows you to enter a time for obtaining a measured value with the trigger point position fixed at zero.</td> </tr> <tr> <td><b>Calc. No.</b></td> <td><b>Calculation No.</b></td> <td>Allows you to choose a calculation number when you use numerical calculation results. You cannot specify a number that exceeds the calculation number you specify.  Specifying a range is not available.</td> </tr> </table>	<b>Time</b> <sup>☑</sup>		<b>Time</b>	Allows you to enter a time for obtaining a measured value with the trigger point position fixed at zero.	<b>Calc. No.</b>	<b>Calculation No.</b>
<b>Time</b> <sup>☑</sup>	<b>Time</b>	Allows you to enter a time for obtaining a measured value with the trigger point position fixed at zero.					
<b>Calc. No.</b>	<b>Calculation No.</b>	Allows you to choose a calculation number when you use numerical calculation results. You cannot specify a number that exceeds the calculation number you specify.  Specifying a range is not available.					
+Width -Width	<b>Target channel</b> (Analog, waveform calculation)	Allows you to specify calculation target channels.					
	<b>Filter(samples)</b> (Off <sup>☑</sup> , 10 to 10,000)	Allows you to enter duration used to determine that a waveform crosses the specified level. Only if a waveform does not cross the level again within the specified filter duration after it has crossed the level, the waveform is considered to have crossed the level. This is useful to eliminate false level-crossing events caused by noise.					
	<b>Stat.</b>	<b>Top</b> <sup>☑</sup>		Detects a value obtained first from the beginning within the specified range.			
		<b>Average</b>		Calculates the average, maximum, or minimum value for each parameter within the specified range.			
		<b>Max</b>					
	<b>Min</b>						

7

Numerical Calculation Function

Calculation type	Setting	Description	Example of screen	
Burst width	<b>Target channel</b> (Analog, logic, waveform calculation)	Allows you to specify calculation target channels.		
	<b>Slope</b> (Logic channels only)	<input type="checkbox"/>		Detects rising edges and calculates a burst width.
		<input type="checkbox"/>		Detects falling edges and calculates a burst width.
	<b>Filter(samples)</b> (Off <input type="checkbox"/> , 10 to 10,000)	Allows you to enter duration used to determine that a waveform crosses the specified level. Only if a waveform does not cross the level again within the specified filter duration after it has crossed the level, the waveform is considered to have crossed the level. This is useful to eliminate false level-crossing events caused by noise.		
	<b>Burst end filter (samples)</b> (Off <input type="checkbox"/> , 10 to 10,000)	Allows you to set duration used to determine whether a waveform is a burst signal. If the period between the time when the waveform data falls within the range, which is specified with the window levels, and the time when it gets out of the range becomes longer than the specified filter period, the detected period is determined to be a burst duration.		
	Window-level range* (Up, Low)	Allows you to enter an upper and lower limit values used to determine whether a waveform is a burst signal.		
	Stat.	<b>Top</b> <input type="checkbox"/>		Detects a value obtained first from the beginning within the specified range.
<b>Average</b>		Calculates the average, maximum, or minimum value for each parameter within the specified range.		
<b>Max</b>				
<b>Min</b>				

\*: The range you can specify are between  $-9.9999E+29$  and  $-1.0000E-29$ , 0, and between  $+1.0000E-29$  and  $+9.9999E+29$ . A value to five significant figures can be set (a value to 10 significant figures can be set for a time of the level at time setting).

Calculation type	Setting	Description	Example of screen	
Time difference Phase contrast	Reference channel, Target channel (Analog, logic, waveform calculation)	Allows you to specify the reference channel and the target channel.		
	Level*	The instrument calculates the value based on the time when the waveform crossed the level specified here. No setting is available for logic channels.		
	Slope			Makes calculations using values based on a period of time when a waveform crossed the specified level in the positive direction.
				Makes calculations using values based on a period of time when a waveform crossed the specified level in the negative direction.
	Filter(samples) (Off <sup>☑</sup> , 10 to 10,000)	Allows you to enter duration used to determine that a waveform crosses the specified level. Only if a waveform does not cross the level again within the specified filter duration after it has crossed the level, the waveform is considered to have crossed the level. This is useful to eliminate false level-crossing events caused by noise.		
	Stat.	Top <sup>☑</sup>		Detects a value obtained first from the beginning within the specified range.
		Average		Calculates the average, maximum, or minimum value for each parameter within the specified range.
Max				
Min				

7

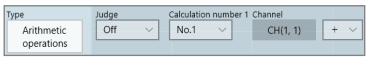
Calculation type	Setting	Description	Example of screen
Arithmetic operations	Calculation number 1, Calculation number 2 (No. 1 through No. 107)	Allows you to specify two numerical calculation numbers to use for calculations.	
	Target channel	Allows you to specify a target channel that has a numerical calculation number to use for calculations.	
	Operator (+, -, ×, ÷)	Allows you to choose among the four basic arithmetic operations.	

\*: The range you can specify are between  $-9.9999E+29$  and  $-1.0000E-29$ , 0, and between  $+1.0000E-29$  and  $+9.9999E+29$ . A value to five significant figures can be set (a value to 10 significant figures can be set for a time of the level at time setting).

- With the **[Period]**, **[Frequency]**, **[Rise time]**, and **[Fall time]** calculations, the instrument may not be able to perform calculations depending on the condition of waveform data.
- With the **[Period]** and **[Frequency]** calculation, correct measurement results may not be obtained if the filter setting is close to half the period (an integer multiple of an actual period may be calculated).
- When the scaling is enabled, the instrument scales waveform data before calculation. Units for parameter values are those set in the scaling function.
- If a waveform across a calculation target channel exceeds the measurable range (overrange waveform), the instrument substitutes the upper or lower measurement limit for values that exceed the measurable range before calculation.

Refer to “3.2 Converting Input Values (Scaling Function)” (p. 40).

### Settings: Calculations for which **[Stat.]** can be set

Period, Frequency, Rise time, Fall time, Pulse width, Duty ratio, Time difference, Phase contrast, +Width, -Width, and Burst width

<b>Top</b> <sup>□</sup>	Makes calculations within the calculation range in the initial condition.
<b>Average</b>	Calculates the average value of the calculation results for the data within the calculation range.
<b>Max</b>	Calculates the maximum value of calculation results for data within the calculation range.
<b>Min</b>	Calculates the minimum value of calculation results for data within the calculation range.

## Displaying numerical calculation results

You can check calculation results on the waveform screen.

 > [Numeric Calc.]

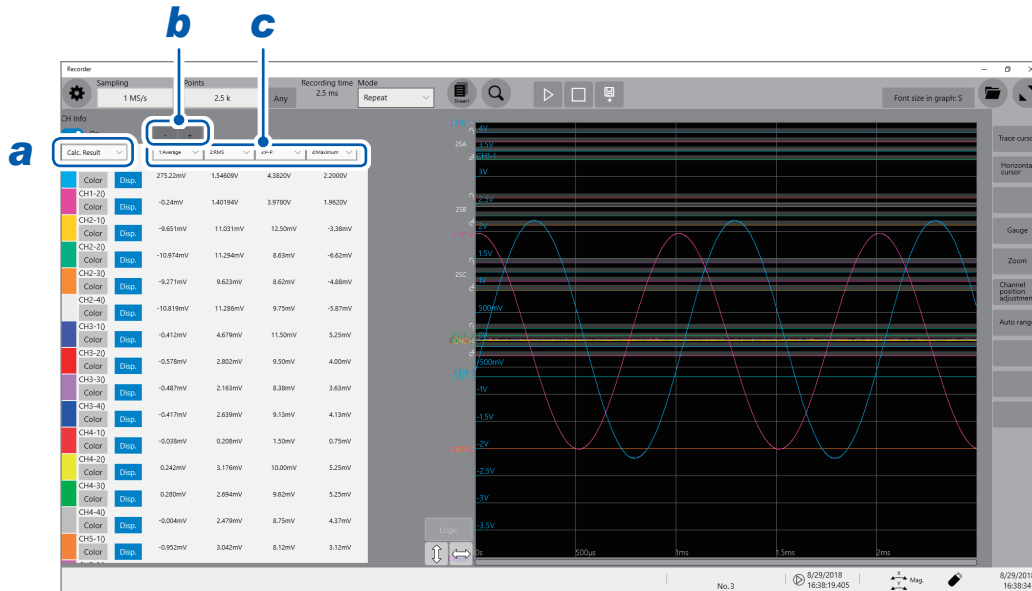

- You can display or hide the screen of the numerical calculation results every time you click [CH info].
- If no periods are found or a calculation is aborted, the character string [\*\*\*\*\*] appears instead of a calculation result.
- For channels not specified as a calculation target, the character, [-] appears.

Click [

### To save calculation results after measurement

Refer to “Freely selecting data items to be saved and save files (save icon)” (p. 108).

### To change the display width of the calculation result screen

You can change the display width of the calculation results by clicking [-] or [+] (b).

You can choose calculation numbers to be displayed by clicking the buttons (c).

- You can specify up to four calculation results to be displayed.
- Choose calculation numbers you want to display from the list.

## 7.3 Evaluating Calculation Results on a Pass/Fail Basis

You can specify evaluation criteria (**[Up]** and **[Low]**) to evaluate numerical calculation results on a pass/fail basis.

Each numerical calculation can have different evaluation criteria.

The waveform acquisition process varies depending on the recording mode setting (**[Single]** or **[Repeat]**) and the stop condition specified to stop the measurement depending on an evaluation (**[PASS]**, **[FAIL]**, or **[PASS & FAIL]**).

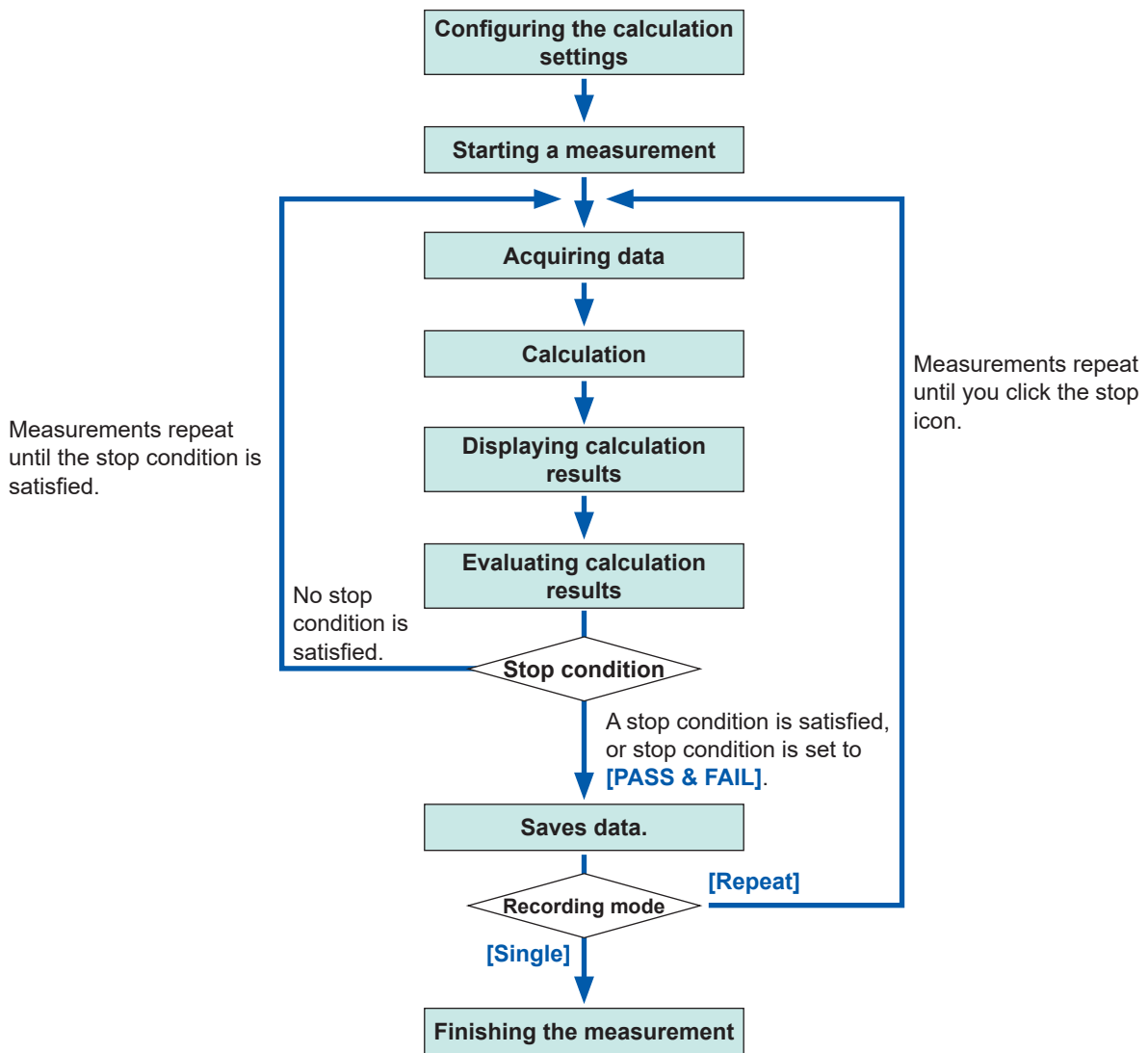

Auto-save is not carried out until the stop condition is satisfied at the end of calculation evaluation.

 > [Calculation] > [Numerical calculation]

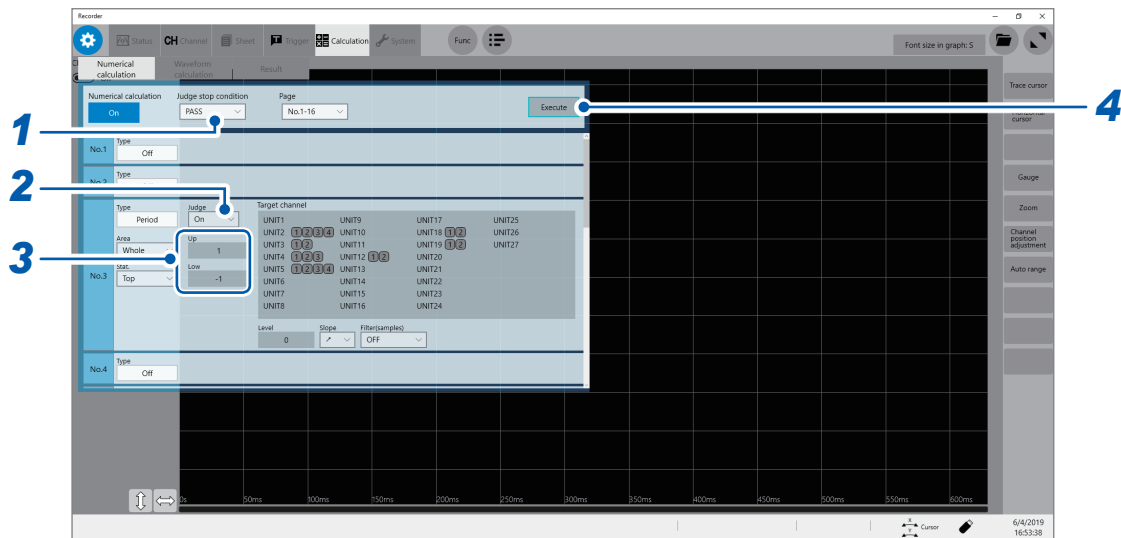

**1** Click the **[Judge stop condition]** box, and then from the list, choose a stopping condition applied according to judgments.

<b>PASS</b>	Stops measurement when a calculation result falls within a criteria range (pass judgment).
<b>FAIL</b>	Stops measurement when a calculation result is outside a criteria range (fail judgment).
<b>PASS &amp; FAIL</b> 	Stops measurement regardless whether a pass or fail judgment is given.

**2** Click the **[Judge]** box, and then from the list, choose whether or not to evaluate calculation results.

<b>Off</b> 	Evaluates calculation results.
<b>On</b>	Yields a fail judgment if a result is outside a criteria range. Calculated values in a channel with the fail judgment are highlighted in red.

**3** Click the **[Up]** and **[Low]** boxes in turn, and then enter evaluation criteria values in each of them.

Enterable range:  $-9.9999E+29$  to  $-1.0000E29$ , 0,  $+1.0000E29$  to  $+9.9999E-29$

**(To evaluate existing data)**

Click **[Execute]**.

**(To automatically execute evaluation after measurement)**

Click the start icon.

**About upper and lower limit values**

You cannot specify an upper limit value lower than a lower limit value.  
Neither can you specify a lower limit value higher than a upper limit value.

**To record all calculation results**

Choose **[PASS & FAIL]** for the stopping condition.

## Displaying evaluation results and externally outputting signals

The numerical calculation result screen of the waveform screen displays numerical calculation evaluation results.

Values that fall within an evaluation criteria range: Pass judgment

Values outside an evaluation criteria range: Fail judgment (highlighted in red)

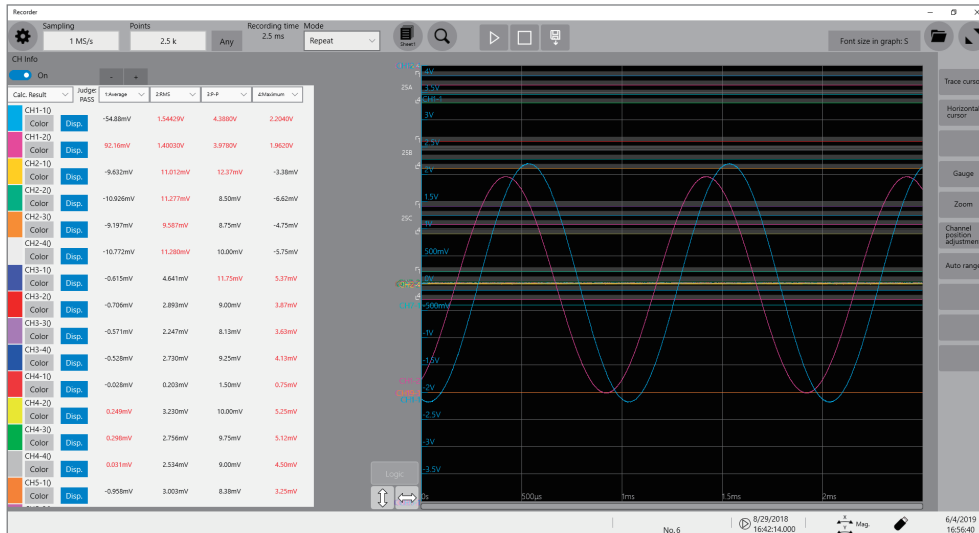

### When a pass judgment is given

When the external output terminals (OUT 1, OUT 2) are set to **[Judge(Pass)]**, a PASS signal is output from the external output terminals (OUT 1, OUT 2).

### When a fail judgment is given

When the external output terminals (OUT 1, OUT 2) are set to **[Judge(Fail)]**, a FAIL signal is output from the external output terminals (OUT 1, OUT 2). A fail judgment is given when any one of the channels is judged to be a fail.

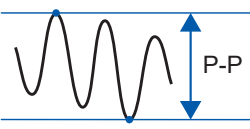
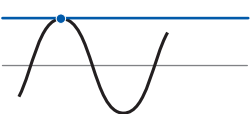
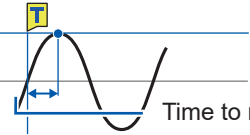
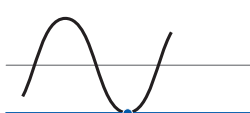
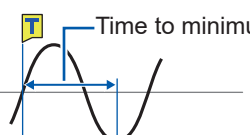
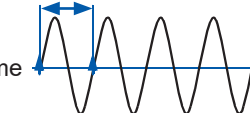

# 7.4 Numerical Calculation Types and Descriptions

Calculation type	Description	
<b>Average value</b>	Calculates an average value of waveform data. $AVE = \frac{1}{n} \sum_{i=1}^n di$ AVE: Average value n: Number of data points di: ith data point acquired across the channel	
<b>RMS</b>	Calculates an RMS value of waveform data. When the scaling is enabled, the instrument scales waveform data before calculation. $RMS = \sqrt{\frac{1}{n} \sum_{i=1}^n di^2}$ RMS: Root-mean-square value n: Number of data points di: ith data point acquired across the channel	
<b>P-P</b>	Calculates a difference (peak-to-peak value) between the maximum and minimum values of waveform data.	Maximum  Minimum
<b>Maximum</b>	Calculates the maximum value of waveform data.	Maximum  Minimum
<b>Time to maximum</b>	Calculates a period of time (unit: s) from a trigger point to the maximum value. When waveform has two or more points of the maximum value, the instrument determines the first of them in the waveform used for a calculation to be the maximum value.	Maximum  Minimum Time to maximum
<b>Minimum</b>	Calculates the minimum value of waveform data.	Minimum  Maximum
<b>Time to minimum</b>	Calculates a period of time (unit: s) from a trigger point to the minimum value. When waveform has two or more points of the minimum value, the instrument determines the first of them in the waveform used for a calculation to be the minimum value.	Maximum  Minimum Time to minimum
<b>Period Frequency</b>	Displays a period (unit: s) and frequency (unit: Hz) of a signal waveform. The instrument calculates a period and frequency based on a time lag between the time when a waveform crossed the specified level in the positive (or negative) direction the first time and the time when it next crossed the specified level. Settings: <b>Level, Slope, Filter, Stat.</b>	
		Level at time 

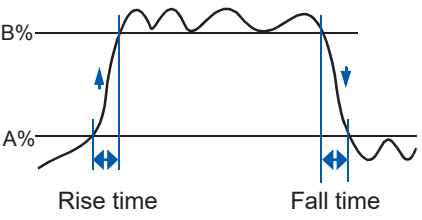
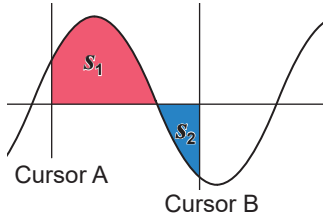
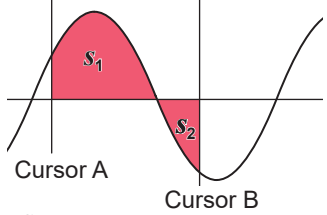
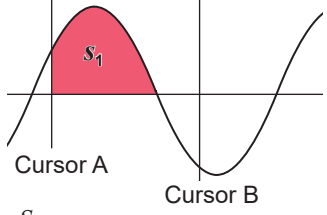
Calculation type	Description	
<p><b>Rise time</b> <b>Fall time</b></p>	<p>Calculates a A%-to-B% rise time (or a B%-to-A% fall time; unit: s) based on the 0% and 100% levels based on a histogram (frequency distribution) of acquired waveform data.</p> <p>The instrument calculates a rise time (or fall time) of the first rising (or falling) slope that appears in acquired waveform data. When the range is specified, the instrument calculates the rise time (or fall time) of the first rising (or falling) slope that appears between the cursors.</p> <p>The values of A and B can be specified (unit: percent). The values of A and B varies along with each other. When the value of A is 5%, the value of B is specified at 95%; when the value of A is 30%, the value of B is specified at 70%.</p> <p>Settings: <b>Rise time</b> (A% to B%) and <b>Fall time</b> (B% to A%) values (%), <b>Stat.</b></p>	 <p>Rise time                      Fall time</p> <p>A: 5% to 30% B: 95% to 70%</p>
<p><b>Standard deviation</b></p>	<p>Calculates a standard deviation of waveform data.</p> $\sigma = \sqrt{\frac{1}{n} \sum_{i=1}^n (d_i - AVE)^2}$ <p><math>\sigma</math>: Standard deviation  <math>AVE</math>: Average value  <math>n</math>: Number of data points  <math>d_i</math>: <math>i</math>th data point acquired across the channel</p>	
<p><b>Area</b> <b>Method: Total</b></p>	<p>Calculates an area by subtracting an area (unit: V·s) enclosed by the zero-level (zero-potential) line and the negative-amplitude part of a signal waveform from an area (unit: V·s) enclosed by the zero-level (zero-potential) line and the positive-amplitude part of the signal waveform. When the range is specified, calculates the area between the cursors.</p> $S = \sum_{i=1}^n d_i \cdot h$ <p><math>S</math>: Area  <math>n</math>: Number of data points  <math>d_i</math>: <math>i</math>th data point acquired across the channel  <math>h = \Delta t</math>: Sampling interval</p>	 <p>Cursor A                      Cursor B</p> $S = s_1 - s_2$
<p><b>Area</b> <b>Method: Absolute value</b></p>	<p>Calculates an area value (unit: V·s) enclosed by the zero-level (zero-potential) line and a signal waveform. When the range is specified, calculates the area between the cursors.</p> $S = \sum_{i=1}^n  d_i  \cdot h$ <p><math>S</math>: Area  <math>n</math>: Number of data points  <math>d_i</math>: <math>i</math>th data point acquired across the channel  <math>h = \Delta t</math>: Sampling interval</p>	 <p>Cursor A                      Cursor B</p> $S = s_1 + s_2$
<p><b>Area</b> <b>Method: Positive</b> (Only the positive-amplitude part)</p>	<p>Calculates an area enclosed by the zero-level (zero-potential) line and the positive-amplitude part of a signal waveform. When the range is specified, calculates the area between the cursors.</p> $S = \sum_{i=1, d_i > 0}^n d_i \cdot h$ <p><math>S</math>: Area  <math>n</math>: Number of data points  <math>d_i</math>: <math>i</math>th data point acquired across the channel  <math>h = \Delta t</math>: Sampling interval</p>	 <p>Cursor A                      Cursor B</p> $S = s_1$

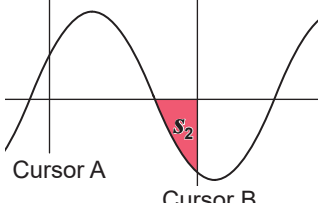
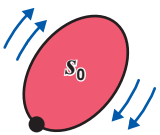
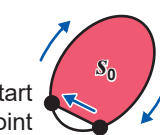
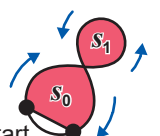
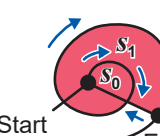
Calculation type	Description	
<p><b>Area</b>  <b>Method:</b>  <b>Negative</b>                      (Only the negative-amplitude part)</p>	<p>Calculates an area enclosed by the zero-level (zero-potential) line and the negative-amplitude part of a signal waveform.                      When the range is specified, calculates the area between the cursors.</p> $S = \sum_{i=1}^n di \cdot h$ <p><math>S</math>: Area  <math>n</math>: Number of data points  <math>di</math>: <math>i</math>th data point acquired across the channel  <math>h = \Delta t</math>: Sampling interval</p>	 <p>Cursor A                      Cursor B</p> <p><math>S = -s_2</math></p>
<p><b>X-Y area</b>  <b>Method:</b>  <b>Coordinate</b>  <b>method</b></p>	<p>Calculates the area (unit: <math>V^2</math>) of the figure enclosed by the X-Y composite curve. The instrument calculates an area enclosed by the lines as illustrated below. An area can be calculated even when no X-Y composite curve is displayed.                      You can specify a calculation range on the horizontal axis (time-axis) waveform of each channel with the cursors. The area of the X-Y composite curve is calculated within the specified range (you cannot directly specify the range on the X-Y waveform with the cursors).                      Refer to “2.1 Reading Measured Values (Trace Cursors, Horizontal cursor)” (p. 22).</p> <div style="display: flex; justify-content: space-around;"> <div data-bbox="475 817 885 1019"> <p><b>When multiple loops plot</b></p>  <p><math>S = n \times s_0</math>  <math>S</math>: Area  <math>n</math>: Number of loops</p> <p>Start point, end point</p> </div> <div data-bbox="901 817 1412 1041"> <p><b>When an open curve plots</b></p>  <p><math>S = s_0</math>  <math>S</math>: Area                      (Closed area is created by connecting the start and end points with a straight line.)</p> <p>Start point                      End point</p> </div> </div> <div style="display: flex; justify-content: space-around; margin-top: 20px;"> <div data-bbox="475 1052 798 1276"> <p><b>When a figure of eight plots</b></p>  <p><math>S =  s_0 - s_1 </math>  <math>S</math>: Area</p> <p>Start point                      End point</p> </div> <div data-bbox="901 1052 1412 1299"> <p><b>When a spiral loop plots</b></p>  <p><math>S = s_0 \times 2 + s_1</math>  <math>S</math>: Area                      (The number of overlapping segments increases with a loop count.)</p> <p>Start point                      End point</p> </div> </div>	
<p><b>X-Y area</b>  <b>Method:</b>  <b>Trapezoidal</b>  <b>approximation</b></p>	<p>Calculates an area (unit: <math>V^2</math>) enclosed by an X-Y composite curve using the trapezoidal approximation method. The instrument calculates an area enclosed by the lines as illustrated below. An area can be calculated even when no X-Y composite curve is displayed.                      You can specify a calculation range on the horizontal axis (time-axis) waveform of each channel with the cursors. The area of the X-Y composite curve is calculated within the specified range (you cannot directly specify the range on the X-Y waveform with the cursors).</p>	

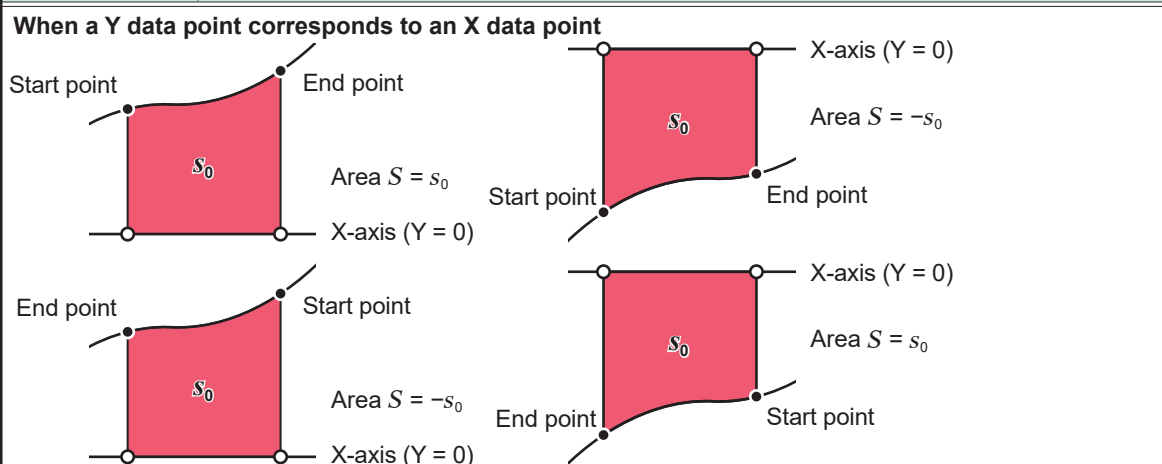
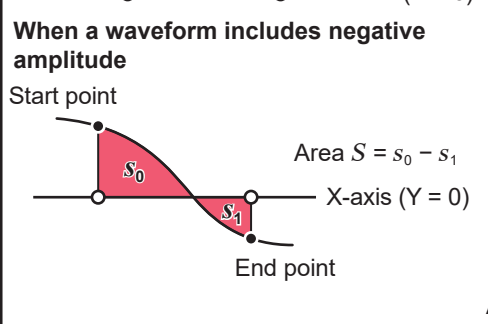
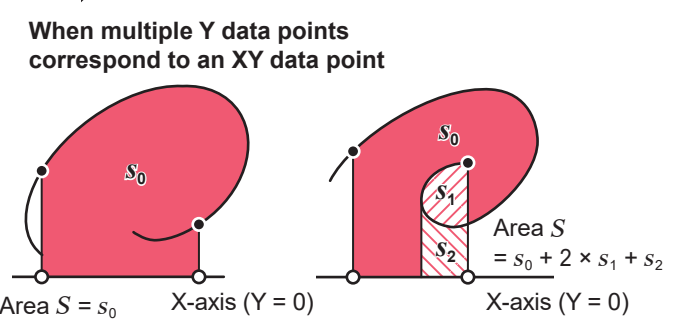
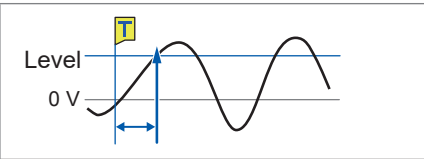
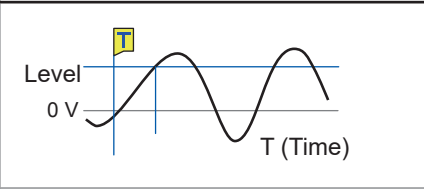
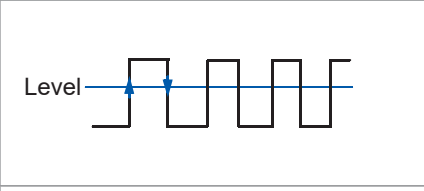
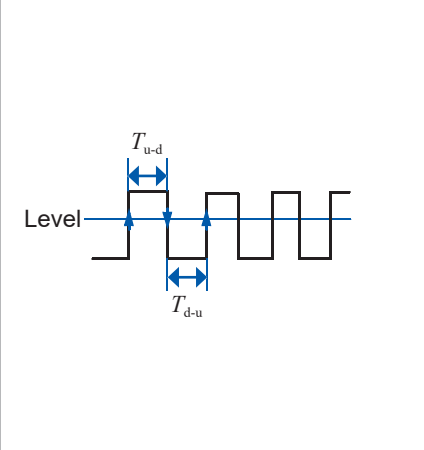
Calculation type	Description	
<p><b>When a Y data point corresponds to an X data point</b></p>  <p><b>When a waveform includes negative amplitude</b></p>  <p><b>When multiple Y data points correspond to an XY data point</b></p> 		
<b>Time to level</b>	<p>Searches a calculation range from the beginning for the time when a signal crossed the specified level and calculates a period of time from a trigger point to a point searched for. Settings: <b>Level, Slope, Filter</b></p>	
<b>Level at time</b>	<p>Calculates a level when the specified time has elapsed from a trigger point. You can also specify a time based on previously calculated results. Settings: <b>Method (Time, Calc. No.), Time/calculation number (No. 1 to No.107)</b></p>	
<b>Pulse width</b>	<p>Calculates a pulse width based on a time lag between the time when a waveform crossed the specified level in the positive (or negative) direction and the time when it next crossed the specified level in the opposite direction. Settings: <b>Level, Slope, Filter, Stat.</b></p>	
<b>Duty ratio</b>	<p>Calculates a duty ratio based on a time lag between the time when a waveform crossed the specified level in the positive direction and the time when it next crossed the specified level in the opposite direction, and a time lag between the time when the waveform crossed the specified level in the negative direction and the time when it next crossed the specified level in the opposite direction.</p> $\text{Duty ratio} = \frac{T_{u-d}}{T_{u-d} + T_{d-u}} \times 100 [\%]$ <p><math>T_{u-d}</math>: Time from rising edge to falling edge (unit: s) <math>T_{d-u}</math>: Time from falling edge to rising edge (unit: s) Settings: <b>Level, Filter, Stat.</b></p>	

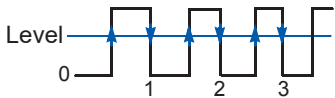
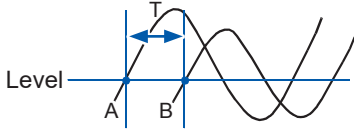
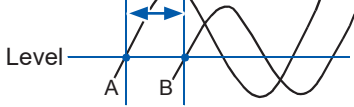
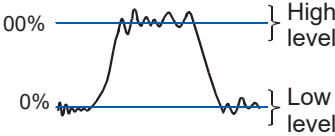
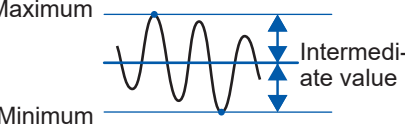
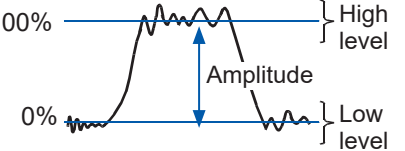
Calculation type	Description	
<p><b>Pulse count</b></p>	<p>Counts the number of pulses that crossed the specified level in the positive (or negative) direction. For the pulse counts, it is considered as one count that a period between the point when a pulse crossed the level in the positive direction and the point when the pulse crossed the level in the negative direction (otherwise, between that in the negative direction and in the positive direction). Settings: <b>Level, Slope, Filter</b></p>	
<p><b>Arithmetic operations</b></p>	<p>Allows you to freely choose numerical calculation results and the instrument performs arithmetic operations of the results of your choice. Settings: <b>Calculation number 1</b>, Arithmetic operations (+, -, ×, ÷), <b>Calculation number 2</b></p>	
<p><b>Time difference</b></p>	<p>Calculates the time lag T (unit: s) between when waveform A crossed the specified level in the positive (or negative) direction and when waveform B crossed it in the same direction. (Time lag T) = (Time when waveform B crossed the level) - (Time when waveform A crossed the level) (Time when waveform A crossed the level) Settings: Waveform A (<b>Reference channel, Level, Slope, Filter</b>); Waveform B (<b>Target channel, Level, Slope, Filter</b>)</p>	
<p><b>Phase contrast</b></p>	<p>Calculates a phase difference (unit: degree) with reference to waveform A based on a time lag between the time when waveform A crossed the specified level in the positive (or negative) direction and the time when waveform B crossed it in the same direction. <math display="block">\text{Phase difference} = \frac{\text{Time lag between waveforms A and B}}{\text{Period of Waveform A}} \times 360 [^\circ]</math> Settings: Waveform A (<b>Reference channel, Level, Slope, Filter</b>); Waveform B (<b>Target channel, Level, Slope, Filter</b>)</p>	
<p><b>High level Low level</b></p>	<p>Calculates a low and high levels letting 0% and 100% of acquired waveform data be them, respectively, based on a histogram (frequency distribution).</p>	
<p><b>Intermediate value</b></p>	<p>Calculates the average of the maximum and minimum values of waveform data. [(Maximum value) + (Minimum value)] / 2</p>	
<p><b>Amplitude</b></p>	<p>Calculates a value (amplitude) between a low and high levels letting 0% and 100% of acquired waveform data be them, respectively, based on a histogram (frequency distribution). (High level) - (Low level)</p>	

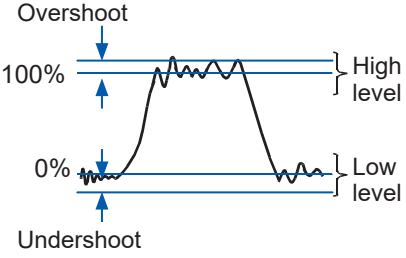
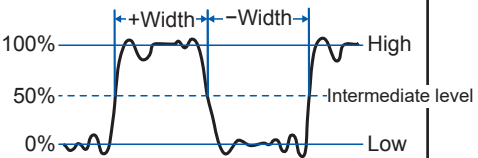
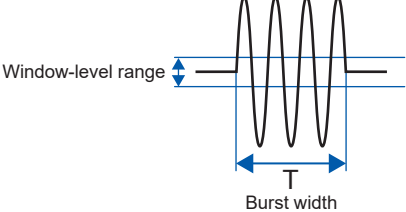
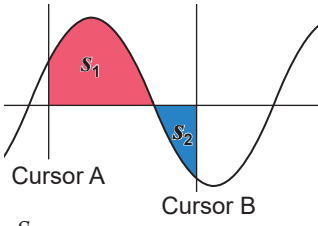
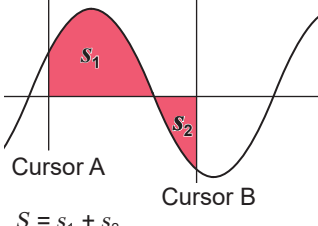
Calculation type	Description	
<p><b>Overshoot</b> <b>Undershoot</b></p>	<p>Calculates a ratio of a difference between the maximum (or minimum) value and a high (or low) level to a difference between a high and low levels, which are calculated letting 0% and 100% of acquired waveform data be them, respectively, based on a histogram (frequency distribution).</p> $\frac{[(\text{Maximum value}) - (\text{High level})] / [(\text{High level}) - (\text{Low level})] \times 100}{[(\text{Low level}) - (\text{Minimum value})] / [(\text{High level}) - (\text{Low level})] \times 100}$	
<p><b>+Width</b> (Period during which a waveform is above the intermediate level) <b>-Width</b> (Period during which a waveform is below the intermediate level)</p>	<p>Calculates a time lag between the time a waveform crossed the intermediate line level (50%) in the positive (or negative) direction and the time it next crossed the intermediate level in the opposite direction. Settings: <b>Filter</b>, <b>Stat</b>.</p>	
<p><b>Burst width</b></p>	<p>Calculates a time during which a burst signal is outputted. Settings: <b>Filter</b>, <b>Burst end filter</b>, Window (<b>Up</b>, <b>Low</b>), <b>Stat</b>.</p>	
<p><b>Accumulation Method: Total</b></p>	<p>Calculates an accumulation by subtracting an accumulation (V) enclosed by the zero-level (zero-potential) line and the negative-amplitude part of a signal waveform from an accumulation (unit: V) enclosed by the zero-level (zero-potential) line and the positive-amplitude part of a signal waveform. When the range is specified, calculates the accumulation between the cursors.</p> $S = \sum_{i=1}^n di$ <p>S: Accumulation n: Number of data points di: ith data point acquired across the channel</p>	 <p><math>S = s_1 - s_2</math></p>
<p><b>Accumulation Method: Absolute value</b></p>	<p>Calculates an accumulation (unit: V) enclosed by the zero-level (zero-potential) line and a signal waveform. When the range is specified, calculates the accumulation between the cursors.</p> $S = \sum_{i=1}^n  di $ <p>S: Accumulation n: Number of data points di: ith data point acquired across the channel</p>	 <p><math>S = s_1 + s_2</math></p>

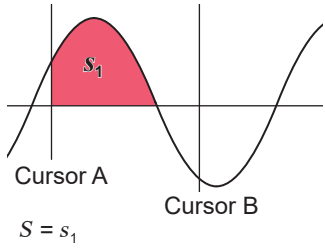
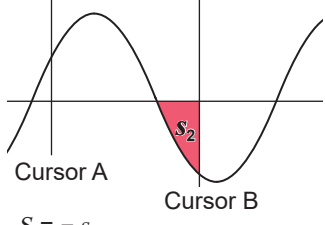
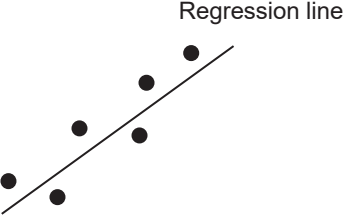
Calculation type	Description	
<p><b>Accumulation Method: Positive</b> (Only the positive-amplitude part)</p>	<p>Calculates an accumulation (unit: V) enclosed by the zero-level (zero-potential) line and the positive-amplitude part of a signal waveform. When the range is specified, calculates the accumulation between the cursors.</p> $S = \sum_{i=1, di > 0}^n di$ <p>S: Accumulation n: Number of data points di: ith data point acquired across the channel</p>	
<p><b>Accumulation Method: Negative</b> (Only the negative-amplitude part)</p>	<p>Calculates an accumulation (unit: V) enclosed by the zero-level (zero-potential) line and the negative-amplitude part of a signal waveform. When the range is specified, calculates the accumulation between the cursors.</p> $S = \sum_{i=1, di < 0}^n di$ <p>S: Accumulation n: Number of data points di: ith data point acquired across the channel</p>	
<p><b>Angle of XY waveform</b></p>	<p>Calculates a regression line of an X-Y composite curve, and then a slope angle.</p> $SLOPE = \frac{\sum_{i=1}^n (x_i - \bar{x}) \cdot (y_i - \bar{y})}{\sum_{i=1}^n (x_i - \bar{x})^2}$ $\theta = \arctan(SLOPE) \cdot 180 / \pi [^\circ]$ <p><math>\theta</math>: Angle at which the regression line is with X-axis xi: ith data point acquired across the X-axis channel yi: ith data point acquired across the Y-axis channel <math>\bar{x}</math>: Average value of the X-axis channel <math>\bar{y}</math>: Average value of the Y-axis channel</p>	





# 8

# Waveform Calculation Function

The instrument makes calculations using acquired waveform data and pre-defined arithmetic expressions to numerically display calculation results on the waveform screen.

When the real-time save is set to **[On]**, you cannot use the waveform calculation function.

 > **[Calculation]** > **[Waveform calculation]**

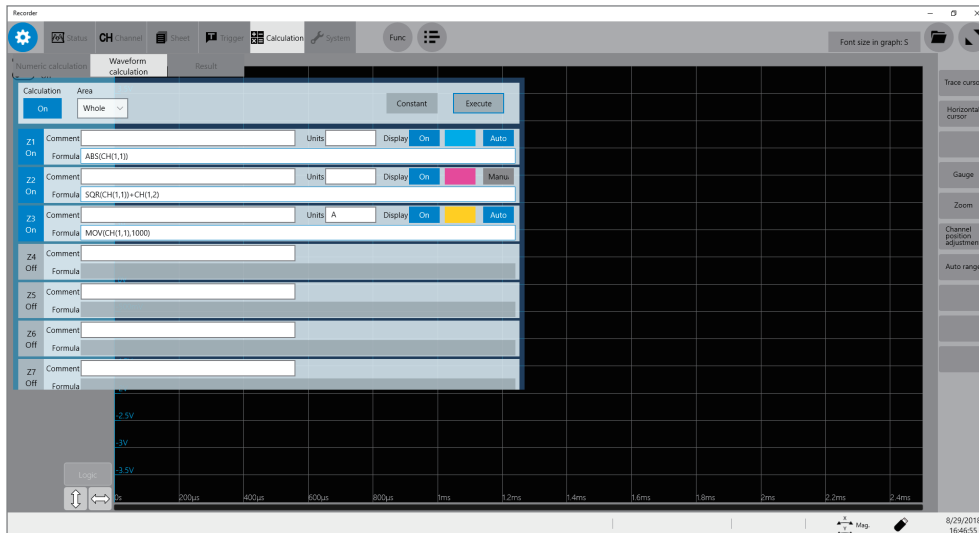

## Operation available on the **[Waveform calculation]** screen

### Waveform Calculation

- Four arithmetic operations (+, -, ×, ÷)
  - Absolute value (ABS)
  - Exponent (EXP)
  - Common logarithm (LOG)
  - Square root (SQR), cube root (CBR)
  - Moving average (MOV)
  - Parallel move in the time axis direction (SLI)
  - Differential (1st-order [DIF], 2nd-order [DIF2])
  - Integration (1st-order [INT], 2nd-order [INT2])
  - Trigonometric function (SIN, COS, TAN)
  - Inverse trigonometric function (ASIN, ACOS, ATAN, ATAN2)
  - Waveform shifting by the PLC delay time specified in Model MR8990 Digital Voltmeter Unit (PLCS)
  - Calculation by specifying a range between cursors
- (12 types in total)
- Waveform parameter
- Average value (PAVE)
  - Maximum value (PMAX)
  - Minimum value (PMIN)
  - Level (PLEVEL)
- Details about arithmetic expressions  
 “8.3 Operators of Waveform Calculation and Calculation Results”  
 (p. 186)

In addition to the four arithmetic operations, 11 functions are available to calculate waveform data. You can specify up to 16 arithmetic expressions.

When the scaling function is enabled, the instrument makes calculations using scaled values.

# 8.1 Waveform Calculation Procedure

The following two methods are available:

Automatically making calculations after measurement	You have to configure the waveform calculation settings before starting measurement. (not available when the real-time save is set to on)
Making calculations using existing data	The instrument can make calculations using waveform data that has already been acquired or that saved on storage devices.

## Performing calculation during measurement

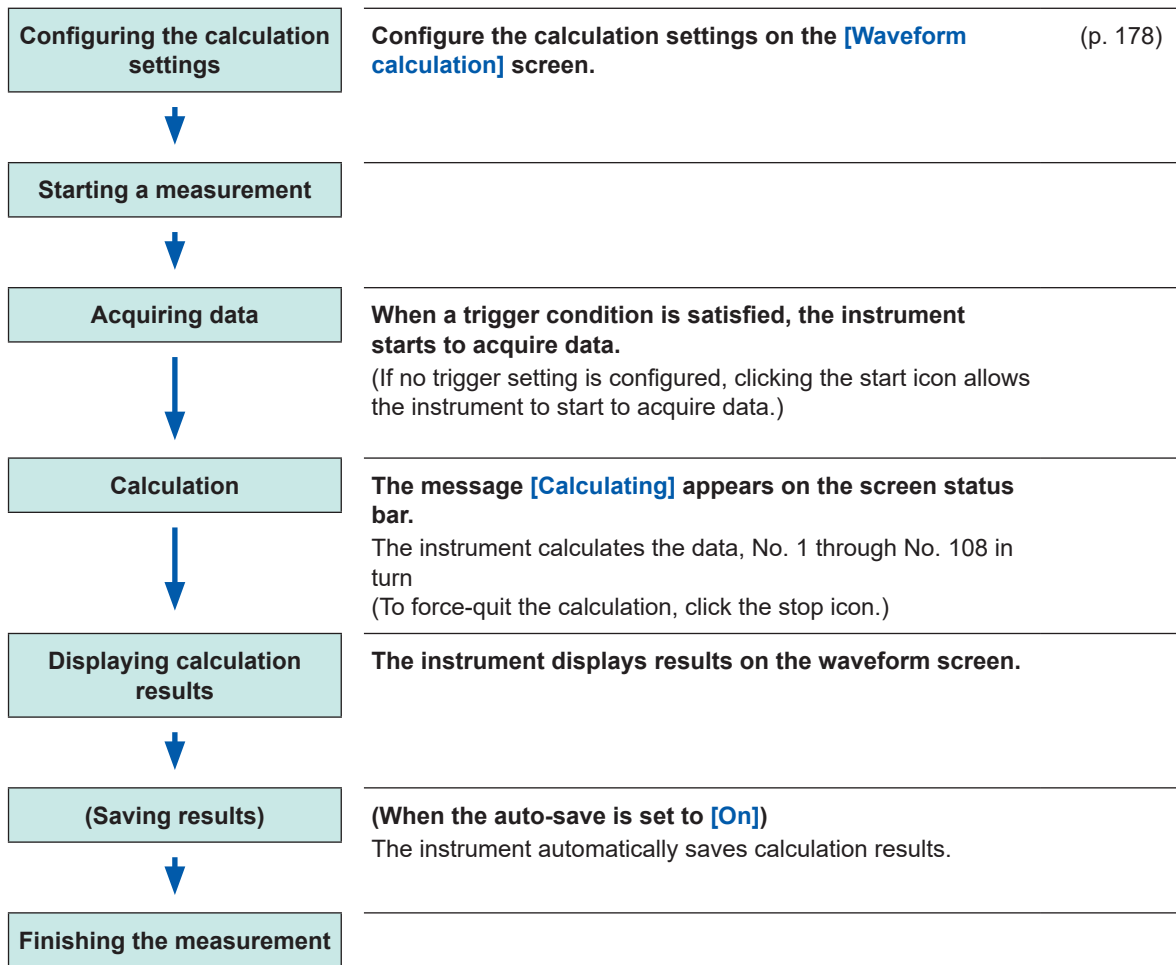

## Calculating existing data

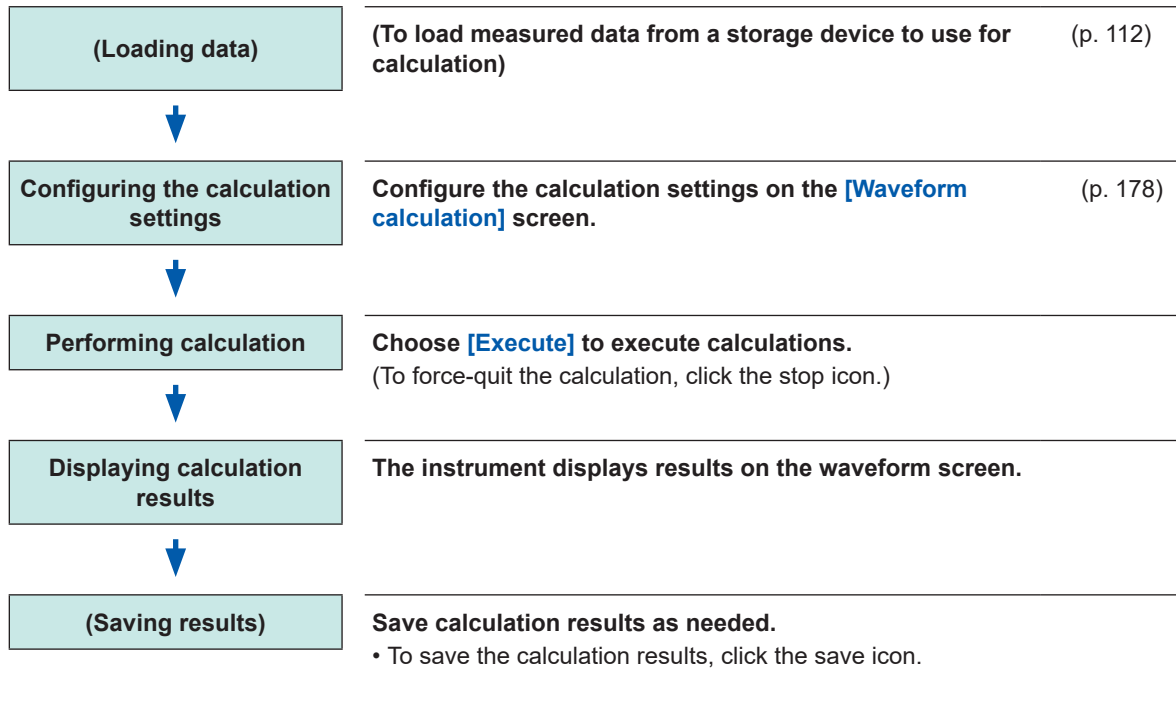

- The instrument can make calculations using waveforms with a length of up to 2,000,000 points. To make a calculation using waveforms with a length longer than this points, partly save the waveforms with a length of less than 2,000,000 points and then reload the waveforms to make another calculation.
- Using the memory division function allows the instrument to display calculation results of the last measured block.
- When the instrument make a calculation using waveforms during measurement, force-quitting calculation prohibits the instrument from displaying calculation results.
- To restart the calculation, choose [\[Execute\]](#) in the [\[Waveform calculation\]](#) screen.

### To specify a range for calculation

Before executing calculation, specify a calculation range with the trace cursors on the waveform screen. Set [\[Area\]](#) to [\[A\\_B\]](#) or [\[C\\_D\]](#) on the [\[Waveform calculation\]](#) screen.

With the [\[A\\_B\]](#) setting, the instrument calculates the data between trace cursors A and B; with the [\[C\\_D\]](#) setting, between trace cursors C and D.

Refer to “8.2 Configuring Waveform Calculation Settings” (p. 178).

### To automatically save waveform calculation results after measurement

Refer to “Automatically saving waveform data” (p. 102).

## 8.2 Configuring Waveform Calculation Settings

 > [Calculation] > [Waveform calculation]

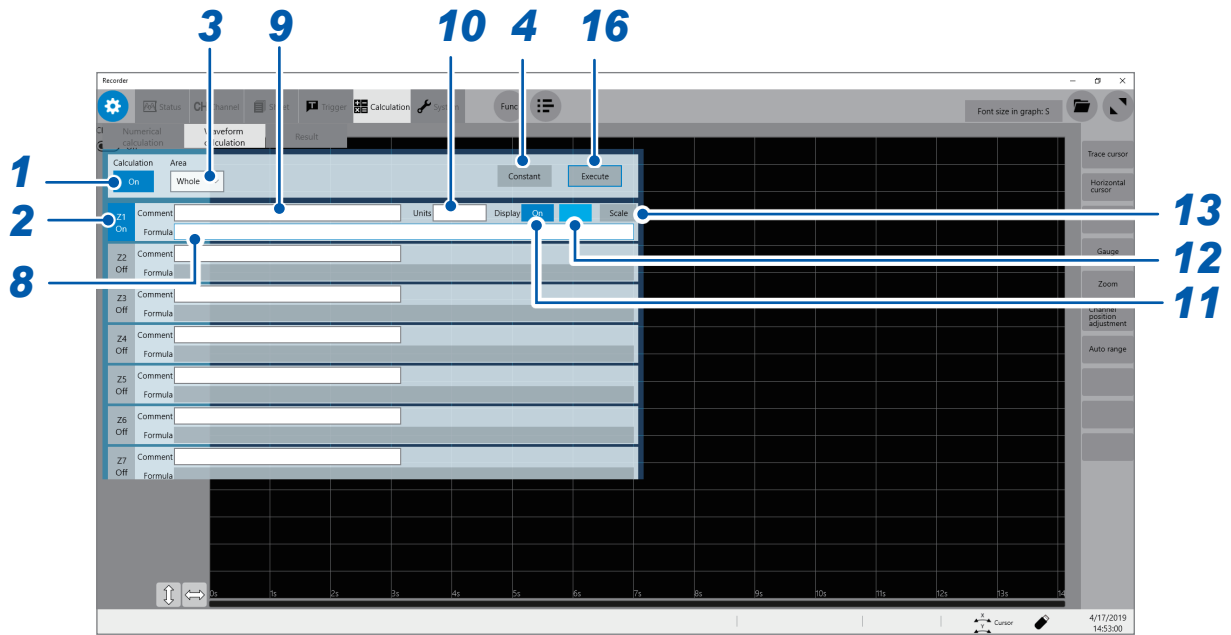

- 1** Click the [Waveform calculation] button to set it to [On].
- 2** Click any of the channels, [Z1] through [Z16], you want to specify a arithmetic calculation to set it to [On].
- 3** Click the [Area] box, and then from the list, choose an option for a waveform calculation range.

<b>Whole</b> <input checked="" type="checkbox"/>	Calculates whole waveform data.
<b>A_B</b>	Calculates waveform data between cursors A and B.
<b>C_D</b>	Calculates waveform data between cursors C and D.

- 4** When a constant is used.  
 Click **[Constant]**, and then specify constants to be used for calculation.  
 The numerical entry dialog box appears.

- 5** Click a box that has an alphabet you want to allocate a constant to.



The numerical entry dialog box appears.

- 6** Enter a constant.

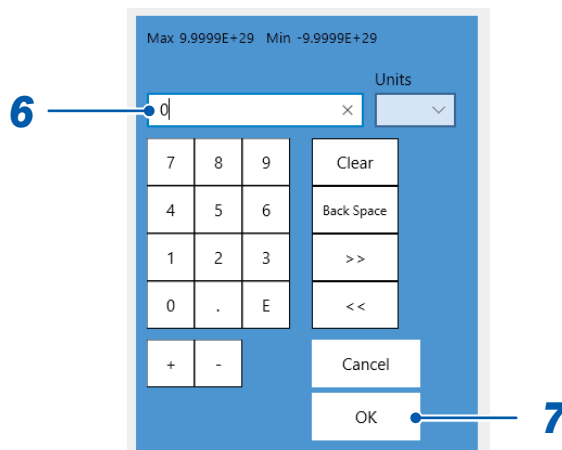

**-9.9999E+29 to -1.0000E29, 0, +1.0000E29 to +9.9999E-29**

You can specify a number to five or less significant figures.  
 Use the numerical keypad, **[+]** button, and **[-]** button to enter.  
 The instrument feeds constants you have defined to the constant display on the arithmetic expression setting dialog box.

- 7** Click **[OK]**.  
 The numerical entry dialog box closes.

**8** Click to the arithmetic expression field and enter an arithmetic expression.

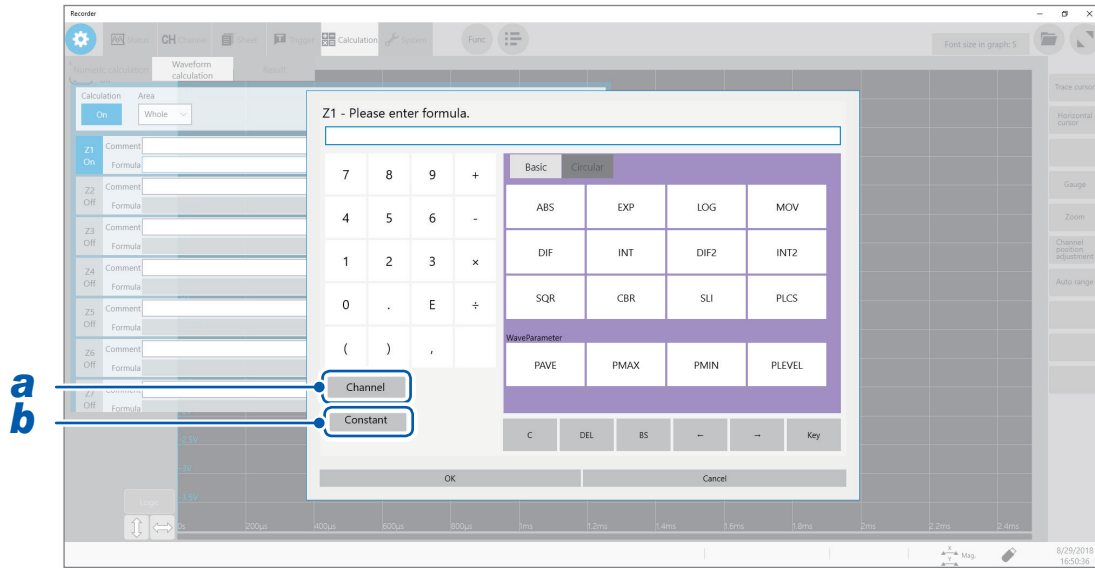

**a** (When choosing a channel)

Click **[Channel]** and choose a channel you want to use for calculation.

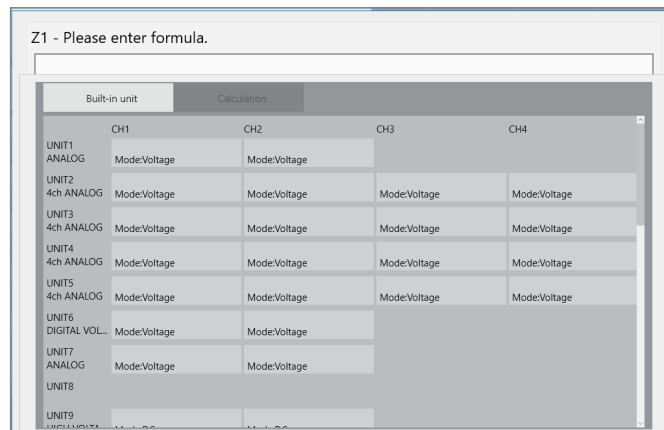

**b** (When entering a constant)

Click **[Constant]**, and then enter a numerical value (p. 178).

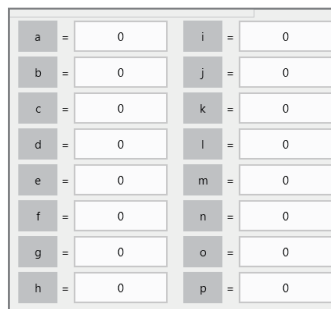

**9** Click the **[Comment]** box, and then enter a comment.

**10** Click the **[Units]** box, and then enter a unit.

**11** Click the **[Display]** button to set it to **[On]** or **[Off]**.

<b>Off</b> <input type="checkbox"/>	Displays no calculated waveform.
<b>On</b> <input type="checkbox"/>	Displays a calculated waveform.

**12** Click the color button to the right of the **[Display]** button, and then choose a waveform display color from the color pallet.

**13** Click **[Scale]** to the right of the color button.

The scale setting dialog box appears.

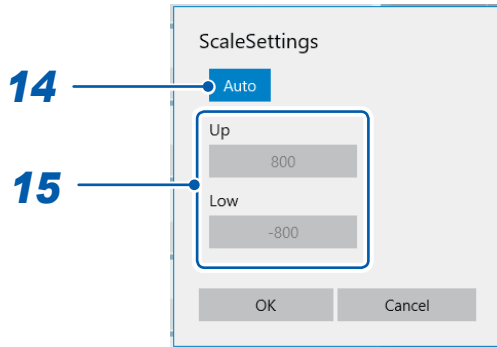

**14** Click the **[Scale]** button to set it to **[Auto]** or **[Manual]**.

<b>Auto</b> <input type="checkbox"/>	Automatically scales a calculation result.
<b>Manual</b> <input type="checkbox"/>	Allows you to change the scale settings.

**15** (When you choose **[Manual]** in the **[Scale Settings]** box.)

Click the **[Up]** or **[Low]** box.

The numerical entry dialog box appears.

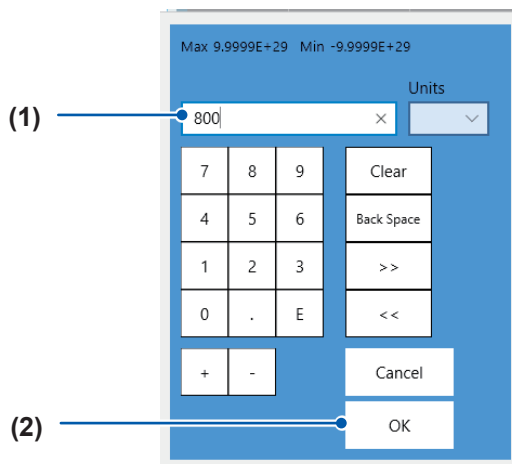

**(1)** Enter an upper and lower value in each box.

Use the numerical keypad, **[+]** button, and **[-]** button to enter.

**-9.9999E+19 to 9.9999E+19**

**(2)** Click **[OK]**.

The numerical entry dialog box closes.

(To manually specify the scale setting for the calculation result)

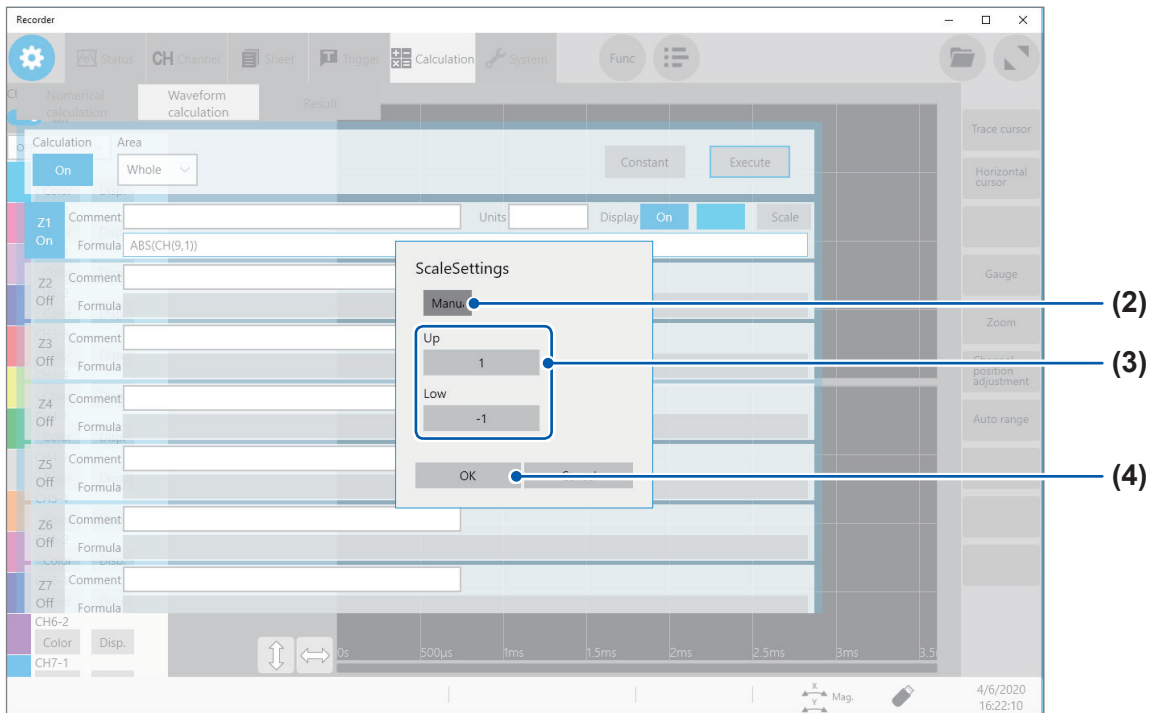
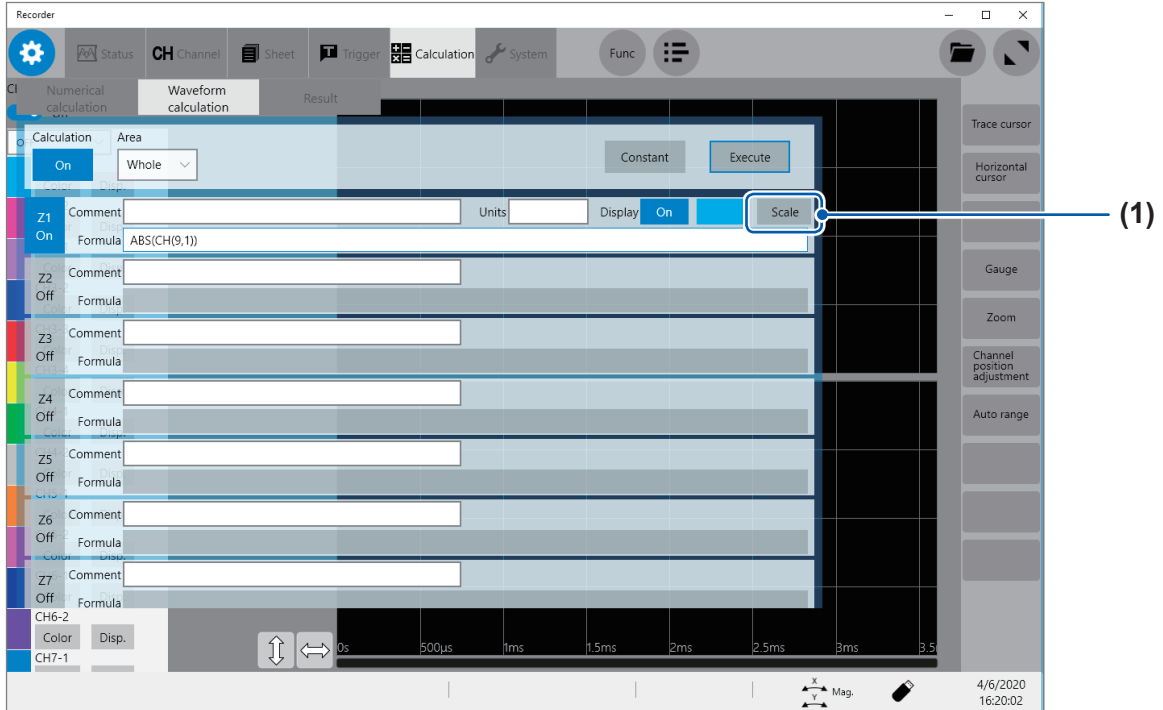

- (1) Click **[Scale]**.  
The scale setting dialog box appears.
- (2) Click **[Manual]**.
- (3) Set an upper and lower value.
- (4) Click **[OK]**.

## 16 (To making calculations using measured data)

Click **[Execute]**.

(To make calculations during measurement)

Click the start icon.

Once the instrument has acquired waveforms, it displays waveforms calculated.





When an expression includes an operator **MOV**, **SLI**, **DIF**, **DIF2**, **PLEVEL**, or **ATAN2** (about second parameter)

The operators above require a comma and second parameter to follow the first parameter, which is enclosed in parentheses.

**Examples of operators and settings**

Operator	Setting	Setting example
<b>MOV</b> (moving average) <b>SLI</b> (parallel move)	Specify the number of moving points. Setting range <b>MOV</b> (moving average): 1 to 5000 <b>SLI</b> : -5000 to 5000 If you omit the second parameter, the instrument specifies [1] to make calculations.	To calculate a 10-point moving average of the CH1 waveform <b>MOV(CH1,10)</b>
<b>DIF</b> (differential) <b>DIF2</b> (2nd-order differential)	Specify a sampling interval for differentials Normally specify "1." Specify a larger number, however, to monitor the variation in a slowly changing waveform. Setting range for <b>DIF</b> and <b>DIF2</b> : 1 to 5000 If you omit the second parameter, the instrument specifies [1] to make calculations.	To calculate differentials of data acquired across CH2 at intervals of 20 sampled points. <b>MOV(CH2,20)</b>
<b>PLEVEL</b> (level at time)	Specify a time from a trigger point. If you omit the second parameter, the instrument specifies [0] to make calculations.	Obtains the level a signal reaches 1 ms after the trigger point generated from a signal acquired across CH1-3. <b>PLEVEL(CH(1,3),0.001)</b>
<b>ATAN2</b> (2-argument arc tangent)	When you type " <b>ATAN2(y,x)</b> ," the instrument calculates the expression <b>ATAN(y/x)</b> . (p. 187) If you omit "x," the instrument makes calculations supposing that x equals 1.0. You can specify "CH," "Z," or a constant only at "x." No function or expression can be specified. Not available	To calculate 2-argument arc tangent of CH1-1 / CH1-2 <b>ATAN2(CH(1,1),CH(1,2))</b>

**If a calculation result is overflowing (OVER)**

- The instrument regards a calculation result that falls within the following range as an overflow.
  1. Greater than +9.9999E+29
  2. Less than -9.9999E+29
- The instrument assigns +9.9999E+29 to positive overflows, and -9.9999E+29 to negative overflows.
- Trace cursors (A through H) read +9.9999E+29 at a positively overflowing point, and -9.9999E+29 at a negatively overflowing point.

### Calculation result

Example: To display the waveform processed through the absolute value calculation using a waveform acquired across CH1\_1

$$\text{Arithmetic expression } Z1 = \text{ABS}(\text{CH}(1,1))$$

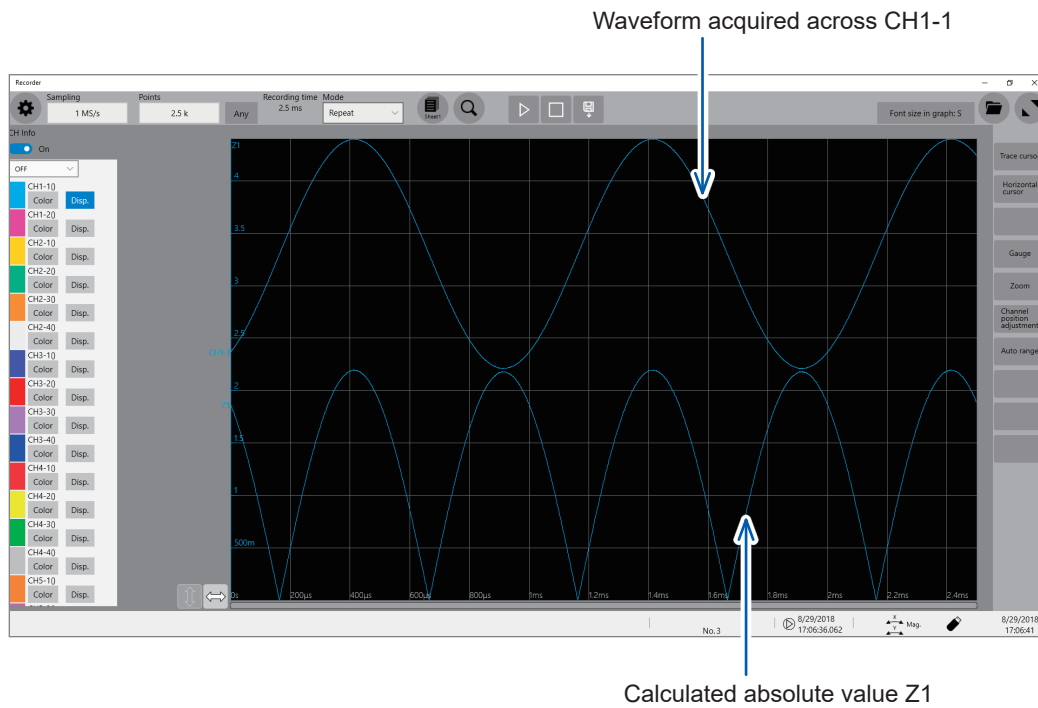

## 8.3 Operators of Waveform Calculation and Calculation Results

$b_i$ :  $i$ th data point of calculation results,  $d_i$ :  $i$ th data point acquired across the source channel

Waveform calculation type	Description
<b>Four arithmetic operations (+, -, ×, ÷)</b>	Makes calculations using operators specified from the four arithmetic operations, which consists of addition (+), subtraction (-), multiplication (×), and division (÷). Multiplication signs (×) and division signs (÷) are represented as asterisks (*) and slashed (/), respectively.
<b>Absolute value (ABS)</b>	$b_i =  d_i $ ( $i = 1, 2, \dots, n$ )
<b>Exponent (EXP)</b>	$b_i = \exp(d_i)$ ( $i = 1, 2, \dots, n$ )
<b>Common logarithm (LOG)</b>	<p>With <math>d_i &gt; 0</math> <math>b_i = \log_{10} d_i</math>                      With <math>d_i = 0</math> <math>b_i = -\infty</math> (Outputs overflowing values)                      With <math>d_i &lt; 0</math> <math>b_i = \log_{10}  d_i </math> (<math>i = 1, 2, \dots, n</math>)</p> <p>Note: The following expressions can convert common logarithms into natural logarithms.  <math>\ln X = \log_e X = \log_{10} X / \log_{10} e</math>  <math>1 / \log_{10} e \approx 2.30</math></p>
<b>Square root</b>	<p>For <math>d_i \geq 0</math> <math>b_i = \sqrt{d_i}</math>                      With <math>d_i &lt; 0</math> <math>b_i = -\sqrt{ d_i }</math> (<math>i = 1, 2, \dots, n</math>)</p>
<b>Cube root (CBR)</b>	$b_i = \sqrt[3]{d_i}$
<b>Moving average (MOV)</b>	<p>For this function, specify the number of moving points at the second parameter <math>k</math>.                      When <math>k</math> is an odd number <span style="margin-left: 150px;">When <math>k</math> is an even number</span></p> $b_i = \frac{1}{k} \sum_{t=i-\frac{k-1}{2}}^{i+\frac{k-1}{2}} d_t \quad (i = 1, 2, \dots, n)$ $b_i = \frac{1}{k} \sum_{t=i-\frac{k}{2}+1}^{i+\frac{k}{2}} d_t \quad (i = 1, 2, \dots, n)$ <p><math>d_i</math>: <math>i</math>th data point acquired across the source channel  <math>k</math>: Number of moving point (1 to 5000)</p> <p>Specify the constant <math>k</math> following a comma. Example: To calculate 100-point moving averages of the Z1 data. MOV(Z1,100)                      For each <math>k/2</math> points of data at the beginning and end of the calculation interval, the instrument makes calculations by plugging in zero for data-missing parts</p>
<b>Parallel move in the time axis direction (SLI)</b>	<p>For this function, specify the number of moving points at the second parameter <math>k</math>. The instrument yields waveforms parallel moving in the time axis direction by the specified number of points.  <math>b_i = d_{i-k}</math> (<math>i = 1, 2, \dots, n</math>)  <math>k</math>: Number of moving point (-5000 to 5000)</p> <p>Specify the constant <math>k</math> following a comma. Example: To move data Z1 by 100 points SLI(Z1,100)</p> <p>Note When waveforms are parallelly moved, the non-data parts at the beginning or end of the calculation interval measure a voltage of 0 V.</p>
<b>Sine (SIN)</b>	<p><math>b_i = \sin(d_i)</math> (<math>i = 1, 2, \dots, n</math>)                      For the trigonometric and inverse trigonometric functions, specify numbers in radians (rad).</p>
<b>Cosine (COS)</b>	<p><math>b_i = \cos(d_i)</math> (<math>i = 1, 2, \dots, n</math>)                      For the trigonometric and inverse trigonometric functions, specify numbers in radians (rad).</p>
<b>Tangent (TAN)</b>	<p><math>b_i = \tan(d_i)</math> (<math>i = 1, 2, \dots, n</math>)                      For the trigonometric and inverse trigonometric functions, specify numbers in radians (rad).</p>

$b_i$ :  $i$ th data point of calculation results,  $d_i$ :  $i$ th data point acquired across the source channel

Waveform calculation type	Description
<b>Arc sine (ASIN)</b>	With $d_i > 1$ $b_i = \pi / 2$ With $-1 \leq d_i \leq 1$ $b_i = \arcsin(d_i)$ With $d_i < -1$ $b_i = -\pi / 2$ ( $i = 1, 2, \dots, n$ ) For the trigonometric and inverse trigonometric functions, specify numbers in radians (rad).
<b>Arc cosine (ACOS)</b>	With $d_i > 1$ $b_i = 0$ With $-1 \leq d_i \leq 1$ $b_i = \arccos(d_i)$ With $d_i < -1$ $b_i = \pi$ ( $i = 1, 2, \dots, n$ ) For the trigonometric and inverse trigonometric functions, specify numbers in radians (rad).
<b>Arc tangent (ATAN)</b>	$b_i = \arctan(d_i)$ ( $i = 1, 2, \dots, n$ ) For the trigonometric and inverse trigonometric functions, specify numbers in radians (rad).
<b>Arc tangent 2 (ATAN2(y, x))</b>	Responses arc tangent of ( $y/x$ ) in the range of $[-\pi, \pi]$ . Specify numbers in radians (rad). $ATAN2(y, x) =$ With $x \geq 0$ $ATAN(y/x)$ With $x < 0$ and $y \geq 0$ $ATAN(y/x) + \pi$ With $x < 0$ and $y < 0$ $ATAN(y/x) - \pi$
<b>1st-order differential (DIF) 2nd-order differential (DIF2)</b>	The instrument makes 1st-order differential and 2nd-order differential calculations using 5th-order Lagrange interpolation formula to obtain 1-point data from 5-point values that includes before and after the point. The instrument differentiates data $d_1$ to $d_n$ considering them as the corresponding data for the sampling time $t_1$ to $t_1$ .  Note If the instrument differentiates a waveform that oscillates slowly, calculation results vary significantly. In such a case, raise the second parameter of the function. The following expressions hold provided the second parameter equals one.  <b>Arithmetic expressions of 1st-order differential</b> Point $t_1$ $b_1 = (-25d_1 + 48d_2 - 36d_3 + 16d_4 - 3d_5) / 12h$ Point $t_2$ $b_2 = (-3d_1 - 10d_2 + 18d_3 - 6d_4 + d_5) / 12h$ Point $t_3$ $b_3 = (d_1 - 8d_2 + 8d_4 - d_5) / 12h$ ↓ Point $t_i$ $b_i = (d_{i-2} - 8d_{i-1} + 8d_{i+1} - d_{i+2}) / 12h$ ↓ Point $t_{n-2}$ $b_{n-2} = (d_{n-4} - 8d_{n-3} + 8d_{n-1} - d_n) / 12h$ Point $t_{n-1}$ $b_{n-1} = (-d_{n-4} + 6d_{n-3} - 18d_{n-2} + 10d_{n-1} + 3d_n) / 12h$ Point $t_n$ $b_n = (3d_{n-4} - 16d_{n-3} + 36d_{n-2} - 48d_{n-1} + 25d_n) / 12h$  $b_1$ through $b_n$ : Calculation result data $h = \Delta t$ : Sampling interval  <b>Arithmetic expressions of 2nd-order differential</b> Point $t_1$ $b_1 = (35d_1 - 104d_2 + 114d_3 - 56d_4 + 11d_5) / 12h^2$ Point $t_2$ $b_2 = (11d_1 - 20d_2 + 6d_3 + 4d_4 - d_5) / 12h^2$ Point $t_3$ $b_3 = (-d_1 + 16d_2 - 30d_3 + 16d_4 - d_5) / 12h^2$ ↓ Point $t_i$ $b_i = (-d_{i-2} + 16d_{i-1} - 30d_i + 16d_{i+1} - d_{i+2}) / 12h^2$ ↓ Point $t_{n-2}$ $b_{n-2} = (-d_{n-4} + 16d_{n-3} - 30d_{n-2} + 16d_{n-1} - d_n) / 12h^2$ Point $t_{n-1}$ $b_{n-1} = (-d_{n-4} + 4d_{n-3} + 6d_{n-2} - 20d_{n-1} + 11d_n) / 12h^2$ Point $t_n$ $b_n = (11d_{n-4} - 56d_{n-3} + 114d_{n-2} - 104d_{n-1} + 35d_n) / 12h^2$

$b_i$ :  $i$ th data point of calculation results,  $d_i$ :  $i$ th data point acquired across the source channel

Waveform calculation type	Description
<p><b>1st-order integration (INT)</b> <b>2nd-order integration (INT2)</b></p>	<p>To calculate values of 1st-order and 2nd-order integration, the instrument uses the trapezoidal formula. The instrument integrates data <math>d_1</math> to <math>d_n</math> considering them as the corresponding data for the sampling time <math>t_1</math> to <math>t_n</math>.</p> <p><b>Arithmetic expressions of 1st-order integration</b> Point <math>t_1</math> <math>I_1 = 0</math> Point <math>t_2</math> <math>I_2 = (d_1 + d_2) h / 2</math> Point <math>t_3</math> <math>I_3 = (d_1 + d_2) h / 2 + (d_2 + d_3) h / 2 = I_2 + (d_2 + d_3) h / 2</math> ↓ Point <math>t_n</math> <math>I_n = I_{n-1} + (d_{n-1} + d_n) h / 2</math></p> <p><math>I_1</math> through <math>I_n</math>: Calculation result data <math>h = \Delta t</math>: Sampling period</p> <p><b>Arithmetic expressions of 2nd-order integration</b> Point <math>t_1</math> <math>II_1 = 0</math> Point <math>t_2</math> <math>II_2 = (I_1 + I_2) h / 2</math> Point <math>t_3</math> <math>II_3 = (I_1 + I_2) h / 2 + (I_2 + I_3) h / 2 = II_2 + (I_2 + I_3) h / 2</math> ↓ Point <math>t_n</math> <math>II_n = II_{n-1} + (I_{n-1} + I_n) h / 2</math></p> <p><math>II_1</math> through <math>II_n</math>: Calculation result data</p> <p>Note Integration is susceptible to minor deviation of the zero-position. Be sure to execute zero-adjustment before performing a measurement. In addition, zero-point offset correction may be required. Example: To adjust the zero point by 0.124 mV <math>Z1 = INT (CH1-0.000124)</math></p>
<p><b>Waveform shifting by PLC delay time specified in digital voltmeter module (PLCS)</b></p>	<p>The instrument shifts a waveform by a frequency (PLC) specified in a digital voltmeter module and a delay time of PLCS. Since digital voltmeter modules calculate averages during periods specified in the NPLC setting, observed waveforms will lag behind waveforms acquired with Model 8966 Analog Unit by a half of the NPLC setting. The PLCS calculation advances the waveforms acquired with the digital voltmeter module by the delay time and thus compensates the results for the lag behind the waveforms acquired with Model 8966.</p> <p>Note If the end of the calculation result contains no data, this part measures a voltage of 0 V.</p>
<p><b>Average value (PAVE)</b></p>	<p>Calculates an average value of waveform data to use this numerical calculation result for waveform calculations.</p> $AVE = \frac{1}{n} \sum_{i=1}^n d_i$ <p><math>AVE</math>: Average <math>n</math>: Number of data points <math>d_i</math>: <math>i</math>th data point acquired across the channel</p>

$b_i$ :  $i$ th data point of calculation results,  $d_i$ :  $i$ th data point acquired across the source channel

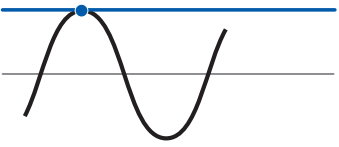
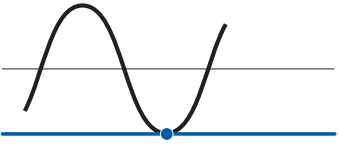
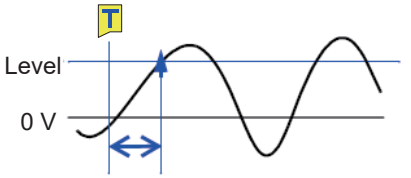
Waveform calculation type	Description
<b>Maximum value (PMAX)</b>	Calculates the maximum value of waveform data to use this numerical calculation result for waveform calculations. 
<b>Minimum value (PMIN)</b>	Calculates the minimum value of waveform data to use this numerical calculation result for waveform calculations. 
<b>Level at time (PLEVEL)</b>	Calculates a measured value at a time a specified time has elapsed from a trigger point to use this numerical calculation result for waveform calculations. 





# 9

# Memory Dividing Function

You can divide the memory capacity into several blocks, each of which is used to store waveforms.

 > [Status] > [Condition]

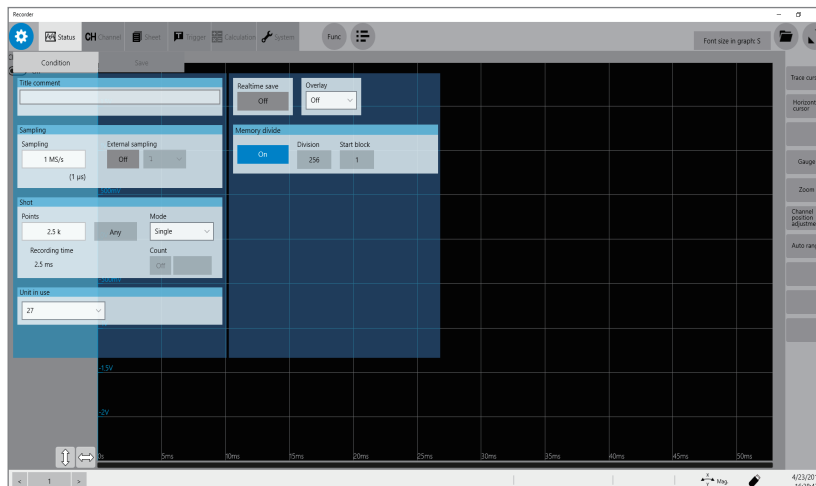

## Operation available with the memory dividing function

- You can divide the memory capacity into several blocks and save waveforms onto any blocks.
- When triggered, the instrument starts to sequentially acquire waveform data and store the data onto the block you specified (start block).

During use of the memory division, the instrument may switch the trigger output (TRIG\_OUT terminal) to a low level or irregularly output signals.

- The trigger output method is set to pulse.
- Recording (measuring) length: 5 ms or less
- You can divide a memory into up to 1024 blocks.
- You cannot use the real-time save function concurrently with the memory division function. Refer to "Real-time save" (p. 106).

## 9.1 Configuring the memory division settings

 > [Status] > [Condition]

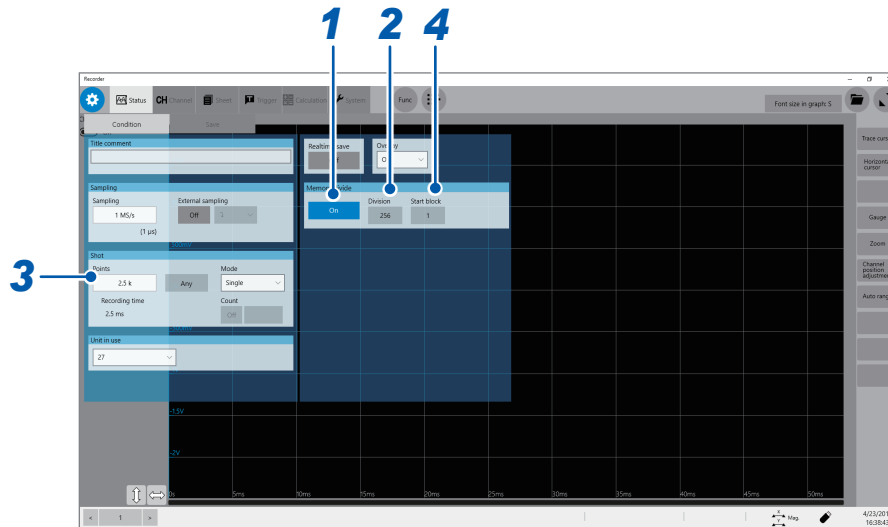

**1** Click the **[Memory divide]** button to set it to **[On]**.

**2** Click the **[Division]** box, and then enter the number of blocks the memory capacity is divided into.

2, 4, 8, 16, 32, 64, 128, 256, 512, 1024

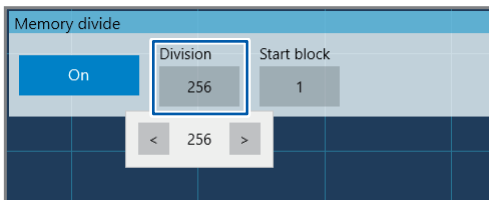

**3** Click the **[Points]** box, and then enter a recording length.

The maximum recording length varies depending on the division number specified in **[Division]**.

**4** Enter the start block number in **[Start block]**.

The instrument stores the waveforms in the block with the number you specified.

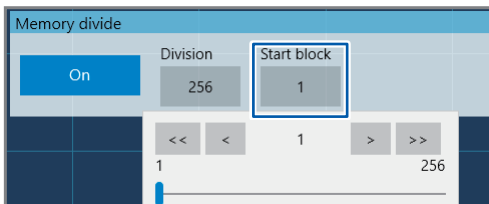

## 9.2 Displaying Waveforms

You can choose a block to display waveforms stored in it.

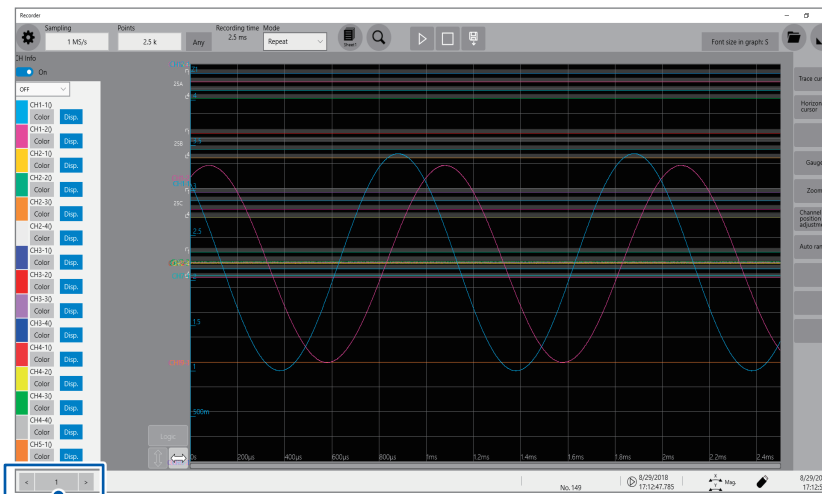

Choose a block number you specified.

### Waveform calculation with the memory dividing setting

- With the memory dividing enabled, waveforms Z1 through Z16, which are obtained through waveform calculations, remain in the block finally calculated only.
- To observe calculated waveforms stored in other blocks, execute another calculation.



# 10

## Configuring the System Environment Settings

You can configure the system environment settings for the instrument.

### IMPORTANT

Do not change any Windows® setting unless otherwise indicated in this document. Doing so may cause unstable system operation.

 > [System] > [Env.]

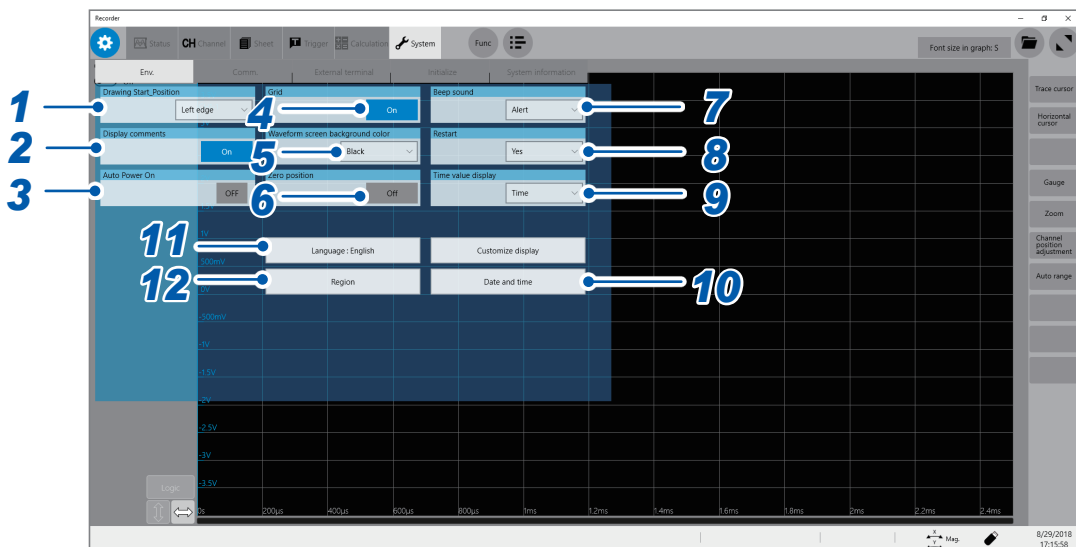

- 1 Click the **[Drawing Start Position]** box, and then choose a start position of the scrolling display from the list.

<b>Left edge</b> <input checked="" type="checkbox"/>	Starts scrolling through waveforms from the left side of the waveform screen.
<b>Right edge</b>	Starts scrolling through waveforms from the right side of the waveform screen.

- 2 Click the **[Display comments]** button to choose a comment display setting.

You can display a title comment and each channel comment on the waveform screen. Each channel comment appears along with each input-channel marker.

<b>On</b> <input checked="" type="checkbox"/>	Displays comments.
<b>Off</b>	Does not display any markers.

- 3 Click the **[Auto Power on]** button, and then configure the automatic power-on setting.

When you choose **[On]**, just supplying power allows the instrument to start Windows® and to be ready for measurement. You do not have to operate the start button on the front side or the main power switch on the rear side. Always set the switch on the rear side to on.

The instrument does not store the **[Auto Power On]** setting in any file.

<b>Off</b> <input checked="" type="checkbox"/>	Disables the auto-power-on setting.
<b>On</b>	Enables the auto-power-on setting.

**4** Click the **[Grid]** button to choose a grid display setting of the waveform screen.

<b>On</b> <input type="checkbox"/>	Displays the solid-line grid.
<b>Off</b>	Does not display any grids.

**5** Click the **[Waveform screen background color]** box, and then from the list, choose a background color of the waveform screen.

Some background colors of waveforms may cause waveforms to get difficult to see. Change the waveform colors in such a case.

<b>Black</b> <input type="checkbox"/>	Sets the background color of the waveform screen to black.
<b>White</b>	Sets the background color of the waveform screen to white.

**6** Click the **[Zero position]** button to set it to **[On]** or **[Off]**.

You can display markers at the zero position of each input channel on the time-axis waveform display.

<b>Off</b> <input type="checkbox"/>	Does not display any markers.
<b>On</b>	Displays markers at the zero position on the right side of the waveform screen.

**7** Click the **[Beep sound]** box, and then choose a beep setting from the list.

<b>Off</b>	Does not allow the instrument to beep.
<b>Alert</b> <input type="checkbox"/>	Allows the instrument to beep in the following cases: <ul style="list-style-type: none"><li>• If an error message or warning appears</li><li>• If a fail judgment is given</li></ul>
<b>Alert+Action</b>	Allows the instrument to beep when the instrument starts a measurement, is triggered, stops the measurement, and completes auto-saving, in addition to the cases described above.

**8** Click the **[Restart]** box, and then from the list, choose whether to immediately restart the measurement after changing a setting that affects measurement during the measurement.

<b>No</b>	Does not restart any measurement. You cannot change any settings during measurement.
<b>Yes</b> <input type="checkbox"/>	If you change a setting during measurement, the instrument confirms the changes and then restart the measurement.

**9** Click the **[Time value display]** box, and then from the list, choose a display format for the lapse time from a trigger point.

<b>Time</b> <input type="checkbox"/>	Displays the lapse time from the trigger point (the unit is fixed).
<b>Mod 60</b>	Displays the lapse time from the trigger point (in the sexagesimal [base 60] system).
<b>Date</b>	Displays the time when the instrument acquired a waveform.
<b>Samples</b>	Displays the number of data points acquired during the period from the trigger point.

- During the external sampling is used, this setting is fixed to **[Samples]**.
- These settings are also applied to the values of the trace cursors.

## 10 Click [Date and time], and then set the clock.

Refer to “2.7 Setting the Clock” in Quick Start Manual.

## 11 Change the display languages.

### (1) Click [Language: English].

The setting dialog box appears.

### (2) Click the [Display language] box, and then choose a user interface language from the list.

English , Japanese, Chinese

### (3) Click [OK].

The instrument is turned off.

### (4) Press the start button on the front side.

The instrument starts up with the display in the selected language.

## 12 Click [Region].

Choose characters that represent the decimal point and the separator used in data included in waveform files (text format) and numerical calculation result files.

Click the [Decimal point], and then from the list, choose a character that represents the decimal symbol.

Period . <input checked="" type="checkbox"/>	Designates the period (.) as the decimal point.
Comma ,	Designates the comma (,) as the decimal point.

Click the [Separator], and then from the list, choose a character that represents the separator.

Comma , <input checked="" type="checkbox"/>	Designates the comma (,) as the separator.
Space	Designates the space character as the separator.
Tab	Designates the tab character as the separator.
Semicolon ;	Designates the semicolon (;) as the separator.

- Either the decimal point or separator, but not both, can be set to [Comma ,].
- For the [Comma ,] setting, the instrument saves files with a CSV extension; for the other separator settings than [Comma ,], with a TXT extension.





# Connecting the Instrument to Computers

Familiarize yourself with the section “Before connecting to an external device” in “Operation Precautions” of Quick Start Manual.

This instrument is equipped with the Ethernet 1000BASE-T interface for LAN communications. You can control the instrument using computers or other devices connected to your network with 10BASE-T, 100BASE-TX, or 1000BASE-T cable.

 > [System] > [Comm.]

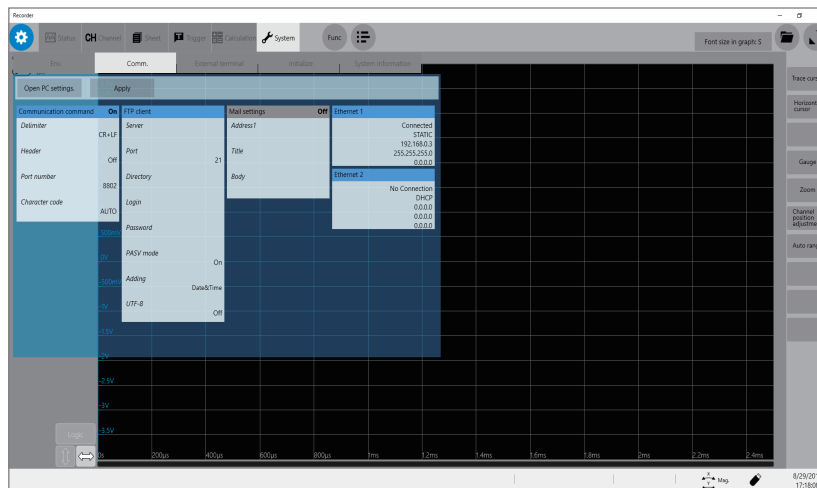

## Operation available on the [Comm.] screen

### Configuring the LAN settings and connecting the instrument via LAN (p. 200)

- Connecting the instrument to your computer via the network

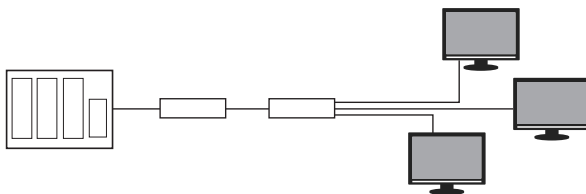

- Directly connecting the instrument to your computer



### FTP server function (p. 204)

Using an FTP client software installed on your computer allows you to transfer files from a storage device inserted to the instrument to the computer, and handle the files.

### FTP client function (p. 208)

Using this function allows you to send data to the FTP server of the computer. The instrument can send measured data on completion of each measurement. You can also send data manually.

### Controlling the instrument with the command communications (p. 219)

You can control the instrument using programs you have created after connecting your computer to the command communications port using the TCP.

For more information about the communication commands, refer to the Communications Command Instruction Manual on the accompanying application disc.

### Sending email messages (p. 214)

# 11.1 Configuring the LAN Settings and Connecting the Instrument to the Network

Configure the LAN settings of the instrument and connect the instrument to your computers with LAN cables before accessing the instrument from your computers using the FTP or a web browser, or using command communication.

Be sure to specify the LAN settings before connecting the instrument to the network. When you change the settings while the instrument is connected to the network, the IP addresses may fail to be unique or invalid address data may be transmitted over the network.

For more information on how to connect the instrument to computers, refer to “2.4 Connecting the Instrument With Computers” in Quick Start Manual.

**IMPORTANT**  
Do not change any Windows® setting unless otherwise indicated in this document. Doing so may cause unstable system operation.

## Configuring the LAN settings with the instrument

### Items to be checked before configuring the LAN settings

The required settings are different depending on whether to connect the instrument to an existing network or to establish a new network consisting of only the instrument and a computer.

#### When connecting the instrument to the existing network

Ask your network administrator to assign the following items in advance. Be sure that there is no conflict with other devices.

- **The computer name and address of the instrument**  
Computer name (up to 15 characters): \_\_\_\_\_  
IP address: .....:.....:.....:.....  
Subnet mask: .....:.....:.....:.....
- **Gateway**  
Whether to use a gateway: ..... Yes/No  
IP address (When used): .....:.....:.....:.....

#### When establishing a new network consisting of the instrument and a computer

(Using the instrument on the local network not connect to any external networks)

When no administrator exists for your network or you are entrusted with the settings, the following addresses are recommended.

Setting example:

IP Address  
Computer: 192.168.0.1  
Recorder 1: 192.168.0.2  
Recorder 2: 192.168.0.3 . . . Assign numbers in a sequential order.  
↓ ↓  
Computer name..... Any name (required to be unique)  
Subnet mask..... 255.255.255.0  
Gateway ..... Off

## Setting items

 > [System] > [Comm.]

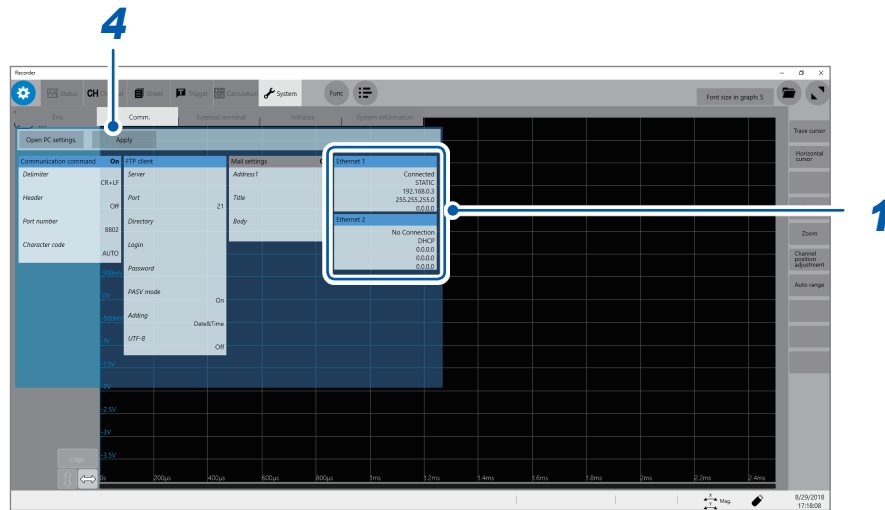

- 1 Click [Ethernet 1] or [Ethernet 2].  
The Ethernet settings screen appears.

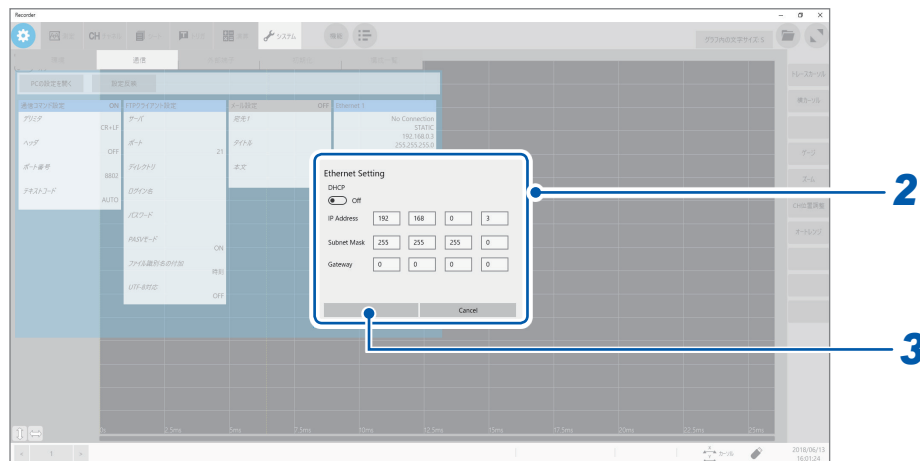

- 2 Enter the necessary items.

<b>IP Address</b>	The IP addresses are used to identify individual devices on the network. Assign a unique address different from that of other devices.
<b>Subnet Mask</b>	The subnet mask divides the IP address into the network address and the host address. Configure the subnet mask settings in the same way as those of other devices on the network.
<b>Gateway</b>	For network connection When your computer to be used (host device) connects to another network than the instrument, specify a gateway device. When your computer connects to the same network, usually assign the same address as the default gateway in the computer communications settings.

- 3 Click [OK].
- 4 Click [Apply].

## Renaming the computer

This name in the **[Current PC name]** box identifies the instrument on the network. If necessary, change the computer name to a unique one among the network devices.

 > **[System]** > **[Comm.]**

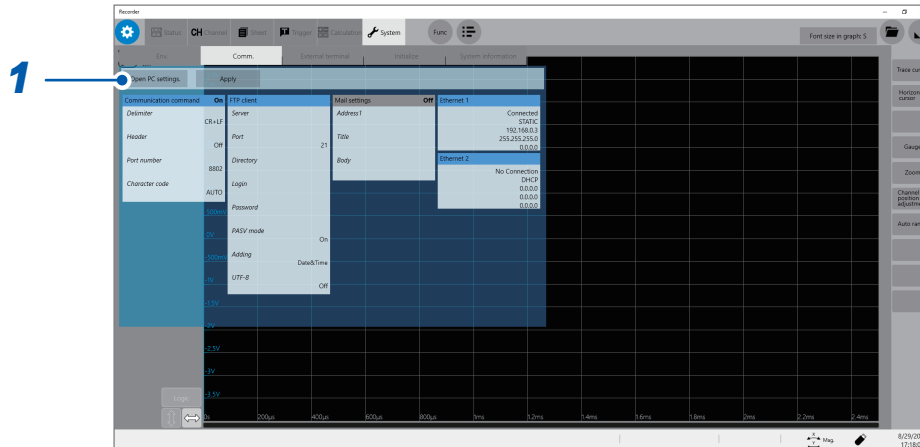

- 1** Click **[Open PC settings.]**.  
The Ethernet settings screen appears.
- 2** Click **[Home]**.  
The Windows® settings screen appears.
- 3** Click **[System]**.
- 4** Click **[About]** under **System**.
- 5** Click **[Rename PC]**, and then enter another name in the **[Current PC name]** box.
- 6** Click **[Next]**.  
Restarting the instrument is required.
- 7** Click **[Restart now]**.

## LAN setting procedure

Follow this procedure in accordance with the intended usage.

For details on each setting, refer to “Setting items” (p. 201).

For details on your network including the IP address, contact your network administrator.

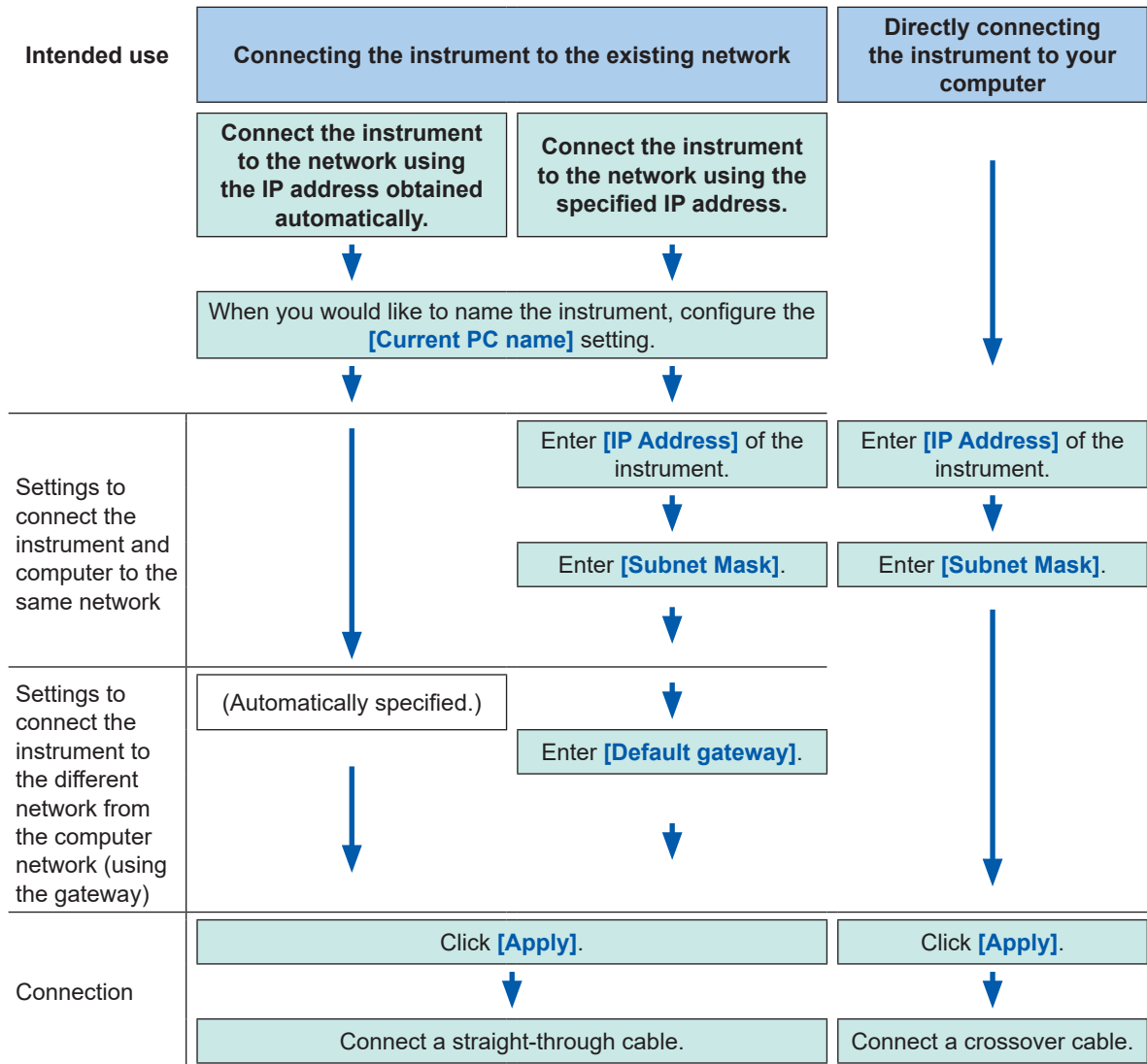

# 11.2 Managing Data in the Instrument With the FTP Server Function

## Configuring the FTP sever setting with the instrument

You can configure the FTP server setting of the instrument using the Windows Control Panel feature.

Right-click the Windows start button, at the lower-right corner of the MR8740T's screen, to open Control Panel.

### Enabling the FTP

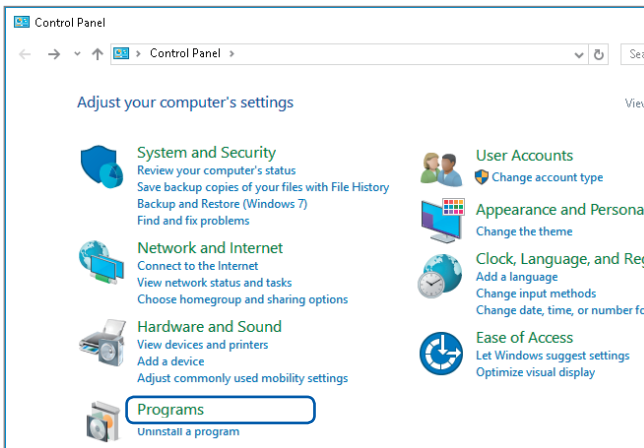

**1** Start [Control Panel], and then click [Programs].

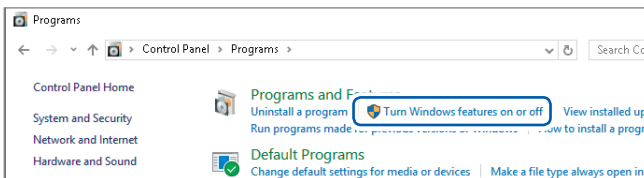

**2** Click [Turn Windows features on or off].

The [Windows Features] dialog box appear.

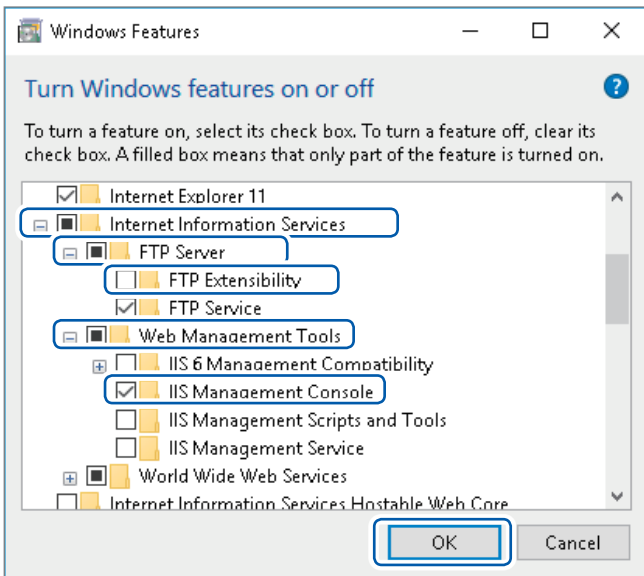

**3** Click [+] on the left of [Internet Information Services] to expand it.

Click [+] on the left of [FTP Server] to expand it, and then choose [FTP Service].

Click [+] on the left of [Web Management Tools] to expand it, and then choose [IIS Management Console].

Click [OK].

## Configuring the FTP settings

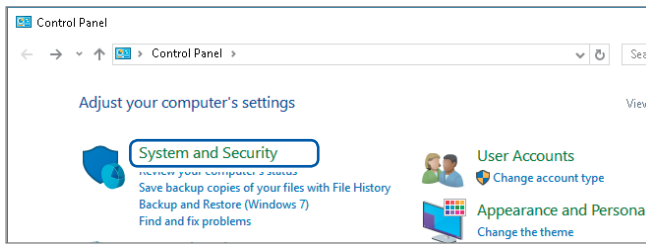

**4** Click **[System and Security]** on **[Control Panel]**.



**5** Click **[Administrative Tools]**.

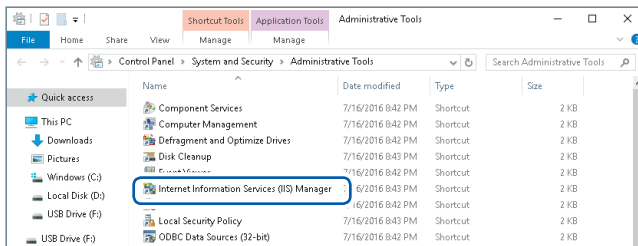

**6** Double-click **[Internet Information Services (IIS) Manager]**.

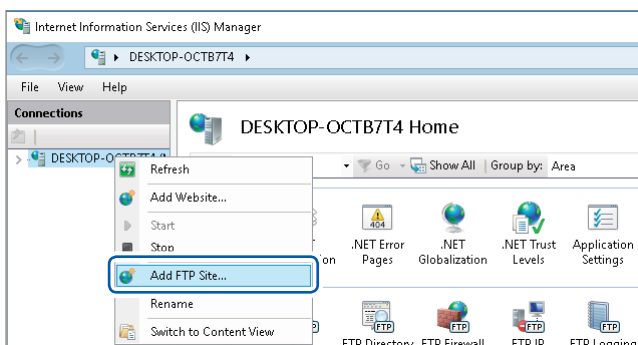

**7** Right-click on the item displayed under **[Connections]** on the left side of the screen to display the shortcut menu, then click **[Add FTP Site]**.

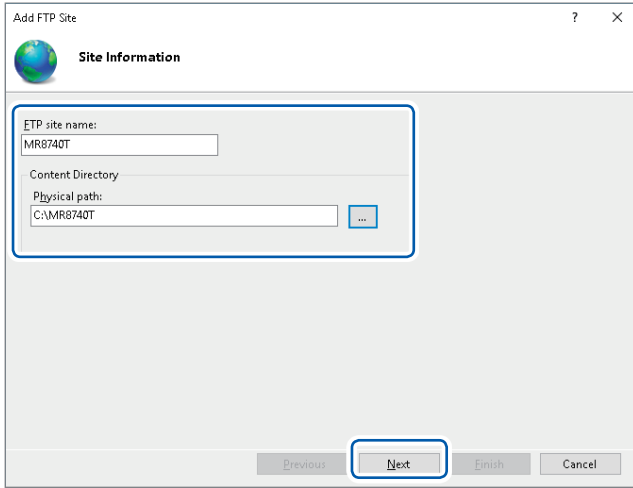

**8 Enter site information.**

Example:

**[FTP site name]: [MR8740T]**

**[Content Directory]:**

Choose a directory in which data from the FTP client will be saved.

Click **[Next]**.

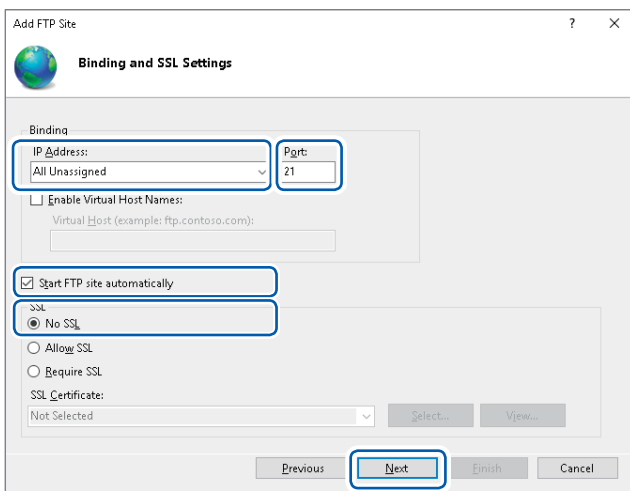

**9 Configure the [Binding] and [SSL] settings as follows:**

<b>[IP Address]</b>	<b>[All Unassigned]</b>
<b>[Port]</b>	<b>[21]</b>
<b>[Start FTP site automatically]</b>	Select
<b>[SSL]</b>	<b>[No SSL]</b>

Click **[Next]**.

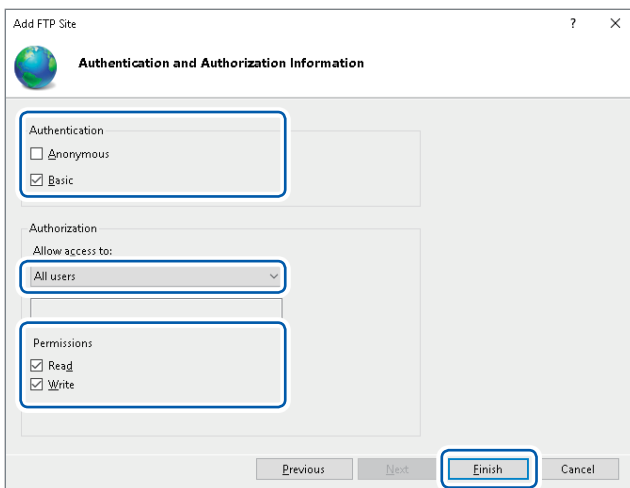

**10 Configure the [Authentication and Authorization Information] settings as follows:**

<b>[Authentication]</b>	Choose <b>[Basic]</b> .
<b>[Authorization]</b>	<b>[All users]</b>
<b>[Permissions]</b>	Choose both <b>[Read]</b> and <b>[Write]</b> .

Click **[Finish]**.



## Operating the instrument with your computer (FTP server function)

The following example shows how to operate the instrument with File Explorer on Windows 10.



### 1 Run File Explorer on your computer.

Click the File Explorer icon on the Windows 10 taskbar to start File Explorer.

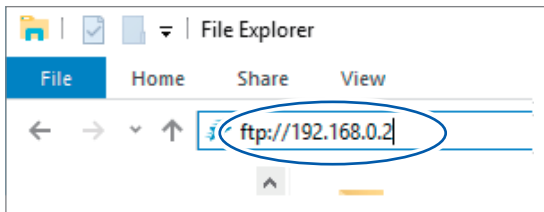

### 2 Enter an IP address.

Click the address bar in File Explorer and enter an IP address. Enter the character string **[ftp://]** followed by the IP address.

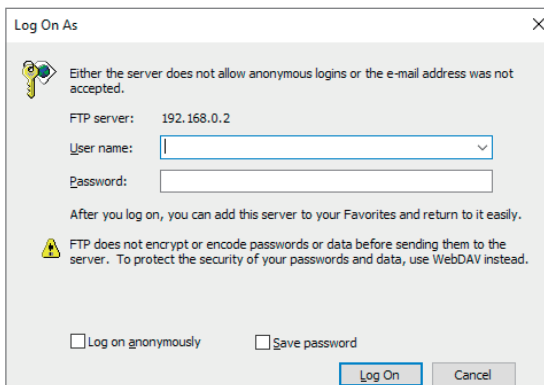

### 3 Log on to the FTP server.

The Log On As screen appears when you have been registered your authentication user name and password in the communication screen or the instrument. Enter your user name and password to log on.

Drag

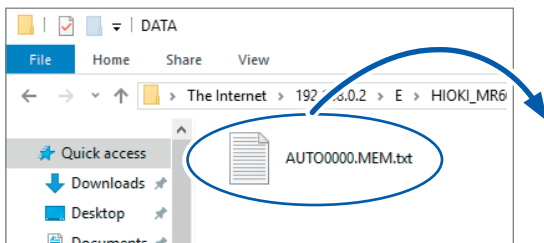

### 4 Download a file.

Choose a file you would like to download from the file list. Drag the file to the download destination (press and hold the mouse left button on the file, move it to the intended location while pressing the button, and then release the button).

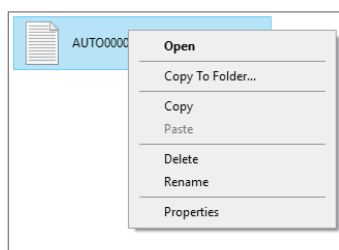

### 5 Delete or rename a file.

Right-click a file in the FTP folder list, and select **[Delete]** or **[Rename]** from the shortcut menu.

## 11.3 Sending Data to a Computer With the FTP Client Function

The instrument is equipped with the FTP transmission function (FTP client). You can send data to the FTP server on the network.

### FTP transmission method

Real-time save data transmission	Automatically sends waveform data during measurement. Configure the real-time save settings and specify the save destination to <b>[FTP]</b> .
Auto-save data transmission	Automatically sends save target data on completion of the measurement, according to the auto-save settings. Configure the auto-save settings and set the save destination to <b>[FTP]</b> .
Transmission with the save icon	When you click the save icon, the data to be saved is automatically sent. In the manually-saving setting, set the save destination to <b>[FTP]</b> .

- The date of a file sent to the computer is set at when the file was sent.
- Transmission to all FTP servers is not necessarily guaranteed due to differences among servers.
- If a file with the same name exists in the destination, the file is overwritten.

## Configuring an FTP server setting on a computer

The following example shows how to configure the FTP server settings on Windows 10. The Microsoft® Windows® Home Edition does not include any FTP server. Use free software such as the FileZilla Server.

- The setting contents may vary with environment. When necessary, refer to the help topics of the FTP server or consult your network administrator.
- Microsoft® Windows® administrator privileges are required for setup.

### Enabling the FTP

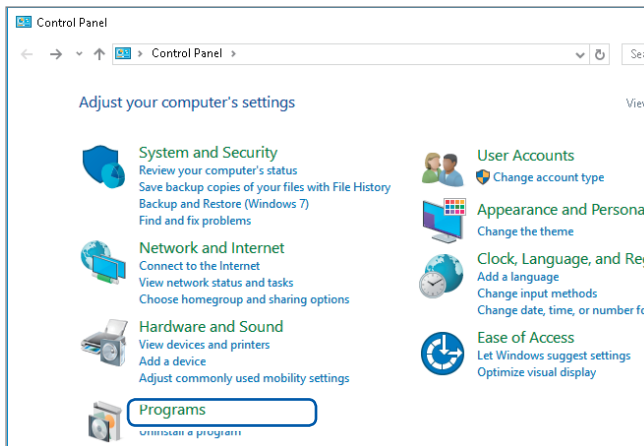

**1** Start [Control Panel], and then click [Programs].

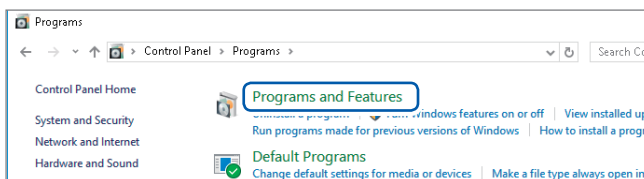

**2** Click [Turn Windows features on or off].  
The [Windows Features] dialog box appear.

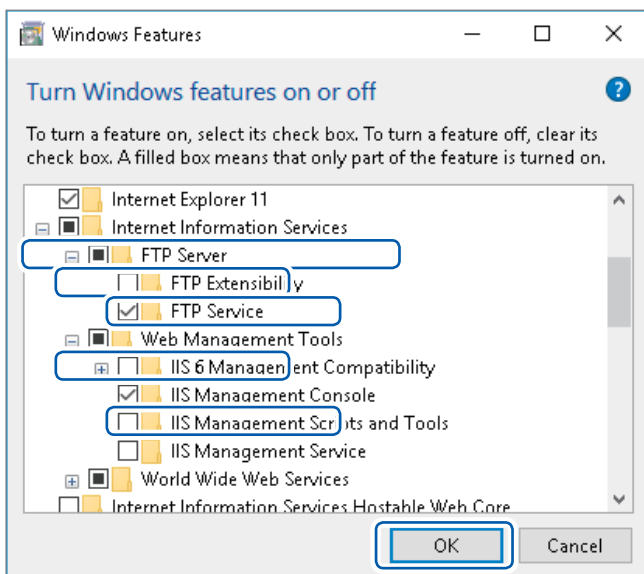

**3** Click [+] on the left of [Internet Information Services] to expand it.

Click [+] on the left of [FTP Server] to expand it, and then choose [FTP Service].

Click [+] on the left of [Web Management Tools] to expand it, and then select [IIS Management Console].

Click [OK].

## Configuring the FTP settings

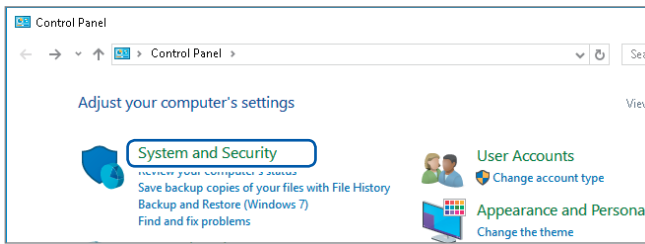

4 Click **[System and Security]** on **[Control Panel]**.



5 Click **[Administrative Tools]**.

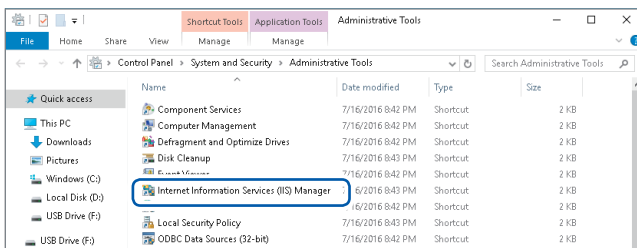

6 Double-click **[Internet Information Services (IIS) Manager]**.

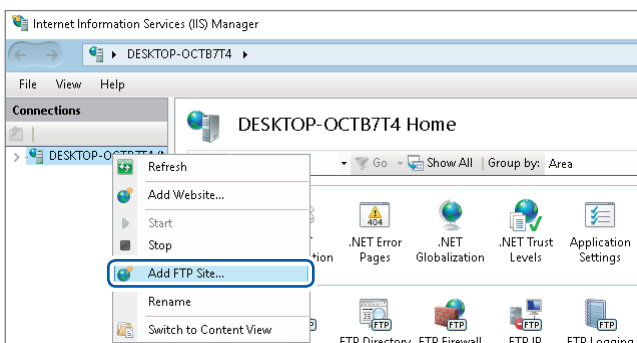

7 Right-click on the item displayed under **[Connections]** on the left side of the screen, then click **[Add FTP Site]**.

Communication may be blocked depending on the settings of the computer-protecting software (example: firewall).

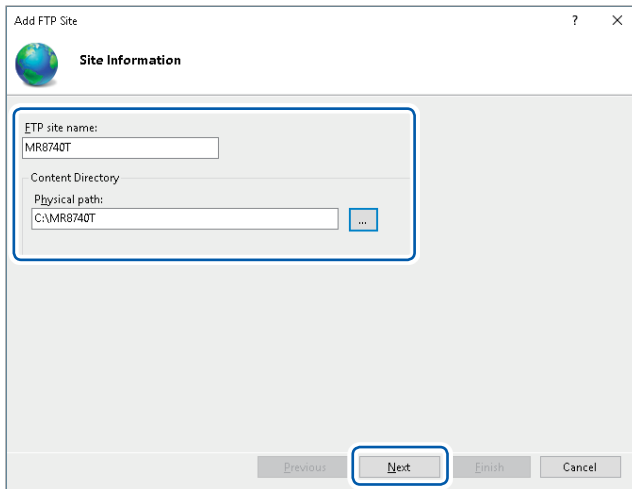

**8 Enter site information.**

Example:

**[FTP site name]: [MR8740T]**

**[Content Directory]:**

Choose a directory in which data from the FTP client will be saved.

Click **[Next]**.

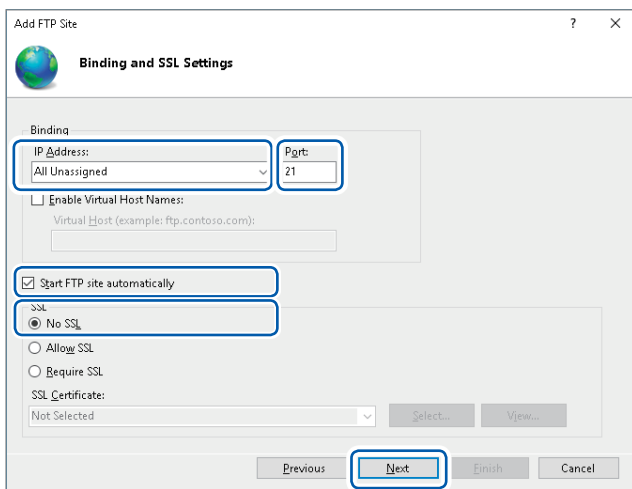

**9 Configure the [Binding] and [SSL] settings as follows:**

<b>[IP Address]</b>	<b>[All Unassigned]</b>
<b>[Port]</b>	<b>[21]</b>
<b>[Start FTP site automatically]</b>	Select
<b>[SSL]</b>	<b>[No SSL]</b>

Click **[Next]**.

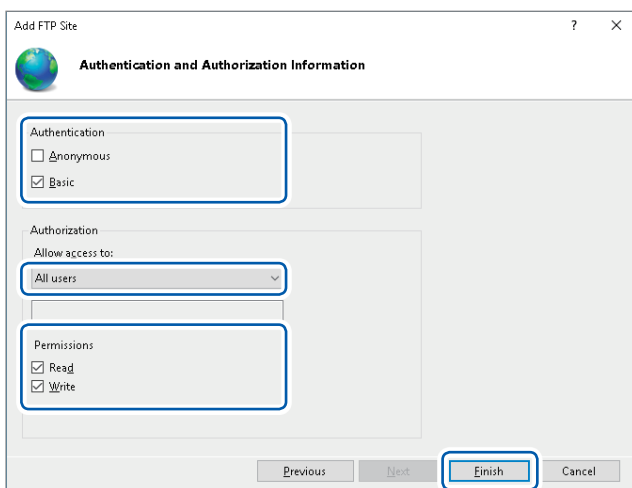

**10 Configure the [Authentication and Authorization Information] settings as follows:**

<b>[Authentication]</b>	Select <b>[Basic]</b> .
<b>[Authorization]</b>	<b>[All users]</b>
<b>[Permissions]</b>	Choose both <b>[Read]</b> and <b>[Write]</b> .

Click **[Finish]**.

### Configure the access user setting

Configure this setting to use the FTP client with the instrument. (See step 4 “Enter your login name and password in the [Login] and [Password] boxes, respectively” on p. 213.)

You can use the FTP with a user name and password you specified.

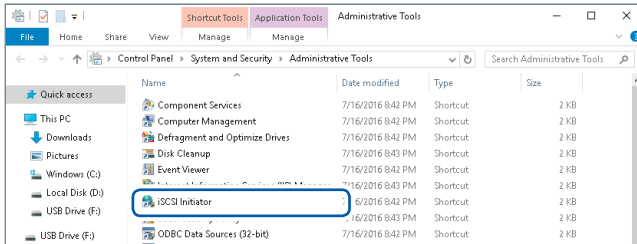

**11** Choose **[Computer Management]** in **[Administrative Tools]** mentioned in step **5** (p. 210).

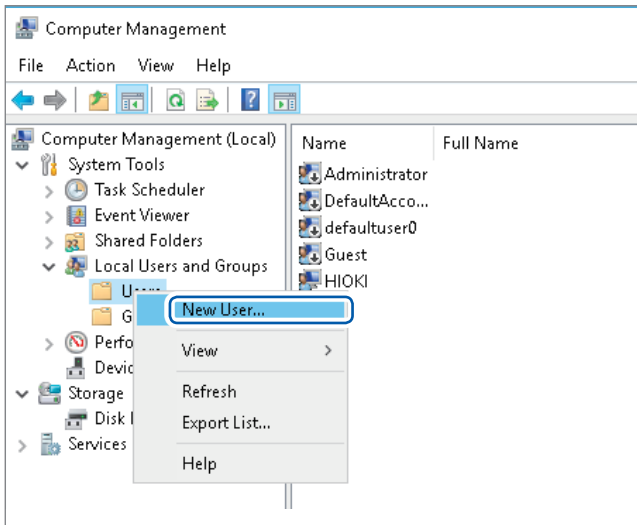

**12** Right-click **[Users]** under **[Local Users and Groups]**, then choose **[New User]**.

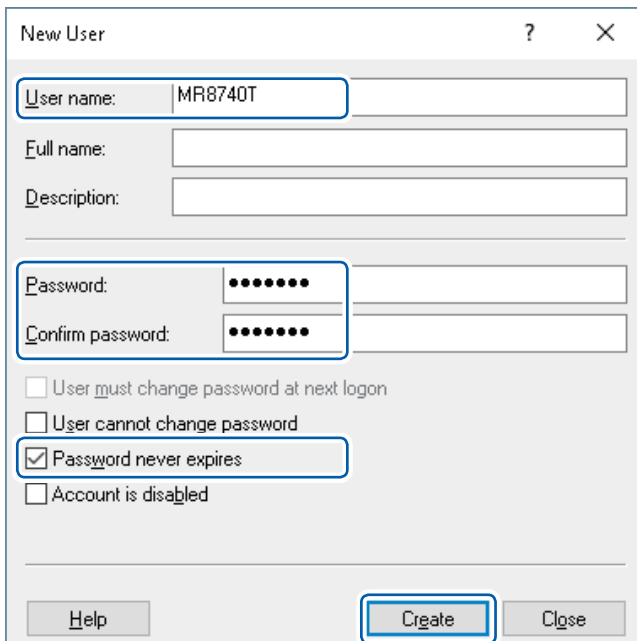

**13** Enter your user name, password, and the same password entered in the **[User name]**, **[Password]**, and **[Confirm password]** boxes, respectively, then select the **[Password never expires]** check box.

**14** Click **[Create]**.

## Configuring the FTP client setting with the instrument

 > [System] > [Comm.]

### 1 Click [FTP Client].

The setting dialog box will appear.

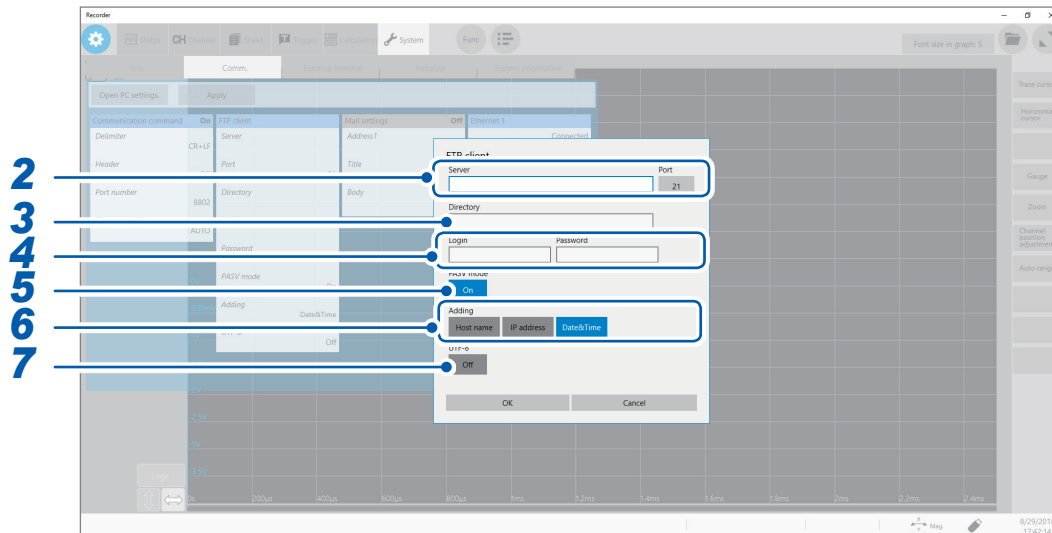

### 2 Click the [Server] box and the [Port] button in turn.

Click the boxes to open the touch key or the numeric input dialog box.

Enter a computer name or an IP address in the [Server] box. In the [Port] box, enter a port number with which the FTP server is operating if the number is not the standard number of 21.

### 3 Enter a directory name in the [Directory] box.

Choose a directory of the FTP server you would like to save data into.

### 4 Enter a login name and password to use for logging in to the FTP server in the [Login] and [Password] box, respectively.

Enter the user name and password specified for the FTP server of the computer. Refer to “Configure the access user setting” (p. 212).

### 5 Click the [PASV Mode].button to choose a PASV mode setting.

To establish communications in PASV mode, set it to [On].

### 6 Click any of the buttons in the [Adding] area, and choose an identifier.

Click the buttons to add identifiers to the file name.

- No identifiers are added when you select a file to be sent on the file screen. Files with the same name are overwritten.
- When you have configured the setting to append numerical calculation results to existing files (when you set the [Calculation result] button to [On] or choose [Append] in the [File] box), no identifiers representing time of day are added.
- Moreover, if a file with the same name exists, the instrument tries to append the file.
- No button in the [Adding] area is enabled, a file with the same name is overwritten when it exists. Note that all files with the same name will be overwritten if [Date&Time] is disabled with the continuous measurement setting and some others.

### 7 Click the [UTF-8] button to choose an UFT-8 support setting.

## 11.4 Sending Email messages

The instrument is equipped with the email transmission function. You can send email messages to computers in the network or to those installed in remote locations via the SMTP server. Moreover, you can install the instrument in a remote location and collect measured data through an email attachment.

### How to send email messages

Auto-save email message	Automatically sends an email message with data saved on completion of measurement attached, according to the auto-save settings. Set <b>[Auto save settings]</b> to <b>[On]</b> and choose <b>[Mail]</b> in the <b>[Media]</b> box in advance. (p. 102)
Manual email transmission with the save icon	When you click the save icon, an email with the data saved attached is automatically sent. Set the <b>[Media]</b> box of the manual save setting to <b>[Mail]</b> in advance.
Test email message	Checks if an email message is successfully sent.

### Encryption of email attachments

You can encrypt email attachments, such as screen data and measured data, to prevent it from getting into outsiders.

- If transmission conditions are frequently satisfied, email messages will frequently be sent.
- Data size of an email attachment may get extremely large. Depending on the communication environment, an email message cannot correctly be sent if the size is extremely large.
- Email attachment data is encrypted in ZIP format by WinZip 128-bit AE-2 / AES encryption. Encrypted files can be unzipped by Corel WinZip or free software such as 7z. (The WinZip AES encryption is much securer than the standard zip encryption; however, supporting software is limited. The built-in ZIP feature of Microsoft® Windows® cannot unzip encrypted files in this format.)
- Files are encrypted by 128-bit AES encryption. Presently, this encryption method is sufficiently strong; however, Hioki does not guarantee that files are never decrypted.
- Do not reveal your encryption password to outsiders. Note that you cannot decrypt any files if you forget your password or enter an invalid password.
- When you have set or changed the password, send a test email message first to check whether you can unzip an attachment before actual use.
- Encrypted ZIP files are not compressed.
- When files are encrypted and zipped, sending email messages require a long time due to conversion time.
- The instrument supports pop-before-smtp and smtp-auth (PLAIN, LOGIN, CRAM-MD5) as the SMTP authentication (since the instrument does not support IMAP, SSL, or STARTTLS, you cannot send email messages to some mail servers, such as Gmail).
- We cannot guarantee transmission to all SMTP servers due to differences among servers.
- AES is the encryption standard specified in the U.S. Federal Information Processing Standard (FIPS) PUB 197.
- The instrument have no email reception function but the transmission function.
- You cannot load any compressed and encrypted data as it is on the instrument or on the Wave Viewer (Wv).

\*: Trademark of another company



## Configuring the basic setting for sending email messages

 > [System] > [Comm.]

### 1 Click [Mail setting].

The setting dialog box will appear.

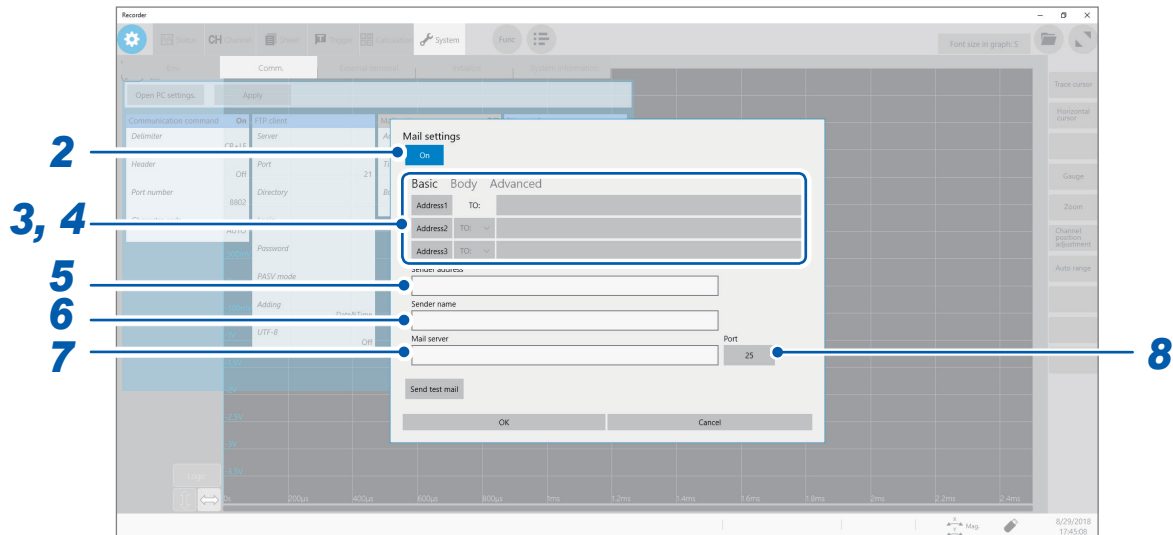

### 2 Click the [Mail settings] button to set it to [On].

### 3 Click [Basic].

### 4 Click [Address1] to choose it, and then enter an email address in the blank box.

To send email messages to multiple destinations, enter other email addresses in the [Address2] and [Address3] boxes in the same manner.

Choose a recipient type ([To] or [Bcc]) for [Address2] and [Address3].

### 5 Enter a sender address in [Sender address].

### 6 Click the [Sender name] box, and then enter a name so that the recipients identify email messages received from the instrument.

### 7 Click the [Server] and [Port] boxes in turn, and then enter a computer name or computer address, respectively.

### 8 (When the SMTP server is operating with the number other than the standard number, 25.)

Click [Port] button, and then enter a port number.

## Configuring the email contents settings

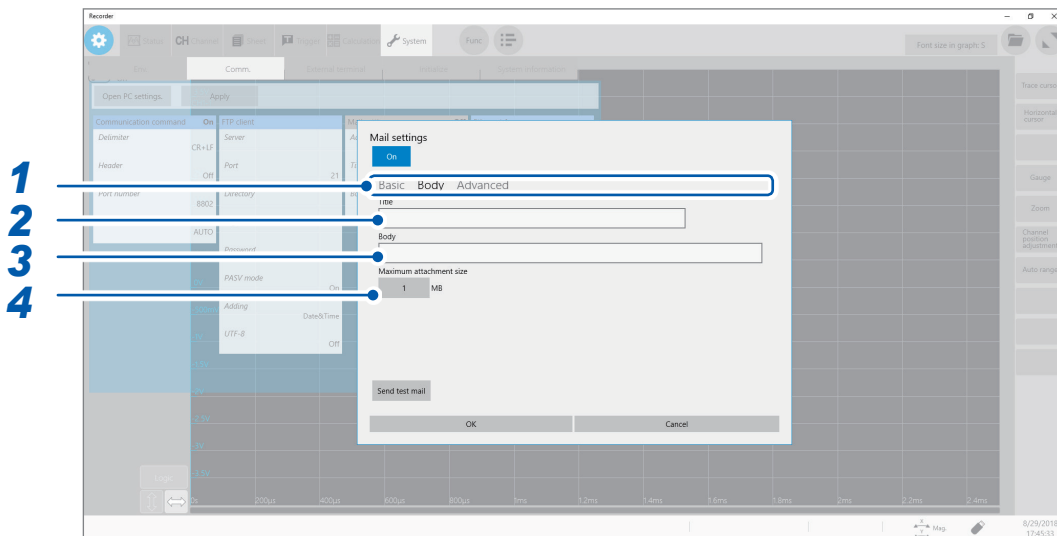

- 1** Click **[Body]**.
- 2** Click the **[Title]** box, and then enter a mail title.
- 3** Click the **[Body]** box, and then enter an email body.
- 4** Click the **[Maximum attachment size]** button, and then enter the maximum attachment size.

1 ▢ to 2048

Specify the maximum file size so that no large-size data is sent to the mail server. If a waveform data size automatically saved is larger than the specified size, the instrument does not send email messages.

- Data with the specified file size or less may also not be sent due to server restrictions.
- Data is converted (encoded by Base64, compressed, and encrypted) for attachment; however, the maximum file size is determined by the size before conversion. Thus, the actually sent data may be larger (about 1.3 times) than the size limitation.

# Configuring the authentication, compression, and encryption settings for email messages to be sent

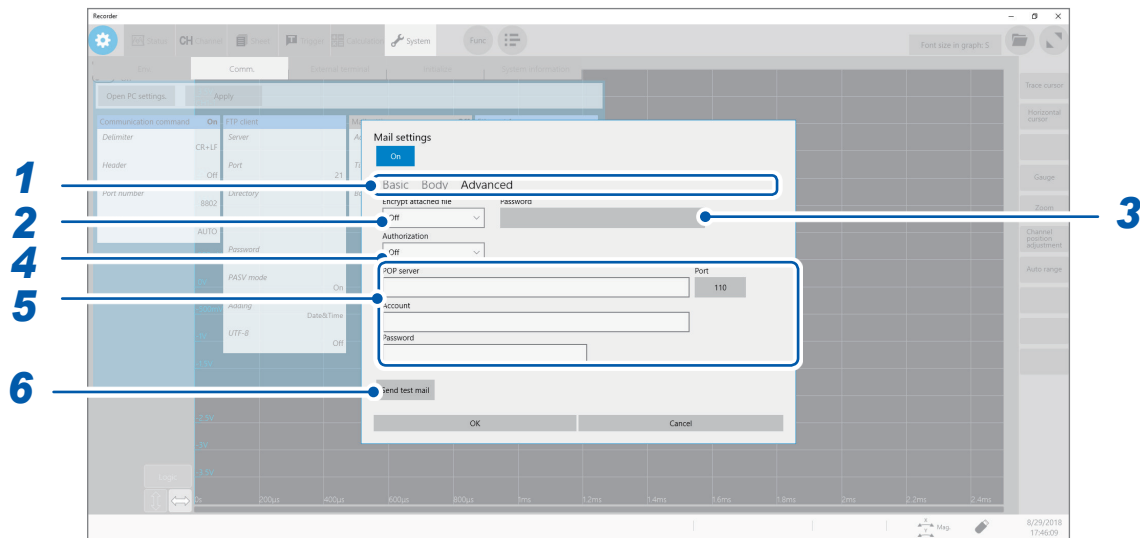

- 1 Click **[Advanced]**.
- 2 Click the **[Encrypt attached file]** box, and then choose an attachment setting from the list.

<b>Off</b> <input type="checkbox"/>	Attaches files in original format.
<b>ZIP</b>	Attaches ZIP-compressed files.
<b>ZIP+AES</b>	Attaches files in encrypted ZIP format. The instrument does not compress files.

- 3 (To encrypt attachments)  
Enter an encryption password in the **[Password]** box.  
Number of characters: up to 16

- 4 (When an email authentication is required)  
Click the **[Authentication]** box, and then choose a authentication protocol from the list.

<b>Off</b> <input type="checkbox"/>	Sends mails with no user authentication.
<b>POP</b>	Sends mails using POP (APOP) before SMTP.
<b>SMTP</b>	Sends mails using SMTP (supports CRAM-MD5, PLAIN, and LOGIN).

- 5 **Configure the authorization information settings.**

- When you use the POP authentication  
Click the **[POP server]** box and the **[Port]** button in turn, and then enter a POP server name and its port number, respectively.  
When the **[POP server]** is left blank, the instrument uses the figure entered in the **[Mail server]** box.  
Click the **[Account]** and **[Password]** boxes in turn, and then enter an authentication user name and password, respectively.
- When you use the SMTP authentication  
Click the **[POP server]** box and the **[Port]** button in turn, and then enter a POP server name and its port number, respectively.  
Click the **[Account]** and **[Password]** boxes in turn, and then enter an authentication user name and password, respectively.

## **6 Make sure that the email can normally be sent.**

Click [\[Send test mail\]](#).

A test email that includes the specified contents is sent.

Make sure that the specified destination can correctly receive the test email message. If the specified destination cannot receive the test email message, review your settings.

If encryption is enabled for the attached file, images in the test email are encrypted.

Be sure to decompress the attachment to check whether the password is correctly set.

## 11.5 Controlling the Instrument with Command Communications (LAN)

You can externally control the instrument using commands via the communication interface. Communications can be established with a LAN connection.

For details, refer to the Communication Command Instruction Manual on the accompanying application disc.

Configure the LAN settings and connect the instrument before using the command communications. Refer to “11.1 Configuring the LAN Settings and Connecting the Instrument to the Network” (p. 200).

 > [System] > [Comm.]

### 1 Click [Communication command].

The setting dialog box will appear.

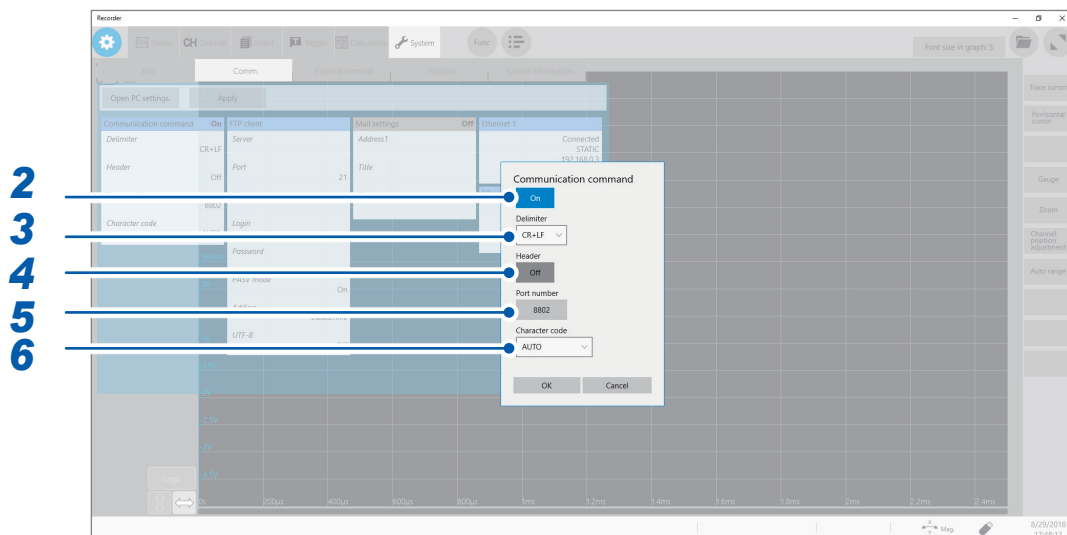

### 2 Click the [Communication command] button to set it to [On].

### 3 Click the [Delimiter] box, and then choose a character code (line feed code) that represents the data delimiter.

<b>CR+LF</b> <sup>☑</sup>	Sends the character codes 0x0d and 0x0a.
<b>LF</b>	Sends the character code 0x0a.

### 4 Click the [Header] to choose whether to prefix a header to command responses.

<b>Off</b> <sup>☑</sup>	Does not prefix any header to response data.
<b>On</b>	Prefixes a header to response data.

- 5** Click **[Port number]** box, and then enter the port number ranging from 1002 to 49002.  
The last digit is fixed at **[2]**.

- 6** Click the **[Character code]** box, and then choose a character code setting from the list.

<b>AUTO</b> <input type="checkbox"/>	Automatically specifies a text code depending on the display language. The text code UTF-8 is set for English; SJIS for Japanese.
<b>SJIS</b>	Sets the character code to SJIS.
<b>UTF-8</b>	Sets the character code to UTF-8.

Using a 4K-resolution monitor with the maximum resolution set may require longer time for processing command communication.

## 11.6 Operating the Instrument With a Browser Installed in a Computer

You can configure the instrument settings, display waveforms, and acquire data from a computer with a web browser, such as Internet Explorer®, installed in the instrument or your computer. Internet Explorer® Version 8 or later is recommended.

Such web browser allows you to configure settings of the instrument and modules. You can also configure settings of MR8790 Waveform Generator Unit, MR8791 Pulse Generator Unit, and Model U8794 VIR Generator Unit using the instrument.

 > [System] > [Comm.]

### 1 Start a web browser.

When using the web browser installed in the instrument

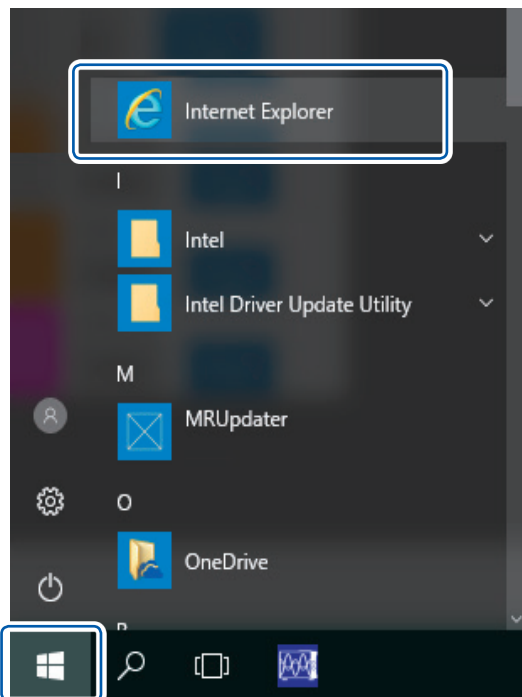

Click the start button on the bottom-left corner, and then click **[Internet Explorer]** in the menu.

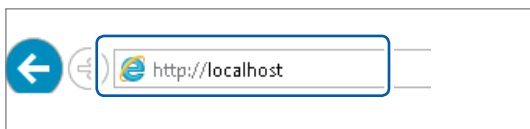

Enter **[http://localhost]** in the address bar.

### When connecting your computer to the instrument using a web browser

The following example describes how to connect your computer to the instrument with Internet Explorer®.

- (1) Click the start button on the bottom-left corner of the computer screen, and then click **[Internet Explorer]** in the menu.
- (2) Enter the character string **[http://]** followed by the IP address or the computer name in the address bar

**When the IP address of the instrument is “192.168.0.2”**

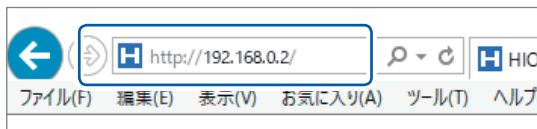

**2 Configure settings of the instrument using the web browser**

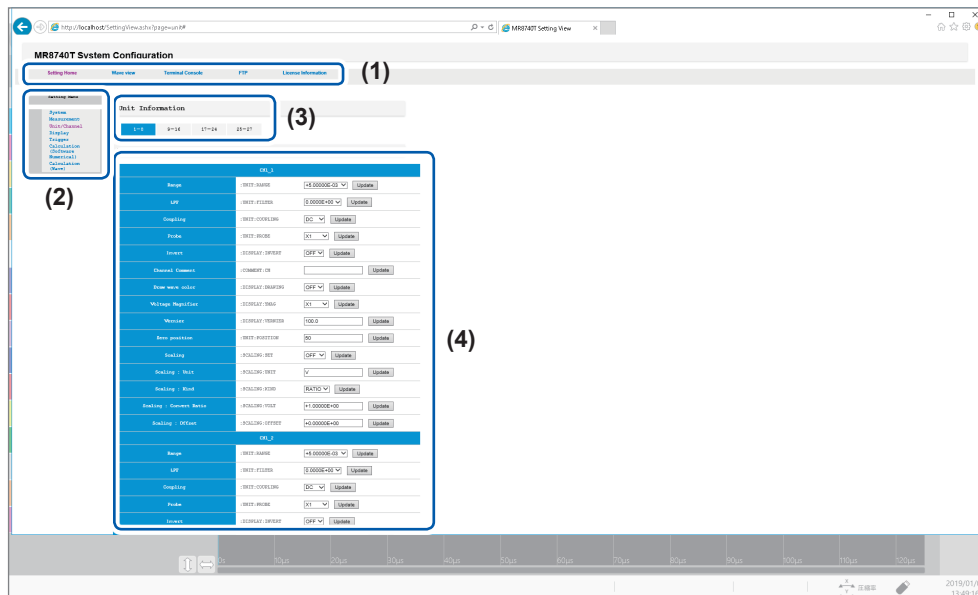

(1) Web browser menu

<b>Setting Home</b>	Allows you to configure settings of the instrument
<b>Wave view</b>	Displays measured waveforms (cannot display waveforms during measurement)
<b>Terminal Console</b>	Allows you enter commands. (You can directly enter communication commands.)
<b>FTP</b>	Acquires the FTP information and data written in the memory of the instrument.
<b>License Information</b>	Acquires the license information.

(2) Various settings of the instrument

<b>System</b>	Allows you to configure the system settings
<b>Measurement</b>	Allows you to set measurement conditions (such as the sampling rate and recording length).
<b>Unit/Channel</b>	Allows you to configure settings of modules and channels (such as measurement range).
<b>Display</b>	Allows you to configure the screen display settings.
<b>Trigger</b>	Allows you to configure the trigger settings.
<b>Calculation (Software Numerical)</b>	Allows you to configure the numerical calculation settings.
<b>Calculation (Wave)</b>	Allows you to configure the waveform calculation settings.

(3) Choosing slots (With the Unit/Channel setting enabled)

You can switch slots.

(4) Detailed settings

You can configure advanced settings the instrument.



# Externally Controlling the Instrument

Familiarize yourself with the section “Before connecting to an external device” in “Operation Precautions” of Quick Start Manual.

Connecting the external control terminals with external devices allows the instrument to start and stop measurement.

This section describes the procedure and the external control terminal function to externally control the instrument.

The terminals are referred to collectively as “external control terminals.”

For more information on how to connect the instrument to computers, refer to “2.3 Connecting the External Control Terminals” in Quick Start Manual.

# 12.1 External Input and Output

## External input (IN1), (IN2)

Externally inputting signals can start and stop measurement as well as save data. In factory default settings, the START signal is assigned to the IN1, and the STOP signal to the IN2 terminal.

### How to input signals

- 1 Connect each of the IN1, IN2, and GND terminals to an external signal-outputting device with wires.

Refer to “2.3 Connecting the External Control Terminals” in Quick Start Manual.

- 2  > [System] > [External terminal]

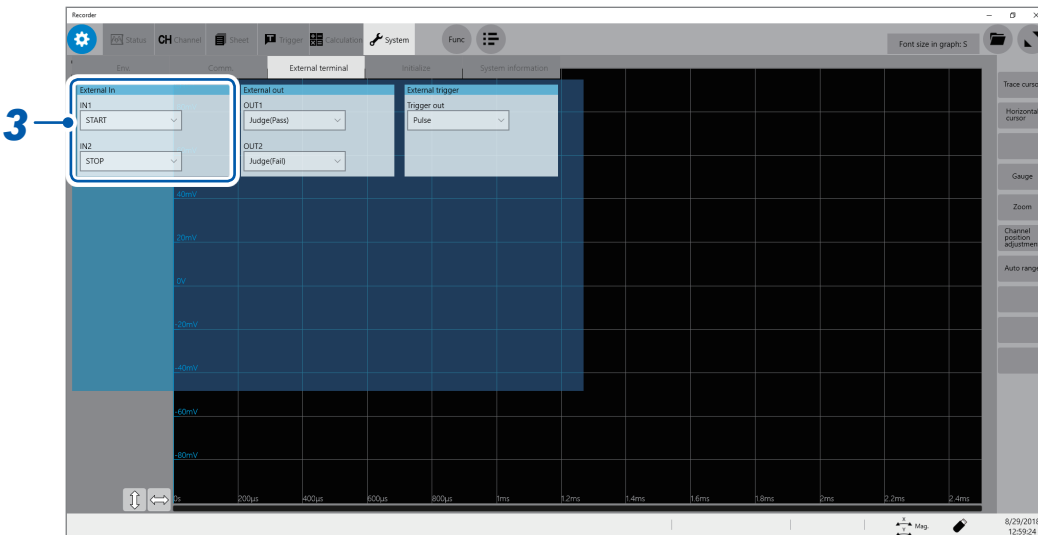

- 3 Click the [IN1] and [IN2] boxes in the [External In] area in turn, and then from the list, choose an action performed when an input signal is inputted.

<b>START</b>	Starts a measurement.
<b>STOP</b>	Stops the measurement (post-measurement processes such as numerical calculations and automatic saving are performed).
<b>START/STOP</b>	Starts a measurement when the low-level signal is inputted; stops the measurement when the high-level signal is inputted.
<b>SAVE</b>	Saves data on the specified conditions into a storage device that is specified in ([Status] > [Save] > [Save Icon operation] >) [Quick].
<b>ABORT</b>	Forcibly terminates the measurement. (No post-measurement processes such as numerical calculations or automatic saving are performed. However, the instrument automatically saves a waveform file that contains data acquired until the forcible termination)
<b>EVENT</b>	Puts on an event mark. The event marks are put on the waveform screen. You can put event marks by clicking the start icon during a measurement.

**4** Connect the terminal to GND.

Otherwise, input pulse waves or rectangular waves to the terminal. The signal shall have a high-level voltage of between 2.5 V and 10 V and a low-level voltage of between 0 V and 0.8 V. The low level of the input waveform activate the input circuit, controlling the instrument.

Available voltage range	High level: 2.5 V to 10 V; low level: 0 V to 0.8 V
Pulse width	High-level period: 50 ms or more; low-level period: 50 ms or more
Pulse interval	200 ms or more
Maximum input voltage	10 V DC

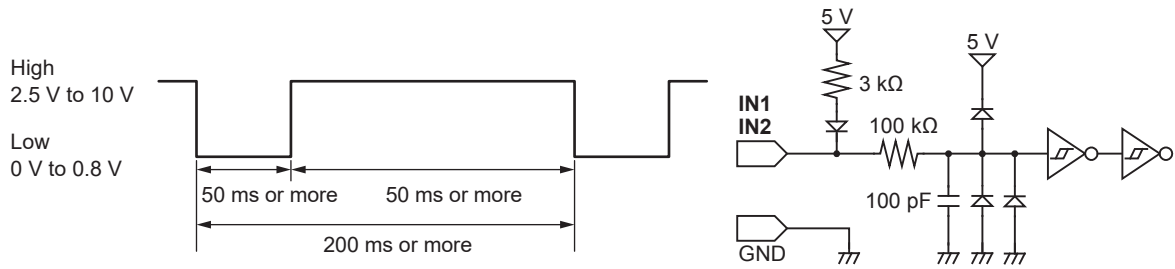

**External output (OUT1), (OUT2)**

The instrument can output various signals depending on its state.

**How to output signals**

- 1 Connect each of the OUT1, OUT2, and GND terminals to an external signal-inputting device with wires.

Refer to “2.3 Connecting the External Control Terminals” in Quick Start Manual.

- 2 > [System] > [External terminal]

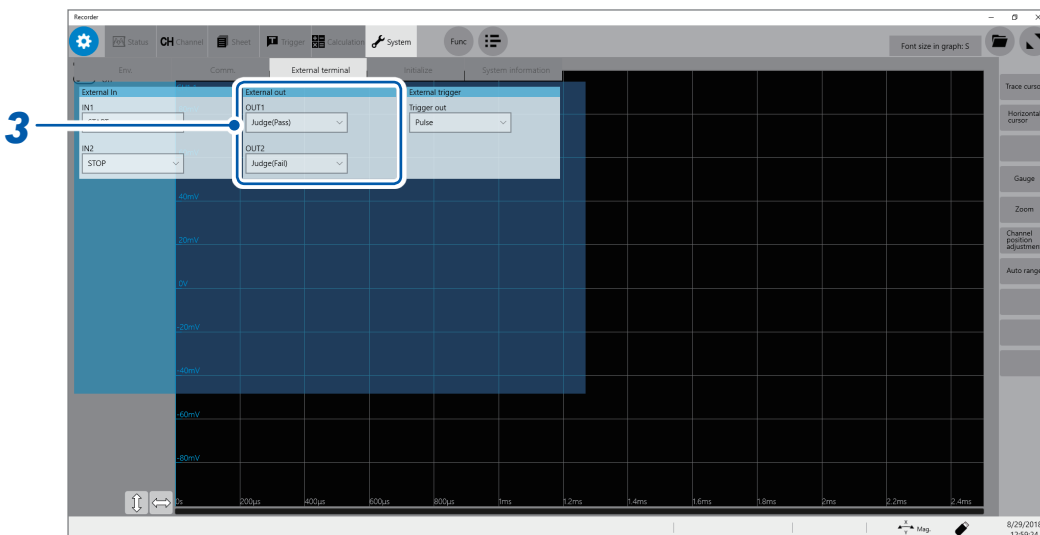

**3** Click the [OUT1] and [OUT2] boxes in the [External out] area in turn, and then from the list, choose a signal output action.

Choose a condition where the instrument outputs a signal.

<b>Judge(Pass)</b>	Outputs a low-level signal when a pass judgment is given for the numerical calculation result.
<b>Judge(Fail)</b>	Outputs a low-level signal when a fail judgment is given for the numerical calculation result.
<b>Error</b>	Outputs a low-level signal when an error occurs.
<b>Busy</b>	Outputs a low-level signal while rejecting a START signal because the instrument is in the busy state such as performing a measurement and saving data.
<b>Waiting trigger</b>	Outputs a low-level signal while waiting for a trigger.

The instrument continuously outputs the signal for a pass/fail judgment (low-level output) until it starts the next measurement.

The instrument can output various signals depending on its state.

Output signal	Open-drain output (with voltage output), active low
Output voltage range	High level: 4.0 V to 5.0 V Low level: 0 V to 0.5 V
Maximum input voltage	50 V DC, 50 mA, 200 mW

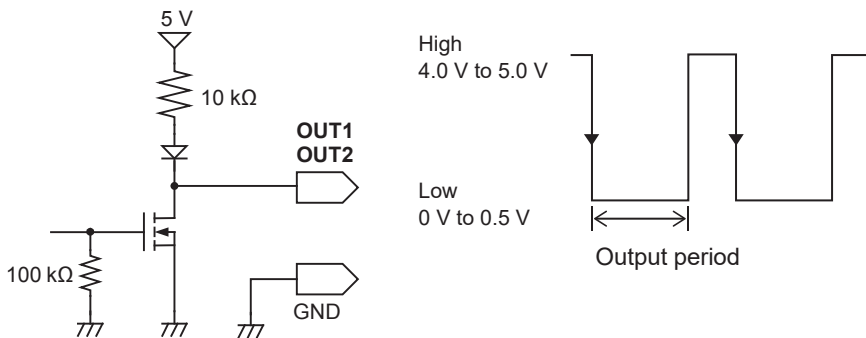

## Trigger output (TRIG.OUT)

The instrument outputs the signal when it is triggered. You can use this signal to control multiple instruments, achieving synchronous operation.

### How to output the signal

- 1 Connect each of the TRIG OUT and GND terminals to an external signal-inputting device with wires.

Refer to “2.3 Connecting the External Control Terminals” in Quick Start Manual.

- 2  > [System] > [External terminal]

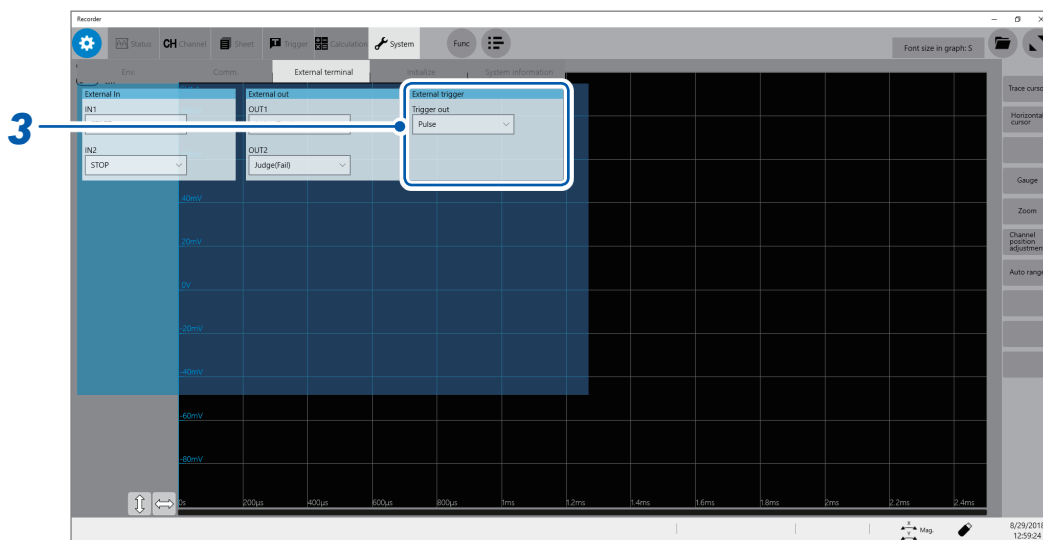

- 3 In the [External trigger] area, click the [Trigger out] box, and then from the list, choose a signal output method.

<b>Pulse</b> <input checked="" type="checkbox"/>	Outputs a low-level signal, and then switches it to the high level after the specified time has elapsed.
<b>Level at time</b>	Continuously outputs a low-level signal after triggered during the measurement.

When triggered, the instrument outputs a pulse wave, which switches from the high level (4.0 V to 5.0 V) to the low level (0 V to 0.5 V).

Output signal	Open-drain output (with voltage output), active low*
Output voltage range	High level: 4.0 V to 5.0 V Low level: 0 V to 0.5 V
Pulse width	With the pulse setting: 2 ms ±1 ms When the level setting: (Sampling rate) × (Number of data points after trigger) or longer
Maximum input voltage	50 V DC, 50 mA, 200 mW

\*: The instrument is triggered when the signal voltage level switches from the high level to the low level.

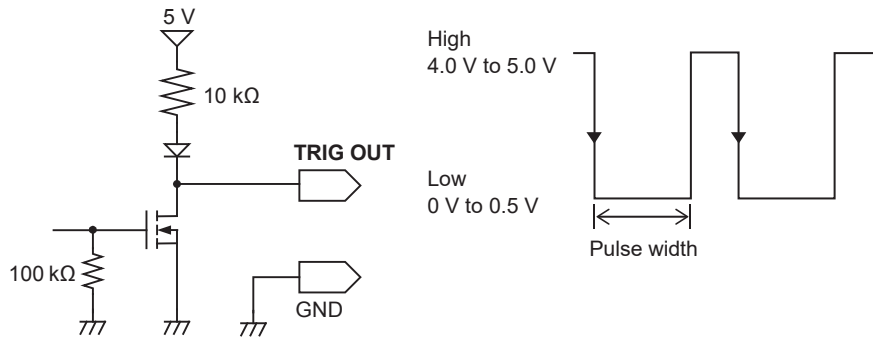

When the auto-range function is used, the instrument is triggered, outputting the TRIG OUT signal. Be careful when performing auto-range measurement while using the TRIG OUT signals.

## External trigger terminal (EXT.TRIG)

Externally inputting the trigger signal can trigger the instrument. You can use this signal to control multiple instruments, achieving synchronous operation.

### How to an input signal

- 1 Connect each of the EXT.TRIG and GND terminals to an external signal-outputting device with wires.  
Refer to “2.3 Connecting the External Control Terminals” in Quick Start Manual.
- 2  > [Trigger] > [Common]
- 3 Click the [Trigger] button to set it to [On].

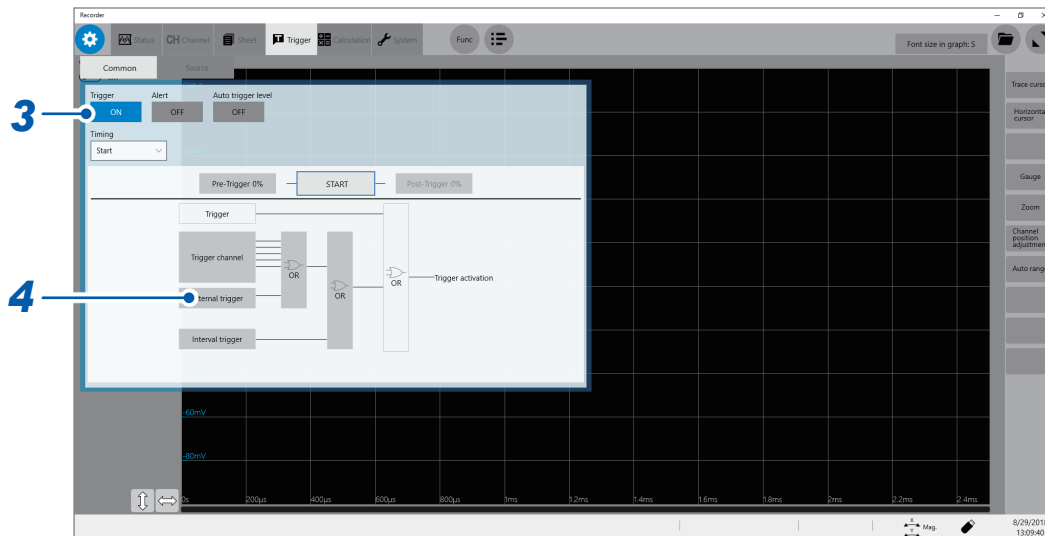

**4** Click **[External trigger]**.

The setting dialog box will appear.

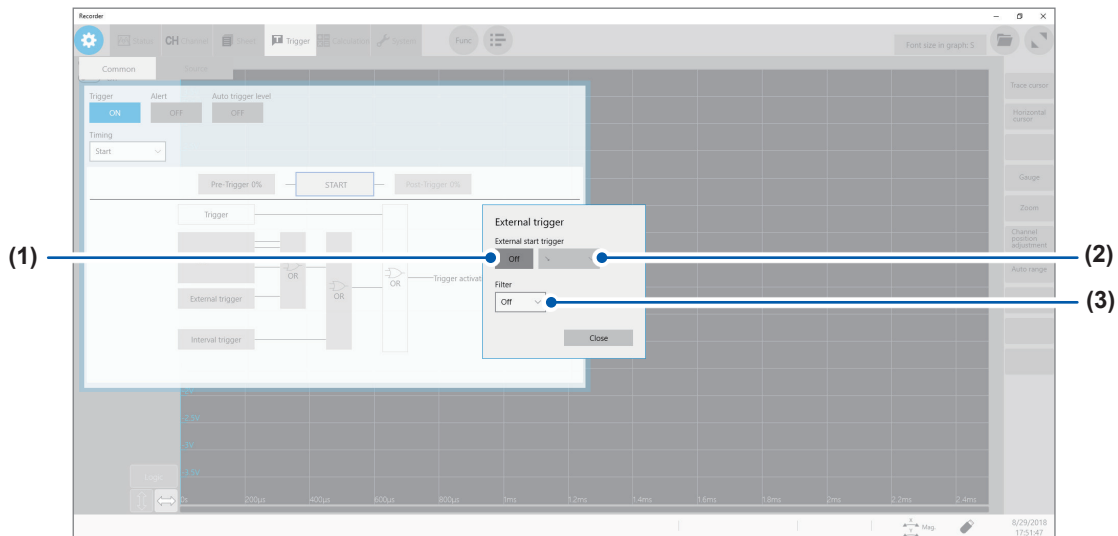

- (1) Set **[External start trigger]** to **[On]**.
- (2) Click the box to the right of the **[External start trigger]** box, and then from the list, choose which direction to use for reception of the external trigger.  
 With the rising edge setting: **[↗]\***  
 With the falling edge setting: **[↘]\***
- (3) Click the **[Filter]** box, and then choose a filter setting from the list.

**5** Connect the EXT.TRIG terminal and GND, or input the pulse waves or rectangular waves to the EXT.TRIG terminal. The signal shall have a high-level voltage of between 2.5 V and 10 V and a low-level voltage of between 0 V and 0.8 V.

The instrument accepts the external trigger on the rising or falling edge of the input waveform.

Available voltage range	High level: 2.5 V to 10 V; low level: 0 V to 0.8 V	
Pulse width	Whit the filter disabled	High level: 1 ms or more; Low level: 2 μs or more
	With the filter enabled	High and low level: 2.5 ms or more
Maximum input voltage	10 V DC	

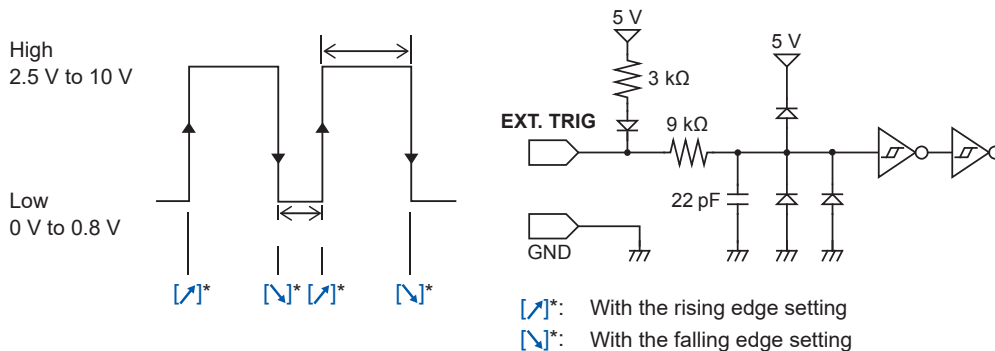

\*: When the trigger logical-condition is set to **[AND]**, **[High]** or **[Low]** is displayed.



## 12.2 External Sampling (EXT.SMPL)

Externally inputting the signal can control the sampling rate.

### How to an input signal

- 1 Connect each of the EXT.SMPL and GND terminals to an external signal-outputting device with wires.
- 2  > [Status] > [Condition]
- 3 Click the [External sampling] button to set it to [On].
- 4 Click the box to the right of the [External sampling] box, and then from the list, choose which direction to use for reception of the external sampling signal.
  - With the rising edge setting: [↑]
  - With the falling edge setting: [↓]
- 5 Input pulse waves or rectangular waves to the EXT.SMPL terminal. The signal shall have a high-level voltage of between 2.5 V and 10 V and a low-level voltage of between 0 V and 0.8 V.

Available voltage range	High level: 2.5 V to 10 V; low level: 0 V to 0.8 V
Pulse width	High and low level: 50 ns or more
Response frequency	10 MHz or less
Maximum input voltage	10 V DC

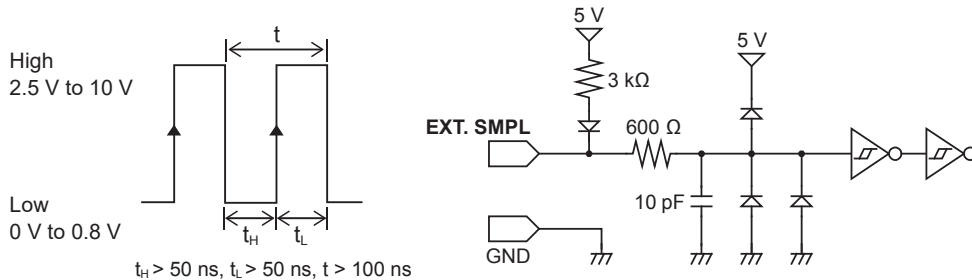

- If a sampling signal with 5 MHz or more is inputted, trigger points are delayed by one sample.
- When Model 8968 High Resolution Unit is used, the anti-aliasing filter ( > [Channel] > [each Unit] > [A.A.F.]) setting of [On] is invalid.



# 13 Appendix

## 13.1 Information for Reference Purposes

### Waveform file size (values for reference purposes)

#### Waveform file size (for reference)

<p><b>(MEM file size) = (Setting part size) + (Data part size)</b>          (Setting part size) = <math>791040 + 512 \times [(\text{Number of analog channels}) + 4 \times (\text{Number of logic channels}) + (\text{Number of real-time calculation channels})]</math>          (Data part size) = <math>\{2 \times [(\text{Number of analog channels other than Model MR8990 or U8991}) + (\text{Number of logic modules})] + 4 \times [(\text{Number of channels of Models MR8990 and U8991}) + (\text{Number of real-time calculation channels})]\} \times (\text{Number of data sets})</math></p>
---

Recording length (Points)	Number of channels saved					
	4	8	16	32	54	108
2.5 k	815 KB	839 KB	887 KB	983 KB	1.1 MB	1.4 MB
5 k	835 KB	879 KB	967 KB	1.1 MB	1.4 M	2.0 MB
10 k	875 KB	959 KB	1.1 MB	1.5 MB	2.0 MB	3.0 MB
20 k	955 KB	1.1 MB	1.4 MB	2.1 MB	3.0 MB	5.2 MB
50 k	1.2 MB	1.6 MB	2.4 MB	4.0 MB	6.2 MB	11.7 MB
100 k	1.6 MB	2.4 MB	4.0 MB	7.2 MB	11.6 MB	22.5 MB
200 k	2.4 MB	4.0 MB	7.2 MB	13.6 MB	22.4 MB	44.1 MB
500 k	4.8 MB	8.8 MB	16.8 MB	32.8 MB	54.8 MB	108.9 MB
1 M	8.8 MB	16.8 MB	32.8 MB	64.8 MB	108.8 MB	216.9 MB
2 M	16.8 MB	32.8 MB	64.8 MB	128.8 MB	216.8 MB	432.9 MB
5 M	40.8 MB	80.8 MB	160.8 MB	320.8 MB	540.8 MB	1.1 GB
10 M	80.8 MB	160.8 MB	320.8 MB	640.8 MB	1.1 GB	–

- These sizes, which can be used only as a reference, of text files are acquired when analog channels (other than Model MR8990 or Model U8991) are used. Any number of logic channels on one module occupies one channel; one analog channel (Model MR8990 and Model U8991) occupies two channels each.
- The instrument divides files with a size that exceeds 512 MB into multiple files of about 512 MB each to save them.

**Waveform (text) file size**

**(Text file size) = (Header part size) + (Data part size)**

(Header part size) = (About 14 KB at a maximum) (varies depending on the setting condition)

(Data part size) = [24 + 14 × (Number of analog channels) + 32 × (Number of logic modules) + 14 × (Number of real-time calculation channels)] × (Number of data points)

Recording length (Points)	Number of channels saved					
	4	8	16	32	54	108
2.5 k	214 KB	354 KB	634 KB	1.2 MB	2.0 MB	3.9 MB
5 k	414 KB	694 KB	1.3 MB	2.4 MB	3.9 MB	7.7 MB
10 k	814 KB	1.4 MB	2.5 MB	4.7 MB	7.8 MB	15.4 MB
20 k	1.6 MB	2.7 MB	5.0 MB	9.5 MB	15.6 MB	30.7 MB
50 k	4.0 MB	6.8 MB	12.4 MB	23.6 MB	39.0 MB	76.8 MB
100 k	8.0 MB	13.6 MB	24.8 MB	47.2 MB	78.0 MB	153.6 MB
200 k	16.0 MB	27.2 MB	50.0 MB	94.4 MB	156.0 MB	307.2 MB
500 k	40.0 MB	68.0 MB	124.0 MB	236.0 MB	390.0 MB	768.0 MB
1 M	80.0 MB	136.0 MB	248.0 MB	472.0 MB	780.0 MB	1.54 GB
2 M	160.0 MB	272.0 MB	496.0 MB	944.0 MB	1.56 GB	3.07 GB
5 M	400.0 MB	680.0 MB	1.24 GB	2.36 GB	3.90 GB	7.68 GB
10 M	800.0 MB	1.36 GB	2.48 GB	4.72 GB	7.80 GB	–

- These sizes, which can be used only as a reference, of text files are acquired when analog channels (other than Model MR8990 or Model U8991) are used.
- Depending on the setting conditions, the size may slightly differ from those provided in the above table. Allow 20% of the size provided in the above table for margin.
- The instrument divides files with a size that exceeds 512 MB into multiple files of about 512 MB each to save them.

## Maximum recordable time when the real-time save is enabled (values for reference purposes)

The maximum recordable time is expressed in the following equation.

$$(\text{Maximum recordable time}) = [(\text{Recording capacity}) \times (\text{Sampling time})] \div [(\text{Number of channels used}) \times 2]$$

$$(\text{Number of channels used}) = [(\text{Number of analog channels other than Model MR8990}) + (\text{Number of logic modules}) + (\text{Number of Model MR8990 channels})] \times 2 + (\text{Number of real-time calculation channels}) \times 2$$

The maximum recordable times for saving data to each storage device are shown in the following table (assume that each storage device is empty). Since no capacity of the header of a waveform file is included, use about 90% of the recordable time provided in the table as a reference. Some conditions allow a long-term recordable time (one year or more, shaded areas in the tables) to be set; however, the operation cannot be guaranteed because the warranty period or product life may disturb it.

### For saving data on the built-in SSD

d: days, h: hours, min: minutes, s: seconds

Sampling rate	Number of channels used			
	4 (16 channels)	8 (32 channels)	16 (64 channels)	27 (108 channels)
5 MS/s*	50 min 00 s	–	–	–
2 MS/s	2 h 5 min 00 s	1 h 2 min 00 s	–	–
1 MS/s	4 h 10 min 00 s	2 h 5 min 00 s	1 h 2 min 30 s	–
500 kS/s	8 h 20 min 00 s	4 h 10 min 00 s	2 h 5 min 00 s	1 h 2 min 30 s
200 kS/s	20 h 50 min 00 s	10 h 25 min 00 s	5 h 12 min 30 s	2 h 36 min 15 s
100 kS/s	1 d 17 h 40 min 00 s	20 h 50 min 00 s	10 h 25 min 00 s	5 h 12 min 30 s
50 kS/s	3 d 10 h 20 min 00 s	1 d 17 h 40 min 00 s	20 h 50 min 00 s	10 h 25 min 00 s
20 kS/s	8 d 16 h 20 min 00 s	4 d 8 h 10 min 00 s	2 d 4 h 5 min 00 s	1 d 2 h 2 min 30 s
10 kS/s	17 d 8 h 40 min 00 s	8 d 16 h 20 min 00 s	4 d 8 h 10 min 00 s	2 d 4 h 5 min 00 s
5 kS/s	34 d 17 h 20 min 00 s	17 d 8 h 40 min 00 s	8 d 16 h 20 min 00 s	4 d 8 h 10 min 00 s
2 kS/s	86 d 19 h 20 min 00 s	43 d 9 h 40 min 00 s	21 d 16 h 50 min 00 s	10 d 20 h 25 min 00 s
1 kS/s	173 d 14 h 40 min 00 s	86 d 19 h 20 min 00 s	43 d 9 h 40 min 00 s	21 d 16 h 50 min 00 s
500 S/s	347 d 5 h 20 min 00 s	173 d 14 h 40 min 00 s	86 d 19 h 20 min 00 s	43 d 9 h 40 min 00 s
200 S/s	868 d 1 h 20 min 00 s	434 d 0 h 40 min 00 s	217 d 0 h 20 min 00 s	108 d 12 h 10 min 00 s
100 S/s	1736 d 2 h 40 min 00 s	868 d 1 h 20 min 00 s	434 d 0 h 40 min 00 s	217 d 0 h 20 min 00 s
50 S/s	3472 d 5 h 20 min 00 s	1736 d 2 h 40 min 00 s	868 d 1 h 20 min 00 s	434 d 0 h 40 min 00 s
20 S/s	8680 d 13 h 20 min 00 s	4340 d 6 h 40 min 00 s	2170 d 3 h 20 min 00 s	1085 d 1 h 40 min 00 s
10 S/s	10000 d	8680 d 13 h 20 min 00 s	4340 d 6 h 40 min 00 s	2170 d 3 h 20 min 00 s
5 S/s	10000 d	10000 d	8680 d 13 h 20 min 00 s	4340 d 6 h 40 min 00 s
2 S/s	10000 d	10000 d	10000 d	10000 d
1 S/s	10000 d	10000 d	10000 d	10000 d

\*: You can set the sampling rate at 5 MS/s only if the number of channels to be saved is 12 or less.

## For saving data on Model Z4006 USB Drive

d: days, h: hours, min: minutes, s: seconds

Sampling rate	Number of channels used			
	4 (16 channels)	8 (32 channels)	16 (64 channels)	27 (108 channels)
1 MS/s*	8 min 20 s	–	–	–
500 kS/s*	16 min 40 s	8 min 20 s	–	–
200 kS/s	41 min 40 s	20 min 50 s	10 min 25 s	–
100 kS/s	1 h 23 min 20 s	41 min 40 s	20 min 50 s	10 min 25 s
50 kS/s	2 h 46 min 40 s	1 h 23 min 20 s	41 min 40 s	20 min 50 s
20 kS/s	6 h 56 min 40 s	3 h 28 min 20 s	1 h 44 min 10 s	52 min 5 s
10 kS/s	13 h 53 min 20 s	6 h 56 min 40 s	3 h 28 min 20 s	1 h 44 min 10 s
5 kS/s	1 d 3 h 46 min 40 s	13 h 53 min 20 s	6 h 56 min 40 s	3 h 28 min 20 s
2 kS/s	2 d 21 h 26 min 40 s	1 d 10 h 43 min 20 s	17 h 21 min 40 s	8 h 40 min 50 s
1 kS/s	5 d 18 h 53 min 20 s	2 d 21 h 26 min 40 s	1 d 10 h 43 min 20 s	17 h 21 min 40 s
500 S/s	11 d 13 h 46 min 40 s	5 d 18 h 53 min 20 s	2 d 21 h 26 min 40 s	1 d 10 h 43 min 20 s
200 S/s	28 d 22 h 26 min 40 s	14 d 11 h 13 min 20 s	7 d 5 h 36 min 40 s	3 d 14 h 48 min 20 s
100 S/s	57 d 20 h 53 min 20 s	28 d 22 h 26 min 40 s	14 d 11 h 13 min 20 s	7 d 5 h 36 min 40 s
50 S/s	115 d 17 h 46 min 40 s	57 d 20 h 53 min 20 s	28 d 22 h 26 min 40 s	14 d 11 h 13 min 20 s
20 S/s	289 d 8 h 26 min 40 s	144 d 16 h 13 min 20 s	72 d 8 h 6 min 40 s	36 d 4 h 3 min 20 s
10 S/s	578 d 16 h 53 min 20 s	289 d 8 h 26 min 40 s	144 d 16 h 13 min 20 s	72 d 8 h 6 min 40 s
5 S/s	1157 d 9 h 46 min 40 s	578 d 16 h 53 min 20 s	289 d 8 h 26 min 40 s	144 d 16 h 13 min 20 s
2 S/s	2893 d 12 h 26 min 40 s	1446 d 18 h 13 min 20 s	723 d 9 h 6 min 40 s	361 d 16 h 33 min 20 s
1 S/s	5787 d 0 h 53 min 20 s	2893 d 12 h 26 min 40 s	1446 d 18 h 13 min 20 s	723 d 9 h 6 min 40 s

\*: You can set the sampling rate at 1 MS/s only if the number of channels to be saved is 12 or less; 500 kS/s, 24 or less.

## Scaling method for strain gauges

This section describes how to determine the scaling conversion ratio when measurement is performed with strain gauges and Model U8969 Strain Unit.

The appropriate conversion equation into stress varies depending on how the strain gauges are used.

Three methods are available: the 1-gauge (for a gauge), 2-gauge (for two gauges), and 4-gauge methods (for four gauges). The 2-gauge method is used for strain measurement involving temperature compensation.

E: Young's modulus,  $\nu$ : Poisson's ratio,  $\varepsilon$ : Measured strain value

### Measuring tensile and compressive stress: $\text{Stress } (\sigma) = E \times \varepsilon$

When 2- or 4-gauge method measurement is performed involving temperature compensation, position the gauges perpendicularly to each other.

The stress ( $\sigma$ ) is multiplied by  $1 / (1 + \nu)$  for the 2-gauge method, and  $1 / [2 (1 + \nu)]$  for the 4-gauge method.

### Measuring bending stress: $\text{Stress } (\sigma) = E \times \varepsilon$

When 2- or 4-gauge measurement is performed involving temperature compensation, the stress ( $\sigma$ ) is multiplied by 1/2 or 1/4, respectively.

### Measuring torsional stress: $\text{Stress } (\sigma) = E / [2 (1 + \nu)] \times \varepsilon$ (2-gauge method)

When the 4-gauge method is used, the stress is halved.

Refer to the instruction manual of the strain gauge for how to combine strain gauges for each measurement.

Example: Measuring compressive stress

Using the 1-gauge method, material of measured object: aluminum, Young's modulus: 73 (GPa)  
(Refer to the table below.)

$$\begin{aligned}\sigma &= 73 \times 10^9 \times (\text{Measured value}) \times 10^{-6} \text{ (unit of measured value: } \mu\varepsilon\text{)} \\ &= 73 \times (\text{Measured value}) \text{ (unit: kPa)} \\ &= 7.44^* \times (\text{Measured value}) \text{ (unit: gf/mm}^2\text{)} \\ &*: 1 \text{ Pa} = 1.01971621 \times 10^{-7} \text{ kgf/mm}^2 = 1 \text{ N/m}^2\end{aligned}$$

Conversion ratio: 7.44, unit: gf/mm<sup>2</sup>

Enter this value as the scaling conversion ratio.

**Mechanical properties of industrial materials**

Material	Modulus of longitudinal elasticity (Young's modulus)	Poisson's ratio
	E (GPa)	$\nu$
Carbon steel (Carbon content: 0.1% to 0.25%)	205	0.28 to 0.3
Carbon steel (Carbon content: 0.25% or more)	206	0.28 to 0.3
Spring steel (Quenched)	206 to 211	0.28 to 0.3
Nickel steel	205	0.28 to 0.3
Cast iron	98	0.2 to 0.29
Brass (Cast)	78	0.34
Phosphor bronze	118	0.38
Aluminum	73	0.34
Concrete	20 to 29	0.1

Refer to "Converting Input Values (Scaling Function)" (p. 40).



## Example of a waveform text file

The waveform text file consists of a header and data.  
The header includes the following information:

- (1) Title comment
- (2) Recording length, sampling rate, trigger time
- (3) Channel number, module type, measurement range, LPF, channel comment, scaling (setting, conversion ratio, offset), invert

### Saves data.

```
"Title comment".....(1)
"Rec length","Sampling","Trigger Time"
"2500 sample","1MS/s","17/09/20 16:42:07.044" .....(2)

"Channel","Mode","Range(f.s)","L.P.F.,"Comment","Scaling","Ratio","Offset","Invert"
"CH1-1","VOLTAGE","10V","OFF","Analog 1-1","OFF","-","-","OFF".....(3)
"CH1-2","VOLTAGE","100mV","OFF","Analog 1-2","OFF","-","-","OFF"
"CH2-1","K","200^cC","---","Temperature 1","ON(SCI)","2.1568E+00","4.9874E+00","OFF"
"CH2-2","K","200^cC","---","Temperature 2","OFF","-","-","ON"
"CH3-1","VOLTAGE","10V","---","Digital Voltmeter Unit 3-1","ON(ENG)","2.4178E+00","1.0254E+01","OFF"
"CH3-2","VOLTAGE","10V","---","Digital Voltmeter Unit 3-2","OFF","-","-","ON"
"L4 A1","-","-","-","4LA1","-","-","-","-"
"L4 A2","-","-","-","4LA2","-","-","-","-"
"L4 A3","-","-","-","4LA3","-","-","-","-"
"L4 A4","-","-","-","4LA4","-","-","-","-"

"Time[s]","CH1-1[V]","CH1-2[V]","CH2-1[^cC]","CH2-2[^cC]","CH3-1[V]","CH3-2[V]","L4A1","L4A2","L4A3","L4A4"
+0.000000000E+00,+1.510000E+00,-3.000000E-04,+3.997600E+02,+3.997600E+02,-9.997559E-03,-9.340576E-02,1,1,1,1
+1.000000000E-06,+1.510000E+00,-2.500000E-04,+3.997600E+02,+3.997600E+02,-9.997559E-03,-9.340576E-02,1,1,1,1
0.000000000E-06,+1.510000E+00,-3.000000E-04,+3.997600E+02,+3.997600E+02,-9.997559E-03,-9.340576E-02,1,1,1,1
+3.000000000E-06,+1.440000E+00,+3.500000E-04,+3.997600E+02,+3.997600E+02,-9.997559E-03,-9.340576E-02,1,1,1,1
+4.000000000E-06,+1.430000E+00,+2.000000E-04,+3.997600E+02,+3.997600E+02,-9.997559E-03,-9.340576E-02,1,1,1,1
```



# Index

## Symbol

+Width .....	153, 159, 172
-Width .....	153, 159, 172

## 0-9

2-point setting .....	42
-----------------------	----

## A

A.A.F. ....	63
Accumulation .....	153, 155, 172
Aliasing .....	9
Amplitude .....	153, 155, 171
Analog channel .....	13
Analog trigger .....	124
Angle of XY waveform .....	153, 157, 173
Anti-aliasing filter .....	64
Area .....	153, 155, 168
Absolute value .....	168
Only the negative-amplitude part .....	169
Only the positive-amplitude part .....	168
Total .....	168
Arithmetic operations .....	153, 162, 171
Auto-balance .....	51
Auto-save .....	101, 102
Auto-setup .....	113
Auto-trigger level .....	138
Average value .....	153, 155, 167

## B

Beep .....	196
Binary .....	100, 103
BMP .....	100
Burst width .....	153, 160, 172

## C

Calibration .....	59
Character code .....	220
Command .....	219
Comment .....	7, 13, 17
Communications .....	199
Command communications .....	219, 221
IP address .....	201
Subnet mask .....	201
Concierge .....	146
Copy function .....	47
Cursor value .....	22

## D

Decibels (dB) .....	43
Delimiter .....	219

## Display position

Waveform .....	31
Duty ratio .....	153, 156, 170

## E

Email transmission .....	214
Evaluation on a pass/fail basis .....	164
Externally controlling the instrument .....	223
Externally control terminal .....	223
External sampling .....	231
External trigger .....	229
EXT.SMPL .....	231
EXT.TRIG .....	229

## F

Fall time .....	153, 157, 168
File size	
MEM file .....	233
Waveform (text) file .....	234
File type .....	100
Filter .....	125, 126, 131
Forcible trigger .....	135
Format .....	114
Frequency .....	153, 156, 167
FTP .....	204, 208

## G

Gauge .....	27
Glitch trigger .....	130

## H

Header .....	219
High level .....	153, 155, 171
High-speed response .....	58
Horizontal cursor .....	22, 26

## I

IN1 .....	224
IN2 .....	224
Initializing the instrument .....	6
Input coupling .....	15
Intermediate value .....	153, 155, 171
Interval trigger .....	133
In trigger .....	126
Invert .....	46
IP address .....	201

## L

LAN .....	200, 219
-----------	----------

Level at time .....	153, 159, 170
Level trigger.....	125
Loading data.....	112
File type.....	100
Local maximum (maximal) value .....	139, 140
Local minimum (minimal) value .....	139, 140
Logical AND/OR operation .....	123
Logic channel .....	17
Logic trigger.....	131
Low level.....	153, 155, 171
L.P.F.....	15

## M

---

Magnification	
Waveform.....	31
Zoom function .....	35
Maximum value .....	153, 155, 167
Measurement range .....	14
Memory HiConcierge.....	146
Minimum value .....	153, 155, 167

## N

---

NPLC.....	58, 66
Number of events .....	125
Number of modules to be used .....	8
Number of sampling points.....	138
Numerical calculation .....	149
Evaluation on a pass/fail basis.....	164
Numerical calculation result .....	163
Setting.....	152

## O

---

OUT1.....	225
OUT2.....	225
Out trigger.....	126
Overlay .....	38
Overshoot.....	153, 155, 172

## P

---

Period .....	153, 156, 167
Period-in trigger .....	128
Period-out trigger.....	128
Phase contrast calculation.....	153, 161, 171
Port number.....	220
P-P.....	153, 155, 167
Pre-trigger.....	120
Trigger priority .....	122
Probe ratio .....	15
Pulse count.....	153, 158, 171
Pulse width .....	153, 156, 170

## Q

---

Quick save.....	101, 108
-----------------	----------

## R

---

Real-time save.....	106
Recordable time .....	235
Recording length .....	8
Response .....	57, 60
Rise time.....	153, 157, 168
RMS.....	153, 155, 167

## S

---

Sampling rate .....	7
Save icon.....	101, 111
Save type.....	101, 103, 109
Saving data.....	101
Auto-save .....	101, 102
File type.....	100
Quick save .....	101, 108
Selective save .....	101, 108
Scaling.....	40
Using a strain gauge .....	44, 237
Using Model U8969 Strain Unit.....	44
Screenshot .....	100, 104
Saving data .....	108
Scroll.....	29
Search .....	139
Selective save .....	101, 108
Setting	
Input channel.....	11
Measurement conditions .....	7
Numerical calculation .....	152
Saving data .....	101
Trigger.....	116
Sheet .....	18
Shot (recording length).....	8
Standard deviation.....	153, 155, 168
Starting measurement .....	20
STARTUP .....	113

## T

---

Text.....	100, 103
Thermocouple.....	49
Time lag calculation .....	153, 161, 171
Time to level .....	153, 158, 170
Time value	
Time to maximum.....	153, 155, 167
Time to minimum.....	153, 155, 167
Trace cursor .....	22
Trigger .....	115
Glitch.....	130
In .....	126
Level.....	125

Out .....	126
Period-in .....	128
Period-out .....	128
Voltage drop .....	127
Trigger filter .....	125, 126, 131
Trigger output .....	227
Trigger priority .....	122
Trigger setting .....	116
Trigger source (AND/OR operation) .....	123
TRIG.OUT .....	227

## U

---

Undershoot .....	153, 155, 172
------------------	---------------

## V

---

Vernier .....	45
Vertical scale (gauge) .....	27
Voltage drop trigger .....	127

## W

---

Waveform	
Display position .....	31
Magnification .....	31
Magnification/demagnification .....	35
Waveform calculation .....	175
Operator .....	186
Waveform file size .....	233
Waveform image .....	100
Web browser .....	221

## X

---

X-Y area .....	153, 157, 169
Coordinate method .....	169
Trapezoidal approximation .....	169

## Z

---

Zoom function .....	35
---------------------	----





**HIOKI**  
**www.hioki.com/**



**All regional  
contact  
information**

**HEADQUARTERS**  
81 Koizumi  
Ueda, Nagano 386-1192 Japan

**HIOKI EUROPE GmbH**  
Rudolf-Diesel-Strasse 5  
65760 Eschborn, Germany  
hioki@hioki.eu

2103 EN

Edited and published by HIOKI E.E. CORPORATION

Printed in Japan

- CE declarations of conformity can be downloaded from our website.
- Contents subject to change without notice.
- This document contains copyrighted content.
- It is prohibited to copy, reproduce, or modify the content of this document without permission.
- Company names, product names, etc. mentioned in this document are trademarks or registered trademarks of their respective companies.