

**CT6710**  
**CT6711**

**HIOKI**

Instruction Manual

**CURRENT PROBE**



Read carefully before use.  
Keep for future reference.

**EN**

Oct. 2023 Revised edition 2  
CT6710A961-02



# Measurement Procedure

Be sure to familiarize yourself with the “Usage Notes” section (p.8), each instruction of use, and safety notes presented at the beginning of each instruction of use.

## Inspecting the Device Before Use (p.26)

## Preparing for Measurement (p.28)

- Provide power to the device.
- Connect the termination unit to your waveform measuring instrument.
- Execute demagnetization and automatic zero-adjustment.

## Measuring Currents (p.41)

- Clamp the sensor around a conductor to be measured.
- Measure a current.

## Finishing Measurement (p.65)

## Connection Example

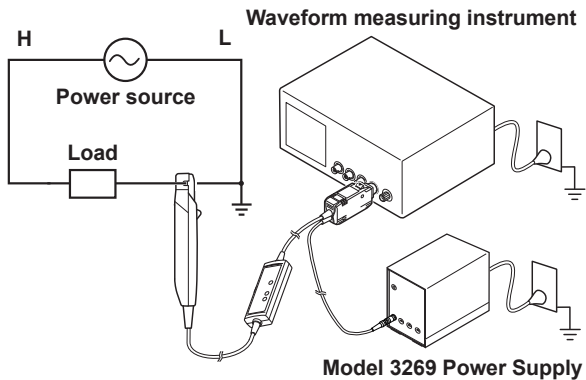

See “Example of connection to the circuit to be measured” (p.49).

# Contents

|                                 |   |
|---------------------------------|---|
| Introduction.....               | 1 |
| Notations .....                 | 2 |
| Checking Package Contents ..... | 5 |
| Safety Notes.....               | 7 |
| Usage Notes.....                | 8 |

## **1** Overview 13

|  |    |
|--|----|
| 1.1 Product Overview .....                             | 13 |
| 1.2 Product Features .....                             | 14 |
| 1.3 Name and Function of Each Part .....               | 16 |
| Termination unit .....                                 | 16 |
| Junction box (keys, LEDs).....                         | 18 |
| Sensor .....   | 20 |
| 1.4 Specifications of Lighting Up / Blinking LEDs..... | 22 |

## **2** Current Measurement 25

|  |    |
|--|----|
| 2.1 Inspecting the Device Before Use .....                       | 26 |
| 2.2 Preparing for Measurement .....                              | 28 |
| Providing power to the CT6710/CT6711.....                        | 29 |
| Executing demagnetization and automatic<br>zero-adjustment ..... | 33 |
| 2.3 Measuring Currents .....                                     | 41 |
| How to measure a current .....                                   | 50 |
| To measure a low current .....                                   | 58 |
| To measure a current accurately .....                            | 60 |
| When the device has entered protection mode .....                | 62 |
| 2.4 Finishing Measurement.....                                   | 65 |

1

2

3

4

Index

|          |   |           |
|----------|---|-----------|
| <b>3</b> | <b>Specifications</b>   | <b>69</b> |
| 3.1      | <b>General Specifications</b> .....                           | <b>69</b> |
| 3.2      | <b>Specifications of Input, Output, and Measurement</b> ..... | <b>71</b> |
|          | Basic specifications .....                                    | 71        |
|          | Specifications of accuracy .....                              | 73        |
| 3.3      | <b>Specifications of Functionality</b> .....                  | <b>75</b> |
| 3.4      | <b>Typical Characteristics</b> .....                          | <b>77</b> |
|          | Frequency characteristics.....                                | 77        |
|          | Frequency derating curve .....                                | 78        |
|          | Input impedance .....   | 80        |
|          | Consumption current .....                                     | 81        |
|          | Influence of common-mode voltage.....                         | 82        |
| <b>4</b> | <b>Maintenance and Service</b>                                | <b>83</b> |
| 4.1      | <b>Troubleshooting</b> .....                                  | <b>84</b> |
|          | Before sending back your device for repair .....              | 85        |
| 4.2      | <b>Errors</b> .....   | <b>88</b> |
|          | Types of errors.....  | 89        |
| 4.3      | <b>Cleaning</b> .....   | <b>96</b> |
| 4.4      | <b>Disposal</b> .....   | <b>97</b> |
|          | <b>Index</b>  | <b>99</b> |

## Warranty

## Introduction

Thank you for choosing the Hioki CT6710, CT6710 Current Probe. To ensure your ability to get the most out of this device over the long term, please read this manual carefully and keep it available for future reference.

### **The latest edition of the instruction manual**



The contents of this manual are subject to change, for example as a result of product improvements or changes to specifications.

The latest edition can be downloaded from Hioki's website.

<https://www.hioki.com/global/support/download/>

### **Product registration**



Register your product in order to receive important product information.

<https://www.hioki.com/global/support/myhioki/registration/>

Each model offers a different frequency band listed below:

Model CT6710: DC to 50 MHz

Model CT6711: DC to 120 MHz

The following manuals are provided along with these models. Refer to manuals relevant to your purpose.

- Current Sensor Operating Precautions  
Information on the device for safe operation
- Instruction Manual (this document)  
Basic instructions and specifications of the device

Please review the separate “Current Sensor Operating Precautions” before using the device.

### Target audience



This manual has been written for use by individuals who use the product in question or who teach others to do so.

It is assumed that the reader possesses basic electrical knowledge (equivalent to that of someone who graduated from the electrical program at a technical high school).

## Notations

### Safety notations

This manual classifies seriousness of risks and hazard levels as described below.

|  |  |
|--|--|
|  <b>DANGER</b>    | Indicates an imminently hazardous situation that, if not avoided, will result in death or serious injury.  |
|  <b>WARNING</b>   | Indicates a potentially hazardous situation that, if not avoided, could result in death or serious injury.   |
|  <b>CAUTION</b> | Indicates a potentially hazardous situation that could result in minor or moderate injury or potential risks of damage to the supported product (or to other property) if not avoided. |

|                  |   |
|------------------|---|
| <b>IMPORTANT</b> | Indicates information or content that is particularly important from the standpoint of operating or maintaining the device. |
| <b>NOTE</b>      | Indicates useful advice concerning device performance and operation.  |



Indicates a high-voltage hazard.

Failure to verify safety or improper handling of the device could lead to electric shock, burn injury, or death.



Indicates an action that must not be performed.



Indicates an action that must be performed.

## Symbols shown on the device



Indicates the presence of a potential hazard. For more information about locations where this symbol appears on device components, see the “Usage Notes” section (p.8), warning messages listed at the beginning of operating instructions, and the accompanying document entitled “Current Sensor Operating Precautions.”



Indicates that the device can only be used at a location on an insulated wire with sufficient insulation for the circuit voltage.



## Symbols for various standards



Indicates the Waste Electrical and Electronic Equipment Directive (WEEE Directive) in EU member states.



Indicates that the product complies with standards imposed by EU directives.

## Others

\*

Indicates additional information is described below.

**Bold**

Indicates the names of the control keys.

## Accuracy

Hioki defines tolerances for measured values in terms of percentage of reading, as indicated below.

**rdg.**

Reading (Displayed value)  
Indicates the value the measuring instrument displays. Tolerances for reading errors are expressed in percent of reading (% of reading, % rdg).

## Checking Package Contents

When you receive the device, inspect it to ensure that no damage occurred during shipment. Pay particular attention to keys and connectors. If you find any damage or discover that the device does not perform as indicated in its specifications, please contact your authorized Hioki distributor or reseller.

Check that the package contents are correct.

The carrying case contains the current probe, Instruction Manual, and Current Sensor Operating Precautions.

**Carrying case**

(Accessory)

**Model CT6710/CT6711 Current Probe**

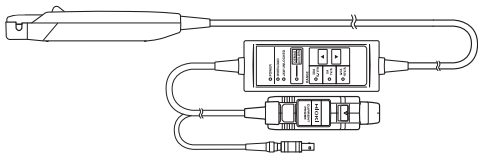

**Instruction Manual**

(Accessory)

**Current Sensor Operating Precautions  
(0990A901)**

(Accessory)

## Option

The option below is available for the device. To order an option, please contact your authorized Hioki distributor or reseller.

Options are subject to change. Check Hioki's website for the latest information.

### **Model 3269 Power Supply**

The 3269 Power Supply can provide the power to up to two probes of the CT6710/CT6711.

(The 3272 Power Supply cannot be used as a power supplying unit for the CT6710/CT6711.)

## Precautions for transportation

- Store packaging materials for future use. You will need the packaging materials when shipping the device.
- Transport the device in its carrying case.

## Safety Notes

The device has been designed in accordance with the IEC 61010 safety standard, and its safety has been verified by means of testing prior to shipment. However, failure to follow the information in this manual could render safety-related functionality provided by the device ineffective.

Please review the safety information below before using the device.

### **DANGER**

- **Read this manual carefully and ensure you understand its contents before using the device.**



Improper use of the device could result in serious bodily injury or damage to the device.

### **WARNING**

- **If using an electrical measuring instrument for the first time, seek instruction from an individual with electrical measurement experience first.**



Failure to do so may lead to electric shock, overheating, fire, arcing due to a short-circuit, or other hazards.

## Usage Notes

Be sure to follow the precautions listed below in order to use the device safely and in a manner that allows it to function effectively.

Use of the device should conform not only to its specifications, but also to the specifications of all accessories, options, and other equipment in use.

### **DANGER**

- **Do not use the device for measuring bare conductors.**



- **Take measurements at a location on an insulated wire with sufficient insulation for the circuit voltage.**

Doing so may result in electric shock or a short-circuit.

---

 **DANGER**

- **Do not remove any covers of the sensor, junction box, and termination unit.**

The internal components of the device carry high voltages and may become very hot during operation. Touching them could cause electric shock or burns.

---

- **Do not connect the device to the primary side of a distribution panel.**



If a short-circuit occurs on the primary side, an unrestricted current flow can damage the device and facilities, resulting in serious bodily injury. Even if a short-circuit occurs on the secondary side of the distribution panel, the panel will interrupt the short-circuit current.

---

- **Do not use the device in powerful magnetic fields.**

Doing so could cause the sensor to become abnormally hot, resulting in bodily injury, damage to the device, or fire.

---

- **Follow all operating precautions for a waveform measuring instrument or any other measuring instruments to which this device is connected.**



Failure to observe this could cause serious bodily injury or damage to these instruments.

---

## **WARNING**

- **Do not use the device to measure circuits that exceed the ratings or specifications of the device.**

Doing so could cause damage to the device or overheating, resulting in bodily injury.

---

- **Do not install the instrument in locations such as the following:**

- In locations where it would be subject to direct sunlight
- In locations where it would be subject to high temperatures
- In locations where it would be exposed to corrosive or explosive gases
- In locations where it would be exposed to water, oil, chemicals, or solvents
- In locations where it would be exposed to high humidity or condensation
- In locations where it would be exposed to powerful electromagnetic radiation
- Close to objects carrying an electric charge
- In locations with an excessive amount of dust
- Close to inductive heating devices (high-frequency inductive heating devices, IH cooktops, etc.)
- In locations characterized by a large amount of mechanical vibration
- Close to HF power supply units

Doing so could cause damage to the device or cause it to malfunction, resulting in bodily injury.

---



 **WARNING**

- **Ensure that the insulation on the cords is undamaged and that no bare conductors are improperly exposed before using the device.**



Any damage to the cords leads to electric shock. Contact your authorized Hioki distributor or reseller for repair.

 **CAUTION**

- **Do not place the device on an unstable stand or angled surface.**



Doing so could cause the device to fall or overturn, resulting in bodily injury or damage to the device.

- **Do not store or use the device in locations subject to abrupt temperature changes.**

Doing so could damage the sensor heads.



## CAUTION

- Do not apply force in the directions shown in the figure below while the upper jaw is locked in place.

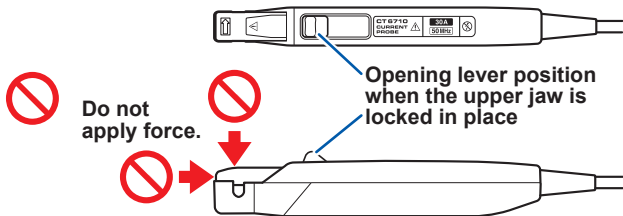

Doing so may damage the retracting/extending mechanism.

- 
- **Properly connect the device to a circuit to be measured and your waveform measuring instrument.**

Improperly connecting them could cause electric shock or damage to the circuit, device, or your instrument.



- **Keep the upper jaw locked in place when the device is not in use.**

Leaving the upper jaw unlocked will cause dust or dirt to settle on the facing core surfaces, resulting in damage to the device.

# 1

## Overview

### 1.1 Product Overview

# 1

Model CT6710/CT6711 is a clamp-on current probe that features high current-detection sensitivity and broad frequency band. The probe uses three current ranges to detect current waveforms from 1 mA to 50 A.

You can directly connect the termination unit to a BNC input terminal of your waveform measuring instrument such as an oscilloscope and recorder, and then clamp the sensor around a conductor to be measured to observe current waveforms easily.

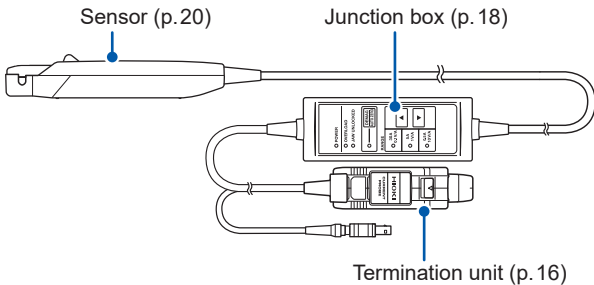

## 1.2 Product Features

### **Clamp-on sensor heads** (p.21)

The clamp-on sensor heads allow current measurement without the need to make physical contact with a conductor to be measured or to disconnect it. You can observe current waveforms while maintaining the flow of electric current.

### **Sliding jaw retracting/extending mechanism**

(p.21)

This feature lets you easily retract, extend, and lock the upper jaw in place to clamp the sensor around a conductor to be measured.

### **Easy-to-connect output terminal** (p. 17, p.38)

Insert the output terminal into a BNC input terminal on your waveform measuring instrument to connect the termination unit.

### **Warning LED lights** (p. 18)

The warning LEDs alert you to an overload (indicating that an input current value exceeds the rated current of the device) or jaw-unlocked condition (indicating that the upper jaw has not been locked in place).

**Three current measurement ranges (p.53)**

You can choose from the three ranges according to the magnitude of the current to be measured. This feature lets you observe a wide range of currents, from 1 mA to 50 A.

**Broad frequency band (p.71)**

Model CT6710: DC to 50 MHz

Model CT6711: DC to 120 MHz

**Demagnetizing and automatic zero-adjustment functions (p.33)**

You can use a single key to demagnetize the magnetic cores and correct variations in offset voltage, both of which are required before measuring.

**Protection mode (p.62)**

The device automatically enters protection mode to prevent damaging itself when overheating.

## 1.3 Name and Function of Each Part

### Termination unit

See p.34 and p.35.

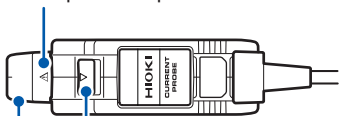

Top view

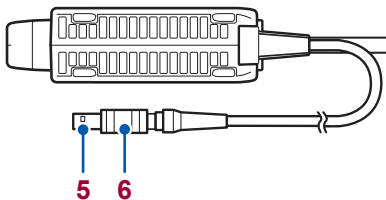
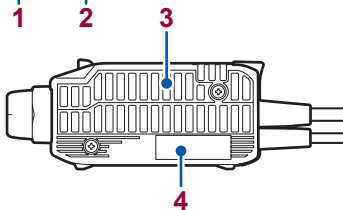

---

**1 Output terminal**

The device converts a captured current waveform into a voltage waveform by multiplying a particular rate according to a specified current range and outputs the voltage waveform from this terminal. Connect this terminal to a BNC input terminal of your waveform measuring instrument.

---

**2 Unlock lever**

To disconnect the output terminal, pull on the termination unit while simultaneously pulling this lever.

---

**3 Vents**

The unit has the vents on the sides and bottom. Do not clog them.

---

**4 Serial number**

The serial number consists of nine digits. The first two digits indicate the year of manufacture, while the second two digits indicate the month of manufacture. Do not remove this sticker as the number is important.

---

**5 Power plug**

Power is provided to the CT6710/CT6711 through this plug. Connect this plug with the 3269 Power Supply.

---

**6 Shell**

Pull on the power plug while simultaneously pulling this shell to disconnect the plug.

---

You can easily connect and disconnect the termination unit with two fingers even when multiple termination units are connected to a waveform measuring instrument.

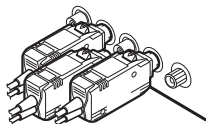

## Junction box (keys, LEDs)

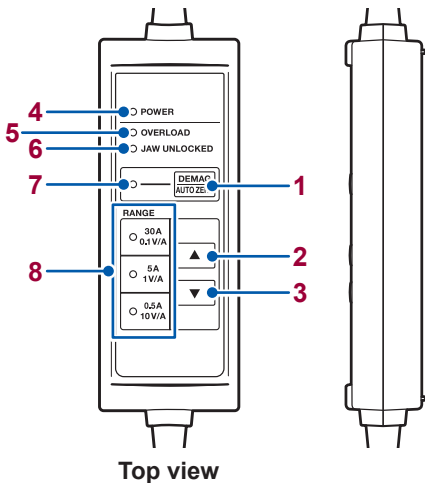

---

### 1 DEMAG / AUTO ZERO key

Hold down (about 1 s)      Performs demagnetization followed by automatic zero-adjustment. (p.33)

Press momentarily (less than 0.5 s)      Performs automatic zero-adjustment alone. (p.40)

---

### 2 ▲ (Higher range) key (p.53)

Switch over to a next higher current range.  
(Does not switch from the 30 A range to the 0.5 A range)

---

### 3 ▼ (Lower range) key (p.53)

Switch over to a next lower current range.  
(Does not switch from the 0.5 A range to the 30 A range)

---

---

**4 POWER LED** (green light)

- Lights up when the power is on (p.31). (Normal operation)
- Rapidly blinks when a checksum error has occurred (p.95).

---

**5 OVERLOAD LED** (red light)

- Flashes three times when demagnetizing or automatic zero-adjustment cannot be performed (p.91).
- Rapidly blinks when an overload state is detected (p.90), the device has entered protection mode (p.62), or a checksum error has occurred (p.95).

---

**6 JAW UNLOCKED LED** (red light)

- Lights up when the upper jaw is unlocked.
- Flashes three times when demagnetizing or automatic zero-adjustment cannot be performed (p.91).
- Rapidly blinks when the device has entered protection mode (p.62) or a checksum error has occurred (p.95).

---

**7 DEMAG / AUTO ZERO LED** (orange light)

- Slowly blinks when demagnetization or automatic zero-adjustment has not yet been performed (p.33).
- Lights up when demagnetization and automatic zero-adjustment are in execution (p.39).
- Goes out when demagnetization and automatic zero-adjustment have been completed (p.39).
- Flashes three times when demagnetization and automatic zero-adjustment cannot be performed (p.91).
- Rapidly blinks when the device has entered protection mode (p.62) or a checksum error has occurred (p.95).

---

**8 RANGE LEDs** (green lights)

- Lights up when its current range is chosen (p.53). (Normal operation)
  - Blinks rapidly when the device has entered protection mode (p.62) or a checksum error has occurred (p.95).
-



## Sensor

### ⚠ CAUTION



- Do not store or use the device in locations subject to abrupt temperature changes.
- Do not apply force or mechanical shock to the device.
- Do not subject the device to static electricity. Doing so could damage the device.

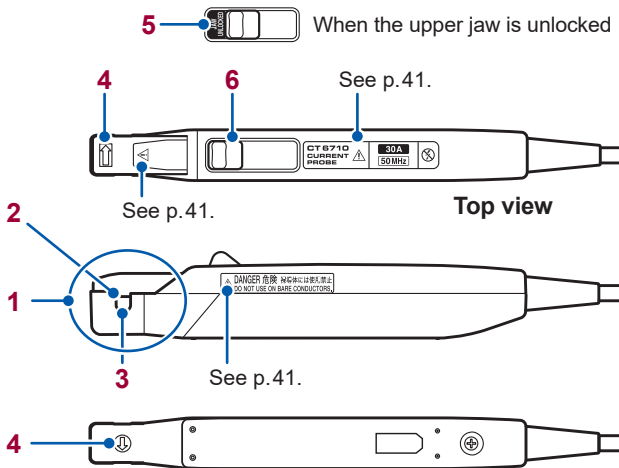

---

**1 Jaws**

Clamp this part around a conductor to be measured by operating the opening lever, which allows the upper jaw to slide (retract/extend).

---

**2 Sensor aperture**

A conductor to be measured must pass through this aperture.

---

**3 Sensor heads**

The sensor heads, located inside the jaws, detects currents.

---

**4 Current direction indicator**

Clamp the sensor around the conductor such that the direction this arrow indicates matches the current direction of a conductor to be measured.

---

**5 JAW UNLOCKED indicator**

If this indicator appears, the upper jaw is not locked in place.

---

**6 Opening lever**

To retract and extend the upper jaw, always operate this lever. This lever allows you to retract and lock the upper jaw in place.

---

## 1.4 Specifications of Lighting Up / Blinking LEDs

○: Lighting up ●: Off ◐: Blinking

|    | Device state                |                          |  | LED        |
|----|-----------------------------|--------------------------|--|------------|
|    | Automatic zero-adjustment   | Overload                 | Others                                       | Green      |
|    |                             |                          |  | POWER      |
| 1  | -                           | -                        | (On start-up)                                | ○          |
| 2  | Not performed               | Not detected             | (Initial state)                              | ○          |
| 3  | In execution (Incl. demag.) | -                        | (No range keys available)                    | ○          |
| 4  | In execution (excl. demag.) | -                        | (No range keys available)                    | ○          |
| 5  | Completed                   | Not detected             | (Before use, normal state)                   | ○          |
| 6  | Completed                   | Exceeds prescribed level | -  | ○          |
| 7  | Not performed               | Exceeds prescribed level | -  | ○          |
| 8  | Completed                   | Not detected             | Upper jaw unlocked                           | ○          |
| 9  | Completed                   | Exceeds prescribed level | Upper jaw unlocked                           | ○          |
| 10 | Not performed               | Not detected             | Upper jaw unlocked                           | ○          |
| 11 | Not performed               | Exceeds prescribed level | Upper jaw unlocked                           | ○          |
| 12 | -                           | *1                       | *1   | ○          |
| 13 | -                           | -                        | Excess heat detected in junction box*2       | ○          |
| 14 | -                           | -                        | ROM checksum error at power-on (CPU failure) | ◐: Rapidly |

- \*1. When the **DEMAG / AUTO ZERO** key is pressed under any one of the following conditions (p.91):
- The upper jaw is unlocked.
  - An overload has been detected whether or not the upper jaw is locked in place.
  - A current exceeding 0.5 A rms has been detected whether or not the upper jaw is locked in place.
- \*2. Press any key to restore the device. The ranges cannot be switched until the device is restored.  
See "When the device has entered protection mode" (p.62).

○: Lighting up ●: Off ☉: Blinking

| LED                          |                              |                              |                        |       |       |       |    |
|------------------------------|------------------------------|------------------------------|------------------------|-------|-------|-------|----|
| Red                          | Red                          | Orange                       | Green                  |       |       |       |    |
| OVERLOAD                     | JAW UNLOCKED                 | DEMAG / AUTO ZERO            | RANGE                  |       |       |       |    |
|                              |                              |                              | 30 A                   | 5 A   | 0.5 A |       |    |
| ○ 1 s                        | ○ 1 s                        | ○ 1 s                        | ○ 1 s                  | ○ 1 s | ○ 1 s | ○ 1 s | 1  |
| ●                            | ●                            | ☉ Slowly* <sup>4</sup>       | ○                      | ●     | ●     | ●     | 2  |
| ●                            | ●                            | ○                            | ●                      | ●     | ●     | ●     | 3  |
| ●                            | ●                            | ○                            | ○ Specified range only |       |       |       | 4  |
| ●                            | ●                            | ●                            | ○ Specified range only |       |       |       | 5  |
| ☉ Rapidly* <sup>3</sup>      | ●                            | ●                            | ○ Specified range only |       |       |       | 6  |
| ☉ Rapidly* <sup>3</sup>      | ●                            | ●* <sup>5</sup>              | ○ Specified range only |       |       |       | 7  |
| ●                            | ○                            | ●                            | ○ Specified range only |       |       |       | 8  |
| ☉ Rapidly* <sup>3</sup>      | ○                            | ●                            | ○ Specified range only |       |       |       | 9  |
| ●                            | ○                            | ●                            | ○ Specified range only |       |       |       | 10 |
| ☉ Rapidly* <sup>3</sup>      | ○                            | ●* <sup>5</sup>              | ○ Specified range only |       |       |       | 11 |
| ☉ Rapidly<br>flashes 3 times | ☉ Rapidly<br>flashes 3 times | ☉ Rapidly<br>flashes 3 times | ○ Specified range only |       |       |       | 12 |
| ☉ Rapidly                    | ☉ Rapidly                    | ☉ Rapidly                    | ☉ Rapidly              |       |       |       | 13 |
| ☉ Rapidly                    | ☉ Rapidly                    | ☉ Rapidly                    | ☉ Rapidly              |       |       |       | 14 |

\*3. Blinks at 250-ms intervals. (duty ratio: 50%)

\*4. After the device is turned on and then all LEDs light up for 1 second, the **DEMAG / AUTO ZERO** LED blinks, which indicates that demagnetization or automatic zero-adjustment has not yet been performed.

\*5. Even when demagnetization or automatic zero-adjustment has not yet been performed, the device that has detected an overload and that with the upper jaw unlocked leave the **DEMAG / AUTO ZERO** LED unlit.



 **WARNING**

- **Do not clog the vents on the sides and bottom of the termination unit (p. 16).**

Doing so could cause internal overheating of the termination unit, resulting in bodily injury, fire, or damage to the device.



- **Do not pile the junction box (p. 18) on another.**

- **Do not cover the junction box with a cloth.**

Doing so could cause internal overheating of the junction box, resulting in bodily injury, fire, or damage to the device.

**IMPORTANT**

- Do not drop the device.
- Do not subject the device to an impact.
- Do not place any foreign object between the facing core surfaces of the sensor heads.
- Do not scratch the facing core surfaces between the sensor heads.
- Do not touch the facing core surfaces.
- Do not insert any foreign object into the gap around the sensor heads.



Doing so could adversely affect the measurement accuracy and the retracting/extending mechanism.

## 2.1 Inspecting the Device Before Use

Check the device for any damage that may have occurred during storage or shipping, and verify proper operation before use. If you find any damage or failure, contact your authorized Hioki distributor or reseller.

See “Before sending back your device for repair” (p.85).

### Items to prepare

- Model CT6710/CT6711 Current Probe
- Model 3269 Power Supply (available as an option)
- Waveform measuring instrument (such as oscilloscope and recorder)

Connecting the CT6710/CT6711 to a Hioki Memory HiCorder with a power supply module for current probes (option) installed allows the CT6710/CT6711 to operate without the 3269 Power Supply. For more information, contact your authorized Hioki distributor or reseller.

### IMPORTANT

- Use a waveform measuring instrument (such as oscilloscope and recorder) with an input impedance of 1 M $\Omega$  or more.



The output of the device is internally terminated. Accurate measurement is not possible with waveform measuring instruments with an input resistance of 50  $\Omega$ .

## Inspecting appearance and functionality of the device and condition of conductors to be measured

Are the sensor, junction box, and termination unit damaged?

Yes



▷ Have the device repaired.  
Damage can cause electric shock.

No



Is the insulation of each cord damaged?

Yes



▷ Have the device repaired.  
Damage can cause electric shock.

No



Provide power to the device. (p.29)

Do the seven LEDs light up for about one second after the device is turned on?

Off or blinking



▷ Have the device repaired.  
The device is damaged.

Yes



Is the insulation of each conductor to be measured damaged?

Yes



 Do not clamp the sensor around any damaged conductor.

No



The inspection is completed.



## 2.2 Preparing for Measurement

### WARNING



- **Turn off all equipment before connecting the device.**

Failure to do so can cause electric shock or a short-circuit.

### CAUTION



- **Before connecting the power cord to the inlet on the rear panel of the 3269 Power Supply, verify that the supply voltage you plan to use falls within the supply voltage range noted on the 3269.**

Supplying a voltage that falls outside the specified range to the 3269 could damage the CT6710/CT6711 or the 3269, causing bodily injury.

- **Always operate the opening lever to retract, extend, and lock the upper jaw.**

If you retract, extend, or lock the upper jaw directly by hand, the sensor may be damaged.

## Providing power to the CT6710/CT6711

### IMPORTANT

- Do not allow the total consumption current of the current sensors connected with the 3269 Power Supply to exceed the rated output current of the 3269.



The consumption current of the CT6710/CT6711 depends on current under measurement. One unit of the 3269 can simultaneously provide power to up to two current probes (the CT6710/CT6711) each of which measures a current with the maximum rated current value. For information about the consumption current, see “Consumption current” (p.81) in “Typical Characteristics.”

The 3272 Power Supply, which does not have sufficient current capacity, cannot activate the CT6710/CT6711.

## How to provide the power to the CT6710/CT6711

---

- 1** Ensure that the **POWER** switch of the 3269 Power Supply is set to OFF.
- 2** Connect the power cord to the power inlet on the back of the 3269 Power Supply.
- 3** Slide the opening lever of the sensor toward the lower jaw until the **JAW UNLOCKED** indicator is hidden.

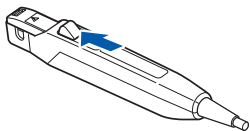

The upper jaw will be locked in place.



- Do not clamp the sensor around any conductor.

- 4** Connect the power plug of the CT6710/CT6711 to the power receptacle of the 3269 Power Supply.

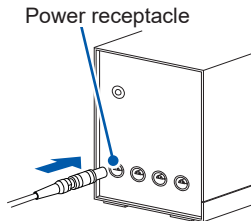

## 5 Set the **POWER** switch of the 3269 Power Supply to the ON position.

The LEDs of the CT6710/CT6711 and the 3269 will light up or blink as follows:

### Model 3269

The **POWER** indicator will light up.

### Model CT6710/CT6711

All LEDs will light up for 1 s, and then the CT6710/CT6711 will operate as follows:

- The **POWER** LED will light up.
- The **DEMAG / AUTO ZERO** LED will blink slowly.

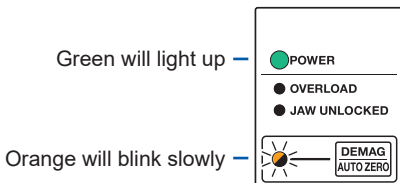

- Keep the upper jaw locked in place while the **POWER** LED lights up.

## **6** Wait for 30 minutes or more.

Wait at least 30 minutes after starting to supply power to the CT6710/CT6711 to accurately measure a current before executing demagnetization and automatic zero-adjustment. See “Executing demagnetization and automatic zero-adjustment” (p.33).

- Do not execute demagnetization and automatic zero-adjustment or measure current immediately after starting to supply power to the CT6710/CT6711.



An offset voltage may increase due to the heat generation of the CT6710/CT6711.

---

## Executing demagnetization and automatic zero-adjustment

---

### WARNING

- Do not hold down the **DEMAG / AUTO ZERO** key when the sensor is clamped around a conductor under measurement.

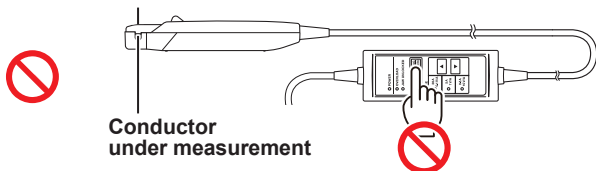

**Do not hold down the key.**

Doing so will start magnetization, causing bodily injury or damage to the circuit under measurement.

## CAUTION

- Do not subject the connection to force.
- Do not rotate the output terminal while the termination unit is connected with a waveform measuring instrument.

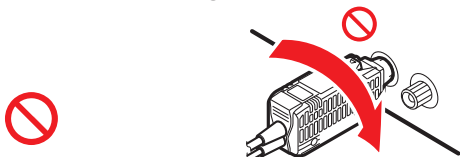

Doing so could damage the output terminal on the termination unit or the BNC input terminal on the waveform measuring instrument.

- 
- Do not short-circuit the output terminal
  - Do not apply voltage to the output terminal.  
Doing so could damage the device.
-

**CAUTION**

- Arrange the termination unit and a BNC input terminal of your waveform measuring instrument in a straight line when connecting the termination unit.

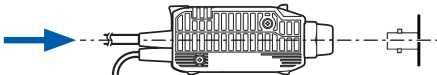

Failure to do so may damage the output terminal.

- When connecting the output terminal to an input terminal that is not a BNC terminal through a conversion plug, make sure that the polarity is as follows:

**BNC center contact: Positive**

**Outer conductor: Ground potential  
(or negative)**

Failure to do so may damage the device and your waveform measuring instrument.



### **What is *demagnetization*?**

The magnetic core can be magnetized, which results from turning power on and off, inputting an excessively large current, or other factors. Executing demagnetization eliminates magnetic charges.

### **What is *automatic zero-adjustment*?**

Automatic zero-adjustment corrects variations in the offset voltage caused by factors such as the device-specific offset voltage and variations in temperature.

When the **DEMAG / AUTO ZERO** LED blinks slowly, execute demagnetization and automatic zero-adjustment. The **DEMAG / AUTO ZERO** LED blinks slowly in the following states:

- The power supply to the CT6710/CT6711 just started.
- A current exceeding the rated current was inputted to the device, but this condition was resolved. (The current value fell below the rated value or stopped. Otherwise, the sensor was removed from the conductor under measurement.)

During demagnetization (with the **DEMAG / AUTO ZERO** LED lit), the device outputs a demagnetization waveform (which attenuates over time) from its output terminal. This waveform, which appears on a waveform measuring instrument, may be asymmetric along the horizontal axis; however, this does not represent a device malfunction.

## How to execute demagnetizing and automatic zero-adjustment

### IMPORTANT

- Do not move the sensor during demagnetization or automatic zero-adjustment.



Disturbance (such as external magnetic fields and temperature changes) may prevent demagnetization or automatic zero-adjustment from being completed normally.

2

- 1** Slide the opening lever of the sensor toward the lower jaw until the **JAW UNLOCKED** indicator is hidden.

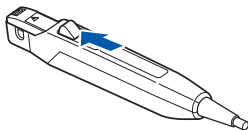

The upper jaw will be locked in place.

The **JAW UNLOCKED** LED will go out.



- Do not clamp the sensor around any conductor.

- 2** Set the input coupling of your waveform measuring instrument to **GND**, then adjust the zero position of the display.

**3** Set the input coupling of the waveform measuring instrument to DC.

**4** Connect the output terminal of the termination unit to a BNC input terminal of the waveform measuring instrument.

- Insert the output terminal straight.
- Insert the output terminal until it clicks so that it is securely locked in position.

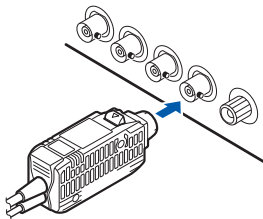

The connection can be established with the unlock lever of the termination unit pointing up, regardless of whether the pair of the locking studs in the BNC input terminal on the waveform measuring instrument is fixed in the horizontal or vertical orientation.

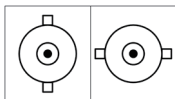
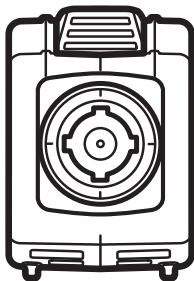

Vertical Horizontal

- 5** Hold down the **DEMAG / AUTO ZERO** key on the junction box for about 1 second.

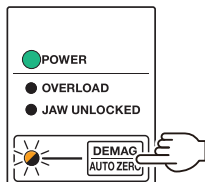

Hold down

The **DEMAG / AUTO ZERO** LED will light up. Demagnetization and automatic zero-adjustment will start.

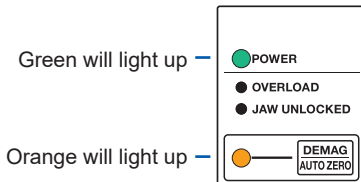

After the completion, the **DEMAG / AUTO ZERO** LED will go out.

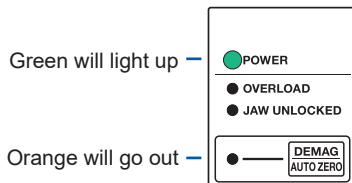

If the **DEMAG / AUTO ZERO** LED flashes three times, the device cannot perform demagnetization or automatic zero-adjustment.

- ▷ Implement the remedy described on the following page. “Demagnetizing / automatic zero-adjustment unavailable” (p. 92)
- 

### **To halt demagnetization or automatic zero-adjustment on the middle of its execution**

- ▷ Pull the unlock lever toward you to unlock the upper jaw.

When you halt demagnetization or automatic zero-adjustment, re-execute demagnetization and automatic zero-adjustment before taking a measurement.

### **To execute automatic zero-adjustment alone (without executing demagnetization)**

- ▷ Press the **DEMAG / AUTO ZERO** key momentarily (Do not hold down the key). (p. 18)

## 2.3 Measuring Currents

Be sure to read the following sections and perform the steps described there before taking measurements:

“2.1 Inspecting the Device Before Use” (p.26)

“2.2 Preparing for Measurement” (p.28)

Follow all operating precautions for your waveform measuring instrument or any other measuring instrument.

2

### DANGER

- **Do not cause a short-circuit between the wire to be measured and another wire with the metallic parts of the tips of the sensor.**

Doing so can cause arc flash, resulting in serious bodily injury or damage to the device or other equipment.



- **Do not measure any current in excess of the derating curve.**

Doing so can cause overheating of the device, resulting in bodily injury, fire, or damage to the device.

See “Frequency derating curve” (p.78).

The maximum measurement current varies with the frequency, and the current that can be measured continuously is limited. Operating the device at less than this limitation is referred to as derating.

## **⚠ DANGER**

- **Do not subject the ground side of other input terminals to a different potential when you use one of the following waveform measuring instruments:**
  - an instrument that does not provide electrical insulation between its input terminals and chassis
  - an instrument that does not provide electrical insulation among its input terminals

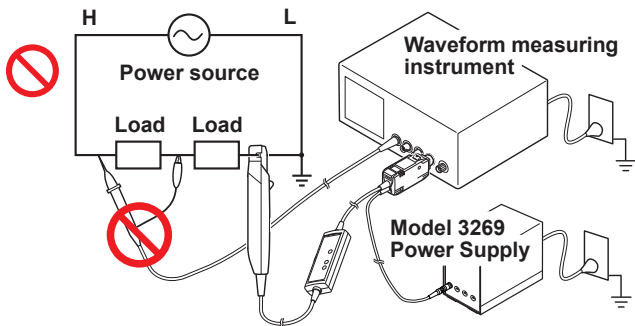

If you do so, a short-circuit current will flow through the 3269 Power Supply and the CT6710/CT6711 from the ground terminal, causing electric shock or damage to the CT6710/CT6711 and the 3296.

See the figure in “Example of connection to the circuit to be measured” (p.49) for a proper connection.

 **DANGER**

- **Ensure that the insulation on a conductor is not worn or damaged before clamping the sensor around the conductor to be measured.**
- **Take care not to damage the insulation when clamping the sensor around the conductor.**

Damage to the conductor insulation can cause electric shock.



- **Connect the CT6710/CT6711 to the 3269 Power Supply and a waveform measuring instrument (oscilloscope or recorder) before clamping the device around a live line to be measured.**

Failure to do so may cause electric shock or a short-circuit.



 **WARNING**

- **While measuring a high-frequency current or a current that includes high-frequency components, keep hands and other body parts away from the jaws.**

Eddy current loss may cause heating of the sensor heads. Failure to do so could fire or damage to the measurement target and device, resulting in burns.



- **Keep away any cords and other parts, which include the cords of the device, from the conductor under measurement.**

Dielectric heating may cause heating of cords and other parts, resulting in burns.

**⚠ CAUTION**

- **Do not place any conductor carrying a current with a frequency of 10 kHz or more close to the jaws even when the sensor is not clamped around a conductor.**

Do not place conductors not to be measured close to the jaws.

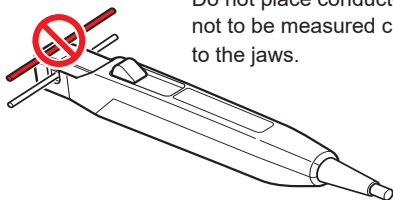

A current flowing through conductors near the sensor may heat up the sensor heads, leading to damage to the device, resulting burns.

When the device is clamped around one of the go-and-return conductors and the other conductor is placed close to the jaws, self-heating of both currents will synergistically heat up the sensor heads even if the electric current is lower than the maximum rated current.

 **CAUTION**

- **Do not prevent heat radiation from the device.**
- **Do not input a current that exceeds the maximum rated current value\*.**

An temperature increase in the device cause burns, damage to the device, or a short-circuit.

- **Never input a current that exceeds  $\pm 50$  A even momentarily.**

Doing so can damage the device, resulting in bodily injury.

See “Maximum peak current” (p.72).



- **Do not exceed the maximum rated current, regardless of the blinking state of the OVERLOAD LED.**

Doing so can damage the device, resulting in bodily injury.

Overload warnings are detectable in a frequency band of DC and 45 Hz to 66 Hz (sine wave). When measuring a current with a frequency outside the frequency detection band, the overload warning function may not work properly.

See “Frequency characteristics” (p.77).

\* The maximum rated current has been specified in light of a temperature increase caused by self-heating during measurement. The maximum rated current varies depending on the frequency of the current under measurement.

See the figures in “Frequency derating curve” (p.78).”

 **CAUTION**

- **Do not subject the sensor to high voltage, including static electricity.**

Doing so may damage the device.



- **Do not pass a current through a conductor under measurement when the 3269 Power Supply or your waveform measuring instrument is off.**

Doing so may damage the device and instrument.

 **CAUTION**

- **Use the device for measuring currents much lower than the maximum rated current value if an ambient temperature is relatively high or a current to be measured can contain frequency components other than the fundamental.**

Self-heating could cause burns or damage to the device even if the current under measurement is lower than the maximum rated current.

The maximum rated current is defined as a recommended value for when a sine-wave current is inputted to the device at the temperatures and humidity specified for the guaranteed accuracy.

See “Frequency derating curve” (p.78).



- **Connect the device and other probes properly to a circuit to be measured and your waveform measuring instrument.**

Improperly connecting them could cause electric shock or damage to the device, other probes, and instrument.

- **Keep the upper jaw locked in place except the following occasions:**
  - **When clamping the sensor around a conductor to be measured**
  - **When removing the sensor from the conductor.**

Leaving the upper jaw unlocked can damage the device.

## Example of connection to the circuit to be measured

The figure below illustrates a connection between the device and a measuring instrument with non-isolated input terminals equipped, such as a general oscilloscope.

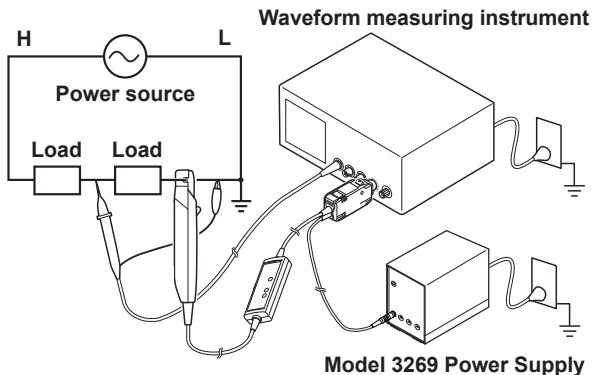

The 3269 Power Supply can provide the power to up to two probes of the CT6710/CT6711.

Connecting the CT6710/CT6711 to a Hioki Memory HiCorder with a power supply module for current probes (option) installed allows the CT6710/CT6711 to operate without the 3269 Power Supply. For more information, contact your authorized Hioki distributor or reseller.

## How to measure a current

### IMPORTANT

- Do not place the sensor close to a heat source.
- Do not roughly operate the opening lever to lock the upper jaw.
- Do not subject the jaws and opening lever to force.
- Do not subject the sensor aperture to force while the sensor is clamped around the conductor.



Changes in ambient temperature and an impact on the sensor head can cause fluctuations in the offset voltage, resulting in an adverse effect on the measurement accuracy.

- 
- Be sure to execute demagnetization and automatic zero-adjustment before taking measurements.



Failure to do so can adversely affect the measurement accuracy.

See “Executing demagnetization and automatic zero-adjustment” (p. 33).

- 1** Pull the opening lever of the sensor toward you to retract the upper jaw.

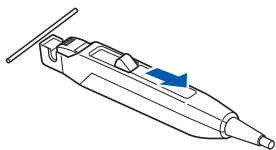

- 2** Clamp the sensor around a conductor to be measured.

- Have the current direction indicator match the direction of the current to be measured.
- Place the conductor at the center of the sensor aperture.

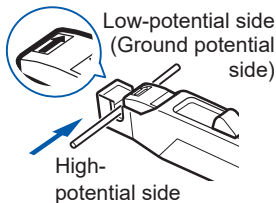

- 3** Slide the opening lever toward the lower jaw until the **JAW UNLOCKED** indicator is hidden.

The upper jaw will be locked in place.

The **JAW UNLOCKED** LED will go out.

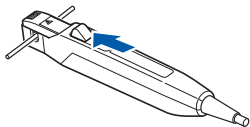



## **4** Check the LEDs on the junction box.

The **POWER** LED and one of the **RANGE** LEDs light up.

There is no error.

▷ Go on to step **5**.

The **OVERLOAD** LED blinks rapidly.

The device has detected a measurement current in excess of the level defined for the current range.

See “Overload” (p.90).

When you use the 30 A range

▷ Immediately remove the sensor from the conductor under measurement.

When you use the 0.5 A range or 5 A range

▷ Switch a higher current range.

### **IMPORTANT**

- The instrument may be unable to properly detect overload states immediately after the current range has changed.
- The currents for which an overload state can be detected are DC and sine waves with frequencies of 45 Hz to 66 Hz. The device is unable to detect the currents listed below as an overload state.
  - Currents that exceed the defined level on a momentary basis
  - High-frequency currents that exceed the defined level

**Any other LEDs lights up or blinks.**

A different error is occurring.

▷ See “4.2 Errors” (p.88) to identify a reason and take necessary measures.

## 5 Press the ▲ (higher range) key or ▼ (lower range) key to choose a current range.

- Choose a current range with a maximum peak current higher than the peak value of a current under measurement.

See “Maximum peak current” (p.72).

If the peak value of the current under measurement exceeds the maximum peak current of the chosen current range, the output waveform will be saturated or distorted, preventing you from correctly observing the current waveform.

- You need to choose a current range according to the level of the current under measurement to minimize an adverse effect of noise on observation of the current waveform. The following table shows the recommended current ranges for each of the levels of currents under measurement.

| Electric current level    | Recommended current range<br>(Output rate) |
|---------------------------|--|
| $\pm 5$ A to $\pm 50$ A   | 30 A (0.1 V/A)                             |
| $\pm 0.5$ A to $\pm 5$ A  | 5 A (1 V/A)                                |
| $\pm 1$ mA to $\pm 0.5$ A | 0.5 A (10 V/A)                             |

## 6 Convert a voltage sensitivity of the waveform measuring instrument into a current sensitivity.

Using the following formula can convert a voltage sensitivity (unit: V/div) specified on the waveform measuring instrument into a current sensitivity (unit: A/div).

$$S_I = S_V / R_O$$

$S_I$ : Current sensitivity (A/div)

$S_V$ : Voltage sensitivity (V/div)

$R_O$ : Output rate (V/A)

### Example

When your waveform measuring instrument with its voltage sensitivity set at 10 mV/div measures a current that has an RMS value of 1 mA

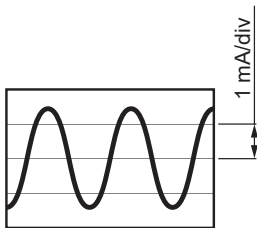

0.5 A range (10 V/A)

$$\begin{aligned} S_I &= (10 \times 10^{-3}) / 10 \\ &= 1 \times 10^{-3} \text{ (A/div)} \end{aligned}$$

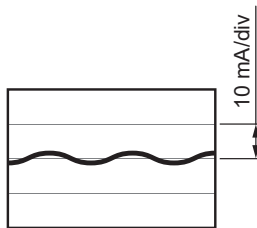

5 A range (1 V/A)

$$\begin{aligned} S_I &= (10 \times 10^{-3}) / 1 \\ &= 10 \times 10^{-3} \text{ (A/div)} \end{aligned}$$

**IMPORTANT**

- After you measured a current that exceeds the maximum rated current value of each current range, re-execute the demagnetization and automatic zero-adjustment.

The sensor heads have been magnetized, causing incorrect current measurements.

See “Executing demagnetization and automatic zero-adjustment” (p.33).

**IMPORTANT**

When you measure high-frequency currents, the position of the conductor under measurement in the sensor aperture may vary the magnitude of load applied to the circuit under measurement, adversely affecting the measurement accuracy.

See “Input impedance” (p.80).

The following methods can minimize the adverse effect:

- Straighten the conductor under measurement as long as possible.
- Clamp the sensor at the center of the straight portion of the conductor as close as possible.
- Arrange the conductor at the center of the sensor aperture as close as possible.
- Do not wind the conductor around a jaw.

### IMPORTANT

When you measure high-frequency currents, Clamping the sensor around the high-potential side of a circuit may cause common-mode noise to affect the measurement accuracy adversely.

See “Influence of common-mode voltage” (p.82).

As needed, reduce the frequency band of the waveform measuring instrument, or clamp the sensor around the low-potential side conductor.

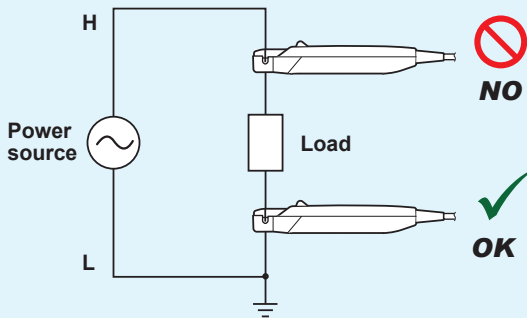

Displayed values can frequently fluctuate due to induction potential even when no voltage is applied. This, however, is not a malfunction.

**NOTE**

- Depending on the amplitude and frequency of a current under measurement, the sensor heads may emit a resonant sound. Such a sound may also be emitted during demagnetization. This, however, does not represent a device malfunction.
- If foreign matter adheres to the facing core surfaces on the sensor heads and thus creates a slight gap between the upper and lower sensor heads, the sensor heads may emit a resonant sound.
  - ▷ Remove any foreign matter by following the cleaning method.  
See “4.3 Cleaning” (p.96).
- An increase in the resonant sound while the device is in use may indicate that the gap between the upper and lower heads has widened. The gap may adversely affect the measurement accuracy. Calibrating the device is recommended.  
See “Maintenance and Service” (p.83).

## To measure a low current

---

When measuring low DC or low-frequency low AC, you can increase the current-detection sensitivity of the device in the following way.

### How to measure a low current

---

**1** Coil a single conductor to be measured into several loops with a diameter of 200 mm or more.

---

**2** Clamp the sensor around the loops in a bundle.

This will make the conductor pass through the sensor aperture one time more than the loop count consecutively in one direction.

---

**3** Arrange the loops radially as shown on the following page.

---

**4** Measure the current.

---

As shown in the figure below, clamping the sensor around the seven loops in a bundle allows the conductor to pass through the sensor aperture eight times, which increases the voltage of the output signal by a factor of eight.

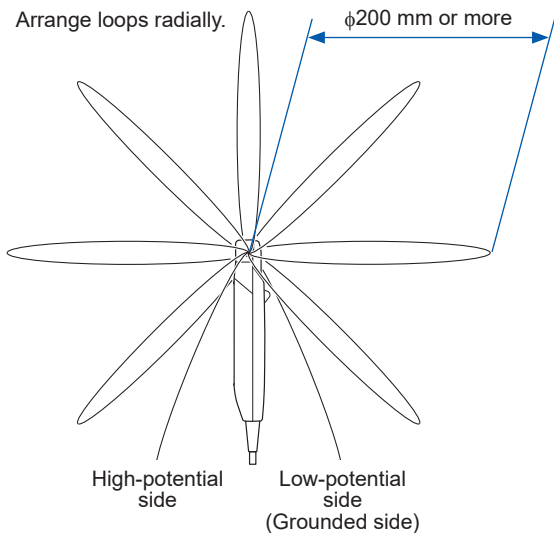



## To measure a current accurately

---

Retracting and extending the upper jaw can cause an offset voltage of several millivolts. Perform the steps described below before measuring a current to measure it accurately.

### How to measure a current accurately

---

- 1** Hold down the **DEMAG / AUTO ZERO** key on the junction box for about 1 second.

The **DEMAG / AUTO ZERO** LED will light up. Demagnetization and automatic zero-adjustment will start.

After the completion, the **DEMAG / AUTO ZERO** LED will go out.

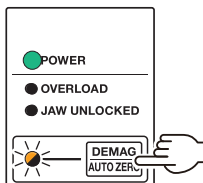

**Hold down**

Before execution, orange blinks or goes out.

- 2** Wait for about 5 minutes.

The fluctuation in the offset voltage will stabilize.

- 3** Operate the opening lever of the sensor back and forth to retract and extend the upper jaw 4 or 5 times.

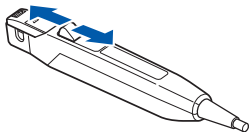

- 4** Slide the opening lever toward the lower jaw until the **JAW UNLOCKED** indicator is hidden.

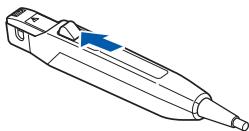

The upper jaw will be locked with the upper and lower sensor heads arranged in position relative to each other.

The **JAW UNLOCKED** LED will go out.

- 5** Momentarily press the **DEMAG / AUTO ZERO** key on the junction box. (Do not hold down the key.)

The **DEMAG / AUTO ZERO** LED will light up. Automatic zero-adjustment will be performed alone.

After the completion, the **DEMAG / AUTO ZERO** LED will go out.

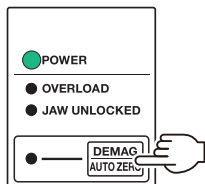

**Press**  
(Do not hold down)

- 6** Measure a current.

See “How to measure a current” (p. 50).

### When the device has entered protection mode

To protect the device against self-generated heat, it enters protection mode when the temperature of the junction box exceeds a specified level.

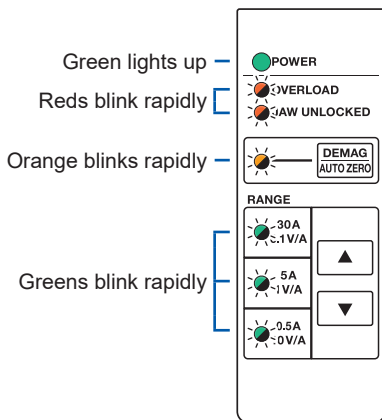

In protection mode, the device cannot correctly measure any current. Moreover, you cannot switch the current ranges. When the device has entered protection mode, follow the procedure presented on the following pages to restore it to normal operation.

If the device has entered protection mode, it is recommended to re-calibrate it because internal components may have been subjected to thermal stress.

## How to restore the device

---

- 1** Pull the opening lever of the sensor toward you to retract the upper jaw, and remove the sensor from the conductor under measurement.

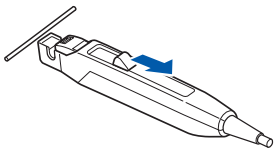

- 2** Slide the opening lever toward the lower jaw until the **JAW UNLOCKED** indicator is hidden.

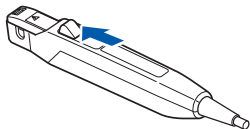

The upper jaw will be locked in place.

- 3** Wait for a while to let the junction box cool down to a normal temperature.
-

#### 4 Press any key.

One of the **RANGE** LEDs (of the range used before the device entered protection mode) will light up, and the device will get back to normal.

The **DEMAG / AUTO ZERO** LED will blink slowly.

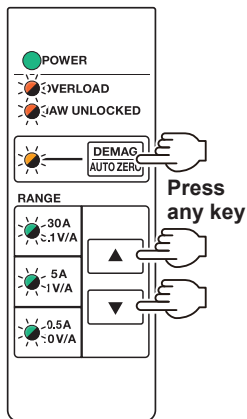

#### 5 Perform demagnetization and automatic zero-adjustment.

See "Executing demagnetization and automatic zero-adjustment" (p.33).

## 2.4 Finishing Measurement

### CAUTION



- **Do not pull the cord to unplug the output terminal.**

Doing so can damage the cord and output terminal.

- **Hold the termination unit and disconnect the output terminal while pulling the unlock lever toward you.**

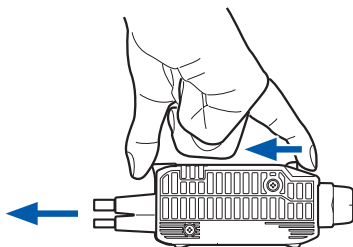

 **CAUTION**

- **To disconnect the power plug of the device, do not pull the cord.**



- **Do not twist the power plug.**

Doing so could damage the cord and the power receptacle of the 3269 Power Supply.

---

- **While holding the shell (p. 17), pull the power plug out.**



Pulling the shell lets the plug be unlocked, so you can disconnect the plug from the power receptacle.

---

## How to finish measurement

---

- 1** Pull the opening lever of the sensor toward you to retract the upper jaw, and remove the sensor from the conductor under measurement.

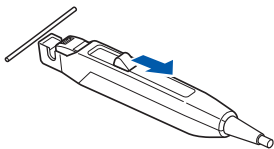

- 2** Slide the opening lever toward the lower jaw until the **JAW UNLOCKED** indicator is hidden.

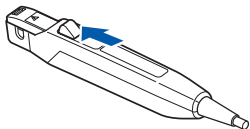

The upper jaw will be locked in place.  
The **JAW UNLOCKED** LED will go out.

- 3** Disconnect the termination unit from the BNC input terminal on the waveform measuring instrument.

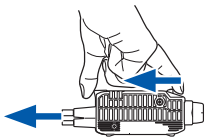

While pulling the unlock lever, pull out the termination unit straight.

2



- 4** Set the **POWER** switch of the 3269 Power Supply in the OFF position.
- 

- 5** Disconnect the power plug of the CT6710/CT6711 from the 3269 Power Supply.

Hold the shell (p. 17) of the power plug when you disconnect it.

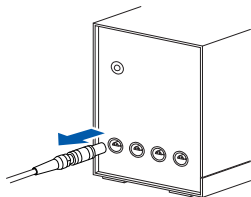

- Do not pull the cord.
  - Do not twist the power plug.
- 

- 6** Unplug the power cord of the 3269 Power Supply from the outlet.
-

# 3

## Specifications

Unless otherwise specified, each specification item is applied to both Model CT6710 and Model CT6711.

Items with a model number, “(Model CT6710)” or “(Model CT6711),” indicated are applicable to each model.

Each item is specified for the device operated at  $23^{\circ}\text{C}\pm 5^{\circ}\text{C}$  ( $73^{\circ}\text{F}\pm 9^{\circ}\text{F}$ ) and 80% RH (no condensation), 30 minutes elapses after the device is turned on before use.

### 3.1 General Specifications

3

---

#### Operating environment

Indoor, Pollution Degree 2, Operating altitude up to 2000 m (6562 ft.)

---

#### Operating temperature and humidity

$0^{\circ}\text{C}$  to  $40^{\circ}\text{C}$  ( $32^{\circ}\text{F}$  to  $104^{\circ}\text{F}$ ), 80% RH or less (no condensation)

---

#### Storage temperature and humidity range

$-10^{\circ}\text{C}$  to  $50^{\circ}\text{C}$  ( $14^{\circ}\text{F}$  to  $122^{\circ}\text{F}$ ), 80% RH or less (no condensation)

---

#### Standards

Safety: EN61010  
EMC: EN61326

---

#### Measurable conductors

Insulated conductors

---

#### Measurable diameter of conductors

5 mm or less in diameter

---

---

|                     |   |
|---------------------|---|
| <b>Power supply</b> | External power supply (Model 3269)<br>Rated supply voltage: $\pm 12$ V DC $\pm 0.5$ V<br>Maximum rated power: 7.8 VA<br>(For current probe only, when measuring<br>30 A rms continuously) |
|---------------------|---|

---

**Consumption current**

See "Consumption current" (p.81) in "3.4  
Typical Characteristics."

---

**Dimensions**

- Sensor  
Approx. 155W  $\times$  18H  $\times$  26D mm  
(6.10"W  $\times$  0.71"H  $\times$  1.02"D)
  - Junction box  
Approx. 45W  $\times$  120H  $\times$  25D mm  
(1.77"W  $\times$  4.72"H  $\times$  0.98"D)
  - Termination unit  
Approx. 29W  $\times$  83H  $\times$  40D mm  
(1.14"W  $\times$  3.27"H  $\times$  1.57"D)
- Excluding BNC connector or protrusions
- 

**Mass**

Approx. 370 g (13.1 oz.)

---

**Cord lengths**

- Between sensor and junction box  
Approx. 1500 mm (59.06")
  - Between junction box and termination unit  
Approx. 150 mm (5.91")
  - Power cord  
Approx. 1000 mm (39.37")
- 

**Product warranty period**

1 year

---

**Accessories  
Option**

See "(Accessory)" (p.5) and "Option"  
(p.6).

---

## 3.2 Specifications of Input, Output, and Measurement

### Basic specifications

---

#### Frequency band

DC to 50 MHz (-3 dB) (Model CT6710)  
DC to 120 MHz (-3 dB) (Model CT6711)  
See “Frequency characteristics” (p. 77) in “3.4 Typical Characteristics.”

---

#### Rise time (10% to 90%)

7.0 ns or less (Model CT6710)  
2.9 ns or less (Model CT6711)

---

#### Delay time (the time lag between the input signal with a rise time of 1 ns and the output signal)

30 A range: 12 ns (typical)  
5 A range: 12 ns (typical)  
0.5 A range: 13 ns (typical)

---

#### Current range (output rate)

30 A range (Rate: 0.1 V/A)  
5 A range (Rate: 1 V/A)  
0.5 A range (Rate: 10 V/A)

---

**Maximum rated current\*<sup>1</sup>**

30 A range: 30 A rms

5 A range: 5 A rms

0.5 A range: 0.5 A rms

Derating is needed as input frequency increases.

See “Frequency derating curve” (p.78) in “3.4 Typical characteristics.”

Specified for currents of DC and sine wave

---

**Maximum peak current**

30 A range:  $\pm 50$  A peak

(maximum duration of input:  $2 \text{ s}^{*2}$ )

5 A range:  $\pm 7.5$  A peak

0.5 A range:  $\pm 0.75$  A peak (less than 10 MHz)

$\pm 0.3$  A peak (10 MHz or more)

---

**Noise**

75  $\mu\text{A}$  rms or less (Typical: 60  $\mu\text{A}$  rms)

(For only the probe, at the 0.5 A range, connected with a measuring instrument that has a frequency band of 20 MHz)

---

**Input impedance**

See “Input impedance” (p.80) in “3.4 Typical characteristics.”

---

- \*1. Depending on the ambient temperature and measurement conditions, internal overheating can result in an overload condition, limiting the maximum rated current lower than those specified here.
- \*2. The device requires to cool down for 10 times the length of time the current was inputted.

## Specifications of accuracy

---

### Accuracy warranty conditions

- Accuracy warranty period  
1 year (until the upper jaw has been retracted and locked up to 10,000 cycles)
  - Temperature and humidity for guaranteed accuracy  
23°C±5°C (73°F±9°F), 80% RH or less
  - Warm-up time  
At least 30 minutes
  - Power voltage range  
±12 V DC ±0.5 V
- 

### Amplitude accuracy\*<sup>3</sup>

30 A range: ±3.0% rdg. ±1 mV

(Typical: ±1.0% rdg. ±1 mV  
[for 10 A rms or less])

5 A range: ±3.0% rdg. ±1 mV

(Typical: ±1.0% rdg. ±1 mV)

0.5 A range: ±3.0% rdg. ±10 mV

(Typical: ±1.0% rdg. ±10 mV)

For a direct current and a sine-wave current with frequencies of 45 Hz to 66 Hz within the maximum peak current value of each current range

---

\*3. Unless there is any change in the state of the facing core surfaces, which includes scratches, adhesion of foreign objects, or any change in the operating environment.

**Temperature characteristics of sensitivity\*3, \*4**

±2.0% rdg. or less

After automatic zero-adjustment was executed,  
in the temperature range except 23°C±5°C,  
under the following input conditions:

30 A range: AC with 50 Hz, 30 A

5 A range: AC with 50 Hz, 5 A

0.5 A range: AC with 50 Hz, 0.5 A

---

**Effect of radiated radio-frequency electro-magnetic field**

±10 mA or less at 3 V/m

---

**Effect of conducted radio-frequency electro-magnetic field**

±10 mA or less at 3 V

---

**Effect of external magnetic field**

20 mA or less (Model CT6710)

(DC and 60 Hz, in a magnetic field of  
400 A/m)

5 mA or less (Model CT6711)

(DC and 60 Hz, in a magnetic field of  
400 A/m)

---

\*3. Unless there is any change in the state of the facing core surfaces, which includes scratches, adhesion of foreign objects, or any change in the operating environment.

\*4. The values of the temperature characteristics of sensitivity are added to the amplitude accuracy.

## 3.3 Specifications of Functionality

### Demagnetizing and automatic zero-adjustment functions

When the upper jaw is not locked in place, an overload is detected, or an inputted current exceeds the values listed below, the functions are not available.

0.50 ±0.25 A rms

(DC and sine wave with frequencies of 45 Hz to 66 Hz)

- Demagnetizing and automatic zero-adjustment  
Operation: Executes demagnetization and automatic zero-adjustment.

Means: Hold down the **DEMAG / AUTO ZERO** key (1 s).

- Automatic zero-adjustment  
Operation: Executes automatic zero-adjustment alone.

Means: Press the **DEMAG / AUTO ZERO** key.

### Jaw-unlocked detection

When the upper jaw is not locked in place, the **JAW UNLOCKED** LED lights up.



### Overload detection

- Typical sampling frequency: 7.8125 kHz
- Typical checking cycle: 500 ms

#### Breakdown

Typical sampling period: 400 ms

Typical computing-and-judging period:

100 ms

#### (1) Excess of rated current level

When the input current exceeds the following level, the **OVERLOAD** LED blinks rapidly.

30 A range:  $32.5 \pm 2.5$  A rms

5 A range:  $5.25 \pm 0.25$  A rms

0.5 A range:  $0.525 \pm 0.025$  A rms

(For all the ranges, the target currents are of DC and sine wave with frequencies of 45 Hz to 66 Hz)

#### (2) Excess of specified temperature

Detects an internal temperature anomaly and issues an alert by blinking all of the LEDs except the **POWER** LED.

Typical specified-temperature: 80°C

Typical hysteresis: 10°C

Recovery means: Press any key. Then, the device requires demagnetization and automatic zero-adjustment.

---

### Specifications of lighting up / blinking LEDs

See “1.4 Specifications of Lighting Up / Blinking LEDs” (p.22).

---

## 3.4 Typical Characteristics

All of the characteristics shown in this section are typical.

### Frequency characteristics

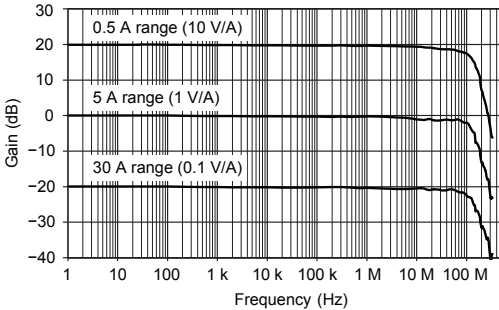

Fig. 1 Frequency characteristics (Model CT6710)

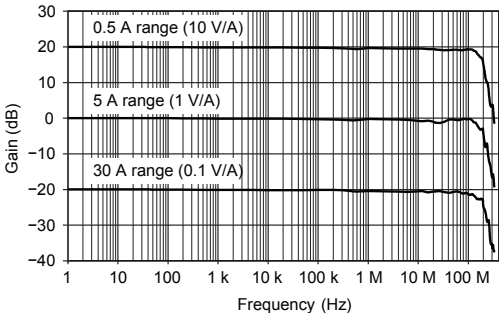

Fig. 2 Frequency characteristics (Model CT6711)

## Frequency derating curve

---

Figures 3 and 4 show the derating curves with a sine-wave current inputted in the temperature and humidity range for the guaranteed accuracy. If the ambient temperature ( $T_A$ ) rises or the current under measurement contains high-frequency components, the device temperature will rise, and thus its continuously inputtable current value and frequency will lower.

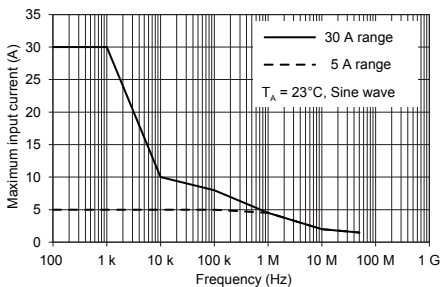

Fig. 3 Derating curve according to frequency (Model CT6710)

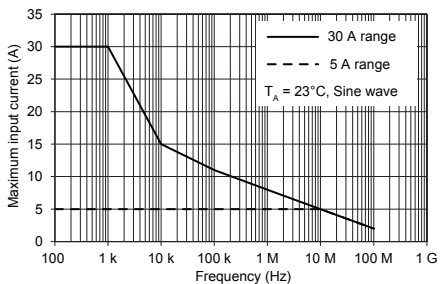

Fig. 4 Derating curve according to frequency (Model CT6711)

## Input impedance

The location where the sensor is clamped will exhibit impedance as shown in Figs. 5 and 6, which inserts a load in a circuit under measurement. In particular, take this characteristic into account when measuring a high-frequency current.

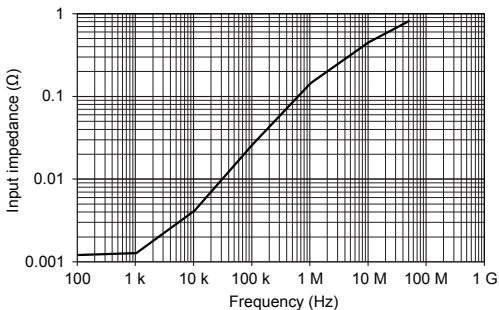

Fig. 5 Input impedance (Model CT6710)

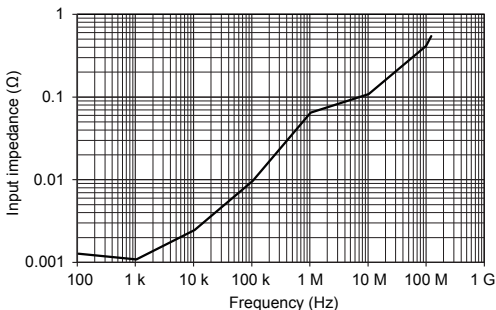

Fig. 6 Input impedance (Model CT6711)

## Consumption current

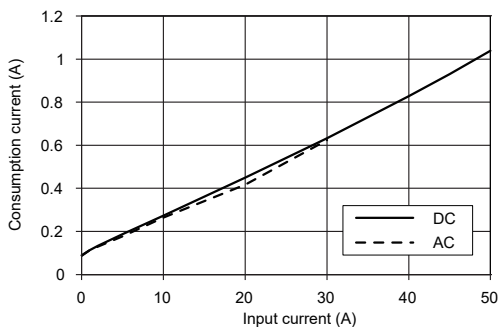
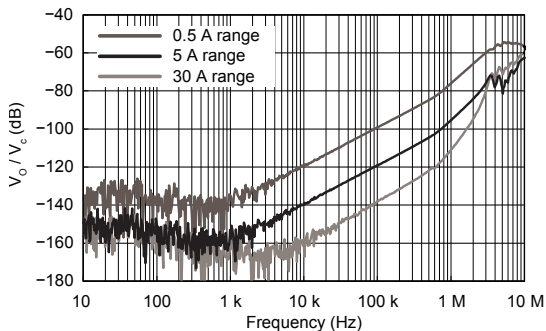

Fig. 7 Consumption current (with the 30 A range specified)

## Influence of common-mode voltage

The figure below indicates the ratio of common-mode voltage (external noise voltage) applied to a conductor under measurement positioned in the sensor aperture and the resulting output voltage.



$V_o$ : Output voltage (V)

$V_c$ : Common-mode voltage (V)

Fig. 8 Influence of common-mode voltage

 **WARNING**

- **Do not attempt to modify, disassemble, or repair the device yourself.**

Attempting the above may cause bodily injury or fire.

### Calibration

The calibration interval depends on factors such as operating conditions and environment.

Please determine the appropriate calibration interval based on your operating conditions and environment and have Hioki calibrate it accordingly on a regular basis.



## 4.1 Troubleshooting

If damage is suspected, read “Before sending back your device for repair” (p. 85) and check the device as described. If this cannot resolve problems, contact your authorized Hioki distributor or reseller.

When transporting the device, be sure to observe the following precautions:

- Remove the CT6710/CT6711 from the 3269 Power Supply.
- Include a memo that describes the problem in detail.
- Pack the device in the packaging in which it was initially delivered and double-pack it.

Damage that occurs during transportation is not covered by the warranty.

## Before sending back your device for repair

### Symptom / Cause, remedy

#### **No waveform is displayed on the waveform measuring instrument.**

- ▷ Re-execute demagnetization and automatic zero-adjustment. (p.33)
- ▷ Make sure that the input coupling of the waveform measuring instrument is set to DC. (p.38)

If the issue has not been resolved, the device may be malfunctioning.

- ▷ Have the device repaired.

---

#### **A resonant sound is emitted from the sensor heads.**

This does not affect the measurement accuracy.

The sensor head may emit a resonant sound depending on the amplitude and frequency of the current under measurement.

---

#### **The resonant sound emitted from the sensor heads becomes louder.**

Calibration of the device is recommended because the gap may adversely affect the measurement accuracy.

The gap between the upper and lower sensor heads may have increased.

---

**Symptom / Cause, remedy**

**Demagnetization and automatic zero-adjustment cannot be performed.**

**Demagnetization or automatic zero-adjustment has not been completed normally.**

Under the following conditions, demagnetizing and automatic zero-adjustment cannot be performed. Alternatively, demagnetization or automatic zero-adjustment has not been completed normally.

- The upper jaw is unlocked.
- An overload has been detected whether or not the upper jaw is locked.
- A current exceeding 0.5 A rms has been detected whether or not the upper jaw is locked.

▷ Implement the remedy described on the following pages:

See “Demagnetizing / automatic zero-adjustment unavailable” (p.92).

Then, re-execute demagnetization and automatic zero-adjustment.

See “Executing demagnetization and automatic zero-adjustment” (p.33).

When demagnetization or automatic zero-adjustment has not been normally completed even with the sensor not clamped around any conductor and the upper jaw locked in place, the device may be malfunctioning.

▷ Send the device for repair.

**Symptom / Cause, remedy**

**The waveform outputted during the demagnetization is asymmetric along the horizontal axis.**

This does not represent a device malfunction.

- ▷ After demagnetization and automatic zero-adjustment are completed, make sure that the zero position on the waveform measuring instrument is appropriate.
-

## 4.2 Errors

If an error occurs, the LEDs on the junction box will light up or blink.

See “1.4 Specifications of Lighting Up / Blinking LEDs” (p.22).

When an error occurs, remedy the error according to measures described on the following pages. If the device needs to be repaired, contact your authorized Hioki distributor or reseller.

## Types of errors

You can identify the type of an error with the LED indicators displayed on the junction box.

### Protection mode

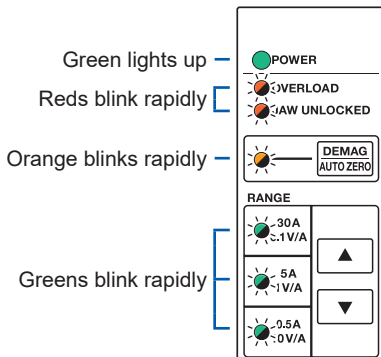

The abnormal internal temperature was detected in the junction box, and thus the device has entered protection mode.

▷ Follow the procedure on the following page.

“When the device has entered protection mode” (p.62)

Calibration of the device is recommended. Internal components may have been subject to thermal stress.

## Overload

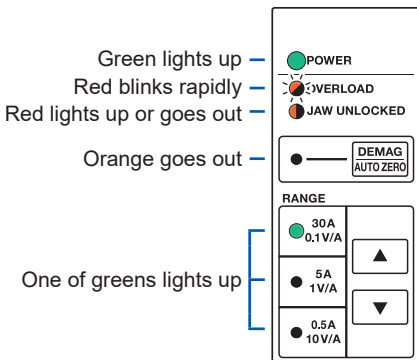

The input current exceeding the specified level of each current range is detected.

When you use the 30 A range

▷ Immediately remove the sensor from the conductor under measurement.

When you use the 0.5 A range or 5 A range

▷ Switch a higher current range.

**IMPORTANT**

- The instrument may be unable to properly detect overload states immediately after the current range has changed.
- The currents for which an overload state can be detected are DC and sine waves with frequencies of 45 Hz to 66 Hz. The device is unable to detect the currents listed below as an overload state.
  - Currents that exceed the defined level on a momentary basis
  - High-frequency currents that exceed the defined level
- Although external magnetic fields may cause the **OVERLOAD** LED to blink while the upper jaw is retracted, this does not indicate an issue with the device.



## Demagnetizing / automatic zero-adjustment unavailable

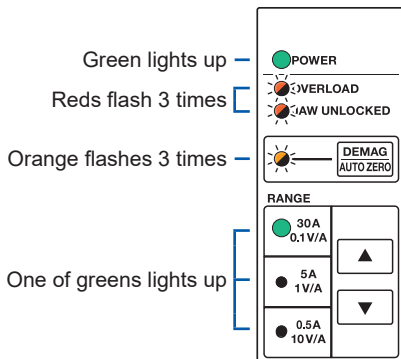

Demagnetizing and automatic zero-adjustment cannot be performed; otherwise, demagnetization or automatic zero-adjustment has not been completed normally.

The device must be in the following conditions:

- The upper jaw is unlocked.
- An overload has been detected whether or not the upper jaw is locked.
- A current exceeding 0.5 A rms has been detected whether or not the upper jaw is locked.

▷ Depending on the LED status exhibited after the three blinks, implement the remedy described on the following pages. After that, re-execute demagnetization and automatic zero-adjustment (p.33).

## LED status after three flashes

---

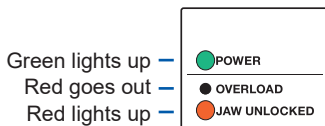

### The upper jaw is unlocked.

- ▷ Slide the opening lever of the sensor toward the lower jaw until the **JAW UNLOCKED** indicator is hidden to lock the upper jaw in place.
- 

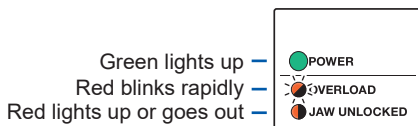

### An overload is detected.

- ▷ Remove the sensor from the conductor under measurement.  
Then, slide the opening lever of the sensor toward the lower jaw until the **JAW UNLOCKED** indicator is hidden to lock the upper jaw in place.
-

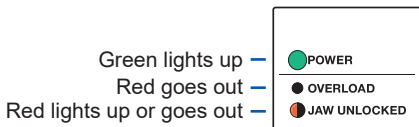

**A current exceeding 0.5 A rms has been detected.**

- ▷ Remove the sensor from the conductor under measurement.  
Then, slide the opening lever of the sensor toward the lower jaw until the **JAW UNLOCKED** indicator is hidden to lock the upper jaw in place.
-

## Checksum error

All LEDs blink rapidly.

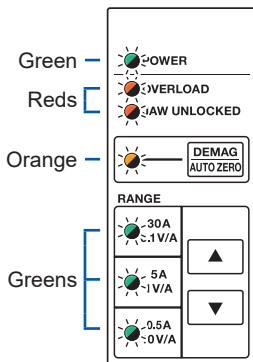

An internal CPU error (checksum error) has occurred.

▷ Have the device repaired.

4

## Malfunction

No LEDs light up.

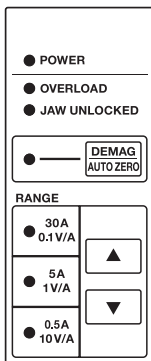

The device is malfunctioning.

▷ Have the device repaired.

## 4.3 Cleaning

### CAUTION



- **Do not wipe the facing core surfaces of the sensor heads and metallic parts of the connectors with a soft cloth moistened with any liquid.**

Doing so damage the device.

---

 **CAUTION**

- **Discharge any static electricity on your body before cleaning the facing core surfaces of the sensor heads and the metallic parts of the connectors.**

Subjecting the device to high voltage may damage the internal Hall elements and circuitry.



- **Periodically clean the vents to avoid blockage.**

When the vents get clogged, the internal cooling effect of the device is hampered, and this can lead to damage to the device.

- **If the instrument becomes dirty, wipe the instrument softly with a soft cloth moistened with water or a neutral detergent.**

Do not wipe the instrument strongly and never use solvents such as benzene, alcohol, acetone, ether, ketones, thinners, or gasoline. Failure to follow this instructions can deform and discolor the instrument.

**IMPORTANT**

- Keep the facing core surfaces of the sensor heads clean by gently wiping them with a soft dry cloth.

Dirt on the facing core surfaces can adversely affect the measurement accuracy.

## 4.4 Disposal

Dispose of the device in accordance with local regulations.

## A

---

|                                 |    |
|---------------------------------|----|
| Accessories .....               | 5  |
| Accuracy .....                  | 73 |
| Amplitude accuracy .....        | 73 |
| Automatic zero-adjustment ..... | 36 |
| Abnormal operation .....        | 86 |

## C

---

|                                   |        |
|-----------------------------------|--------|
| Calibration .....                 | 83     |
| Cleaning .....                    | 96     |
| Common-mode noise .....           | 56     |
| Common-mode voltage .....         | 82     |
| Consumption current .....         | 29, 81 |
| Current direction indicator ..... | 21     |

## D

---

|                                |        |
|--------------------------------|--------|
| DEMAG / AUTO ZERO key .....    | 18     |
| DEMAG / AUTO ZERO LED .....    | 19, 23 |
| Blinking slowly .....          | 36     |
| Demagnetization .....          | 36     |
| Abnormal operation .....       | 86     |
| Demagnetization waveform ..... | 36, 87 |
| Dielectric heating .....       | 44     |
| Disposal .....                 | 97     |

## E

---

|                         |    |
|-------------------------|----|
| Eddy current loss ..... | 44 |
| Error .....             | 88 |



## F

---

|                                |        |
|--------------------------------|--------|
| Frequency band.....            | 15, 71 |
| Frequency characteristics..... | 77     |
| Frequency derating.....        | 41, 78 |

## H

---

|                        |        |
|------------------------|--------|
| Higher range key ..... | 18, 53 |
|------------------------|--------|

## I

---

|                       |        |
|-----------------------|--------|
| Input coupling .....  | 37     |
| Input impedance ..... | 26, 80 |

## J

---

|                              |        |
|------------------------------|--------|
| Jaws .....                   | 21     |
| JAW UNLOCKED indicator ..... | 21     |
| JAW UNLOCKED LED .....       | 19, 23 |
| Junction box .....           | 18     |

## K

---

|                        |        |
|------------------------|--------|
| Keys.....              | 18     |
| DEMAG / AUTO ZERO..... | 18     |
| Higher range.....      | 18, 53 |
| Lower range.....       | 18, 53 |

**L**

|                        |            |
|------------------------|------------|
| LEDs.....              | 18, 22     |
| Blinking rapidly.....  | 89, 90, 95 |
| Blinking slowly .....  | 36         |
| DEMAG / AUTO ZERO..... | 19, 23, 36 |
| Flashing 3 times.....  | 92         |
| JAW UNLOCKED .....     | 19, 23     |
| OVERLOAD.....          | 19, 23, 90 |
| POWER.....             | 19, 22     |
| RANGE.....             | 19, 23     |
| Low current.....       | 58         |
| Lower range key.....   | 18, 53     |

**M**

|                              |       |
|------------------------------|-------|
| Maintenance.....             | 83    |
| Maximum peak current.....    | 72    |
| Maximum rated current.....   | 72    |
| Model 3269 Power Supply..... | 6, 30 |

**O**

|                      |            |
|----------------------|------------|
| Offset voltage ..... | 36, 50, 60 |
| Opening lever .....  | 21         |
| Option .....         | 6          |
| Output terminal..... | 17         |
| Overload.....        | 22, 52, 90 |
| OVERLOAD LED.....    | 19, 23, 90 |

**P**

|                       |        |
|-----------------------|--------|
| POWER LED .....       | 19, 22 |
| Power plug.....       | 17, 30 |
| Protection mode ..... | 62     |

## R

---

|                      |        |
|----------------------|--------|
| RANGE LEDs .....     | 19, 23 |
| Resonant sound ..... | 57, 85 |

## S

---

|                     |    |
|---------------------|----|
| Sensor .....        | 20 |
| Sensor heads .....  | 21 |
| Serial number ..... | 17 |
| Service.....        | 83 |
| Shell.....          | 17 |

## T

---

|                        |    |
|------------------------|----|
| Termination unit ..... | 16 |
|------------------------|----|

## U

---

|                   |    |
|-------------------|----|
| Unlock lever..... | 17 |
|-------------------|----|

## V

---

|            |    |
|------------|----|
| Vents..... | 17 |
|------------|----|

## W

---

|                     |    |
|---------------------|----|
| Waveform            |    |
| Not displayed ..... | 85 |

# Warranty Certificate

# HIOKI

|       |               |   |
|-------|---------------|---|
| Model | Serial number | Warranty period<br>One (1) year from date of purchase ( ___ / ___ ) |
|-------|---------------|---|

Customer name: \_\_\_\_\_  
Customer address: \_\_\_\_\_

### Important

- Please retain this warranty certificate. Duplicates cannot be reissued.
- Complete the certificate with the model number, serial number, and date of purchase, along with your name and address. The personal information you provide on this form will only be used to provide repair service and information about Hioki products and services.

This document certifies that the product has been inspected and verified to conform to Hioki's standards.

Please contact the place of purchase in the event of a malfunction and provide this document, in which case Hioki will repair or replace the product subject to the warranty terms described below.

### Warranty terms

- The product is guaranteed to operate properly during the warranty period (one [1] year from the date of purchase).  
If the date of purchase is unknown, the warranty period is defined as one (1) year from the date (month and year) of manufacture (as indicated by the first four digits of the serial number in YYMM format).
- If the product came with an AC adapter, the adapter is warranted for one (1) year from the date of purchase.
- The accuracy of measured values and other data generated by the product is guaranteed as described in the product specifications.
- In the event that the product or AC adapter malfunctions during its respective warranty period due to a defect of workmanship or materials, Hioki will repair or replace the product or AC adapter free of charge.
- The following malfunctions and issues are not covered by the warranty and as such are not subject to free repair or replacement:
  - 1. Malfunctions or damage of consumables, parts with a defined service life, etc.
  - 2. Malfunctions or damage of connectors, cables, etc.
  - 3. Malfunctions or damage caused by shipment, dropping, relocation, etc., after purchase of the product
  - 4. Malfunctions or damage caused by inappropriate handling that violates information found in the instruction manual or on precautionary labeling on the product itself
  - 5. Malfunctions or damage caused by a failure to perform maintenance or inspections as required by law or recommended in the instruction manual
  - 6. Malfunctions or damage caused by fire, storms or flooding, earthquakes, lightning, power anomalies (involving voltage, frequency, etc.), war or unrest, contamination with radiation, or other acts of God
  - 7. Damage that is limited to the product's appearance (cosmetic blemishes, deformation of enclosure shape, fading of color, etc.)
  - 8. Other malfunctions or damage for which Hioki is not responsible
- The warranty will be considered invalidated in the following circumstances, in which case Hioki will be unable to perform service such as repair or calibration:
  - 1. If the product has been repaired or modified by a company, entity, or individual other than Hioki
  - 2. If the product has been embedded in another piece of equipment for use in a special application (aerospace, nuclear power, medical use, vehicle control, etc.) without Hioki's having received prior notice
- If you experience a loss caused by use of the product and Hioki determines that it is responsible for the underlying issue, Hioki will provide compensation in an amount not to exceed the purchase price, with the following exceptions:
  - 1. Secondary damage arising from damage to a measured device or component that was caused by use of the product
  - 2. Damage arising from measurement results provided by the product
  - 3. Damage to a device other than the product that was sustained when connecting the device to the product (including via network connections)
- Hioki reserves the right to decline to perform repair, calibration, or other service for products for which a certain amount of time has passed since their manufacture, products whose parts have been discontinued, and products that cannot be repaired due to unforeseen circumstances.

**HIOKI E.E. CORPORATION**

<http://www.hioki.com>

18-07 EN-1

# HIOKI

[www.hioki.com/](http://www.hioki.com/)



**All regional  
contact  
information**

## **HIOKI E.E. CORPORATION**

81 Koizumi, Ueda, Nagano 386-1192 Japan

2309 EN

Edited and published by HIOKI E.E. CORPORATION

Printed in Japan

- Contents subject to change without notice.
- This document contains copyrighted content.
- It is prohibited to copy, reproduce, or modify the content of this document without permission.
- Company names, product names, etc. mentioned in this document are trademarks or registered trademarks of their respective companies.

### **Europe only**

• EU declaration of conformity can be downloaded from our website.

• Contact in Europe: HIOKI EUROPE GmbH  
Helfmann-Park 2, 65760 Eschborn, Germany

[hioki@hioki.eu](mailto:hioki@hioki.eu)