

3158

Instruction Manual

AC WITHSTANDING VOLTAGE HiTESTER



Contents

Inspection	i
Safety Notes	ii
Notes on Use	iv
Contents and Indications of This Manual	vi
Chapter 1 Overview	1
1.1 Product Introduction	2
1.2 Names and Functions of Parts	3
Chapter 2 Testing Arrangements	7
2.1 Connecting the Protective Ground Terminal	7
2.2 Wearing rubber gloves	8
2.3 Connecting the External I/O Connector	9
2.4 Power Cord Connection	10
2.5 Powering On and Off the Unit	11
2.6 Connecting the 9615 H.V. TEST LEAD	12
2.7 Connecting the REMOTE CONTROL BOX	14
2.8 Installation of the Unit	15
2.9 Connection to the Measured Equipment	16
2.10 Startup Inspection	17
Chapter 3 Testing Method	19
3.1 State of the 3158 and Preset Parameters	20
3.2 Making Testing Arrangements (in READY State)	22
3.2.1 Selecting an Output-Voltage Range	23
3.2.2 Key-lock Function	23
3.2.3 Initial Settings for Optional Functions	24
3.3 Setting the "SETTING" State	25
3.3.1 Setting the Comparative Voltage Value	26
3.3.2 Setting the Upper (Lower) Level Value	27
3.3.3 Setting the Test Time	28
3.3.4 Examples of Settings	29
3.4 Starting a Test	32
3.4.1 Setting the Output Voltage	33
3.4.2 Executing a Test	35
3.4.3 Screening in "TEST State"	37
3.5 PASS or FAIL Determination	38
3.5.1 "PASS" State	38
3.5.2 Screening in "PASS" State	39

3.5.3	"FAIL" State	40
3.5.4	Screening in "FAIL" State	43
Chapter 4	Optional Functions	45
4.1	PASS Hold Function	48
4.2	FAIL Hold Function	49
4.3	Hold Function	50
4.4	Momentary Out	52
4.5	Double Action	53
4.6	FAIL Mode	54
4.7	RS Command [START]	55
4.8	Inter-lock Function	56
4.9	Voltage Comparator Position	57
4.10	Example of Optional Function Settings	58
4.11	Example of Optional Functions Use	59
Chapter 5	Saving/Loading Preset Values	61
5.1	Saving Preset Values	62
5.1.1	Procedure for Saving Data	63
5.1.2	Example of Saving	64
5.2	Loading Preset Values	66
5.2.1	Procedure for Loading Data	67
5.2.2	Example of Loading	68
Chapter 6	External Interface	71
6.1	External I/O Terminal	71
6.1.1	Signal Line	72
6.1.2	Example of Input Signal Connection	74
6.1.3	Example of Output Signal Connection	76
6.1.4	Inter-lock Function	78
6.1.5	Timing Chart of External I/O Terminal	80
6.2	Buzzer	83
Chapter 7	RS-232C Interface	85
7.1	Specifications	85
7.2	Connection Method	86
7.3	Command Transfer Methods	87
7.4	Command	89
7.5	Transmission and Response Formats	100
7.6	Command Summary	101

Chapter 8 Maintenance and Inspection	103
8.1 Maintenance	104
8.2 Fuse Replacement	105
8.3 Troubleshooting	106
8.4 Displaying Errors	107
8.5 Resetting the System	107
8.6 External Dimensions	108
Chapter 9 Specifications	109
9.1 Basic Specifications	109
9.2 General Specifications	113
Appendix	APPENDIX1
9613 REMOTE CONTROL BOX (SINGLE)	APPENDIX1
9614 REMOTE CONTROL BOX (DUAL)	APPENDIX2
9615 H.V. TEST LEAD (Standard Accessory)	APPENDIX3
Table of Optional Functions	APPENDIX4

Introduction

Thank you for purchasing the HIOKI "3158 AC WITHSTANDING VOLTAGE HiTESTER". To obtain maximum performance from the product, please read this manual first, and keep it handy for future reference.

Inspection

When you receive the product, inspect it carefully to ensure that no damage occurred during shipping. In particular, check the accessories, panel switches, and connectors. If damage is evident, or if it fails to operate according to the specifications, contact your dealer or Hioki representative.

Checking the main unit and accessories

Main unit

"3158 AC WITHSTANDING VOLTAGE HiTESTER."

Accessories

Verify that the following standard accessories are complete.

- | | |
|------------------------------------------------------------------|---|
| (1) Instruction Manual | 1 |
| (2) Spare fuse (built into the power inlet) | 1 |
| (3) Grounded three-core power cord | 1 |
| (4) 9615 H.V. TEST LEAD
(High voltage and return side) | 1 |

Shipment of the unit

If reshipping the unit, preferably use the original packing.

Warranty

HIOKI cannot be responsible for losses caused either directly or indirectly by the use of the 3158 with other equipment, or if ownership is transferred to a third party.

NOTE

Before using the product, make sure that the insulation on the test leads is undamaged and that no bare conductors are improperly exposed. Using the product in such conditions could cause an electric shock, so contact your dealer or Hioki representative for repair.

Safety Notes

DANGER



This product is designed to comply with IEC 61010 Safety Standards, and has been thoroughly tested for safety prior to shipment. However, mishandling during use could result in injury or death, as well as damage to the product. However, using the product in a way not described in this manual may negate the provided safety features.

Be certain that you understand the instructions and precautions in the manual before use. We disclaim any responsibility for accidents or injuries not resulting directly from product defects.

This manual contains information and warnings essential for safe operation of the product and for maintaining it in safe operating condition. Before using the product, be sure to carefully read the following safety notes.

Safety symbols



- The  symbol printed on the product indicates that the user should refer to a corresponding topic in the manual (marked with the  symbol) before using the relevant function.
- In the manual, the  symbol indicates particularly important information that the user should read before using the product.



Indicates that dangerous voltage may be present at this terminal.



Indicates a fuse.



Indicates AC (Alternating Current).



Indicates a protective conductor terminal.



Indicates a functional earth terminal.



Indicates the ON side of the power switch.



Indicates the OFF side of the power switch.

The following symbols in this manual indicate the relative importance of cautions and warnings.

⚠ DANGER	Indicates that incorrect operation presents an extreme hazard that could result in serious injury or death to the user.
⚠ WARNING	Indicates that incorrect operation presents a significant hazard that could result in serious injury or death to the user.
⚠ CAUTION	Indicates that incorrect operation presents a possibility of injury to the user or damage to the product.
NOTE	Advisory items related to performance or correct operation of the product.

Measurement categories

To ensure safe operation of measuring instruments, IEC 61010 establishes safety standards for various electrical environments, categorized as CAT II to CAT IV, and called measurement categories.

⚠ DANGER

- **Using a measuring instrument in an environment designated with a higher-numbered category than that for which the instrument is rated could result in a severe accident, and must be carefully avoided.**
- **Never use a measuring instrument that lacks category labeling in a CAT II to CAT IV measurement environment. Doing so could result in a serious accident.**

- CAT II: When directly measuring the electrical outlet receptacles of the primary electrical circuits in equipment connected to an AC electrical outlet by a power cord (portable tools, household appliances, etc.)
- CAT III: When measuring the primary electrical circuits of heavy equipment (fixed installations) connected directly to the distribution panel, and feeders from the distribution panel to outlets
- CAT IV: When measuring the circuit from the service drop to the service entrance, and to the power meter and primary overcurrent protection device (distribution panel)

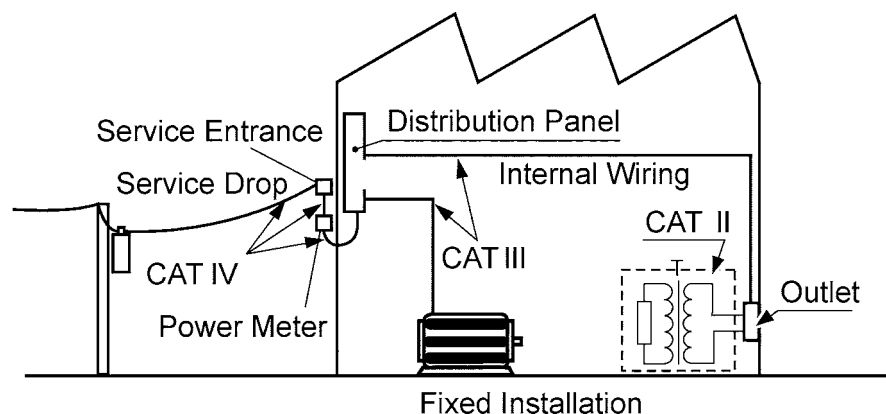

Notes on Use



Follow these precautions to ensure safe operation and to obtain the full benefits of the various functions.

DANGER

To avoid any life-threatening electric shock accidents, ensure that the following rules are observed.

- The AC Withstanding Voltage Hitester is a dangerous product which discharges high voltages. To prevent getting electrocuted, always wear high-voltage protective rubber gloves when carrying out any operation.
 - Be careful when using the product and ensure that you do not touch this product, any tested object that is connected or any H.V. TEST LEAD, etc.
 - To avoid electric shock, do not remove the cover panel. The internal components of the product carry high voltages and may become very hot during operation.
 - Vinyl shield on 9615 H.V. TEST LEAD alligator clip is not high voltage insulated. DO NOT touch when high voltage is applied.
-
-

WARNING

- To avoid electric shock, be sure to connect the protective ground terminal to a grounded conductor.
- The unit is constructed so as to be connected to a ground line via a three-core power cord that is supplied with the unit. To avoid electric shock and ensure safe operation, connect the power cable to a grounded (3-contact) outlet.
- Before turning the product on, make sure the source voltage matches that indicated on the product's power connector. Connection to an improper supply voltage may damage the product and present an electrical hazard.
- To avoid electric shock, do not allow the product to get wet, and do not use it when your hands are wet.
- This product should be installed and operated indoors only, between 0 and 40 and 80%RH max. Do not use the unit in direct sunlight, dusty conditions, or in the presence of corrosive gases.
- Replace the fuse only with one of the specified characteristics and voltage and current ratings. Using a non-specified fuse or shorting the fuse holder may cause a life-threatening hazard.

Fuse type: 250VT8AL (3158-01)

250VT4AL (3158-03 to 3158-05)

CAUTION

-
- Do not insert a board other than optional interface boards into the Interface slot. The unit software or calibration data may be lost.
 - To avoid electrocution, turn off the power to all devices before plugging or unplugging any of the interface connectors.
 - To avoid damaging the power cord, grasp the plug, not the cord, when unplugging the cord from the power outlet.
 - To avoid damaging test leads, do not kink or pull on the leads.
 - Keep in mind that, in some cases, conductors to be measured may be hot.
 - Take care not to block the ventilation openings on the sides of the unit.
 - For safety reasons, only use the 9615 H.V. TEST LEAD for measurement.
 - To avoid damage to the product, protect it from vibration or shock during transport and handling, and be especially careful to avoid dropping.
 - In the event that the equipment malfunctions in any manner during use, turn off the power immediately, and contact your dealer or HIOKI representative.
 - To avoid electric shock, do not exceed the lower of the ratings shown on the instrument and test leads.
-

NOTE

- Do not use the unit near any device which generates strong electromagnetic radiation or near a static electrical charge, as these may cause errors.
- This instrument may cause interference if used in residential areas. Such use must be avoided unless the user takes special measures to reduce electromagnetic emissions to prevent interference to the reception of radio and television broadcasts.

Contents and Indications of This Manual

Chapter 1: Overview

Describes an overview, features, and the names and functions of the parts of the unit.

Chapter 2: Testing Arrangements

Describes particulars of testing arrangements.

Chapter 3: Testing Method

Describes procedures for setting, testing, and test results judgment.

Chapter 4: Optional Functions

Describes procedures for setting optional functions.

Chapter 5: Saving/Loading Preset Values

Describes procedure for saving and loading test values.

Chapter 6: External Interface

Describes use of the external I/O and REMOTE CONTROL BOX.

Chapter 7: RS-232C Interface

This chapter explains the testing procedure using RS-232C.

Chapter 8: Maintenance and Inspection

Covers the maintenance and inspection, fuse replacement, and ultimate disposal.

Chapter 9: Specifications

Contains the unit specifications such as the general specifications, measurement accuracy, etc. of the unit.

Appendix:

Covers the options of the unit.

Chapter 1

Overview

1.1 Product Introduction

(1) Easy testing conforming to standards

The unit allows pressure tests based on a wide variety of standards to be conducted. The timer function and the comparative screening function using upper- and lower-level values provide accurate test results. The unit does not operate until the output voltage preset using the voltage adjustment knob is within $\pm 5\%$ (output voltage 1 kV: ± 50 V) of the comparative voltage value, thus further ensuring accurate readings.

(2) Fluorescent indicator

The large, easy-to-read fluorescent display permits quick checking of the testing state and result.

(3) Analog Voltage Measurement

The voltage is digitally displayed on the fluorescent indicator. This value can also be checked on the analog voltmeter.

(4) Zero-Toggle Switch

This function ensure that test voltage can be toggled on and off only at a sine wave zero crossings, to prevent damage to the device under test if it happens to be faulty.

(5) Saving testing set values

This unit is provided with a function for saving the set values used in a test, allowing quick switching between different testing set values to meet a variety of standards and regulations. Up to 20 values may be saved.

The values immediately prior to a power shutdown are saved in the unit. These values are valid at the next startup.

(6) REMOTE CONTROL BOX

The 9613 REMOTE CONTROL BOX (SINGLE) or the 9614 REMOTE CONTROL BOX (DUAL) can be connected to the external switch terminal to perform 3158 start/stop control.

(7) External I/O

The external I/O terminal generates signals according to the state of the 3158. It can be used to feed signals for the start and stop key.

(8) RS-232C interface as a standard feature

Automatic testing and saving of the test results are possible with the use of a computer.

1.2 Names and Functions of Parts

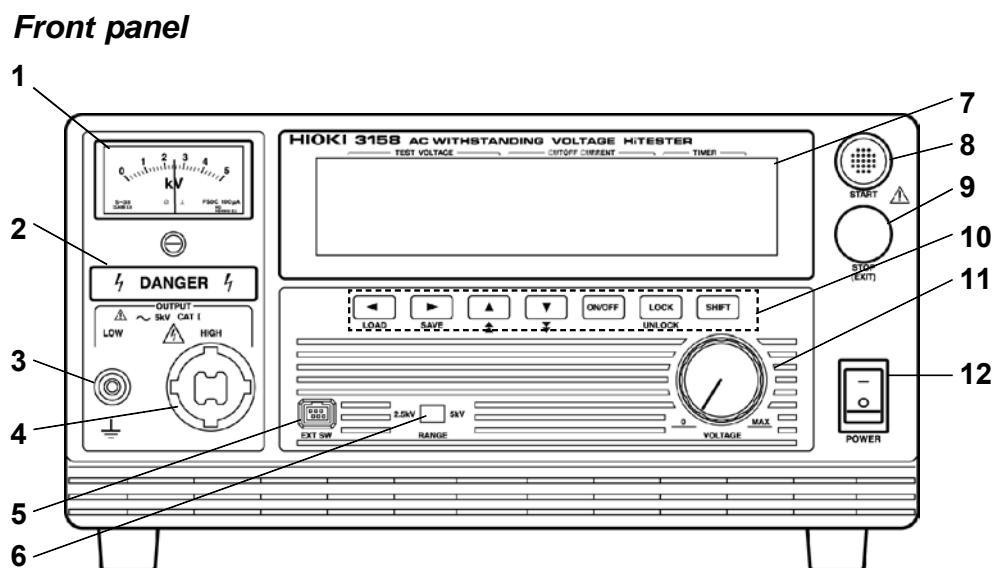

1 Analog voltmeter

Indicates output voltage.

2 Danger Lamp

This lamp lights to warn that voltage is present between the terminals during testing.

When the **DANGER** lamp is lit, never touch the HIGH terminal, probe, or tested object.

3 LOW Terminal

The LOW terminal is a low-voltage terminal for voltage outputs. It has the same electric potential as the unit body.

4 HIGH Terminal

The HIGH terminal is a high-voltage terminal for voltage outputs. A high voltage is generated between this terminal and the LOW terminal.

When the **DANGER** lamp is lit, never touch this terminal.

5 External Switch Terminal

Used for the signal line for the remote-control box.

6 Range Selection switch

Used to switch among output-voltage ranges.

7 VFD (Vacuum Fluorescent Display)

Displays various kinds of information, such as test state and results.

8 START key

Used to start a test. This key functions only when the **READY** lamp is lit.

9 STOP key

Normally used to terminate a test.

10 Rubber keys

The seven rubber keys include six function keys and a SHIFT key.

The six function keys offer a variety of settings, used in combination with the SHIFT key.

11 Output Voltage Knob

Sets the output voltage.

12 Main power switch

Powers the 3158 on or off.

Rubber keys

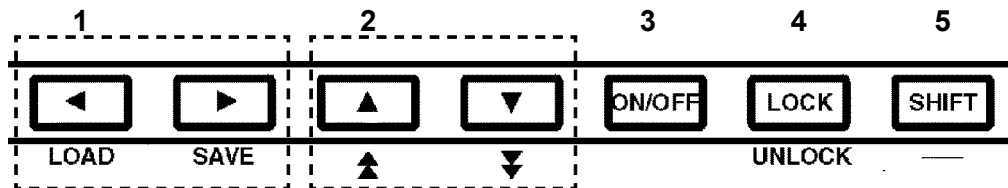

1 Left/Right cursor key

Moves the flashing cursor. The switching range is preset before shipment:

Preset Comparative voltage value ↔ Upper limit Value ↔ Test time.

To display the flashing cursor, press the [◀]/[▶] keys. The cursor appears, displaying the preset comparative voltage value.

2 Up/Down cursor key

Changes the position at which the flashing cursor appears.

3 ON/OFF key

Switches on/off the set value for the position of the flashing cursor.

However, this key can't perform the switching on/off of the preset Upper level Value. If turned off, the set value is not used in testing.

4 LOCK key

Used to lock the keys. When pressed, the LOCK key disables all keys except the [START] key, [STOP] key, and Key Lock Cancel key. See 3.2.2, "Key-lock Function."

5 SHIFT key

Used in combination with other keys.

(1) Displaying the Preset-data loading screen

Press [SHIFT] + [◀] keys to display the Preset-data loading screen. For more information, see Chapter 5, "Saving/loading the Parameters Set."

(2) Displaying the Preset-data saving screen

Press [SHIFT] + [▶] keys to display the Preset-data saving screen. For more information, see Chapter 5, "Saving/Loading Preset Values."

(3) Disabling the key lock function

To disable the key lock function, press the [SHIFT] + [LOCK] keys.

Rear panel

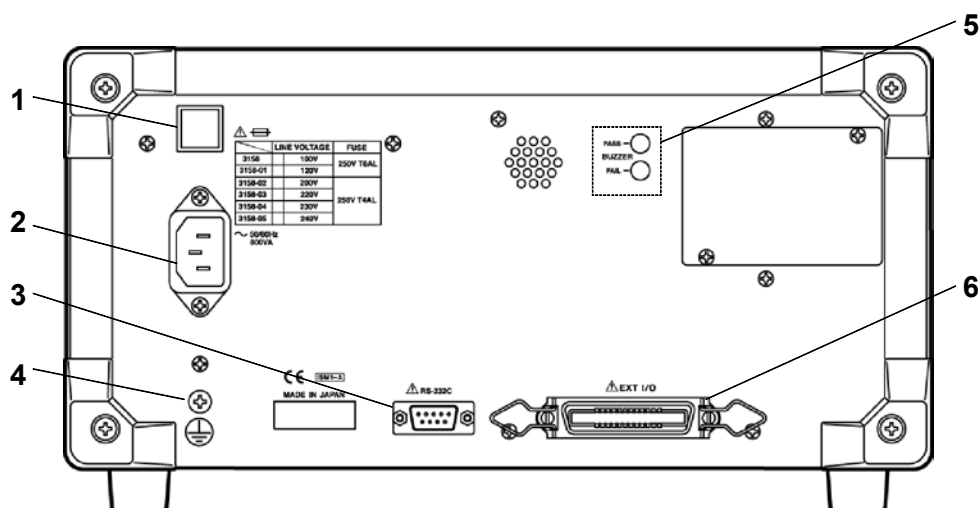

1 Fuse Holder

Contains a power fuse.

2 Power inlet

Connect the grounded three-core power cord supplied here. Integrated with a fuse holder.

3 RS-232C terminal

Used for remote control with RS-232C.

4 Protective ground terminal

Used to earth a protective ground wire. Be sure to make grounding connections before starting a test.

5 Buzzer adjustment knob

Used for buzzer sound adjustment. Two knobs are provided: one for PASS screening and one for FAIL screening.

6 External I/O terminal

For output of 3158 state and input of start and stop signals.

9615 H.V. TEST LEAD

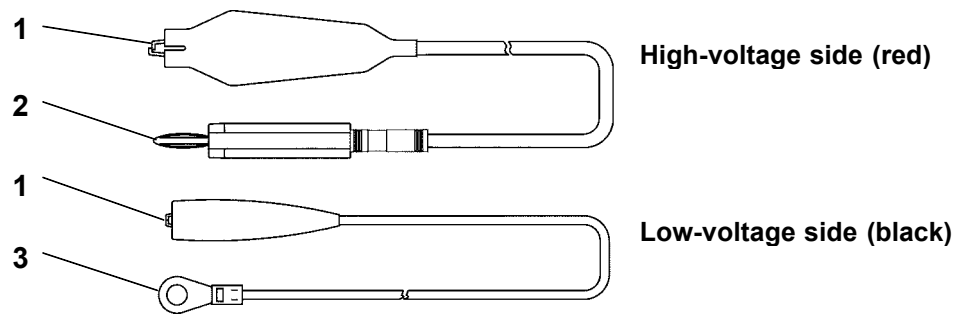

1 Alligator clip

Connect to a test point on the tested object.

Vinyl shield on 9615 H.V. TEST LEAD alligator clip is not high voltage insulated. DO NOT touch when high voltage is applied.

2 High-voltage output plug

Connect to the HIGH terminal on the unit.

3 Low-voltage output plug

Connect to the LOW terminal on the unit.

REMOTE CONTROL BOX

9613 REMOTE CONTROL BOX (SINGLE)

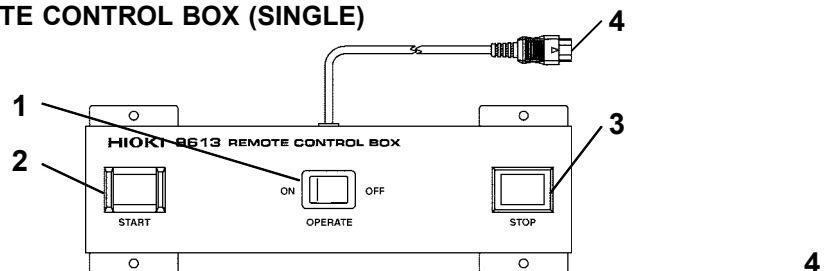

9614 REMOTE CONTROL BOX (DUAL)

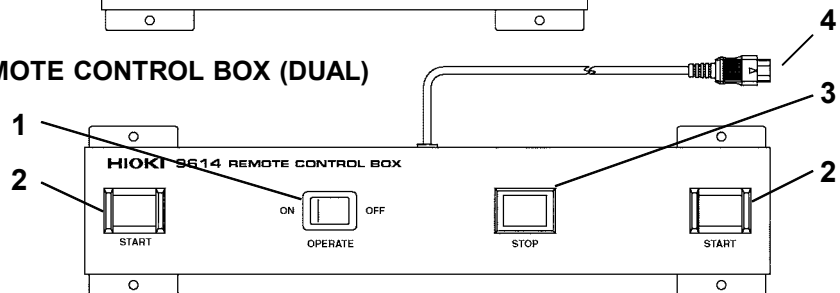

1 OPERATE switch

Used to enable remote-control operation. When this switch is ON, the START and STOP keys for remote control are active. Changing this switch during testing will forcibly terminate the test.

2 START key

Works in the same manner as the **START** key on the unit. With the 9614 REMOTE CONTROL BOX (DUAL), the two START switches must be pressed.

3 STOP key

Works in the same manner as the **STOP** key on the unit. The STOP key is ON during a test or when a voltage is being output.

4 Switch signal-line plug

Connect to the external switch terminal on the unit.

Chapter 2

Testing Arrangements

2.1 Connecting the Protective Ground Terminal

⚠ WARNING

- To avoid electric shock, be sure to connect the protective ground terminal to a grounded conductor.
- To avoid electric shock, connect the protective ground terminal to a grounded conductor before making any other connections.

- (1) Using a Phillips-head screwdriver, remove the protective ground terminal from the rear of the unit.
- (2) Connect an electric wire with a sufficient current capacity to the protective ground terminal, and secure the wire using a Phillips-head screwdriver.
- (3) Ground the other end of the wire.

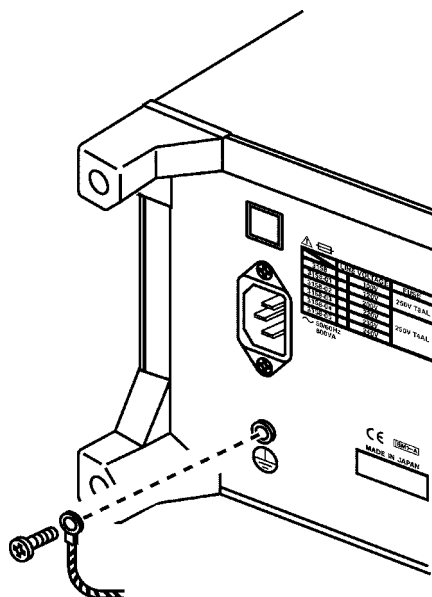

2.2 Wearing rubber gloves

 DANGER

To avoid any life-threatening electric shock accidents, ensure that the following rules are observed.

- The AC Withstanding HiTester is a dangerous product which discharges high voltages. To prevent getting electrocuted, always wear high-voltage protective rubber gloves when carrying out any operation.
 - Be careful when using the product and ensure that you do not touch this product, any tested object that is connected or any H.V. Test Lead, etc.
-
-

1. To avoid electrocution, always wear high-voltage protective rubber gloves when using this product.
2. Contact your dealer or Hioki representative to help you look for high-voltage protective rubber gloves.

2.3 Connecting the External I/O Connector



WARNING

- Always turn both devices OFF when connecting and disconnecting an interface connector. Otherwise, an electric shock accident may occur.
- To avoid electric shock or damage to the equipment, always observe the following precautions when connecting to external I/O.
 - (1) Always turn off the power to the instrument and to any devices to be connected before making connections.
 - (2) Be careful to avoid exceeding the ratings of external I/O signal.

Connect the external I/O connector before turning on the power. If the external I/O connector is installed or removed following startup, malfunction may result.

- (1) Make sure that the power switch is turned off.
- (2) Insert the external I/O connector into the external I/O terminal.
- (3) Secure the external I/O connector using the hooks of the external I/O terminal.

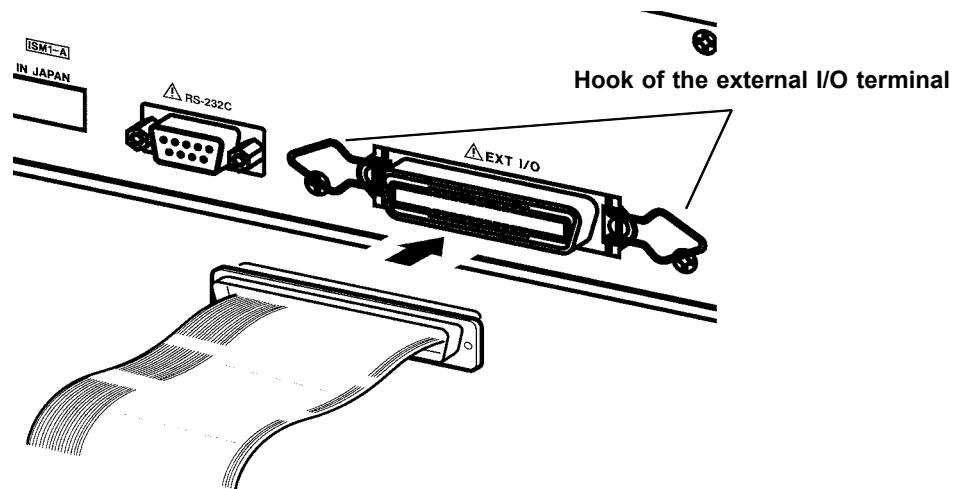

NOTE

- For the specifications of the external I/O connector, see 6.1, "External I/O Terminal."
- If the optional "Inter-lock" function is set to "1: Set," set Pin 10 of the external I/O terminal to "Lo" before starting a test. "Err. 0" will be indicated until "Lo" is set. For details, see 6.1.4, "Inter-lock Function."

2.4 Power Cord Connection

⚠ WARNING

- The rated power voltage for the 3158 varies depending on the settings of the unit. Before turning on the power, make sure that the voltage of the power supply being used matches the supply voltage indicated on the rear panel of the unit.
- The unit has no protective ground terminal other than the power inlet, and is connected to a ground line via a three-core power cord that is supplied with the unit. In order to prevent electric shock, always connect the unit to a properly grounded power outlet using the power cord provided.

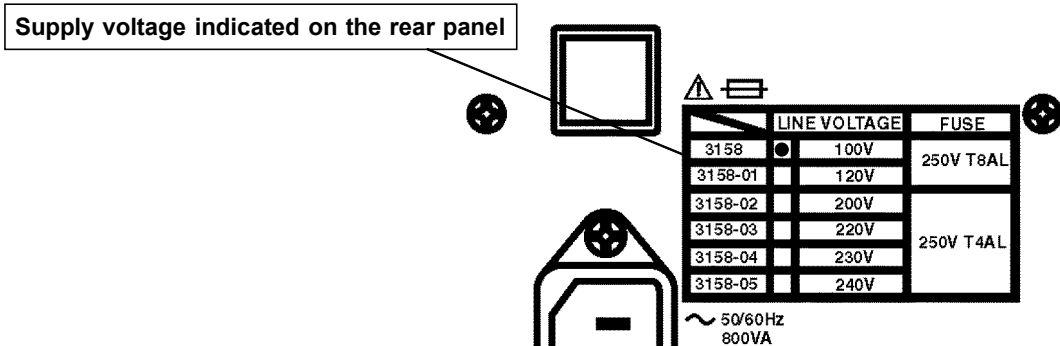

- (1) Be sure that the main power switch is turned to OFF.
- (2) Connect the grounded three-core power cord provided to the power inlet on the back of the unit.
- (3) Insert the plug into the grounded outlet.

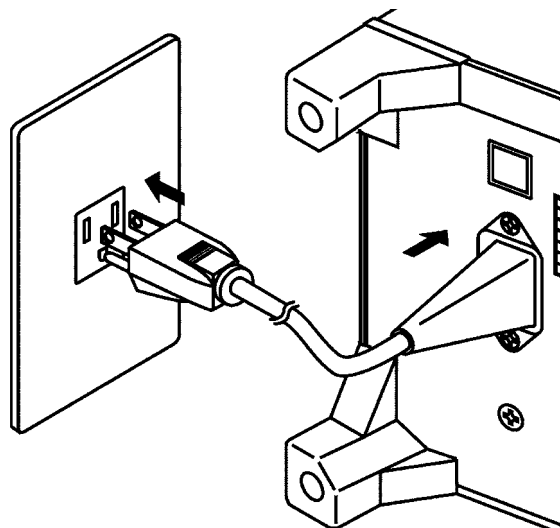

2.5 Powering On and Off the Unit

2

WARNING

Before turning the product on, make sure the source voltage matches that indicated on the product's power connector. Connection to an improper supply voltage may damage the product and present an electrical hazard.

NOTE

- The settings immediately prior to power shutdown are saved. The unit restarts with these settings, even following a power interruption. When settings are modified, however they are only saved after running a test.
- Allow 5 minutes warming up after powering on.
- The remote-control box, external I/O device, and RS-232C interface are active only when they are connected prior to startup. If these devices are connected after the power is turned on, the protective function may be activated, thus causing a malfunction.

Powering on the unit

- (1) Turn the main power switch to ON (**1**).

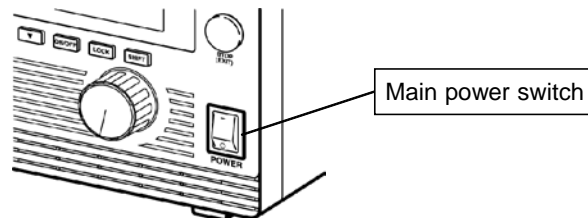

- (2) The model name and version number are displayed as below:
- (3) When the READY lamp is lit (it does not light up in the Double Action mode), the keys are ready for operation.

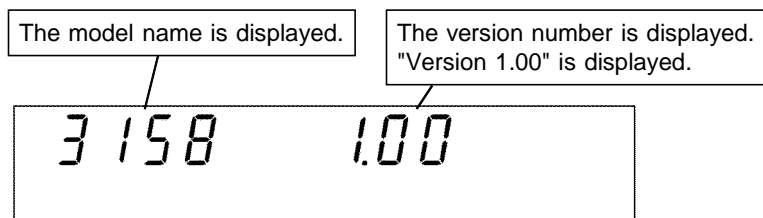

Powering off the unit

- (1) Following a test, make sure the analog voltmeter is at 0 kV, the **DANGER** lamp is OFF, and the READY lamp is lit.
- (2) Turn the voltage adjustment knob counterclockwise until the output reaches 0 kV. Do not turn OFF the Main Power switch when a voltage is being output, as the unit may be damaged as a result.
- (3) Turn OFF (**0**) the Main Power switch.

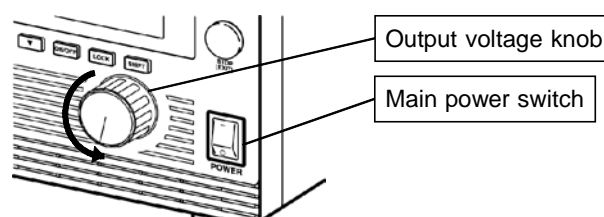

2.6 Connecting the 9615 H.V. TEST LEAD



⚠ DANGER

To avoid any life-threatening electric shock accidents, ensure that the following rules are observed.

- The AC Withstanding Voltage HiTester is a dangerous product which discharges high voltages. To prevent getting electrocuted, always wear high-voltage protective rubber gloves when carrying out any operation.
 - Be careful when using the product and ensure that you do not touch this product, any tested object that is connected or any H.V. TEST LEAD, etc.
-
-

⚠ WARNING

To prevent electrical shock, turn off the power unit and tested object, make sure that there is no high voltage being applied to the output, confirm the following 3 items, and connect the 9615 H.V. TEST LEAD.

- (1) The analog voltmeter reads 0 kV.
 - (2) The DANGER lamp is OFF.
 - (3) The **TEST** lamp is OFF.
- Before connecting the 9615 H.V. TEST LEAD, be sure to check its insulation for tearing and metal exposure. Using the product in such conditions could cause an electric shock, so contact your dealer or Hioki representative for repair.
 - To avoid electric shock, make sure the 9615 H.V. TEST LEAD is securely connected before starting a test, as a loose test lead can cause a hazard when a voltage is output.
-
-

- (1) Remove the LOW terminal by turning it counterclockwise.

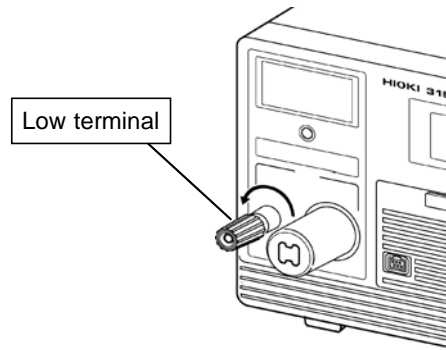

- (2) As shown in the figure, insert the plug on the low-voltage test lead.
- (3) Secure the LOW terminal by turning it clockwise.
- (4) Connect the plug on the high-voltage test lead to the HIGH terminal.

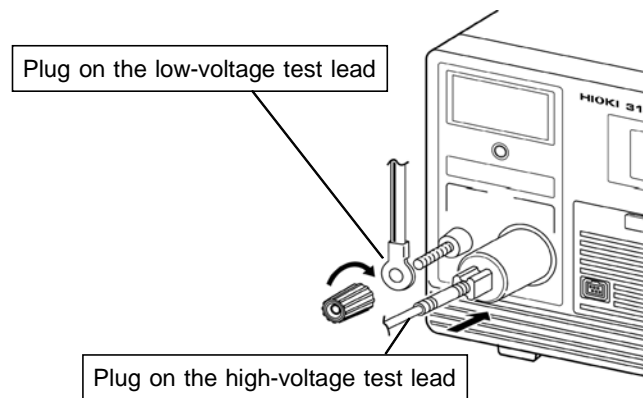

2.7 Connecting the REMOTE CONTROL BOX

⚠ WARNING

- To prevent electrical shock, turn off the power unit and tested object, make sure that there is no high voltage being applied to the output, confirm the following 3 items, and connect the remote-control box.
 - (1) The analog voltmeter reads 0 kV.
 - (2) The DANGER lamp is OFF.
 - (3) The **TEST** lamp is OFF.
- To prevent malfunctions, do not remove the REMOTE CONTROL BOX following startup. Before removing it, be sure to turn OFF the power.
- To avoid electric shock, when using the REMOTE CONTROL BOX, provide safety measures to keep the output-voltage terminal, tested object, and H.V. TEST LEAD out of contact with one another when they are in the TEST state.

Connection of the remote-control box (9613/9614) enables start/stop operations to be performed easily.

- (1) Make sure the Main Power switch and OPERATE switch on the remote-control box are OFF.

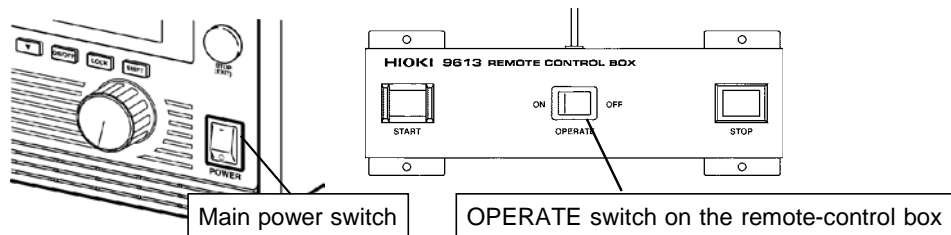

- (2) Insert the switch signal-line plug into the external switch terminal.
Check the direction of the switch signal line.
- (3) Turn ON the OPERATE switch of the remote-control box. The OPERATE switch can be turned ON/OFF even following startup.

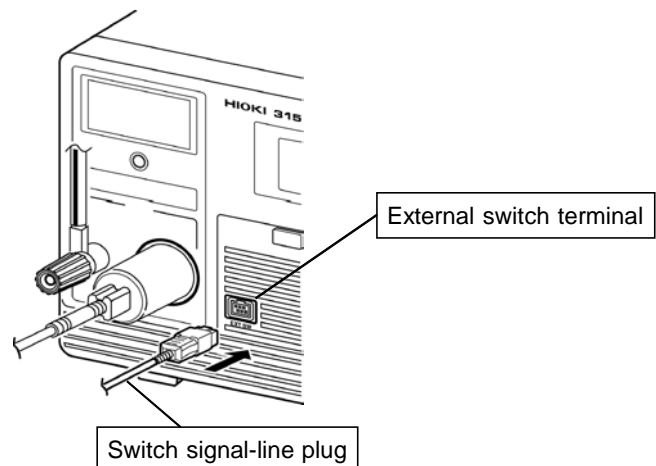

2.8 Installation of the Unit

Install the unit on a stable surface using the four rubber feet on the bottom of the unit.

Install on a stable surface using the four stands on the bottom of the unit.

- (1) Temperature 0 to 40 °C, 23 ± 5 °C recommended for high-precision measurements.
- (2) Humidity 80 %RH max. (no condensation)
- (3) Avoid the following locations:
 - Subject to direct sunlight.
 - Subject to high levels of dust, steam, or corrosive gases (Avoid using the equipment in an environment containing corrosive gases (e.g., H₂S, SO₂, NI₂, and Cl₂) or substances that generate harmful gasses (e.g., organic silicones, cyanides, and formalins)).
 - Subject to vibrations.
 - In the vicinity of equipment generating strong electromagnetic fields.

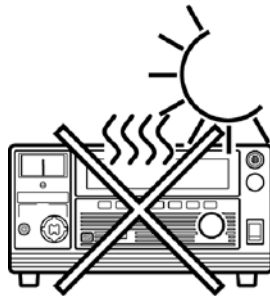
**NOTE**

Noise from the unit may affect peripheral equipment.

2.9 Connection to the Measured Equipment



⚠ DANGER

To avoid any life-threatening electric shock accidents, ensure that the following rules are observed.

- The AC Withstanding Voltage HiTester is a dangerous product which discharges high voltages. To prevent getting electrocuted, always wear high-voltage protective rubber gloves when carrying out any operation.
- Be careful when using the product and ensure that you do not touch this product, any tested object that is connected or any H.V. TEST LEAD, etc.
- Make sure that no high voltage is being applied to the output, confirm the following items, and connect the H.V. TEST LEAD.
 - (1) The analog voltmeter reads 0 kV.
 - (2) The DANGER lamp is OFF.
 - (3) The **TEST** lamp is OFF.
- In the TEST state, never touch the output-voltage terminal, H.V. TEST LEAD, or tested object.
- Even following a test, there may be a residual voltage at the output terminal. Therefore, before touching the output-voltage terminal, H.V. TEST LEAD, or tested object, make sure that no high voltage is being applied between the output terminals.

NOTE

- If the HIGH and LOW voltage output terminals short-circuit or a dielectric breakdown occurs in the tested object during the test, noise will be generated and such noise may lead to a malfunction of this unit or of a nearby electronic device. If this problem occurs, connect a ferrite core or a resistor to the H. V. TEST LEAD (high voltage side).
When using a resistor, choose one appropriate for the power rating and withstand voltage. Also, be alert to any drop in test voltage.
Beware of electric shock when connecting the resistor.
 - Do not the test lead and the EXT/IO cable arranged closely to each other. Doing so may lead to a malfunction of the external control due to a noise. Additionally, if the test lead touches to other metallic parts, it may cause an increase in leakage current.
Prevent the test lead from coming into contact with other parts as much as possible.
- (1) Make sure the analog voltmeter is at 0 kV and the **DANGER** lamp is OFF, and the **TEST** lamp is OFF.
 - (2) Connect the LOW terminal probe to the tested object. Fasten the probe securely to prevent it from loosening during a test.
 - (3) Following the procedure described above, connect the HIGH terminal probe to the tested object.

2.10 Startup Inspection



To ensure safe testing, check the following before starting operation:

Breaking current

- (1) Calculate the resistance based on the output voltage to be set and the upper level value, and then provide a resistor suitable for the resistance.

$$(\text{Output voltage} \div \text{Upper-level value (Breaking current)}) = \text{Resistance}$$

A high-voltage resistor with a power rating larger than the power calculated from the output voltage and resistance is recommended.

$$((\text{Output voltage})^2 \div \text{Resistance}) < \text{Power rating}$$

Ex.)

For the case that the output voltage is 2 kV and the upper level value is 4 mA,

Resistance value = $2 \text{ kV} / 4 \text{ mA} = 0.5 \text{ M}$

Rated power = $(2 \text{ kV})^2 / 0.5 \text{ M} = 8 \text{ W}$

the 16 W resistor ((Rated power) x 2)) is recommendable to leave a margin.

Example high-voltage resistor:

KOA Corp.'s GS Series High Voltage High Resistance Thick Film Resistor

- (2) Set an upper-level value.
- (3) Connect the resistor to the test lead.
- (4) Increase the output voltage beyond the set value, and make sure the current is cut off (i.e., make sure the unit is in the FAIL state).

Analog voltmeter

- (1) Before turning on the power, make sure the analog voltmeter is at 0 kV.
- (2) If the voltage reading is not at zero, adjust the value to zero using a slotted screwdriver.

Inter-lock

If the Inter-lock function is set, make sure the Inter-lock function works properly before starting operation.

Key inspection

- (1) Turn off the power, and unplug the power cord from the power outlet.
- (2) For both the START and STOP keys on the front panel of the unit, press the center of the key, and make sure you feel it click. The click is less noticeable when the edges of the keys are pressed.

* Clicking

When a key is pressed slowly, there is a moment of slight resistance and a feeling that the key cannot be pressed any further. When the key is pressed further after this point, a clicking sensation can be felt.

- (3) If you do not feel a click, the key may be broken.

Chapter 3

Testing Method

3

This chapter describes the procedural flow for testing, making settings, and proper testing procedure.

Read Chapter 2, "Testing Arrangements" and make the necessary arrangements for testing.

Press **SHIFT** + **STOP** keys to display the Optional function setting screen.

Setting the optional functions allows testing under various conditions.

For more information, see Chapter 4, "Optional Functions."

DANGER

To avoid any life-threatening electric shock accidents, ensure that the following rules are observed.

- **The AC Withstanding HiTester is a dangerous product which discharges high voltages. To prevent getting electrocuted, always wear high-voltage protective rubber gloves when carrying out any operation.**
 - **Be careful when using the product and ensure that you do not touch this product, any tested object that is connected or any H.V. Test Lead, etc.**
-
-

NOTE

- Note that the output waveform may be distorted when conducting an AC withstand voltage test for a voltage-dependent device or object (e.g., ceramic capacitor). Excessively large distortion may damage the device or tested object.
- When the device or tested object is a capacitive load, resonance may occur (when conducting an AC withstand voltage test) with the coil inductance of the output high-voltage transformer, depending on the capacitance value. This condition may generate several tens of volts at the voltage output terminal before the test is started. If the **START** key is disabled, reset the output voltage knob to zero, then set it back to the desired voltage after starting the test.

3.1 State of the 3158 and Preset Parameters

The 3158 is in one of the following five states:

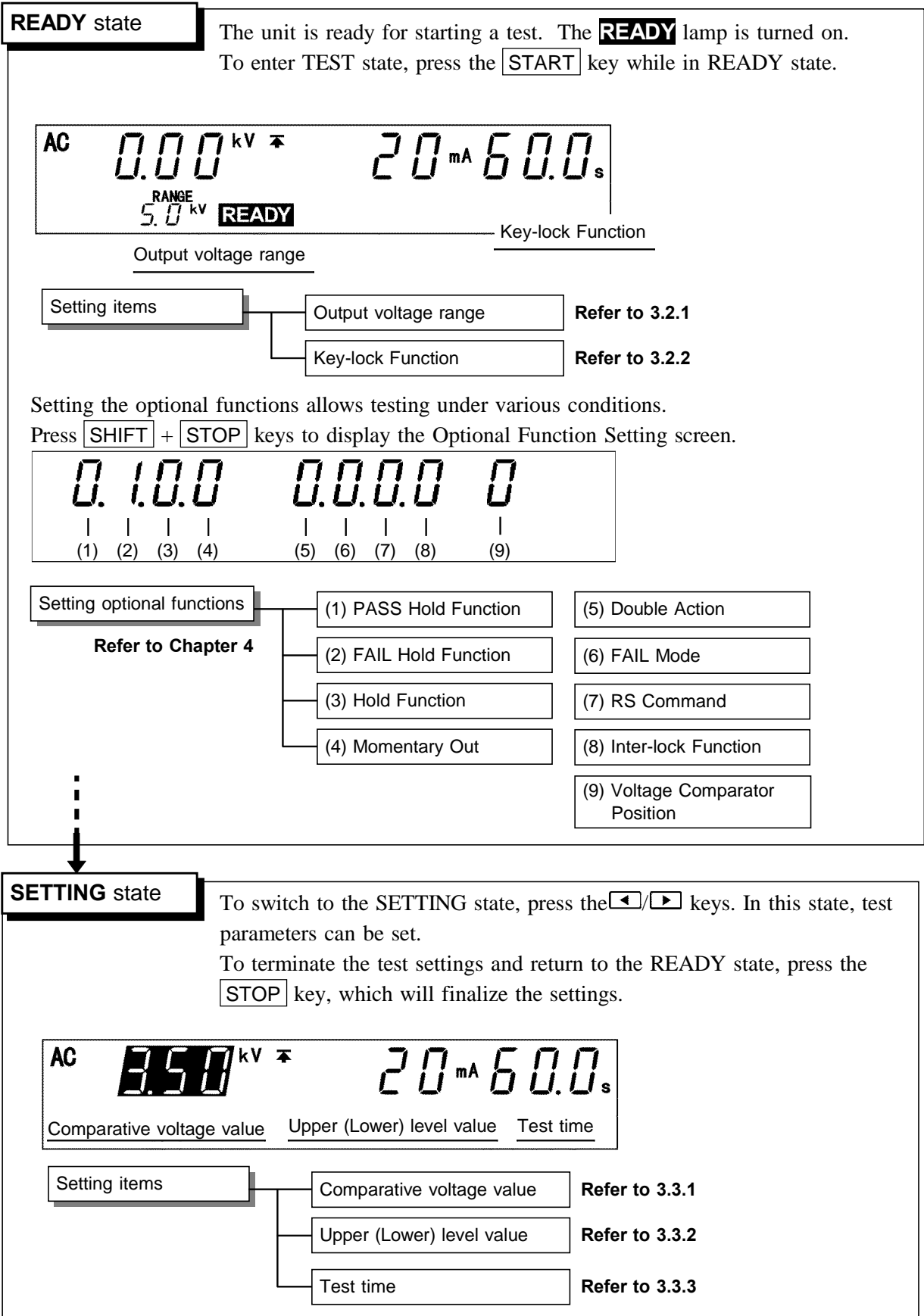

"TEST" state

Refer to 3.4.3

When the unit is in the TEST state, the **TEST** lamp is lit. This indicates that a test is in progress. The measured-voltage value is compared with the comparative-voltage value set in the SETTING state. If the measured-voltage value deviates from the comparative-voltage range, the unit shifts to the FAIL state. The measured-current value is compared with the upper- and lower-level values. If the measured-current value deviates from these values, the unit shifts to the FAIL state and the test is terminated. When the preset test time has elapsed, if there have been no deviations, the unit shifts to the PASS state.

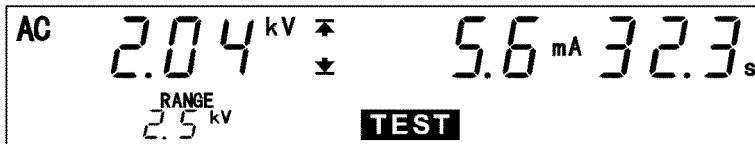

Key operation in the TEST status

Forced ending

Press the **STOP** key.**"PASS" state**

Refer to 3.5.1

PASS indicates that the measured object passed the test set in READY state. The **PASS** lamp is turned on. The PASS state screen is displayed for about 0.5 second before switching to READY state.

The PASS state can be maintained if the PASS Hold function is disabled in the optional settings. To return to the READY state, press the **STOP** key, which will cancel the PASS Hold function.

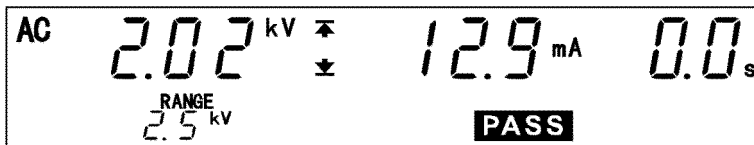
**"FAIL" state**

Refer to 3.5.3

READY indicates that the tested object failed to pass the test set in the READY state. The **FAIL** lamp will light up, accompanied by **UPPER** if the measured value exceeds the upper-level value, or by **LOWER** if the measured value is below the lower-level value. If the measured value deviates from the comparative-voltage range, the **FAIL** lamp will light up, accompanied by both **UPPER** and **LOWER**. The FAIL-state screen is displayed for 0.5 seconds, and the unit then switches to the READY state. The FAIL state can be maintained if the FAIL Hold function is disabled in the optional settings. To return to the READY state, press the **STOP** key, which will cancel the FAIL Hold function.

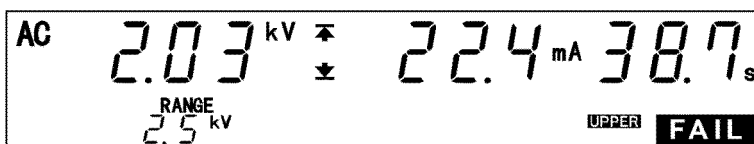

3.2 Making Testing Arrangements (in READY State)

In the READY state, the unit is always ready to start a test. The unit can be shifted to the SETTING state only when it is in the READY state.

The **READY** lamp remains lit to indicate READY state. Saving and loading for setting data and the setting of optional functions are made following the READY state.

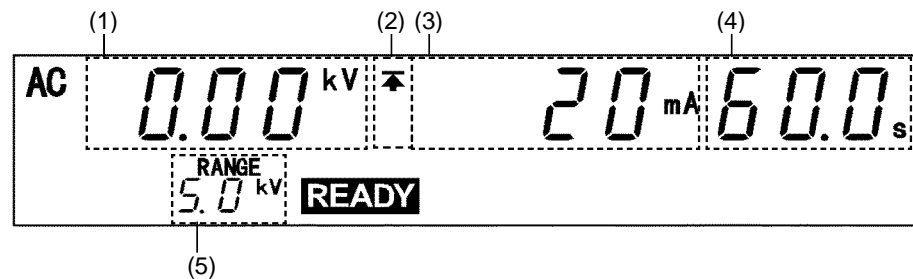

(1) Measured voltage value

Indicates the voltage value being output. In the READY state, the value indicates at 0 kV.

(2) Upper level value icon and Lower level value icon

The symbol \blacktriangle appears when the upper level value is set, and the symbol \blacktriangledown appears when the lower level value is set.

(3) Upper (Lower) level value

Indicates Upper (Lower) level value.

(4) Test time

Indicates the preset test time. "OFF" is indicated when no test-time setting has been made.

(5) Output voltage range

Indicates the output-voltage range selected using the Range Selection switch

Analog voltmeter

Indicates the voltage value being output. In the READY state, the value remains at 0 kV.

Danger lamp

Indicates that a voltage is being output. This lamp remains lit as long as a voltage of at least 0.03 kV is being applied to the output terminal. It does not light up in the READY state.

External I/O

The $\overline{\text{READY}}$ signal is ON when **READY** is lit on the fluorescent indicator. The $\overline{\text{READY}}$ signal is turned OFF when **READY** is not lit.

3.2.1 Selecting an Output-Voltage Range

⚠ WARNING

The output voltage set using the output-voltage knob nearly doubles when the output-voltage range is changed from 2.5 kV to 5.0 kV. Conversely, if the range is changed from 5.0 kV to 2.5 kV, the output voltage is reduced by approximately half. After changing the output-voltage range, be sure to reset the output voltage using the output-voltage knob.

In the READY state, change the output-voltage range (2.5 kV/5.0 kV) using the Range Selection switch. When the output-voltage range is shifted, **RANGE** flickers. This change is effective for the next test.

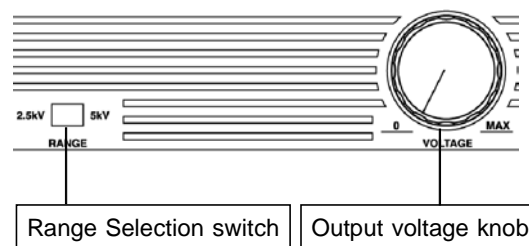
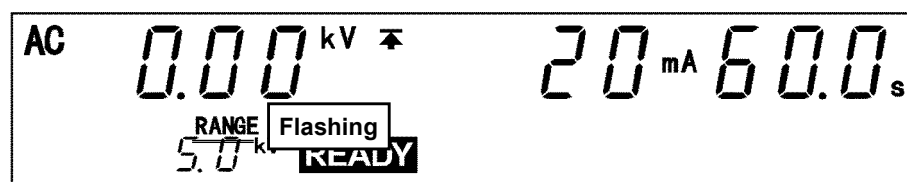

NOTE

If you turn the output-voltage knob fully clockwise, the voltage may exceed the set output-voltage range.

3.2.2 Key-lock Function

It inactivates all keys except the **START** key, **STOP** key, and the range switch. The **KEYLOCK** lamp is lit while the key-lock function is active.

To switch to the **KEYLOCK** state, press the **LOCK** key. To cancel the key-lock function, press the **LOCK** key in the Key-lock state while holding down the **SHIFT** key.

The output-voltage set using the output-voltage knob will not become invalid.

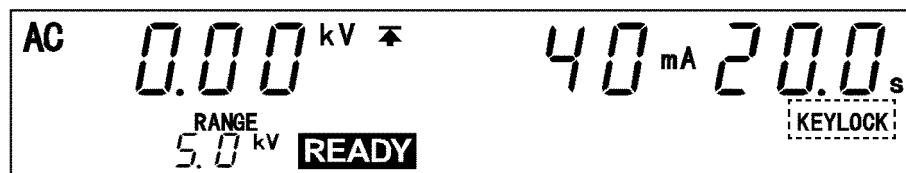

NOTE

Even when the key-lock function is activated, the **START** and **STOP** keys on the remote control box and the signals on the external I/O terminal remain active.

3.2.3 Initial Settings for Optional Functions

Press **SHIFT** + **STOP** keys while in READY state to display the Optional function setting screen.

Setting the optional functions allows testing under various conditions.

Settings can be made for the following eight optional functions. One number is assigned to each function. Settings are made by changing the number by using the **▲**/**▼** keys.

For more information on the settings, see Chapter 4, "Optional Functions."

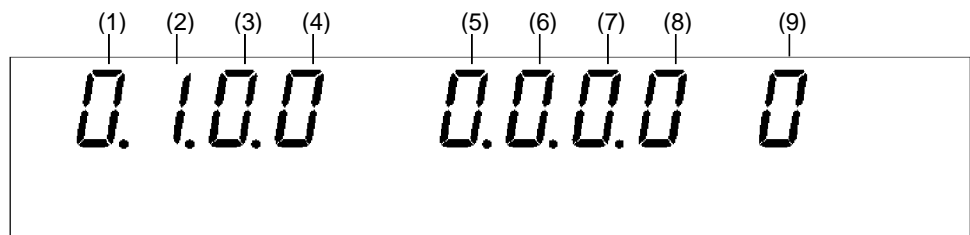

The optional functions of the 3158 are factory-preset to the following settings:

Setting item	Initial setting
(1) PASS Hold Function	0 : PASS not held
(2) FAIL Hold Function	1 : FAIL held
(3) Hold Function	0 : Not held
(4) Momentary Out	0 : Not set
(5) Double Action	0 : Not set
(6) FAIL mode	0 : Not set
(7) RS Command [Start]	0 : Not set
(8) Inter-lock Function	0 : Not set
(9) Voltage Comparator Position	0 : Start test

3.3 Setting the "SETTING" State

To change settings, switch to the SETTING state. In the READY state, press the \leftarrow/\rightarrow keys. The flashing cursor will then appear at the position where the comparative voltage is indicated to show that the unit is in the SETTING state. The **READY** light will go out. In the SETTING state, a test will not start even if the **START** key is pressed. To start a test, complete the test settings and then return to the READY state.

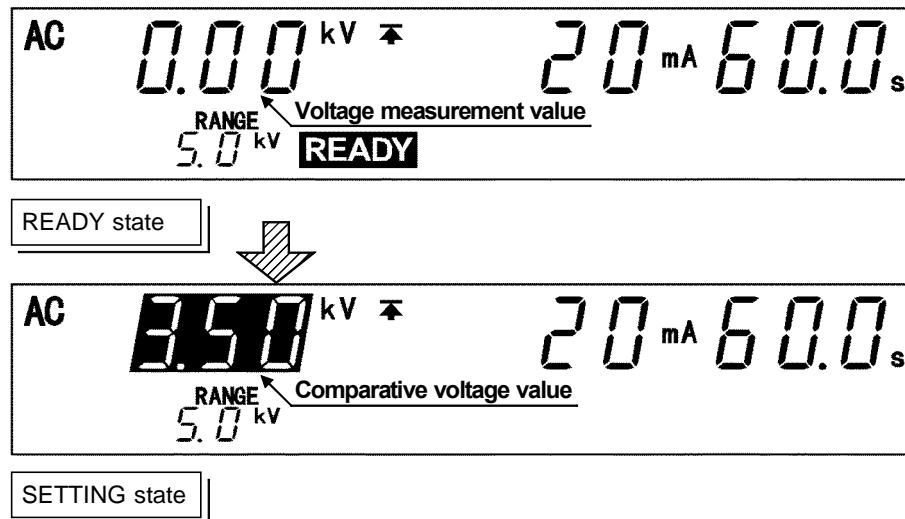

Setting procedure

In the SETTING state, set test values while moving the flashing cursor using the \leftarrow/\rightarrow keys.

The flashing cursor will move between the comparative-voltage value, the upper-level value, the lower-level value, and the test time, in that order. If the value indicated by the flashing cursor is not needed in the test, turn it OFF using the **ON/OFF** key. The upper-level value, however, cannot be turned OFF.

In the SETTING state, a test will not start even if the **START** key is pressed. To finalize the test settings, press the **STOP** key, which will return the unit to the READY state. Note that the unit will not return to the READY state if the set lower-level value is greater than the upper-level value. In such a case, correct the settings and then press the **STOP** key to return to the READY state.

NOTE

A voltage being measured is displayed in the READY state. In the SETTING state, the comparative voltage value is displayed. Note that the display of the comparative voltage value does not mean that the voltage is being output.

3.3.1 Setting the Comparative Voltage Value

If a comparative-voltage value is to be set, value settings must be made. Once a comparative-voltage value is set, a test will not start until the output voltage reaches the comparative-voltage range, which is $\pm 5\%$ of the comparative-voltage value (output voltage: 1 kV : ± 50 V). **TEST** will flicker until the value reaches the value range. If the value fails to reach the value range within approximately five seconds, **FAIL** will light along with **UPPER** and **LOWER** and the test will quit with the **FAIL** judgment. Also, in the same way the test will quit with the **FAIL** judgment if it is outside of the standard voltage range during the test. If a comparative-voltage value is not to be used, press the **ON/OFF** key to turn the setting for that value OFF. Any voltage value can then be output in the TEST state.

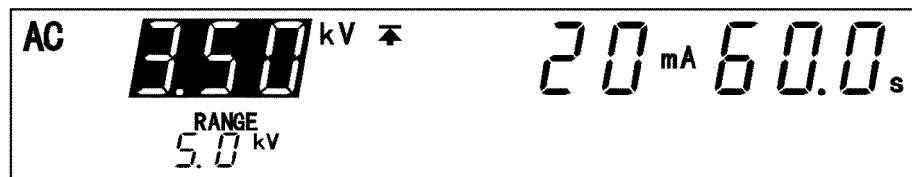

Comparative voltage value: 3.50 kV

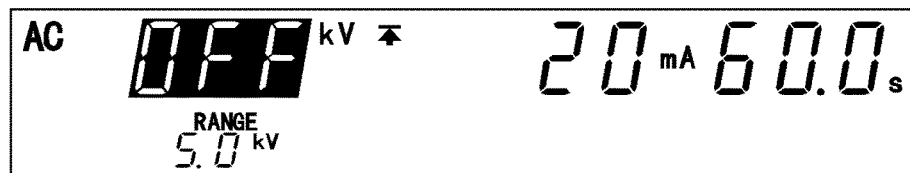

Comparative voltage value: OFF

- (1) If no flashing cursor is displayed in the READY state, press either the **◀**/**▶** key to display the cursor while the comparative voltage value is lit.
- (2) Change the comparative voltage value using the **▲**/**▼** keys. The value changes in 0.01 kV increments. To change the value by 0.10 kV, press **SHIFT** + **▲**/**▼** keys.

The comparative voltage value can be set from 0.00 kV to 5.00 kV.

If a comparative voltage value is not to be used, press the **ON/OFF** key to turn the setting for that value OFF.

- (3) When settings are complete, press the **STOP** key.
- (4) In the READY state, press the **START** key to output the measured voltage. If the value fails to reach the value range within approximately five seconds, the unit returns to the READY state. During those five seconds, use the output-voltage knob to set the output voltage to the comparative-voltage value.
- (5) When the output voltage is equal to the comparative-voltage value, terminate the settings for the comparative-voltage value.

NOTE

If the test time is set to OFF, the settings for the comparative-voltage value will become invalid. Therefore, when the output-voltage settings are made, it is advisable to set the test time to OFF.

OPTION

- You can select whether you want to check the output-voltage when the test starts or ends. (Starting a test with default settings:) (See Section 4.9)

3.3.2 Setting the Upper (Lower) Level Value

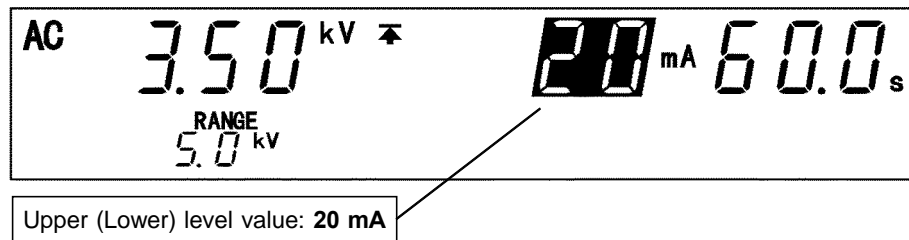

- (1) If the flashing cursor does not appear in the READY state, display the cursor at the position where the Upper-Level Value (Lower-Level Value) is indicated by pressing the \leftarrow / \rightarrow keys.
- (2) Set the upper (lower) level value using the \uparrow / \downarrow keys.
The upper (lower)-level value will change by 0.1 mA (by 1 mA at 10 mA to 120 mA). While holding down the **SHIFT** key, press the \uparrow / \downarrow keys. The upper (lower)-level value will change by 1.0 mA (by 10 mA at 10 mA to 120 mA). If no lower level value is required, turn off the **ON/OFF** key. Upper level value can not be turn off.
- (3) When settings are complete, press the **STOP** key.

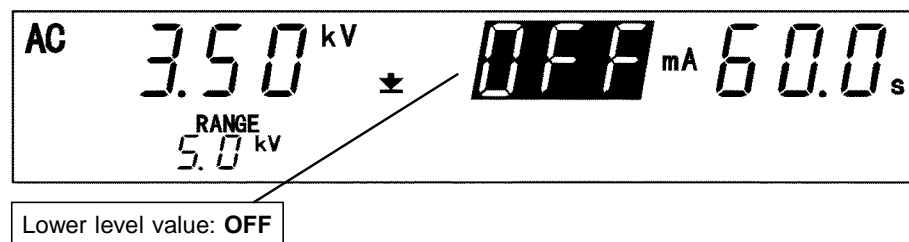
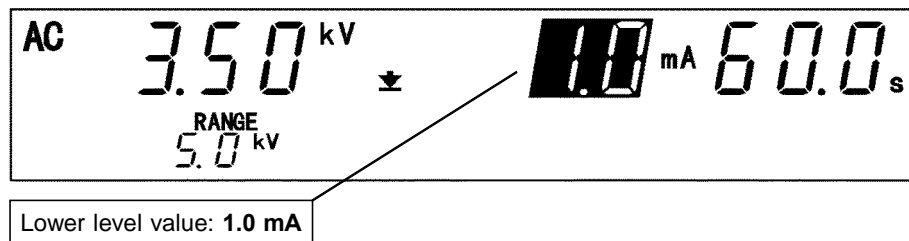

NOTE

- The setting resolution of the upper (lower)-level value is 0.1 mA at 0.1 mA to 9.9 mA, and 1 mA at 10 mA to 120 mA.
- The current measurement resolution during a test depends on the set upper-level value: 0.01 mA at 0.1 mA to 8.0 mA, 0.1 mA at 8.1 mA to 32 mA, and 1 mA at 33 mA to 120 mA.
- If the set lower-level value is greater than the upper-level value, the unit will not return to the READY state even when the **STOP** key is pressed. In such a case, correct the upper- or lower-level value.
- The electric current range will be decided by the upper-limit test value (2 mA-range for "upper-limit test value 2.0 mA", 8 mA-range for "2.0 mA < upper-limit test value 8.0 mA", 32 mA-range for "8.0mA < upper-limit test value 32 mA", 120 mA-range for "32 mA < upper-limit test value")

3.3.3 Setting the Test Time

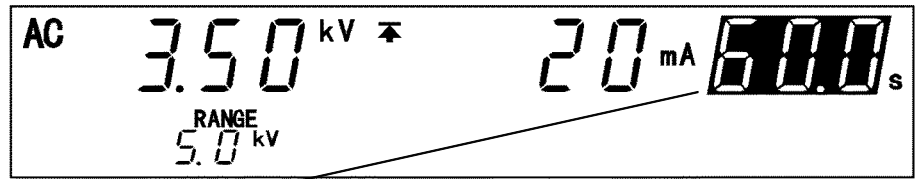

Test Time: 60.0s

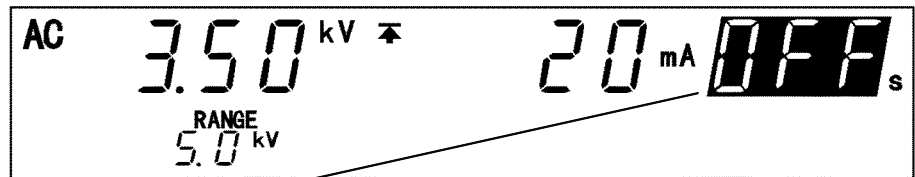

Test Time: OFF

(1) If the flashing cursor does not appear in the READY state, display the cursor at the position where the Test Time is indicated by pressing the \leftarrow/\rightarrow keys.

(2) Set the test time using the \uparrow/\downarrow keys.

With time set the time changes in 0.1 s increments (1 s increments when the set time scale is 100 s to 999 s).

With time set at 0.5 s to 99.9 s, press $\text{SHIFT} + \uparrow/\downarrow$ keys. The time changes in 1.0 s increments (10 s increments when the set time scale is 100 s to 999 s).

Settings may be made along a scale ranging from 0.5 s to 999 s (in gradations of 0.1 s for the range 0.5 s to 99.9 s and 1 s for the range 100 s to 999 s).

If no testing time is required, turn off the ON/OFF key.

(3) When settings are complete, press the STOP key.

NOTE

- If a test time has been set, the reduction timer will operate during the test.
- If the test time is set to OFF, the time elapsed during the test is displayed. When this time exceeds 999 s, "—" will appear, but the test will continue.
- If the test time is set to OFF, the comparative-voltage value becomes ineffective.

3.3.4 Examples of Settings

NOTE

The settings immediately prior to power shutdown are saved. The unit restarts with these settings, even following a power interruption. When settings are modified, however they are only saved after running a test.

The following shows an example of a test at a comparative-voltage value of 2.00 kV and an upper-level value of 20 mA, with the lower-level value set to OFF, at a test time of 60.0 s. The 3158 is in the READY state.

Values currently set		Values to be set	
Comparative voltage value	OFF	Comparative voltage value	2.00 kV
Upper level value	120 mA	Upper level value	20 mA
Lower level value	40 mA	Lower level value	OFF
Test time	120 s	Test time	60.0 s

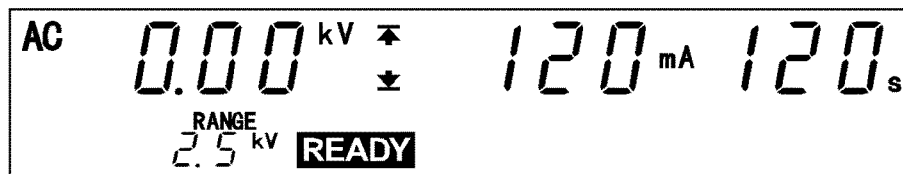

(1) Changing to the SETTING state

Press the / keys to switch to the SETTING state. The **READY** light will go out, and the flashing cursor will be displayed at the position where the comparative-voltage value is indicated.

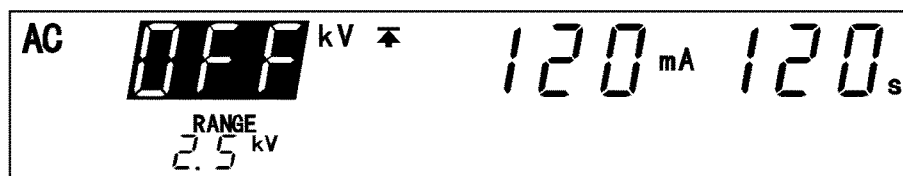

In the READY state, a measured-voltage value is displayed. In the SETTING state, the display changes to the comparative-voltage value (in this example, OFF).

(2) Setting the comparative-voltage value

The comparative-voltage value is initially set to OFF. It must be changed to ON before the value is changed. To do so, press the **ON/OFF** key.

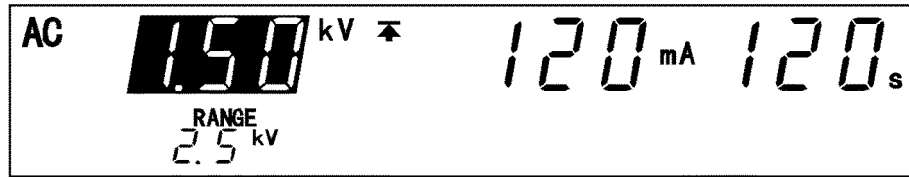

The comparative-voltage value in the OFF state is displayed. In this example, the value is 1.50 kV.

Using the **▲/▼** keys, set the comparative voltage value to 2.00 kV.

To change the value by 0.01 kV, press **▲/▼** keys.

To change the value by 0.10 kV, press **SHIFT** + **▲/▼** keys.

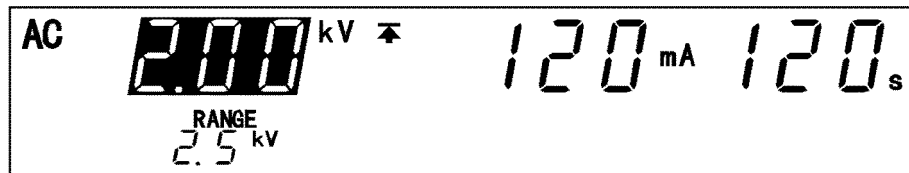

(3) Setting an upper-level value

Press the **▶** key to move the flashing cursor to the upper-level value.

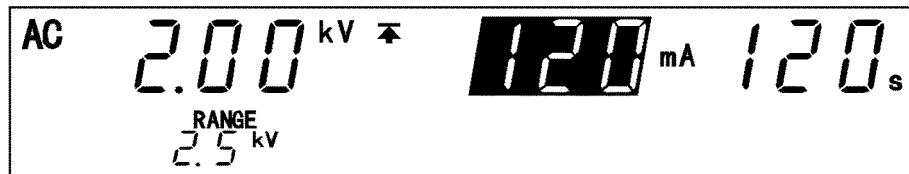

In this example, switch from 120 mA to 20 mA using the **▲/▼** keys.

To change the upper level value by 1 mA, press **▲/▼** keys.

To change the upper level value by 10 mA, press **SHIFT** + **▲/▼** keys.

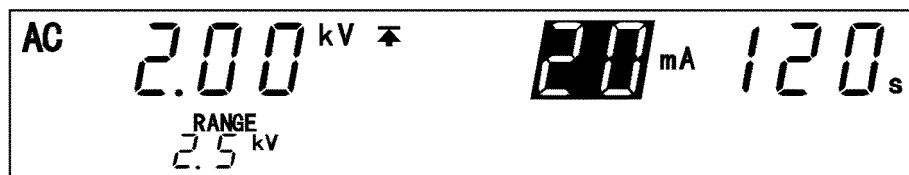

(4) Setting a lower-level value

Using the **▶** key, move the flashing cursor to the lower level value.

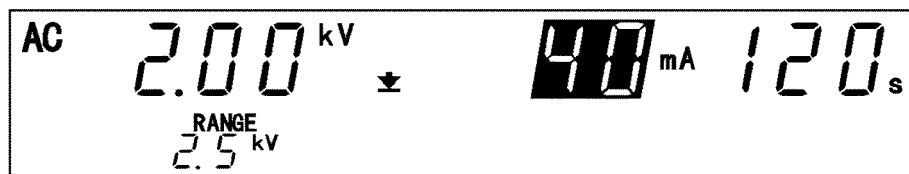

The lower-level value is set at 40 mA. Turn it OFF, as it is not needed. To change to OFF, press the **ON/OFF** key.

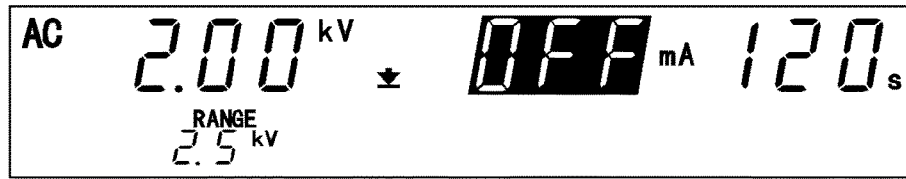

(5) Setting the test time

Using the **▶** key, move the flashing cursor to the test time.

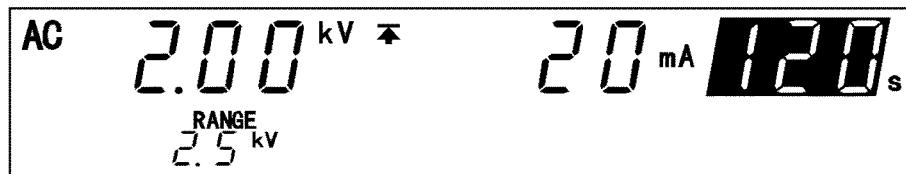

In this example, change the test time from 120 s to 60.0 s.

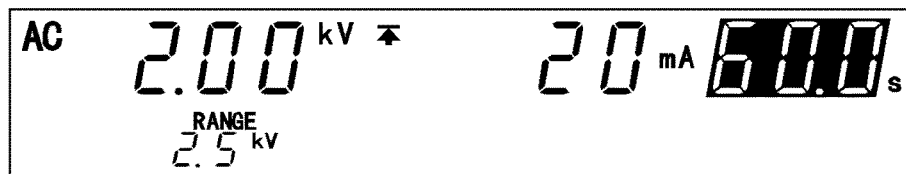

(6) Changing to the READY state

To conduct a test using these settings, switch to the READY state. To return to the READY state, press the **STOP** key, which will finalize the test settings. In the READY state, the displayed comparative-voltage value is replaced with a measured-voltage value, and **READY** lights up.

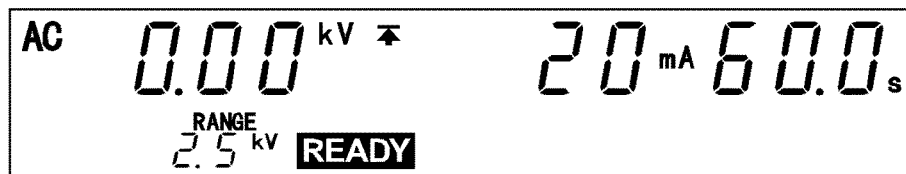

The new parameters following setting are shown below:

Comparative voltage value	2.00 kV
Upper level value	20 mA
Lower level value	OFF
Test time	60.0 s

Press the **START** key while in this state. The unit enters TEST state to begin testing.

3.4 Starting a Test

The flowchart below explains how a test is carried out.

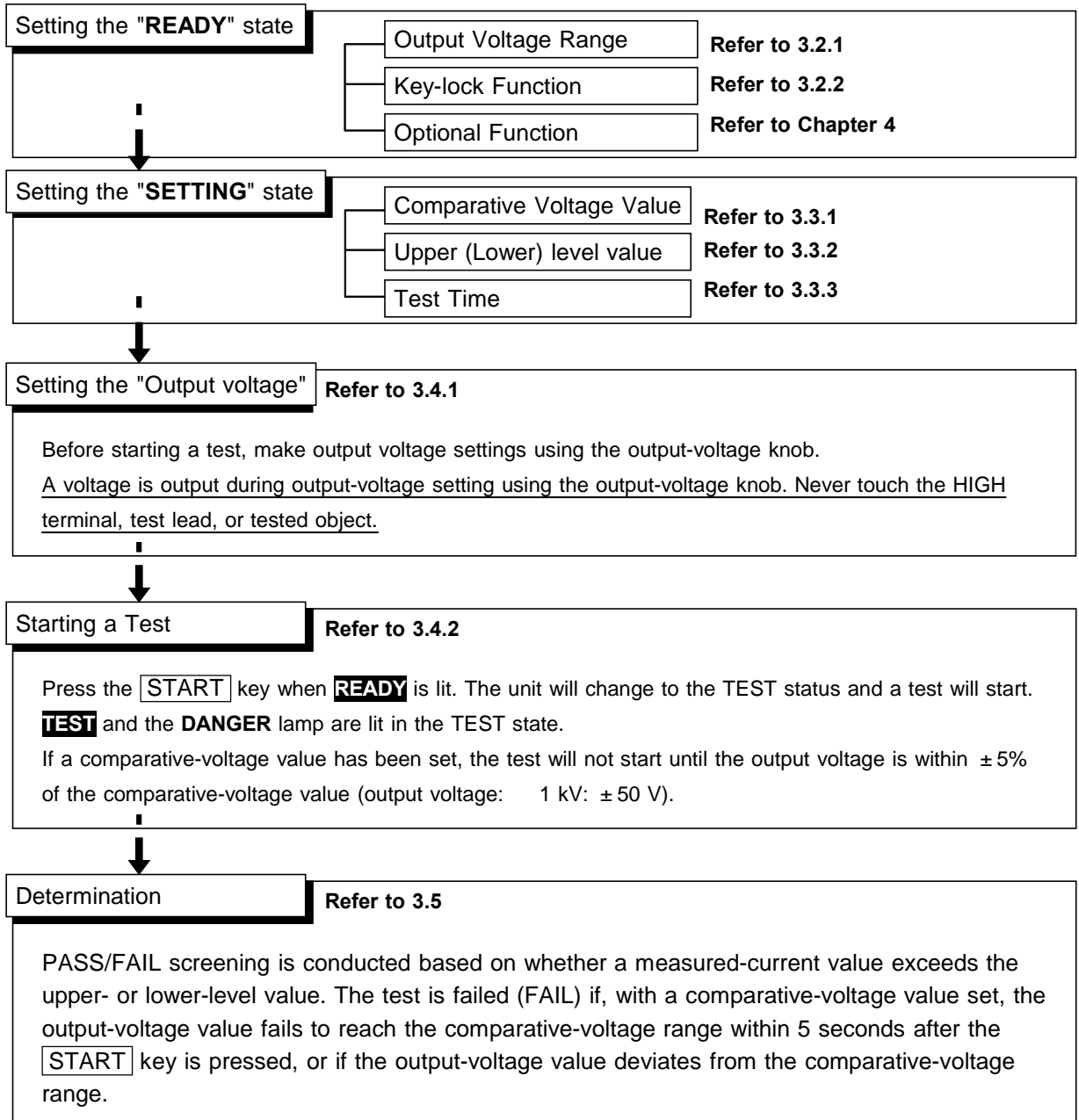

3.4.1 Setting the Output Voltage



⚠ DANGER

To avoid any life-threatening electric shock accidents, ensure that the following rules are observed.

- The AC Withstanding HiTester is a dangerous product which discharges high voltages. To prevent getting electrocuted, always wear high-voltage protective rubber gloves when carrying out any operation.
- Be careful when using the product and ensure that you do not touch this product, any tested object that is connected or any H.V. Test Lead, etc.
- Make sure that no high voltage is being applied to the output, confirm the following items, and output voltage.
 - (1) The analog voltmeter reads 0 kV.
 - (2) The **DANGER** lamp is OFF.
 - (3) The **READY** lamp is lit (it is off in the Double Action mode).
- A voltage is output during output-voltage setting using the output-voltage adjustment knob. Never touch the HIGH terminal, H.V. TEST LEAD, or tested object.

Before starting a test, make output voltage settings using the output-voltage knob. If a comparative-voltage value has already been set, press the **START** key and set an output voltage within 5 seconds after pressing the **START** key. If the setting is not successful, the test switches to the FAIL state.

- (1) In accordance with the instructions given in 2.9, "Connection to the Measured Equipment," connect the probe to the tested object.
- (2) Make sure the analog voltmeter is at 0 kV, the **DANGER** lamp is OFF, and the unit is in the READY state.
- (3) Set the output-voltage range using the Range Selection switch.
- (4) Press the **START** key. **TEST** will light up and a voltage will be output.
- (5) Set an output voltage using the output-voltage knob. The output-voltage knob increases the output voltage when turned clockwise, and decreases the voltage when turned counterclockwise. The maximum value is 2.5 kV or 5.0 kV, depending on the output-voltage range set in Step (3). The output voltage is displayed on the analog voltmeter and the fluorescent indicator.
- (6) Upon completion of the output-voltage settings, press the **STOP** key to stop the output.

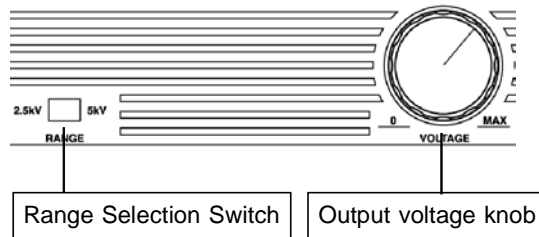
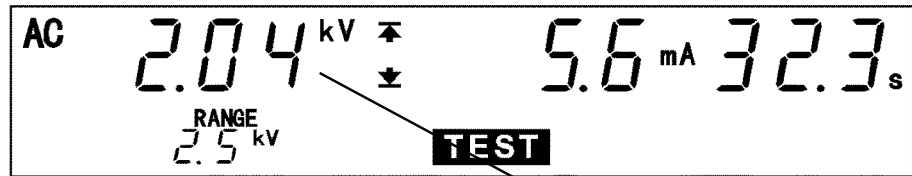

Set an output voltage using the output-voltage knob.

NOTE

If you turn the output-voltage knob fully clockwise, the voltage may exceed the set output-voltage range.

Rated time for output voltages (at an ambient temperature of 40 °C)

The transformer capacity of the unit is approximately half the rated output. Use the unit within the rated time. If the rated time is exceeded, the unit may overheat and thereby cause the thermal fuse for the internal circuit to blow out.

Current measurement range	Maximum test time	Pause
$I < 60 \text{ mA}$	Continuous	None
$60 \text{ mA} < I < 100 \text{ mA}$	30 minutes	30 minutes
$100 \text{ mA} < I < 120 \text{ mA}$	10 minutes	30 minutes

NOTE

- If the test time is set to OFF, the comparative-voltage value becomes ineffective, thereby facilitating output-voltage adjustments.
- The output-voltage range can only be changed in the READY state. The range cannot be changed in other states, even using the Range Selection switch.

OPTION

The Double Action increases the safety of testing by preventing operational errors. Refer to Section 4.5 Double Action

3.4.2 Executing a Test



DANGER

To avoid any life-threatening electric shock accidents, ensure that the following rules are observed.

- The AC Withstanding HiTester is a dangerous product which discharges high voltages. To prevent getting electrocuted, always wear high-voltage protective rubber gloves when carrying out any operation.
- Be careful when using the product and ensure that you do not touch this product, any tested object that is connected or any H.V. Test Lead, etc.
- Make sure that no high voltage is being applied to the output, confirm the following items, and output voltage.
 - (1) The analog voltmeter reads 0 kV.
 - (2) The **DANGER** lamp is OFF.
 - (3) The **READY** lamp is lit (it is off in the Double Action mode).
- A voltage is output during output-voltage setting using the outputvoltage adjustment knob. Never touch the HIGH terminal, H.V. TEST LEAD, or tested object.
- When the **TEST** and **DANGER** lamps are lit, the voltage displayed on the analog voltmeter and the fluorescent indicator is being output. Never touch the HIGH terminal, test lead, or tested object.

CAUTION

- For output, the unit uses a high-voltage transformer that boosts the power voltage. If an unstable power voltage is used to operate the unit, the tested object may be damaged by the distortion of the output-voltage waveform and by the output of a voltage higher than the preset voltage.
- If a capacity load is applied to the tested object, the output voltage may exceed the preset voltage, thereby damaging the equipment.
- Continuous output of a high voltage may heat the bottom of the unit. Take special care when handling the unit (e.g. transporting the unit).

NOTE

Priority for control of the **START** key is in the following order: the START switch on the REMOTE CONTROL BOX, the external I/O, and the front panel of the unit. Connecting the switch signal line plug on the REMOTE CONTROL BOX disables the **START** key on the front panel of the unit and the start signal for the external I/O.

- (1) Press the **START** key when **READY** is lit. The unit will change to the TEST status and a test will start. **TEST** and the **DANGER** lamp are lit in the TEST state.
- (2) If a comparative-voltage value has been set, the test will not start until the output voltage is within $\pm 5\%$ of the comparative-voltage value (output voltage: 1 kV: ± 50 V).

- (3) In a test with a comparative-voltage value set, the test is forcibly terminated when the output voltage deviates by $\pm 5\%$ from the comparative-voltage value (output voltage: 1 kV: ± 50 V). In such a case, **UPPER**, **LOWER**, and **FAIL** will light up. Reset the output voltage and restart the test.

To terminate the test, press the **STOP** key. The unit will immediately stop outputting a voltage and switch to the READY state. In such a case, no screening is conducted.

OPTION

- The Hold function can be used to hold the value that was effective at the time of forced termination of the test. Refer to Section 4.3 Hold Function.
- When a comparative-voltage value is set, the FAIL Hold function enables the unit to forcibly terminate the test when the output voltage deviates from the comparative-voltage range. The most recently set value is held. Refer to Section 4.2 FAIL Hold Function.
- You can select whether you want to check the output-voltage when the test starts or ends. (Starting a test with default settings:) Refer to Section 4.9 Voltage Comparator Position
- The Double Action increases the safety of testing by preventing operational errors. Refer to Section 4.5 Double Action

3.4.3 Screening in "TEST State"

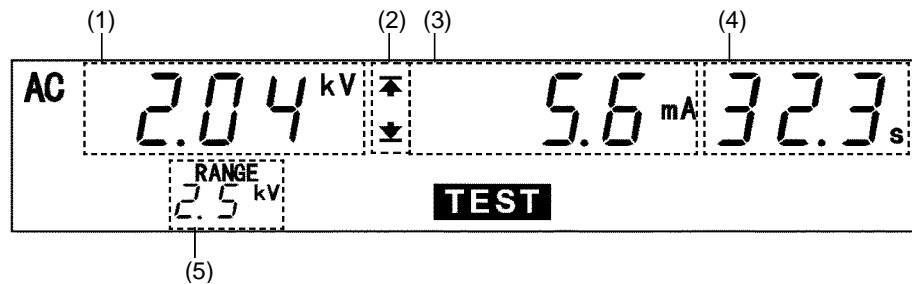

- (1) Measured voltage value
Indicates the voltage value being output.
- (2) Upper level value icon and Lower level value icon
The symbol ▲ appears when the upper level value is set, and the symbol ▼ appears when the lower level value is set.
- (3) Measured current value
Represent the value of a current flowing between the HIGH and LOW terminals.
- (4) Test time elapsed
When the testing time is set, countdown starts from the time set, and is displayed. When the testing time is set to OFF, the time elapsed after the start of the test is displayed.
If the elapsed test time exceeds 999 s, "_" is displayed, but the voltage continues to be output.
- (5) Output voltage range
Indicates the output-voltage range selected using the Range Selection switch
- (6) TEST
Remains lit during the test. **TEST** flickers for up to five seconds at the start of a test and when the output voltage exceeds the comparative-voltage range.

Analog voltmeter

Indicates the voltage value being output.

Danger lamp

Indicates that a voltage is being output. This lamp remains lit as long as a voltage of at least 0.03 kV is being applied to the output terminal. It does not light up in the READY state.

External I/O

The $\overline{\text{TEST}}$ signal is turned ON when **TEST** on the fluorescent indicator lights up. The $\overline{\text{H.V.ON}}$ signal is turned on when the **DANGER** lamp lights up. The two signals are turned OFF at the same time. At the start of a test, the unit waits for up to five seconds for the output voltage to switch to the comparative-voltage range. During this period, **TEST** flickers but the $\overline{\text{TEST}}$ signal is ON. The $\overline{\text{U-FAIL}}$ and $\overline{\text{L-FAIL}}$ signals are turned ON when the output-voltage value deviates from the comparative-voltage value range when **UPPER**, **LOWER**, and **FAIL** are lit.

3.5 PASS or FAIL Determination

3.5.1 "PASS" State



WARNING

Even when a test has been terminated, there may still be voltage in the output-voltage terminal when the **DANGER** lamp is lit. Before touching the output-voltage terminal, test lead, or tested object, make sure the analog voltmeter is at 0 kV, the **DANGER** lamp is OFF, and the **TEST** lamp is OFF.

When the preset test time has elapsed, the unit switches to the PASS state and immediately stops outputting a voltage. If the test time has not been set, PASS screening is not performed. To the test, press the **STOP** key, which will forcibly terminate the test.

OPTION

- The PASS state is held using the PASS Hold function. Refer to Section "4.1 PASS Hold Function".

Flow of PASS determination

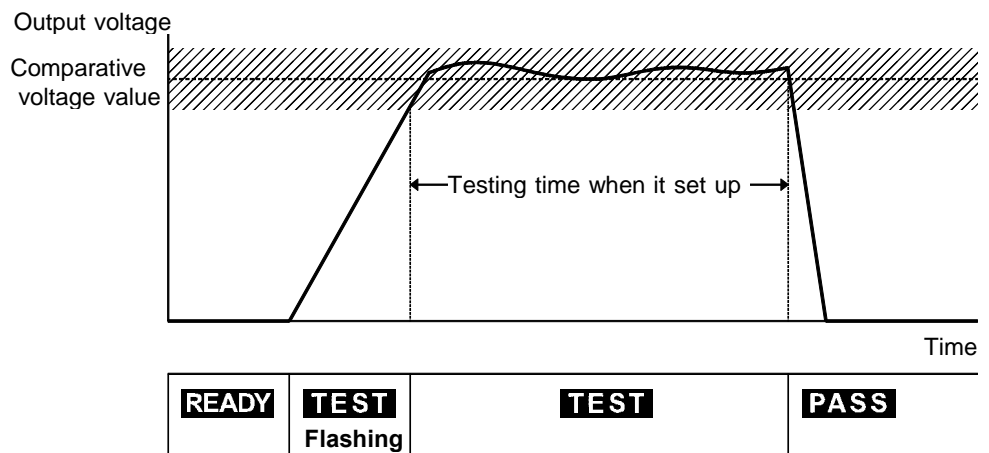

- Press the **START** key to start a test.
- If a comparative-voltage value has been set, **TEST** flickers until the output voltage switches to the comparative-voltage range. When the output voltage switches to that range, **TEST** remains lit and the reduction timer begins counting down the test time.
- A voltage is output until the test time elapses. (If the measured-current value deviates from the upper- and lower-level values, the unit switches to the FAIL state.)
- When the preset test time has elapsed, the unit stops outputting a voltage and switches to the PASS state. **PASS** lights up in the PASS state.

NOTE

If a comparative-voltage has not been set, **TEST** does not flicker. If the optional "Voltage Comparator Position" function is set to "1: End of test time", **TEST** does not flicker.

3.5.2 Screening in "PASS" State

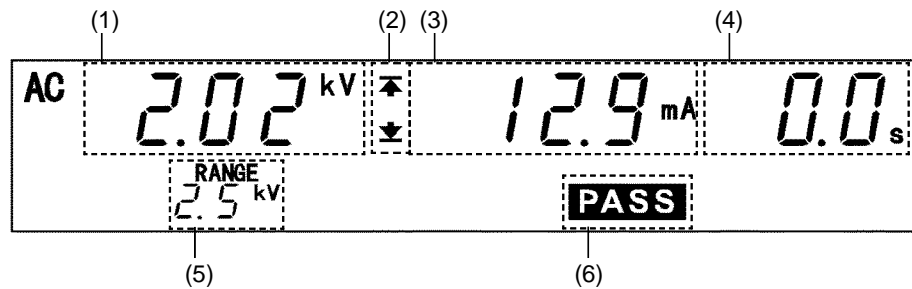

- (1) Measured voltage value
Indicates the voltage in the PASS state.
- (2) Upper level value icon and Lower level value icon
The symbol \blacktriangle appears when the upper level value is set, and the symbol \blacktriangledown appears when the lower level value is set.
- (3) Measured current value
Indicates the value of the current flowing between the HIGH and LOW terminals in the PASS state.
- (4) Test completion time
Displays the time in which the test has been completed. In PASS state, **0.0s** is displayed.
- (5) Output voltage range
Indicates the output-voltage range selected using the Range Selection switch.
- (6) PASS
Indicates that the unit is in the PASS state.

Analog voltmeter

Indicates the voltage being output. The PASS Hold function cannot be used on the analog voltmeter.

Danger lamp

Indicates that a voltage is being output. This lamp remains lit as long as a voltage of at least 0.03 kV is being applied to the output terminal. It does not light up in the READY state.

External I/O

The $\overline{\text{PASS}}$ signal is turned ON when PASS on the fluorescent indicator is lit. As long as the PASS state is held, the $\overline{\text{PASS}}$ signal remains ON. The $\overline{\text{PASS}}$ signal is turned OFF when the $\overline{\text{PASS}}$ light on the fluorescent indicator goes out. If voltage remains in the output-voltage terminal following termination of a test, the $\overline{\text{H.V.ON}}$ signal remains ON. When the **DANGER** lamp goes out, the $\overline{\text{H.V.ON}}$ signal is immediately turned OFF.

3.5.3 "FAIL" State



Even when a test has been terminated, there may still be voltage in the output-voltage terminal when the DANGER lamp is lit. Before touching the output-voltage terminal, test lead, or tested object, make sure the analog voltmeter is at 0 kV, the DANGER lamp is OFF, and the **TEST** lamp is OFF.

If the measured voltage deviates from the upper- or lower-level value during the test, the unit switches to the FAIL state and immediately stops outputting a voltage. The FAIL state can be divided into UPPER FAIL and LOWER FAIL states.

- UPPER FAIL indicates that the measured voltage has exceeded the upper-level value.
- LOWER FAIL indicates that the measured voltage has dropped below the lower-level value.

(When the lower-level value is set to OFF, LOWER FAIL is ineffective.)

With a comparative voltage value set, if the output voltage deviates from the comparative-voltage range, the unit switches to the FAIL state and **UPPER**, **LOWER**, and **FAIL** light up.

OPTION

- The FAIL state is held using the FAIL Hold function. Refer to Section "4.2 FAIL Hold Function".

Flow of FAIL determination

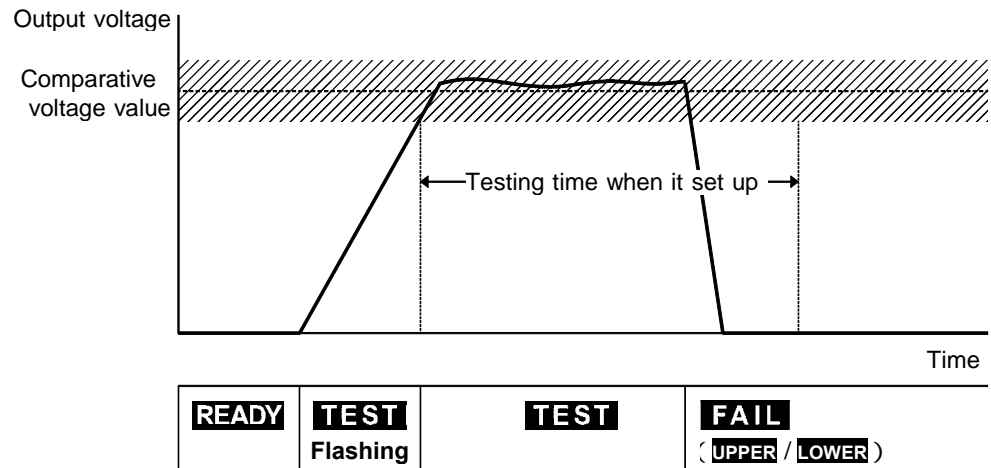

- (1) Press the **START** key to start a test.
- (2) When a comparative-voltage value has been set, **TEST** flickers until the output voltage switches to the comparative-voltage range. Once the output voltage switches to this range, **TEST** lights up and the reduction timer begins counting down the test time.
- (3) A voltage continues to be output until the test time elapses. If the measured current deviates from the upper- or lower-level value during this period, the unit switches to the FAIL state.
- (4) Once a switch is made to the FAIL state, **FAIL** lights up, together with **UPPER** or **LOWER**. The unit stops outputting a voltage and the reduction timer stops.

NOTE

- If the current generated is several times as large as the upper-level value, for example when the test object is short-circuited and etc., a circuit promptly cuts off the high voltage, thereby switching the unit to UPPER FAIL before measuring the current.
- If a comparative-voltage has not been set, **TEST** does not flicker. If the optional "Voltage Comparator Position" function is set to "1: End of test time", **TEST** does not flicker.

FAIL Screening Using the Comparative-Voltage Value

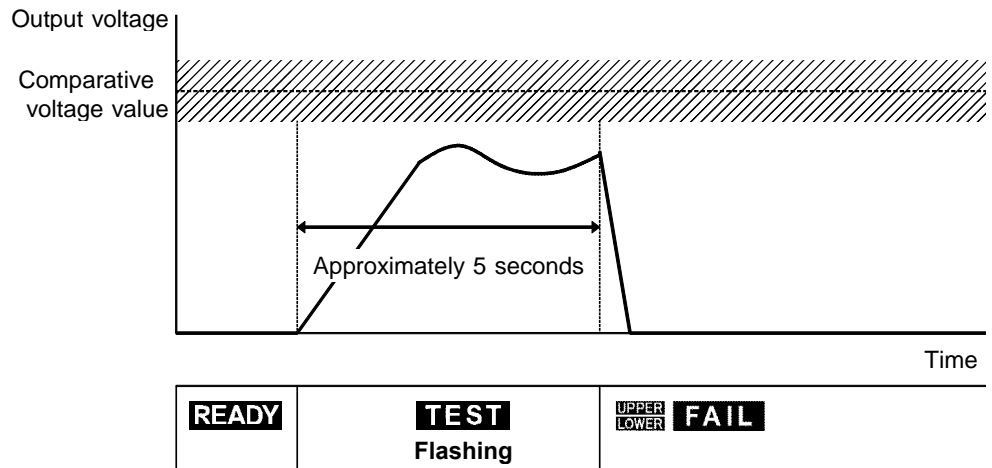

- (1) Press the **START** key to start a test.
- (2) **TEST** will flicker until the output voltage switches to the comparative-voltage range.
- (3) If the output voltage fails to switch to this range in 5 seconds, the unit switches to the FAIL state and stops outputting a voltage.
- (4) In the **FAIL** state, **UPPER**, **LOWER**, and **FAIL** light up to indicate that an improper voltage has been output.

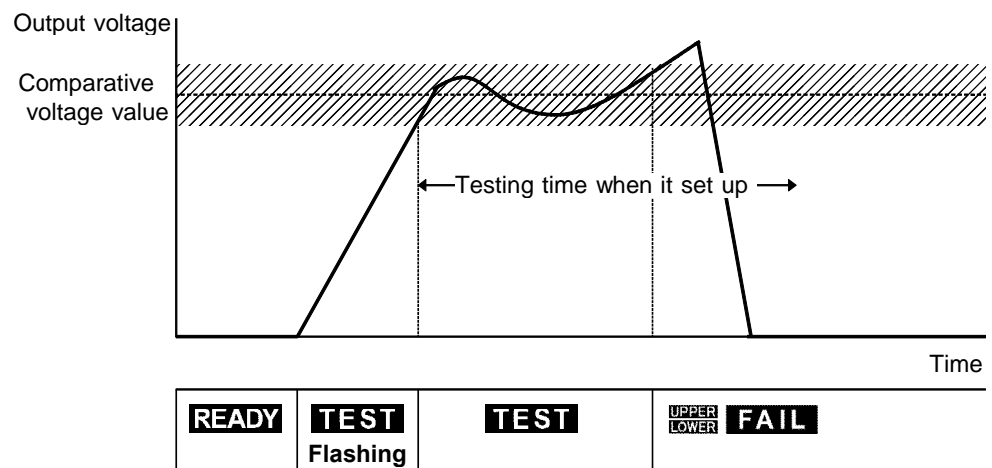

- (1) Press the **START** key to start a test.
- (2) **TEST** will flicker until the output voltage switches to the comparative-voltage range. When the output voltage switches to this range, **TEST** lights up and the subtraction timer begins counting down the test time.
- (3) If the output voltage deviates from the comparative-voltage range during the test, the unit immediately stops outputting a voltage and the test is terminated.
- (4) In the **FAIL** state, **UPPER**, **LOWER**, and **FAIL** light up to indicate that an improper voltage has been output.

NOTE

- If the optional "Voltage Comparator Position" function is set to "1: End of test time", since the unit shifts to the TEST state whenever voltage is output, **TEST** does not flash before the output-voltage value reaches the comparative-voltage value range.
- If the optional "Voltage Comparator Position" function is set to "1: End of test time", this function checks whether the output voltage is within the standard voltage range only when the test is terminated.

3.5.4 Screening in "FAIL" State

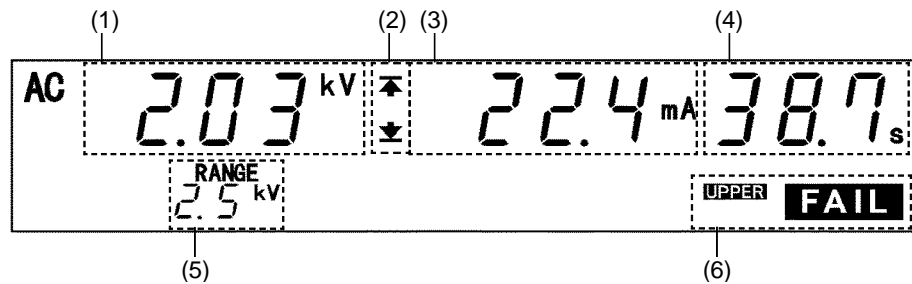

- (1) Measured voltage value
Indicates the voltage in the FAIL state
- (2) Upper level value icon and Lower level value icon
The symbol \blacktriangle appears when the upper level value is set, and the symbol \blacktriangledown appears when the lower level value is set.
- (3) Measured current value
Indicates the current flowing between the HIGH and LOW terminals in the FAIL state
- (4) Test completion time
Indicates the time when the unit switched to the FAIL state. If the test time has been set, the remaining test time is displayed. If the test time is set at OFF, the period of time during which a voltage is output is displayed.
- (5) Output voltage range
Indicates the output-voltage range selected using the Range Selection switch
- (6) FAIL
Indicates that the unit is in the FAIL state. **FAIL** lights up with **UPPER** to indicate UPPER FAIL, and with **LOWER** to indicate LOWER FAIL. If the output voltage deviates from the comparative-voltage range and switches the unit to the FAIL state, **UPPER**, **LOWER**, and **FAIL** light up.

Analog voltmeter

Indicates the voltage being output. The analog voltmeter is not held even if the FAIL Hold function is disabled.

Danger lamp

Indicates that a voltage is being output. This lamp remains lit as long as a voltage of at least 0.03 kV is being applied to the output terminal. It does not light up in the READY state.

External I/O

The $\overline{\text{U-FAIL}}$ or $\overline{\text{L-FAIL}}$ signal is turned ON when **FAIL** lights up on the fluorescent indicator. If the output voltage deviates from the comparative-voltage range, both the $\overline{\text{U-FAIL}}$ and $\overline{\text{L-FAIL}}$ signals are turned ON. Both the $\overline{\text{U-FAIL}}$ and $\overline{\text{L-FAIL}}$ signals remain ON as long as the FAIL state is held. The $\overline{\text{U-FAIL}}$ and $\overline{\text{L-FAIL}}$ signal are turned OFF when the **FAIL** light on the fluorescent indicator goes out. If voltage remains in the output-voltage terminal following the termination of a test, the $\overline{\text{H.V.ON}}$ signal remains ON. When the **DANGER** lamp goes out, the $\overline{\text{H.V.ON}}$ signal is immediately turned OFF.

Chapter 4

Optional Functions

Setting the optional functions allows testing under various conditions.

Settings can be made for the following eight optional functions. One number is assigned to each function. Settings are made by changing the number by moving the cursor key.

Since improper settings can produce inaccurate results, this chapter explains the correct way to make settings. Please read it carefully.

Entering the Optional function setting screen

Press **[SHIFT]** + **[STOP]** keys while in READY state to display the Optional function setting screen.

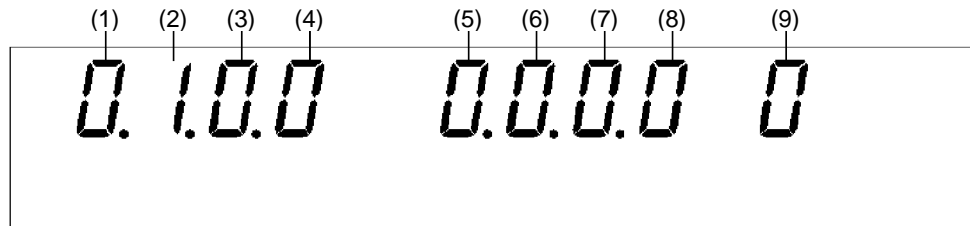

Setting optional functions

Use the **[◀]**/**[▶]** keys to move the flashing cursor to the target function.

Use the **[▲]**/**[▼]** keys to set a value at the flashing cursor location.

To complete the optional settings, press **[SHIFT]** + **[STOP]** keys. The unit reverts to the READY state.

Press the **[STOP]** key to abort the setting process. The unit reverts to the READY state without finalizing settings.

The following describes the numbers corresponding to the functions. For additional information, see Appendix 4, "Table of Optional Functions."

(1) PASS Hold Function	
This function retains PASS state to help verify the value screened in the test.	
Selection	0: Not held (initial setting) 1: Held
(2) FAIL Hold Function	
This function retains FAIL state to help verify the value screened in the test.	
Selection	0: Not held 1: Held (initial setting)
(3) Hold Function	
Enable this function to hold the current state when testing is interrupted by the [STOP] key.	
Selection	0: Not held (initial setting) 1: Held
(4) Momentary Out	
The momentary OUT function allows current output only while the [START] key is held down.	
The [START] key on the remote control or the START signal via external I/O has the same effect.	
Selection	0: Not set (initial setting) 1: Set

(5) Double Action	
Enable this function to allow testing to start only when the START key is pressed within about 0.5 seconds after the STOP key.	
Selection	0: Not set (initial setting) 1: Set
(6) FAIL Mode	
Enable this function to restrict hold release to the STOP key on the main unit.	
Selection	0: Not set (initial setting) 1: Set
(7) RS Command [START]	
Turn this function on to enable the RS-232C START command.	
Selection	0: Not set (initial setting) 1: Set
(8) Inter-lock Function	
Enable this function to activate the external I/O interlock terminals.	
Selection	0: Not set (initial setting) 1: Set
(9) Voltage Comparator Position	
When the voltage comparator is set to ON for a withstand voltage test, select whether you want to use the voltage comparator when starting and during the test, or only when terminating the test.	
Selection	0: Start test (initial setting) 1: End test

4.1 PASS Hold Function

This function retains the value for the PASS state on test completion.

To inactivate the hold function, press the **STOP** key. The unit reverts to the READY state.

If the PASS hold function is not selected, the test result is displayed for about 0.5 second before the unit reverts to the READY state.

Setting procedure

- (1) Press **SHIFT** + **STOP** keys while in READY state to display the Optional function setting screen.

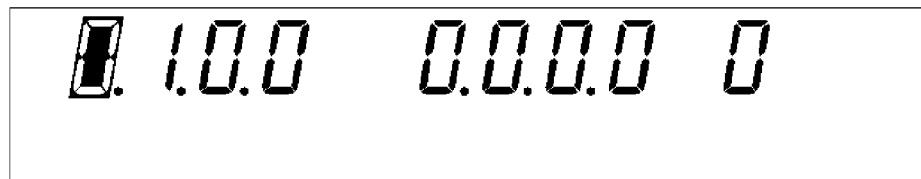

- (2) Use the **◀**/**▶** keys to move the flashing cursor to the position shown in the figure.
- (3) Use the **▲**/**▼** keys to set a value at the flashing cursor location.

0: Not held (Initial setting)

1: Held

- (4) To complete the optional settings, press **SHIFT** + **STOP** keys. The unit reverts to the READY state.

4.2 FAIL Hold Function

This function retains the value for the FAIL state on test completion.

To inactivate the hold function, press the **STOP** key. The unit reverts to the READY state.

If the FAIL hold function is not selected, the test result is displayed for about 0.5 second before the unit reverts to the READY state.

Setting procedure

- (1) Press **SHIFT** + **STOP** keys while in READY state to display the Optional function setting screen.

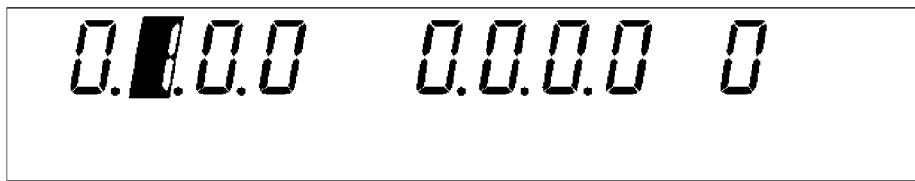

- (2) Use the **◀**/**▶** keys to move the flashing cursor to the position shown in the figure.
- (3) Use the **▲**/**▼** keys to set a value at the flashing cursor location.

0: Not held

1: Held (Initial setting)

- (4) To complete the optional settings, press **SHIFT** + **STOP** keys. The unit reverts to the READY state.

4.3 Hold Function

Enable this function to hold the current state when testing is interrupted by the **STOP** key.

To inactivate the hold function, press the **STOP** key. The unit reverts to the READY state.

If the Hold function is not selected, the unit switches to the READY state upon forced termination of the test.

- (1) Press **SHIFT** + **STOP** keys while in READY state to display the Optional function setting screen.

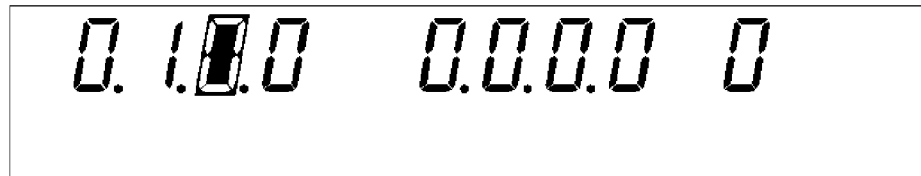

- (2) Use the **◀**/**▶** keys to move the flashing cursor to the position shown in the figure.
- (3) Use the **▲**/**▼** keys to set a value at the flashing cursor location.

0: Not held (Initial setting)

1: Held

- (4) To complete the optional settings, press **SHIFT** + **STOP** keys. The unit reverts to the READY state.

Distinction between the PASS Hold Function, FAIL Hold Function, and Hold Function

- With a comparative-voltage value set, if the output voltage deviates from the comparative-voltage range, the unit switches to the FAIL state.
- If the test time is set to OFF, PASS screening is not performed. In such a case, FAIL screening is performed or the test is terminated using the **STOP** key.

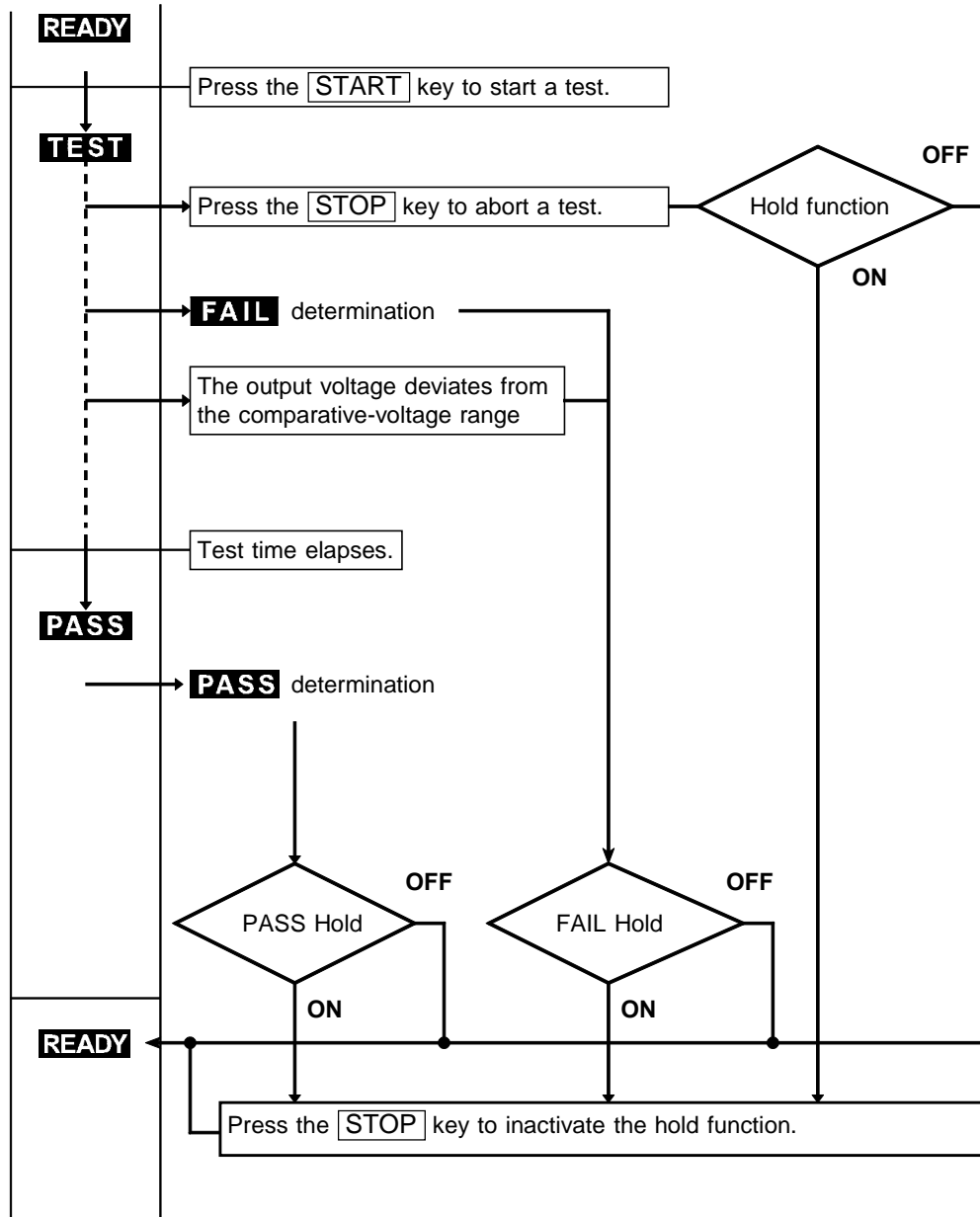

4.4 Momentary Out

The momentary out function allows current output only while the **START** key is held down. Releasing the **START** key is equivalent to pressing the **STOP** key and ends the test.

To perform PASS/FAIL screening, hold down the **START** key until the preset test time elapses.

The **START** key on the remote control or the START signal via external I/O has the same effect.

Setting procedure

- (1) Press **SHIFT** + **STOP** keys while in READY state to display the Optional function setting screen.

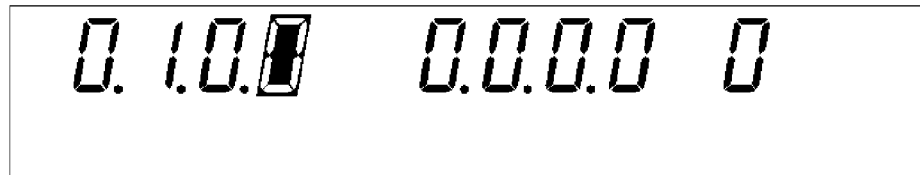

- (2) Use the **◀**/**▶** keys to move the flashing cursor to the position shown in the figure.
- (3) Use the **▲**/**▼** keys to set a value at the flashing cursor location.

0: Not set (Initial setting)

1: Set

- (4) To complete the optional settings, press **SHIFT** + **STOP** keys. The unit reverts to the READY state.

NOTE

Priority for control of the **START** key is in the following order: the switch on the REMOTE CONTROL BOX, the external I/O, and the front panel of the unit.

4.5 Double Action

If the Double Action function is set, **READY** will not light up in the READY state. **READY** only lights up for approximately 0.5 seconds after the **STOP** key is pressed. While **READY** is lit, press the **START** key to start a test. If the Double Action function is set, the **STOP** key must be pressed once. Thus, this function increases the safety of testing by preventing operational errors.

Setting procedure

- (1) Press **SHIFT** + **STOP** keys while in READY state to display the Optional function setting screen.

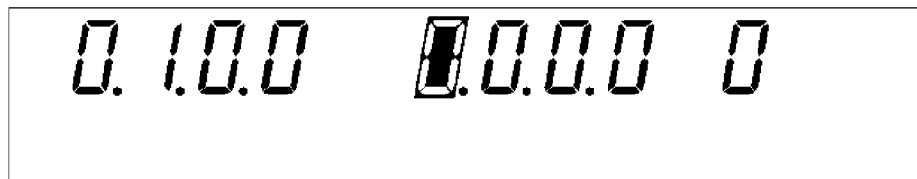

- (2) Use the **◀**/**▶** keys to move the flashing cursor to the position shown in the figure.
- (3) Use the **▲**/**▼** keys to set a value at the flashing cursor location.

0: Not set (Initial setting)

1: Set

- (4) To complete the optional settings, press **SHIFT** + **STOP** keys. The unit reverts to the READY state.

NOTE

The Double Action function can be set in combination with the Momentary-Out function. If settings are made in this way, press the **START** key within 0.5 seconds after the **STOP** key is pressed to start a test. Hold down the **START** key during the test.

4.6 FAIL Mode

Enable this function to restrict hold release to the **STOP** key on the main unit.

Setting procedure

- (1) Press **SHIFT** + **STOP** keys while in READY state to display the Optional function setting screen.

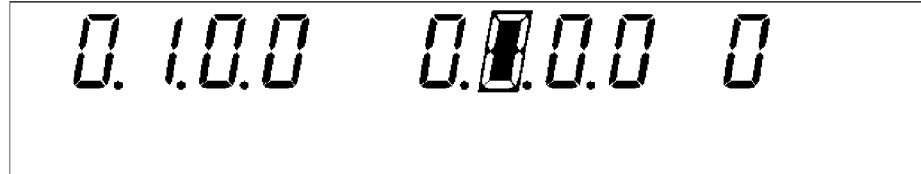

- (2) Use the **◀**/**▶** keys to move the flashing cursor to the position shown in the figure.
- (3) Use the **▲**/**▼** keys to set a value at the flashing cursor location.

0: Not set (Initial setting)

1: Set

- (4) To complete the optional settings, press **SHIFT** + **STOP** keys. The unit reverts to the READY state.

4.7 RS Command [START]

When RS-232C is used for control, settings can be made to specify whether to accept the test start command ":STAR."

If "1: Set" is selected, a test is started when the ":STAR" command is received.

If "0: Not set" is selected, this command is disregarded.

Setting procedure

- (1) Press **SHIFT** + **STOP** keys while in READY state to display the Optional function setting screen.

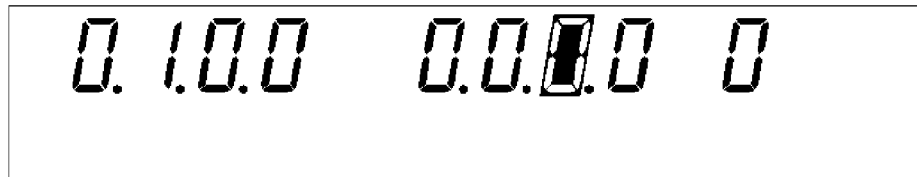

- (2) Use the **◀**/**▶** keys to move the flashing cursor to the position shown in the figure.
- (3) Use the **▲**/**▼** keys to set a value at the flashing cursor location.

0: Not set (Initial setting)

1: Set

- (4) To complete the optional settings, press **SHIFT** + **STOP** keys. The unit reverts to the READY state.

NOTE

Unless the control program on your PC is complete, select "0: Not set."

4.8 Inter-lock Function

Settings can be made to specify whether to use the Inter-lock function with the external I/O terminal.

If "0: Not set" is selected, the Inter-lock function is cancelled regardless of the state of Pin 10 on the external I/O terminal.

If "1: Set" is selected, the Inter-lock function may be disabled, depending on the state of Pin 10 of the external I/O terminal. For the Inter-lock function, see 6.1.4, "Inter-lock function."

Setting procedure

- (1) Press **SHIFT** + **STOP** keys while in READY state to display the Optional function setting screen.

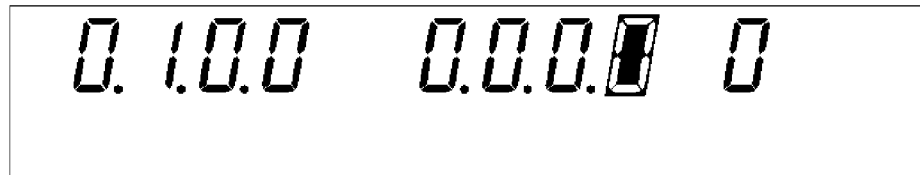

- (2) Use the **◀**/**▶** keys to move the flashing cursor to the position shown in the figure.
- (3) Use the **▲**/**▼** keys to set a value at the flashing cursor location.

0: Not set (Initial setting)

1: Set

- (4) To complete the optional settings, press **SHIFT** + **STOP** keys. The unit reverts to the READY state.

NOTE

The Inter-lock function can be set only when $\overline{\text{INT.LOCK}}$ (Pin 10) of the external I/O terminal is set at Lo. If the terminal is set at Hi, "0: Not set" remains effective even if the **▲**/**▼** keys are pressed.

4.9 Voltage Comparator Position

When performing a voltage test, you can select whether you want to view the output-voltage when the test starts, or when the test ends.

If "0: Start test" is selected, the Voltage Comparator function is active immediately before and during the withstand voltage test.

If "1: End test" is selected, the Voltage Comparator function is only active when the withstand voltage test ends.

Setting procedure

- (1) Press **SHIFT** + **STOP** keys while in READY state to display the Optional function setting screen.

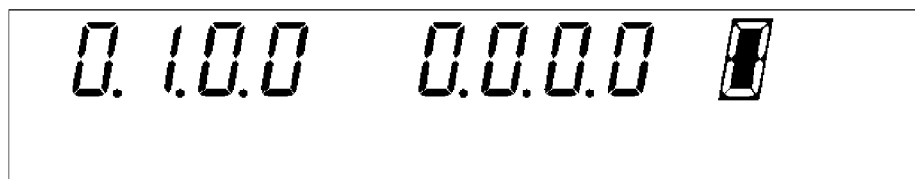

- (2) Use the **◀**/**▶** keys to move the flashing cursor to the position shown in the figure.
- (3) Use the **▲**/**▼** keys to set a value at the flashing cursor location.

0: Not test(Initial setting)

1: End test

- (4) To complete the optional settings, press **SHIFT** + **STOP** keys. The unit reverts to the READY state.

NOTE

When the Voltage Comparator function is set to OFF or the Voltage Comparator function is set to ON but the timer is set to OFF, the Voltage Comparator function is disabled and optional settings are ineffective.

4.10 Example of Optional Function Settings

Assume that the 3158 is in the READY state, with the PASS Hold function and FAIL Hold function disabled. The following example shows how to activate the two functions:

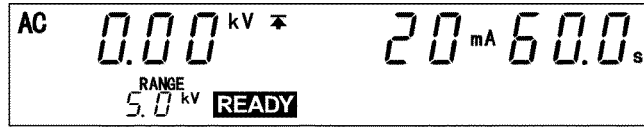

- (1) While holding down the **SHIFT** key, press the **STOP** key to switch to the Optional Function Setting screen.

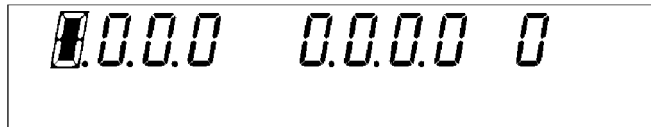

- (2) The first and second figures from the left are set at "0: Not held," as the PASS Hold function and the FAIL Hold function are inactive. Change the numbers to "1."

The flashing cursor is at the PASS Hold function. Press the **▲**/**▼** keys to set it to "1: Hold." This setting enables the PASS Hold function.

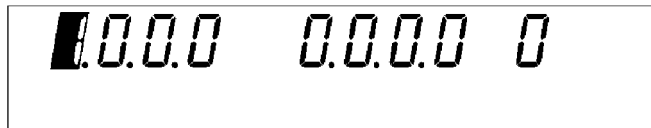

- (3) Next, activate the FAIL Hold function. Press the **▶** key once to move the flashing cursor to the FAIL Hold function.

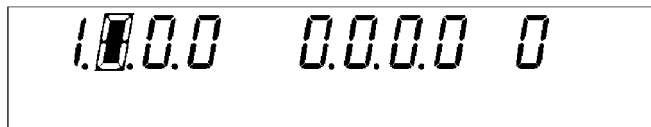

- (4) Using the **▲**/**▼** keys, select "1: Hold." This setting enables the FAIL Hold function.

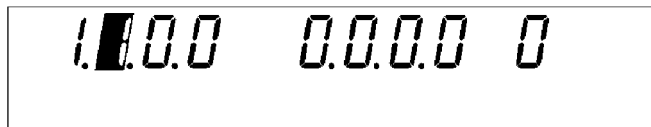

- (5) While holding down the **SHIFT** key, press the **STOP** key to finalize the new settings for the optional functions. Following finalization, the unit returns to the READY state.

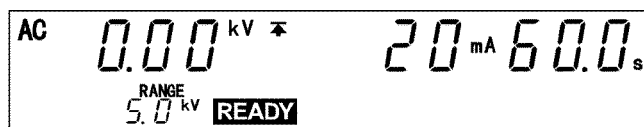

4.11 Example of Optional Functions Use

The following describes how 3158 optional functions are used in testing. Varying combinations of optional functions are available for testing.

(1) Testing to check test results, using the 3158

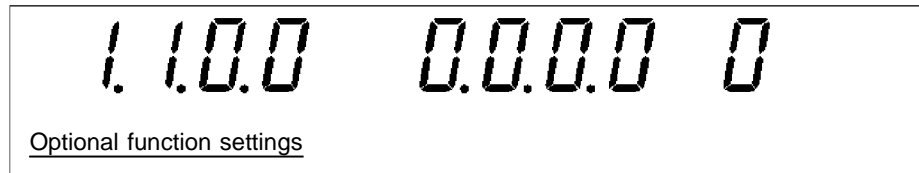

Optional function	Selection
PASS Hold Function	1: Held
FAIL Hold Function	1: Held

Advantages of these settings

PASS or FAIL state is held, allowing inspection of test results.

(2) Safe testing by remote control

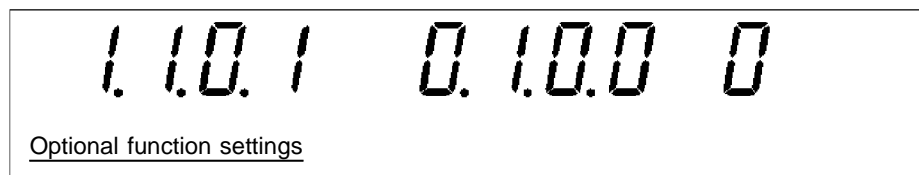

Optional function	Selection
PASS Hold Function	1: Held
FAIL Hold Function	1: Held
Momentary Out	1: Set
FAIL Mode	1: Set

Advantages of these settings

- PASS or FAIL state is held, allowing inspection of test results.
- Hold down the **START** key during the test, as the Momentary-OUT function is set. The 9614 REMOTE CONTROL BOX (DUAL) must be operated with both hands during the test. This prevents high-voltage devices such as the probe and tested device from being touched by hand.
- The FAIL Hold function must be cancelled using the **STOP** key on the unit, as the FAIL mode is set. The use of the FAIL mode enables the FAIL state to be set.

Chapter 5

Saving/Loading Preset Values

5.1 Saving Preset Values

The following describes a function used to save values set in the READY state. Up to twenty parameters may be saved. To retrieve saved data, follow the procedures described in Section 5.2, "Loading Preset Values."

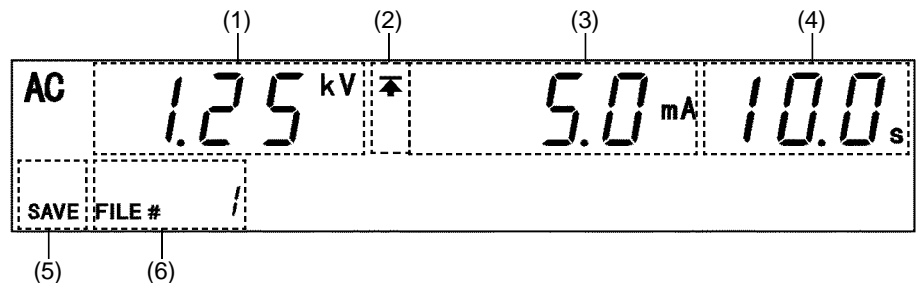

- (1) Comparative voltage value
Shows the preset comparative voltage value for the set data being displayed.
- (2) Upper level value icon and Lower level value icon
The symbol \uparrow appears when the upper level value is displayed, and the symbol \downarrow appears when the lower level value is displayed.
- (3) Upper and Lower level values
Shows upper and lower level values for the data being displayed.
- (4) Test time
Shows the test time for the data being displayed.
- (5) SAVE
Shows that the screen appearing is for saving the data (the save screen).
- (6) File number
This value indicates the file number for the data containing the preset comparative voltage value, upper level value, lower level value, and the test time currently displayed.

5.1.1 Procedure for Saving Data

To select a preset value to be saved, the unit must be in the READY state. Preset values cannot be changed in the save screen.

The following four parameters may be saved:

- (1) Comparative voltage value
- (2) Upper level value
- (3) Lower level value
- (4) Test time

(1) Displaying the save screen

With the target preset value displayed in the READY state, press **SHIFT** + **▶** keys to shift to the save screen.

In the save screen, the saved data for the file number replaces the target value displayed in the READY state.

The first saved data displayed is the last data from the previous save screen.

(2) Selecting a file to save

The new data overwrites the previous data. Look for the saved data to be deleted, using the **▲**/**▼** keys. Use the **◀**/**▶** keys to switch between upper and lower level values.

(3) Saving and canceling data

When the saved data to be deleted is displayed, press **SHIFT** + **▶** keys. This deletes the saved data and saves the value set in the READY state.

After the saving the data, the unit reverts to the READY state.

Press the **STOP** key to revert to the READY state without saving the target data.

NOTE

For comparative voltage, the test lower limit, and test time, both ON/OFF settings and set values used (when on) are saved.

5.1.2 Example of Saving

The following example shows how to save in File No.3. We assume that the 3158 is in the READY state.

- (1) In the READY state, set the preset value to save. For more information on making these settings, see Chapter 3, "Testing Method."

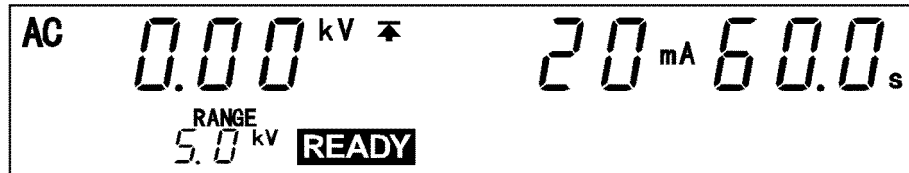

In this example, settings are made as follows:

Comparative voltage value	2.00 kV
Upper level value	20 mA
Lower level value	OFF
Test time	60.0 s

- (2) Press **SHIFT** + **▶** keys to bring up the save screen.

In the save screen, the value set in the READY state is replaced by the saved data being displayed. The first saved data displayed is the last data item from the previous save screen. This example shows "File No.1."

The new data overwrites the previous data. Use the **▲**/**▼** keys to select the data to be overwritten. The new data in this example is to be saved in File No.3.

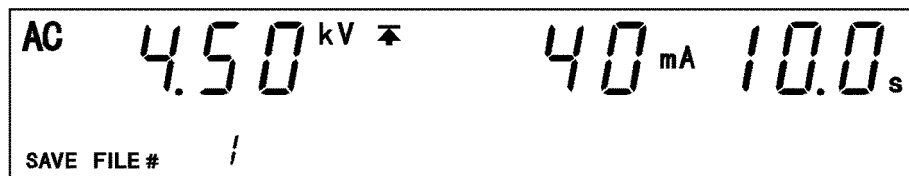

In this status, the preset upper test valve can be checked by using the **◀**/**▶** keys.

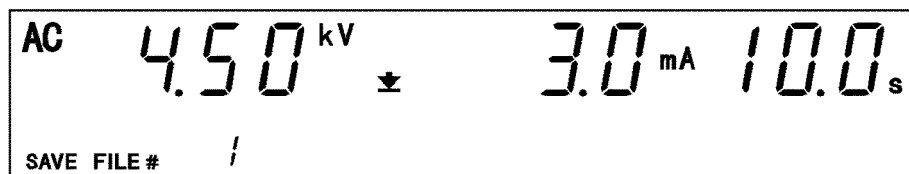

In this example, File No. 1 contains the following settings.

Comparative voltage value	4.50 kV
Upper level value	40 mA
Lower level value	3 mA
Test time	10.0 s

- (3) Use the \uparrow/\downarrow keys to select File No.3.

This example shows File No. 1. Press the \uparrow key twice to display File No.3.

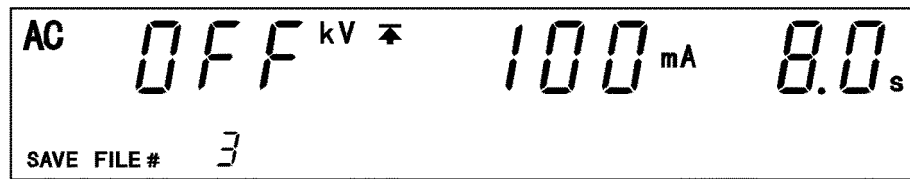

- (4) Use the \leftarrow/\rightarrow keys to check upper and lower level values.

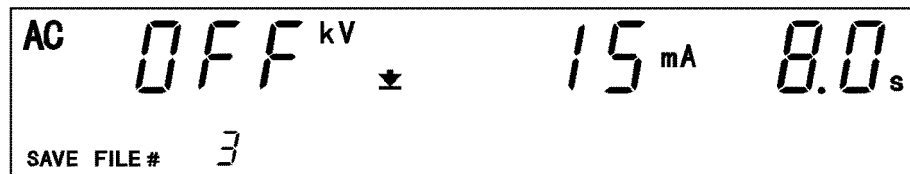

In this example, File No. 3 contains the following settings.

Comparative voltage value	OFF
Upper level value	100 mA
Lower level value	15 mA
Test time	8.0 s

- (5) To save the data, press $\text{SHIFT} + \rightarrow$ keys. The unit reverts to the READY state. Once saved, the value set in the READY state is retained in File No.3. Note that File No.3, shown in Step (4) above, is deleted.

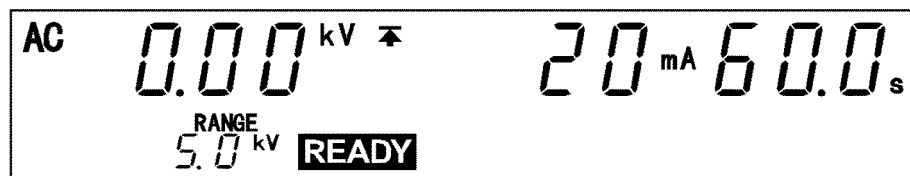

To abort the save procedure, press the STOP key at Step (4). The unit halts the save procedure and reverts to the READY state.

5.2 Loading Preset Values

The following describes how to load saved data. Twenty preset values may be saved. Use this function to instantly change a preset value.

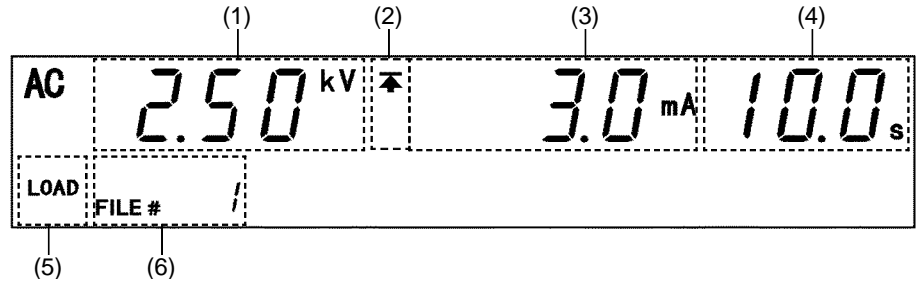

- (1) Comparative voltage value
Shows the preset comparative voltage value for the set data being displayed.
- (2) Upper level value icon and Lower level value icon
The symbol \uparrow appears when the upper level value is displayed, and the symbol \downarrow appears when the lower level value is displayed.
- (3) Upper and Lower level values
Shows upper and lower level values for the data being displayed.
- (4) Test time
Shows the test time for the data being displayed.
- (5) LOAD
Shows that the screen appearing is for loading the data (the load screen).
- (6) File number
This value indicates the file number for the data containing the preset comparative voltage value, upper level value, lower level value, and the test time currently displayed.

5.2.1 Procedure for Loading Data

Before loading, carefully read Section 5.1, "Saving Preset Values" and prepare the data to be saved. The following are factory-set data.

Comparative voltage value	OFF (0.00 kV)
Upper level value	0.2 mA
Lower level value	OFF (0.1 mA)
Test time	0.5 s

The following four parameters may be loaded:

- (1) Comparative voltage value
- (2) Upper level value
- (3) Lower level value
- (4) Test time

(1) Displaying the load screen

To load the saved data, Press **SHIFT** + **◀** keys in the READY state to shift to the load screen.

In the load screen, a number for saved data equal to the file preset replaces the target value displayed in the READY state.

The first saved data displayed is the last data from the previous load screen.

(2) Selecting a file to save

Look for the saved data to be loaded, using the **▲**/**▼** keys.

Use the **◀**/**▶** keys to switch between upper and lower level values

(3) Loading and canceling data

When the saved data to be loaded is displayed, press **SHIFT** + **▶** keys. This loads the saved data and the unit reverts to the READY state.

Press the **STOP** key to revert to the READY state without loading the target data.

NOTE

For comparative voltage, the test lower limit, and test time, both ON/OFF settings and set values used (when on) are saved.

5.2.2 Example of Loading

The following example shows how to load File No.3. We assume that the 3158 is in the READY state.

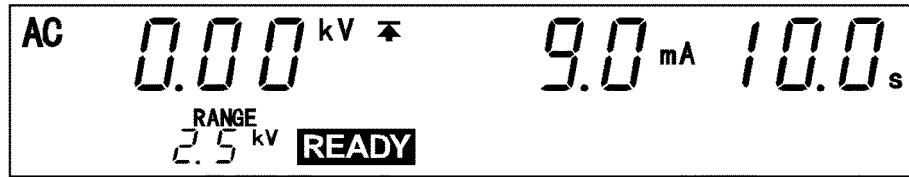

- (1) Press **SHIFT** + \leftarrow keys to bring up the load screen.

In the load screen, the value set in the READY state is replaced by the saved data being displayed. The first saved data displayed is the last data item from the previous load screen. This example shows "File No.1."

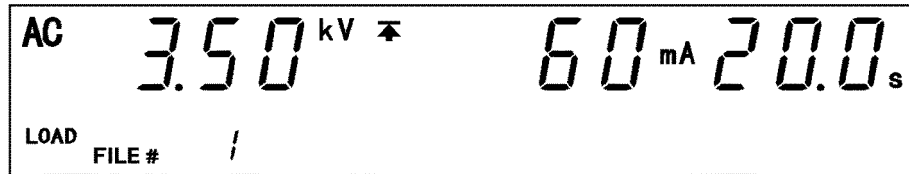

In this status, the preset lower level valve can be checked by using the \leftarrow / \rightarrow keys.

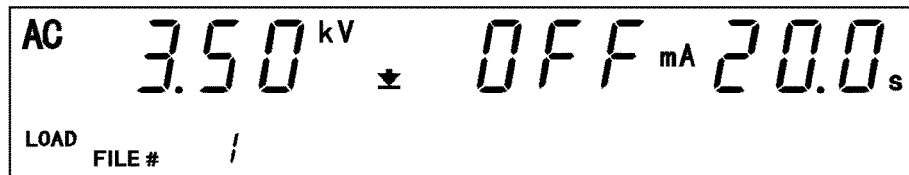

In this example, File No. 1 contains the following settings.

Comparative voltage value	3.50 kV
Upper level value	60 mA
Lower level value	OFF
Test time	20.0 s

- (2) Use the \uparrow / \downarrow keys to select File No.3.

This example shows File No. 1. Press the \uparrow key twice to display File No.3.

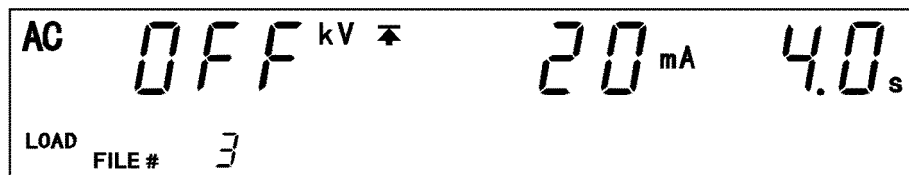

- (3) Use the / keys to check upper and lower level values.

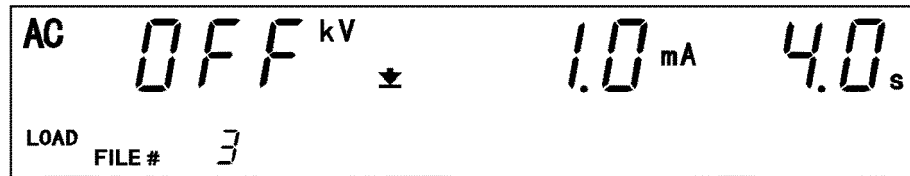

In this example, File No. 3 contains the following settings.

Comparative voltage value	OFF
Upper level value	20 mA
Lower level value	1.0 mA
Test time	4.0 s

- (4) To load the data, press SHIFT +  keys. The unit reverts to the READY state. To abort the load procedure, press the **STOP** key.

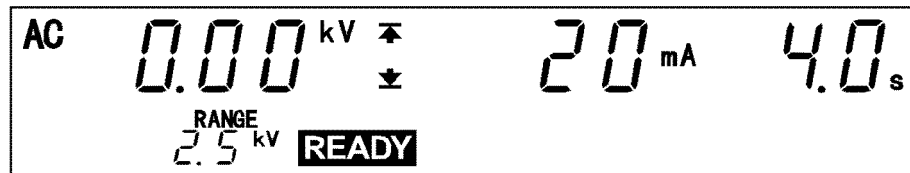

Chapter 6

External Interface

6.1 External I/O Terminal



Both output signals regarding the status of the 3158 (e.g., READY state) and input signals to the **START** key and the **STOP** key are controlled through the external I/O terminal, located at the back of the unit.

An inter-lock terminal is provided to ensure safety. All signal lines are insulated internally with a photocoupler. A power voltage of 15 V (0.1 A), insulated from the internal supply, is output from the external I/O terminal. This voltage can be used as external power. If the unit power capacity is insufficient, add an external power supply.

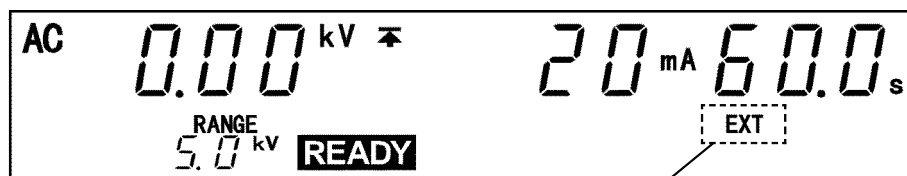

When $\overline{\text{EXT-E}}$ of the external I/O terminal is at LO, EXT lights up when the remote-control box is active.

NOTE

When $\overline{\text{EXT-E}}$ of the external I/O terminal is at LO, the unit **START** key is disabled. If you use the remote control box, the START signal for the external I/O terminal is disabled. The priority hierarchy for the **START** keys is given below. When a **START** key with a higher priority is in use, lower-priority keys are disabled: Priority: Remote control box > External I/O > Front panel of the unit.

6.1.1 Signal Line

Use the following external I/O connectors or their equivalents:

Connector of the 3158 main unit: 57GE-40360-751-FA(DDK Ltd.)

Compatible connector: 57-30360 (DDK Ltd.)

57E-30360 (DDK Ltd.)

57F-30360 (DDK Ltd.)

57FE-30360 (DDK Ltd.)

External I/O connector pin numbering

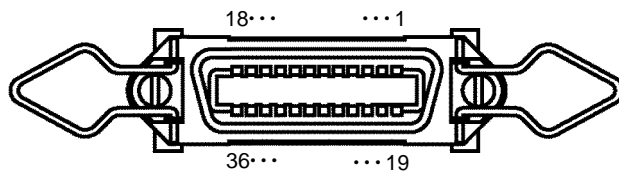

Pin number	I/O	Signal line name	Pin number	I/O	Signal line name
1	OUT	READY	19	OUT	NC
2	OUT	L-FAIL	20	OUT	NC
3	OUT	U-FAIL	21	OUT	NC
4	OUT	PASS	22	OUT	NC
5	OUT	TEST	23	OUT	NC
6	OUT	H.V.ON	24	OUT	NC
7	IN	EXT-E	25	OUT	NC
8	IN	START	26	OUT	NC
9	IN	STOP	27	OUT	NC
10	IN	INT.LOCK	28	OUT	NC
11	OUT	NC	29	OUT	NC
12	OUT	NC	30	OUT	NC
13	OUT	NC	31	OUT	NC
14	OUT	NC	32	OUT	NC
15	IN	ISO.COM	33	OUT	ISO.DCV
16	IN	ISO.COM	34	OUT	ISO.DCV
17	IN	ISO.COM	35	OUT	ISO.DCV
18	IN	ISO.COM	36	OUT	ISO.DCV

Function of the signal line

Signal line name	I/O	Function
READY	OUT	LO in the READY state
L-FAIL	OUT	LO in the FAIL state at LOWER (minimum value)
U-FAIL	OUT	LO in the FAIL state at UPPER (maximum value)
PASS	OUT	LO in the PASS state
TEST	OUT	LO in the TEST state
H.V.ON	OUT	LO when a voltage is generated in the output terminal
EXT-E	IN	At LO, the external I/O input signal is active. INT.LOCK remains active regardless of this signal. Changing this switch during testing will forcibly terminate the test.
START	IN	LO is equivalent to pressing the unit START key and provides the same functions.
STOP	IN	LOW is equivalent to pressing the unit STOP key and provides the same functions.
INT.LOCK	IN	Inter-lock function terminal. This signal is always active regardless of the status of the EXT-E terminal. When connected to ISO.COM, this terminal cancels the Inter-lock function, enabling the unit to function properly. When disconnected, the terminal disables all keys. To activate the Inter-lock function, set the optional Inter-lock function to "1: Set." Use this terminal for a protective device against electric shock that uses an area sensor or the like. See Section 6.1.4.
ISO.COM	IN	Generates an internal GND for the unit. Used temporarily to activate the external I/O function. Note that the signal line is not insulated.
ISO.DCV	OUT	Outputs a power voltage of 15 V (0.1 A), insulated from the internal power supply.

6.1.2 Example of Input Signal Connection

The unit can be controlled externally using the external I/O input signal. Provide a connector that conforms to the External I/O Specifications.

To enable the external I/O signal, set the EXT-E signal (Pin 7) to Lo. Connect the EXT-E signal to ISO.COM for the GND signal (Pins 15 to 18), which is insulated from the unit's internal power supply. (The EXT indicator on the display screen lights.)

EXT I/O Input signals Specifications

Input signals	Active low input (photocoupler isolated)
Max. testing voltage	30 VDC
HIGH level voltage	15 VDC or more, open
LOW level voltage	5 VDC or less (-6 mA typ)
Input signals	START, STOP, EXT-E, INTERLOCK

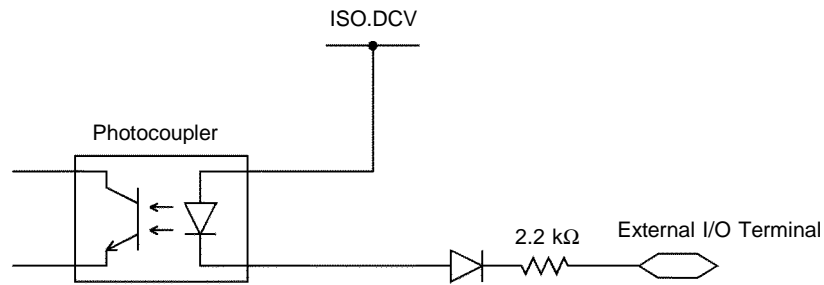

(1) Control using the external switch (example)

To control the START and STOP signals using a relay or switch, make connections as shown below: (Connect the EXT-E signal (Pin 7) and ISO.COM (Pins 15 to 18) to enable external I/O signals.)

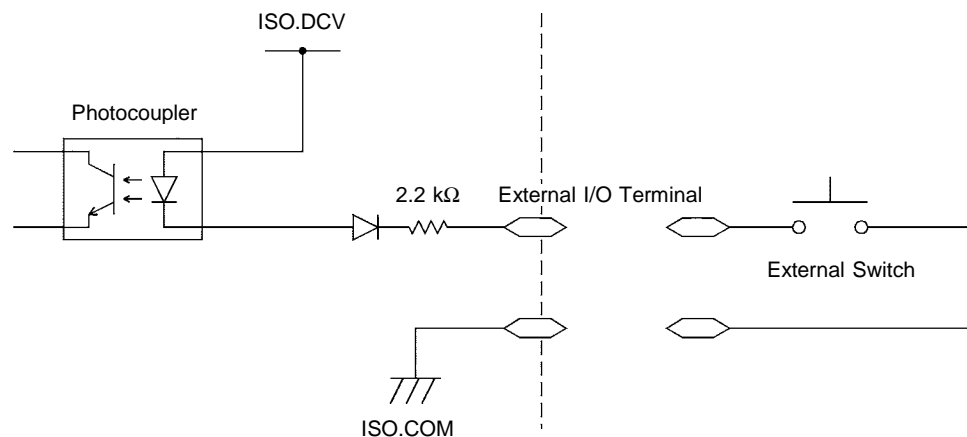

NOTE

For connection to the input signal, provide a circuit that protects the relay and switch from chattering to prevent malfunctioning.

(2) Control using the transistor (example)

For control using a transistor or FET, make connections as shown below.

Design the signals so that 6 mA is absorbed into each of the signals. (Connect the EXT-E signal (Pin 7) and ISO.COM (Pins 15 to 18) to enable external I/O signals.)

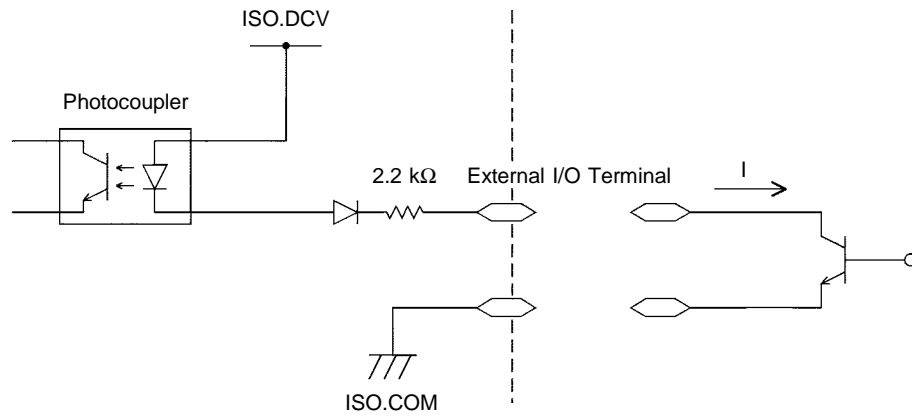

6.1.3 Example of Output Signal Connection

The output signal becomes Lo depending on the condition of the unit. Prepare a connector that conforms to the External I/O Specifications.

To enable the external I/O signal function, set the EXT-E signal (Pin 7) to Lo. Connect the EXT-E signal to ISO.COM for the GND signal (Pins 15 to 18). An output example is presented in 6.1.5, "Timing Chart of External I/O Terminal."

EXT I/O Output signals Specifications

Output signal	Open collector output
Max. load	30 VDC
Max. output current	100 mADC per signal
Output saturation voltage	1.5 VDC or less
Output signals	HV-ON, TEST, PASS, UFAIL, LFAIL, READY

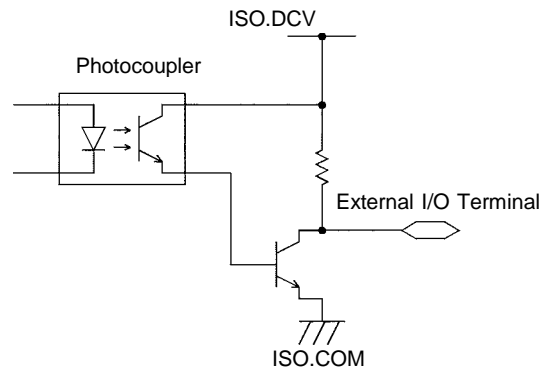

(1) Controlling the relay (example)

To link the relay to an external device, make connections as shown below. Use of the power supply ISO.DCV (Pins 33 to 36, 15 VDC 0.1 A) will facilitate the connections.

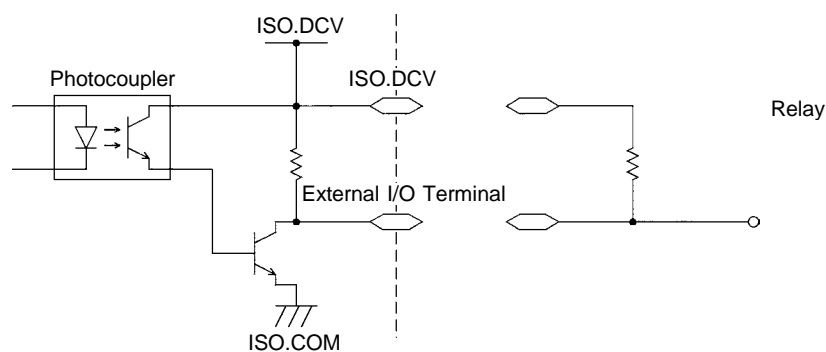

NOTE

- A signal can absorb up to 100 mA.
- When connecting an inductive load such as a relay, connect the diode in parallel with the coil.

(2) Obtaining a signal level (example)

To obtain a signal level, make connections as shown below. In addition, check the output current.

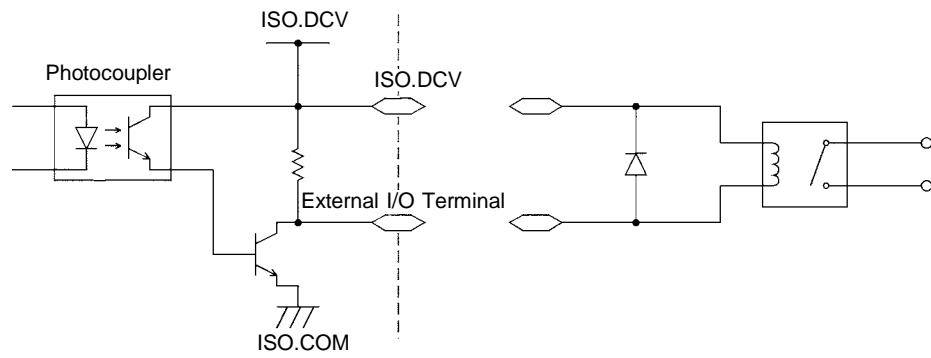
**NOTE**

The output signal status upon power-on may be undetermined. Care should be taken in the operation of equipment connected to the external I/O.

6.1.4 Inter-lock Function

The inter-lock function is used to cut off output from the 3158 in combination with other devices, including external equipment. This function cuts off output from the 3158, and disables all key operations.

Setting the inter-lock function

- (1) Connect Pin 10 INT.LOCK on the external I/O terminal to ISO.COM (Pins 15 to 18), and set the pin to Lo.
- (2) In Optional Functions, set "Inter-lock" to "1: Set."

NOTE

- The INT.LOCK terminal is always active, regardless of the status of the EXT-E terminal.
- If "0: Not set" is selected for "Inter-lock" in Optional Functions, the inter-lock function is inactive, regardless of the status of the INT.LOCK terminal. The function is set at "0: Not set" by default. If the inter-lock function is to be used, be sure to select "1: Set."

Using the inter-lock function

The inter-lock function is active when the INT.LOCK terminal is open, with the following displayed:

To disable the function, connect the INT.LOCK terminal to ISO.COM and set it to Lo. The unit changes to READY status once the inter-lock function is disabled.



Err0

Connections for the inter-lock function (example)

For example, to ensure the safety of workers, the unit and the tested object are placed in a box so that they are not in contact with each other. The door of the box cover is also equipped with a switch that works in combination with the inter-lock function. If a connection is made to the switch, the inter-lock function is enabled when the box cover is opened. When the cover is closed, the function is disabled, making the unit ready for testing.

All keys are inactive provided that the inter-lock function is active. As a result, once the unit is mounted in the box, the settings cannot be changed. In such a case, connect the setting adjustment switch the door switch such that these switches are arranged in parallel, as shown below:

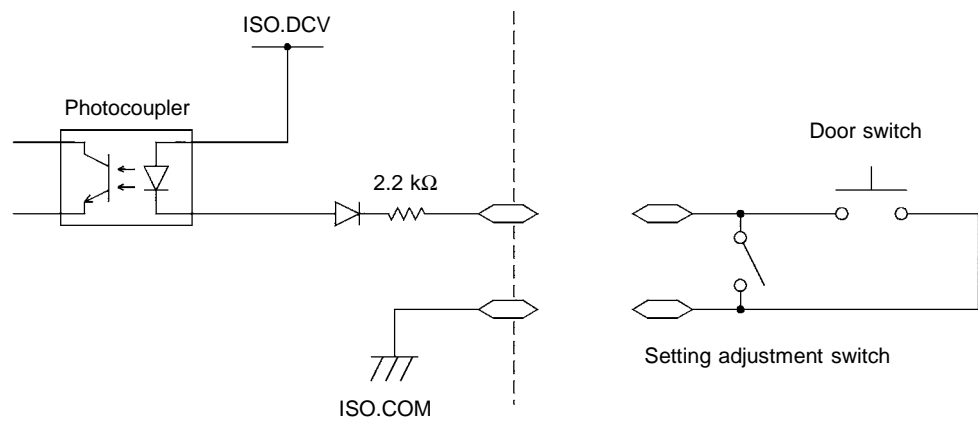

6.1.5 Timing Chart of External I/O Terminal

(1) Timing chart at time of start of testing

When a test begins, the $\overline{\text{READY}}$ signal becomes HI, and the $\overline{\text{TEST}}$ signal and H.V.ON signal become LO.

The $\overline{\text{TEST}}$ signal changes at the same time **TEST** on the fluorescent indicator changes. If the comparative-voltage value has been set, the $\overline{\text{TEST}}$ signal becomes LO when **TEST** is flickering.

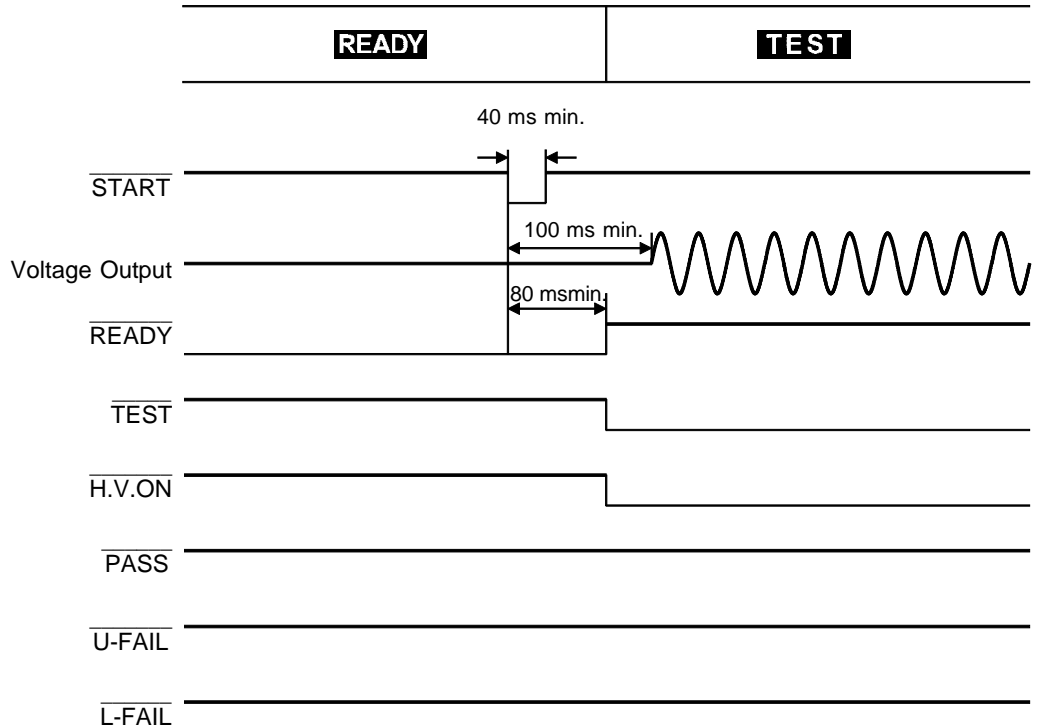

When running a test immediately after modifying test settings, voltage output response time is less than 300 ms.

(2) Timing chart during a test decision

The figure shows the timing chart of the unit in PASS state after a test. In PASS state, the $\overline{\text{TEST}}$ signal indicates HI.

The H.V.ON signal remains at LO provided that the voltage between the output terminals remains unchanged, as the signal is synchronized with the **DANGER** lamp. Once the voltage reaches 0, the signal changes to HI.

The $\overline{\text{PASS}}$ signal changes according to the **PASS** indicator on the fluorescent display. If the PASS hold function is enabled, the $\overline{\text{PASS}}$ signal continues to indicate LO until the function is disabled.

When the Hold function is disabled or the unit automatically returns to the READY state, the $\overline{\text{PASS}}$ signal becomes HI and the $\overline{\text{READY}}$ signal becomes LO.

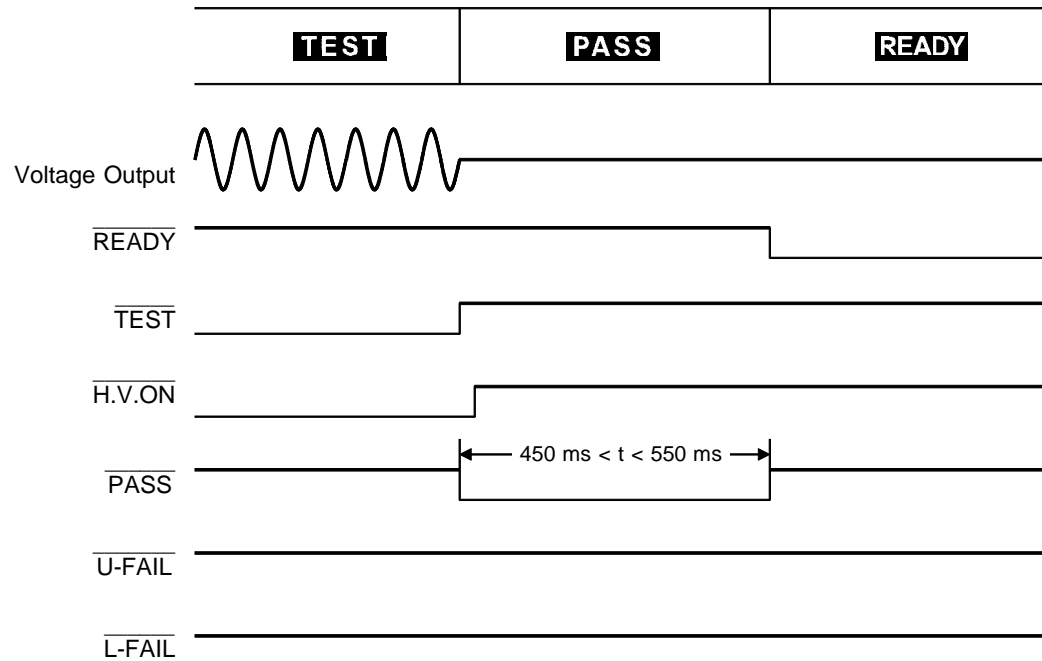

With UPPER-LOWER FAIL, which is activated when the output voltage fails to reach the comparative-voltage value, the $\overline{\text{U-FAIL}}$ and $\overline{\text{L-FAIL}}$ signals are at LO. Even in the FAIL state, when UPPER FAIL is activated, the $\overline{\text{U-FAIL}}$ signal becomes LO. Similarly, with LOWER-FAIL, the $\overline{\text{L-FAIL}}$ signal becomes LO. When the FAIL Hold function is set, the signal remains at LO until the Hold function is disabled. When the Hold function is disabled or the unit automatically returns to the READY state, the $\overline{\text{PASS}}$ signal becomes HI and the $\overline{\text{READY}}$ signal becomes LO.

(3) Timing chart at forced termination

When the **STOP** key is pressed to forcibly terminate testing, the unit does not change to either PASS or FAIL status, as test screening is not performed. In this case, the signal becomes HI. In the absence of status indicators (READY/TEST/FAIL/PASS) -- in the SETTING state, when set values are being saved or loaded, or when settings are being made for the optional functions -- all signals become HI.

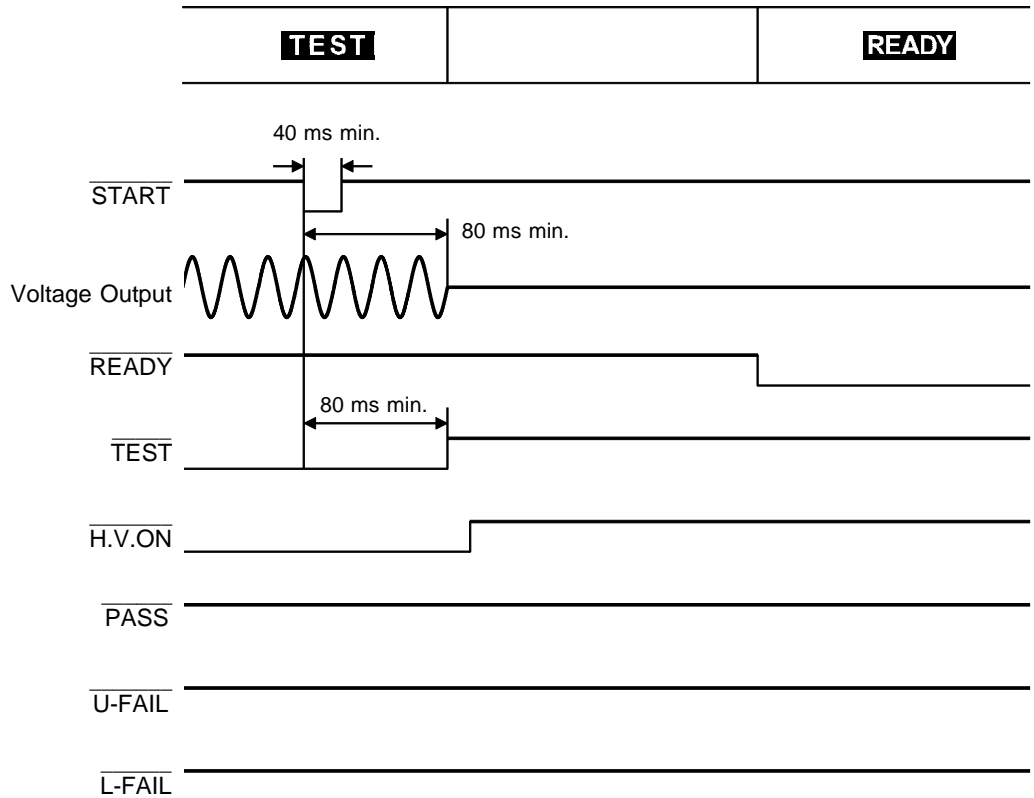

6.2 Buzzer



A buzzer sounds during PASS or FAIL screening and in the event of an error due to improper key operations. Two buzzer volume adjustment knobs are provided on the rear panel: one for PASS screening and one for FAIL screening. Volume adjustments can be made using the knobs.

Tools required for adjustment

No. 0 Phillips screwdriver or 3-mm slotted screwdriver

- (1) Check the analog voltmeter and the **DANGER** lamp to make sure a voltage is not being output.
- (2) Using a No. 0 Phillips screwdriver or 3-mm slotted screwdriver, adjust the volume adjustment knob. To increase the volume, turn the knob clockwise. To decrease it, turn it counterclockwise.

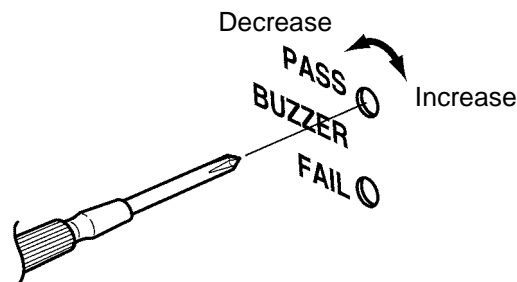

NOTE

If an excessive force is placed on the volume adjustment knob, it may be fractured. During screening, the length of time the buzzer sounds depends on the settings for the PASS and FAIL hold. For more about the PASS hold setting, see "4.1 PASS Hold Function," and for more about the FAIL hold setting, see "4.2 FAIL Hold Function."

PASS hold setting	PASS buzzer
PASS not held	Approx. 0.5 s
PASS held	Until held status is reset

FAIL hold setting	FAIL buzzer
FAIL not held	Approx. 0.5 s
FAIL held	Until held status is reset

Chapter 7

RS-232C Interface



7.1 Specifications

The RS-232C settings of 3158 are as follows. Since the 3158 settings are fixed and cannot be changed, these settings must be matched on the computer side.

RS-232C Settings

Transmission mode	Start-stop synchronization, full duplex
Transfer rate	9600 bps
Data length	8 bit
Parity	None
Stop bit	1 bit
Hand shake	No x flow, hardware flow control
Delimiter	CR, CR + LF for reception CR + LF for transmission

No hardware flow control. RTS is connected with CTS in the 3158.

Electrical Characteristics

Input voltage level	+5 V to +15 V	ON
	-15 V to -5 V	OFF
Out put voltage (load resistance 3 kΩ to 7 kΩ)	+5 V to +9 V	ON
	-9 V to -5 V	OFF

Connector

Pin arrangement of interface connector (D-sub 9 Pin male)

The signal lines of the 3158's RS-232C connector are as follows.

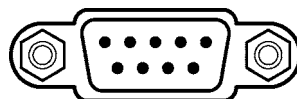

RS-232C

Pin number	signal	I/O	Contents
2	RxD	IN	Incoming data
3	TxD	OUT	Outgoing data
5	GND	GND	Signal ground

Other pins are not used

7.2 Connection Method

Use a cross cable for connection to the PC. If the hardware flow control signal (RTS and CTS) is not used, the 3158 will not perform hardware flow control. RTS is connected with CTS in the 3158.

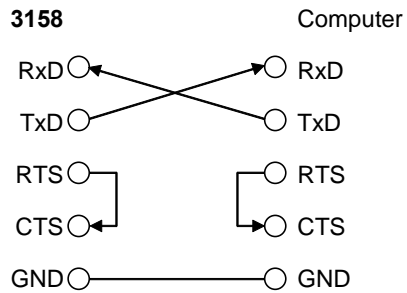
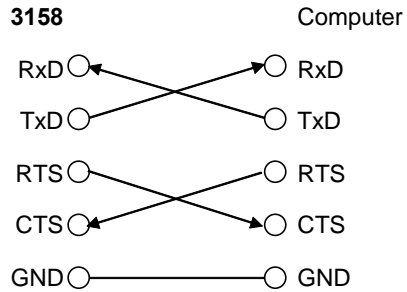

Connecting cable

Connector on cable side: D-Sub 9 Pin female

Connection: Reverse connection

Connection to Computer

- (1) Connect the 3158 to the computer using a cross cable.
- (2) Perform the RS-232C settings on the computer side. For details on how to make the settings, refer to the instruction manual for the computer.

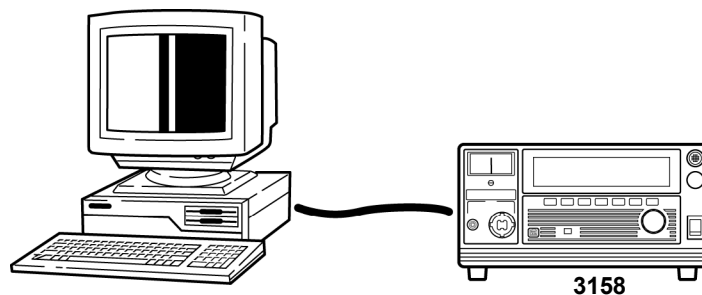

7.3 Command Transfer Methods

The command is issued from the computer.

When the 3158 receives the incoming command from the computer, it executes the processing specified by the command.

When 3158 has completed processing of the command, it always returns a response to the computer.

When the computer has confirmed the response, it sends the next command.

RMT lights up on the screen during interface communication.

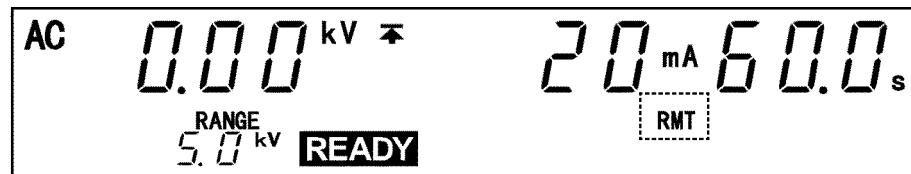

NOTE

- Every time the computer has sent a command, a response is always returned. Make sure that the computer only sends the next command after it has received the response to the previous command issued from the 3158. If multiple commands are sent consecutively, the 3158 may not execute the commands, or command errors may occur.
- There is a need to add ":" to the front of the command except standard commands in the instrument.

Command Format

The 3158 commands have the following structure.

Command + **Parameter** + **Delimiter**

The command and the parameter are separated by " " (one character space)

If there is no parameter, send the delimiter after the command.

The command may consist of both upper and lower case letters.

Make sure to use one character space as the separator between the command and the parameter.

(1) When the command contains a parameter

:CONF:CUPP 5.0 (+ delimiter)

The command format consists of the command ":CONF:CUPP" followed by the separator " ". Then follows the parameter "5.0". Following the parameter comes the delimiter.

(2) When the command contains no parameter

:STOP (+ delimiter)

The command format consists of the command ":STOP" immediately followed by the delimiter.

NOTE

The meaning of the delimiter is to separate commands and data. When the 3158 receives the delimiter, it starts analysis of the command.

Response format

When a command is sent to 3158 processes the command. When processing is completed, 3158 always returns a response.

- (1) When there is no information from 3158,
OK (+ delimiter)
- (2) When there is information from 3158 (measurement values, etc.),
Response character string related to the command (+delimiter)
- (3) When the command contained an error,
CMD ERR (+ delimiter) : Command error
EXEC ERR (+ delimiter) : Execution error
- (4) When the command contained an Transmission error,
TIME OUT ERR (+ delimiter) :
Time out error (When the delimiter is not transmitted for
approximately 10 seconds)
SIO ERR : Serial Transmission error

Parameters

The 3158 uses parameters composed of decimal numbers. There are three different formats for decimal data: NR1, NR2, and NR3. Each has two values: one with a code and one without it. A value without a code is regarded as a positive number. If a number exceeds the accuracy resolution of the 3158, the value is rounded up or down.

NR1 format: Integer data

+12, -23, 34

NR2 format: Fixed point numbers

+1.23, -23.45, 3.456

NR3 format: Floating point numbers.

+1E-2, -2.3E+4

The format that contains all three formats is referred to as the "NRf format." In the 3158, a format is specified for each command. For details, see 7.5, "Transmission and Response Formats."

Delimiter

Depending on transmission direction, the delimiter is as follows.

From computer to 3158: CR or CR + LF

From 3158 to computer: CR + LF

7.4 Command

Explanation of Command Reference

Syntax describes the syntax of the command.

data Explains the parameter data.

Response Explains the received data.

Function Explains the actions specified by the command.

Error Describes errors that may occur when the command is executed.

Example PC > denotes command from the computer.
3158 > denotes command from 3158.

NOTE

The optional functions cannot be set using an RS command.

***IDN?**

Queries manufacturer's name, model name, and software version.

Syntax *IDN?

Response <data>

data Manufacturer's name, Model name, Serial number (Not used - always zero), Software version

Function Queries manufacturer's name, model name, and software version.

Example

PC

 > *IDN?

3158

 > HIOKI, 3158, 0, V01.00

***RST**

Performs device initial setting.

Syntax *RST

Response OK Resetting completion

Function Resets the 3158. The items which are reset are listed below.
 Comparative voltage value setting: OFF
 Test time setting: ON, Lower level value setting: OFF
 Output voltage value: 0.00 kV, Upper level value: 0.2 mA
 Lower level value: 0.1 mA, Test time: 0.5 s

Example

PC

 > *RST Performs device initial setting.

3158

 > OK Resetting completion.

:VOLT

Enables and disables the Comparative voltage value.

Syntax :VOLT <data>

data 0: OFF 1: ON

Response OK Setting completion

Function Makes ON/OFF settings for the comparative-voltage value, in the READY or SETTING state.

Error The execution of this command in a state other than the READY and SETTING state causes an execution error.

Example

PC

 > :VOLT 1

3158

 > OK Setting completion.

:VOLT?

Queries the Comparative voltage value enablement.

Syntax :VOLT?

Response <data>

data 0: OFF 1: ON

Function Queries the Comparative voltage value enablement.

Example PC > :VOLT?
3158 > 1 The Comparative voltage value enablement is on.

:LOW

Enables and disables the lower level value.

Syntax :LOW <data>

Response OK Setting completion

data 0: OFF 1: ON

Function Makes ON/OFF settings for the lower level value, in the READY or SETTING state.

Example PC > :LOW 1
3158 > OK Setting completion.

Error The execution of this command in a state other than the READY and SETTING state causes an execution error.

Note that an execution error occurs when setting the test lower limit to on when the test lower limit is equal to or greater than the test upper limit.

:LOW?

Queries the lower level value enablement.

Syntax :LOW?

Response <data>

data 0: OFF 1: ON

Function Queries the lower level value enablement.

Example PC > :LOW?
3158 > 1 The lower level value enablement is on.

:TIM

Enables and disables the test time.

Syntax :TIM <data>

data 0: OFF 1: ON

Response OK Setting completion

Function Makes ON/OFF settings for the test time, in the READY or SETTING state.

Example Sets the test time to on.

```
PC > :TIM 1
3158 > OK Setting completion.
```

Error The execution of this command in a state other than the READY and SETTING state causes an execution error.

:TIM?

Queries the test time.

Syntax :TIM?

Response <data>

data 0: OFF 1: ON

Function Queries the test time.

```
PC > :TIM?
3158 > 1 The test time is on.
```

:CONF:VOLT

Sets the comparative voltage value.

Syntax :CONF:VOLT <data>

data 0.00 - 5.00
(Numerical data in NR2 format, three digits)
The comparative voltage value (Refer to section 7.5.)

Response OK

Function In the READY or SETTING state, set the comparative-voltage value.

Example Sets the comparative voltage value to 1.50 kV.

```
PC > :CONF:VOLT 1.50
3158 > OK Setting completion.
```

Error The execution of this command in a state other than the READY and SETTING state causes an execution error.

:CONF:VOLT?

Queries the comparative voltage value enablement.

Syntax :CONF:VOLT?

Response <data>

data Comparative voltage value (Refer to section 7.5.)

Function Queries the comparative voltage value enablement.

```
PC > :CONF:VOLT?
3158 > 1.50 The comparative voltage value is 1.50 kV.
```

:CONF:CUPP

Sets the upper level value.

Syntax :CONF:CUPP <data>

data 0.1 - 9.9 (Numerical data in NR2 format, two digits)
 10 - 120 (Numerical data in NR1 format, two or three digits)
 Upper level value (Refer to section 7.5.)

Response OK

Function In the READY or SETTING state, set the upper level value.

Example Sets the upper level value to 5.0 mA.

```
PC > :CONF:CUPP 5.0
3158 > OK Setting completion.
```

Error In states other than the READY and SETTING states, or when a value below the comparative-voltage value is set, an execution error occurs.
 Note that an execution error occurs when setting the test upper limit to a value less than the test lower limit when the latter is on.

:CONF:CUPP?

Queries the upper level value enablement.

Syntax :CONF:CUPP?

Response <data>

data Upper level value (Refer to section 7.5.)

Function Queries the upper level value enablement.

```
PC > :CONF:CUPP?
3158 > 5.0 Upper level value is 5.0 mA.
```

:CONF:CLOW

Sets the lower level value.

Syntax :CONF:CLOW <data>

data 0.1 - 9.9 (Numerical data in NR2 format, two digits)
 10 - 120 (Numerical data in NR1 format, two or three digits)
 Lower level value (Refer to section 7.5.)

Response OK

Function In the READY or SETTING state, set the lower level value.

Example Sets the lower level value to 0.1 mA.

```
PC > :CONF:CLOW 0.1
3158 > OK Setting completion.
```

Error In states other than the READY and SETTING states, or when a value below the comparative-voltage value is set, an execution error occurs.
 Note that an execution error occurs when setting the test lower limit to a value more than the test upper limit when the former is on.

:CONF:CLOW?

Queries the lower level value enablement.

Syntax :CONF:CLOW?

Response <data>

data Lower level value (Refer to section 7.5.)

Function Queries the lower level value enablement.

```
PC > :CONF:CLOW?
3158 > 0.1 The lower level value is 0.1 mA.
```

:CONF:TIM

Sets the test time.

Syntax :CONF:TIM <data>

data 0.5 - 99.9 (Numerical data in NR2 format, two or three digits)
 100 - 999 (Numerical data in NR1 format, three digits)
 Test time (Refer to section 7.5.)

Response OK

Function In the READY or SETTING state, set the test time.

Example Sets the test time to 1.0 s.

Example

 > :CONF:TIM 1.0

 > OK Setting completion.

Error The execution of this command in a state other than the READY and SETTING state causes an execution error.

:CONF:TIM?

Queries the test time.

Syntax :CONF:TIM?

Response <data>

data Test time (Refer to section 7.5.)

Function Queries the test time.

Example

 > :CONF:TIM?

 > 1.0 Test time is 1.0 s.

:STAR

Starts a test.

Syntax : STAR

Response OK

Function Starts a test in the READY state
In the optional functions, if "START" for the RS command is set to "0: Not set," this command will not start testing.

Example

PC

 > :STAR

3158

 > OK Completed.

Error The execution of this command in a state other than the READY state causes an execution error.
In the optional functions, if "START" for the RS command is set to "0: Not set," an execution error will occur.

Note

- The ":STAR" command cannot be accepted for approximately 0.5 seconds after the ":STOP" command has been sent.
- In this command, set Momentary Out in the optional function setting to "0:OFF". At "1:ON", the test forcibly stops immediately after test starts.

:STOP

Performs forcible ending of a test and releases the hold state.

Syntax : STOP

Response OK

Function In the TEST state, performs forcible ending of a test.
When retaining the test result, returns to the READY state.
However, in the optional functions, if "FAIL Mode Function" is set to ON, the Hold function cannot be disabled by this command.

Example

PC

 > :STOP

3158

 > OK Ended.

Error In the optional functions, if "FAIL Mode Function" is set to ON, an execution will occur when the unit is in the FAIL Hold Mode.

Note The ":STAR" command cannot be accepted for approximately 0.5 seconds after the ":STOP" command has been sent.

:STAT?

Queries the state.

Syntax :STAT?

Response <data>

data 0: PASS
 1: UPPER FAIL
 2: LOWER FAIL
 3: READY
 4: TEST
 5: VOLTAGE SETTING FAIL
 6: ELSE

Function Queries the state.

Example PC > :STAT?
3158 > 3 State is READY state.

:MEAS?

Queries the measured value.

Syntax :MEAS?

Response <data>

data Measured voltage value, measured current value, test time elapsed, determination
 Excluding determination: (Numerical data in NR2 format)
 Determination: (Numerical data in NR1 format)
 0: PASS
 1: UPPER FAIL
 2: LOWER FAIL
 5: VOLTAGE SETTING FAIL
 (Refer to section 7.5.)

Function Queries the results of the preceding test. Returns the screening results and values valid upon termination of the preceding test. The test results are updated upon termination of a new test.

Example Queries the measured value.

PC > :MEAS?
3158 > 5.00, 5.00, 30.0, 0

Measured voltage value: 5.00 kV, Measured current value: 5.00 mA.
 Test time elapsed: 30.0 s, Determination: PASS.

- Note** When the test time exceeds 999.9 s, "999.9" is returned.
 If the command is sent with no decision results given, a response of <6> is returned.
 *For the case that a test is stopped before a decision result is given, or others

:MEAS:VOLT?

Queries the measured voltage value.

Syntax :MEAS:VOLT?

Response <data>

data Measured voltage value(Refer to section 7.5.)

Function Queries the measured voltage value.

Example

PC

 > :MEAS:VOLT?

3158

 > 1 . 50 Measured voltage value is 1.50 kV.

:MEAS:CURR?

Queries the measured current value.

Syntax :MEAS:CURR?

Response <data>

data Measured current value(Refer to section 7.5.)

Function Queries the measured current value.

Example

PC

 > :MEAS:CURR?

3158

 > 5 . 00 Measured current value is 5.00 mA.

:MEAS:TIM?

Queries the test time elapsed.

Syntax :MEAS:TIM?

Response <data>

data Test time elapsed (Refer to section 7.5.)

Function Queries the test time elapsed.

Example

PC

 > :MEAS:TIM?

3158

 > 30 . 0 Test time elapsed is 30.0 s.

- Note** When the test time exceeds 999.9 s, "999.9" is returned.

7.5 Transmission and Response Formats

The transmission format is identical to the VFD display format, except that the former lacks spaces (" ").

The response format is identical to the VFD display format, except that the former lacks spaces (" ").

Comparative voltage value, Measured voltage value

Transmission and response formats are as follows.

.
Two digits (in NR2 format)

Upper level value, Lower level value

Transmission and response formats are as follows.

.
Two or three digits (in NR1 or NR2 format)

Measured current value

Transmission and response formats are as follows.

.
One, two or three digits (in NR1 or NR2 format)

Test time

Transmission and response formats are as follows.

.
Two or three digits (in NR1 or NR2 format)

Test time elapsed

Response formats are as follows.

.
Two, three or four digits (in NR2 format)

Others

Transmission and response formats are as follows.

One digits (in NR1 format)

7.6 Command Summary

Command	Data	Explanation	Page
*IDN?		Queries manufacturer's name, model name, and software version.	86
*RST		Performs device initial setting.	86
:VOLT <data>	0: OFF 1: ON	Enables and disables the Comparative voltage value.	86
:VOLT?		Queries the Comparative voltage value enablement.	87
:LOW <data>	0: OFF 1: ON	Enables and disables the lower level value.	87
:LOW?		Queries the lower level value enablement.	87
:TIM <data>	0: OFF 1: ON	Enables and disables the test time.	88
:TIM?		Queries the test time.	88
:CONF:VOLT <data>	0.00 - 5.00 (Numerical data in NR2 format, three digits) The comparative voltage value (Refer to section 7.5.)	Sets the comparative voltage value.	89
:CONF:VOLT?		Queries the comparative voltage value enablement.	89
:CONF:CUPP <data>	0.1 - 9.9 (Numerical data in NR2 format, two digits) 10 - 120 (Numerical data in NR1 format, two or three digits) Upper level value (Refer to section 7.5.)	Sets the upper level value.	90
:CONF:CUPP?		Queries the upper level value enablement.	90
:CONF:CLOW <data>	0.1 - 9.9 (Numerical data in NR2 format, two digits) 10 - 120 (Numerical data in NR1 format, two or three digits) Lower level value (Refer to section 7.5.)	Sets the lower level value.	91

Command	Data	Explanation	Page
:CONF:CLOW?		Queries the lower level value enablement.	91
:CONF:TIM <data>	0.5 - 99.9 (Numerical data in NR2 format, two or three digits) 100 - 999 (Numerical data in NR1 format, three digits) Test time (Refer to section 7.5.)	Sets the test time.	92
:CONF:TIM?		Queries the test time.	92
:STAR		Starts a test.	93
:STOP		Performs forcible ending of a test and releases the hold state.	93
:STAT?	0: PASS 1: UPPER FAIL 2: LOWER FAIL 3: READY 4: TEST 5: VOLTAGE SETTING FAIL 6: ELSE	Queries the state.	94
:MEAS?		Queries the measured value.	94
:MEAS:VOLT?		Queries the measured voltage value.	95
:MEAS:CURR?		Queries the measured current value.	95
:MEAS:TIM?		Queries the test time elapsed.	95

Chapter 8

Maintenance and Inspection

8.1 Maintenance

To ensure the safe operation of this unit, perform maintenance regularly.

- Be sure to read assiduously the various items highlighted in this manual for attention, in order to use the unit correctly.
- If damage is suspected, check the "Troubleshooting" section before contacting your dealer or Hioki representative.
- Pack the product carefully so that it will not be damaged during shipment, and include a detailed written description of the problem. Hioki cannot be responsible for damage that occurs during shipment. Please refer to "8.3 Troubleshooting" for points to note during transportation.
- If the unit has been subject to moisture, or if oil and dust have accumulated in the unit interior, the danger of electrical shock or fires resulting from the deterioration of insulation increases greatly. If the unit is ever subject to excessive moisture, oil, or dust, cease use immediately, and return the unit to us for maintenance.
- Replaceable Parts

Main parts to be replaced periodically, and their life times:(Useful life depends on the operating environment and frequency of use. Operation cannot be guaranteed beyond the following periods)

Part	Life
Start Switch	Approx. 500000 cycles
Stop Switch	Approx. 500000 cycles

Part (9613/ 9614)	Life
Operate Switch	Approx. 25000 cycles
Start Switch	Approx. 1000000 cycles
Stop Switch	Approx. 1000000 cycles

- Periodic calibration is necessary to verify and maintain accuracy. If calibration becomes necessary, return the unit to us for maintenance.
- This product uses a lithium battery to back up it's memory. As the battery power is consumed, it's ability to store measurement conditions diminishes. In the event that measurement conditions can no longer be stored, please contact the manufacturer for repair service.
- Spare and replacement parts for this product are guaranteed to be available only until 7 years after manufacture of this model is terminated.

Cleaning

To clean the product, wipe it gently with a soft cloth moistened with water or mild detergent. Never use solvents such as benzene, alcohol, acetone, ether, ketones, thinners or gasoline, as they can deform and discolor the case.

8.2 Fuse Replacement

⚠ WARNING

- To avoid electric shock accident, before replacing the power fuse, confirm that the instrument is turned off and that the power cord and test leads are disconnected.
- Replace the fuse only with one of the specified characteristics and voltage and current ratings. Using a non-specified fuse or shorting the fuse holder may cause a life-threatening hazard.

Fuse type: 250VT8AL (3158-01)

250VT4AL (3158-03 to 3158-05)

- (1) Turn the power OFF, and disconnect the power cord.
- (2) Unlock the fastener on the fuse holder on the rear panel using a slotted screwdriver, and remove the fuse holder (Fig. 1).
- (3) Replace the power fuse with a rated fuse (Fig. 2).
- (4) Reset the fuse holder.

Fuse holder

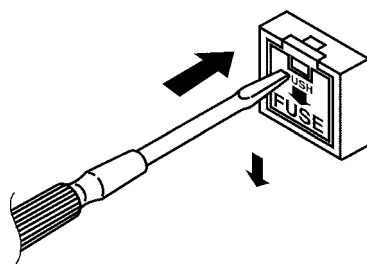
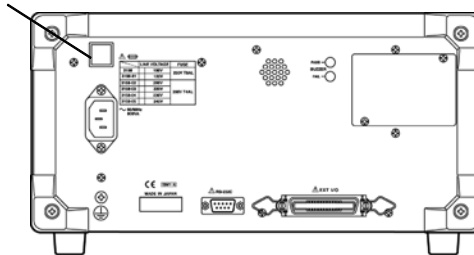

(Fig. 1)

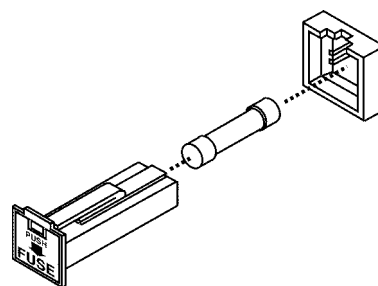

(Fig. 2)

8.3 Troubleshooting

If the unit is not functioning properly, check the following items before sending it for repair.

Symptom	What to check and Solution
The screen does not illuminate when the power is turned on.	Is the power cord disconnected? <ul style="list-style-type: none"> • Connect the power cord. Has the fuse blown? <ul style="list-style-type: none"> • Replace the fuse.
The test will not begin even if the START key is pressed.	Is READY lit? Is EXT lit? <ul style="list-style-type: none"> • The external I/O and the remote-control box have priority over the unit's START key. Turn off the power to disable the external I/O and the remote-control box, then turn on the power.
	Is Double Action set in Optional Functions? <ul style="list-style-type: none"> • If Double Action is set, press the STOP key first and then press the START key.
	Is the STOP signal, at the LOW level, inputting via the external I/O connector? <ul style="list-style-type: none"> • The START key has a lower priority than the STOP signal. Switch the STOP signal to the HIGH level when the START key is pressed.
	Does the STOP key remain pressed for any reason? <ul style="list-style-type: none"> • The START key has a lower priority than the STOP key. • Do not leave the STOP key pressed when the START key is pressed.
The unit is reset during the test. / The current value is not measured correctly.	Does spark discharge occur during the test? The noise generated by the spark discharge may lead to a malfunction of the unit. <ul style="list-style-type: none"> • Attach a ferrite around the test lead (high-voltage side) close to the unit. • Connect the current limiting resistor the degree of which has no influence on the test between the output terminal and the tested object. (Beware of the power rating and the withstand-voltage of the resistor.)

If any of the following should occur, stop using the unit, disconnect the power cord and probe, and contact your dealer or HIOKI representative.

- If you are certain that the unit is damaged.
- If the measurement you wish to perform is inoperative.
- If the unit was stored for a long period of time in high temperatures and humidity, or other undesirable conditions.
- If the unit was damaged in transit.

Notes on Transportation

- To ensure safe handling, when transporting the instrument, please use the original

box and packing materials. However, do not use if the box is torn or out of shape, or if the packing materials are crushed.

- When packing the instrument, make sure to remove the test leads and power supply cords from the main device.
- When transporting, protect it from strong impact such as dropping it.

8.4 Displaying Errors

If an error occurs, the 3158 displays the following on the screen.

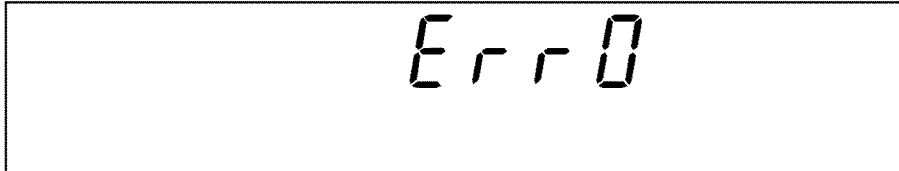

Err0	Interlock state. (See Section 6.1.4)
Err1	There is a problem with the external switch. A device other than a remote-control box (9613/9614) is connected. If this error appears when a proper remote-control box is connected, there may be a malfunction. Contact your sales agent or nearest sales office.
Err2	The EXT I/O may be malfunctioning. Contact your sales agent or nearest sales office.
Err3	The EEP-ROM may be malfunctioning. Contact your sales agent or nearest sales office.
Err4	The RAM, ROM may be malfunctioning. Contact your sales agent or nearest sales office.

8.5 Resetting the System

Resetting the system

While pressing the **SHIFT** key, press the main power switch to turn on power.

Parameters after resetting the system

Once the system is reset, the following parameters are initialized together with the saved setting data. The optional settings are reset to default values (initial settings).

Comparative voltage value setting	OFF
Comparative voltage value	0.00 kV
Upper level value	0.2 mA
Lower level value setting	OFF
Lower level value	0.1 mA
Test time setting	ON
Test time	0.5 s

8.6 External Dimensions

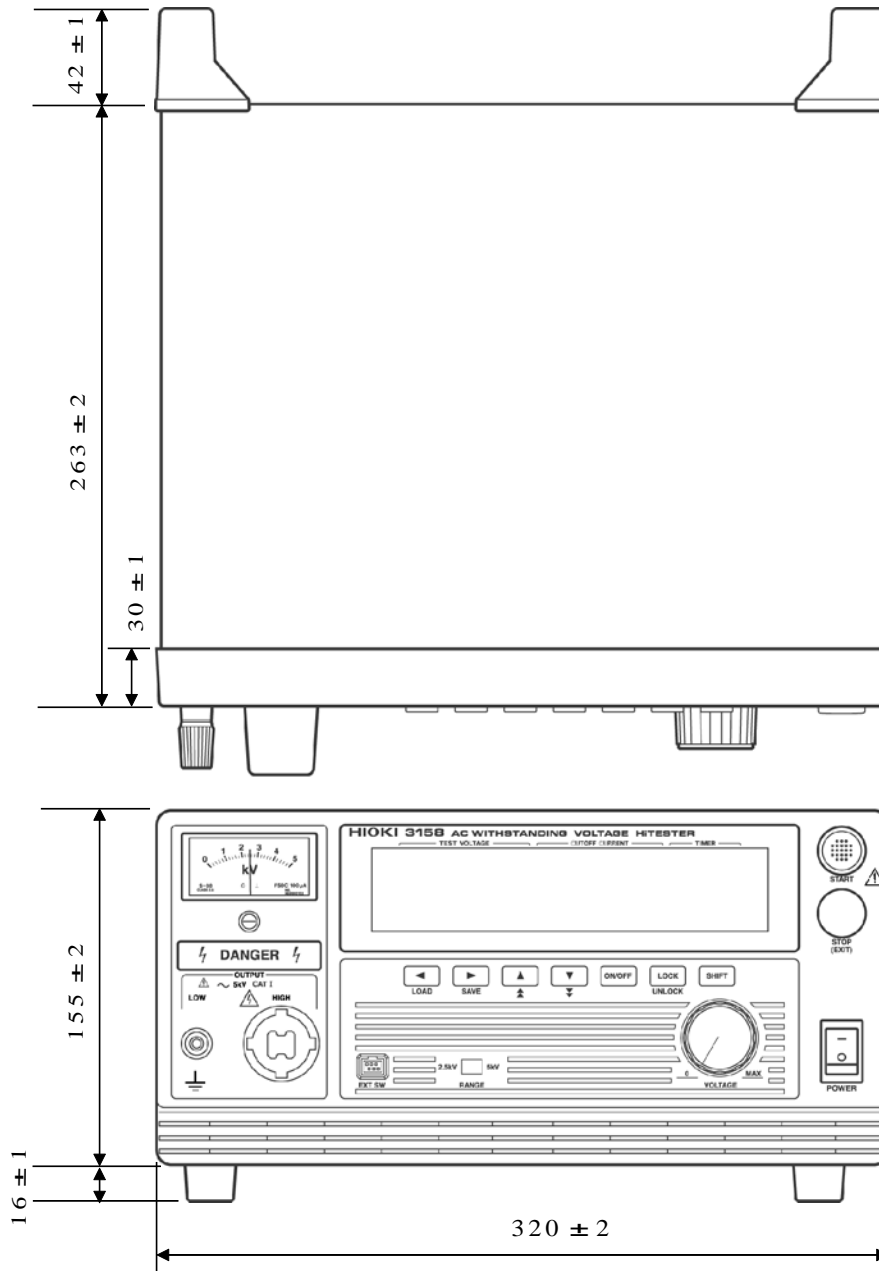

Chapter 9

Specifications

9.1 Basic Specifications

Test Voltage

Voltage	0 - 2.5 kVAC / 0 - 5.0 kVAC. dual-range configuration
Voltage testing method	Zero-toggle switch
Transformer capacity	500 VA (maximum 30 min)*
Voltage adjustment method	Manually adjusted with output voltage knob
Voltage measurement	Average value rectified effective value display • Digital: 0.00 - 5.00 kVAC (full-scale) Accuracy: ± 1.5 %f.s. • Analog: 0 - 5 kVAC (full scale) Accuracy: ± 5 %f.s.
Waveform	Mains waveform
Frequency	Mains synchronous

*: Rated time for output voltages (at an ambient temperature of 40 °/104°F)

The transformer capacity of the unit is approximately half the rated output. Use the unit within the rated time. If the rated time is exceeded, the unit may overheat and thereby cause the thermal fuse for the internal circuit to blow out.

Current measurement range	Maximum test time	Pause
$I \leq 60$ mA	Continuous	None
60 mA < $I \leq 100$ mA	30 minutes	30 minutes
100 mA < $I \leq 120$ mA	10 minutes	30 minutes

Current Detection Section

Current measurement range	0.01 mA to 120 mA
Designated value	Average value rectified effective value display (digital)
Resolution	0.01 mA (2 mA / 8 mA ranges) 0.1 mA (32 mA range) 1 mA (120 mA range)
Accuracy	± 3 %f.s. ± 20 μ A ... for all ranges (power waveform distortion is less than 5%)

NOTE

f.s. (maximum display or scale value, or length of scale)

Signifies the maximum display (scale) value or the length of the scale (in cases where the scale consists of unequal increments or where the maximum value cannot be defined).

In general, this is the range value (the value written on the range selector or equivalent) currently in use.

Decision Function

Decision method	Window comparator method (digital setting)
Decision contents	UPPER-FAIL: when measured current exceeds the upper level setting PASS: when measured current remains between the upper / lower level settings for set time LOWER-FAIL: when the measured current is below the lower level setting
Decision process	Output to the display, beeper sound, signals to EXT I/O for each decision result
Setting range	0.1 mA - 120 mA (both upper / lower level value)
Setting resolution	0.1 mA (0.1 mA - 9.9 mA) / 1 mA (10 mA - 120 mA)

Timer Section

Setting ON	Counts down time from start to preset time
Setting OFF	Shows elapsed time from start
Setting range	0.5 s to 999 s
Setting resolution and accuracy	0.1 s (0.5 s - 99.9 s) ± 50 ms / 1 s (100 s - 999 s) ± 0.5 s

EXT I/O (Rear panel) : Input/Output signal lines are insulated internally with a photocoupler.

Output signal	Open collector output
Max. load	30 VDC
Max. output current	100 mADC per signal
Output saturation voltage	1.5 VDC or less
Signal names	HV-ON : Generating voltage for output TEST : TEST in progress PASS : when measured current remains between the upper / lower limit settings for set time UFAIL : When measured current exceeds the upper limit setting LFAIL : When the measured current is below the lower limit setting READY : Standby ISO.DCV: Internal support resistance current (15VDC,0.1A)
Input signals	Active low input (insulated with a photocoupler)
Max. testing voltage	30 VDC
HIGH level voltage	15 VDC or more, open
LOW level voltage	5 VDC or less (-6 mA typ)
Signal names	START : Measurement start STOP : Measurement stop EXT-E : External I/O effective INTERLOCK: Inter-lock function effective

EXT SW (Front socket)

Input signal (contact input)	START/STOP/SW.EN (front socket SW enable)
Output signal	LED light signal (40 mA max. load current)

RS-232C

Transmission mode	Start-stop synchronization, full duplex
Transfer rate	9600 bps
Data length	8 bit
Parity	None
Stop bit	1 bit
Hand shake	No X flow, hardware flow control
Delimiter	CR, CR + LF for reception CR + LF for transmission

START key priority order

RS-232C interface > External SW > External I/O > START key on this units panel
 (However, this is when START is enabled using the RS-232C interface.)

Other Functions

Memory function	The Comparative Voltage Value, current determination for upper- and lower-level values, and test time. Storage of up to 20 test conditions allows quick switching between test conditions for different standards.
Voltage comparator	Testing begins only when voltage is within $\pm 5\%$ of the preset value. (± 50 V when the output-voltage ≤ 1 kV) The voltage comparator prevents inadvertent testing with incorrect voltage settings. (Can be changed to check voltage immediately prior to the end of a test, depending on optional settings.)
Buzzer settings	Buzzer volume settings for test screening and errors (buzzer volume settings are to be performed for PASS and FAIL separately)
Hold function	Enable this function to hold the current state when testing is interrupted by the STOP key.
Pass hold function	Enable this function to hold the Pass state when detected, to facilitate confirmation.
Fail hold function	Enable this function to hold the Fail state when detected, to facilitate confirmation.
Momentary output	This function allows current output only when the START key is pressed. The START key on the remote control or the START signal via external I/O has the same effect.
Double action	Enable this function to allow testing to start only when the START key is pressed within about 0.5 seconds after the STOP key.
FAIL mode	Enable this function to restrict hold release to the STOP key on the main unit.
RS Command [START]	Turn this function on to enable the RS-232C START command.
Inter-lock function	Enable this function to activate the external I/O interlock terminals.

9.2 General Specifications

Display	Fluorescent tube display (digital display)
Monitor function	Output voltage / current
Monitor cycle	2 Hz or faster
Ambient operating conditions	0 to 40 (32 to 104° F), 80%RH max. (no condensation)
Ambient storage conditions	-10 to 50 (14 to 122° F), 90%RH max. (no condensation)
Operating temperature and humidity for guaranteed accuracy	23 ± 5 (73° F ± 9° F), 80%RH max. (no condensation) after 5 minutes minimum warm-up
Guaranteed accuracy period	For 1 year
Product warranty period	3 years
Operating Environment	Indoors, Pollution Degree 2, < 2000 mASL (6562 feet)
Power supply	120 VAC (3158-01) / 220 VAC (3158-03) 230 VAC (3158-04) / 240 VAC (3158-05) (Voltage fluctuations of 10% from the rated supply voltage are taken into account.)
Rated power frequency	50 to 60 Hz
Dielectric strength	1.39 kVAC, 10 mA, 1 minute between power supply and frame
Maximum rated power	800 VA
Dimensions	Approx. 320W x 155H x 263D mm (12.60"W x 6.10"H x 10.73"D) (excluding projections)
Mass	Approx. 16 kg (564.4 oz.) (3158-01) Approx. 18 kg (634.9 oz.) (3158-03, -04, -05)
Fuse	250VT8AL (3158-01), 250VT4AL (3158-03, -04, -05)
Accessories	9615 H.V. TEST LEAD (high voltage side and return, 1 each) Power cord Instruction manual Spare fuse
Options	9613 REMOTE CONTROL BOX (SINGLE) 9614 REMOTE CONTROL BOX (DUAL) 9267 SAFETY TEST DATA MANAGEMENT SOFTWARE 9637 RS-232C CABLE (9pin-9pin/ 1.8 m) 9638 RS-232C CABLE (9pin-25pin/ 1.8 m)
Standard Applying	EMC: EN61326 CLASS A Safety: EN61010

Appendix

Appendix 1 9613 REMOTE CONTROL BOX (SINGLE)

Two types of remote-control boxes are available: the 9613 for use with a single hand and the 9614 for use with both hands. The 9613 REMOTE CONTROL BOX (SINGLE) is equipped with a START key, a STOP key, and an OPERATE switch, which turns ON/OFF the remote-control box. The STOP key remains lit as long as a voltage is being output.

Ambient operating conditions	0 to 40 (32 to 104° F), 80%RH max. (no condensation)
Ambient storage conditions	-10 to 50 (14 to 122° F), 90%RH max. (no condensation)
Operating Environment	Indoors < 2000 mASL (6562 feet)
Dimensions	Approx. 193W x 50H x 30D mm (7.60"W x 1.97"H x 1.18"D) (excluding projections)
Mass	Approx. 500 g (17.6 oz.)
Cord length	Approx. 1500 mm (59.06")

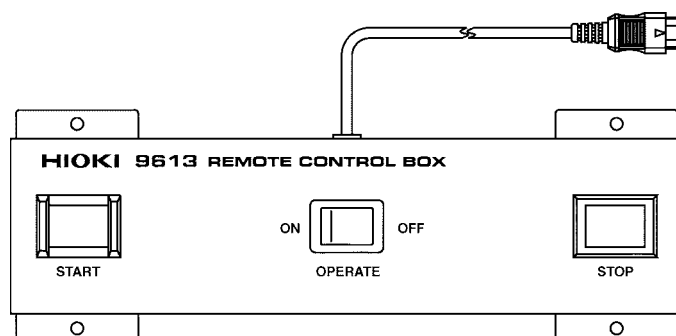

Appendix 2 9614 REMOTE CONTROL BOX (DUAL)

Unlike the 9613, the 9614 REMOTE CONTROL BOX (DUAL) has two START keys. Pressing both keys is equivalent to pressing the **START** key on the unit. By using the Momentary-OUT function in Optional Functions, the 9614 allows the control box to be used with both hands, thus ensuring safer testing.

Ambient operating conditions	0 to 40 (32 to 104° F), 80%RH max (no condensation)
Ambient storage conditions	-10 to 50 (14 to 122° F), 90%RH max. (no condensation)
Operating Environment	Indoors < 2000 mASL (6562 feet)
Dimensions	Approx. 270W x 50H x 30D mm (10.63"W x 1.97"H x 1.18"D) (excluding projections)
Mass	Approx. 700 g (24.7 oz.)
Cord length	Approx. 1500 mm (59.06")

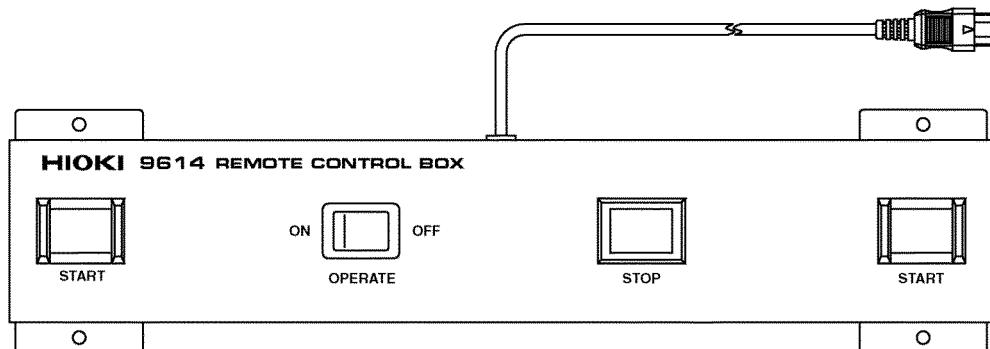

Appendix 3 9615 H.V. TEST LEAD (Standard Accessory)

Testing of the grounded lead should be avoided, unless absolutely necessary. If a part such as the lead must be tested, be sure to connect the low-side crocodile clip (black) to the grounded end of the lead. Connecting the high-side crocodile clip (red) to the grounded end of the lead may result in electric shock or damage to the equipment.

Rated voltage	5 kVAC or 5 kVDC (High voltage side) 600 VAC or 600 VDC (Return side)
Rated current	150 mAAC or 150 mADC (High voltage side) 10 AAC or 10 ADC (Return side)
Dielectric strength	6.25 kVAC Sensitivity current 5 mA 1 minute (High voltage side) 1.35 kVAC Sensitivity current 5 mA 1 minute (Return side) Test point (between the core wire and the cable exterior)
Ambient operating conditions	0 to 40 (32 to 104° F), 80%RH max (no condensation)
Ambient storage conditions	-10 to 50 (14 to 122° F), 90%RH max. (no condensation)
Operating Environment	Indoors < 2000 mASL (6562 feet)
Dimensions	Approx. 1500 mm (59.06")
Mass	Approx. 100 g (3.5 oz.)

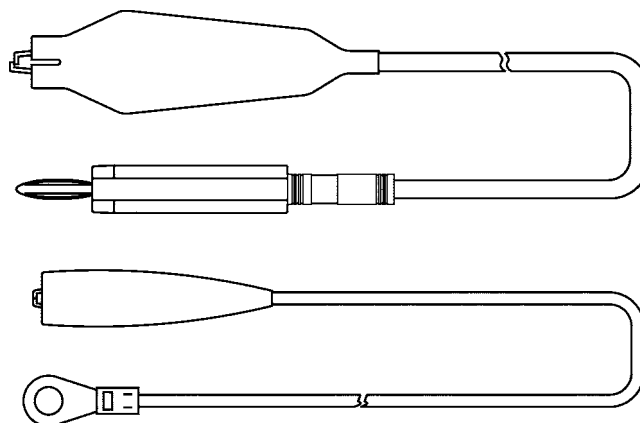

Appendix 4 Table of Optional Functions

The following shows the optional functions.

For more information on settings, see Chapter 4, "Optional Functions."

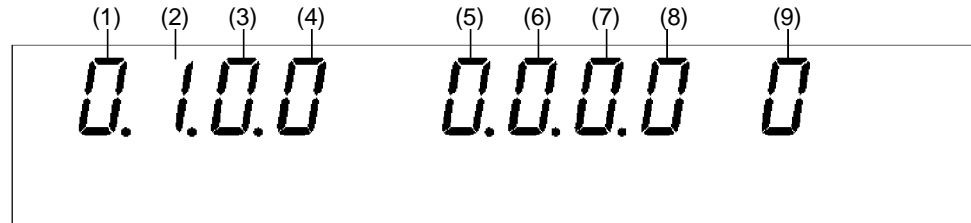

Optional function	Selection
(1) PASS hold function	0: Not held 1: Held
(2) FAIL hold function	0: Not held 1: Held
(3) Hold function	0: Not held 1: Held
(4) Momentary out	0: Not set 1: Set
(5) Double Action	0: Not set 1: Set
(6) FAIL mode	0: Not set 1: Set
(7) RS command [START]	0: Not set 1: Set
(8) Inter-lock function	0: Not set 1: Set
(9) Voltage Comparator Position	0: Start test 1: End test

Index

- A -

Alligator clip 6
 Analog voltmeter 17,22,37,39,43

- B -

Buzzer 83
 Buzzer adjustment knob 5

- C -

Comparative voltage value 26,38,41,42,93,107

- D -

DANGER lamp 3
 Delimiter 85,88
 Double Action function 53

- E -

Error 107
 External dimensions 108
 External I/O terminal 9,71,80
 External switch terminal 3,14

- F -

FAIL hold function 49,51
 FAIL mode 54,97
 FAIL state 40
 File number 62,66
 Flashing cursor 4,25,46
 Forcible ending 97
 Fuse 105,109
 Fuse holder 5

- H -

HIGH terminal 3
 Hold function 50,51
 H.V. TEST LEAD 6,12,APPENDIX3

- I -

Initial settings 24
 Inter-lock function 9,17,56,78,APPENDIX4

- K -

Key-lock function 23

- L -

Load 66
 LOW terminal 3
 Lower level value 27,95,107
 Lower level value icon 22,37,39,43,62,66

- M -

Main power switch 4,11
 Measured current value 37,39,43,99
 Measured voltage value 22,37,39,43,99
 Momentary out 52

- O -

OPERATE switch 6,14
 Optional functions 24,46,APPENDIX4
 Output voltage knob 4,33

- P -

Parameter 87,88
 PASS hold function 48,51
 PASS state 38
 Power cord 10
 Priority for control of the START key 35,52
 Protective ground terminal 5,7

- R -

Range selection switch 3,23,33
 READY state 22
 Remote control box 6,14,71,APPENDIX1
 REMOTE CONTROL BOX (DUAL)
 6,APPENDIX2
 REMOTE CONTROL BOX (SINGLE)
 6,APPENDIX1
 RS-232C terminal 5

- S -

Save 62
 SETTING state 25,29
 Startup inspection 17
 Switch signal-line plug 6,14

- T -

TEST state 35,37,73
 Test time 28,38,41,42,92,96,107,109
 Test time elapsed 37,99
 Timing chart 80

- U -

Upper level value 27,94,107
 Upper level value icon 22,37,39,43,62,66

- V -

Voltage comparator position 26,38,41,42,57

Warranty Certificate

HIOKI

Model	Serial number	Warranty period Three (3) years from date of purchase (___ / ___)
-------	---------------	------------------------------------------------------------------------

Customer name: _____
Customer address: _____

Important

- Please retain this warranty certificate. Duplicates cannot be reissued.
- Complete the certificate with the model number, serial number, and date of purchase, along with your name and address. The personal information you provide on this form will only be used to provide repair service and information about Hioki products and services.

This document certifies that the product has been inspected and verified to conform to Hioki's standards. Please contact the place of purchase in the event of a malfunction and provide this document, in which case Hioki will repair or replace the product subject to the warranty terms described below.

Warranty terms

1. The product is guaranteed to operate properly during the warranty period (three [3] years from the date of purchase). If the date of purchase is unknown, the warranty period is defined as three (3) years from the date (month and year) of manufacture (as indicated by the first four digits of the serial number in YYMM format).
2. If the product came with an AC adapter, the adapter is warranted for one (1) year from the date of purchase.
3. The accuracy of measured values and other data generated by the product is guaranteed as described in the product specifications.
4. In the event that the product or AC adapter malfunctions during its respective warranty period due to a defect of workmanship or materials, Hioki will repair or replace the product or AC adapter free of charge.
5. The following malfunctions and issues are not covered by the warranty and as such are not subject to free repair or replacement:
 - 1. Malfunctions or damage of consumables, parts with a defined service life, etc.
 - 2. Malfunctions or damage of connectors, cables, etc.
 - 3. Malfunctions or damage caused by shipment, dropping, relocation, etc., after purchase of the product
 - 4. Malfunctions or damage caused by inappropriate handling that violates information found in the instruction manual or on precautionary labeling on the product itself
 - 5. Malfunctions or damage caused by a failure to perform maintenance or inspections as required by law or recommended in the instruction manual
 - 6. Malfunctions or damage caused by fire, storms or flooding, earthquakes, lightning, power anomalies (involving voltage, frequency, etc.), war or unrest, contamination with radiation, or other acts of God
 - 7. Damage that is limited to the product's appearance (cosmetic blemishes, deformation of enclosure shape, fading of color, etc.)
 - 8. Other malfunctions or damage for which Hioki is not responsible
6. The warranty will be considered invalidated in the following circumstances, in which case Hioki will be unable to perform service such as repair or calibration:
 - 1. If the product has been repaired or modified by a company, entity, or individual other than Hioki
 - 2. If the product has been embedded in another piece of equipment for use in a special application (aerospace, nuclear power, medical use, vehicle control, etc.) without Hioki's having received prior notice
7. If you experience a loss caused by use of the product and Hioki determines that it is responsible for the underlying issue, Hioki will provide compensation in an amount not to exceed the purchase price, with the following exceptions:
 - 1. Secondary damage arising from damage to a measured device or component that was caused by use of the product
 - 2. Damage arising from measurement results provided by the product
 - 3. Damage to a device other than the product that was sustained when connecting the device to the product (including via network connections)
8. Hioki reserves the right to decline to perform repair, calibration, or other service for products for which a certain amount of time has passed since their manufacture, products whose parts have been discontinued, and products that cannot be repaired due to unforeseen circumstances.

HIOKI E.E. CORPORATION

<http://www.hioki.com>

18-07 EN-3

HIOKI

<http://www.hioki.com>



**Our regional
contact
information**

HEADQUARTERS

81 Koizumi
Ueda, Nagano 386-1192 Japan

HIOKI EUROPE GmbH

Rudolf-Diesel-Strasse 5
65760 Eschborn, Germany
hioki@hioki.eu

1808EN

Edited and published by HIOKI E.E. CORPORATION

Printed in Japan

- CE declarations of conformity can be downloaded from our website.
- Contents subject to change without notice.
- This document contains copyrighted content.
- It is prohibited to copy, reproduce, or modify the content of this document without permission.
- Company names, product names, etc. mentioned in this document are trademarks or registered trademarks of their respective companies.