

LR8520

Measurement Guide

WIRELESS FUNGAL LOGGER



The latest edition of the instruction manual



**Read carefully before use.
Keep for future reference.**

Fungal Index ▶ p.16
Collecting Measurement Data
Using a Windows® PC ▶ p.21
Collecting Measurement Data
Using an Android™ Terminal ▶ p.23

Troubleshooting ▶ p.27
Error Display ▶ p.29

EN

May 2024 Revised edition 4
LR8520B961-04



Contents

Introduction.....	1
Trademark	1
Verifying Package Contents	2
■ Options	3
Safety Notes.....	4
Usage Notes.....	7
1 Overview	15
1.1 Overview and Features.....	15
1.2 Fungal Index	16
1.3 Parts Names and Functions.....	17
2 Preparation for Measurements	19
3 Collecting Measurement Data Using a Windows® PC	21
4 Collecting Measurement Data Using an Android™ Terminal	23
5 Maintenance and Service	27
5.1 Troubleshooting.....	27
5.2 Error Display.....	29

Introduction

Thank you for purchasing the HIOKI LR8520 Wireless Fungal Logger. To obtain maximum performance from the product, please read this manual first, and keep it handy for future reference.

There are the following instruction manuals available for this instrument. Please refer to the appropriate manuals for the intended usage.

Model	Manual contents	Printed edition	DVD edition
Measurement Guide (this manual)	For customers who use this instrument for the first time, this manual describes the basic operation procedures.	✓	–
Instruction Manual	Describes details of the functions, operations, and specifications of this instrument.	–	✓
Precautions Concerning Use of Equipment That Emits Radio Waves	Precautions relating to use of equipment that emits radio waves, countries in which the instrument has been certified, etc.	✓	–
Logger Utility* User Manual	Describes how to operate the PC application software.	–	✓

*: To install the PC application software, Logger Utility, see “4.3 Installing the software” in the Instruction Manual. For information about its operating procedure, see the Logger Utility User Manual contained in the accompanying DVD.

Request for product user registration

Please register this product so that you can receive important information regarding the product.

<https://www.hioki.com/global/support/myhioki/registration/>



Trademark

- Excel and Windows are trademarks of the Microsoft group of companies.
- The Bluetooth® word mark and logos are registered trademarks owned by Bluetooth SIG, Inc. and any use of such marks by Hioki E.E. Corporation is under license. Other trademarks and trade names are those of their respective owners.
- Adobe and Adobe Reader are either trademarks or registered trademarks of Adobe Systems Incorporated in the United States and other countries.
- Android and Google Play are trademarks of Google, Inc.

Verifying Package Contents

When you receive the instrument, inspect it carefully to ensure that no damage occurred during shipping. In particular, check the accessories, panel keys, and connectors. If damage is evident, or if it fails to operate according to the specifications, contact your authorized Hioki distributor or reseller.

Check the package contents as follows.

Instrument

- LR8520 × 1

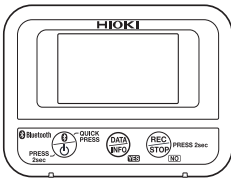

Accessories

- Logger Application Disc (DVD)***
 - Instruction Manual (PDF)
 - Logger Utility
 - Wireless Logger Collector
 - Logger Utility Instruction Manual (PDF)



*: The latest version of the application software can be downloaded from our website.

- Measurement Guide**



- Precautions Concerning Use of Equipment That Emits Radio Waves**



- LR6 Alkaline battery × 2**



- L1010 Connection Cable (length approx. 1.5 m) × 1**

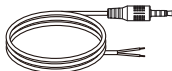

Options

The following options are available for this instrument.

Contact your authorized Hioki distributor or reseller when ordering.

Optional equipment is subject to change with no advance notice. Check Hioki's website for the latest information.

- Z2010 Humidity Sensor**
(Length including the sensor: Approx. 50 mm)

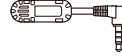

- Z2011 Humidity Sensor (Cable length: Approx. 1.5 m)**

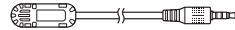

- Z2003 AC Adapter (power cord attached)**

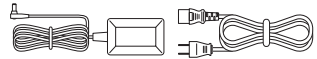

- Z5004 Magnetic Strap**

- Z5020 Magnetic Strap**



- L1010 Connection Cable (length approx. 1.5 m)**

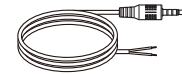

Supported instrument

- LR8410 Wireless Logging Station**

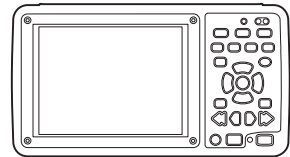

Safety Notes

This instrument is designed to conform to IEC 61010 Safety Standards, and has been thoroughly tested for safety prior to shipment. However, using the instrument in a way not described in this manual may negate the provided safety features.

Before using the instrument, be certain to carefully read the following safety notes.

⚠️ DANGER



Mishandling during use could result in injury or death, as well as damage to the instrument. Be certain that you understand the instructions and precautions in the manual before use.

⚠️ WARNING





If you do not have knowledge or experience of electrical measurements, use this instrument under supervision of experienced personnel.

Notation



In this manual, the risk seriousness and the hazard levels are classified as follows.

DANGER	Indicates an imminently hazardous situation that will result in death or serious injury to the operator.
WARNING	Indicates a potentially hazardous situation that may result in death or serious injury to the operator.
CAUTION	Indicates a potentially hazardous situation that may result in minor or moderate injury to the operator or damage to the instrument or malfunction.
IMPORTANT	Indicates information related to the operation of the instrument or maintenance tasks with which the operators must be fully familiar.
	Indicates a strong magnetic-field hazard. The effects of the magnetic force can cause abnormal operation of heart pacemakers and/or medical electronics.
	Indicates prohibited actions.
	Indicates an action that must be performed.
*	Additional information is presented below.
Windows	Windows 7, Windows 8, Windows 10, and Windows 11 are referred to as “Windows,” otherwise specified.
Dialog	Windows dialog boxes are referred to as dialogs.
[]	The names and keys on the screen including menus, commands, dialogs, dialog button names, etc. are enclosed in brackets [].

Symbols affixed to the instrument

	Indicates cautions and hazards. When the symbol is printed on the instrument, refer to a corresponding topic in the Instruction Manual.
	Indicates a grounding terminal.
	Indicates DC (Direct Current).

Symbols for various standards

	Indicates the Waste Electrical and Electronic Equipment Directive (WEEE Directive) in EU member states.
	Indicates that the instrument conforms to regulations set out by the EU Directive.
	Indicates that the product incorporates Bluetooth® wireless technology.
FCC ID	Indicates the ID number of the wireless module certified by the U.S. Federal Communications Commission (FCC).
IC	Indicates the identification number of a wireless module approved by Industry Canada (IC).

Screen display

The instrument screen displays the alphanumeric characters as follows.

A	B	C	D	E	F	G	H	I	J	K	L	M	N	O	P	Q	R	S	T	U	V	W	X	Y	Z
A	b	C	d	E	F	G	H	I	J	K	L	ñ	n	o	P	q	r	S	t	U	u	Y	1	4	3

1	2	3	4	5	6	7	8	9	0
1	2	3	4	5	6	7	8	9	0

Accuracy

We define measurement tolerances in terms of rdg. (reading) and dgt. (digit) values, with the following meanings:

f.s.	(Maximum display value or scale length/range) The maximum displayable value or scale length. This is usually the name of the currently selected range.
rdg.	(Reading or displayed value) The value currently being measured and indicated on the measuring instrument.
dgt.	(Resolution) The smallest displayable unit on a digital measuring instrument, i.e., the input value that causes the digital display to show a "1" as the least-significant digit.

Measurement categories

To ensure safe operation of measuring instruments, IEC 61010 establishes safety standards for various electrical environments, categorized as CAT II to CAT IV, and called measurement categories.

⚠ DANGER



- **Using a measuring instrument in an environment designated with a higher-numbered category than that for which the instrument is rated could result in a severe accident, and must be carefully avoided.**
- **Using a measuring instrument without categories in an environment designated with the CAT II to CAT IV category could result in a severe accident, and must be carefully avoided.**

- CAT II: When directly measuring the electrical outlet receptacles of the primary electrical circuits in equipment connected to an AC electrical outlet by a power cord (portable tools, household appliances, etc.)
- CAT III: When measuring the primary electrical circuits of heavy equipment (fixed installations) connected directly to the distribution panel, and feeders from the distribution panel to outlets
- CAT IV: When measuring the circuit from the service drop to the service entrance, and to the power meter and primary overcurrent protection device (distribution panel)

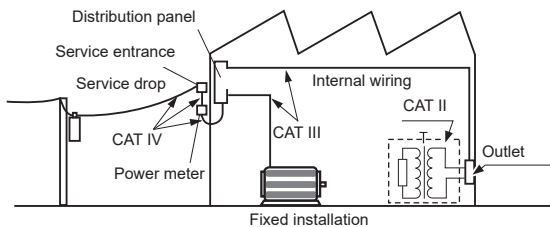

Usage Notes

Follow these precautions to ensure safe operation and to obtain the full benefits of the various functions.

Bluetooth®

This instrument, the LR8410 uses radio waves of a band frequency of 2.4 GHz. No radio station license is required to use this product, however, be aware of the following.

WARNING



- **Do not use this instrument in a system that requires high safety and reliability.**
- **Do not use this instrument near any medical equipment, such as a pacemaker, etc.**
- **Do not modify, disassemble, or repair the instrument.**

CAUTION



- If this instrument is used near any equipment that uses the same frequency band, such as wireless LAN equipment, etc., communications may become unstable or other equipment may be affected.
- The line-of-sight distance between the instrument and the LR8410 is 30 m. If there is an obstacle (wall, metal screen, etc.), communications may become unstable or the communications distance may become shorter. In addition, even if multiple instruments are installed in the same environment, each instrument may show a different radio-field strength (antenna-like indication).
- Communications between the instrument and the LR8410 are encrypted by SSP, however, the confidentiality of any information is not guaranteed. We are not responsible for any leakage of measurement data by wireless communications.
- This instrument, the LR8410 generates electric waves. Usage of electric waves requires permission and authorization in each country. Using electric waves in any country or region other than the ones listed in the attached document “Precautions Concerning Use of Equipment That Emits Radio Waves” is against the law and may be subject to punishment.

- When the instrument is positioned on a stand instead of directly on the floor, communications can become more stable.
- The Wireless Logger Collector may not correctly work according to the mobile communication device.

Check before use

Verify that it operates normally to ensure that no damage occurred during storage or shipping. If you find any damage, contact your authorized Hioki distributor or reseller.

Installation

WARNING

Installing the instrument in inappropriate locations may cause a malfunction of the instrument or may give rise to an accident. Avoid the following locations.

- Exposed to direct sunlight or high temperature
- Exposed to corrosive or combustible gases
- Exposed to water, oil, chemicals, or solvents
- Exposed to high humidity or condensation
- Exposed to a strong electromagnetic field or electrostatic charge
- Exposed to high quantities of dust particles
- Near induction heating systems (such as high-frequency induction heating systems and IH cooking equipment)
- Susceptible to vibration



Operating temperature: -20°C to 60°C (-4°C to 140°C)

Humidity: 80% rh or less (non-condensing)

(When using batteries as a power source, refer to the battery's specifications.)

CAUTION

- This instrument is not drip-proof. Water that drips on the connector could cause a malfunction.
- Do not allow any condensation to form. Condensation can form particularly in an environment where the temperature changes drastically.
- Do not allow the instrument to become wet or take measurements with wet hands. Doing so may cause a malfunction.
- Do not position the instrument on an unstable table or inclined surface. When the instrument falls or tips, an injury or malfunction can occur.



Handling of this instrument

CAUTION



Avoid any vibration or impact to prevent damage to the instrument during transportation and handling. Be especially careful regarding the impact by a fall.

This instrument may cause interference if used in residential areas. Such use must be avoided unless the user takes special measures to reduce electromagnetic emissions to prevent interference to the reception of radio and television broadcasts.

Handling of cords and cables

WARNING



Make sure to use the specified power cord when using the instrument. Otherwise, a fire may be caused.

CAUTION



- Avoid stepping on or pinching the cables to prevent damage to the cables. Do not bend or pull the cables.



- To prevent any wires from breaking, pull on the connector end, not the cable, to disconnect the output connector.
- To prevent any wires from breaking, pull on the connector end, not the cord, to disconnect the power cord from the outlet or the instrument.
- The cables become stiff below 0°C. If the cables are bent or pulled in this condition, the cable insulation may be damaged or the wires may be cut.
- Observe the following precautions when making a connection to the alarm output terminal to prevent damage to the instrument.
 - (1) Turn off the power to the instrument to be connected before making a connection.
 - (2) Do not make any connection that exceeds the rating of the alarm output terminal.
Maximum rating: 30 V DC, 200 mA

Position the sensor cable away from the power line or ground cable.

Before turning on the power

CAUTION



- When operating the instrument using a UPS (uninterruptible power supply) or DC-AC inverter, do not use any square-wave and pseudo sine-wave UPS or DC-AC inverter. Doing so may damage the instrument.



- Make sure that the power voltage connection is correct. Connection errors could damage the internal circuit.

The instrument and measurement unit will not fail due to a momentary power failure under 40 ms. If the power failure is longer than 40 ms, the power may be shut off temporarily. Install the instrument in consideration of power conditions at the installation location.

Magnet of the optional strap

DANGER



Those with medical electronics such as pacemakers should not use the Z5004/Z5020 Magnetic Strap. Nor should such persons approach the Z5004/Z5020. It is extremely dangerous. The electronics may not operate properly and the life of the operator may be put at great risk.

WARNING



Swallowing magnets could be life-threatening. Keep any magnets out of reach, especially of small children. If you accidentally swallow magnets, immediately seek medical attention.

CAUTION



- Do not use the Z5004/Z5020 in locations where it may be exposed to rainwater, dust, or condensation. In those conditions, the magnet may be decomposed or deteriorated. The magnet adhesion may be diminished. In such case, the instrument may not be hung in place and may fall.
- Do not bring the Z5004/Z5020 near magnetic media such as floppy disks, magnetic cards, pre-paid cards, or magnetized tickets. Doing so may corrupt and may render them unusable. Furthermore, if the Z5004/Z5020 is brought near precision electronic equipment such as PCs, TV screens, or electronic wrist watches, they may fail.
- Keep magnets away from any impact by a fall. The magnets may chip or crack due to impact.

AC adapter

WARNING



- Make sure to use the optional Z2003 AC Adapter. The rated power voltage for the AC adapter is 100 V to 240 V AC and the rated power frequency is 50 Hz/60 Hz. Do not use the AC adapter at any voltage other than the above to avoid damage to the instrument and electrical accidents.
- Before turning on the power, make sure that the power voltage indicated on the AC adapter matches the power voltage to be used. Using the AC adapter outside the specified power voltage range could cause damage to the instrument or AC adapter or electrical accidents.

CAUTION



- Connect the output plug to the instrument and then connect the plug to an outlet. Connecting the energized output plug to the instrument may damage the instrument.
- When connecting an external power supply, connect the output plug to the instrument and then supply external power.

Handling of batteries

WARNING



- Do not short circuit, disassemble, or incinerate batteries. Do not charge alkaline batteries. Doing so may cause an explosion. Handle and dispose of batteries in accordance with local regulations.
- In order to prevent electric shocks, remove measurement cables and then replace the batteries.
- After battery replacement, reattach and screw down the battery cover before use.
- To prevent damage to the instrument or electric shocks, make sure to use the battery cover screw (screw with a spring) that is attached at the time of shipment. If you lose the screw or spring or find any damage, contact your authorized Hioki distributor or reseller.

CAUTION

Poor performance or damage from battery leakage could result. Observe the cautions listed below.



- Do not mix new and old batteries, or different types of batteries.
- Be careful to observe the battery polarity during installation. Poor performance or damage from battery leakage could result.
- Do not use batteries after their recommended expiry date.
- Do not allow used batteries to remain in the instrument.



- To avoid corrosion from battery leakage and/or damage to the instrument, remove the batteries from the instrument if it is to be kept in storage for an extended period.

IMPORTANT

The displayed remaining battery level may be different from the actual remaining battery level due to the battery characteristics, settings during use, temperature or consumption level. When a battery is used in a low temperature environment or a weak and deteriorated battery is used, the power may shut off regardless of the battery indicator display.

Batteries

The battery indicator display and battery life are based on the use of a new alkaline battery.

Use of nickel-metal hydride batteries

When nickel-metal hydride batteries are used, the battery indicator display does not operate correctly.

The battery life varies depending on the capacity, charging condition, deterioration due to repeated use, etc. Use batteries in consideration of the factors above.

Use of manganese dioxide batteries

Do not use manganese dioxide batteries as the instrument may not be able to measure or communicate.

Wire connection

DANGER



Do not permanently connect the instrument in an environment where there is a possibility of surges exceeding the dielectric withstand voltage. Doing so may damage the instrument and result in personal injury.

WARNING



Do not connect any equipment other than the specified temperature and humidity sensor to the instrument. Doing so may cause electric shocks or damage to the instrument.



The power supply ground and alarm output terminal (ground) are common and not isolated. When using an external power supply, use an isolated external power supply or connect the wires so that there is no potential difference between the ground of the external power supply and the object for which an alarm is to be output to prevent damage to the instrument or electric shocks. In addition, when the instrument measures the external power that drives it, displayed readings may be inaccurate.

Handling of DVD

- Do not allow any dirt or scratches on the disk recording surface. When writing on the label face, use a pen with a soft tip.
- Store the disk in a protective case and do not expose the disk to direct sunlight or high temperatures and humidity.
- We are not responsible for any trouble in the Windows® computer system when this disk is used.

Precautions during shipment

CAUTION



- To avoid damaging the instrument, remove accessories and options from the instrument.
- Avoid any vibration or impact to prevent damage to the instrument and humidity sensor during transportation and handling. Be careful especially with impact by a fall.

Handling of temperature and humidity sensor

CAUTION



- The temperature and humidity sensor is not dustproof or waterproof. Do not use the sensor in locations where it may be exposed to dust or water. It may cause a malfunction of the instrument.
- The temperature and humidity sensor is not drip-proof. Water that drips onto the connector could cause a malfunction.

- Sensor sensitivity and precision will degrade over time, even under normal operating conditions. To maintain the instrument's ability to make measurements that conform to the accuracy specifications, it is recommended to replace the temperature and humidity sensor with a new unit once it has been used for one year after being opened.
- When the sensor is used outside the specified operating (storage) environment, the sensor accuracy may deteriorate even within the 1 year accuracy warranty period and accurate measurement cannot be performed.
- In principle, the surface of the instrument's temperature and humidity sensor may become contaminated if exposed to an environment containing organic gases (ketone, acetone, ethanol, toluene, etc.), increasing the error component of humidity measurement.
- Do not expose the temperature and humidity sensor to any concentrated chemical solvent for an extended period of time while it is used or stored.
- The sensor may become contaminated by organic gases released from some types of vinyl chloride and packaging material.
- When the temperature and humidity sensor is not used, place it with a drying agent in a plastic bag, seal the bag completely, and store it in a cool, dark place.
- Do not allow any condensation to form. Condensation can form particularly in any environment where the temperature changes drastically.
- This instrument does not come with a guarantee against any problem when the sensor is used outside the specified operating (storage) environment.
- Due to a humidity change (from low to high humidity or high to low humidity), up to $\pm 1\%$ RH of change (hysteresis) occurs in the measured humidity value.
- If left in a high humidity environment (80% RH or higher) for an extended period of time, the temperature and humidity sensor may output humidity values higher than the actual. It may take some time for the sensor to return to outputting normal values; however, it will recover quickly if left in a low humidity environment (30% RH or lower) for several days.

1

Overview

1.1 Overview and Features



Possible fungal growth at a glance

A fungal index enables you to predict a time period before fungal growth starts.



Easy operation

You can start recording immediately by pressing the **REC/STOP** key as soon as the instrument is installed. Data is collected and managed as a batch by the terminal. Analyze the data using the software provided with the instrument.

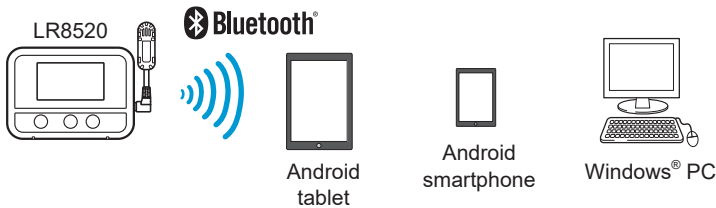

Mass memory installed

The memory capacity per channel is 500,000 data units.



3-way power supply

You can choose a power supply from LR6 alkaline batteries, AC adapter, and external power supply (5 V to 13.5 V).



Compatible with HIOKI LR8410

When the instrument is used as a unit for the LR8410, data can be collected in real time. For the connection procedure, see the instruction manual for each instrument.

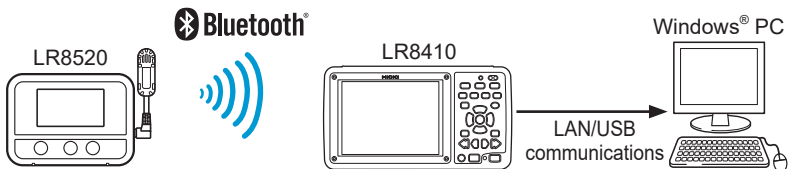

1.2 Fungal Index

A fungal index is an indicator to help predict how fungi are likely to grow. Fungal growth correlates with temperature and relative humidity and a fungal index can be calculated from temperature and relative humidity.

It is mainly used to quantitatively indicate the climate of fungal growth indoors as a numerical value (Japanese Patent Number 2710903). The instrument calculates a fungal index between 0 and 200 from temperature and humidity using a highly accurate temperature and humidity sensor.

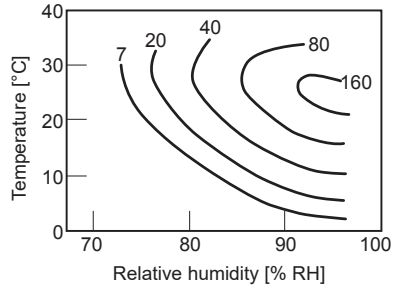

Fungal index	Time period before fungal growth starts (estimate)	Time period before fungal contamination starts (estimate)	Example of indoor living environment
1	2 months	10 years or more	<ul style="list-style-type: none"> • Dry area • Living space • Closet • Shoe cabinet
2	1 month	8 years	
5	2 weeks	3 years	
10	5 days	2 years	<ul style="list-style-type: none"> • Underfloor • Bathroom • Inside air-conditioner during cooling operation
20	3 days	1 year	
50	1 day	4 months	
100	12 hours	2 months	
200	6 hours	1 month	

Fungal contamination starts even more quickly in an environment where the contamination is already progressing or fungi are fed and nourished.

Predicted fungal growth

Fungal growth is predicted at 5 levels (measurement value: 0 to 4) from the accumulated fungal index.

The following symbols appear in the display of the instrument.

(No symbol)					
No new spores are growing.	➔ A hypha starts extending.	➔ New spores are growing.	➔ Spores start spreading.	➔ A lot of spores are spreading (the spore part in the display blink).	
Measurement value: 0	Measurement value: 1	Measurement value: 2	Measurement value: 3	Measurement value: 4	

A fungal index is a highly reliable indicator based on academic research, however, it does not guarantee that fungal growth is completely controlled in any environment with a low fungal index.

1.3 Parts Names and Functions

Front

Rear

(Common areas of each model are described.)

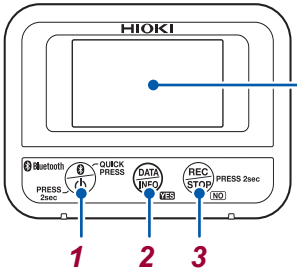

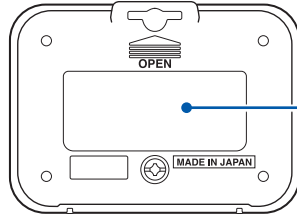

Display



Battery cover

⚠ (p. 19)

Operation keys	Press briefly	Hold down (for at least 2 seconds)
1 Power 	Bluetooth ON/OFF	Power ON/OFF
2 Display 	Display change YES (During operation verification)	—
3 Measurement 	NO (During operation verification)	Measurement start/stop

Left side

Right side

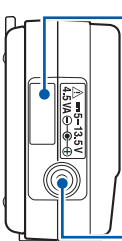

Serial number label

The serial number consists of 9 digits. The first two (from the left) indicate the year of manufacture, and the next two indicate the month of manufacture. It is necessary for production control requirements such as the product warranty. Do not peel off the label.

AC adapter connection terminal

⚠ (p. 19)

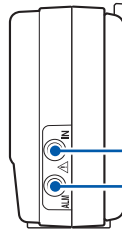

Sensor connection terminal

Alarm output terminal

⚠ (p. 19)

Display

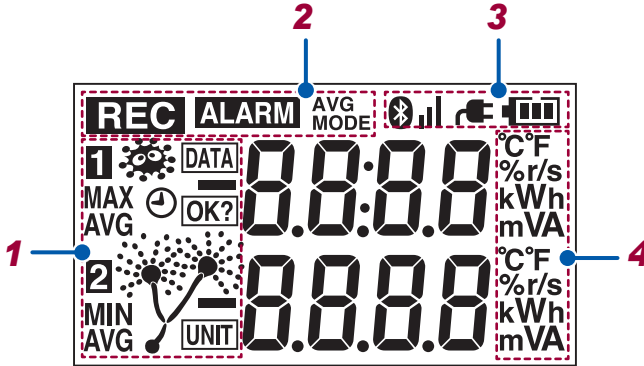

Display	Description
1	<p>1 2 Channel (CH) Blinking: During monitoring</p> <p>MAX Maximum value MIN Minimum value AVG Average value</p> <p>DATA Data number</p> <p>UNIT Unit number (1 to 7)</p> <p>⌚ Date and time</p> <p>OK? Operation verification</p>
2	<p>REC Measurement Lit: Performing measurement Blinking: Waiting for a measurement start to be preset</p> <p>ALARM Alarm Lit: The current measurement value is outside the range. Blinking: There was a value that was outside the range but the current value is in the range. (Alarm hold)</p>

Display	Description
2	<p> Fungal index display</p> <p> Predicted fungal growth display</p> <p>AVG MODE Average recording mode (Not used for this instrument)</p>
3	<p>Bluetooth Lit: Bluetooth ON Blinking: Bluetooth OFF (The power saving function is enabled.) Off: Bluetooth OFF</p> <p>Signal Bluetooth connection status (3 levels) (Signal strength) 1: Weak to 3: Strong Blinking: Security lock Off: Bluetooth not connected</p> <p>AC Operating with the AC adapter</p> <p>Battery Battery indicator display</p>
4	Displays the unit of measurement values.

- While the Bluetooth is being connected (the antenna symbol (Bluetooth) is lit), it cannot be turned off.
- The power cannot be turned off during measurement.
- During real-time measurement using the LR8410 Wireless Logging Station, the measurement cannot be stopped with key operation on the instrument.

2

Preparation for Measurements

1 Select a power supply. (AC adapter or batteries)

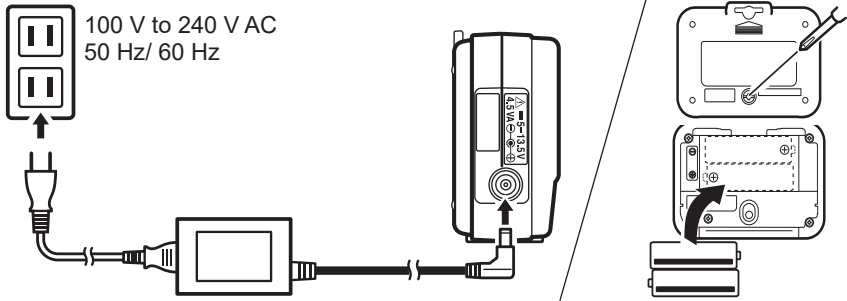

The instrument is automatically turned on.



2 Connect the humidity sensor.

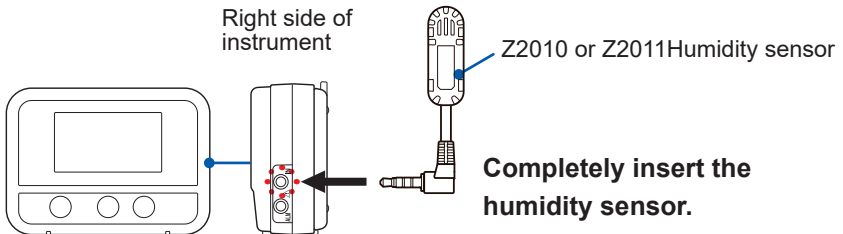

3 Connect the alarm output cable (L1010 Connection Cable) to the alarm output terminal of the instrument.

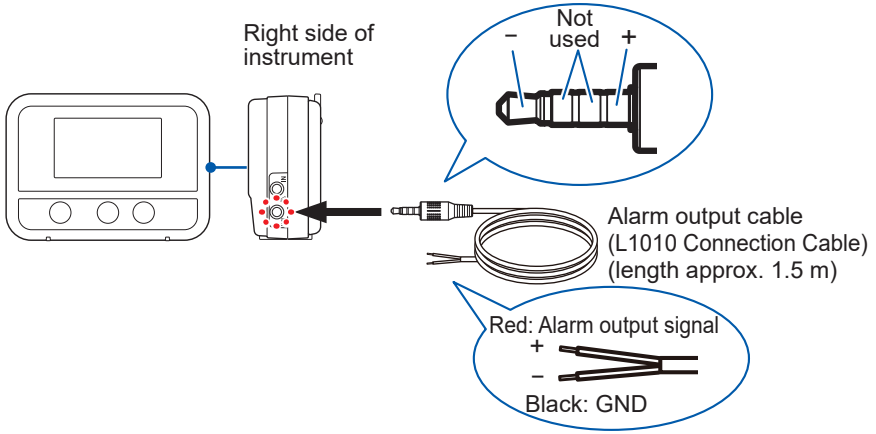

Alarm output circuit diagram

Open drain output (Maximum rating: 30 V DC, 200 mA)

A switch (FET) is installed between the alarm output terminal and ground and turns

ON (short circuit) when the signal is active (during alarm output).

Example of connection with an alarm signal light, buzzer, etc.

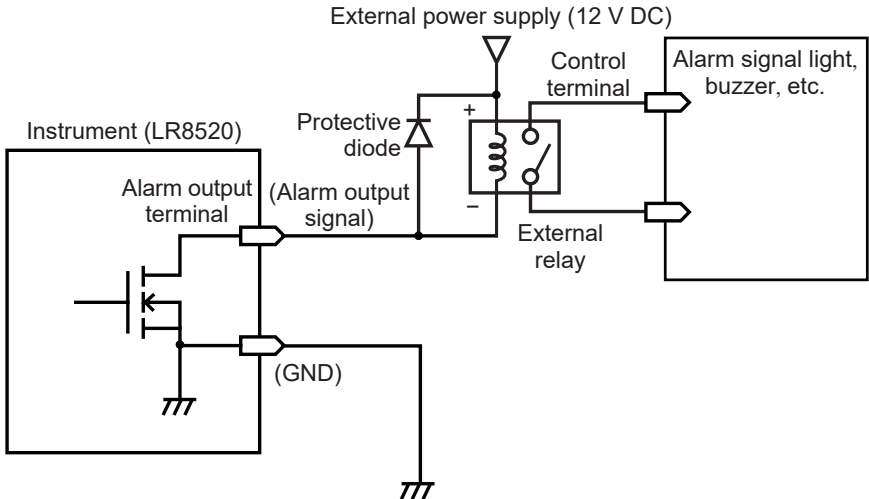

3

Collecting Measurement Data Using a Windows® PC



- 1 Install the instrument referring to “Preparation for Measurements” (p. 19).
- 2 Install the software on the Windows® PC.

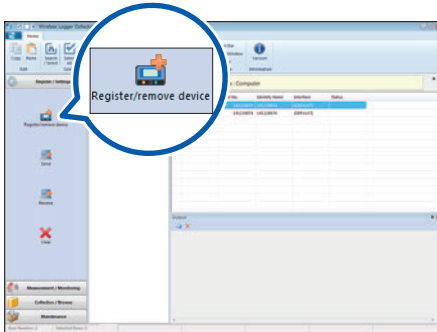

- 3 Register the instrument in Wireless Logger Collector (up to 100 units).



When no wireless logger is found

- When the  symbol in the screen is off, press the power key to turn ON the Bluetooth function.
- When the  symbol in the screen is off, a wireless connection is not established. Place the instrument closer to the PC or remove any obstacle and then search for the logger again.

- 4 Set the measurement conditions in Wireless Logger Collector.

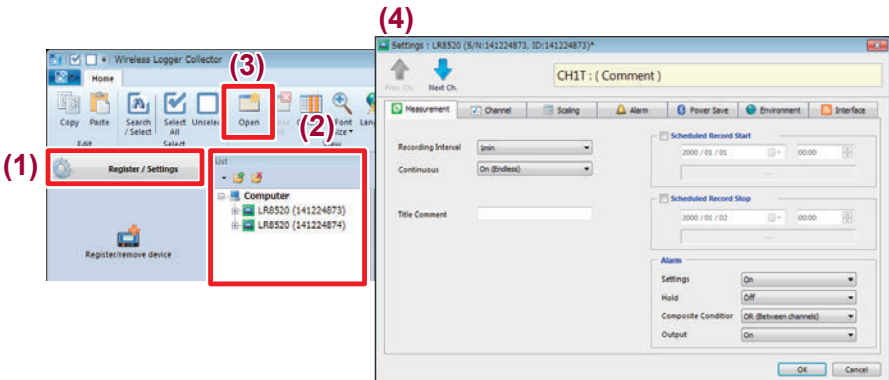

5 Send the measurement conditions to the instrument.

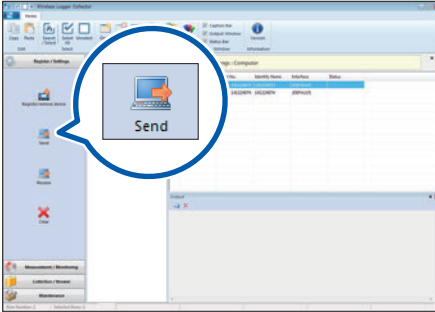

6 Start measurement.



You can also start measurement by holding down this button.

7 Collect measurement data using Wireless Logger Collector.

Measurement data can be collected during measurement and after measurement stop.

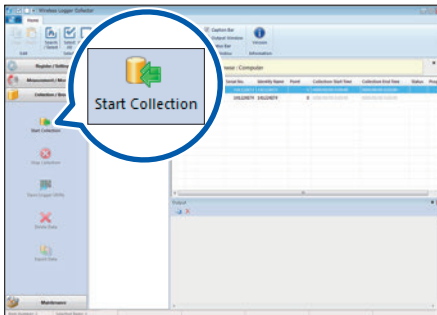

8 Analyze the data on the Windows® PC.

1. **Display measurement data in the Logger Utility:** The data is displayed in a graph and analyzed.
2. **Output the collected data in the CSV file format:** The data is displayed in a graph using a spreadsheet program, such as Microsoft® Excel®.

4

Collecting Measurement Data Using an Android™ Terminal

- 1 Install the instrument referring to “Preparation for Measurements” (p. 19).
- 2 Install Wireless Logger Collector on the Android terminal.

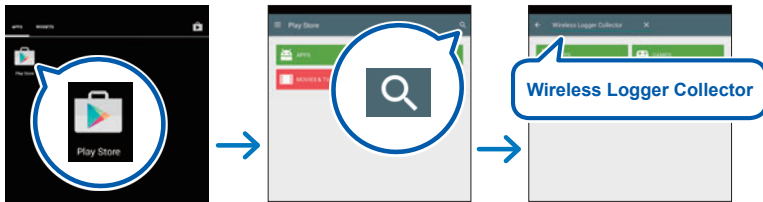

- 3 Register the instrument in Wireless Logger Collector (up to 100 units).

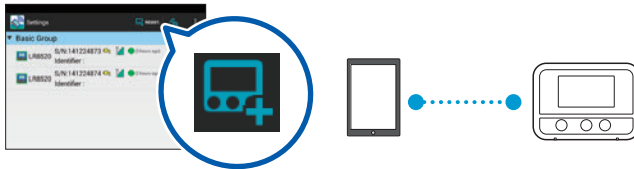

- 4 Set the measurement conditions in Wireless Logger Collector and send the conditions to the instrument.

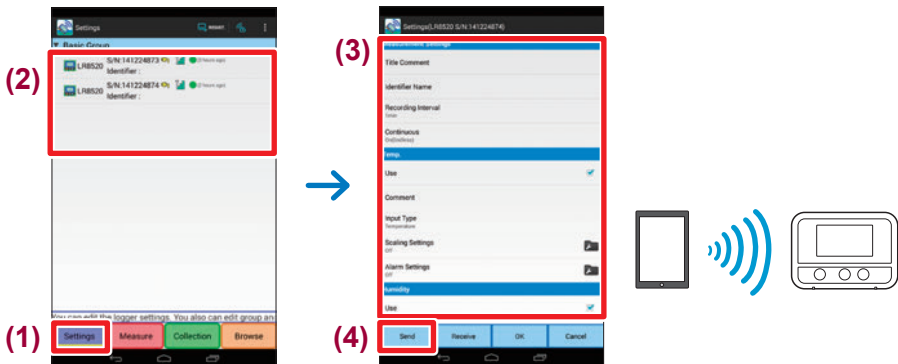

5 Start measurement.

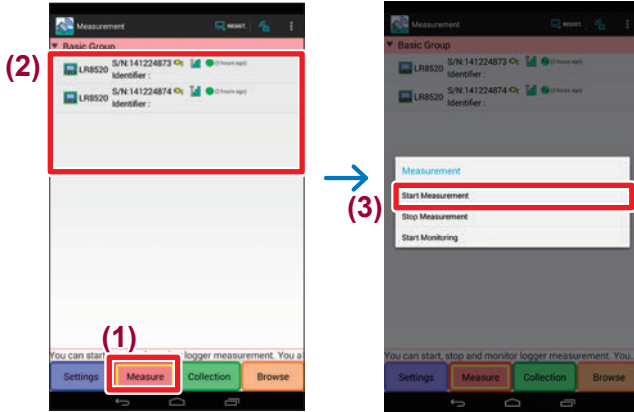

6 Collect measurement data using Wireless Logger Collector.

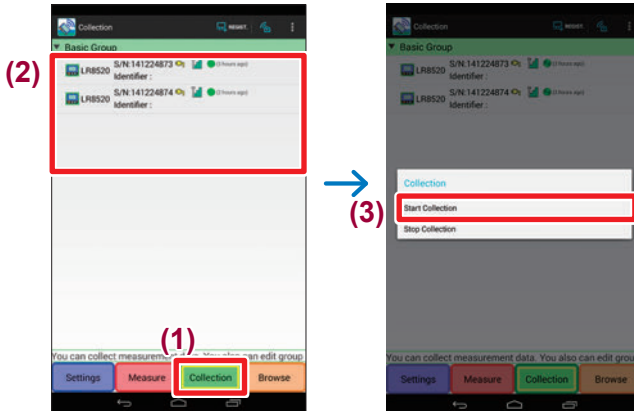

7 Export the measurement data to a file.

(1) You can view overview of collected data

(2) Browse

(3)

Title Comment	Start Time	Measured Data	Update Time
Lab	2015/02/25 15:26:04	42616	2015/03/02 13:50:24
Lab	2015/03/02 13:52:12	192	2015/03/02 13:53:47
Lab	2015/03/02 13:54:25	960	2015/03/02 13:57:35

(4) Data Management

File Name : 20150302135425.km

Title Comment : Lab

Start Time : 2015/03/02 13:54:25

Measured Data : 960

(5) Select the target for the exported data

Storage1 : /storage/emulated/0/HOKU/Wireless Logger Collector/

8 Copy the exported file onto the Windows® PC.

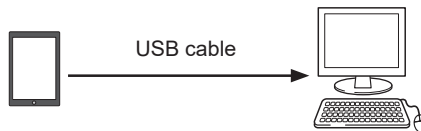

9 Analyze the data on the Windows® PC.



5 Maintenance and Service

5.1 Troubleshooting

When a malfunction of the instrument is suspected, check “Before sending the instrument for repair” and then contact your authorized Hioki distributor or reseller.

Before sending the instrument for repair

When the instrument operation does not seem normal, check the following items.

Symptom	Possible cause	Solution and reference
Nothing appears in the display.	<ul style="list-style-type: none"> The power is OFF. The AC adapter is improperly attached. The AC adapter is incorrectly connected. The batteries are exhausted. 	<ul style="list-style-type: none"> Hold down the power key to turn the power ON. Check that the AC adapter is connected correctly. Check to see that the batteries are properly installed. Use new LR6 alkaline batteries. <p>If the problem persists, the instrument needs to be repaired or inspected. Contact your authorized Hioki distributor or reseller.</p>
<ul style="list-style-type: none"> The wireless logger cannot be found. A connection to the wireless logger cannot be established. 	<p>Are you using the LR8410 to perform real-time measurement?</p> <p>The Bluetooth module power is OFF ( is off or blinking).</p> <p>The wireless logger cannot be searched for or connected if another terminal (LR8410, PC, or Android terminal) is connected ( is lit).</p> <p>Communication with all Bluetooth compatible instruments is not guaranteed.</p>	<p>Data cannot be collected with Wireless Logger Collector during real-time measurement by the LR8410.</p> <p>Press the power key of the instrument and turn ON the Bluetooth module power.</p> <p>Cut off the communications of the connected terminal and then search for or connect the wireless logger again.</p> <p>Try other terminals.</p>

Symptom	Possible cause	Solution and reference
<p>Communications with the wireless logger cannot be established. An error occurs.</p>	<p>The settings cannot be sent or received or maintenance cannot be performed while the wireless logger is busy (during measurement or monitoring).</p>	<p>Stop measurement or monitoring and then try again.</p>
	<p>As the security settings are enabled, an authentication error occurs.</p>	<p>Enter the correct password.</p>

5.2 Error Display

When there is an error in the instrument, the error is displayed as follows.

Instrument error display

Error display	Meaning	Solution and reference
Err.1	Adjustment data error An error has occurred in the internal adjustment data.	Repair or inspection is required. Contact your authorized Hioki distributor or reseller.
Err.2	Serial number error An error has occurred in the internal memory.	
Err.3	Microcomputer operation error An error has occurred in the program ROM.	
Err.4	Bluetooth module error An error has occurred in the Bluetooth module.	<ul style="list-style-type: none"> • Disconnect the Z2003 adapter and connect it again. • Remove the batteries and place new LR6 alkaline batteries. • If the problem persists, the instrument needs to be repaired or inspected. Contact your authorized Hioki distributor or reseller.
Err.5	Hardware error An error has occurred in the hardware.	
Err.140	Backup battery error An error has occurred during clock backup.	
O.F. U.F.	The measurement value is outside of the measurement range or display range.	The measurement value cannot be displayed as it is outside of the measurement range or display range. Check the input signal.
BURN	A temperature and humidity sensor error has been detected.	Completely insert the temperature and humidity sensor.
BATT LO	Power supply error The power voltage drops to the point where the instrument cannot operate properly.	<ul style="list-style-type: none"> • Remove the Z2003 AC adapter and connect the AC Adapter. • Remove the batteries and place new LR6 alkaline batteries.
----	Not measured A measurement value cannot be displayed as measurement has not been performed.	Start measurement.

Warranty Certificate

HIOKI

Model	Serial number	Warranty period Three (3) years from date of purchase (___ / ___)
-------	---------------	--

Customer name: _____

Customer address: _____

Important

- Please retain this warranty certificate. Duplicates cannot be reissued.
- Complete the certificate with the model number, serial number, and date of purchase, along with your name and address. The personal information you provide on this form will only be used to provide repair service and information about Hioki products and services.

This document certifies that the product has been inspected and verified to conform to Hioki's standards.

Please contact the place of purchase in the event of a malfunction and provide this document, in which case Hioki will repair or replace the product subject to the warranty terms described below.

Warranty terms

1. The product is guaranteed to operate properly during the warranty period (three [3] years from the date of purchase).
If the date of purchase is unknown, the warranty period is defined as three (3) years from the date (month and year) of manufacture (as indicated by the first four digits of the serial number in YYMM format).
2. If the product came with an AC adapter, the adapter is warranted for one (1) year from the date of purchase.
3. The accuracy of measured values and other data generated by the product is guaranteed as described in the product specifications.
4. In the event that the product or AC adapter malfunctions during its respective warranty period due to a defect of workmanship or materials, Hioki will repair or replace the product or AC adapter free of charge.
5. The following malfunctions and issues are not covered by the warranty and as such are not subject to free repair or replacement:
 - 1. Malfunctions or damage of consumables, parts with a defined service life, etc.
 - 2. Malfunctions or damage of connectors, cables, etc.
 - 3. Malfunctions or damage caused by shipment, dropping, relocation, etc., after purchase of the product
 - 4. Malfunctions or damage caused by inappropriate handling that violates information found in the instruction manual or on precautionary labeling on the product itself
 - 5. Malfunctions or damage caused by a failure to perform maintenance or inspections as required by law or recommended in the instruction manual
 - 6. Malfunctions or damage caused by fire, storms or flooding, earthquakes, lightning, power anomalies (involving voltage, frequency, etc.), war or unrest, contamination with radiation, or other acts of God
 - 7. Damage that is limited to the product's appearance (cosmetic blemishes, deformation of enclosure shape, fading of color, etc.)
 - 8. Other malfunctions or damage for which Hioki is not responsible
6. The warranty will be considered invalidated in the following circumstances, in which case Hioki will be unable to perform service such as repair or calibration:
 - 1. If the product has been repaired or modified by a company, entity, or individual other than Hioki
 - 2. If the product has been embedded in another piece of equipment for use in a special application (aerospace, nuclear power, medical use, vehicle control, etc.) without Hioki's having received prior notice
7. If you experience a loss caused by use of the product and Hioki determines that it is responsible for the underlying issue, Hioki will provide compensation in an amount not to exceed the purchase price, with the following exceptions:
 - 1. Secondary damage arising from damage to a measured device or component that was caused by use of the product
 - 2. Damage arising from measurement results provided by the product
 - 3. Damage to a device other than the product that was sustained when connecting the device to the product (including via network connections)
8. Hioki reserves the right to decline to perform repair, calibration, or other service for products for which a certain amount of time has passed since their manufacture, products whose parts have been discontinued, and products that cannot be repaired due to unforeseen circumstances.

HIOKI E.E. CORPORATION

<http://www.hioki.com>

18-07 EN-3

HIOKI

www.hioki.com/



**All regional
contact
information**

HIOKI E.E. CORPORATION

81 Koizumi, Ueda, Nagano 386-1192 Japan

2402 EN

Edited and published by HIOKI E.E. CORPORATION

Printed in Japan

- Contents subject to change without notice.
- This document contains copyrighted content.
- It is prohibited to copy, reproduce, or modify the content of this document without permission.
- Company names, product names, etc. mentioned in this document are trademarks or registered trademarks of their respective companies.

Europe only

- EU declaration of conformity can be downloaded from our website.
- Contact in Europe: HIOKI EUROPE GmbH
Helfmann-Park 2, 65760 Eschborn, Germany hioki@hioki.eu