

LR8432-20

HIOKI

Instruction Manual

HEAT FLOW LOGGER



EN

June 2018 Revised edition 1
LR8432B980-01 18-06H



Contents

Introduction	1
Confirming Package Contents	2
Safety Information	4
Operating Precautions	7

Chapter 1

Overview 13

1.1 Product Overview and Features	13
1.2 Measurement Flow	14
1.3 Names and Functions of Parts	16
1.4 Screen Configurations	18
1.5 Basic Operation	21
■ Screen Operations	21
■ Starting and Stopping Recording	22
■ Disabling Key Operations (Key-Lock Function)	23
■ Saving Data	23
■ Verifying the Input Level (Level Monitor)	24

Chapter 2

Measurement Preparations 25

2.1 Using the Battery Pack (Option)	26
■ Install the Battery Pack	30
■ Charge the Battery Pack	30
2.2 Connecting the AC Adapter	31
2.3 Connecting Measurement Cables to the Instrument	32
■ Connecting Measurement Leads or Thermocouples (for voltage or temperature, respectively)	34
■ Connect the Heat Flow Sensor (Heat flow measurement)	35
■ Connecting the Optional Model 9641 Connection Cable (for Pulse Signal Input)	37
2.4 Turning the Power On and Off	38
2.5 Zero Adjustment	39

Chapter 3	
Setting before Measurement	41
3.1 Pre-Operation Inspection	41
3.2 Operating Flow Overview	42
3.3 Setting Configuration 1 – Recording Settings 46	
■ Specify the Recording Interval	46
■ Setting the Display Time Base (horizontal axis magnification, set as needed).....	47
■ Selecting the Recording Start/stop Method	49
■ Set the Recording Length for Repeated or One-time Recording.....	50
■ Enable Digital Filtering (noise suppression) (as needed)	50
■ Automatic Saving	51
■ Replacing Removable Storage During Real-Time Saving	53
3.4 Setting Configuration 2 – Input Channel Settings 54	
■ Voltage Measurement Settings	56
■ Temperature Measurement Settings	57
■ Heat Flow Measurement Settings	59
■ Integration (Count) Measurement Settings	61
■ Revolution Measurement Settings	62
3.5 Display Settings	64
■ Selecting Waveform Display Color	64
■ Specifying Vertical Display Range by Magnification and Zero Position (vertical axis expansion/compression).....	64
■ Specifying the Vertical Display Range by Upper and Lower Limits (expansion/compression)	65
■ Converting Units (Scaling function)	67
3.6 Entering Comments	70
3.7 Viewing All Channel Settings in a List	72
■ Switching Channel Display Settings	73
■ Batch Copying Channel Settings	74
■ Batch Setting Waveform Display/Hide and Waveform Color Settings for All Channels	75
■ Initializing Settings (to factory defaults)	75
■ Aligning Zero Positions on the Grid	76
■ Display Celsius (°C) temperature values as Fahrenheit (°F)	77

Chapter 4

Specifying Criteria for Measurements (Triggering, Alarm and Timer) _____ 79

- 4.1 Setting Criteria to Start and Stop Recording 80**
 - Setting the Input Signal Trigger Threshold (Level Trigger) 81
 - Setting Lower and Upper Trigger Thresholds (Window Trigger)..... 83
 - Selecting Trigger Sources and Combinations 84
 - Setting Criteria for Pre-Trigger Recording (Pre-Trig) 85
- 4.2 Alarm Output 86**
- 4.3 Confirming Trigger and Alarm Criteria Settings (List)..... 89**
- 4.4 Starting and Stopping Recording by Timer 90**
- 4.5 About Recording Operation 92**

Chapter 5

Waveform Analysis _____ 95

- 5.1 Viewing Waveforms 96**
 - Scrolling Waveforms 96
 - Verifying Waveform Display Position 96
 - Magnifying and Compressing Horizontally 97
 - Viewing Any Waveform Location (Jump Function) 97
- 5.2 Selecting Display Options 98**
 - Displaying Gauges 98
 - Displaying Cursor Values 99
 - Specifying a Waveform Time Span 101
 - Viewing Input Signals as Numerical Values 102
- 5.3 Inserting Event Marks (Search Function) 104**
 - Inserting Event Marks While Viewing Waveforms 104
 - Inserting Event Marks Using External Input Signals 105
 - Searching Event Marks 106

Chapter 6

Saving & Loading Data _____ 107

- 6.1 About Saving and Loading Data 107**
- 6.2 Using a CF Card/USB flash drive 109**
 - CF Card Insertion & Removal 110

■	USB flash drive Insertion & Removal	110
■	Formatting a CF Card/USB flash drive	111
6.3	Saving Data	112
■	Automatic Saving	113
■	Selecting the Manual Saving Method [Quick Save]/[Select & Save]	114
■	Saving Waveform Data (with the SAVE Key)	115
■	Capturing a Screen Image (With the SAVE Key)	116
■	Saving Numerical Calculation Results (With the SAVE Key).....	117
■	Saving Setting Configurations	118
6.4	Loading Data on the Instrument	119
■	Loading a Setting Configuration	119
■	Loading Waveform Data and Screen Images	120
6.5	Data Management	121
■	Switching removable storage	121
■	Viewing Folder Contents and the Parent Folder	122
■	Deleting Data	122
■	Renaming Files and Folders	123
■	Copying Data	124
■	Sorting Files	125
6.6	Transferring Data to a Computer (USB Drive Mode)	126
■	Select the USB Drive Mode	126
■	Connecting the USB Cable	127

Chapter 7

Numerical/Waveform Calculations _____ 129

7.1	Performing Numerical Calculation	129
■	Key Operation During Setting	131
■	Calculating values in real time during measurement (Automatic calculation)	132
■	Manual Calculation	135
■	Apply Calculations to a Specific Time Span (Manual Calculation Only)	136
7.2	Numerical Value Calculation Expressions	137
7.3	Performing Waveform Calculation	139
■	Key Operation During Setting	139

■ Setting the Waveform Display Color	142
■ Setting the Display Format	142
■ Setting the Display Range in the Vertical Axis Direction Using Upper/Lower Limit Values	142
7.4 Waveform Calculation Formula	143

Chapter 8 **System Environment Settings** _____ **145**

8.1 Screen and Key Operation Settings	146
■ Using the Auto-Resume Function (Resume After Power Restoration)	146
■ Adjust Backlight Brightness	146
■ Enabling and Disabling the Backlight Saver	147
■ Setting the Screen Color Scheme	147
■ Enabling or Disabling the Beeper	147
■ Selecting the Horizontal (Time) Axis Display	148
■ Selecting the Display Language	148
8.2 CSV File Saving Settings	149
■ CSV File Data Decimal and Separator Characters	149
8.3 Making System Settings	150
■ Setting the Date and Time	150
■ Initializing the Instrument (System Reset)	151
■ Switching the USB mode	152
■ Self-Test	153

Chapter 9 **External Control** _____ **155**

9.1 Connecting to the External Control Terminals ...	155
9.2 External Trigger Input	157
9.3 External Signal Output (Trigger Output)	158
9.4 Alarm Signal Output (Alarm Output)	160
9.5 Synchronous Measurements with Multiple Instruments	161

Chapter 10 **Specifications** _____ **163**

Chapter 11	
Maintenance and Service	173
11.1 Troubleshooting	173
11.2 Cleaning	176
11.3 Disposing of the Instrument	177
Appendix	A1
Appendix 1 Error Messages and Remedial Actions	A1
Appendix 2 File Naming	A7
Appendix 3 Text File (CSV) Internal Format	A9
Appendix 4 Binary File Size Calculation	A10
Appendix 5 List of Default Settings	A11
Appendix 6 Maximum Recordable Time	A12
Appendix 7 Reference	A13
Appendix 8 Concerning Noise Countermeasures	A14
Appendix 9 Using the Application Program	A20
■ Installing Logger Utility	A21
■ Installing the USB Driver	A24
■ Connecting the Instrument to the Computer with a USB Cable	A27
■ Starting and Ending Logger Utility	A30
■ Uninstalling the Logger Utility	A30
Appendix 10 Frequently Asked Questions	A31
■ Installation and Settings	A31
■ Triggering	A33
■ Measuring	A34
■ Data Saving	A35
■ Logger Utility	A39
Appendix 11 Pulse Input Circuit Diagram	A40
Appendix 12 Heat Flow	A41
Index	Index 1

Introduction

Thank you for purchasing the HIOKI “Model LR8432-20 Heat Flow Logger.”

To obtain maximum performance from the instrument, please read this manual carefully, and keep it handy for future reference.

Trademarks

- Microsoft, Windows, Excel, are either registered trademarks or trademarks of Microsoft Corporation in the United States and other countries.
 - CompactFlash is a registered trademark of Sandisk Corporation (USA).
-

Confirming Package Contents

When you receive the instrument, inspect it carefully to ensure that no damage occurred during shipping. In particular, check the accessories, panel switches, and connectors. If damage is evident, or if it fails to operate according to the specifications, contact your authorized Hioki distributor or reseller.

Confirm that these contents are provided.

- Model LR8432-20 1
Heat Flow Logger
- Measurement Guide 1

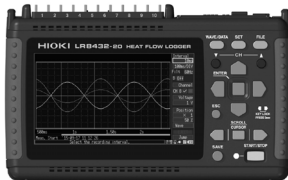

- USB Cable 1



(p. A27)

Accessories:

- Model Z1005 AC Adapter 1
with supplied power cord

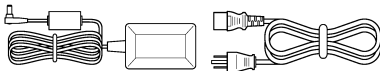

(p. 31)

- CD 1

- Instruction Manual (PDF)
(This document)
- Logger Utility Instruction Manual (PDF)
- Logger Utility (Data acquisition application program)



The latest version can be downloaded from our web site.

About options:

Contact your authorized Hioki distributor or reseller for details.

- Model 9780 Battery Pack
- Model Z1005 AC Adapter
- Model 9641 Connection Cable (for pulse inputs)
- Model 9782 Carrying Case
- Model 9812 Soft Case
- Model 9728 PC Card 512 M
- Model 9729 PC Card 1 G
- Model 9830 PC Card 2 G
- Model 9809 Protection Sheet
- Z2012 Heat Flow Sensor
- Z2013 Heat Flow Sensor
- Z2014 Heat Flow Sensor
- Z2015 Heat Flow Sensor
- Z2016 Heat Flow Sensor
- Z2017 Heat Flow Sensor
- Z2018 Heat Flow Sensor
- Z2019 Heat Flow Sensor
- Z2012-01 Heat Flow Sensor
- Z2013-01 Heat Flow Sensor
- Z2014-01 Heat Flow Sensor
- Z2015-01 Heat Flow Sensor
- Z2016-01 Heat Flow Sensor
- Z2017-01 Heat Flow Sensor
- Z5008 Thermally Conductive Tape



Applying any excessive force to the Heat Flow Sensor can damage the sensor. When transporting the Heat Flow Sensor in a case, store the sensor in the pocket of the 9782 Carrying Case. Do not store the Heat Flow Sensor in the 9812 Soft Case.

Safety Information

This instrument is designed to conform to IEC 61010 Safety Standards, and has been thoroughly tested for safety prior to shipment. However, using the instrument in a way not described in this manual may negate the provided safety features. Before using the instrument, be certain to carefully read the following safety notes:







Mishandling during use could result in injury or death, as well as damage to the instrument. Be certain that you understand the instructions and precautions in the manual before use.







With regard to the electricity supply, there are risks of electric shock, heat generation, fire, and arc flash due to short circuits. If persons unfamiliar with electricity measuring instrument are to use the instrument, another person familiar with such instruments must supervise operations.

Safety Symbols



	Indicates cautions and hazards. When the symbol is printed on the instrument, refer to a corresponding topic in the Instruction Manual.
	Indicates DC (Direct Current).
	Indicates AC (Alternating Current).
	Indicates the ON side of the power switch.
	Indicates the OFF side of the power switch.

Notation

In this document, the risk seriousness and the hazard levels are classified as follows.

	Indicates an imminently hazardous situation that will result in death or serious injury to the operator.
	Indicates a potentially hazardous situation that may result in death or serious injury to the operator.
	Indicates a potentially hazardous situation that may result in minor or moderate injury to the operator or damage to the instrument or malfunction.
	Indicates advisory items related to performance or correct operation of the instrument.
	Indicates information related to the operation of the instrument or maintenance tasks with which the operators must be fully familiar.

Symbols for Various Standards

	Indicates that the product conforms to regulations set out by the EU Directive.
	This is a recycle mark established under the Resource Recycling Promotion Law (only for Japan).
	WEEE marking: This symbol indicates that the electrical and electronic appliance is put on the EU market after August 13, 2005, and producers of the Member States are required to display it on the appliance under Article 11.2 of Directive 2002/96/EC (WEEE).

Other Symbols

	Indicates the prohibited action.
(p. #)	Indicates the location of reference information.
*	Indicates that descriptive information is provided below.
[]	The names of setting objects and buttons on the screen are indicated by square brackets [].
SET (Bold characters)	Bold characters within the text indicate operating key labels.
Unless otherwise specified, “Windows” represents Windows XP, Windows Vista, Windows 7, Windows 8, or Windows 10.	
Click: Press and quickly release the left button of the mouse. Double click: Quickly click the left button of the mouse twice.	

Accuracy

We define measurement tolerances in terms of f.s. (full scale), rdg. (reading) and dgt. (digit) values, with the following meanings:

f.s. (maximum display value or scale length)

The maximum displayable value or scale length. This is usually the name of the currently selected range.

Example: For the 1 V range, f.s. = 1 V

rdg. (reading or displayed value)

The value currently being measured and indicated on the measuring instrument.

dgt. (resolution)

The smallest displayable unit on a digital measuring instrument, i.e., the input value that causes the digital display to show a “1” as the least-significant digit.

Measurement categories

To ensure safe operation of measurement instruments, IEC 61010 establishes safety standards for various electrical environments, categorized as CAT II to CAT IV, and called measurement categories.



- **Using a measuring instrument in an environment designated with a higher-numbered category than that for which the instrument is rated could result in a severe accident, and must be carefully avoided.**
- **Never use a measuring instrument that lacks category labeling in a CAT II to CAT IV measurement environment. Doing so could result in a serious accident.**

CAT II	When directly measuring the electrical outlet receptacles of the primary electrical circuits in equipment connected to an AC electrical outlet by a power cord (portable tools, household appliances, etc.)
CAT III	When measuring the primary electrical circuits of heavy equipment (fixed installations) connected directly to the distribution panel, and feeders from the distribution panel to outlets
CAT IV	When measuring the circuit from the service drop to the service entrance, and to the power meter and primary overcurrent protection device (distribution panel)

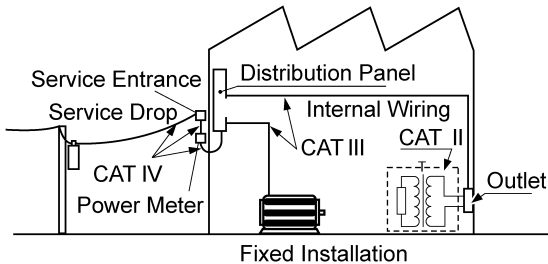
**Difference between “Measurement” and “Recording”**

The measurement and recording processes are distinguished as follows for the purposes of these instructions.

Measurement:	The acquisition of input values into the instrument's internal memory or to a PC via communications.
Recording:	Storing measurement data on a CF card, USB flash drive or on a PC via data communication.

Measured data (data acquired in internal memory) is erased whenever a new measurement starts. To retain data, always record (save) it.

Operating Precautions



Follow these precautions to ensure safe operation and to obtain the full benefits of the various functions.

Before Use

- Before using the instrument for the first time, verify that it operates normally to ensure that no damage occurred during storage or shipping. If you find any damage, contact your authorized Hioki distributor or reseller.
- Before using the instrument, make sure that the insulation on the cables is undamaged and that no bare conductors are improperly exposed. Using the instrument in such conditions could cause an electric shock, so contact your authorized Hioki distributor or reseller for replacements.

Instrument Installation

Installation environment

CAUTION

- This instrument is not drip-proof. Install the instrument with the measurement cables hanging lower than the instrument to prevent water or other fluid from entering the instrument through the measurement cables and terminal block.
- The maximum operating (ambient) temperature for the LR8432-20 is 40°C. Do not attempt to use in higher temperature environments.

NOTE

- Correct measurement may be impossible in the presence of strong magnetic fields, such as near transformers and high-current conductors, or in the presence of strong electromagnetic fields such as near radio transmitters.
- If liquid enters the enclosure through an air vent or other opening, it may damage the instrument's internal circuitry. Exercise caution concerning the surrounding environment when installing the instrument.

CAUTION

Do not place the instrument on an unstable table or an inclined place. Dropping or knocking down the instrument can cause injury or damage to the instrument.

Operating Precautions

Installation Precautions

- If the instrument is used in any state other than the following, the measurement accuracy may not satisfy the device specifications.

Horizontal placement



Upright placement



- Leave sufficient space around the ventilation holes and install the instrument with the holes unobstructed.
- Avoid temperature changes around the terminal block. Especially avoid directed airflow such as from an electric fan or air conditioner vent. Thermocouple inputs are prone to measurement errors.
- When the instrument is moved to a location with significantly different ambient temperature, allow at least 30 minutes for thermal equalization before measuring.

Handling the Instrument

⚠ WARNING

- **Do not allow the instrument to get wet, and do not take measurements with wet hands. This may cause an electric shock.**
- **Do not attempt to modify, disassemble or repair the instrument; as fire, electric shock and injury could result.**

⚠ CAUTION

To avoid damage to the instrument, protect it from physical shock when transporting and handling. Be especially careful to avoid physical shock from dropping.

NOTE

This instrument may cause interference if used in residential areas. Such use must be avoided unless the user takes special measures to reduce electromagnetic emissions to prevent interference to the reception of radio and television broadcasts.

Handling the Cords and Cables

⚠ CAUTION

The cable is hardened under the 0°C or colder environment. Do not bend or pull it to avoid tearing its shield or cutting cable.

Before Turning Power On

⚠️ WARNING

Using the Battery Pack

- For battery operation, use only the HIOKI Model 9780 Battery Pack. We do not take any responsibility for accidents or damage related to the use of any other batteries.

Refer to “2.1 Using the Battery Pack (Option)” (p. 26).

Using the AC Adapter

- Use only the supplied Model Z1005 AC Adapter. AC adapter input voltage range is 100 V to 240 VAC at 50 Hz/60 Hz. To avoid electrical hazards and damage to the instrument, do not apply voltage outside of this range.
- Turn the instrument off before connecting the AC adapter to the instrument and to AC power.
- To avoid electrical accidents and to maintain the safety specifications of this instrument, connect the power cord provided only to a 3-contact (two-conductor + ground) outlet.
- Use only the designated power cord with this instrument. Use of other power cords may cause fire.
- Before turning the instrument on, make sure the supply voltage matches that indicated on its power connector. Connection to an improper supply voltage may damage the instrument and present an electrical hazard.

⚠️ CAUTION

- Do not connect the supply voltage improperly. Doing so may damage the instrument's internal circuitry.
- Avoid using an uninterruptible power supply (UPS) or DC/AC inverter with rectangular wave or pseudo-sine-wave output to power the instrument. Doing so may damage the instrument.
- When the power is turned off, do not apply voltage or current to the terminals. Doing so may damage the instrument.

NOTE

- After use, always turn OFF the power.
- Brief power interruptions of 40 ms or less will not cause this instrument to malfunction. However, longer interruptions may cause the instrument to shut itself off, so consider local power conditions before installing, as appropriate.
- To ensure that recording is not interrupted by power outages, you can use the Z1005 AC Adapter and 9780 Battery Pack together.

About Inputs and Measurement

- Do not use the instrument with circuits that exceed its ratings or specifications. Doing so may cause it to become hot, resulting in bodily injury.
- To avoid electrical hazards and damage to the instrument, do not apply voltage exceeding the rated maximum to the input terminals.
- The maximum input voltage (and the maximum rated voltage to earth) for the analog input terminals is 30 V AC rms (or 60 V DC). If these limits are exceeded, the instrument may be damaged and personal injury or death could occur, so do not attempt measurement.
- Do not leave the instrument connected to test objects in environments where a voltage surge might exceed the dielectric withstand voltage. Doing so could result in damage to the instrument, bodily injury or fatal accident.
- Channels are insulated by semiconductor relays. When a voltage beyond the specification is applied between the channels, the semiconductor relay may short circuit. Please ensure that a voltage beyond specification, especially a surge such as a lightning, is never applied. When an abnormal measurement value is observed, please contact your authorized Hioki distributor or reseller for inspection.

IMPORTANT

Select Hioki 9641 Connection Cable for use as a cable for the pulse input connector.

NOTE

The waveform for an open channel may sometimes appear to be influenced by the signals of the other channels being measured. If you do not like this, please set the waveform display of the open channel to OFF or short-circuit the input terminals of the open channel by connecting the positive and negative terminal.

CD Handling



CAUTION CD precautions

- Exercise care to keep the recorded side of discs free of dirt and scratches. When writing text on a disc's label, use a pen or marker with a soft tip.
- Keep discs inside a protective case and do not expose to direct sunlight, high temperature, or high humidity.
- Hioki is not liable for any issues your computer system experiences in the course of using this disc."

Using a CF Card/USB flash drive



CAUTION

- Inserting a CF card/USB flash drive upside down, backwards or in the wrong direction may damage the CF card, USB flash drive, or instrument.
- Never eject a CF card /USB flash drive while measuring or when the instrument is or accessing the card. Data on the CF card/USB flash drive may be destroyed. (The CF icon/USB flash drive icon at the lower right is red while the card is being accessed.)
- Do not transport the instrument while a USB flash drive is connected. Damage could result.
- As the CF card/USB flash drive is sensitive to static electricity, damage to the CF card/USB flash drive or wrong operations by the instrument may occur due to static electricity. Please be careful when handling it.
- With some USB flash drives, the instrument may not start up if power is turned on while the USB flash drive is inserted. In such a case, turn power on first, and then insert the USB flash drive. It is recommended to try out operation with a USB flash drive before starting to use it for actual measurements.

Operating Precautions

NOTE

- The Flash memory in a CF card/USB flash drive has a limited operating life. After long-term usage, data storage and retrieval become difficult. In this case, replace the CF card/USB flash drive with a new one.
- We cannot provide compensation for data loss in a CF card/USB flash drive, regardless of content or cause of the damage. Data is also cleared from memory if a long time passes after measuring. Always maintain a backup of important data stored on a CF card/USB flash drive.
- Although real-time saving to USB flash drive is supported, a CF card is recommended for data preservation. Performance cannot be guaranteed when using storage media other than a Hioki-specified CF card option.
- Use a USB flash drive whose continuous current consumption does not exceed 300 mA (peak 500 mA). (The peak value is displayed as “Max Power” under the USB flash drive self-test on the **[System]** screen.)
- Depending on how USB is used, the USB connector and instrument settings may vary as shown in the chart below.
- The three USB methods of use described in the chart below involve exclusive settings and cannot be used simultaneously.

USB method of use	Connector used	[System] screen USB mode setting
Use a USB flash drive.	Type A	USB Memory (Default)
Communicate with the LR8432-20 and initiate measurement using the Logger Utility software from a computer (using a USB cable).	Type B	USB Communication
Read files on a CF card that is connected to the LR8432-20 from a computer (using a USB cable).	Type B	USB Drive

Heat Flow Sensor (Models Z2012, Z2013, Z2014, Z2015, Z2016, Z2017, Z2018, Z2019, Z2012-01, Z2013-01, Z2014-01, Z2015-01, Z2016-01, Z2017-01)



CAUTION

Do not subject the Heat Flow Sensor to excessive force.

Refer to the instruction manual included with the Heat Flow Sensor for details.

Thermally Conductive Tape Z5008



CAUTION

Stop using double-sided Thermally Conductive Tape immediately if it touches the human body and causes an abnormality.

Overview

Chapter 1

1.1 Product Overview and Features

The Hioki LR8432-20 Heat Flow Logger is a compact, lightweight, easy-to-operate waveform recorder. It can run on batteries, and can be quickly deployed when a power anomaly occurs.

Measurement data can be monitored, subjected to calculations and analyzed on a personal computer using the supplied application program.

Observe voltage fluctuations, temperature, and heat flow

Just connect measurement leads, thermocouples, or heat flow sensors to perform measurement as needed.



Acquire pulse signals

Measure integrated pulses or revolutions from sensors and pulse output devices such as watt-hour meters.



Record anomalies

Abnormal events can be analyzed by recording with the trigger function (p. 79). Use the alarm function to output signals when anomalies occur (p. 86).

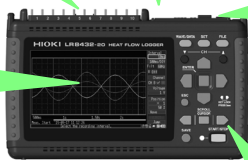
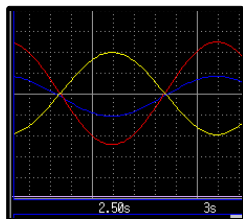
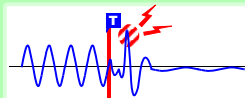

Measurement data and setting configurations are stored, read and managed as data files

Measurement data can be stored to and read from a CF card or USB flash drive (p. 107).

Waveform analysis

Gauge display (p. 98) Zoom in/out (p. 97) Numerical display (p. 102) Event search (p. 104)



Cursor Measurements (p. 99)



Using the A/B cursors, values at cursor locations on waveforms and the time at trigger positions can be displayed.

Numerical Calculations (p. 129)



Performs seven calculation types, including maximum and average values.

Waveform Calculations (p. 99)

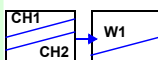

Performs five types of calculations, including four arithmetic operations and a moving average, and displays results in a waveform format.

Analysis on a PC

Monitor and analyze measurement data with the supplied application program (p. A20).

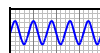

Display in converted units

Using the scaling function, input values can be displayed in units of the actual physical quantity being measured, such as current or flow volume (p. 67).

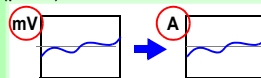

1.2 Measurement Flow

Installing, Connecting and Turning On

Install the Battery Pack (option) (p. 26)

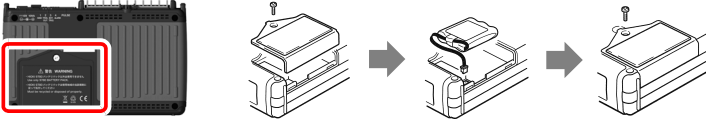

Connect to the Model LR8432-20 (p. 25), and Set Up (p. 8)

2

Measurement cables connections (p. 32)

1

AC adapter connection (p. 31)

To save data, insert a CF card or USB flash drive. (p. 110)

Turn the Power On (p. 38)

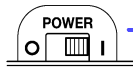

Settings

Configure Recording Settings (p. 42)

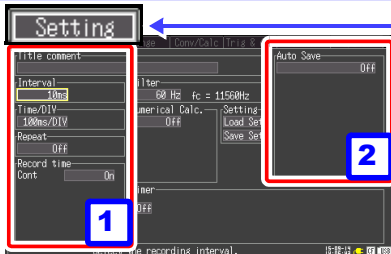
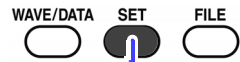

Set the data acquisition (recording) interval, and recording length (time span). Select the type of measurement data to save when automatically saving to a CF card or USB flash drive. Remaining data stored in the instrument can be saved when finished measuring.

Using a previously saved setting configuration

Reload a previously stored setting configuration from Model LR8432-20 memory or a CF card or USB flash drive, and measure (p. 119)

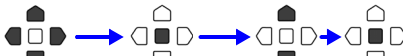

Move to a setting item Open the setting options Select Apply

Configure Input Channels (p. 42)

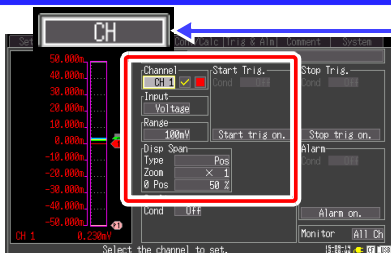

Select input channels, and set input types and measurement ranges.
Make other settings as desired.



Move to a setting item Open the setting options Select Apply

Starting and Stopping Measurement

Press the START/STOP Key (p. 22)

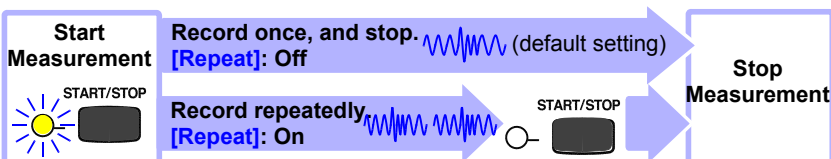

When recording using the trigger function, recording occurs only when the input waveform satisfies specified trigger criteria.

Data Analysis

View Measurement Data (p. 95)

Waveforms can be zoomed and numerical values confirmed.

Save Data (p. 107)

Measurement data, waveform data, screen images and numerical calculation results can be saved.

Calculate (p. 129)

Numerical measurement data can be applied to calculations.

View on a Computer (p. A20)

Analyze recorded data using the supplied application program.

When Finished

Turn the Instrument Off (p. 38)

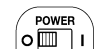

1.3 Names and Functions of Parts

Front Panel

Display Screen (p. 95)

4.3-inch TFT color LCD

Screen Configurations (p. 18)

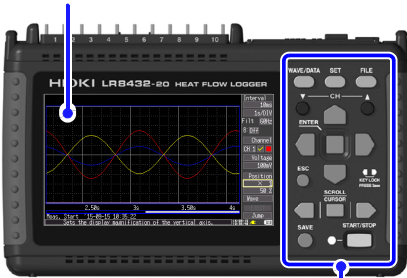

Operating Keys

Rear Panel

Manufacturer's Serial No.

Shows the serial number. The serial number consists of 9 digits. The first two (from the left) indicate the year of manufacture, and the next two indicate the month of manufacture. Do not remove this label, as it is required for product support.

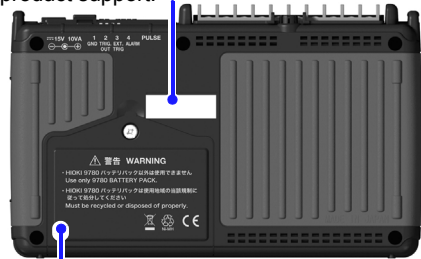

Battery Compartment (p. 26)

The optional Model 9780 Battery Pack is installed here. [▲] (p. 9)

Operating Keys

Choose a screen

■ WAVE/DATA

Selects among waveform screen displays (p. 18).

■ SET

Displays the Settings screens, and switches among the screen tabs with each press (p. 20).

■ FILE

Displays file information (p. 19).

Scroll waveforms and read cursor values

Press the center key to select waveform scrolling or A/B cursor movement, then press the left and right cursor keys to scroll or move (p. 21).

Saving operations

Press to save data manually (p. 112).

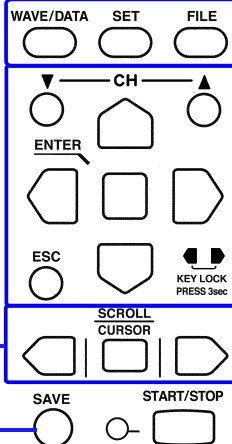

Start and stop measurement

Start and stop measurement. The LED at the left lights green while measuring (p. 22).

Setup and display

■ CH▼/▲

Select channels.

■ ESC

Cancels changes to settings.

■ Cursor Keys

Moves the position of the cursor (blinking section) on the screen.



■ ENTER

Accepts displayed settings.



■ KEY LOCK

Disables keypad operations. Press and hold the left and right cursor keys simultaneously for three seconds to lock and unlock the keys.



■ (Zero Adjust)

Performs zero adjustment. Press the up and down keys simultaneously to execute (p. 39).



Top Panel

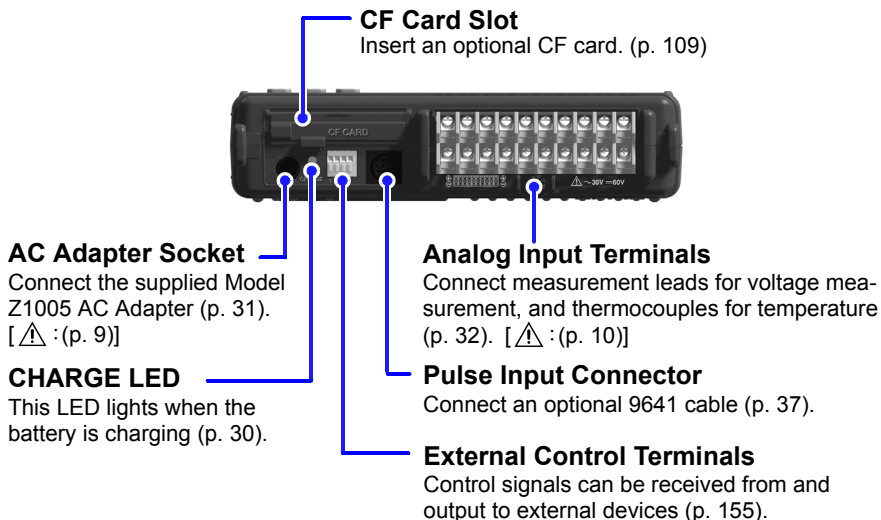

Right Side

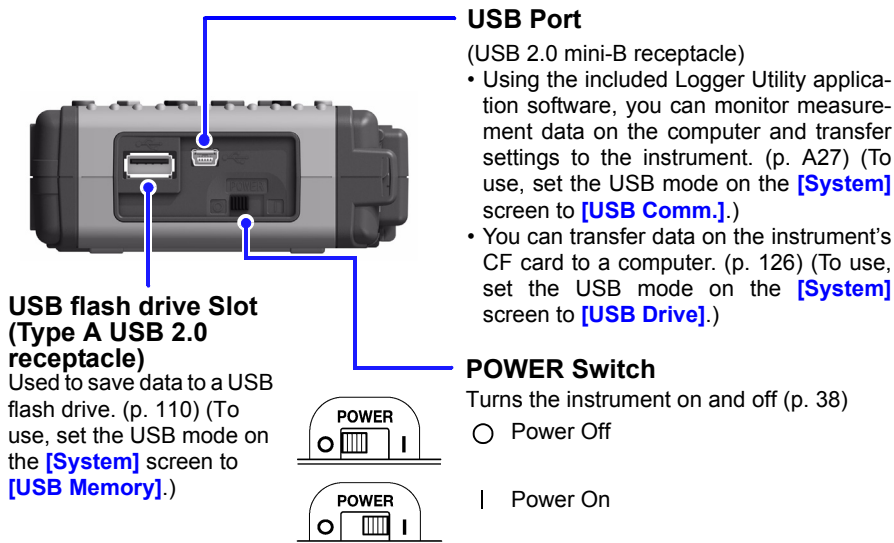

NOTE The [USB Memory], [USB Comm.], and [USB Drive] USB mode settings are exclusive and cannot be used simultaneously.

1.4 Screen Configurations

Waveform/Numerical Screens



Selects between seven display types.

The screen switches each time you press the key.

Operational information is displayed along the bottom of the screen.



Selection is also available from the name of the current screen displayed near the bottom right

[Gauge+Wave]

[Wave]

[Wave+Value]

[Value+Cmnt]

[Value]

[Wave+Calc]

[Wave+Crsr]

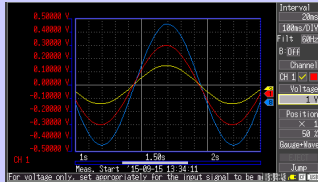

[Gauge+Wave] Screen

Measurement data is displayed as waveforms with gauges (p. 98).

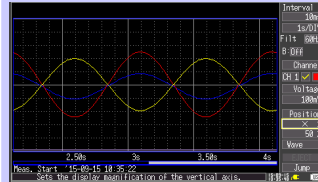

[Wave] Screen

Measurement data is displayed as waveforms (p. 95).

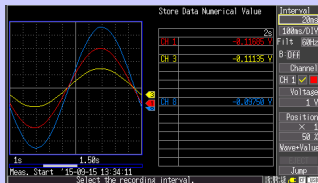

[Wave+Value] Screen

Measurement data is displayed as waveforms and numerical values (p. 102).

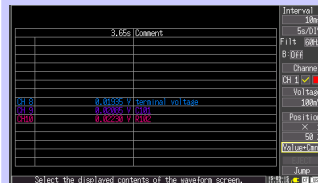

[Value+Cmnt] Screen

Measurement data is displayed as numerical values with comments (p. 102).

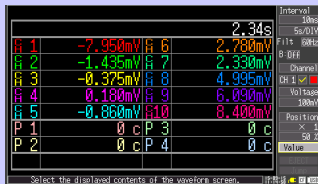

[Value] Screen

Measurement data is displayed as numerical values (p. 102).

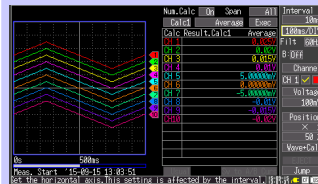

[Wave+Calc] Screen

Measurement data is displayed as waveforms with calculation results (p. 135).

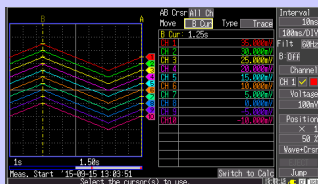

[Wave+Crsr] Screen

Measurement data is displayed as waveforms with cursor values (p. 99).

Icons (Commonly used on all of the screens)

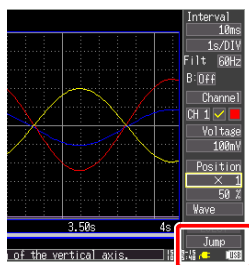

Clock

“Setting the Date and Time”
(p. 150).



USB source indicator

Indicates the USB status.



USB flash drive inserted
in USB Memory mode.



Operating in USB
Communication mode.

CF card

Displayed when a CF card is inserted.
The icon appears red when accessing the card.

Power source indicator

Indicates the instrument’s power source.



AC adapter operation



Battery pack operation
(Fully charged battery pack)



Battery pack operation



Battery pack operation
(Low battery indicator)

File Screen



Operational information is displayed along the bottom of the screen.

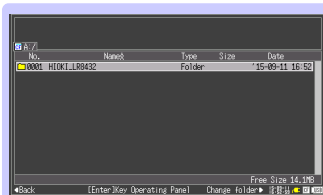

File Screen

View and manage files on the
CF card or USB flash drive
(p. 107).

Settings Screens

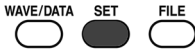

Selects between seven display types.

The screen switches each time you press the key.

Operational information is displayed along the bottom of the screen.

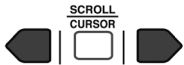

Press the left/right cursor keys to select between the Settings screens.

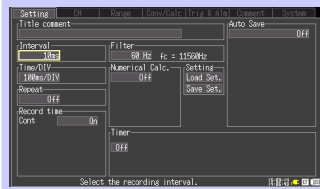
**[Setting] Screen**

Make settings for recording (p. 46). Set numerical calculation, auto-saving and timers.

**[CH] Screen**

Make input channel settings while viewing the monitor display (p. 54).

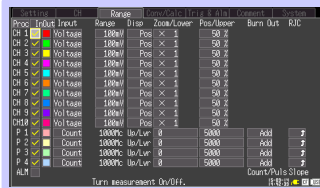
**[Range] Screen**

Make settings while viewing all channel settings (p. 72).

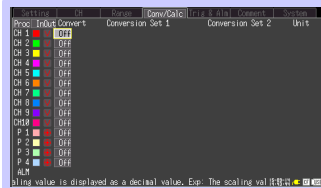
**[Conv/Calc] Screen**

Make these settings to convert measured values to arbitrary units for display (p. 67).

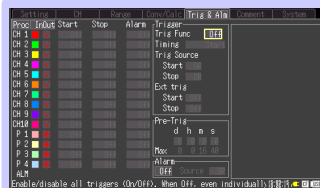
**[Trig & Alm] Screen**

Recording criteria (triggering) and warning sounds can be set for each channel (p. 79).

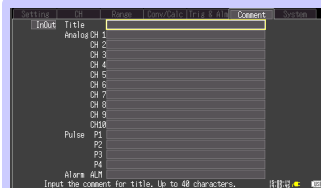
**[Comment] Screen**

Enter channel comments (p. 70)

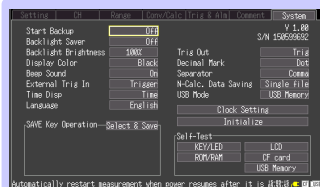
**[System] Screen**

Configure the system environment (p. 145).

1.5 Basic Operation

1

Chapter 1 Overview

Screen Operations

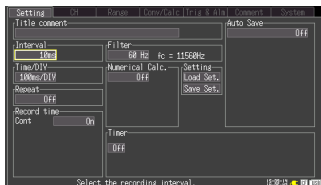

Setting Screen

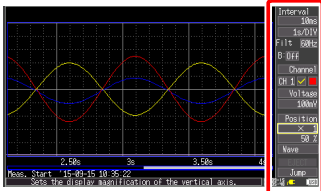

Waveform Screen

Changing screen contents

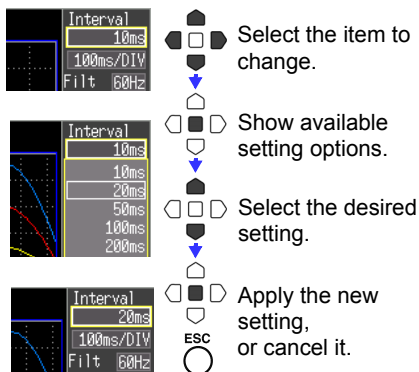

Scrolling a waveform

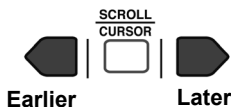

Refer to “Scrolling Waveforms” (p. 96).

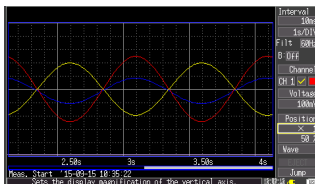

Reading values at cursors

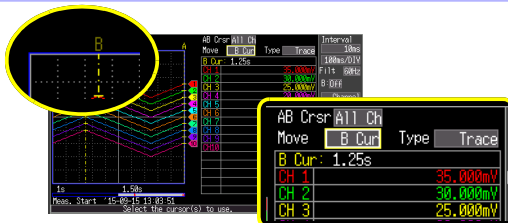
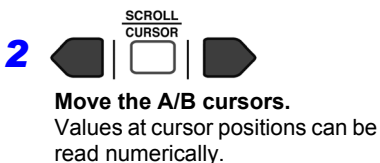
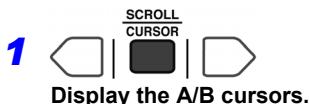

You can select the cursor display type and which cursor(s) to use (p. 99).

Starting and Stopping Recording

Acquire measurement data on the instrument, and start recording.

When recording stops depends on data recording settings (repeat recording, triggering, timers, etc.). (p. 92)

When you want measurement data to be automatically saved, before starting recording, check that auto-save is enabled (p. 51), that a CF card or USB flash drive is correctly inserted (p. 110), and that sufficient storage capacity is available (p. A12).

Start Measurement



Press the **START/STOP** key.

The green LED lights.

When using the trigger function, the times when measurement starts and when recording (data acquisition) starts are not the same.

A confirmation message appears when you press the **START/STOP** key to start recording. Save important data to a CF card or USB flash drive before starting, because previous measurement data will be overwritten when recording starts.

Finish Measurement

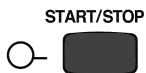

When **[Repeat]** (record multiple instances of the specified recording length) or **[Cont]** (record continuously) is enabled:

Pressing the **START/STOP** key stops recording.

When [Repeat] and [Cont] are disabled (Off):

Recording stops after the specified recording length. Pressing the **START/STOP** key during recording displays a confirmation message. Select **[Yes]** to stop recording.

For details about repeating and continuous recording:

Refer to "Selecting the Recording Start/stop Method" (p. 49).

"Set the Recording Length for Repeated or One-time Recording" (p. 50).

Disabling Key Operations (Key-Lock Function)

Keys can be disabled to avoid inadvertent operations.

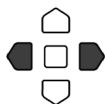

Press and hold the right and left cursor keys for three seconds to lock the other keys, and repeat to unlock.

Saving Data

Measurement data, settings, screen images and numerical calculation results can be saved.

For details of the saving methods, refer to “Chapter 6 Saving & Loading Data” (p. 107).

(Default settings)

Saving Method: **[Select & Save]** (Press the **SAVE** key to select and save data.)

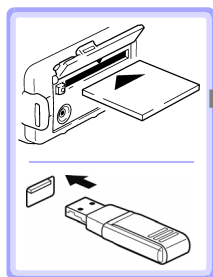

Insert a CF card or USB flash drive.

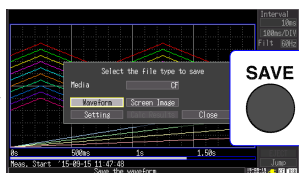

Press the **SAVE** key.
A dialog appears.

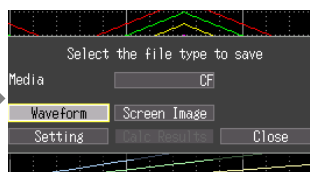

Select the save destination and item to save, and press the **ENTER** key.
Select **[Yes]** in the confirmation dialog, and press the **ENTER** key again to save the data to the CF card or USB flash drive.

NOTE

- When using a USB flash drive, set the USB mode on the **[System]** screen to **[USB Memory]**. USB flash drives cannot be used while the USB mode setting is **[USB Comm.]** or **[USB Drive]**.
- The **[USB Memory]**, **[USB Comm.]**, and **[USB Drive]** USB mode settings are exclusive and cannot be used simultaneously.

Verifying the Input Level (Level Monitor)

You can verify the input status and display range while making settings on the Setting screen. This is not available while measuring.

The screenshot shows the Level Monitor interface with a vertical gauge and a list of channel values. Callouts point to the following features:

- Level Monitor:** Points to the entire gauge and list area.
- Displayable Waveform Range:** Points to the vertical scale of the gauge.
- Current Input Signal Level and Channel Number:** Points to the green needle and the '75' value on the gauge.
- Display Channel and Gauge:** Points to the 'CH 1' label at the bottom of the gauge.
- Input Waveform Amplitude:** Points to the '10 V' value in the 'Range' section of the settings.
- Monitor:** Points to the 'Monitor' button in the bottom right corner of the settings panel.

Changing the Monitor Display

Select whether to display all channels, or only selected channels. **[All Ch]/[SlctCh]/[Value]**

- **[All Ch]**
The channels displayed in the level monitor are those with a check mark (☑) displayed next to the channel number in the settings.
- **[SlctCh]** (Selected Channels)
The level monitor displays the channel selected on this screen.
- **[Value]**
The input values of all channels are displayed numerically.
Via a link to the channel selected on this screen, the input values are displayed in a list as below.
 - When CH1 to CH10, P1 to P4, or ALM is selected, the value of the analog, pulse, or alarm channel is displayed.
 - When W1 to W10 is selected, the value of the waveform calculation channel is displayed.

Measurement Preparations

Chapter 2

2

Chapter 2 Measurement Preparations

1

Install the 9780 Battery Pack (option) (p. 26)



Rear View

2

Connect measurement cables (p. 32)

Voltage measurement:
Connect the measurement leads.

Temperature measurement:
Connect thermocouples.

Heat flow measurement:
Connect the Heat Flow Sensor.

Pulse signals:
Connect the Hioki 9641
Connection Cable

3

Connect the AC adapter (p. 31)



4

(To save data)
Insert a CF card or USB flash
drive (p. 109)

External control signal
inputs
External control signal
outputs (p. 155)

5

Turn the power on (p. 38)
Execute zero adjustment (p. 39)

2.1 Using the Battery Pack (Option)



If commercial power is not available when the AC adapter is connected, the instrument can operate from the Model 9780 battery pack, so when using commercial power, the battery pack serves as a backup supply during power outages.

Charge the battery pack fully before using it the first time.



Be sure to observe the following precautions. Incorrect handling may result in liquid leaks, heat generation, ignition, bursting and other hazards:

- **The battery pack contains lye, which may cause blindness if it comes into contact with the eyes. Should battery liquid get into your eyes, avoid rubbing them. Flush them with water and seek immediate medical attention.**
- **When storing the instrument, make sure no objects that could short-circuit the connectors are placed near them.**
- **Do not use a battery pack other than the 9780 Battery Pack. We cannot accept responsibility for accidents or damage related to the use of any other batteries.**
- **Battery may explode if mistreated. Do not short-circuit, recharge, disassemble or dispose of in fire.**

Installing and replacing the battery pack

- **To prevent electric shocks, remove the cables and then replace the battery pack.**
- **To prevent electric shocks, turn off the power switch and remove the cables, and then replace the battery pack.**
- **After installing or replacing the battery pack, replace the battery compartment cover and screw.**
- **Handle and dispose of batteries in accordance with local regulations.**
- **To prevent instrument damage or electric shock, use only the screw for securing the battery cover in place that are originally installed. If you have lost the screw (special screw dedicated for this model) or find that the screw is damaged, please contact your Hioki distributor for a replacement.**

 CAUTION

Observe the following to avoid damage to the instrument.

- Use the battery pack in an ambient temperature range of 0°C to 40°C and charge it in an ambient temperature range of 5°C to 30°C to be on the safe side.
- If the battery packs fails to complete charging within the stipulated time, disconnect the AC adapter from the pack to stop charging.
- Contact your authorized Hioki distributor or reseller should liquid leaks, strange odor, heat, discoloration, deformation and other abnormal conditions occur during use, charging or storage. Should these conditions occur during use or charging, turn off and disconnect the instrument immediately.
- Do not expose the instrument to water and do not use it in excessively humid locations or locations exposed to rain.
- Do not expose the instrument to strong impacts and do not throw it around.

2.1 Using the Battery Pack (Option)

NOTE

- The battery pack is subject to self-discharge. Be sure to charge the battery pack before initial use. If the battery capacity remains very low after correct recharging, the useful battery life is at an end.
 - When charging a battery pack with a low charge, charge it for 10 minutes or longer with the instrument's power off. Then turn on the instrument's power to achieve optimal performance from the battery pack.
 - The battery pack is a consumable. If you are able to use the instrument for only a limited period of time despite the battery pack being properly charged, the battery pack's service life is at an end, and it should be replaced.
 - When a battery pack that has not been used for a long time is used, charging may end before the battery pack is fully charged. In such a case, repeat charging and discharging a number of times before use. (A battery pack may also be in such a state immediately after purchase.)
 - The life of the battery pack (when capacity is 60% or more of initial capacity) is approximately 500 charge-discharge cycles. (The life differs depending on the conditions of use.)
 - To prevent battery pack deterioration when the battery will not be used for 1 month or longer, remove it and store it in a dry location with an ambient temperature range of between -10°C to 30°C. Be sure to discharge and charge it every two months. Long-term storage at low battery capacity will reduce performance.
 - When a battery pack is used, the instrument turns off automatically when the capacity drops. Leaving the instrument in this state for a long time may lead to over discharge so be sure to turn off the power switch on the instrument.
 - The charging efficiency of the battery pack deteriorates at high and low temperatures.
 - Remove the battery pack from the instrument once a month and check it for any abnormality in appearance, etc.
 - The battery pack slowly loses its charge, as it retains waveform data even when turned off. Backup waveform data is deleted when the battery completely loses its charge.
-

When to charge

When powering the instrument from the battery pack without the Model Z1005 AC Adapter, the low battery icon () is displayed when the battery charge is depleted, indicating that the battery pack requires charging.

Note that if the instrument is turned off under this situation, waveform data may fail to be backed up, and could be lost.

Approximate charging time:

About 200 minutes at 23°C when recharged at the first appearance of the low battery indicator.

Approximate continuous battery-only operating time

(When saving data to a CF card at a temperature of 23°C)

When using a USB flash drive, the continuous operating time may decrease depending on the particular USB flash drive in use.

- After a full charge, with the LCD backlight always on (default setting): approximately 2.5 hours
- After a full charge, with the LCD backlight off (five minutes after last key-press): approximately 3 hours

Refer to “Enabling and Disabling the Backlight Saver” (p. 147).

2.1 Using the Battery Pack (Option)

Install the Battery Pack

Required tool:

One Phillips screwdriver
(No.2)

Important

Disconnect the AC adapter when installing the battery pack.

Battery Compartment
Cover

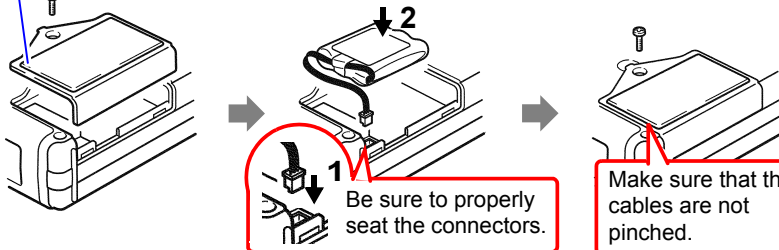

- 1** Place the Heat Flow Logger face down, and remove the battery compartment cover screw and cover.
- 2** Connect the plugs of the battery pack to the connectors and insert the battery pack with the label side up.
- 3** Replace the battery compartment cover and screw.

Pull the battery pack plug straight out to remove the battery pack.

Charge the Battery Pack

Regardless of whether the instrument is on or off, the battery pack recharges whenever the Z1005 AC Adapter is plugged in to a power source. Therefore, charging is provided by merely keeping the battery installed in the instrument.

- 1** Connect the power cord to the inlet socket on the AC adapter.

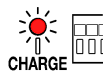
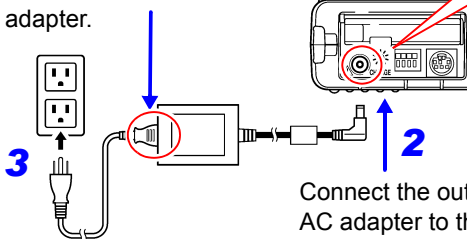

The CHARGE LED lights red when charging begins. Charging is finished when the CHARGE LED turns off.

2 Connect the output plug of the AC adapter to the instrument.

Plug the power cord into the mains outlet.

Refer to “2.2 Connecting the AC Adapter” (p. 31) for details about the AC adapter.

2.2 Connecting the AC Adapter



Connect the power cord and the instrument to the supplied Model Z1005 AC Adapter, then plug the power cord into an outlet. When used with the battery pack installed, the battery serves as an operating backup supply in case of power failure, and the AC adapter otherwise has priority.

Before Connecting



WARNING

- Use only the supplied Model Z1005 AC Adapter. AC adapter input voltage range is 100 V to 240 V AC at 50 Hz or 60 Hz. To avoid electrical hazards and damage to the instrument, do not apply voltage outside of this range.
- Turn the instrument off before connecting the AC adapter to the instrument and to AC power.
- To avoid electrical accidents and to maintain the safety specifications of this instrument, connect the power cord only to a 3-contact (two-conductor + ground) outlet.



CAUTION

To avoid damaging the power cord, grasp the plug, not the cord, when unplugging it from the power outlet.

- 1 Connect the power cord to the inlet socket on the AC adapter.

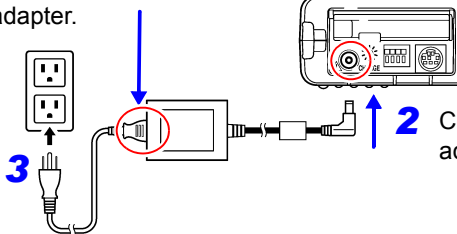

Rated supply voltage is 100 V to 240 V AC, and rated supply frequency is 50 Hz or 60 Hz.

- 2 Connect the output plug of the AC adapter to the instrument.

Plug the power cord into the mains outlet.

2.3 Connecting Measurement Cables to the Instrument



Connect the appropriate cables for the intended recording application.

- When recording voltage fluctuations or temperature changes (p. 34)
- When recording the heat flow (p. 35)
- When recording pulse signals (p. 37)

Be sure to read the “Operating Precautions” (p. 7). before connecting the cables.

Connecting to the Analog Input Terminals



- The maximum input voltage (and the maximum rated voltage to earth) for the analog input terminals is 30 V AC rms (or 60 V DC). If the voltage is exceeded, this device will be damaged and personal injury will result. Therefore, do not perform measurement in this case.
- Do not leave the instrument connected to test objects in environments where a voltage surge might exceed the dielectric withstand voltage. Doing so could result in damage to the instrument, bodily injury or fatal accident.



- Do not connect a cable to the instrument while it is connected to the object to be measured. Otherwise, an electric shock accident may occur.
- To avoid short-circuit accidents, make certain that connections are secure.
- Channels are insulated by semiconductor relays. When a voltage beyond the specification is applied between the channels, the semiconductor relay may short circuit. Please ensure that a voltage beyond specification, especially a surge such as a lightning, is never applied. When an abnormal measurement value is observed, please contact your authorized Hioki distributor or reseller for inspection.

2.3 Connecting Measurement Cables to the Instrument

NOTE

- Measurements may be affected by noise or other electromagnetic ingress if input leads are longer than about three meters.
- Route measurement leads and cables as far away as possible from power and earth lines.
- Measurement values may be scattered if the leads are routed in parallel with other devices. If they must be parallel, check operation before taking measurements.
- Avoid temperature changes around the terminal block. Especially avoid directed airflow such as from an electric fan or air-conditioner vent.
- If connecting crimped terminals to the analog input terminals, use insulated terminals for M3 screws with the size shown below.

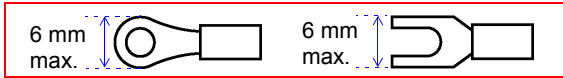

Connecting Measurement Leads or Thermocouples (for voltage or temperature, respectively)

Connect the voltage and temperature measurement (thermocouple) leads to the analog input terminals.

Tools required: Phillips screwdriver (for M3 screws)

The insulation colors of wires, which are to be connected to the plus and minus terminals, differ depending on countries or manufactures. Check with the manufacturer on the colors and connect them according to instructions.

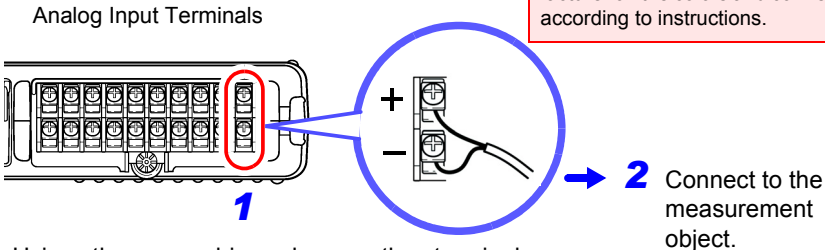

Using the screwdriver, loosen the terminal block screws, insert the bare ends of the leads, and tighten the screws.

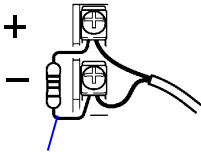
When applying 4 - 20 mA input current

Connect a 250 Ω shunt resistor as shown.

(For details on instrumentation control equipment measurements, see p. 56 .)

NOTE

K,E thermocouples experience a physical phenomenon known as short range ordering, which can prevent accurate measurement within the range of 250°C to 600°C.

Please choose a sensor after checking with the manufacturer of the thermocouple you intend to use.

Connect the Heat Flow Sensor (Heat flow measurement)

Connect the Heat Flow Sensor to the analog input terminal.

Tools required: Phillips screwdriver (for M3 screws)

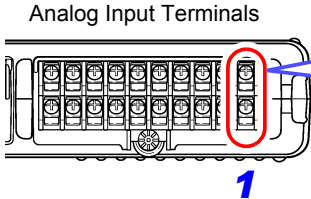

Using the screwdriver, loosen the terminal block screws, insert the wires of the cable as shown in the figure and tighten the screws.

+ - Red (+) White (-)	For Heat Flow Sensor Models Z2012, Z2013, Z2014, Z2015, Z2016, Z2017, Z2018, Z2019
Heat flow + - Yellow (+) Blue (-)	For Heat Flow Sensor Models Z2012-01, Z2013-01, Z2014-01, Z2015-01, Z2016-01, Z2017-01
Temperature + - Green (+) White (-)	

→ **2** Connect the cable to the measurement object.

For the procedure to install the Heat Flow Sensor, “Appendix 12 Heat Flow” (p. A41).

2.3 Connecting Measurement Cables to the Instrument

Connecting to the Pulse Input Connector



To avoid electric shock and short circuit accidents or damage to the instrument, pay attention to the following:

- The ground terminal for the optional 9641 Connection Cable is not isolated from the instrument's ground (chassis ground). Therefore, if the measurement object connects to AC, it should have a grounded, polarized plug, and be connected to the same power outlet as the instrument's AC adapter. If the instrument and measurement object are connected to different mains circuits, or if an ungrounded power cord is used, the potential difference between the different grounding paths may result in current flow through a connection cable that could damage the measurement object or instrument.
- Do not apply any voltage that exceeds the rated voltage (maximum input voltage: 0 V to 10 V) indicated in the specifications.
Damage or heating of the instrument could cause personal injury.

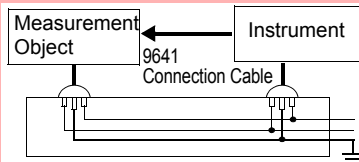

For safety, we recommend using only Hioki's connection cable (measurement lead cable).

Ends of the
9641 Connection Cable

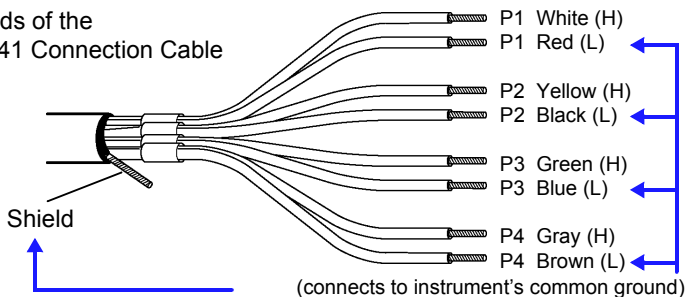

**Connecting the Optional Model 9641 Connection Cable
(for Pulse Signal Input)**

Connect the optional 9641 connection cable to the pulse input connector.

Pulse Input Connector

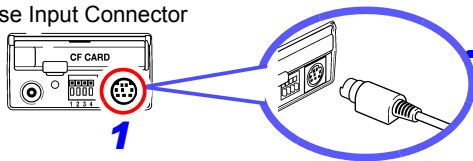

2 Connect the other end of the cable to the pulse source(s) to be measured.

2.4 Turning the Power On and Off

**WARNING**

Using the AC Adapter

Before turning the instrument on, make sure the supply voltage matches that indicated on its power connector. Connection to an improper supply voltage may damage the instrument and present an electrical hazard.

Rated supply voltage is 100 V AC to 240 V AC

Rated supply frequency is 50 Hz or 60 Hz.

Turning Power On

Verify that the instrument and peripheral devices are correctly connected.

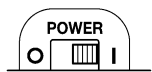

Turn the power switch on (I).



Right Side



Initial screen

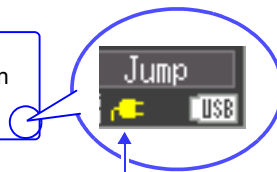

The power supply icon appears near the bottom right corner of the screen (p. 19).

If the icon “” is not displayed, the instrument is not being powered from the AC line. In this state, the battery charge will be depleted if measuring for a long time, and measurement may be interrupted. Verify that the AC adapter is securely connected to an AC power source and to the instrument.

Execute zero-adjust 30 minutes after turning power on (p. 39).

Turning Power Off

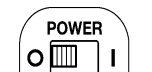

Turn the power switch off (O).

The installed battery pack is charged whenever the AC adapter is plugged into a power outlet, even when the instrument is off. In addition, providing there is some remaining battery charge, waveform data and the setting configuration are memorized whenever the instrument is turned off, so that when the instrument is turned back on, the same operating state is displayed.

2.5 Zero Adjustment

Zero adjustment corrects for voltage offset at the input terminals, so that the relative potential of the instrument is zero volts.

Perform the zero adjustment procedure when using the instrument in a location where the ambient temperature is markedly different.

Turn on the power and wait for 30 minutes to stabilize the internal temperature of the instrument.

- 1**  With the Waveform or [CH] screen displayed, press and hold these keys simultaneously for one second.

(simultaneously)

The Zero Adjust dialog appears.

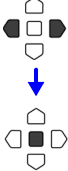
- 2** 

Select [Zero Adjust].

Apply

Zero adjustment is executed.

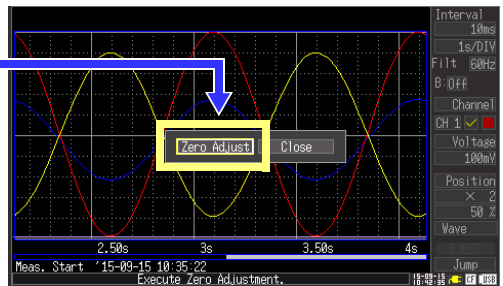

From the Setting screen

NOTE Any zero-adjust setting is cleared upon system reset (p. 151).

Setting before Measurement

Chapter 3

3.1 Pre-Operation Inspection

Before using the instrument the first time, verify that it operates normally to ensure that no damage occurred during storage or shipping. If you find any damage, contact your authorized Hioki distributor or reseller.

1 Peripheral Device Inspection

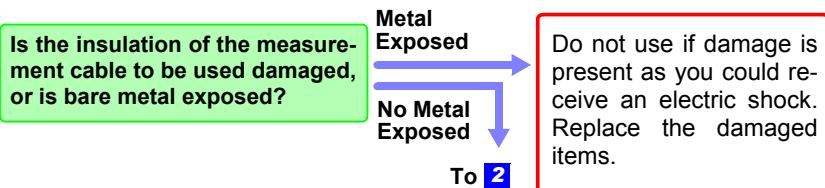

2 Instrument Inspection

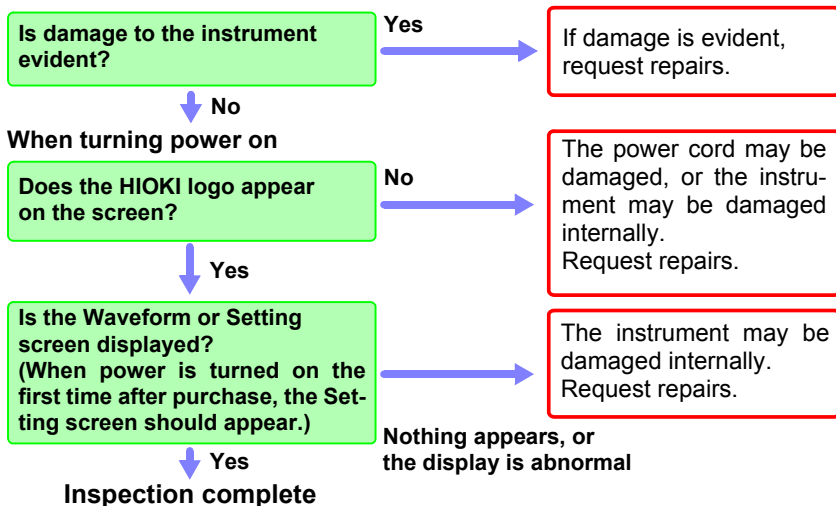

3.2 Operating Flow Overview

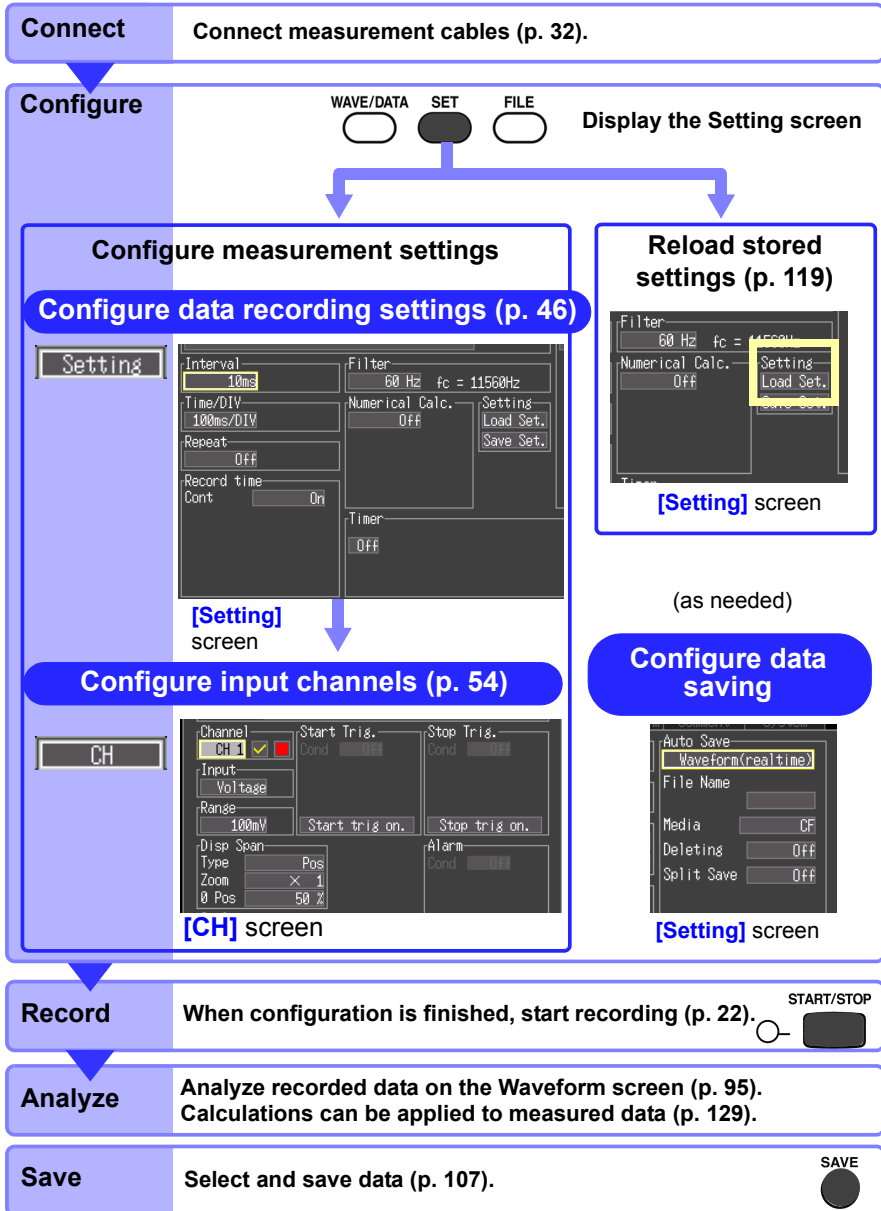

Measurement Configuration (Setting Screen)

Before measuring, configure the measurement settings on the [Setting] and [CH] screens. A brief operational description of the currently selected (high-lighted) setting item appears at the bottom of the screen.

Three recording methods are available. Timed recording, which record between specified start and stop times, can be used in combination with these methods (p. 90).

Recording Method	Description
Normal Recording	Records for the specified recording length beginning when measurement starts (Cont: Off).
Continuous Recording	Records continuously beginning when measurement starts (Cont: On).
Repeat Recording	Records repeatedly for the specified recording length (time span) (Repeat: On).

Configure recording settings: [Setting] screen

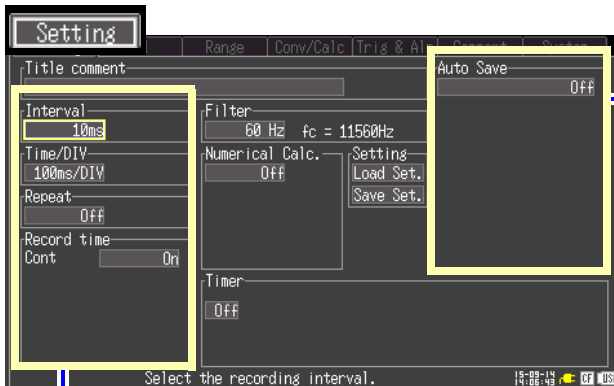

Make other settings as needed.

- Save automatically while measuring (p. 51)*
- Reloading Settings (p. 119)
- Saving Settings (p. 118)
- Enter a title for measurements (p. 70)
- Filter out noise (p. 50)
- Perform numerical calculations (p. 129)
- Perform waveform calculations (p. 139)
- Record by timer (p. 90)*

*. Must be set before measuring.

Horizontal Axis (Time Axis) Settings

- Data recording (acquisition) interval (p. 46)*
- Display time base (time per horizontal division) (p. 47)
- Recording start/stop method (p. 49)*
- Recording length (time span) for repeated or one-time recording (p. 50)*

Configure input channel settings: [CH] screen

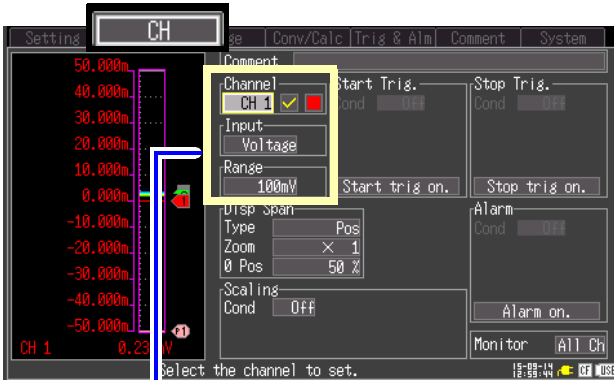
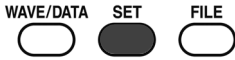

Input Channel Settings

- Voltage measurement (p. 56)
- Temperature measurement (p. 57)
- Heat flow measurement (p. 59)
- Integration (pulse count) (p. 61)
- Revolution measurement (p. 62)

Make other settings as needed.

- Entering channel comments (p. 70)
- Selecting channel display colors (p. 64)
- Setting the display range
 - Specifying the display position (p. 64)
 - Specifying upper and lower display limits (p. 65)
- Recording specific events (triggering) (p. 80)
- Setting alarm output (alarm function) (p. 86)
- Setting Unit Conversion (Scaling) (p. 67)
- Switching the monitor display (p. 24)

Measurement Configuration (Waveform Screen)

Certain setting items are available on the Waveform screen. Setting details are the same as for those on the Setting screen.

WAVE/DATA SET FILE

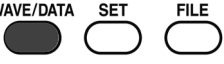

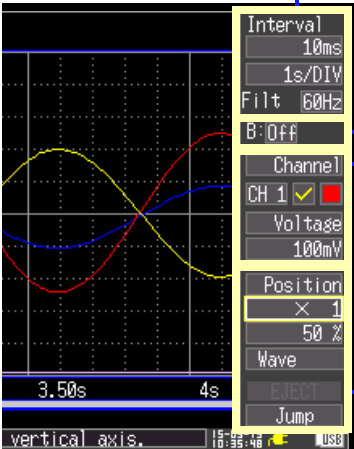

Horizontal Axis Settings

- Specify the recording interval (data acquisition interval) (p. 46)
- Specify the display time base (time per horizontal division) (p. 47)
- Enable digital filtering (noise suppression) (p. 50)

Input Channel Settings

- Voltage measurement (p. 56)
- Temperature measurement (p. 57)
- Heat flow measurement (p. 59)
- Integration (pulse count) (p. 61)
- Revolution measurement (p. 62)

Waveform Display Settings

- Setting the display range
Specifying the display position (p. 64)
Specifying upper and lower display limits (p. 65)
- Select the alarm display type (p. 98)
- Eject (replace the CF card/USB flash drive during real-time save operation)(p. 53)
- Displaying any point in time (Jump function) (p. 97)

Waveform Screen

About Channel Settings

Pressing the **CH ▲/▼** keys selects channel setting and gauge display items. However, while measurement data is displayed, such changes affect only those channels selected (by a check mark).

■ Channel switching

(Input channel setting) CH1 → CH2 → ... → CH10 → (Pulse input channel setting) P1 → P2 → ... → P4 → (Alarm channel setting) ALM → (Waveform calculation channel setting) W1 → W2 → ... → W10 → Back to CH1

3.3 Setting Configuration 1 – Recording Settings

Configure the horizontal axis and recording settings on the **[Setting]** screen. To save data while measuring, auto save must be enabled beforehand (p. 51).

1 WAVE/DATA SET FILE → Select the **[Setting]** screen.

2 → Move to a setting item.

→ Open the setting options for the item to be set.

→ Select from the listed options.

→ Apply

The **Setting** screen shows the following options:

- Interval: 10ms
- Time/DIV: 100ms/DIV
- Repeat: Off
- Record time: On
- Cont: Off
- Filter: 60 Hz fc = 11500Hz
- Numerical Calc.: Off
- Setting: Load Set., Save Set.
- Auto Save: Off

Specify the Recording Interval

Select the data acquisition interval to suit your measurement objectives. Note that shorter recording intervals restrict the maximum recording time.

Select from the **[Interval]** setting options.

Setting options:

10ms*, 20ms, 50ms, 100ms, 200ms, 500ms, 1s, 2s, 5s, 10s, 20s, 30s, 1min, 2min, 5min, 10min, 20min, 30min, 1h (* default setting)



Broken wire detection is automatically disabled when the interval is set to 10 ms, 20 ms or 50 ms (p. 57).

Some waveform peaks may not be displayable with certain interval settings.

For example, when the **[Interval]** is 1 s and the **[Time/DIV]** (time base) is 5 s.

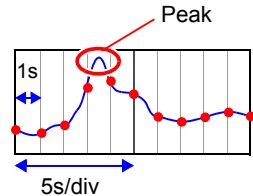

Setting the Display Time Base (horizontal axis magnification, set as needed)

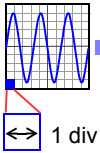

Displayed waveforms can be expanded or compressed along the horizontal axis. Shorter setting values correspond to greater magnification. This setting can be changed both during and after measurement without affecting acquired data (p. 97).

Select from the [Time/DIV] setting options.

Setting options:

100ms*, 200ms, 500ms, 1s, 2s, 5s, 10s, 20s, 30s, 1min, 2min, 5min, 10min, 20min, 30min, 1h, 2h, 5h, 10h, 12h, 1day [/DIV] (* default setting)

When auto save is enabled for waveforms, 100 ms, 200 ms and 500 ms settings are automatically changed to 1 s when measurement starts, and the shorter values cannot be selected while measuring.

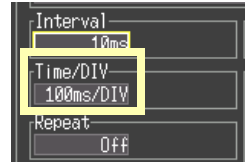

Selecting the Recording Start/stop Method

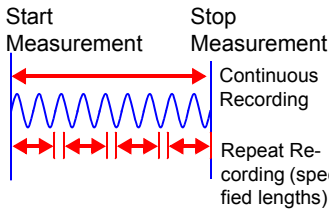

Specify how you want recording to start and stop. The following methods are available.

- Record continuously: Record continuously between starting and stopping measurement.
- Specified length (time span): Record only for a specified time span (can be set to automatically repeat) (p. 50)

To record continuously, Enable continuous recording (set [Cont] to [On]). (default setting)

Recording continues until you press the **START/STOP** key, or until a “stop trigger” event occurs. When auto save is enabled for measurement data, the saving method depends on whether **[Deleting]** or **[Split Save]** (segmented save) is selected (p. 51).



To record for a specified length (time span),

- 1** Set [Cont] to [Off].
- 2** Specify the duration of one recording length (time span).

Setting options:

d (days) 0 to 499, h (hours) 0 to 23,
min (minutes) 0 to 59, s (seconds) 0 to 59

Recording proceeds for the specified length. Recording stops early if you press the **START/STOP** key before the recording length has elapsed, or if a “stop trigger” event occurs.

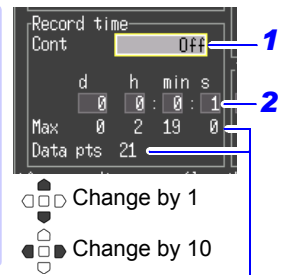

Maximum recording length and data samples

Indicates the maximum recording time to internal memory, and the maximum number of data samples. These values are limited by the specified recording length and the number of measurement channels used.

Refer to “Appendix 6 Maximum Recordable Time” (p. A12).

The number of data samples also includes data of 0 second. (Example) With a recording interval of 1 second and a recording length of 10 seconds, the number of data samples is 11.

3.3 Setting Configuration 1 – Recording Settings

Set the Recording Length for Repeated or One-time Recording

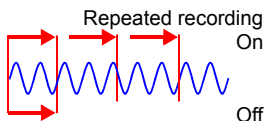

Select whether recording should be resumed after the specified recording length has elapsed or after recording is stopped by a “stop trigger” event.

Select from the [Repeat] setting options.

Setting options: (* default setting)

- Off*** Recording stop after one recording length (time span).
- On** Recording restarts after the specified recording length has elapsed or after recording is stopped by a “stop trigger” event. To manually stop recording, press the **START/STOP** key.

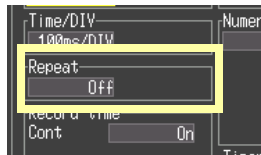

When repeating recording is enabled ([Repeat] set to [On])

After a recording length has elapsed, some “dead time” is needed for internal processing before recording can resume.

Because recording is not available during the dead time, enable continuous recording (set [Cont] to [On]) if you need to record without data loss.

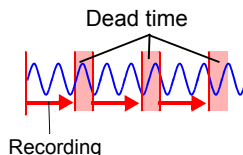

Enable Digital Filtering (noise suppression) (as needed)



Electrical noise mixed with input signals can be removed by digital filtering. Noise suppression is most effective for longer recordings, where it can provide higher measurement accuracy and less scattering. Set as needed to suit your measurement environment.

Refer to “Cut-off frequency” (p. 167).

Select from the [Filter] setting options.

Setting options: 60 Hz*, 50 Hz, Off (* default setting)

When disabled (set to Off), broken wire detection is also disabled (p. 57).

When the 60 Hz digital filter is selected, optimum line noise suppression occurs when the recording length is between two seconds and one hour.

Noise is suppressed with either 50 Hz or 60 Hz filter selections, although the measurement timing difference between channels may be increased, depending on the recording length. Disabling the filter (set to Off) minimizes such timing differences (to less than 1 ms between channels).

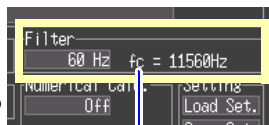

fc: cut-off frequency

Automatic Saving

Measurement data can be automatically saved to a CF card or USB flash drive while measuring.

The available types and formats of automatically saved data are as follows.

Saved Content	Setting	File Extension	Description
Waveform data only	Waveform (realtime)	.MEM	Waveform data is saved to the CF card while recording.
	CSV (realtime)*2	.CSV	Waveform data is saved in CSV text format while recording. Saved data cannot be reloaded in the instrument.
Calculation results only *1	Calc (post meas.)	.CSV	After recording, calculation results are saved to the CF card. When [Repeat] is enabled ([On]), calculation results for each recording are included in the recorded data file. When [Split Calc.] is enabled ([On]), calculation results are included for each split time.
Waveform data and calculation results *1	Waveform + Calc	.MEM, .CSV	Waveform data is saved while recording, and calculation results are saved when recording finishes.
	CSV + Calc*2	.CSV, .CSV	Waveform is saved in CSV text format while recording, and calculation results are saved when recording finishes. Saved data cannot be reloaded in the instrument.

*1. Numerical calculation settings must be made before starting recording (p. 129).

*2. The **[CSV (real time)]** and **[CSV + Calc]** settings are not available when the record interval is 10 ms or 20 ms. Also, when opening a CSV file in a spreadsheet program, note that the number of rows that can be loaded at one time is limited (p. A7).

3.3 Setting Configuration 1 – Recording Settings

1 Select which content to save from the [Auto Save] settings.

Setting options: **Off***, **Waveform(realtime)**, **CSV(realtime)**, **Calc(post meas.)**, **Waveform + Calc**, **CSV + Calc** (* default setting)

2 (As needed) You can enter a file name for the waveform files in the [File Name] box.

Refer to “3.6 Entering Comments” (p. 70).

If left blank, file names are created automatically.

Refer to “Appendix 2 File Naming” (p. A7).

3 Select the removable storage priority (CF card or USB flash drive)

When **[Waveform(realtime)]**, **[CSV(realtime)]**, **[Waveform + Calc]**, **[CSV + Calc]** is selected

4 Select the [Deleting] method for saving data when the CF card or USB flash drive becomes full.

Setting options:(* default setting)

Off* Saving stops when the CF card or USB flash drive becomes full.

On When space on the CF card or USB flash drive declines to a certain level when starting or during automatic saving, the oldest file is deleted. If the file cannot be deleted, saving stops. Only waveform files can be deleted in this way. “Appendix 2 File Naming” (p. A7).

5 Select whether to create a new file for each recording length, or to create new files at specified intervals (using [Split Save]).

Setting options:(* default setting)

Off* One file is created for each recording length.

On Specify the length (time span) of saved segments. A measurement data file is created for each segment.

Ref Time Specify a reference time and segment length (time span). A file is saved after each segment time span beginning at the reference time.

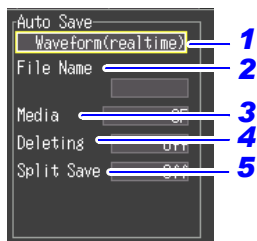

Horizontal axis settings are inhibited during automatic saving of waveforms (p. 47).

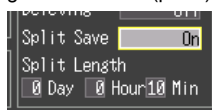

[Split Save: On]

Segment length: Days (0 to 30), Hours (0 to 23), Minutes (0 to 59)

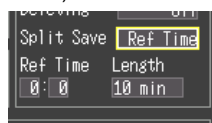

[Split Save: Ref Time]

Ref Time (reference time):

0:0 to 23:59

Length (Segment length):

1, 2, 5, 10, 15, 20, 30 minutes, 1, 2, 3, 4, 6, 8, 12 hours, 1 day

When starting measurement, the message “Sync fixed time” is displayed until the recording interval synchronizes with specified reference time.

NOTE

Regardless of the split save setting, the file will be automatically split when the file size nears 2 GB.

Replacing Removable Storage During Real-Time Saving

During real-time saving, removable storage can be replaced without interrupting measurement. This procedure describes replacing a USB flash drive.

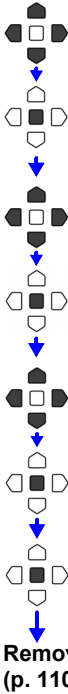

Move the cursor to [EJECT].  Right bottom of the screen

Execute

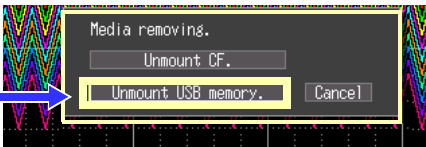
Move the cursor to [Unmount USB memory]. 

Execute

Move the cursor to [Yes]. 

Execute

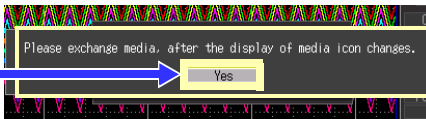
Execute  Bottom of the screen

Remove the USB flash drive (p. 110).

Insert a formatted removable storage.
Measurement data acquired while the device was removed is automatically written.*

Refer to “Formatting” (p. 111).
“Insertion” (p. 110).



When both a CF card and USB flash drive are installed and either is removed, the save destination automatically switches to the remaining media.

NOTE

- If a storage device is not replaced within two minutes after selecting “Yes” in the “Do you want to remove the USB memory/CF card?” confirmation dialog, data may overflow internal memory and be lost.
- If a storage device is replaced during real-time saving, data is saved to a new file.
- If measurement ends while the removable storage is ejected, even if a removal storage is then inserted, the remaining data is lost. If this occurs, the measurement data remaining on the instrument can be retrieved with the manual save function.

Refer to “6.3 Saving Data” (p. 112).

3.4 Setting Configuration 2 – Input Channel Settings

Configure the input channel settings on the **[CH]** screen. You can make these settings while viewing input signal amplitude on the level monitor.

There are two general types of input signals, analog channels CH1 – CH10 and pulse channels P1 to P4. The analog channels can be used to measure voltage, temperature (with thermocouples), and heat flow, and the pulse channels can be used for pulse counting (integration) and revolution measurement.

Analog channels	Pulse channels
“Voltage Measurement Settings” (p. 56).	“Integration (Count) Measurement Settings” (p. 61).
“Temperature Measurement Settings” (p. 57).	“Revolution Measurement Settings” (p. 62).
“Heat Flow Measurement Settings” (p. 59).	

Settings can be changed while viewing all channel settings on the **[Range]**, **[Conv/Calc]**, **[Trig & Alm]**, and **[Comment]** screens.

In this example, settings are made on the **[CH]** screen while viewing the level monitor.

You can specify recording criteria with the input settings to control recording, or to output alarm signals. Refer to “Chapter 4 Specifying Criteria for Measurements (Triggering, Alarm and Timer)” (p. 79). for details.

3.4 Setting Configuration 2 – Input Channel Settings

1 WAVE/DATA SET FILE → Select the [CH] screen.

2 → Move to a setting item.

↓ Open the setting options for the item to be set.

↓ Select from the listed options.

↓ Apply

Level monitor (p. 24)

Use the CH ▼/▲ keys to change the selected channel.

■ Channel switching

(Input channel setting) CH1 → CH2 → ... → CH10 → (Pulse input channel setting) P1 → P2 → ... → P4 → (Alarm channel setting) ALM → (Waveform calculation channel setting) W1 → W2 → ... → W10 → Back to CH1

Voltage Measurement Settings

Configure these settings for each voltage measurement channel.

- 1** Select a channel (**CH 1** to **CH 10**) for the **[Channel]** setting contents.
- 2** To enable measurement on the channel, select **On** to display the check mark (☑).
- 3** Select **[Voltage]** for the **[Input]** (input type) setting.
- 4** Select the appropriate measurement amplitude range for the **[Range]** setting.

Setting options:

10 mV*, **100 mV**, **1 V**, **10 V**, **20 V**, **100 V**, **1-5 V**

(* default setting)

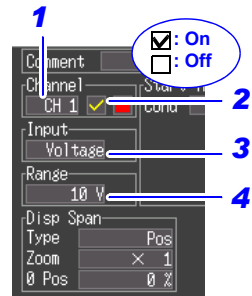

Instrumentation and Control Device Measurements

For instrumentation control signal measurements, select **[1-5 V]**. This range corresponds to the 4-20 mA output standard for instrumentation control. This setting automatically sets 1- and 5-volt lower and upper limits, respectively, in the 10 V range. Measurement accuracy is $\pm 10 \text{ mV} \pm 5 \text{ mV}$. To measure 4-20 mA current, connect a 250Ω shunt resistor between + and – analog input terminals (p. 34).

Use the scaling function to scale measurements to any arbitrary unit value for display (p. 67).

If the Allowable Measurement Range of each Range is Significantly Exceeded

“OVER” or “-OVER” is displayed for the numerical value or cursor value and the calculated value or saved data is handled as a full scale value.

Refer to “LR8432-20 Measurement Values” (p. A13).

Temperature Measurement Settings

Configure these settings for each temperature measurement channel.

1 Select a channel (**CH 1** to **CH 10**) for the **[Channel]** setting contents.

2 To enable measurement on the channel, select **On** to display the check mark (☑).

3 Select **[Tc]** for the **[Input]** (input type) setting.

4 Select the type of thermocouple to be used.

Setting options:

K*, J, E, T, N, R, S, B (* default setting)

5 Enable or disable **[Burn Out]**.

Setting options:(* default setting)

Off* Do not detect broken (disconnected) wires.
Normally when the thermocouple is disconnected, the value will fluctuate, etc. and will not be stable.

On Detect broken wires.
(This setting is available only when the recording interval is at least 100 ms, and the 50 Hz or 60 Hz digital filter is enabled.)
When the wires are disconnected, "OVER" will be displayed as the measurement value.

6 Select the reference junction compensation (**RJC**) method for the **[RJC]** setting.

Setting options:(* default setting)

Int* Use the instrument's internal compensation. This setting is made when a thermocouple (or compensating lead wire) is connected directly to the instrument. Measurement accuracy is the sum of the temperature measurement accuracy and the RJC accuracy.

Ext Use an external RJC method (0°C ice water, etc.) instead of the instrument's internal compensation. The instrument's measurement accuracy is equivalent to the temperature measurement accuracy.

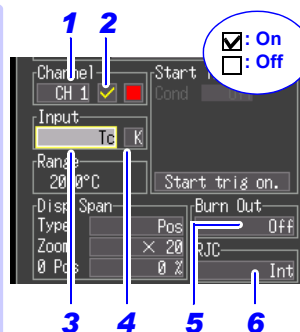

Temperature Measurement Range
(Depends on thermocouple type)

K	-200°C to 1350°C
J	-200°C to 1200°C
E	-200°C to 1000°C
N	-200°C to 1300°C
T	-200°C to 400°C
R	0°C to 1700°C
S	0°C to 1700°C
B	400°C to 1800°C

JIS C 1602-1995

With type B, the display shows 0 to 400°C, but accuracy is not guaranteed.

3.4 Setting Configuration 2 – Input Channel Settings

About Burn Out Detection

Broken (disconnected) thermocouple wires are detected using a tiny (300 nA) sensing current. The thermal equivalent of the thermoelectromotive force (thermocouple resistance (Ω) times the 300 nA sensing current) is added to the measured value. However, measurement errors can occur if the thermocouple wire is long or if the wire itself has a large resistance, in which cases broken wire detection should be disabled (set to Off).

When the Thermocouple Measurement Range is Exceeded or the Allowable Measurement Range of Each Range is Significantly Exceeded

- Example: Using a type T thermocouple with range -200°C to $+400^{\circ}\text{C}$

When measurements are outside of the range of the thermocouple, the waveform saturates and clings to the top of the screen as shown at the right.

If the allowable measurement range of each range is significantly exceeded, "OVER" or "-OVER" is displayed for the numerical value or cursor value and the calculated value or saved data is handled as a full scale value.

Refer to "LR8432-20 Measurement Values" (p. A13).

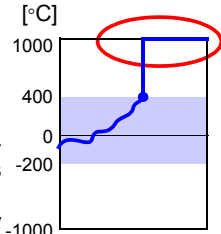

Heat Flow Measurement Settings

Configure these settings for each heat flow measurement channel when measuring heat flow using heat flow sensors.

- 1** Select a channel (**CH 1 to CH 10**) for the **[Channel]** setting contents.
- 2** To enable measurement on the channel, select On to display the check mark .
- 3** Select **[Heat]** for the **[Input]** (input type) setting.
- 4** Select the appropriate measurement amplitude range for the **[Range]** setting.
Setting options:
10 mV*, 100 mV, 1 V, 10 V, 20 V, 100 V, 1-5 V
(* default setting)
- 5** Enter the sensitivity constant of the sensor.
(When the sensitivity constant is set, the scaling setting for the corresponding channel is configured.)

*The test report that came with the Heat Flow Sensor contains the sensor's sensitivity constant.

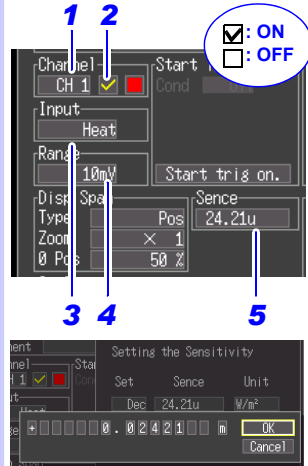

Example

For a sensitivity constant of $0.02421 \text{ mV/W m}^{-2}$, enter the figures shown in the above figure. Also enter a unit prefix, if necessary.

Integration (Count) Measurement Settings

Configure these settings for each pulse channel receiving input from a pulse output device such as a watt-hour or flow meter.

Use the scaling function to display integrated pulse counts as the corresponding physical units (such as Wh or VA) of the measurement parameter (p. 67).

1 Select a channel (P 1 to P 4) for the [Chan-] setting contents.

2 To enable measurement on the channel, select On to display the check mark (☑).

3 Select [Count] for the [Input] (input type) setting.

4 Select the measurement method from the [Count Mode] settings.

Setting options:(* default setting)

Add* Counts the number of pulses acquired from the start of measurement.

Inst Counts the number of pulses acquired during each recording interval. The pulse count is reset at the beginning of each recording interval.

5 Select the basis of measurement from the [Slope] settings.

Setting options:(* default setting)

↑* Counts the number of L - H transitions.

↓ Counts the number of H - L transitions.

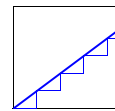
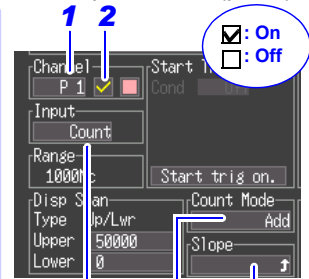

Totalized
[Add]

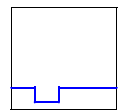

Instantaneous
[Inst]

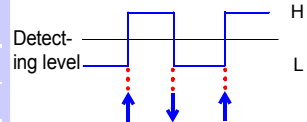

If the allowable measurement range of each range is significantly exceeded, “OVER” or “-OVER” is displayed for the numerical value or cursor value and the calculated value or saved data is handled as a full scale value.

Refer to “LR8432-20 Measurement Values” (p. A13).

NOTE

- When using the scaling function, the integrated pulse count can be displayed after conversion to the measurement target’s property (Wh, VA, etc.). (p. 67)
- The count will be saturated when the pulse count exceeds 1,073,741,823. If there is a possibility that this number may be exceeded, it is recommended to set the integration mode to instantaneous and tabulate the results later with spreadsheet software or a similar application.

Revolution Measurement Settings

Configure these settings for each pulse channel on which you will be counting pulses corresponding to revolutions, such as output from a rotary encoder or tachometer. The revolution measurement is obtained by counting the number of pulses input per second. The scaling function can be used to display the results of converting measured values to physical properties of the measurement target (p. 67).

1 Select a channel (P 1 to P 4) for the [Channel] setting contents.

2 To enable measurement on the channel, select On to display the check mark (☑).

3 Select [Revolve] for the [Input] (input type) setting.

4 Set the [Pulse/Rev] setting to the number of pulses per revolution.

Setting options: 1* to 1000 (* default setting)

The range is automatically determined by this setting.

5 Select the basis of measurement from the [Slope] setting.

Setting options: (* default setting)

↑* Counts the number of revolutions based on L - H transitions.

↓ Counts the number of revolutions based on H - L transitions.

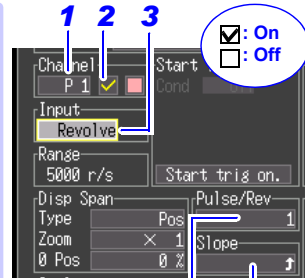

□ □ □ □ Change by 1

● □ □ □ Change by 10

5000 r/s (n=1)

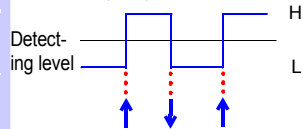

Revolution Measurement Theory

Pulse count is measured using the instrument's internal 10 ms sampling interval.

The revolution rate (r) per second during time t_s is obtained by dividing the number of pulses from $(t-1)$ to t_s by the number of pulses per revolution.

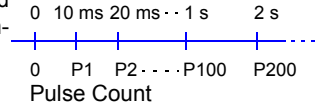

$$r [r/s] = \frac{\text{Pulse count at } t_s \text{ minus pulse count at } (t-1)_s}{\text{Pulses per revolution}}$$

(r/s : Revolutions per second)

Example: Pulses per revolution = 4

When the number of pulses counted in one second is $P_{100} = 1000$ c,

and the number of pulses counted in two seconds is $P_{200} = 2000$ c,

then the revolution rate (r/s) at $t=2s$ ($r_{t=2}$) can be obtained.

$$r_{t=2} = \frac{2000 - 1000}{4} = 250 [r/s]$$

When time t_s is less than one second

The pulse count at $(t-1)_s$ (whole seconds) cannot be measured, so 100 times the pulse count between $(t-0.01)_s$ and t_s serves and the pulse count for one second to obtain the revolution rate.

As a result, revolution measurements when t is less than one second are scattered.

$$r [r/s] = \frac{\text{Pulse count at } t_s \text{ minus pulse count at } (t-0.01)_s}{\text{Pulses per revolution}} \times 100$$

If the allowable measurement range of each range is significantly exceeded, "OVER" or "-OVER" is displayed for the numerical value or cursor value and the calculated value or saved data is handled as a full scale value.

Refer to "LR8432-20 Measurement Values" (p. A13).

3.5 Display Settings

Configure how each channel is displayed, as needed. These settings can be changed on the Waveform/Numerical screen after measurement.

Selecting Waveform Display Color

A waveform display color can be set for each input channel. The color can be changed in **[CH]**, **[Range]**, and Waveform/Numerical screen. It can be changed even during measurement in the Waveform/Numerical screen.

Select from the waveform display color setting options.

Setting options: **Off (x)**, 24-color

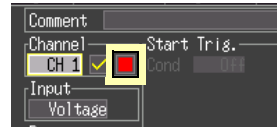

Specifying Vertical Display Range by Magnification and Zero Position (vertical axis expansion/compression)

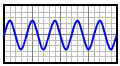

Normal Display

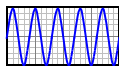

Magnified Display (x2)

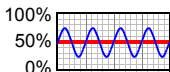

Zero Position: 50%

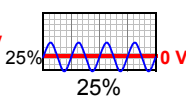

25%

The vertical display range and zero position can be specified for each channel.

The magnification setting determines the displayed range. Waveforms are expanded or compressed vertically relative to the center of the screen.

Magnification and zero-position settings are ignored when the display range is defined by upper and lower limits.

In the 1-5V range of a voltage measurement and in integration measurement, **[Position]** cannot be specified.

1 Select [Pos] for the [Type] setting options.

2 Select from the [Zoom] setting options.

Setting options:

x100, x50, x20, x10, x5, x2, x1*, x1/2

(* default setting)

3 Set the desired zero position [0 pos] as a percentage of screen height.

Setting options:

-50 to 150% (with x1 magnification)

Zoom	Zero-position setting range	Zoom	Zero-position setting range
x1/2	0 to 100%	x10	-950 to 1050%
x1	-50 to 150%	x20	-1950 to 2050%
x2	-150 to 250%	x50	-4950 to 5050%
x5	-450 to 550%	x100	-9950 to 10050%



Change by 1

The expansion/compression range depends on the selected magnification.

3

Chapter 3 Setting before Measurement

Default Setting

Input type	Zoom	Zero position	Input type	Zoom	Zero position
Voltage/heat flow	x1	50	Integration (Count)	—	—
Temperature (Tc)	x20	0	Revolution (Revolve)	x1	0

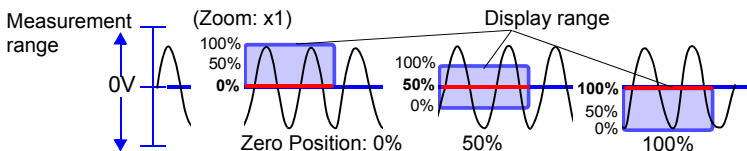

Specifying the Vertical Display Range by Upper and Lower Limits (expansion/compression)

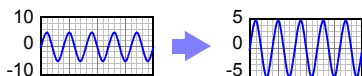

The vertical display range can be defined by upper and lower limits.

Using this method, the voltage range does not need to be selected because the optimum range is selected automatically for the display. However, upper and lower limit settings are ignored when magnification and zero position are enabled to define the display range.

3.5 Display Settings

As the upper and lower limits in the 1-5V range are fixed, they cannot be changed.

- 1** Select [Up/Lwr] for the [Type] setting item.
- 2** Specify the [Upper] value for the top of the display.
- 3** In the same way, specify the [Lower] value for the bottom of the display.

The display range and scaling settings are interlinked.

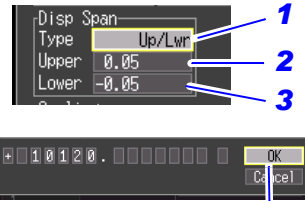

After making the settings, press [OK].

The range is not automatically optimized when the upper and lower limits are set on the waveform screen.

Default Setting

Input type	Range
Voltage/heat flow	-50m to 50m
Temperature (Tc)	0 to 100
Integration (Count)	0 to 5000
Revolution (Revolve)	0 to 5000

Converting Units (Scaling function)

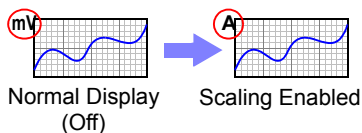

Use the scaling function to convert input voltage to the physical units of the measurement parameter for display, such to convert voltage input for display as electrical current. Converted values can be displayed in fixed- or floating-point notation.

Setting Analog Channel or Pulse Channel (Revolution) Scaling

1 For the [Cond](condition) setting, select the desired numerical notation.

Setting options:(* default setting)

Dec Displays converted values using fixed-point notation

Exp Displays converted values using floating-point notation

Off* Scaling is disabled.

2 Move to the next item to the right, and select the scaling method.

Setting options:(* default setting)

Ratio* Convert by specifying the ratio of physical units per volt of input signal (conversion ratio), offset, and the name of the units.

2-pt Convert by specifying the input signal voltage at two points, the physical unit values at those points, and the name of the units.

3 Enter the [Unit] name on the comment entry screen.

Refer to “3.6 Entering Comments” (p. 70).

4 **Ratio:** Enter the conversion ratio and offset.
2-pt: Enter the values at two points before and after conversion.

[Cond: Dec]

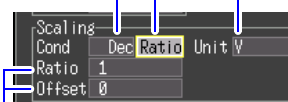

Conversion Ratio Setting



2-Point Setting

[Cond: Exp]

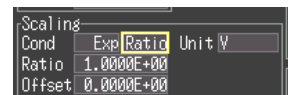

Conversion Ratio Setting

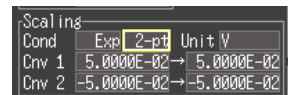

2-Point Setting

NOTE Scaling (voltage [V] to heat flow [W/m²]) is automatically set when the sensitivity constant is set during heat flow measurement. (p. 59)

3.5 Display Settings

Conversion Ratio Setting Method

2-Point Setting Method

Units (eu)

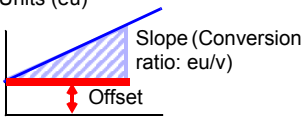

Converted unit values

Example

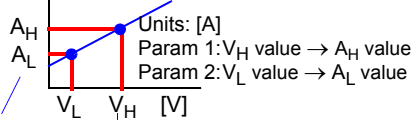

Actual measurement values (input values)

V _H :High value
A _H :Converted high value
V _L :Low value
A _L :Converted low value

Combining scaling and display positioning (upper/lower limits)

To use both scaling and upper/lower display limits, set the scaling first, then upper/lower limit values. With scaling enabled, the upper and lower limit setting ranges are constrained as follows:

$$-9.9999E+19 \leq \text{Setting value} \leq -1.0000E-19, \text{ Setting value} = 0, \\ +1.0000E-19 \leq \text{Setting value} \leq +9.9999E+19$$

Setting Pulse Channel (Integration) Scaling

Integrated pulse values can be converted for display as physical units of the measurement parameter (such as Wh or VA).

Pulse output devices determine the amplitude per pulse in physical units, or the number of pulses per fundamental unit (for example, per kWh, liter or m³).

1 For the [Cond] (condition) setting, select the desired numerical notation.

Setting options: (* default setting)

Dec Displays converted values using fixed-point notation

Exp Displays converted values using floating-point notation

Off* Scaling is disabled.

2 Enter the [Unit] name on the comment entry screen.

Refer to “Entering Comments” (p. 70).

3 Specify the physical units per pulse or the number of pulses per fundamental unit (for example, if 1 c = 1 pulse, select [1 pulse]). The settings for physical units per pulse and pulses per fundamental unit are interlinked.

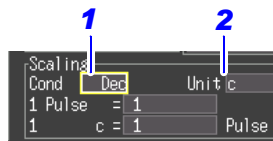

Using fixed-point notation

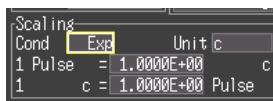

Using floating-point notation

Scaling Setting Example

For integration with a 50,000 pulse/kWh watt-hour meter:

Cond: Dec

Units: k Wh

1 kwh=50000 pulse

For integration with a 10 liter/pulse flow meter:

Cond: Dec

Units: L

1 pulse=10 L

3.6 Entering Comments

Comments of up to 40 characters can be entered as a title for the measurement data, and as a label for each input waveform.

Titles and comments are displayed on the waveform screen (Comments appear only when **[Value+Cmnt]** display is selected).

Titles can be entered on the **[Setting]** and **[Comment]** screens, and comments can be entered on the **[CH]** and **[Comment]** screens. This description enters a comment on the **[CH]** screen.

1  Select the **[CH]** screen.

2  Select the field to enter the comment.

 Apply
The character entry screen appears.

3  Select the characters to enter
To enter a space, select a blank character.

 Apply
Characters appear in the entry field as you select them.

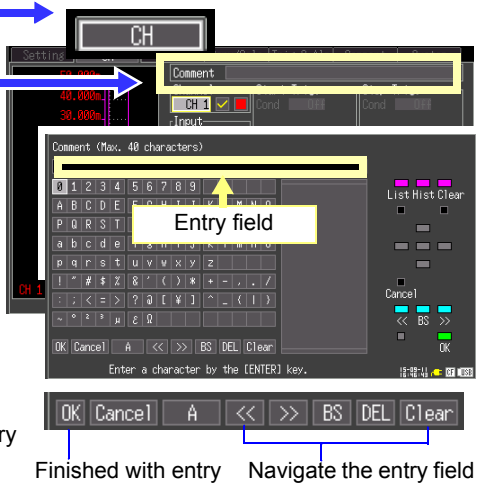





Finished with entry Navigate the entry field

Select **[OK]**

Accepts your entry and returns to the **[Comment]** screen.

The following characters are converted as follows when saved to a text file.

Entered character						
Converted plain text equivalent	^2	^3	^u	~o	~c	~e

Operating Panel

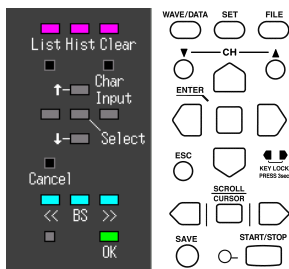

The operating panel depicts the functions of instrument's operating keys.

Only the keys displayed on the operating panel are enabled.

- **List** (WAVE/DATA key)
Measurement related terms are registered in the list beforehand.
- **Hist** (History, SET key)
You can select previously entered terms from the pick list.
- **Clear** (FILE key)
Clears all entered characters.
- **Char Input** (CH▲ key)
Switches between the pick list and character selection frames.
- **↑/↓** (Cursor up/down key)
Selects from the pick list frame.
- **Select** (ENTER key)
Accepts the item selected in the pick list.
- **Cancel** (ESC key)
Cancels entry.
- **<</ >>** (SCROLL/CURSOR left/right key)
Move input position.
- **BS** (SCROLL/CURSOR middle key)
Deletes one character.
- **OK** (START/STOP key)
Accepts entry.

3.7 Viewing All Channel Settings in a List

All channel settings can be viewed and changed in the list. You can copy batches of settings between channels.



[Range] screen

Setting	CH	Range	Disp	Zoom/Lower	Pos/Upper	Comment	System
Proc	InOut	Input					
CH 1		Voltage	100mV	Pos	× 1	50 %	Burn Out
CH 2		Voltage	100mV	Pos	× 1	50 %	
CH 3		Voltage	100mV	Pos	× 1	50 %	
CH 4		Voltage	100mV	Pos	× 1	50 %	

[Conv/Calc] screen

Setting	CH	Range	Conv/Calc	Trig & Alm	Comment	System				
Proc	InOut	Convert	Conversion Set 1	Conversion Set 2	Unit					
CH 1		Dec	Rat	Ratio	2	Offset	0	A		
CH 2		Dec	Rat	Ratio	10	Offset	0	m/s ²		
CH 3		Dec	2-pt	0	→	0	10	→	100	Pa
CH 4		Dec	Rat	Ratio	4	Offset	3	V		

Input Types

(: Voltage, : Temperature, : Heat flow, : Integration, : Revolution, : Alarm)

[Trig & Alm] screen

Setting	CH	Range	Conv/Calc	Trig & Alm	Comment	System
Proc	InOut	Start	Stop	Alarm	Trigger	
CH 1		Level	Off	Off	Trig Func	On
CH 2		Off	Off	Level	Timing	Start/Stop
CH 3		Off	Off	Off	Trig Source	
CH 4		Off	Off	Off	Start	AND

Input Types



(: Voltage, : Temperature, : Heat flow, : Integration, : Revolution, : Alarm)



[Comment] screen

Setting	CH	Range	Conv/Calc	Trig & Alm	Comment	System
InOut	Title					
	Analogue CH 1	TEST1				
	CH 2	TEST2				
	CH 3	TEST3				
	CH 4	TEST4				
	CH 5	TEST5				

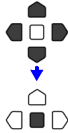

Switching Channel Display Settings

The list display settings can be switched to analog channel, pulse, alarm display, or waveform calculation display.

- 1**    Select the screen to switch the display.
[Range], [Conv/Calc], [Trig & Alm], [Comment]

- 2**   Select **[InOut]**
-  ENTER
 • The list is displayed.



Settings	CH	Range	Conv/Calc	
Prog	InOut			
CH 1	Heat	100mV	Pos	× 1
CH 2	Voltage	100mV	Pos	× 1
CH 3	Voltage	100mV	Pos	× 1
CH 4	Voltage	100mV	Pos	× 1

- 3**  Select items to be displayed.
- **[InOut]**
Analog, Pulse, Alarm are displayed.
 - **[Calc]**
Waveform Calculation is displayed.
-  Apply

3.7 Viewing All Channel Settings in a List

Batch Copying Channel Settings

The CH 1, P 1, and W 1 channel settings can be copied to other channels.

- 1**    Select the screen showing the channel to copy.
[Range], [Conv/Calc], [Trig & Alm]

- 2**  Select **[Proc.]**.

 Apply

Settings	CH	Range	Conv/Calc	Trig
[Proc.]	InOut Input	Range	Disp	Zoom/Lower
CH 1	✓ Voltage	100mV	Pos	× 1
CH 2	✓ Voltage	100mV	Pos	× 1
CH 3	✓ Voltage	100mV	Pos	× 1
CH 4	✓ Voltage	100mV	Pos	× 1
CH 5	✓ Voltage	100mV	Pos	× 1

The selected items are displayed.

- 3**  Select the desired action.
 (When the analog, pulse, or alarm channels is displayed)

- **[Copy settings of CH1 to all other analog channels]** :
Copy the settings from channel 1 to channels 2 through 10.
- **[Copy settings of P1 to all other pulse channels]** :
Copy the settings from channel P1 to channels P2 through P4.

Select command
Reset all settings in this page
Copy settings of CH1 to all other analog channels
Copy settings of P1 to all other pulse channels
Put all analog channels in order 5%
Put all analog channels in order 10%

Except for the following, the settings displayed on the screen are copied.

- Waveform display color
- Input type (although this can also be copied from the **[Range]** screen, p. 72)

When the waveform calculation channel is displayed

- **[Copy settings of W1 to all other waveform calc. CHs]** :
Copy the settings from channel W1 to channels W2 through W10.

 Apply

Batch Setting Waveform Display/Hide and Waveform Color Settings for All Channels

The display of all waveforms can be hidden, and all waveform display colors can be set to defaults.

This setting is only available on the **[Range]** screen.

1  Select **[Proc.]**.

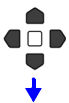

Apply
The selected items are displayed.

2  Select the desired action.

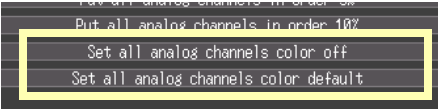

- **[Set all analog channels color off]:**
Sets all channel waveforms to be hidden.
- **[Set all analog channels color default]:**
Sets all channel waveform colors to their defaults.

Apply

Initializing Settings (to factory defaults)

All settings in the current window are reset to their factory default values.

1  WAVE/DATA SET FILE Select which screen you want to initialize, from the **[Range]**, **[Conv/Calc]**, **[Trig & Alm]** screens.

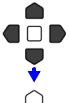
2  Select **[Proc.]**.

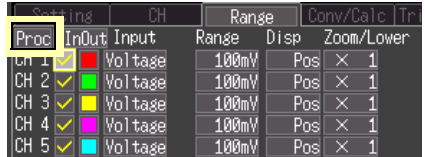

Apply
The selected items are displayed.

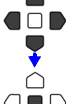
3  Select **[Reset all settings in this page]**.

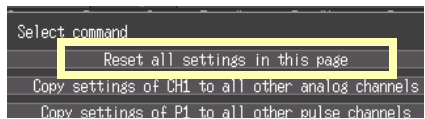

Apply

3.7 Viewing All Channel Settings in a List

Aligning Zero Positions on the Grid

Analog channel waveforms can be positioned evenly along the vertical grid, with CH1 at the top. ([Range] screen only)

This functionality is valid only for channels with the same input time as CH1 and for which [Display range] has been set to [Setting: Position].

CH1 to CH10 waveforms can be displayed together with each allotted 5% or 10% of the screen height.

This setting is only available on the [Range] screen.

- 1 Select [Proc].
- Apply
- The selected items are displayed.

Proc	InOut	Input	Range	Disp	Zoom/Lower	Pos
CH 1	✓	Red	Voltage	100mV	Pos	× 1
CH 2	✓	Green	Voltage	100mV	Pos	× 1
CH 3	✓	Yellow	Voltage	100mV	Pos	× 1

- 2 Select the desired action.
- Apply

Copy settings of P1 to all other pulse channels	
<input type="checkbox"/>	Put all analog channels in order 5%
<input type="checkbox"/>	Put all analog channels in order 10%
<input type="checkbox"/>	Set all analog channels color off

Alignment Example (with CH1 zero-position aligned at 95% and occupying 10% of vertical screen height)

Channel	Zero-position (%)
CH1	95
CH2	85
CH3	75
CH4	65
CH5	55
CH6	45
CH7	35
CH8	25
CH9	15
CH10	5

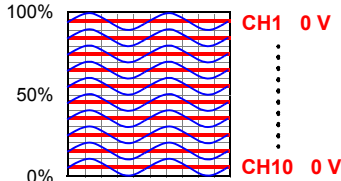

Specifying Criteria for Measurements (Triggering, Alarm and Timer) Chapter 4

You can set recording to start and stop under specific criteria (start/stop triggers), and to output alarm signals. You can also set specific times to start and stop recording, using the Timer function.

Triggering is the process of controlling the start and stop of recording by specific signals or conditions (criteria). When recording is started or stopped by a specific signal, we say the trigger is “applied” or “triggering occurs”.

In this manual, **T** indicates a “trigger point”, as the time at which a trigger is applied.

Trigger criteria met

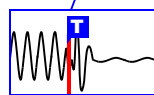

Criteria can be specified for the following event trigger types.

Trigger Type	Description	Setting Screen	Ref.
Start Trigger	Recording starts when the specified Start Trigger criteria are satisfied.	[CH]/ [Trig & Alm]	(p. 80)
Stop Trigger	Recording stops when the specified Stop Trigger criteria are satisfied. When [Repeat] is enabled (set to [On]), recording restarts automatically.	[CH]/ [Trig & Alm]	(p. 80)
Pre-trigger	Records data acquired during a specified period prior to each trigger event.	[Trig & Alm]	(p. 85)
Trigger Source	Various trigger criteria can be combined with logical AND/OR operations for each channel.	[Trig & Alm]	(p. 84)
External Trigger	Triggering can be applied by an external signal at the EXT.TRIG input terminal.	[Trig & Alm]	(p. 84)
Alarm	An alarm signal can be output when any specified criteria are met.	[CH]/ [Trig & Alm]	(p. 86)
Timer	Records at a specified date and time.	[Setting]	(p. 90)

Set trigger criteria for individual channels on the [CH] screen, and set trigger and alarm settings for all channels on the [Trig & Alm] screen (p. 89).

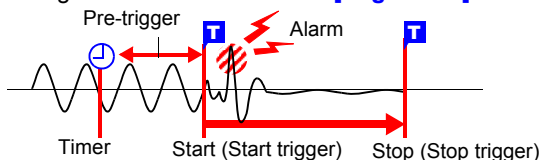

4.1 Setting Criteria to Start and Stop Recording

There are two ways to set the criteria to start and stop recording according to waveform slope.

Select whether to trigger at the rising or falling edge of the input signal.

Type of Analog Trigger	Trigger Example	Description
Level Trigger (p. 81) [Level]		Recording starts (or stops) when the input signal crosses the specified trigger level (voltage).
Window Trigger (p. 83) [In]		Recording starts (or stops) when the input signal enters a range defined by upper and lower thresholds.
[Out]		Recording starts (or stops) when the input signal exits a range defined by upper and lower thresholds.

Enable the Trigger Function

Select the trigger to use, and press the **ENTER** key. Press it again when the confirmation message appears, and you are ready to set trigger criteria (at the same time, the [Trigger] setting on the [Trig & Aim] screen turns on).



Set trigger criteria

Select the trigger criteria to be applied.



The [Timing] setting on the [Trig & Aim] screen determines the effect of triggering, as follows:

- Start recording upon trigger: [Start]
- Stop recording upon trigger: [Stop]
- Alternately start and stop upon trigger: [Start&Stop]

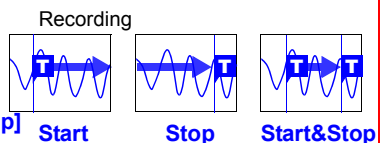

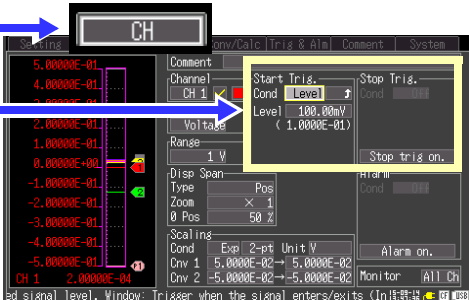

1 WAVE/DATA SET FILE → Select the [CH] screen.

2 → Move to a setting item.

→ Open the setting options for the item to be set.

→ Select from the listed options.

→ Apply

Setting the Input Signal Trigger Threshold (Level Trigger)

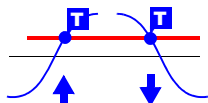

Enter the signal level threshold at which to start or stop recording, and whether triggering occurs on the upslope or downslope of the input signal.

Recording starts or stops when the signal crosses the specified threshold. The level value is an instantaneous (not rms) value.

Levels can be confirmed on the level monitor or on the Waveform screen.

1 Select [Level] as the [Cond] setting option for the start or stop trigger.

2 Select the input signal rising (↑) or falling (↓) edge setting option.

Setting options: (* default setting)

↑* Recording starts (or stops) when the signal crosses the threshold on the upslope (rising edge ↑).

↓ Recording starts (or stops) when the signal crosses the threshold on the downslope (falling edge ↓).

3 Set the [Level] setting to the input signal level at which to start or stop recording.

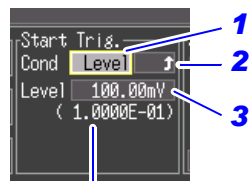

When scaling is enabled, the scaled value is also displayed.

Default setting: 0

4.1 Setting Criteria to Start and Stop Recording

Level Setting Ranges and Resolution

Channels	Input type	Range	Resolution	Channels	Input type	Range	Resolution
CH1 - CH10	Voltage/ heat flow	10 mV	2.5 μ V	P1 - P4	Count	—	1 c
		100 mV	25 μ V		Revolve	—	1 r/s
		1 V	250 μ V				
		10 V	2.5 mV				
		20 V	5 mV				
		100 V	25 mV				
		1-5 V	2.5 mV				
	Tc	—	0.5°C				

Setting Lower and Upper Trigger Thresholds (Window Trigger)

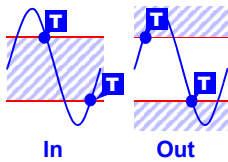

An input signal level “window” within which recording will (or will not) occur can be defined by upper and lower threshold levels. You can select whether recording starts or stops when the input signal level enters (In) or exits (Out) of this window.

Upper and lower thresholds can be verified in the level monitor or on the Waveform screen. When scaling is enabled, the scaled threshold values are displayed.

1 Select **[Window]** as the **[Cond]** setting option for the start or stop trigger.

2 Select inside **[In]** or outside **[Out]**.

Setting options: (* default setting)

In* Trigger when the input signal level enters the window defined by the upper/lower thresholds.

Out Trigger when the input signal level exits the window defined by the upper/lower thresholds.

3 Enter the upper threshold value for the **[Upper]** setting.

4 Enter the lower threshold value for the **[Lower]** setting.

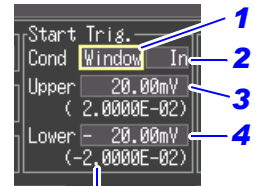

When scaling is enabled, the scaled value is also displayed.

Upper/Lower Threshold Ranges and Resolution

Channels	Input	Range	Resolution	Default setting	
				Upper	Lower
CH1 - CH10	Voltage/ heat flow	10 mV	2.5 μ V	0.2 mV	-0.2 mV
		100 mV	25 μ V	2 mV	-2 mV
		1 V	250 μ V	20 mV	-20 mV
		10 V	2.5 mV	0.2 V	-0.2 V
		20 V	5 mV	0.4 V	-0.4 V
		100 V	25 mV	2 V	-2 V
	1-5 V	2.5 mV	0.2 V	-0.2 V	
	Tc	---	0.5°C	40°C	-40°C
P1 - P4	Count	---	1 c	80	0
	Revolve	---	1 r/s	80	0

4.1 Setting Criteria to Start and Stop Recording

Selecting Trigger Sources and Combinations

Enable the trigger function (set to On), select recording start/stop timing, and set trigger criteria. Triggering is affected only by those channels for which trigger criteria have been set.

Make these settings on the **[Trig & Alm]** screen.

If trigger settings have been made on the **[CH]** screen, skip steps 1 and 2.

The settings in steps 1 and 2 are interlinked with those on the **[CH]** screen.

1 Set the **[Trigger]** to **[On]**.

2 Select the **[Timing]** setting option to determine how triggering will affect recording.

Setting options: (* default setting)

Start* Start recording according to Start Trigger criteria.

Stop Stop recording according to Stop Trigger criteria.

Start&Stop Start and stop recording according to the Start and Stop Trigger criteria, respectively.

(Start and stop triggers can be set for each channel independently.)

3 Select how trigger sources are logically combined using the **[Trig Source]** - **[Start]** and **[Stop]** setting options.

Setting options:(* default setting)

OR* Triggering occurs when any one of the specified trigger source criteria is met. (includes external trigger signal)

AND Triggering occurs only when all of the specified trigger source criteria are met. (includes external trigger signal)

4 (When an external trigger is applied)

Set the **[Ext trig]** - **[Start]** or **[Stop]** setting to **[On]**.

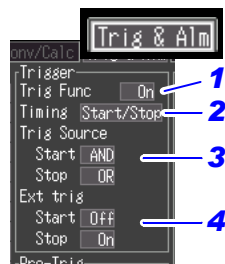

To apply a trigger when the upslope (\uparrow) of the waveform crosses zero volts:

Trigger..... Level
Level..... 0 V
Slope..... \uparrow

When the trigger combining logic is set to **[AND]**

If trigger criteria are already met when you press the **START/STOP** key, no triggering occurs. Triggering occurs only after all trigger sources have ceased to meet the criteria at once, and are subsequently met again.

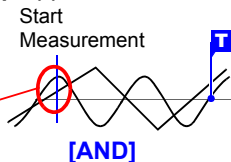

[AND]
One waveform has crossed above 0V as the other crosses on the upslope

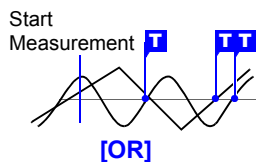

[OR]
Either waveform crosses 0V on the upslope

Setting Criteria for Pre-Trigger Recording (Pre-Trig)

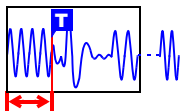

Select the **[Start]** or **[Start&Stop]** trigger timing setting to record waveforms both before and after trigger events.

However, pre-trigger recording is disabled when **[Stop]** trigger timing is selected.

Make the setting on the **[Trig & Alm]** screen.

For the **[Pre-Trig]** setting, specify the time (or number of days) to record before a trigger event.

To record waveforms after a trigger event, simply specify a recording time that is longer than the pre-trigger recording time.

Difference between **[Waiting for pre-trigger]** and **[Waiting for trigger]**

When measurement is started, the specified pre-trigger length is recorded. This period is indicated as the **[Waiting for pre-trigger]**.

After the specified pre-trigger length has been recorded, the period indicated as **[Waiting for trigger]** continues until a trigger occurs.

During the **[Waiting for pre-trigger]** period, trigger events are not recognized even when the trigger criteria are met.

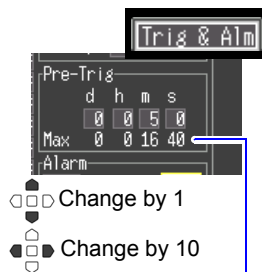

The maximum settable time span is displayed.

Pre-Trigger vs. Recording Time

Recording Time shorter than Pre-Trigger Time

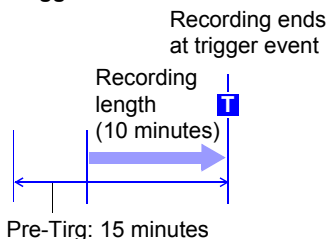

Recording Time longer than Pre-Trigger Time

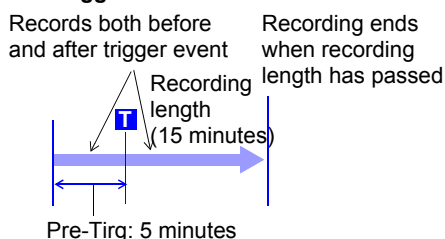

4.2 Alarm Output

You can enable beep tones and an alarm output signal (for external use) for each input channel by setting its alarm criteria. You can also view alarm output status on screens that display numerical values ([Wave+Value], [Value+Cmnt] and [Value]).

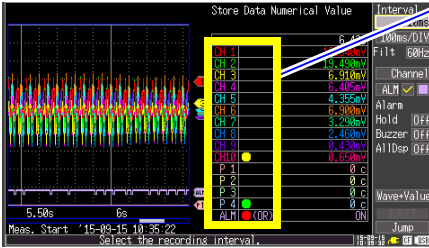

Alarm Criteria

Channel alarm status (CH 1 to CH10, P 1 to P 4, and W 1 to W10)

- Yellow*: alarm criteria are satisfied
- Green: alarm criteria are not satisfied

*. When [Hold Alarm] is enabled (set to [On]), the indicator remains yellow because the criteria remain satisfied (until measurement is finished).

The [Buzzer] alarm sound can be set to on or off. When [AllDsp] is set to [On], the detected waveforms for CH 1 to CH10 and P 1 to P 4 set to the alarm source will also be displayed (The detected waveforms for W1 to W10 are not displayed).

Alarm output status (ALM)

- Red: alarm signal output active
- Green: alarm signal output inactive

No alarm signal or alarm sound is output after measurement stops.

External alarm output requires connection to the external control terminals. Refer to “Chapter 9 External Control” (p. 155) for details.

Select alarm input channels on the [CH] screen, and specify alarm criteria on the [Trig & Alm] screen.



Select the [CH] screen.



Configuring Alarm Output

- 1** Select the [Channel] setting option to [ALM].
- 2** Set a check mark [] as shown to enable alarm output.
- 3** Set the [Hold Alarm] as required for your alarm output destination device.
Setting options:(* default setting)

Off*	Disable the alarm output signal when alarm criteria are no longer met.
On	Hold the alarm output active state until measurement is finished.
- 4** Enable or disable the alarm beeper by the [Buzzer] setting.
Setting options:(* default setting)

Off*	The instrument will not sound an audible beep during alarm signal output.
On	The instrument will sound an audible beep during alarm signal output.

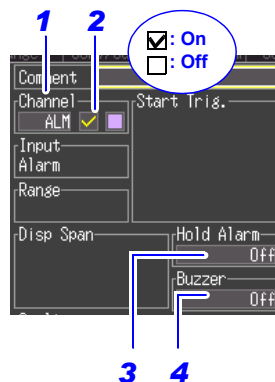

To stop the alarm beeper while measuring, set the beeper to [Off] in the ALM channel settings on the Waveform screen.

Setting Alarm Criteria for Each Channel

- 1** For the [Channel], select a channel for which you want to set alarm criteria.
- 2** Select [Alarm on.] to enable alarm criteria settings.
- 3** Select the alarm criteria type from the [Cond] setting options.

Setting options:(* default setting)

Off* Disable alarms for this channel.

Level Trigger an alarm when the input reaches a specified level.

Window Trigger an alarm when the input transitions through upper and lower limits (window).

Alarm criteria settings are not available unless a check mark is displayed next to the channel number.

- 4** Set the alarm criteria.
If you have selected [Level].

Setting options:

↑ Alarm output occurs when the input signal rises above the specified level threshold.

↓ Alarm output occurs when the input signal falls below the specified level threshold.

If you have selected [Window].

Setting options:

In Alarm output occurs when the input signal enters the range defined by the thresholds.

Out Alarm output occurs when the input signal exits the range defined by the thresholds.

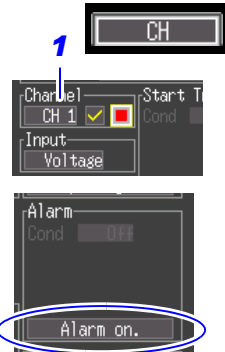

ALM appears when no channel output is checked (). In this case, select [Alarm on.] to enable alarm output settings, and then set alarm criteria.

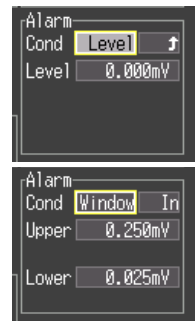

WAVE/DATA SET FILE Select the [Trig & Alm] screen.



Selecting Combined Alarm Output Criteria

Select how you want to combine alarm output criteria from the [Alarm] setting options.

Setting options:(* default setting)

OR* Alarm output occurs when the alarm criteria specified for any alarm-enabled channel are satisfied.

AND Alarm output occurs only when the alarm criteria for every alarm-enabled channel are satisfied.

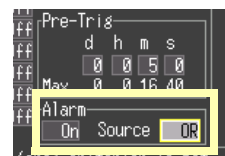





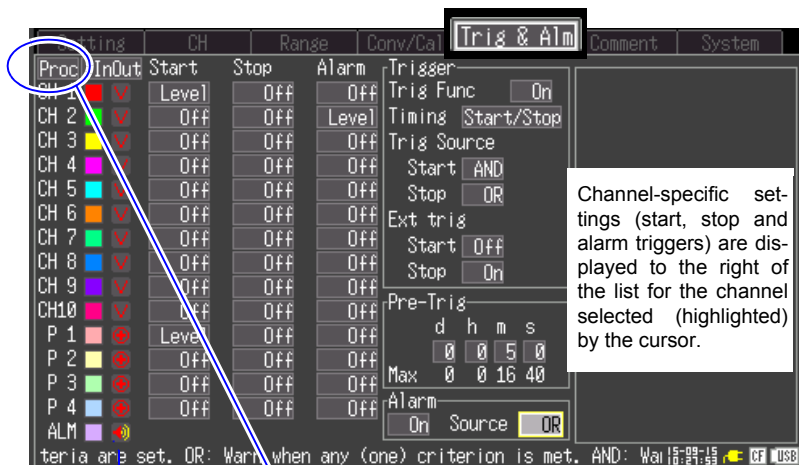

If set to [Off], change it to [On].

4.3 Confirming Trigger and Alarm Criteria Settings (List)

You can view and change trigger and alarm criteria settings for all channels. However, detailed criteria settings such as level, threshold and slope can only be changed on the [CH] screen (p. 80).



Input type

-  : Voltage
-  : Temperature
-  : Heat flow
-  : Integration
-  : Revolution
-  : Alarm

Select [Proc] to initialize settings and to copy trigger and alarm settings from CH 1, P 1, and W 1 to the other channels. Copyable settings include level, window thresholds and slope.

[Refer to "Batch Copying Channel Settings" \(p. 74\).](#)

4.4 Starting and Stopping Recording by Timer

Make these settings to record at a specific time. Recording can be set to repeat at specific intervals between the set start and stop times.

Before setting, confirm that the instrument's clock is set to the correct time. If not, reset the clock on the **[System]** screen (p. 150).

1 Select the **[Setting]** screen

2 Move to a setting item.

Open the setting options for the item to be set.

Select from the listed options.

Apply

Change by 1

Change by 10

The screenshot shows the 'Setting' screen with various parameters. The 'Timer' section is highlighted, showing options for Start, Stop, and Interval, each with a clock icon for time selection. The 'Timer' status is currently set to 'On'.

1 Set the **[Timer]** setting to **[On]**.

2 Enable (set to **[On]**) the desired timer setting items.

Setting options:

Start Set the recording start time.

Stop Set the recording stop time.

Interval Set the recording repetition interval.
This setting is enabled on when **[Repeat]** is set to **[On]**.

3 Set the year, month, day, hour, minute and second for the start or stop time.

To enter the current time as the start or stop time, select the clock mark (⌚) and press the **ENTER** key.

4 For the **[Interval]** settings, set the amount of time (days, hours, minutes and seconds) between recording repetitions.

5 Press **START**.

[Wait Timer] will be displayed at the bottom of the waveform screen.

Timer: On Start On 15-9-19 12:0:0 ⌚
Stop Off
Interval Off

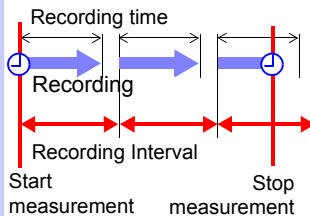

When recording times are specified, recording operation depends on the repetition and recording time settings (p. 92).

4.4 Starting and Stopping Recording by Timer

Example: To record daily from 9:00 to 17:00 for one month beginning January 1, 2015,
Repeat Recording: On, Timer: On

		(YY-M-D)	(H:M:S)	15-1-1	15-1-1	15-1-2
(From)	Start	On	15-1-1	9: 0: 0	9:00	17:00
(Until)	Stop	On	15-1-31	17: 0: 0		9:00
(Time from one recording to the next)	Interval	On	1	0: 0: 0		
(recording length)	Cont:	Off		8: 0: 0	9:00 to 17:00 is 8 hours	

Note: As internal memory is limited, recording cannot be performed more than 8 hours depending on the recording interval when all analog and pulse channels are measured. To perform recording for more than 8 hours, set the recording interval to more than 200 ms.

4.5 About Recording Operation

Recording operation depends on the combination of trigger, timer and repeat recording (On/Off) settings.

○ Press **START/STOP**
 ⌚ Timer start/stop time
 ⏏ Trigger criteria match

Cont.	Trigger	Timer	Repeat: Off	Repeat: On
Off	Off	Off	<p>Start recording Stop recording</p>	<p>Start recording Stop recording</p>
Recording is stopped before one recording length has elapsed	Off	Off	<p>Start recording Stop recording</p>	<p>Start recording Stop recording</p>
Off	Off	Start	<p>Start recording Stop recording</p>	<p>Start recording Stop recording</p>
The stop time setting is after the recording length has elapsed	Off	Stop	<p>Start recording Stop recording</p>	<p>Start recording Stop recording</p>
The stop time setting is within the recording length	Off	Stop	<p>Start recording Stop recording</p>	<p>Start recording Stop recording</p>
The stop time setting is within the recording length	Off	Start/Stop	<p>Start recording Stop recording</p>	(Repeat Recording: same as Off)

4.5 About Recording Operation

○ Press **START/STOP** ⌚ Timer start/stop time T Trigger criteria match

Cont.	Trig-ger	Timer	Repeat: Off	Repeat: On
Off	Start	Off		
Off	Stop	Off		
A stop trigger occurs before one recording length has elapsed				
Off	Start/Stop	Start/Stop		
A start trigger occurs after the timer start time, and a stop trigger occurs before the timer stop time				
On	Off	Off		(Repeat Recording: same as Off)
On	Stop	Off		

Waveform Analysis

Chapter 5

About the Waveform and Numerical Value Screens

Analog waveform, pulse waveform, alarm, waveform calculation

Displays acquired data as waveforms.

Time Values

Scroll Bar

Shows the range and position of the displayed waveform.
Viewing the Scroll bar (p. 96)
Information such as measurement start time and trigger times is displayed below the scroll bar.

Trigger Mark
Indicates a trigger event

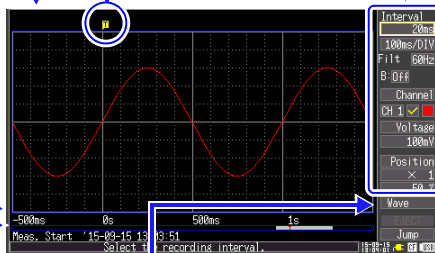

Jump Function (p. 97)

Measurement Configuration

You can change these settings (p. 45)
You can switch between channel settings and event settings.
"Event Search" (p. 104)

Eject

Allows you to change the CF card or USB flash drive while saving data in real time. (p. 53)

You can select from seven screen configurations (p. 18)

- Gauges can be displayed for each channel (p. 98)
- Numerical values at waveform cursor positions can be viewed (p. 99)
- Numerical calculation results can be displayed (p. 129)
- Measurement data can be displayed as waveforms and numerical values, as numerical values with comments, or as numerical values only (p. 102).

Settings can be changed on the Waveform/Numerical screen.

- 1 **WAVE/DATA SET FILE**

 Select the Waveform Screen.
- 2 **Move to a setting item**
 (Navigation arrows)
 Open the setting options for the item to be set.
- (Navigation arrows)
 Select from the listed options.
- (Navigation arrows)
 Apply

5.1 Viewing Waveforms

Scrolling Waveforms

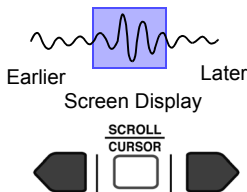

A waveform that is being measured or that has already been measured can be scrolled leftward and rightward using the **SCROLL/CURSOR** keys.

You can scroll to any part of a waveform while measuring. To return to the current waveform position, move the selection cursor to **[Trace]** at the lower right of the screen, and press the **ENTER** key.

To jump to the start or end of a waveform, hold the **ESC** key while scrolling.

If internal memory becomes full when measuring with **[Cont]** set to **[On]**, recording continues by overwriting the oldest acquired data. Therefore, even when scrolling earlier parts of waveforms, the overwritten data is lost.

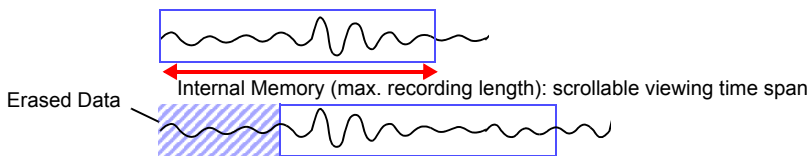

Verifying Waveform Display Position

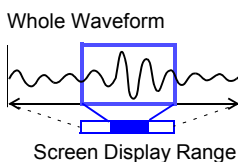

From the scroll bar you can verify the relative position and size of the displayed portion of a waveform within the overall recorded waveform.

The width of the currently displayed time span indicator within the scroll bar depends on the time base (time per horizontal division) setting, even when the recording length is unchanged.

Magnifying and Compressing Horizontally

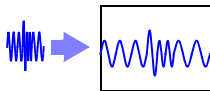

Waveforms can be magnified (expanded or compressed) along the time axis by changing the time per horizontal division.

Detailed waveform data is usually best observed with the time axis expanded, while longer-term trends are best observed with it compressed.

Horizontal magnification can be changed while measuring. However, when measuring with auto saving enabled, the 100, 200 and 500 ms settings are not selectable.

Select from the **[Time/DIV]** setting options.

Setting options:

100ms*, 200ms, 500ms, 1s, 2s, 5s, 10s, 20s, 30s, 1min, 2min, 5min, 10min, 20min, 30min, 1h, 2h, 5h, 10h, 12h, 1day [div] (* default setting)

Indicates the center point for horizontal magnification. When the A/B cursors are displayed, the position of cursor A becomes the reference point.

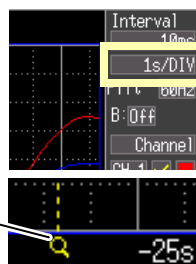

Viewing Any Waveform Location (Jump Function)

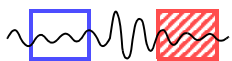

When the recording length of a waveform is long, you can specify the portion to be displayed immediately.



1 **WAVE/DATA** **SET** **FILE**
 Select the Waveform Screen

2 Select **[Jump]**.

Apply

The location of the currently displayed portion of the overall waveform is indicated by the ▼ mark on the scroll bar.

3 Move the ▼ mark to display a different portion of the waveform.

4 Apply

The portion of the waveform at the ▼ mark is displayed.

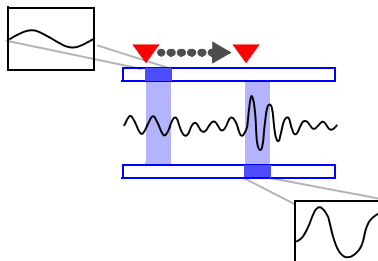
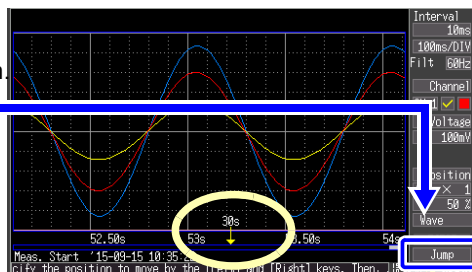

5.2 Selecting Display Options

Displaying Gauges

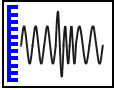

A gauge corresponding to the measurement range of each channel can be displayed at the left side of the screen, for confirming measurement values. The color of the gauge matches the waveform display color of its input channel.

Press the **CH ▲** or **▼** key to switch channels to be displayed on Gauge A from one to another. However, note that when measurement data is displayed, only those channels that are enabled (set to On) for measurement can be selected.

Gauge B display and channel can be selected.

When **[B]** is enabled (**[ON]**), the display channel can be selected and Gauge B is displayed on the left side of the screen.

- 1 **WAVE/DATA** **SET** **FILE**
- 2
 - Select the Waveform Screen.
 - Select **[Gauge+Wave]**.
 - Apply

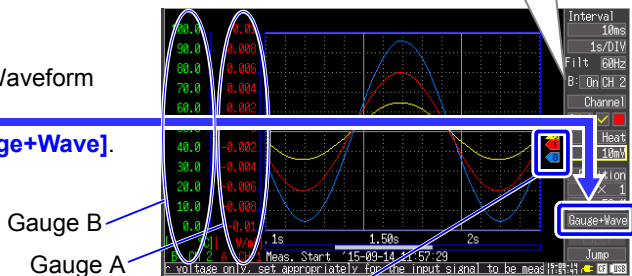

Channel Markers

The channel of the channel marker waveform is displayed. The channel marker colors are the same as the input waveform colors. The channel markers are not displayed in the **[Wave]**, **[Value+Cmnt]**, or **[Value]** screen.

Displaying Cursor Values

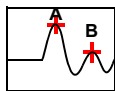

Time difference and potential difference (and when scaling is enabled, scaling values) can be read as numerical values using the A/B cursors.

About Cursor Values

Cursor Type	Example	Cursor Value
Trace Cursors		<p>Displays the time and measurement values at the A/B cursors, or the time and measurement differences between the A/B cursors.</p> <p>Displays the intersections (trace points) of cursors and waveforms. (the intersections of waveform traces of selected channels)</p>
Vertical Cursors		<p>Displays the time and frequency values at the A/B cursors, or the time and frequency differences between the A/B cursors.</p>
Horizontal Cursors		<p>Displays the measurement values at the A and B cursors for the selected channel(s), or the difference between A/B cursor values.</p> <p>A/B cursors can be enabled for any channel.</p>

- Cursor values may be displayed as “OVER” or “-OVER” instead of numerical values. Refer to “LR8432-20 Measurement Values” (p. A13).
- When there is no data over the specified cursor, the cursor value is displayed as “---”.

5.2 Selecting Display Options

There are two ways to display cursor values: displaying a list of values or displaying the values of only two channels.



Select the waveform screen.

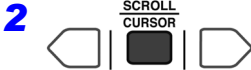

The A/B cursors and the values are displayed.

To hide the display, press the SCROLL/CURSOR key again.

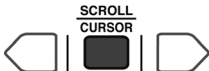

Move the cursor.

The values on the waveform can be checked.

Changing the display of cursor values
Select from the **[AB Crsr]** setting options.

• **All Ch***

Displays the list of cursor values.

Via a link to the channel selected in the channel setting in this screen, the list of cursor values is displayed as below.

- When CH1 to CH10, P1 to P4, or ALM is selected
The analog, pulse, or alarm channel is displayed.
- When W1 to W10 is selected
The waveform calculation channel is displayed.

The cursor value selected for **[Move]** is displayed. Select **[AB Cur]** to display B-A values.

• **Ch Set**

Specify which channels (CH1 to CH10, P1 to P4, or W1 to W10) to display with each A and B cursor. The cursor values for the specified channels are displayed.

(* default setting)

Changing the cursor position

Select from the **[Move]** setting options.

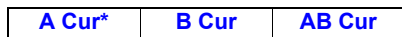

(* default setting)

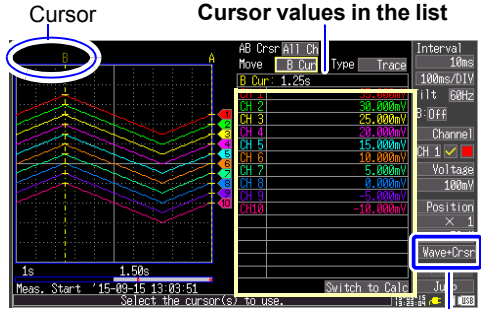

Display **[Wave+Crsr]**

as follows.

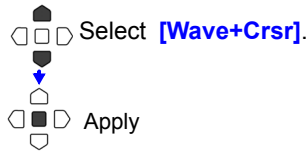

Specified two cursor values

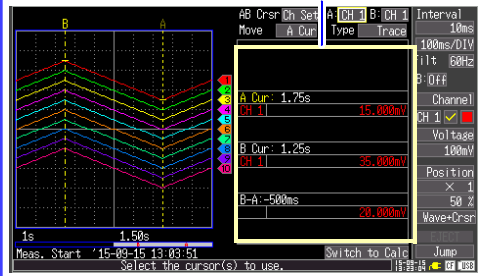

Changing the cursor value type

Select from the **[Type]** setting options.



(* default setting)

Moving the cursor while holding down the ESC key increases the travel distance.

Specifying a Waveform Time Span

Specify a waveform time span when saving a partial waveform or applying numerical calculations (Trace cursors or Vertical cursors).

- 1** WAVE/DATA SET FILE
Select the waveform screen.

- 2** SCROLL CURSOR
The A/B cursors and the values are displayed.

- 3** Select **[Move]**.
 Open the setting options for the item to be set.
 Select which cursor(s) to move.
 Apply

- 4** SCROLL CURSOR
Move the A/B cursors to specify the time span.

When **[Switch to Calc]** is selected, numerical calculation can be performed while checking the A/B cursor. Refer to "Apply Calculations to a Specific Time Span (Manual Calculation Only)" (p. 136).

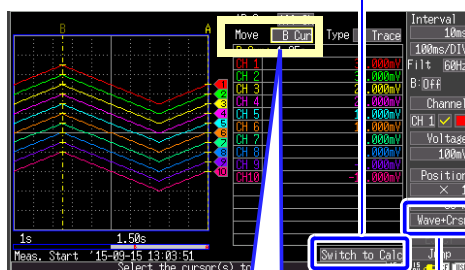

[Move]
A Cur
B Cur
AB Cur

Display **[Wave+Crsr]** as follows.

- Select **[Wave+Crsr]**.
 Apply

5.3 Inserting Event Marks (Search Function)

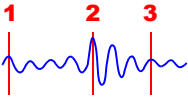

You can insert up to 100 event marks at any point while measuring, to help find them later. Refer to “Searching Event Marks” (p. 106). Event marks can be inserted while viewing waveforms or by applying external signals.

Inserting Event Marks While Viewing Waveforms

Use this procedure to insert event marks while viewing data on the Waveform/Numerical Value screen during measurement. Event marks are numbered in the sequence they are inserted.



1 Select the Waveform Screen.

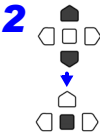

2 Select [Channel].

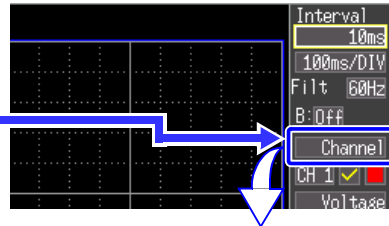

Event mark settings are displayed.

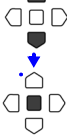

3 Select [Event].



Apply

3 Move to [Make Mark].

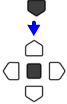



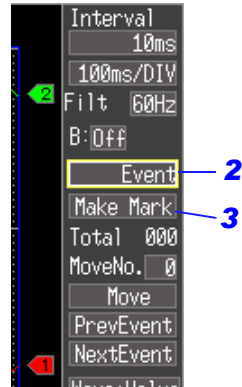

Press to insert an event mark. Event numbers appear on the waveform displayed when you select [Make Mark].



Inserting Event Marks Using External Input Signals

Event marks can be inserted by applying external input signals.

Refer to Input signal specifications in section “9.2 External Trigger Input” (p. 157).

- 1  Select the **[System]** screen.
- 2  Select **[External Trig In.]**.
 Open the setting options for the item to be set.
 Select **[Event]**.
 Apply



an external signal for triggering. Event: Use an external signal 外部信号を使用する

- 3 Connect the external signal input (p. 155).
 Event marks are inserted when the external trigger signal (EXT.TRIG input terminal 2) transitions on the falling edge from High level (3.0 V to 5.0 V) to Low level (0 V to 0.8 V).

5.3 Inserting Event Marks (Search Function)

Searching Event Marks

Any event mark can be found by searching.

1 Select the Waveform Screen.

2 When **[Channel]** is displayed, switch to **[Event]**.
 The event setting items are displayed.

Apply

3 For the **[MoveNo.]** setting, select the number of the event you want to find.

4 Select **[Move]**.

The waveform with the specified event number is displayed.

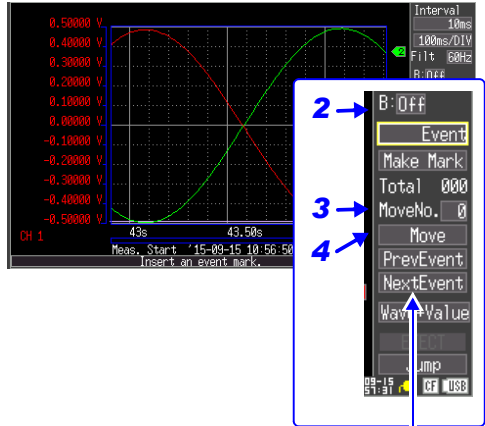

You can search by incrementing and decrementing the event number.

[PrevEvent]: Search for the previous event mark.

[NextEvent]: Search for the next event mark.

Saving & Loading Data

Chapter 6

Measurement data acquired by the instrument can be saved to a CF card or USB flash drive. (p.109)

The CF card is treated as Drive A:, while the USB flash drive is treated as Drive B:. There are three save methods: **[Auto Save]**, which saves data automatically at the time of measurement; **[Select & Save]**, which allows data to be saved after measurement; and **[Quick Save]**.

Refer to “6.3 Saving Data” (p. 112) for details.

6.1 About Saving and Loading Data

When saving data, a folder named “HIOKI_LR8432” is created, and files are stored in the folder as follows.

O = Available, X = Not available

File Type	File Format	Folder Name	File Name *3 (Auto-numbered from 1)	Save		Load	
				Auto	Man-ual	Model LR8432 -20	PC
Settings Data	Binary	CONFIG	CONF0001.SET	×	○	○	×
Waveform Data*1	Binary	DATA\{Date}*4 (e.g. 15-07-30)	AUTO0001.MEM WAVE0001.MEM	○	○	○	○
	Text *5		AUTO0001.CSV WAVE0001.CSV	○	○	×	○
Numerical Calculation Results	Text *5	MEASUREMENT	AUTO0001.CSV MEAS0001.CSV *6	○	○	×	○
Captured Screen Image	BMP *2	PICTURE	SCR00001.BMP	×	○	○	○

*1. Save waveform data in binary format if you intend to view it later in the instrument or on a computer with the supplied Logger Utility program. Waveform data and some measurement-related settings data are saved.

To save a waveform partially, specify a period by using A/B cursors before saving (p.101).

*2. BMP Format: This is a standard Windows® graphics format. These files can be handled by many graphics programs.

*3. “Appendix 2 File Naming” (p. A7).

*4. Date (YY-MM-DD) folders are automatically created inside the DATA folder.

6.1 About Saving and Loading Data

*5. When opening a CSV file in a spreadsheet program, note that the number of rows that can be loaded at one time is limited (p. A7).

When an option other than **[Separator: Comma]** has been selected on the **[System]** screen, the file extension will be .TXT rather than .CSV.

*6. When files are saved for each calculation, (_Number) is added to the end of the file name (MEAS0001_1.CSV, MEAS0001_2.CSV, etc.).

Depending on file size and CF card or USB flash drive capacity, each folder can store over 1,000 files. However, the file screen display is limited to a maximum of 1,000 files. Also, as more files are created, more time is needed to start and stop recording. We recommend setting measurement criteria so that the number of saved files stays below 1,000 whenever possible.

Directory Structure for Saved Data

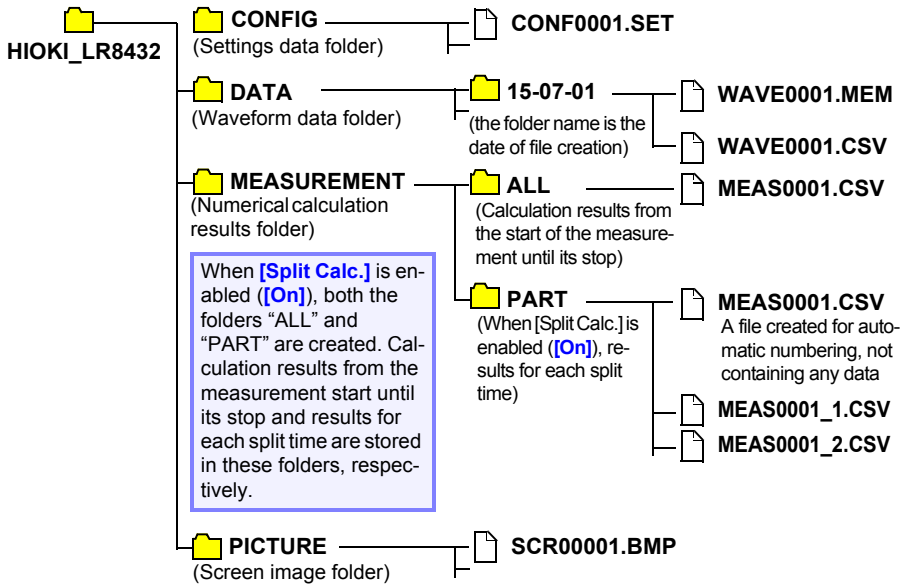

6.2 Using a CF Card/USB flash drive

To save and reload instrument's measurement data, use an optional CF card or an after-market USB flash drive.

Hioki options PC cards
(includes adapter)

- Model 9728 PC Card 512 M
- Model 9729 PC Card 1 G
- Model 9830 PC Card 2 G

*The Model 9726 PC Card 12 8M and Model 9727 PC Card 256 M can also be used.

Important

Use only CF cards sold by Hioki. Compatibility and performance are not guaranteed for CF cards made by other manufacturers. You may be unable to read from or save data to such cards.

This instrument does not require a CF (CompactFlash) adapter. Refer to "6.5 Data Management" (p. 121) for details about managing data storage in the card.

CAUTION

- Some USB flash drives are vulnerable to static electricity. Handle USB flash drives with care as static can damage the drive or cause the instrument to malfunction.
- During battery-only operation, data may fail to be stored properly if battery charge is exhausted while saving. In the worst case, the CF card could be damaged, so pay appropriate attention to the discharge state of the battery pack.
- If the Eject button is in the released position, press it in first before inserting the CF card all the way in. Inserting the CF card when the Eject button is released may damage the instrument. If the CF card does not go all the way in, do not force it in. Press the Eject button once to release it, then press it again and insert the CF card all the way in.

NOTE

- When the power is turned on while a USB flash drive is inserted, the instrument may not start up (depending on the type of USB flash drive). Turn the power on and then insert the USB flash drive. Check the USB flash drive before using it.
- Although data can be saved in real time to a USB flash drive, it is recommended to use a CF card for this purpose due to the superior data protection offered by that media. Proper operation of media other than Hioki optional CF cards is not guaranteed.
- USB flash drives with security functionality such as password or fingerprint authentication cannot be used.

CF Card Insertion & Removal

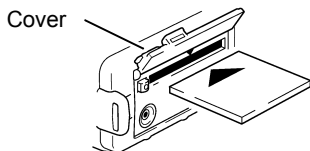

Eject Button

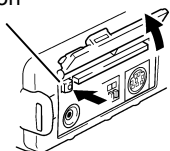

Inserting a CF card

- 1** Open the CF card slot cover.
- 2** Press the Eject button in if it is in the released position.
- 3** Face the CF card with the arrow mark (▲) on top, and insert it in the direction of the arrow all the way in the slot.

Removing a CF card

- 1** Open the CF card slot cover.
- 2** Press the Eject button (to release it).
- 3** Press the Eject button again and pull the card out.

USB flash drive Insertion & Removal

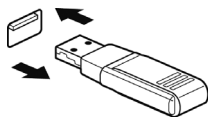

Inserting a USB flash drive

Align the USB flash drive connector with the USB port, and insert it all the way in.

Removing a USB flash drive

Pull the USB flash drive out.

Refer to “Replacing Removable Storage During Real-Time Saving” (p. 53).

NOTE

- When using a USB flash drive, set the USB mode on the **[System]** screen to **[USB Memory]**. USB flash drives cannot be used while the USB mode setting is **[USB Comm.]** or **[USB Drive]**.
- The **[USB Memory]**, **[USB Comm.]**, and **[USB Drive]** USB mode settings are exclusive and cannot be used simultaneously.

Formatting a CF Card/USB flash drive

The CF card or USB flash drive can be formatted with a computer or the instrument. Format a new CF card or USB flash drive before use.

This procedure describes how to format a CF card or USB flash drive in the instrument.



Select the File Screen.

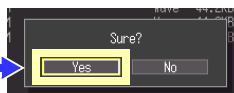
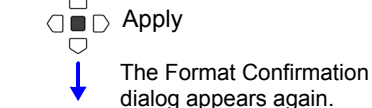
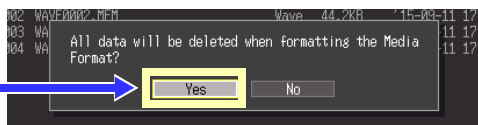
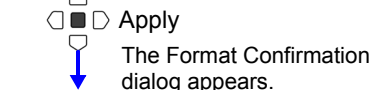
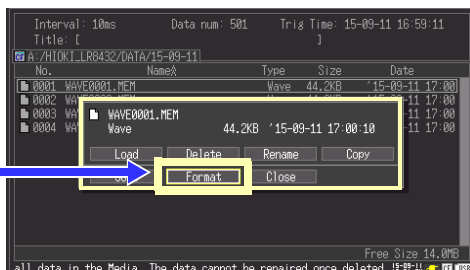
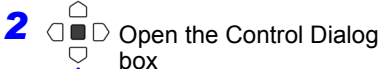

NOTE Formatting irretrievably erases all data on the CF card/USB flash drive. Always backup important data from the CF card/USB flash drive before formatting.

6.3 Saving Data

Basically, three methods are available for saving.

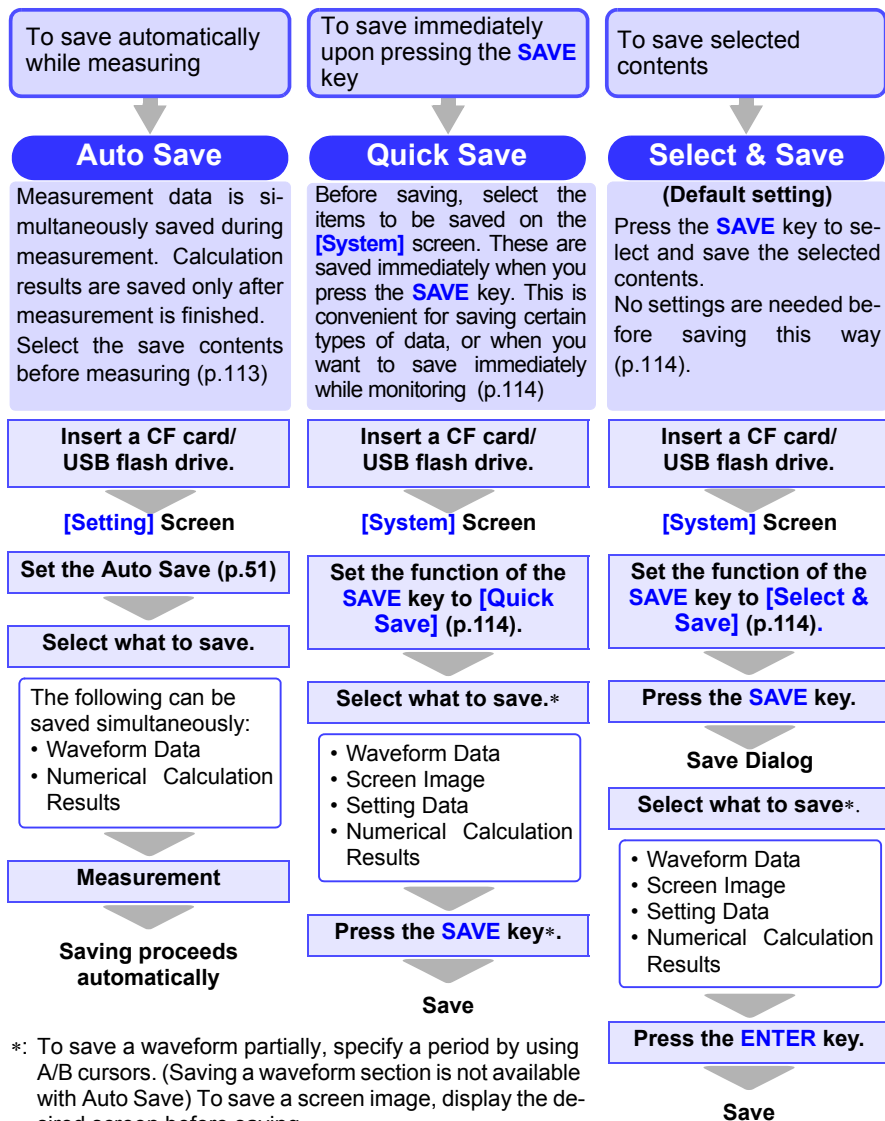

LR8431-20 and 8430-20 waveform data, display image, and setting data can be read by the LR8432-20.

Automatic Saving

Before measuring, configure saving on the **[Setting]** screen. Waveforms and numerical calculation results can be saved automatically. Folders are created for saved data according to data type, and files are automatically numbered (p.107). For waveform data, folders named with the current date (YY-MM-DD) are created automatically. Before starting to measure, confirm that Auto Save is configured correctly, and that the CF card or USB flash drive is properly installed.

1  Select the **[Setting]** screen.

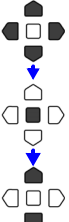
2  Select the desired save method from the **[Auto Save]** setting options.

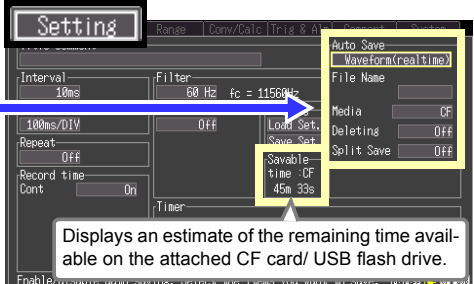

Save methods:

Off

Automatic saving is disabled.

Waveform

Waveform data in binary format is saved to CF card while recording.

(realtime) *1

CSV(realtime)

Waveform data in text format is saved to CF card while recording. Saved data cannot be reloaded in the instrument.

***1,*2**

Calc(post meas.)

Calculation results are saved to CF card after recording. When **[Repeat]** is enabled (**[On]**), calculation results for each recording are included in the recorded data file. When **[Repeat]** is enabled (**[On]**), calculation results are saved for each split time.

***1**

Waveform + Calc

Waveform data in binary format is saved while recording, and calculation results are saved when recording stops.

***1**

CSV + Calc *1,*2

Waveform data in text format is saved while recording, and calculation results are saved when recording stops.

*1. Otherwise, make advanced settings as needed (p.51).

Refer to“(As needed) You can enter a file name for the waveform files in the [File Name] box.” (p. 52).

*2. The **[CSV (real time)]** and **[CSV + Calc]** settings are not available when the record interval is 10 ms or 20 ms. Also, when opening a CSV file in a spreadsheet program, note that the number of rows that can be loaded at one time is limited (p. A7). When an option other than **[Separator: Comma]** has been selected on the **[System]** screen, the file extension will be .TXT rather than .CSV.

To save calculation results automatically, configure calculation settings before starting measurement (p.129).

When saving waveforms automatically, horizontal axis display setting is restricted when starting measurement, but can be freely adjusted for analysis afterwards (although 100, 200 and 500 ms horizontal axis settings are automatically changed to 1 s when measurement starts, and cannot be reselected while measuring).

Apply

3 After making any other necessary settings, press the **START/STOP** key.

Data is automatically saved to the CF card or USB flash drive when measurement finishes. (“Directory Structure for Saved Data” (p. 108).)

Selecting the Manual Saving Method [Quick Save]/[Select & Save]

Two manual saving methods are available: [Quick Save] and [Select & Save], both of which offer the same setting options.

When saving measurement data, folders are created on the CF card or USB flash drive for each data type, and files are automatically numbered (p.107)

1 WAVE/DATA SET FILE → **System**

2 Select the [System] screen.

Move to a setting item.

Open the setting options for the item to be set.

Select from the listed options.

Apply

Start Backup: Off
Backlight Saver: Off
Backlight Brightness: 100%
Display Color: Black
Beep Sound: On
External Trig In: Trigger
Time Disp: Time
Language: English

Trig Out: Trig
Decimal Mark: Dot
Separator: Comma
N-Calc., Data Saving: Single file
USB Mode: USB Memory

SAVE Key Operation—Select & Save

System V 1.00 S/N 150599632

Trig Out: Trig
Decimal Mark: Dot
Separator: Comma
N-Calc., Data Saving: Single file
USB Mode: USB Memory

Clock Settings
Initialize

Self-Test
KEY/LED: LCD
ROM/RAM: CF card
USB Memory

Automatically restart measurement when power resumes after it is 時時時時 時時時時

Selecting [SAVE Key Operation] setting options.

Setting options: (* default setting)

Select & Save* Pressing **SAVE** displays a dialog. Select the type of contents to be saved, and save the data.

Quick Save Pressing **SAVE** saves data according to the settings on the [System] screen.

[Select & Save]

SAVE

The Save dialog appears. Select from the saving options in this dialog.

- Save Waveforms (p.115)
- Save Screen Image (p.116)
- Save Numerical Calculation Results (p.117)
- Save Settings (p.118)

[Quick Save]

Setting items are displayed. Select your saving options.

Select the file type to save

Media: CF

Waveform Screen Image

Setting

Interval: 10ms
100ms/DIV
Filter: 60Hz
B: Off
Channel: CH 1
Voltage: 100mV
Position: X 1, 50%
Wave
Jump

0s 500ms 1s 1.50s
Meas. Start: '15-09-15 11:47:48
Save the waveform.

Settings CH Range Conv/Calc Trig & Alim Comment System

Start Backup: Off
Backlight Saver: Off
Backlight Brightness: 100%
Display Color: Black
Beep Sound: On
External Trig In: Trigger
Time Disp: Time
Language: English

Trig Out: Trig
Decimal Mark: Dot
Separator: Comma
N-Calc., Data Saving: Single file
USB Mode: USB Memory

SAVE Key Operation—Quick Save

Media: CF
Save Type: Waveform
Format: Binary
Span: All

System V 1.00 S/N 150599632

Trig Out: Trig
Decimal Mark: Dot
Separator: Comma
N-Calc., Data Saving: Single file
USB Mode: USB Memory

Clock Settings
Initialize

Self-Test
KEY/LED: LCD
ROM/RAM: CF card
USB Memory

*Select & Save displays the selection dialog when the [SAVE] key is pressed.

Saving Waveform Data (with the SAVE Key)

Waveform data is saved in files named **WAVEnnnn.MEM** in folders named with the date of recording (YY-MM-DD), created in the **[HIOKI_LR8432]-[DATA]** folder (p.107).

To save a partial waveform, specify the time span to save beforehand (p.101).

Select & Save

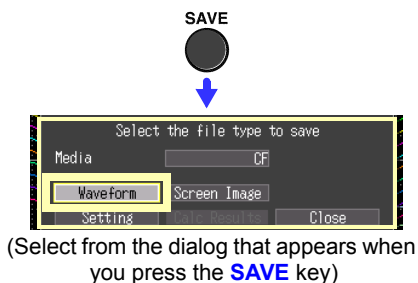

Set the **[Media]**.
(CF card/USB flash drive)

Select **[Waveform]**, and press the **ENTER** key.

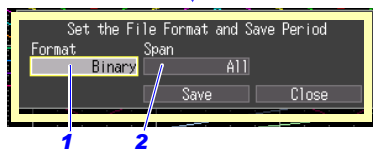

1 For the **[Format]** setting, select the data saving format. (* default setting)

Binary Select this format to be able to reload the saved data into the instrument, or so that it can be loaded into the Logger Utility program.

Text Select this format to save the data as a text file.

2 From the **[Span]** setting options, select the portion of the data to save.

All *, **A-B**, **Start-A**, **Start-B**, **A-End**, **B-End**

(All = all acquired waveforms, A = Cursor A, B = Cursor B,

Start = start of acquired waveforms, End = end of acquired waveforms)

Select **[Save]** and press the **ENTER** key.

Select **[Yes]** in the confirmation dialog, and press the **ENTER** key.

Quick Save

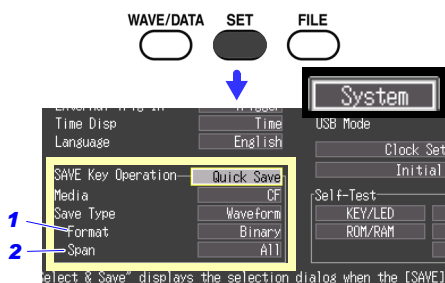

(Before pressing the **SAVE** key, make settings on the System screen)

Set the **[Media]**.
(CF card/USB flash drive)

Select **[Waveform]** as the **[Save Type]**.

(* default setting)

SAVE

Capturing a Screen Image (With the SAVE Key)

Captured screen image files are automatically named **SCRnnnnn.BMP** in a folder named **[HIOKI_LR8432]-[PICTURE]** (p.107).

Select & Save

SAVE  Display the screen to capture, and press the **SAVE** key.

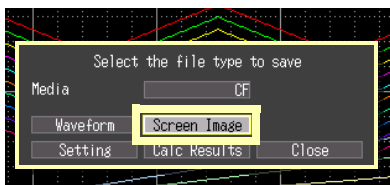

(Select from the dialog that appears when you press the **SAVE** key)

↓
Set the **[Media]**.
(CF card/USB flash drive)

↓
Select **[Screen Image]**, and press the **ENTER** key.

↓
Select **[Yes]** in the confirmation dialog, and press the **ENTER** key.

Quick Save

WAVE/DATA  **SET**  **FILE** 

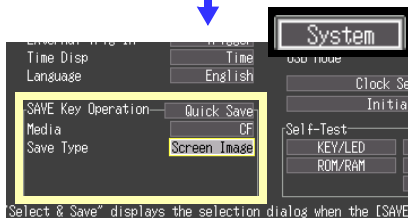

Select & Save displays the selection dialog when the [SAVE]

(Before pressing the **SAVE** key, make settings on the System screen)

↓
Set the **[Media]**.
(CF card/USB flash drive)

↓
Select **[Screen Image]** as the **[Save Type]**.

↓
Display the screen to capture

SAVE 

Saving Numerical Calculation Results (With the SAVE Key)

Numerical calculation settings are necessary before saving results (p.129). Numerical calculation result files are automatically named **MEASnnnn.CSV** in a folder named **[HIOKI_LR8432]-[MEASUREMENT]** (p.107).

Select & Save

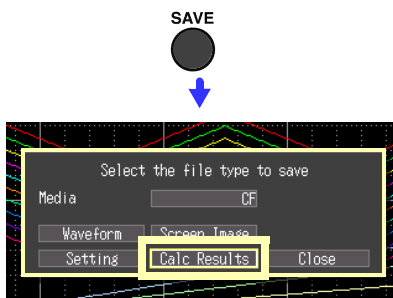

(Select from the dialog that appears when you press the **SAVE** key)

Set the **[Media]**.

(CF card/USB flash drive)

Select **[Calc Results]**, and press the **ENTER** key (p.129).

Select **[Yes]** in the confirmation dialog, and press the **ENTER** key.

Quick Save

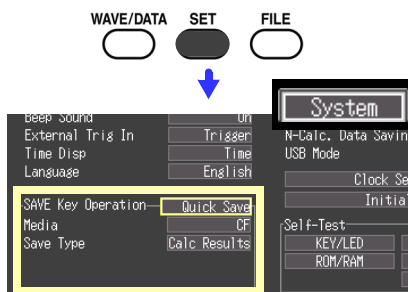

(Before pressing the **SAVE** key, make settings on the System screen)

Set the **[Media]**.

(CF card/USB flash drive)

Select **[Calc Results]** as the **[Save Type]**.

Display the numerical calculation results to be saved.

SAVE



By specifying a particular time span for numerical calculation, only the results for that time span are saved.

Saving Setting Configurations

Setting configurations can be saved as data files and later reloaded into the instrument when you need to make more measurements with the same settings.

Up to ten setting configurations can be saved to internal memory, and more can be stored on a CF card or USB flash drive.

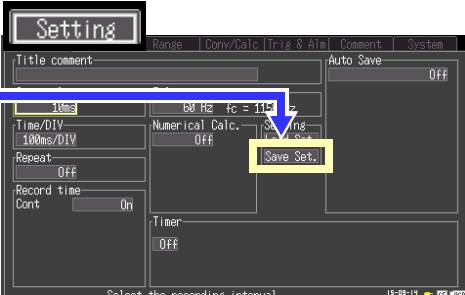
1  → 

Select the **[Setting]** screen.

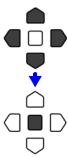
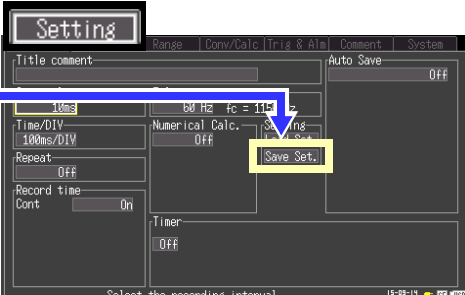
2  → 

Select **[Save Set.]**.

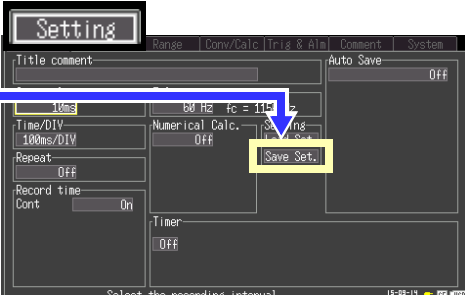
 → 

Apply

The Save dialog appears.

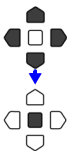
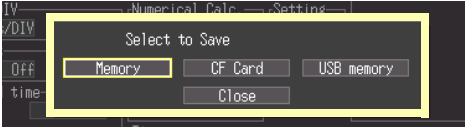

3  → 

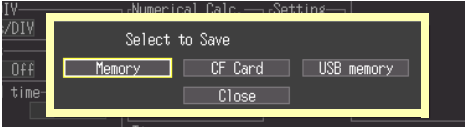
Select whether to save to the LR8432-20's memory or to a CF card or USB flash drive.

 → 



Apply

4 (When **[Memory]** is selected)

 → 

Select **[Save]** for the configuration instance (No.) to save.

Enter a comment as needed.

 → 

Apply

Comments entered on the **[Comment]** screen are displayed here.

(When **[CF Card/USB memory]** is selected)

Setting configuration files are automatically named CONFnnnn.SET in a folder named [HIOKI_LR8432]-[CONFIG] (p.107)

To reload a setting configuration (p.119)

6.4 Loading Data on the Instrument

Previously stored binary waveform data, captured screen images and saved setting configurations can be reloaded into the instrument (p.107)

Loading a Setting Configuration

Setting configurations saved in the instrument's memory or on a CF card or USB flash drive can be reloaded.

Refer to "Saving Setting Configurations" (p. 118).

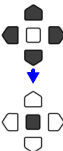
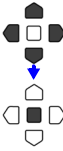
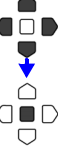
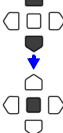
- 1  Select the [Setting] screen.
- 2  Select [Load Set.].
Apply
The loading dialog appears.
- 3  Select whether to load a setting configuration from LR8432-20's memory or CF card or USB flash drive.
Apply
- 4 (If you selected [Memory])
 Select [Load] for the configuration you want to load.
Apply
(If you selected [CF Card/USB memory])
 Select the configuration file to load. (CONFnnnn.SET)
Apply

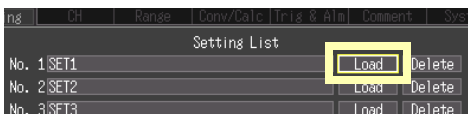
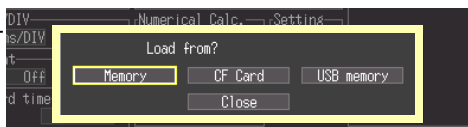
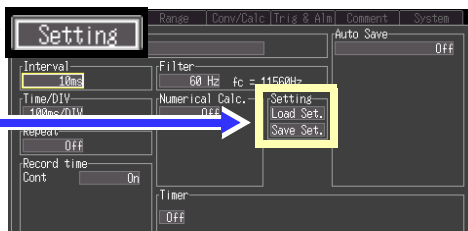

When Loading from Instrument's Memory
The list of configurations stored in instrument's memory is displayed.

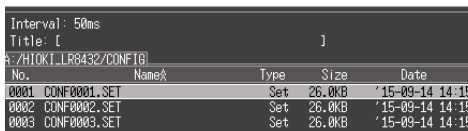

No.	NameA	Type	Size	Date
0001	CONF0001.SET	Set	26.0KB	'15-09-14 14:15
0002	CONF0002.SET	Set	26.0KB	'15-09-14 14:15
0003	CONF0003.SET	Set	26.0KB	'15-09-14 14:15

When Loading from CF card or USB flash drive
Configuration files stored in the [HIOKI_LR8432]-[CONFIG] folder on the CF card or USB flash drive are displayed.

Instrument's settings are reconfigured to those in the loaded configuration file.

To automatically load settings data (auto-setup)

Settings data saved under the filename "STARTUP.SET" in the "HIOKI_LR8432"- "CONFIG" folder will be loaded automatically when the instrument is turned on. If settings have been saved on both the CF card and USB flash drive, the CF card's settings will take precedence. ("STARTUP.SET" may not be loaded from USB flash drives that take a long time to be recognized.)

6.4 Loading Data on the Instrument

Loading Waveform Data and Screen Images

Binary waveform data or captured screen images can be reloaded into the instrument.



Select the File Screen.



The contents of the CF card are displayed.

Select a file to load

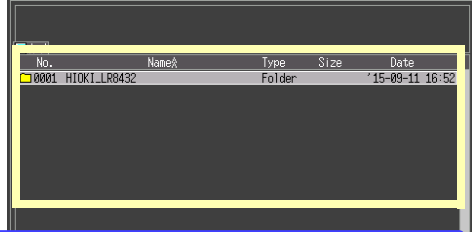

Displays the child folder.
After selecting a folder by pressing the **ENTER** key, select **[Change]** in the displayed control dialog box.

Displays the parent folder.

HIOKI_LR8432	Folder	'15-09-11 16:52
--------------	--------	-----------------

Buttons: Change, Delete, Rename, Sort, Format, Close



Apply

The control dialog box appears.



Select **[Load]**.

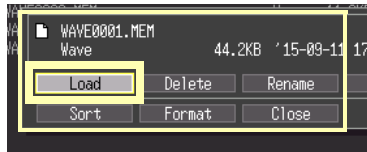

Apply

(When loading waveforms)

When the amount of data in a file to be loaded exceeds the internal memory capacity, you can specify a data point (number) at which to start loading. The loadable data size shows the maximum number of data points that can be loaded. This setting is not needed if the data to be loaded will fit in internal memory. Select **[OK]** to load the data.

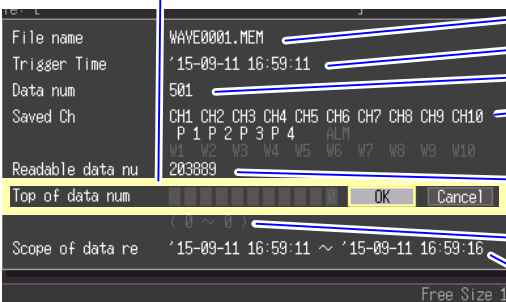

- Waveform data file name
- Waveform data trigger time
- Number of data points in the file
- Channels saved in waveform data to be loaded (Analog, Pulse, Alarm, Waveform Calculation)
- Maximum number of data points that can be loaded (to internal memory)
- Settable range of offset to first data point
- Times of first and last data points to be loaded

6.5 Data Management

You can manage data stored on a CF card or USB flash drive in the instrument.

- Load a file (when the file is selected) (p.119)
- Move displayed folders (when the folder is selected) (p.122)
- Delete data (p.122)
- Rename files and folders (p.123)
- Sort files (p.125)
- Format a CF card (p.111)
- Copy data (p.124)

The following operations can be performed from the control dialog box displayed by pressing the **ENTER** key from the File screen.

1  Select the File Screen.

2  Opens the control dialog box.

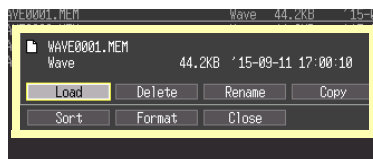

Switching removable storage

1  **Select the File screen**
CF card contents* are displayed.

2  **Press FILE again.**
USB flash drive contents are displayed.
Press FILE to toggle between drive A (CF card) and B (USB flash drive).

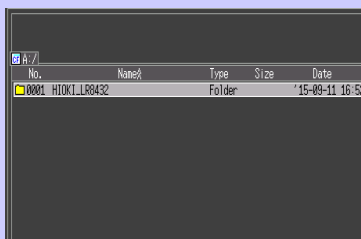

*: When only a USB flash drive is inserted in the instrument, its contents are displayed.

The drive cannot be switched.

Viewing Folder Contents and the Parent Folder



Select the File Screen.

The contents of the card are displayed.

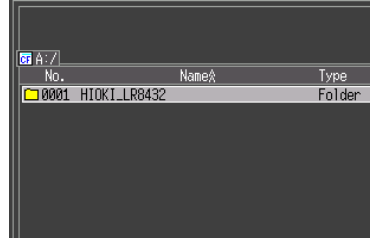

Select a folder to view.



View child folder (view contents of the currently highlighted folder) (press the **ENTER** key and select **[Change]** in the displayed control dialog box)

Displays the parent folder.

Deleting Data

Folder and files on the CF card or USB flash drive can be deleted.



Select the File Screen.

The contents of the CF card are displayed.



Select a file to delete.



Apply



Select **[Delete]**.

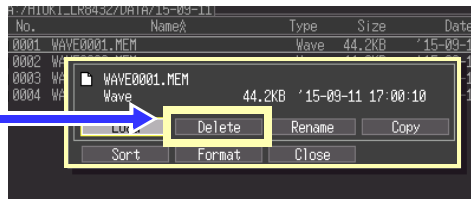

Apply

A confirmation dialog appears. Select **[Yes]** and press the **ENTER** key to delete.

NOTE

- The “HIOKI_LR8432” and “DATA” folders are locked to prevent the inadvertent deletion of data. If you wish to delete these folders, change their names.
- Files whose read-only attribute has been set cannot be deleted. Delete them with a computer or other means.

Copying Data

Files and folders can be copied between a CF card and USB flash drive.

1  **Select the File Screen.**

2  **Select a folder or file to copy.**

 **Apply**

3  **Select [Copy].**

 **Apply**

4  **Select the copy destination folder.**

 **Apply**

A confirmation dialog is displayed. Select **[Yes]** and press the **ENTER** key to execute the copy operation.

What if the file I want to copy is not displayed?

Refer to “Switching removable storage” (p. 121).

Refer to “Viewing Folder Contents and the Parent Folder” (p. 122).

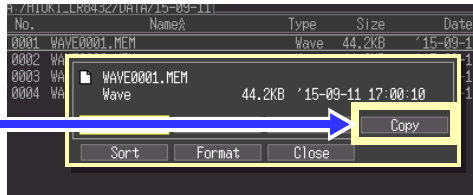



NOTE • Folder copying is supported for up to eight hierarchical levels. Folders more than eight levels deep cannot be copied.

• A file cannot be copied if one with the same name already exists at the destination.

Sorting Files

Files can be sorted in ascending or descending order according to a selected sort key.

1  Select the File Screen.

2  Apply
The control dialog box appears.

3  Select **[Sort]**.

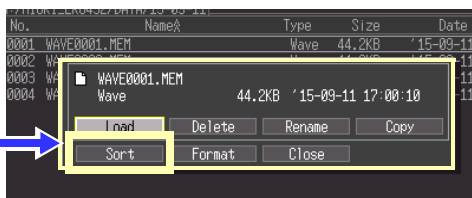

 Apply

4  Select the key on which to sort.



 Apply

5  Select the desired sort order.
(Ascending or Descending)
Files are displayed in the new sort order

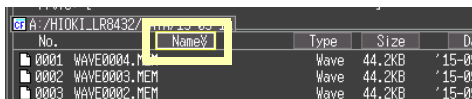

6  Finish

6.6 Transferring Data to a Computer (USB Drive Mode)





Data saved to a CF card can be transferred to a computer using the supplied USB cable.

Before connecting the USB cable to the instrument, set the USB mode on the **[System]** screen to **[USB Drive]**.

To analyze data with the supplied Logger Utility program, refer to the program's instruction manual on the CD.

Refer to "Appendix 9 Using the Application Program" (p. A20).

Select the USB Drive Mode

- 1  Select the **[System]** screen.
- 2  Select **[USB Drive]** on the USB mode pull-down menu.
 Apply
 A confirmation dialog appears.
- 3  Select **[Yes]**.
 Apply
 The USB Drive Mode is enabled.

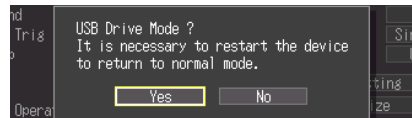
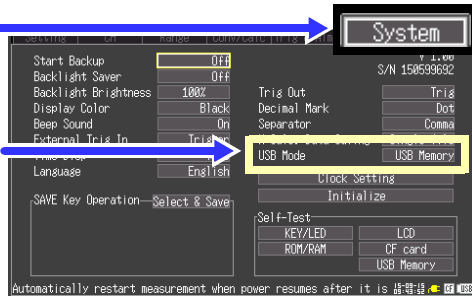

No other instrument's operations are available when the USB Drive Mode is enabled. Also, instrument's communications with the supplied Logger Utility program are disabled.

Refer to "To exit USB Drive Mode" (p. 128).

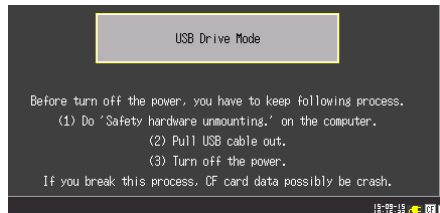

- 4 Connect the USB cable (p.127)

Connecting the USB Cable

Compatible OS: Windows XP, Windows Vista®, Windows 7, Windows 8, Windows 10

CAUTION

- Do not eject the CF card or pull out the USB cable during data transfer. Doing so would prevent proper data transfer.
- The instrument and computer should be connected to the same earth ground. If grounded separately, potential difference between the ground points can cause malfunctions or damage when connecting the USB cable.

Before connecting the USB cable to the instrument, set the USB mode on the [System] screen to [USB Drive]. Otherwise, the instrument's CF card cannot be accessed.

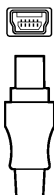

- 1** Orient the USB cable plug properly, and insert it into the receptacle.

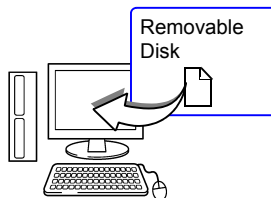

- 2** Connect the other end of the cable to a USB port on the computer.
The computer should recognize the instrument as a removable disk when the cable is connected.

6.6 Transferring Data to a Computer (USB Drive Mode)

To exit USB Drive Mode

- 1** Click the Safely Remove Hardware () icon in the Windows® notification area.
- 2** Click the appropriate line “Safely remove USB Mass Storage Device – Drive(H:)” where H is the drive letter that Windows® assigned to the instrument.
- 3** When “Safe to remove hardware” appears, click **[X]** or **[OK]**.
- 4** Disconnect the USB cable.
- 5** Turn the instrument off and back on.



Numerical/Waveform Calculations

Chapter 7

7.1 Performing Numerical Calculation

Calculations can be applied to measured data. Seven types of numerical calculation are available, four of which can be applied at the same time. Refer to “7.2 Numerical Value Calculation Expressions” (p. 137) for details of the calculation methods. You can specify the measurement time span over which calculations are to be applied (p. 136).

Types of calculations

- Average value Average value of waveform data
- Peak value Peak-to-peak value of waveform data
- Maximum value Maximum value of waveform data
- Minimum value Minimum value of waveform data
- Time to maximum value Time elapsed from the start of measurement to the maximum value
- Time to minimum value Time elapsed from the start of measurement to the minimum value
- Integrating Integrated value of waveform data

7.1 Performing Numerical Calculation

Two methods are available for applying calculations, as follows.

Calculating in real time during measurement (Auto calculation)

Configure numerical calculations before starting measurement. Calculations are performed automatically after measurement (p. 131).

- The latest calculation value can be checked in the calculation/numerical value screen ([Wave+Calc] screen).
- Calculation values at a certain time interval can be saved in a text (CSV) format.

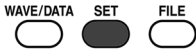

(Setting Screen)
Set Numerical Calculation to [On], and select the calculation types

To save calculation results automatically
(Setting Screen)
Enable Auto Save (p. 113)



Start and finish measuring

Analyze (p. 95)

Calculating After Measuring (Manual calculation)

Configure numerical calculations after measurement (p. 135).

End of Measurement

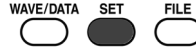









(Setting screen or Waveform screen)
Set Numerical Calculation to [On], and select the calculation types.

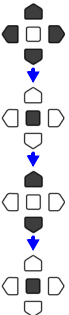

(Waveform Screen)
Execute Calculations

Analyze (p. 95)

Key Operation During Setting

- 1    Select the [Setting] screen.
- 2  Move the cursor to the item to be set.
-   Open the setting options for the item to be set.
-   Select from the listed options.
-   Apply

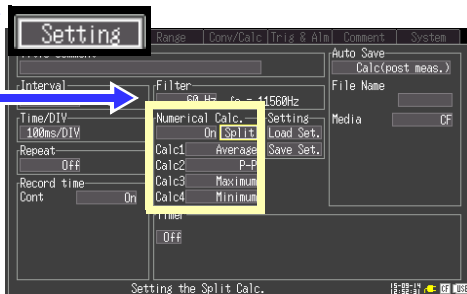

Calculating values in real time during measurement (Automatic calculation)

Numerical calculations are automatically performed in real time during measurements.

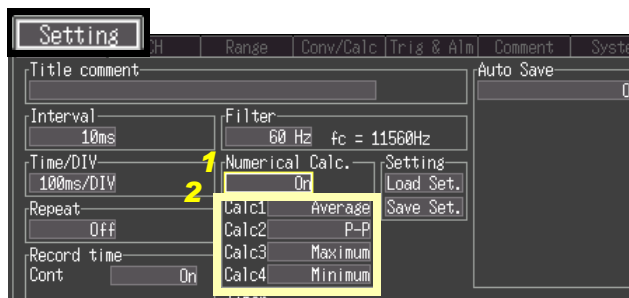

- 1 Select [On].
- 2 Select a type of calculation.

Setting options: (* default setting)

Average, P-P, Maximum, Minimum, Time To Max, Time To Min, Sum, Off(No calculations performed) *

To record calculation values obtained during every regular time interval (split calculation), follow steps 3 and 4.

(To record simply calculation values from the start of the measurement until the latest data, skip to step 5.)

- 3 Configure automatic storing setting.

Select either [Calc(post meas.)], [Waveform + Calc], or [CSV + Calc].

When [Waveform(realtime)] or [CSV(realtime)] is selected, skip step

4.

7.1 Performing Numerical Calculation

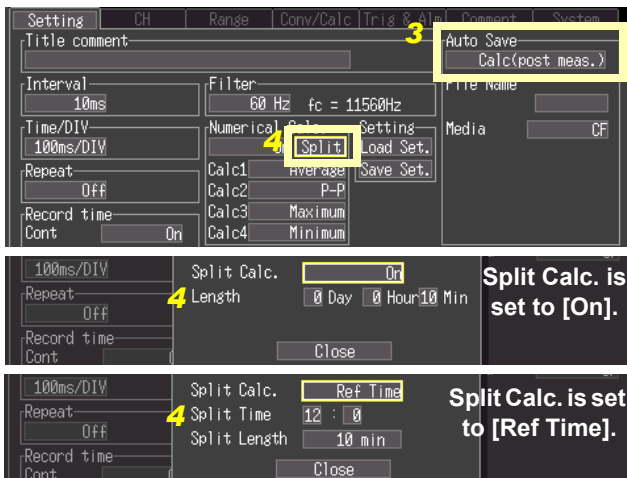

- 4** Configure the split calculation setting. (Select **[Close]** at the end.)

Setting options: (* default setting)

- Off*** Only the calculation value obtained last is saved.
- On** Calculation values obtained from the measurement start during regular time intervals (**[Length]**) are saved. Set **[Length]** to the time interval for obtaining calculation values.
- Ref Time** The first interval is automatically adjusted so that the next calculation value obtained during regular time interval that starts at the time set in Split Time box is saved. (Only the first interval becomes shorter than the interval set in **[Split Length]**.) Set the reference time and time interval in **[Split Time]** and **[Split Length]**, respectively.

7.1 Performing Numerical Calculation

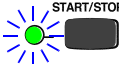
5 Start the measurement. 

6 Select the **[Wave+Calc]** display on the Waveform screen. Numerical calculation results are displayed.



Calc1 The results of the selected calculation number are displayed.

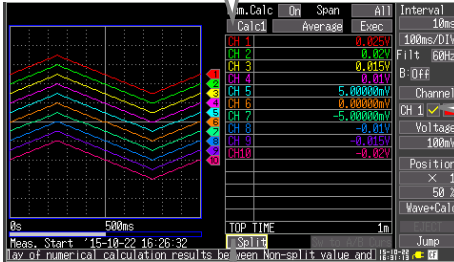

CH 1 ✓
Via a link to the channel selected on this screen, the calculation results are displayed in a list as below.

- When any one of the channels from CH1 to CH10 or that from P1 to P4 or ALM is selected, the analog, or pulse channel is displayed.
- When any one of the channels from W1 to W10 is selected, the waveform calculation channel is displayed.

Usual **Split**

The values display is switchable between the calculation values from the start of the measurement (normal values) and the newest calculation values during the every regular time interval (split values). Split value will be indicated as “---” with the split calculation disabled.

Manual Calculation

1 **START/STOP** Start and finish measuring.

2 **WAVE/DATA** **SET** **FILE**
Select the Waveform Screen.
You can select it from the **[Setting]** screen.

3 Select **[Wave+Calc]** display.

4 Enable (set to **[On]**) numerical calculation.

5 Select **[Calc1]** to **[Calc4]** and move to the setting options.

Open the setting options for the item to be set.

Select the calculation type.
Calculation types:
Average, P-P, Maximum, Minimum, Time To Max., Time To Min., Sum, or Off (default setting)

Apply

6 Select **[Exec.]**.

Apply

7 Analyze (p. 95)
A list of numerical calculation results is displayed. When the calculation number is selected, the desired calculation result can be displayed. Via a link to the channel selected on this screen, the calculation result is displayed in a list as below.

- When any one of the channels from CH1 to CH10 or that from P1 to P4 or ALM is selected → The analog or pulse channel is displayed.
- When any one of the channels from W1 to W10 is selected → The waveform calculation channel is displayed.

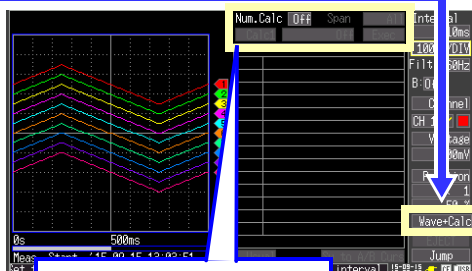

Num. Calc	On	Span	All
Calc1	Average	Exec	
Calc Result, Calc1			
CH 1			0.025V
CH 2			0.02V
CH 3			0.015V

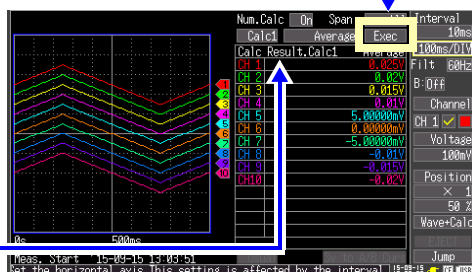



Apply Calculations to a Specific Time Span (Manual Calculation Only)

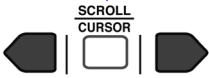

After measuring, calculation can be applied to a specified time span. Make any other calculation settings before specifying the calculation time span (p. 135).

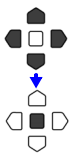

1  Display A/B Cursors.

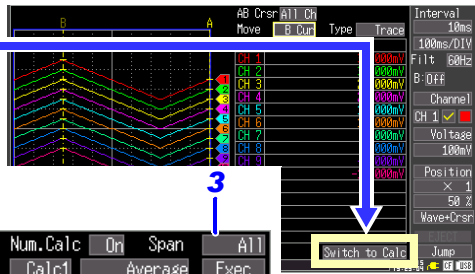
 Position the A/B cursors to define the calculation time span.
To select which cursor to move: (p. 101)

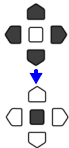

2  Select **[Switch to Calc]**.
 Apply

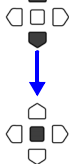

3  Select the **[Span]** setting option
 Open the setting options for the item to be set.

 Select the calculation time span
All, A-B, Start-A, Start-B, A-End, B-End
 Apply

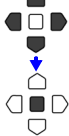
- **All**: The entire acquired waveform
- **A-B**: The time span between cursors A and B
- **Start-A**: From the start of the acquired waveform to cursor A
- **Start-B**: From the start of the acquired waveform to cursor B
- **A-End**: From cursor A to the end of the acquired waveform
- **B-End**: From cursor B to the end of the acquired waveform

4  Select **[Exec]**.
 Apply

The results of calculations are displayed.

When you select **[Switch to Calc]** the calculation display screen appears, and A/B cursor motion is enabled. However, changing to the **[Wave+Calc]** display hides the A/B cursors (so they are not movable), although the calculation range can still be changed.

7.2 Numerical Value Calculation Expressions

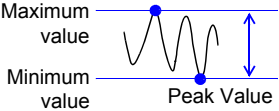
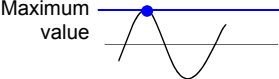
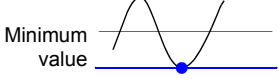
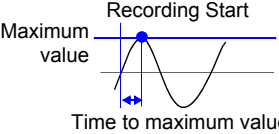
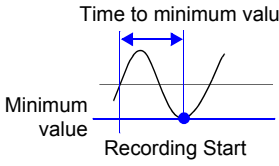
Average	$AVE = \frac{1}{n} \sum_{i=1}^n di$	<p>Obtains the average value of waveform data.</p> <p><i>AVE</i>: Average value <i>n</i>: Data count <i>di</i>: Data on channel number <i>i</i></p>
Peak Value (P-P)		<p>Obtains the value of the difference (peak-to-peak value) between maximum and minimum values of waveform data.</p>
Maximum Value		<p>Obtains the maximum value of waveform data.</p>
Minimum Value		<p>Obtains the minimum value of waveform data.</p>
Time to maximum value		<p>Acquires the time (s) elapsed from the start of recording to maximum value. When there are two or more maxima, this value is the first to occur.</p>
Time to minimum value		<p>Acquires the time (s) elapsed from the start of recording to minimum value. When there are two or more minima, this value is the first to occur.</p>
Integrated value	$SUM = \sum_{i=1}^n di$	<p>Acquires an integrated value for the waveform data.</p> <p><i>SUM</i>: Integrated value <i>n</i>: Number of data <i>di</i>: Data on channel number <i>i</i></p>

7.2 Numerical Value Calculation Expressions

Split calculation (at auto calculation only (p. 133))

When **[On]** is selected

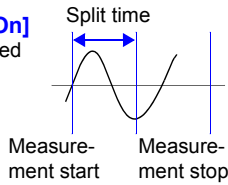

When **[Ref Time]** is selected

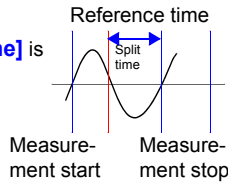

Setting **[Split Calc.]** to **[On]** or **[Ref Time]** saves the calculation value at a certain time interval.

When **[On]** is selected:

Set **[Length]**. The calculation value for the specified time is automatically saved.

0 day, 0 hour, and 0 minute cannot be specified for the split time. 0 day, 0 hour, and 1 minute is set automatically.

When **[Ref Time]** is selected

Set **[Split Time]** and **[Split Length]**. The calculation value for the specified time period is automatically saved.

7.3 Performing Waveform Calculation









Waveform calculation can be selected from **Four operations**, **Sum**, **Average**, **Moving average**, or **Heat flow rate**.

(CHA and CHB can be selected among the channels from CH1 to CH10, those from P1 to P4, and the calculation channels from W1 to W9 with a channel number that is smaller than the number of the calculation channel to be set. For example, W1 and W2 data can be set for [CHA] and [CHB] for W3.)

If the above formula is set ahead of time, a waveform after calculation can be displayed on the waveform screen and the calculation value can be saved during measurement. 10 calculations (W1 to W10) can be performed at a time.

NOTE Waveform calculation cannot be performed after measurement.

Key Operation During Setting

- 1  Select the [CH] screen.
- 2  Move the cursor to the item to be set.
-   Open the setting options.
-   Select the item.
-   Apply

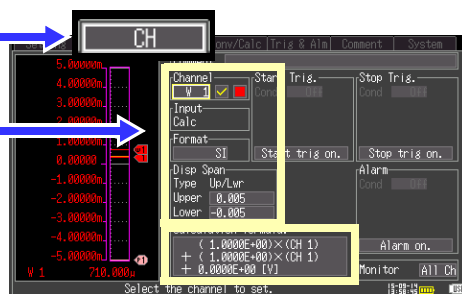

Switch the channel to be set using the channel key.

7.3 Performing Waveform Calculation

- 1** Select the channel (**W1 to W10**) and set the calculation to (ON).
- 2** Select **[calculation formula.]** and press the **ENTER** key. The coefficient settings dialog box is displayed.
- 3** Select the calculation type and set necessary items.

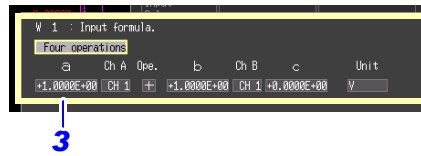
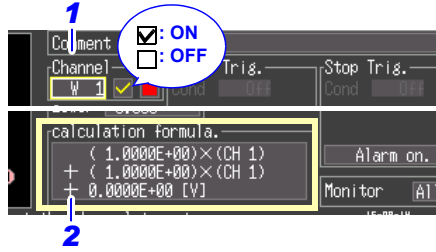

Calculation type	Setting item
Moving average	Enter/select CHA, number of points, and unit and press the ENTER key. (The upper/lower limit values for the selected waveform calculation are the same as for the target calculation channel.)
Average	Enter/select CHA, start reset, reset time, and unit and press the ENTER key. (The upper/lower limit values for the selected waveform calculation are the same as for the target calculation channel.)
Sum	Enter/select CHA, start reset, reset time, and unit and press the ENTER key.
Heat flow rate	Enter/select CH, temperature CH1, temperature CH2, and unit and press the ENTER key. NOTE This is a reference formula to calculate the heat flow rate.
Four operations	Enter/select coefficient a, CHA, calculation, coefficient b, CHB, coefficient c, and unit and press the ENTER key.

Description	
Reset timing	Select whether or not to reset the calculation at the point of a trigger event. (Selection → OFF, trigger position)
Reset time	Select whether or not to reset the calculation at the specified time. (Selection → OFF, ON, scheduled time) When ON is set, the calculation is reset at the specified reset time interval. When Ref Time is set, the calculation is reset at the reset time interval beginning at the specified reference time.

Coefficient settings dialog box



- Increases/decreases by 1, changes +/-.
- Moves the digit.

7.3 Performing Waveform Calculation

The calculation formula can be entered in the [Conv/Calc] screen.
The W1 calculation formula can be copied to other channels. (p. 72)

WAVE/DATA SET FILE

1 Select the [Conv/Calc] screen.

2 Select [Calc].

3 Select the waveform calculation formula for the channel (W1 to W10). The dialog box is displayed.

4 Select the calculation type and set necessary items.

The image shows three screenshots illustrating the steps. Screenshot 1 shows the 'Conv/Calc' menu option highlighted. Screenshot 2 shows the 'Calc' option selected, with a formula '1.0000E+00 x (CH 1)' entered. Screenshot 3 shows the 'Four operations' dialog box with fields for coefficient 'a', channel 'Ch A', operation 'Ope.', channel 'Ch B', coefficient 'c', and unit 'Unit'.

Calculation type	Setting item
Moving average	Enter/select CHA, number of points, and unit and press the ENTER key. (The upper/lower limit values for the selected waveform calculation are the same as for the target calculation channel.)
Average	Enter/select CHA, start reset, reset time, and unit and press the ENTER key. (The upper/lower limit values for the selected waveform calculation are the same as for the target calculation channel.)
Sum	Enter/select CHA, start reset, reset time, and unit and press the ENTER key.
Heat flow rate	Enter/select CH, temperature CH1, temperature CH2, and unit and press the ENTER key. NOTE This is a reference formula to calculate the heat flow rate.
Four operations	Enter/select coefficient a, CHA, calculation, coefficient b, CHB, coefficient c, and unit and press the ENTER key.

Description

Reset timing	Select whether or not to reset the calculation at the point of a trigger event. (Selection → OFF, trigger position)
Reset time	Select whether or not to reset the calculation at the specified time. (Selection → OFF, ON, scheduled time) When ON is set, the calculation is reset at the specified reset time interval. When Ref Time is set, the calculation is reset at the reset time interval beginning at the specified reference time.

Coefficient settings dialog box



Increases/decreases by 1, changes +/-.

Moves the digit.

7.3 Performing Waveform Calculation

Set the display method for waveform calculation channels as necessary. The display method can be changed even after measurement.

Setting the Waveform Display Color

A waveform display color can be set for each waveform calculation channel.

Select from the waveform display color setting options.

Setting options: OFF (x), 24 colors

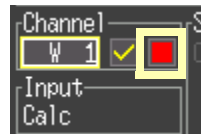

Setting the Display Format

Select a display format for waveform calculation results.

Select from the [Format] setting options.

Setting options: (* default setting)

SI * Displays calculation results with a unit prefix (k, m, etc.).

Dec Displays calculation results with a decimal.

Exp Displays calculation results in an exponential format.

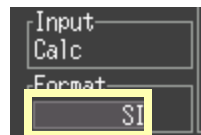

Setting the Display Range in the Vertical Axis Direction Using Upper/Lower Limit Values

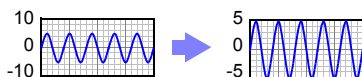

Set the display range in the vertical axis direction using upper/lower limit values.

1 Select the upper limit value for the display in [Upper].

2 Set the lower limit value for the display in [Lower] in the same way. (Initial settings: Upper limit 0.005, lower limit: 0.005)

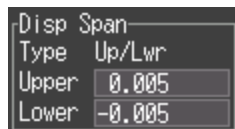

The setting range for the upper/lower limit values is set to a significant figure of 5 decimal places as below.

$-9.9999\text{E} + 19 \leq \text{Setting value} \leq -1.0000\text{E} - 19$, setting value = 0

$+1.0000\text{E} - 19 \leq \text{Setting value} \leq +9.9999 + 19$

7.4 Waveform Calculation Formula

bi: The i-th piece of data of calculation results

Waveform calculation type	Description
Moving average	$bi = 1/k \sum_{t=i-k}^i dt \quad (i = 1, 2, \dots, n)$ <p>dt: The t-th piece of data obtained through the source channel k: When the moving point number (1 to 1000) i is less than k, k = i.</p>
Average	$bi = 1/(n-r) \sum_{t=r+1}^i dt \quad (i = r+1, r+2, \dots, n)$ <p>dt: The t-th piece of data obtained through the source channel r: Reset position</p>
Sum	$bi = \sum_{t=(1+r)}^i dt \quad (i = 1, 2, \dots, n)$ <p>dt: The t-th piece of data obtained through the source channel r: Reset position</p>
Heat flow rate	Heat flow CH/(Temperature CH1 - Temperature CH2)
Four operations (+, -, ×, ÷)	Performs the four operations, which is addition (+), subtraction (-), multiplication (×), and division (÷), using the specified operators

System Environment Settings

Chapter 8

Settings affecting the clock, SAVE key operation and self testing are made from the System screen.

Screen and Key Operation Settings

- Specify operating behavior when recovering from power outages (Start Backup) (p. 146)
- Set backlight power saving (p. 147)
- Set backlight brightness (p. 146)
- Select black or white screen background (p. 147)
- Enable or disable the beeper (p. 147)
- Set the horizontal axis (time value display) (p. 148)
- Select display language (p. 148)

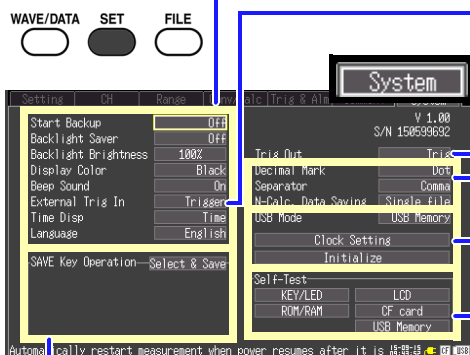

External Control Terminals

- Select external triggering (p. 157)
- Insert event marks by external input (p. 105)
- Set the trigger output (p. 158)

CSV File Saving

- Select CSV file data decimal and separator characters (p. 149)

System-Related Settings

- Set the clock (p. 150)
- Reinitialize the Heat Flow Logger (p. 151)
- Transfer data (p. 126)
- Switch the USB mode (p. 152)

Save (Storage) Settings (SAVE key)

- Select the saving method for the SAVE key (p. 114)

(for **[Quick Save]**)

- Select the type of data to save (p. 115)
- Select the time span to save (p. 115)

Self Testing

- KEY/LED test (p. 153)
- LCD test (p. 153)
- ROM/RAM test (p. 153)
- CF card test (p. 153)
- USB memory check (p. 153)

8.1 Screen and Key Operation Settings

1 **WAVE/DATA** **SET** **FILE**
Select the **[System]** screen.

2 Move to a setting item.

Open the setting options for the item to be set.

Select from the listed options.

Apply

Settings | CH | Range | Copy/Calc | Trig & Arr | **System**

Start Backup	Off
Backlight Saver	Off
Backlight Brightness	100%
Display Color	Black
Beep Sound	On
External Trig In	Trigger
Time Disp	Time
Language	English
SAVE Key Operation—Select & Save	

V 1.00
S/N 150599692

Trig Out: Trig
Decimal Mark: Dot
Separator: Comma
N-Calc, Data Savng: Single file
USB Mode: USB Memory

Clock Settings
Initialize

Self-Test
KEY/LED: LCD
ROM/RAM: CF card
USB Memory

Automatically restart measurement when power resumes after it is 電源復帰時 自動再開

Using the Auto-Resume Function (Resume After Power Restoration)

If a power outage or other power loss causes an interruption in recording (while the LED on the left side of the **START/STOP** key is lit), you can automatically resume recording when the power is restored. If you are using triggers, the triggers are restored to the **[Waiting for trigger]** state.

NOTE Bear in mind that data on the CF card or USB flash drive can be lost if power is disrupted while writing to it.

Select from the **[Start Backup]** setting options.

Setting options:(* default setting)

Off* Do not use the Auto-Resume Function.

On Use the Auto-Resume Function.

Settings	CH	Range	Copy
Start Backup		Off	
Backlight Saver		Off	
Backlight Brightness		100%	
Display Color		Black	
Beep Sound		On	
External Trig In		Trigger	

Adjust Backlight Brightness

Backlight brightness can be selected from four levels. Lower brightness settings provide longer battery operating time.

When the **[Backlight Brightness]** setting is selected, pressing the **ENTER** key repeated cycles through the four brightness levels.

Setting options: **100%***, **70%**, **40%**, **25%** (four-step brightness setting) (* default setting)

Backlight Saver	Off
Backlight Brightness	100%
Display Color	Black
Beep Sound	On
External Trig In	Trigger
Time Disp	Time

Enabling and Disabling the Backlight Saver

A backlight saver can be activated after a specified number of minutes during which no operation key is pressed. The backlight saver turns off the backlight of the LCD, prolonging the lifetime of the backlight by turning it off when not needed.

To deactivate the backlight saver, press any key. The operating screen appears again.

While the backlight saver is active, the instrument's measuring state is still indicated by the LED (lights green when measuring, and blinks when not measuring).

Select from the **[Backlight Saver]** setting options.

Setting options:(* default setting)

Off* Disables the backlight saver function. The operating screen is always displayed.

1min, 2min, 3min, 4min, 5min The backlight saver is activated if the specified time is exceeded.

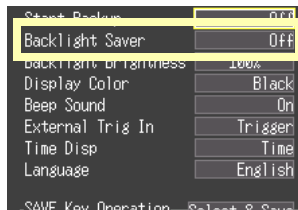

Be aware that power is still consumed even when the backlight is off, so be sure to turn the instrument's power switch off when not in use.

Setting the Screen Color Scheme

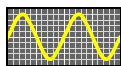

Black

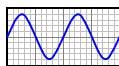

White

The screen color scheme can be selected from 2 colors.

Select from the **[Display Color]** setting options.

Setting options:(* default setting)

Black* Sets the color scheme to black.

White Sets the color scheme to white.

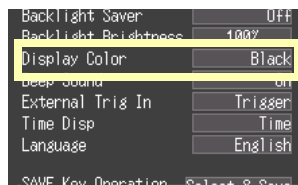

Enabling or Disabling the Beeper

The beeper can be set to sound when an error occurs.

Select from the **[Beep Sound]** setting options.

Setting options:(* default setting)

On* Emit a beep sound on error messages (error and warning displays).

Off Do not emit beep sound.

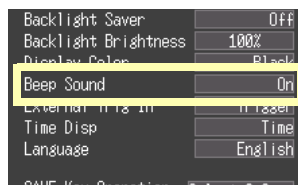

8.1 Screen and Key Operation Settings

Selecting the Horizontal (Time) Axis Display

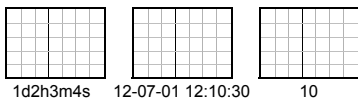

Select the display method for the horizontal axis at the bottom of the screen.

Select from the **[Time Disp]** setting options.

Setting options:(* default setting):

- Time*** Displays the time span from the start of measurement. If triggering is enabled, the displayed time span is from the last trigger event.
- Date** Displays the date and time of data acquisition.
- Data Pts** Displays the number of data points from the start of measurement. If triggering is enabled, the displayed data points begin from the last trigger event.

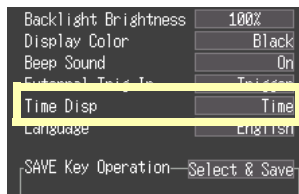

Selecting the Display Language

Select the display language.

Select from the **[Language]** setting options.

Setting options:(* default setting)

- English*** Display in English.
- Japanese** Display in Japanese.

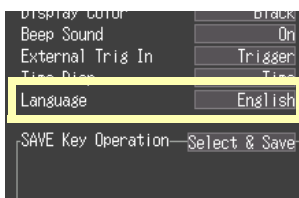

8.2 CSV File Saving Settings

CSV File Data Decimal and Separator Characters

Select from the **[Decimal Mark]** setting options.

Setting options:(* default setting)

- | | |
|--------------|------------------------------|
| Dot* | Select the period character. |
| Comma | Select the comma character. |

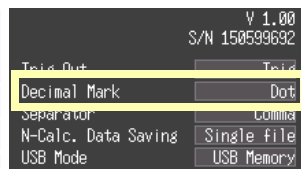

Select from the **[Separator]** setting options.

Setting options:(* default setting)

- | | |
|------------------|---------------------------------|
| Comma* | Select the comma character. |
| Space | Select the space character. |
| Tab | Select the tab character. |
| Semicolon | Select the semicolon character. |

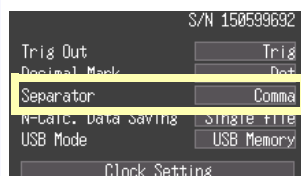

NOTE

The comma character cannot be selected for both decimal point and separator at the same time. By default, comma is the separator character, so it is not available as the decimal character. To select comma as the decimal character, first select a different separator character.

Select from the **[N-calc. Data Saving]** setting options.

Setting options:(* default setting)

- | | |
|---------------------|---|
| Single File* | Saves numerical calculation results in one file. |
| Split save | Saves numerical calculation results in separate files for each calculation. |

"Appendix 2 File Naming" (p. A7)

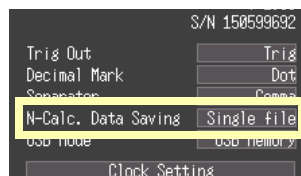

8.3 Making System Settings

Setting the Date and Time

The LR432-20 is equipped with an auto-calendar, automatic leap year detection, and a 24-hour clock.

If the clock is not set to the correct time, measurement start time (trigger time) and file date information will be incorrect. If this occurs, reset the clock.

1  Select the **[System]** screen.

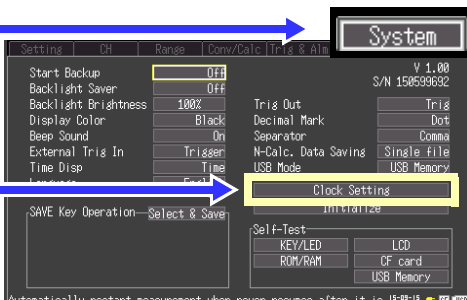

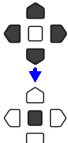
2  Select **[Clock Setting]**.

 Apply
The setting dialog appears.

3  Select an item to change.
(year, month, day, hour, minute or second)

 Apply

 Adjust the setting.

 Apply

4  Select **[Set]**.

 Apply

The clock is reset.

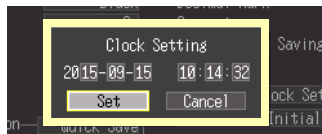

 Change by 1

 Change by 10



Initializing the Instrument (System Reset)



This procedure resets all settings to their factory defaults.

The system is reset by pressing and holding the **START/STOP** key while turning the instrument's POWER switch on.

For details about the factory default settings, Refer to “Appendix 5 List of Default Settings” (p. A11).

1  Select the **[System]** screen.

2  Select **[Initialize]**.
 Apply
 A confirmation dialog appears.

3  Select **[Yes]**.
 Apply
 Initialization proceeds.

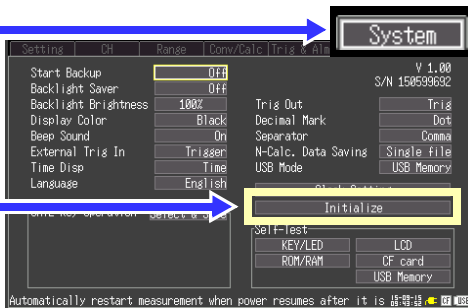
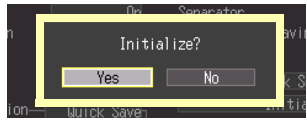
Settings stored in the instrument's memory and language and USB mode settings will not be reset.

Initializing all settings (reset all)

- If you wish to reset settings stored in the instrument's memory as well as language and USB mode settings, turn on the instrument while holding down the **SAVE** key and the **START/STOP** key.
- When the power is switched on, the language selection screen will display for you to choose the language you wish to use.
- After resetting all settings, the USB mode will be set to USB Memory.

NOTE The clock settings are retained even when a system reset or setting initialization is performed.

Switching the USB mode

Three USB modes are available: **[USB Memory]**, **[USB Comm.]**, and **[USB Drive]**.

NOTE Before changing the USB mode, disconnect both the USB communication cable and the USB flash drive from the instrument. Failure to do so will cause a message warning you to eject the devices to appear on the screen.

1 Select the **[System]** screen.

2 Select **[USB Memory]**, **[USB Comm.]**, or **[USB Drive]** from the pull-down menu.

3 Select **[Yes]**.

Apply
A confirmation dialog appears.

[USB Memory]

[USB Comm.]

[USB Drive]

NOTE

USB method of use	Connector used	[System] screen USB mode setting
Use a USB flash drive.	Type A	USB Memory (Default)
Communicate with the LR8432-20 and initiate measurement using the Logger Utility software from a computer (using a USB cable).	Type B	USB Communication
Read files on a CF card that is connected to the LR8432-20 from a computer (using a USB cable).	Type B	USB Drive

Self-Test

The following self tests are available. Results are displayed on the screen. If any faults are found, have the instrument repaired. Contact your authorized Hioki distributor or reseller.

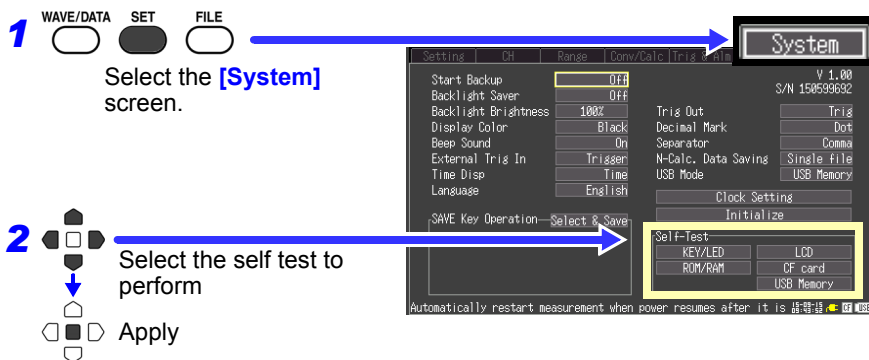

Self-Test	Details
KEY/LED	<p>Tests the keys and LEDs for correct operation. After every key has been pressed, the KEY/LED check finishes. Pressing the START/STOP key also tests whether the LED lights.</p> <p>If you notice a malfunction, press the SAVE and START/STOP keys simultaneously to abort the test.</p>
LCD	<p>Tests the screen display (color test, gradation test, character test) The screen changes each time you press an operation key.</p> <p>If the display screen seems abnormal, request repairs.</p>
ROM/RAM	<p>Tests the instrument's internal memory (ROM and RAM) If "NG" appears, request repairs.</p>
CF card	<p>Tests whether the instrument recognizes the inserted CF card. The CF card is formatted (p. 111)</p>
USB Memory	<p>Tests whether the inserted USB flash drive is recognized by the instrument.</p> <p>When the USB flash drive is recognized by the instrument, its capacity and peak current consumption will be displayed.</p>

External Control

Chapter 9

The external control terminals on the instrument support trigger signal input and output.

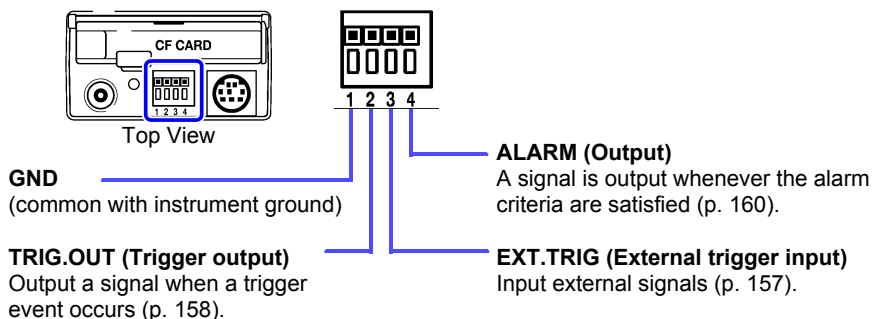

9.1 Connecting to the External Control Terminals



To avoid electrical hazards and damage to the instrument, do not apply voltage exceeding the rated maximum to the external control terminals.

	I/O terminals	Maximum input voltage
Input	EXT.TRIG	0 to 7 V DC
Output	TRIG.OUT	30 V DC
	ALARM	5 mA max, 200 mW max



To prevent electric shock accidents and damage to the equipment, always observe the following precautions when making connections to external terminal blocks and external connectors.

- Before making connections, turn off the power on the instrument and the equipment to connect.
- Do not exceed the specified signal levels for signals supplied to external terminal blocks.
- Ensure that devices and systems to be connected to the external control terminals are properly isolated.

9.1 Connecting to the External Control Terminals



- Ground the instrument and computer using a common wiring. If the instrument and computer do not share the same earthing location, there will be a potential difference. Connecting a USB cable while there is a potential difference can cause a malfunction or failure.
- The external control ground terminal is not isolated from the instrument's chassis ground. Make certain that there will be no potential difference between the external control ground terminal and the ground of any connected device. Otherwise, the instrument or device could be damaged.
- To avoid electric shock, use the recommended wire type to connect to the external control terminals, or otherwise ensure that the wire used has adequate current-handling capacity and insulation.

Terminal Connections

Required items:

Recommended cables:

Single strand diameter ϕ 0.65 mm (AWG22),

Multi-strand ϕ 0.32 mm² (AWG22)

Usable cables:

Single strand diameter ϕ 0.32 to 0.65 mm (AWG28 to 22),

Multi-strand 0.08 to 0.32 mm² (AWG28 to 22)

Strand diameter ϕ 0.12 mm or greater (per wire)

Standard insulation stripping length: 9 to 10 mm

Button operation specified tool: Flat-blade screwdriver
(shaft diameter ϕ 3 mm, tip width 2.6 mm)

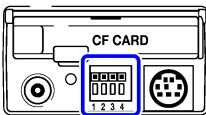
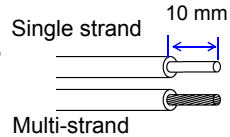

Top View

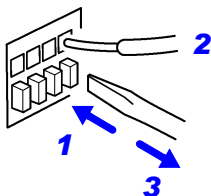

- 1 Push in the button on the connector with a flat-blade screwdriver or other tool.
- 2 With the button held in, insert the cable into the cable connection hole.
- 3 Release the button.
The cable is locked.

9.2 External Trigger Input

Triggering can be controlled by applying a signal from an external trigger source. This allows synchronous operation of multiple instruments by parallel triggering (p. 161).

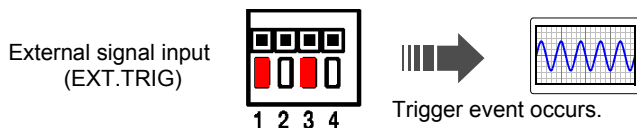

Trigger Input Signals

Voltage range	HIGH level: 3.0 to 5.0 V, LOW level: 0 to 0.8 V
Pulse width	HIGH level: 1 ms or greater, LOW level: 2 μ s or greater
Maximum input voltage	0 to 7 V DC

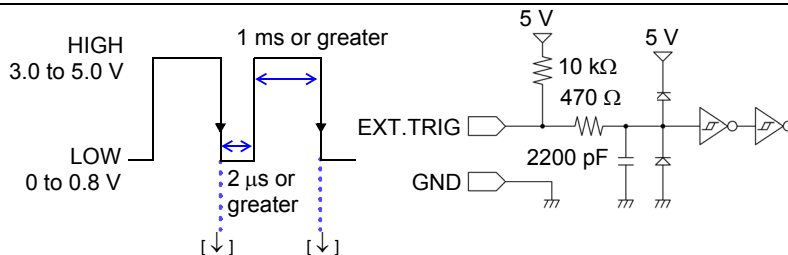

Signal Input Procedure

- 1 Connect the external trigger signal source and signal ground to external control terminals 3 (EXT.TRIG) and 1 (GND), respectively.
- 2 Press the **SET** key to open the **[System]** screen.
- 3 Set the **[External Trig In]** setting to **[Trigger]** (default setting).
- 4 Open the **[Trig & Alm]** screen, and set the **[Trig Func]** to **[On]**.
- 5 Specify trigger start and stop times by the **[Timing]** settings, as needed.
- 6 Set the **[Ext Trig] - [Start]** and **[Stop]** settings to **[On]**.
- 7 Either short the EXT.TRIG terminal to ground, or apply a pulse train (rectangular wave) to the EXT.TRIG terminal, with 3.0 to 5.0 V High and 0 to 0.8 V Low levels. Triggering occurs on the falling edge of the input waveform.

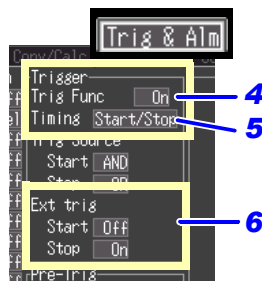
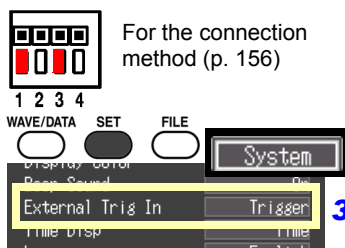

9.3 External Signal Output (Trigger Output)

You can output a signal when a trigger event occurs. This allows synchronous operation of multiple instruments by parallel triggering (p. 161)



Trigger Output Signals

Output signal	Open collector output (with voltage output), active LOW
Output voltage range	HIGH level: 4.0 to 5.0 V, LOW level: 0 to 0.5 V
Pulse width	LOW level: 10 ms or greater
Maximum input voltage	30 V DC, 50 mA max, 200 mW max

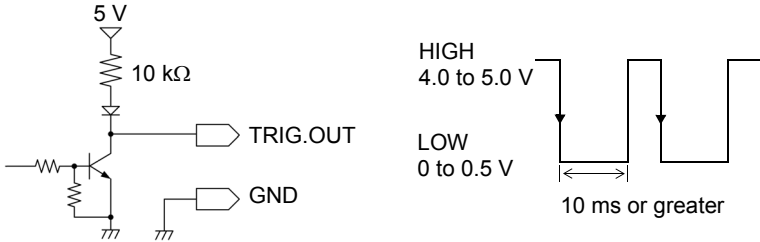

NOTE When triggering is not otherwise used, a trigger signal is output during measurement.

Signal Output Procedure

- 1 Connect the external trigger signal destination and signal ground to external control terminals 2 (TRIG.OUT) and 1 (GND), respectively.
- 2 Press the **SET** key to open the **[System]** screen.
- 3 Select from the **[Trig Out]** settings.

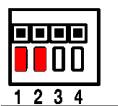

For the connection method (p. 156)

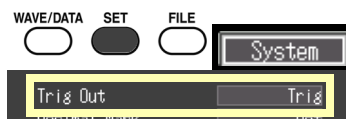

Trig *	Output a signal only when a trigger event occurs. The signal outputs are synchronized with the setting of the trigger timing.
Start	Output a signal even at the start of a measurement that is not a trigger event.

Trigger output setting	Trigger setting	Trigger timing	Trigger output timing	
Trig	Disabled	-	no output	
	Enabled *1	Start	Start trigger	
		Stop	Stop trigger	
Start	Enabled *1	Start/Stop	Start trigger/stop trigger	
		Disabled	-	Start recording
		Start	Start trigger	
	Stop	Start recording/ Stop trigger		
	Start/Stop	Start trigger/stop trigger		

*1. Indicates that in trigger function On, the trigger is set at one of the following - analog channel, pulse channel, waveform calculation channel, or external trigger.

When a trigger event occurs, a pulse wave changing from the HIGH level (4.0 to 5.0 V) to the LOW level (0 to 0.5 V) is output from the TRIG.OUT terminal.

9.4 Alarm Signal Output (Alarm Output)

This signal is output when alarm criteria are satisfied. Specify the desired alarm criteria.

Refer to “4.2 Alarm Output” (p. 86)

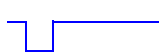
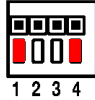
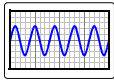

Alarm signal output (ALARM)

When alarm criteria are satisfied

About the Alarm Output Signal

Output signal	Open-drain output (with voltage output), active LOW
Output voltage range	HIGH level: 4.0 to 5.0 V, LOW level: 0 to 0.5 V
Output Refresh	Every recording interval
Maximum input voltage	30 V DC, 5 mA max, 200 mW max

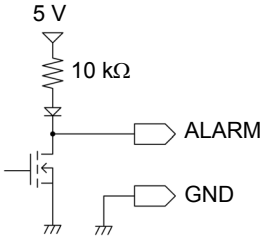

Connect the ALARM (No. 4) and GND (No. 1) terminals of the external control terminal block to the signal output line and ground, respectively. When the alarm criteria are satisfied, a Low level (0 to 0.5V) signal is output.



For the connection method (p. 156)

ALARM pin circuit architecture and example relay connection

The ALARM pin implements active-low operation. In the example connection, current flows to the coil when there is no alarm output. Choose a relay with a contact architecture that implements the desired operation.

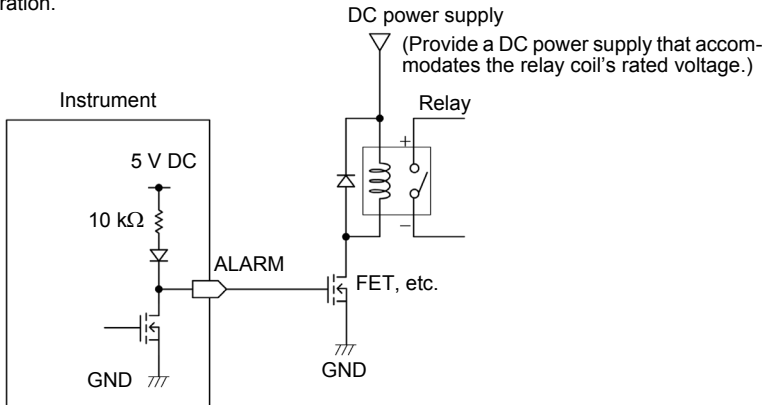

9.5 Synchronous Measurements with Multiple Instruments

Multiple instruments can be synchronized with each others using the external control terminals.

Parallel synchronization

Set one instrument to master, and set the others to slave.

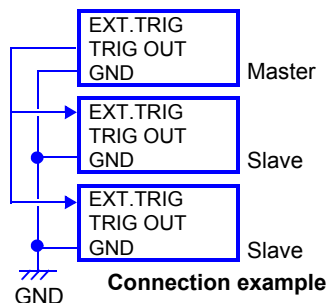

Set the master instrument.

- 1 Press the **SET** key to open the **[System]** screen.
- 2 Set the **[Trig Out]** setting to **[Start]**.

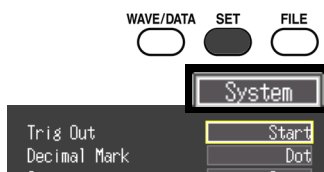

9.5 Synchronous Measurements with Multiple Instruments

Set the slave instrument.

- 1 Press the **SET** key to open the **[System]** screen.
- 2 Set the **[External Trg In]** setting to **[Trigger]**.
- 3 Press the **SET** key to open the **[Trig&Alm]** screen.
- 4 Set as follows.
 - Trig Func: On**
 - Timing: Start**
 - Trig Source Start: OR**
 - Ext Trig Start: On**

Turn the start trigger setting for all the channels (analog, pulse) to **Off**. Failure to do so may start the measurement without synchronization.

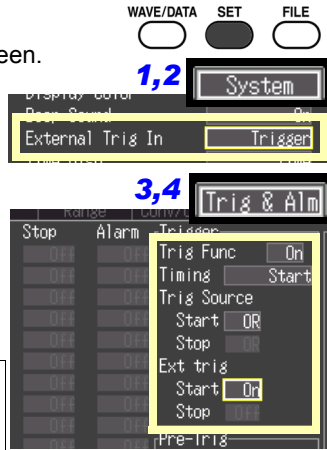

Press the **START/STOP** key of the slave instrument to start the measurement (trigger waiting state). In this state, press the **START/STOP** key of the master instrument to start the measurement. The slave instrument will start the measurement at the same time.

Specifications Chapter 10

(1) General Specifications

Basic Specifications

Number of channels	10 analog channels + 4 pulse channels Standard product configuration. Pulse grounds share common ground with instrument.
Internal memory capacity	Total 3.5 megawords
Maximum sampling rate	10 ms for all channels
Timebase accuracy	±0.01%
External terminals	External trigger input, trigger output, alarm output, GND
Clock functions	Auto-calendar, auto-leap year judgment, 24-hour clock Accuracy: ±50 ppm (0°C to 40°C), Value for reference: ±10 ppm (25°C)
Backup battery	Approx. five years for clock and settings (Value for reference at 25°C)
Conditions of guaranteed accuracy	Defined for an instrument with a 30-minute-long or longer warm-up and zero adjustment that are completed. Cutoff frequency 10 Hz/50 Hz/60 Hz (See the table of cutoff frequency.)
Operating temperature and humidity	Temperature: 0°C to 40°C (32°F to 104°F) Humidity: 80% RH or less (no condensation)
Temperature and humidity for guaranteed accuracy	Temperature: 23°C±5°C (73°F±9°F) Humidity: 80% RH or less (no condensation)
Storage temperature and humidity	Temperature: -10°C to 50°C (14°F to 122°F) Humidity: 80% RH or less (no condensation)
Guaranteed accuracy period	1 year
Guaranteed accuracy period from adjustment made by Hioki	1 year
Product warranty period	3 years AC adapter: 1 year Connector, cable, etc.: Not covered by the warranty
Operating environment	Indoors, Pollution degree 2, altitude up to 2000 m (6562 ft.)

Basic Specifications

Dielectric strength	350 V AC for 15 seconds (between each analog input channel and chassis, and between analog input channels)
Power supply	<ul style="list-style-type: none"> • Model Z1005 AC Adapter Rated supply voltage 100 V to 240 V AC (A voltage fluctuation of $\pm 10\%$ is taken into account for the rated power voltage.) Rated supply frequency 50 Hz/60 Hz Anticipated transient overvoltage 2500 V • Model 9780 Battery Pack 3.6 V (Model Z1005 has priority when connected) • The external 12 V DC power source (10 V to 16 V DC) (Wiring from the external power to instrument should not be more than 3 m long)
Maximum rated power	When using the Z1005 AC adapter: 30 VA (including the AC adapter), 10 VA (Instrument only) When using an external 12 V DC power source: 10 VA When using the 9780 Battery Pack: 3 VA
Continuous operating time	When using the 9780 Battery Pack and saving data to a CF card, approx. 2.5 hours (Value for reference at 25°C)
Charging function	Available if the AC Adapter is connected to the instrument with the 9780 Battery Pack installed Charging time: Approx. 200 minutes (Value for reference at 25°C) (Actual charging time depends on battery condition) (Charging temperature range: 5°C to 30°C)
Dimensions	Approx. 176W × 101H × 41D mm (6.93"W × 3.98"H × 1.61"D) (excluding protrusions)
Mass	Approx. 550 g (19.4 oz.) (Without Model 9780 Battery Pack) Approx. 620 g (21.9 oz.) (With Model 9780 Battery Pack installed)
Effect of conducted radio-frequency electromagnetic field	$\pm 5.0\%$ f.s. at 3 V
Effect of radiated radio-frequency electromagnetic field	$\pm 5.0\%$ f.s. at 3 V/m
Standards	Safety EN61010 EMC EN61326 Class A

Display Section

Display character	English/Japanese selectable
Display type	4.3-in TFT Color LCD (480 × 272 dots)
Display resolution	Waveform: Max. 20 divisions (time axis) × 10 divisions (voltage axis) (1 division = 20 dots (time axis) × 20 dots (voltage axis)) (The number of displayed time axis divisions depends on the display configuration.)
Dot pitch	0.198 mm × 0.198 mm
Backlight	On, Off
Backlight life span	Approx. 10,000 hours (when continuously on)
Backlight saver function	Selectable from on, or auto-off after specified interval
Backlight brightness	Selectable from four levels (100%, 70%, 40%, 25%)

External Interfaces

USB standard	USB2.0 compliant High Speed
Connector	Series mini-B receptacle
Connecting devices	Computer
Function	Supports data acquisition using a data acquisition application program Supports remote setting of measurement criteria using a data acquisition application program Transfer files between an installed CF card and connected PC

External storage

CF card

Slot	One CompactFlash specification compliant slot CF card Type I accepted
Card type	Flash ATA card
Card capacities	Model 9728 (512 MB), 9729 (1 GB), 9830 (2 GB)
Data formats	FAT and FAT32 supported
Storage contents	<ul style="list-style-type: none"> • Setting configurations • Measurement data (binary and csv format) (data between A and B cursors can be saved) • Screen images (bitmap format) • Calculation results

USB flash drive

Supported standard	USB2.0 compliant High Speed
Connector	Series A receptacle
Data formats	FAT and FAT32 supported
Storage contents	<ul style="list-style-type: none"> • Setting configurations • Measurement data (binary and csv format) (data between A-B cursors can be saved) • Screen images (bitmap format) • Calculation results Function not available when the USB external interface is in use.
Usable device	USB flash drive

CF card/USB flash drive common functionality

Drive-to-drive copying	Files and folders can be copied between drives.
-------------------------------	---

Measurement Input Section

Input terminals	M3 screw type terminal block (2 terminals per channel) Pulse inputs use a special connector
Measurement object	<ul style="list-style-type: none"> • Voltage • Heat flow • Thermocouple (K, J, E, T, N, R, S, B) • Pulse count integration (cumulative and instantaneous), revolution fluctuations

Measurement ranges and resolution

Measurement object	Range	Measurable range	Max. resolution
Voltage/heat flow	10 mV f.s.	-10 mV to +10 mV	500 nV
	100 mV f.s.	-100 mV to +100 mV	5 μ V
	1 V f.s.	-1 V to +1 V	50 μ V
	10 V f.s.	-10 V to +10 V	500 μ V
	20 V f.s.	-20 V to +20 V	1 mV
	100 V f.s.	-60 V to +60 V	5 mV
	1-5 V	1 V to 5 V	500 μ V
Temperature (thermocouple)	2000°C f.s.	-200°C to 1800°C *1	0.1°C
Pulse integration	1,000 megapulses f.s.	0 to 1,000 megapulses	1 pulse
Revolution fluctuation	5,000/n r/s f.s.	0 to 5,000/n r/s	1/n r/s
	n = pulses/revolution, from 1 to 1,000		

Measurement Input Section

Temperature measurement input range	K: -200°C to 1350°C	J: -200°C to 1200°C
	E: -200°C to 1000°C	T: -200°C to 400°C
	N: -200°C to 1300°C	R: 0°C to 1700°C
	S: 0°C to 1700°C	B: 400°C to 1800°C
	(JIS C 1602-1995)	

Measurement accuracy	<ul style="list-style-type: none"> Voltage/heat flow: $\pm 0.1\%$ f.s. (For the 1-5 V range, f.s. = 10 V) Thermocouple: <ul style="list-style-type: none"> K, J, E, T: (-200°C or higher and less than -100°C) $\pm 1.5^\circ\text{C}$ (-100°C or more) $\pm 1.0^\circ\text{C}$ N: (-200°C or higher and less than -100°C) $\pm 2.2^\circ\text{C}$ (-100°C or more) $\pm 1.2^\circ\text{C}$ R, S: (0°C or higher and less than 300°C) $\pm 4.5^\circ\text{C}$ (300°C or more) $\pm 2.2^\circ\text{C}$ B: (400°C or higher and less than 1,000°C) $\pm 5.5^\circ\text{C}$ (1000°C or more) $\pm 2.5^\circ\text{C}$ Reference junction compensation accuracy: <ul style="list-style-type: none"> $\pm 0.5^\circ\text{C}$ (Horizontal placement) $\pm 1^\circ\text{C}$ (Upright placement) (Add to thermocouple measurement accuracy when internal RJC is enabled.)
	<ul style="list-style-type: none"> Reference junction compensation accuracy: <ul style="list-style-type: none"> $\pm 0.5^\circ\text{C}$ (Horizontal placement) $\pm 1^\circ\text{C}$ (Upright placement) (Add to thermocouple measurement accuracy when internal RJC is enabled.)

Temperature characteristic	Add (Measurement accuracy \times 0.1) /°C to measurement accuracy
-----------------------------------	---

Reference junction compensation	Internal/External selectable (for thermocouple measurements)
--	--

Digital filter	Off, 50 Hz, 60 Hz (cut-off frequency set automatically according to recording interval)
-----------------------	---

Recording interval	Digital filter			Recording interval	Digital filter		
	60 Hz	50 Hz	Off		60 Hz	50 Hz	Off
10 ms	11.56 k	11.56 k	11.56 k	1 s	108.2	108.2	11.56 k
20 ms	5.78 k	5.78 k		2 s	60	54.03	
50 ms	2.216 k	2.216 k		5 s	60	50	
100 ms	1.096 k	1.096 k		10 s	60	50	
200 ms	542.5	542.5		20 s or more	10	10	
500 ms	216.6	216.6					

Input resistance	<p>1 M$\Omega$$\pm$5% (broken wire detection disabled, for voltage, heat flow, and thermocouple measurements)</p> <p>At least 800 kΩ (with broken wire detection enabled for thermocouple measurements)</p>
-------------------------	---

Normal mode rejection ratio	<p>50 dB minimum (with 50 Hz input with 5 s recording interval, and 50 Hz digital filter enabled)</p> <p>(with 60 Hz input with 2 s recording interval, and 60 Hz digital filter enabled)</p>
------------------------------------	---

Measurement Input Section

Common mode rejection ratio	with 100 Ω maximum signal source impedance 100 dB minimum (with 50 Hz or 60 Hz input and digital filter disabled) 140 dB minimum (with 50 Hz input with 5 s recording interval, and 50 Hz digital filter enabled) (with 60 Hz input with 2 s recording interval, and 60 Hz digital filter enabled)
Broken wire detection	(Thermocouple input) selectable On or Off, approx. 300 nA detection current
Maximum input voltage	30 V AC rms or 60 V DC (analog input channel)
Maximum rated voltage to earth	30 V AC rms or 60 V DC (between each input channel and chassis, and between input channels) Anticipated transient overvoltage 330 V
Pulse input	Non-voltage “a” contact (normally open) open collector or voltage input
Maximum input voltage	0 V to 10 V DC
Maximum channel-to-channel voltage	Non-isolated (channels use the instrument’s common ground)
Maximum rated voltage to earth	Non-isolated (channels use the instrument’s common ground)
Detecting level	High: 2.5 V min., Low: 0.9 V max.
Pulse input period	At least 200 μ s (both H and L levels at least 100 μ s)
Slope	Either rising or falling edge pulse detection can be set for each channel
Function	Integrated count, revolution variation

(2) Measurement Functions

Basic Specifications

Recording interval	10 ms, 20 ms, 50 ms, 100 ms, 200 ms, 500 ms, 1 s, 2 s, 5 s, 10 s, 20 s, 30 s, 1 min, 2 min, 5 min, 10 min, 20 min, 30 min, 1 h
Recording length	Any, with continuous recording selectable
Recording repetition function	Repeatedly measures using the specified recording length
Timer function	Records between specified start and stop times
Specifiable waveform colors	24 colors

Basic Specifications

Hybrid display configurations	<ul style="list-style-type: none"> • Simultaneous waveform and gauge display (Up to two gauges) • Waveform display • Simultaneous waveform and numerical value display • Simultaneous numerical value and comment display • Numerical value display • Numerical calculation display (simultaneous calculation results and waveforms) • Cursor value display (simultaneous A/B cursor values and waveforms)
Waveform magnification and compression	<ul style="list-style-type: none"> • Time axis (horizontal axis) 100 ms, 200 ms, 500 ms, 1 s, 2 s, 5 s, 10 s, 20 s, 30 s, 1 min, 2 min, 5 min, 10 min, 20 min, 30 min, 1 h, 2 h, 5 h, 10 h, 12 h, 1 day/division • Voltage axis (vertical axis) ×100, ×50, ×20, ×10, ×5, ×2, ×1, ×1/2 (switchable to upper and lower limit settings)
Waveform scrolling	Horizontal scrolling
Waveform storage	The last 3.5 M data points (during recording of one analog channel) are stored in internal memory. Data retained in memory can be observed by backward scrolling.

Trigger Section

Trigger method	Digital comparison
Trigger timing	Start, stop, start&stop
Trigger source	Analog input (CH1 to CH10), Integrated pulse input (P1 to P4)
External trigger	Triggering occurs when the external trigger and ground terminals are short-circuited, or on falling edges from High (3 V to 5 V) to Low (0 V to 0.8 V) levels. Maximum input voltage: 0 V to 7 V DC Minimum response pulse width: 1 ms for High, 2 μs for Low
Trigger criteria	AND or OR of each trigger source, Trigger criteria can be set for each channel.
Trigger types (analog and pulse)	<ul style="list-style-type: none"> • Level Trigger Triggering occurs when the signal rises (or falls) through a specified value. • Window Trigger Triggering occurs when the input signal level enters or exits the amplitude window defined by upper/lower thresholds.
Trigger level resolution	Analog channel: 0.025% f.s. (f.s. = 10 divisions) Pulse channel: 1c (Pulse count integration), 1/n r/s (revolution) n = pulses/revolution
Pre-trigger	Time span setting (any span). Settable with real-time saving.

Trigger Section

Trigger output	Open-collector output (with 5 V voltage output, active low) Pulse width: at least 10 ms You can choose to enable output at trigger activation only or at both trigger activation and measurement start.
Trigger input and output terminals	Push-button terminals

Alarm Output

Output settings	OR, AND Output occurs when the logical sum (OR) or product (AND) of alarm trigger sources is true.
Alarm Types	The following criteria can be specified for each channel. <ul style="list-style-type: none"> • Level : An alarm is output by input rising above or falling below a preset level • Window : An alarm is output by input crossing into or out of a window defined by preset upper and lower trigger levels
Latch setting	Alarm output can be set to be held (latched), or not.
Beeper	On/Off
Alarm output characteristic	Open-drain output (with 5 V voltage output, active low)
Output refresh	At every recording interval

Miscellaneous

Numerical calculations	Up to four of seven calculations are available at the same time
Calculations	Average value, peak value, maximum value, time to maximum value, minimum value, time to minimum value, sum
Calculation time span (after measurement stop)	Period between A and B cursors or whole waveform period can be determined.
Calculation range (during measurement)	Whole waveform period can be specified. Split calculation: Calculation is performed at the specified time interval and the latest calculation value is displayed. Select split time from 1 min, 2 min, 5 min, 10 min, 15 min, 20 min, 30 min, 1 h, 2 h, 3 h, 4 h, 6 h, 8 h, 12 h, or 1 day.

Miscellaneous

Calculation result auto save	After measurement, the final calculation value is automatically saved to a CF card or USB flash drive in a text format. Split calculation: The calculation value at a certain time interval is saved in a text format in real time.
Waveform calculation	
Calculation method	Calculation (+, -, ×, ÷) between channels is performed and the calculation data is displayed as data for the calculation channel (W1 to W10). (Enabled only during measurement) Calculation is performed for the specified channel selected from average, moving average, sum, and heat flow rate. The calculation data is displayed as data for the calculation channel (W1 to W10). (Enabled only during measurement) <ul style="list-style-type: none"> • The number of points for the moving average can be set between 1 and 1000. • For the average and sum, the calculation value can be reset at the start trigger position and at a specified time interval after the start trigger event.
Calculation result auto save	Calculation results are saved in real time as waveform data for any channel.
Cursor measurement functions	Time difference between A and B cursors, potential difference between A and B cursors, potential at each cursor, time at each cursor
Scaling functions	Available for each channel independently Scaling can be set in ratio or with two points. The conversion ratio can be automatically set based on the sensitivity of the Heat Flow Sensor.
Gauge functions	The gauges of two different channels can be displayed simultaneously.
Comment entry	Provided
Event mark insertion	Event markers can be inserted by pressing a screen button or inputting a signal to the trigger input terminal (exclusive function)
Screen image capture function	Provided (compressed bitmap format)
Retain start condition function	Provided
Automatic save function	Waveform data (real-time), numerical calculation results (after measurement) Power to the instrument must not be interrupted while data is being saved.

Miscellaneous

Real-time saving	Saves real-time waveform data to CF card or USB flash drive in binary or csv format Data recorded during each recording length can be save in a separate file Overwriting save is available Up to 3.5 M data points in binary format can be loaded from a specified point (using one analog channel) Power to the instrument must not be interrupted while data is being saved.
Automatic setup function	Automatically loads settings from CF card or USB flash drive at power on
Monitor function	Indicates momentary values without storing data into memory
Waveform backup function	Memory is retained (backed up) while the instrument is turned off when a charged 9780 Battery Pack is present or with the Z1005 AC Adapter connected.
Waveform backup time	100 hours with a 9780 Battery Pack after full charge
Saving of settings	Up to 10 setting profiles can be saved in the instrument's memory.

(3) Miscellaneous

Accessories	<ul style="list-style-type: none"> • Measurement Guide 1 • CD 1 (Logger Utility [Data acquisition application program], Instruction Manual) • USB cable 1 • Z1005 AC Adapter (with supplied power cord)..... 1
Options	<ul style="list-style-type: none"> • Model 9780 Battery Pack (Ni-MH, 3.6 V, 1500 mAh) • Model Z1005 AC Adapter • Model 9782 Carrying Case • Model 9812 Soft Case • Model 9641 Connection Cable (for pulse input) • Model 9728 PC Card 512 M • Model 9729 PC Card 1 G • Model 9830 PC Card 2 G • Model 9809 Protection Sheet • Model Z2012 Heat Flow Sensor • Model Z2013 Heat Flow Sensor • Model Z2014 Heat Flow Sensor • Model Z2015 Heat Flow Sensor • Model Z2016 Heat Flow Sensor • Model Z2017 Heat Flow Sensor • Model Z2018 Heat Flow Sensor • Model Z2019 Heat Flow Sensor • Model Z2012-01 Heat Flow Sensor • Model Z2013-01 Heat Flow Sensor • Model Z2014-01 Heat Flow Sensor • Model Z2015-01 Heat Flow Sensor • Model Z2016-01 Heat Flow Sensor • Model Z2017-01 Heat Flow Sensor • Model Z5008 Thermally Conductive Tape

Maintenance and Service

Chapter 11

11.1 Troubleshooting

Inspection and Repair



WARNING

The customer should never modify, disassemble, or repair the instrument. Doing so may cause fire, electric shocks, or injury.

NOTE

- The calibration frequency varies depending on the status of the instrument or the installation environment. We recommend that the calibration frequency is determined in accordance with the status of the instrument or installation environment and that you request that calibration be performed periodically.
- If damage is suspected, check the “Before Returning for Repair” (p.175) section before contacting your authorized Hioki distributor or reseller.

Transporting

- Use the original packing materials when transporting the instrument, if possible.
- Pack the instrument so that it will not sustain damage during shipping, and include a description of existing damage. We cannot accept responsibility for damage incurred during shipping.

Replaceable Parts and Operating Lifetimes

Useful life depends on the operating environment and frequency of use. Operation cannot be guaranteed beyond the following periods

For replacement parts, contact your authorized Hioki distributor or reseller.

Part	Life
LCD (to half brightness)	Approx. 10,000 hours
Model 9780 Battery pack	60% of initial battery capacity can be expected to remain after 500 complete charge/discharge cycles.
Battery pack connectors	Disconnection/connection times: 30 (the number of times that provides stable connection)
Electrolytic Capacitors	Approx. 10 years

11.1 Troubleshooting

Part	Life
Lithium Battery	Approx. 5 years The instrument contains a built-in backup lithium battery. If the date and time deviate substantially when the instrument is switched on, it is the time to replace that battery. Contact your authorized Hioki distributor or reseller.

The fuse is housed in the power unit of the instrument. If the power does not turn on, the fuse may be blown. If this occurs, a replacement or repair cannot be performed by customers. Please contact your authorized Hioki distributor or reseller.

Before Returning for Repair

If abnormal operation occurs, check the following items.

Symptom	Check Items	
The display does not appear when you turn the power on.	<ul style="list-style-type: none"> • Is the power cord disconnected? • Are connections made correctly? • Is the battery pack installed correctly? 	<p>Verify that the power cord is connected properly (p.31). Verify that the battery pack is correctly installed (p.26).</p>
Keys do not work.	<ul style="list-style-type: none"> • Is any key being held down? • Is the key-lock state active? (A message appears when a key is pressed while key-lock is active.) 	<p>Verify key operation. Cancel key-lock: (Hold the □ □ cursor keys for three seconds)</p>
Power does not turn on.	<ul style="list-style-type: none"> • A power protection component may be damaged. 	<p>Customers should not attempt to perform parts replacement and repair. Contact your authorized Hioki distributor or reseller for service.</p>
A waveform does not appear when you press the START/STOP key.	<ul style="list-style-type: none"> • Is the "Waiting for pre-trigger" message displayed? • Is the "Waiting for trigger" message displayed? • Is the waveform display color selection box selected (<input checked="" type="checkbox"/>)? 	<p>When pre-triggering is enabled, triggering is ignored until the pre-trigger portion of the waveform has been acquired. Recording starts when a trigger occurs.</p>
No changes occur in the displayed waveform.	<ul style="list-style-type: none"> • Is the measurement cable connected correctly? • Is the measurement range set properly? 	<p>Verify that the clamp sensor or connection cable is connected correctly (p.32).</p>
Data cannot be saved to the removal storage.	<ul style="list-style-type: none"> • Is the removal storage inserted properly? • Is the removal storage formatted? • Is the remaining capacity of the removal storage too low? 	<p>"Using a CF Card/USB flash drive" (p.109)</p>
If the cause is unknown	<ul style="list-style-type: none"> • Try performing a system reset (p.151). • All settings are returned to their factory defaults. "Appendix 5 List of Default Settings" (p. A11) 	

Model 9780 Battery Pack cannot be charged (CHARGE LED is not lit).	Please confirm that the surrounding temperature is within 5°C to 30°C range.	The temperature allowed for charging on the instrument is surrounding temperature of 5°C to 30°C. (p.26)
	Is the instrument stored for a long time in a plugged condition?	The battery pack may have deteriorated and the battery life may be expiring soon. (p.173) Please purchase a new battery pack. Please contact your authorized Hioki distributor or reseller. If the instrument is not used for more than a month, please remove the battery pack for storage. (p.27)
Time that can be used with the battery pack has become shorter.	Possibility of capacity decrease due to the deterioration of the battery pack.	The battery pack may have deteriorated and the battery life may be expiring soon. (p.173) Please purchase a new battery pack. Please contact your authorized Hioki distributor or reseller.

11.2 Cleaning

To clean the instrument, wipe it gently with a soft cloth moistened with water or mild detergent.

Wipe the LCD gently with a soft, dry cloth.

11.3 Disposing of the Instrument

The instrument contains a lithium battery for memory backup. When disposing of this instrument, remove the lithium battery and dispose of battery and instrument in accordance with local regulations.

Removing the Lithium Battery



- To avoid electric shocks, turn off the power switch, remove the power cord and cables, and then remove the lithium batteries.
- Do not short circuit, charge, disassemble, or incinerate the batteries. Doing so may cause an explosion.
- Keep batteries out of reach of children to prevent them from being swallowed.

Required tools:

- One Phillips screwdriver (No.1)
- One wire cutter (to remove the lithium battery)

- 1 Verify that the power is off, and remove the measurement cables and power cord.
- 2 Turn the instrument over and remove the five screws affixing the lower case.
- 3 Remove the lower case. Then remove the two screws affixing the circuit board, and remove it.

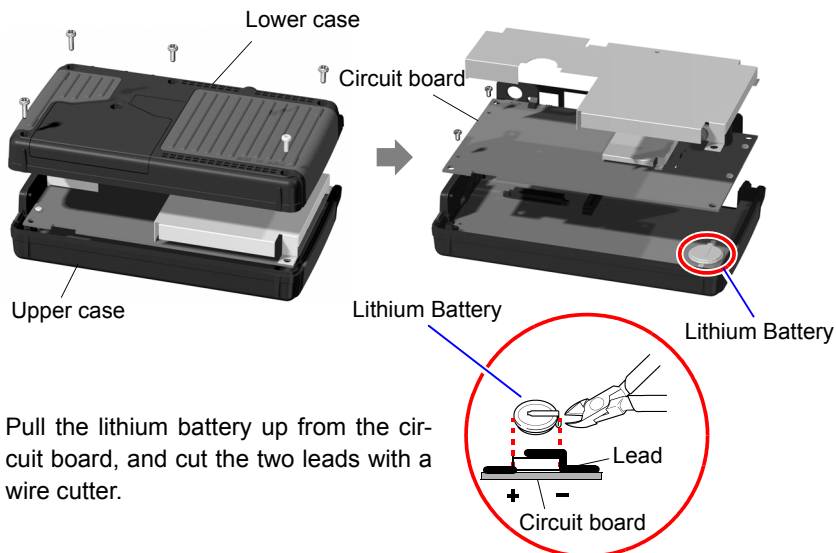

- 4 Pull the lithium battery up from the circuit board, and cut the two leads with a wire cutter.

11.3 Disposing of the Instrument

CALIFORNIA, USA ONLY

This product contains a CR Coin Lithium Battery which contains Perchlorate Material - special handling may apply.

See www.dtsc.ca.gov/hazardouswaste/perchlorate

Appendix

Appendix 1 Error Messages and Remedial Actions

Error messages consist of either “Error” or “Warning” displays. A screen message appears whenever an error occurs. In either case, take the remedial action indicated.

Error Messages



To clear an error message, press the **ENTER** or **ESC** key.

Message	Remedial Action
004 Battery low. Cannot access to the waveform backup and Media.	Low battery charge: recharge or replace with a fresh battery pack.
005 FPGA error.	Incompatible FPGA firmware version. Try updating the firmware, and if the error persists, submit the instrument for repair.
013 Failure has been detected on power source for USB memory.	Replace the USB flash drive. If the error persists after replacement, the instrument needs to be repaired.
014 Storage media has been removed without going through a proper [EJECT] process.	When removing storage media during auto save operation, be sure to perform the [EJECT] procedure.

Warning Messages

Appears just once when an error occurs. Disappears within a few seconds. Also disappears when any key is pressed.

Message	Remedial Action
101 Invalid key.	The pressed key is disabled due to measuring or other operation. Press the key again after the current operation finishes.
102 Cannot start measurement.	The START/STOP key is disabled when the current screen is displayed. Switch to the Waveform screen before starting measurement.
103 Cannot change while measuring.	Press the START/STOP key to stop measuring before changing the setting.

Appendix 1 Error Messages and Remedial Actions

Message		Remedial Action
201	Exceeding the setting range.	The entered numerical value is out of the valid range. Enter a valid value.
204	Measurement range was changed.	When [Type] - [Range] is selected, the measurement range is automatically changed to match the upper and lower limits.
230	Recording time has been changed due to memory limit.	Increasing the number of measurement channels has decreased Internal memory waveform data capacity.
231	The pre-trigger time setting has been changed.	Increasing the recording interval or length requires reducing pre-trigger recording time.
232	Recording and pre-trigger times have been shortened due to memory limit.	Increasing the recording interval requires reducing recording length and pre-trigger recording time.
233	Trigger or alarm settings for this channel have been changed.	The setting ranges for count integration and revolutions have been changed.
234	The burn out setting has been disabled.	Broken wire detection is disabled (turned Off) when the recording interval is set to 10, 20 or 50 ms, or when the digital filter is disabled.
235	Burn out cannot be enabled with current settings.	Broken wire detection is disabled (turned Off) when the recording interval is set to 10, 20 or 50 ms, or when the digital filter is disabled.
236	File partition period was changed.	The segment time span has been changed in response to changing the recording interval.
237	File partition time was changed.	The segment time span has been changed in response to changing the recording interval.
238	When the record interval is 10ms or 20ms, the CSV automatic saving cannot be set.	To select [CSV (real time)] or [CSV + Calc] for auto saving, the recording interval must first be set to at least 50 ms.
239	Because the CSV automatic saving is set, the record interval cannot be set to 10ms or 20ms.	To select 10 ms or 20 ms recording interval, first select a non-CSV auto saving method.
240	The timer stop time has been passed.	Set the timer stop time to a future time.
301	No waveform data	No waveform data is preset, so data saving and calculations cannot be performed. Press the START/STOP key to start acquiring measurement data.
302	Confirm the A-B cursor position.	The A/B cursor positions are invalid (out of waveform range). Check the cursor positions.
303	No numeric calculation data	Execute numerical calculation (p.129).
304	Invalid event marker.	Try moving to an event mark that is not in memory.

Appendix 1 Error Messages and Remedial Actions

Message		Remedial Action
401	File processing error	An unexpected fault occurred while processing a file on the CF card or USB flash drive. Turn the instrument off and back on.
402	Cannot load this file.	The format of the file is incompatible with the instrument, or the file is corrupt. Refer to "6.1 About Saving and Loading Data" (p.107) for loadable file formats.
403	Insert a Media.	A CF card or USB flash drive is not present. Insert storage media.
404	Directory full	No more files can be created because the directory is full. Check or perform the following: 1. System reset (p.151) 2. Verify that the removal storage is specified by Hioki (p.109) 3. Reformat the removal storage (p.111) If the message persists after performing the above, either the removal storage or instrument may be damaged. Contact your authorized Hioki distributor or reseller.
405	Not enough capacity	The removal storage as insufficient space to save the file. Delete files to increase free space, or replace the removal storage.
406	Process interrupted (not enough battery capacity).	There is inadequate battery life remaining. Charge the battery or connect the AC adapter. If you check the above and find no problem, the CF card or instrument may be broken. Contact your authorized Hioki distributor or reseller.
430	Some data was not saved.	The removal storage is not inserted, or does not have enough free space. Insert a removal storage and manually save needed data.
431	Insert media to save waveform data. Insert recording media.	Insert a removal storage.
432	Change media.	Removable storage cannot be accessed. Replace the CF card or USB flash drive.
434	Media is full or cannot delete oldest wave file.	This may appear while measuring using waveform auto save. A file could not be saved: Not enough space on the removable storage.
435	Media is nearly full.	Not enough space on the removal storage. Replace with a new removal storage.
436	Saving interrupted (low battery).	Battery charge is too low to save. Recharge, or connect the AC adapter.

Appendix 1 Error Messages and Remedial Actions

Message		Remedial Action
437	Saving wave data. Please wait for a moment.	Some key operations are disabled because of the increased load during real-time saving. Minimize key operations as much as possible during real-time saving.
438	This folder is protected. Please rename for deleting.	This message is displayed to prevent accidental deletion of data folders. To delete a folder, first rename it.
441	Insert the recording media. Unsaved data will be lost soon.	Real-time saving was attempted without removable storage, and with less than 50% internal memory available. Insert removable storage.
442	File name is too long to change.	The instrument cannot rename files with names longer than 26 characters. Use a PC to rename the file.
443	For USB Communication mode, USB memory is not available.	Switch to USB Memory mode on the [System] screen.
450	The save media changed to the CF card.	If the USB flash drive is removed while being used as the save media during auto save operation, the save media will be changed to the CF Card.
451	The save media changed to the USB memory.	If the CF card is removed while being used as the save media during auto save operation, the save media will be changed to the USB flash drive.
501	File system error (I/O error).	An I/O error occurred while accessing the removal storage. Reformat the removal storage. If the error persists, try a different removal storage. If this error occurs while using a good removal storage, the instrument may be damaged, in which case contact your authorized Hioki distributor or reseller.
502	File system error (Incorrect file handle)	Turn the instrument off and back on. If the fault persists, perform system reset (p.151).
503	File system error (system configuration)	
504	File system error (not enough memory)	
505	File system error (incompleted information).	The removable storage could not be recognized. Reformat the removable storage on a PC. If the error persists, try a different removable storage. If this error occurs while using a good removable storage, the instrument may be damaged, in which case contact your authorized Hioki distributor or reseller.

Appendix 1 Error Messages and Remedial Actions

Message		Remedial Action
506	File system error (incorrect device)	Turn the instrument off and back on. If the fault persists, perform system reset (p.151).
507	File system error (file protected)	The requested write process (including deletion) could not be performed because the file attribute is read-only. Use a computer to cancel the read-only setting.
508	File system error (failed to recognize the format).	The removable storage could not be recognized. Reformat the removable storage on a PC. If the error persists, try a different removable storage. If this error occurs while using a good removable storage, the instrument may be damaged, in which case contact your authorized Hioki distributor or reseller.
509	File system error (limit of the number of files).	The number of files to be processed exceeds the limit, so processing cannot be performed. Delete files to increase free space, or try another removable storage.
510	File system error (same name file)	An attempt was made to create a file with the same name as an existing file. Change the name of the file to be created (p.123).
511	File system error (system busy)	Processing could not be performed because files are in use by another executing process. Wait for the current process to finish. If there is no other executing process, turn the instrument off and back on.
512	File system error (too long path name).	The specified path name is too long. Re-enter the name of a removable storage folder from the PC.
513	File system error (no file)	Turn the instrument off and back on. If the fault persists, perform system reset (p.151).
514	File system error (mode error)	
515	File system error (invalid file handle)	
516	File system error (file offset error)	
517	File system error (not enough capacity).	Insufficient free space is available on the removable storage for the process to execute. Delete files to increase free space, or try another removable storage.
518	File system error (invalid file name)	The file name contains an invalid character. Rename the file (p.123).

A6

Appendix 1 Error Messages and Remedial Actions

Message		Remedial Action
519	File system error (directory error)	Turn the instrument off and back on. If the fault persists, perform system reset (p.151).
520	File system error (invalid file type)	
521	File system error (file rename error)	
522	File system error (internal parameter error)	
523	File system error (block size error)	
524	File system error (semaphore error)	
525	File system error (not supported action)	
680	Now in USB Communication mode. Do not connect anything to USB memory receptacle. (You can choose USB mode on the System screen.)	Disconnect the USB flash drive from the instrument. To use a USB flash drive, set the USB mode setting on the [System] screen to [USB Memory] and then connect the USB flash drive.
681	Now in USB Memory mode. Do not connect anything to USB cable receptacle. (You can choose USB mode on the System screen.)	Disconnect the USB communication cable from the instrument. To use USB communication functionality, set the USB mode setting on the [System] screen to [USB Comm.] and then connect the USB communication cable.

Appendix 2 File Naming

File names are constructed as follows (must be exactly eight characters, not including extension).

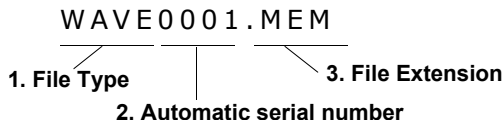

File Type	Folder Name	1. File Type	2. Automatic serial number	3. File Extension
Settings Data	CONFIG	CONF	0001,... 99999999	.SET
Waveform Data	DATA (Folders named by date are automatically created) *2	Manual Save: WAVE Auto Save: (specified name) or AUTO	0001, ...99999999 *1	.MEM (Binary) .CSV (Text) *3, 4
Numerical Calculation Results (calculation results from start to stop)	MEASURE-MENT /ALL	Manual Save: MEAS Auto Save: (Specified name) or AUTO	When [N-calc. Data Saving] is set to [Single file] in the system screen When [N-calc. Data Saving] is set to [Split save] in the system screen	.CSV*3, 4
Numerical Calculation Results (calculation results for each split time when split calculation is ON)	MEASURE-MENT /PART	Auto Save: (Specified name) or AUTO	An additional file with 1 to 4 corresponding to calculation 1 to 4 is created for 0001 to 99999999.	.CSV*3, 4
Captured Screen Image	PICTURE	SCR	00001...99999999	.BMP

*1 When auto saving waveform data and calculation results, automatically generated serial numbers (up to eight digits) are appended to the specified file name. If no file name is specified, AUTO is automatically entered.

(XXXX0001.MEM, XXX00001.MEM, XX000001.MEM, X0000001.MEM)

When auto numbering exceeds 9999, the file name characters are overwritten (right to left) until all eight digits are used for serial numbers.

(Example: WAVE9999.MEM, WAV10000.MEM, ..)

Appendix 2 File Naming

*2 When **[Deleting]** is enabled with auto save, the oldest waveform file is deleted when the CF card is full. When all waveform files within a date folder have been deleted, the folder name (date) is automatically updated.

(Example:) Before updating: 15-07-17

After updating: 15_07_17_150719_101113 (*old date_new date_new day and time*)

Hyphens (-) are changed to underbars (_) and the date when the folder name was last changed is appended.

(The example shows a new date and time of July 19, 2015, 10:11:13.)

*3 The TXT file extension is applied except when **[Separator:Comma]** is selected on the **[System]** screen.

*4 Before loading data into a spreadsheet program, note that the number of rows that can be loaded at one time is limited (to 60,000 rows in Microsoft Excel® 97-2003, and to one million rows in Excel® 2007).

Larger CSV files can be split by the following methods:

- Use a CSV file-splitting program (downloadable for free from Hioki's website).
- Before saving, select the **[Split Save]** saving method in the instrument.

Note: The number of rows recorded per minute with 10 ms recording interval is:

100 (data points per second) x 60 (seconds) = 6,000 rows

Appendix 4 Binary File Size Calculation

(Byte units)

File size = Header size + Data size

Header size = Text header size + Binary header size

Text header size = $512 \times (4 + \text{number of analog channels} \times 2 + \text{number of pluse channels} \times 2 + \text{number of waveform calculation channels} \times 3 + \text{number of alarm channels} \times 58)$

Binary header size = $512 \times (7 + \text{number of analog channels} + \text{number of pulse channels} + \text{number of waveform calculation channels} \times 3 + \text{number of alarm channels})$

Data size = $\text{number of analog channels} \times 2 + \text{number of pulse channels} \times 4 + \text{number of waveform calculation channels} \times 8 + \text{number of alarm channels} \times 4$

You can check an estimate of the remaining time available on the attached CF card/ USB flash drive on the **[Setting]** screen.

(About 90% of the time calculated using the above formulas is displayed as the **[Savable]** on the **[Setting]** screen, reflecting the fact that file and other information apart from actual data is also stored on the media.)

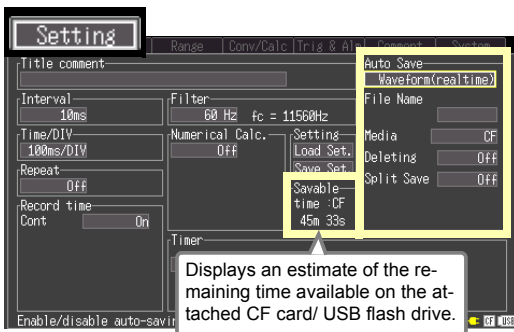

Appendix 5 List of Default Settings

When shipped from the factory or initialized to factory defaults, the settings are as follows.

Screen	Setting Item	Default Setting	
Setting	Interval	10ms	
	Filter	60 Hz	
	Time/DIV	100ms/div	
	Cont	On	
	Repeat	Off	
	Numerical Calc.	Off	
	Calc1	Off	
	Calc2	Off	
	Calc3	Off	
	Calc4	Off	
	Timer	Off	
	Auto Save	Off	
	CH	On/Off	CH1 to 10 and P1 to 4 all On
		Input	CH1 to 10: Voltage, P1 to 4: Count
Range		10 mV	
Thermo couple		K	
Burn Out		Off	
RJC		Int	
Count Mode		Add	
Pulse/Rev		1	
Slope		↑	
Disp Span		Position	
Zoom		Voltage and Revolve: x1, Tc: x20	
0 pos		Voltage: 50%, Tc and Revolve: 0%	
Upper		Voltage/heat flow: 0.005, Temperature: 100, Count and Revolve: 5000	
Lower		Voltage: -0.05, Tc, Count and Revolve: 0	
Scaling		Off	
Start Trig.		Off	
Stop Trig.		Off	
Alarm	Off		

Screen	Setting Item	Default Setting	
Trig& Alm	Trig Func	Off	
	Timing	Start	
	Trig Source	Start	OR
		Stop	OR
	Ext Trig	Start	Off
		Stop	Off
	Pre-Trig	0d 0h 0m 0s	
	Alarm	Off	
	Source	OR	
	System	Start Backup	Off
Backlight Saver		Off	
Backlight Brightness		100%	
Display Color		Black	
Beep Sound		On	
External Trig In		Trigger	
Time Disp		Time	
Language		English	
SAVE Key Operation		Select & Save	
Trig Out		Trigger	
Decimal Mark		Dot	
Separator		Comma	
N-Calc. Data Saving	Single file		
USB memory mode	USB Memory		

Appendix 6 Maximum Recordable Time

When saving waveform files in the form of binary data to either the instrument's internal memory or the CF card or USB flash drive, maximum recording times are as follows. The recording time when data obtained through 10 analog channels, four pulse channels, and one alarm channel (no waveform calculation channels) are recorded is shown in the table below as an example. Maximum recording time is inversely proportional to the number of recording channels.

Because the header portion of waveform files is not included in these calculations, actual times should be expected to be about 90% of the listed values.

Day values beyond 365 are not shown in the table.

When saving data in text format (CSV), the maximum recording time is reduced to 1/10 of the value indicated in the table or less.

(d: days/ h: hours/ min: minutes/ s: seconds)

Interval	Recording capacity				
	LR8432-20 internal memory (7MB)	9727 (256MB)*3	9728 (512MB)	9729 (1GB)	9830 (2GB)
10 ms	32 min	19 h 37 min	1 d 15 h 14 min	3 d 6 h 29 min	6 d 12 h 58 min
20 ms	1 h 4 min	1 d 15 h 14 min	3 d 6 h 29 min	6 d 12 h 58 min	13 d 1 h 57 min
50 ms	2 h 40 min	4 d 2 h 6 min	8 d 4 h 13 min	16 d 8 h 26 min	32 d 16 h 53 min
100 ms	5 h 21 min	8 d 4 h 13 min	16 d 8 h 26 min	32 d 16 h 53 min	65 d 9 h 47 min
200 ms	10 h 43 min	16 d 8 h 26 min	32 d 16 h 53 min	65 d 9 h 47 min	130 d 19 h 35 min
500 ms	1 d 2 h 49 min	40 d 21 h 7 min	81 d 18 h 14 min	163 d 12 h 29 min	327 d 59 min
1 s	2 d 5 h 39 min	81 d 18 h 14 min	163 d 12 h 29 min	327 d 59 min	–
2 s	4 d 11 h 18 min	163 d 12 h 29 min	327 d 59 min	–	–
5 s	11 d 4 h 16 min	–	–	–	–
10 s	22 d 8 h 33 min	–	–	–	–
20 s	44 d 17 h 6 min	–	–	–	–
30 s	67 d 1 h 39 min	–	–	–	–
1 min	134 d 3 h 18 min	–	–	–	–
2 min	268 d 6 h 36 min	–	–	–	–
5 min or more	–	–	–	–	–

$$\text{Maximum Recordable Time} = \frac{\text{Recording capacity}^{*1} \times \text{Recording interval (s)}}{\text{No. of recording channels}^{*2} \times 2}$$

*1. Recording capacity: $7 \times 1024 \times 1024$ (for internal memory)

*2. Number of recording channels = (number of analog channels) + (number of pulse channels $\times 2$) + (alarm channel) + (number of waveform calculation channels) $\times 4$

*3 Discontinued model

Appendix 7 Reference

LR8432-20 Measurement Values

Under the conditions below, “OVER” or “-OVER” is displayed for the numerical calculation or cursor value and the calculation value or saved data is handled as shown in the table below.

- When the allowable measurement range of each range is significantly exceeded
- When the thermocouple measurement range is significantly exceeded
- When the thermocouples are disconnected and disconnection detection is ON

Model LR8432-20		16 bits				
		0 (-OVER)	1	8000	FFFE	FFFF (OVER)
Voltage/ heat flow	10 mV	-16.3840 mV	-16.3835 mV	0.0000 mV	16.3830 mV	16.3835 mV
	100 mV	-163.840 mV	-163.835 mV	0.000 mV	163.830 mV	163.835 mV
	1 V	-1.63840 V	-1.63835 V	0.00000 V	1.63830 V	1.63835 V
	10 V	-16.3840 V	-16.3835 V	0.0000 V	16.3830 V	16.3835 V
	20 V	-32.7680 V	-32.7670 V	0.0000 V	32.7660 V	32.7670 V
	100 V	-163.840 V	-163.835 V	0.0000 V	163.830 V	163.835 V
Thermocouple		-3276.8°C	-3276.7°C	0.0°C	3276.6°C	3276.7°C

Model LR8432-20		32 bits			
		0	1	3FFFFFFE	3FFFFFFF (OVER)
Integration	0 c	1 c	1073741822 c	1073741823 c	
Revolution	0 r/s	1 r/s	1073741822 r/s	1073741823 r/s	

Appendix 8 Concerning Noise Countermeasures

Mechanism of Noise Introduction into Thermocouple Temperature Measurements

What are the sources of noise?

Within a factory, power is provided by large current flows at 50 Hz/60 Hz. The main loads are primarily L loads, such as motors and solenoids; in addition, large current pulses are produced by capacitor input-type switching power supplies for device such as inverters and high-frequency induction furnaces. Basic wave component leak current, harmonic wave current, and other types of noise become mixed into the flow from each ground point to ground lines.

What are the paths of noise propagation?

- Common mode voltage introduced between the ground points of the device being tested and the instrument leaks to the input signal lines
- AC magnetic fields produced by current in power lines couple into loops in the input signal lines
- Coupling due to electrostatic capacitance between input signal lines and power supply lines

What is common mode noise?

Noise that is generated between ground and the “+” and “-” input terminals of the instrument.

What is normal mode noise?

Inter-line noise that is generated between the “+” and “-” input terminals of the instrument.

Example of Connections Where Noise Can Affect Measurements

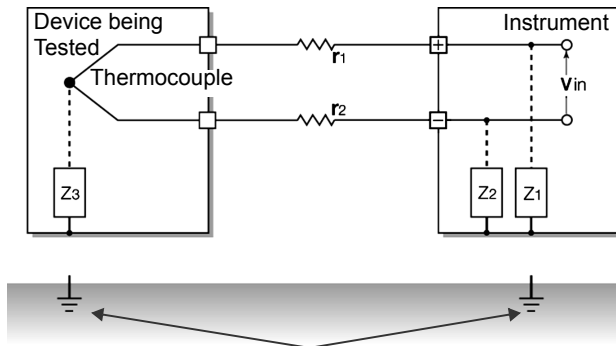

When using a thermocouple to measure temperature, noise can affect measurements unless both the device being tested and the instrument are grounded. Although there is no problem if the instrument is running on battery power, the instrument must be connected to ground if an AC adapter is being used.

Equivalent Circuit of Noise Introduction Path

Measurements are directly affected by normal mode voltages from electromagnetically induced noise resulting from electromagnetic coupling into looped instrument input lines by AC magnetic fields produced by inverters and commercial power lines, as well as the capacitive coupling that results from interline capacitance.

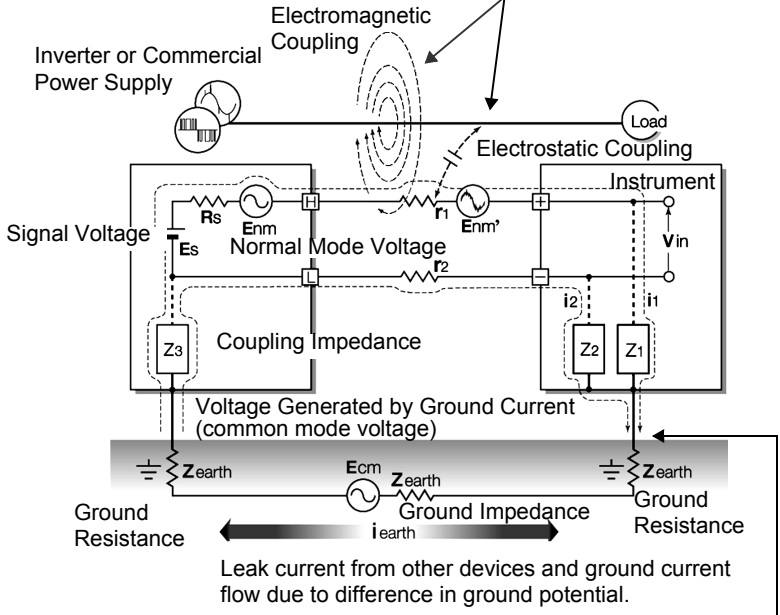

Common mode noise results from the interposition of ground impedance between the ground point of the device being tested and the ground point of the instrument, and from capacitor coupling between the ground wire and noise source. Common mode noise is converted to normal mode voltage (E_{nm}) that is added to the "+" and "-" input terminals of the instrument as a result of the noise current (i_1) and (i_2) that flows to the coupling impedance (Z_1) and (Z_2) between the "+" and "-" input terminals of the instrument and ground. Because common mode noise is generated between the input pins, it has a direct effect on the measurements.

The Importance of Device Grounding

Ground the instruments (Model LR8432-20) securely

The LR8432-20 is designed so that the chassis is grounded when the three-prong power cord from the adapter is plugged directly into a grounded, three-prong receptacle.

If a three-prong-to-two-prong adapter must be used on the AC adapter power cord and therefore the instrument is not grounded, the instrument can still be grounded by connecting a grounded wire to the GND terminal (a pushbutton terminal) located on the side of the LR8432-20.

Securely ground the chassis of the device being tested.

Securely connect the chassis of the device being tested to a good ground.

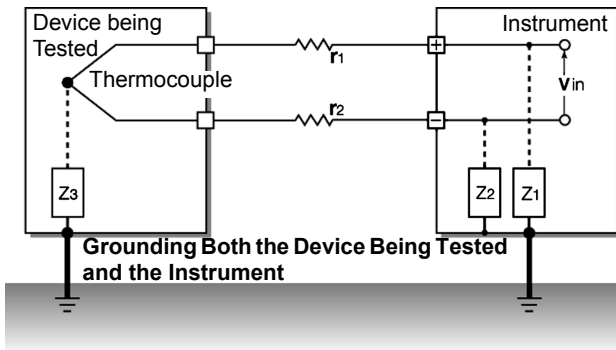

Connecting the chassis GND on the signal side to the instrument chassis

When connecting the chassis ground of the LR8432-20 to the chassis ground of the device being tested and then to ground, use a wire that is as short and as thick as possible to bring both pieces of device to equal potential.

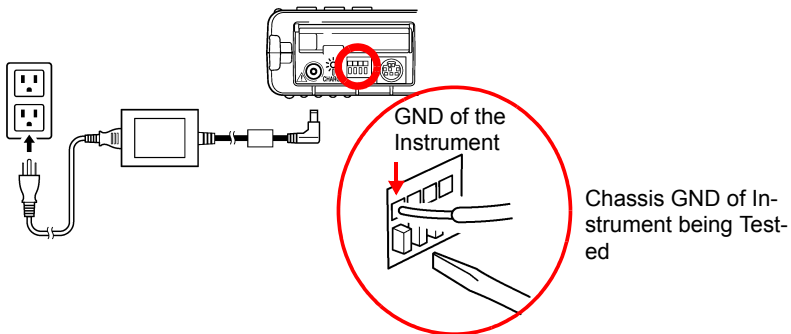

Running the instrument (Model LR8432-20) on battery power

When the instrument is being powered by batteries and the AC adapter is not connected, the ground current loop is eliminated, making it possible to reduce the effects of common mode noise.

For measurements of short duration, powering the LR8432-20 with batteries is an effective method for eliminating noise.

Common Mode Noise Countermeasures

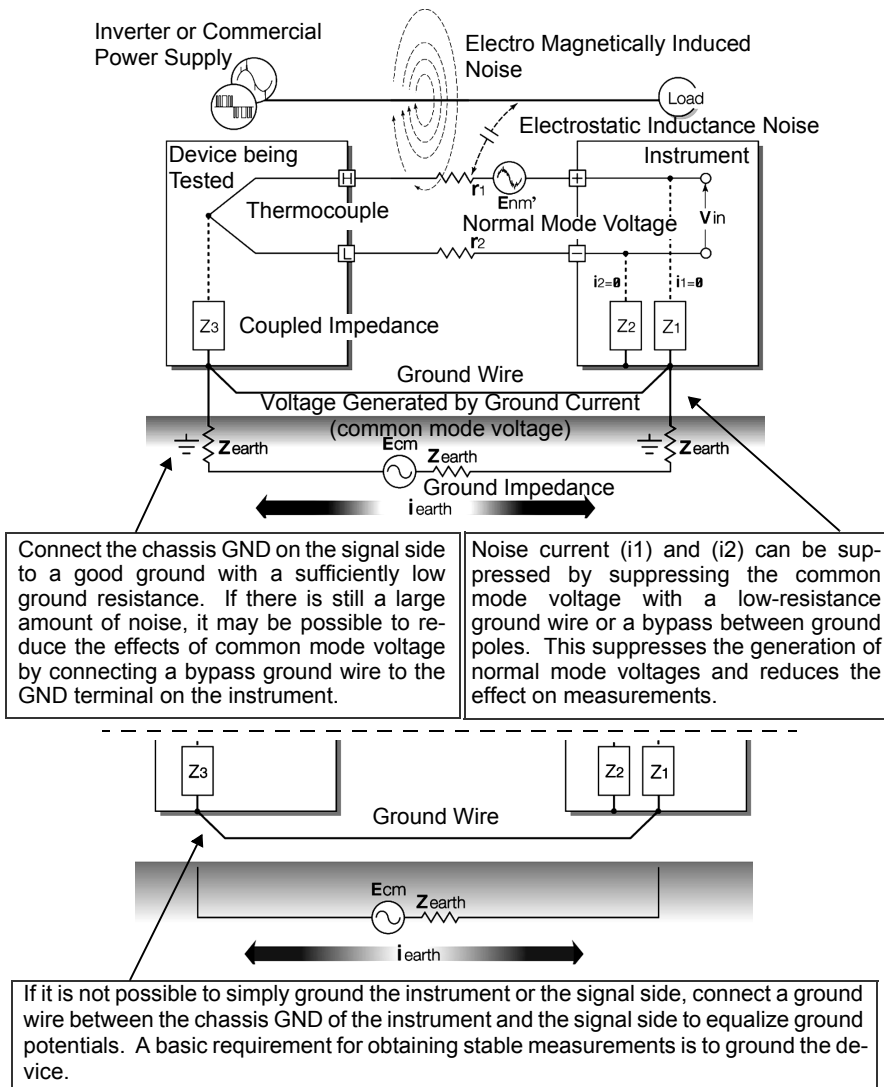

Blocking Noise from External Sources

Keep signal lines away from noise sources

Keep input signal lines (of the thermocouple) away from wiring that is a noise source (such as power lines, etc.), and make any permanent installation with as much separation as possible; for example, by running wires through a separate duct.

Use shielded twisted pair wiring

It is effective to use shielded twisted pairs for the input signal lines (of the thermocouple). Twisted pairs are effective for preventing electromagnetic induction, and shielded wires are effective for preventing electrostatic induction.

The shielded wires should basically be grounded on the signal source side. If it is not possible to connect the signal source to ground, connect it to the chassis GND on the LR8432-20. Note that doing so has no effect if the LR8432-20 is not itself connected to ground through the three-prong power cord, etc.

Shielded twisted pair wires for the thermocouple can be obtained from thermocouple manufacturers.

Normal Mode Noise Countermeasures

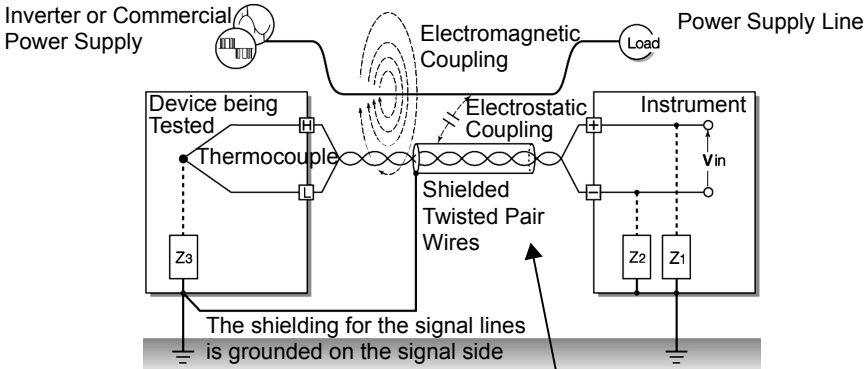

Keep the signal lines (of the thermocouple) away from wiring that is a noise source (such as power lines, etc.). It is also possible to shield the signal lines from electrostatic coupling and to block noise by grounding the shield.

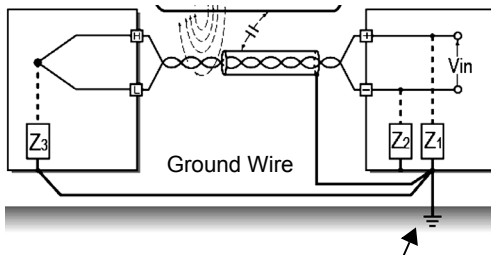

If the signal side is not grounded or if it is grounded inadequately, connect the instrument to ground. Also ground the shielding for the signal wires on the instrument side securely.

Insulation from noise sources (temperature measurement by thermocouple)

The analog input channels are insulated from the chassis and each other. Therefore, the instrument allows you to attach the thermocouple directly to a conductor with a potential to measure it, provided that the voltage to ground does not exceed the maximum rating. If noise is likely affect measurement, wrap heat-resistant tape around the thermocouple for insulation, or use an ungrounded thermocouple and electrically insulate the input line.

Setting the Digital Filter

To remove noise from input signals, the digital filter can be set for the analog channels.

The longer the recording interval is, the larger the noise reduction effect becomes; this ensures highly accurate measurement with little scatter.

Refer to “For recording interval and cutoff frequency” (p.167).

For example, assuming that the digital filter is set to 60Hz, noise reduction in the supply frequency is maximized at a recording interval from 2 sec. to 1 hr.

Inserting a Capacitor in the Signal Line

When noise affects the signal source directly or when measuring high-frequency pulses, it is effective to insert a capacitor between the “+” and “-” input terminals so that the noise does not enter the LR8432-20. When inserting a capacitor, use one with a rated voltage that is equal to or exceeds the input voltage.

When a capacitor is inserted between the “+” and “-” input terminals, there are no restrictions on the recording interval because the filter is applied before the channel scan operation.

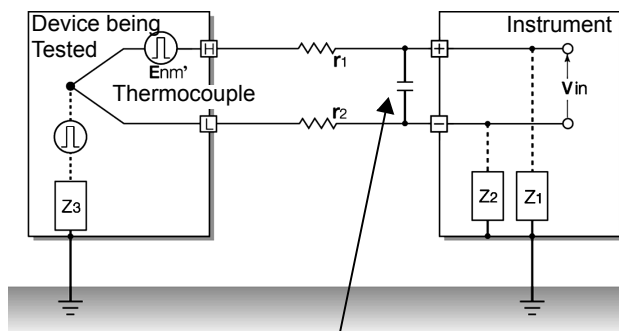

The capacitance of the capacitor should range from several μF to several thousand μF . Insert the capacitor between the “+” and “-” input terminals.

Appendix 9 Using the Application Program

The following features are available when using the supplied computer application program.

Display on the computer screen waveform files that were saved to CF card or USB flash drive on the instrument.
Convert binary data to CSV format for importing to spreadsheet programs on the computer.

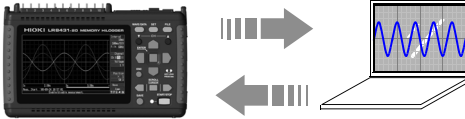

Configure instrument's settings on the computer, and transfer to the instrument.

Search event marks and measurement data using various criteria such as maxima and fluctuation values.

Acquire batch measurement data in real time from up to five units of Heat Flow Logger on one computer using USB connections. Monitor waveforms, numerical values and alarm output status in real time while measuring.

The Logger Utility application program needs to be installed on the computer before use. A USB driver also needs to be installed on the computer to enable communications with the instrument. The application program can be installed from the supplied CD, or you can download the latest version from the Hioki web site.

Use the following procedure to install the software on the computer. Verify operating environment compatibility before installing. For details such as application program operating instructions, read the instruction manual (PDF file) provided on the CD.

Operating Environment

- OS: Windows XP (32-bit)
Windows Vista® (32-bit/64-bit)
Windows 7 (32-bit/64-bit)
Windows 8 (32-bit/64-bit)
Windows 10 (32-bit/64-bit)
- CPU: 1 GHz or faster x86 or 64-bit processor
- Monitor Resolution: 1024 x 768 dots or better 65536 colors or more
- Memory: 1 GB or more RAM (32-bit), 2 GB or more RAM (64-bit)
- Interface: USB
- Hard disk: 3.0 GB or more of available space

- 1** Set the CD into the drive of the computer.
- 2** Install Logger Utility (p. A21).
- 3** Install the USB driver (p. A24).
- 4** Connect the AC adapter to the instrument and turn on the power.
- 5** Set the USB mode to **[USB Comm.]** on the **[System]** screen.
- 6** Connect the instrument and computer with the USB cable (p. A27).

NOTE

Because the USB mode on the **[System]** screen must be set to **[USB Comm.]**, it is not possible to record data to or load data from a USB flash drive while using the Logger Utility application software. The **[USB Memory]**, **[USB Comm.]**, and **[USB Drive]** USB mode settings are exclusive and cannot be used simultaneously.

Installing Logger Utility

Follow the procedure below to install Logger Utility. This explanation is for installing the software on Windows XP. The messages displayed may differ slightly depending on other operation system or settings you are using.

Important

If you are running software such as antivirus software, be sure to end the software before you start the installation. The installation may not be performed properly if antivirus software is running.

1 Start up Windows®.

Exit all running applications.

2 Insert the included CD into the computer's CD-ROM drive, the installer run automatically.

If the installer do not start, execute "setup.exe" from the CD-ROM drive.

If the installer do not start, execute "setup.exe" from the CD-ROM drive.

In Windows Vista®/Windows 7/Windows 8/Windows 10, Although the dialog which ask for installation permission of application, click **[Allow]**.

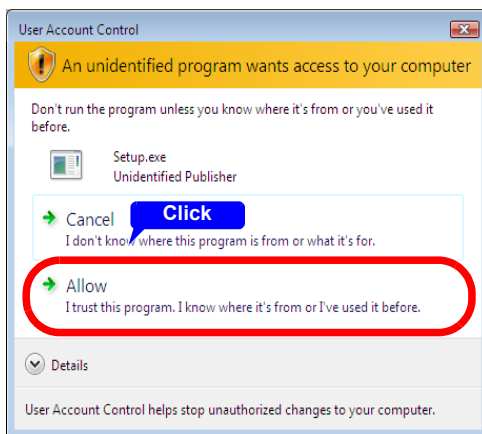

Appendix 9 Using the Application Program

3 In the installer, click **[Next]** and confirm the installation destination.

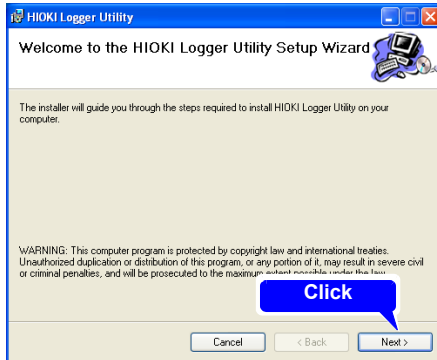

The end user license agreement is displayed. Read the EULA, then select **[I Agree]**, and click **[Next]**.

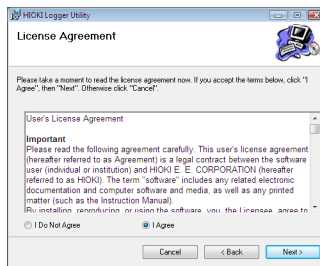

The installation destination folder can be changed on this screen.

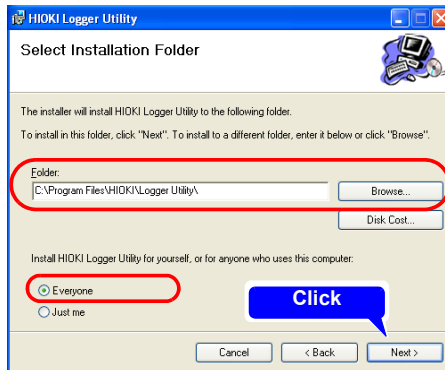

If you are not changing the installation destination, click **[Next]**.

To change the installation destination, click **[Browse]** to select another folder.

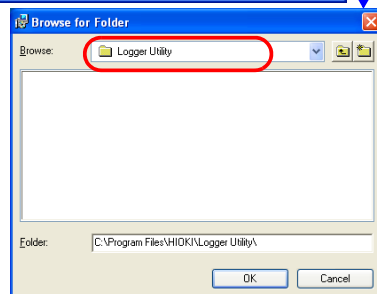

4 Click **[Next]** to start installing.

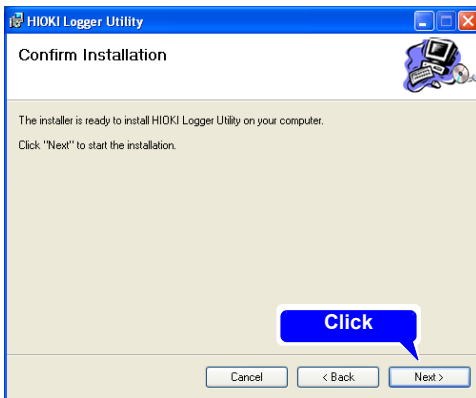

Installation starts.

Progress is displayed during installation.

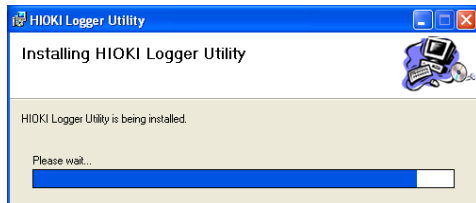

To interrupt installation in progress, click **[Cancel]**.

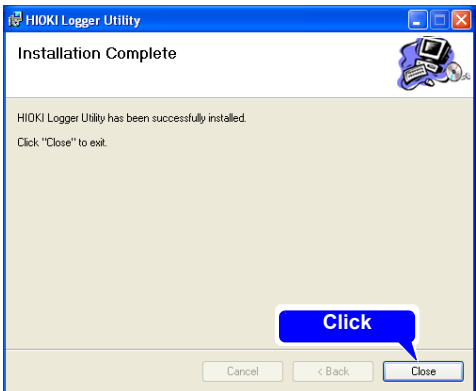

Installation finished

Installing the USB Driver

Install the USB driver before you use the instrument with a USB connection.

1 (Insert the CD found in the package into the CD-ROM drive.)

Install the driver.

- Run [SetupDriver32.msi] in the CD.
If [Logger Utility] is already installed, run the CD from the following location.
[c:\Program Files\HIOKI\LoggerUtility\Driver\SetupDriver32.msi]

If you are using the Windows Vista®/Windows 7/Windows 8/Windows 10 64-bit version:

- Run [SetupDriver64.msi] in the CD.
If [Logger Utility] is already installed, run the CD from the following location.
[c:\Program Files(x86)\HIOKI\LoggerUtility\Driver\SetupDriver64.msi]

Depending on the environment, the dialog box may take some time to appear so please wait till it does so.

2 Click [Next].

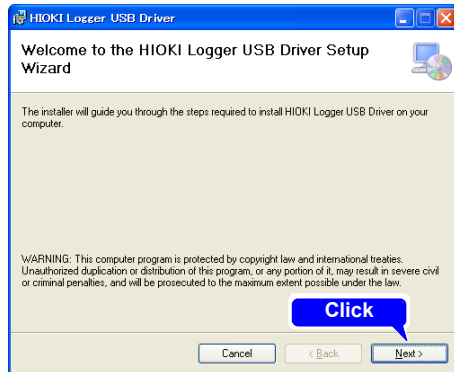

3 Check [Next].

When you want to change the installation destination, click [Browse...] to change the folder to install into. Normally, there is no need to change.

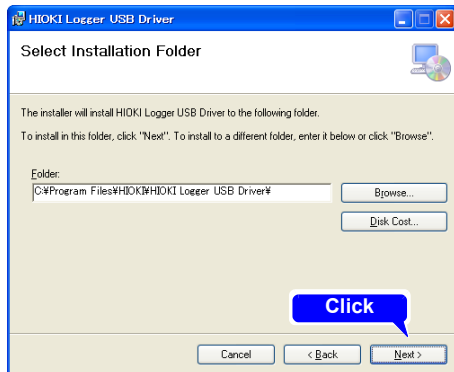

4 Click **[Next]**.

Start installing.



Installing.



For Windows XP

During the installation, a message saying that the software has not passed Windows® Logo testing will appear a few times, click **[Continue Anyway]** to continue installing.



Appendix 9 Using the Application Program

For Windows Vista®/ Windows 7/Windows 8/ Windows 10

When a dialog box requesting your permission to continue the program appears, click **[Continue]**.

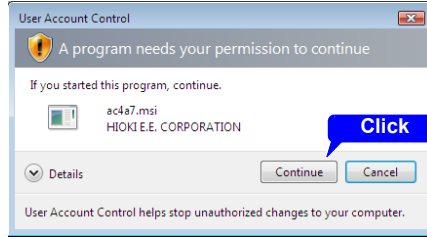

Sometimes another dialog box requesting your permission to install the software may appear. When it does, check **“Always trust software from “HIOKI E.E. CORPORATION”** and click **[Install]** to continue.

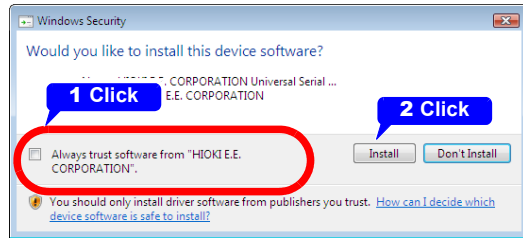

5 When installation is completed and the dialog box appears, click **[Close]** to exit.

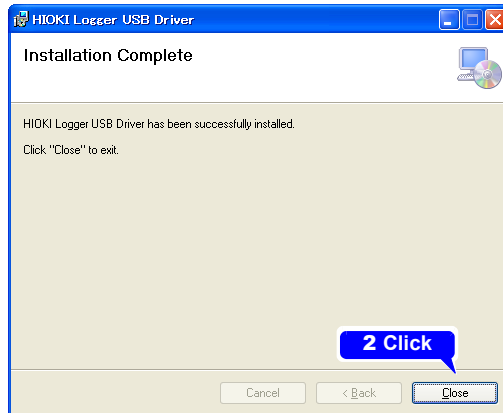

This completes the driver installation.

Connecting the Instrument to the Computer with a USB Cable

Install the USB driver before you use the instrument with a USB connection. (p. A24)



CAUTION

- Do not pull out the USB cable during data transfer. Doing so would prevent proper data transfer.
- The instrument and computer should be connected to the same earth ground. If grounded separately, potential difference between the ground points can cause malfunctions or damage when connecting the USB cable.

Set the USB mode on the [System] screen to [USB Comm.] before connecting the USB cable to the instrument. Connecting the USB cable without enabling USB Communication mode will prevent the instrument from being able to communicate with the Logger Utility.

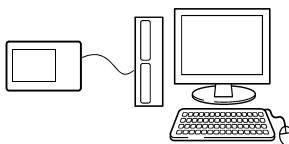

1 Orient the USB cable plug properly, and insert it into the receptacle.

2 Connect the AC adapter to the instrument and turn on the power.

3 Connect the other end of the cable to a USB port on the computer.

Connecting with the instrument the first time

For Windows Vista®/Windows 7/ Windows 8/Windows 10

The instrument will be recognized automatically and the device will be ready to use.

For Windows XP

A “**Found New Hardware Wizard**” dialog box will appear and the new hardware detection wizard will begin (next page).

The instrument is already recognized

Start the Logger Utility (p. A30)

Appendix 9 Using the Application Program

Windows XP

- 1 Connect the instrument and computer with the USB cable.
After the “Found New Hardware” window appears, the **[Found New Hardware Wizard]** dialog box will appear.
- 2 Check “No, not this time” and click **[Next]**.



- 3 Check “Install the software automatically (Recommended)” and click **[Next]**.

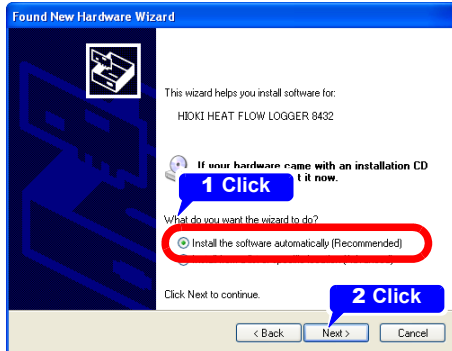

Please wait while the driver is being installed.

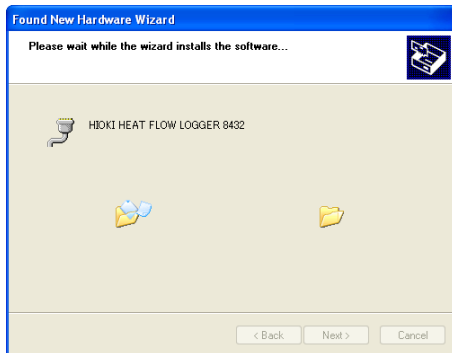

- 4 A message saying that the software has not passed Windows® Logo testing will appear a few times, click **[Continue Anyway]** to continue installing.



- 5 When installation is complete, the next dialog will appear. Click **[Finish]**.



This completes the driver installation.

Starting and Ending Logger Utility**Starting Logger Utility**

From the Start Menu of Windows®, click **[All Programs] - [HIOKI] - [Logger Utility] - [Logger Utility]**.

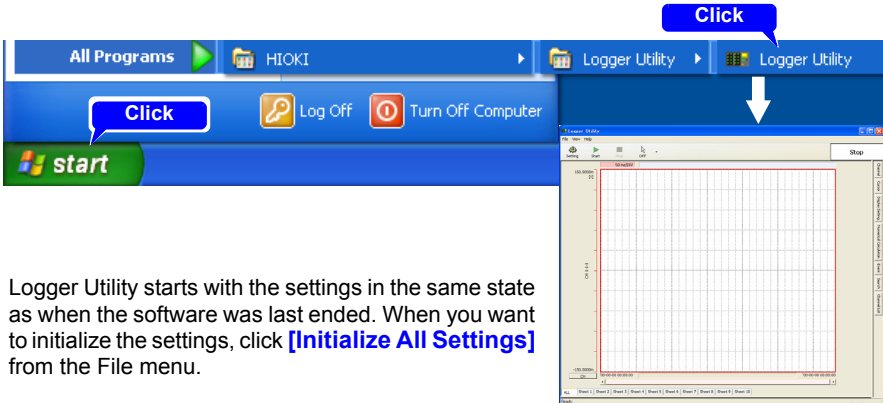

Logger Utility starts with the settings in the same state as when the software was last ended. When you want to initialize the settings, click **[Initialize All Settings]** from the File menu.

Ending Logger Utility

Click **[Exit Application]** from the File menu of the main screen. Alternatively, you can click the **[x]** close button at the top right of the main screen.

Uninstalling the Logger Utility

Use the following procedure to uninstall the program.

- 1 From the Windows® Start menu, select the **[Control Panel]**, and double click **[Add or Remove Programs]**.

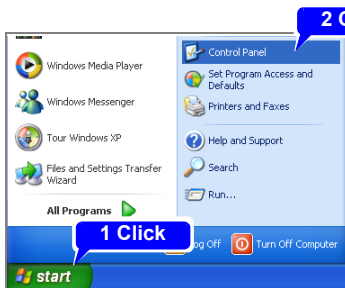

The **[Add or Remove Programs]** screen appears.

- 2 From the list of installed programs, select **[Logger Utility]**, and remove it. You are returned to the **[Add or Remove Programs]** screen. Settings files are not deleted during uninstall, so if no longer needed, delete them manually.

Appendix 10 Frequently Asked Questions

Here are some common questions and answers about the instrument.

Installation and Settings

Question	Remedial Action	Reference page
How to measure the temperature of an object having applied voltage?	The instrument provides this functionality. Since the maximum channel-to-channel and channel-to-ground voltage is 30 V rms AC or 60 V DC, exercise caution not to exceed those levels. When exceeding them, take steps to prevent the voltage from being applied to the instrument, for example by using an ungrounded thermocouple.	Precautions in “2.3 Connecting Measurement Cables to the Instrument” (p.32)
What is the maximum measuring time using the battery pack?	The maximum measuring time is about 2.5 hours (25°C reference value when saving data to a CF card). When using a USB flash drive, note that the amount of time that measurement can be performed with the battery pack may be shortened depending on the USB flash drive being used.	“2.1 Using the Battery Pack (Option)” (p.26)
What is the power consumption?	Normal consumption is about 3.5 VA, and maximum (while charging the battery with maximum LCD brightness) is 10 VA.	“Maximum rated power” (p.164)

Appendix 10 Frequently Asked Questions

Question	Remedial Action	Reference page
Can recording resume automatically after a power outage?	<p>Enable Auto Resume. Recording will automatically resume after a power outage.</p> <p>Because data measured before the outage is not retained in internal memory, we recommend enabling auto saving to removable storage. However, if the power goes out during real-time save operation, the data on the CF card may be corrupted. It is recommended to back up the power supply with the battery pack. However, data on the CF card may still be corrupted if the battery pack power supply fails during an extended power outage.</p> <p>High-end LR8400 series instruments use a built-in, high-capacity capacitor to perform file termination processing in the event of a power outage, allowing them to save data up to the time of the outage.</p>	"Using the Auto-Resume Function (Resume After Power Restoration)" (p.146)
If battery power fails while the instrument is being powered by the battery, will recording resume when AC power is restored?	<p>When battery power fails while the instrument is being powered by the battery, the instrument will not turn back on until the power switch is cycled from OFF to ON. A high-end LR8400 series instrument is recommended for applications requiring this type of operation.</p>	"2.1 Using the Battery Pack (Option)" (p.26)
How to minimize thermocouple measurement error when moving the instrument between places with much different temperatures?	<p>For thermocouple measurements, terminal temperature is measured by an internal sensor to provide reference junction compensation.</p> <p>When the ambient temperature changes abruptly, or when air flows directly on the terminals, errors occur due to thermal imbalance between the terminals and temperature sensor.</p> <p>When the instrument is moved to a location with significantly different ambient temperature, allow at least 30 minutes for thermal equalization before measuring.</p>	"Instrument Installation" (p.7)

Appendix 10 Frequently Asked Questions

Question	Remedial Action	Reference page
When connecting a thermocouple directly to the instrument, should reference junction compensation be set to external (EXT) or internal (INT)? How is accuracy affected?	Select INT when connecting a thermocouple (or compensating leads) directly to the instrument. Overall measurement accuracy is the sum of the accuracies of the thermocouple and the reference junction compensation (RJC). Example: When measuring a temperature from -100°C to 1,300°C with a K thermocouple The measurement accuracy is $\pm 1.5^\circ\text{C}$, obtained by adding the reference junction compensation accuracy of $\pm 0.5^\circ\text{C}$ to the temperature measurement accuracy of $\pm 1.0^\circ\text{C}$.	"Temperature Measurement Settings" (p.57)
How to display only CH1 to CH3?	Select only the channels to be used on the Input Channel Settings display. To acquire data without displaying it, select x as the waveform display color.	"3.4 Setting Configuration 2 – Input Channel Settings" (p.54) "Selecting Waveform Display Color" (p.64)
I am measuring humidity with a converter that converts 0 to 100% RH to 1 to 5 V. How can I read humidity directly?	Set the scaling method to [2-pt] , and enter the values. (1:1 conversion \rightarrow 0, 2:5 conversion \rightarrow 100, units: % RH)	"Converting Units (Scaling function)" (p.67)

Triggering

Question	Remedial Action	Reference page
Why does measurement not start when "Waiting for trigger" is displayed?	Triggering is enabled. To start recording immediately with the START key, disable all trigger criteria or the trigger function on the [Trig & Alm] screen.	"4.3 Confirming Trigger and Alarm Criteria Settings (List)" (p.89)
How to acquire data before a trigger?	Enable pre-triggering to acquire data before trigger events.	"Setting Criteria for Pre-Trigger Recording (Pre-Trig)" (p.85)

Appendix 10 Frequently Asked Questions

Question	Remedial Action	Reference page
How can I acquire data continuously starting on April 1, 2015, daily from 9:00 to 17:00, for one month?	Set as follows: Measurement Criteria [Interval]-[Cont] : Off, 8 hr 0 min 0 s [Repeat] : On Timer [Start] : On, 15 Year, 4 Mon, 1 Day, 9 Hour 0 Min 0 Sec [Stop] : On, 15 Year, 5 Mon, 1 Day, 9 Hour 0 Min 0 Sec [Interval] : On, 1 Day, 0 Hour 0 Min 0 Sec	“3.3 Setting Configuration 1 – Recording Settings” (p.46) “4.4 Starting and Stopping Recording by Timer” (p.90)
Is it possible to measure on 20 channels using two instruments synchronized with each other?	Measurement start can be synchronized with each others using an external trigger. Sampling cannot be synchronized with them.	“9.5 Synchronous Measurements with Multiple Instruments” (p.161)

Measuring

Question	Remedial Action	Reference page
What should I do about zero offset when the input is shorted?	Execute zero adjustment to compensate for offset when the inputs are shorted.	“2.5 Zero Adjustment” (p.39)
Even though a signal is only input on CH1, why do similar waveforms appear on unused channels?	An open-circuit input terminal can be affected by signals on other channels. By closing the input terminal circuit, normal measurement is possible. If this is impractical, disable unused measurement channels, or short the + and - terminals together.	
How to display numerical data values?	Press WAVE/DATA repeatedly to cycle through the Waveform (only), Waveform + Numerical Values, and Numerical Values (only) displays. Numerical values can be displayed in a large font on the enlarged numerical display. Numerical values at specific locations can be displayed using A/B cursors.	“1.4 Screen Configurations” (p.18) “Displaying Cursor Values” (p.99) “Viewing Input Signals as Numerical Values” (p.102)
What happens to pulse integration when there are more than one million pulses?	The counter saturates at 1,073,741,823 counts. If you expect to exceed this count, we recommend measuring with the Integration Mode ([Count]) set to Instantaneous ([Inst]), and summing later with a spreadsheet program.	“Integration (Count) Measurement Settings” (p.61)

Question	Remedial Action	Reference page
What is the timing difference between CH1 and CH2?	When the [Filter] is Off, the time difference between data on neighboring channels is about 780 μ s, regardless of recording interval. When the [Filter] is enabled (50 or 60 Hz), the time difference increases with longer recording intervals.	
How can I apply markers while measuring for easy searching later? How can I search for alarm event locations?	Event marks can be applied by the following methods. <ul style="list-style-type: none"> • Press the on-screen [Make Mark] button. • Apply a signal to the EXT.TRIG terminal 	"5.3 Inserting Event Marks (Search Function)" (p.104)

Data Saving

Question	Remedial Action	Reference page
Can after-market CF cards be used?	Operation cannot be guaranteed. Please use a Hioki-specified card to avoid problems.	"6.2 Using a CF Card/USB flash drive" (p.109)
Can after-market USB flash drives be used?	They can be used, although for real-time saving, we recommend using a Hioki-specified CF card option for data protection. Operation can only be guaranteed for Hioki CF card options. Also, USB flash drive security features such as fingerprint authentication are not supported. Use a USB flash drive whose continuous current consumption does not exceed 300 mA (peak 500 mA). (The peak value is displayed as "Max Power" under the USB flash drive self-test on the [System] screen.)	"6.2 Using a CF Card/USB flash drive" (p.109)
Can removable media be replaced while measuring?	Yes. Put the cursor on the [EJECT] button at the lower right of the screen, press ENTER, and remove the media following the displayed message.	"Replacing Removable Storage During Real-Time Saving" (p.53)
How much recording space is available?	It depends on setting conditions (number of channels and recording interval). About 327 days of recording is possible using 10 analog channels at 1 s recording interval to 1 GB media.	"Appendix 6 Maximum Recordable Time" (p. A12)

Appendix 10 Frequently Asked Questions

Question	Remedial Action	Reference page
<p>How can I process acquired data later with a spreadsheet program?</p>	<p>Auto-saved files recorded in [Waveform(realtime)] mode to removable storage can be quickly and conveniently converted to a text (CSV) file with the Utility Logger Program, which can then be loaded into a spreadsheet program. Auto-saved files recorded in [CSV(realtime)] mode can be directly loaded into a spreadsheet program, but note that the data cannot be reloaded into the instrument.</p>	<p>"Automatic Saving" (p.113)</p>
<p>How can I load data from a CF card onto the PC when it has no CF card slot?</p>	<p>Data can be transferred to a PC using the supplied USB cable and the USB Drive mode.</p>	<p>"6.6 Transferring Data to a Computer (USB Drive Mode)" (p.126)</p>
<p>How can I create files every hour, from 0:00 (ideal split time)?</p>	<p>Set auto-saving [Split Save] to Periodic ([Ref Time]).</p>	<p>"Automatic Save" (p.52)</p>
<p>What is the file limit when auto saving to removable storage?</p>	<p>Depending on file size and CF card capacity, more than 1,000 files can be saved in one folder, although only 1,000 can be displayed on the file screen. As the number of files increases, the time required to start and stop measurement also increases, so we recommend storing no more than 1,000 files, if possible. (When saving, a folder named "HIOKI_LR8432" is created, and files with different data types are saved in subfolders within it.)</p>	<p>"6.1 About Saving and Loading Data" (p.107)</p>
<p>Is data retained in internal memory when I turn the power off after measuring? I did not use auto saving to removable storage.</p>	<p>If the instrument is turned off with a 9780 Battery Pack with remaining power connected or the Z1005 AC Adapter connected, waveform data will be backed up to the instrument's internal memory. For the LR8432-20 with a fully charged 9780 Battery Pack, the waveform backup time is 100 hours.</p>	<p>"Waveform backup function" (p.172)</p>

Question	Remedial Action	Reference page
<p>If the power goes out while measurement is in progress, is the integrity of data being saved in real time to the CF card guaranteed?</p>	<p>If the power goes out during real-time save operation, the data on the CF card may be corrupted. It is recommended to back up the power supply with the battery pack. However, data on the CF card may still be corrupted if the battery pack power supply fails during an extended power outage.</p> <p>High-end LR8400 series instruments use a built-in, high-capacity capacitor to perform file termination processing in the event of a power outage, allowing them to save data up to the time of the outage.</p>	<p>"2.1 Using the Battery Pack (Option)" (p.26)</p>
<p>Why is only part of the data saved when saving to removable storage after measuring?</p>	<p>When a save range has been set with the A and B cursors, only the selected range is saved. Only data remaining in the instrument's internal memory (the last 3.5 M of data) will be saved after measurement.</p> <p>To save data in excess of that 3.5 M of data, enable the auto save (real-time) setting prior to measurement.</p>	<p>"Specifying a Waveform Time Span" (p.101) "Automatic Saving" (p.113)</p>
<p>After starting measurement with real-time auto saving, can I still acquire data if I neglected to insert removable storage media until later?</p>	<p>As long as storage media is inserted before internal memory overflows, data from the start of measurement will be saved to the removable storage.</p> <p>The instrument's internal memory can become full in as little as 32 minutes. However, since it takes time to save unsaved data to a CF card or USB flash drive inserted during measurement, it is best to use one-third of that 32-minute figure, or about 10 minutes, as a rough estimate of the length of data that can be saved once measurement starts.</p>	<p>"Replacing Removable Storage During Real-Time Saving" (p.53)</p>
<p>Why does "Saving" continue to be displayed and saving not finish when saving internal memory data as text after measurement?</p>	<p>To save all data from a full internal memory to removable media as text after measurement takes about one hour.</p> <p>To abort the saving process, press and hold STOP for some time.</p> <p>We recommend saving binary data, and later converting to text with the Logger Utility (which takes only a few seconds).</p>	<p>"7.1.1 Saving Measurement Data as Text," Logger Utility instruction manual</p>

Appendix 10 Frequently Asked Questions

Question	Remedial Action	Reference page
<p>How to view data saved in binary format on a PC?</p>	<p>The Logger Utility PC application program is included on the supplied CD. Install it on the PC and use it to open the file. Double-clicking on a binary-format MEM file will not cause the file to be opened if the file has not been associated with the Logger Utility. Instead of double-clicking the file, MEM files can be opened with the Logger Utility by dragging and dropping them onto the Logger Utility. (Similarly, they can be opened by using the "Open Waveform File" command on the "File" menu.)</p>	<p>"Appendix 9 Using the Application Program" (p. A20)</p>
<p>When opened in Excel®, the time displayed is elapsed time from start. How can I display real time?</p>	<p>When saving data in CSV format on the LR8432-20, the displayed time is determined by the [Time Disp] setting on the System screen. Select [Date] to display real time. When converting CSV format with the Logger Utility, set the [Time Axis Format] to [Absolute Time].</p>	<p>"Selecting the Horizontal (Time) Axis Display" (p.148) "7.1.1 Saving Measurement Data as Text," Logger Utility instruction manual</p>
<p>What are the files with .MEM and .LUW extensions?</p>	<p>MEM is the file extension for LR8432-20's waveform data, and LUW is the file extension for Logger Utility waveform data. LUW files cannot be loaded into the instrument.</p>	<p>"6.1 About Saving and Loading Data" (p.107) Logger Utility instruction manual</p>
<p>How are event marks handled when converting data to text (CSV)?</p>	<p>When converting data to text with the LR8432-20's: Event numbers are included alongside measurement data. This is convenient when you need to later extract only marked data. When converting data to text with the Logger Utility: Event mark information is not included.</p>	<p>"5.3 Inserting Event Marks (Search Function)" (p.104)</p>
<p>Can't I use a USB flash drive? Or, warning 680 is displayed.</p>	<p>Set the USB mode on the LR8432-20's [System] screen to [USB Memory]. (However, when [USB Memory] is selected, USB communications with the Logger Utility cannot be used.)</p>	<p>"Switching the USB mode" (p.152)</p>

Logger Utility

Question	Remedial Action	Reference page
<p>What kind of program is the Logger Utility?</p>	<p>Running on a PC connected to the instrument by USB cable, it provides real time data acquisition, display, and calculation; display and analysis of waveform (binary) data acquired by the instrument; conversion of binary data to text (CSV) data; and printing.</p>	<p>Logger Utility instruction manual</p>
<p>What is the method for converting data to a text (CSV) file with the Logger Utility?</p>	<ol style="list-style-type: none"> 1. In the menu bar, select [File]-[Save File in Text Format]. 2. Select a file for CSV conversion in the displayed dialog, and set [CSV (comma separated)] as the file type. 3. Make other settings as necessary, and click the [Save] button. 	<p>Logger Utility instruction manual</p>
<p>The Logger Utility cannot communicate with the LR8432-20. Or, warning 681 is displayed.</p>	<p>Set the USB mode setting on the LR8432-20's [System] screen to [USB Comm.]. (However, when [USB Comm.] is selected, USB flash drives cannot be used.) If the USB driver has not been installed, install it. If the above procedure cannot be used to establish communications, uninstall the USB driver by deleting "HIOKI 8423, 8430, LR8400 USB Driver" or "HIOKI Logger USB Driver" on the "Add or Remove Programs" screen under "Control Panels." Then reinstall the USB driver.</p>	<p>"Switching the USB mode" (p.152) "Installing the USB Driver" (p.A24)</p>

Appendix 11 Pulse Input Circuit Diagram

The following diagram illustrates an example connection to the instrument's pulse input circuit:

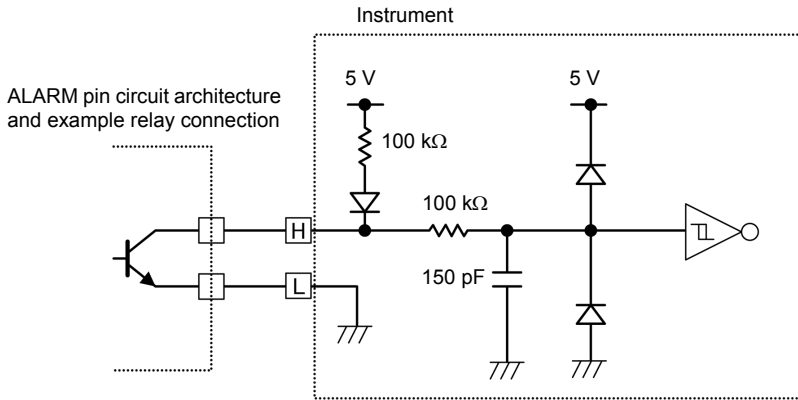

Appendix 12 Heat Flow

Heat flow

Heat flow indicates a quantity of heat energy that flows through the unit area per unit time (unit: W/m^2).

Temperature, on the other hand, indicates a result of heat energy movement (varies depending on the thermophysical property of a material). The Heat Flow Sensor allows you to determine the heat flow (in and out) and quantity of heat. As a result, it is now possible to find fluctuations in heat energy that are not apparent when using only temperature measurement.

■ Heat quantity

Example: Evaluation of insulation performance

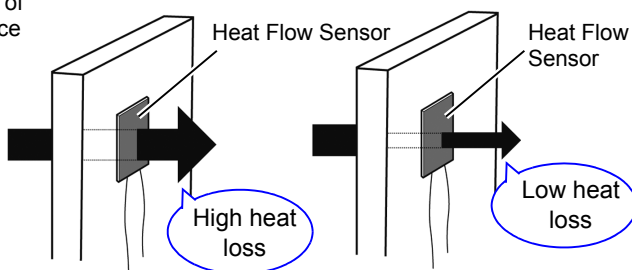

Measurement using LR8432

- Measurement can be performed with the Heat Flow Sensor attached to one side of the insulation material.
- The quantity of heat can be found from the numerical value and waveform.

Example: Evaluation of insulation performance based on temperature

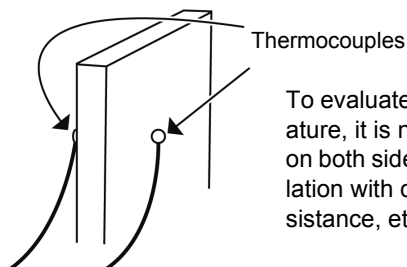

To evaluate the performance based on the temperature, it is necessary to measure the temperature on both sides of the material and perform the calculation with consideration for the material's heat resistance, etc.

Heat flow

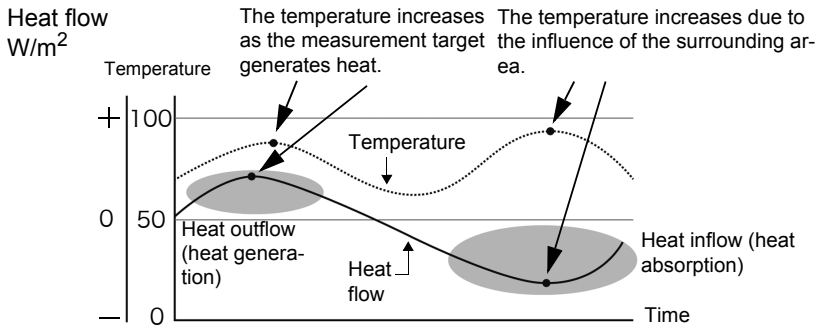

Measurement using LR8432

- The heat flow is identified depending on whether the heat flow gauge indicates positive or negative.
- The double gauge function allows you to see at a glance the relationship between temperature and heat flow.

Heat flow (in and out) cannot be found from temperature data alone. The cause of a temperature increase can be identified by checking the heat flow.

Using Models Z2012, Z2013, Z2014, Z2015, Z2016, Z2017, Z2018, Z2019, Z2012-01, Z2013-01, Z2014-01, Z2015-01, Z2016-01, or Z2017-01

Heat flow sensors (Z2012, Z2013, Z2014, Z2015, Z20165, Z2017, Z2018, Z2019, Z2012-01, Z2013-01, Z2014-01, Z2015-01, Z2016-01, Z2017-01) and double-sided Thermally Conductive Tape (Z5008) can be purchased via an authorized Hioki distributor or reseller.

Refer to the instruction manual included with the Heat Flow Sensor for details.

Index

Number

0 pos	65
4-20 mA	34

A

A/B cursors	100, 101
Alarm	79, 86
Alarm Output	86, 160
Analog input terminal	32
AND	84
Auto Calculation	130, 131
Auto Save	52, 112, 113
Automatic calculation	132
Average value	129, 137

B

Backlight Brightness	146
Backlight Saver	147
Battery pack	26
Continuous battery-only operating time	29
Beep Sound	147
Binary	107
Burn Out	57

C

Calc(post meas.)	113
Calculation time span	136
CF card	109, 153
Copy	124
Delete	122
Folder	122
Format	111
Load	119
Load Set.	119
Rename	123
Sort	125
Clock Setting	150
Comment	70
Cont	49
Cursor values	99

D

Decimal Mark	149
Default setting	A 11
Deleting (for saving data)	52
Display Color	147
Display Range	64
Drive	121

E

Error Messages	A 1
Event mark	104
EXT.TRIG	155, 157, 158, 160
External control terminals	155
External Trigger	79, 155

F

File name	A 7
File screen	111, 121
Format (CF card)	111

G

Gauge	98
GND	155, A 16

H

Heat flow	59
Horizontal cursors	99

I

Initializing	75, 151
Installing	A 21
Integration	61

J

Jump	97
------------	----

K

Key	
Keys do not work.	175
KEY LOCK	16, 23
KEY/LED	153

Index 2

Index

L

LCD	153
Length (Segment length)	52
Level	80, 81
Level Monitor	24
Level Trigger	80
Load	119, 120
Load Set.	119

M

Maximum value	129, 137
Measurement Configuration	
Setting screen	43
Waveform screen	45
Memory	118, 119
Minimum value	129, 137
Monitor Display	24

N

Noise	A 14
Noise suppression	50
Numerical Calculations	129
Numerical values	102

O

Operating Keys	16
OR	84

P

Peak value	129
Pre-Trig	85
Proc	74, 75

Q

Quick Save	112, 114
------------------	----------

R

Reference time	52
Repair	173
Before Returning for Repair	175
Repeat	50
Revolution Measurement	62
RJC	57
ROM/RAM	153

S

Save	
Auto Save	112
Calc Results	117
File Type	107
Numerical Calculation Results	117
Quick Save	112
Save Set.	118
Screen Image	116
Select & Save	112
Waveform Data	115
SAVE Key Operation	114
Scaling	67
Scrolling	96
Select & Save	112, 114
Self-Test	153
Separator	149
Slope	62
Specifications	163
Split calculation	133
Start Backup	146
Synchronous Measurements	161
System reset	151
System screen	145

T

Tc	57
Temperature Measurement	57
Time base (horizontal axis)	47
Time Disp	148
Timer	79, 90
Title	70
Trace	96
Trace cursors	99
TRIG.OUT	155
Trigger	79
In	80
Level	80
Out	80
Trigger Input	157
Trigger output	155, 158
Trigger source	84

U

Uninstalling	A 30
USB cable	127, A 27
USB Drive Mode	126
USB driver	A 20, A 24
USB flash driver	

Copy	124
USB mode	152

V

Values	21
Vertical cursors	99
Voltage Measurement	56

W

Waveform	115
Waveform + Calc	113
Waveform Display Color	64
Waveform screen	95
Waveform(realtime)	113
Window Trigger	80

Z

Zero Adjust	39
Zoom (vertical axis expansion/ compression)	65

HIOKI

www.hioki.com/



**All regional
contact
information**

HIOKI E.E. CORPORATION

81 Koizumi, Ueda, Nagano 386-1192 Japan

2309 EN

Edited and published by HIOKI E.E. CORPORATION

Printed in Japan

- Contents subject to change without notice.
- This document contains copyrighted content.
- It is prohibited to copy, reproduce, or modify the content of this document without permission.
- Company names, product names, etc. mentioned in this document are trademarks or registered trademarks of their respective companies.

Europe only

- EU declaration of conformity can be downloaded from our website.
- Contact in Europe: HIOKI EUROPE GmbH
Helfmann-Park 2, 65760 Eschborn, Germany hioki@hioki.eu