

CT6844 CT6844-05

AC/DC CURRENT PROBE

Instruction Manual

EN

Oct. 2018 Revised edition 2
CT6844A961-02 18-10H



HIOKI
<http://www.hioki.com>



Our regional contact information

HEADQUARTERS
81 Koizumi
Ueda, Nagano 386-1192 Japan

HIOKI EUROPE GmbH
Rudolf-Diesel-Strasse 5
65760 Eschborn, Germany
hioki@hioki.eu

Edited and published by HIOKI E.E. CORPORATION Printed in Japan

- CE declarations of conformity can be downloaded from our website.
- Contents subject to change without notice.
- This document contains copyrighted content.
- It is prohibited to copy, reproduce, or modify the content of this document without permission.
- Company names, product names, etc. mentioned in this document are trademarks or registered trademarks of their respective companies.

Warranty

Warranty malfunctions occurring under conditions of normal use in conformity with the Instruction Manual and Product Precautionary Markings will be repaired free of charge. This warranty is valid for a period of three (3) years from the date of purchase. Please contact the distributor from which you purchased the product for further information on warranty provisions.

Introduction

Thank you for purchasing the HIOKI Model CT6844, CT6844-05 AC/DC Current Probe. To obtain maximum performance from the device, please read this manual first, and keep it handy for future reference.

Inspection

When you receive the device, inspect it carefully to ensure that no damage occurred during shipping. In particular, check the accessories and cables. If damage is evident, or if it fails to operate according to the specifications, contact your dealer or Hioki representative.

Precautions during Shipment

Handle the device carefully so that it is not damaged due to a vibration or shock.

Safety

This device is designed to conform to IEC 61010 Safety Standards, and has been thoroughly tested for safety prior to shipment. However, using the instrument in a way not described in this manual may negate the provided safety features. Before using the instrument, be certain to carefully read the following safety notes.

DANGER

Mishandling during use could result in injury or death, as well as damage to the device. Be certain that you understand the instructions and precautions in the manual before use.

WARNING

With regard to the electricity supply, there are risks of electric shock, heat generation, fire, and arc discharge due to short circuits. If persons unfamiliar with electricity measuring instrument are to use the instrument, another person familiar with such instruments must supervise operations.

Notation

In this manual, the risk seriousness and the hazard levels are classified as follows.

| | | |
|--|----------------|---|
| | DANGER | Indicates an imminently hazardous situation that will result in death or serious injury to the operator. |
| | WARNING | Indicates a potentially hazardous situation that may result in death or serious injury to the operator. |
| | CAUTION | Indicates a potentially hazardous situation that may result in minor or moderate injury to the operator or damage to the device or malfunction. |

Safety Symbols

| | |
|--|--|
| | Indicates hazardous high voltage. Provides warning that negligent safety check or incorrect operation presents a significant hazard that could result in electrical shock, burn injury, or even death to the user. |
| | Indicates the prohibited action. |
| | Indicates the compulsory action. |

Symbols Affixed to the Device

| | |
|--|---|
| | Indicates cautions and hazards. When the symbol is printed on the device, refer to a corresponding topic in the Instruction Manual. |
| | Indicates that only insulated conductors suited to the voltage of the conductor under test can be measured. |

Symbols for Various Standards

| | |
|--|---|
| | Indicates the Waste Electrical and Electronic Equipment Directive (WEEE Directive) in EU member states. |
| | Indicates that the product conforms to regulations set out by the EU Directive. |

Usage Notes

Follow these precautions to ensure safe operation and to obtain the full benefits of the various functions.

DANGER

Do not use the device to measure bare conductors. Doing so may result in a short-circuit or electrical shock. Make measurements at a location on an insulated wire that has a suitable amount of insulation for the circuit voltage.

The maximum measurable current varies with the frequency, and the current that can be measured continuously is limited. Operating the device at less than this limitation is referred to as derating. Do not measure currents in excess of the derating curve. Doing so may result in device damage or malfunction, fire, or burns due to sensor heating.

CAUTION

- Do not place foreign objects between the jaws or insert foreign objects into the gaps of the sensor head. Doing so may worsen the performances of the sensor or interfere with clamping action.
- When the connected instrument's power is turned off, do not apply current to the sensor. Doing so may damage the device.
- Avoid stepping on or pinching cables, which could damage the cables insulation.
- Be careful to avoid dropping the device or otherwise subjecting them to mechanical shock, which could damage the jaw and adversely affect measurement.
- Do not touch the cores with the jaw opened. If the cores are subject to static electricity, the device may be damaged.
- Keep the jaw closed when not in use, to avoid accumulating dust or dirt on the facing core surfaces, which could interfere with clamp performance.
- When the power to conductors to be measured is turned on or off, a current flowing through the lines can exceed considerably the maximum allowable current of the device. This could result in damage to the device. Make sure that there is not any over-current.
- When disconnecting the output connector, be sure to release the lock before pulling off the connector. Forcibly pulling the connector without releasing the lock, or pulling on the cable, can damage the connector.
- The cable is hardened under the 0°C or colder environment. Do not bend or pull it to avoid tearing its shield or cutting cable.

Installation Environment

WARNING

Installing the device in inappropriate locations may cause a malfunction of device or may give rise to an accident.

Avoid the following locations:

- Exposed to direct sunlight or high temperature
- Exposed to corrosive or combustible gases
- Exposed to a strong electromagnetic field or electrostatic charge
- Near induction heating systems (such as high-frequency induction heating systems and IH cooking equipment)
- Susceptible to vibration
- Exposed to water, oil, chemicals, or solvents
- Exposed to high humidity or condensation
- Exposed to high quantities of dust particles

Overview

The CT6844 and CT6844-05 are openable and closable clamp current sensors that are designed to measure AC and DC currents of up to 500 A at a high level of precision. They offer excellent frequency characteristics (amplitude and phase) as well as excellent temperature characteristics (sensitivity and offset) and can be used not only for current measurement, but also for high-precision power measurement.

Usage with Other Hioki Products

This device is used in connection with a dedicated instrument (Hioki product). Refer to "Combined accuracy and conditions" specified in the specifications for details.

Maintenance and Service

- To clean the device, wipe it gently with a soft cloth moistened with water or mild detergent.

- Measurements are degraded by dirt on the mating surfaces of the jaw, so keep the surfaces clean by gently wiping with a soft, dry cloth.

Names of Parts

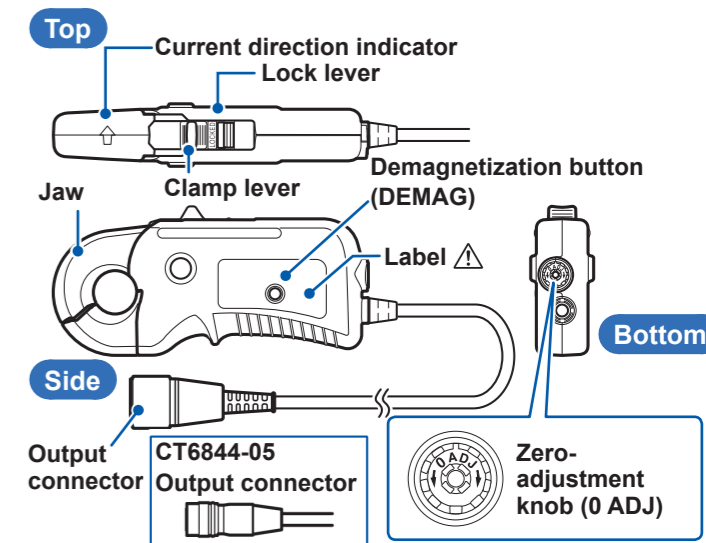

Options

9705 Conversion Cable*1, 9318 Conversion Cable*1, CT9900 Conversion Cable*1, CT9901 Conversion Cable*2

The Conversion Cable makes it possible to connect to and use with products that cannot be directly connected to the CT6844 or CT6844-05. (Refer to "Connection example")(No figures are added to the accuracy.)

CT9902 Extension Cable*2(5 m), CT9903 Extension Cable*1(5 m)

- Single sensor cable, 5 m extension (max. 10 m extension).
- Up to two extension cable is connectable. (If three or more extension cables are connected to the device, its performance is not guaranteed)
- Add the following values to each of the accuracy per cable:
Amplitude accuracy: $\pm 0.1\%$ rdg. ($DC \leq f^{*3} \leq 1$ kHz)
 $\pm 0.5\%$ rdg. (1 kHz $< f^{*3}$)
Phase accuracy: $\pm(0.1 \times f^{*3} \text{ kHz})^\circ$ (1 kHz $< f^{*3}$)

*1: For CT6844, *2: For CT6844-05, *3: frequency

Connection Example

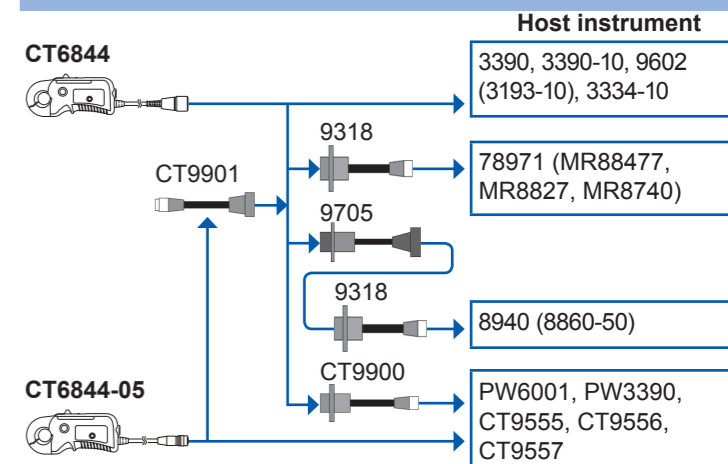

Cannot be directly connected to any parenthesized models. A module is required. Refer to "Combined accuracy and conditions" specified in the specifications.

Measurement

Pre-operation Inspection

Verify that the device operates normally to ensure that no damage occurred during storage or shipping. If you find any damage, contact your authorized Hioki distributor or reseller.

| Check Items | Solution |
|--|---|
| Is there any wiring break involving the output connector or sensor base? | If any, proper measurement cannot be made. Discontinue use and contact your authorized Hioki distributor or reseller. |
| Is the cable insulation torn? | If there is any damage, electric shock may result. Discontinue use and have the sensor repaired. |
| Is there any cracking or damage on the jaw? | Is there any cracking or repaired. |

CAUTION

Do not place conductors carrying currents with frequencies of 10 kHz or higher in close proximity to the jaw, even if the device does not clamp them. Current flowing through nearby conductors may cause self-heating of the jaw, damaging the device.

This device has the protective resistance (output resistance) in the signal output circuit. To monitor the output signal, it is recommended to use a measuring instrument, such as digital multimeter, that has an input resistance of 1 MΩ or higher.

Procedures

- Attach the device to the host instrument that is powered off.
- Turn on the host instrument.
- Perform a demagnetization (DEMAG) and/or zero-adjustment (0 ADJ) (if needed). Refer to "Demagnetization (DEMAG) and Zero-adjustment (0 ADJ)."
- Release the jaw lock (UNLOCKED will appear).
- Open the jaw.
- Clamp only one conductor to be measured and close the jaw.
 - Check that the tips of jaw are engaged each other.
 - If the current direction indication is oriented against the current direction, a polarity of output signal is reversed.
- Lock the jaw (LOCKED will appear).

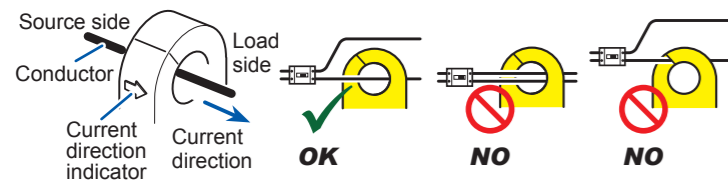

- Lock the jaw (LOCKED will appear).

Slide the clamp lever.

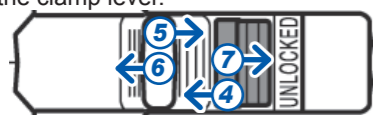

Slide the lock lever.

- Start measurement.
- On completion of the measurement, remove the device from the conductor.
- Turn off the host instrument.
- Detach the device from the host instrument.

Demagnetization (DEMAG) and Zero-Adjustment (0 ADJ)

Immediately after the power is turned on or an over-current exceeding the rated current is input, an offset can be output. Because the offset behaves as an error during DC current measurement, perform a demagnetization and/or zero-adjustment, going through the following procedure.

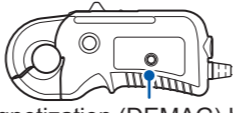
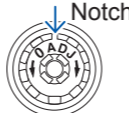
- Open the jaw and press the demagnetization (DEMAG) button. 
- Open and close the jaw several times and check if the offset output is stabilized, observing the host instrument display.
- Lock the jaw (LOCKED will appear).
- Perform a zero-adjustment by turning the zero-adjust knob (0 ADJ), observing the offset output displayed on the host instrument display. 

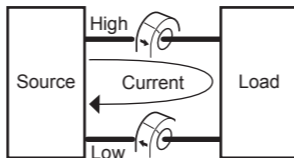
- No zero-adjustment can be performed while any current is input.
- Because offset output varies with the surrounding environment and the ambient temperature (terrestrial magnetism and other devices that generate magnetic fields), perform the zero-adjustment at the same location at which measurements will be made.
- If the device is connected to an host instrument with a zero correction function, align the notch of the zero-adjustment knob with the upper center.
- Mechanical shock, for example from dropping the instrument, may cause the offset to shift.
- If no zero-adjustment can be completed, perform demagnetizations (DEMAGs) several times with the jaw remaining closed.
- When measuring a DC or low-frequency (1 kHz or less) current of small magnitude, you can increase sensitivity on a relative basis by wrapping the conductor several times around the jaw. Wrapping the conductor 10 times will cause the device to output a signal equal to 10 times the measured current.
- In the high-frequency domain, when the high-potential side of a circuit (the High side) is clamped, measured values may be affected by common-mode noise. 
- 1.5 MHz harmonic noise arising from the operating principle can be emitted.
- Place the clamped conductor to be measured as close to the jaw center as possible. Separate other conductors from the device as far away as possible. Measuring large currents with a frequency of 1 kHz or more or locating unclamped conductors carrying 500 A or more of such high-frequency currents close to the jaw can cause increases in errors or waveform distortions.

Specifications

Accuracy

| | |
|------|--|
| f.s. | Maximum display value or scale length (Rated current) |
| rdg. | Reading value (The value currently being measured and indicated on the measuring instrument) |

The specs of the CT6844-05 are the same as those of the CT6844 except the output connector and options.

| | |
|-----------------------|--|
| Operating environment | Indoors, Pollution Degree II, altitude up to 2000 m (6562 ft.) |
|-----------------------|--|

| | |
|--|---|
| Operating temperature and humidity | -40°C to 85°C (-40.0°F to 185.0°F), 80% RH or less (no condensation) |
| Storage temperature and humidity | -40°C to 85°C (-40.0°F to 185.0°F), 80% RH or less (no condensation) |
| Standards | Safety: EN61010 EMC: EN61326 |
| Dielectric strength | 4260 V AC (current sensitivity: 1 mA), 50 Hz/60 Hz, for 1 minute, between jaw and output connector of cable |
| Product warranty period | 3 years |
| Rated current | 500 A AC/DC |
| Output voltage | 4 mV/A |
| Maximum input current | Within the derating curve |
| Output resistance | 50 Ω (±5%) |
| Temperature and humidity for guaranteed accuracy | 0°C to 40°C (32.0°F to 104.0°F), 80% RH or less |
| Guaranteed accuracy | 1 year, opening and closing of the jaw: up to 10000 times |
| Guaranteed accuracy period from adjustment made by Hioki | 1 year, opening and closing of the jaw: up to 10000 times |

Accuracy

Sine wave input; Conductor at center position; Connected with Model 9555-10; Not including each effect; Measuring instrument that has an input resistance of 1 MΩ or higher
Amplitude accuracy (Defined at the rated value or less and within the derating curve; The accuracy defined for the frequency range of DC < f < 5 Hz is the design value)
Phase accuracy (Defined at the rated value or less and within the derating curve; The accuracy defined for the frequency range of DC < f < 10 Hz is the design value)

| Frequency | Amplitude | Phase |
|-----------------------|------------------------|-----------------------|
| DC | ±0.3% rdg.±0.02% f.s.* | - |
| DC < f ≤ 100 Hz | ±0.3% rdg.±0.01% f.s. | ±0.1° |
| 100 Hz < f ≤ 500 Hz | ±0.3% rdg.±0.02% f.s. | ±0.2° |
| 500 Hz < f ≤ 1 kHz | ±0.5% rdg.±0.02% f.s. | ±0.5° |
| 1 kHz < f ≤ 5 kHz | ±1.0% rdg.±0.02% f.s. | ±1.0° |
| 5 kHz < f ≤ 10 kHz | ±1.5% rdg.±0.02% f.s. | ±1.5° |
| 10 kHz < f ≤ 50 kHz | ±5% rdg.±0.02% f.s. | ±(0.5 + 0.1 × f kHz)° |
| 50 kHz < f ≤ 100 kHz | ±15% rdg.±0.05% f.s. | |
| 100 kHz < f ≤ 200 kHz | ±30% rdg.±0.05% f.s. | |

* An accuracy of ±0.02% f.s. is accomplished after the offset voltage is adjusted within a range of ±0.2 mV.

| | |
|---|---|
| Offset adjustable range | ±2 mV |
| Emitted noise | 5 mV pp or less (100 kHz or less) |
| Temperature coefficient | -40°C to 0°C and 40°C to 85°C Amplitude sensitivity: ±0.01% rdg./°C or less Offset voltage: ±0.005% f.s./°C or less |
| Effect of conductor position | ±0.1% rdg. or less (input current of 100 A, DC to 100 Hz, with the use of a 10 mm diameter wire) |
| Effect of external electromagnetic field | 100 mA or less (value scaled to the input, in a DC or 60 Hz magnetic field of 400 A/m) |
| Effect of magnetic | 75 mA or less (value scaled to the input, after 500 A DC input) |
| Effect of common-mode voltage | 0.05% f.s. or less (1000 V rms, DC to 100 Hz) |
| Effect of radiated radio-frequency electromagnetic field | 6% f.s. at 10 V/m |
| Effect of conducted radio-frequency electromagnetic field | 6% f.s. at 3 V |
| Measurable conductor diameter | φ20 mm or less |

| | |
|------------------|---|
| Supply voltage | ±11 V to ±15 V (tracking) |
| Power capacity | ±300 mA or less (When measuring a current of 500 A with a frequency of 55 Hz, while ±12 V power is supplied) |
| Rated power | 7 VA or less (When measuring a current of 500 A with a frequency of 55 Hz, while ±12 V power supplied) |
| Dimensions | Approx. 153W×67H×25D mm (6.02"W×2.64"H×0.98"D) (excluding protrusions or cable) |
| Mass | Approx. 400 g (14.1 oz.) |
| Cable length | Approx. 3 m |
| Output connector | CT6844: Hioki PL23 (Male) CT6844-05: Hioki ME15W (Male) |
| Accessories | Mark bands (×6), Carrying case, Instruction manual |
| Options | |
| | CT9900 Conversion Cable |
| For CT6844 | CT9903 Extension Cable |
| | 9318 Conversion Cable |
| | 9705 Conversion Cable |
| For CT6844-05 | CT9901 Conversion Cable |
| | CT9902 Extension Cable |

Combined accuracy and conditions

Combined accuracy = Accuracy of CT6844(-05) + Accuracy of combined product (Power factor: 1)

| Combined product | Required option | |
|---|-----------------|------------------|
| | CT6844 | CT6844-05 |
| CT9555, CT9556, CT9557 Sensor Unit ¹ | CT9900 | - |
| PW3390 Power Analyzer | CT9900 | - |
| PW6001 Power Analyzer | CT9900 | - |
| 9602 AC/DC Clamp Input Unit ² | - | CT9901 |
| 3334-10 AC/DC Power HiTester | - | CT9901 |
| 8940 F/V Unit ³ | 9705+9318 | CT9901+9705+9318 |
| 8971 Current Unit ³ | 9318 | CT9901+9318 |
| 9555-10 Current Unit | - | CT9901 |
| 3390, 3390-10 Power Analyzer | - | CT9901 |

*1: Add the sensor unit output accuracy to the combined accuracy when one of the addition functions, that is, RMS output or TOTAL OUTPUT, is used.

*2: Add ±0.1% rdg. to the combined accuracy.

*3: The sensor recognition methods vary according to the Memory HiCorder settings (refer to the manuals of Memory HiCorder to be connected).

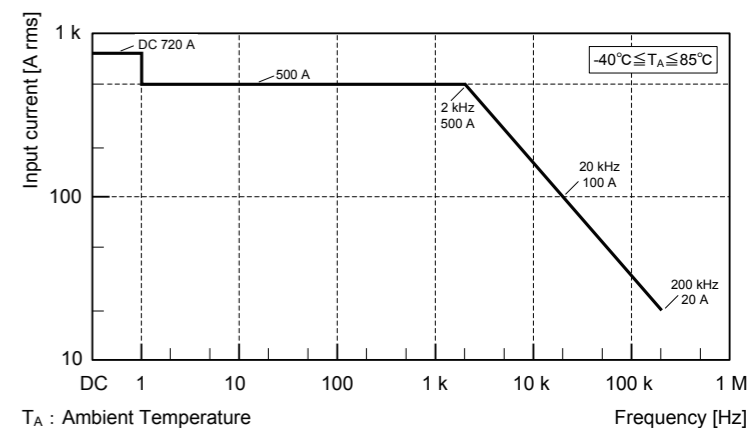

Frequency derating curve