

SS7012

Instruction Manual

DC SIGNAL SOURCE



EN

Sept.2018 Revised edition 9
SS7012A981-09 18-09H



Contents

Introduction	1
Confirming Package Contents	2
Safety Information	3
Operating Precautions	7
Chapter 1 Overview	13
<hr/>	
1.1 Product Overview	13
1.2 Features	14
1.3 Names and Functions of Parts	15
1.4 Sourcing and Measurement Flowchart	23
Chapter 2 Sourcing, Measurement and Test Preparation	25
<hr/>	
2.1 Supplying Power	25
■ Installing or Replacing the Batteries	25
■ Connecting the AC Adapter (Option)	27
2.2 Connecting the Input Cord and the Test Lead ..	28
2.3 Turning the Power On and Off	33
2.4 Pre-Operation Inspection	34
Chapter 3 Sourcing	37
<hr/>	
3.1 Sourcing Example	38
3.2 Sourcing Constant Voltage and Constant Current	39
3.3 Sourcing Thermoelectromotive Force	43
3.4 0°C Check of the 100 Ω Resistance Thermometer	50
3.5 Output Monitor Function	51
3.6 Memory Source Function	54
■ Saving setting value to memory	55
■ Recall sourcing	59

■ Scan sourcing	61
■ Initializing setting values	63
3.7 When setting value is flashing	65
Chapter 4 Measurement	67
<hr/>	
4.1 Measurement Example	67
4.2 Voltage Measurement and Current Measurement	68
4.3 Temperature Measurement	71
Chapter 5 Loop Test	75
<hr/>	
5.1 Loop Test Overview	75
5.2 Testing a Distributor (4-20 mA)	76
5.3 Testing a two-wire transmitter	79
Chapter 6 Other Function	81
<hr/>	
6.1 USB Communication Function	81
Chapter 7 Specifications	83
<hr/>	
7.1 General Specifications	83
7.2 Accuracy	86
Chapter 8 Maintenance and Service	91
<hr/>	
8.1 Troubleshooting	91
8.2 Replacing the Circuit Protection Fuse	94
8.3 Cleaning	96
8.4 Error Indication	97
8.5 Other Indication	97
8.6 When calibrating the instrument	98
Index	Index 1
<hr/>	

Introduction

Thank you for purchasing the HIOKI Model SS7012 DC Signal Source. To obtain maximum performance from the instrument, please read this manual first, and keep it handy for future reference.

Confirming Package Contents

When you receive the instrument, inspect it carefully to ensure that no damage occurred during shipping. In particular, check the accessories, panel switches, and connectors. If damage is evident, or if it fails to operate according to the specifications, contact your dealer or Hioki representative.

Confirm that these contents are provided.

- SS7012 DC Signal Source (1)



- 9168 Input Cord (1 set)

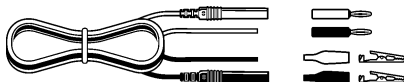

- L9170-10 Test lead (1 set)

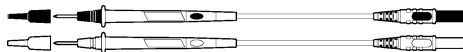

- LR6 alkaline batteries (4)



- Spare fuse (1)



- Instruction Manual (1)



Options

- 9184 Temperature Probe (reference junction compensation)
- 9380 Carrying Case (Holds main unit only, soft case)
- 9782 Carrying Case (Holds options, hard case)
- 9445-02 AC Adapter
- SS9000 Communication Package
(Includes USB cable and USB driver software)

Safety Information

WARNING

This instrument is designed to comply with IEC 61010 Safety Standards, and has been thoroughly tested for safety prior to shipment. However, mishandling during use could result in injury or death, as well as damage to the instrument. Using the instrument in a way not described in this manual may negate the provided safety features.



Be certain that you understand the instructions and precautions in the manual before use. We disclaim any responsibility for accidents or injuries not resulting directly from instrument defects.

This manual contains information and warnings essential for safe operation of the instrument and for maintaining it in safe operating condition. Before using it, be sure to carefully read the following safety precautions.

Safety Symbols



In the manual, the  symbol indicates particularly important information that the user should read before using the instrument.

The  symbol printed on the instrument indicates that the user should refer to a corresponding topic in the manual (marked with the  symbol) before using the relevant function.



Indicates a grounding terminal.



Indicates DC (Direct Current).



Indicates the ON side of the power switch.



Indicates the OFF side of the power switch.

The following symbols in this manual indicate the relative importance of cautions and warnings.



Indicates that incorrect operation presents an extreme hazard that could result in serious injury or death to the user.



Indicates that incorrect operation presents a significant hazard that could result in serious injury or death to the user.



Indicates that incorrect operation presents a possibility of injury to the user or damage to the instrument.



Indicates advisory items related to performance or correct operation of the instrument.

Measurement categories

To ensure safe operation of measurement instruments IEC 61010 establishes safety standards for various electrical environments, categorized as CAT II to CAT IV, and called measurement categories.

CAT II	Primary electrical circuits in equipment connected to an AC electrical outlet by a power cord (portable tools, household appliances, etc.) CAT II covers directly measuring electrical outlet receptacles.
CAT III	Primary electrical circuits of heavy equipment (fixed installations) connected directly to the distribution panel, and feeders from the distribution panel to outlets.
CAT IV	The circuit from the service drop to the service entrance, and to the power meter and primary overcurrent protection device (distribution panel).

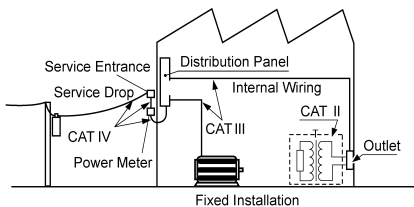

Using a measurement instrument in an environment designated with a higher-numbered category than that for which the instrument is rated could result in a severe accident, and must be carefully avoided.

Use of a measurement instrument that is not CAT-rated in CAT II to CAT IV measurement applications could result in a severe accident, and must be carefully avoided.

Operating Precautions



Follow these precautions to ensure safe operation and to obtain the full benefits of the various functions.

Preliminary Checks

Before using the instrument for the first time, verify that it operates normally to ensure that no damage occurred during storage or shipping. If you find any damage, contact your dealer or Hioki representative.

Instrument Installation

Operating temperature and humidity: 0 to 40°C at 80%RH or less (non-condensating)

Temperature and humidity range for guaranteed accuracy: 23±5°C, 80%RH or less (non-condensating)

Avoid the following locations that could cause an accident or damage to the instrument.	
	Exposed to direct sunlight Exposed to high temperature
	In the presence of corrosive or explosive gases
	Exposed to liquids Exposed to high humidity or condensation
	Exposed to strong electromagnetic fields Near electromagnetic radiators
	Exposed to high levels of particulate dust
	Near electromagnetic radiators (e.g., high-frequency induction heating systems and IH cooking utensils)
	Subject to vibration

NOTE

Correct measurement may be impossible in the presence of strong magnetic fields, such as near transformers and high-current conductors, or in the presence of strong electromagnetic fields such as near radio transmitters.

Handling the Instrument

DANGER

The maximum rated voltage between input terminals and ground is 30 VAC/ 60 VDC. Attempting to measure voltages exceeding 30 VAC/ 60 VDC with respect to ground could damage the instrument and result in personal injury.

WARNING

- This instrument is designed for safe operation only at low voltage. Ensure that no more than 60 V is present between any terminal and ground, and that the potential difference between any two terminals does not exceed 60 V. The instrument cannot be guaranteed in an overrange situation, such as due to an inadvertent electric shock or faulty insulation, and we cannot accept responsibility for any consequences that might occur from misuse.
- The output terminals and the voltage and current input terminals (terminals for the standard resistor) are all isolated. Before connecting the terminals, ensure that the target device will not provide excessive output to, or require excessive input from, the terminals. The instrument cannot be guaranteed in an overrange situation, such as due to an inadvertent electric shock or faulty insulation, and we cannot accept responsibility for any consequences that might occur from misuse.
- Ensure that the input does not exceed the maximum input voltage or current to avoid instrument damage, short-circuiting and electric shock resulting from heat building.
- Do not allow the instrument to get wet, and do not take measurements with wet hands. This may cause an electric shock.
- The case is not hermetically sealed for protection against explosion, so do not use in a flammable atmosphere.

! CAUTION

- When the power is turned off, do not apply voltage to the voltage input terminals. Doing so may damage the instrument.
- To avoid damage to the instrument, protect it from physical shock when transporting and handling. Be especially careful to avoid physical shock from dropping.
- If this instrument has been vibrated or impacted, restart it before use.
- Before sourcing or measurement, make sure of the function position. If current or voltage in excess of sourcing or measurement range is input, the instrument may be damaged.
- Note that the instrument may be damaged if the applied voltage or current exceeds the measurement range.
- If output is impossible when **ON** is displayed which indicates outputting, set to **OFF** with **OUTPUT ON/OFF** key and set output to ON again.
- To avoid corrosion and damage to this instrument from battery leakage, remove the batteries from the instrument if it is to be stored for a long time.

NOTE

To avoid problems with battery operation, remove the batteries from the instrument if it is to be stored for a long time.

Handling the Cords

WARNING

- Before using the instrument, make sure that the insulation on the test lead and input cord is undamaged and that no bare conductors are improperly exposed. Using the instrument in such conditions could cause an electric shock, so contact your dealer or Hioki representative for repair.
- Use the 9168 Input Cord with DC 28 V or less. If this level is exceeded, electric shock may occur.
- Always turn both devices OFF when connecting and disconnecting an interface connector. Otherwise, an electric shock accident may occur.
- To avoid electric shock, do not exceed the lower of the ratings shown on the instrument and test leads.

CAUTION

- To avoid breaking the test lead and input cord, do not bend or pull them.
- For safety reasons, when taking measurements, only use the L9170-10 Test lead provided with the instrument.

Handling the AC Adapter and the Nickel Hydride Batteries

! WARNING

- Turn the instrument off before connecting the AC adapter to the instrument and to AC power.
- Use only the supplied Model 9445-02 AC Adapter. AC adapter input voltage range is 100 to 240 VAC (with $\pm 10\%$ stability) at 50/60 Hz. To avoid electrical hazards and damage to the instrument, do not apply voltage outside of this range.

! CAUTION

- To avoid damaging the power cord, grasp the plug, not the cord, when unplugging it from the power outlet.

NOTE

The nickel hydride battery is subject to self-discharge. Be sure to charge the nickel hydride batteries before initial use. If the battery capacity remains very low after correct recharging, the useful battery life is at an end.

Overview

Chapter 1

1.1 Product Overview

This instrument is a compact DC signal source (calibrator). It can perform maintenance or loop tests of instrumentation systems and can be operated from a computer via a USB cable. Furthermore, it can calibrate thermometers and measure DC voltage and DC current.

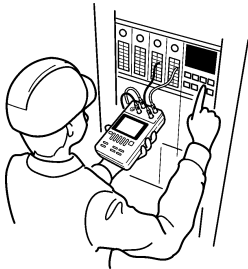

Two-wire transmitter and distributor tests (4-20mA) can be easily performed. (Loop tests)

Source waveforms can be freely programmed through communication with a computer.

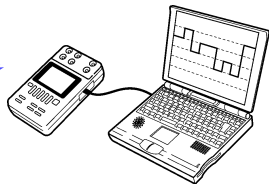

1.2 Features

- ◆ **Source function (p.39) (p.43)**

Sourcing DC voltage from -25.000 V to +25.000 V (minimum resolution 100 μ V), and DC current from -25.000 mA to 25.000 mA (minimum resolution 1 μ A). Sourcing thermoelectromotive force by setting temperature (thermocouples: K, E, J, T, R, S, B, N; JIS C1602-1995, IEC 584).
- ◆ **Measure function (p.68) (p.71)**

Measurement of DC voltage from -28.000 V to +28.000 V (minimum resolution 100 μ V), and of DC current from -28.000 mA to 28.000 mA (minimum resolution 1 μ A). Temperature measurement from -25°C to 80°C with the optional Model 9184 Temperature Probe.
- ◆ **Loop test (p.75)**

The output of this instrument is bipolar and it can sink current. Therefore, loop test in the instrumentation system is possible.
- ◆ **Output monitor function (p.51)**

This function monitors the applied current of the constant voltage source.
This function monitors the applied voltage of the constant current source.
This function monitors the reference junction temperature of the thermoelectromotive force source.
- ◆ **Memory source function (p.54)**

Up to 20 units of source data (settings) for each function can be saved to memory. Settings saved to memory can be sourced in recall source mode or scan source mode.
- ◆ **AC power is not required for operation**

Common LR6 alkaline batteries or nickel hydride batteries support use in situations where AC power is not available.
- ◆ **Continuous long-term operation**

The optional Model 9445-02 AC Adapter allows continuous long-term operation.

1.3 Names and Functions of Parts

Front panel

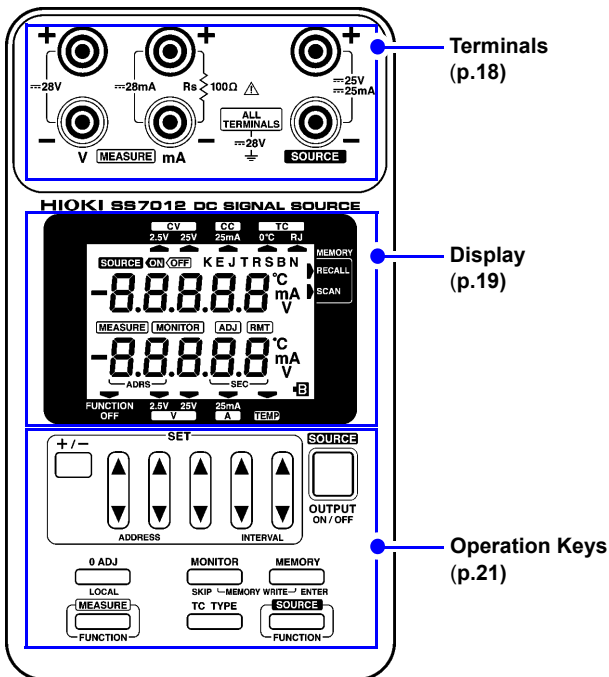

Right side

AC adapter terminal

Connect the optional Model 9445-02 AC Adapter. The input voltage range is 9 V DC \pm 10% and the adapter has a positive center pin. (p.27)

Power switch

Turns the power for the instrument on or off. (p.33)

- : Power switch OFF
- | : Power switch ON

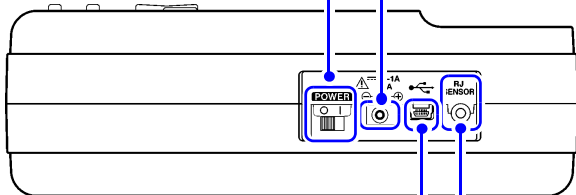

USB port

The SS7012 can communicate with a computer via a USB cable. (p.81)

RJ sensor terminal

Connect the optional Model 9184 Temperature Probe (reference junction compensation). (p.30) (p.71)

Rear panel

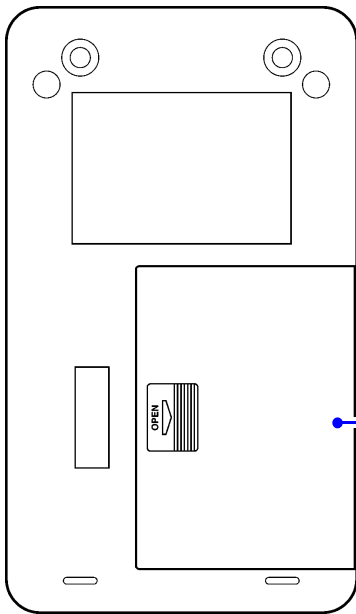
**Battery cover**

Open this battery cover to install the LR6 alkaline batteries or the nickel hydride batteries. (p.25)

Terminals

Voltage input terminal

Inputs voltage for voltage measurement. Input resistance is about 1 M Ω .

Output terminal

When output is on, the setting value will be output. This terminal is shorted with about 50 k Ω resistance when output is off. The SS7012 has built-in output protection fuse.

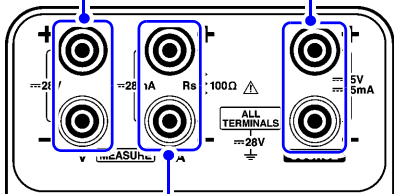

Current input terminal/

Terminal for the standard resistor

Current input

Inputs current for current measurement function. The SS7012 has built-in input protection fuse. The input resistance of current detection and input protection fuse is about 30 Ω .

Standard resistor





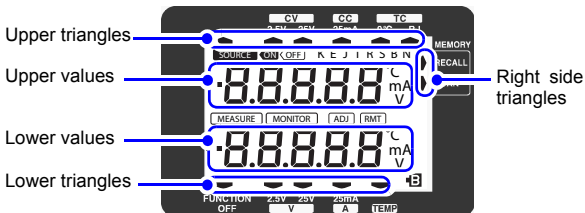

When current measurement function is off, a 100 Ω standard resistor is connected for the 0°C check of the 100 Ω standard resistance thermometer.

Display





Various values are displayed, including functions, source values, measurement values, monitor values, thermocouples, polarity, units, output status and warnings.



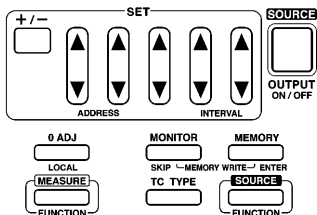



SOURCE	Indicates values and settings related to source functions.
ON	Indicates that the setting for the source function is being output.
OFF	Indicates that the setting for the source function is not being output.
K/ E/ J/ T/ R/ S/ B/ N	Indicates the specified thermocouple type.
MEASURE	Indicates values and settings related to measure functions.
MONITOR	Indicates that the output monitor function has been set. (p.51)
B	This is the battery indicator (Battery low warning). When this indicator starts flashing, either exchange the batteries or connect the AC adapter. When this indicator is flashing, output cannot be set to ON. (If the SS7012 is outputting when the indicator starts flashing, output continues until the output is set to OFF. Furthermore, the accuracy of measurement values cannot be guaranteed.
Flashing of setting value	The setting value flash when it is not being output. (p.65) If a setting value is flashing, press the OUTPUT key to set the output to OFF.

	<p>Indicates that the SS7012 is in remote control mode. The instrument cannot be operated by the keys. Use the LOCAL key to enable key operation. If the USB cable is removed when the  is displayed, the  indicator does not turn off.</p>
<p>Upper triangles</p> 	<p>Indicates the specified source function.</p>
<p>Upper values</p>	<p>Displays setting value for the source functions.</p>
<p>Lower values</p>	<p>Displays the measurement values of the measure function and the address and sourcing time interval of the memory source function.</p>
<p>Lower triangles</p> 	<p>Indicates the specified measure function.</p>
<p>Right side triangles</p> 	<p>Indicates the specified source mode.</p> <p>Off : Normal source mode RECALL : Recall source mode SCAN : Scan source mode</p>

Operation Keys

	+/- key	Selects the polarity of the output setting value.
	0 ADJ/ LOCAL key	<ol style="list-style-type: none"> 1. Possible to return the display to "00000" in voltage measurement function ([V:2.5V], [V:25V]), or current measurement function ([A: 25mA]). 2. If pushed while RMT is displayed, the RMT indicator goes out and local control is possible.
	MONITOR/ SKIP key	<ol style="list-style-type: none"> 1. Toggles the measure function and output monitor function. (p.51) 2. When writing to memory in the memory source function, this key sets a skip setting. (p.55) 3. When pushed simultaneously with the MEMORY/ENTER key, toggles the source function and the memory write mode of the source function. (p.55)
	MEMORY/ ENTER key	<ol style="list-style-type: none"> 1. Toggles between the normal source, recall source, and scan source. (p.59) (p.61) 2. When writing to memory in the memory source function, this key confirms the setting value. (p.55) 3. When pushed simultaneously with the MONITOR/SKIP key, toggles the source function and the memory write mode of the source function. (p.55)
	MEASURE FUNCTION key	Sets the measure function for the instrument.

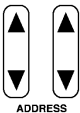
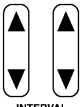
	<p>TC TYPE key</p>	<p>Sets the thermocouple type in the thermoelectromotive force source function ([TC:0°C], [TC:RJ]).</p>
	<p>SOURCE FUNCTION key</p>	<p>Sets the source function for the instrument.</p>
	<p>OUTPUT ON/OFF key</p>	<p>Switches the output on or off in the source function. This key can be used as the start/stop for memory source function.</p>
	<p>▲ / ▼ key</p>	<p>The digit increases or decreases by one count each time the key is pressed. Press and hold the key to change the digit continuously.</p>
	<p>ADDRESS key</p>	<p>These are the two ▲ / ▼ keys on the left of the arrow key group. In the memory source function, these keys specify the address.</p>
	<p>INTERVAL key</p>	<p>These are the two ▲ / ▼ keys on the right of the arrow key group. In the memory source function, these keys specify the sourcing time interval.</p>

1.4 Sourcing and Measurement Flowchart

1. Inspections before switching on the power and using the instrument

Connecting the AC Adapter (p.27)

Installing the Batteries (p.25)

Turning the Power On (p.33)

Pre-Operation Inspection (p.34)



2. Sourcing

Constant voltage (p.39)

Constant current (p.39)

Thermoelectromotive force (p.43)

Standard register (100 Ω) (p.50)

Output monitor function (p.51)

Memory source function (p.54)

or

2. Measurement

Voltage (p.68)

Current (p.68)

Temperature (p.71)

or

2. Loop test (p.75)



3. Turning the Power Off (p.33)

Sourcing, Measurement and Loop test Preparation

Chapter 2

2.1 Supplying Power



Installing or Replacing the Batteries



!WARNING

- Use the common LR6 alkaline batteries or the common nickel hydride batteries.
- To avoid electric shock, turn off the power switch and disconnect the test leads or input cords from the target device before replacing the batteries.
- After replacing the batteries, replace the cover before using the instrument.
- Do not mix old and new batteries, or different types of batteries. Also, be careful to observe battery polarity during installation. Otherwise, poor performance or damage from battery leakage could result.
- Battery may explode if mistreated. Do not short-circuit, disassemble or dispose of in fire. Do not recharge alkaline batteries. Handle and dispose of batteries in accordance with local regulations.

CAUTION

- Do not use the LR6 alkaline batteries together with the nickel hydride batteries.
- To avoid corrosion and damage to this instrument from battery leakage, remove the batteries from the instrument if it is to be stored for a long time.

NOTE

- The **B** indicator flashes when the remaining battery capacity is low. In this case, the instrument's reliability is not guaranteed. Replace the battery immediately.
- When the nickel hydride batteries have not been used for a long time and are not repeat charge and discharge, the device may not operate normally. (This may also occur immediately after purchase.)
- Please use only LR6 alkaline batteries or nickel hydride (HR6) batteries. Please do not use manganese, oxyride batteries, etc.

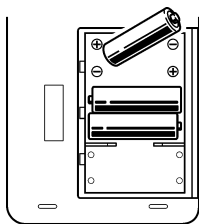

- 1.** Before installing or exchanging batteries, turn the power switch off (○).
- 2.** Open the battery cover and install four batteries with the correct polarity.
- 3.** Be sure to close the battery cover.

Connecting the AC Adapter (Option)



WARNING

- Turn the instrument off before connecting the AC adapter to the instrument and to AC power.
- Use only the supplied Model 9445-02 AC Adapter. AC adapter input voltage range is 100 to 240 VAC (with $\pm 10\%$ stability) at 50/60 Hz. To avoid electrical hazards and damage to the instrument, do not apply voltage outside of this range.

1. Turn the power switch off (○).
2. Connect the 9445-02 AC Adapter output plug to the AC adapter terminal for the instrument. (The input voltage range is 9 VDC $\pm 10\%$ and the adapter has a positive center pin)
3. After making sure that the voltage of the power supply being used matches the supply voltage of the AC adapter, put the plug in the outlet.

2.2 Connecting the Input Cord and the Test Lead



The SS7012 has voltage input terminal, current input terminal (terminal for the standard resistor) and output terminal. In addition, RJ sensor terminal is provided for temperature measurement.

CAUTION

To prevent an electric shock accident, confirm that the white or red portion (insulation layer) inside the cable is not exposed. If a color inside the cable is exposed, do not use the cable.

NOTE

Removable sleeves are attached to the metal pins at the ends of the test leads. The test leads can also be used with the sleeves removed.

Removing and attaching the sleeves

CAUTION

The tips of the metal pins are sharp, so take care not to injure yourself.

Removing the sleeves

Hold the bottom of the sleeves and pull the sleeves off. Safely store the removed sleeves so as not to lose them.

Attaching the sleeves

Insert the metal pins of the test leads into the holes of the sleeves, and firmly push them all the way in.

Connecting Method

Voltage measurement

Connect the L9170-10 Test lead to the voltage input terminal.

Connect the red and black connectors to the + and - input terminals, respectively.

Input only voltage to the voltage input terminal.

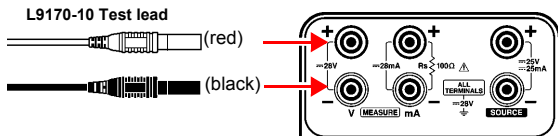

Current measurement

Connect the L9170-10 Test lead to the current input terminal.

Connect the red and black connectors to the + and - input terminals, respectively.

Input only current to the current input terminal.



Sourcing

With the output off, connect the 9168 Input Cord to the output terminal.

Connect the red and black connectors to the + and - output terminals, respectively.

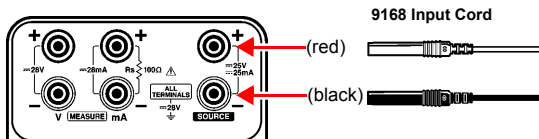

0°C check for the 100 Ω resistance thermometers

Connect the 100 Ω standard resistance thermometer to the terminal for the standard resistor.

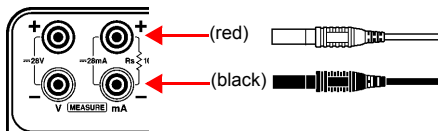

[TC:RJ] sourcing, Temperature measurement

Connect the optional 9184 Temperature Probe to the RJ sensor terminal.

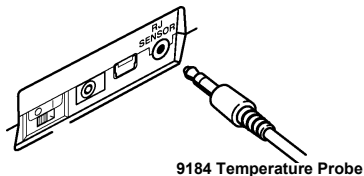

 WARNING

- This instrument is designed for safe operation only at low voltage. Ensure that no more than 60 V is present between any terminal and ground, and that the potential difference between any two terminals does not exceed 60 V. The instrument cannot be guaranteed in an overrange situation, such as due to an inadvertent electric shock or faulty insulation, and we cannot accept responsibility for any consequences that might occur from misuse.
 - The output terminals and the voltage and current input terminals (terminals for the standard resistor) are all isolated. Before connecting the terminals, ensure that the target device will not provide excessive output to, or require excessive input from, the terminals. The instrument cannot be guaranteed in an overrange situation, such as due to an inadvertent electric shock or faulty insulation, and we cannot accept responsibility for any consequences that might occur from misuse. (For the maximum value of the output voltage/current and voltage/current input, refer to the specifications)
 - To avoid electrical accidents, confirm that all connections are secure. The increased resistance of loose connections can lead to overheating and fire.
 - Be sure to connect the voltage input and current input terminals correctly. An incorrect connection could damage or short circuit this instrument.
-

! CAUTION

- When switching the power on and off, remove the target device from all terminals. Furthermore, always set the output to OFF when connecting or disconnecting the output terminal and target device. In either of these cases, failure to heed this caution may result in damage to the instrument or to the target device.
- Do not input current more than 25 mA DC to the terminal for the standard resistor. Doing so may damage the resistor of the instrument.
- Output terminal and current input terminal have circuit protection fuses. If the fuse is blown, output or current measurement is impossible. Exchange the fuses before operation.

[See:](#) "8.2 Replacing the Circuit Protection Fuse" (p.94)

NOTE

- When output is off, the output terminals are shorted with a resistance of about 50 k Ω .
- Input resistance of the voltage input terminal is approx. 1 M Ω and that of the current input terminal is approx. 30 Ω .

2.3 Turning the Power On and Off



WARNING

Before turning the instrument on, make sure the supply voltage matches that indicated on the AC adapter. Connection to an improper supply voltage may damage the instrument or AC adapter and present an electrical hazard.

CAUTION

When switching the power on and off, remove the target device from all terminals. Furthermore, always set the output to OFF when connecting or disconnecting the output terminal and target device. In either of these cases, failure to heed this caution may result in damage to the instrument or to the target device.

NOTE

- If power switch is set to on () for the instrument, even when sourcing or measurement is not executed current is still consumed. The lifetime of battery therefore shortens. The power switch should be turned off () when unused.
- Because turning the power on or off places a load on the instrument, wait at least 5 seconds before turning the power off or on again.
- If the power doesn't turn on when turning on the power again, turn the power off and leave for more than 5 seconds.
- The warm-up time of this instrument is 5 minutes. Source values and measurement values can be unstable within 5 minutes after turning the power on.

Turning Power On



Set the power switch to the " I " position. When the power switch is on, all settings except memory are initialized to appear initial screen after LCD display indications are all lit.

Turning Power Off



Set the power switch to the " O " position. Turn off the power switch to go off the LCD display indications.

2.4 Pre-Operation Inspection

Before using the instrument, verify that it operates normally to ensure that no damage occurred during storage or shipping.

1. Instrument inspection

Check the following points.

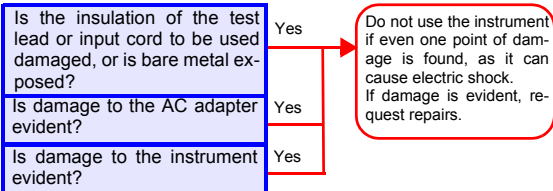

2 Inspection at power on

< When using batteries >

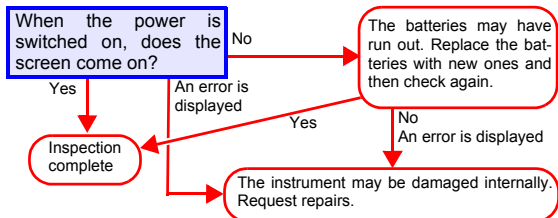

< When using AC adapter >

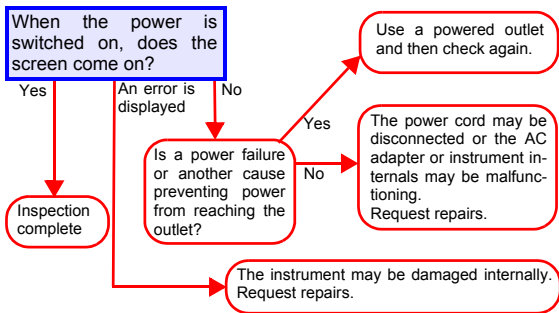

Always inspect the instrument before sourcing.

See: "2.4 Pre-Operation Inspection" (p.34)

! CAUTION

Always set the output to OFF when connecting or disconnecting the output terminal and target device.

NOTE

- If the display shows all zeros or is out of the setting range while using the +/- keys, polarity changing is disabled.
- Settings can be changed consecutively using the ▲/▼ keys. However, this operation cannot be used in the following cases.
 - When the changed setting exceeds the permitted range
 - When the changed setting exceeds "00000" and the polarity changes (For example, when the setting is "00001", all ▲ keys and the right-most ▼ key can be used.)

3.1 Sourcing Example

The SS7012 can source constant voltage, constant current, and standard register.

Instead of the thermocouple, a voltage corresponding to a specified temperature can be sourced.

◆ Constant voltage (CV) (p.39)

In [CV:2.5V], constant voltage can be sourced from -2.5 to +2.5 V with the resolution of 100 μ V.

In [CV:25V], constant voltage can be sourced from -25 to +25 V with the resolution of 1 mV.

◆ Constant current (CC) (p.39)

In [CC:25mA], constant current can be sourced from -25 to +25 mA with the resolution of 1 μ A.

◆ Thermocouple (TC) (p.43)

In [TC], voltage can be sourced according to the setting temperature instead of thermocouples.

Eight types of thermocouples are supported: K, E, J, T, R, S, B, and N. Thermometers using thermocouples can be calibrated.

◆ Standard register (Rs) (p.50)

100 Ω standard resistor is connected to the terminal for the standard resistor (current input terminal).

The resistor can be used for the 0°C check of the 100 Ω standard resistance thermometer.

◆ Output monitor function (p.51)

When a constant voltage is sourced, the current flowing in the target device can be monitored. (this function is used when testing the two-wire transmitter in a loop test.)

When a constant current is sourced, the voltage between the output terminals can be monitored.

When a thermoelectromotive force is sourced, the reference junction temperature can be monitored. ("0°C" is displayed in [TC:0°C], the temperature measured with the optional 9184 Temperature Probe is displayed in [TC:RJ])

◆ Memory source function (p.54)

Values to be sourced can be recorded ahead of time.

The recorded value can be switched using a single key operation or automatically. (When testing a distributor in the loop test, 4-20 mA can be easily sourced.)

For each source function, up to 20 values can be recorded.

3.2 Sourcing Constant Voltage and Constant Current

Source DC voltage and DC current.

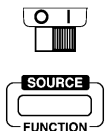

1. Turn the power switch on.

2. Press the **SOURCE FUNCTION** key the required number of times to set the constant voltage source function (**[CV:2.5V]**, **[CV:25V]**) or constant current source function (**[CC:25mA]**).

At power on, **[CV:2.5V]** is set. Pressing the **SOURCE FUNCTION** key changes the setting in the lower shown sequence.

[CV:25V] → **[CC:25mA]** → **[TC:0°C]**
 ↑ ↓
[CV:2.5V] ← **[TC:RJ]**

In the upper part of the screen, the cursor moves to the specified function.

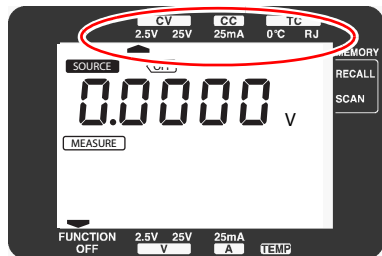

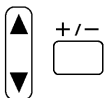

3. Use the ▲/▼ keys and +/- key to set the value to be sourced.

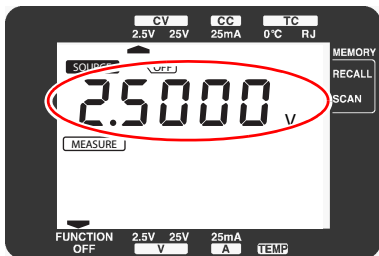

The five ▲/▼ keys correspond to the five columns of the setting.

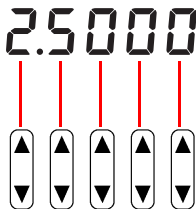

The ranges within which the values can be set are as follows:

[CV:2.5V] : -2.5000 V to 2.5000 V

[CV:25V] : -25.000 V to 25.000 V

[CC:25mA] : -25.000 mA to 25.000 mA

4. If the target device has a power source, switch it off and then connect the target device to the output terminal of the SS7012. If necessary, switch the power of the target device back on.

If the target device doesn't have a power source, simply connect the target device to the output terminal of the instrument.

**OUTPUT
ON / OFF****5. Press the OUTPUT ON/OFF key.**

ON is displayed on the screen and the setting value is output.

However, if the load gets excessive and the setting value cannot be output, the setting value flashes. If the setting value starts flashing, press the **OUTPUT ON/OFF** key to set the output to OFF.

See: "3.7 When setting value is flashing" (p.65)

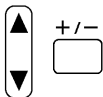
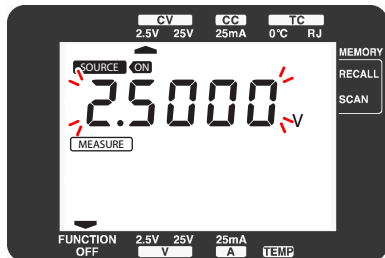
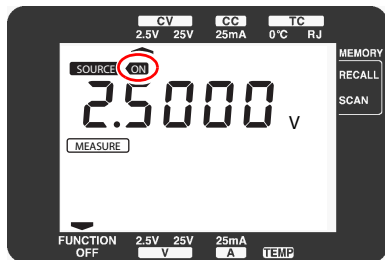
**6. If you want to change the value to be sourced during sourcing, use the ▲/▼ keys and +/- key.**

The new set value is output.

OUTPUT
ON / OFF

7. Press the **OUTPUT ON/OFF** key.

is displayed on the screen and the output changes to OFF.

! WARNING

Never connect this instrument to any voltage sources when sourcing constant voltage. Furthermore, never connect this instrument to an electric current source when sourcing constant current. Doing so may damage the instrument and the target device.

! CAUTION

- In constant voltage source function ([CV:2.5V], [CV:25V]), do not set the output to exceed ± 25 mA. Furthermore, in constant current source function ([CC:25mA]), do not set the output to exceed ± 25 V. Doing so may damage the instrument and the target device.
- When using constant current source function, if the target device is connected incorrectly, overvoltage can be applied to the target device, which may result in damage to this instrument or to the target device.

NOTE

If the **B** indicator is flashing, output cannot be set to ON. (If it flashes during output, output continues until output is set to OFF.) Replace the batteries or connect the AC adapter.

3.3 Sourcing Thermoelectromotive Force

Outputs voltage according to the setting temperature instead of thermocouples.

Thermometers using thermocouples can be calibrated.

There are 2 types of thermoelectromotive force source functions.

The temperature of voltage input terminal (reference junction) of the thermometer can be set to either 0°C or room temperature.

[TC: 0°C] : Use when sourcing thermoelectromotive force with the temperature of voltage input terminal (reference junction) of the thermometer at 0°C . As shown in the diagram below, use the **[TC: 0°C]** setting when the calibrating the thermometer measuring the thermoelectromotive force using 0°C as a reference. When using this function, create 0°C by putting ice water in a thermos flask or other means and make the reference junction to 0°C .

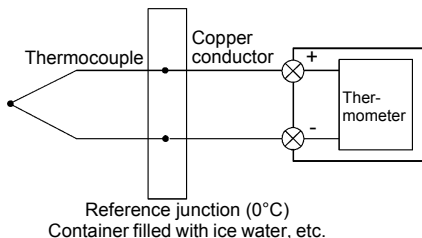

[TC:RJ] : Use when calibrating a thermometer that can compensate the temperature of voltage input terminal (reference junction) of the thermometer. As shown in the diagram below, use the [TC:RJ] setting when calibrating a thermometer that compensates the thermoelectromotive force of thermocouples at the reference junction temperature. However, the optional 9184 Temperature Probe is required to measure the temperature to compensate when using this function.

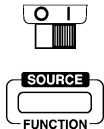
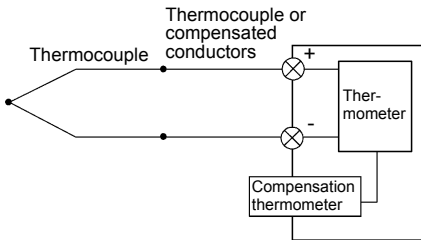

1. Turn the power switch on.
2. Press the **SOURCE FUNCTION** key the required number of times to set the thermoelectromotive force source function ([TC:0°C], [TC:RJ]).

At power on, [CV:2.5V] is set. Pressing the **SOURCE FUNCTION** key changes the setting in the lower shown sequence.

[CV:25V] → [CC:25mA] → [TC:0°C]
 ↑ ↓
 [CV:2.5V] ← [TC:RJ]

In the upper part of the screen, the  moves to the specified function.

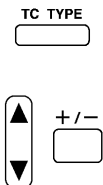

- 3.** Press the **TC TYPE** key to set thermocouple ([K], [E], [J], [T], [R], [S], [B] or [N]).
- 4.** Use the **▲/▼** keys and **+/-** key to set the value.

The ranges within which the values can be set are as follows:

[K] : -174.0°C to 1372.0°C

[E] : -220.0°C to 839.0°C

[J] : -208.0°C to 1108.0°C

[T] : -169.0°C to 400.0°C

[R] : -50 °C to 1768 °C

[S] : -50 °C to 1768 °C

[B] : 300 °C to 1820 °C

[N] : -113 °C to 1300.0°C

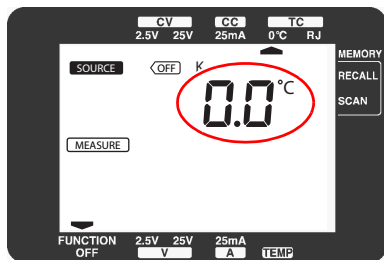

5. Connect the thermometer to the output terminal.

The connection methods for [TC:0°C] and [TC:RJ] differ.

[TC:0°C]: Connect it as indicated in Figure 1. The optional 9184 Temperature Probe may be connected to the RJ sensor terminal or not, without effect. Create 0°C by putting ice water in a thermos flask or other means and make the reference junction to 0°C.

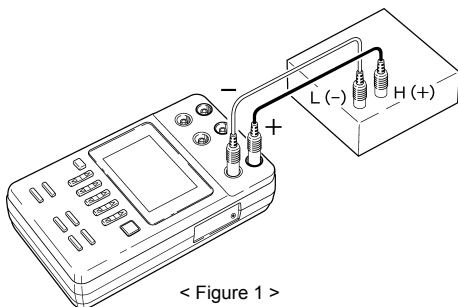

< Figure 1 >

[TC:RJ]: Connect the optional 9184 Temperature Probe to the RJ sensor terminal. As indicated in Figure 2, connect the temperature probe close to the thermometer when using a copper conductor, or close to the output terminal of the SS7012 as indicated Figure 3, when using a thermocouple the same type as the thermometer or compensated conductors.

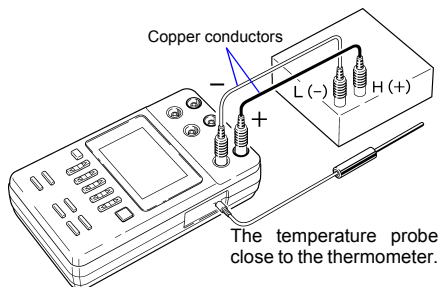

< Figure 2: When using a copper conductor >

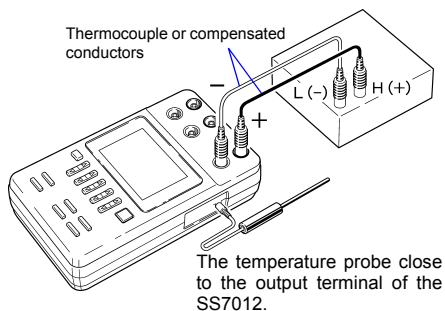

< Figure 3: when using a thermocouple the same type as the thermometer or compensated conductors >

OUTPUT
ON / OFF**6. Press the OUTPUT ON/OFF key.**

ON is displayed on the screen and the setting value is output.

However, if the load gets excessive and the setting value cannot be output, the setting value flashes. If the setting value starts flashing, press the **OUTPUT ON/OFF** key to set the output to OFF.

See: "3.7 When setting value is flashing" (p.65)

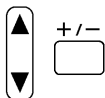
**7. The output value will change if the setting value is changed with the ▲/▼ keys and +/- key.**OUTPUT
ON / OFF**8. Press the OUTPUT ON/OFF key.**

OFF is displayed on the screen and the output changes to OFF.

! CAUTION

To avoid damage to the instrument and the target device, in the thermoelectromotive force source function ([TC:0°C], [TC:RJ]), never apply an external voltage or current to the output terminal.

NOTE

- The reference junction compensation temperature ranges are as follows:

[K], [E], [J], [T], [R], [S], [N]: -25.0 to 80.0°C

[B]: 0 to 80°C

- In the thermoelectromotive force source function ([TC:0°C], [TC:RJ]), use a thermocouples thermometer with an input resistance of at least 100 kΩ. If the input resistance is under 100 kΩ, the following error will be added to the specification precision: $100 \times (1 - R_{in} / (2.2 + R_{in}))\%$ (where R_{in} is the thermocouples thermometer input resistance.)

NOTE

- When output in the thermoelectromotive force source function (**[TC:RJ]**) is on, reference junction compensation will be performed about every 5 seconds, and the output value compensated.
- In the thermoelectromotive force source function (**[TC:RJ]**), when the detected temperature of the optional 9184 Temperature Probe is outside the -25°C to 80°C range, or if connection is incorrect, the messages "rJErr" will be displayed even when the output on switch is pressed, and output will remain off.

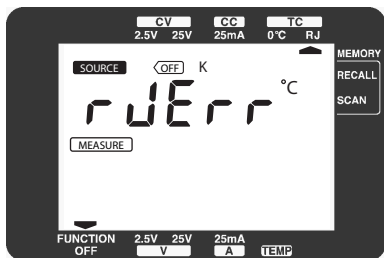

- To perform reference junction compensation at a temperature out of the operating temperature range of the main instrument, be careful that the ambient temperature of the main instrument.
- If the instrument is moved to a new location, or the thermometer being compensated for is changed, errors may result due to changes in the temperature constants. Do not attempt to perform measurements until the instrument has had sufficient time to reach thermal stability.
- If the **[B]** indicator is flashing, output cannot be set to ON. (If it flashes during output, output continues until output is set to OFF.) Replace the batteries or connect the AC adapter.

3.4 0°C Check of the 100 Ω Resistance Thermometer

100 Ω reference resistor is connected between reference resistor terminals, which are the same terminals as the current input terminals. This resistor is for 0°C check of the 100 Ω standard resistance thermometer. Usable except for current measurement function (**[A:25mA]**). Make sure measurement function is never set to current measurement function before connecting the instrument to the 100 Ω standard resistance thermometer.

CAUTION

Do not input current more than 25 mA DC to the terminal for the standard resistor. Doing so may damage the resistor of the instrument.

3.5 Output Monitor Function

- In the constant voltage source function ([CV:2.5V], [CV:25V]), the current that flows into the target device is displayed on the LCD display.
- In the constant current source function ([CC:25mA]), the voltage between the output terminals is displayed on the LCD display.
- In the thermoelectromotive force source function, the reference junction temperature is displayed on the LCD display ("0°C" is displayed in [TC:0°C], the temperature measured with the optional 9184 Temperature Probe is displayed in [TC:RJ]).

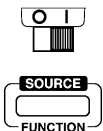

1. Turn the power switch on.

2. Press the **SOURCE FUNCTION** key the required number of times.

Set the source function.

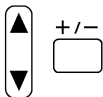

3. Use the **▲/▼** keys and **+/-** key to set the value to be sourced.

4. If the target device has a power source, switch it off and then connect the target device to the output terminal of the SS7012. If necessary, switch the power of the target device back on.

OUTPUT
ON / OFF

MONITOR

SKIP

5. Press the **OUTPUT ON/OFF** key.

ON is displayed on the screen and the setting value is output.

However, if the load gets excessive and the setting value cannot be output, the setting value flashes. If the setting value starts flashing, press the **OUTPUT ON/OFF** key to set the output to OFF.

See: "3.7 When setting value is flashing" (p.65)

6. Press the **MONITOR** key.

The instrument switches from the measure function to the output monitor function.

MONITOR is displayed.

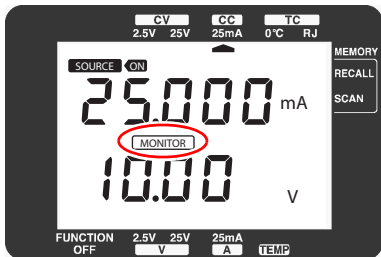

7. Read the monitor value at the lower portion of the display.



MONITOR

SKIP

8. Press the **MONITOR** key again.

The instrument switches from the output monitor function to the measure function.

MONITOR is displayed.

OUTPUT
ON / OFF

9. Press the **OUTPUT ON/OFF** key.

OFF is displayed on the screen and the output changes to OFF.

Monitor ranges are shown below:

[CV:2.5V]	Load current	: -28.00 mA to 28.00 mA
[CV:25V]	Load current	: -28.00 mA to 28.00 mA
[CC:25mA]	Load voltage	: -28.00 V to 28.00 V
[TC:0°C]	Reference junction temperature:	0°C
[TC:RJ]	Reference junction temperature	: -25.0°C to 80.0°C

CAUTION

If the output is outside this range, the display will indicate "oF" in the constant voltage source function ([CV:2.5V], [CV:25V]) and constant current source function ([CC:25mA]), and "rJErr" in the thermocouple power function ([TC:RJ]). In this case, turn off the output and confirm the target device. If output is continued, the unit and the target device may be damaged.

NOTE

- If the output is OFF, the display will indicate " - - - - -".
- If the **B** indicator is flashing, output cannot be set to ON. (If it flashes during output, output continues until output is set to OFF.) Replace the batteries or connect the AC adapter.

3.6 Memory Source Function

This function records sourcing values and then later recalls them for sourcing.

For each source function, up to 20 values can be recorded. In [TC:0°C] and [TC:RJ], the thermocouple type can also be recorded.

There are 2 sourcing methods.

- Recall sourcing (p.59): Single key operation for changing the setting.
- Scan sourcing (p.61) : Automatically changes the setting value at a set time interval.

In Chapter 5, a loop test method is introduced as a practical example of using the memory source function.

See: "Chapter 5 Loop Test" (p.75)

In [CV:25V] and [CC:25mA], setting values are already saved as a default.

Address	1	2	3	4	5
CV:25V	1 V	2 V	3 V	4 V	5 V
CC:25mA	-4 mA	-8 mA	-12 mA	-16 mA	-20 mA

Saving setting value to memory



1. Turn the power switch on.

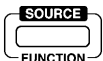

2. Press the **SOURCE FUNCTION** key to set the source function.

NOTE Confirm that a  does not appear near [MEMORY] at the upper right of the screen (normal source mode).

If a  is displayed, press the **MEMORY** key the required number of times until it is no longer displayed.

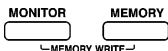

3. Press the **MONITOR** key and the **MEMORY** key together.

The system will shift to the memory write mode.

"01" is displayed in the memory address and output setting value of the address is displayed. At this time, if the address "01" has been skipped before, "-----" is displayed and numerical value is not displayed.

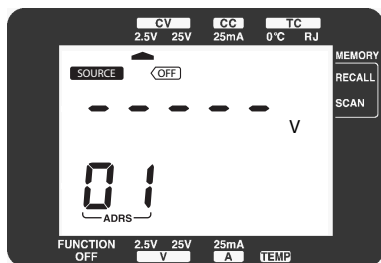

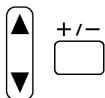

4. Use the \blacktriangle / \blacktriangledown keys and $+/-$ key to set the value to be sourced.

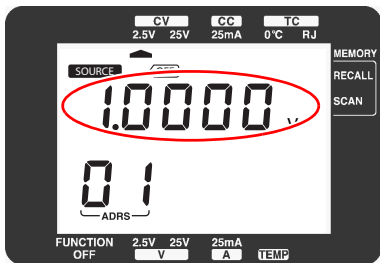

The five \blacktriangle / \blacktriangledown keys correspond to the five columns of the setting.

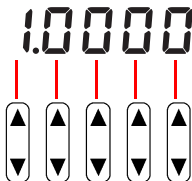

5. Press the **ENTER** key.

After flashing, the setting value is set. Next, the instrument advances automatically to the next address.

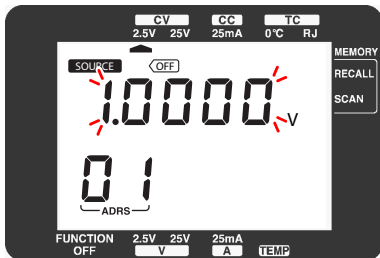

MONITOR

SKIP

If you do not want to save a setting value to the address, press the **SKIP** key. (Skip setting)

"-----" flashes and then the instrument advances automatically to the next address.

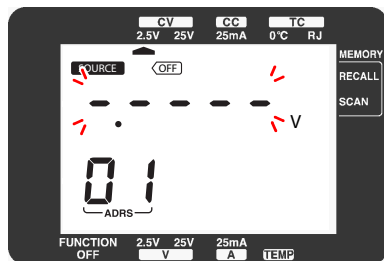

Repeat steps 4. and 5. to save setting values to memory. A maximum of 20 items can be saved.

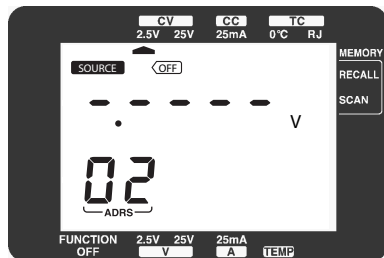
**MONITOR****MEMORY**

← MEMORY WRITE →

6. Press the **MONITOR** key and the **MEMORY** key together.

Exit memory write mode.

! CAUTION

Never switch off the power in memory write mode. It may damage the SS7012.

NOTE

- Addresses with skip settings cannot be called by the memory source function.
- If the setting value or "- - - -" is flashing, the setting value or skip setting is being written to memory.
- The sourcing time interval is set using scan source mode ([\[SCAN\]](#)).
- In memory write mode, measurements and output monitoring cannot be performed.
- Memory data is shared in the thermoelectromotive force source functions ([\[TC:0°C\]](#), [\[TC:RJ\]](#)).

Recall sourcing

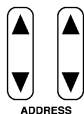
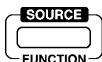

1. Press the **SOURCE FUNCTION** key to set the memory sourcing function.
2. Press the **MEMORY** key once to set to the recall source mode (**[RECALL]**).
3. Use the **ADDRESS** keys (the 2 left-side **▲/▼** keys) to set the address to be sourced.

The output setting value in memory is displayed at the sourcing screen.

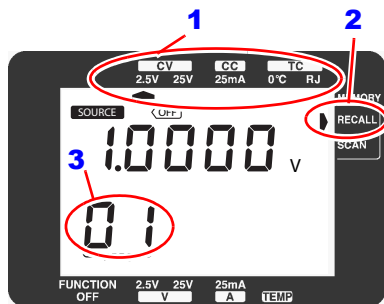

4. Connect the target device.
5. Press the **OUTPUT ON/OFF** key.



ON is displayed on the screen and the setting value is output.

OUTPUT
ON/OFF**6.** Press the **OUTPUT ON/OFF** key.

is displayed on the screen and the output changes to OFF.

7. Repeat steps **3.** to **6.****8.** Press the **MEMORY** key twice.

ENTER

Exit recall source mode.

NOTE

- In recall source mode, the output setting value cannot be changed. The **▲**/**▼** keys only set addresses. To change the setting value, see "Saving setting value to memory" (p.55).
- When output is ON, press the **MONITOR** key to enable the output monitor function and monitor output. When output is OFF, measurement and monitoring cannot be performed.
- Every time the **MEMORY** key is pressed, the source mode changes in the following sequence.

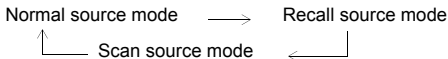

- Addresses that can be set for recall sourcing are only those set between 1 and 20. (Those with no skip setting.)
- If the **B** indicator is flashing, output cannot be set to ON. (If it flashes during output, output continues until output is set to OFF.) Replace the batteries or connect the AC adapter.

Scan sourcing

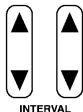
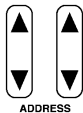
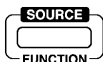

1. Press the **SOURCE FUNCTION** key to set the memory sourcing function.
2. Press the **MEMORY** key twice to set to the scan source mode ([SCAN]).
3. Use the **ADDRESS** keys (the 2 left-side $\blacktriangle/\blacktriangledown$ keys) to set the address to be sourced.

The output setting value in memory is displayed at the sourcing screen.

4. Use the **INTERVAL** keys (the 2 right-side $\blacktriangle/\blacktriangledown$ keys) to set the sourcing time interval.

The sourcing time interval is from 1 to 99 seconds. A sourcing time interval cannot be set for each address.

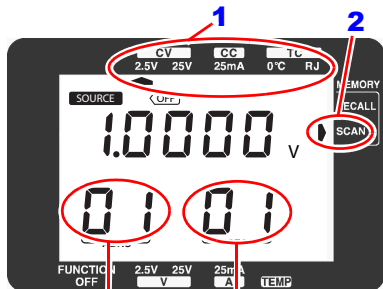

- 3 Start address for sourcing
- 4 Sourcing time interval

5. Connect the target device.



OUTPUT
ON / OFF

6. Press the OUTPUT ON/OFF key.

ON is displayed on the screen and output starts.

The setting switches by the specified time interval.



OUTPUT
ON / OFF

7. Press the OUTPUT ON/OFF key.

OFF is displayed on the screen and the output changes to OFF. Scan sourcing also stops.



ENTER

8. Press the MEMORY key once.

Exit scan source mode.

NOTE

- In scan source mode, the output setting value cannot be changed. The ▲/▼ keys only set addresses. To change the setting value, see "Saving setting value to memory" (p.55).
- When output is ON, press the **MONITOR** key to enable the output monitor function and monitor output. When output is OFF, measurement and monitoring cannot be performed.
- Every time the **MEMORY** key is pressed, the source mode changes in the following sequence.

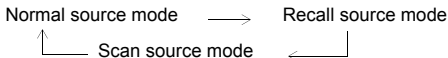

- Addresses that can be set for scan sourcing are only those set between 1 and 20. (Those with no skip setting.)
- If the **B** indicator is flashing, output cannot be set to ON. (If it flashes during output, output continues until output is set to OFF.) Replace the batteries or connect the AC adapter.

Initializing setting values

- Initialize setting values saved to memory. Initialization by source function is possible. Furthermore, all functions can be initialized at same time.
- This feature is useful when re-saving settings to memory or when batch initializing the contents of functions that are no longer used.
- After initialization, the memory contents are as follows.

Address	1	2	3	4	5
CV:25V	1 V	2 V	3 V	4 V	5 V
CC:25mA	-4 mA	-8 mA	-12 mA	-16 mA	-20 mA

Those not listed above are as follows.

Setting count : 00000
 Source setting : Skip (Not used)
 Sourcing time interval : 1 s
 Thermocouple : [K] ([TC:0°C], [TC:RJ] source function)

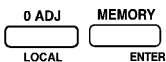

- 1. Turn the power switch on while holding both the 0 ADJ and the MEMORY keys.**

The display shows "CLr" when the Memory Clear mode is activated.

If it does not, repeat step 1.

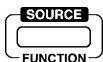

- 2.** Press the **SOURCE FUNCTION** key to select the function for which settings are to be initialized.

After selecting the thermoelectromotive force source function, all functions will be selected: ([CV:2.5V] → [CV:25V] → [CC:25mA] → [TC:0°C], [TC:RJ] → All functions)

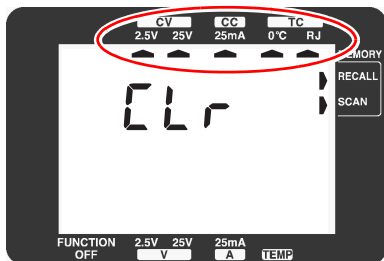

- 3.** Press the **MONITOR** key.

The settings of selected functions are initialized and "CLr" flashes on the screen.



- 4.** Turn the power off.

CAUTION

To avoid damaging the instrument, do not turn the power off in the middle of the Memory Clear procedure. The "CLr" display should be blinking before turning the power off.

3.7 When setting value is flashing

When the **OUTPUT** key is pressed and output is set to ON, setting value may flash.

When setting value is flashing, the value being output may be lower than the setting value. (Overload) Press the **OUTPUT** key to set the output to OFF.

Check the connection of the SS7012 and the target device. If there are unexpected shorts or contact failures, eliminate them. If the setting value is still flashing even after setting output to ON, the performance level of the SS7012 is being exceeded. (See below.)

In the constant voltage source function of this instrument, the possible electrical current that can flow is ± 25 mA. (Current must flow to source the specified constant voltage.) If a current exceeding ± 25 mA flows, the source voltage may become lower than the setting value. In other words, the set voltage cannot be sourced in this condition.

Furthermore, in the constant current source function, the applied voltage is ± 25 V. (Voltage must be applied for the specified constant current to flow.) If a voltage exceeding ± 25 V is applied, the source current may become lower than the setting value. In other words, the set current cannot be sourced in this condition.

Measurement

Chapter 4

Always inspect the instrument before measurement.

See: "2.4 Pre-Operation Inspection" (p.34)

4.1 Measurement Example

The following are the voltages, currents, and temperatures that the SS7012 can measure.

◆ Voltage (V) (p.68)

In [V:2.5V], measurement is possible from -2.8 to +2.8 V with the resolution of 100 μ V.

In [V:25V], measurement is possible from -28 to +28 V with the resolution of 1 mV.

In all cases, DC voltage can be measured.

◆ Current (A) (p.68)

In [A:25mA], measurement is possible from -28 to +28 mA with the resolution of 1 μ A.

DC current can be measured.

◆ Temperature (TEMP) (p.71)

In [TEMP], measurement is possible from -25 to +80°C with the resolution of 0.1°C.

The optional 9184 Temperature Probe is required.

4.2 Voltage Measurement and Current Measurement

Measure DC voltage or DC current as following procedure.

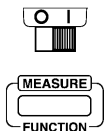

1. Turn the power switch on.
2. Press the **MEASURE FUNCTION** key the required number of times to set the voltage measure function ([V:2.5V], [V:25V]) or current measure function ([A:25mA]).

At power on, [FUNCTION OFF] is set. Pressing the **MEASURE FUNCTION** key changes the setting in the lower shown sequence.

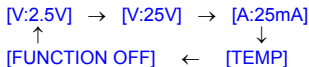

In the lower part of the screen, the  moves to the specified function.

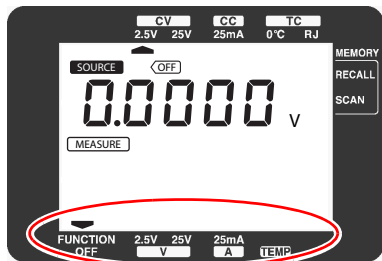

3. <For voltage measurement>

Connect the test leads to the voltage input terminals for the instrument and short out the ends of the test leads.

<For current measurement>

Connect the test leads to the current input terminals for the instrument and open the ends of the test leads.

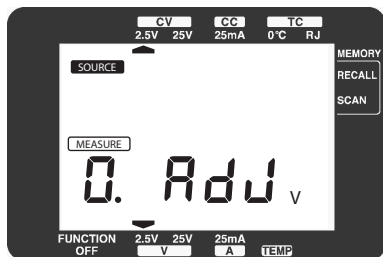
**4. Press the 0 ADJ key to execute the zero adjustment.****5. Connect the end of the test lead to the target device and read the displayed value.****CAUTION**

In order to prevent damage to the instrument or the target device, do not input voltage in excess of ± 28 V to the voltage input terminal and do not input current in excess of ± 28 mA to the current input terminal. Do not input voltage to the current input terminal.

70 4.2 Voltage Measurement and Current Measurement

NOTE

- If the input is outside the measurement range, the display will indicate "oF".

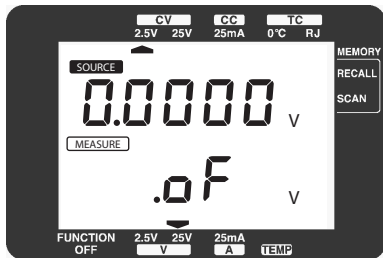

- The zero adjustment function works only when the measurement value is within ± 100 counts. When the measurement value is within ± 100 counts, press the **0 ADJ** key to revert the display to "00000".
- Every time pressing the **0 ADJ** key, the input value is memorized. The LCD shows the difference between the memorized value and the input value.
- In the following cases, the zero adjustment function does not work and "AdJEr" is displayed, even if the **0 ADJ** key is pressed.
 - In [V:2.5V], the input value exceeds ± 0.0100 V
 - In [V:25V], the input value exceeds ± 0.100 V
 - In [A:25mA], the input value exceeds ± 0.100 mA

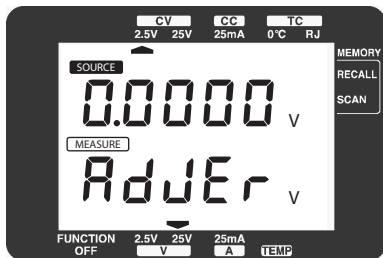

4.3 Temperature Measurement

Temperature measurement is possible with the optional 9184 Temperature Probe.

1. Connect the optional 9184 Temperature Probe to the instrument.

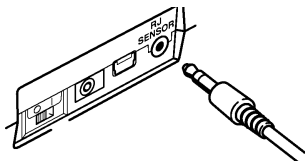

9184 Temperature Probe



2. Turn the power switch on.

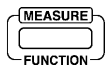

3. Press the **MEASURE FUNCTION** key 4 times to set the temperature measurement function ([TEMP]).

At power on, [FUNCTION OFF] is set. Pressing the **MEASURE FUNCTION** key changes the setting in the lower shown sequence.

[V:2.5V] → [V:25V] → [A:25mA]
↑ ↓
[FUNCTION OFF] ← [TEMP]

In the lower part of the screen, the  moves to the specified function.

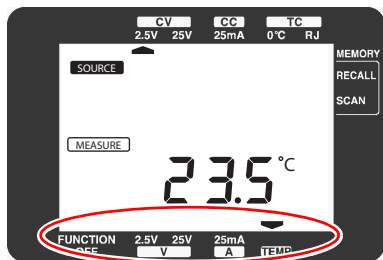

4. Read the displayed value.

NOTE

- If the temperature measurement function is selected without the optional 9184 Temperature Probe being connected, the message "rJErr" will be displayed. When a Temperature Probe is connected, the error disappears and temperature measurement starts.

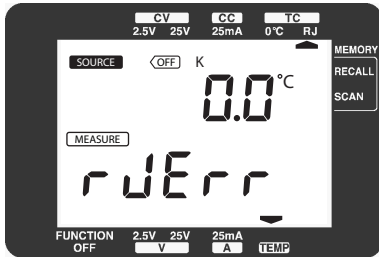

- The optional 9184 Temperature Probe cannot be used out of the temperature measurement range between -25 and 80°C. If measurement exceeds this temperature range, the lead insulation of the temperature probe being used is damaged. In addition, if the input is outside measurement range, the display will indicate "rJErr".

Loop Test

Chapter 5

5.1 Loop Test Overview

Loop tests can be performed with the SS7012.

The loop tests are for systems that include two-wire transmitters and distributors. (See the diagram below).

Two-wire transmitters and distributors can be tested using the SS7012.

The two-wire transmitter receives the sensor output and converts it to a 4-20 mA current signal.

In addition to supplying the power to the two-wire transmitter, the distributor outputs a signal corresponding to the current signal to a later stage.

The connections for the two-wire transmitter, etc.

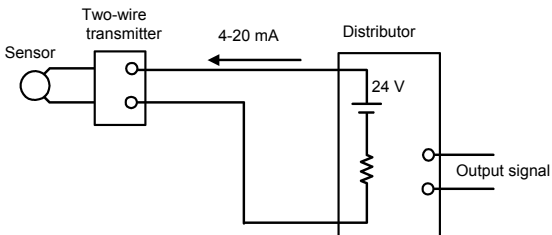

5.2 Testing a Distributor (4-20 mA)

The 4-20 mA current flow of the distributor can be tested by using the SS7012 to sink the 4-20 mA current (a two-wire transmitter simulation).

For the distributor test, setting values of the source current are minus because the SS7012 sinks current.

It is assumed that the memory source function setting of the SS7012 is default. When the setting is not at the default, initialize the memory settings or set -4 mA/ -8 mA/ -12 mA/ -16 mA/ -20 mA.

See: "Initializing setting values" (p.63)

"Saving setting value to memory" (p.55)

Note that when you make the setting yourself, they may not match with the [ADRS] values of the following procedure.

Distributor test

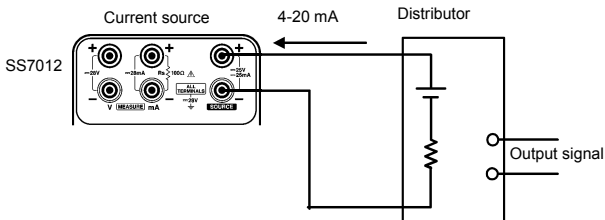

Test procedure

1. Check which distributor input terminal has the higher potential.

- 1.** Power on the SS7012 and perform the pre-operation inspection.
See: "2.4 Pre-Operation Inspection" (p.34)
- 2.** Press the **MEASURE FUNCTION** key to set the measure function to [V:25V].
- 3.** Connect the voltage input terminal of the SS7012 and the input terminal of the instrumentation.
- 4.** Read the voltage of the distributor input terminals and check which terminal has the higher potential.
- 5.** Release the connection with the distributor of the SS7012.

2. Checking the memory source function setting

- 1.** Press the **SOURCE FUNCTION** key to set the source function to [CC:25mA].
- 2.** Press the **MEMORY** key to switch from normal source to recall source. (The selected memory source function is displayed at the upper right display area.)
- 3.** Check that [ADRS] is "01" and the setting is -4.000 mA.
- 4.** Press the right **ADDRESS** key (the **ADDRESS** keys are the 2 ▲/▼ keys on the left) and switch [ADRS] from "01" to "02".
- 5.** Check that the setting is -8.000 mA.
- 6.** Press the **ADDRESS** key. Check that, as [ADRS] increases from "03" to "04" to "05", the setting changes to -12.000 mA to -16.000 mA to -20.000 mA.
- 7.** Press the **ADDRESS** key to set [ADRS] to "01".

3. Connect the SS7012 and the distributor and then test.
 1. Connect the output terminal of the SS7012 and the input terminal of the distributor as shown in the figure. Be careful of the connection direction. Connect the positive side of the output terminal of the SS7012 with the input terminal of the distributor with the higher potential. Connect the negative side of the output terminal of the SS7012 with the input terminal of the distributor with the lower potential.
 2. Press the **OUTPUT ON/OFF** key to set the output to ON. (During output, **ON** is displayed in the display area.) A current of 4.000 mA is now flowing. (The setting is -4.000 mA.)
 3. Check the indicated value of the meter.
 4. In this state, press the **ADDRESS** key to set [ADRS] to "02". A current of 8.000 mA is now flowing. (The setting is -8.000 mA.)
 5. Check the indicated value of the meter.
 6. Similarly to below, increase [ADRS] to "03", "04", and "05". (The current flow increases to 12.000 mA, 16.000 mA, and 20.000 mA). Check that the indicated value of the meter accordingly.
 7. Press the **OUTPUT ON/OFF** key to set the output to OFF.
 8. Release the connection with the distributor of the SS7012.
 9. Turn off the power of the SS7012.

5.3 Testing a two-wire transmitter

The two-wire transmitter can be tested by sourcing voltage (voltage of the power for the transmitter of the distributor) from the SS7012 and monitoring the output current. In this case, it is assumed that the power voltage of the two-wire transmitter is 24 V. (24 V loop power)

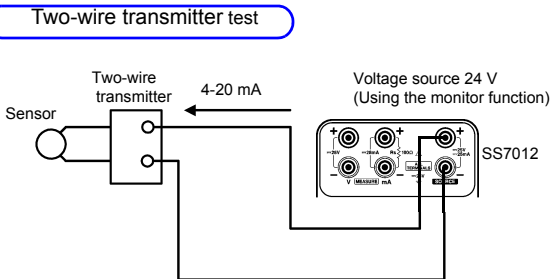

1. Power on the SS7012 and perform the pre-operation inspection.
See: "2.4 Pre-Operation Inspection" (p.34)
2. Press the **SOURCE FUNCTION** key to set the source function to [CV:25V].
3. Press the **▲/▼** keys to set the source setting to 24.000 V (the voltage of the distributor).
4. Connect the two-wire transmitter and the SS7012 as shown in diagram "Two-wire transmitter test".
5. Press the **OUTPUT ON/OFF** key to set the output to ON. (During output, **ON** is displayed in the display area.)
6. Press the **MONITOR** key to set the output monitor function to ON.

7. Insert a suitable input into the two-wire transmitter (pressure, temperature, etc.). Read and check the current value from the SS7012 at this time. (Do this for all the inputs that required for testing. The display example is as follows.)

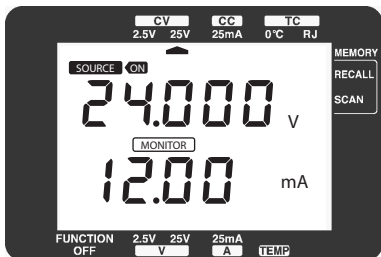

8. Press the **MONITOR** key to set the output monitor function to OFF.
9. Press the **OUTPUT ON/OFF** key to set the output to OFF.
10. Release the connection with the distributor of the SS7012.
11. Turn off the power of the SS7012.

Other Function

Chapter 6

6.1 USB Communication Function

The SS7012 can communicate with a computer. (Remote control)



The communication function can set the SS7012, as well as record and save settings and measurements on the computer.

NOTE To use this function, the optional SS9000 Communication Package is required.
For more details about using the communication function, see the Remote operation manual included with the SS9000 Communication Package.

Specifications**Chapter 7****7.1 General Specifications**

Operating environment	Indoors, Pollution degree 2, up to 2000 m (6562-ft.) ASL
Storage temperature and humidity	-20 to 50°C (-4 to 122°F) 80%RH or less (non-condensating)
Operating temperature and humidity	0 to 40°C (32 to 104°F) 80%RH or less (non-condensating)
Dielectric strength	720 V rms AC (Current sensitivity: 1 mA) for 1 minute Between output terminals and input terminals
Applicable Standards	Safety EN61010 EMC EN61326
Effect of radiated radio-frequency electromagnetic field	5%f.s. at 3 V/m
Effect of conducted radio-frequency electromagnetic field	3%f.s. at 3 V

Power supply	9445-02 AC Adapter 9 V, 1 A Rated supply voltage: 100 to 240 VAC (Voltage fluctuations of $\pm 10\%$ from the rated supply voltage are taken into account.) Rated supply frequency: 50/60 Hz Anticipated transient overvoltage: 2500 V Maximum rated power: 6 VA
	LR6 alkaline battery Rated supply voltage: 1.5 DC \times 4 Maximum rated power: 6 VA
	Nickel hydride batteries (HR6 \times 4) Rated supply voltage: 1.2 DC \times 4 Maximum rated power: 6 VA
Continuous operating time	When using nickel hydride batteries (min. 2450 mAh) (23°C reference value) Approx. 200 minutes (after full recharge, [CC:25mA], 20 mA source, 250 Ω load) Approx. 170 minutes (after full recharge, [CV:25V], 25 V source, 1 k Ω load) Approx. 280 minutes (after full recharge, [V:2.5V], when input terminal is shorted)
Dimensions	Approx. 104W \times 180H \times 58D mm (4.09"W \times 7.09"H \times 2.28"D) (without protrusions)
Mass	Approx. 570 g (20.1 oz.) (without batteries)
Product warranty period	3 years
Output resistance	CV: 300 m Ω or less TC: 5 Ω or less
Input resistance	DCV: 1 M Ω \pm 1% DCA: 30 Ω or less (Including approx. 15 Ω for the fuse)
Maximum input voltage	28 VDC
Maximum input current	28 mADC
Maximum rated voltage to earth	28 VDC Anticipated transient overvoltage: 330 V
Temperature and humidity for guaranteed accuracy	23 \pm 5°C, 80%RH or less
Warm-up time	5 minutes

Battery voltage	 (Battery low warning indicator) When flashing, accuracy cannot be guaranteed.	
Period of guaranteed accuracy	1 year	
Source output method	Bipolar sink-source system	
Source functions	DC constant voltage	[CV:2.5V] [CV:25V]
	DC constant current	[CC:25mA]
	Thermoelectromotive force	[TC:0°C] [TC:RJ]
	Standard resistance	[Rs]
Measure functions	DC voltage	[V:2.5V] [V:25V]
	DC current	[A:25mA]
	Temperature	[TEMP]
Monitor measurement	Load current	[CV:2.5V] [CV:25V]
	Load voltage	[CC:25mA]
	Reference junction temperature	[TEMP]
Added functions	Memory source function (Recall sourcing [RECALL], Scan sourcing [SCAN]) Zero adjustment function ([V:2.5V] [V:25V] [A:25mA] Within ± 100) Overload display function Communication function (Virtual COM port by USB interface 1.1) Battery low warning function (When the power voltage is 4.6 V or less,  flashes.)	
Accessories	9168 Input Cord	1set
	L9170-10 Test Lead	1set
	Fuse 250VF50mAH ($\phi 5.2 \times 20$ mm)	1
	LR6 alkaline batteries	4
	Instruction Manual	1
Options	9184 Temperature Probe (reference junction compensation) 9380 Carrying Case (Holds main unit only, soft case) 9782 Carrying Case (Holds options, hard case) 9445-02 AC Adapter SS9000 Communication Package (Includes USB cable and USB driver software)	

7.2 Accuracy

Sourcing

	Function	Resolution	Accuracy	Remarks
Sourcing	Constant voltage [CV:2.5V] 0 to ± 2.5000 V	100 μ V	$\pm 0.03\%$ of setting ± 300 μ V	Maximum output ± 25 mA or more (sink-source)
	Constant voltage [CV:25V] 0 to ± 25.000 V	1 mV	$\pm 0.03\%$ of setting ± 3 mV	When shorted, 50 mA or less. Load regulation 0.3 mV/mA
	Constant current [CC:25mA] 0 to ± 25.000 mA	1 μ A	$\pm 0.03\%$ of setting ± 3 μ A	Maximum output ± 25 V or more (sink-source) When open, 40 V or less.
	Thermoelectromotive force [TC:0°C]			
	[K] -174.0 to 1372.0°C	0.1°C	$\pm 0.05\%$ of setting ± 0.5 °C	
	[E] -220.0 to 839.0°C	0.1°C	$\pm 0.05\%$ of setting ± 0.5 °C	
	[J] -208.0 to 1108.0°C	0.1°C	$\pm 0.05\%$ of setting ± 0.5 °C	
	[T] -169.0 to 400.0°C	0.1°C	$\pm 0.05\%$ of setting ± 0.5 °C	
	[R] -50 to 100°C	1°C	$\pm 0.05\%$ of setting ± 1.5 °C	
	101 to 1768°C	1°C	$\pm 0.05\%$ of setting ± 1.0 °C	
	[S] -50 to 100°C	1°C	$\pm 0.05\%$ of setting ± 1.5 °C	
	101 to 1768°C	1°C	$\pm 0.05\%$ of setting ± 1.0 °C	
	[B] 300 to 600°C	1°C	$\pm 0.05\%$ of setting ± 2.5 °C	
	601 to 1820°C	1°C	$\pm 0.05\%$ of setting ± 1.5 °C	
[N] -113.0 to 1300.0°C	0.1°C	$\pm 0.05\%$ of setting ± 0.5 °C		

	Function	Resolution	Accuracy	Remarks
Sourcing	Thermoelectromotive force [TC:RJ]			<p>Using the 9184 Temperature Probe</p> <p>The accuracies listed to the left are when the monitor measurement value is $23 \pm 5^\circ\text{C}$</p> <p>At other temperatures, 9184 temperature measurement accuracy portions are added.</p> <p>$\pm 0.5^\circ\text{C}$ added (0 to 50°C)</p> <p>$\pm 1.5^\circ\text{C}$ added (-25 to 80°C)</p>
	[K] -174.0 to 1372.0°C	0.1°C	$\pm 0.05\%$ of setting $\pm 1.0^\circ\text{C}$	
	[E] -220.0 to 839.0°C	0.1°C	$\pm 0.05\%$ of setting $\pm 1.0^\circ\text{C}$	
	[J] -208.0 to 1108.0°C	0.1°C	$\pm 0.05\%$ of setting $\pm 1.0^\circ\text{C}$	
	[T] -169.0 to 400.0°C	0.1°C	$\pm 0.05\%$ of setting $\pm 1.0^\circ\text{C}$	
	[R] -50 to 100°C	1°C	$\pm 0.05\%$ of setting $\pm 2.0^\circ\text{C}$	
	101 to 1768°C	1°C	$\pm 0.05\%$ of setting $\pm 1.5^\circ\text{C}$	
	[S] -50 to 100°C	1°C	$\pm 0.05\%$ of setting $\pm 2.0^\circ\text{C}$	
	101 to 1768°C	1°C	$\pm 0.05\%$ of setting $\pm 1.5^\circ\text{C}$	
	[B] 300 to 600°C	1°C	$\pm 0.05\%$ of setting $\pm 3.0^\circ\text{C}$	
	601 to 1820°C	1°C	$\pm 0.05\%$ of setting $\pm 2.0^\circ\text{C}$	
	[N] -113.0 to 1300.0°C	0.1°C	$\pm 0.05\%$ of setting $\pm 1.0^\circ\text{C}$	
Standard resistor [Rs] 100 Ω		$\pm 0.2 \Omega$	When current measure function is off, standard resistance input terminal	
Memory sourcing	Memory [RECALL], [SCAN] One of the following 4 functions: [CV:2.5V] [CV:25V] [CC:25mA] [TC:0°C]/[TC:RJ] Maximum number of steps: 20 Sourcing time interval: 1 to 99 s (1 s step)		Accuracy of sourced value depends on accuracy of selected function. The timing accuracy of the sourcing time interval is not rated.	Memory data is shared in [TC:0°C] and [TC:RJ] functions.

Measurement

% rdg. is the % of the reading

Sampling rate: Approx. 1.67 times/s

	Function	Resolution	Accuracy	Remarks
Measurement	Voltage [V:2.5V] 0 to ±2.8000 V	100 μV	±0.03% rdg. ±300 μV	After executing a zero adjustment
	Voltage [V:25V] 0 to ±28.000 V	1 mV	±0.03% rdg. ±3 mV	
	Current [A:25mA] 0 to ±28.000 mA	1 μA	±0.03% rdg. ±3 μA	
	Temperature [TEMP] -25.0 to 80.0°C	0.1°C	±0.5°C (23±5°C) ±1.0°C (0 to 50°C) ±2.0°C (-25 to 80°C)	Using the 9184 Temperature Probe
Monitor	Load current [CV:2.5V] 0 to ±28.00 mA	10 μA	±0.1% rdg. ±20 μA	
	Load current [CV:25V] 0 to ±28.00 mA	10 μA	±0.1% rdg. ±20 μA	
	Load voltage [CC:25mA] 0 to ±28.00 V	10 mV	±0.1% rdg. ±20mV	
	Reference junction temperature [TC:0°C]		0.0°C	0°C reference
	Reference junction temperature [TC:RJ] -25.0 to 80.0°C	0.1°C	±0.5°C (23±5°C) ±1.0°C (0 to 50°C) ±2.0°C (-25 to 80°C)	Using the 9184 Temperature Probe

Temperature coefficient

For temperatures other than $23^{\circ}\text{C} \pm 5^{\circ}\text{C}$, the following is added.

Sourcing

[CV:2.5V]	: $\pm 0.005\%$ of setting $\pm 30 \text{ mV}/^{\circ}\text{C}$
[CV:25V]	: $\pm 0.005\%$ of setting $\pm 0.2 \text{ mV}/^{\circ}\text{C}$
[CC:25mA]	: $\pm 0.005\%$ of setting $\pm 0.2 \text{ mA}/^{\circ}\text{C}$
[TC:0°C] ([K], [E], [J], [T], [N])	: $\pm 0.005\%$ of setting $\pm 0.05^{\circ}\text{C}/^{\circ}\text{C}$
[TC:0°C] ([R], [S], [B])	: $\pm 0.005\%$ of setting $\pm 0.10^{\circ}\text{C}/^{\circ}\text{C}$
[TC:RJ] ([K], [E], [J], [T], [N], [R], [S], [B])	: $\pm 0.01\%$ of setting $\pm 0.10^{\circ}\text{C}/^{\circ}\text{C}$
[Rs]	: $\pm 0.005 \Omega/^{\circ}\text{C}$

Measurement

% rdg. is the % of the reading

[V:2.5V]	: $\pm 0.005\%$ rdg. $\pm 10 \mu\text{V}/^{\circ}\text{C}$
[V:25V]	: $\pm 0.005\%$ rdg. $\pm 0.1 \text{ mV}/^{\circ}\text{C}$
[A:25mA]	: $\pm 0.005\%$ rdg. $\pm 0.1 \mu\text{A}/^{\circ}\text{C}$
[TEMP]	: $\pm 0.05^{\circ}\text{C}/^{\circ}\text{C}$
[MONITOR] ([CV:2.5V], [CV:25V])	: $\pm 0.01\%$ rdg. $\pm 1 \mu\text{A}/^{\circ}\text{C}$
[MONITOR] ([CC:25mA])	: $\pm 0.01\%$ rdg. $\pm 1 \text{ mV}/^{\circ}\text{C}$
[MONITOR] ([TC:RJ])	: $\pm 0.05^{\circ}\text{C}/^{\circ}\text{C}$

Maintenance and Service

Chapter 8

8.1 Troubleshooting

!WARNING

Do not attempt to modify, disassemble or repair the instrument; as fire, electric shock and injury could result.

NOTE

- If damage is suspected, check the "Before returning for repair" (p.93) before contacting your dealer or Hioki representative.
- Getting the instrument wet or letting oil or dust enter inside its casing will certainly damage it, and is quite likely to cause an electric shock accident or a dangerous conflagration. If the instrument has gotten seriously wet, oily, or dusty, stop using it and send it for service at an approved Hioki calibration facility.

Transporting

When sending the instrument for repair, remove the batteries and pack carefully to prevent damage in transit. Include cushioning material so the instrument cannot move within the package. Be sure to include details of the problem. Hioki cannot be responsible for damage that occurs during shipment.

Replaceable Parts and Operating Lifetimes

Useful life depends on the operating environment and frequency of use. Operation cannot be guaranteed beyond the following periods. For replacement parts, contact your dealer or Hioki representative.

Part	Life
Electrolytic Capacitors	Approx. 9 years

There is a fuse inside in the power unit of the instrument. If the power does not turn on, the fuse may be blown. If this occurs, a replacement or repair cannot be performed by customers. Please contact your dealer or Hioki representative.

Before returning for repair

Symptom	Cause	Remedy
Although you have turned on the power switch, the screen display does not appear.	<ul style="list-style-type: none"> • Are the batteries correctly inserted? • Is the useful battery life at an end? 	Insert the new batteries. See: "Installing or Replacing the Batteries" (p.25)
	<ul style="list-style-type: none"> • Is the optional 9445-02 AC Adapter connected? 	Connect the AC Adapter. (Check that power is reaching the outlet.) See: "Connecting the AC Adapter (Option)" (p.27)
Constant voltage, constant current, thermoelectromotive force sourcing or current measurement are impossible.	<ul style="list-style-type: none"> • Is the circuit protection fuse fitted? • Has the circuit protection fuse blown? 	Change the circuit protection fuse. See: "8.2 Replacing the Circuit Protection Fuse" (p.94)
The value is unusual when sourcing thermoelectromotive force.	<ul style="list-style-type: none"> • Are you attempting to calibrate the thermometer for internal reference junction compensation using [TC:0°C]? 	Use the 9184 Temperature Probe and calibrate using [TC:RJ].
Sourcing is not possible.	<ul style="list-style-type: none"> • Is the  indicator flashing? 	<ul style="list-style-type: none"> • Insert the new batteries. See: "Installing or Replacing the Batteries" (p.25) • Connect the AC Adapter. (Check that power is reaching the outlet.) See: "Connecting the AC Adapter (Option)" (p.27)

8.2 Replacing the Circuit Protection Fuse

WARNING

- To avoid electric shock, turn off the power switch and disconnect the test leads or input cords from the target device before replacing the fuse.
- After replacing the batteries, replace the cover before using the instrument.
- Replace the fuse only with one of the specified characteristics and voltage and current ratings. Never use unspecified fuses and never use the instrument after the fuse holder has shorted. This will damage the instrument and cause injury.

Fuse type: 250VF50mAH ($\phi 5.2 \times 20$ mm)

The fuses are fitted on the PCB where the lower case is removed.

- The SS7012 has three fuses: two of them are for source function, one for measure function. Fuses are common for all the function.
- The fuse for the constant voltage ([CV:2.5V], [CV:25V]) and constant current ([CC:25mA]) source functions is labeled "F201" on the circuit board.
- The fuse for the thermoelectromotive force source functions ([TC:0°C] and [TC:RJ]) is labeled "F202" on the circuit board.
- The fuse for the current measure function ([A:25mA]) is labeled "F401" on the circuit board.

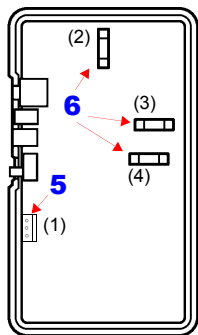
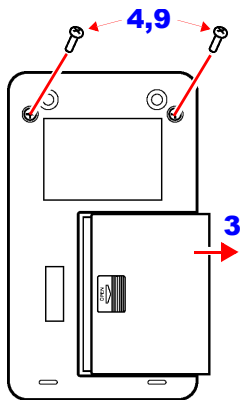

- 1.** Turn off the power switch.
- 2.** Remove the AC adapter, if the AC adapter or something is connected to the AC adapter terminal.
- 3.** Remove the battery cover and then remove all LR6 alkaline batteries or nickel hydride batteries.
- 4.** Remove the two screws from the lower case, and then remove the lower case.
- 5.** Release the connector cable connected to (1).
- 6.** Change the blowing fuses. Confirm the following functions:
 - (2): F202
Thermoelectromotive force source functions ([TC:0°C] and [TC:RJ])
 - (3): F401
Current measure function ([A:25mA])
 - (4): F201
Constant voltage source functions ([CV:2.5V] and [CV:25V])
Constant current source function ([CC:25mA])

7. Connect the connector cable to (1).
8. Hook the back of the case into the tracks in the front of the case. Do not allow the connector cable to be pinched by the case.
9. Retighten the two screws removed in step 4.
10. Install the batteries and mount the battery cover.

NOTE When removing fuses, use a minus screwdriver and do not damage the parts on the circuit board.



8.3 Cleaning

To clean the instrument, wipe it gently with a soft cloth moistened with water or mild detergent. Never use solvents such as benzene, alcohol, acetone, ether, ketones, thinners or gasoline, as they can deform and discolor the case.

NOTE Wipe the LCD gently with a soft, dry cloth.

8.4 Error Indication

Error indication	Description	Remedial Action
rJErr	Poor temperature probe connection	Connect the temperature probe correctly.
	The measurement temperature at thermocouple B for [TC:RJ] is a minus value.	Set the measurement temperature between 0°C and 80°C.
	The input temperature is outside the measurement range (of -25°C to 80°C).	Set the input temperature within the measurement range.
AdjErr	Zero adjustment is not functioning	Set the measurement value to within ±100 counts.
Err.03 EEP	Internal error.	Contact your dealer or Hioki representative.
Err.04 EEP2	Abnormal setting values saved to memory.	Initialize the setting values saved to memory (p.63).

8.5 Other Indication

Indication	Description	Remedial Action
.oF	The input is out of the measurement range.	Set the input within the measurement range. (Change either the input value or range.)

8.6 When calibrating the instrument

When calibrating the instrument, please ensure that the following conditions are met.

Environment Temperature	23±5°C
SS7012 Warm-up time	10 minutes or more

To calibrate the instrument, the following devices are necessary.

Voltmeter, ammeter, voltage/current generator, insulator and resistor with a sufficient accuracy to meet the accuracy specifications for the instrument

Temperature probe resistance and temperature conversion

0°C	918.57 Ω
23°C	993.51 Ω
40°C	1048.52 Ω

WARNING

Ensure that the input does not exceed the maximum input voltage or current to avoid instrument damage, short-circuiting and electric shock resulting from heat building.

CAUTION

To avoid damage to the instrument and the target device, never apply voltage to the current input terminal.

NOTE

- Please refer to the respective calibrating devices' instruction manuals for the handling instructions.
- Please refer to JIS C1602-1995 and IEC 584 for the corresponding table for temperature and thermoelectromotive force.

Index

Numerics

0 ADJ key	21
0°C Check	50
24 V Loop Power	79

A

A:25mA	68
AC Adapter Terminal	16
ADDRESS keys	59, 61
AdJEr	70, 97

C

CC:25mA	39
Cleaning	96
Communication Function ..	81
Current Input Terminal	18
CV:2.5V	39
CV:25V	39

D

Default Memory Values	63
Distributor Test	76

E

ENTER key	21
Error Indication	97

F

Flashing Setting Value	65
------------------------------	----

I

Initializing Memory	63
INTERVAL keys	61

L

Load Current	53
Load Voltage	53
LOCAL key	21
Loop Test	75

M

MEASURE	19
MEASURE FUNCTION key	21
Measurement (Current)	68
Measurement (Temperature)	71
Measurement (Voltage)	68
Measurement Range	67
MEMORY key	21, 59, 61
Memory Source Function ..	54
MEMORY WRITE	55
Memory Write Mode	55
MONITOR	19
Monitor	51
MONITOR key	21

O

oF	70, 97
Output Monitor	51
Output Terminal	18

Index 2

R

Recall Sourcing	59
Reference Junction	43
Remote Control	81
Replacing the Batteries	25
Replacing the Fuse	94
Resistance Thermometer	50
RJ Sensor Terminal	16
rJErr	73, 97
RMT	20

S

Saving to Memory	55
Scan Sourcing	61
SKIP key	21
Skip Setting	57
SOURCE FUNCTION key	22
Sourcing (Constant Current)	
.....	39
Sourcing (Constant Voltage)	
.....	39
Sourcing	
(Thermoelectromotive Force)	
.....	43
Sourcing Range	38
Standard Resistance	50

T

TC:0°C	43
TC:RJ	44
TC TYPE key	22
TEMP	71
Temperature Coefficient ..	89
Terminal for the	
Standard Resistor	18

Testing a

Two-wire Transmitter	79
Thermocouple	43
Thermometer Calibration ..	43
Two-wire Transmitter	
Simulation	76

U

Unusual value in sourcing	
thermoelectromotive force	
.....	93
USB Port	16

V

V:2.5V	68
V:25V	68
Voltage Input Terminal	18

Z

Zero Adjustment	69, 70
-----------------------	--------

Warranty Certificate

HIOKI

Model	Serial number	Warranty period Three (3) years from date of purchase (___ / ___)
Customer name: _____		
Customer address: _____		
Important		
<ul style="list-style-type: none">• Please retain this warranty certificate. Duplicates cannot be reissued.• Complete the certificate with the model number, serial number, and date of purchase, along with your name and address. The personal information you provide on this form will only be used to provide repair service and information about Hioki products and services.		
This document certifies that the product has been inspected and verified to conform to Hioki's standards. Please contact the place of purchase in the event of a malfunction and provide this document, in which case Hioki will repair or replace the product subject to the warranty terms described below.		
Warranty terms		
1. The product is guaranteed to operate properly during the warranty period (three [3] years from the date of purchase). If the date of purchase is unknown, the warranty period is defined as three (3) years from the date (month and year) of manufacture (as indicated by the first four digits of the serial number in YYMM format).		
2. If the product came with an AC adapter, the adapter is warranted for one (1) year from the date of purchase.		
3. The accuracy of measured values and other data generated by the product is guaranteed as described in the product specifications.		
4. In the event that the product or AC adapter malfunctions during its respective warranty period due to a defect of workmanship or materials, Hioki will repair or replace the product or AC adapter free of charge.		
5. The following malfunctions and issues are not covered by the warranty and as such are not subject to free repair or replacement: <ul style="list-style-type: none">-1. Malfunctions or damage of consumables, parts with a defined service life, etc.-2. Malfunctions or damage of connectors, cables, etc.-3. Malfunctions or damage caused by shipment, dropping, relocation, etc., after purchase of the product-4. Malfunctions or damage caused by inappropriate handling that violates information found in the instruction manual or on precautionary labeling on the product itself-5. Malfunctions or damage caused by a failure to perform maintenance or inspections as required by law or recommended in the instruction manual-6. Malfunctions or damage caused by fire, storms or flooding, earthquakes, lightning, power anomalies (involving voltage, frequency, etc.), war or unrest, contamination with radiation, or other acts of God-7. Damage that is limited to the product's appearance (cosmetic blemishes, deformation of enclosure shape, fading of color, etc.)-8. Other malfunctions or damage for which Hioki is not responsible		
6. The warranty will be considered invalidated in the following circumstances, in which case Hioki will be unable to perform service such as repair or calibration: <ul style="list-style-type: none">-1. If the product has been repaired or modified by a company, entity, or individual other than Hioki-2. If the product has been embedded in another piece of equipment for use in a special application (aerospace, nuclear power, medical use, vehicle control, etc.) without Hioki's having received prior notice		
7. If you experience a loss caused by use of the product and Hioki determines that it is responsible for the underlying issue, Hioki will provide compensation in an amount not to exceed the purchase price, with the following exceptions: <ul style="list-style-type: none">-1. Secondary damage arising from damage to a measured device or component that was caused by use of the product-2. Damage arising from measurement results provided by the product-3. Damage to a device other than the product that was sustained when connecting the device to the product (including via network connections)		
8. Hioki reserves the right to decline to perform repair, calibration, or other service for products for which a certain amount of time has passed since their manufacture, products whose parts have been discontinued, and products that cannot be repaired due to unforeseen circumstances.		
HIOKI E.E. CORPORATION http://www.hioki.com 18-07 EN-3		

HIOKI

www.hioki.com/



**All regional
contact
information**

HIOKI E.E. CORPORATION

81 Koizumi, Ueda, Nagano 386-1192 Japan

2309 EN

Edited and published by HIOKI E.E. CORPORATION

Printed in Japan

- Contents subject to change without notice.
- This document contains copyrighted content.
- It is prohibited to copy, reproduce, or modify the content of this document without permission.
- Company names, product names, etc. mentioned in this document are trademarks or registered trademarks of their respective companies.

Europe only

- EU declaration of conformity can be downloaded from our website.
- Contact in Europe: HIOKI EUROPE GmbH
Helfmann-Park 2, 65760 Eschborn, Germany

hioki@hioki.eu