

Communication Command Instruction Manual

RM3544-01
RM3545 RM3545-01 RM3545-02
RM3545A-1 RM3545A-2
RESISTANCE METER

- ✓ This manual explains the communication commands for Models RM3544 / RM3545 / RM3545A Resistance Meter.
- ✓ Please refer to the instruction manual for Models RM3544 / RM3545 / RM3545A for details regarding command settings.
- ✓ Although all reasonable care has been taken in the production of this instruction manual, should you find any points which are unclear or in error, please contact your local distributor or HIOKI's website. (<https://www.hioki.com/contact>)
- ✓ In the interest of product development, the contents of this manual may be subject to revision without notice.
- ✓ Unauthorized copying and replication of the contents of this instruction manual are strictly prohibited. All Rights Reserved.

Contents

1	Introduction.....	1
	Message Format.....	1
	Output Queue and Input Buffer	5
	Status Byte Register.....	6
	Event Registers	8
	Initialization Items	11
	Command Execution Time	12
	Errors During Communications	12
2	Message List	13
3	Message Reference	21
	Message Reference Interpretation.....	21
	Standard Commands.....	22
	(1) System Data Command	22
	*IDN	
	(2) Internal Operation Command.....	22
	*RST	
	*TST	
	(3) Synchronization Commands	23
	*OPC	
	*WAI	
	(4) Status and Event Control Commands.....	23
	*CLS	
	*ESE	
	*ESR	
	*SRE	
	*STB	
	*TRG	
	Device-Specific Commands	25
	(1) Event Status Register.....	25
	:ESE0	
	:ESR0	
	:ESE1	
	:ESR1	
	(2) Reading Measured Values	26
	:FETCh	
	:FETCh:TEMPerature	
	:READ	
	:MEASure:RESistance	
	:MEASure:RESistance:LP	
	:MEASure:TEMPerature	
	:ABORt	
	(3) Zero Adjustment	32
	:ADJust	
	:ADJust:CLEar	
	:ADJust:STATe	
	:ADJust:ENABle	
	(4) Measurement Speed	33
	:SAMPle:RATE	
	(5) Averaging Function.....	33
	:CALCulate:AVERAge:STATe	
	:CALCulate:AVERAge:COUNT	
	(6) Comparator.....	33
	:CALCulate:LIMit:STATe	
	:CALCulate:LIMit:BEEPer	
	:CALCulate:LIMit:MODE	
	:CALCulate:LIMit:UPPer	
	:CALCulate:LIMit:LOWer	
	:CALCulate:LIMit:REFerence	
	:CALCulate:LIMit:PERCent	

	:CALCulate:LIMit:RESult	
	:CALCulate:LIMit:JUDGe:CONDition	
	:CALCulate:LIMit:JUDGe	
	:CALCulate:LIMit:JUDGe:TOTal	
(7)	BIN Function RM3545 RM3545A	36
	:CALCulate:BIN:STATe	
	:CALCulate:BIN:ENABle	
	:CALCulate:BIN:MODE	
	:CALCulate:BIN:UPPer	
	:CALCulate:BIN:LOWer	
	:CALCulate:BIN:REFerence	
	:CALCulate:BIN:PERCent	
	:CALCulate:BIN:RESult	
(8)	Statistical Functions RM3545 RM3545A	38
	:CALCulate:STATistics:STATe	
	:CALCulate:STATistics:CLEar	
	:CALCulate:STATistics:NUMBer?	
	:CALCulate:STATistics:MEAN?	
	:CALCulate:STATistics:MAXimum?	
	:CALCulate:STATistics:MINimum?	
	:CALCulate:STATistics:LIMit?	
	:CALCulate:STATistics:BIN?	
	:CALCulate:STATistics:DEVIation?	
	:CALCulate:STATistics:CP?	
(9)	Scaling	39
	:CALCulate:SCALing:STATe	
	:CALCulate:SCALing:PARAmeterA	
	:CALCulate:SCALing:PARAmeterB	
	:CALCulate:SCALing:UNIT	
(10)	Temperature Conversion (ΔT) RM3545 RM3545A	40
	:CALCulate:TCONversion:DELTA:STATe	
	:CALCulate:TCONversion:DELTA:PARAmeter	
(11)	Temperature Correction (TC)	41
	:CALCulate:TCORrect:STATe	
	:CALCulate:TCORrect:PARAmeter	
(12)	LCD Settings	41
	:DISPlay:CONTrast	
	:DISPlay:BACKlight	
(13)	Memory Functions RM3545 RM3545A	42
	:MEMory:STATe	
	:MEMory:CLEar	
	:MEMory:COUNt	
	:MEMory:DATA	
(14)	Hold	42
	[[:SENSe:]]HOLD:AUTO	
	[[:SENSe:]]HOLD:STATe	
	[[:SENSe:]]HOLD:OFF	
(15)	Multiplexer Settings RM3545 RM3545A	43
	[[:SENSe:]]WIRE	
	[[:SENSe:]]SCAN:MODE	
	[[:SENSe:]]SCAN:STATe	
	[[:SENSe:]]SCAN:RESet	
	[[:SENSe:]]SCAN:FAIL:STOP	
	[[:SENSe:]]SCAN:DATA	
	[[:SENSe:]]FRONTcheck?	
	[[:SENSe:]]CH	
	[[:SENSe:]]CH:STATe	
	[[:SENSe:]]CH:AVAIrable	
	[[:SENSe:]]INSTrument	
	[[:SENSe:]]TERMinal	
(16)	Multiplexer Channel Reset RM3545 RM3545A	46

	[:SENSe:]CHRReset	
(17)	Low-Power Resistance Measurement RM3545 RM3545A	47
	[:SENSe:]RESistance:LP:STATe	
(18)	Pure Resistance measurement RM3545A	47
	[:SENSe:]RESistance:PR:STATe	
(19)	Measurement Range	47
	[:SENSe:]RESistance:RANGe	
	[:SENSe:]RESistance:RANGe:AUTO	
	[:SENSe:]RESistance:LP:RANGe	
(20)	100MΩ Range High Precision Function RM3545 RM3545A	49
	[:SENSe:]RESistance:PRECision	
(21)	Switching Measurement Current RM3545 RM3545A	49
	[:SENSe:]RESistance:CURRent	
(22)	Offset Voltage Correction Function (OVC) RM3545 RM3545A	50
	[:SENSe:]RESistance:OVC	
(23)	Contact Improver RM3545 RM3545A	50
	[:SENSe:]RESistance:CIMProve	
(24)	Current Error Mode	50
	[:SENSe:]RESistance:ERRor:CURRentcheck	
	[:SENSe:]RESistance:ERRor:OVER	
(25)	Contact Check RM3545 RM3545A	51
	[:SENSe:]RESistance:CONTactcheck	
	[:SENSe:]RESistance:LP:CONTactcheck	
(26)	Setting Number of Digits	51
	[:SENSe:]RESistance:DIGits	
(27)	Temperature Measurement (Analog Input) RM3545 RM3545A	52
	[:SENSe:]TEMPerature:SENSor	
	[:SENSe:]TEMPerature:PARAmeter	
(28)	Triggering	53
	:INITiate:CONTInuous	
	:INITiate[:IMMediate]	
	:TRIGger:SOURce	
	:TRIGger:EDGE	
(29)	Delay RM3545 RM3545A	57
	:TRIGger:DELay	
	:TRIGger:DELay:AUTO	
(30)	Self-Calibration RM3545 RM3545A	57
	:SYSTem:CALibration	
	:SYSTem:CALibration:AUTO	
(31)	Saving and Reading Measurement Conditions	58
	:SYSTem:PANel:SAVE/:LOAD	
	:SYSTem:PANel:NAME	
	:SYSTem:PANel:CLEar	
(32)	Key-Lock	59
	:SYSTem:KLOCK	
(33)	Line Frequency	59
	:SYSTem:LFRequency	
(34)	Clock RM3545 RM3545A	59
	:SYSTem:DATE	
	:SYSTem:TIME	
(35)	Key Beeper	60
	:SYSTem:BEEPer:STATe	
(36)	Communications Settings	60
	:SYSTem:LOCal	
	:SYSTem:DATAout	
	:SYSTem:HEADer	
	:SYSTem:TERMinator	
	:SYSTem:COMMunicate	
	:SYSTem:COMMunicate:MONitor	
	:SYSTem:COMMunicate:LAN:IPADdress	

	:SYSTem:COMMunicate:LAN:SMASk	
	:SYSTem:COMMunicate:LAN:GATeway	
	:SYSTem:COMMunicate:LAN:CONTRol	
	:SYSTem:COMMunicate:LAN:MAC?	
	:SYSTem:COMMunicate:LAN:UPDate	
	:SYSTem:COMMunicate:RS232C:SPEED	
(37)	System Reset	63
	:SYSTem:RESet	
(38)	EXT I/O	64
	:IO:MODE?	
	:IO:INPut?	
	:IO:OUTPut	
	:IO:FILTer:STATe	
	:IO:FILTer:TIME	
	:IO:JUDGe:MODE	
	:IO:EOM:MODE	
	:IO:EOM:PULSe	
(39)	Multiplexer Unit RM3545 RM3545A	66
	:UNIT:IDN	
	:UNIT:SCOunt	
	:UNIT:TEST	
4	Multiplexer Commands	67
	Multiplexer Settings	67
	Multiplexer Measurement.....	68
5	Data Exporting Methods.....	71
6	Examples of communication commands	74
	■ Confirmation before measurement.....	74
	■ Setting measurement conditions.....	74
	■ Simple resistance measurement.....	74
	■ Resistance measurement using computer keys	74
	■ Measurement by external trigger 1	75
	■ Measurement by external trigger 2	75
	■ LAN communication setting example RM3545A	75
7	Sample Programs.....	76
	Using Visual Basic.....	76
	Using Visual C#	84
8	Device Compliance Statement [GP-IB].....	93

1 Introduction

In this publication, items relevant only to the RM3544-01 are indicated as **RM3544**, and items relevant only to the RM3545, RM3545-01, and RM3545-02 are indicated as **RM3545**, and items relevant only to the RM3545A-1, RM3545A-2 are indicated as **RM3545A**. Also, the RM354-01, RM3545, RM3545-01, RM3545-02, RM3545A-2, , and RM3545A-2 are indicated as “the instrument.”

If the communication monitoring function is used at the time of program creation, commands and responses will be conveniently displayed on the measurement screen. For information on the communication monitoring function, see the instruction manual of the instruments.

Various messages are supported for controlling the instrument through the interfaces. Messages can be either program messages, sent from the controller such as PC to the instrument, or response messages, sent from the instrument to the controller.

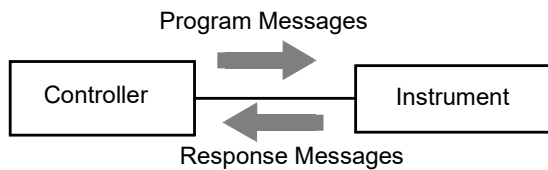

Message types are further categorized as follows.

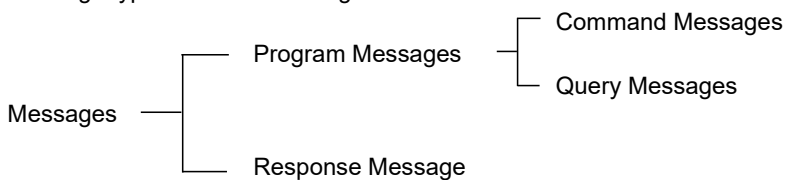

When issuing commands that contain data, make sure that the data is provided in the specified format.

Message Format

■ Program Messages

Program messages can be either Command Messages or Query Messages.

(1) Command Messages

Instructions to control the instrument, such as to change settings or reset
Example: (instruction to set the measurement range)

RESISTANCE:RANGE 100E3

↑ ↑ ↑
Header portion Space Data portion

(2) Query Messages

Requests for responses relating to results of operation or measurement, or the state of instrument settings
Example: (request for the current measurement range)

RESISTANCE:RANGE?

↑ ↑
Header portion Question mark

See: “Headers (p.2)”, “Separators (p.3)”, “Data Formats (p.4)”

■ Response Messages

When a query message is received, its syntax is checked and a response message is generated.

The **:SYSTEM:HEADer** command determines whether headers are prefixed to response messages.

Header ON **:SENSE:RESISTANCE:RANGE 100.000E+03**

Header OFF **100.000E+03**

(The current resistance measurement range is 100kΩ)

At power-on, Header OFF is selected.

If an error occurs when a query message is received, no response message is generated for that query.

Some query message has no header, such as **:FETCh?** and **:CALCulate:LIMit:RESult?**.

■ Command Syntax

Command names are chosen to mnemonically represent their function, and can be abbreviated. The full command name is called the “long form”, and the abbreviated name is called the “short form”. The command references in this manual indicate the short form in upper-case letters, extended to the long form in lower case letters, although the commands are not case-sensitive in actual usage.

ADJUST? OK (long form)

ADJ? OK (short form)

ADJU? Error

AD? Error

Response messages generated by the instrument are in long form and in upper case letters.

■ Headers

Headers must always be prefixed to program messages.

(1) Command Program Headers

There are three types of commands: Simple, Compound and Standard.

- **Headers for Simple Commands**

This header type is a sequence of letters and digits

:ESE0

- **Headers for Compound Commands**

These headers consist of multiple simple command type headers separated by colons “:”

:SAMPle:RATE

- **Headers for Standard Commands**

This header type begins with an asterisk “*”, indicating that it is a standard command defined by IEEE 488.2.

***RST**

(2) Query Program Header

These commands are used to interrogate the instrument about the results of operations, measured values and the current states of instrument settings.

As shown by the following examples, a query is formed by appending a question mark “?” after a program header.

:FETCh?

:CALCulate:LIMit:REFerence?

Characters within square brackets [] may be omitted.

[:SENSe:]RESistance:RANGe



Either form is valid

:SENSe:RESistance:RANGe
RESistance:RANGe

■ Message Terminators

This instrument recognizes the following message terminators (delimiters):

[RS-232C/USB/LAN]

- CR
- CR+LF

[GP-IB]

- LF
- CR+LF
- EOI
- LF with EOI

Depending on the instrument's interface settings, the following can be selected as the terminator for response messages.

For information on settings, see “Delimiter Setting” (p. 61).

[RS-232C/USB/LAN]

- CR+LF

[GP-IB]

- LF with EOI (default setting)
- CR+LF with EOI

■ Separators

(1) Message Unit Separator

Multiple messages can be written in one line by separating them with semicolons “;”

:SYSTEM:LFREQUENCY 60;*IDN?

- When messages are combined in this way and if one command contains an error, all subsequent messages up to the next terminator will be ignored.
- A command error occurs if a query command is combined with an immediately followed semicolon and subsequent command.

(2) Header Separator

In a message consisting of both a header and data, the header is separated from the data by a space “ ” (ASCII code 20H).

:SYSTEM:HEADER OFF

(3) Data Separator

In a message containing multiple data items, commas are required to separate the data items from one another.

:CALCulate:LIMit:BEEPer IN,1,0

■ Data Formats

The instrument uses character data, decimal numeric data and character string data depending on the command.

(1) Character Data

Character data always begins with an alphabetic character, and subsequent characters may be either alphabetic or numeric. Character data is not case-sensitive, although response messages from the instrument are only upper case. When the command data portion contains `<1/0/ON/OFF>`, the operation will be similar to when 0 is OFF and 1 is ON.

`:SYSTEM:HEADER OFF`

(2) Decimal Numeric Data

Three formats are used for numeric data, identified as NR1, NR2 and NR3. Numeric values may be signed or unsigned. Unsigned numeric values are handled as positive values. Values exceeding the precision handled by the instrument are rounded to the nearest valid digit.

- NR1 Integer data (e.g.: +12, -23, 34)
- NR2 Fixed-point data (e.g.: +1.23, -23.45, 3.456)
- NR3 Floating-point exponential representation data (e.g.: +1.0E-2, -2.3E+4)

The term "NRf format" includes all three of the above numeric decimal formats.

The instrument accepts NRf format data. The format of response data is specified for each command, and the data is sent in that format.

Note: A "+" sign is returned as a space (ASCII code 20H).

`:ESE0 106`

`:FETCH?`

`+106.5710E+03`

(3) Character string data

- Character string data is enclosed by quotation marks.
- This type of data consists of 8-bit ASCII characters.
- Characters that cannot be handled by the instrument are replaced by a parameter error.
- As for quotation marks, the sender uses double quotes (") only, while the receiver receives both double quotes and single quotes (').

`:SYSTEM:PANEL:NAME 1, "PANEL_01"`

[GP-IB]

The instrument does not fully support IEEE 488.2. As much as possible, please use the data formats shown in the Reference section.

Also, be careful to avoid constructing single commands line that could overflow the input buffer or output queue.

■ Compound Command Header Omission

When several commands having a common header are combined to form a compound command (e.g., **:CALCulate:LIMit:REference** and **:CALCulate:LIMit:PERCent**) if they are written together in sequence, the common portion (here, **:CALCulate:LIMit:**) can be omitted after its initial occurrence.

This common portion is called the “current path” (analogous to the path concept in computer file storage), and until it is cleared, the interpretation of subsequent commands presumes that they share the same common portion.

This usage of the current path is shown in the following example:

Full expression

:CALCulate:LIMit:REference 1.0E+3;:CALCulate:LIMit:PERCent 1.0

Compacted expression

:CALCulate:LIMit:REference 1.0E+3;PERCent 1.0



This portion becomes the current path, and can be omitted from the messages immediately following.

The current path is cleared when the power is turned on, when reset by key input, by a colon “:” at the start of a command, and when a message terminator is detected.

Standard command messages can be executed regardless of the current path. They have no effect upon the current path.

A colon “:” is not required at the start of the header of a Simple or Compound command. However, to avoid confusion with abbreviated forms and operating mistakes, we recommend always placing a colon at the start of a header.

Output Queue and Input Buffer

■ Output Queue

Response messages are stored in the output queue until read by the controller. The output queue is also cleared in the following circumstances:

- Power on
- Device clear [GP-IB]
- Query Error

The output queue capacity of the instrument is 64 bytes. If response messages overflow the buffer, a query error is generated and the output queue is cleared.

Also, with GP-IB, if a new message is received while data remains in the output queue, the output queue is cleared and a query error is generated.

■ Input Buffer

The input buffer capacity of the instrument is 256 bytes.

If 256 bytes are allowed to accumulate in this buffer so that it becomes full, the USB and GP-IB interface bus enters the waiting state until space is cleared in the buffer.

The RS-232C interface will not accept data beyond 256 bytes.

Note: Ensure that the no command ever exceeds 256 bytes.

Status Byte Register

[GP-IB]

This instrument implements the status model defined by IEEE 488.2 with regard to the serial poll function using the service request line. The term “event” refers to any occurrence that generates a service request.

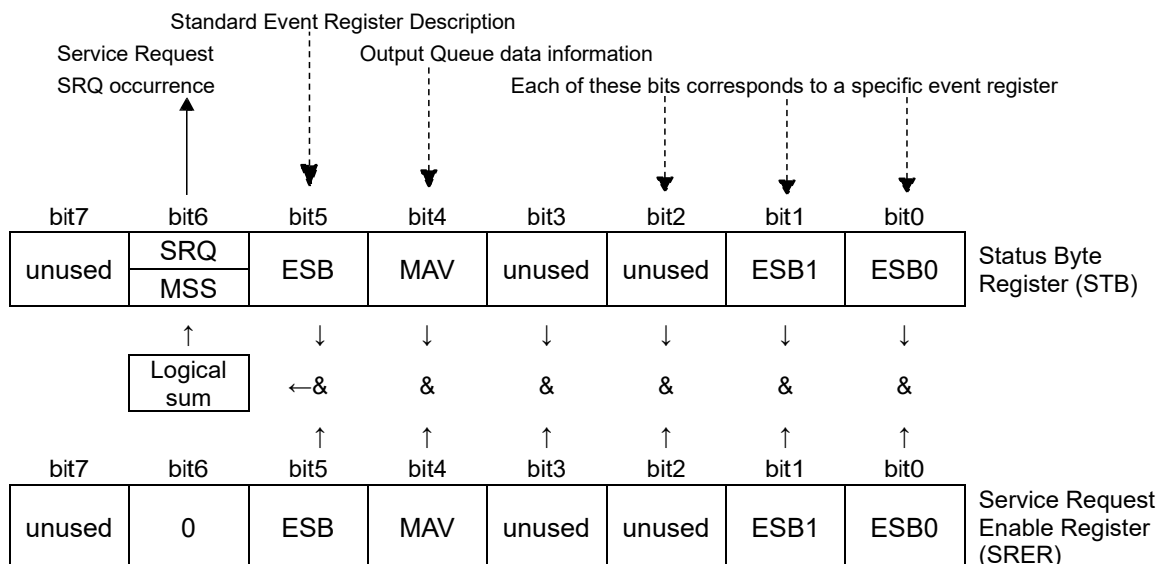

Overview of Service Request Occurrence

The Status Byte Register contains information about the event registers and the output queue. Required items are selected from this information by masking with the Service Request Enable Register. When any bit selected by the mask is set, bit 6 (MSS; the Master Summary Status) of the Status Byte Register is also set, which generates an SRQ (Service Request) message and dispatches a service request.

Note:SRQ (Service Request) is a GP-IB function only. However, STB (Status Byte Register) information can be acquired with RS-232C/USB/LAN using the *STB? command.

[RS-232C/USB/LAN]

RS-232C/USB/LAN does not provide a function for issuing service requests. Still, SRER setup and STB reading are available.

■ Status Byte Register (STB)

During serial polling, the contents of the 8-bit Status Byte Register are sent from the instrument to the controller. When any Status Byte Register bit enabled by the Service Request Enable Register has switched from 0 to 1, the MSS bit becomes 1. Consequently, the SRQ bit is set to 1, and a service request is dispatched.

The SRQ bit is always synchronous with service requests, and is read and simultaneously cleared during serial polling. Although the MSS bit is only read by an ***STB?** query, it is not cleared until a clear event is initiated by the ***CLS** command.

Bit 7		unused
Bit 6	SRQ	Set to 1 when a service request is dispatched.
	MSS	This is the logical sum of the other bits of the Status Byte Register.
Bit 5	ESB	Standard Event Status (logical sum) bit This is logical sum of the Standard Event Status Register.
Bit 4	MAV	Message available Indicates that a message is present in the output queue.
Bit 3		unused
Bit 2		unused
Bit 1	ESB1	Event Status (logical sum) bit 1 This is the logical sum of Event Status Register 1.
Bit 0	ESB0	Event Status (logical sum) bit 0 This is the logical sum of Event Status Register 0.

■ Service Request Enable Register (SRER)

This register masks the Status Byte Register. Setting a bit of this register to 1 enables the corresponding bit of the Status Byte Register to be used.

Event Registers

■ Standard Event Status Register (SESR)

The Standard Event Status Register is an 8-bit register. If any bit in the Standard Event Status Register is set to 1 (after masking by the Standard Event Status Enable Register), bit 5 (ESB) of the Status Byte Register is set to 1.

See: “Standard Event Status Register (SESR) and Standard Event Status Enable Register (SESER)” (p.9)

The Standard Event Status Register is cleared in the following situations:

- When a ***CLS** command is executed
- When an event register query (***ESR?**) is executed
- When the instrument is powered on

Bit 7	PON	Power-On Flag Set to 1 when the power is turned on, or upon recovery from an outage.
Bit 6	URQ	User Request unused
Bit 5	CME	Command error (The command to the message terminator is ignored.) This bit is set to 1 when a received command contains a syntactic or semantic error: <ul style="list-style-type: none"> • Program header error • Incorrect number of data parameters • Invalid parameter format • Received a command not supported by the instrument
Bit 4	EXE	Execution Error This bit is set to 1 when a received command cannot be executed for some reason. <ul style="list-style-type: none"> • The specified data value is outside of the set range • The specified setting data cannot be set • Execution is prevented by some other operation being performed
Bit 3	(unused) DDE	Not used by this instrument Device-Dependent Error This bit is set to 1 when a command cannot be executed due to some reason other than a command error, a query error or an execution error.
Bit 2	QYE	Query Error (the output queue is cleared) This bit is set to 1 when a query error is detected by the output queue control. <ul style="list-style-type: none"> • When an attempt has been made to read an empty output queue (GP-IB only) • When the data overflows the output queue • When data in the output queue has been lost • When the next command is received while there is data in the output queue
Bit 1	RQC (unused)	Request Control
Bit 0	OPC	Operation Complete This bit is set to 1 in response to an *OPC command. <ul style="list-style-type: none"> • It indicates the completion of operations of all messages up to the *OPC command

■ Standard Event Status Enable Register (SESER)

Setting any bit of the Standard Event Status Enable Register to 1 enables access to the corresponding bit of the Standard Event Status Register.

Standard Event Status Register (SESR) and Standard Event Status Enable Register (SESER)

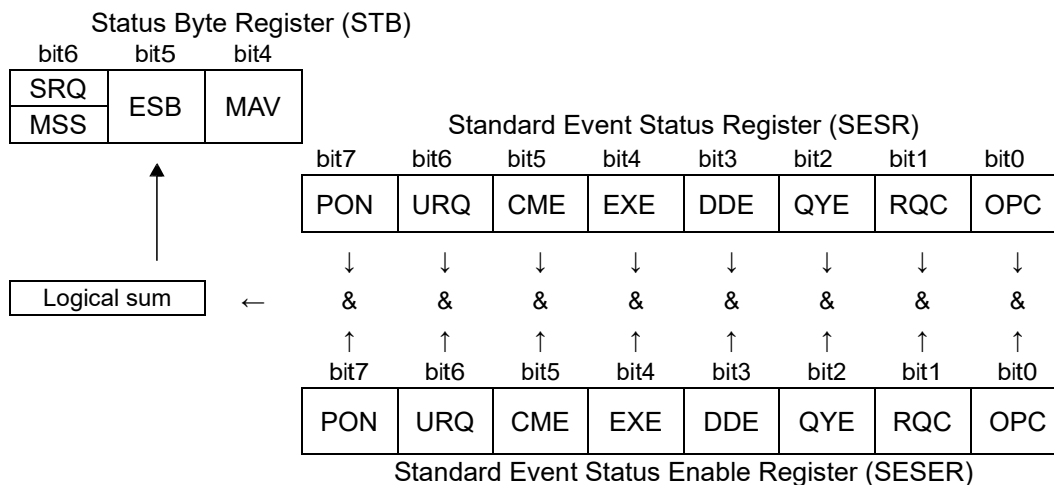

■ Device-Specific Event Status Registers (ESR0 and ESR1)

This instrument provides two Event Status Registers for controlling events. Each event register is an 8-bit register. With RM3545/RM3545A Event Status Register 1, only RM3545/RM3545A is valid.

When any bit in one of these Event Status Registers enabled by its corresponding Event Status Enable Register is set to 1, the following happens:

- For Event Status Register 0, bit 0 (ESB0) of the Status Byte Register (STB) is set to 1.
- For Event Status Register 1, bit 1 (ESB1) of the Status Byte Register (STB) is set to 1.

Event Status Registers 0 and 1 are cleared in the following situations:

- When a ***CLS** command is executed
- When an Event Status Register query (**:ESR0?** or **:ESR1?**) is executed
- When the instrument is powered on

Event Status Register 0 (ESR0)

Bit 7	OutBIN	Out of BIN RM3545 RM3545A
Bit 6	OvrRng	Out-of-Range
Bit 5	ERR	Measurement Fault
Bit 4	Hi	High Comparator Result
Bit 3	IN	IN Comparator Result
Bit 2	Lo	Low Comparator Result
Bit 1	INDEX	End of Reading
Bit 0	EOM	End of Measurement

Event Status Register 1 (ESR1) [RM3545](#) [RM3545A](#)

Bit 7		Unused
Bit 6		Unused
Bit 5		Unused
Bit 4	NO UNIT	Multiplexer Unit Not Inserted, Terminal Setting Error
Bit 3	SW.ERR	Multiplexer Relay Hot Switching Prevention Function Fault
Bit 2	CURR	Current Monitor Fault
Bit 1	CONTACT TERM.A	Contact Check – A side Fault
Bit 0	CONTACT TERM.B	Contact Check – B side Fault

Event Status Registers 0 (ESR0) and 1 (ESR1), and Event Status Enable Registers 0 (ESER0) and 1 (ESER1)

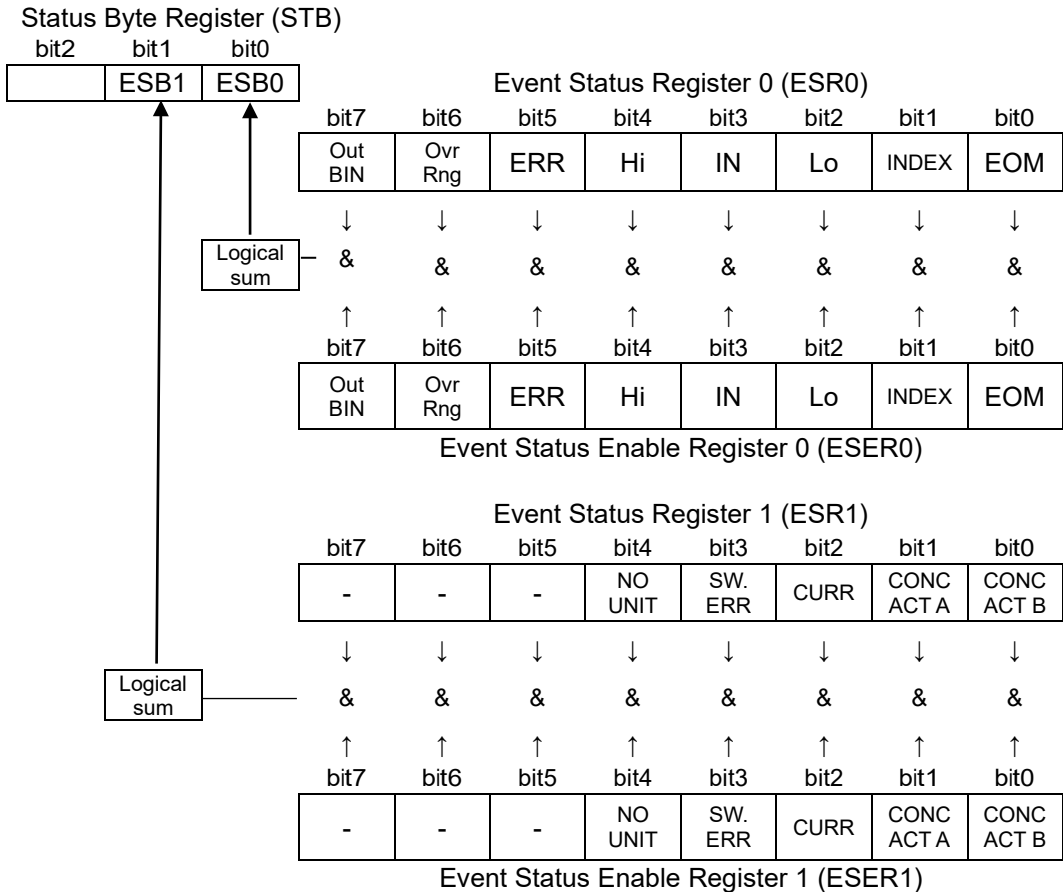

■ Register Reading and Writing

Register	Read	Write
Status Byte Register	*STB?	-
Service Request Enable Register	*SRE?	*SRE
Standard Event Status Register	*ESR?	-
Standard Event Status Enable Register	*ESE?	*ESE
Event Status Register 0	:ESR0?	-
Event Status Enable Register 0	:ESE0?	:ESE0
Event Status Register 1	:ESR1?	-
Event Status Enable Register 1	:ESE1?	:ESE1

■ GP-IB Commands(RM3545-01)

The following commands can be used for performing interface functions.

Command	Description
GTL	Go To Local Cancels the Remote state and enters the Local state.
LLO	Local Lock Out Disables all keys, including the Local key.
DCL	Device CLear Clears the input buffer and the output queue.
SDC	Selected Device Clear Clears the input buffer and the output queue.
GET	Group Execute Trigger When an external trigger (trigger source <EXTERNAL>) occurs, processes one sample.

Initialization Items

Item	Initialization Method	At Power-on	Key Reset	*RST Com-mand	Device Clear (GP-IB only)	*CLS Com-mand	Factory Default
LAN setting RM3545A	IP address	-	0.0.0.0	-	-	-	0.0.0.0
	Subnet mask		255.255.255.0				255.255.255.0
	Gateway		0.0.0.0				0.0.0.0
	Communications command port number		23				23
GP-IB Address RM3545-01		-	1	-	-	-	1
RS-232C setting (baud rate)		-	9600	-	-	-	9600
Device-specific functions (range, etc.)		-	●	●	-	-	●
Output Queue		●	●	-	●	-	●
Input buffer		●	●	-	●	-	●
Status Byte Register		●	●	-	●*1	●*2	●
Event registers		●*3	●	-	-	●	●
Enable register		●	●	-	-	-	●
Current path		●	●	-	●	-	●
Headers on/off		OFF	OFF	OFF	-	-	OFF

Response message terminator (GP-IB) RM3545-01	LF+EOI	LF+EOI	-	-	-	LF+EOI
Response message separator	;	;	;	-	-	;

*1. Only the MAV bit (bit 4) is cleared.

*2. All bits except the MAV bit are cleared.

*3. Except the PON bit (bit 7).

Command Execution Time

Command execution time indicates the time for analyzing and processing long form commands.

However, the command execution time for commands with data is the time described according to the data format specified in the <data portion>, and for query commands it is the time when the header is ON.

- Display delays may occur depending on the frequency of communication processes and process contents.
- All commands except ***TRG** and **:INIT** are processed sequentially.
- In communications with the controller, time must be added for data transmission. USB, LAN and GP-IB transfer time depends on the controller.

The RS-232C transfer time, with start bit 1, data length 8, no parity, and stop bit 1, has a total of 10-bit. When the transfer speed (baud rate) setting is N bps, the general result will be as follows:

Transfer time T [1 character/sec] = Baud rate N [bps]/10 [bits]

Since a measurement value is 11 characters, a 1 data transfer time will be 11/T.

(Example) For 9600 bps, $11/(9600/10)$ = Approx. 11 ms

- Wait until measurements stabilize after a change before using a setting command.

Command	Execution time (except communication time)	
	RM3544	RM3545, RM3545A
*RST	700 ms or less	1.5s or less
:RESistance:RANGe	300 ms or less	100 ms or less
:SAMPlE:RATE	200 ms or less	30 ms or less
[[:SENSE:]CH	-	50 ms or less *1
:ADJusT?	600 ms or less *2	
:FETCh?	5 ms or less	
:READ?	Measurement time + 15 ms or less	
:SYSTem:PANel:LOAD	500 ms or less	Panel 1 to 30:100 ms or less Panel 31 to 38:200 ms or less
:SYSTem:CALibration	-	400ms or less
*TST?	1 s or less	
:UNIT:TEST?	3s or less	
Commands other than those above	10 ms or less	

*1 If there is a counter-electromotive force, such as a transformer, the switching takes longer due to the hot switching prevention function for the relay. The hot switching prevention function is canceled when the counter-electromotive force is lost or a maximum 1 second + delay set value elapses.

*2 Manual range, for one channel

Errors During Communications

An error occurs when messages are executed in the following cases:

- **Command Error**
When message syntax (spelling) is invalid
When the data format in a command or query is invalid
- **Query Error**
When the response message exceeds 64 bytes
- **Execution Error**
When invalid character or numeric data is present

2 Message List

Message [: Omissible]	Data Formats [: Omissible (): Response data	Description	Corresponding Model				
			RM 3544	RM3545		RM3545A	
					By channel		By channel
Standard Commands							
*IDN?	(<Manufacturer name>,<Model name>,<Serial number>,<Software version>)	Queries the Device ID.	√	√	-	√	-
*RST		Initializes the device.	√	√	-	√	-
*TST?	(0 to 3)	Initiates a self-test and queries the result.	√	√	-	√	-
*OPC		Requests an SRQ after execution completion.	√	√	-	√	-
*OPC?	(1)	Queries execution completion.	√	√	-	√	-
*WAI		Wait for operations to finish.	√	√	-	√	-
*CLS		Clears the event registers and the Status Byte Register.	√	√	-	√	-
*ESE	0 to 255	Sets the Standard Event Status Enable Register.	√	√	-	√	-
*ESE?	0 to 255	Queries the Standard Event Status Enable Register.	√	√	-	√	-
*ESR?	0 to 255	Queries the Standard Event Status Register.	√	√	-	√	-
*SRE	0 to 255	Sets the Service Request Enable Register.	√	√	-	√	-
*SRE?	(0 to 255)	Queries the Service Request Enable Register.	√	√	-	√	-
*STB?	(0 to 255)	Queries the Status Byte Register.	√	√	-	√	-
*TRG		Executes one sampling.	√	√	-	√	-
Event Registers							
:ESE0	0 to 255	Sets the Event Status Enable Register 0.	√	√	-	√	-
:ESE0?	(0 to 255)	Queries the Event Status Enable Register 0.	√	√	-	√	-
:ESR0?	(0 to 255)	Queries the Event Status Register 0.	√	√	-	√	-
:ESE1	0 to 255	Sets the Event Status Enable Register 1.	√	√	-	√	-
:ESE1?	(0 to 255)	Queries the Event Status Enable Register 1.	√	√	-	√	-
:ESR1?	(0 to 255)	Queries the Event Status Register 1.	√	√	-	√	-
Reading Measured Values							
:FETCh?	RM3544:[<LIMit> (<Measurement value> [,<HI/IN/LO/OFF/ERR>]) RM3545/RM3545A : [<LIMit/ JUDGE/LIMJdge>,<Channel number>](Measured value>,[<HI/IN/LO/OFF/ERR>][<PASS/FAIL/OFF/ERR>]	Reads the most recent measurement. • When data has been omitted: Reads the measurement value only. • When data has been set to LIMit: Reads the measurement value and comparator result. • When data has been set to JUDGE: Reads the measured value and PASS/FAIL result. • When data has been set to LIMJdge: Reads the measured value, and comparator and PASS/FAIL results.	√	√	√	√	√
:FETCh:TEMPerature?	(<Temperature measurement value>)	Reads the temperature measurement value.	√	√	-	√	-
:READ?	RM3544:(<Measurement value>) RM3545/RM3545A : <NDAT a/JUDGE> For scanning OFF/STEP:(< Measured value>) For AUTO scanning:([<	Waits for trigger and reads the measured value. RM3545/RM3545A : Responds with the total judgment or PASS/FAIL result only if NDATa is included in the data formats.	√	√	-	√	-

Message [: Omissible]	Data Formats [: Omissible (): Response data	Description	Corresponding Model				
			RM 3544	RM3545		RM3545A	
					By channel		By channel
	Measured value>, <Measured value> ...<Measured value>] [<PASS/FAIL/OFF/ERR>]	Adds and responds with the total judgment if JUDGE is included in the data formats.					
:MEASure:RESistance?	[<Expected measurement value>](measurement value)	Presets to the specified resistance measurement range; then measures.	√	√	-	√	-
:MEASure:RESistance:LP?	[<Expected measurement value>](measurement value)	Presets to the specified Low-Power Resistance measurement range; then measures.		√	-	√	-
:MEASure:TEMPerature?	(<Temperature measurement value>)	Reads the temperature measurement value.	√	√	-	√	-
:ABORt		:READ /Scan measurement / Scan zero adjustment is aborted (forcibly terminated).	√	√	-	√	-

Zero Adjustment

:ADJust?	(0/1)	Executes zero adjustment.	√	√	-	√	-
:ADJust:CLEar		Clears zero adjustment.	√	√	√	√	√
:ADJust:STATe?	(ON/OFF)	Queries the zero adjustment execution state.	-	√	√	√	√
:ADJust:ENABle	1/0/ON/OFF	Sets the scan zero adjustment execution (execution error for [:SENSe:]CH FRONT).	-	√	√	√	√
:ADJust:ENABle?	(ON/OFF)	Queries the scan zero adjustment execution (execution error for [:SENSe:]CH FRONT).	-	√	√	√	√

Measurement Speed

:SAMPlE:RATE	RM3544:FAST/MEDIUM/SLOW RM3545/RM3545A :FAST/MEDIUM/SLOW1/SLOW2	Sets the measurement speed.	√	√	√	√	√
:SAMPlE:RATE?	RM3544:(FAST/MEDIUM/SLOW) RM3545/RM3545A :(FAST/MEDIUM/SLOW1/SLOW2)	Queries the measurement speed.	√	√	√	√	√

Averaging Functions

:CALCulate:AVERage:STATe	1/0/ON/OFF	Sets the averaging function execution.	√	√	√	√	√
:CALCulate:AVERage:STATe?	(ON/OFF)	Queries the averaging function execution.	√	√	√	√	√
:CALCulate:AVERage:COUNT	2 to 100	Sets the average count.	√	√	√	√	√
:CALCulate:AVERage:COUNT?	(2 to 100)	Queries the average count.	√	√	√	√	√

Comparator

:CALCulate:LIMit:STATe	1/0/ON/OFF	Sets the comparator operating state.	√	√	√	√	√
:CALCulate:LIMit:STATe?	(ON/OFF)	Queries the comparator operating state.	√	√	√	√	√
:CALCulate:LIMit:BEEPer	RM3544:<HI/IN/LO>,<0 to 3 (Type)>,<0 to 5 (Count)> RM3545/RM3545A :<HI/IN/LO/PASS/FAIL>,<0 to 3 (Type)>,<0 to 5 (Count)>	Sets the beep sound.	√	√	√	√	√
:CALCulate:LIMit:BEEPer?	RM3544:<HI/IN/LO>(<HI/IN/LO>,<0 to 3 (Type)>,<0 to 5 (Count)>) RM3545/RM3545A :<HI/IN/LO/PASS/FAIL>(<HI/IN/LO>,<0 to 3 (Type)>,<0 to 5 (Count)>)	Queries the beep sound.	√	√	√	√	√
:CALCulate:LIMit:MODE	ABSolute/REFerence	Sets the judgment mode.	√	√	√	√	√
:CALCulate:LIMit:MODE?	(ABSOLUTE/REFERENCE)	Queries the judgment mode.	√	√	√	√	√
:CALCulate:LIMit:UPPer	<Upper threshold>	Sets the upper threshold.	√	√	√	√	√
:CALCulate:LIMit:UPPer?	(<Upper threshold>)	Queries the upper threshold.	√	√	√	√	√
:CALCulate:LIMit:LOWer	<Lower threshold>	Sets the lower threshold.	√	√	√	√	√
:CALCulate:LIMit:LOWer?	(<Lower threshold>)	Queries the lower threshold.	√	√	√	√	√
:CALCulate:LIMit:REFerence	<Reference resistance>	Sets the reference resistance.	√	√	√	√	√

Message [: Omissible]	Data Formats [: Omissible (): Response data	Description	Corresponding Model				
			RM 3544	RM3545		RM3545A	
					By channel		By channel
		(Channel 1 can be set for commands other than [:SENSe:]CH FRONT.)					
:CALCulate:LIMit:REfERENCE?	(<Reference resistance>)	Queries the reference resistance. (Response may be Channel1 for commands other than [:SENSe:]CH FRONT.)	√	√	√	√	√
:CALCulate:LIMit:PERCent	<Range [%]>	Sets the judgment range.	√	√	√	√	√
:CALCulate:LIMit:PERCent?	(<Range [%]>)	Queries the judgment range.	√	√	√	√	√
:CALCulate:LIMit:RESult?	[<Channel number>] (HI/IN/LO/OFF/ERR)	Queries the comparator result.	√	√	√	√	√
:CALCulate:LIMit:JUDGe:CON Dition	OFF/IN/HI/LO/HILO/ALL	Sets the PASS judgment conditions.	-	√	√	√	√
:CALCulate:LIMit:JUDGe:CON Dition?	(OFF/IN/HI/LO/HILO/ALL)	Queries the PASS judgment conditions.	-	√	√	√	√
:CALCulate:LIMit:JUDGe?	[<Channel number>] (PASS/FAIL/OFF/ERR)	Queries the PASS/FAIL result.	-	√	√	√	√
:CALCulate:LIMit:JUDGe:TOTAl ?	(PASS/FAIL/OFF/ERR)	Queries the total judgment result.	-	√	√	√	√

BIN Functions

:CALCulate:BIN:STATe	1/0/ON/OFF	Sets the measurement execution.		√	-	√	-
:CALCulate:BIN:STATe?	(ON/OFF)	Queries the BIN measurement execution.		√	-	√	-
:CALCulate:BIN:ENABle	<Mask pattern>	Sets the mask pattern.		√	-	√	-
:CALCulate:BIN:ENABle?	(<Mask pattern>)	Queries the mask pattern.		√	-	√	-
:CALCulate:BIN:MODE	<BINNo.>,<ABSolute/REFerence>	Sets the judgment mode.		√	-	√	-
:CALCulate:BIN:MODE?	<BINNo.>(<ABSOLUTE/RE FERENCE>)	Queries the judgment mode.		√	-	√	-
:CALCulate:BIN:UPPer	<BINNo.>,<Upper threshold>	Sets the upper threshold.	√	√	-	√	-
:CALCulate:BIN:UPPer?	<BINNo.>(<Upper threshold>)	Queries the upper threshold.	√	√	-	√	-
:CALCulate:BIN:LOWer	<BINNo.>,<Lower threshold>	Sets the lower threshold.	√	√	-	√	-
:CALCulate:BIN:LOWer?	<BINNo.>(<Lower threshold>)	Queries the lower threshold.	√	√	-	√	-
:CALCulate:BIN:REFerence	<BINNo.>,<Reference resistance>	Sets the reference resistance.		√	-	√	-
:CALCulate:BIN:REFerence?	<BINNo.>(<Reference resistance>)	Queries the reference resistance.		√	-	√	-
:CALCulate:BIN:PERCent	<BINNo.>,<Range [%]>	Sets the judgment range.		√	-	√	-
:CALCulate:BIN:PERCent?	<BINNo.>(<Range [%]>)	Queries the judgment range.		√	-	√	-
:CALCulate:BIN:RESult?	0 to 1023	Queries the comparator result.		√	-	√	-

Statistical Functions

:CALCulate:STATistics:STATe	1/0/ON/OFF	Sets the statistical calculation function execution.		√	-	√	-
:CALCulate:STATistics:STATe?	(ON/OFF)	Queries the statistical calculation function execution.		√	-	√	-
:CALCulate:STATistics:CLEar	Clear Statistical Calculation Result			√	-	√	-
:CALCulate:STATistics:NUMBer?	(<Total data count>,<Valid data count>)	Queries the data count.		√	-	√	-
:CALCulate:STATistics:MEAN?	(<Mean>)	Queries the mean value.		√	-	√	-
:CALCulate:STATistics:MAXimu m?	(<Maximum value>,<Data no.>)	Queries the maximum value.		√	-	√	-
:CALCulate:STATistics:MINimu m?	(<Minimum value>,<Data no.>)	Queries the minimum value.		√	-	√	-
:CALCulate:STATistics:LIMit?	(<Hi count>,<IN count>,<Lo count>,<Measurement fault count>)	Queries the comparator results.		√	-	√	-
:CALCulate:STATistics:BIN?	(<BIN0 count>,...,<BIN9 count>,<OUT count>,<Measurement fault count>)	Queries the BIN result.		√	-	√	-
:CALCulate:STATistics:DEViati on?	(<σn>,<σn-1>)	Queries the standard deviation.		√	-	√	-

Message [:]: Omissible	Data Formats [:]: Omissible (): Response data	Description	Corresponding Model				
			RM 3544	RM3545		RM3545A	
					By channel		By channel
:CALCulate:STATistics:CP?	<Cp>,<Cpk>	Queries the process capability indices.		√	-	√	-

Scaling

:CALCulate:SCALing:STATe	1/0/ON/OFF	Sets the scaling function execution.	√	√	√	√	√
:CALCulate:SCALing:STATe?	(ON/OFF)	Queries the scaling function execution.	√	√	√	√	√
:CALCulate:SCALing:PARAmeterA	<0.2000E-3 to 2.0000E+3>	Sets the scaling gain.	√	√	√	√	√
:CALCulate:SCALing:PARAmeterA?	(0.2000E-3 to 2.0000E+3)	Queries the scaling gain.	√	√	√	√	√
:CALCulate:SCALing:PARAmeterB	RM3544:<0.0000E-9 to ±1.0000E+9> RM3545:<0.0000E-9 to ±9.0000E+9>	Sets the scaling offset.	√	√	√	√	√
:CALCulate:SCALing:PARAmeterB?	RM3544: (0.0000E-9 to ±1.0000E+9) RM3545: (0.0000E-9 to ±9.0000E+9)	Queries the scaling offset.	√	√	√	√	√
:CALCulate:SCALing:UNIT	<OFF/OHM/Any unit>	Sets the scaling unit.	√	√	√	√	√
:CALCulate:SCALing:UNIT?	(OFF/OHM/Any unit)	Queries the scaling unit.	√	√	√	√	√

Temperature Conversion (ΔT)

:CALCulate:TCONversion:DELTA:STATe	1/0/ON/OFF	Sets the temperature conversion execution.		√	√	√	√
:CALCulate:TCONversion:DELTA:STATe?	(ON/OFF)	Queries the temperature conversion execution.		√	√	√	√
:CALCulate:TCONversion:DELTA:PARAmeter	<Initial resistance>,<Initial temperature>,<Constant>	Sets the temperature conversion constant.		√	√	√	√
:CALCulate:TCONversion:DELTA:PARAmeter?	(<Initial resistance>,<Initial temperature>,<Constant>)	Queries the temperature conversion constant.		√	√	√	√

Temperature Correction (TC)

:CALCulate:TCORrect:STATe	1/0/ON/OFF	Sets the temperature correction execution.	√	√	√	√	√
:CALCulate:TCORrect:STATe?	(ON/OFF)	Queries the temperature correction execution.	√	√	√	√	√
:CALCulate:TCORrect:PARAmeter	<Reference temperature>,<Temperature coefficient>	Sets the temperature correction constant.	√	√	√	√	√
:CALCulate:TCORrect:PARAmeter?	(<Reference temperature>,<Temperature coefficient>)	Queries the temperature correction constant.	√	√	√	√	√

LCD Settings

:DISPlay:CONTRast	<0 to 100>	Sets the contrast.	√	√	-	√	-
:DISPlay:CONTRast?	(0 to 100)	Queries the contrast.	√	√	-	√	-
:DISPlay:BACKlight	<0 to 100>	Sets the backlight brightness.	√	√	-	√	-
:DISPlay:BACKlight?	(0 to 100)	Queries the backlight brightness.	√	√	-	√	-

Memory Function

:MEMory:STATe	1/0/ON/OFF	Sets the memory mode.		√	-	√	-
:MEMory:STATe?	(ON/OFF)	Queries the memory mode.		√	-	√	-
:MEMory:CLear		Clears the memory data.		√	-	√	-
:MEMory:COUNt?	(0 to 50)	Queries the number of measurements stored in memory.		√	-	√	-
:MEMory:DATA?	<Measurement value>,<Measurement value>,...,<Measurement value>	Reads the measurements stored in memory.		√	-	√	-

Hold

[[:SENSe:]]HOLD:AUTO	1/0/ON/OFF	Sets the auto hold execution.	√	√	-	√	-
[[:SENSe:]]HOLD:AUTO?	(ON/OFF)	Queries the auto hold execution.	√	√	-	√	-
[[:SENSe:]]HOLD:STATe?	(ON/OFF)	Queries the hold state.	√	√	-	√	-
[[:SENSe:]]HOLD:OFF		Cancels hold.	√	√	-	√	-

Multiplexer Settings

[[:SENSe:]]WIRE	4/2/W4/W2	Sets the measurement method.	-	√	-	√	-
[[:SENSe:]]WIRE?	(W4/W2)	Queries the measurement method.	-	√	-	√	-
[[:SENSe:]]SCAN:MODE	OFF/AUTO/STEP	Sets the scanning function.	-	√	-	√	-
[[:SENSe:]]SCAN:MODE?	(OFF/AUTO/STEP)	Queries the scanning function.	-	√	-	√	-
[[:SENSe:]]SCAN:STATe?	(1/0)	Queries the scanning execution	-	√	-	√	-

Message [: Omissible]	Data Formats [: Omissible (): Response data	Description	Corresponding Model				
			RM 3544	RM3545		RM3545A	
					By channel		By channel
		state.					
[:SENSe:]SCAN:RESet		Initializes the scan channel and measured value or judgment value.	-	√	-	√	-
[:SENSe:]SCAN:FAIL:STOP	1/0/ON/OFF	Sets the scan fail stop.	-	√	-	√	-
[:SENSe:]SCAN:FAIL:STOP?	(ON/OFF)	Queries the scan fail stop.	-	√	-	√	-
[:SENSe:]SCAN:DATA?	<Measured value>, <Measured value> ... , <Measured value>	Reads the scanned measured data in a batch.	-	√	-	√	-
[:SENSe:]FRONtcheck?	(1/0)	Queries the front measurement terminal connection.	-	√	-	√	-
[:SENSe:]CH	FRONT/0/<Channel number>	Sets the channel switching.	-	√	-	√	-
[:SENSe:]CH?	(FRONT/<Channel number>)	Queries the channel switching.	-	√	-	√	-
[:SENSe:]CH:STATe	<1/0/ON/OFF>,[<Channel number>]	Sets the channel for the multiplexer to be used (execution error when the front measurement terminal is used).	-	√	√	√	√
[:SENSe:]CH:STATe?	[<Channel number>] (ON/OFF)	Queries the channel for the multiplexer to be used (execution error when the front measurement terminal is used).	-	√	√	√	√
[:SENSe:]CH:AVAIlable?	(Number of channels)	Queries the number of channels for the multiplexer to be used.	-	√	-	√	-
[:SENSe:]INSTrument	INTernal/EXTernal	Sets the use of external equipment (execution error when the front measurement terminal is used).	-	√	√	√	√
[:SENSe:]INSTrument?	(INTERNAL/EXTERNAL)	Queries the use of external equipment (execution error when the front measurement terminal is used).	-	√	√	√	√
[:SENSe:]TERMinal	<Unit number>,<A terminal number>,<B terminal number>	Sets the allocation of terminals for the multiplexer (the current flows from terminal B to terminal A, execution error when the front measurement terminal is used).	-	√	√	√	√
[:SENSe:]TERMinal?	(<Unit number>,<A terminal number>,<B terminal number>)	Queries the allocation of terminals for the multiplexer (the current flows from terminal B to terminal A, execution error when the front measurement terminal is used).	-	√	√	√	√

Multiplexer Channel Reset

[:SENSe:]CHReset		Resets the multiplexer channel settings including the measurement conditions.	-	√	-	√	-
------------------	--	---	---	---	---	---	---

Low-Power Resistance Measurement

[:SENSe:]RESistance:LP:STATe	1/0/ON/OFF	Sets the Low-Power Resistance measurement.	-	√	√	√	√
[:SENSe:]RESistance:LP:STATe?	(ON/OFF)	Queries the Low-Power Resistance measurement.	-	√	√	√	√

Pure Resistance easurement

[:SENSe:]RESistance:PR:STATe	1/0/ON/OFF	Sets the Pure Resistance measurement.	-	-	-	√	√
[:SENSe:]RESistance:PR:STATe?	(ON/OFF)	Queries the Pure Power Resistance measurement.	-	-	-	√	√

Measurement Range

[:SENSe:]RESistance:RANGe	RM3544:0 to 3.5E+6 RM3545/RM3545A :0 to 1200E+6	Sets the resistance measurement range.	√	√	√	√	√
[:SENSe:]RESistance:RANGe?	RM3544:(30.000E-3 to 3.0000E+6) RM3545:(10.00000E-3 to 1000.0000E+6) RM3545A :(1000.000E-6 to 1000.0000E+6)	Queries the resistance measurement range.	√	√	√	√	√
[:SENSe:]RESistance:RANGe:AUTO	1/0/ON/OFF	Sets the resistance measurement AUTO range.	√	√	√	√	√
[:SENSe:]RESistance:RANGe:AUTO?	(ON/OFF)	Queries the resistance measurement AUTO range.	√	√	√	√	√
[:SENSe:]RESistance:LP:RAN	0 to 1000E+0	Sets the Low-Power Resistance	-	√	√	√	√

Message [:]: Omissible	Data Formats [:]: Omissible (): Response data	Description	Corresponding Model				
			RM 3544	RM3545		RM3545A	
					By channel		By channel
Ge		measurement range.					
[:SENSe:]RESistance:LP:RANGe?	(1000.00E-3 to 1000.00E+0)	Queries the Low-Power Resistance measurement range.	-	√	√	√	√
100MΩ Range High Precision Function							
[:SENSe:]RESistance:PRECision	1/0/ON/OFF	Sets the 100MΩ range high precision function.	-	√	√	√	√
[:SENSe:]RESistance:PRECision?	(ON/OFF)	Queries the 100MΩ high precision function.	-	√	√	√	√
Switching Measurement Current							
[:SENSe:]RESistance:CURRent	HIGH/LOW	Sets the measurement current.	-	√	√	√	√
[:SENSe:]RESistance:CURRent?	(HIGH/LOW)	Queries the measurement current.	-	√	√	√	√
Offset Voltage Correction Function (OVC)							
[:SENSe:]RESistance:OVC	1/0/ON/OFF	Sets the offset voltage correction function execution.	-	√	√	√	√
[:SENSe:]RESistance:OVC?	(ON/OFF)	Queries the offset voltage correction function execution.	-	√	√	√	√

Contact Improver

[:SENSe:]RESistance:CIMProve	ON/OFF/1/0	Sets the Contact Improver.		√	√	√	√
[:SENSe:]RESistance:CIMProve?	(ON/OFF)	Queries the Contact Improver.		√	√	√	√

Current Error Mode

[:SENSe:]RESistance:ERRor:CURRentcheck	ERRor/OVER	Sets the current error mode.	√	√	√	√	√
[:SENSe:]RESistance:ERRor:CURRentcheck?	(ERRor/OVER)	Queries the current error mode.	√	√	√	√	√
[:SENSe:]RESistance:ERRor:OVER	ERRor/NORMal	Setting the overrange external Err terminal	-	-	-	√	-
[:SENSe:]RESistance:ERRor:OVER?	(ERRor/NORMal)	Queries the overrange external Err terminal	-	-	-	√	-

Contact Check

[:SENSe:]RESistance:CONtactcheck	ON/OFF/1/0	Sets the resistance measurement contact check.	-	√	√	√	√
[:SENSe:]RESistance:CONtactcheck?	(ON/OFF)	Queries the resistance measurement contact check.	-	√	√	√	√
[:SENSe:]RESistance:LP:CONtactcheck	ON/OFF/1/0	Sets the Low-Power Resistance measurement contact check.	-	√	√	√	√
[:SENSe:]RESistance:LP:CONtactcheck?	(ON/OFF)	Queries the Low-Power Resistance measurement contact check.	-	√	√	√	√

Setting Number of Digits

[:SENSe:]RESistance:DIGits	RM3544:4/5 RM3545/RM3545A: 5/6/7	Sets the measurement value's number of digits.	√	√	-	√	-
[:SENSe:]RESistance:DIGits?	RM3544:(4/5) RM3545/RM3545A: (5/6/7)	Queries the measurement value's number of digits.	√	√	-	√	-

Temperature Measurement (Analog Input)

[:SENSe:]TEMPerature:SENSor	THERmistor/ANALog	Sets the temperature sensor.	-	√	-	√	-
[:SENSe:]TEMPerature:SENSor?	(THERMISTOR/ANALOG)	Queries the temperature sensor.	-	√	-	√	-
[:SENSe:]TEMPerature:PARAmeter	<V1>,<T1>,<V2>,<T2>	Sets the analog input scaling constants.	-	√	-	√	-
[:SENSe:]TEMPerature:PARAmeter?	(<V1>,<T1>,<V2>,<T2>)	Queries the analog input scaling constants.	-	√	-	√	-

Trigger

:INITiate:CONTinuous	1/0/ON/OFF	Sets the continuous	√	√	-	√	-
----------------------	------------	---------------------	---	---	---	---	---

Message [: Omissible]	Data Formats [: Omissible (): Response data	Description	Corresponding Model				
			RM 3544	RM3545		RM3545A	
					By channel		By channel
		measurement.					
:INITiate:CONTinuous?	(ON/OFF)	Queries the continuous measurement.	√	√	-	√	-
:INITiate[:IMMEDIATE]		Initiates the trigger wait state.	√	√	-	√	-
:TRIGger:SOURce	IMMEDIATE/EXTernal	Sets the trigger source.	√	√	-	√	-
:TRIGger:SOURce?	(IMMEDIATE/EXTERNAL)	Queries the trigger source.	√	√	-	√	-
:TRIGger:EDGE	1/0/ON/OFF	Sets the trigger logic (ON edge/OFF edge).	√	√	-	√	-
:TRIGger:EDGE?	(ON/OFF)	Queries the trigger logic (ON edge/OFF edge).	√	√	-	√	-
Delay							
:TRIGger:DELay	<Delay time>	Sets the delay time.	-	√	√	√	√
:TRIGger:DELay?	(0 to 9.999)	Queries the delay time.	-	√	√	√	√
:TRIGger:DELay:AUTO	1/0/ON/OFF	Sets the preset delay.	-	√	√	√	√
:TRIGger:DELay:AUTO?	(ON/OFF)	Queries the preset delay.	-	√	√	√	√
Self-Calibration							
:SYSTem:CALibration		Executes self-calibration.	-	√	-	√	-
:SYSTem:CALibration:AUTO	1/0/ON/OFF	Sets the automatic self-calibration.	-		-		-
:SYSTem:CALibration:AUTO?	(ON/OFF)	Queries the automatic self-calibration.	-	√	-	√	-
Saving and Reading Measurement Conditions							
:SYSTem:PANel:SAVE	<TableNo>	Saves the panel.	√	√	-	√	-
:SYSTem:PANel:LOAD	<TableNo>, <Zero adjustment load=1/0/ON/OFF>	Reads the panel.	√	√	-	√	-
:SYSTem:PANel:NAME	<TableNo>, <Panel name>	Sets the panel name.	√	√	-	√	-
:SYSTem:PANel:NAME?	<TableNo> (<Panel name>)	Obtains the panel name.	√	√	-	√	-
:SYSTem:PANel:CLEar	<TableNo>	Clears the panel.	√	√	-	√	-
Key-Lock							
:SYSTem:KLOCK	1/0/ON/OFF	Sets the key-lock.	√	√	-	√	-
:SYSTem:KLOCK?	(ON/MENU/OFF)	Queries the key-lock.	√	√	-	√	-
Line Frequency							
:SYSTem:LFRequency	AUTO/50/60	Sets the AC line frequency.	√	√	-	√	-
:SYSTem:LFRequency?	(AUTO/50/60)	Queries the AC line frequency.	√	√	-	√	-
Clock							
:SYSTem:DATE	<Year>, <Month>, <Day>	Sets the system date.	-	√	-	√	-
:SYSTem:DATE?	(<Year>, <Month>, <Day>)	Queries the system date.	-	√	-	√	-
:SYSTem:TIME	<Hour>, <Minute>, <Second>	Sets the system time.	-	√	-	√	-
:SYSTem:TIME?	(<Hour>, <Minute>, <Second>)	Queries the system time.	-	√	-	√	-
Key Beeper							
:SYSTem:BEEPer:STATe	1/0/ON/OFF	Sets the key beeper.	√	√	-	√	-
:SYSTem:BEEPer:STATe?	(ON/OFF)	Queries the key beeper.	√	√	-	√	-
Communications Settings							
:SYSTem:LOCal		Enables the local control state.	√	√	-	√	-
:SYSTem:DATAout	1/0/ON/OFF	Sets the measurement-synchronized data output.	√	√	-	√	-
:SYSTem:DATAout?	(ON/OFF)	Queries the measurement-synchronized data output.	√	√	-	√	-
:SYSTem:HEADer	1/0/ON/OFF	Sets the header presence.	√	√	-	√	-
:SYSTem:HEADer?	(ON/OFF)	Queries the header presence.	√	√	-	√	-
:SYSTem:TERMinator	0/1	Sets the command delimiter.		√	-	√	-
:SYSTem:TERMinator?	(0/1)	Queries the command delimiter.		√	-	√	-
:SYSTem:COMMunicate	USB/LAN/RS232c/PRINter	Sets the Communication interface	-	-	-	√	-
:SYSTem:COMMunicate?	(USB/LAN/RS232C/PRINER)	Queries the Communication interface	-	-	-	√	-
:SYSTem:COMMunicate:MONI tor	1/0/ON/OFF	Sets the Communication monitor	-	-	-	√	-
:SYSTem:COMMunicate:MONI tor?	(ON/OFF)	Queries the Communication monitor	-	-	-	√	-

Message [: Omissible]	Data Formats [: Omissible (): Response data	Description	Corresponding Model				
			RM 3544	RM3545		RM3545A	
					By channel		By channel
:SYSTem:COMMunicate:LAN:IPADdress	IP address	Sets the IP address	-	-	-	√	-
:SYSTem:COMMunicate:LAN:IPADdress?	(IP address)	Queries the IP address	-	-	-	√	-
:SYSTem:COMMunicate:LAN:SMASK	Sub-net mask	Sets the Sub-net mask for LAN	-	-	-	√	-
:SYSTem:COMMunicate:LAN:SMASK?	(Sub-net mask)	Queries the Sub-net mask for LAN	-	-	-	√	-
:SYSTem:COMMunicate:LAN:GATeway	Gateway	Sets the Gateway for LAN	-	-	-	√	-
:SYSTem:COMMunicate:LAN:GATeway?	(Gateway)	Queries the Gateway for LAN	-	-	-	√	-
:SYSTem:COMMunicate:LAN:CONTRol	Port NO.	Sets the LAN port number	-	-	-	√	-
:SYSTem:COMMunicate:LAN:CONTRol?	(Port NO.)	Queries the LAN port number	-	-	-	√	-
:SYSTem:COMMunicate:LAN:MAC?	(MAC address)	Queries the MAC address for LAN	-	-	-	√	-
:SYSTem:COMMunicate:LAN:UPDate		Update LAN settings	-	-	-	√	-
:SYSTem:COMMunicate:RS232C:SPEED	Baud rate	Sets the RS-232C communication speed	-	-	-	√	-
:SYSTem:COMMunicate:RS232C:SPEED?	(9600/19200/38400/115200)	Queries the RS-232C communication speed	-	-	-	√	-
System Reset							
:SYSTem:RESet		Executes reset, including the saved data on measurement conditions.	√	√	-	√	-
EXT I/O							
:IO:MODE?	(NPN/PNP)	Queries the NPN/PNP switch status.	√	√	-	√	-
:IO:INPut?	(0 to 3)	Executes the external I/O input.	√	√	-	√	-
:IO:OUTPut	0 to 7	Executes the external I/O output.	√	√	-	√	-
:IO:FILTer:STATE	1/0/ON/OFF	Sets the TRIG/PRINT signal filter function execution.	√	√	-	√	-
:IO:FILTer:STATE?	(ON/OFF)	Queries the TRIG/PRINT signal filter function execution.	√	√	-	√	-
:IO:FILTer:TIME	<0.050 to 0.500>	Sets the TRIG/PRINT signal filter time.	√	√	-	√	-
:IO:FILTer:TIME?	(0.050 to 0.500)	Queries the TRIG/PRINT signal filter time.	√	√	-	√	-
:IO:JUDGE:MODE	JUDGE/BCD	Selects the judgment mode/BCD mode.	√	√	-	√	-
:IO:JUDGE:MODE?	(JUDGE/BCD)	Queries the judgment mode/BCD mode.	√	√	-	√	-
:IO:EOM:MODE	<HOLD/PULSE>	Sets the EOM output mode.	√	√	-	√	-
:IO:EOM:MODE?	(<HOLD/PULSE>)	Queries the EOM output mode.	√	√	-	√	-
:IO:EOM:PULSE	<Pulse width>	Sets the EOM pulse width.	√	√	-	√	-
:IO:EOM:PULSE?	(0.001 to 0.100)	Queries the EOM pulse width.	√	√	-	√	-
Multiplexer Unit							
:UNIT:IDN?	<Unit number> (<Model name>, <Serial number>)	Queries the unit.	-	√	-	√	-
:UNIT:SCOUNT?	<Unit number> (<Relay count>)	Queries the relay usage count.	-	√	-	√	-
:UNIT:TEST?	<Unit number> (<0 to 8>)	Queries the unit test and result.	-	√	-	√	-

3 Message Reference

Message Reference Interpretation

< >: Indicates the contents (character or numeric parameters) of the data portion of a message. Character parameters are returned as all capital letters.

Numeric Parameters:

- NRf Number format may be any of NR1, NR2 and NR3
- NR1 Integer data (e.g.: +12, -23, 34)
- NR2 Fixed-point data (e.g.: +1.23, -23.45, 3.456)
- NR3 Floating-point exponential representation data (e.g.: +1.0E-2, -2.3E+4)

Shows the command description.

Shows the message syntax. Explains the command data or response message. Describes the message.

Read/Write the Standard Event Status Enable Register (SESER)

Syntax	Command	*ESE <0 to 255 (NR1)>
	Query	*ESE?
	Response	<0 to 255 (NR1)>
Description	Command	The SESER mask is set to the numerical value 0 to 255. The initial value (at power-on) is 0.
	Query	The contents of the SESER, as set by the *ESE command, are returned as an NR1 value (0 to 255).

128	64	32	16	8	4	2	1
bit 7	bit 6	bit 5	bit 4	bit 3	bit 2	bit 1	bit 0
PON	URQ	CME	EXE	DDE	QYE	RQC	OPC

Example ***ESE 36**
(Sets bits 5 and 2 of SESER)

Shows an example of an actual command application. (Normally described with HEADER OFF [except the HEADER command itself].)

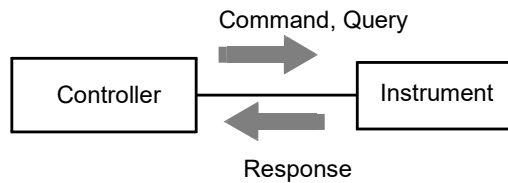

Standard Commands

(1) System Data Command

Query Device ID (Identification Code)

Syntax Query ***IDN?**
 Response <Manufacturer name>, <Model name>, <Serial number>, <Software version>

Example *IDN?
 HIOKI, RM3545, 123456789, V1.00
 The Device ID is HIOKI RM3545, 123456789, software version 1.00. The <Model name> includes the following devices in addition to the example RM3544-01, RM3545-01, RM3545-02, RM3545A-1 and RM3545A-2 .

Note The response message has no header.

(2) Internal Operation Command

Initialize Device

Syntax Command ***RST**

Description Command Resets the instrument to its initial state.

Note The communications state is not initialized.
 RM3545 RM3545A An execution error occurs during scanning.

Execute Self-Test and Query Result

Syntax Query ***TST?**
 Response <0 to 15 (NR1)>
 128 64 32 16 8 4 2 1
 bit 7 bit 6 bit 5 bit 4 bit 3 bit 2 bit 1 bit 0

unused	unused	unused	unused	Blown FUSE	memory	CPU RAM	CPU ROM
--------	--------	--------	--------	------------	--------	---------	---------

Description Perform the instrument self-test and return the result as NR1 value 0 to 15. Returns zero when no error occurs.

Example *TST?
 4
 A memory error occurred. Correct measurement may not be possible. Obtain repair before further use.

Note RM3545 RM3545A An execution error occurs during scanning.

(3) Synchronization Commands

Set OPC bit of SESR when Finished with All Pending Operations

Syntax Command ***OPC**

Description Sets OPC bit 0 of the Standard Event Status Register (SESR) when all commands prior to *OPC have finished processing.

Respond with ASCII "1" when Finished with All Pending Operations

Syntax Query ***OPC?**
Response **1**

Description Responds with ASCII "1" when all commands prior to *OPC have finished processing.

Wait for Pending Commands to Finish

Syntax Command ***WAI**

Description The instrument waits until all prior commands finish before executing any subsequent commands.

(4) Status and Event Control Commands

Clear Event Register, Status Byte Register (Except Output Queue)

Syntax Command ***CLS**

Description Clears the event status registers. The Status Byte Register bits corresponding to the event status registers are also cleared. (SESR, ESR0, ESR1)

Note [RS-232C/USB/LAN] The output queue is unaffected.
[GP-IB] The output queue, various enable registers and MAV bit 4 of the Status Byte Register are unaffected.

Read/Write Standard Event Status Enable Register (SESER)

Syntax Command ***ESE <0 to 255 (NR1)>**
Query ***ESE?**
Response **<0 to 255 (NR1)>**

Description Command The SESER mask is set to the numerical value 0 to 255. The initial value (at power-on) is 0.
Query The contents of the SESER, as set by the *ESE command, are returned as an NR1 value (0 to 255).

128	64	32	16	8	4	2	1
bit 7	bit 6	bit 5	bit 4	bit 3	bit 2	bit 1	bit 0
PON	URQ	CME	EXE	DDE	QYE	RQC	OPC

Example *ESE 36
(Sets bits 5 and 2 of SESER)

Read and Clear Standard Event Status Register (SESR)

Syntax Query ***ESR?**
Response <0 to 255 (NR1)>

Description Returns the contents of the SESR as an NR1 value from 0 to 255, then clears register contents.

The response message has no header.

[RS-232C/USB/LAN]

128	64	32	16	8	4	2	1
bit 7	bit 6	bit 5	bit 4	bit 3	bit 2	bit 1	bit 0
PON	unused	CME	EXE	DDE	QYE	unused	OPC

[GP-IB]

128	64	32	16	8	4	2	1
bit 7	bit 6	bit 5	bit 4	bit 3	bit 2	bit 1	bit 0
PON	URQ	CME	EXE	DDE	QYE	RQC	OPC

Example *ESR?

32

Bit 5 of the SESR has been set to 1.

Write and Read Standard Event Status Enable Register (SRER)

Syntax Command ***SRE** <0 to 255 (NR1)>
Query ***SRE?**
Response <0 to 255 (NR1)>

Description Command The SRER mask is set to the numerical value 0 to 255. Although NRf numerical values are accepted, values to the right of the decimal are rounded to the nearest integer. Bit 6 and unused bits 2, 3 and 7 are ignored. The data is initialized to zero at power-on.

Query The contents of the SRER, as set by the *SRE command, are returned as an NR1 value (0 to 255). Bit 6 and unused bits 2, 3 and 7 always return as zero.

128	64	32	16	8	4	2	1
bit 7	bit 6	bit 5	bit 4	bit 3	bit 2	bit 1	bit 0
unused	0	ESB	MAV	unused	unused	ESB1	ESB0

Example *SRE

33

Set SRER bits 0 and 5 to 1.

*SRE?

33

SRER bits 0 and 5 have been set to 1.

Read Status Byte and MSS Bit

Syntax Query ***STB?**
Response <0 to 255 (NR1)>

Description The contents of the STB are returned as an NR1 value (0 to 255).
The response message has no header.

128	64	32	16	8	4	2	1
bit 7	bit 6	bit 5	bit 4	bit 3	bit 2	bit 1	bit 0
unused	MSS	ESB	MAV	unused	unused	ESB1	ESB0

Example ***STB?**
16
STB bit 4 has been set to 1.

Request a Sample

Syntax Command ***TRG**

Description Performs one measurement when external triggering (trigger source <EXTERNAL>) is enabled.
When Statistical Calculation is ON, imports calculation data. [RM3545](#) [RM3545A](#)
When the memory function is enabled, the measured value is stored. [RM3545](#)
[RM3545A](#)
It may be necessary to insert wait processing after panel load or range selection. Wait time depends on Measurement target.

Example **:TRIG:SOUR EXT;*TRG**

Device-Specific Commands

(1) Event Status Register

Set and Query Device-Specific Event Status Enable Register ESER0

Syntax Command **:ESE0** <0 to 255 (NR1)>
Query **:ESE0?**
Response <0 to 255 (NR1)>

Description Command Sets the mask pattern in Event Status Enable Register 0 (ESER0) for the Event Status Register.

128	64	32	16	8	4	2	1
bit 7	bit 6	bit 5	bit 4	bit 3	bit 2	bit 1	bit 0
OutBIN	OvrRng	ERR	Hi	IN	Lo	INDEX	EOM

Note Data initializes to zero at power-on.
OvrRng and ERR can not be Changed by [RES:ERR:CURR OVER](#).

Read Device-Specific Event Status Register ESR0

Syntax Query **:ESR0?**
Response <0 to 255 (NR1)>

Note Executing **ESR0?** clears the contents of ESR0.

Set and Query Device-Specific Event Status Enable Register ESER1 RM3545 RM3545A

Syntax Command **:ESE1** <0 to 255 (NR1)>
Query **:ESE1?**
Response <0 to 255 (NR1)>

Description Command Sets the mask pattern in Event Status Enable Register 1 (ESER1) for the Event Status Register.

128	64	32	16	8	4	2	1
bit 7	bit 6	bit 5	bit 4	bit 3	bit 2	bit 1	bit 0
unused	unused	unused	NO UNIT	SW.ERR	CURR	CONTACT A	CONTACT B

Data initializes to zero at power-on.

Read Device-Specific Event Status Registers ESR1 RM3545 RM3545A

Syntax Query **:ESR1?**
Response <0 to 255 (NR1)>

Note Executing **ESR1?** clears the contents of ESR1.

(2) Reading Measured Values

Measurement Value Formats

• Resistance (absolute value display: unit Ω)

RM3544

Measurement Range	Measured Value	\pm OvrRng	Measurement Fault
30m Ω	\pm 00 . 000 E-03	\pm 10.000E+19	10.000E+29
300m Ω	\pm 000 . 00 E-03	\pm 100.00E+18	100.00E+28
3 Ω	\pm 0 . 0000 E+00	\pm 1.0000E+20	1.0000E+30
30 Ω	\pm 00 . 000 E+00	\pm 10.000E+19	10.000E+29
300 Ω	\pm 000 . 00 E+00	\pm 100.00E+18	100.00E+28
3k Ω	\pm 0 . 0000 E+03	\pm 1.0000E+20	1.0000E+30
30k Ω	\pm 00 . 000 E+03	\pm 10.000E+19	10.000E+29
300k Ω	\pm 000 . 00 E+03	\pm 100.00E+18	100.00E+28
3M Ω	\pm 0 . 0000 E+06	\pm 1.0000E+20	1.0000E+30

Low-Power	Measurement Range	Measured Value	±OvrRng	Measurement Fault
OFF	1000μΩ	± □□□□.□□□ E-06	±1000.000E+17	1000.000E+27
	10mΩ	± □□.□□□□□ E-03	±10.00000E+19	10.00000E+29
	100mΩ	± □□□.□□□□ E-03	±100.0000E+18	100.0000E+28
	1000mΩ	± □□□□.□□□ E-03	±1000.000E+17	1000.000E+27
	10Ω	± □□.□□□□□ E+00	±10.00000E+19	10.00000E+29
	100Ω	± □□□.□□□□ E+00	±100.0000E+18	100.0000E+28
	1000Ω	± □□□□.□□□ E+00	±1000.000E+17	1000.000E+27
	10kΩ	± □□.□□□□□ E+03	±10.00000E+19	10.00000E+29
	100kΩ	± □□□.□□□□ E+03	±100.0000E+18	100.0000E+28
	1000kΩ	± □□□□.□□□ E+03	±1000.000E+17	1000.000E+27
	10MΩ	± □□.□□□□□ E+06	±10.00000E+19	10.00000E+29
	100MΩ	± □□□.□□□□ E+06	±100.0000E+18	100.0000E+28
	1000MΩ	± □□□□.□□□ E+06	±1000.000E+17	1000.000E+27
ON	1000mΩ	± □□□□.□□ E-03	±1000.00E+17	1000.00E+27
	10Ω	± □□.□□□□□ E+00	±10.0000E+19	10.0000E+29
	100Ω	± □□□.□□□□ E+00	±100.000E+18	100.000E+28
	1000Ω	± □□□□.□□ E+00	±1000.00E+17	1000.00E+27

Note: • The decimal point position and exponent part will change according to the scaling gain.

For information on scaling, see the instrument's instruction manual.

- When the displayed number of digits has changed, the undisplayed digits will become 0. The number of characters in the measurement value format will not change.
- 1000μΩ range are only available in RM3545A.
- Resistance (relative value display: unit %)

RM3544

Measured Value	±OvrRng	Measurement Fault
± □□□.□□ E+00	±100.00E+18	100.00E+28

RM3545 RM3545A

Measured Value	±OvrRng	Measurement Fault
± □□□.□□□ E+00	±100.000E+18	100.000E+28

- Temperature / Temperature conversion display (unit °C)

Z2001 temperature sensor

Measured Value	±OvrRng	Measurement Fault
± □□.□ E+00	±10.0E+19	10.0E+29

Analog output thermometer

Temperature conversion display

Measured Value	±OvrRng	Measurement Fault
± □□□.□ E+00	±100.0E+18	100.0E+28

Note: For positive measured values, a space (ASCII 20H) represents the sign.

Time to receive measured values is different for the :FETCh? and :READ? commands.

See: Data Exporting Methods (p.71), Triggering (p.53)

Also see "4 Multiplexer Commands (p.67)" for the multiplexer unit.

Read Most Recent Measurement

Syntax Query `:FETCh? [LIMit] RM3544`
`:FETCh? [<LIMit/JUDGe/LIMJdGe>]`
`<Channel number> RM3545 RM3545A`
 <Channel number> = 1 to 42

Response `RM3544`
`<Measurement value> [, <HI/IN/LO/OFF/ERR>]`
`RM3545 RM3545A`
`<Measurement value> [, <HI/IN/LO/OFF/ERR>]`
`[, <PASS/FAIL/OFF/ERR>]`
 See: "Measurement Value Formats" (p.26)

Description Reads the most recent measurement. No trigger occurs.
 See: Data Exporting Methods (p.71), Triggering (p.53)
 Data and response are as follows.

data	Response
omitted	Reads the measurement value only.
LIMit	Reads the measurement value and comparator result.
JUDGe RM3545	Reads the measurement value and PASS/FAIL result.
LIMJdGe RM3545 RM3545A	Reads the measurement value, comparator result and PASS/FAIL result.

RM3545 RM3545A

By assigning a channel number to the data, the value of the channel number is read. If a measurement has not been performed, the value for a measurement fault is returned. The channel number is not returned. If the channel number is omitted, the measured value of the current channel is read.

The relationship between judgment and response is as follows.

Judgment	Response
Hi	HI
IN	IN
Lo	LO
Comparator not used	OFF
Measurement Fault	ERR

Example (RM3544 examples)

`:FETC?`
`102.50E-03`
`:FETC? LIM`
`102.50E-03, HI`

(RM3545 ,RM3545A examples)

`:FETC?`
`1023.579E-03`
`:FETC? LIM`
`1023.579E-03, IN`

(Examples when the RM3545-02 multiplexer is used)

`:FETC?` ... Obtains the measured value of the current channel.
`1023.579E-03`
`:FETC? LIMJ` ... Obtains the current measured value and judgment.
`1023.579E-03,IN,PASS`
`:FETC? 10` ...Obtains the measured value of Channel 10.
`1023.579E-00`
`:FETC? LIMJ,10` ...Obtains the measured value of Channel 10 and judgment.
`1023.579E-03,IN,PASS`

Note If a measurement has not been performed, the value for a measurement fault is returned.RM3545 RM3545A

In the following cases, an execution error occurs.

- When the front terminal is used or the scanning function is OFF, JUDGe or LIMJdGe is selected as the data.
- When the front terminal is used, a channel number is specified for the data.
- During auto scanning

Read Temperature Measurement Value

Syntax	Query	:FETCh:TEMPerature?
	Response	<Measurement value> See: "Measurement Value Formats" (p.26)
Description	Reads the last (most recent) temperature measurement value. Performs the same operation as :MEASure:TEMPerature?.	

Example :FETC:TEMP?
25.1E+00

Measure (Await Triggers and Read Measurements)

Syntax	Query	:READ?	RM3544
		:READ? [<NDATa/JUDGe>]	RM3545 RM3545A
	Response	RM3544 <Measurement value> RM3545 RM3545A	

The response varies depending on the scanning function or command

data portion. Data and response are as follows.

Scanning function	Data	Response
OFF	None	Reads the measured value only. <Measured value>
AUTO	Omitted	Reads only the measured values of all channels. <Measured value>, <Measured value>, ... <Measured value>
	NDATa	Reads the total judgment only. <Total judgment result>
	JUDGe	Reads the measured values and total judgment results of all channels. <Measured value>, <Measured value>, ... <Measured value>, <Total judgment result>
STEP	None	Reads only the measured value of the current channel. <Measured value>

<Total judgment result> = <PASS/FAIL/OFF/ERR>

See: "Measurement Value Formats" (p.26)

Description Switches from the Idle State to the Trigger Wait State, then reads the next measured value. With the auto range enabled, the most suitable range is selected before measurement.

See: "5 Data Exporting Methods" (p.71), Triggering (p.53)

Trigger Source	Operation
IMMediate	Triggers and reads the measured value.
EXTernal	Triggers by TRIG signal input, and continuously reads the measured values.

RM3545 RM3545A

When the scanning function is set to AUTO or STEP, the Trigger Wait State is entered and scanning begins after a trigger is detected.

The following operations are performed according to the scanning function.

Scanning function	Operation
AUTO	All channels are measured when a trigger is received. After all the channels are measured, a response is returned. The measured values at the time of scanning completion are separated by commas (",") and returned. Only the data with [:SENSe:]STATe ON is returned. The number of data items is the same as the channel count that can be obtained using a [:SENSe:]CH:AVAIlable? query. If a measurement has not been performed, the value for a measurement fault is returned.
STEP	One channel is measured when a trigger is received. A response is returned after one channel is measured.

Note

- Automatically switches to `:INITiate:CONTinuous OFF` when this message is received.
- The next command does not execute until measurement is finished. However, `*TRG` and `:ABORt` are received.
- If a trigger is input with the `*TRG` command, an external trigger (trigger source `<EXTERNAL>`) is enabled and a command is sent. With GP-IB, after the command is sent and then after allowing a wait time corresponding to the sampling time, specify the talker.
- With an external trigger (trigger source `<EXTERNAL>`), the measurement value's response will be doubled when the data output function is ON. When using, switch the data output function OFF.
- It may be necessary to insert wait processing after panel load or range selection. Wait time depends on Measurement target.
- `RM3545` `RM3545A` An execution error occurs during auto scanning.

Preset to Value Appropriate for Expected Measurement Value, and Measure Resistance `RM3545` `RM3545A`

Syntax Query `:MEASure:RESistance? <Expected measurement value>`
`<Expected measurement value> = 0 to 1200E+06`

Response `<Measurement value>`
 See: "Measurement Value Formats" (p.26)

Description When expected measurement values are input, the instrument will be set to an optimum range that enables provided numerical data to be measured. When omitted, it enters the auto range.

The MEASURE command operates as follows:

1. Disables continuous measurement of the trigger system.
2. Enables the internal trigger (trigger source `<IMMEDIATE>`).
3. Switches Low-Power Resistance measurement to OFF.
4. Moves to the specified range.
5. Executes one-time trigger.
6. Reads the measurement value.

The MEASURE command executes the following commands internally:

`RES:LP:STAT OFF`

`RES:RANG <Expected measurement value>`

(If the `<Expected measurement value>` is not present, then `:RANG:AUTO ON`)

`:INIT:CONT OFF`

`:TRIG:SOUR IMM`

`:READ?`

Example `:MEAS:RES?`
`150.1124E+03`

- Note**
- When the scaling function is being used, set the `<expected value>` to the value that existed prior to scaling (value in the range being used).
 - If a transformer, coil, or other sample is inductive, measurement data may be returned before values have stabilized in auto range. In this case, either specify the range and measure, or utilize the delay function.
 - An execution error occurs when the auto range is turned ON if the comparator function and BIN measurement function are ON.
 - When the scanning function is set to STEP or AUTO, an execution error occurs.

Preset to Value Appropriate for Expected Measurement Value, and Measure Low-Power Resistance RM3545 RM3545A

Syntax Query **:MEASure:RESistance:LP?** <Expected measurement value>

<Expected measurement value> = 0 to 1200E+03

Response **<Measurement value>**

See: "Measurement Value Formats" (p.26)

Description When expected measurement values are input, the instrument will be set to an optimum range that enables provided numerical data to be measured. When omitted, it enters the auto range.

The MEASURE command operates as follows:

1. Disables continuous measurement of the trigger system.
2. Enables internal trigger (trigger source <IMMEDIATE>).
3. Switches Low-Power Resistance measurement to ON.
4. Moves to the specified range.
5. Executes one-time trigger.
6. Reads the measurement value.

The MEASURE command executes the following commands internally:

RES:LP:STAT ON

RES:LP:RANG <Expected measurement value>

(If the <Expected measurement value> is not present, then **:RANG:LP:AUTO ON**)

:INIT:CONT OFF

:TRIG:SOUR IMM

:READ?

Example **:MEAS:RES:LP?**
104.140E+00

- Note**
- When the scaling function is being used, set the <expected value> to the value that existed prior to scaling (value in the range being used).
 - If a transformer, coil, or other sample is inductive, measurement data may be returned before values have stabilized in auto range. At such time, either specify the range and measure, or utilize the delay function.
 - An execution error occurs when the auto range is turned ON if the comparator function and BIN measurement function are ON.
 - When the scanning function is set to STEP or AUTO, an execution error occurs.

Read Temperature Measurement Value

Syntax Query **:MEASure:TEMPerature?**

Response **<Measurement value>**

See: "Measurement Value Formats" (p.26)

Description Reads the last (most recent) temperature measurement value. Performs the same operation as **:FETCh:TEMPerature?**.

Example **:MEAS:TEMP?**
25.1E+00

Abort Measurement

Syntax Query **:ABORT**

Description Executes **:READ** /Scan measurement/Scan zero adjustment is abort (forced ermination).

Example **:READ?**
:ABOR
Executes an abort.

- Note** An abort cannot be executed as the instrument waits until all prior commands finish if the query is sent after ***WAI** command.

(3) Zero Adjustment

RM3545 RM3545A An execution error occurs during scanning.

Execute Zero Adjustment

Syntax Query **:ADJust?**

Response <0/1>

0 = Indicates zero adjustment succeeded.

1 = Indicates that zero adjustment has failed. For information on zero adjustment, see the instrument instruction manual.

Description RM3545 RM3545A

Executes scan zero adjustment (performs zero adjustment for the channels with :ADJust:ENABle ON) if the scanning function of the multiplexer is set to STEP or AUTO. Zero adjustment is performed only for the current channel if the scanning function is OFF. Scan zero adjustment can be aborted using :ABORt.

Clear Zero Adjustment

Syntax Command **:ADJust:CLEAr**

Description Clears any zero-adjustment offset.

Example ADJ:CLE

Note RM3545 RM3545A

When the multiplexer is used, zero adjustment for the current channel is canceled.

Query Zero Adjustment Execution State RM3545 RM3545A

Syntax Query **:ADJust:STATe?**

Response <ON/OFF>

Example CH 10
:ADJ:STAT?
ON

Set and Query Scan Zero Adjustment Execution RM3545 RM3545A

Syntax Command **:ADJust:ENABle** <1/0/ON/OFF>

Query **:ADJust:ENABle?**

Response <ON/OFF>

Example CH 10
:ADJ:ENAB ON
:ADJ:ENAB?
ON

(4) Measurement Speed

RM3545 RM3545A An execution error occurs during scanning.

Set and Query Measurement Speed

Syntax	Command	:SAMPle:RATE <Measurement speed> RM3544 <Measurement speed>=FAST/MEDIUm/SLOW SLOW1/SLOW2 are handled the same as with SLOW. RM3545 RM3545A <Measurement speed>=FAST/MEDIUm/SLOW1 /SLOW2 SLOW is handled the same as with SLOW2.
	Query	:SAMPle:RATE?
	Response	RM3544 <Measurement speed>=FAST/MEDIUm/SLOW RM3545 RM3545A <Measurement speed>=FAST/MEDIUm/SLOW1 /SLOW2

Example :SAMP:RATE MED
:SAMP:RATE?
MEDIUM

(5) Averaging Function

RM3545 RM3545A An execution error occurs during scanning.

Execute and Query Averaging Function

Syntax	Command	:CALCulate:AVERage:STATe <1/0/ON/OFF>
	Query	:CALCulate:AVERage:STATe?
	Response	<ON/OFF>

Example :CALC:AVER:STAT ON
:CALC:AVER:STAT?
ON

Set and Query Average Count

Syntax	Command	:CALCulate:AVERage:COUNt <Count>
	Query	:CALCulate:AVERage:COUNt?
	Response	<Count (NR1)> = 2 to 100

Example :CALC:AVER:COUN 10
:CALC:AVER:COUN?
10

(6) Comparator

- When making comparator settings by commands, the measurement range is not automatically selected.

Execute and Query Comparator

Syntax	Command	:CALCulate:LIMit:STATe <1/0/ON/OFF>
	Query	:CALCulate:LIMit:STATe?
	Response	<ON/OFF>

Example :CALC:LIM:STAT ON
:CALC:LIM:STAT?
ON

Note When the comparator is executed, the auto range , the temperature conversion function and BIN function enter the OFF state.

RM3545 RM3545A An execution error occurs during scanning.

Set and Query Beeper

Syntax Command :CALCulate:LIMit:BEEPer <Condition>,<Type>,<Count>
 Query :CALCulate:LIMit:BEEPer? <Condition>
 Response <Condition>,<Type>,<Count>
 <Condition> = RM3544 HI/ IN /LO
RM3545 RM3545A HI/ IN /LO /PASS/ FAIL
 <Type> = 0: Buzzer OFF, 1 to 3: Type 1 to 3
 <Count> = 0: Continuous, 1 to 5: Count [times]

Example :CALC:LIM:BEEP IN,1,0
 :CALC:LIM:BEEP? IN
 IN,1,0

Note RM3545 RM3545A An execution error occurs during scanning.

Set and Query Judgment Mode

Syntax Command :CALCulate:LIMit:MODE <ABSolute/REFerence>
 Query :CALCulate:LIMit:MODE?
 Response <ABSOLUTE/REFERENCE>
 <ABSOLUTE> = Upper threshold/Lower threshold comparison
 <REFERENCE> = Reference percentage/tolerance comparison

Example :CALC:LIM:MODE ABS
 :CALC:LIM:MODE?
 ABSOLUTE

Note RM3545 RM3545A An execution error occurs during scanning.

Set and Query ABS Mode Upper Comparator Threshold Values

Syntax Command :CALCulate:LIMit:UPPer <Upper threshold>
 Query :CALCulate:LIMit:UPPer?
 Response <Upper threshold[Ω]>
RM3544 <Upper threshold[Ω]> = 0 to 1E+9 (NR3)
RM3545 RM3545A <Upper threshold[Ω]> = 0 to 9E+9 (NR3)

Example :CALC:LIM:UPP 1.0
 The upper threshold is 1.0Ω (regardless of range).

Note The value will be 0 when the upper threshold is less than 1E-9.
RM3545 RM3545A An execution error occurs during scanning.

Set and Query ABS Mode Lower Comparator Threshold Values

Syntax Command :CALCulate:LIMit:LOWer <Lower threshold>
 Query :CALCulate:LIMit:LOWer?
 Response <Lower threshold[Ω]>
RM3544 <Lower threshold[Ω]> = 0 to 1E+9 (NR3)
RM3545 RM3545A <Lower threshold[Ω]> = 0 to 9E+9 (NR3)

Example :CALC:LIM:LOW 0.9
 The lower threshold is 0.9Ω (regardless of range).

Note The value will be 0 when the lower threshold is less than 1E-9.
RM3545 RM3545A An execution error occurs during scanning.

Set and Query REF% Mode Reference Resistance

Syntax Command **:CALCulate:LIMit:REFerence** <Reference Resistance>
 Query **:CALCulate:LIMit:REFerence?**
 Response <Reference Resistance[Ω]>
 RM3544 <Reference Resistance[Ω]> = 1E-9 to 1E+9 (NR3)
 RM3545 RM3545A <Reference Resistance[Ω]> = 1E-9 to 9E+9 (NR3)/CH1

Channel 1 can be set as a reference value when the multiplexer is used.

Example :CALC:LIM:REF 1.2E+3

The reference resistance is 1.2kΩ (regardless of range).

Note When the reference resistance is less than 1E-9, an execution error occurs.
 RM3545 RM3545A An execution error occurs during scanning.

Set and Query REF% Mode Judgment Range

Syntax Command **:CALCulate:LIMit:PERCent** <Range[%]>
 Query **:CALCulate:LIMit:PERCent?**
 Response <Range[%]>
 RM3544 <Range[%]> = 0 to 99.99 (NR2)
 RM3545 RM3545A
 <Range[%]> = 0 to 99.999 (NR2)

Example :CALC:LIM:PERC 1.5

Note RM3545 RM3545A An execution error occurs during scanning.

Query Judgment Result

Syntax Query **:CALCulate:LIMit:RESult?** RM3544
:CALCulate:LIMit:RESult? [<Channel number>]
 RM3545 RM3545A <Channel number> = 1 to 42
 Response <HI/IN/LO/OFF/ERR>

Description RM3545 RM3545A

The comparator result of the channel number is read by assigning a channel number to the data.

If a measurement has not been performed, **ERR** is returned. The channel number is not returned. If the channel number is omitted, the comparator result of the current channel is read.

Example :CALC:LIM:RES? ... Obtains the comparator result of the current channel.
 HI
 :CALC:LIM:RES? 10 ... Obtains the comparator result of Channel 10.
 IN

Set and Query PASS Judgment Condition RM3545 RM3545A

Syntax Command **:CALCulate:LIMit:JUDGe:CONDition** <Condition>
 Query **:CALCulate:LIMit:JUDGe:CONDition?**
 Response <Condition>
 <Condition> = OFF/IN/HI/LO/HILO/ALL

Example :CALC:LIM:JUDG:COND IN
 :CALC:LIM:JUDG:COND?
 IN

Note An execution error occurs during scanning.

Query PASS/FAIL Result RM3545 RM3545A

Syntax Query **:CALCulate:LIMit:JUDGe?** [**<Channel number>**]
 <Channel number> = 1 to 42
 Response **<PASS/FAIL/OFF/ERR>**

Description The PASS/FAIL result of the channel number is read by assigning a channel number to the data. If a measurement has not been performed, **OFF** is returned. The channel number is not returned. If the channel number is omitted, the comparator result of the current channel is read.

Example **:CALC:LIM:JUDG?** ... Obtains the PASS/FAIL result of the current channel.
PASS
:CALC:LIM:JUDG? 10 ... Obtains the PASS/FAIL result of Channel 10.
FAIL

Note When the front terminal is used or the scanning function is OFF, an execution error occurs.

Query Total Judgment Result RM3545 RM3545A

Syntax Query **:CALCulate:LIMit:JUDGe:TOTal?**
 Response **<PASS/FAIL/OFF/ERR>**

Example **:CALC:LIM:JUDG:TOT?**
PASS

Note When the front terminal is used or the scanning function is OFF, an execution error occurs. An execution error occurs during scanning. If a measurement has not been performed, **OFF** is returned.

(7) BIN Function RM3545 RM3545A

An execution error occurs during scanning.

Execute and Query BIN Measurement

Syntax Command **:CALCulate:BIN:STATe** **<1/0/ON/OFF>**
 Query **:CALCulate:BIN:STATe?**
 Response **<ON/OFF>**

Example **:CALC:BIN:STAT ON**
:CALC:BIN:STAT?
ON

Note When the BIN function is executed, the comparator function, auto range, and temperature conversion function all switch to OFF. In addition, the front terminal is used as a measurement terminal.

Set Mask Pattern

Syntax Command **:CALCulate:BIN:ENABle** **<Mask pattern>**
 Query **:CALCulate:BIN:ENABle?**
 Response **<Mask pattern (NR1)> = 0 to 1023 (decimal number)**
 "1" will be the BIN number bit used to execute the BIN measurement.

512	256	128	64	32	16	8	4	2	1
bit9	bit8	bit7	bit6	bit5	bit4	bit3	bit2	bit1	bit0
BIN9	BIN8	BIN7	BIN6	BIN5	BIN4	BIN3	BIN2	BIN1	BIN0

Example **:CALC:BIN:ENAB 15**
 BIN0 to BIN3 can be used.

Set and Query Judgment Mode

Syntax Command **:CALCulate:BIN:MODE** <BIN No.>, <ABSolute/REFerence>
 Query **:CALCulate:BIN:MODE?** <BIN No.>
 Response <ABSOLUTE/REFERENCE>
 <BIN No.> = 0 to 9
 <ABSOLUTE> = Upper threshold/Lower threshold comparison
 <REFERENCE> = Reference percentage/tolerance comparison

Example :CALC:BIN:MODE 0,ABS
 :CALC:BIN:MODE? 0
 ABSOLUTE

Set and Query ABS Mode Upper Comparator Threshold Values

Syntax Command **:CALCulate:BIN:UPPer** <BIN No.>, <Upper threshold>
 Query **:CALCulate:BIN:UPPer?** <BIN No.>
 Response <Upper threshold[Ω]>
 <Upper threshold[Ω]> = 0 to 9E+9 (NR3)

Example :CALC:BIN:UPPer 0,1.0
 The upper threshold is 1.0Ω (regardless of range).

Note The value will be 0 when the upper threshold is less than 1E-9.

Set and Query ABS Mode Lower Comparator Threshold Values

Syntax Command **:CALCulate:BIN:LOWer** <BIN No.>, <Lower threshold>
 Query **:CALCulate:BIN:LOWer?**
 Response <Lower threshold[Ω]>
 <Lower threshold[Ω]> = 0 to 9E+9 (NR3)

Example :CALC:BIN:LOW 0,0.9
 The lower threshold is 0.9Ω (regardless of range).

Note The value will be 0 when the lower threshold is less than 1E-9.

Set and Query REF% Mode Reference Resistance

Syntax Command **:CALCulate:BIN:REFerence** <BIN No.>, <Reference Resistance>
 Query **:CALCulate:BIN:REFerence?** <BIN No.>
 Response <Reference Resistance[Ω]>
 <BIN No.> = 0 to 9
 <Reference Resistance[Ω]> = 1E-9 to 9E+9 (NR3)

Example :CALC:BIN:REF 0,1.2E+3
 The reference resistance is 1.2kΩ (regardless of range).

Note When the reference resistance is less than 1E-9, a command error occurs.

Set and Query REF% Mode Judgment Range

Syntax Command **:CALCulate:BIN:PERCent** <BIN No.>, <Range[%]>
 Query **:CALCulate:BIN:PERCent?** <BIN No.>
 Response <Range[%]>
 <BIN No.> = 0 to 9
 <Range[%]> = 0 to 99.999 (NR2)

Example :CALC:BIN:PERC 0,1.5

Query Judgment Result

Syntax Query **:CALCulate:BIN:RESult?**
 Response **<Result (NR1)> = 0 to 1024 (decimal number)**
 "1" will be the BIN number bit for the PASS with BIN measurement.

1024

bit10	bit9	bit8	bit7	bit6	bit5
OB	BIN9	BIN8	BIN7	BIN6	BIN5
	bit4	bit3	bit2	bit1	bit0
	BIN4	BIN3	BIN2	BIN1	BIN0

Example **:CALC:BIN:RES?**
128
 BIN7 is PASS.

(8) Statistical Functions RM3545 RM3545A

- A data sample can be taken by the following three methods:
 1. Press the [ENTER] key.
 2. Input the TRIG signal from EXT I/O.
 3. Send a *TRG command.
 - The **:CALCulate:STATistics:STATe** command does not clear calculation results.
 - When the valid data count is 0, σ_{n-1} returns 0.
 - Even if the calculation results are cleared, the statistical calculation function does not switch to OFF.
 - The upper threshold of Cp and Cpk is 99.99. If Cp or Cpk exceeds 99.99, the value 99.99 is returned.
- An execution error occurs during scanning.

Execute Statistical Calculation

Syntax Command **:CALCulate:STATistics:STATe <1/0/ON/OFF>**
 Query **:CALCulate:STATistics:STATe?**
 Response **<ON/OFF>**

Example **:CALC:STAT:STAT ON**
:CALC:STAT:STAT?
ON

Note When the statistical calculation function is executed, the temperature conversion function switches to OFF.
 In addition, the front terminal is used as a measurement terminal.

Clear Statistical Calculation Results

Syntax Command **:CALCulate:STATistics:CLEar**

Query Data Count

Syntax Query **:CALCulate:STATistics:NUMBer?**
 Response **<Total data count (NR1)>, <Valid data count (NR1)>**
 Data count = 0 to 30000

Example **:CALC:STAT:NUMB?**
23456,23449

Query Mean Value

Syntax Query **:CALCulate:STATistics:MEAN?**
 Response **<Mean[Q] (NR3)>**

Example **:CALC:STAT:MEAN?**
11.4859E+03

Query Maximum Value

Syntax Query **:CALCulate:STATistics:MAXimum?**
 Response <Maximum value[Q] (NR3)>,<Data No. of Maximum value (NR1)>

Example :CALC:STAT:MAX?
 12.4859E+03,1124

Query Minimum Value

Syntax Query **:CALCulate:STATistics:MINimum?**
 Response <Minimum value[Q] (NR3)>,<Data No. of Minimum value (NR1)>

Example :CALC:STAT:MIN?
 10.4859E+03,1125

Query Comparator Results

Syntax Query **:CALCulate:STATistics:LIMit?**
 Response <Hi count (NR1)>,<IN count (NR1)>,<Lo count (NR1)>,
 <Measurement fault count (NR1)>,<Out-of-range count (NR1)>

Example :CALC:STAT:BIN?
 1516,9310,737,16,5

Query BIN Result

Syntax Query **:CALCulate:STATistics:BIN?**
 Response <BIN0 count (NR1)>,...<BIN9 count (NR1)>,<OUT count (NR1)>,
 <Measurement fault count (NR1)>

Example :CALC:STAT:BIN?
 1516,9310,10,10,10,10,10,10,10,10,100,737,16

Query Standard Deviation

Syntax Query **:CALCulate:STATistics:DEViation?**
 Response < σ_n [Q] (NR3)>,< σ_{n-1} [Q] (NR3)>

Example :CALC:STAT:DEV?
 0.0159E-3,0.0161E-3

Query Process Capability Indices

Syntax Query **:CALCulate:STATistics:CP?**
 Response <Cp (NR2)>,<Cpk (NR2)>

Example CALC:STAT:CP?
 0.86,0.14

(9) Scaling

RM3545 RM3545A An execution error occurs during scanning.

Execute and Query Scaling Function

Syntax Command **:CALCulate:SCALing:STATe** <1/0/ON/OFF>
 Query **:CALCulate:SCALing:STATe?**
 Response <ON/OFF>

Example :CALC:SCAL:STAT ON
 :CALC:SCAL:STAT?
 ON

Set and Query Scaling Correction Coefficient

Syntax	Command	:CALCulate:SCALing:PARAmeterA <Correction coefficient>
	Query	:CALCulate:SCALing:PARAmeterA?
	Response	<Correction coefficient (NR3)> <Correction coefficient> = 0.2000E-03 to 1.9999E+03
Example		:CALC:SCAL:PARA 2E+00
		:CALC:SCAL:PARA?
		0.2000E+00

Set and Query Scaling Offset

Syntax	Command	:CALCulate:SCALing:PARAmeterB <Offset>
	Query	:CALCulate:SCALing:PARAmeterB?
	Response	<Offset [Q]> RM3544 <Offset> = -1.0000E+09~1.0000E+09 RM3545 RM3545A <Offset> = -1.0000E+09~9.0000E+09
Example		:CALC:SCAL:PARB 1E+03
		:CALC:SCAL:PARB?
		1.0000E+03

Note When the offset is less than +/-1E-9, "0" will result.

Set and Query Scaling Unit

Syntax	Command	:CALCulate:SCALing:UNIT <Unit>
	Query	:CALCulate:SCALing:UNIT?
	Response	<Unit> <Unit> = OFF(no unit)/OHM[Q]/Any unit (any unit is character string data:maximum 3 characters) For information on character string data, see Data Formats. (p.4)
Example		:CALC:SCAL:UNIT "m"
		:CALC:SCAL:UNIT?
		"m"

(10) Temperature Conversion (ΔT) **RM3545** **RM3545A**

An execution error occurs during scanning.

Execute and Query Temperature Conversion (ΔT)

Syntax	Command	:CALCulate:TCONversion:DELTA:STATe <1/O/ON/OFF>
	Query	:CALCulate:TCONversion:DELTA:STATe?
	Response	<ON/OFF>
Example		:CALC:TCON:DELT:STAT ON
		:CALC:TCON:DELT:STAT ON?
		ON

Note When the temperature conversion function is executed, the comparator function, temperature correction function, BIN function, and statistical calculation function switch to OFF.

Set and Query Temperature Conversion (ΔT)

Syntax	Command	:CALCulate:TCONversion:DELTA:PARAmeter <Initial resistance>,<Initial temperature>,<Constant>
	Query	:CALCulate:TCONversion:DELTA:PARAmeter?
	Response	<Initial resistance[Q]>,<Initial temperature[°C]>,<Constant[°C]> <Initial resistance[Q]> = 0 to 9000.000E+6 (NR3) <Initial temperature[°C]> = -10.0 to 99.9 (NR2) <Constant[°C]> = -999.9 to 999.9 (NR2)
Example		:CALC:TCON:DELT:PAR 100,20,235
		:CALC:TCON:DELT:PAR?
		100.000E+0,20.0E+0,235.0

(11) Temperature Correction (TC)

RM3545 RM3545A An execution error occurs during scanning.

Execute and Query Temperature Correction (TC)

Syntax Command :**CALCulate:TCORrect:STATe** <1/0/ON/OFF>
 Query :**CALCulate:TCORrect:STATe?**
 Response <ON/OFF>

Example :**CALC:TCOR:STAT ON**
 :**CALC:TCOR:STAT?**
 ON

Note RM3545 RM3545A When the temperature correction function is executed, the temperature conversion function switches to OFF.

Set and Query Temperature Correction (TC)

Syntax Command :**CALCulate:TCORrect:PARAmeter**
 <Reference temperature>,<Temperature coefficient>
 Query :**CALCulate:TCORrect:PARAmeter?**
 Response <Reference temperature [°C]>,<Temperature coefficient [ppm/°C]>
 <Reference temperature[°C]> = -10.0 to 99.9 (NR2)

RM3544
 <Temperature coefficient [ppm/°C]> = -9999 to 9999 (NR1)
RM3545 RM3545A
 <Temperature coefficient [ppm/°C]> = -99999 to 99999 (NR1)

Example :**CALC:TCOR:PAR 20,3930**
 :**CALC:TCOR:PAR?**
 70.0,4500

(12) LCD Settings

RM3545 RM3545A An execution error occurs during scanning.

Set and Query Contrast

Syntax Command :**DISPlay:CONTRast** <0 to 100>
 Query :**DISPlay:CONTRast?**
 Response <0 to 100 (NR1)>

Example :**DISP:CONT 80**
 :**DISP:CONT?**
 80

Set and Query Backlight

Syntax Command :**DISPlay:BACKlight** <0 to 100>
 Query :**DISPlay:BACKlight?**
 Response <0 to 100 (NR1)>

Example :**DISP:BACK 50**
 :**DISP:BACK?**
 50

(13) Memory Functions RM3545 RM3545A

You can save and load up to 50 measurement data entries. This function cannot be used when a multiplexer is used. An execution error occurs.

This is enabled only with a remote command.

Measurement values are entered in memory through the [ENTER] key, TRIG signal, and *TRG command.

Set and Query Memory Functions

Syntax	Command	:MEMory:STATe <1/0/ON/OFF>
	Query	:MEMory:STATe?
	Response	<ON/OFF>

Note Changing the memory mode setting erases the stored data.

Example :MEM:STAT ON
:MEM:STAT?
ON

Clear Memory Data

Syntax	Command	:MEMory:CLEAr
Example		:MEM:CLE

Query Memory Data Count

Syntax	Query	:MEMory:COUNt?
	Response	<Memory data count (NR1) > = 0 to 50

Example :MEM:COUN?
3

Read Memory Data

Syntax	Query	:MEMory:DATA?
	Response	<Measurement value>,<Measurement value>,..., <Measurement value>

Description Measured values transferred from memory are separated by commas (","). The number of stored measurement values to be exported can be acquired by the **:MEMory:COUNt?** query.

See: "Measurement Value Formats" (p.26)

Note When fifty (50) measurement values have been entered into memory, no additional measurement values can be stored until the memory content is cleared.

(14) Hold

RM3545 RM3545A An execution error occurs during scanning.

Execute and Query Auto Hold

Syntax	Command	[:SENSe:]HOLD:AUTO <1/0/ON/OFF >
	Query	[:SENSe:]HOLD:AUTO?
	Response	<ON/OFF>

Example HOLD:AUTO ON
HOLD:AUTO?
ON

Note When auto hold is executed, **:INITIATE:CONTINUOUS ON** and internal trigger (trigger source <IMMEDIATE>) are enabled.

Query Auto Hold State

Syntax Query **[[:SENSe:]HOLD:STATe?**
 Response **<ON/OFF>**

Description Queries the current hold state.
 <ON> = HOLD indicator on the screen turns on, and hold is executed.
 <OFF> = HOLD indicator on the screen turns off, and hold is not executed.

Example **HOLD:STAT?**
ON

Cancel Hold

Syntax Command **[[:SENSe:]HOLD:OFF**

Description Cancels the hold state. (HOLD indicator on the screen turns off.)

Example **HOLD:OFF**

(15) Multiplexer Settings RM3545 RM3545A

- Also see “4 Multiplexer Commands (p.67)” for the multiplexer unit.

Set and Query Measurement Method

Syntax Command **[[:SENSe:]WIRE <4/2/W4/W2>**
 Query **[[:SENSe:]WIRE?**
 Response **<W4/W2>**
 <4/W4> = 4-wire type
 <2/W2> = 2-wire type

Example **WIRE W4**
WIRE?
W4

Note When the measurement method is switched, the multiplexer channel reset is activated. The multiplexer settings including the measurement conditions are reset. Make sure to determine the measurement method before measuring each channel. An execution error occurs during scanning.

Set and Query Scanning Function

Syntax Command **[[:SENSe:]SCAN:MODE <OFF/AUTO/STEP>**
 Query **[[:SENSe:]SCAN:MODE?**
 Response **<OFF/AUTO/STEP>**

Example **SCAN:MODE:AUTO**
SCAN:MODE?
AUTO

Note An execution error occurs during scanning.

Query Scanning Execution State

Syntax Query **[[:SENSe:]SCAN:STATe?**
 Response **<0/1/2 (NR1)>**

Description Responds with whether scanning is being executed or not.
 0 is returned when the scanning function is OFF or scanning is paused.
 1 is returned during auto scanning or step scanning.
 2 is returned during the scanning and the measuring.

Example (During step scanning)
 SCAN:STAT?
 1
 *TRG
 SCAN:STAT?
 1
 *TRG
 SCAN:STAT?
 0

Initialize Scan Channel and Measured Value or Judgment Value

Syntax Command **[[:SENSE:]]SCAN:RESet**

Description Returns the scan channel to the initial channel. Also, the measured value and judgment value are cleared and the instrument is set to the non-measurement state.

Set and Query Scan Fail Stop

Syntax Command **[[:SENSE:]]SCAN:FAIL:STOP <1/0/ON/OFF>**
 Query **[[:SENSE:]]SCAN:FAIL:STOP?**
 Response **<ON/OFF>**

Example :SCAN:FAIL:STOP ON
 :SCAN:FAIL:STOP?
 ON

Note An execution error occurs during scanning.

Read Scanned Measurement Data in a Batch

Syntax Query **[[:SENSE:]]SCAN:DATA?**
 Response **<Measured value>,<Measured value>, ...<Measured value>**

Description The measured values at the time of scanning completion are separated by commas (","),. Only the data with **[[:SENSE:]]STATe ON** is returned. The number of data items is the same as the channel count that can be obtained using a **[[:SENSE:]]CH:AVAIrable?** query. If a measurement has not been performed, the value for a measurement fault is returned. See: "Measurement Value Formats" (p.26)

Example CH:AVA?
 3
 SCAN:DATA?
 1023.579E-00,1000.000E-03, 100.0000E-03

Note An execution error occurs during scanning.

Query Connected to The Front Measurement Terminal

Syntax Query **[:SENSe:]FRONTcheck?**
 Response **<1/0 (NR1)>**
 <0> = A test lead is not connected to the front measurement terminal.
 <1> = A test lead is connected to the front measurement terminal.

Description If a test lead is connected to the front terminal, the data cannot be displayed properly when a measurement is performed using a multiplexer. When there is a possibility that a test lead may be connected to the front terminal, make sure to check that the response is 0.

Example Check the front measurement terminal.
FRON?
 0
 Measurement
READ?
 1020.000E-03, 100.000E-03, 100.000E-03

Note An execution error occurs during scanning.

Set and Query Channel Switching

Syntax Command **[:SENSe:]CH <FRONT/0/Channel number>**
 Query **[:SENSe:]CH?**
 Response **<FRONT/Channel number>**
 <FRONT><0> = The front terminal is used as a measurement terminal.
 <Channel number> = 1 to 42 (NR1) (The measurement terminal is used as a multiplexer.)

Description Sets the switching of the multiplexer channel and queries the current channel. The measurement conditions, measurement, and comparator result of each channel need to be set and obtained after the channel is switched.
 See: "4 Multiplexer Commands (p.67)".

Example The front terminal is used.
CH FRON
CH?
FRONT
 Check the front measurement terminal.
FRON?
 0
 Use a multiplexer and switch the channel to 10.
CH 10
CH?
 10

Note When the channel is not set to the front terminal, the statistical calculation function and memory function switch to OFF.
 If a test lead is connected to the front terminal, the data cannot be displayed properly when a measurement is performed using a multiplexer. When there is a possibility that a test lead may be connected to the front terminal, make sure to check that the response to the **[:SENSe:]FRONTcheck?** command is 0.
 An execution error occurs during scanning.

Set and Query Multiplexer Channel

Syntax Command **[:SENSe:]CH:STATe <1/0/ON/OFF>[,<Channel number>]**
 Query **[:SENSe:]CH:STATe? [<Channel number>]**
 Response **<ON/OFF>**
 <Channel number> = 1 to 42 (NR1)

Example **CH:STAT ON,10**
CH:STAT? 10
 ON

Note An execution error occurs during scanning.

Query Multiplexer Channel Count

Syntax Query **[:SENSe:]CH:AVAIable?**
 Response <Channel count (NR1)>

Description Only the number of the channels with [:SENSe:]CH:STATe ON is returned.

Example CH:AVA?
 20

Note An execution error occurs during scanning.

Setting and Query Multiplexer channel pin assignment

Syntax Command **[:SENSe:]INSTrument** <INTernal/EXTernal>
 Query **[:SENSe:]INSTrument?**
 Response <INTernal/ EXTernal>
 <INTernal> = Measurement using RM3545 and RM3545A
 <EXTernal> = Measurement using external equipment (multiplexer EX terminal is used.)

Example CH 10
 INST INT
 INST?
 INT

Note When the front terminal is used, an execution error occurs.
 An execution error occurs during scanning.

Set and Query Allocation of Multiplexer Channel Terminals

Syntax Command **[:SENSe:]TERMIal** <Unit number>,<A terminal number>,<B terminal number>
 Query **[:SENSe:]TERMIal?**
 Response <Unit number>,<A terminal number>,<B terminal number>
 <Unit number> = 1/2 (NR1)
 <Terminal A number> = 1 to 10 (NR1) for 4-wire type, 1 to 21 (NR1) for 2-wire type
 <Terminal B number> = 1 to 10 (NR1) for 4-wire type, 1 to 21 (NR1) for 2-wire type

Example CH 10
 TERM 1,1,2
 TERM?
 1,1,2

Note When the front terminal is used, an execution error occurs.
 The measurement current flows from terminal B to terminal A.
 An execution error occurs during scanning.

(16) Multiplexer Channel Reset RM3545 RM3545A

An execution error occurs during scanning.

Execute Multiplexer Channel Reset

Syntax Command **[:SENSe:]CHReset**

Description Initializes the multiplexer channel settings including the measurement conditions.

Note An execution error occurs when the front terminal is used as a measurement terminal or during scanning.

(17) Low-Power Resistance Measurement RM3545 RM3545A

An execution error occurs during scanning.

Set and Query Low-Power Resistance Measurement

Syntax	Command	<code>[:SENSe:]RESistance:LP:STATe <1/0/ON/OFF></code>
	Query	<code>[:SENSe:]RESistance:LP:STATe?</code>
	Response	<code><ON/OFF></code>

Example `RES:LP:STAT ON`
 Selects the Low-Power Resistance measurement.
`RES:LP:STAT?`
`OFF`
 The Resistance measurement has been selected.

(18) Pure Resistance measurement RM3545A

An execution error occurs during scanning.

Set and Query Low-Power Resistance Measurement

Syntax	Command	<code>[:SENSe:]RESistance:PR:STATe <1/0/ON/OFF></code>
	Query	<code>[:SENSe:]RESistance:PR:STATe?</code>
	Response	<code><ON/OFF></code>

Example `RES:LP:STAT ON`
 Selects the Pure Resistance measurement.
`RES:LP:STAT?`
`OFF`
 The Resistance measurement has been selected.

(19) Measurement Range

RM3545 RM3545A An execution error occurs during scanning.

Set and Query Resistance Measurement Range

Syntax	Command	<code>[:SENSe:]RESistance:RANGe <Expected measurement value></code>
	Query	<code>[:SENSe:]RESistance:RANGe?</code>
	Response	<code><Measurement Range (NR3)></code>

RM3544

`<Expected measurement value> = 0 to 3.5E+06`
`<Measurement Range (NR3)> = 30.000E-3/ 300.00E-3/ 3.0000E+0/
 30.000E+0/300.00E+0/ 3.0000E+3/
 30.000E+3/ 300.00E+3/3.0000E+6`

RM3545 RM3545A

`<Expected measurement value> = 0 to 1200E+06`
`<Measurement Range (NR3)> = 1000.000E-6 *1/
 10.00000E-3/100.0000E-3/1000.000E-3/
 10.00000E+0/100.0000E+0/1000.000E+0/
 10.00000E+3/100.0000E+3/1000.000E+3/
 10.00000E+6/100.0000E+6/1000.000E+6`

*1 : RM3545A only

Description Command
 Enter the expected measurement value. The instrument is set to the most suitable range for measuring the given numerical value data. When the scaling function is being used, set the `<Expected measurement value>` to the value that existed prior to scaling (value in range being used).
 When a range is set, the auto-range function will be automatically turned off.

Query

Queries the measurement range setting.

The setting will be that of Low-Power OFF. For the Low-Power ON setting, use:

```
[[:SENSe:]RESistance:LP:RANGe
[:SENSe:]RESistance:LP:RANGe?
```

Example

```
RES:RANG 95
```

RM3544 Sets the Resistance measurement to the 300Ω range.

RM3545 **RM3545A** Sets the Resistance measurement to the □ 100Ω range.

Note

RM3545 **RM3545A** When the multiplexer measurement method is the 2-line type, the measurement range is not set to 10Ω or less.

Set and Query Resistance Measurement Auto Range

Syntax	Command	[[:SENSe:]RESistance:RANGe:AUTO <1/0/ON/OFF>
	Query	[[:SENSe:]RESistance:RANGe:AUTO?
	Response	<ON/OFF>

Description The auto range setting will be the same for Low-Power OFF/ON.

Example

```
RES:RANG:AUTO OFF
RES:RANG:AUTO?
OFF
```

Note

An execution error occurs when the auto range is turned ON if the comparator function and BIN measurement function are ON.

Set and Query Low-Power Resistance Measurement Range **RM3545** **RM3545A**

Syntax	Command	[[:SENSe:]RESistance:LP:RANGe <Expected measurement value>
	Query	[[:SENSe:]RESistance:LP:RANGe?
	Response	<Measurement Range (NR3)>
		<Expected measurement value> = 0 to 1200E+00
		<Measurement Range (NR3)> = 1000.00E-03/10.0000E+00/100.000E+00/1000.00E+00

Description**Command**

Enter the expected measurement value. The instrument is set to the most suitable range for measuring the given numerical value data. When the scaling function is being used, set the <Expected measurement value> to the value that existed prior to scaling (value in range being used).

Query

Queries the measurement range setting.

The setting will be that of Low-Power ON. For the Low-Power OFF setting, use:

```
[[:SENSe:]RESistance:RANGe
[:SENSe:]RESistance:RANGe?
```

Example

```
RES:LP:RANG?
1000.00E+00
```

Low-Power Resistance measurement has been set to the 1000mΩ range.

(20) 100MΩ Range High Precision Function RM3545 RM3545A

An execution error occurs during scanning.

Set and Query 100MΩ Range High Precision Function RM3545 RM3545A

Syntax Command **[:SENSe:]RESistance:PRECision <1/0/ON/OFF>**
 Query **[:SENSe:]RESistance:PRECision?**
 Response **<ON/OFF>**

Description The 100MΩ range becomes the high precision mode. The 1000MΩ range cannot be used when the high precision function is ON.

Example **:RES:PREC ON**
:RES:PREC?
ON

(21) Switching Measurement Current RM3545 RM3545A

An execution error occurs during scanning.

Set and Query Measurement Current RM3545 RM3545A

Syntax Command **[:SENSe:]RESistance:CURREnt <HIGH/LOW>**
 Query **[:SENSe:]RESistance:CURREnt?**
 Response **<HIGH/LOW>**

Description The measurement current will be as shown in the table below.

Range	Measurement Current		Compatible models	
	High	Low	RM3545	RM3545A
1000 μΩ	1 A	-	-	√ (High only)
PR1000 μΩ*1			-	√ (High only)
10 mΩ	1 A	-	√ (High only)	√ (High only)
PR10 mΩ*1			-	√ (High only)
100 mΩ	1 A	100 mA	√	√
PR100 mΩ*1		-	-	√ (High only)
1000 mΩ	100 mA	10 mA	√	√
10 Ω	10 mA	1 mA	√	√
100 Ω	10 mA	1 mA	√	√

*1 : PR mode is RM3545A only

Example **:RES:CURR HIGH**
:RES:CURR?
HIGH

(22) Offset Voltage Correction Function (OVC) RM3545 RM3545A

An execution error occurs during scanning.

Set and Query Offset Voltage Correction Function (OVC)

Syntax	Command	[[:SENSE:]RESistance:OVC <1/0/ON/OFF>
	Query	[[:SENSE:]RESistance:OVC?
	Response	<ON/OFF>

Example RES:OVC ON
 RES:OVC?
 ON

Note When Low-Power is ON, the query response will definitely be ON.

(23) Contact Improver RM3545 RM3545A

An execution error occurs during scanning.

Set and Query Contact Improver Operating Mode

Syntax	Command	[[:SENSE:]RESistance:CIMProve <1/0/ON/OFF>
	Query	[[:SENSE:]RESistance:CIMProve?
	Response	<ON/OFF>

Example RES:CIMP ON
 RES:CIMP?
 ON

Note When Low-Power is ON, the query response will definitely be OFF.

(24) Current Error Mode

An execution error occurs during scanning.

Set and Query Current Error Mode

Syntax	Command	[[:SENSE:]RESistance:ERRor:CURRentcheck <ERRor/OVER>
	Query	[[:SENSE:]RESistance:ERRor:CURRentcheck?
	Response	<ERROR/OVER>

Example RES:ERR:CURR ERR
 RES:ERR:CURR?
 ERROR

<ERROR> = Current error
 <OVER> = Out-of-range

Set and Query Overrange external Err terminal RM3545A

Syntax Command **:SENSe:RESistance:ERRor:OVER** <ERRor/NORMal>
 Query **:SENSe:RESistance:ERRor:OVER?**
 Response <ERRor/NORMal>
 <ERRor> = External Err terminal output when over range
 <NORMal> = External Err terminal does not output when over range

Description Use when you want to distinguish between over range and Hi/Lo during judgment.
Note *RST command does not revert to default.
 :SYSTem:RESet returns to default.

(25) Contact Check RM3545 RM3545A

An execution error occurs during scanning. Contact check errors can be checked using the event status register.(p.25)

Set and Query Resistance Measurement Contact Check

Syntax Command **[:SENSe:]RESistance:CONtactcheck** <1/0/ON/OFF>
 Query **[:SENSe:]RESistance:CONtactcheck?**
 Response <ON/OFF>

Description The setting will be that of Low-Power OFF. For the Low-Power ON setting, use:
 [:SENSe:]RESistance:LP:CONtactcheck
 [:SENSe:]RESistance:LP:CONtactcheck?

Example RES:CONt ON
 RES:CONt?
 ON

Note Contact check cannot be ON when the multiplexer measurement method is the 2-wire type. An execution error occurs.

Set and Query Low-Power Resistance Measurement Contact Check

Syntax Command **[:SENSe:]RESistance:LP:CONtactcheck** <1/0/ON/OFF>
 Query **[:SENSe:]RESistance:LP:CONtactcheck?**
 Response <ON/OFF>

Description The setting will be that of Low-Power ON. For the Low-Power OFF setting, use:
 [:SENSe:]RESistance:CONtactcheck
 [:SENSe:]RESistance:CONtactcheck?

Example RES:LP:CONt ON
 RES:LP:CONt?
 ON

(26) Setting Number of Digits

RM3545 RM3545A An execution error occurs during scanning.

Set and Query Measurement Value's Number of Digits

Syntax Command **[:SENSe:]RESistance:DIGits** <Number of digits>
 Query **[:SENSe:]RESistance:DIGits?**
 Response <Number of digits>

Example RM3544 <Number of digits> = 4/5 (NR1)
RM3545 RM3545A <Number of digits> = 5/6/7 (NR1)
 :RES:DIG 5
 :RES:DIG?
 5

Note When Low-Power is ON, six (6) digits will actually be displayed even when the number of digits is set to seven (7).

(27) Temperature Measurement (Analog Input) RM3545 RM3545A

An execution error occurs during scanning.

Select and Query Temperature Sensor

Syntax Command **[:SENSE:]TEMPerature:SENSor <THERmistor/ANALog>**
 Query **[:SENSE:]TEMPerature:SENSor?**
 Response **<THERMISTOR/ANALOG>**
 <THERMISTOR> = Z2001 temperature sensor is used as the temperature sensor.
 <ANALOG> = Analog output thermometer is used as the temperature sensor.

Example TEMP:SENS ANAL
 TEMP:SENS?
 ANALOG

Set and Query Analog Input Parameters

Syntax Command **[:SENSE:]TEMPerature:PARAmeter
<V1>,<T1>,<V2>,<T2>**
 Query **[:SENSE:]TEMPerature:PARAmeter?**
 Response **<V1>,<T1>,<V2>,<T2>**
 <V1> = 0 to 2.00 (NR2).....Reference voltage 1 [V]
 <T1> = -99.9 to 999.9 (NR2).....Reference temperature 1 [°C]
 <V2> = 0 to 2.00 (NR2).....Reference voltage 2 [V]
 <T2> = -99.9 to 999.9 (NR2).....Reference temperature 2 [°C]

Example TEMP:PAR 0,-10,2,100
 TEMP:PAR?
 0.00,0.00,1.00,100.0
 0°C is displayed with 0 V, and 100°C is displayed with 1 V.

(28) Triggering

Relationship between Trigger Source and Continuous Measurement Operation

Operation depends on the continuous measurement setting (:INITIATE:CONTINUOUS) (p.56) and the trigger source setting (:TRIGGER:SOURCE) (p.56) as follows.

See: "4 Data Exporting Methods" (p.71)

Also see "4 Multiplexer Commands (p.67)" for the multiplexer unit.

- **RM3544**, **RM3545** and **RM3545A** When the front measurement terminal is used or the scanning function is set to OFF (:SENSE:SCAN:MODE OFF)

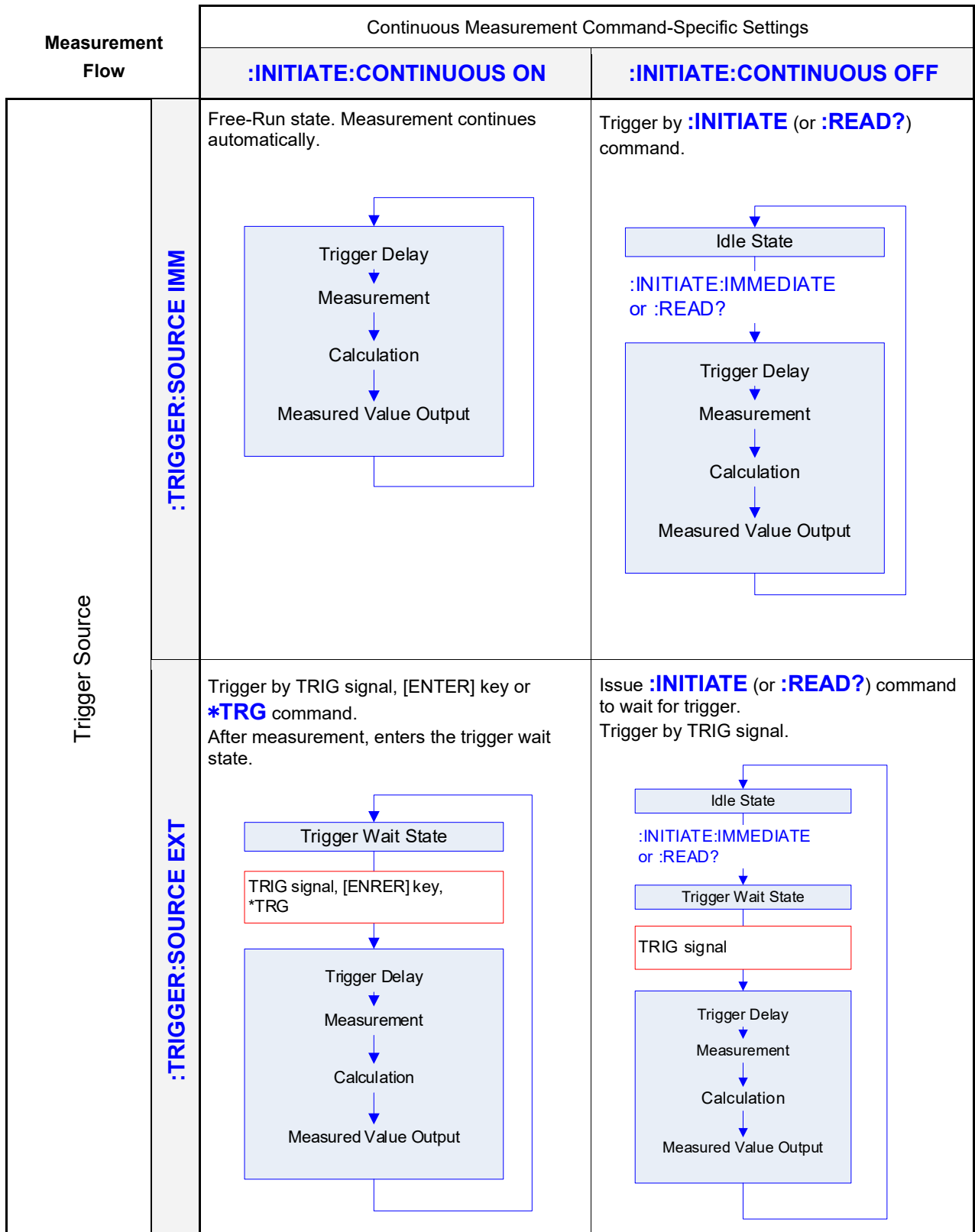

• RM3545 RM3545A When the scanning function is set to AUTO (:SENSE:SCAN:MODE AUTO)

Measurement flow		Continuous Measurement Command-Specific Settings	
		:INITIATE:CONTINUOUS ON	:INITIATE:CONTINUOUS OFF
Trigger Source	:TRIGGER:SOURCE IMM	<p>Triggered by :INITIATE (or :READ?) command.</p>	<p>Triggered by :INITIATE (or :READ?) command to enter the Trigger Wait State. Triggered by TRIG signal.</p>
	:TRIGGER:SOURCE EXT	<p>Triggered by TRIG signal, [ENTER] key, or *TRG command. After measurement, enters the Trigger Wait State.</p>	<p>Issue :INITIATE (or :READ?) command to enter the Trigger Wait State. Triggered by TRIG signal.</p>

- RM3545 RM3545A When the scanning function is set to STEP (:SENSE:SCAN:MODE STEP)

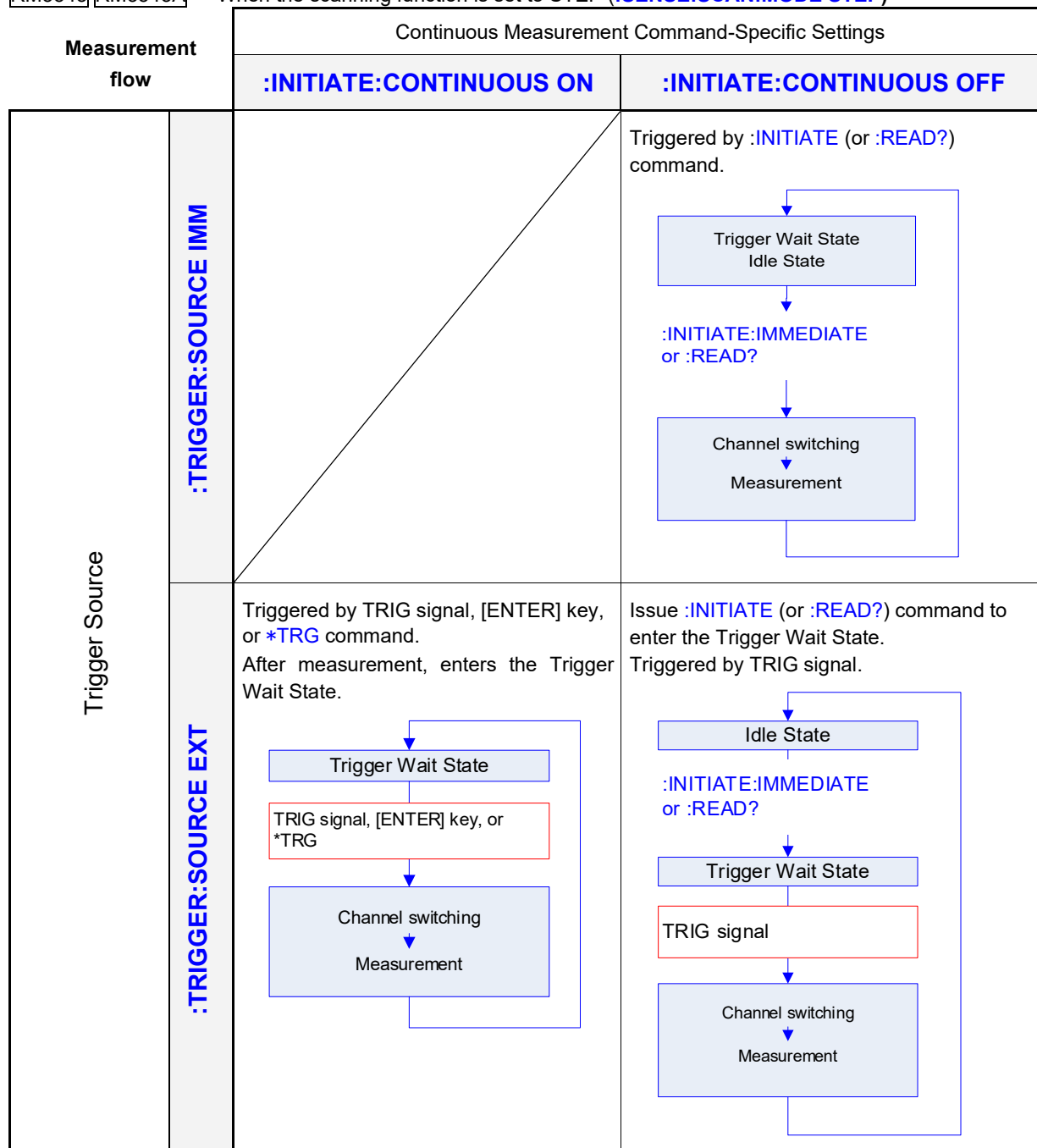

The :INITIATE:CONTINUOUS OFF is can only be set by Remote command.

If this has been set to OFF, when operation is returned to the Local state or power is turned off, the :INITIATE:CONTINUOUS ON state occurs when power is turned back on.

See "Return to Local Control" (p.60) or Exporting measured values: "Data Exporting Methods" (p.71)

Set and Query Continuous Measurement

Syntax Command **:INITiate:CONTinuous** <1/0/ON/OFF>
 Query **:INITiate:CONTinuous?**
 Response <ON/OFF>
 <ON> = Continuous Measurement Enabled
 <OFF> = Continuous Measurement Disabled

Description

- Continuous Measurement Enabled:
After measurement, enters the Trigger Wait State. When there is an internal trigger (trigger source <IMMEDIATE>), the next trigger is promptly generated and enters a free run state.
- Continuous Measurement Disabled:
After measurement, enters the Idle State instead of the Trigger Wait State.
- Triggering is ignored in the Idle State. Executing :INITiate[:IMMediate] enables the Trigger Wait State.
- Continuous measurement is enabled upon exiting from the Remote State.

Example :INIT:CONT OFF
 :INIT:CONT?
 ON

Note RM3545 RM3545A An execution error occurs during scanning.

Set Trigger Wait

Syntax Command **:INITiate[:IMMediate]**

Description Switches triggering from the Idle State to the Trigger Wait State.

Example Disable continuous measurement, and read one value for each trigger event.
 Sending
 :TRIG:SOUR IMM Trigger immediately when entering Trigger Wait State.
 :INIT:CONT OFF Disables continuous measurement.
 :INIT Enable Trigger Wait. Trigger immediately upon :TRIG:SOUR IMM.

Note

- When this message is received, automatically switches to **:INITiate:CONTINUOUS OFF**.
- When there is an internal trigger (trigger source <IMMEDIATE>), triggering promptly occurs and enters the idle state.
- When there is an external trigger (trigger source <EXTERNAL>), the external trigger wait state is entered. When a trigger is received, a single measurement is performed and enters the idle state.

Set and Query Trigger Source

Syntax Command **:TRIGger:SOURce** <IMMediate/EXTernal>
 Query **:TRIGger:SOURce?**
 Response <IMMEDIATE/EXTERNAL>
 <IMMEDIATE> = Internal triggering
 <EXTERNAL> = External triggering

Example :TRIG:SOUR IMM
 :TRIG:SOUR?
 IMMEDIATE

Note RM3545 RM3545A An execution error occurs during scanning.

Set and Query Trigger Signal Logic

Syntax Command **:TRIGger:EDGE** <1/0/ON/OFF>
 Query **:TRIGger:EDGE?**
 Response <ON/OFF>
 <ON> = ON edge (OFF→ON)
 <OFF> = OFF edge (ON→OFF)

Example :TRIG:EDGE ON
 :TRIG:EDGE?
 ON

Note RM3545 RM3545A An execution error occurs during scanning.

(29) Delay RM3545 RM3545A

An execution error occurs during scanning.

Set and Query Delay

Syntax Command **:TRIGger:DELay** <Delay time>
 Query **:TRIGger:DELay?**
 Response <Delay time>
 <Delay time> = 0 to 9.999 (NR2) [sec]

Example :TRIG:DEL 0.01
 :TRIG:DEL?
 0.010

Note When the delay is at the default setting (:TRIGger:DELay:AUTO ON), setting values are invalid (disabled). When setting the delay, be sure to turn the default setting OFF.

Set and Query Delay Default

Syntax Command **:TRIGger:DELay:AUTO** <1/0/ON/OFF>
 Query **:TRIGger:DELay:AUTO?**
 Response <ON/OFF>

Setting When the auto delay (preset setting) is set to ON, the delay will be the value specified internally.
 When set to OFF, the set delay value (:TRIGger:DELay <delay time>) will govern.

Example :TRIG:DEL:AUTO ON
 :TRIG:DEL:AUTO?
 ON

(30) Self-Calibration RM3545 RM3545A

An execution error occurs during scanning.

Execute Self-Calibration

Syntax Command **:SYSTem:CALibration**

Note If this command is received while measuring, self-calibration executes after the measurement is finished.

Execute and Set Self-Calibration

Syntax Command **:SYSTem:CALibration:AUTO** <1/0/ON/OFF>
 Query **:SYSTem:CALibration:AUTO?**
 Response <ON/OFF>

<ON> = AUTO Self-Calibration selected
 <OFF> = MANUAL Self-Calibration selected

Example :SYST:CAL:AUTO OFF
 :SYST:CAL:AUTO?
 OFF

(31) Saving and Reading Measurement Conditions

RM3545 RM3545A An execution error occurs during scanning.

Save and Read Measurement Conditions

Syntax Command :SYSTEM:PANel:SAVE <Table No>
 :SYSTEM:PANel:LOAD <Table No>,<Zero adjustment load>
RM3544 <Table No> = 1 to 10 (NR1)
RM3545 RM3545A
 <Table No> = 1 to 30 (NR1) (When the front terminal is used as a
 measurement terminal.)/31 to 38 (NR1)
 (When the multiplexer is used as a measurement terminal.)
 <Zero adjustment load> = 1/0/ON/OFF
 <ON> = Zero adjustment value is also read during panel loading.
 <OFF> = Zero adjustment is not read during panel loading.

Example :SYST:PAN:SAVE 10
 :SYST:PAN:LOAD 5,OFF

Note When the measurement conditions for the Table No. have already been saved and :SYSTEM:PANel:SAVE is executed, the measurement conditions will be overwritten.
 When the Table No. that does not have the measurement conditions is specified and :SYSTEM: PANel:LOAD is executed., an execution error will occur.
RM3545 RM3545A When the front terminal is used as a measurement terminal, the measurement conditions cannot be saved to 31 to 38. When the multiplexer is used, the measurement conditions cannot be saved to 1 to 30. When a test lead is connected to the front measurement terminal, cannot be read to 31 to 38. An execution error occurs in either case.

Set and Query Panel Name

Syntax Command :SYSTEM:PANel:NAME <Table No>,<Panel name (character string data: maximum 10 characters)>
 Query :SYSTEM:PANel:NAME? <Table No>
 Response <Table No>,<Panel name (character string data: maximum 10 characters)>
RM3544 <Table No> = 1 to 10 (NR1)
RM3545 RM3545A <Table No> = 1 to 38 (NR1)
 For information on character string data, see Data Formats. (p.4)

Example :SYST:PAN:NAME 1,"PANEL_1"
 :SYST:PAN:NAME? 1
 1,"PANEL_1"

Clear Panel

Syntax Command :SYSTEM:PANel:CLEAR <Table No>
RM3544 <Table No> = 1 to 10 (NR1)
RM3545 RM3545A <Table No> = 1 to 38 (NR1)

Example :SYST:PAN:CLE 10

(32) Key-Lock

RM3545 RM3545A An execution error occurs during scanning.

Set and Query Key-Lock State

Syntax Command **:SYSTEM:KLOCK <1/0/ON/OFF>**
 Query **:SYSTEM:KLOCK?**
 Response **<ON/MENU/OFF>**

Description Switches to FULL key-lock state. (Prohibits all setting changes by key operation.) MENU is returned during MENU key-lock state. the scanning and the measuring.

Example :SYST:KLOC ON
 :SYST:KLOCK?
 ON

(33) Line Frequency

RM3545 RM3545A An execution error occurs during scanning.

Set and Query Line Frequency

Syntax Command **:SYSTEM:LFRrequency <AUTO/50/60>**
 Query **:SYSTEM:LFRrequency?**
 Response **<AUTO/50/60>**

Example :SYST:LFR 50
 :SYST:LFR?
 50

(34) Clock RM3545 RM3545A

An execution error occurs during scanning.

Set and Query System Date

Syntax Command **:SYSTEM:DATE <Year>,<Month>,<Day>**
 Query **:SYSTEM:DATE?**
 Response **<Year>,<Month>,<Day>**
 <Year> = 00 to 99 (NR1)
 <Month> = 01 to 12 (NR1)
 <Day> = 01 to 31 (NR1)

Description Sets and queries the date of the real-time system clock.

Example :SYST:DATE 13,01,10
 Sets the date to January 10, 2013.
 :SYST:DATE?
 13,12,10

The date is December 10, 2013.
Note Attempting to set an out-of-range numerical value returns an execution error. Attempting to set a non-existent date (such as 13,06,31) returns an execution error.

Set and Query System Time

Syntax Command **:SYSTEM:TIME** <Hour>,<Minute>,<Second>
 Query **:SYSTEM:TIME?**
 Response <Hour>,<Minute>,<Second>
 <Hour> = 00 to 23 (NR1)
 <Minute> = 00 to 59 (NR1)
 <Second> = 00 to 59 (NR1)

Description Sets the time of the real-time system clock.

Example **:SYST:TIME 08,25,00**
 Sets the time to 8:25 and 00 seconds.
:SYST:TIME?
 23,09,53

The time is 23:09 and 53 seconds.
Note Attempting to set an out-of-range numerical value returns an execution error. Attempting to set a non-existent time (such as 09,06,71) returns an execution error.

(35) Key Beeper

RM3545 RM3545A An execution error occurs during scanning.

Set and Query Key Beeper

Syntax Command **:SYSTEM:BEEPer:STATE** <1/0/ON/OFF>
 Query **:SYSTEM:BEEPer:STATE?**
 Response <ON/OFF>

Example **:SYST:BEEP:STAT ON**
:SYST:BEEP:STAT?
 ON

(36) Communications Settings

RM3545 RM3545A An execution error occurs during scanning.

Return to Local Control

Syntax Command **:SYSTEM:LOCAl**
Description Disables communications remote control and re-enables local control. The panel keys are re-enabled.

Example **:SYST:LOC**

Set and Query Measurement-Synchronized Data Output [RS-232C/USB/LAN]

Syntax Command **:SYSTEM:DATAout** <1/0/ON/OFF>
 Query **:SYSTEM:DATAout?**
 Response <ON/OFF>

Description <ON> = With an external trigger (trigger source <EXTERNAL>), measurement values are automatically sent when trigger measurements are completed. When there is an internal trigger (trigger source <IMMEDIATE>), measurement values are automatically sent when the [ENTER] key is pressed and TRIG signal have been input.
 <OFF> = Measured values are not automatically sent.

Note This command is not applicable to the GP-IB Interface.

Set and Query Header Presence

Syntax Command :**SYSTem:HEADer** <1/0/ON/OFF>
 Query :**SYSTem:HEADer?**
 Response <ON/OFF>

Example :SYST:HEAD ON
 :SYST:HEAD?
 :SYSTEM:HEADER ON
 :SYST:HEAD OFF
 :SYST:HEAD?
 OFF

Note When turning the power on or after the *RST command, this is initialized to OFF (no header).

Set and Query Delimiter

Syntax Command :**SYSTem:TERMinator** <0/1>
 Query :**SYSTem:TERMinator?**
 Response <0/1>
 <0> = LF+EOI
 <1> = CR, LF+EOI

Example :SYST:TERM 1
 :SYST:TERM?
 0

Note

- At power-on, this is set to 0 (LF+EOI).
- The RS-232C/USB/LAN delimiter is fixed as CR+LF.

Set and Query Communication interface

Syntax Command :**SYSTem:COMMunicate** <USB/LAN/RS232c/PRINter>
 Query :**SYSTem:COMMunicate?**
 Response <USB/LAN/RS232C/PRINTER>
 <USB> = USB
 <LAN> = LAN RM3545A
 <RS232c> = RS232C
 <PRINter> = PRINTER(RS232C)

Description Configure and inquire about communication interfaces

Example :SYST:COMM USB
 :SYST:COMM?
 USB

Note Changes the interface upon receiving a command.
 (Communication during command will be disconnected)

Set and Query Command Monitor

Syntax Command :**SYSTem:COMMunicate:MONitor** <1/0/ON/OFF>
 Query :**SYSTem:COMMunicate:MONitor?**
 Response <ON/ OFF>
 <1/ON> = display ON
 <0/OFF> =display OFF

Description Configure the command monitor.
Note

Set and Query IP Address RM3545A

Syntax Command :**SYSTem:COMMunicate:LAN:IPADdress** <IP address>
 Query :**SYSTem:COMMunicate:LAN:IPADdress?**
 Response <IP address>
 <IP address> = nnn,nnn,nnn,nnn

Description Sets and queries the LAN IP address.
Example :SYST:COMM:LAN:IPAD 192,168,1,2
 :SYST:COMM:LAN:UPD
 :SYST:COMM:LAN:IPAD?
 192,168,1,2

Note Updates are reflected when you run ":SYSTem:COMMunicate:LAN:UPDate"
 Parameter separator is ",". Please do not separate with "."

Set and Query LAN sub-net mask RM3545A

Syntax Command :**SYSTem:COMMunicate:LAN:SMASK** <subnet mask>
 Query :**SYSTem:COMMunicate:LAN:SMASK?**
 Response <subnet mask>
 <subnet mask> = nnn,nnn,nnn,nnn

Description Sets and queries the LAN subnet mask.
Example :SYST:COMM:LAN:SMAS 255,255,0,0
 :SYST:COMM:LAN:UPD
 :SYST:COMM:LAN:SMAS?
 255,255,0,0

Note Updates are reflected when you run ":SYSTem:COMMunicate:LAN:UPDate"
 Parameter separator is ",". Please do not separate with "."

Set and Query LAN gateway RM3545A

Syntax Command :**SYSTem:COMMunicate:LAN:GATeway** <gateway>
 Query :**SYSTem:COMMunicate:LAN:GATeway?**
 Response <gateway>
 <gateway> = nnn,nnn,nnn,nnn

Description Sets and queries the LAN gateway.
Example :SYST:COMM:LAN:GAT 192,168,1,1
 :SYST:COMM:LAN:UPD
 :SYST:COMM:LAN:GAT?
 192,168,1,1

Note Updates are reflected when you run ":SYSTem:COMMunicate:LAN:UPDate"
 Parameter separator is ",". Please do not separate with "."

Set and Query LAN port RM3545A

Syntax Command :**SYSTem:COMMunicate:LAN:CONTrol** <port NO.>
 Query :**SYSTem:COMMunicate:LAN:CONTrol?**
 Response <port NO.>
 <port No.> = 11~65535(80 is excluded)

Description Sets and queries the LAN port number.
Example :SYST:COMM:LAN:CONT 3545
 :SYST:COMM:LAN:UPD
 :SYST:COMM:LAN:CONT?
 3545

Note Updates are reflected when you run ":SYSTem:COMMunicate:LAN:UPDate"

Query MAC address RM3545A

Syntax	Query	:SYSTem:COMMunicate:LAN:MAC?
	Response	<MAC address>
Description	It will respond with the LAN MAC address as a hexadecimal string separated by hyphens.	
Example	:SYST:COMM:LAN:MAC? "00-01-67-07-03-85"	

Update LAN settings RM3545A

Syntax	Command	:SYSTem:COMMunicate:LAN:UPDate
Description	If you change the LAN IP address, subnet mask, gateway, or port using a command, it will be reflected using this command.	
Note	If communicating via LAN, the connection will be disconnected.	

Set and Query RS-232C Communication speed RM3545A

Syntax	Command	:SYSTem:COMMunicate:RS232C:SPEED <baud rate>
	Query	:SYSTem:COMMunicate:RS232C:SPEED?
	Response	<baud rate>
	<baud rate> = 9600/19200/38400/115200 (NR1)	
Description	Change and inquire about RS-232C communication speed.	
Example	:SYST:COMM:RS232C 9600 :SYST:COMM:RS232C:SPEED? 9600	

Note**(37) System Reset**

RM3545 RM3545A An execution error occurs during scanning.

Execute System Reset

Syntax	Command	:SYSTem:RESet
Description	Initializes all except communications and clock settings. After initialization, panel data, too, is initialized.	

(38) EXT I/O

RM3545 RM3545A An execution error occurs during scanning.

Query NPN/PNP Switch Status

Syntax Query **:IO:MODE?**
Response **<NPN/PNP>**

Example **:IO:MODE?**
NPN

External I/O Input

Syntax Query **:IO:INPut?**
Response **0 to 3 (NR1)**

Description Reads the ON edge of TRIG of the EXT I/O and the PRINT terminal, and then clears them. (If the trigger signal edge has the OFF edge setting, the TRIG terminal reads the OFF edge.)

When the edge is detected, the bits are set. When reading is performed through this query, it is cleared to 0. Also, input by key is also detected in the same manner as signals.

	bit7	bit6	bit5	bit4	bit3	bit2	bit1	bit0
	-	-	-	-	-	-	PRINT	TRIG
Pin No.	-	-	-	-	-	-	26	1

See the instrument instruction manual regarding external control (EXT I/O) as well.

Note While the filter setting of the input signal is ON, the edge after the set filter time will be read.

External I/O Output

Syntax Command **:IO:OUTPut <Output data 0 to 7>**

Description When the judgment output mode is selected with the EXT I/O output mode, any 3-bit data can be output from the EXT I/O terminal.

	bit7	bit6	bit5	bit4	bit3	bit2	bit1	bit0
	-	-	-	-	-	OUT2	OUT1	OUT0
Pin No.	-	-	-	-	-	19	37	18

See the instrument instruction manual regarding external control (EXT I/O) as well.

Execute and Query TRIG/PRINT Signal's Filter Function

Syntax Command **:IO:FILTer:STATe <1/0/ON/OFF>**
Query **:IO:FILTer:STATe?**
Response **<ON/OFF>**

Example **:IO:FILT:STAT ON**
:IO:FILT:STAT?
ON

Set and Query TRIG/PRINT Signal's Filter Time

Syntax Command **:IO:FILTer:TIME <Filter time>**
Query **:IO:FILTer:TIME?**
Response **<Filter time>**

<Filter time> = 0.05 to 0.50 (NR2) [sec]

Example **:IO:FILT:TIME 0.1**
:IO:FILT:TIME?
0.10

Set and Query Judgment Mode/BCD Mode

Syntax Command **:IO:JUDGe:MODE** <JUDge/BCD>
 Query **:IO:JUDGe:MODE?**
 Response <JUDGE/BCD>
 <JUDGE> = Judgment mode
 <BCD> = BCD mode

Example :IO:JUDG:MODE BCD
 :IO:JUDG:MODE?
 BCD

Set and Query EOM Output Method

Syntax Command **:IO:EOM:MODE** <HOLD/PULSe>
 Query **:IO:EOM:MODE?**
 Response <HOLD/ PULSE>
 <HOLD> = Holds the EOM signal until measurement starts by the next trigger signal.
 <PULSE> = Sets EOM=OFF according to the specified pulse width.

Example :IO:EOM:MODE PULS
 :IO:EOM:MODE?
 PULSE

Set and Query EOM Pulse Width

Syntax Command **:IO:EOM:PULSe** <Pulse width>
 Query **:IO:EOM:PULSe?**
 Response <Pulse width (NR2)>
 <Pulse width> = 0.001 to 0.100 (NR2) [sec]

Example :IO:EOM:PULS 0.005
 :IO:EOM:PULS?
 0.005

(39) Multiplexer Unit RM3545 RM3545A

- Also see 4 Multiplexer Commands (p.67) for the multiplexer unit.
An execution error occurs during scanning.

Query Unit

Syntax Query **:UNIT:IDN?** <Unit number>
<Unit number> = 1/2
Response <Model name>,<Serial number>
If the unit is not inserted: <Model name> = NONE

Example :UNIT:IDN? 1
Z3003,123456789

Query Relay Usage Count

Syntax Query **:UNIT:SCOut?** <Unit number>
<Unit number> = 1/2
Response <Relay count (NR1)>

Description Responds with the count of the relay with the highest usage count of all the relays for each unit.
-1 is returned if the unit is not inserted and an execution error occurs.

Example :UNIT:SCO? 1
10000

Query Multiplexer Unit Test Execution and Result

Syntax Query **:UNIT:TEST?** <Unit number>
<Unit number> = 1/2
Response <0 to 8 (NR1)>

128	64	32	16	8	4	2	1
bit7	bit6	bit5	bit7	bit3	bit2	bit1	bit0
Unused	Unused	Unused	Unused	NO UNIT	Blown FUSE	FRONT ERR	UNIT ERR

Description Performs a multiplexer test and responds with the result in NR1 number (0 to 4).
0 is returned if there is no error.
UNIT ERR(1)
Multiplexer short circuit resistance check error
FRONT ERR(2)
When a test lead is connected to the front measurement terminal. Remove the test lead and execute the test again.
Blown FUSE (4)
The fuse on the back of the instrument for measurement terminal protection has been blown. Replace the fuse and execute the test again.
NO UNIT(8)
The unit is not inserted. Insert the unit and execute the test again.
For information on unit test, see the instrument instruction manual.

Example :UNIT:TEST? 1
0

Note RM3545 RM3545A An execution error occurs during scanning.

4 Multiplexer Commands

RM3545

RM3545A

Multiplexer Settings

There are two types of multiplexer commands, commands for individual channels and those common to all channels. The commands for individual channels are applied to the current channel. When specifying a channel, it is necessary to switch the channel in advance.

Check Message List to see the type of each command.

For example, `[[:SENSe:]:RESistance:RANGe]` is a command for individual channels and `[[:SENSe:]:RESistance:DIGits]` is a command common to all channels. An example of command communication is shown below.

<code>CH?</code>	
<code>5</code>	The current channel number is 5.
<code>RES:RANG?</code>	
<code>1</code>	The resistance range of Channel 5 is 1Ω.
<code>RES:DIG?</code>	
<code>7</code>	The number of digits is 7 and this is common to all channels.
<code>CH 3</code>	Switches the channel number to 3.
<code>RES:RANG 10</code>	Switches the resistance range of Channel 3 to 10Ω.
<code>RES:DIG 6</code>	The number of digits is 6 and this is common to all channels.

The state after command execution is as follows.

- Current channel: 3
- State of each channel

Channel	Measurement range	Number of digits
3	10Ω range	6
5	1Ω range	

Example A1: Setting all channels in a batch

<code>CH:STAT ON,1</code>	Channel 1 is used.
<code>CH:STAT ON,2</code>	Channel 2 is used.
<code>CH:STAT ON,3</code>	Channel 3 is used.
<code>CH 1</code>	Channel 1 settings
<code>TERM 1,1,2</code>	Measures between Unit 1 TERM 1 and TERM 2.
<code>RES:RANG 10E-03</code>	Sets the range.
<code>:CALC:LIM:STAT ON</code>	Sets the comparator.
<code>:CALC:LIM:UPP 10E-03</code>	
<code>:CALC:LIM:LOW 1E-03</code>	
<code>:CALC:LIM:JUDG:COND IN</code>	
<code>CH 2</code>	Channel 2 settings
<code>TERM 1,3,4</code>	Measures between Unit 1 TERM 3 and TERM 4
<code>RES:RANG 10E-03</code>	Sets the range.
<code>:CALC:LIM:STAT ON</code>	Sets the comparator.
<code>:CALC:LIM:UPP 8E-03</code>	
<code>:CALC:LIM:LOW 3E-03</code>	
<code>:CALC:LIM:JUDG:COND IN</code>	

Example A2: Performing a measurement while switching the terminal

:INIT:CONT ON	Continuous measurement ON
:TRIG:SOUR IMM	Internal trigger
SCAN:MODE OFF	Scan OFF
CH:STAT ON,1	Channel 1 is used.
CH 1	Channel 1 settings
TERM 1,1,2	Measures between Unit 1 TERM 1 and TERM 2.
:FETC?	
10.00000E+00	
TERM 1,3,4	Measures between Unit 1 TERM 3 and TERM 4.
:FETC?	
20.00000E+00	
TERM 1,5,6	Measures between Unit 1 TERM 5 and TERM 6.
:FETC?	
30.00000E+00	

Multiplexer Measurement

Using a multiplexer, a measurement can be performed in various ways when the scanning function, trigger source, and continuous measurement are combined.

See: Triggering (p.53), "4 Data Exporting Methods" (p.71)

- (1) Performing a measurement while the channel is switched by a command without using the scanning function

Example B1-1 Activating the trigger using a command with continuous measurement OFF

SCAN:MODE OFF	Scan OFF
:TRIG:SOUR IMM	Internal trigger
:INIT:CONT OFF	Continuous measurement OFF
CH:STAT ON,1	Selects the channel to be used.
CH:STAT ON,2	
CH 1	Switches the channel.
:READ?	Reads the measured value.
1020.000E-03	
CH 2	Switches the channel.
:READ?	Reads the measured value.
100.000E-03	

- (2) Executing scanning using a command

Example B2-1 When the scanning function is set to AUTO (SCAN:MODE AUTO)

SCAN:MODE:AUTO	Scanning function: AUTO
:TRIG:SOUR IMM	Internal trigger (continuous measurement OFF)
CH:STAT ON,1	Selects the channel to be used.
CH:STAT ON,2	
:READ?	Executes scanning (all channels measured).
1020.000E-03, 100.000E-03	Reads the measured values of all channels.
:CALC:LIM:RES? 1	Obtains the comparator result of each channel.
HI	
:CALC:LIM:RES? 2	
IN	
:CALC:LIM:JUDG? 1	Obtains the PASS/FAIL result of each channel.
FAIL	
:CALC:LIM:JUDG? 2	
PASS	
:CALC:LIM:JUDG:TOT?	Obtains the total judgment result.
FAIL	
:READ? NDAT	Executes scanning (all channels measured).
FAIL	Reads the total judgment result.

:READ? JUDG 1020.000E-03, 100.000E-03,FAIL	Executes scanning (all channels measured). Reads the measured values of all channels and total judgment result.
--	--

Example B2-2 When the scanning function is set to STEP ([SCAN:MODE STEP](#))

SCAN:MODE STEP	Scanning function: STEP
:TRIG:SOUR IMM	Internal trigger (continuous measurement OFF)
CH:STAT ON,1 CH:STAT ON,2	Selects the channel to be used.
:READ? 1020.000E-03	Measures Channel 1 and reads the measured value.
:CALC:LIM:RES? HI	Reads the comparator result of Channel 1.
:CALC:LIM: JUDG? FAIL	Reads the PASS/FAIL result of Channel 1.
:READ? 100.000E-03	Measures Channel 2 and reads the measured value.
:CALC:LIM:RES? IN	Reads the comparator result of Channel 2.
:CALC:LIM:JUDG? PASS	Reads the PASS/FAIL result of Channel 2.
:CALC:LIM:JUDG:TOT? FAIL	Obtains the total judgment result.
SCAN:RES	Clears the measured value and switches to Channel 1.

(3) Executing scanning using an external trigger

Example B3-1 When the scanning function is set to AUTO ([SCAN:MODE AUTO](#))

SCAN:MODE:AUTO	Scanning function: AUTO
:TRIG:SOUR EXT	External trigger
CH:STAT ON,1 CH:STAT ON,2	Selects the channel to be used.
:READ? (External trigger input)	Waits for a trigger (continuous measurement OFF).
1020.000E-03, 100.000E-03	Reads the measured values of all channels.
SCAN:MODE AUTO	Scanning function: AUTO
:TRIG:SOUR EXT	External trigger
:INIT:CONT ON	Continuous measurement ON
CH:STAT ON,1 CH:STAT ON,2 CH:STAT ON,3	Selects the channel to be used.
(External trigger input)	Executes scanning.
:FETC? 1 1020.000E-03	Reads the measured values and judgment values of all channels.
:FETC? LIM,2 100.000E-03,HI	
:FETC? JUDG,3 100.000E-03,PASS	
:SCAN:DATA? 1020.000E-03, 100.000E-03, 100.000E-03	Reads the measured values of all channels.

Example B3-2 When the scanning function is set to STEP ([SCAN:MODE STEP](#))

<pre> SCAN:MODE STEP :TRIG:SOUR IMM CH:STAT ON,1 CH:STAT ON,2 :READ? (External trigger input) 1020.000E-03 :READ? (External trigger input) 100.000E-03 SCAN:RES </pre>	<p>Scanning function: STEP</p> <p>Internal trigger (continuous measurement OFF)</p> <p>Selects the channel to be used.</p> <p>Measures Channel 1.</p> <p>Reads the measured value of Channel 2.</p> <p>Measures Channel 2.</p> <p>Reads the measured value of Channel 2.</p> <p>Clears the measured value and switches to Channel 1.</p>
<pre> SCAN:MODE STEP :TRIG:SOUR EXT :INIT:CONT ON CH:STAT ON,1 CH:STAT ON,2 CH:STAT ON,3 (External trigger input) :FETC? 1020.000E-03 (External trigger input) :FETC? LIM 100.000E-03,HI (External trigger input) :FETC? JUDG 100.000E-03,PASS SCAN:RES </pre>	<p>Scanning function: STEP</p> <p>External trigger</p> <p>Continuous measurement ON</p> <p>Selects the channel to be used.</p> <p>Measures Channel 1.</p> <p>Reads the measured value of Channel 1.</p> <p>Measures Channel 2.</p> <p>Reads the measured value and comparator result of Channel 2.</p> <p>Measures Channel 3.</p> <p>Reads the measured value and PASS/FAIL result of Channel 3.</p> <p>Clears the measured value and switches to Channel 1.</p>
<pre> SCAN:MODE STEP :TRIG:SOUR EXT :INIT:CONT ON CH:STAT ON,1 CH:STAT ON,2 CH:STAT ON,3 (External trigger input) (External trigger input) (External trigger input) :FETC? 1 1020.000E-03 :FETC? LIM,2 100.000E-03,HI :FETC? JUDG,3 100.000E-03,PASS :SCAN:DATA? 1020.000E-03, 100.000E-03, 100.000E-03 SCAN:RES </pre>	<p>Scanning function: STEP</p> <p>External trigger</p> <p>Continuous measurement ON</p> <p>Selects the channel to be used.</p> <p>Measures Channel 1.</p> <p>Measures Channel 2.</p> <p>Measures Channel 3.</p> <p>Reads the measured values and judgment values of all channels.</p> <p>Reads the measured values of all channels.</p> <p>Clears the measured value and switches to Channel 1.</p>

5 Data Exporting Methods

Basic Data Exporting Methods

Flexible data exporting is available depending on the application.

Export Free-Run Data

Default Setting	:INITiate:CONTInuous ON (continuous measurement enable) :TRIGger:SOURce IMMEDIATE (internal triggering)
Exporting	:FETCh? Imports the most recent measurement. RM3545 RM3545A When the scanning function is set to AUTO or STEP, free-run data cannot be exported.

Export by Controller (PC, PLC) Triggering

Default Setting	:INITiate:CONTInuous OFF (continuous measurement disable) :TRIGger:SOURce IMMEDIATE (internal triggering)
Exporting	:READ? A trigger occurs, and a measurement is performed and the result is transferred. RM3545 RM3545A When the scanning function is set to AUTO or STEP, scanning begins when :READ? is received (a trigger is not required separately).
Note	When :READ? is sent, :INITiate:CONTInuous OFF automatically occurs.

Export by Pressing [ENTER] Key or Applying TRIG Signal

Default Setting	:INITiate:CONTInuous OFF (continuous measurement disable) :TRIGger:SOURce EXT (external triggering)
Exporting	:READ? When triggered by the [ENTER] Key or TRIG signal, a measurement is performed and the result is transferred.
Note	When :READ? is sent, :INITiate:CONTInuous OFF automatically occurs.

Using the :FETCh? Command during Continuous Measurement with Internal Triggering

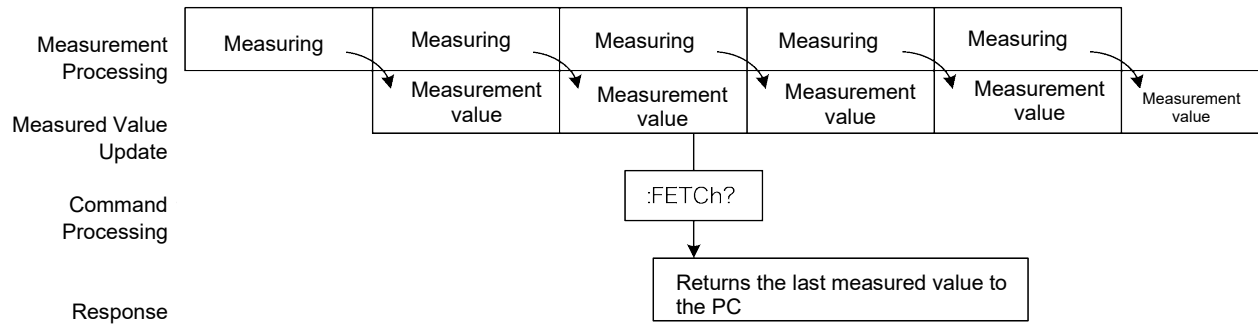

This is the simplest method for exporting measured values. It is ideal when measurement (tact) time is not limited, and when external synchronization is not needed. After connecting to the measurement target, wait for twice the measurement time before exporting the measured value.

Using the :READ? Command while Continuous Measurement is Disabled

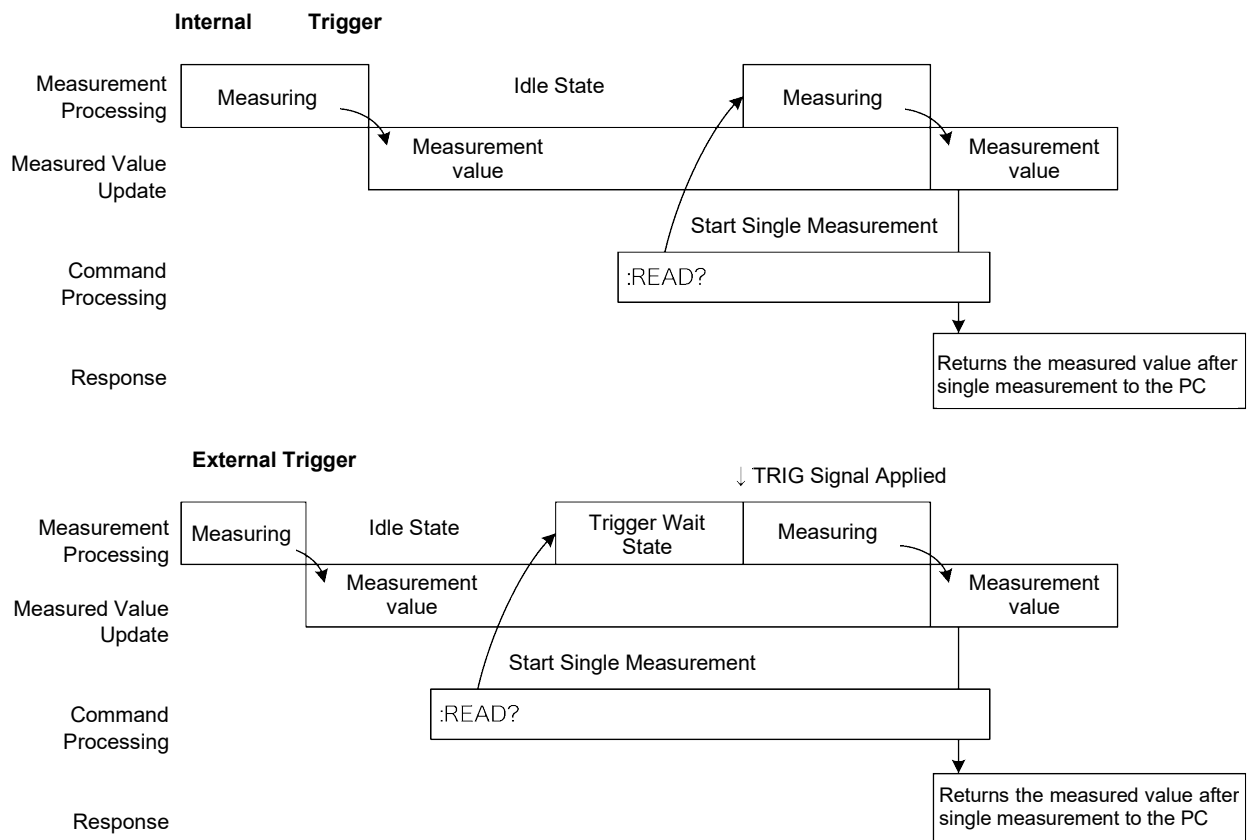

Use this method to measure (and export) synchronously with the controller (PC, PLC) or external trigger signal. Measurement time can be minimized.

 Using the **:FETCh?** Command when the Scanning Function is Set to AUTO or STEP RM3545 RM3545A

When the scanning function is set to AUTO or STEP, the measured value of any channel is obtained with the **:FETCh?** command after scanning.

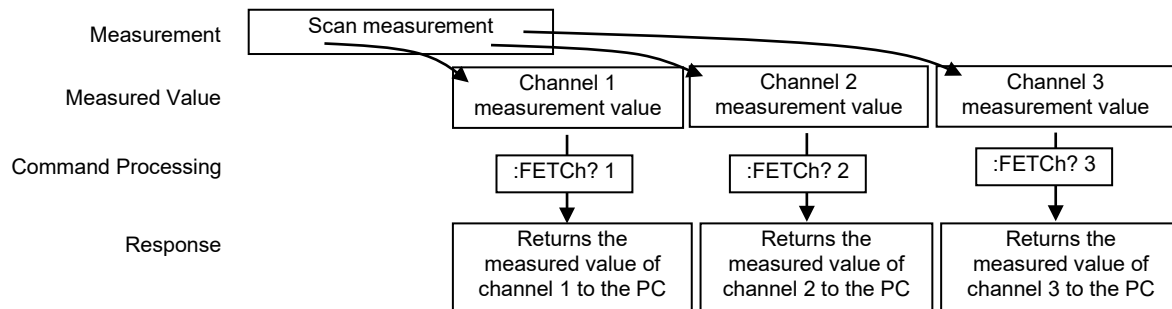

 Using the **SCAN:DATA?** Command when the Scanning Function is Set to AUTO or STEP RM3545 RM3545A

When the scanning function is set to AUTO or STEP, the measured values of all channels are obtained with the **SCAN:DATA?** command after scanning.

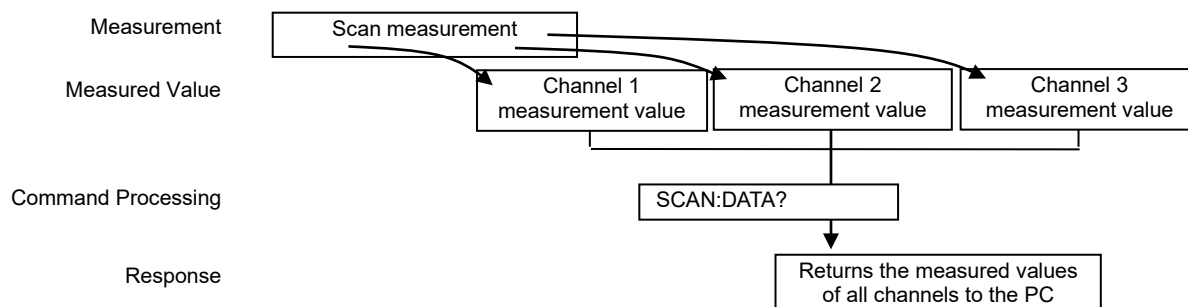

6 Examples of communication commands

This section introduces the communication commands used when controlling the instrument using the communication function.

When sending a command, it is necessary to add a message terminator (CR+LF, etc.), but this notation is omitted in this explanation. Similarly, the terminator (CR+LF) added to the response is also omitted.

You can also download sample programs compatible with various programming languages from our website. Please refer to this when creating communication programs for measuring instruments. Please search for [Sample program for communication with HIOKI products](#) on an internet search site.

Confirmation before measurement

This is an example of checking the status of the device and acquiring information about the device before measurement.

	Content	Send from controller to instrument	Example of response of this device
1	Communication confirmation	*IDN?	HIOKI, RM3545A-2, 230822756, V1.00
2	Check date	:SYST:DATE?	23,10,1
3	Check the time	:SYST:TIME?	12,34,56
4	Self-test confirmation	*TST?	0

Setting measurement conditions

Set measurement conditions.

- Range: 1000mΩ
- Sampling: FAST
- Trigger: EXTERNAL
- Comparator: ON, ABS mode, Upper limit 1000mΩ, lower limit 500mΩ, Sound the buzzer on Hi and Lo

	Content	Send from controller to instrument	Example of response of this device
1	Set measurement range to 1000mΩ	:RES:RANG 1E+0	
2	Set sampling to FAST	:SAMP:RATE FAST	
3	Select external trigger	:TRIG:SOUR EXT	
4	Continuous measurement ON	:INIT:CONT ON	
5	Comparator ABS mode	:CALC:LIM:MODE ABS	
6	IN buzzer OFF	:CALC:LIM:BEEP IN,0,0	
7	Hi buzzer type 1 continuous	:CALC:LIM:BEEP HI,1,0	
8	Lo buzzer type 1 continuous	:CALC:LIM:BEEP LO,1,0	
9	Upper limit value 1Ω	:CALC:LIM:UPP 1E+0	
10	Lower limit value 0.5Ω	:CALC:LIM:LOW 0.5E+0	
11	Comparator ON	:CALC:LIM:STAT ON	

Simple resistance measurement

Capture 10 measurements and save as a text file.

	Content	Send from controller to instrument	Example of response of this device
1	Select internal trigger	:TRIG:SOUR IMM	
2	Continuous measurement ON	:INIT:CONT ON	
3	Get the latest measurements	:FETCH?	(measured value)
4	Save (measured value) to text file		
5	Repeat steps 3 and 4 10 times		

Resistance measurement using computer keys

Measure and import data using computer keystrokes and save as a text file.

	Content	Send from controller to instrument	Example of response of this device
1	Select internal trigger	:TRIG:SOUR IMM	
2	Continuous measurement OFF	:INIT:CONT OFF	
3	(Waiting for computer key input)		
4	Get measured value after measurement	:READ?	(measured value)
5	Save (measured value) to text file		
6	Repeat steps 3 to 5		

■ Measurement by external trigger 1

Measure and import data using an external trigger ([ENTER] key, TRIG signal input) or computer key input, and save it as a text file.

	Content	Send from controller to instrument	Example of response of this device
1	Select external trigger	:TRIG:SOUR EXT	
2	Continuous measurement OFF	:INIT:CONT OFF	
3	Get measured value after measurement	:READ?	
4	(send external trigger or trigger command)	*TRG	(measured value)
5	Save (measured value) to text file		
6	Repeat steps 3 to 5		

■ Measurement by external trigger 2

Capture data using an external trigger ([ENTER] key, TRIG signal input) and save it as a text file. (The main unit is in continuous measurement mode, and the latest measured value is acquired at the timing of trigger input.)

	Content	Send from controller to instrument	Example of response of this device
1	Select internal trigger	:TRIG:SOUR IMM	
2	Continuous measurement ON	:INIT:CONT ON	
3	Clear external I/O trigger input confirmation	:IO:INP?	1
4	Wait for external I/O trigger input	:IO:INP?	1
5	Get the latest measurements	:FETCH?	(measured value)
6	Save (measured value) to text file		
7	Repeat steps 4 to 6		

■ LAN communication setting example RM3545A

This is an example of setting the IP address, port number, etc.

	Content	Send from controller to instrument	Example of response of this device
1	IP address settings	:SYST:COMM:LAN:IPAD 172,16,1,100	
2	Setting the subnet mask	:SYST:COMM:LAN:SMASK 255,255,255,0	
3	Setting the default gateway	:SYST:COMM:LAN:GAT 172,16,1,1	
4	Setting the port number	:SYST:COMM:LAN:CONT 523	
5	Confirming LAN settings (LAN restart)	:SYST:COMM:LAN:UPD	
6	Check IP address	:SYST:COMM:LAN:IPAD?	172,16,1,100
7	Check subnet mask	:SYST:COMM:LAN:SMASK?	255,255,255,0
8	Checking the default gateway	:SYST:COMM:LAN:GAT?	172,16,1,1
9	Check port number	:SYST:COMM:LAN:CONT?	523

7 Sample Programs

Using Visual Basic

These programs can be created using Visual Basic 2022.

Describes an example of how to use the Visual Basic 2022 to operate from a Computer via RS-232C/USB, incorporate measurement values, and save measurement values to a file.

Visual Basic 2022 is referred to as VB2022 hereafter.

Note: Depending on the environment of the PC and VB2022, the procedure may differ slightly from the one described here. For a detailed explanation on how to use VB2022, refer to the instruction manual or Help of VB2022.

1. Create a new project.

1. Startup Visual Studio.
2. Select [Create a new project].

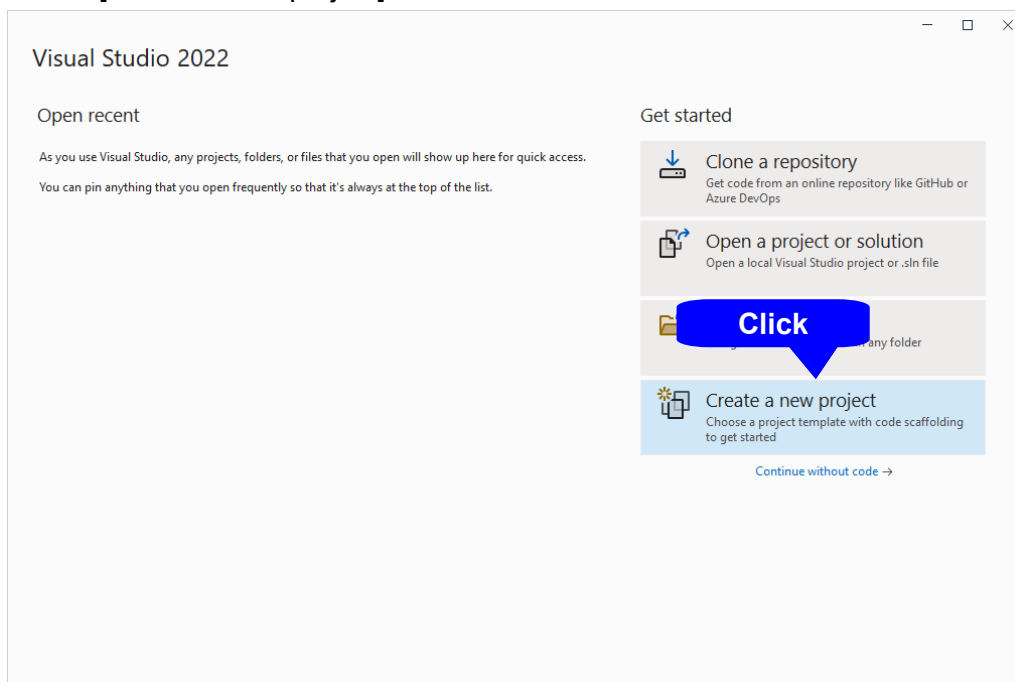

3. Select [Visual Basic]-[Windows]-[Desktop]-[Windows Forms App (.NET Framework)] from the templates.

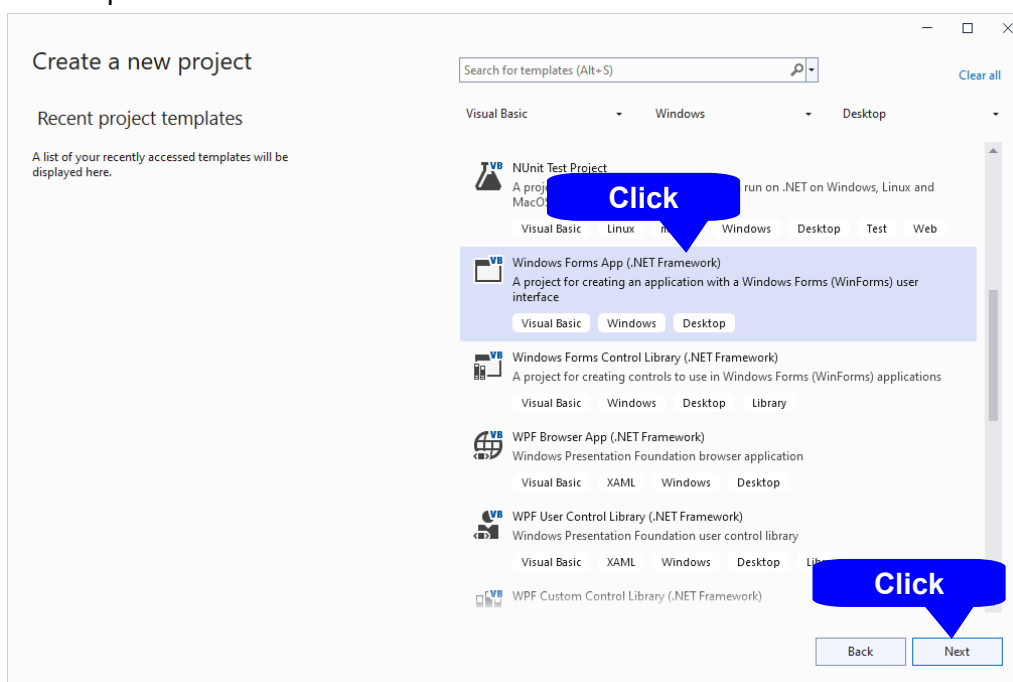

4. Click [Next].

5. Click [Create].

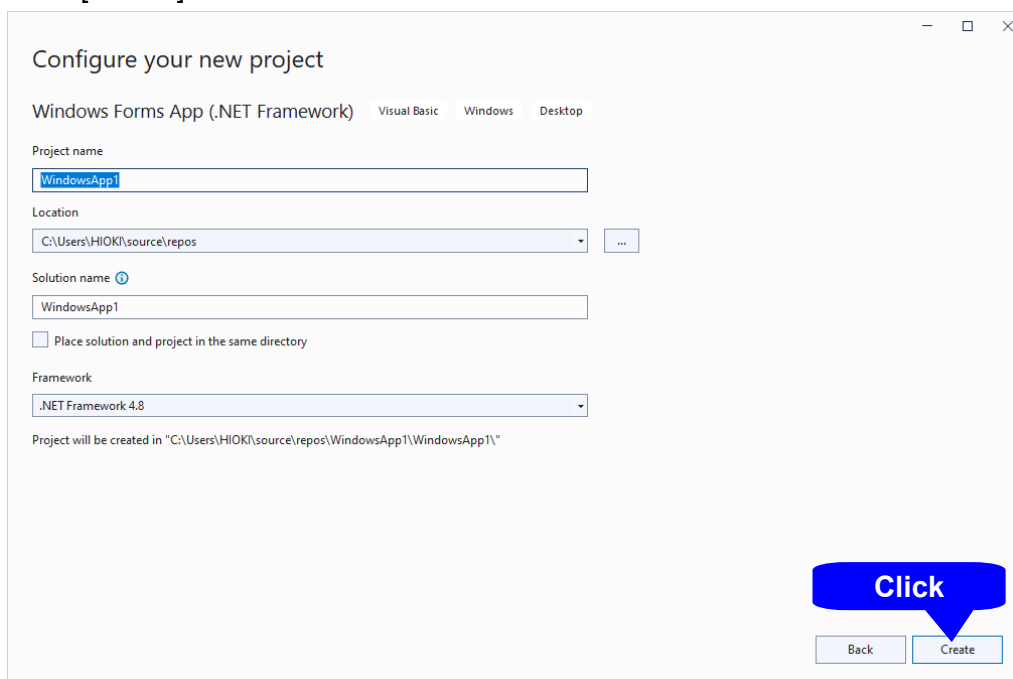

2. Place a button.

1. Click [Button] from [Common Controls] of [Toolbox].

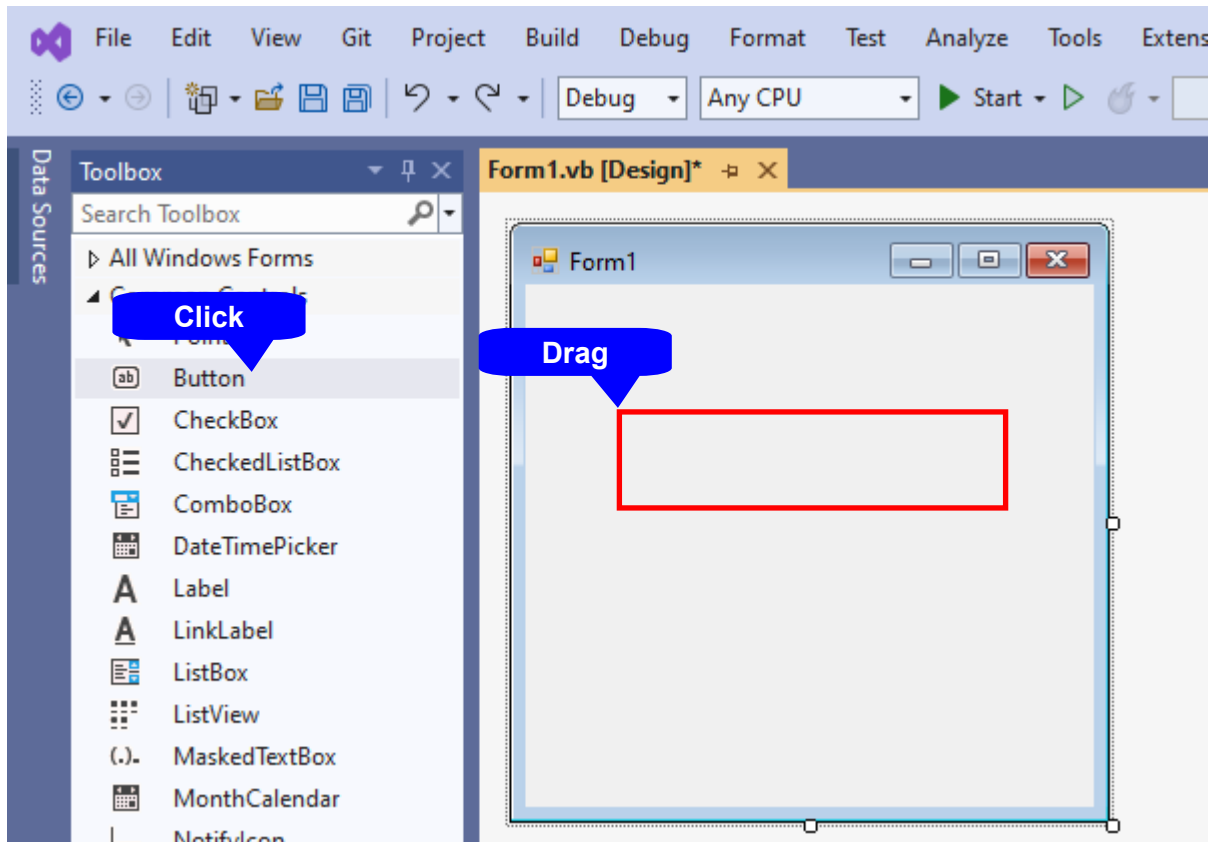

2. Drag and drop the button onto the form layout screen.

3. Change [Text] to "Start Measurement" from the Properties window.

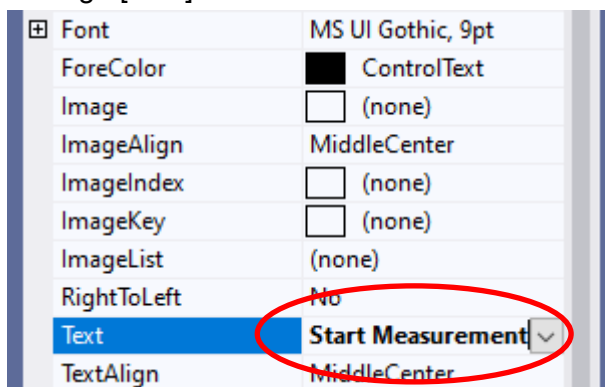

4. The [Start Measurement] is placed on the form.

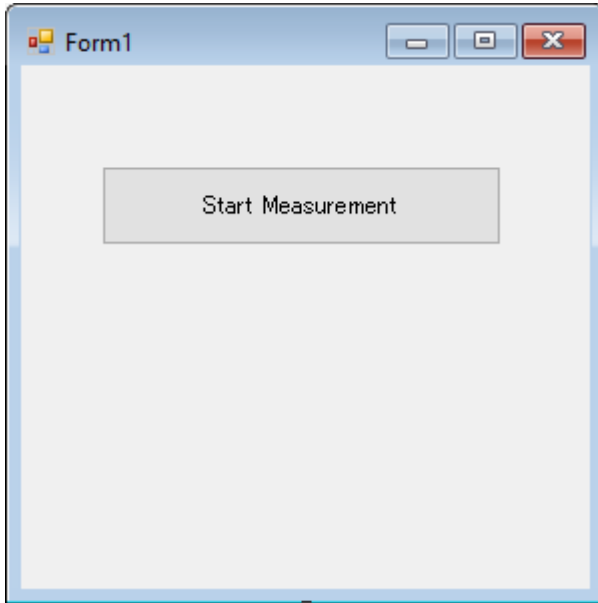

3. Place a serial communication component.

1. Click [SerialPort] from [Components] of [Toolbox].

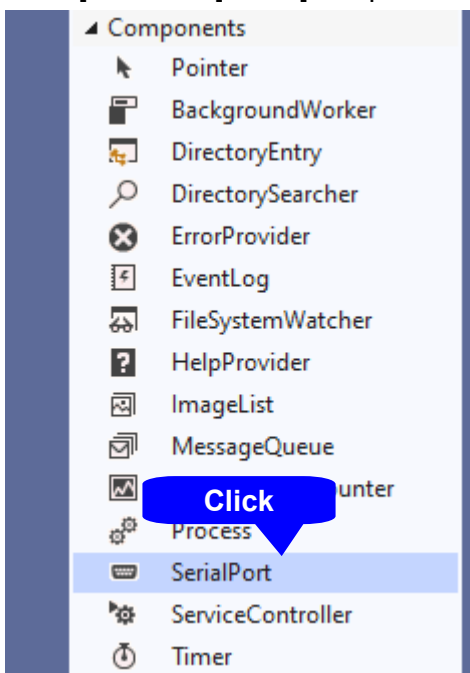

2. Drag and drop the [SerialPort] component onto the form layout screen.

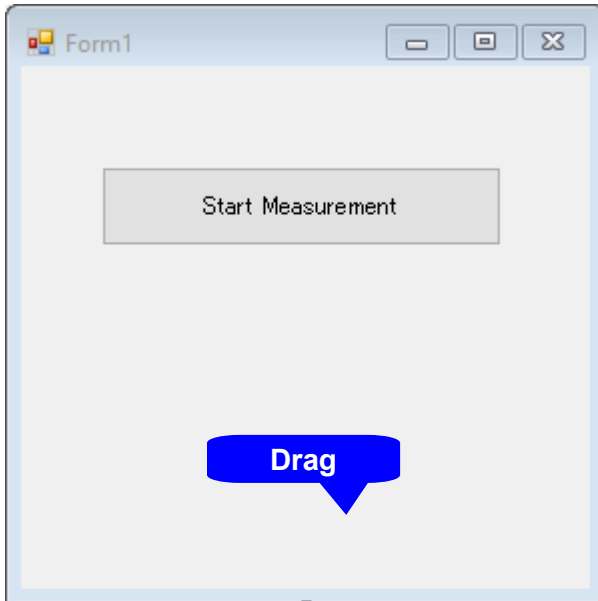

3. Change [PortName] to the port name to use for communication from the properties window.

Check the port to use for communication beforehand.

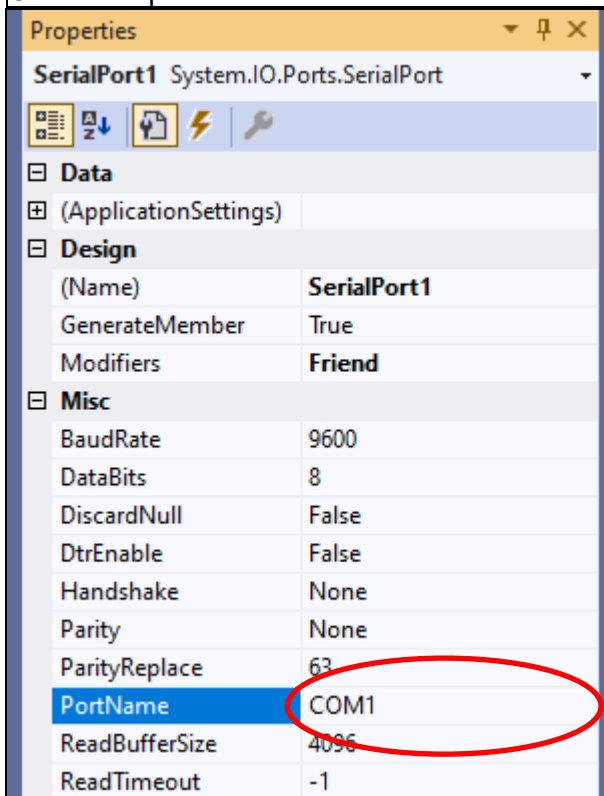

4. Describe the code.

1. Double-click the placed button to display the code editor.

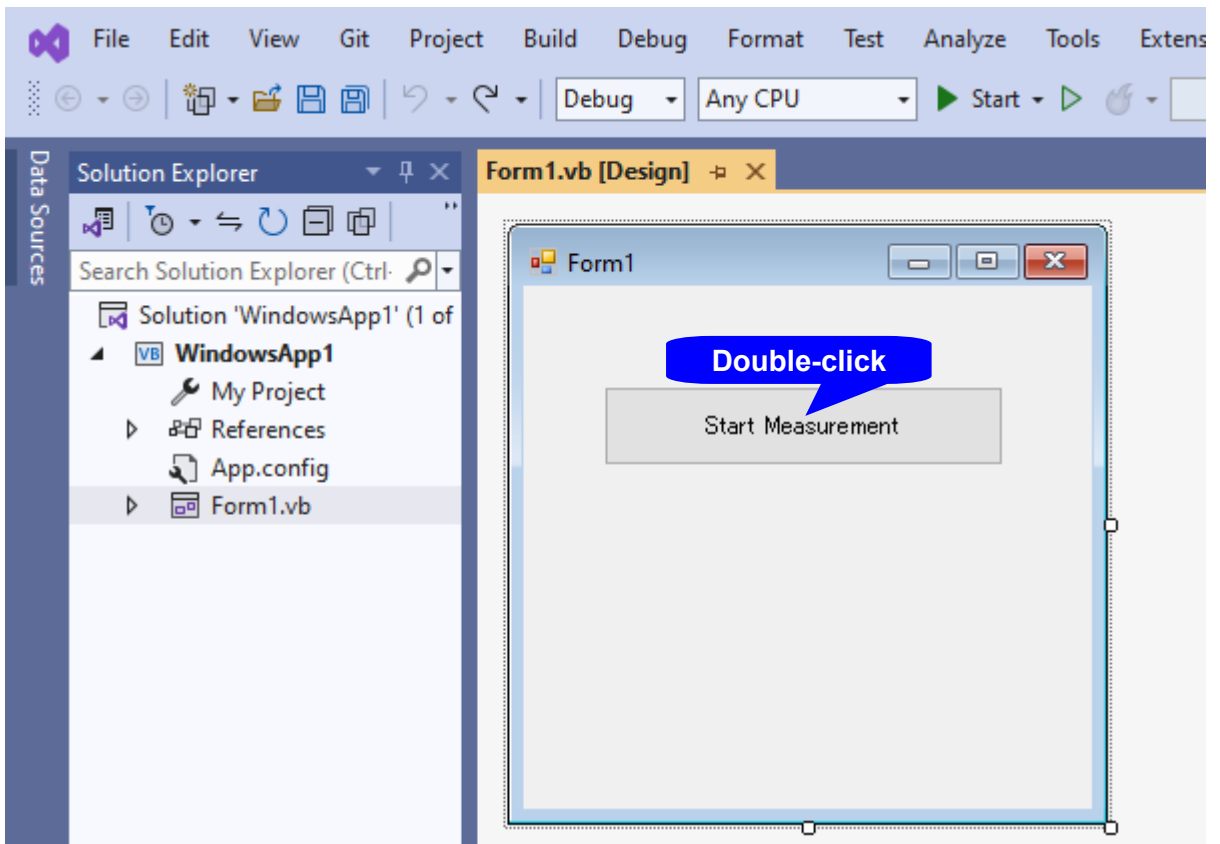

2. Enter the sample program into the code editor.

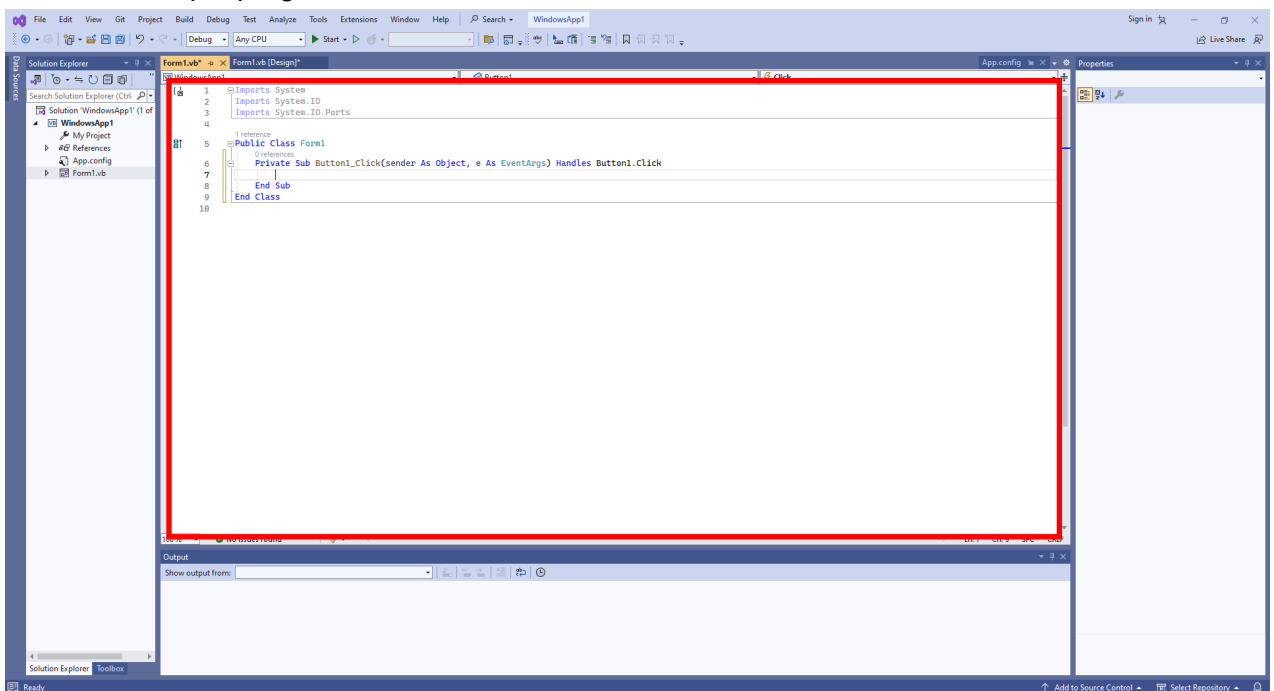

3. Select [Save All] from the [File] menu.

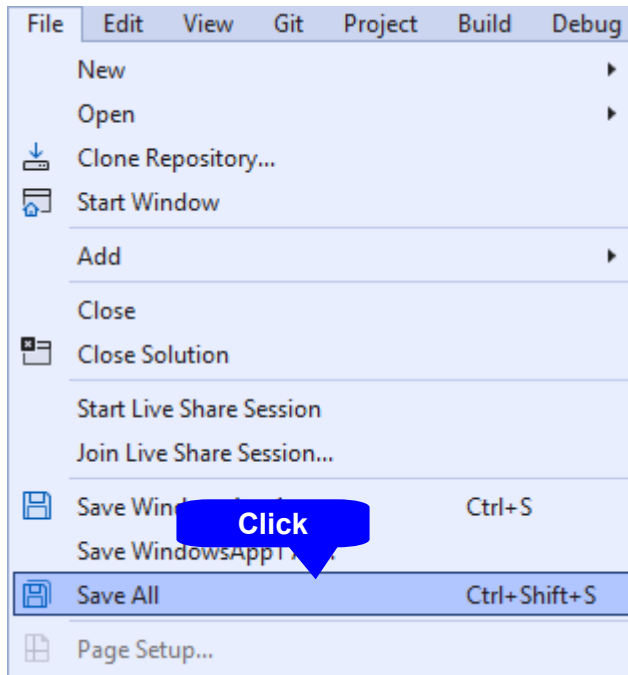

Shown below is a sample program which uses VB2022 to enact RS-232C/USB communication, set the instrument measurement conditions, read measurement results and then save them to file.

The sample program will be written in the following manner.

Description of creation procedure	Description in sample program
Button created to begin measurement	Button1

When the [Begin Measurement] button is pressed, the instrument performs 10 measurements and writes the measurement values to a "data.csv" file.

When the [X] button is pressed, the program closes.

The following program is written entirely in [Form1] code.

```
Imports System.IO.Ports

Public Class Form1
    'Perform process when Button1 is pressed
    Private Sub Button1_Click(sender As Object, e As EventArgs) Handles Button1.Click
        Dim recvstr As String
        Dim i As Integer
        Try
            Button1.Enabled = False 'Disable buttons during communication
            SerialPort1.NewLine = vbCrLf 'Terminator setting
            SerialPort1.ReadTimeout = 2000 '2 seconds time out
            SerialPort1.Open() 'Open a port
            SendSetting(SerialPort1) 'Instrument settings
            FileOpen(1, "data.csv", OpenMode.Output) 'Create text file to be saved
            For i = 1 To 10
                SerialPort1.WriteLine(":FETCH?")
                'Begin measurement and read measurement results command
                recvstr = SerialPort1.ReadLine() 'Read measurement results
                WriteLine(1, recvstr) 'Write to file
            Next i
            FileClose(1) 'Close file
            SerialPort1.Close() 'Close port
            Button1.Enabled = True
        Catch ex As Exception
            MessageBox.Show(ex.Message, "Error", MessageBoxButtons.OK, MessageBoxIcon.Error)
        End Try
    End Sub

    'Set measurement conditions
    Private Sub SendSetting(ByVal sp As SerialPort)
        Try
            sp.WriteLine(":TRIG:SOUR IMM") 'Select internal triggering
            sp.WriteLine(":INIT:CONT ON") 'Continuous measurement ON
        Catch ex As Exception
            MessageBox.Show(ex.Message, "Error", MessageBoxButtons.OK, MessageBoxIcon.Error)
        End Try
    End Sub
End Class
```

Using Visual C#

These programs can be created using Visual C# 2022.

Describes an example of how to use the Visual C# 2022 to operate from a Computer via LAN, incorporate measurement values, and save measurement values to a file.

Visual Basic C# 2022 is referred to as CS2022 hereafter.

Note: Depending on the environment of the PC and CS2022, the procedure may differ slightly from the one described here. For a detailed explanation on how to use CS2022, refer to the instruction manual or Help of CS2022.

1. Create a new project.

1. Startup Visual Studio.
2. Select [Create a new project].

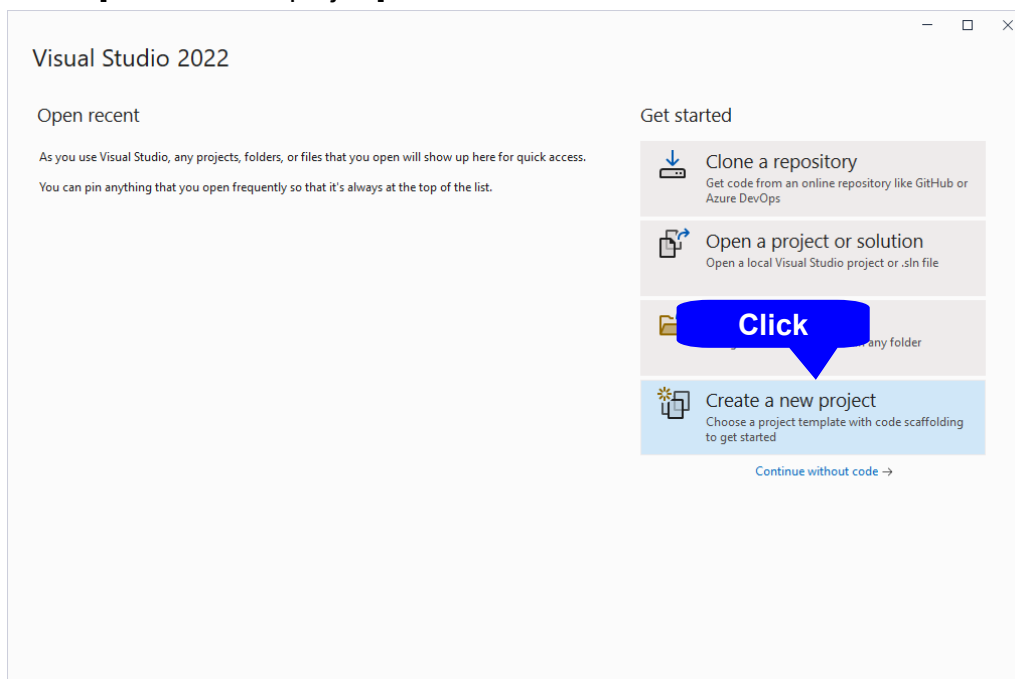

3. Select [C#]-[Windows]-[Desktop]-[Windows Forms App (.NET Framework)] from the templates.

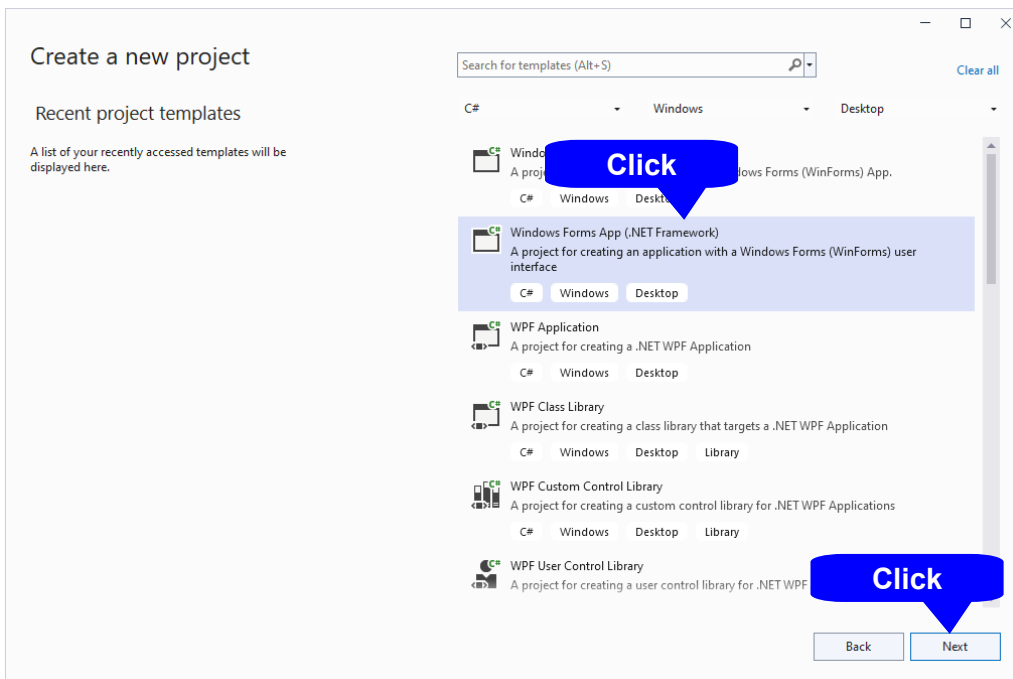

4. Click [Next].

5. Click [Create].

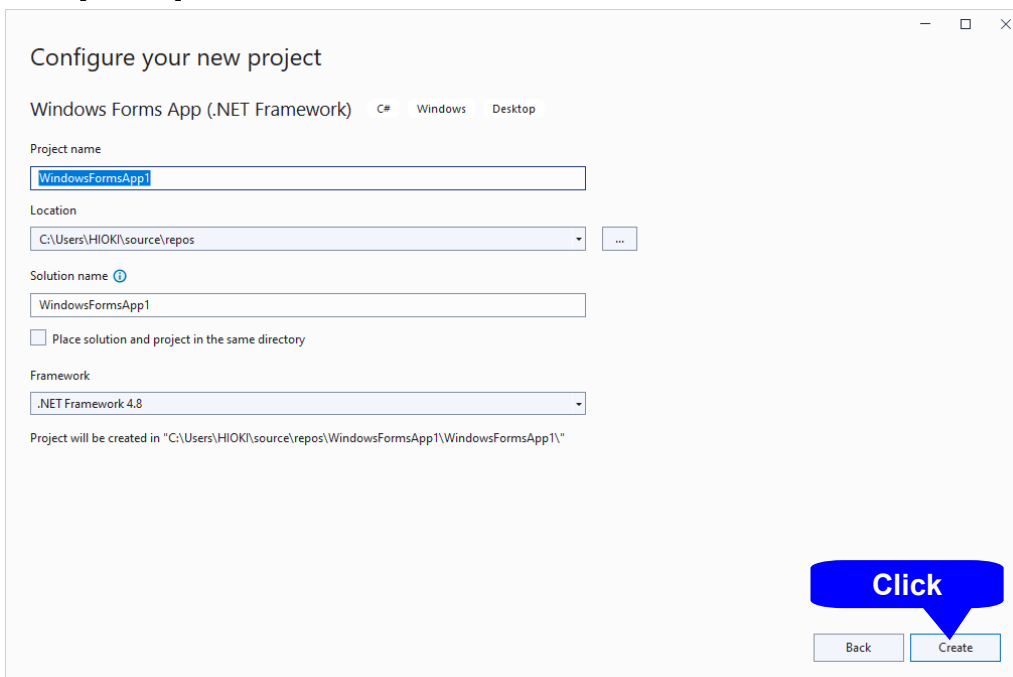

2. Place a button.

1. Click [Button] from [Common Controls] of [Toolbox].

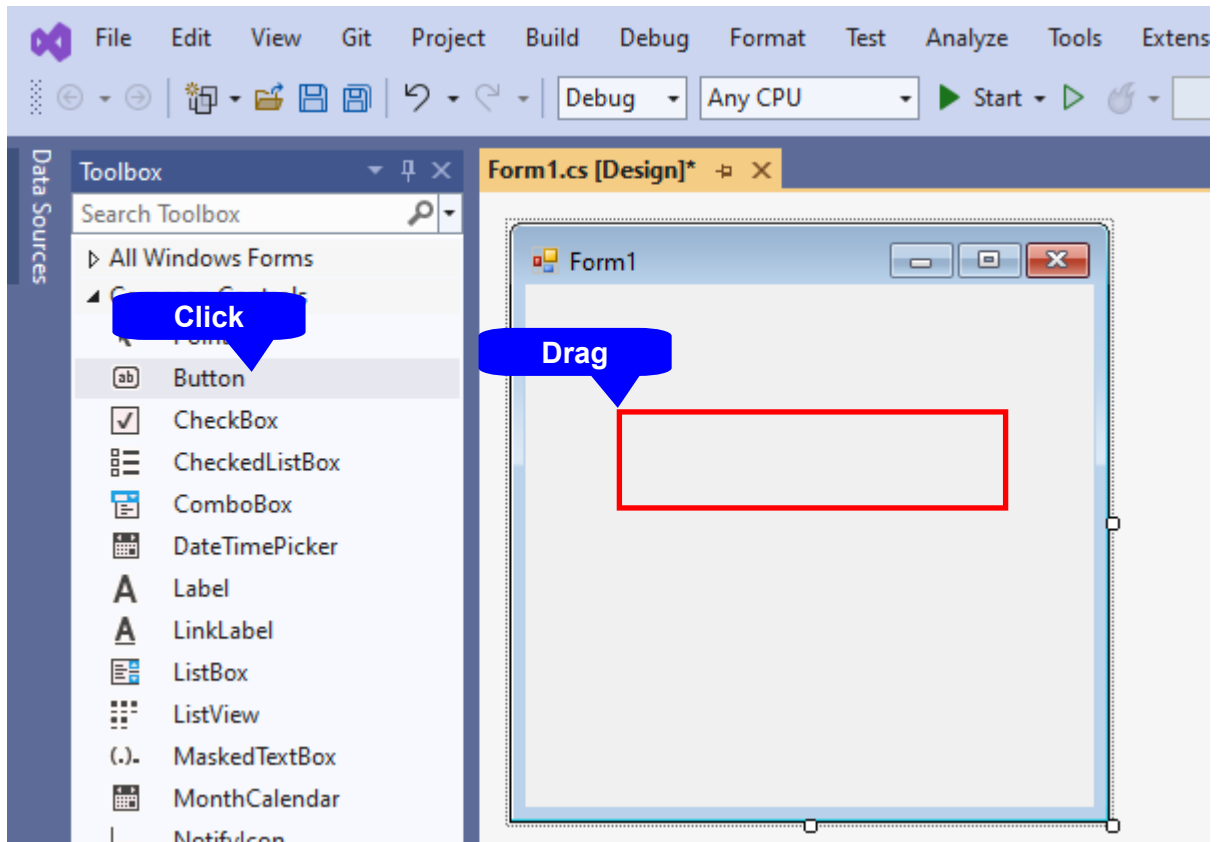

2. Drag and drop the button onto the form layout screen.

3. Change [Text] to "Start Measurement" from the Properties window.

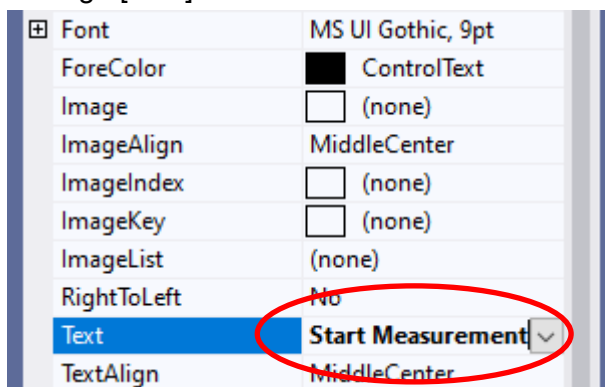

4. The [Start Measurement] is placed on the form.

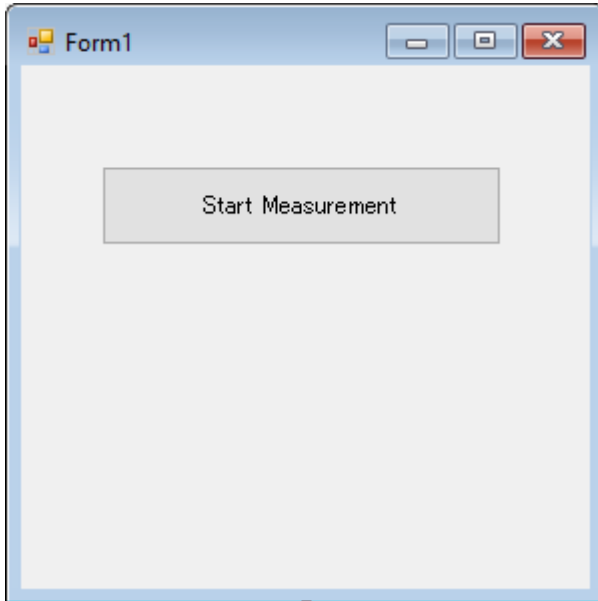

4. Describe the code.

1. Double-click the placed button to display the code editor.

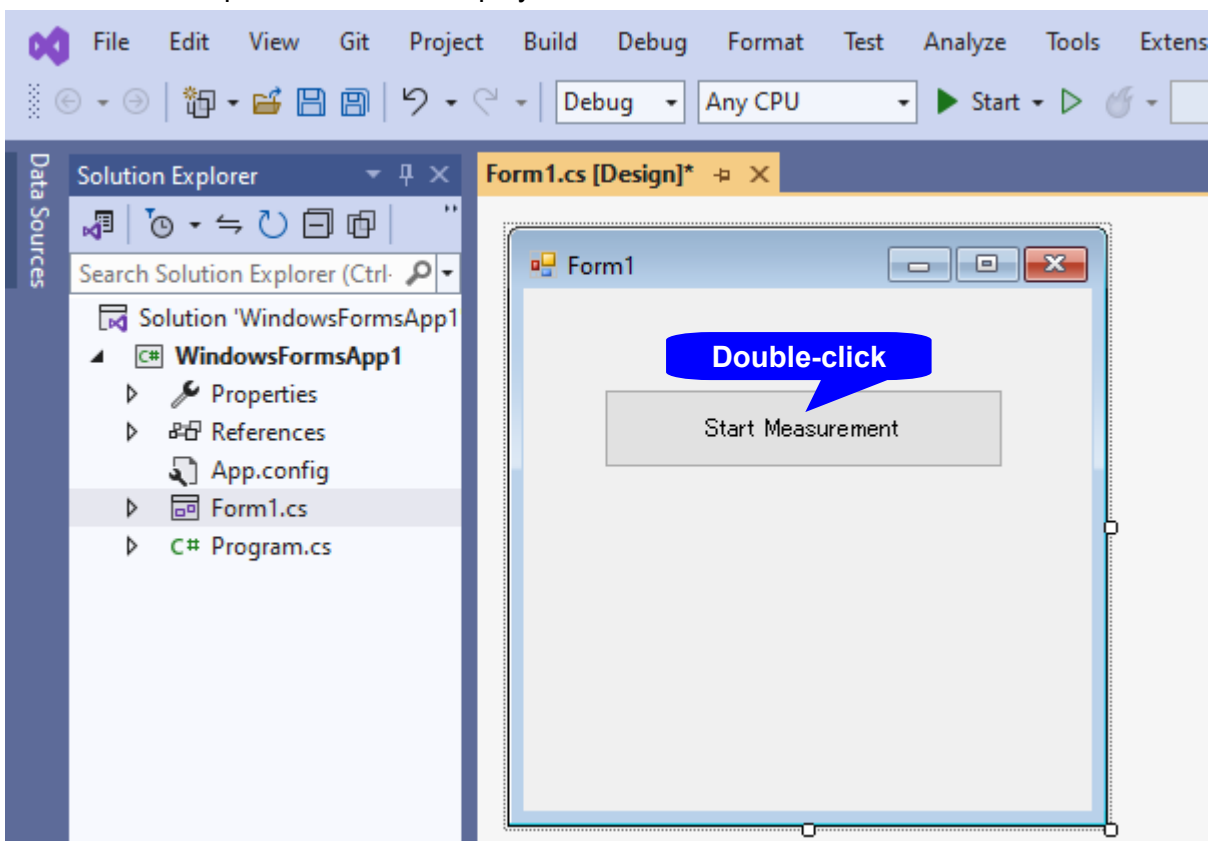

2. Enter the sample program into the code editor.

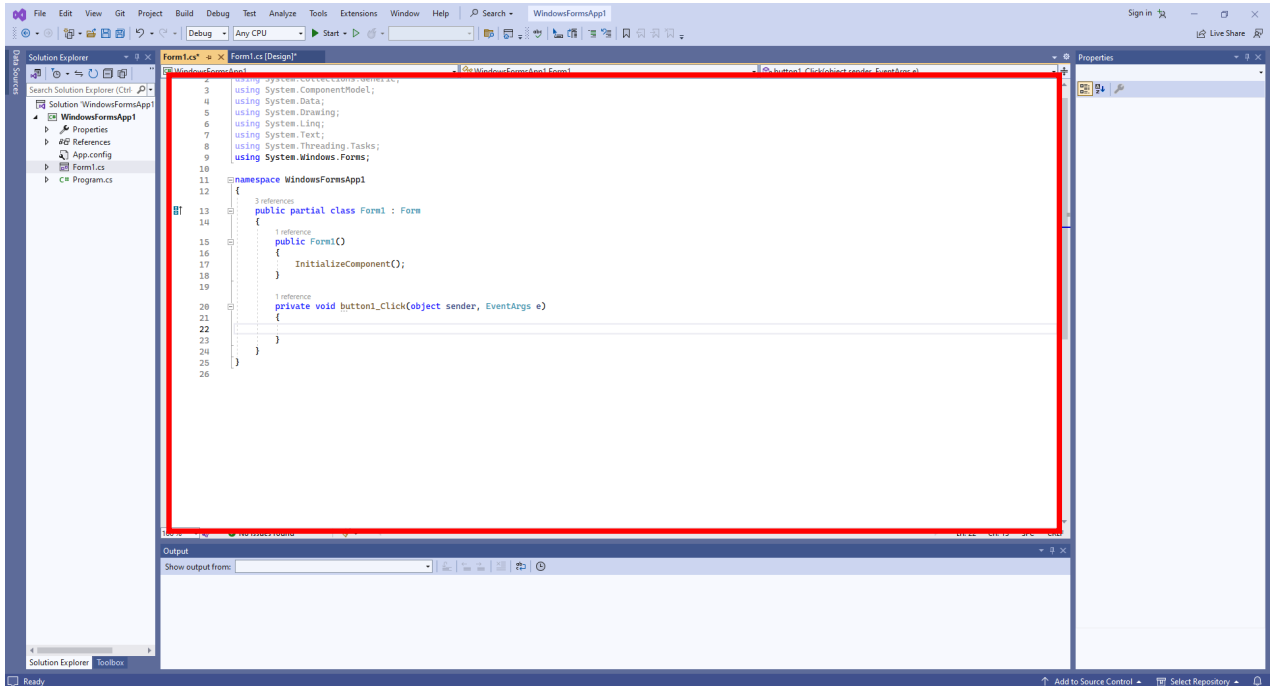

3. Select [Save All] from the [File] menu.

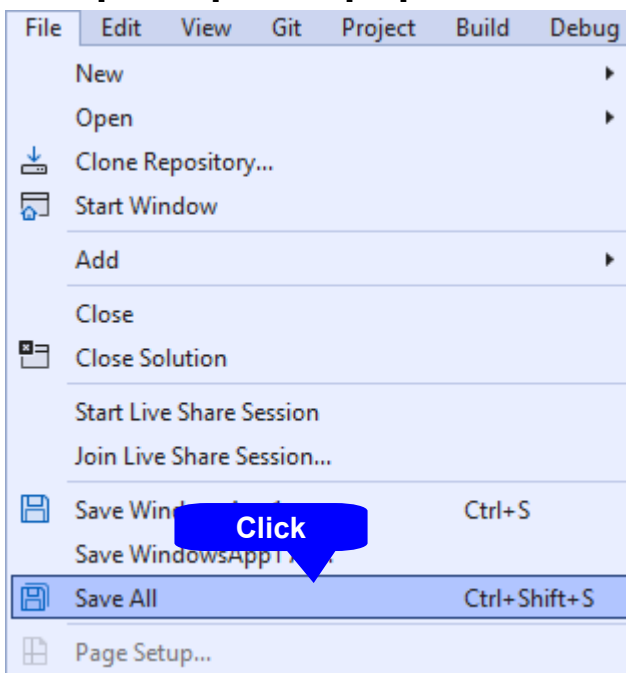

Shown below is a sample program which uses CS2022 to enact LAN communication, set the instrument measurement conditions, read measurement results and then save them to file.

The sample program will be written in the following manner.

Description of creation procedure	Description in sample program
Button created to begin measurement	button1

When the [Begin Measurement] button is pressed, the instrument performs 10 measurements and writes the measurement values to a "data.csv" file.

When the [X] button is pressed, the program closes.

The following program is written entirely in [Form1] code.

```
using System;
using System.Diagnostics;
using System.IO;
using System.Net;
using System.Net.Sockets;
using System.Reflection;
using System.Text;
using System.Windows.Forms;

namespace WindowsFormsAppl
{
    public partial class Form1 : Form
    {
        private TcpClient LanSocket;           // LAN socket
        private String MsgBuf = "";           // Received data
        private const long Timeout_default = 2000; // Receive timeout default time (ms)

        public Form1()
        {
            InitializeComponent();
        }

        private void button1_Click(object sender, EventArgs e)
        {
            String ip = "192.168.0.1";        // IP address
            String port = "23";               // Port number
            int i;

            button1.Enabled = false;          // Disable buttons during communication

            // Connect
            if (OpenInterface(ip, port))
            {
                // Open text file to output test result values
                Assembly myAssembly = Assembly.GetEntryAssembly();
                string path = Path.GetDirectoryName(myAssembly.Location);
                // Output path (where executable file is located)
                StreamWriter fp = new StreamWriter(path + "\\data.csv", false, Encoding.UTF8);

                // Set measurement conditions
                SendMsg(":TRIG:SOUR IMM");     // Select internal triggering
                SendMsg(":INIT:CONT ON");     // Continuous measurement ON

                for (i = 1; i <= 10; i++)
                {
                    SendQueryMsg(":FETCH?"); // Get the latest measurement results
                    fp.Write(MsgBuf + "\r\n"); // Write to file
                }

                // Close the file
                fp.Close();

                // Disconnection
                CloseInterface();
            }
        }
    }
}
```

```
        // Enable buttons
        button1.Enabled = true;
    }
}

// Connect
private Boolean OpenInterface(String ipaddress, String port)
{
    Boolean ret = false;
    IPAddress ip = new IPAddress(0);          // IP address

    try
    {
        if (System.Net.IPAddress.TryParse(ipaddress, out ip))
        {
            LanSocket = new TcpClient();      // Create LAN socket object
            LanSocket.NoDelay = true;        // Disable transmission delay (Nagle algorithm)
            LanSocket.Connect(ip, Convert.ToInt32(port)); // LAN socket open
            ret = true;
        }
    }
    catch (Exception e)
    {
        MessageBox.Show(e.Message);
    }
    return ret;
}

// Disconnection
private Boolean CloseInterface()
{
    Boolean ret = false;

    try
    {
        LanSocket.Close();                  // LAN socket close
        ret = true;
    }
    catch (Exception e)
    {
        MessageBox.Show(e.Message);
    }
    return ret;
}

// Send command
private Boolean SendMsg(String strMsg)
{
    Boolean ret = false;
    Byte[] sendBuffer;

    try
    {
        strMsg += "\r\n";                    // Add terminator "CR+LF"
        sendBuffer = Encoding.Default.GetBytes(strMsg); // Convert to byte type
        LanSocket.GetStream().Write(sendBuffer, 0, sendBuffer.Length);
                                                // Write to send buffer

        ret = true;
    }
}
```

```
    }
    catch (Exception e)
    {
        MessageBox.Show(e.Message);
    }
    return ret;
}

// Receive command response
private Boolean ReceiveMsg(long timeout = Timeout_default)
{
    Boolean ret = false;
    Byte[] rcv = new Byte[1024];
    System.Diagnostics.Stopwatch sw = new System.Diagnostics.Stopwatch();

    try
    {
        MsgBuf = ""; // Clear received data
        sw.Start(); // Start stopwatch for timeout

        // Loop until terminator "LF" is received
        while (true)
        {
            // Received one character at a time
            if (LanSocket.GetStream().DataAvailable) // Read if data is in the receive buffer
            {
                LanSocket.GetStream().Read(rcv, 0, 1); // Read one character from the receive buffer
                if (Convert.ToChar(rcv[0]) == '\n') // Terminate when terminator "LF" is received
                {
                    break;
                }
                else if (Convert.ToChar(rcv[0]) == '\r') // Ignore terminator 'CR'
                {
                    ;
                }
                else
                {
                    MsgBuf += Convert.ToChar(rcv[0]); // Save received data
                }
            }
            // Timeout processing
            if (sw.ElapsedMilliseconds > timeout)
            {
                MsgBuf = "Timeout";
                MessageBox.Show(MsgBuf);
                return ret;
            }
        }
        sw.Stop(); // Stop the stopwatch
        ret = true;
    }
    catch (Exception e)
    {
        MsgBuf = "Error";
        MessageBox.Show(e.Message);
    }
}
```

```
    }
    return ret;
}

// Send and receive commands
private Boolean SendQueryMsg(String strMsg, long timeout = Timeout_default)
{
    Boolean ret = false;

    ret = SendMsg(strMsg);          // Send command
    if (ret)
    {
        ret = ReceiveMsg(timeout); // Receive response after successful transmission
    }
    return ret;
}
}
```

8 Device Compliance Statement [GP-IB] RM3545

"Information on compliance to standards" based on the IEEE 488.2 standard

Item	Description
1. IEEE 488.1 interface functions	See: "GP-IB Specifications (Interface Functions) (RM3545-01 only)" (Instrument instruction manual)
2. Operation with a device address other than 0 through 30	A setting outside the 0 to 30 range cannot be made.
3. Timing of changed device address recognition	A change of address is recognized immediately after changing.
4. Device settings at power on	The status information is cleared, and all other items are preserved. However, the header on/off setting, and response message separator and terminator are all initialized.
5. List of message exchange options	<ul style="list-style-type: none"> • Input buffer capacity and operation See: "Input Buffer" (p.5) <p>Queries to which multiple response message units are returned</p> <p>:FETCh? :READ? :CALCulate:LIMit:BEEPPer? :CALCulate:STATistics:NUMBer? :CALCulate:STATistics:MAXimum? :CALCulate:STATistics:MINimum? :CALCulate:STATistics:LIMit? :CALCulate:STATistics:BIN? :CALCulate:STATistics:DEViation? :CALCulate:STATistics:CP? :CALCulate:TCONversion:DELta:PARAmeter? :CALCulate:TCORrect:PARAmeter? :MEMory:DATA? [:SENSe:]SCAN:DATA? [:SENSe:]TERMinal? [:SENSe:]TEMPerature:PARAmeter? :UNIT:IDN? :SYSTem:DATE? :SYSTem:TIME?</p> <ul style="list-style-type: none"> • Queries producing responses when syntax checking is performed: All queries produce responses when syntax checking is performed. • Whether any queries produce responses when read: There are no queries which produce response messages when they are read in by the controller. • Whether any commands are coupled: There are no relevant commands.

Item	Description
6. Summary of functional elements for use when constructing device specific commands, and whether compound commands or program headers can be used	<p>The followings can be used:</p> <ul style="list-style-type: none"> • Program message • Program message terminator • Program message unit • Program message unit separator • Command message unit • Query message unit • Command program header • Query program header • Program data • Character program data • Decimal program data • Character string program data • Compound commands and program headers
7. Buffer capacity limitations for block data	Block data is not used.
8. Summary of program data elements used in expressions, and deepest nesting level allowable in sub-expressions, including syntax restrictions imposed by the device	Sub-expressions are not used. Character data, decimal data and character string program data are the only program data elements used.
9. Response syntax for queries	See: Message Reference (p.21)
10. Transmission congestion relating to device-to-device messages which do not conform to the general principles for basic response messages	There are no device to device messages.
11. Response capacity for block data	Block data does not appear in responses.
12. Summary of standard commands and queries used	See: Message List (p.13)
13. Device state after a calibration query has been completed without any problem	The “*CAL?” query is not used.
14. Existence/nonexistence of “*DDT” command	The “*DDT” command is not used.
15. Existence/nonexistence of macro command	Macros are not used.
16. For queries related to identification, explanation of the response to the “*IDN?” query	See: Standard Commands (p.22)
17. Capacity of the user data storage area reserved for when the “*PUD” command and the “*PUD?” query are being executed	The “*PUD” command and the “*PUD?” query are not used. Further, there is no user data storage area.
18. Resources when the “*RDT” command and the “*RDT?” query are being used	The “*RDT” command and the “*RDT?” query are not used. Further, there is no user data storage area.
19. Conditions which are influenced when “*RST”, “*LRN?”, “*RCL”, and “*SAV” are used	<p>“*LRN?”, “*RCL”, and “*SAV” are not used. The “*RST” command returns the instrument to its initial state.</p> <p>See: Standard Commands (p.22), Initialization Items (p.11)</p>
20. Scope of the self-testing executed as a result of the “*TST?” query	See: Standard Commands (p.22)
21. Additional organization of the status data used in a device status report	See: Event Registers (p.8)
22. Whether commands are overlap or sequential type	All the commands are sequential commands.
23. Criterion relating to the functions required at the instant that the termination message is produced, as a response to each command	<p>Termination occurs when the command has been parsed.</p> <p>The :READ? query finishes when the measurement data is received.</p>

HIOKI
www.hioki.com/



**All regional
contact
information**

HIOKI E.E. CORPORATION

81 Koizumi, Ueda, Nagano 386-1192 Japan

2309 EN

Edited and published by HIOKI E.E. CORPORATION

Printed in Japan

- Contents subject to change without notice.
- This document contains copyrighted content.
- It is prohibited to copy, reproduce, or modify the content of this document without permission.
- Company names, product names, etc. mentioned in this document are trademarks or registered trademarks of their respective companies.

Europe only

- EU declaration of conformity can be downloaded from our website.

• Contact in Europe: **HIOKI EUROPE GmbH**
Helfmann-Park 2, 65760 Eschborn, Germany hioki@hioki.eu