

Application Note

Use of the SM7110 to Evaluate I-V Characteristics of Photodiodes in Optical Communications

This application note proposes a method for evaluating the I-V characteristics of photodiodes and avalanche photodiodes using synchronized measurement of minuscule currents while a DC voltage is varied.

Target

Evaluation of the I-V characteristics of photodiodes and avalanche photodiodes

Market trends

The volume of data handled in wireless communications is forecasted to grow due to growing adoption of next-generation communications standards such as 5G as well as inter-vehicle communications like vehicle-to-everything (V2X), remote medicine, and other technologies. Signal transmission using cables is subject to concerns of loss and delay times when sending large amounts of data at high speeds. Optical communications using semiconductors with optical characteristics known as photodiodes (PDs) and avalanche photodiodes (APDs) are attracting attention as one solution to those concerns.



PDs and APDs are elements that convert between optical energy and electrical energy. They have the same physical structure as a PN junction diodes and exhibit current-voltage (I-V) characteristics such as those illustrated in Figure 1. When a PD receives light, the current response of the I-V characteristics shifts downward. This amount of shift in current is known as the photocurrent. Since the photocurrent increases in proportion to the strength of the light, the elements can be used as photosensors by detecting this photocurrent.

Current through other diodes usually flows from the anode (positive side) to the cathode (negative side). In order to evaluate its impedance qualities, these diodes are measured by applying positive voltages from the anode to the cathode, and current measured (I-V characteristics). On the other hand, photocurrent in photodiodes flows from the cathode to the anode.

When measuring the I-V characteristics of a photodiode, different current measurements are recorded depending on whether a positive or negative voltage is applied (Fig. 1).

When applying a negative voltage to the anode, a current flows from the cathode to the anode (Fig. 2).

When a positive voltage is applied to the same anode, a current flows from the anode to the cathode (Fig. 3).

Fig. 1. Current is measured while applying negative to positive voltages

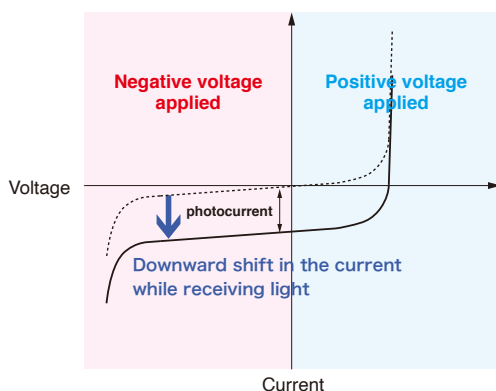

Fig. 2

When a negative voltage is applied to the anode (A), current flows in the reverse direction (K → A)

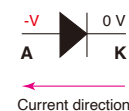
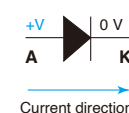

Fig. 3

When a positive voltage is applied to the anode (A), current flows in the regular/forward direction (A → K)



Application Note

Since photodiodes are usually used with current flowing in the reverse direction, I-V measurement also needs to be measured to reflect this reverse direction. To do so, a positive voltage is applied to the cathode (K) Figure 4.

Fig. 4

When a positive voltage is applied to the cathode (K), it is the same current direction as negative voltage (K → A, reverse direction)

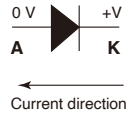

Issues

It's typical to use a DC voltage source and a microammeter (Fig. 5) to measure I-V characteristics (Fig. 6 and Fig. 9), a key electrical characteristic in evaluating PDs and APDs. However, using these two devices can get to be cumbersome. Not only can it quickly become tiresome, accuracy can suffer from the increase in noise due to the complicated wiring between the two devices.

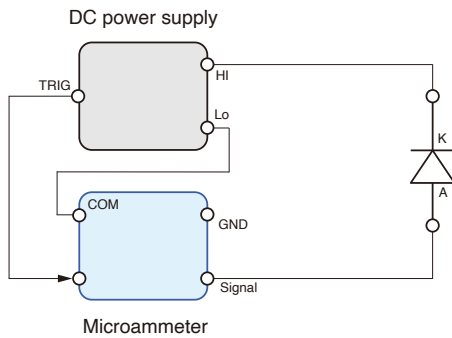

Fig. 5. Example of a conventional setup

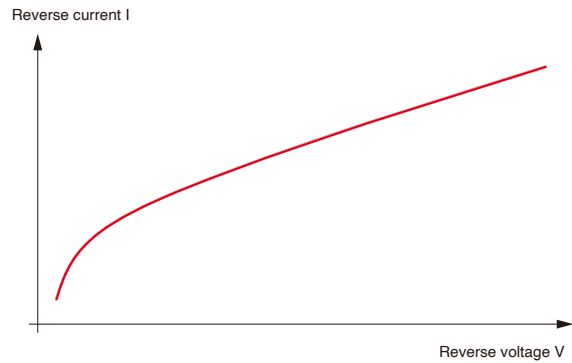

Fig. 6. Example I-V characteristics

Solution

The Super Megohmmeter SM7110 consists of a DC power supply that can apply a DC voltage within the broad range of 0.1 V to 1000 V and a microammeter with a minimum range of 20 pA (resolution: 0.1 fA). As a result, the instrument can perform synchronized measurement of minuscule currents while applying a large range of DC voltage. Furthermore, the SM7000 Series Sample Application (for the SM7110, SM7120, and SM7420), makes it easy to generate graphs of measurement results (free download from Hioki's website).



Fig. 7. Super Megohm Meter SM7110

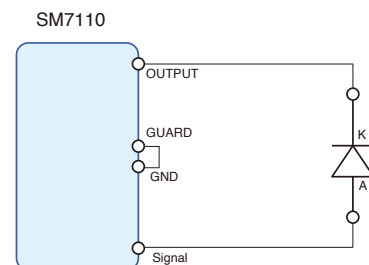

Fig. 8. Using the SM7110

Equipment used

Super Megohm Meter	SM7110	by Hioki E.E. Corporation
--------------------	--------	---------------------------

Measurement data

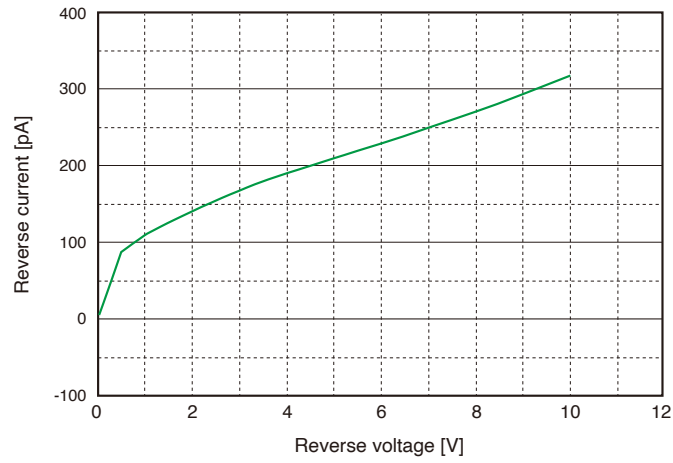

Fig. 9. Actual I-V characteristics of a PD designed for use in optical communications