

MR6000

MR6000-01

HIOKI

Quick Start Manual

MEMORY HiCORDER

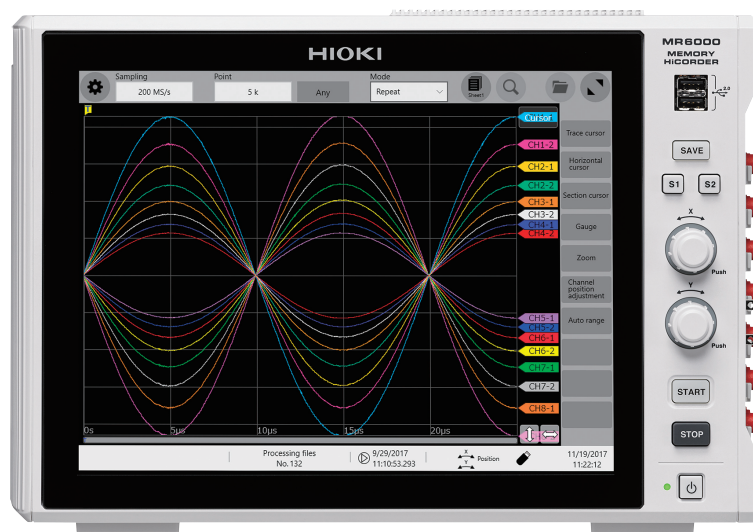

The latest edition of the instruction manual



Read carefully before use.
Keep for future reference.



When using the instrument for the first time

- Name and Function of Each Part ▶ p. 24
- Basic Operation ▶ p. 31
- Preparing for Measurement ▶ p. 41



Troubleshooting

- Maintenance and Service ▶ p. 151
- Troubleshooting ▶ p. 153
- Message ▶ p. 156

EN

July 2024 Revised edition 6
MR6000A965-06



FAQ



To set the measurement range automatically

See “3.7 Measuring Signals With the Automatic Ranging Setting” (p. 91).



To change the measurement range

See “Analog channel” (p. 83).



To add a comment to the data

See “Touch keyboard” (p. 39) and “Analog channel” (p. 83).



To minimize influence of noise (Low-pass filter, LPF)

See “Analog channel” (p. 83).



To change the sampling rate

See “3.2 Setting Measurement Conditions” (p. 80).



To configure the trigger settings

See “3.4 Configuring the Level Trigger Settings” (p. 85).



To scroll through the waveform display

See “4.2 Handling Waveforms” (p. 96).



To read measured values (cursor values) with cursors

See “4.1 Reading Measured Values (Trace Cursors)” (p. 93).



To save data files

See “3.6 Saving Data Consisting of Items Selected” (p. 88).



To estimate file size

See “16.1 Information for Reference Purposes” in the Instruction Manual.



To open data files with your computer

See “4.3 Loading Data on Your Computer (Wave Viewer)” (p. 97).

Measurement Procedure

The basic measurement procedure is as follows. For advanced use, see Instruction Manual (PDF) in the accompanying CD.

Preparing for measurement (p. 41)

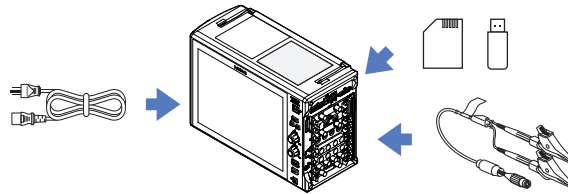

Inspecting the instrument before measurement (p. 79)

Configuring the basic settings for measurement (p. 80)

- Choose a sampling rate.
- Choose a recording length (shot).

Configuring the input channel settings (p. 82)

- Configure the analog channel settings.

Configuring the trigger settings (p. 85)

- Configure the trigger settings.

Starting/Stopping measurement (p. 87)

Saving waveform data files (p. 88)



Analyzing waveforms (p. 93)

- Scroll through, zoom in, and zoom out waveforms.
- Read measured values (with the trace cursors).

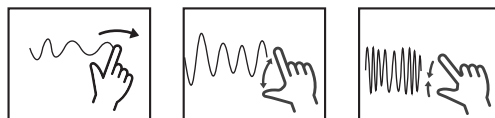

Finishing the measurement

Contents

| | | | | |
|--|-----------|-----------------------------------|---|----|
| Introduction..... | 1 | 2.7 | Preparing Storage Devices (Recording Media)..... | 67 |
| Notations..... | 2 | | SD memory card..... | 67 |
| Confirming Package Contents..... | 4 | | USB flash drive..... | 68 |
| Options (Sold separately)..... | 5 | | Built-in drive..... | 68 |
| Safety Information..... | 7 | | Removing storage devices..... | 69 |
| Operation Precautions..... | 9 | | Formatting storage devices..... | 70 |
| How to Use This Document..... | 21 | 2.8 | How to Open the Media Box..... | 71 |
| 1 Overview | 23 | 2.9 | Supplying Power to the Instrument..... | 72 |
| 1.1 Product Overview and Features..... | 23 | | Turning on the instrument..... | 72 |
| 1.2 Name and Function of Each Part..... | 24 | | GND terminal (Functional earth terminal)..... | 72 |
| 1.3 Screen..... | 28 | | Turning off the instrument..... | 73 |
| Screen configuration..... | 28 | 2.10 | Setting the Clock..... | 74 |
| Explanation of each screen..... | 29 | 2.11 | Executing Zero-Adjustment..... | 75 |
| 1.4 Basic Operation..... | 31 | 2.12 | Executing Calibration (For the Instrument With Model MR8990 Installed)..... | 77 |
| Touch panel..... | 31 | 3 Measurement Method | 79 | |
| Rotary knob..... | 32 | 3.1 | Inspection Before Measurement..... | 79 |
| Changing screens and settings..... | 34 | 3.2 | Setting Measurement Conditions..... | 80 |
| Quick-access menu..... | 36 | | Sampling rate setting guideline..... | 81 |
| Key lock..... | 37 | 3.3 | Configuring the Input Channel Settings..... | 82 |
| Help function (Displaying manuals)..... | 37 | | Analog channel..... | 83 |
| Mouse operation..... | 38 | 3.4 | Configuring the Level Trigger Settings..... | 85 |
| Touch keyboard..... | 39 | 3.5 | Starting/Stopping a Measurement..... | 87 |
| 2 Preparing for Measurement | 41 | 3.6 | Saving Data Consisting of Items Selected..... | 88 |
| 2.1 Installing and Removing Modules..... | 42 | | Save types and setting procedure..... | 88 |
| Allocation of modules and channels..... | 43 | | Selective saving..... | 89 |
| 2.2 Connecting Connection Cords..... | 44 | 3.7 | Measuring Signals With the Automatic Ranging Setting..... | 91 |
| Connection cords (For measuring voltage, frequency, or rotation speed, and obtaining accumulations)..... | 45 | 4 Analysis Method | 93 | |
| Thermocouple (Temperature)..... | 47 | 4.1 | Reading Measured Values (Trace Cursors)..... | 93 |
| Strain gauge transducer..... | 48 | 4.2 | Handling Waveforms..... | 96 |
| Current sensor..... | 50 | | Scrolling through waveforms..... | 96 |
| Acceleration sensor..... | 55 | | Zooming in and out waveforms..... | 96 |
| Logic probe (Measuring logic signals)..... | 57 | 4.3 | Loading Data on Your Computer (Wave Viewer)..... | 97 |
| Connection cable (For precisely measuring voltage)..... | 57 | | | |
| Connection cable (For measuring high voltage)..... | 58 | | | |
| Outputting waveforms..... | 59 | | | |
| Outputting pulse waveforms..... | 60 | | | |
| 2.3 Supplying Power to Current Sensors..... | 61 | | | |
| 2.4 External Sampling (EXT.SMPL)..... | 62 | | | |
| 2.5 Connecting the External Control Terminals..... | 63 | | | |
| 2.6 Connecting the Instrument With Computers..... | 65 | | | |

1

2

3

4

5

6

Index

5 Specifications 99

| | | |
|-----|---|-----|
| 5.1 | Specifications of Model MR6000..... | 99 |
| | General specifications..... | 99 |
| | Trigger..... | 102 |
| | Waveform screen..... | 104 |
| | Setting screen | 105 |
| | File..... | 108 |
| | Calculation | 109 |
| | Memory division..... | 112 |
| | Waveform search..... | 112 |
| | CAN measurement | 113 |
| | LIN measurement | 114 |
| | Others | 115 |
| | Waveform generation..... | 116 |
| 5.2 | Specifications of the Options | 117 |
| | Model Z5021 Probe Power Unit..... | 117 |
| | Model U8332 SSD Unit | 117 |
| | Model U8333 HD Unit | 118 |
| | Model 8966 Analog Unit | 118 |
| | Model 8967 Temp Unit | 119 |
| | Model 8968 High Resolution Unit | 122 |
| | Model U8969 Strain Unit | 123 |
| | Model 8970 Freq Unit | 124 |
| | Model 8971 Current Unit | 126 |
| | Model 8972 DC/RMS Unit | 127 |
| | Model 8973 Logic Unit | 129 |
| | Model MR8990 Digital Voltmeter Unit | 129 |
| | Model U8974 High Voltage Unit..... | 131 |
| | Model U8975 4ch Analog Unit | 133 |
| | Model U8976 High Speed Analog Unit..... | 134 |
| | Model U8977 3CH Current Unit..... | 136 |
| | Model U8978 4CH Analog Unit..... | 138 |
| | Model U8979 Charge Unit..... | 140 |
| | Model MR8790 Waveform Generator Unit | 142 |
| | Model MR8791 Pulse Generator Unit | 145 |
| | Model U8793 Arbitrary Waveform Generator Unit..... | 147 |

6 Maintenance and Service 151

| | | |
|-----|--|-----|
| 6.1 | Troubleshooting | 153 |
| | Before sending the instrument for repair..... | 153 |
| 6.2 | Initializing the Instrument..... | 155 |
| 6.3 | Message | 156 |
| | Error messages | 157 |
| | Warning messages | 159 |

| | | |
|-----|--|-----|
| 6.4 | Self-check..... | 163 |
| | Memory check | 163 |
| | Touch panel check | 164 |
| | Key check..... | 164 |
| | LCD check..... | 164 |
| | LAN check..... | 165 |
| | Media check | 166 |
| | System configuration check..... | 167 |
| 6.5 | Cleaning the Instrument | 167 |
| 6.6 | Disposing of the Instrument (Removing the lithium battery)..... | 168 |
| 6.7 | Open-source software | 170 |

Index 171

Warranty Certificate

Introduction

Thank you for choosing the Hioki MR6000, MR6000-01 Memory HiCorder. Preserve this manual carefully and keep it handy to make full use of this instrument for a long time.

Model MR6000-01 Memory HiCorder is an upper model of Model MR6000, which is equipped with the following calculation functions (options):

- Digital filter calculation
- Real-time waveform calculation

Latest edition of instruction manual

The contents of this manual are subject to change, for example as a result of product improvements or changes to specifications.

The latest edition can be downloaded from Hioki's website.

<https://www.hioki.com/global/support/download>



Request for product user registration

This product may be upgraded for improvements or specification changes. We kindly request that you visit the following link to register your product to receive critical updates and information about the product:

<https://www.hioki.com/global/support/myhioki/registration/>



Following manuals are provided along with these models. See manuals relevant to your purpose.

| Type | Contents | Printed | CD-stored file name |
|---|---|---------|------------------------|
| Operating Precautions | Information on the instrument for safe operation | ✓ | — |
| Quick Start Manual (This document) | Basic instructions and specifications of the instrument | ✓ | ✓ MR6000A965-XX.pdf |
| Instruction Manual | Functions and instructions for the instrument | — | ✓ MR6000A966-XX.pdf |
| MR6000-01 Dedicated Functions | Method to use functions including the calculation available only with Model MR6000-01 | — | ✓ MR6000A968-XX.pdf |
| U8793, MR8790, MR8791 Instruction Manual | Functions, specifications, and instructions of Models U8793, MR8790, and MR8791 | — | ✓ U8793A981-XX.pdf |

Target audience

This manual has been written for use by individuals who use the product in question or who teach others to do so.

It is assumed that the reader possesses basic electrical knowledge (equivalent to that of someone who graduated from the electrical program at a technical high school).







Trademarks

- Internet Explorer, Microsoft Edge, and Windows are trademarks of the Microsoft group of companies.
- The SD logo is a trademark of SD-3C, LLC.





Notations

Safety notations



In this document, the risk seriousness and the hazard levels are classified as follows.

| | |
|--|--|
|  DANGER | Indicates an imminently hazardous situation that will result in death or serious injury to the operator. |
|  WARNING | Indicates a potentially hazardous situation that may result in death or serious injury to the operator. |
|  CAUTION | Indicates a potentially hazardous situation that may result in minor or moderate injury to the operator or damage to the instrument or malfunction. |
| IMPORTANT | Indicates information related to the operation of the instrument or maintenance tasks with which the operators must be fully familiar. |
|  | Indicates a high voltage hazard. If a particular safety check is not performed or the instrument is mishandled, this may give rise to a hazardous situation; the operator may receive an electric shock, may get burnt or may even be fatally injured. |
|  | Indicates prohibited action. |
|  | Indicates the action which must be performed. |

Symbols affixed to the instrument

| | |
|---|---|
|  | Indicates cautions and hazards. When the symbol is printed on the instrument, see "Operation Precautions" (p. 9) in this document and accompanying "Operating Precautions." |
|  | Indicates the power button that switches the instrument between on and off states. |
|  | Indicates a grounding terminal. |
|  | Indicates DC (Direct Current). |
|  | Indicates AC (Alternating Current). |

Symbols for Standards

| | |
|---|---|
|  | Indicates the Waste Electrical and Electronic Equipment Directive (WEEE Directive) in EU member states. |
|  | Indicates that the product conforms to regulations set out by the EU Directive. |

Others

| | |
|------------------------------|---|
| * | Additional information is presented below. |
| ☑ | Indicates the initial setting values of the items. Initializing the instrument restores settings to each of these values. |
| (p.) | Indicates the location of reference information. |
| START (Bold-faced) | Names and keys on the screen are indicated in boldface. |
| [] | Menus, dialog boxes, buttons in a dialog box, and other names on the screen are indicated in brackets. |
| Windows | Unless otherwise specified, “Windows” represents Windows 7, Windows 8, and Windows 10. |
| Current sensor | Sensors measuring current are referred to as “current sensor.” |
| S/s | The number of times per second the analog input signals are digitized by the instrument is represented in “samples per second (S/s).” Example: “20 MS/s” (20 megasamples per second) indicates that the signal is digitized 20×10^6 times per second. |

Accuracy

We define measurement tolerances in terms of f.s. (full scale), rdg. (reading) values, and setting values, with the following meanings:

| | |
|---------|---|
| f.s. | (maximum display value or scale length) The maximum displayable value or scale length. |
| rdg. | (displayed value) The value currently being measured and displayed on the measuring instrument. |
| Setting | (set value) Indicates the set value, such as voltage and current, that the instrument has been configured to output. |

Confirming Package Contents





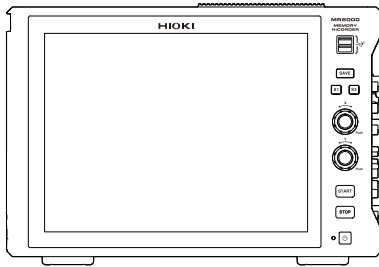

When you open the package, inspect the instrument carefully to ensure that everything is in good condition, and that no damage occurred during shipping. Carefully check the accessories, panel keys and switches, and connectors. If the instrument seems to have been damaged or does not work as specified, contact your authorized Hioki distributor or reseller. Check that the package contents are correct.

Instrument

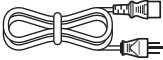
- Model MR6000 Memory HiCorder / Model MR6000-01 Memory HiCorder



Accessories

- | | | |
|--|---|---------|
| <input type="checkbox"/> Power cord |  | (p. 72) |
| <input type="checkbox"/> Operating Precautions (0990A903) |  | |
| <input type="checkbox"/> Quick Start Manual (This document) |  | |
| <input type="checkbox"/> Instruction Manual CD* ¹ <ul style="list-style-type: none"> • Quick Start Manual MR6000A965-XX.pdf • Instruction Manual MR6000A966-XX.pdf • MR6000-01 Dedicated Functions MR6000A968-XX.pdf |  | (p. 37) |
| <input type="checkbox"/> Application disc* ¹ |  | (p. 97) |
| <input type="checkbox"/> Blank panel (for slots with no module installed) |  | (p. 42) |

*1: The latest version can be downloaded from our website.

Options (Sold separately)

The following options are available for the instrument. Contact your authorized Hioki distributor or reseller when ordering.

The options are subject to change. Visit our website for updated information.

Options available only at the time of purchase order issuance for the instrument

| | |
|-------------|------------------|
| Model U8332 | SSD Unit |
| Model U8333 | HD Unit |
| Model Z5021 | Probe Power Unit |

Input modules

| | |
|--------------|------------------------|
| Model 8966 | Analog Unit |
| Model 8967 | Temp Unit |
| Model 8968 | High Resolution Unit |
| Model U8969 | Strain Unit |
| Model 8970 | Freq Unit |
| Model 8971 | Current Unit |
| Model 8972 | DC/RMS Unit |
| Model 8973 | Logic Unit |
| Model U8974 | High Voltage Unit |
| Model U8975 | 4ch Analog Unit |
| Model U8976 | High Speed Analog Unit |
| Model MR8990 | Digital Voltmeter Unit |
| Model U8977 | 3CH Current Unit |
| Model U8978 | 4CH Analog Unit |
| Model U8979 | Charge Unit |

Output module

| | |
|--------------|-----------------------------------|
| Model MR8790 | Waveform Generator Unit |
| Model MR8791 | Pulse Generator Unit |
| Model U8793 | Arbitrary Waveform Generator Unit |

Carrying case

| | |
|-------------|---------------|
| Model C1010 | Carrying Case |
|-------------|---------------|

Software

| | |
|------------|----------------|
| Model 9335 | Wave Processor |
|------------|----------------|

For voltage measurement

| | |
|----------------|---|
| Model L9197 | Connection Cord (CAT III 600 V, CAT IV 300 V, 1 A) |
| Model L9198 | Connection Cord (CAT II 600 V, CAT III 300 V, 0.2 A) |
| Model L9790 | Connection Cord (CAT II 600 V, CAT III 300 V, 1 A) |
| Model L9217 | Connection Cord (CAT II 600 V, CAT III 300 V, 0.2 A) |
| Model 9166 | Connection Cord (for inputting voltage to Model U8979) |
| Model 9665 | 10:1 Probe |
| Model 9666 | 100:1 Probe |
| Model 9322 | Differential Probe |
| Model P9000-01 | Differential Probe |
| Model P9000-02 | Differential Probe |

SD memory cards

| | |
|-------------|-----------------------|
| Model Z4001 | SD Memory Card (2 GB) |
| Model Z4003 | SD Memory Card (8 GB) |

USB flash drive

| | |
|-------------|-------------------|
| Model Z4006 | USB Drive (16 GB) |
|-------------|-------------------|

Logic probes

| | |
|-----------------|-------------|
| Model 9320-01 | Logic Probe |
| Model MR9321-01 | Logic Probe |
| Model 9327 | Logic Probe |

LAN cable

| | |
|------------|-----------|
| Model 9642 | LAN Cable |
|------------|-----------|

For external sampling measurement

| | |
|----------------|------------------|
| Model L9795-01 | Connection Cable |
| Model L9795-02 | Connection Cable |

For voltage generation

| | |
|----------------|------------------|
| Model L9795-01 | Connection Cable |
| Model L9795-02 | Connection Cable |

For current measurement

| | | | |
|-----------------|--------------------------------|-----------------|----------------------|
| Model CT6700 | Current Probe | Model CT6830 | AC/DC Current Probe |
| Model CT6701 | Current Probe | Model CT6831 | AC/DC Current Probe |
| Model CT6710 | Current Probe | Model CT6841A | AC/DC Current Probe |
| Model CT6711 | Current Probe | Model CT6843A | AC/DC Current Probe |
| Model 3273-50 | Clamp on Probe | Model CT6844A | AC/DC Current Probe |
| Model 3274 | Clamp on Probe | Model CT6845A | AC/DC Current Probe |
| Model 3275 | Clamp on Probe | Model CT6846A | AC/DC Current Probe |
| Model 3276 | Clamp on Probe | Model CT6875A | AC/DC Current Sensor |
| Model 9709 | AC/DC Current Sensor | Model CT6875A-1 | AC/DC Current Sensor |
| Model 9709-05 | AC/DC Current Sensor | Model CT6876A | AC/DC Current Sensor |
| Model 9272-05 | Clamp on Sensor | Model CT6876A-1 | AC/DC Current Sensor |
| Model 9272-10 | Clamp on Sensor | Model CT6877A | AC/DC Current Sensor |
| Model CT6841 | AC/DC Current Probe | Model CT6877A-1 | AC/DC Current Sensor |
| Model CT6841-05 | AC/DC Current Probe | Model CT6872 | AC/DC Current Sensor |
| Model CT6843 | AC/DC Current Probe | Model CT6872-01 | AC/DC Current Sensor |
| Model CT6843-05 | AC/DC Current Probe | Model CT6873 | AC/DC Current Sensor |
| Model CT6844 | AC/DC Current Probe | Model CT6973-01 | AC/DC Current Sensor |
| Model CT6844-05 | AC/DC Current Probe | Model CT6904A | AC/DC Current Sensor |
| Model CT6845 | AC/DC Current Probe | Model CT6904A-1 | AC/DC Current Sensor |
| Model CT6845-05 | AC/DC Current Probe | Model CT6904A-2 | AC/DC Current Sensor |
| Model CT6846 | AC/DC Current Probe | Model CT6904A-3 | AC/DC Current Sensor |
| Model CT6846-05 | AC/DC Current Probe | | |
| Model CT6862 | AC/DC Current Sensor | | |
| Model CT6862-05 | AC/DC Current Sensor | | |
| Model CT6863 | AC/DC Current Sensor | | |
| Model CT6863-05 | AC/DC Current Sensor | | |
| Model CT6865 | AC/DC Current Sensor | | |
| Model CT6865-05 | AC/DC Current Sensor | | |
| Model CT6875 | AC/DC Current Sensor | | |
| Model CT6876 | AC/DC Current Sensor | | |
| Model CT6877 | AC/DC Current Sensor | | |
| Model CT7631 | AC/DC Current Sensor | | |
| Model CT7636 | AC/DC Current Sensor | | |
| Model CT7642 | AC/DC Current Sensor | | |
| Model CT7731 | AC/DC Auto-Zero Current Sensor | | |
| Model CT7736 | AC/DC Auto-Zero Current Sensor | | |
| Model CT7742 | AC/DC Auto-Zero Current Sensor | | |
| Model CT7044 | AC Flexible Current Sensor | | |
| Model CT7045 | AC Flexible Current Sensor | | |
| Model CT7046 | AC Flexible Current Sensor | | |
| Model CT9900 | Conversion Cable | | |
| Model CT9920 | Conversion Cable | | |

Safety Information

This instrument is designed to conform to IEC 61010 Safety Standards, and has been thoroughly tested for safety prior to shipment. However, using the instrument in a way not described in this manual may negate the provided safety features.

Read the following safety notes carefully before using the instrument.

DANGER



Mishandling the instrument could result in bodily injury or even death, as well as damage to the instrument. Familiarize yourself with the instructions and precautions in this manual before using the instrument.

WARNING



Electricity can cause potentially serious events such as an electric shock, heat generation, fire, and an arc flash due to a short-circuit. If you have not used electrical measuring instruments before, you should be supervised by a technician who has experience in electrical measurement.

Protective gear

WARNING



This instrument is measured on a live line. To prevent an electric shock, use appropriate protective insulation and adhere to applicable laws and regulations.

Measurement categories

To ensure safe operation of measuring instruments, IEC 61010 establishes safety standards for various electrical environments, categorized as CAT II to CAT IV, and called measurement categories.

DANGER



- Using a measuring instrument in an environment designated with a higher-numbered category than that for which the instrument is rated could result in a severe accident, and must be carefully avoided.
- Never use a measuring instrument that lacks category labeling in a CAT II to CAT IV measurement environment. Doing so could result in a serious accident.

- CAT II: When directly measuring the electrical outlet receptacles of the primary electrical circuits in equipment connected to an AC electrical outlet by a power cord (portable tools, household appliances, etc.).
- CAT III: When measuring the primary electrical circuits of heavy equipment (fixed installations) connected directly to the distribution panel, and feeders from the distribution panel to outlets.
- CAT IV: When measuring the circuit from the service drop to the service entrance, and to the power meter and primary overcurrent protection device (distribution panel).

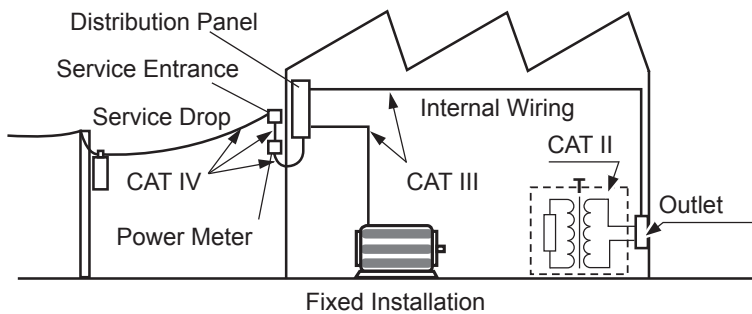

The applicable measurement category is determined based on the module being used. See "Handling the instrument and modules" (p. 11).

Operation Precautions

Follow these precautions to ensure safe operation and to obtain the full benefits of the various functions.

Ensure that your use of the instrument falls within the specifications not only of the instrument itself, but also of any accessories, options and other equipment being used.

Checks before use

DANGER

If the connection cords or the instrument is damaged, there is a risk of an electric shock. Perform the following inspection before using the instrument:

- Check that the insulation of the connection cords are neither ripped nor torn and that no metal parts are exposed before using the instrument. Using the instrument under such conditions could result in an electric shock. Replace the connection cords with those specified by our company.
- Check if there is any damage to the instrument occurred during storage or shipping and verify that it operates normally before using the instrument. If you find any damage, contact your authorized Hioki distributor or reseller.



Installing the instrument and modules

WARNING

Installing the instrument in inappropriate locations could cause a malfunction of the instrument an accident, or fire. Avoid the locations that are:



- Exposed to direct sunlight or high temperatures
- Exposed to corrosive or combustible gases
- Exposed to strong electromagnetic fields or electrostatic charges
- Near induction heating systems (such as high-frequency induction heating systems and IH cooking equipment)
- Susceptible to vibration
- Exposed to water, oil, chemicals, or solvents
- Exposed to high humidity or condensation
- Exposed to high quantities of dust particles



Unplugging the power cord kills power to the instrument. Be sure to provide enough unobstructed space to unplug the power cord immediately in an emergency.

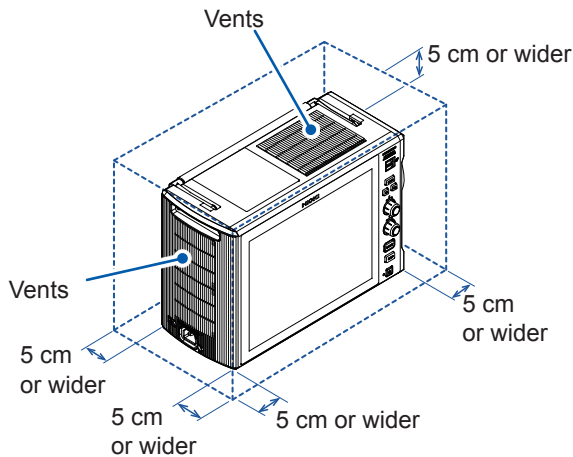

- Do not place the instrument on an unstable table.
-  Do not place the instrument on an inclined surface.
- Do not stack the multiple instruments.
- Vents must not be obstructed.



- The instrument should be operated only with the bottom or rear side downwards.
- Leave at least 5 cm (2 inches) of space on every surface other than the underside to keep the instrument's temperature from rising.

Power supply

CAUTION



To avoid damage to the instrument, do not unplug the power cord from the instrument when operations are in progress. Be sure to use the power key to turn off the instrument.

Handling the instrument and modules

DANGER



- Do not use the modules or the cords to measure circuits that exceed those ratings or specifications. Damage to the instrument or overheating can cause bodily injury.
- The maximum input voltage and maximum rated terminal-to-ground voltage of the modules and connection cords are shown in the following table. To avoid an electric shock and damage to the instrument, ensure that input voltage never exceeds these limits. The lower maximum input voltage of the module or connection cord must be used. Measuring a voltage exceeding this value can cause damage to the instrument, resulting in bodily injury. The same applies to the maximum rated terminal-to-ground voltage using an input attenuator for the measurement. Ensure that the connection does not allow the input voltage to exceed the maximum rated terminal-to-ground voltage.
See “5.2 Specifications of the Options” (p. 117).

Ratings of modules

| Modules | Maximum input voltage | Maximum rated terminal-to-ground voltage |
|-------------------------------------|--|--|
| Model 8966 Analog Unit | 400 V DC | 300 V AC, DC (CAT II) |
| Model 8967 Temp Unit | – | 300 V AC, DC (CAT II) |
| Model 8968 High Resolution Unit | 400 V DC | 300 V AC, DC (CAT II) |
| Model U8969 Strain Unit | – | 30 V rms AC, 60 V DC |
| Model 8970 Freq Unit | 400 V DC | 300 V AC, DC (CAT II) |
| Model 8971 Current Unit | – | Non-isolated |
| Model 8972 DC/RMS Unit | 400 V DC | 300 V AC, DC (CAT II) |
| Model 8973 Logic Unit | – | Non-isolated |
| Model U8974 High Voltage Unit | 1000 V DC 700 V AC | 1000 V AC, DC (CAT III) 600 V AC, DC (CAT IV) |
| Model U8975 4ch Analog Unit | 200 V DC | 300 V AC, DC (CAT II) |
| Model U8976 High Speed Analog Unit | 400 V DC (Direct input) 1000 V DC (with Model 9665 10:1 Probe used) | 1000 V AC, DC (CAT II) |
| Model U8977 3CH Current Unit | – | Non-isolated |
| Model U8978 4CH Analog Unit | 40 V DC (Direct input) 400 V DC (with Model 9665 10:1 Probe used) | 30 V DC, 60 V AC (Direct input) 300 V AC, DC (CAT II) (with Model 9665 10:1 Probe used) |
| Model U8979 Charge Unit | 40 V DC | 30 V AC 60 V DC |
| Model MR8990 Digital Voltmeter Unit | 500 V DC | 300 V AC, DC (CAT II) |

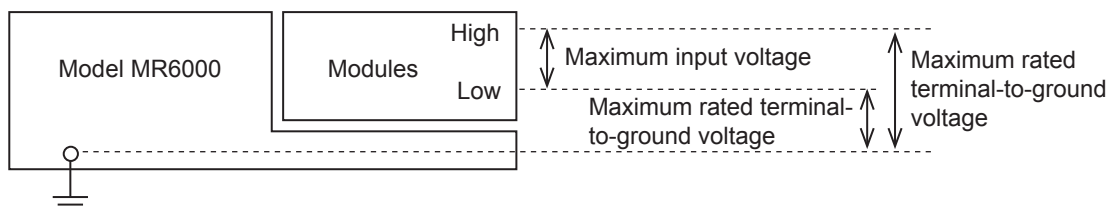

Ratings of generator modules

| Intended use | Modules | Number of channels | Maximum output frequency | Output voltage |
|------------------------------------|--|--------------------|--------------------------|---|
| For generating sine wave and DC | Model MR8790 Waveform Generator Unit | 4 | 20 kHz | -10 V to 10 V |
| For generating pulse | Model MR8791 Pulse Generator Unit | 8 | 20 kHz | TTL level (amplitude: 0 V to 5 V) Open-collector output |
| For generating arbitrary waveforms | Model U8793 Arbitrary Waveform Generator Unit | 2 | 100 kHz | -10 V to 15 V |

Ratings of connection cords

| Connection cord | Maximum input voltage | Maximum rated terminal-to-ground voltage | Maximum rated current |
|--------------------------------------|------------------------|--|-----------------------|
| Model L9197 Connection Cord | 600 V AC, DC | 600 V AC, DC (CAT III) 300 V AC, DC (CAT IV) | 1 A |
| Model L9198 Connection Cord | 300 V AC, DC | 600 V AC, DC (CAT II) 300 V AC, DC (CAT III) | 0.2 A |
| Model L9217 Connection Cord | | | |
| Model L9790 Connection Cord | 600 V AC, DC | <ul style="list-style-type: none"> • With Model L9790-01 Alligator Clip or Model 9790-03 Contact Pin connected 600 V AC, DC (CAT II) 300 V AC, DC (CAT III) • With Model 9790-02 Grabber Clip connected 300 V AC, DC (CAT II) 150 V AC, DC (CAT III) | 1 A |
| Model 9322 Differential Probe | 2000 V DC 1000 V AC | <ul style="list-style-type: none"> • With grabber clips connected 1000 V AC, DC (CAT II) • With alligator clips connected 1000 V AC, DC (CAT II) 600 V AC, DC (CAT III) | – |
| Model L4940 Connection Cable Set | 1000 V DC* | <ul style="list-style-type: none"> • With Model L4935 Alligator Clip Set or Model L4932 Test Pin Set connected 600 V AC, DC (CAT IV) 1000 V AC, DC (CAT III) | 10 A |
| | | <ul style="list-style-type: none"> • With Model L9243 Grabber Clip connected 1000 V AC (CAT II) | 1 A |
| | | <ul style="list-style-type: none"> • With Model L4936 Bus Bar Clip connected 600 V AC, DC (CAT III) | 5 A |
| | | <ul style="list-style-type: none"> • With Model L4937 Magnetic Adapter Set connected 1000 V AC, DC (CAT III) | 2 A |
| | | <ul style="list-style-type: none"> • With Model L4934 Small Alligator Clip Set connected 300 V AC, DC (CAT III) 600 V AC, DC (CAT II) | 3 A |
| Model P9000-01 Differential Probe | 1000 V AC, DC | 1000 V AC, DC (CAT III) | – |
| Model P9000-02 Differential Probe | | | |
| Model 9166 Connection Cord | 30 V AC 60 V DC | For inputting voltage into Model U8979 | – |

| Connection cord | Maximum input voltage | Maximum rated terminal-to-ground voltage | Maximum rated current |
|--|-----------------------|---|-----------------------|
| Model L9795-01 Connection Cable (for generating) | ±30 V | 30 V rms AC, 42.4 V peak AC or 60 V DC | – |
| Model L9795-02 Connection Cable (for generating) | | | |

*: When Model U8974 High Voltage Unit is used

DANGER



It is recommended to measure the secondary side of a distribution panel with the U8974 High Voltage Unit. Do not connect the connection cords on the primary side of the distribution panel because an unrestricted current flow can damage the connection cords and facilities if a short-circuit occurs.

WARNING



Each channel of Model U8979 Charge Unit has the BNC terminal and miniature connector terminal with the common ground. Do not connect cords with each of the terminals simultaneously to avoid a short-circuit.



- To avoid an electric shock and damage to the module and the instrument, confirm that the instrument is turned off and that the connection cords are disconnected before removing or replacing a module.
- To avoid an electric shock, install a blank panel over any slot with a module removed.
- To prevent the instrument damage or an electric shock, use only the screws that are originally installed for securing the module in place. If you have lost any screws or find that any screws are damaged, please contact your authorized Hioki distributor or reseller.
- Setting the measurement mode to [Preamp] allows Model U8979 Charge Unit to constantly provide power (3.0 mA, 22 V) to sensors. Set any measurement mode other than [Preamp] or turn off the instrument before connecting a sensor or probe with a BNC terminal to avoid an electric shock or damage to the measurement target.

CAUTION



- Do not touch module connectors inserted to the instrument to avoid damaging a module.



- Model U8979 Charge Unit has miniature connectors with the maximum input charge of ±500 pC (for six higher-sensitivity range) or ±50,000 pC (for six lower-sensitivity range). Inputting a charge that exceeds these value causes damage to the instrument.
- Use an acceleration sensor with a built-in pre-amplifier that conforms to the specification of Model U8979 (3.0 mA, 22 V). Using an inapplicable sensor may cause damaging itself.
- The mounting screws must be firmly tightened or the module may not work as specified, or may even fail.

IMPORTANT

If any unexpected waveform is observed or a module is not recognized, send the instrument for repair.

- Before carrying the instrument, disconnect all cords and remove the USB flash drive and SD memory card.
- Waveforms can frequently fluctuate even when no voltage is applied due to an induction voltage. This, however, is not a malfunction.
- This instrument may cause interference if used in residential areas. Such use must be avoided unless the user takes special measures to reduce electromagnetic emissions to prevent interference to the reception of radio and television broadcasts.

Precautions During Shipment

Store the packaging materials even after unpacking, because you will need them when you transport the instrument.

 **CAUTION**



To avoid damage to the instrument, protect it from physical shock when transporting and handling. Be especially careful to avoid physical shock due to dropping it.

CD precautions

- Exercise care to keep the recorded side of discs free of dirt and scratches. When writing text on a disc's label, use a pen or marker with a soft tip.
- Keep discs inside a protective case and do not expose to direct sunlight, high temperature, or high humidity.
- Hioki is not liable for any issues your computer system experiences in the course of using this disc.

Handling storage devices

CAUTION



- Do not carry the instrument with a USB flash drive inserted. Damage could result.
- Do not subject the instrument to extreme shock or vibration. Shock can cause damage to the HD unit or built-in SSD unit.
- Inserting a storage device upside down, backward, or in the wrong direction may damage the storage device and instrument.



Exercise care when using such products because static electricity could damage the external storage media or cause a malfunction of the instrument.

IMPORTANT

- Do not extract any external storage device or turn off the instrument while the instrument is accessing the storage device (while the blue **SAVE** key is lighting up). Data stored in the device could be lost.
- No compensation is available for loss of data stored on any external storage device (USB flash drive, SD card) or the built-in HD and SSD units of the instrument, regardless of contents or causes of damage or loss. Be sure to back up any important data stored on the external storage device (USB flash drive, SD card), and the built-in HD and SSD units of the instrument.
- When the instrument is left powered off for a long period of time (about one year or more), the data saved to the built-in SSD may be lost. Be sure to back up the data if the instrument is to be left powered off for a long time.
- Proper operation of the instrument is only guaranteed when using Hioki optional SD Memory Cards and USB Drives as external storage devices. Proper operation is not guaranteed with other recording media.
- Do not remove the seals that are affixed to the instrument's internal hard drive and SSD unit. The product warranty does not cover damage or operational issues caused by use of any components other than HIOKI options.

- With some external storage device, the instrument may not start up if power is turned on while the device is inserted. In such a case, turn off and cycle the instrument.
- The instrument does not support certain types of USB flash drives, such as those that require fingerprint authentication or a password.
- Number of writes for the external media (USB flash drive, SD memory card) and the built-in SSD unit of the instrument is limited by their flash memory. If data has been rewritten many times, data reading and writing capabilities will be degraded. In that case, replace the device.
- Media that can be used to save data is as follows. Use the product available as Hioki's option only. (p. 5)
 - Model Z4006 USB Drive (16 GB)..... (external)
 - Model Z4001 SD Memory Card (2 GB)..... (external)
 - Model Z4003 SD Memory Card (8 GB)..... (external)
 - Model U8332 SSD Unit (built-in)
 - Model U8333 HD Unit (built-in)

Before connecting cords

For detailed precautions and instructions on connections, see the instruction manuals of your connection cords.

DANGER

- If the insulation on a connecting cord melts, the metal conductor may be exposed. Do not use any cord whose metal conductor is exposed. Doing so could result in an electric shock, burn, or other hazards.

When measuring power line voltage



- Only connect connection cords on the secondary side of a distribution panel. If a short-circuit occurs on the secondary side of the distribution panel, the panel will interrupt the short-circuit current. Do not connect the connection cords on the primary side of the distribution panel because an unrestricted current flow can damage the connection cords and facilities if a short-circuit occurs.
- To prevent an electrical shock and bodily injury, do not touch any input terminals on the VT (PT), CT or the instrument when they are in operation.
- Do not leave the measurement cords connected to the instrument in an environment where voltage may surge beyond the maximum input voltage. Applying voltage may result in damage to the instrument, or serious accidents.
- Do not cause a short-circuit between another wire and the wire to be measured with the metal tip of the connection cord. Arcs or such grave accidents are likely to occur.
- To avoid a short-circuit or electric shock, do not touch the metal tip of the connection cord.

WARNING



- To prevent an electric shock, confirm that the white or red portion (insulation layer) inside the cable is not exposed. If a color inside the cable is exposed, do not use the cable.
- Do not place a cord in contact with the lines to be measured. Any contact can cause the instrument to malfunction and lead to a short-circuit or electric shock, resulting in bodily injury.



- Use only the specified connection cords. Using a non-specified cord may result in unsafe measurements. Using a non-specified cord may also result in incorrect measurements due to poor connection or other reasons.
- To avoid electric shock, do not exceed the lower of the ratings shown on the modules and connection cords.

CAUTION



- To prevent cord damage, do not step on cords or pinch them between other objects. Do not bend or pull on cords at their base.



- The cable is hardened in freezing temperatures. Do not bend or pull it to avoid tearing its shield or cutting the cable.
- Do not use any cable terminated with a metal BNC connector for connecting cables to the BNC jacks on modules. If you connect a metal BNC cable to insulated BNC connector, the insulated BNC connector and instrument may be damaged.

Before connecting a logic probe to a measurement target

⚠ DANGER

To avoid an electric shock, a short-circuit and damage to the instrument, supply power from a single main to the instrument and a measurement target with the accompanying power cord.

The ground pin of logic terminal of Model 9320-01 Logic Probe (or Model 9327 Logic Probe) is not isolated from the instrument ground. The ground is shared. If each of the terminals are supplied with power from separate mains or power is supplied through a non-grounded power cord, the measurement target and the instrument may be damaged because a current may flow through the logic probe due to the resulting ground potential difference between the terminals. The following connection procedure is recommended to avoid this problem:



- Connect the accompanying power cord to the instrument and supply power from a single outlet as the measurement target.
- Connect the ground of the measurement target to the GND terminal (functional earth terminal) of the instrument.
(Always supply power from a single main.)
See “2.9 Supplying Power to the Instrument” (p. 72).

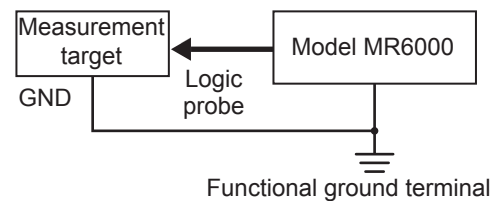
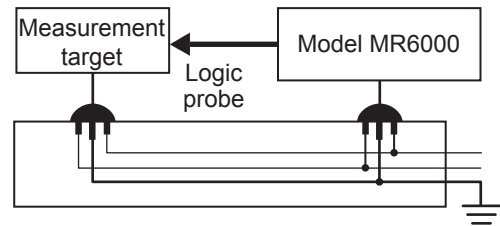

Before turning on the instrument

WARNING



- To prevent electrical shock and to maintain the safety specifications of this instrument, connect the accompanying power cord only to an inlet.
- Before turning the instrument on, make sure the supply voltage matches that indicated on its power connector. Connection to an improper supply voltage may damage the instrument and present an electrical hazard.

CAUTION



- Do not operate the instrument on any of the power sources that provide rectangular-wave or pseudo-sine-wave power (UPS or uninterruptible power supply, DC/AC inverter). Doing so may damage the instrument.
- Supply power to the instrument in combination with an uninterruptible power supply (UPS) if instantaneous power interruptions occur frequently. If the power to the MR6000 goes off during the operation, the built-in system disc will be damaged. See “13 Configuring the System Environment Settings” in the Instruction Manual.

IMPORTANT

Supply power to the instrument in combination with an uninterruptible power supply (UPS) if instantaneous power interruptions occur frequently. Although the instrument will not be affected by an instantaneous interruption of up to 40 ms in length, it can malfunction if the power goes off for over 40 ms. If the instrument is shut down while saving files onto an external storage device, it cannot save data correctly.

Before connecting the instrument to external equipment

DANGER



To avoid electrical hazards and damage to the instrument, do not apply voltage exceeding the rated maximum to the external control terminals.

Model MR6000

| I/O terminals | Maximum input voltage |
|---------------|------------------------|
| IN1 | 10 V DC |
| IN2 | 10 V DC |
| OUT1 | 50 V DC, 50 mA, 200 mW |
| OUT2 | 50 V DC, 50 mA, 200 mW |
| TRIG.OUT | 50 V DC, 50 mA, 200 mW |
| EXT.TRIG | 10 V DC |

| I/O terminals | Maximum input voltage |
|---------------|-----------------------|
| EXT.SMPL | 10 V DC |

Model U8793 Arbitrary Waveform Generator Unit

| I/O terminals | Maximum input voltage |
|---------------|-----------------------|
| IN | -0.5 V to 7 V DC |
| OUT | 30 V DC, 50 mA |

WARNING

To avoid an electric shock or damage to the equipment, always observe the following precautions when connecting your external equipment to external control terminals.



- **Always turn off the instrument and any equipment to be connected before making connections.**
- **Be careful to avoid exceeding the ratings of the external control terminals.**
- **The ground is shared between the instrument and the external control terminals. Isolate the devices and systems to be connected to the external control terminals from one another, as needed.**

CAUTION



You can configure Windows® settings only when Quick Start Manual or Instruction Manual instruct to do so. Do not configure any Windows® settings that are not instructed in these manuals. In addition, do not install any software other than the pre-installed software. Doing so will cause instable operation of the system, with the result that the instrument cannot launch.



- Use a common ground to both the instrument and the connected equipment. Using different ground circuits will result in a ground potential difference between the instrument and the connected equipment. If a cable is connected while such a potential difference exists, it may result in equipment malfunction or failure.
- Before connecting or disconnecting any cable, always turn off the instrument and your device to be connected. Failure to do so could result in an equipment malfunction or damage to the equipment.
- After connecting the cable, tighten the screws on the connector securely. Failure to do so could result in an equipment malfunction or damage to the equipment.
- To prevent damage to the equipment, use the recommended type of wires to connect your external equipment to the external control terminals, or otherwise ensure that the wires have sufficient withstand voltage and current capacity. See “2.5 Connecting the External Control Terminals” (p. 63).

How to Use This Document

How to open a screen

Indicates the order of tapping the screens.

The button  represents the setting key.

Procedure numbers

Numbered same as a corresponding step-by-step instruction.

Options and explanations

Describes options available when an item is tapped.

The icon indicates the default setting of the item.

 > [Channel] > each module (UNIT)

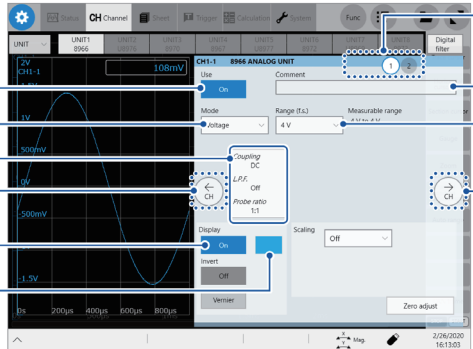

- 1** Tap the [Use] button to set it to [On] or [Off].

| | |
|------------------------|---|
| On [□] | Measures a waveform through this module. |
| Off | Does not measure any waveform through this module. Since no data is acquired, the instrument displays or saves nothing. |

- 2** Enter a comment in the [Comment] box.
Number of characters that can be entered: up to 40
- 3** Tap the [Mode] box, and then choose a measurement mode from the list.

| | |
|-----------------------------|--|
| Voltage [□] | Measures a waveform in voltage mode. |
| Temperature | Measures a waveform in temperature mode. |

Selectable modes vary depending on the installed modules.
See "3.6 Configuring Module-Specific Settings" in the Instruction Manual.

- 4** Tap the [Range (f.s.)] box, and then choose a measurement range from the list.
The measurement ranges that can be chosen varies depending on modules.
If an input voltage exceeds the measurable range (overrange), change the measurement range to one with a lower sensitivity.

1.1 Product Overview and Features

This recorder allows you to observe a wide range of waveforms from low-speed signals to high-speed waveforms.

You can mainly use this instrument for analyzing test and evaluation results of various products and troubleshooting those products.

● High-speed sampling rate: 200 M sampling

The high-speed sampling rate allows capturing instantaneous changes such as PWM switching waveforms of inverters.

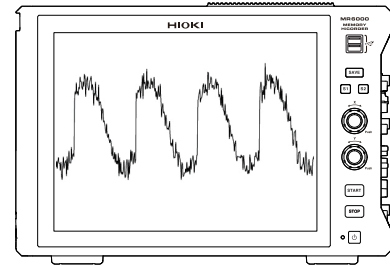

● Extensive line of measurement modules

Many types of measurement modules let the instrument measure a variety of signals that include voltage, current, temperature, and frequency.

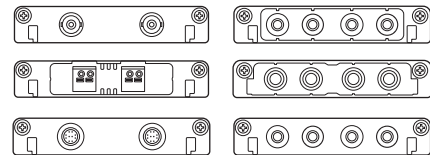

● Real-time saving function

Recording the waveform data to optional media allows measurements with high-speed and for long durations.

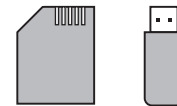

● The touch panel allows intuitive operations.

The touch panel allows intuitive operations.

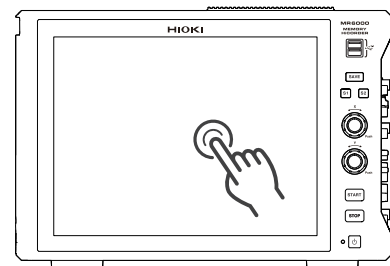

1.2 Name and Function of Each Part

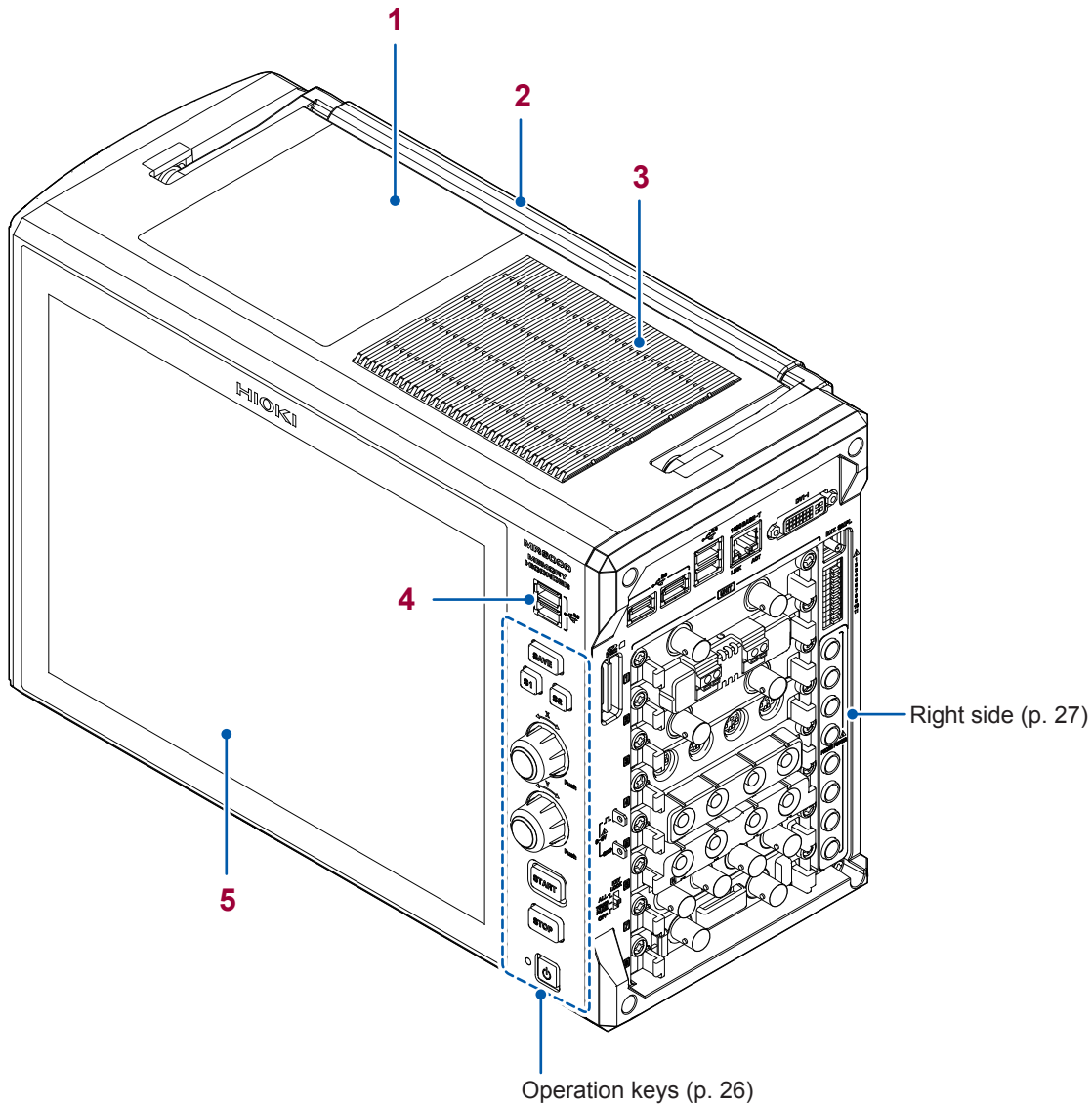

| No. | Name | Function | Reference |
|----------|--------------------------|---|-----------|
| 1 | Media box | Holds the SSD or HD unit. One port is available for USB 3.0 connector (dedicated to USB flash drives). Always use the instrument with the cover closed. | p. 71 |
| 2 | Handle | The handle used to carry the instrument. | — |
| 3 | Vents | These holes provide ventilation to prevent the internal temperature of the instrument from increasing to a high temperature. | p. 10 |
| 4 | USB 2.0 connector | Connect a USB flash drive, USB mouse, or USB keyboard. | p. 68 |
| 5 | Display | The 12.1-inch TFT color LCD equipped with the capacitive touch panel | p. 28 |

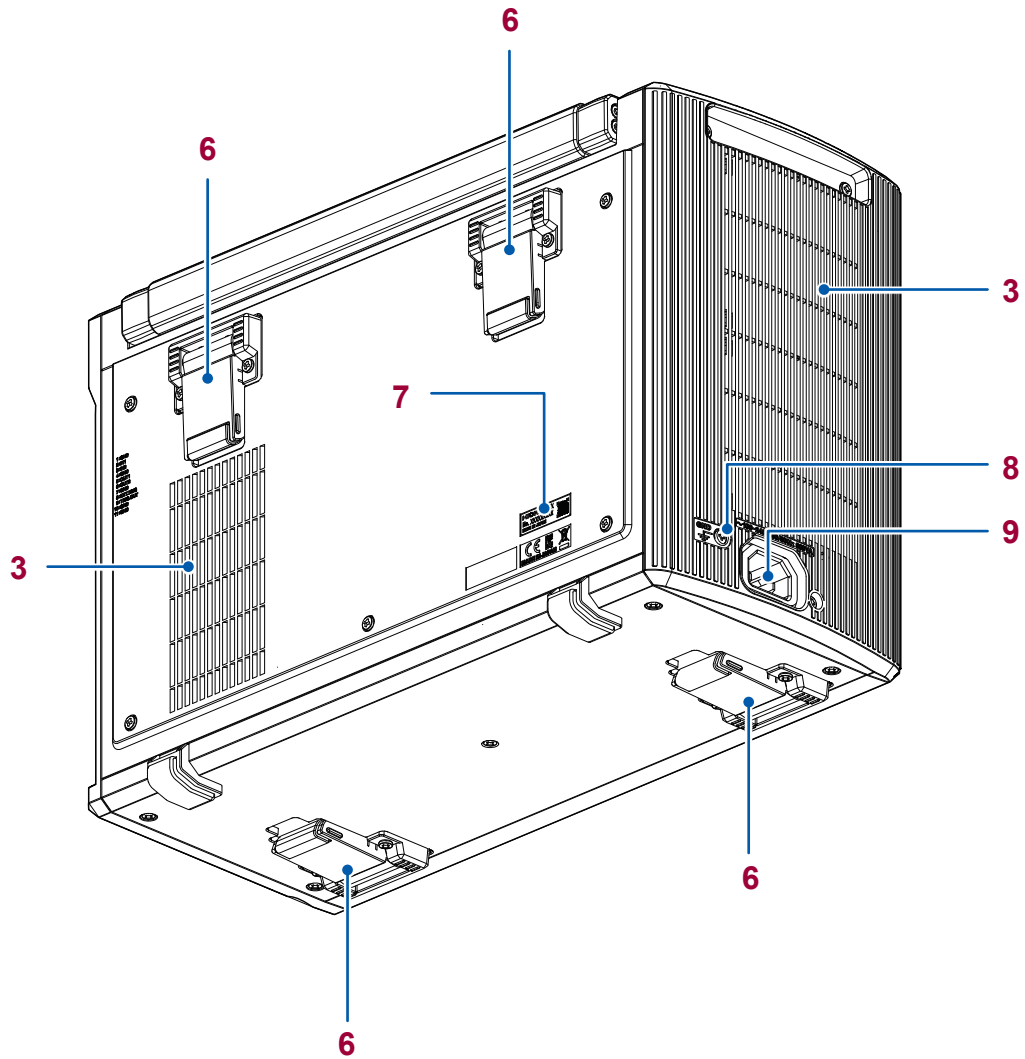

| No. | Name | Function | Reference |
|-----|---|---|----------------|
| 6 | Feet | These feet are used to incline the instrument for better visibility of the screen. | – |
| 7 | Serial number | The serial number consists of nine digits. The first two (from the left) indicate the year of manufacture, and the next two indicate the month of manufacture. Required for product control. Do not remove this label. Inform your authorized Hioki distributor or reseller of this number if required. | – |
| 8 | GND terminal (Functional earth terminal) | Connects this terminal to a grounded conductor. | p. 19 p. 72 |
| 9 | Power inlet | Connects the power cord provided. | |

Operation keys

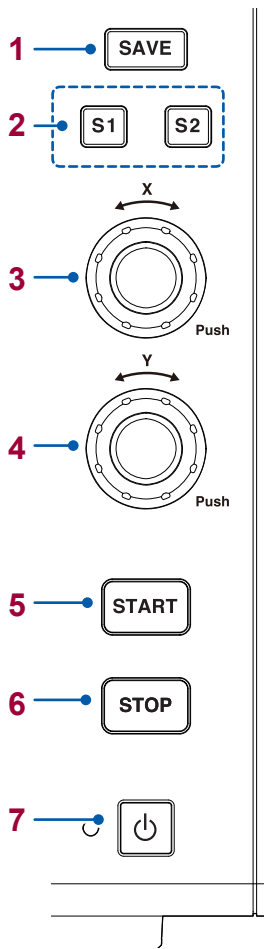

| No. | Name | Function | Reference |
|-----|----------------------|--|-----------|
| 1 | SAVE key | Opens the manual saving dialog box. Lights up in blue while accessing the storage device. | p. 88 |
| 2 | Shortcut keys | Frequently-used settings can be registered on the keys. | * |
| 3 | Rotary knob X | Allows you to choose a sampling rate and moves the cursors. | p. 32 |
| 4 | Rotary knob Y | Allows you to choose a measurement range and moves waveform positions. | |
| 5 | START key | Starts a measurement. Lights up in green during a measurement. | p. 87 |
| 6 | STOP key | Pressing the key once: Acquires the recording length of waveforms before stopping the measurement. Pressing the key twice: Stops the measurement. | |
| 7 | Power key | Used to turn on and off the instrument. | p. 72 |

*: "13 Configuring the System Environment Settings" in the Instruction Manual

IMPORTANT

Do not press several operation keys simultaneously. Besides, do not execute excessively consecutive actions. Doing so may cause unstable behavior of the instrument.

Right side

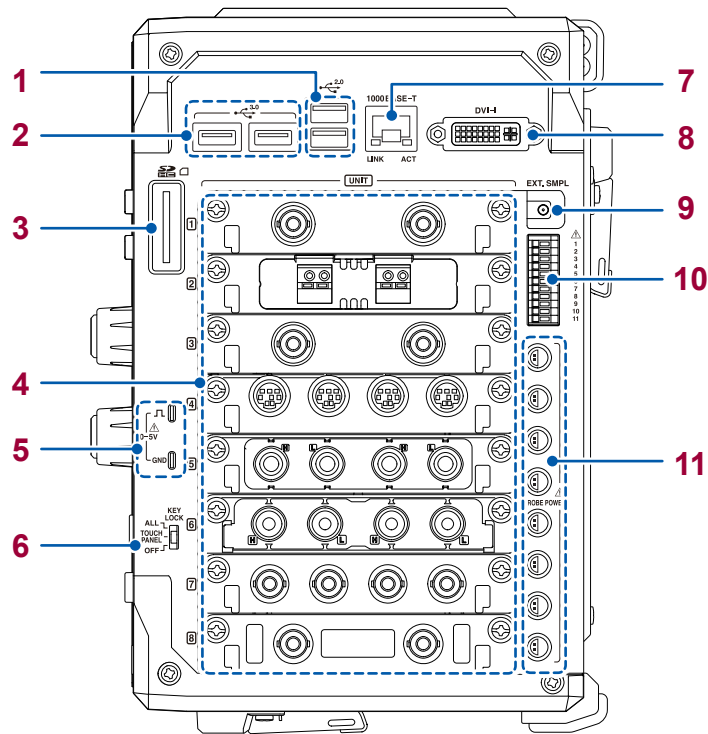

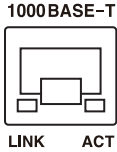
| No. | Name | Function | Reference |
|-----|---|---|----------------|
| 1 | USB 2.0 connector | Connect a USB flash drive, USB mouse, or USB keyboard. | p. 68 |
| 2 | USB 3.0 connector | | |
| 3 | SD memory card slot | Insert an SD memory card. | p. 67 |
| 4 | Modules | Install modules required for measurement targets. | p. 10 p. 42 |
| 5 | Probe compensation signal output terminal | Outputs the signals to compensate Model 9665 10:1 Probe or Model 9666 100:1 Probe for influences. | p. 46 |
| 6 | KEY LOCK | Disables the touch panel and key operation. | p. 37 |
| 7 | 1000BASE-T connector  | Plug a LAN cable to connect the instrument to your network. ACT LED Blinking: Communicating data LINK LED Green light: 1000BASE Yellow light: 100BASE Off: 10BASE | p. 65 |
| 8 | DVI-I terminal | Outputs the screen data signal (digital or analog). | – |
| 9 | External sampling terminal | Input an external sampling signal. | p. 62 |
| 10 | External control terminals | Enables to control the instrument by inputting external signals, or output signals externally. | p. 19 p. 63 |
| 11 | Dedicated power terminal for current sensors | Model Z5021 Probe Power Unit (optional) can be installed. | p. 16 p. 61 |

1.3 Screen

Screen configuration

Waveform screen (p. 29)



Setting screen



Status

Status

This screen is used to set the measurement conditions such as the sampling rate, recording length (shot), and saving data.
See “3.2 Setting Measurement Conditions” (p. 80).

CH Channel

Channel

This screen is used to configure the input channel settings such as the measurement range and low-pass filter.
See “3.3 Configuring the Input Channel Settings” (p. 82) and “1 Digital-Filter Calculation” of MR6000-01 Dedicated Functions.
This screen is also used to configure the CAN/LIN measurement settings.
See “12 CAN/LIN Measurement Function” in the Instruction Manual.



Sheet

Sheet

This screen is used to configure a display settings for each sheet.
Choose channels to be displayed on each sheet.
See “1.4 Configuring the Sheet Settings” in the Instruction Manual.



Trigger

Trigger

This screen is used to configure the trigger settings.
See “3.4 Configuring the Level Trigger Settings” (p. 85).



Calculation

Calculation

This screen is used to configure the settings of the numerical, waveform, FFT, real-time waveform (Model MR6000-01 only) calculations.
See “7 Numerical Calculation Function” in the Instruction Manual, and “2 Real-time Waveform Calculation” of MR6000-01 Dedicated Functions.



System

System

This screen is used to configure the system environment, communications, and external control terminal settings, and to initialize the instrument. You can also check the instrument configuration on this screen.
See “6.2 Initializing the Instrument” (p. 155).

Explanation of each screen

Waveform screen

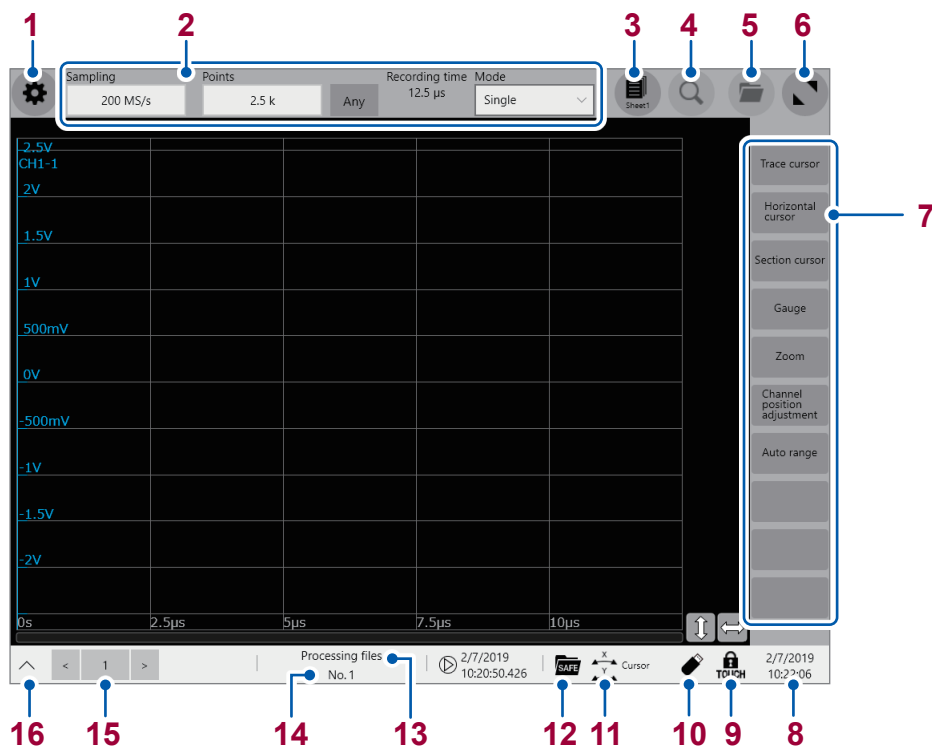

| No. | Item | Description | Reference |
|-----|--------------------------------------|---|--------------|
| 1 | | Switches between the setting and waveform screens. | p. 80, p. 93 |
| 2 | Measurement condition setting | Allows you to choose a sampling rate, recording length (the number of points and user-defined length), and recording mode (single or repeat). | p. 80 |
| 3 | Sheet selection | Switches among preset sheets. | *1 |
| 4 | Search setting screen | Allows you to specify search conditions. | *2 |
| 5 | File screen | Opens the file screen. To work with files, display the settings screen and then select <i>Explorer</i> from the function button. | *3 |
| 6 | Waveform area zooming-in | Zooms in the waveform area. | — |
| 7 | Function buttons | Allows you to choose a function among those available on the waveform screen. | p. 93 |
| 8 | Current date and time | Displays the current date and time. | p. 74 |
| 9 | KEY LOCK state | Indicates a key lock state. | p. 37 |
| 10 | Eject button | Ejects a USB flash drive or SD memory card. | p. 69 |
| 11 | Rotary knob setting | Indicates functions assigned to the rotary knob. Each time you press the rotary knob, the function is switched. | p. 32 |
| 12 | System protection state | Indicates the system protection state. | *4 |
| 13 | Processing state | Indicates the processing state of the instrument. | — |
| 14 | Measurement count | Displays the measurement count. | — |
| 15 | Displayed-block number | The number of the block displayed on the waveform screen with the memory division enabled | *5 |
| 16 | | Displays the quick-access menu. | p. 36 |

- *1: See “1.4 Configuring the Sheet Settings” in the Instruction Manual.
- *2: See “6 Search Function” in the Instruction Manual.
- *3: See “4 Saving/Loading Data and Managing Files” in the Instruction Manual.
- *4: See “13 Configuring the System Environment Settings” in the Instruction Manual.
- *5: See “10.2 Configuring the Display Settings” in the Instruction Manual.

Cross-screen functions

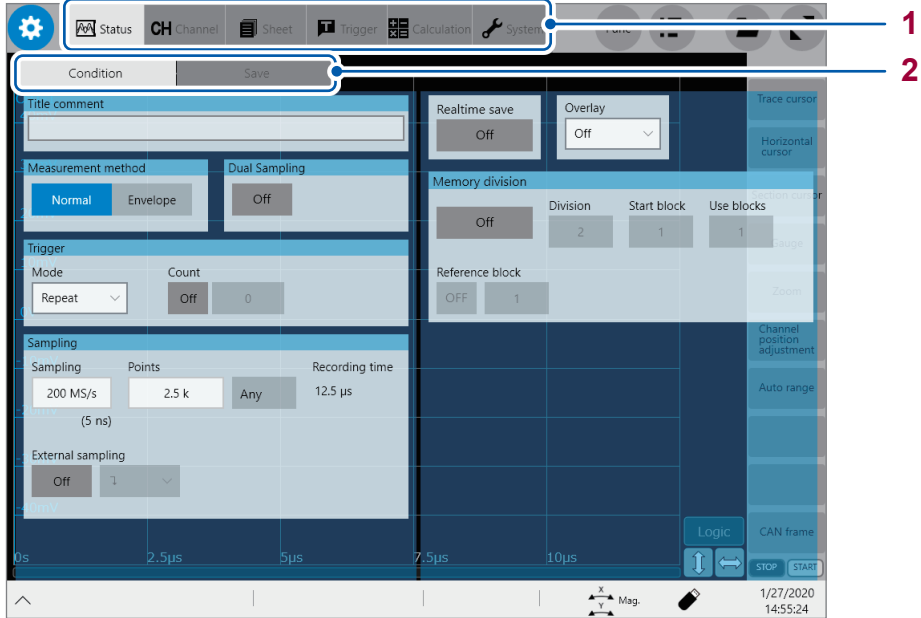





| No. | Name | Description |
|-----|--------------|---|
| 1 | Menu tab | Tap a tab to choose a menu to open. |
| 2 | Sub-menu tab | Tap a tab to choose a sub-menu to open. |

1.4 Basic Operation

Touch panel

The touch panel allows the following operations.

| Touch operation | Description |
|--|---|
|  Tap | “Tap” means to touch the display with a finger and then to lift the finger quickly. |
|  Drag | “Drag” means to choose something shown on the display with a finger by touching it and to slide the finger while touching the display. To scroll through screens or waveforms, drag them. |
|  Pinch in | “Pinch in” means to move the thumb and a finger (or two fingers) together while touching the display. |
|  Pinch out | “Pinch out” means to move the thumb and a finger (or two fingers) apart while touching the display. |
|  Swipe | “Swipe” means to move a finger quickly across the display while touching it. |

Rotary knob

Push the rotary knob to choose an action and turn the knob to perform the action.

Operation of the rotary knob

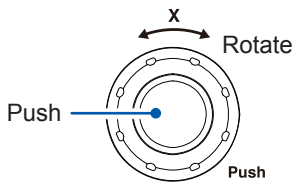

Each time you push the rotary knob X, the following actions are chosen one after another.

| | |
|--|---|
| Magnification/demagnification ratio | Changes the magnification/demagnification ratio of waveforms acquired across all channels in the horizontal axis direction. |
| Position | Changes the display position of waveforms acquired across all channels in the horizontal axis direction. |
| Cursor | Moves the chosen cursor. |
| Setting | Changes the sampling rate. |

Operation for the rotary knob Y

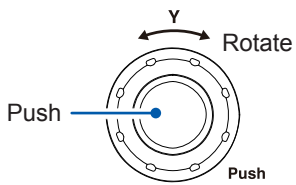

Each time you push the rotary knob X, the following actions are chosen one after another.

| | |
|--|---|
| Magnification/demagnification ratio | Changes the display magnification of the chosen channel in the vertical axis direction. |
| Position | Changes the display position of the chosen channel in the vertical axis direction. |
| Cursor | Moves the chosen cursor by one sample. |
| Setting | Changes the measurement range. This operation can be used on the waveform screen only. |

When you operate a rotary knob, the channel selection panel is displayed, which allows you to choose a channel to be operated by tapping the [←] or [→] button. In addition, you can directly choose a channel to be operated by tapping a channel marker.

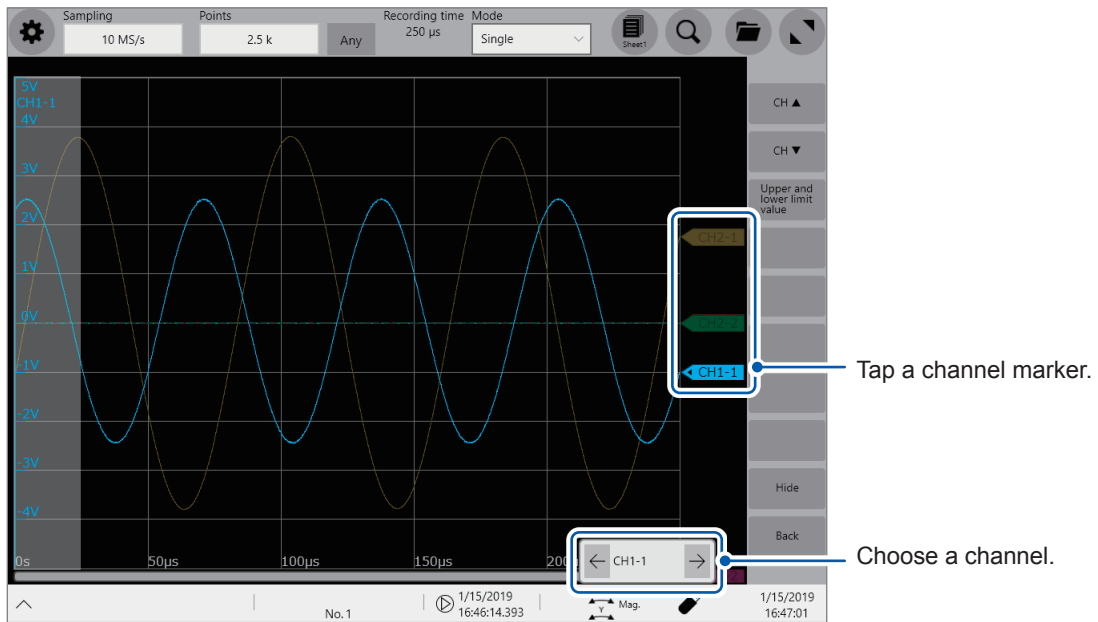

Changing screens and settings

Switching between the waveform and setting screens

Tap the button  to switch between the waveform and setting screens.

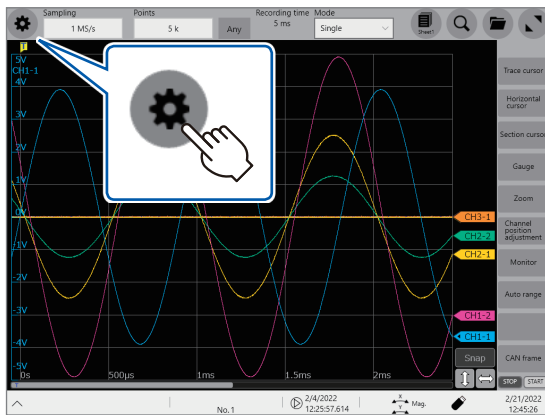

Waveform screen

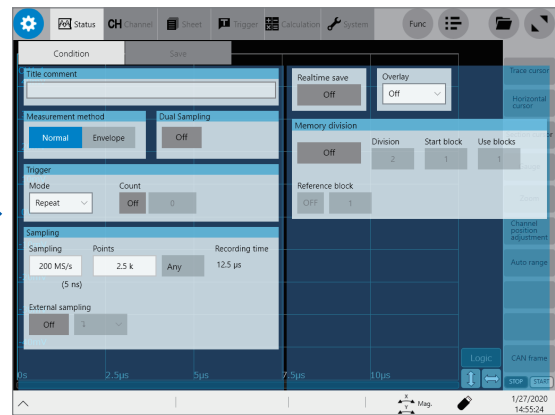

Setting screen

Switching the setting screens

Tap a tab to switch the setting screens.

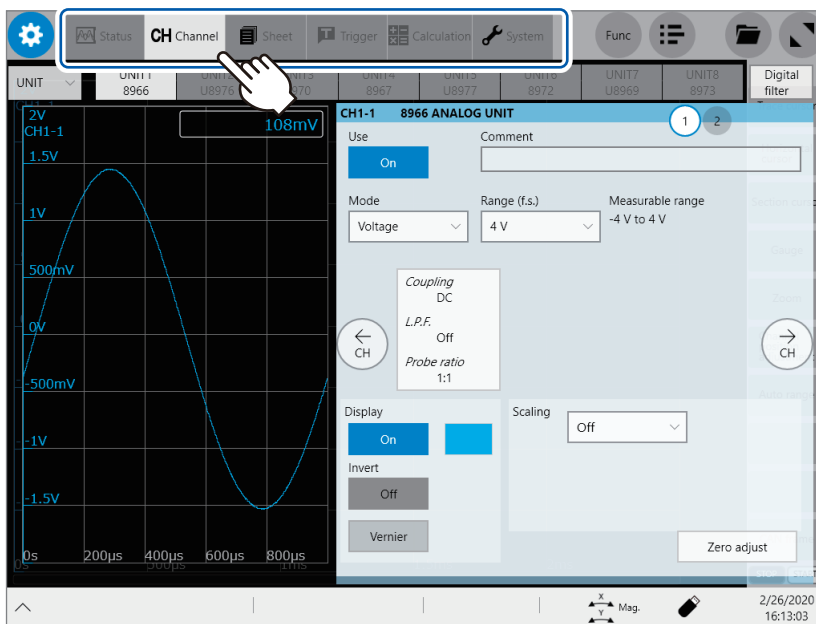

Choosing an option from a list

Example: Choosing a sampling rate



Example: Choosing a measurement range of Model 8966

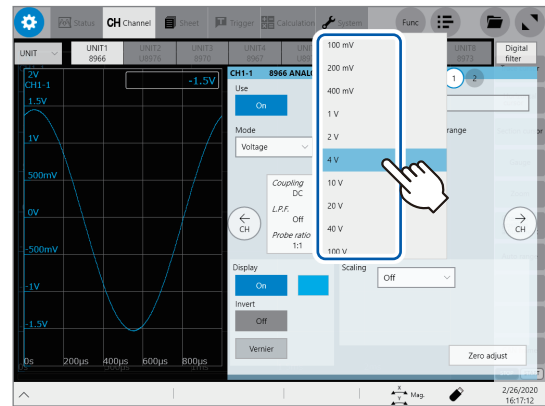

Entering numerical values

Example: Entering a user-defined recording length

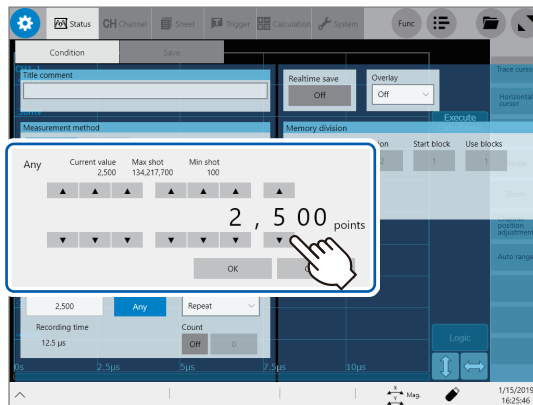

Example: Entering a scaling ratio

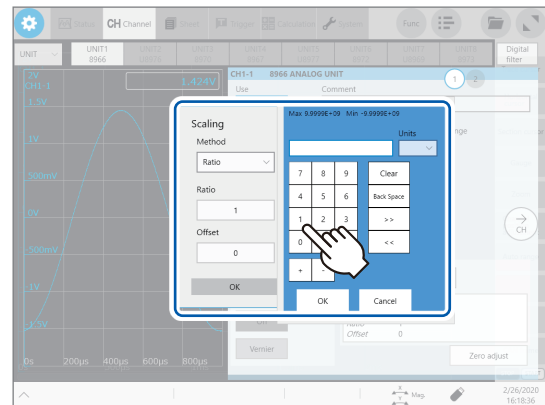

Quick-access menu

The quick-access menu allows various operation that includes undoing the action and switching over to the entire waveform display.

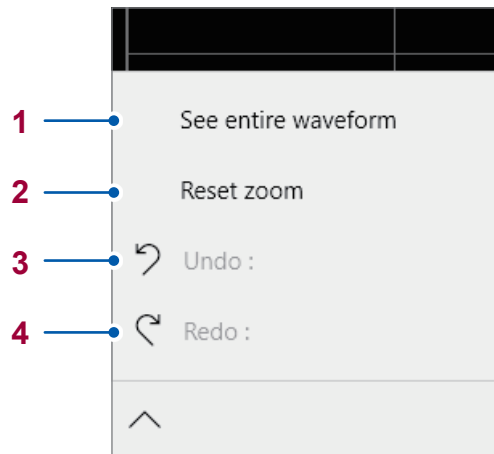

| No. | Item | Description |
|-----|---------------------|---|
| 1 | See entire waveform | Displays the recording length of the waveforms so that they fit the single screen width. If the recording length is relatively long, displaying the waveforms may require a lot of time. |
| 2 | Reset zoom | Displays the waveforms at the default display magnification. |
| 3 | Undo | Cancels the previous action, which restores the instrument to the previous setting. |
| 4 | Redo | Performs the action canceled by tapping [Undo]. |

- You cannot restore the instrument to a former condition after performing an action that includes the following actions: loading data, restoring data to the default condition, executing the automatic ranging, and sending a communication command.
- You cannot retrieve measurement waveforms.

Key lock

The key lock function disables touch panel operation and key operation to prevent an operation error during measurement. Even if the key lock is engaged, the external control terminals and remote operation are enabled.

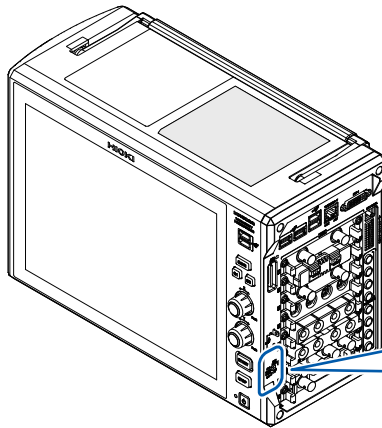

KEY LOCK

ALL TOUCH PANEL OFF

To disable touch panel and key operations:
Set the switch in "ALL."

KEY LOCK

ALL TOUCH PANEL OFF

To disable touch panel operation only:
Set the switch in "TOUCH PANEL."

KEY LOCK

ALL TOUCH PANEL OFF

To disengage the key lock:
Set the switch in "OFF."

Help function (Displaying manuals)

The screen can display the HTML file of a selected manual.

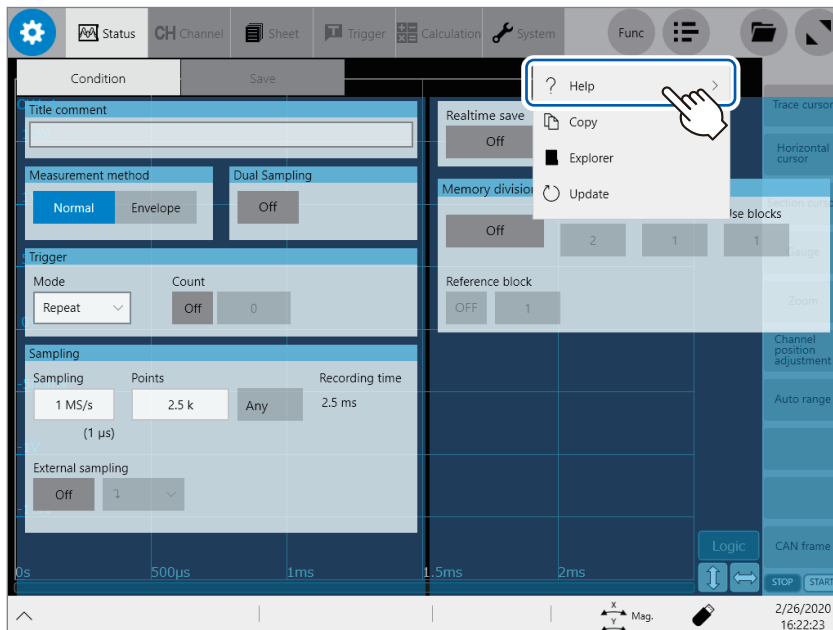

> [Func] > [Help]



Mouse operation

Using a commercially available USB mouse enables you to operate the instrument as with the touch panel.

Basic mouse operation for the instrument is as follows:

| Mouse operation | Touch panel operation | Description |
|---|-----------------------------------|---|
|  Click | Same action as tapping the screen | Allows you to choose a menu or execute an action. |
|  Wheel button | – | Changes options to be selected. |
|  Up/down/left/right | – | Moves the mouse cursor around. |

External noise may cause the mouse to malfunction. Keep the mouse and mouse cable as far away as possible from sources of noise.

Use the mouse on an insulated table. Some mice commercially available are susceptible to noise and using such a mouse on a metal table may cause the instrument to malfunction.

Touch keyboard

Tapping a comment box allows you to enter characters with the touch keyboard.
See “3.2 Setting Measurement Conditions” (p. 80) and “3.3 Configuring the Input Channel Settings” (p. 82).

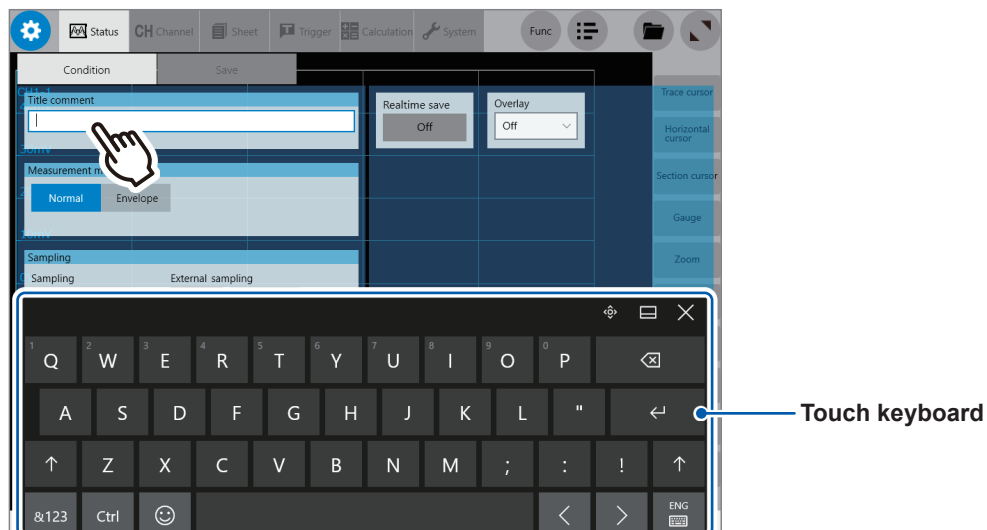

| Icon | Description |
|------|---|
| | You can drag the keyboard. The icon appears to the left of this icon. Each tap switches between the icon and the icon . |
| | You cannot drag the keyboard. Each tap switches between the icon and the icon . |
| | Closes the keyboard. |

2

Preparing for Measurement

Carefully read "Operation Precautions" (p. 9) before starting preparation.

Keyboard, mouse

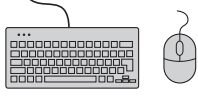

(p. 38)

Modules

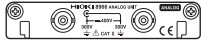

(p. 42)

Connection cords

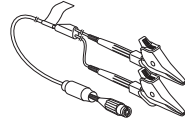

(p. 44)

External sampling



(p. 62)

External control terminals



(p. 63)

Computer

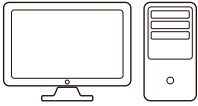

(p. 65, p. 97)

Storage devices

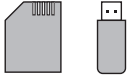

(p. 67)

Power cord

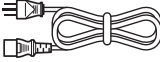

(p. 72)

Setting the clock



(p. 74)

Zero-adjustment



(p. 75)

2

2.1 Installing and Removing Modules

If you order the instrument with modules specified, the instrument will be delivered with the modules pre-installed. Follow the procedures below to install a module additionally, replace modules, or remove a module. Up to four modules of Model 8971 Current Unit can be installed to the instrument. Up to three modules of Model U8977 3CH Current Unit can be installed to the instrument.

See “Handling the instrument and modules” (p. 11).

Required items: Phillips-head screwdriver (No. 2)

How to install a module

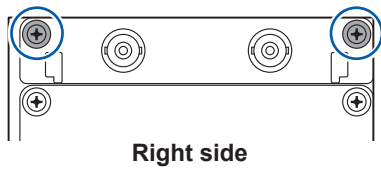

- 1** Turn the instrument off.
- 2** Orient and insert the module all the way into the instrument.
- 3** Tighten the two screws with the Phillips-head screwdriver to secure the module.

How to remove the module

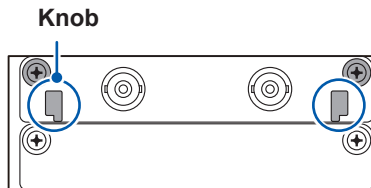

- 1** Turn the instrument off.
- 2** Loosen the two module mounting screws with the Phillips-head screwdriver.
- 3** Pinch the two knobs and pull out the module.

When not installing any module after removal

Install a blank panel. To order additional blank panels, contact your authorized Hioki distributor or reseller.

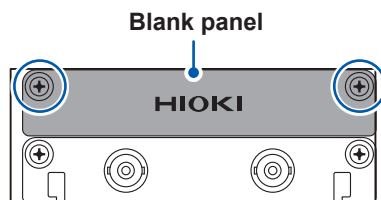

- 1** Place a blank panel.
- 2** Tighten the two screws with the Phillips screwdriver to secure the blank panel.

Allocation of modules and channels

Module numbers

Modules are numbered beginning at the top.

Channel numbers

Channels of each module are numbered beginning from the left.

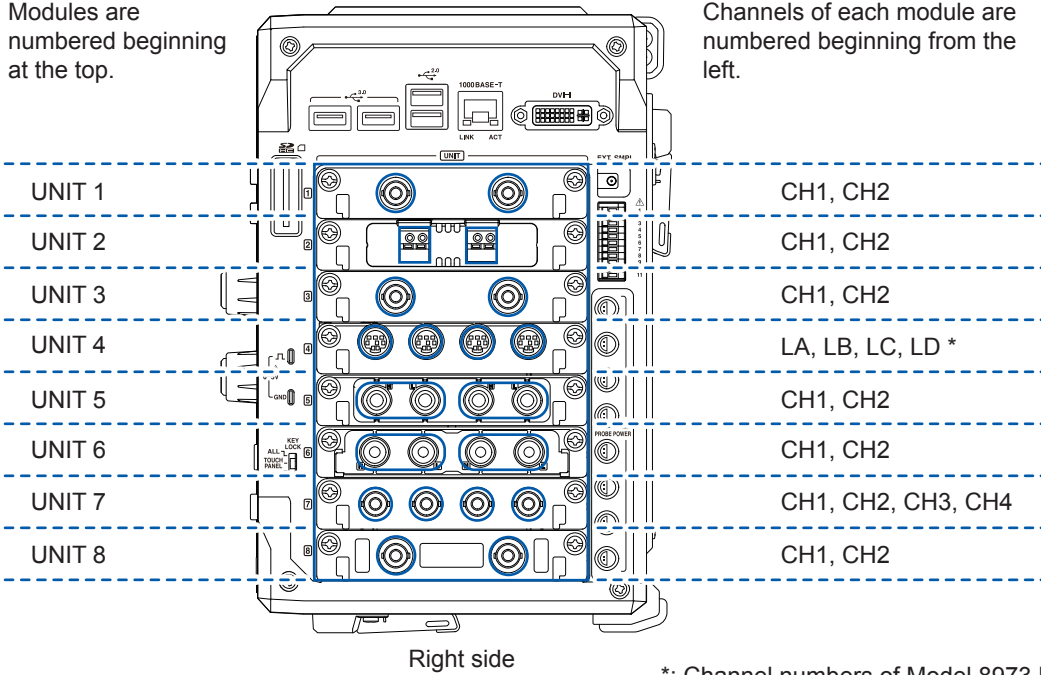

*: Channel numbers of Model 8973 Logic Unit

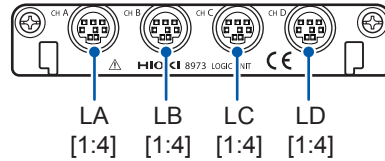

You can find out information about the modules installed in the instrument in [\[System information\]](#). See “System configuration check” (p. 167).

> [\[System\]](#) > [\[System information\]](#)

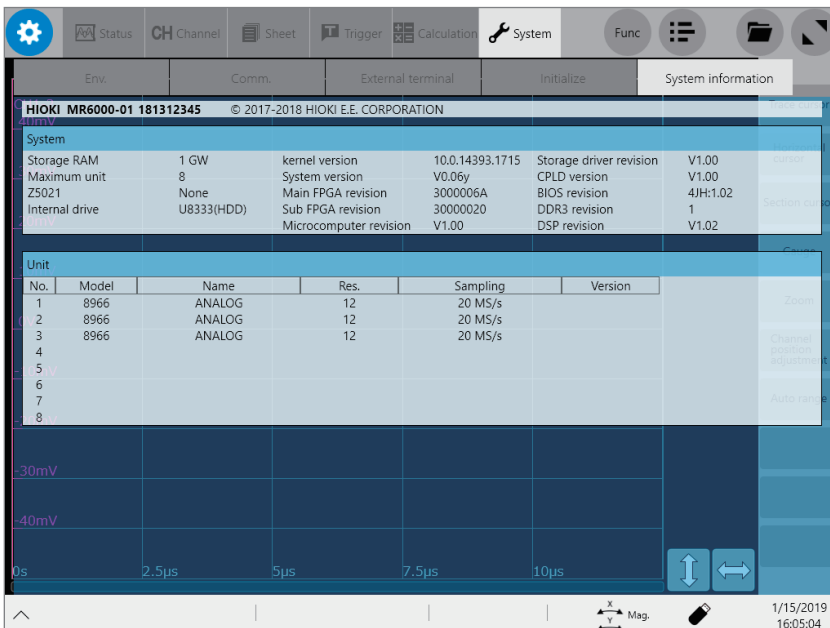

2.2 Connecting Connection Cords

See the instruction manual of each module and each connection cord if provided.

| Measurement target | Applicable module | | Cord to be connected | | Reference |
|---|------------------------|-----------------------------------|---|--|----------------|
| Voltage | Model 8966 | Analog Unit | Model L9197 | Connection Cord | p. 16 p. 45 |
| | Model 8968 | High Resolution Unit | Model L9198 | Connection Cord | |
| Model 8972 | DC/RMS Unit | Model L9217 | Connection Cord | | |
| Model U8975 | 4ch Analog Unit | Model L9790 | Connection Cord | | |
| Model U8976 | High Speed Analog Unit | Model 9665 | 10:1 Probe | | |
| Model U8978 | 4CH Analog Unit | Model 9666 | 100:1 Probe | | |
| Model U8979 | Charge Unit* | Model 9322 | Differential Probe | | |
| Frequency Rotation speed Count | Model 8970 | Freq Unit | Model P9000-01 | Differential Probe | |
| | | | Model P9000-02 | Differential Probe | |
| | | | Model 9166 | Connection Cord* (For inputting voltage into Model U8979) | |
| Temperature | Model 8967 | Temp Unit | Thermocouple | | p. 47 |
| Vibration Load Pressure Acceleration Torque Displacement | Model U8969 | Strain Unit | Strain gauge transducer | | p. 48 |
| | Model U8979 | Charge Unit | Acceleration sensor | | p. 55 |
| Current | Model 8971 | Current Unit | Current sensor | | p. 50 |
| | Model U8977 | 3CH Current Unit | | | |
| Logic signal | Model 8973 | Logic Unit | Model 9320-01 | Logic Probe | p. 57 |
| | | | Model MR9321-01 | Logic Probe | |
| | | | Model 9327 | Logic Probe | |
| Voltage (precision) | Model MR8990 | Digital Voltmeter Unit | Model L2200 | Test Lead | p. 57 |
| High voltage | Model U8974 | High Voltage Unit | Model L4940 | Connection Cable Set | p. 58 |
| Waveform output | Model MR8790 | Waveform Generator Unit | Model L9795-01 | Connection Cable | p. 59 |
| | Model U8793 | Arbitrary Waveform Generator Unit | Model L9795-02 | Connection Cable | |
| Pulse output | Model U8791 | Pulse Generator Unit | Commercially available cable (Half-pitch 50 pins) | | p. 60 |



*: Model 9166 Connection Cord can be used for Model U8979 Charge Unit only.

Connection cords (For measuring voltage, frequency, or rotation speed, and obtaining accumulations)

Insert connection cords to modules. Choose an appropriate connection cord based on the maximum input voltage and tips of cords.

The maximum input voltage of the instrument or connection cord, whichever is lower, is applicable. See "" (p. 16).

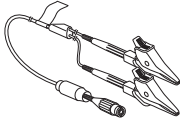
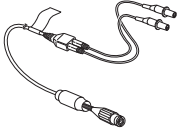
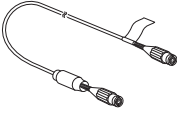
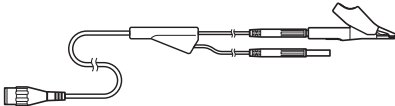
Required items: Connection cords

| Connection cord | Maximum input voltage | Terminal type |
|---|-----------------------|---|
| Model L9197 Connection Cord  | 600 V | Large alligator clip |
| Model L9198 Connection Cord (for lower voltage)  | 300 V | Small alligator clip |
| Model L9217 Connection Cord  | 300 V | BNC output |
| Model L9790 Connection Cord Example: with the alligator clip connected.  | 600 V | Alligator clip Grabber clip Contact pin |
| Model 9166 Connection Cord (For inputting voltage into Model U8979)  | 30 V AC, 60 V DC | Small alligator clip |
| When the voltage of a measurement target exceeds the maximum input rating of the module being used, use any of the following probes: Model 9665 10:1 Probe* ¹ Model 9666 100:1 Probe* ¹ Model 9322 Differential Probe* ² Model P9000-01 Differential Probe* ³ Model P9000-02 Differential Probe* ³ Example: Model P9000-02 Differential Probe  | | Alligator clip |

*1: The maximum rated terminal-to-ground voltage depends on a module to be used.

*2: An optional power cord or AC adapter is required.

*3: An optional AC adapter or a commercially available USB cable is required.

How to connect a cord

Example: Model 8966 Analog Unit

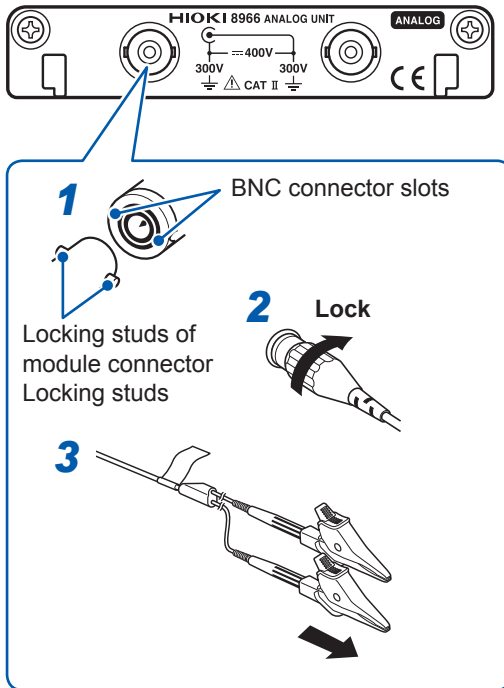

- 1** Align the slots in the BNC connector of a connection cord with the locking studs of a BNC connector on the module, and insert the connector.
- 2** Turn the BNC connector of the connection cord clockwise until it locks.
- 3** Connect the connection cord clips to a measurement target.

How to disconnect the cord

Turn the BNC connector of the connection cord counterclockwise, and then pull out the connector.

When using Model 9665 10:1 Probe or Model 9666 100:1 Probe

Connect the probe tips to the probe compensation signal output terminals of the instrument to compensate the probe for influences before use.

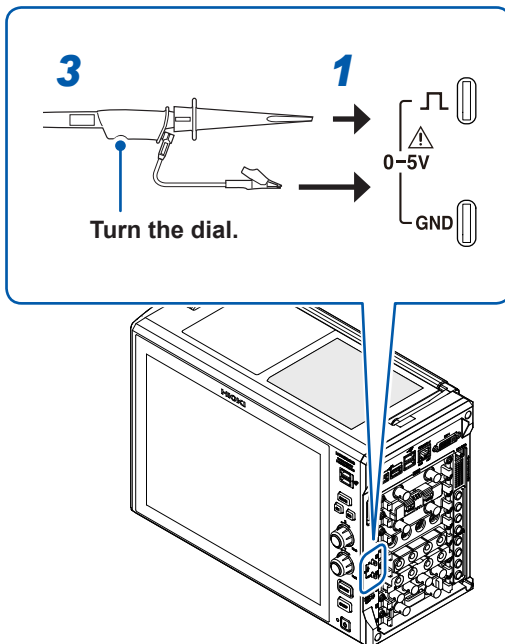

- 1** Connect the probe tips to the probe compensation signal output terminals of the instrument.
- 2** On the instrument, select **[System] > [External terminal]** to set **[Probe compensation signal output]** to **[On]** (p. 64).

A square wave (1 kHz, 0 V to 5 V) outputs from the probe compensation signal output terminals of the instrument.

- 3** Adjust the waveform by turning the dial of the probe grip.

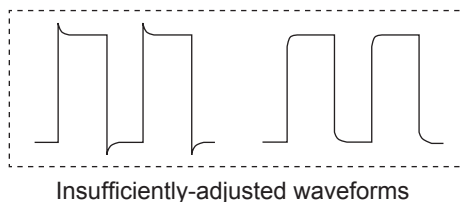
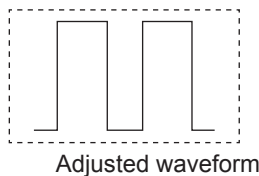

Thermocouple (Temperature)

Connect thermocouples to Model 8967 Temp Unit.

Required items: Thermocouple and flat-blade screwdriver (2.6-mm-width blade)

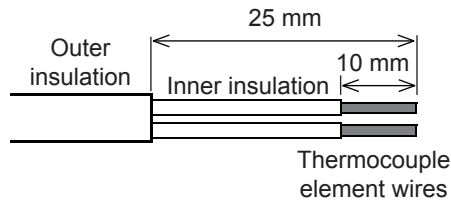

Recommended cable

Compatible wire: Thermocouple element wires with a diameter of 0.4 mm to 1.2 mm

Standard insulation stripping length: About 10 mm

Strip the insulation of the thermocouple wires as shown on the left.

How to connect a thermocouple

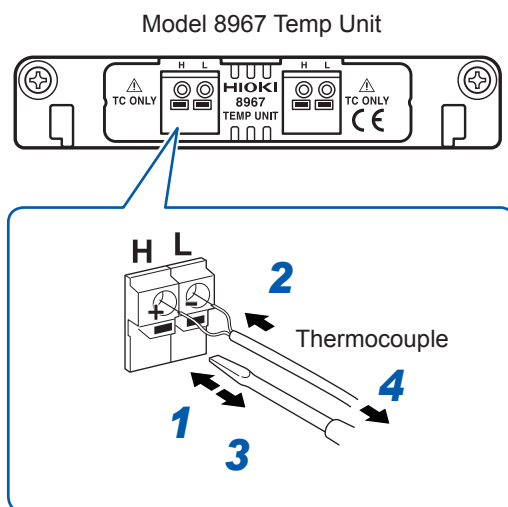

- 1** Depress a button on the terminal block on the module with the flat-blade screwdriver.
- 2** While depressing the button, insert each thermocouple wire into the appropriate terminal hole
- 3** Release the button.
The thermocouple is secured.
- 4** Attach the thermocouple on a measurement target.

How to disconnect the thermocouple

While depressing the button, pull the thermocouple wire.

- If noise influences surrounding equipment, pass the thermocouple element wires through the center hole of the ferrite clamp-on choke (comes with Model 8967 Temp Unit) several times successively from the same end.
- If a thermocouple three meters long or longer is connected, the measurement may be influenced by the EMC environment that includes external noise.
- For K type and E type thermocouples, the physical phenomenon, short-range ordering can probably cause incorrect temperature measurement in the range of 250°C to 600°C. Contact a thermocouple manufacturer to select proper thermocouples.

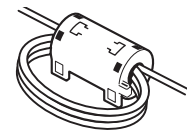

Strain gauge transducer

Connect a strain gauge transducer*¹ to Model U8969 Strain Unit via Model L9769 Conversion Cable*².

*1: Hioki does not offer any strain gauge transducers.

*2: Model L9769 Conversion Cable is an accessory of Model U8969 Strain Unit.

⚠ CAUTION



To prevent damage due to snapped wires, do not excessively bend, pull, or twist the cables and joints between the cables and connectors.

Required items: Strain gauge transducer and Model L9769 Conversion Cable

How to connect the transducer

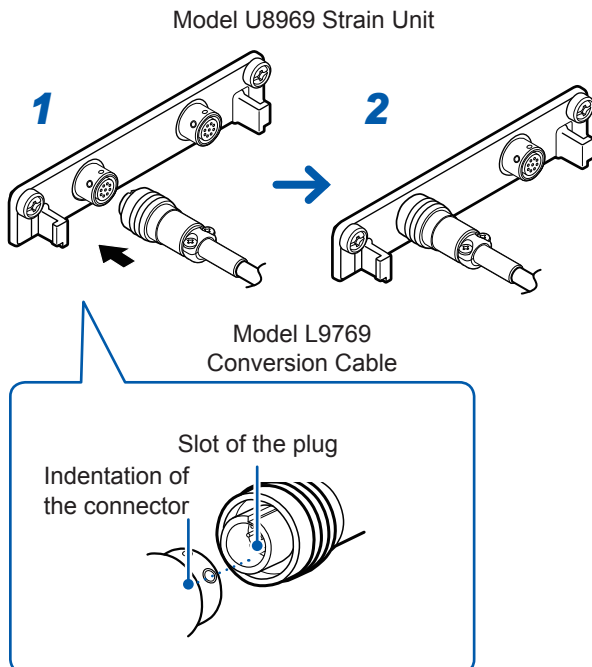

- 1** Align the plug slot of Model L9769 with the outward indentation of Model U8969, and then insert the plug into the connector on Model U8969.
- 2** Insert the plug until it locks.
- 3** Connect Model L9769 Conversion Cable to the strain gauge transducer.
- 4** Connect the strain gauge transducer to a measurement target.

How to disconnect the transducer

Gently pull the collar of the plug, which releases the lock, and disconnect the cable.

Connector pin-out

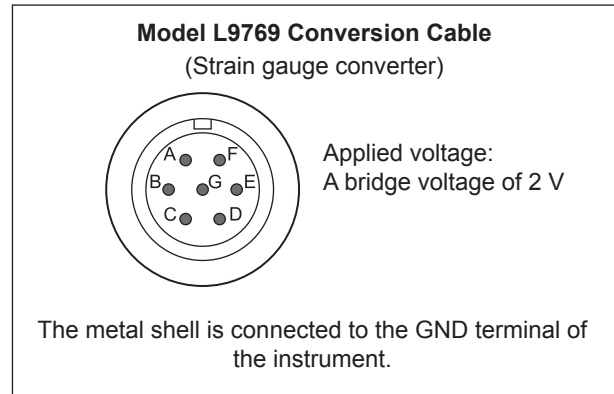
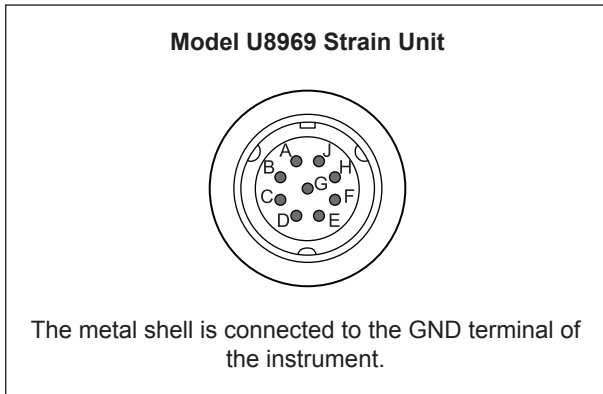

| Pin mark | Description |
|----------|-----------------|
| A | BRIDGE+ |
| B | INPUT- |
| C | BRIDGE- |
| D | INPUT+ |
| E | FLOATING COMMON |
| F | SENSE+ |
| G | SENSE- |
| H | N.C. |
| J | N.C. |

| Pin mark | Description |
|----------|-----------------|
| A | BRIDGE+, SENSE+ |
| B | INPUT- |
| C | BRIDGE-, SENSE- |
| D | INPUT+ |
| E | FLOATING COMMON |
| F | N.C. |
| G | N.C. |

Model L9769 connection

- Pin F of the conversion cable (module end) is connected to pin A of the conversion cable (transducer end).
- Pin G of the conversion cable (module end) is connected with pin C of the conversion cable (transducer end).

IMPORTANT

- A bridge box is required to measure strain using a strain gauge. Use a commercially available strain gauge and a bridge box.
- Some bridge boxes may be susceptible to noise. In that case, grounding the bridge box allows the box to be less susceptible to noise. For information about how to ground the bridge box, see the instruction of the bridge box or contact the manufacturer.

You can use your Model 8969 Strain Unit with the instrument. The instrument with Model 8969 Strain Unit installed refers to Model 8969 as **[U8969]** on the display.

Current sensor

Familiarize yourself with “Operation Precautions” (p. 9) before connecting a current sensor. See the instruction manual that comes with each current sensor for details on specifications and directions for use.

CAUTION



Do not connect and remove a current sensor while the instrument is left turned on. Doing so will cause damage to the current sensor.

You can connect up to nine current sensors in total to the following modules: Model Z5021 Probe Power Unit, Model 8971 Current Unit, and Model U8977 3CH Current Unit. However, the instrument can provide current sensors with power with a current of 4.8 A or less. When Model CT6710 Current Probe or Model CT6711 Current Probe is used, their consumption current limits the number of current sensors that can be connected.

See “Warning messages” (p. 159). (Nos. 630 and 631)

Current sensors that can be connected to current modules

The following current sensors can be connected to the Model U8977 3CH Current Unit and Model 8971 Current Unit. Use of conversion cables may be required depending on sensors and modules.

✓: Directly connectible

| Model number | Model name | Maximum input current / Frequency | Conversion cable for U8977 | Conversion cable for 8971 | Connector*1 |
|--------------------------------|----------------------|-----------------------------------|----------------------------|---------------------------|-------------|
| 9709 | AC/DC Current Sensor | 500 A DC to 100 kHz | CT9900 | 9318 | Plastic |
| 9709-05 | | | ✓ | CT9900 + 9318 | Metal |
| 9272-05 | Clamp on Sensor | 20 A / 200 A 1 Hz to 100 kHz | ✓ | CT9900 + 9318 | Metal |
| 9272-10 | | | CT9900 | 9318 | Plastic |
| CT6830 | AC/DC Current Probe | 2 A DC to 100 kHz | ✓ | Unable to connect | Metal |
| CT6831 | AC/DC Current Probe | 20 A DC to 100 kHz | ✓ | Unable to connect | Metal |
| CT6841 | AC/DC Current Probe | 20 A DC to 1 MHz | CT9900 | 9318 | Plastic |
| CT6841-05 CT6841A | | | ✓ | CT9900 + 9318 | Metal |
| CT6843 | AC/DC Current Probe | 200 A DC to 500 kHz | CT9900 | 9318 | Plastic |
| CT6843-05 CT6846A | | | ✓ | CT9900 + 9318 | Metal |
| CT6844 | AC/DC Current Probe | 500 A DC to 200 kHz | CT9900 | 9318 | Plastic |
| CT6844-05 CT6844A | | | ✓ | CT9900 + 9318 | Metal |
| CT6845 | AC/DC Current Probe | 500 A DC to 100 kHz | CT9900 | 9318 | Plastic |
| CT6845-05 CT6845A | | | ✓ | CT9900 + 9318 | Metal |
| CT6846 | AC/DC Current Probe | 1000 A DC to 20 kHz | CT9900 | 9318 | Plastic |
| CT6846-05 CT6846A | | | ✓ | CT9900 + 9318 | Metal |
| CT6862 | AC/DC Current Sensor | 50 A DC to 1 MHz | CT9900 | 9318 | Plastic |
| CT6862-05 | | | ✓ | CT9900 + 9318 | Metal |
| CT6863 | AC/DC Current Sensor | 200 A DC to 500 kHz | CT9900 | 9318 | Plastic |
| CT6863-05 | | | ✓ | CT9900 + 9318 | Metal |
| CT6865 | AC/DC Current Sensor | 1000 A DC to 20 kHz | CT9900 | 9318 | Plastic |
| CT6865-05 | | | ✓ | CT9900 + 9318 | Metal |
| CT6875 CT6875A CT6875A-1 | AC/DC Current Sensor | 500 A DC to 2 MHz | ✓ | CT9900 + 9318 | Metal |
| CT6876 CT6876A CT6876A-1 | AC/DC Current Sensor | 1000 A DC to 1.5 MHz | ✓ | CT9900 + 9318 | Metal |

| Model number | Model name | Maximum input current / Frequency | Conversion cable for U8977 | Conversion cable for 8971 | Connector* ¹ |
|--------------------------------|----------------------|-----------------------------------|----------------------------|---------------------------|-------------------------|
| CT6877 CT6877A CT6877A-1 | AC/DC Current Sensor | 1000 A DC to 1 MHz | ✓ | Unable to connect | Metal |
| CT6872 CT6872-01 | AC/DC Current Sensor | 50 A DC to 10 MHz | ✓ | CT9901 + 9318 | Metal |
| CT6873 CT6873-01 | AC/DC Current Sensor | 200 A DC to 10 MHz | ✓ | CT9901 + 9318 | Metal |
| CT6904A | AC/DC Current Sensor | 500 A DC to 4 MHz | ✓ | CT9901 + 9318 | Metal |
| CT6904A-1 | AC/DC Current Sensor | 500 A DC to 2 MHz | ✓ | CT9901 + 9318 | Metal |
| CT6904A-2 | AC/DC Current Sensor | 800 A DC to 4 MHz | ✓ | CT9901 + 9318 | Metal |
| CT6904A-3 | AC/DC Current Sensor | 800 A DC to 2 MHz | ✓ | CT9901 + 9318 | Metal |

*1: Metal connector (ME15W), plastic connector (PL23)

Connecting a current sensor with Model U8977 3CH Current Unit

You can directly connect a current sensor with the sub model-number “-05,” which has a metal connector (ME15W).

Point the widest key upward.

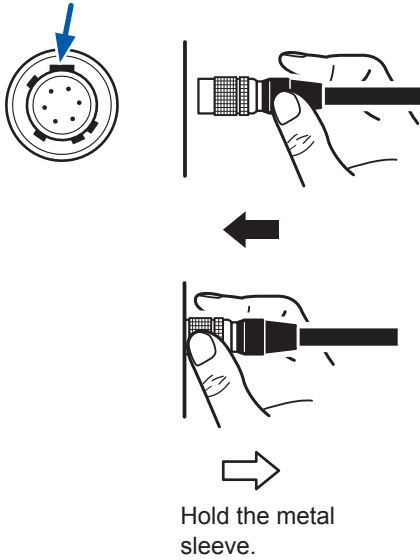

1 Align the guides of the cable connector with those of the module connector.

2 Straightly insert the connector until it locks.
Hold the part other than metal to insert the connector. The instrument automatically recognizes the model of the current sensor.

How to disconnect the current sensor

1 Hold and pull the metal collar, which releases the lock.

2 Pull the connector.

Hold the metal sleeve.

Using Model CT9900 Conversion Cable, you can connect a current sensor without the sub model-number “-05,” which has a plastic connector (PL23), with Model U8977 3CH Current Unit.

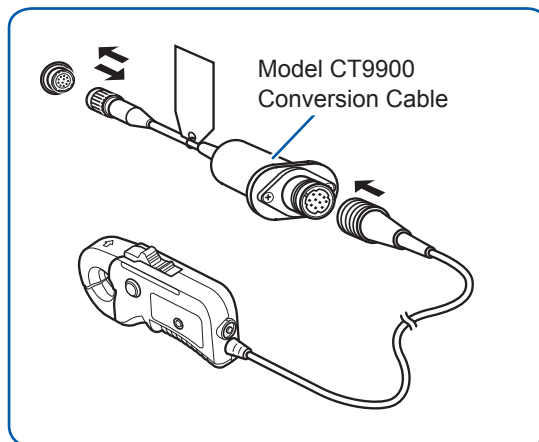

When Model CT9900 Conversion Cable is used, the instrument recognizes Model CT6846 or CT6865 (1000 A rating) as a 500-A AC/DC sensor. Set the conversion ratio to 2.00.

By using Model CT9920 Conversion Cable (optional), you can connect a current sensor of Model CT7000 series with Model U8977 3CH Current Unit. The instrument cannot recognize any sensor with Model CT9920 connected. Select a mode in the setting screen.

Applicable models: CT7631, CT7636, CT7642, CT7731, CT7736, CT7742, CT7044, CT7045, CT7046

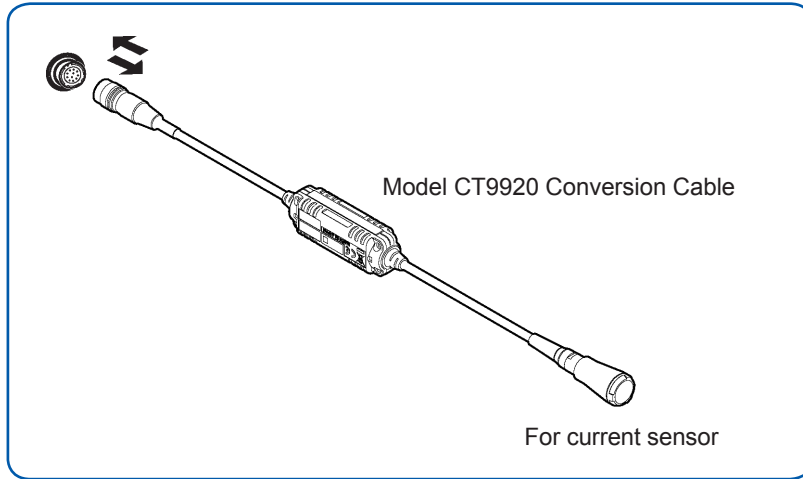

Connecting a current sensor with Model 8971 Current Unit

By using Model 9318 Conversion Cable*, you can connect a current sensor without the sub model number “-05,” which has a plastic connector (PL23), with Model 8971 Current Unit.

*: Model 9318 Conversion Cable is an accessory of Model 8971 Current Unit.

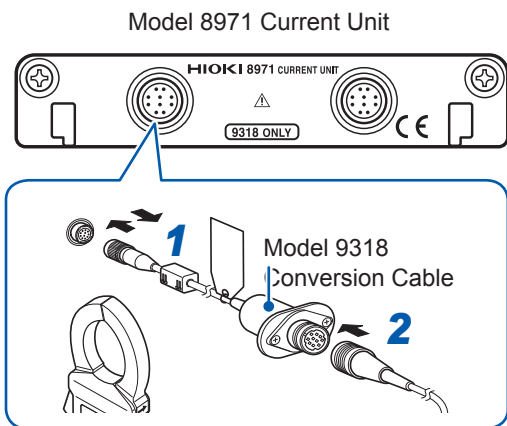

- 1** Align the guides of the conversion cable with those of the sensor connector on the module, and straightly insert the plug until it locks.
- 2** Align the guides of the current sensor to be used with those of the conversion cable connector, and straightly insert the plug until it locks.
The instrument automatically recognizes the model of the current sensor.
- 3** Clamp the current sensor around a line of a measurement target.

How to remove the current sensor

- 1** Hold and pull the plastic collar of the conversion cable, which releases the lock, and then remove the connector.
- 2** Hold and pull the plastic collar of the current sensor, which releases the lock, and then remove the connector.

When measuring currents with a voltage module

By using Model 9018-50 Clamp on Probe, you can measure a current using a voltage measurement module such as Model 8966 Analog Unit.

Specifying the scaling allows measured waveforms to be displayed as current values. For the setup procedure, see “Converting Input Values (Scaling Function)” in the Instruction Manual.

Acceleration sensor

Connect an acceleration sensor* to Model U8979 Charge Unit.

Familiarize yourself with “Operation Precautions” (p. 9) before connecting a current sensor.

*: Hioki does not offer any acceleration sensors.

Acceleration sensor connectible with Model U8979

CAUTION



Use an acceleration sensor with a built-in pre-amplifier that conforms to the specification of Model U8979 Charge Unit. Using an inapplicable sensor may cause damaging itself.

| Acceleration sensor type | Terminal the sensor is connected to | Note |
|-------------------------------|-------------------------------------|---------------------------|
| With a built-in pre-amplifier | BNC connector | Drive power: 3.0 mA, 22 V |
| Charge output | Miniature connector (#10-32) | — |

Connecting an acceleration sensor with a built-in pre-amplifier

Connecting a BNC-output acceleration sensor with a built-in pre-amplifier

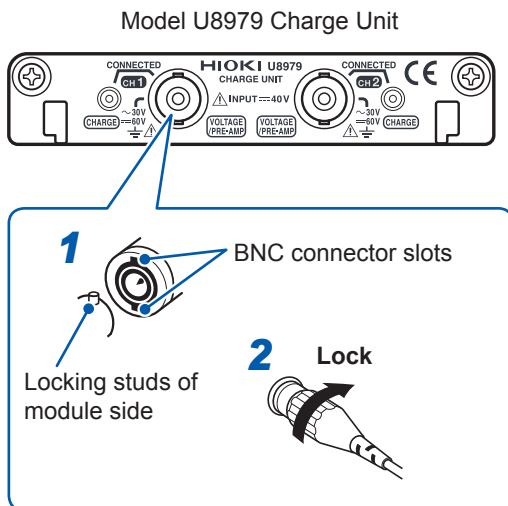

- 1 Align the slots in the BNC connector of an acceleration sensor with the locking studs of a BNC connector on the module, and insert the connector.
- 2 Turn the BNC connector of the acceleration sensor clockwise until it locks.
- 3 Attach the acceleration sensor with the built-in pre-amplifier to a measurement target.

How to remove the acceleration sensor

Turn the BNC connector of the acceleration sensor counter-clockwise to release the lock and remove the connector.

Connecting an acceleration sensor other than a sensor with a built-in pre-amplifier

Convert the output connector into the BNC connector using a commercially available conversion connector or conversion cable to connect the sensor.

Connecting a charge-output acceleration sensor

Connecting a charge-output acceleration sensor equipped with the miniature connector (#10-32).

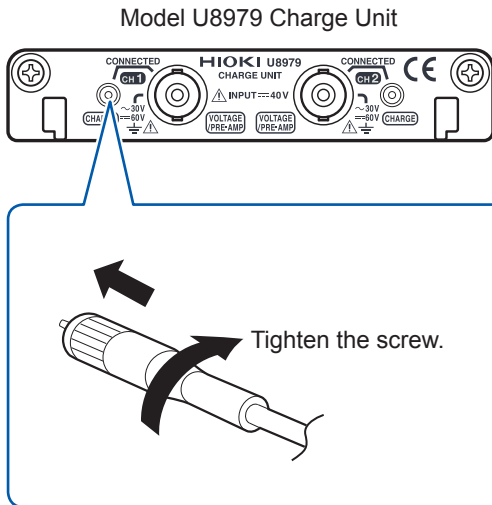

- 1** Align the screw of the miniature connector, and turn the connector clockwise to tighten it.
- 2** Attach the charge-output acceleration sensor to a measurement target.

How to disconnect the current sensor

Turn the miniature connector counterclockwise, and then pull out the connector.

Connecting a charge-output acceleration sensor equipped with a connector other than a miniature connector (#10-32)

Convert the output connector into the miniature connector (#10-32) using a commercially available conversion connector or conversion cable to connect the sensor.

Logic probe (Measuring logic signals)

Connect logic probes to Model 8973 Logic Unit.
See “Before connecting a logic probe to a measurement target” (p. 18).
See an instruction manual of each logic probe.

Required item: Logic Probe (Model 9320-01, Model MR9321-01, or Model 9327)

How to connect the Logic Probe

Example: Connecting Model 9327 Logic Probe

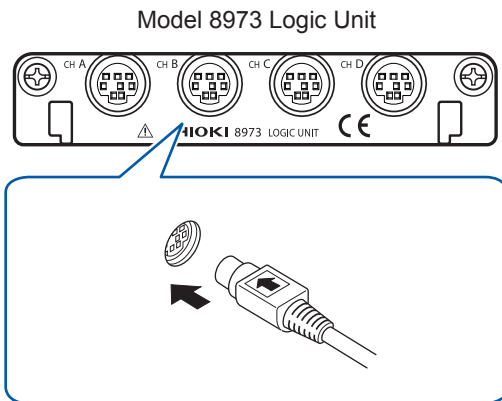

- 1** Align the plug slots of the logic probe with a logic terminal, and insert the logic probe plug.
- 2** Connect the logic probe to a measurement target.

2

Preparing for Measurement

Connection cable (For precisely measuring voltage)

Connect Model L2200 Test Lead to a module.

Required item: Model L2200 Test Lead (maximum input voltage: 1000 V)

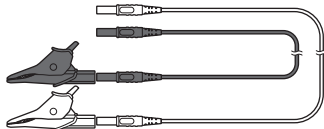

How to connect the Test Lead

Model MR8990 Digital Voltmeter Unit

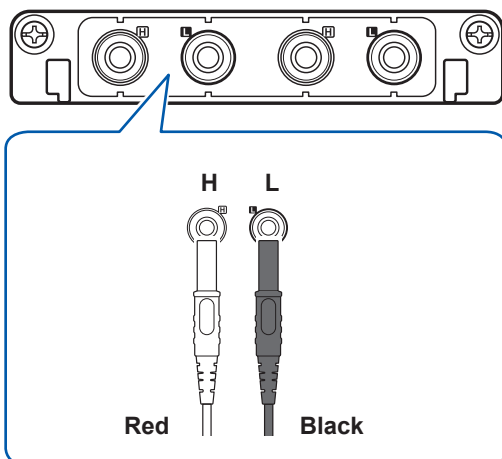

- 1** Connect the test leads to the banana jacks on the module.
Connect the black lead to the L jack; and the red lead to the H jack. Make sure the test leads are fully inserted into the jacks.
- 2** Connect the test leads to a measurement target.

Connection cable (For measuring high voltage)

Connect Model L4940 Connection Cable Set to Model U8974 High Voltage Unit. Choose appropriate connection cord tips based on the maximum input voltage and terminal type.

Required item: Model L4940 Connection Cable Set

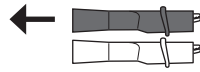
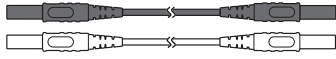

Model L4934* Small Alligator Clip Set

CAT III 300 V
CAT II 600 V



Model L4935 Alligator Clip Set

CAT III 1000 V
CAT IV 600 V



Model L9243 Grabber Clip

CAT II 1000 V

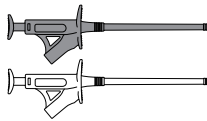

Model L4936 Bus Bar Clip Set

CAT III 600 V

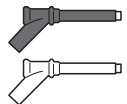

Model L4937 Magnetic Adapter Set

CAT III 1000 V

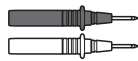

Model L4932 Test Pin Set

CAT III 1000 V
CAT IV 600 V

* Using Model L4934 requires Model L4932.

How to connect the thermocouple

Model U8974 High Voltage Unit

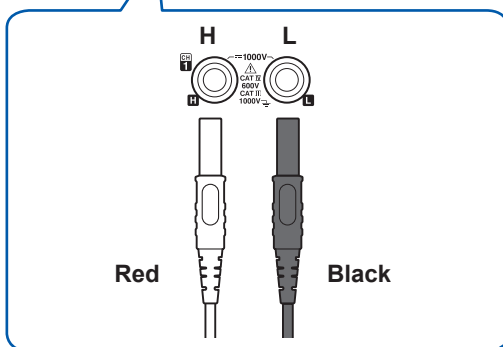
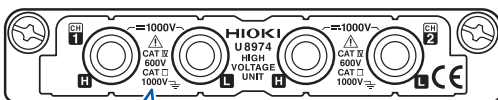

- 1** Connect the plugs of the connection cord to the banana jacks on the module.

Connect the plugs to the banana jacks of their respective colors.

- 2** Insert the accessory clips into the clip ends of the connection cord.

- 3** Connect the connection cord clips to a measurement target.

Outputting waveforms

Connect Model L9795-01 or Model 9795-02 Connection Cable with the output terminals of MR8790 Waveform Generator Unit or U8793 Arbitrary Waveform Generator Unit.

**Required items: Model L9795-01 Connection Cable (terminal type: mini alligator clip),
Model L9795-02 Connection Cable (terminal type: BNC terminal)**

Model L9795-01

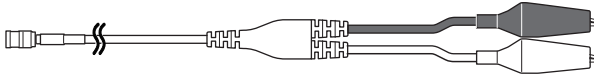

Model L9795-02

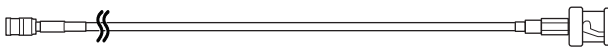

How to connect the Connection Cable

Model U8793 Arbitrary Waveform Generator Unit

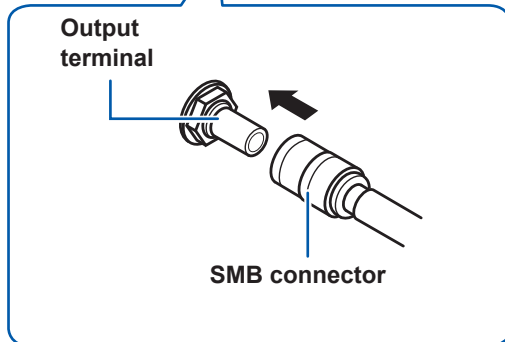
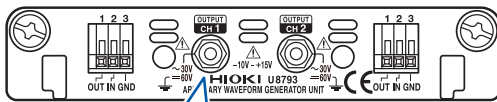

- 1** Connect the SMB connector of the Connection Cable with an output terminal of the U8793 Arbitrary Waveform Generator Unit until the connector clicks.
- 2** Connect the clips of the Connection Cable with an object across which the signal is being applied.

How to disconnect the Connection Cable

Hold the head of the SMB connector (other than the cable) and pull it out.

Outputting pulse waveforms

Connect the Connection Cables with the output terminals of MR8791 Pulse generator Unit.

Required items: Commercially available cable (Half-pitch 50 pins)

How to connect the Connection Cable

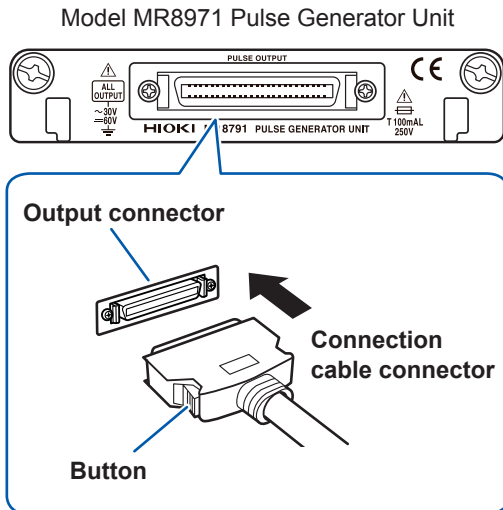

1 Connect the connector of the Connection Cable with an output connector of the MR8791 Pulse Generator Unit until the connector clicks.

2 Attach the connection cable to a target.

How to disconnect the Connection Cable

Press the buttons, and pull it out.

Output connector

10250-52A2PL: 3M (SCSI-2 connector, Centronics half-pitch, 50 pins, female)

See "Model MR8791 Pulse Generator Unit" (p. 145)

- Metal shell of the connector 10250-52A2PL is the same as GND of the instrument (frame GND).
- Use a lock-type connector to attach a harness to the connector of the module.

2.3 Supplying Power to Current Sensors

Model Z5021 Probe Power Unit (option available only at the time of purchase order issuance for the instrument) allows the instrument to supply power to current sensors.

You can connect up to nine sensors to the instrument's modules that may consist of Model Z5021 Probe Power Unit, Model 8971 Current Unit, and Model U8977 3CH Current Unit. However, the instrument can provide current sensors with power with a current of 4.8 A or less. When Model CT6710 Current Probe or Model CT6711 Current Probe is used, their consumption current limits the number of current sensors that can be connected.

See "Warning messages" (p. 159). (Nos. 630 and 631)

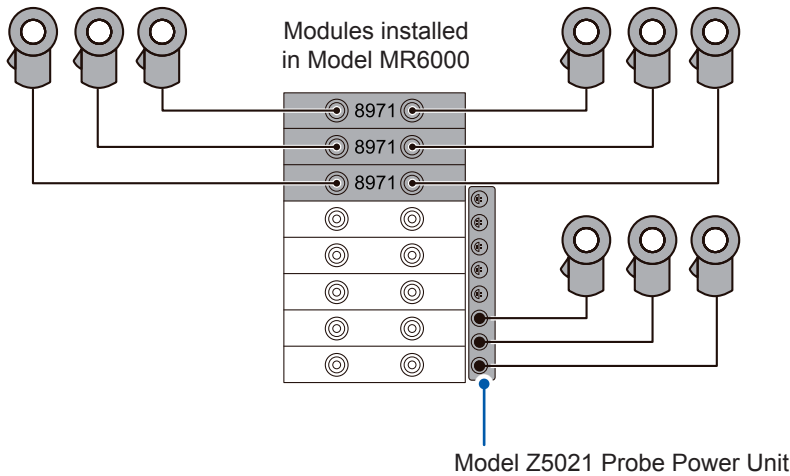

2
Preparing for Measurement

How to connect a current sensor

Insert the power plug of the current sensor into the power terminal dedicated to current sensors.

! CAUTION



You may not be able to connect a connection cord to channels adjacent to a module that has a BNC connector with a current probe connected to because the termination unit interferes with adjacent channels. Attempting to forcedly insert a connection cord could cause damage to the connectors of the current sensor and module, as well as the instrument. For resolving this problem, a conversion cable is available on a special order basis. Contact your authorized Hioki distributor or reseller.

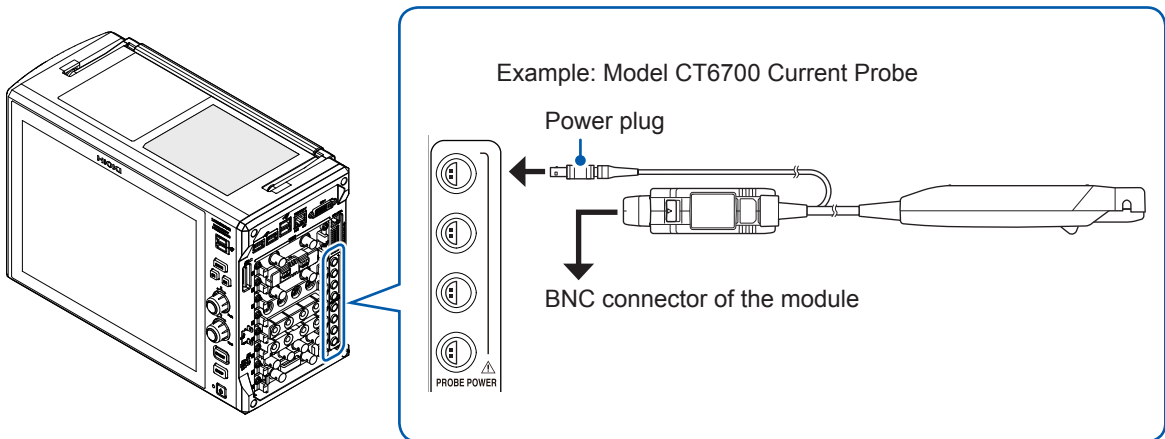

2.4 External Sampling (EXT.SMPL)

Externally inputting the signal can control the sampling rate.
See “Before connecting the instrument to external equipment” (p. 19).

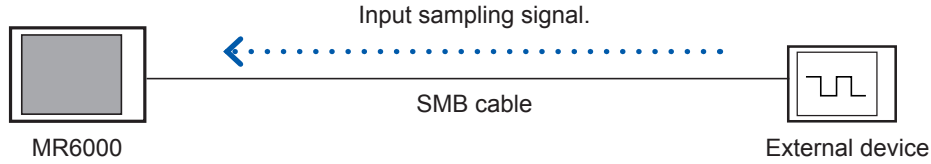

How to connect the external device

Connect the external sampling terminal of the instrument and the external device (sampling signal source) with each other using an SMB cable. Connect the connector of the SMB cable* to the external sampling terminal until it clicks.

*: Use one of the following cables:

Model L9795-01 Connection Cable (terminal type: SMB terminal–mini alligator clip, optional)

Model L9795-02 Connection Cable (terminal type: SMB terminal–BNC terminal, optional)

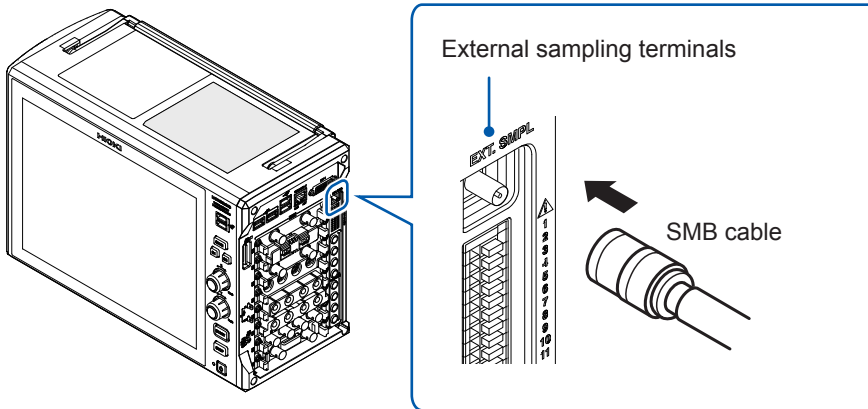

How to remove the external device

Hold the head of the SMB connector (other than the cable) and pull it out.

How to configure the external sampling terminal settings

See “15.2 External Sampling (EXT.SMPL)” in the Instruction Manual.

2.5 Connecting the External Control Terminals

This section describes the procedure and the external control terminal function to control the instrument externally. Connecting the external control terminals with external devices allows the instrument to start and stop a measurement. Signals inputted into the external control terminals operate the instrument even when the key lock function is enabled.

The term “external control terminals” is used to see all of these terminals collectively. See “Before connecting the instrument to external equipment” (p. 19).



Wires to be connected

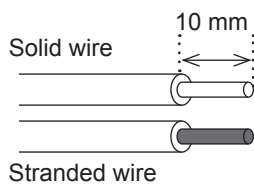

| | |
|----------------------|---|
| Acceptable wire | Solid wire: 0.32 mm to 0.65 mm in diameter (AWG28 to AWG22) Stranded wire: 0.08 mm ² to 0.32 mm ² (AWG28 to AWG22) Strand diameter 0.12 mm or more (per wire) |
| Stripped length | 9 mm to 10 mm |
| Button pressing tool | Flat-blade screwdriver (tip width: 2.6 mm) |

How to connect wires

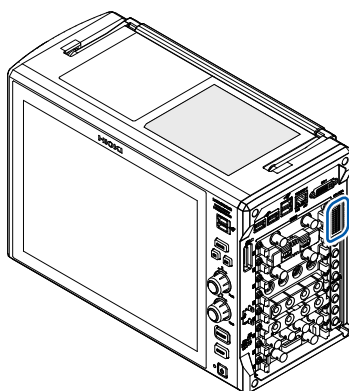

- 1** Depress a button of the external control terminals with a flat-blade screwdriver.
- 2** Insert the wire into the wire connection hole while depressing the button.
- 3** Release the button.
The wire is secured.

Terminal block

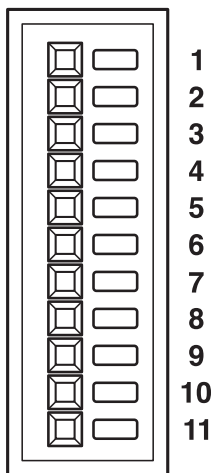

| No. | Pin name | Operation |
|-----|----------|--|
| 1 | GND | Ground (common with the instrument's ground) |
| 2 | IN1 | Starts/stops measurement, saves data files, aborts measurement, enters events |
| 3 | IN2 | |
| 4 | GND | Ground (common with the instrument's ground) |
| 5 | OUT1 | Outputs signals indicating judgments and status (error, busy, waiting for a trigger) |
| 6 | OUT2 | |
| 7 | GND | Ground (common with the instrument's ground) |
| 8 | EXT.TRIG | The instrument is triggered when an external signal is inputted as a trigger source. |
| 9 | TRIG.OUT | Outputs a signal when the instrument is triggered. |
| 10 | GND | Ground (common with the instrument's ground) |
| 11 | GND | Ground (common with the instrument's ground) |

How to configure the external control terminal settings

On the **[External terminal]** screen, you can configure the following terminal: the external input (IN1, IN2), external output (OUT1, OUT2), and trigger output (TRIG.OUT). Use the **[Trigger]** screen to configure the external trigger (EXT.TRIG) setting.

 > **[System]** > **[External terminal]**

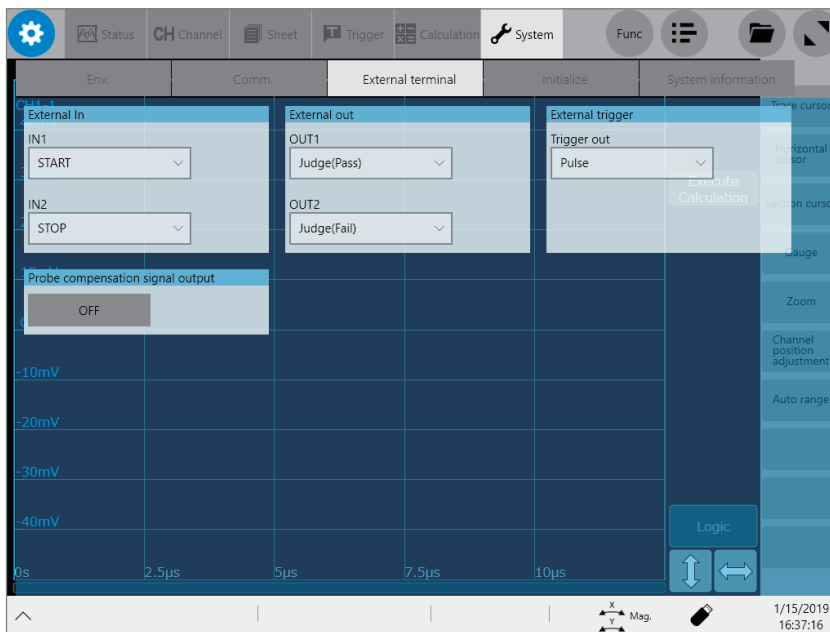

2.6 Connecting the Instrument With Computers

Connecting the instruments with computers via a LAN cable allows computers to control and monitor the instrument. Connect LAN cables to the 1000BASE-T connector of computers and instrument.

⚠ CAUTION



When connecting the instrument to your LAN using a LAN cable of more than 30 m or with a cable laid outdoors, take appropriate countermeasures that include installing a surge protector for LANs. Such signal wiring is susceptible to induced lightning, which can cause damage to the instrument.

The following two ways are available:

(1) Connecting the instrument to the existing network

Connecting the instruments with a hub via LAN cables allows computers to control and monitor the instruments.

Connecting one instrument to multiple computers

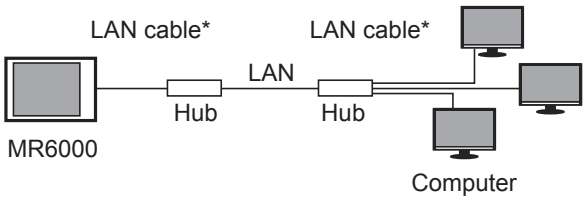

Connecting multiple instruments to a computer

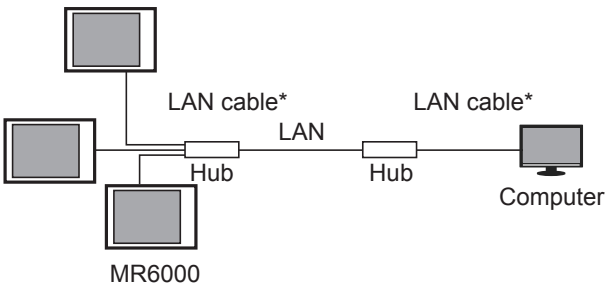

- *: Use one of the following cables:
- 1000BASE-T straight-through cable (commercially available)
 - Model 9642 LAN Cable (optional)

(2) One-to-one connection of the instrument and your computer

Connecting the instrument with your computer via a LAN cable allows the computer to control and monitor the instrument.

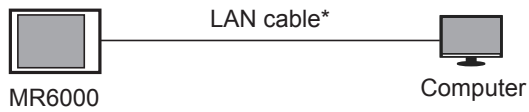

*: Use one of the following cables:

- 1000BASE-TX compatible crossover cable
- 1000BASE-T straight-through cable and crossover connector
- Model 9642 LAN Cable (optional, coming with crossover connector)

When connecting the instrument and the computer using Model 9642 LAN Cable and the accompanying crossover connector

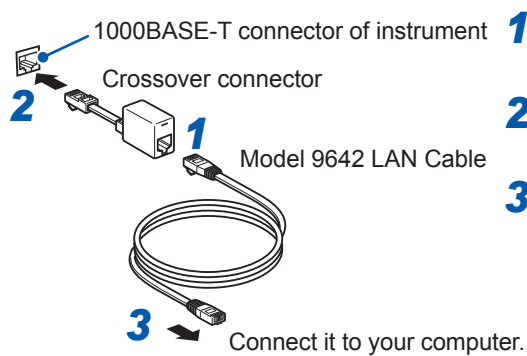

- 1** Connect Model 9642 LAN Cable to the accompanying crossover connector.
- 2** Connect the crossover connector to the 1000BASE-T connector of the instrument.
- 3** Connect Model 9642 LAN Cable to the 1000BASE-T connector of your computer.

2.7 Preparing Storage Devices (Recording Media)

You can use the following recording media on the instrument: SD memory cards, USB flash drives, and a built-in drive.

Use only the following Hioki options, which are more reliable than their commercial equivalents.

Z4001 SD Memory Card (2 GB), Z4003 SD Memory Card (8 GB), Z4006 USB Drive (16 GB)

See “” (p. 14).

SD memory card

You have to configure the SD memory card setting on the instrument to use SD memory cards.

See “Formatting storage devices” (p. 70).

Use only the following Hioki options, which are more reliable than their commercial equivalents.

Z4001 SD Memory Card (2 GB), Z4003 SD Memory Card (8 GB), Z4006 USB Drive (16 GB)

How to insert a USB flash drive

- 1** Orient the face with triangle marked of the SD memory card toward the front of the instrument.
- 2** Fully insert the SD memory card.

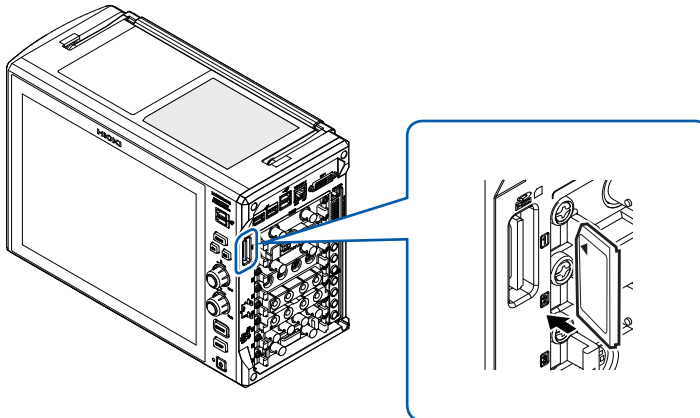

USB flash drive

You have to configure the USB flash drive setting on the instrument to use USB flash drives. See “Formatting storage devices” (p. 70).
Before handling a USB flash drive, eliminate any static on your body.

How to insert a USB flash drive

Align the USB flash drive with the connector, and fully insert it.
When using Model Z4006 USB Drive for real-time saving, connect the drive to the USB 3.0 connector on the right side of the instrument or in the media box (p. 71). Connecting the drive to the USB 2.0 connector cannot deliver the real-time saving speed specified in the product specifications.

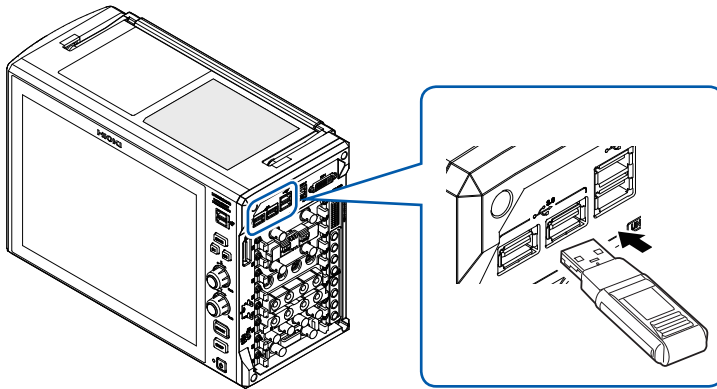

Built-in drive

The built-in drive is factory-formatted.
Model U8332 SSD Unit (capacity: 256 GB*, option available only at the time of purchase order issuance for the instrument)
Model U8333 HD Unit (capacity: 320 GB*, option available only at the time of purchase order issuance for the instrument)
*: Once the drive has been formatted, the actual capacity available decreases.

You cannot remove the built-in drive.

Removing storage devices

Use the following procedure to remove the SD memory card and USB flash drive.

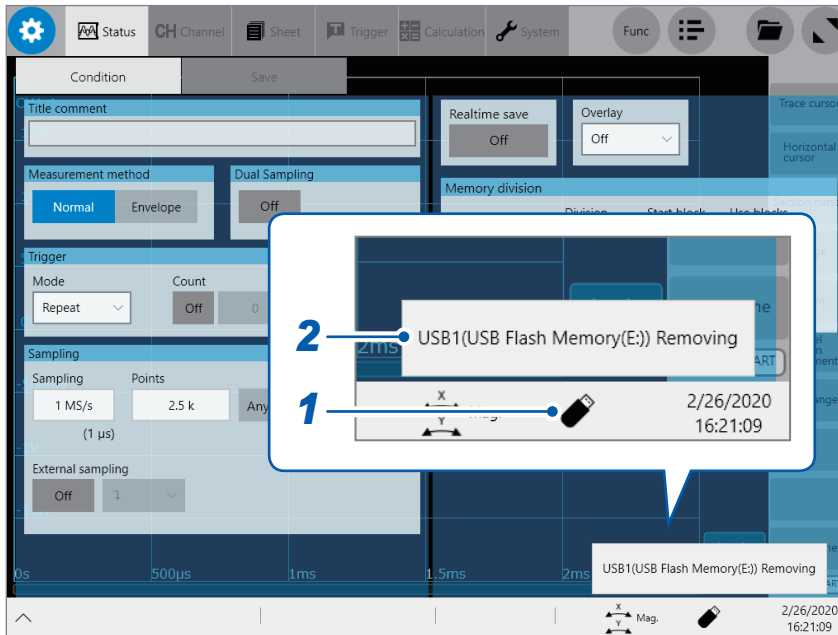

- 1** Tap the remove button.
- 2** Tap the media to be removed.
- 3** Remove the storage device according to the message.

| | |
|---------------------------------------|---|
| This device can be removed. | Remove the storage device. |
| This device cannot be removed. | Check whether the storage device is being accessed. |

Be sure to use the remove button to remove any storage device. Do not use Windows® Explorer or an icon on the Windows® taskbar to remove the storage device.

Formatting storage devices

The instrument can format SD cards, USB flash drives, and the built-in drive. Once they are formatted, the “HIOKI_MR6000” folder is created.

IMPORTANT

Note that formatting a storage device deletes all the information stored on the storage device, and deleted information cannot be recovered.

 > [Func] > [Explorer]

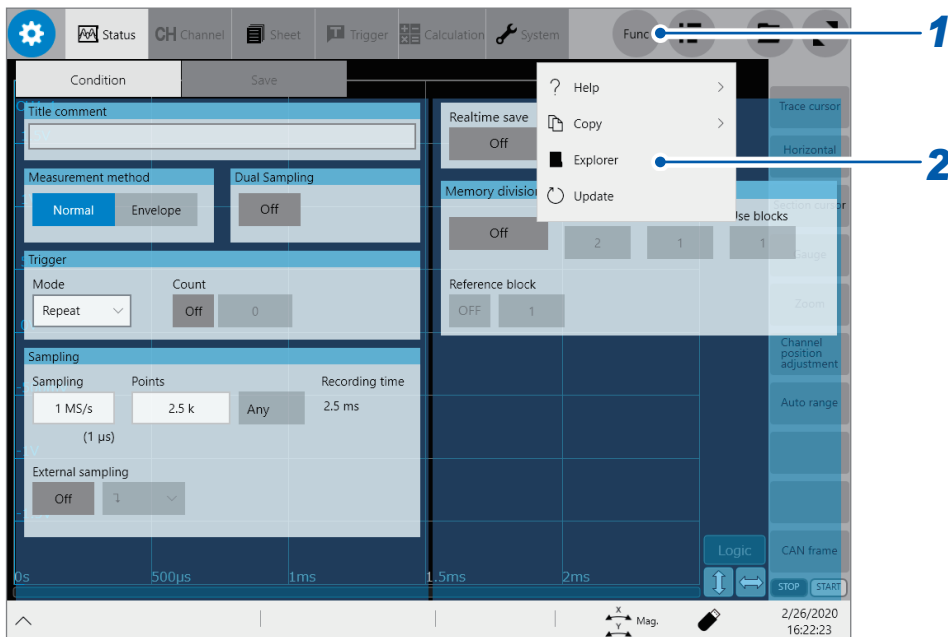

- 1** Tap [Func].
- 2** Tap [Explorer].
Explorer appears.
- 3** Touch and hold a storage device to be formatted for 2 seconds.
The shortcut menu appears
- 4** Tap [Format].

2.8 How to Open the Media Box

The USB 3.0 connector in the media box is dedicated to USB flash drives. Be sure to use the instrument with the cover closed. Before handling a USB flash drive, eliminate any static on your body.

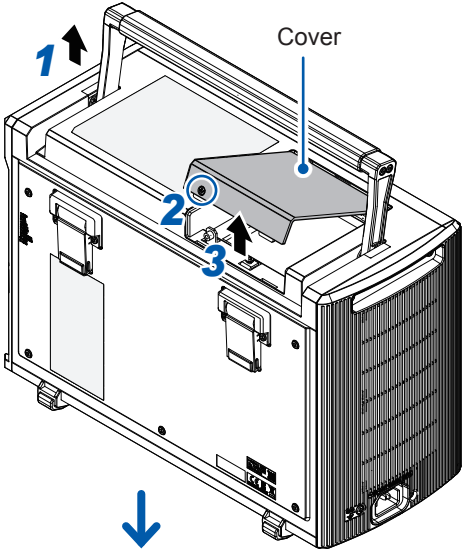

1 Extend the handle.

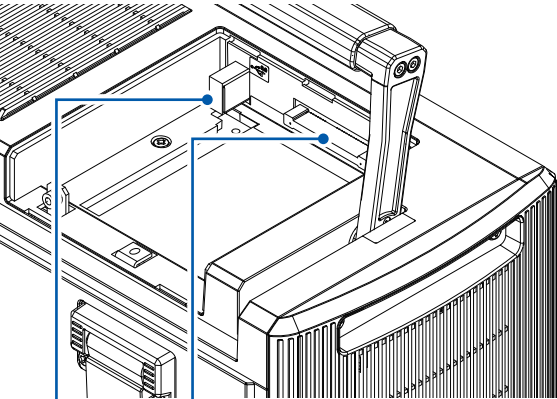

2 Loosen the cover screw until its head is completely removed from the cover.

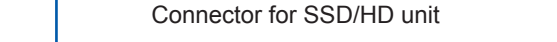

3 Lift the front of the cover.

USB 3.0 connector

Connector for SSD/HD unit

2

Preparing for Measurement

2.9 Supplying Power to the Instrument

See “Before turning on the instrument” (p. 19).

Turning on the instrument

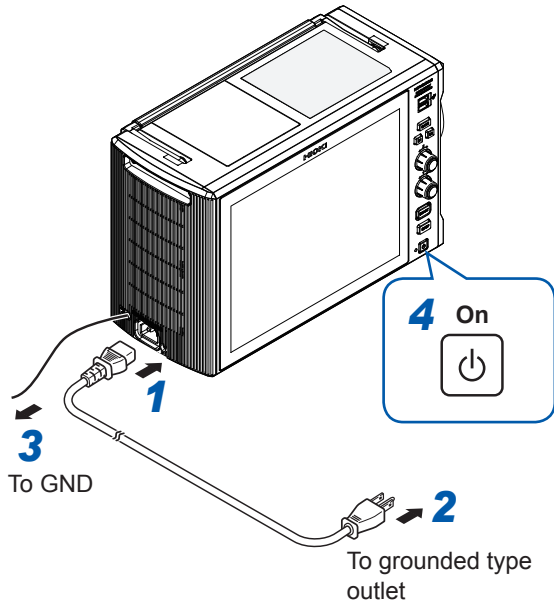

- 1** Connect the power cord to the power inlet on the instrument.
- 2** Connect the plug to a grounded type outlet.
- 3** Connect the GND terminal (functional earth terminal) to the earth.
- 4** Press the power key to turn on the instrument.
The splash screen appears, and then the waveform screen appears.
- 5** Warm up the instrument for about 30 minutes.
This warm-up stabilizes the temperature in the modules, yielding accurate measurement.
- 6** Execute zero-adjustment.
See “2.11 Executing Zero-Adjustment” (p. 75).
- 7** Start a measurement.
See “3.5 Starting/Stopping a Measurement” (p. 87).

GND terminal (Functional earth terminal)

If you perform measurement in a noisy environment, connecting the GND terminal (functional earth terminal) to the earth allows the instrument to be less susceptible to noise.

Turning off the instrument

IMPORTANT

- If the instrument is shut down while saving files onto an external storage device, it cannot save data correctly. Supply power to the instrument in combination with an uninterruptible power supply (UPS) if instantaneous power interruptions occur frequently.
- Turning off the instrument causes data recorded in the internal memory to be deleted. To retain the recorded data, save the data to an external storage device before turning off the instrument.
See “3.6 Saving Data Consisting of Items Selected” (p. 88).

1 Save the acquired data if needed.

2 Press the power key.

Following the message, tap **[OK]** to turn off the instrument.

Alternatively, pressing the power key once again turns off the instrument. After the instrument has been turned on again, it loads the settings configured before turned off.

2.10 Setting the Clock

Specify the date, time, and time zone. The instrument has the automatic calendar with leap year correction and 24-hour clock.

 > [System] > [Env.]

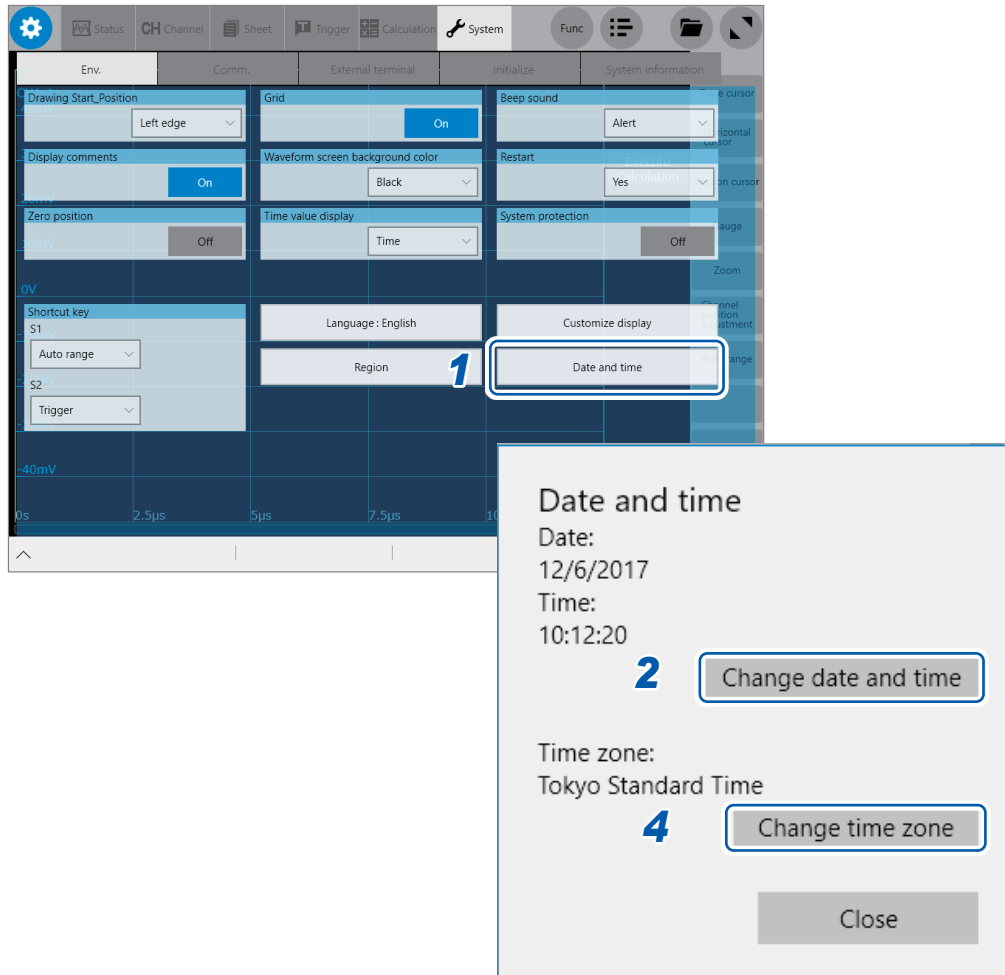

- 1** Tap [Date and time].
The [Date and time] dialog box will appear.
- 2** Tap [Change date and time].
- 3** Set the date and time and then tap [OK].
- 4** Tap [Change time zone].
- 5** Select a time zone in the list of the [Time zone] box and then tap [OK].
The application re-launches.

IMPORTANT

The instrument regulates the clock internally. Always select  > [System] > [Env.], and then tap [Date and time] to set the clock. In other ways besides, the clock could not be set.

2.11 Executing Zero-Adjustment

Executing zero-adjustment regulates the zero positions of all channels in each module on the reference potential of the instrument. Zero-adjustment involves all ranges of all channels.

Before executing zero-adjustment

- Warm up the instrument for about 30 minutes after the power-on to stabilize the internal temperature of the modules, and then execute zero-adjustment.
- Execute zero-adjustment with no signals inputted. Zero-adjustment may not correctly be executed with a signal inputted.
- Note that you can not execute zero-adjustment during measurement.
- No key operation is acceptable during zero-adjustment.
- The time required for zero-adjustment varies depending on the type and number of modules installed in the instrument (In some cases, it takes several seconds.).

To execute zero-adjustment

 > [Channel] > each module (UNIT)

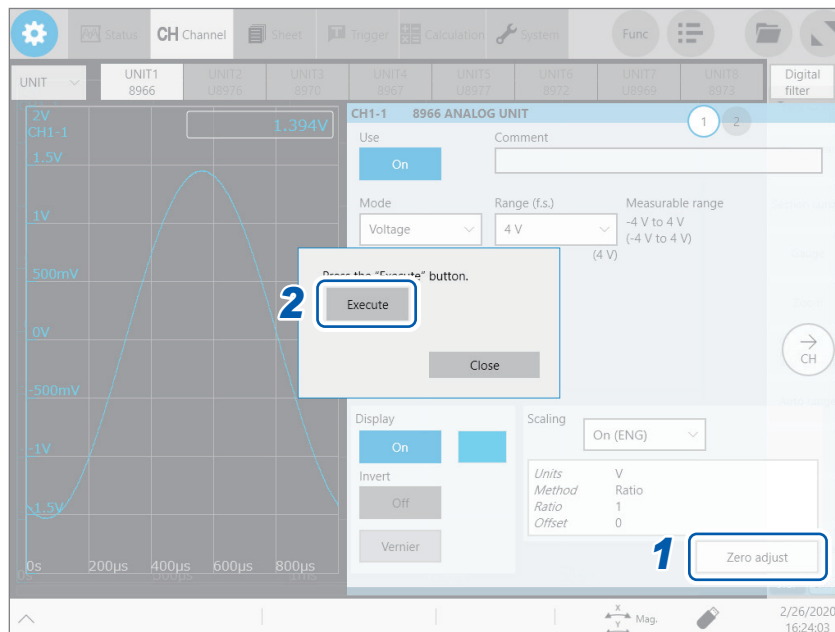

1 Tap [Zero adjust].

2 Tap [Execute].

The instrument performs zero-adjustment.

You cannot regulate the zero position of Model U8969 by this method. Regulate the zero position using the automatic balancing.

See “Model U8969 Strain Unit” (p. 123).

See “Settings of the Model U8969 Strain Unit” in “3.7 Configuring Measurement Module-Specific Settings” in the Instruction Manual.

Re-execute zero-adjustment in the following cases:

- After replacing any modules
- After cycling the instrument
- After initializing the instrument
- After switching between DC mode and RMS mode on Model 8971 Current Unit, Model 8972 DC/RMS Unit, or Model U8974 High Voltage Unit.
- When the ambient temperature has significantly changed
The zero position may drift*.

*: Drift:

A phenomenon where a shift in the operating point of an operational amplifier causes a false output. Drift can result from a change in temperature and component aging over a period of use.

2.12 Executing Calibration (For the Instrument With Model MR8990 Installed)

Executing calibration regulates the zero position of each channel in Model MR8990 Digital Voltmeter Unit on the reference potential of the instrument. Calibration involves all ranges of all channels.

Before executing calibration

- Warm up the instrument for about 30 minutes after the power-on to stabilize the internal temperature of the modules before executing calibration.
- You cannot execute calibration during measurement. However, the instrument performs calibration at the start of measurement with the calibration setting set to on.
- No key operation is acceptable during calibration.
- The time required for calibration varies depending on the type and number of modules installed in the instrument (it may take several seconds).

Executing calibration

 > [Channel] > [MR8990]

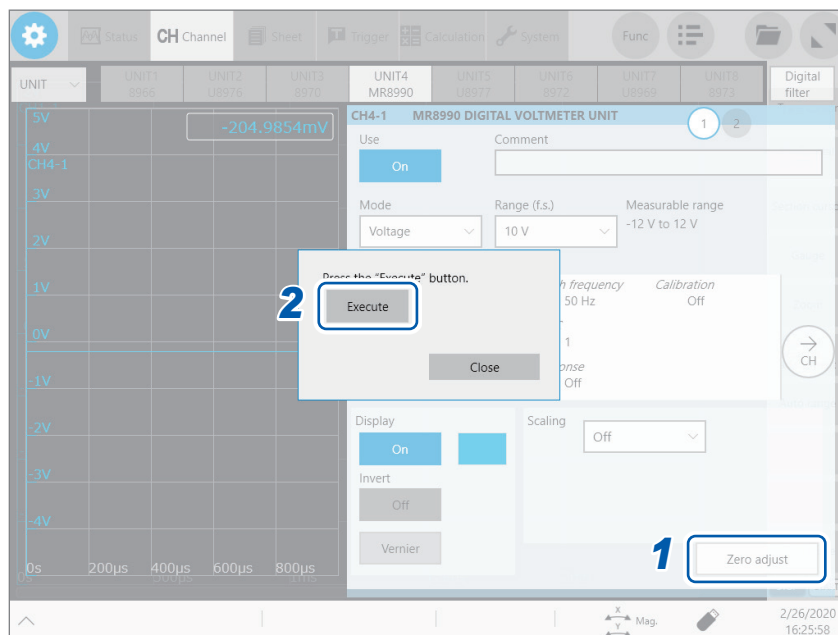

1 Tap [Zero adjust].

2 Tap [Execute].

The instrument starts calibration.

Re-execute calibration in the following cases:

- After replacing any modules
- After cycling the instrument
- After initializing the instrument
- When the ambient temperature has significantly changed
The zero position may drift.

3

Measurement Method

3.1 Inspection Before Measurement

Check if there is any damage to the instrument occurred during storage or shipping and verify that it operates normally before using the instrument. If you find any damage, contact your authorized Hioki distributor or reseller.

Inspecting peripheral devices

When using probes and connecting cords

Is the insulation of each probe of each cord damaged?
Is the metal part exposed?

Yes

Do not use them because it may cause an electric shock. Send them for repair.

No

When using a current sensor

Does the current sensor (jaw) have cracks or damage?

Yes

Do not use them because it may cause an electric shock. Send them for repair.

No

Inspecting the instrument and modules

Are the instrument and modules damaged?

Yes

Send them for repair.

No

When turning on the instrument

Does the screen display the logo "HIOKI"?

No

The power cord may have a brake or the internal circuit of the instrument may have failed. Send the instrument for repair.

Yes

The screen displays nothing or something abnormal.

Does the screen display waveforms?

Yes

The instrument may have an anomaly inside. Send the instrument for repair.

Yes

The inspection is completed.

3.2 Setting Measurement Conditions

Set conditions required for measurement, such as the sampling rate and recording length.

 > [Status] > [Condition]

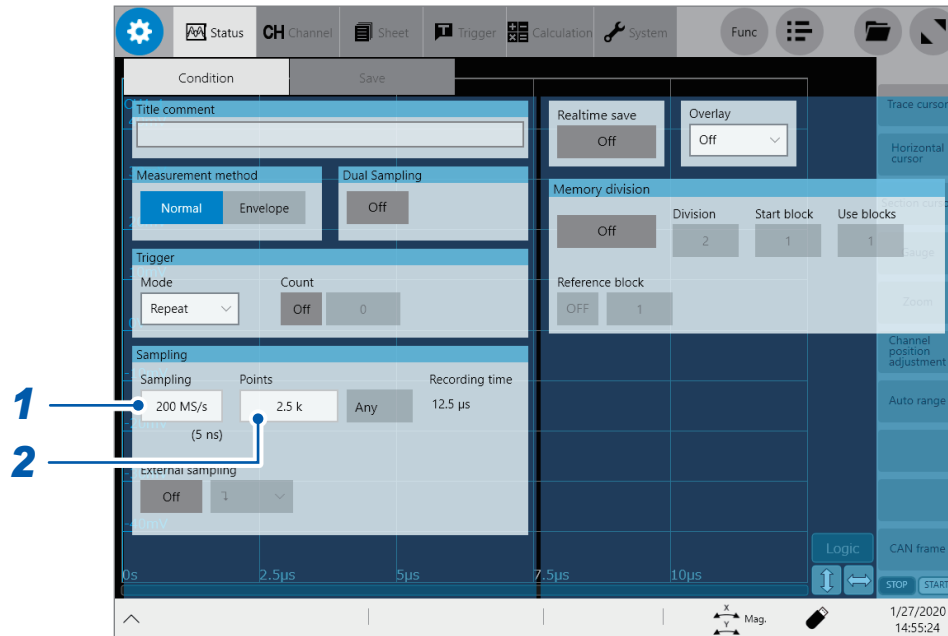

1 Tap the [Sampling] box, and then choose a sampling rate from the list.

See “Sampling rate setting guideline” (p. 81).

200 MS/s , 100 MS/s, 50 MS/s, 20 MS/s, 10 MS/s, 5 MS/s, 2 MS/s, 1 MS/s,
500 kS/s, 200 kS/s, 100 kS/s, 50 kS/s, 20 kS/s, 10 kS/s, 5 kS/s, 2 kS/s, 1 kS/s,
500 S/s, 200 S/s, 100 S/s, 50 S/s, 20 S/s, 10 S/s, 5 S/s, 2 S/s, 1 S/s

The instrument can measure signals at a sampling rate of 200 MS/s even with several modules other than Model U8976 installed together. However, the data update rate does not exceed the maximum sampling rate of each module.

2 Tap the [Points] box, and then choose an option for the number of points to be measured from the list.

2.5 k , 5 k, 10 k, 20 k, 50 k, 100 k, 200 k, 500 k, 1 M, 2 M, 5 M, 10 M, 20 M, 50 M, 100 M, 200 M,
500 M, 1 G

Sampling rate setting guideline

Choose a sampling rate using the following table as a guideline.

| Maximum display frequency | Sampling rate | Maximum display frequency | Sampling rate |
|---------------------------|---------------|---------------------------|---------------|
| 8 MHz | 200 MS/s | 400 Hz | 10 kS/s |
| 4 MHz | 100 MS/s | 200 Hz | 5 kS/s |
| 2 MHz | 50 MS/s | 80 Hz | 2 kS/s |
| 800 kHz | 20 MS/s | 40 Hz | 1 kS/s |
| 400 kHz | 10 MS/s | 20 Hz | 500 S/s |
| 200 kHz | 5 MS/s | 8 Hz | 200 S/s |
| 80 kHz | 2 MS/s | 4 Hz | 100 S/s |
| 40 kHz | 1 MS/s | 2 Hz | 50 S/s |
| 20 kHz | 500 kS/s | 0.8 Hz | 20 S/s |
| 8 kHz | 200 kS/s | 0.4 Hz | 10 S/s |
| 4 kHz | 100 kS/s | 0.2 Hz | 5 S/s |
| 2 kHz | 50 kS/s | 0.08 Hz | 2 S/s |
| 800 Hz | 20 kS/s | 0.04 Hz | 1 S/s |

If the instrument plots false waveforms (aliasing)

If a measured signal oscillates at a higher frequency compared to the sampling rate you chose, the instrument may plot a false waveform oscillating at a frequency lower than that of the actual signal once the signal frequency reaches a certain level. This phenomenon is called aliasing.

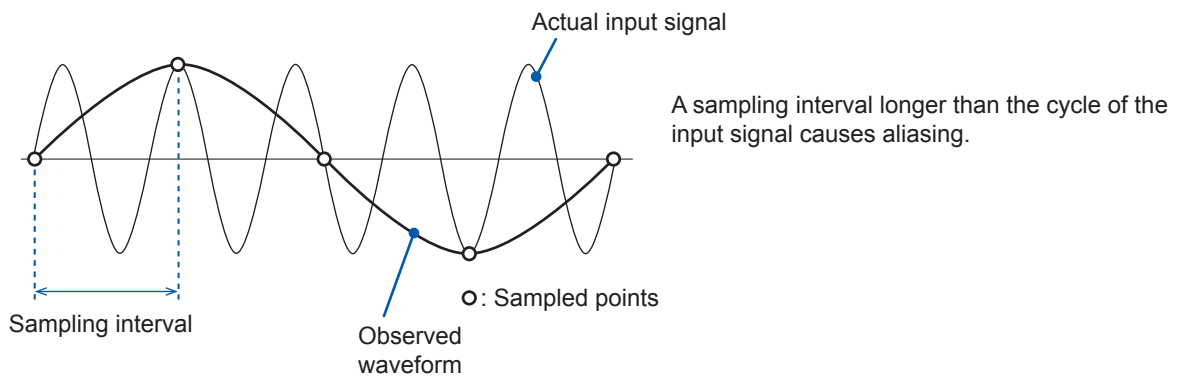

To plot a sign wave that allows you to observe the peaks without any aliasing, the instrument needs to sample the waveform at a minimum of 25 points per cycle.

To set the sampling rate automatically

See “3.7 Measuring Signals With the Automatic Ranging Setting” (p. 91).

3.3 Configuring the Input Channel Settings

Configure the analog channel settings.

How to configure the channel settings

This section describes how to configure the analog channel (CH1-1 through CH8-4) settings. For details of analog channels such as a setting of each module, see “1.3 Configuring the Input Channel Settings” in the Instruction Manual.

Configuring the input settings

Choose a measurement mode.

Choose an appropriate range for measurement target.

Choose an input coupling method.

Configure the low-pass filter settings (for measurement in a noisy environment).

Configure each module settings (as required).

Configuring the display settings

Choose a waveform display color.

Optionally set the display position, magnification ratio, upper limit value, and lower limit value (as required).

Fine-adjust waveform amplitude. (vernier function)

Convert input values. (scaling function)

Specifying the trigger settings (as required)

Configure the level trigger settings.

- When the input coupling method is set to GND, the instrument measures the ground potential in the module; thus, it does not measure any input waveforms.
- An influence of the filter attenuation may prevent the instrument from choosing an appropriate range.

Analog channel

 > [Channel] > each module (UNIT)

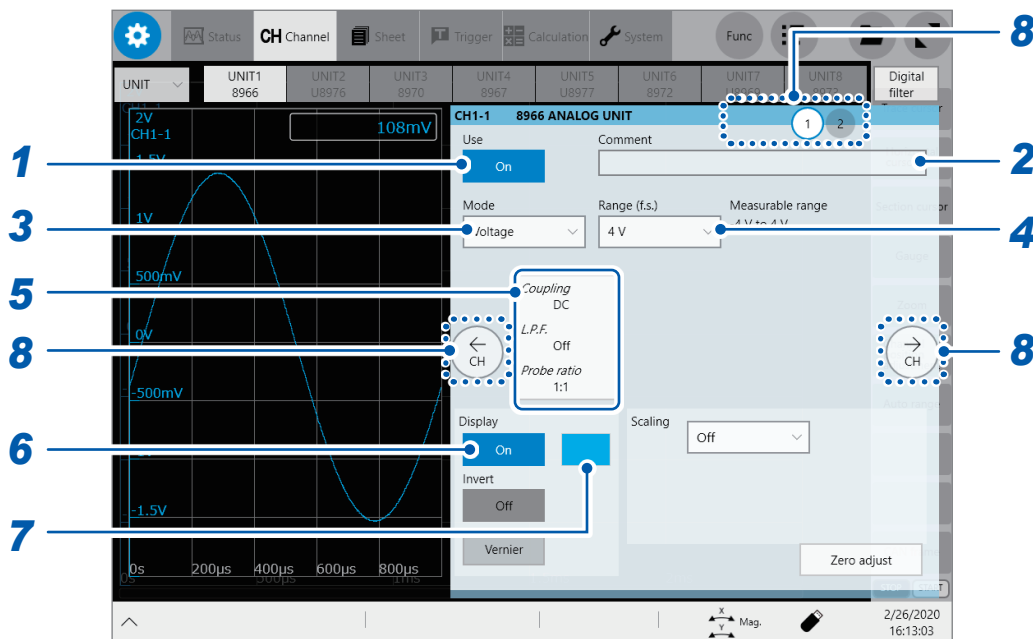

1 Tap the [Use] button to set it to [On] or [Off].

| | |
|---|---|
| On <input checked="" type="checkbox"/> | Measures a waveform through this module. |
| Off <input type="checkbox"/> | Does not measure any waveform through this module. Since no data is acquired, the instrument displays or saves nothing. |

2 Enter a comment in the [Comment] box.

Number of characters that can be entered: up to 40

3 Tap the [Mode] box, and then choose a measurement mode from the list.

| | |
|--|--|
| Voltage <input checked="" type="checkbox"/> | Measures a waveform in voltage mode. |
| Temperature <input type="checkbox"/> | Measures a waveform in temperature mode. |

Selectable modes vary depending on the installed modules.

See “3.7 Configuring Measurement Module-Specific Settings” and “3.8 Configuring Generator Module-Specific Settings” in the Instruction Manual.

4 Tap the [Range (f.s.)] box, and then choose a measurement range from the list.

The measurement ranges that can be chosen varies depending on modules.

If an input voltage exceeds the measurable range (overrange), change the measurement range to one with a lower sensitivity.

5 Specify the cutoff frequency of the low-pass filter and the probe ratio in [L.P.F] and [Probe ratio], respectively.

Tapping the area that includes [L.P.F] and [Probe ratio] allows the setting dialog box to appear.

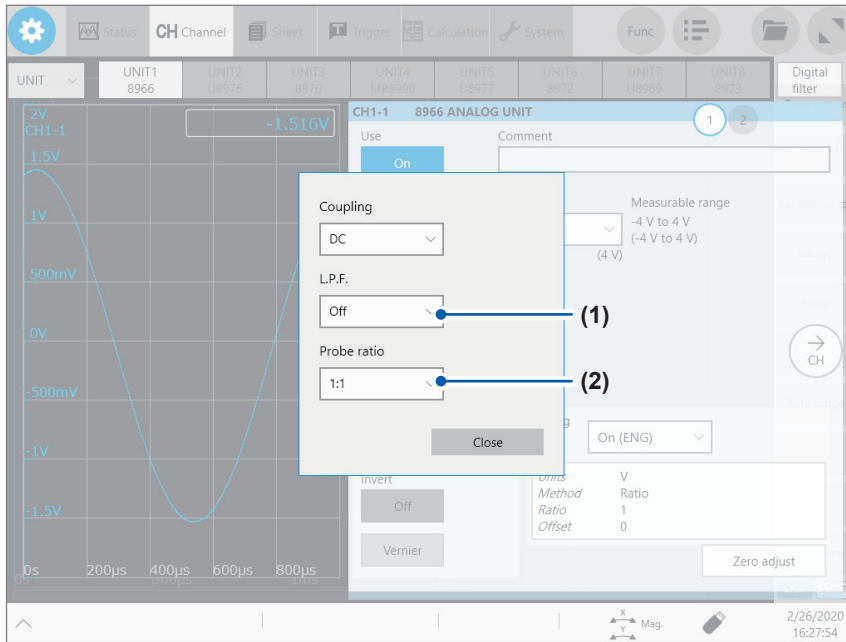

(1) Tap the [L.P.F] box, and then choose a cutoff frequency of the low-pass filter from the list.

Enabling the low-pass filter in the module eliminates excessive harmonic components. Available cutoff frequencies of the low-pass filter vary depending on the module type. Choose an adequate cutoff frequency depending on the characteristics of an input signal.
Example: Model 8966 Analog Unit

Off, 5 Hz, 50 Hz, 500 Hz, 5 kHz, 50 kHz, 500 kHz

(2) Tap the [Probe ratio] box, and then choose a probe ratio from the list.

Configure this setting when you perform measurement using the instrument with connection cords or probes connected.

| | |
|---------------|--|
| 1:1 | Choose this option when using any of the following cords: <ul style="list-style-type: none"> • Model L9197 Connection Cord • Model L9790 Connection Cord • Model L9198 Connection Cord • Model L9217 Connection Cord |
| 1:10 | Choose this option when using Model 9665 10:1 Probe. |
| 1:100 | Choose this option when using Model 9666 100:1 Probe, Model P9000-01 Differential Probe, or Model P9000-02 Differential Probe. |
| 1:1000 | Choose this option when using Model 9322, Model P9000-01, or Model P9000-02 Differential Probe. |

6 Tap the [Display] button to set it to [On] or [Off].

| | |
|------------|---|
| On | Displays the waveform on the waveform screen. |
| Off | Does not display any waveform on the waveform screen. |

7 When the [Display] button has been set to [On], tap the box next to [On] on the right, and choose a display color from the color pallet.

You can also choose the same color as the lines acquired across other channels.

8 Switch the channels.

Tap the corresponding location to switch the channels, and then set the measurement conditions by following the procedure above.

3.4 Configuring the Level Trigger Settings

The trigger function allows you to start and stop measurement using specific signals. When recording is started or stopped by specific signals, it is called “The instrument is triggered.” The trigger function is useful to find trends in unexpected events. This section explains “level trigger,” which triggers the instrument at a specified value. For details about triggers other than the level trigger, see “5 Configuring the Trigger Settings” in the Instruction Manual.

Cross-trigger settings

 > [Trigger] > [Common]

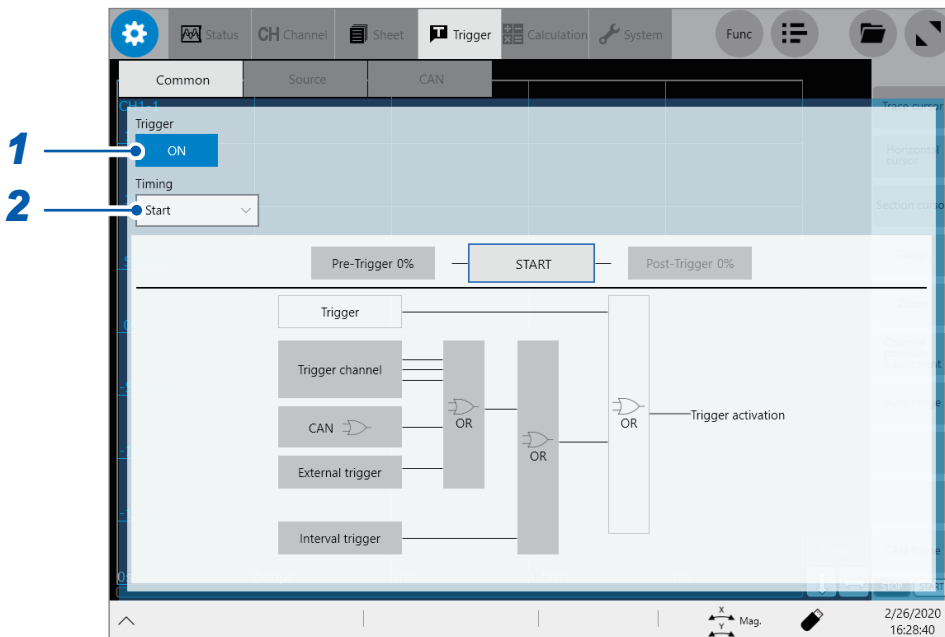

1 Tap the [Trigger] button to set it to [ON] or [OFF].

When the real-time saving is set to [On], you cannot use the trigger function.

| | |
|--|--------------------------------|
| OFF <input checked="" type="checkbox"/> | Disables the trigger function. |
| ON | Enables the trigger function. |

2 Tap the [Timing] box, and then choose a trigger recording method from the list.

| | |
|--|---|
| Start <input checked="" type="checkbox"/> | Starts recording when the instrument is triggered, and stops the recording after the instrument has acquired the recording length of waveforms. |
| Stop | Starts recording when you press the START key, and stops the recording when the instrument is triggered. |
| Start/Stop | Starts recording when a start trigger is activated and records data until a stop trigger is activated. |

Configuring the trigger source settings

 > [Trigger] > [Source]

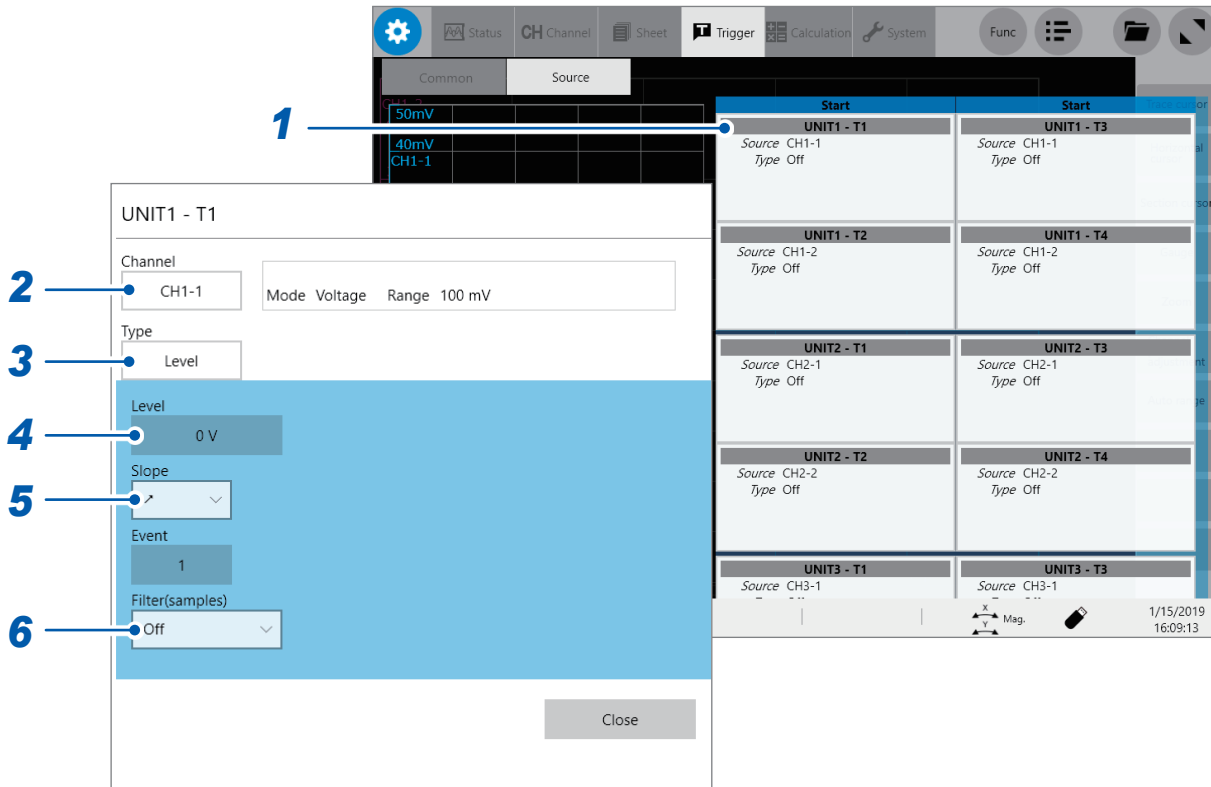

1 Tap a trigger source to be set.



The setting dialog box will appear.
You can set up to four triggers per module.

2 Tap the [Channel] box, and then choose a channel to be used for the level trigger from the list.

3 Tap the [Type] box, and then choose [Level] from the list.

4 Tap the [Level] box, and then enter a threshold value the level trigger condition is satisfied at.

5 Tap the [Slope] box, and then choose a signal direction that allows the level trigger condition to be satisfied from the list.

| | |
|---|---|
|  | The level-trigger condition is satisfied when a signal crosses the threshold value while rising. |
|  | The level-trigger condition is satisfied when a signal crosses the threshold value while falling. |

6 Tap the [Filter] box, and then choose a sampling count of the filter from the list.

Only after the level-trigger condition is continuously satisfied during the specified period, an analog trigger is generated. This is useful to prevent the instrument from triggering due to noise.

3.5 Starting/Stopping a Measurement

Starting a measurement



Pressing the **START** key starts a measurement.
Waveforms shown on the screen are cleared once the measurement starts.

Stopping the measurement



Pressing the **STOP** key once stops the measurement after the instrument has acquired the specified recording length of the waveforms.



Pressing the **STOP** key twice stops the measurement immediately.

Initializing the instrument (Restoring the basic settings)

Select  > **[System]** > **[Initialize]** to restore the instrument settings to the factory default. The setting after the initialization is suitable for simple measurement. Initialize the instrument when you have found any unexpected or complicated operation.
See “6.2 Initializing the Instrument” (p. 155).

To configuring measurement settings automatically

Tapping **[Auto range]** on the waveform screen automatically configures the settings for the sampling rate, measurement range, and zero position of an input waveform, and then starts a measurement.

The instrument sets the zero position before starting the measurement.
See “3.7 Measuring Signals With the Automatic Ranging Setting” (p. 91).

3.6 Saving Data Consisting of Items Selected

Save types and setting procedure

There are mainly three types of saving operation.

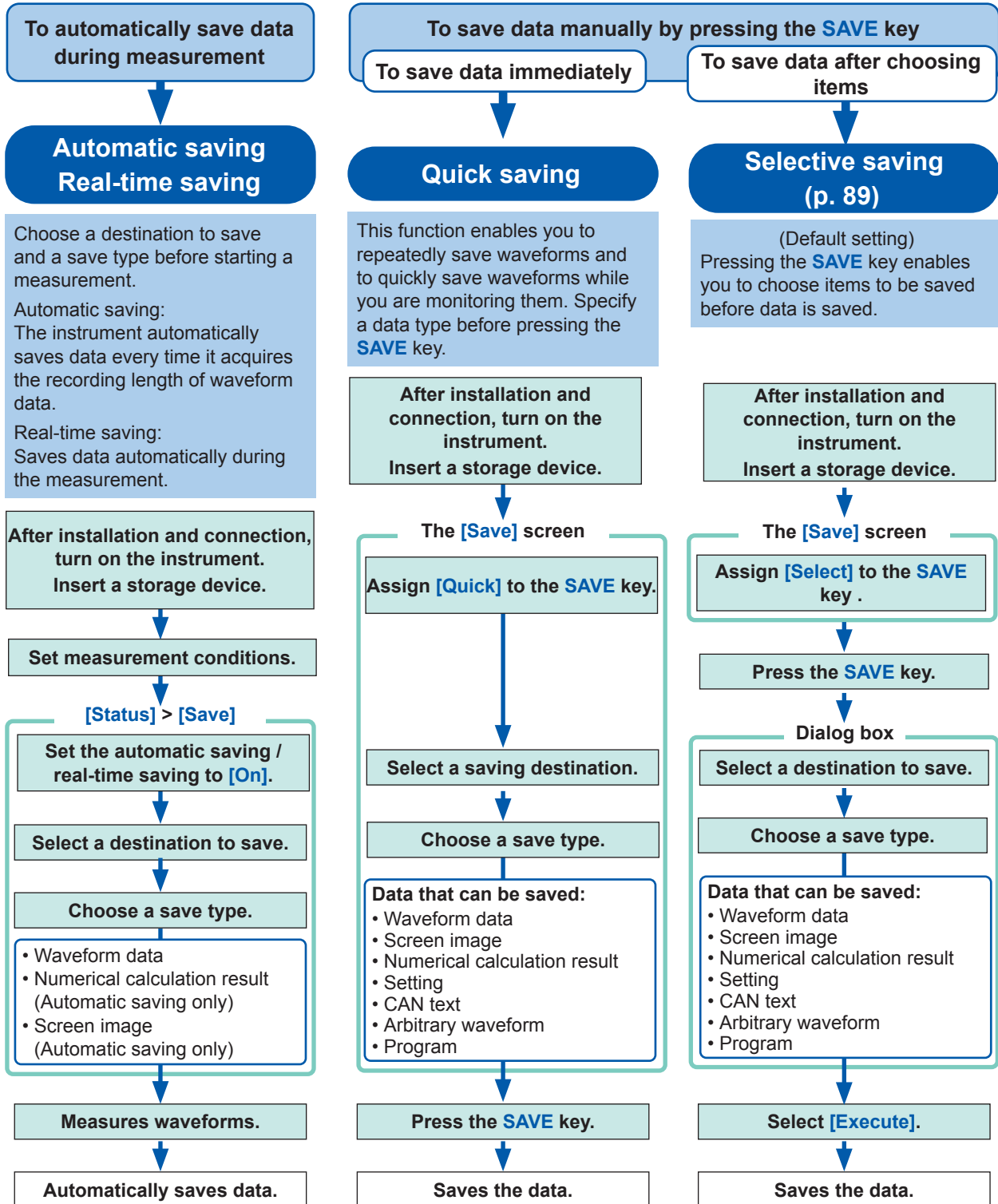

Check the following before saving data:

- Have you already inserted and initialized a storage device?
See "Formatting storage devices" (p. 70).
- Is the destination to save specified correctly?
- When the automatic saving is used, is [Auto save settings] set to [On]?

Selective saving

Pressing the **SAVE** key allows you to choose any of the following items and save them:

- Waveform data
- Screenshot
- Numerical calculation result
- Setting

See “4 Saving/Loading Data and Managing Files” in the Instruction Manual.

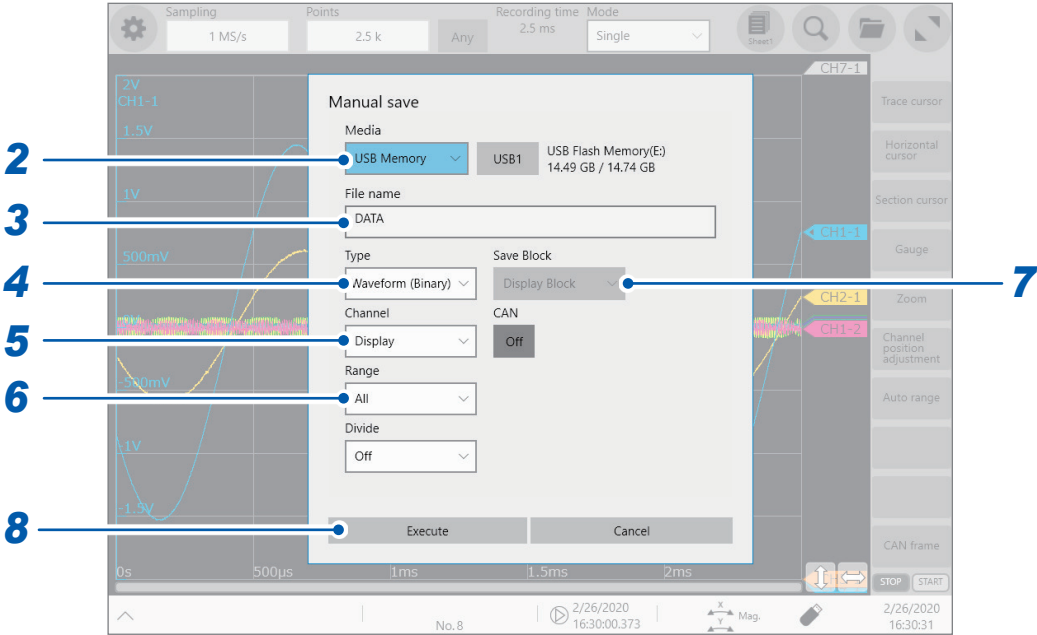

1 Press the **SAVE** key.

2 Tap the **[Media]** box, and then choose a destination to save from the list.

| | |
|---|---|
| SSD/HDD | Saves data on the built-in SSD/HDD. |
| SD Card | Saves data on the SD memory card. |
| USB Memory <input checked="" type="checkbox"/> | Saves data on the USB flash drive. |
| E-mail transmission | Sends email messages with waveform data attached to computers in the network or to a remote computer. See “14.5 Sending Email Messages” in the Instruction Manual. |
| FTP transfer | Sends waveform data to a computer connected to a network. See “14.3 Sending Data to a computer With the FTP Client Function” in the Instruction Manual. |
| Network | Sends waveform data to a computer connected to a network. See “14.7 Connecting to a Network Drive” in the Instruction Manual. |

3 Enter the file name in the **[File name]** box.

Number of characters for a file name: Up to 100 characters
 The maximum length of a file name that includes its path: Up to 255 characters
 Some characters or symbols are not accepted due to the file system restrictions.
 See “Touch keyboard” (p. 39).

4 Tap the [Type] box, and then choose a save format of waveform data or save target from the list.

| | |
|---------------------------------------|--|
| Waveform (Binary) [☑] | Saves waveform data in binary format. Choose this option to reload the waveforms into the instrument. |
| Waveform (Text) | Saves waveform data in text format. Choose this option to load the waveform data into a computer. The instrument cannot read this type of files. |
| Waveform (Float) | Saves waveform data in binary format (32-bit floating point). Choose this option to load the waveform data into MATLAB. The instrument cannot read this type of files. |
| Waveform (MDF) | Saves waveform data in MDF format. Choose this option to load the data using an MDF-capable waveform viewer. The instrument cannot load MDF files. |
| Screen image | Saves image data on the screen in BMP, PNG or JPEG format. You can display the data saved on a computer with image viewing software. |
| Calc. Result | Saves numerical calculation results. |
| Setting | Saves the present measurement conditions. |

When the save type is set to **[Waveform (Binary)]** or **[Waveform (Text)]**

5 Tap the [Channel] box, and then choose an option for channels to be saved.

| | |
|-----------------------------|---|
| All | Saves waveform data acquired across channels with the [Use] button set to [On] on the channel screen The instrument saves waveform data acquired across channels with the [Use] button set to [On] even when the [Display] button of each channel is set to [Off] . |
| Display [☑] | Saves waveform data acquired across channels with the [Display] button set to [On] on the channel screen. |

6 Tap the [Range] box, and then choose an option for saving range from the list.

| | |
|-------------------------|--|
| All [☑] | Saves the whole recorded waveform data. |
| Segment 1 | Saves the waveform data in the section between section cursors [1A] and [1B] . |
| Segment 2 | Saves the waveform data in the section between section cursors [2A] and [2B] . |

When using the memory division function

7 Tap the [Save Block] box, and then choose an option for blocks to be saved.

| | |
|-----------------------------------|---|
| Display Block [☑] | Saves waveforms included in displayed blocks. |
| All Block | Saves waveforms included in blocks being used beginning from the start block. |

8 Tap [Execute].

You can use the file screen to load data. The file screen will display files the instrument can load only.

See “4.3 Loading Data” in the Instruction Manual.

You can use Explorer to check files the instrument does not support, including those in text and BMP formats.

See “4.4 Managing Files” in the Instruction Manual.

3.7 Measuring Signals With the Automatic Ranging Setting

The automatic ranging function is available only for signals inputted to analog measuring modules. You cannot use the automatic ranging function concurrently with the envelope function.

- 1** Input signals to an analog measuring module.
- 2** Tap **[Auto range]** on the waveform screen.
- 3** Tap **[Execute]**.

The instrument specifies the sampling rate, measurement range, and zero position for each input waveform automatically, and starts a measurement.

The sampling rate is appropriately specified according to the lowest numbered channel among the channels with the **[Display]** button set to **[On]**. In addition, it is automatically specified so that waveforms have a length of one cycle to 2.5 cycles while 2500 points are recorded.

The automatic ranging function changes the following items:

| Module conditions (for all channels) | |
|--------------------------------------|-------------------------------|
| Range (f.s.) | Automatically specified value |
| Zero position | |
| L.P.F | Off |
| Input coupling | DC |

| Triggering condition (for one channel only) | |
|---|--|
| Selecting the trigger logical operation (AND or OR) among trigger sources | OR |
| Pre-trigger | 20% |
| Internal trigger | Detects trigger levels beginning from the channel lowest-numbered among the channels with the [Display] button set to [On] . |
| Trigger type | Level trigger (Slope: ↗, Level: Automatically specified value, Filter: 10 samples) |

| Measurement conditions | |
|------------------------|-------------------------------|
| Sampling rate | Automatically specified value |
| Points | 2.5 k |
| Recording mode | Repeat |

- Be careful when performing automatic ranging measurement while using the TRIG OUT signals. Starting a measurement with the automatic ranging setting outputs a trigger signal from the TRIG OUT terminal.
- Input signals (waveforms) before starting a measurement with the automatic ranging setting. The automatic ranging function changes the setting depending on a signal inputted on the start of execution.
- When an input signal acquired across the channel lowest-numbered among the channels with the **[Display]** button set to **[On]** has an extremely small level, the sampling rate is specified depending on the input signal of the next lowest-numbered channel.
- If the range setting fails for every channel with the **[Display]** button set to **[On]**, the instrument displays a warning message and cancels the measurement.
- When the automatic saving is set to on, the instrument saves the data after specifying the setting value of the automatic ranging.
- When the real-time saving is set to on, the automatic ranging function is unavailable.
- The instrument cannot automatically choose an adequate range for a signal with a frequency of lower than 10 Hz. Manually choose a measurement range.
- The automatic ranging function is not available for the following modules:

| | |
|--------------|------------------------|
| Model 8967 | Temp Unit |
| Model U8969 | Strain Unit |
| Model 8970 | Freq Unit |
| Model MR8990 | Digital Voltmeter Unit |
| Model 8973 | Logic Unit |

4 Analysis Method

4.1 Reading Measured Values (Trace Cursors)

You can read measured values (scaled values when the scaling is used) using trace cursors on the waveform screen. The instrument can simultaneously display up to eight trace cursors. You can read differences in times and measured values at any two cursors you choose from among all cursors.

- 1 Tap **[Trace cursor]** on the wave screen.

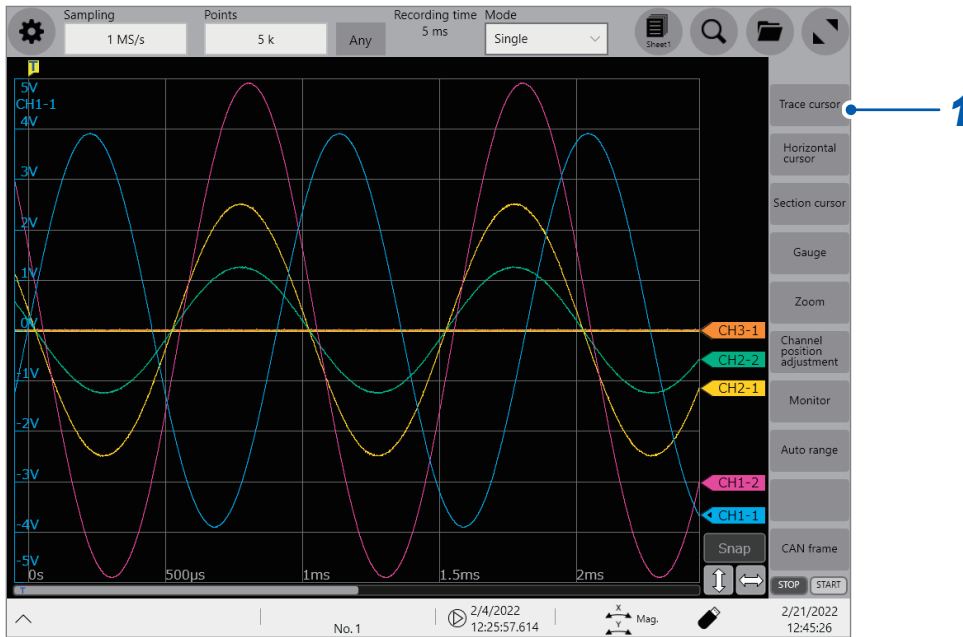

- 2 Choose one or more cursors from **[Trace cursor A]** through **[Trace cursor H]** by tapping them.

The chosen trace cursors are displayed on the waveform screen. You can drag the trace cursors on the waveform screen.

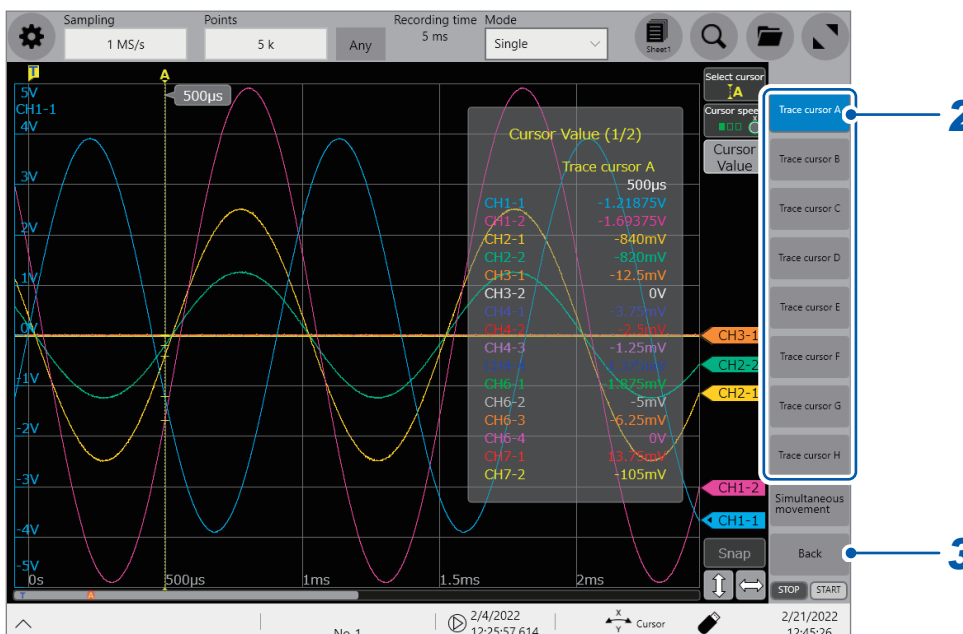

- 3 Tap **[Back]**.

4 Tap [Cursor Value].

You can switch between on and off for the cursor value display every time you tap [Cursor Value].

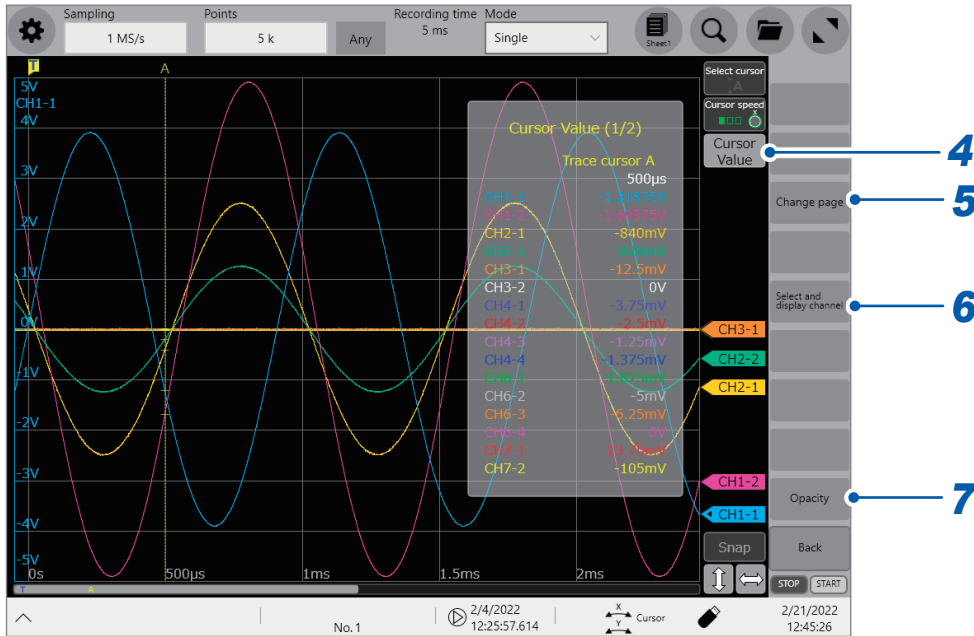

5 Tap [Change page].

When the instrument displays multiple channels, you can switch the pages to check cursor values of each channel. Every time you tap it, the pages are switched.

6 Tap [Select and display channel].

The function buttons switch.

Tapping [Show only channels in the sheet] can only display channels in the present sheet.

Tapping [Select channel to display] allows you to select channels of which you want to display cursor values.

7 Tap [Opacity].

The function buttons switch.

Tapping [▲] or [▼] allows you to change the opacity of the screen background between 0% and 100% in 10 percent points increments.

8 Tap [1: Trace cursor A] or [2: Trace cursor B].

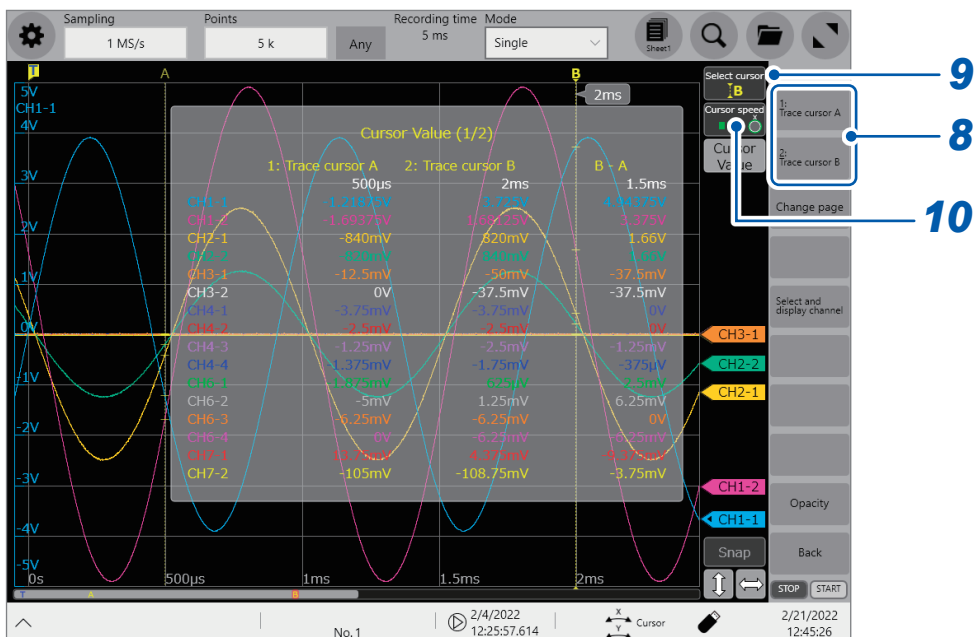

9 Tap [Select cursor].

Every time you tap it when the instrument displays multiple trace cursors, a cursor is activated one by one in sequence. In addition, you can activate any one of the cursors displayed on the screen by tapping it.

While you are operating the cursors on the waveform screen, the instrument may not display **[Cursor Value]** and **[Select cursor]** depending on the screen operation.

In this case, tap the waveform plotting field to redisplay **[Cursor Value]** and **[Select cursor]**.

10 Tap [Cursor Speed].

You can switch the cursor moving speed on the rotary knob X on three levels every time you tap it.

Changing the display magnification of waveforms while moving the trace cursor

Sliding your finger upward on the screen while dragging the trace cursor enlarges the waveform display centered around the trace cursor in proportion to the dragging distance. Sliding your finger downward compresses the waveform display.

Once you have adjusted the display to a suitable size, move the trace cursor along the horizontal axis to change the display position.

Releasing your finger from the screen reverts the display to the original magnification.

To move the trace cursor using the rotary knob X

When **[Cursor]** is assigned to the rotary knob, you can move the active trace cursor with the rotary knob X.

Tapping **[Cursor speed]** allows you to switch the cursor moving distance on the rotary knob X on three levels.

The moving distance on the rotary knob X is fixed at one.

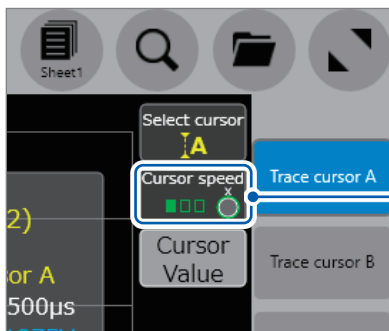

The moving distance switches every time you tap it.

4.2 Handling Waveforms

Scrolling through waveforms

You can use the scroll bar to check the position of waveforms presently displayed on the waveform screen.

You can swipe or drag waveforms displayed on the waveform screen to scroll through.





Scroll bar

Zooming in and out waveforms

Horizontally pinching in or pin out the waveform screen enlarges or compresses waveforms horizontally.

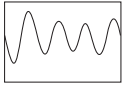
Vertically pinching in or pin out the waveform screen enlarges or compresses waveforms vertically

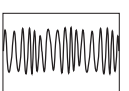
| | | | |
|---|------------------|---|----------------------|
|  | Pinch out |  | Zooms in waveforms. |
|  | Pinch in |  | Zooms out waveforms. |

4.3 Loading Data on Your Computer (Wave Viewer)

You can load waveform data saved in CSV format into spreadsheets. This section explains how to install, uninstall, start, and exit the Wave Viewer.

Supported computer: Computers running on Windows 7, or Windows 8, or Windows 10

Installing Wave viewer (for computers running on Windows 7)

- 1** **Insert the accompanying application disc into the CD-ROM drive.**
The top page appears automatically.
If the page does not appear, open the "index.htm" file with your web browser.
- 2** **Choose a display language (Click the [English] icon to display the installation program in English).**
- 3** **Click the [Wave viewer (Wv)] icon.**
The specifications and revision history of Waveform viewer (Wv) appear.
- 4** **Click the [Install] icon at the top right of the page.**
The [File Download] dialog box appears.
- 5** **Click [Open].**
The confirmation dialog box appears to check whether to continue the installation.
- 6** **Click [Next].**
The window for selecting the installation folder appears.
Click [Browse] to change the installation folder.
- 7** **Click [Next].**
The installation starts.

Starting Wave viewer

Before using Wave viewer, read the “READ ME.txt.”

Click the Start button of Windows®, select [Program] > [HIOKI] > [Wv].

Waveform Viewer starts.

Exiting Wave viewer

On the [File] menu of Wave viewer, click [Exit].

Alternatively, you can click the [Close] button at the top right of the screen.

Uninstalling Wave viewer

- 1** Click the Start button to display the Windows® start menu, and then select [Control Panel] > [Uninstall a program].

When you use Windows 10, click the Start button and select [Settings] > [Apps].

- 2** Select [HIOKI Wave Viewer (Wv)] to uninstall.

Wave viewer is uninstalled.

When updating Wave viewer to the latest version, uninstall the earlier version before installing the latest version.

5 Specifications

5.1 Specifications of Model MR6000

General specifications

1. Basic specifications

| | |
|---|---|
| Measurement method | Normal: Records waveforms normally. Envelop: Records the maximum and minimum values during each specified regular period. (Not available when the external sampling is used.) Dual sampling: Records waveforms at a sampling speed different from the envelope sampling speed during envelope measurement. |
| Number of channels | Analog: Up to 32 channels (when Model U8975 4ch Analog Unit or Model U8978 4CH Analog Unit is installed in every slot) Logic: Up to 128 channels (when Model 8973 Logic Unit* is installed in every slot*) *: The logic probe input connectors have the same-potential ground as Model MR6000. CAN/LIN: Up to 64 channels (when a CAN/LIN interface is used) |
| Maximum sampling rate | 200 MS/s (when Model U8976 High Speed Analog Unit is used), Samples values acquired across all channels simultaneously. 10 MS/s for external sampling |
| Memory capacity | 1 gigaword |
| Operating environment | Indoors, pollution degree 2, operating altitude: up to 2000 m (6562 ft.) |
| Operating temperature and humidity range | 0°C to 40°C (32°F to 104°F), 80% RH or less (no condensation) |
| Storage temperature and humidity range | -10°C to 50°C (14°F to 122°F), 80% RH or less (no condensation) |
| Standards | Safety: EN61010 EMC: EN61326 Class A |
| Power supply | Rated supply voltage: 100 V to 240 V AC (Assuming voltage fluctuation of ±10%). Rated supply frequency: 50 Hz / 60 Hz Anticipated transient overvoltage: 2500 V |
| Maximum rated power | 300 VA |
| Clock | Automatic calendar, automatic leap year adjustment, 24-hour clock |
| Backup battery life | About 10 years (at 23°C, for reference) Backup for the clock and setting conditions |
| Interfaces (outline) | LAN, USB, SD, SATA, monitor |
| Dimensions | Approx. 353W × 235H × 154.8D mm (13.90"W × 9.25"H × 6.09"D) (excluding protrusions) |
| Weight | Approx. 6.5 kg (229.3 oz.) (instrument only) Approx. 6.7 kg (236.3 oz.) (When Model Z5021 Probe Power Unit, and either Model U8332 SSD Unit or Model U8333 HD Unit are installed) Approx. 8.9 kg (313.9 oz.) (When Model U8976 High Speed Analog Unit is installed) |
| Product warranty period | 3 years |
| Accessories | p. 4 |
| Options | p. 5 |

2. Specifications for accuracy

| | |
|--------------------------------------|--|
| Accuracy guarantee conditions | Accuracy guarantee period: 1 year Accuracy guarantee temperature and humidity range: 23°C ±5°C (73°F ±9°F), 80% RH or less |
| Time axis accuracy | ±0.0005% |
| Clock accuracy | ±8 ppm |

3. Display

| | |
|---------------------|--|
| Display type | 12.1-inch XGA TFT color LCD (1024 × 768 dots) With capacitive touch panel |
|---------------------|--|

4. Specifications of the interfaces

(1) LAN interface

| | |
|------------------|---|
| Standards | IEEE802.3 Ethernet 1000BASE-T, 100BASE-TX, 10BASE-T |
| Functions | DHCP, DNS, FTP, HTTP, network drive, email transmission |
| Connector | RJ-45 |

(2) USB interface

| | |
|-------------------------|--|
| Standards | USB 3.0 compliant ×3, USB 2.0 compliant ×4 |
| Host | Connector: Series-A receptacle Peripheral devices: keyboard, mouse, USB flash drive |
| Available option | Model Z4006 USB Drive (16 GB) |

(3) SD card slot

| | |
|-------------------------|---|
| Standards | SD standard compatible ×1 (with support for SD, SDHC, SDXC memory card) |
| Available option | Model Z4001 SD Memory Card (2 GB), Model Z4003 SD Memory Card (8 GB) |

(4) SATA interface

| | |
|-------------------------|---|
| Standards | Serial ATA Revision 3.0 compatible × 1 |
| Available option | Model U8332 SSD Unit (256 GB), Model U8333 HD Unit (320 GB) |

(5) Output for monitor

| | |
|----------------------|---|
| Connector | DVI-I |
| Output format | Digital output* and analog output for external display 1024 × 768 (XGA) *: Dual-link not supported |

5. Auxiliary I/O

(1) External sampling terminals

| | |
|--------------------------------|---|
| Connector | SMB |
| Maximum input voltage | 10 V DC |
| Input voltage | High level: 2.5 V to 10 V, low level: 0 V to 0.8 V |
| Acceptable pulse width | High-level period: 50 ms or more; Low-level period: 50 ms or more |
| Maximum input frequency | 10 MHz |
| Functions | External sampling clock input Rising, falling, and both rising & falling (user-selectable) |

(2) External control terminals

| | | | |
|-------------------------|-------------------------|---|--|
| Terminal block | Push-button type | | |
| External input | Maximum input voltage | 10 V DC | |
| | Input voltage | High level: 2.5 V to 10 V, low level: 0 V to 0.8 V | |
| | Acceptable pulse width | High-level period: 50 ms or more; low-level period: 50 ms or more | |
| | Pulse interval | 200 ms or more | |
| | Number of terminals | 2 | |
| | Functions | START, STOP, START/STOP, SAVE, ABORT, EVENT | |
| External output | Output format | Open-drain output (equipped with a 5-volt voltage output, active-low) | |
| | Output voltage | High level: 4.0 V to 5.0 V, low level: 0 V to 0.5 V | |
| | Maximum input voltage | 50 V DC, 50 mA, 200 mW | |
| | Number of terminals | 2 | |
| | Functions | Judgment (pass), judgment (fail), occurrence of an error, busy, waiting for a trigger | |
| External trigger | Maximum input voltage | 10 V DC | |
| | External trigger filter | On/Off | |
| | Acceptable pulse width | When the external trigger filter is off High-level period: 1 ms or more Low-level period: 2 μs or more | |
| | | When the external trigger filter is on High-level period: 2.5 ms or more Low-level period: 2.5 ms or more | |
| | Functions | Rising, falling, and either rising & falling (user-selectable) Rising: Triggered when a pulse rises from the low level (between 0 V and 0.8 V) to the high level (between 2.5 V and 10 V). Falling: Triggered when a pulse falls from the high level (between 2.5 V and 10 V) to the low level (between 0 V and 0.8 V), or when the terminal is connected with the GND terminal. (When the trigger timing is set to [START&STOP] , the edge to be used can be chosen between rising, falling, and both rising & falling for each of [START] and [STOP] .) | |

| | | |
|-----------------------|-----------------------|---|
| Trigger output | Output format | Open-drain output (equipped with a 5-volt voltage output, active-low) |
| | Output voltage | High level: 4.0 V to 5.0 V, low level: 0 V to 0.5 V |
| | Maximum input voltage | 50 V DC, 50 mA, 200 mW |
| | Output pulse width | The pulse width to be used can be chosen between level and pulse. Level: [(sampling interval) × (number of data points after trigger)] or more Pulse: 2 ms ±1 ms |

(3) Probe compensation signal output terminal

| | |
|----------------------|--|
| Output signal | 0 V to 5 V ±10%, 1 kHz ±1%, square wave |
| Functions | Compensation of Model 9665 10:1 Probe and Model 9666 100:1 Probe |

(4) Dedicated power terminals for current sensors

Applicable to the instrument with Model Z5021 Probe Power Unit (the option available only when ordered with the instrument) installed.

| | |
|----------------------------|--|
| Number of terminals | Consistent with the specifications of Model Z5021 Probe Power Unit |
| Output voltage | Consistent with the specifications of Model Z5021 Probe Power Unit |

Trigger

When the real-time saving is set to **[On]**, the trigger function is not available.

| | |
|---------------------------|--|
| Trigger method | Digital comparison method |
| Trigger conditions | Logical AND or OR operation among each trigger source and the interval trigger |
| Trigger source | <p>Analog, logic, real-time waveform calculation</p> <ul style="list-style-type: none"> • When [START] or [STOP] is chosen: Up to 32 channels (Up to four analog triggers are available for one analog channel.) (Up to four logic triggers are available for one logic probe.) (Up to two analog triggers are available for one real-time waveform calculation channel.) • When [START&STOP] is selected: Up to 16 channels per group Analog: Up to 16 channels per group (Two channels can be selected per module.) Logic: Up to 16 probes per group (Two probes can be selected per module.) Real-time waveform calculation: Up to 16 calculations per group (Up to two trigger types per group are available for each analog channel.) (Up to two logic triggers per group are available for each logic probe.) <p>External trigger CAN Note: The instrument immediately starts a measurement (freely running) when all trigger sources are set to off.</p> |

| | | |
|---|--|--|
| Analog trigger | Level trigger: | The instrument is triggered when an input signal voltage exceeds (or falls below) a user-defined voltage level. |
| | Voltage sag trigger*: | The instrument is triggered when the peak voltage of an input signal falls below a user-defined voltage. (Dedicated to 50 Hz / 60 Hz commercial power) (Not available when Model MR8990 Digital Voltmeter Unit or Model 8970 Freq Unit is used.) (Not available when the envelope is used.) |
| | Window trigger*: | A range, which is defined by an upper level and lower level, shall previously be specified. The instrument is triggered when an input signal voltage falls within (IN) or outside (OUT) the user-defined range. |
| | Period trigger*: | A period-measuring level and a period range shall previously be specified. The instrument measures periods by acquiring moments when a voltage exceeds (or falls below) a user-defined level, and is triggered when a period falls outside or within the user-defined range. (Not available when Model MR8990 Digital Voltmeter Unit or Model 8970 Freq Unit is used.) (Not available when the envelope is used.) |
| | Glitch trigger*: | A voltage level and a pulse width (glitch width) shall be previously specified. The instrument measures pulse widths by acquiring moments when rising edges (or falling edges) cross the user-defined level and is triggered when a signal pulse width becomes narrower than the user-defined pulse width. (Not available when Model MR8990 Digital Voltmeter Unit is used.) (Not available when the envelope is used.) |
| | Event designation: | The number of events shall previously be specified (1 to 4000). The instrument counts the number of times the trigger condition of each trigger source is satisfied and is triggered when the event counts exceeds the user-defined number. (Not available when the trigger condition is set to AND.) |
| *: Setting invalid with the sampling rate set at 200 MS/s | | |
| Logic trigger | Pattern trigger defined by 1, 0, or disregard (×) | |
| Forcible trigger | Available (A forcible trigger can trigger the instrument in priority to any trigger sources.) | |
| CAN trigger | The instrument is triggered when receiving a specific data frame, error frame, or remote frame. When a data frame is chosen, the instrument can be triggered by comparing between bits in specific byte positions. | |
| Interval trigger | Data can be recorded at a user-defined measuring interval (in hours, minutes, and seconds). The instrument is triggered at the start of a measurement and then repeatedly triggered at a user-defined measurement interval. | |
| Trigger filter | Normal: Off, 10, 20, 50, 100, 150, 200, 250, 500, 1000, 2000, 5000, 10000 (samples) Envelope: Off, 1 ms, 10 ms | |
| Trigger level resolution | 1 LSB 256 LSB for Model MR8990 Digital Voltmeter Unit (uses only high 16 bits of the 24-bit A/D resolution) | |
| Pre-trigger | 0% to 100% (freely settable in one percentage point increments) The instrument displays waveforms acquired during the pre-trigger period. | |
| Post-trigger | 0% to 40% The instrument displays waveforms acquired during the post-trigger period. | |
| Trigger priority | On/Off | |
| Trigger mark | The instrument displays trigger marks, which indicate the positions of trigger events. | |
| Trigger timing | [START], [STOP], [START&STOP] | |
| Waveform monitor display | While waiting for a trigger, the instrument displays the waveform monitor (Hiding the monitor is available). | |

Waveform screen

| | | |
|----------------------------------|--|--|
| Display format | Time-domain waveform representation: XY composite waveform display: FFT representation: | 1, 2, 3, 4, 6, 8, 9, 16 screens (Up to 64 channels can be displayed on each sheet.) (Every channel can be set to be displayed on multiple sheets.) 1, 2, 4 screens, combination of time-series waveforms and XY (2 screens) (Unsettable when envelope is enabled) (Up to eight XY composite waveforms can be set) (Multiple sheets can display the same composite waveforms) 1, 2, 4 screens, combination of time-series waveforms and FFT representation (1, 2, 4 screens) |
| Sheet function | Up to 16 sheets A display format can be chosen for each sheet. | |
| Zoomed display | On/Off The instrument displays time-domain waveforms on the upper waveform screen and zoomed waveforms on the lower screen. | |
| Full-screen display | The instrument zooms the waveform screen to full screen. | |
| Grid anchoring mode | The waveform display position can be defined by specifying a waveform display magnification and a zero-level position. | |
| Waveform display | Waveform color: Interpolation: Variable display: Waveform display magnification: Waveform display zero-display position: Vernier: Grid: Logic width: Inverted waveform: | Fixed colors (32 colors) Line Always enabled when grid anchoring mode is disabled. 100× to 1/10× (available when grid anchoring mode is enabled) In increments of 1 percent point (available when grid anchoring mode is enabled) Amplitudes of inputted waveforms can be adjusted. (Adjustable range: 50% to 250% of input) Off/On Wide, standard, narrow The instrument displays polarity-reversed waveforms. (Not available for Model 8967 Temp Unit, Model 8970 Freq Unit, or Model 8973 Logic Unit) |
| Zoom in/out | The instrument displays waveforms at a user-preferred magnification by users' pinching in or out on the display. (when grid anchoring mode is disabled) | |
| Waveform scrolling | Waveforms can be scrolled through horizontally by swiping and dragging the display. Scrolling through waveforms backward is available during a measurement. | |
| Rolling display | The instrument always displays latest data while following measurement. The drawing starting position can be chosen between the left edge and right edge. (The rolling display is not available when the overlay setting is used.) | |
| Waveform monitor function | On/Off (The instrument can display the waveform monitor while waiting for a trigger.) | |
| Overlaying waveforms | Overlaying setting can be chosen from among off, automatic, and manual. (The rolling display is not available when the overlay setting is used.) | |

| | | |
|-------------------|---|--|
| Cursor | Trace cursor: | Up to eight cursors can be displayed. (The instrument displays potential, time from trigger, time lag between cursors, and potential difference between cursors.) |
| | Horizontal cursor: | Up to eight cursors can be displayed. (The instrument displays potential and potential difference between cursors.) |
| | Gauge: | Up to eight cursors can be displayed. |
| | Section designation: | Section cursor 1 or section cursor 2 (Specifies calculation range, save range, and search area.) |
| | Jump: | Jumps to the position specified by touch operation. |
| Event mark | Can be placed during measurement (up to 10000 markings). Event marks can be placed by pressing the START key or inputting an external signal. | |

Setting screen

| | | |
|----------------------|----------------------|--|
| Sampling rate | Normal | <p>200 M, 100 M, 50 M, 20 M, 10 M, 5 M, 2 M, 1 M 500 k, 200 k, 100 k, 50 k, 20 k, 10 k, 5 k, 2 k, 1 k 500, 200, 100, 50, 20, 10, 5, 2, 1 (unit: S/s) The sampling rate can be set at 100 MS/s or slower when the real-time waveform calculation is used.</p> <p>When the external sampling is used: Depends on a signal input to the external sampling terminal. Up to 10 MHz</p> |
| | Envelope | <p>10 M, 5 M, 2 M, 1 M 500 k, 200 k, 100 k, 50 k, 20 k, 10 k, 5 k, 2 k, 1 k 500, 200, 100, 50, 20, 10, 5, 2, 1 (unit: S/s) 30, 12, 6, 2, 1 (unit: S/min) The sampling rate for the envelope setting means the speed of calculating the maximum and the minimum values. Oversampling rate: 100 MS/s</p> |
| | Dual sampling | <p>Instantaneous waveform: 100 M, 50 M, 20 M, 10 M, 5 M, 2 M, 1 M, 500 k, 200 k, 100 k, 50 k, 20 k, 10 k, 5 k, 2 k, 1 k, 500, 200, 100, 50, 20, 10, 5, 2, 1 (unit: S/s) • A sampling rate faster than that chosen for trend waveforms can be chosen. • When the real-time waveform calculation is used, a sampling rate of 50 MS/s or slower can be chosen.</p> <p>Trend waveform: 10 M, 5 M, 2 M, 1 M, 500 k, 200 k, 100 k, 50 k, 20 k, 10 k, 5 k, 2 k, 1 k, 500, 200, 100, 50, 20, 10, 5, 2, 1 (unit: S/s), 30, 12, 6, 2, 1 (unit: S/min) • The sampling rate represents a rate at which maximum and minimum values are calculated. • The instrument performs oversampling at the sampling rate set for instantaneous waveforms.</p> |

| | | | | | | | | | | | | | | | |
|---|---|---------------|--|--|---|-----------------|---|--|---|----------------------|---|--|---|---|---|
| For the real-time saving setting | Available maximum sampling rate | | | | | | | | | | | | | | |
| | When the destination to save data is set to SSD: 20 MS/s (2 ch.), 10 MS/s (4 ch.), 5 MS/s (8 ch.), 2 MS/s (16 ch.), 1 MS/s (32 ch.), 500 kS/s (64 ch.) | | | | | | | | | | | | | | |
| | When the destination to save data is set to HDD: 10 MS/s (2 ch.), 5 MS/s (4 ch.), 2 MS/s (8 ch.), 1 MS/s (16 ch.), 500 kS/s (32 ch.), 200 kS/s (64 ch.) | | | | | | | | | | | | | | |
| | When the destination to save data is set to SD memory card, USB flash drive, FTP transmission, or network drive: 5 MS/s (1 ch.), 2 MS/s (4 ch.), 2 MS/s (8 ch.), 500 MS/s (16 ch.), 200 kS/s (32 ch.), 100 kS/s (64 ch.) | | | | | | | | | | | | | | |
| | <ul style="list-style-type: none"> • The figures in above parentheses means the number of channels to be used. • Only when the available optional devices are specified as the destination to save data, the sampling rates are guaranteed. • The operation of the USB flash drive is guaranteed only when the drive connects to the USB 3.0 connector. | | | | | | | | | | | | | | |
| Maximum recording length | <table border="1"> <tr> <td data-bbox="438 770 526 808">Normal</td> <td data-bbox="635 770 1268 898"> For the fixed recording length setting: 20 M (32 ch.), 50 M (16 ch.), 100 M (8 ch.), 200 M (4 ch.), 500 M (2 ch.), 1 G (1 ch.) (unit: points) </td> </tr> <tr> <td></td> <td data-bbox="635 909 1276 1061"> For freely-specified recording length: 33554400 (32 ch.), 67108800 (16 ch.), 134217700 (8 ch.), 268435400 (4 ch.), 536870900 (2 ch.), 1073741800 (1 ch.) (unit: points) Can be set in 100 points increments </td> </tr> <tr> <td data-bbox="438 1077 550 1111">Envelope</td> <td data-bbox="635 1077 1252 1200"> For the fixed recording length setting: 10 M (32 ch.), 20 M (16 ch.), 50 M (8 ch.), 100 M (4 ch.), 200 M (2 ch.), 500 M (1 ch.) (unit: points) </td> </tr> <tr> <td></td> <td data-bbox="635 1216 1268 1368"> For freely-specified recording length: 16777200 (32 ch.), 33554400 (16 ch.), 67108800 (8 ch.), 134217700 (4 ch.), 268435400 (2 ch.), 536870900 (1 ch.) (unit: points) Can be set in 100 points increments </td> </tr> <tr> <td data-bbox="438 1384 606 1417">Dual sampling</td> <td data-bbox="635 1384 1332 1585"> Instantaneous waveform: Less than half of the maximum recording length provided for the normal method </td> </tr> <tr> <td></td> <td data-bbox="635 1491 1332 1585"> Trend waveform: Less than half of the maximum recording length provided for the envelope method </td> </tr> <tr> <td data-bbox="438 1601 582 1682">For the real-time saving setting</td> <td data-bbox="635 1601 1348 1682"> The maximum recording length is defined depending on a free space of a destination, file systems, and the number of measuring channels. </td> </tr> </table> | Normal | For the fixed recording length setting: 20 M (32 ch.), 50 M (16 ch.), 100 M (8 ch.), 200 M (4 ch.), 500 M (2 ch.), 1 G (1 ch.) (unit: points) | | For freely-specified recording length: 33554400 (32 ch.), 67108800 (16 ch.), 134217700 (8 ch.), 268435400 (4 ch.), 536870900 (2 ch.), 1073741800 (1 ch.) (unit: points) Can be set in 100 points increments | Envelope | For the fixed recording length setting: 10 M (32 ch.), 20 M (16 ch.), 50 M (8 ch.), 100 M (4 ch.), 200 M (2 ch.), 500 M (1 ch.) (unit: points) | | For freely-specified recording length: 16777200 (32 ch.), 33554400 (16 ch.), 67108800 (8 ch.), 134217700 (4 ch.), 268435400 (2 ch.), 536870900 (1 ch.) (unit: points) Can be set in 100 points increments | Dual sampling | Instantaneous waveform: Less than half of the maximum recording length provided for the normal method | | Trend waveform: Less than half of the maximum recording length provided for the envelope method | For the real-time saving setting | The maximum recording length is defined depending on a free space of a destination, file systems, and the number of measuring channels. |
| Normal | For the fixed recording length setting: 20 M (32 ch.), 50 M (16 ch.), 100 M (8 ch.), 200 M (4 ch.), 500 M (2 ch.), 1 G (1 ch.) (unit: points) | | | | | | | | | | | | | | |
| | For freely-specified recording length: 33554400 (32 ch.), 67108800 (16 ch.), 134217700 (8 ch.), 268435400 (4 ch.), 536870900 (2 ch.), 1073741800 (1 ch.) (unit: points) Can be set in 100 points increments | | | | | | | | | | | | | | |
| Envelope | For the fixed recording length setting: 10 M (32 ch.), 20 M (16 ch.), 50 M (8 ch.), 100 M (4 ch.), 200 M (2 ch.), 500 M (1 ch.) (unit: points) | | | | | | | | | | | | | | |
| | For freely-specified recording length: 16777200 (32 ch.), 33554400 (16 ch.), 67108800 (8 ch.), 134217700 (4 ch.), 268435400 (2 ch.), 536870900 (1 ch.) (unit: points) Can be set in 100 points increments | | | | | | | | | | | | | | |
| Dual sampling | Instantaneous waveform: Less than half of the maximum recording length provided for the normal method | | | | | | | | | | | | | | |
| | Trend waveform: Less than half of the maximum recording length provided for the envelope method | | | | | | | | | | | | | | |
| For the real-time saving setting | The maximum recording length is defined depending on a free space of a destination, file systems, and the number of measuring channels. | | | | | | | | | | | | | | |

- The numbers in parentheses above show the number of channels to be used.
Definition of the number of channels to be used
 1. For modules with two input channels
Consider that use of one input channel occupies one channel.
For Model MR8990 only, consider that use of one input channel occupies two channels.
 2. For modules with three or four input channels (Models U8975, U8977, U8978)
 - 1. Consider that use of either CH1 or CH2 or simultaneous use of CH1 and CH2 occupies one channel.
 - 2. Consider that use of either CH3 or CH4 or simultaneous use of CH3 and CH4 occupies one channel.
 Using channels under the combined condition of those provided in items -1. and -2. occupies two channels.
 3. Real-time waveform calculation
Consider that one expression occupies one channel.
- When either any one of Model U8975, U8977, U8978, and MR8990 or the real-time waveform calculation is used, each maximum recording length reduces to half or less for a sampling rate of 10 MS/s or slower.

| Repeat measurements | Single, repeat, count (Repeat and count are not available for the real-time saving.) | | | | | | | | | | |
|--|--|--------------------------|----------|------------------------------|----------|------------------|-------------------|------------------|------|-------|------------------------------|
| Waveform monitor function | The instrument displays waveforms on the channel setting screen | | | | | | | | | | |
| Scaling | Ratio and offset, 2-point, model name, output rate, decibel, rating Model name: The scaling is automatically specified by choosing a connected model. The combination use of automatic recognition and automatic scaling is supported when a current measuring module is used. | | | | | | | | | | |
| Comment | Title comment, channel comment The instrument displays both of channel numbers and channel comments on the setting and waveform screens. | | | | | | | | | | |
| Help | The instrument displays the instruction manuals. | | | | | | | | | | |
| Digital filter (Model MR6000-01 only) | <p>Maximum number of 32 expressions expressions:</p> <p>Calculation target: Measurement channel of the following modules: Models 8966, 8967, 8968, U8969, 8970, 8971, 8972, U8974, U8975, U8976, U8977, U8978, and U8979 (Measurement channels of Model 8973 Logic Unit and Model MR8990 Digital Voltmeter Unit are not supported.)</p> <p>Calculation refresh rate: 10 M, 1 M, 100 k, 10 k, 1 k, 100, 10, 1 (unit: S/s) Up to eight calculations are available for the 10 MS/s setting. Up to 16 calculations are available for the 1 MS/s setting.</p> <p>Calculation delay:</p> <table border="1" data-bbox="464 1556 1441 1704"> <thead> <tr> <th>Calculation refresh rate</th> <th>10 MS/s</th> <th>1 MS/s</th> <th>100 kS/s</th> <th>10 kS/s or lower</th> </tr> </thead> <tbody> <tr> <td>Calculation delay</td> <td>6.2 μs or 6.3 μs</td> <td>5 μs</td> <td>20 μs</td> <td>Calculation refresh interval</td> </tr> </tbody> </table> <p>Filter type: FIR (LPF, HPF, BPF, BSF), IIR (LPF, HPF, BPF, BSF), moving average, delayer</p> | Calculation refresh rate | 10 MS/s | 1 MS/s | 100 kS/s | 10 kS/s or lower | Calculation delay | 6.2 μs or 6.3 μs | 5 μs | 20 μs | Calculation refresh interval |
| Calculation refresh rate | 10 MS/s | 1 MS/s | 100 kS/s | 10 kS/s or lower | | | | | | | |
| Calculation delay | 6.2 μs or 6.3 μs | 5 μs | 20 μs | Calculation refresh interval | | | | | | | |

File

1. Data saving

| | |
|---|--|
| Destination to save | SD memory card: Model Z4001 SD Memory Card (2 GB) Model Z4003 SD Memory Card (8 GB) |
| | USB flash drive Model Z4006 USB Drive (16 GB) |
| | SSD: Model U8332 SSD Unit (256 GB) |
| | HDD: Model U8333 HD Unit (320 GB) |
| | FTP transfer: Computer connected via LAN |
| | Network drive: Drive connected via LAN |
| | Email transmission: The instrument sends email messages with a file attached to user-defined destination. |
| Backup | Only when the destination to save data is set to FTP transmission, network drive or mail transmission, an alternative destination used in the case of transmission failure can be set. Choose from SSD/HDD, SD card, and USB flash drive. |
| File format | FAT, FAT32, NTFS, exFAT |
| File name | Alphanumeric file names can be entered. |
| Handling when a file name same as an exiting file is specified | A sequence number is added to the file name to be saved. Sequence number position: preceding, following, and automatically added to file names (user-selectable) |
| Automatic saving | On/Off The instrument automatically saves the recording length of acquired data after each measurement. No setting files are supported. Not available when the real-time saving is selected. With the memory division setting enabled, the instrument can start to measure the next block while saving data. (Sampling speed and recording length are limited) |
| Real-time saving | On/Off The instrument directly saves waveform data (in binary) acquired to the destination during measurement. The automatic saving cannot be set. File division: • Automatically divides a file every time the file size reaches about 512 MB. • Divides a file at specified intervals. |
| Older-file overwriting | If a free space of a destination is insufficient, the existing files are overwritten beginning with the oldest. (Enabled for the automatic saving and the real-time saving) |
| Saving format | Setting data: .SET Waveform data: Binary format (.MEM, .REC, .FLT, .MDF, .MF4) Text format (.TXT, .CSV) COMTRADE format (.CFG, .DAT) Index: Division saving (.IDX) Memory division (.SEQ) Dual-sampling batch saving (.R_M) Screen image: .BMP, .PNG, .JPG Numerical calculation result: .CSV, .TXT Start-up: STARTUP.SET CAN frame data: Binary format (.CLG), test format (.TXT, .CSV) Arbitrary waveform data: .WFG (when Model U8793 is installed) Waveform generation program data: .FPG (when Model U8793 is installed) Pulse pattern data: .PLS (when Model MR8791 is installed) |

| Channels to be saved | With the saving format set to waveform data, the channels to be saved can be chosen between all channels and displayed channels. | | | | | | | | |
|---|--|---------------|------------------|---------------|--|-------------|--|------------------------------|----------------------------|
| Data decimation saving | With the saving format set to waveform data (in text format), the instrument decimates data points by retaining one out of the specified decimation number (2 to 1000) and saves the remaining data points. | | | | | | | | |
| File division (Not available for real-time saving) | <table border="1"> <thead> <tr> <th>Saving format</th> <th>Division content</th> </tr> </thead> <tbody> <tr> <td>Binary format</td> <td>Off, every 16 MB, every 32 MB, every 64 MB</td> </tr> <tr> <td>Text format</td> <td>Off, every 60,000 pieces of data, every 1,000,000 pieces of data</td> </tr> <tr> <td>Numerical calculation result</td> <td>Off, by calculation number</td> </tr> </tbody> </table> | Saving format | Division content | Binary format | Off, every 16 MB, every 32 MB, every 64 MB | Text format | Off, every 60,000 pieces of data, every 1,000,000 pieces of data | Numerical calculation result | Off, by calculation number |
| Saving format | Division content | | | | | | | | |
| Binary format | Off, every 16 MB, every 32 MB, every 64 MB | | | | | | | | |
| Text format | Off, every 60,000 pieces of data, every 1,000,000 pieces of data | | | | | | | | |
| Numerical calculation result | Off, by calculation number | | | | | | | | |
| File designation | New file or existing file (Enabled when the saving format is set to the numerical calculation result) (Before starting a measurement, choose whether a new file is created or data is appended to the existing file) | | | | | | | | |
| SAVE key operation | Quick saving: The SAVE key is used to save data based on a pre-defined destination, file name, and saving setting. Saving range: Selectable between whole range or a specified segment range (Available only for saving data started by pressing the SAVE key) | | | | | | | | |

2. Data loading

| | |
|---|---|
| Drive data is loaded from | SD memory card: Model Z4001 SD Memory Card (2 GB) Model Z4003 SD Memory Card (8 GB) USB flash drive: Model Z4006 USB Drive (16 GB) SSD: Model U8332 SSD Unit (256 GB) HDD: Model U8333 HD Unit (320 GB) Network drive: Drive connected via LAN |
| Loadable data formats | Setting data (.SET) Waveform data: Binary format (.MEM, .REC, .MDF, .MF4) Index: Division saving (.IDX), memory division (.SEQ), dual-sampling batch saving (.R_M) Start-up (STARTUP.SET) Arbitrary waveform data (.WFG, .TFG) (when Model U8793 is installed) Waveform generation program data: (.FPG) (when Model U8793 is installed) Pulse pattern data: (.PLS) (when Model MR8791 is installed) |
| Automatic loading of divided files | Divided waveform files (in binary format) can be loaded seamlessly. When a chosen file is adjacent to the end of a waveform saved in the instrument's internal memory, the instrument will additionally load files, leaving the waveform in the internal memory. |

Calculation

1. Numerical calculation

Numerical calculation is disabled when the envelope is used.

| | |
|---------------------------------------|---|
| Maximum number of calculations | (32 items) × (the number of measuring channels) |
| Calculation range | Whole range or a specified segment range |
| Calculation items | P-P, maximum, minimum, high level, low level, average, RMS, standard deviation, rise time*, fall time*, frequency*, period*, duty ratio*, pulse count, area, X-Y area, time lag*, phase contrast*, time to maximum, time to minimum, time to level, level at time, pulse width*, arithmetic operation, intermediate, amplitude, accumulation, burst width*, angle of XY waveform, overshoot, undershoot, +Width*, -Width*, CAN statistics *: Statistical functions (start, average, maximum, minimum, count) available |

| | |
|---------------------------|---|
| Numerical judgment | Target waveform: Analog channels, logic channels, real-time waveform calculation channels, waveform calculation results |
| | Judge setting: On/Off |
| | Stopping condition: PASS, FAIL, PASS&FAIL |

2. Waveform calculation

The waveform calculation is disabled when the envelope is used. The waveform calculation cannot be used in combination with the real-time saving.

| | |
|---------------------------------------|---|
| Maximum number of calculations | 16 expressions |
| Calculation range | Whole range or a specified segment range |
| Standard operators | +, -, ×, ÷ |
| Calculation items | Absolute value, exponent, common logarithm, moving average, derivative, second derivative, integral, second integral, square root, cubic root, parallel move (translation), PLC shift, sine, cosine, tangent, arc sine, arc cosine, arc tangent, 2-argument arc tangent, FIR (LPF, HPF, BPF, BSF), IIR (LPF, HPF, BPF, BSF), half-wave average, half-wave period, half-wave frequency, half-wave RMS value, full-wave average, full-wave period, full-wave frequency, full-wave RMS value, polarity, binarization, CAN/LIN average* ¹ , maximum value* ¹ , minimum value* ¹ , level at specified time* ¹ , resolver, ABZ encoder *1: Calculation results can be specified as constants in expressions. |
| Power calculation | Maximum number of circuits that can be analyzed: 4 Supported wiring methods: 1-phase/2-wire (1P2W), 1-phase/3-wire (1P3W), 3-phase/3-wire (3P3W), 3-phase/3-wire (3-voltage/3-current method)(3V3A), 3-phase/4-wire (3P4W) Measurement method: Zero-cross synchronization method Calculation items: Voltage RMS value, voltage average value, voltage simple average value, current RMS value, current average value, current simple average value, active power value, apparent power value, reactive power value, power factor, power phase angle, efficiency, loss |
| Averaging | Simple average, exponential average (the number of averaging can be specified from 2 to 10,000) Each simple average expression occupies three expressions (two expressions immediately following each of calculation numbers the simple average is specified to is not available). |

3. Real-time waveform calculation (Model MR6000-01 only)

| | |
|---------------------------------------|--|
| Maximum number of calculations | 16 expressions |
| Calculation target | Measurement channels of the following modules: Models 8966, 8967, 8968, U8969, 8970, 8971, 8972, 8973, U8974, MR8990*, U8975, U8976, U8977, U8978, and U8979 *: Model MR8990 Digital Voltmeter Unit makes calculation using only the upper 16 bits of the 24-bit A/D resolution. |
| Calculation refresh rate | 10 M, 1 M, 100 k, 10 k, 1 k, 100, 10, 1 (unit: S/s) • Up to eight calculations are available for the 10 MS/s setting. (Some of calculation types are not available depending on the refresh rate.) |

| | | | | | |
|--------------------------|---------------------------------|----------------------------|---------------|-----------------|------------------------------|
| Calculation delay | Calculation refresh rate | 10 MS/s | 1 MS/s | 100 kS/s | 10 kS/s or lower |
| | Calculation delay | 6.2 μ s or 6.3 μ s | 5 μ s | 20 μ s | Calculation refresh interval |

The following delays have to be added when a real-time waveform calculation channel is chosen for a calculation target.

| | | | | |
|---------------------------------|-------------------|---------------|-----------------|-------------------------|
| Calculation refresh rate | 10 MS/s | 1 MS/s | 100 kS/s | 10 kS/s or lower |
| | Calculation delay | 1.6 μ s | 2 μ s | 10 μ s |

Calculation type Addition, subtraction, multiplication, division, arithmetic operation with coefficient, quadratic polynomial, monomial, polynomial add/subtract, derivation, integration, count, FIR (LPF, HPF, BPF, BSF), IIR (LPF, HPF, BPF, BSF), moving average, delayer

4. FFT calculation

The FFT calculation is disabled when the envelope is used. The FFT calculation cannot be used in combination with the real-time saving.

| | |
|---------------------------------------|---|
| Maximum number of calculations | 8 expressions |
| Frequency range | 500 mHz to 100 MHz ([sampling rate] \times 0.5), external sampling |
| Number of sampling points | 1 k, 2 k, 5 k, 10 k, 20 k, 50 k, 100 k |
| Frequency resolution | 1/500, 1/1000, 1/2500, 1/5000, 1/10000, 1/25000, 1/50000 |
| Anti-aliasing filter | AAF (Model 8968, Model U8979), LPF filter for waveform calculation (FIR, IIR), LPF filter for real-time waveform calculation (FIR, IIR) |
| Calculation target | Analog waveform, waveform calculation, real-time waveform calculation |
| Data to be analyzed | Newly acquired: Data newly acquired by pressing the START key Memory: Data previously measured or loaded from a storage device |
| Calculation type | Linear spectrum*, RMS spectrum*, power spectrum*, 1-channel phase spectrum, cross power spectrum, transfer function, coherence function, 2-channel phase spectrum *: Total harmonic distortion (THD) is displayed with a cursor set to on. |
| Window function | Rectangular, Hann (also referred to as <i>Hanning</i>), Hamming, Blackman, Blackman-Harris, flat top, exponential |
| Display scale | Liner scale, logarithmic scale |
| Peak value display | Off, maximal, maximum |
| Averaging | Simple average, exponential average, peak hold (the number of sampling points can be specified from 2 to 10,000) |
| Calculation execution button | The [Execute] button is displayed on the screen. |

Memory division

| | |
|--------------------------------|--|
| Maximum division number | 1,024 blocks |
| Block search | The instrument can search through data stored divided memory blocks. |
| Reference block | Superimposes waveforms of a specific block. The waveforms presently displayed on the screen can be compared with previously measured waveform data that is loaded in the reference block. |
| Batch saving | The instrument saves previously measured data that has been recorded in all blocks in one operation. |

Waveform search

| | |
|---------------------------------|---|
| Search method | <p>Peak Maximum, minimum, maximal, minimal</p> <p>Trigger Level, window-in, window-out Logic trigger points can be searched for when the target channel is set to the logic channels. No logic trigger points cannot searched for when the envelope is used.</p> <p>Concierge Histogram, standard deviation (For each of them, a target for comparison can be chosen between the fundamental waveform and the previously observed waveform.) The concierge function cannot be used when the envelope is used.</p> <p>Jump Event mark, cursor, time (specified using an absolute time, a relative time, or the number of points), trigger point, search mark.</p> |
| Scope of search | All: All data stored in the internal memory Specified segment: Either one of the areas specified by [Segment 1] or [Segment 2] is chosen. |
| Number of search results | Up to 1000 points can be specified. |
| Target channel | Installed module, real-time waveform calculation, waveform calculation |
| Search position | Cursors can be moved to search position, and event marks can be put on at search positions. |
| Continuous search | When the scope of search is found to include retrieved data points more than the specified number after the search, the instrument can continuously search waveform data points after the last retrieved data point. |
| Display method | A retrieved data point can be displayed by specifying its position. |

CAN measurement

| | | |
|------------------------------------|---|--|
| Interface | Conforming standards | CAN FD, CAN (high speed) |
| | Supported products | VN1610, VN1630A, VN1640 (Vector Informatik) Installable transceiver: CANpiggy 1051cap/1057Gcap |
| | Connector | USB |
| | Number of connectible interfaces | 1 (If more than one interface is connected, only the one detected first can be used.) |
| | Number of input CAN ports | Up to four (C1 to C4) When four transceivers are connected to VN1630A or VN1640 (Not available simultaneously with LIN measurement) |
| | Baud rate | 33.3 k, 50 k, 83.3 k, 100 k, 125 k, 250 k, 500 k, 1 M (Baud) |
| | Data rate | 33.3 k, 50 k, 83.3 k, 100 k, 125 k, 250 k, 500 k, 1 M, 2 M, 4 M (Baud) (Available only when CAN FD is selected) |
| | Acceptance filter | 11 bits (standard), 29 bits (extended) Block setting is available for all frames |
| | ACK | Normal, ACK off |
| | Storage memory | CAN frame data inputted in sync with the start of measurement can be stored in the build-in memory (up to 10 MB). Data is cleared every time measurement starts. |
| | Monitor function | Available |
| Signal configuration | Definition setting | Signal number: From 1 |
| | | Signal name: up to 32 characters |
| | | ID: 0 to 1FFFFFFF |
| | | Start bit: 0 to 511 |
| | | Bit length: 1 to 64 |
| | | Bite order: Big, little |
| | | Data type: Signed, Unsigned, Float, Double |
| | | Conversion into physical quantity: Conversion using conversion ratio and offset |
| | Number of definitions that can be registered | Up to 300 |
| | Input method | Direct entry on the instrument's display Import of a CANdb file (.DBC) or Hioki CAN definition data file (.CDF) |
| Real-time waveform display | Number of displayed waveforms | Up to 64 |
| Calculated waveform display | How to configure | Select the arithmetic expression <i>CAN/LIN</i> in the waveform calculation setting and specify signals using signal numbers. |
| | Number of displayed waveforms | Up to 16 |

| | | |
|---------------------|--------------------------------|--|
| Transmission | Timing | S1 key, S2 key, start, trigger, response, pass, fail, error |
| | Type | Standard CAN, extended CAN, standard CAN remote, extended CAN remote, standard CAN FD, extended CAN FD |
| | Transmission port | C1, C2, C3, C4, ALL |
| | Transmission ID | 0 to 1FFFFFFF |
| | DLC | 0 to 8, 12, 16, 20, 24, 32, 48, 64 |
| | Delay | 0 to 10000 (ms) |
| | Periodical transmission | Transmission can periodically be performed. (When S1 key, S2 key, or start is selected) |
| | Regular interval | At intervals of 1 to 10000 (ms) (user-selectable) |
| | Response ID | 0 to 1FFFFFFF (timing is set to response) |

LIN measurement

| | | |
|-------------------------------------|---|--|
| Interface | Conforming standard | LIN |
| | Supported products | VN1611, VN1630A (Vector Informatik) Installable transceiver: LINpiggy 7269mag |
| | Connector | USB |
| | Number of connectible interfaces | One (If more than one interface is connected, only the one detected first can be used.) |
| | Number of input LIN ports | Up to four (C1 to C4) When four transceivers are connected to VN1630A (Not available simultaneously with CAN / CAN FD measurement) |
| | Baud rate | 2400, 9600, 14400, 19200 (bps) |
| | LIN protocol | 1.3, 2.0, 2.1, 2.2 |
| | Storage memory | LIN packet data inputted in sync with the start of measurement can be stored in the built-in memory (up to 10 MB). Data will be cleared every time measurement starts. |
| | Monitor function | Yes |
| Signal configuration | Definition configuration | Signal number: From 1 |
| | | Signal name: Up to 32 characters |
| | | ID: 0 to 63 |
| | | Start bit: 0 to 63 |
| | | Bit length: 1 to 64 |
| | | Byte order: Big, Little |
| | | Data type: Signed, Unsigned, Float, Double |
| | | Checksum: Classic, Enhanced |
| | | Conversion into physical quantity: Conversion using conversion ratio and offset |
| | Number of definitions that can be registered | Up to 300 |
| | Input method | Direct entry using the instrument's display Loading of an LDF file |
| Real-time waveform display | Number of displayed waveforms | Up to 64 |
| Calculation waveform display | How to configure | Select the arithmetic expression <i>CAN/LIN</i> in the waveform calculation setting and specify signals using signal numbers. |
| | Number of displayed waveforms | Up to 16 |

Others

| | |
|--|---|
| Automatic setup | Available The instrument loads settings data previously saved (STARTUP.SET) at turn-on and starts up. The instrument searches the following locations for the settings data (in this order): HDD/SSD, SD memory card, and USB flash drive. |
| Rotary knob | X: The horizontal manipulations are available: changing the sampling rate, magnification/demagnification ratio, and display positions and moving cursors. Y: The vertical manipulations are available: switching the measurement ranges, changing the magnification/demagnification ratio and display positions, and moving cursors. |
| Shortcut keys | The S1 key and the S2 key: Functions can be assigned. |
| Automatic ranging | Available The instrument automatically configures appropriate settings that include the sampling rate and measurement range depending on input waveforms. (Not available when the envelope, real-time saving, or external sampling is used.) |
| Key lock | Three permission levels are available: <ul style="list-style-type: none"> • ALL (Touch panel operation and key operation are disabled.) • TOUCH PANEL (Only touch panel operation is disabled.) • OFF (The key lock is disengaged.) |
| Beep sound | Three conditions are available: <ul style="list-style-type: none"> • Off • Alert • Alert + action |
| Email transmission | Email transmission function using SMTP When to send an email: when data is automatically saved; when data is saved by pressing the SAVE key Contents: An email includes the text entered in the Body box with a file in the format specified in the Type box attached. |
| Initialization | Discarding the existing waveform data, restoring the settings to the initial values, initializing the instrument |
| Self-check | Memory check, touch panel check, key check, LCD check, LAN check, storage device check |
| Language | English, Japanese, Chinese |
| Error indication Warning indication | The instrument displays details of an error or warning. |
| Touch keyboard | The instrument displays the keyboard on the screen. |
| Region-specific setting | Choose characters that represent the decimal point and the separator used in waveform files (text format) and numerical calculation result files. Decimal point: period, comma Separator: comma, space, tab, semicolon |
| Time value display | Time, time in sexagesimal, date, the number of data points |
| Zero position display | On/Off |
| Waveform screen background color | Black or white |
| Restart permission | Permitted or prohibited Permitted: When a setting is changed during a measurement, another measurement starts. Prohibited: Changing any settings are prohibited during measurement. |
| Display setting | Brightness can be adjusted. Automatic power-off can be set for the display. |
| Time setting | A date and time can be set. |

| | |
|--|---|
| System protection | On/Off The system is protected against an unexpected shutdown. However, it is recommended disengaging the system protection and supplying the power from an external UPS for long-term continuous operation. |
| Number of current sensors to be connected | Up to nine sensors can connect to Model Z5021 Probe Power Unit, Model 8971 Current Unit, and Model U8977 3CH Current Unit in total. When Model CT6710 or CT6711 is included, up to four probes can be connected. |
| Limitation of the number of modules | Model 8971 Current Unit: Up to four slots Model U8977 3CH Current Unit: Up to three slots |

Waveform generation

Details of the hardware functions comply with the generator module specifications of Model MR8790, Model MR8791 and Model U8793.

| | | |
|--|---|---|
| Waveform generation control | Signal generation | On (generation), off (halt) |
| | Synchronized control | Synchronization of all channels with one another: Outputs generated signals via all channels in sync with one another. |
| | | Synchronization with measurement: Outputs signals in sync with the start and stop of measurement. |
| Output waveforms | MR8790 Waveform Generator Unit: DC, sine wave MR8791 Pulse Generator Unit: Pulse wave, pattern wave U8793 Arbitrary Waveform Generator Unit: DC, sine wave, triangular wave, rectangular wave, pulse wave, ramp-up wave, ramp-down wave, arbitrary waveform, programmed waveform | |
| Supported waveforms for output (Model U8793 only) | Waveforms measured with Model MR6000/MR6000-01 Memory HiCorder (logic waveforms not supported) Waveforms saved with Model 7075 Waveform Generator Waveforms generated with Model SF8000 Waveform Maker | |

5.2 Specifications of the Options

Model Z5021 Probe Power Unit

Specified, unless otherwise designated, at 23°C ±5°C (73°F ±9°F) and 80% RH or less.

| | |
|---|--|
| Supported probe | Model CT6700 Current Probe Model CT6701 Current Probe Model CT6710 Current Probe* Model CT6711 Current Probe* Model 3273-50 Clamp on Probe Model 3274 Clamp on Probe Model 3275 Clamp on Probe Model 3276 Clamp on Probe *: When Model CT6710 or CT6711 is included, up to four probes can be connected. |
| Number of terminals | 8 |
| Operating environment | Indoors, pollution degree 2, operating altitude: up to 2000 m (6562 ft.) |
| Operating temperature and humidity range | 0°C to 40°C (32°F to 104°F), 80% RH or less (no condensation) |
| Storage temperature and humidity range | -10°C to 50°C (14°F to 122°F), 80% RH or less (no condensation) |
| Standards | Safety: EN 61010 EMC: EN 61326 Class A |
| Product warranty period | 3 years |
| Output voltage | ±12 V DC ±0.5 V DC |
| Rated output current | ±0.6 A (for each terminal) |
| Ripple voltage | 200 mV p-p or less (at rated output current) |

Model U8332 SSD Unit

| | |
|---|--|
| Recording capacity | 256 GB (MLC) |
| Supported interface standard | Serial ATA Revision 3.0 compatible (2.5-inch) |
| Operating temperature and humidity range | Consistent with the specifications of Memory HiCorder in which Model U8332 is installed. |
| Storage temperature and humidity range | Consistent with the specifications of Memory HiCorder in which Model U8332 is installed. |

Model U8333 HD Unit

| | |
|---|--|
| Recording capacity | 320 GB |
| Supported interface standard | Serial ATA Revision 2.0 compatible (2.5-inch) |
| Operating temperature and humidity range | Consistent with the specifications of Memory HiCorder in which Model U8333 is installed. |
| Storage temperature and humidity range | Consistent with the specifications of Memory HiCorder in which Model U8333 is installed. |

Model 8966 Analog Unit

Accuracy guarantee conditions

Specified under the following conditions: installed in a Memory HiCorder and operated at 23°C ±5°C (73°F ±9°F) in the range of 20% to 80% RH after a half-hour (at least) warm-up and execution of zero-adjustment.

| | |
|---|--|
| Product warranty period | 3 years |
| Accuracy guarantee period | 1 year |
| Number of input channels | 2 channels |
| Measurement range | 100, 200, 400 mV f.s., 1, 2, 4, 10, 20, 40, 100, 200, 400 V f.s. |
| Measurement accuracy | ±0.5% f.s. (with the filter set at 5 Hz) |
| Temperature characteristics | ±0.06% f.s./°C |
| Frequency characteristics | DC to 5 MHz -3 dB (DC-coupled) 7 Hz to 5 MHz -3 dB (AC-coupled, at a lower cutoff frequency of 7 Hz ±50%) |
| Noise | 1.5 mV p-p (typ.), 2 mV p-p (max.); with the highest sensitivity range and the terminals of each input connector connected with each other |
| Common-mode rejection ratio | 80 dB or more (at 50 Hz / 60 Hz, a signal source resistance of 100 Ω or less) |
| Low-pass filter | Off, 5 ±50%, 50 ±50%, 500 ±50%, 5 k ±50%, 50 k ±50%, 500 k ±50% (Hz) -3 dB |
| Input type | Unbalanced input (floating) |
| Input coupling | AC/DC/GND |
| Input resistance | 1 MΩ ±1% |
| Input capacitance | 30 pF ±10 pF (at 100 kHz) |
| A/D resolution | 12 bits |
| Maximum sampling rate | 20 MS/s |
| Input terminals | Insulated BNC terminal |
| Maximum input voltage | 400 V DC |
| Maximum rated terminal-to-ground voltage | 300 V AC, DC (between each input channel and the enclosure, between any two of input channels) Measurement category II, anticipated transient overvoltage: 2500 V |

| | |
|--|---|
| Operating temperature and humidity range | Consistent with the specifications of the Memory HiCorder in which Model 8966 is installed. |
| Operating environment | Consistent with the specifications of the Memory HiCorder in which Model 8966 is installed. |
| Storage temperature and humidity range | -10°C to 50°C (14°F to 122°F), 80% RH or less (no condensation) |
| Dimensions | Approx. 106W × 19.8H × 196.5D mm (4.17"W × 0.78"H × 7.74"D) |
| Weight | Approx. 250 g (8.8 oz.) |
| Effect of radiated radio-frequency electromagnetic field | ±15% f.s. (max.) at 3 V/m |
| Effect of conducted radio-frequency electromagnetic field | ±45% f.s. (max.) at 3 V (with the 2 V f.s. range, with 1 V DC inputted) |
| Standards | Safety: EN61010 EMC: EN61326 Class A |
| Options | Model L9197 Connection Cord (CAT IV 300 V, CAT III 600 V, 1 A) Model L9198 Connection Cord (CAT III 300 V, CAT II 600 V, 0.2 A) Model L9217 Connection Cord (CAT III 300 V, CAT II 600 V, 0.2 A) Model L9790 Connection Cord (With the L9790-01 or 9790-03 connected: CAT III 300 V, CAT II 600 V, 1 A) (With the 9790-02 connected: CAT III 150 V, CAT II 300 V, 1 A) Model 9322 Differential Probe (With grabber clips connected: CAT II 1000 V) (With alligator clips connected: CAT III 600 V, CAT II 1000 V) Model P9000-01 Differential Probe (CAT III 1000 V) Model P9000-02 Differential Probe (CAT III 1000 V) Model 9665 10:1 Probe (CAT II 300 V) Model 9666 100:1 Probe (CAT II 300 V) |

Model 8967 Temp Unit

Accuracy guarantee conditions

Specified under the following conditions: installed in a Memory HiCorder and operated at 23°C ±5°C (73°F ±9°F) in the range of 20% to 80% RH after a half-hour (at least) warm-up and execution of zero-adjustment.

| | |
|---|---|
| Product warranty period | 3 years |
| Accuracy guarantee period | 1 year |
| Number of input channels | 2 channels |
| Input terminals | Push-button type terminal block (2 terminals/channel) |
| Measurement target | Thermocouple (K, J, E, T, N, R, S, B, W) |
| Reference junction compensation accuracy | ±1.5°C (When the reference junction compensation is set to internal, add this value to the accuracy of thermocouple measurement.) |
| Reference junction compensation | Switchable between internal or external (for temperature measurement with thermocouples) |
| Temperature characteristics | Add [(measurement accuracy) × 0.1]/°C to the measurement accuracy. |

| | |
|--|---|
| Data refresh | The data refresh rate can be switched. Fast: Approx. 1.2 ms Normal: Approx. 100 ms Slow: Approx. 500 ms |
| Wire break detection | Switchable between on and off |
| Input resistance | 5 M Ω or more (regardless of the wire break detection setting) |
| Common-mode rejection ratio | 80 dB or more (at 50 Hz / 60 Hz, for a signal source resistance of 100 Ω or less, with the data refresh set to Fast) 100 dB or more (at 50 Hz / 60 Hz, for a signal source resistance or 100 Ω or less, with the data refresh set to Normal) |
| Input type | Unbalanced input (floating) |
| Maximum rated terminal-to-ground voltage | 300 V AC, DC (between each input channel and the enclosure, between any two of input channels) Measurement category II, anticipated transient overvoltage: 2500 V |
| Operating temperature and humidity range | Consistent with the specifications of the Memory HiCorder in which Model 8967 is installed. |
| Storage temperature and humidity range | -20°C to 50°C (-4°F to 122°F), 90% RH or less (no condensation) |
| Operating environment | Consistent with the specifications of the Memory HiCorder in which Model 8967 is installed. |
| Dimensions | Approx. 106W × 19.8H × 204.5D mm (4.17"W × 0.78"H × 8.05"D) |
| Weight | Approx. 240 g (8.5 oz.) |
| Effect of radiated radio-frequency electromagnetic field | ±2% f.s. (max.) at 3 V/m |
| Effect of conducted radio-frequency electromagnetic field | ±2% f.s. (max.) at 3 V |
| Standards | Safety: EN61010 EMC: EN61326 Class A |
| Accessories | Ferrite clamp-on choke ×2 |
| Options | Model 9810 Thermocouple (K) |

Table: Measurable ranges, resolutions, and measurement accuracy of each thermocouple type and measurement range

| Measurement target | Measurement range setting | Measurable range | Resolution | Measurement accuracy | |
|------------------------------|---------------------------|------------------|------------------|----------------------|--|
| Thermocouple* ¹ | K* ² | 200°C f.s. | -100°C to 200°C | 0.01°C | ±0.1% f.s. ±1°C (0°C or higher) |
| | | 1000°C f.s. | -200°C to 1000°C | 0.05°C | |
| | | 2000°C f.s. | -200°C to 1350°C | 0.1°C | |
| | J* ² | 200°C f.s. | -100°C to 200°C | 0.01°C | ±0.1% f.s. ±2°C (-200°C or higher but lower than 0°C) |
| | | 1000°C f.s. | -200°C to 1000°C | 0.05°C | |
| | | 2000°C f.s. | -200°C to 1100°C | 0.1°C | |
| | E* ² | 200°C f.s. | -100°C to 200°C | 0.01°C | |
| | | 1000°C f.s. | -200°C to 800°C | 0.05°C | |
| | | 2000°C f.s. | -200°C to 800°C | 0.1°C | |
| | T* ² | 200°C f.s. | -100°C to 200°C | 0.01°C | |
| | | 1000°C f.s. | -200°C to 400°C | 0.05°C | |
| | | 2000°C f.s. | -200°C to 400°C | 0.1°C | |
| | N* ² | 200°C f.s. | -100°C to 200°C | 0.01°C | |
| | | 1000°C f.s. | -200°C to 1000°C | 0.05°C | |
| | | 2000°C f.s. | -200°C to 1300°C | 0.1°C | |
| | R* ² | 200°C f.s. | 0°C to 200°C | 0.01°C | ±0.1% f.s. ±3.5°C (0°C or higher but lower than 400°C) (For Type B, accuracy is not guaranteed below 400°C.) |
| | | 1000°C f.s. | 0°C to 1000°C | 0.05°C | |
| | | 2000°C f.s. | 0°C to 1700°C | 0.1°C | |
| | S* ² | 200°C f.s. | 0°C to 200°C | 0.01°C | ±0.1% f.s. ±3°C (400°C or higher) |
| | | 1000°C f.s. | 0°C to 1000°C | 0.05°C | |
| | | 2000°C f.s. | 0°C to 1700°C | 0.1°C | |
| B* ² | 1000°C f.s. | 400°C to 1000°C | 0.05°C | | |
| | 2000°C f.s. | 400°C to 1800°C | 0.1°C | | |
| W* ³ (WRe5-26) | 200°C f.s. | 0°C to 200°C | 0.01°C | | |
| | 1000°C f.s. | 0°C to 1000°C | 0.05°C | | |
| | 2000°C f.s. | 0°C to 2000°C | 0.1°C | | |

*1: Not including reference junction compensation accuracy

*2: JIS C 1602-1995

*3: ASTM E-988-96

Model 8968 High Resolution Unit

Accuracy guarantee conditions

Specified under the following conditions: installed in a Memory HiCorder and operated at 23°C ±5°C (73°F ±9°F) in the range of 20% to 80% RH after a half-hour (at least) warm-up and execution of zero-adjustment.

| | |
|---|---|
| Product warranty period | 3 years |
| Accuracy guarantee period | 1 year |
| Number of input channels | 2 channels |
| Measurement range | 100, 200, 400 mV f.s., 1, 2, 4, 10, 20, 40, 100, 200, 400 V f.s. |
| Measurement accuracy | ±0.3% f.s. (with the filter setting set at 5 Hz, operated after zero-adjustment) |
| Temperature characteristics | ±0.045% f.s./°C |
| Frequency characteristics | DC to 100 kHz -3 dB (DC-coupled) 7 Hz to 100 kHz -3 dB (AC-coupled, at a lower cutoff frequency of 7 Hz ±50%) |
| Noise | 500 µV p-p (typ.), 1 mV p-p (max.) (with the highest sensitivity range and the terminals of each input connector connected with each other) |
| Common-mode rejection ratio | 80 dB or more (at 50 Hz / 60 Hz, a signal source resistance of 100 Ω or less) |
| Low-pass filter | Off, 5 ±50%, 50 ±50%, 500 ±50%, 5 k ±50%, 50 k ±50% (Hz) -3 dB |
| Anti-aliasing filters | Cutoff frequency (fc): 20, 40, 80, 200, 400, 800, 2 k, 4 k, 8 k, 20 k, 40 k (Hz) (Automatically set when the anti-aliasing filter is on.) Attenuation property: -66 dB or higher at a frequency of 1.5 fc |
| Input type | Unbalanced input (floating) |
| Input coupling | AC/DC/GND |
| Input resistance | 1 MΩ ±1% |
| Input capacitance | 30 pF ±10 pF (at 100 kHz) |
| A/D resolution | 16 bits |
| Maximum sampling rate | 1 MS/s |
| Input terminals | Insulated BNC terminal |
| Maximum input voltage | 400 V DC |
| Maximum rated terminal-to-ground voltage | 300 V AC, DC (between each input channel and the enclosure, between any two of input channels) Measurement category II, anticipated transient overvoltage: 2500 V |
| Operating temperature and humidity range | Consistent with the specifications of the Memory HiCorder in which Model 8968 is installed. |
| Operating environment | Consistent with the specifications of the Memory HiCorder in which Model 8968 is installed. |
| Storage temperature and humidity range | -10°C to 50°C (14°F to 122°F), 80% RH or less (no condensation) |
| Dimensions | Approx. 106W × 19.8H × 196.5D mm (4.17"W × 0.78"H × 7.74"D) |
| Weight | Approx. 250 g (8.8 oz.) |

| | |
|--|---|
| Effect of radiated radio-frequency electromagnetic field | ±15% f.s. (max.) at 3 V/m |
| Effect of conducted radio-frequency electromagnetic field | ±20% f.s. (max.) at 3 V (with the 2 V f.s. range, with 1 V DC inputted) |
| Standards | Safety: EN61010 EMC: EN61326 Class A |
| Options | Model L9197 Connection Cord (CAT IV 300 V, CAT III 600 V, 1 A) Model L9198 Connection Cord (CAT III 300 V, CAT II 600 V, 0.2 A) Model L9217 Connection Cord (CAT III 300 V, CAT II 600 V, 0.2 A) Model L9790 Connection Cord (With the L9790-01 or 9790-03 connected: CAT III 300 V, CAT II 600 V, 1 A) (With the 9790-02 connected: CAT III 150 V, CAT II 300 V, 1 A) Model 9322 Differential Probe (With grabber clips connected: CAT II 1000 V) (With alligator clips connected: CAT III 600 V, CAT II 1000 V) Model P9000-01 Differential Probe (CAT III 1000 V) Model P9000-02 Differential Probe (CAT III 1000 V) Model 9665 10:1 Probe (CAT II 300 V) Model 9666 100:1 Probe (CAT II 300 V) |

Model U8969 Strain Unit

Accuracy guarantee conditions

Specified under the following conditions: installed in a Memory HiCorder and operated at 23°C ±5°C (73°F ±9°F) and 80% RH or less after a half-hour (at least) warm-up and execution of the automatic balancing.

| | |
|---|--|
| Operating environment | Indoors, pollution degree 2, operating altitude: up to 2000 m (6562 ft.) |
| Operating temperature and humidity range | -10°C to 40°C (14°F to 104°F), 80% RH or less (no condensation) |
| Storage temperature and humidity range | -20°C to 50°C (-4°F to 122°F), 90% RH or less (no condensation) |
| Standards | Safety: EN 61010 EMC: EN 61326 Class A |
| Dimensions | Approx. 106W × 19.8H × 196.5D mm (4.17"W × 0.78"H × 7.74"D) |
| Weight | Approx. 245 g (8.6 oz.) |
| Product warranty period | 3 years |
| Accuracy guarantee period | 1 year |
| Accessories | Model L9769 Conversion Cable ×2 (Compatible connector: NDIS connector PRC03-12A10-7M10.5) |
| Number of input channels | 2 channels |
| Input terminals | NDIS connector EPRC07-R9FNDIS |
| Measurement target | Strain gauge transducer |
| Gauge ratio | 2.0 |
| Bridge voltage | 2 V ±0.05 V |
| Bridge resistor | 120 Ω to 1 kΩ |
| Balance adjustment range | ±10000 με or lower |

| | |
|--|---|
| Balancing method | Electronic automatic balancing |
| Measurement range | 400, 1000, 2000, 4000, 10000, 20000 $\mu\epsilon$ f.s. |
| Frequency characteristics | DC to 20 kHz, +1/-3 dB |
| A/D resolution | 16 bits (\pm f.s. = \pm 25000 data points) |
| Maximum sampling rate | 200 kS/s |
| Maximum rated terminal-to-ground voltage | 30 V rms AC or 60 V DC (between each input channel and the enclosure, between any two of input channels) Anticipated transient overvoltage: 330 V |
| Measurement accuracy | \pm 0.5% f.s. \pm 4 $\mu\epsilon$ (with the filter set at 5 Hz) |
| Temperature characteristics | Gain: \pm 0.05% f.s./ $^{\circ}$ C Zero position: \pm 2.5 $\mu\epsilon$ / $^{\circ}$ C |
| Effect of radiated radio-frequency electromagnetic field | \pm 10% f.s. (max.) at 3 V/m (with the filter set at 5 Hz) |
| Effect of conducted radio-frequency electromagnetic field | \pm 10% f.s. (max.) at 3 V (with the filter set at 5 Hz) |
| Low-pass filter | Off, 5 \pm 30%, 10 \pm 30%, 100 \pm 30%, 1 k \pm 30% (Hz) -3 dB |

Model 8970 Freq Unit

Accuracy guarantee conditions

Specified under the following conditions: installed in a Memory HiCorder and operated at 23 $^{\circ}$ C \pm 5 $^{\circ}$ C (73 $^{\circ}$ F \pm 9 $^{\circ}$ F) in the range of 20% to 80% RH and operated after a half-hour (at least) warm-up.

| | |
|---|--|
| Product warranty period | 3 years |
| Accuracy guarantee period | 1 year |
| Measurement functions | The following types of measurement based on voltage input: frequency, rotation speed, power frequency, count, pulse duty ratio, and pulse width |
| Input terminals | Insulated BNC terminal |
| Input resistance | 1 M Ω \pm 1% |
| Input capacitance | 30 pF \pm 10 pF |
| Maximum input voltage | 400 V DC |
| Maximum rated terminal-to-ground voltage | 300 V AC, DC (Measurement category II) Anticipated transient overvoltage: 2500 V (between each input channel and the enclosure, between any two of input channels) |
| Input type | Unbalanced input (floating) |
| Frequency mode | Measurement range settings: 20, 100, 200 Hz, 1, 2, 10, 20, 100 kHz f.s. Measurement accuracy: \pm 0.1% f.s. (except for the 100 kHz range) \pm 0.7% f.s. (the 100 kHz range) Measurable range: DC to 100 kHz (minimum pulse width: 2 μ s) |
| Rotation speed mode | Measurement range settings: 2 k, 10 k, 20 k, 100 k, 200 k, 1 M, 2 Mr/min f.s. Measurement accuracy settings: \pm 0.1% f.s. (except for the 2 Mr/min range) \pm 0.7% f.s. (the 2 Mr/min range) Measurable range: 0 Mr/min to 2 Mr/min (minimum pulse width: 2 μ s) |

| | |
|--|--|
| Power frequency mode | Measurement range settings: 50 Hz (40 Hz to 60 Hz), 60 Hz (50 Hz to 70 Hz), 400 Hz (390 Hz to 410 Hz) Measurement accuracy: ± 0.03 Hz (50 Hz, 60 Hz), ± 0.1 Hz (400 Hz) |
| Accumulation mode | Measurement range settings: 40 k, 200 k, 400 k, 2 M, 4 M, 20 M counts f.s. Measurement accuracy: 0.0025% f.s. Measurable range: DC to 100 kHz (minimum pulse width: 2 μ s) |
| Duty ratio mode | Measurement range setting: 100% f.s. Measurement accuracy: $\pm 1\%$ (10 Hz to 10 kHz) $\pm 4\%$ (10 kHz to 100 kHz) Measurable range: 10 Hz to 100 kHz (minimum pulse width: 2 μ s) |
| Pulse width mode | Measurement range settings: 10 ms, 20 ms, 100 ms, 200 ms, 1 s, 2 s f.s. Measurement accuracy: $\pm 0.1\%$ f.s. Measurable range: 2 μ s to 2 s |
| Measurement resolution | 0.0025% f.s. (accumulation mode) 0.01% f.s. (except for accumulation mode or power frequency mode) 0.01 Hz (power frequency mode) |
| Response time | Within the sum of 40 μ s and the sampling interval of the instrument in which the module is installed |
| Input voltage range | ± 10 V, ± 20 V, ± 50 V, ± 100 V, ± 200 V, ± 400 V |
| Threshold value | ± 10 V range: Variable in the range of -10 V to $+10$ V (in 0.1 V increments) ± 20 V range: Variable in the range of -20 V to $+20$ V (in 0.2 V increments) ± 50 V range: Variable in the range of -50 V to $+50$ V (in 0.5 V increments) ± 100 V range: Variable in the range of -100 V to $+100$ V (in 1 V increments) ± 200 V range: Variable in the range of -200 V to $+200$ V (in 2 V increments) ± 400 V range: Variable in the range of -400 V to $+400$ V (in 5 V increments) |
| Slope | Rising, falling (frequency mode, rotation speed mode, power frequency mode, accumulation mode) |
| Level | High, low (duty ratio mode, pulse width mode) |
| Hold | Frequency mode, rotation speed mode: On, Off (1 Hz, 0.5 Hz, 0.2 Hz, 0.1 Hz) Operation with Off: When the instrument cannot determine a subsequent measured value while the waiting time (period) elapses, the instrument calculates a frequency and rotation speed based on the time interval between the time when previously determining measured value and the time when sampling the data, and records these calculated values. When these calculated values are less than user-defined values, then the values will be assumed to be zero. |
| Smoothing | Off, On (frequency mode, rotation speed mode) The permissible smoothing frequency is up to 10 kHz. |
| Low-pass filter | Off, 5, 50, 500, 5 k, 50 k (Hz) |
| Input coupling | DC, AC (Lower cutoff frequency in AC-coupled mode: 7 Hz) |
| Frequency division function | Setting range: 1 to 4096, in one increments (frequency mode, rotation speed mode, accumulation mode) |
| Accumulation start timing | Start, trigger (accumulation mode) |
| Process performed when accumulation overflows | Hold, back (accumulation mode) |
| Operating temperature and humidity range | Consistent with the specifications of the Memory HiCorder in which Model 8970 is installed. |
| Operating environment | Consistent with the specifications of the Memory HiCorder in which Model 8970 is installed. |

| | |
|---|---|
| Storage temperature and humidity range | Consistent with the specifications of the Memory HiCorder in which Model 8970 is installed. |
| Standards | Safety: EN61010 EMC: EN61326 Class A |
| Dimensions | Approx. 106W × 19.8H × 196.5D mm (4.17"W × 0.78"H × 7.74"D) |
| Weight | Approx. 250 g (8.8 oz.) |
| Options | Model L9197 Connection Cord (CAT IV 300 V, CAT III 600 V, 1 A) Model L9198 Connection Cord (CAT III 300 V, CAT II 600 V, 0.2 A) Model L9217 Connection Cord (CAT III 300 V, CAT II 600 V, 0.2 A) Model L9790 Connection Cord (With the L9790-01 or 9790-03 connected: CAT III 300 V, CAT II 600 V, 1 A) (With the 9790-02 connected: CAT III 150 V, CAT II 300 V, 1 A) Model 9322 Differential Probe (With grabber clips connected: CAT II 1000 V) (With alligator clips connected: CAT III 600 V, CAT II 1000 V) Model P9000-01 Differential Probe (CAT III 1000 V) Model P9000-02 Differential Probe (CAT III 1000 V) Model 9665 10:1 Probe (CAT II 300 V) Model 9666 100:1 Probe (CAT II 300 V) |

Model 8971 Current Unit

Accuracy guarantee conditions

Specified under the following conditions: installed in a Memory HiCorder and operated at 23°C ±5°C (73°F ±9°F) in the range of 20% to 80% RH after a half-hour (at least) warm-up and execution of zero-adjustment.

| | |
|----------------------------------|--|
| Product warranty period | 3 years |
| Accuracy guarantee period | 1 year |
| Number of input channels | 2 channels |
| Supported current sensors | <ul style="list-style-type: none"> • Models 9272-10, 9277, 9278, 9279, 9709, CT6862, CT6863, CT6865*², CT6841, CT6843, CT6844, CT6845, CT6846*² (Each sensor requires Model 9318 Conversion Cable to connect with Model 8971 Current Unit) • Models 9272-05, 9709-05, CT6862-05, CT6863-05, CT6865-05*², CT6841-05, CT6843-05, CT6844-05, CT6845-05, CT6846-05*², CT6875, CT6876*², CT6841A, CT6843A, CT6844A, CT6845A, CT6846A, CT6872, CT6872-01, CT6873, CT6873-01, CT6875A, CT6875A-1, CT6876A*², CT6876A-1*² (Each sensor requires both Model 9318 Conversion Cable and Model CT9901 Conversion Cable to connect with Model 8971 Current Unit) • Hioki current sensors with RM515EPA-10PC (Hirose) installed (Supported conversion ratio: 2 V/20 A, 2 V/50 A, 2 V/200 A, 2 V/500 A, 2 V/1000 A*²) |
| Measurement range | <ul style="list-style-type: none"> • When Model 9272-10 (20 A), Model 9272-05 (20 A), Model 9277, Model CT6841, Model CT6841-05, or Model CT6841A is used 2, 4, 10, 20, 40, 100 A f.s. • When Model CT6862, Model CT6862-05, Model CT6872, or Model CT6871-01 is used 4, 10, 20, 40, 100, 200 A f.s. • When Model 9272-10 (200 A), Model 9272-05 (200 A), Model 9278, Model CT6863, Model CT6863-05, Model CT6843, Model CT6843-05, Model CT6873, Model CT6873-01, or Model CT6843A is used 20, 40, 100, 200, 400, 1000 A f.s. • When Model 9279, Model 9709, Model 9709-05, Model CT6865*², Model CT6865-05*², Model CT6844, Model CT6844-05, Model CT6845, Model CT6845-05, Model CT6846*², Model CT6846-05*², Model CT6875, Model CT6876*², Model CT6844A, Model CT6845A, Model CT6846A*², Model CT6875A, Model CT6875A-1, Model CT6876A*², or Model CT6876A-1*² is used 40, 100, 200, 400, 1000, 2000 A f.s. |

| | |
|---|---|
| Measurement accuracy*1 | ±0.65% f.s. (with the filter set at 5 Hz) ±0.85% f.s. (with the filter set at 5 Hz) when Model 9278 or Model 9279 is used. |
| RMS accuracy*1 | ±1% f.s. (DC, 30 Hz to 1 kHz) ±3% f.s. (1 kHz to 10 kHz) (Sine wave input, with the filter set at 5 Hz, crest factor: 2) |
| Response time*1 | 100 ms (rising from 0% of f.s. to 90% of f.s.) |
| Temperature characteristics*1 | ±0.075% f.s./°C |
| Frequency characteristics*1 | DC to 100 kHz ±3 dB (DC-coupled) 7 Hz to 100 kHz ±3 dB (AC-coupled, at a lower cutoff frequency of 7 Hz ±50%) |
| Noise*1 | 10 mA p-p (max.), with the highest sensitivity range and the terminals of each input connector connected with each other (for 20 A/2 V range) |
| Low-pass filter | Off, 5 ±50%, 50 ±50%, 500 ±50%, 5 k ±50%, 50 k ±50% (Hz) -3 dB |
| Input type | Unbalanced input (Not isolated) |
| Input coupling | AC/DC/GND |
| Input resistance | 1 MΩ ±1% |
| A/D resolution | 12 bits |
| Maximum sampling rate | 1 MS/s |
| Input terminals | Sensor connector HR10A-10R-S (Hirose connector) |
| Operating temperature and humidity range | Consistent with the specifications of the Memory HiCorder in which Model 8971 is installed. |
| Operating environment | Consistent with the specifications of the Memory HiCorder in which Model 8971 is installed. |
| Storage temperature and humidity range | -10°C to 50°C (14°F to 122°F), 80% RH or less (no condensation) |
| Dimensions | Approx. 106W × 19.8H × 196.5D mm (4.17"W × 0.78"H × 7.74"D) |
| Weight | Approx. 250 g (8.8 oz.) |
| Standards | Safety: EN61010 EMC: EN61326 Class A |
| Accessories | Model 9318 Conversion Cable ×2 (for connecting current sensors) |
| Options | Model 9318 Conversion Cable, Model CT9901 Conversion Cable |
| Number of installable modules | Up to four modules |

*1: For current measurement, add accuracy and characteristics of a current sensor

*2: Since the instrument recognizes these sensors as a sensor that has a conversion ratio of 2 V/500 A, the scaling conversion ratio shall be set at 2.

Model 8972 DC/RMS Unit

Accuracy guarantee conditions

Specified under the following conditions: installed in a Memory HiCorder and operated at 23°C ±5°C (73°F ±9°F) in the range of 20% to 80% RH after a half-hour (at least) warm-up and execution of zero-adjustment.

| | |
|----------------------------------|---------|
| Product warranty period | 3 years |
| Accuracy guarantee period | 1 year |

| | |
|--|---|
| Number of input channels | 2 channels |
| Measurement range | 100, 200, 400 mV f.s. 1, 2, 4, 10, 20, 40, 100, 200, 400 V f.s. |
| Measurement accuracy | ±0.5% f.s. (with the filter set at 5 Hz) |
| RMS accuracy | ±1% f.s. (DC, 30 Hz to 1 kHz) ±3% f.s. (1 kHz to 100 kHz) (Sine wave input, response time setting: Slow) |
| Response time | Slow: 5 s (rising from 0% of f.s. to 90% of f.s.) Normal: 800 ms (rising from 0% of f.s. to 90% of f.s.) Fast: 100 ms (rising from 0% of f.s. to 90% of f.s.) |
| Crest factor | 2 |
| Temperature characteristics | ±0.045% f.s./°C |
| Frequency characteristics | DC to 400 kHz: -3 dB (DC-coupled) 7 Hz to 400 kHz: -3 dB (AC-coupled, at a lower cutoff frequency of 7 Hz ±50%) |
| Noise | 500 µV p-p (typ.), 750 µV p-p (max.), with the highest sensitivity range and the terminals of each input connector connected with each other |
| Common-mode rejection ratio | 80 dB or more (at 50 Hz / 60 Hz, a signal source resistance of 100 Ω or less) |
| Low-pass filter | Off, 5 ±50%, 50 ±50%, 500 ±50%, 5 k ±50%, 100 k ±50% (Hz) -3 dB |
| Input type | Unbalanced input (floating) |
| Input coupling | AC/DC/GND |
| Input resistance | 1 MΩ ±1% |
| Input capacitance | 30 pF ±10 pF (at 100 kHz) |
| A/D resolution | 12 bits |
| Maximum sampling rate | 1 MS/s |
| Input terminals | Insulated BNC terminal |
| Maximum input voltage | 400 V DC |
| Maximum rated terminal-to-ground voltage | 300 V AC, DC (between each input channel and the enclosure, between any two of input channels) Measurement category II, anticipated transient overvoltage: 2500 V |
| Operating temperature and humidity range | Consistent with the specifications of the Memory HiCorder in which Model 8972 is installed |
| Operating environment | Consistent with the specifications of the Memory HiCorder in which Model 8972 is installed |
| Storage temperature and humidity range | -10°C to 50°C (14°F to 122°F), 80% RH or less (no condensation) |
| Dimensions | Approx. 106W × 19.8H × 196.5D mm (4.17"W × 0.78"H × 7.74"D) |
| Weight | Approx. 250 g (8.8 oz.) |
| Effect of radiated radio-frequency electromagnetic field | ±15% f.s. (max.) at 3 V/m |
| Effect of conducted radio-frequency electromagnetic field | ±20% f.s. (max.) at 3 V (with the 2 V f.s. range, with 1 V DC inputted) |

| | |
|------------------|---|
| Standards | Safety: EN61010 EMC: EN61326 Class A |
| Options | Model L9197 Connection Cord (CAT IV 300 V, CAT III 600 V, 1 A) Model L9198 Connection Cord (CAT III 300 V, CAT II 600 V, 0.2 A) Model L9217 Connection Cord (CAT III 300 V, CAT II 600 V, 0.2 A) Model L9790 Connection Cord (With the L9790-01 or 9790-03 connected: CAT III 300 V, CAT II 600 V, 1 A) (With the 9790-02 connected: CAT III 150 V, CAT II 300 V, 1 A) Model 9322 Differential Probe (With grabber clips connected: CAT II 1000 V) (With alligator clips connected: CAT III 600 V, CAT II 1000 V) Model P9000-01 Differential Probe (CAT III 1000 V) Model P9000-02 Differential Probe (CAT III 1000 V) Model 9665 10:1 Probe (CAT II 300 V) Model 9666 100:1 Probe (CAT II 300 V) |

Model 8973 Logic Unit

| | |
|---|---|
| Product warranty period | 3 years |
| Number of input channels | 4 probes (16 channels) |
| Input terminals | Mini DIN |
| Supported probes | Model 9320-01 Logic Probe, Model MR9321-01 Logic Probe, Model 9327 Logic Probe |
| Operating temperature and humidity range | Consistent with the specifications of the Memory HiCorder in which Model 8973 is installed. |
| Operating environment | Consistent with the specifications of the Memory HiCorder in which Model 8973 is installed. |
| Storage temperature and humidity range | -20°C to 50°C (-4°F to 122°F), 80% RH or less (no condensation) |
| Dimensions | Approx. 106W × 19.8H × 196.5D mm (4.17"W × 0.78"H × 7.74"D) |
| Weight | Approx. 190 g (6.7 oz.) |
| Standards | Safety: EN61010 EMC: EN61326 Class A |

Model MR8990 Digital Voltmeter Unit

Accuracy guarantee conditions

Specified under the following conditions: installed in a Memory HiCorder and operated at 23°C ±5°C (73°F ±9°F) in the range of 20% to 80% RH after a half-hour (at least) warm-up and execution of calibration.

| | |
|----------------------------------|------------|
| Product warranty period | 3 years |
| Accuracy guarantee period | 1 year |
| Number of input channels | 2 channels |
| Measurement item | DC voltage |

| Measurement range | Measurement range setting | Effective input range* | Maximum resolution | Input resistance |
|-------------------|---------------------------|------------------------|------------------------|------------------------|
| | 100 mV f.s. | -120 mV to 120 mV | 0.1 μ V | 100 M Ω or more |
| 1 V f.s. | -1200 mV to 1200 mV | 1 μ V | | |
| 10 V f.s. | -12 V to 12 V | 10 μ V | | |
| 100 V f.s. | -120 V to 120 V | 100 μ V | 10 M Ω \pm 5% | |
| 1000 V f.s. | -500 V to 500 V | 1 mV | | |

*: Guaranteed range of measurement accuracy

| Measurement accuracy | Measurement range setting | NPLC: Less than 1 | NPLC: 1 or more |
|----------------------|--------------------------------------|------------------------------------|-----------------------------------|
| | 100 mV f.s. | \pm 0.01% rdg. \pm 0.015% f.s. | \pm 0.01% rdg. \pm 0.01% f.s. |
| 1 V f.s. | \pm 0.01% rdg. \pm 0.0025% f.s. | | |
| 10 V f.s. | \pm 0.01% rdg. \pm 0.0025% f.s. | | |
| 100 V f.s. | \pm 0.025% rdg. \pm 0.0025% f.s. | | |
| 1000 V f.s. | \pm 0.025% rdg. \pm 0.0025% f.s. | | |

Temperature characteristics \pm (0.002% rdg. + 0.00025% f.s.)/ $^{\circ}$ C

A/D conversion measurement method Delta-sigma modulation method

| Integration time | Power frequency | Integration time |
|------------------|------------------------|---------------------|
| | 50 Hz | 20 ms \times NPLC |
| 60 Hz | 16.67 ms \times NPLC | |

NPLC: Settable from 0.1 to 0.9 (in 0.1 increments), 1 to 9 (in one increments), and 10 to 100 (in 10 increments)

Response time Within [2 ms + 2 \times (integration time)] (rising from - f.s. to +f.s., and falling from +f.s. to -f.s.)

High-speed response On/Off

Common-mode rejection ratio 100 dB or more (at 50 Hz / 60 Hz, a signal source resistance of 100 Ω or less)

Input type Unbalanced input (floating)

Input terminals Banana jacks

Maximum input voltage 500 V DC

Maximum rated terminal-to-ground voltage 300 V AC, DC (between each input channel and the enclosure, between any two of input channels) Measurement category II, anticipated transient overvoltage: 2500 V

Operating temperature and humidity range Consistent with the specifications of Memory HiCorder in which Model MR8990 is installed.

Operating environment Consistent with the specifications of Memory HiCorder in which Model MR8990 is installed.

Storage temperature and humidity range -10 $^{\circ}$ C to 50 $^{\circ}$ C (14 $^{\circ}$ F to 122 $^{\circ}$ F), 80% RH or less (no condensation)

Dimensions Approx. 106W \times 19.8H \times 196.5D mm (4.17"W \times 0.78"H \times 7.74"D)

| | |
|---|---|
| Weight | Approx. 260 g (9.2 oz.) |
| Effect of radiated radio-frequency electromagnetic field | $\pm 0.1\%$ f.s. (max.) at 3 V/m (with the 100 mV f.s. range) |
| Standards | Safety: EN61010 EMC: EN61326 Class A |
| Options | Model L2200 Test Lead (CAT IV 600 V, CAT III 1000 V, 10 A) |

Model U8974 High Voltage Unit

Accuracy guarantee conditions

Specified under the following conditions: installed in a Memory HiCorder and operated at $23^{\circ}\text{C} \pm 5^{\circ}\text{C}$ ($73^{\circ}\text{F} \pm 9^{\circ}\text{F}$) in the range of 20% to 80% RH after a half-hour (at least) warm-up and execution of zero-adjustment.

| | |
|--------------------------------------|---|
| Product warranty period | 3 years |
| Accuracy guarantee period | 1 year |
| Number of input channels | 2 channels |
| Measurement functions | Instantaneous value, RMS value (Each channel can have a different setting.) |
| Measurement range | 4, 10, 20, 40, 100, 200, 400, 1000 V f.s. (DC mode) 10, 20, 40, 100, 200, 400, 1000 V f.s. (RMS mode) |
| Measurement accuracy | $\pm 0.25\%$ f.s. (with the filter set at 5 Hz) |
| RMS measurement accuracy | $\pm 1.5\%$ f.s. (DC, 30 Hz or higher but lower than 1 kHz, sine wave, response time: slow) $\pm 3\%$ f.s. (1 kHz to 10 kHz, sine wave) Crest factor: 2 (sine wave, a peak voltage of up to 1000 V) |
| RMS measurement response time | Fast: 150 ms (rising from 0% of f.s. to 90% of f.s.) Normal: 500 ms (rising from 0% of f.s. to 90% of f.s.) Slow: 2.5 s (rising from 0% of f.s. to 90% of f.s.) |
| Temperature characteristics | $\pm 0.05\%$ f.s./ $^{\circ}\text{C}$ |
| Frequency characteristics | DC to 100 kHz, -3 dB |
| Noise | 30 mV p-p (typ.), 50 mV p-p (max.), with the highest sensitivity range and the terminals of each input connector connected with each other |
| Common-mode rejection ratio | 80 dB or more (at 50 Hz / 60 Hz, with input terminals connected with each other) |
| Low-pass filter | Off, $5 \pm 50\%$, $50 \pm 50\%$, $500 \pm 50\%$, $5 \text{ k} \pm 50\%$, $50 \text{ k} \pm 50\%$ (Hz) -3 dB |
| Input type | Balanced input (floating) |
| Input coupling | DC/GND |
| Input resistance | $4 \text{ M}\Omega \pm 1\%$ |
| Input capacitance | 5 pF or less (at 100 kHz) |
| A/D resolution | 16 bits |
| Maximum sampling rate | 1 MS/s |
| Input terminals | Banana jacks |

| | |
|--|--|
| Maximum input voltage | 1000 V DC, 700 V AC |
| Maximum rated terminal-to-ground voltage | 1000 V AC, DC, Measurement category III; 600 V AC, DC, Measurement category IV (between each input channel and the enclosure, between any two of input channels) Anticipated transient overvoltage: 8000 V |
| Operating temperature and humidity range | Consistent with the specifications of Memory HiCorder in which Model U8974 is installed. |
| Operating environment | Consistent with the specifications of Memory HiCorder in which Model U8974 is installed. |
| Storage temperature and humidity range | -20°C to 50°C For -20°C or higher but lower than 40°C (-4°F or higher but lower than 104°F), 80% RH or less (no condensation) For 40°C or higher but lower than 45°C (104°F or higher but lower than 113°F), 60% RH or less (no condensation) For 45°C to 50°C (113°F to 122°F), 50% RH or less (no condensation) |
| Dimensions | Approx. 106W × 19.8H × 196.5D mm (4.17"W × 0.78"H × 7.74"D) |
| Weight | Approx. 230 g (8.1 oz.) |
| Effect of radiated radio-frequency electromagnetic field | ±5% f.s. (max.) at 3 V/m |
| Effect of conducted radio-frequency electromagnetic field | ±5% f.s. (max.) at 3 V (with the 10 V f.s. range, with 1 V DC inputted) |
| Standards | Safety: EN61010 EMC: EN61326 Class A |
| Options | Model L4940 Connection Cable Set (1.5 m) Model L4935 Alligator Clip Set (connected to the tips of Model L4940, CAT III 1000 V, CAT IV 600 V, 10 A) Model L9243 Grabber Clip (connected to the tips of Model L4940, CAT II 1000 V, 1 A) Model L4936 Bus Bar Clip Set (connected to the tips of Model L4940, CAT III 600 V, 5 A) Model L4937 Magnetic Adapter Set (connected to the tips of Model L4940, CAT III 1000 V, 2 A) Model L4931 Extension Cable Set (to extend the length of Model L4940, 1.5 m, CAT III 1000 V, CAT IV 600 V, 10 A) Model L4932 Test Pin Set (connected to the tips of Model L4940, CAT III 1000 V, CAT IV 600 V, 10 A) Model L4934* Small Alligator Clip Set (CAT II 600 V, CAT III 300 V, 3 A) *: Model L4932 is required when Model L4934 is used. |

Model U8975 4ch Analog Unit

Accuracy guarantee conditions

Specified under the following conditions: installed in a Memory HiCorder and operated at 23°C ±5°C (73°F ±9°F) and 80% RH or less after a half-hour (at least) warm-up and execution of zero-adjustment.

| | |
|---|--|
| Operating environment | Indoors, pollution degree 2, operating altitude: up to 2000 m (6562 ft.) |
| Operating temperature and humidity range | 0°C to 40°C (32°F to 104°F), 80% RH or less (no condensation) |
| Storage temperature and humidity range | -10°C to 50°C For -10°C or higher but lower than 40°C (14°F or higher but lower than 104°F), 80% RH or less (no condensation) For 40°C or higher but lower than 45°C (104°F or higher but lower than 113°F), 60% RH or less (no condensation) For 45°C to 50°C (113°F to 122°F), 50% RH or less (no condensation) |
| Standards | Safety: EN61010 EMC: EN61326 Class A |
| Dimensions | Approx. 106W × 19.8H × 196.5D mm (4.17"W × 0.78"H × 7.74"D) |
| Weight | Approx. 250 g (8.8 oz.) |
| Product warranty period | 3 years |
| Measurement range | 4, 10, 20, 40, 100, 200 V f.s. |
| Maximum input voltage | 200 V DC |
| Maximum rated terminal-to-ground voltage | 300 V AC, DC, Measurement category II (between each input channel and the enclosure, between any two of input channels) Anticipated transient overvoltage: 2500 V |
| Measurement terminals | Insulated BNC terminal |
| Number of channels | 4 channels |
| Frequency characteristics | DC to 2 MHz, -3 dB |
| Noise | 5 mV p-p (typ.), 10 mV p-p (max.) (with the highest sensitivity range and input terminals connected with each other) |
| Input type | Unbalanced input (floating) |
| Input coupling | DC/GND |
| Input resistance | 1 MΩ ±1% |
| Input capacitance | 30 pF ±10 pF (at 100 kHz) |
| A/D resolution | 16 bits (± f.s. = ±32000 data points) |
| Maximum sampling rate | 5 MS/s |
| Accuracy guarantee period | 1 year |
| Measurement accuracy | ±0.1% f.s. (with the filter set at 5 Hz) |
| Temperature characteristics | ±0.02% f.s./°C |

| | |
|--|---|
| Effect of radiated radio-frequency electromagnetic field | ±5% f.s. (max.) at 3 V/m (with the filter set at 5 Hz) |
| Effect of conducted radio-frequency electromagnetic field | ±5% f.s. (max.) at 3 V (in the 10 V f.s. range, with the filter set at 5 Hz, with 1 V DC inputted) |
| Common-mode rejection ratio | 80 dB or more (at 50 Hz / 60 Hz, a signal source resistance of 100 Ω) |
| Low-pass filter | Off, 5 ±50%, 500 ±50%, 5 k ±50%, 200 k ±50% (Hz) -3 dB |
| Options | Model L9197 Connection Cord (CAT IV 300 V, CAT III 600 V, 1 A) Model L9198 Connection Cord (CAT III 300 V, CAT II 600 V, 0.2 A) Model L9217 Connection Cord (CAT III 300 V, CAT II 600 V, 0.2 A) Model L9790 Connection Cord (With the L9790-01 or 9790-03 connected: CAT III 300 V, CAT II 600 V, 1 A) (With the 9790-02 connected: CAT III 150 V, CAT II 300 V, 1 A) Model 9322 Differential Probe (With grabber clips connected: CAT II 1000 V) (With alligator clips connected: CAT III 600 V, CAT II 1000 V) Model P9000-01 Differential Probe (CAT III 1000 V) Model P9000-02 Differential Probe (CAT III 1000 V) Model 9665 10:1 Probe (CAT II 300 V) Model 9666 100:1 Probe (CAT II 300 V) |

Model U8976 High Speed Analog Unit

Accuracy guarantee conditions

Specified under the following conditions: installed in a Memory HiCorder and operated at 23°C ±5°C (73°F ±9°F) and 80% RH or less after a half-hour (at least) warm-up and execution of zero-adjustment.

| | |
|---|--|
| Operating environment | Indoors, pollution degree 2, operating altitude: up to 2000 m (6562 ft.) |
| Operating temperature and humidity range | 0°C to 40°C (32°F to 104°F), 80% RH or less (no condensation) |
| Storage temperature and humidity range | -10°C to 50°C For -10°C or higher but lower than 40°C (14°F or higher but lower than 104°F), 80% RH or less (no condensation) For 40°C or higher but lower than 45°C (104°F or higher but lower than 113°F), 60% RH or less (no condensation) For 45°C to 50°C (113°F to 122°F), 50% RH or less (no condensation) |
| Standards | Safety: EN61010 EMC: EN61326 Class A |
| Dimensions | Approx. 106W × 19.8H × 196.5D mm (4.17"W × 0.78"H × 7.74"D) |
| Weight | Approx. 280 g (9.9 oz.) |
| Product warranty period | 3 years |
| Measurement range | 100, 200, 400 mV f.s. 1, 2, 4, 10, 20, 40, 100, 200, 400 V f.s. |
| Maximum input voltage | 400 V DC (direct input), 1000 V DC (when Model 9665 10:1 Probe is used) |
| Maximum rated terminal-to-ground voltage | 1000 V AC, DC, Measurement category II (between each input channel and the enclosure, between any two of input channels) Anticipated transient overvoltage: 6000 V |
| Measurement terminals | Insulated BNC terminal |

| | |
|--|---|
| Number of channels | 2 channels |
| Frequency characteristics | DC to 30 MHz -3 dB (DC-coupled) 7 Hz to 30 MHz -3 dB (AC-coupled) |
| Noise | 1.5 mV p-p (typ.), 2 mV p-p (max.) (with the highest sensitivity range and the terminals of each input connector connected with each other) |
| Input type | Unbalanced input (floating) |
| Input coupling | AC /DC /GND |
| Input resistance | 1 M Ω \pm 1% |
| Input capacitance | 22 pF \pm 5 pF (at 100 kHz) |
| A/D resolution | 12 bits (\pm f.s. = \pm 1600 pieces of data) |
| Maximum sampling rate | 200 MS/s |
| Accuracy guarantee period | 1 year |
| Measurement accuracy | \pm 0.5% f.s. (with the filter set at 5 Hz) |
| Temperature characteristics | \pm 0.15% f.s./ $^{\circ}$ C |
| Effect of radiated radio-frequency electromagnetic field | \pm 5% f.s. (max.) at 3 V/m (with the filter set at 5 Hz) |
| Effect of conducted radio-frequency electromagnetic field | \pm 5% f.s. (max.) at 3 V (in the 10 V range, with the filter set at 5 Hz, with 1 V DC inputted) |
| Common-mode rejection ratio | 80 dB or more (at 50 Hz / 60 Hz, a signal source resistance of 100 Ω) |
| Low-pass filter | Off, 5 \pm 50%, 500 \pm 50%, 5 k \pm 50%, 1 M \pm 50% (Hz) -3 dB |
| Options | Model L9197 Connection Cord (CAT IV 300 V, CAT III 600 V, 1 A) Model L9198 Connection Cord (CAT III 300 V, CAT II 600 V, 0.2 A) Model L9217 Connection Cord (CAT III 300 V, CAT II 600 V, 0.2 A) Model L9790 Connection Cord (With the L9790-01 or 9790-03 connected: CAT III 300 V, CAT II 600 V, 1 A) (With the 9790-02 connected: CAT III 150 V, CAT II 300 V, 1 A) Model 9322 Differential Probe (With grabber clips connected: CAT II 1000 V) (With alligator clips connected: CAT III 600 V, CAT II 1000 V) Model P9000-01 Differential Probe (CAT III 1000 V) Model P9000-02 Differential Probe (CAT III 1000 V) Model 9665 10:1 Probe (CAT II 1000 V) Model 9666 100:1 Probe (CAT II 1000 V) |

Model U8977 3CH Current Unit

Accuracy guarantee conditions

Specified under the following conditions: installed in a Memory HiCorder and operated at 23°C ±5°C (73°F ±9°F) and 80% RH or less after a half-hour (at least) warm-up and execution of zero-adjustment.

| | |
|---|---|
| Operating environment | Indoors, pollution degree 2, operating altitude: up to 2000 m (6562 ft.) |
| Operating temperature and humidity range | 0°C to 40°C (32°F to 104°F), 80% RH or less (no condensation) |
| Storage temperature and humidity range | <p>–10°C to 50°C (14°F to 122°F)</p> <p>For –10°C or higher but lower than 40°C (14°F or higher but lower than 104°F), 80% RH or less (no condensation)</p> <p>For 40°C or higher but lower than 45°C (104°F or higher but lower than 113°F), 60% RH or less (no condensation)</p> <p>For 45°C to 50°C (113°F to 122°F), 50% RH or less (no condensation)</p> |
| Standards | <p>Safety: EN61010</p> <p>EMC: EN61326 Class A</p> |
| Dimensions | Approx. 106W × 19.8H × 196.5D mm (4.17"W × 0.78"H × 7.74"D) |
| Weight | Approx. 250 g (8.8 oz.) |
| Product warranty period | 3 years |
| Options | <p>Model CT9900 Conversion Cable (PL23 receptacle–ME15W plug)</p> <p>Model CT9920 Conversion Cable (PL14 receptacle–ME15W plug)</p> |
| Number of input channels | 3 channels |

Supported current sensors

- Directly connectible current sensors
 - Model 9272-05 Clamp on Sensor (20 A/200 A AC)
 - Model CT6841-05 AC/DC Current Probe (20 A)
 - Model CT6843-05 AC/DC Current Probe (200 A)
 - Model CT6844-05 AC/DC Current Probe (500 A, ϕ 20 mm)
 - Model CT6845-05 AC/DC Current Probe (500 A, ϕ 50 mm)
 - Model CT6846-05 AC/DC Current Probe (1000 A)
 - Model CT6862-05 AC/DC Current Sensor (50 A)
 - Model CT6863-05 AC/DC Current Sensor (200 A)
 - Model 9709-05 AC/DC Current Sensor (500 A)
 - Model CT6904 AC/DC Current Sensor (500 A)
 - Model CT6865-05 AC/DC Current Sensor (1000 A)
 - Model CT6875 AC/DC Current Sensor (500 A)
 - Model CT6876 AC/DC Current Sensor (1000 A)
 - Model CT6877 AC/DC Current Sensor (2000 A)
 - Model CT6841A AC/DC Current Probe (20 A)
 - Model CT6843A AC/DC Current Probe (200 A)
 - Model CT6844A AC/DC Current Probe (500 A, ϕ 20 mm)
 - Model CT6845A AC/DC Current Probe (500 A, ϕ 50 mm)
 - Model CT6846A AC/DC Current Probe (1000 A)
 - Model CT6872 AC/DC Current Sensor (50 A)
 - Model CT6872-01 AC/DC Current Sensor (50 A, cord length: 10 m)
 - Model CT6873 AC/DC Current Sensor (200 A)
 - Model CT6873-01 AC/DC Current Sensor (200 A, cord length: 10 m)
 - Model CT6875A AC/DC Current Sensor (500 A)
 - Model CT6875A-1 AC/DC Current Sensor (500 A, cord length: 10 m)
 - Model CT6876A AC/DC Current Sensor (1000 A)
 - Model CT6876A-1 AC/DC Current Sensor (1000 A, cord length: 10 m)
 - Model CT6877A AC/DC Current Sensor (2000 A)
 - Model CT6877A-1 AC/DC Current Sensor (2000 A, cord length: 10 m)
 - Model CT6904A AC/DC Current Sensor (500 A)
- Current sensors that require Model CT9920 for connection
 - Model CT7631 AC/DC Current Sensor (100 A)
 - Model CT7636 AC/DC Current Sensor (600 A)
 - Model CT7642 AC/DC Current Sensor (2000 A)
 - Model CT7731 AC/DC Auto-Zero Current Sensor (100 A)
 - Model CT7736 AC/DC Auto-Zero Current Sensor (600 A)
 - Model CT7742 AC/DC Auto-Zero Current Sensor (2000 A)
 - Model CT7044 AC Flexible Current Sensor (6000 A, ϕ 100 mm)
 - Model CT7045 AC Flexible Current Sensor (6000 A, ϕ 180 mm)
 - Model CT7046 AC Flexible Current Sensor (6000 A, ϕ 254 mm)

Measurement range

- For the directly connectible current sensors, the instrument automatically recognizes the rating of the current sensor.
 - 200 mA, 400 mA, 1 A, 2 A, 4 A, 10 A (rating: 2 A)
 - 2 A, 4 A, 10 A, 20 A, 40 A, 100 A (rating: 20 A)
 - 4 A, 10 A, 20 A, 40 A, 100 A, 200 A (rating: 50 A)
 - 20 A, 40 A, 100 A, 200 A, 400 A, 1000 A (rating: 200 A)
 - 40 A, 100 A, 200 A, 400 A, 1000 A, 2000 A (rating: 500 A)
 - 100 A, 200 A, 400 A, 1000 A, 2000 A, 4000 A (rating: 1000 A)
- For the current sensors that require Model CT9920 for connection, choose a conversion rate or a model number.
 - 200 A (Model CT7631, Model CT7731)
 - 200 A, 400 A, 1000 A (Model CT7636, Model CT7736)
 - 2000 A, 4000 A (Model CT7642, Model CT7742)
 - 2000 A, 4000 A, 10000 A (Model CT7044, Model CT7045, Model CT7046)
 - 2000 A, 4000 A, 10000 A, 20000 A, 40000 A, 100000 A (0.1 mV/A)
 - 200 A, 400 A, 1000 A, 2000 A, 4000 A, 10000 A (1 mV/A)
 - 20 A, 40 A, 100 A, 200 A, 400 A, 1000 A (10 mV/A)
 - 2 A, 4 A, 10 A, 20 A, 40 A, 100 A (100 mV/A)
 - 0.2 A, 0.4 A, 1 A, 2 A, 4 A, 10 A (1000 mV/A)

Frequency characteristicsDC to 2 MHz (\pm 3 dB)

| | |
|--|--|
| Noise | 10 mA p-p (max.) (using the 20-A sensor, with the 2 A f.s. range and input terminals connected with each other) |
| Low-pass filter | Off, 5 Hz, 500 Hz, 5 kHz, 200 kHz $\pm 50\%$ (-3 dB) |
| Input type | Current sensor |
| Measurement terminal | Dedicated connector (ME15W) |
| Input coupling | DC/GND |
| Input resistance | 1 M Ω $\pm 1\%$ |
| Maximum input current | Depends on a sensor. |
| Maximum rated terminal-to-ground voltage | Non-isolated |
| Maximum sampling rate | 5 MS/s |
| A/D resolution | 16 bits (\pm f.s. = ± 32000 data points) |
| Accuracy guarantee period | 1 year |
| Measurement accuracy | $\pm 0.3\%$ f.s. + (accuracy of current sensor) |
| Temperature characteristics | $\pm 0.045\%$ f.s./ $^{\circ}\text{C}$ |
| Effect of radiated radio-frequency electromagnetic field | $\pm 5\%$ f.s. (max.) at 3 V/m (with the filter set at 5 Hz) |
| Effect of conducted radio-frequency electromagnetic field | $\pm 5\%$ f.s. (max.) at 3 V (using the 20-A sensor, with the 20 A f.s. range, with the filter set at 5 Hz, with a current of 2 A DC inputted) |

Model U8978 4CH Analog Unit

Accuracy guarantee conditions

Specified under the following conditions: installed in a Memory HiCorder and operated at $23^{\circ}\text{C} \pm 5^{\circ}\text{C}$ ($73^{\circ}\text{F} \pm 9^{\circ}\text{F}$) and 80% RH or less after a half-hour (at least) warm-up and execution of zero-adjustment.

| | |
|---|--|
| Operating environment | Indoors, pollution degree 2, operating altitude: up to 2000 m (6562 ft.) |
| Operating temperature and humidity range | 0°C to 40°C (32°F to 104°F), 80% RH or less (no condensation) |
| Storage temperature and humidity range | -10°C to 50°C (14°F to 122°F) For -10°C or higher but lower than 40°C (14°F or higher but lower than 104°F), 80% RH or less (no condensation) For 40°C or higher but lower than 45°C (104°F or higher but lower than 113°F), 60% RH or less (no condensation) For 45°C to 50°C (113°F to 122°F), 50% RH or less (no condensation) |
| Standards | Safety: EN61010 EMC: EN61326 Class A |
| Dimensions | Approx. 106W \times 19.8H \times 196.5D mm (4.17"W \times 0.78"H \times 7.74"D) |
| Weight | Approx. 250 g (8.8 oz.) |

| | |
|--|---|
| Product warranty period | 3 years |
| Measurement range | 100, 200, 400 mV f.s., 1, 2, 4, 10, 20, 40 V f.s. |
| Maximum input voltage | (Direct input) 40 V DC (In combination with Model 9665) 400 V DC |
| Maximum rated terminal-to-ground voltage | (Direct input) 30 V AC, 60 V DC (between each input channel and the enclosure, between any two of input channels) (In combination with Model 9665) 300 V AC, DC, Measurement category II (between each input channel and the enclosure, between any two of input channels) |
| Measurement terminals | Insulated BNC terminal |
| Number of channels | 4 channels |
| Frequency characteristics | DC to 2 MHz, -3 dB |
| Noise | 500 μ V p-p (typ.), 1 mV p-p (max.) (with the highest sensitivity range and the terminals of each input connector connected with each other) |
| Input type | Unbalanced input (floating) |
| Input coupling | DC/GND |
| Input resistance | 1 M Ω \pm 1% |
| Input capacitance | 30 pF \pm 10 pF (at 100 kHz) |
| A/D resolution | 16 bits (\pm f.s. = \pm 32,000 data points) |
| Maximum sampling rate | 5 MS/s |
| Accuracy guarantee period | 1 year |
| Measurement accuracy | \pm 0.3% f.s. (with the filter set at 5 Hz) |
| Temperature characteristics | \pm 0.045% f.s./ $^{\circ}$ C |
| Effect of radiated radio-frequency electromagnetic field | \pm 5% f.s. (max.) at 3 V/m (with the filter set at 5 Hz) |
| Effect of conducted radio-frequency electromagnetic field | \pm 5% f.s. (max.) at 3 V (in the 10 V range, with the filter set at 5 Hz, with 1 V DC inputted) |
| Common-mode rejection ratio | 80 dB or more (at 50 Hz / 60 Hz, a signal source resistance of 100 Ω) |
| Low-pass filter | Off, 5 \pm 50%, 500 \pm 50%, 5 k \pm 50%, 200 k \pm 50% (Hz) -3 dB |
| Options | Model L9197 Connection Cord (CAT IV 300 V, CAT III 600 V, 1 A) Model L9198 Connection Cord (CAT III 300 V, CAT II 600 V, 0.2 A) Model L9217 Connection Cord (CAT III 300 V, CAT II 600 V, 0.2 A) Model L9790 Connection Cord (With the L9790-01 or 9790-03 connected: CAT III 300 V, CAT II 600 V, 1 A) (With the 9790-02 connected: CAT III 150 V, CAT II 300 V, 1 A) Model 9322 Differential Probe (With grabber clips connected: CAT II 1000 V) (With alligator clips connected: CAT III 600 V, CAT II 1000 V) Model P9000-01 Differential Probe (CAT III 1000 V) Model P9000-02 Differential Probe (CAT III 1000 V) Model 9665 10:1 Probe (CAT II 300 V) Model 9666 100:1 Probe (CAT II 300 V) |

Model U8979 Charge Unit

1. General specifications

| | |
|---|---|
| Operating environment | Indoors, pollution degree 2, operating altitude: up to 2000 m (6562 ft.) |
| Operating temperature and humidity range | 0°C to 40°C (32°F to 104°F), 80% RH or less (no condensation) |
| Storage temperature and humidity range | <p>–10°C to 50°C (14°F to 122°F)</p> <p>For –10°C or higher but lower than 40°C (14°F or higher but lower than 104°F), 80% RH or less (no condensation)</p> <p>For 40°C or higher but lower than 45°C (104°F or higher but lower than 113°F), 60% RH or less (no condensation)</p> <p>For 45°C to 50°C (113°F to 122°F), 50% RH or less (no condensation)</p> |
| Standards | <p>Safety: EN61010</p> <p>EMC: EN61326 Class A</p> |
| Dimensions | Approx. 106W × 19.8H × 196.5D mm (4.17"W × 0.78"H × 7.74"D) |
| Weight | Approx. 250 g (8.8 oz.) |
| Product warranty period | 3 years |
| Accuracy guarantee period | 1 year |
| Option | Model 9166 Connection Cord (for voltage measurement) |

2. Specifications of input, output, and measurement

(1) Common specifications

| | |
|---|---|
| Number of channels | 2 channels |
| Measurement mode | Charge, pre-amplifier, voltage (selectable for each channel) |
| Input type | <p>Unbalanced input (floating)</p> <p>In each channel, the voltage input terminal has the same-potential ground as the charge input terminal.</p> |
| Common-mode rejection ratio | 80 dB or more (at 50 Hz / 60 Hz, a signal source resistance of 100 Ω) |
| Anti-aliasing filters | <p>Cutoff frequency (fc): 20, 40, 80, 200, 400, 800, 2 k, 4 k, 8 k, 20 k, 40 k (Hz)</p> <p>Switchable between on and off; the instrument automatically chooses a cutoff frequency along with the sampling rate.</p> <p>Attenuation property: –66 dB or higher at a cutoff frequency of 1.5 fc</p> |
| Maximum sampling rate | 200 kS/s |
| A/D resolution | 16 bits (± f.s. = ±25,000 data points) |
| Maximum rated terminal-to-ground voltage | <p>30 V AC, 60 V DC</p> <p>(between each input channel and the enclosure, between any two of input channels)</p> <p>Anticipated transient overvoltage: 330 V</p> |

(2) Voltage input

| | |
|------------------------------|---|
| Measurement range | 10, 20, 40, 100, 200, 400 mV f.s., 1, 2, 4, 10, 20, 40 V f.s. |
| Maximum input voltage | 40 V DC |

| | |
|----------------------------------|---|
| Frequency characteristics | DC to 50 kHz -3 dB (DC-coupled) 1 Hz to 50 kHz -3 dB (AC-coupled, lower cutoff frequency: 1 Hz \pm 50%) |
| Noise | 80 μ V p-p (typ.), 120 μ V p-p (max.), with the highest sensitivity range and the terminals of each input connector connected with each other |
| Input resistance | 1 M Ω \pm 1% |
| Input capacitance | 200 pF or less (at 100 kHz) |
| Input coupling | AC/DC/GND |
| Input terminals | Metallic BNC terminal |

(3) Charge input

| | |
|----------------------------------|---|
| Supported detector | Charge-output acceleration detector |
| Measurement sensitivity | 0.1 pC/(m/s ²) to 10 pC/(m/s ²) |
| Measurement range | 40, 100, 200, 400, 1 k, 2 k, 4 k, 10 k, 20 k, 40 k, 100 k, 200 k m/s ² f.s. Measurement sensitivity: 0.1 pC/(m/s ²) to 0.25 pC/(m/s ²) 20, 40, 100, 200, 400, 1 k, 2 k, 4 k, 10 k, 20 k, 40 k, 100 k m/s ² f.s. Measurement sensitivity: 0.251 pC/(m/s ²) to 0.5 pC/(m/s ²) 10, 20, 40, 100, 200, 400, 1 k, 2 k, 4 k, 10 k, 20 k, 40 k m/s ² f.s. Measurement sensitivity: 0.501 pC/(m/s ²) to 1.0 pC/(m/s ²) 4, 10, 20, 40, 100, 200, 400, 1 k, 2 k, 4 k, 10 k, 20 k m/s ² f.s. Measurement sensitivity: 1.001 pC/(m/s ²) to 2.5 pC/(m/s ²) 2, 4, 10, 20, 40, 100, 200, 400, 1 k, 2 k, 4 k, 10 k m/s ² f.s. Measurement sensitivity: 2.501 pC/(m/s ²) to 5.0 pC/(m/s ²) 1, 2, 4, 10, 20, 40, 100, 200, 400, 1 k, 2 k, 4 k m/s ² f.s. Measurement sensitivity: 5.001 pC/(m/s ²) to 10.0 pC/(m/s ²) |
| Frequency characteristics | 1.5 Hz to 50 kHz -3 dB |
| Maximum input charge | \pm 500 pC (when one of the higher six ranges is chosen) \pm 50,000 pC (when one of the lower six ranges is chosen) |
| Input coupling | AC/GND |
| Input terminals | Miniature connector (#10-32UNF) |

(4) Input from acceleration sensor with the built-in pre-amplifier

| | |
|----------------------------------|---|
| Supported detector | Acceleration detector with built-in pre-amplifier |
| Measurement sensitivity | 0.1 mV/(m/s ²) to 10 mV/(m/s ²) |
| Measurement range | 40, 100, 200, 400, 1 k, 2 k, 4 k, 10 k, 20 k, 40 k, 100 k, 200 k m/s ² f.s. Measurement sensitivity: 0.1 mV/(m/s ²) to 0.25 mV/(m/s ²) 20, 40, 100, 200, 400, 1 k, 2 k, 4 k, 10 k, 20 k, 40 k, 100 k m/s ² f.s. Measurement sensitivity: 0.251 mV/(m/s ²) to 0.5 mV/(m/s ²) 10, 20, 40, 100, 200, 400, 1 k, 2 k, 4 k, 10 k, 20 k, 40 k m/s ² f.s. Measurement sensitivity: 0.501 mV/(m/s ²) to 1.0 mV/(m/s ²) 4, 10, 20, 40, 100, 200, 400, 1 k, 2 k, 4 k, 10 k, 20 k m/s ² f.s. Measurement sensitivity: 1.001 mV/(m/s ²) to 2.5 mV/(m/s ²) 2, 4, 10, 20, 40, 100, 200, 400, 1 k, 2 k, 4 k, 10 k m/s ² f.s. Measurement sensitivity: 2.501 mV/(m/s ²) to 5.0 mV/(m/s ²) 1, 2, 4, 10, 20, 40, 100, 200, 400, 1 k, 2 k, 4 k m/s ² f.s. Measurement sensitivity: 5.001 mV/(m/s ²) to 10.0 mV/(m/s ²) |
| Frequency characteristics | 1 Hz to 50 kHz -3 dB |

| | |
|----------------------------------|---------------------------------|
| Power supply for detector | 3.0 mA \pm 20%, 22 V \pm 5% |
| Input coupling | AC/GND |
| Input terminals | Metallic BNC terminal |

(5) Specifications for accuracy

| | |
|--|--|
| Accuracy guarantee conditions | Accuracy guarantee period: 1 year Accuracy guarantee temperature and humidity range: 23°C \pm 5°C (73°F \pm 9°F), 80% RH or less Warm-up time: 30 minutes or more Specified after execution of zero-adjustment |
| Accuracy of voltage measurement | \pm 0.5% f.s. (with the filter set at 5 Hz) |
| Temperature characteristic of voltage measurement | \pm 0.05% f.s./°C |
| Accuracy of amplitude with charge inputted | \pm 2% f.s. (1 kHz) |
| Temperature characteristic with charge inputted | \pm 0.2% f.s./°C |
| Accuracy of amplitude inputted from acceleration detector with built-in pre-amplifier | \pm 2% f.s. (1 kHz) |
| Temperature characteristics of input from acceleration sensor with the built-in pre-amplifier | \pm 0.2% f.s./°C |
| Effect of radiated radio-frequency electromagnetic field | \pm 10% f.s. (max.) at 3 V/m (with the filter set at 5 Hz) |
| Effect of conducted radio-frequency electromagnetic field | \pm 10% f.s. (max.) at 3 V (with the filter set at 5 Hz) |

3. Specifications of functions

| | |
|------------------------|---|
| Low-pass filter | Off, 5 \pm 50% (voltage input only), 500 \pm 50%, 5 k \pm 50% (Hz) -3 dB |
| TEDS | IEEE1451.4 Class 1 compliant The instrument reads out sensor information to automatically configure the sensitivity setting. |

Model MR8790 Waveform Generator Unit

Accuracy guarantee conditions

Specified under the following conditions: installed in a Memory HiCorder and operated at 23°C \pm 5°C (73°F \pm 9°F) and 80% RH or less after a half-hour (at least) warm-up.

| | |
|--|--|
| Product warranty period | 3 years |
| Accuracy guarantee period | 1 year |
| Number of output channels | 4 channels (isolated between enclosure and output, and between every channel) |
| Self-diagnosis function | Available (with the voltage and current monitors) |
| Switchable between the voltage and current monitors | Resolution: 5 μ A (current monitor), 10 mV (voltage monitor) Monitor accuracy: \pm 3.0% f.s. (f.s. = 10 V: voltage monitor, f.s. = 5 mA: current monitor) |
| Maximum output current | \pm 5 mA |
| Allowable load resistance | 2 k Ω or more |
| Output terminal | SMB terminal |
| Output configuration | Waveform output / open / short-circuit |
| Output relay switching time | 5 ms or less |
| Output protection | The output current is limited to 40 mA (when the output terminals are are connected with each other) |
| Maximum rated terminal-to-ground voltage | 30 V rms AC or 60 V DC (between each output channel and enclosure, between any two of output channels) Anticipated transient overvoltage: 330 V |
| Withstanding voltage | 350 V AC (sensitivity current: 1 mA) (between each output channel and enclosure, between any two of output channels) |
| Operating temperature and humidity range | Consistent with the specifications of Memory HiCorder in which Model MR8790 is installed. |
| Operating environment | Consistent with the specifications of Memory HiCorder in which Model MR8790 is installed. |
| Storage temperature and humidity range | -20°C to 50°C (-4°F to 122°F), 90% RH or less (no condensation) |
| Dimensions | Approx. 106W \times 19.8H \times 196.5D mm (4.17"W \times 0.78"H \times 7.74"D) (excluding protrusions) |
| Weight | Approx. 230 g (8.1 oz.) |
| Standards | Safety: EN61010 EMC: EN61326 Class A |
| Effect of radiated radio-frequency electromagnetic field | \pm 3% f.s. (max.) at 3 V/m (f.s. = 10 V) |
| Effect of conducted radio-frequency electromagnetic field | \pm 1% f.s. (max.) at 3 V (f.s. = 10 V) |
| Options | Model L9795-01 Connection Cable (terminal type: SMB terminal - alligator clip) Model L9795-02 Connection Cable (terminal type: SMB terminal - BNC terminal) |
| Maximum output voltage | \pm 10 V |
| Resolution | 16 bits |

| | |
|-------------------------|---|
| Output frequency | Output frequency: DC, 0 Hz to 20 kHz (sine wave) Setting resolution: 1 Hz Frequency accuracy: $\pm 0.01\%$ of setting |
| Amplitude | Measurable range: 0 V p-p to 20 V p-p Setting resolution: 1 mV Amplitude accuracy: $\pm 0.25\%$ of setting ± 2 mV p-p (1 Hz to 10 kHz), $\pm 0.6\%$ of setting ± 2 mV p-p (more than 10 kHz to 20 kHz) |
| DC offset | Setting range: -10 V to 10 V (The peak value, which is the total of amplitude and DC offset, is limited to ± 10 V) Setting resolution: 1 mV, offset accuracy: ± 3 mV |
| DC output | Output accuracy: ± 0.6 mV |

Model MR8791 Pulse Generator Unit

General specifications

| | |
|--|---|
| Accuracy guarantee temperature and humidity range | 23°C±5°C (73°F±9°F), 80% RH or less (no condensation) (when installed in a Memory HiCorder) |
| Accuracy guarantee period | 1 year |
| Product warranty period | 3 years |
| Operating temperature and humidity range | Consistent with the specifications of Memory HiCorder in which Model MR8791 is installed. |
| Operating environment | Consistent with the specifications of Memory HiCorder in which Model MR8791 is installed. |
| Storage temperature and humidity range | -20°C to 50°C (-4°F to 122°F), 90% RH or less (no condensation) |
| Maximum rated terminal-to-ground voltage | 30 V rms AC or 60 V DC (between each output channel and enclosure) Anticipated transient overvoltage: 330 V |
| Withstanding voltage | 350 V AC (sensitivity current: 1 mA) (between each output channel and enclosure, between any two of output modules) |
| Dimensions | Approx. 106W × 19.8H × 196.5D mm (4.17"W × 0.78"H × 7.74"D) (excluding protrusions) |
| Weight | Approx. 230 g (8.1 oz.) |
| Number of output channels | 8 channels (isolated between each output channel and enclosure, and between any two of input channels; not isolated between any two of output channels [cross-channel GND terminal]; not isolated between output connector frame and instrument's GND terminal) |
| Output mode 1 | Pattern output / pulse output (8 channels are commonly switched) |
| Output mode 2 | Logic output / open-collector output (configurable for 8 channels individually) |
| Logic output: | Output voltage level: 0 V to 5 V (High level: 3.8 V or more, low level: 0.8 V or less) Rated current: ±5 mA |
| Open-collector output: | Absolute maximum rated voltage between collector and emitter: 50 V Overcurrent protection: 100 mA |
| Output mode 3 | Output / open (for self-diagnosis) (8 channels are commonly switched) |
| Open-collector output specification (rising time from 10% to 90%) | 5 μs (max.) (load capacity: 1000 pF, pull-up resistor: 1 kΩ) |
| Self-diagnosis function | Detection voltage High level: 3.4 V or more, low level: 1.6 V or less |
| Relay switching time | 5 ms or less (switching between logic and open-collector, between output and open [self-diagnosis]) |
| Standards | Safety: EN 61010 EMC: EN 61326 Class A |

Specifications of the pulse outputting

| | |
|-------------------------|---|
| Output frequency | Setting range: 0 Hz to 20 kHz (configurable for 8 channels individually) Setting resolution: 0.1 Hz Frequency accuracy: Consistent with the time-axis accuracy of Memory HiCorder in which Model MR8791 is installed. |
| Duty ratio | Setting range: 0.1% to 99.9%, 0, 100% (DC) Setting resolution: 0.1% Duty ratio accuracy: Consistent with the time-axis accuracy of Memory HiCorder in which Model MR8791 is installed. |

Minimum pulse width 1 μ s

Specifications of the pattern outputting

Clock frequency Range: 0 Hz to 120 kHz (common for 8 channels)
 Setting resolution: 10 Hz
 Frequency accuracy: Consistent with the time-axis accuracy of Memory HiCorder in which Model MR8791 is installed.

Memory (pattern) 2,048 words (16,384 bits = 2,048 words \times 8 bits/word)

Specifications of the output connector

10250-52A2PL: manufactured by 3M (SCSI-2 connector, Centronics half-pitch, 50 pins, female)

| Pin | Signal name | Pin | Signal name |
|-------|---------------|-----|-------------|
| 1 | I_GND: | 26 | I_GND: |
| 2 | CH1 | 27 | I_GND: |
| 3 | CH2 | 28 | I_GND: |
| 4 | CH3 | 29 | I_GND: |
| 5 | CH4 | 30 | I_GND: |
| 6 | I_GND: | 31 | I_GND: |
| 7 | CH5 | 32 | I_GND: |
| 8 | CH6 | 33 | I_GND: |
| 9 | CH7 | 34 | I_GND: |
| 10 | CH8 | 35 | I_GND: |
| 11 | I_GND: | 36 | I_GND: |
| 12 | NC | 37 | I_GND: |
| 13 | NC | 38 | I_GND: |
| 14 | NC | 39 | I_GND: |
| 15 | NC | 40 | I_GND: |
| 16 | I_GND: | 41 | I_GND: |
| 17 | NC | 42 | I_GND: |
| 18 | NC | 43 | I_GND: |
| 19 | NC | 44 | I_GND: |
| 20 | NC | 45 | I_GND: |
| 21 | I_GND: | 46 | I_GND: |
| 22 | TEST2 (DIN03) | 47 | I_GND: |
| 23 | TEST3 (DIN02) | 48 | I_GND: |
| 24 | NC | 49 | I_GND: |
| 25 | NC | 50 | I_GND: |
| Frame | F_GND: | | |

CH1 through CH8: Pulse output
 I_GND: Isolated ground
 F_GND: Non-isolated ground (frame ground)
 NC: Not connected
 TESTn: Do not connect a test pin.

Recommended connection cable: Model KB-SHH2K manufactured by Sanwa Supply (SCSI-2 connector, Centronics half-pitch, 50 pins, male)

Model U8793 Arbitrary Waveform Generator Unit

1. General specifications

| | |
|---|---|
| Operating environment | Consistent with the specifications of the Memory HiCorder in which Model U8793 is installed. |
| Operating temperature and humidity range | Consistent with the specifications of the Memory HiCorder in which Model U8793 is installed. |
| Storage temperature and humidity range | Temperature: -20°C to 50°C (-4°F to 122°F) Humidity: 80% RH or less (no condensation) |
| Standards | Safety: EN61010 EMC: EN61326 Class A |
| Dimensions | Appx. 106W × 19.8H × 196.5D mm (4.17"W × 0.78"H × 7.74"D) (excluding protrusions) |
| Weight | Approx. 250 g (8.8 oz.) |
| Product warranty period | 3 years |
| Options | Model L9795-01 Connection Cable (terminal type: SMB terminal-mini alligator clip) Model L9795-02 Connection Cable (terminal type: SMB terminal-BNC terminal) |

2. Output specifications

(1) Basic specifications (common between the function generator function and arbitrary waveform generator function)

| | |
|---|---|
| Accuracy guarantee conditions | Accuracy guarantee period: 1 year Accuracy guarantee temperature and humidity range: $23^{\circ}\text{C} \pm 5^{\circ}\text{C}$ ($73^{\circ}\text{F} \pm 9^{\circ}\text{F}$), 80% RH or less Warm-up time: 30 minutes or more Power frequency range of Memory HiCorder in which Model U8793 is installed: $50 \text{ Hz}/60 \text{ Hz} \pm 2 \text{ Hz}$ |
| Number of output channels | 2 channels |
| Output terminals | SMB terminals |
| Output type | Unbalanced (floating) |
| Maximum rated terminal-to-ground voltage | 30 V rms AC or 60 V DC (between each output channel and the enclosure, between each output channel and the external I/O terminal, between any two of output channels) Anticipated transient overvoltage: 330 V |
| Maximum output voltage | -10 V to 15 V |
| Amplitude setting range | 0 V p-p to 20 V p-p (setting resolution: 1 mV) |
| DC offset Setting range | -10 V to 15 V (setting resolution: 1 mV) |
| Output impedance | 1Ω or less |
| Maximum output current | $\pm 10 \text{ mA}$ (per channel) |
| Allowable load resistance | $1.5 \text{ k}\Omega$ or more |
| Output type | Waveform output, open-circuit, short-circuit |

(2) Function generator function specifications

| | |
|---|---|
| Output waveforms | Sine wave, rectangular wave, pulse wave (duty cycle adjustable), triangular wave, lamp wave, DC |
| Output frequency range | 0 Hz to 100 kHz (setting resolution: 10 mHz) |
| Output frequency accuracy | ±0.015% of setting |
| DC output accuracy | ±0.05% of setting ±10 mV |
| Temperature characteristics of DC output | (±0.005% of setting ±1 mV)/°C |
| Amplitude accuracy | ±0.5% of setting ±10 mV p-p (more than or equal to 10 mHz but less than or equal to 10 kHz) ±0.8% of setting ±10 mV p-p (more than 10 kHz but less than or equal to 50 kHz) ±1.0% of setting ±10 mV p-p (more than 50 kHz but less than or equal to 100 kHz) |
| Temperature characteristics of amplitude | (±0.05% of setting ±1 mV p-p)/°C |
| DC offset accuracy | ±0.5% of setting ±10 mV |
| Temperature characteristics of DC offset | (±0.05% of setting ±1 mV)/°C |
| Phase difference setting range | -360° to 360° (setting resolution: 0.1°) |
| Jitter | Within 50 ns p-p (rectangular wave, pulse wave, triangular wave, lamp wave) |
| Setting range of pulse-wave duty cycle | 0.1% to 99.9% (setting resolution: 0.1 percent point) Effective for a pulse width of 500 ns or more in length |
| Accuracy of pulse-wave duty cycle | ±0.1% of period (more than or equal to 10 mHz but less than or equal to 5 kHz) ±0.5% of period (more than 5 kHz but less than or equal to 20 kHz) ±1.0% of period (more than 20 kHz but less than or equal to 100 kHz) |

(3) Specification of arbitrary waveform generator function

| | |
|-----------------------------------|---|
| Output waveforms | Waveforms measured with the following Memory HiCorders: Model 8847, Model MR8847, Model MR8847A, Model MR8827, Model MR8740, Model MR8741, and Model MR6000 (Logic waveforms not supported) Waveforms measured with Model PW3198 Power Quality Analyzer (via Model SF8000) Waveforms saved with Model 7075 Waveform Generator (via Model SF8000) Waveforms saved as CSV files (via Model SF8000) Waveforms created with Model SF8000 Waveform Maker |
| Resolution of voltage axis | 16 bits |
| Waveform memory capacity | 256 kW/channel × 8 blocks |
| Low-pass filter | 2nd-order LPF, 50 Hz to 1 MHz (1-2-5 series, 14 levels) |
| D/A refresh rate | Up to 2 MHz (setting resolution: 10 mHz) |
| Clock frequency accuracy | ±150 ppm |
| Clock-frequency jitter | Within 50 ns p-p |
| Delay | -250,000 to 250,000 (settable in increments of one data point) |

| | |
|--------------------------------|-------------------------------|
| Number of looping times | 1 to 50,000 times or infinity |
|--------------------------------|-------------------------------|

(4) Specifications of sweep function

| | |
|------------------------------------|---|
| Swept waveforms | Function generator waveforms and arbitrary waveforms (except DC) |
| Sweeping form | Linear |
| Sweeping target parameters | Function generator waveforms: Frequency, amplitude, offset, duty cycle (for pulse wave only) (Frequency, amplitude, and offset can be swept simultaneously) Arbitrary waveforms: Clock frequency, amplitude, offset (Clock frequency, amplitude, and offset can be swept simultaneously) |
| Sweeping-time setting range | 10 μ s to 1000 s (setting resolution: 10 μ s) |

3. Specifications of program function

| | |
|---|--|
| Sequence length | Outputs 128 steps with pieced together. |
| Step control | Individual steps can be set to output a function generator waveform, a swept waveform, or an arbitrary waveform. The number of looping times (swept waveforms) or the output length in time (function generator waveforms and arbitrary waveforms) can be set for individual steps. |
| Holding setting | Can be enabled/disabled for individual steps. |
| Output time setting range | 10 μ s to 1000 s (function generator waveforms, arbitrary waveforms) |
| Setting range of the number of sweeping times | 1 to 1000 times (swept waveforms) |
| Setting range of the number of whole looping times | 1 to 50,000 times or infinity |
| Monitor function | The iteration count for the whole loop, the running step number, and the number of sweeping times can be displayed. |

4. Other specifications

| | |
|---|--|
| Synchronization of all channels with one another | Phase settings between channels of individual modules and phase settings between modules can be configured. |
| Self-diagnosis function | Output voltages can be monitored. Monitor resolution: 10 mV Accuracy of monitor: $\pm 3.0\%$ f.s. (f.s. = 15 V) |
| Start/stop of output | Available with soft-key operation and input of signals to the instrument's external control terminal. |
| External input | When a low-level signal is externally input during the use of the program function, the instrument can exit hold mode and proceed to the subsequent step. Control voltage level: 3.5 V to 5.0 V (high level), 0 V to 0.8 V (low level) Responsive pulse width: 100 μ s or more (low level) |
| External output | A signal is output at the time of waveform output. Output type: Open-drain output (equipped with a 5-volt voltage output, active-low) Output voltage level: 4.0 V to 5.0 V (high level), 0 V to 0.5 V (low level) Maximum switching capacity: 5 V to 30 V DC, 50 mA |

| | |
|-----------------------------------|---|
| External I/O terminal | Push-button type terminal block |
| Waveform output indication | A red indicator goes on if waveforms are output; goes off if not. |

 **WARNING**

Touching any of the high-voltage points inside the instrument is very dangerous. Do not attempt to modify, disassemble, or repair the instrument. Doing so may cause a fire, electric shock, or injury.

Calibration

The calibration period varies depending on the state of the instrument and installation environment. We recommend that the calibration period be determined in accordance with the state of the instrument and installation environment. Please contact your authorized Hioki distributor or reseller to have your instrument periodically calibrated.

Backing up the data

The instrument may be initialized (returned to the factory default settings) when it is repaired or calibrated.

Before you ask for repair or calibration, it is recommended to back up (save or record) the measurement conditions and waveform data.

See “4 Saving/Loading Data and Managing Files” in the Instruction Manual.

Precautions During Shipment

Be sure to observe the following precautions:

- To avoid damage to the instrument, remove any accessories and optional equipment from the instrument. Use the original packing materials the instrument was shipped in. Damage that occurs during transportation is not covered by the warranty.
- When sending the instrument for repair, be sure to include a memo that describes the problem in detail.

Replaceable parts and operating lifetimes

The characteristics of some of the parts used in the instrument may deteriorate with extended use. To ensure the instrument can be used over the long term, it is recommended to replace these parts on a periodic basis. When replacing batteries, please contact your authorized Hioki distributor or reseller.

The service life of parts varies with the operating environment and frequency of use. Parts are not guaranteed to operate throughout the recommended replacement cycle.

| Part Name | Recommended replacement cycle | Remarks/conditions |
|--|-------------------------------|--|
| Fan motor | Approx. 5 years | |
| LCD (backlight) (Half-life of brightness) | Approx. 80,000 hours | At an ambient temperature of 25°C The service life varies significantly depending on the ambient environment. In particular, the service life reduces in an environment containing sulfur and halogen, and high temperature environment. |
| Model U8332 SSD Unit | Approx. 1,400 hours | At an ambient temperature of 25°C Total bytes written (TBW): Approx. 300 TB Data retention period: About one year (When the instrument is turned off) Data backup at regular intervals is recommended. |
| Model U8333 HD Unit | Approx. 20,000 hours | — |
| Electrolytic capacitors | Approx. 10 years | Deteriorates in approx. 10 years when the instrument is used in a severe environment (at an ambient temperature of 40°C). |
| Lithium battery | Approx. 10 years | The instrument contains built-in backup lithium batteries, which offer a service life of about 10 years. If the date and time deviate substantially at power-on, it is the time to replace that battery. Contact your authorized Hioki distributor or reseller. |

The fuse is housed in the power unit of the instrument. If the instrument is not powered on, the fuse may be blown. Customers cannot replace the fuse or repair the instrument. Please contact your authorized Hioki distributor or reseller.

6.1 Troubleshooting

If damage is suspected, read the “Before having the instrument repaired” section before contacting your authorized Hioki distributor or reseller.

Before sending the instrument for repair

If the power or operating keys does not operate properly

| Problem | Check item or cause | Remedy | Reference |
|--|--|--|-----------|
| Nothing appears on the screen even if you press the power key. | <ul style="list-style-type: none"> Is the power cord connected? Is the power cord connected correctly? | Check that the power cord is connected properly. | p. 72 |
| The instrument does not operate even if you press the keys. | Is any key being held down? | Check if the keys are stuck. | – |
| | Is the key lock engaged? | Disengage the key lock. | p. 37 |

If the display or behavior shows an abnormality

| Condition | Check item or cause | Remedy | Reference |
|--|--|---|-----------|
| Blank screen | <ul style="list-style-type: none"> Is the display in automatic power-off mode? | Press any key and check if the screen appears. | * |
| The screen does not display any waveforms even if you press the START key. | <ul style="list-style-type: none"> Is the message “Waiting for Pre-Trigger” displayed? Is the message “Waiting for Trigger” displayed? | When the pre-trigger is engaged, the instrument is not triggered while it is writing data in the pre-trigger memory. Recording starts when the instrument is triggered. | p. 85 |
| The displayed waveforms do not change. | <ul style="list-style-type: none"> Are current sensors or connection cords connected correctly? | Check the current sensors and connection cords for disconnection. | p. 44 |
| | <ul style="list-style-type: none"> Is the measurement range suitable for the measurement target? Is the low-pass filter setting configured to be used? | Check the settings of the input channels. | p. 83 |
| During a measurement, the instrument displays waveforms with much lower frequencies than the actual. | <ul style="list-style-type: none"> Aliasing may be exhibited. | Use a faster sampling rate. | p. 81 |
| | | Use [Auto range] to automatically set the measurement range. | p. 91 |

*: “13 Configuring the System Environment Settings” in the Instruction Manual

If the instrument cannot save any data

| Condition | Check item or cause | Remedy | Reference |
|---|---|---|-----------|
| The instrument cannot save any data on a storage device including an SD card. | • Do you use Hioki's optional SD card? | Use Hioki's optional SD card. | p. 5 |
| | • Does the storage device have sufficient free space? • Has the number of files in the folder reached 5,000? | Initialize or replace the storage device. | p. 67 |
| | | Up to 5000 files can be saved in a folder. If you would like to create more files, adjust the quantity. | * |
| | • Is the storage device properly inserted? | Properly insert the storage device. | p. 67 |
| | • Have you formatted the storage device? | Format the storage device before initial use. | p. 70 |

*: "4.4 Managing Files" in the Instruction Manual

If the cause cannot be revealed

Initialize the instrument. All settings are restored to the factory default.
See "6.2 Initializing the Instrument" (p. 155).



6.2 Initializing the Instrument

Choose settings configured on the instrument and restore them to the factory default.

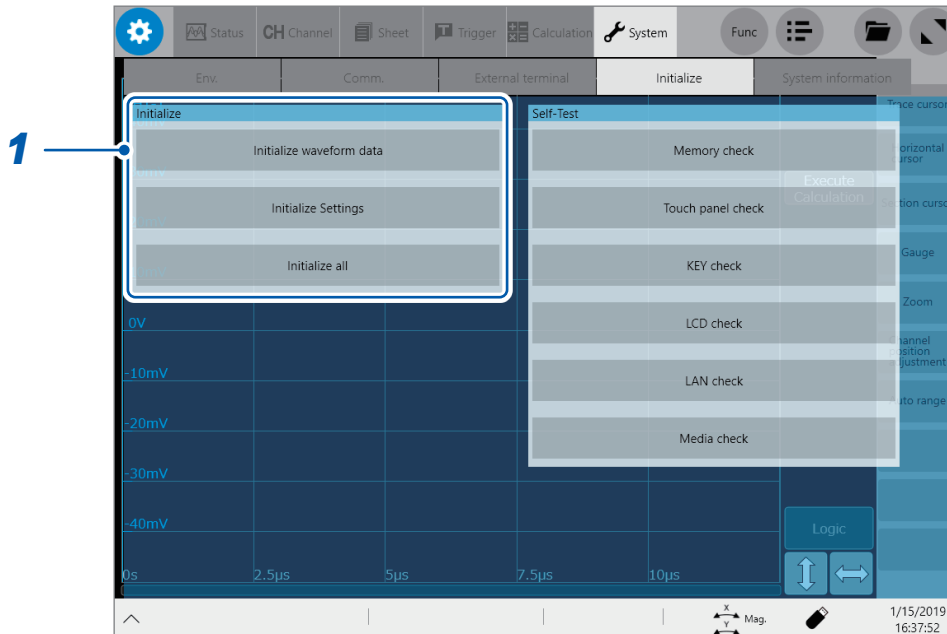
 > [System] > [Initialize]



1 Choose an item to be restored.

| | |
|---------------------------------|--|
| Initialize waveform data | Discards the waveform data saved in the internal memory. |
| Initialize Settings | Restores the settings for measurement, channels, sheets, triggers, and calculation tabs. |
| Initialize all | Restores all the settings to the factory default. However, the following settings are not restored: <ul style="list-style-type: none"> • Display setting ( > [System] > [Env.] > [Customize display]) • Clock setting ( > [System] > [Env.] > [Date and time]) • Computer setting ( > [System] > [Comm.] > [Open PC settings.] |

2 Tap [OK].

6.3 Message

If any problem is found, the screen will display an error message or a warning message. It also displays an information message with advice for usage.

Action that should be taken after a message

If a message remains

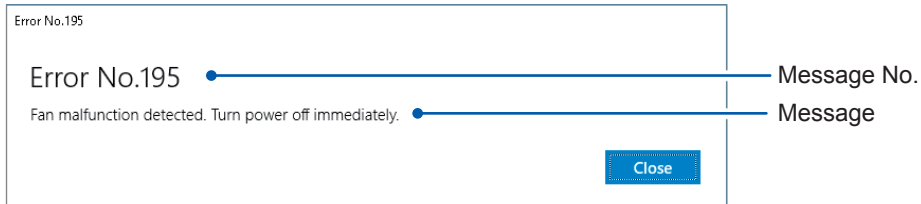

If an error or warning message remains, check the details and tap **[Close]**.

If a message disappears in several seconds

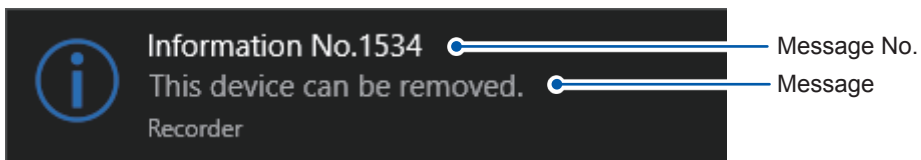

Some of the warning and information messages disappear in a few seconds. Check the details while the screen is displaying the message.

To inform of a message with a beep

Select  > **[System]** > **[Env.]**, and set **[Beep sound]** to **[Alert]** or **[Alert+Action]**.

See "13 Configuring the System Environment Settings" in the Instruction Manual.

Error messages

The list of error messages is as follows. Check the solution.

If an error is displayed on the screen at power-on, the instrument is necessary to be repaired.

Contact your authorized Hioki distributor or reseller.

| No. | Message | Solution | Reference |
|-----|---|--|---|
| 176 | Internal temperature is abnormal. Please turn the power off. | Check the operating temperature environment and the fan rotation, and then send the instrument for repair. | — |
| 195 | Fan malfunction detected. Power off immediately. | High internal temperature may damage the instrument. Immediately turn off the instrument and send the instrument for repair. | — |
| 196 | Change the input unit setup so that the total number of channels of Model 8971 does not exceed 8. | Up to four pieces of Model 8971 Current Unit can be installed in the instrument. Turn off the instrument and change the module configuration. | “2.1 Installing and Removing Modules” (p. 42) |
| 639 | Hardware error | A hardware error is detected. Immediately turn off the instrument and send the instrument for repair. | — |
| 643 | Hardware error | | |
| 644 | Hardware error | | |
| 645 | Hardware error | A hardware error is detected. Immediately turn off the instrument and remove the module. The version of the firmware may be outdated, which does not support the installed modules. Install the latest version of the firmware to update the instrument. When no cause is found in the firmware version, send the instrument and modules for repair. | — |
| 646 | Hardware error | | |
| 647 | Hardware error | | |
| 648 | Hardware error | | |
| 649 | Unit X*: ROM checksum error | A hardware error is detected. Immediately turn off the instrument, remove the corresponding module, and then send them for repair. *: The character “X” indicates the module numbers that has failed (1 through 8). | “2.1 Installing and Removing Modules” (p. 42) |
| 651 | System power supply error. Power off immediately. | A system power supply malfunction detected. Immediately turn off the instrument and send the instrument for repair. | — |
| 652 | Hardware error | A hardware error is detected. Immediately turn off the instrument and send the instrument for repair. | — |

| No. | Message | Solution | Reference |
|-----|---|--|-----------|
| 653 | Processing could not be successfully completed. | An error occurred during an internal process of the instrument. Tap [Shutdown] to turn off the instrument and cycle the instrument. You can continue the measurement by tapping [Continue] ; however, you should turn off the instrument once. | – |

Warning messages

The list of warning messages is as follows. Check the solution.

| No. | Message | Solution | Reference |
|-----|---|--|---|
| 10 | Please insert media. | Insert an SD card or a USB flash drive. | "2.7 Preparing Storage Devices (Recording Media)" (p. 67) |
| 13 | Disk full. | The instrument cannot save any files because of insufficient free space on the storage device. Delete unnecessary files to free up enough space or use a new storage device. | "2.7 Preparing Storage Devices (Recording Media)" (p. 67) "4.4 Managing Files" in the Instruction Manual |
| 14 | Cannot load this file. | The chosen file cannot be loaded. | "4.3 Loading Data" in the Instruction Manual |
| 15 | Unable to access file. | Check that the storage device is properly inserted. | "2.7 Preparing Storage Devices (Recording Media)" (p. 67) |
| 22 | No waveform data to save. | Perform another measurement or load a file. | "4.3 Loading Data" in the Instruction Manual |
| 25 | This device cannot be removed. | The instrument is accessing the device. After the SAVE key is turned off remove the device. | "1.2 Name and Function of Each Part" (p. 24) |
| 30 | Auto-ranging failed. | Check the input signals. | "3.7 Measuring Signals With the Automatic Ranging Setting" (p. 91) |
| 31 | Invalid section cursor position. | Section cursors are placed at improper positions (outside the waveform range). Check the section cursor positions. | "2.4 Scrolling Through Waveforms" in the Instruction Manual |
| 44 | No event mark. | Put an event mark. | "15.1 External Input and Output" in the Instruction Manual |
| 45 | Out of range. | – | – |
| 60 | No waveform data. | Acquire waveform data. | – |
| 70 | Voltage Sag triggering is disabled (valid time base range: 2 kS/s to 100 MS/s). | You can use the voltage sag trigger setting only when the sampling rate is set to one from 2 kS/s to 100 MS/s. | "5.6 Triggering the Instrument Using Analog Signals" in the Instruction Manual |
| 74 | Auto balance failed. | Check if the strain gauge transducer is not loaded, or if it is correctly connected. | "Strain gauge transducer" (p. 48) |
| 78 | Recording length is too long. | For waveform calculation, the recording length have to be 5,000,000 points or less. Shorten the recording length. | "3.2 Setting Measurement Conditions" (p. 80) |
| 83 | No channel selected for use. | Set the [Use] buttons on one or more of the channels to [On] . | "Analog channels" in Section 1.3 in the Instruction Manual |
| 85 | Invalid search condition. | Check the search condition settings. | "6 Search Function" in the Instruction Manual |
| 112 | Aborted. | – | – |

| No. | Message | Solution | Reference |
|-----|--|--|--|
| 113 | Save processing was interrupted. | Real-time saving has been canceled due to slow writing speed to the storage device. Check solutions below before measurement. <ul style="list-style-type: none"> • Choose a slower sampling speed. • Reduce the number of saving channels. • Replace with a storage device that has a faster writing speed. | "4.2 Saving Data" in the Instruction Manual |
| 123 | No data matching the search criteria has not been found. | Check the search criteria setting. | "6 Search Function" in the Instruction Manual |
| 124 | No waveform, or recording length is not long enough. | Acquire waveform data. Otherwise, specify a correct recording length. | "3.2 Setting Measurement Conditions" (p. 80) "1.2 Setting Measurement Conditions" in the Instruction Manual |
| 207 | Server not connect. | There may be an error in the FTP client configuration, cable connection, or firewall configuration of a connected computer, resulting in faulty connection. | "14 Connecting the Instrument to Computers" in the Instruction Manual |
| 208 | Server communication error. | Communication may be unstable, or the instrument may not support the email or FTP servers running on the server. The connection may be established by enabling PASV for the FTP or changing the server security setting. | "14 Connecting the Instrument to Computers" in the Instruction Manual |
| 209 | LAN disconnected. | Check the network environment. | "14 Connecting the Instrument to Computers" in the Instruction Manual |
| 210 | LAN timed out. | Check the network environment. | "14 Connecting the Instrument to Computers" in the Instruction Manual |
| 211 | LAN authentication required. | Email or FTP server authentication is required. Enable the authentication. | "14 Connecting the Instrument to Computers" in the Instruction Manual |
| 212 | LAN authentication failed. | Login to email or FTP server failed. The user name or password may be incorrect. | "14 Connecting the Instrument to Computers" in the Instruction Manual |
| 213 | Authentication setup invalid. | The user name or password for email authentication has not been set. | "14 Connecting the Instrument to Computers" in the Instruction Manual |
| 214 | Encryption password not set. | Encryption is enabled, but a password has not been set. | "14 Connecting the Instrument to Computers" in the Instruction Manual |
| 215 | Invalid server address. | Check the address setting. | "14 Connecting the Instrument to Computers" in the Instruction Manual |
| 216 | POP3 Server not found. | Check the POP3 server address. | "14 Connecting the Instrument to Computers" in the Instruction Manual |

| No. | Message | Solution | Reference |
|-----|--|--|---|
| 217 | Cannot connect to POP3 Server. | Check the POP3 server address. POP3 may not be running on the specified server. | "14 Connecting the Instrument to Computers" in the Instruction Manual |
| 218 | E-mail 'to' or 'from' settings invalid. | Check the recipient's and sender's addresses of the email setting. | "14 Connecting the Instrument to Computers" in the Instruction Manual |
| 219 | E-mail recipient error. | The server refused to send the email to the recipient. Check the recipient's address. | "14 Connecting the Instrument to Computers" in the Instruction Manual |
| 221 | The sent e-mail size exceeds the limit. | The email size exceeds limits. Reduce the recording length or increase the size setting. | "14 Connecting the Instrument to Computers" in the Instruction Manual |
| 222 | E-mail size exceeds server limits. | The sent email size exceeds the email server limit. Reduce the recording length or change the attachment contents. | "14 Connecting the Instrument to Computers" in the Instruction Manual |
| 223 | FTP transfer failed. | Check the network environment. The FTP server may have rejected the file. Check the FTP server setting. For example, creating a directory (DIR) or file is prohibited, or the server is full. | "14 Connecting the Instrument to Computers" in the Instruction Manual |
| 224 | E-mail transfer failed. | Check the network environment. The email server may have rejected the email message. Check the transmission condition of the email server. For example, the size or the number of mails reaches the limit of the server. | "14 Connecting the Instrument to Computers" in the Instruction Manual |
| 225 | Data send aborted. | The transmission is aborted. Incomplete data may have been transmitted via FTP or email. Check the transmitted data. | "14 Connecting the Instrument to Computers" in the Instruction Manual |
| 226 | Network error. | A network error occurred during communication. Check the network environment. | "14 Connecting the Instrument to Computers" in the Instruction Manual |
| 232 | File processing could not be successfully completed. | An unexpected error occurred while a file is being processed in the SD card or USB flash drive. Replace the storage device with another or cycle the instrument. | "2.7 Preparing Storage Devices (Recording Media)" (p. 67) |
| 241 | File processing error. | | |
| 601 | Zero-adjustment required. | Execute zero-adjustment. | "2.11 Executing Zero-Adjustment" (p. 75) |
| 606 | Current sensor recognized. | – | – |
| 607 | Current sensor removed. | Check the connection of the current sensors. | – |
| 616 | Search target channel has no data. | Perform another measurement or load a file. | "4.3 Loading Data" in the Instruction Manual |
| 626 | Numerical calculation function has been turned off. | Numerical calculation is not available when the envelope is in use. | "7 Numerical Calculation Function" in the Instruction Manual |

| No. | Message | Solution | Reference |
|-----|---|--|--|
| 630 | Remaining clamp current that can be supplied from Z5021 Current Clamp's power supply terminal is A [A]. | When Model 8971 Current Unit or U8977 3CH Current Unit is installed, the instrument automatically recognizes connected current sensors to total their current consumption and displays the current available capacity. Choose current sensors to be connected depending on the current capacity displayed. | "2.3 Supplying Power to Current Sensors" (p. 61) |
| 631 | Total clamp current that can be supplied from Z5021 Current Clamp's power supply terminal is 4.8 [A]. | The instrument does not recognize any current sensors connected because neither Model 8971 Current Unit or U8977 3CH Current Unit is installed. Choose current sensors to be connected so that the total current consumption does not exceed 4.8 A. | "2.3 Supplying Power to Current Sensors" (p. 61) |
| 634 | Digital filter calculation function has been turned off. | The real-time waveform and digital filter calculations cannot simultaneously be used. | - |
| 635 | Real-time waveform calculation function has been turned off. | | |
| 640 | Number of search results exceeded 1000. Search has been canceled. | The instrument can display up to 1000 search results. | "6 Search Function" in the Instruction Manual |
| 641 | Insufficient data to perform search. | Check the scope of search. | "6 Search Function" in the Instruction Manual |
| 642 | Unable to capture a stable fundamental wave. | Check the setting for the fundamental wave. | "6 Search Function" in the Instruction Manual |
| 650 | Cannot set numerical value. Check the setting of upper and lower limits. | - | - |

6.4 Self-check

Executing the self-check function checks the instrument for malfunctions. The self-check consists of the following checks:

 > [System] > [Initialize]

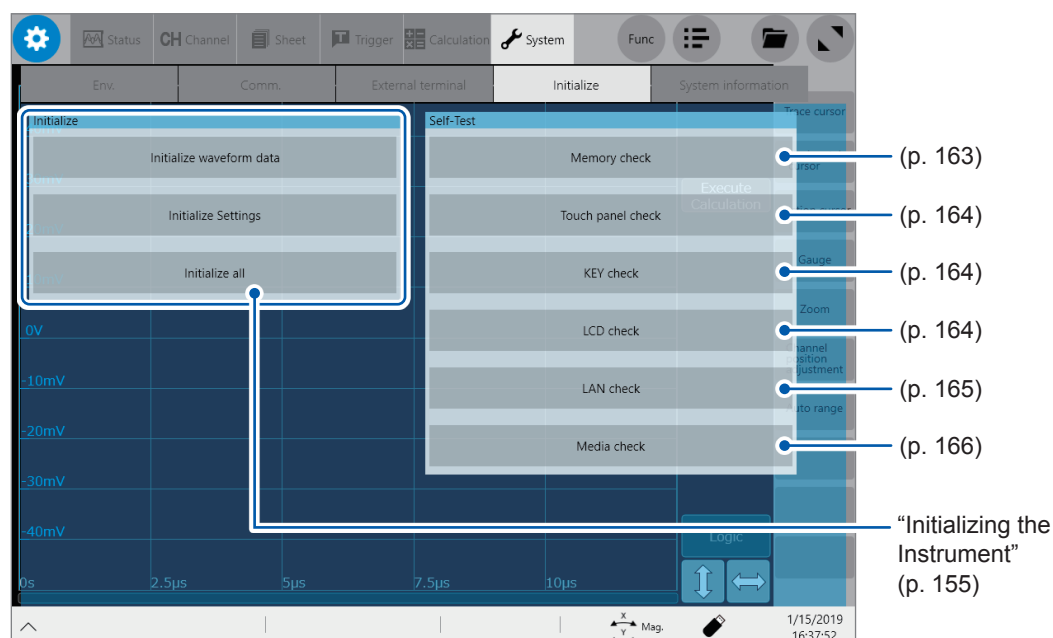

Memory check

This function checks the storage memory, backup memory (SRAM memory), and calculation memory (DSP memory).

IMPORTANT

- Save waveform data in a storage device before performing the memory check. Any waveform data will be deleted after the memory check.
- Do not turn off the instrument during the memory check.

1 Tap [Memory check].

2 Tap [Execute].

The memory check starts.

To cancel the check:

Pressing the **STOP** key interrupts the item being checked.
Pressing the operation keys other than the **STOP** key is ignored.
The results are displayed once the memory check has been complete.

| | |
|---------------|--|
| PASS | The instrument has passed the check. |
| FAIL | The instrument has failed the check. Send it for repair. |
| Cancel | One of the items was interrupted. |

Touch panel check

This check tests the touch panel for proper operation.

1 Tap [Touch panel check].

The sides to be checked go white.

2 Place your finger on a mark on the edge of a side and trace the side to the other mark on the side.

When the mark changes [✓], release your finger.

The screen displays the test conclusion after all of the marks have changed to [✓].

| | |
|------|---|
| PASS | The touch panel had passed the check. |
| FAIL | The touch panel has failed the check. Send instrument for repair. |

Key check

This check tests the keys and rotary knobs for proper operation.

1 Tap [KEY check].

2 Press each operation key once or several times.

The corresponding key is highlighted.

3 Turn the rotary knob clockwise and counterclockwise one or more times each.

Operating all of the keys completes the check.

To cancel the check:

Tapping [Close] redisplay the previous screen.

LCD check

This check tests the display for proper operation.

1 Tap [LCD check].

The screen becomes uniformly red.

2 Tap the screen or press any key to check the display state.

Every operation changes the screen in the following order, eventually redisplay the original screen. Red, green, blue, black, and white.

LAN check

This check tests the LAN cable for malfunction such as disconnection.

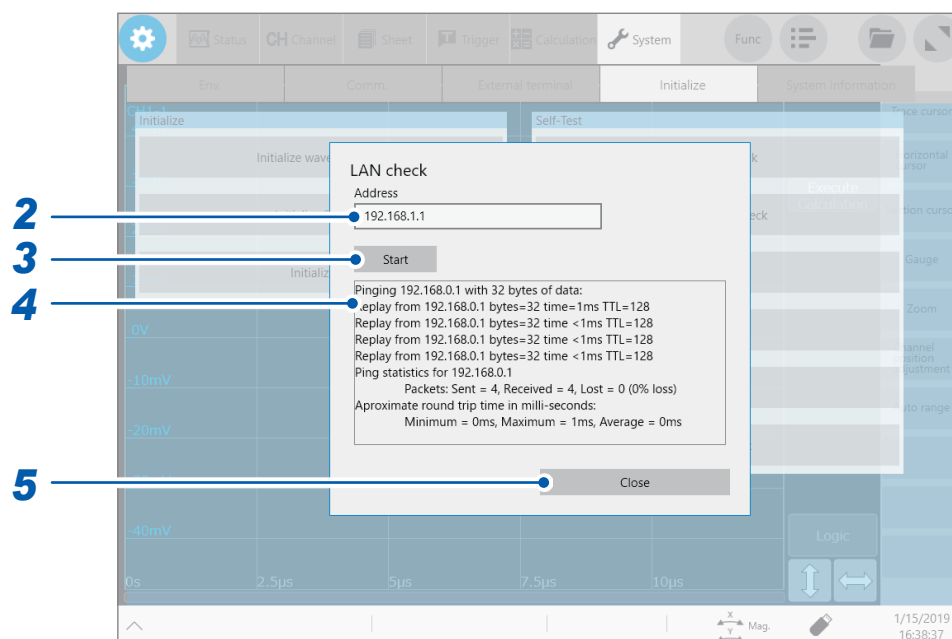

- 1 Tap [LAN check].
- 2 Enter an IP address used for connecting to LAN in the [Address] box.
- 3 Tap [Start].
- 4 Check the transmission/reception result on the screen.
- 5 Tap [Close].

Media check

This check tests the storage devices for malfunction.

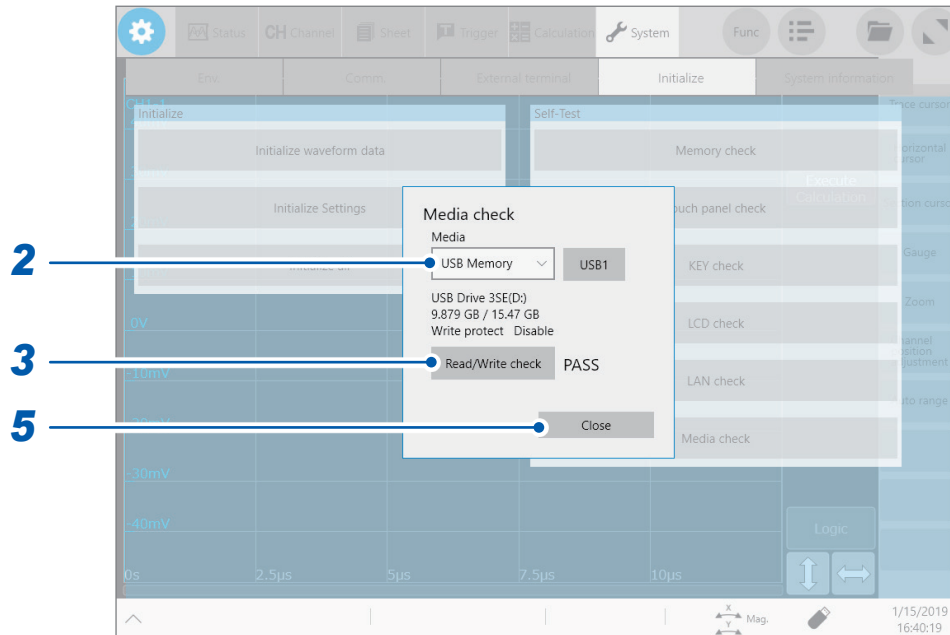

- 1** Tap **[Media check]**.
- 2** Tap the **[Media]** box and choose a storage device from the list.
The screen displays the information of the chosen storage device.
- 3** Tap **[Read/Write check]**.
The read/write check starts.
- 4** Check the transmission/reception result on the screen.
- 5** Tap **[Close]**.

System configuration check

You can check the functions and devices installed in the instrument in a list.

 > [System] > [System information]

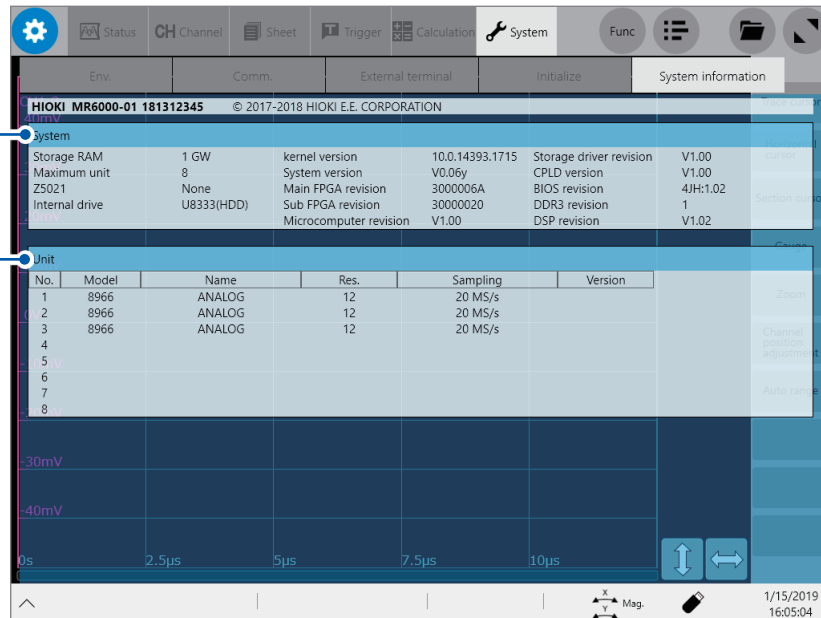

| No. | Item | Description |
|-----|-----------------------------|---|
| 1 | System configuration | You can check the system configuration, software version, and board version of the instrument. |
| 2 | Module configuration | You can check the model number, name, resolution, sampling rate, and firmware version number of each module (unit) installed in the instrument. |

6.5 Cleaning the Instrument

To clean the instrument and modules, wipe it gently with a soft cloth moistened with water or mild detergent. Wipe the LCD gently with a soft, dry cloth.

IMPORTANT

Never use solvents such as benzene, alcohol, acetone, ether, ketone, thinners or gasoline. Doing so could deform and discolor the instrument.

CAUTION



Clean the vents periodically to avoid blockage.

When the vents get clogged, the instrument's internal cooling effect is hampered, and this can lead to damage to the instrument.

6.6 Disposing of the Instrument (Removing the lithium battery)

When disposing of this instrument, remove the lithium battery and dispose of the battery and instrument in accordance with local regulations. The instrument contains the lithium battery for memory backup.

WARNING



To avoid an electric shock, turn off the instrument and disconnect any connection cords from the instrument before removing the lithium battery.



Do not short-circuit, recharge, disassemble or dispose of them in fire. The battery may explode if mistreated.



Keep batteries away from children to prevent accidental swallowing.

CALIFORNIA, USA ONLY
Perchlorate Material - special handling may apply.
See <https://dtsc.ca.gov/perchlorate/>

Removing the lithium battery

Required tools:

Flat-head screwdriver (No.2), Torx screwdriver (T10), hex wrench (2.5), and nippers (one each)

- 1 Turn off the instrument and remove any cords and storage media.**
- 2 Remove rear and left panels.**
Pushing the left panel downward enables easy removal from the body.
- 3 Remove right panel.**
Pushing the right panel downward enables easy removal from the body.
- 4 Remove the handle.**
- 5 Remove the cover of the media box.**
- 6 Remove the upper panel.**
- 7 Use nippers to remove the lithium battery from the board.**
Pull the lithium battery up from the circuit board, and cut the positive and negative leads with the nippers.

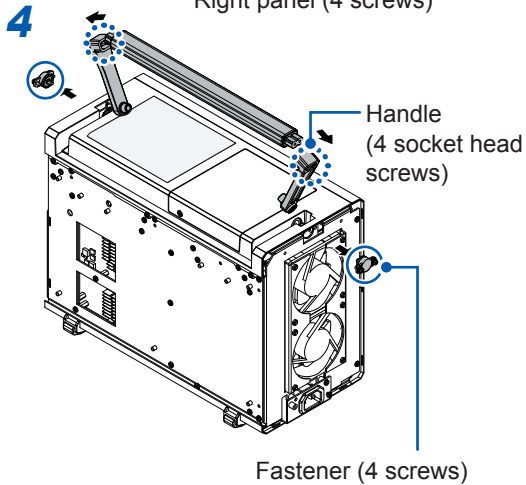
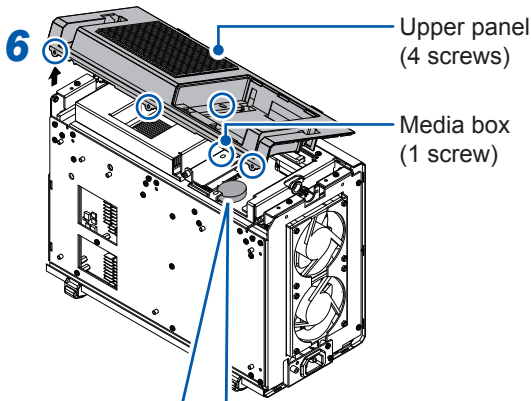
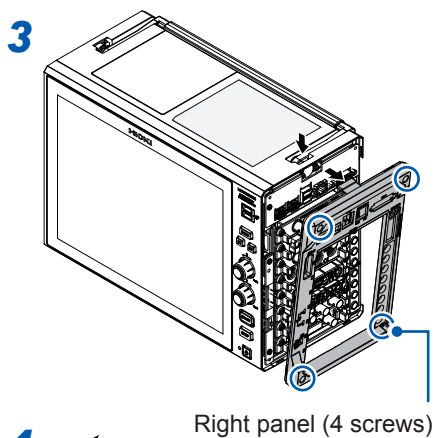
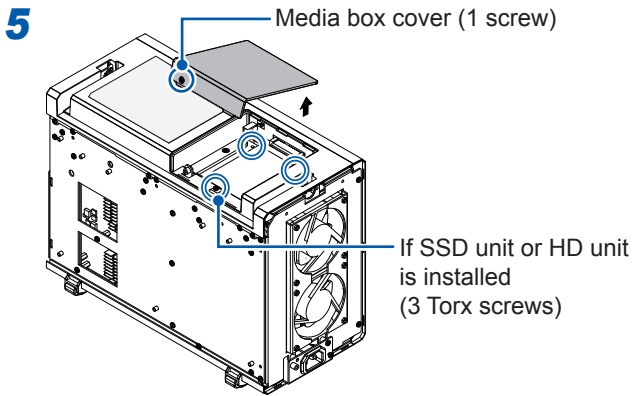
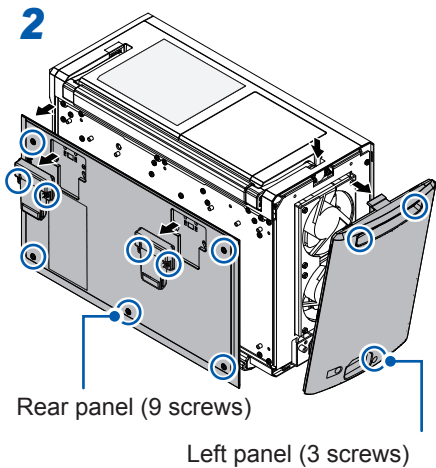

7 Lithium battery

Do not connect the positive and negative (positive and chassis) with each other.

Tools used

- : Phillips-head screwdriver (No.2)
- ⊙ : Torx screwdriver (T10)
- ⊛ : Hex wrench (2.5)

6.7 Open-source software

This instrument includes software to which GNU General Public License and other licenses are applied.

You have the right to obtain, modify, and redistribute the source code of the software under there license.

For details, visit the following website:

<https://www.hioki.com/en/support/oss/>

Hioki would prefer you not to direct any inquiries on the content of the source code.

Index

When the reference pages of an index entry include "Instruction Manual," please also see the Index pages of the Instruction Manual.

A

| | |
|---------------------------|----|
| Acceleration sensor | 55 |
| Aliasing | 81 |
| Analog channel | 82 |
| Automatic ranging | 91 |
| Automatic saving | 88 |

B

| | |
|----------------------|-----|
| Beep | 156 |
| Blank panel | 13 |
| BMP | 90 |
| Built-in drive | 68 |

C

| | |
|-----------------------|------------|
| Calibration | 77 |
| Carrying case | 5 |
| Channel number | 43 |
| Clock | 74 |
| Comment | 39, 83 |
| Computer | 65, 97 |
| Connection cord | 12, 44, 45 |
| Current sensor | 50, 61 |

D

| | |
|-----------------------|--------------------|
| Date and time | 74 |
| Display setting | Instruction Manual |
| Disposal | |
| Lithium battery | 168 |

E

| | |
|---------------------------------|--------------------|
| Email transmission | Instruction Manual |
| Error | 157 |
| External control terminal | 63 |
| External sampling | 62 |
| External trigger | 64 |
| EXT.SMPL | 19, 62 |
| EXT.TRIG | 19, 64 |

F

| | |
|---------------------------------|--------------------|
| File management | Instruction Manual |
| File screen | Instruction Manual |
| File size | Instruction Manual |
| Format | 70 |
| FTP transfer | Instruction Manual |
| Functional earth terminal | 72 |

H

| | |
|---------------------|----|
| Help function | 37 |
|---------------------|----|

I

| | |
|-----------------------------------|--------|
| IN1 | 19, 64 |
| IN2 | 19, 64 |
| Initializing the instrument | 155 |
| Input channel | 82 |

K

| | |
|-----------------|-----|
| Key check | 164 |
| Key lock | 37 |

L

| | |
|-----------------------|--------|
| LAN | 65 |
| LCD check | 164 |
| Level trigger | 85 |
| Lithium battery | 168 |
| Logic probe | 18, 57 |
| Low-pass filter | 84 |
| L.P.F | 84 |

M

| | |
|---|--------------------|
| Magnification/demagnification ratio | 32 |
| Maximum input voltage | 11 |
| Maximum rated voltage to earth | 11 |
| Measurement range | 83 |
| Measurement target | 44 |
| Media box | |
| How to open | 71 |
| Memory check | 163 |
| Model 9665 10:1 Probe | 46 |
| Model 9666 100:1 Probe | 46 |
| Model U8332 SSD Unit | 68, 117 |
| Model U8333 HD Unit | 68, 118 |
| Model Z5021 Probe Power Unit | 61, 117 |
| Module | 5, 42 |
| Ratings of modules | 11 |
| Module-specific setting | Instruction Manual |
| Mouse | 38 |

N

| | |
|-----------------------------|--------------------|
| Number of points | 80 |
| Numerical calculation | Instruction Manual |

O

| | |
|-------------|--------|
| Option..... | 5 |
| OUT1..... | 19, 64 |
| OUT2..... | 19, 64 |

P

| | |
|---------------------------------------|----|
| Power key..... | 73 |
| Probe compensation signal output..... | 46 |
| Probe ratio..... | 84 |

Q

| | |
|------------------------|----|
| Quick-access menu..... | 36 |
| Quick saving..... | 88 |

R

| | |
|--|-----|
| Replaceable parts and operating lifetimes..... | 152 |
|--|-----|

S

| | |
|----------------------------------|--------------------|
| Sampling rate..... | 32, 80 |
| SAVE key..... | 88, 89 |
| Save type..... | 88, 90 |
| Saving data | |
| Automatic saving..... | 88 |
| Quick saving..... | 88 |
| Screenshot..... | 89 |
| Selective saving..... | 88 |
| Scaling..... | Instruction Manual |
| Scrolling through waveforms..... | 96 |
| SD memory card..... | 67 |
| Search..... | Instruction Manual |
| Selective saving..... | 88 |
| Self-check..... | 163 |
| Sheet selection..... | Instruction Manual |
| Sheet setting..... | Instruction Manual |
| Shortcut key..... | Instruction Manual |
| SMB cable..... | 62 |
| START key..... | 87 |
| STOP key..... | 87 |
| Storage device..... | 67 |
| System protection..... | Instruction Manual |

T

| | |
|---------------------|--------|
| Thermocouple..... | 47 |
| Touch keyboard..... | 39 |
| Rotary knob..... | 32 |
| Touch panel..... | 31 |
| Trace cursor..... | 93 |
| Trigger..... | 85 |
| TRIG.OUT..... | 19, 64 |

U

| | |
|----------------------|----|
| USB flash drive..... | 68 |
|----------------------|----|

W

| | |
|----------------------|-----|
| Warm-up..... | 72 |
| Warning..... | 159 |
| Waveform..... | 59 |
| Waveform viewer..... | 97 |

Z

| | |
|----------------------|----|
| Zero-adjustment..... | 75 |
| Zoom in..... | 96 |
| Zoom out..... | 96 |

Warranty Certificate

HIOKI

| | | |
|-------|---------------|--|
| Model | Serial number | Warranty period Three (3) years from date of purchase (___ / ___) |
|-------|---------------|--|

Customer name: _____

Customer address: _____

Important

- Please retain this warranty certificate. Duplicates cannot be reissued.
- Complete the certificate with the model number, serial number, and date of purchase, along with your name and address. The personal information you provide on this form will only be used to provide repair service and information about Hioki products and services.

This document certifies that the product has been inspected and verified to conform to Hioki's standards.

Please contact the place of purchase in the event of a malfunction and provide this document, in which case Hioki will repair or replace the product subject to the warranty terms described below.

Warranty terms

1. The product is guaranteed to operate properly during the warranty period (three [3] years from the date of purchase).
If the date of purchase is unknown, the warranty period is defined as three (3) years from the date (month and year) of manufacture (as indicated by the first four digits of the serial number in YYMM format).
2. If the product came with an AC adapter, the adapter is warrantied for one (1) year from the date of purchase.
3. The accuracy of measured values and other data generated by the product is guaranteed as described in the product specifications.
4. In the event that the product or AC adapter malfunctions during its respective warranty period due to a defect of workmanship or materials, Hioki will repair or replace the product or AC adapter free of charge.
5. The following malfunctions and issues are not covered by the warranty and as such are not subject to free repair or replacement:
 - 1. Malfunctions or damage of consumables, parts with a defined service life, etc.
 - 2. Malfunctions or damage of connectors, cables, etc.
 - 3. Malfunctions or damage caused by shipment, dropping, relocation, etc., after purchase of the product
 - 4. Malfunctions or damage caused by inappropriate handling that violates information found in the instruction manual or on precautionary labeling on the product itself
 - 5. Malfunctions or damage caused by a failure to perform maintenance or inspections as required by law or recommended in the instruction manual
 - 6. Malfunctions or damage caused by fire, storms or flooding, earthquakes, lightning, power anomalies (involving voltage, frequency, etc.), war or unrest, contamination with radiation, or other acts of God
 - 7. Damage that is limited to the product's appearance (cosmetic blemishes, deformation of enclosure shape, fading of color, etc.)
 - 8. Other malfunctions or damage for which Hioki is not responsible
6. The warranty will be considered invalidated in the following circumstances, in which case Hioki will be unable to perform service such as repair or calibration:
 - 1. If the product has been repaired or modified by a company, entity, or individual other than Hioki
 - 2. If the product has been embedded in another piece of equipment for use in a special application (aerospace, nuclear power, medical use, vehicle control, etc.) without Hioki's having received prior notice
7. If you experience a loss caused by use of the product and Hioki determines that it is responsible for the underlying issue, Hioki will provide compensation in an amount not to exceed the purchase price, with the following exceptions:
 - 1. Secondary damage arising from damage to a measured device or component that was caused by use of the product
 - 2. Damage arising from measurement results provided by the product
 - 3. Damage to a device other than the product that was sustained when connecting the device to the product (including via network connections)
8. Hioki reserves the right to decline to perform repair, calibration, or other service for products for which a certain amount of time has passed since their manufacture, products whose parts have been discontinued, and products that cannot be repaired due to unforeseen circumstances.

HIOKI E.E. CORPORATION

<http://www.hioki.com>

18-07 EN-3

HIOKI
www.hioki.com/



**All regional
contact
information**

HIOKI E.E. CORPORATION
81 Koizumi, Ueda, Nagano 386-1192 Japan

2402 EN

Edited and published by HIOKI E.E. CORPORATION

Printed in Japan

- Contents subject to change without notice.
- This document contains copyrighted content.
- It is prohibited to copy, reproduce, or modify the content of this document without permission.
- Company names, product names, etc. mentioned in this document are trademarks or registered trademarks of their respective companies.

Europe only

- EU declaration of conformity can be downloaded from our website.
- Contact in Europe: HIOKI EUROPE GmbH
Helfmann-Park 2, 65760 Eschborn, Germany hioki@hioki.eu