

HIOKI

MEMORY HILOGGER LR8450, LR8450-01



Wireless* data logging at 1 kS/s (1 ms)

330-channel portable logger
available with your choice of plug-in modules and wireless* modules

* LR8450-01 only

NEW



Voltage
1 kS/s (1 ms)

Strain
1 kS/s (1 ms)

Temperature
100 S/s (10 ms)

Humidity
100 S/s (10 ms)

Resistance
100 S/s (10 ms)

CAN
100 S/s (10 ms)

Current
1 kS/s (1 ms)



Instruments with firmware version 2.20 and later support Current measurement.
(Measurement photographs for illustrative purposes only.)

Two models: Standard Model and Wireless LAN Model

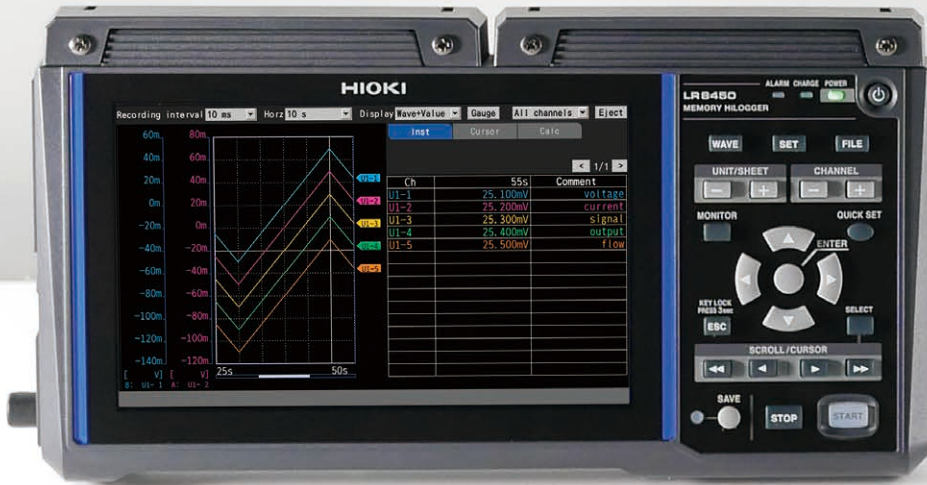

Standard model (designed for use with plug-in modules only) LR8450

You can add up to 4 plug-in modules which provides 120 channels of measurement



Configuration example:
120 channels of analog input

Plug-in units

VOLTAGE/TEMP UNIT U8552 × 4

Each VOLTAGE/TEMP UNIT U8552 accepts 30 channels of input. Add four units for 120 channels of measurement.

Depending on various scenes, you can freely combine seven types of plug-in modules

Measurement target	CAN 100 S/s (10 ms)
Current kS/s (1 ms)	Voltage kS/s (1 ms)
Temperature 100 S/s (10 ms)	Strain kS/s (1 ms)
Humidity 100 S/s (10 ms)	Resistance 100 S/s (10 ms)

Analog input



Configuration example:
60 channels of analog input +
1,000 channels of CAN input

Plug-in units

VOLTAGE/TEMP UNIT U8552 × 2
CAN UNIT U8555 × 2

Each VOLTAGE/TEMP UNIT U8552 accepts 30 channels of input. Each CAN UNIT U8555 accepts 500 channels of input.

Wireless LAN model

Add channels freely via either plug-in or wireless modules

Can also be used exclusively with wireless modules



Wireless LAN model LR8450-01

Add up to 7 wireless modules in total for a maximum of 330 channels

Configuration example: 330 channels

Plug-in modules

VOLTAGE/TEMP UNIT U8552 × 4



+

Wireless modules

WIRELESS VOLTAGE/TEMP UNIT LR8532 × 7



With four U8552 VOLTAGE/TEMP UNITS and seven LR8532 WIRELESS VOLTAGE/TEMP UNITS, you can measure a total of 330 channels.

Mix plug-in and wireless modules

Mixing and matching plug-in modules and wireless modules will allow you to build a measurement system that suits your needs.*1

If wireless modules are used with other modules (wireless or plug-in), the sampling-timing shift between the units is periodically corrected.*2

In addition, at times when the wireless communication is cut off, the correction function works after the communication is restored and the sampling-timing shift between the modules is corrected.

*1 Up to four CAN modules can be used at the same time. (Plug-in and wireless modules may be used in any combination.)

*2 Even in good wireless communication conditions (low interference) the sampling-timing between modules may shift about 20 ms. In bad wireless conditions, the sampling-timing shift will be much worse than this.

Visualize energy loss with multi-point current consumption measurement

Power management tools for e-mobility: a current consumption recording solution that can access auxiliary components

..... The first step to improving efficiency is assessing the status quo.

Beyond their motors, electric vehicles (EVs) incorporate a variety of electronic components such as ECUs, all of which consumes electrical energy. To extend these vehicles' ranges, it's necessary to eliminate wasteful energy loss. The best way to accurately assess the actual energy consumption of ECUs and other electrical components is to make measurements after their installation in the host vehicle.

?A

Power management for ECUs and electrical components

- ECUs
- Windshield wipers
- Power windows
- Heaters
- Headlamps
- Cooling fans
- Interior lighting
- Sensors
- Audio systems
- And more...

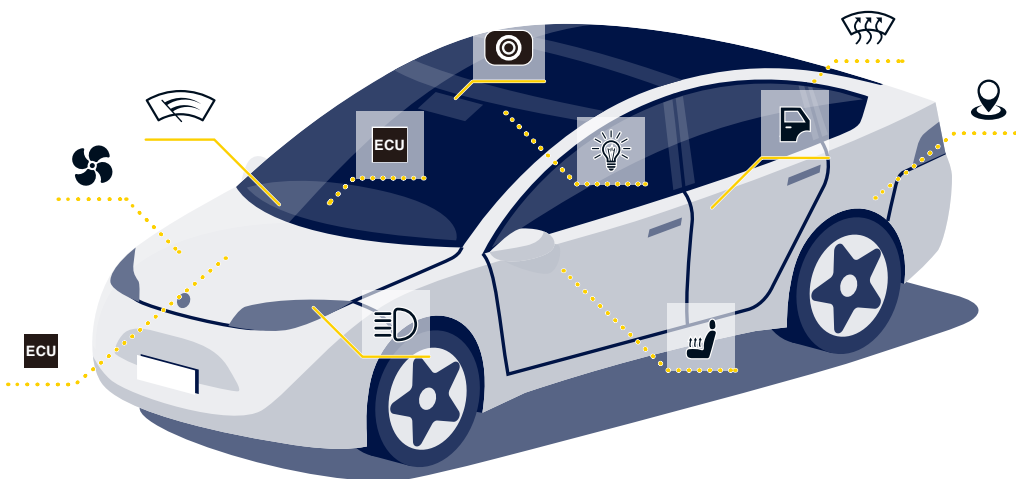

Hioki measurement solution

Read on to learn more about a solution that uses Hioki products. The LR8450 makes it easy to perform multi-point measurement in vehicles using current modules and current sensors. Recorded current consumption data can be used to identify areas for improvement, helping eliminate energy loss.

Simultaneous multi-point measurement

Use the LR8450-01 and current modules to measure up to 55 channels^{*1} with a single instrument.



Compact, lightweight clamp-on sensors

- Ideal for use with dense wiring
- Broad operating temperature range of -40°C to 85°C (-40°F to 185°F)
- Capable of high-accuracy DC current measurement



Wireless modules

- Compact, so you can position them close to the circuit under measurement
- About 5 hr.^{*2} of continuous operation on battery power

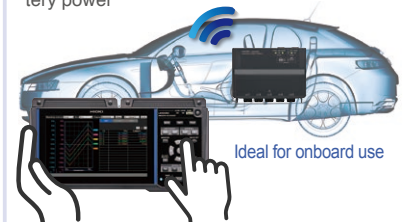

Data example

Current consumption testing in an operating vehicle

By measuring current under actual conditions of an operating vehicle, you can analyze and verify component operation, timing, and maximum load conditions.

*1 LR8450-01 equipped with the maximum of four plug-in modules and seven wireless modules

*2 With Battery Pack Z1007 and the module-maximum of five current sensors

Current modules used

NEW

Sample current every 1 ms

The high speed is ideal for checking operation timing and current consumption of ECUs and electrical components. Up to five channels (per module) can be sampled simultaneously.



CURRENT MODULE U8556



WIRELESS CURRENT MODULE LR8536

Measure a broad range of current magnitudes, from, high-current-consumption pumps and air-conditioning components to low-current-consumption interior accessories and ECUs.

Current sensors used

NEW

One of the industry's smallest current sensors

These current sensors, which use the flux gate detection method^{*1}, deliver high performance despite their extremely small size. Designed so that their clamp can be opened and closed with a single hand, they also offer exceptional ease of use.

*1 The current sensor of zero flux method (fluxgate detection type) achieves high performance (high accuracy, wide bandwidth, and wide operating temperature range) by combining the fluxgate and the negative feedback circuit.



Rated current: 2 A AC/DC
AC/DC CURRENT SENSOR CT7812



Rated current: 20 A AC/DC
AC/DC CURRENT SENSOR CT7822

Compact

Compare with size of hand

Sliding action
φ5 mm
77 mm
11.5 mm
Size

Broad operating temperature range

-40°C to +85°C
(-40°F to 185°F)

High accuracy for DC too	accuracy	resolution
CT7812 AC/DC 2 A	±0.38% rdg. ±0.0037 A	2 A range 0.0002 A
CT7822 AC/DC 20 A	±0.38% rdg. ±0.037 A	20 A range 0.002 A

Supported current sensors

Output connector: Hioki PL14

- Choose the model that suits your application from a selection whose ratings range from leakage-current-level currents to 6000 A
- Switch between instantaneous and RMS values via LR8450 settings

DC AC	CT7812 NEW	CT7822 NEW	CT7731 (Auto-zero)	CT7736 (Auto-zero)	CT7742 (Auto-zero)		
	 φ 5 mm 2 A	 φ 5 mm 20 A	 φ 33 mm 100 A	 φ 33 mm 600 A	 φ 55 mm 2000 A		
AC	CT7126	CT7131	CT7116	CT7136	CT7044	CT7045	CT7046
	 φ 15 mm 60 A	 φ 15 mm 100 A	 φ 40 mm 6 A (for leakage current)	 φ 46 mm 600 A	 φ 100 mm 6000 A	 φ 180 mm 6000 A	 φ 254 mm 6000 A

Voltage measurement



Measure outputs from a pressure sensor and other sensors at 1 kS/s max. sampling rate (1 ms interval sampling)

1 kS/s sampling is necessary to record outputs of several tens of Hertz from pressure sensors and vibration sensors.



HIGH SPEED VOLTAGE UNIT U8553



WIRELESS HIGH SPEED VOLTAGE UNIT LR8533

Temperature measurement



Measure temperature near inverters and batteries at a sampling rate of up to 100 S/s (10 ms interval sampling)



VOLTAGE/TEMP UNIT U8550
UNIVERSAL UNIT U8551
VOLTAGE/TEMP UNIT U8552(*)



WIRELESS VOLTAGE/TEMP UNIT LR8530
WIRELESS UNIVERSAL UNIT LR8531
WIRELESS VOLTAGE/TEMP UNIT LR8532(*)

* Sampling rate of 100 S/s (10 ms) is available when using 15 or fewer channels.

Consistent sampling rate even with added modules

Each module incorporates its own A/D converter. This design keeps the maximum sampling rate high even when Modules are added.

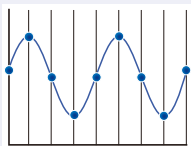

Example 1: use four U8553 HIGH SPEED VOLTAGE UNITS (with 5 channels each) to measure 20 channels at a sampling rate of 1 kS/s (1 ms).

Example 2: Use four U8550 VOLTAGE/TEMP UNITS (with 15 channels each) to sample 60 channels at a sampling rate of 100 S/s (10 ms).

Consistent noise resistance even with added modules

Since increasing the number of modules has no effect on the cutoff frequency, which changes with the sampling rate, power supply noise can be reduced without sacrificing noise resistance.

(ex.) Sampling rate: 1 S/s

Number of channels	Cutoff frequency
1 ch to 15 ch	60 Hz
16 ch to 30 ch	60 Hz
31 ch to 45 ch	60 Hz
46 ch to 60 ch	60 Hz

*When using a power supply frequency of 60 Hz.

Same cutoff frequency

Set filters

Set filters for each module

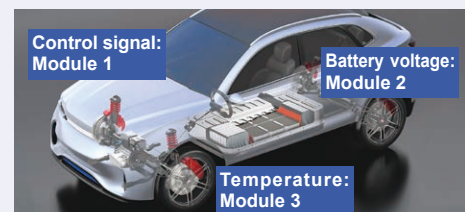

The cutoff frequency, which varies with the data refresh interval, can be set separately for each module. You can use long data refresh intervals, which boost filter effectiveness, and short data refresh intervals for different modules at the same time.

- Measure control signals at maximum speed: module 1 (data refresh interval: 1 ms)
- Measure battery voltage fluctuations: module 2 (data refresh interval: 1 ms)
- Measure temperature using thermocouples: module 3 (data refresh interval: 1 s) with **strong filter**

Strain measurement

Measure strain with a 1 kS/s sampling rate (1 ms)

Connect strain gages directly and measure at a sampling rate of up to 1 kS/s. Strain gages tend to have long, thin wires that are easily broken, but that potential pitfall can be avoided by using wireless modules so that wiring is minimized.



STRAIN UNIT U8554



WIRELESS STRAIN UNIT LR8534

Connect strain gages directly

The strain units have a built-in bridge box, allowing you to connect strain gages directly to their input terminals.

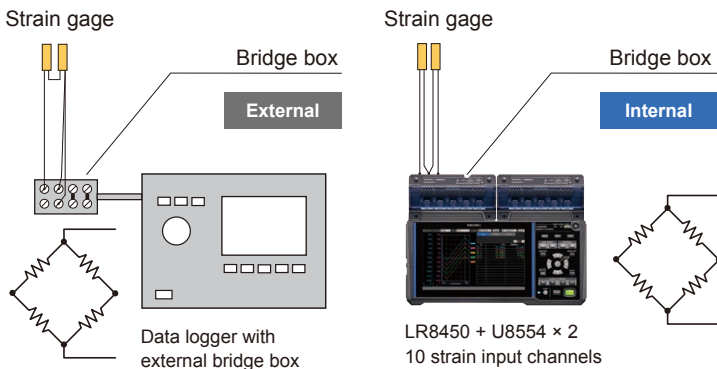

Strain-gage-type converters such as load sensors and pressure sensors can be connected directly to make measurement.



Stress and load on moving parts



Aircraft wing strain measurement



Brake and pipe strain measurement



Pipe strain measurement

Reduced influence of noise

Stable measurement, even at high voltages and high frequencies

Most competing loggers are incapable of measuring temperature accurately in noisy environments due to the influence of high frequencies, causing values to shift or fluctuate significantly. The LR8450 uses a new design to dramatically reduce the influence of high-frequency noise.

Example: measure temperature by connecting the tip of a K thermocouple to the screw on an inverter's PWM output terminal (W-phase) when using the U8550 VOLTAGE/TEMP UNIT (settings: 10 S/s sampling in the 100°C f.s. range).

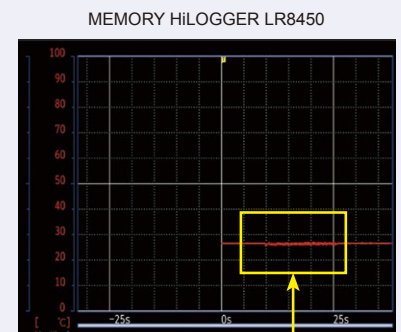
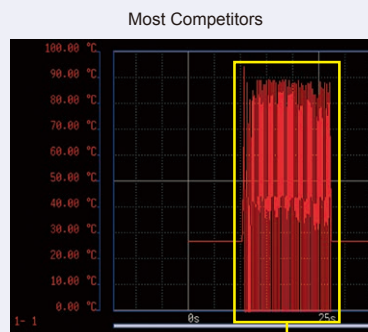
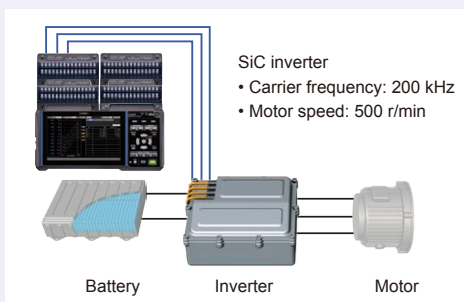

Most competing loggers exhibit significant fluctuations when the inverter is operating, whereas the MEMORY HILOGGER LR8450 does not.

CAN measurement



One instrument, two uses:
CAN input + CAN output of measured values

	U8555	LR8535
Input: CAN and CAN FD	Yes	Yes
Output: CAN and CAN FD	Yes	No

CAN input

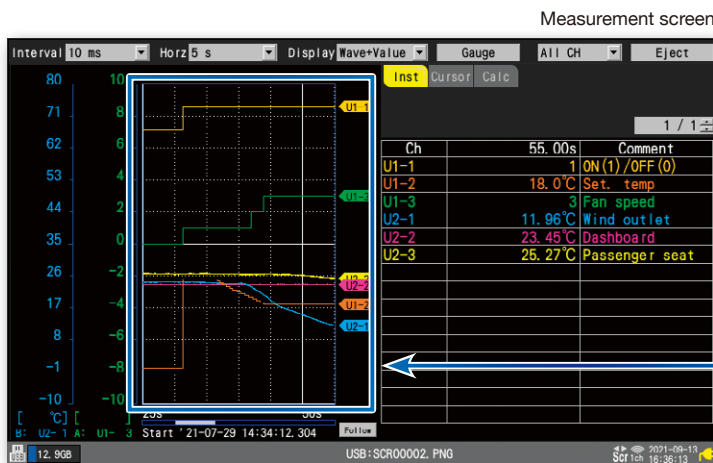
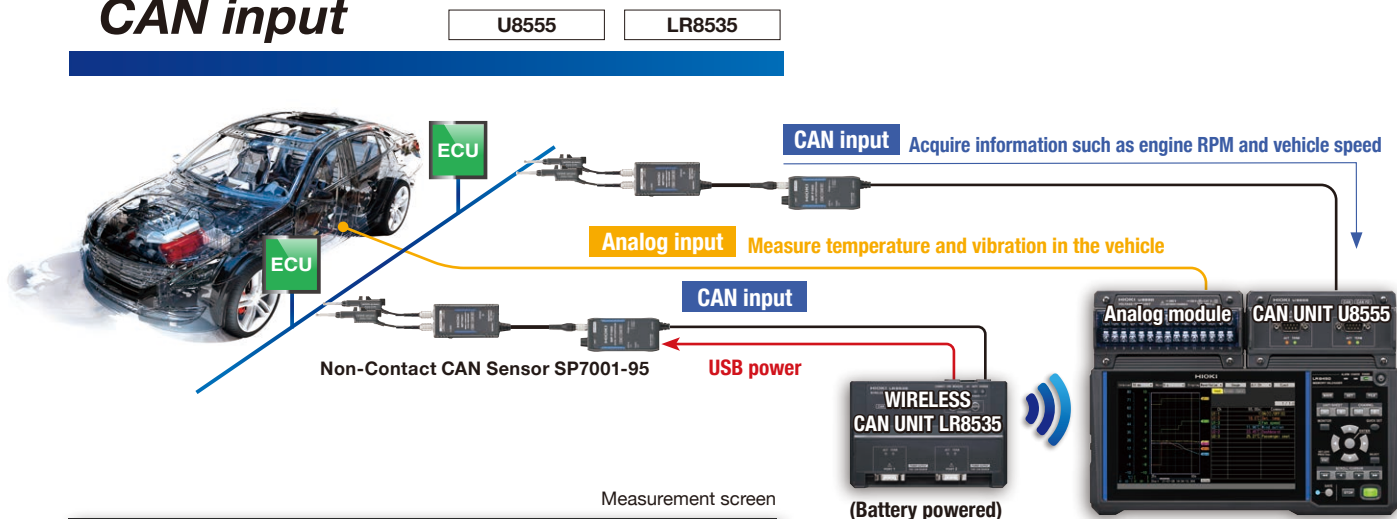

Graph CAN signal information and analog data simultaneously



CAN signals are converted into analog waveforms and graphed in real time. (CAN signal waveforms themselves cannot be observed.) Simultaneously review waveforms for analog data such as voltage, temperature, and strain along with information acquired from the CAN bus such as vehicle speed and engine RPM.

Receive CAN signals using a contactless, wireless setup!

Wireless modules interoperate flawlessly with the NON-CONTACT CAN SENSOR SP7001-95! Supply power from the battery-driven wireless unit to the NON-CONTACT CAN SENSOR SP7001-95 via USB to implement a wireless CAN measurement setup that requires no external power supply. (The system can operate for about five hours on battery power.) Since no ECU analysis tools or computer is required, the setup takes little space to reduce the amount of wiring needed for driving tests.

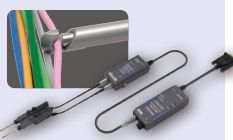

Support for multichannel measurement: receive up to 500 channels with 1 module

As a result of electrification, automobiles now use enormous quantities of data internally, and the amount of data on CAN buses consequently is growing. A single CAN module can capture up to 500 channels*1 of data. The LR8450 can accommodate up to four modules, allowing you to measure up to 2000 channels of CAN data. Each channel can collect information for one signal *1 With a recording interval of 100 ms

Convenient function 1 Notification when a specific ID is received

Start and stop measurement when a CAN signal with a specific ID occurs

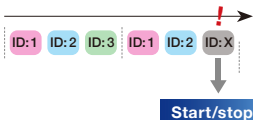

Convenient function 2 Bit mask trigger function

Set a trigger that corresponds to a particular pattern with the bit mask trigger function. For example, this function can be used when you wish to start recording when a control signal exhibits the specific pattern of "10101010."

Convenient function 3 Sending user-defined CAN frames

Sometimes it's necessary to send a CAN signal to an ECU in advance so that the ECU will output data to the CAN bus. With the U8555, you can send user-defined CAN frames to a CAN bus while performing CAN measurement.

One-time transmission

When you need to send a CAN control frame once in order to change an ECU's operating mode

Repeated transmission

When an ECU won't output the value you wish to capture unless you send specific CAN data each time



CAN UNIT U8555

CAN and CAN FD input or output



WIRELESS CAN UNIT LR8535

CAN and CAN FD input only



Driving tests of automobiles

CAN output

U8555 only

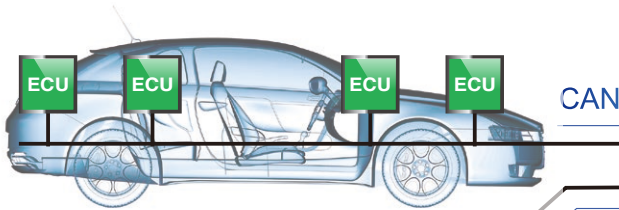

Capturing measurement data
Measure temperature and vibration in the vehicle.

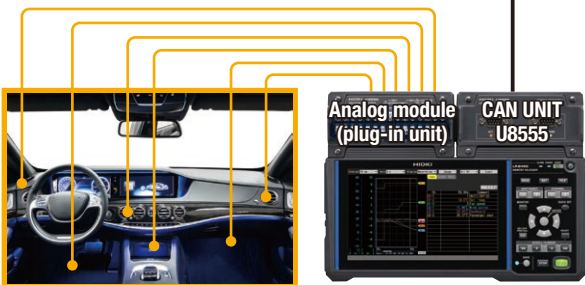

Temperature measurement: max. 100 S/s (10 ms)

High-speed output

Higher vehicle performance is creating a demand for faster, more complex communications control. Thanks to its ability to output voltage and temperature measured values to the CAN bus with a data refresh period as short as 1 ms (1 kS/s), the LR8450 can accommodate the need to acquire measurement data for systems that require real-time control.

CAN output

Output data measured by modules as CAN signals

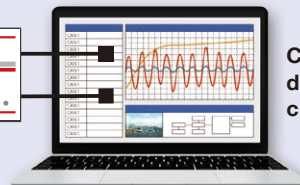

Combine all data as CAN data onto your system of choice

Enjoy managing CAN data and measured analog data on one CAN system of your choice!

Send analog data measured using a plug-in module over a CAN bus. This capability lets you integrate reliable data acquired using calibrated instruments with data on the CAN bus and upstream systems to realize unified management.

Only data measured with a plug-in measurement module can be output as CAN signals. Data measured with a wireless module cannot be output.

CAN output

Generate CAN signal output as an alarm when a malfunction is detected

Set a threshold for analog measured values like voltage or temperature so that the CAN signal is output if the threshold is exceeded. This feature lets you use a CAN logging system to detect malfunctions.

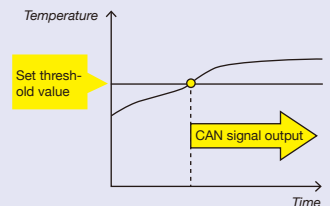

CAN Editor (standard CAN configuration software accessory)

Install this software from the application disc that comes with the MEMORY HiLOGGER LR8450 onto a PC to easily configure CAN Unit settings.

Setting method Online or offline

Save settings configured using the CAN Editor in the CES format and then load them with the LR8450. You can also configure instruments offline when a LAN or USB connection is difficult to establish.

Receive mode Loading DBC files

In addition to setting up channels manually, you can complete CAN communication definition settings simply by loading a DBC file.

Output mode Automatically configuring output targets

Creating output communication definitions one channel at a time for a logger that's handling a large number of channels is extremely time-consuming. With the CAN Editor, you need only specify the start ID and click the "Configure Automatically" button to complete all communication definitions. Those definitions can then be output as a DBC file and loaded onto an upstream system to complete the configuration process.

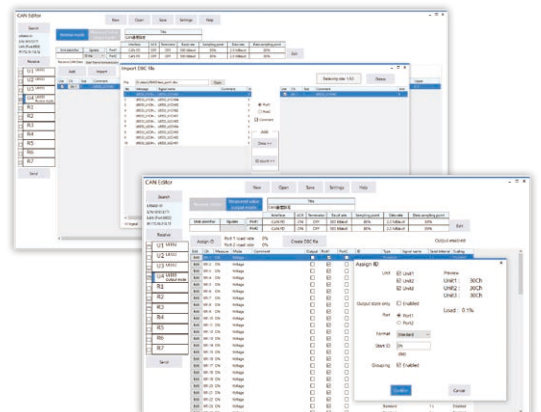

Wireless for ease of use

Collect data from dispersed locations all at the same time

The LR8450-01 can simultaneously collect measurement data from wireless units installed on various test equipment.

- Collect measurement data from multiple locations with a single logger
- Manage data in a single time sequence
- Units can be placed in confined locations
- Check the display during measurement



Install wireless units in testing equipment

* Better connection may be attained from placing the LR8450-01 and/or wireless module on the floor or ground for a shorter communication distance.

Peace of mind in the event of an interruption in power or wireless connectivity

Peace of mind if communications are temporarily interrupted

Buffer memory holds up to 5 min.*1 of measurement data

Each wireless unit has a built-in buffer memory that can hold up to 5 min.*1 of measurement data. Data are resent along with more recent measurement data once communications resume, after which the data are restored inside the LR8450-01*2.

The system can be configured to output an alarm if communications are interrupted or if a module encounters a low-battery state.

*1 The duration for which measurement data can be maintained does not vary with the recording interval (up to a maximum of 5 min.)

*2 Data collected using the Logger Utility software measurement cannot be restored in this manner.

Battery operation

Use modules in locations where there's no AC power

Example:

The wireless VOLTAGE/TEMP UNIT LR8530 can operate for about 9 hours on battery power. If the unit is charged at night, it can operate on just the battery pack during the day.

Using the Battery Pack Z1007

Wireless module model	Continuous operating time
LR8530	Approx. 9 hr.
LR8531	Approx. 7 hr.
LR8532	Approx. 9 hr.
LR8533	Approx. 9 hr.
LR8534	Approx. 5 hr.
LR8535	Approx. 10 hr.*
LR8536	Approx. 5 hr.

* Approx. 5 hours when using two non-contact CAN sensors.



Peace of mind in the event of a power outage during measurement

Install a battery pack for peace of mind

If you've installed a battery pack in a module that's being powered by an AC adapter, the unit will automatically switch to battery power in the event of an outage so that the LR8450-01 can continue making measurements.

Make measurements in locations where it would be difficult to route wires

Work time can be reduced using the LR8450-01 and wireless modules, since only minimal wiring is required. If the measurement target is located in a lab, this approach eliminates the need for wiring and avoids having to drill holes in the walls of the monitoring room where data is being checked.

Inside a room, or outside, you can make measurements with the door closed.



Simple registration of wireless modules

Wireless modules, located within the range, that are not connected to another LR8450-01, can be automatically detected. Simply choose the module you wish to register from the list.

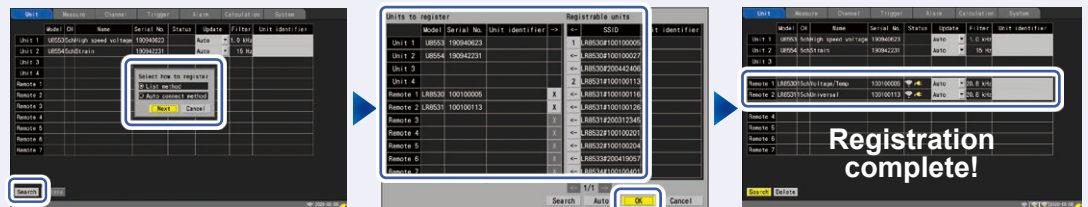

Check the unused wireless LAN channels and select the wireless channel to use

You can reduce interference from other wireless devices by using an open channel (wireless frequency range being used by wireless devices in the area). Check for open channels on the instrument's screen.

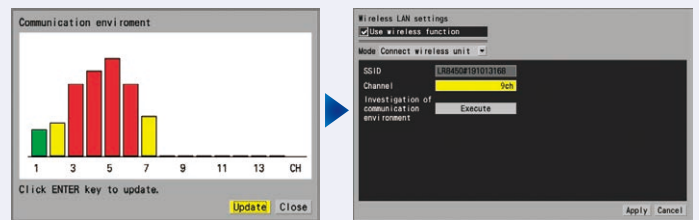

Observe data from a remote location using a PC or a tablet

By connecting the LR8450-01 to a PC or a tablet via wireless LAN, you can control the instrument remotely using the built-in HTTP server or obtain older data files using the built-in FTP server.

(You cannot use Logger Utility when using Station Mode or Access Point Mode. See below.)

Station mode

Connect wirelessly to a third-party access point (AP).

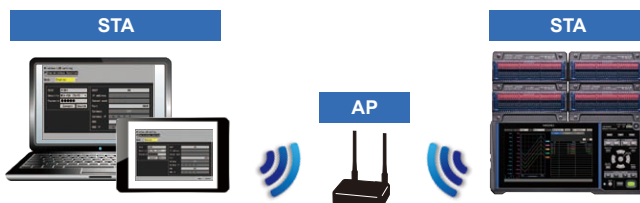

Access point mode

The LR8450 can be directly connected to a PC via wireless LAN.



Easy-to-read display of measured values

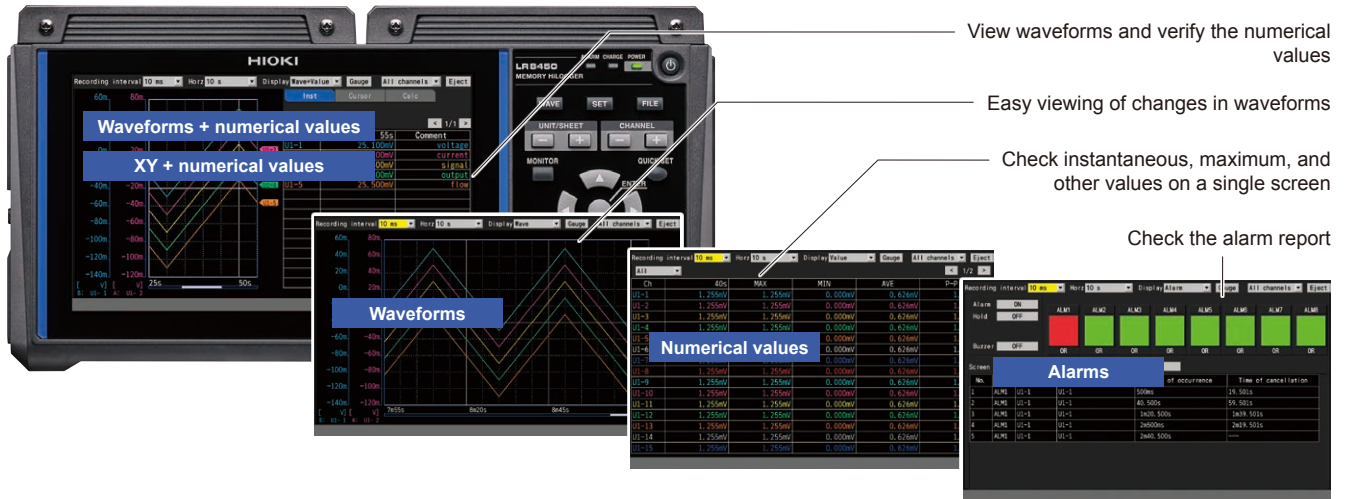

External control terminals and interfaces to accommodate a broad range of use cases



Motor speed, flow rate integration, etc.

8 channel pulse measurement

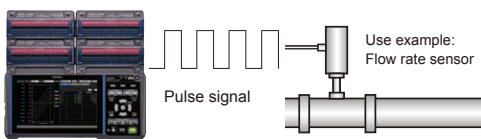

In "Revolve" mode, monitor production equipment by measuring the variations in revolution speed of motors or drills. In "Count" mode, identify operation status by acquiring integrated power or flow rate.

Two terminals for voltage outputs (5, 12, or 24 V)

Supplying power to the sensors

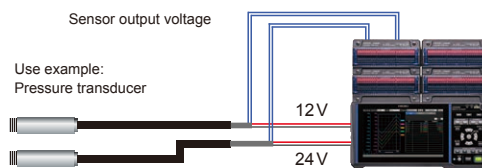

The LR450, LR450-01 provides two output terminals for voltages, each of which can supply 100 mA current, eliminating the need for a separate sensor power supply. You can select 5 V, 12 V, or 24 V from the VOUTPUT1 terminal and 5 V or 12 V from the VOUTPUT2 terminal.

Useful in preventive maintenance

8 channel alarm outputs

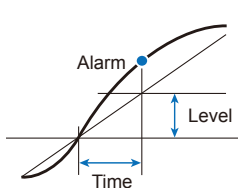

Slope
Set the level and time. It generates an alarm if the reading exceeds the preset rate of change (level/time)

You can set alarm output for eight channels. You can set a level, a window, a slope, and a logic pattern on channels you wish to monitor.

Connect and measure up to 5 units

Analog 600 CH Synchronous Sampling

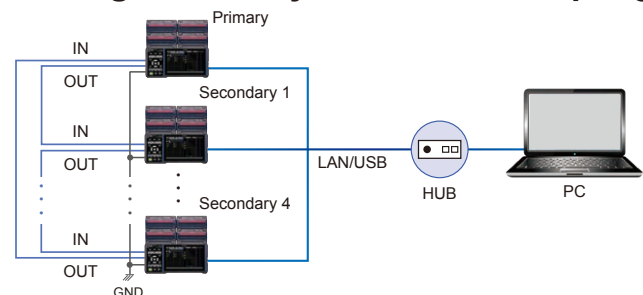

Synchronized sampling up to 5 plug-in modules (600 analog channels) can be measured when multiple LR450's external sync terminals (SYNC.IN, SYNC.OUT) are connected.

Note: This function cannot be used when wireless modules are connected.

Extensive calculation functions

Numerical calculation function

In addition to the maximum and minimum value calculation functions provided by previous models, the LR8450/LR8450-01 offers an extensive range of calculations, including on/off time, count, and usage ratio.

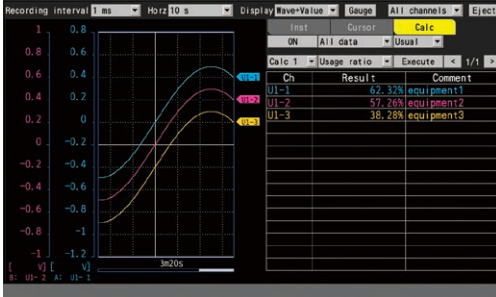

Types of calculations

- Average value
- Peak-to-peak value
- Maximum value
- Minimum value
- Time at which maximum value occurred
- Time at which minimum value occurred
- Integration
- Aggregation
- Usage ratio
- On time
- Off time
- On count
- Off count

Waveform calculation function

Calculate data while measurement continues and display calculated waveforms in real time. Calculation results are saved on a separate and dedicated calculation channel.

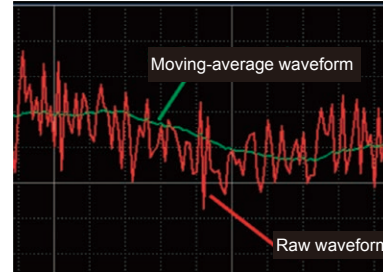

Types of calculations

- Basic arithmetic operations
- Aggregation
- Simple average
- Moving average
- Integration

Recording over extended periods of time without interruption

Collect data on a storage device (SD memory card or USB drive) while measuring continues. The ability to segment files by hour or day without stopping measurement is convenient when you need to review data later.

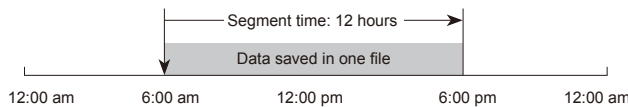

Maximum recording time (estimate)

Example: Recording 30 analog channels with 2 modules (no alarm output or waveform processing)

Because the header portion of waveform files is not included in capacity calculations, expected actual maximum time is about 90% of those in the tables. The maximum recording time varies with the number of measurement channels. Recording times are doubled if the number of measurement channels shown in the table is halved.

When recording 30 analog channels with two U8550/U8551 modules or one U8552 module (no alarm output, no waveform processing)
 When recording 30 analog channels with two LR8530/LR8531 modules or one LR8532 module (no alarm output, no waveform processing)

Recording intervals	Internal buffer memory (512 MB)	SD MEMORY CARD Z4001 (2 GB)	SD MEMORY CARD Z4003 (8 GB)	USB DRIVE Z4006 (16 GB)
10 ms	1 d	3 d 20 h	15 d 8 h	30 d 12 h
100 ms	10 d 8 h	38 d 18 h	153 d 9 h	305 d 5 h
1 s	103 d 13 h	387 d 12 h	1,533 d 21 h	3,052 d 9 h
10 s	500 d	3,875 d 6 h	15,339 d 3 h	30,523 d 19 h

When recording 20 channels with four U8553 modules or U8554 modules (no alarm output, no waveform processing)
 When recording 20 channels with four U8553 modules or LR8534 modules (no alarm output, no waveform processing)

Recording intervals	Internal buffer memory (512 MB)	SD MEMORY CARD Z4001 (2 GB)	SD MEMORY CARD Z4003 (8 GB)	USB DRIVE Z4006 (16 GB)
1 ms	3 h 43 min	13 h 56 min	2 d 7 h	4 d 13 h
10 ms	1 d 13 h	5 d 19 h	23 d	45 d 18 h
100 ms	15 d 12 h	58 d 3 h	230 d 2 h	457 d 20 h
1 s	155 d 8 h	581 d 7 h	2,300 d 21 h	4,578 d 13 h
10 s	500 d	5,813 d 1 h	23,008 d 20 h	45,785 d 20 h

When recording 330 channels with four U8552 modules and seven LR8532 modules (no alarm output, no waveform processing)

Recording intervals	Internal buffer memory (512 MB)	SD MEMORY CARD Z4001 (2 GB)	SD MEMORY CARD Z4003 (8 GB)	USB DRIVE Z4006 (16 GB)
20 ms	4 h 8 min	15 h 28 min	2 d 13 h	5 d 2 h
100 ms	20 h 42 min	3 d 5 h	12 d 18 h	25 d 10 h
1 s	8 d 15 h	32 d 6 h	127 d 19 h	254 d 8 h
10 s	86 d	322 d 16 h	1,277 d 23 h	2,543 d 9 h

Control the instrument remotely and capture data on a PC



FTP server function

Download data files onto a PC

Your PC can get files from inside the SD memory card or USB drive inserted to the LR8450/LR8450-01.

FTP client

Automatically transfer data files to an FTP server

Automatically transmit files to an FTP server from the SD memory card or in the USB drive inserted to the LR8450/LR8450-01.

HTTP server function

Control the instrument remotely from a PC

Use a standard Web browser to control the LR8450/LR8450-01, start and stop measurement, then enter comments.

Use with other tools

Output measured values using XCP on Ethernet

The LR8450 supports XCP Secondary operation based on the XCP protocol, a standard developed by the Association for Standardisation of Automation and Measuring Systems (ASAM). You can perform control to start and stop measurement and acquire measured values using an XCP Primary. (Measured values from CAN modules cannot be output.)

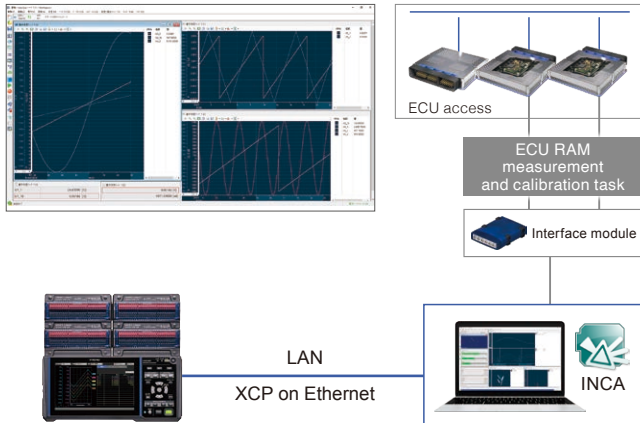

Load data using MDF-compatible waveform viewers

Current, voltage, temperature, strain, CAN, and other measurement data captured by the LR8450 can be saved in the Measurement Data Format (MDF) and loaded by other software that supports the format.

Commercially available software

FAMOS

- More than 400 calculation processing variables
- Easy report creation functionality

NI DIAdem

- Functionality ranging from searching and loading of data to analyzing and creating of reports
- Dialog-based interface

FlexPro

- High-speed search and processing of large volumes of data
- Share analysis templates within your company

Oscope 2

- Freely edit large data that cannot be handled by Excel
- Simultaneously display the waveforms which have different frequencies

standard accessory

Logger Utility Collect data at sampling speeds of up to 10 ms on a PC

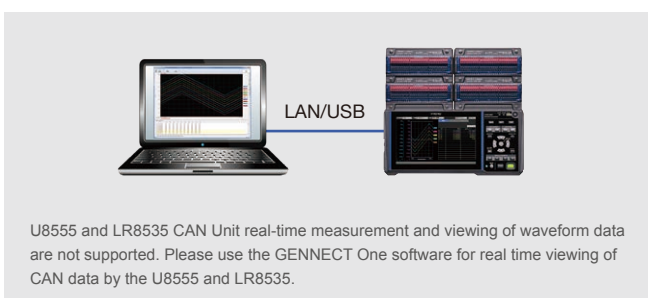

Recording interval	Simultaneous recording	No. of connected units	Connection method	CAN
10 ms	600 channels + 60 waveform calculation channels	up to 5	LAN/USB	-



Simultaneously log data from five LR8450 instruments at a speed of up to 10 ms.



Display logged data in real time as a graph.

GENNECT Cloud

Connect loggers in the field to the cloud

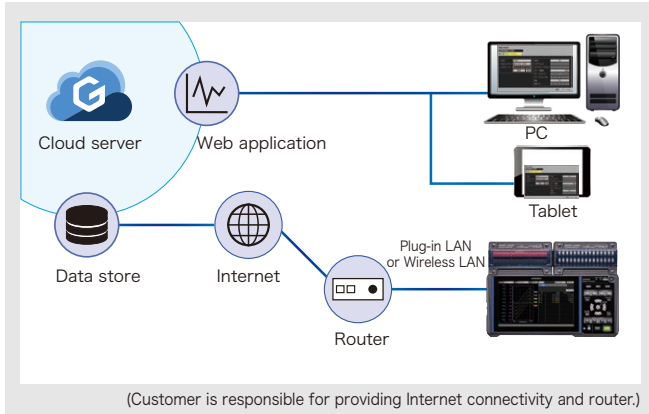

Recording interval	Simultaneous recording	Connectable instruments	CAN
1 min.	1000 channels/instrument (Pro plan)	100 (Pro plan)	✓

Values are logged at a 1-minute interval. Data is saved on a cloud server and shared immediately.

Receive notification via email, LINE, Microsoft Teams, or Slack as soon as anomalous data is detected.

Retrieve data files saved on the logger's SD card via the cloud.

Change logger settings via remote control.

GENNECT Cloud is available free of charge.
(Some features require a paid plan.)
Scan the QR Code for details.



GENNECT One

Make simultaneous measurements using multiple instruments

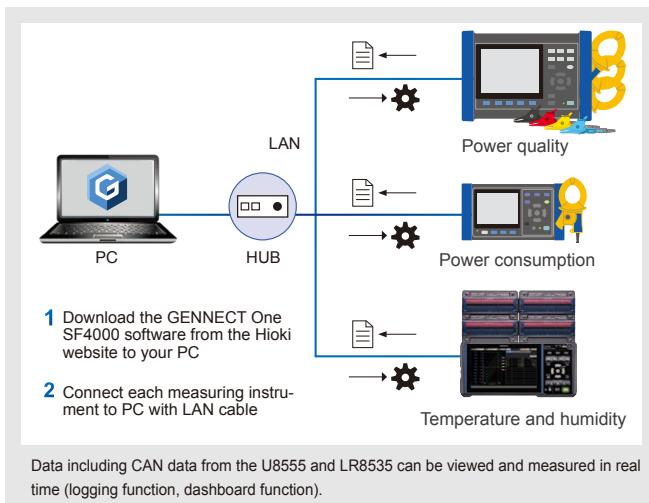

Recording interval	Simultaneous recording	Total No. of connected devices	Connection method	CAN
1 s	512 channels	Up to 15* <small>*Up to 30 devices can be connected when using only the logging or dashboard functions</small>	LAN	✓

Simultaneously log data from instruments like recorders and power meters as frequently as 1 s.

Display logged data in real time as a graph. Automatically create CSV files and daily/monthly reports.

Graphically display measured values using the dashboard function. Visually identify anomalies.

Download instrument data files saved on instruments' SD cards.

Change instrument settings remotely.

GENNECT One is a free application.
Access this code for details and downloads.



Specifications

LR8450, LR8450-01 Memory HiLogger General specifications, basic specifications	
Product warranty period	3 years
Accuracy guarantee period	1 year
Maximum number of connectable modules	4 plug-in modules + 7 wireless modules*(LR8450-01 only) No more than 4 CAN modules (U8555 and/or LR8535) can be connected.
Connectable modules (plug-in modules)	U8550 VOLTAGE/TEMP UNIT U8553 HIGH SPEED VOLTAGE UNIT U8551 UNIVERSAL UNIT U8554 STRAIN UNIT U8552 VOLTAGE/TEMP UNIT U8555 CAN UNIT U8556 CURRENT MODULE
Connectable modules (wireless modules, LR8450-01 only)	LR8530 Wireless Voltage/Temp Unit LR8531 Wireless Universal Unit LR8532 Wireless Voltage/Temp Unit LR8533 Wireless High Speed Voltage Unit LR8534 Wireless Strain Unit LR8535 Wireless Can Unit LR8536 Wireless Current Module
No. of measurement channels	Up to 120ch with plug-in modules. U8555 can input up to 500 channels per unit.
Pulse/logic input	[Number of ch] 8 ch (common GND, non-isolated, exclusive setting for pulse/logic input for individual channels) [Adaptive input format] Non-voltage contact, open collector, or voltage input [Count] 0 to 1000 M pulse, 1 pulse resolution [Rotational speed] 0 to 5000/n (r/s), 1/n (r/s) resolution, 0 to 300,000/n (r/min.), 1/n (r/min.) resolution, n: Number of pulses per rotation (1 to 1000) [Logic input] Records 1 or 0 for each recording interval
Recording intervals	1 ms*, 2 ms*, 5 ms* (*: Can be set only when using 1 ms/S modules), 10 ms to 1 hour, 22 selections (Data refresh interval can be set for each unit)
Data storage	SD Memory Card/USB Drive (user-selectable) (Only storage media sold by HIOKI are guaranteed for operation)
LAN interface	100BASE-TX / 1000BASE-T, DHCP, DNS support, Functions: Data acquisition, condition settings used with the Logger Utility software, configuring settings and controlling recording using communications commands, FTP server / FTP client, HTTP server, Email transmission, NTP client, XCP on Ethernet, GENNECT Cloud integration function
Wireless LAN interface (LR8450-01 only)	IEEE 802.11b/g/n Communications range: 30 m, line of sight Encryption function: WPA-PSK/WPA2-PSK, TKIP/AES Usable channels: 1 to 11 Supported modes: Wireless unit connectivity, access point, station Functions: Configuring settings and controlling recording using communications commands, FTP server / client, HTTP server, Email transmission, NTP client, XCP on Ethernet, GENNECT Cloud integration function
USB interface	Series A receptacle × 2: USB 2.0 compliant (USB drive, keyboard, or hub) Series mini-B receptacle × 1: Data acquisition, condition settings used with the Logger Utility, configuring settings and controlling recording using communications commands, transferring data from a connected SD Memory Card to a computer
SD card slot	SD standard-compliant slot × 1 (with SD memory card/SDHC memory card support), Guaranteed-operation options: Z4001, Z4003
Display	7 inch TFT color liquid crystal display (WVGA 800 × 480 pixel)
Functions	Save waveform data in real time to the SD memory card or USB drive, numerical value calculations, waveform calculations, 8ch alarm output, voltage output ×2 (5 V /12 V /24 V selectable)
Power supply	[AC adapter] Using the Z1014 (100 to 240 V AC, 50/60 Hz), 95 VA Max. (including AC adapter), 28 VA Max. (exclusive of AC adapter) [Battery Pack] Using the Z1007 (accommodates 2 batteries), continuous use 4 hr (reference value for 2 pieces), 20 VA Max. [External power] 10 to 30 V DC, 28 VA Max.
Dimensions and mass	Without any modules: 272 mm (10.71 in) W × 145 mm (5.71 in) H × 43 mm (1.69 in) D (excluding protrusions), 1108 g (39.1 oz) (excluding battery pack) With 2 modules: 272 mm (10.71 in) W × 198 mm (7.80 in) H × 63 mm (2.48 in) D (excluding protrusions) With 4 modules: 272 mm (10.71 in) W × 252 mm (9.92 in) H × 63 mm (2.48 in) D (excluding protrusions)
Included accessories	Quick Start Manual ×1, LOGGER Application Disc (Quick Start Manual, Instruction Manual, Logger Utility, Logger Utility Instruction Manual, CAN editor, CAN editor instruction manual, Communication Instruction Manual, GENNECT One, GENNECT One User's Manual) ×1, USB Cable ×1, AC Adapter Z1014 ×1, Precautions Concerning Use of Equipment that Emits Radio Waves ×1*(LR8450-01 only)

Software Logger Utility specifications

U8555 CAN Unit and LR8535 Wireless CAN Unit are not supported.

Operating Environment	Windows7, Windows8, Windows10 (32 bit/64 bit) Windows11 (64 bit)
Overview	Control PC-connected logger to receive, display, and save measured waveform data sequentially. (Total recording samples is maximum 10 million data. Data exceeding this number will be segmented into separate measurement files while recording continues.) *Real-time measurement on the LR8450, LR8450-01 is possible with a recording interval of 10 ms or more. Max. number of analog CH: 600 CH
Function	Controllable loggers: 5 Data Collection System: 1 system Display Format: • Waveforms (split time-axis display is possible) • Numerical values (logging): numerical display can be enlarged • Alarms Above items can be displayed simultaneously Numerical value monitor Display: display in a separate window is possible. Scroll: waveforms can be scrolled during measurement.
Data Collection	Settings: data collection settings of logger modules can be configured Monitor function can be checked before measurement Save: save settings from multiple devices supporting real-time measurement (LUS format) and measurement data (LUW format) as one file Data save format: real-time data collection file (LUW format), transfer data in real-time or non-real-time to Microsoft Excel®, Excel® template can be specified Event mark: recording during measurement is possible
Waveform Display	Supported files: waveform data file (LUW format, MEM format) Display format: waveforms (split time-axis display available), simultaneous display of numerical values (logging) is available Maximum number of channels: 2,035 channels (measured) + 60 channels (waveform calculation) Waveform display sheets: waveform of each channel can be displayed on any of the ten sheets Scroll: available Event mark recording: available Cursors: cursors A and B can be used to display voltage values at cursor positions. Screen capture: screen capture of waveform display is available
Data Conversion	Applicable files: waveform data file (LUW format, MEM format) Conversion section: all data, specified section Conversion format: CSV format (comma delimited, space delimited, tab delimited), transfer to Excel® sheet, LR5000 format (hrp2,hrp) Data thinning: simple thinning with any thinning number
Waveform Calculation	Calculation items: arithmetic operations Number of calculation channel: 60 channels
Numerical Calculations	Applicable data: waveform data file (LUW format, MEM format), real-time measurement data, waveform calculation Calculation items: average value, peak value, maximum value, time to maximum value, minimum value, time to minimum value, on time, off time, on count, off count, standard deviation, aggregation, area value, and integration Save calculation: performs numerical calculation and save to file
Search	Applicable data: real-time data collection file (LUW format), main unit measurement file (MEM format), waveform calculation data Search mode: event mark, date and time, maximum position, minimum position, local maximum position, local minimum position, alarm position, level, window, and variation
Print	Applicable printer: printer compatible to the OS in use Applicable data: waveform data file (LUW format, MEM format) Print format: waveform image, report print, list print (channel settings, event, cursor value) Print area: all area, specified area by A-B cursor Print preview: available

Option specifications (sold separately)

Plug-in modules: U8550, U8551, U8552, U8553, U8554, U8555, U8556 Common

Host model	LR8450, LR8450-01 Memory HiLogger
Operating temperature and humidity range	-10°C to 50°C, 80% RH or less (non-condensing)
Storage temperature and humidity range	-20°C to 60°C, 80% RH or less (non-condensing)
Vibration resistance	JIS D 1601:1995 5.3 (1), Class 1 A (passenger vehicle) equivalent
Included accessories	User manual, mounting screw × 2, wiring confirmation label* ¹ (*1 U8554 only), 5 caps* ² (*2 U8556 only)

Wireless modules: LR8530, LR8531, LR8532, LR8533, LR8534, LR8535, LR8536 Common

Host model	LR8450-01 Memory HiLogger
Control communications method	Connect wirelessly via Wireless LAN Adapter Z3230 (included) Wireless LAN (IEEE 802.11b/g/n) Communication range: 30 m (line of sight) Encryption function: WPA-PSK/WPA2-PSK, TKIP/AES Available number of channels: 1 to 11
Communications buffer memory	4 Mword (volatile memory) Saves data in the event of a communications error. Data is resent when communications are restored.
Operating temperature and humidity range	-20°C to 55°C, 80% RH (non-condensing) (charging temperature range: 5°C to 35°C)
Storage temperature and humidity range	-20°C to 60°C, 80% RH (non-condensing)
Vibration resistance	JIS D 1601:1995 5.3 (1), Class 1 A (passenger vehicle) equivalent
LED display	Wireless connection and measurement status, error status, AC adapter or external power, battery power, charge status
Auto-connect function	Available
Included accessories	Z3230 Wireless Lan Adapter, user manual, Z1008 AC Adapter, mounting plate, M3×4 screw × 2 (for use with mounting plate), wiring confirmation label* (*LR8534 only)
Z3230 wireless specifications	Wireless LAN (IEEE 802.11b/g/n) Range: 30 m (line of sight) Encryption: WPA-PSK/WPA2-PSK, TKIP/AES Channels: channel 1 to 11

Power supply specifications

AC adapter	Z1008 AC Adapter (12 V DC, standard accessory) Rated supply voltage: 100 to 240 V AC Rated power supply frequency: 50/60 Hz Maximum rated power: 25 VA (including AC adapter)
Battery	Z1007 Battery Pack (when using AC adapter, AC adapter takes precedence.) Maximum rated power LR8530, LR8532: 1.5 VA LR8531, LR8533: 2.0 VA LR8534, LR8535, LR8536: 3.5 VA
External power supply	Rated supply voltage: 10 to 30 V DC Maximum rated power: 8 VA (30 V DC external power supply, while charging battery) Normal power consumption (12 V DC external power supply, without battery pack) LR8530, LR8532, LR8533: 2.5 VA LR8531: 3.0 VA LR8534, LR8535: 4.0 VA LR8536: 2.4 VA
Continuous operating time	When using Z1007 Battery Pack (all data refresh rates, good communications state, 23°C reference values) LR8530, LR8532, LR8533: approx. 9 h LR8531: approx. 7 h LR8534, LR8536: approx. 5 h LR8535: approx. 10 h (approx. 5 h when using two non-contact CAN sensors)
Charging function	When Z1007 Battery Pack installed while connected to AC adapter or 10 to 30 V DC external power supply Charging time: approx. 7 h (23°C reference value)

VOLTAGE/TEMP UNIT U8550 UNIVERSAL UNIT U8551 VOLTAGE/TEMP UNIT U8552	WIRELESS VOLTAGE/TEMP UNIT LR8530 WIRELESS UNIVERSAL UNIT LR8531 WIRELESS VOLTAGE/TEMP UNIT LR8532
--	--

Accuracy guaranteed for 1 year

Number of input channels	U8550: 15 (set voltage, thermocouple, or humidity for each channel) LR8530: 15 (set voltage or thermocouple for each channel) U8551, LR8531: 15 (set voltage, thermocouple, humidity, RTD, or resistor for each channel) U8552: 30 (set voltage, thermocouple, or humidity for each channel) LR8532: 30 (set voltage or thermocouple for each channel)
Input terminals	U8550, LR8530: M3 screw-type terminal block (2 terminals per channel) U8551, LR8531: push-button type terminal block (4 terminals per channel) U8552, LR8532: push-button type terminal block (2 terminals per channel)
Output terminals	M3 screw-type terminal block (1 output, 2 terminals, Z2000 Humidity Sensor power supply [can power up to 15 Z2000 Humidity Sensor])(LR8531 only)
Measurement target	U8550, U8552: voltage, temperature (thermocouples), humidity LR8530, LR8532: voltage, temperature (thermocouples) U8551, LR8531: voltage, temperature (thermocouples), humidity, temperature (RTD), resistor
Input type	Scanning by semiconductor relays All channels isolated (not isolated when measuring with RTD, resistance or humidity)
A/D resolution	16 bits
Maximum input voltage	±100 V DC (maximum voltage between input terminals without causing damage)
Maximum channel-to-channel voltage	300 V DC (maximum voltage that can be applied between each input channel without causing damage; not isolated when measuring with RTD, resistance or humidity) *Channels are isolated from each other with semiconductor relays. Never allow a voltage exceeding the product specifications, for example a lightning surge, to be applied across channels as doing so may cause the semiconductor relays to short.
Maximum rated terminal-to-ground voltage	300 V AC, DC (maximum voltage that can be applied between input channels and the instrument or its chassis, or between units without causing damage; humidity measurement not isolated)
Input resistance	10 MΩ or greater (10 mV f.s. to 2 V f.s. voltage ranges, thermocouple ranges, RTD and resistor ranges) 1 MΩ ±5% (10 V f.s. to 100 V f.s. voltage range, 1-5 V f.s. voltage range, humidity measurement)
Allowable signal source resistance	1 kΩ or less
Data refresh interval	10 ms to 10 s (10 selectable levels)
Digital filters	Digital filter cutoff frequency is automatically set to data refresh interval, burnout setting, and power supply frequency filter setting
Dimensions	U8550, U8551, U8552: approx. 134W × 70H × 63D mm (5.28"W × 2.76"H × 2.48"D) LR8530, LR8531, LR8532: approx. 154W × 106H × 57D mm (6.06"W × 4.17"H × 2.24"D)
Mass	U8550: approx. 345 g (12.2 oz.), U8551: approx. 318 g (11.2 oz.), U8552: approx. 319 g (11.3 oz.), LR8530: approx. 423 g (14.9 oz.), LR8531: approx. 386 g (13.6 oz.), LR8532: approx. 388 g (13.7 oz.), (including Z3230 Wireless Lan Adapter)

HIGH SPEED VOLTAGE UNIT U8553	WIRELESS HIGH SPEED VOLTAGE UNIT LR8531
-------------------------------	---

Accuracy guaranteed for 1 year

Number of input channels	5 (voltage only)
Input terminals	M3 screw-type terminal block (2 terminals per channel), outfitted with terminal block cover
Measurement target	Voltage
Input type	Scanning by semiconductor relays, all channels isolated
A/D resolution	16 bits
Maximum input voltage	±100 V DC (maximum voltage between input terminals without causing damage)
Maximum channel-to-channel voltage	300 V DC (maximum voltage between input channels without causing damage) *Channels are isolated from each other with semiconductor relays. Never allow a voltage exceeding the product specifications, for example a lightning surge, to be applied across channels as doing so may cause the semiconductor relays to short.
Maximum rated terminal-to-ground voltage	300 V AC, DC (maximum voltage between input channel and chassis, or between modules, without causing damage)
Input resistance	1 MΩ ±5%
Allowable signal source resistance	100 Ω or less
Data refresh interval	1 ms to 10 s (13 selectable levels)
Digital filters	Digital filter cutoff frequency is automatically set to data refresh interval, burnout detection setting, and power supply frequency filter setting.
Dimensions	U8553: approx. 134W × 70H × 63D mm (5.28"W × 2.76"H × 2.48"D) LR8531: approx. 154W × 106H × 57D mm (6.06"W × 4.17"H × 2.24"D)
Mass	U8553: approx. 237 g (8.4 oz.) LR8531: approx. 370 g (13.1 oz.) (including Z3230 Wireless Lan Adapter)

CAN UNIT U8555
WIRELESS CAN UNIT LR8535

Accuracy guaranteed for 1 year

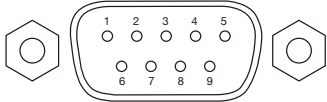
Number of ports	2	
Input terminals	D-sub 9 pin MALE × 2	
		
	Pin No.	Signal
	1	N.C.
	2	CAN_L
	3	GND
	4	N.C.
	5	N.C.
	6	N.C.
	7	CAN_H
8	N.C.	
9	N.C.	
Power supply terminals (LR8535 only)	USB port (connectors: Series A receptacle × 2) Dedicated power supply for Hioki Non-Contact Can Sensor	
Interface	Protocols supported	CAN (ISO11898) CAN FD (ISO11898) CAN FD (non-ISO)
	Physical layer	ISO11898 (High Speed)
Terminator	On/off setting available for each port 120 Ω ±10 Ω built-in resistance	
ACT LED	Displays CAN bus operating status	
TERM LED	Illuminates when terminator is on	
Data refresh interval	10 ms to 10 s (10 selectable levels)	
Baud rate	CAN/CAN FD (arbitration): 50k, 62.5k, 83.3k, 100k, 125k, 250k, 500k, 800k, 1000k [Baud] CAN FD (data): 0.5M, 1M, 2M, 2.5M, 4M, 5M [Baud]	
Sampling point	CAN or CAN FD (arbitration): 50.0% to 95.0% CAN FD (data): 50.0% to 95.0%	
ACK transmission	ACK response when receiving CAN data can be set to on or off	
Operation mode	U8555: supports switching between receive mode and measured value output mode LR8535: supports only receive mode	
Dimensions	U8553: approx. 134W × 70H × 54D mm (5.28"W × 2.76"H × 2.13"D) LR8531: approx. 154W × 106H × 48D mm (6.06"W × 4.17"H × 1.89"D)	
Mass	U8553: approx. 235 g (8.3 oz.) LR8531: approx. 355 g (12.2 oz.) (including Z3230 Wireless Lan Adapter)	

Receive mode specifications

No. of measurement channels	Data refresh interval 10 ms: max. 50 channels (max. 50 signals) Data refresh interval 20 ms: max. 100 channels (max. 100 signals) Data refresh interval 50 ms: max. 250 channels (max. 250 signals) Data refresh interval 100 ms or greater: max. 500 channels (max. 500 signals)
Receive ID count	Function for recording the number of times a target ID is received during the data refresh interval
User-defined frame transmission (U8555 only)	Sends user-defined CAN frames during receive mode operation No. of configurable conditions: 8 per unit

Measured values output mode specifications (U8555 only)

Overview	Converts LR8450 measured values and output them as CAN frames.
Output target	Measurement data from plug-in modules (other than CAN Unit) Measurement time
Output data refresh period	Depends on data refresh interval of module generating output (as fast as 1 ms)
Response	Data refresh interval × 2 + 1 ms + analog response time* (*Varies with filter settings) (U8554: 5 ms with 120 Hz low-pass filter)

CAN Editor (software) specifications
General specifications

Operating environment	Windows 10 (32/64-bit), Windows 11 (64-bit)
Interface	LAN/USB
Supported languages	Japanese/English/Chinese
Supported instruments	HIOKI LR8450/LR8450-01 MEMORY HILOGGER
Set module position	Module 1 to module 4 Wireless module 1 to wireless module 7
CAN interface setting	Interface, terminator, baud rate, data rate, sampling points, data sampling points, ACK
Module operating mode	Switch between receive mode and measured value output mode on a module-by-module basis

Receive mode settings

Data refresh interval	10 ms to 10 s (10 selectable levels)	
Receive channel definition settings	CAN input port settings	Port 1 or Port 2
	Channel type	Data or ID count
	Shared settings	1. Format: standard/extended 2. ID: 0h to 1 FFFFFFFh 3. Comment 4. Unit 5. Factor, offset
	Channel type: data	1. Start bits: 0 to 511 2. Bit length: 1 to 64 [bits] 3. Byte order: Motorola/Intel 4. Data type: unsigned/signed/IEEE/float/IEEE-double
User-defined frame transmission settings	LR8450 display settings	1. Display upper limit value or display lower limit value 2. No. of display digits, display format 3. Numerical calculation threshold 4. Waveform color
	Receive condition number	No. 1 to No. 8
	CAN output port setting	Port 1 or Port 2
	No. of frame	1 to 8
	Regular transmission setting	On/off
	Regular transmission interval	1 to 9999 (× 10 [ms])
	Timing	At measurement start, at measurement stop, at start trigger, at alarm, manual
	Frame type	CAN standard, CAN extended, CAN FD standard, CAN FD extended
	Transmit ID	0 h to 1FFFFFF h
	DLC (bite)	0 to 15 (0, 12, 16, 20, 24, 32, 48, 64)
Transmit data	Set as hexadecimal value	
Delay	0 to 9999 (× 10 [ms])	

Measured value output mode setting

Measured value output setting	CAN output port setting	Port 1 or Port 2
	Frame type	Standard/extended
	ID	0 h to 1FFFFFF h
	Data	Measured values from the following modules can be set as output data U8550, U8551, U8552, U8553, U8554, U8556
CAN bus load ratio estimation function	Displays what would be the CAN bus load increase rate if measured values were to be output using the current settings	

File specifications

Save function	1. CANdb file (.dbc) for transmit data defined using measured value output mode settings 2. Overall settings data for CAN Editor (.CES)
Load function	1. Loads CANdb files (.dbc) and MR8904 definition files (.CDF) and use them to configure receive channel settings. 2. Loads LR8450 settings (.SET) and CAN Editor settings (.CES) and applies them to the CAN Editor's overall settings.
Title	Sets titles for settings data (.CES) (up to 50 single-byte or 25 double-byte characters).

STRAIN UNIT U8554	WIRELESS STRAIN UNIT LR8534
--------------------------	------------------------------------

Accuracy guaranteed for 1 year

Number of input channels	5 (set voltage or strain for each channel)
Input terminals	Push-button type terminal block (5 terminals per channel), outfitted with terminal block cover, set DIP switches according to measurement target
Measurement target	Voltage
	Strain Strain gage-type converter Strain gage: 1-gage method (2-wire setup), 1-gage method (3-wire setup), 2-gage method (adjacent sides), 4-gage method
Adaptive gage resistance	1-gage method, 2-gage method: 120 Ω (external bridge box required for 350 Ω) 4-gage method: 120 Ω to 1 kΩ
Gage ratio	2.0 (fixed)
Bridge voltage	2 V ±0.05 V DC
Balance adjustment	Electronic auto-balancing method
Input type	Balanced differential input, simultaneous sampling of all channels (non-isolated channels)
A/D resolution	16 bit
Maximum input voltage	±0.5 V DC (maximum voltage between input terminals without causing damage)
Maximum channel-to-channel voltage	Non-isolated (all channels share common GND)
Maximum rated terminal-to-ground voltage	30 V rms AC or 60 V DC (maximum voltage between input channel and chassis without causing damage)
Input resistance	2 MΩ ±5%
Data refresh interval	1 ms to 10 s (13 selectable levels)
Low-pass filter	Cut-off frequency: -3 dB ±30%, Auto, 120, 60, 30, 15, 8, 4 (Hz) Auto: cut-off frequency of low-pass filter is automatically set based on set data refresh interval.
	Attenuation characteristics: 5th-order butterworth filter, -30 dB/oct
Dimensions	U8554: approx. 134W × 70H × 63D mm (5.28"W × 2.76"H × 2.48"D) LR8534: approx. 154W × 106H × 57D mm (6.06"W × 4.17"H × 2.24"D)
Mass	U8554: approx. 236 g (8.3 oz.) LR8534: approx. 372 g (13.1 oz.) (including Z3230 Wireless Lan Adapter)

CURRENT MODULE U8556	WIRELESS CURRENT MODULE LR8536
-----------------------------	---------------------------------------

Accuracy guaranteed for 1 year

Number of input channels	5
Input terminals	Dedicated connector (HIOKI PL14)
Measurement target	Current (with optional current sensor)
Applicable current sensor	CT7812 AC/DC Current Sensor (2 A AC/DC) CT7822 AC/DC Current Sensor (2 A AC/DC) CT7126 AC Current Sensor (60 A AC) CT7131 AC Current Sensor (100 A AC) CT7136 AC Current Sensor (600 A AC) CT7044 AC Flexible Current Sensor (6000 A AC, φ 100 mm or less) CT7045 AC Flexible Current Sensor (6000 A AC, φ 180 mm or less) CT7046 AC Flexible Current Sensor (6000 A AC, φ 254 mm or less) CT7731 AC/DC Auto-zero Current Sensor (100 A AC/DC) CT7736 AC/DC Auto-zero Current Sensor (600 A AC/DC) CT7742 AC/DC Auto-zero Current Sensor (2000 A AC/DC) CT7116 AC Leakage Current Sensor (6 A AC)
	Measurement range
Response time for instantaneous values	150 μs (Step input 90% of final value Design value)
Frequency characteristics for RMS values	DC to 5 kHz (-3 dB)
Response time for RMS values	0.8 s (Step input Time for measured value to enter accuracy specification range, design value)
A/D resolution	16 bit
Input resistance	1 MΩ ±5%
Current sensor power supply	+5 V ± 0.25 V, -5 V ± 0.25 V
Maximum rated terminal-to-ground voltage	Non-isolated

U8556, LR8536 Specifications continued

Data refresh interval	1 ms to 10 s (13 selectable levels)
Measurement item	Instantaneous value, RMS value (switchable)
RMS value measurement method	True RMS value calculation of AC+DC with RMS value IC
Low-pass filter	OFF, 220 Hz(-3 dB)
Dimensions	U8556: approx. 134W × 70H × 63D mm (5.28"W × 2.76"H × 2.48"D) LR8536: approx. 154W × 115H × 48D mm (6.06"W × 4.53"H × 1.89"D)
Mass	U8556: approx. 256 g (9.0 oz.) LR8536: approx. 377 g (13.3 oz.) (including Z3230 Wireless Lan Adapter)

Combination accuracy of U8556, LR8536 and each sensor

CT7812 AC/DC Current Sensor

Range	Resolution	Instantaneous value combination accuracy
2.0000A	0.0002A	±0.38% rdg.±0.0037A
200.0mA	0.1 mA	±0.38% rdg.±2.4 mA

CT7822 AC/DC Current Sensor

Range	Resolution	Instantaneous value combination accuracy
20.000A	0.002A	±0.38% rdg.±0.037A
2.000A	0.001A	±0.38% rdg.±0.024A

CT7126 AC Current Sensor

Range	Resolution	RMS value combination accuracy		
		45 ≤ f ≤ 66 Hz	66 < f ≤ 500 Hz	500 < f ≤ 1 kHz
50.00A	0.01A	±1.1% rdg.±0.09A	±2% rdg.±0.09A	±2.6% rdg.±0.09A
5.000A	0.001A	±1.1% rdg.±0.022A	±2% rdg.±0.022A	±2.6% rdg.±0.022A

CT7131 AC Current Sensor

Range	Resolution	RMS value combination accuracy		
		45 ≤ f ≤ 66 Hz	66 < f ≤ 500 Hz	500 < f ≤ 1 kHz
100.00A	0.01A	±1.1% rdg.±0.18A	±1.8% rdg.±0.18A	±2.4% rdg.±0.18A

CT7136 AC Current Sensor

Range	Resolution	RMS value combination accuracy		
		45 ≤ f ≤ 66 Hz	66 < f ≤ 500 Hz	500 < f ≤ 1 kHz
500.0A	0.1A	±1.1% rdg.±0.9A	±1.8% rdg.±1A	±2.4% rdg.±1A
50.00A	0.01A	±1.1% rdg.±0.22A	±1.8% rdg.±0.28A	±2.6% rdg.±0.28A

CT7044, CT7045, CT7046 AC Flexible Current Sensor

Range	Resolution	RMS value combination accuracy
		45 ≤ f ≤ 66 Hz
5000A	1A	±2.3% rdg.±33A
500.0A	0.1A	±2.3% rdg.±3.3A
50.00A	0.01A	±2.3% rdg.±2.66A

CT7731 AC/DC Auto-zero Current Sensor

Range	Resolution	Instantaneous value combination accuracy
100.00A	0.01A	±1.08% rdg.±0.58A

CT7736 AC/DC Auto-zero Current Sensor

Range	Resolution	Instantaneous value combination accuracy
500.0A	0.1A	±2.08% rdg.±3.6A
50.00A	0.01A	±2.08% rdg.±3.06A

CT7742 AC/DC Auto-zero Current Sensor

Range	Resolution	Instantaneous value combination accuracy
2000.0A	0.2A	±1.58% rdg.±11.7A
200.0A	0.1A	±1.58% rdg.±10.4A

CT7116 AC Leakage Current Sensor

Range	Resolution	RMS value combination accuracy		
		45 ≤ f ≤ 66 Hz	66 < f ≤ 500 Hz	500 < f ≤ 1 kHz
5.000A	0.001A	±1.8% rdg.±0.011A	±4% rdg.±0.014A	±4.6% rdg.±0.014A
500.0mA	0.1 mA	±1.8% rdg.±4.6 mA	±4% rdg.±7.6 mA	±4.6% rdg.±7.6 mA

Model: MEMORY HILOGGER LR8450



Model No.(order code)	Specifications
LR8450	Standard model, main unit only
LR8450-01	Wireless LAN equipped model, main unit only

- The LR8450 and LR8450-01 cannot perform measurement on their own. One or more plug-in modules or wireless modules are required (sold separately).
- The LR8450-01 and each wireless module emit radio waves. Use of radio waves is subject to licensing requirements in certain countries. Using it in a country or region other than those indicated may violate the law and may result in legal penalties for the operator. For the latest information about countries and regions where wireless operation is currently supported, please visit the Hioki website.

Option:

Plug-in modules

	VOLTAGE/TEMP UNIT U8550 Channels: 15; maximum sampling rate: 10 ms
	UNIVERSAL UNIT U8551 Channels: 15; maximum sampling rate: 10 ms
	VOLTAGE/TEMP UNIT U8552 Channels: 30; maximum sampling rate: 20 ms (When 15 or fewer channels are used, 10 ms)
	HIGH SPEED VOLTAGE UNIT U8553 Channels: 5; maximum sampling rate: 1 ms
	STRAIN UNIT U8554 Channels: 5; maximum sampling rate: 1 ms
	CAN UNIT U8555 Ports: 2, input: CAN or CAN FD, output: CAN or CAN FD maximum sampling rate: 10 ms
	CURRENT MODULE U8556 Channels: 5; maximum sampling rate: 1 ms

Wireless modules

	WIRELESS VOLTAGE/TEMP UNIT LR8530 Channels: 15; maximum sampling rate: 10 ms
	WIRELESS UNIVERSAL UNIT LR8531 Channels: 15; maximum sampling rate: 10 ms
	WIRELESS VOLTAGE/TEMP UNIT LR8532 Channels: 30; maximum sampling rate: 20 ms (When 15 or fewer channels are used, 10 ms)
	WIRELESS HIGH SPEED VOLTAGE UNIT LR8533 Channels: 5; maximum sampling rate: 1 ms
	WIRELESS STRAIN UNIT LR8534 Channels: 5; maximum sampling rate: 1 ms
	WIRELESS CAN UNIT LR8535 Ports: 2, input: CAN or CAN FD, maximum sampling rate: 10 ms
	WIRELESS CURRENT MODULES LR8536 Channels: 5; maximum sampling rate: 1 ms

Power supplies

<p>For instrument and wireless modules</p> <p>BATTERY PACK Z1007 <small>Li-ion</small></p> <p>Instrument takes two; wireless modules take one <small>(Li-ion, DCT 2 V-2170 mAh, DCT 7.4 V-300 mAh)</small></p>	<p>For instrument</p> <p>AC ADAPTER Z1014</p> <p>Ships standard with LR8450/LR8450-01</p>	<p>For instrument</p> <p>POWER CABLE L1012</p> <p>DC drive. Connect to external battery. Unprocessed ends. Approx. 2 m (6.6 ft)</p>	<p>For wireless modules</p> <p>AC ADAPTER Z1008</p> <p>Ships standard with wireless modules</p>
--	---	---	---

Fixed Stand

FIXED STAND Z5040
For installing logger on wall

Case

CARRYING CASE C1012
Accommodates instrument and four plug-in modules or seven wireless modules

Wireless Lan Adapter

For wireless modules

WIRELESS LAN ADAPTER Z3230
Ships standard with wireless modules

Cables, sensors, etc.

<p>LAN CABLE 9642 Straight Ethernet cable, supplied with straight to cross conversion adapter, 5 m (16.41 ft) length</p>	<p>HUMIDITY SENSOR Z2000 (analog output), 3 m (9.84 ft) length</p>	<p>Thermocouple For reference only. Please purchase locally.</p>	<p>CAN CABLE 9713-01 For the U8555, LR8535. Unprocessed on one end, 1.8 m (5.91 ft) length</p>	<p>NON-CONTACT CAN SENSOR SP7001-95 Supports CAN FD or CAN signals, SP7001, SP9250, SP7150 set</p>
---	---	---	---	---

Storage media

*Always use HIOKI optional storage media. Proper operation is not guaranteed when using storage media from other manufacturers, and may prevent the product from saving and loading data properly.

<p>SD memory card Z4001 2 GB capacity</p>	<p>SD memory card Z4003 8 GB capacity</p>	<p>USB drive Z4006 16 GB, long-life, high-reliability SLC flash memory</p>
--	--	---

For the PC

<p>LOGGER UTILITY/CAN EDITOR LOGGER UTILITY: The control of the measurement of loggers, real-time data collection CAN EDITOR: CAN configuration software Standard accessory You can download the latest version from our website.</p>	<p>GENNECT One Displays measurement results from multiple instruments in graph form Free application for Windows</p>
--	---

Note: Company names and product names appearing in this catalog are trademarks or registered trademarks of various companies.

HIOKI
HIOKI E. E. CORPORATION

DISTRIBUTED BY

HEADQUARTERS
81 Koizumi,
Ueda, Nagano 386-1192 Japan
<https://www.hioki.com/>

