

RM3544

HIOKI

RM3544-01

Instruction Manual

RESISTANCE METER



! Be sure to read this manual before using the instrument.

▶ p.3

✓ When using the instrument for the first time

Names and Functions of Parts ▶ p.17

Measurement Preparations ▶ p.25

📖 Troubleshooting

Troubleshooting ▶ p.160

Error Displays and Remedies ▶ p.169

EN

Mar. 2019 Revised edition 4
RM3544A981-04 19-03H



Using This Instruction Manual

To do this...

Refer to these sections in this manual.

Review important information

- ▶ Safety Information (p.3)
- ▶ Operating Precautions (p.5)

Start using the instrument right away

- ▶ Overview (p.15)

Learn more about instrument functions

- ▶ Search for the function in question in the table of contents (p.i) or the index (p.Index 1).

Learn more about product specifications

- ▶ Specifications (p. 145)

Troubleshoot a problem

- ▶ Troubleshooting (p. 160)

Learn more about resistance measurement

- ▶ Appendix (p. A1)

Learn more about communications commands

- ▶ Communications Command Instruction Manual (on the application disc)

Contents

Introduction.....	1
Verifying Package Contents.....	1
Safety Information.....	3
Operating Precautions.....	5

Chapter 1 Overview 15

1.1 Product Overview and Features	15
1.2 Names and Functions of Parts	17
1.3 Measurement Process	19
1.4 Screen Organization and Operation Overview	21

Chapter 2 Measurement Preparations 25

2.1 Connecting the Power Cord.....	25
2.2 Connecting Measurement Leads	26
2.3 Connecting Z2001 Temperature Sensor (When using the TC)	27
2.4 Turning the Power On and Off	28
■ Turning On the Instrument with the Main Power Switch	28
■ Turning Off the Instrument with the Main Power Switch	28
■ Canceling the Standby State	28
■ Placing the Instrument in the Standby State	29
2.5 Pre-Operation Inspection	30

Chapter 3 Basic Measurements 31

3.1 Selecting the Measurement Range	32
3.2 Setting the Measurement Speed	33
3.3 Connecting Measurement Leads to the Measurement Target	34
3.4 Checking Measured Values	35
■ Switching the Display	35
■ Confirming Measurement Faults	38
■ Holding Measured Values	41

Chapter 4 Customizing Measurement Conditions 43

4.1 Zero Adjustment	44
4.2 Stabilizing Measured Values (Averaging Function)	50
4.3 Correcting for the Effects of Temperature (Temperature Correction (TC))	52
4.4 Correcting Measured Values and Displaying Physical Properties Other than Resistance Values (Scaling Function)	54
4.5 Changing the Number of Measured Value Digits	58

Chapter 5 Judgment Function 59

5.1 Judging Measured Values (Comparator Function)	60
■ Enabling and Disabling the Comparator Function	61
■ Decide According to Upper/Lower Thresholds (ABS Mode)	62
■ Decide According to Reference Value and Tolerance (REF% Mode)	64
■ Delaying the judge timing	66
■ Checking Judgments Using Sound (Judgment Sound Setting Function)	68
■ Checking Judgments with the L2105 LED Comparator Attachment (Option)	70

Chapter 6 Saving and Loading Panels (Saving and Loading Measurement Conditions) 71

6.1 Saving Measurement Conditions (Panel Save Function)	72
6.2 Loading Measurement Conditions (Panel Load Function)	73
■ Preventing Loading of Zero-adjustment Values	74

1

2

3

4

5

6

Contents

6.3	Changing Panel Names	75
6.4	Deleting Panel Data	76

Chapter 7 System Settings 77

7.1	Disabling and Enabling Key Operations	78
■	Disabling Key Operations (Key-Lock Function)	78
■	Re-Enabling Key Operations (Key-Lock Cancel)	79
7.2	Power Line Frequency Manual Setting	80
7.3	Enabling or Disabling the Key Beeper	82
7.4	Adjusting Screen Contrast	83
7.5	Adjusting the Backlight	84
7.6	Initializing (Reset)	85
■	Default Settings	87

Chapter 8 External Control (EXT I/O) 89

8.1	External Input/Output Connector and Signals	90
■	Switching between Current Sink (NPN) and Current Source (PNP)	90
■	Connector Type and Signal Pinouts	91
■	Signal Descriptions	93
8.2	Timing Chart	97
■	From Start of Measurement to Acquisition of Judgment Results	97
■	Zero-adjustment timing	99
■	Panel Load Timing	100
■	BCD Signal Timing	100
■	Output Signal State at Power-On	101
■	Acquisition Process When Using an External Trigger	102
8.3	Internal Circuitry	104
■	Electrical Specifications	106
■	Connection Examples	107
8.4	External I/O Settings	109
■	Setting Measurement Start Conditions (Trigger Source)	109
■	Setting the TRIG Signal Logic	111
■	Eliminating TRIG/PRINT Signal Chatter (Filter Function)	113
■	Setting EOM Signal	115

■	Switching Output Modes (JUDGE Mode/ BCD Mode)	117
8.5	Checking External Control	118
■	Performing an I/O Test (EXT I/O Test Function)	118
8.6	Supplied Connector Assembly	120

Chapter 9 Communications (USB/ RS-232C Interface) 121

9.1	Overview and Features	121
■	Specifications	122
9.2	Preparations before Use (Connections and Settings)	123
■	Using the USB Interface	123
■	Using the RS-232C Interface	126
9.3	Controlling the Instrument with Commands and Acquiring Data	130
■	Remote and Local States	130
■	Displaying Communications Commands (Communications Monitor Function)	131
9.4	Auto-Exporting Measured Values (at End of Measurement) (Data Output Function)	133

Chapter 10 Printing (Using an RS-232C Printer) 137

10.1	Connecting the Printer to the Instrument	137
10.2	Printing	140
■	Printing Measured Values and Comparator Judgments	140
■	Printing List of Measurement Conditions and Settings	140

Chapter 11 Specifications 145

11.1 Instrument Specifications	145
■ Measurement Ranges	145
■ Measurement Method	145
■ Measurement Specifications	146
■ About Instrument Accuracy	148
■ Functions	149
■ Interface	154
■ Environment and Safety Specifications ..	158
■ Accessories	158
■ Options	158

Chapter 12 Maintenance and Service 159

12.1 Troubleshooting	160
■ Q&A (Frequently Asked Questions)	160
■ Error Displays and Remedies	169
12.2 Replacing the Measurement Circuit's Protective Fuse	171
12.3 Inspection and Repair	172

Appendix A 1

Appendix 1 Block Diagram	A 1
Appendix 2 Four-Terminal (Voltage-Drop) Method	A 2
Appendix 3 DC and AC Measurement	A 3
Appendix 4 Temperature Correction (TC) Function	A 4
Appendix 5 Effect of Thermal EMF	A 6
Appendix 6 Zero Adjustment	A 8
Appendix 7 Unstable Measured Values ...	A 13
Appendix 8 Using Multiple RM3544s	A 21
Appendix 9 Detecting the Location of a Short on a Printed Circuit Board	A 22
Appendix 10 JEC 2137 Induction Machine-compliant Resistance Measurement	A 23
Appendix 11 Making Your Own Measurement Leads	A 24
Appendix 12 Checking Measurement Faults	A 26
Appendix 13 Using the Instrument with a Withstanding Voltage TesterA ...	A 27
Appendix 14 Measurement Leads (Options)	A 28
Appendix 15 Rack Mounting	A 29
Appendix 16 Dimensional Diagram	A 33
Appendix 17 Calibration	A 34
Appendix 18 Adjustment Procedure	A 38
Appendix 19 Instrument Settings (Memo) .	A 39

Index**Index 1**

6

7

8

9

10

11

12

Appendix

Index

Introduction

Thank you for purchasing the HIOKI Model RM3544/ RM3544-01 Resistance Meter. To obtain maximum performance from the instrument, please read this manual first, and keep it handy for future reference.

Model RM3544-01 is the same as the RM3544, but with USB, RS-232C, and EXT I/O included.

Trademarks

- Microsoft and Windows are either registered trademarks or trademarks of Microsoft Corporation in the United States and other countries.
- TEFLON is a registered trademark or trademark of The Chemours Company FC, LLC

Verifying Package Contents

Inspection

When you receive the instrument, inspect it carefully to ensure that no damage occurred during shipping. In particular, check the accessories, panel switches, and connectors. If damage is evident, or if it fails to operate according to the specifications, contact your authorized Hioki distributor or reseller.

Content confirmation

Confirm that these contents are provided.

- | | |
|--|--|
| <input type="checkbox"/> Model RM3544 or RM3544-01 1 | <input type="checkbox"/> Instruction Manual (This document) ...1 |
|--|--|



- | |
|---|
| <input type="checkbox"/> Power Cord (2-line + ground) (p. 25) 1 |
|---|

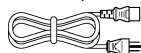

- | |
|---|
| <input type="checkbox"/> Model L2101 Clip Type Lead 1 |
|---|



- | |
|---|
| <input type="checkbox"/> Spare Fuse (F500mAH/250V)..... 1 |
|---|

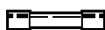

RM3544-01 only

- | |
|---|
| <input type="checkbox"/> Application disc (CD)*.....1 |
| (Communications Command Instruction Manual, USB driver) |



- | |
|--|
| <input type="checkbox"/> USB cable (A-B type)1 |
|--|

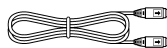

- | |
|--|
| <input type="checkbox"/> EXT I/O Male Connector (p. 120).....1 |
|--|

* The latest version of the application disc can be downloaded from the Hioki web site.

Options

Contact your authorized Hioki distributor or reseller for details.

See: "Appendix 14 Measurement Leads (Options)" (p. A28)

Measurement

Model L2101 Clip Type Lead

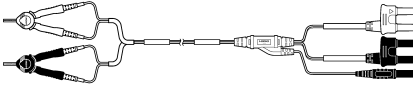

Model L2105 LED Comparator Attachment

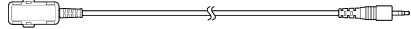

Model L2102 Pin Type Lead



Model Z2001 Temperature Sensor

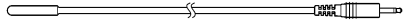

Model L2103 Pin Type Lead



Model L2104 4-Terminal Lead

**Interface Cables**

Model 9637 RS-232C Cable (9pin-9pin/ 1.8 m/ crossover cable)

Model 9638 RS-232C Cable (9pin-25pin/ 1.8 m/ crossover cable)

Safety Information

This instrument is designed to conform to IEC 61010 Safety Standards, and has been thoroughly tested for safety prior to shipment.

However, using the instrument in a way not described in this manual may negate the provided safety features.

Before using the instrument, be certain to carefully read the following safety notes.



DANGER

Mishandling during use could result in injury or death, as well as damage to the product. Be certain that you understand the instructions and precautions in the manual before use.



WARNING

With regard to the electricity supply, there are risks of electric shock, heat generation, fire, and arc discharge due to short circuits. If persons unfamiliar with electricity measuring instruments are to use the product, another person familiar with such instruments must supervise operations.

This manual contains information and warnings essential for safe operation of the instrument and for maintaining it in safe operating condition. Before using it, be sure to carefully read the following safety precautions.

Safety Symbols



In the manual, the symbol indicates particularly important information that the user should read before using the instrument.

The symbol printed on the instrument indicates that the user should refer to a corresponding topic in the manual (marked with the symbol) before using the relevant function.



Indicates AC (Alternating Current).



Indicates the ON side of the power switch.



Indicates the OFF side of the power switch.



Indicates a fuse.

The following symbols in this manual indicate the relative importance of cautions and warnings.



DANGER

Indicates that incorrect operation presents an extreme hazard that could result in serious injury or death to the user.



WARNING

Indicates that incorrect operation presents a significant hazard that could result in serious injury or death to the user.



CAUTION

Indicates that incorrect operation presents a possibility of injury to the user or damage to the instrument.

NOTE

Indicates advisory items related to performance or correct operation of the instrument.

Symbols for Various Standards



Indicates that the product conforms to regulations set out by the EU Directive.



WEEE marking:

This symbol indicates that the electrical and electronic appliance is put on the EU market after August 13, 2005, and producers of the Member States are required to display it on the appliance under Article 11.2 of Directive 2002/96/EC (WEEE).

Other Symbols



Indicates the prohibited action.

(p.)

Indicates the location of reference information.

*

Indicates that descriptive information is provided below.

[]

Square brackets indicate instrument display labels (such as setting item names).

SET

Bold characters within the text indicate operating key labels.

(Bold characters)

Accuracy

We define measurement tolerances in terms of f.s. (full scale), rdg. (reading) and dgt. (digit) values, with the following meanings.

f.s.	(maximum display value) This is usually the name of the maximum displayable value. For this instrument, it indicates the currently selected range.
rdg.	(reading or displayed value) The value currently being measured and indicated on the measuring instrument.
dgt.	(resolution) The smallest displayable unit on a digital measuring instrument, i.e., the input value that causes the digital display to show a "1" as the least-significant digit.

See: "Example accuracy calculations" (p. 148)

Operating Precautions



Follow these precautions to ensure safe operation and to obtain the full benefits of the various functions.

Preliminary Checks

Before using the instrument for the first time, verify that it operates normally to ensure that no damage occurred during storage or shipping. If you find any damage, contact your authorized Hioki distributor or reseller.









Before using the instrument, make sure that the insulation on the power cord, leads or cables is undamaged and that no bare conductors are improperly exposed. Using the instrument in such conditions could cause an electric shock, so contact your authorized Hioki distributor or reseller for replacements.

Instrument Installation

Operating temperature and humidity: 0 to 40°C at 80% RH or less (non-condensating)

Storage temperature and humidity : -10°C to 50°C at 80% RH or less (non-condensating)

Avoid the following locations that could cause an accident or damage to the instrument.

	Exposed to direct sunlight Exposed to high temperature		In the presence of corrosive or explosive gases
	Exposed to water, oil, other chemicals, or solvents Exposed to high humidity or condensation		Exposed to strong electromagnetic fields Near electromagnetic radiators
	Exposed to high levels of particulate dust		Near induction heating systems (e.g., high-frequency induction heating systems and IH cooking utensils)
	Subject to vibration		

NOTE Correct measurement may be impossible in the presence of strong magnetic fields, such as near transformers and high-current conductors, or in the presence of strong electromagnetic fields such as near radio transmitters.

Installation Precautions

- The instrument should be operated only with the bottom downwards.
- Do not place the instrument on an unstable or slanted surface.

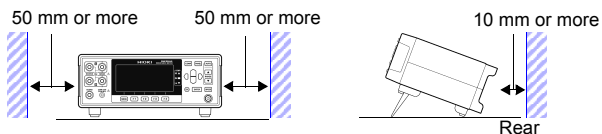

The instrument can be used with the stand (p. 18).
It can also be rack-mounted. (p. A29).

NOTE Unplugging the power cord kills power to the instrument. Be sure to provide enough unobstructed space to unplug the power cord immediately in an emergency.

Handling the Instrument

WARNING

- Do not allow the instrument to get wet, and do not take measurements with wet hands. This may cause an electric shock.
- Do not attempt to modify, disassemble or repair the instrument; as fire, electric shock and injury could result.

CAUTION

- To avoid damage to the instrument, protect it from physical shock when transporting and handling. Be especially careful to avoid physical shock from dropping.
- To avoid damage to the instrument, do not apply voltage or current to measurement terminals, TEMP.SENSOR jack, or COMP.OUT jack.

NOTE

- This instrument may cause interference if used in residential areas. Such use must be avoided unless the user takes special measures to reduce electromagnetic emissions to prevent interference to the reception of radio and television broadcasts.
- Use the original packing materials when transporting the instrument, if possible.

Handling the Cords and Leads

DANGER

To avoid electrical shock, be careful to avoid shorting live lines with the test leads.

CAUTION

- Avoid stepping on or pinching cables, which could damage the cable insulation.
- To avoid breaking cables or lead wires, do not bend or pull them.
- To avoid damaging the power cord, grasp the plug, not the cord, when unplugging it from the power outlet.
- To avoid damaging the cable, grasp the connector, not the cable, when unplugging the cable.
- The ends of the pin type lead are sharp. Be careful to avoid injury.
- Keep the cables well away from heat sources, as bare conductors could be exposed if the insulation melts.
- Temperature sensors are precision devices. Be aware that excessive voltage pulses or static discharges can destroy the film.
- Avoid subjecting the temperature sensor tip to physical shock, and avoid sharp bends in the leads. These may damage the probe or break a wire.
- To avoid electric shock, do not exceed the lower of the ratings shown on the instrument and test leads.

Operating Precautions

- NOTE**
- Use only the specified cords and leads. Using a non-specified cord or lead may result in incorrect measurements due to poor connection or other reasons.
 - If the part of the temperature sensor that connects to the instrument becomes dirty, wipe it clean. The presence of dirt may affect temperature measured values by increasing the contact resistance.
 - Exercise care so that the temperature sensor connector does not become disconnected. (If the sensor is disconnected, it will not be possible to perform temperature correction.)

CD-R disc precautions

CAUTION

- Exercise care to keep the recorded side of discs free of dirt and scratches. When writing text on a disc's label, use a pen or marker with a soft tip.
- Keep discs inside a protective case and do not expose to direct sunlight, high temperature, or high humidity.
- Hioki is not liable for any issues your computer system experiences in the course of using this disc.

Before Connecting the Power Cord

WARNING

- **To avoid electrical accidents and to maintain the safety specifications of this instrument, connect the power cord provided only to a 3-contact (two-conductor + ground) outlet.**
- **Use only the designated power cord with this instrument. Use of other power cords may cause fire.**
- **Before using the instrument, make sure that the insulation on the power cord is undamaged and that no bare conductors are improperly exposed. Any damage could cause electric shock, so contact your authorized Hioki distributor or reseller.**

CAUTION

To avoid damaging the power cord, grasp the plug, not the cord, when unplugging it from the power outlet.

Before Connecting Measurement Leads

DANGER

To avoid shock and short circuits, turn off all power before connecting measurement leads.

Before Connecting the LED Comparator Attachment

CAUTION

- To keep from damaging the instrument or LED Comparator Attachment, turn off the instrument before connecting the attachment.
- The COMP.OUT jack is provided exclusively for use with the L2105. Do not connect any device other than the L2105.
- The attachment may not fulfill the specifications if the connector is not attached securely.
- Do not over-tighten the cable tie around the measurement leads. Doing so may damage the measurement leads.
- Avoid the following as damage to the cable conductor or insulation may result:
 - Twisting or pulling on cables
 - Bending cables near the lamp excessively in order to connect them

Before Connecting the Temperature Sensor

WARNING

Failure to fasten the connectors properly may result in sub-specification performance or damage to the equipment.

CAUTION

Note the following precautions to avoid damaging the instrument:

- To keep from damaging the instrument or temperature sensor, turn off the instrument's main power switch before connecting the sensor.
- Connect the temperature sensor by inserting the plug all the way into the TEMP.SENSOR jack. A loose connection can cause a large error component in measured values.

NOTE

If the temperature sensor jack becomes dirty, wipe it clean. The presence of dirt will cause an error in temperature measured values.

Before Connecting Data Cables (USB, RS-232C)**⚠ CAUTION**

Observe the following precautions when connecting the instrument and a controller:

- To avoid faults, do not disconnect or reconnect the USB cable during instrument operation.
- The USB and RS-232C interfaces are not isolated from the ground circuit. Connect the instrument and the controller to a common earth ground. Using different grounds could result in potential difference between the instrument and the controller. Potential difference on the data cable can result in malfunctions and faults.
- Before connecting or disconnecting the RS-232C Cable, always turn off the instrument and the controller. Failure to do so could result in equipment malfunction or damage.
- After connecting the RS-232C Cable, tighten the screws on the connector securely. Failure to secure the connector could result in equipment malfunction or damage.

Before Connecting the Printer**⚠ WARNING**

Because electric shock and instrument damage hazards are present, always follow the steps below when connecting the printer.

- **Always turn off the instrument and the printer before connecting.**
 - **A serious hazard can occur if a wire becomes dislocated and contacts another conductor during operation. Make certain connections are secure.**
-

Before Switching between Current Sink (NPN) and Current Source (PNP)

-  **CAUTION**
- Configure the NPN/PNP setting to accommodate externally connected equipment.
 - Do not operate the NPN/PNP switch while the instrument is on.

Before Connecting EXT I/O

-  **WARNING**
- To avoid electric shock or damage to the equipment, always observe the following precautions when connecting to the EXT I/O connector.
- Always turn off the main power switch on the instrument and on any devices to be connected before making connections.
 - Be careful to avoid exceeding the ratings of external terminals (p. 106).
 - During operation, a wire becoming dislocated and contacting another conductive object can be serious hazard. Use screws to secure the external connectors.
 - The ISO_5V pin of the EXT I/O connector is a 5V (NPN)/ -5V (PNP) power output. Do not apply external power to this pin. (External power cannot be supplied to the instrument's EXT I/O connector.)

-  **CAUTION**
- To avoid damage to the instrument, observe the following cautions:
- Do not apply voltage or current to the EXT I/O terminals that exceeds their ratings.
 - When driving relays, be sure to install diodes to absorb counter-electromotive force.
 - Be careful not to short-circuit ISO_5V to ISO_COM.
 - Configure the NPN/PNP setting to accommodate externally connected equipment.
 - Do not operate the NPN/PNP switch while the instrument is on.
- See: "Connector Type and Signal Pinouts" (p. 91)

Before Turning Power On

-  **WARNING**
- Before turning the instrument on, make sure the supply voltage matches that indicated on its power connector. Connection to an improper supply voltage may damage the instrument and present an electrical hazard.

-  **CAUTION**
- Avoid using an uninterruptible power supply (UPS) or DC/AC inverter with rectangular wave or pseudo-sine-wave output to power the instrument. Doing so may damage the instrument.

Before Measuring

⚠ WARNING

- To avoid electric shock or damage to the instrument, do not apply voltage to the measurement terminals. Also, to avoid electrical accidents, only take measurements after turning off the power to the measurement targets being measured.

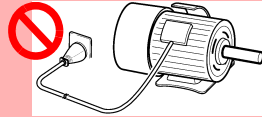

The measurement target is connected to a power supply.

- Sparks may result at the moment the instrument is connected to, or disconnected from, the measurement target. To avoid fire or bodily injury, avoid use in the presence of explosive gases.

⚠ CAUTION

- Never attempt to measure at a point where voltage is present. Even if the power supply to the motor is turned off, while the motor is rotating inertially, high electromotive power is generated in terminals. When attempting to measure a transformer or motor immediately after voltage withstanding test, induced voltage or residual charge may damage the instrument.

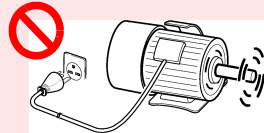

Rotating inertially

- When the RM3544 is used in a way that connects to a withstanding voltage tester via switching relays, construct a testing line bearing the following in mind.

See: "Appendix 13 Using the Instrument with a Withstanding Voltage Tester" (p. A27)

- (1) The voltage withstanding specification of switching relays should include a safe margin over the withstanding testing voltage.
- (2) To protect against damage due to arc discharge in relay contacts, all RM3544 measurement terminals should be grounded during voltage withstanding testing.
- (3) To protect against damage due to residual charge, measure resistance first, and voltage withstanding last.

3158 AC Withstanding Voltage HiTester

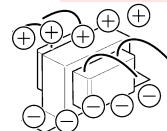
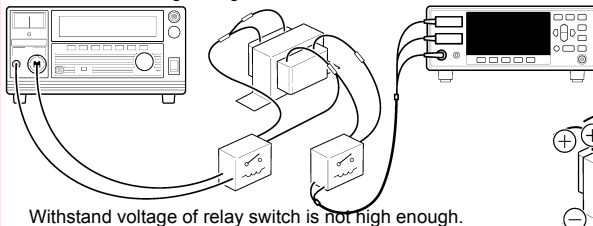

Residual charge from voltage withstanding test is present.

- Battery internal resistance cannot be measured with this instrument. It will sustain damage. To measure battery internal resistance, we recommend the HIOKI 3554, 3555, BT3562, BT3563 and 3561 Battery HiTesters.

- NOTE**
- When measuring devices such as power supply transformers with high inductance or open-type solenoid coils, measured value may be unstable. In such cases, connect a film capacitor of about 1 μF between SOURCE A and SOURCE B.
 - Carefully insulate all SOURCE A, SENSE A, SENSE B, and SOURCE B wiring. Proper 4-terminal measurements cannot be performed and an error will occur if core and shield wires touch.
 - The SOURCE terminal is protected by a fuse. If the fuse is tripped, the instrument will display "**Blown Fuse.**" and you will not be able to measure resistance values. If the fuse is tripped, replace the fuse.
[See: "12.2 Replacing the Measurement Circuit's Protective Fuse" \(p. 171\)](#)

When using the temperature sensor



The temperature sensor is not waterproof. Do not submerge it in water or other liquid.

- NOTE**
- Allow the measurement target for which temperature correction is being performed and the temperature sensor to adjust to the ambient temperature prior to measurement. Failure to do so will result in a large error component.
 - Handling of the temperature sensor with bare hands may cause the sensor to pick up inductive noise, resulting in unstable measured values.
 - The temperature sensor is designed for use in applications in which ambient temperature is measured. It is not possible to accurately measure the temperature of the measurement target itself by placing the sensor in contact with the surface of the target.
 - Connect the temperature sensor by inserting the plug all the way into the TEMP.SENSOR jack. A loose connection may cause a large error component in measured values.

Overview

Chapter 1

1

1.1 Product Overview and Features

The RM3544 is capable of performing high-speed, high-precision measurement of the winding resistance of components such as motors and transformers, the contact resistance of relays and switches, the pattern resistance of printed circuit boards, and the DC resistance of fuses, resistors, and materials such as conductive rubber using four-terminal measurement. Since the instrument incorporates a temperature correction function, it is particularly well suited to the measurement of targets whose resistance values vary with temperature.

Compact yet reliable specifications

- **Installed footprint: 215 mm × 166 mm**

Compact footprint and limited depth leave plenty of work space in front of the instrument.

- **Measurement range: 30.000 mΩ to 3.0000 MΩ with a basic accuracy of 0.02% rdg.**

- **Maximum measurement current: 300 mA**

Ensures stable measurement, even when there is a significant amount of external noise.

- **No need for warm-up operation or zero-adjustment**

Since wasteful wait times are not required, you can start making measurements as soon as the instrument is turned on.

- **Choice of interfaces**

RM3544 (no interface), RM3544-01 (USB, RS-232C, EXT I/O)

1.2 Names and Functions of Parts

1

Front Panel

Viewing Measured Values and Settings

Display Screen (Monochrome graphical LCD)

Display of measurements and settings (p. 21)

Viewing Comparator Results

COMP indicator LEDs

Indicate the judgment result of the measured value (p.60).

- Hi** Measured value is above upper limit
- IN** Pass (meets criteria)
- Lo** Measured value is below lower limit

Settings

PANEL key

PANEL Saving and loading of panels (p.72)

COMP key

COMP Configuration of comparator settings (p.60)

AUTO

AUTO, RANGE key

▲ Range switching (p.32)

▼

SPEED key

SPEED Measurement speed switching (p.33)

Cursor keys

◀ ▶ Selection of settings and digits

ENTER key

ENTER Acceptance of settings and manual trigger input

ESC key

ESC Cancellation of operation

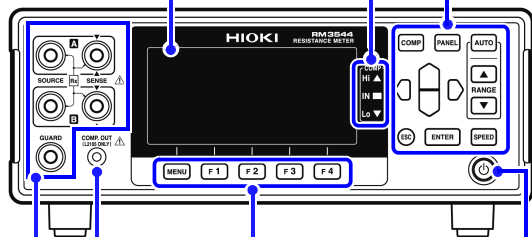

MENU

MENU key

Switching of F key pages

F keys

F1 · **F4** Selection of settings displayed on the screen

Connecting the LED Comparator Attachment

COMP.OUT jack

Connect the L2105 LED Comparator Attachment to view judgment results without needing to refer to the instrument display. (p.70)

Connecting Measurement Leads

Measurement Terminals

Connect measurement leads (p. 26).

- SOURCE A : Current detection terminal
- SOURCE B : Current source terminal
- SENSE A : Voltage detection terminal
- SENSE B : Voltage detection terminal
- GUARD : Guard terminal

Initiating and Canceling the Standby State

STANDBY Key: Initiates or cancels the standby state. (p. 28).

- Unlit: power off (when no power supplied)
- Red light: Standby State (while power is supplied)
- Green light: power on

Rear Panel

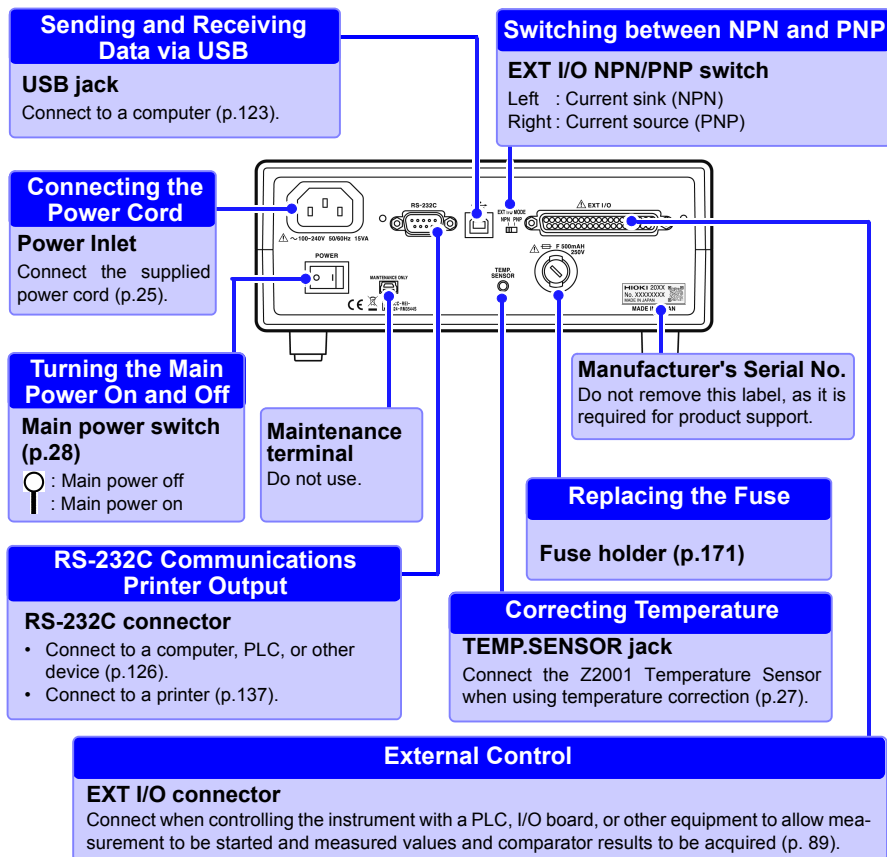

Bottom Panel

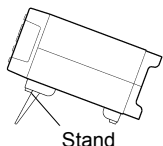
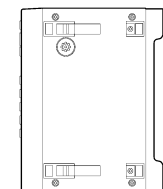

This instrument can be rack mounted.

See: "Appendix 15 Rack Mounting" (p. A29)

Parts removed from this instrument should be stored in a safe place to enable future reuse.

When using the stand

Extend the legs all the way. Do not extend partially.
 Make sure to extend both legs of the stand.

Collapsing the stand

Do not collapse the stand partway. Be sure to collapse it all the way.



CAUTION

Do not apply heavy downward pressure with the stand extended. The stand could be damaged.

1.3 Measurement Process

1

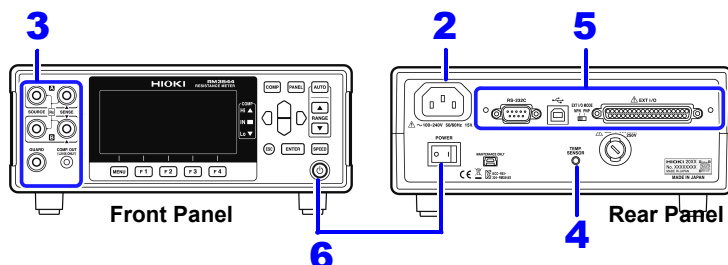

- 1** Install this instrument (p. 5)
 - 2** Connect the power cord (p.25)

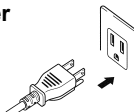

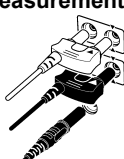
 - 3** Connect measurement leads (p.26)

 - 4** Connect the temperature sensor (p.27)
(When using the temperature correction function)
 - 5** Connect the external interface (RM3544-01; as necessary)

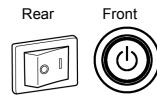
 - Using the printer (p.137)
 - Using the USB or RS-232C interface (p.121)
 - Using the EXT I/O (p.89)
 - 6** Turn on the instrument and cancel the standby state (p.28)

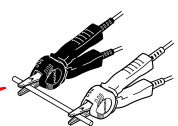
 - 7** Make instrument settings ^{*1}
 - 8** Connect to the test sample (p.34)

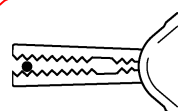
- When clipping a small-gauge wire**
(Clip with the tip of the alligator clips.)

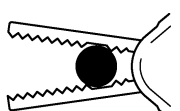

When clipping a large-gauge wire
(Clip with the back of the alligator clips, where there are no teeth.)

- When finished measuring, turn the power off (p.28).**

*1 About zero-adjustment

Perform zero-adjustment in the following circumstances:

- The measured value is not cleared due to thermal EMF or other factors.
 - The measured value will be adjusted to zero. (Accuracy is not affected by whether or not the zero adjustment is performed.)
- Four-terminal connection (called Kelvin connection) is difficult.
 - The residual resistance of the two-terminal connection wires will be canceled.

See: "4.1 Zero Adjustment" (p.44)
"Appendix 6 Zero Adjustment" (p.8)

1.4 Screen Organization and Operation Overview

1

The instrument's screen interface consists of a Measurement screen and various Settings screens.

The screen examples in this guide appear reversed (black on white) for best visibility on the printed page. However, the instrument screens can actually be displayed only as white characters on black background.

Measurement screen layout

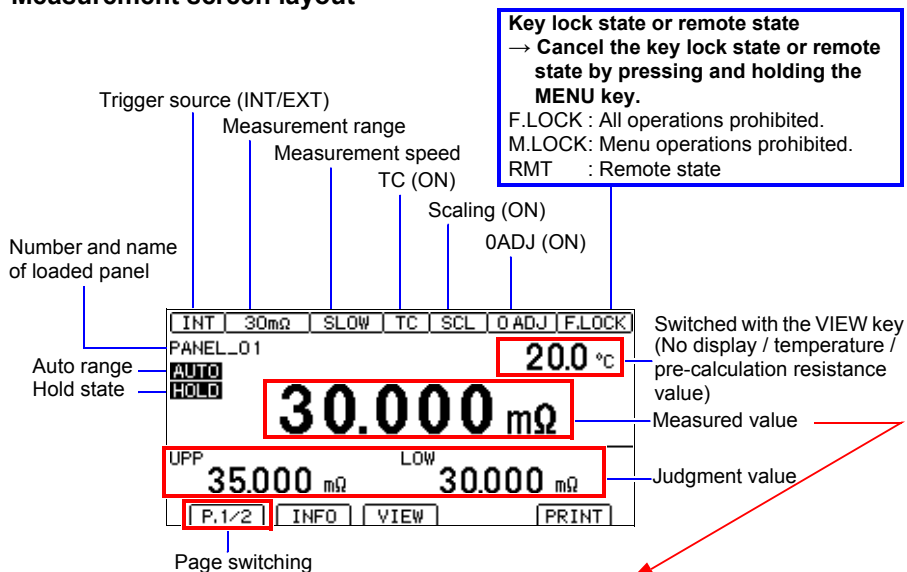

Display of information other than measured values

(For more information, see "Confirming Measurement Faults" (p.38).)

Display	Description
+OvrRng -OvrRng	Over-range
-----	Not measured, or broken connection in measurement target *

* To treat current faults (when the source wiring is open) as over-range events, change the current fault output mode setting. (p.40)

Overview of screen operation

(1) Measurement screen

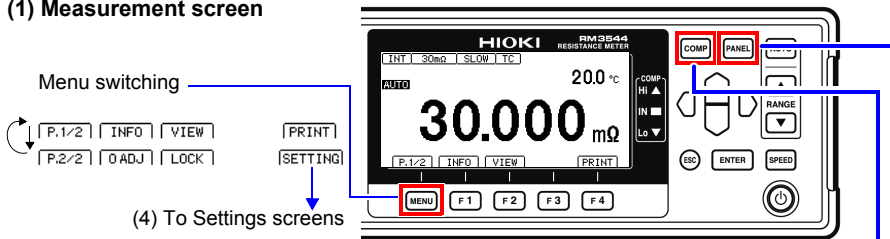

(4) To Settings screens

(2) Comparator Settings screen

- 1 Select the mode with an F key.
- 2 Change the range with the \blacktriangle and \blacktriangledown keys.
- 3 \blacktriangleleft \blacktriangleright Move among digits. \blacktriangleleft \blacktriangleright Change values.
- 4 Accept the setting with the **ENTER** key or cancel with the **ESC** key.

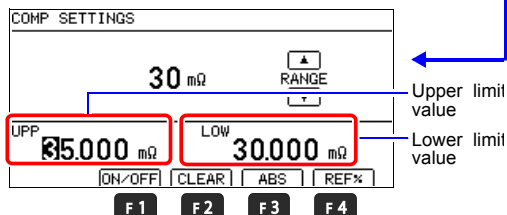

(3) Panel Save/Load screen

- 1 \blacktriangleleft \blacktriangleright Select a panel number.
- 2 Perform action with an F key.

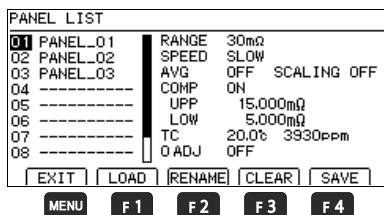

(4) Settings screen

- 1 \blacktriangleleft \blacktriangleright Move to the [MEAS], [SYS], [I/O], or [IF] tab.
([I/O] and [IF] tabs: RM3544-01 only. Not shown on RM3544.)
- 2 \blacktriangleleft \blacktriangleright Select a setting. \blacktriangleleft \blacktriangleright Move among settings.
- 3 Switch functions with an F key or set values.
- 4 Return to the Measurement screen with the **MENU** key.

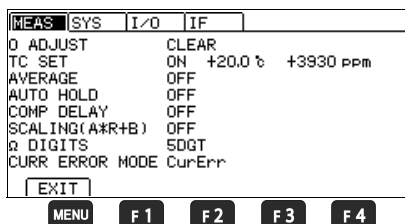

< Setting values >

- 1 Make the value editable with the **F4** key.
- 2 \blacktriangleleft \blacktriangleright Move among digits. \blacktriangleleft \blacktriangleright Change values.
- 3 Accept the setting with the **ENTER** key or cancel with the **ESC** key.

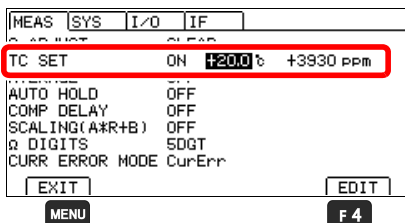

List of settings

Screen		Setting and key	Overview	See	
Measurement screen		COMP	Comparator function	(p.61)	
		PANEL	Save/load panel	(p.71)	
		AUTO			
		▲ (RANGE)	Measurement range	(p.32)	
		▼ (RANGE)			
		SPEED	Measurement speed	(p.33)	
Measurement screen (P.1/2)		INFO (F1)	Display setting conditions		
		VIEW (F2)	Switch measurement screen display		
		PRINT (F4)	Print	(p.139)	
Measurement screen (P.2/2)		0 ADJ (F1)	Zero-adjustment	(p.44)	
		LOCK (F2)	Key lock	(p.78)	
		SETTING (F4)	Switch to Settings screen		
Settings screen (SETTING)	Measurement Settings screen (MEAS)	0 ADJUST	Clear zero-adjustment	(p.48)	
		TC SET	Temperature correction	(p.52)	
		AVERAGE	Averaging	(p.50)	
		AUTO HOLD	Hold measured value	(p.41)	
		COMP DELAY	Judge delay	(p.66)	
		SCALING(A*R+B)	Scaling	(p.54)	
		A:			
		B:			
		UNIT:			
		Ω DIGITS	Set the display digits	(p.58)	
		CURR ERROR MODE	Set the current fault output mode	(p.40)	
		System Settings screen (SYS)	KEY CLICK	Set the operation sound	(p.82)
			COMP BEEP Hi	Set the judgment sound	(p.68)
	IN				
	Lo				
	PANEL LOAD 0ADJ		Load zero-adjustment values	(p.74)	
	0ADJ RANGE		Zero-adjustment range	(p.47)	
	CONTRAST		Set the contrast	(p.83)	
	BACKLIGHT		Set the contrast brightness	(p.84)	
	POWER FREQ		Set the power frequency	(p.80)	
	RESET		Reset the instrument	(p.85)	
	ADJUST	Adjust the instrument	(p.A38)		
	EXT I/O Settings screen (I/O) *1	TRIG SOURCE	Set the trigger source	(p.109)	
		TRIG EDGE	Set the trigger signal logic	(p.111)	
		TRIG/PRINT FILT	Trigger/print filter function	(p.113)	
		EOM MODE	EOM signal setting	(p.115)	
		JUDGE/BCD MODE	EXT I/O output mode	(p.117)	
		EXT I/O TEST	Test EXT I/O	(p.118)	
	Communication Interface Settings screen (IF) *1	INTERFACE	Configure interface settings	(p.123)	
		SPEED	Communications	(p.121)	
		DATA OUT			
		CMD MONITOR			
		PRINT INTRVL	Printing	(p.137)	
PRINT COLUMN					

*1 RM3544-01 only.

Measurement Preparations

Chapter 2

2

Be sure to read the "Operating Precautions" (p.5) before installing and connecting this instrument.

Refer to "Appendix 15 Rack Mounting" (p. A29) for rack mounting.

2.1 Connecting the Power Cord



Turn off the power before disconnecting the power cord.

Rear Panel

Power inlet

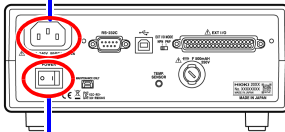

Main power switch

1 Confirm that the instrument's Main power switch (rear panel) is OFF(○).

2 Confirm that the mains supply voltage matches the instrument, and connect the power cord to the power inlet on the instrument.

3 Plug the power cord into the mains outlet.

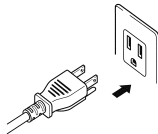

If power to the instrument is cut off with the power switch in the ON position (by a circuit breaker, etc.), the instrument will start up when power is restored, without any need to press the STANDBY key.

2.2 Connecting Measurement Leads



Connect the included or optional Hioki measurement leads to the measurement terminals. Before connecting the measurement leads, read "Operating Precautions" (p.5) carefully. Refer to "Options" (p.2) for details.

NOTE We recommend using optional Hioki measurement leads.

Connection Methods



Connecting measurement leads

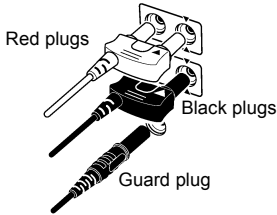

Connect the red plugs to the SOURCE A and SENSE A terminals, the black plugs to the SOURCE B and SENSE B terminals, and the guard plug to the GUARD terminal.

Measurement leads

(Example: When using the L2101 Clip Type Lead)

The "V" mark indicates the SENSE side.

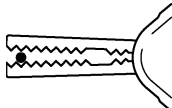
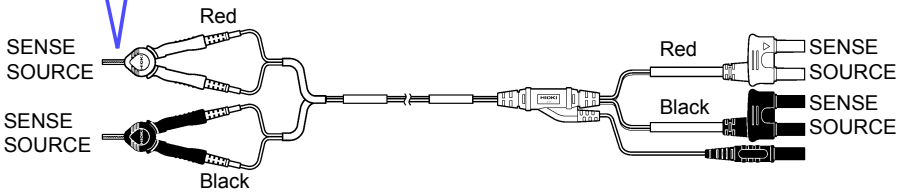

When clipping a small-gauge wire
(Clip with the tip of the alligator clips.)

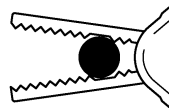

When clipping a large-gauge wire
(Clip with the back of the alligator clips, where there are no teeth.)

NOTE When making your own measurement leads or extending a measurement lead, see "Appendix 11 Making Your Own Measurement Leads" (p. A24).

2.3 Connecting Z2001 Temperature Sensor (When using the TC)

Before connecting the temperature sensor, read "Operating Precautions" (p.5) carefully.

Connection Methods

Connecting the Z2001 Temperature Sensor

Rear Panel

TEMP.SENSOR jack

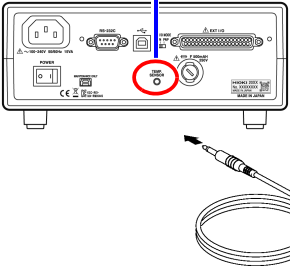

Z2001 Temperature Sensor

- 1** Confirm that the instrument's Main power switch (rear panel) is OFF(○).
- 2** Plug the Z2001 Temperature Sensor into the TEMP.SENSOR jack on the rear panel.

Insert the plug securely all the way into the jack.
- 3** Place the tip of the temperature sensor near the measurement target.

2.4 Turning the Power On and Off

Turning On the Instrument with the Main Power Switch

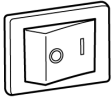

Power ON |

Turn on (|) the main power switch on the rear of the instrument.

If the main power switch was turned off while the instrument was not in the standby state, the standby state will be automatically canceled when the main power switch is turned on.

Turning Off the Instrument with the Main Power Switch

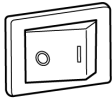

Power OFF ○

Turn off (○) the main power switch on the rear of the instrument.

Canceling the Standby State



Press the STANDBY key (the STANDBY key will change from red to green).

After the standby state is canceled, a self-test (instrument diagnostic routine) is performed.

During the self-test, the following information is displayed while the hardware is verified.

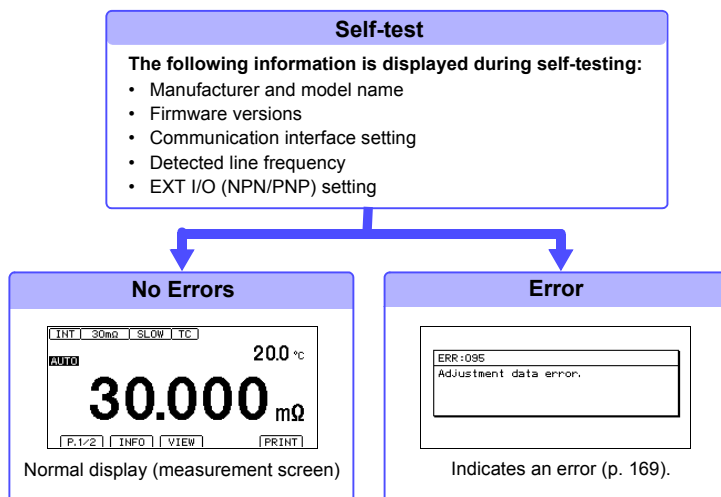

When powered up for the first time, the default settings appear.

See: "Default Settings" (p.87)

Before Starting Measurement

The SOURCE terminal is protected by a fuse. If the fuse is tripped, the instrument will display "**Blown FUSE.**" and you will not be able to measure resistance values. In this case, replace the fuse.

See: "12.2 Replacing the Measurement Circuit's Protective Fuse" (p.171)

Measurement settings are recalled from when the power was previously turned off (settings backup).

Placing the Instrument in the Standby State

Press the Standby key (the Standby key will change from green to red).

Disconnect the power cord from the outlet to extinguish the standby key light.

When power is turned on again, operation resumes with the same state as when last turned off.

If a power outage (e.g., breaker trip) occurs when the instrument is on, it will automatically turn on again when power is restored (without pressing the standby key).

2.5 Pre-Operation Inspection

Before using the instrument for the first time, verify that it operates normally to ensure that no damage occurred during storage or shipping. If you find any damage, contact your authorized Hioki distributor or reseller.

1 Peripheral Device Inspection

Is the power cord insulation torn, or is any metal exposed?

Metal Exposed

Do not use the instrument if damage is found, as electric shock or short-circuit accidents could result. Contact your authorized Hioki distributor or reseller.

No Metal Exposed

Is the insulation on a measurement lead torn, or is any metal exposed?

Metal Exposed

If there is any damage, measured values may be unstable and measurement errors may occur. Replace the cable with an undamaged one.

No Metal Exposed

2 Instrument Inspection

Is damage to the instrument evident?

Yes

If damage is evident, request repairs.

No

When turning power on

Is the STANDBY key red or green?

No

The power cord may be damaged, or the instrument may be damaged internally. Request repairs.

Yes

After the completion of the self-test (when the model number is shown on the screen), is the Measurement screen displayed?

An error indication occurs

The instrument may be damaged internally. Request repairs.
See: "12.1 Troubleshooting" (p. 160)
"Error Displays and Remedies" (p.169)

Yes

Inspection complete

Basic Measurements

Chapter 3

Before making measurements, read "Operating Precautions" (p. 12) carefully.

This chapter explains basic operating procedures for the instrument.

"3.1 Selecting the Measurement Range" (p.32)

"3.2 Setting the Measurement Speed" (p.33)

"3.3 Connecting Measurement Leads to the Measurement Target" (p.34)

"3.4 Checking Measured Values" (p.35)

To customize measurement conditions, see "Chapter 4 Customizing Measurement Conditions" (p.43).

3.1 Selecting the Measurement Range

The measurement range can be set as follows. Auto-ranging (the AUTO range) can also be selected.

Manual Range Setting



Select the range to use. (AUTO off)



The decimal point location and unit indicator change with each key press.

Auto-Ranging



Press this while a manual range is selected. (AUTO lights)
The optimum measurement range is automatically selected.

Switching from Autoranging back to Manual range selection

Press  again. The range can now be changed manually.

NOTE

- When the comparator function is turned ON, the range cannot be changed from fixed (it cannot be switched to auto-ranging). To change the range, turn OFF the comparator function or change the range from within the comparator settings.
 - When measuring certain motor, transformer or coil components, the auto range setting may not stabilize. In such cases, use manual range selection.
 - The measurement target power is given by $(\text{resistance value} \times (\text{measurement current})^2)$ if the measured value is within the measurement range. If the measurement range is exceeded, the power may reach a maximum value that is given by $(\text{open voltage} \times \text{measurement current})$. Check the measurement range before connecting the measurement target.
A rush current of up to 500 mA will flow at the moment the instrument is connected to the measurement target.
(Convergence time: For pure resistance, approximately 1 ms)
 - Refer to "Resistance Measurement Accuracy" (p. 146) for information on each range measurement accuracy.
-

3.2 Setting the Measurement Speed

The measurement speed can be set to FAST, MED (medium), or SLOW. The MED (medium) and SLOW settings offer increased measurement precision compared to the FAST setting as well as greater resistance to the effects of the external environment. If the setup is excessively susceptible to the effects of the external environment, shield the measurement target and measurement leads adequately and twist the cables together.
 See: "Appendix 7 Unstable Measured Values" (p.13)



Press this to change the measurement speed.

Relationship Between Measurement Range and Speed

Measurement speed	FAST		MEDIUM	SLOW
	50 Hz	60 Hz		
Measurement time	21 ms	18 ms	101 ms	401 ms

With TC ON, comparator ON, and error of $\pm 10\% \pm 2$ ms

Integration time (detected voltage data acquisition time) reference values

FAST (50 Hz): 20.0 ms, FAST (60 Hz): 16.7 ms, MEDIUM: 100 ms, SLOW: 400 ms

3.3 Connecting Measurement Leads to the Measurement Target

Before making measurements, read "Operating Precautions" (p.5) carefully.

Example with L2101

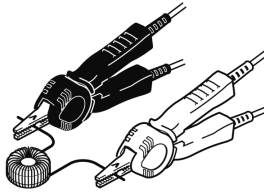

Example with L2102

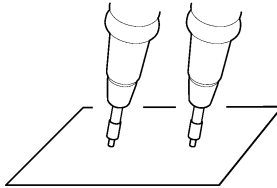

(Place leads in contact with target.)

Example with L2104

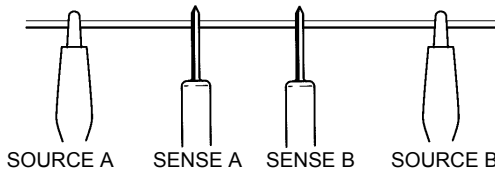

The SENSE terminals are placed to the inside of the SOURCE terminals.

3.4 Checking Measured Values

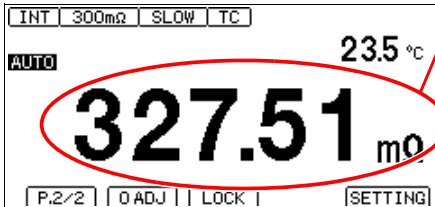

The resistance value will be displayed.

- If the display does not indicate the measured value, see "Confirming Measurement Faults" (p. 38).
- To convert the value into a parameter other than resistance, see below.

See: "4.4 Correcting Measured Values and Displaying Physical Properties Other than Resistance Values (Scaling Function)" (p.54)

3

NOTE

When measuring close to 0 Ω , measured values may turn negative. If measured values turn negative otherwise, check the following:

- Are the SOURCE or SENSE wires connected backwards?
 - Rewire correctly.
- Has the contact resistance decreased since you performed zero-adjustment?
 - Repeat the zero-adjustment process.
- Is the scaling calculation result negative?
 - Change the scaling settings.

Switching the Display

You can change what information is shown on the Measurement screen.

Displaying temperature and pre-calculation measured values

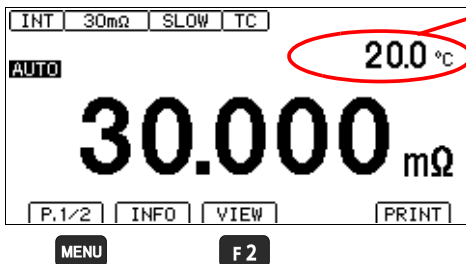

You can switch this part of the display to show nothing, the temperature, or the pre-calculation measured value.

See: "Example displays" (p.36)

- 1 **MENU** Switch the function menu to P.1/2.
- 2 **F2** [VIEW] Switch the Measurement screen.

3.4 Checking Measured Values

Example displays

Display of pre-calculation measured values varies with the settings.

(No display)

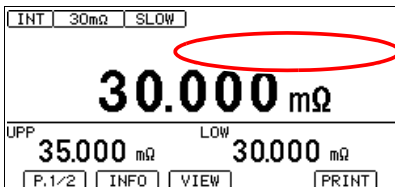

(Temperature display)

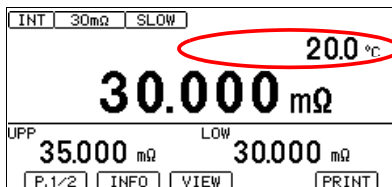

(Value before TC calculation
: With TC ON)

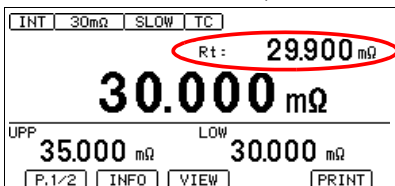

Rt: Resistance measured value
before TC calculation

(Value before scaling calculation
: With scaling ON)

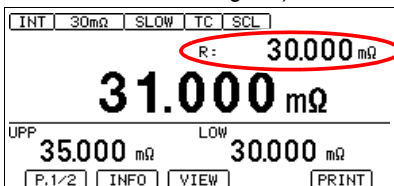

R: Resistance measured value
before scaling

(Value before REF% calculation
: With REF% comparator setting and
scaling OFF)

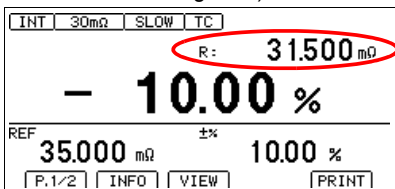

R: Resistance measured value
(before relative calculation)

(Value before REF% calculation
: With REF% comparator setting and
scaling ON)

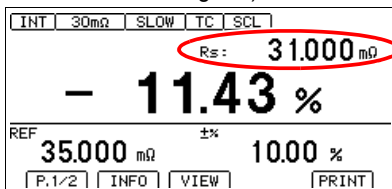

RS: Resistance measured value
after scaling (before relative calculation)

Displaying a list of measurement conditions and settings

1 Display the measurement conditions.

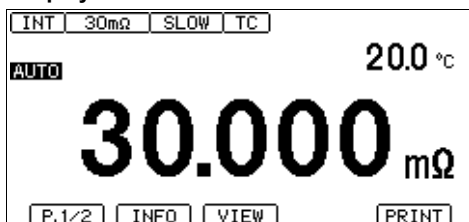

F1

1 **MENU** Switch the function menu to P.1/2.

2 **F1** [INFO] Display measurement conditions.

3

2 Check the measurement conditions.

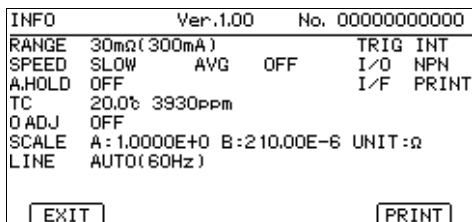

F4

If the interface type has been set to "printer," you can print settings with **F4**.

3 Return to the Measurement screen.



MENU Return to the Measurement screen.

Confirming Measurement Faults

When a measurement is not performed correctly, a measurement fault indicator appears and a ERR signal of the EXT I/O is output (no ERR signal is output for over-range or unmeasured events). Operation when a current fault occurs can be changed with the settings.

NOTE

An unstable measured value may be displayed if the SOURCE terminal is connected to the measurement target but the SENSE terminal has poor contact.

Over-range

Display
+OvrRng
-OvrRng

This fault is displayed in the following two instances.
 (1) Appears when the measured value is outside of the measurement or display range. (*1)
 (2) Appears when a measurement fault(*2) occurs (when the current fault mode setting is "Over-range").
 When no measurement current flows from the SOURCE A terminal to the SOURCE B terminal
 Similarly, if the measurement range is exceeded in temperature measurement, **OvrRng** is displayed.
 The comparator result is Hi when **+OvrRng** is displayed, and Lo when **-OvrRng** is displayed. No ERR signal is output.

Current Fault or measurement not performed

Display

This fault is displayed in the following instances. If "-----" is displayed, a comparator judgment will not be made.
 (1) Appears when a measurement fault(*2) occurs (when the current fault mode setting is "Current fault").
 When no measurement current flows from the SOURCE A terminal to the SOURCE B terminal
 (2) This fault is displayed when no measurement has been performed since the measurement conditions were changed.

Temperature sensor not connected

Display
---. - °C

Temperature measurement cannot be performed because the temperature sensor has not been connected. There is no need to connect the temperature sensor when not using temperature correction. Switch the display if you do not wish to display the temperature.
 See: "Switching the Display" (p.35)

Example displays: Display and output when the probes are open or when the measurement target is open

Current fault mode setting (p. 40)	
Current fault	Over-range
Display: ----- COMP indicator: No judgment EXT I/O: ERR signal output, no HI signal output	Display: +OvrRng COMP indicator: Hi EXT I/O: No ERR signal output, HI signal output

*1 Over-range Detection Function

Examples of Over-range Faults

Over-range Detection	Measurement Example
The measured value is outside of the measurement range.	Attempting to measure 40 mΩ with the 30 mΩ range selected
The relative tolerance (%) display of the measured value exceeds the display range (999.99%).	Measuring 500 Ω (+2400%) with a reference value of 20 Ω
The zero-adjusted value is outside of the display range.	Performing zero-adjustment after connecting 50 mΩ with the 300 mΩ range →Measuring 10 mΩ yields a -40 mΩ reading, exceeding the display range.
While measuring, input voltage exceed the A/D converter input range.	Measuring a large resistance value in an electrically noisy environment
Current did not flow normally to the measurement target. (When the current fault mode setting is set to "Over-range output" only)	When the measurement target yields an open FAIL result When either the SOURCE A or SOURCE B terminal suffers from poor contact. *To display "- - - -" when a current fault occurs, set the current fault mode setting to "Current fault."(p.40)

3

*2 Current Fault Detection Function

Example of Current Fault

- SOURCE A or SOURCE B probe open
- Broken measurement target (open work)
- SOURCE A or SOURCE B cable break, poor connection

NOTE

- SOURCE wiring resistance in excess of the following values may cause a current fault, making measurement impossible. When using measurement current 300 mA ranges, keep the wiring resistance as well as the contact resistance between the measurement target and measurement lead low.

(Reference value)

Range	Wiring resistance and contact resistance (Resistance value between SOURCE B and SOURCE A, excluding measurement target)
30 mΩ, 300 mΩ	2 Ω
3 Ω	70 Ω
30 Ω	100 Ω
300 Ω	2 kΩ
3 kΩ	700 Ω
30 kΩ to 3 MΩ	2 kΩ

- If a measurement is performed using a high-resistance range, it will take time after the probes are actually open until a constant current error occurs.

Example: 300 kΩ range 20 ms

3 MΩ range 250 ms

Setting the measurement method for an open target (current fault mode setting)

This section describes how to configure instrument operation when current fault output is detected.

When set to current fault, a break in the measurement target wiring is determined to be an error, and no comparator judgment is made. When set to over-range, a break in the measurement lead or other open state is determined to be an over-range event, and a comparator judgment of Hi results. Choose the setting that best suits your application.

1 Open the Settings Screen.

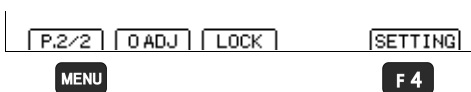

1 **MENU** Switch the function menu to P.2/2.

2 **F4** The Settings screen appears.

2 Open the Measurement Settings Screen.

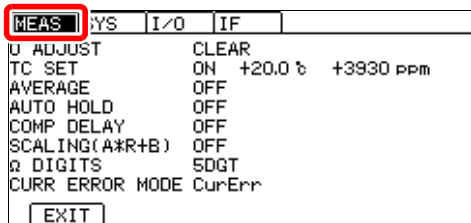

Move the cursor to the [MEAS] tab with the left and right cursor keys.

3 Select the desired current fault mode.

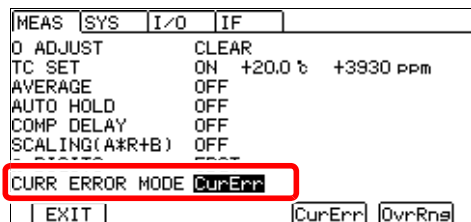

1 Selection

2 **F3** Current fault (default)

F4 Over-range

F3 **F4**

4 Return to the Measurement screen.

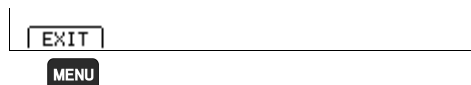

MENU Return to the Measurement screen.

Holding Measured Values

The auto-hold function provides a convenient way to check measured values. Once the measured value stabilizes, the beeper will sound, and the value will be automatically held.

1 Open the Settings Screen.

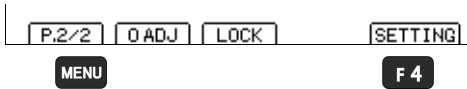

1 **MENU** Switch the function menu to P.2/2.

2 **F 4** The Settings screen appears.

2 Open the Measurement Settings Screen.

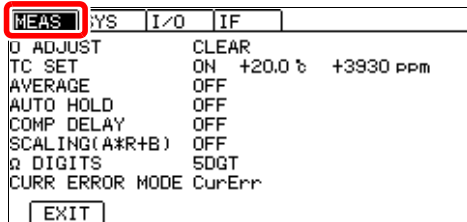

Move the cursor to the [MEAS] tab with the left and right cursor keys.

3 Enable the auto-hold function.

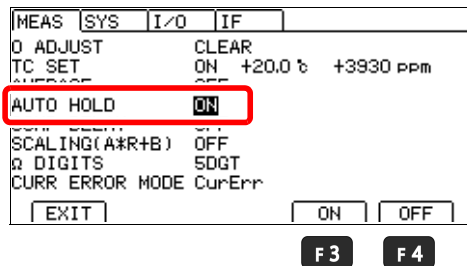

1  Selection

2
F 3 ON
F 4 OFF (default)

4 Return to the Measurement screen.

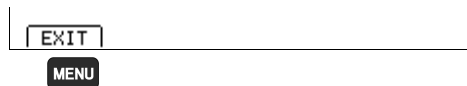

MENU Return to the Measurement screen.

5 While the measured value is being held, the HOLD indicator will light up.

Canceling auto-hold operation

Hold operation is automatically canceled when the measurement leads are removed from the measurement target and then brought into contact with the measurement target again. You can also cancel hold operation by pressing **ESC** or changing the range and measurement speed. When hold operation is canceled, the HOLD indicator will go out.

Customizing Measurement Conditions

Chapter 4

Before making measurements, read "Operating Precautions" (p. 12) carefully.

This chapter explains functionality employed to make more advanced, more accurate measurements.

4

"4.1 Zero Adjustment" (p. 44)

"4.2 Stabilizing Measured Values (Averaging Function)" (p. 50)

"4.3 Correcting for the Effects of Temperature (Temperature Correction (TC))" (p. 52)

"4.4 Correcting Measured Values and Displaying Physical Properties Other than Resistance Values (Scaling Function)" (p. 54)

"4.5 Changing the Number of Measured Value Digits" (p. 58)

4.1 Zero Adjustment

Perform zero-adjustment in the following circumstances:

- The measured value is not cleared due to thermal EMF or other factors.
 - The measured value will be adjusted to zero. (Accuracy is not affected by whether or not the zero adjustment is performed.)
- Four-terminal connection (called Kelvin connection) is difficult.
 - The residual resistance of the two-terminal connection wires will be canceled.

For more information about how to perform zero-adjustment properly, see "Appendix 6 Zero Adjustment" (p. A8).

Before Zero Adjustment

- Execute zero adjustment when the ambient temperature has changed, or when a measurement lead is replaced after zero adjustment was performed. However, when performing zero-adjustment is difficult, for example when using the L2102 or L2103 Pin Type Lead, perform zero-adjustment using the standard included L2101 Clip Type Lead or similar lead and then switch to the pin type lead to perform measurement.
- Zero adjustment should be executed in each range to be used. Perform zero-adjustment for the current range only when setting the range manually or for all ranges when using auto-ranging.
- Zero adjustment values are retained internally even when the instrument is turned off. They are also saved with panels. You can also elect not to load zero-adjustment values from panels.
 - See: "6.1 Saving Measurement Conditions (Panel Save Function)"(p.72)
 - "6.2 Loading Measurement Conditions (Panel Load Function)"(p.73)
- Zero-adjustment can be performed even when the EXT I/O 0ADJ signal is ON (when shorted with the EXT I/O connector's ISO_COM pin).
- Although resistance of -3%f.s. to 50%f.s. can be canceled in each range, try to keep the canceled resistance to 3%f.s. (f.s.=30,000dgt.) The zero-adjustment range can be changed to TIGHT (-3%f.s. to 3%f.s.).
 - See: "Changing the zero-adjustment range" (p. 47)
- If a resistance that is smaller than the resistance value when zero-adjustment was performed is measured, the measured value will be negative.
 - Example: If you set an offset of 20 mΩ for the 300 mΩ range
 - If you measure 10 mΩ, -10 mΩ will be displayed.

Performing zero-adjustment

1 Short the measurement leads together.

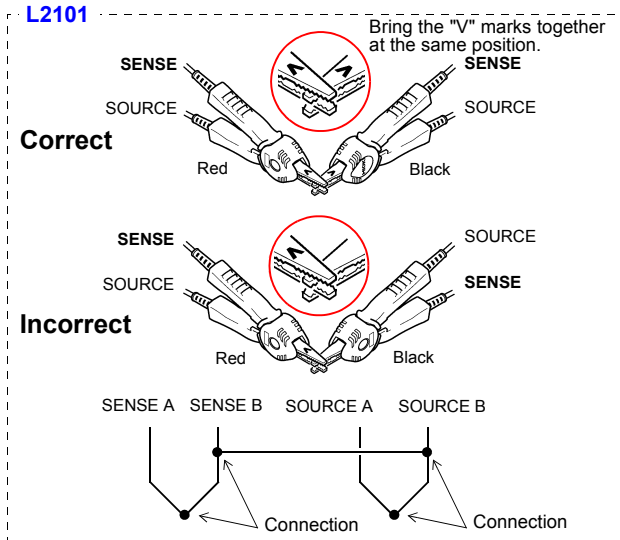

L2102, L2103 (options)

Since zero-adjustment cannot be performed with the L2102 or L2103, use the L2101 Clip Type Lead or other lead type to perform zero-adjustment.

L2104 (option)

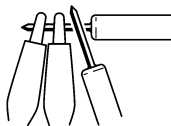

Place the alligator clips on the outside and the lead rods on the inside when performing zero-adjustment.

- 2** Verify that the measured value is within $\pm 3\%$ f.s. If the zero-adjustment range is set to NORMAL (-3%f.s. to 50%f.s.), zero-adjustment can be performed when the measured value is 50%f.s. or less in each range, but a warning will be issued when it is greater than 3%f.s.

If no measured value is displayed, verify whether the measurement leads have been wired properly.

Proper wiring



Improper wiring

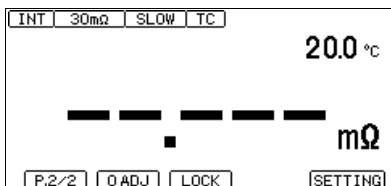

- 3** Perform zero-adjustment.

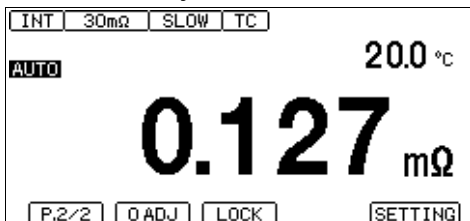

- 1** **MENU** Switch the function menu to P.2/2.
- 2** **F1** [0ADJ] Perform zero-adjustment.

- 4** A confirmation message will be displayed. Confirm and return to the Measurement screen.

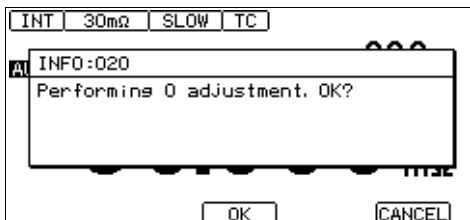

- F2** Perform zero-adjustment and return to the Measurement screen.
- F4** Cancel the operation and return to the previous screen.

Zero Adjustment Faults

If zero adjustment fails, the following error message appears.

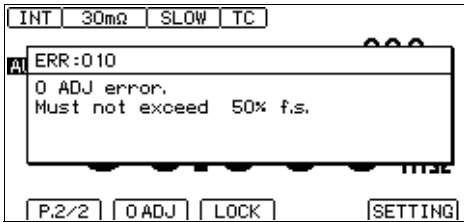

Before attempting zero adjustment again, confirm the following:

- Verify that the measured value is within each range (NORMAL: -3%f.s. to 50%f.s., TIGHT: -3%f.s. to 3%f.s.).
- When using measurement leads that you made, reduce the wiring resistance.
- Confirm that the measurement leads connections are correct.

See: "2 Current Fault Detection Function" (p. 39)

NOTE

- If zero-adjustment fails for auto-ranging, zero-adjustment will be canceled for all ranges.
- If zero-adjustment fails for a manually set range, zero-adjustment will be canceled for the current range.

Changing the zero-adjustment range

Although the default setting of the zero-adjustment range is -3%f.s. to 50%f.s. (the warning will be issued when the value is more than 3%f.s.), the zero-adjustment range can be changed to the setting that a value exceeding 3%f.s. results in an error without issuing any warning.

1 Open the Settings Screen.

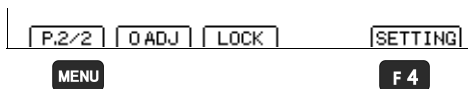

- 1 **MENU** Switch the function menu to P.2/2.

- 2 **F4** The Settings screen appears.

2 Open the System Setting Screen.

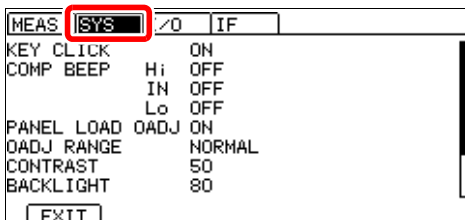

Move the cursor to the [SYS] tab with the left and right cursor keys.

3 Select the zero-adjustment range setting function to be TIGHT.

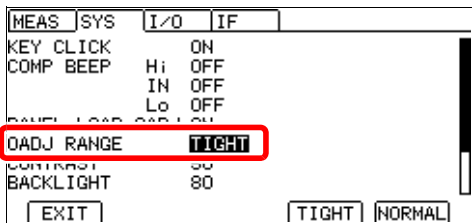

1 Selection

2

F3 Range: -3%f.s. to 3%f.s.

F4 Range: -3%f.s. to 50%f.s.
(default)

F3 **F4**

4 Return to the Measurement screen.

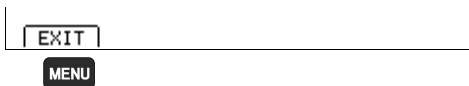

MENU Return to the Measurement screen.

NOTE

The changed setting will be applied to the zero-adjustment that will be performed after the setting is changed. The zero-adjustment that has been already performed and panel-saved remains effective. Perform zero-adjustment again as necessary.

Canceling zero-adjustment

Cancels zero-adjustment for all ranges.

1 Open the Settings Screen.

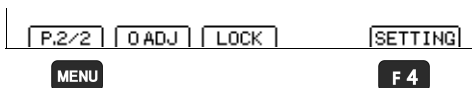

1 **MENU** Switch the function menu to P.2/2.

2 **F4** The Settings screen appears.

2 Open the Measurement Settings Screen.

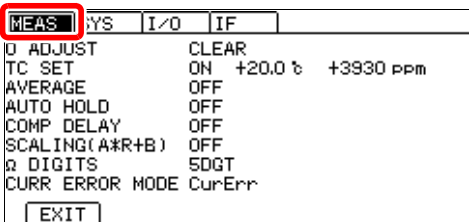

Move the cursor to the [MEAS] tab with the left and right cursor keys.

3 Select 0 ADJUST.

MEAS	SYS	I/O	IF
0 ADJUST			CLEAR
TC SET		ON	T20.0 °C +3930 PPM
AVERAGE		OFF	
AUTO HOLD		OFF	
COMP DELAY		OFF	
SCALING(A*R+B)		OFF	
Ω DIGITS		50GT	
CURR ERROR MODE		CurErr	
EXIT			EXEC

F4

1  Selection

2

F4 Cancel zero-adjustment.

4 A confirmation message will be displayed. Confirm and return to the Measurement screen.

MEAS	SYS	I/O	IF
0 ADJUST			CLEAR
TC			INFO:021
AL			Clear 0 adjustment data. OK?
SC			
Ω			
CL			
OK			CANCEL

F2

F4

F2 Clear zero-adjustment and return to the Settings screen.

F4 Cancel the operation and return to the previous screen.

5 Return to the Measurement screen.

EXIT

MENU

MENU Return to the Measurement screen.

4

4.2 Stabilizing Measured Values (Averaging Function)

The averaging function averages multiple measured values and displays the results. It can be used to reduce variation in measured values.

For internal trigger measurement (Free-Run), a moving average is calculated.

For external trigger measurement (and **:READ?** command operation) (Non-Free-Run), a mean average is used.

For more information about communications commands, see the included application disc.

Average (of measurements D1 to D6) with Averaging Samples set to 2.

	1st Sample	2nd Sample	3rd Sample
Free-Run (Moving Avg.)	$(D1+D2)/2$	$(D2+D3)/2$	$(D3+D4)/2$
Non-Free-Run (Mean Avg.)	$(D1+D2)/2$	$(D3+D4)/2$	$(D5+D6)/2$

1 Open the Settings Screen.

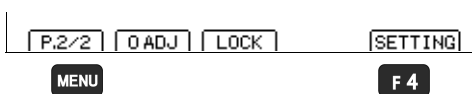

1 **MENU** Switch the function menu to P.2/2.

2 **F4** The Settings screen appears.

2 Open the Measurement Settings Screen.

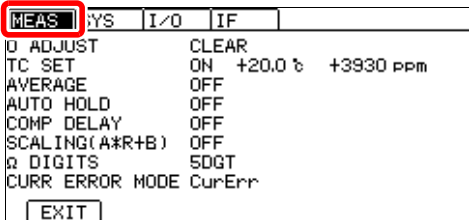

Move the cursor to the [MEAS] tab with the left and right cursor keys.

3 Enable the averaging function.

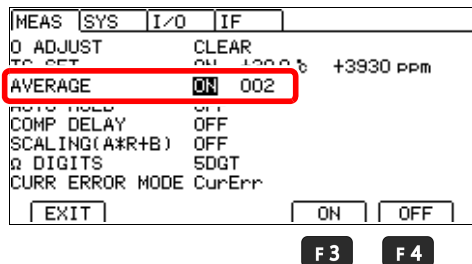

1 Selection

2 **F3** Enables the averaging function

F4 Disables the averaging function (default) (go to step 5)

4 Set the number of averaging iterations.

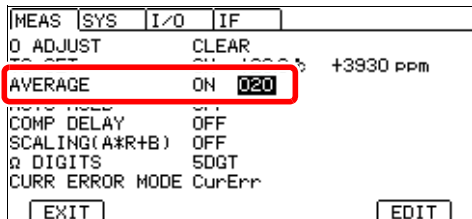

F4

Setting range: 2 to 100 times (default: 2 times)



Move the cursor to the setting you wish to configure. Make the value editable with the **F4** key.

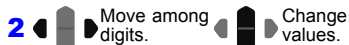

Move the cursor to the digit you wish to set with the left and right cursor keys. Change the value with the up and down cursor keys.



(**ESC** Cancel)

4

5 Return to the Measurement screen.

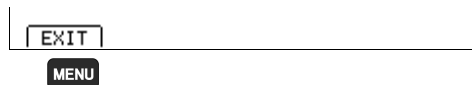

MENU Return to the Measurement screen.

4.3 Correcting for the Effects of Temperature (Temperature Correction (TC))

Temperature correction converts resistance values to resistance values at standard temperature and displays the result.

For more information about the principle of temperature correction, see "Appendix 4 Temperature Correction (TC) Function" (p. A4).

To perform temperature correction, connect the temperature sensor to the TEMP.SENSOR jack on the back of the instrument.

See: "2.3 Connecting Z2001 Temperature Sensor (When using the TC)" (p. 27)

1 Open the Settings Screen.

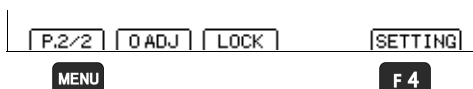

1 **MENU** Switch the function menu to P.2/2.

2 **F4** The Settings screen appears.

2 Open the Measurement Settings Screen.

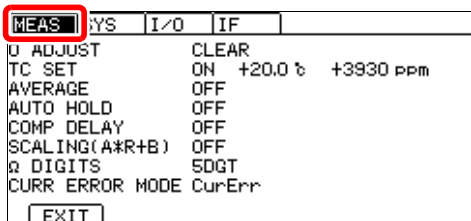

Move the cursor to the [MEAS] tab with the left and right cursor keys.

3 Enable the temperature correction function. (TC)

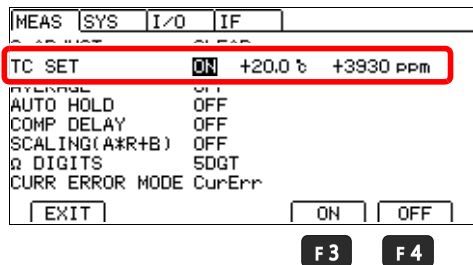

1 Selection

2 **F3** Enables the TC function
F4 Disables the TC function (default) (go to step 5)

4 Set the reference temperature and temperature coefficient.





(Set the reference temperature and temperature coefficient by following steps 1 through 3 for each.)

MEAS	SYS	I/O	IF
TC SET	ON	+20.0	+3930 ppm
TEMPERATURE	OFF		
AUTO HOLD	OFF		
COMP DELAY	OFF		
SCALING(A*R+B)	OFF		
Ω DIGITS	SDGT		
CURR ERROR MODE	CurErr		

F 4

1  

Move the cursor to the setting you wish to configure. Make the value editable with the **F 4** key.

2   Move among digits.   Change values.

Move the cursor to the digit you wish to set with the left and right cursor keys. Change the value with the up and down cursor keys.

3 **ENTER** Accept

(**ESC** Cancel)

Setting range

reference temperature : -10.0 to 99.9°C (default: 20°C)

temperature coefficient : -9999 to 9999ppm/°C (default: 3930ppm/°C)

5 Return to the Measurement screen.

EXIT
MENU

MENU Return to the Measurement screen.

4.4 Correcting Measured Values and Displaying Physical Properties Other than Resistance Values (Scaling Function)

This function applies a correction to measured values. It can be used to cancel the effects of the probing position or differences between measuring instruments, or to apply a user-specified offset as an alternative to zero-adjustment. In addition, units can be specified, allowing it to be used to convert measured values to physical properties other than resistance (for example, length).

Scaling is performed by means of the following equations:

$$R_s = A \times R + B$$

R_s : Resistance value after scaling

R : Measured value after zero-adjustment and temperature correction

A : Gain coefficient Setting range: 0.2000×10^{-3} to 1.9999×10^3

B : Offset Setting range: 0 to $\pm 1 \times 10^9$ (maximum resolution: 1 n Ω)

Displayed and sent/received measured values as well as the printer output format vary with the gain coefficient.

Range	Gain coefficient						
	(0.2000 to 1.9999) $\times 10^{-3}$	(0.2000 to 1.9999) $\times 10^{-2}$	(0.2000 to 1.9999) $\times 10^{-1}$	(0.2000 to 1.9999) $\times 1$	(0.2000 to 1.9999) $\times 10$	(0.2000 to 1.9999) $\times 10^2$	(0.2000 to 1.9999) $\times 10^3$
30 m Ω	00.000 μ	000.00 μ	0.0000 m	00.000 m	000.00 m	0.0000	00.000
300 m Ω	000.00 μ	0.0000 m	00.000 m	000.00 m	0.0000	00.000	000.00
3 Ω	0.0000 m	00.000 m	000.00 m	0.0000	00.000	000.00	0.0000 k
30 Ω	00.000 m	000.00 m	0.0000	00.000	000.00	0.0000 k	00.000 k
300 Ω	000.00 m	0.0000	00.000	000.00	0.0000 k	00.000 k	000.00 k
3 k Ω	0.0000	00.000	000.00	0.0000 k	00.000 k	000.00 k	0.0000 M
30 k Ω	00.000	000.00	0.0000 k	00.000 k	000.00 k	0.0000 M	00.000 M
300 k Ω	000.00	0.0000 k	00.000 k	000.00 k	0.0000 M	00.000 M	000.00 M
3 M Ω	0.0000 k	00.000 k	000.00 k	0.0000 M	00.000 M	000.00 M	0.0000 G

1 Open the Settings Screen.

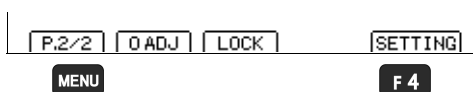

1 **MENU** Switch the function menu to P.2/2.

2 **F4** The Settings screen appears.

2 Open the Measurement Settings Screen.

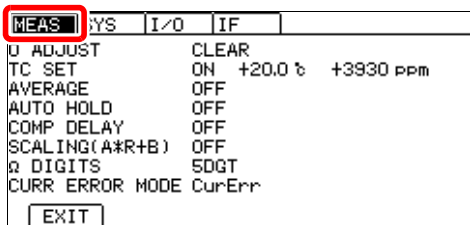

Move the cursor to the [MEAS] tab with the left and right cursor keys.

3 Enable the scaling function.

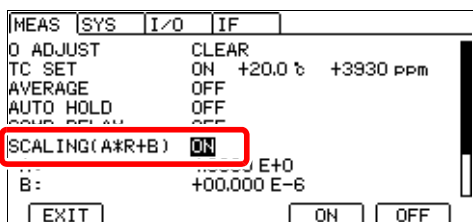

F3

F4

1 Selection

2 Enables the scaling function

4 Disables the scaling function (default) (go to step 8)

4 Set the gain coefficient.

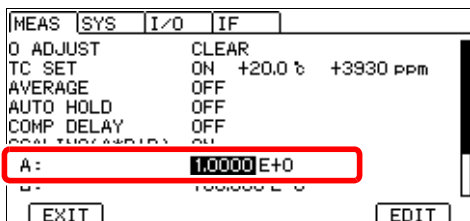

F4

1 Move the cursor to the setting you wish to configure.

Make the value editable with the key.

2 Move among digits. Change values.

Move the cursor to the digit you wish to set with the left and right cursor keys. Change the value with the up and down cursor keys.

Multiply by 10.

Multiply by 1/10.

Clear value.

It is not possible to set the exponent (E+3, etc.) directly. Use and to multiply by 10 and 1/10 as necessary.

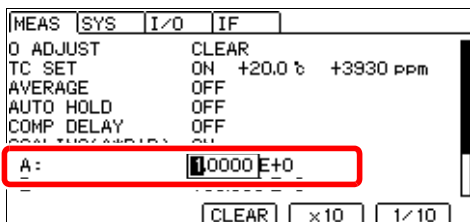

F2

F3

F4

Setting range: 0.2000×10^{-3} to 1.9999×10^3

3 Accept

(Cancel)

5 Set the offset.

MEAS	SYS	I/O	IF
0 ADJUST		CLEAR	
TC SET	ON	+20.0 °C	+3930 PPM
AVERAGE	OFF		
AUTO HOLD	OFF		
COMP DELAY	OFF		
SCALING(A*R+B)	ON		
B: +00.000 E-6			
EXIT			EDIT

F4

MEAS	SYS	I/O	IF
0 ADJUST		CLEAR	
TC SET	ON	+20.0 °C	+3930 PPM
AVERAGE	OFF		
AUTO HOLD	OFF		
COMP DELAY	OFF		
SCALING(A*R+B)	ON		
B: +00.000 E-6			
CLEAR			1/10

F2

F3

F4

Setting range: 0 to $\pm 1 \times 10^9$
 (maximum resolution: 1 n Ω , default: 0)



1 Move the cursor to the setting you wish to configure. Make the value editable with the **F4** key.

2 Move among digits. Change values.

Move the cursor to the digit you wish to set with the left and right cursor keys. Change the value with the up and down cursor keys.

F3 Multiply by 10.

F4 Multiply by 1/10.

F2 Clear value.

It is not possible to set the exponent (E+3, etc.) directly. Use **F3** and **F4** to multiply by 10 and 1/10 as necessary.

3 **ENTER** Accept

(**ESC** Cancel)

6 Set the units for the displayed measured values.

MEAS	SYS	I/O	IF
TC SET	ON	+20.0 °C	+3930 PPM
AVERAGE	OFF		
AUTO HOLD	OFF		
COMP DELAY	OFF		
SCALING(A*R+B)	ON		
A:		1.0000 E+0	
UNIT: Ω			
EXIT			Ω NONE USER

F2

F3

F4

1 Selection

2 **F2** Use Ω as the unit. (default)
(go to step 8)

F3 Eliminate the unit.
(go to step 8)

F4 Use a user-defined unit.

7 Edit the unit as desired.

MEAS	SYS	I/O	IF
TC SET	ON	+20.0 °C	+3930 ppm
AVERAGE	OFF		
AUTO HOLD	OFF		
COMP DELAY	OFF		
SCALING(A*R+B)	ON		
A:	1.0000	E+0	
UNIT:	USER	AB	
	0-9	A-z	DEL

F1

F2

F4

1 Make the value editable with the **F4** key.

◀ Move among digits. ▶ Change values.

Move the cursor to the digit you wish to set with the left and right cursor keys. Change the value with the up and down cursor keys.

F1 Enter a number from 0 to 9

F2 Enter a letter from A to z

F4 Delete 1 character.

2 **ENTER** Accept

(**ESC** Cancel)

8 Return to the Measurement screen.

EXIT
MENU

MENU Return to the Measurement screen.

NOTE

Scaling calculation is performed on measured values after zero-adjustment calculation. Consequently, measured values may not equal zero even after zero adjustment.

- If the calculation result exceeds the display range, the measured value will not be displayed at full scale.

Example: If you set an offset of 9 Ω for the 3 Ω range

→ Values in excess of 1 Ω will be displayed as OvrRng.

- If the calculation result is negative, the displayed value will be negative.

Example: If you set an offset of -50 m Ω for the 300 m Ω range

→ If you measure 30 m Ω , -20 m Ω will be displayed.

4.5 Changing the Number of Measured Value Digits

1 Open the Settings Screen.

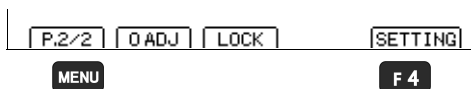

1 **MENU** Switch the function menu to P.2/2.

2 **F4** The Settings screen appears.

2 Open the Measurement Settings Screen.

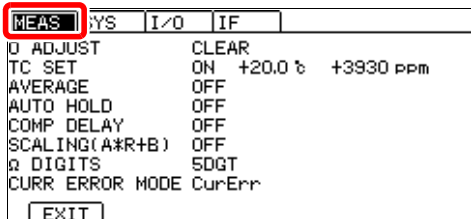

Move the cursor to the [MEAS] tab with the left and right cursor keys.

3 Select the number of measurement digits.

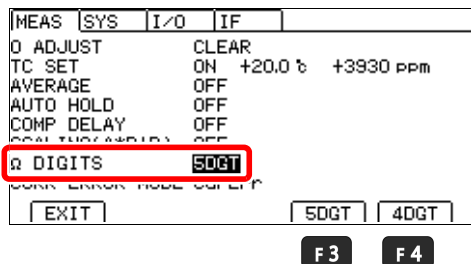

1  Selection

2 **F3** 5digits (35,000dgt.)
(default)

F4 4digits (3,500dgt.)

4 Return to the Measurement screen.

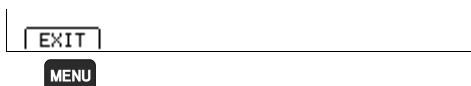

MENU Return to the Measurement screen.

Judgment Function

Chapter 5

This chapter explains measured value judgments (the comparator function). The comparator function provides the following capabilities:

- Displaying information on the instrument (COMP lamp Hi/IN/Lo)

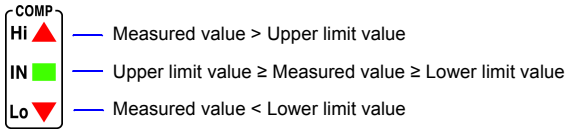

- Sounding the beeper
(By default, the beeper is disabled.)
[See: "Checking Judgments Using Sound \(Judgment Sound Setting Function\)"\(p.68\)](#)
- Displaying data away from the instrument
The L2105 LED Comparator Attachment is an option.
[See: "Checking Judgments with the L2105 LED Comparator Attachment \(Option\)"\(p.70\)](#)
- Outputting judgment results to external equipment
[See: "Chapter 8 External Control \(EXT I/O\)" \(p. 89\)](#)

Moreover, the judgment timing can be delayed.

[See: "Delaying the judge timing"\(p.66\)](#)

5.1 Judging Measured Values (Comparator Function)

The comparator judgment mode can be set as one of the following:

Decide whether a measured value is between specified upper and lower threshold values (absolute values) (p. 62)

Select the ABS (absolute values) judgment mode

example

100.00 mΩ . upper threshold
80.00 mΩ ... lower threshold

Upper
threshold [Ω]
Lower
threshold [Ω]



Decide whether a measured value is within specified tolerance limits relative to a specified reference value (p. 64)

Select the REF% (relative values) judgment mode

example

12.000 kΩ... reference value
±0.08% positive/negative
tolerance

Positive
tolerance [%]
Reference value [Ω]
Negative
tolerance [%]



Before Using the Comparator Function

- The comparator judgment indicator will function as follows for over-range events (“OvrRng” display) and measurement faults (“-----” display):

See: "Confirming Measurement Faults"(p.38)

Measured value display	Comparator Judgment Indicator
+OvrRng	Hi
-OvrRng	Lo
-----	Off (no judgment)

- If power is turned off during comparator setting, changes to settings are lost as they revert to their previous values. To accept the settings, press the **ENTER** .

Enabling and Disabling the Comparator Function

The comparator function is disabled by default.
When the function is disabled, comparator settings are ignored.

1 Open the Comparator Settings screen.

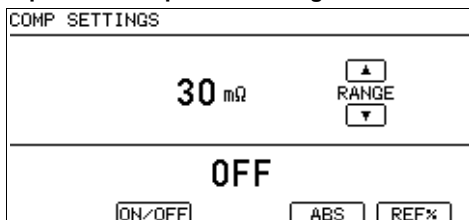

COMP The Comparator Settings screen appears.

2 Enable or disable the comparator function.

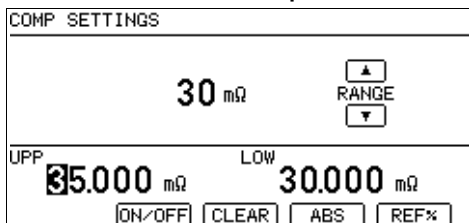

F1 Switch the comparator function ON or OFF.

3 Return to the Measurement screen.



When the comparator function is OFF



When the comparator function is ON

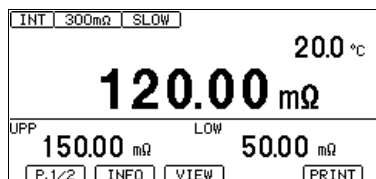

Comparator judgments are indicated only when the comparator function is enabled.

NOTE

The range cannot be changed while using the comparator function. To change the range, do so with the **▲** and **▼** keys on the Comparator Settings screen. To use auto-ranging, turn OFF the comparator function.

Decide According to Upper/Lower Thresholds (ABS Mode)

Setting example: Upper threshold 150 mΩ, lower threshold 50 mΩ

To abort the setting process, press **ESC**. Settings are abandoned and the display returns to the previous screen.

1 Open the absolute value threshold setting screen.

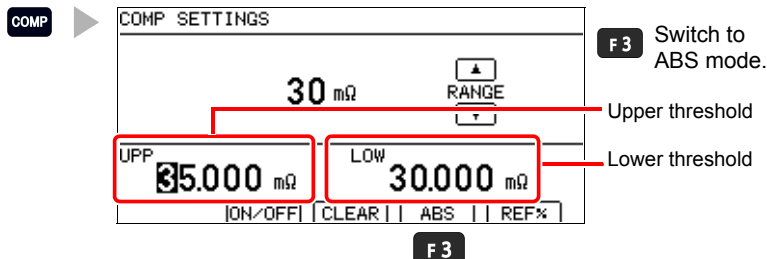

2 Set the range.

- Select the range you wish to use.
- Change the decimal point position and unit (changes each time you press the button).

3 Set the positive tolerance.

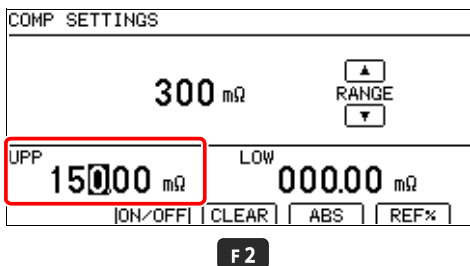

Move among digits. Change values.

Move the cursor to the digit you wish to set with the left and right cursor keys. Change the value with the up and down cursor keys.

To Reset Numerical Values

Press **F2** to clear the upper limit value. The upper limit value will be reset to 0.

4 Set the negative tolerance in the same way.

COMP SETTINGS	
300 mΩ	▲ RANGE ▼
UPP 150.00 mΩ	LOW 050.00 mΩ
[ON/OFF]	[CLEAR] [ABS] [REF%]

5 Accept the settings and return to the Measurement screen.

ENTER ▶

INT	300mΩ	SLOW
20.0 °C		
120.00 mΩ		
UPP	150.00 mΩ	LOW 50.00 mΩ
[P.1/2]	[INFO]	[VIEW] [PRINT]

5

Decide According to Reference Value and Tolerance (REF% Mode)

When REF% mode is enabled, the measured value will be displayed as an absolute value (%).

$$\text{Relative Value (tolerance)} = \left(\frac{\text{Measured Value}}{\text{Reference Value}} - 1 \right) \times 100 [\%]$$

Display range: -999.99% to +999.99%

Example setting: Set a reference value of 100 mΩ with ±1% allowable range.

To abort the setting process, press **ES0**. Settings are abandoned and the display returns to the previous screen.

1 Open the relative tolerance setting screen.

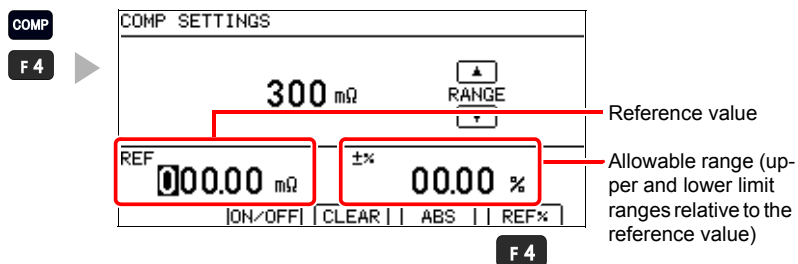

2 Set the range.

- ▲ Select the range you wish to use.
- ▼ Change the decimal point position and unit (changes each time you press the button).

3 Set the reference value.

Pressing an inoperative key during setting sounds a low-pitch beep (when the key beeper is enabled).

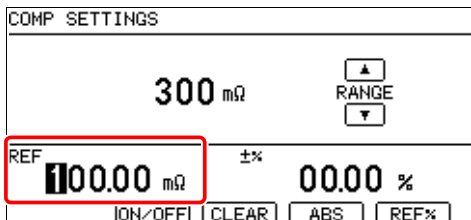

◀ Move among digits. ▶ Change values.

Move the cursor to the digit you wish to set with the left and right cursor keys. Change the value with the up and down cursor keys.

To Reset Numerical Values

Press **F2** to clear the reference value. The reference value will be reset to 0.

4 Set the allowable range (upper and lower limit values).

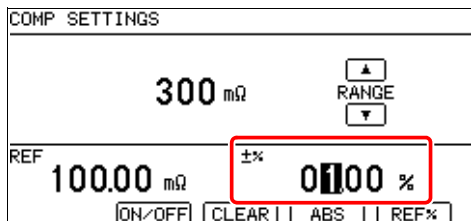

F2

Move among digits. Change values.

Move the cursor to the digit you wish to set with the left and right cursor keys. Change the value with the up and down cursor keys.

To Reset Numerical Values

Press **F2** to clear the upper and lower limit values. The upper and lower limit values will be reset to 0.

5 Accept the settings and return to the Measurement screen.

ENTER

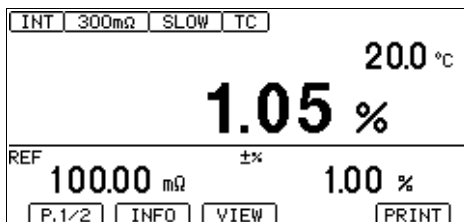

5

Delaying the judge timing

The judge timing can be delayed not to decide any judgment until a measurement value becomes stable.

Example when the judge delay function is set to OFF

Measurement order	Measurement Fault ("-----") is displayed	1st	2nd	3rd	4th	5th	6th
Judge	Unjudged	1st judgment	2nd judgment	3rd judgment	4th judgment	5th judgment	6th judgment

Example when the judge delay function is set to ON and the number of unjudged measurements is three

Measurement order	Measurement Fault ("-----") is displayed	1st	2nd	3rd	4th	5th	6th
Judge	Unjudged				4th judgment	5th judgment	6th judgment

1 Open the Settings Screen.

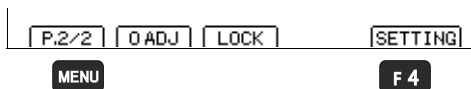

1 **MENU** Switch the function menu to P.2/2.

2 **F4** The Settings screen appears.

2 Open the Measurement Settings Screen.

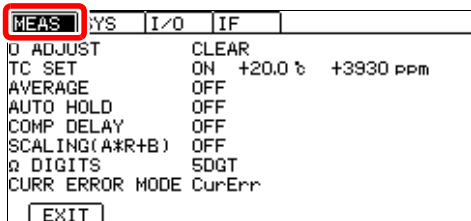

Move the cursor to the [MEAS] tab with the left and right cursor keys.

3 Enable the judge delay function.

MEAS	SYS	I/O	IF
0 ADJUST		CLEAR	
TC SET	ON	+20.0 t	+3930 ppm
AVERAGE		OFF	
COMP DELAY	ON	001	
Ω DIGITS	5DGT		
CURR ERROR MODE	CurErr		

F3

F4

1  Selection

2

F3 Enables the judge delay function

F4 Disables the judge delay function (default) (go to step 5)

4 Set the the number of unjudged measurements.





MEAS	SYS	I/O	IF
0 ADJUST		CLEAR	
TC SET	ON	+20.0 t	+3930 ppm
AVERAGE		OFF	
COMP DELAY	ON	010	
Ω DIGITS	5DGT		
CURR ERROR MODE	CurErr		

F4

Setting range: 1 to 100 times (default: 1 times)

1  

Move the cursor to the setting you wish to configure. Make the value editable with the F4 key.

2   Move among digits.   Change values.

Move the cursor to the digit you wish to set with the left and right cursor keys. Change the value with the up and down cursor keys.

3  Accept
( Cancel)

5 Return to the Measurement screen.

EXIT

MENU

MENU Return to the Measurement screen.

NOTE

- When the auto-hold function is set to ON, the judge delay function is automatically set to OFF.
- For Non-Free-Run, the judge delay function is automatically set to OFF.

Checking Judgments Using Sound (Judgment Sound Setting Function)

The comparator judgment beeper can be enabled and disabled. The judgment beeper is disabled (OFF) by default.

Separate judgment tones can be set for Hi, IN, and Lo judgments.

1 Open the Settings Screen.

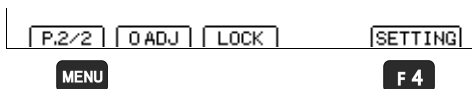

1 **MENU** Switch the function menu to P.2/2.

2 **F4** The Settings screen appears.

2 Open the System Setting Screen.

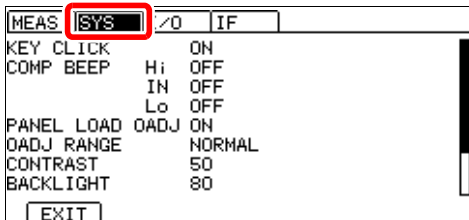

Move the cursor to the [SYS] tab with the left and right cursor keys.

3 Select the sound you desire for Hi judgments.

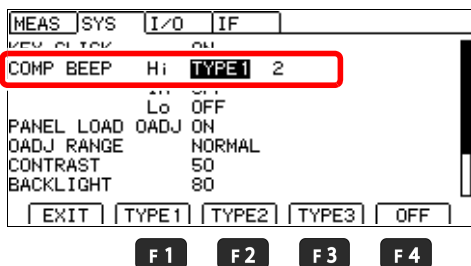

1  Selection

2 **F1** to **F3** Select the sound you desire.

F4 Disable the beeper. (default) (go to step 5)

4 Select the number of times to sound the beeper for Hi judgments.

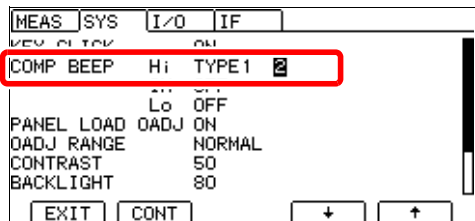

F1

F3

F4

Setting range: 1 to 5 times, continuous



Move the cursor to the setting you wish to configure.

F1 To sound the beeper continuously

To set the number of beeps:

F3 **F4** Change the number of beeps.

5 Repeat this process to configure settings for IN and Lo judgments.

5

6 Return to the Measurement screen.

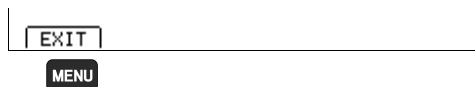

MENU

Return to the Measurement screen.

NOTE

The volume cannot be adjusted.

If the volume is too loud, cover the opening on the bottom of the instrument, for example with a piece of tape.

Checking Judgments with the L2105 LED Comparator Attachment (Option)

By connecting the L2105 LED Comparator Attachment to the COMP.OUT jack, you can check judgment results easily at a distance from the instrument. The indicator will turn green for IN judgments and red for Hi and Lo judgments.

Connection Methods

Before connecting the LED Comparator Attachment, read "Operating Precautions"(p.5) carefully.

Attaching the LED Comparator Attachment

Position the LED Comparator Attachment where you wish.

Example: Using a tie band and two of the spiral wrappers that came with the L2105, attach the LED Comparator Attachment to a measurement lead.

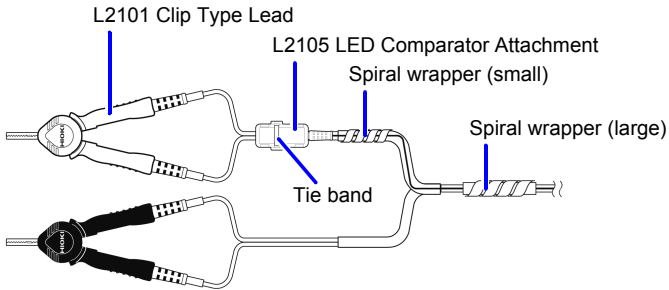

Connecting the LED Comparator Attachment to the Instrument

Front Panel

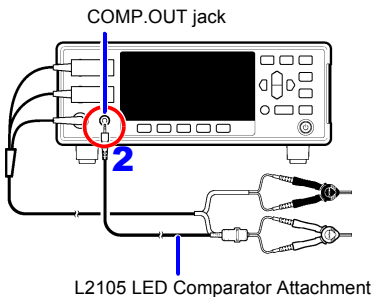

- 1** Confirm that the instrument's Main power switch (rear panel) is OFF(O).
- 2** Plug the L2105 LED Comparator Attachment into the COMP.OUT jack on the front panel.

Insert the plug securely all the way into the jack.

Saving and Loading Panels

(Saving and Loading
Measurement Conditions)

Chapter 6

Current measurement conditions can be saved and loaded using the panel load function from the key operations, communications commands, or EXT-I/O.

The instrument can save up to 10 sets of measurement conditions. Saved conditions are retained even when the instrument is turned off.

Settings that can be saved with the Panel Save function

- Panel name
- Resistance measurement range
- Measurement speed
- Averaging
- Comparator
- Comparator judgment beeper
- Scaling
- Temperature correction (TC)
- Auto-hold
- Zero-Adjust (Loading of these values can be disabled.)

6.1 Saving Measurement Conditions (Panel Save Function)

1 Open the Panel List Screen.

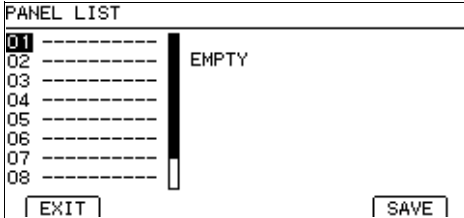

PANEL The Panel List Screen appears.

2 Save the measurement conditions.

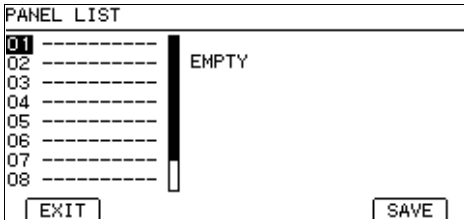

1 Selection

2 **F4** Save the conditions.

F4

3 Enter the panel name.

(If you enter the number of a previously saved panel, a warning message will be displayed.)

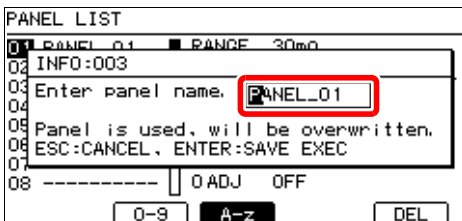

1 Move among characters. Change characters.

Move the cursor to the character you wish to set with the left and right cursor keys. Change the character with the up and down cursor keys.

F1 Enter a number from 0 to 9

F2 Enter a letter from A to Z, or an underbar character (_).

F4 Delete 1 character.

2 **ENTER** Accept

(**ESC** Cancel)

6.2 Loading Measurement Conditions (Panel Load Function)

Loads the measurement settings saved by the Panel Save function.

By default, loading a panel causes zero-adjustment values to be loaded. If you do not wish to load zero-adjustment values, see "Preventing Loading of Zero-adjustment Values"(p.74).

1 Open the Panel List Screen.

PANEL LIST			
01	PANEL_01	RANGE	30mΩ
02	PANEL_02	SPEED	SLOW
03	PANEL_03	AVG	OFF SCALING OFF
04	-----	COMP	ON
05	-----	UPP	15.000mΩ
06	-----	LOW	5.000mΩ
07	-----	TC	20.0% 3930ppm
08	-----	O ADJ	OFF

EXIT LOAD RENAME CLEAR SAVE

PANEL The Panel List Screen appears.

2 Select a panel number.

PANEL LIST			
01	PANEL_01	RANGE	30mΩ
02	PANEL_02	SPEED	SLOW
03	PANEL_03	AVG	OFF SCALING OFF
04	-----	COMP	ON
05	-----	UPP	15.000mΩ
06	-----	LOW	5.000mΩ
07	-----	TC	20.0% 3930ppm
08	-----	O ADJ	OFF

EXIT LOAD RENAME CLEAR SAVE

Data saved for selected panel

1 ◀ ▶ Selection

2 **F1** Load the panel.
(You can also load the panel with the **ENTER** key.)

3 Verify that the confirmation message is shown and return to the Measurement screen.

PANEL LIST			
01	PANEL_01	RANGE	30mΩ
02	INFO:001		
03	Panel load, OK?		
04	-----		
05	PANEL_01		
06	-----		
07	-----		
08	-----	O ADJ	OFF

OK CANCEL

F2 Load the panel and switch to the Measurement screen (you can also do this with the **ENTER** key).

F4 Cancel the operation and return to the previous screen. (you can also do this with the **ESC** key)

INT1	30mΩ	SLOW	TC
No.1	PANEL_01		20.0 °C
12.000			mΩ

The name of the loaded panel will be displayed on the Measurement screen.

6.2 Loading Measurement Conditions (Panel Load Function)

NOTE

- Panels can also be loaded with the EXT I/O LOAD0 to LOAD3 control and communications commands.
See: "Chapter 8 External Control (EXT I/O)"; "Input Signals" (p. 93)
For more information about commands, see the included application disc.
- If measurement conditions are changed after being loaded, the panel name will no longer be displayed.

Preventing Loading of Zero-adjustment Values

By default, zero-adjustment values are also loaded along with panel data. The following procedure can be used to prevent loading of zero-adjustment values.

1 Open the Settings Screen.

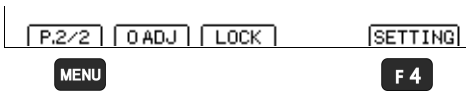

1 **MENU** Switch the function menu to P.2/2.

2 **F4** The Settings screen appears.

2 Open the System Setting Screen.

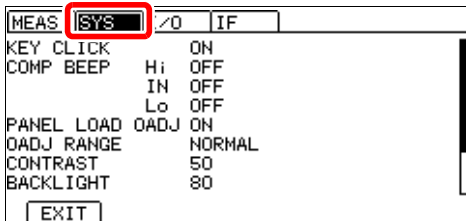

Move the cursor to the [SYS] tab with the left and right cursor keys.

3 Select whether to load zero-adjustment values.

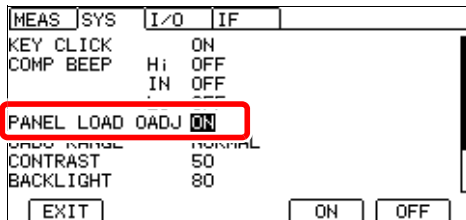

1 Selection

2 **F3** When a panel is loaded, change zero-adjustment values to the values in effect when the panel was saved. (default)

F4 Do not change zero-adjustment values, even when panel data is loaded.

4 Return to the Measurement screen.

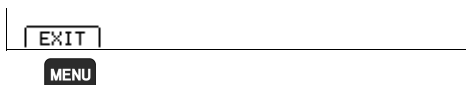

MENU Return to the Measurement screen.

6.3 Changing Panel Names

1 Open the Panel List Screen.

PANEL LIST			
01	PANEL_01	RANGE	30mΩ
02	PANEL_02	SPEED	SLOW
03	PANEL_03	AVG	OFF SCALING OFF
04	-----	COMP	ON
05	-----	UPP	15.000mΩ
06	-----	LOW	5.000mΩ
07	-----	TC	20.0% 3930ppm
08	-----	O ADJ	OFF

PANEL The Panel List Screen appears.

2 Select a panel number.

PANEL LIST			
01	PANEL_01	RANGE	30mΩ
02	PANEL_02	SPEED	SLOW
03	PANEL_03	AVG	OFF SCALING OFF
04	-----	COMP	ON
05	-----	UPP	15.000mΩ
06	-----	LOW	5.000mΩ
07	-----	TC	20.0% 3930ppm
08	-----	O ADJ	OFF

F2

1 Selection

2 **F2** Edit the panel name.

6

3 Edit the panel name.

PANEL LIST			
01	PANEL_01	RANGE	30mΩ
02	PANEL_02	SPEED	SLOW
03	PANEL_03	AVG	OFF SCALING OFF
04	-----	COMP	ON
05	-----	UPP	15.000mΩ
06	-----	LOW	5.000mΩ
07	-----	TC	20.0% 3930ppm
08	-----	O ADJ	OFF

1 Move among characters. Change characters.

Move the cursor to the character you wish to set with the left and right cursor keys. Change the character with the up and down cursor keys.

F1 Enter a number from 0 to 9

F2 Enter a letter from A to Z, or an underbar character (_).

F4 Delete 1 character.

2 **ENTER** Accept

(**ESC** Cancel)

4 Return to the Measurement screen.

<input type="button" value="EXIT"/>

MENU

MENU Return to the Measurement screen.

6.4 Deleting Panel Data

1 Open the Panel List Screen.

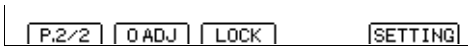

PANEL The Panel List Screen appears.

2 Select a panel number.

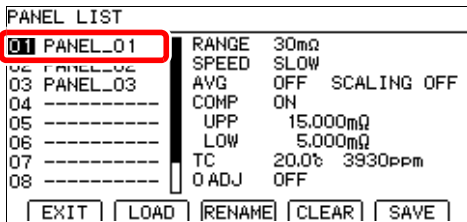

F3

1 Selection

2 **F3** Delete the panel.

3 Verify that the confirmation message is shown and return to the Measurement screen.

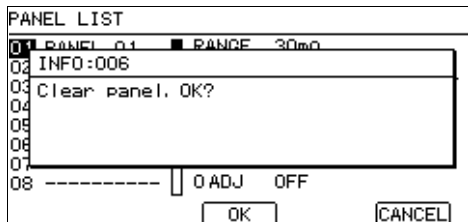

F2

F4

F2 Delete the panel and switch to the previous screen (you can also do this with the **ENTER** key).

F4 Cancel the operation and return to the previous screen. (you can also do this with the **ESC** key)

4 Return to the Measurement screen.



MENU

MENU Return to the Measurement screen.

NOTE

Once a panel's data is deleted, it cannot be restored (the delete operation cannot be undone).

System Settings Chapter 7

This chapter describes system settings.

"7.1 Disabling and Enabling Key Operations" (p. 78)

"7.2 Power Line Frequency Manual Setting" (p. 80)

"7.3 Enabling or Disabling the Key Beeper" (p. 82)

"7.4 Adjusting Screen Contrast" (p. 83)

"7.5 Adjusting the Backlight" (p. 84)

"7.6 Initializing (Reset)" (p. 85)

7.1 Disabling and Enabling Key Operations

Disabling Key Operations (Key-Lock Function)

Activate the key-lock function to disable the instrument's front panel key operations. Three key-lock levels are available to suit specific purposes.

Only basic settings (range, speed, comparator, panel load) are enabled.

Disabling All Except Comparator Settings

Key operations other than **AUTO**, **RANGE** ▲▼, **SPEED**, **COMP**, **PANEL**, **0ADJ**, **PRINT**, **ENTER** (trigger) and **MENU** [UNLOCK] (key-lock cancel) keys are disabled.

To disable key operations: select [MENU]
[M.LOCK] is displayed when returning to the measurement screen.

Key operations to change settings are disabled (although key-lock can be canceled).

Disabling All Key Operations Including Comparator Settings

All key operations except **ENTER** (trigger) and **MENU** [UNLOCK] (key-lock cancel) are disabled.

To disable key operations: select [FULL]
[F.LOCK] is displayed when returning to the measurement screen.

All key operations are disabled.

Disabling All Panel Keys

Asserting (ON) the EXT I/O KEY_LOCK signal disables all panel keys, including **MENU** [UNLOCK] (key-lock cancel) and **MENU** [LOCAL] (disables remote control). However, the **ENTER** (trigger) key remains enabled (p. 89).

To cancel the key lock state: Turn OFF the EXT I/O KEY_LOCK signal. When you execute panel load operation by sending a LOAD signal, no key operation is available while the LOAD signal is being on state. To enable key operation, switch the LOAD signal to the off state after the panel load is complete.

1



1 **MENU** Switch the function menu to P.2/2.

2 **F2** Display the Key Lock Selection screen.

2 Enable or disable key operations.

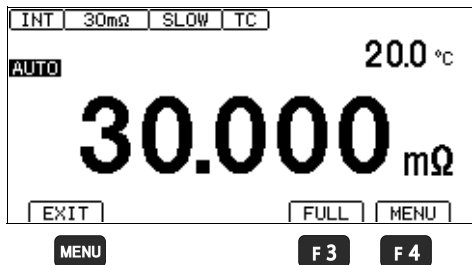

- F3** Disable all except key-lock cancel and return to the Measurement screen.
- F4** Disable all except key-lock cancel and basic settings change and return to the Measurement screen.
- MENU** Return to the Measurement screen.

[UNLOCK] is displayed.

(Key-lock operation triggered by the EXT I/O KEY_LOCK signal is not displayed.)

Re-Enabling Key Operations (Key-Lock Cancel)

Key-lock can be canceled only when **[UNLOCK]** is displayed.

Press and hold **MENU** **[UNLOCK]** for one second.

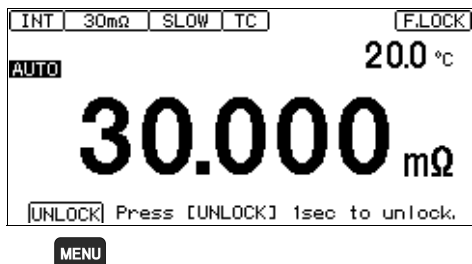

NOTE

If key operations are disabled by the KEY_LOCK signal, de-assert (OFF) the signal to unlock the keys.

When you execute panel load operation by sending a LOAD signal, no key operation is available while the LOAD signal is being the on state.

To enable key operation, switch the LOAD signal to the off state after the panel load is complete.

7.2 Power Line Frequency Manual Setting

With the default setting (AUTO), the instrument attempts to automatically detect the line frequency, but manual setting is also available.

NOTE

- Unless the line frequency is set correctly, measured values may be unstable. An error message appears if line noise is high enough to prevent correct frequency detection (ERR:097 (p.169)). In that case, set the instrument's line frequency manually.
- When the AUTO setting is selected, the line frequency is automatically set to 50 or 60 Hz when the instrument is turned on or reset. However, automatic detection is not available when the line frequency changes after turning power on or resetting. If the actual line frequency deviates from 50 or 60 Hz, select the closest frequency.

Examples:

If the actual line frequency is 50.8 Hz, select the 50 Hz setting.

If the actual line frequency is 59.3 Hz, select the 60 Hz setting.

1 Open the Settings Screen.

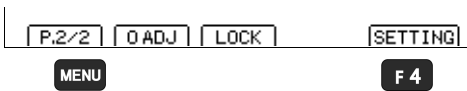

- 1 **MENU** Switch the function menu to P.2/2.

- 2 **F 4** The Settings screen appears.

2 Open the System Setting Screen.

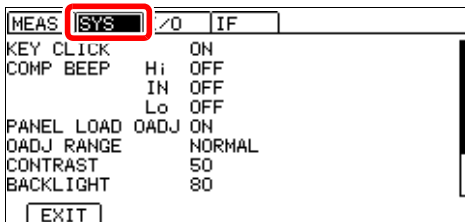

Move the cursor to the [SYS] tab with the left and right cursor keys.

3 Select the line frequency being used.

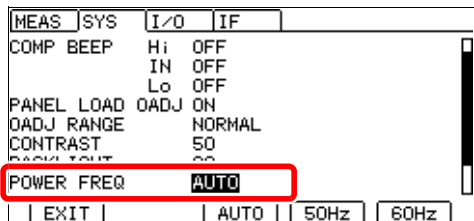

1 ◀ ▶ Selection

2

F2 Automatically detect local line frequency (default)

F3 When the line frequency is 50 Hz

F4 When the line frequency is 60 Hz

4 Return to the Measurement screen.



MENU Return to the Measurement screen.

7.3 Enabling or Disabling the Key Beeper

The key beeper sound can be enabled and disabled.
The key beeper is enabled (ON) by default.

1 Open the Settings Screen.

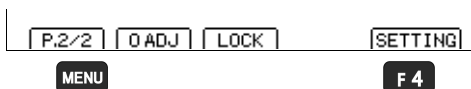

1 **MENU** Switch the function menu to P.2/2.

2 **F4** The Settings screen appears.

2 Open the System Setting Screen.

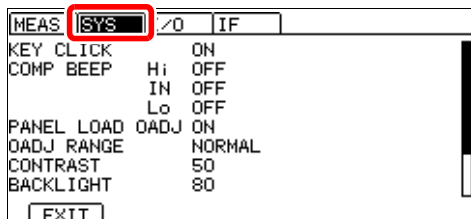

Move the cursor to the [SYS] tab with the left and right cursor keys.

3 Select whether to enable or disable the key beeper.

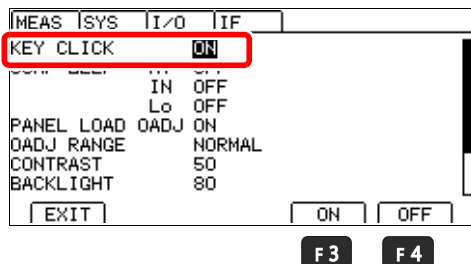

1 Selection

2 **F3** Enables the beeper (default)

F4 Disables the beeper

4 Return to the Measurement screen.



MENU Return to the Measurement screen.

NOTE

(Version 2.00 and later only)

To disable the key beeper, error beep, and auto-hold beep, turn off the instrument and then turn it back on while holding down the **[F1]** and **[ENTER]** keys. "(ERR,AUTO HOLD)" will be displayed as the KEY CLICK setting, and the error beep and auto-hold beep will be set to the same setting as the keep deeper.

7.4 Adjusting Screen Contrast

The screen may become hard to see when ambient temperature changes. In this case, adjust the contrast.

1 Open the Settings Screen.

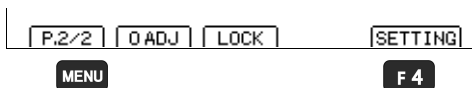

1 **MENU** Switch the function menu to P.2/2.

2 **F4** The Settings screen appears.

2 Open the System Setting Screen.

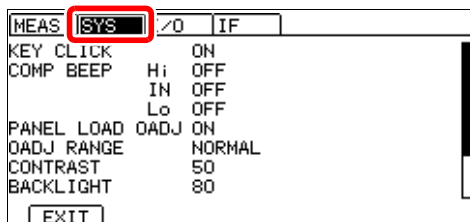

Move the cursor to the [SYS] tab with the left and right cursor keys.

3 Adjust the contrast.

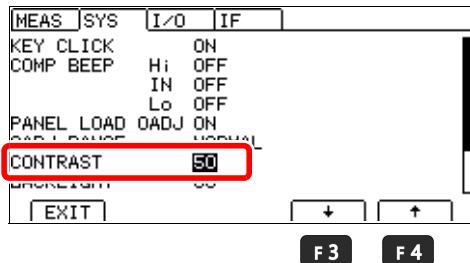

1  Selection

2
F3 Decrease the contrast.
F4 Increase the contrast.

Setting range: 0 to 100%, 5% step (default: 50%)

4 Return to the Measurement screen.

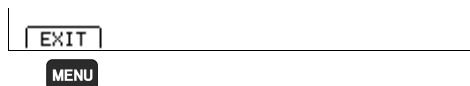

MENU Return to the Measurement screen.

7.5 Adjusting the Backlight

Adjust backlight brightness to suit ambient illumination.

NOTE

- When external (EXT) triggering is selected, backlight brightness is automatically reduced after non-operation for one minute.

(Version 2.00 and later only)

To disable automatic dimming of the backlight, turn off the instrument and then turn it back on while holding down the **[F1]** and **[ENTER]** keys. The backlight will no longer be dimmed. If the key beeper is turned off while using this setting, the error beep and auto-hold beep will also be disabled.

See: (p.82)

- Be aware that the display may be hard to see when brightness is set too low (near 0%).

1 Open the Settings Screen.

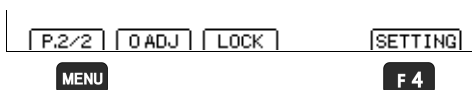

- MENU** Switch the function menu to P.2/2.

- F4** The Settings screen appears.

2 Open the System Setting Screen.

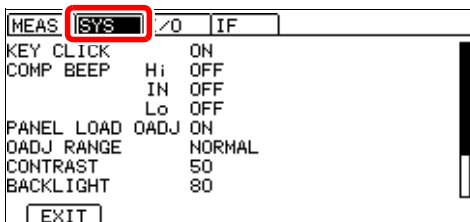

Move the cursor to the **[SYS]** tab with the left and right cursor keys.

3 Adjust the backlight.

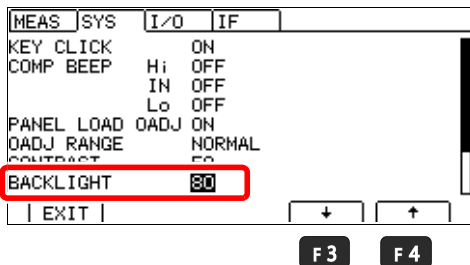

- Selection

- F3** Decrease the backlight brightness.

- F4** Increase the backlight brightness.

Setting range: 0 to 100%, 5% step (default: 80%)

4 Return to the Measurement screen.

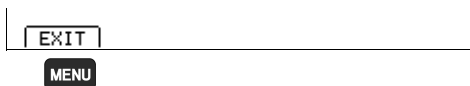

- MENU** Return to the Measurement screen.

7.6 Initializing (Reset)

Two reset functions are available.

For more information about communications commands, see the included application disc.

Reset: Returns measurement conditions (except the panel data) to factory defaults.

The instrument can be reset by three methods.

- Reset from the System setting screen
- Turn on the instrument while holding down **ESC** and **ENTER**.
- Reset by remote control command
*RST command (Interface settings are not initialized.)

System reset: Returns all measurement conditions and the panel save data to factory defaults.

The instrument can be system reset by three methods.

- System reset from the System setting screen
- Turn on the instrument while holding down **ESC**, **ENTER**, and **▶**.
- Reset by remote control command
:SYSTEM:RESet command (Interface settings are not initialized.)

This procedure describes reset from the System setting screen.

1 Open the Settings Screen.

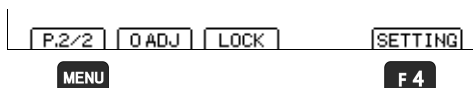

- 1 **MENU** Switch the function menu to P.2/2.

- 2 **F4** The Settings screen appears.

2 Open the System Setting Screen.

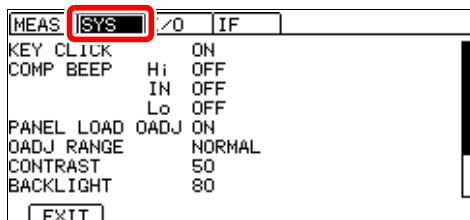

Move the cursor to the [SYS] tab with the left and right cursor keys.

3 Select RESET.

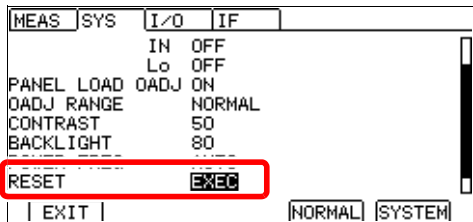

F3 **F4**

1 Selection

2 **F3** Perform a reset.

F4 Perform a system reset.

4 Select whether to initialize the instrument.

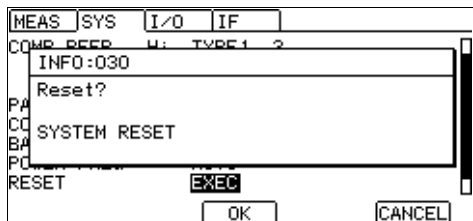

F2

F4

F2 Execute

F4 Cancel the operation

The Measurement screen is displayed when system reset finishes.

Default Settings

Screen		Setting and Key	Default Settings	See
Measurement screen		COMP	OFF	(p.61)
		AUTO	ON	(p.32)
		▲▼ (RANGE)	3MΩ	
		SPEED	SLOW	(p.33)
Measurement screen (P.1/2)		VIEW (F2)	OFF	(p.35)
Measurement screen (P.2/2)		0 ADJ (F1)	OFF	(p.44)
		LOCK (F2)	OFF	(p.78)
Setting screen (SETTING)	Measurement Settings screen (MEAS)	TC SET	OFF	(p.52)
		AVERAGE	OFF	(p.50)
		AUTO HOLD	OFF	(p.41)
		COMP DELAY	OFF	(p.66)
		SCALING(A*R+B)	OFF	(p.54)
		A:	+1.0000E+0	
		B:	+0.0000E+0	
		UNIT:	Ω	
		Ω DIGITS	5DGT	(p.58)
		CURR ERROR MODE	CurErr	(p.40)
	System Settings screen (SYS)	KEY CLICK	ON	(p.82)
		COMP BEEP Hi	OFF	(p.68)
		IN	OFF	
		Lo	OFF	
		PANEL LOAD 0ADJ	ON	(p.74)
		0ADJ RANGE	NORMAL	(p.47)
		CONTRAST	50	(p.83)
		BACKLIGHT	80	(p.84)
	POWER FREQ	AUTO	(p.80)	
	EXT I/O Settings screen (I/O) *1	TRIG SOURCE	INT	(p.109)
		TRIG EDGE	OFF → ON (ON EDGE)	(p.111)
		TRIG/PRINT FILT	OFF	(p.113)
		EOM MODE	HOLD	(p.115)
JUDGE/BCD MODE		JUDGE	(p.117)	
Communications Interface Settings screen (IF) *1	INTERFACE	RS232C	(p.123)	
	SPEED	9600bps	(p.126)	
	DATA OUT	OFF	(p.133)	
	CMD MONITOR	OFF	(p.131)	
	PRINT INTRVL	OFF	(p.142)	
	PRINT COLUMN	1LINE	(p.141)	

*1 RM3544-01 only

External Control (EXT I/O)

Chapter 8

The EXT I/O connector on the rear of the instrument supports external control by providing output of the EOM and comparator judgment signals, and accepting input of TRIG and KEY_LOCK signals. All signals are isolated from the measurement circuit and ground (I/O common pins are shared). Input circuit can be switched to accommodate either current sink output (NPN) or current source output (PNP).

Confirm input and output ratings, understand the safety precautions for connecting a control system, and use accordingly.

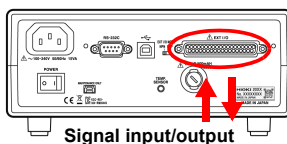

Check the controller's I/O specifications.



Set the instrument's NPN/PNP switch. (p.90)



Connect the instrument's EXT I/O connector to the controller. (p.91)



Make instrument settings. (p. 109)

8.1 External Input/Output Connector and Signals



Switching between Current Sink (NPN) and Current Source (PNP)

Before switching, see "Before Switching between Current Sink (NPN) and Current Source (PNP)" (p. 11).

The NPN/PNP switch allows you to change the type of programmable controller that is supported.

The instrument ships with the switch set to the NPN position.

See: "8.3 Internal Circuitry"(p.104)

	NPN/PNP switch setting	
	NPN	PNP
RM3544 input circuit	Supports sink output.	Supports source output.
RM3544 output circuit	Non-polar	Non-polar
ISO_5V output	+5 V output	-5 V output

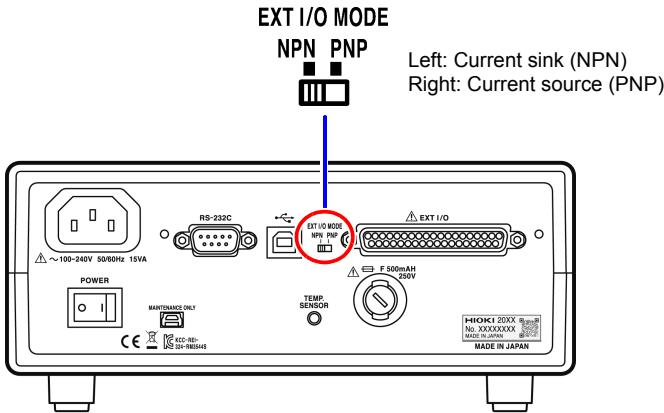

Connector Type and Signal Pinouts

Before connecting a connector, see "Before Connecting EXT I/O" (p. 11). Use of EXT I/O enables the following control functionality:

- Measurement start (TRIG) → Measurement end (EOM, INDEX)
→ Acquisition of judgment results (HI, IN, LO, ERR)
- Measurement start (TRIG) → Measurement end (EOM, INDEX)
→ Acquisition of measured values (BCD_LOW, BCDm_n, RNG_OUTn)
- Panel load (LOAD0 to LOAD3, TRIG)
- General-purpose I/O (IN0, IN1, OUT0, OUT1, OUT2)

The functionality described in "Performing an I/O Test (EXT I/O Test Function)" (p. 118) provides a convenient way to check external I/O operation.

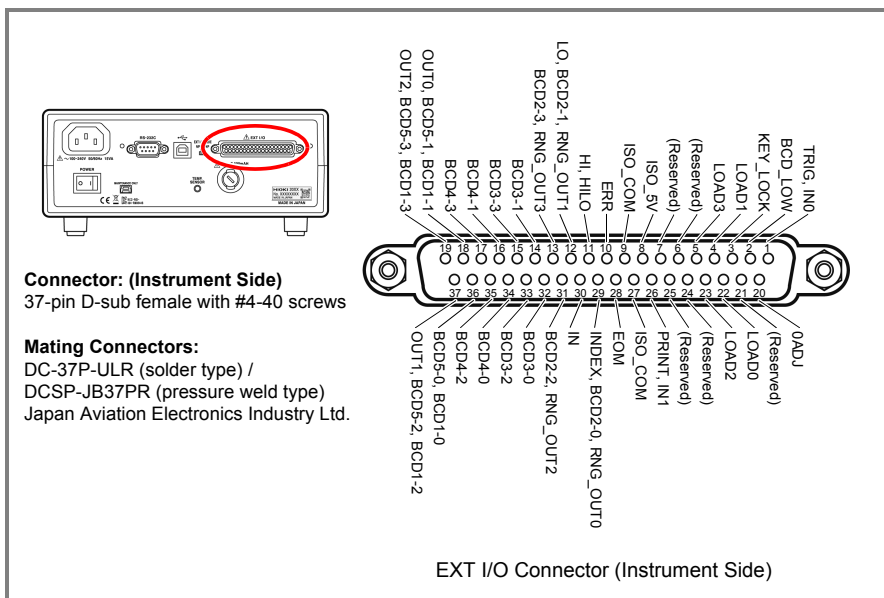

Pin	Signal name	I/O	Function	Logic	Pin	Signal name	I/O	Function	Logic
1	TRIG IN0	IN	External trigger General-purpose input	Edge	20	0ADJ	IN	Zero adjust	Edge
2	BCD_LOW	IN	BCD Lower byte output	Level	21	(Reserved)	-	-	-
3	KEY_LOCK	IN	Key-Lock	Level	22	LOAD0	IN	Panel load	Level
4	LOAD1	IN	Panel load	Level	23	LOAD2	IN	Panel load	Level

8.1 External Input/Output Connector and Signals

Pin	Signal name	I/O	Function	Logic	Pin	Signal name	I/O	Function	Logic
5	LOAD3	IN	Panel load	Level	24	(Reserved)	-	-	-
6	(Reserved)	-	-	-	25	(Reserved)	-	-	-
7	(Reserved)	-	-	-	26	PRINT IN1	IN	Printing of measured values General-purpose input	Edge
8	ISO_5V	applicable	Isolated power supply +5 V (-5 V) output	-	27	ISO_COM	-	Isolated common signal ground	-
9	ISO_COM	-	Isolated common signal ground	-	28	EOM	OUT	End of measurement	Level
10	ERR	OUT	Measurement fault	Level	29	INDEX, BCD2-0, RNG_OUT0	OUT	Analog measurement finished	Level
11	HI, HILO	OUT	Comparator judgment	Level	30	IN	OUT	Comparator judgment	Level
12	LO, BCD2-1, RNG_OUT1	OUT	Comparator judgment BCD	Level	31	BCD2-2, RNG_OUT2	OUT	BCD	Level
13	BCD2-3, RNG_OUT3	OUT	BCD	Level	32	BCD3-0	OUT	BCD	Level
14	BCD3-1	OUT	BCD	Level	33	BCD3-2	OUT	BCD	Level
15	BCD3-3	OUT	BCD	Level	34	BCD4-0	OUT	BCD	Level
16	BCD4-1	OUT	BCD	Level	35	BCD4-2	OUT	BCD	Level
17	BCD4-3	OUT	BCD	Level	36	BCD5-0, BCD1-0	OUT	BCD	Level
18	OUT0, BCD5-1, BCD1-1	OUT	General-purpose output BCD	Level	37	OUT1, BCD5-2, BCD1-2	OUT	General-purpose output BCD	Level
19	OUT2, BCD5-3, BCD1-3	OUT	General-purpose output BCD	Level					

NOTE

- The 0ADJ signal should be asserted (ON) for at least 10 ms.
- The connector's frame is connected to the instrument's rear panel (metal portions) as well as the power inlet's protective ground terminal.

When switching panel load operation using commands or key operation, fix pins 4 and 5 as well as 22 and 23 to ON or OFF.

Signal Descriptions

(1) Isolated power supply

Pin	Signal name	NPN/PNP switch setting	
		NPN	PNP
8	ISO_5V	Isolated power supply +5 V	Isolated power supply -5 V
9, 27	ISO_COM	Isolated common signal ground	

(2) Input Signals

TRIG	<p>The TRIG signal operates at either the ON or OFF edge. ON or OFF edge triggering can be selected on the EXT I/O setting screen (default: ON edge).</p> <ul style="list-style-type: none"> When external triggering (EXT) is enabled The TRIG signal causes one measurement to be performed. When internal triggering (INT) is enabled The TRIG signal does not trigger measurement. <p>A wait is necessary to allow the measured value to stabilize after switching ranges or loading a panel. The wait time varies with the measurement target. Trigger input can also be performed using the ENTER (trigger) key or the *TRG command.</p>	p.111
0ADJ	<p>When the 0ADJ signal is switched from OFF to ON, one zero-adjustment operation will be performed at the signal edge.</p> <p><u>To avoid malfunction, this signal should be asserted (ON) for at least 10 ms.</u></p> <p>The ERR signal turns ON when zero-adjustment fails.</p>	p.44
PRINT	<p>Asserting the PRINT signal prints the current measured value.</p>	p.140
KEY_LOCK	<p>While the KEY_LOCK signal is held ON, all front panel keys (except standby key and ENTER (trigger) key) are disabled (key unlock and remote control cancellation operations are also disabled).</p>	p.78
BCD_LOW	<p>When used with the BCD output setting, turning the BCD_LOW signal OFF causes the higher digits to be output. Turn the BCD_LOW signal ON causes the lower digits and range information to be output.</p>	p.95
LOAD0 to LOAD3	<p>LOAD0 is the LSB, while LOAD3 is the MSB. For more information, see "(4) Signal correspondence chart" (p.96).</p> <p>If any of the LOAD signals changes and then there are no changes for an interval of 10 ms, the panel load operation will be performed. Do not change the LOAD0 to 3 signals until load operation completes.</p> <p>LOAD signals are also enabled when controlling the instrument via communications (remotely). All key operation is disabled when the LOAD signal for a valid panel number is ON.</p> <p>When loading panels using commands or key operation, fix pins 4 and 5 as well as 22 and 23 to either ON or OFF.</p>	p.96
IN0, IN1	<p>The input state can be monitored by using the :IO:INPut? command, using these pins as general-purpose input pins.</p> <p>See: Communications Command Instruction Manual on the included application disc.</p>	

(3) Output Signals

EOM	This signal indicates the end of measurement and zero-adjustment. At this point in time, the comparator judgment results and the ERR and BCD signals have been finalized.	p.115
INDEX	This signal indicates that A/D conversion in the measurement circuit is finished. When the asserted (ON) state occurs, the measurement target can be removed.	
ERR	This signal indicates that a measurement fault has occurred (except out-of-range detection). It is updated simultaneously with the EOM signal. At this time, comparator judgment outputs are all de-asserted (OFF).	p.38
HI, IN, LO	These are the comparator judgment output signals.	
HILO	When using BCD output, pin 11 outputs the result of an OR operation applied to the Hi and Lo judgments.	
BCDm-n	When using BCD output, this signal outputs n bits of digit m. (When BCD1-x is the lowermost digit, BCDX-0 is the LSB.) When the measured value display is "OvrRng" or "- - - -", all digits of BCD output will be 9. When the measured value display is a negative value, all digits of BCD output will be 0. When the lower limit value has been set to 0 and a negative measured value is encountered, the LO signal will be output in accordance with the display screen result. However, when using the comparator's REF% mode, an unsigned value equivalent to the absolute value being displayed (i.e., an absolute value) will be output.	p.96
OUT0 to OUT2	When the output mode is judgment mode, pins 18, 19 and 37 can be used as general-purpose output pins. The output signals can be controlled with the :IO:OUTPut command. See: Communications Command Instruction Manual on the included application disc.	p.117
RNG_OUT0 to RNG_OUT3	When BCD_LOW is turned ON when using BCD output, range information can be acquired from pins 12, 13, 29, and 31.	p.96

NOTE

- When not displaying the Measurement screen and while error messages are being displayed, input signals are disabled.
- EXT I/O input and output signals are not usable while changing measurement settings.

JUDGE mode and BCD mode

Output signals operate under either JUDGE mode or BCD mode. In BCD mode, signals are used for both the upper and lower digits (and range information).

See: "Switching Output Modes (JUDGE Mode/ BCD Mode)" (p. 117)

Pin functions in JUDGE mode

Pin	Function	Pin	Function
9	ISO_COM	28	EOM
10	ERR	29	INDEX
11	HI	30	IN
12	LO	31	–
13	–	32	–
14	–	33	–
15	–	34	–
16	–	35	–
17	–	36	–
18	OUT0	37	OUT1
19	OUT2		

Pin functions in BCD mode

The BCD upper digits and lower digits (and range information) are switched using the BCD_LOW signal.

Pin	BCD_LOW (2pin)		Pin	BCD_LOW (2pin)	
	OFF	ON		OFF	ON
9	ISO_COM		28	EOM	
10	ERR		29	BCD2-0	RNG_OUT0
11	HILO		30	IN	
12	BCD2-1	RNG_OUT1	31	BCD2-2	RNG_OUT2
13	BCD2-3	RNG_OUT3	32	BCD3-0	–
14	BCD3-1	–	33	BCD3-2	–
15	BCD3-3	–	34	BCD4-0	–
16	BCD4-1	–	35	BCD4-2	–
17	BCD4-3	–	36	BCD5-0	BCD1-0
18	BCD5-1	BCD1-1	37	BCD5-2	BCD1-2
19	BCD5-3	BCD1-3			

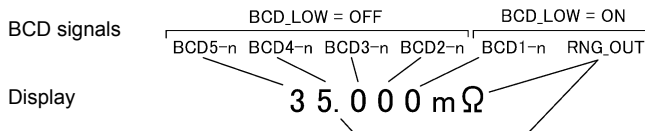
Relation between BCD signals and display

(4) Signal correspondence chart

LOAD0 to LOAD3

LOAD3	LOAD2	LOAD1	LOAD0	Panel number
OFF	OFF	OFF	OFF	No change
OFF	OFF	OFF	ON	1
OFF	OFF	ON	OFF	2
OFF	OFF	ON	ON	3
OFF	ON	OFF	OFF	4
OFF	ON	OFF	ON	5
OFF	ON	ON	OFF	6
OFF	ON	ON	ON	7
ON	OFF	OFF	OFF	8
ON	OFF	OFF	ON	9
ON	OFF	ON	OFF	10
ON	OFF	ON	ON	No change
ON	ON	OFF	OFF	No change
ON	ON	OFF	ON	No change
ON	ON	ON	OFF	No change
ON	ON	ON	ON	No change

RNG_OUT0 to RNG_OUT3

RNG_OUT3	RNG_OUT2	RNG_OUT1	RNG_OUT0	Range
OFF	OFF	OFF	ON	30 mΩ
OFF	OFF	ON	OFF	300 mΩ
OFF	OFF	ON	ON	3 Ω
OFF	ON	OFF	OFF	30 Ω
OFF	ON	OFF	ON	300 Ω
OFF	ON	ON	OFF	3 kΩ
OFF	ON	ON	ON	30 kΩ
ON	OFF	OFF	OFF	300 kΩ
ON	OFF	OFF	ON	3 MΩ

BCDm-0 to BCDm-3

BCDm-3	BCDm-2	BCDm-1	BCDm-0	Measured value
OFF	OFF	OFF	OFF	0
OFF	OFF	OFF	ON	1
OFF	OFF	ON	OFF	2
OFF	OFF	ON	ON	3
OFF	ON	OFF	OFF	4
OFF	ON	OFF	ON	5
OFF	ON	ON	OFF	6
OFF	ON	ON	ON	7
ON	OFF	OFF	OFF	8
ON	OFF	OFF	ON	9

8.2 Timing Chart

Each signal level indicates the ON/OFF state of a contact. When using the current source (PNP) setting, the level is the same as the EXT I/O pin voltage level. When using the current sink (NPN) setting, the high and low voltage levels are reversed.

From Start of Measurement to Acquisition of Judgment Results

(1) External trigger [EXT] setting (EOM output hold)

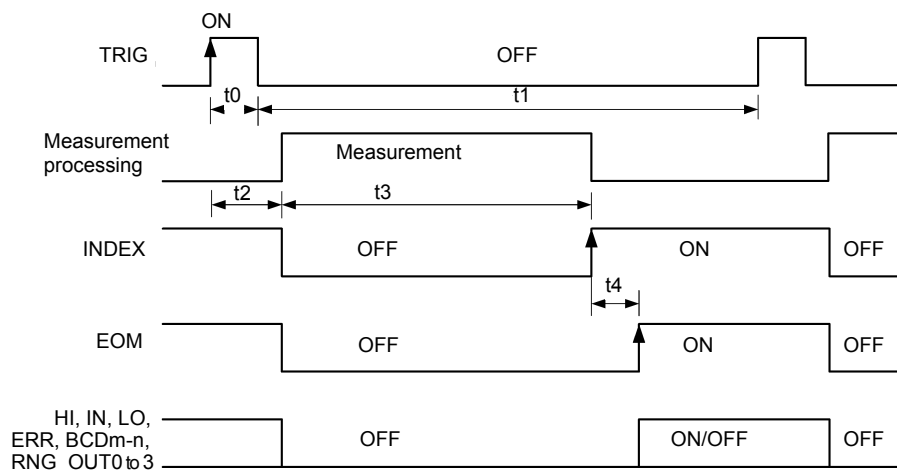

NOTE

- Do not apply a TRIG signal while measuring (when the INDEX signal is OFF) (the signal will be retained only once).
- When changing settings such as measurement range, allow about 300 ms processing time before applying a TRIG signal.
- When not displaying the Measurement screen and while error messages are being displayed, input signals are disabled.
- HI, IN, LO, ERR and BCDm-n signal output is finalized before the EOM signal changes to ON. However, if the controller's input circuit response is slow, it may be necessary to insert wait processing after EOM=ON is received until the judgment results are acquired.

(2) External trigger [EXT] setting (EOM output pulse)

The EOM signal turns ON at the end of measurement and then reverts to the OFF state once the time (t_5) that has been set as the EOM pulse width elapses.

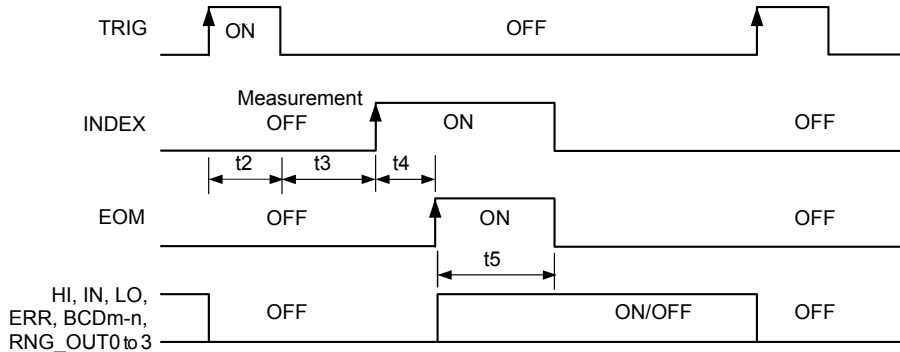

See: "Setting EOM Signal" (p. 115)

When the TRIG signal is input while the EOM signal is ON, the EOM signal will turn OFF once measurement processing is started in response to the TRIG signal.

(3) Internal trigger [INT] setting

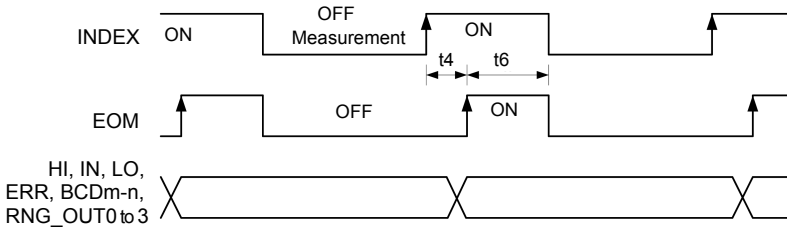

When using the internal trigger [INT] setting, the EOM signal consists of pulse output with a width of 5 ms. The judgment result and ERR signals do not turn OFF at the start of measurement.

Timing Chart Interval Descriptions

Interval	Description	Duration	Remarks
t0	Trigger Pulse Asserted (ON)	0.1 ms or more	ON/ OFF-edge selectable
t1	Trigger Pulse De-asserted (OFF)	1 ms or more	
t2	Measurement start time	1 ms, max	
t3*	Acquisition processing time	FAST (50 Hz): 20 ms FAST (60 Hz): 17 ms MEDIUM : 100 ms SLOW : 400 ms	Reference value
t4	Calculation time	1 ms, max	
t5	EOM pulse width	1 to 100 ms	Setting-dependent
t6	EOM pulse width with internal trigger	5 ms	Cannot be changed.

* When the number of averages is set to n while using the external trigger setting (or when using a `:READ?` query), t3 must be approximately a multiple of n. (For more information about commands, see the Communications Command Instruction Manual on the included application disc.) When using the internal trigger setting, the measurement time does not depend on the number of averages.

Zero-adjustment timing

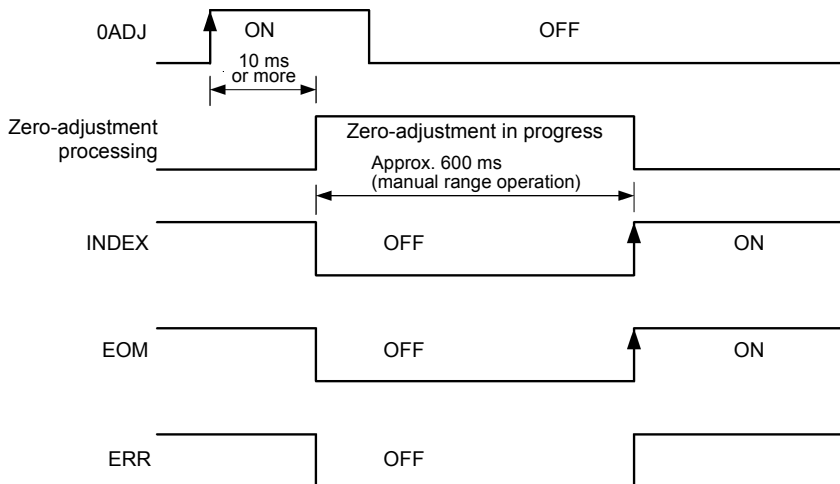

- For pulse EOM output, the EOM signal turns OFF when the pulse width time elapses.
- When using the internal trigger [INT] setting, the EOM signal consists of pulse output with a width of 5 ms. The ERR signals do not turn OFF at the start of measurement. They are updated at the completion of the next measurement.

Panel Load Timing

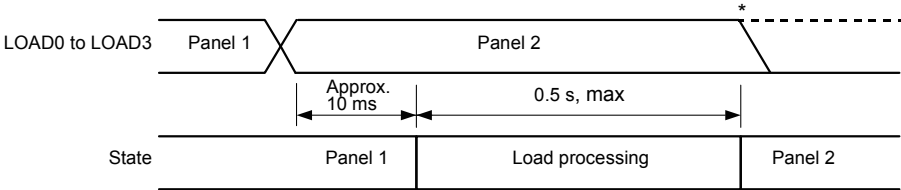

If any of the LOAD signals changes and then there are no changes for an interval of 10 ms, the panel load operation will be performed. Do not change the LOAD0 to 3 signals until load operation completes.

- *: No key operation is available while the LOAD signal is being the on state.
- : To enable key operation, switch the LOAD signal to the off state after the panel load is complete.

BCD Signal Timing

BCDm_n signal transition time based on the BCD_LOW signal

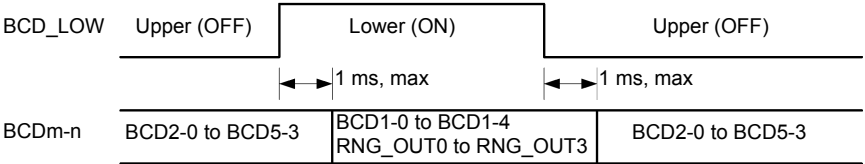

Output Signal State at Power-On

When transitioning from the Startup screen to the Measurement screen after turning on the instrument's power, the EOM and INDEX signals will turn ON. When using pulse EOM output, the signals will remain OFF.

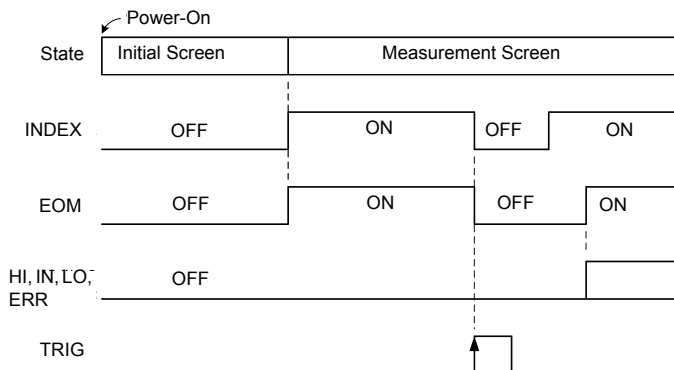

The chart depicts operation when the trigger source is set to EXT while using hold EOM output.

Acquisition Process When Using an External Trigger

This section describes the process from measurement start to acquisition of judgment results or measured values when using an external trigger.

The instrument outputs the EOM signal immediately once the judgment result (HI, IN, LO, ERR) has been finalized. If the controller's input circuit response is slow, it may be necessary to insert wait processing after the EOM signal's changing to ON is detected until the judgment result is acquired.

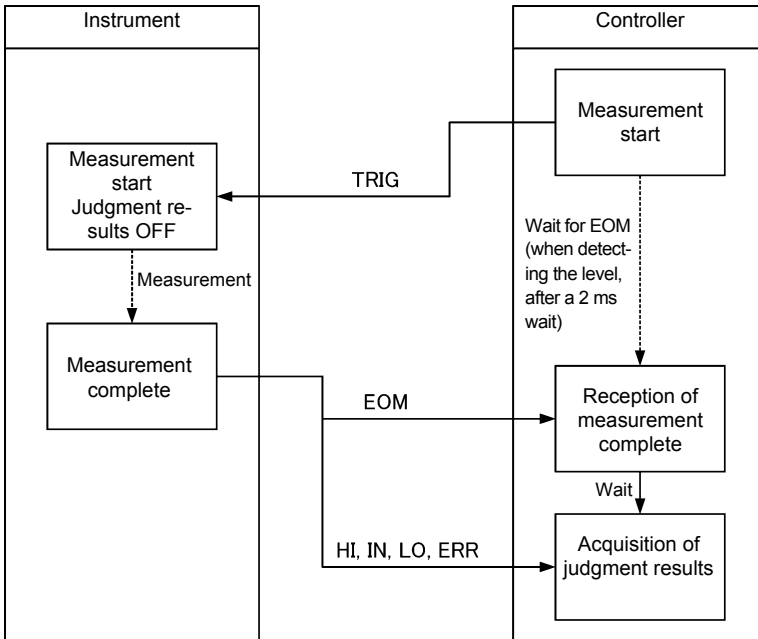

Measured value (BCD) acquisition processing when using an external trigger

For BCD output, the upper and lower digits must be acquired separately. The upper and lower digits can be acquired in any order. In the following example, the upper digits are acquired first. If the response of the input circuit in the controller is slow, inserting wait processing after the EOM signal switching to ON is detected until a measurement value (in the BCD format) is acquired.

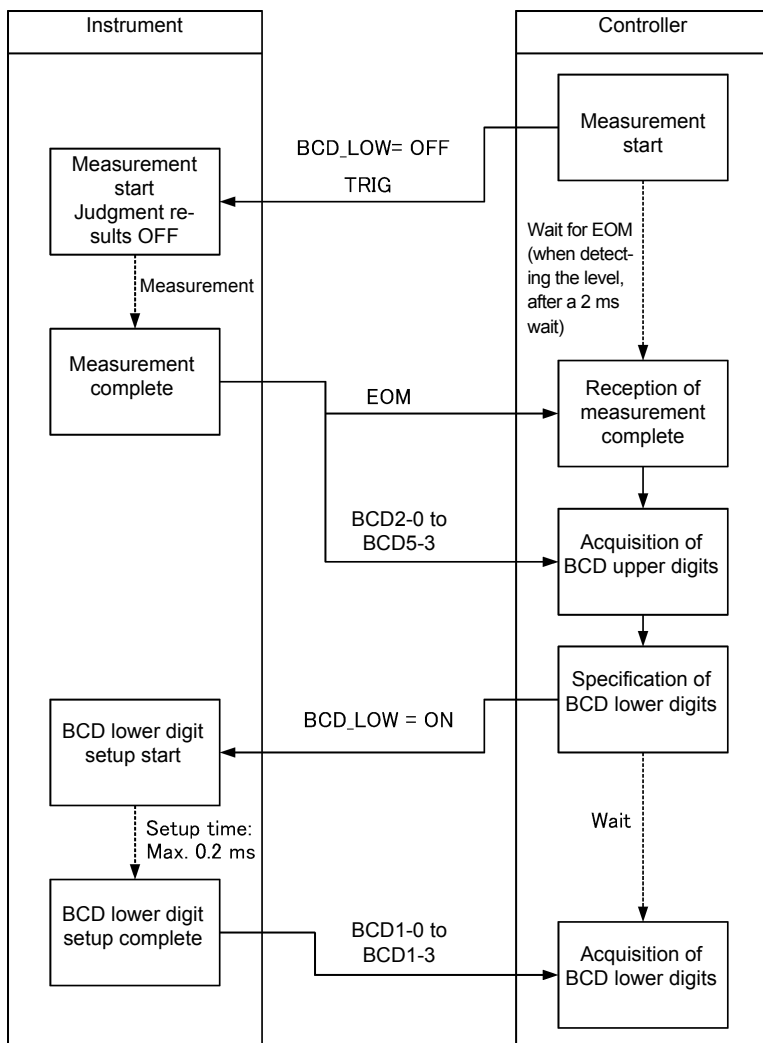

8.3 Internal Circuitry

NPN Setting

Do not connect external power to pin 8.

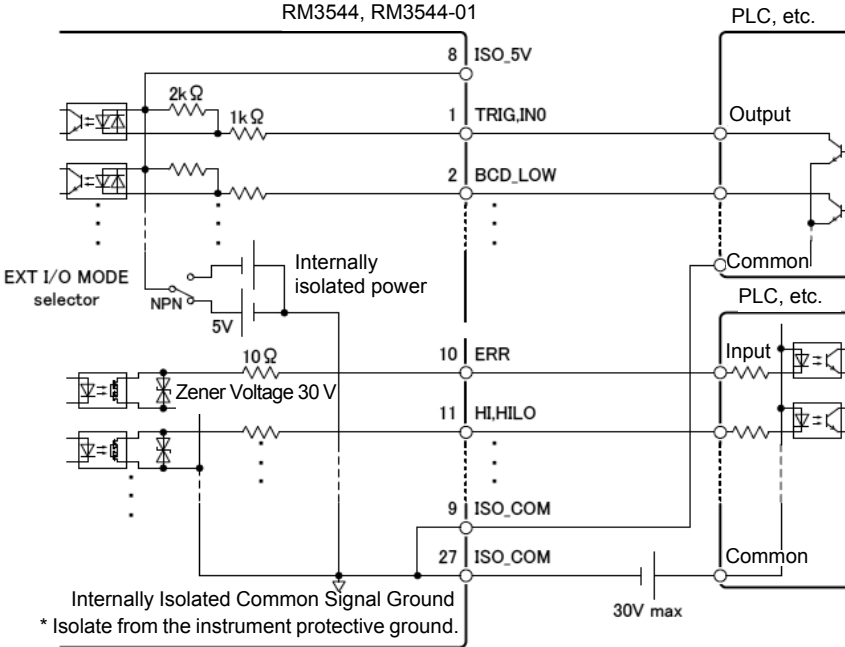

NOTE

- Use ISO_COM as the common pin for both input and output signals.
- If a high current will flow to common wiring, branch the output signal common wiring and input signal common wiring from a point lying close to the ISO_COM pin.

PNP Setting

Do not connect external power to pin 8.

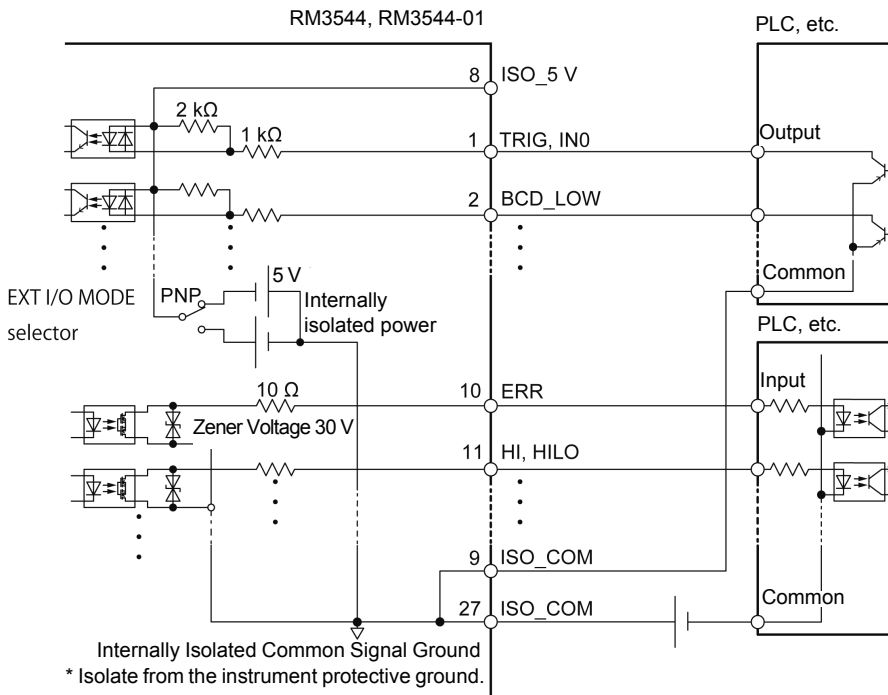

NOTE

Use ISO_COM as the common pin for both input and output signals.

Electrical Specifications

Input Signals	Input type	Optocoupler-isolated, non-voltage contact inputs (Current sink/source output compatible)
	Input asserted (ON)	Residual voltage: 1 V (Input asserted (ON) current: 4 mA typ)
	Input de-asserted (OFF)	Open (shutoff current: 100 μ A or less)
Output Signals	Output type	Optocoupler-isolated, open drain output (non-polar)
	Maximum load voltage	30 V _{MAX} DC
	Maximum output current	50 mA/ch
	Residual voltage	1 V or less (load current: 50 mA) / 0.5 V or less (load current: 10 mA)
Internally Isolated Power Output	Output Voltage	Sink output: 5.0 V \pm 10% Source output: -5.0 V \pm 10%
	Maximum output current	100 mA
	External power input	none
	Isolation	Floating relative to protective ground potential and measurement circuit
	Insulation rating	Terminal-to-ground voltage of 50 V DC, 30 V _{rms} AC, 42.4 V _{pk} AC or less

Connection Examples

Input Circuit Connection Examples

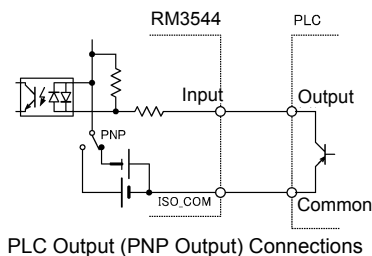
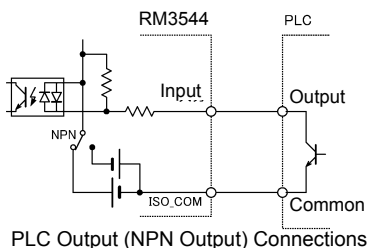
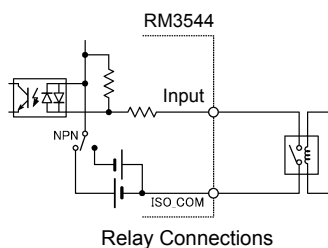
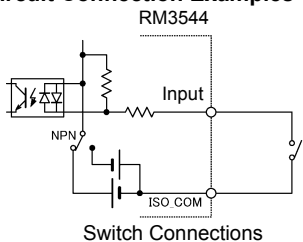

Output Circuit Connection Examples

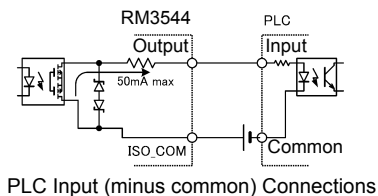
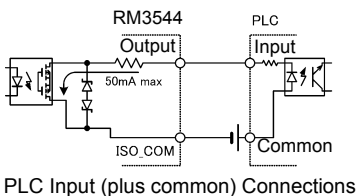
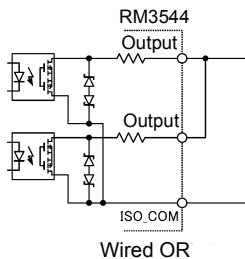
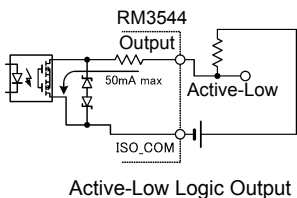
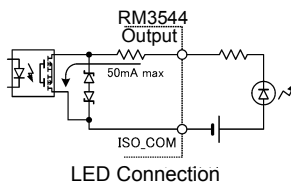
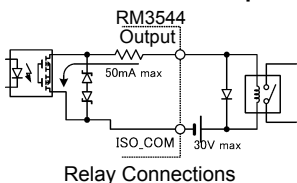

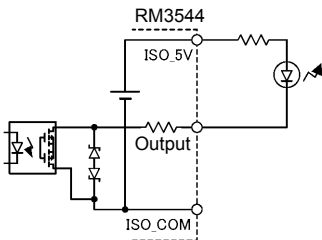

LED Connections
(Using ISO_5V, NPN setting)

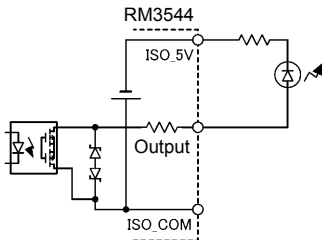

LED Connections
(Using ISO_5V, PNP setting)

8.4 External I/O Settings

The following external I/O settings are provided:

Input settings

- Set the measurement start conditions (trigger source).(p.109)
- Set the TRIG signal logic.(p.111)
- Eliminate TRIG/PRINT signal chatter (filter function).(p.113)

Output settings

- Set the EOM signal.(p.115)
- Switch output modes (judgment mode/BCD mode).(p.117)

Setting Measurement Start Conditions (Trigger Source)

Measurements can be started in two ways.

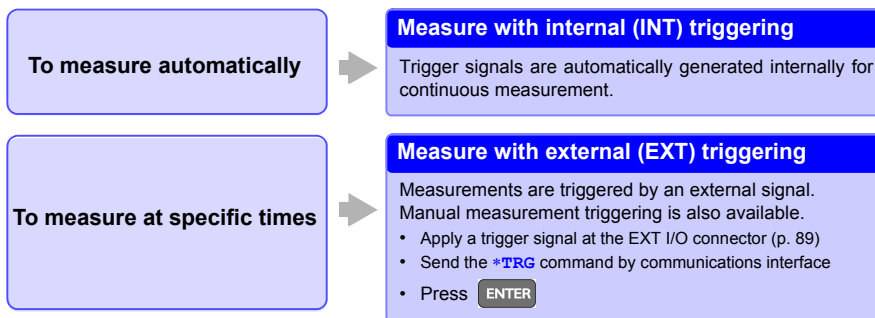

NOTE

When internal triggering is enabled, the EXT I/O TRIG signal and the ***TRG** command are ignored.

Switching the trigger source

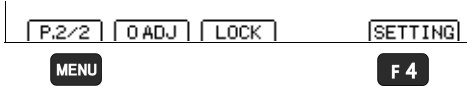
1 Open the Settings Screen.

1 **MENU** Switch the function menu to P.2/2.

2 **F4** The Settings screen appears.

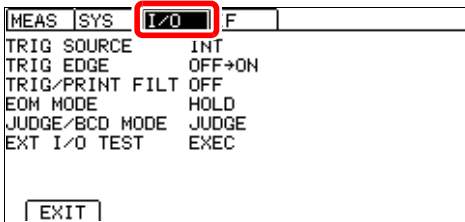
2 Open the EXT I/O Setting Screen.

Move the cursor to the [I/O] tab with the left and right cursor keys.

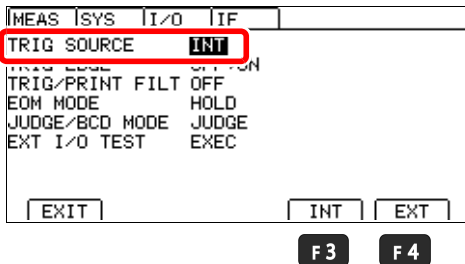
3 Select the trigger source.

1  Selection

2
F3 (INT) Internal trigger (default)
F4 (EXT) External trigger

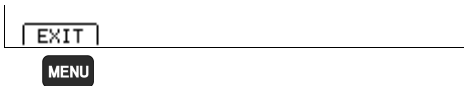
4 Return to the Measurement screen.

MENU Return to the Measurement screen.

Continuous measurement (: **INITIATE:CONTINUOUS ON**) is the normal trigger state when using key operation from the front panel. Selecting the internal (INT) trigger source activates continuous triggering ("free-run"). When external (EXT) triggering is selected, each external trigger event initiates one measurement. Continuous measurement can be disabled by sending the **:INITIATE:CONTINUOUS OFF** command via RS-232C or USB. When continuous measurement is disabled, trigger acceptance is controlled only by the controller (computer or PLC).

See: For trigger command: See the included application disc.

Setting the TRIG Signal Logic

Select the ON or OFF edge as the logic at which the TRIG signal is enabled. When using the OFF edge, measurement times will be increased by approximately 1.0 ms.

1 Open the Settings Screen.

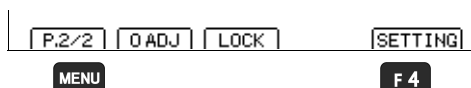

1 **MENU** Switch the function menu to P.2/2.

2 **F4** The Settings screen appears.

2 Open the EXT I/O Setting Screen.

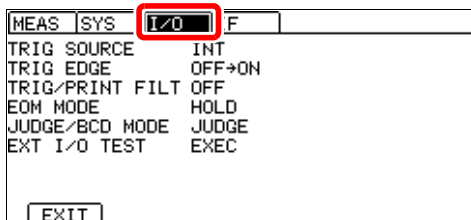

Move the cursor to the [I/O] tab with the left and right cursor keys.

3 Select the trigger conditions.

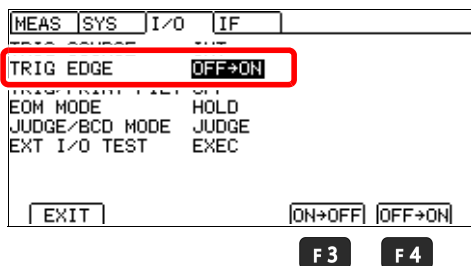

1 Selection

2
F3 [ON → OFF]
Start measurement at the OFF edge.

F4 [OFF → ON]
ON edge (default)

4 Return to the Measurement screen.

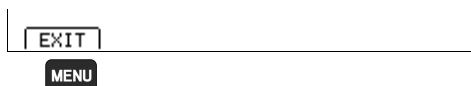

MENU Return to the Measurement screen.

ON edge and OFF edge operation

- ON edge

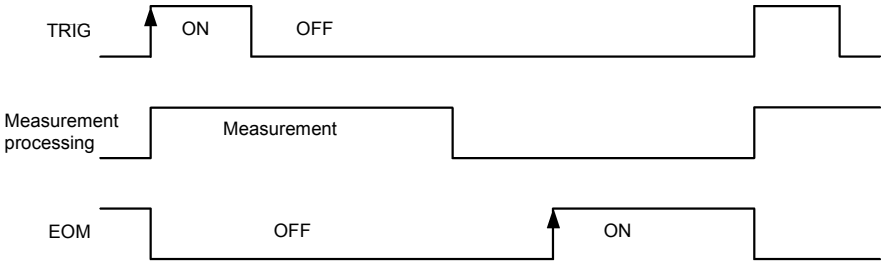

- OFF edge

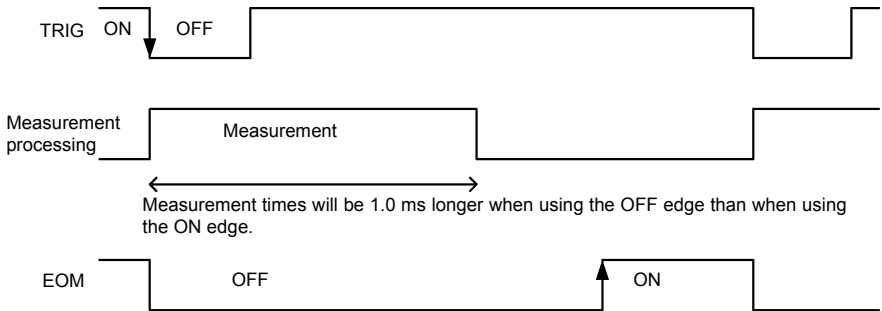

Eliminating TRIG/PRINT Signal Chatter (Filter Function)

The filter function, which eliminates chatter, is useful when connecting a foot switch or similar device to the TRIG/PRINT signal.

1 Open the Settings Screen.

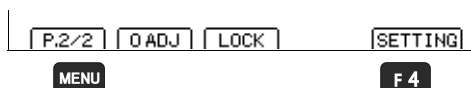

1 **MENU** Switch the function menu to P.2/2.

2 **F 4** The Settings screen appears.

2 Open the EXT I/O Setting Screen.

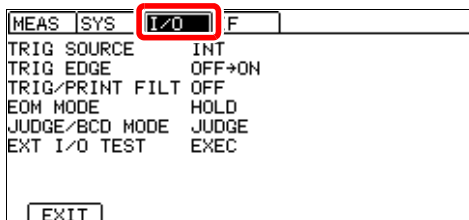

Move the cursor to the [I/O] tab with the left and right cursor keys.

3 Select the filter function.

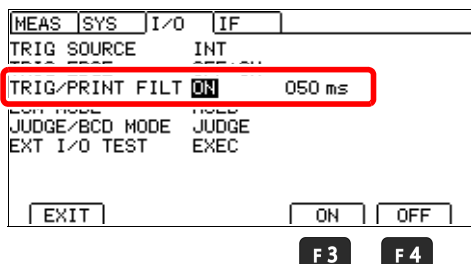

1  Selection

2
F 3 ON
F 4 OFF (default)

4 Set the response time.

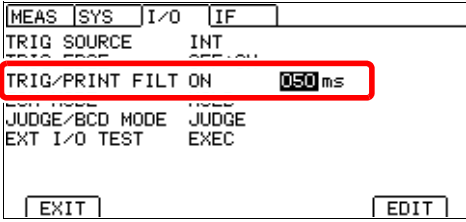

1 Move the cursor to the setting you wish to configure. Make the value editable with the **F4** key.

2 Move among digits. Change values. Move the cursor to the digit you wish to set with the left and right cursor keys. Change the value with the up and down cursor keys.

F4

Setting range: 50 ms to 500 ms (default: 50 ms) **3** **ENTER** Accept

(**ESC** Cancel)

5 Return to the Measurement screen.

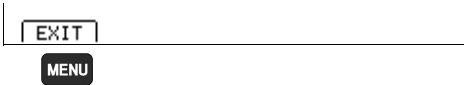

MENU Return to the Measurement screen.

Filter function (TRIG signal example)

- Using the ON edge

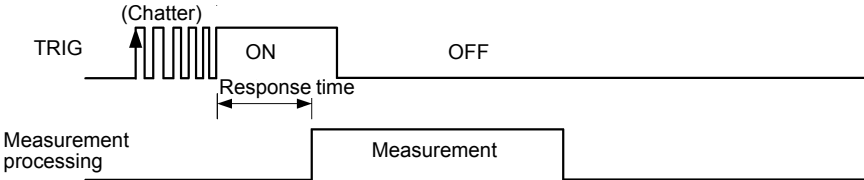

- Using the OFF edge

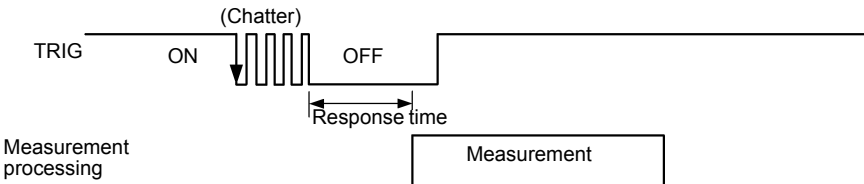

Hold the input signal until the response time elapses.

Setting EOM Signal

You can select whether to hold EOM signal output until the next trigger is input or output a user-specified pulse width.

NOTE

When using the internal trigger [INT], the EOM pulse width is fixed at 5 ms, regardless of the settings.

1 Open the Settings Screen.

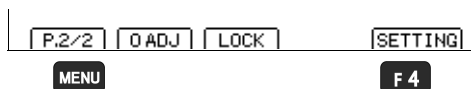

1 **MENU** Switch the function menu to P.2/2.

2 **F 4** The Settings screen appears.

2 Open the EXT I/O Setting Screen.

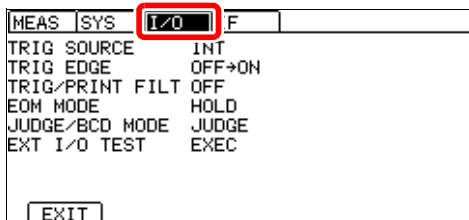

Move the cursor to the [I/O] tab with the left and right cursor keys.

3 Select the EOM signal output type.

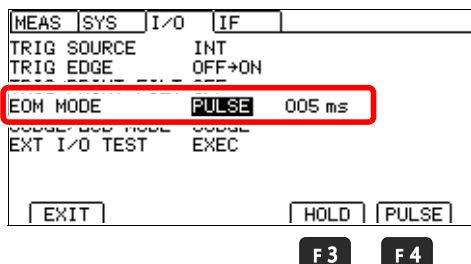

1  Selection

2
F 3 The EOM signal remains asserted after end-of-measurement (default) (to step 5).

F 4 The specified pulse is output after end-of-measurement.

4 (When PULSE is selected)

Select the pulse width.

MEAS	SYS	I/O	IF
TRIG SOURCE		INT	
TRIG EDGE		OFF→ON	
EDM MODE		PULSE	005 ms
EDGE1 POS	EDGE2 POS	EDGE3 POS	
EXT I/O TEST		EXEC	

EXIT EDIT

F4

Setting range: 1 ms to 100 ms (default: 5 ms)



Move the cursor to the setting you wish to configure. Make the value editable with the **F4** key.

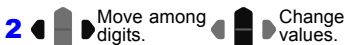

Move the cursor to the digit you wish to set with the left and right cursor keys. Change the value with the up and down cursor keys.



5 Return to the Measurement screen.

EXIT

MENU

MENU Return to the Measurement screen.

Switching Output Modes (JUDGE Mode/ BCD Mode)

1 Open the Settings Screen.

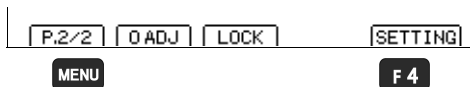

1 [MENU] Switch the function menu to P.2/2.

2 [F 4] The Settings screen appears.

2 Open the EXT I/O Setting Screen.

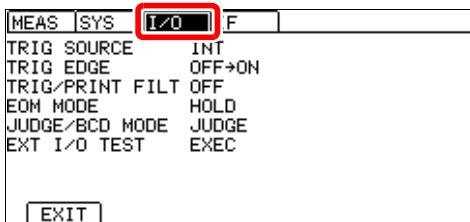

Move the cursor to the [I/O] tab with the left and right cursor keys.

3 Select the output mode.

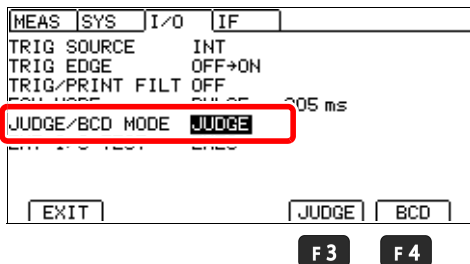

1 ◀ ▶ Selection

2 [F 3] JUDGE mode (default)
[F 4] BCD mode

4 Return to the Measurement screen.

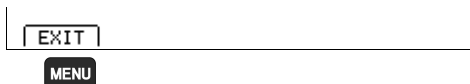

[MENU] Return to the Measurement screen.

8.5 Checking External Control

Performing an I/O Test (EXT I/O Test Function)

In addition to switching output signals ON and OFF manually, you can view the input signal state on the screen.

1 Open the Settings Screen.

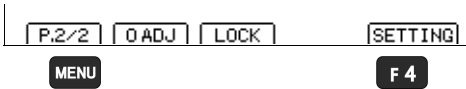

1 **MENU** Switch the function menu to P.2/2.

2 **F4** The Settings screen appears.

2 Open the EXT I/O Setting Screen.

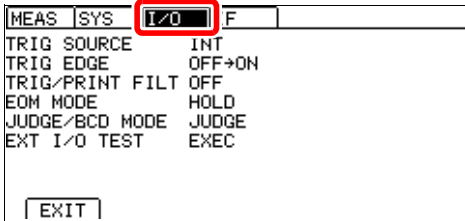

Move the cursor to the [I/O] tab with the left and right cursor keys.

3 Open the EXT I/O Test Screen.

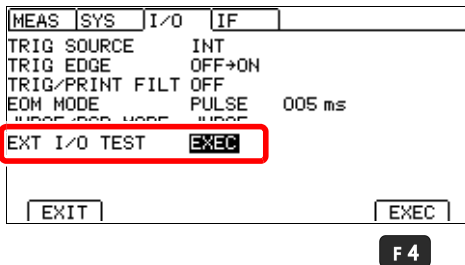

1  Selection

2 **F4** Open the Test screen.

4 Perform the EXT I/O test.

EXT I/O TEST					I/O TYPE:NPN				
EQM	ERR	BCD20	HILO	IN					
BCD21	BCD22	BCD23	BCD30	BCD31					
BCD32	BCD33	BCD40	BCD41	BCD42					
BCD43	BCD50	BCD51	BCD52	BCD53					
TRIG	QADJ	BCDLO	RESRV	KLOCK					
LOAD0	LOAD1	LOAD2	LOAD3	RESRV					
DECBU	DECBU	DECBU	DECBU	DECBU					
EXIT			ON	OFF					
			F3	F4					

Output signals

Allows you to perform signal operations. (ON: Reverse video; OFF: Normal display)

  : Select signal.

F3 : Turn signal ON.

F4 : Turn signal OFF.

Input signals

Displays the signal state. (ON: Reverse video; OFF: Normal display)

5 Return to the EXT/IO setting screen.

EXIT
MENU

MENU Return to the EXT/IO setting screen.

6 Return to the Measurement screen.

EXIT
MENU

MENU Return to the Measurement screen.

8.6 Supplied Connector Assembly

The EXT I/O connector and shell are supplied with the instrument. Assemble as shown below.

NOTE

- Use shielded cables to connect a PLC to the EXT I/O connector. Using non-shielded conductors may result in system errors from electrical noise.
- Connect the shield to the ISO_COM pin of the EXT I/O connector.

Required tools:

- Screwdriver
- Shielded cable
- Soldering iron

Accessories

- **A** Cover2
- **B** Screws (+/-) #4-40UNC (16.9 mm overall length)...2
- **C** Screws (+/-) #4-40UNC (12.6 mm overall length)...2
- **D** Screws (-) #4-40UNC (15.0 mm overall length)...2
- **E** Nuts #4-40UNC2
- **F** Cable Clamps2
- **G** Saddle Washers (shell protection).....2
- **H** Connector1

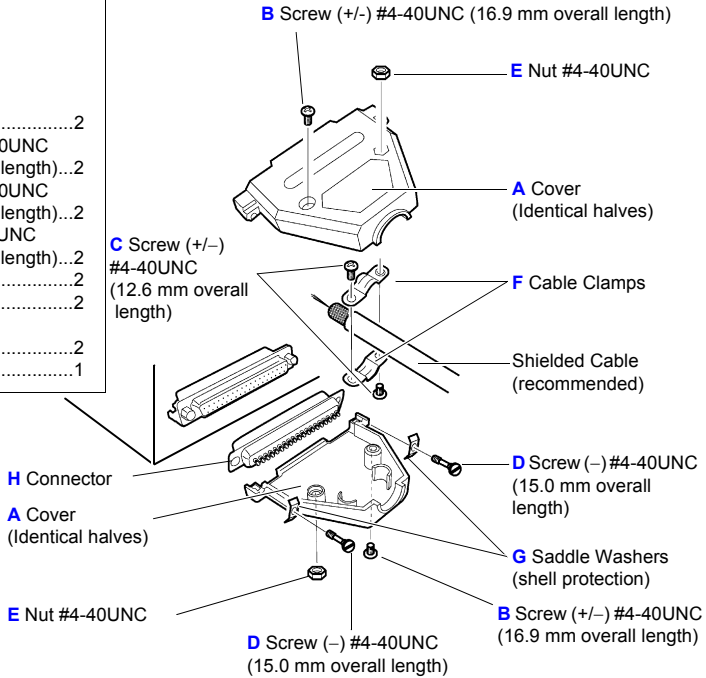

Assembly Sequence

1. Solder the (shielded) cable wires to the supplied EXT I/O connector (H) pins.
2. Affix the cable clamps (F) on the cable with screws (C).
3. Position the cable clamps (F) to fit properly inside the cover (A).
4. Insert screws (D) through the saddle washers (G).
5. In one half of cover (A), place connector (H), clamps (F), saddle washers (G) and screws (D).
6. Place the other half of cover (A) on top.
7. Affix the halves of the cover (A) together with screws (B) and nuts (E).

Be careful not to overtighten the screws, which could damage the covers.

Communications

(USB/ RS-232C Interface)

Chapter 9

Before connecting data cables, read "Operating Precautions" (p.10) carefully.

9.1 Overview and Features

The instrument's communications interfaces can be used to control the instrument and acquire data. See the section that's relevant to your goal.

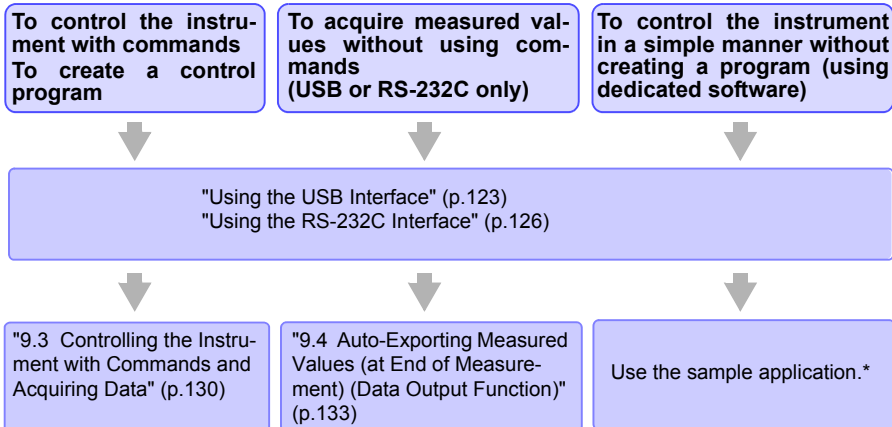

* The sample application can be downloaded from the Hioki website (<http://www.hioki.com>).

Communications times

- There may be a display processing lag depending on the frequency and nature of any communications processing performed.
- Time spent transferring data must be added when communicating with a controller. USB transfer times vary with the controller. RS-232C transfer times can be approximated with the following formula, where the transfer speed (baud rate) is N bps using 1 stop bit, 8 data bits, no parity, and 1 stop bit, for a total of 10 bits:

$$\text{Transfer time } T \text{ [1 character/sec]} = \text{Baud rate } N \text{ [bps]} / 10 \text{ [bits]}$$

Since measured values are 11 characters in length, the transfer time for 1 piece of data is $11/T$.

Example: For a 9,600 bps connection, $11 (9,600 / 10) =$ Approximately 11 ms

- For more information about command execution times, see the Communications Command Instruction Manual on the included application disc.

Specifications

NOTE

You must select one communications interface for use. Communications control using different interfaces cannot be performed simultaneously.

USB Specifications

Connector	Series B receptacle
Electrical specification	USB2.0 (Full Speed)
Class	CDC Class, HID Class
Message terminator (delimiter)	Receiving: CR+LF, CR Transmitting: CR+LF

RS-232C Specifications

Transfer method	Communications: Full duplex Synchronization: Start-stop synchronization
Baud rate	9,600 bps (default)/ 19,200 bps/ 38,400 bps/ 115,200bps
Data length	8bits
Parity	none
Stop bit	1bit
Message terminator (delimiter)	Receiving: CR+LF, CR Transmitting: CR+LF
Flow control	none
Electrical specification	Input voltage levels 5 to 15 V: ON, -15 to -5 V: OFF Output voltage levels 5 to 9 V: ON, -9 to -5 V: OFF
Connector	Interface Connector Pinout (Male 9-pin D-sub, with #4-40 attachment screws) The I/O connector is a DTE (Data Terminal Equipment) configuration Recommended cables: 9637 RS-232C Cable(for PC) 9638 RS-232C Cable(for D-sub25pin connector)

Operating Code: ASCII codes

9.2 Preparations before Use (Connections and Settings)

Using the USB Interface

1. Configuring USB Interface Communications

Make these instrument settings.

1 Open the Settings Screen.

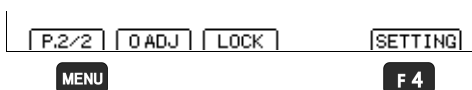

1 **MENU** Switch the function menu to P.2/2.

2 **F 4** The Settings screen appears.

2 Open the Communications Interface Settings Screen.

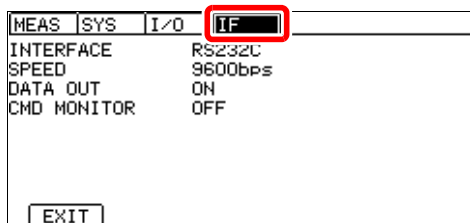

Move the cursor to the [IF] tab with the left and right cursor keys.

3 Select the interface type.

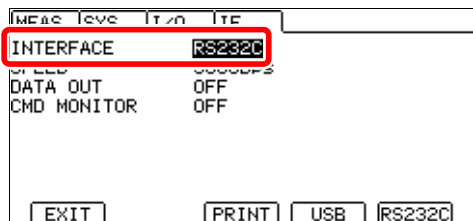

1  Selection

2 **F 3** USB Interface

4 Select the USB connection mode.

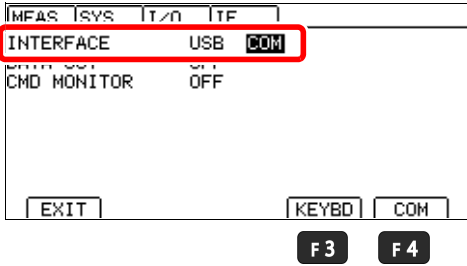

1 Move the cursor to the setting you wish to configure.

2

- F3** USB keyboard mode
- F4** COM mode (default)

5 Return to the Measurement screen.

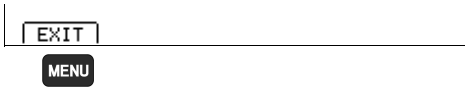

MENU Return to the Measurement screen, and enable the communications interface.

NOTE

- USB keyboard mode is provided for data output use only. When using commands, set the connection to COM mode.
- There is no need to install the USB driver in USB keyboard mode.
- Install the USB driver when using COM mode for the first time. (p.125)

2. Install the USB driver. (When COM mode is selected)

When connecting the instrument to the computer for the first time using the COM Class method, you will need a dedicated USB driver. The following procedure need not be followed if the driver has already been installed, for example in the course of using another Hioki product. The USB driver can be found on the included application disc or downloaded from the Hioki website (<http://www.hioki.com>).

There is no need to install the driver when using the USB keyboard Class method.

Installation procedure

Install the driver before connecting the instrument and computer with a USB cable. If the instrument has already been connected, disconnect the USB cable in order to perform the installation.

- 1** Log in to a user account on the computer with administrator privileges (for example, “**administrator**”).
- 2** Before starting the installation, exit all applications running on the computer.
- 3** Launch **HiokiUsbCdcDriver.msi**. After doing so, follow the instructions on the screen to complete the installation.

To run the installer from the included application disc, execute the following file:

X:\driverHiokiUsbCdcDriver.msi (X: CD-ROM drive)

In some operating environments, it may take some time for the dialog box to be displayed.

- 4** After installing the software, the instrument will be recognized automatically when it is connected to the computer with the USB cable.
- If the “**Found New Hardware Wizard**” screen is displayed, select “**No, not this time**” when asked whether to connect to Windows Update and then choose “**Install the software automatically.**”
 - If an instrument with a different serial no. is connected, the computer may recognize it as a new device. Follow the instructions on the screen to install the device driver.
 - A warning message will be displayed since the device driver has not undergone Windows Logo testing. Choose “**Continue Anyway.**”

Procedure to uninstall the driver (uninstall the driver once it is no longer needed)

Delete the Hioki USB CDC Driver using [Control Panel] - [Add or Remove Programs].

3. Connect the USB cable.

Connect the included USB cable to the instrument’s USB jack.

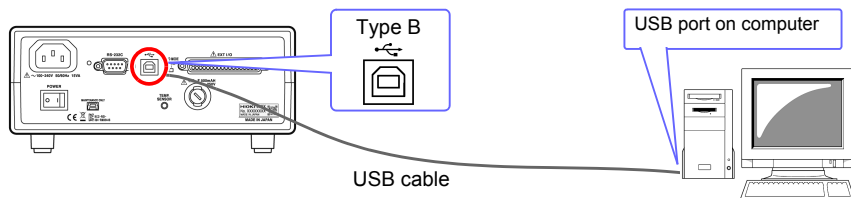

Using the RS-232C Interface

1. Configuring RS-232C Interface Communications

Make these instrument settings.

1 Open the Settings Screen.

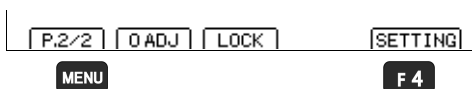

1 **MENU** Switch the function menu to P.2/2.

2 **F4** The Settings screen appears.

2 Open the Communications Interface Settings Screen.

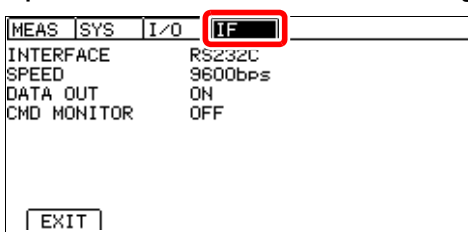

Move the cursor to the [IF] tab with the left and right cursor keys.

3 Select the interface type.

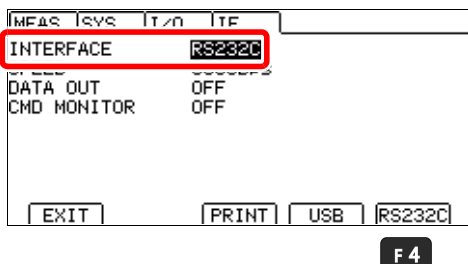

1 Selection

2 **F4** RS-232C Interface

4 Select the interface transfer rate (baud rate).

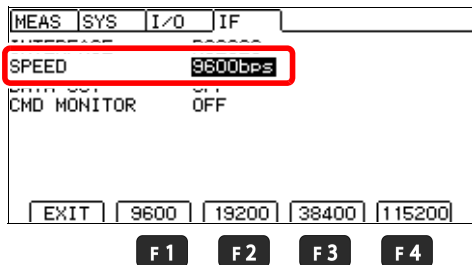

1 ◀ ▶ Selection

- 2
- F1 9600 (bps) (default)
 - F2 19200 (bps)
 - F3 38400 (bps)
 - F4 115200 (bps)

5 Return to the Measurement screen.



MENU Return to the Measurement screen, and enable the communications interface.

NOTE

Some transmission speed (baud rate) settings may not be usable with some computers due to a large error component. In this case, switch to a slower setting.

Configure the controller (PC or PLC).

Be sure to make set up the controller as shown below.

- Asynchronous communication
- Transfer rate: 9600bps/ 19200bps/ 38400bps/ 115200bps (set to match the instrument setting)
- Stop bit: 1
- Data length: 8
- Parity check: None
- Flow control: None

2. Connect the RS-232C cable.

Connect the RS-232C cable to the RS-232C connector. When connecting the cable, be sure to tighten the connector in place with screws.

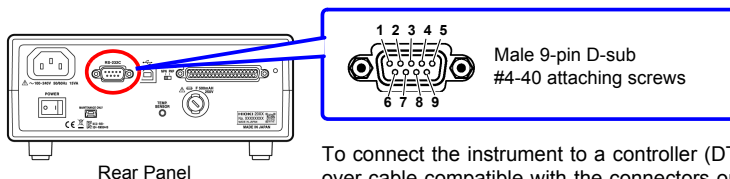

Rear Panel

To connect the instrument to a controller (DTE), use a cross-over cable compatible with the connectors on both the instrument and the controller.

The I/O connector is a DTE (Data Terminal Equipment) configuration. This instrument uses only pins 2, 3, and 5. The other pins are unconnected.

Pin No	Signal Name	Code Addr.		Mutual connection circuit name	Remarks
		EIA	JIS		
1	DCD	CF	CD	Carrier Detect	Not used
2	RxD	BB	RD	Receive Data	
3	TxD	BA	SD	Transmit Data	
4	DTR	CD	ER	Data Terminal Ready	Active (ON) level is +5 to +9 V (constant)
5	GND	AB	SG	Signal Ground	
6	DSR	CC	DR	Data Set Ready	Not used
7	RTS	CA	RS	Request to Send	Active (ON) level is +5 to +9 V (constant)
8	CTS	CB	CS	Clear to Send	Not used
9	RI	CE	CI	Ring Indicator	Not used

Connecting a controller with a 9-pin D-sub male port

Use a crossover cable with female 9-pin D-sub connectors.

Crossover Wiring

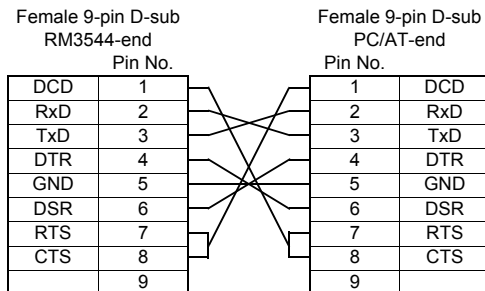

Recommended cable: HIOKI Model 9637 RS-232C Cable (1.8 m)

Connecting a controller with a 25-pin D-sub female port

Use a crossover cable with a female 9-pin D-sub and a male 25-pin D-sub connector. As the figure shows, RTS and CTS pins are shorted together and crossed to DCD in the other connector.

Crossover Wiring

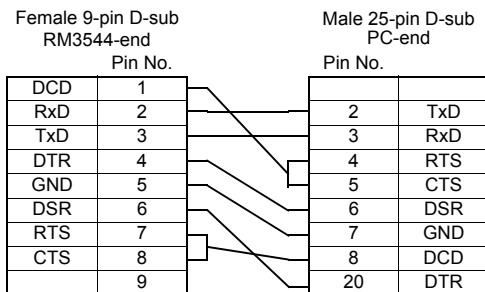

Recommended cable: HIOKI Model 9638 RS-232C Cable

Note that the combination of a dual male 25-pin D-sub cable and a 9- to 25-pin adapter cannot be used.

9.3 Controlling the Instrument with Commands and Acquiring Data

For more information about communications commands and query notation (from the communications message reference), see the Communications Command Instruction Manual on the included application disc. When creating programs, the communications monitor function can be used to display commands and their associated responses on the Measurement screen.

NOTE

When the output queue becomes full, a query error will be issued, and the output queue will be cleared.

When the interface setting is set to the printer, proper command operation is not guaranteed. Do not send commands.

Remote and Local States

During remote control operation, **[RMT]** appears on the Measurement screen, and all except the **MENU** key are disabled.

Pressing the **MENU** **[LOCAL]** disables remote control and re-enables the operating keys.

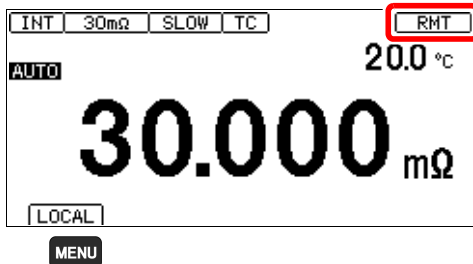

If the Setting screen was displayed when remote control was enabled, the instrument returns to the Measurement screen automatically.

Displaying Communications Commands (Communications Monitor Function)

The communications monitor function can be used to display communications commands and query responses on the instrument's screen.

1 Open the Settings Screen.

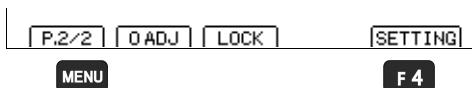

1 **MENU** Switch the function menu to P.2/2.

2 **F 4** The Settings screen appears.

2 Open the Communications Interface Settings Screen.

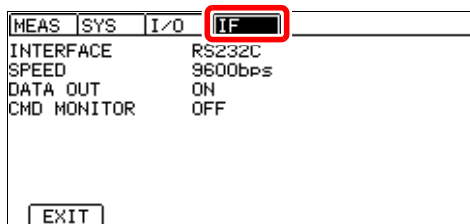

Move the cursor to the [IF] tab with the left and right cursor keys.

3 Set the communications monitor to either ON or OFF.

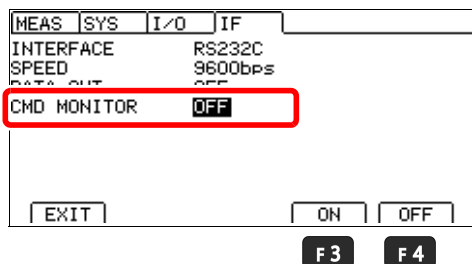

1 Selection

2 **F 3** ON

F 4 OFF (default)

4 Return to the Measurement screen.



MENU Return to the Measurement screen.

5 Command and queries will be displayed on the bottom of the Measurement screen.

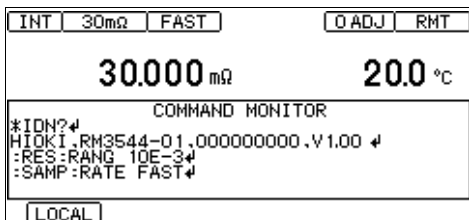

Messages displayed in the communications monitor and their meanings

If an error occurs during command execution, the following information will be displayed:

- Command error (improper command, improper argument format, etc.)

> #CMD ERROR

- Argument out of range

> #PARAM ERROR

- Execution error

> #EXE ERROR

The approximately location of the error will also be shown.

- Argument error (-1 is out of range)

> :RES:RANG -1

> # ^ PARAM ERROR

- Spelling error (for example, using "RENGE" instead of "RANGE")

> :RES:RENGE 100

> # ^ CMD ERROR

NOTE

- If an illegal character code is received, the character code will be shown in hexadecimal notation enclosed in angle brackets (< >). For example, the character 0xFF would be displayed as <FF>, and 0x00 would be displayed as <00>. If all you see is hexadecimal characters like this when using the RS-232C interface, check the communications conditions or try using a lower communications speed.

- When using the RS-232C interface

If an RS-232C error occurs, the following information will be displayed:

Overrun error (signal lost)..... #Overrun Error

Break signal received..... #Break Error

Parity error..... #Parity Error

Framing error..... #Framing Error

If any of these messages is displayed, check the communications conditions or try using a lower communications speed.

- The error position may shift, for example when sending a series of consecutive commands.

9.4 Auto-Exporting Measured Values (at End of Measurement) (Data Output Function)

Once measurement completes, the instrument can send measured values automatically as data to a computer via its USB or RS-232C interface.

There are two methods for sending data. For more information about how to switch between the methods, see "Using the USB Interface" (p.123).

(1) COM mode

Data is output to serial communications (COM, RS-232C communication) verification software or to a receiving program created by the user.

(2) USB keyboard mode (available only with the USB interface)

Data is written to a text editor or spreadsheet application as if it were being typed on the keyboard.

When using USB keyboard mode, be sure to launch the text editor or spreadsheet application and position the cursor where you wish the data to be written before outputting the data. Improper placement of the cursor will cause the data to be overwritten at that point. Be sure to set the input mode to single-byte characters.

Output data format

Measured value format when scaling is off

(The measured value format varies depending on scaling. (p.50))

Changing the number of digits in the measured value will not change the format. Undisplayed digits have a value of 0.

Measurement Range	Measured Value	±OvrRng	Measurement Fault
30mΩ	±□□.□□□E-03	±10.000E+19	+10.000E+29
300mΩ	±□□□.□□E-03	±100.00E+18	+100.00E+28
3Ω	±□.□□□□E+00	±1.0000E+20	+1.0000E+30
30Ω	±□□.□□□E+00	±10.000E+19	+10.000E+29
300Ω	±□□□.□□E+00	±100.00E+18	+100.00E+28
3kΩ	±□.□□□□E+03	±1.0000E+20	+1.0000E+30
30kΩ	±□□.□□□E+03	±10.000E+19	+10.000E+29
300kΩ	±□□□.□□E+03	±100.00E+18	+100.00E+28
3MΩ	±□.□□□□E+06	±1.0000E+20	+1.0000E+30

For positive measured values, a space (ASCII 20H) represents the "+" sign.

When ±OvrRng is displayed, values are ±1E+20.

When a measured value fault occurs, values are +1E+30.

NOTE

- When using the internal trigger [INT], data is automatically sent at TRIG signal input or when the **ENTER** key is pressed.
- Do not use commands when data output is ON. Doing so may cause measured values to be sent twice or other issues.

1 Open the Settings Screen.

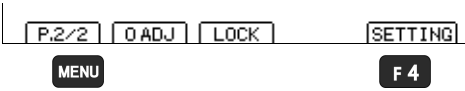

1 **MENU** Switch the function menu to P.2/2.

2 **F4** The Settings screen appears.

2 Open the Communications Interface Settings Screen.

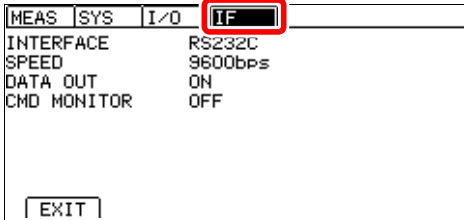

Move the cursor to the [IF] tab with the left and right cursor keys.

3 Enable or disable auto-exporting (DATA OUT)

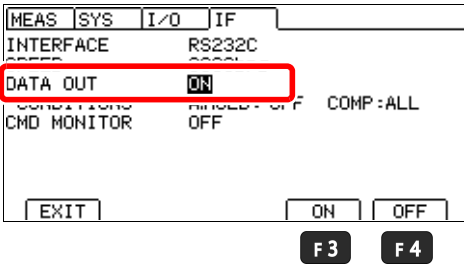

1 Selection

2
F3 Enable auto-exporting
F4 Disable auto-exporting (default)

4 Select the auto-exporting condition (applied when auto-hold function is set to ON).

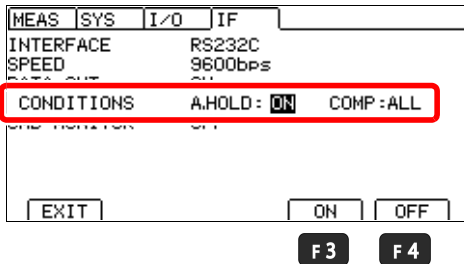

1 Selection

2
F3 Enable auto-exporting when auto-hold is set to ON.
F4 Disable auto-exporting even when auto-hold is set to ON. (default)

5 Select the auto-exporting condition (depending on a judgment).

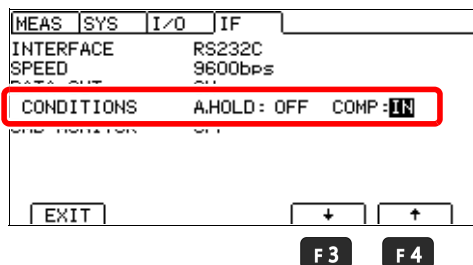

1 Selection

2 Select judgment condition

ALL Exports measurement values regardless of judgments (default)

Hi Exports measurement values only with Hi judgments

IN Exports measurement values only with IN judgments

Lo Exports measurement values only with Lo judgments

HL Exports measurement values only with Hi or Lo judgments

In USB keyboard mode, measurement values are automatically exported regardless of judgments.

6 Return to the Measurement screen.

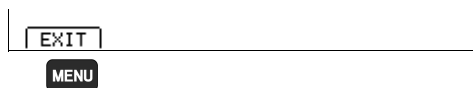

MENU Return to the Measurement screen.

Preparing connected equipment (PC or PLC)

- When outputting data with the COM port
Place the equipment in the receive standby state. If connecting the instrument to a computer, launch the application software and place it in the receive standby state.
- When outputting data with a virtual keyboard
Launch the application and position the cursor where you wish to enter the text.

Printing

(Using an RS-232C Printer) Chapter 10

Connecting
the printer to
the instrument

Make instrument
settings (p.139)

Make printer
settings

Printing (p.140)

- Measured values and comparator judgments
- List of measurement conditions and settings

10.1 Connecting the Printer to the Instrument

Before connecting a printer, read "Operating Precautions" (p.10) carefully.

Printer

The requirements for a printer to be connected to the instrument are as follows.

Confirm compatibility and make the appropriate settings on the printer before connecting it to the instrument.

See: "Instrument Settings" (p. 139)

- Interface RS-232C
- Characters per line At least 45
- Communication speed 9600 bps (default)/ 19,200bps/ 38,400bps/ 115,200bps
- Data bits 8
- Parity none
- Stop bits 1
- Flow control none
- Control codes Capable of directly printing plain text
- Message terminator (delimiter) .. CR+LF

Connection Methods

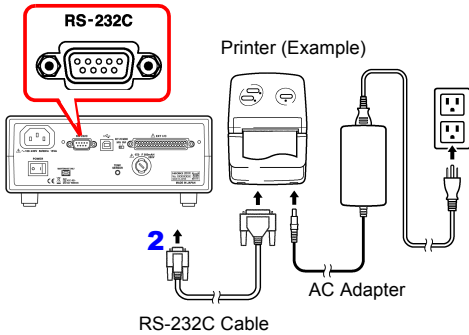

- 1** Confirm that the instrument and printer are turned off.
- 2** Connect the RS-232C Cable to the RS-232C connectors on the instrument and printer.
- 3** Turn the instrument and printer on.

Connector Pinouts

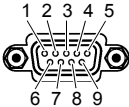

RM3544 (9-pin) Connector

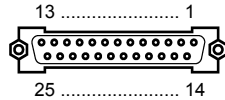

Printer (25-pin) Connector (Example)

Circuit name	Signal Name	Pin
Receive Data	RxD	2
Transmit Data	TxD	3
Signal or Common Ground	GND	5

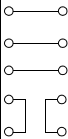

Pin	Signal Name	Circuit name
2	TxD	Transmit Data
3	RxD	Receive Data
7	GND	Signal or Common Ground
4	RTS	Request to Send
5	CTS	Clear to Send

Be sure to check the connector pin assignments for the printer being used.

Instrument Settings

1 Open the Settings Screen.

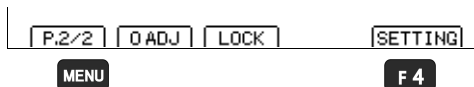

- 1 **MENU** Switch the function menu to P.2/2.
- 2 **F4** The Settings screen appears.

2 Open the Communications Interface Settings Screen.

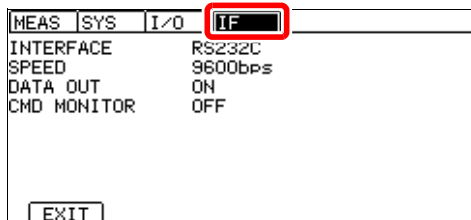

Move the cursor to the [IF] tab with the left and right cursor keys.

3 Select PRINT as the interface type.

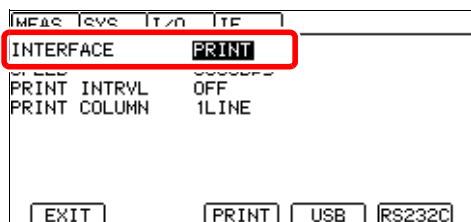

1 Selection

2

F2 To use the printer

4 Return to the Measurement screen.

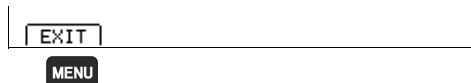

MENU

Return to the Measurement screen.

10.2 Printing

Before Printing

Verify that the instrument settings (p.139) are correct.

Printing Measured Values and Comparator Judgments

Printing by key operation

Pressing **F4** [**PRINT**] on Measurement screen P.1/2 causes the current measured value to be printed. When the **ENTER** is used as the trigger, one measurement will be performed and the results printed. When the temperature is not being displayed, only the resistance value will be printed. When the temperature is being displayed, both the resistance value and the temperature will be printed.

See: "Switching the Display" (p.35)

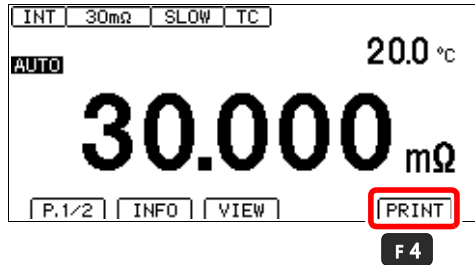

Printing by external control

When the instrument's EXT I/O connector's PRINT signal is turned ON (by shorting it with the EXT I/O connector's ISO_COM pin), you can print measured values and judgment results.

- To print continuously for each measurement, connect the EOM signal to the PRINT signal and set the instrument to use the internal trigger.
- To print after the completion of trigger-based measurement using an external trigger, connect the external I/O EOM signal to the PRINT signal.

Printing List of Measurement Conditions and Settings

Pressing **F4** after pressing **F1** [**INFO**] on Measurement screen P.1/2 to display a list of settings prints a list of measurement conditions and settings.

See: "Displaying a list of measurement conditions and settings" (p.37)

INFO	Ver.1.00	No. 000000000000
RANGE	30mΩ(300mA)	TRIG INT
SPEED	SLOW AVG OFF	I/O NPN
A.HOLD	OFF	I/F PRINT
TC	20.0% 3930ppm	
O.ADJ	OFF	
SCALE	A:1.0000E+0 B:210.00E-6	UNIT:Ω
LINE	AUTO(60Hz)	

The screenshot shows the list of measurement conditions and settings. At the bottom, there are buttons for 'EXIT' and 'PRINT'. The 'PRINT' button is highlighted with a red box, and a 'F4' key icon is shown below it.

Changing the number of columns printed per row

Normally a row consists of one column, but you can also print three columns per row. When printing three columns per row, the temperature and interval time are not printed.

1 Open the Settings Screen.

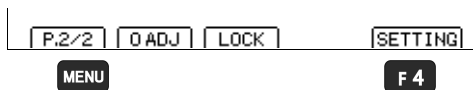

1 **MENU** Switch the function menu to P.2/2.

2 **F 4** The Settings screen appears.

2 Open the Communications Interface Settings Screen.

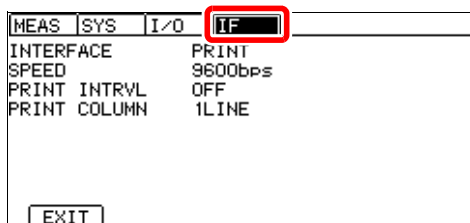

Move the cursor to the [IF] tab with the left and right cursor keys.

3 Select the number of print columns.

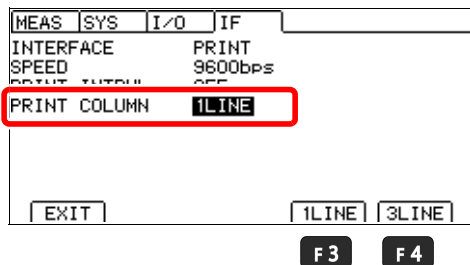

1  Selection

2 **F 3** 1 column (default)

F 4 3 columns

4 Return to the Measurement screen.

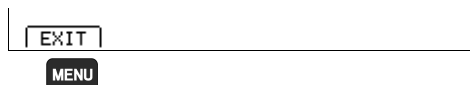

MENU Return to the Measurement screen.

Interval printing

You can automatically print measured values at a fixed time interval.

1 Open the Settings Screen.

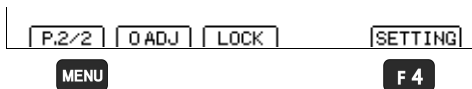

1 **MENU** Switch the function menu to P.2/2.

2 **F4** The Settings screen appears.

2 Open the Communications Interface Settings Screen.

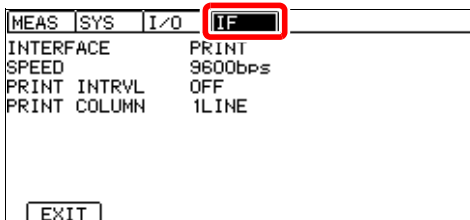

Move the cursor to the [IF] tab with the left and right cursor keys.

3 Turn ON the interval function.

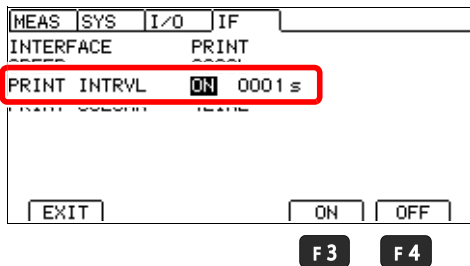

1  Selection

2 **F3** ON

F4 OFF (default)

4 Set the interval.

MEAS	SYS	I/O	IF
INTERFACE		PRINT	
PRINT INTRVL	ON	0001	s
EXIT		EDIT	

F 4

Setting range: 0 to 3600 seconds



Move the cursor to the setting you wish to configure. Make the value editable with the **F 4** key.

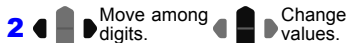

Move the cursor to the digit you wish to set with the left and right cursor keys. Change the value with the up and down cursor keys.



5 Return to the Measurement screen.

EXIT

MENU

MENU Return to the Measurement screen.

Interval printing operation

- Interval printing starts with **F 4** [PRINT] key or EXT I/O PRINT signal input.
- Every time the set interval elapses, the elapsed time (in hours:minutes:seconds format)^{*1} and measured value are printed.
Note that when the **ENTER** or EXT I/O TRIG signal is input, the elapsed time and measured value at that point in time are displayed.
- Interval printing stops when **F 4** [PRINT] key or PRINT signal input is received again.

*1 When the elapsed time reaches 100 hours, it is reset to 00:00:00 and starts counting from 0 again.

Example: 99 hours 59 minutes 50 seconds elapsed: 99:59:50
100 hours 2 minutes 30 seconds elapsed: 00:02:30

NOTE

Since measurement conditions and measured values will be mixed together when measurement conditions are printed during interval printing, avoid printing settings while interval printing is in progress.

Example Printouts

Resistance measured value, relative value, temperature measured value (printing one column per row)

```

2.8725mOhm Lo, ----
0.484mOhm Lo, 25.0 C
10.999 Ohm IN, +OvrRng
9.998 Ohm Hi
+OvrRng Hi
-OvrRng Lo
----- ERR
-10.00 Ohm
9.996 Ohm
0.010kOhm
0.200MOhm
-10.25 %
25.25 %

```

Resistance measured value (printing three columns per row)

```
10.999 Ohm IN , 11.998 Ohm Hi , 11.998 Ohm Hi
```

Interval printing

```

00:00:00 21.597mOhm
00:00:01 21.600mOhm
00:00:02 21.605mOhm
00:00:03 21.608mOhm
00:00:04 21.612mOhm
00:00:05 21.615mOhm

```

List of measurement conditions and settings

```

MODEL RM3544-01
NO. 000000000
RANGE 300Ohm(1mA)
SPEED SLOW
AVG OFF
A.HOLD OFF
TC OFF
0 ADJ OFF
SCALE OFF
LINE AUTO(60Hz)
TRIG INT
I/O PNP
I/F PRINT

```

Specifications Chapter 11

11.1 Instrument Specifications

Measurement Ranges

0.000 m Ω (30 m Ω range) to 3.500 0 M Ω (3 M Ω range) (in 9 ranges)

Measurement Method

Measurement signal Constant current

Measurement method Four-terminal

Measurement terminals Banana terminals

SOURCE A Current detection terminal

SOURCE B Current sourcing terminal

SENSE A Voltage detection terminal

SENSE B Voltage detection terminal

GUARD Guard terminal

Measurement Specifications

(1) Resistance Measurement Accuracy

Conditions of guaranteed accuracy

Temperature and humidity range for guaranteed accuracy 23°C±5°C (73°F±9°F), 80%RH or less

Period of guaranteed accuracy 1 year

Temperature coefficient Add (±1/10th of measurement accuracy per °C) from 0 to 18°C and from 28 to 40°C.

■ **Accuracy** ±(%rdg. + %f.s.) (Calculate as f.s. = 30,000 dgt., so that 0.010% f.s. = 3 dgt.)

Range	Max. measurement range *1*2	FAST	MED/ SLOW	Measurement current *3	Open voltage
30 mΩ	35.000 mΩ	0.030+0.080	0.030+0.070	300 mA	5.5 V _{MAX}
300 mΩ	350.00 mΩ	0.025+0.017	0.025+0.014	300 mA	
3 Ω	3.5000 Ω	0.025+0.017	0.025+0.014	30 mA	
30 Ω	35.000 Ω	0.020+0.010	0.020+0.007	10 mA	
300 Ω	350.00 Ω	0.020+0.010	0.020+0.007	1 mA	
3 kΩ	3.5000 kΩ	0.020+0.010	0.020+0.007	1 mA	
30 kΩ	35.000 kΩ	0.020+0.010	0.020+0.007	100 μA	
300 kΩ	350.00 kΩ	0.040+0.010	0.040+0.007	5 μA	
3 MΩ	3.5000 MΩ	0.200+0.010	0.200+0.007	500 nA	

*1. Negative values: To -10% f.s.

*2. The maximum display range is 99,999dgt.

(If the maximum measurement range is exceeded, the display will indicate over-range even if the value is within the maximum display range.)

*3. The measurement current precision is ±5%.

*During temperature correction, the following value is added to the resistance measurement accuracy rdg. error:

$$\frac{-\alpha_{t_0}\Delta t}{1 + \alpha_{t_0} \times (t + \Delta t - t_0)} \times 100 [\%]$$

t_0 : Standard temperature (°C)

t : Current ambient temperature (°C)

Δt : Temperature measurement accuracy

α_{t_0} : Temperature coefficient (1/°C) at t_0

■ **Measurement time (unit: ms) from TRIG input to EOM output**

Measurement speed	FAST		MEDIUM	SLOW
	50 Hz	60 Hz		
Measurement time	21	18	101	401

TC: ON, comparator: ON, tolerance ±10%±2ms

■ **Integration time (detected voltage data acquisition time) reference values**

FAST (50 Hz): 20.0 ms, FAST (60 Hz): 16.7 ms, MEDIUM: 100 ms, SLOW: 400 ms

(2) Temperature measurement accuracy (Thermistor sensor)

Guaranteed accuracy range -10.0 to 99.9°C

Display range -10.0 to 99.9°C

Measurement period (speed) 2 ± 0.2 s

Period of guaranteed accuracy 1 year

Combined accuracy with Model Z2001 Temperature Sensor

Accuracy	Temperature range
$\pm(0.55 + 0.009 \times t - 10)$ °C	-10.0°C to 9.9°C
± 0.50 °C	10.0°C to 30.0°C
$\pm(0.55 + 0.012 \times t - 30)$ °C	30.1°C to 59.9°C
$\pm(0.92 + 0.021 \times t - 60)$ °C	60.0°C to 99.9°C

t : measurement temperature (°C)

Accuracy of instrument alone: ± 0.2 °C

(3) Calculation order

1. Zero-adjustment 2. Temperature correction 3. Scaling

About Instrument Accuracy

We define measurement tolerances in terms of f.s. (full scale), rdg. (reading) and dgt. (digit) values, with the following meanings.

f.s.	(maximum display value) This is usually the name of the maximum displayable value. For this instrument, it indicates the currently selected range.
rdg.	(reading or displayed value) The value currently being measured and indicated on the measuring instrument.
dgt.	(resolution) The smallest displayable unit on a digital measuring instrument, i.e., the input value that causes the digital display to show a "1" as the least-significant digit.

Example accuracy calculations

(Digits in excess of display range are truncated.)

• Resistance measurement accuracy

Measurement conditions: 300 mΩ range, SLOW, 100 mΩ measurement target

Resistance measurement accuracy: $\pm(0.025\% \text{ rdg.} + 0.014\% \text{ f.s.})$

$$\pm(0.025\% \times 100 \text{ m}\Omega + 0.014\% \times 300 \text{ m}\Omega) = \pm 0.067 \text{ m}\Omega$$

(Truncate digits in excess of display range: 0.06 mΩ)

• Temperature measurement accuracy

Measurement conditions: Thermistor temperature sensor, measurement temperature of 35°C

Temperature measurement accuracy: $\pm(0.50 + 0.0012 \times |t-30|)$

$$\pm(0.55 + 0.012 \times |35-30|) = \pm 0.610^\circ\text{C}$$

(Truncate digits in excess of display range: 0.6°C)

• Temperature correction additional accuracy

Measurement conditions: Temperature coefficient of 3,930 ppm/°C, standard temperature of 20°C, measurement temperature of 35°C

Additional error $\frac{-\alpha_0 \Delta t}{1 + \alpha_0 \times (t + \Delta t - t_0)} \times 100 [\%]$

$$\frac{-0.393\% \times (\pm 0.6)}{1 + 0.393\% \times (35 \pm 0.6 - 20)} = \pm 0.222\% \text{ rdg.}, -0.223\% \text{ rdg.}$$

Functions

(1) Resistance range switching function

Mode	AUTO/ MANUAL (fixed to MANUAL when comparator function is ON)
Default setting	AUTO

(2) Number of measurement digits selection function

Number of measurement digits selection	5digits/ 4digits
Default setting	5digits

(3) Measurement Speed

Setting	FAST/ MED/ SLOW
Default setting	SLOW

(4) Power Line Frequency Setting

Operation	Selects the line voltage frequency
Setting	AUTO (50 or 60 Hz, auto-detect)/ 50 Hz / 60 Hz
Default setting	AUTO (auto-detect upon power on and resetting)

(5) Zero Adjustment

Operation	Cancels the internal offset voltage and the surplus resistance.
Setting	ON/ OFF (clear) : for each range
Range setting function	NORMAL/ TIGHT
Adjustment range	Selectable using the range setting function <ul style="list-style-type: none"> • NORMAL: Within -3% f.s. to 50% f.s. for each range (warning displayed when in excess of 3% f.s. for each range) (f.s. = 30,000 dgt.) • TIGHT: Within -3% f.s. to 3% f.s. for each range (f.s. = 30,000 dgt.)
Default setting	Zero adjustment: OFF, Range setting function: NORMAL

(6) Averaging function

Operation	A moving average is used when using the internal trigger source with continuous measurement on (free-run). A mean average is used when using an external trigger source or with continuous measurement off (non-free-run).				
	<table border="1"> <thead> <tr> <th>Moving average</th> <th>Mean average</th> </tr> </thead> <tbody> <tr> <td>$R_{\text{avg}(n)} = \frac{1}{A} \sum_{k=n}^{n+A-1} R_k$</td> <td>$R_{\text{avg}(n)} = \frac{1}{A} \sum_{k=(n-1)A+1}^{nA} R_k$</td> </tr> </tbody> </table> <p>R_{avg} : Average, A : Number of averaging iterations, n : Number of measurements, R_k : Measured value No. k</p>	Moving average	Mean average	$R_{\text{avg}(n)} = \frac{1}{A} \sum_{k=n}^{n+A-1} R_k$	$R_{\text{avg}(n)} = \frac{1}{A} \sum_{k=(n-1)A+1}^{nA} R_k$
Moving average	Mean average				
$R_{\text{avg}(n)} = \frac{1}{A} \sum_{k=n}^{n+A-1} R_k$	$R_{\text{avg}(n)} = \frac{1}{A} \sum_{k=(n-1)A+1}^{nA} R_k$				
Setting	ON/ OFF				
Number of averaging iterations	2 to 100 times				
Default setting	OFF, Number of averaging iterations: 2 times				

(7) Temperature Correction Function (TC)

Operation	Converts the resistance value for a user-selected temperature coefficient to the resistance value for a user-selected temperature and displays the result.
Formula	$R_{t_0} = \frac{R_t}{1 + \alpha_{t_0}(t - t_0)}$ <p> R_t : Measured resistance value (Ω) R_{t_0} : Corrected resistance value (Ω) t_0 : Standard temperature ($^{\circ}\text{C}$) Setting range: -10.0 to 99.9$^{\circ}\text{C}$ t : Current ambient temperature ($^{\circ}\text{C}$) α_{t_0} : Temperature coefficient (1/$^{\circ}\text{C}$) at t_0 Setting range: -9999 to 9999ppm/$^{\circ}\text{C}$ </p>
Setting	ON/ OFF
Default setting	OFF, t_0 : 20 $^{\circ}\text{C}$, α_{t_0} : 3930ppm/ $^{\circ}\text{C}$

(8) Scaling Function

Operation	Measured values are corrected with the linear function $R_S = A \times R + B$ R_S : Value after scaling A : Gain coefficient Setting range: 0.2000×10^{-3} to 1.9999×10^3 R : Measured value after zero-adjustment and temperature correction B : Offset Setting range: 0 to $\pm 1 \times 10^9$ (maximum resolution: 1 n Ω)						
Setting	ON/ OFF						
Display format	See below.						
Range	Gain coefficient						
	(0.2000 to 1.9999) $\times 10^{-3}$	(0.2000 to 1.9999) $\times 10^{-2}$	(0.2000 to 1.9999) $\times 10^{-1}$	(0.2000 to 1.9999) $\times 1$	(0.2000 to 1.9999) $\times 10$	(0.2000 to 1.9999) $\times 10^2$	(0.2000 to 1.9999) $\times 10^3$
30 m Ω	00.000 μ	000.00 μ	0.0000 m	00.000 m	000.00 m	0.0000	00.000
300 m Ω	000.00 μ	0.0000 m	00.000 m	000.00 m	0.0000	00.000	000.00
3 Ω	0.0000 m	00.000 m	000.00 m	0.0000	00.000	000.00	0.0000 k
30 Ω	00.000 m	000.00 m	0.0000	00.000	000.00	0.0000 k	00.000 k
300 Ω	000.00 m	0.0000	00.000	000.00	0.0000 k	00.000 k	000.00 k
3 k Ω	0.0000	00.000	000.00	0.0000 k	00.000 k	000.00 k	0.0000 M
30 k Ω	00.000	000.00	0.0000 k	00.000 k	000.00 k	0.0000 M	00.000 M
300 k Ω	000.00	0.0000 k	00.000 k	000.00 k	0.0000 M	00.000 M	000.00 M
3 M Ω	0.0000 k	00.000 k	000.00 k	0.0000 M	00.000 M	000.00 M	0.0000 G
Unit	Ω / none/ user-selected 3 characters (Except SI prefix)						
Default setting	OFF, A : 1.0000 $\times 1$, B : 0, Unit: Ω						

(9) Faulty Measurement Detection

■ Over Range Detection Function

Operation	Indicates under- or over-range values in the following conditions: <ul style="list-style-type: none"> Measured value is outside of the measurement range Measured value is outside of the A/D converter input range Calculation result exceeded the number of display digits
------------------	---

■ Current fault detection function

Operation	Detects faults in which the stipulated measurement current cannot be applied. No cancelation function.
Current fault mode setting	Current fault (ERR signal output) / over-range (HI signal output)
Default setting	Current fault (ERR signal output)

(10)Comparator Function

Operation	Compares setting and measured values
Setting	ON/OFF (fixed range when comparator function is ON)
Comparator mode	REF%/ ABS
Default state	OFF, ABS mode
Judgment	Hi Measured value > Upper limit value IN Upper limit value ≥ measured value ≥ Lower limit value Lo Lower limit value > measured value

■ ABS Mode

Upper/Lower limit ranges	0.000 mΩ to 9.9999 MΩ (When the scaling function is on, depends on the scaling display format; maximum resolution of 1 nΩ, maximum value of 1 GΩ.)
Default setting	0.000 mΩ

■ REF% Mode

Display	Relative value display $\text{Relative value} = \left(\frac{\text{Measured value}}{\text{Reference value}} - 1 \right) \times 100 [\%]$
Absolute value display range	-999.99% to +999.99%
Reference value range	0.001 mΩ to 9.9999 MΩ (When the scaling function is on, depends on the scaling display format; maximum resolution of 1 nΩ, maximum value of 1 GΩ.)
Upper/ Lower limit ranges	0.00% to ±99.99%
Default setting	Reference value: 0.001 mΩ, Upper/ Lower limit ranges: 0.00%

(11)Judge delay function

Operation	After recovering from current fault (after making contact with the measurement leads), no judgments for measurement values are performed the same times as the number of unjudged measurements, and a judgment begins from next measurement.
Setting	ON/ OFF (Available only when the auto-hold is set to OFF, the internal trigger source is selected and the continuous measurement is set to ON [Free-Run].)
The number of unjudged measurements	1 to 100times

(12)Comparator Beeper Setting

Operation	Sounds a beeper based on the comparator judgment result.
Operation settings and tones	Hi : type 1/ type 2/ type 3/ OFF IN : type 1/ type 2/ type 3/ OFF Lo : type 1/ type 2/ type 3/ OFF
Number of beeps	Hi : 1 to 5 times / continuous IN : 1 to 5 times / continuous Lo : 1 to 5 times / continuous
Default setting	Hi: OFF, 2times, IN: OFF, 2times, Lo: OFF, 2times

(13)Auto Hold Function

Operation	Holds measured values automatically (only when the internal trigger source is selected and the continuous measurement is set to ON [Free-Run]). The hold is canceled when the measurement leads are removed from the target and the next measurement performed, when the range is changed, or when the ESC key is pressed.
Operation setting	ON/ OFF
Default setting	OFF

(14)Panel Save, Panel Load

Operation	Saves and loads measurement conditions using user-specified panel numbers.
Number of panels	10
Panel names	10 characters (letters or numbers)
Saved data	Resistance measurement range, measurement speed, zero-adjustment, average, comparator, judgment sound, scaling, temperature correction, Auto Hold
Loading of zero-adjustment values	ON/ OFF
Default setting	ON

(15)Reset Functions

■ Reset

Operation	Resets settings (except panel data) to factory defaults
------------------	---

■ System reset

Operation	Reverts all settings, including panel data, to their default values.
------------------	--

(16)Self-Test

At power-on	ROM/RAM check, measurement circuit's protective fuse check
--------------------	--

Interface

(1) Display

LCD type	Monochrome graphical LCD 240 × 110
Backlight	White LED Brightness adjustment range: 0 to 100% (5% increments), Default setting: 80% When using EXT trigger source, brightness is automatically reduced when keys are not used. Brightness recovers upon front panel key operation.
Contrast	Adjustment range: 0 to 100% (5% increments), Default setting: 50%

(2) Keys

COMP, PANEL, ▼, ▲, ►, ◀, MENU, F1, F2, F3, F4, ESC, ENTER, AUTO, ▼, ▲ (RANGE), ⏻, SPEED

■ Key-Lock Functions

Operation	Disables operation of unneeded keys. Can also be canceled using a communication command.
Setting	OFF/menu lock/all-key lock Menu lock : Disables all keys other than direct keys (below) and the cancel key. COMP, PANEL, AUTO, ▼, ▲ (RANGE), SPEED, 0ADJ, PRINT All-key lock: Disables all except the cancel key. All front panel keys are disabled when the KEY_LOCK signal is received.
Default setting	OFF

■ Key-Press Beeper Setting

Setting	ON/ OFF
Default setting	ON

(3) Communications interfaces

Interface types	RS-232C/ PRINTER/ USB
Default setting	RS-232C

■ RS-232C and printer communications settings

Communication contents	Remote control, measured value output (export)
Transfer method	Asynchronous, Full duplex
Transmission speed	9,600bps (default setting)/ 19,200bps/ 38,400bps/ 115,200bps
Data length	8 bit
Stop bit	1
Parity	none
Delimiter	Transmit CR+LF, Receive CR or CR+LF
Handshaking	No X-flow, no hardware flow
Protocol	Non-procedure
Connector	Male 9-pin D-sub, with #4-40 attachment screws

■ USB

Communication contents	Remote control, measured value output (export)
Connector	Series B receptacle
Electrical specifications	USB2.0 (Full Speed)
Class (mode)	CDC Class (COM mode), HID Class (USB keyboard mode)
Default setting	COM mode

■ Printer

Operation	Prints data when the PRINT signal is input or when the print key is pressed.
Compatible printers	Interface: RS-232C, no. of characters per line: 45 (single-byte) or more Communication speed: 9,600bps/ 19,200bps/ 38,400bps/ 115,200bps Data length: 8bit, Parity: none, Stop bit: 1bit, Flow control: none, Message terminator (delimiter): CR+LF Control codes: Must be able to print plain text directly.
Printing Contents	Resistance measured values, temperature measured values, judgment results, measurement conditions
Interval	ON/ OFF
Interval time	0 to 3,600 s
Number of columns printed per row	1 column/ 3 columns
Default setting	Interval: OFF, interval time: 1 s, number of columns printed per row: 1 column

■ Communications functionality

Remote function	During remote operation by USB or RS-232C, all front panel operations are disabled. Remote operation is canceled as follows: <ul style="list-style-type: none"> • LOCAL key, Reset, At power-on • By USB or RS-232C : SYSTEM:LOCa1 command
Communications monitor function	Displays the send/receive status of commands and queries. ON/ OFF
Data output function	During INT trigger source operation, measured values are output at TRIG signal or ENTER key input. During EXT trigger source operation, measured values are automatically output each time measurement completes. (USB keyboard mode is available during INT trigger source use only.) Setting ON/ OFF Auto-exporting when the auto-hold setting is set to ON ON/ OFF Auto-exporting depending on judgments Hi/ IN/ Lo/ Hi or Lo/ ALL
Default setting	Communications monitor function: OFF, Data output function: OFF, Auto-exporting when the auto-hold setting is set to ON: OFF, Auto-exporting depending on judgments: ALL

■ Maintenance terminal

Function	Unused (maintenance use only)
-----------------	-------------------------------

(4) EXT I/O (RM3544-01 only)

Input Signals	TRIG (IN0), KEY_LOCK, 0ADJ, PRINT (IN1), LOAD0 to LOAD3 Valid only with BCD mode output: BCD_LOW Optocoupler-isolated : no-voltage contact inputs (current sink/source output compatible) Input ON : Residual voltage; 1 V or less (Input ON current: 4 mA (reference value)) Input OFF : OPEN (shutoff current: 100 μ A or less) Response time : ON edge; Max. 0.1 ms, OFF edge; Max. 1.0 ms
Output Signals	Output mode switching: JUDGE mode/ BCD mode 1. JUDGE mode : EOM, ERR, INDEX, HI, IN, LO, OUT0 to OUT2 2. BCD mode : EOM, ERR, IN, HILO When BCD_LOWER is ON : BCD1 \times 4 digits, RNG_OUT0 to RNG_OUT3 When BCD_LOWER is OFF: BCD2 to BCD5 \times 4 digits Optocoupler-isolated, open-drain output Maximum load voltage 30 V _{MAX} DC Residual voltage 1 V or less (load current: 50 mA) / 0.5 V or less (load current: 10 mA) Maximum output current 50 mA _{MAX} /ch Default setting: JUDGE mode

■ Trigger Source Setting

Setting	INT (Internal)/ EXT (External)
Default setting	INT (Internal)

■ TRIG/ PRINT filter function

Setting	ON/ OFF
Response time	50 to 500 ms
Default setting	OFF, 50 ms

■ Start Logic Setting

Setting	OFF edge/ ON edge
Default setting	ON edge

■ EOM output timing setting

Setting	HOLD/ PULSE
Pulse width	1 ms to 100 ms
Default setting	HOLD, 5 ms

■ EXT I/O test function

Operation	Displays the EXT I/O input signal state and generates output signals as desired.
-----------	--

■ External power output

Output voltage	Sink output: 5 V \pm 10%, source output: -5 V \pm 10%, 100 mA max.
Isolation	Floating from protective ground potential and measurement circuit
Insulation rating	Terminal to ground voltage: Not more than 50 VDC, 30 Vrms AC, and 42.4 Vpk AC

(5) L2105 LED Comparator Attachment output

Output	Comparator judgment output (HiLo or IN)
Output jack	3-pole earphone jack (ϕ 2.5 mm)
Output voltage	5 V \pm 0.2 V DC, 20 mA

Environment and Safety Specifications

Operating environment	Indoors, Pollution degree 2, up to 2000 m (6562-ft.) ASL
Storage temperature and humidity	-10°C to 50°C (14 to 122°F), 80%RH or less (non-condensating)
Operating temperature and humidity	0°C to 40°C (32 to 104°F), 80%RH or less (non-condensating)
Dielectric strength	1.62 kV AC for 1 min, Cutoff current 10 mA, between all power terminals and protective ground, interfaces, and measurement terminals
Applicable Standards	
Safety	EN61010
EMC	EN61326 Class A Effect of radiated radio-frequency electromagnetic field: 3%f.s. at 10V/m Effect of conducted radio-frequency electromagnetic field: 2%f.s. at 3 V (f.s.=30,000dgt.)
Power source	Rated supply voltage: 100 to 240 VAC (Voltage fluctuations of ±10% from the rated supply voltage are taken into account) Rated supply frequency: 50/60 Hz Anticipated transient overvoltage: 2,500 V
Maximum rated power	15 VA
Dimensions	Approx. 215W × 80H × 166D mm (8.46"W × 3.15"H × 6.54"D)
Mass	Approx. 0.9 kg (31.7 oz.) (RM3544) Approx. 1.0 kg (35.3 oz.) (RM3544-01)
Product warranty period	3 years

Accessories

• Power Cord (2-line + ground)	(1)
• Model L2101 Clip Type Lead	(1)
• EXT I/O Male Connector	(1) (RM3544-01 only)
• Instruction Manual (This document)	(1)
• Application disc	(1) (RM3544-01 only)
• USB cable (A - B type)	(1) (RM3544-01 only)
• Spare Fuse (F500mAH/250V)	(1)

Options

• Model L2101 Clip Type Lead	• Model Z2001 Temperature Sensor
• Model L2102 Pin Type Lead	• Model 9637 RS-232C Cable (9pin-9pin/ 1.8 m/ crossover cable)
• Model L2103 Pin Type Lead	• Model 9638 RS-232C Cable (9pin-25pin/ 1.8 m/ crossover cable)
• Model L2104 4-Terminal Lead	
• Model L2105 LED Comparator Attachment	

Maintenance and Service

Chapter 12

Calibrations

IMPORTANT

Periodic calibration is necessary in order to ensure that the instrument provides correct measurement results of the specified accuracy.

The calibration frequency varies depending on the status of the instrument or installation environment. We recommend that the calibration frequency is determined in accordance with the status of the instrument or installation environment and that you request that calibration be performed periodically.

NOTE

If damage is suspected, check the "Q&A (Frequently Asked Questions)" (p.160) section before contact your authorized Hioki distributor or reseller.

Transporting

- Use the original packing materials when transporting the instrument, if possible.
- Pack the instrument so that it will not sustain damage during shipping, and include a description of existing damage. We do not take any responsibility for damage incurred during shipping.

Cleaning

To clean the instrument and optional equipment, wipe it gently with a soft cloth moistened with water or mild detergent.

Wipe the LCD gently with a soft, dry cloth.

IMPORTANT

Never use solvents such as benzene, alcohol, acetone, ether, ketones, thinners or gasoline, as they can deform and discolor the case.

Disposal

Handle and dispose of the instrument and optional equipment in accordance with local regulations.

12.1 Troubleshooting

Q&A (Frequently Asked Questions)

The following tables provide information about general issues. For more information about issues related to measured values, or the instrument's external interfaces, see the following pages.

If you are unable to find information about a particular issue, please contact your distributor.

1. General issues

No	Issue	Items to check	Possible causes → Solutions	See	
1-1	The instrument cannot be turned on. (The display shows nothing.)	Color of the STANDBY key	Green	The display settings have not been configured correctly. →Adjust the backlight brightness and contrast.	p.84 p.83
			Red	The instrument is in the standby state. →Press the STANDBY key.	p.28
			None (Off)	The instrument is not receiving power. →Check the continuity of the power cord. →Verify that a circuit breaker has not been tripped. →Turn on the main power switch (on the back of the instrument).	p.28
				The supply voltage or frequency is incorrect. →Check the power supply ratings (100 to 240 V, 50/60 Hz).	
1-2	The keys are unresponsive.	Display	LOCK is shown.	The key lock function is active. →Cancel the key lock function. →Turn OFF the EXT I/O KEY_LOCK signal.	p.79
			RMT is shown.	The instrument is in the remote state. →Cancel the remote state.	p.130
			Panel name is shown.	A panel load operation has been triggered by the EXT I/O. →Turn off the EXT I/O's LOAD signal.	(p.93)
			Neither LOCK nor RMT and panel name is shown.	Certain functions cannot be used simultaneously. →See the list of functional limitations.	p.61

No	Issue	Items to check		Possible causes → Solutions	See
1-3	The instrument's comparator lamp will not turn on.	Measured values	Displayed	The comparator function is OFF. →Turn ON the function.	p.61
			Not displayed (Display other than value)	If the measured value is not being displayed, no judgment will be made, and the lamp will not turn on.	—
1-4	The LED Comparator Attachment will not turn on.	Instrument's comparator lamp	On	The attachment is not properly connected. →Connect the LED Comparator Attachment properly to the COMP.OUT jack.	p.70
				There is a broken connection. →Replace the LED Comparator Attachment.	—
			Off	See No. 1-3 above, "The instrument's comparator lamp will not turn on."	p.161
1-5	The beeper is not audible.	Key operation sound setting	OFF	The function is OFF. →Turn ON the function.	p.82
		Judgment sound setting	OFF	The function is OFF. →Turn ON the function.	p.68
1-6	You wish to change the beeper volume.	The instrument's beeper volume cannot be changed.		—	—

2. Measurement issues

No	Issue	Items to check	Possible causes → Solutions	See	
2-1	Measured values are unstable.	Effects of noise	Susceptibility to noise	See Appendix 7(1)(2).	p.A13 p.A15
		Measurement leads	Clip-type leads	See Appendix 7(3).	p.A16
			Wiring becomes two-terminal wiring in middle.	See Appendix 7(10).	p.A19
		Measurement target	Wide or thick	See Appendix 7(4).	p.A17
			Temperature is unstable (just manufactured, just opened, being held by hand, etc.).	See Appendix 7(5).	p.A17
			Low heat capacity	See Appendix 7(6).	p.A18
			Transformer, motor, choke coil, solenoid	See Appendix 7(1)(7)(8).	p.A13 p.A18 p.A18
		TC	ON	The temperature sensor is not appropriately positioned. →Move the temperature sensor closer to the measurement target. →Position the temperature sensor so that it is not exposed to wind. →If the response to the measurement target's temperature change is slower than the temperature sensor's response, increase the response time by covering the temperature sensor with something. The temperature sensor's response time is about 10 minutes (reference value).	p.13
			OFF	The measurement target's resistance value is changing due to the temperature, for example because the room temperature has not stabilized. →Turn ON temperature correction (TC).	p.52

No	Issue	Items to check		Possible causes → Solutions	See
2-2	Measured values differ from expected values. (A negative value is shown.)	Zero-adjustment	ON	Zero-adjustment is not accurate. →Perform zero-adjustment again.	p.44 p.35
			OFF	Values are being affected by wiring resistance or thermoelectric power due to two-terminal measurement. →Perform zero-adjustment.	p.44
		Scaling function	ON	The offset setting is incorrect. →Turn scaling OFF, or reconfigure the setting properly.	p.54 p.35
				The measurement leads are not connected properly. →Check the connections.	p.34 p.35
		Other: See No. 2-1 above.			p.162
2-3	No measured value is displayed. (Concerning the display of measured value faults, see also p.38.)	Measured values	-----	There is a break in the measurement leads. →Replace the measurement leads.	p.26
				The contact resistance is too high (for user-made leads). →Increase the contact pressure. →Clean or replace the probe tips.	–
				The wiring resistance is too high (for user-made leads). →Make the wiring thicker and shorter.	–
			OvrRng	The measurement range is low. →Select a high-resistance range or use auto-ranging.	p.32
			Nothing is shown.	Auto-ranging is not selecting a range. →See No. 2-4 below.	p.163
			No measured value is shown, even if the measurement leads are shorted.	The fuse may have tripped. →Cycle the instrument's power and perform the self-test to check whether the fuse has tripped. The measurement and guard terminals can short each other. →Check whether the measurement leads are damaged.	p.29
2-4	Auto-ranging is not selecting a range.	Measurement target	Transformer, motor	Auto-ranging is not able to select a range for measurement targets that have high inductance. →Use a fixed range.	p.32
		Noise may be affecting measurement.		See Appendix 7(1)(2).	p.A13

12.1 Troubleshooting

No	Issue	Items to check		Possible causes → Solutions	See
2-5	It is impossible to perform zero-adjustment.	Measured values before zero-adjustment exceed -3% to 50% of each range full-scale, or a measurement fault has occurred.		There is a problem with the wiring. →Repeat zero-adjustment with the correct wiring. Since zero-adjustment cannot be performed if the resistance value is too high, for example with a user-made cable, work to minimize the wiring resistance.	p.A8
2-6	The auto-hold function is not working (hold operation is not being canceled).	Measured values	Are unstable.	See No. 2-1 above, "Measured values are unstable."	p.162
			Do not change.	An appropriate range has not been selected. →Select an appropriate range or use auto-ranging.	p.32
2-7	Measured temperature is displayed incorrectly.			The temperature sensor or thermometer is not properly connected. →Connect the temperature sensor by inserting the plug all the way. The settings have been improperly configured. →Check the settings. A temperature sensor other than that specified is used. →Model 9451 Temperature Probe is not supported.	p.27

3. EXT I/O issues

The EXT I/O test (p.118) function can be used to more easily check operation.

No	Issue	Items to check	Possible causes→Solutions	See
3-1	The instrument is not operating at all.	The IN and OUT values displayed on the instrument's EXT I/O test do not agree with the controller.	The wiring is incorrect. →Check EXT I/O (p.89) again. • A connector is disconnected. • A pin number is incorrect. • ISO-COM pin wiring • NPN/PNP setting • Contact (or open collector) control (voltage does not provide control) • Supply of power to the controller (power cannot be supplied to the instrument)	p.89
3-2	The TRIG signal is not working.	The trigger source is set to the internal trigger (INT).	If the internal trigger setting is being used, the TRIG signal will not serve as a trigger. →Select the external trigger setting.	p.109
		The TRIG ON time is less than 0.1 ms.	The TRIG ON time is too short. →Ensure that the ON time is at least 0.1 ms.	
		The TRIG OFF time is shorter than 1 ms.	The TRIG OFF time is too short. →Ensure that the OFF time is at least 1 ms.	
		The TRIG/PRINT signal filter function is ON.	A longer signal control time is required. →Increase the signal ON time. →Turn OFF the filter function.	p.113
		The :INIT:CONT (command) is OFF.	The instrument is not in the trigger wait state. →Send the :INIT or :READ? command.	
3-3	The instrument will not print.	The interface setting is not set to the printer.	The setting must be configured. →Set the interface to the printer.	p.139
		The TRIG/PRINT signal filter function is ON.	A longer signal control time is required. →Turn OFF the function.	p.113
3-4	The instrument will not load panel data.	No panel has been saved using the panel number that you are trying to load.	The instrument cannot load a panel that has not been saved. →Change the LOAD signal or re-save the panel before the LOAD signal is asserted.	

12.1 Troubleshooting

No	Issue	Items to check	Possible causes→Solutions	See
3-5	EOM is not being output.	The measured value is not being updated.	See No. 3-2 above.	p.165
		EOM signal logic	(The EOM signal turns ON when measurement completes.)	—
		EOM signal setting	Pulse	The pulse width is too narrow, and the EOM signal is not being read while it is on. →Increase the EOM signal's pulse width setting or set the EOM signal setting to "hold."
		Hold	The measurement time is too short, and the interval during which the EOM signal is OFF cannot be detected. →Change the EOM signal setting to "pulse."	p.115
3-6	The Hi, IN and Lo signals are not being output.	The instrument's comparator lamp is off.	See No. 1-3 above.	p.161
		The output mode is set to BCD.	Change to judgment mode (in BCD mode, the result of a logical OR operation applied to Hi and Lo is output from one signal line).	p.117
3-7	The BCD signal is not being output.	The output mode is judgment mode.	Change to BCD mode.	p.117
		The BCD_LOW signal is not being controlled.	Control the BCD_LOW signal (failure to do so will cause only the upper digits to be output).	p.93
3-8	The RANGE_OUT signal is not being output.	The BCD_LOW signal is not being controlled.	Control the BCD_LOW signal (failure to do so will cause the range signal not to be output).	p.93

4. Communications issues

The communications monitor (p.131) function can be used to more easily check operation.

No	Issue	Items to check	Possible causes→Solutions	See	
4-1	The instrument is not responding at all.	Display	RMT is not being displayed.	No connection has been established. →Check whether the connector has been connected. →Check whether the interface settings have been configured properly. →(USB) Install the driver on the control device. →(RS-232C) Use a cross cable. →(USB, RS-232C) Check the COM port number on the control device. →(RS-232C) Use the same communications speed for the instrument and the control device.	p.123
			RMT is being displayed.	Commands are not being accepted. →Check the software delimiter.	

No	Issue	Items to check		Possible causes→Solutions	See
4-2	An error is being encountered.	Display	Command error	The command isn't being recognized as a valid instruction. →Check the spelling of the command (space: x20H). →Do not append a question mark to commands that are not queries. →(RS-232C) Use the same communications speed for the instrument and the control device.	
				The input buffer (256 bytes) is full. →Insert a dummy query after sending several lines of commands. Example: Send *OPC? → Receive 1	
			Execution error	The command string is correct, but the instrument is not able to execute it. Examples: The data portion was spelled incorrectly. :SAMP:RATE SLOW3 →Check the specifications of the command(s) in question.	
				The input buffer (256 bytes) is full. →Insert a dummy query after sending several lines of commands. Example: Send *OPC? → Receive 1	
4-3	The instrument fails to respond to queries.	Communications monitor	No response	The :TRIG:SOUR EXT setting is being used, and the instrument is waiting for the trigger after :READ? transmission. →Check the command specifications.	
			Response	There is a mistake in the program. →Check the receive portion of the program.	

5. Printer issues

No	Issue	Items to check	Possible causes→Solutions	See
5-1	No data is being printed.		The printer is not connected. →Check whether the connector has been connected. →Check whether the interface setting is correct.	p.137
			If using the PRINT signal, see No. 3-3 above.	p.165
5-2	Printed text is garbled		The printer and instrument settings do not match. →Check the printer settings again.	

External Control (EXT I/O) Q&A

Common Questions	Answers
How do I connect external trigger input?	Connect the TRIG signal to an ISO_COM pin using a switch or open-collector output.
Which pins are common ground for input and output signals?	The ISO_COM pins.
Are the common (signal ground) pins shared by both inputs and outputs?	Use ISO_COM as the common pin for input and output signals. The ISO_COM pin serves as the shared common pin.
How do I confirm output signals?	Confirm voltage waveforms with an oscilloscope. To do this, the output pins such as EOM and comparator judgment outputs need to be pulled up (through several k Ω).
How do I troubleshoot input (control) signal issues?	For example, if TRIG signal does not operate properly, bypass the PLC and short the TRIG pin directly to an ISO_COM pin. Be careful to avoid power shorts.
Are the comparator judgment signals retained during measurement (or can they be off)?	When using the external trigger [EXT] setting, the state is determined at the end of measurement, and is off once at the start of measurement. When using the internal trigger [INT] setting, judgment results are held during measurement.
What situations cause measurement faults to occur?	An error is displayed in the following cases: <ul style="list-style-type: none"> • A probe is not connected • A contact is unstable • A probe or measurement target is dirty or corroded • Measurement target resistance is much higher than the measurement range
Is a connector or flat cable for connection provided?	A solder-type connector is supplied. The cable must be prepared at the user's side.
Is direct connection to a PLC possible?	If the PLC's outputs are relays or open collectors and the PLC's input circuit supports contact input, it can be connected directly. (Before connecting, confirm that voltage and current ratings will not be exceeded.)
Can external I/O be used at the same time as RS-232C or other communications?	After setting up communications, it is possible to control measurement with the TRIG signal while acquiring measurement data via a communications interface.
How should external power be connected?	The instrument's external I/O input and output signals all operate from an internal isolated power source, so power must not be supplied from the PLC side.
Can free-running measured values be acquired using a footswitch?	Measured values can be acquired using the sample application. The sample application can be downloaded from the Hioki website (http://www.hioki.com).

Error Displays and Remedies

The following messages are displayed when the instrument detects an error or abnormal measurement setting. If repair is necessary, contact your authorized Hioki distributor or reseller.

- If damage is suspected, check the "Q&A (Frequently Asked Questions)" (p.160) section before contact your authorized Hioki distributor or reseller.
- If an error is shown on the LCD and the instrument needs to be repaired, please contact your authorized Hioki distributor or reseller.

Display		Description	Remedy
+OvrRng/-OvrRng		Over-range (p. 38)	Select the appropriate range.
ERR:001	LOW limit is higher than UPP limit.	Cannot set because the lower limit value is larger than the upper limit value.	Set an upper limit value that is larger than the lower limit value. (p.62)
ERR:002	REF setting is zero.	Cannot set because the reference value setting is zero.	Set a reference value that is larger than zero. (p.64)
ERR:003	Cannot enable while comparator is ON.	Cannot switch ranges when the comparator is ON.	Set the range after turning the comparator OFF or select the range to use on the Comparator Settings screen. (p.60)
ERR:004	Cannot enable while comparator is ON.	Cannot turn auto-ranging ON while the comparator is ON.	Use with the comparator set to OFF.(p.61)
ERR:010	0 ADJ error. Must not exceed 50% f.s.	Out of zero-adjust range. The reading must be within 50% of range full-scale.	Check the zero-adjustment procedure (p. 44).
ERR:011	Temp. sensor error. Cannot calculate.	Cannot perform calculations due to a temperature sensor error.	Check the temperature sensor.
ERR:030	Command error.	Command Error.	Check for incorrect commands (Included application disk).
ERR:031	Execution error. (Parameter error)	Execution Error. The parameter value is out of range.	Check whether the parameter range is correct.
ERR:032	Execution error.	Execution Error.	Check whether any command has resulted in execution error conditions.
ERR:090	ROM check sum error.	Program ROM checksum error	The instrument is malfunctioning. Request repairs.
ERR:091	RAM error.	CPU RAM error	The instrument is malfunctioning. Request repairs.
ERR:092	Memory access failed. Main power off, restart after 10s.	A communications error occurred while attempting to access the memory.	Turn off the main power switch, wait at least 10 seconds, and turn it back on.
ERR:093	Memory read/write error.	Memory read/write test error	The instrument is malfunctioning. Request repairs.
ERR:095	Adjustment data error.	Adjustment data error	The instrument is malfunctioning. Request repairs.

Display		Description	Remedy
ERR:096	Backup data error.	Settings backup error	Settings were reinitialized. Reconfigure measurement conditions and other settings.
ERR:097	Power line detection error. Select power line cycle.	Power frequency detection error	Set the frequency to match that of the power being supplied to the instrument.
ERR:098	Blown FUSE. Or measurement lead is broken.	The fuse has been tripped.	Replace the fuse. If the fuse has not been tripped, there may be a short between the measurement terminal and the guard terminal. Check whether the measurement lead is damaged.
INFO:001	Panel load. OK?	Panel data will be loaded. Continue?	–
INFO:002	Panel loading...	Panel data is being loaded.	–
INFO:003	Enter panel name. ESC: CANCEL, ENTER: SAVE EXEC	Enter a name for the panel being saved. Cancel the save operation with the ESC key or save the panel with the ENTER key.	–
INFO:004	Enter panel name. Panel is used, will be overwritten. ESC: CANCEL, ENTER: SAVE EXEC	Enter a name for the panel being saved. The specified name already exists and will be overwritten if you proceed. Cancel the save operation with the ESC key or save the panel with the ENTER key.	–
INFO:005	Panel saving...	Panel data is being saved.	–
INFO:006	Clear panel. OK?	Panel data will be cleared. Continue?	–
INFO:007	Panel clearing...	Panel data is being cleared.	–
INFO:008	Printing...	Printing in progress.	–
INFO:010	Start interval print.	Interval printing started.	–
INFO:011	Stop interval print.	Interval printing stopped.	–
INFO:020	Performing 0 adjustment. OK?	Zero-adjustment will be performed. Continue?	–
INFO:021	Clear 0 adjustment data. OK?	Zero-adjustment values will be cleared. Continue?	–
INFO:022	Cleared 0 adjustment data.	Zero-adjustment data was cleared.	–
INFO:023	0 ADJ warning. Adjust within 3% f.s.	Zero-adjustment data values are large. (Warning)	It is recommended that values be within 3% of range full-scale.
INFO:030	Reset? NORMAL RESET (or SYSTEM RESET)	The instrument will be initialized.	–
INFO:040	Enter password for Adjustment Mode.	Enter the password for adjustment mode.	The Adjustment screen is used in repairs and adjustment carried out by HIOKI. It is not available for use by end-users.

12.2 Replacing the Measurement Circuit's Protective Fuse



WARNING

- Replace the fuse only with one of the specified type, characteristics, rated current, and rated voltage. Do not use fuses other than those specified (especially, do not use a fuse with higher-rated current) or do not short circuit and use the fuse holder. Doing so may damage the instrument and result in personal injury.
Fuse type: F500mA/250V (non-arcing) 20 mm × 5 mm dia.
- To avoid electric shock, turn off the main power switch and disconnect the cords and leads before replacing the fuse.

NOTE

Inserting the fuse holder without first placing a replacement fuse into it may make it difficult to remove the fuse holder. Be sure to load a replacement fuse before inserting the holder.

Rear panel

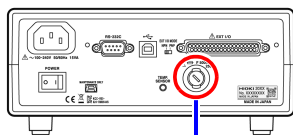

Fuse holder

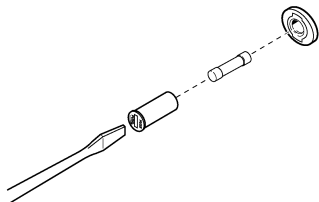

- 1** Confirm that the instrument's Main power switch (rear panel) is OFF(○), and disconnect the power cord.
- 2** Unlock the fastener on the fuse holder on the rear panel using a slotted screwdriver, and remove the fuse holder.
- 3** Replace the fuse with a rated fuse. (The replacement method may differ depending on the shape of the fuse holder.)
- 4** Reset the fuse holder.

12.3 Inspection and Repair

 **WARNING** Do not attempt to modify, disassemble or repair the instrument; as fire, electric shock and injury could result.

Replaceable Parts and Operating Lifetimes

Useful life depends on the operating environment and frequency of use. Operation cannot be guaranteed beyond the following periods. For replacement parts, contact your authorized Hioki distributor or reseller.

Part	Life
Electrolytic Capacitors	Approx. 10 years
Relays	Approx. 50 million operations
Backlight of LCD (Half-life of Brightness)	Approx. 50,000 hours

Appendix

Appendix 1 Block Diagram

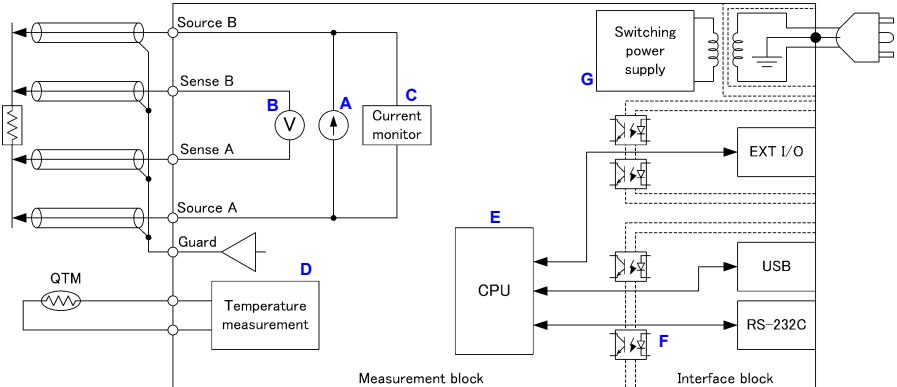

- Constant current (determined by the measurement range) is applied between the SOURCE B and SOURCE A terminals while voltage is measured between the SENSE B and SENSE A terminals. The resistance value is obtained by dividing the measured voltage (B) by the constant current flow (A).
- The low-noise voltmeter can perform stable measurement, even with an integration time of 17 ms (B).
- When measurement starts, the constant current monitor (C) are activated to monitor for fault conditions while measuring.
- The instrument incorporates a built-in temperature measurement circuit that can be used to correct resistance measured values according to the temperature when measuring a target that exhibits a high level of temperature dependence (D).
- The high-speed CPU (E) provides ultra-high-speed measurements and fast system response.
- Immunity from electrical noise is provided by isolation between the Measurement and Interface blocks.
- EXT I/O is isolated from the USB and RS-232C interfaces. The USB and RS-232C interfaces use the same potential as the protective ground. (F).
- The auto-ranging 100-to-240 V switching power supply (G) can provide stable measurements even in poor power quality environments.

Appendix 2 Four-Terminal (Voltage-Drop) Method

The resistance of the wiring connecting the measuring instrument and probes and the contact resistance that occurs between probes and the measurement target may prevent low resistance values from being measured at a high level of precision.

Wiring resistance varies greatly depending on the thickness and length of the wire. Cables used in resistance measurement may, for example, exhibit resistance of 90 m Ω /m (for No. 24 AWG [0.2 sq] wiring) or 24 m Ω /m (for No. 18 AWG [0.75 sq] wiring).

Contact resistance varies with probe wear, contact pressure, and measurement current. With good contact, resistance values are generally on the order of several milliohms but may reach as high as several ohms on occasion.

The four-terminal method is used to facilitate reliable measurement of low resistance values.

With two-terminal measurements (Fig. 1), the resistance of the test leads is included in the measurement target's resistance, resulting in measurement errors.

The four-terminal method (Fig. 2) consists of current source terminals (SOURCE A, SOURCE B) to provide constant current, and voltage detection terminals (SENSE A, SENSE B) to detect voltage drop.

Little current flows to the voltage detection terminal lead lines that are connected to the measurement target due to the voltmeter's high input impedance. Consequently, measurement can be performed accurately without being affected by the measurement lead resistance or contact resistance.

*RM3544 voltmeter's input impedance: Approx. 1 G Ω (reference value)

Two-Terminal Measurement Method

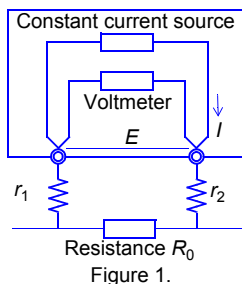

Measurement current I flows through measurement target resistance R_0 as well as lead resistances r_1 and r_2 .

The voltage to be measured is obtained by $E = I(r_1 + R_0 + r_2)$, which includes lead resistances r_1 and r_2 .

Four-Terminal Measurement Method

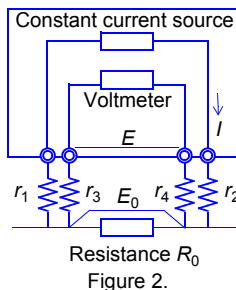

Current I flows from r_2 through measurement target resistance R_0 and through r_1 . The high input impedance of the voltmeter allows only negligible current flow through r_3 and r_4 .

So the voltage drop across r_3 and r_4 is practically nil, and voltage E across the measurement terminals and voltage E_0 across measurement target resistance R_0 are essentially equal, allowing measurement target resistance to be measured without being affected by r_1 to r_4 .

Appendix 3 DC and AC Measurement

Resistance (impedance) measurement can be performed using the DC or AC method.

- DC method
 - RM3542, RM3543, RM3544, RM3545, RM3548 resistance meters
 - Standard digital multimeters
 - Standard insulation resistance meters
- AC method
 - 3561, BT3562, BT3563, 3554 Battery HiTesters
 - Standard LCR meters

The DC measurement method is used widely in applications such as measurement of general-purpose resistors, winding resistance, contact resistance, and insulation resistance. In the DC method, the measurement setup consists of a DC power supply and a DC voltmeter. While its simple circuitry makes it easier to increase accuracy, it is prone to measurement errors due to electromotive force that may be present in the measurement path.

See: "Appendix 5 Effect of Thermal EMF" (p.A6)

The AC method is used when it is not possible to measure using DC, for example in impedance measurement of inductors, capacitors, or batteries. Since an AC ohmmeter consists of an AC power supply and an AC voltmeter, it is not affected by DC electromotive force. On the other hand, caution is necessary since results differ from those obtained using DC measurement, for example due to components such as core loss in coils' series equivalent resistance.

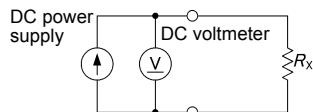
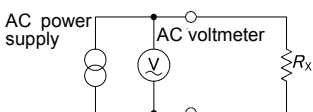
	DC ohmmeter	AC ohmmeter
Measurement signal Detection voltage	DC 	AC 
Advantages	High-precision measurement is possible.	Not affected by electromotive force. Reactance measurement is possible.
Disadvantages	Affected by electromotive force since not capable of performing DC superimposed measurement. (Thermal EMFs can be corrected by the OVC function.)	Difficult to increase precision.
Applications	DC resistance of windings such as transformers and motors, contact resistance, insulation resistance, PCB wiring resistance	Battery impedance, inductors, capacitors, electrochemical measurement
Measurement range	10^{-8} to 10^{16}	10^{-3} to 10^8
HIOKI instruments	Ohmmeters : RM3542 to RM3548 DMMs : 3237 to 3238 Insulation resistance meters : IR4000 series, DSM series	Battery HiTesters : 3561, BT3562, BT3563 LCR meters : 3570, IM3533, IM3523, etc.

Appendix 4 Temperature Correction (TC) Function

The temperature correction function converts the resistance values of temperature-dependent measurement targets such as copper wire into resistance values at a specific temperature (known as the standard temperature) and displays the results.

Resistances R_t and R_{t_0} below are the resistance values of the measurement target (having resistance temperature coefficient at $t_0^\circ\text{C}$ of α_{t_0}) at $t^\circ\text{C}$ and $t_0^\circ\text{C}$.

$$R_t = R_{t_0} \times \{ 1 + \alpha_{t_0} \times (t - t_0) \}$$

R_t	Actual measured resistance [Ω]
R_{t_0}	Corrected resistance [Ω]
t_0	Reference temperature [$^\circ\text{C}$]
t	Ambient temperature [$^\circ\text{C}$]
α_{t_0}	Temperature coefficient at t_0 [$1/^\circ\text{C}$]

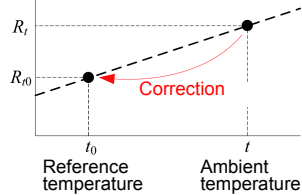

Example

If a copper measurement target (with resistance temperature coefficient of $3930 \text{ ppm}/^\circ\text{C}$ at 20°C) measures $100 \text{ } \Omega$ at 30°C , its resistance at 20°C is calculated as follows:

$$\begin{aligned}
 R_{t_0} &= \frac{R_t}{1 + \alpha_{t_0} \times (t - t_0)} \\
 &= \frac{100}{1 + (3930 \times 10^{-6}) \times (30 - 20)} \\
 &= 96.22 \text{ } \Omega
 \end{aligned}$$

Refer to the following for temperature correction settings and execution method:

See: "4.3 Correcting for the Effects of Temperature (Temperature Correction (TC))" (p.52)

NOTE

- The temperature sensor detects only ambient temperature; not surface temperature.
- Place the temperature sensor near the measurement target and allow both the sensor and the target to adequately adjust to the ambient temperature prior to use.

Reference

Conductive Properties of Metals and Alloys

Material	Content [%]	Density ($\times 10^3$) [kg/m ³]	Conductivity	Temp. Coeff. (20°C) [ppm/°C]
Annealed copper wire	Cu>99.9	8.89	1.00 to 1.02	3810 to 3970
Hard-drawn copper wire	Cu>99.9	8.89	0.96 to 0.98	3770 to 3850
Cadmium copper wire	Cd 0.7 to 1.2	8.94	0.85 to 0.88	3340 to 3460
Silver copper	Ag 0.03 to 0.1	8.89	0.96 to 0.98	3930
Chrome copper	Cr 0.4 to 0.8	8.89	0.40 to 0.50 0.80 to 0.85	2000 3000
Carlson alloy wire	Ni 2.5 to 4.0 Si 0.5 to 1.0		0.25 to 0.45	980 to 1770
Annealed aluminum wire	Al>99.5	2.7	0.63 to 0.64	4200
Hard-drawn aluminum wire	Al>99.5	2.7	0.60 to 0.62	4000
Aldrey wire	Si 0.4 to 0.6 Mg 0.4 to 0.5 Al remaining portion		0.50 to 0.55	3600

Copper Wire Conductivity

Diameter [mm]	Annealed copper wire	Tinned annealed copper wire	Hard-drawn copper wire
0.01 to less than 0.26	0.98	0.93	–
0.26 to less than 0.29	0.98	0.94	–
0.29 to less than 0.50	0.993	0.94	–
0.50 to less than 2.00	1.00	0.96	0.96
2.00 to less than 8.00	1.00	0.97	0.97

The temperature coefficient changes according to temperature and conductivity. If the temperature coefficient at 20°C is α_{20} and the temperature coefficient for conductivity C at t °C is α_{Ct} , α_{Ct} is determined as follows near ambient temperature.

$$\alpha_{Ct} = \frac{1}{\frac{1}{\alpha_{20} \times C} + (t - 20)}$$

For example, the temperature coefficient of international standard annealed copper is 3930 ppm/°C at 20°C. For tinned annealed copper wire (with diameter from 0.10 to less than 0.26 mm), the temperature coefficient α_{20} at 20°C is calculated as follows:

$$\alpha_{20} = \frac{1}{\frac{1}{0.00393 \times 0.93} + (20 - 20)} \approx 3650 \text{ ppm/°C}$$

Reference documentation: Handbook for Electronics, Information and Communication Engineers, Volume 1, published by the Institute of Electronics, Information and Communication Engineers

Appendix 5 Effect of Thermal EMF

Thermoelectromotive force (thermal EMF) is the potential difference that occurs at the junction of two dissimilar metals, including between the probe tips and the lead wire of the measurement target. If the difference is sufficiently large, it can cause erroneous measurements. (Fig. 1). The amplitude of thermal EMF depends on the temperature of the measurement environment, with the force generally being greater at higher temperature.

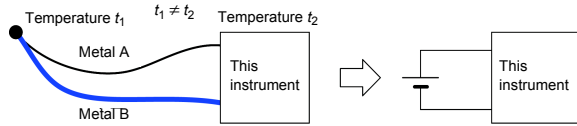

Figure 1. Thermal EMF generation

Increasing thermal EMF examples

- The measurement target is a fuse, thermal fuse, thermistor, bimetal, or thermostat.
- The voltage detection lines incorporate a single stable relay as a contact.
- An alligator clip is used as a voltage detection terminal.
- A voltage detection terminal is held by hand.
- There is a large temperature difference between the measurement target and the instrument.
- Wire materials differ between the SENSE A and SENSE B.

In a resistance measurement, measurement current I_M is applied to measurement target R_X to detect voltage drop $R_X I_M$ across the target. In a low resistance measurement, the voltage $R_X I_M$ to be detected is naturally lower due to the low R_X . When the detected voltage is low, the measurement will be affected by thermal EMF that is generated between the measurement target and probes, and between the cables and the instrument, as well as the voltmeter offset voltage V_{EMF} (Fig. 2). If a measurement target is held by hand, the target will be warmed. A probe will also be warmed by holding it by hand. For these reasons, even if every care is taken, it will be difficult to control thermal EMF so that it does not exceed $1 \mu\text{V}$.

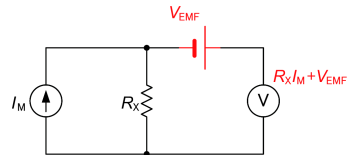

Figure 2. Thermal EMF generation

If a measurement target is held by hand, the target will be warmed. A probe will also be warmed by holding it by hand. For these reasons, even if every care is taken, it will be difficult to control thermal EMF so that it does not exceed $1 \mu\text{V}$.

As an example, if a measurement target with an actual resistance of $1\text{m}\Omega$ is measured with a measurement current of 100mA in an environment with an thermal EMF of $10\mu\text{V}$, the instrument will indicate the following measured value. This is a significant error of 10% higher than the actual resistance.

$$\frac{1\text{m}\Omega \times 100\text{mA} + 10\mu\text{V}}{100\text{mA}} = 1.1\text{m}\Omega$$

The voltmeter offset voltage will also be very large, ranging between $1\mu\text{V}$ and 10mV . This will cause a large low resistance measurement error.

To reduce the effects of thermal EMF, the following actions are possible:

1. Increasing the detection voltage by increasing the measurement current
2. Using zero-adjustment to cancel thermal EMF
3. Changing the detection signal to AC

- Increasing the detection voltage by increasing the measurement current
In the above thermal EMF example, assume that the measurement current is increased from 100 mA to 1 A. The error will be reduced to 1%.

$$\frac{1 \text{ m}\Omega \times 1 \text{ A} + 10 \text{ }\mu\text{V}}{1 \text{ A}} = 1.01 \text{ m}\Omega$$

However, it is important to note that $R I^2$ power is applied.

- Using zero adjustment to cancel thermal EMF

If current is blocked from being applied to measurement target R_x , the voltmeter will only be supplied with thermal EMF V_{EMF} . However, if the SOURCE terminals are made open-circuit, a current fault will be detected and a measured value will not be displayed. Thus, thermal EMF can be canceled by shorting the SOURCE lines to block current flow to R_x and performing zero adjustment. (Fig. 3).

See: "3.4 Checking Measured Values" (p.35)

See: "Appendix 6 Zero Adjustment" (p.A8)

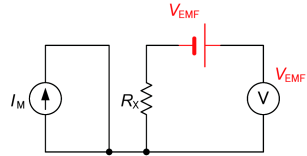

Figure 3. Using zero adjustment to block current flow to R_x

- Changing the detection signal to AC

Changing the detection signal to AC is a fundamental solution. Both the thermal EMF and voltmeter offset voltage can be treated as stable DC voltages as they are viewed for a short period of time in seconds. This allows frequency domain separation by changing the detection signal to AC. Resistance meters with offset voltage compensation (OVC) functionality, including the RM3542, RM3543, RM3545, and RM3548, can eliminate thermal EMF by treating the current as a pulse waveform.

Appendix 6 Zero Adjustment

Zero adjustment is a function which adjusts the zero point by deducting the residual value obtained during $0\ \Omega$ measurement. For this reason, zero adjustment must be performed when connection is made to $0\ \Omega$. However, connecting a sample with no resistance is difficult and therefore is not practical.

In this respect, when performing the actual zero adjustment, create a pseudo connection to $0\ \Omega$ and then adjust the zero point.

To create $0\ \Omega$ connection state

If an ideal $0\ \Omega$ connection is made, the voltage between SENSE A and SENSE B becomes $0\ \text{V}$ according to the Ohm's Law of $E = I \times R$. In other words, if you set the voltage between SENSE A and SENSE B to $0\ \text{V}$, this gives you the same state of $0\ \Omega$ connection.

To perform zero adjustment using the instrument

The instrument uses a measurement fault detection function to monitor the state of connection between measurement terminals. For this reason, when performing zero adjustment, you need to make connections between the terminals appropriately in advance (Fig. 1).

First, short between SENSE A and SENSE B to set the voltage between SENSE A and SENSE B to $0\ \text{V}$. If lead resistances R_{SEA} and R_{SEB} of the cable are less than few Ω , there will be no problem. Because the SENSE terminal is a voltage measurement terminal, almost no current I_0 flows. Therefore, in the $E = I_0 \times (R_{\text{SEA}} + R_{\text{SEB}})$ formula, $I_0 \approx 0$ is achieved; if lead resistances R_{SEA} and R_{SEB} are less than few Ω , voltage between SENSE A and SENSE B will become almost zero.

Next, make connection between SOURCE A and SOURCE B. This is to avoid display of error when no measurement current flows through. Lead resistances R_{SOA} and R_{SOB} of the cable must be less than the resistance for flowing measurement current.

Furthermore, if the instrument also monitors the connection between SENSE and SOURCE, you need to make connection between SENSE and SOURCE. If lead resistance R_{short} of the cable has only few Ω , there will be no problem.

If you wire in the way described above, measurement current I flowing out from SOURCE B will go to SOURCE A but not to the lead of SENSE A or SENSE B. This enables the voltage between SENSE A and SENSE B to be kept accurately at $0\ \text{V}$, and appropriate zero adjustment becomes possible.

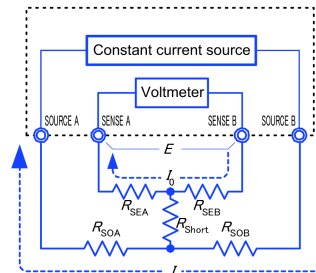

$$\begin{aligned} E &= (I_0 \times R_{\text{SEB}}) + (I_0 \times R_{\text{SEA}}) \\ &= (0 \times R_{\text{SEB}}) + (0 \times R_{\text{SEA}}) \\ &= 0 \text{ [V]} \end{aligned}$$

Figure 1.
Pseudo connection to $0\ \Omega$

To perform zero adjustment appropriately

Table 1 shows the correct and wrong connections. The resistances in the figure indicate lead resistances; there will be no problem if they are less than few Ω respectively

In (a), if you connect SENSE A and SENSE B as well as SOURCE A and SOURCE B respectively, and use one path to make connection between SENSE and SOURCE, no potential difference occurs between SENSE A and SENSE B, and 0 V is input. This enables zero adjustment to be carried out correctly.

In (b), on the other hand, if you connect SENSE A and SOURCE A as well as SENSE B and SOURCE B respectively, and use one path to make connection between A and B, $I \times R_{Short}$ voltage occurs between SENSE A and SENSE B. For this reason, the pseudo 0 V connection state cannot be achieved and zero adjustment cannot be carried out correctly.

Table 1: Connection methods

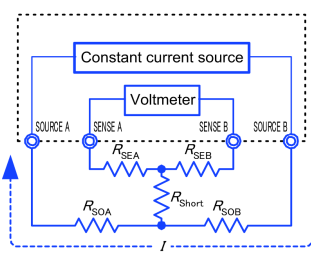
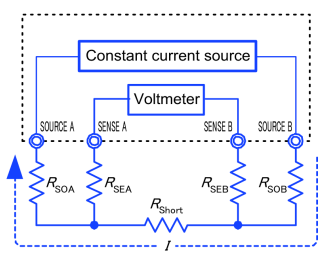
<p>Connection methods</p>	 <p>(a) Use one point each between SENSE and SOURCE for connection</p>	 <p>(b) Use one point each between A and B for connection</p>
<p>Resistance between SENSE A and SENSE B</p>	$R_{SEA} + R_{SEB}$	$R_{SEA} + R_{Short} + R_{SEB}$
<p>Measurement current I's flow path</p>	$R_{SOB} \rightarrow R_{SOA}$	$R_{SOB} \rightarrow R_{Short} \rightarrow R_{SOA}$
<p>Voltage occurring between SENSE A and SENSE B</p>	<p>0</p>	$I \times R_{Short}$
<p>As connection method for zero adjustment</p>	<p>Correct</p>	<p>Wrong</p>

To perform zero adjustment using measurement leads

When you actually perform zero adjustment using measurement leads, you may unexpectedly make the connection shown in Table 1 (b). Therefore, when performing zero adjustment, you need to pay sufficient attention to the connection state of each terminal.

Here, L2101 Clip Type Lead is used as an example for the connection explanation. Table 2 shows the connection state of the tip of the lead and equivalent circuit in the respective correct and wrong connections. Table 1 (a) indicates the correct connection method, resulting in 0 V between SENSE A and SENSE B. However, Table 1 (b) is the wrong connection method, so that 0 V is not obtained between SENSE A and SENSE B.

Table 2: Clip type lead connection methods used during zero adjustment

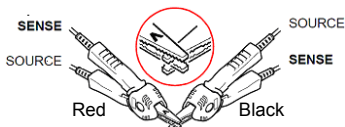
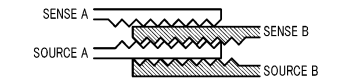
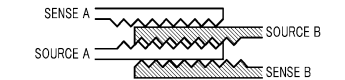
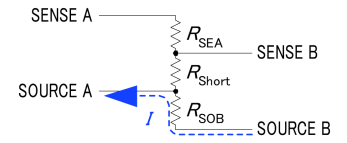
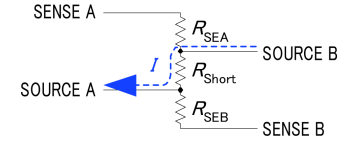
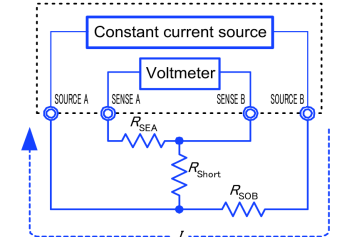
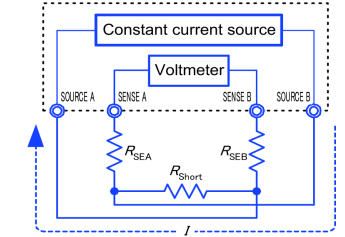
	Correct	Wrong
Connection method		
Tip of lead		
Equivalent circuit		
Deformed equivalent circuit		
As connection method for zero adjustment	Correct	Wrong



To perform zero adjustment using 9454 Zero Adjustment Board

When performing zero adjustment, you cannot use a metal board or similar object to replace 9454 Zero Adjustment Board.

9454 Zero Adjustment Board is not just a metal board. Its structure consists of two layers of metal boards screwed at one point. The zero adjustment board is used when performing zero adjustment of 9465 Pin Type Lead.

Table 3 shows cross sectional diagrams and equivalent circuits of the two connection methods: connecting Pin Type Lead to zero adjustment board, and connecting that to a metal board or similar object. Table 1 (a) indicates the connection using zero adjustment board, resulting in 0 V between SENSE A and SENSE B. However, Table 1 (b) is the connection using a metal board or similar object, so that 0 V is not obtained between SENSE A and SENSE B.

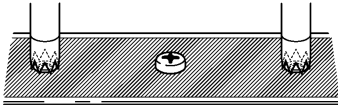
Table 3: Pin type lead connection methods in zero adjustment

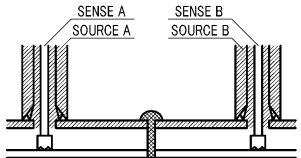
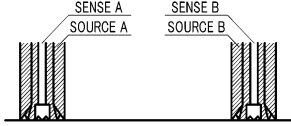
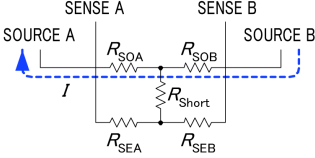
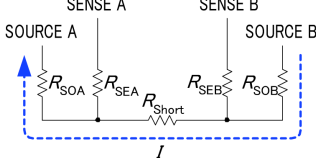
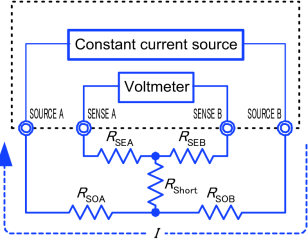
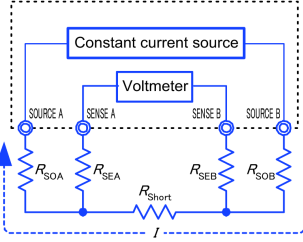
<p>Connection method</p>	 <p>If connection is made using 9454 Zero Adjustment Board</p>	 <p>If connection is made using metal board or similar object</p>
<p>Tip of lead</p>		
<p>Equivalent circuit</p>		
<p>Deformed equivalent circuit</p>		
<p>As connection method for zero adjustment</p>	<p>Correct</p>	<p>Wrong</p>

A12

Appendix 6 Zero Adjustment

If zero adjustment is difficult when using self-made measurement lead to measure

When you perform zero adjustment using a self-made measurement lead to do measurement, connect the tip of the self-made measurement lead as shown in Table 1 (a). However, if such connection is difficult, you can try the following methods.

If DC resistance meter is used

The main purpose of performing zero adjustment is to remove offset of the measurement instrument. For this reason, the value to be deducted as a result of zero adjustment almost does not depend on the measurement lead. Therefore, after using the standard measurement lead to make the connection shown in Table 1 (a) and performing zero adjustment, you can replace it with a self-made measurement lead to measure with offset removed from the measurement instrument.

If AC resistance meter is used (HIOKI 3561, BT3562, BT3563, etc.)

In addition to removing offset of the measurement instrument, another main purpose of performing zero adjustment is to remove influence of the measurement lead shape. For this reason, when performing zero adjustment, try as much as possible to set the form of the self-made measurement lead close to the actual measurement state. Then, you need to make the connection as shown in Table 1 (a) and perform zero adjustment. However, if a HIOKI product is used, even in AC resistance measurement, if the required resolution exceeds 100 $\mu\Omega$, the same zero adjustment method used in DC resistance meter may be sufficient.

Appendix 7 Unstable Measured Values

If the measured value is unstable, verify the following.

(1) Effects of induced noise

Power cords, fluorescent lights, solenoid valves, computer displays, and other devices emit large amounts of noise. Two sources of noise with the potential to affect resistance measurement are:

1. Capacitive coupling from high-voltage lines
2. Electromagnetic coupling from high-current lines

Capacitive coupling from high-voltage lines

Current flowing from a high-voltage line is dominated by the coupled capacitance. As an example, if a 100 V commercial power line and a wire used in resistance measurement are subject to capacitive coupling of 1 pF, a current of about 38 nA will be induced.

$$I = \frac{V}{Z} = 2\pi \cdot 60 \cdot \text{1pF} \cdot 100V_{\text{RMS}} = 38\text{nA}_{\text{RMS}}$$

When measuring a 1 Ω resistor with 100 mA, this effect is just 0.4 ppm and can be safely ignored.

However, when measuring 1 M Ω with 10 μA , the effect increases to 0.38%. In this way, capacitive coupling from high-resistance lines requires caution during high-resistance measurement. It is effective to provide static shielding for wires and measurement targets (see Fig. 1).

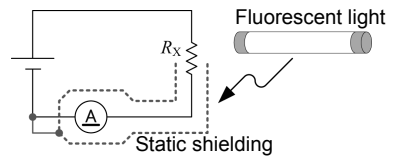

Figure 1. Static Shielding near High-voltage Wires

Electromagnetic coupling from high-current lines

High-current lines emit a magnetic field. Transformers and choke coils with a large number of turns emit an even stronger magnetic field. The voltage induced by the magnetic field is affected by the distance and area. A loop of 10 cm² located 10 cm from a 1 A commercial power line will generate a voltage of about 0.75 μV .

$$\begin{aligned} v &= \frac{d\phi}{dt} = \frac{d}{dt} \left(\frac{\mu_0 IS}{2\pi r} \right) = \frac{4\pi \cdot 10^{-7} f I}{r} \\ &= \frac{4\pi \cdot 10^{-7} \cdot 60\text{Hz} \cdot 0.001\text{m}^2 \cdot 1\text{A}_{\text{RMS}}}{0.1\text{m}} = 0.75 \mu\text{V}_{\text{RMS}} \end{aligned}$$

Appendix 7 Unstable Measured Values

When measuring a 1 mΩ resistor with 1 A, the effect measures 0.07%. Since the detection voltage can easily be increased for high-resistance measurement, this effect does not pose a significant problem.

The influence of electromagnetic coupling can be reduced by keeping the noise generating line away from the voltage detection line and twisting the cables for each (see Fig. 2).

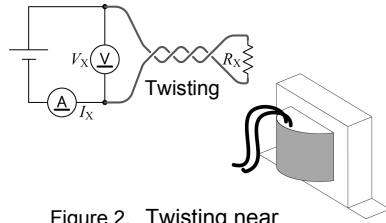

Figure 2. Twisting near High-current Wires

Induced noise countermeasures at the instrument

To counteract noise, it is effective to attach a ferrite core to the measurement leads, as shown in Fig. 3-1, or to twist the four shielded wires and to shield the measurement target with the guard potential, as shown in Fig. 3-2.

It is important to take similar precautions not only for the instrument, but also for the noise source. It is effective to twist nearby high-current wires that may serve as noise sources and to shield high-voltage wires.

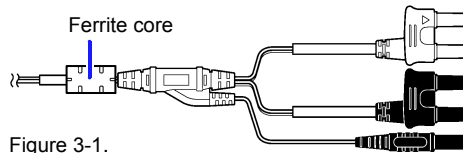

Figure 3-1.

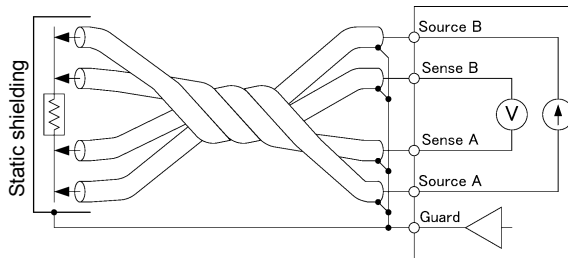

Figure 3-2. Noise Countermeasures at the Instrument

When induced noise is caused by a commercial power supply

Induced noise caused by commercial power supplies is emitted not only by commercial power lines and power outlets, but also from fluorescent lights and household electronics. Noise caused by commercial power supplies occurs at frequencies of 50 Hz and 60 Hz, depending on the frequency of the power supply in use.

To mitigate the effects of noise caused by commercial power supplies, it is standard practice to use a whole-number multiple of the power supply period as the integration time (see Fig. 4).

The instrument offers three measurement speeds: FAST, MED, and SLOW. Measured values may fail to stabilize during either high-resistance or low-resistance measurement. If this occurs, either decrease the measurement speed or implement adequate noise countermeasures.

If the line frequency setting is left at 60 Hz while the instrument is used in a region with a 50 Hz line frequency, measured values will fluctuate, even if the measurement speed is set such that the integration time is equal to the integral multiple of the line frequency. Check the instrument's line frequency setting.

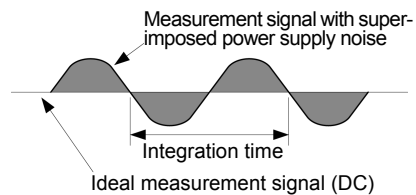

Figure 4. Noise Caused by a Commercial Power Supply

(2) Effects of conductive noise

Conductive noise is distinct from induced noise, which is superimposed on measurement targets and measurement leads. Conductive noise is noise that is superimposed on power lines and control lines such as USB.

A variety of devices, including motors, welders, and inverters, can be connected to power supply lines. A large spike current flows to the power supply while this equipment is operating and each time it starts and stops. Due to this spike current and the power supply line's wiring impedance, a large spike voltage occurs in the power supply line and the power supply ground line, and these spikes may affect measuring instruments.

Similarly, noise may be introduced from the controller's control lines. Noise from the controller's power supply and noise from sources such as DC-DC converters in the controller may reach measuring instruments via USB and EXT I/O wires (see Fig. 5).

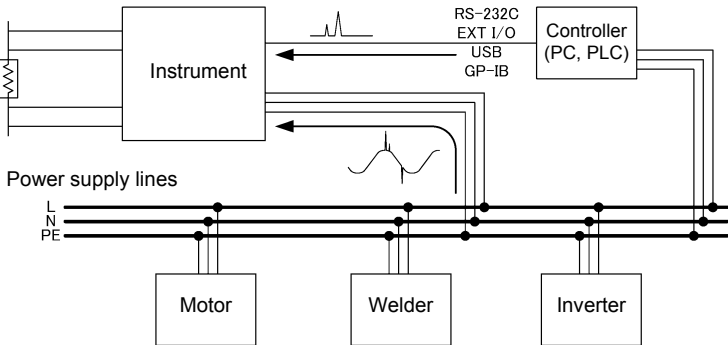

Figure 5. Susceptibility to Conductive Noise

An effective approach is to monitor conductive noise with an instrument such as the Hioki 3145 Noise HiLogger and implement countermeasures as appropriate. Once the path along which the noise is traveling has been identified, the countermeasures show in Fig. 6 are effective.

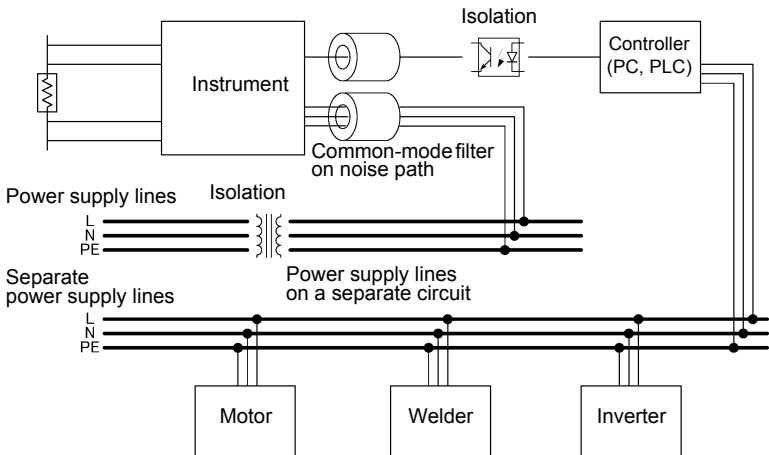

Figure 6. Conductive Noise Countermeasures

A16

Appendix 7 Unstable Measured Values

Using separate power supply lines

It is preferable to place power circuits, welders, and other equipment on a separate power supply from the instrument.

Adding a common-mode filter (EMI choke) to the noise path

Choose common mode filters with as high an impedance as possible and use multiple filters for increased effectiveness.

Isolating lines

It is highly effective to optically isolate control lines. It is also effective to isolate power supply lines using a noise-cutting transformer. However, note that shared ground lines before or after the isolation can make this approach less effective.

(3) Multi-Point Contacts with Clip Leads

The ideal conditions for four-terminal measurements are shown in Fig. 7: current flows from the far probe and voltage is detected with uniform current distribution.

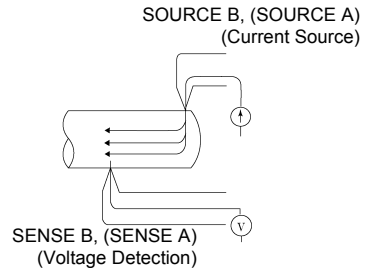

Figure 7. Ideal Four-Terminal Method

To facilitate measurement, the tips of the Model L2101 Clip Type Lead are jagged.

When a clip is opened as shown in Fig. 8, measurement current flows from multiple points, and voltage is detected at multiple points. In such cases, the measured value varies according to the total contact area.

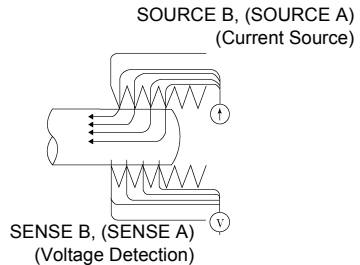

Figure 8. Measurement with Model L2101 Clip Type Lead

Additionally, as shown in Fig. 9, when measuring the resistance of a 100 mm length of wire, the length between the nearest edges of the clips is 100 mm, but the length between the farthest edges of the clips is 110 mm, so the actual measurement length (and value) has an uncertainty of 10 mm (10%).

If measured values are unstable for any of these reasons, maximize stability by measuring with point contacts as far as possible.

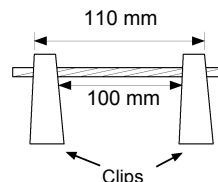

Figure 9. Measuring the resistance of a 100 mm length of wire

(4) Wider/Thicker measurement targets

When the measurement target is wide or thick like a board or block, or when using a current sensing resistor (shunt resistor) of less than 100 mΩ, it will be difficult to measure accurately using Pin Type Leads or Clip Type Leads. By using such measurement probes, there may be considerable fluctuation of the measured value due to contact pressure or contact angle. For example, when measuring a W300 × L370 × t0.4 mm metal board, the measured values are fairly different, even if measuring the same points, as shown below:

- 0.2mm pitch Pin type lead: 1.1 mΩ
- 0.5mm pitch Pin type lead: 0.92 to 0.97 mΩ
- Model L2101 Clip Type Lead: 0.85 to 0.95 mΩ

Additionally, since the resistance values of current sensing resistors assume mounting on a printed circuit board, the desired resistance value cannot be obtained if the resistor's terminals are measured using a pin-type lead.

This does not depend on the contact resistance between probes and the measurement target, but on the current distribution on the measurement target.

Fig. 10 is an example of plotting equivalent electric potential lines of a metal board. Similar to the relation between atmospheric pressure distribution and wind on a weather forecast diagram, current density is higher in locations where the equivalent electric potential lines are narrowly spaced, and lower in locations where they are widely spaced. Through this example, it is shown that the electric potential slope is larger around current applying points. This phenomenon is caused by high current density while current expands on the metal board. Due to this phenomenon, measured values should be rather different, even if the connected position difference is quite slight, in case connecting voltage detection terminals (of measurement probes) near current applying points.

It is known that such effects can be minimized by detecting the voltage within the space between the current contact points.

Generally, if the probes are inside by a margin that is at least three times the measurement target's width (W) or thickness (t), current distribution may be considered uniform.

As shown in Fig. 11, SENSE leads should be 3W or 3t mm or more inside from the SOURCE leads.

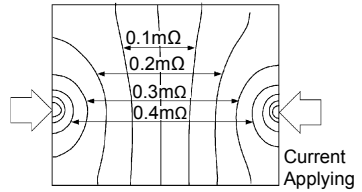

Figure 10. Equipotential lines on a metal board (W300 × L370 × t0.4 mm)

* Applying 1 A current on points on edges and plotting equivalent electric potential lines at each 50 μV level

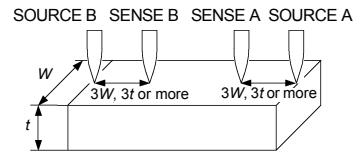

Figure 11. Probe Positions on Wider/Thicker measurement target

(5) Unstable Temperature of the measurement target

Copper wire resistance has a temperature coefficient of about 0.4%/°C. Just holding a copper wire in the hand raises its temperature, causing its resistance to be increased as well. When the hand is removed from the wire, temperature and resistance decrease.

Windings are more susceptible to temperature increase immediately after treatment with varnish, so the resistance tends to be relatively high.

When the temperature of the measurement target and probe differ, thermal EMFs will be generated, causing an error. Allow the measurement target to adjust to room temperature as much as possible prior to measurement.

A18

Appendix 7 Unstable Measured Values

(6) Measurement target Becomes Warm

The maximum applied power to a measurement target by this instrument is determined as follows. The resistance of samples with small thermal capacity can change due to heating. In such cases, switch to a range with a lower measurement current.

Range	Measurement Current	Maximum Applied Power = (Measured Resistance) × (Measurement Current) ²
30 mΩ	300 mA	3.2 mW
300 mΩ	300 mA	32 mW
3 Ω	30 mA	3.2 mW
30 Ω	10 mA	3.5 mW
300 Ω	1 mA	350 μW
3 kΩ	1 mA	3.5 mW
30 kΩ	100 μA	350 μW
300 kΩ	5 μA	8.8 μW
3 MΩ	500 nA	0.88 μW

(7) Measuring Transformers and Motors

If noise enters an unconnected terminal of a transformer or if motor rotor moves, measurements may be unstable due to induced voltage on the measured winding.

The effects of noise can be reduced by shorting transformers' empty terminals. Exercise care not to induce motor oscillation.

(8) Measuring Large Transformers or Motors

When measuring measurement targets with a large inductance component and a high Q value, such as large transformers or motors, measured values may be unstable.

The RM3544 depends on constant current flow through the measurement target. To obtain stability in a constant-current source with a large inductance, response time is sacrificed. If you find that resistance values are scattered when measuring large transformers or motors, please consider the above or contact your local HIOKI distributor for further assistance.

(9) Non-Four-Terminal Measurements

The four-terminal method requires that four probes be connected to the measurement target.

By measuring as shown in Fig.12, the measured resistance includes that of the contacts between the probes and measurement target. Typical contact resistance is several milliohm with gold plating, and several tens of milliohm with nickel plating. With measured values of several kΩ this would not seem to be a problem, but if a probe tip is oxidized or dirty, contact resistance on the order of a kΩ is not unusual.

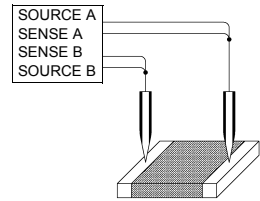

Figure 12. Two-Terminal Measurement

To maximize the opportunity for accurate measurement, separate the four probes so that they make contact with the measurement target as shown in Fig. 13.

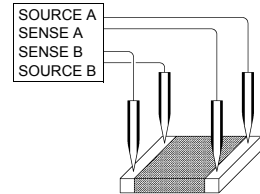

Figure 13. Four-Terminal Measurement

(10) Measurement of current sensing resistors (shunt resistors)

When mounting a two-terminal type current sensing resistor on a printed circuit board, separate the current and voltage detection wires as shown in Fig. 14 in order to avoid the effects of wiring resistance. To ensure that the current will flow evenly to the sensing resistor, it is necessary to use the same width for the current wire as the electrode and to avoid bending the wire near the electrode (see Fig. 15). When testing the current sensing resistor, wire probes are generally used (see Fig. 16). In this case, the measurement current will gradually expand inside the current sensing resistor from the point of application (SOURCE B) and flow back again to the probe point (SOURCE A) (see Fig. 17). Current density is high at the current application points (SOURCE A, SOURCE B), and placing the voltage terminals (SENSE A, SENSE B) near them will yield resistance values that tend to be higher than the actual mounted value (see Fig. 18).

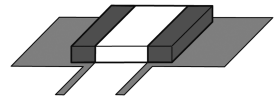

Figure. 14A Current Sensing Resistor mounted on a Printed Circuit Board

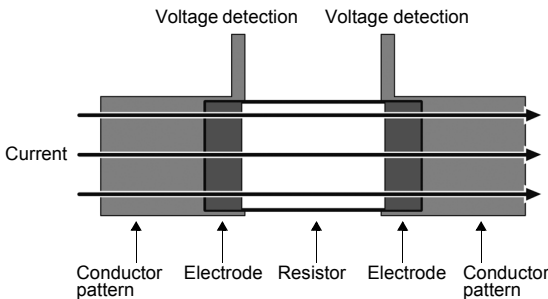

Figure. 15 Current Flow in the Mounted State

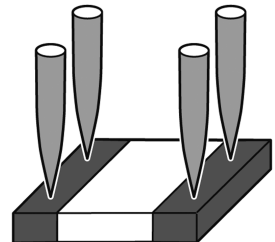

Figure. 16 Probing in the Test State

A20

Appendix 7 Unstable Measured Values

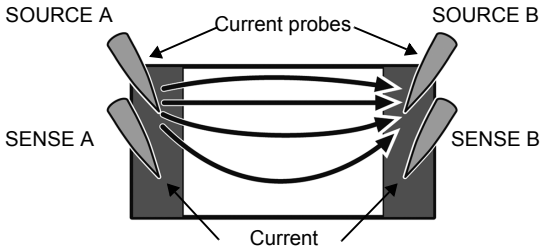

Figure. 17 Flow of Current in the Test State

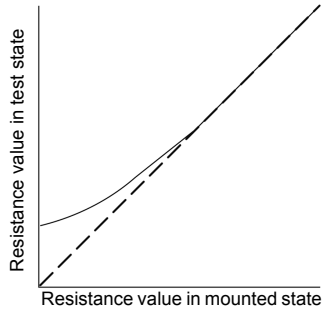

Figure. 18 Difference between Mounted State and Test State

Appendix 8 Using Multiple RM3544s

This section describes how to measure multiple locations such as rotary switches using multiple RM3544s to which two measurement targets are connected.

The RM3544 measures resistance by applying a constant current to the sample under measurement. However, when multiple probes are placed in contact with a single point, the measurement current from one RM3544 may be superposed with the measurement current from the other RM3544, preventing accurate measurement.

For example, if measuring two resistance values using two RM3544s as shown in the figure to the right, current I1 will flow to R1, and current I2 will flow to R2. However, a minuscule current may also flow from one RM3544 to the other, preventing accurate measurement.

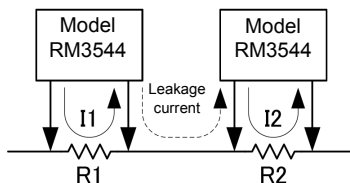

As shown in the figure below, the measurement currents from the two instruments will flow in common relative to the 10 m resistance, resulting in an error.

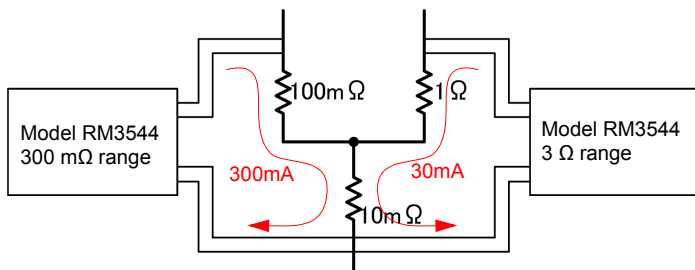

In this case, the RM3544 on the left will measure the following resistance value:

$$\frac{(100\text{m}\Omega \times 300\text{mA} + 10\text{m}\Omega \times 330\text{mA})}{300\text{mA}} = 111\text{m}\Omega$$

In this case, the RM3544 on the right will measure the following resistance value:

$$\frac{(1\Omega \times 30\text{mA} + 10\text{m}\Omega \times 330\text{mA})}{30\text{mA}} = 1.1\Omega$$

Appendix 9 Detecting the Location of a Short on a Printed Circuit Board

Comparing the resistance values at multiple locations provides a useful way to infer the location of a short on an unpopulated printed circuit board. Short patterns X and Y as described below:

- 1** Connect SOURCE A and SOURCE B to their respective patterns.
- 2** Connect SENSE A to a point near SOURCE A, and SENSE B to location (1).
- 3** Observe the measured values as you move SENSE B from (1) to (2), (3), and (4). Higher resistance values indicate greater distance from the short location. Narrow down the short location by moving the SOURCE B and SENSE B terminals.

Example
(1) 20 mΩ
(2) 11 mΩ
(3) 10 mΩ
(4) 10 mΩ

Based on the above measured values, the short can be inferred to be near (3).

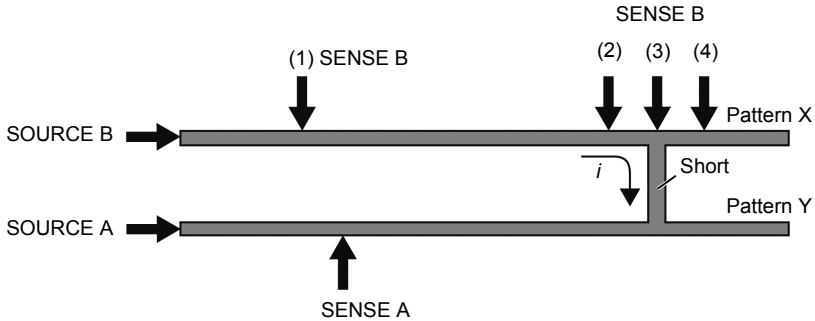

Appendix 10 JEC 2137 Induction Machine-compliant Resistance Measurement

Standard JEC 2137 specifies the determination of resistance values according to the following formula:

$$R_{tR} = R_{tT} \times \frac{t_R + k}{t_T + k} \quad \dots\dots\dots \text{Formula 1}$$

R_{tR}	Winding resistance at reference temperature t_R
R_{tT}	Measured value of winding resistance at t_T
t_R	Reference temperature [°C]
t_T	Temperature of winding during measurement [°C]
k	Constant (235 for copper wire)

Transforming Formula 1 provides the following:

$$\frac{R_{tR}}{R_{tT}} = \frac{t_R + k}{t_T + k} = \frac{1}{1 + \frac{1}{t_R + k} (t_T - t_R)} \quad \dots\dots\dots \text{Formula 2}$$

On the other hand, Formula 3 shows the temperature correction process with the RM3544. So the temperature coefficient to be set is determined as shown in Formula 4.

$$R_{tR} = \frac{R_{tT}}{1 + \alpha_{tR} \times (t_T - t_R)} \quad \dots\dots\dots \text{Formula 3}$$

$$\alpha_{tR} = \frac{1}{t_R + k} \quad \dots\dots\dots \text{Formula 4}$$

For example, if the reference temperature is 20°C, set the temperature coefficient for the instrument as follows.

$$\alpha_{tR} = \frac{1}{t_R + k} = \frac{1}{20 + 235} = 3922 \text{ [ppm/°C]}$$

Appendix 11 Making Your Own Measurement Leads

Recommended Measurement Lead Specifications

Conductor resistance	500 mΩ/m or less
Capacitance	150 pF/m or less
Cable dielectric material	Polyethylene (PE), Teflon (TFE), polyethylene foam (PEF) Insulation resistance at least 10 GΩ (Performance value)

Example: UL1354, UL1631, UL1691

Before Wiring

See: "Appendix 7 Unstable Measured Values" (p. A13)

- Use shielded wiring for measurement leads and connect the shield potential to the instrument's GUARD terminal. Use the GUARD potential to shield probes and near the measurement target.

Twist the four wires together and keep loop area small.

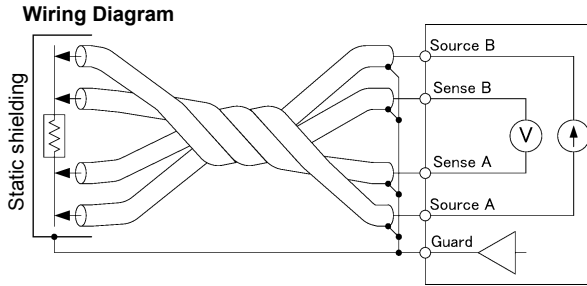

- Keep measurement leads and the measurement target away from high-current, high-voltage, and high-frequency wires (withstanding voltage testers, power cords, motors, solenoid valves).

Measurement leads are close to power supply wires.

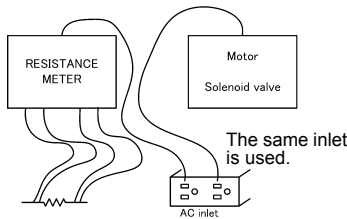

Poor example

Power supply on a separate circuit

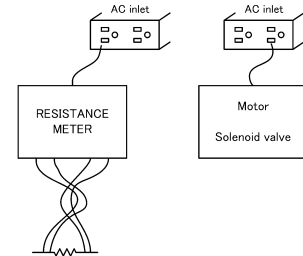

Good example

- When using two or more RM3544 units, do not group the wires from multiple instruments together. Induction phenomena may cause measured values to become unstable.
- Refer to the block diagram (p. A1) for internal circuit details.

- Wiring resistance in excess of the values listed in the table to the right may cause a current fault, making measurement impossible. When using measurement current 300 mA ranges, keep the wiring resistance (cable line resistance, relay on-resistance) as well as the contact resistance between the measurement targets and probe low.

Range	Wiring resistance and contact resistance
30 mΩ, 300 mΩ	2 Ω
3 Ω	70 Ω
30 Ω	100 Ω
300 Ω	2 kΩ
3 kΩ	700 Ω
30 kΩ to 3 MΩ	2 kΩ

- Since the voltage detection circuit's input resistance is at least 1 GΩ, the SENSE line wiring resistance can be as high as 1 kΩ without affecting measured values. However, the wiring resistance should be minimized due to susceptibility to noise.
- Long wires are susceptible to noise, and measured values may be unstable.
- Extensions should maintain the four-terminal structure. If converted to a two-terminal circuit in the wiring, correct measurement may not be possible due to the effects of wiring and contact resistance.

Example that would result in error:

Four-terminal wiring from the instrument to the relay, but two-terminal wiring from the relay

- After extending measurement leads, confirm operation and accuracy ("Measurement Specifications" (p.146)).
- If cutting the ends off of HIOKI measurement leads, make sure that the shield does not touch the center conductor of the SOURCE A, SENSE A, SENSE B and SOURCE B leads. Correct measurement is not possible with a shorted lead.
- Do not connect the end of the shielding wire to a ground or other terminal. Doing so will create a ground loop, making the instrument more susceptible to noise. Keeping the shielding wire away from the center conductor, process the ends of the leads so that they do not come into contact with nearby metal objects.
- Do not apply a current of 1 mA or more to the GUARD terminal. This terminal is not for guarding network resistance measurements.

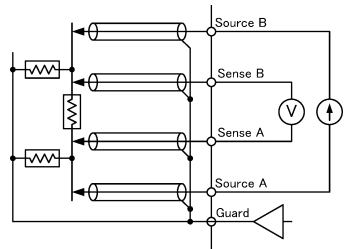
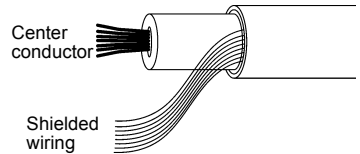

Example of defeated guard measurement

Appendix 12 Checking Measurement Faults

The instrument monitors the connection status of SOURCE A, SOURCE B, SENSE A, and SENSE B. If you experience an unexpected measurement fault, check the following.

- 1 Disconnect the measurement lead plugs from the instrument while keeping the probes in contact with the measurement target.**

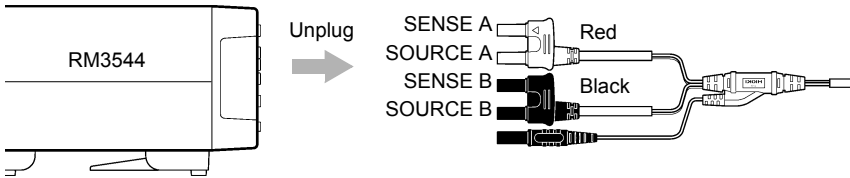

- 2 Check the resistance between SOURCE A and SENSE A with a tester or other instrument. See (1) below.**

Check the resistance between SOURCE B and SENSE B with a tester or other instrument. See (2) below.

If good contact has been established, the resistance should be 1 Ω or less.

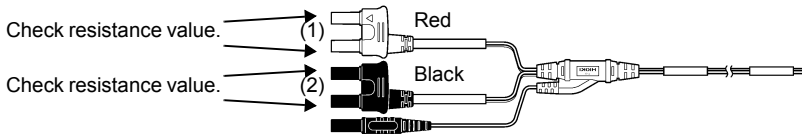

- 3 Check the resistance between SOURCE A and SOURCE B with a tester or other instrument. See (3) below.**

If good contact has been established, the resistance should be the sum of the measurement target resistance value and the wiring resistance.

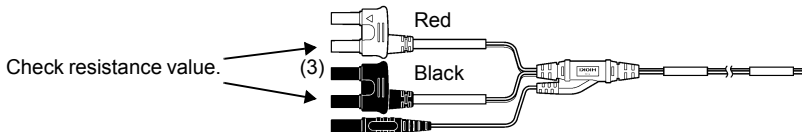

If the above resistance values are too high, check the following:

- Is the probe dirty or worn?
- Is the probe's contact pressure too low?
- Is a power relay being used to switch the wiring (in particular, the sense wiring)?
Use of power relay contacts without applying current will cause the contact resistance to increase gradually over time.
- Is the wiring too small?
- Is there a break in a measurement lead?
Switch the lead with another lead or jiggle the wiring and check the resistance value.

Appendix 13 Using the Instrument with a Withstanding Voltage Tester

The instrument can also be used in conjunction with a withstanding voltage tester to test windings. When used with a withstanding voltage tester, the charge stored in the winding may flow into the instrument at the moment it is connected, damaging it. When using the instrument in this manner, take the following into account during the production line design process:

- (1) Ensure the contact withstanding voltage of the relays used for switching has a sufficient safety margin relative to the withstanding test voltage (at a minimum, it should be twice the peak voltage).

Example high-voltage relays

Okita Works	LRL-101-50PC (5 kV DC between contacts)
	LRL-101-100PC (10 kV DC between contacts)
Sanyu Switch	USM-11524 (5 kV DC between contacts)
	USM-13624SB (10 kV DC between contacts)

- (2) During withstanding voltage testing, ground all of the instrument's terminals.
- (3) Perform resistance measurement first and the withstanding voltage test last.

If you must perform the withstanding voltage test before resistance measurement, ground both of the measurement target's terminals after the withstanding voltage test to discharge any charge accumulated during the test. Then perform resistance measurement.

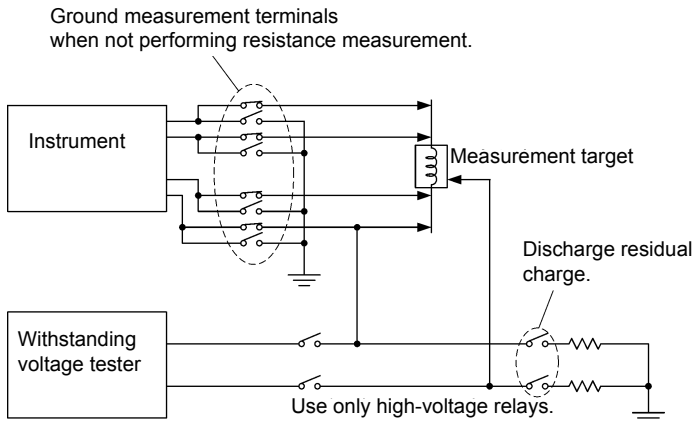

Using the instrument with a withstanding voltage tester

Appendix 14 Measurement Leads (Options)

To purchase any of the options, contact your authorized Hioki distributor or reseller.

Model L2101 Clip Type Lead

These leads have clip tips. Four-terminal measurements are provided just by clipping on to the measurement target.

Overall length: approx. 1500 mm
 Bifurcation-to-lead length: approx. 250 mm
 Clippable diameter: ϕ 0.3 to 5.0 mm

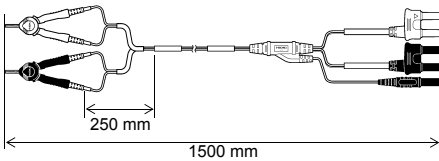

Model L2102 Pin Type Lead

Even on flat contact points that cannot be clipped to, or on measurement targets with small contacts such as relay terminals or connectors, four-terminal measurements are available by just pressing.

Overall length: approx. 1500 mm
 Bifurcation-to-lead length: approx. 250 mm
 Pin base: ϕ 1.8 mm
 Initial contact pressure: approx. 70 g
 Total compression pressure: approx. 100 g
 (Stroke: approx. 2 mm)

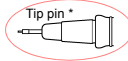
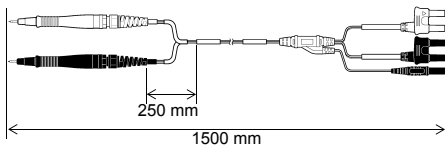

* Tip pins can be exchanged ahead.

Model L2103 Pin Type Lead

The tips have a four-terminal design developed for floating-foot testing of ICs mounted on boards. Resistance can be correctly measured even with small measurement targets.

Overall length: approx. 1500 mm
 Bifurcation-to-lead length: approx. 250 mm
 Between pin bases: 0.2 mm
 Initial contact pressure: approx. 60 g
 Total compression pressure: approx. 140 g
 (Stroke: approx. 1.3 mm)

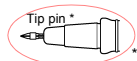
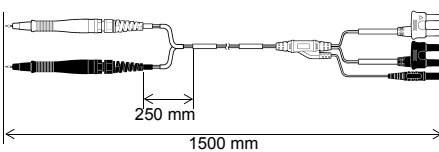

* Tip pins can be exchanged ahead.

Model L2104 4-Terminal Lead

The SOURCE leads of this four-terminal lead set have covered alligator clips, and the SENSE leads have standard test probes. Use for measuring printed circuit board pattern resistance, and where SOURCE and SENSE leads need to be connected separately.

Overall length: approx. 1500 mm
 Bifurcation-to-lead length: approx. 280 mm

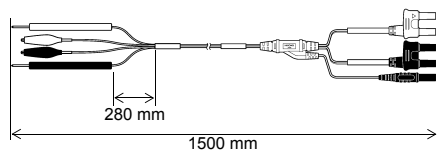

Appendix 15 Rack Mounting

By removing the screws on the bottom, this instrument can be installed in a rack mounting plate.



Observe the following precautions regarding the mounting screws to avoid instrument damage and electric shock accidents.

- When removing the Rack Mounting Plate to return the instrument to stand-alone use, replace the same screws that were installed originally. (Feet: M3 × 6 mm)

If you loose any screw or find that any screws are damaged, please contact your Hioki distributor for a replacement.

Rack Mounting Plate Template Diagram and Installation Procedure

A30

Appendix 15 Rack Mounting

Rack Mounting Plate (EIA)

SPCC t2.0

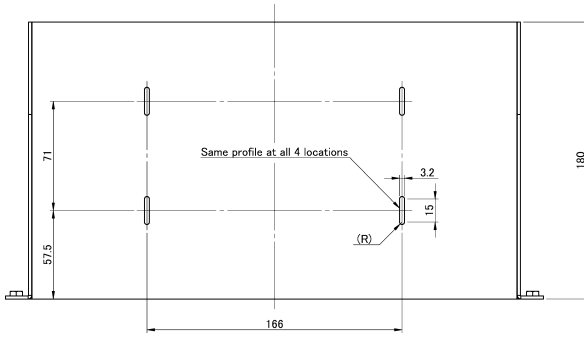
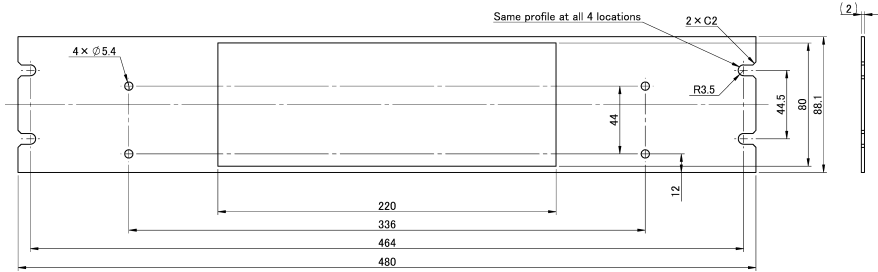

SPCC t2.0

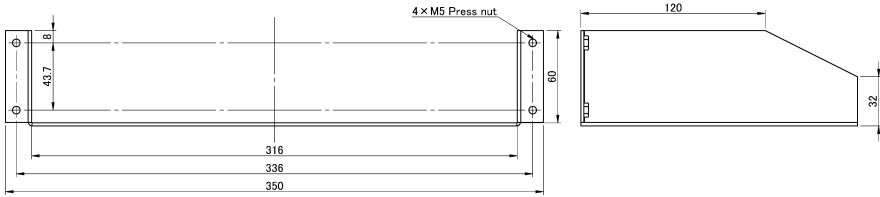

Rack Mounting Plate (JIS)

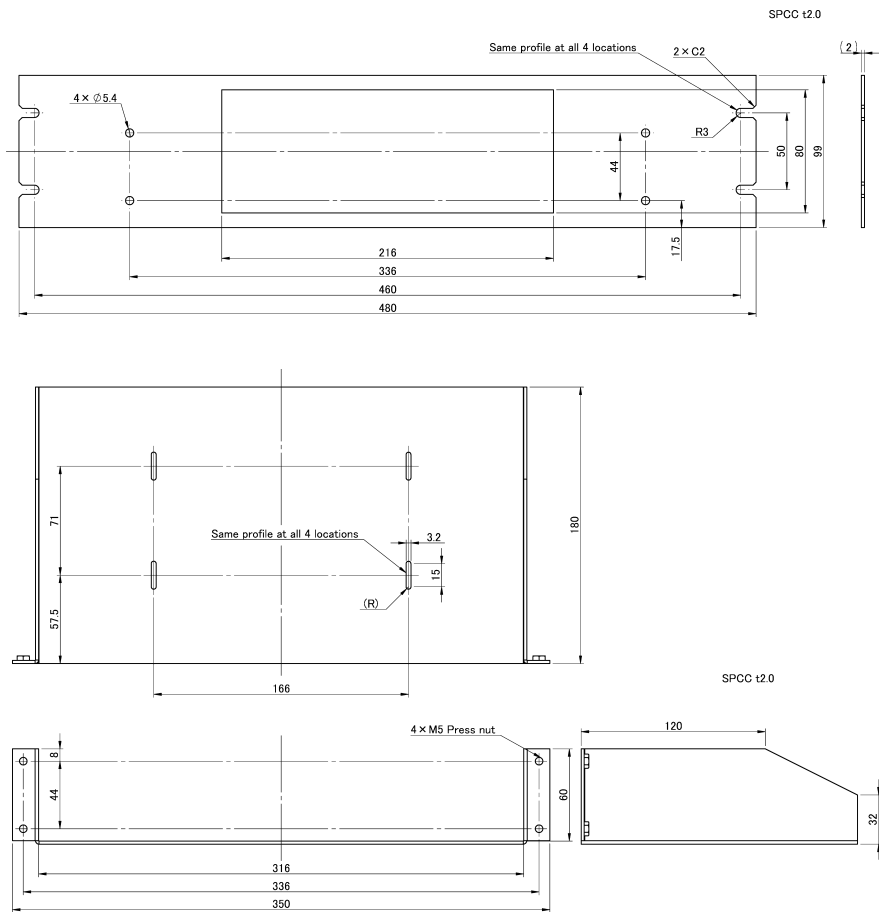

A32

Appendix 15 Rack Mounting

M3×6 mm

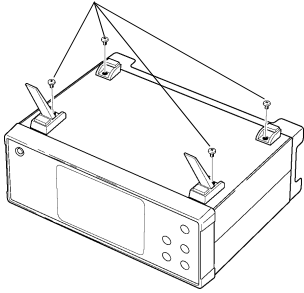

- 1** Extend the legs on the bottom of the instrument and remove the four screws.

- 2** Affix the Rack Mounting Plate with the M3×6 mm screws.

When installing into the rack, reinforce the installation with a commercially available support stand.

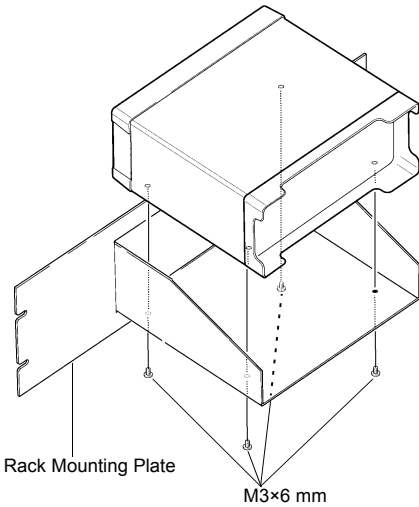

Screw location dimensional drawing

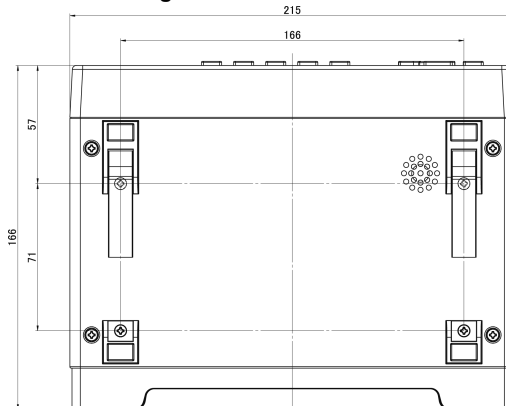

Appendix 16 Dimensional Diagram

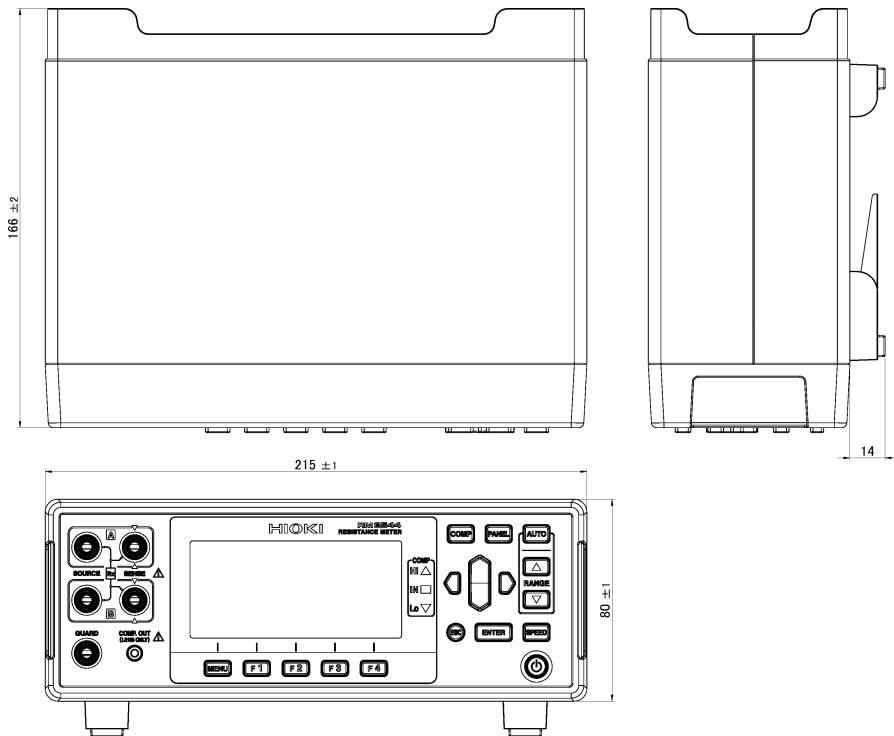

Appendix 17 Calibration

Calibration Conditions

- Ambient temperature and humidity 23±5°C, 80%RH or less
- Power supply 100 to 240 V±10%, 50/60 Hz, distortion rate of 5% or less
- External magnetic field Environment close to the Earth's magnetic field
- Initialize settings by resetting the instrument.

Calibration equipment

Please use the following for calibration equipment.

Resistance measurement function

Equipment	Calibration point	Manufacturer	Standard model
Standard resistor	10 mΩ	Alpha Electronics	Equivalent to CSR-10N
Standard resistor	100 mΩ	Alpha Electronics	Equivalent to CSR-R10
Multi-product calibrator	3 Ω	FLUKE	Equivalent to 5520A
Multi-product calibrator	30 Ω	FLUKE	Equivalent to 5520A
Multi-product calibrator	300 Ω	FLUKE	Equivalent to 5520A
Multi-product calibrator	3 kΩ	FLUKE	Equivalent to 5520A
Multi-product calibrator	30 kΩ	FLUKE	Equivalent to 5520A
Multi-product calibrator	300 kΩ	FLUKE	Equivalent to 5520A
Multi-product calibrator	3 MΩ	FLUKE	Equivalent to 5520A
Resistance measurement leads		HIOKI	L2104 4-Terminal Lead

If the FLUKE 5520A cannot be used, please use the following equipment.

Equipment	Calibration point	Manufacturer	Standard model
Standard resistor	1 Ω	Alpha Electronics	Equivalent to CSR-1R0
Standard resistor	10 Ω	Alpha Electronics	Equivalent to CSR-100
Standard resistor	100 Ω	Alpha Electronics	Equivalent to CSR-101
Standard resistor	1 kΩ	Alpha Electronics	Equivalent to CSR-102
Standard resistor	10 kΩ	Alpha Electronics	Equivalent to CSR-103
Standard resistor	100 kΩ	Alpha Electronics	Equivalent to CSR-104
Standard resistor	1 MΩ	Alpha Electronics	Equivalent to CSR-105

Equipment	Calibration point	Manufacturer	Standard model
Dial-type resistor	30 Ω to 300 kΩ	Alpha Electronics	Equivalent to ADR-6105M
Dial-type resistor	3 MΩ	Alpha Electronics	Equivalent to ADR-6106M

Temperature measurement (Thermistor)

Equipment	Calibration point	Manufacturer	Standard model
Multi-product calibrator	25°C, 2186.0 Ω	FLUKE	Equivalent to 5520A

If the FLUKE 5520A cannot be used, please use the following equipment.

Equipment	Calibration point	Manufacturer	Standard model
Dial-type resistor	25°C, 2186.0 Ω	Alpha Electronics	Equivalent to ADR-6105M

Calibration points

	Range	Calibration points
Resistance measurement	30 mΩ	0 Ω, 10 mΩ
	300 mΩ	0 Ω, 100 mΩ
	3 Ω	0 Ω, 1 Ω or 3 Ω
	30 Ω	0 Ω, 10 Ω or 30 Ω
	300 Ω	0 Ω, 100 Ω or 300 Ω
	3 kΩ	0 Ω, 1 kΩ or 3 kΩ
	30 kΩ	0 Ω, 10 kΩ or 30 kΩ
	300 kΩ	0 Ω, 100 kΩ or 300 kΩ
	3 MΩ	0 Ω, 1 MΩ or 3 MΩ
Temperature (thermistor)		25°C: 2186.0 Ω input

Connection Methods

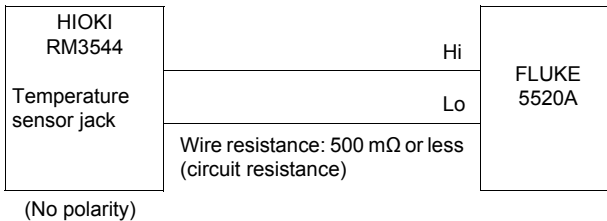
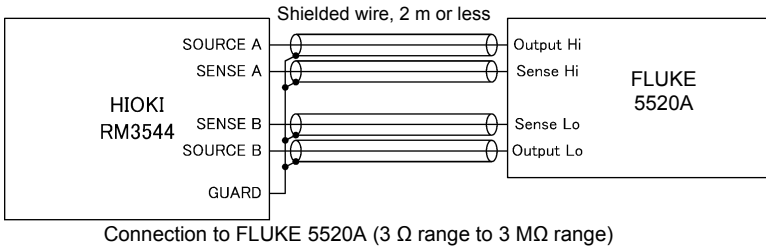
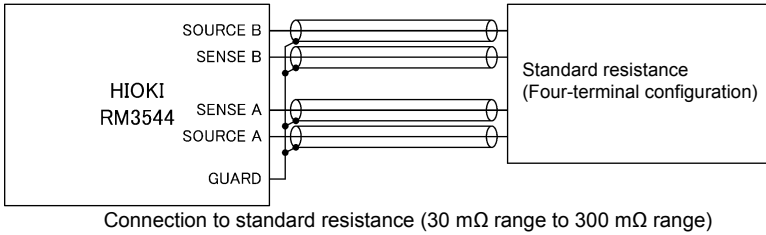
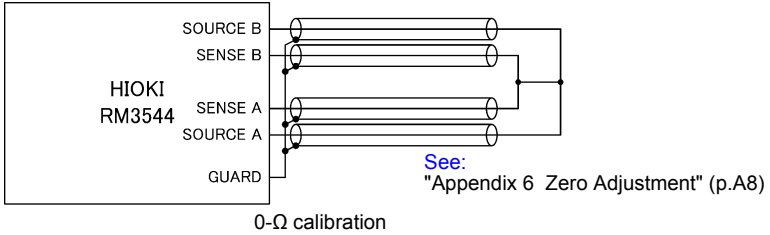

NOTE

- For more information about 0 Ω calibration connections, see "Appendix 6 Zero Adjustment" (p.A8).
- Adequate noise countermeasures must be implemented during calibration. Excessive noise will cause measured values to fluctuate or diverge. Connect the metal exterior of standard resistors and dial resistors to the instrument's GUARD potential.
[See: "Appendix 7 Unstable Measured Values" \(p.A13\)](#)
- Do not use alligator clips with the voltage detection terminals. Thermal EMFs may cause measured values to diverge.

When using the YOKOGAWA 2792 to calibration

Use the 4-terminal Lead from Hioki. Note that connection cannot be made with the Clip Type Lead.

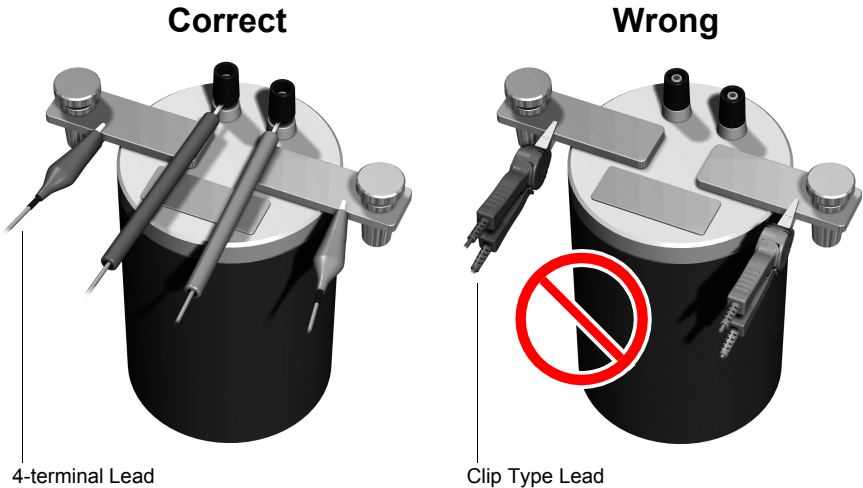

A38

Appendix 18 Adjustment Procedure

Appendix 18 Adjustment Procedure

The System Settings screen includes an adjustment screen.

The Adjustment screen is used in repairs and adjustment carried out by Hioki. It is not available for use by end-users.

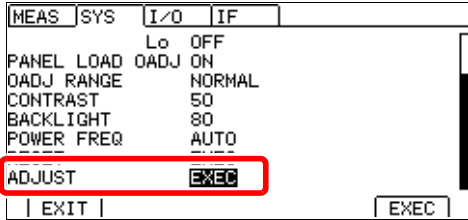

F4 Do not press.

Appendix 19 Instrument Settings (Memo)

When you return your instrument to be calibrated or repaired, its settings will be reset to their default values. It is recommended to make note of the instrument's settings using the following table before sending it to be calibrated or repaired

Screen		Setting and Key	Setting
Measurement screen		COMP	
		AUTO	
		▲▼ (RANGE)	
		SPEED	
Measurement screen (P.1/2)		VIEW (F2)	
Measurement screen (P.2/2)		0 ADJ (F1)	
		LOCK (F2)	
Setting screen (SETTING)	Measurement Settings screen (MEAS)	TC SET	
		AVERAGE	
		AUTO HOLD	
		COMP DELAY	
		SCALING(A*R+B)	
		A:	
		B:	
		UNIT:	
		Ω DIGITS	
		CURR ERROR MODE	
	System Settings screen (SYS)	KEY CLICK	
		COMP BEEP Hi	
		IN	
		Lo	
		PANEL LOAD 0ADJ	
		0ADJ RANGE	
		CONTRAST	
		BACKLIGHT	
		POWER FREQ	
	EXT I/O Settings screen (I/O) *1	TRIG SOURCE	
		TRIG EDGE	
		TRIG/PRINT FILT	
		EOM MODE	
	Communications Interface Settings screen (IF) *1	JUDGE/BCD MODE	
		INTERFACE	
		SPEED	
		DATA OUT	
		CMD MONITOR	
	PRINT INTRVL		
	PRINT COLUMN		

*1: RM3544-01 only

A40

Appendix 19 Instrument Settings (Memo)

Index

Number

0ADJ93

A

ABS mode60, 62
 AC method A 3
 Accuracy148
 Example calculation of148
 Resistance Measurement146
 Temperature measurement147
 Adjustment A 38
 AUTO17, 32
 Auto-hold41
 Auto-Ranging32
 Averaging Function50

B

Backlight84
 Backup function29
 Baud Rate122
 BCD_LOW93
 BCDm-n94
 Binary130
 Block Diagram A 1

C

Calibration 159, A 34
 Capacitive coupling A 13
 Cleaning159
 Clip Leads A 16
 COMP17, 61
 COMP.OUT Terminal17
 Comparator
 Does not light up161
 Comparator Function60
 Comparator judgment beeper68
 Continuous measurement110
 Crossover wiring129
 Current Fault Detection Function39
 Current sensing resistor A 19
 Cursor keys17

D

Data Output Function133

DC method A 3
 Default settings 87
 Dimensional diagram A 33

E

Electromagnetic coupling A 13
 ENTER 17
 EOM 94
 ERR 94, A 26
 ESC 17
 EXT 109
 EXT I/O 89
 Connection examples 107
 Connector 120
 EXT I/O Connector 18
 External triggering (EXT) 109

F

F keys 17
 F.LOCK 78
 Four-Terminal A 2, A 19
 Free-run 110, 168
 Frequency 80
 FULL 78
 Fuse 171
 Fuse holder 18

H

HI 94
 HILO 94
 Hold 41

I

IN 94
 IN0, IN1 93
 INDEX 94
 Initializing 85
 Inspection 30
 INT 109
 Internal Circuitry 104
 Internal triggering (INT) 109

K

Key Beeper 82

Index 2

Index

KEY_LOCK	93
Key-Lock Cancel	79
Key-Lock Function	78

L

Line frequency	80
LO	94
LOAD0 to LOAD3	93
Lower threshold	62

M

M.LOCK	78
Manual Range	32
Measure automatically	109
Measured Values	
Are not displayed	163
Changing the number of digits	58
Checking values	35
Holding values	41
Making judgments	60
Unstable	162, A 13
Unstable and errors	A 24
Measurement Conditions	43, 71
Loading	73
Saving	72
Measurement faults	38, 94, 168, A 26
Measurement Leads	
Connecting	26, 34
Connecting leads	34
Options	A 28
User-made	A 24
Measurement Process	19
Measurement ranges	32, 146
Measurement speed	33
Measurement target	A 17
Unstable temperature	A 17
Warms up	A 18
MENU key	17
Motors	A 18

N

Negative measured values	35
Noise	A 13, A 14, A 25

O

OUT0 to OUT2	94
Output signals	94
Over-range Detection Function	39
OvrRng	38, 60, 169

P

PANEL	17
-------------	----

Panel	
Changing panel names	75
Deleting panel data	76
Panel Load	73
Panel Save	72
Power cord	25
Power switch	28
PRINT	93, 140
Printed circuit board	A 22
Printer	137, 155
Printing	137, 140

Q

Q&A	160
-----------	-----

R

Rack Mounting	A 29
RANGE	17, 32
REF% mode	60, 64
Reference Value	64
Reset	85
RNG_OUT0 to RNG_OUT3	94
RS-232C	155
RS-232C Connector	18
RS-232C Interface	126

S

Scaling Function	54
Screen contrast	83
Screen Organization	21
Self-test	29, 30
Shunt resistor	A 19
Signal pinouts	91
SPEED	17, 33
System reset	85

T

TC	52, A 4
Temperature Correction	52, A 4
Temperature Sensor	27
Test fixtures	26
Thermal emf	A 6
Timing chart	97
EXT I/O	97
Tolerance	64
Transformers	A 18
TRIG	93

U

UNLOCK	79
Unstable and errors	A 2

Upper threshold	62
Upper/Lower Thresholds	62
USB Interface	123
USB jack	18

V

VIEW	21
Voltage-Drop	A 2

W

Wiring	A 24
--------------	------

Z

Zero Adjustment	44, A 8
Zero Adjustment Faults	47

Warranty Certificate

HIOKI

Model	Serial number	Warranty period Three (3) years from date of purchase (___ / ___)
-------	---------------	--

Customer name: _____

Customer address: _____

Important

- Please retain this warranty certificate. Duplicates cannot be reissued.
- Complete the certificate with the model number, serial number, and date of purchase, along with your name and address. The personal information you provide on this form will only be used to provide repair service and information about Hioki products and services.

This document certifies that the product has been inspected and verified to conform to Hioki's standards.

Please contact the place of purchase in the event of a malfunction and provide this document, in which case Hioki will repair or replace the product subject to the warranty terms described below.

Warranty terms

1. The product is guaranteed to operate properly during the warranty period (three [3] years from the date of purchase).
If the date of purchase is unknown, the warranty period is defined as three (3) years from the date (month and year) of manufacture (as indicated by the first four digits of the serial number in YYMM format).
2. If the product came with an AC adapter, the adapter is warranted for one (1) year from the date of purchase.
3. The accuracy of measured values and other data generated by the product is guaranteed as described in the product specifications.
4. In the event that the product or AC adapter malfunctions during its respective warranty period due to a defect of workmanship or materials, Hioki will repair or replace the product or AC adapter free of charge.
5. The following malfunctions and issues are not covered by the warranty and as such are not subject to free repair or replacement:
 - 1. Malfunctions or damage of consumables, parts with a defined service life, etc.
 - 2. Malfunctions or damage of connectors, cables, etc.
 - 3. Malfunctions or damage caused by shipment, dropping, relocation, etc., after purchase of the product
 - 4. Malfunctions or damage caused by inappropriate handling that violates information found in the instruction manual or on precautionary labeling on the product itself
 - 5. Malfunctions or damage caused by a failure to perform maintenance or inspections as required by law or recommended in the instruction manual
 - 6. Malfunctions or damage caused by fire, storms or flooding, earthquakes, lightning, power anomalies (involving voltage, frequency, etc.), war or unrest, contamination with radiation, or other acts of God
 - 7. Damage that is limited to the product's appearance (cosmetic blemishes, deformation of enclosure shape, fading of color, etc.)
 - 8. Other malfunctions or damage for which Hioki is not responsible
6. The warranty will be considered invalidated in the following circumstances, in which case Hioki will be unable to perform service such as repair or calibration:
 - 1. If the product has been repaired or modified by a company, entity, or individual other than Hioki
 - 2. If the product has been embedded in another piece of equipment for use in a special application (aerospace, nuclear power, medical use, vehicle control, etc.) without Hioki's having received prior notice
7. If you experience a loss caused by use of the product and Hioki determines that it is responsible for the underlying issue, Hioki will provide compensation in an amount not to exceed the purchase price, with the following exceptions:
 - 1. Secondary damage arising from damage to a measured device or component that was caused by use of the product
 - 2. Damage arising from measurement results provided by the product
 - 3. Damage to a device other than the product that was sustained when connecting the device to the product (including via network connections)
8. Hioki reserves the right to decline to perform repair, calibration, or other service for products for which a certain amount of time has passed since their manufacture, products whose parts have been discontinued, and products that cannot be repaired due to unforeseen circumstances.

HIOKI E.E. CORPORATION

<http://www.hioki.com>

18-07 EN-3

HIOKI

<http://www.hioki.com>



**Our regional
contact
information**

HEADQUARTERS

81 Koizumi
Ueda, Nagano 386-1192 Japan

HIOKI EUROPE GmbH

Rudolf-Diesel-Strasse 5
65760 Eschborn, Germany
hioki@hioki.eu

1808EN

Edited and published by HIOKI E.E. CORPORATION

Printed in Japan

- CE declarations of conformity can be downloaded from our website.
- Contents subject to change without notice.
- This document contains copyrighted content.
- It is prohibited to copy, reproduce, or modify the content of this document without permission.
- Company names, product names, etc. mentioned in this document are trademarks or registered trademarks of their respective companies.