

# IM3570

Instruction Manual

# IMPEDANCE ANALYZER



EN





# Contents

## Chapter 1 Overview 9

1.1	Product Overview Features .....	9
1.2	Names and Functions of Parts .....	10
1.3	Screen Configuration and Operation ..	12
1.3.1	Initial Screen .....	12
1.3.2	Measurement Mode Selection Screen	13
1.3.3	Advanced Settings Screen .....	14
1.3.4	Compensation Settings Screen .....	21
1.3.5	System Settings Screen .....	22
1.3.6	Save Settings Screen .....	24
1.3.7	Parameter Settings Screen .....	25

## Chapter 2 Measurement Preparations 27

2.1	Preparation Flowchart .....	27
2.2	Pre-Operation Inspection .....	28
2.3	Connecting the Power Cord .....	29
2.4	Connecting the Measurement Cables, Probes, or Fixture .....	30
2.5	Turning the Power On and Off .....	31

## Chapter 3 Measurement Example 33

3.1	When LCR Measurement Mode .....	33
3.2	When Analyzer Measurement Mode ..	35

## Chapter 4 LCR Function 37

4.1	About LCR function .....	37
4.1.1	Initial screen .....	38
4.1.2	Setting Display Parameters .....	39
4.2	Setting Basic Settings of Measurement Conditions .....	41
4.2.1	Setting the Measurement frequency ..	41
4.2.2	Setting the Measurement signal level	43

4.2.3	Setting the Measurement Range .....	49
■	Setting AUTO Ranging .....	49
■	Setting the Ranging to HOLD .....	51
■	Low Z High Accuracy Mode .....	53
4.2.4	Perform Measurements with User-defined Timing (Trigger Measurement) .....	55
4.2.5	Setting the DC bias .....	57
4.2.6	Setting the Measurement speed .....	59
4.2.7	Setting the Voltage/Current Limit .....	60
4.2.8	Displaying Average Values (Averaging Set) .....	62
4.2.9	Measuring at Desired Time (Trigger Delay) .....	64
4.3	Setting DC Resistance Measurement	65
4.3.1	Setting the Measurement signal level	66
4.3.2	Setting the Measurement Range .....	69
■	Setting AUTO Ranging .....	69
■	Setting the Ranging to HOLD .....	71
■	Low Z High Accuracy Mode .....	73
4.3.3	Setting the DC Adjustment Function ..	75
4.3.4	Setting the Measurement speed .....	77
4.3.5	Setting the Voltage/Current Limit .....	78
4.3.6	Displaying Average Values (Average set) .....	80
4.3.7	Setting the Delay Time .....	82
4.4	Judging Measurement Results .....	84
4.4.1	Judging with Upper and Lower Limit Values(Comparator Measurement Mode) .....	86
■	Setting the Upper or Lower Limit Value as an Absolute Value (ABS) (Absolute Value mode)	88
■	Setting the Upper or Lower Limit Value as a Percentage (%) Relative to a Reference Value (Percentage mode) .....	89
■	Setting Upper and Lower Limit Values as ( $\Delta$ %) Values Relative to the Offset from the Reference Value (Deviation Percentage Mode) .....	91
4.4.2	Classifying Measurement Results (BIN Measurement) .....	93
■	Setting the Upper or Lower Limit Value as an Absolute Value (ABS) (Absolute Value mode)	95

## Contents

---

■ Setting the Upper or Lower Limit Value as a Percentage (%) Relative to a Reference Value (Percentage mode) .....	98
■ Setting Upper and Lower Limit Values as ( $\Delta\%$ ) Values Relative to the Offset from the Reference Value (Deviation Percentage Mode) .....	101
4.5 Setting Application Settings .....	104
4.5.1 Synchronizing Measurement (Trigger Synchronous Output Function) .....	104
4.5.2 Saving Measurement Results (Memory function) .....	106
4.5.3 Detecting OPEN during 2-terminal Measurement (HIGH-Z Reject Function) .....	108
4.5.4 Monitoring the Detection Level (Monitoring the Detection Level Function) .....	110
4.5.5 Setting the Detection Sensitivity for Measurement Errors (Overflow or Underflow) .....	113
4.5.6 Setting the Delay Time from the Output of Comparator and BIN Judgment Results until Output of EOM (LOW) and Resetting Judgment Results .....	115
4.5.7 Enabling Trigger Input for during Measurement and Setting the Valid Edge of Trigger Input .....	117
4.5.8 Setting the $\overline{\text{EOM}}$ Output Method .....	119
4.5.9 Disabling Key Operation (Key-lock Function) .....	121
4.5.10 Setting the Number of Display Digits .....	124
4.5.11 Enlarging Display of Measurement Values .....	126
4.5.12 Setting the LCD to ON/ OFF .....	127
4.5.13 Setting Operation Sounds (Beep Sounds) .....	128
4.5.14 Initializing (System Reset) .....	129
5.2.3 Setting the Trigger .....	137
5.2.4 Setting the Display Timing .....	139
5.2.5 Setting the Trigger Delay .....	140
5.2.6 Segment Setting .....	142
5.3 Normal Sweep .....	143
5.3.1 Setting Sweep Points .....	143
5.3.2 Setting the Measurement Signal .....	157
5.3.3 Setting the Measurement Range .....	160
■ Setting AUTO Ranging .....	160
■ Setting the Ranging to HOLD .....	162
5.3.4 Setting the Measurement speed .....	164
5.3.5 Displaying as Average Values (Average set) .....	165
5.3.6 Setting the Point Delay .....	166
5.3.7 Setting the DC Bias .....	167
5.4 Segment Sweep .....	169
5.4.1 Select Segments .....	169
5.5 Setting the Graph Display Method ...	176
5.5.1 Setting the Horizontal Axis .....	176
■ Overwrite Setting .....	176
■ Horizontal Axis Scale Setting .....	177
■ Span Setting .....	179
5.5.2 Setting the Vertical Axis .....	181
■ Draw Color Setting .....	181
■ Vertical Axis Scale Setting .....	183
■ Manual Scaling Setting .....	184
5.5.3 Setting Grid Display .....	186
5.6 Checking the Measurement Values .	188
5.6.1 Setting the Cursor .....	188
■ Cursor Display Setting .....	189
■ Cursor Move Setting .....	190
■ Search Function Setting .....	190
■ Search Target Parameter Setting .....	191
■ Option setting .....	191
■ Auto Search Setting .....	192
5.6.2 Moving the Cursor .....	193
5.6.3 Performing Measurement Value Search .....	194
5.7 Judging Measurement Results (Comparator Function) .....	197
■ Area Judgment .....	197
■ Peak Judgment .....	208
5.8 Editing Judgment Points .....	217
5.9 Application Settings .....	219
5.9.1 Saving Measurement Results (Memory function) .....	219

---

## Chapter 5 ANALYZER Function 131

5.1 About ANALYZER function .....	131
5.1.1 Initial screen .....	132
5.2 Setting Basic Settings of Measurement .....	133
5.2.1 Setting the measurement parameter .....	133
5.2.2 Setting the Sweep Parameter .....	135

---

5.9.2	Detecting OPEN during 2-terminal Measurement (HIGH-Z Reject Function)	222
5.9.3	Setting the Detection Sensitivity for Measurement Errors (Overflow or Underflow)	224
5.9.4	Setting the Delay Time from the Output of Comparator Judgment Results until Output of $\overline{EOM}$ (LOW) and Resetting Judgment Results	226
5.9.5	Enabling Trigger Input for during Measurement and Setting the Valid Edge of Trigger Input	228
5.9.6	Setting the $\overline{EOM}$ Output Method	229
5.9.7	Disabling Key Operation (Key-lock Function)	230
5.9.8	Setting the LCD to ON/ OFF	233
5.9.9	Setting Operation Sounds (Beep Sounds)	234
5.9.10	Applying the Signal to the Sample Only during Measurement (Trigger Synchronous Output Function)	235
5.9.11	Initializing (System Reset)	237
5.10	Equivalent Circuit Analysis Function	238
5.10.1	About the Equivalent Circuit Analysis Function	238
5.10.2	Configuring Basic Settings for Analysis	239
	■ Setting the equivalent circuit model	239
	■ Setting the method of analysis	241
	■ Setting the frequency range to analyze	243
	■ Selecting the segment to analyze	245
	■ Configuring calculation of the electromechanical coupling coefficient (K)	247
	■ Setting the position at which to display analysis results	250
5.10.3	Performing Equivalent Circuit Analysis	252
	■ Performing frequency sweep measurement	252
	■ Performing equivalent circuit analysis	253
5.10.4	Simulating Frequency Characteristics	258
5.10.5	Judging analysis results	260
	■ Setting the Upper or Lower Limit Value	260
	■ Making judgments using analysis results	262
5.10.6	Generating X-Y Displays	263
	■ Creating an X-Y display	263

---

## Chapter 6 Continuous Measurement Function 265

6.1	Initial Screen	265
6.2	Setting Continuous Measurement	266
6.3	Performing Continuous Measurement	267
6.4	Checking the Continuous Measurement Results	268
6.5	Setting Application Settings	269
6.5.1	Setting the Display Timing	269
6.5.2	Setting the Trigger	270
6.5.3	Halting Continuous Measurement at a FAIL judgment result	271
6.5.4	Setting the LCD to ON/ OFF	272

---

## Chapter 7 Error Compensation 273

7.1	Setting Open Circuit Compensation	273
7.1.1	All Compensation	274
7.1.2	Spot Compensation	277
7.2	Short Circuit Compensation	280
7.2.1	All Compensation	282
7.2.2	Spot Compensation	285
7.3	Compensating Values to Match Reference Values (Load Compensation)	288
7.4	Compensating Measurement Cable Errors (Cable Length Compensation)	301
7.5	Calculating Values Scaling	302

---

## Chapter 8 Setting the SYSTEM 305

8.1	Setting the Interface	305
8.2	Checking the Version of the Instrument	306
8.3	Self Checks (Self Diagnosis)	307
8.4	Setting the Date and Time	314

---

---



---

## Chapter 9 Saving and Loading Panel Information 315

- 9.1 Saving Measurement Conditions (Panel Save Function) .....317
- 9.2 Loading Measurement Conditions (Panel Load Function) .....322
- 9.3 Changing a Panel Name .....324
- 9.4 Deleting a Panel .....326

---

## Chapter 10 Using USB Flash Drive 329

- 10.1 Inserting and Removing USB flash drive .....330
- 10.2 About the File Operation Screen .....331
- 10.3 About the File Save Setting Screen .332
- 10.4 Saving Measurement Data .....333
  - Saving Measurement Data ..... 333
  - Saving a Copy of the Screen ..... 341
  - Checking the Contents of Files ..... 343
  - Changing the Save Folder ..... 344
- 10.5 Loading Measurement Data .....346
- 10.6 Saving Instrument Settings .....349
  - Saving Instrument Settings ..... 349
  - Saving All Settings of Instrument (ALL SAVE Function) ..... 351
- 10.7 Reading Setting Conditions .....353
  - Loading instrument settings ..... 353
  - Loading all settings saved on a USB flash drive (ALL LOAD Function) ..... 355
- 10.8 File and Folder Operations .....357
  - Formatting a USB Flash Drive ..... 357
  - Deleting Files and Folders ..... 359
  - Creating Folders ..... 360
  - Displaying the USB Flash Drive Information ..... 362

---

## Chapter 11 External Control 363

- 11.1 External Input/Output Connector and Signals 363
  - Connector Type and Signal Pinouts ..... 364
  - Signal Descriptions ..... 367
- 11.2 Timing Chart .....369

- 11.2.1 LCR Measurement ..... 369
- 11.2.2 Analyzer Measurement ..... 372
- 11.2.3 Continuous Measurement (Sequential Operation) ..... 373
- 11.2.4 Continuous Measurement (Step Operation) ..... 375
- 11.3 Internal Circuitry ..... 376
  - Electrical Specifications ..... 377
  - Connection Examples ..... 378
- 11.4 External I/O Settings ..... 379
  - Setting Delay Time from Output of Comparator and BIN Judgment Results until Output of EOM (LOW) ..... 379
  - Setting Reset of Judgment Results ..... 379
  - Enabling Trigger Input for during Measurement ..... 379
  - Setting Valid Edge of Trigger Input ..... 379
- 11.5 External Control Q&A ..... 380
- 11.6 Measurement Using a Computer ..... 380

---

## Chapter 12 Printing 381

- 12.1 Connecting the Printer ..... 381
  - Connecting the Printer to the Instrument 382
- 12.2 Instrument and Printer Settings ..... 383
  - Make Instrument Settings ..... 383
- 12.3 Printing ..... 384

---

## Chapter 13 Specifications 387

- 13.1 General Specifications ..... 387
- 13.2 Measurement Range and Accuracy 395
- 13.3 About Measurement Times and Measurement Speed ..... 399

---

## Chapter 14 Maintenance and Service 403

- 14.1 Inspection, Repair and Cleaning ..... 403
  - 14.2 Troubleshooting ..... 405
  - 14.3 Error display ..... 407
  - 14.4 Discarding the Instrument ..... 409
-

---

**Appendix** **A 1**

Appendix 1 Measurement Parameters and Arithmetic Expressions .....	A 1
Appendix 2 Measurement of High Impedance Components .....	A 3
Appendix 3 Measurement of In-circuit Components .....	A 4
Appendix 4 Countermeasures Against Incorporation of External Noise	A 5
Appendix 5 Supplying DC Bias .....	A 7
Appendix 6 The Residual Charge Protection Function .....	A 10
Appendix 7 Series Equivalent Circuit Mode and Parallel Equivalent Circuit Mode .....	A 11
Appendix 8 Selecting the Equivalent Circuit Model .....	A 12
Appendix 9 Open Circuit Compensation and Short Circuit Compensation....	A 13
Appendix 10 Rack Mounting .....	A 14
Appendix 11 Dimensional Diagram .....	A 16
Appendix 12 Initial Settings Table .....	A 17
Appendix 13 Device Compliance Statement .....	A 23

---

**Index** **Index 1**

---





## Introduction

Thank you for purchasing the HIOKI Model IM3570 Impedance Analyzer. To obtain maximum performance from the instrument, please read this manual first, and keep it handy for future reference.

In this document, the "instrument" means the Model IM3570 Impedance Analyzer.

## Verifying Package Contents

### Inspection

When you receive the instrument, inspect it carefully to ensure that no damage occurred during shipping. In particular, check the accessories, panel switches, and connectors. If damage is evident, or if it fails to operate according to the specifications, contact your dealer or Hioki representative.

### Content confirmation

#### Confirm that these contents are provided.

IM3570 Impedance Analyzer ..... 1



Instruction Manual (This document) ..... 1



Communication Instruction Manual (CD) ..... 1

Power Cord (2-line + ground) ..... 1

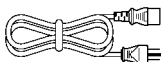

The latest version can be downloaded from our web site.

**NOTE** Probes, fixture are not supplied with the unit as standard equipment. You should order them separately, according to requirements.

### Transporting the instrument

Use the original packing materials when transporting the instrument, if possible.

See "Transporting the instrument" (p. 404)

## Safety Information

**⚠ WARNING** This instrument is designed to comply with IEC 61010 Safety Standards, and has been thoroughly tested for safety prior to shipment. However, mishandling during use could result in injury or death, as well as damage to the instrument. However, using the instrument in a way not described in this manual may negate the provided safety features.

Be certain that you understand the instructions and precautions in the manual before use. We disclaim any responsibility for accidents or injuries not resulting directly from instrument defects.

This manual contains information and warnings essential for safe operation of the instrument and for maintaining it in safe operating condition. Before using it, be sure to carefully read the following safety precautions.

### Safety Symbols



In the manual, the symbol indicates particularly important information that the user should read before using the product.

The symbol printed on the product indicates that the user should refer to a corresponding topic in the manual (marked with the symbol) before using the relevant function.



Indicates AC (Alternating Current).



Indicates a grounding terminal.



Indicates the ON side of the power switch.



Indicates the OFF side of the power switch.

The following symbols in this manual indicate the relative importance of cautions and warnings.



Indicates that incorrect operation presents a significant hazard that could result in serious injury or death to the user.



Indicates that incorrect operation presents a significant hazard that could result in serious injury or death to the user.



Indicates that incorrect operation presents a possibility of injury to the user or damage to the product.



Advisory items related to performance or correct operation of the product.

### Symbols for Various Standards



Indicates the Waste Electrical and Electronic Equipment Directive (WEEE Directive) in EU member states.



This symbol indicates that the product conforms to regulations set out by the EC Directive.

## Notation

### Marks for individual functions

<b>LCR</b>	Indicates the function is enabled in LCR mode.
<b>ANALYZER</b>	Indicates the function is enabled in ANALYZER mode.
<b>CONTINUOUS</b>	Indicates the function is enabled in CONTINUOUS mode.

### Symbols in this manual

	Indicates the prohibited action.
(p. )	Indicates the location of reference information.
*	Indicates that descriptive information is provided below.
[ ]	Menus, commands, dialogs, buttons in a dialog, and other names on the screen and the keys are indicated in brackets.
<b>CURSOR</b> (Bold character)	Bold characters within the text indicate operating key labels.
<b>Windows</b>	Unless otherwise specified, "Windows" represents Windows 95, 98, Me, Widows NT4.0, Windows 2000, Windows XP, Windows Vista or Windows 7.
<b>Dialogue</b>	Dialogue box represents a Windows dialog box.

### Accuracy

We define measurement tolerances in terms of f.s. (full scale), rdg. (reading) and dgt. (digit) values, with the following meanings:

<b>f.s.</b> (maximum display value or scale length)	The maximum displayable value or scale length. This is usually the name of the currently selected range.
<b>rdg.</b> (reading or displayed value)	The value currently being measured and indicated on the measuring instrument.
<b>dgt.</b> (resolution)	The smallest displayable unit on a digital measuring instrument, i.e., the input value that causes the digital display to show a "1" as the least-significant digit.

## Measurement categories

To ensure safe operation of measurement instruments, IEC 61010 establishes safety standards for various electrical environments, categorized as CAT II to CAT IV, and called measurement categories.

<b>CAT II</b>	Primary electrical circuits in equipment connected to an AC electrical outlet by a power cord (portable tools, household appliances, etc.) CAT II covers directly measuring electrical outlet receptacles.
<b>CAT III</b>	Primary electrical circuits of heavy equipment (fixed installations) connected directly to the distribution panel, and feeders from the distribution panel to outlets.
<b>CAT IV</b>	The circuit from the service drop to the service entrance, and to the power meter and primary overcurrent protection device (distribution panel).

Using a measurement instrument in an environment designated with a higher-numbered category than that for which the instrument is rated could result in a severe accident, and must be carefully avoided.

Use of a measurement instrument that is not CAT-rated in CAT II to CAT IV measurement applications could result in a severe accident, and must be carefully avoided.

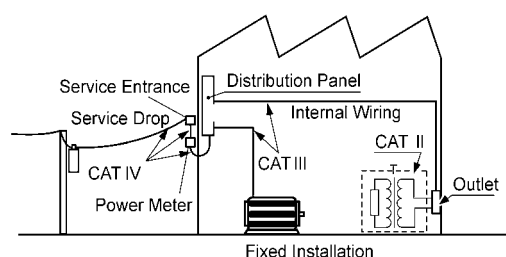

# Operating Precautions



Follow these precautions to ensure safe operation and to obtain the full benefits of the various functions.

## Preliminary Checks

Before using the instrument the first time, verify that it operates normally to ensure that no damage occurred during storage or shipping. If you find any damage, contact your dealer or Hioki representative.



**Before using the instrument, make sure that the insulation on the voltage cords is undamaged and that no bare conductors are improperly exposed. Using the instrument in such conditions could cause an electric shock, so contact your dealer or Hioki representative for replacements.**

## Instrument Installation

Operating temperature and humidity to RH or less, Indoors only non-condensating

Storing temperature and humidity to RH or less, Indoors only

Temperature and humidity range for guaranteed accuracy, RH or less

**Avoid the following locations that could cause an accident or damage to the instrument.**



Exposed to direct sunlight  
Exposed to high temperature



In the presence of corrosive or explosive gases



Exposed to water, oil, other chemicals, or solvents  
Exposed to high humidity or condensation



Exposed to strong electromagnetic fields  
Near electromagnetic radiators



Exposed to high levels of particulate dust



Near induction heating systems (e.g., high-frequency induction heating systems and IH cooking utensils)



Subject to vibration

- The instrument should be operated only with the bottom or rear side downwards.
- The instrument must not be placed on an unstable table or tilted surface.
- Vents must not be obstructed.

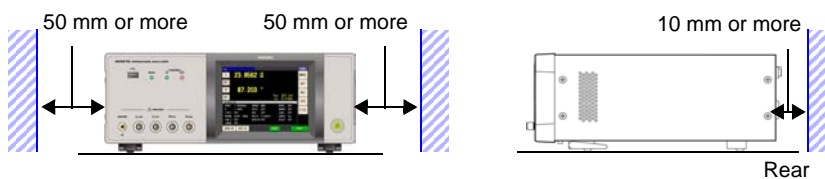

The instrument can be used with the stand. (p. 11)

It can also be rack-mounted. (p.A14)

## Shipping precautions

Hioki disclaims responsibility for any direct or indirect damages that may occur when this instrument has been combined with other devices by a systems integrator prior to sale, or when it is resold.

## Handling the Instrument

### **DANGER**

- To avoid electric shock, do not remove the instrument's case. The internal components of the instrument carry high voltages and may become very hot during operation.
- Do not allow the instrument to get wet, and do not take measurements with wet hands. This may cause an electric shock.

### **CAUTION**

- If the instrument exhibits abnormal operation or display during use, review the information in "Inspection, Repair and Cleaning" (p. 403) and "Error display" (p. 407) before contacting your dealer or Hioki representative.
- Do not connect charged capacitors to measurement terminals or input voltages or currents from an external source. Doing so may damage the instrument.
- This instrument is not designed to be entirely water- or dust-proof. Do not use it in an especially dusty environment, nor where it might be splashed with liquid. This may cause damage.
- To avoid damage to the instrument, protect it from physical shock when transporting and handling. Be especially careful to avoid physical shock from dropping.
- To move the instrument, first disconnect all cables, remove any CF card and USB memory, and carry it by the handle.
- Do not apply heavy downward pressure with the stand extended. The stand could be damaged.
- Do not use excessive force on the touch panel, and do not use sharp objects that could damage the touch screen.
- After use, always turn OFF the power.

### **NOTE**

This instrument may cause interference if used in residential areas. Such use must be avoided unless the user takes special measures to reduce electromagnetic emissions to prevent interference to the reception of radio and television broadcasts.

## Before Turning Power On

### **WARNING**

- Before turning the instrument on, make sure the supply voltage matches that indicated on its power connector. Connection to an improper supply voltage may damage the instrument and present an electrical hazard.
- Be careful to avoid connecting voltage improperly, as the internal circuitry may be destroyed.
- To avoid electrical accidents and to maintain the safety specifications of this instrument, connect the power cord provided only to a 3-contact (two-conductor + ground) outlet.
- To avoid shock and short circuits, turn off the power to lines to be measured before making connections to terminals to be measured and turning on the instrument.

**About Handling of Cords and Fixtures****! CAUTION**

- For safety reasons, disconnect the power cord when the instrument is not used. To avoid damaging the power cord, grasp the plug, not the cord, when unplugging it from the power outlet.
- Do not apply a voltage to the measurement terminals. Doing so may damage the instrument.
- When disconnecting the BNC connector, be sure to release the lock before pulling off the connector. Forcibly pulling the connector without releasing the lock, or pulling on the cable, can damage the connector.
- To avoid breaking the cables or probes, do not bend or pull them.
- Avoid stepping on or pinching cables, which could damage the cable insulation.
- Keep the cables well away from heat sources, as bare conductors could be exposed if the insulation melts. Keep in mind that, in some cases, conductors to be measured may be hot.

**NOTE**

- Use only the specified connection cables. Using a non-specified cable may result in incorrect measurements due to poor connection or other reasons.
- Before using a fixture or the like, read the instruction manual supplied with the product to be used.

**Before Connecting EXT I/O****! WARNING**

To avoid electric shock or damage to the equipment, always observe the following precautions when connecting to the EXT I/O connector.

- Always turn off the power to the instrument and to any devices to be connected before making connections.
- Be careful to avoid exceeding the ratings of external terminals.(p. 377)
- During operation, a wire becoming dislocated and contacting another conductive object can be serious hazard. Make sure that connections are secure and use screws to secure the external connectors.
- Properly insulate any devices and mechanisms to be connected to the EXT I/O connector.
- The ISO\_5V pin of the EXT I/O connector is a 5V power output. Do not apply external power to this pin.

## Handling the CD

### **CAUTION**

- Always hold the disc by the edges, so as not to make fingerprints on the disc or scratch the printing.
- Never touch the recorded side of the disc. Do not place the disc directly on anything hard.
- Do not wet the disc with volatile alcohol or water, as there is a possibility of the label printing disappearing.
- To write on the disc label surface, use a spirit-based felt pen. Do not use a ball-point pen or hard-tipped pen, because there is a danger of scratching the surface and corrupting the data. Do not use adhesive labels.
- Do not expose the disc directly to the sun's rays, or keep it in conditions of high temperature or humidity, as there is a danger of warping, with consequent loss of data.
- To remove dirt, dust, or fingerprints from the disc, wipe with a dry cloth, or use a CD cleaner. Always wipe from the inside to the outside, and do not wipe with circular movements. Never use abrasives or solvent cleaners.
- Hioki shall not be held liable for any problems with a computer system that arises from the use of this CD, or for any problem related to the purchase of a Hioki product.

# 8

## Operating Precautions

---

---



# Overview

# Chapter 1

## 1.1 Product Overview Features

The HIOKI IM3570 impedance analyzer is an impedance measuring instrument which achieves high speed and high accuracy.

It has two functions: an impedance analyzer capable of the sweep measurement of frequencies and measurement signals, and an LCR meter capable of simultaneously displaying up to four items under individual measurement conditions.

This instrument can be used for a wide range of applications because you can set a wide range of measurement conditions - a measurement frequencies from 4 Hz to 5 MHz and a measurement signal levels from 5 mV to 5 V.

### Wide range of measurement conditions (p. 41)

Capable of measurement under a wide range of measurement conditions: measurement frequencies from 4 Hz to 5 MHz and measurement signal levels from 5 mV to 5 V.

### Capable of high-speed measurement

High-speed measurement is possible. Measurement can be performed at a maximum speed of 0.5 ms (when 100 kHz, FAST, and display OFF).

### Various interfaces supported

Supports the most suitable external I/O (handler interface) for production lines, RS-232C, GP-IB, USB, and LAN.



### Sweep measurement (p. 131)

Measures frequency characteristics and level characteristics, and displays a graph on the color LCD of the instrument.

### Comparator function

LCR function: (p. 86)  
Capable of making HI/IN/LO pass/fail judgments based on the measurement values for two parameters.  
ANALYZER function: (p. 197)  
A pass/fail judgment can be made for sweep measurement results.

### BIN function (p. 93)

With LCR mode, easily ranks measurement items into up to 10 classifications based on the measurement values.

### Continuous measurement function (p. 265)

Capable of consecutive measurements using measurement conditions stored in the memory of the instrument. This function enables, for example, making pass/fail judgment with different measurement conditions.  
(Example: Performing C-D measurement with 120 Hz and Rs measurement with 100 kHz in succession)

### Low impedance can be measured with high degree of accuracy

LCR meter mode includes a setting for measuring low impedance with a high degree of accuracy. When this setting is selected, the influence of contact resistance is reduced and a disconnection (incorrect connection of a probe) can be detected during 4-terminal measurement.

# 1.2 Names and Functions of Parts

### Front

**Measurement LEDs**  
Lights during measurement.

**Judgment Result Indication LEDs**  
Indicates the judgment results for comparator and BIN measurement.  
LCR mode (p. 86)  
ANALYZER mode (p. 131)

**LCD Display**  
This is a touch panel display.  
Press the keys displayed on the screen to operate the instrument.

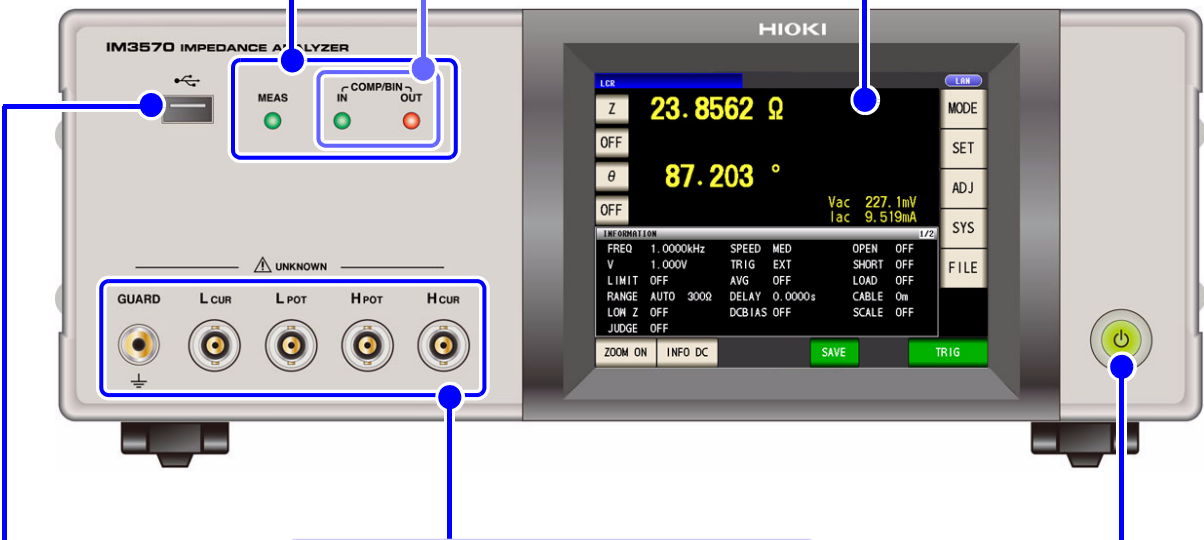

**Front USB connector**  
Connect a USB flash drive storage device. (p. 330)

**Measurement Terminals**  
Connect measurement cables or a fixture. (p. 30)

- H<sub>CUR</sub> jack: Current source terminal
- H<sub>POT</sub> jack: Detected voltage high terminal
- L<sub>POT</sub> jack: Detected voltage low terminal
- L<sub>CUR</sub> jack: Measurement current detected terminal
- GUARD jack: Shield (measurement ground) terminal

**Power Switch**  
Turns the power on and off. (p. 31)  
(The main power switch is located at the rear.)

### Bottom Panel

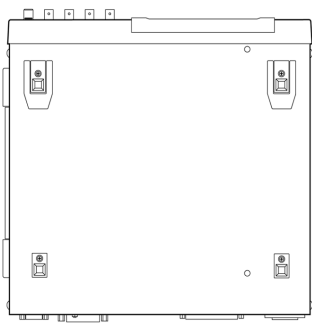

This instrument can be rack mounted.  
See "Appendix 10 Rack Mounting"(p. A14)

Parts removed from this instrument should be stored in a safe place to enable future reuse.

**Rear**

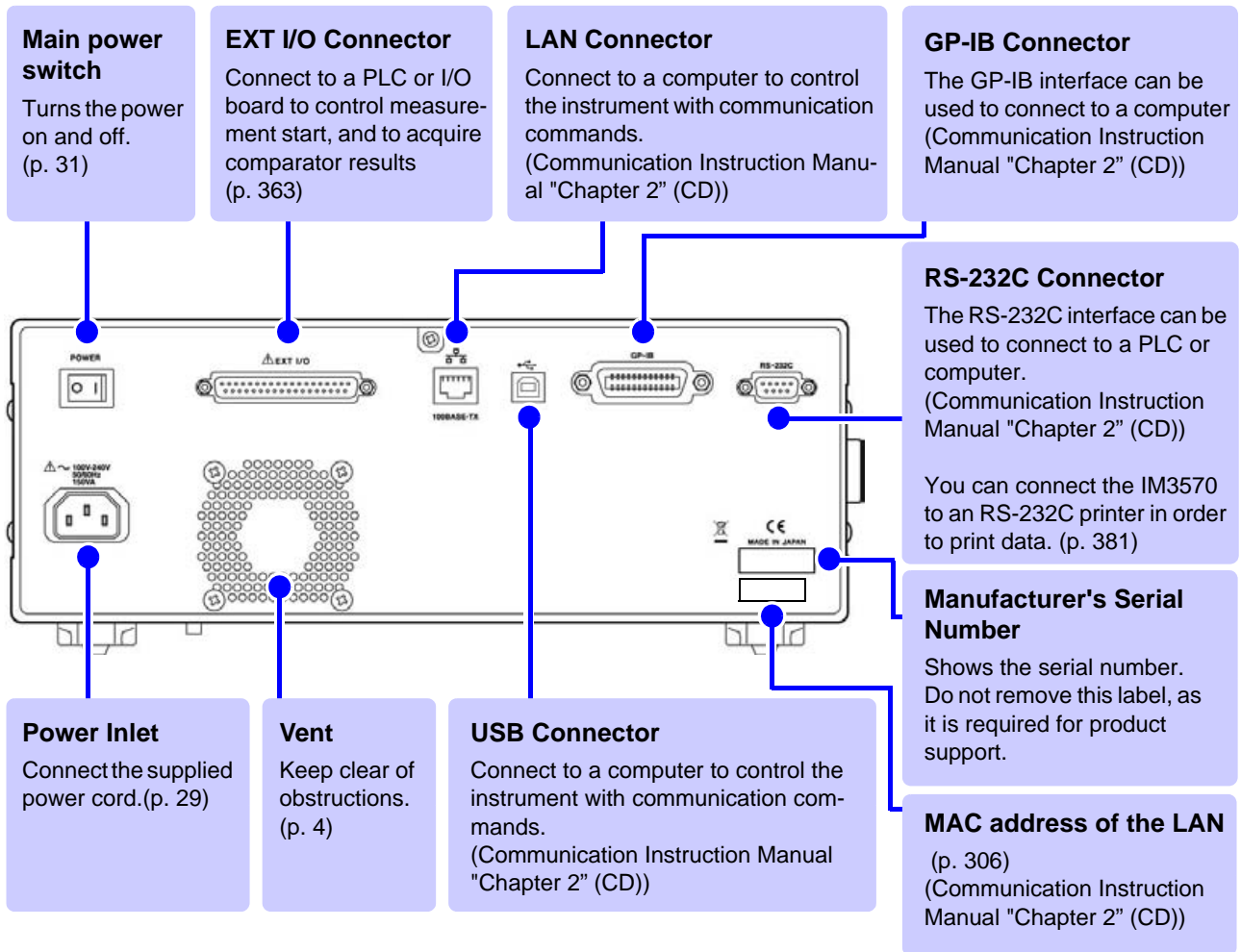

**Left side**

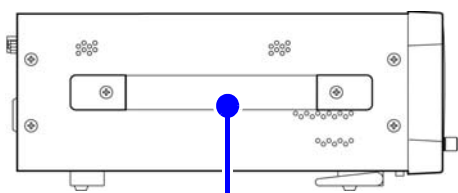

**Handle**  
Use to carry the instrument.

**Right side**

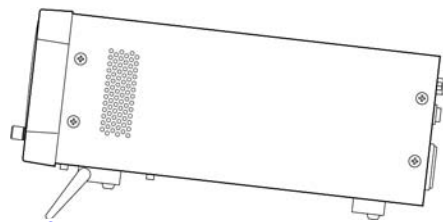

**Stand**  
Enables the instrument to be tilted.

**CAUTION**  
Do not apply heavy downward pressure with the stand extended. The stand could be damaged.

- **When using the stand**  
Extend the stand until it clicks into place. Make sure to extend both legs of the stand.
- **Collapsing the stand**  
Fold in the stand until it clicks into place.

# 1.3 Screen Configuration and Operation

This instrument allows you to use a touch panel to set and change all measurement conditions. Gently touch a key on the screen to select the item or numerical value set for that key. A selected key turns black.

In this manual, to gently touch the screen is referred to as "press."

**CAUTION** Do not use excessive force on the touch panel, and do not use sharp objects that could damage the touch screen.

## 1.3.1 Initial Screen

This is the screen that is first displayed when the power is turned on. It allows you to perform measurement while checking all of the measurement conditions. When the power is turned on again, display is in accordance with the measurement mode used immediately before the power was turned off.

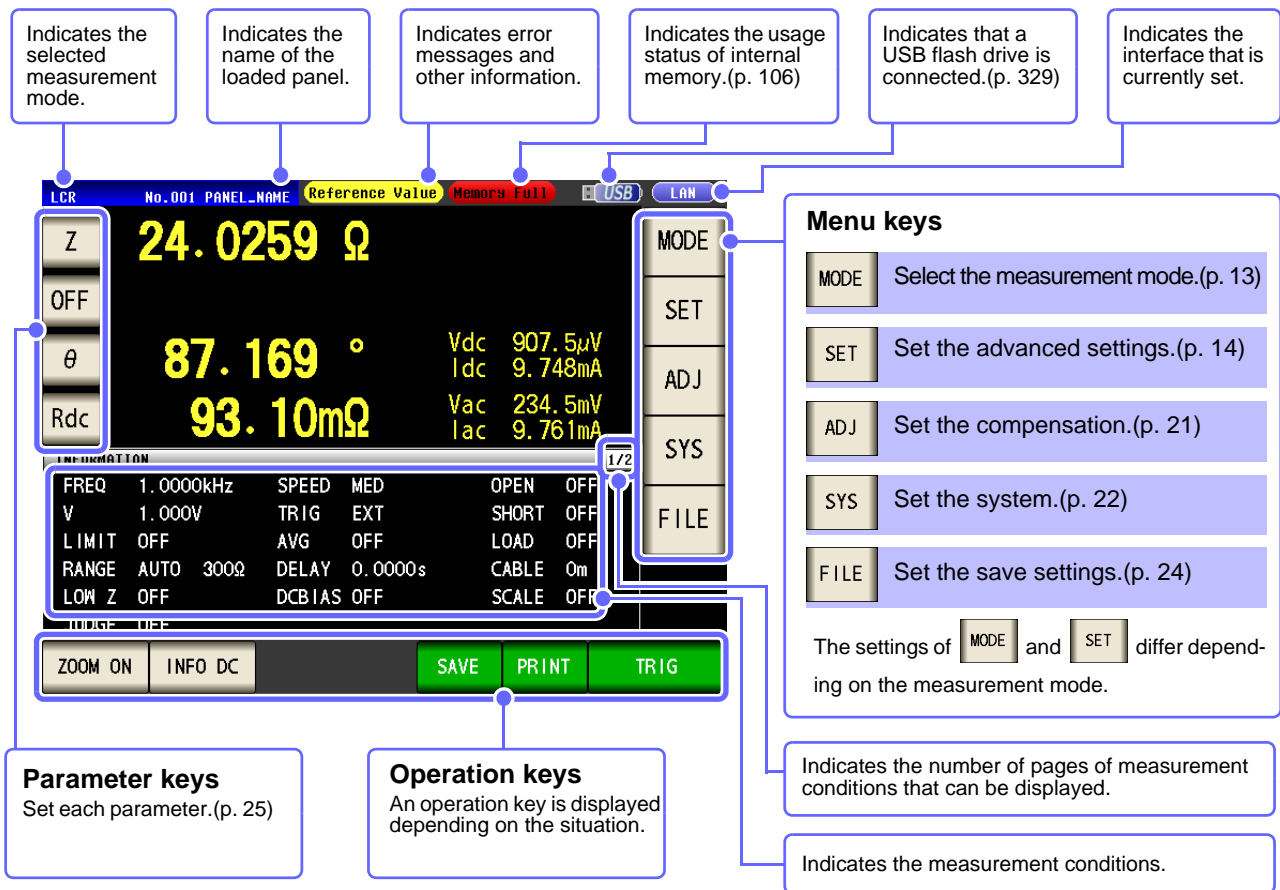

**NOTE** When a measurement value is outside the guaranteed accuracy range, "Reference Value" is displayed in the error display area. When this happens, the cause is likely to be one of the following. Check the guaranteed accuracy range in "13.2 Measurement Range and Accuracy" (p. 395) and change the measurement conditions or you should consider the measured values as values for reference.

- Perhaps the test signal level is too low, increase the test signal level.
- If the current measurement range (during HOLD setting) is not appropriate, set again in the AUTO range, or change the range by manual.

See "4.2.3 Setting the Measurement Range" (p. 49)

### 1.3.2 Measurement Mode Selection Screen

Select the measurement mode.

#### Procedure

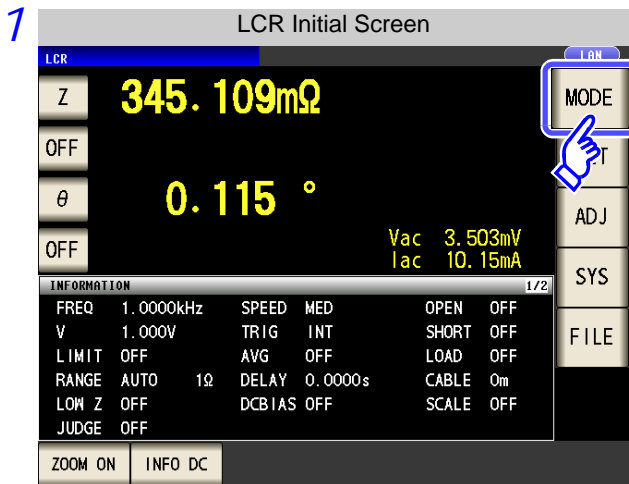

Press .

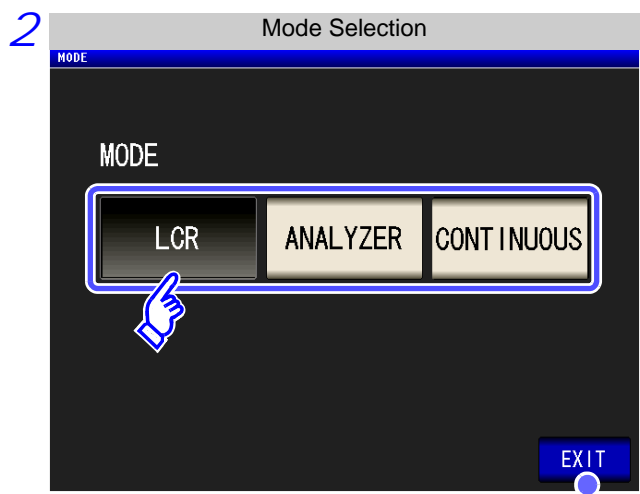

Select the measurement mode. Select

- LCR measurement (p. 37)
- ANALYZER measurement (p. 131)
- CONTINUOUS measurement (p. 265)

Initial screen is displayed.

### 1.3.3 Advanced Settings Screen

This screen is for configuring the measurement conditions you want to change and other advanced settings. Select the measurement mode (p. 13) before configuring the advanced settings.

#### Procedure

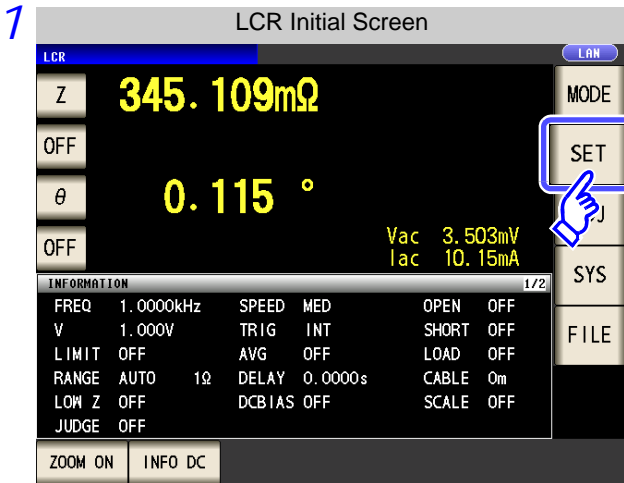

Press **SET** .

2 LC on figure the settings of each of the LCR mode, analyzer mode, and continuous measurement mode.

### LCR Mode

#### Basic setting

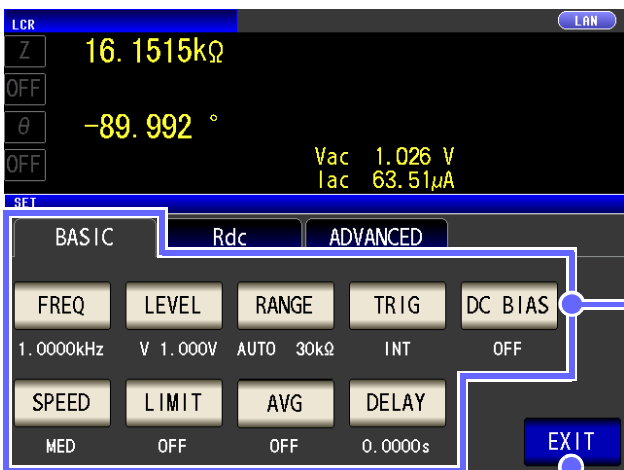

Initial screen is displayed.

- FREQ** Measurement frequency setting (p. 41)
- LEVEL** Measurement signal level setting (p. 43)
- RANGE** Measurement range setting (p. 49)
- TRIG** Trigger setting (p. 55)
- DC BIAS** DC bias setting (p. 57)
- SPEED** Measurement speed setting (p. 59)
- LIMIT** Voltage and current limit settings (p. 60)
- AVG** Average setting (p. 62)
- DELAY** Trigger delay setting (p. 64)

DC resistance measurement setting



Initial screen is displayed.

- LEVEL** Measurement signal level setting (p. 66)
- RANGE** Measurement range setting (p. 69)
- DC ADJ** DC adjustment setting (p. 75)
- SPEED** Measurement speed setting (p. 77)
- LIMIT** Voltage and current limit settings (p. 78)
- AVG** Average setting (p. 80)
- DC DELAY** DC delay setting (p. 82)

Application settings



Initial screen is displayed.

- PANEL** Panel loading and saving (p. 315)
- RESET** System reset (p. 129)

- JUDGE** Measurement result judgment setting (p. 84)
- SYNC** Trigger synchronous output function (p. 104)
- MEMORY** Save settings of measurement results (p. 106)
- LEVOVER** Set detection sensitivity for measurement errors (p. 113)
- IO SET** IO setting (p. 115), (p. 117)
- Hi Z** HIGH-Z reject function setting (p. 108)
- LEVCHK** Detection level monitoring function setting (p. 110)
- DIGIT** Number of display digits setting for each parameter (p. 124)
- DISP** LCD setting (p. 127)
- BEEP** Beep sound setting (p. 128)
- KEYLOCK** Key-lock setting (p. 121)

# 16

## 1.3 Screen Configuration and Operation

### Checking the setting information

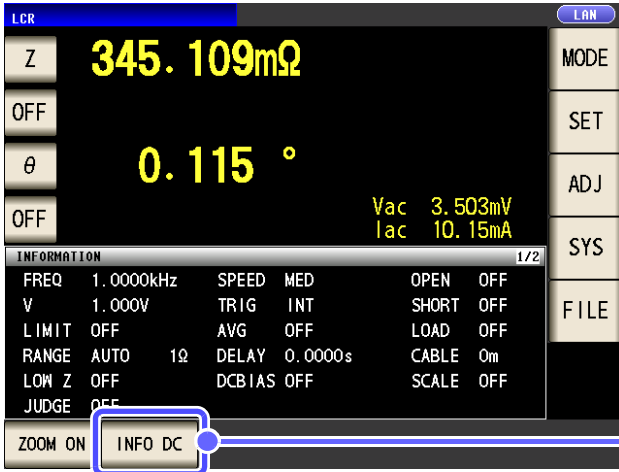

You can check the settings on the measurement screen.

**INFO AC** Displays information regarding the AC signal.

**INFO DC** Displays information regarding the DC signal.



ANALYZER Mode

Basic setting

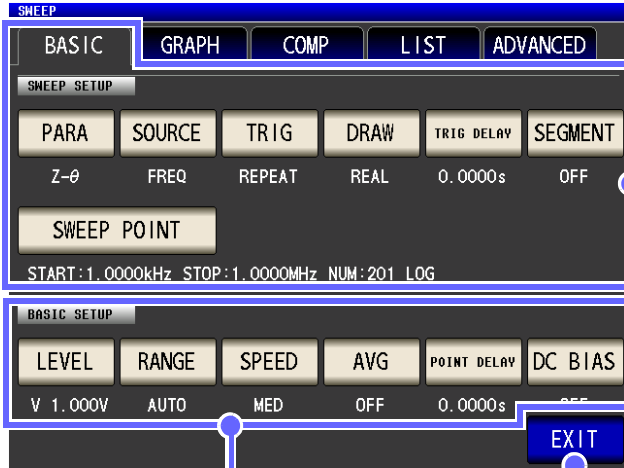

Initial screen is displayed.

- PARA** Measurement parameter setting (p. 133)
- SOURCE** Sweep parameter setting (p. 135)
- TRIG** Trigger setting (p. 137)
- DRAW** Display timing setting (p. 139)
- TRIG DELAY** Trigger delay setting (p. 140)
- SEGMENT** Segment setting (p. 142)
- SWEEP POINT** Sweep point setting (p. 143)

- LEVEL** Measurement signal level setting (p. 157)
- RANGE** Measurement range setting (p. 160)
- SPEED** Measurement speed setting (p. 164)
- AVG** Average setting (p. 165)
- POINT DELAY** Point delay setting (p. 166)
- DC BIAS** DC bias setting (p. 167)

## 1.3 Screen Configuration and Operation

### Graph setting

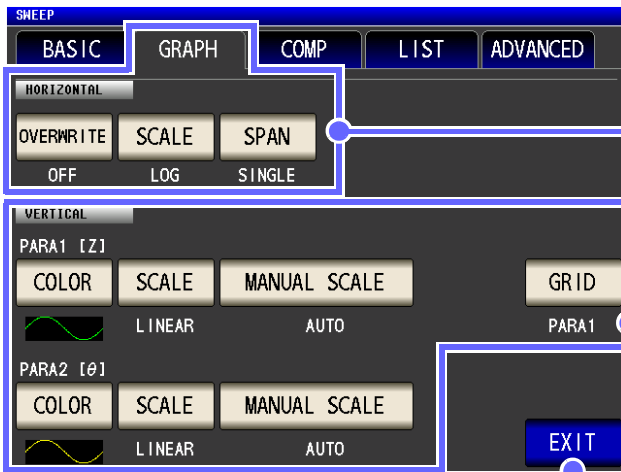

Initial screen is displayed.

- OVERWRITE** Overwrite setting (p. 176)
- SCALE** Horizontal axis scale setting (p. 177)
- SPAN** Span setting (p. 179)

- COLOR** Draw color setting (p. 181)
- SCALE** Vertical axis scale setting (p. 183)
- MANUAL SCALE** Manual scaling setting (p. 184)
- GRID** Grid display setting (p. 186)

### Comparator setting

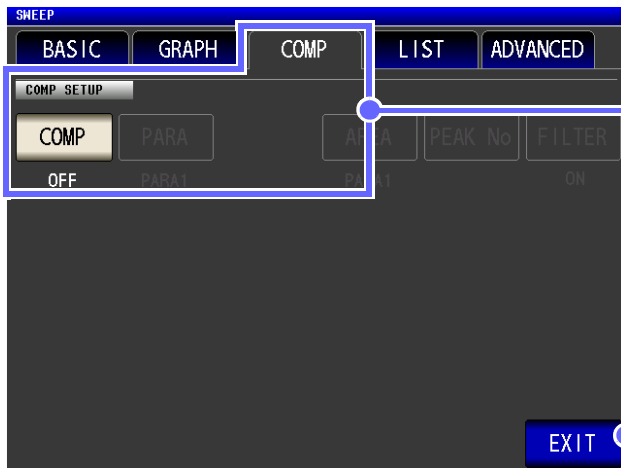

- COMP** Comparator setting (p. 197)

Initial screen is displayed.

List settings



**EDIT** Sweep point editing (p. 217)

**EXIT** Initial screen is displayed.

Application settings

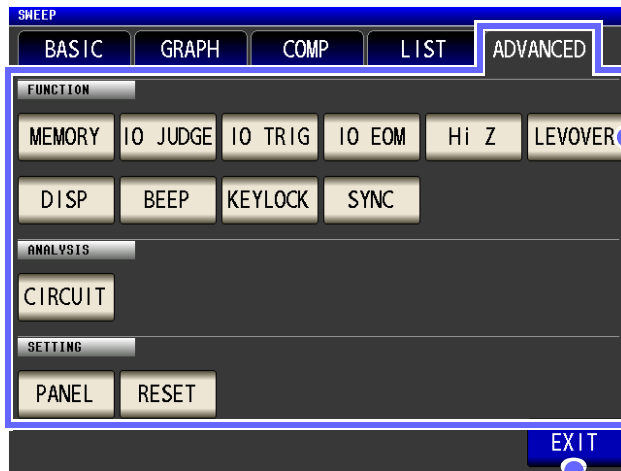

**EXIT** Initial screen is displayed.

- MEMORY** Memory function setting (p. 219)
- IO JUDGE** I/O output setting of judgment results (p. 226)
- IO TRIG** IO trigger setting (p. 228)
- IO EOM**  $\overline{\text{EOM}}$  output method setting (p. 229)
- Hi Z** HIGH-Z reject function setting (p. 222)
- LEVOVER** Set detection sensitivity for measurement errors (p. 224)
- DISP** LCD setting (p. 233)
- BEEP** Beep sound setting (p. 234)
- KEYLOCK** Key-lock setting (p. 230)
- SYNC** Trigger synchronous output function (p. 235)
- CIRCUIT** Equivalent circuit analysis (p. 238)  
\* This key is displayed only when the IM9000 Equivalent Circuit Analysis Firmware has been installed.
- PANEL** Panel loading and saving (p. 315)
- RESET** System reset (p. 237)

### Continuous Measurement Mode

#### Basic setting



Initial screen is displayed.

- OFF** Removes item from targets for continuous measurement(p. 266)
- ON** Sets item as target for continuous measurement(p. 266)
- ALL OFF** Removes all items from targets for continuous measurement(p. 266)
- ALL ON** Sets all items as targets for continuous measurement(p. 266)
- INFO** Displays panel information(p. 266)

#### Application settings

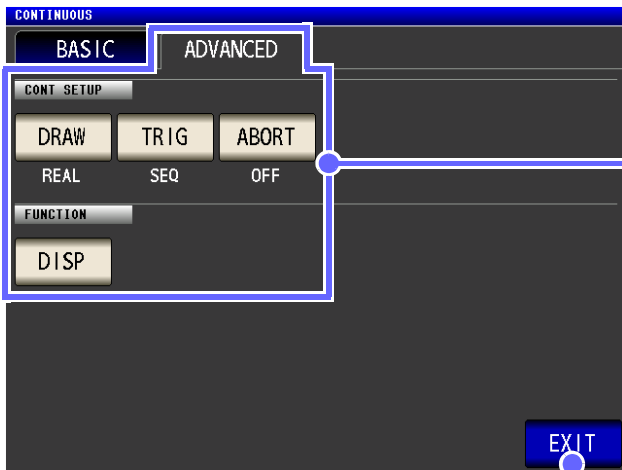

Initial screen is displayed.

- DRAW** Display timing setting (p. 269)
- TRIG** Trigger setting (p. 270)
- ABORT** Stops continuous measurement (p. 271)
- DISP** LCD setting (p. 272)

1.3.4 Compensation Settings Screen

Procedure

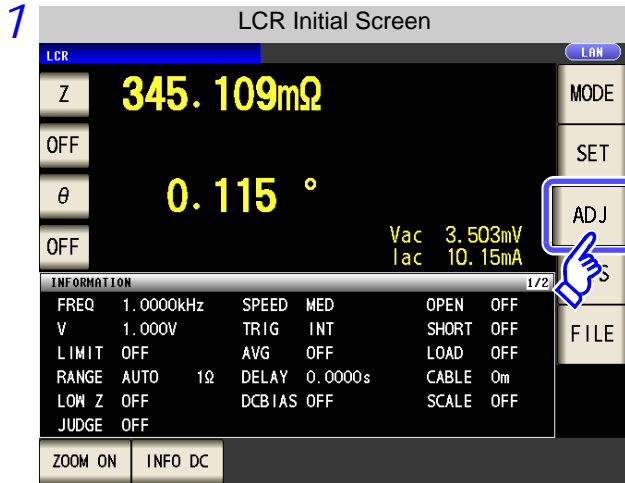

Press **ADJ** .

2 Set the compensation condition.

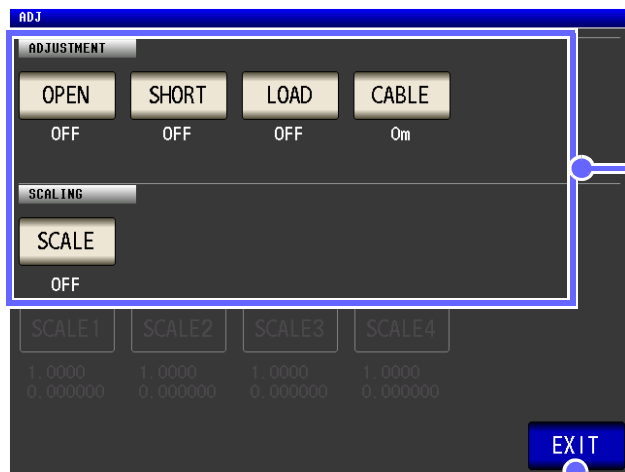

- OPEN** Open circuit compensation setting (p. 273)
- SHORT** Short circuit compensation setting (p. 280)
- LOAD** Load circuit compensation setting (p. 288)
- CABLE** Cable length compensation setting (p. 301)
- SCALE** Scaling setting (p. 302)

Initial screen is displayed.

# 1.3.5 System Settings Screen

## Procedure

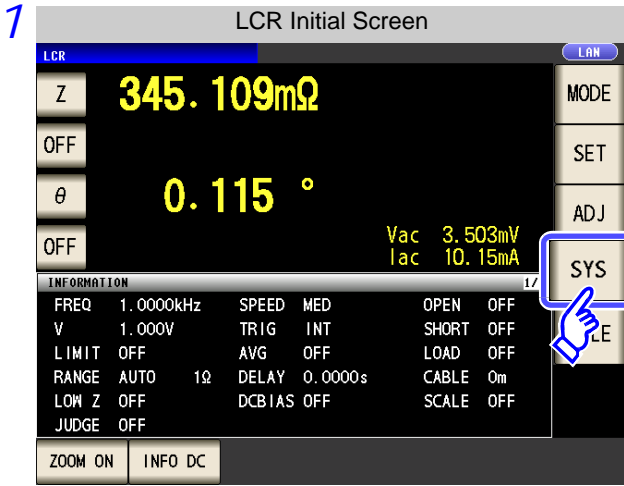

Press **SYS** .

2 To set the details of the system.

## Interface type settings

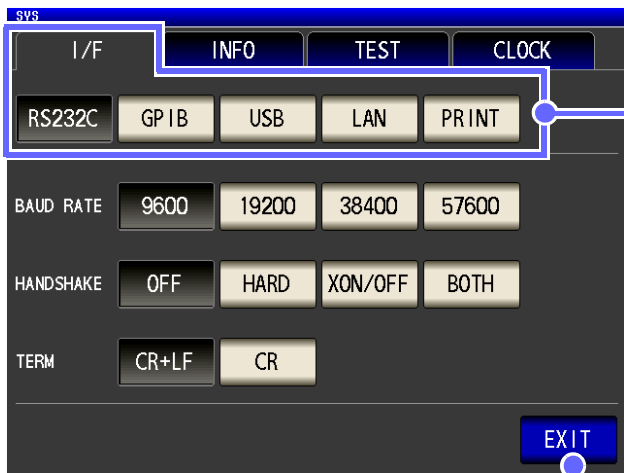

- RS232C** RS-232C Setting (Communication Instruction Manual (CD))
- GPIB** GP-IB Setting (Communication Instruction Manual (CD))
- USB** USB Setting (Communication Instruction Manual (CD))
- LAN** LAN Setting (Communication Instruction Manual (CD))
- PRINT** Printer Setting (p. 381)

Initial screen is displayed.

**Check the version of the instrument** (p. 306)

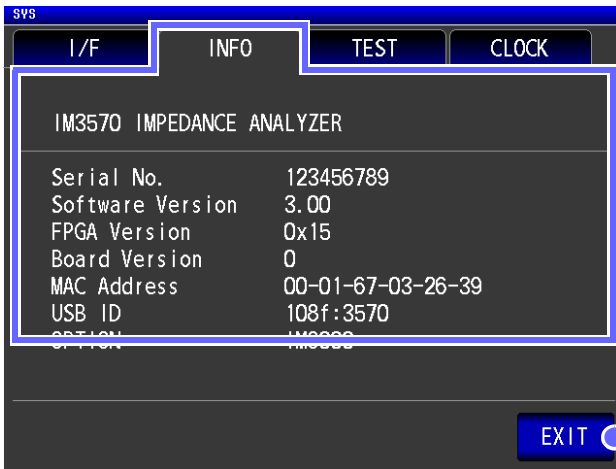

Initial screen is displayed.

**Checking the Display Screen**

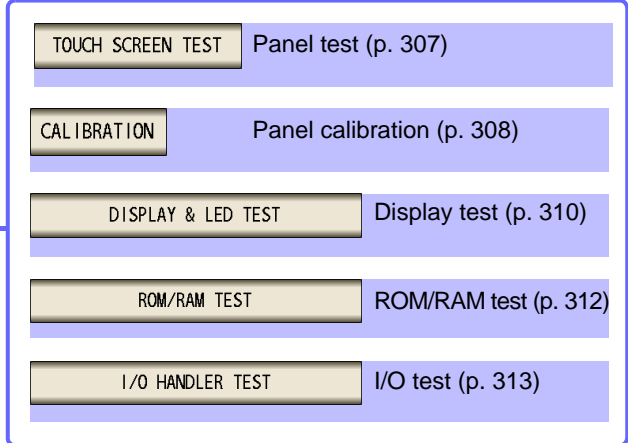
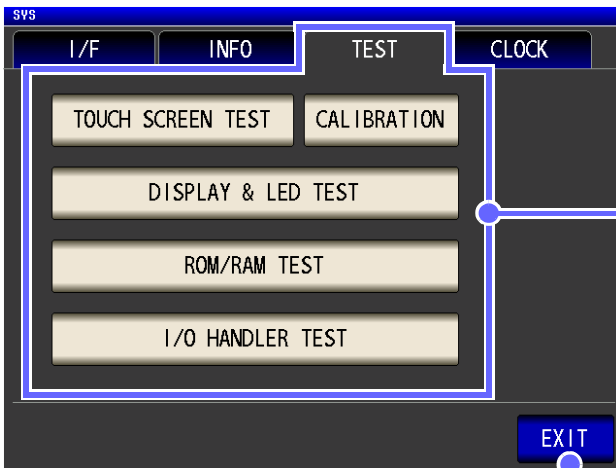

Initial screen is displayed.

**Setting the Date and Time** (p. 314)

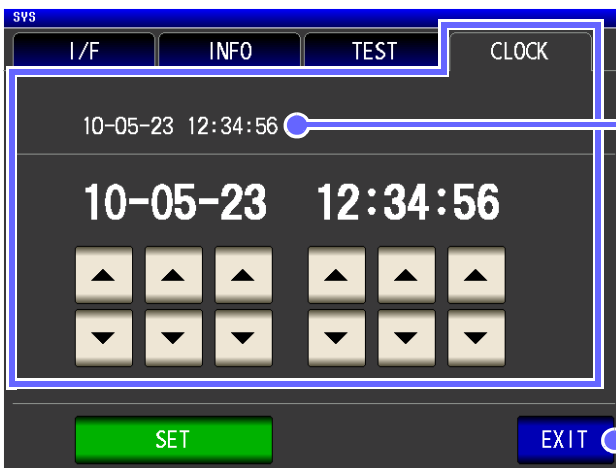

Indicates the current date and time set on the instrument.

Initial screen is displayed.

### 1.3.6 Save Settings Screen

#### Procedure

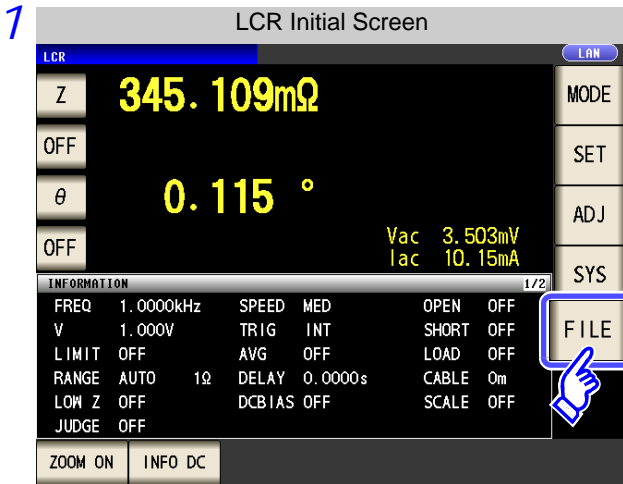

Press **FILE**.

2 Set the save destination and type.

#### Save method setting

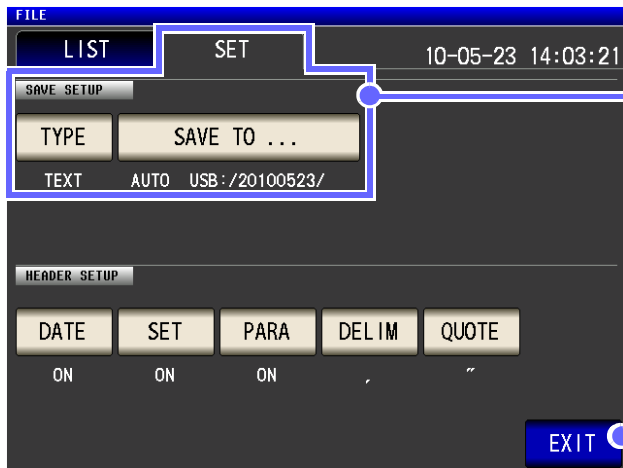

**TYPE** Save type setting (p. 333)

**SAVE TO ...** Save destination folder setting (p. 344)

**EXIT** Initial screen is displayed.

#### Save the measurement condition

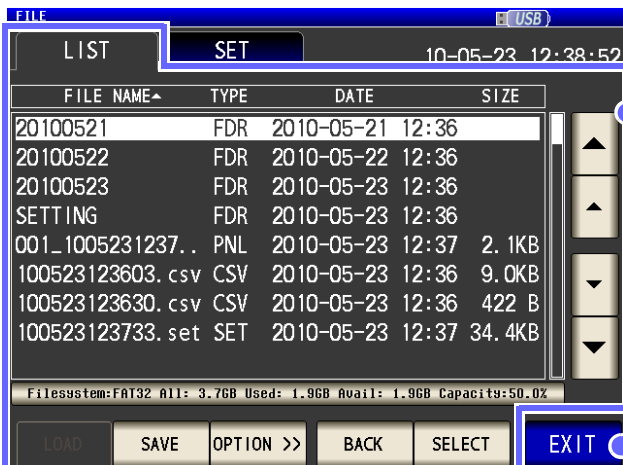

**SAVE** Saves the setting conditions (p. 349)

**OPTION >>** Switches the advanced settings screen (p. 331)

**BACK** Displays the screen immediately above (p. 331)

**SELECT** Selects a file (p. 331)

**EXIT** Initial screen is displayed.



## 1.3.7 Parameter Settings Screen

This screen is for selecting the measurement parameters to display.

See "4.1.2 Setting Display Parameters" (p. 39), "Appendix 7 Series Equivalent Circuit Mode and Parallel Equivalent Circuit Mode"(p. A11)

### Procedure

#### 1 Press the key to set.

- The first parameter key
- The second parameter key
- The third parameter key
- The fourth parameter key

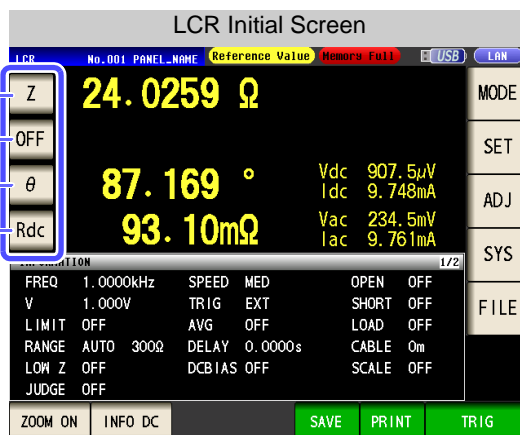

#### 2 Select parameters.

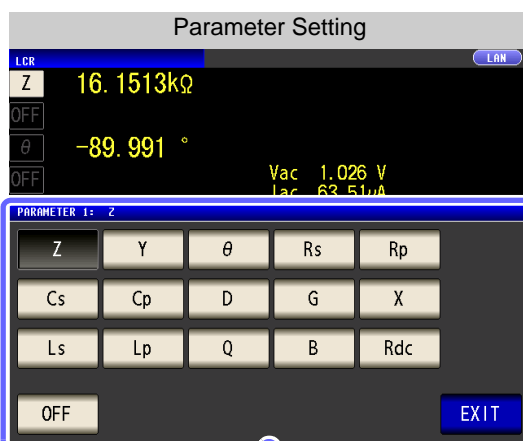

Z	Impedance ( $\Omega$ )	G	Conductance (S)
Y	Admittance (S)	X	Reactance ( $\Omega$ )
$\theta$	*Impedance phase angle ( $^{\circ}$ )	Ls	Inductance in series equivalent circuit mode (H)
Rs	Effective resistance in series equivalent circuit mode ESR = ( $\Omega$ )	Lp	Inductance in parallel equivalent circuit mode (H)
Rp	Effective resistance in parallel equivalent circuit mode ( $\Omega$ )	Q	Q factor
Cs	Static capacitance in series equivalent circuit mode (F)	B	Susceptance (S)
Cp	Static capacitance in parallel equivalent circuit mode (F)	Rdc	DC Resistance( $\Omega$ )
D	Loss coefficient = $\tan\delta$	OFF	Display no measurement parameter in the chosen position.

\* The phase angle  $\theta$  is shown based on the impedance Z. When measuring based on the admittance, the sign of the phase angle  $\theta$  must be reversed.



# Measurement Preparations

## Chapter 2

2

Chapter 2 Measurement Preparations

Be sure to read the "Follow these precautions to ensure safe operation and to obtain the full benefits of the various functions." (p. 4) before installing and connecting this instrument. Refer to "Appendix 10 Rack Mounting"(p. A14) for rack mounting.

### 2.1 Preparation Flowchart

#### 1 Installing the Instrument (p. 4)

#### 2 Connecting the Power Cord (p. 29)

#### 3 Connect measurement cables, optional Hioki probes or test fixture (p. 30)

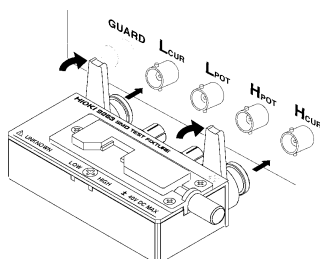

#### 4 Connect the external interface (as needed)

- Using the printer (p. 381)
  - RS-232C
  - GP-IB
  - USB
  - LAN
- See** Communication Instruction Manual "Chapter 2" (CD)

#### 5 Turning Power On (p. 31)

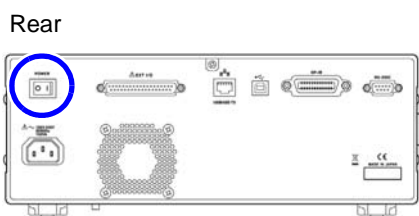

#### 6 Make instrument settings

# 2.2 Pre-Operation Inspection

Before using the instrument for the first time, verify that it operates normally to ensure that no damage occurred during storage or shipping. If you find any damage, contact your dealer or Hioki representative.

## 1 Peripheral Device Inspection

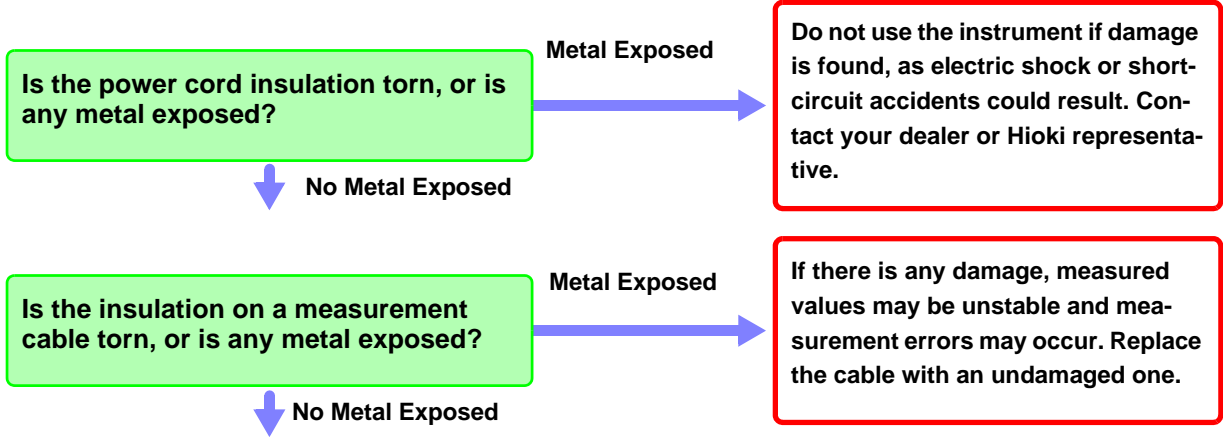

## 2 Instrument Inspection

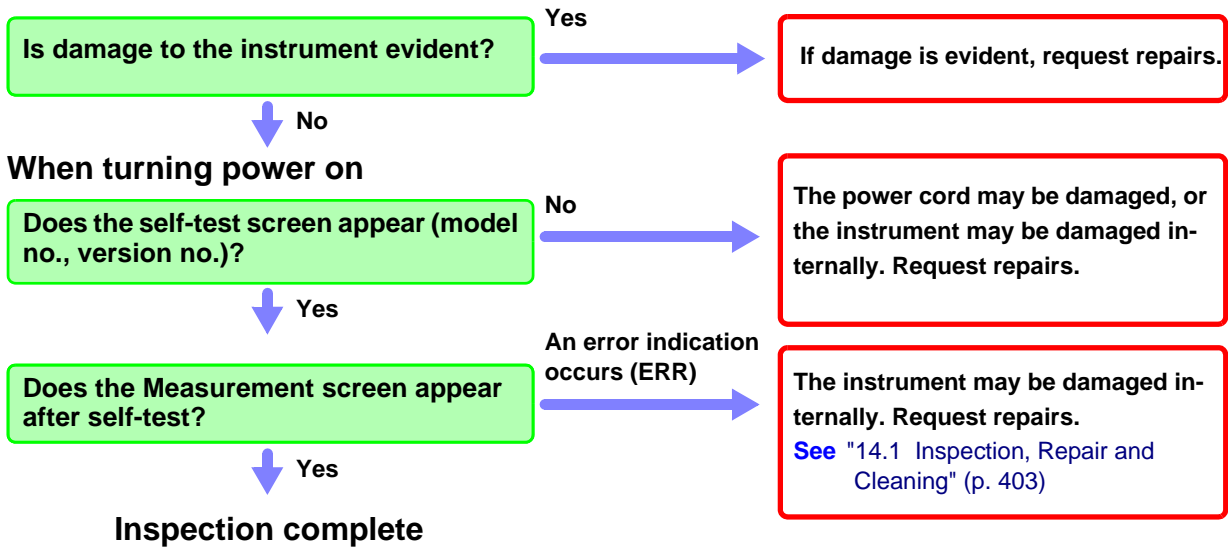

Please read the "Follow these precautions to ensure safe operation and to obtain the full benefits of the various functions." (p. 4) before use.

## 2.3 Connecting the Power Cord



**Be sure to read the “Usage Notes” (p. 7) before connecting power.**

Connect the power cord to the power inlet on the instrument, and plug it into an outlet.

### Connection Procedure

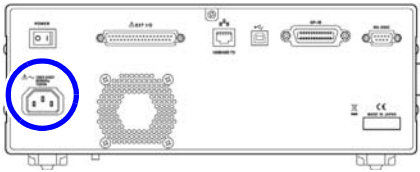

**1** Check that the instrument’s power switch is turned off.

**2** Confirm that the line voltage matches instrument requirements, and plug the power cord into the power inlet on the instrument.

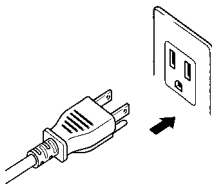

**3** Plug the other end of the power cord into an outlet.

Turn off the power before disconnecting the power cord.

# 2.4 Connecting the Measurement Cables, Probes, or Fixture



Be sure to read the “Usage Notes” (p. 7) before connecting measurement cables, probes or test fixture.

Connect your measurement cables, optional Hioki probes or test fixture to the measurement terminals. Refer to "Options" (p. 393) for details.

See the instructions provided with the fixture for operating details.

## Connecting a measurement cable/fixture

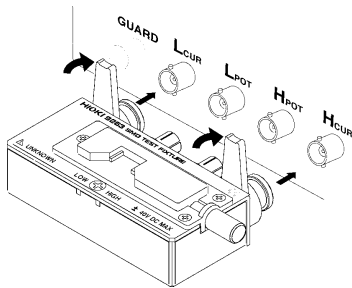

Connect directly to the measurement jacks with the label side up, and affix with the levers on the left and right.



## Points to pay attention to when making your own probe

- Use 50 Ω coaxial cable for the measurement cable.
- Ensure that the length of the cable is the same as that set for the instrument.
- Make the portion of the core wire that is exposed as short as possible.
- Connect the H<sub>CUR</sub>, L<sub>CUR</sub>, H<sub>POT</sub>, and L<sub>POT</sub> shield pairs at the measurement object side. (Ensure that a shield is not connected to a core wire.)

**NOTE**

- Basically, when you make a probe yourself, it may not be able to satisfy the specifications of this instrument.
- **See:** "Options" (p. 393)
- If all four terminals are disconnected, a meaningless number may be displayed on the unit.
- If all four terminals are disconnected, a measurement signal and DC voltage of 6 V may be generated at the H<sub>POT</sub> terminal, and a DC voltage of 6 V at the L<sub>POT</sub> terminal.

Measurement Terminal Configuration

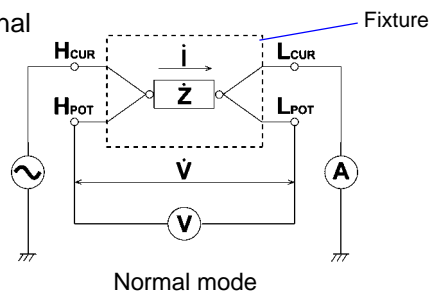

## 2.5 Turning the Power On and Off



Connect the power cord and voltage and current measurement cables before turning the instrument on.

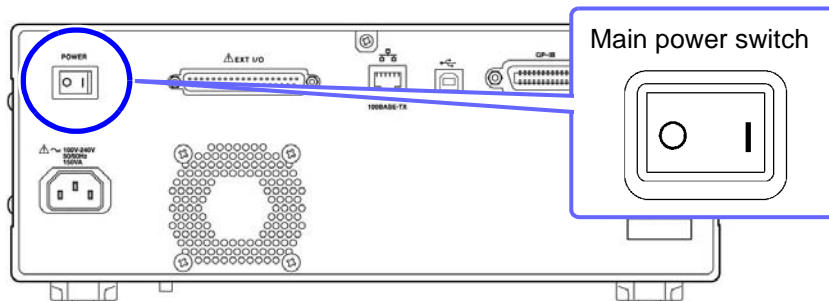

### Turning main power on

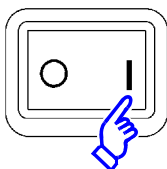

Turn the **MAIN POWER switch** on ( | ).

When the power is turned on, the same setting as when the power was last turned off appears.



Lights green

For high-precision measurements, allow at least 60 minutes warm-up before executing zero adjustment.

### Turning main power off

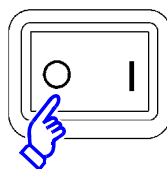

Turn the **MAIN POWER switch** off ( ○ ).

At that time, the measurement conditions are saved.



OFF

**NOTE** When the power supply is interrupted by a power failure or the like, the instrument recovers in the measurement mode used before the power failure.

## 2.5 Turning the Power On and Off

### Be on standby

ON the main power in the state, hold down the front POWER switch 2 seconds approximately.



### To cancel the standby

The instrument is in standby state, press the POWER switch on the front.





# Measurement Example

# Chapter 3

The following shows measurement examples of the LCR measurement mode and analyzer measurement mode.

## 3.1 When LCR Measurement Mode

LCR ANALYZER

### Measuring a Laminated Ceramic Capacitor

Necessary items: 9263 SMD test fixture  
Laminated ceramic capacity you want to measure

- 1 Connect the 9263 SMD test fixture to the measurement terminals.

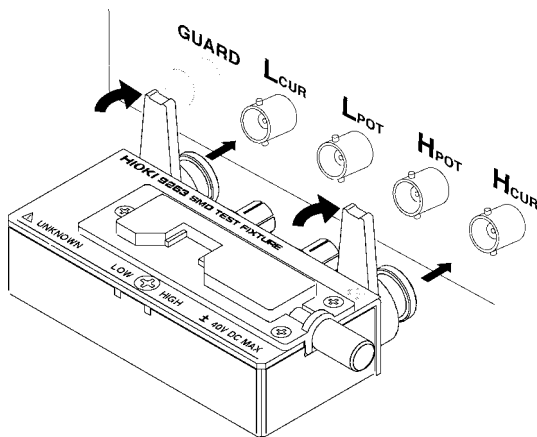

For the connection procedure, refer to the instruction manual supplied with the fixture.

- 2 Set the measurement conditions. Select the item you want to set, and set it as follows.

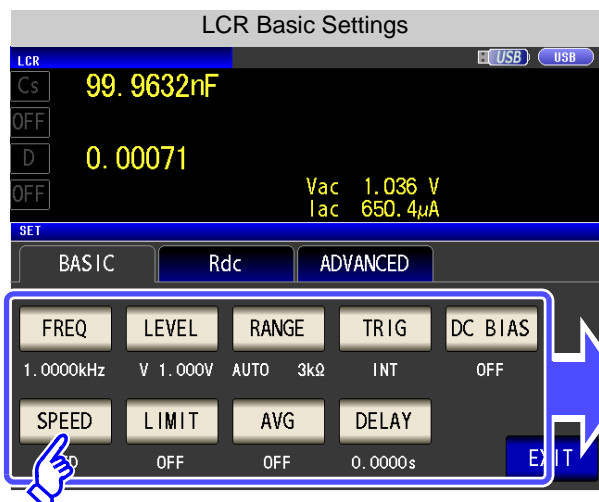

FREQ	Measurement frequency: 1 kHz(p. 41)
LEVEL	Measurement signal level: 1 V (p. 43)
RANGE	Measurement range: AUTO (p. 49)
TRIG	Trigger: INT(p. 55)
DC BIAS	DC bias: OFF (p. 57)
SPEED	Measurement speed: MED(p. 59)
LIMIT	Voltage and current limit: (p. 60)
AVG	Average: OFF (p. 62)
DELAY	Trigger delay: 0 s (p. 64)

### 3.1 When LCR Measurement Mode

#### 3 Connect the test sample to the 9263 SMD test fixture.

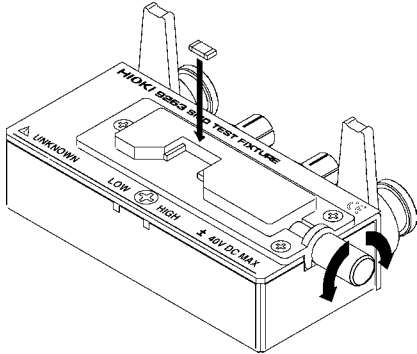

For the connection procedure of the test sample, refer to the instruction manual supplied with the fixture.

#### 4 Check the measurement results.

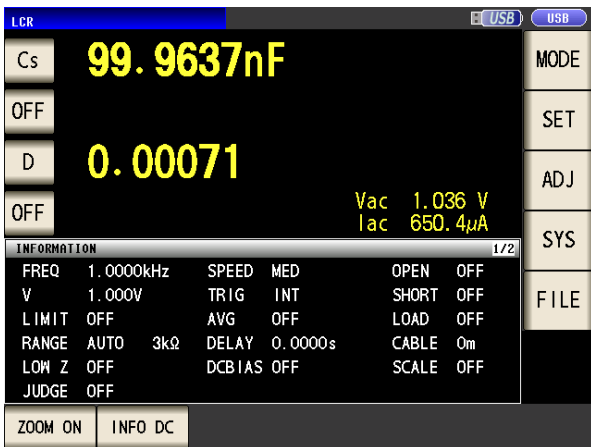

- When you want to measure under desired condition and timing  
**See:** "4.2.4 Perform Measurements with User-defined Timing (Trigger Measurement)" (p. 55)
- When you want to judge the measurement results  
**See:** "4.4.1 Judging with Upper and Lower Limit Values (Comparator Measurement Mode)" (p. 86)
- When you want to save the measurement results  
**See:** "4.5.2 Saving Measurement Results (Memory function)" (p. 106)

# 3.2 When Analyzer Measurement Mode

LCR  
ANALYZER

In analyzer measurement mode, the sweep can be performed with frequencies and signal levels within the desired range.

See "Chapter 5 ANALYZER Function" (p. 131)

## Measuring Element with Resonance Point

Necessary items: 9262 Test fixture  
Element you want to measure

1 Connect the 9262 Test Fixture to the measurement terminals.

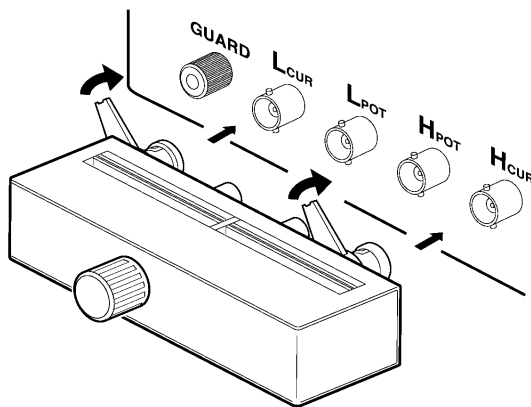

For the connection procedure, refer to the instruction manual supplied with the fixture.

2 Set the measurement conditions.

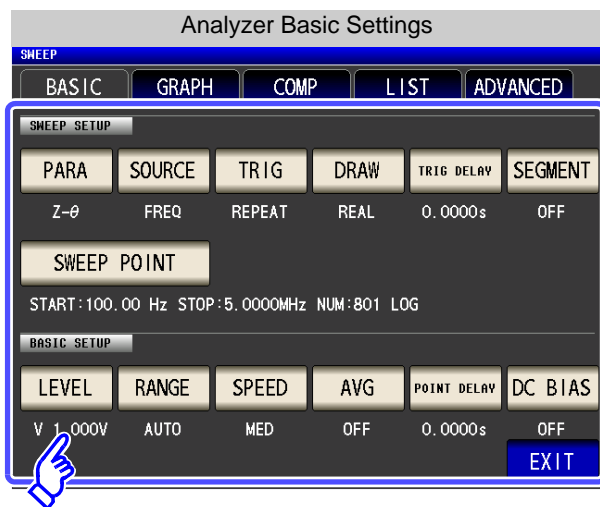

- PARA Parameter: Z-θ (p. 133)
- SOURCE Sweep parameter: FREQ (p. 145)
- SWEEP POINT Sweep point: 100Hz to 5MHz (p. 145)
- LEVEL Measurement signal level: 1 V (p. 157)
- RANGE Range: AUTO (p. 160)

See For details on the other items, see from page 131.

## 3.2 When Analyzer Measurement Mode

- 3 Connect the test sample to the 9263 Test Fixture.

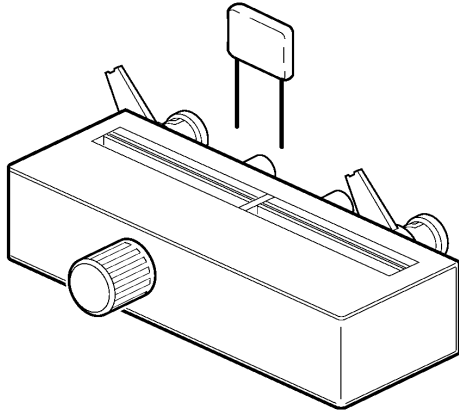

- 4 Execute the sweep.

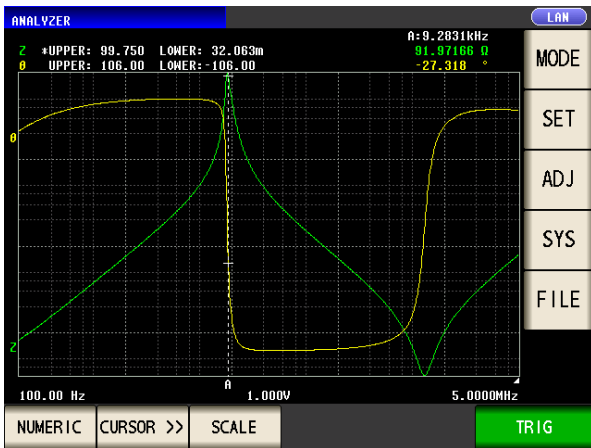

- When you want to check the measurement values.  
**See:** "5.6.1 Setting the Cursor" (p. 188)
- When you want to check the local maximum and local minimum values quickly.  
**See:** "5.6.3 Performing Measurement Value Search" (p. 194)
- When you want to judge sweep results.  
**See:** "Area Judgment" (p. 197)
- When you want to judge whether the peak position is appropriate.  
**See:** "Peak Judgment" (p. 208)

# LCR Function

# Chapter 4

## 4.1 About LCR function

LCR

ANALYZER

The LCR function allows you to measure the impedance, phase angle, and other items by applying any frequency or level (effective value) signal to the element you want to measure. This function is suitable for evaluating the passive element of a capacitor, coil, or the like.

**NOTE**

The settings are synchronized between LCR mode and analyzer mode.

4.1 About LCR function

4.1.1 Initial screen

This is the screen that is first displayed when the power is turned on. It allows you to perform measurement while checking the measurement conditions.

When the power is turned on again, display is in accordance with the measurement mode used immediately before the power was turned off.

For details on the screen configuration. (p. 14)

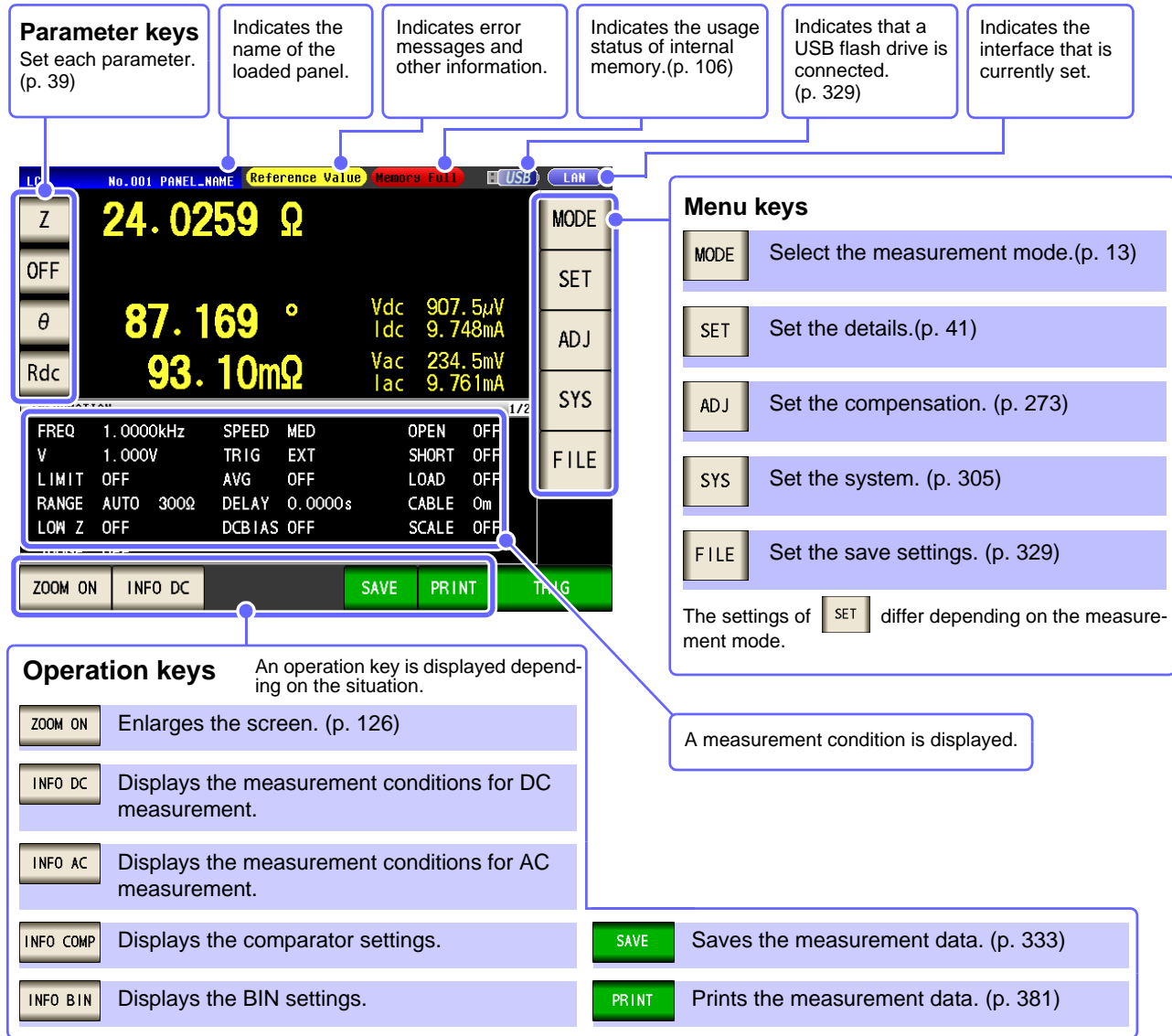

**NOTE**

When a measurement value is outside the guaranteed accuracy range, "Reference Value" is displayed in the error display area. When this happens, the cause is likely to be one of the following. Check the guaranteed accuracy range in "13.2 Measurement Range and Accuracy" (p. 395) and change the measurement conditions or you should consider the measured values as values for reference.

- Perhaps the test signal level is too low, increase the test signal level.
- If the current measurement range (during HOLD setting) is not appropriate, set again in the AUTO range, or change the range by manual.

## 4.1.2 Setting Display Parameters

You can select up to four measurement parameters to display in any location from 15 types.

See "1.3.7 Parameter Settings Screen" (p. 25)

"Appendix 2 Measurement of High Impedance Components"(p. A3)

"Appendix 7 Series Equivalent Circuit Mode and Parallel Equivalent Circuit Mode"(p. A11)

**Procedure** Example: 1st: Capacitance Cs, 3rd: Loss coefficient D

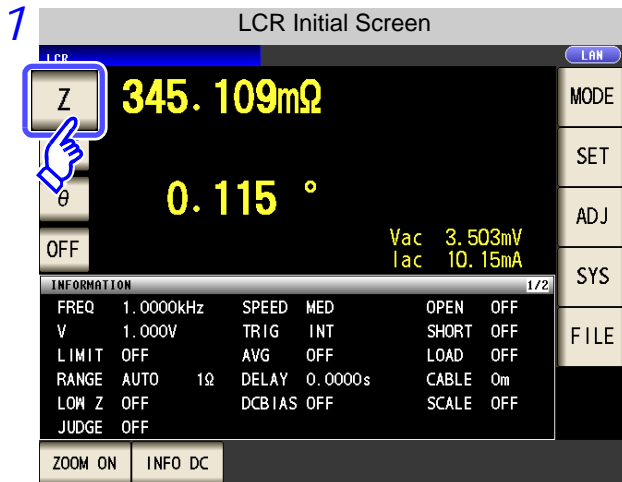

Press the first parameter key.

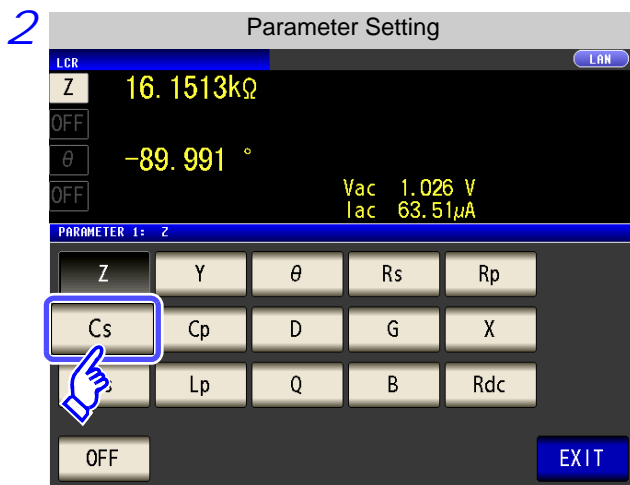

Press **Cs**.

Press **EXIT** to confirm the setting.

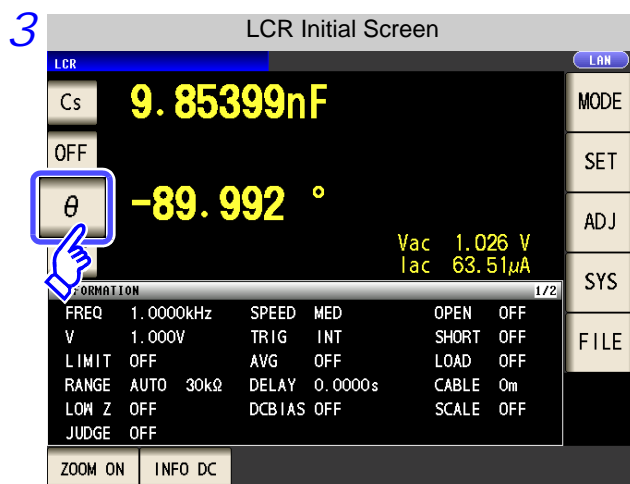

Press the third parameter key.

# 40

## 4.1 About LCR function

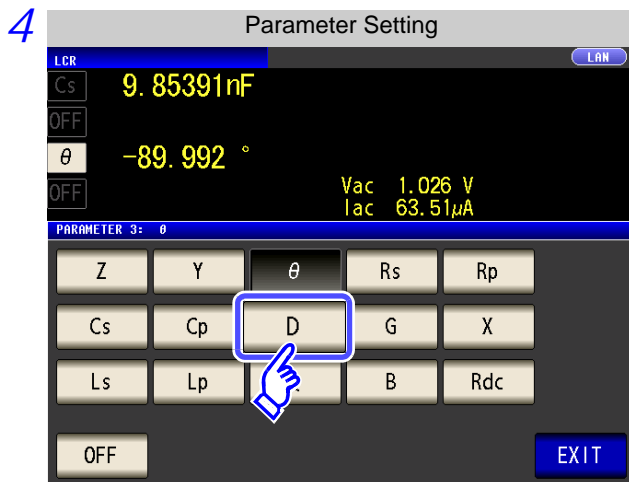

Press **D** .

Press **EXIT** to confirm the setting.

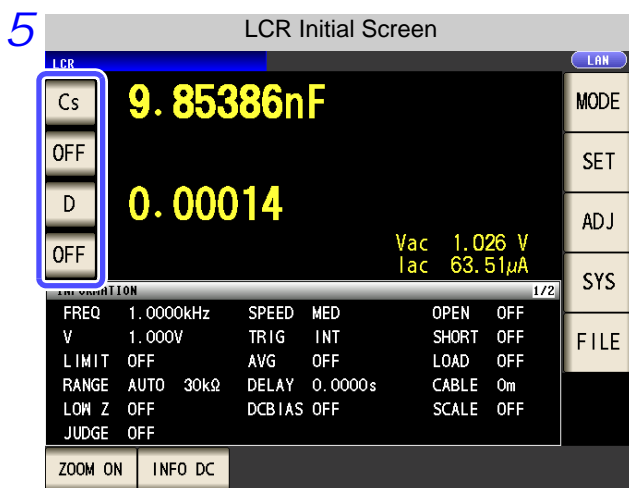

**Cs** and **D** are set as the parameters.

**NOTE** If **OFF** is selected in the parameter setting, a measurement value is not displayed.



# 4.2 Setting Basic Settings of Measurement Conditions

LCR ANALYZER

## 4.2.1 Setting the Measurement frequency

Set the frequency of the signal to apply to the test sample. For some test samples, the value may vary depending on the measurement frequency.

**Procedure** Example: Measurement frequency: 1 kHz

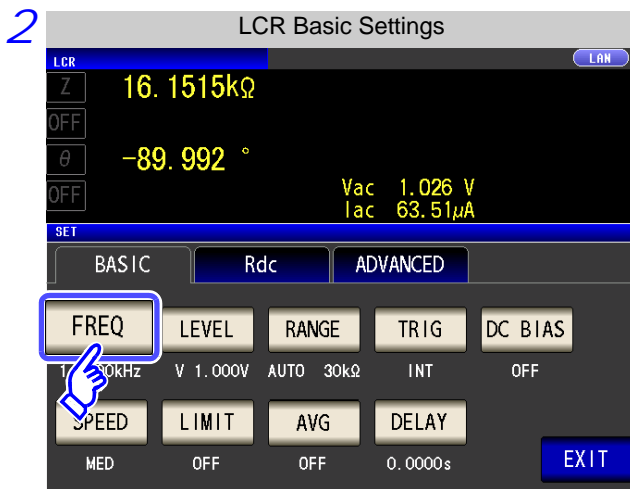
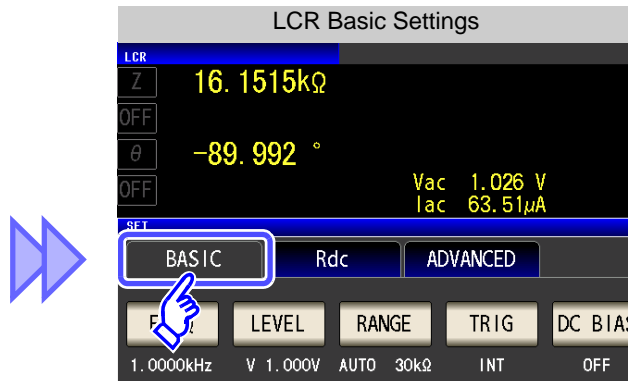
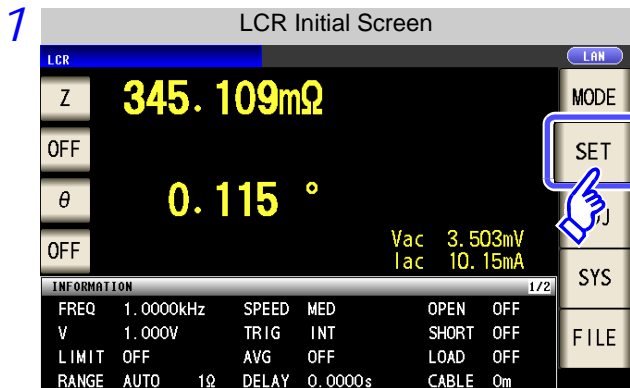

Press **FREQ**.

There are the following two frequency input methods.

Press **10-KEY** or **DIGIT** to change the input method.

3 Set each digit.

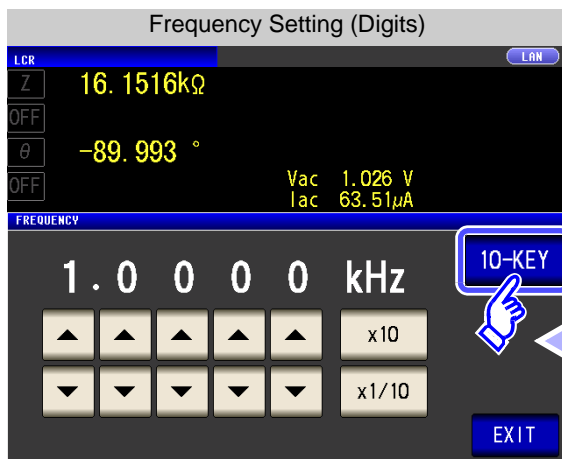

Set the frequency with the numeric keypad.

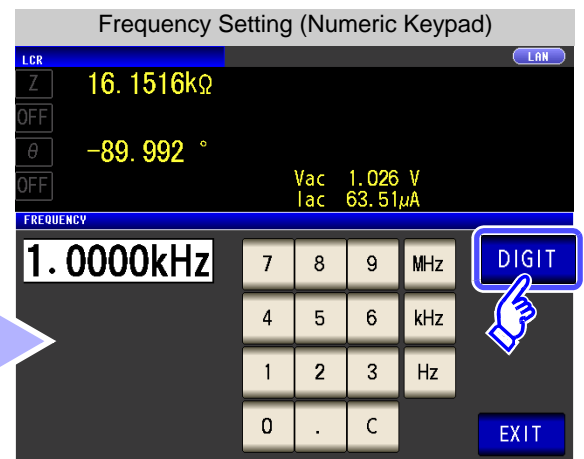

4.2 Setting Basic Settings of Measurement Conditions

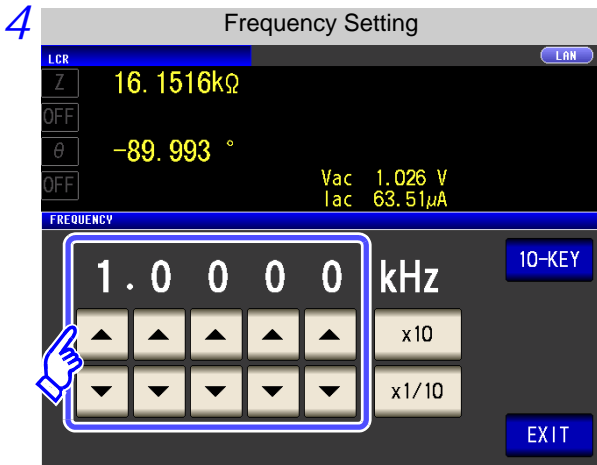

Use or to enter each digit of the frequency.

Holding down a digit key changes the value continuously.

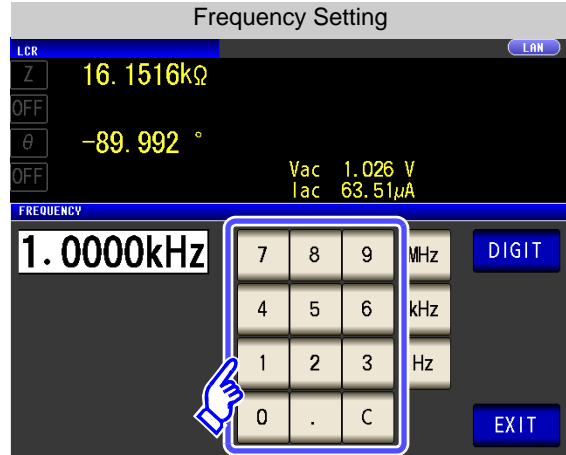

Use the numeric keypad to enter the frequency.

**If you make a mistake during input:**  
Press the to cancel the input so far, and start again.

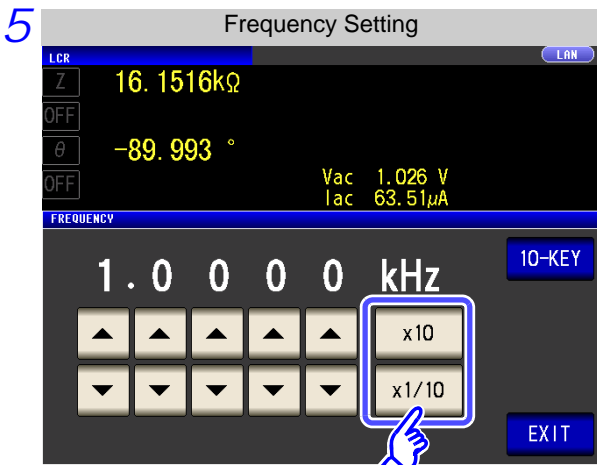

Use or to select the position of the decimal point and the unit.

- Sets the measurement frequency to x10.
- Sets the measurement frequency to x1/10.

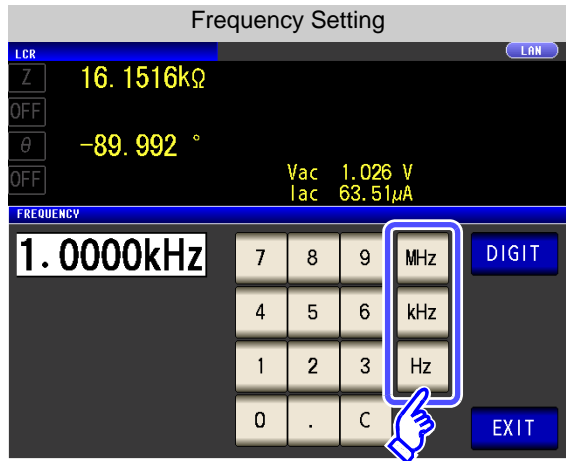

Press a unit key to confirm the setting.

- The frequency is not confirmed until a unit key is pressed.
  - The unit keys are disabled until a number is entered.
  - If you attempt to set a test frequency greater than 5 MHz, it will automatically be reduced to 5 MHz.
  - If you attempt to set a test frequency lower than 4 Hz, it will automatically be increased to 4 Hz.
- [See](#) (p. 387)

6 Press to close the setting screen.

**NOTE**

Setting the measurement frequency may change the setting for the measurement signal level.  
[See](#) "For setting range and accuracy" (p. 45)

### 4.2.2 Setting the Measurement signal level

The value of the test signal level may change according to the sample which is being tested. This instrument is possible to vary the level of the test signal applied to the object under test over a wide range using the following three methods.

**Set open circuit voltage (V)**

▶ The value of the open circuit voltage is set.

**Set constant voltage (CV)**

▶ The value of the voltage between the terminals of the object under test is set.

**Set constant current (CC)**

▶ The value of the current flowing through the object under test is set.

**CAUTION** Do not switch between V, CV and CC while the test sample is still connected to the measurement terminals because doing so may damage the test sample.

**Procedure**

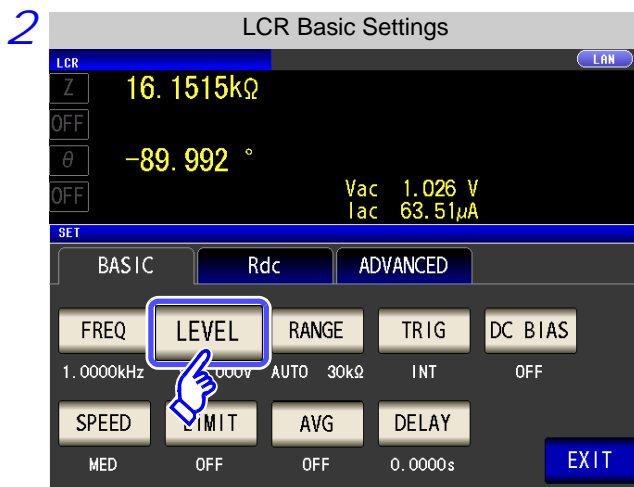
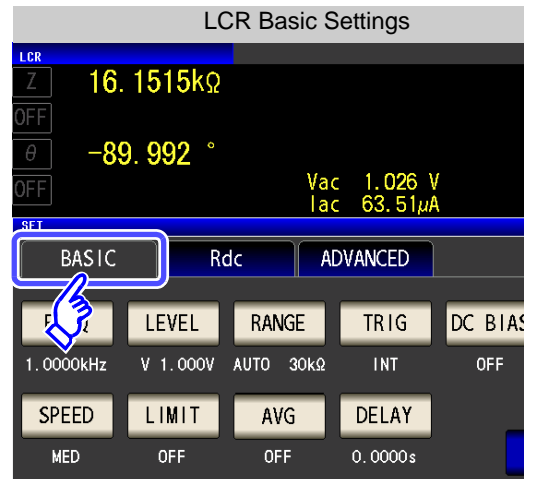
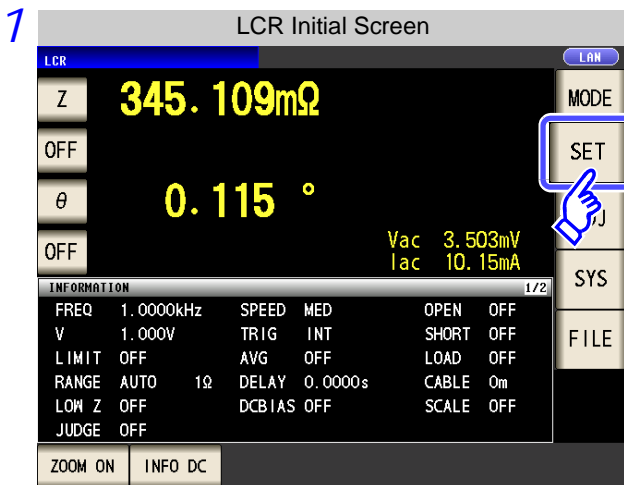

Press **LEVEL**.

## 4.2 Setting Basic Settings of Measurement Conditions

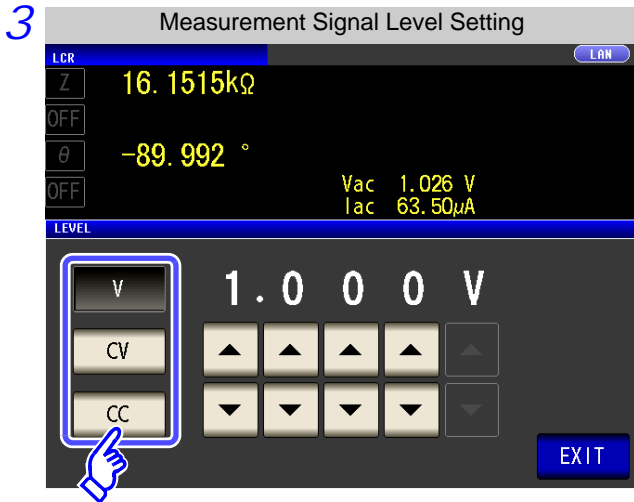

To select the measurement signal level.

V	open circuit voltage (p. 45)
CV	Voltage level between test sample terminals (p. 45)
CC	Current level through test sample (p. 47)

The accuracy of testing varies according to the test signal level.

See "13.2 Measurement Range and Accuracy" (p. 395)

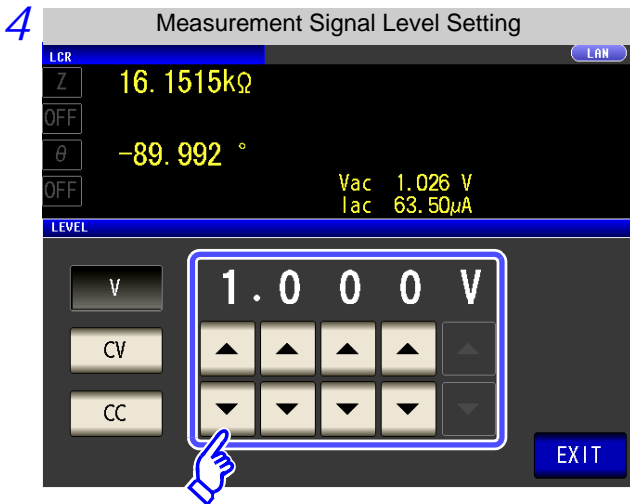

Use ▲ or ▼ to enter the voltage or current value.

See "For setting range and accuracy" (p. 45)

5 Press **EXIT** to close the setting screen.

### NOTE

When the measurement value is outside the guaranteed accuracy range, the following icon appears at the top of the screen.

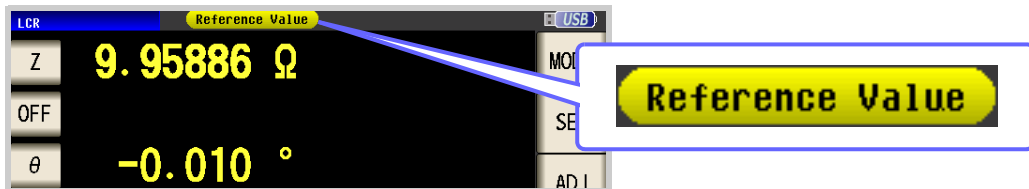

In this case, you should consider the following possible causes, and you should either change the test conditions while checking the accuracy assured ranges "13.2 Measurement Range and Accuracy" (p. 395), or you should consider the measured values as values for reference.

- Perhaps the test signal level is too low, increase the test signal level.
- If the current measurement range (during HOLD setting) is not appropriate, set again in the AUTO range, or change the range by manual.

### About the test signal level

Relationship between the measurement signal level of the instrument and the sample is as follows.

#### Open circuit voltage level (V)

This voltage value is the value which is applied across the two terminals of the series combination of the object which is being tested and the output impedance. As for the voltage which is applied across the terminals of the object which is being tested (by itself), if required, you should either check the monitor voltage value, or select constant voltage (CV) and set a voltage value across these terminals.

#### Constant current level (CC)

You should select this if you wish to set the current passing through the object to be tested to a constant value.

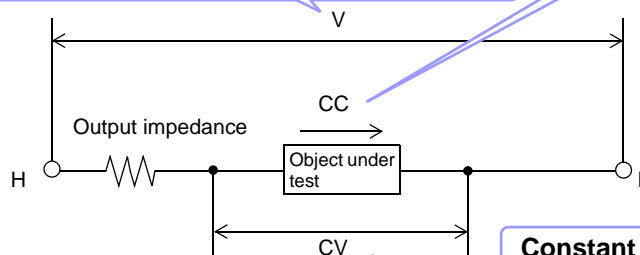

#### Constant voltage level (CV)

You should select this if you wish to set the voltage across the terminals of the object to be tested to a constant value.

### For setting range and accuracy

#### Open circuit voltage level (V) and Constant voltage level (CV) setting

- When normal mode (p. 54)

Measurement frequency setting range	Open circuit voltage setting range	Open circuit voltage accuracy
4 Hz to 1.000 MHz	0.005 V to 5.000 V	$\pm 10\% \pm 10$ mV
1.0001 MHz to 5.000 MHz	0.010 V to 1.000 V	$\pm 20\% \pm 10$ mV

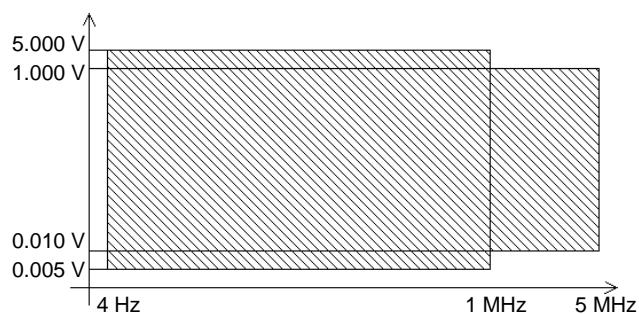

## 4.2 Setting Basic Settings of Measurement Conditions

- When Low Z high accuracy mode (p. 54)

Measurement frequency setting range	Open circuit voltage setting range	Open circuit voltage accuracy
4 Hz to 100 kHz	0.005 V to 1 V	±10%±10 mV

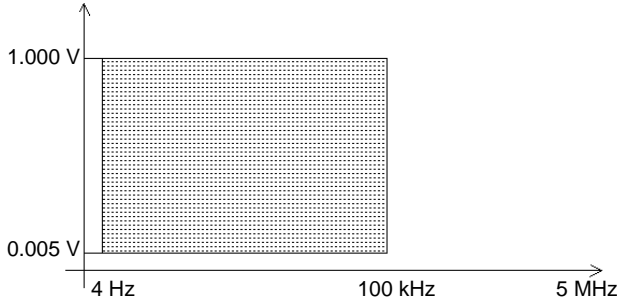

- The open circuit voltage that can be set differs depending on the frequency.
- When the test frequency is higher than 1 MHz at an open-circuit voltage of more than 1 V, the voltage is automatically set to 1 V.
- When the measurement frequency is set higher than 1 MHz at an open circuit voltage of less than 0.010 V, the voltage is automatically set to 0.010 V.

### NOTE

Testing some types of sample is not possible using constant voltage. In this case, the following symbol appears on the display:



In such a case, constant voltage testing is not performed. Change the constant voltage level to a value not more than the value being shown as  $V_{moni}$ .

When a  $1 \mu\text{F}$  capacitance is measured at 10 kHz, the CV operation range can be obtained as follows. Sample impedance  $Z_m$  becomes as follows:

Sample impedance  $Z_m$  becomes as follows:

$$Z_m = R_m + jX_m = 0 [\Omega] - j15.9 [\Omega] \qquad X_m = \frac{-1}{(2\pi fC)}$$

The impedance  $Z_m'$  observed from the generator is as follows:

$$Z_m' = R_o + Z_m = 100 [\Omega] - j15.9 [\Omega] \qquad R_o: \text{Output resistance (100 } [\Omega] \text{)}$$

Accordingly, the voltage  $V_m$  across both leads of the sample is as follows:

$$V_m = \frac{|Z_m| \times V_o}{|Z_m'|} = \frac{15.9 [\Omega] \times V_o}{101.3 [\Omega]} \qquad V_o: \text{generator output}$$

Because the generator output voltage range is 5[mV] to 5[V] for 10 kHz, the CV operation range per the above expression is  $V_m = 0.8[\text{mV}]$  to  $0.78[\text{V}]$ .

In low Z high accuracy mode, the output resistance  $R_o$  becomes 10[Ω].

## 4.2 Setting Basic Settings of Measurement Conditions

### Constant current level (CC) setting

- When normal mode (p. 54)

However, the constant current operation range differs depending on the test sample to be measured.

Measurement frequency setting range	Constant current setting range	Constant current accuracy
4 Hz to 1.000 MHz	0.01 mA to 50 mA	$\pm 10\% \pm 10 \mu\text{A}$
1.0001 MHz to 5.000 MHz	0.01 mA to 10 mA	$\pm 20\% \pm 10 \mu\text{A}$

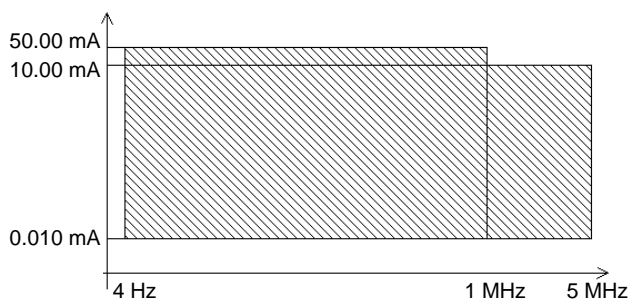

- When Low Z high accuracy mode (p. 54)

However, the constant current operation range differs depending on the test sample to be measured.

Measurement frequency setting range	Constant current setting range	Constant current accuracy
4 Hz to 100 kHz	0.01 mA to 100.00 mA	$\pm 10\% \pm 10 \mu\text{A}$

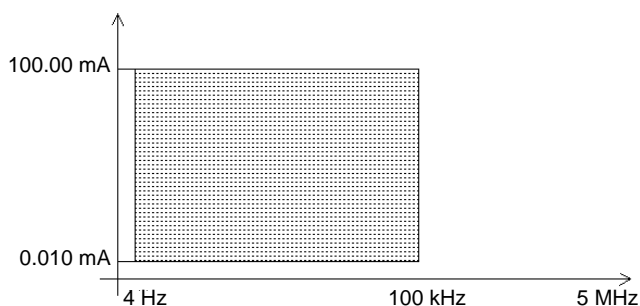

- The constant current that can be set differs depending on the frequency.
- When the test frequency is higher than 1 MHz at a constant current of more than 10 mA, the current is automatically set to 10 mA.

## 4.2 Setting Basic Settings of Measurement Conditions

### NOTE

Testing some types of sample is not possible using constant current. In this case, the following symbol appears on the display:

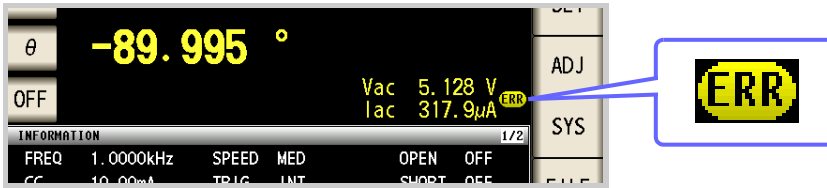

In such a case, constant current testing is not performed. Change the constant current level to a value not more than the value being shown as  $I_{moni}$ .

Reference When a 1 mH impedance is measured at 1 kHz, the CC operation range can be obtained as follows.

Sample impedance  $Z_m$  becomes as follows:

$$Z_m = R_m + jX_m = 0 [\Omega] - j62.8 [\Omega] \qquad X_m = 2\pi fL$$

The impedance  $Z_m'$  observed from the generator is as follows:

$$Z_m' = R_o + Z_m = 100 [\Omega] - j62.8 [\Omega] \qquad R_o: \text{output resistance (100 } [\Omega] \text{)}$$

Accordingly, the current  $I_m$  across both leads of the sample is as follows:

$$I_m = \frac{V_o}{|Z_m'|} = \frac{V_o}{118.1 [\Omega]} \qquad V_o: \text{generator output}$$

Because the generator output voltage range is 5[mV] to 5[V] for 1 kHz, the CC operation range per the above expression is  $I_m = 8.47[\mu\text{A}]$  to  $42.3[\text{mA}]$ .

In low Z high accuracy mode, the output resistance  $R_o$  becomes 10[Ω].



### 4.2.3 Setting the Measurement Range

There are the following two methods for setting the measurement range.

**AUTO**

The most suitable test range is set automatically.  
(This allows the most suitable measurement range to be set when measuring, for example, a test sample whose impedance varies greatly with frequency or a test sample whose nature is unknown.)

**HOLD**

The test range is fixed, and may only be altered manually.  
(When the range is fixed, high-speed measurement is possible.)

**NOTE**

The ranges are all defined in terms of impedance. Therefore, for a parameter other than impedance, the value is obtained by calculating from the measured values of  $|Z|$  and  $\theta$ .  
See "Appendix 1 Measurement Parameters and Arithmetic Expressions"(p. A1)

#### 1 Setting AUTO Ranging

**Procedure**

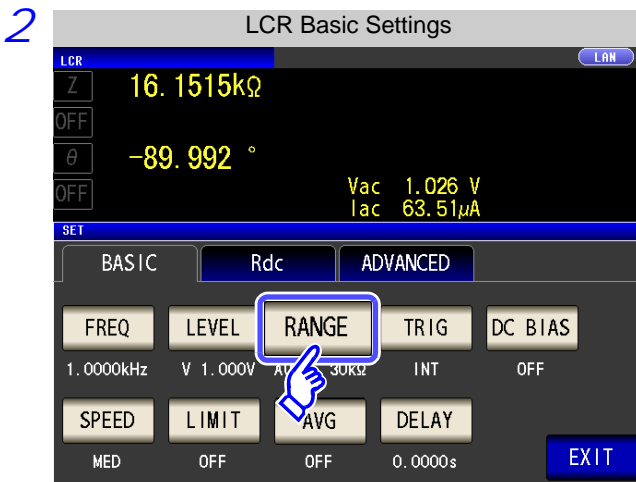
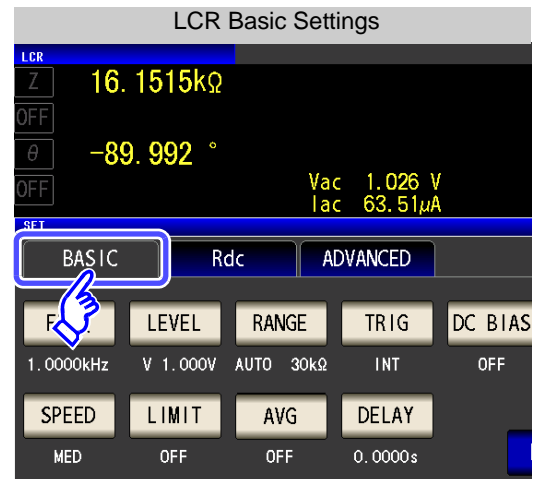
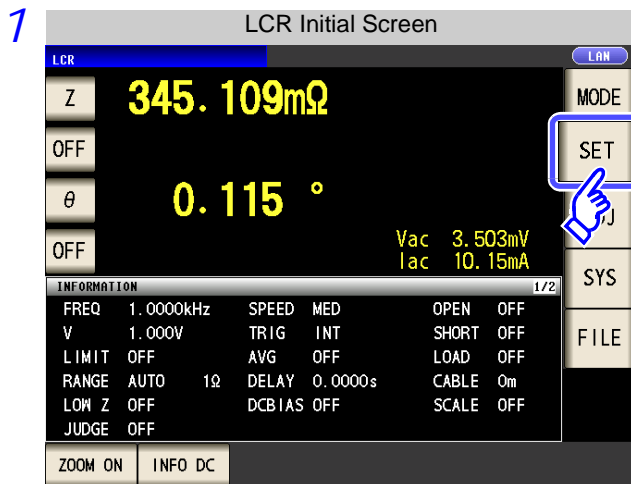

Press RANGE .

## 4.2 Setting Basic Settings of Measurement Conditions

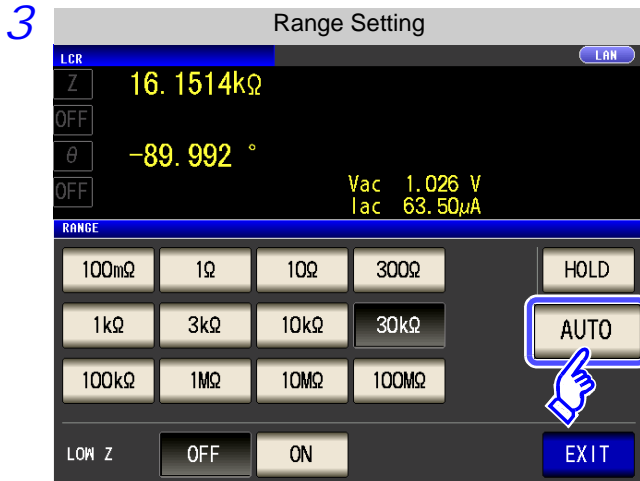

Press **AUTO** .

If the instrument is being used outside the limits of its specification, the suitable range may not be set in auto ranging function. In this case, check the accuracy assured ranges in "13.2 Measurement Range and Accuracy" (p. 395) and then change the test conditions.

4 Press **EXIT** to close the setting screen.

**NOTE** When an element other than a capacitor or a capacitor with a low DC resistance is measured while using DC bias, the AUTO range may not work properly and a range may not be able to be determined.

## 4.2 Setting Basic Settings of Measurement Conditions

### 2 Setting the Ranging to HOLD

#### Procedure

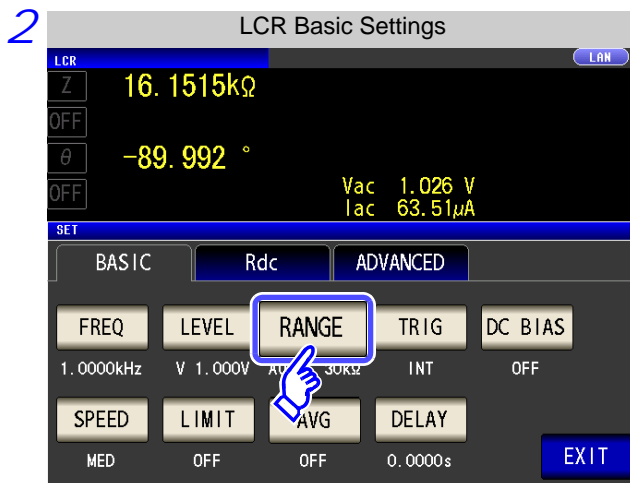
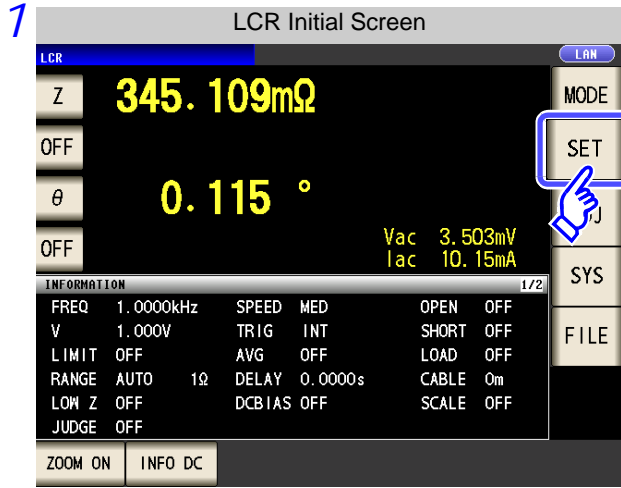

Press RANGE .

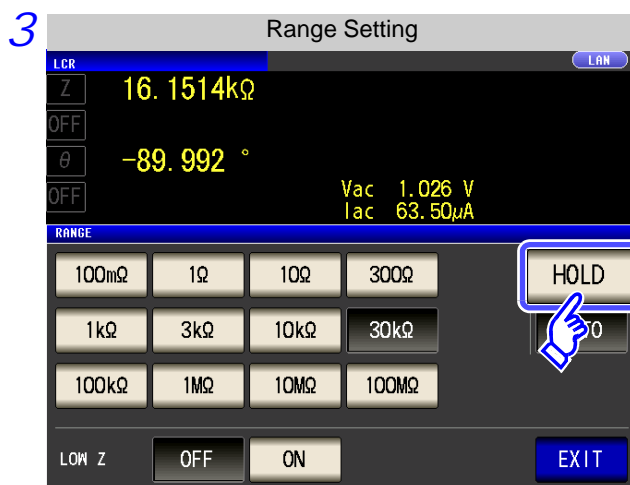

Press HOLD .

4.2 Setting Basic Settings of Measurement Conditions

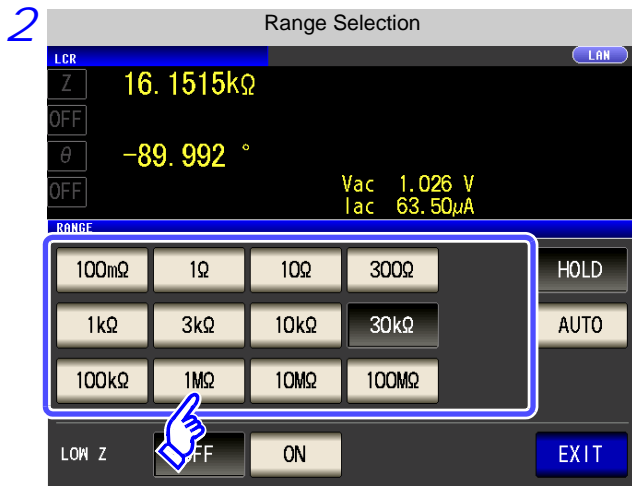

Set the test range according to the combined impedance value of the sample to be tested and the test cables.

To select the measurement range.

Test range	Accuracy guaranteed range	AUTO Ranging Range
100 MΩ	8 MΩ to 200 MΩ	8 MΩ to 999.999 MΩ
10 MΩ	800 kΩ to 100 MΩ	800 kΩ to 10 MΩ
1 MΩ	80 kΩ to 10 MΩ	80 kΩ to 1 MΩ
100 kΩ	24 kΩ to 1 MΩ	24 kΩ to 100 kΩ
30 kΩ	8 kΩ to 300 kΩ	8 kΩ to 30 kΩ
10 kΩ	2.4 Ω to 100 kΩ	2.4 kΩ to 10 kΩ
3 kΩ	800 Ω to 30 kΩ	800 Ω to 3 kΩ
1 kΩ	240 Ω to 10 kΩ	240 Ω to 1 kΩ
300 Ω	8 Ω to 300 Ω	8 Ω to 300 Ω
10 Ω	800 mΩ to 10 Ω	800 mΩ to 10 Ω
1 Ω	80 mΩ to 1 Ω	80 mΩ to 1 Ω
100 mΩ	1 mΩ to 100 mΩ	0 Ω to 100 mΩ

**NOTE**

- The guaranteed accuracy range varies depending on the measurement conditions. See Check the accuracy assured ranges in "13.2 Measurement Range and Accuracy" (p. 395)
- The measurement range is determined according to the test range setting. If the display for the measured value shows "OVER FLOW" or "UNDER FLOW", that means that measurement cannot be performed using the currently set test range. Either you should set AUTO ranging so as to select the most suitable test range automatically, or you should set a more suitable test range manually. If a measurement result is outside the display range (p. 387), "DISP OUT" is displayed.
- The guaranteed accuracy range is for the measurement values before compensation.

3 Press **EXIT** to close the setting screen.

**NOTE**

- In the case of a test sample whose impedance changes according to the frequency, when testing is being performed with HOLD set, it may happen, when the frequency is changed over, that measurement cannot be continued to be performed upon the same test range. You should change the test range if this happens.
- The test range setting is made according to the combination of the impedances of the sample being tested and the test cables. Therefore it can happen that testing is not possible, if the test range is held with HOLD only upon the basis of the impedance of the sample under test. If this happens, you should change the test range, making reference to "7.1 Setting Open Circuit Compensation" (p. 273) and "7.2 Short Circuit Compensation" (p. 280).
- When the measurement value is outside the guaranteed accuracy range, the following icon appears at the top of the screen.

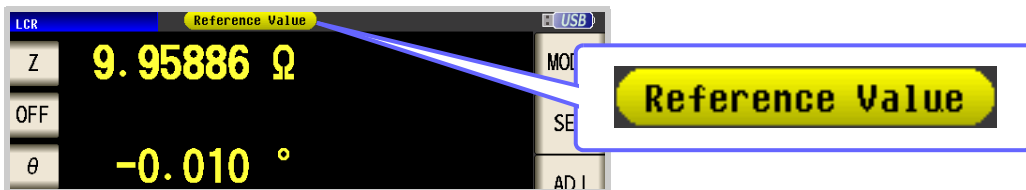

In this case, you should consider the following possible causes, and you should either change the test conditions while checking the accuracy assured ranges "13.2 Measurement Range and Accuracy" (p. 395), or you should consider the measured values as values for reference.

- Perhaps the test signal level is too low, increase the test signal level.
- If the current measurement range (during HOLD setting) is not appropriate, set again in the AUTO range, or change the range by manual.

## 4.2 Setting Basic Settings of Measurement Conditions

### 3 Low Z High Accuracy Mode

This mode balances the  $L_{POT}$  terminal at 0 V to reduce the influence of contact resistance during low impedance measurement. Furthermore, since the output resistance becomes  $10\ \Omega$  and sufficient current can flow to the test sample to be measured, this mode enables highly accurate measurement.

#### Procedure

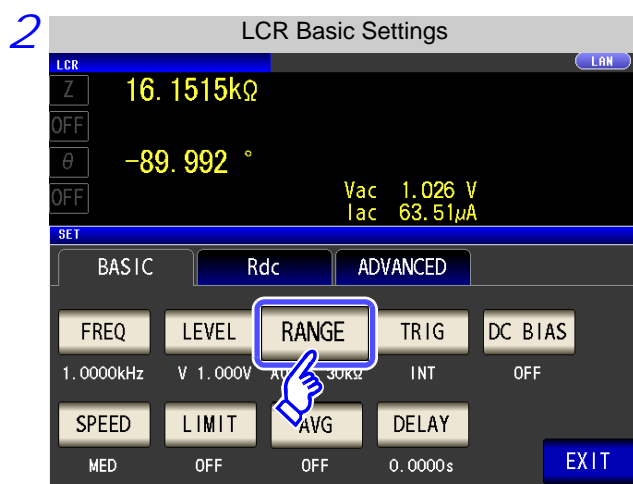
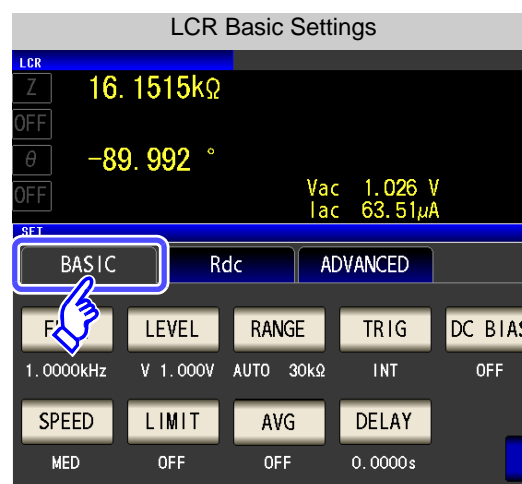
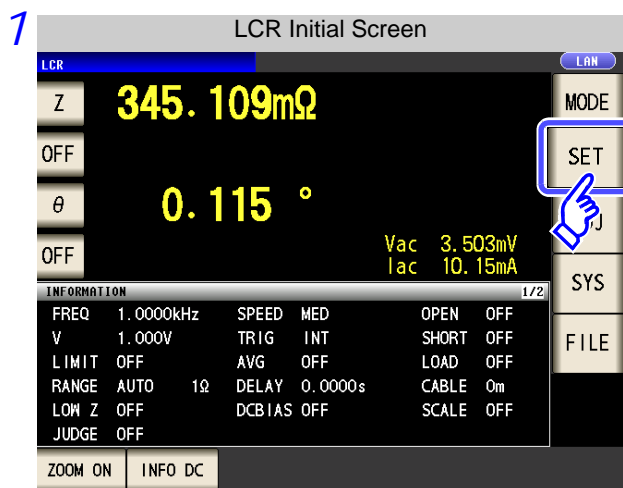

Press **RANGE**.

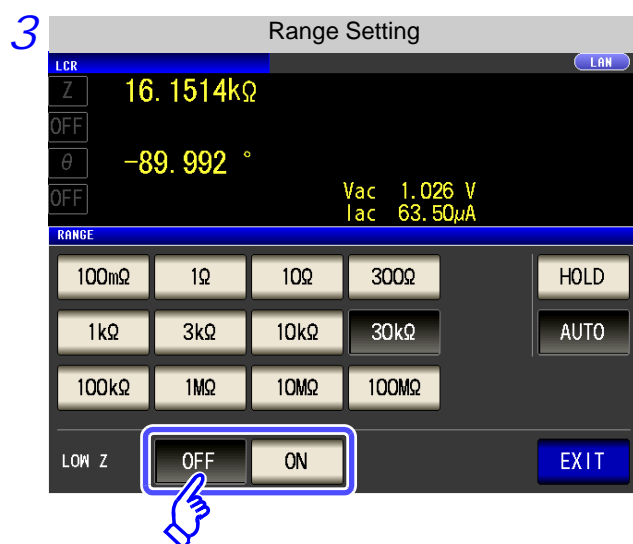

Select ON/ OFF for the low Z high accuracy mode.

OFF

Sets the low Z high accuracy mode to OFF.

ON

Sets the low Z high accuracy mode to ON.

4 Press **EXIT** to close the setting screen.

**4.2 Setting Basic Settings of Measurement Conditions**

**NOTE**

With low Z high accuracy mode, the possible setting ranges of the frequency and measurement signal level differ. Refer to the following.

No.	Measurement range	to 1 kHz	to 10 kHz	to 100 kHz	to 1 MHz	to 5 MHz	
1	100 MΩ	Normal mode only (setting not possible for low Z high accuracy mode).				None	
2	10 MΩ						
3	1 MΩ						
4	100 kΩ						
5	30 kΩ						
6	10 kΩ						
7	3 kΩ						
8	1 kΩ						
9	300 Ω						
10	10 Ω						
11	1 Ω	Low Z high accuracy mode/ normal mode					
12	100 mΩ						

Settable range of measurement signal level: (p. 45)

Low Z high accuracy mode is only valid when the frequency is between 4 Hz and 100 kHz.

**Detecting Disconnection of 4 Terminals  
(When Low Z High Accuracy Mode)**

This function operates when measurement is being performed in low impedance high accuracy mode (p. 53). It detects whether each of the L<sub>POT</sub>, H<sub>POT</sub> and L<sub>CUR</sub> terminals is disconnected.

If a terminal is not connected properly, an indication like the following is displayed. Check the connections again.

See "2.4 Connecting the Measurement Cables, Probes, or Fixture" (p. 30)

The error is also output via EXT I/O.

See "Chapter 11 External Control" (p. 363)



**NOTE**

When an element other than a capacitor or a capacitor with a low DC resistance is measured while using DC bias, the contact check function may not work properly.

### 4.2.4 Perform Measurements with User-defined Timing (Trigger Measurement)

Triggering is the process of controlling the start and stop of recording by specific signals or conditions (criteria). When recording is started or stopped by a specific signal, we say the trigger is "applied" or "triggering occurs".

With this instrument, you can select the following two types of trigger.

- Internal Trigger** ▶ Trigger signals are automatically generated internally for continuous measurement.
- External trigger** ▶ Measurements are triggered by an external signal. Manual measurement triggering is also available.

**Procedure**

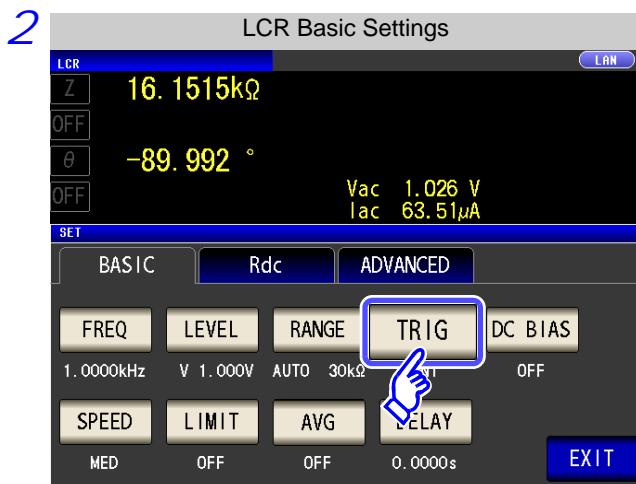
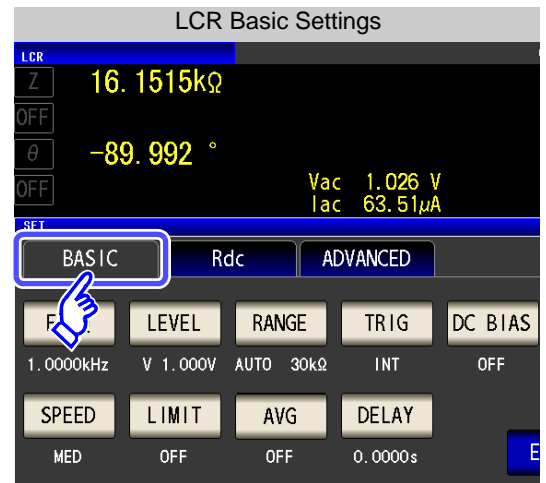
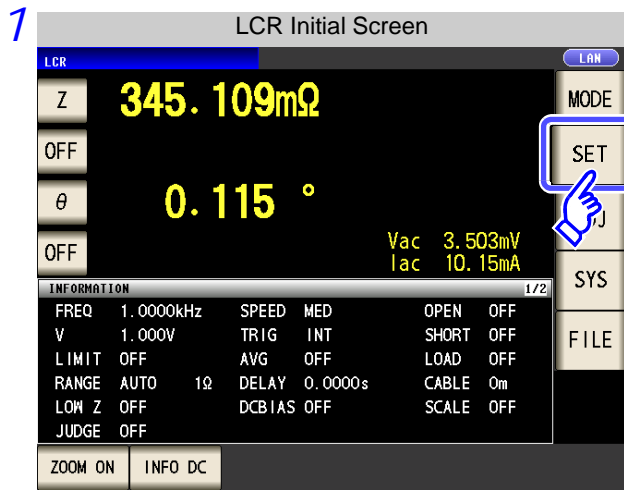

Press **TRIG**.

## 4.2 Setting Basic Settings of Measurement Conditions

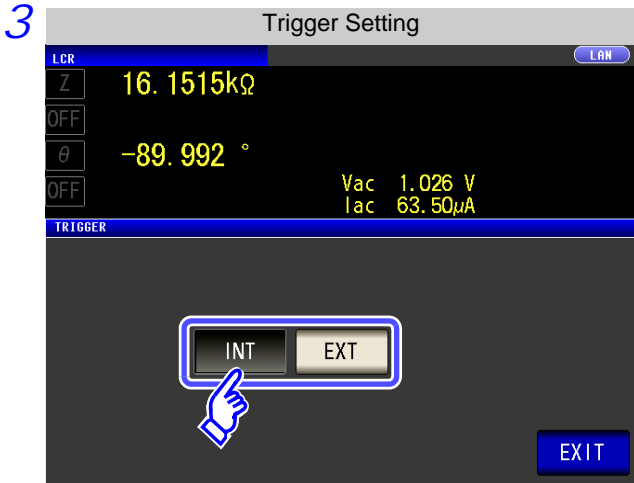

Select the trigger type.



Internal trigger

Perform continuous measurement automatically.



External trigger

Input the trigger manually via EXT I/O or from the interface.

When **EXT** is selected

There are the following three types of input method for a trigger.

- Press **TRIG** on the screen to manually input a trigger: Measurement is performed once.
- Input via EXT I/O: Measurement is performed once each time a negative logic pulse signal is applied.  
See "Connector Type and Signal Pinouts" (p. 364)
- Input from interface: Measurement is performed once when \*TRG is transmitted.  
See Included CD

**TRIG** is displayed on the screen.

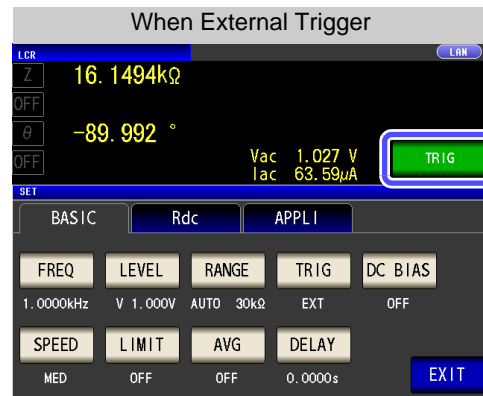
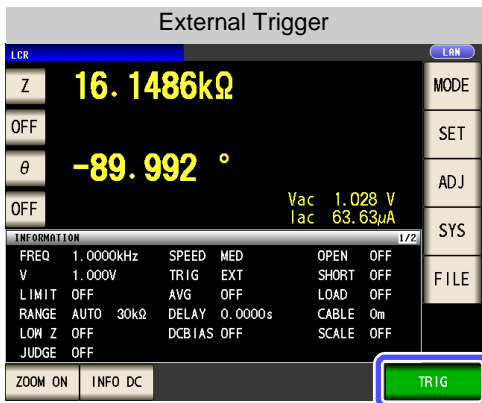

4 Press **EXIT** to close the setting screen.



4.2 Setting Basic Settings of Measurement Conditions

4.2.5 Setting the DC bias

You can superimpose a DC voltage on the measurement signal during capacitor measurement. You can superimpose a DC signal on the measurement signal.

Procedure

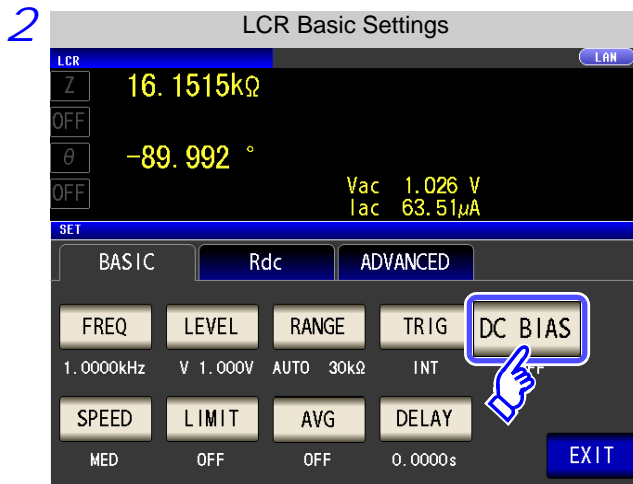
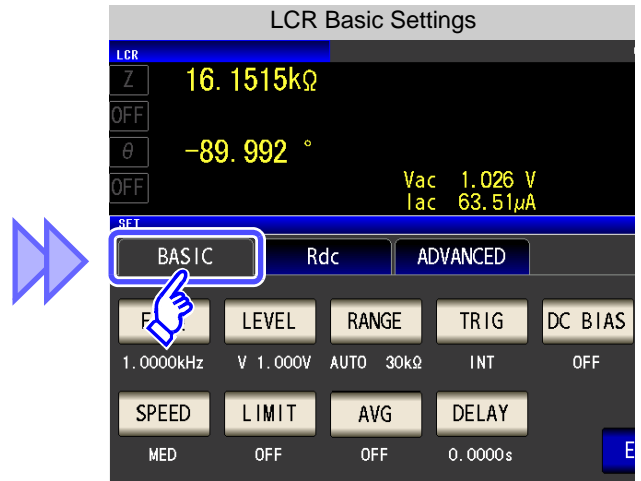
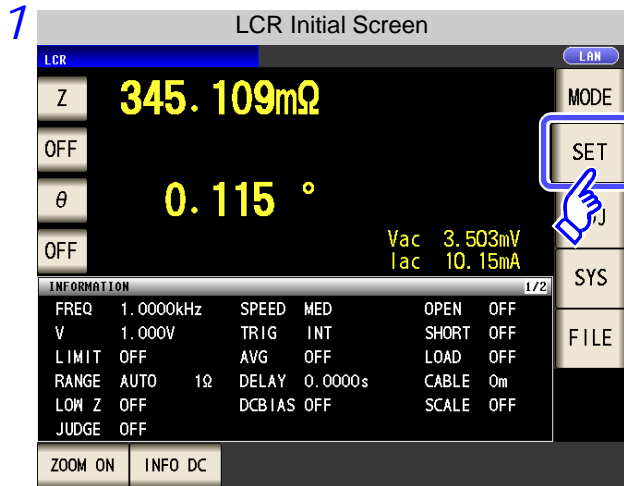

Press **DC BIAS**.

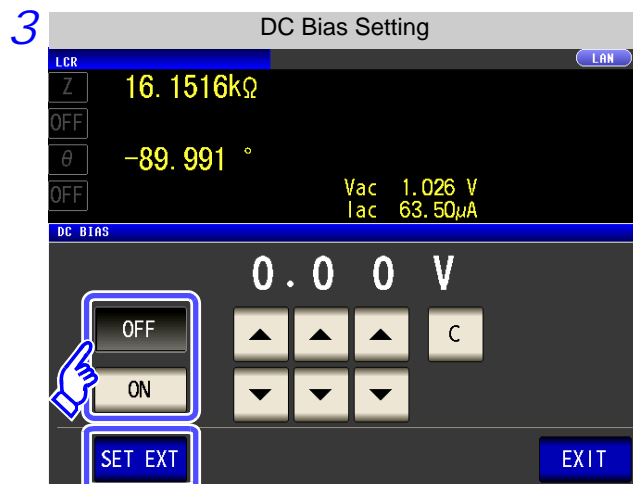

Select ON/ OFF for the DC bias.

- Sets the DC bias to OFF.
- Sets the DC bias to ON.

Press this button when using an external DC bias unit. The DC bias will be set to ON, and the bias value will be set to 0.00 V.

## 4.2 Setting Basic Settings of Measurement Conditions

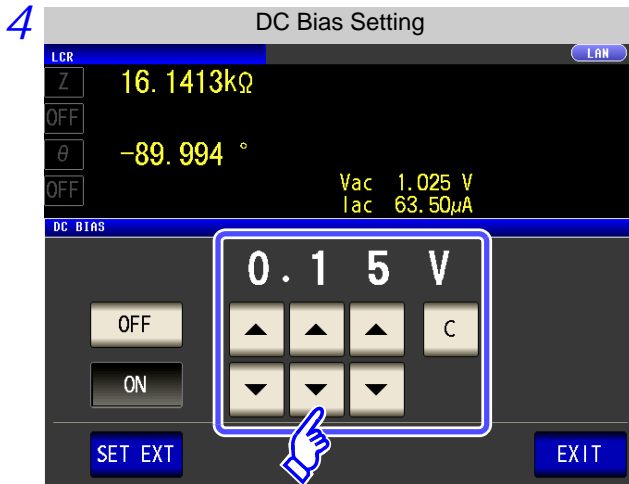

Use or to set the DC level to superimpose.

- Settable range: 0.00 V to 2.50 V (Normal mode)  
0.00 V to 1.00 V (low Z high accuracy mode)
- If you make a mistake during input:  
press to cancel the input and start again.

The setting is not reflected if is not pressed.

5 Press to close the setting screen.

### NOTE

- The DC bias function is specifically for capacitor measurement. If it is used for resistor, inductor, and other elements with low DC resistance, the following are likely.
  - Normal measurement is not possible
  - AUTO ranging is unable to determine a range.
  - In low impedance high accuracy mode, a contact error is generated even though the terminal connections are correct.
- The DC bias function cannot be set during Rdc measurement.
- The DC bias function cannot be set when RDC measurement has been selected with the **:MEASure:ITEM** setting.
- When superimposing a DC voltage of 2.5 V or above, refer to "Appendix5.1 How to Supply a DC Bias Voltage"(p. A7).
- When superimposing a DC voltage on a coil or the like, refer to "Appendix5.2 How to Supply a DC Bias Current"(p. A9).
- A value for which the sum of the effective value of the AC signal level and the DC signal level will exceed 7.07 V cannot be set.
- If the total value for the measurement signal level (AC level + DC bias value) will become  $> 5\sqrt{2}$  [V], the measurement signal cannot be raised any higher. Reduce the AC level or DC bias value, and then configure the setting. In low Z high accuracy mode, the AC level and DC bias value can be set when the total value is in the range of  $\sqrt{2}$  [V] or below.

### 4.2.6 Setting the Measurement speed

The testing speed can be set. The slower the testing speed is, the more accurate are the results.

#### Procedure

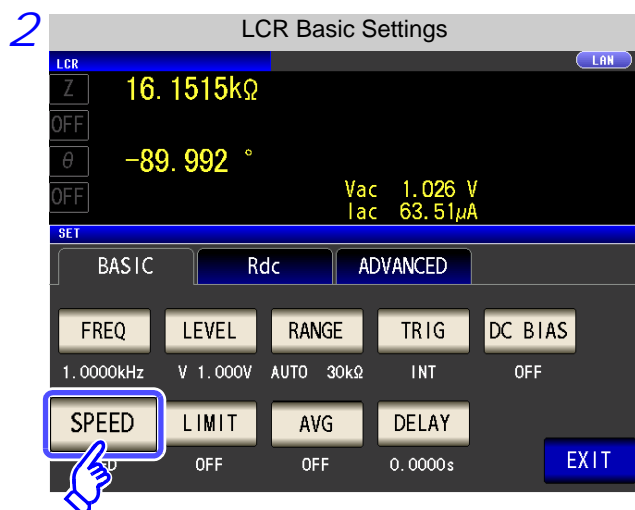
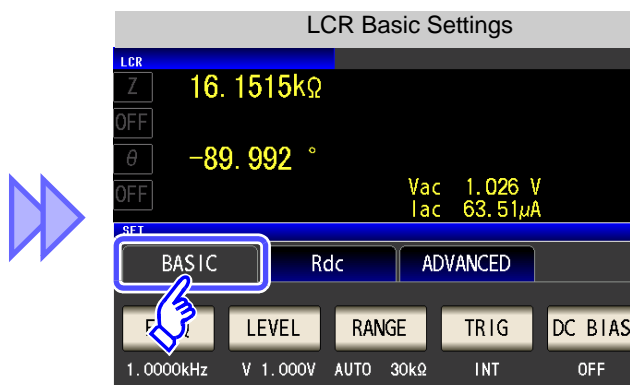
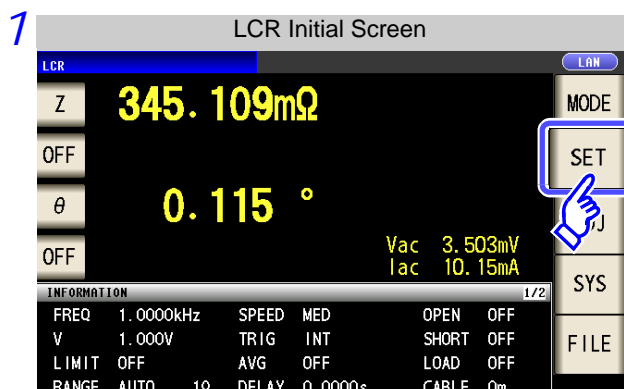

Press **SPEED**.

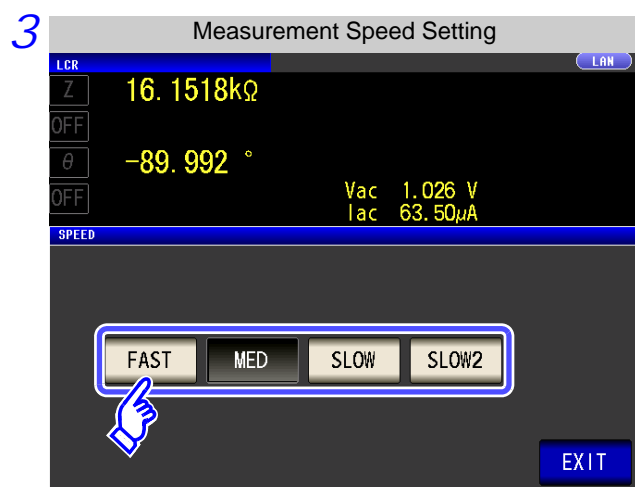

To select the measurement speed.

**FAST** Performs high-speed measurement.

**MED** This is the normal measurement speed.

**SLOW** Measurement precision improves.

**SLOW2** Measurement accuracy is better than SLOW.

The testing speed varies according to the number of parameters being displayed, and according to their type.

See "About Measurement Times and Measurement Speed" (p. 399)

4 Press **EXIT** to close the setting screen.

4.2 Setting Basic Settings of Measurement Conditions

4.2.7 Setting the Voltage/Current Limit

Depending on the measurement signal level, in some cases it is possible to damage the sample which is being tested by applying to it a voltage or a current greater than its rated value. For this reason, set a limit value to restrict the voltage that can be applied to the test sample or current that can flow to the test sample.

- When open circuit voltage (V) or constant voltage (CV) is set: Set the current limit.
- When constant current (CC) is set: Set the voltage limit.

Procedure

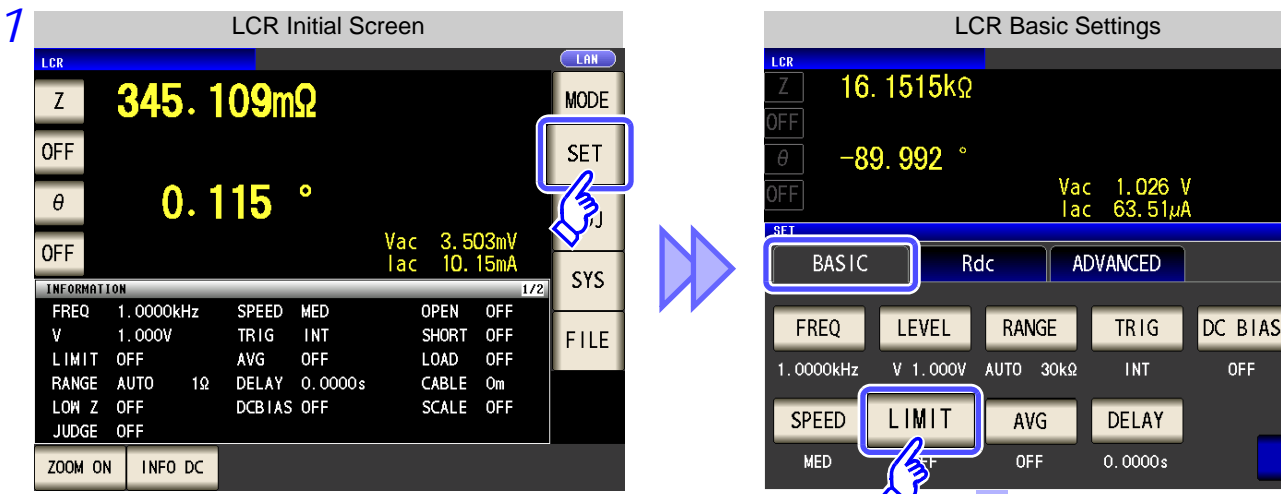

3 When the measurement signal level is a voltage (V, CV)

The screenshot shows the 'Current Limit Setting' screen. The top part displays the same measurement data as the previous screen. Below, the 'LIMIT' section shows a digital display with the value '100.00 mA'. There are 'OFF' and 'ON' buttons, and a grid of arrow keys for adjustment. An 'EXIT' button is at the bottom right.

When the measurement signal level is a current (CC)

The screenshot shows the 'Voltage Limit Setting' screen. The top part displays the same measurement data. Below, the 'LIMIT' section shows a digital display with the value '5.000 V'. There are 'OFF' and 'ON' buttons, and a grid of arrow keys for adjustment. An 'EXIT' button is at the bottom right.

- The present situation can be checked using the monitor display.
- The monitor display is different for V, CV, and CC.

**NOTE** First set the measurement signal level, and thereafter set the voltage or current limit. The setting for voltage or current limit changes automatically to current or voltage limit, according to the present measurement signal level setting.  
 See "4.2.2 Setting the Measurement signal level" (p. 43)

## 4.2 Setting Basic Settings of Measurement Conditions

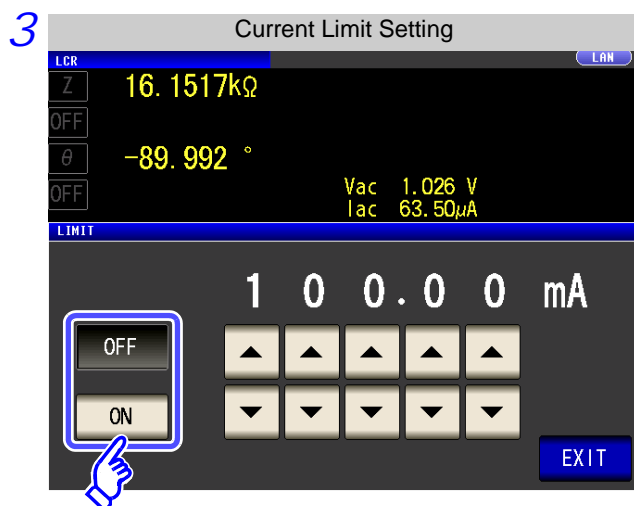

Select ON/ OFF for the limit function.

**OFF** Sets the limit function to OFF.

**ON** Sets the limit function to ON.

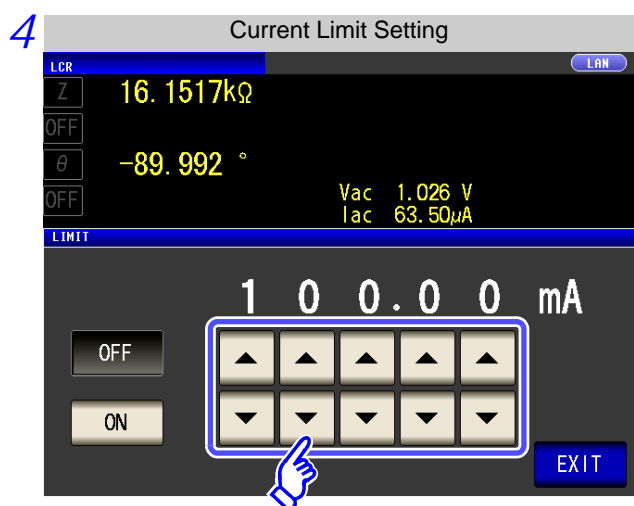

Use **▲** or **▼** to enter the limit value.

Limit range

Measurement signal level	Limit set	Setting range
V, CV	Current limit	0.01 mA to 100.00 mA
CC	Voltage limit	0.005 V to 5 V

Current limit accuracy

Frequency	Accuracy
4 Hz to 1.000 MHz	±10%±10 μA
1.0001 MHz to 5.000 MHz	±20%±10 μA

Voltage limit accuracy

Frequency	Accuracy
4 Hz to 1.000 MHz	±10%±10 mV
1.0001 MHz to 5.000 MHz	±20%±10 mV

When the limit function is ON, the display is as shown below.

Example: When constant voltage (CV) setting

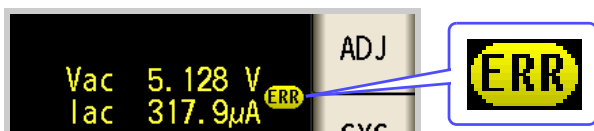

If the voltage or current which is applied to the sample under test exceeds the limit value (the current exceeding the limit value flows through the sample even when the open-circuit voltage is set to minimum value.)

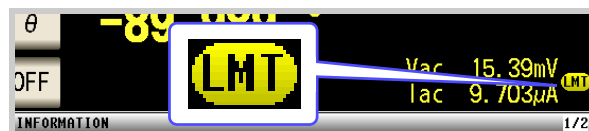

Depending on the limit value setting, the voltage or current applied to the sample may not reach the measurement signal level.

At this time, the voltage or current which exceeds the limit value is not being applied to the sample under test. You should change the test signal level so that it does not exceed the limit value.

5 Press **EXIT** to close the setting screen.

4.2 Setting Basic Settings of Measurement Conditions

4.2.8 Displaying Average Values (Averaging Set)

With the averaging function, the measured values can be averaged. Using this function, it is possible to reduce fluctuations in the measured value display.

- With internal trigger

▶

A rolling average of the tested values over the set number of times for averaging is always calculated backwards from the present.  
 (When the sample to be tested is changed over, it takes a little time for a certain stabilization time period until the results is reliable.)
- With external trigger

▶

An average of the test values is calculated over the set number of times for averaging forwards from when the trigger is input.

When the number of averaging times is 4, the number of measurements, measurement output points, and measurement value calculation method during output are as follows.

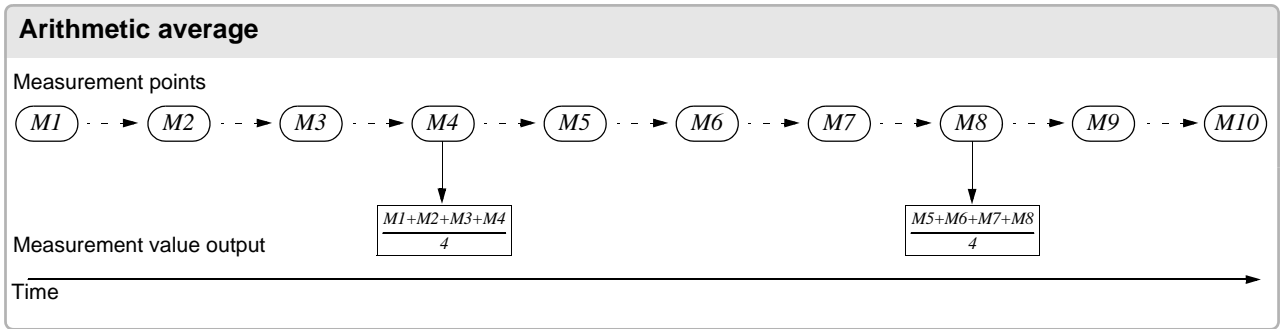
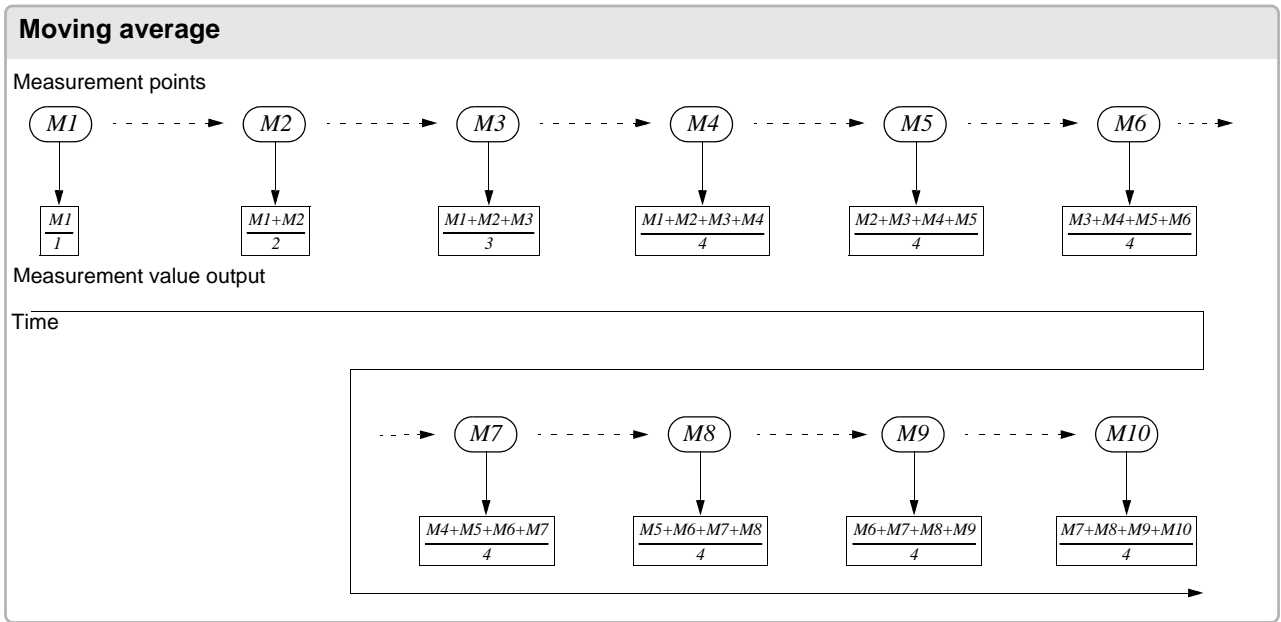

## 4.2 Setting Basic Settings of Measurement Conditions

### Procedure

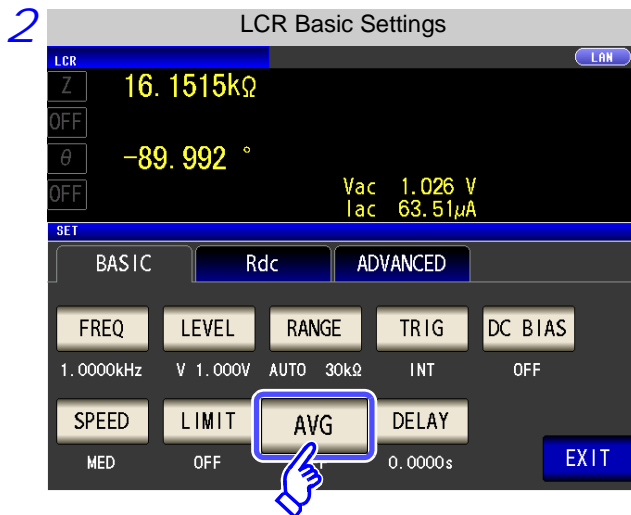
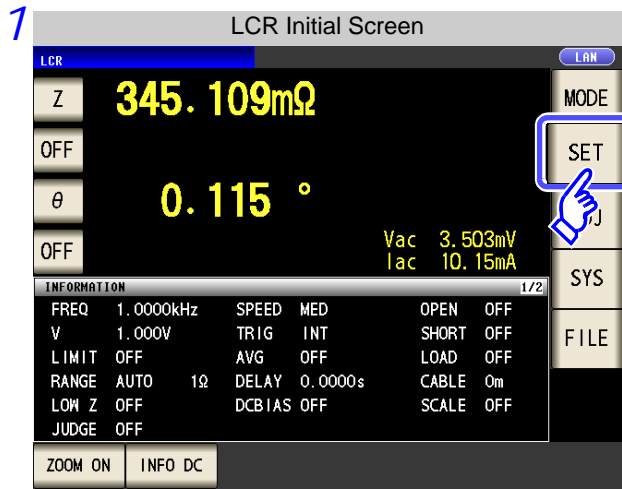

Press .

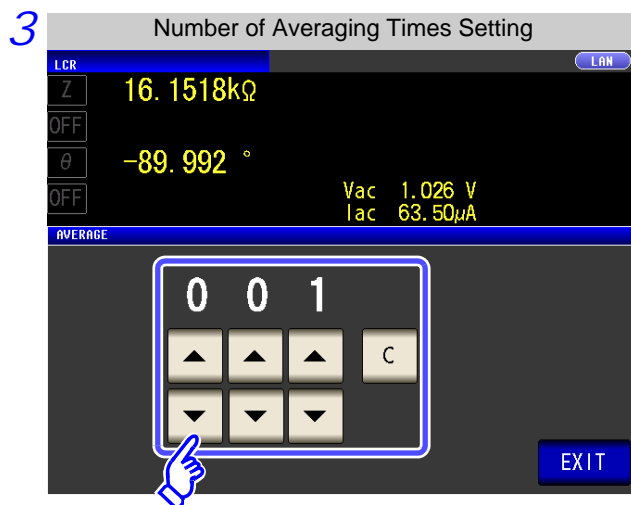

Use or to enter the number of averaging times.

Settable range: 1 to 256 times

**When you want to cancel the averaging**

**function:** Press .

The number of averaging times is set to 001, and the averaging function is set to OFF.

4 Press to close the setting screen.

4.2 Setting Basic Settings of Measurement Conditions

4.2.9 Measuring at Desired Time (Trigger Delay)

The delay time period from input of the trigger signal to reading of the test data can be set. With this function it is possible to ensure that testing is started after the connection condition of the object being tested and the test cables has stabilized.

Procedure

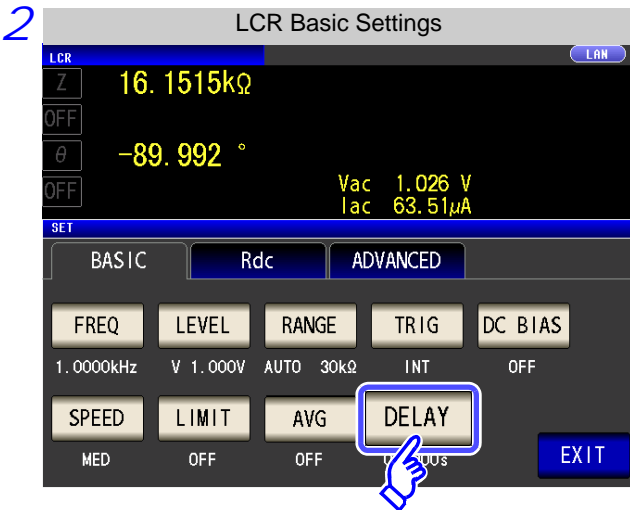
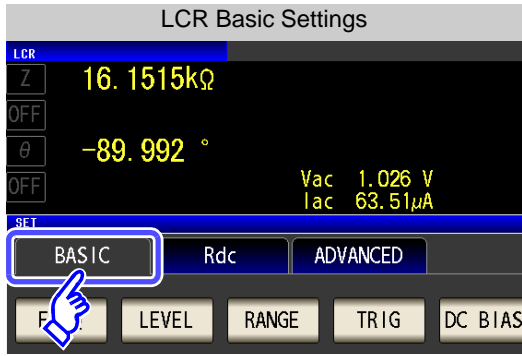
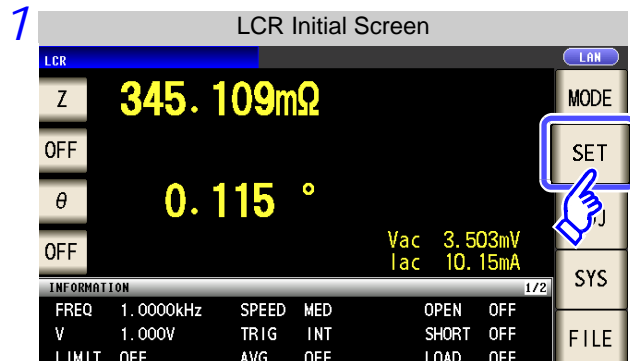

Press **DELAY**.

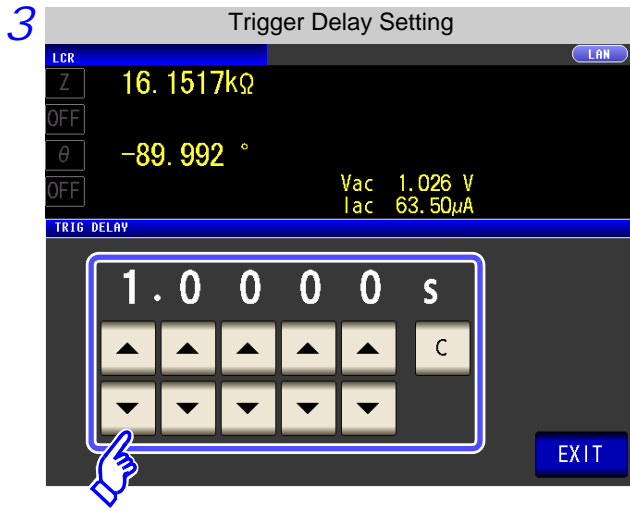

Use **▲** or **▼** to enter the delay time.

Settable range: 0 to 9.9999 s with resolution of 0.1 ms

When you want to cancel the trigger delay function: Press **C**.  
The set time is set to 0 s.

4 Press **EXIT** to close the setting screen.

**NOTE** When trigger delay is used, the LED for indicating that measurement is in progress is lit from when the trigger is input until measurement ends.



## 4.3 Setting DC Resistance Measurement

LCR  
ANALYZER

You can output a DC signal of any level (up to 2.5 V) and measure the DC resistance Rdc.

### NOTE

- To measure DC resistance, you need to set **Rdc** in the measurement parameters beforehand.
  - See "1.3.7 Parameter Settings Screen" (p. 25)
  - "4.1.2 Setting Display Parameters" (p. 39)
- When **Rdc** and other parameters are set, the DC resistance is measured after those other parameters have been measured with the AC signal. The measurement conditions can be set individually.
- The DC bias function cannot be enabled when RDC measurement is performed.

### Adding Rdc to Measurement Parameters

4

Chapter 4 LCR Function

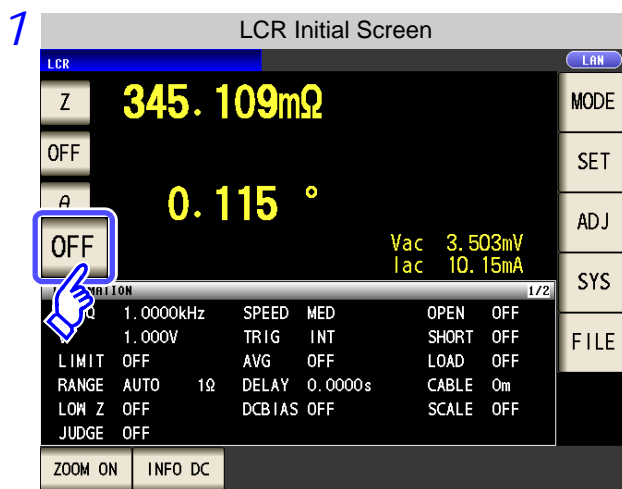

Select the parameter you want to change.

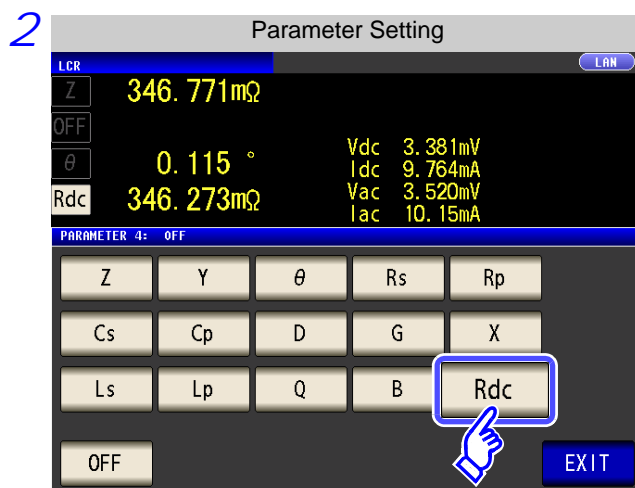

Press **Rdc**.

3 Press **EXIT** to close the setting screen.

4.3 Setting DC Resistance Measurement

4.3.1 Setting the Measurement signal level

The value of the test signal level may change according to the sample which is being tested. This instrument is possible to vary the level of the test signal applied to the object under test over a wide range using the following three methods.

- Set open circuit voltage (V)
▶

The value of the open circuit voltage is set.
- Set constant voltage (CV)
▶

The value of the voltage between the terminals of the object under test is set.
- Set constant current (CC)
▶

The value of the current flowing through the object under test is set.

**⚠ CAUTION** Do not switch between V, CV and CC while the test sample is still connected to the measurement terminals because doing so may damage the test sample.

Procedure

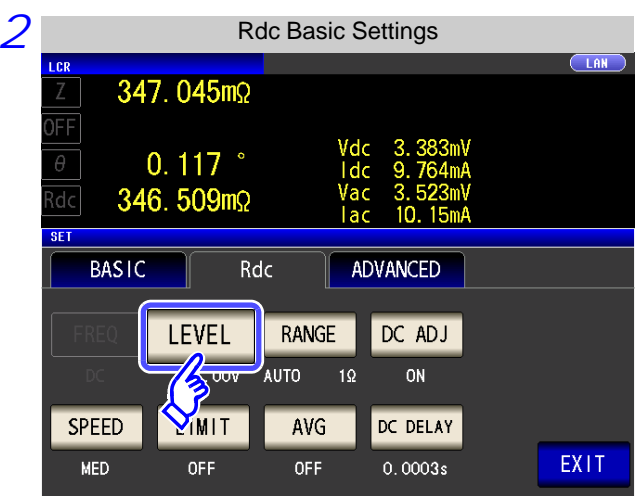
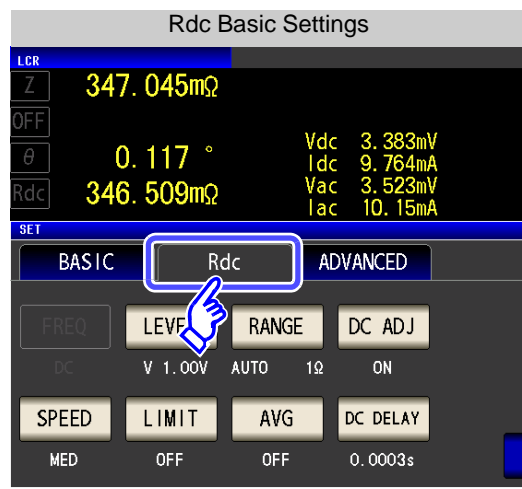
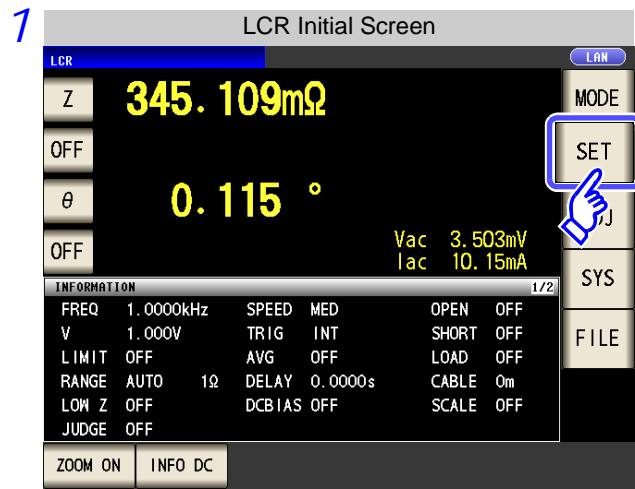

Press LEVEL.

### 4.3 Setting DC Resistance Measurement

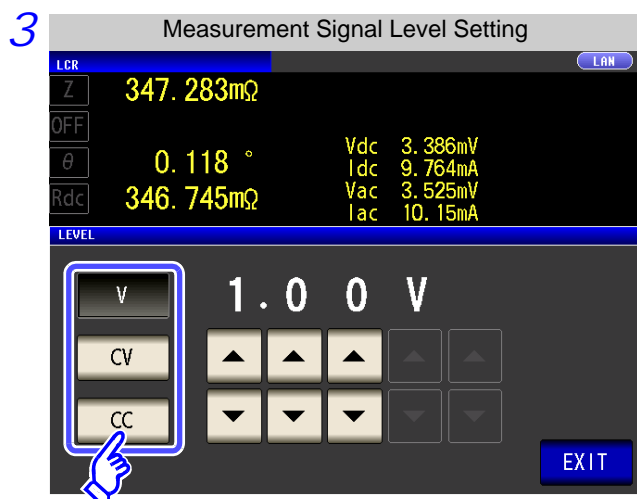

To select the measurement signal level.

V open circuit voltage (p. 45)



CV Voltage level between test sample terminals (p. 45)

CC Current level through test sample (p. 47)

The accuracy of testing varies according to the test signal level.

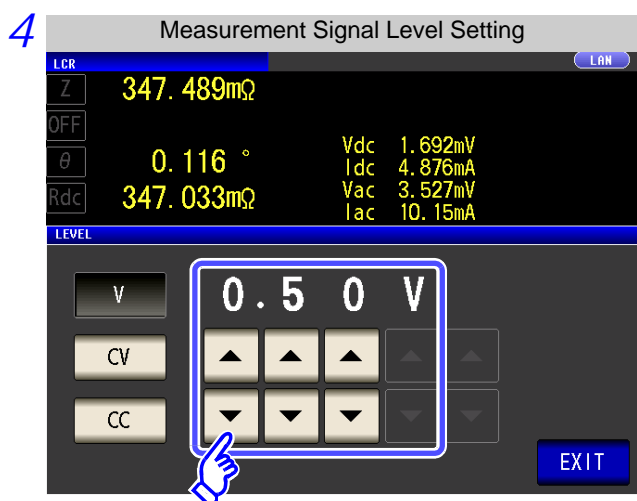
See "13.2 Measurement Range and Accuracy" (p. 395)



Use  or  to enter the voltage or current value.

See "For setting range and accuracy" (p. 68)

5 Press  to close the setting screen.

#### NOTE

When the measurement value is outside the guaranteed accuracy range, the following icon appears at the top of the screen.

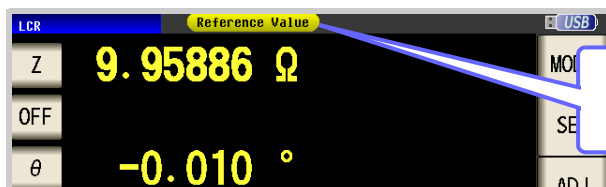

In this case, you should consider the following possible causes, and you should either change the test conditions while checking the accuracy assured ranges "13.2 Measurement Range and Accuracy" (p. 395), or you should consider the measured values as values for reference.

- Perhaps the test signal level is too low, increase the test signal level.
- If the current measurement range (during HOLD setting) is not appropriate, set again in the AUTO range, or change the range by manual.

4.3 Setting DC Resistance Measurement

About the test signal level

Relationship between the measurement signal level of the instrument and the sample is as follows.

**Open circuit voltage level (V)**

This voltage value is the value which is applied across the two terminals of the series combination of the object which is being tested and the output impedance. As for the voltage which is applied across the terminals of the object which is being tested (by itself), if required, you should either check the monitor voltage value, or select constant voltage (CV) and set a voltage value across these terminals.

**Constant current level (CC)**

You should select this if you wish to set the current passing through the object to be tested to a constant value.

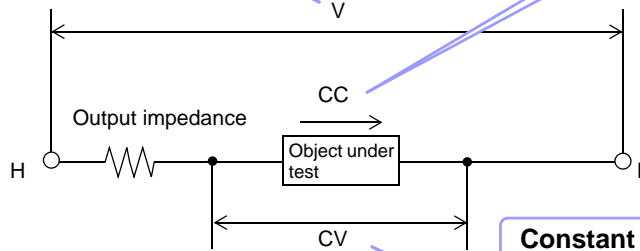

**Constant voltage level (CV)**

You should select this if you wish to set the voltage across the terminals of the object to be tested to a constant value.

For setting range and accuracy

**Open circuit voltage level (V) setting**

- When normal mode (p. 74)

Open circuit voltage setting range	Open circuit voltage accuracy
0.10 to 2.50 V	±10% ±10 mV

- When Low Z high accuracy mode (p. 74)

Open circuit voltage setting range	Open circuit voltage accuracy
0.10 to 1.00 V	±10% ±10 mV

**Constant voltage level (CV) setting**

- When normal mode (p. 74)

Constant voltage setting range	Constant voltage accuracy
0.10 to 2.50 V	±10% ±10 mV

- When Low Z high accuracy mode (p. 74)

Constant voltage setting range	Constant voltage accuracy
0.10 to 1.00 V	±10% ±10 mV

**Constant current level (CC) setting**

- When normal mode (p. 74)

Constant current setting range	Constant current accuracy
0.01 to 25.00 mA	±10% ±10 μA

- When Low Z high accuracy mode (p. 74)

Constant current setting range	Constant current accuracy
0.01 to 100.00 mA	±10% ±10 μA

### 4.3.2 Setting the Measurement Range

There are the following two methods for setting the measurement range.

**AUTO**

The most suitable test range is set automatically.  
(This allows the most suitable measurement range to be set when, for example, measuring a test sample whose nature is unknown.)

**HOLD**

The test range is fixed, and may only be altered manually.  
(When the range is fixed, high-speed measurement is possible.)

#### 1 Setting AUTO Ranging

##### Procedure

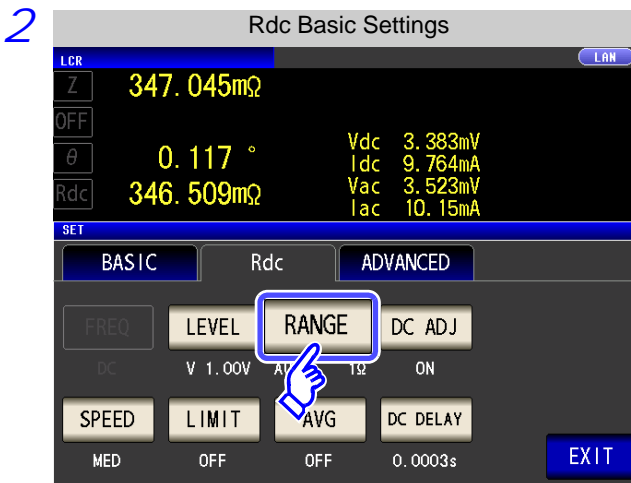
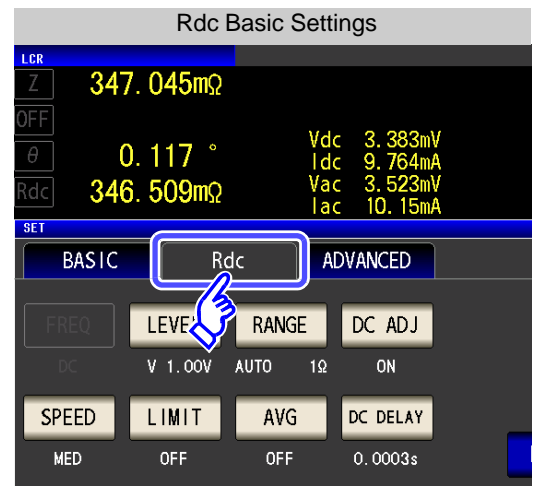
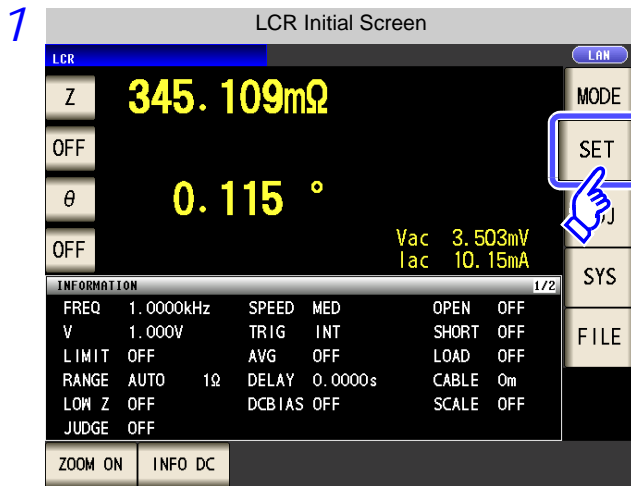

Press RANGE.

### 4.3 Setting DC Resistance Measurement

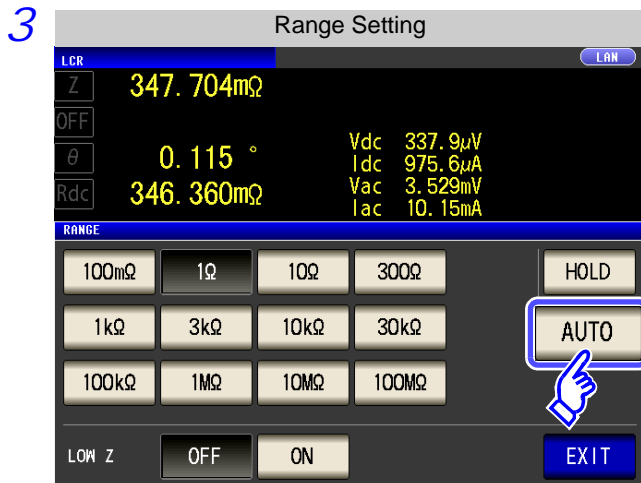

Press **AUTO**.

If the instrument is being used outside the limits of its specification, the suitable range may not be set in auto ranging function. In this case, check the accuracy assured ranges in "13.2 Measurement Range and Accuracy" (p. 395) and then change the test conditions.

4 Press **EXIT** to close the setting screen.

4.3 Setting DC Resistance Measurement

2 Setting the Ranging to HOLD

Procedure

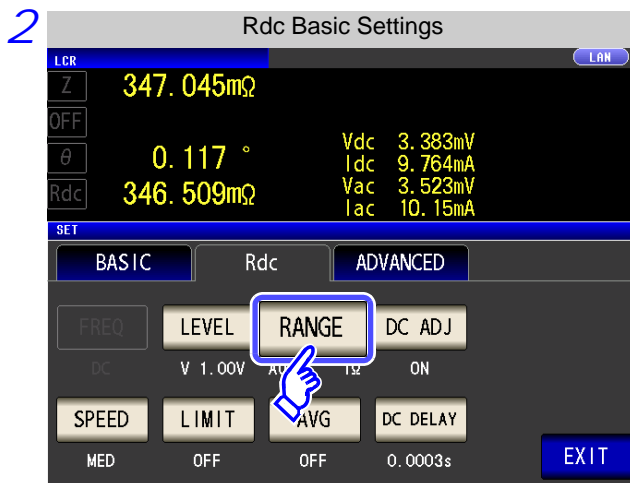
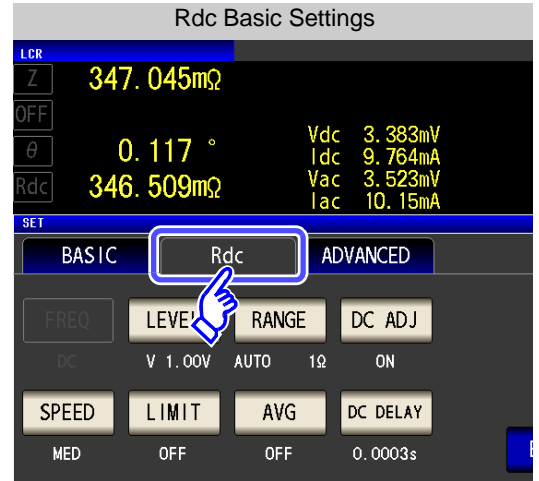
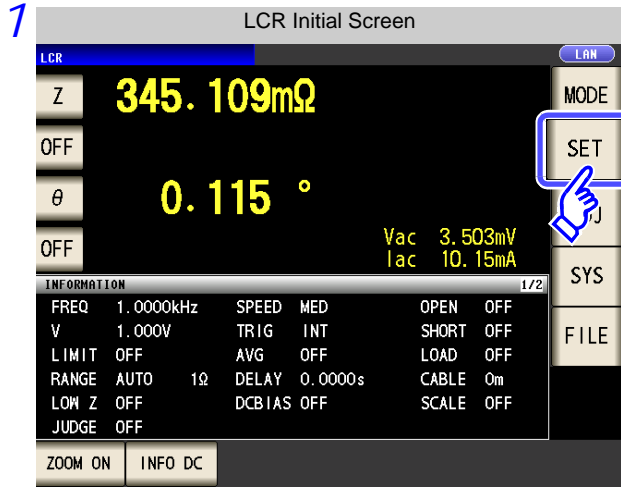

Press RANGE .

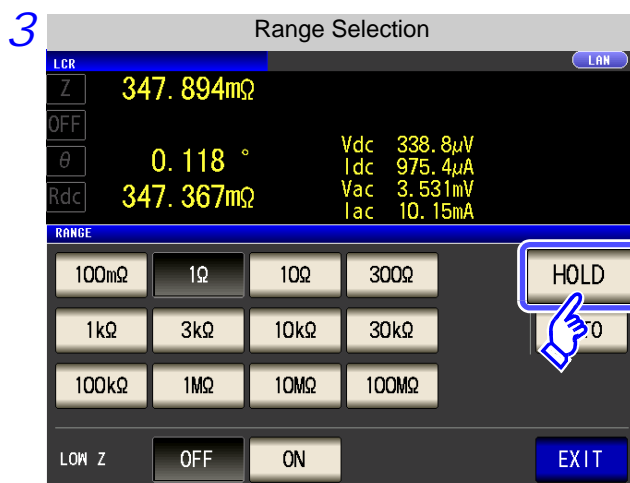

Press HOLD .

4.3 Setting DC Resistance Measurement

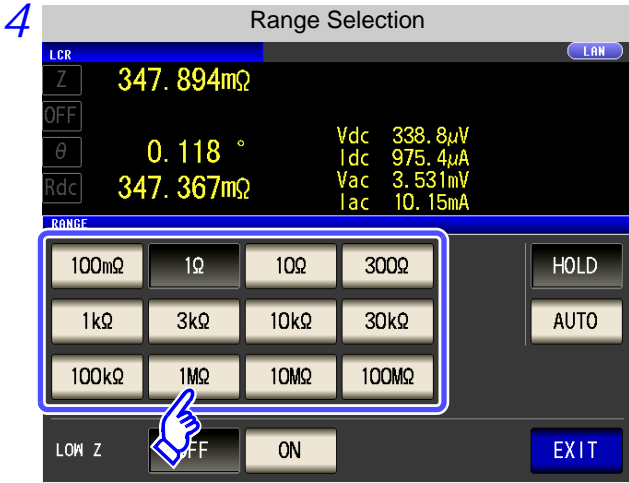

Set the test range according to the combined impedance value of the sample to be tested and the test cables.

To select the measurement range.

Test range	Accuracy guaranteed range	AUTO Ranging Range
100 MΩ	8 MΩ to 200 MΩ	8 MΩ to 999.999 MΩ
10 MΩ	800 kΩ to 100 MΩ	800 kΩ to 10 MΩ
1 MΩ	80 kΩ to 10 MΩ	80 kΩ to 1 MΩ
100 kΩ	24 kΩ to 1 MΩ	24 kΩ to 100 kΩ
30 kΩ	8 kΩ to 300 kΩ	8 kΩ to 30 kΩ
10 kΩ	2.4 Ω to 100 kΩ	2.4 kΩ to 10 kΩ
3 kΩ	800 Ω to 30 kΩ	800 Ω to 3 kΩ
1 kΩ	240 Ω to 10 kΩ	240 Ω to 1 kΩ
300 Ω	8 Ω to 300 Ω	8 Ω to 300 Ω
10 Ω	800 mΩ to 10 Ω	800 mΩ to 10 Ω
1 Ω	80 mΩ to 1 Ω	80 mΩ to 1 Ω
100 mΩ	10 mΩ to 100 mΩ	0 Ω to 100 mΩ

**NOTE**

- The guaranteed accuracy range varies depending on the measurement conditions. See Check the accuracy assured ranges in "13.2 Measurement Range and Accuracy" (p. 395)
- The measurement range is determined according to the test range setting. If the display for the measured value shows "OVER FLOW" or "UNDER FLOW", that means that measurement cannot be performed using the currently set test range. Either you should set AUTO ranging so as to select the most suitable test range automatically, or you should set a more suitable test range manually. If a measurement result is outside the display range (p. 387), "DISP OUT" is displayed.

5 Press **EXIT** to close the setting screen.

**NOTE**

- The test range setting is made according to the combination of the impedances of the sample being tested and the test cables. Therefore it can happen that testing is not possible, if the test range is held with HOLD only upon the basis of the impedance of the sample under test. If this happens, you should change the test range, making reference to "7.1 Setting Open Circuit Compensation" (p. 273) and "7.2 Short Circuit Compensation" (p. 280).
- When the measurement value is outside the guaranteed accuracy range, the following icon appears at the top of the screen.

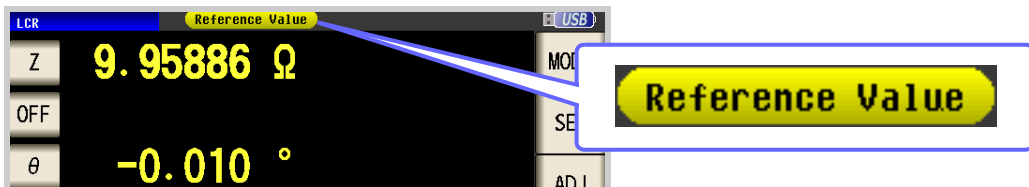

In this case, you should consider the following possible causes, and you should either change the test conditions while checking the accuracy assured ranges "13.2 Measurement Range and Accuracy" (p. 395), or you should consider the measured values as values for reference.

- Perhaps the test signal level is too low, increase the test signal level.
- If the current measurement range (during HOLD setting) is not appropriate, set again in the AUTO range, or change the range by manual.



4.3 Setting DC Resistance Measurement

3 Low Z High Accuracy Mode

This mode balances the  $L_{POT}$  terminal at 0 V to reduce the influence of contact resistance during low impedance measurement. Furthermore, since the output resistance becomes  $10\ \Omega$  and sufficient current can flow to the test sample to be measured, this mode enables highly accurate measurement.

Procedure

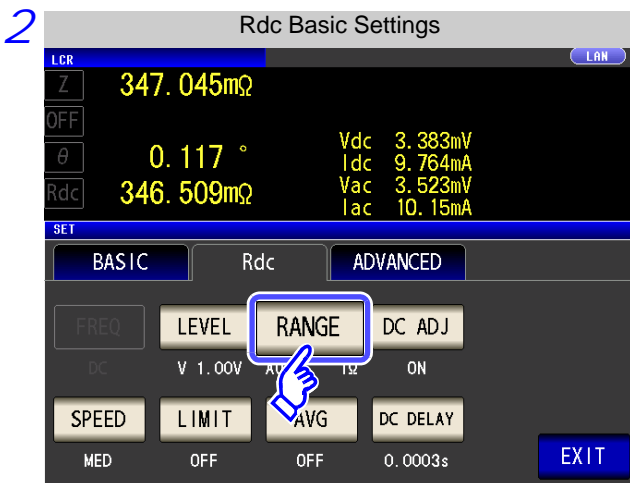
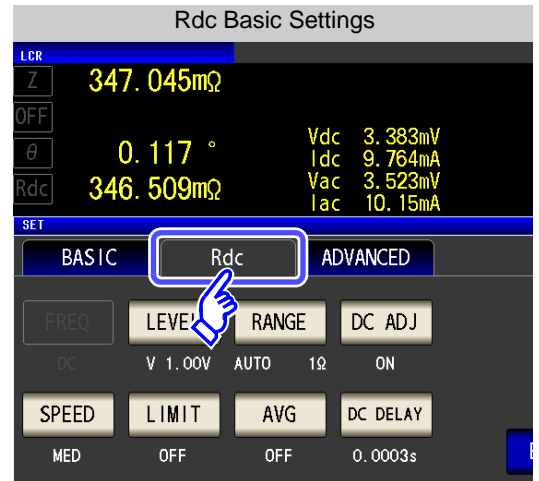
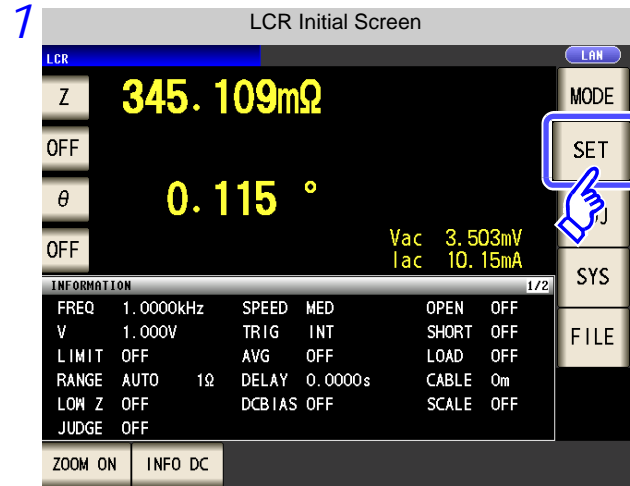

Press **RANGE**.

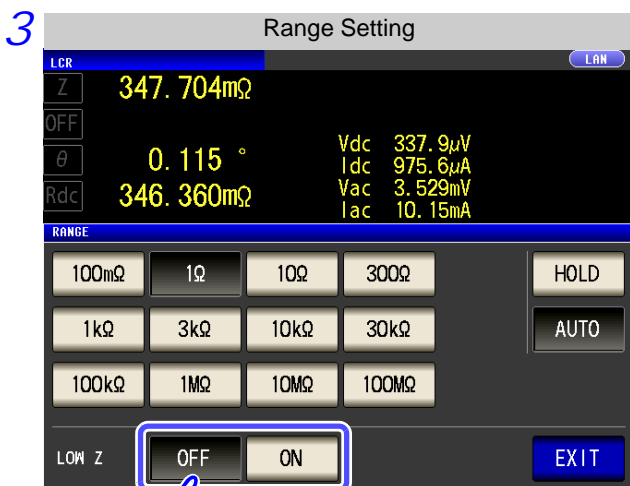

Select ON/ OFF for the low Z high accuracy mode.

- Sets the low Z high accuracy mode to OFF.
- Sets the low Z high accuracy mode to ON.

4 Press **EXIT** to close the setting screen.

### 4.3 Setting DC Resistance Measurement

#### NOTE

With low Z high accuracy mode, the possible setting range of the measurement signal level differs. Refer to the table below.

Measurement range	
100 M $\Omega$	Normal mode only (setting invalid for low Z high accuracy mode)
10 M $\Omega$	
1 M $\Omega$	
100 k $\Omega$	
30 k $\Omega$	
10 k $\Omega$	
3 k $\Omega$	
1 k $\Omega$	
300 $\Omega$	
10 $\Omega$	
1 $\Omega$	
100 m $\Omega$	

Settable range of measurement signal level: (p. 68)

### Detecting Disconnection of 4 Terminals (When Low Z High Accuracy Mode)

This function operates when measurement is being performed in low impedance high accuracy mode (p. 53). It detects whether each of the L<sub>POT</sub>, H<sub>POT</sub> and L<sub>CUR</sub> terminals is disconnected.

If a terminal is not connected properly, an indication like the following is displayed. Check the connections again.

**See** "2.4 Connecting the Measurement Cables, Probes, or Fixture" (p. 30)

The error is also output via EXT I/O.

**See** "Chapter 11 External Control" (p. 363)



### 4.3.3 Setting the DC Adjustment Function

DC adjustment sets the generation voltage to 0 V, obtains the offset value generated in the internal circuit of the instrument, and reduces the measurement error.

**Procedure**

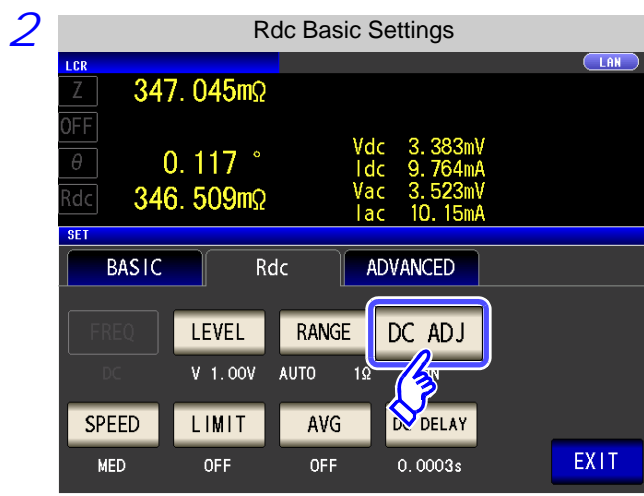
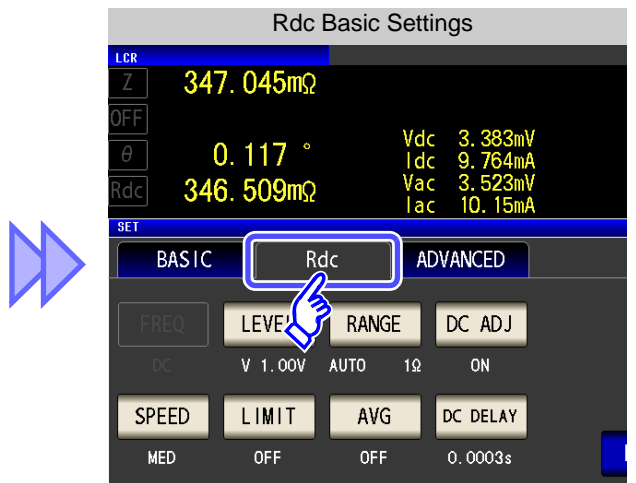
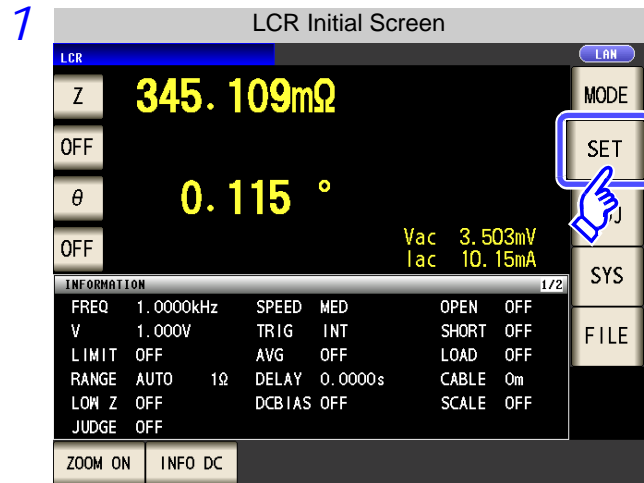

Press DC ADJ .

### 4.3 Setting DC Resistance Measurement

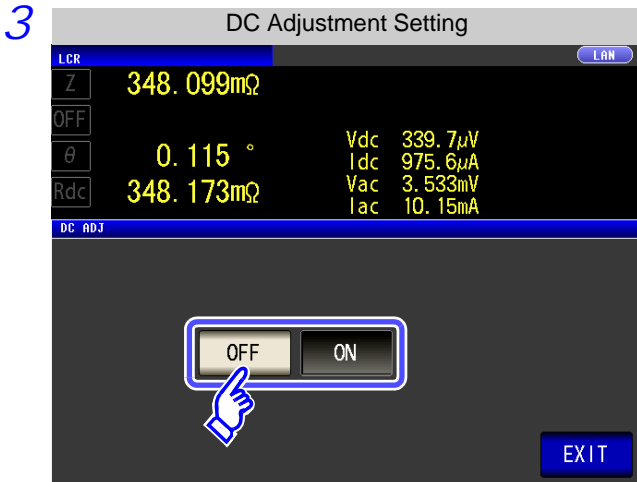

Select ON/ OFF for DC adjustment.

OFF

Obtains the offset value with the CALIB signal of EXT I/O or a communication command (:DCResistance:ADJust:DEMAND).

ON

Obtains the offset value for each measurement.

#### NOTE

- Since the transient response time becomes long as a result of the impedance value of the measurement object, set a long DC delay time.(p. 82)  
When DC adjustment is ON, the measurement time becomes about twice as long because time is required both for normal measurement and for offset measurement.
- DC adjustment measurement is performed in the following cases even if DC adjustment is set to OFF.
  - When measurement is first performed after the power is turned on
  - When the DC delay time is changed
  - When the measurement range is changed
  - When low Z high accuracy mode is turned ON/OFF
  - When the measurement signal level is changed

4 Press **EXIT** to close the setting screen.

### 4.3.4 Setting the Measurement speed

The testing speed can be set. The slower the testing speed is, the more accurate are the results.

**Procedure**

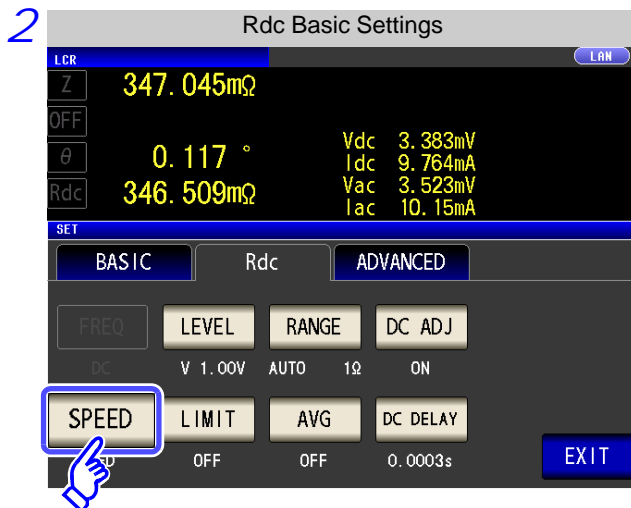
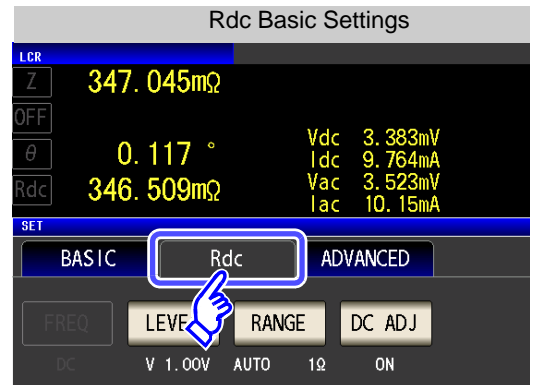
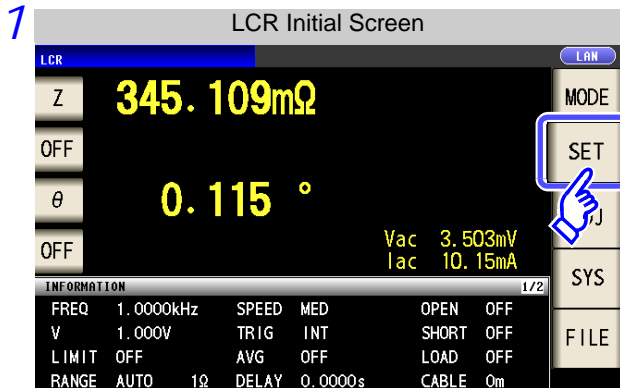

Press **SPEED**.

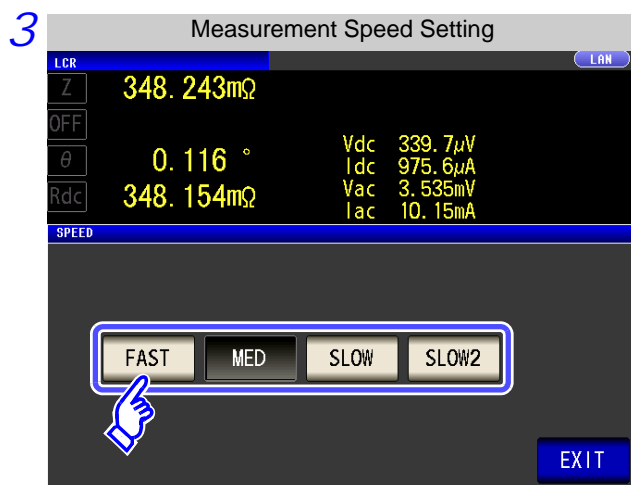

To select the measurement speed.

- FAST** Performs high-speed measurement.
- MED** This is the normal measurement speed.
- SLOW** Measurement precision improves.
- SLOW2** Measurement accuracy is better than SLOW.

The testing speed varies according to the number of parameters being displayed, and according to their type.  
 See "About Measurement Times and Measurement Speed" (p. 399)

4 Press **EXIT** to close the setting screen.

4.3 Setting DC Resistance Measurement

4.3.5 Setting the Voltage/Current Limit

Depending on the measurement signal level, in some cases it is possible to damage the sample which is being tested by applying to it a voltage or a current greater than its rated value. For this reason, set a limit value to restrict the voltage that can be applied to the test sample or current that can flow to the test sample.

- When open circuit voltage (V) or constant voltage (CV) is set: Set the current limit.
- When constant current (CC) is set: Set the voltage limit.

Procedure

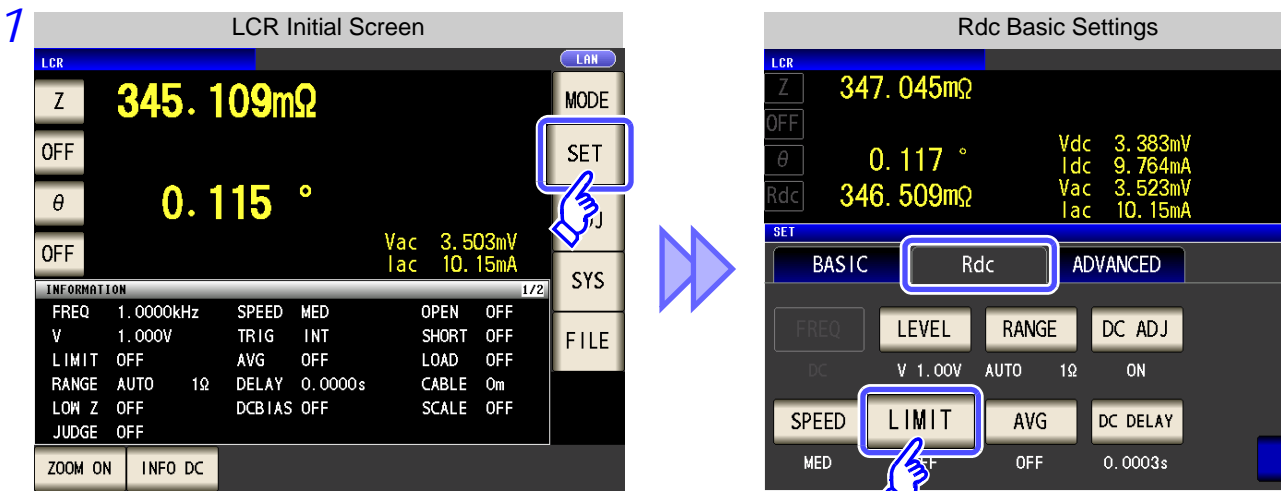

2 When the measurement signal level is a voltage (V, CV)

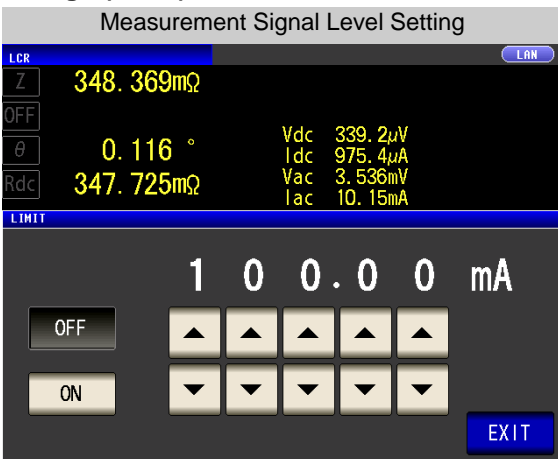

When the measurement signal level is a current (CC)

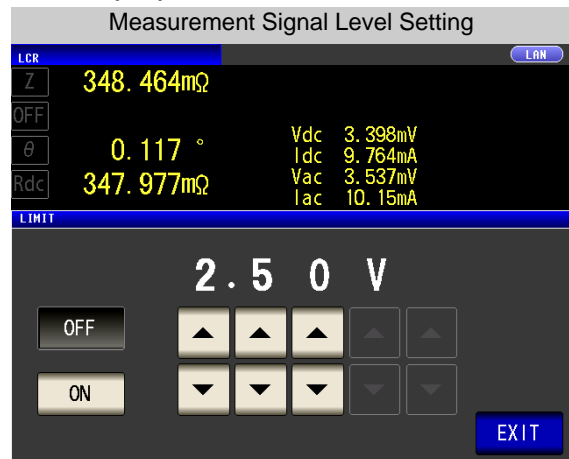

- The present situation can be checked using the monitor display.
- The monitor display is different for V, CV, and CC.

**NOTE** First set the measurement signal level, and thereafter set the voltage or current limit. The setting for voltage or current limit changes automatically to current or voltage limit, according to the present measurement signal level setting. See "4.2.2 Setting the Measurement signal level" (p. 43)

### 4.3 Setting DC Resistance Measurement

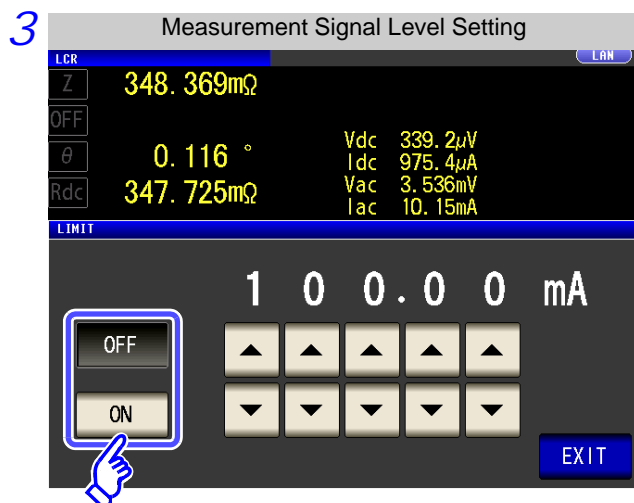

Select ON/ OFF for the limit function.

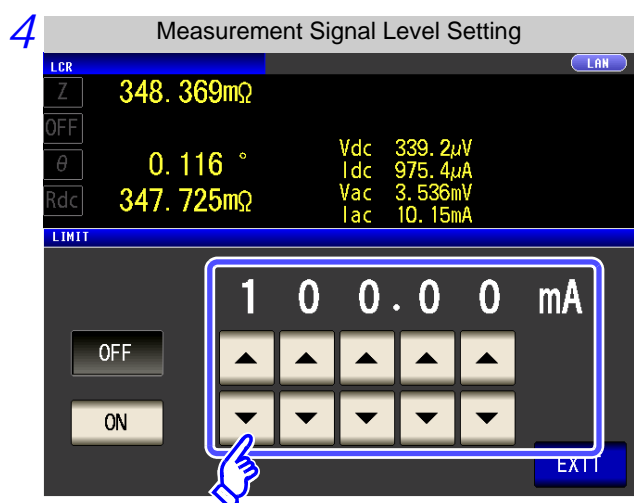
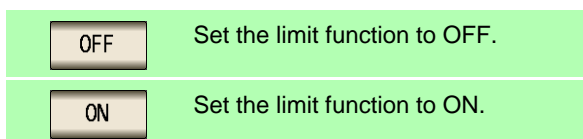

Use ▲ or ▼ to enter a limit value.

Limit range:

Measurement signal level	Limit set	Setting range
V, CV	Current limit	0.01 mA to 100 mA
CC	Voltage limit	0.10 V to 2.5 V

Current limit accuracy:  $\pm 10\% \pm 10 \mu\text{A}$

Voltage limit accuracy:  $\pm 10\% \pm 10 \text{mV}$

When the limit function is ON, the display is as shown below.

Example: When constant voltage (CV) setting

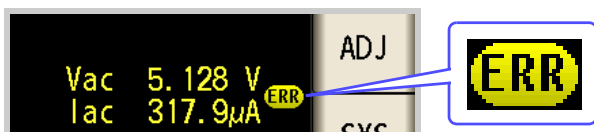

If the voltage or current which is applied to the sample under test exceeds the limit value (the current exceeding the limit value flows through the sample even when the open-circuit voltage is set to minimum value.)

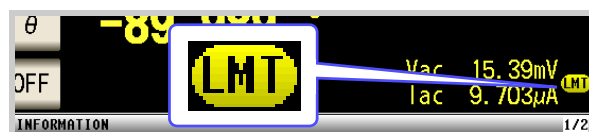

If the test signal level which is being applied to the sample under test exceeds the limit value. Then the test signal level is stopped changing.

At this time, the voltage or current which exceeds the limit value is not being applied to the sample under test. You should change the test signal level so that it does not exceed the limit value.

5 Press **EXIT** to close the setting screen.

4.3 Setting DC Resistance Measurement

4.3.6 Displaying Average Values (Average set)

With the averaging function, the measured values can be averaged. Using this function, it is possible to reduce fluctuations in the measured value display.

After the signal level and range are set, measurement is performed for the set number of averaging times and the measurement values are displayed.

**NOTE** The averaging process during Rdc measurement performs arithmetic averaging processing regardless of the trigger setting.

Procedure

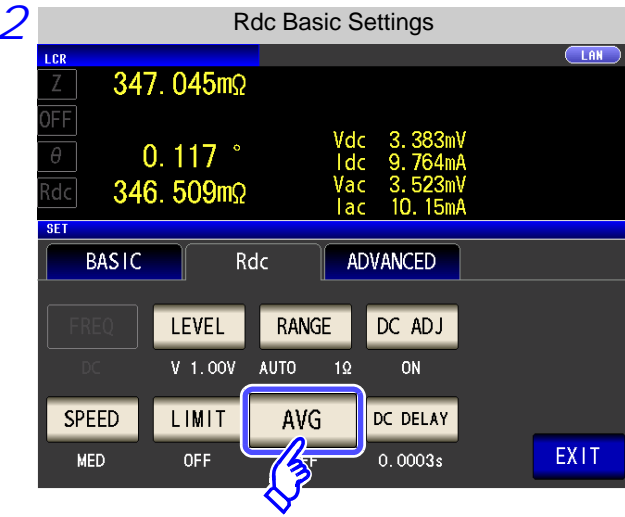
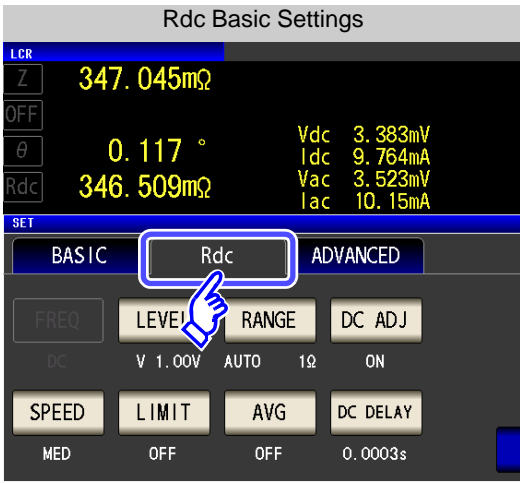
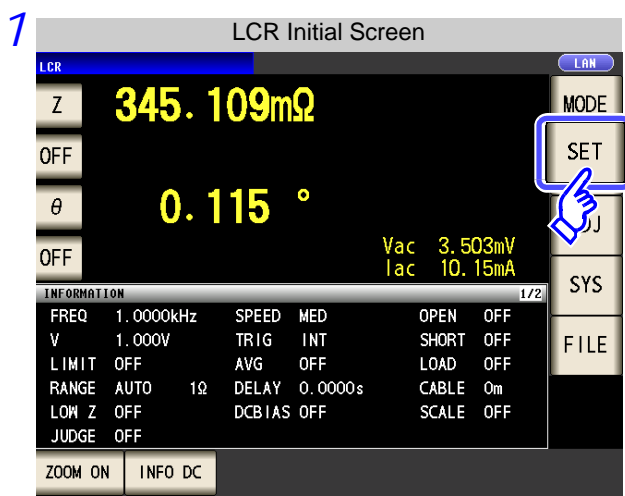



Press **AVG**.

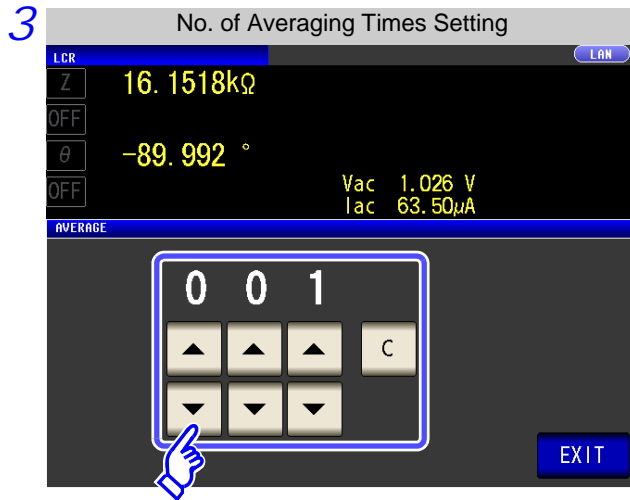

### 4.3 Setting DC Resistance Measurement



Use  or  to enter the number of averaging times.

Settable range: 1 to 256

**When you want to cancel the averaging**

**function:** Press  .

The number of averaging times is set to 1.

4 Press  to close the setting screen.

4.3 Setting DC Resistance Measurement

4.3.7 Setting the Delay Time

In cases such as the following, set the time to wait before starting DC resistance measurement.

- When measurement is changed from AC signal measurement to DC resistance measurement.
- When the voltage level is changed.
- When DC adjustment is enabled.

This delay time is for delaying measurement until the DC level and 0 VDC has stabilized.

When measuring DC resistance, observe the measurement waveform and then insert the delay time required until the transient phenomenon disappears because the time required until the DC level stabilizes differs depending on the test sample.

When number of averaging times is 1

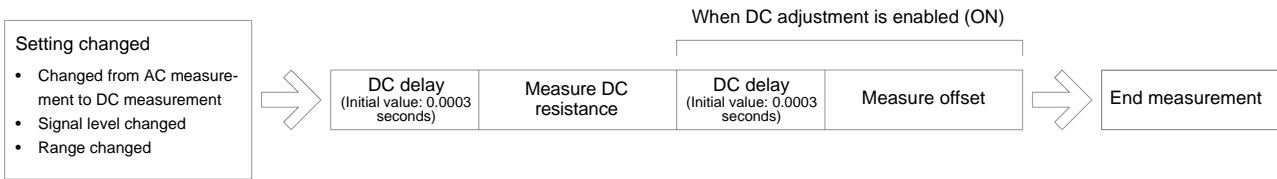

When the number of averaging times is 2 or more  
(The number of times is 2 in this example)

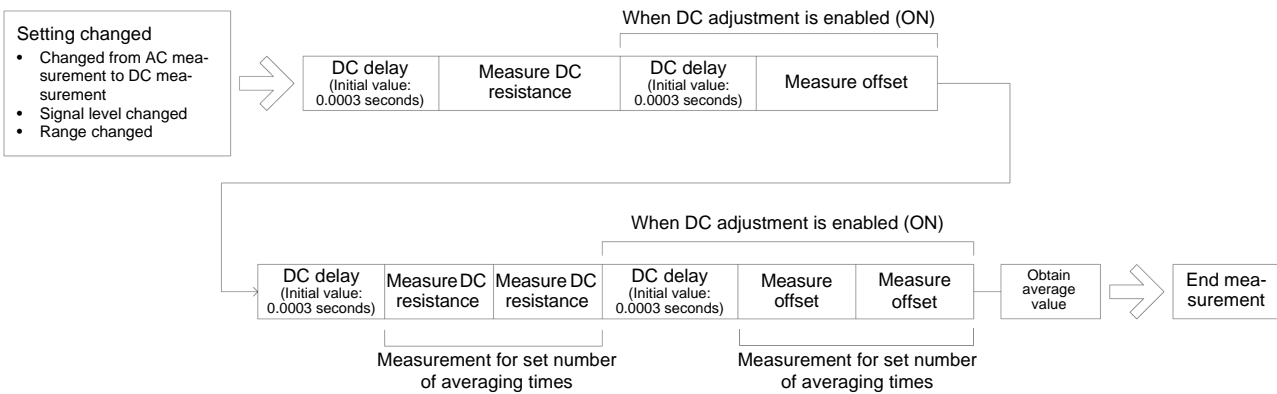

Procedure

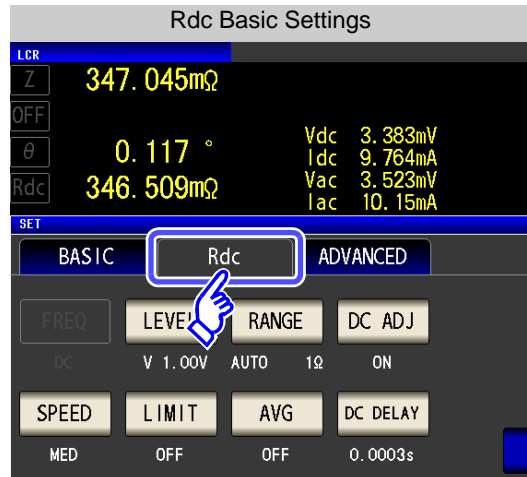
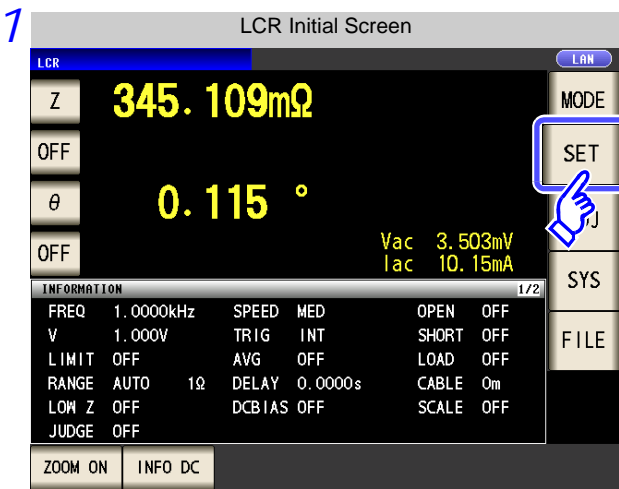

### 4.3 Setting DC Resistance Measurement

**NOTE** The time required until the DC signal level stabilizes differs depending on the test sample to be measured. To ensure measurement is performed accurately, observe the measurement waveform in advance and then set the delay time required until the DC signal level stabilizes.

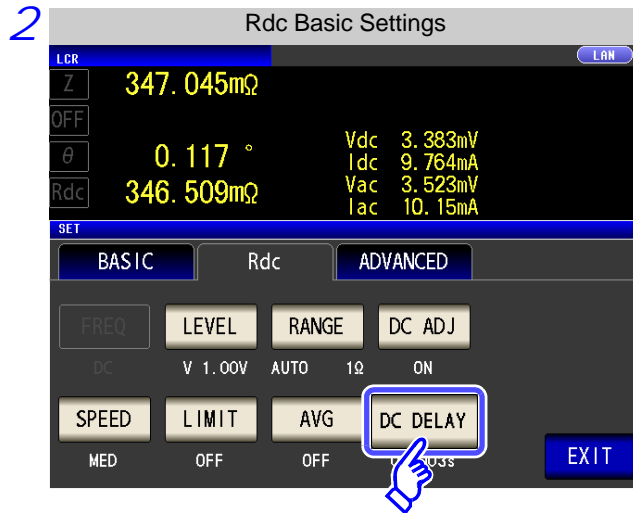

Press **DC DELAY**.

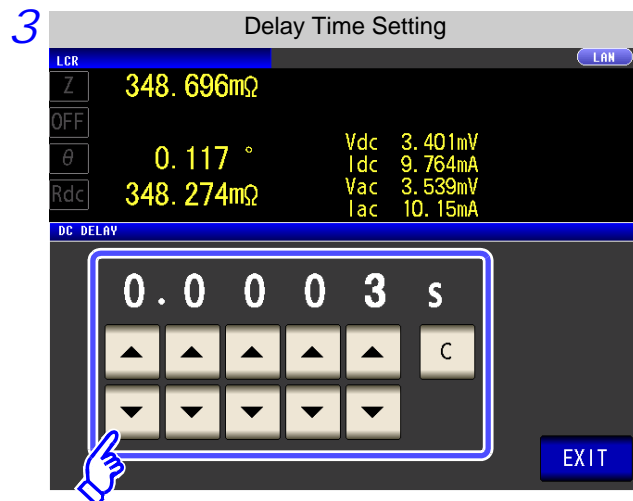

Use **▲** or **▼** to enter the delay time.

Settable range: 0.0003 to 9.9999 s

**When you want to cancel setting of the delay**

**time:** Press **C**.

The set time is set to 0.0003 s.

4 Press **EXIT** to close the setting screen.

# 4.4 Judging Measurement Results LCR ANALYZER

The measurement results are compared to an arbitrarily set reference and then the judgment results are displayed. This function is useful for quality evaluation and the like.

There is comparator measurement which compares one judgment reference and the measurement values, and BIN measurement which compares multiple judgment reference values (up to 10) and the measurement values.

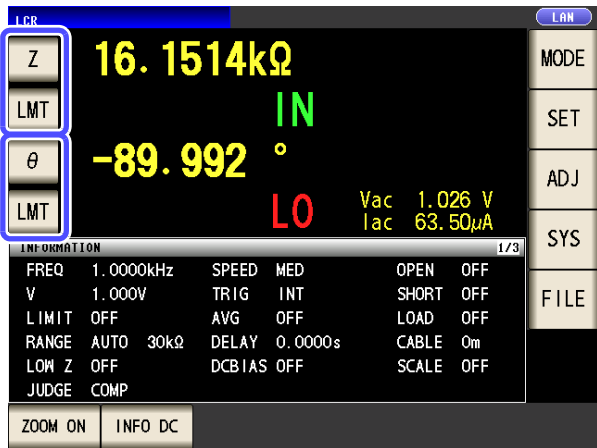

Judgment by comparator measurement and BIN measurement is performed for the first parameter and third parameter.

Judgment Target	Result Display
First parameter	Second parameter area
Third parameter	Fourth parameter area

Therefore, set the measurement values you want to judge for the first parameter and third parameter in advance.

See "4.1.2 Setting Display Parameters" (p. 39)

## Setting the judgment mode

Use the following procedure to select and set one of the modes.

### Procedure

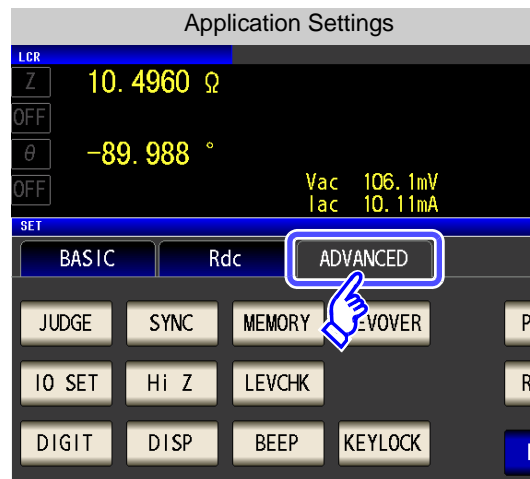
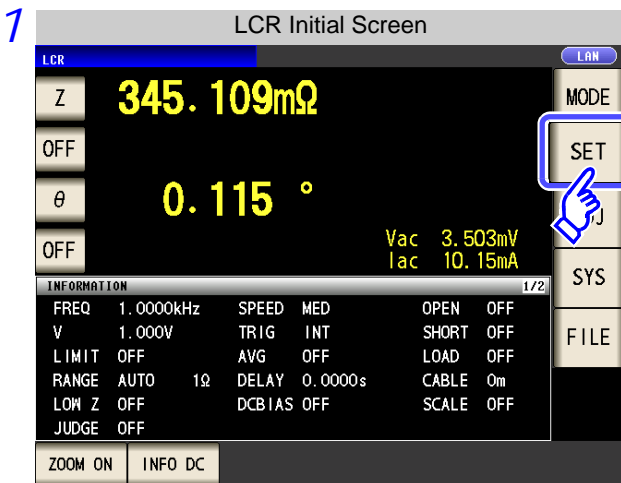

## 4.4 Judging Measurement Results

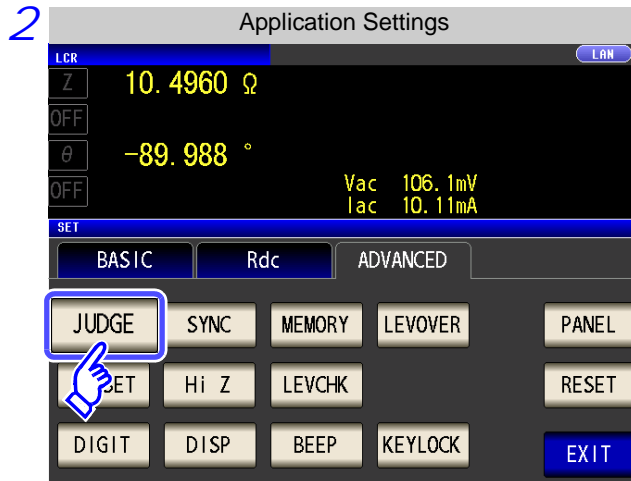

Press **JUDGE**.

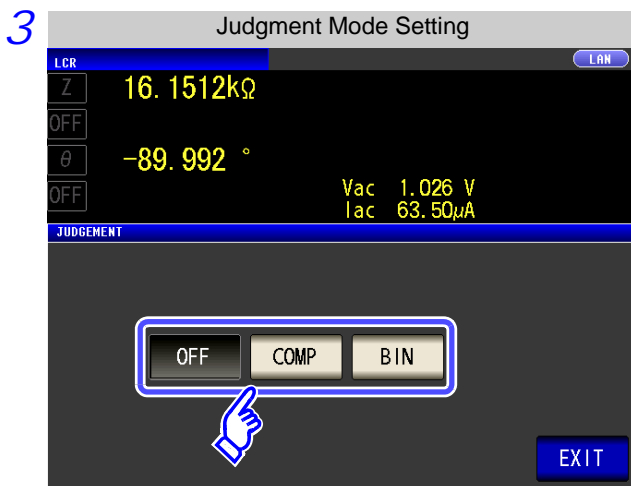

To select the judgment mode.

**OFF**

Cancels the comparator and BIN measurement settings.

**COMP**

Sets comparator measurement. (p. 86)

**BIN**

Sets BIN measurement. (p. 93)

When comparator measurement and BIN measurement are performed, only the first and third parameters can be set.

The second and fourth parameters become LMT.

4 Press **EXIT** to close the setting screen.

4.4 Judging Measurement Results

4.4.1 Judging with Upper and Lower Limit Values (Comparator Measurement Mode)

The comparator measurement allows you to do the following.

- **Preset a reference value and upper and lower limit values as the judgment reference, and display a judgment result as HI (higher than the upper limit value), IN (within the range set for the upper and lower limit values), or LO (lower than the lower limit value).**
- **Output the judgment results to an external device (via the EXT I/O connector).**
- **Select different settings and perform judgment for up to two parameters.**
- **Be notified of judgment results by buzzer.**  
See "4.5.13 Setting Operation Sounds (Beep Sounds)" (p. 128)
- **Confirm the judgment result from the judgment result indication LEDs on the front panel of the instrument.**  
See "Judgment Result Indication LEDs" (p. 10)

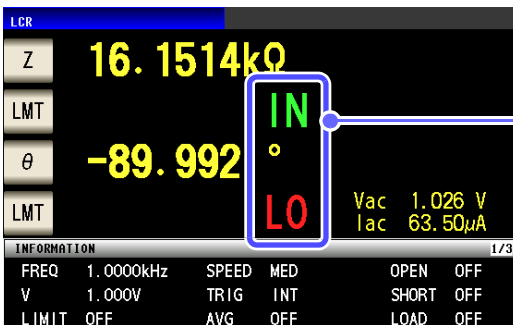
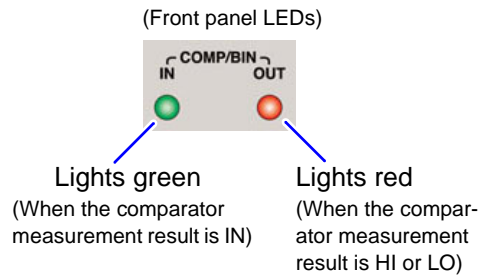

<b>HI</b>	Measured value is above upper limit
<b>IN</b>	Pass (meets criteria)
<b>LO</b>	Measured value is below lower limit

The comparator decision mode can be set as one of the following:

<p><b>Absolute value (ABS) setting (p. 88)</b></p>	<p>Set absolute values for the upper limit and lower limit values of the measurement parameters. The measurement values displayed are the same as those of the measurement parameters.</p>
<p><b>Percent (%) Setting (p. 89)</b></p>	<p>Enter reference values and then set percentages corresponding to the reference values as the upper limit and lower limit values. The measurement values displayed are the same as those of the measurement parameters.</p>
<p><b>Deviation Percent (Δ%) Setting (p. 91)</b></p>	<p>Enter reference values and then set percentages corresponding to the reference values as the upper limit and lower limit values. The measurement values are displayed in deviations (Δ%) from the reference value.</p>

## 4.4 Judging Measurement Results

- \*1: The following equation is used to calculate the comparison upper limit value and comparison lower limit value. (In the case of the comparison lower limit value, if a value that is lower than the reference value is set, the minus (-) sign is required for the percentage setting value.)

$$\text{Upper limit comparison value (Lower limit comparison value)} = \text{reference value} + |\text{reference value}| \times \frac{\text{Percentage set value}}{100}$$

- \*2: The following equation is used to calculate the  $\Delta\%$  value.

$$\Delta\% = \frac{\text{measurement}}{|\text{reference value}|} \times 100$$

### **NOTE**

- The comparator judgment is made in the following order.
  1. If the measurement value is "OVER FLOW", **HI** is displayed. (However, LO is displayed when the parameters are Y, Cs, Cp, G, and B.)  
If the measurement value is "UNDER FLOW", **LO** is displayed. (However, HI is displayed when the parameters are Y, Cs, Cp, G, and B.)  
If the measurement value is "L NO CNTCT" or "H NO CNTCT", **HI** is displayed.
  2. Whether the measurement value is higher than the lower limit value is judged, and **LO** is displayed if the judgment is NG.
  3. Whether the measurement value is lower than the upper limit value is judged, and **HI** is displayed if the judgment is NG.
  4. When both 2 and 3 are satisfied, **IN** is displayed.

**No test is performed to ensure that the upper limit value is greater than the lower limit value, so no error message will be displayed if you set the upper limit value and lower limit value the wrong way around.**

- If the power is turned off while the comparator measurement screen is displayed, the comparator measurement screen will be displayed when the instrument starts the next time you turn the power on.

4.4 Judging Measurement Results

1 Setting the Upper or Lower Limit Value as an Absolute Value (ABS) (Absolute Value mode)

Procedure

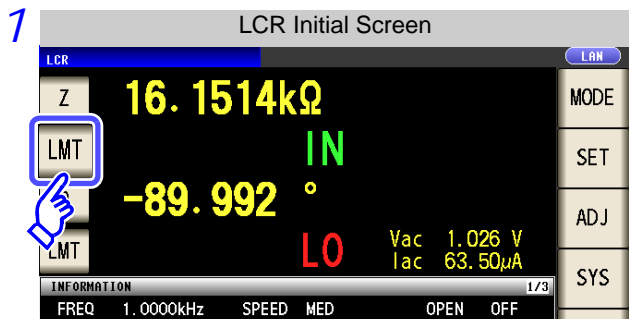

Press **LMT**.

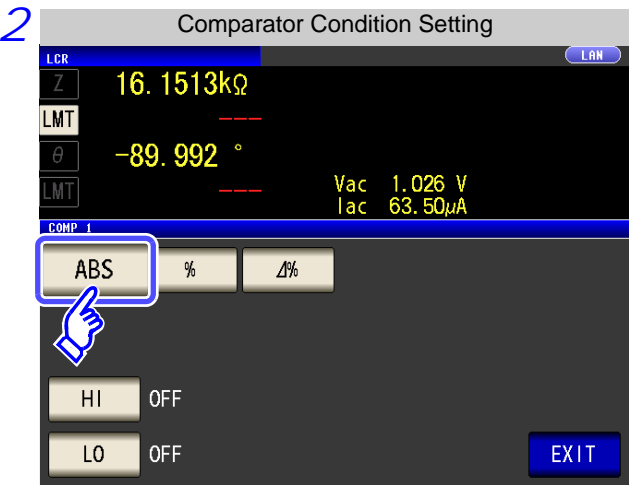

Press **ABS**.

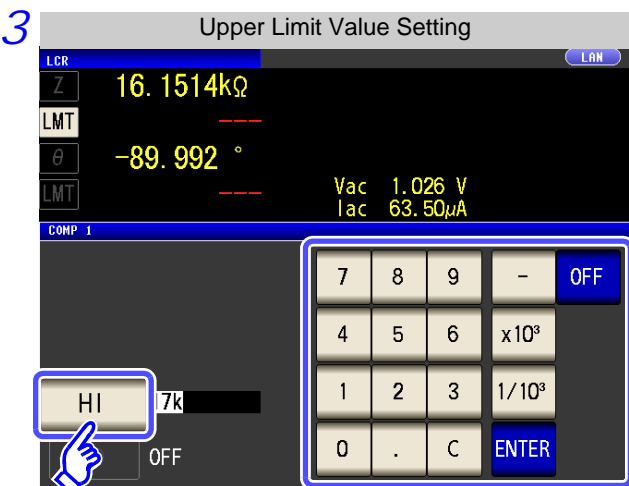

Press **HI** and use the numeric keypad to set the upper limit value.

Settable range: -9.999999 G to 9.999999 G

Changing the unit (a/ f/ p/ n/ μ/ m/ None/ k/ M/ G)

<b>x10<sup>3</sup></b>	Step the units up.
<b>1/10<sup>3</sup></b>	Step the units down.

When you do not want to set the upper and lower limit values: Press **OFF**.

4 Press **ENTER** to confirm the upper limit value.

5 Return to step 2, press **LO**, use the numeric keypad to set the lower limit value, and press **ENTER**.

Settable range: -9.999999 G to 9.999999 G

6 Press **EXIT** to close the setting screen.



2 Setting the Upper or Lower Limit Value as a Percentage (%) Relative to a Reference Value (Percentage mode)

Procedure

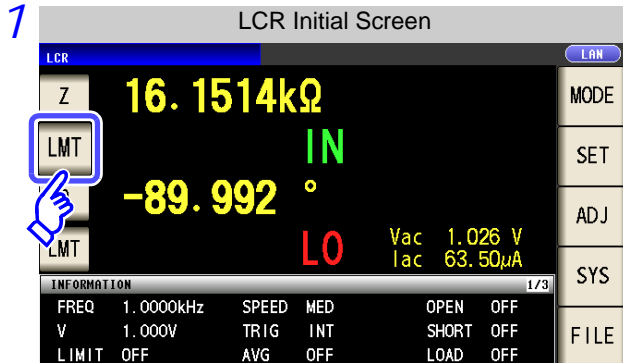

Press **LMT**.

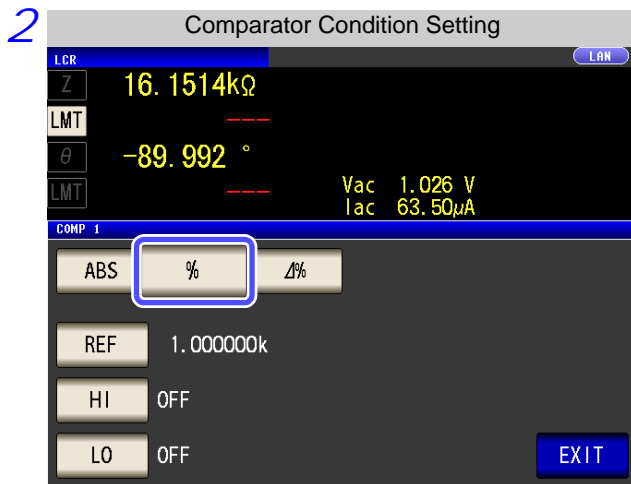

Press **%**.

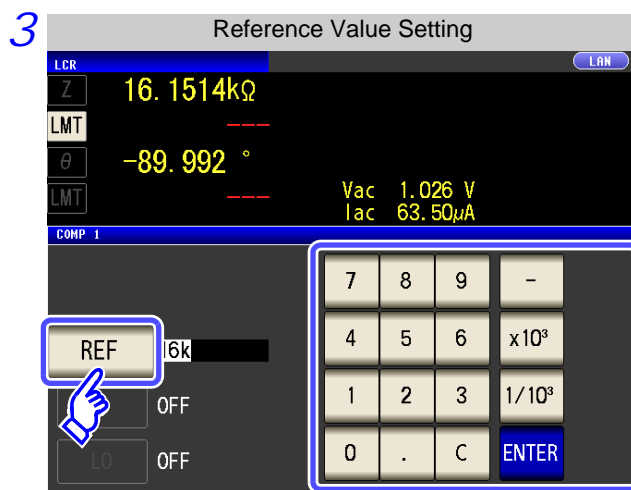

Press **REF** and use the numeric keypad to set the reference value.

Settable range: -9.999999G to 9.999999G

Changing the unit (a/ f/ p/ n/ μ/ m/ None/ k/ M/ G)

**x10<sup>3</sup>** Step the units up.

**1/10<sup>3</sup>** Step the units down.

4 Press **ENTER** to confirm the reference value.

## 4.4 Judging Measurement Results

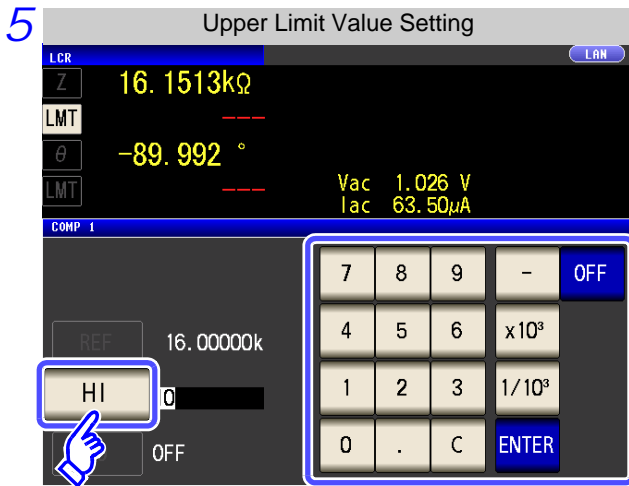

Press **HI** and use the numeric keypad to set the upper limit value.

Set the upper limit value as a percentage relative to the reference value.

When you do not want to set the upper limit: Press **OFF**.

- Settable range: -999.9999% to 999.9999%
- The actual internal operation consists of calculating the upper-limit value of comparison using the equation given below, and comparing it to the measurement value to enable a decision to be made.

$$\text{Upper limit comparison value} = \text{reference value} + |\text{reference value}| \times \frac{\text{Percentage set value}}{100}$$

6 Press **ENTER** to confirm the upper limit value.

7 Return to step 2, press **LO**, use the numeric keypad to enter the lower limit value, and press **ENTER**.

- Settable range: -999.9999% to 999.9999%
- The actual internal operation calculates the lower limit comparison value with the following equation, and when a value that is lower than the reference value is set, the minus (-) sign is required for the percentage setting value.

$$\text{Lower limit comparison value} = \text{reference value} + |\text{reference value}| \times \frac{\text{Percentage set value}}{100}$$

8 Press **EXIT** to close the setting screen.

### NOTE

The set reference value and upper and lower limit values are common to percentage mode and percentage deviation mode.

3 Setting Upper and Lower Limit Values as ( $\Delta\%$ ) Values Relative to the Offset from the Reference Value (Deviation Percentage Mode)

Procedure

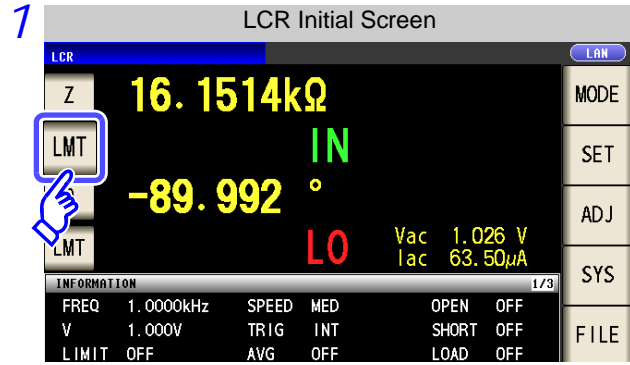

Press **LMT**.

- In the deviation percentage mode, the measurement value is displayed as a deviation ( $\Delta\%$ ) from the reference value.
- The reference value and upper and lower limit values are set in the same manner as in the percentage mode.
  - See "Setting the Upper or Lower Limit Value as a Percentage (%) Relative to a Reference Value (Percentage mode)" (p. 89)
- The settings of the reference value and the upper and lower limit values are common to both the percentage mode and deviation percentage mode.
- The  $\Delta\%$  value is calculated using the following equation:
 
$$\Delta\% = \frac{\text{measurement value} - \text{reference value}}{|\text{reference value}|} \times 100$$

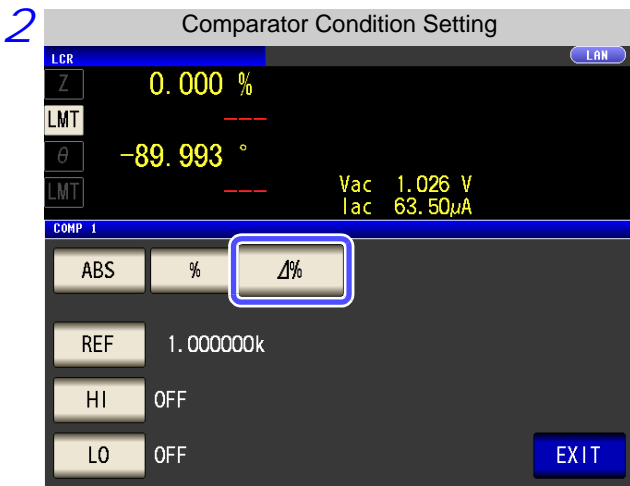

Press  **$\Delta\%$**  to select deviation percentage mode.

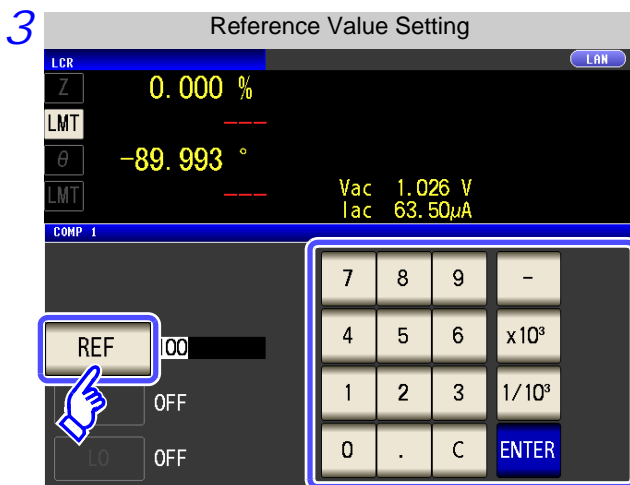

Press **REF** and use the numeric keypad to enter the reference value.

Settable range: -9.999999G to 9.999999G

**$\times 10^3$**  /  **$1/10^3$**  a/ f/ p/ n/  $\mu$ / None/ k/ M/ G

4 Press **ENTER** to confirm the reference value.

## 4.4 Judging Measurement Results

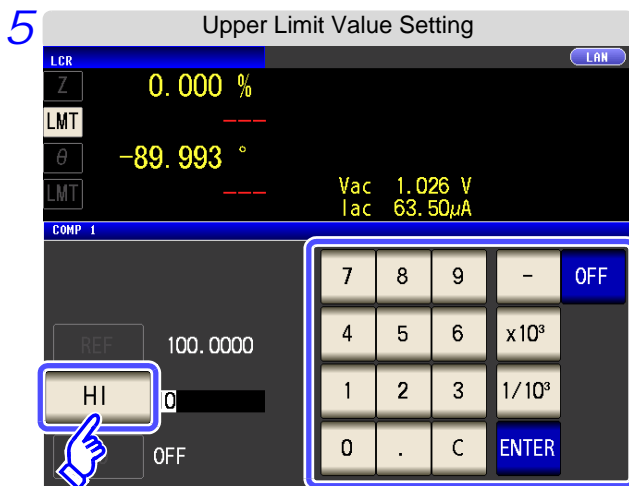

Press **HI** and use the numeric keypad to set the upper limit value.

Settable range: -999.9999% to 999.9999%

When you do not want to set the upper limit: Press **OFF**.

6 Press **ENTER** to confirm the upper limit value.

7 Return to step 2, press **LO**, and use the numeric keypad to enter the lower limit value.

Settable range: -999.9999% to 999.9999%

8 Press **EXIT** to close the setting screen.

**NOTE** The set reference value and upper and lower limit values are common to percentage mode and percentage deviation mode.

### 4.4.2 Classifying Measurement Results (BIN Measurement)

Set the upper and lower limit values for two parameters and display up to 10 classifications of judgment results. You can also output the judgment results to an external device.

Select the judgment mode for BIN measurement before setting the judgment conditions. (p. 84)

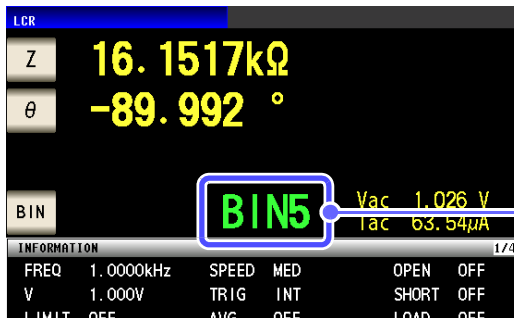
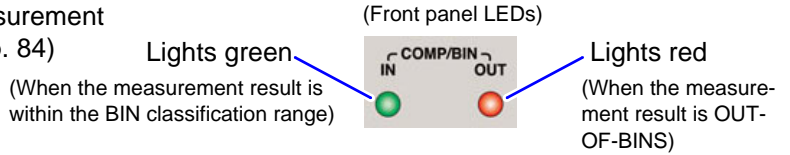

<b>BIN5</b>	When BIN judgment
<b>---</b>	When BIN is not set
<b>OUT OF BINS</b>	When does not match any BIN

#### About BIN function

Perform judgment in the order of BIN1 to BIN10. The BIN number for when a measurement value is first judged to be within the set judgment reference is displayed.

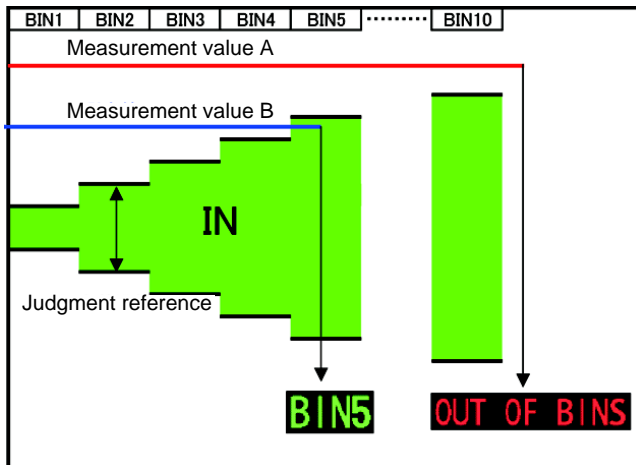

In the example above, measurement value A is judged not to be within all of the set judgment references, so **OUT OF BINS** is displayed. In contrast, the first reference that measurement value B is judged to be within is the judgment reference that was set for BIN5, so **BIN 5** is displayed.

## 4.4 Judging Measurement Results

The comparator decision mode can be set as one of the following:

### Absolute value (ABS) setting (p. 88)

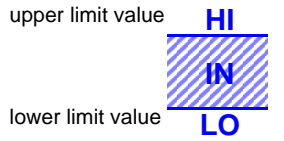

Set absolute values for the upper limit and lower limit values of the measurement parameters.  
The measurement values displayed are the same as those of the measurement parameters.

### Percent (%) Setting (p. 89)

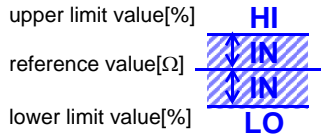

Enter reference values and then set percentages corresponding to the reference values as the upper limit and lower limit values.  
The measurement values displayed are the same as those of the measurement parameters.

### Deviation Percent (Δ%) Setting (p. 91)

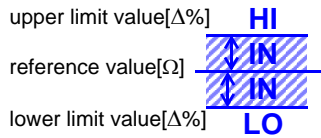

Enter reference values and then set percentages corresponding to the reference values as the upper limit and lower limit values.  
The measurement values are displayed in deviations (Δ%) from the reference value.

\*1: The following equation is used to calculate the comparison upper limit value and comparison lower limit value.  
(In the case of the comparison lower limit value, if a value that is lower than the reference value is set, the minus (-) sign is required for the percentage setting value.)

$$\text{Upper limit comparison value (Lower limit comparison value)} = \text{reference value} + |\text{reference value}| \times \frac{\text{percentage set value}}{100}$$

\*2: The following equation is used to calculate the Δ% value.

$$\Delta\% = \frac{\text{measurement value} - \text{reference value}}{|\text{reference value}|} \times 100$$

### **NOTE**

- If the power is turned off in BIN measurement mode, the mode will be BIN measurement mode when the instrument starts the next time you turn the power on.
- For a BIN number that does not require a BIN judgment, set the upper and lower limit values to OFF.
- The measurement conditions that are used when normal measurement is performed are inherited as is for the measurement conditions when BIN is performed.

1 Setting the Upper or Lower Limit Value as an Absolute Value (ABS) (Absolute Value mode)

Procedure

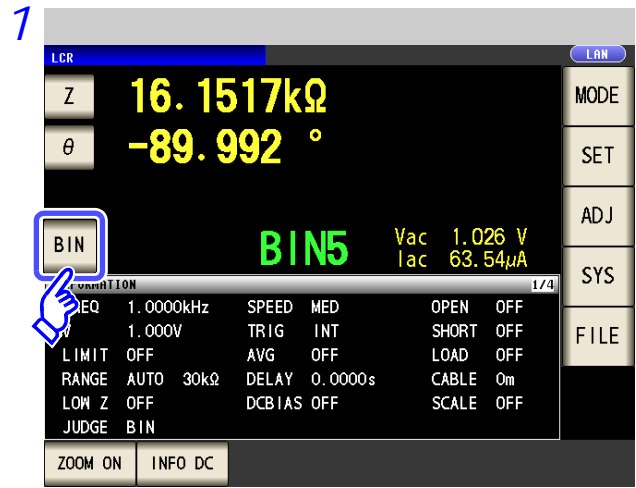

Press **BIN** .

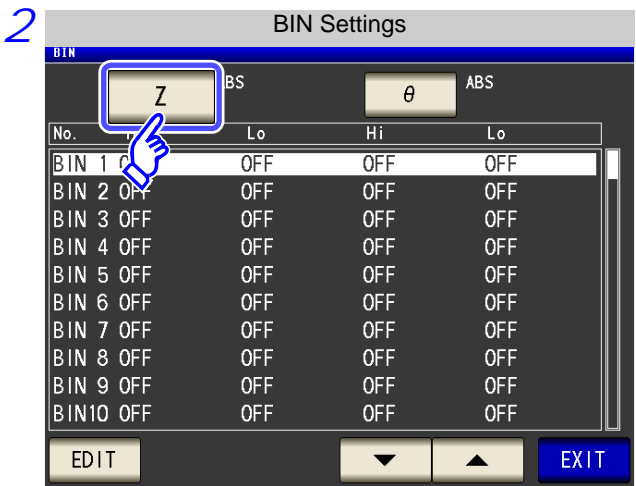

Press **Z** .

The button display differs depending on the measurement parameter.

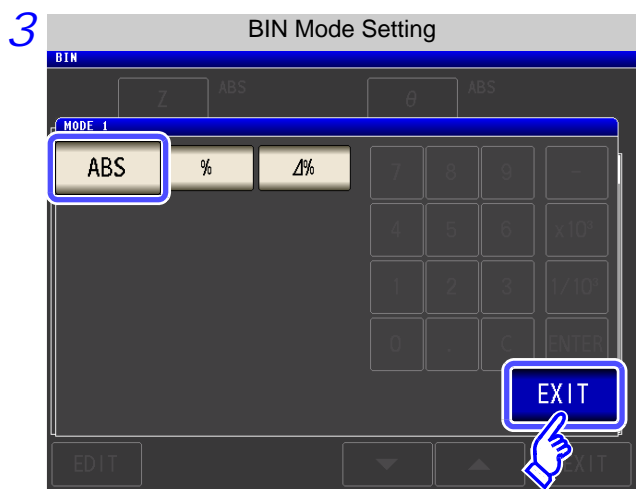

Press **ABS** .

Press **EXIT** to return to the BIN setting screen.

## 4.4 Judging Measurement Results

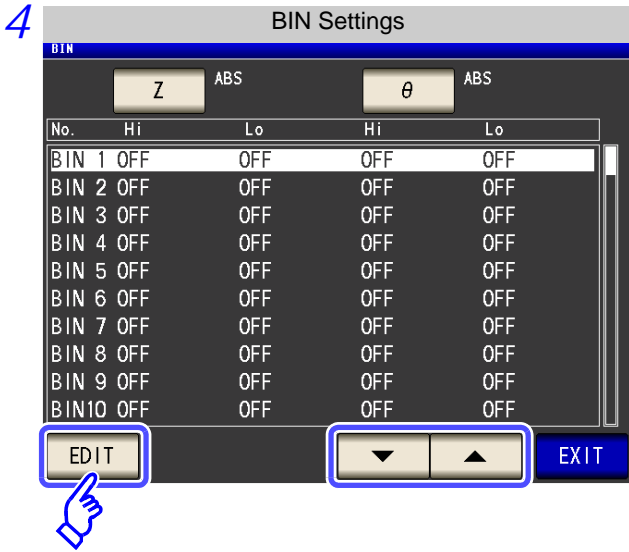

Use or to select the BIN number to set, and press .

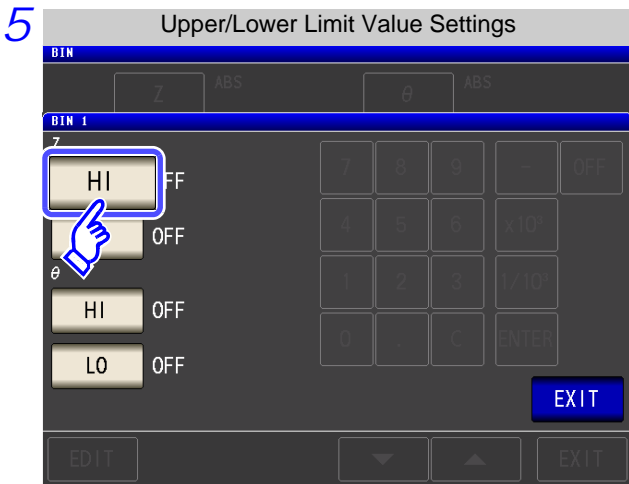

Press .

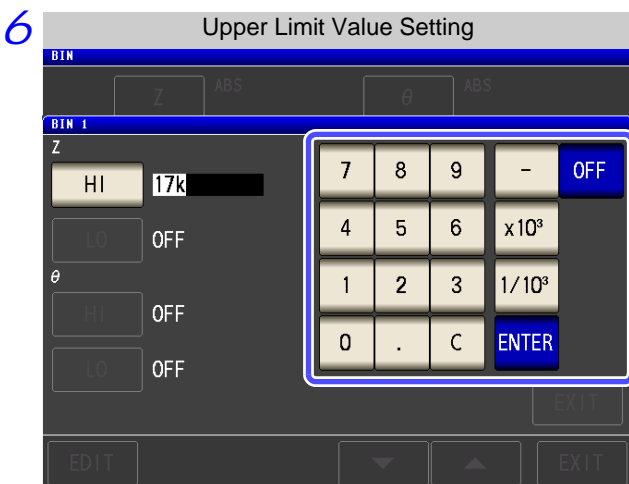

Use the numeric keypad to set the upper limit value of the first parameter.

Settable range: -9.999999G to 9.999999G



Press to confirm the upper limit value.

When you do not want to set the upper and lower limit values: Press .



- 7 Return to step 5, press , and use the numeric keypad to set the lower limit value.

Settable range: -9.999999G to 9.999999G

- 8 Press  to confirm the lower limit value.
- 9 Return to step 4, and set the upper and lower limit values of the second parameter in the same way.
- 10 Press  to return to the BIN setting screen.
- 11 Press  to close the setting screen.

### 4.4 Judging Measurement Results

## 2 Setting the Upper or Lower Limit Value as a Percentage (%) Relative to a Reference Value (Percentage mode)

### Procedure

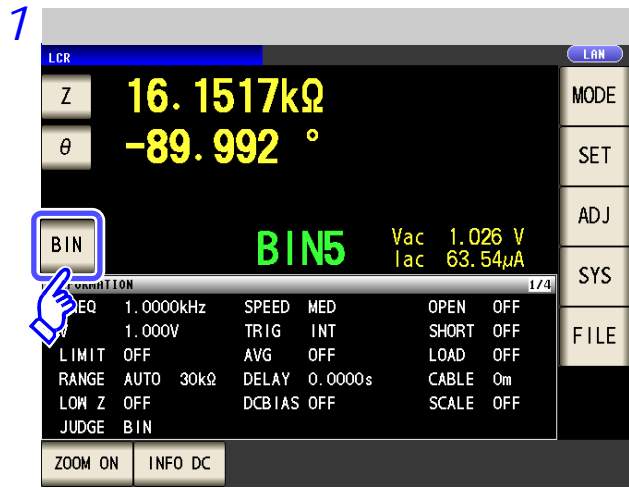

Press **BIN**.

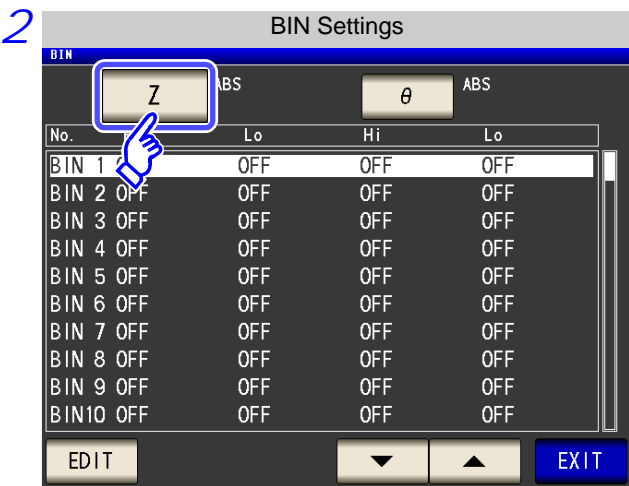

Press **Z**.

The button display differs depending on the measurement parameter.

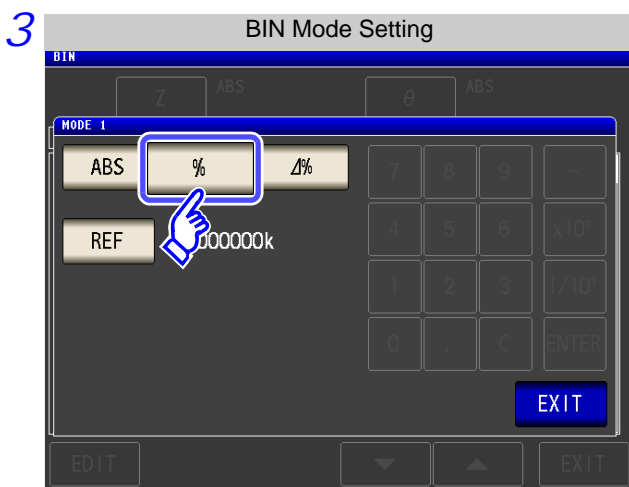

Press **%** to select percentage mode.

4.4 Judging Measurement Results

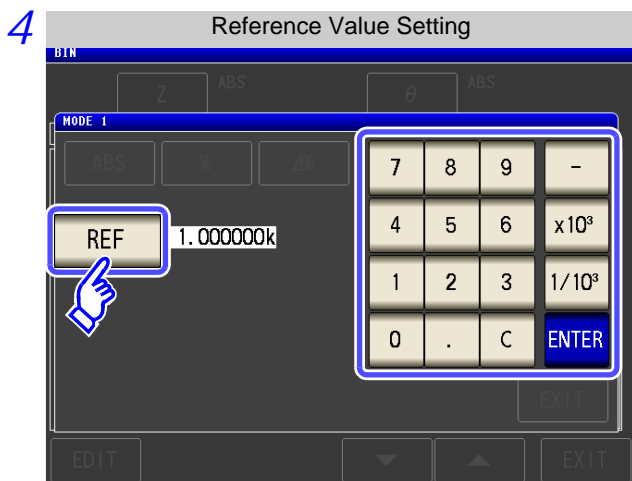

Press **REF** .

Use the numeric keypad to enter the reference value and press **ENTER** .

Settable range: -9.999999G to 9.999999G

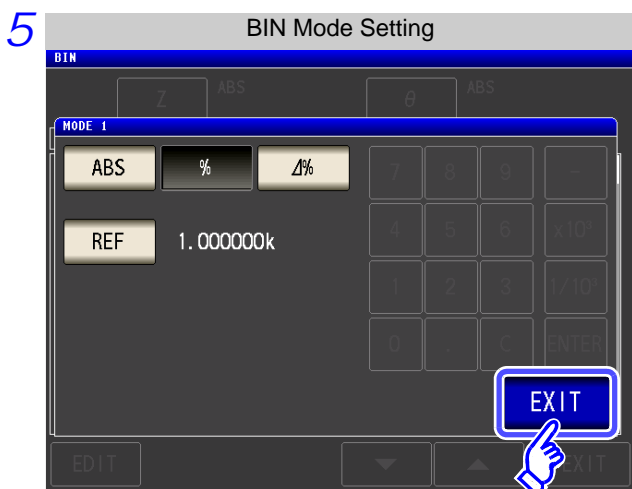

Press **EXIT** to return to the BIN setting screen.

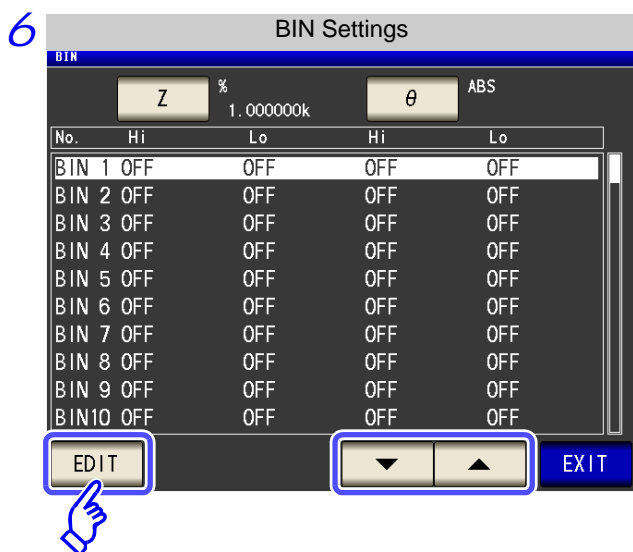

Use **▲** or **▼** to select the BIN number to set, and press **EDIT** .

## 4.4 Judging Measurement Results

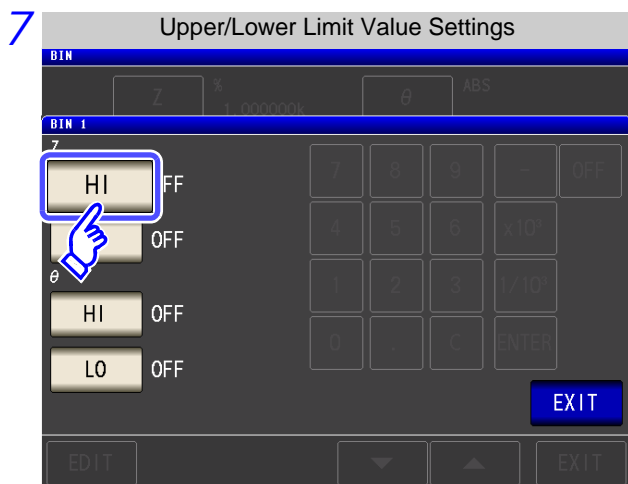

Press **HI** .

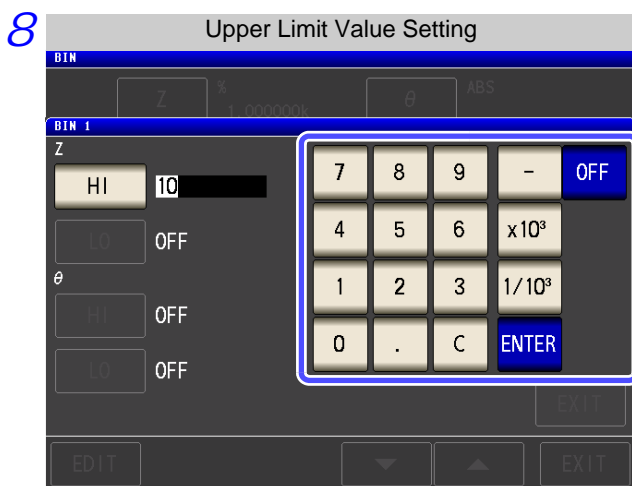

Use the numeric keypad to enter the upper limit value of the first parameter.

Settable range: -999.9999% to 999.9999%

Press **ENTER** to confirm the upper limit value.

When you do not want to set the upper and lower limit values: Press **OFF** .

9 Return to step 7, press **LO** , and use the numeric keypad to enter the lower limit value.

Settable range: -999.9999% to 999.9999%

10 Press **ENTER** to confirm the lower limit value.

11 Return to step 6, and set the upper and lower limit values of the second parameter in the same way.

12 Press **EXIT** to return to the BIN setting screen.

13 Press **EXIT** to close the setting screen.

### **NOTE**

The set reference value and upper and lower limit values are common to percentage mode and percentage deviation mode.

3 Setting Upper and Lower Limit Values as ( $\Delta\%$ ) Values Relative to the Offset from the Reference Value (Deviation Percentage Mode)

Procedure

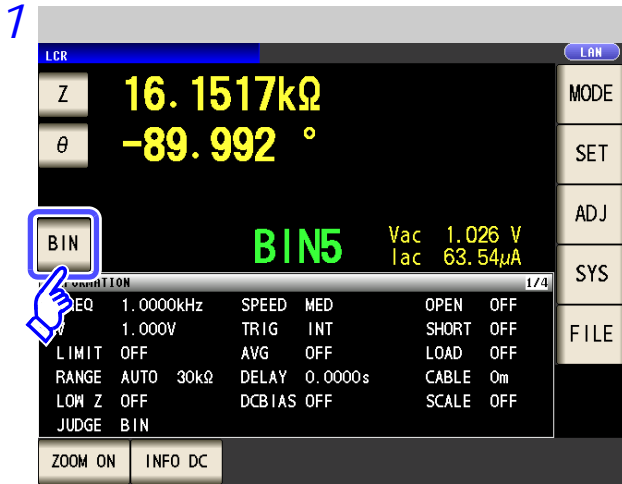

Press **BIN**.

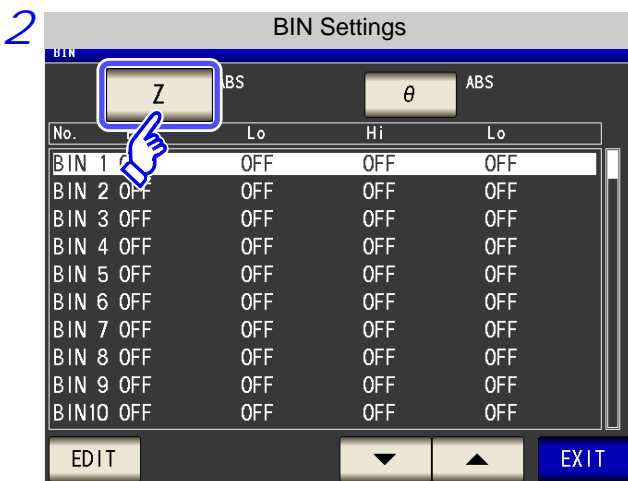

Press **Z**.

The button display differs depending on the measurement parameter.

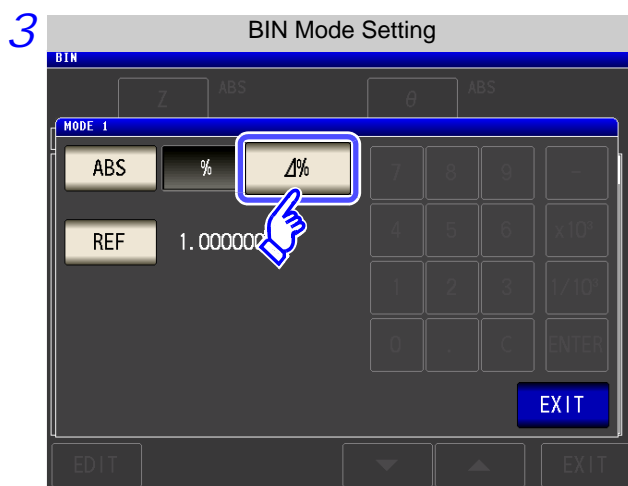

Press  **$\Delta\%$**  to select percentage mode.

## 4.4 Judging Measurement Results

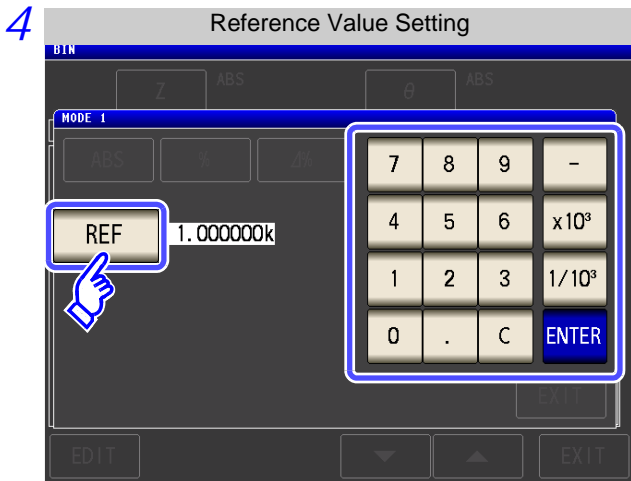

Press **REF** .

Use the numeric keypad to enter the reference value and press **ENTER** .

Settable range: -9.999999G to 9.999999G

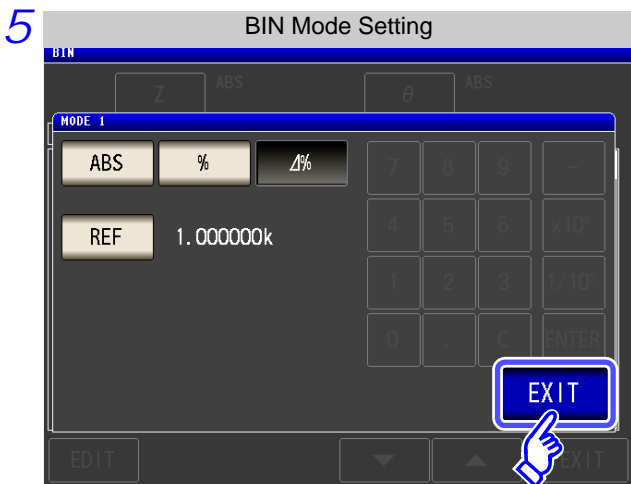

Press **EXIT** to return to the BIN setting screen.

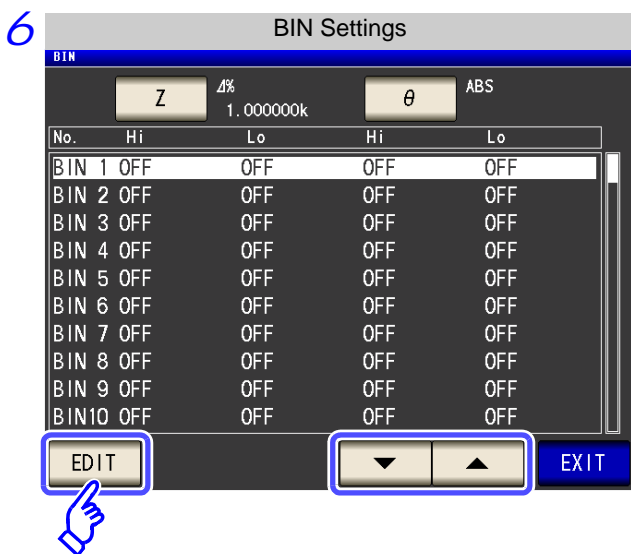

Use **▲** or **▼** to select the BIN number to set, and press **EDIT** .

## 4.4 Judging Measurement Results

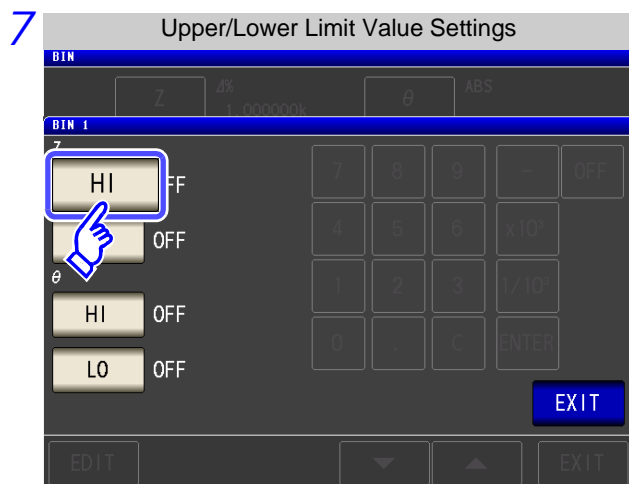

Press **HI** .

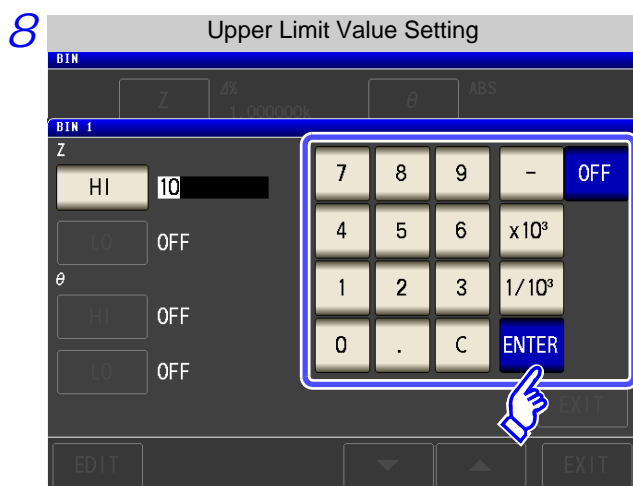

Use the numeric keypad to enter the upper limit value of the first parameter.

Settable range: -999.9999% to 999.9999%

Press **ENTER** to confirm the upper limit value.

When you do not want to set the upper and lower limit values: Press **OFF** .

9 Return to step 7, press **LO** , and use the numeric keypad to enter the lower limit value.

Settable range: -999.9999% to 999.9999%

10 Press **ENTER** to confirm the lower limit value.

11 Return to step 6, and set the upper and lower limit values of the second parameter in the same way.

12 Press **EXIT** to return to the BIN setting screen.

13 Press **EXIT** to close the setting screen.

**NOTE** The set reference value and upper and lower limit values are common to percentage mode and percentage deviation mode.

# 4.5 Setting Application Settings LCR ANALYZER

## 4.5.1 Synchronizing Measurement (Trigger Synchronous Output Function)

This function enables the measurement signal to be output after measurement is triggered and ensures that the signal is applied to the sample only during measurement. Thus reducing the generation of heat in the sample and decreasing electrode wear.

**Procedure**

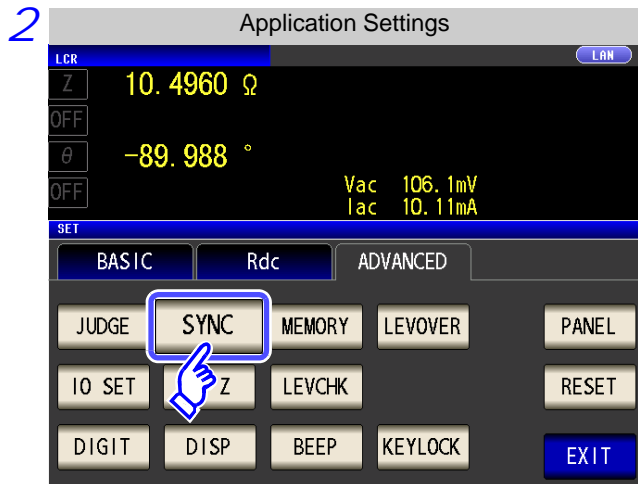
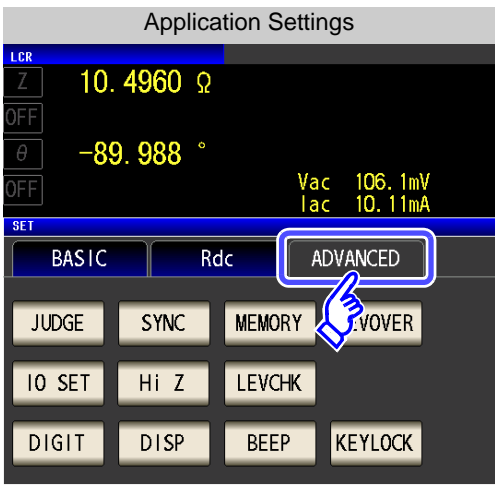
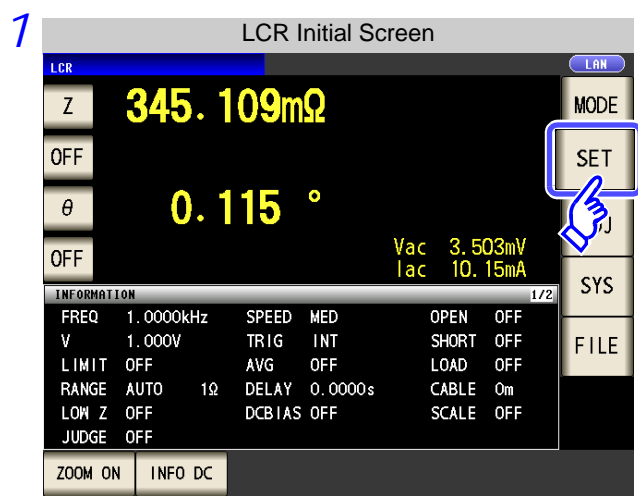

Press **SYNC**.



## 4.5 Setting Application Settings

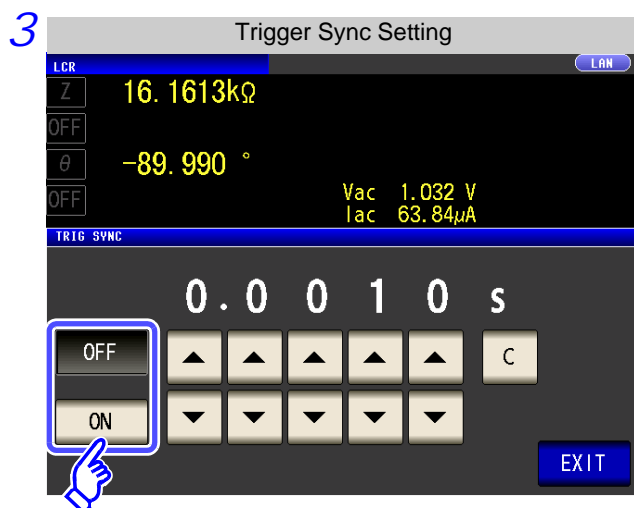

Select ON/ OFF for the trigger synchronous output function.

**OFF** Sets the trigger synchronous output function to OFF.

**ON** Sets the trigger synchronous output function to ON.

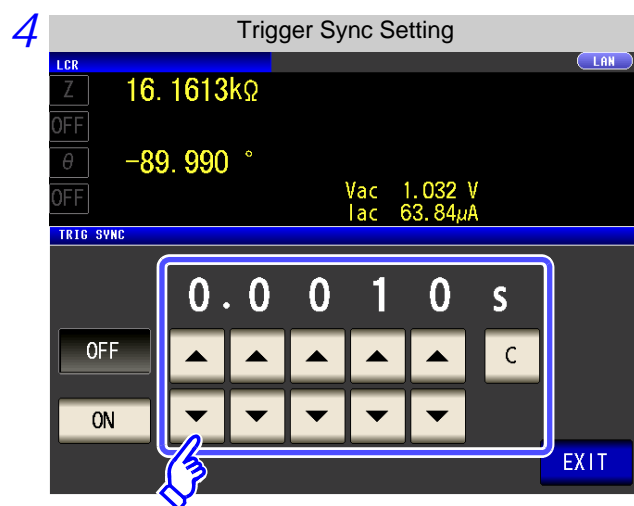

Use **▲** or **▼** to set the wait time from after the measurement signal is output by applying a trigger to the start of measurement.

Settable range: 0.0010 to 9.9999 s

When you want to return the time to the initial state: Press **C**.

The set time is set to 0.0010 s.

5 Press **EXIT** to close the setting screen.

### NOTE

- When the trigger synchronous output function is set to ON, there is a measurement time delay because the unit enters a wait time which spans from when the measurement signal is output to when measurement starts.  
[See "13.3 About Measurement Times and Measurement Speed" \(p. 399\)](#)
- When the trigger synchronous output function is set to ON, the set DC level may be output if a measurement condition is changed. Also, output will stop when measurement is performed once.
- The measurement signal is output when the trigger signal is input and stops after measurement ends.
- In continuous measurement mode, the measurement signal stops after measurement of the last panel ends.

4.5 Setting Application Settings

4.5.2 Saving Measurement Results (Memory function)

You can save the measurement results inside the instrument. (Up to 32,000 items) The saved measurement results can be saved to a USB flash drive. They can also be acquired using a communication command. (The memory function is the same in **LCR** mode and **ANALYZER** mode.)

The items saved to memory are in accordance with the **:MEASure:VALid** setting.

For details on how to acquire the saved measurement results or set **:MEASure:VALid**, refer to the included CD.

Saving Measurement Values

Procedure

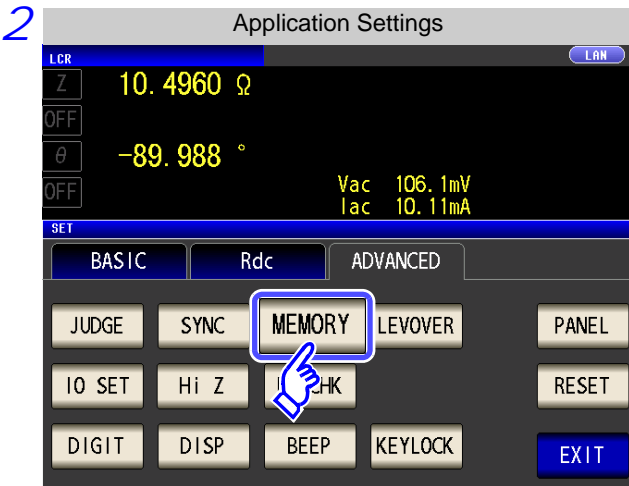
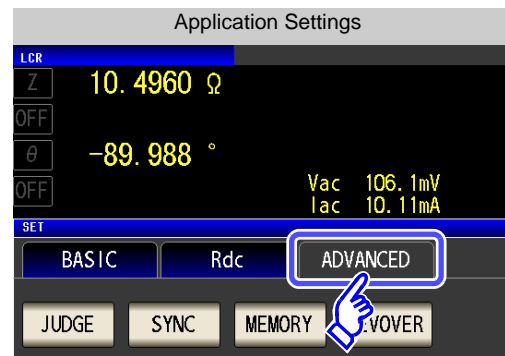
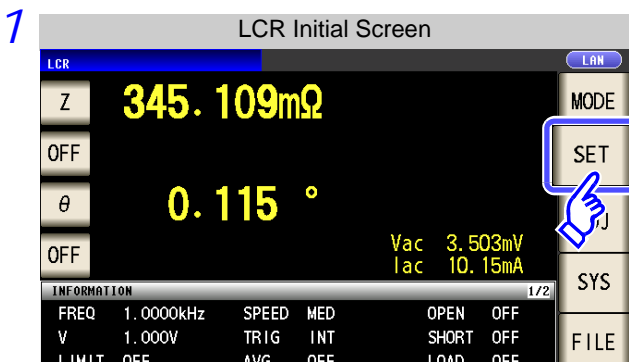

Press **MEMORY**.

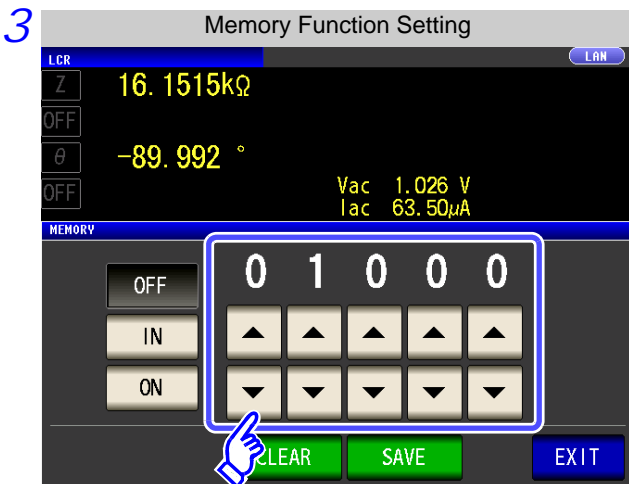

Use **▲** or **▼** to set the number of measurement results.

Settable range: 1 to 32000  
The number of measurement results can only be set when the memory function is set to OFF.

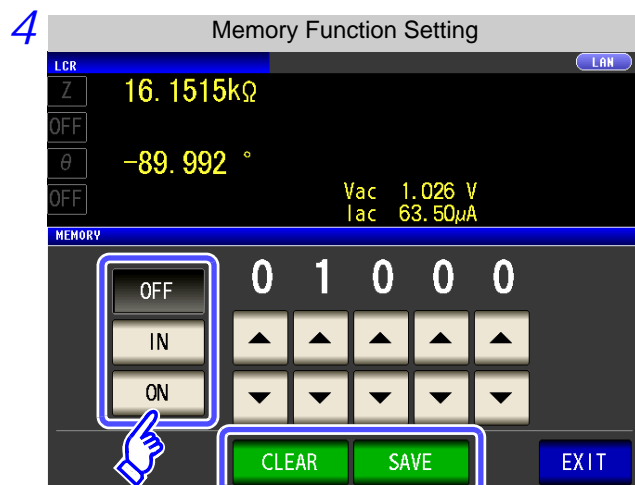

Select ON/ OFF for the memory function.

<input type="button" value="OFF"/>	Sets the memory function to OFF.
<input type="button" value="IN"/>	Saves the measurement results to memory only when a pass judgment is made for all of the parameters judged with the comparator and BIN functions. (The measurement results are not saved if even one of the comparator results is Hi or Lo or the BIN result is OUT-OF-BINS.)
<input type="button" value="ON"/>	Saves all measurement values to memory.

If the comparator and BIN functions are not set, the operation for  is the same as that of .

5 Press  to close the setting screen.

<input type="button" value="CLEAR"/>	Clears all of the saved measurement results from the instrument memory.
<input type="button" value="SAVE"/>	Saves the measurement values stored in the instrument memory to a USB flash drive and then clears the measurement values from the instrument memory. The measurement values are saved to the MEMORY folder in the USB flash drive. The file name is automatically assigned from the date and time.

### NOTE

- If the memory function is set to ON, the number of memory items currently saved is displayed in the measurement screen.

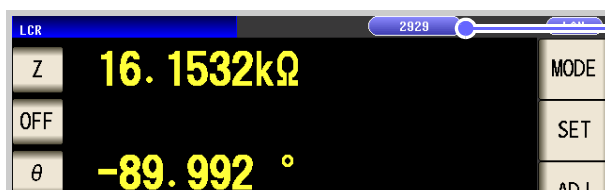

Indicates that the number of memory items currently saved is 2,929.

- Save the measurement results stored in the instrument to a USB flash drive or acquire them with the **:Memory?** command.
- The internal data is lost when the memory function setting is changed.
- When the instrument memory becomes full, the following message appears on the measurement screen. If this message appears, subsequent measurement results will not be saved.

To resume saving, load or clear the measurement results from the instrument memory.

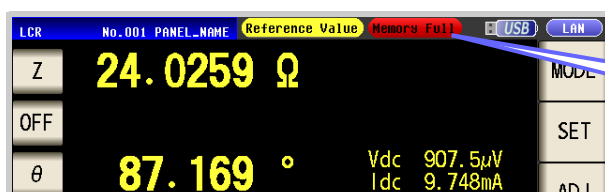

Memory Full

### 4.5.3 Detecting OPEN during 2-terminal Measurement (HIGH-Z Reject Function)

This function is for outputting a measurement terminal connector error when the measurement result is high relative to the set judgment reference value. The setting value can be set as an absolute value, and the error is output via the EXT I/O.

See "Chapter 11 External Control" (p. 363)

The judgment reference is calculated from the nominal value (range name) of the current measurement range and the judgment reference value as shown below.

Judgment reference = Nominal value of current measurement range × Judgment reference value (%)

Example Current measurement range: 30 kΩ  
 Judgment reference value: 150%  
 Judgment reference = 30 k × 1.50 = 45 k

#### Procedure

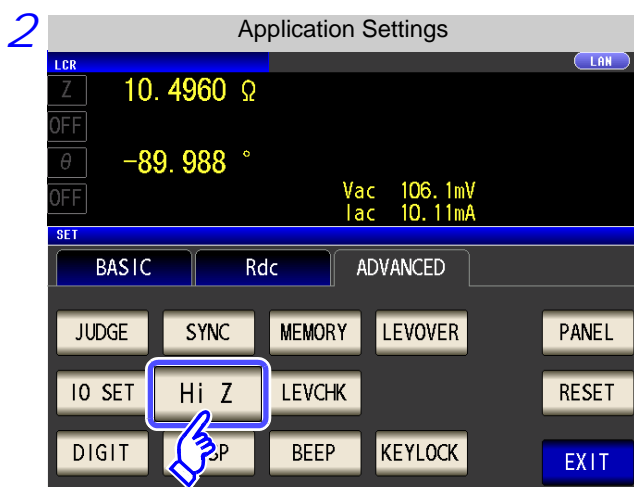
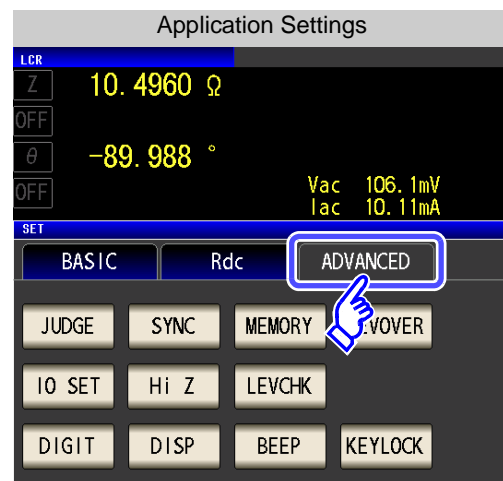
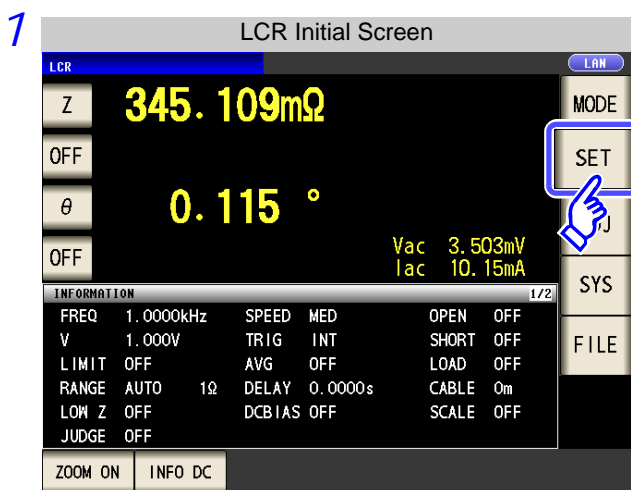

Press **Hi Z**.

4.5 Setting Application Settings

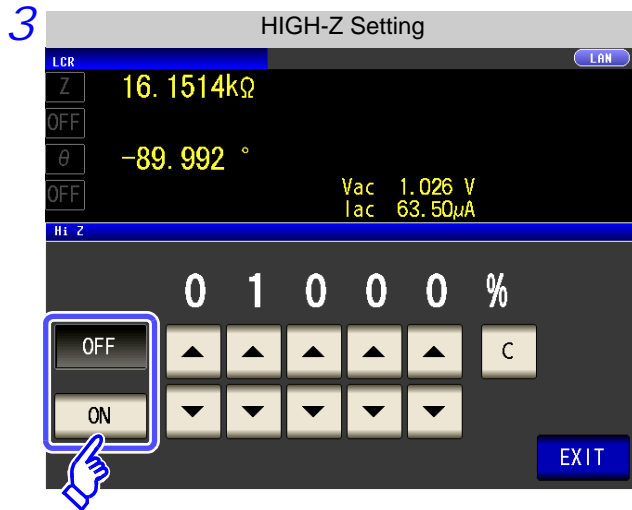

Select ON/ OFF for the HIGH-Z reject function.

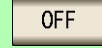

Sets the HIGH-Z reject function to OFF.



Sets the HIGH-Z reject function to ON.

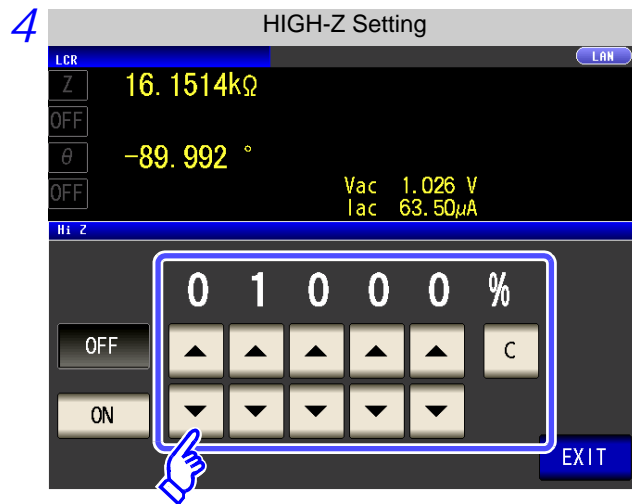

Use or to set the judgment reference value.

Settable range: 0 to 30000%

- A ratio is set using the range name as the reference value.  
Example: When the 1 kΩ range is used:  
A ratio to the value of 1 kΩ is set.
- If you make a mistake during input:  
press to cancel the input and start again.

5 Press to close the setting screen.

### 4.5.4 Monitoring the Detection Level (Monitoring the Detection Level Function)

Measurement waveform errors that occur when the test sample and instrument contact each other can be detected by monitoring the voltage effective value and current effective value.

The voltage effective value and current effective value are calculated several times during analog measurement.

The effective value of each of the voltage and current that is calculated the first time is treated as the reference value, and then following calculation expression is used to calculate the  $\Delta\%$  value for the voltage effective value and current effective value calculated for the second and subsequent times.

$$\Delta\% = \left| \frac{(\text{Effective value} - \text{reference value})}{\text{reference value}} \right| \times 100[\%]$$

An error is detected when  $\Delta\%$  exceeds the set limit value.

#### Procedure

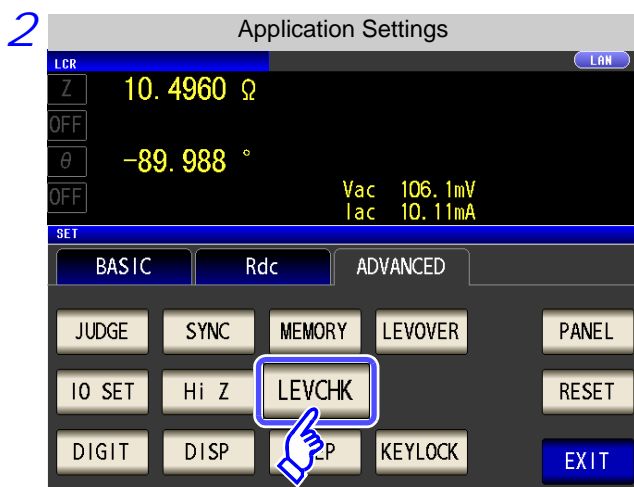
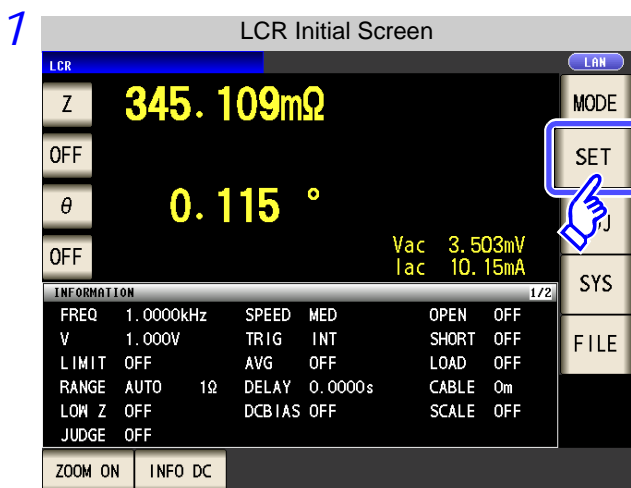

Press **LEVCHK**.

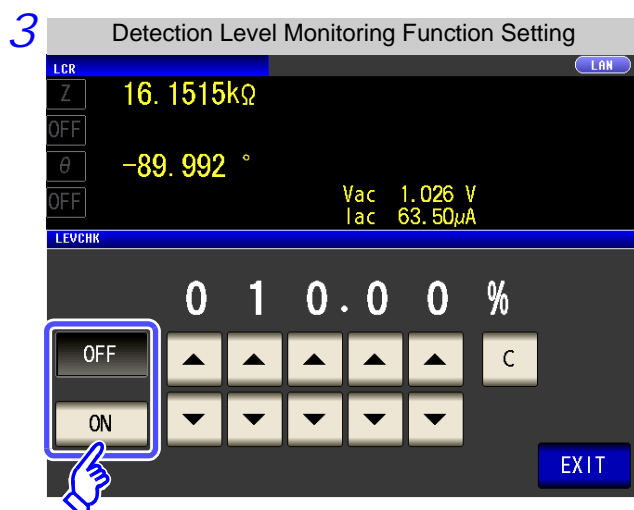

Select ON/OFF for the function to monitor the detection level.

**OFF** Sets the detection level monitoring function to OFF.

**ON** Sets the detection level monitoring function to ON.

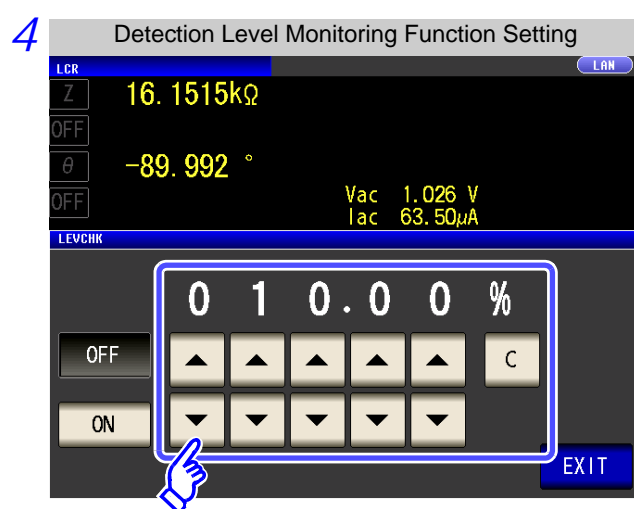

Use  or  to enter the limit value.

Settable range: 0.01 to 100.00%

5 Press **EXIT** to close the setting screen.

### Monitoring the Detection Level Function Operation by Set Frequency

The number of waves that can be monitored differs depending on the frequency set on the instrument.

Frequency	FAST	MED	SLOW	SLOW2
DC	x	●	●	●
4.00 Hz to 19.99 Hz	x	●	●	●
20.00 Hz to 100.00 Hz	x	●	●	●
100.01 Hz to 999.99 Hz	x	●	●	●
1.0000 kHz to 3.0000 kHz	x	●	●	●
3.0001 kHz to 10.000 kHz	x	●	●	●
10.001 kHz to 30.000 kHz	●	●	●	●
30.001 kHz to 100.00 kHz	●	●	●	●
100.01 kHz to 300.00 kHz	1/2	1/2	1/2	1/2
300.01 kHz to 1.0000 MHz	1/4	1/4	1/4	1/4
1.0001 MHz to 5.0000 MHz	●	●	●	●

x :The monitoring the detection level function is not activated.

● :The monitoring the detection level function is activated for all acquired waves.

1/2 :The monitoring function is activated for the first half of acquired waves.

1/4 :The monitoring function is activated for the first quarter of acquired waves.

## 4.5 Setting Application Settings

---

**NOTE**

- If a detection level error is detected, the following comment is displayed at the top of the screen.

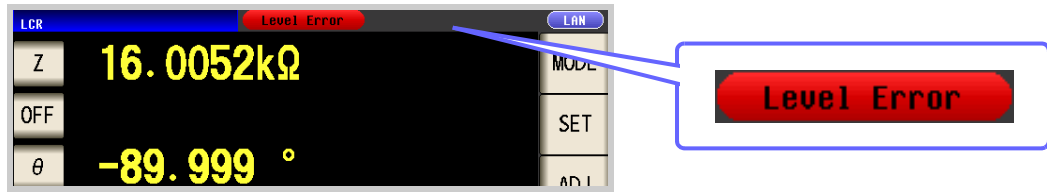

- The detection level error is reflected in the response result of `:MEASure?`, `:MEMory?`.  
[See](#) Description of communications commands on the included CD (`:MEASure?`, `:MEMory?`)  
Furthermore, it is output as a measurement error to the ERR terminal (10-pin) of the EXT I/O.  
[See](#) "Connector Type and Signal Pinouts" (p. 364)
- Even in a normal contact state, an error may be output due to the influence of external noise. (It is possible to judge external noise.)  
Use the shielding process as a measure against external noise.
- Chattering monitoring is not performed during offset measurement when DC adjustment is enabled.  
[See](#) "4.3.3 Setting the DC Adjustment Function" (p. 75)



### 4.5.5 Setting the Detection Sensitivity for Measurement Errors (Overflow or Underflow)

The instrument monitors the detectable range of the measurement signals (voltage and current) during measurement, and displays a measurement error (OVERFLOW or UNDERFLOW) if that range is exceeded. However, if measurement is performed under a noisy environment, the detection range may be exceeded resulting in a measurement error regardless of whether an appropriate measurement range is set. Under normal circumstances, the countermeasures described in "Appendix 4 Countermeasures Against Incorporation of External Noise"(p. A5) need to be taken but if a measurement error occurs even after taking the countermeasures, increase the setting value which defines the error of the measurement signal to reduce the detection sensitivity for measurement errors so that you can reduce the frequency of measurement error occurrence.

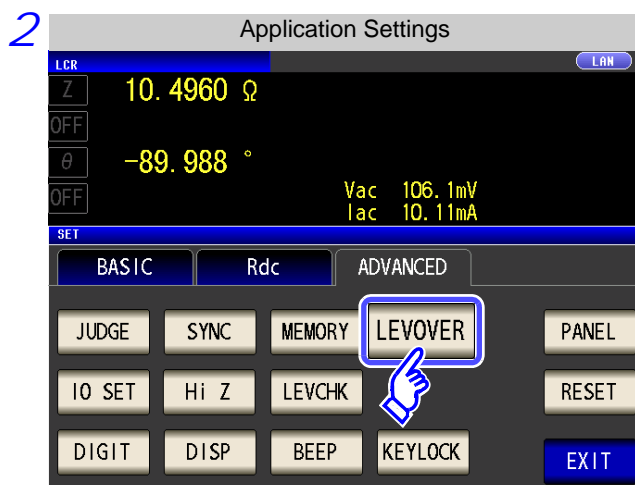
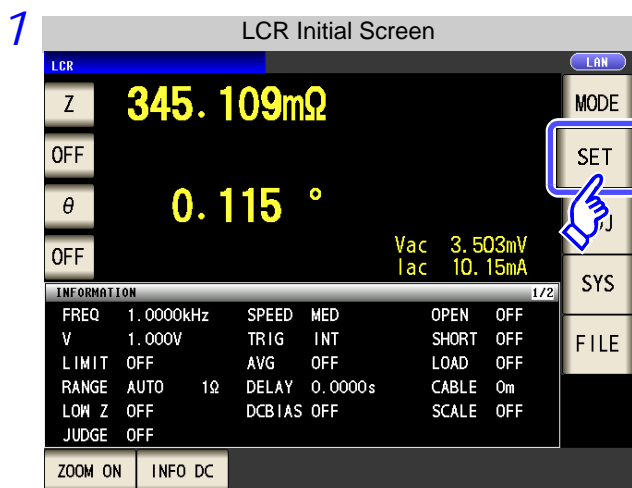

#### Procedure

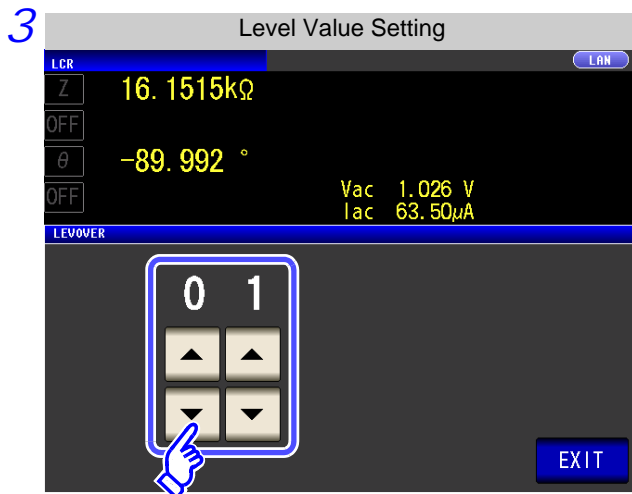

Press LEVOVER .

## 4.5 Setting Application Settings



Use  or  to enter the level value.

Settable range: 1 to 32

4 Press  to close the setting screen.

### **NOTE**

The higher the setting value, the greater the measurement errors. If the setting value is set to 2 or higher, the accuracy specifications may not be able to be satisfied. Furthermore, shifting to the most suitable range may not occur during auto range operation.

### 4.5.6 Setting the Delay Time from the Output of Comparator and BIN Judgment Results until Output of EOM (LOW) and Resetting Judgment Results

You can set the delay time for the period from the output of the comparator and BIN judgment results until the output of EOM (LOW) from the EXT I/O.

You can also set whether to reset the comparator and BIN judgment results simultaneously with the measurement start signal.

See "11.2 Timing Chart" (p. 369)

**Procedure**

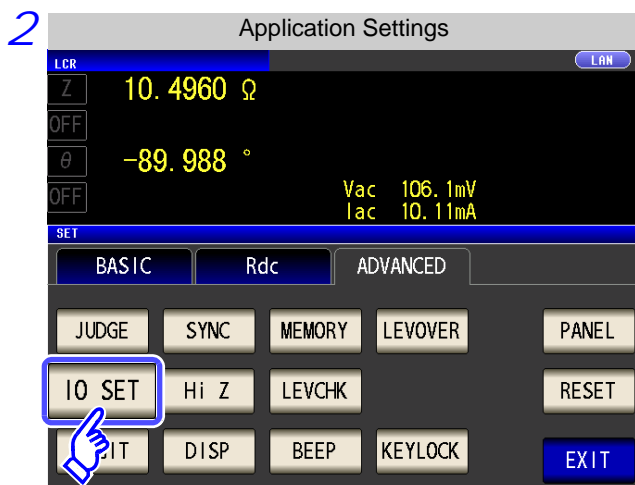
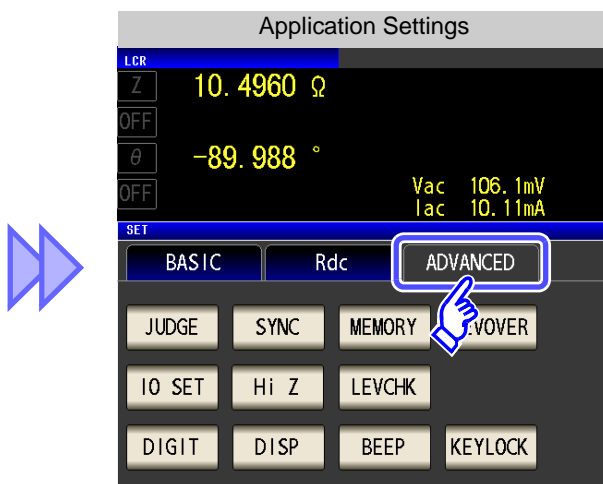
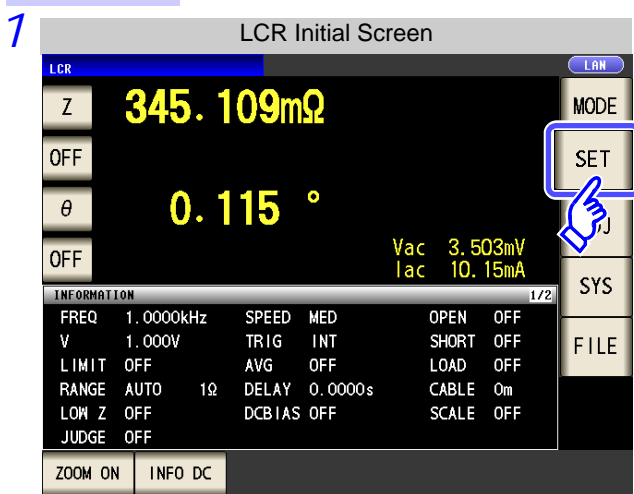

Press **IO SET**.

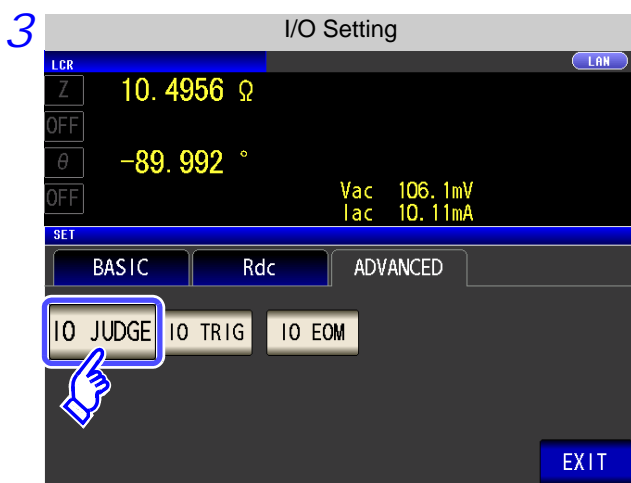

Press **IO JUDGE**.

## 4.5 Setting Application Settings

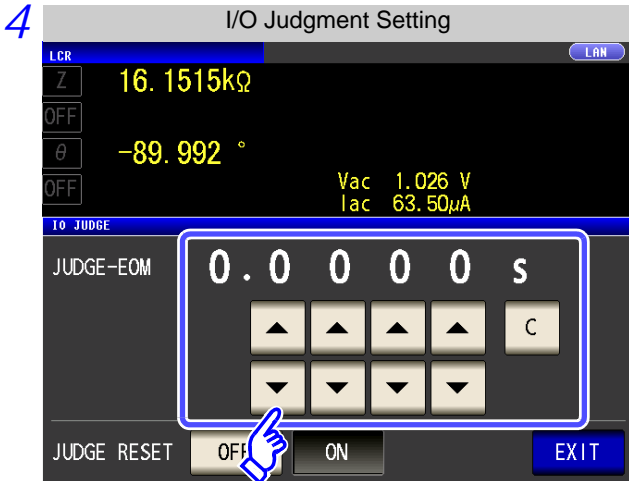

Use or to set the delay time for the period from the output of the comparator and BIN judgment results until the output of EOM (LOW).

- Settable range: 0.0000 s to 0.9999 s
- If you make a mistake during input: press to cancel the input and start again.

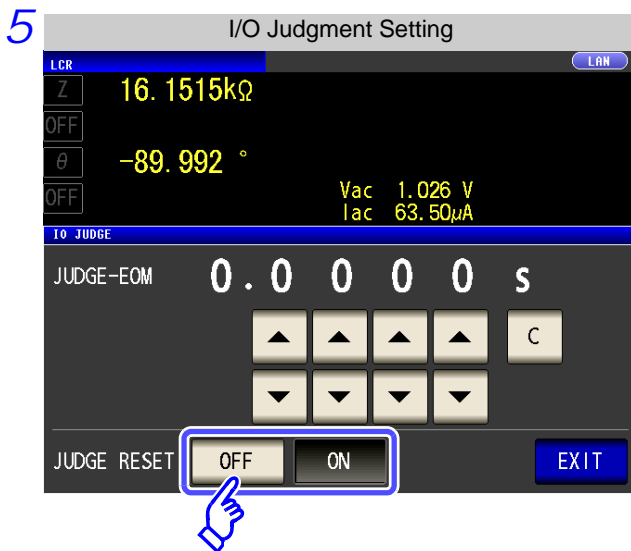

Select whether to reset the comparator and BIN judgment results simultaneously with the measurement start signal.

- Stores the last judgment results until the next judgment results are output.
- Resets the judgments results at the time of the measurement start signal.

6 Press to close the setting screen.

### 4.5.7 Enabling Trigger Input for during Measurement and Setting the Valid Edge of Trigger Input

You can select whether to enable or disable trigger input from the EXT I/O during measurement (during  $\overline{EOM}$  (HI) output after trigger is received). Furthermore, you can also select either the rising edge or falling edge as the valid edge of trigger input from the EXT I/O.

See "11.2 Timing Chart" (p. 369)

**Procedure**

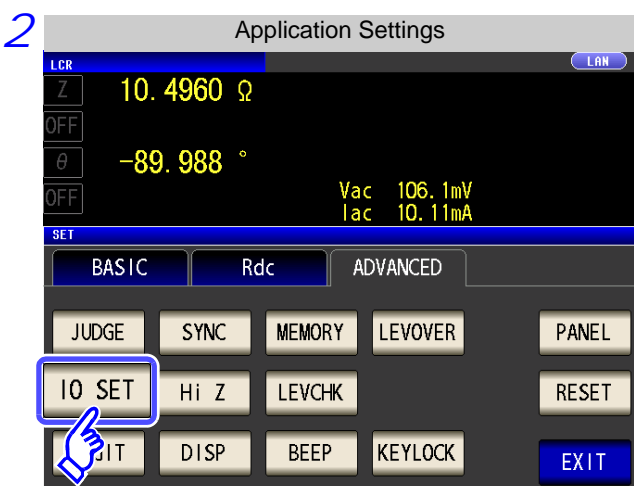
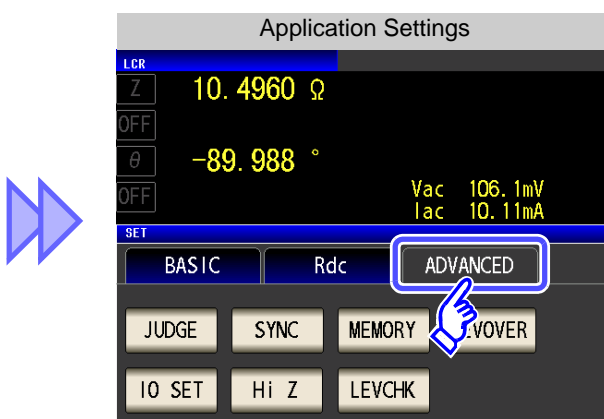
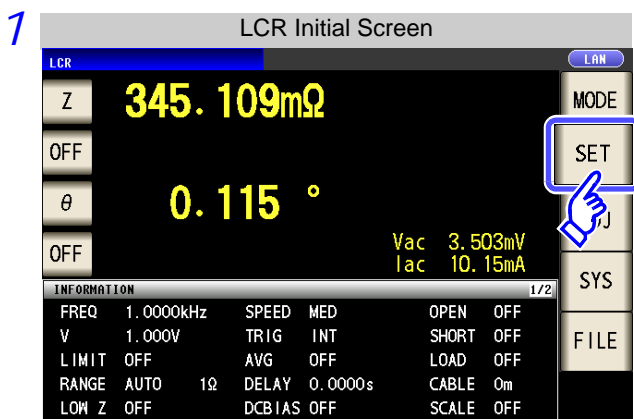

Press **IO SET**.

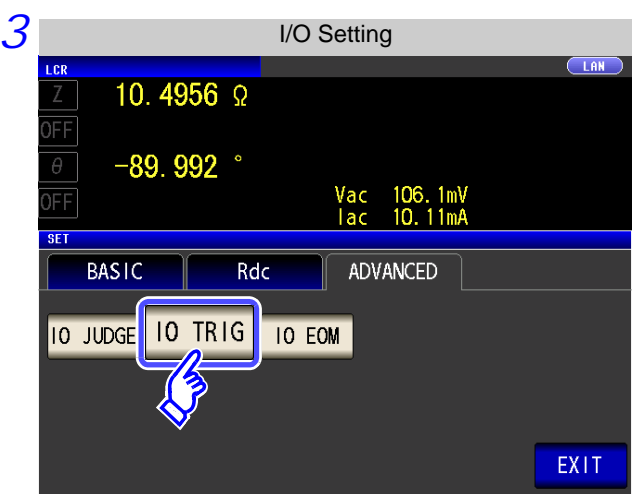

Press **IO TRIG**.

## 4.5 Setting Application Settings

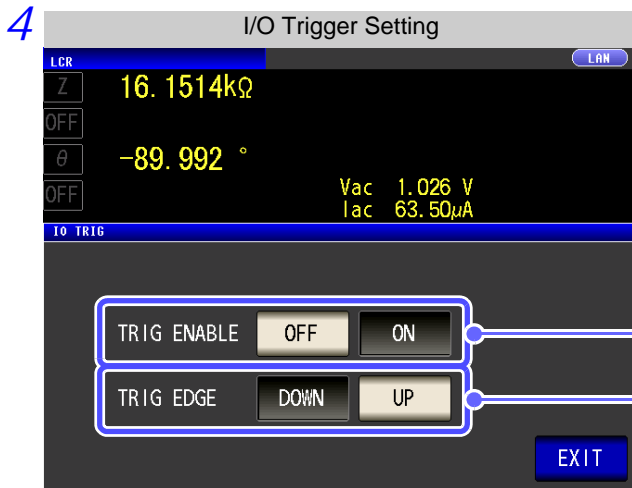

Select the I/O trigger function setting.

OFF

Disables trigger input from the EXT I/O during measurement (during  $\overline{EOM}$  (HI) output after trigger is received).

ON

Enables trigger input from the EXT I/O during measurement (during  $\overline{EOM}$  (HI) output after trigger is received).

DOWN

Sets the falling edge as the valid edge of trigger input.

UP

Sets the rising edge as the valid edge of trigger input.

5 Press **EXIT** to close the setting screen.

### 4.5.8 Setting the EOM Output Method

The higher the measurement frequency, the shorter the time that  $\overline{\text{INDEX}}$  and  $\overline{\text{EOM}}$  are high (off). When the high (off) time is too short due to characteristics of the input circuit, the instrument can be configured to maintain the low (on) state for a preset time once  $\overline{\text{EOM}}$  changes to low (on) before reverting the signal to high (off) after the completion of measurement. The INDEX output method can be changed in the same manner.

See "Chapter 11 External Control" (p. 363)

**Procedure**

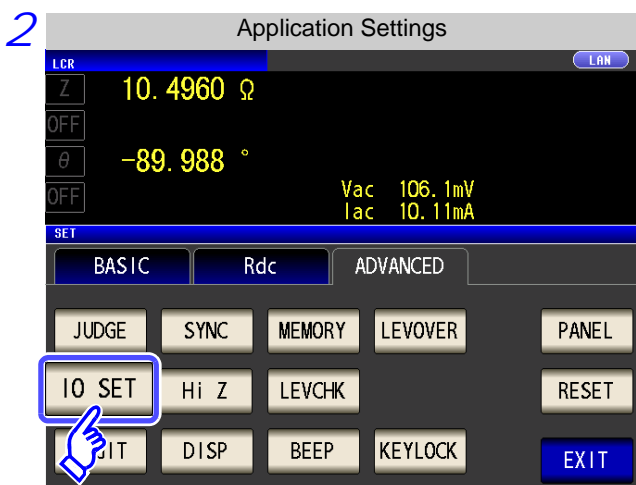
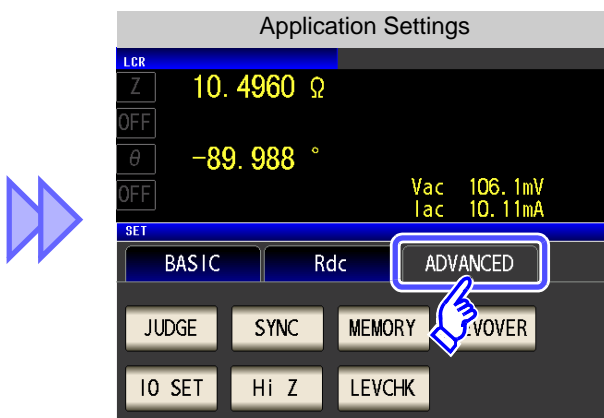
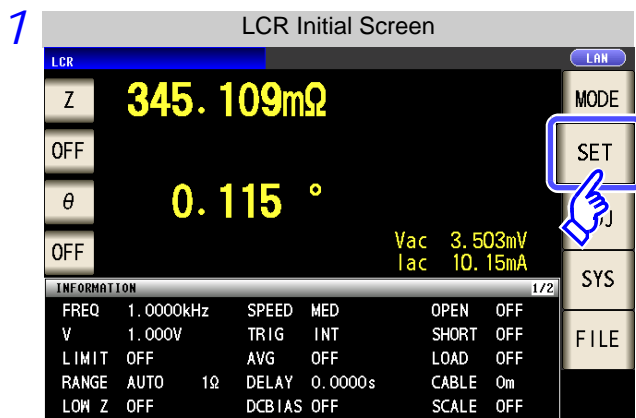

Press **IO SET**.

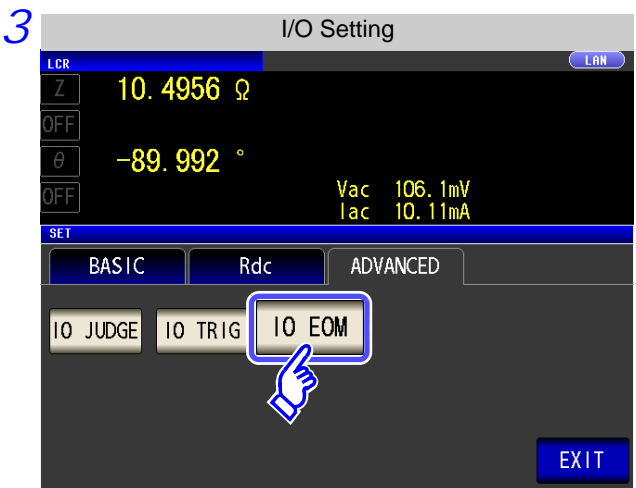

Press **IO EOM**.

## 4.5 Setting Application Settings

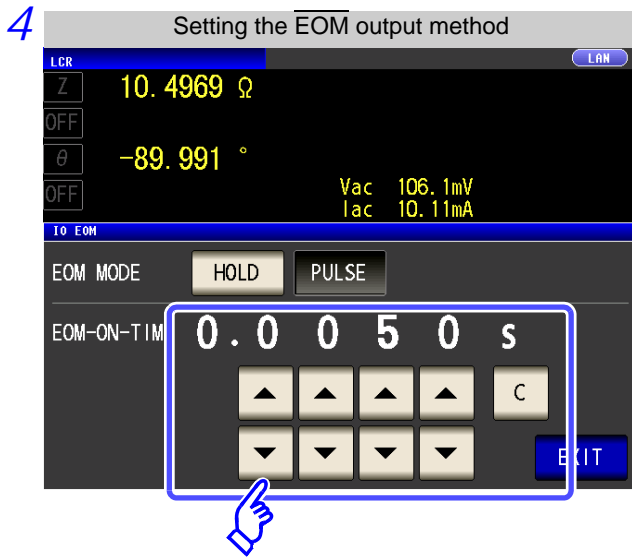

### Setting the output method.

For HOLD and PULSE timing charts, see "Chapter 11 External Control" (p. 363).

Use  $\uparrow$  or  $\downarrow$  to set the  $\overline{\text{EOM}}$  output time for the PULSE setting.

Settable range: 0.0001 to 0.9999 s

5 Press **EXIT** to close the setting screen.



### 4.5.9 Disabling Key Operation (Key-lock Function)

If you turn the key-lock function ON, all operations except disabling the key-lock are disabled to protect the settings. You can also set a passcode (security code).

#### Procedure

1





2

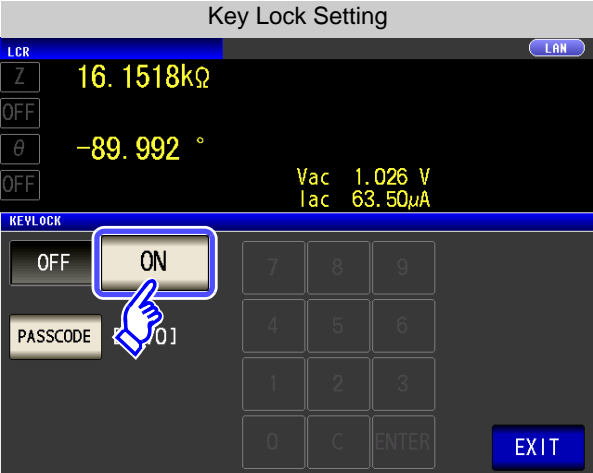

Press **KEYLOCK**.

3



Press **ON**.

4 Press **EXIT** to close the setting screen.

#### NOTE

- In the case of an external trigger, the key lock is not enabled for **TRIG**.
- Turning off the power does not cancel the key-lock function.

## 4.5 Setting Application Settings

### Setting the Passcode of the Key-lock

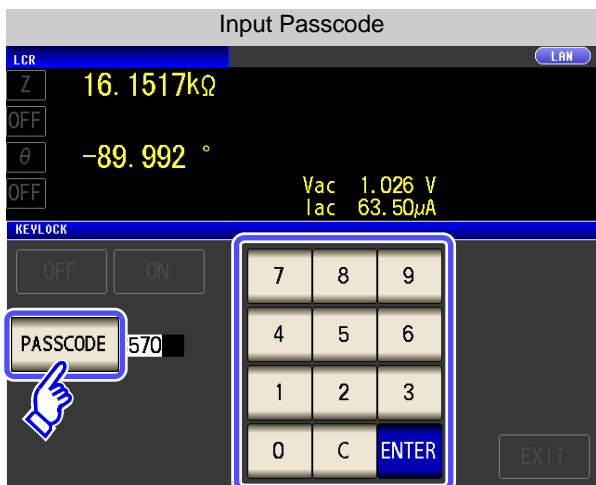

Press **PASSCODE** when the key-lock setting is



Use the numerical keypad to enter the passcode, press **ENTER**, and then press **EXIT**.

Settable range: 1 to 4 digits

**NOTE** If a passcode is set, it needs to be entered to disable the key-lock. Take care not to forget the set passcode.

### Disabling the Key-lock

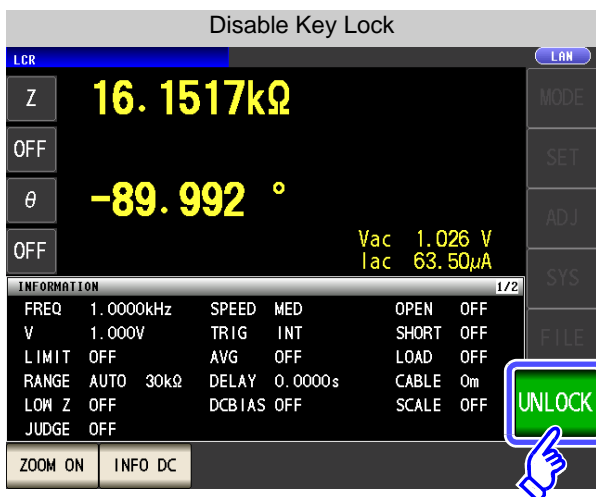

Press **UNLOCK** when the key-lock is enabled.

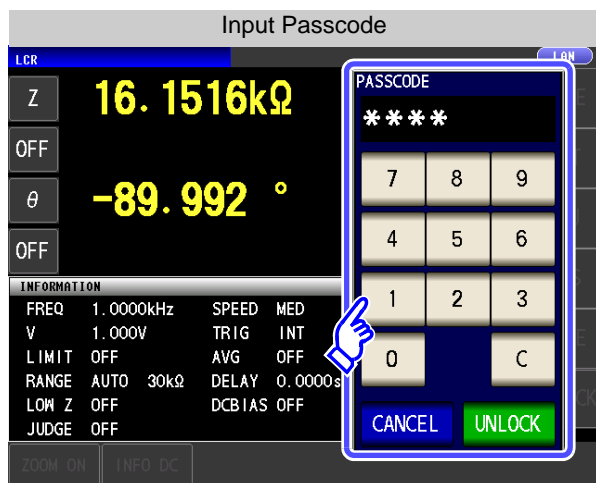

#### When a passcode is set

Enter the passcode and press **UNLOCK**.

The entered passcode is indicated as **\*** on the screen.

(To cancel input: Press **C**)

#### When a passcode is not set

Press **UNLOCK**.

When you want cancel the disabling of the key-lock: Press **CANCEL**.

**NOTE** If you forget the passcode, perform a full reset to restore the instrument to the factory default settings.(p. 406)

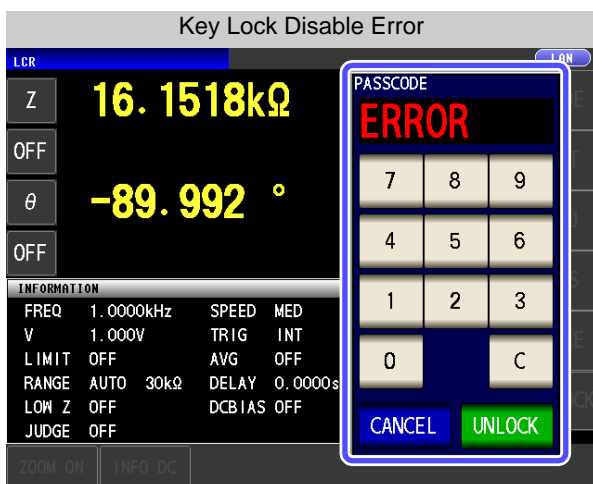

If the error indication shown on the left appears, check the following items.

Cause	Remedy
<b>UNLOCK</b> was pressed before you entered the passcode.	Press <b>C</b> and enter the passcode.
The entered passcode is incorrect.	Press <b>C</b> and enter the passcode again.

## 4.5 Setting Application Settings

### 4.5.10 Setting the Number of Display Digits

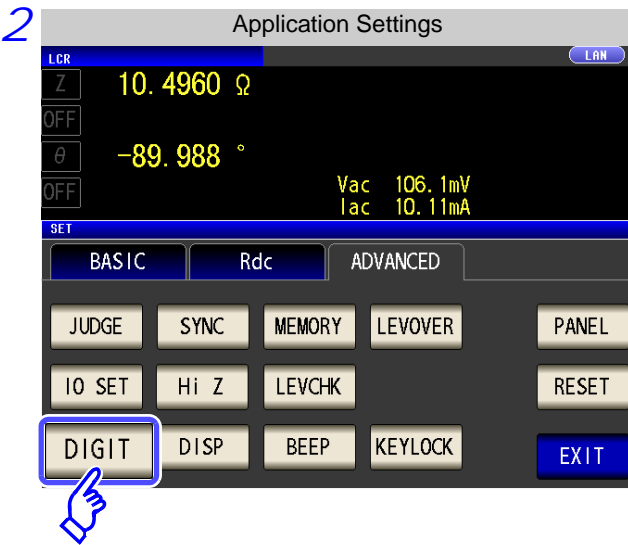
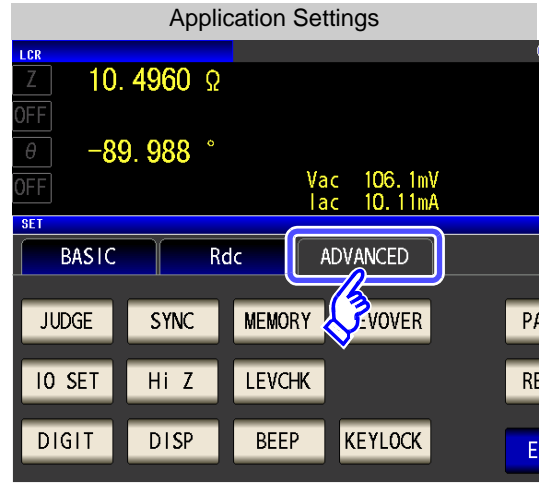
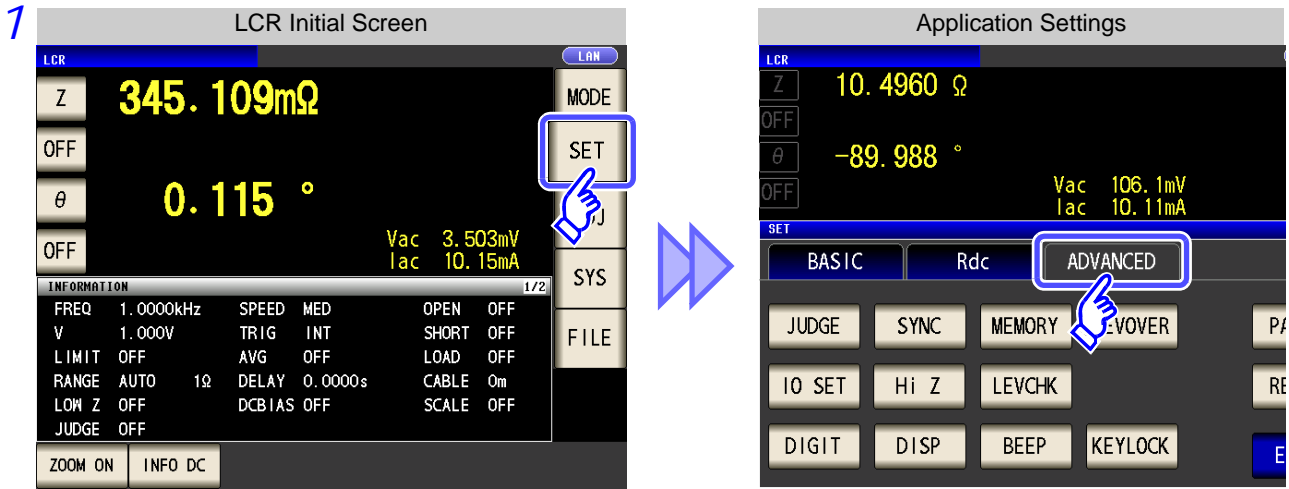

You can set the number of effective digits of the measurement value for each parameter.

#### Procedure

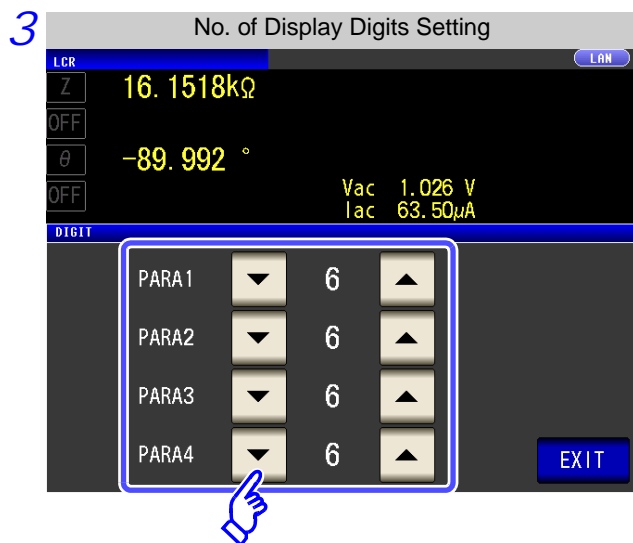

Press **DIGIT**.



Use  or  to set the number of display digits.

(For each parameter)

Settable range: 3 to 7 digits

Setting Value	Parameter				
	$\theta$	D	Q	$\Delta\%$	Other
7	Up to three decimal places	Up to six decimal places	Up to three decimal places	Up to four decimal places	Up to 7 digits
6	Up to three decimal places	Up to five decimal places	Up to second decimal place	Up to three decimal places	Up to 6 digits
5	Up to second decimal place	Up to four decimal places	Up to one decimal place	Up to second decimal place	Up to 5 digits
4	Up to one decimal place	Up to three decimal places	Up to zero decimal places	Up to one decimal place	Up to 4 digits
3	Up to zero decimal places	Up to second decimal place	Up to zero decimal places	Up to zero decimal places	Up to 3 digits

4 Press  to close the setting screen.

### 4.5.11 Enlarging Display of Measurement Values

The measurement values and comparator decision results can be displayed in enlarged form. This function is convenient when the unit is used under constant measurement conditions.

If the power is turned off when **ZOOM ON** is displayed, **ZOOM ON** will be displayed when the instrument starts the next time you turn the power on.

#### Procedure

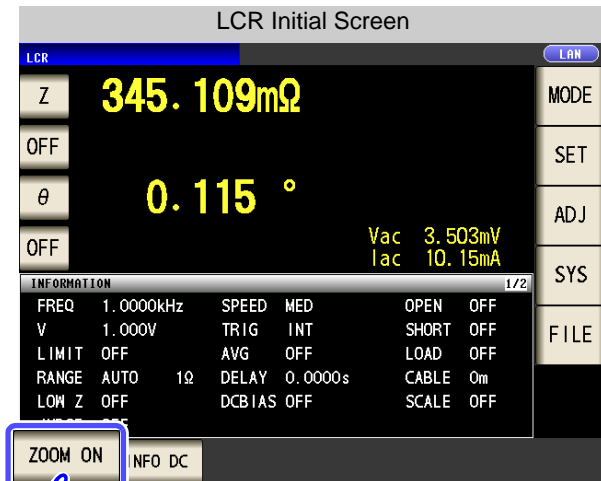

Press **ZOOM ON** in the initial screen to display the magnification display screen.

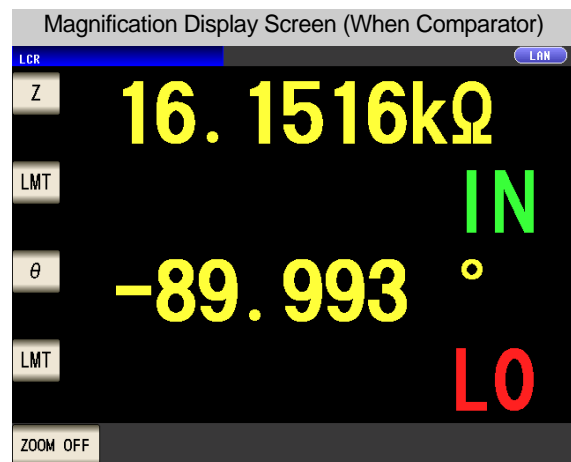
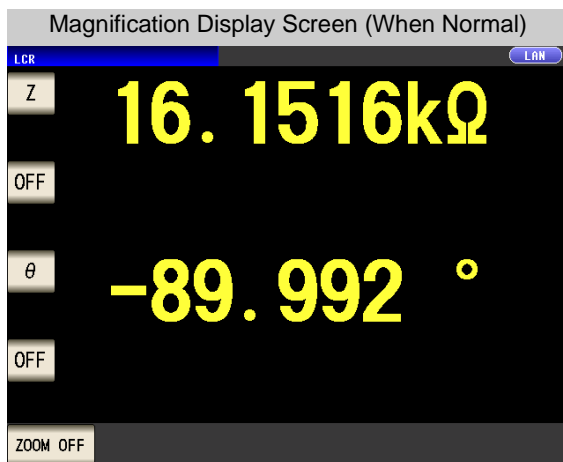

**When you want to show normal display:**

Press **ZOOM OFF** in the magnification display screen.

## 4.5.12 Setting the LCD to ON/ OFF

You can turn the LCD ON/ OFF.

Setting the LCD to OFF saves power because the LCD turns off if the panel is not touched for 10 seconds.

### Procedure

1

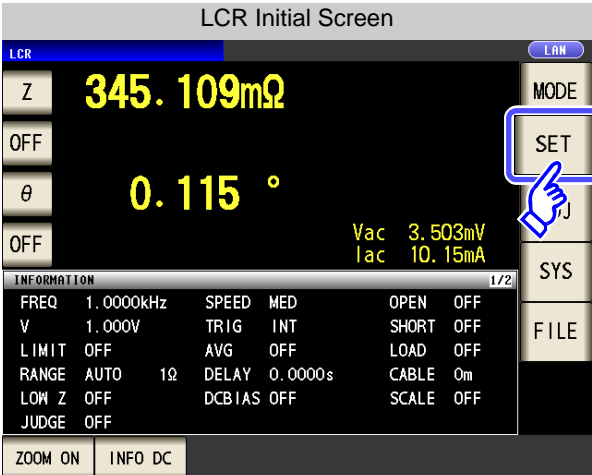

Application Settings

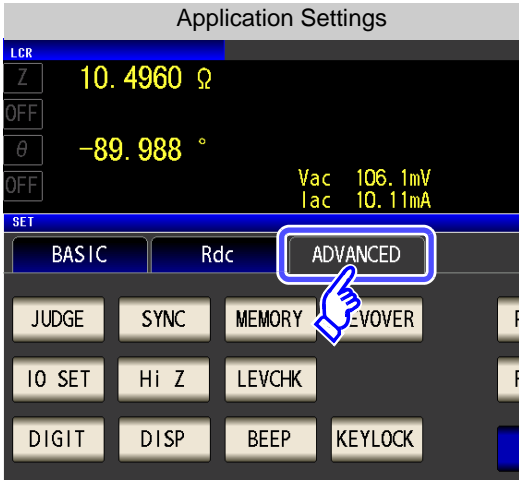

2

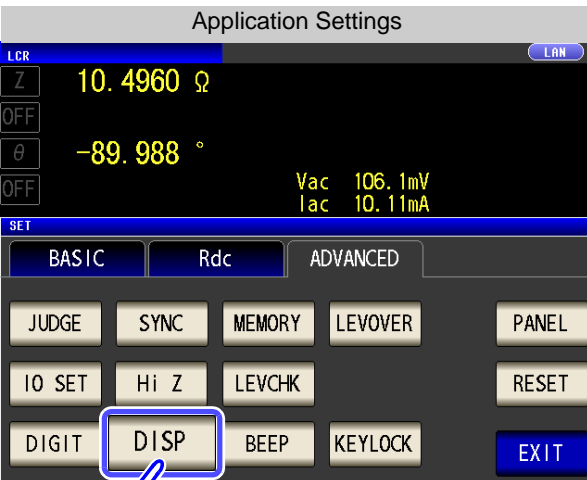

Press **DISP**.

3

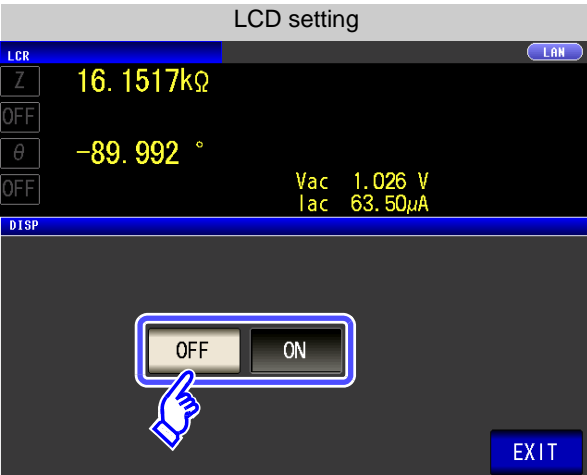

Select the LCD setting, and press **EXIT** to close the setting screen.

**OFF** Turns OFF the LCD.  
The LCD turns off after approximately 10 seconds elapse since the touch panel was last touched.

**ON** Sets the LCD to always on.

**When you want to turn the backlight on again:**

If you touch the touch panel while the backlight is off, the backlight will turn on again.

### 4.5.13 Setting Operation Sounds (Beep Sounds)

You can set the operation sound and each of the beep sounds for judgment results.

#### Procedure

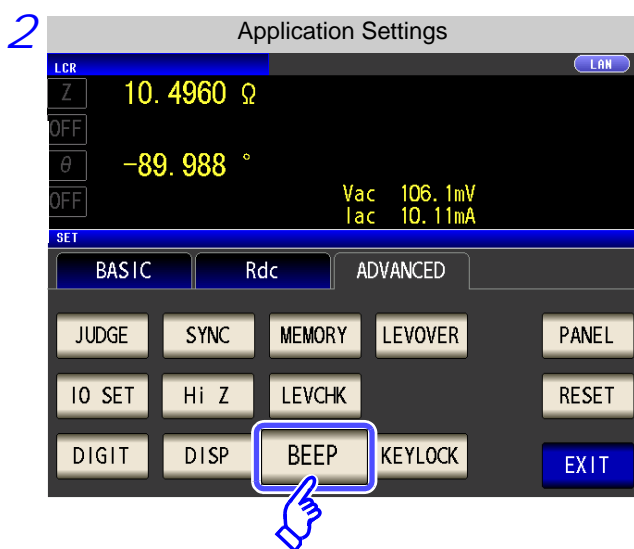
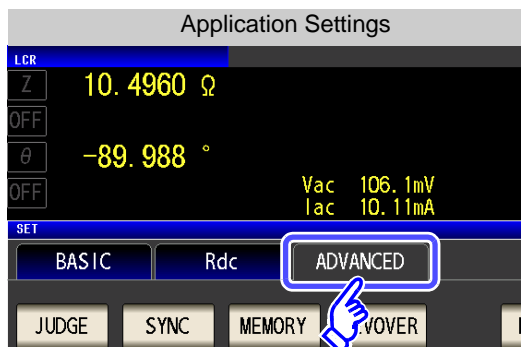
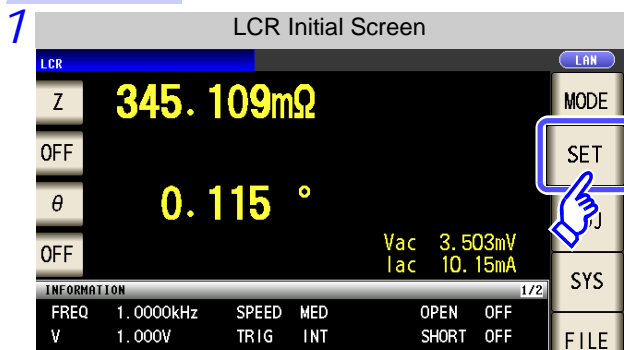

Press **BEEP**.

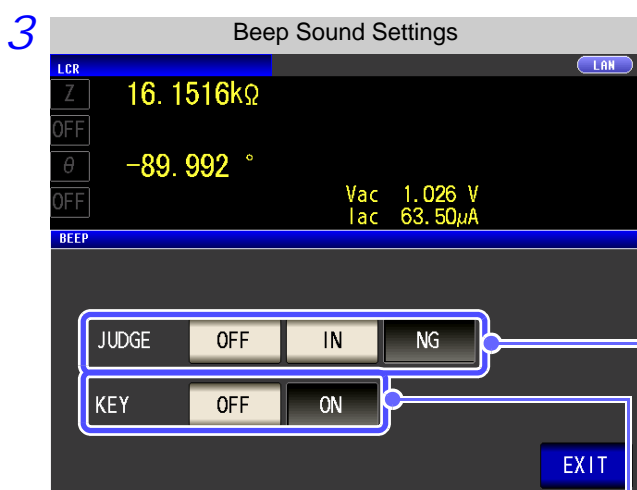

#### Beep sound settings for when comparator judgment

- OFF** When a comparator judgment is made, no beep sound is emitted.
- When judgment performed with 1 comparator
  - IN** When the comparator result is IN, a beep sound is emitted.
  - NG** When the comparator result is LO or HI, a beep sound is emitted.
- When judgment performed with 2 comparators
  - IN** When both of these comparator results are IN, a beep sound is emitted.
  - NG** When either one is LO or HI, a beep sound is emitted.

#### Beep sound setting for when key pressed

- OFF** When a key is pressed, no beep sound is emitted.
- ON** When a key is pressed, a beep sound is emitted.

4 Press **EXIT** to close the setting screen.



### 4.5.14 Initializing (System Reset)

In the event of the instrument malfunctioning, check "Before returning for repair" (p. 405).

If you do not know the cause of the problem, perform a system reset to restore the instrument to its factory default settings.

A system reset can also be performed with the **\*RST** and **:PRESet** communication commands.

See Description of communications commands on the included CD

#### Procedure

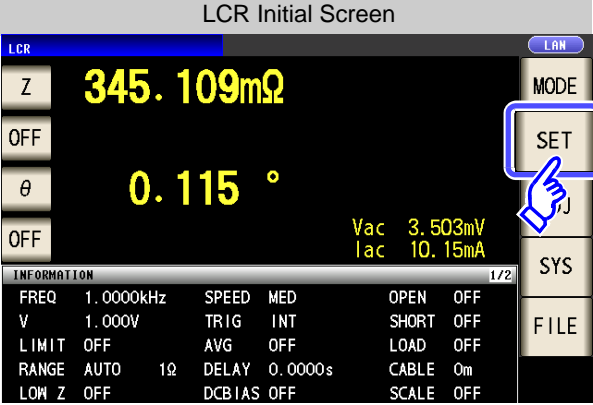
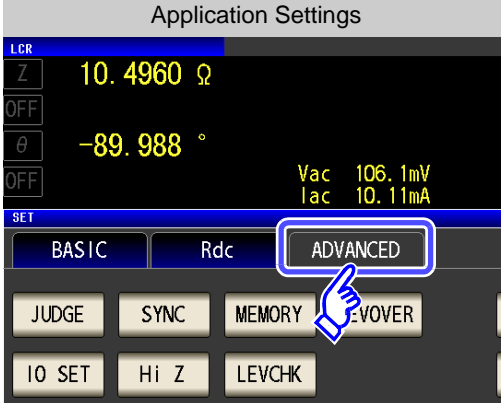
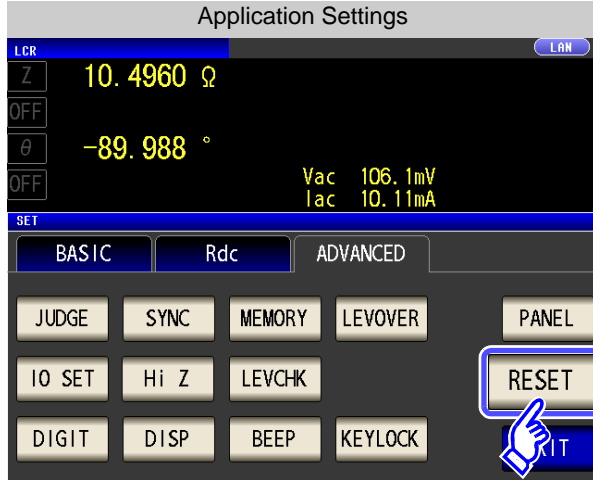
- 

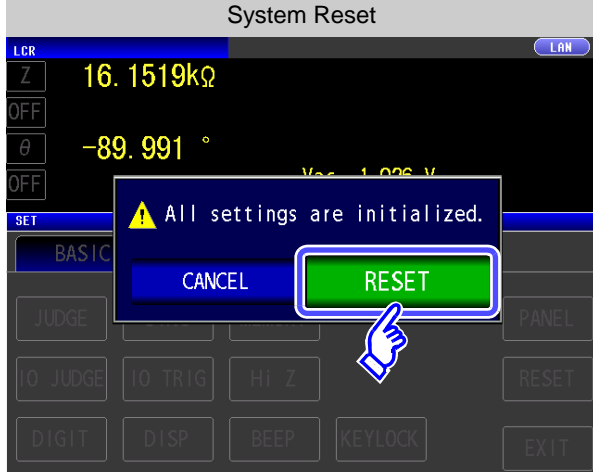
- 

Press **RESET**.
- 

Press **RESET** to restore the factory default settings and automatically redisplay the initial screen.

When you want to cancel the system reset:  
Press **CANCEL**.

**NOTE** If the initialization screen cannot be displayed, perform a full reset. (p. 406)



# ANALYZER Function

## Chapter 5

### 5.1 About ANALYZER function

LCR

ANALYZER

The analyzer function allows you to perform measurement while sweeping the measurement frequency and measurement signal level.

The measurement results can be displayed in a graph. Use this function for measuring frequency characteristics and level characteristics.

**NOTE**

The settings are synchronized between LCR mode and analyzer mode.

## 5.1 About ANALYZER function

### 5.1.1 Initial screen

This is the screen that is first displayed when the power is turned on. It allows you to perform measurement while checking the measurement conditions.

For details on the screen configuration, refer to page 17.

The screenshot shows the ANALYZER initial screen with the following callouts:

- Indicates the maximum and minimum values of the vertical axis of the graph.
- Indicates the name of the loaded panel.
- Indicates the measurement value of the point currently being measured.
- Indicates the usage status of internal memory. (p. 106)
- Indicates that a USB flash drive is connected. (p. 329)
- Indicates the interface that is currently set.

**Menu keys**

- MODE** Select the measurement mode.(p. 13)
- SET** Set the details.(p. 133)
- ADJ** Set the compensation.(p. 273)
- SYS** Set the system.(p. 305)
- FILE** Set the save settings.(p. 329)

The settings of **SET** differ depending on the measurement mode.

Select the screen display method.

- NUMERIC** Displays list of numeric values.
- GRAPH** Displays graph.
- X-Y** Displays an X-Y graph.\* (p. 263)

Set the vertical axis to auto scale. (p. 185)

Save the screen. (p. 333)

Print the screen. (p. 381)

Measurement starts. (p. 137)  
(This is displayed when **SEQ** or **STEP** is selected for the trigger setting.)

The setting of the cursor. (p. 188)

Move the cursor. (p. 188)

Switch measured values and simulation values during equivalent circuit analysis.

Perform a search. (p. 190)

\* **X-Y** is displayed only when the IM9000 Equivalent Circuit Analysis Firmware has been installed.

## 5.2 Setting Basic Settings of Measurement

LCR

ANALYZER

You can set the basic settings for any of **NUMERIC** and **GRAPH** first.

### 5.2.1 Setting the measurement parameter

Set the measurement parameter for analyzer mode.

**NOTE** DC resistance measurement cannot be performed in analyzer mode.

#### Procedure

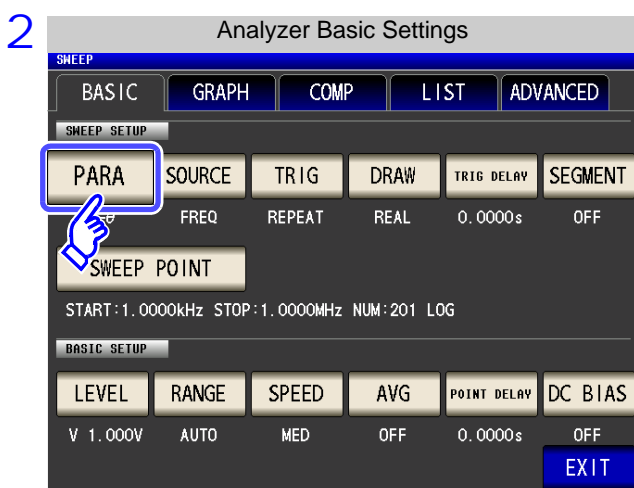
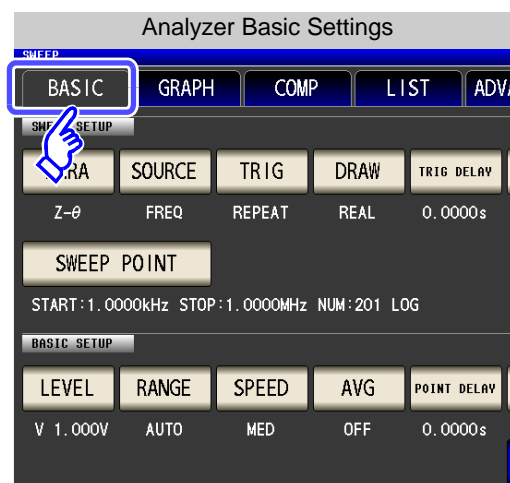
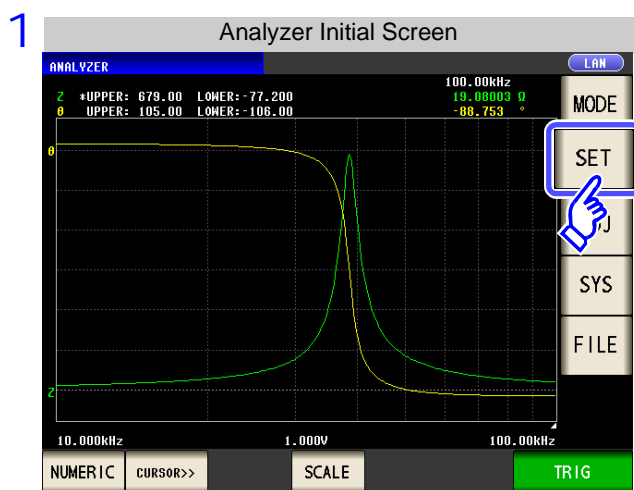

Press **PARAM**.

## 5.2 Setting Basic Settings of Measurement

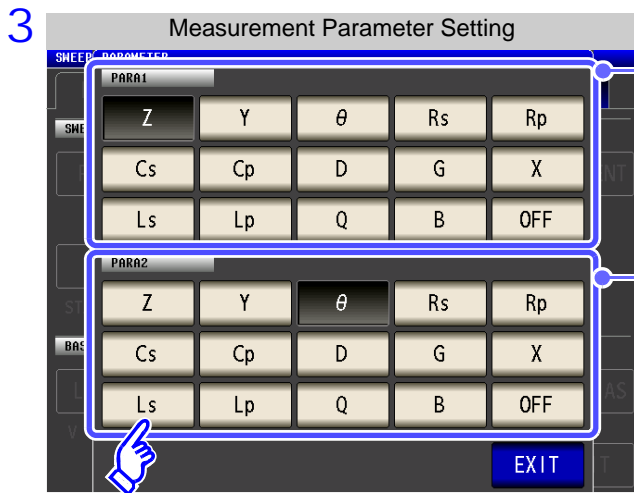

Select the first parameter.

Select the second parameter.

- In analyzer mode, two types of parameter measurement can be performed: PARA1 and PARA2.
- The parameter settings of LCR mode and parameter settings of analyzer mode are synchronized as shown below.

LCR mode	ANALYZER mode
PARA1	PARA1
PARA2	Unused
PARA3	PARA2
PARA4	Unused

4 Press **EXIT** to close the setting screen.

### 5.2.2 Setting the Sweep Parameter

Set the sweep parameter. In analyzer mode, measurement is performed during sweeping for the parameter set for this item. The following four types of parameter can be set as the sweep parameter.

- Frequency
- Constant voltage
- Open circuit voltage
- Constant current

**NOTE** When the sweep parameter is changed, the comparator setting and sweep points are initialized.

**Procedure**

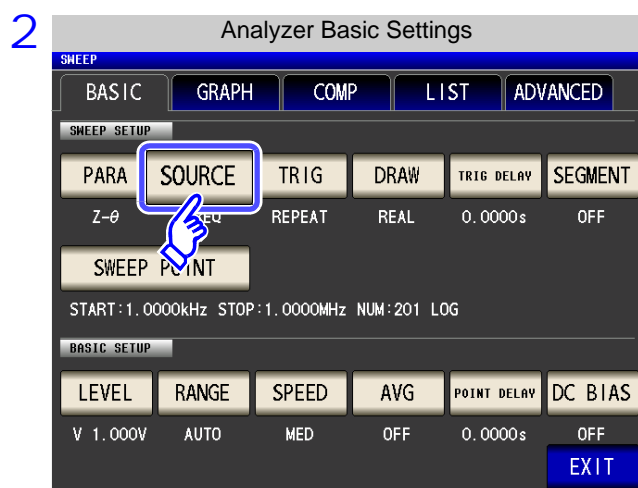
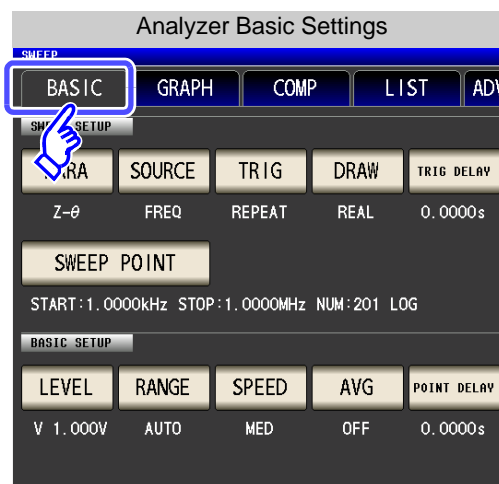
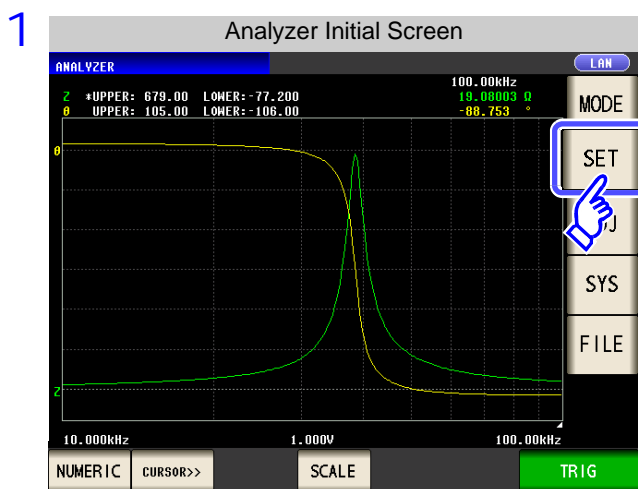

Press SOURCE .

## 5.2 Setting Basic Settings of Measurement

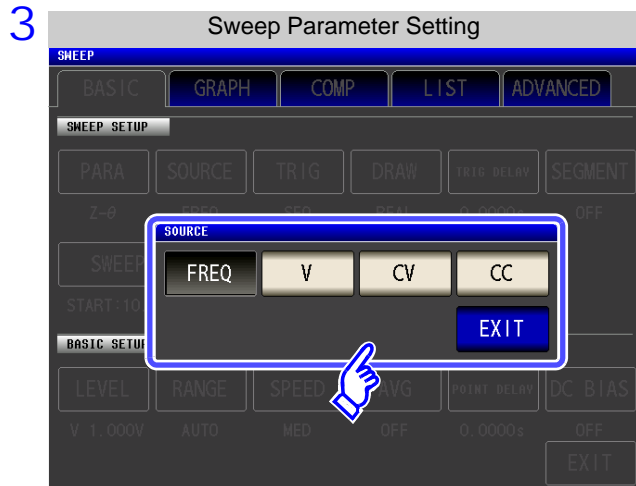

Select the sweep parameter.

FREQ

Performs frequency sweep.

V

Performs open circuit voltage sweep.

CV

Performs constant voltage sweep.

CC

Performs constant current sweep.

4 Press **EXIT** to close the setting screen.



### 5.2.3 Setting the Trigger

Set the trigger. In analyzer mode, sweeping is performed in accordance with the trigger setting that is set for this item.

The following three types of trigger can be set as the trigger setting.

- Sequential sweep
- Repeat sweep
- Step sweep

For details on each of the triggers, refer to Step 1.

#### Procedure

1

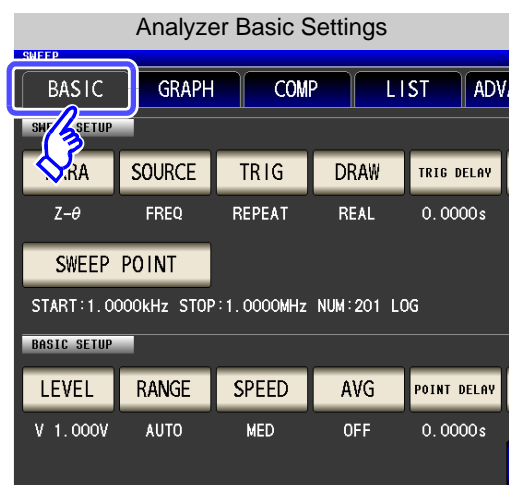
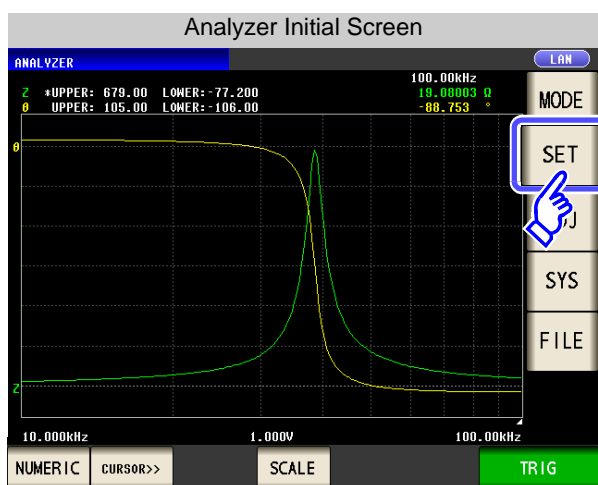

2

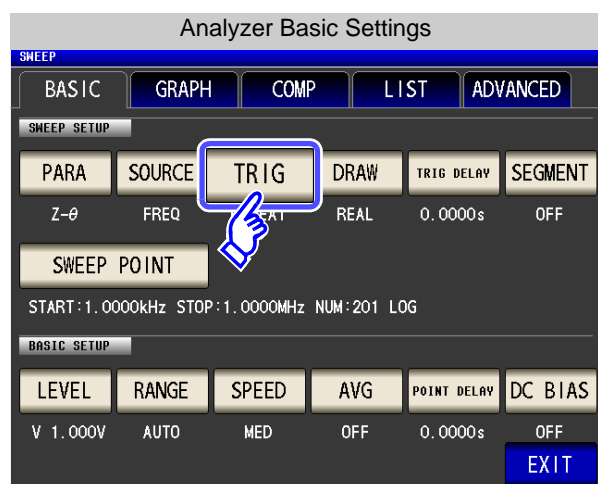

Press **TRIG**.

## 5.2 Setting Basic Settings of Measurement

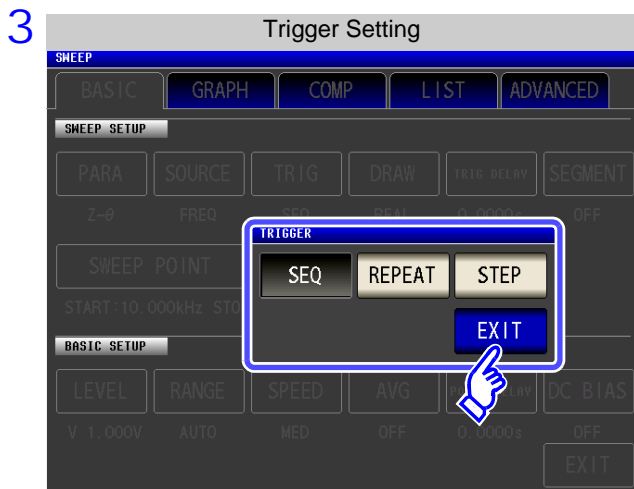

### Select the trigger setting.

- |  |  |
|--|--|
|  | Performs a sequential sweep.<br>When an external trigger is input, sweep measurement is performed once only.   |
|  | Performs a repeat sweep.<br>An internal trigger results in a sweep being performed repeatedly.   |
|  | Performs a step sweep.<br>When an external trigger is input, measurement is performed at the current measurement point and then the process moves to the next measurement point. |

- If this is set to or , is displayed in the measurement screen.
- Each time you press , a sequence sweep or step sweep is performed.

4 Press to close the setting screen.

**NOTE** The trigger setting that is set for this item differs from the trigger setting of LCR mode.  
(It does not influence the trigger setting of LCR mode.)

## 5.2.4 Setting the Display Timing

Set the timing for drawing the graph or list.

If the display timing is set to **REAL**, the time for one sweep becomes long because the screen is updated every time each sweep point is measured.

If it is set to **AFTER** to give priority to the measurement time, the screen update time becomes short.

### Procedure

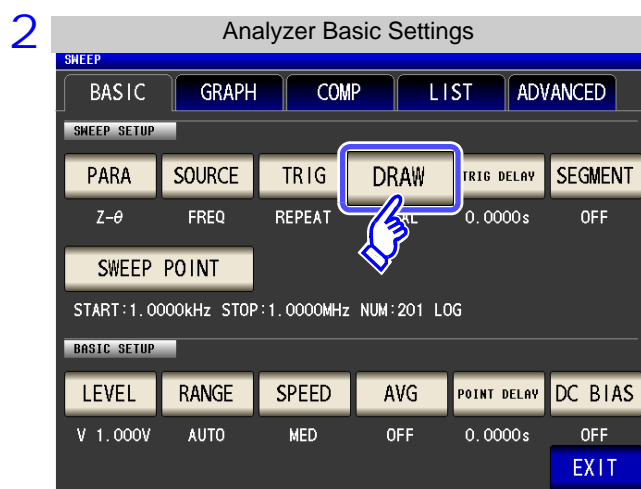
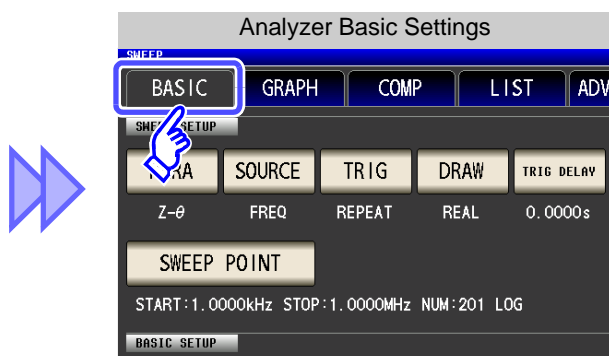
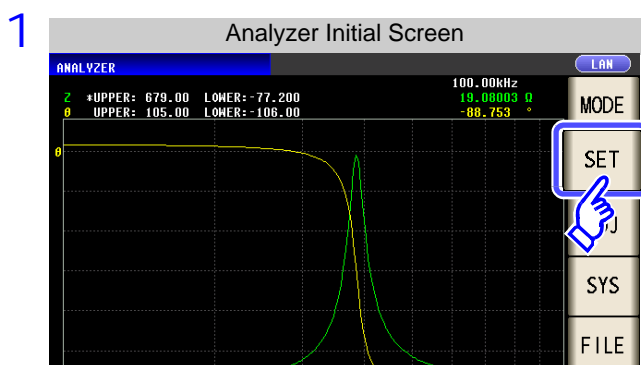

Press **DRAW**.

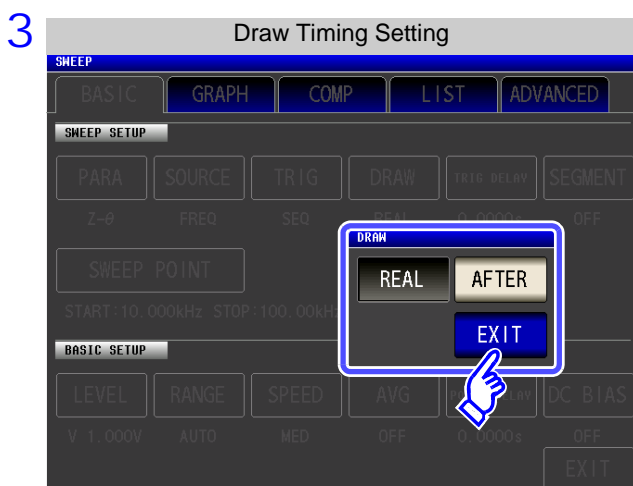

Set the timing for display.

**REAL** Sequentially draws after measurement of each sweep point.

**AFTER** Draws all after one sweep is finished.

4 Press **EXIT** to close the setting screen.

5.2 Setting Basic Settings of Measurement

5.2.5 Setting the Trigger Delay

Set the delay time from when a trigger is input until measurement starts. There are two delay settings: "Trigger Delay" and "Point Delay." With this item, only the setting for the trigger delay is configured.

When sequential sweep

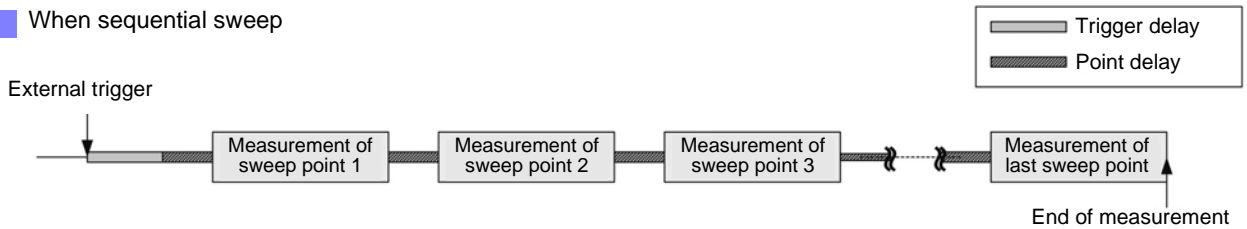

When repeat sweep

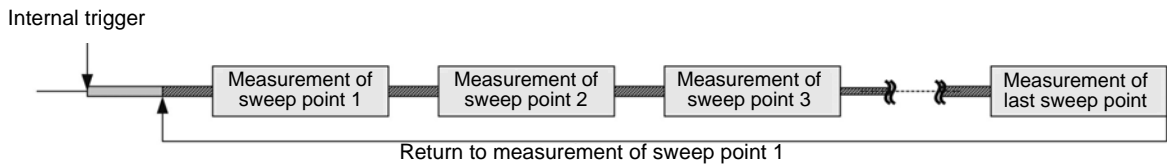

When step sweep

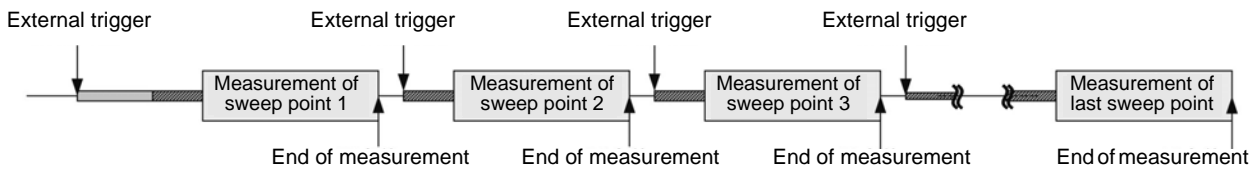

5.2 Setting Basic Settings of Measurement

Procedure

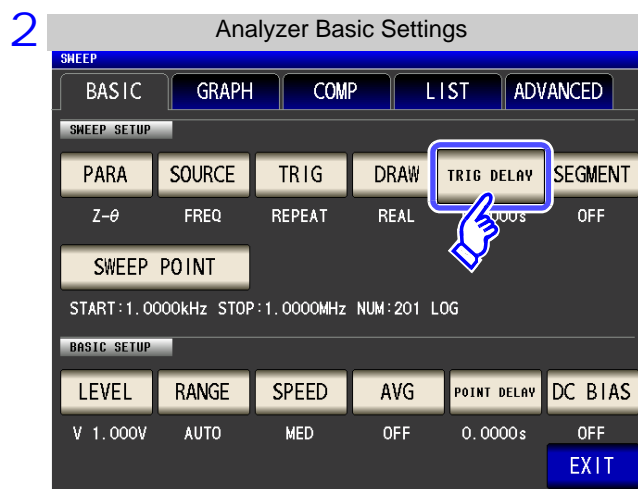
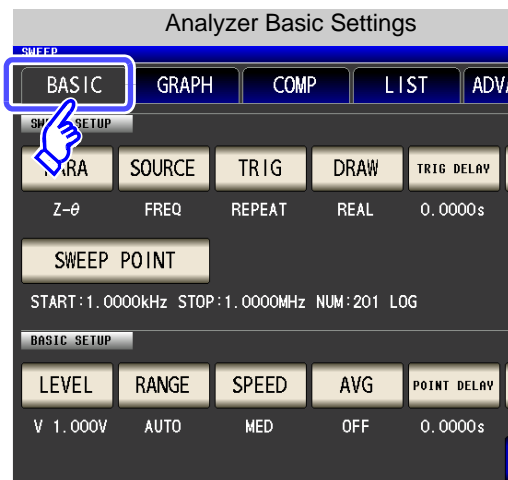
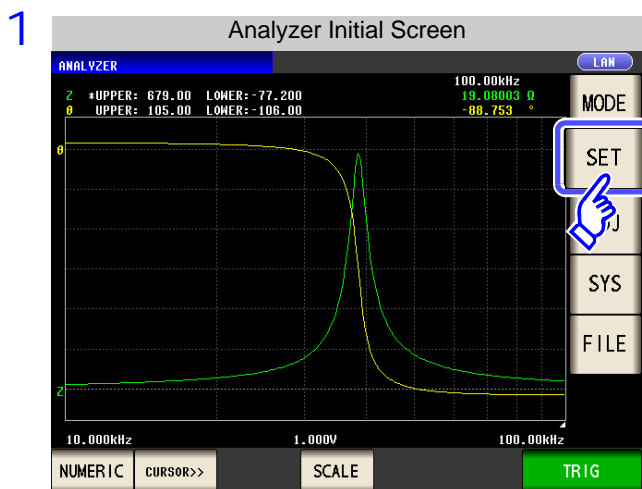

Press **TRIG DELAY**.

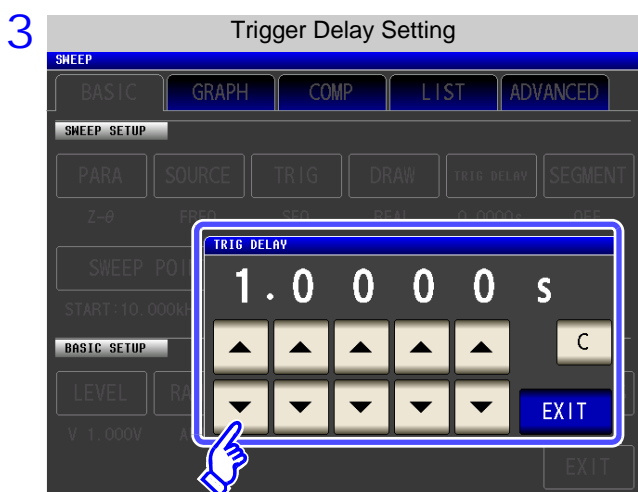

Use **▲** or **▼** to set the delay time.

- Settable range: 0 to 9.9999 s with resolution of 0.1 ms
- If you make a mistake during input: press **C** to cancel the input and start again.

4 Press **EXIT** to close the setting screen.

## 5.2 Setting Basic Settings of Measurement

### 5.2.6 Segment Setting

Set whether to perform a normal sweep or segment sweep.

#### Normal Sweep (p. 143)

Set the sweep range and number of sweep points and then perform measurement.

(For each sweep point, the measurement conditions, except for the sweep parameter, are the same. It is also possible to fix the sweep parameter and perform interval measurement which measures at a set time interval.)

#### Segment Sweep (p. 169)

Divide the sweep range into ranges called segments and then perform sweep measurement.

(The sweep range, sweep points, and measurement conditions can be set for each segment.)

#### Procedure

1

Analyzer Initial Screen

Analyzer Basic Settings

2

Analyzer Basic Settings

Press **SEGMENT**.

3

Segment Setting

Select the segments.

<b>OFF</b>	Normal Sweep (p. 143)
<b>ON</b>	Segment Sweep (p. 169)

4 Press **EXIT** to close the setting screen.

# 5.3 Normal Sweep

LCR ANALYZER

Set just one type for each of the sweep range and number of sweep points and then perform measurement.

## 5.3.1 Setting Sweep Points

The sweep range setting differs depending on the setting of the sweep parameter (SOURCE). (p. 135)

- When **FREQ** (p. 143)
- When **V** or **CV** (p. 148)
- When **CC** (p. 152)

### CAUTION

Do not switch between V, CV and CC while the test sample is still connected to the measurement terminals because doing so may damage the test sample. (p. 45)

When the **SOURCE** setting is **FREQ**

### Procedure

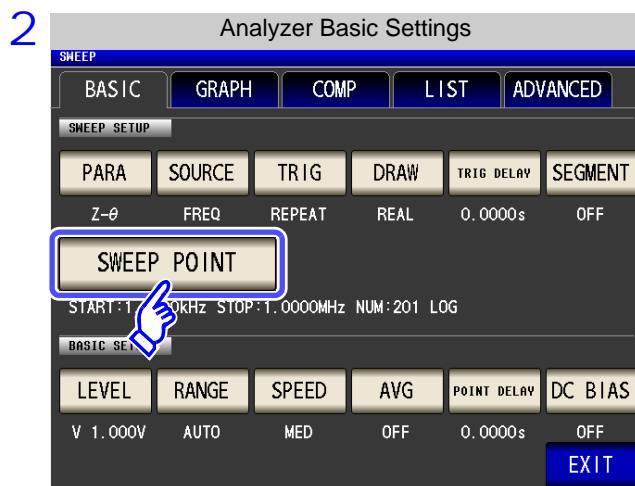
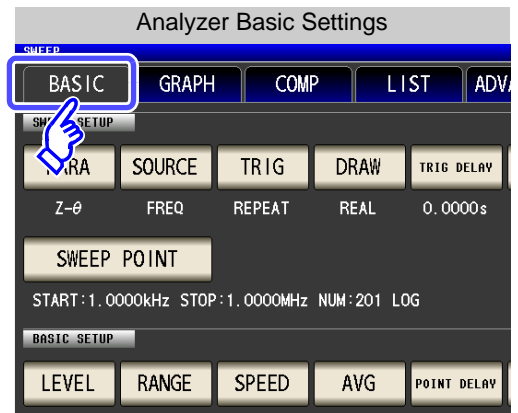
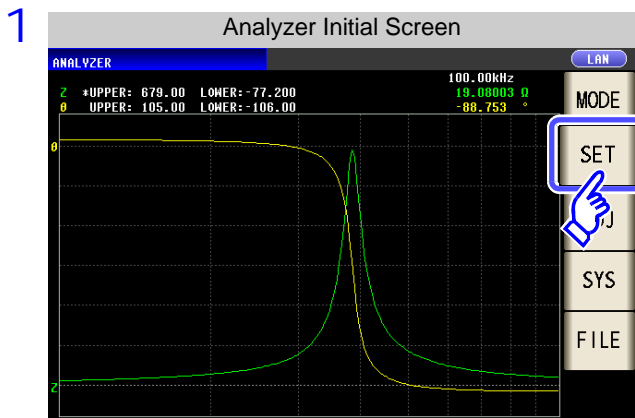

Press **SWEEP POINT**.

## 5.3 Normal Sweep

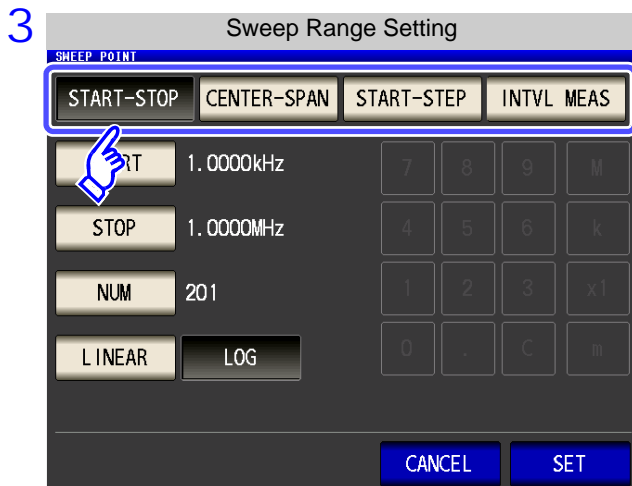

Select the setting method of the sweep range.

For details on the settings, refer to the following figures.

When you want to cancel the setting:

Press **CANCEL**.

**START-STOP**

Sets the start value and end value of the sweep. Each sweep point is automatically calculated from the number of sweep points.

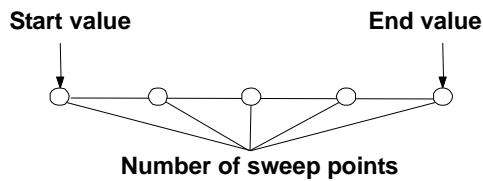

**START-STEP**

Sets the start value of the sweep and the step width of sweep points. Each sweep point is automatically calculated from the number of sweep points.

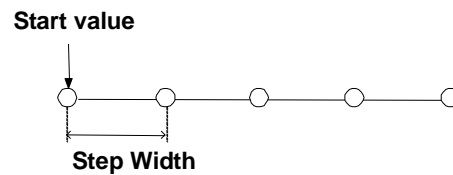

**CENTER-SPAN**

Sets the center value of the sweep range and the sweep width. Each sweep point is automatically calculated from the number of sweep points.

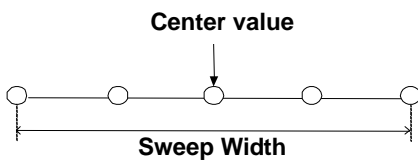

**INTVL MEAS**

Fixes the sweep parameter and performs measurement at a set time interval.

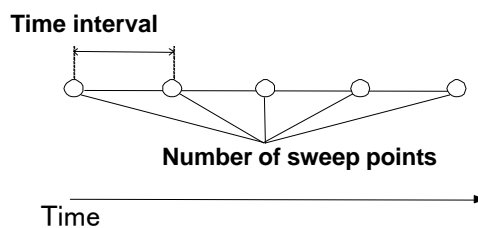



## START-STOP

## Setting the start value and end value of the sweep

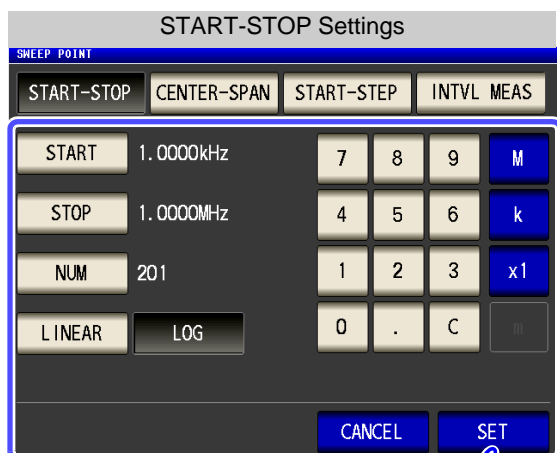

If you make a mistake during input:  
press **C** to cancel the input and start again.

1. Press **START** and use the numeric keypad to set the start value of the sweep.  
Settable range: 4 Hz to 5 MHz
2. Press **M**, **k**, or **x1** key to confirm the setting.
3. Press **STOP** and use the numeric keypad to set the end value of the sweep.  
Settable range: 4 Hz to 5 MHz
4. Press **M**, **k**, or **x1** key to confirm the setting.
5. Press **NUM** and use the numeric keypad to enter the number of sweep points.  
Settable range: 2 to 801
6. Press **x1** key to confirm the setting.
7. Select the setting method for sweep points (when frequency sweep).

<b>L INEAR</b>	The sweep points are calculated linearly from the setting values of <b>START</b> , <b>STOP</b> , and <b>NUM</b> .
<b>LOG</b>	The sweep points are calculated logarithmically from the setting values of <b>START</b> , <b>STOP</b> , and <b>NUM</b> .

8. Press **SET** to confirm the setting.

**NOTE**

- The setting method of the sweep points can only be selected when the sweep parameter is frequency and the setting method of the sweep range is **START-STEP**. In other cases, the setting method of the sweep points is fixed to linear.
- If the setting method of the sweep points is changed, the horizontal axis scale of the graph display screen changes as shown in the figures below. (The horizontal axis scale of the graph can also be changed with the horizontal axis scale setting.)

See: "Horizontal Axis Scale Setting" (p. 177)

When the **SCALE** setting is **L INEAR**.

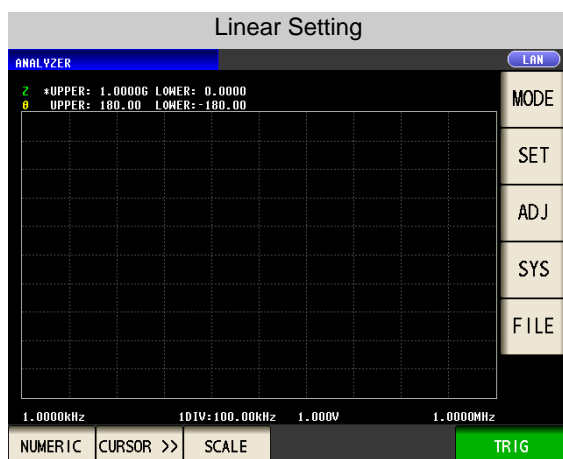

The horizontal scale is linear display.

When the **SCALE** setting is **LOG**.

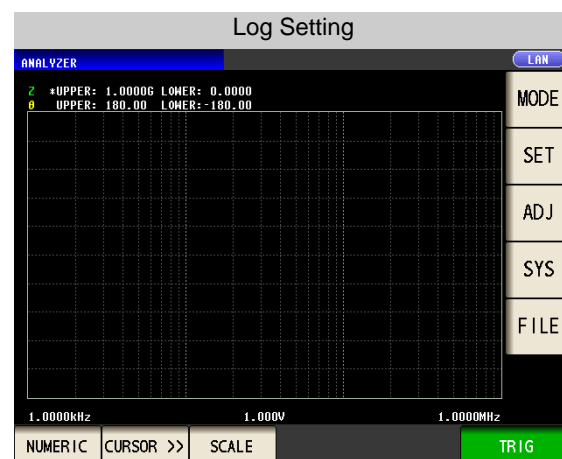

The horizontal scale is log display.

## 5.3 Normal Sweep

## CENTER-SPAN

## Setting the center value of the sweep range and the sweep width

CENTER-SPAN Setting

SWEPT POINT

START-STOP CENTER-SPAN START-STEP INTVL MEAS

CENTER 5.25mA

SPAN 9.50mA

NUM 50

7 8 9 M

4 5 6 k

1 2 3 x1

0 . C

CANCEL SET

If you make a mistake during input:  
press **C** to cancel the input and start again.

1. Press **CENTER** and use the numeric keypad to set the center value of the sweep range.  
Settable range: 4 Hz to 5 MHz
2. Press **M**, **k**, or **x1** key to confirm the setting.
3. Press **SPAN** and use the numeric keypad to set the sweep width.  
Settable range: 4 Hz to 5 MHz
4. Press **M**, **k**, or **x1** key to confirm the setting.
5. Press **NUM** and use the numeric keypad to enter the number of sweep points.  
Settable range: 2 to 801
6. Press **x1** key to confirm the setting.
7. Press **SET** key to confirm the setting.

**NOTE** The sweep width set with **SPAN** is centered on the frequency that was set with **CENTER**. Therefore, the range of values that you can set with **SPAN** varies depending on the value set with **CENTER**.

## START-STEP

## Setting the start value of the sweep and the step width of the sweep point

START-STEP Settings

SWEPT POINT

START-STOP CENTER-SPAN START-STEP INTVL MEAS

START 1.0000kHz

STEP 4.9950kHz

NUM 201

7 8 9 M

4 5 6 k

1 2 3 x1

0 . C

CANCEL SET

If you make a mistake during input:  
press **C** to cancel the input and start again.

1. Press **START** and use the numeric keypad to set the start value of the sweep.  
Settable range: 4 Hz to 5 MHz
2. Press **M**, **k**, or **x1** key to confirm the setting.
3. Press **STEP** and use the numeric keypad to set the step width of the sweep point.  
Settable range: 4 Hz to 5 MHz
4. Press **M**, **k**, or **x1** key to confirm the setting.
5. Press **NUM** and use the numeric keypad to enter the number of sweep points.  
Settable range: 2 to 801
6. Press **x1** key to confirm the setting.
7. Press **SET** key to confirm the setting.

**NOTE** The range of values that can be set for **STEP** varies depending on the values set with **START** and **NUM**.

INTVL MEAS

## Fixing sweep parameter and setting measurement to be performed at a set time interval (Time interval measurement)

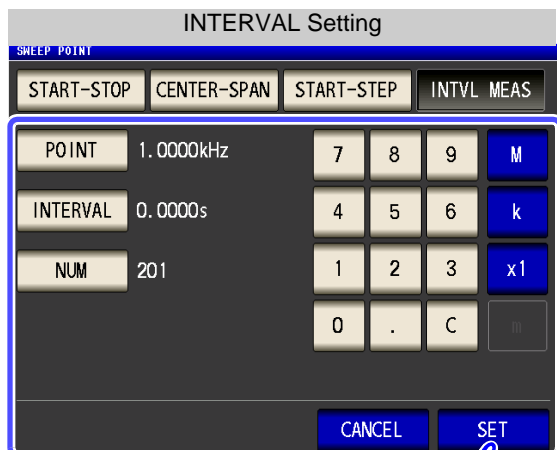

If you make a mistake during input:  
press **C** to cancel the input and start again.

1. Press **POINT** and use the numeric keypad to set the start value of the sweep.  
Settable range: 4 Hz to 5 MHz
2. Press **M**, **k**, or **x1** key to confirm the setting.
3. Press **INTVL MEAS** and use the numeric keypad to set the measurement time interval.  
Settable range: 0 s to 10000 s
4. Press **x1** key to confirm the setting.
5. Press **NUM** and use the numeric keypad to enter the number of measurements.  
Settable range: 2 to 801
6. Press **x1** key to confirm the setting.
7. Press **SET** key to confirm the setting.

**NOTE** When the sweep range setting method is changed, the measurement interval for INTERVAL measurement is reflected in the point delay time.

## 5.3 Normal Sweep

When the **SOURCE** setting is **V** or **CV**

**Procedure** Example: When **V**

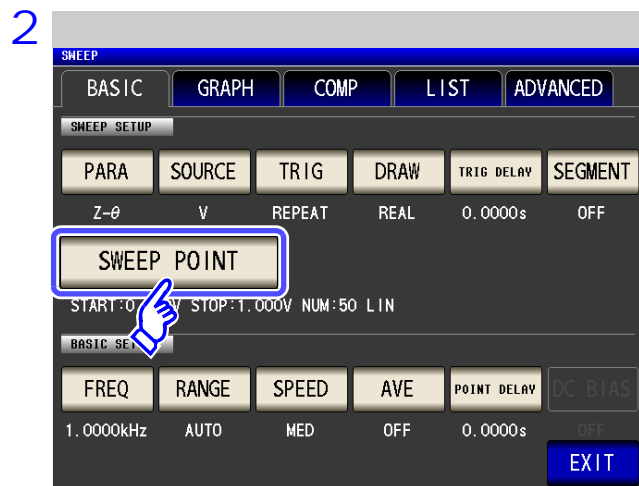
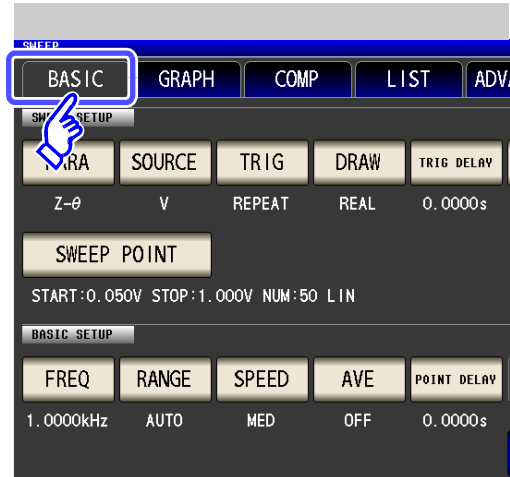
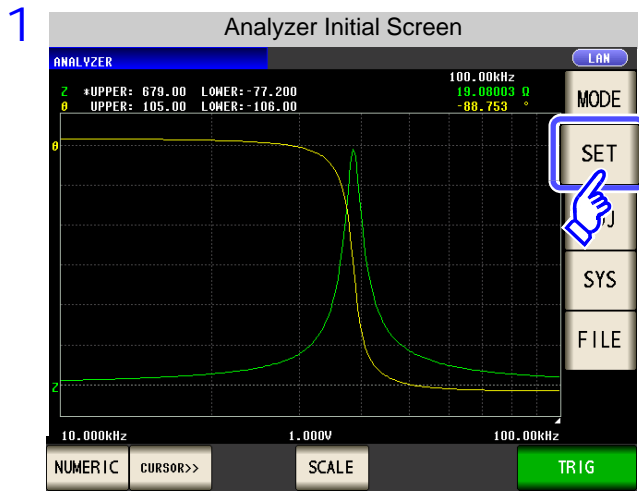

Press **SWEEP POINT**.

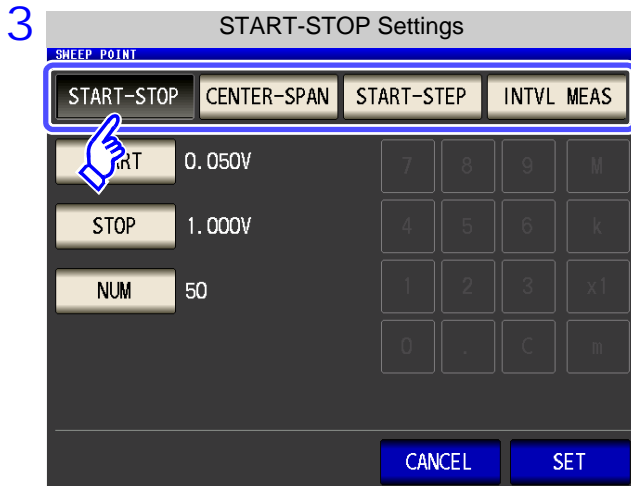

Select the setting method of the sweep range.

For details on the settings, refer to the following figures.

When you want to cancel the setting:

Press **CANCEL**.

**START-STOP**

Sets the start value and end value of the sweep. Each sweep point is automatically calculated from the number of sweep points.

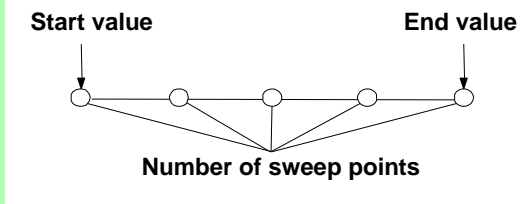

**START-STEP**

Sets the start value of the sweep and the step width of sweep points. Each sweep point is automatically calculated from the number of sweep points.

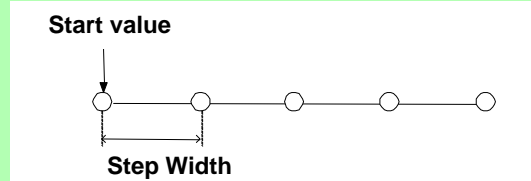

**CENTER-SPAN**

Sets the center value of the sweep range and the sweep width. Each sweep point is automatically calculated from the number of sweep points.

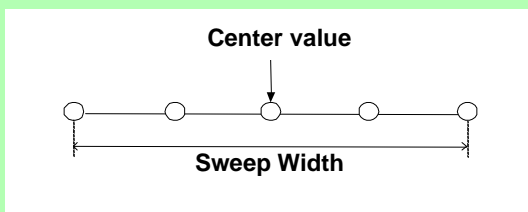

**INTVL MEAS**

Fixes the sweep parameter and performs measurement at a set time interval.

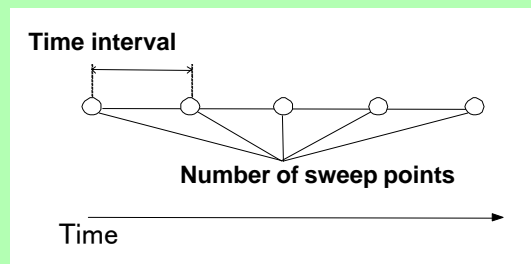

## 5.3 Normal Sweep

START-STOP

## Setting the start value and end value of the sweep

If you make a mistake during input:  
press **C** to cancel the input and start again.

1. Press **START** and use the numeric keypad to set the start value of the sweep.  
Settable range: 0.005 to 5.000 V
2. Press **x1** key to confirm the setting.
3. Press **STOP** and use the numeric keypad to set the end value of the sweep.  
Settable range: 0.005 to 5.000 V
4. Press **x1** key to confirm the setting.
5. Press **NUM** and use the numeric keypad to enter the number of sweep points.  
Settable range: 2 to 801
6. Press **x1** key to confirm the setting.
7. Press **SET** to confirm the setting.

**NOTE** When **V** or **CV** is set for the sweep parameter, the setting method of the sweep points is fixed to linear.

CENTER-SPAN

## Setting the center value of the sweep range and the sweep width

If you make a mistake during input:  
press **C** to cancel the input and start again.

1. Press **CENTER** and use the numeric keypad to set the center value of the sweep range.  
Settable range: 0.005 to 5.000 V
2. Press **x1** key to confirm the setting.
3. Press **SPAN** and use the numeric keypad to set the sweep width.  
Settable range: 0.005 to 5.000 V
4. Press **x1** key to confirm the setting.
5. Press **NUM** and use the numeric keypad to enter the number of sweep points.  
Settable range: 2 to 801
6. Press **x1** key to confirm the setting.
7. Press **SET** to confirm the setting.

**NOTE** The sweep width set with **SPAN** is centered on the frequency that was set with **CENTER**. Therefore, the range of values that you can set with **SPAN** varies depending on the value set with **CENTER**.

## START-STEP

## Setting the start value of the sweep and the step width of the sweep point

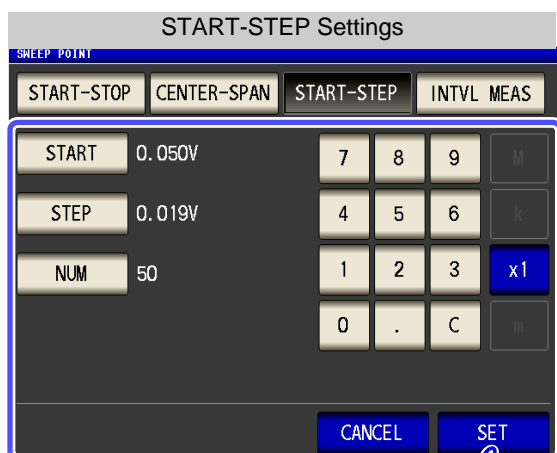

If you make a mistake during input:  
press **C** to cancel the input and start again.

**NOTE**

The range of values that can be set for **STEP** varies depending on the values set with **START** and **NUM**.

1. Press **START** and use the numeric keypad to set the start value of the sweep.  
Settable range: 0.005 to 5.000 V
2. Press **x1** key to confirm the setting.
3. Press **STEP** and use the numeric keypad to set the step width of the sweep point.  
Settable range: 0.005 to 5.000 V
4. Press **x1** key to confirm the setting.
5. Press **NUM** and use the numeric keypad to enter the number of sweep points.  
Settable range: 2 to 801
6. Press **x1** key to confirm the setting.
7. Press **SET** to confirm the setting.

## INTVL MEAS

## Fixing sweep parameter and setting measurement to be performed at a set time interval (Time interval measurement)

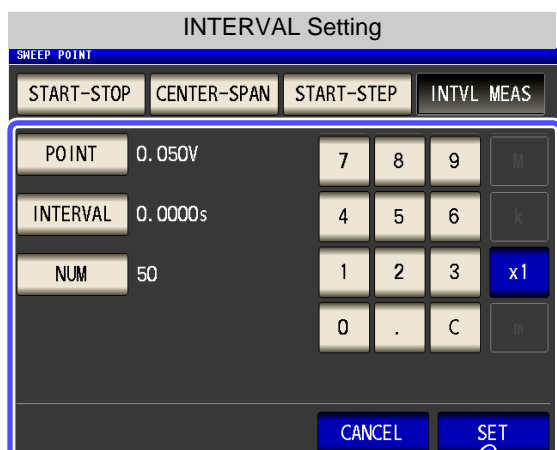

If you make a mistake during input:  
press **C** to cancel the input and start again.

1. Press **POINT** and use the numeric keypad to set the start value of the sweep.  
Settable range: 0.005 to 5.000 V
2. Press **x1** key to confirm the setting.
3. Press **INTVL MEAS** and use the numeric keypad to set the measurement time interval.  
Settable range: 0 s to 10000 s
4. Press **x1** key to confirm the setting.
5. Press **NUM** and use the numeric keypad to enter the number of measurements.  
Settable range: 2 to 801
6. Press **x1** key to confirm the setting.
7. Press **SET** to confirm the setting.

**NOTE**

The measurement interval for INTERVAL measurement is reflected in the point delay time.

## 5.3 Normal Sweep

When the **SOURCE** setting is **CC**

### Procedure

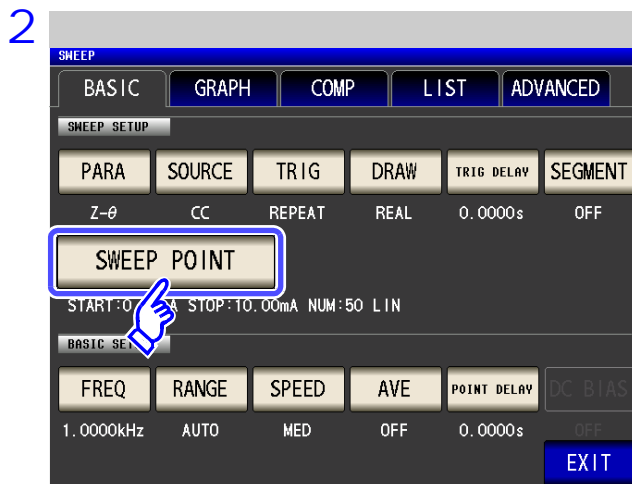
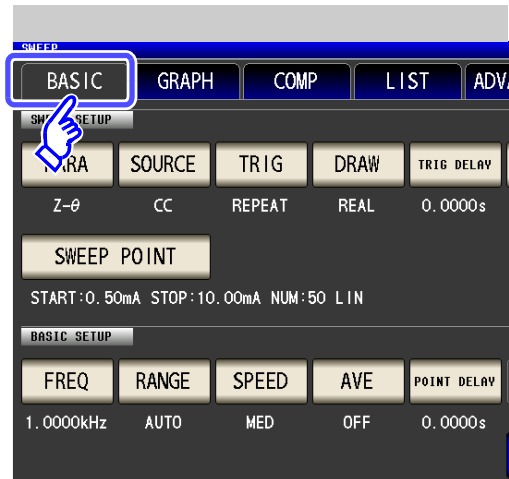
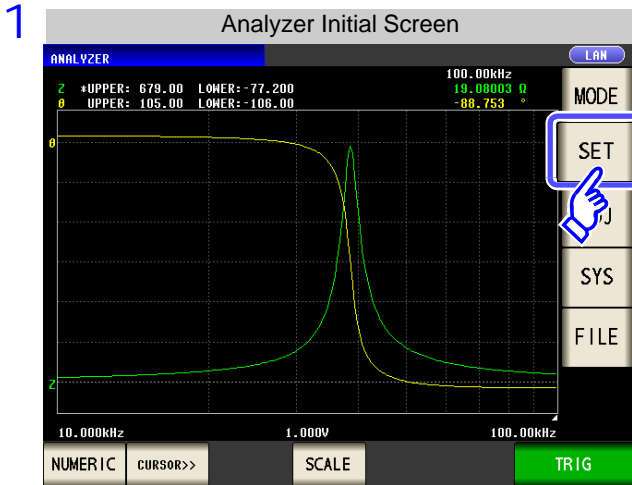

Press **SWEEP POINT**.



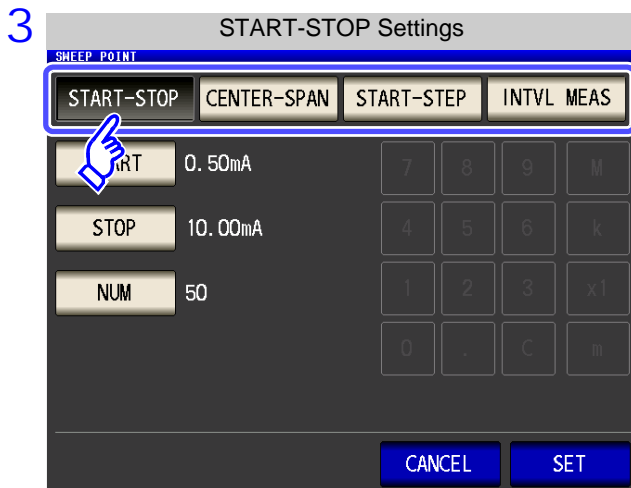

Select the setting method of the sweep range.

For details on the settings, refer to the following figures.

When you want to cancel the setting:

Press **CANCEL**.

**START-STOP**

Sets the start value and end value of the sweep. Each sweep point is automatically calculated from the number of sweep points.

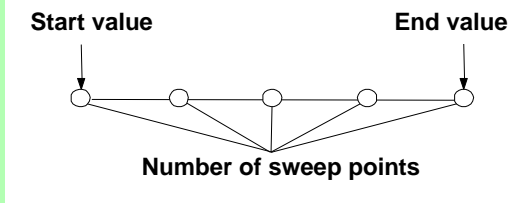

**START-STEP**

Sets the start value of the sweep and the step width of sweep points. Each sweep point is automatically calculated from the number of sweep points.

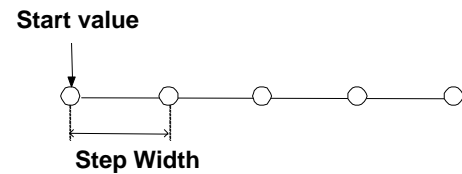

**CENTER-SPAN**

Sets the center value of the sweep range and the sweep width. Each sweep point is automatically calculated from the number of sweep points.

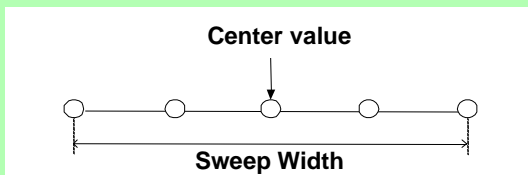

**INTVL MEAS**

Fixes the sweep parameter and performs measurement at a set time interval.

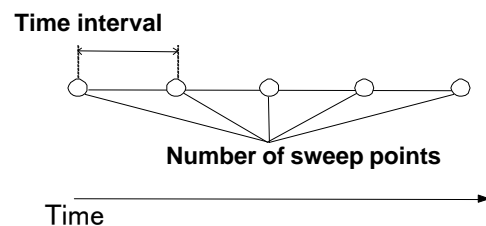

## 5.3 Normal Sweep

START-STOP

## Setting the start value and end value of the sweep

Sweep start value and end value settings

SHEEP POINT

START-STOP CENTER-SPAN START-STEP INTVL MEAS

START	0.50mA	7	8	9	M
STOP	10.00mA	4	5	6	K
NUM	50	1	2	3	x1
		0	.	C	m

CANCEL SET



If you make a mistake during input:  
press **C** to cancel the input and start again.

1. Press **START** and use the numeric keypad to set the start value of the sweep.  
Settable range: 0.01 mA to 50 mA
2. Press **m** key to confirm the setting.
3. Press **STOP** and use the numeric keypad to set the end value of the sweep.  
Settable range: 0.01 mA to 50 mA
4. Press **m** key to confirm the setting.
5. Press **NUM** and use the numeric keypad to enter the number of sweep points.  
Settable range: 2 to 801
6. Press **x1** key to confirm the setting.
7. Press **SET** to confirm the setting.

**NOTE** When **CC** is set for the sweep parameter, the setting method of the sweep points is fixed to linear.

CENTER-SPAN

## Setting the center value of the sweep range and the sweep width

CENTER-SPAN Setting

SHEEP POINT

START-STOP CENTER-SPAN START-STEP INTVL MEAS

CENTER	5.25mA	7	8	9	M
SPAN	9.50mA	4	5	6	K
NUM	50	1	2	3	x1
		0	.	C	m

CANCEL SET



If you make a mistake during input:  
press **C** to cancel the input and start again.

1. Press **CENTER** and use the numeric keypad to set the center value of the sweep range.  
Settable range: 0.01 mA to 50 mA
2. Press **m** key to confirm the setting.
3. Press **SPAN** and use the numeric keypad to set the sweep width.  
Settable range: 0.01 mA to 50 mA
4. Press **m** key to confirm the setting.
5. Press **NUM** and use the numeric keypad to enter the number of sweep points.  
Settable range: 2 to 801
6. Press **x1** key to confirm the setting.
7. Press **SET** to confirm the setting.

**NOTE** The sweep width set with **SPAN** is centered on the frequency that was set with **CENTER**. Therefore, the range of values that you can set with **SPAN** varies depending on the value set with **CENTER**.

## START-STEP

## Setting the start value of the sweep and the step width of the sweep point

START-STEP Settings

SWEET POINT

START-STOP CENTER-SPAN START-STEP INTVL MEAS

START 0.50mA

STEP 0.19mA

NUM 50

7 8 9

4 5 6

1 2 3

0 . C

CANCEL SET

If you make a mistake during input:  
press **C** to cancel the input and start again.

**NOTE** The range of values that can be set for **STEP** varies depending on the values set with **START** and **NUM**.

1. Press **START** and use the numeric keypad to set the start value of the sweep.  
Settable range: 0.01 mA to 50 mA
2. Press **m** key to confirm the setting.
3. Press **STEP** and use the numeric keypad to set the step width of the sweep point.  
Settable range: 0.01 mA to 50 mA
4. Press **m** key to confirm the setting.
5. Press **NUM** and use the numeric keypad to enter the number of sweep points.  
Settable range: 2 to 801
6. Press **x1** key to confirm the setting.
7. Press **SET** to confirm the setting.

## INTVL MEAS

## Fixing sweep parameter and setting measurement to be performed at a set time interval (Time interval measurement)

INTERVAL Setting

SWEET POINT

START-STOP CENTER-SPAN START-STEP INTVL MEAS

POINT 0.50mA

INTERVAL 0.0000s

NUM 50

7 8 9

4 5 6

1 2 3

0 . C

CANCEL SET

If you make a mistake during input:  
press **C** to cancel the input and start again.

**NOTE** The measurement interval for INTERVAL measurement is reflected in the point delay time.

1. Press **POINT** and use the numeric keypad to set the start value of the sweep.  
Settable range: 0.01 mA to 50 mA
2. Press **m** key to confirm the setting.
3. Press **INTVL MEAS** and use the numeric keypad to set the measurement time interval.  
Settable range: 0 s to 10000 s
4. Press **x1** key to confirm the setting.
5. Press **NUM** and use the numeric keypad to enter the number of measurements.  
Settable range: 2 to 801
6. Press **x1** key to confirm the setting.
7. Press **SET** to confirm the setting.

### How to Check the Set Sweep Points

You can check the sweep point setting values in the sweep parameter setting section of the numerical value list display screen.

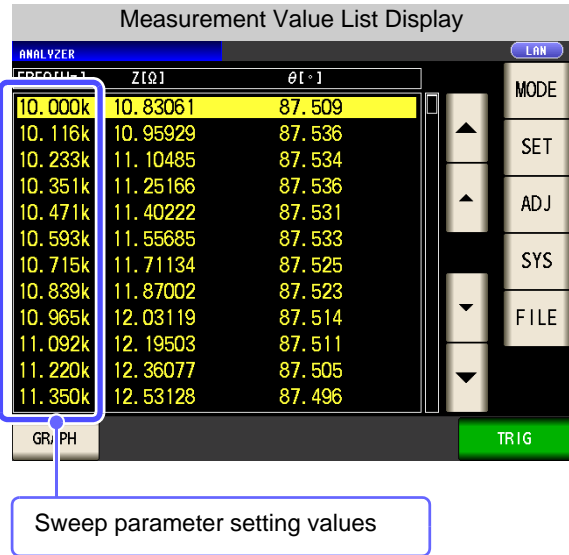
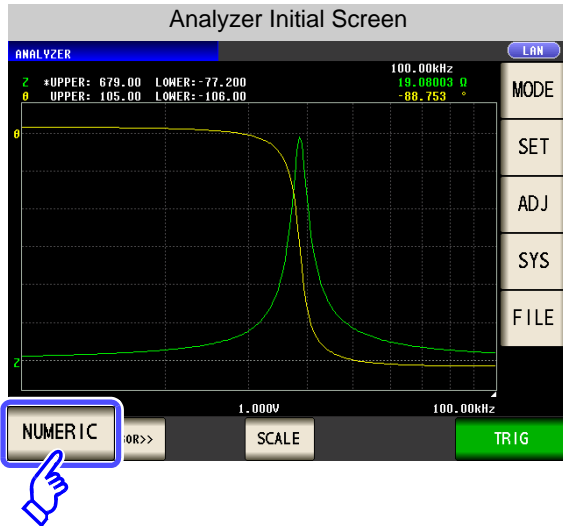

### 5.3.2 Setting the Measurement Signal

For the measurement signal setting, either the measurement frequency or measurement signal level can be set as a measurement signal other than the sweep parameter, depending on the setting of the sweep parameter.

- Frequency Sweep** ▶ You can set the measurement voltage or measurement current.
- Open circuit Voltage Sweep  
Constant Voltage Sweep  
Constant Current Sweep** ▶ You can set the measurement frequency.

**Procedure**

1

The diagram shows the 'Analyzer Initial Screen' on the left, displaying a plot with a peak. A blue box highlights the 'SET' button on the right side of the screen. A blue arrow points to the right, leading to the 'Analyzer Basic Settings' screen. In this screen, the 'BASIC' tab is highlighted with a blue box and a hand icon pointing to it.

2 When the **SOURCE** setting is **FREQ**

When the **SOURCE** setting is **V**, **CV**, or **CC**

When Frequency Sweep

This screenshot shows the 'SWEET' menu with the 'BASIC' tab selected. Under 'SWEET SETUP', the 'SOURCE' is set to 'FREQ'. In the 'BASIC SETUP' section, the 'LEVEL' button is highlighted with a blue box and a hand icon.

When Open-circuit Voltage Sweep, Constant Voltage Sweep, & Constant Current Sweep

This screenshot shows the 'SWEET' menu with the 'BASIC' tab selected. Under 'SWEET SETUP', the 'SOURCE' is set to 'V'. In the 'BASIC SETUP' section, the 'FREQ' button is highlighted with a blue box and a hand icon.

## 5.3 Normal Sweep

3 Open-circuit Voltage, Constant Voltage, & Constant Current Settings

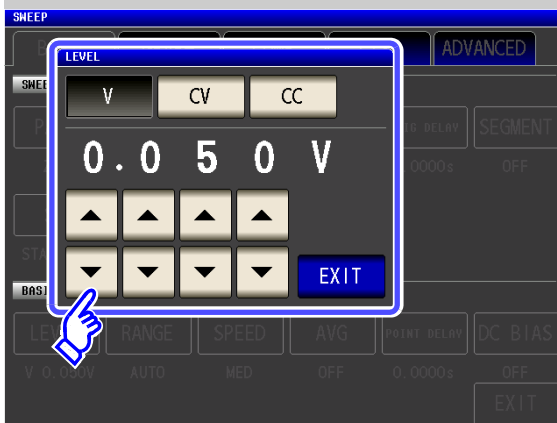

Select the measurement level.

V	Open circuit voltage level (p. 45)
CV	Voltage level between test sample terminals (p. 45)
CC	Current level through test sample (p. 47)

Use ▲ or ▼ to enter the voltage or current value.



4 Press **EXIT** to close the setting screen.

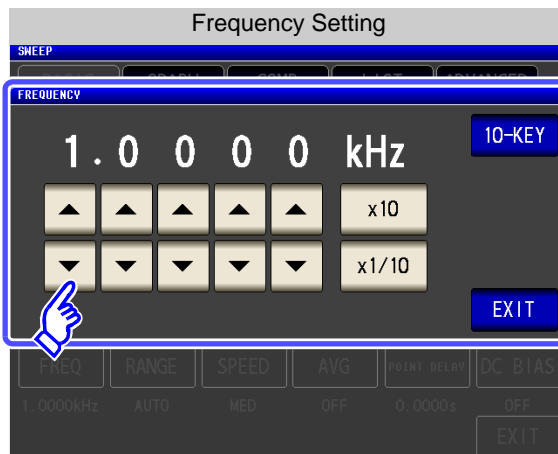

Use ▲ or ▼ to enter each digit of the frequency.

- Settable range: 4.00 Hz to 5.0000 MHz
- Press **10-KEY** or **DIGIT** to change the input method.



**CAUTION** Do not switch between V, CV and CC while the test sample is still connected to the measurement terminals because doing so may damage the test sample.

**NOTE** The frequency and measurement level that can be set vary depending on the set sweep point range.  
 Example: When the sweep parameter is set to open circuit voltage level, the settable range of frequencies is 4.00 Hz to 1.0000 MHz if there is a sweep point of 1 V or above.  
 For details, refer to "4.2.1 Setting the Measurement frequency" (p. 41) and "4.2.2 Setting the Measurement signal level" (p. 43) of the LCR function.

How to Check the Set Measurement Signal

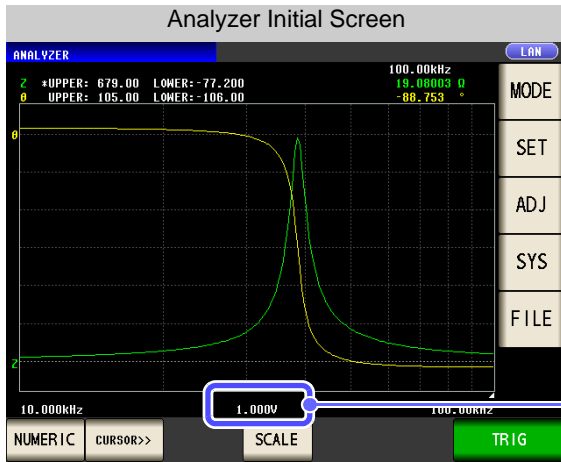

You can check the measurement signal setting value in the measurement signal setting section of the graph display screen.

### 5.3.3 Setting the Measurement Range

When measuring, for example, a test sample whose impedance varies greatly with frequency or a test sample whose nature is unknown, the most suitable measurement range can be set with AUTO. And, fixing the range with HOLD enables high speed measurement.

There are the following two methods for setting the measurement range.

- AUTO** ▶ The most suitable test range is set automatically.
- HOLD** ▶ The test range is fixed, and may only be altered manually.

**NOTE**

- The ranges are all defined in terms of impedance. Therefore, for a parameter other than impedance, the value is obtained by calculating from the measured values of  $|Z|$  and  $\theta$ .  
See "Appendix 1 Measurement Parameters and Arithmetic Expressions"(p. A1)
- In analyzer mode, low Z high accuracy mode is set to OFF.

#### 1 Setting AUTO Ranging

**Procedure**

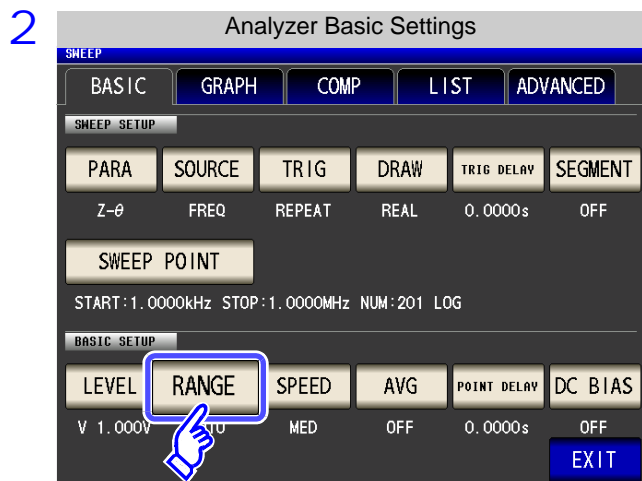
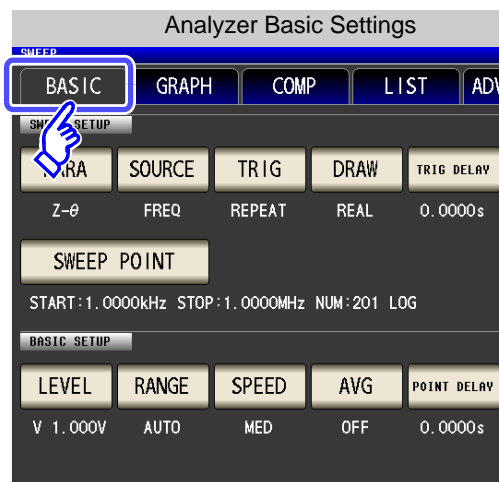
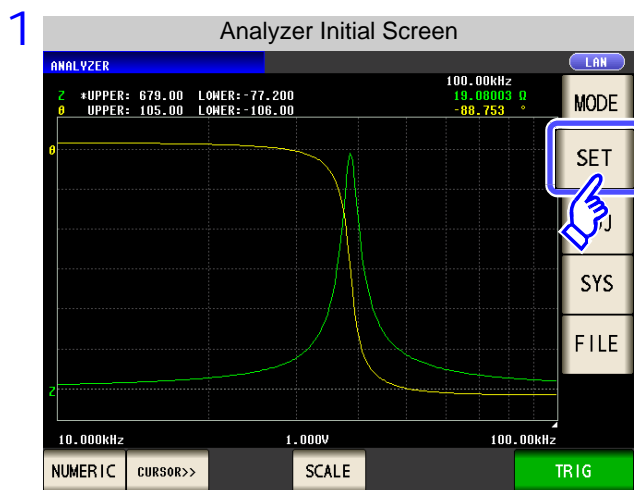

Press **RANGE**.



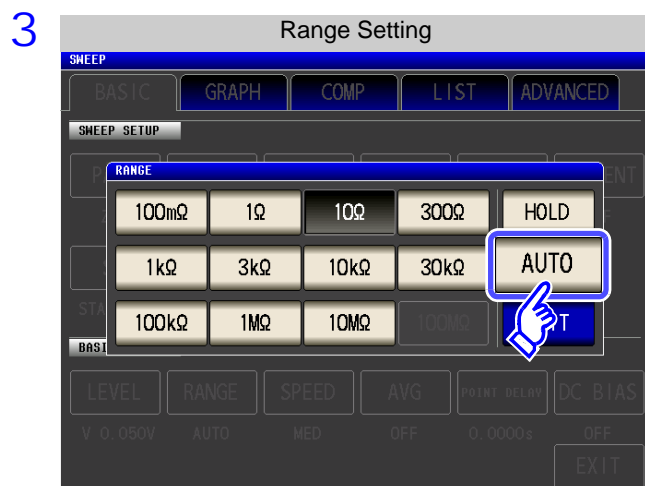

Press **AUTO**.

If the instrument is being used outside the limits of its specification, the suitable range may not be set in auto ranging function. In this case, check the accuracy assured ranges in "13.2 Measurement Range and Accuracy" (p. 395) and then change the test conditions.

4 Press **EXIT** to close the setting screen.

### **NOTE**

When an element other than a capacitor or a capacitor with a low DC resistance is measured while using DC bias, the AUTO range may not work properly and a range may not be able to be determined.

### 2 Setting the Ranging to HOLD

#### Procedure

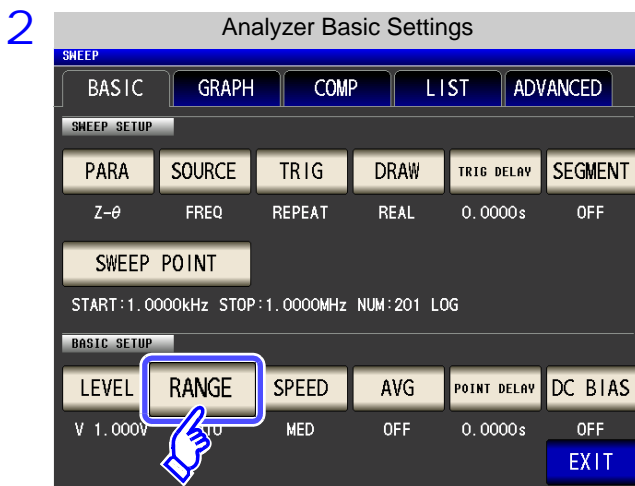
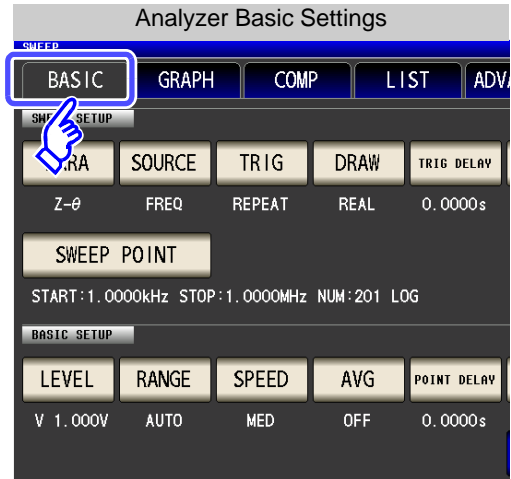
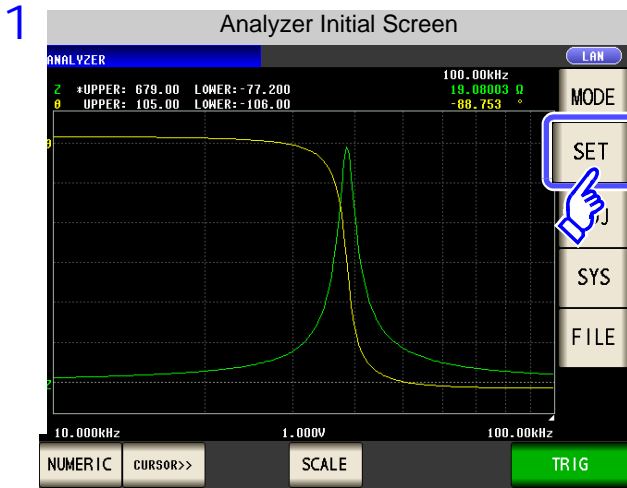

Press **RANGE**.

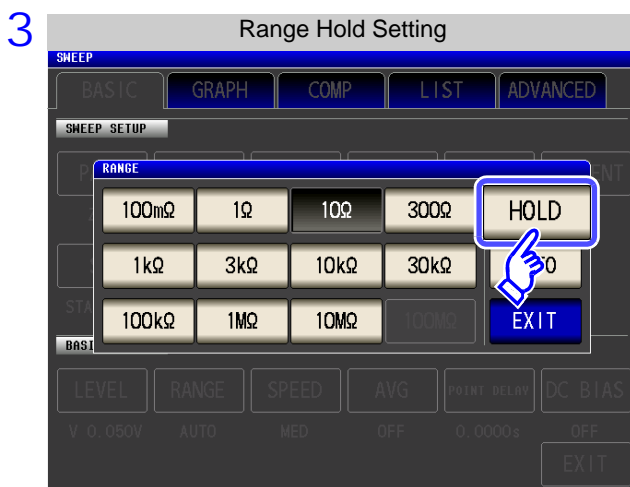

Press **HOLD**.

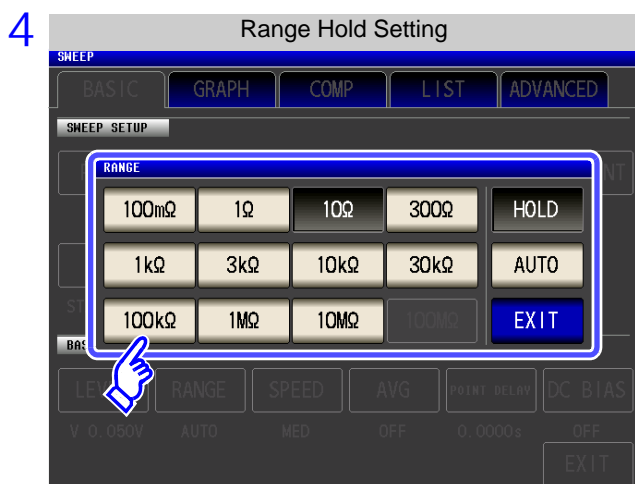

Set the test range according to the combined impedance value of the sample to be tested and the test cables.

To select the measurement range.

Test range	Accuracy guaranteed range	AUTO ranging range
100 MΩ	8 MΩ to 200 MΩ	8 MΩ to 999.999 MΩ
10 MΩ	800 kΩ to 100 MΩ	800 kΩ to 10 MΩ
1 MΩ	80 kΩ to 10 MΩ	80 kΩ to 1 MΩ
100 kΩ	24 kΩ to 1 MΩ	24 kΩ to 100 kΩ
30 kΩ	8 kΩ to 300 kΩ	8 kΩ to 30 kΩ
10 kΩ	2.4 Ω to 100 kΩ	2.4 kΩ to 10 kΩ
3 kΩ	800 Ω to 30 kΩ	800 Ω to 3 kΩ
1 kΩ	240 Ω to 10 kΩ	240 Ω to 1 kΩ
300 Ω	8 Ω to 300 Ω	8 Ω to 300 Ω
10 Ω	800 mΩ to 10 Ω	800 mΩ to 10 Ω
1 Ω	80 mΩ to 1 Ω	80 mΩ to 1 Ω
100 mΩ	1 mΩ to 100 mΩ	0 Ω to 100 mΩ

### NOTE

- The guaranteed accuracy range varies depending on the measurement conditions.
  - See:** Check the guaranteed accuracy range in "13.2 Measurement Range and Accuracy" (p. 395).
- The measurement range is determined according to the test range setting. If the display for the measured value shows "**OVER FLOW**" or "**UNDER FLOW**", that means that measurement cannot be performed using the currently set test range. Either you should set AUTO ranging so as to select the most suitable test range automatically, or you should set a more suitable test range manually.
- If the measurement range setting exceeds the range in the table above when the measurement frequency is set, it is automatically changed to the maximum setting. For example, if the frequency is set to 1.001 MHz when the measurement range is in the 1 MΩ range state, the measurement range is changed to the 100 kΩ range.
- If FREQ (frequency) is set for sweep (p. 143), some ranges cannot be used depending on the frequency range.
  - 10 MΩ range: Up to 1.0000 MHz
  - 100 MΩ range: Up to 100.00 kHz

5 Press **EXIT** to close the setting screen.

### NOTE

- With a test sample whose impedance varies with frequency, if the frequency is changed during measurement using HOLD, measurement within the same range may not be possible. When this happens, change the measurement range.
- The test range setting is made according to the combination of the impedances of the sample being tested and the test cables. Therefore it can happen that testing is not possible, if the test range is held with HOLD only upon the basis of the impedance of the sample under test. If this happens, you should change the test range, making reference to "7.1 Setting Open Circuit Compensation" (p. 273) and "7.2 Short Circuit Compensation" (p. 280).

### 5.3.4 Setting the Measurement speed

The testing speed can be set. The slower the testing speed is, the more accurate are the results.

#### Procedure

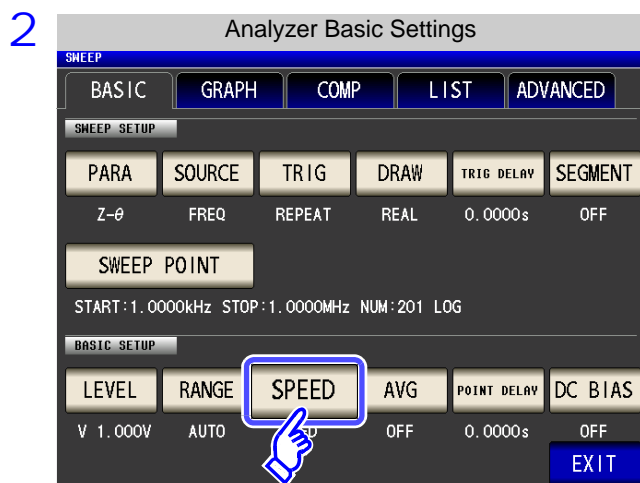
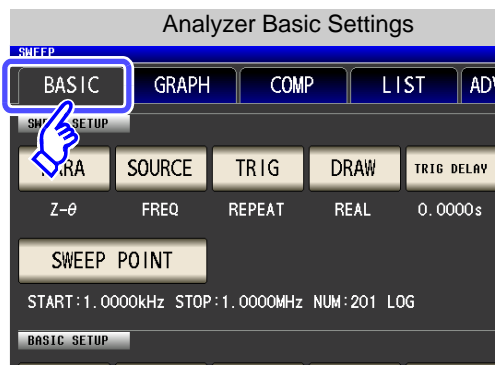
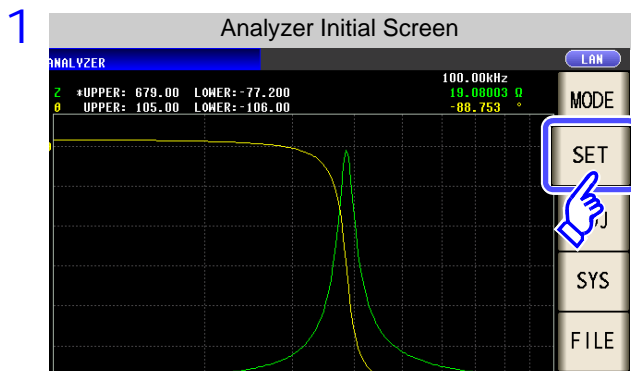

Press **SPEED**.

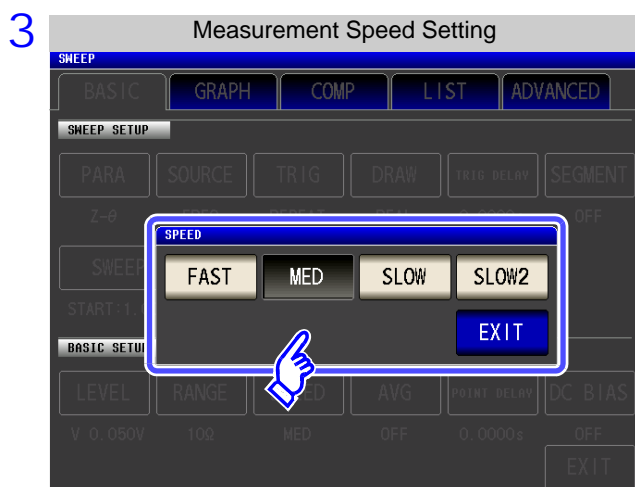

To select the measurement speed

<b>FAST</b>	Performs high-speed measurement.
<b>MED</b>	This is the normal measurement speed.
<b>SLOW</b>	Measurement precision improves.
<b>SLOW2</b>	Measurement accuracy is better than SLOW.

The testing speed varies according to the number of parameters being displayed, and according to their type. The speeds given in the table relate to the case of |Z| only being displayed.

See "About Measurement Times and Measurement Speed" (p. 399)

4 Press **EXIT** to close the setting screen.

### 5.3.5 Displaying as Average Values (Average set)

With the averaging function, the measured values can be averaged. Using this function, it is possible to reduce fluctuations in the measured value display.

**NOTE**

The measurement values are averaged by arithmetic averaging during analyzer measurement regardless of the trigger setting.

**Procedure**

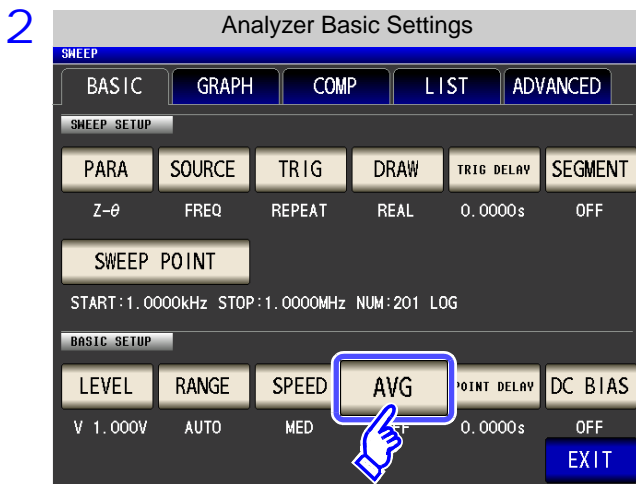
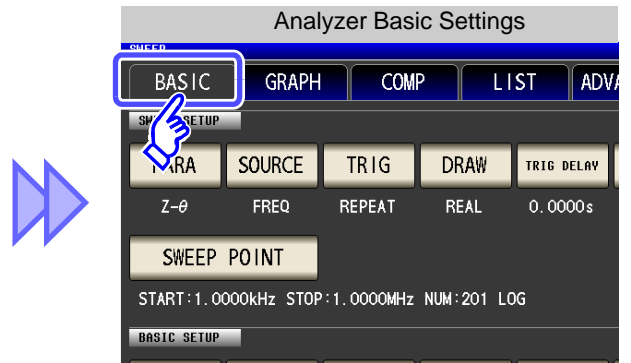
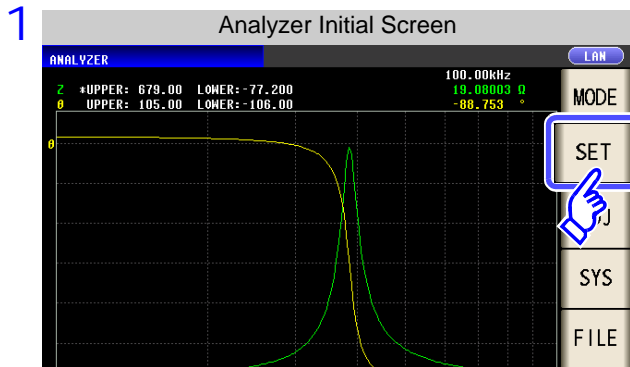

Press **AVG**

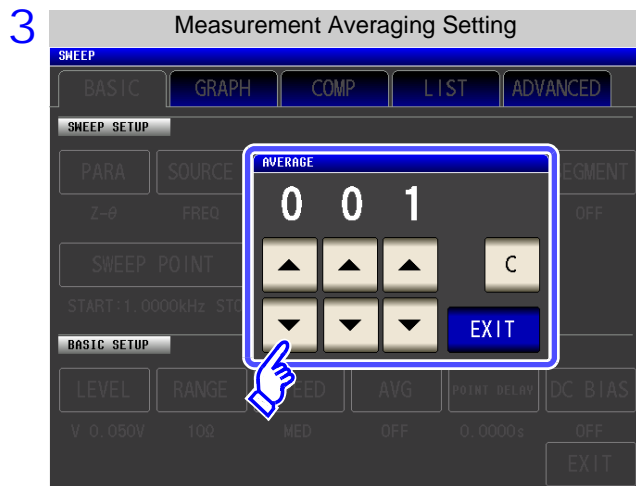

Use **▲** or **▼** to enter the number of averaging times.

Settable range: 1 to 256 times

When you want to cancel the averaging function: Press **C** .  
The number of averaging times is set to 001.

4 Press **EXIT** to close the setting screen.

### 5.3.6 Setting the Point Delay

For the point delay setting, set the delay time for each sweep point.

See "5.2.5 Setting the Trigger Delay" (p. 140)

#### Procedure

1

Analyzer Initial Screen

ANALYZER

LAN

MODE

SET

SYS

FILE

Analyzer Basic Settings

SWEEP

BASIC GRAPH COMP LIST ADV

SWEEP SETUP

PARAM SOURCE TRIG DRAW TRIG DELAY

Z-θ FREQ REPEAT REAL 0.0000s

SWEEP POINT

START:1.0000kHz STOP:1.0000MHz NUM:201 LOG

BASIC SETUP

LEVEL RANGE SPEED AVG POINT DELAY DC BIAS

V 1.000V AUTO MED OFF 0.0000s OFF

EXIT

2

Analyzer Basic Settings

SWEEP

BASIC GRAPH COMP LIST ADVANCED

SWEEP SETUP

PARAM SOURCE TRIG DRAW TRIG DELAY SEGMENT

Z-θ FREQ REPEAT REAL 0.0000s OFF

SWEEP POINT

START:1.0000kHz STOP:1.0000MHz NUM:201 LOG

BASIC SETUP

LEVEL RANGE SPEED AVG POINT DELAY DC BIAS

V 1.000V AUTO MED OFF 0.0000s OFF

EXIT

Press **POINT DELAY**.

3

Point Delay Setting

SWEEP

BASIC GRAPH COMP LIST ADVANCED

SWEEP SETUP

POINT DELAY

1.0000 s

▲ ▲ ▲ ▲ ▲ x10 C

▼ ▼ ▼ ▼ ▼ x1/10 EXIT

LEVEL RANGE SPEED AVG POINT DELAY DC BIAS

V 0.050V 10Ω MED OFF 0.0000s OFF

EXIT

Use ▲ or ▼ to enter the delay time.

Settable range: 0.0000 s to 10000 s with resolution of 0.1 ms

When you want to cancel the point delay

function: Press **C**.

The setting value is cleared to 0.

4 Press **EXIT** to close the setting screen.

### 5.3.7 Setting the DC Bias

For the DC bias setting, set the DC bias value for when sweep measurement is performed. If the DC bias is set, a DC signal can be superimposed on the measurement signal.

**Procedure**

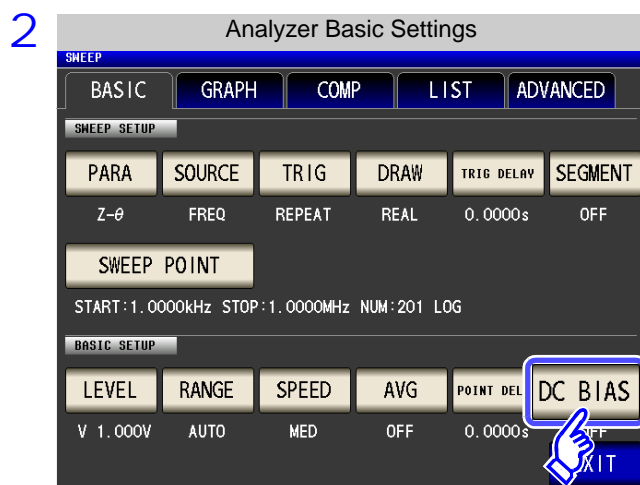
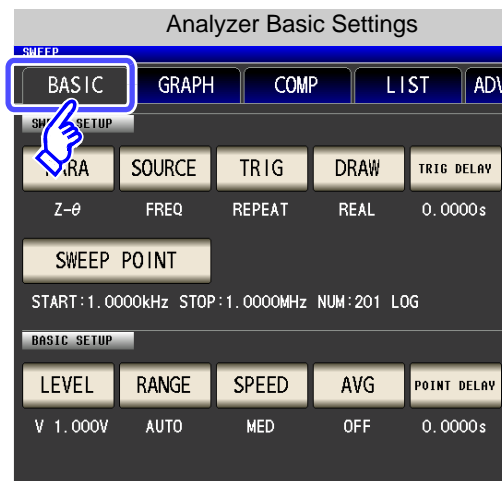
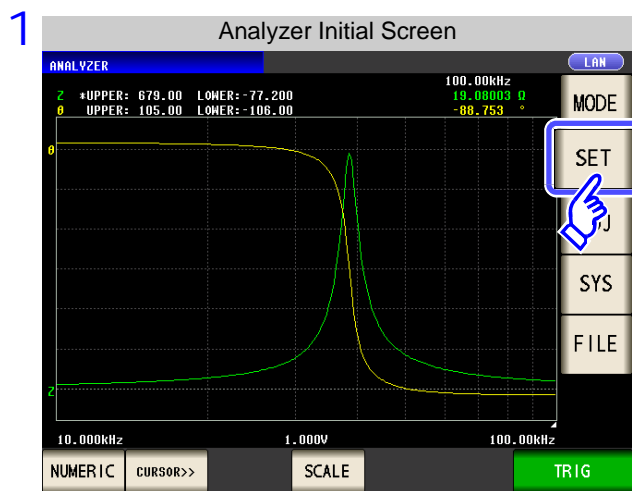

Press **DC BIAS**.

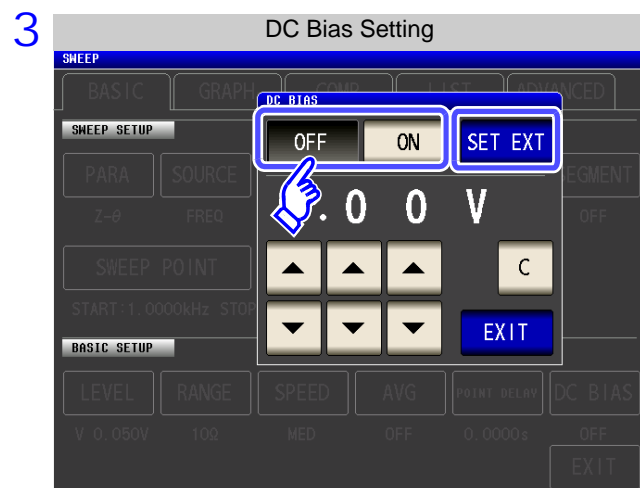

Select ON/ OFF for the DC bias.

- OFF** Sets the DC bias to OFF.
- ON** Sets the DC bias to ON.

Press this button when using an external DC bias unit. The DC bias will be set to ON, and the bias value will be set to 0.00 V.

**SET EXT**

## 5.3 Normal Sweep

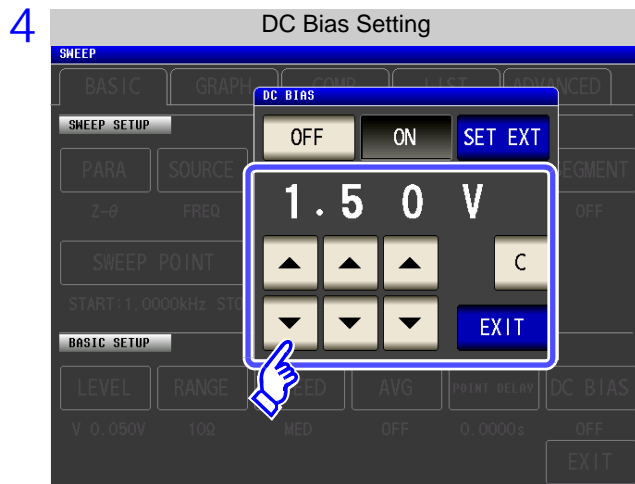

Use or to set the DC bias.

Settable range: 0.00 V to 2.5 V

If you make a mistake during input:  
press to cancel the input and start again.

5 Press to close the setting screen.

**NOTE**

- The DC bias function is specifically for capacitor measurement. If it is used for resistor, inductor, and other elements with low DC resistance, the following are likely.
  - Normal measurement is not possible
  - AUTO ranging is unable to determine a range.
  - In low impedance high accuracy mode, a contact error is generated even though the terminal connections are correct.
- The DC bias function cannot be set during Rdc measurement.
- The DC bias function cannot be set when RDC measurement has been selected with the **:MEASure:ITEM** setting.
- When superimposing a DC voltage of 2.5 V or above, refer to "Appendix5.1 How to Supply a DC Bias Voltage"(p. A7).
- When superimposing a DC voltage on a coil or the like, refer to "Appendix5.2 How to Supply a DC Bias Current"(p. A9).
- A value for which the sum of the effective value of the AC signal level and the DC signal level will exceed 7.07 V cannot be set.
- If the total value for the measurement signal level (AC level + DC bias value) will become  $> 5\sqrt{2}$  [V], the measurement signal cannot be raised any higher. Reduce the AC level or DC bias value, and then configure the setting.



## 5.4 Segment Sweep

 LCR  
ANALYZER

You can set multiple sweep ranges (up to 20) for the frequency or level and perform the sweep continuously.

### What is a Segment?

A segment refers to one block for which individual settings such as the sweep range, number of sweep points, and measurement signal level can be set.

### 5.4.1 Select Segments

Set the segment settings  ON beforehand in "5.2.6 Segment Setting" (p. 142).

You can set up to 20 segments (total of 801 points).

- NOTE**
- The sweep range setting differs depending on the setting of the sweep parameter ( SOURCE). (p. 135)
  - If a segment is edited (including with ADD and DELETE) or the sweep points are edited, the comparator setting becomes invalid. (p. 197)

## Comparison of Normal Sweep and Segment Sweep

### When normal sweep

Sweep Setting Items	Segment
Sweep parameter	Frequency
Sweep Range	1.0000 kHz to 5.0000 MHz
Number of sweep point	801 points
Setting method of sweep points	Log
Measurement signal type	Open circuit voltage level
Measurement signal level	1.000 V
Range	AUTO
Average	5 times
Measurement speed	FAST
Point delay	0.0005 s

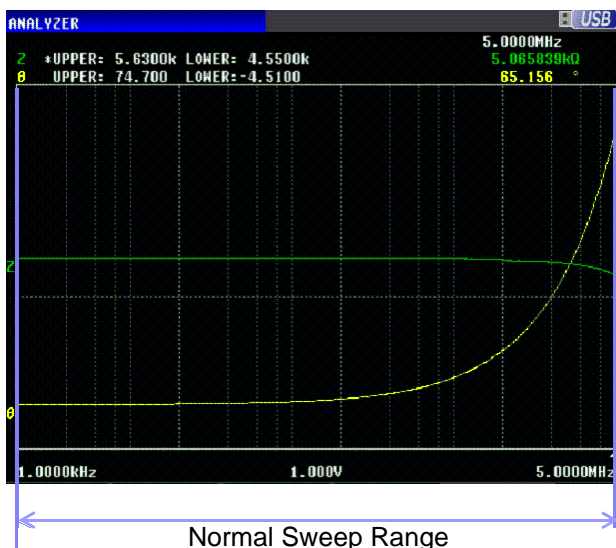

## 5.4 Segment Sweep

### When segment sweep

Sweep Settings	Segment 1	Segment 2	Segment 3
Sweep parameter	Frequency	Frequency	Frequency
Sweep Range	1.0000kHz to 5.0000kHz	10.000kHz to 100.00kHz	100.00 kHz to 5.0000MHz
Number of sweep point	201 points	201 points	399 points
Setting method of sweep points	Log	Log	Linear
Measurement signal type	Open circuit voltage level	Open circuit voltage level	Open circuit voltage level
Measurement signal level	1.000V	1.500V	0.500V
Range	AUTO	3 k $\Omega$	AUTO
Average	10 times	3 times	OFF
Measurement speed	FAST	MEDIUM	SLOW
Point delay	0.0000 s	0.0005 s	0.0000 s

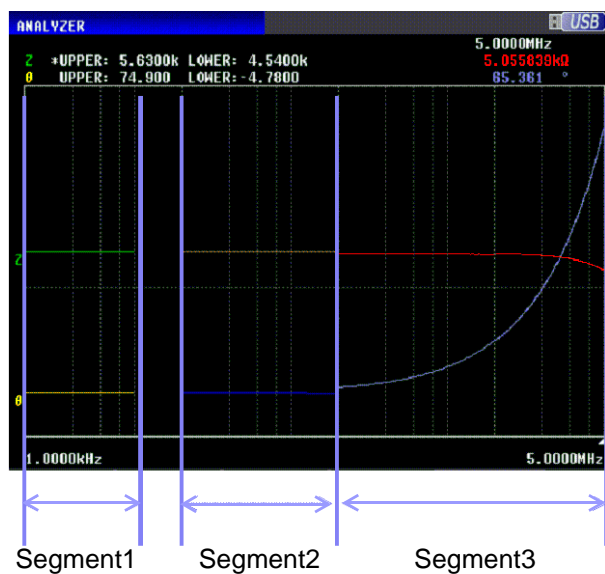

As shown in the figure above, when a segment sweep is performed, the following items can be set individually for each segment.

- Sweep range
- Number of sweep point
- Setting method of sweep points
- Measurement signal level
- Range
- Average
- Measurement speed
- Point delay

**NOTE** The following settings are common to all segments.

- Measurement parameter
- Sweep parameter
- Measurement signal type
- Trigger
- Trigger delay
- DC bias level

Procedure

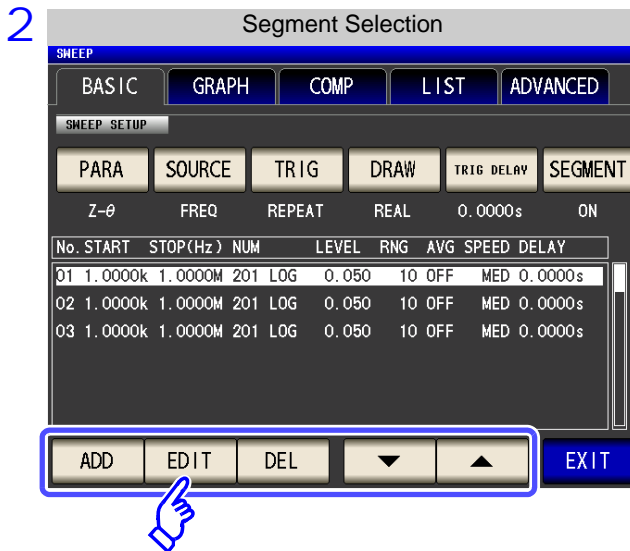
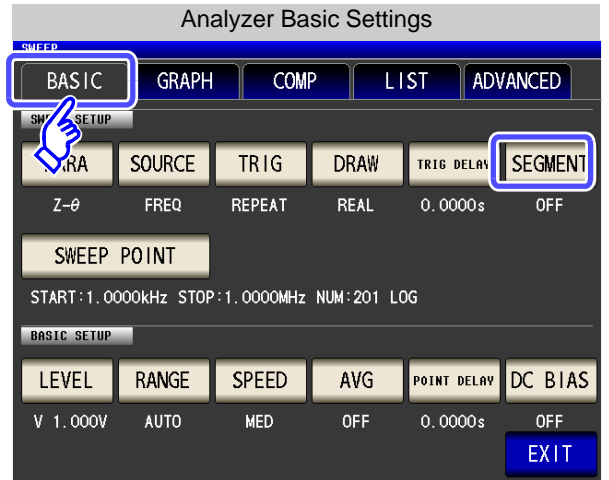
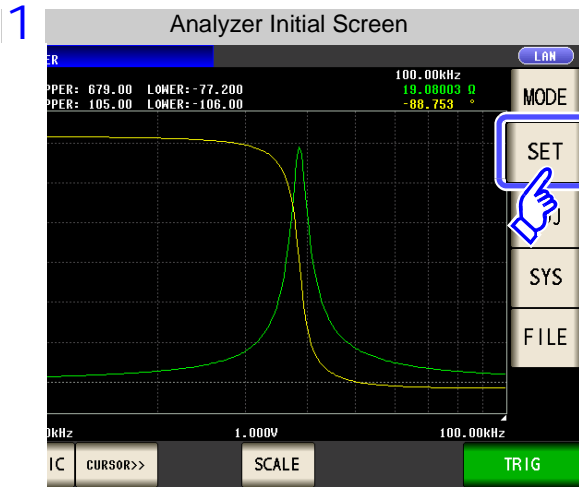

Use or to select the segment for which to change the setting, and press .

**When you want to add a segment:**  
Press .

**When you want to delete a segment:**  
Use or to select the segment and press .

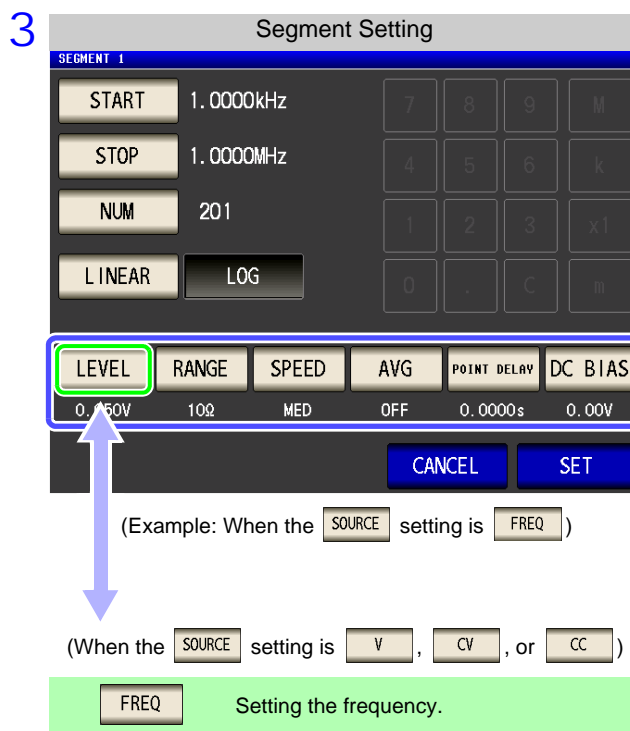

- Select the segment setting.
- Setting the measurement level.
  - Setting the measurement range.
  - Setting the measurement speed.
  - Setting the average.
  - Setting the trigger delay.
  - Setting the DC bias.

The setting for DC bias is common to all segments. A different value cannot be set for each segment.

### Sweep Point Setting

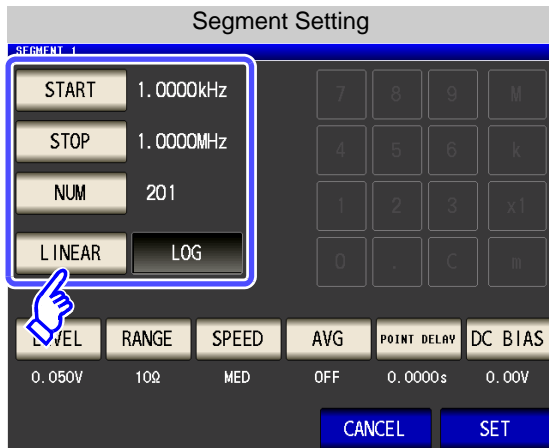

- The setting method of the sweep points is fixed to **START-STOP** (sweep start value and end value settings).
- For the advanced setting method of sweep points, refer to "5.3.1 Setting Sweep Points" (p. 143).

**LEVEL**

**Setting the measurement level. (When the **SOURCE** setting is **FREQ**)**

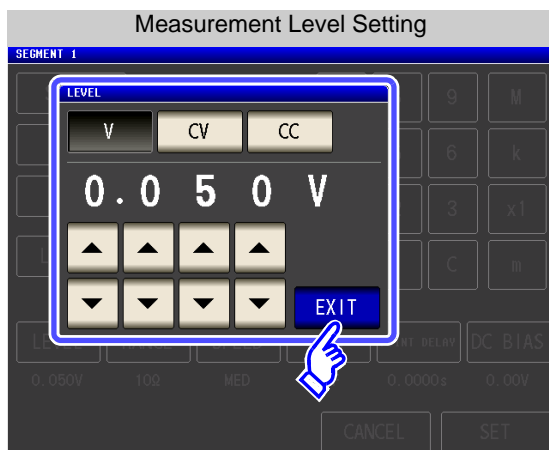

1. Press **LEVEL**.
2. Select the measurement level.
  - V** Open voltage level (p. 45)
  - CV** Voltage level between test sample terminals (p. 45)
  - CC** Current level between test sample terminals (p. 47)
3. Use **▲** or **▼** to enter the voltage or current value.
4. Press **EXIT** to close the setting screen.

The setting for the measurement level type is common for all segments.  
A different type of measurement level cannot be set for each segment.

### **NOTE**

The frequency and measurement level that can be set vary depending on the set sweep point range.  
For details, refer to "4.2.1 Setting the Measurement frequency" (p. 41) and "4.2.2 Setting the Measurement signal level" (p. 43) of the LCR function.

FREQ

**Setting the measurement frequency.**

(When the SOURCE setting is V, CV, or CC)

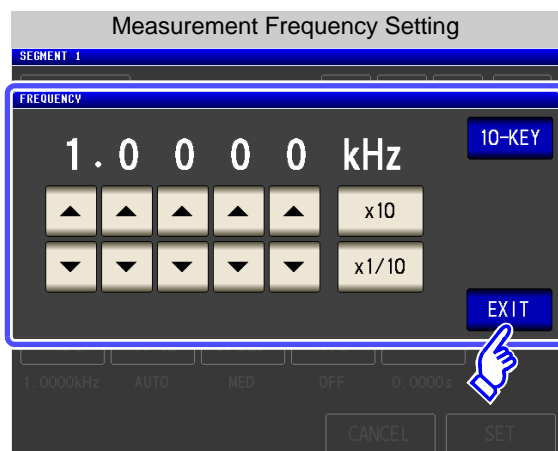

1. Press **FREQ**.
2. Use **▲** or **▼** to set the frequency.  
Settable range: 4.00 Hz to 5.0000 MHz
3. Press **EXIT** to close the setting screen.

Press **10-KEY** or **DIGIT** to change the input method.**NOTE**

The measurement frequency that can be set varies depending on the set sweep point range.

Example: When the sweep parameter is set to open circuit voltage level, the settable range of frequencies is 4.00 Hz to 1.0000 MHz if there is a sweep point of 1 V or above.

For details, refer to "4.2.1 Setting the Measurement frequency" (p. 41) and "4.2.2 Setting the Measurement signal level" (p. 43) of the LCR function.

RANGE

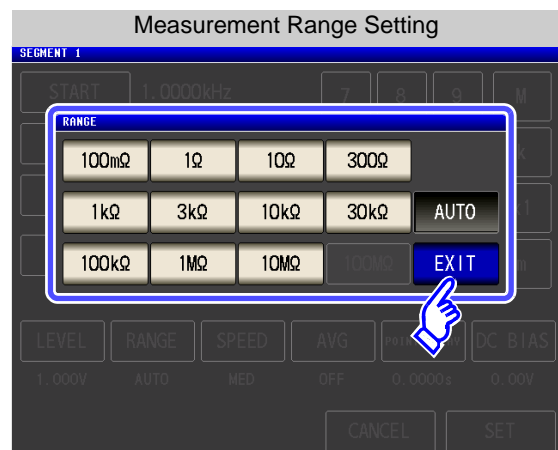
**Setting the measurement range.**

1. Press **RANGE**.
2. Select the measurement range.
3. Press **EXIT** to close the setting screen.

See "5.3.3 Setting the Measurement Range" (p. 160)

## 5.4 Segment Sweep

SPEED

### Setting the measurement speed.

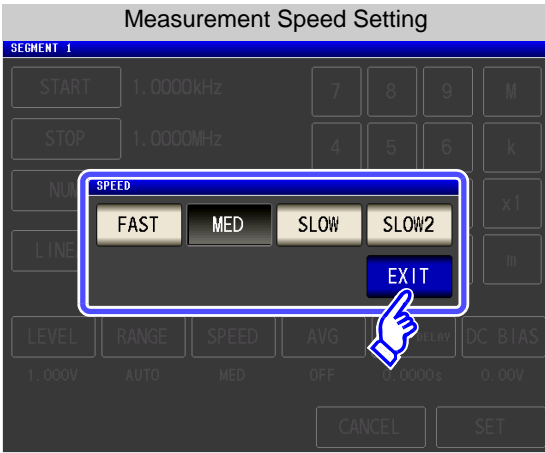

1. Press **SPEED**.
2. Select the measurement speed.

<b>FAST</b>	High-speed measurement
<b>MED</b>	Normal-speed measurement
<b>SLOW</b>	Increases measurement accuracy.
<b>SLOW2</b>	Measurement accuracy is better than SLOW.

3. Press **EXIT** to close the setting screen.

AVG

### Setting the average.

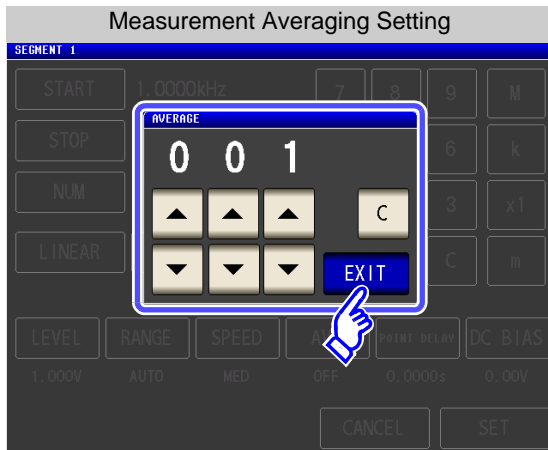

1. Press **AVG**.
2. Use **▲** or **▼** to enter the number of averaging times.  
Settable range: 1 to 256 times
3. Press **EXIT** to close the setting screen.

See "5.3.5 Displaying as Average Values (Average set)" (p. 165)

If you make a mistake during input:  
press **C** to cancel the input and start again.

POINT DELAY

### Setting the trigger delay.

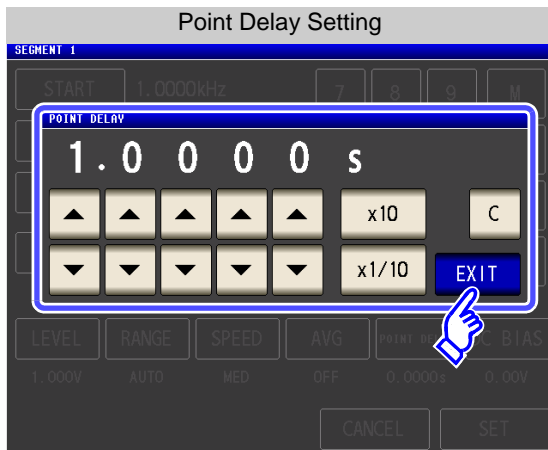

1. Press **POINT DELAY**.
2. Use **▲** or **▼** to enter the delay time.  
Settable range: 0 to 10000 s with resolution of 0.1 ms
3. Press **EXIT** to close the setting screen.

If you make a mistake during input:  
press **C** to cancel the input and start again.

## DC BIAS Setting the DC bias

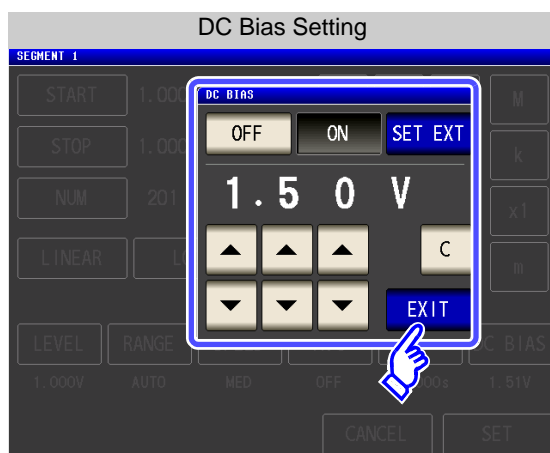

1. Press **DC BIAS**.

2. Select ON/ OFF for the DC bias.

**OFF** Sets the DC bias to OFF.

**ON** Sets the DC bias to ON.

**SET EXT** Press this button when using an external DC bias unit. The DC bias will be set to ON, and the bias value will be set to 0.00 V.

3. Use **▲** or **▼** to enter the DC bias value.

4. Press **EXIT** to close the setting screen.

- If you make a mistake during input:  
press **C** to cancel the input and start again.
- The setting for DC bias is common to all segments. A different value cannot be set for each segment.

# 5.5 Setting the Graph Display Method LCR ANALYZER

## 5.5.1 Setting the Horizontal Axis

### 1 Overwrite Setting

When sweep measurement is to be performed repeatedly, set the graph draw method. If you set overwrite, you can check the variations of the element in a graph.

**Procedure**

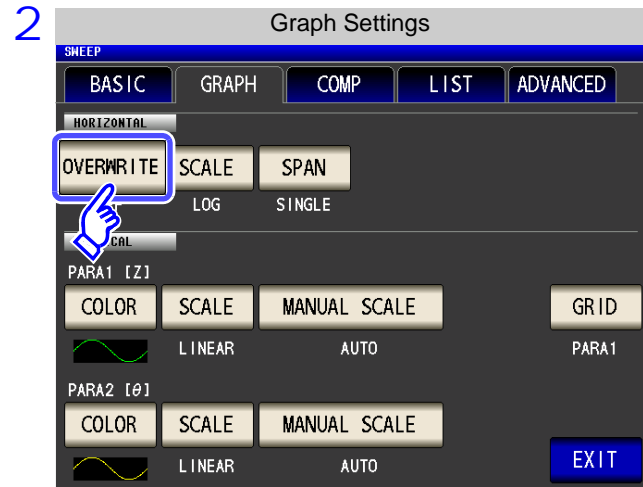
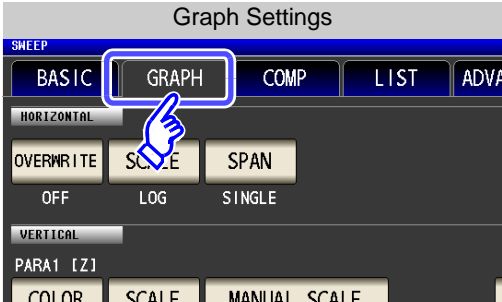
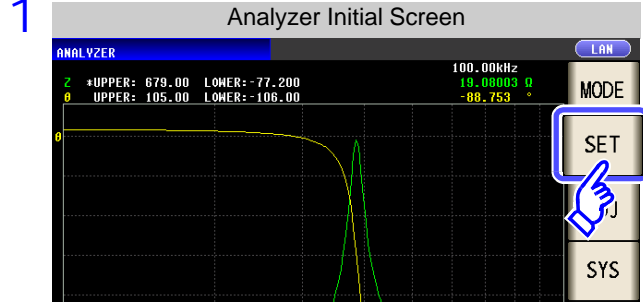

Press **OVERWRITE**.

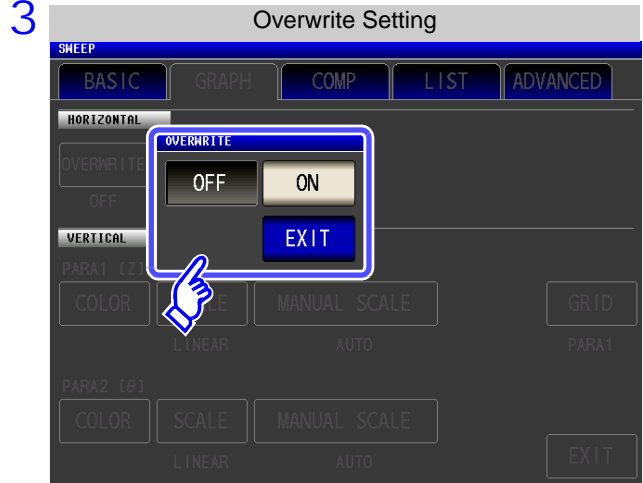

Select the overwrite setting.

- 

When sweep measurement is performed repeatedly, the graph drawn for the last measurement is deleted and a graph for the most recent measurement results is drawn.
- 

When sweep measurement is performed repeatedly, the graph drawn for the last measurement remains and is overwritten with a graph for the most recent measurement results.

4 Press **EXIT** to close the setting screen.



2 Horizontal Axis Scale Setting

Set the scale of the horizontal axis.

Procedure

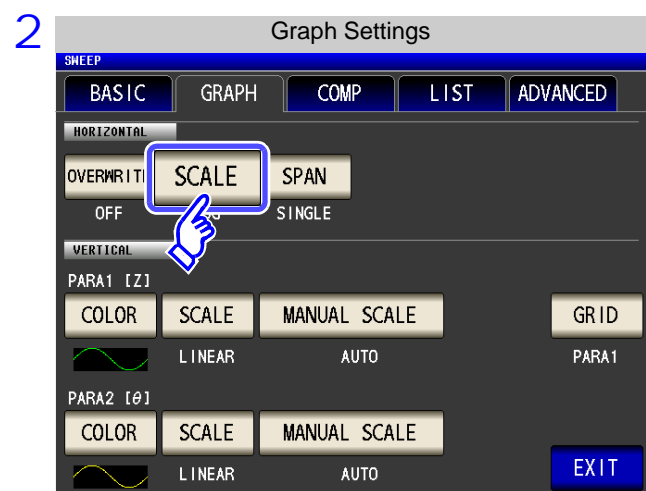
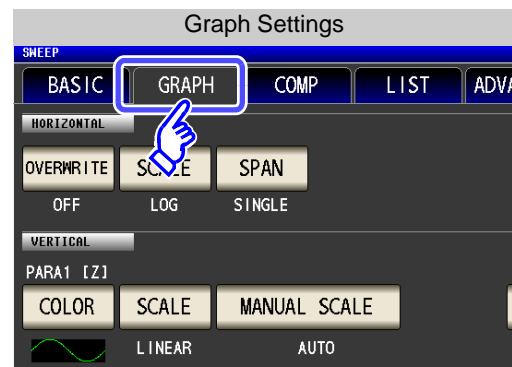
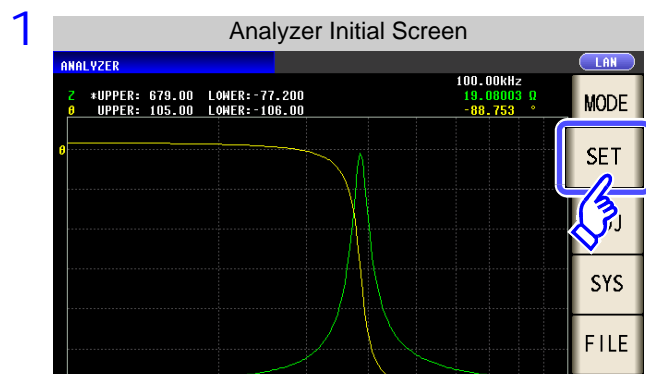

Press **SCALE**.

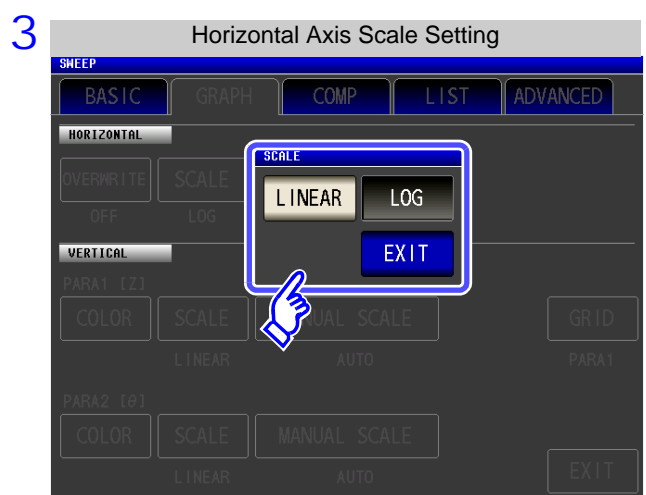

Select the draw type.

- LINEAR** Sets the horizontal axis to linear (linear axis).
- LOG** Sets the horizontal axis to log (logarithmic axis).

4 Press **EXIT** to close the setting screen.

## 5.5 Setting the Graph Display Method

### How to Check the Set Horizontal Axis Scale

If the horizontal axis display scale is changed, the horizontal axis scale of the graph display screen changes as shown in the figures below.

(The horizontal axis scale of the graph also changes when the setting method of the sweep points is changed.)

See "Setting the start value and end value of the sweep" (p. 145)

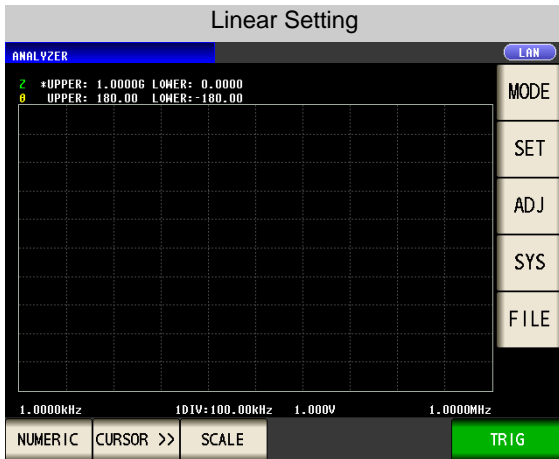

The horizontal scale is linear display.

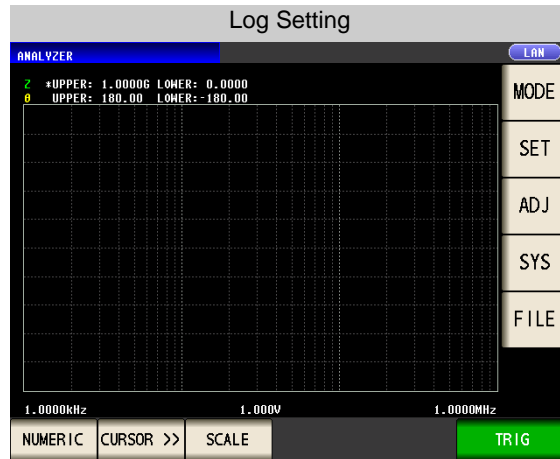

The horizontal scale is log display.

### 3 Span Setting

The span can only be set for segment sweep.

With this instrument, you can select single span mode and segment span mode.

- Single Span Mode** ▶ Draws the measurement result for each segment on the same horizontal axis.
- Segment Span Mode** ▶ Draws a graph for each segment.

#### Procedure

1

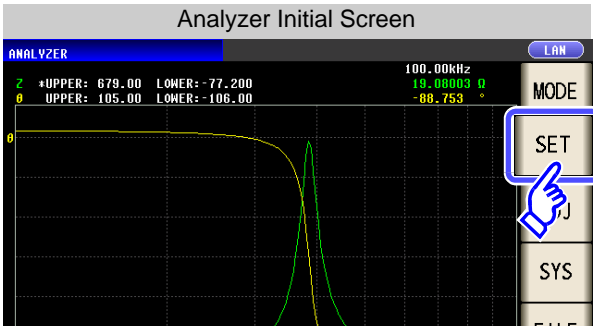
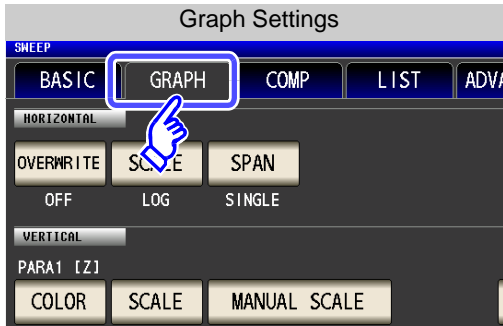

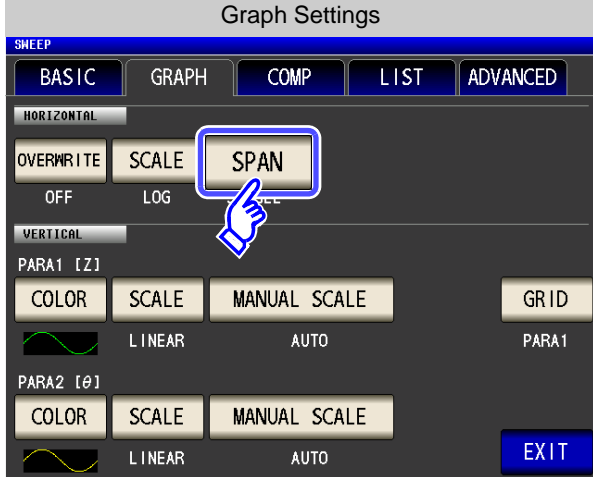

2

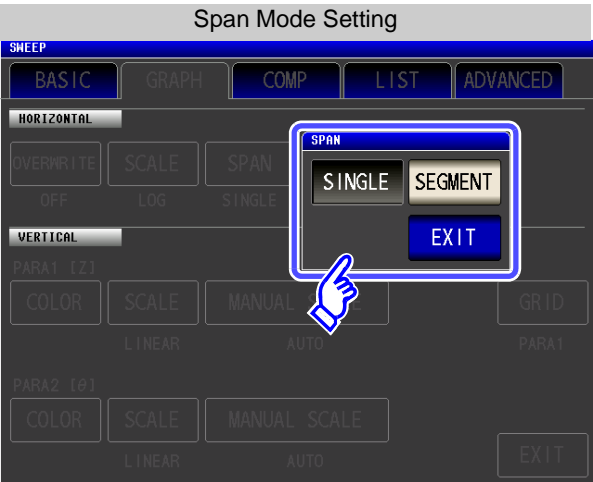

Press **SPAN**.

3



Select the span mode.

- SINGLE** Sets single span mode.
- SEGMENT** Sets segment span mode.

4 Press **EXIT** to close the setting screen.

## 5.5 Setting the Graph Display Method

### Comparison of Single Span Mode and Segment Span Mode

The following shows an example of the graph display methods for single span mode and segment mode. In this example, sweep ranges such as the following are set for the sweep parameter frequency.

Sweep Settings	Segment1	Segment2	Segment3
Sweep parameter	Frequency	Frequency	Frequency
Sweep range	1.0000 kHz to 10.000 kHz	10.000 kHz to 500.00 kHz	100.00 Hz to 5.0000 MHz

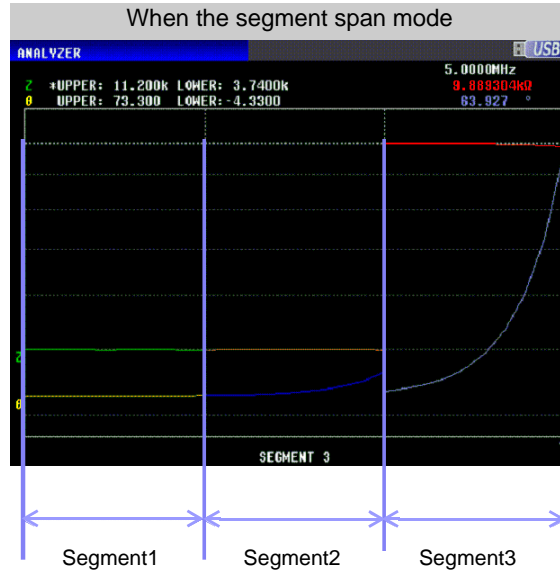
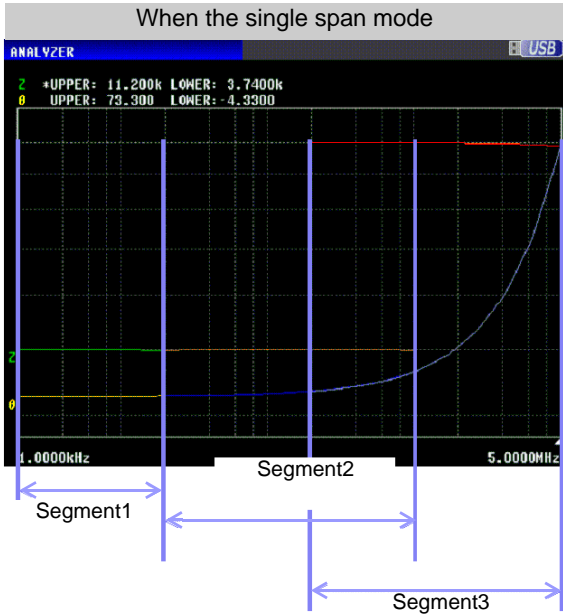

## 5.5.2 Setting the Vertical Axis

### 1 Draw Color Setting

Set the color of the graph to display on the screen. You can set a graph color for each parameter. Furthermore, in the case of segment sweep, you can set a color for each segment.

#### Procedure

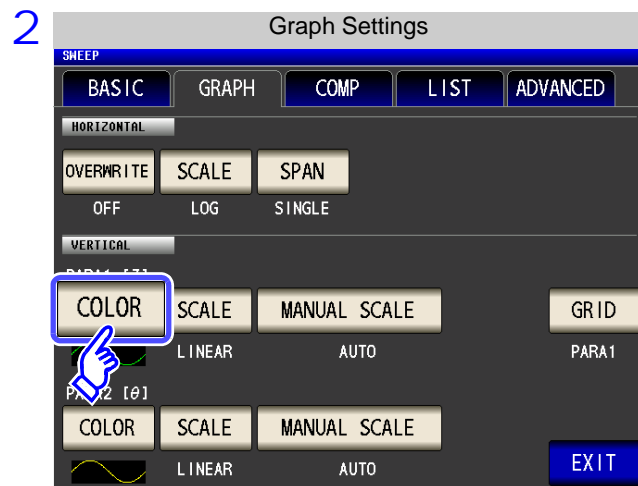
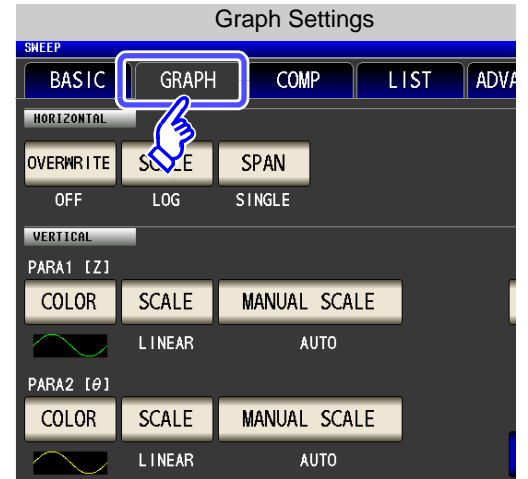
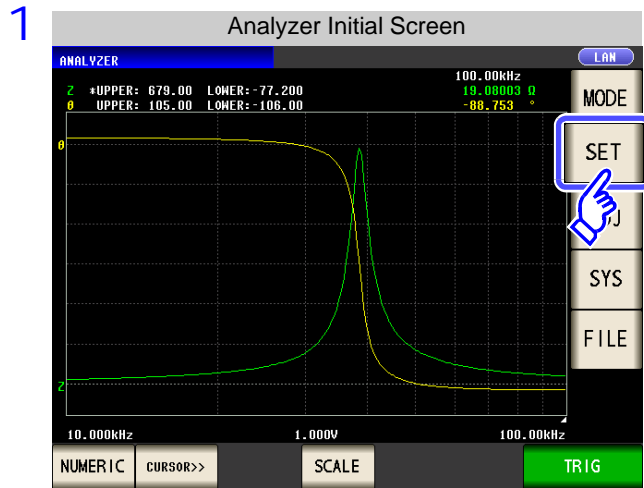

Press **COLOR**.

## 5.5 Setting the Graph Display Method

### 3 Select the segment for which to set the color.

The setting differs depending on "5.2.6 Segment Setting" (p. 142).

When the **SEGMENT** setting is **OFF**:

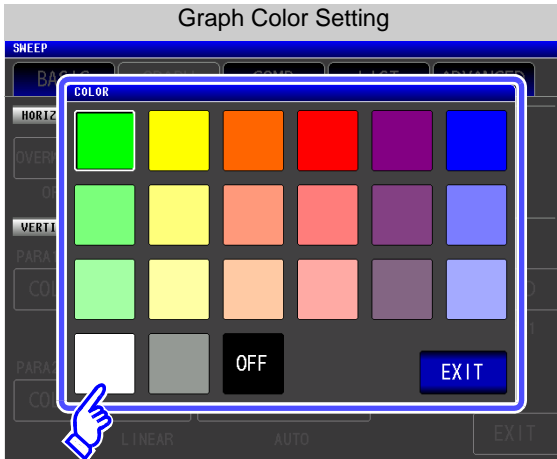

When the **SEGMENT** setting is **ON**:

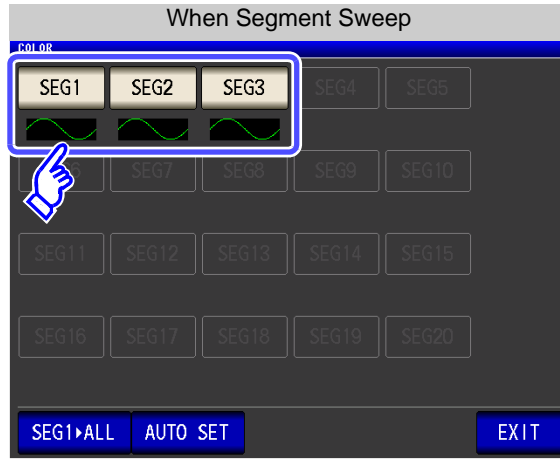

To reflect the color of segment 1 to all segments: Press **SEG1\*ALL**.

To restore the colors of all segments to the initial state: Press **AUTO SET**.

When you do not want to set colors:

If you select **OFF**, a graph will not be drawn.

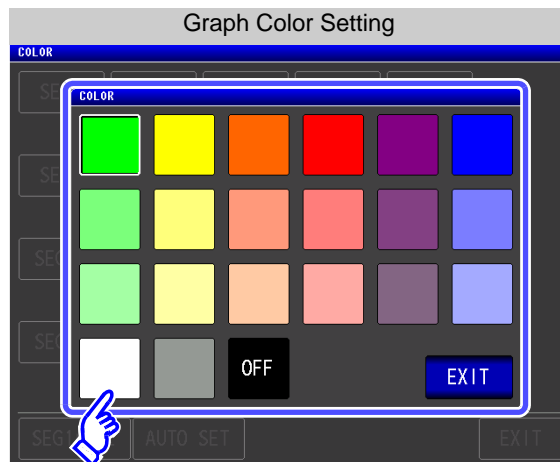

### 4 Press **EXIT** to close the setting screen.

Also set parameter 2 in the same way.

**2 Vertical Axis Scale Setting**

Set the draw method for the vertical axis scale to linear axis or logarithmic axis.

**Procedure**

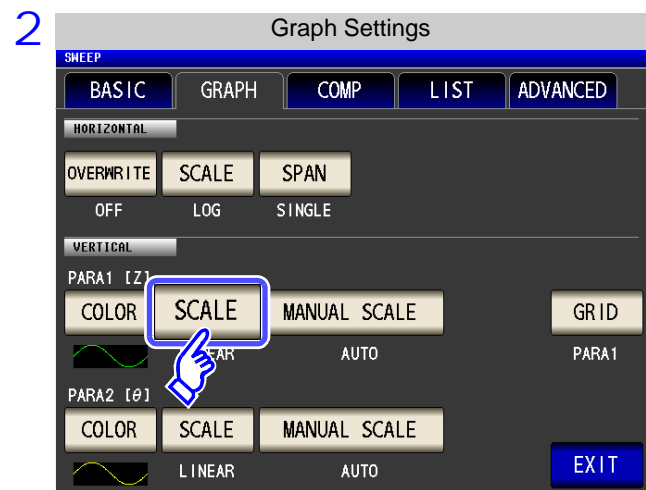
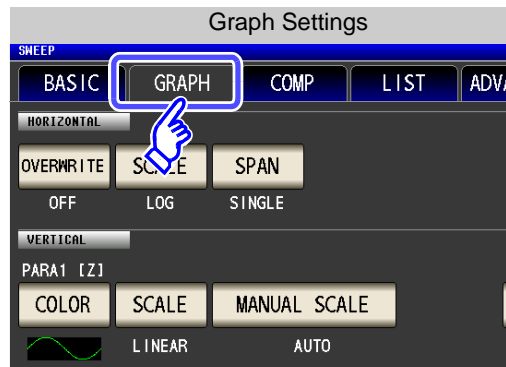
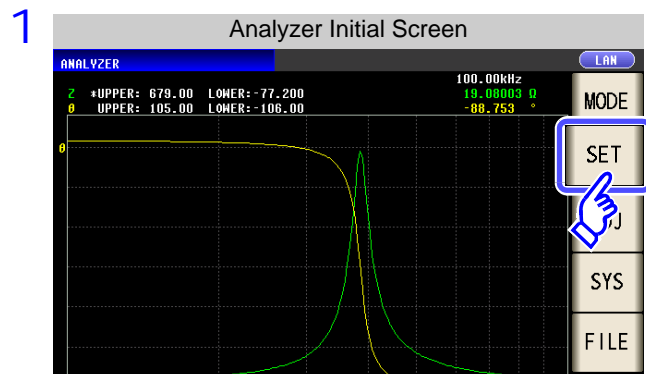

Press **SCALE**.

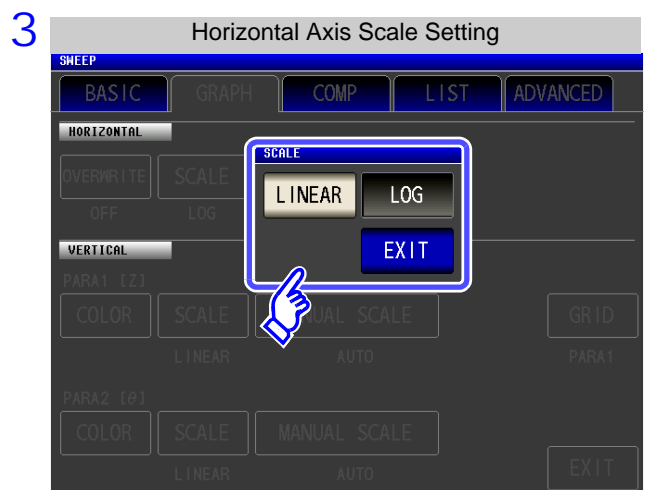

Select the draw type.

- LINEAR** Sets the vertical axis to linear (linear axis).
- LOG** Sets the vertical axis to log (logarithmic axis).

Also set parameter 2 in the same way.

4 Press **EXIT** to close the setting screen.

## 5.5 Setting the Graph Display Method

### 3 Manual Scaling Setting

Set the upper and lower limit values for the vertical axis.

#### Procedure

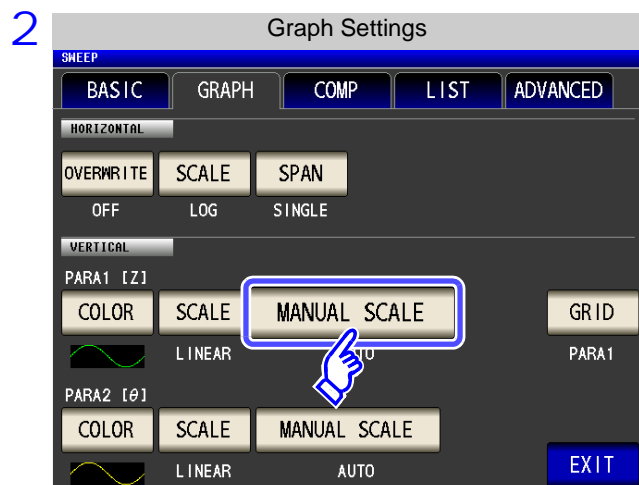
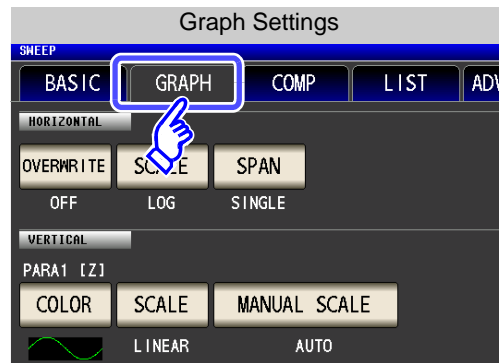
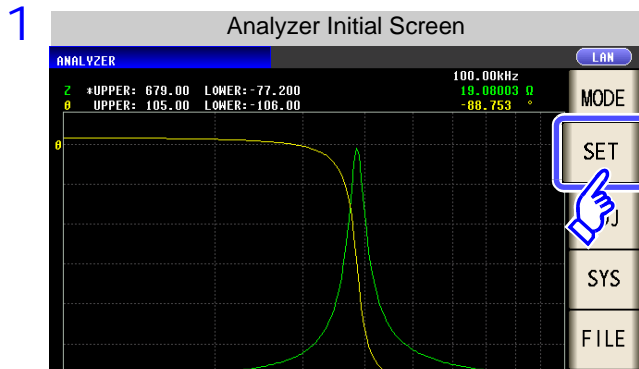

Press **MANUAL SCALE**.

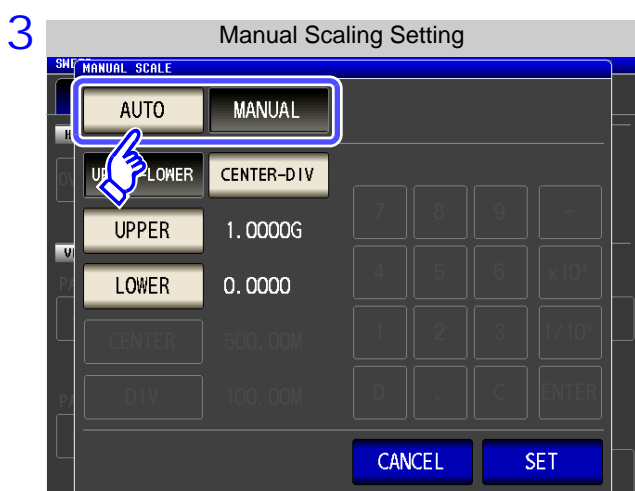

Select the draw mode.

- MANUAL** Sets the upper and lower limit values manually.
- AUTO** Sets the upper and lower limit values from the measurement values automatically.

When you want to cancel the setting:

Press **CANCEL**.

**NOTE** When measurement starts, the display range of the scale is set to the range from the maximum value to the minimum value or the scaling that was set when measurement ended last time.

To set the optimal scaling in accordance with the measurement results, press **SCALE** in the measurement screen.

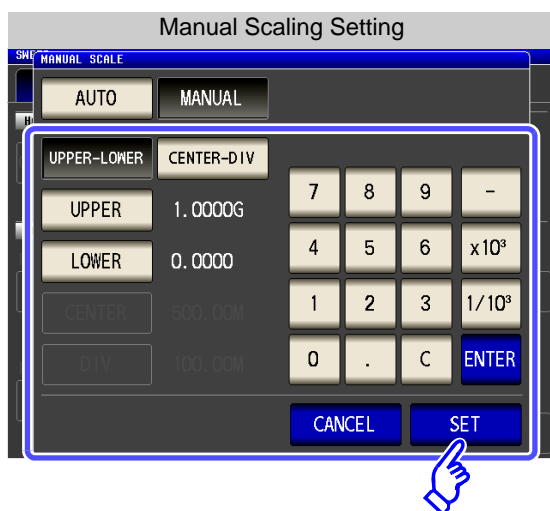

## MANUAL setting

**UPPER-LOWER** Set the upper and lower limit values.

1. Press **UPPER-LOWER**.
2. Press **UPPER** and use the numeric keypad to enter the upper limit value.  
Settable range: -9.9999G to 9.9999G
3. Press **ENTER** to confirm the setting.
4. Press **LOWER** and use the numeric keypad to enter the lower limit value.  
Settable range: -9.9999G to 9.9999G
5. Press **ENTER** to confirm the setting.
6. Press **SET** to confirm the setting.

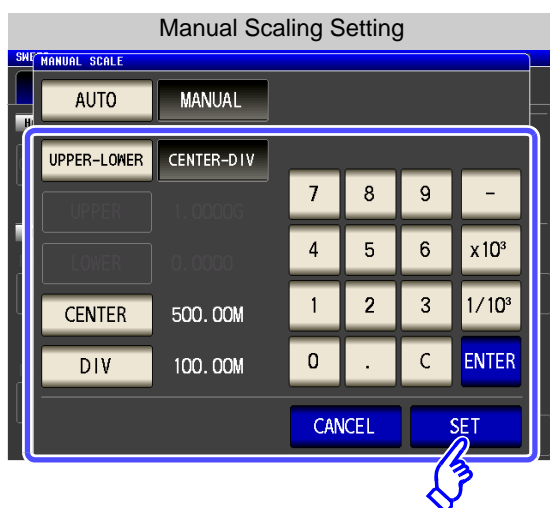
**CENTER-DIV** Set the center value and the width of the vertical axis.

1. Press **CENTER-DIV**.
2. Press **CENTER** and use the numeric keypad to set the center value of the vertical axis.  
Settable range: -9.9999G to 9.9999G
3. Press **ENTER** to confirm the setting.
4. Press **DIV** and use the numeric keypad to set the width of the vertical axis.  
Settable range: -9.9999G to 9.9999G
5. Press **ENTER** to confirm the setting.
6. Press **SET** to confirm the setting.

If you make a mistake during input:  
press **C** to cancel the input and start again.

**NOTE**

- The width of the vertical axis set with **DIV** is centered on the value that was set with **CENTER**. Therefore, the range of values that you can set with **DIV** varies depending on the value set with **CENTER**.
- When **LOG** is selected in the **SCALE** setting, the **CENTER-DIV** setting becomes invalid.

## AUTO setting

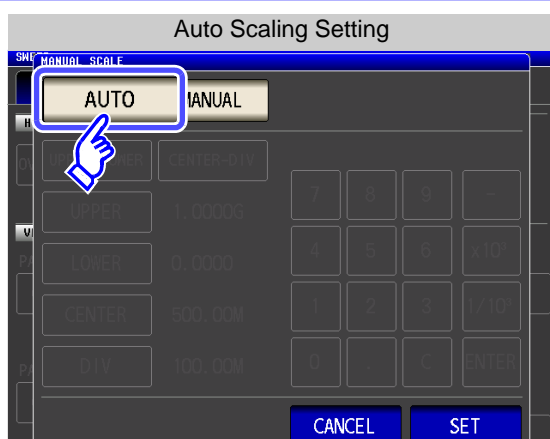

Press **SET** to confirm the setting.

If two parameters are set to AUTO, the measurement results of both parameters are displayed so that they become optimal. If any one of them is set to AUTO, the measurement result of that parameter is displayed so that it becomes optimal.

5.5 Setting the Graph Display Method

5.5.3 Setting Grid Display

Set the sweep parameter for which to display grid lines.

Procedure

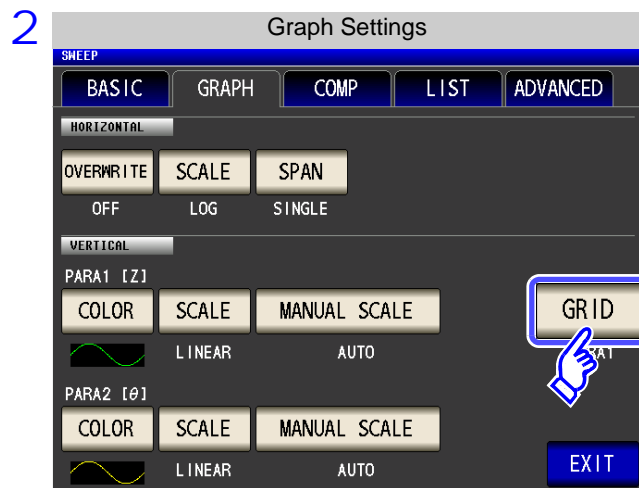
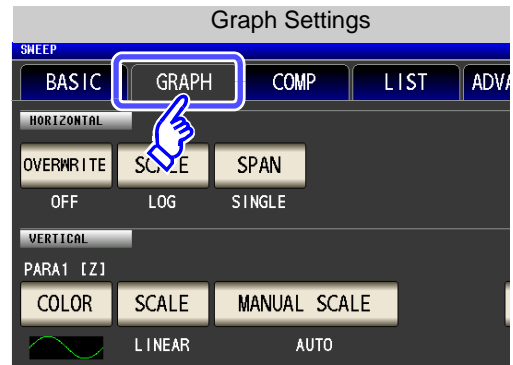
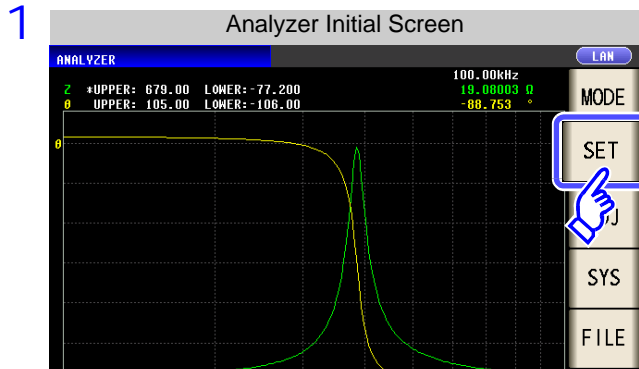

Press **GRID**.

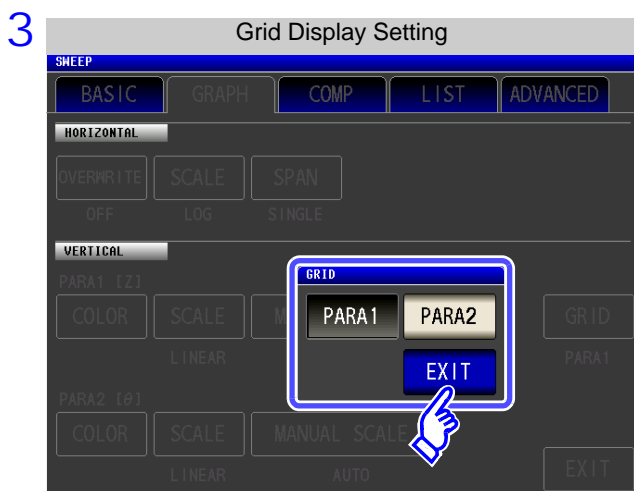

Select the sweep parameter for which to display grid lines.

- PARA1** Displays grid lines for sweep parameter 1.
- PARA2** Displays grid lines for sweep parameter 2.

4 Press **EXIT** to close the setting screen.

About the Timing for Graph Drawing

With this instrument, in order to perform analog measurement efficiently, the timing with which measurement is actually performed and timing with which the data is reflected in the graph differs slightly. The following shows the timing with which analog measurement is performed continuously for multiple measurement points and the timing with which the graph is drawn.

→ : Trigger delay (p. 140)    ⇨ : Point delay (p. 166)

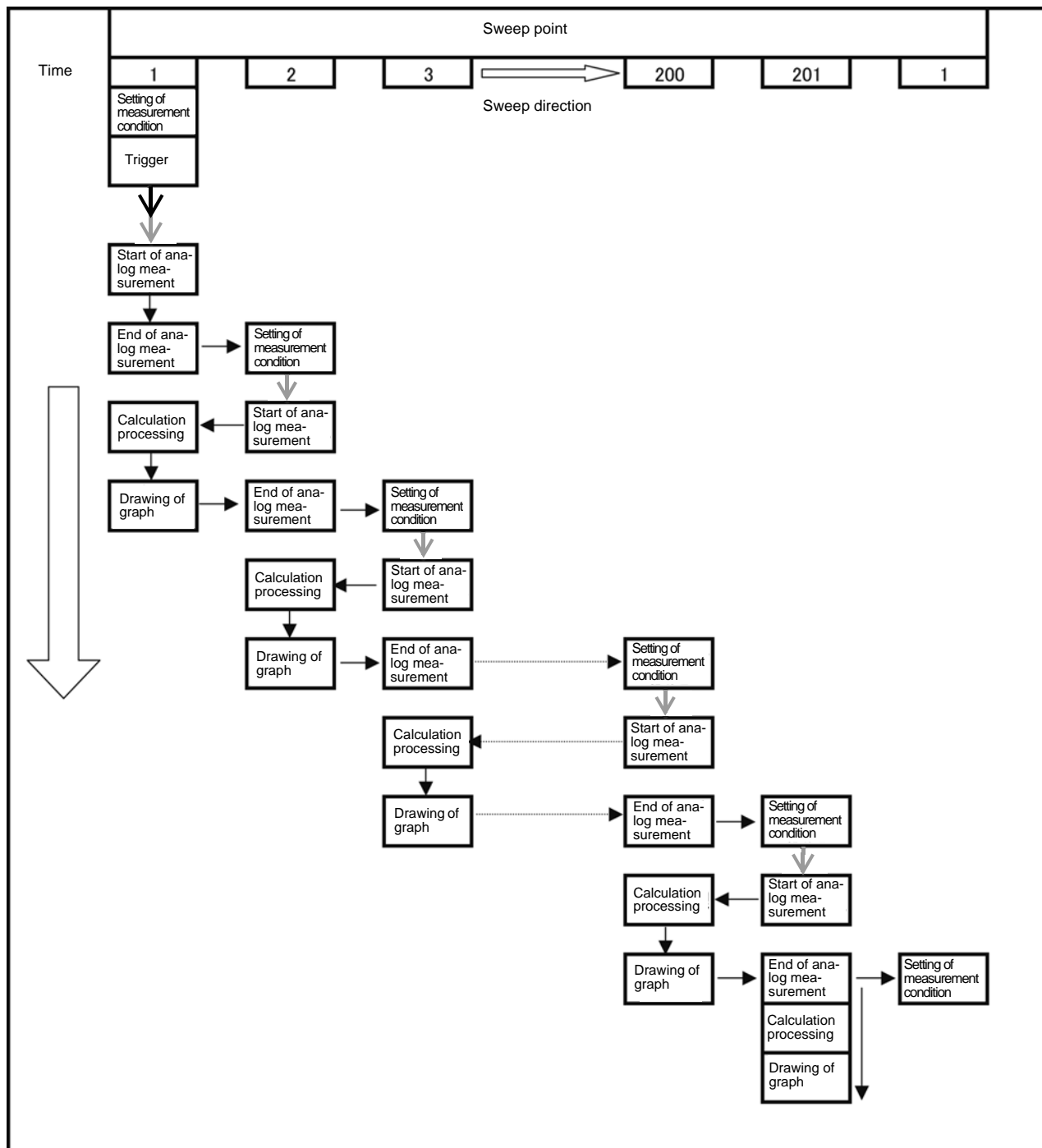

# 5.6 Checking the Measurement Values LCR ANALYZER

You can display a cursor in the measurement screen to check the measurement value of a measurement point.

You can use the search function to easily find the maximum value, minimum value, and peak value.

## 5.6.1 Setting the Cursor

Set the cursor to display in the measurement screen. The two cursors "A" and "B" are available for use.

### Procedure

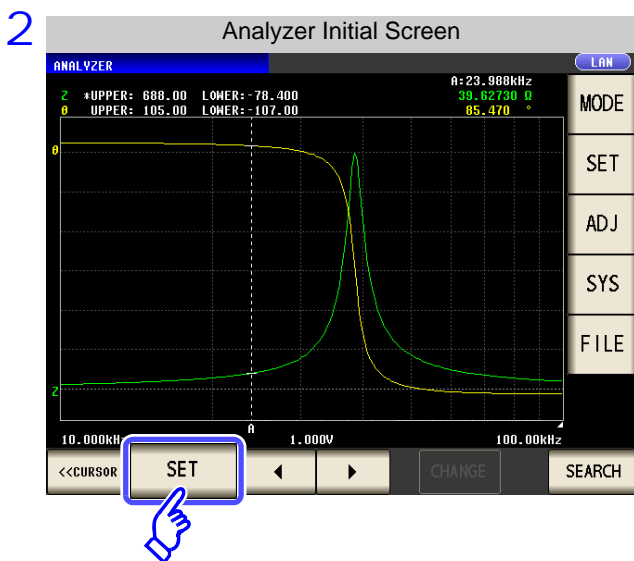
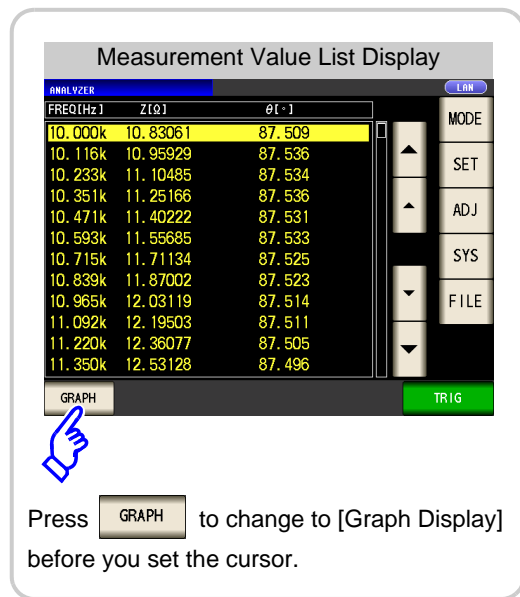
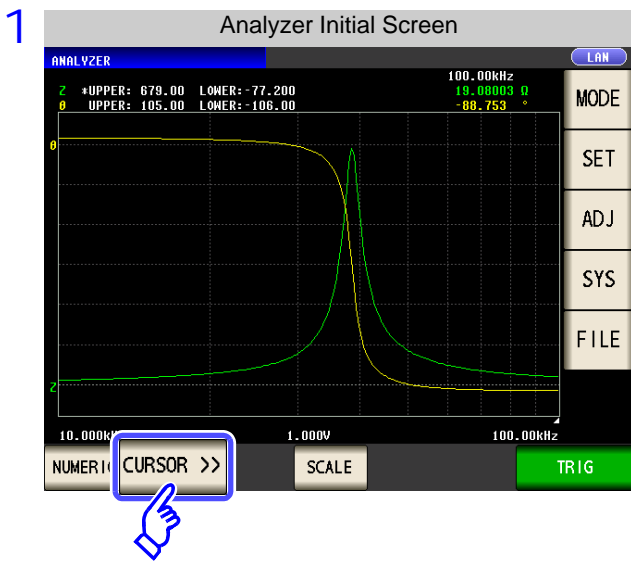

Press **SET**.

5.6 Checking the Measurement Values

3

The screenshot shows the 'Cursor Move Setting' screen with the following callouts:

- Cursor display setting (p. 189) - points to the CURSOR OFF/A/A&B buttons.
- Cursor move setting (p. 190) - points to the MOVE A/B buttons.
- Cursor A search setting (p. 190) - points to the SEARCH\_A MAX/MIN/TARGET/L-MAX/L-MIN buttons.
- Cursor B search setting (p. 190) - points to the SEARCH\_B MAX/MIN/TARGET/L-MAX/L-MIN buttons.
- Auto search setting (p. 192) - points to the AUTO OFF/ON buttons.

4 Press **EXIT** to close the setting screen.

1 **Cursor Display Setting**

The screenshot shows the 'Cursor Display Setting' screen. A hand icon points to the 'OFF' button in the CURSOR section.

Set the cursor to display in the measurement screen.

- OFF** Displays no cursor.
- A** Displays only cursor A.
- A&B** Displays cursors A and B.

### 2 Cursor Move Setting

This can only be set when **A&B** is selected for the display cursor setting.

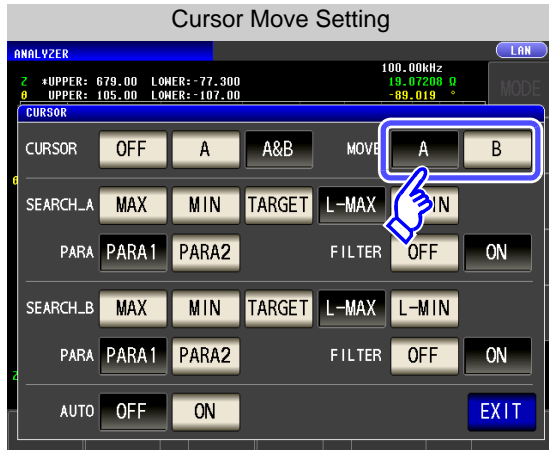

Select the cursor to move using the cursor move keys on the measurement screen.

See "5.6.2 Moving the Cursor" (p. 193)

- A** Moves cursor A.
- B** Moves cursor B.

### 3 Search Function Setting

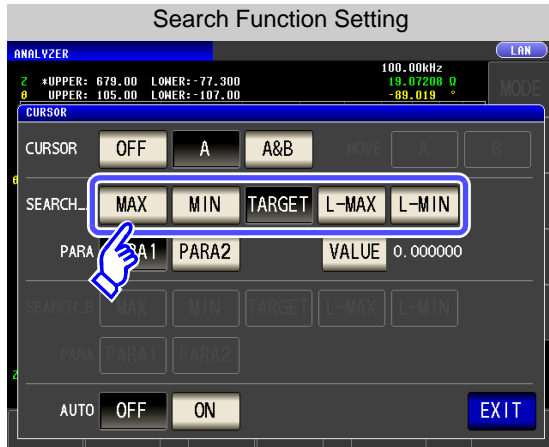

Set the search function.

See "Performing Measurement Value Search" (p. 194)

- MAX** Moves the cursor to the maximum value of the measurement results.
- MIN** Moves the cursor to the minimum value of the measurement results.
- TARGET** Moves the cursor to the measurement value set in the option settings.
- L-MAX** Moves the cursor to the local maximum value of the measurement results. The filter can be set in the option settings.
- L-MIN** Moves the cursor to the local minimum value of the measurement results. The filter can be set in the option settings.

The search function does not work during a sweep. When you use the search function, the **TRIG** setting needs to be set to **SEQ** or **STEP**.

See "5.2.3 Setting the Trigger" (p. 137)

## 4 Search Target Parameter Setting

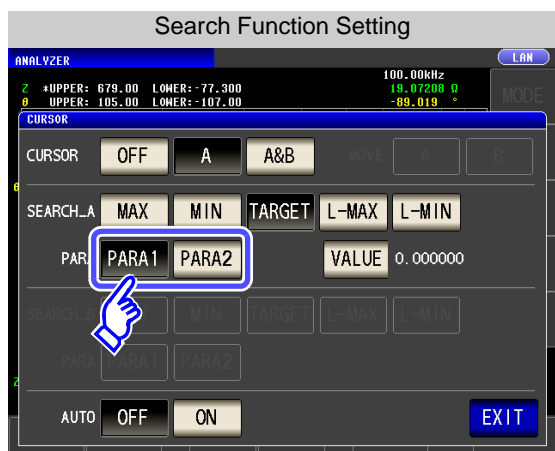

Set the search target parameter.

See "Performing Measurement Value Search" (p. 194)

**PARA1** Sets the measurement result of parameter 1 as the search target.

**PARA2** Sets the measurement result of parameter 2 as the search target.

## 5 Option setting

Set the measurement value for which to search.

? This can be set when **A** or **A&B** is selected for the cursor display setting (p. 189), and **TARGET** for the search function setting (p. 190).

See: "Performing Measurement Value Search" (p. 194)

? Set the value for which to search when executing a target search.

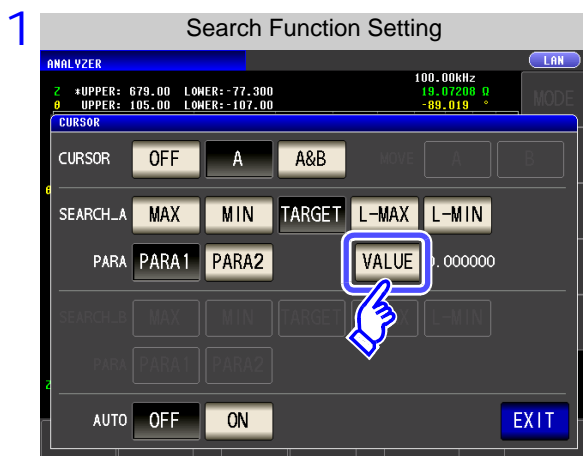

Press **VALUE**.

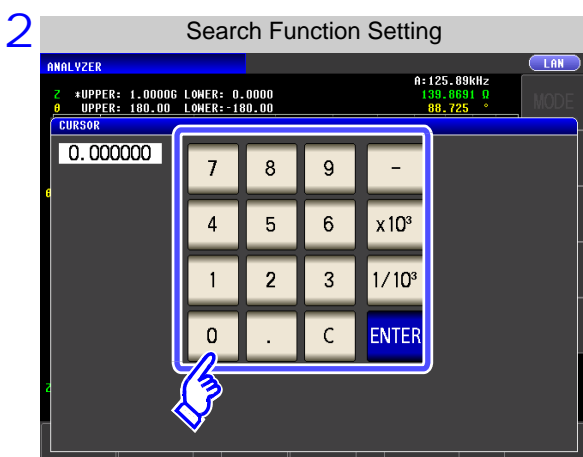

Set the measurement value for which to search.

Settable range: -9.999999G to 9.999999G

Press **ENTER** to confirm the setting.

## 5.6 Checking the Measurement Values

### Set the filter.

This can be set when **L-MAX** or **L-MIN** is selected for the search function setting.

See "Performing Measurement Value Search" (p. 194)

- When judging the local maximum value or local minimum value, set a filter.
- Applying a filter allows you to reduce the misjudgments of variations in measurement values caused by noise and other interference being judged as local maximum values or local minimum values.

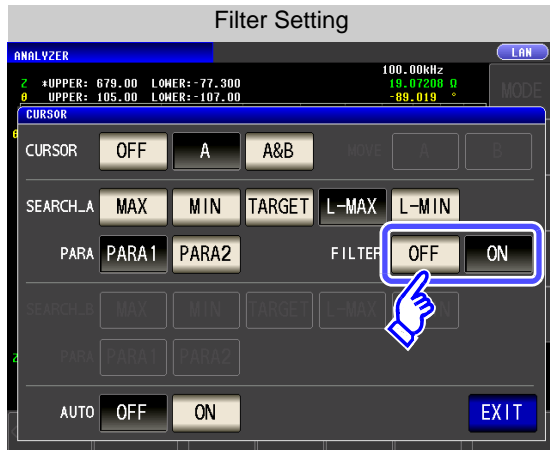

### Set the filter type.

**OFF** Disables the filter function.

**ON** Enables the filter function.

### NOTE

The filter setting is common to cursors A and B.

## 6 Auto Search Setting

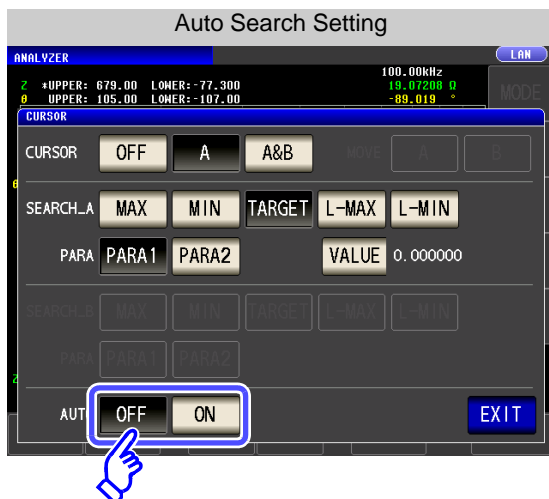

If you turn auto search ON, the search function is executed after sweep measurement ends, and the cursors move in accordance with the search settings.

**OFF** Disables the auto search function.

**ON** Enables the auto search function.



### 5.6.2 Moving the Cursor

You can move a cursor and check the measurement value at the current cursor position.

The cursor(s) set in **A** or **A&B** of "Cursor Display Setting" (p. 189) and **A** or **B** of "Cursor Move Setting" (p. 190) can be moved.

#### Procedure

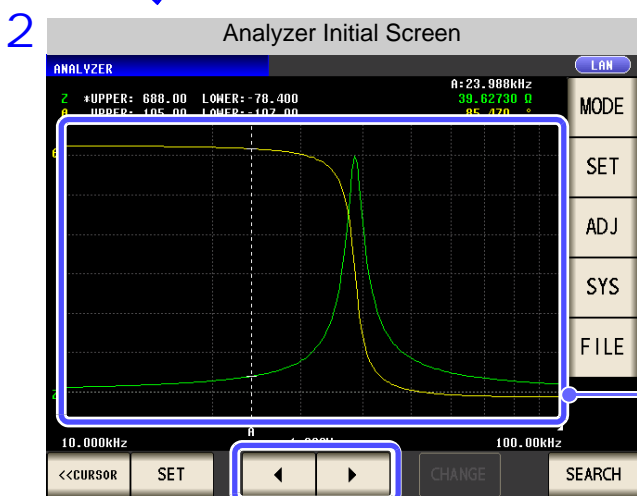
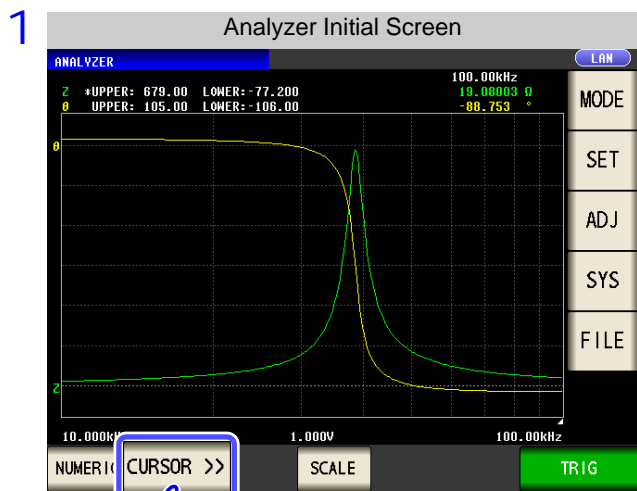

The image shows the 'Measurement Value List Display' screen. It contains a table with the following data:

FREQ[Hz]	Z[Ω]	θ[°]
10.000k	10.83061	87.509
10.116k	10.95929	87.536
10.233k	11.10485	87.534
10.351k	11.25166	87.536
10.471k	11.40222	87.531
10.593k	11.55685	87.533
10.715k	11.71134	87.525
10.839k	11.87002	87.523
10.965k	12.03119	87.514
11.092k	12.19503	87.511
11.220k	12.36077	87.505
11.350k	12.53128	87.496

Below the table, there are buttons for 'GRAPH' and 'TRIG'. A hand icon points to the 'GRAPH' button.

Press **GRAPH** to change to [Graph Display] before you set the cursor.

Press the following keys to move the cursor.

- Moves the cursor to the left by 1 sweep point
- Moves the cursor to the right by 1 sweep point.

You can move the cursor by touching the graph display screen.

### Cursors in Graph Display Screen and How to Check Measurement Values

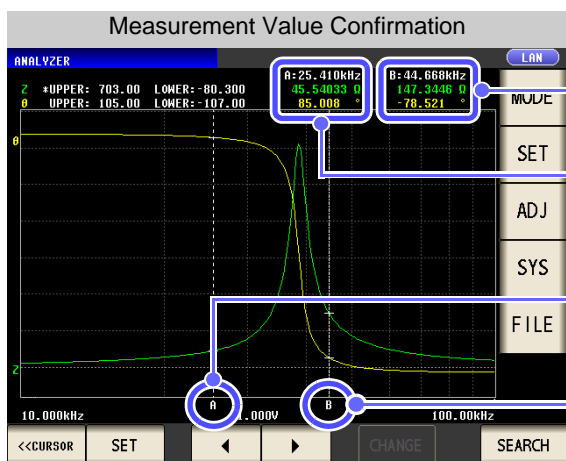

You can check each of the following for cursor A/ B.

- Sweep point
- First parameter value
- Second parameter value

A Cursor

B Cursor

5.6 Checking the Measurement Values

5.6.3 Performing Measurement Value Search

You can perform a measurement value search for the measurement results of one sweep using the method set in the search function setting ( **MAX** , **MIN** , **TARGET** , **L-MIN** , or **L-MAX** ).

When you perform a search, the cursor moves to the search result point so that you can check the search execution result. (p. 193)

The search target parameter is the parameter set in "Search Target Parameter Setting" (p. 191)

( **PARA1** or **PARA2** ).

Procedure

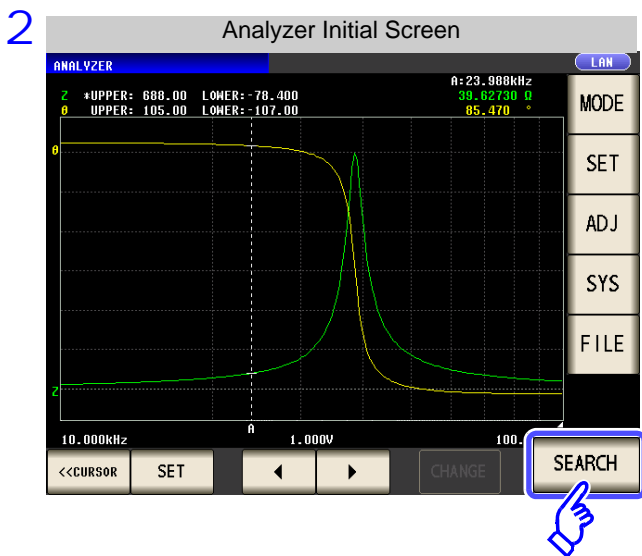
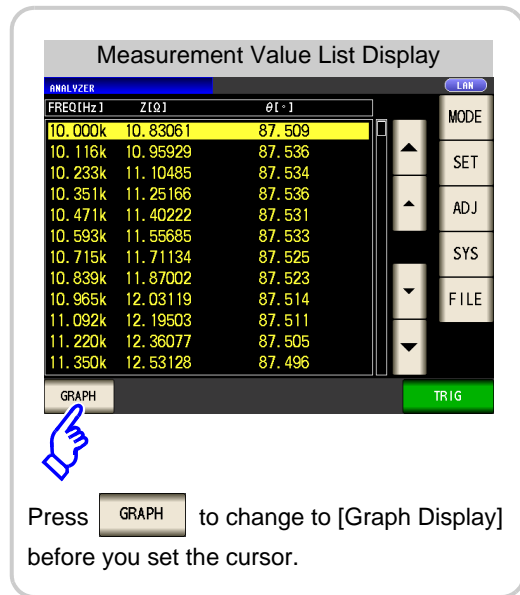
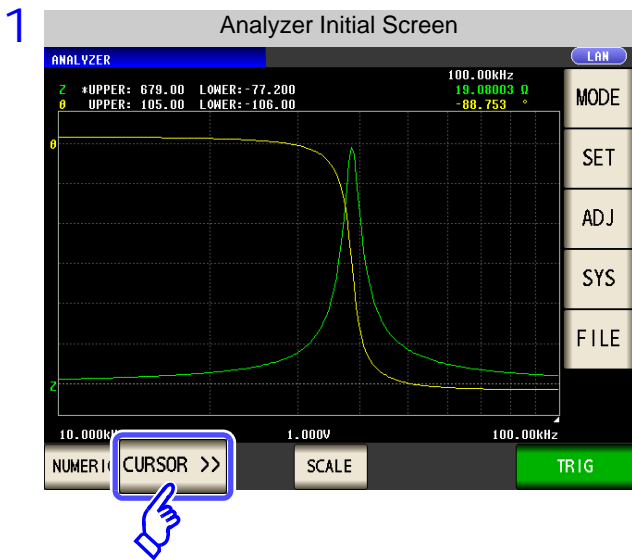

Press **SEARCH** to move the cursor to the sweep point that matches the condition set for the search function setting.

If more than one search point matches the condition, the cursor moves each time you press



**NOTE**

A search cannot be performed when the trigger setting is **REPEAT**.  
 See "5.2.3 Setting the Trigger" (p. 137)

Search Execution Result for Each Search Function Setting

In the search example, only parameter 1 is enabled.

Maximum value search result

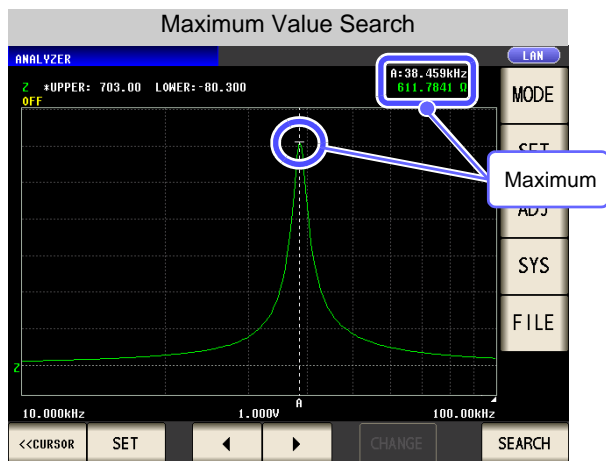

Minimum value search result

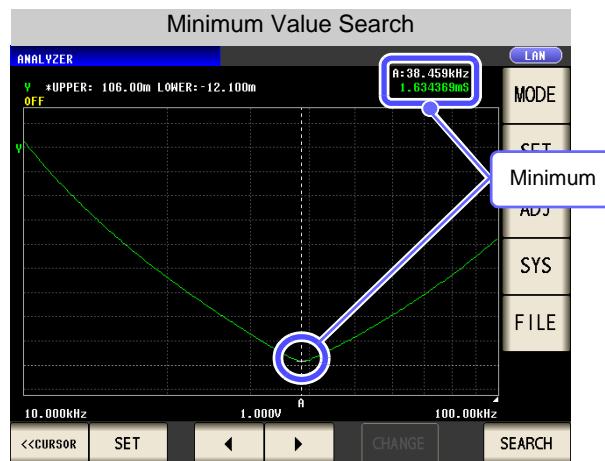

Target value search result

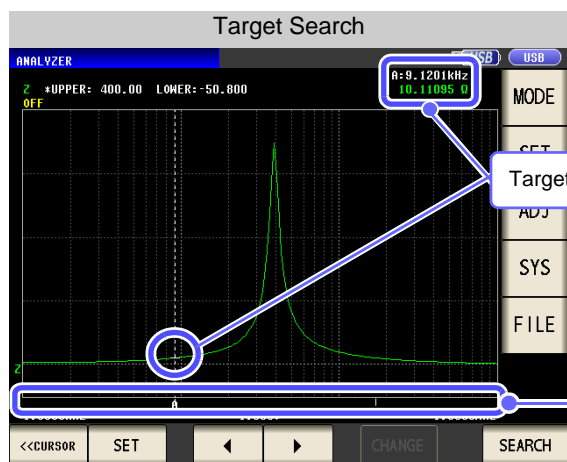

The target value is set to 10.00000. When a search is performed, the search finds the measurement value that is nearest to the target value.

Target point  
The sweep point that matches the condition is indicated by a bar (|) below the X axis.

Local maximum value search result



Local maximum value point  
In the search results, the sweep point that is considered to be the local maximum value is indicated below the X axis. The measurement values of the local maximum value are indicated in order from the largest point to smallest point as "1, 2, 3,...," and from the sixth point by a bar (|).

5.6 Checking the Measurement Values

Local minimum value search result

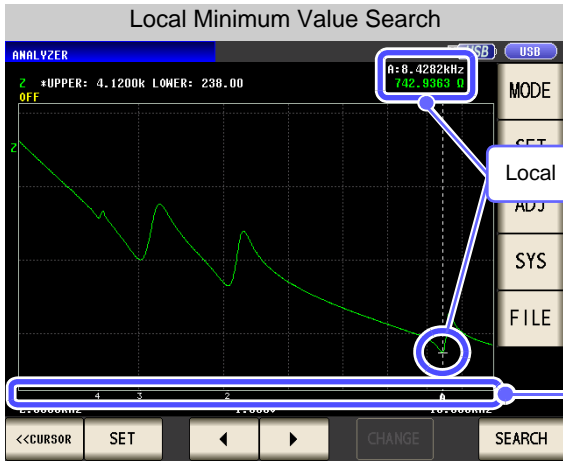

Local minimum value

Local minimum value point  
In the search results, the sweep point that is considered to be the local minimum value is indicated below the X axis.  
The measurement values of the local maximum value are indicated in order from the smallest point to largest point as "1, 2, 3,....," and from the sixth point by a bar (|).

## 5.7 Judging Measurement Results (Comparator Function)

LCR

ANALYZER

With the comparator function, you can preset a judgment area and judge whether measurement values are within the judgment area.

### Area Judgment

Judges whether the measurement values of sweep points are within the judgment area.

### Peak Judgment

Judges whether the peak value of one sweep result is within the judgment area. (p. 208)

### NOTE

With the comparator function of the analyzer function, whenever possible perform a sweep once before setting the comparator function because there are items and the like for configuring the settings of the judgment area which use the sweep results.

## 1 Area Judgment

With area judgment, you can set the upper and lower limit values of the range to enable IN or NG to be displayed as the judgment result.

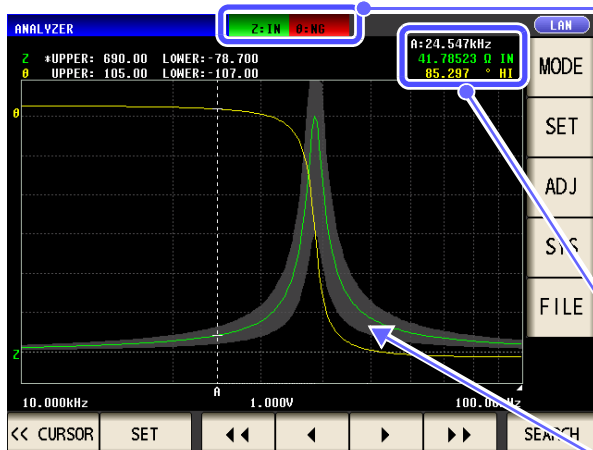

Indicates the overall judgment result.

- IN** When the measurement values of sweep points are within the range set with the upper and lower value settings
- NG** When any of the measurement values of the sweep points are not within the range set with the upper and lower value settings
- When judgment is not made

You can use the cursor to check the judgment result of each sweep point.

The comparator range is displayed in gray. (p. 207)

## 5.7 Judging Measurement Results (Comparator Function)

### Procedure

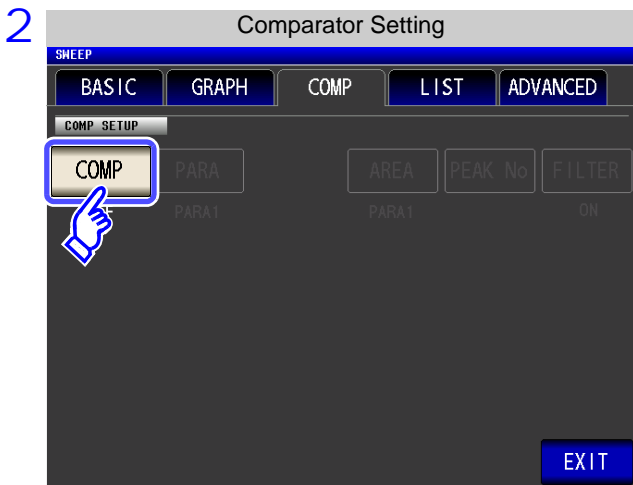
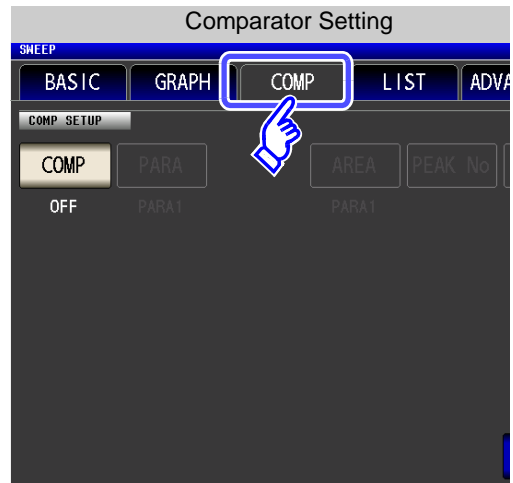
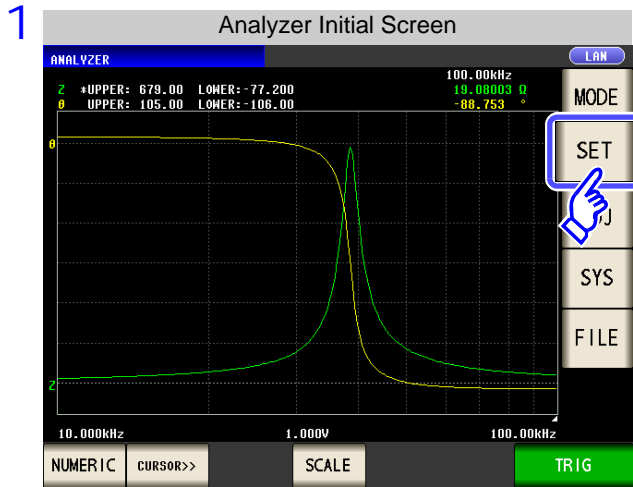

Press **COMP**.

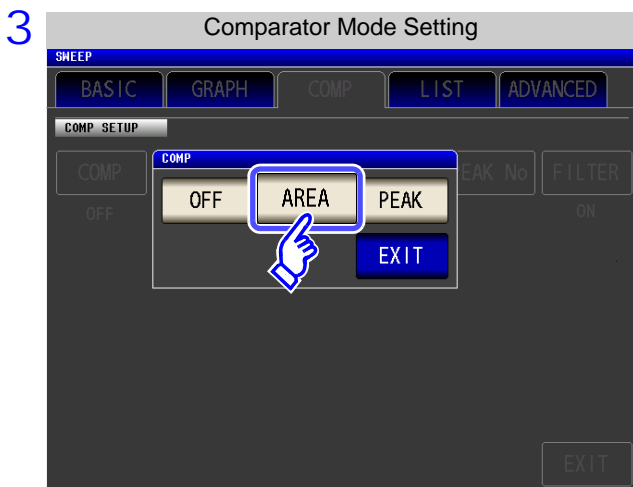

Press **AREA**.

Press **EXIT** to confirm the setting.

## 5.7 Judging Measurement Results (Comparator Function)

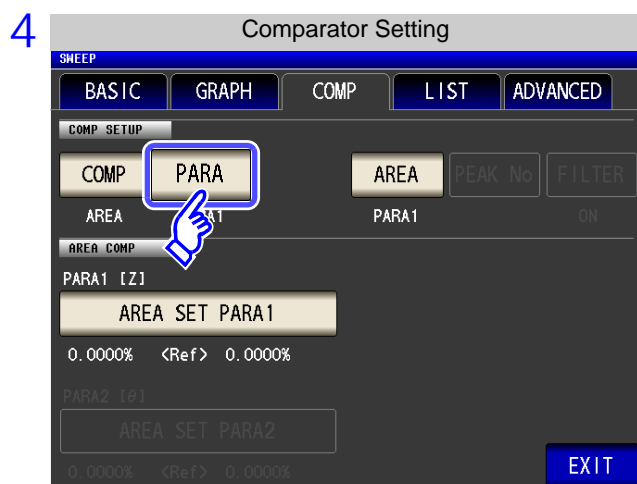

Press **PARA**.

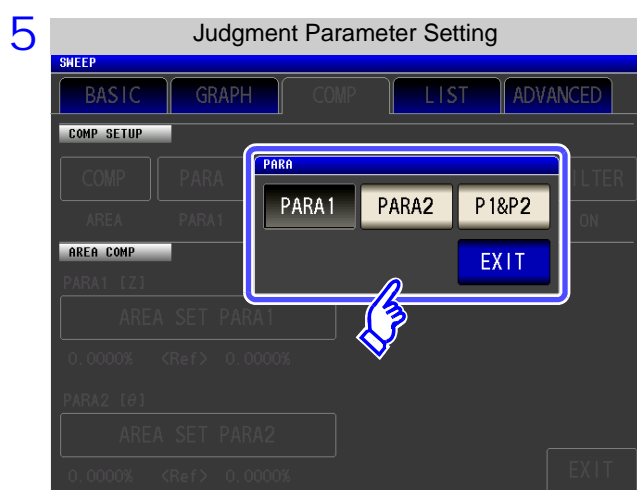

Select the parameter to judge.

**PARA1**

Sets the upper and lower limit values and judges the measurement results for the first measurement parameter.

**PARA2**

Sets the upper and lower limit values and judges the measurement results for the second measurement parameter.

**P1&P2**

Sets the upper and lower limit values and judges the measurement results for both the first and second parameters.

Press **EXIT** to confirm the setting.

- NOTE**
- If a parameter is changed, the comparator setting prior to the change becomes invalid, and the comparator function **COMP** is set to **OFF**.
  - If a measurement point is changed, the comparator setting prior to the change becomes invalid, and the comparator function **COMP** is set to **OFF**.
- See:** "5.3.1 Setting Sweep Points" (p. 143)

## 5.7 Judging Measurement Results (Comparator Function)

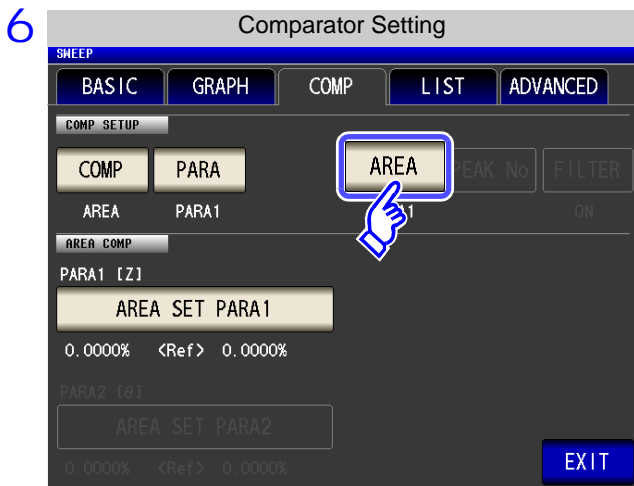

Press **AREA**.

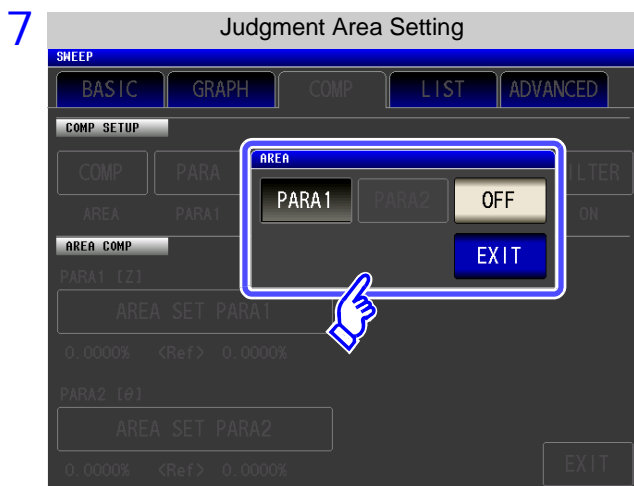

Set the judgment area to display in the measurement screen.

<b>PARA1</b>	Displays the judgment area of the first measurement parameter.
<b>PARA2</b>	Displays the judgment area of the second measurement parameter.
<b>OFF</b>	Displays no judgment area.

- **PARA1**, **PARA2** cannot be selected if the parameter to judge has not been set.
- Both the judgment areas of the first measurement parameter and second measurement parameter cannot be displayed at the same time.

Press **EXIT** to confirm the setting.

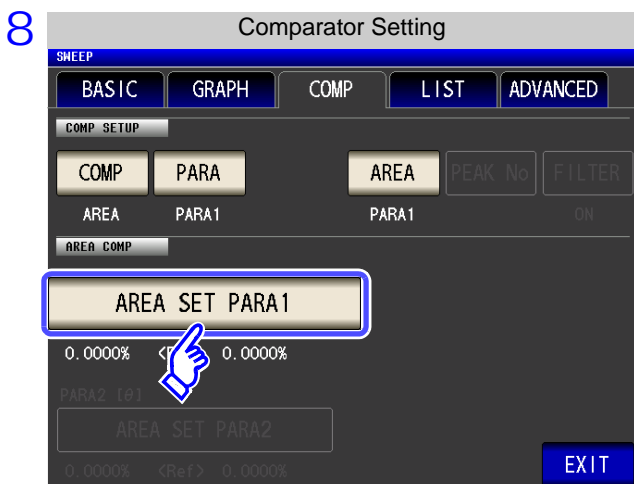

Press **AREA SET PARA1**, and set the judgment area of the first parameter.



## 5.7 Judging Measurement Results (Comparator Function)

When the **SEGMENT** setting is **OFF**

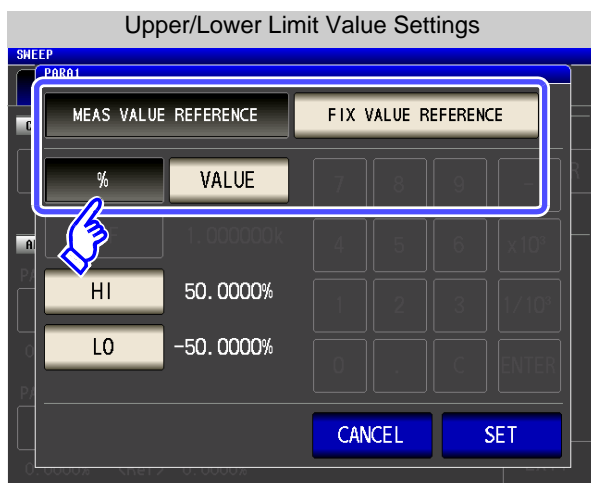

## Set the judgment area.

<b>MEAS VALUE REFERENCE</b>	Sets the upper and lower limit values based on the current measurement values.
<b>FIX VALUE REFERENCE</b>	Sets the reference value, upper limit value, and lower limit value.
<b>%</b>	Sets the upper and lower limit values as percentage values relative to the reference value.
<b>VALUE</b>	Sets the upper and lower limit values as absolute values relative to the reference value.

## When you want to cancel the setting:

Press **CANCEL**.

**MEAS VALUE REFERENCE**

Set the upper and lower limit values based on the current measurement values.

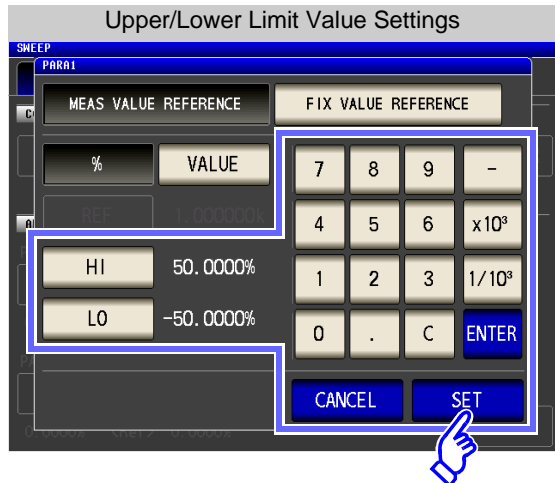

If you make a mistake during input:  
press **C** to cancel the input and start again.

- Press **HI** and use the numeric keypad to set the upper limit value.
  - Settable range: -999.9999 to 999.9999 (Set as a % value)
  - Settable range: -9.999999G to 9.999999G (Set as a reference value)
- Press **ENTER** to confirm the upper limit value.
- Press **LO** and use the numeric keypad to set the lower limit value.
  - Settable range: -999.9999 to 999.9999 (Set as a % value)
  - Settable range: -9.999999G to 9.999999G (Set as a reference value)
- Press **ENTER** to confirm the lower limit value.
- Press **SET** to confirm the setting.

## 5.7 Judging Measurement Results (Comparator Function)

### FIX VALUE REFERENCE

Set the reference value, upper limit value, and lower limit value.

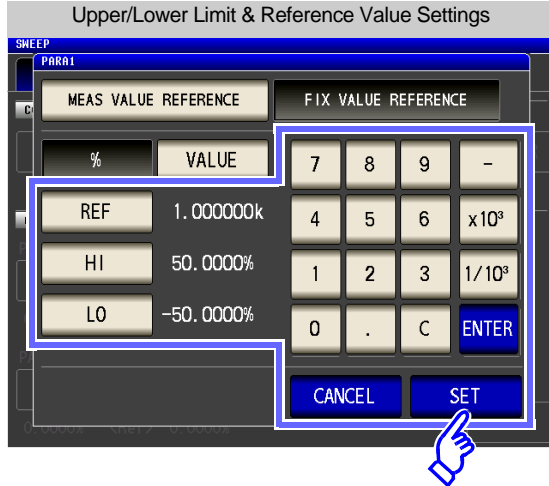

If you make a mistake during input:  
press **C** to cancel the input and start again.

1. Press **REF** and use the numeric keypad to set the reference value.  
Settable range: -9.999999G to 9.999999G
2. Press **ENTER** to confirm the reference value.
3. Press **HI** and use the numeric keypad to set the upper limit value.
  - Settable range: -999.9999 to 999.9999 (Set as a % value)
  - Settable range: -9.999999G to 9.999999G (Set as a reference value)
4. Press **ENTER** to confirm the upper limit value.
5. Press **LO** and use the numeric keypad to set the lower limit value.
  - Settable range: -999.9999 to 999.9999 (Set as a % value)
  - Settable range: -9.999999G to 9.999999G (Set as a reference value)
6. Press **ENTER** to confirm the lower limit value.
7. Press **SET** to confirm the setting.

## 5.7 Judging Measurement Results (Comparator Function)

When the **SEGMENT** setting is **ON**

When the segment function is enabled, a different judgment area can be set for each segment.

Judgment Area Setting

PARA1

MEAS VALUE REFERENCE    FIX VALUE REFERENCE

%    VALUE

SEG	REF	HI	LO
01	<MEAS VAL>	0.0000%	0.0000%
02	<MEAS VAL>	0.0000%	0.0000%
03	<MEAS VAL>	0.0000%	0.0000%

SEG1▶ALL    EDIT    CANCEL    SET

1. Set the judgment area.

MEAS VALUE REFERENCE

Sets the upper and lower limit values based on the current measurement values.

FIX VALUE REFERENCE

Sets the reference value, upper limit value, and lower limit value.

%

Sets the upper and lower limit values as percentage values relative to the reference value.

VALUE

Sets the upper and lower limit values as absolute values relative to the reference value.

**When you want to cancel the setting:**

Press **CANCEL**.

2. Use **▲** or **▼** to select the segment for which you want to set the judgment area.

3. Press **EDIT**.

Judgment Area Setting

PARA1

MEAS VALUE REFERENCE    FIX VALUE REFERENCE

%    VALUE

SEG	REF	HI	LO
01	<MEAS VAL>	0.0000%	0.0000%
02	<MEAS VAL>	0.0000%	0.0000%
03	<MEAS VAL>	0.0000%	0.0000%

SEG1▶ALL    **EDIT**    CANCEL    SET

## 5.7 Judging Measurement Results (Comparator Function)

MEAS VALUE REFERENCE

Set the upper and lower limit values based on the current measurement values.

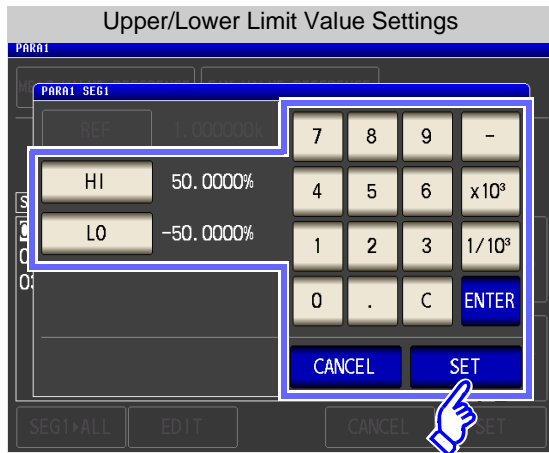

If you make a mistake during input:  
press **C** to cancel the input and start again.

1. Press **HI** and use the numeric keypad to set the upper limit value.
  - Settable range: -999.9999 to 999.9999 (Set as a % value)
  - Settable range: -9.999999G to 9.999999G (Set as a reference value)
2. Press **ENTER** to confirm the upper limit value.
3. Press **LO** and use the numeric keypad to set the lower limit value.
  - Settable range: -999.9999 to 999.9999 (Set as a % value)
  - Settable range: -9.999999G to 9.999999G (Set as a reference value)
4. Press **ENTER** to confirm the lower limit value.
5. Press **SET** to confirm the setting.

## 5.7 Judging Measurement Results (Comparator Function)

FIX VALUE REFERENCE

Set the reference value, upper limit value, and lower limit value.

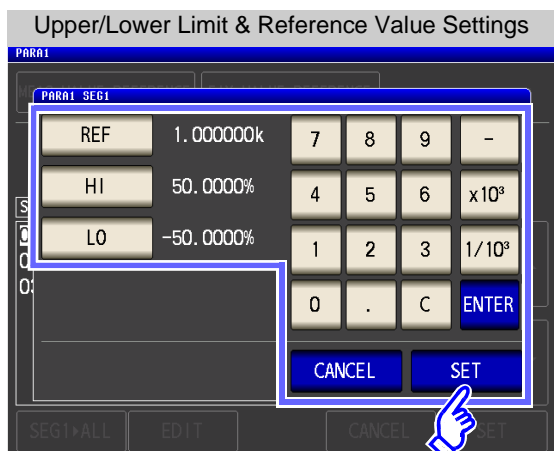

If you make a mistake during input:  
press **C** to cancel the input and start again.

1. Press **REF** and use the numeric keypad to set the reference value.

Settable range: -9.999999G to 9.999999G

2. Press **ENTER** to confirm the reference value.

3. Press **HI** and use the numeric keypad to set the upper limit value.

- Settable range: -999.9999 to 999.9999 (Set as a % value)
- Settable range: -9.999999G to 9.999999G (Set as a reference value)

4. Press **ENTER** to confirm the upper limit value.

5. Press **LO** and use the numeric keypad to set the lower limit value.

- Settable range: -999.9999 to 999.9999 (Set as a % value)
- Settable range: -9.999999G to 9.999999G (Set as a reference value)

6. Press **ENTER** to confirm the lower limit value.

7. Press **SET** to confirm the setting.

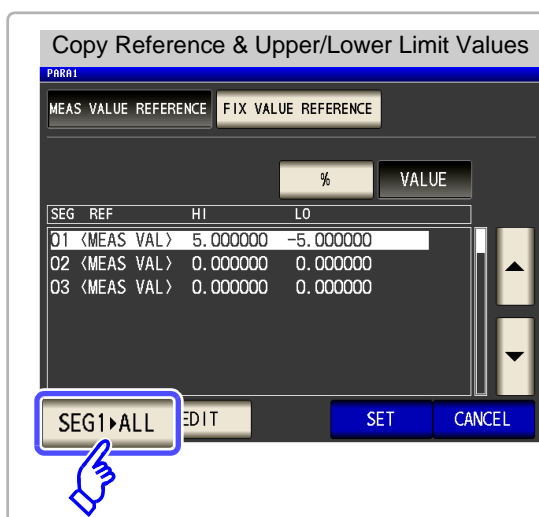

If you press **SEG1>ALL**, the setting value of the first segment is copied to all of the other segments.

9 Press **SET** to confirm the setting.

When you want to cancel the setting:

Press **CANCEL**.

## 5.7 Judging Measurement Results (Comparator Function)

10

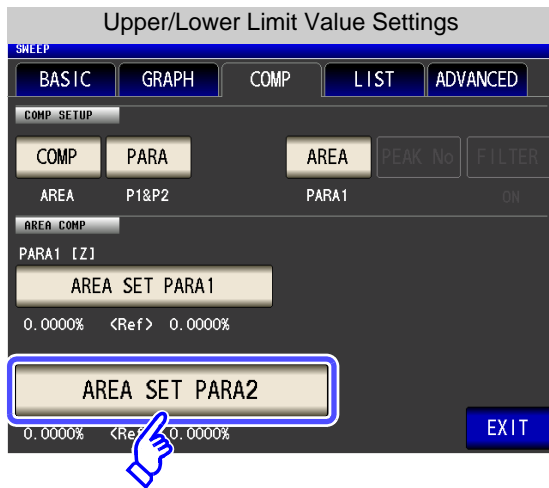

Press **AREA SET PARA2**, and set the judgment area of the second parameter in the same way.

(When the **PARA** Setting is **PARA2** or **P1&P2**)

11 Press **EXIT** to return to the measurement screen.

5.7 Judging Measurement Results (Comparator Function)

12 The comparator range is displayed in gray, and the judgment result is displayed after the sweep ends.

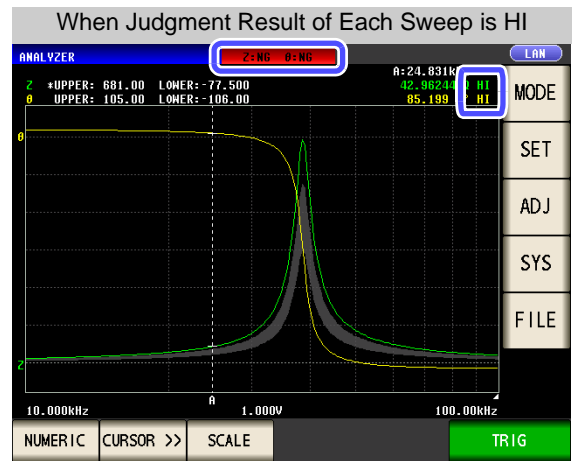
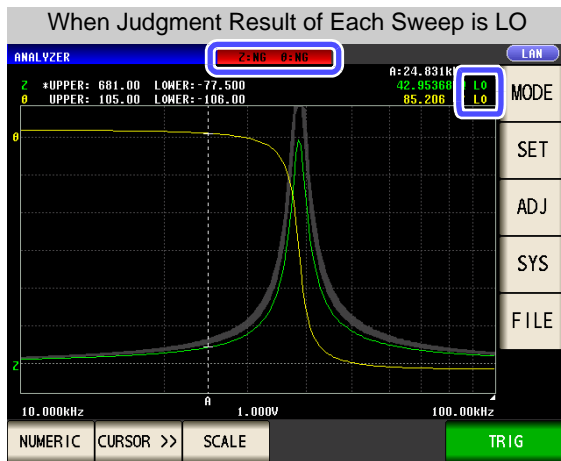
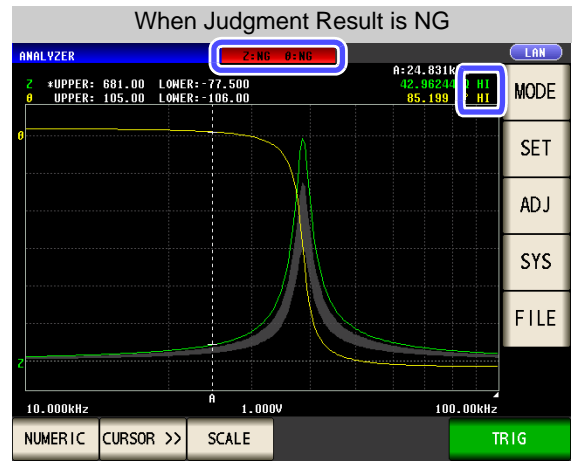
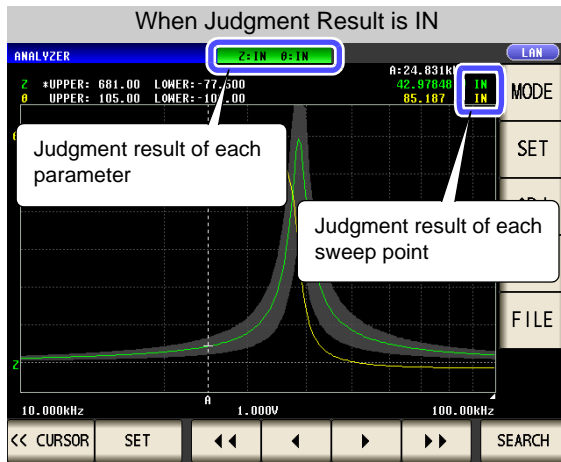

You can set the upper and lower limit values of each sweep point in "5.8 Editing Judgment Points" (p. 217).

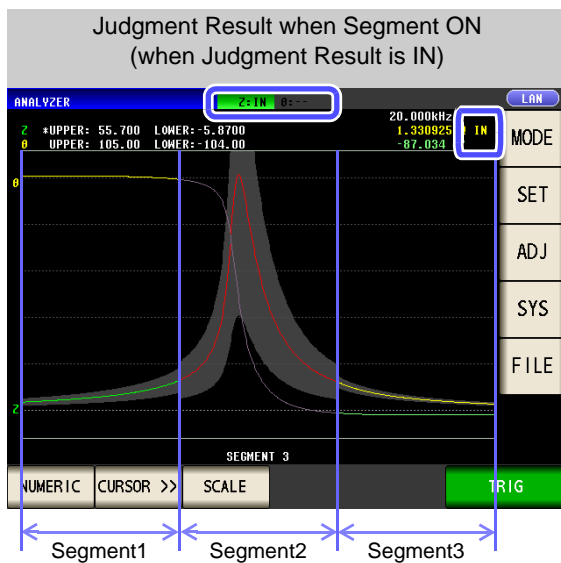

5.7 Judging Measurement Results (Comparator Function)

2 Peak Judgment

With peak judgment, you can judge whether the peak value is within the judgment area. The judgment area can be set with the upper, lower, left, and right limit values.

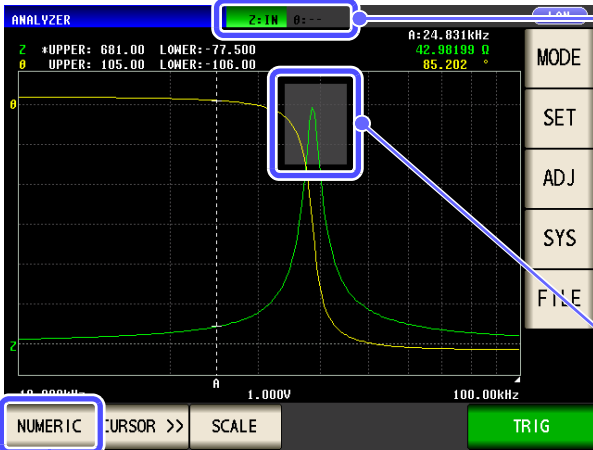

Indicates the overall judgment result.

- IN** When all of the peak values are within the judgment area.
- NG** When any of the peak values are not within the judgment area.
- When judgment is not made

The comparator range is displayed in gray. (p. 214)

Press **GRAPH**, **NUMERIC**, or **COMP** to change the display.

Press **COMP** when numerical value display to display details on the judgment results.(p. 216)

Procedure

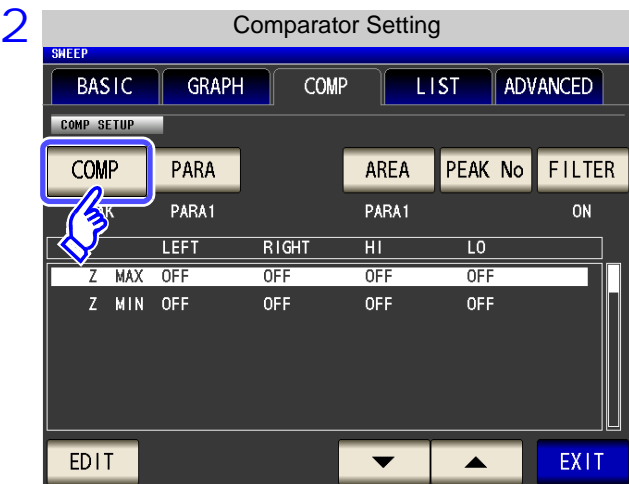
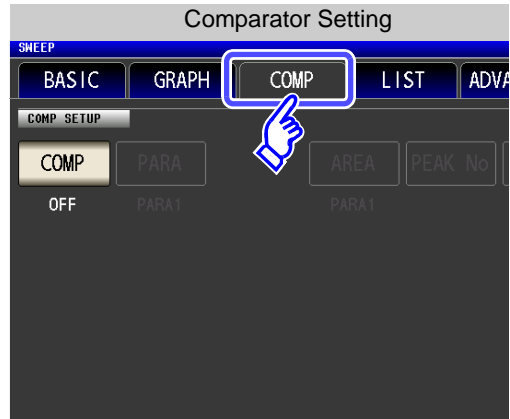
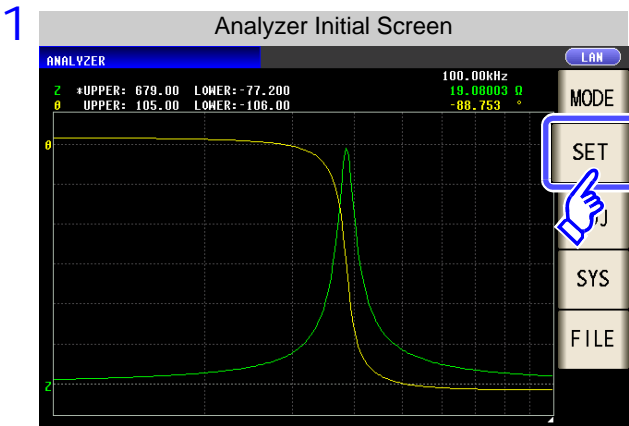

Press **COMP**.



5.7 Judging Measurement Results (Comparator Function)

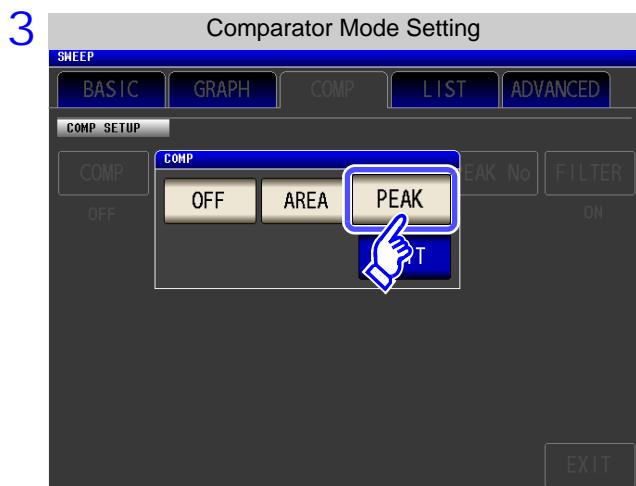

Press **PEAK**.

Press **EXIT** to confirm the setting.

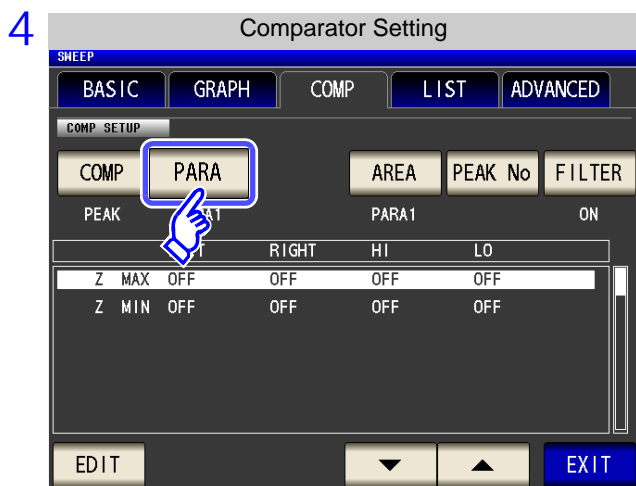

Press **PARA**.

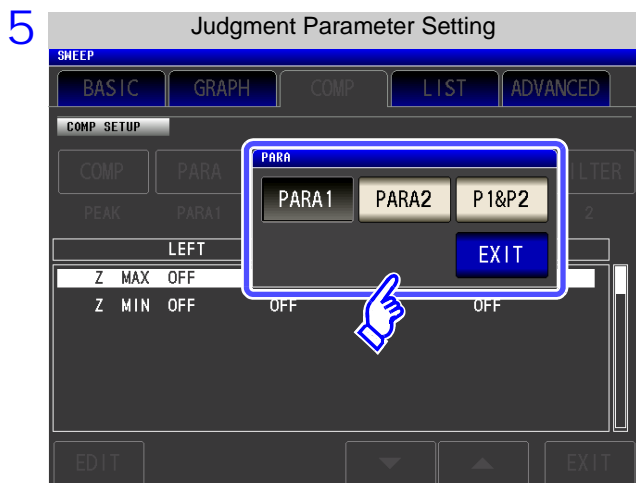

Select the parameter to judge.

- PARA1** Sets the judgment area and judges the measurement results for the first measurement parameter.
- PARA2** Sets the judgment area and judges the measurement results for the second measurement parameter.
- P1&P2** Sets the judgment area and judges the measurement results for both the first and second parameters.

Press **EXIT** to confirm the setting.

## 5.7 Judging Measurement Results (Comparator Function)

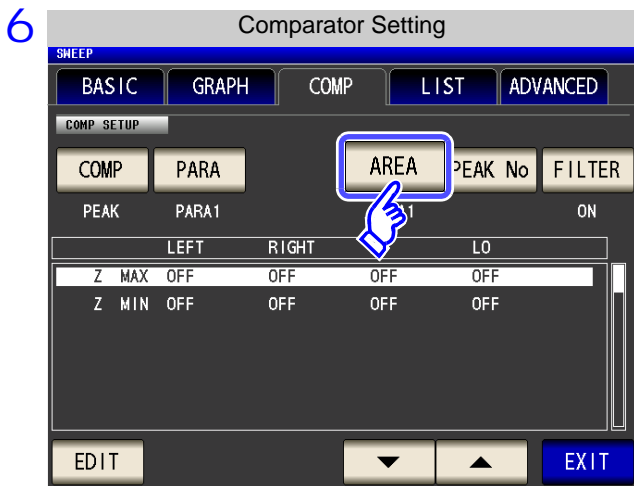

Press **AREA**.

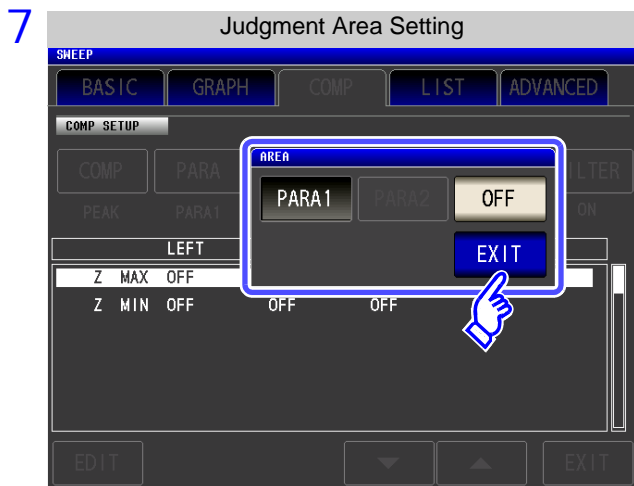

Set the judgment area to display in the measurement screen.

**PARA1** Displays the judgment area of the first measurement parameter.

**PARA2** Displays the judgment area of the second measurement parameter.

**OFF** Displays no judgment area.

- **PARA2** cannot be selected if the parameter to judge has not been set.
- Both the judgment areas of the first measurement parameter and second measurement parameter cannot be displayed at the same time.

Press **EXIT** to confirm the setting.

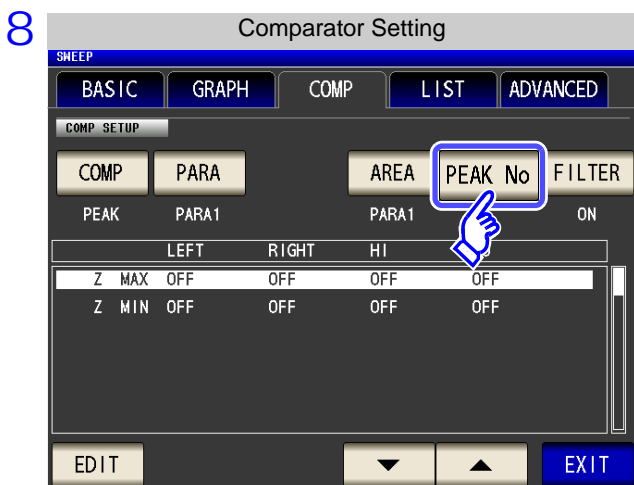

Press **PEAK No**.

## 5.7 Judging Measurement Results (Comparator Function)

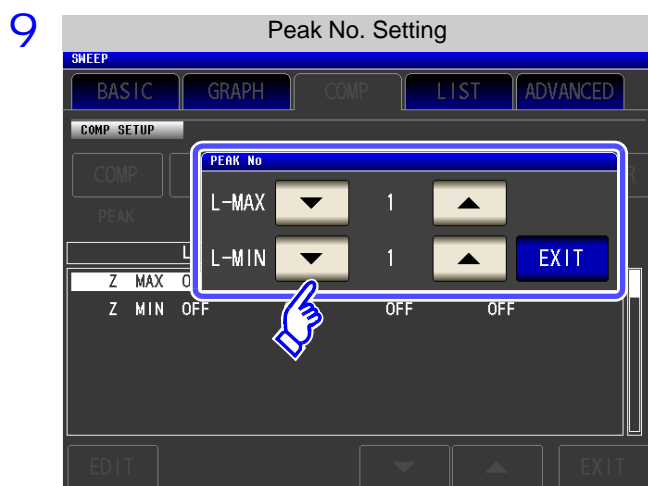

Use or to select the number of the local maximum value or local minimum value for peak judgment.

- L-MAX**
- Select the number of the local maximum value.  
With regards to the numbers, the values are numbered like "1, 2, 3..." in order from the largest measurement value of the detected local maximum values.
  - Settable range: 1 to 5
- L-MIN**
- Select the number of the local minimum value.  
With regards to the numbers, the values are numbered like "1, 2, 3..." in order from the smallest measurement value of the detected local minimum values.
  - Settable range: 1 to 5

See "Search Function Setting" (p. 190)

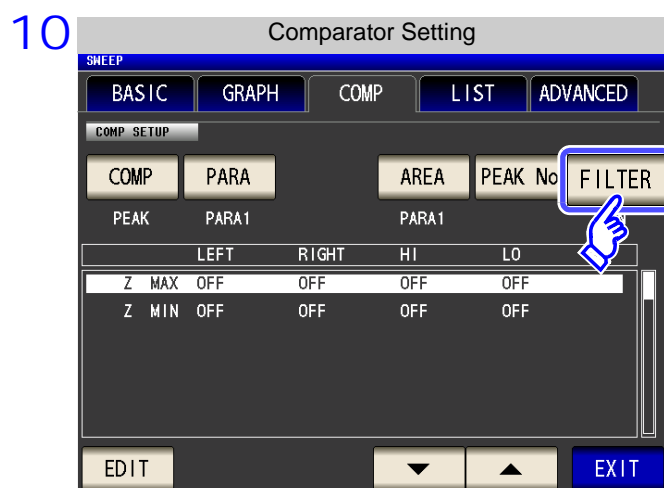

Press to confirm the setting.

Press .

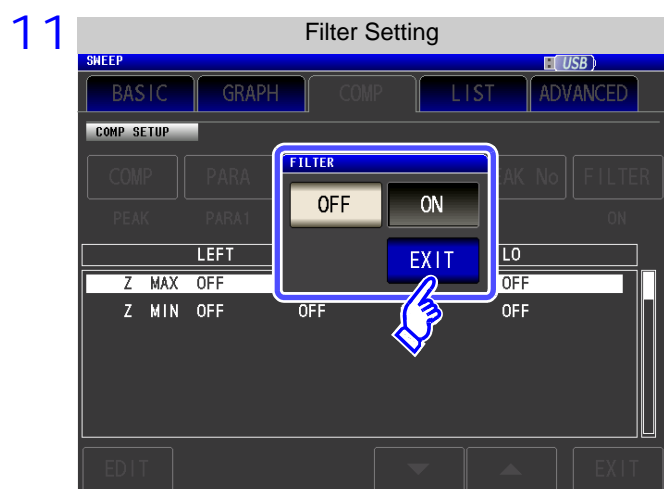

Select enable or disable for the filter.

Disables the filter function.

Enables the filter function.

- Applying a filter allows you to reduce the misjudgments of variations in measurement values caused by noise and other interference being judged as local maximum values or local minimum values.
- The filter setting is synchronized with the filter setting of the cursor setting.

See: "Set the filter." (p. 192)

Press to confirm the setting.

## 5.7 Judging Measurement Results (Comparator Function)

12 Use  or  to select the condition to set for the judgment area.

Select any of the following items for the condition to set for the judgment area.

- Segment No.
- Measurement parameter
- Local maximum value/Local minimum value

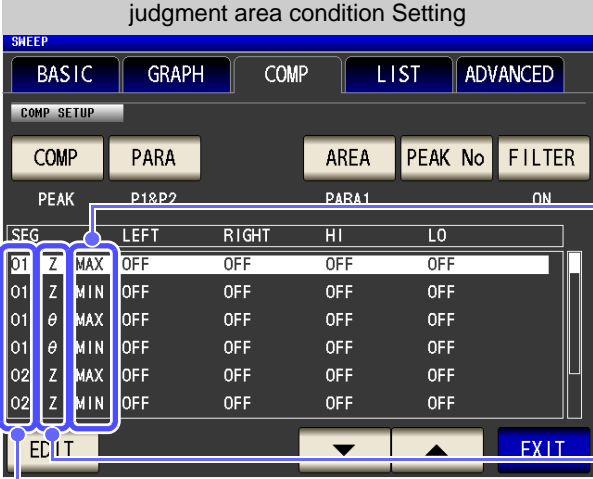

judgment area condition Setting

SWEEP



BASIC GRAPH COMP LIST ADVANCED

COMP SETUP

COMP PARA AREA PEAK No FILTER

PEAK P1&P2 PARA1 ON

SEG	PEAK	P1&P2	LEFT	RIGHT	PARA1	HI	LO
01	Z	MAX	OFF	OFF	OFF	OFF	OFF
01	Z	MIN	OFF	OFF	OFF	OFF	OFF
01	$\theta$	MAX	OFF	OFF	OFF	OFF	OFF
01	$\theta$	MIN	OFF	OFF	OFF	OFF	OFF
02	Z	MAX	OFF	OFF	OFF	OFF	OFF
02	Z	MIN	OFF	OFF	OFF	OFF	OFF

EDIT   EXIT

Local maximum value (MAX), Local minimum value (MIN)

Measurement parameter that is the judgment target

Segment No. for setting the judgment area  
(This is not displayed when the segment function is OFF)

13 Press  and enter the range setting of the selected condition.

## 5.7 Judging Measurement Results (Comparator Function)

### 14 Use the numeric keypad to set the left, right, upper, and lower limit values.

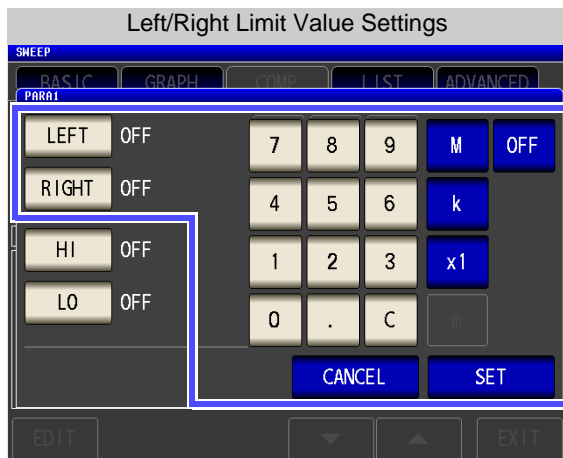

When you do not want to set the left, right, upper, and lower limit values: Press **OFF**.

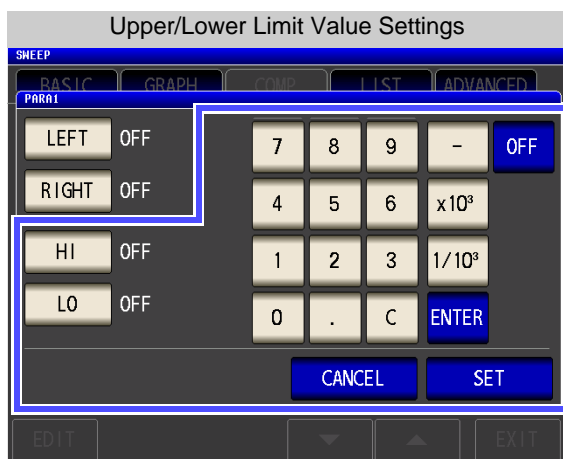

If you make a mistake during input: press **C** to cancel the input and start again.

1. Press **LEFT** and use the numeric keypad to enter the left limit value.

The possible setting range differs depending on the sweep parameter.

Refer to the following for each of the parameters.

- Frequency: (p. 41)
- Open circuit voltage level: (p. 43)
- Voltage level between test sample terminals: (p. 43)
- Current level between test sample terminals: (p. 43)

2. Press a unit key to confirm the setting.

3. Press **RIGHT** and use the numeric keypad to enter the right limit value.

The possible setting range differs depending on the sweep parameter.

Refer to the following for each of the parameters.

- Frequency: (p. 41)
- Open circuit voltage level: (p. 43)
- Voltage level between test sample terminals: (p. 43)
- Current level between test sample terminals: (p. 43)

4. Press a unit key to confirm the setting.

5. Press **HI** and use the numeric keypad to set the upper limit value.

Settable range: -9.999999G to 9.999999G

6. Press **ENTER** to confirm the setting.

7. Press **LO** and use the numeric keypad to set the lower limit value.

Settable range: -9.999999G to 9.999999G

8. Press **ENTER** to confirm the setting.

9. Press **SET** to confirm the setting.

When you do not want to set a judgment area: Press **OFF**.

When you want to cancel the setting:

Press **CANCEL**.

## 5.7 Judging Measurement Results (Comparator Function)



When Editing Local Minimum Value

SHEEP

BASIC GRAPH COMP LIST ADVANCED



COMP SETUP

COMP PARA AREA PEAK No FILTER

PEAK	PARA1	PARA1	ON
SEG	LEFT	RIGHT	HI LO
01	Z MAX	OFF	OFF OFF
01	Z MIN	OFF	OFF OFF
02	Z MAX	OFF	OFF OFF
02	Z MIN	OFF	OFF OFF
03	Z MAX	OFF	OFF OFF
03	Z MIN	OFF	OFF OFF

EDIT

EXIT

Use  or  to select the local minimum value (MIN) you want to edit, and press .

Set the left, right, upper, and lower limit values in the same way.

Press  to return to the measurement screen.

- 15 The comparator range, overall judgment indication, and details of the judgment result are displayed in the graph.

### When the judgment result is NG

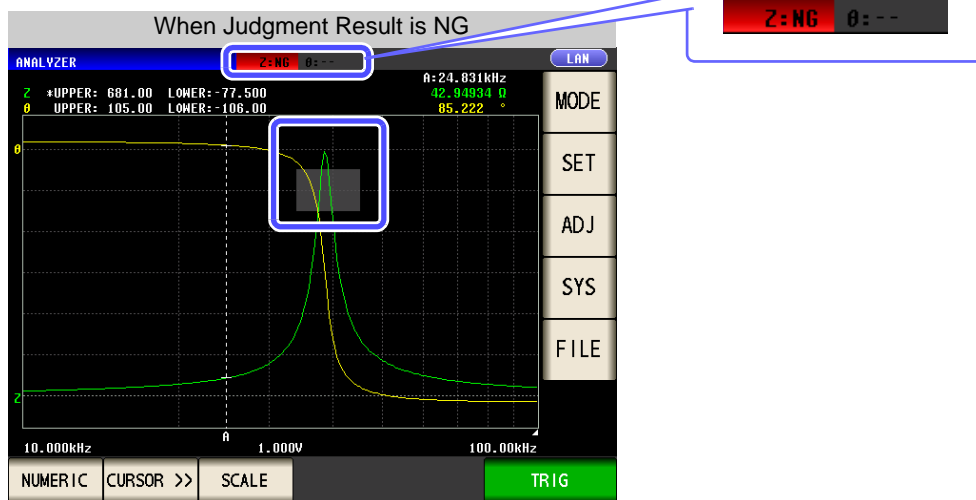

5.7 Judging Measurement Results (Comparator Function)

When the judgment result is IN

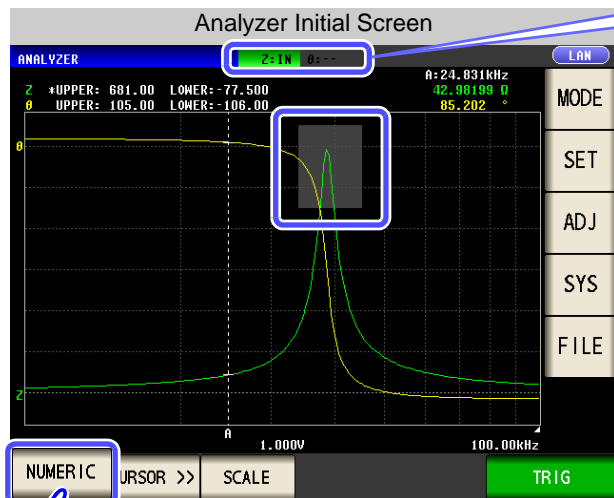

Z: IN θ: --

When you want to display details of the judgment result

Press **NUMERIC**.

Measurement Result List

FREQ[Hz]	Z[Ω]	θ[°]
88.105k	22.93491	-88.537
89.125k	22.53627	-88.548
90.157k	22.14758	-88.558
91.201k	21.77023	-88.569
92.257k	21.40124	-88.578
93.325k	21.04232	-88.586
94.406k	20.69201	-88.594
95.499k	20.35536	-88.601
96.605k	20.01730	-88.608
97.724k	19.69335	-88.618
98.855k	19.37543	-88.619
100.00k	19.06646	-88.624

MODE  
SET  
ADJ  
SYS  
FILE

COMP TRIG

Press **COMP**.

Judgment Result Details Display

SEG	JUDGE	POINT	VALUE
01 Z MAX	IN	7.4131kHz	9.989475GΩ
01 Z MIN	HI	841.40kHz	2.891605MΩ
01 θ MAX	LT	31.623kHz	179.798 °
01 θ MIN	LO	407.38kHz	-178.462 °
02 Z MAX	LT	7.4131kHz	8.603397GΩ
02 Z MIN	---		
02 θ MAX	LO	72.444kHz	179.384 °
02 θ MIN	??		

MODE  
SET  
ADJ  
SYS  
FILE

GRAPH TRIG

Display details of the judgment result.  
See "Viewing Details of the Judgment Result" (p. 216)

5.7 Judging Measurement Results (Comparator Function)

Viewing Details of the Judgment Result

Whether the peak value set in "Peak Judgment" (p. 208) is within the judgment area is indicated as shown below.

Example: When segment sweep

SEG	JUDGE	POINT	VALUE
01	Z MAX	IN	7.4131kHz
01	Z MIN	HI	841.40kHz
01	θ MAX	LT	31.623kHz
01	θ MIN	LO	407.38kHz
02	Z MAX	LT	7.4131kHz
02	Z MIN	---	
02	θ MAX	LO	72.444kHz
02	θ MIN	??	

The gray part is the judgment area. The judgment result indicates the position of the detected peak in relation to the judgment area.

HI-LT	HI	HI-RT
LT	IN	RT
LO-LT	LO	LO-RT

If the peak could not be detected, "??" is displayed.  
If the judgment conditions are not set, "---" is displayed.

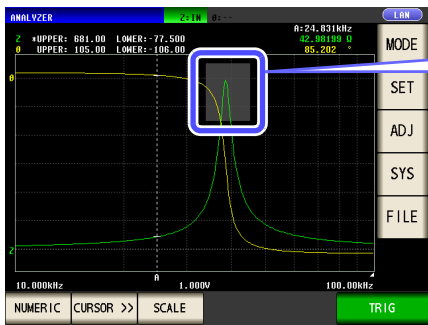

**NOTE**

- When a normal sweep is performed, the segment number is not displayed.
- When the judgment area setting is **OFF**, the judgment result is indicated as [---].
- This is not displayed for area judgment.



## 5.8 Editing Judgment Points

LCR  
ANALYZER

You can edit the setting of each sweep point. For comparator measurement, you can set the upper and lower limit values of each sweep point.

### NOTE

- When the segment function is ON, the settings of judgment points cannot be edited.
- When the setting of the comparator function is **PEAK**, only the settings of the measurement point values can be edited. (The upper and lower limit values of each sweep point cannot be set.)

### Procedure

1

The diagram shows two screens. The first is the 'Analyzer Initial Screen' with a graph and a 'SET' button highlighted. An arrow points to the 'Edit Sweep Point' screen, where the 'LIST' button is highlighted. The 'Edit Sweep Point' screen shows a table of sweep points:

No.	FREQ[Hz]	HI- COMP1( Z) -LO	HI- COMP2( $\theta$ ) -LO
001	1.0000k		
002	1.0351k		
003	1.0715k		
004	1.1092k		
005	1.1482k		
006	1.1885k		
007	1.2303k		
008	1.2735k		
009	1.3183k		
010	1.3646k		

2 When the comparator setting is **OFF**

The 'Edit Sweep Point' screen shows the 'COMP' tab selected. The 'EDIT' button at the bottom left is highlighted with a hand icon.

When the comparator setting is **ON**

The 'Edit Sweep Point' screen shows the 'COMP' tab selected. The 'EDIT' button at the bottom left is highlighted with a hand icon. The table below shows the detailed settings for each sweep point:

No.	FREQ[Hz]	HI- COMP1( Z) -LO	HI- COMP2( $\theta$ ) -LO
001	1.0000k	1.534495	511.4984m 124.3748 41.45828
002	1.0351k	1.587876	529.2920m 124.6692 41.55639
003	1.0715k	1.642670	547.5568m 124.9175 41.63917
004	1.1092k	1.700431	566.8102m 125.1857 41.72857
005	1.1482k	1.759384	586.4614m 125.4863 41.82878
006	1.1885k	1.820463	606.8210m 125.6894 41.89647
007	1.2303k	1.883933	627.9778m 125.9123 41.97076
008	1.2735k	1.949759	649.9198m 126.1546 42.05153
009	1.3183k	2.017317	672.4389m 126.3574 42.11914
010	1.3646k	2.088392	696.1306m 126.5966 42.19888

Use the cursor keys to select the sweep point to edit and then press **EDIT**.



Moves the cursor down by 10 points.



Moves the cursor down by 1 point.



Moves the cursor up by 1 point.



Moves the cursor up by 10 points.

## 5.8 Editing Judgment Points

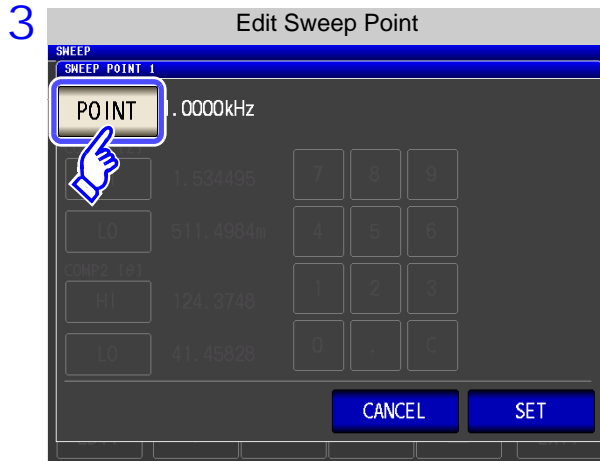

Press **POINT** .

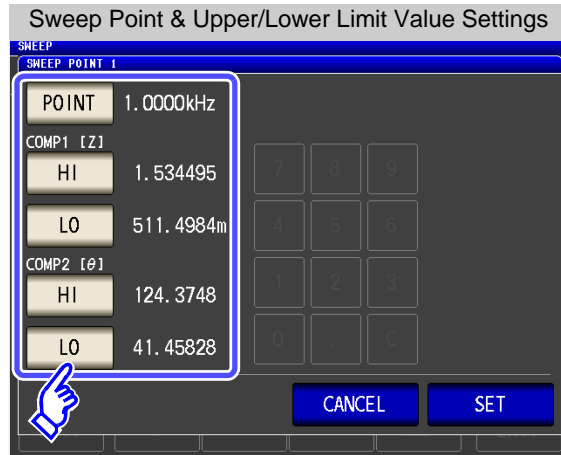

Set each of the following settings.

- POINT** Set the sweep point.
- HI** Set the upper limit value of the comparator.
- LO** Set the lower limit value of the comparator.

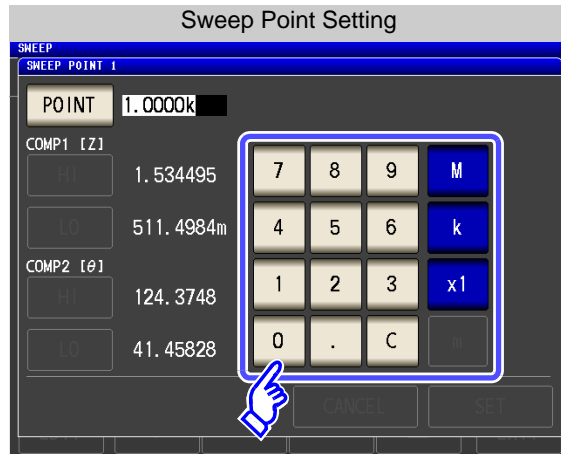
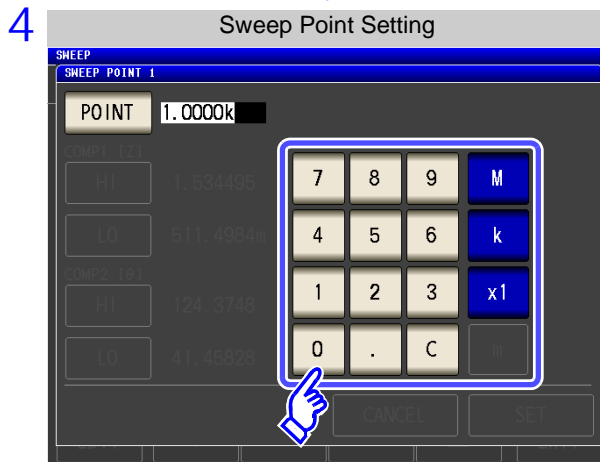

Use the numeric keypad to enter the setting of the sweep point and press a unit key to confirm the setting.

Measurement parameter	Settable range
Frequency	4 Hz to 5 MHz
Open circuit voltage level	0.005 V to 5.000 V
Voltage level between test sample terminals	0.005 V to 5.000 V
Current level between test sample terminals	0.01 mA to 50 mA

Measurement parameter	Settable range
Frequency	4 Hz to 5 MHz
Open circuit voltage level	0.005 V to 5.000 V
Voltage level between test sample terminals	0.005 V to 5.000 V
Current level between test sample terminals	0.01 mA to 50 mA
Upper limit value:	-9.999999G to 9.999999G
Lower limit value:	-9.999999G to 9.999999G

5 Press **SET** to close the setting screen.

When you want to cancel the setting: Press **CANCEL** .

6 Press **EXIT** to close the setting screen.

# 5.9 Application Settings

LCR  
ANALYZER

## 5.9.1 Saving Measurement Results (Memory function)

You can save the measurement results inside the instrument. (Up to 32,000 items) The saved measurement results can be saved to a USB flash drive.

They can also be acquired using a communication command. (The memory function is the same in LCR mode and ANALYZER mode.)

The items saved to memory are in accordance with the :MEASure:VALid setting.

For details on how to acquire the saved measurement results or set :MEASure:VALid, refer to the included CD.

### Saving Measurement Values

#### Procedure

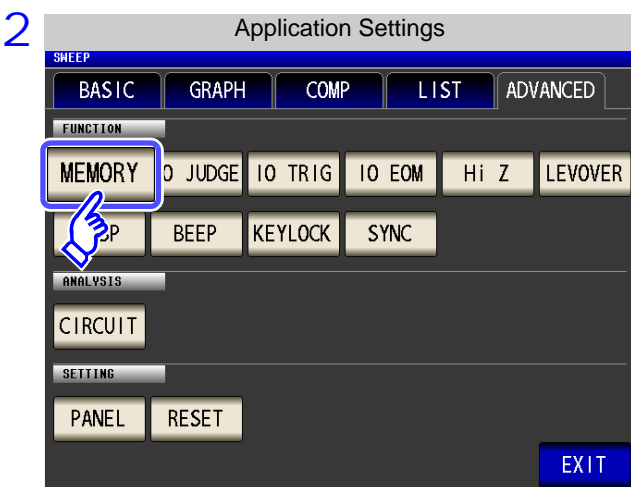
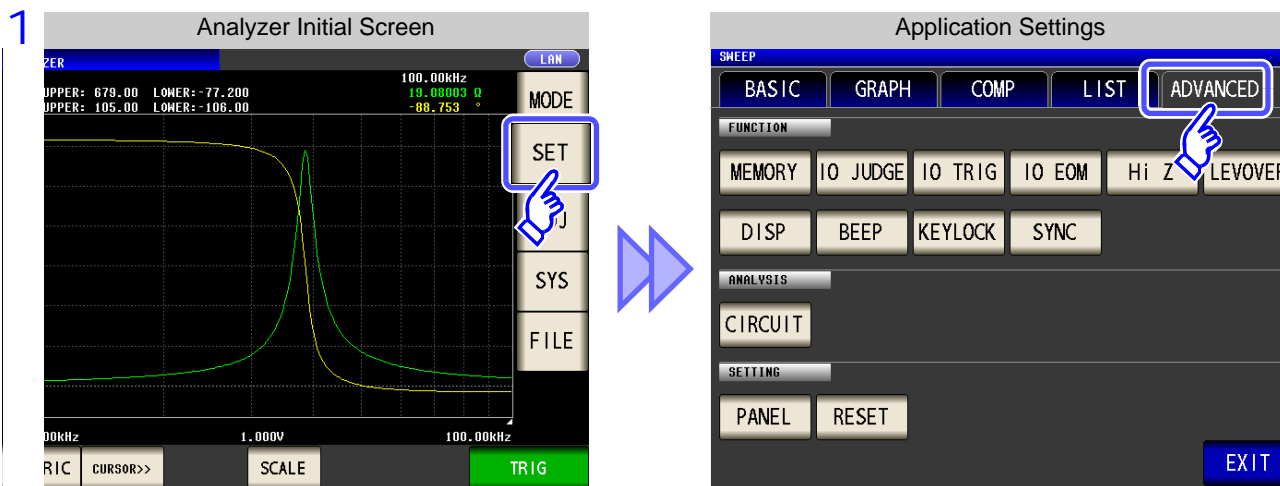

Press MEMORY .

## 5.9 Application Settings

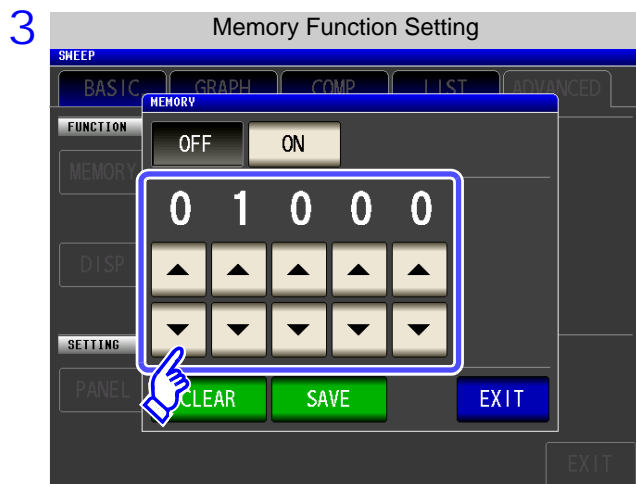

Use or to set the number of measurement results.

Settable range: 1 to 32000

The number of measurement results can only be set when the memory function is set to OFF.

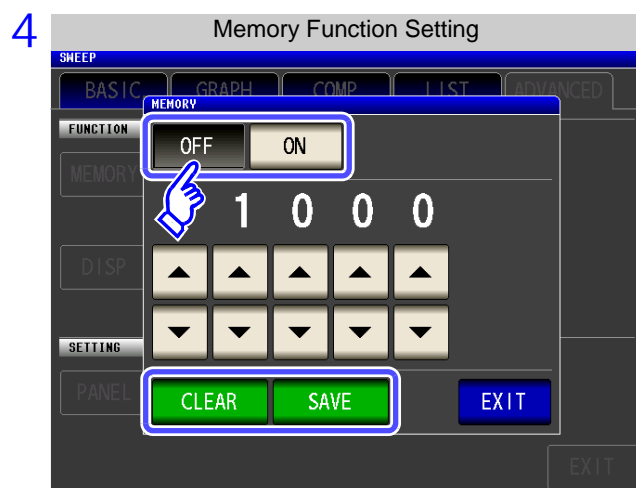

Select ON/OFF for the memory function.

Sets the memory function to OFF.

Saves all measurement values to memory.

Clears all of the saved measurement values from the instrument memory.

Saves the measurement values stored in the instrument memory to a USB flash drive and then clears the measurement values from the instrument memory.

The measurement values are saved to the MEMORY folder in the USB flash drive. The file name is automatically assigned from the date and time.

5 Press to close the setting screen.

## Clearing the Instrument Memory

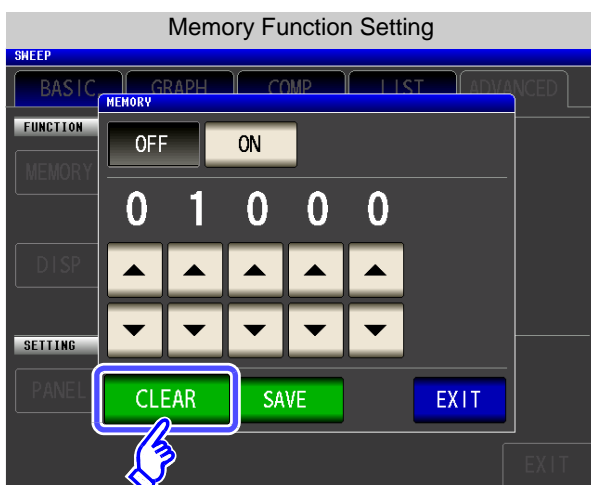

Press to clear the instrument memory.

Saving Data in Instrument Memory to USB Flash Drive

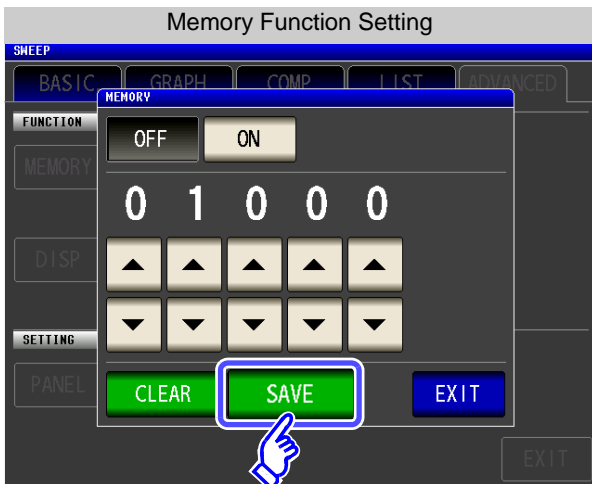

Connect a USB flash drive. (p. 329)

Press **SAVE** to save the data in the instrument memory to a USB flash drive.

When this function is used to save the data in the instrument memory to a USB flash drive, the data is cleared from the instrument memory automatically.

**NOTE**

- If the memory function is set to ON, the number of memory items currently saved is displayed in the measurement screen.

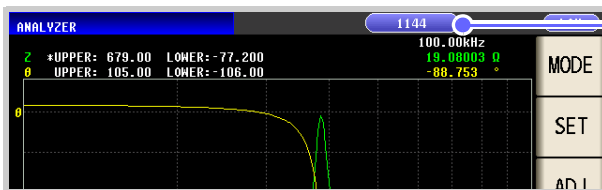

Indicates that the number of memory items currently saved is 1,144.

- Save the data stored in the instrument to a USB flash drive or acquire it with the **:Memory?** command.
- The data in the instrument memory is lost when the memory function setting is changed.
- When the instrument memory becomes full, the following message appears on the measurement screen.

If this message appears, subsequent measurement results will not be saved. To resume saving, load or clear the measurement results from the instrument memory.

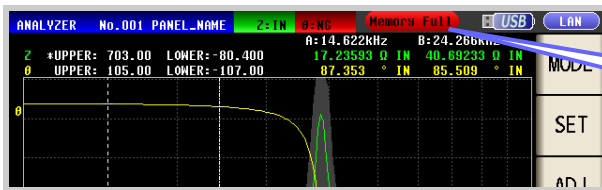

**Memory Full**

5.9 Application Settings

5.9.2 Detecting OPEN during 2-terminal Measurement (HIGH-Z Reject Function)

This function is for outputting a measurement terminal connector error when the measurement result is high relative to the set judgment reference value. The setting value can be set as an absolute value, and the error is output via the EXT I/O.

See "Chapter 11 External Control" (p. 363)

The judgment reference is calculated from the nominal value (range name) of the current measurement range and the judgment reference value as shown below.

$$\text{Judgment reference} = \text{Nominal value of current measurement range} \times \text{Judgment reference value (\%)}$$

Example Current measurement range: 30 kΩ  
Judgment reference value: 150%  
Judgment reference = 30 k × 1.50 = 45 k

Procedure

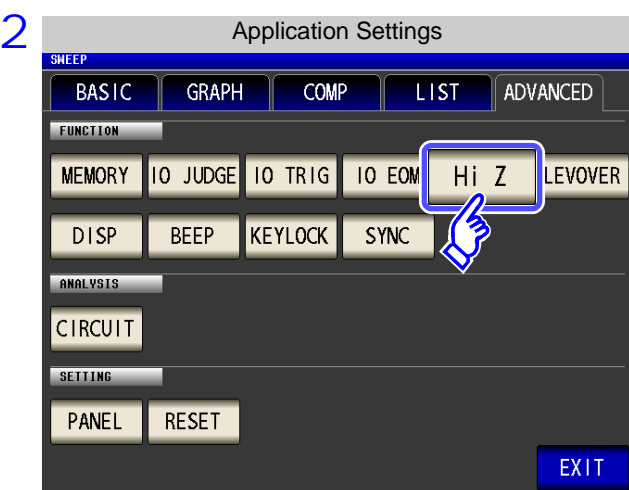
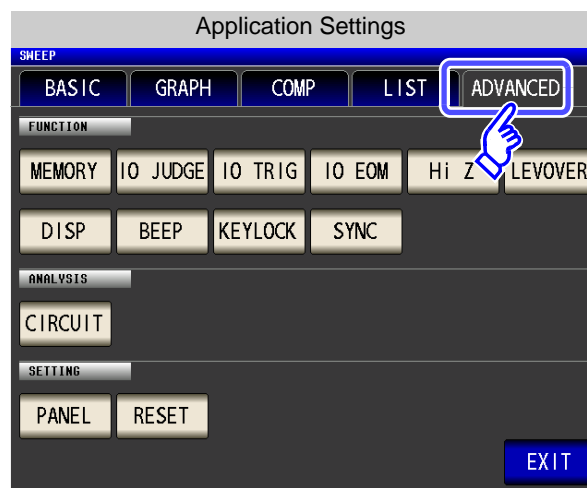
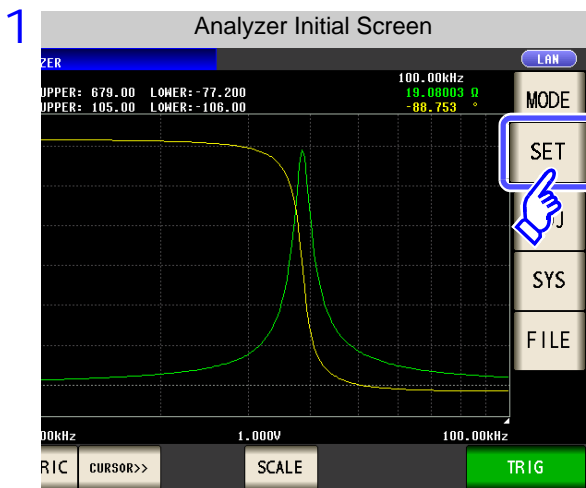

Press  .

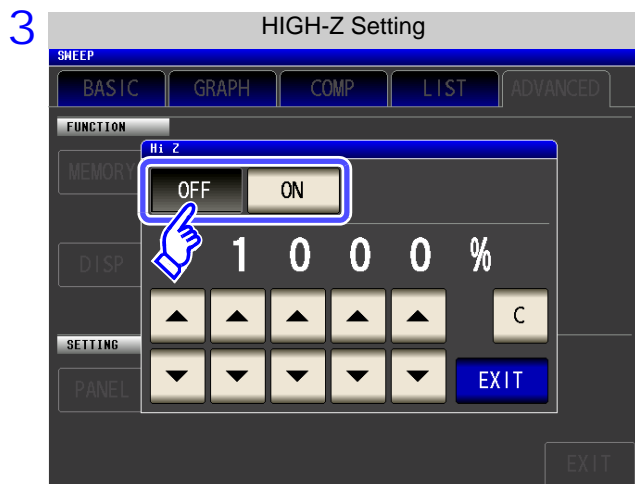



Select ON/ OFF for the HIGH-Z reject function.

**OFF** Sets the HIGH-Z reject function to OFF.

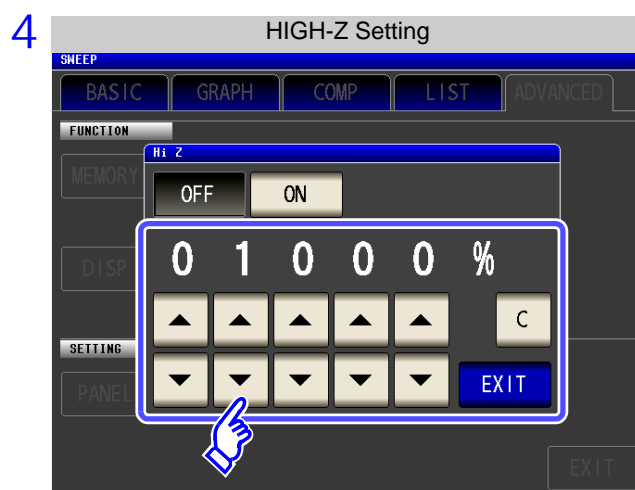
**ON** Sets the HIGH-Z reject function to ON.



Use  or  to set the judgment reference value.

Settable range: 0% to 30000%

- A ratio is set using the range name as the reference value.  
Example: When using the 1 k $\Omega$  range, a ratio to the value of 1 k $\Omega$  is set.
- If you make a mistake during input:  
press  to cancel the input and start again.

5 Press **EXIT** to close the setting screen.

### 5.9.3 Setting the Detection Sensitivity for Measurement Errors (Overflow or Underflow)

The instrument monitors the detectable range of the measurement signals (voltage and current) during measurement, and displays a measurement error (OVERFLOW or UNDERFLOW) if that range is exceeded. However, if measurement is performed under a noisy environment, the detection range may be exceeded resulting in a measurement error regardless of whether an appropriate measurement range is set. Under normal circumstances, the countermeasures described in "Appendix 4 Countermeasures Against Incorporation of External Noise"(p. A5) need to be taken but if a measurement error occurs even after taking the countermeasures, increase the setting value which defines the error of the measurement signal to reduce the detection sensitivity for measurement errors so that you can reduce the frequency of measurement error occurrence.

#### Procedure

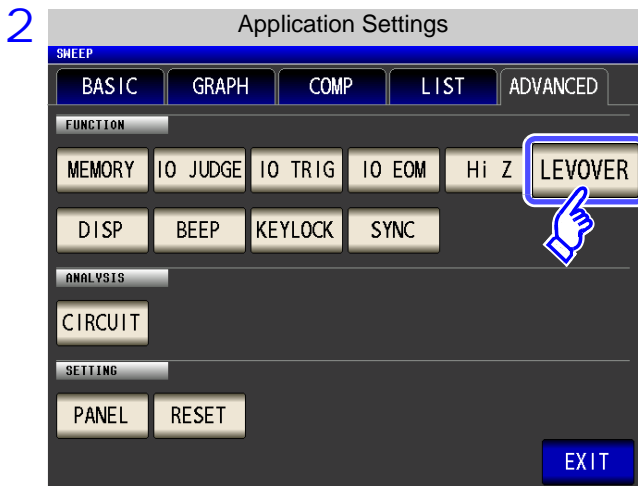
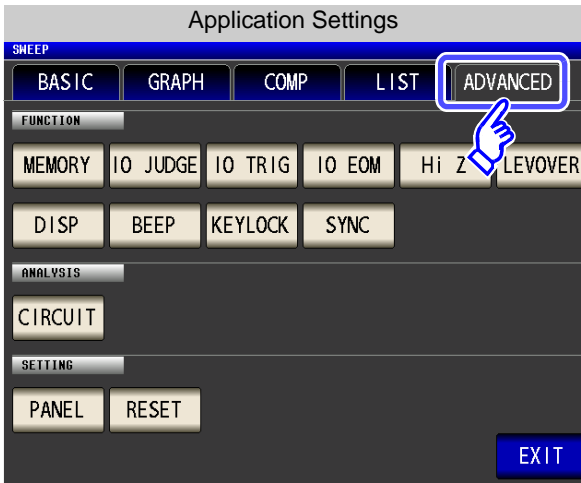
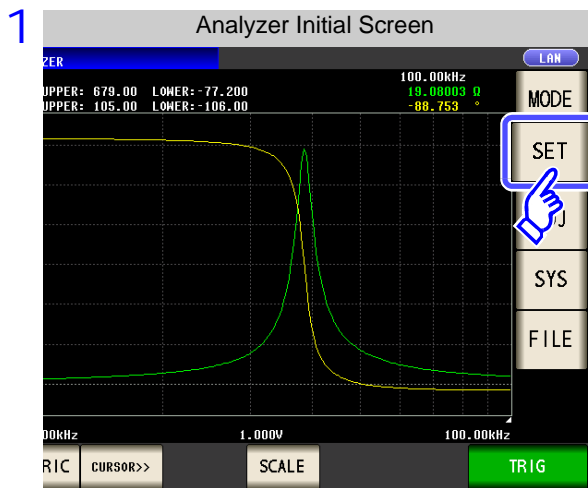

Press **LEVOVER**.



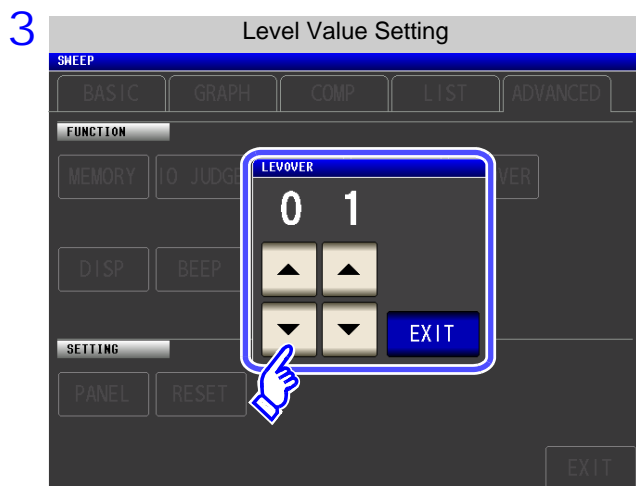

Use  or  to enter the level value.

Settable range: 1 to 32

4 Press  to close the setting screen.

### NOTE

The higher the setting value, the greater the measurement errors. If the setting value is set to 2 or higher, the accuracy specifications may not be able to be satisfied. Furthermore, shifting to the most suitable range may not occur during auto range operation.

## 5.9.4 Setting the Delay Time from the Output of Comparator Judgment Results until Output of EOM (LOW) and Resetting Judgment Results

You can set the delay time for the period from the output of the comparator and BIN judgment results until the output of EOM (LOW) from the EXT I/O. You can also set whether to reset the comparator and BIN judgment results simultaneously with the measurement start signal.

See "11.2 Timing Chart" (p. 369)

**Procedure**

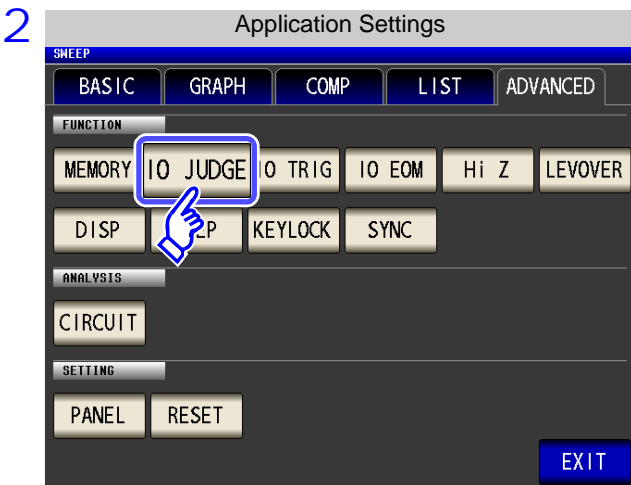
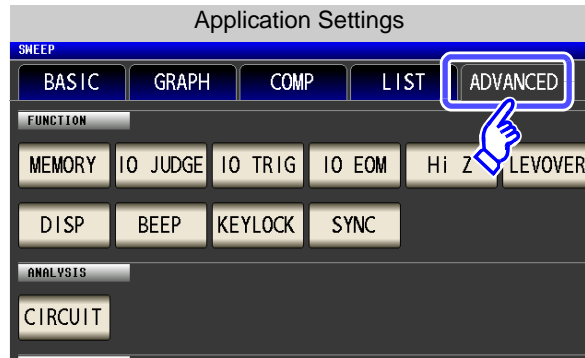
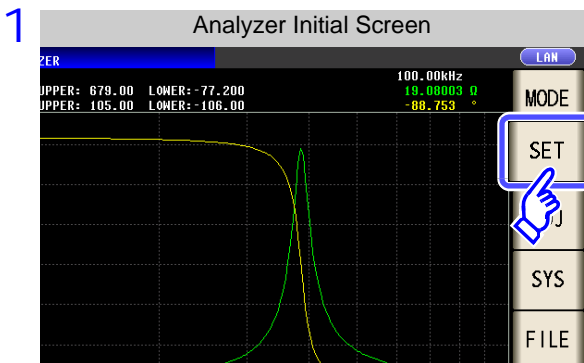

Press **IO JUDGE**.

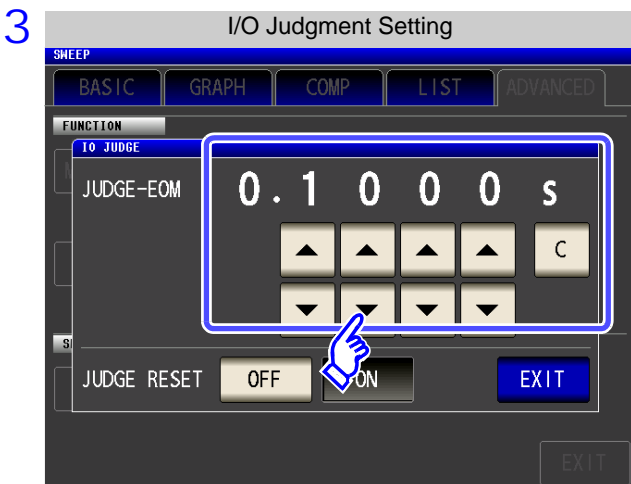

Use **▲** or **▼** to set the delay time for the period from the output of the comparator judgment results until the output of EOM (LOW).

Settable range: 0.0000 s to 0.9999 s

If you make a mistake during input:  
press **C** to cancel the input and start again.

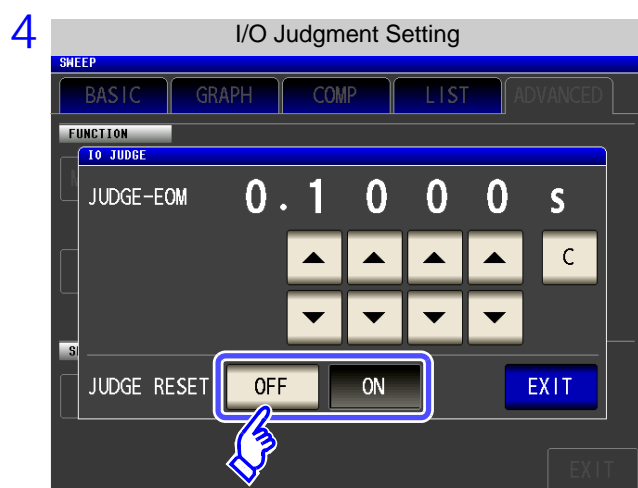

Select whether to reset the comparator judgment results simultaneously with the measurement start signal.

- OFF** Stores the last judgment results until the next judgment results are output.
- ON** Resets the judgments results at the time of the measurement start signal.

5 Press **EXIT** to close the setting screen.

### 5.9.5 Enabling Trigger Input for during Measurement and Setting the Valid Edge of Trigger Input

You can select whether to enable or disable trigger input from the EXT I/O during measurement (during  $\overline{EOM}$  (HI) output after trigger is received). Furthermore, you can also select either the rising edge or falling edge as the valid edge of trigger input from the EXT I/O.

See "11.2 Timing Chart" (p. 369)

**Procedure**

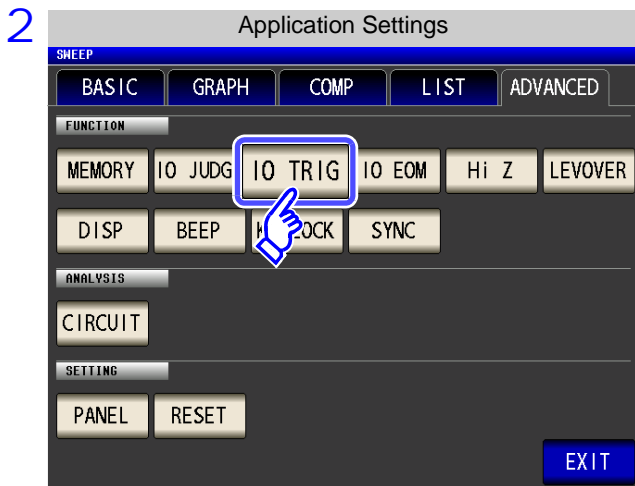
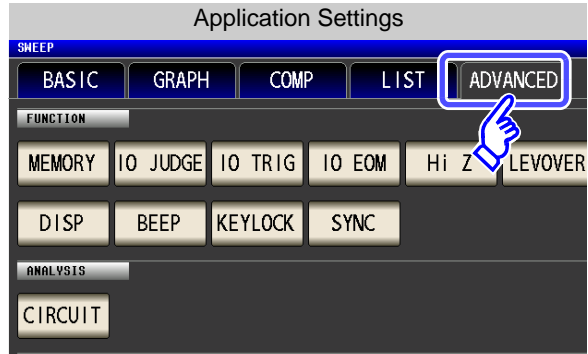
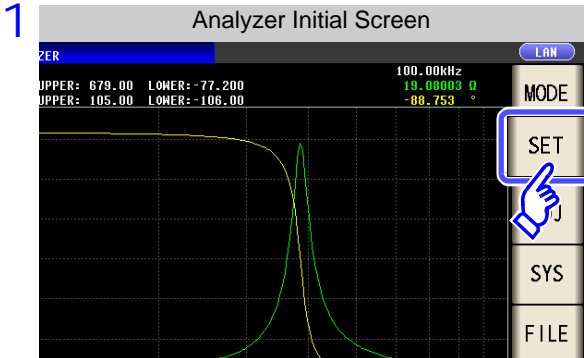

Press **IO TRIG**.

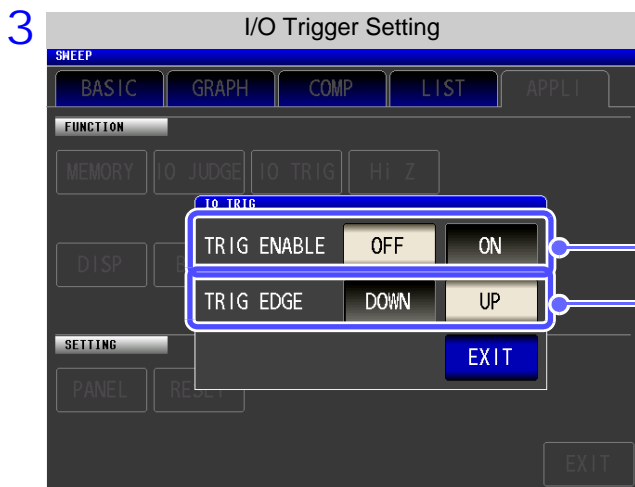

Select the I/O trigger function setting.

- OFF** Disables trigger input from the EXT I/O during measurement (during  $\overline{EOM}$  (HI) output after trigger is received).
- ON** Enables trigger input from the EXT I/O during measurement (during  $\overline{EOM}$  (HI) output after trigger is received).
- DOWN** Sets the falling edge as the valid edge of trigger input.
- UP** Sets the rising edge as the valid edge of trigger input.

4 Press **EXIT** to close the setting screen.

### 5.9.6 Setting the EOM Output Method

The higher the measurement frequency, the shorter the time that  $\overline{\text{INDEX}}$  and  $\overline{\text{EOM}}$  are high (off). When the high (off) time is too short due to characteristics of the input circuit, the instrument can be configured to maintain the low (on) state for a preset time once  $\overline{\text{EOM}}$  changes to low (on) before reverting the signal to high (off) after the completion of measurement. The  $\overline{\text{INDEX}}$  output method can be changed in the same manner.

See "Chapter 11 External Control" (p. 363)

**Procedure**

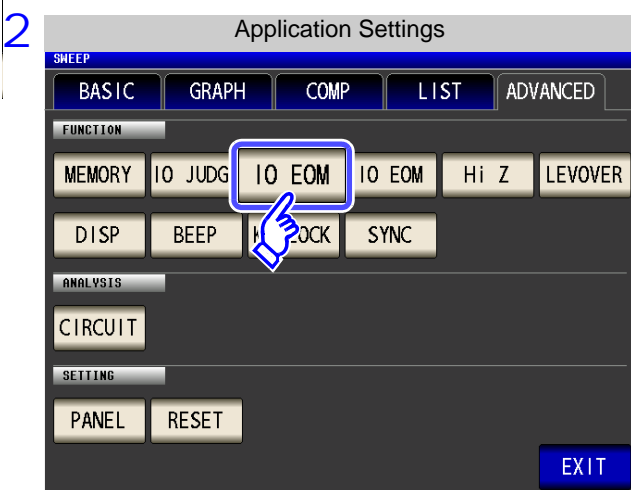
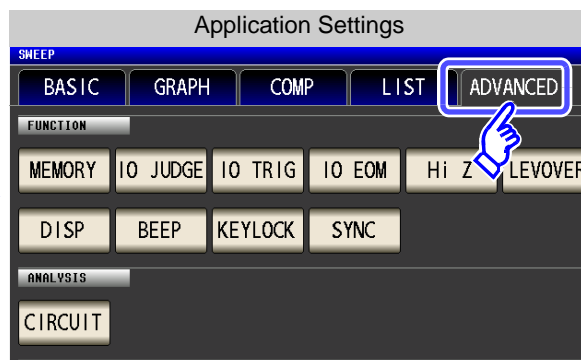
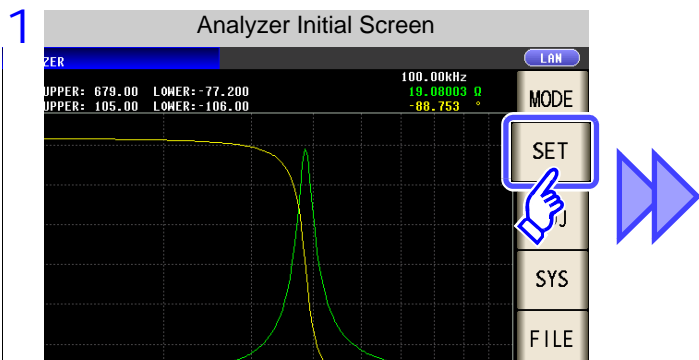

Press **IO EOM**.

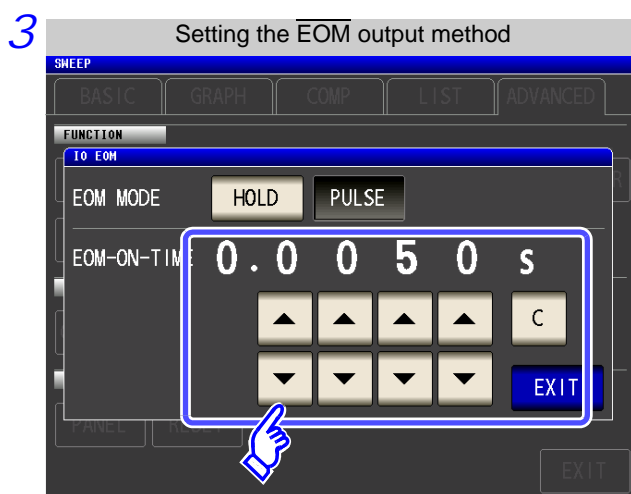

**Setting the output method.**

For HOLD and PULSE timing charts, see "Chapter 11 External Control" (p. 363).

Use **▲** or **▼** to set the  $\overline{\text{EOM}}$  output time for the PULSE setting.

Settable range: 0.0001 to 0.9999 s

4 Press **EXIT** to close the setting screen.

### 5.9.7 Disabling Key Operation (Key-lock Function)

If you turn the key-lock function ON, all operations except disabling the key-lock are disabled to protect the settings. You can also set a passcode (security code).

**Procedure**

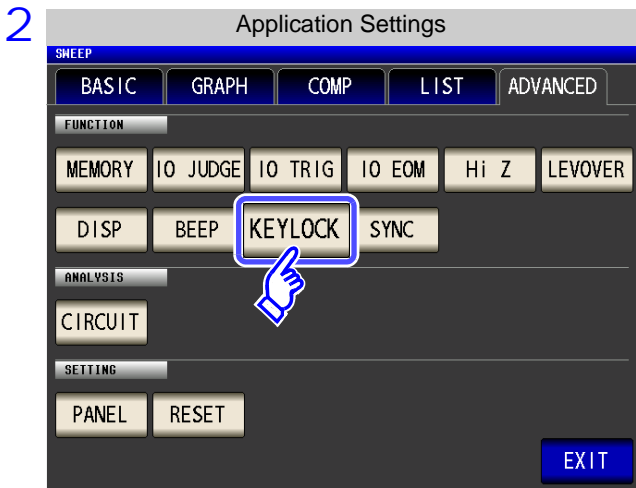
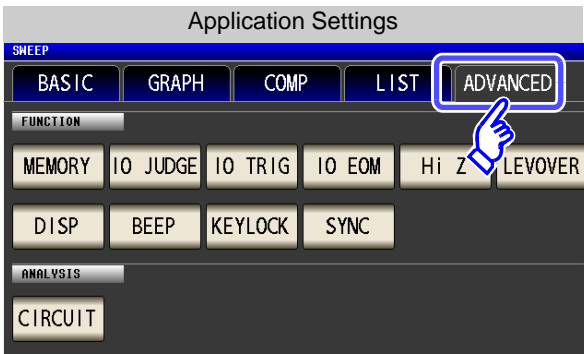
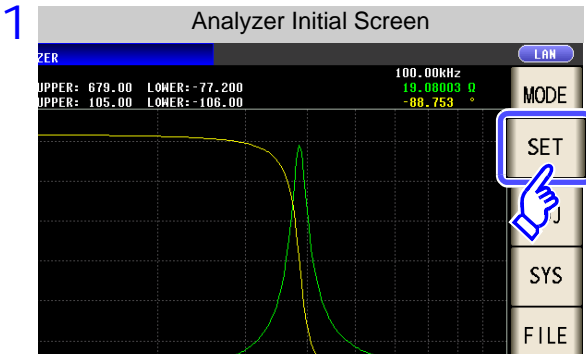

Press **KEYLOCK**.

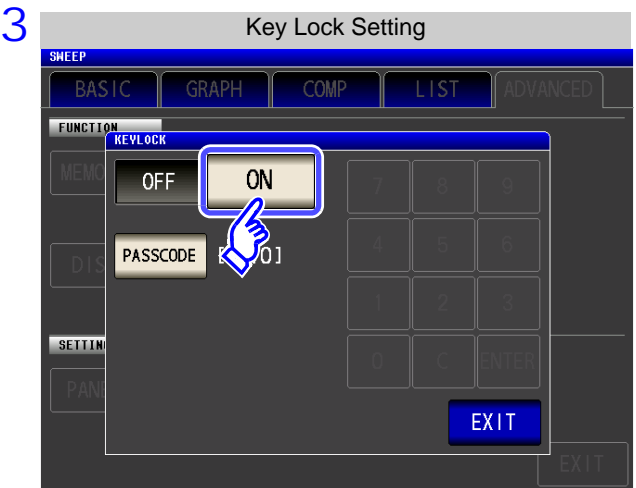

Press **ON**.

4 Press **EXIT** to close the setting screen.

**NOTE**

- In the case of an external trigger, the key lock is not enabled for **TRIG**.
- Turning off the power does not cancel the key-lock function.

Setting the Passcode of the Key-lock

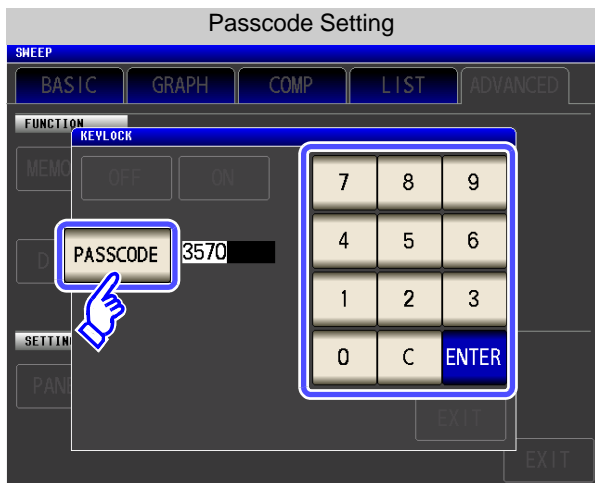

Press **PASSCODE** when the key-lock setting is **ON**.

Use the numerical keypad to enter the passcode, press **ENTER**, and then press **EXIT**.

Settable range: 1 to 4 digits

**NOTE** If a passcode is set, it needs to be entered to disable the key-lock. Take care not to forget the set passcode.

Disabling the Key-lock

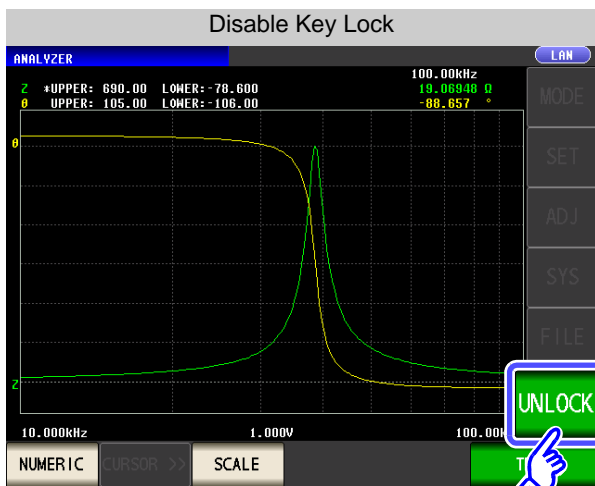

Press **UNLOCK** when the key-lock is enabled.

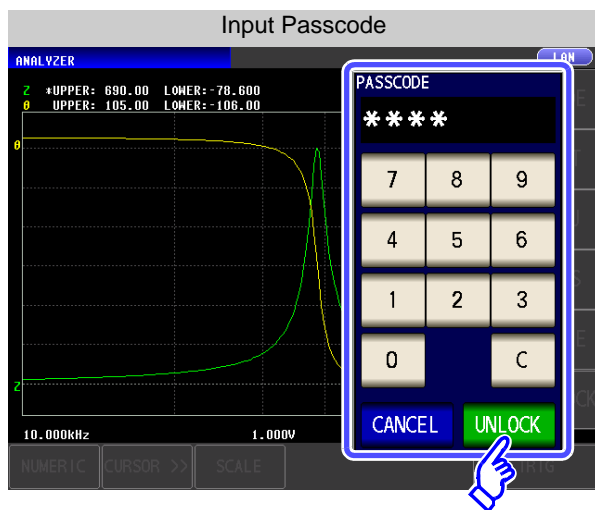

When a passcode is set

Enter the passcode and press **UNLOCK**.

The entered passcode is indicated as \* on the screen.

(To cancel input: Press **C**)

When a passcode is not set

Press **UNLOCK**.

When you want cancel the disabling of the key-lock: Press **CANCEL**.

## 5.9 Application Settings

**NOTE** If you forget the passcode, perform a full reset to restore the instrument to the factory default settings.(p. 406)

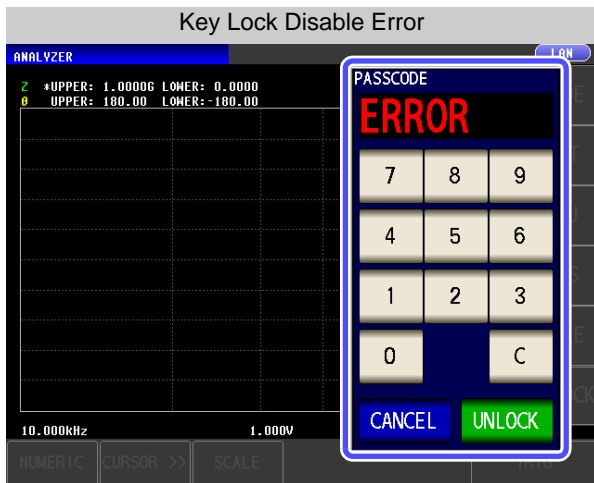

If the error indication shown on the left appears, check the following items.

Cause	Remedy
<b>UNLOCK</b> was pressed before you entered the passcode.	Press <b>C</b> and enter the passcode.
The entered passcode is incorrect.	Press <b>C</b> and enter the passcode again.



## 5.9.8 Setting the LCD to ON/ OFF

You can turn the LCD ON/ OFF.

Setting the LCD to OFF saves power because the LCD turns off if the panel is not touched for 10 seconds.

### Procedure

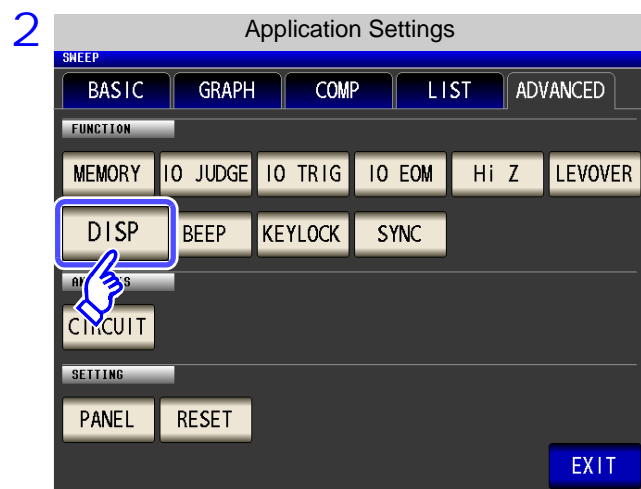
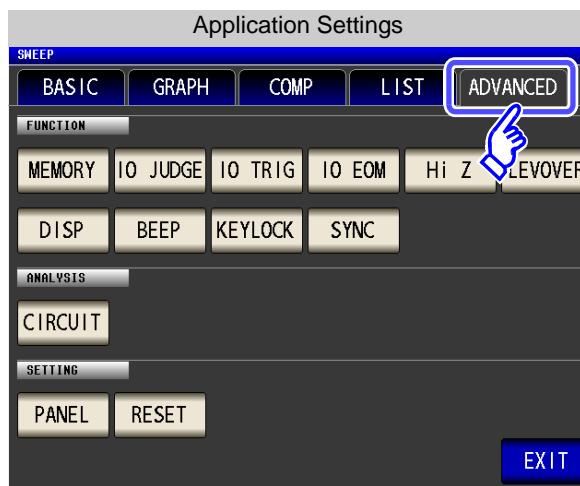
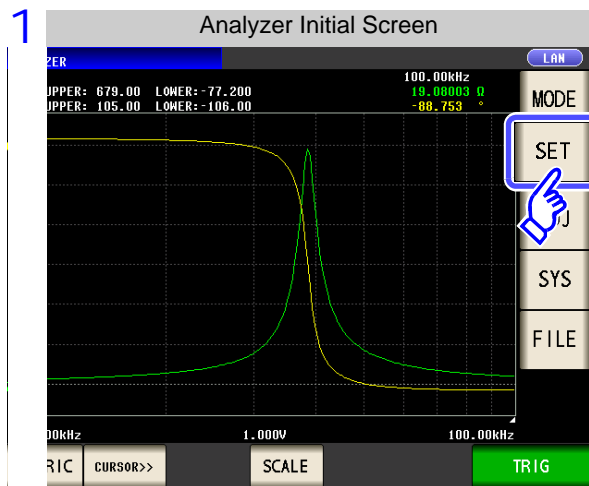

Press **DISP**.

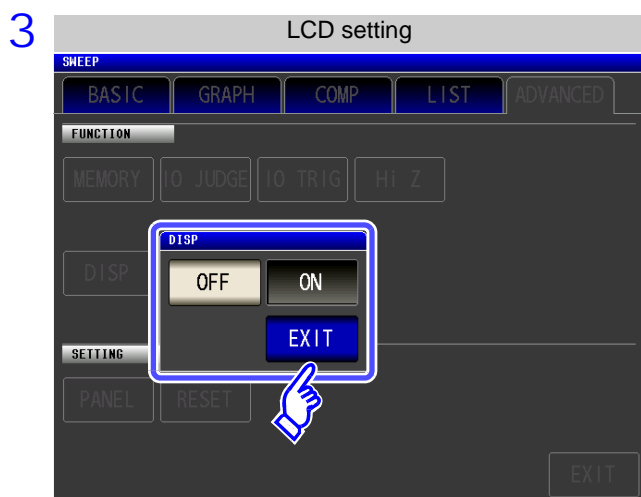

Select the LCD setting, and press **EXIT** to close the setting screen.

- OFF** Turns OFF the LCD. The LCD turns off after approximately 10 seconds elapse since the touch panel was last touched.
- ON** Sets the LCD to always on.

**When you want to turn the backlight on again:**  
If you touch the touch panel while the backlight is off, the backlight will turn on again.

### 5.9.9 Setting Operation Sounds (Beep Sounds)

You can set the operation sound and each of the beep sounds for judgment results.

**Procedure**

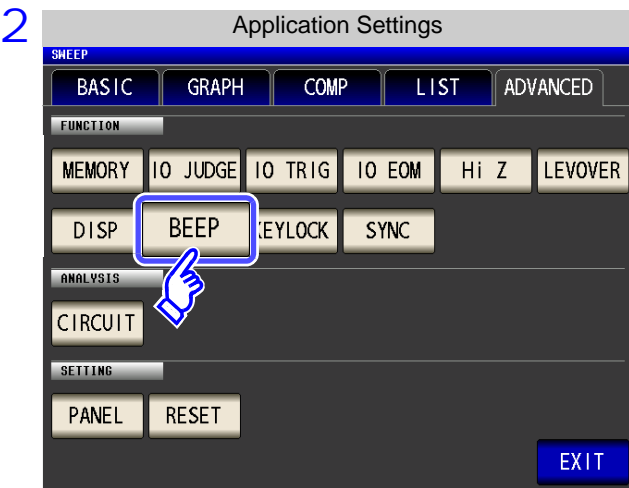
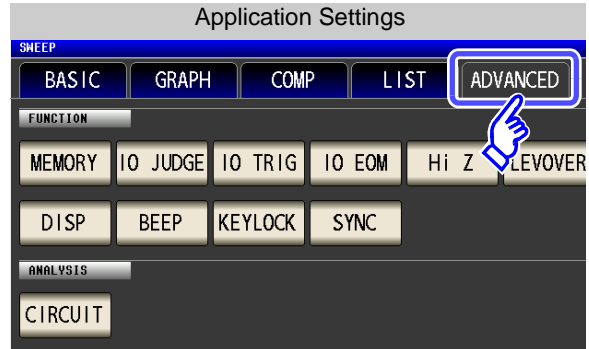
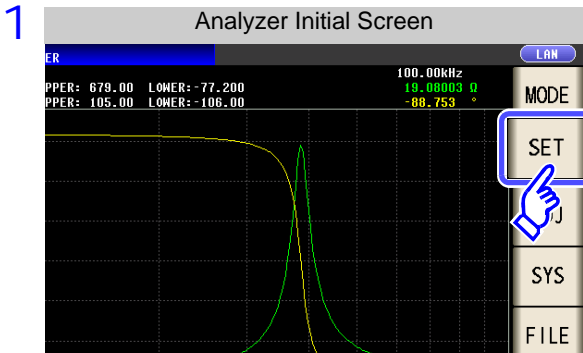

Press **BEEP**.

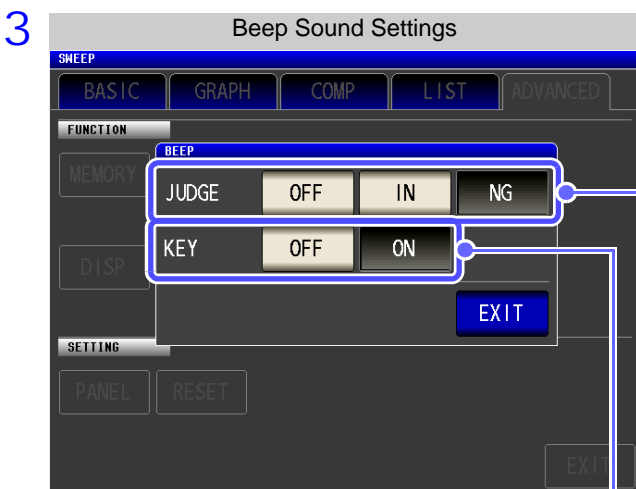

**Beep sound settings for when comparator judgment**

- OFF** When a comparator judgment is made, no beep sound is emitted.
- When judgment performed with 1 comparator
  - IN** When the comparator result is IN, a beep sound is emitted.
  - NG** When the comparator result is LO or HI, a beep sound is emitted.
- When judgment performed with 2 comparators
  - IN** When both of these comparator results are IN, a beep sound is emitted.
  - NG** When either one is LO or HI, a beep sound is emitted.

**Beep sound setting for when key pressed**

- OFF** When a key is pressed, no beep sound is emitted.
- ON** When a key is pressed, a beep sound is emitted.

4 Press **EXIT** to close the setting screen.

### 5.9.10 Applying the Signal to the Sample Only during Measurement (Trigger Synchronous Output Function)

This function enables the measurement signal to be output after measurement is triggered for the initial sweep point only, ensuring that the signal is applied to the sample during measurement only. Thus reducing the generation of heat in the sample and decreasing electrode wear.

**Procedure**

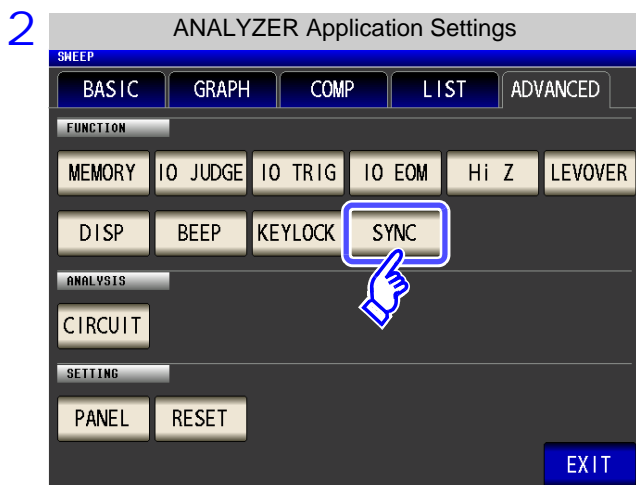
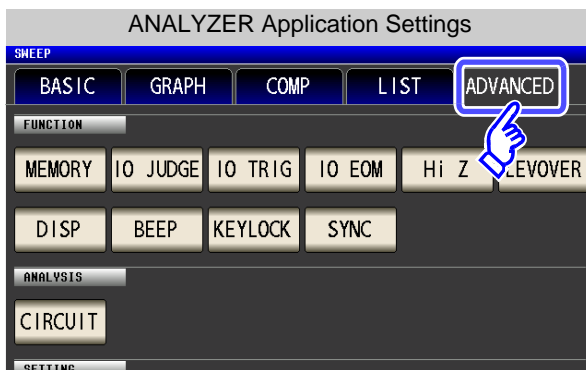
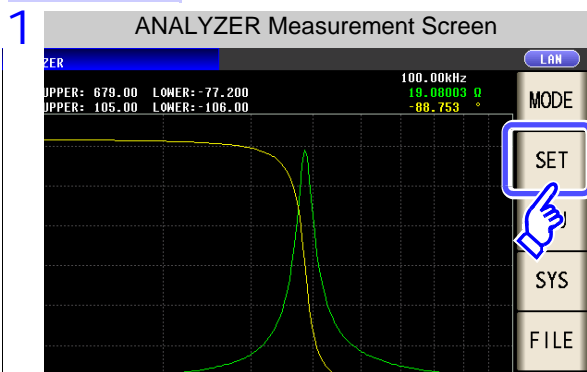

Press **SYNC**.

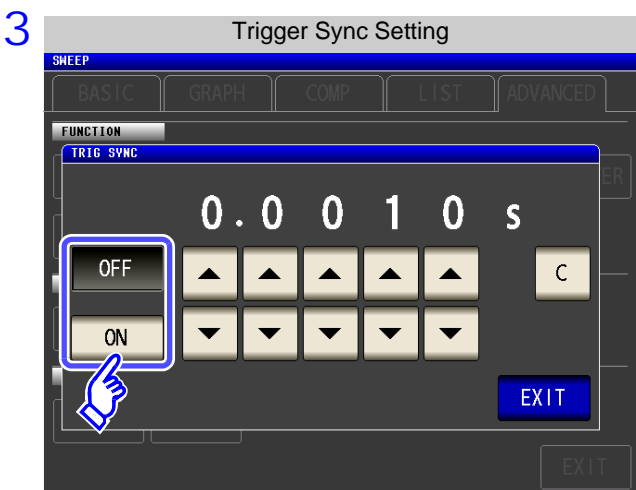

Select **ON/OFF** for the trigger synchronous output function.

- OFF** Disables the trigger synchronous output function.
- ON** Enables the trigger synchronous output function.

## 5.9 Application Settings

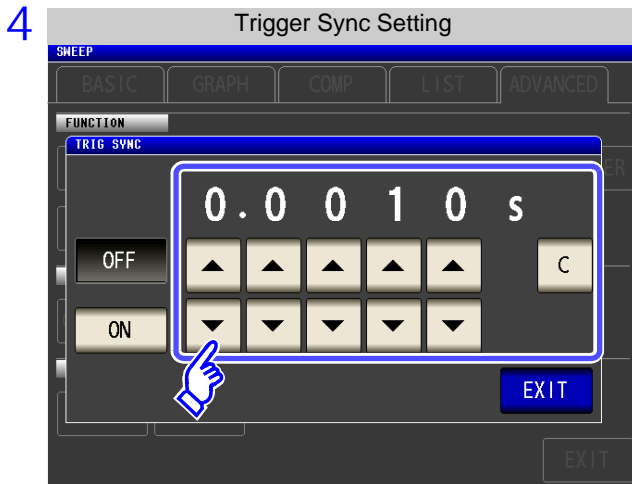

Use or to set the wait time from after the measurement signal is output by applying a trigger to the start of measurement.

Settable range: 0.0010 s to 9.9999 s

When you want to return the time to the initial state: Press .

The set time is set to 0.0010 s.

5 Press to close the setting screen.

### NOTE

- When the trigger synchronous output function is set to ON, there is a measurement time delay because the instrument enters a wait time which spans from when the measurement signal is output to when measurement starts.  
[See "13.3 About Measurement Times and Measurement Speed" \(p. 399\)](#)
- When the trigger synchronous output function is set to ON, the set DC level may be output if a measurement condition is changed.  
Also, output will stop when measurement is performed once.
- The measurement signal is output when the trigger signal is input and stops after measurement ends.
- In CONTINUOUS measurement mode, the measurement signal stops after measurement of the last panel ends.

## 5.9.11 Initializing (System Reset)

In the event of the instrument malfunctioning, check "Before returning for repair" (p. 405).  
 If you do not know the cause of the problem, perform a system reset to restore the instrument to its factory default settings.

A system reset can also be performed with the \*RST and :RESet communication commands.

See Description of communications commands on the included CD

### Procedure

1

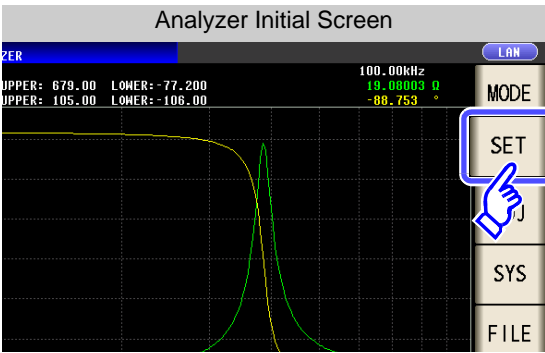
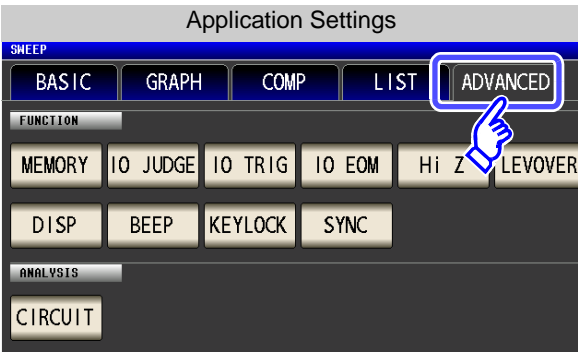

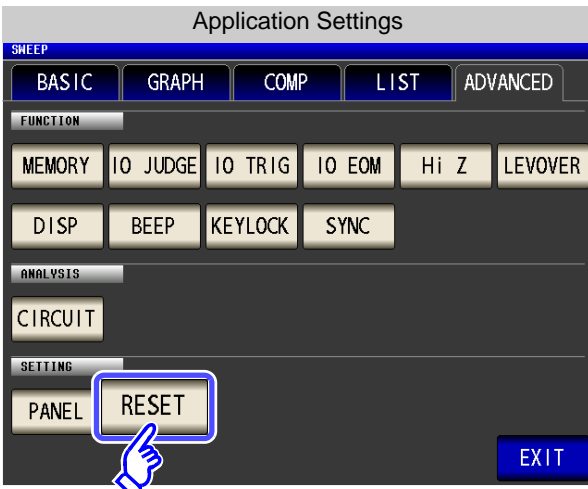

2

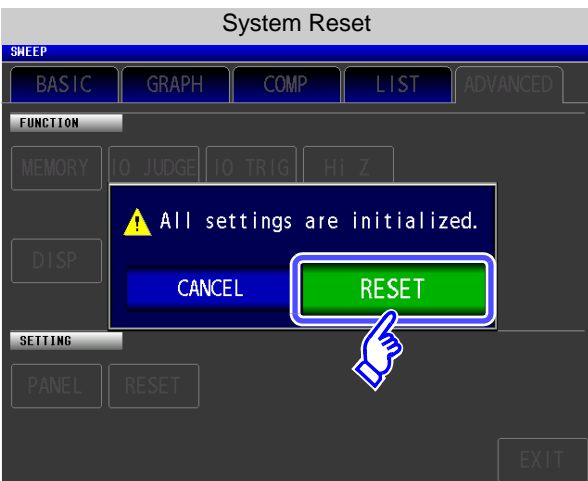

Press **RESET**.

3



Press **RESET** to restore the factory default settings and automatically redisplay the initial screen.

When you want to cancel the system reset:  
 Press **CANCEL**.

**NOTE** If the initialization screen cannot be displayed, perform a full reset. (p. 406)

# 5.10 Equivalent Circuit Analysis Function



## 5.10.1 About the Equivalent Circuit Analysis Function

The optional IM9000 Equivalent Circuit Analysis Firmware is required in order to use the equivalent circuit analysis function. You can verify whether the IM9000 is installed on the Version Confirmation screen.

See "8.2 Checking the Version of the Instrument" (p. 306)

The equivalent circuit analysis function estimates equivalent circuit constants based on measurement results. The IM3570 can estimate 3-element model and 4-element model constants as illustrated below. By using the simulation function, you can display frequency characteristic ideal values using estimation results or user-configured constants.

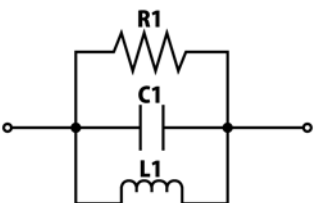
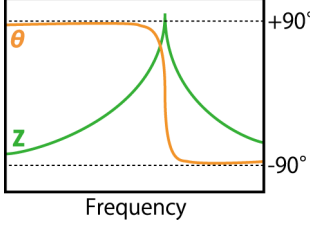
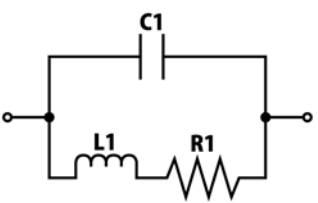
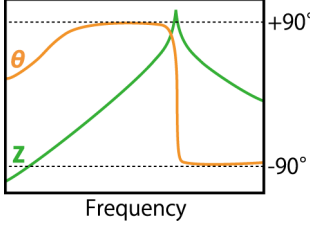
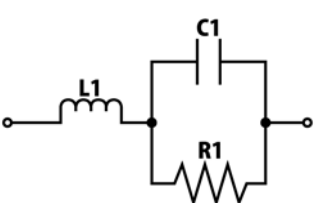
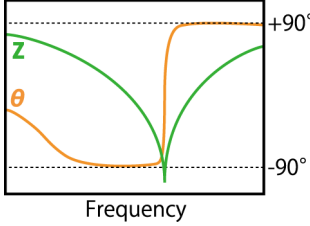
By using the comparator function, you can judge whether estimation results fall inside the judgment area.

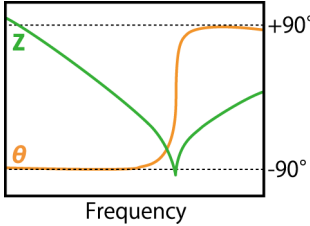
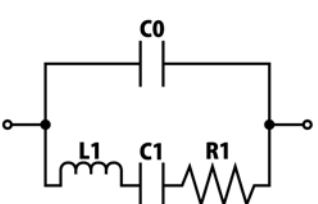
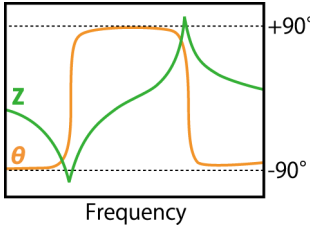
	Equivalent circuit model	Representative frequency characteristics*	Example sample
A			Inductor: Inductor with high core loss and low ESR
B			Inductor: Inductor with comparatively high ESR Resistor: Resistor with low resistance value and significant wiring inductance effect
C			Capacitors: Capacitor with significant leak resistance effect Resistor: Resistor with high resistance value and significant stray capacitance effect
D			Capacitors: Typical capacitor
E			Piezoelectric element

\*Typical frequency characteristics graphs

For models A through D, the horizontal axis is logarithmic, the vertical axis (Z) is logarithmic, and  $\theta$  is linear. For model E, the horizontal axis is linear or logarithmic, the vertical axis (Z) is logarithmic, and  $\theta$  is linear.

## 5.10.2 Configuring Basic Settings for Analysis

### 1 Setting the equivalent circuit model

Select the equivalent circuit model you wish to use for equivalent circuit analysis. By selecting the appropriate equivalent circuit model, you will be able to estimate constants more accurately.

#### Procedure

1

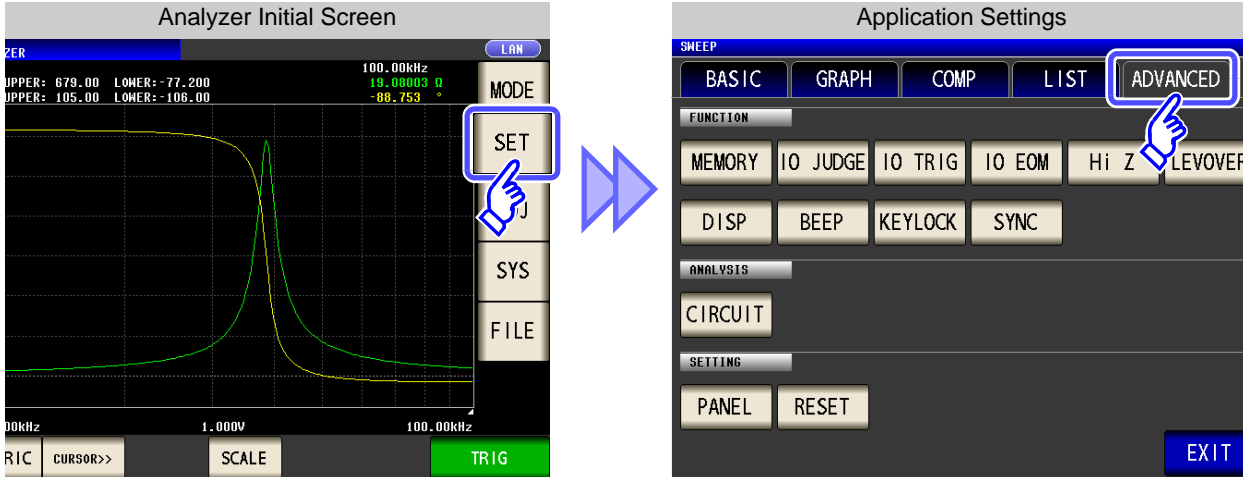

The first step shows the 'Analyzer Initial Screen' with a graph and a 'SET' button highlighted. An arrow points to the 'Application Settings' menu where the 'ADVANCED' tab is selected.

2

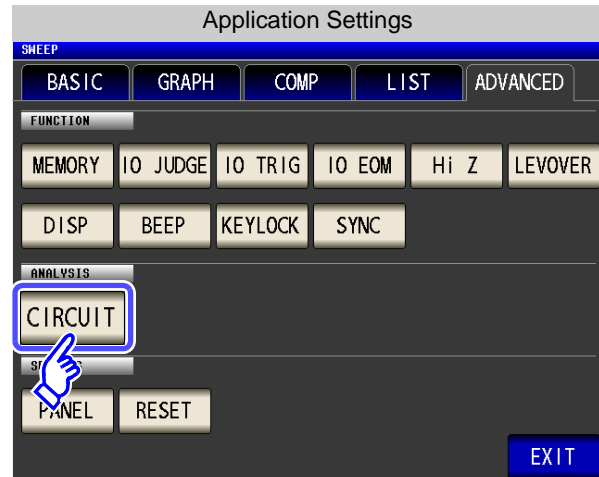

The second step shows the 'Application Settings' menu with the 'CIRCUIT' button highlighted under the 'ANALYSIS' section.

Press **CIRCUIT**.

3

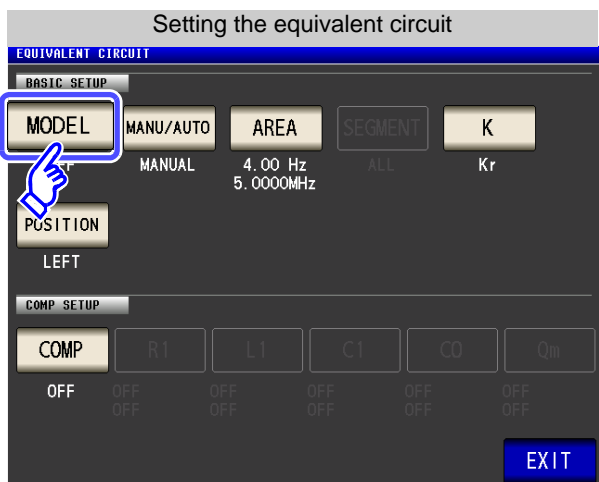

The third step shows the 'Setting the equivalent circuit' screen with the 'MODEL' button highlighted under the 'EQUIVALENT CIRCUIT' section.

Press **MODEL**.

## 5.10 Equivalent Circuit Analysis Function

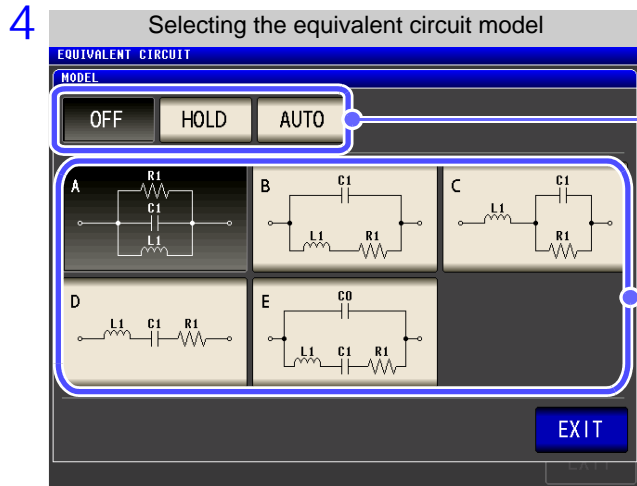

Select the model to use in equivalent circuit analysis.

1. Sets the method used to select the equivalent circuit model.

OFF	Turns off the equivalent circuit function.
HOLD	Selects the equivalent circuit model manually.
AUTO	Automatically selects the optimal equivalent circuit model.

2. Selects the equivalent circuit model to use during

**HOLD** operation.

5 Press **EXIT** to close the setting screen.

### NOTE

- Selecting equivalent circuit models A to E causes the **HOLD** setting to be selected automatically.
- For more information about how to select the equivalent circuit model, see "Appendix 8 Selecting the Equivalent Circuit Model"(p. A12).



### 5.10 Equivalent Circuit Analysis Function

## 2 Setting the method of analysis

This section describes how to set whether to perform equivalent circuit analysis automatically after measurement completes or to wait until **RUN** is pressed.

### Procedure

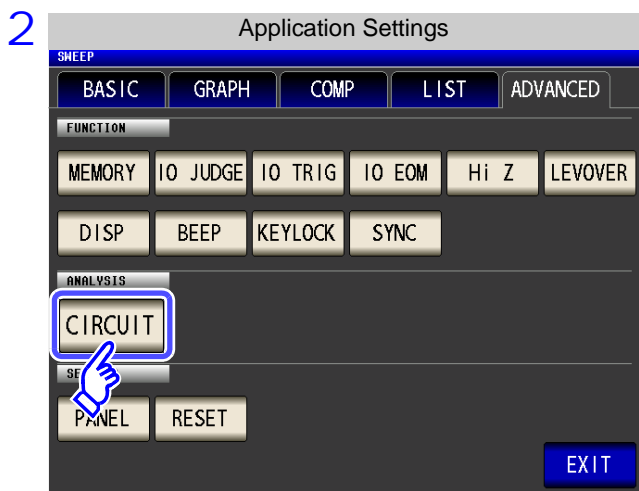
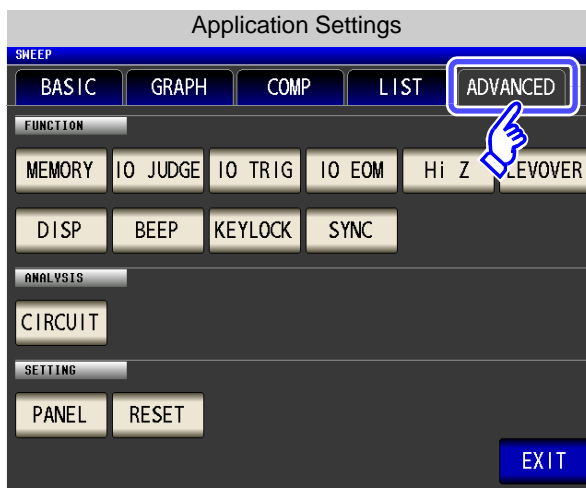
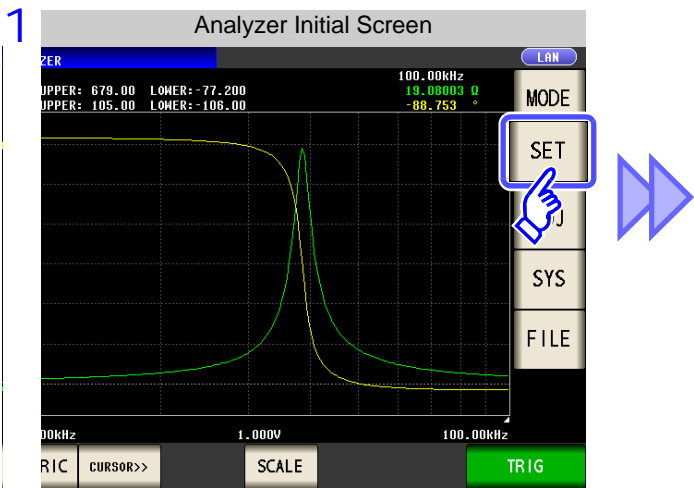

Press **CIRCUIT**.

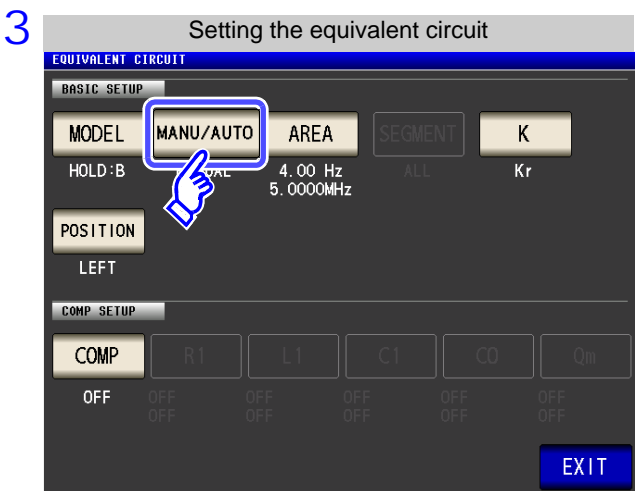

Press **MANU/AUTO**.

## 5.10 Equivalent Circuit Analysis Function

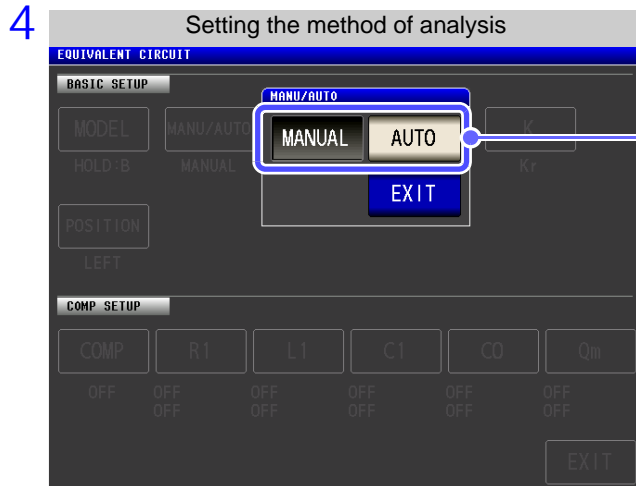

Selects the method of analysis.

MANUAL

Performs analysis when **RUN** is pressed.

AUTO

Performs analysis automatically after measurement completes.

5 Press **EXIT** to close the setting screen.

### NOTE

- **AUTO** is valid only when the trigger is set to "Sequential sweep" or "Step sweep." Analysis will not be performed automatically when the trigger is set to "Repeat sweep."
- Equivalent circuit analysis cannot be performed manually on the Continuous Measurement screen. To perform equivalent circuit analysis during continuous measurement, change the setting to auto and save the panel.

See "5.2.3 Setting the Trigger" (p. 137)

5.10 Equivalent Circuit Analysis Function

3 Setting the frequency range to analyze

This section describes how to set the frequency range for which to perform equivalent circuit analysis when using normal sweep. By using this function, you can limit the local extreme values used in analysis when there are multiple local extreme values in the sweep range. Configure the setting so that the local extreme values are included in the analytical range. This setting is valid only during normal sweep operation.

Procedure

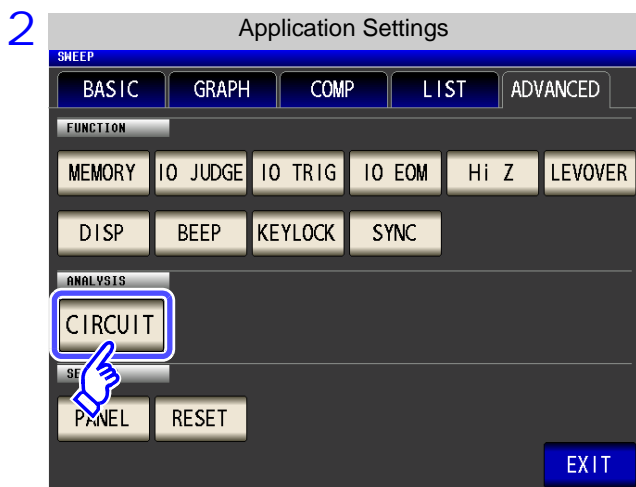
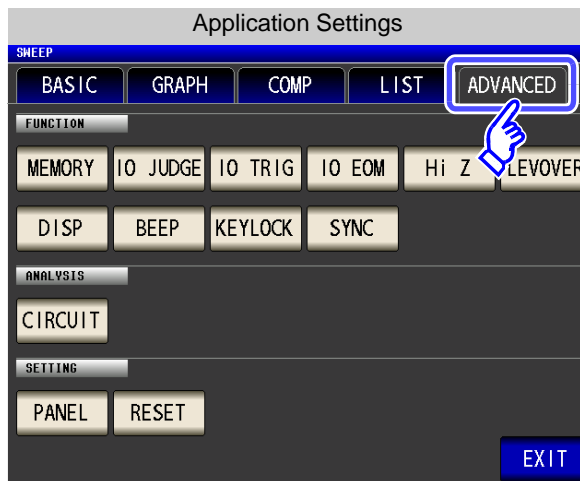
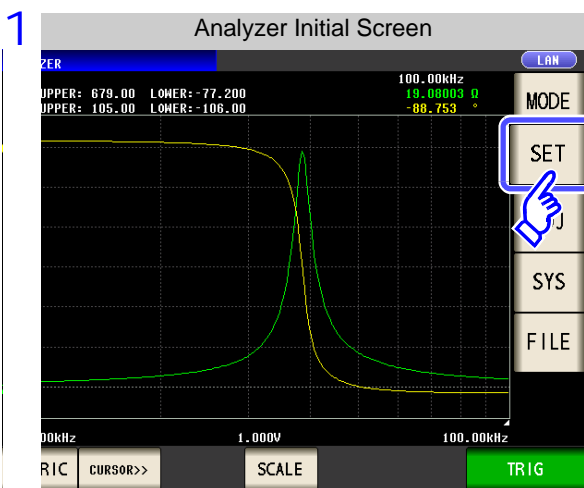

Press **CIRCUIT**.

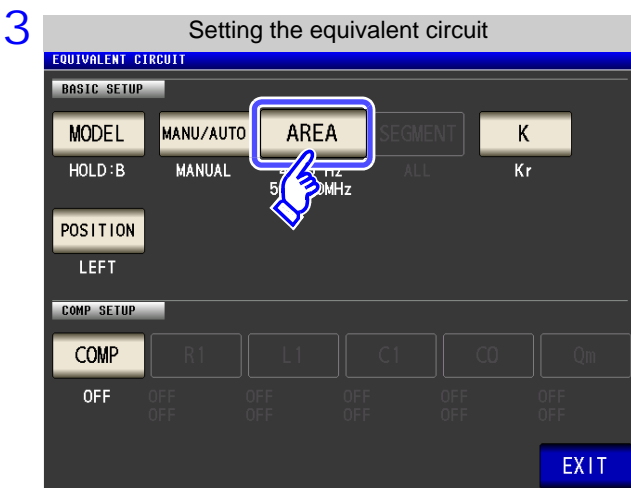

Press **AREA**.

## 5.10 Equivalent Circuit Analysis Function

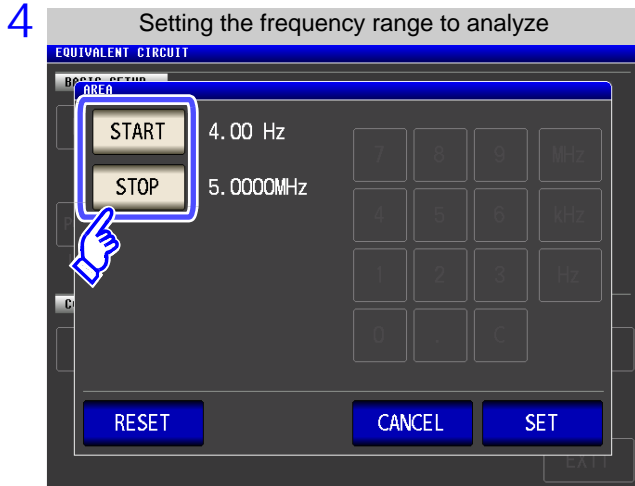

1. Press **START** and enter the frequency at which to start analysis with the numeric keypad.
2. Press **STOP** and enter the frequency at which to stop analysis with the numeric keypad.

Settable range: 4 Hz to 5 MHz

To clear the analytical range, press **RESET**.

3. Press **SET** to accept the frequency range.

- 5 Press **EXIT** to close the setting screen.

### Example of analysis using a set frequency range

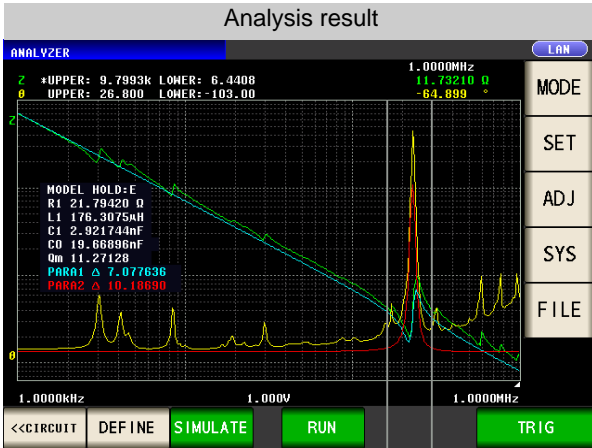

↔ Range over which analysis is performed  
150 kHz 300 kHz

**NOTE** The precision of the analysis may deteriorate if too narrow a frequency range is set.

**4 Selecting the segment to analyze**

This section describes how to select which segment to target for estimation during a segment sweep. By using this function, you can specify which segment to use in analysis when dividing the frequency range into multiple segments for measurement. Set the segment so that it includes local extreme values. This setting is valid only during segment sweep operation.

**Procedure**

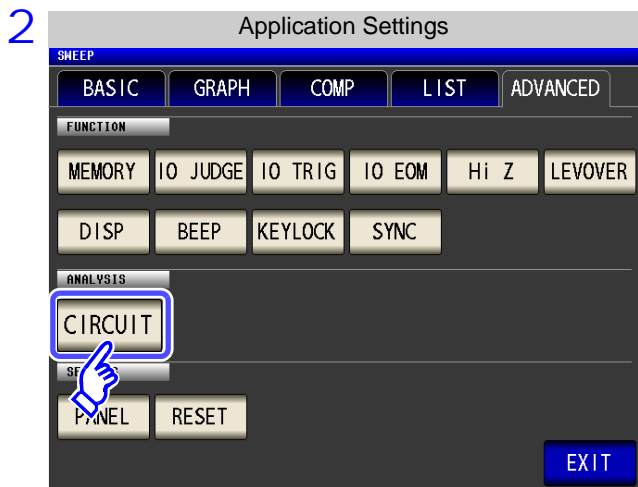
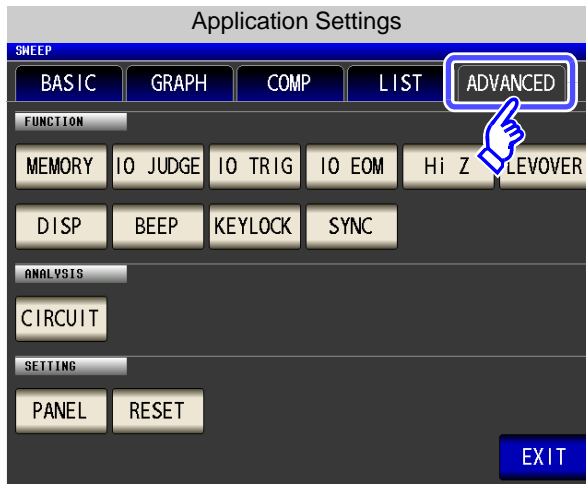
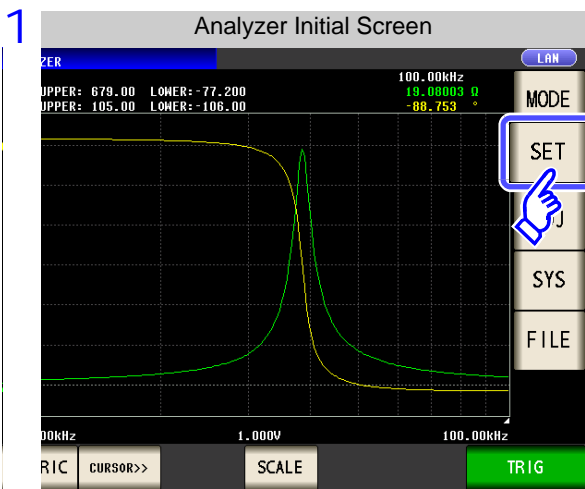

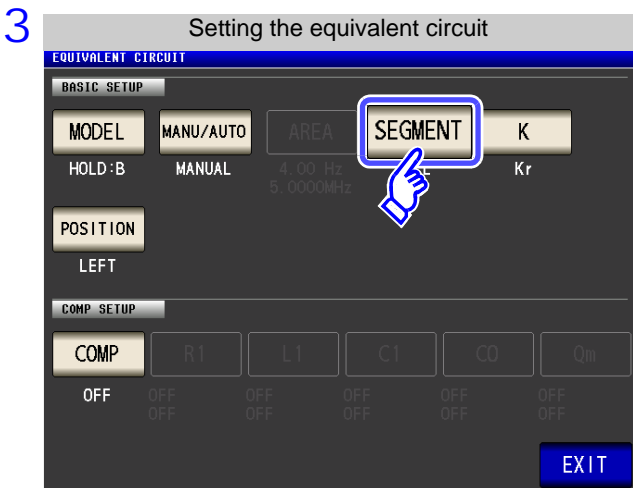

Press **CIRCUIT**.

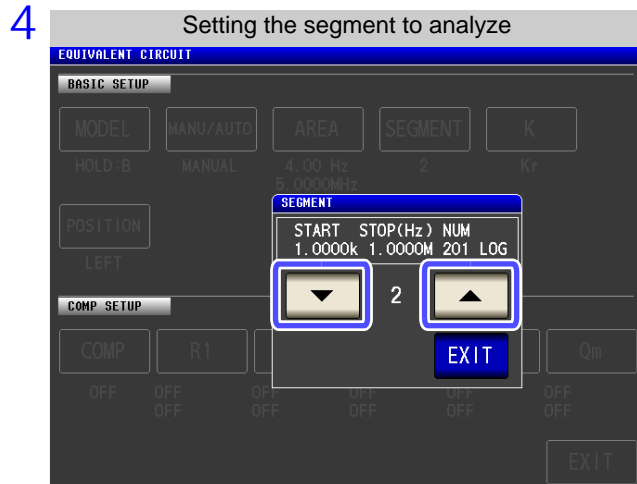

Press **SEGMENT**.

## 5.10 Equivalent Circuit Analysis Function



Select the segment number to use in equivalent circuit analysis with  and  .

**ALL** Targets all segments for analysis.

**1 to 20** Targets only the set segment number for analysis.

5 Press  to close the setting screen.

### Example of analysis using a selected segment

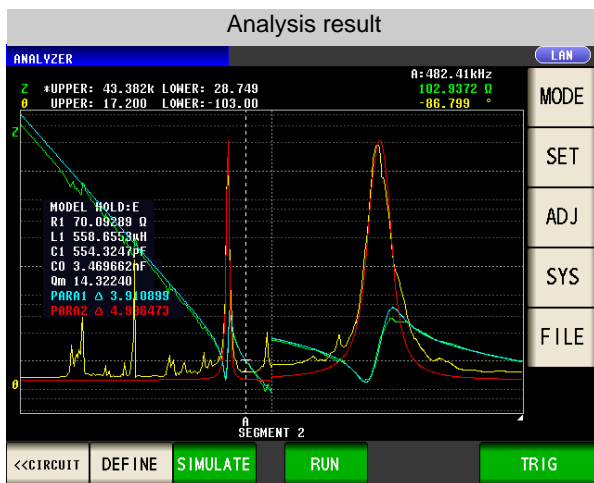

The No. 2 segment has been selected as the segment to use in analysis.

5.10 Equivalent Circuit Analysis Function

**5** Configuring calculation of the electromechanical coupling coefficient (K)

This section describes how to configure settings for calculating the electromechanical coupling coefficient using the E model.

**Procedure**

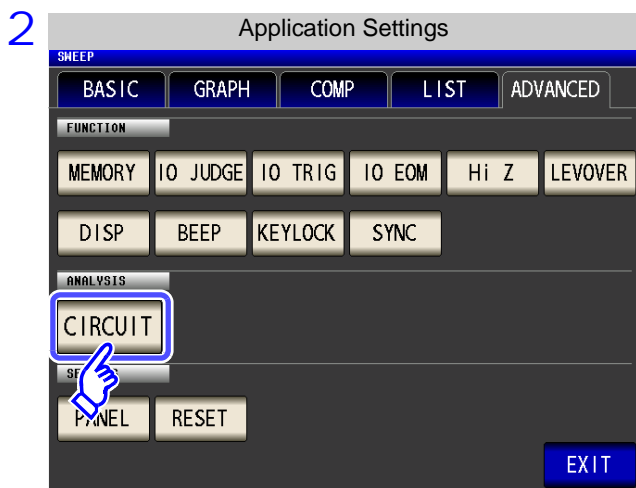
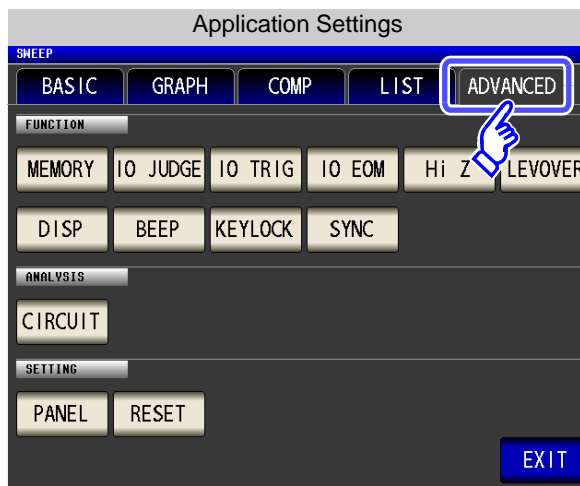
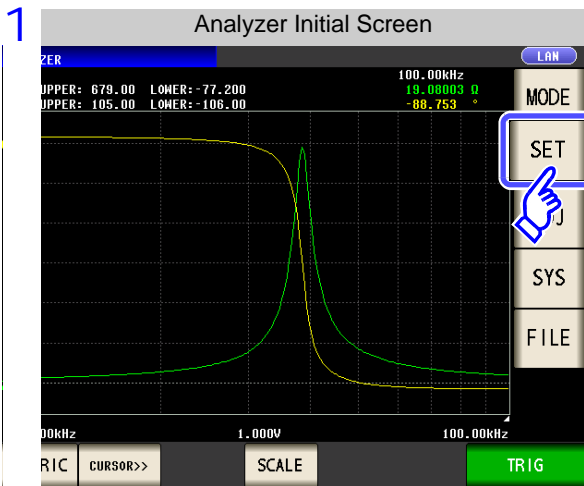

Press **CIRCUIT**.

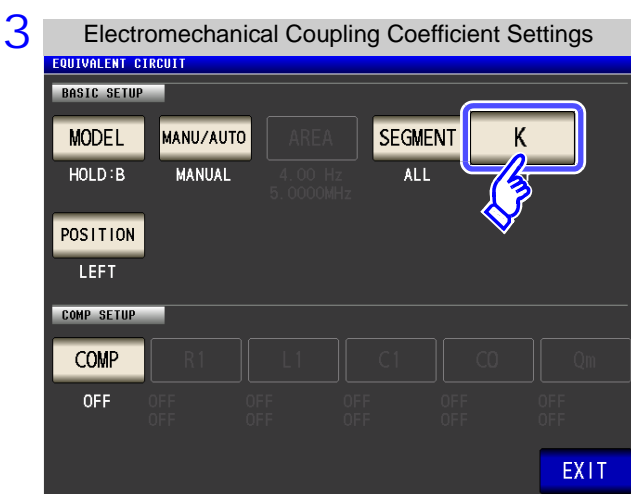

Press **K**.

## 5.10 Equivalent Circuit Analysis Function

4

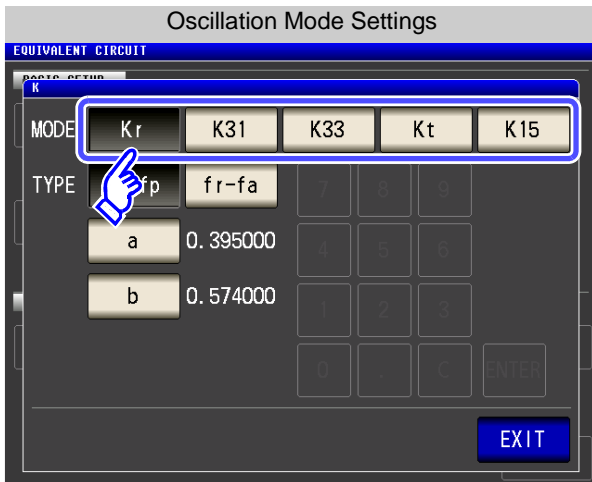

Select the oscillation mode.

Electromechanical coupling coefficient for planar oscillation

$$K_r = \sqrt{\frac{f_p - f_s}{a \times f_s + b \times (f_p - f_s)}}$$

Electromechanical coupling coefficient for long-side extension oscillation

$$K_{31} = \frac{\frac{\pi}{2} \times \frac{f_p}{f_s}}{\sqrt{\frac{\pi}{2} \times \frac{f_p}{f_s} - \tan\left(\frac{\pi}{2} \times \frac{f_p}{f_s}\right)}}$$

Electromechanical coupling coefficient for longitudinal oscillation

$$K_{33} = \sqrt{\frac{f_s}{f_p} \cot\left(\frac{\pi}{2} \times \frac{f_s}{f_p}\right)}$$

Electromechanical coupling coefficient for thickness-mode oscillation

$$K_t = \sqrt{\frac{f_s}{f_p} \cot\left(\frac{\pi}{2} \times \frac{f_s}{f_p}\right)}$$

Electromechanical coupling coefficient for shearing oscillation

$$K_{15} = \sqrt{\frac{f_s}{f_p} \cot\left(\frac{\pi}{2} \times \frac{f_s}{f_p}\right)}$$

5

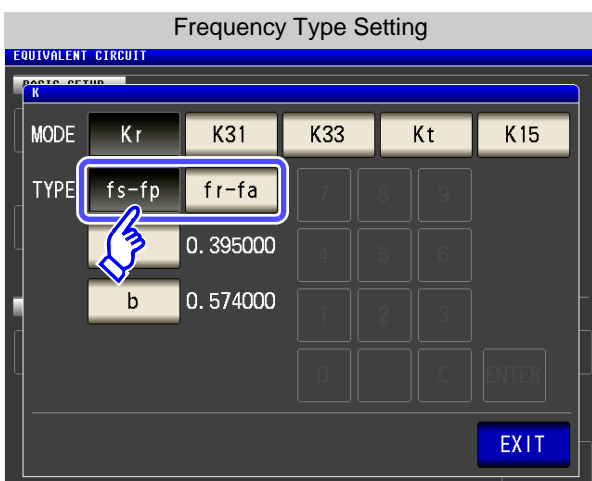

Select the frequency type

Select the resonant frequency to use when calculating the electromechanical coupling coefficient.

**fs-fp** Selects the series/parallel resonant frequency.

**fr-fa** Selects the resonant/anti-resonant frequency. (Substitutes  $f_r$  for  $f_s$  and  $f_a$  for  $f_p$  in the equations in Step 4.)



## 5.10 Equivalent Circuit Analysis Function

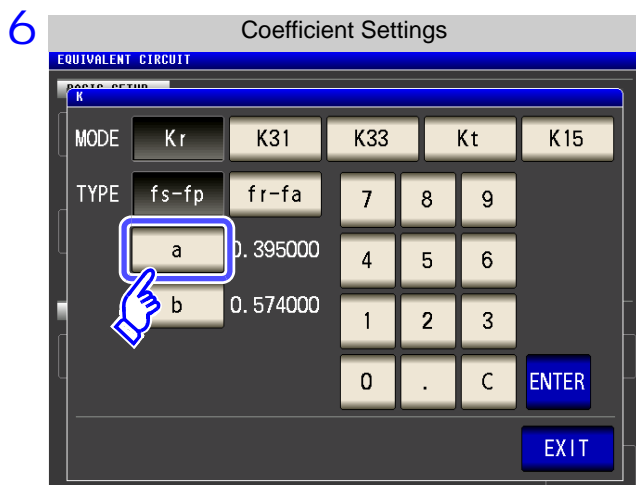

Set a different coefficient relative to Poisson's ratio only when selecting **Kr** (planar oscillation) as the oscillation mode.

Press **a** and set the coefficient with the numeric keypad.

Press **ENTER** to accept the coefficient.

Settable range: 0.000001 to 1.000000

To return to the previous screen without making any change to the set value, press the **ENTER** key when the screen is in the state with nothing being displayed (the state after pressing the **C** key).

7 Press **b** to set the same coefficient as **a**.

8 Press **EXIT** to close the setting screen.

## 5.10 Equivalent Circuit Analysis Function

### 6 Setting the position at which to display analysis results

This section describes how to set the position at which to display analysis results.

If the graph and analysis results displays overlap, set the position so that estimated values are easy to read.

#### Procedure

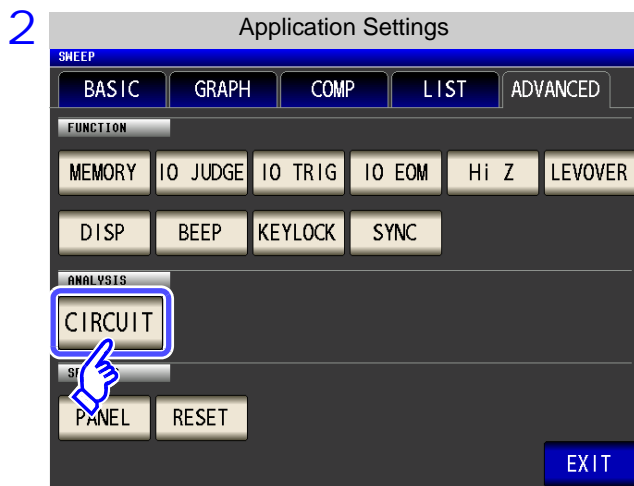
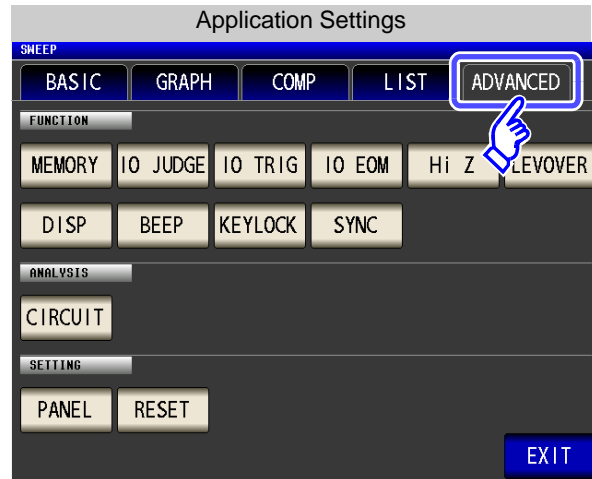
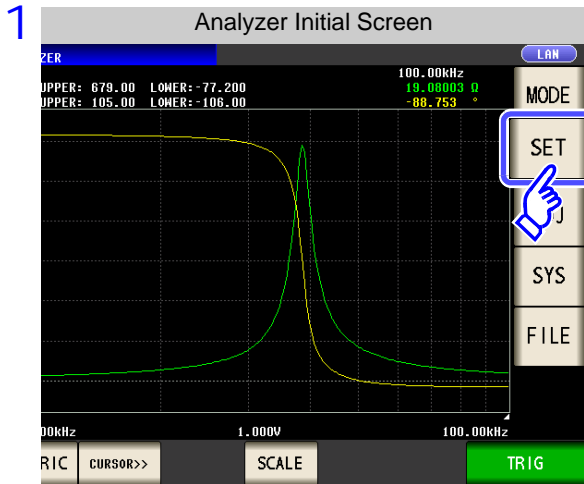

Press **CIRCUIT**.

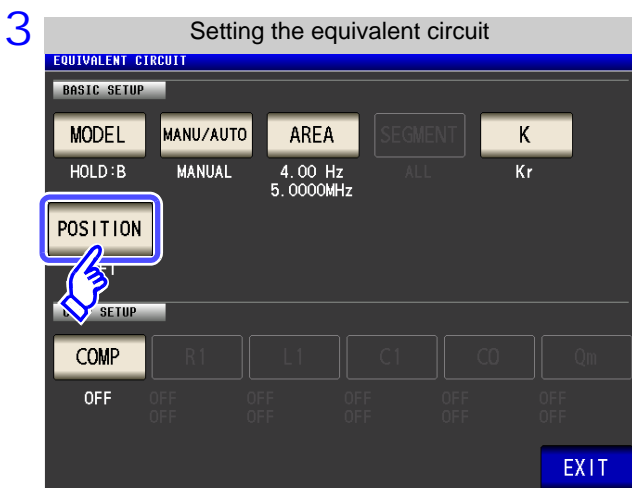

Press **POSITION**.

5.10 Equivalent Circuit Analysis Function

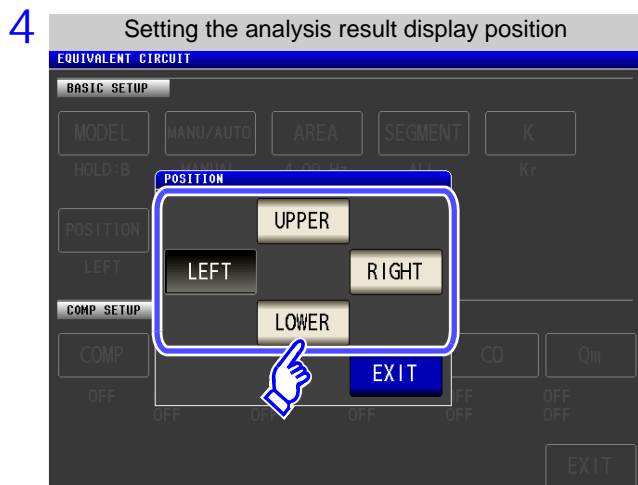

Select the position at which to display analysis results.

LEFT	Displays estimate results on the left.
RIGHT	Displays estimate results on the right.
UPPER	Displays estimate results on the top.
LOWER	Displays estimate results on the bottom.

5 Press **EXIT** to close the setting screen.

Analysis result display position

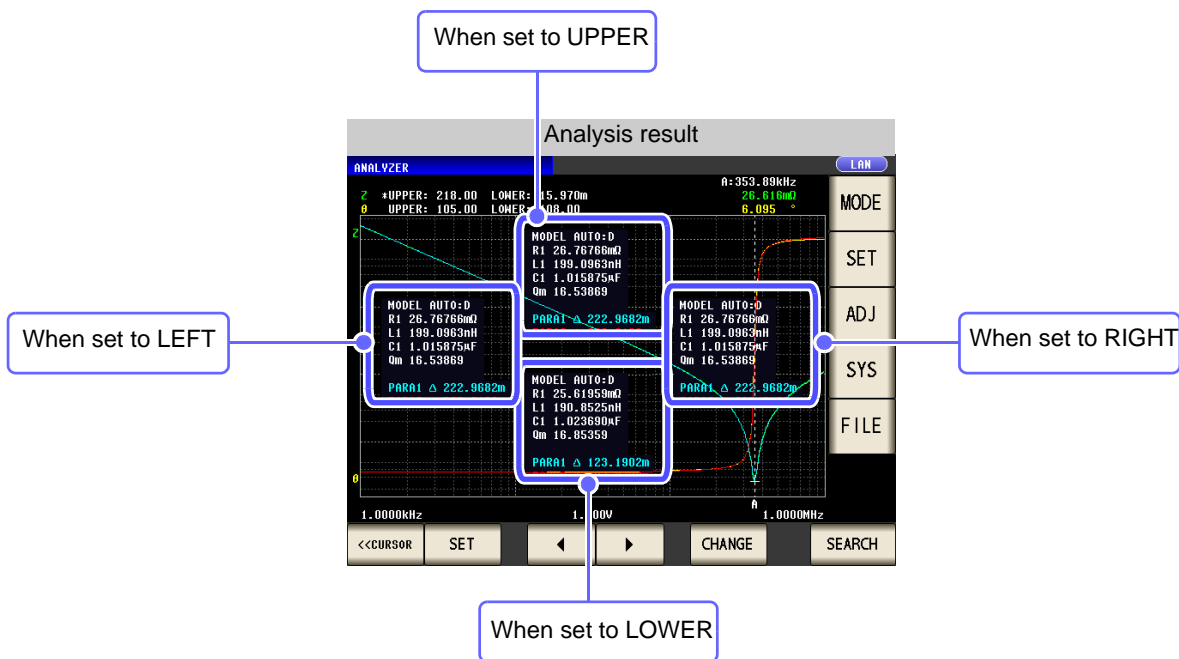

### 5.10.3 Performing Equivalent Circuit Analysis

#### 1 Performing frequency sweep measurement

When performing frequency circuit analysis, it is necessary to set the sweep parameter to "Frequency" and acquire the frequency characteristics for the elements being analyzed.

See "5.2.2 Setting the Sweep Parameter" (p. 135)

Since the local maximum and local minimum measurement points are used when performing equivalent circuit analysis with the IM3570, the frequency range should be set to the range for which the local extreme values can be measured. When performing analysis using the B and C models, configure the settings so that the lowest possible frequencies are measured since low-frequency values are used.

Additionally, when performing analysis using the E model, set the range so that it includes the resonance points for series resonance and parallel resonance.

#### Examples of appropriate sweep range settings

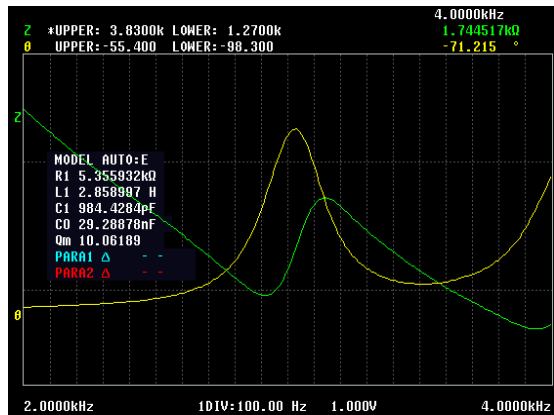
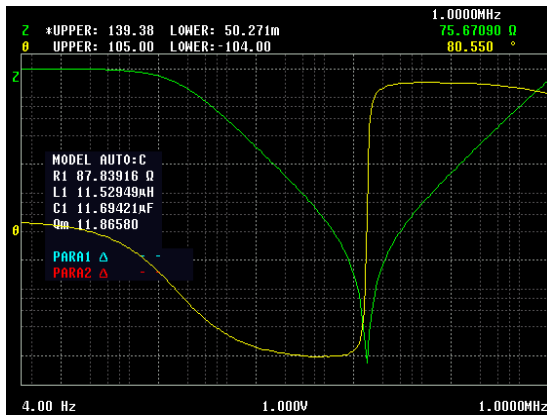
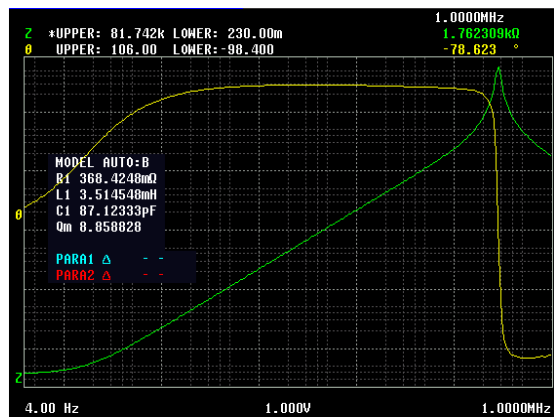
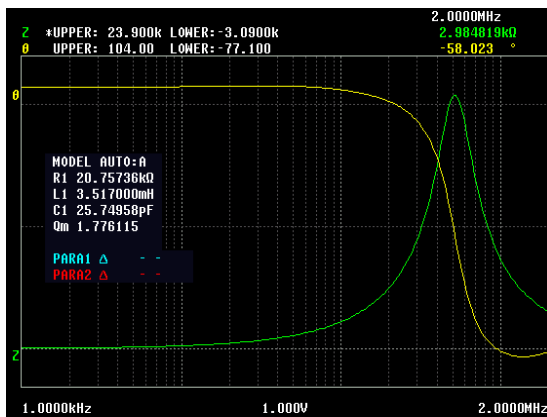

#### Examples of inappropriate sweep range settings

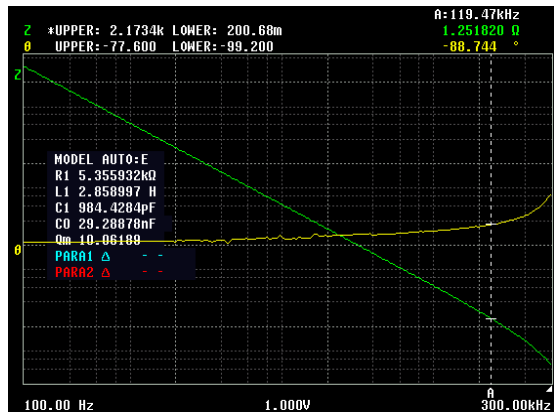
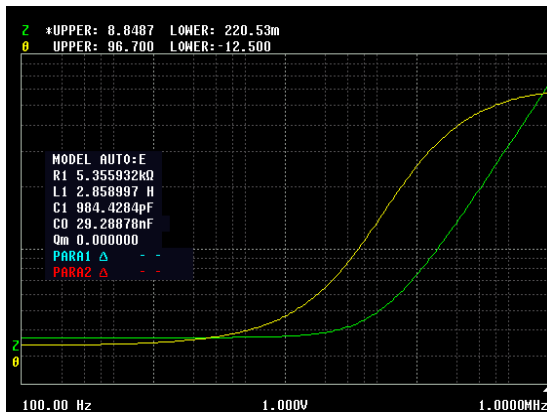

**2 Performing equivalent circuit analysis**

When the method of analysis is set to AUTO, analysis is performed automatically after measurement completes, and the results are displayed.

Equivalent circuit analysis results (normal measurement)

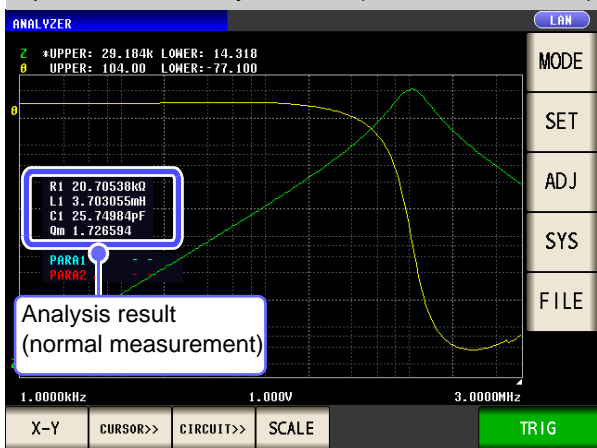

Equivalent circuit analysis results (X-Y display)

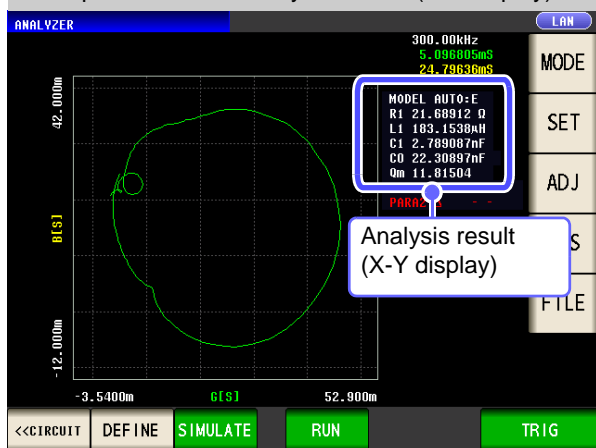

When the method of analysis is set to MANUAL, analysis is performed when **RUN** is pressed.

**Procedure**

1

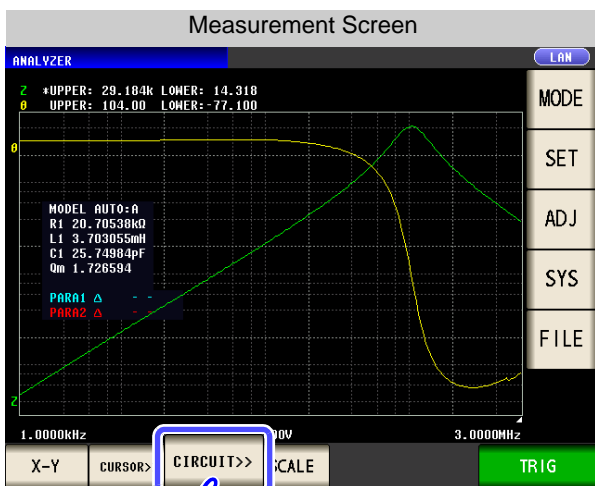

Press **CIRCUIT>>**.

2

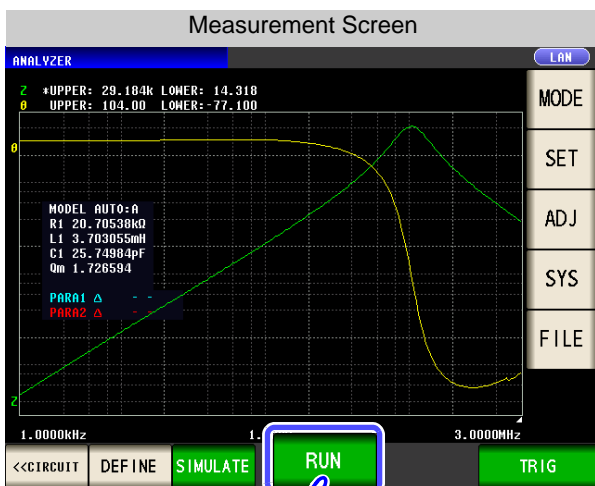

Press **RUN** to perform analysis.

### 5.10 Equivalent Circuit Analysis Function

#### A practical method for setting the measurement range

When performing analysis using the B and C models, it is necessary to measure frequencies that are as low as possible, but low-frequency measurement is time-consuming. The IM3570 uses measured values for the lowest frequency in the measurement range. By setting a low frequency for one point in the sweep range, it is possible to conduct a precise analysis in a short period of time.

The following diagram provides an example of a B mode analysis performed using sweep measurement starting at 100 kHz.

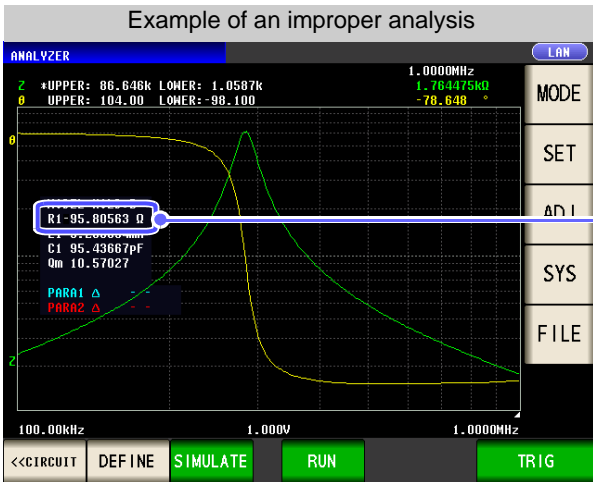

Looking at the analysis results, the negative R value indicates that the analysis has not been performed properly.

In this case, the sweep range setting should specify measurement of just one low frequency.

#### Procedure

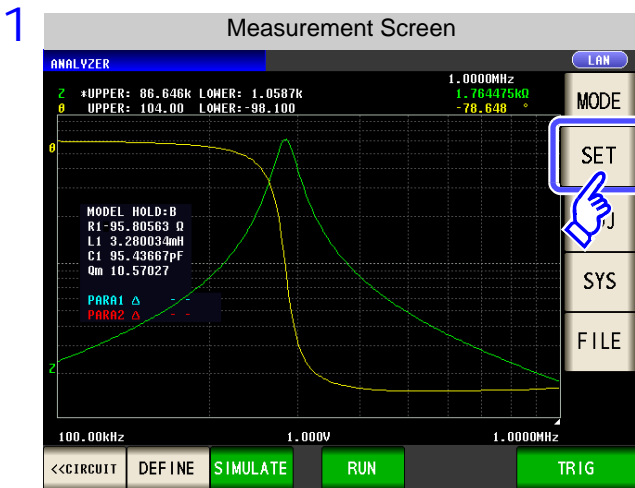

Press **SET** in the [Measurement Screen].

2 Press **LIST** to display a list of sweep points.

3 Press **EDIT**.

5.10 Equivalent Circuit Analysis Function

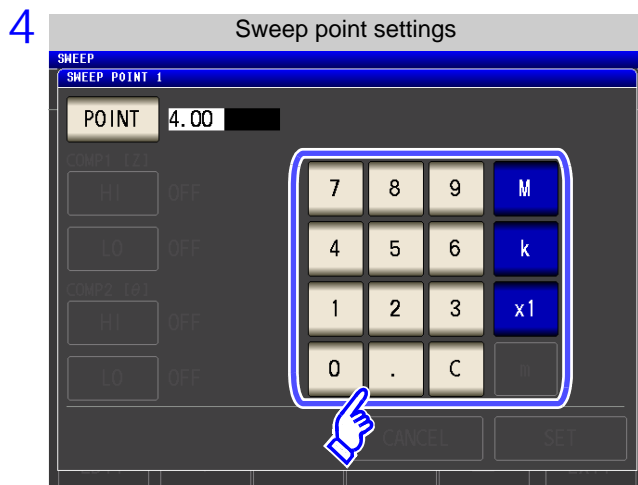

Enter as low a frequency as possible.

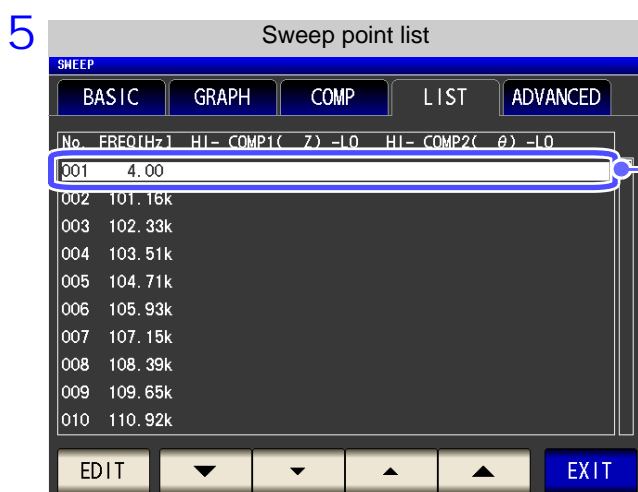

Verify that a low frequency has been set for just one point on the sweep point list.

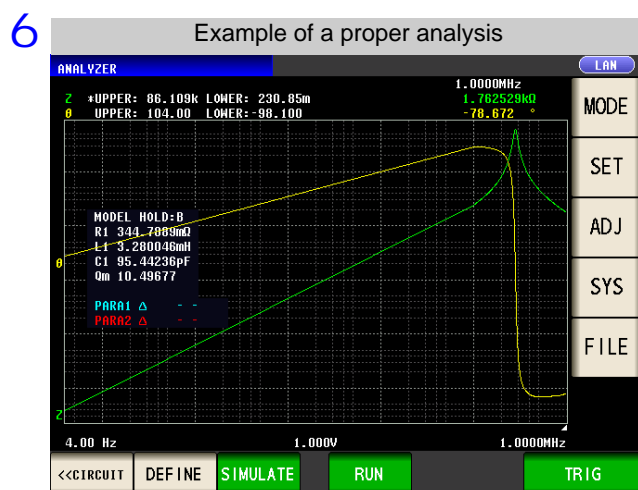

Measured is performed and followed by equivalent circuit estimation.

The above procedure allows the R value to be properly estimated.

## 5.10 Equivalent Circuit Analysis Function

### When unable to detect resonance points

If the instrument is unable to detect the resonance points that are used in analysis, the following error message will be displayed.

Set the sweep range so that it includes resonance points.

Additionally, verify that the frequency range and segments used in the analysis are appropriately configured.

See "Setting the frequency range to analyze" (p. 243)  
"Selecting the segment to analyze" (p. 245)

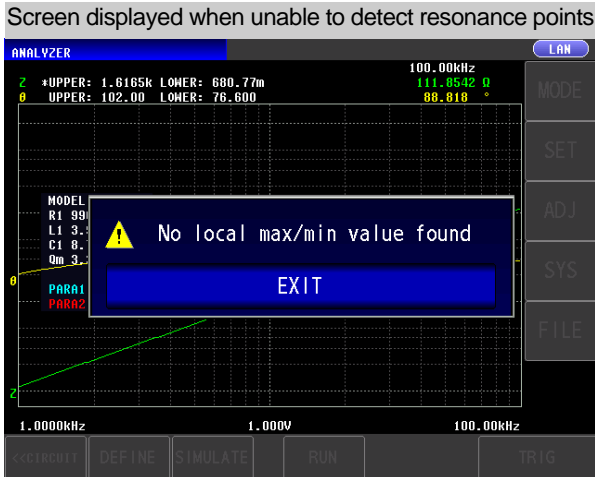

### When the sweep parameter is set to a value other than "Frequency"

When the sweep parameter is set to a value other than "Frequency," the following error message will be displayed. Set the sweep parameter to "Frequency."

See "5.2.2 Setting the Sweep Parameter" (p. 135)

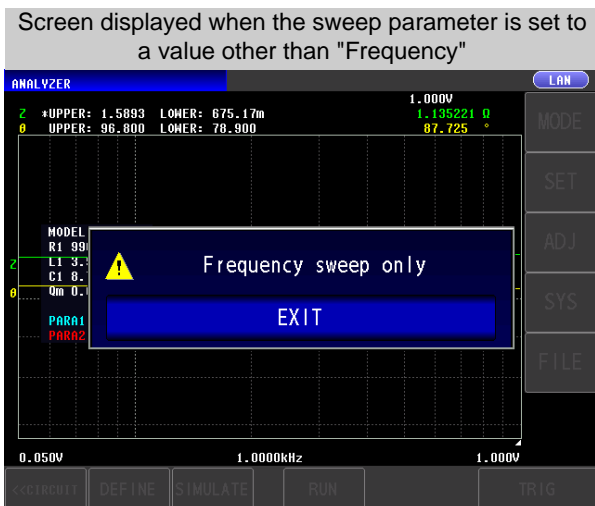



### When there are no measured values that can be analyzed

When there are no measured values that can be analyzed, the following error message will be displayed. If measurement has not yet been performed, perform equivalent circuit analysis after measurement.

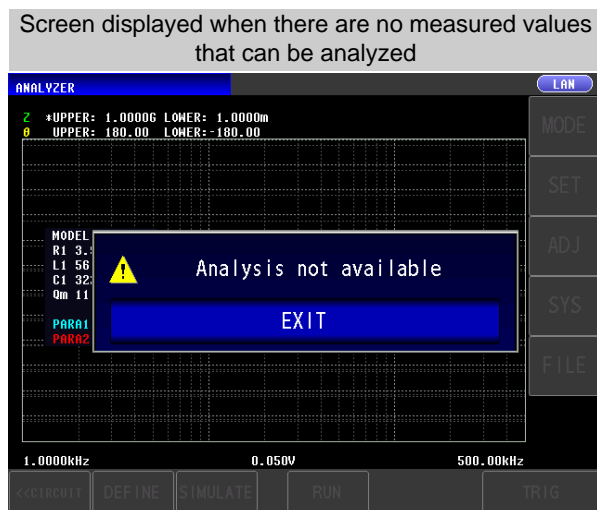

# 5.10.4 Simulating Frequency Characteristics

This section describes how to simulate frequency characteristics using estimated or user-defined constants.

**Procedure**

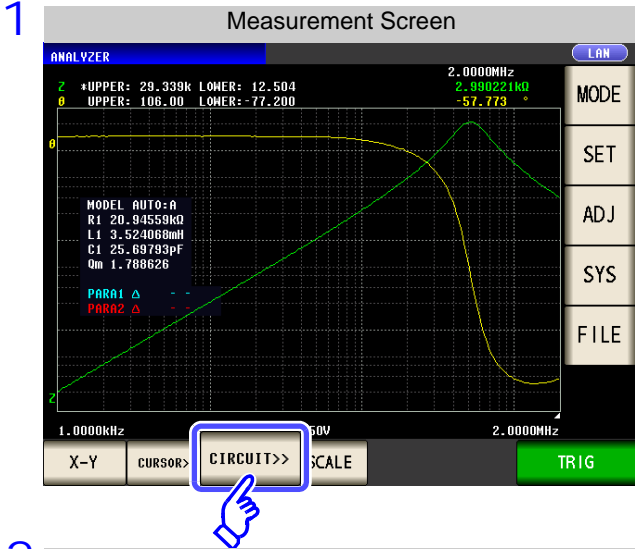

Press **CIRCUIT>>** .

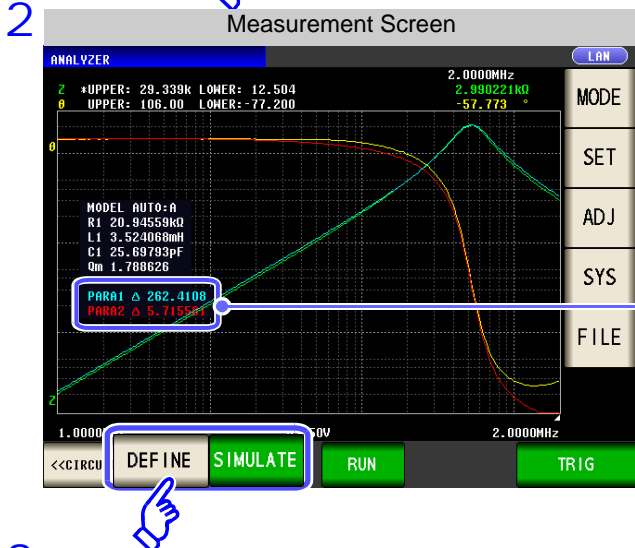

To perform a simulation based on analysis results, press **SIMULATE** .

To set constants, press **DEFINE** .

Differences between observed values and simulation values (For more information, refer to the notes.)

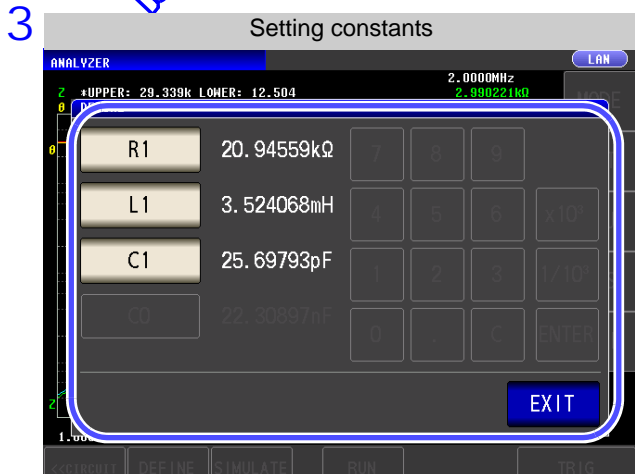

1. Press the button for the constant you wish to change and enter the desired value with the numeric keypad.

2. Touch **EXIT** to close the Constant Settings screen.

3. Press **SIMULATE** to repeat the simulation.

**NOTE**

- The simulation graph will be cleared if you change one or more constants or perform a new measurement. To repeat the simulation, press **SIMULATE** .
- You can check simulation values with the cursor's **CHANGE** .

## 5.10 Equivalent Circuit Analysis Function

### NOTE

The difference between observed values and simulated values is calculated for each measurement parameter in order to judge the suitability of equivalent circuit analysis results. The frequency range that was analyzed or the frequency range for the segment number that was analyzed is used as the range for calculating this difference.

The difference is calculated using the following procedure:

- (1) The squares of the difference between each observed and simulated value pair for the frequency sweep count are added together.
- (2) The result is divided by the frequency sweep count to obtain the mean residual sum of squares.
- (3) The square root is calculated.

More concretely, this can be illustrated as in (A) below:

$$\sqrt{\frac{\sum (\text{Observed value} - \text{Simulated value})^2}{n}} \dots\dots\dots (A)$$

$n = \text{Sweep count}$

However, when using this method with circuits whose impedance frequency characteristics exhibit local extreme values (local maximum or local minimum values), difference values for frequency ranges that do not contain local extreme values will be less than difference values for frequency ranges near local extreme values, as shown in the figure below. Consequently, the circled area in the figure is excluded when calculating the difference between observed and simulated values. The following calculation procedure is used for the circled area:

- (1) The difference value calculated by adding a quantity A to the observed value for the measurement frequency that generated the local extreme value is used as the upper limit value, and the difference calculated by subtracting the quantity A from the observed value for the measurement frequency that generated the local extreme value is used as the lower limit value.
- (2) If the simulated value for the measurement frequency that generated the local extreme value falls outside the range defined by the upper and lower limit values calculated in (1) above, the upper and lower limit values for the observed values before and after the local extreme value are calculated as in (1) above and repeatedly compared to the simulated values.
- (3) If the simulated value falls inside the range defined by the upper and lower limit values for the measurement frequencies before and after the local extreme value, the area is used to calculate the difference, and the areas used in (1) and (2) above become the circled area.

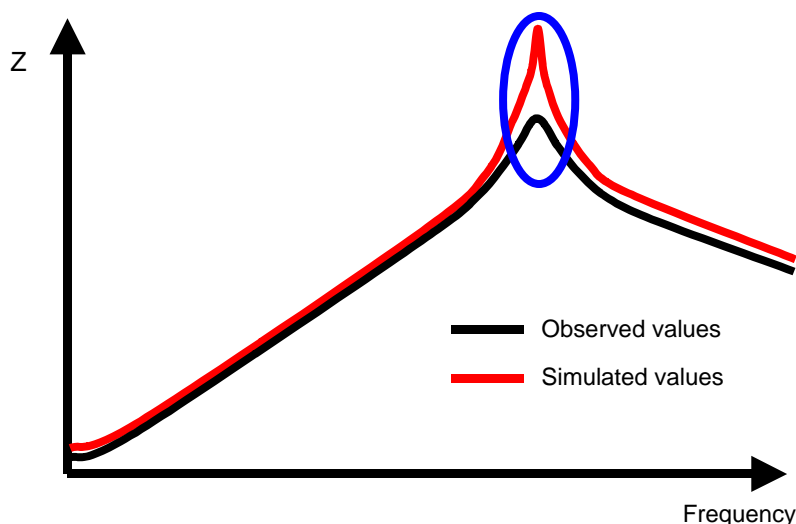

5.10 Equivalent Circuit Analysis Function

5.10.5 Judging analysis results

This section describes how to use the comparator function to determine whether estimation results fall within judgment standards.

1 Setting the Upper or Lower Limit Value

Before using the comparator function, you must set upper and lower limit values for the judgment standards.

Procedure

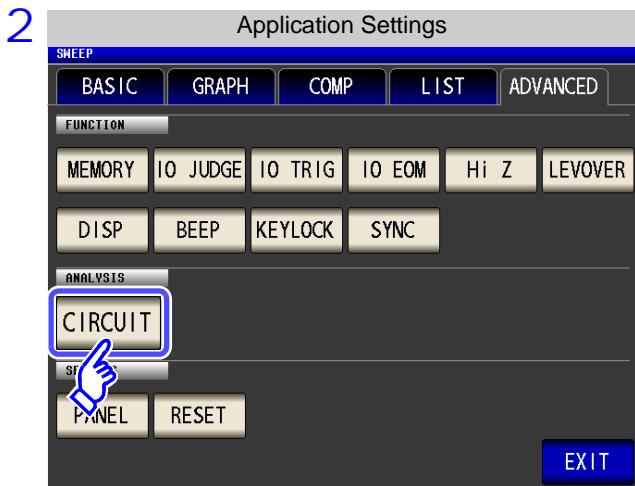
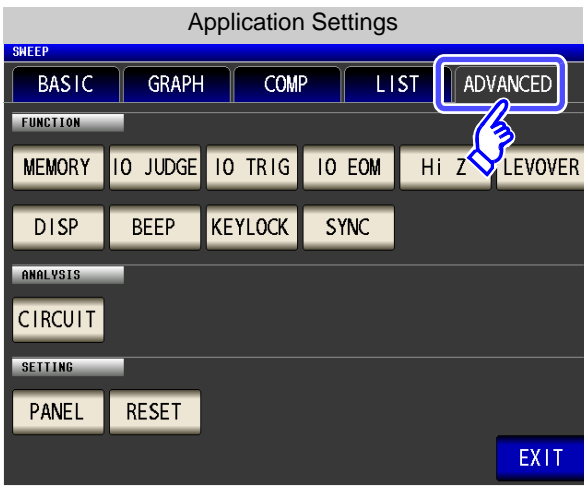
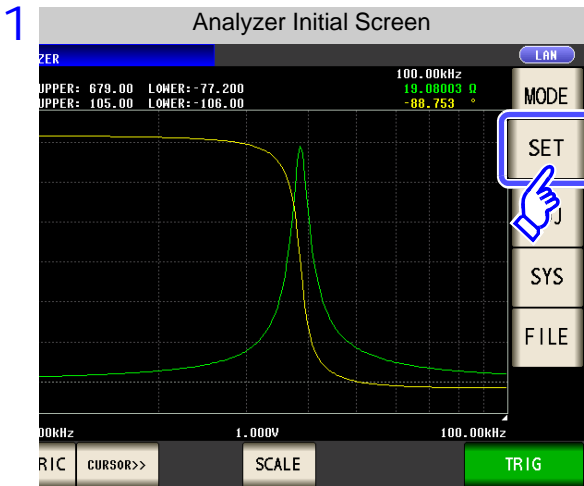

Press **CIRCUIT**.

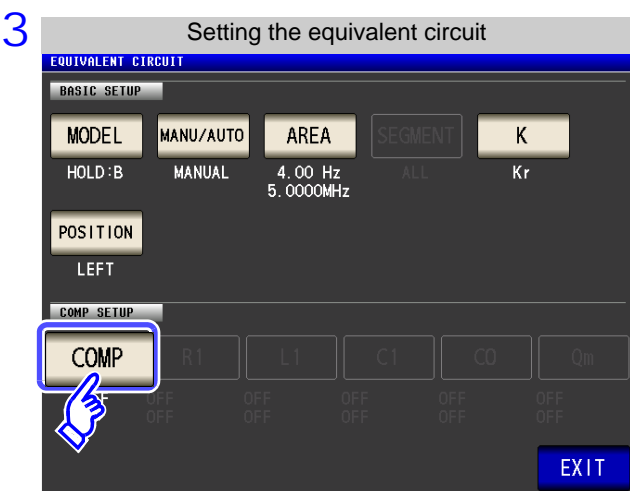

Press **COMP**.

5.10 Equivalent Circuit Analysis Function

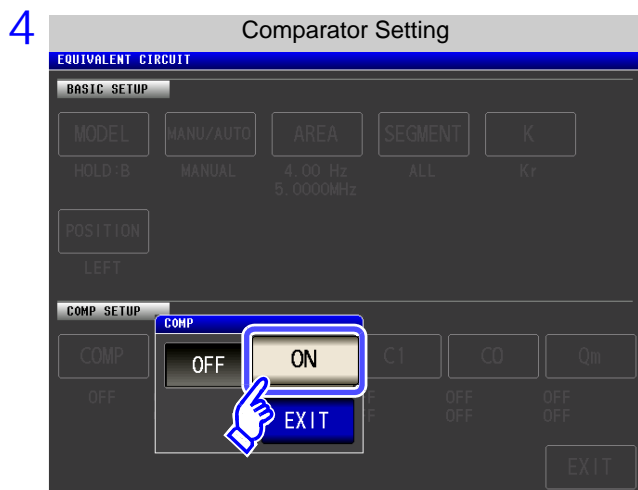

Press **ON** to enable the comparator function.

Press **EXIT** key to confirm the setting.

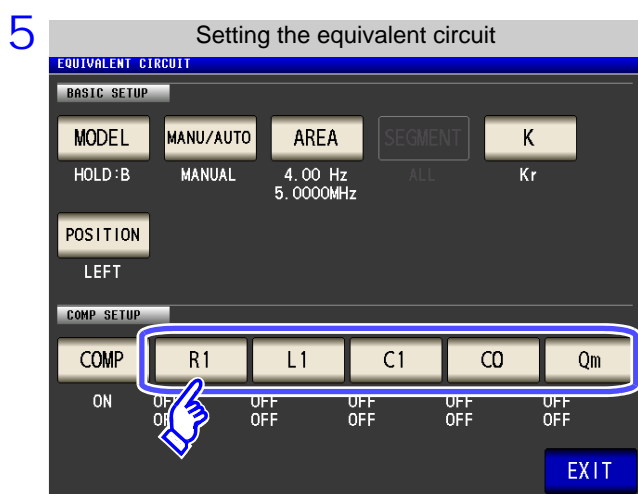

Select the constant for which you wish to set judgment standards.

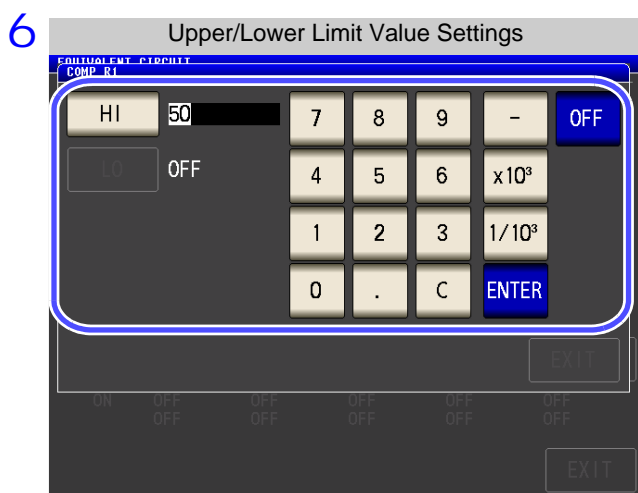

Press **HI** and use the numeric keypad to set the upper limit value.

Press **ENTER** key to confirm the setting.

Press **LO** and use the numeric keypad to set the lower limit value.

Press **ENTER** key to confirm the setting.

Settable range: -9.999999 G to 9.999999 G

Changing the unit (a/ f/ p/ n/ μ/ m/ None/ k/ M/ G)

**x10<sup>3</sup>** Step the units up.

**1/10<sup>3</sup>** Step the units down.

When you do not want to set the upper and lower limit values: Press **OFF**.

Press **EXIT** to close the setting screen.

5.10 Equivalent Circuit Analysis Function

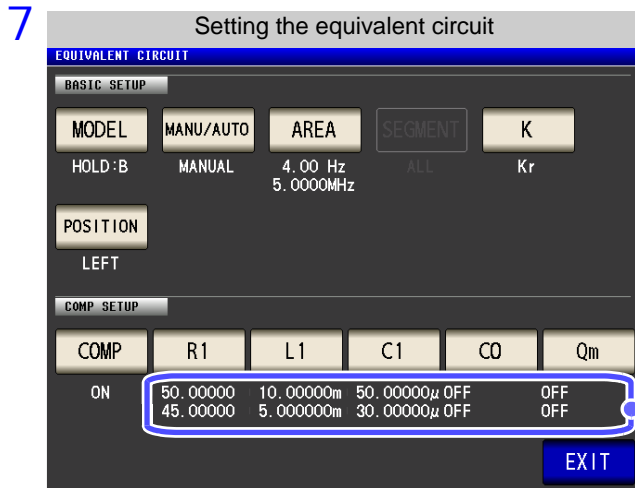

You can check the set upper and lower limit values on the Equivalent Circuit Settings screen.

Top row : Upper limit values  
Bottom row : Lower limit values

8 Press **EXIT** to close the setting screen.

2 Making judgments using analysis results

When the comparator is on and a judgment area has been set, the estimated values and judgment results will be displayed after equivalent circuit estimation. Judgment results can also be acquired using communications commands or external output (EXT I/O).

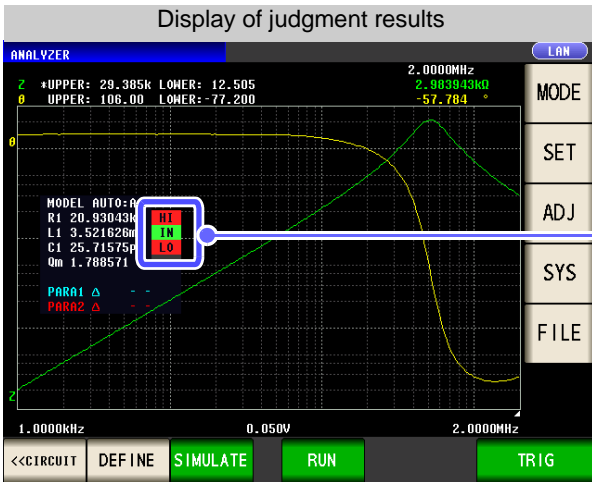

**HI** Estimated value is above upper limit  
**IN** Pass (meets criteria)  
**LO** Estimated value is below lower limit

**NOTE** Changing estimated values manually causes judgment results to be cleared. The overall judgment result is output with the front panel's LED as well as from EXT I/O pin 14. See "Chapter 11 External Control" (p. 363) However, the judgment content differs depending on whether you are performing analysis manually or automatically. For more information, see the following table:

Method of analysis	Judgment timing	Overall judgment result
MANUAL	When measurement completes	Outputs the area comparator or peak comparator judgment result. Outputs nothing when the area comparator or peak comparator have not been configured.
	When equivalent circuit analysis is performed manually	Clears the area comparator or peak comparator judgment results and outputs the overall judgment result for the equivalent circuit analysis results.
AUTO	When equivalent circuit analysis is performed after measurement completes	Outputs the area comparator or peak comparator judgment results as well as the overall judgment result for the equivalent circuit analysis results.

### 5.10.6 Generating X-Y Displays

When the IM9000 Equivalent Circuit Analysis Firmware is installed, you can generate an X-Y display of measurement results. This display consists of a graph with measured values for the No. 1 parameter on the X-axis and measured values for the No. 2 parameter on the Y-axis.

Parameters can be combined to create Cole-Cole plots and admittance circle displays.

#### 1 Creating an X-Y display

##### Procedure

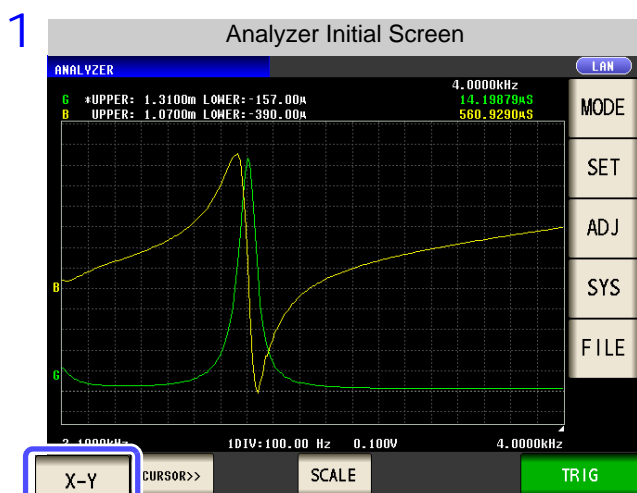

Press .

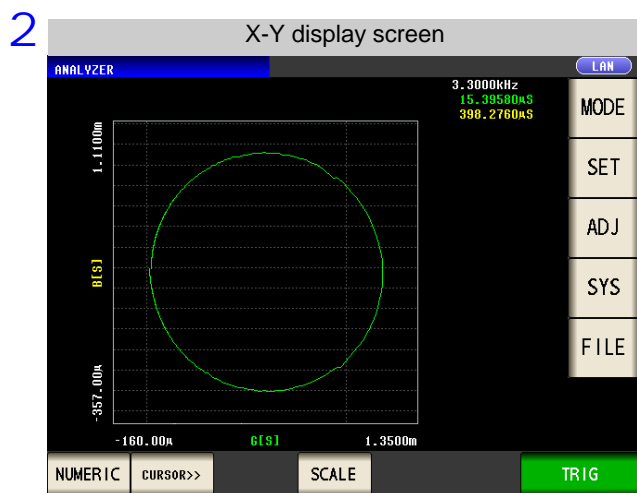

**NOTE** To display a Cole-Cole plot or admittance circle, make the following settings:

Cole-cole plot	Set the No. 1 parameter to Rs.
	Set the No. 2 parameter to X.
	Reverse the No. 2 parameter's polarity (set the compensation coefficient to A = -1 with scaling compensation).
Admittance circle display	Set the No. 1 parameter to G.
	Set the No. 2 parameter to B.





# Continuous Measurement Function

## Chapter 6

### 6.1 Initial Screen

CONTINUOUS

The continuous measurement function reads in order the measurement conditions saved with the panel save function, and performs a number of measurements continuously. It is possible to mix the measurement conditions of the LCR and analyzer.

The continuous measurement of up to 32 items is possible.

For details on the screen configuration (p. 20).

The diagram shows the initial screen of the continuous measurement function. The screen displays a table of measurement conditions and a list of menu keys. Callouts provide detailed information about each element.

**Callouts:**

- Displays a list of panels for which continuous measurement is to be performed.
- Indicates the usage status of internal memory. (p. 106), (p. 219)
- Indicates that a USB flash drive is connected. (p. 329)
- Indicates the interface that is currently set.
- Scrolls the list.

**Menu keys**

MODE	Select the measurement mode. (p. 13)
SET	Set the continuous measurement settings. (p. 266)
FILE	Set the save settings. (p. 329)

**Operation keys** An operation key is displayed depending on the situation.

GRAPH	Displays a sweep measurement graph. (p. 268)	PRINT	Prints the measurement data. (p. 381)
SAVE	Saves the measurement results. (p. 333)	TRIG	Starts continuous measurement. (p. 267)

#### NOTE

- Setting the measurement conditions so that the measurement frequency or measurement signal level differs for each panel allows you to simply evaluate the characteristics of the test sample.
- Continuous measurement can also be performed from the EXT I/O. (p. 364)
- If the power is turned off when the [Continuous Measurement Screen] is displayed, the [Continuous Measurement Screen] will be displayed when the instrument starts the next time you turn the power on.

# 6.2 Setting Continuous Measurement CONTINUOUS

Before you perform continuous measurement, set which panels are target for continuous measurement. Save the measurement conditions with the panel save function in LCR mode or analyzer mode in advance.

**Procedure**

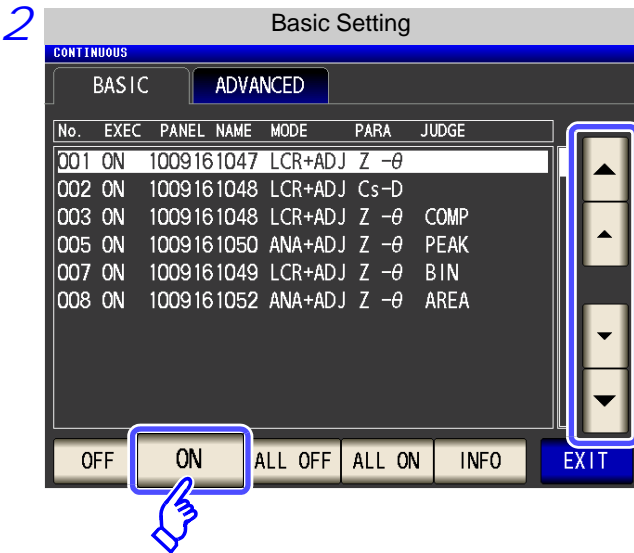
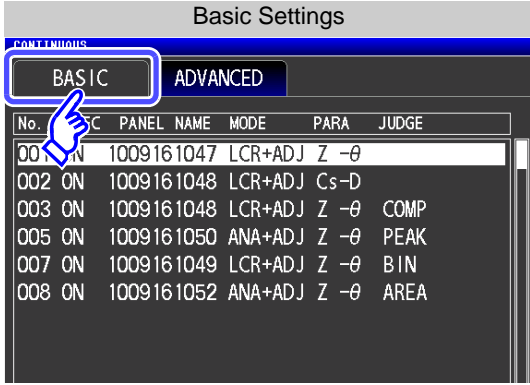
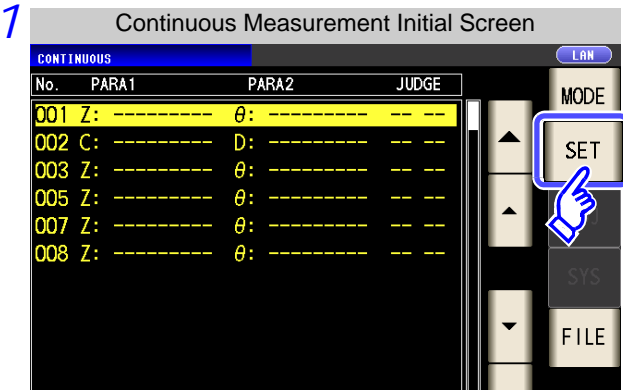

A list of the measurement conditions saved with LCR measurement and analyzer measurement appears.

Any panel for which only the compensation value (ADJ) was saved is not displayed.

Use or to select a panel for which to perform continuous measurement, and press .

- Removes the selected panel from the targets for continuous measurement.
- Sets the selected panel as a target for continuous measurement.
- Removes all panels from the targets for continuous measurement.
- Sets all panels as targets for continuous measurement.
- Display the panel information.

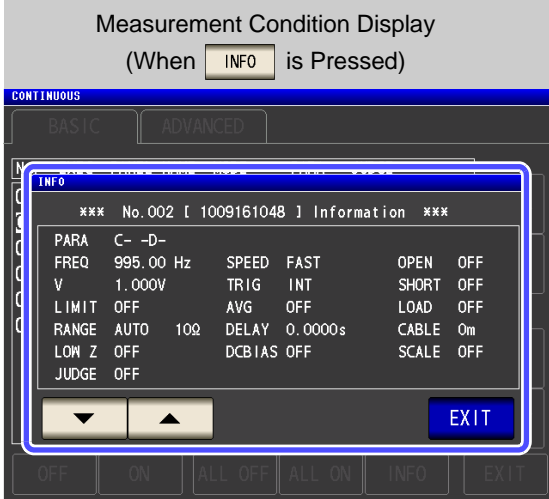

3 Press to close the setting screen.

## 6.3 Performing Continuous Measurement

CONTINUOUS

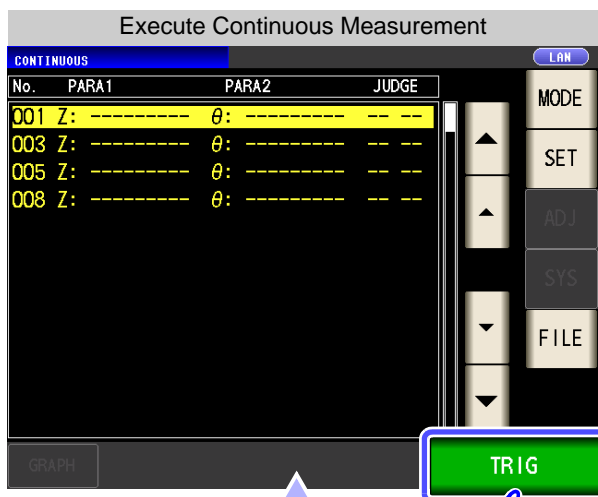

Panels that were set to  ON in the setting screen are displayed in the list.

Press  .

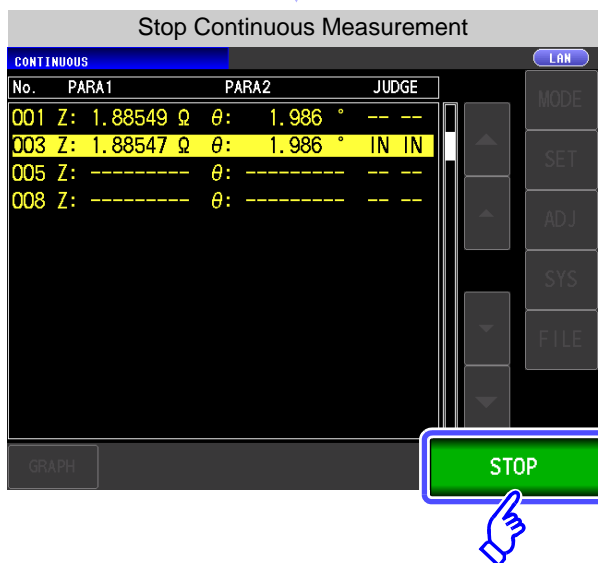

When you want to stop continuous measurement: Press  .

### NOTE

In the following circumstances, measurement will not continue after it:

- When the measurement result yields a contact check error or HIGH-Z reject error in low Z high accuracy mode
- When the instrument is configured to halt measurement when the judgment result is FAIL (**HI/ LO/ OUT OF BINS**) and the judgment function for the measured panel (comparator, BIN function) is enabled

# 6.4 Checking the Continuous Measurement Results

CONTINUOUS

Example: When you want to check the measurement results of analyzer mode

Indicates the panel numbers.

Indicates the measurement values.

Indicates the judgment results.  
LCR mode: First parameter and third parameter  
Analyzer mode: First parameter and second parameter

No.	PARA1	PARA2	JUDGE
001	Z: 1.88458 Ω	θ: 1.983 °	-- --
003	Z: 1.88456 Ω	θ: 1.986 °	IN IN
005	Z: SWEEP	θ: SWEEP	NG --
008	Z: SWEEP	θ: SWEEP	IN --

Use or to select the panel of analyzer mode, and then press .

How to use the cursor to check the measurement result of each sweep point  
See "5.6 Checking the Measurement Values" (p. 188)

When you want to return to the measurement result list: Press .

**NOTE** The measurement values of LCR mode are only displayed for the first parameter and third parameter.

# 6.5 Setting Application Settings

CONTINUOUS

## 6.5.1 Setting the Display Timing

Set the draw timing for during continuous measurement.

If the display timing is set to **REAL**, the time for continuous measurement becomes long because the screen is updated every time measurement is performed.

If it is set to **AFTER** to give priority to the measurement time, the screen update time becomes short.

**Procedure**

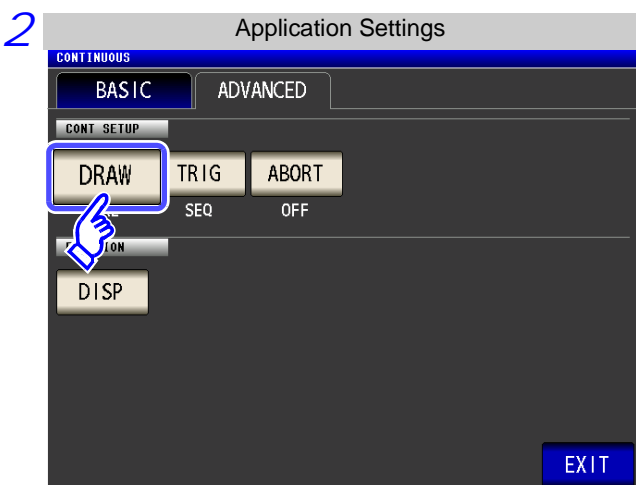
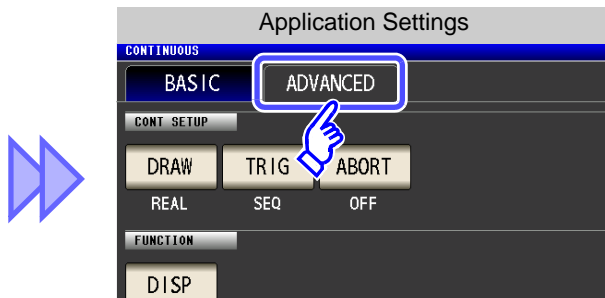
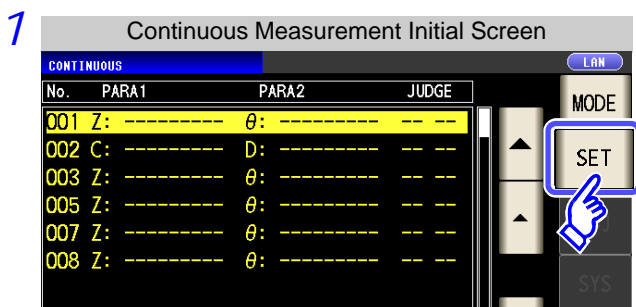

Press **DRAW**.

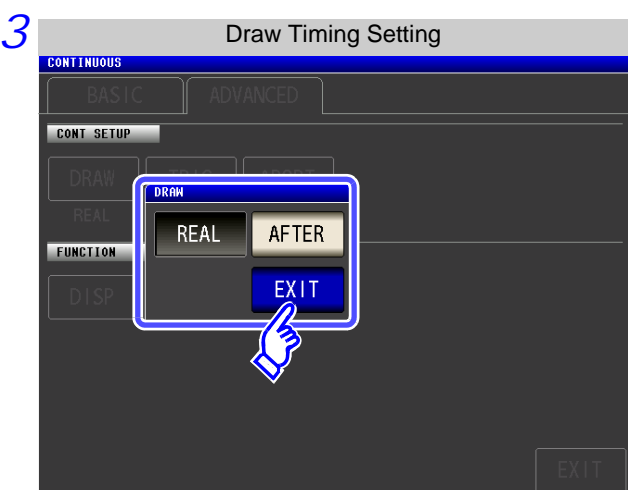

Set the timing for display.

- REAL** Sequentially draws after measurement of each panel.
- AFTER** Draws all after continuous measurement is finished.

4 Press **EXIT** to close the setting screen.

6.5 Setting Application Settings

6.5.2 Setting the Trigger

This section describes how to set the trigger. In continuous measurement mode, measurement will be performed in accordance with the trigger settings configured as described in this section. Two types of triggers can be set: sequential measurement and step measurement.

Procedure

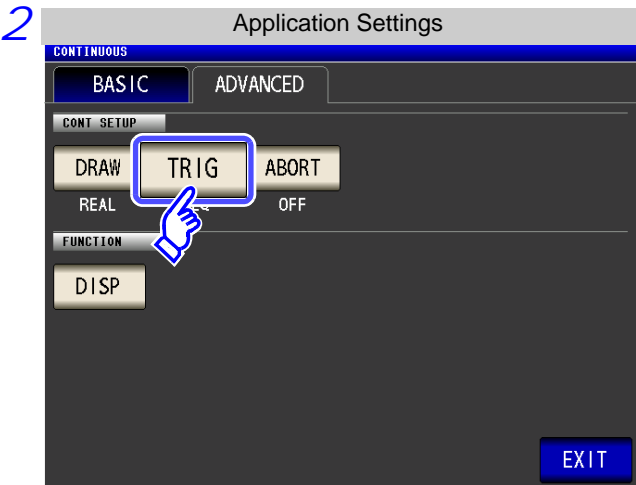
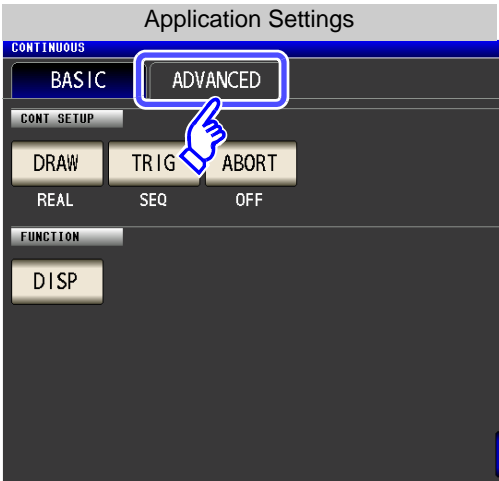
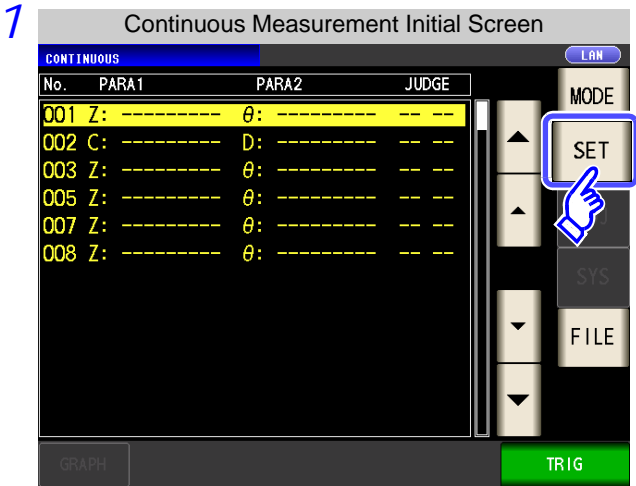

Press **TRIG**.

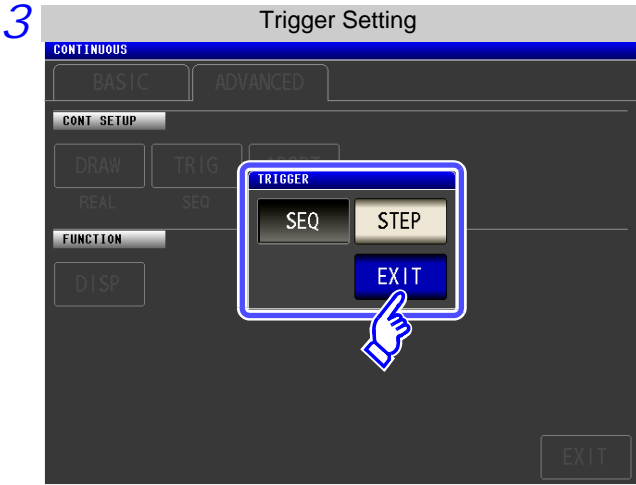

Select the trigger setting.

- SEQ** Performs sequential measurement. When the external trigger is input, all panels set to **ON** on the setting screen are measured.
- STEP** Performs step measurement. When the external trigger is input, the panel set to **ON** on the setting screen is measured, and the instrument switches to the next panel's measurement conditions.

4 Press **EXIT** to close the setting screen.

### 6.5.3 Halting Continuous Measurement at a FAIL judgment result

Measurement can be halted when the judgment result is FAIL (**HI/ LO/ OUT OF BINS**) and the judgment function for the measured panel (comparator, BIN function) is enabled. Continuous measurement is halted regardless of the settings when the measurement result yields a contact check error or HIGH-Z reject error in low Z high accuracy mode.

**Procedure**

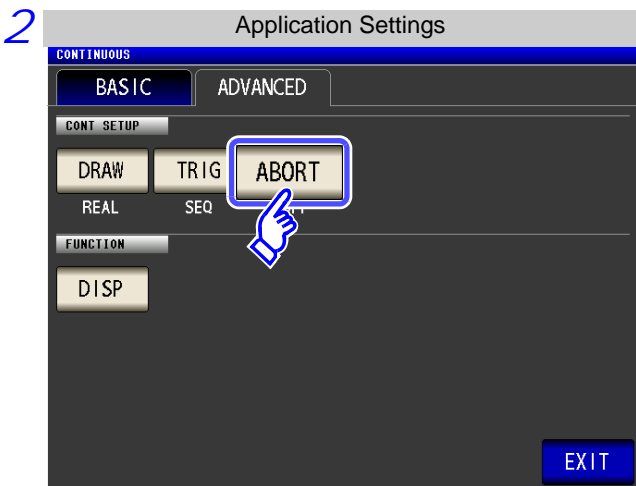
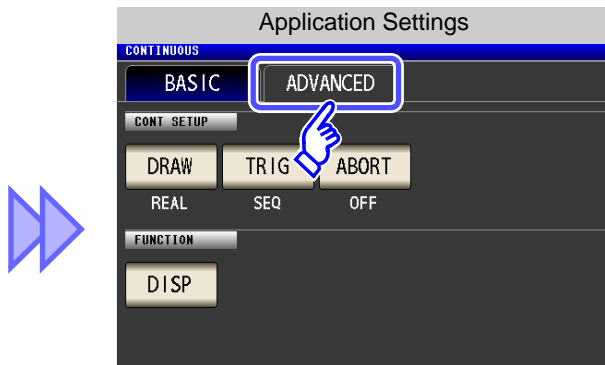
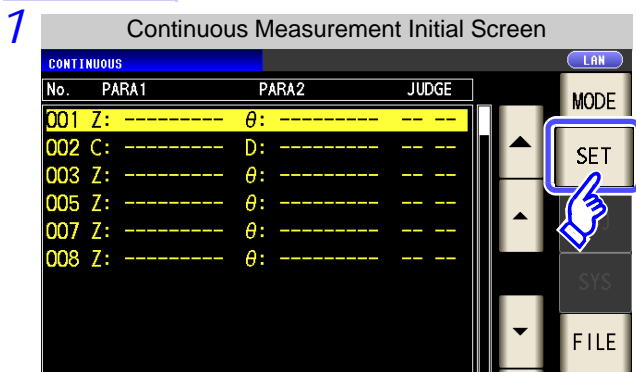

Press **ABORT**.

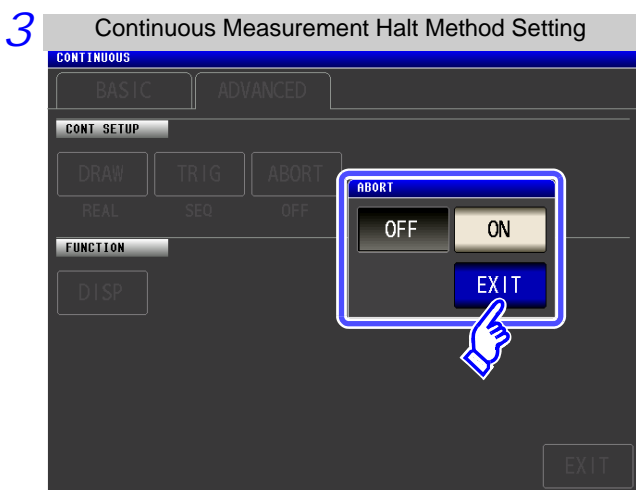

Turn the setting to halt continuous measurement on or off.

- OFF** Performs continuous measurement for all panels, regardless of the judgment result.
- ON** Halts continuous measurement when the judgment result is FAIL.

4 Press **EXIT** to close the setting screen.

6.5 Setting Application Settings

6.5.4 Setting the LCD to ON/ OFF

You can turn the LCD ON/ OFF.  
 Setting the LCD to OFF saves power because the LCD turns off if the panel is not touched for 10 seconds.

Procedure

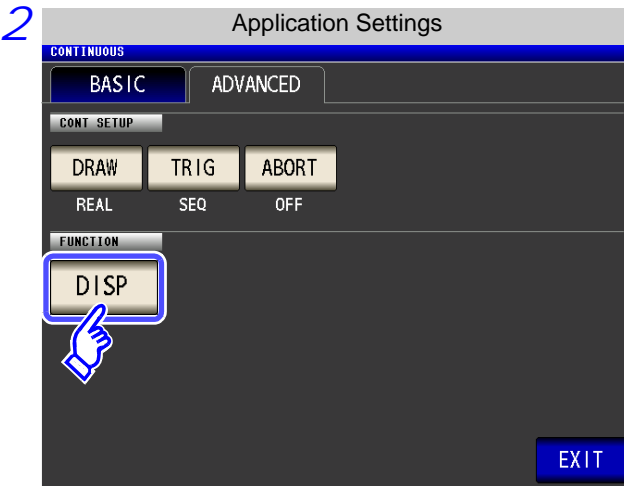
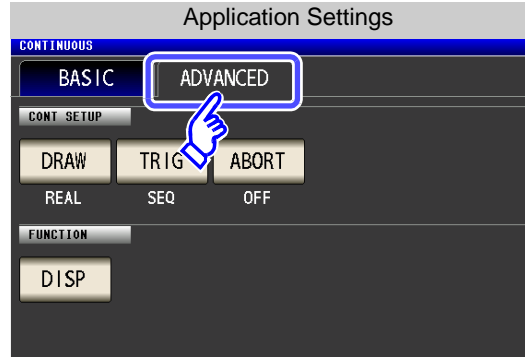
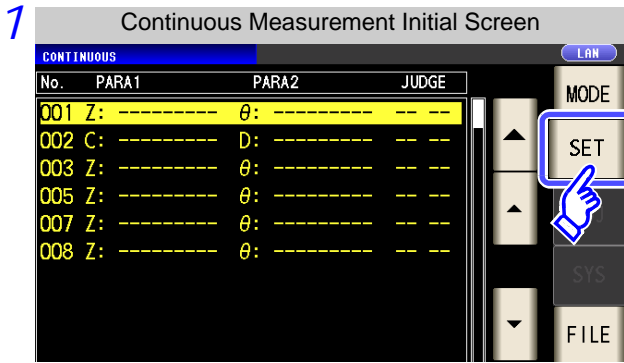

Press **DISP**.

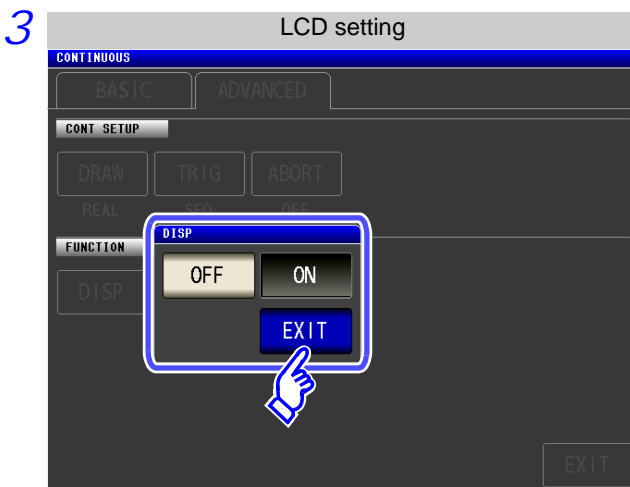

Select the LCD setting, and press **EXIT** to close the setting screen.

- OFF** Turns OFF the LCD. The LCD turns off after approximately 10 seconds elapse since the touch panel was last touched.
- ON** Sets the LCD to always on.

**When you want to turn the backlight on again:**  
 If you touch the touch panel while the backlight is off, the backlight will turn on again.



# Error Compensation

## Chapter 7

Compensate for errors caused by a fixture or measurement cable.

### 7.1 Setting Open Circuit Compensation LCR ANALYZER

With open circuit compensation, it is possible to reduce the influence of the floating impedance of the test cables and thereby to enhance the accuracy of measurement.

It is effective for test samples whose impedance is relatively high.

The comparator decision mode can be set as one of the following:

All Compensation	▶	The compensation values are obtained for all test frequencies.
Spot Compensation	▶	The compensation values are obtained at the set test frequency only.
OFF	▶	Open circuit compensation data becomes invalid.

#### NOTE

- Before open circuit compensation, always set the cable length.  
[See](#) "7.4 Compensating Measurement Cable Errors (Cable Length Compensation)" (p. 301)
- The measurement accuracy values defined in the specifications are for when open circuit compensation and short circuit compensation are performed.
- Be sure to perform compensation again after replacing the measuring cable. You will be unable to obtain correct values if measurement is performed in the compensation state prior to replacement.
- For SPOT compensation, the open circuit compensation will be valid only when the measurement frequency agrees with the SPOT compensation frequency.
- When performing compensation, make sure that there is no noise source nearby. Noise may cause an error when performing compensation.  
ex. Servo Motor, switching power source, high-voltage cable and etc.
- For SPOT compensation, the open circuit compensation will be valid only when the measurement frequency agrees with the SPOT compensation frequency.
- The compensated value is preserved in the memory of the main unit even when power is turned off.
- If the setting of the low Z high accuracy mode is changed, the compensation value becomes invalid.

#### Before Performing Screen Operations

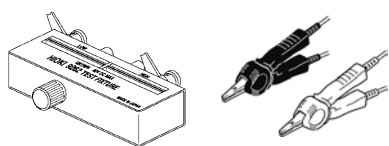

- Arrange the test leads as they will be when measurement will actually be performed. Changing the configuration of the leads may result in compensation not being performed properly.
- Create an open state between the HIGH terminals and LOW terminals of the probes or fixture in accordance with the width of the measurement object. (Connect  $H_{CUR}$  and  $H_{POT}$ , and connect  $L_{CUR}$  and  $L_{POT}$ .)
- When the open circuit compensation is performed, execute the guarding process.  
[See](#) "Appendix 2 Measurement of High Impedance Components" (p. A3)

## 7.1 Setting Open Circuit Compensation

### 7.1.1 All Compensation

Simultaneously acquire the open compensation values for all measurement frequencies.

#### Procedure

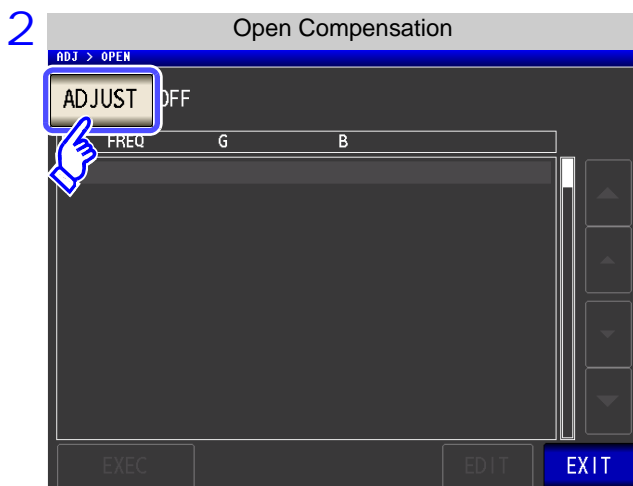
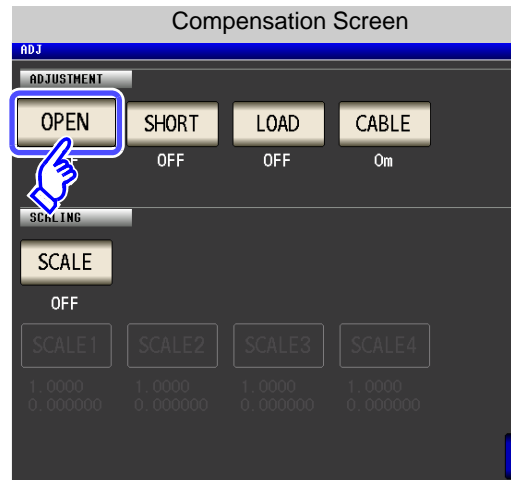
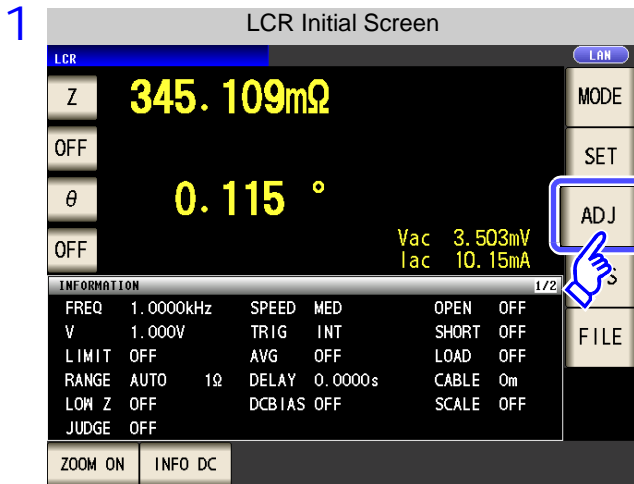

Press **ADJUST**.

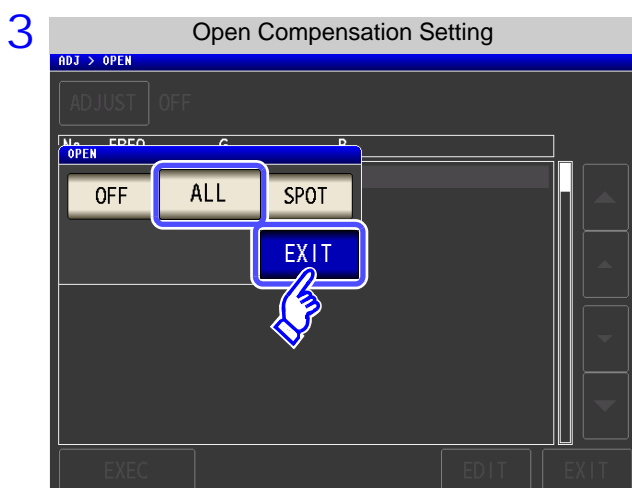

Select **ALL** and press **EXIT** to close the setting screen.

## 7.1 Setting Open Circuit Compensation

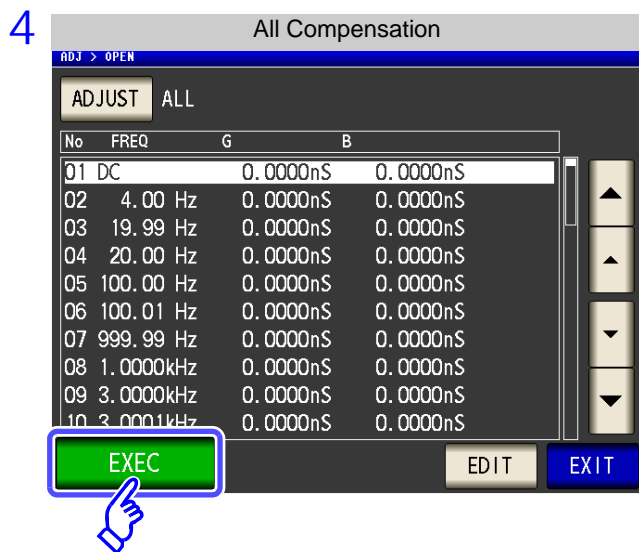

The compensation values from last time are displayed in a confirmation screen. (If compensation has never been performed, the compensation values become 0.)

Check that the measurement cable is in an open circuit state.

Press **EXEC**.

**When you do not want to acquire the compensation values:** Press **EXIT**.

The setting screen is redisplayed, and the compensation values from last time become valid.

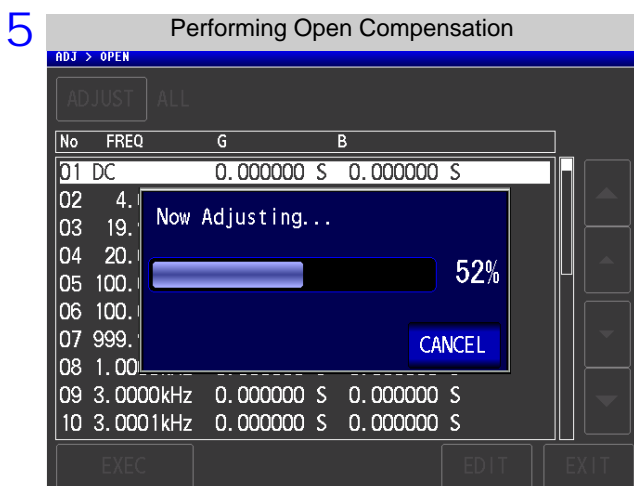

Compensation starts.

Compensation value acquisition time:  
Approximately 2 minutes

**When you want to cancel compensation:**

Press **CANCEL**.

Compensation is cancelled and the compensation screen is redisplayed. (The open circuit compensation value state from last time remains.)

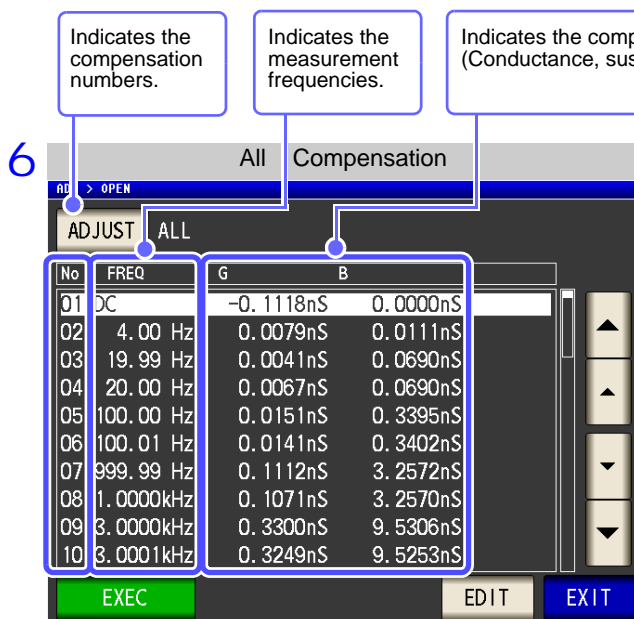

You can use **▲** and **▼** to check the Conductance, susceptance of each compensation point.

- If compensation ends normally, the conductance and susceptance are displayed.
- Compensation can be performed for impedances of at least 1 k $\Omega$ .

**When compensation failed:** (p. 279)

7 Press **EXIT** to close the setting screen.

7.1 Setting Open Circuit Compensation

Acquiring open compensation values for some frequencies only

Procedure

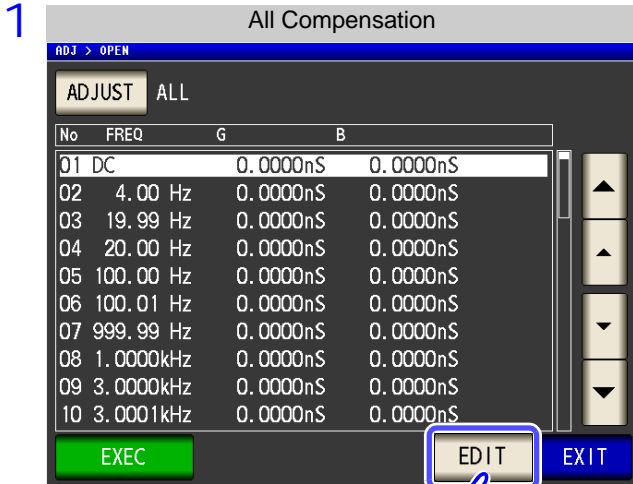

Press **EDIT** in the all compensation screen.

Configuring DC open compensation

- ON** Performs DC open compensation.
- OFF** Does not perform DC open compensation.

Configuring AC open compensation

Press **START** and set the start frequency for open compensation with the numeric keypad.

Press **STOP** and set the stop frequency for open compensation with the numeric keypad.

Press **SET** to accept the settings.

Initial value (perform compensation for all frequencies):

Press **RESET**.

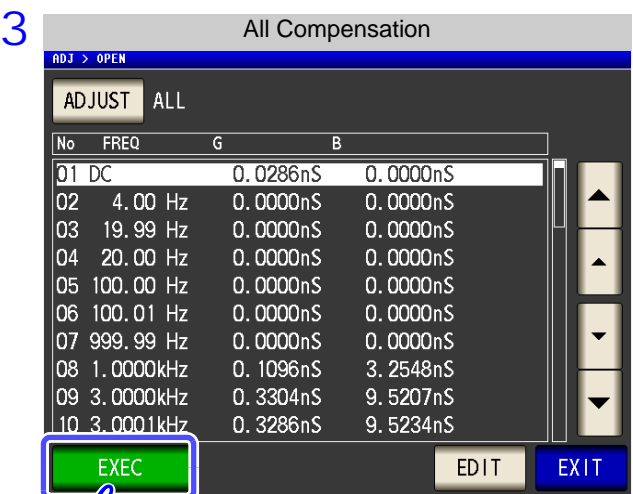
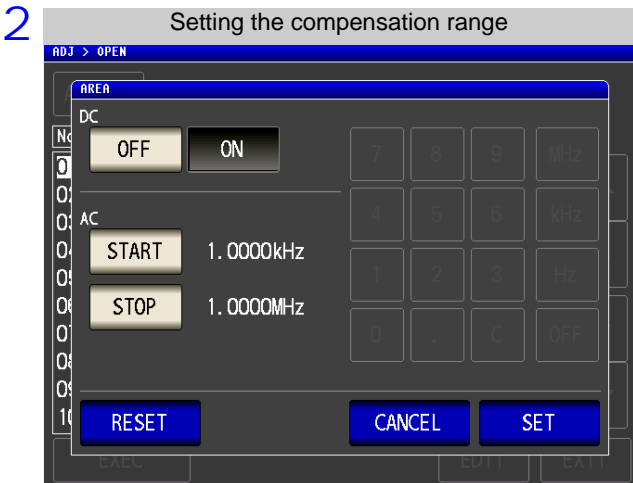

Press **EXEC** to start acquiring compensation values.

**NOTE**

The DC on/off setting and AC start/stop setting apply to both open compensation and short compensation.

## 7.1.2 Spot Compensation

Acquire the compensation values at the set measurement frequencies. Measurement frequencies can be set for up to five points.

### Procedure

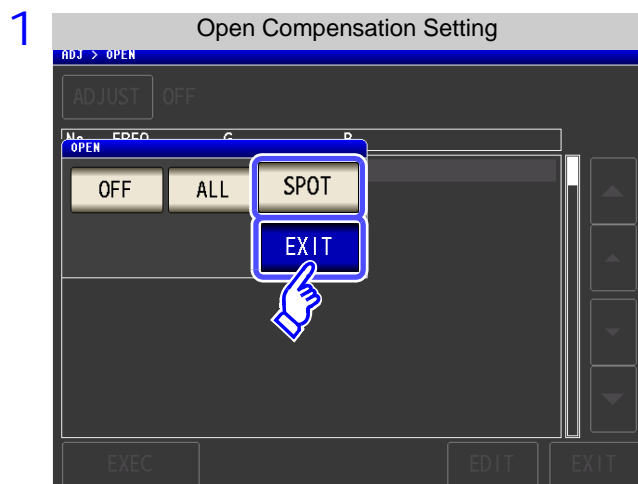

Select **SPOT** in the open circuit compensation screen, and press **EXIT** to confirm the selection.

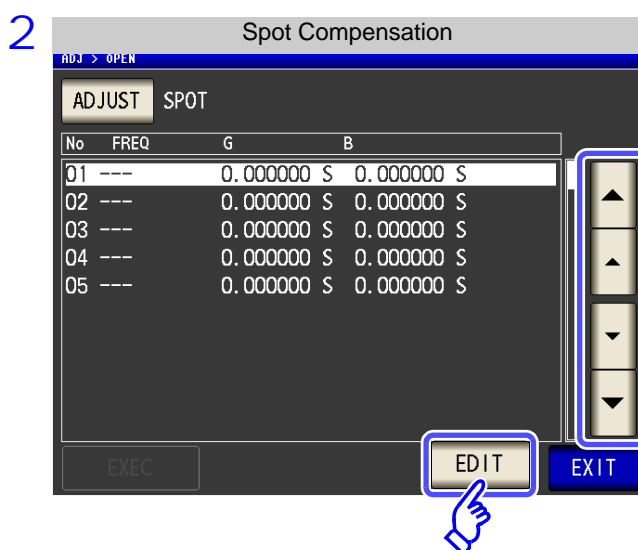

Use **▲** or **▼** to select the compensation point you want to set or edit, and press **EDIT**.

**When you do not want to perform compensation:** Press **EXIT**.

Compensation is not performed and the compensation screen is redisplayed.

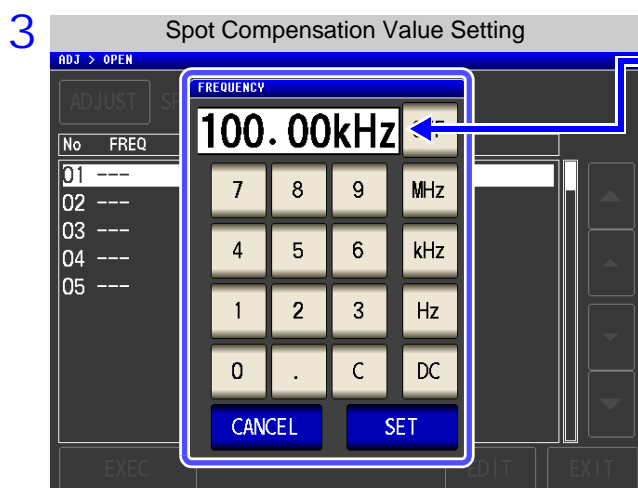

Until one of these keys is pressed for input of a numerical value, the previous frequency for which SPOT compensation was performed is displayed.

**Use the numeric keypad to enter a frequency for compensation.**

- Settable range: DC, 4 Hz to 5.000 MHz  
If a value in excess of 5 MHz is entered, the measurement frequency will automatically set to 5 MHz.
- If a value less than 4 Hz is entered, the measurement frequency will automatically set to 4 Hz.
- If you make a mistake during input:  
press **C** to cancel the input and start again.

4 Press **SET** to confirm the frequency for compensation.

## 7.1 Setting Open Circuit Compensation

5

Spot Compensation Value Setting

No	FREQ	G	B
01	100.00kHz	0.000000 S	0.000000 S
02	---	0.000000 S	0.000000 S
03	---	0.000000 S	0.000000 S
04	---	0.000000 S	0.000000 S
05	---	0.000000 S	0.000000 S

EXEC EDIT EXIT

The compensation values from last time are displayed in a confirmation screen. (If compensation has never been performed, the compensation values become 0.)

Check that the measurement cable is in an open circuit state.

Press **EXEC**.

**When you do not want to acquire the compensation values:** Press **EXIT**.  
The setting screen is redisplayed, and the compensation values from last time become valid.

6

Performing Open Compensation

No	FREQ	G	B
01	100.00kHz	0.000000 S	0.000000 S
02	---		
03	---		
04	---		
05	---		

Now Adjusting... 0% CANCEL

EXEC EDIT EXIT

Compensation starts.

Compensation value acquisition time:  
Approximately 5 seconds

**When you want to cancel compensation:**  
Press **CANCEL**.  
Compensation is cancelled and the compensation screen is redisplayed. (The open circuit compensation value state from last time remains.)

7

Spot Compensation

No	FREQ	G	B
01	100.00kHz	-219.5501pS	11.56738nS
02	---	0.000000 S	0.000000 S
03	---	0.000000 S	0.000000 S
04	---	0.000000 S	0.000000 S
05	---	0.000000 S	0.000000 S

EXEC EDIT EXIT

Indicates the compensation numbers.

Indicates the measurement frequencies.

Indicates the compensation results. (Conductance, susceptance)

You can use **▲** and **▼** to check the Conductance, susceptance of each compensation point.

- If compensation ends normally, the conductance and susceptance are displayed.
- Compensation can be performed for impedances of at least 1 k $\Omega$ .

**When compensation failed:** (p. 279)

8 Press **EXIT** to close the setting screen.

## When Open Compensation Failed

If compensation fails, a window such as the following will be displayed.

When an error message appears and compensation has stopped (when **EXIT** is touched), open circuit compensation is turned OFF.

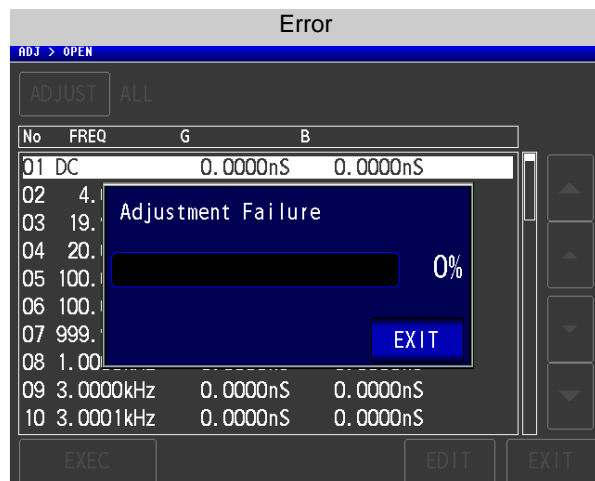

The open circuit compensation process is quite sensitive to noise - both noise originating externally and induced noise. Therefore, if open circuit compensation has been interrupted with a fault, you should check the following points before starting the compensation process again:

- Check that the test cables are properly connected.
- Check that nothing is connected to the test cables. (Open circuit compensation cannot be performed while any test sample is connected to the test cables.)
- Check that the test leads are arranged as closely as possible to their configuration in which measurement will be performed.
- During the compensation process, be sure not to disturb the test cables or to move your hand near them.
- Execute the guarding process.

See "Appendix 2 Measurement of High Impedance Components" (p. A3)

## When You Want to Make Open Circuit Compensation Data Invalid

Press **OFF** in Step 3 of [Open Compensation Setting] (p. 274) to make the compensation data for up until now invalid and return to the [Initial screen].

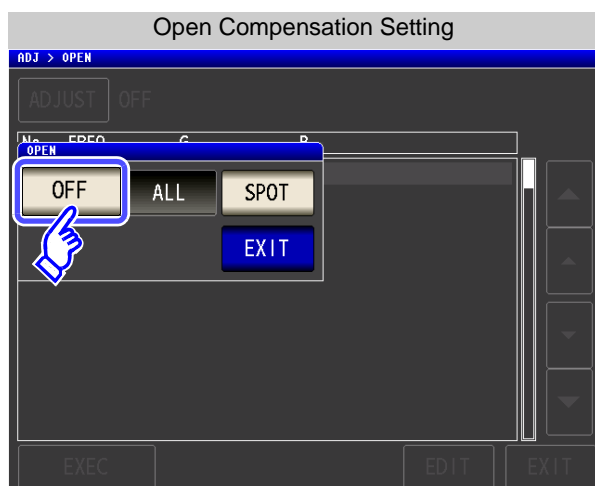

### **NOTE**

The compensation values that are stored internally are not cleared by the operation described above. When ALL or SPOT is selected, the stored compensation values can be used.

## 7.2 Short Circuit Compensation

LCR  
ANALYZER

With short circuit compensation, it is possible to reduce the influence of the residual impedance of the test cables and thereby to enhance the accuracy of measurement.

It is effective for test samples whose impedance is relatively low.

The comparator decision mode can be set as one of the following:

All Compensation	▶	Compensation values are obtained for all test frequencies.
Spot Compensation	▶	Compensation values are obtained at the set test frequency only.
OFF	▶	Short circuit compensation data becomes invalid.

### NOTE

- Before short circuit compensation, always set the cable length.  
**See:** "7.4 Compensating Measurement Cable Errors (Cable Length Compensation)" (p. 301)
- The measurement accuracy values defined in the specifications are for when open circuit compensation and short circuit compensation are performed.
- Be sure to perform compensation again after replacing the measuring cable.  
You will be unable to obtain correct values if measurement is performed in the compensation state prior to replacement.
- For spot compensation, short circuit compensation will be valid only when the measurement frequency and spot compensation frequency match.
- When performing compensation, make sure that there is no noise source nearby. Noise may cause an error when performing compensation.  
ex. Servo Motor, switching power source, high-voltage cable and etc.
- For SPOT compensation, the open circuit compensation will be valid only when the measurement frequency agrees with the SPOT compensation frequency.
- The compensated value is preserved in the memory of the main unit even when power is turned off.
- If the setting of the low Z high accuracy mode is changed, the compensation value becomes invalid.



### Before Performing Screen Operations

Necessary item: Shorting bar

This shorting bar is for short circuiting together the ends of the test leads. Use an object whose impedance is as low as possible.

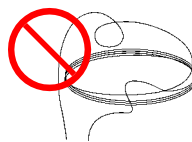
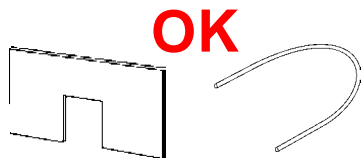

If you use a metallic wire or the like as a shorting bar, try to ensure that it is as thick and short as possible.

Usage example:

Arrange the test leads as closely as possible to their configuration in which measurement will be performed, and short circuit together the HIGH and LOW leads.

(When using a fixture)

In order to keep external influences as low as possible, be sure to thrust the shorting bar in all the way.

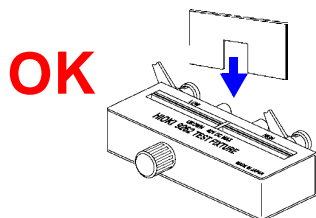

(When using optional L2000)

Short-circuit the tips with the **V** marks on the clips aligned as shown in the diagram, and then perform short compensation.

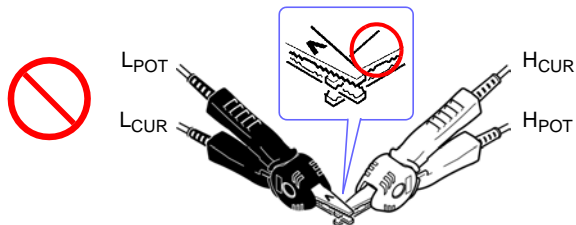
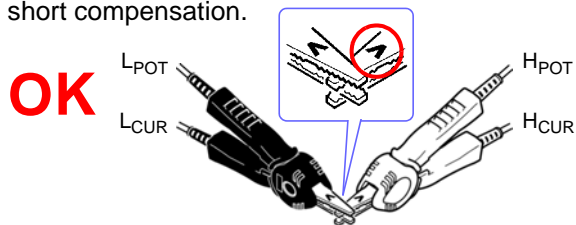

### 7.2.1 All Compensation

Simultaneously acquire the short compensation values for all measurement frequencies.

#### Procedure

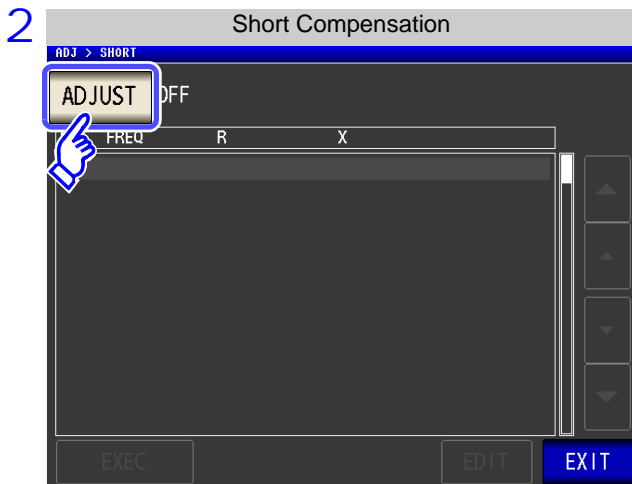
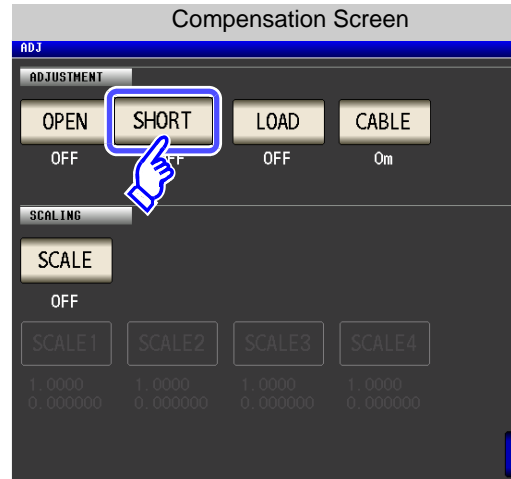
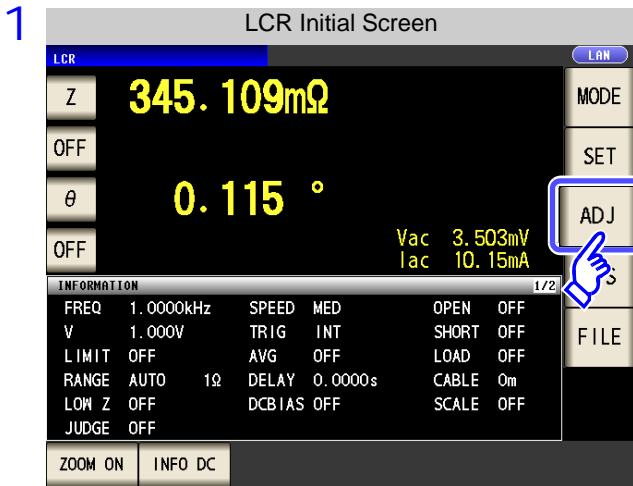

Press **ADJUST**.

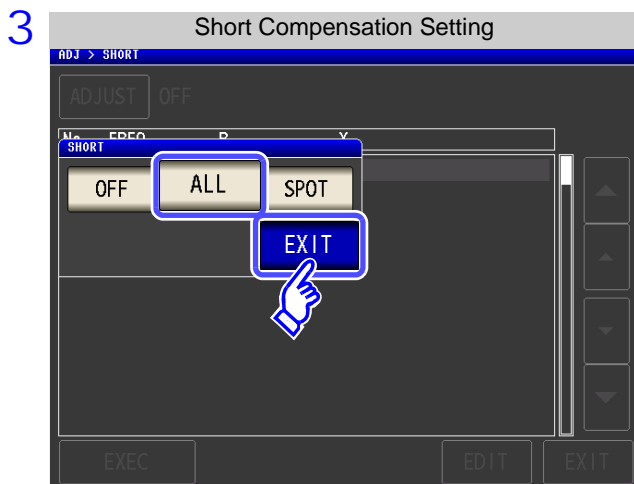

Select **ALL** and press **EXIT** to close the setting screen.

7.2 Short Circuit Compensation

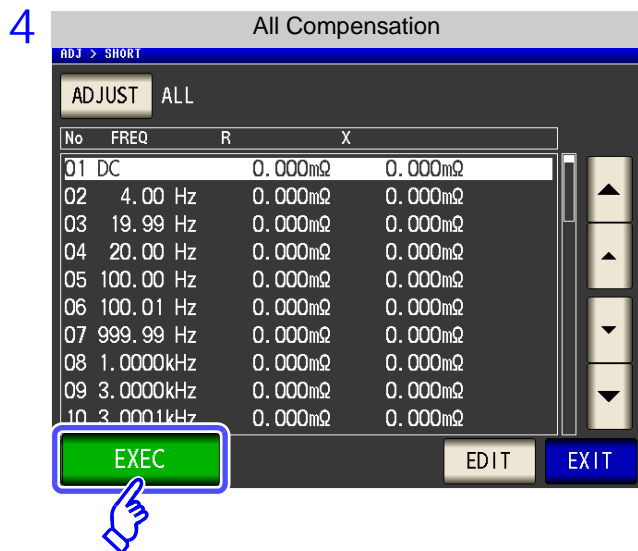

The compensation values from last time are displayed in a confirmation screen. (If compensation has never been performed, the compensation values become 0.)

Check that the measurement cable is in a short-circuit state.

Press **EXEC**.

**When you do not want to acquire the compensation values:** Press **EXIT**.

The setting screen is redisplayed, and the compensation values from last time become valid.

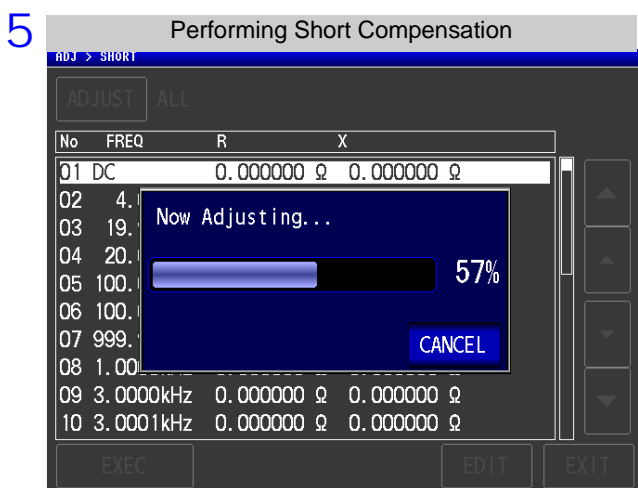

Compensation starts.

Compensation value acquisition time:  
Approximately 2 minutes

**When you want to cancel compensation:**

Press **CANCEL**.

Compensation is cancelled and the compensation screen is redisplayed. (The short circuit compensation values from last time remain.)

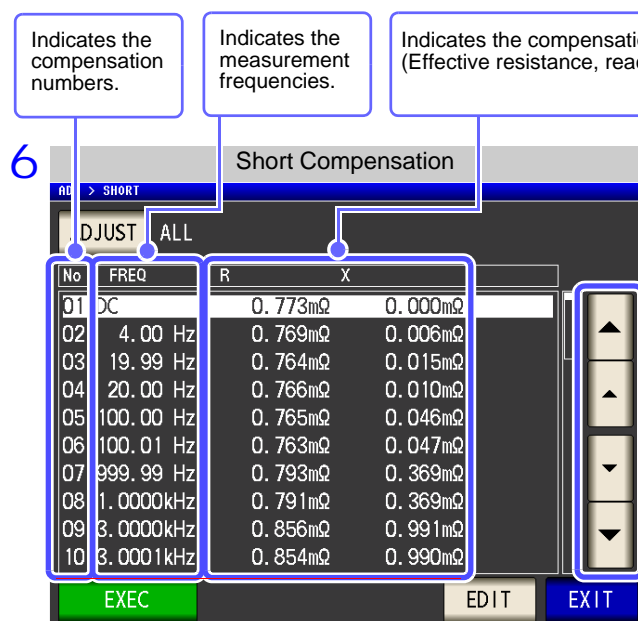

Indicates the compensation numbers.

Indicates the measurement frequencies.

Indicates the compensation results. (Effective resistance, reactance)

Use **▲** or **▼** to check the effective resistance and reactance of each compensation point.

- If compensation ends normally, the effective resistance and reactance are displayed.
- The possible compensation range is 1 kΩ or less for impedance.

**When compensation failed:** (p. 287)

7 Press **EXIT** to close the setting screen.

7.2 Short Circuit Compensation

Acquiring short compensation values for some frequencies only

Procedure

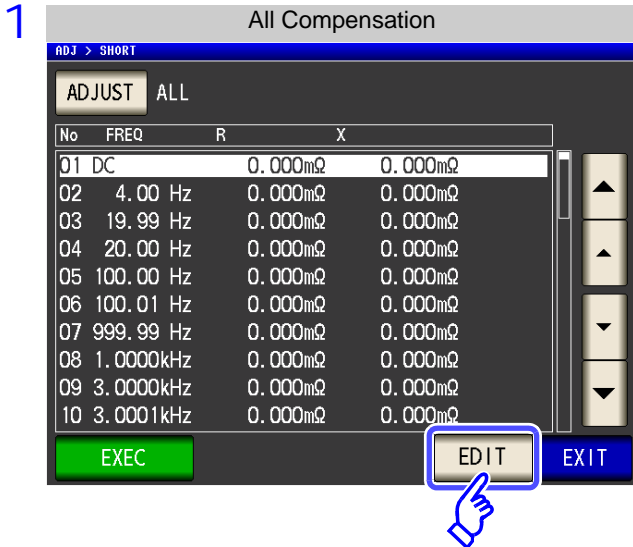

Press **EDIT** in the all compensation screen.

Configuring DC short compensation

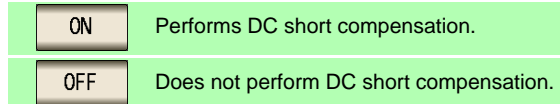

Configuring AC short compensation

Press **START** and set the start frequency for short compensation with the numeric keypad.

Press **STOP** and set the stop frequency for short compensation with the numeric keypad.

Press **SET** to accept the settings.

Initial value (perform compensation for all frequencies):  
Press **RESET**.

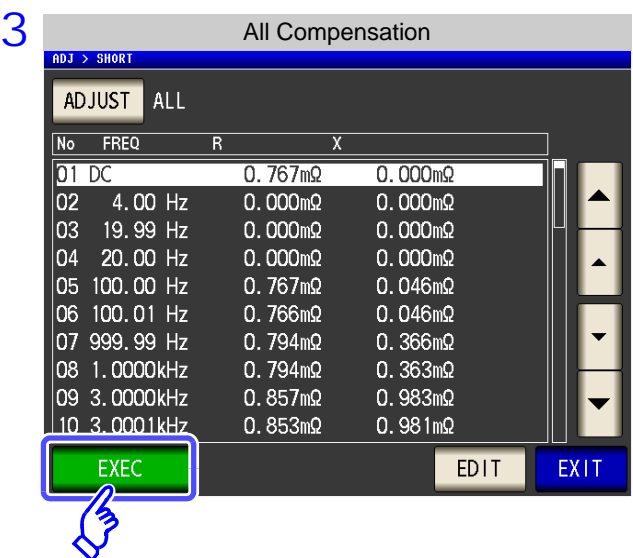
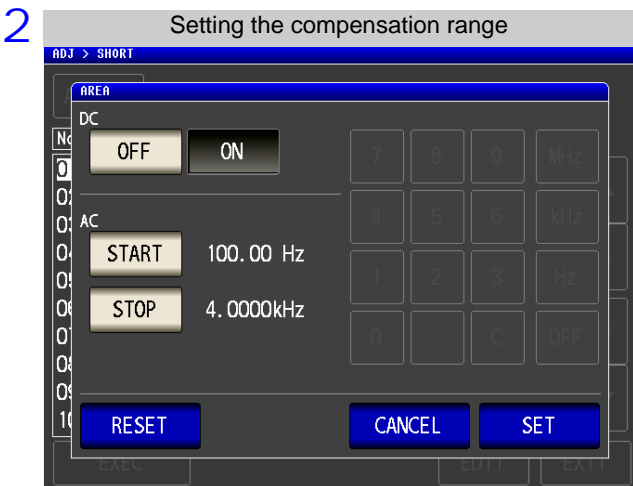

Press **EXEC** to start acquiring compensation values.

**NOTE**

The DC on/off setting and AC start/stop setting apply to both open compensation and short compensation.

## 7.2.2 Spot Compensation

Acquire the compensation values at the set measurement frequencies. Measurement frequencies can be set for up to five points.

### Procedure

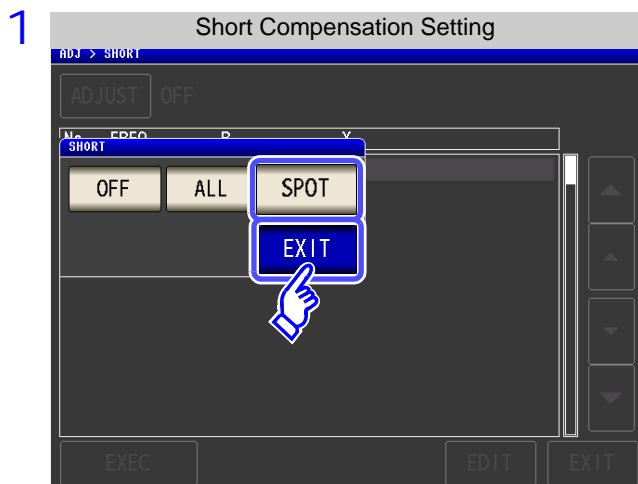

Select **SPOT** in the short circuit compensation screen, and press **EXIT** to confirm the selection.

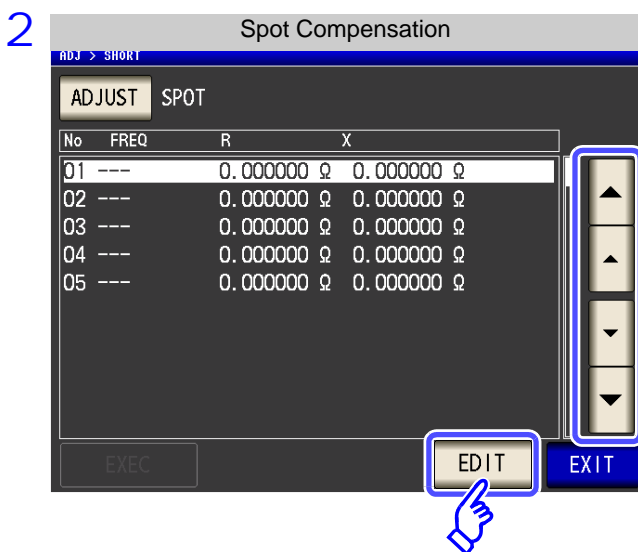

Use **▲** or **▼** to select the compensation point you want to set or edit, and then press **EDIT**.

**When you do not want to perform compensation:** Press **EXIT**.

Compensation is not performed and the compensation screen is redisplayed.

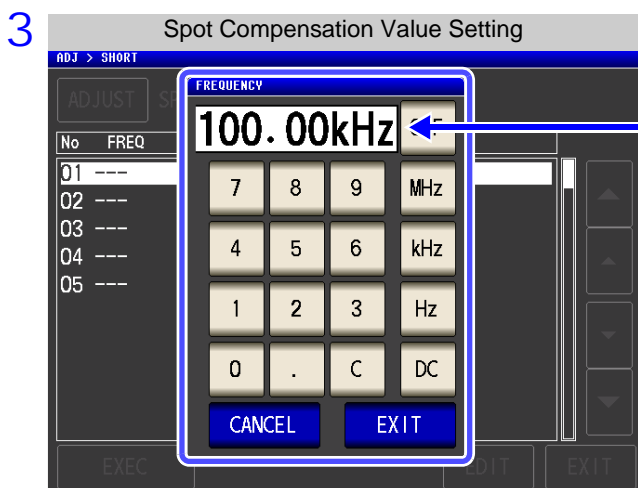

Until one of these keys is pressed for input of a numerical value, the previous frequency for which SPOT compensation was performed is displayed.

Use the numeric keypad to enter a frequency for compensation.

- Settable range: DC, 4 Hz to 5.000 MHz
- If a value in excess of 5 MHz is entered, the measurement frequency will automatically set to 5 MHz.
- If a value less than 4 Hz is entered, the measurement frequency will automatically set to 4 Hz.
- If you make a mistake during input: press **C** to cancel the input and start again.

4 Press **EXIT** to confirm the frequency for compensation.

7.2 Short Circuit Compensation

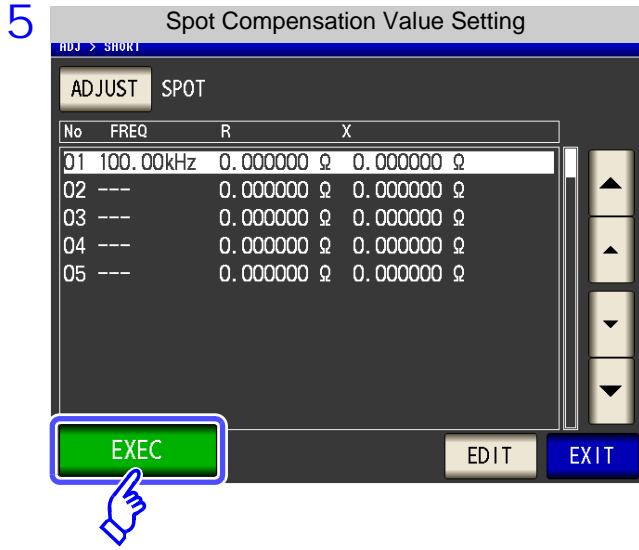

The compensation values from last time are displayed in a confirmation screen. (If compensation has never been performed, the compensation values become 0.)

Check that the measurement cable is in a short-circuit state.

Press **EXEC**.

**When you do not want to acquire the compensation values:** Press **EXIT**.  
The setting screen is redisplayed, and the compensation values from last time become valid.

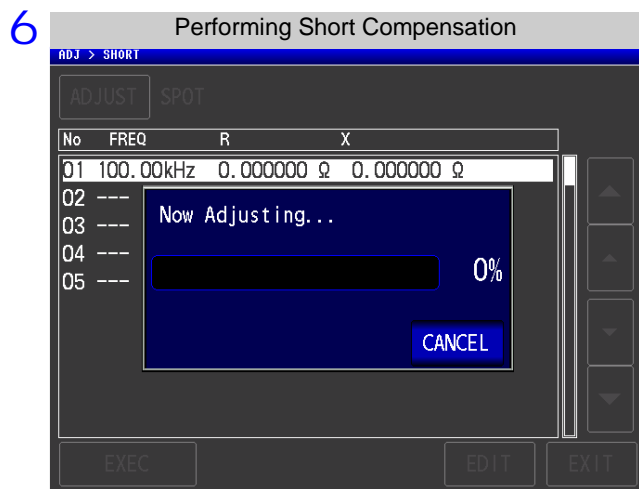

Compensation starts.

Compensation value acquisition time:  
Approximately 5 seconds

**When you want to cancel compensation:**  
Press **CANCEL**.  
Compensation is cancelled and the compensation screen is redisplayed. (The short circuit compensation values from last time remain.)

- Indicates the compensation numbers.
- Indicates the measurement frequencies.
- Indicates the compensation results. (Effective resistance, reactance)

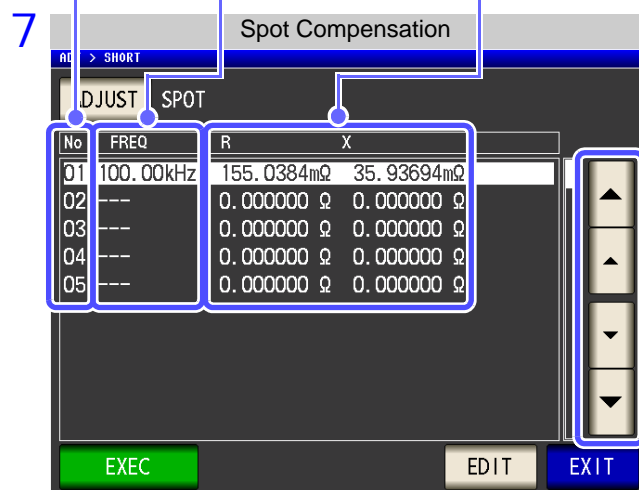

Use **▲** or **▼** to check the effective resistance and reactance of each compensation point.

- If compensation ends normally, the effective resistance and reactance are displayed.
- The possible compensation range is 1 kΩ or less for impedance.

**When compensation failed:** (p. 287)

8 Press **EXIT** to close the setting screen.

## When Short Compensation Failed

**EXIT** When an error message appears and compensation has stopped, short circuit compensation is turned off.

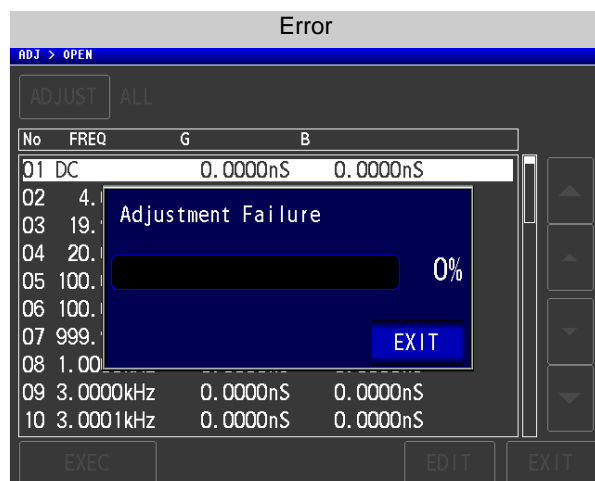

Check the following points before starting the short circuit compensation process again:

- Check that the test cables are properly connected.
- Check that the test cables are properly shorted together with the shorting bar. (Short circuit compensation cannot be performed while any test sample is connected to the test cables.)
- Check that the test leads are arranged as closely as possible to their configuration in which measurement will be performed.
- During the compensation process, be sure not to disturb the test cables or to move your hand near them.

## When You Want to Make Short Circuit Compensation Data Invalid

Press **OFF** in Step 3 of [Short Compensation Setting] (p. 282) to make the compensation data for up until now invalid and return to the [Initial screen].

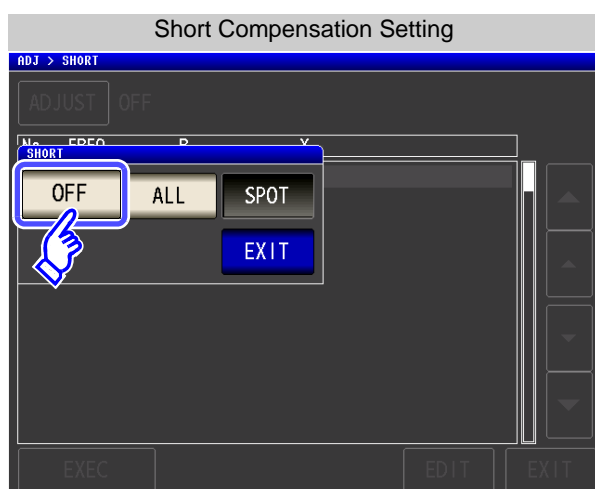

### **NOTE**

The compensation values that are stored internally are not cleared by the operation described above. When ALL or SPOT is selected, the stored compensation values can be used.

# 7.3 Compensating Values to Match Reference Values (Load Compensation) LCR ANALYZER

Compensate measurement values to match the element that will be the reference. With load compensation it is possible to calculate the compensation coefficient by measuring a reference sample with known data and perform the compensation for the test data obtained from the target sample. The compensation coefficient can be acquired using up to five compensation conditions. The reference value of each compensation condition can be set independently. The following seven compensation conditions should be set for each measurement frequency:

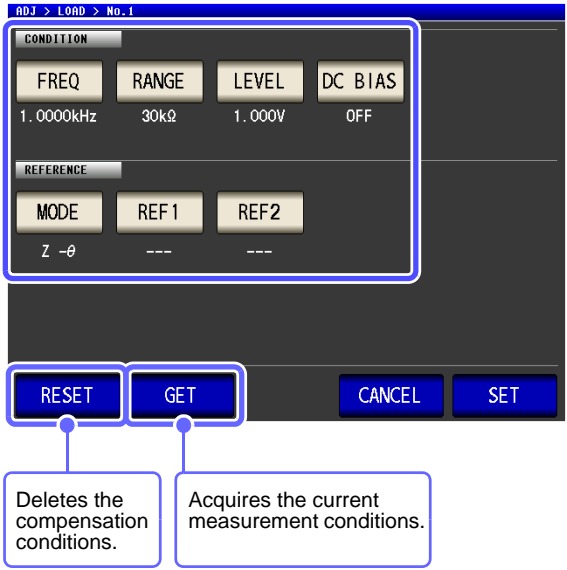

- Compensation frequency** ▶ Define the measurement frequency used to measure and compensate the reference sample.
- Compensation Range** ▶ Set the range to compensate.
- Compensation Signal Level** ▶ Set the type and value of the signal level to compensate.
- DC Bias** ▶ Enable or disable DC bias and set the value.
- Parameter Type** ▶ Set the parameter to use as the reference value.
- Reference Value 1** ▶ Set the Z/ Cs/ Cp/ Ls/ Lp/ Rs reference value selected for the parameter type.
- Reference Value 2** ▶ Set the θ/ D/ Rs/ Rp/ Q/ X reference value selected for the parameter type.

The compensation coefficient is computed from the reference values of Z and θ obtained from the set values and the actual data acquired from the reference sample at each of the compensation frequencies.

Compensation coefficient of Z = (Reference value of Z) / (Actual data of Z)  
 Compensation value of θ = (Reference value of θ) - (Actual data of θ)

The measured values of Z and θ are first compensated using the following equations, and then individual parameters from the compensated Z and θ values are employed.

$Z = (Z \text{ before compensation}) \times (\text{Compensation coefficient of } Z)$   
 $\theta = (\theta \text{ before compensation}) + (\text{Compensation value of } \theta)$



### 7.3 Compensating Values to Match Reference Values (Load Compensation)

#### NOTE

- When all of the compensation conditions match for load compensation, compensation is performed under the optimal conditions.
- If the current measurement frequency and compensation frequency do not match, an error like the following is displayed in the initial screen.

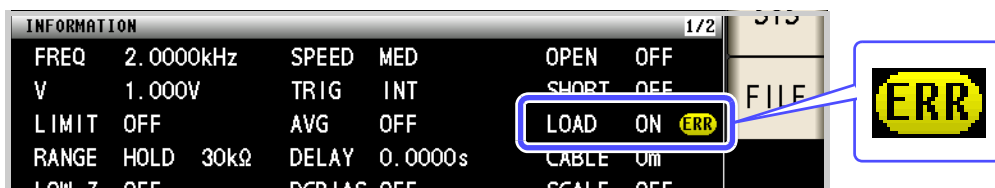

- If a condition other than the compensation frequency does not match, compensation is performed but a warning like the following is displayed in the initial screen.

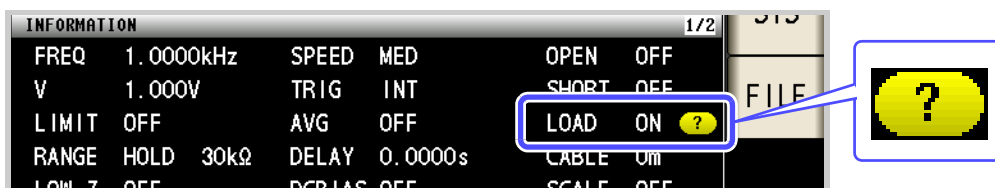

- When the OPEN or SHORT compensation is valid, the load compensation is performed for Z and  $\theta$  processed by the OPEN or SHORT compensation.
- In acquiring load compensation data (i.e., reference sample measurement), the OPEN/SHORT compensation settings, that were defined before entry into the Load Compensation Screen, are valid.
- If the setting of the low Z high accuracy mode is changed, the compensation value becomes invalid.

## 7.3 Compensating Values to Match Reference Values (Load Compensation)

### Procedure

1

LCR Initial Screen

LCR LAM

Z 345.109mΩ

OFF

θ 0.115 °

OFF

Vac 3.503mV  
Iac 10.15mA

INFORMATION 1/2

FREQ	1.0000kHz	SPEED	MED	OPEN	OFF	
V	1.000V	TRIG	INT	SHORT	OFF	
LIMIT	OFF	AVG	OFF	LOAD	OFF	
RANGE	AUTO	Ω	DELAY	0.0000s	CABLE	0m
LOW Z	OFF	DCBIAS	OFF	SCALE	OFF	
JUDGE	OFF					

MODE SET ADJ FILE

ZOOM ON INFO DC

Compensation Screen

ADJ

ADJUSTMENT

OPEN SHORT LOAD CABLE

OFF OFF OFF OFF

SCALING

SCALE

OFF

SCALE1 SCALE2 SCALE3 SCALE4

1.0000 1.0000 1.0000 1.0000  
0.000000 0.000000 0.000000 0.000000

2

ADJ > LOAD

ADJUST OFF

	Freq	Range	Level	Ref1	Ref2
1	---	---	---	---	---
2	---	---	---	---	---
3	---	---	---	---	---
4	---	---	---	---	---
5	---	---	---	---	---

EXEC EDIT

Press **ADJUST**.

3

ADJ > LOAD

ADJUST OFF

No	LOAD	Range	Level	Ref1	Ref2
1	OFF	---	---	---	---
2	---	---	---	---	---
3	---	---	---	---	---
4	---	---	---	---	---
5	---	---	---	---	---

EXEC EDIT

Select **ON**, and press **EXIT** to confirm the selection.

### 7.3 Compensating Values to Match Reference Values (Load Compensation)

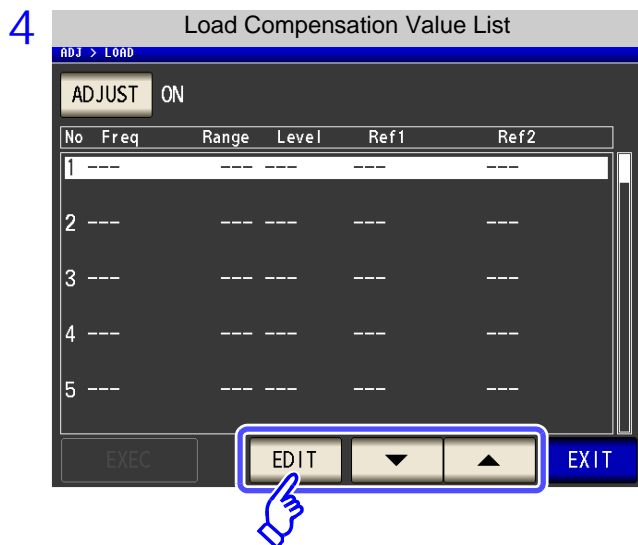

Use or to select the number of the load compensation condition to set.

Press .

#### 5 Set the compensation condition.

- Compensation frequency (p. 293)
- Compensation range (p. 294)
- Type and value of the compensation level (p. 295)
- DC bias (p. 296)
- Parameter to use for reference value (p. 297)
- Reference value (p. 298)

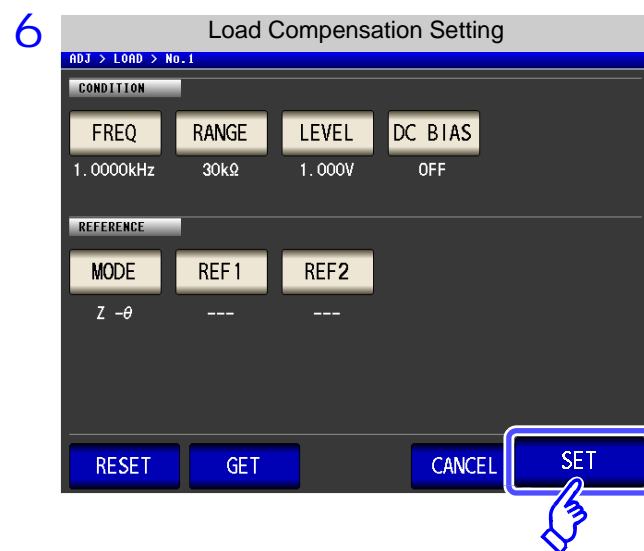

Press to confirm the compensation conditions.

The load compensation screen is redisplayed.

Attach the reference sample to the test fixtures.

#### When you want to cancel compensation:

Press .

The compensation conditions are discarded and the load compensation screen is redisplayed.

**7.3 Compensating Values to Match Reference Values (Load Compensation)**

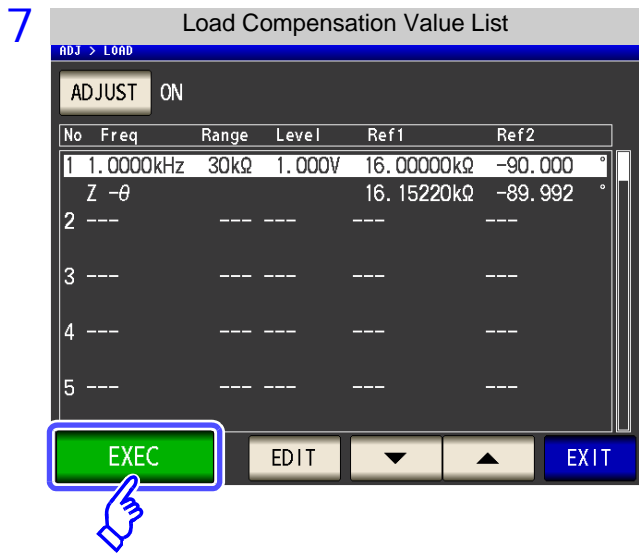

If you select **EXEC**, the compensation values are acquired.

- When data acquisition is completed, the reference sample compensation data is displayed on the screen.
- When an error occurs during data acquisition, a “beep” sound is generated and the compensation data is invalidated.
- If even one of the load compensation conditions is changed following data acquisition, the acquired compensation data is invalidated.

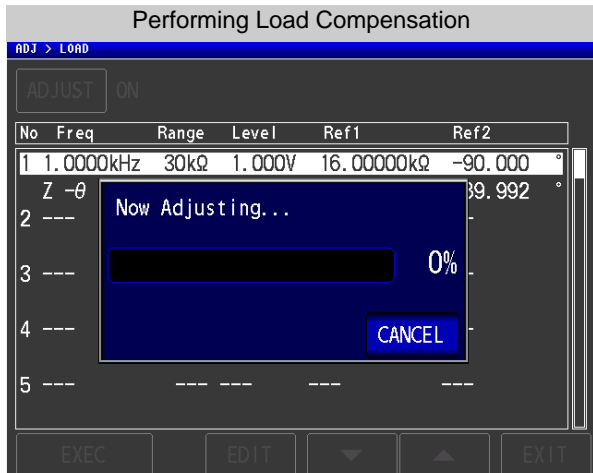

When you want to cancel compensation data acquisition: Press **CANCEL**.

When compensation failed: (p. 300)

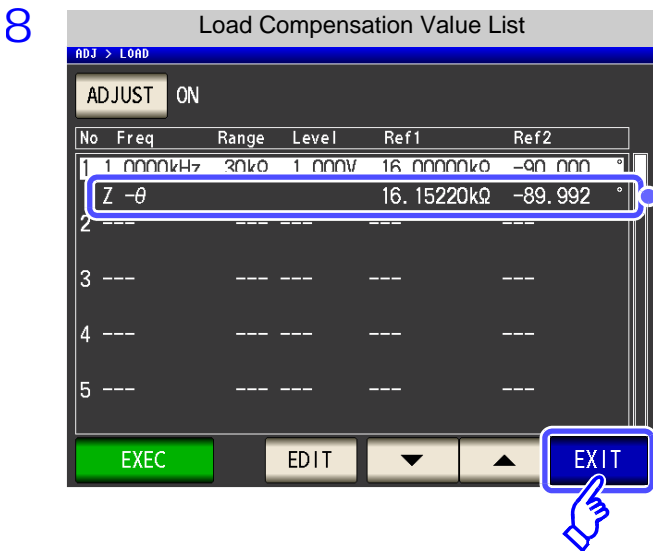

When acquisition of the compensation value is completed, the compensation value is displayed.

Press **EXIT** from the load compensation screen to return to the initial screen.

### 7.3 Compensating Values to Match Reference Values (Load Compensation)

9

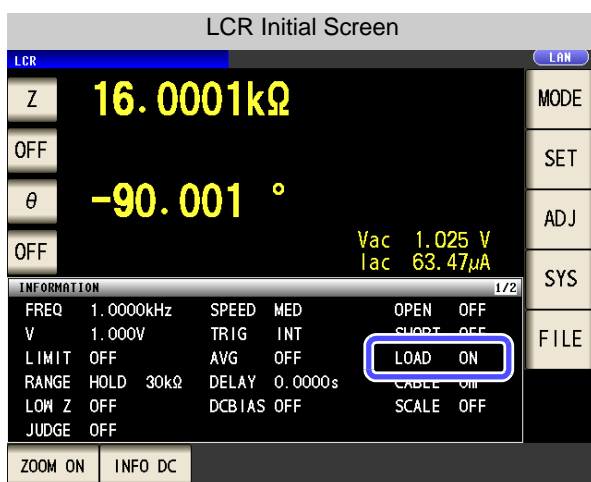

When the load compensation is valid for the set measurement conditions, ON appears on the LOAD parameter in the Initial Screen.

When the same compensation frequency has been set to multiple load compensation groups, only the group with the smallest number will be valid.

When the current measurement frequency does not agree with the load compensation frequency, the load compensation will be invalid and ON will not appear.

**FREQ** Set the compensation frequency.

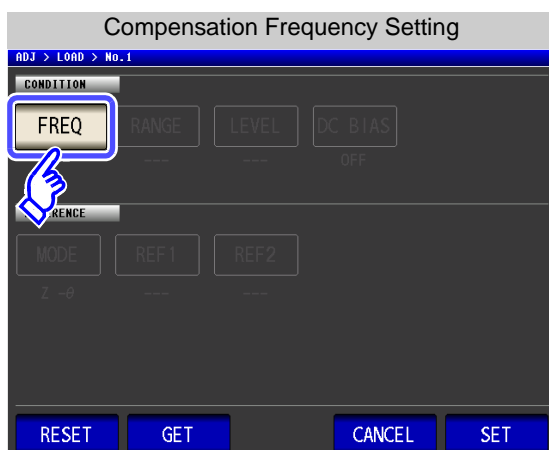

1. Press **FREQ**.

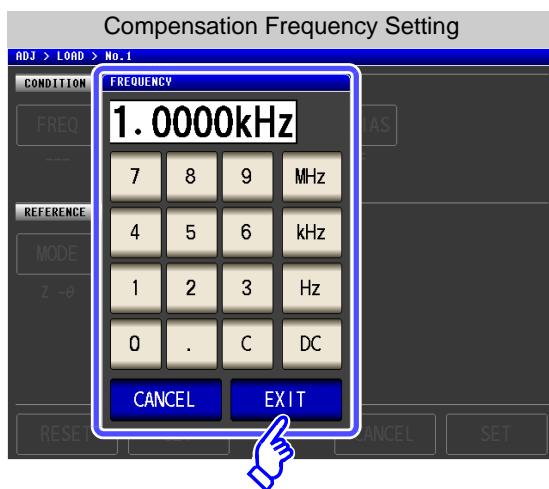

2. Use the numeric keypad to enter the compensation frequency.

Settable range: DC, 4.00 to 5.0000 MHz

3. Press a unit key to confirm the setting.

4. Press **EXIT** to close the setting screen.

- When performing load compensation for DC resistance measurement: Press **DC**.
- If you make a mistake during input: press **C** to cancel the input and start again.
- When you want to cancel input: Press **CANCEL** to close the compensation frequency setting screen.

## 7.3 Compensating Values to Match Reference Values (Load Compensation)

RANGE

### Setting the Compensation Range

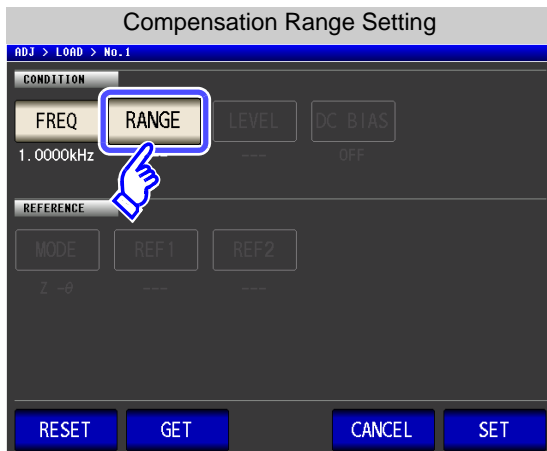

1. Press **RANGE**.

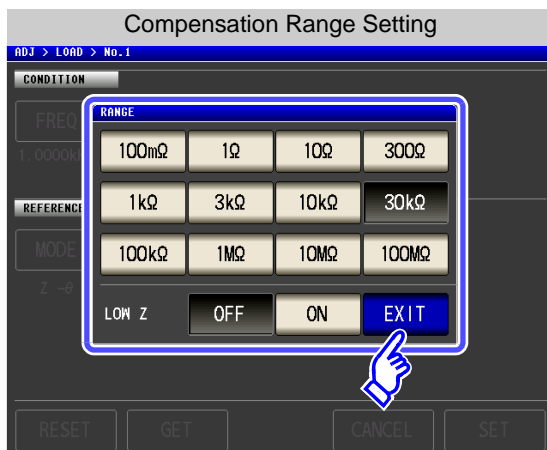

2. Select the range for compensation.

The range that can be set varies depending on the compensation frequency.

Frequency	Settable Range	Range Setting Screen
DC	Entire range	
4.00 Hz to 100.00 kHz		
100.01 kHz to 1.0000 MHz	100 mΩ to 10 MΩ	
1.0001 MHz to 5.0000 MHz	100 mΩ to 1 MΩ	

- To enable LOW Z: Press **ON** of LOW Z.
- If you make a mistake during input: press **C** to cancel the input and start again.

3. Press **EXIT** to close the setting screen.

**NOTE** If the compensation frequency is not set, the compensation range cannot be set.

### 7.3 Compensating Values to Match Reference Values (Load Compensation)

LEVEL

#### Setting the Type and Value of the Compensation Level

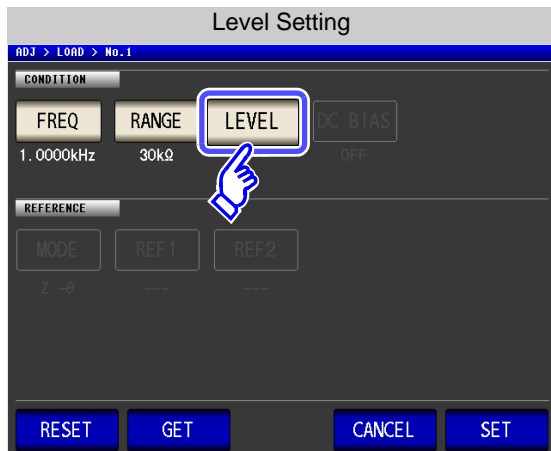

1. Press **LEVEL**.

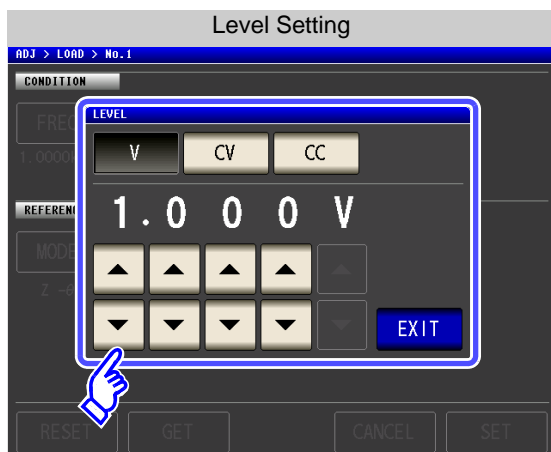

2. Select the compensation level type.

- V** Open voltage level (p. 45)
- CV** Voltage level between test sample terminals (p. 45)
- CC** Current level between test sample terminals (p. 47)

3. Use **▲** or **▼** to enter the voltage or current value. For the possible compensation setting ranges, see the following figures.

4. Press **EXIT** to close the setting screen.

#### AC Load Compensation

V, CV

Frequency	LOW Z	Range	V, CV
4.00 Hz to 1.0000 MHz	OFF	Entire range	0.005 to 5.000 V
1.0001 MHz to 5.0000 MHz	OFF	Entire range	0.010 to 1.000 V
4.00 Hz to 1.0000 MHz	ON	Entire range	0.005 to 1.000 V
1.0001 MHz to 5.0000 MHz	ON	Entire range	0.010 to 1.000 V

CC

Frequency	LOW Z	Range	CC
4.00 Hz to 1.0000 MHz	OFF	Entire range	0.01 m to 50.00 mA
1.0001 MHz to 5.0000 MHz	OFF	Entire range	0.01 m to 10.00 mA
4.00 Hz to 100.00 kHz	ON	100 mΩ, 1 Ω	0.01 m to 100.00 mA
		Range of 10 Ω or more.	0.01 m to 10.00 mA
100.01 kHz to 5.0000 MHz	ON	Entire range	0.01 m to 10.00 mA

#### DC Load Compensation

V, CV

LOW Z	Range	V, CV
OFF	Entire range	0.1 V to 2.50 V
ON	Entire range	0.1 V to 1.00 V

CC

LOW Z	Range	CC
OFF	Entire range	0.01 m to 25.00 mA
ON	100 mΩ, 1 Ω	0.01 m to 100.00 mA
	Range of 10 Ω or more.	0.01 m to 25.00 mA

**NOTE** If the compensation range is not set, the compensation level cannot be set.

## 7.3 Compensating Values to Match Reference Values (Load Compensation)

DC BIAS

### Setting the DC Bias

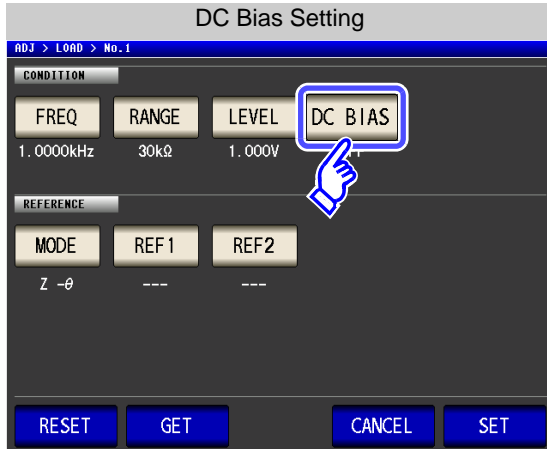

1. Press **DC BIAS**.

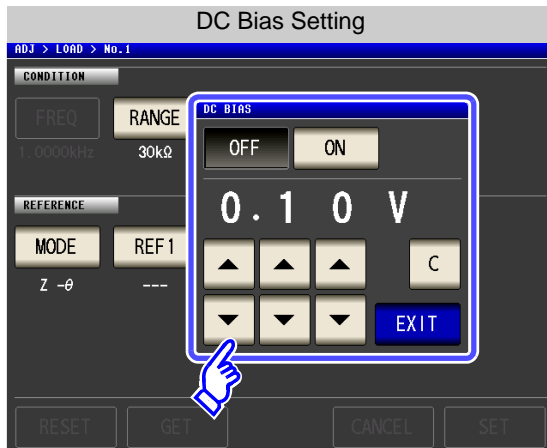

2. Select ON/ OFF for the DC bias.

**OFF** Sets the DC bias to OFF.

**ON** Sets the DC bias to ON.

3. Use **▲** or **▼** to enter the DC bias value.  
Settable range: 0.00 to 2.50 V

4. Press **EXIT** to close the setting screen.

If you make a mistake during input:  
press **C** to cancel the input and start again.

#### **NOTE**

- If the compensation frequency, compensation range, and compensation level are not set, the DC bias setting cannot be set.
- When DC is selected for the compensation frequency setting, the DC bias setting cannot be set.



### 7.3 Compensating Values to Match Reference Values (Load Compensation)

MODE

Setting of Parameter to Use for Reference Value

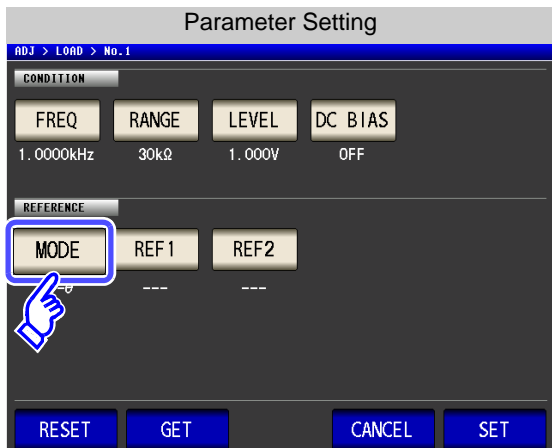

1. Press **MODE**.

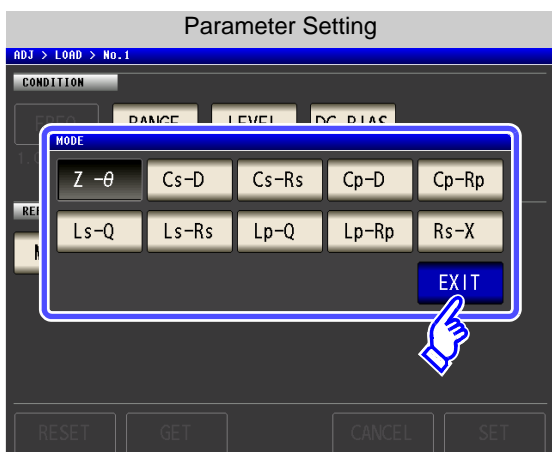

2. Select the parameter mode of the reference value to be set.

3. Press **EXIT** to close the setting screen.

See "1.3.7 Parameter Settings Screen" (p. 25)

#### **NOTE**

- If the compensation frequency, compensation range, and compensation level are not set, the parameter to use for the reference value setting cannot be set.
- When DC is selected for the compensation frequency setting, Rdc is selected automatically and the parameter to use for the reference value setting cannot be set.
- If you change the parameter to use as the reference value, the settings of reference value 1 and reference value 2 are cleared.

## 7.3 Compensating Values to Match Reference Values (Load Compensation)

### REF1 and REF2 Reference Value Settings

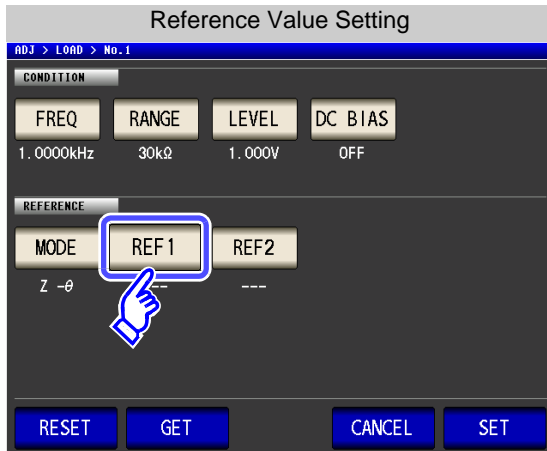

1. Press **REF1**.

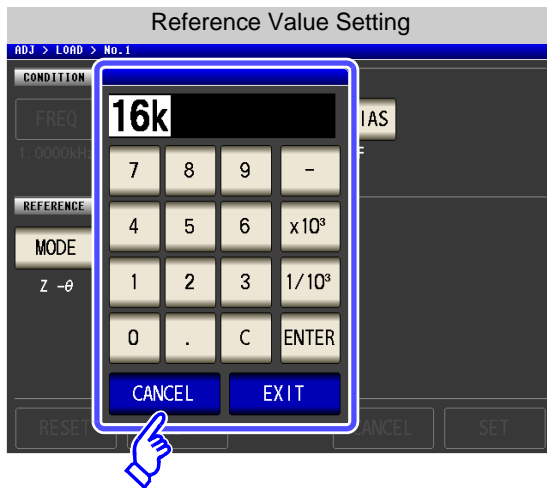

2. Use the numeric keypad to enter the reference value.

3. Press a unit key to confirm the setting.

4. Press **EXIT** to confirm the setting.

5. Also set **REF2** in the same way.

- If the compensation frequency, input mode or reference values are incorrectly set, the load compensation cannot be executed.
- If you make a mistake during input:  
press **C** to cancel the input and start again.

### NOTE

- If the compensation frequency, compensation range, and compensation level are not set, the reference value setting cannot be set.
- When DC is selected for the compensation frequency setting, only reference value 1 can be set.

### 7.3 Compensating Values to Match Reference Values (Load Compensation)

#### When You Want to Reset All Settings



If you press , all settings are cancelled and you can start again from the compensation frequency settings.

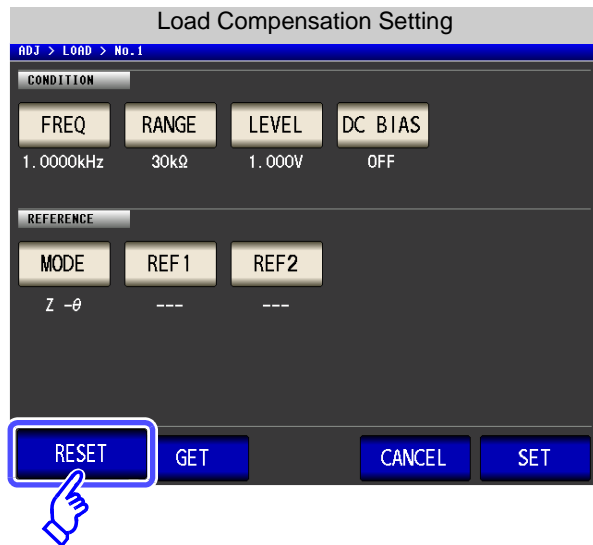



#### When You Want to Use the Current Measurement Conditions as the Load Compensation Conditions

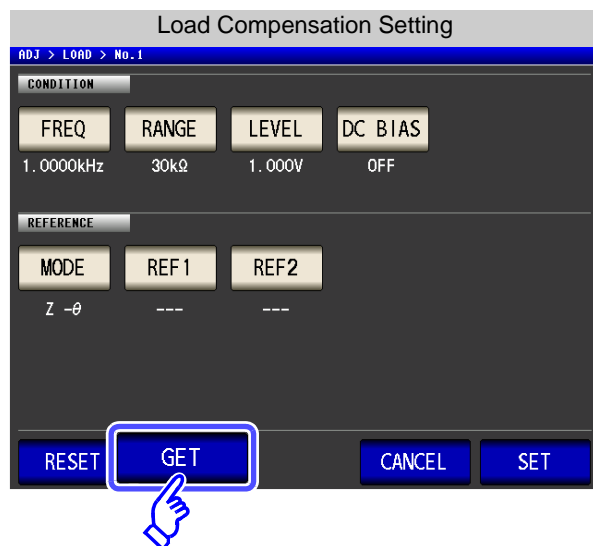

Press  to acquire the current measurement conditions (frequency, range, measurement signal type and level, and DC bias settings) and use them as the load compensation conditions.



#### **NOTE**

When the measurement conditions are acquired with ,  ("Setting of Parameter to Use for Reference Value" (p. 297)) is initialized to Z-θ.

## 7.3 Compensating Values to Match Reference Values (Load Compensation)

### When Load Compensation Failed

If compensation fails, a window like the following appears. An error message is displayed, and if compensation is cancelled with **EXIT**, load compensation is turned OFF.

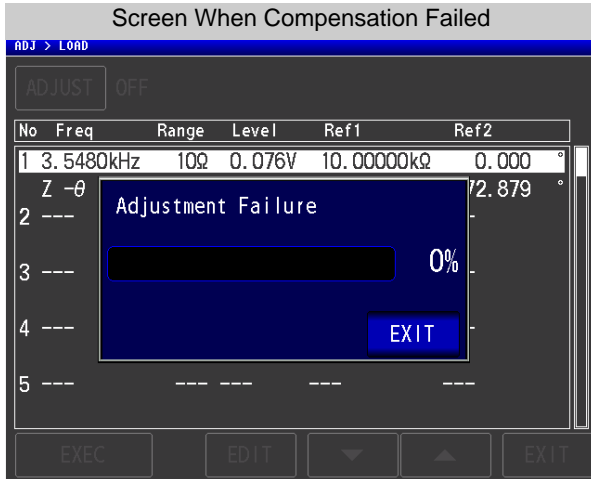

### When You Want to Disable Load Compensation

Press **OFF** in the [Load Compensation Setting] to disable load compensation.

## 7.4 Compensating Measurement Cable Errors (Cable Length Compensation)

LCR  
ANALYZER

With high frequency measurement, the influence of the cable results in large measurement errors. Setting the cable length enables you to reduce the measurement errors. Use a coaxial cable with 50  $\Omega$  impedance.

### Procedure

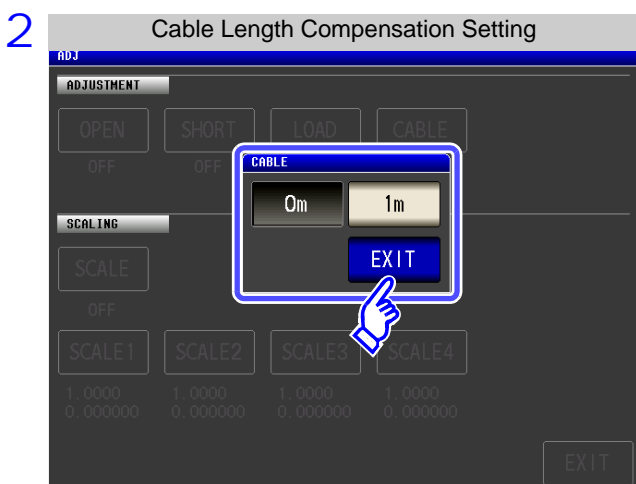
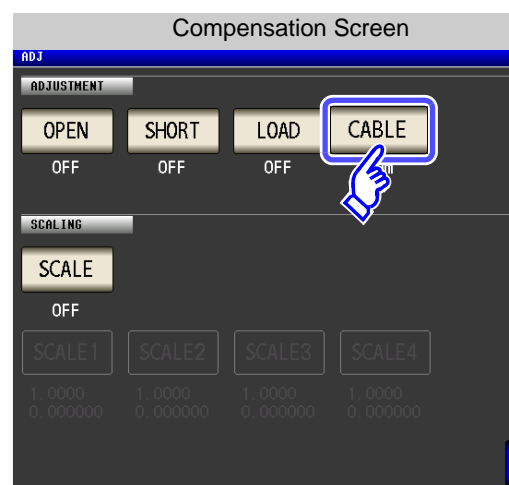
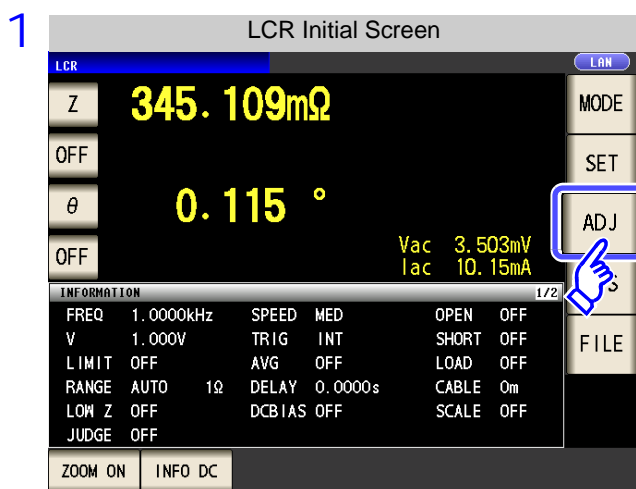

Select the cable length to be used, and press **EXIT** to confirm the selection.

0m

Select this when using a direct-coupled fixture or the like.

1m

Select this when the cable length is 1 m, 2m, or 4 m.

3 Press **EXIT** to close the setting screen.

**NOTE**

- When a 2 m cable is used, the guaranteed accuracy is 1 MHz.
- When a 4 m cable is used, the guaranteed accuracy is up to 100 kHz.

# 7.5 Calculating Values Scaling LCR ANALYZER

Scaling applies a compensation function to the measurement value. This function can be used to provide compatibility among measurement devices. Set the compensation coefficients a and b for the measurement values of the first to fourth parameters to compensate by the following expression.

See "Appendix 1 Measurement Parameters and Arithmetic Expressions"(p. A1)

$$Y = a \times X + b$$

However, if the parameter corresponding to X is either D or Q, scaling is applied to  $\theta$  as shown in the following expression, and then D or Q is obtained from  $\theta'$ .

$$\theta' = a \times \theta + b$$

- X: the first to fourth parameter measurement value
- a: integration value of the measured value X
- Y: the last measurement value
- b: the value added to measured value X
- $\theta'$ : compensation value of  $\theta$

**Procedure**

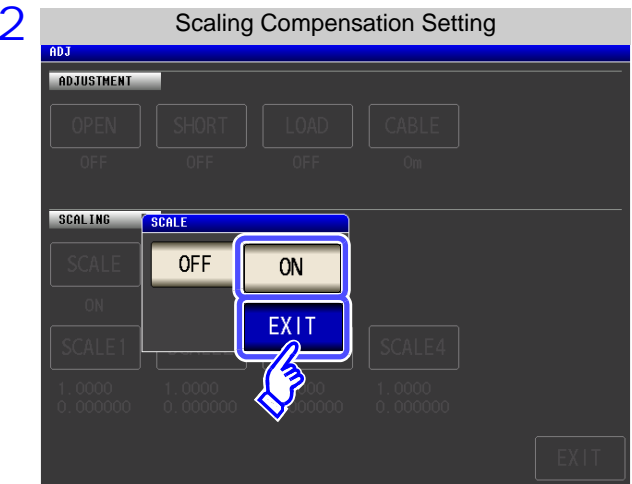
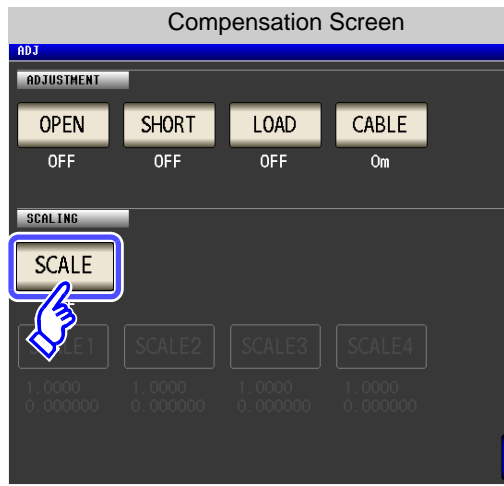
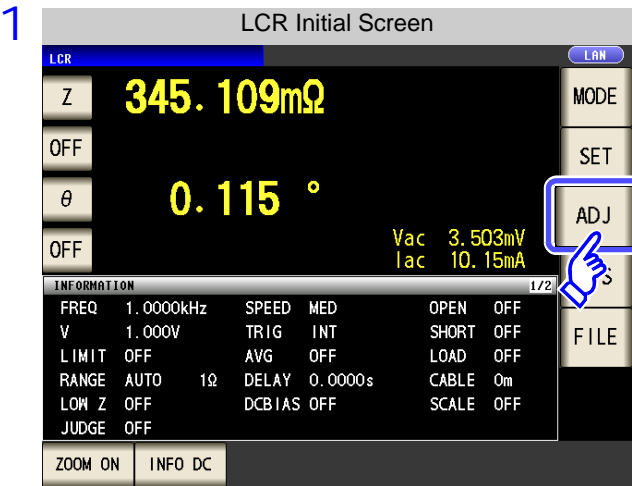

Select **ON**, and press **EXIT** to confirm the selection.

**When you want to cancel scaling:**

1. Press **ADJ** to switch to the [Compensation Screen].
2. Press **SCALE** and select **OFF**.
3. Press **EXIT** to confirm the setting.

7.5 Calculating Values Scaling

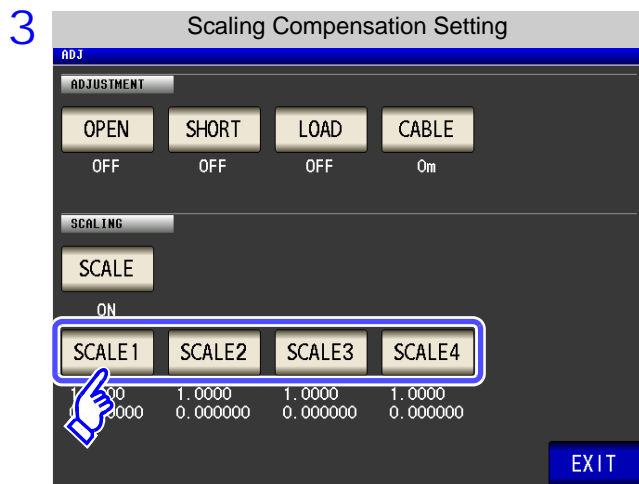

Select the compensation coefficient of the parameter you want to change.

The parameters and compensation coefficient numbers correspond as shown below.

SCALE1	Parameter 1
SCALE2	Parameter 2
SCALE3	Parameter 3
SCALE4	Parameter 4

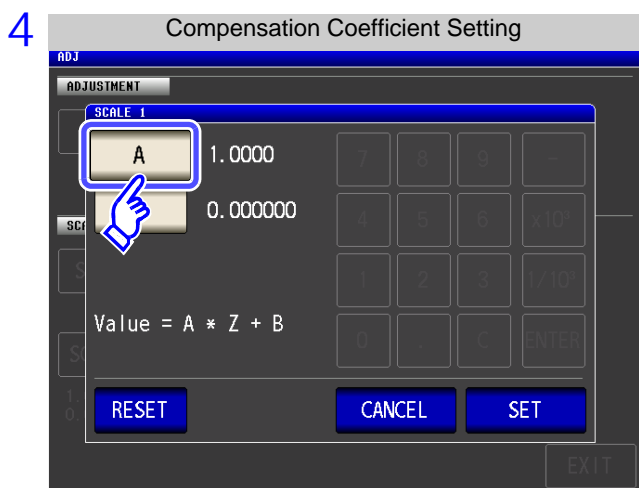

Press **A**.

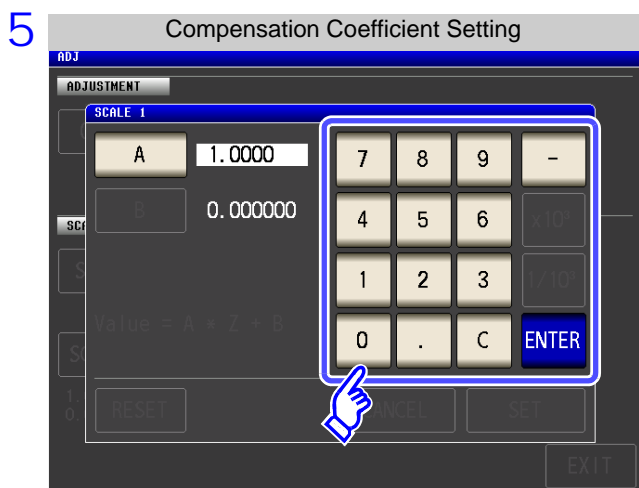

Use the numeric keypad to set compensation coefficient **A**.

Settable range: -999.9999 to 999.9999  
 To return to the previous screen without making any change to the set value, press the **ENTER** key when the screen is in the state with nothing being displayed (the state after pressing the **C** key).

## 7.5 Calculating Values Scaling

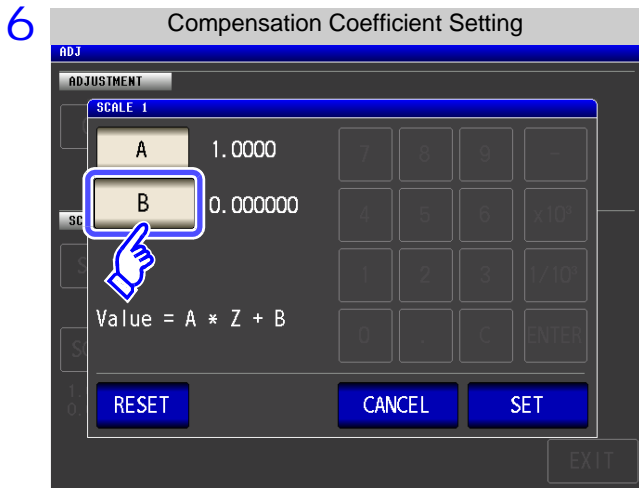

Press **B** and use the numeric keypad to set compensation coefficient **B** in the same way as for **A**.

Settable range: -9.999999G to 9.999999G  
 To return to the previous screen without making any change to the set value, press the **ENTER** key when the screen is in the state with nothing being displayed (the state after pressing the **C** key).

Changing the unit ( a/ f/ p/ n/ μ/ m/ None/ k/ M/ G )

**x10<sup>3</sup>** Step the units up.

**1/10<sup>3</sup>** Step the units down.

**7** Press **SET** to return to the [Scaling Compensation Setting].

### NOTE

- If the same parameter is selected multiple times and a different compensation coefficient is set for each of them, the compensation coefficient of the parameter with the smallest number is used to perform scaling for all of the parameters of the parameter numbers. (The compensation coefficients of the other parameter numbers become invalid.)
- In the case of the following settings, scaling is performed using the compensation coefficient of parameter 1 for all Z of parameters 1, 2, and 4. (The compensation coefficients of parameters 2 and 4 are invalid.)

Reference value 1

Display Parameter Setting	Compensation Coefficient Setting
Parameter 1: Z	a = 1.5000, b = 1.500000
Parameter 2: Z	a = 1.7000, b = 2.500000
Parameter 3: θ	a = 0.7000, b = 1.000000
Parameter 4: Z	a = 1.9000, b = 3.500000



# Setting the SYSTEM

# Chapter 8

## 8.1 Setting the Interface

LCR  
ANALYZER

You can control the instrument from a computer via the GP-IB, RS-232C, USB, and LAN interfaces. Printing can also be performed with an RS-232C printer.

**Procedure**

This operation is possible in any of the **LCR** mode, **ANALYZER** mode.

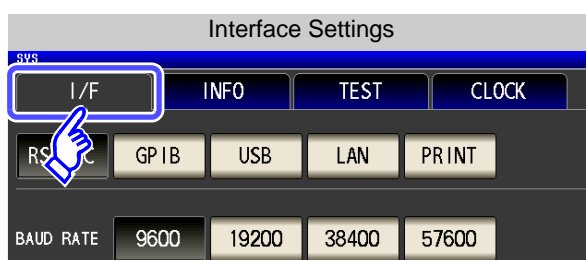
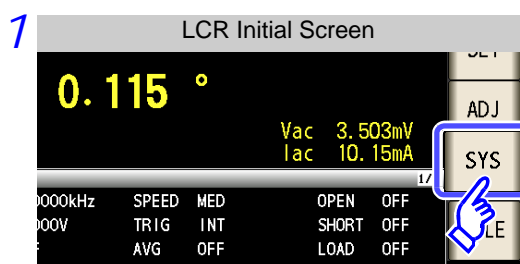

2 Select the interface type.

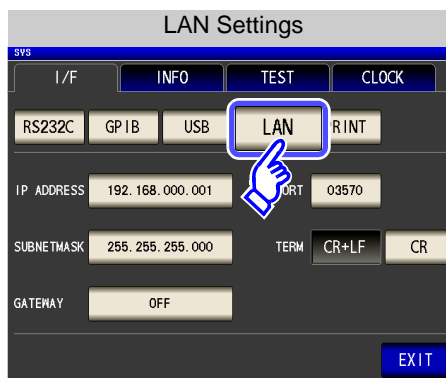
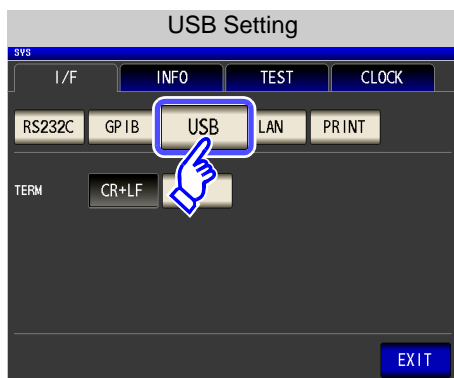
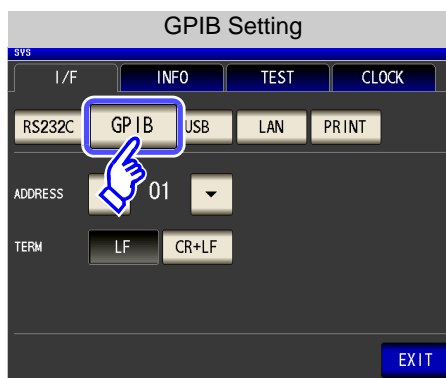
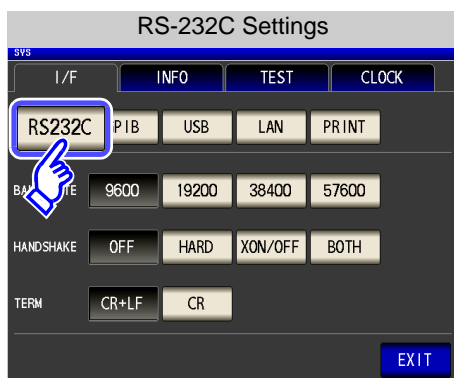

**When setting other than a printer:**

See Communication Instruction Manual "Chapter 2" (CD)



3 Select **SET** and check each of the settings, and press **EXIT** to close the setting screen.

# 8.2 Checking the Version of the Instrument

**Procedure**

This operation is possible in any of the **LCR** mode, **ANALYZER** mode.

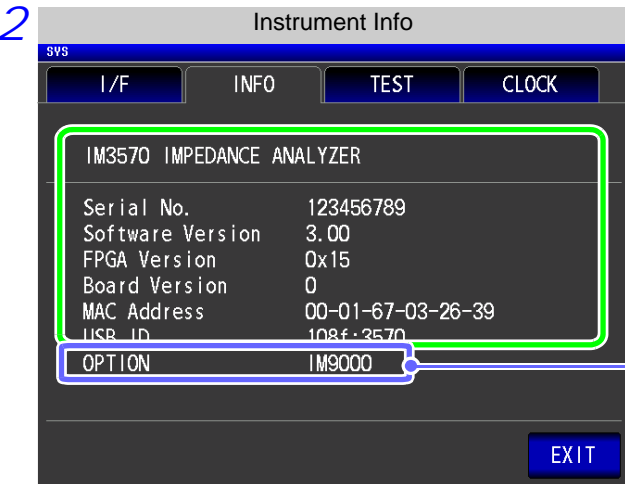
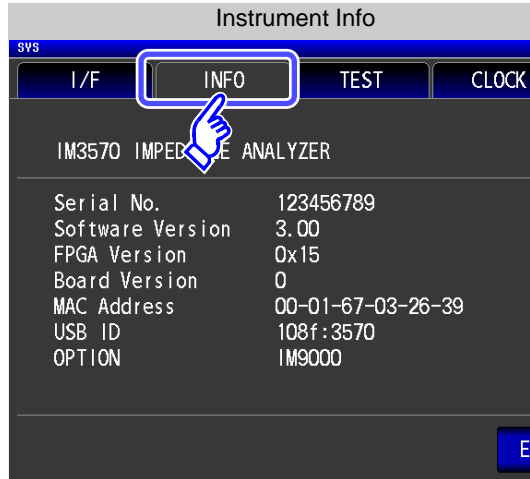
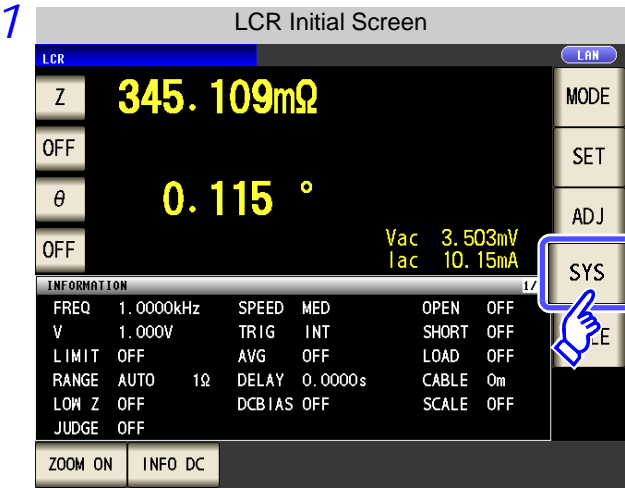

Check the version of the instrument.

This text is displayed only when the IM9000 Equivalent Circuit Analysis Firmware has been installed.

3 Press **EXIT** to close the setting screen.

NOTE

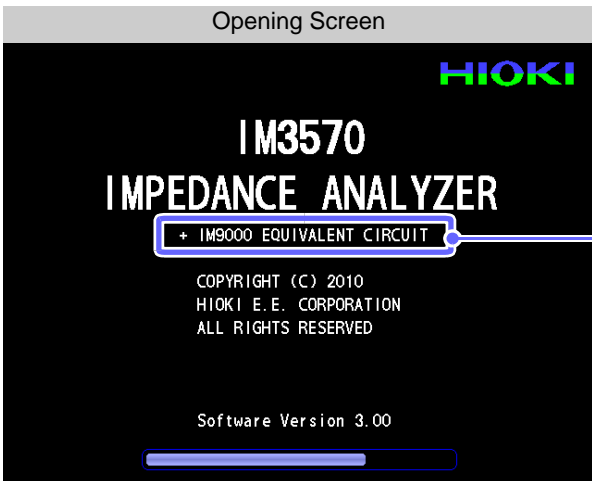

The instrument's version number can also be checked on the opening screen that is shown when it starts up.

The message "+ IM9000 EQUIVALENT CIRCUIT" is displayed when the IM9000 Equivalent Circuit Analysis Firmware has been installed.

# 8.3 Self Checks (Self Diagnosis)

You can check the display screens of the instrument.

## Panel Test

You can check the touch panel.

**Procedure**

This operation is possible in any of the **LCR** mode, **ANALYZER** mode.

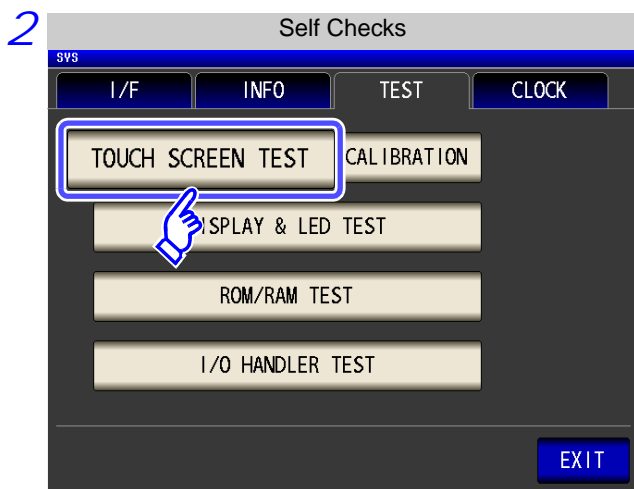
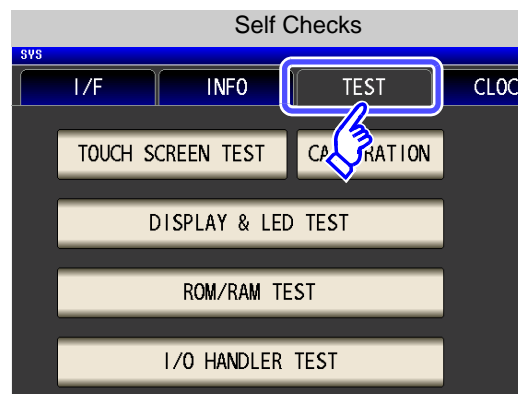
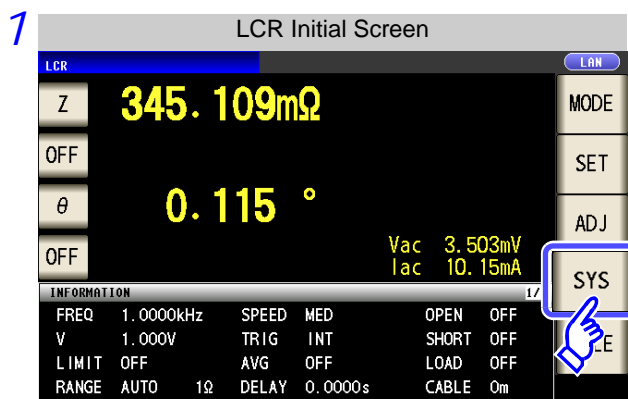

Press **TOUCH SCREEN TEST**.

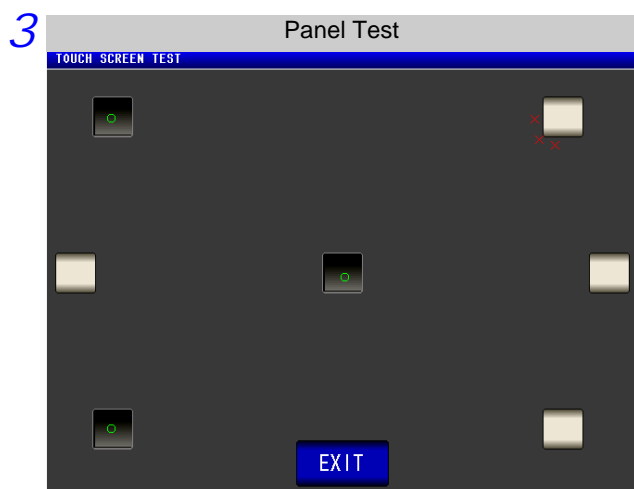

Press the keys displayed on the screen. If the pressed keys are highlighted and the green appears, the touch panel is working properly.

Perform panel compensation (p. 308) if they are not highlighted or the red appears. If there is still problem after performing panel calibration, the panel may be malfunctioning. Contact your dealer or Hioki representative.

8.3 Self Checks (Self Diagnosis)

Panel Compensation

You can perform position compensation of the touch panel.

**Procedure** This operation is possible in any of the **LCR** mode, **ANALYZER** mode.

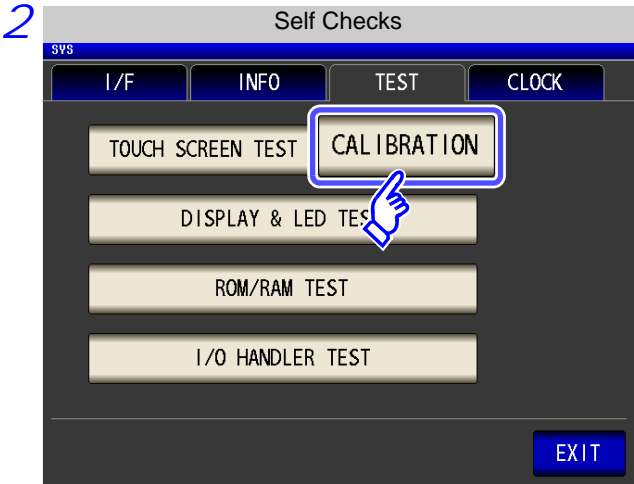
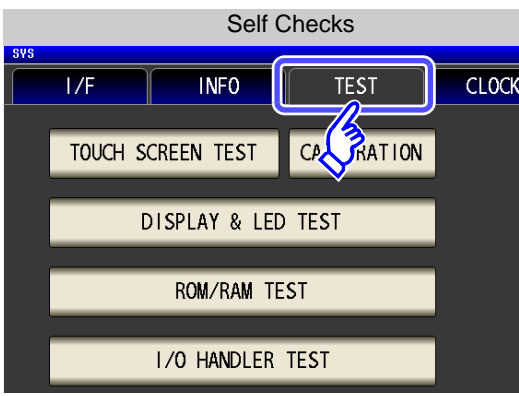
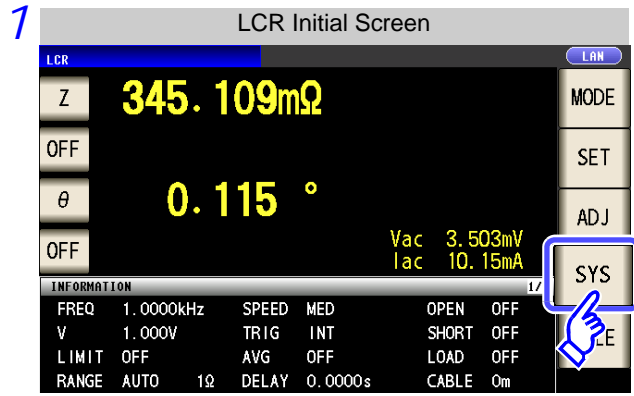

Press **CALIBRATION** .

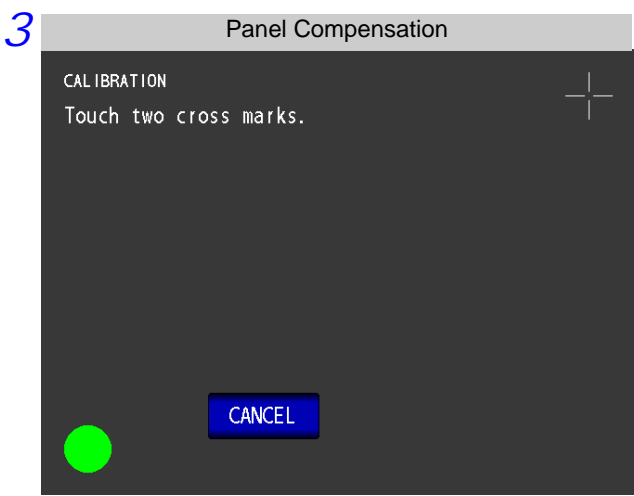

Press in the location of  continuously until the green  appears.

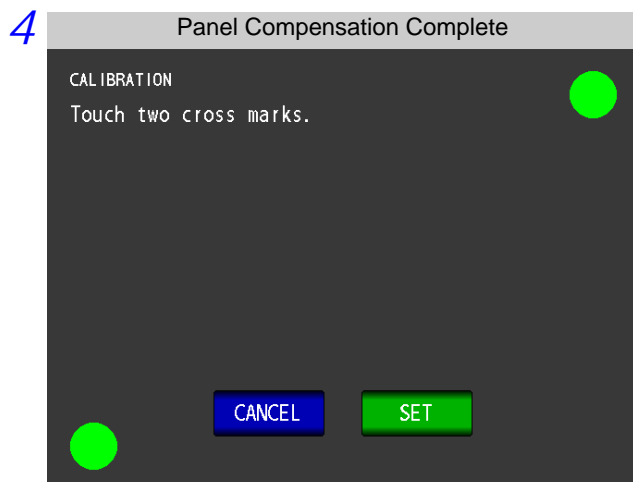

Press **SET** to close the setting screen.

Press **CANCEL** to start panel calibration from the beginning.

If the **SET** indication does not appear, the instrument needs to be repaired. Contact your dealer or Hioki representative.

# 310

## 8.3 Self Checks (Self Diagnosis)

### Screen Display Test

Check the display state of the screen and lighting state of the LEDs.

#### Procedure



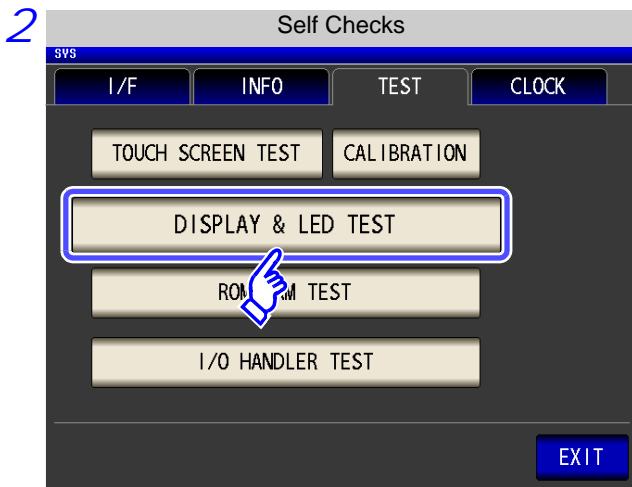
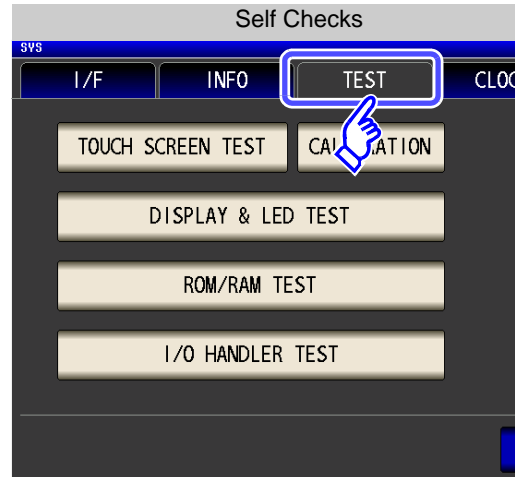
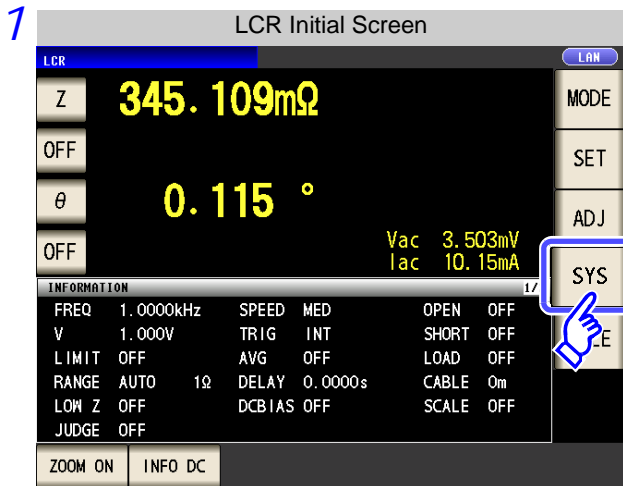







This operation is possible in any of the **LCR** mode, **ANALYZER** mode.

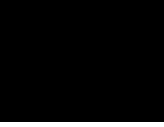

Press

**DISPLAY & LED TEST**

- 3 Each time you touch the screen, the screen color and front panel LEDs change as shown in the following table.

Screen Color	Front Panel LEDs
 Red	 All LEDs turn on
 Green	 All LEDs turn off
 Blue	 The [OUT] LED turns on
 Black	 The [IN] LED turns on
 White	 The [MEAS] LED turns on

If the entire screen does not appear to be the same color or if the LEDs do not turn on as shown in the figure on the left, the instrument needs to be repaired. Contact your dealer or Hioki representative.

- 4 Press **EXIT** to close the setting screen.

## 8.3 Self Checks (Self Diagnosis)

### ROM/RAM Test

Check the internal memory (ROM and RAM) of the instrument.

#### Procedure

This operation is possible in any of the **LCR** mode, **ANALYZER** mode.

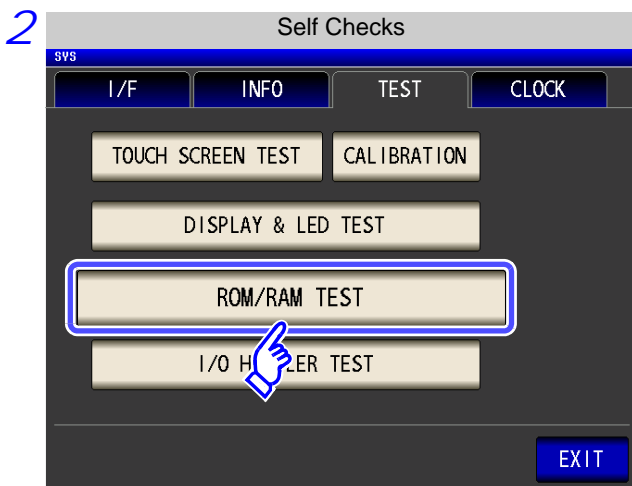
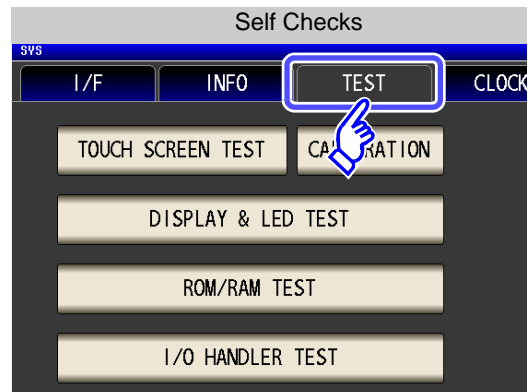
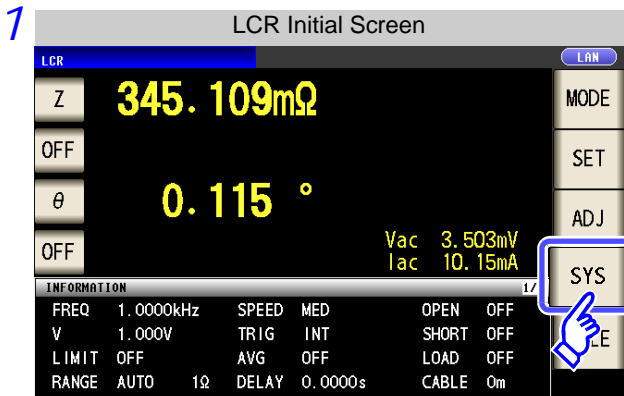

Press **ROM/RAM TEST**.

**Never turn off the power during a test.**

- Press the **ROM/RAM TEST** button to start the test automatically. (Approx. 40 seconds)
- No operation is possible during the ROM/RAM test.

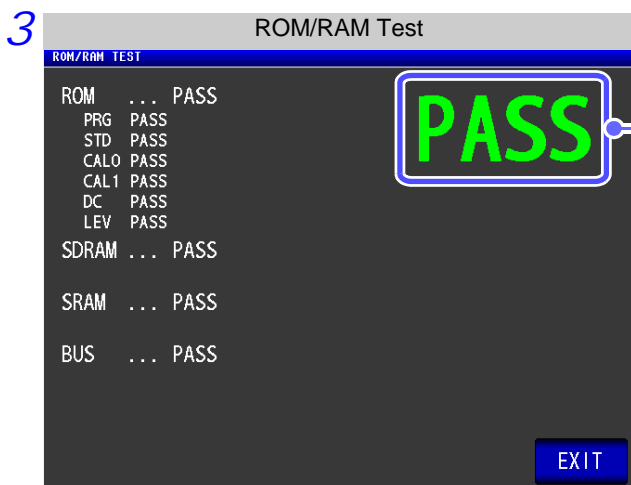

If the overall judgment result indication is **[PASS]**, the test ended normally.

Overall judgment result

If the overall judgment result indication is **[NG]**, the instrument needs to be repaired. Contact your dealer or Hioki representative.

4 Press **EXIT** to close the setting screen.



I/O Test

Check whether an output signal is output normally from the EXT I/O, and whether an input signal is read normally.

Procedure

This operation is possible in any of the **LCR** mode, **ANALYZER** mode.

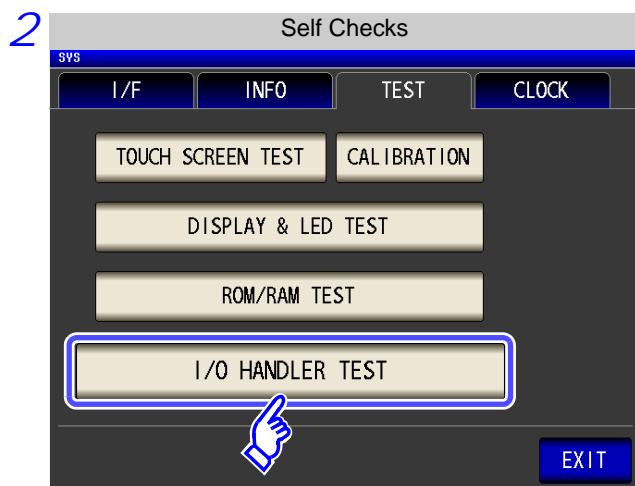
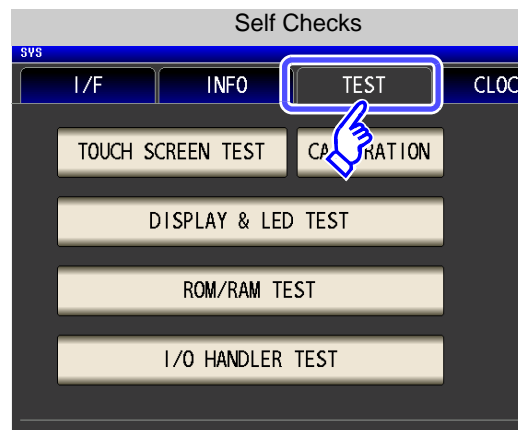
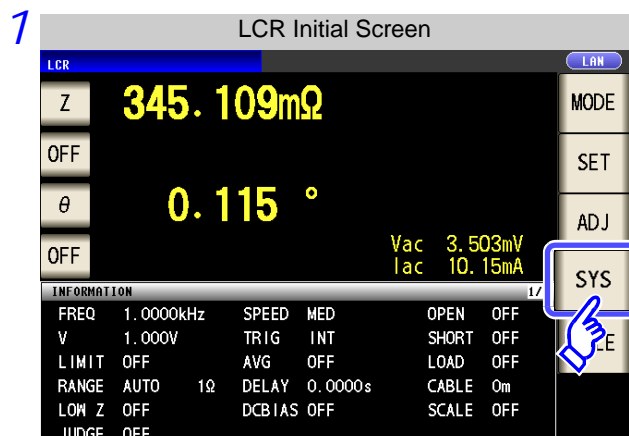

Press **I/O HANDLER TEST**.

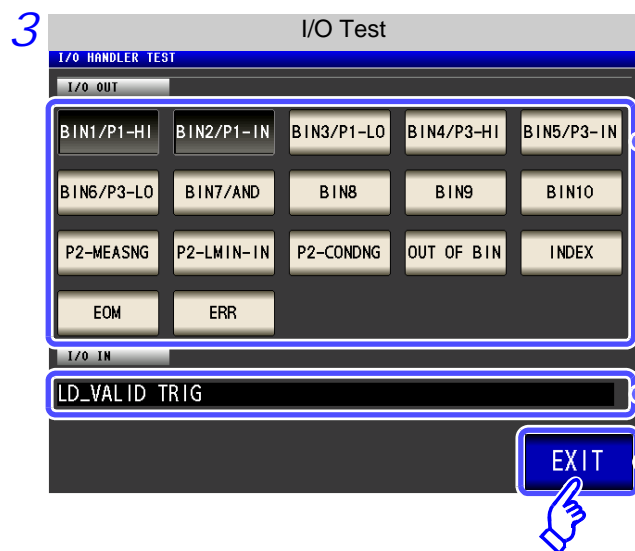

**To perform an output signal test:**  
Press the button with the name of the signal for which you want to check the output.

**To perform an input signal test:**  
The signal line name of the input signal being input (LOW) is displayed in the input signal test window.

**To end the test:**  
Press **EXIT** to close the setting screen.

# 8.4 Setting the Date and Time

You can set the date and time of the instrument.  
Data is recorded and managed based on the set date and time.

### Procedure

This operation is possible in any of the **LCR** mode, **ANALYZER** mode.

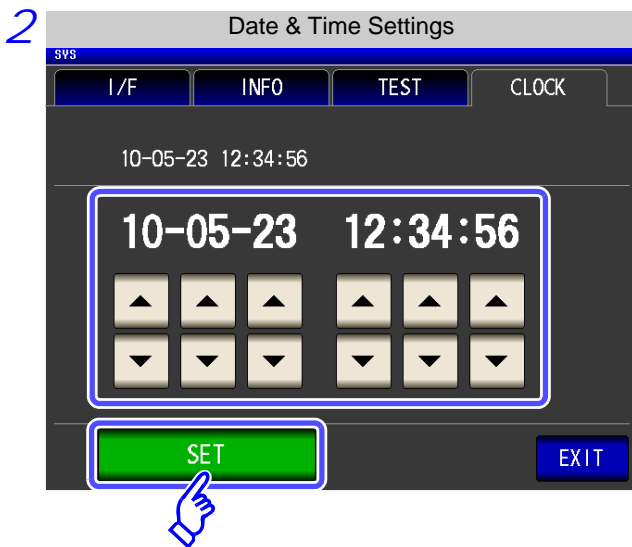
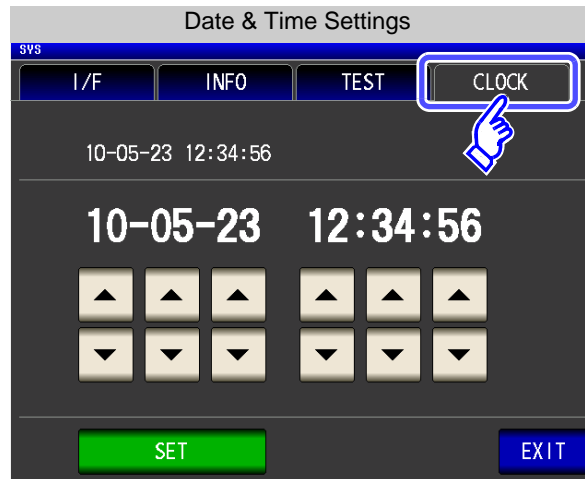
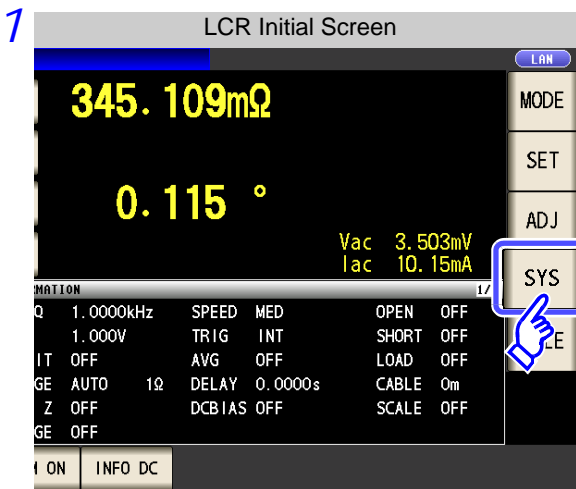

Use  or  to set the date and time.

(Year-Month-Day Hour-Minute-Second)

Settable range:  
00:00:00, January 1, 2000, to  
23:59:59, December 31, 2099

Press  to confirm the setting.

3 Press  to close the setting screen.

# Saving and Loading Panel Information

## Chapter 9

This instrument allows you to save and load data, and edit saved data.

(Data for the point in time  is pressed is saved.)

These operations are possible in both  mode and  mode.

<b>Saving Data</b>	▶	<ul style="list-style-type: none"> <li>• Measurement conditions and compensation values(p. 317)</li> </ul>
<b>Loading Data</b>	▶	<ul style="list-style-type: none"> <li>• Measurement conditions and compensation values(p. 322)</li> </ul>
<b>Editing Saved Data</b>	▶	<ul style="list-style-type: none"> <li>• Change panel name(p. 324)</li> <li>• Delete panel(p. 326)</li> </ul>

- NOTE**
- The instrument contains a built-in backup lithium battery.
  - When the life of the built-in battery ends, the measurement conditions will no longer be able to be saved.  
Submit a request for replacement of the battery to the Hioki repair service. (A fee will be charged.)

## About the Save Screen

Indicates the panel number. (001 to 128)

Indicates the panel name. **See** When you want to change a panel name (p. 324)

Indicates the number of panels currently saved.(p. 317)  
The text color changes in accordance with the number of data items currently saved as shown in the table below.

MODE	White	Yellow	Red
LCR	0 to 14	15 to 29	30
ANALYZER	0	1	2
ADJ	0 to 63	64 to 127	128

Indicates basic information on the saved panels. In order from the left

MODE	Measurement Parameters	Judgment Mode
LCR	[PARA1] - [PARA2] - [PARA3] - [PARA4]	[COMP] or [BIN]
ANALYZER	[PARA1] - [PARA2]	[PEAK] or [AREA]

Indicates the save type.(p. 317)

When saving with  : [LCR+ADJ] or [ANA+ADJ]

When saving with  : [LCR] or [ANA]

When saving with  : [ADJ]

Indicates that nothing is saved.

Loads the save conditions. (p. 322)

Saves the measurement conditions. (p. 317)

Allows you to check the information of the selected panel. (p. 320)

Allows you to changes the panel name. (p. 324)

Allows you to changes the panel name. (p. 324)

Deletes the panel. (p. 326)

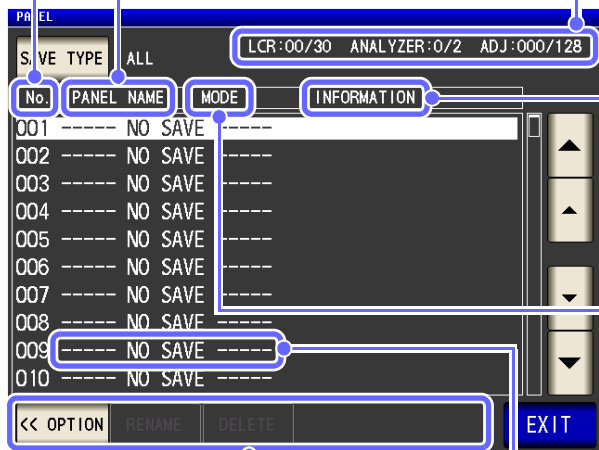

# 9.1 Saving Measurement Conditions (Panel Save Function)

You can save the measurement condition and compensation value. However, each of the measurement condition and compensation value is counted as one save data item when saved with **ALL**.

(Example: When saving is performed with **ALL** in **LCR** mode, LCR is counted as one item, and the compensation value as one item.)

<b>LCR Measurement Condition</b>	▶	Up to 30 items
<b>Analyzer Measurement Condition</b>	▶	Up to 2 items
<b>Compensation Value</b>	▶	Up to 128 items

## Setting the Type to Save

### Procedure

1

Application Settings

2

Press **PANEL**.

## 9.1 Saving Measurement Conditions (Panel Save Function)

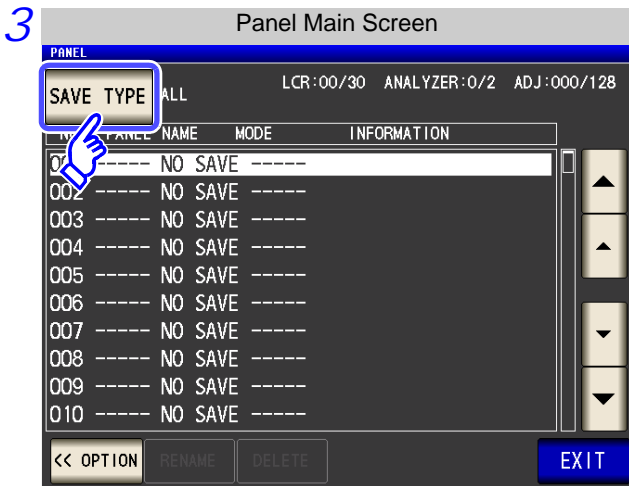

Press **SAVE TYPE**.

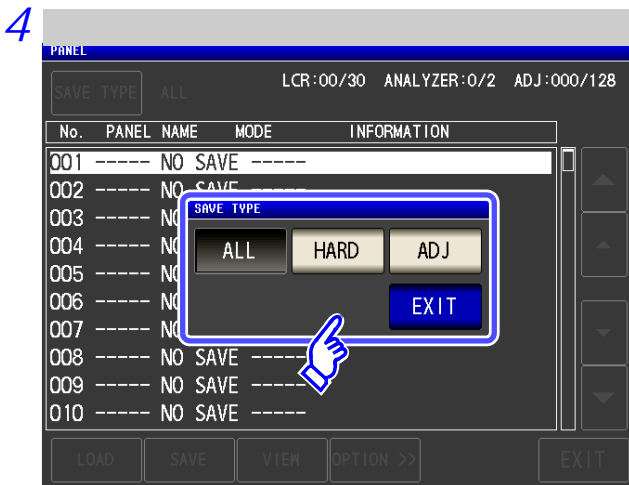

Select the save type.

- ALL** Saves both the measurement condition and compensation value.
- HARD** Saves only the measurement condition.
- ADJ** Saves only each of the setting values and compensation values of open compensation, short compensation, load compensation, cable length compensation, and scaling compensation.

5 Press **EXIT** to close the setting screen.

When analyzer measurement mode

You can save a panel in the same way in analyzer measurement mode.

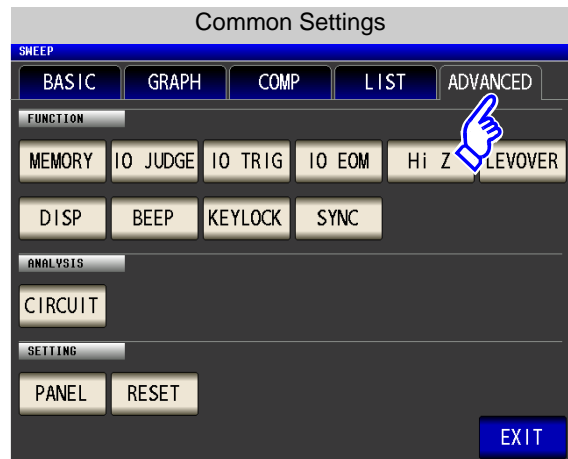
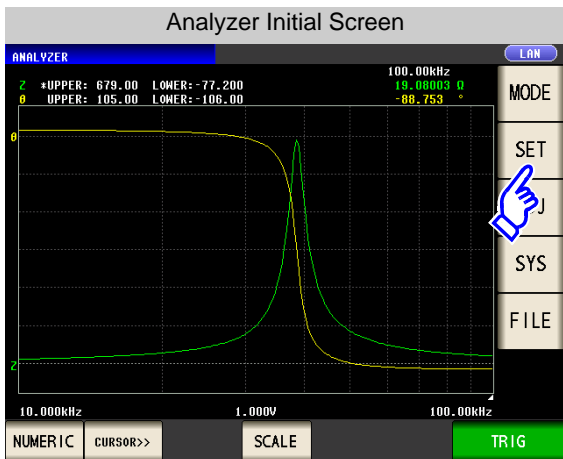

9.1 Saving Measurement Conditions (Panel Save Function)

Setting the Save Conditions

Procedure

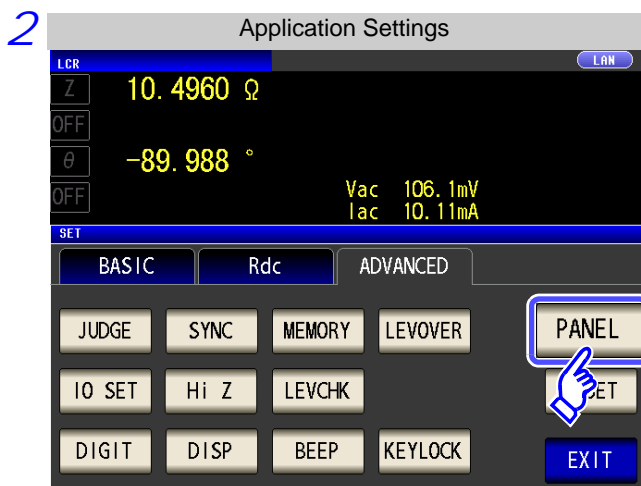
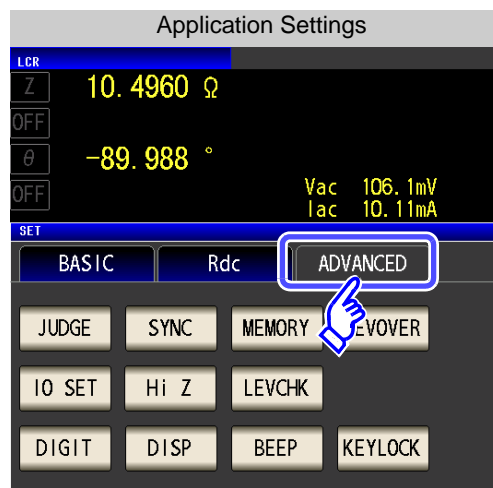
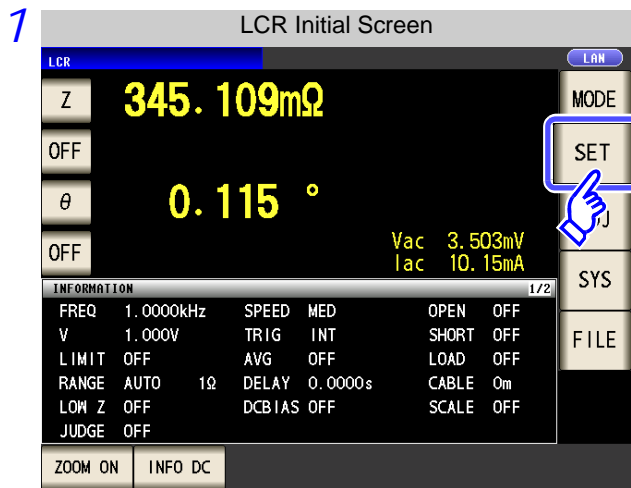

Press **PANEL**.

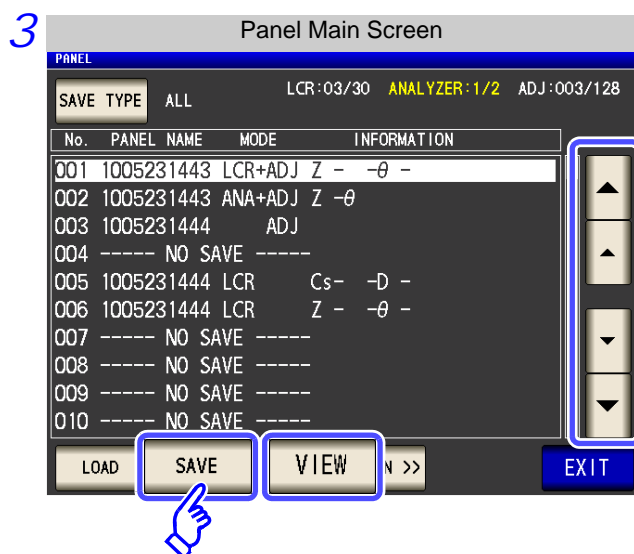

Use **▲** or **▼** to select the number of the panel to save.

- Display range: No. 001 to No. 128
- When you want to check the information of a saved panel:

Press **VIEW**.

Press **SAVE**.

When you want to cancel saving:

Press **EXIT**.

## 9.1 Saving Measurement Conditions (Panel Save Function)

When **VIEW** is selected

You can check the information of a saved panel:

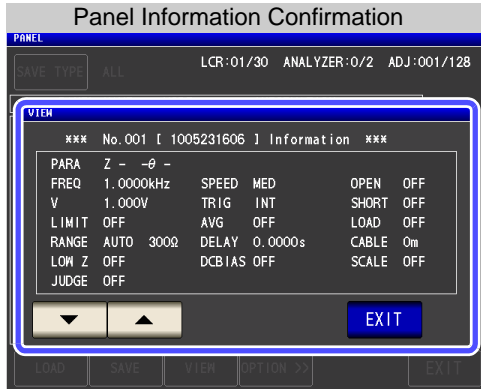

Use **▲** or **▼** to switch to the information of the previous or next panel.

**When you want to return to the panel number selection screen:**

Press **EXIT**.

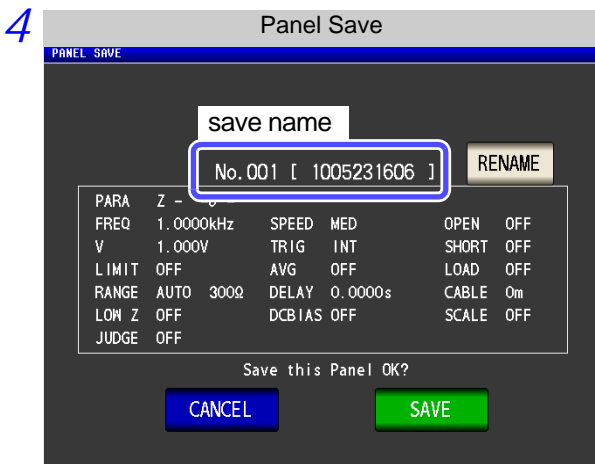

The save name and the measurement condition to be saved are displayed.

**RENAME**

Changes the save name.  
See Step 5

**CANCEL**

Returns to the previous screen.

**SAVE**

Saves the measurement condition under the displayed save name.  
(The initial screen is redisplayed automatically.)

5 When **RENAME** is pressed

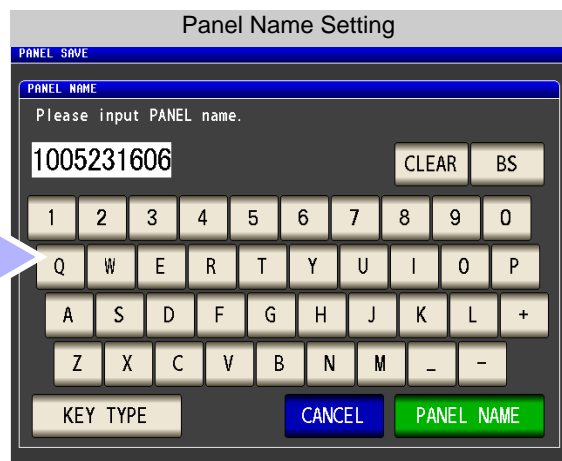
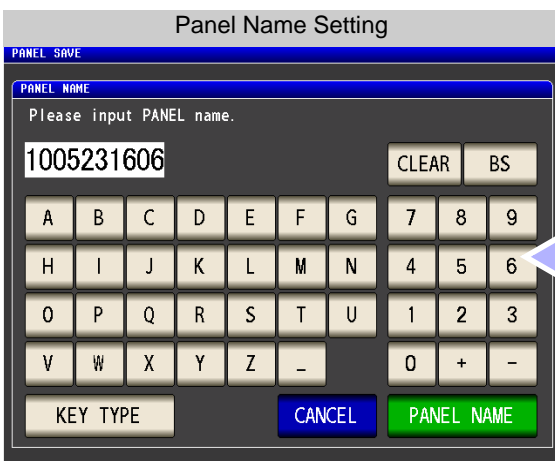

Enter the save name.(Up to 12 characters)

**CLEAR**

Deletes all input characters.

**BS**

Deletes the last character.

**KEY TYPE**

Changes the keyboard type.



## 9.1 Saving Measurement Conditions (Panel Save Function)

- 6 After you enter the save name, press **PANEL NAME** to return to step 4, and press **SAVE** to confirm saving.

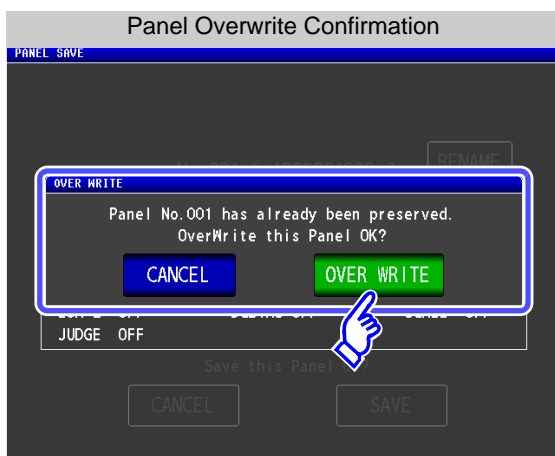

If a panel of the same name already exists, an overwrite confirmation window appears.

To enter a different save name: **CANCEL**

To overwrite the save name: **OVER WRITE**

- 7 Press **EXIT** to close the setting screen.

# 9.2 Loading Measurement Conditions (Panel Load Function)

You can read saved measurement conditions with the panel load function.

**Procedure**

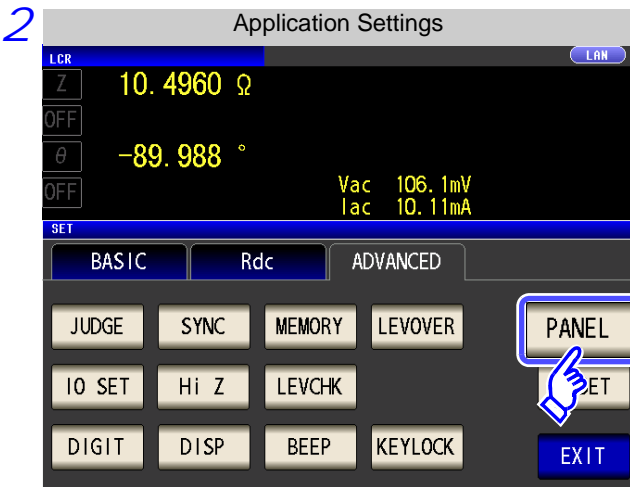
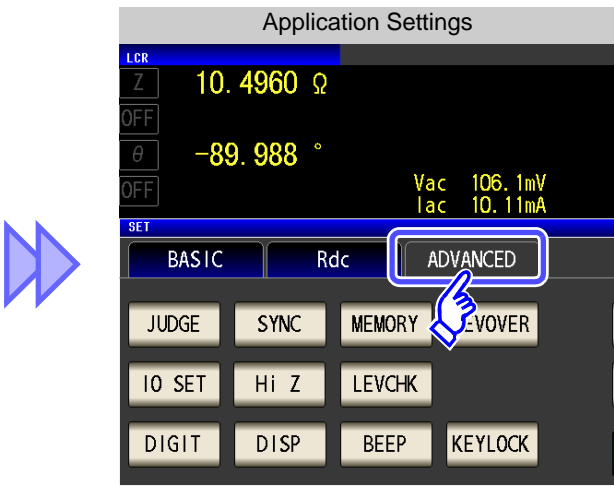
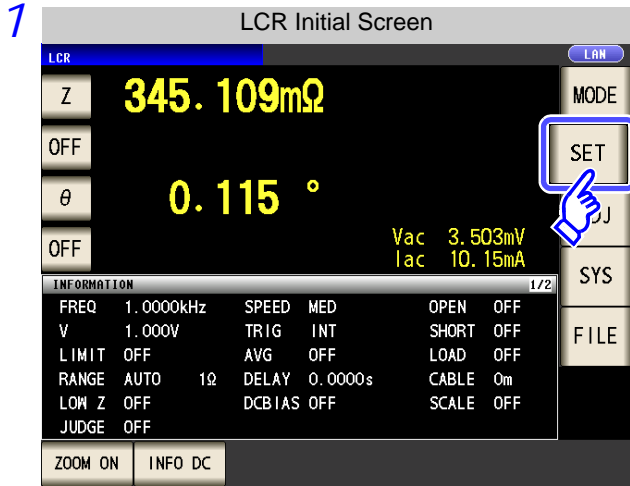

Press **PANEL** .

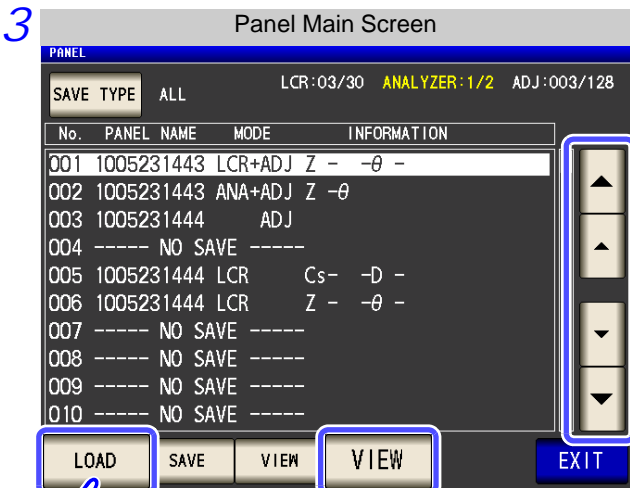

Use **▲** or **▼** to select the number of the panel to load.

- Display range: No. 001 to No. 128
- When you want to check the information of a saved panel: Press **VIEW** .

Press **LOAD** .

**When you want to cancel loading:**  
Press **EXIT** .

## 9.2 Loading Measurement Conditions (Panel Load Function)

When **VIEW** is selected

You can check the information of a saved panel:

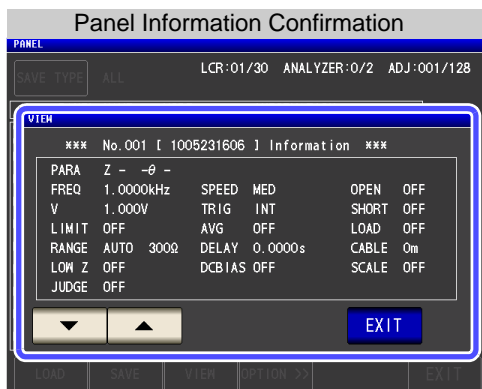

Use or to switch to the information of the previous or next panel.

When you want to return to the panel number selection screen: Press **EXIT**.

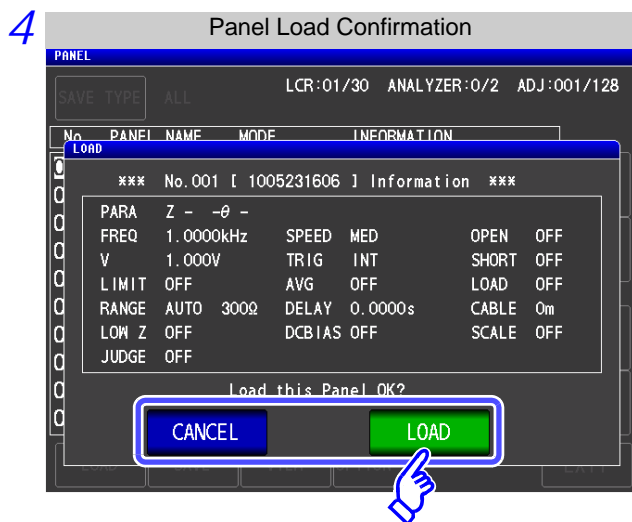

The read confirmation screen appears.

**CANCEL**

Returns to the previous screen.

**LOAD**

Reads the measurement conditions of the selected panel number. (The [Initial Screen] is redisplayed automatically.)

5 When reading of the measurement conditions is finished, the [Initial Screen] is redisplayed automatically.

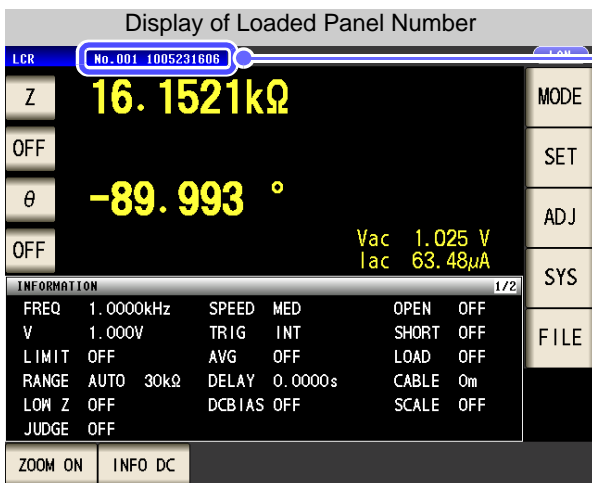

The loaded panel number is displayed in the initial screen.

# 9.3 Changing a Panel Name

You can change the name of a panel saved to the instrument.

**Procedure**

1

LCR Initial Screen

Z 345.109mΩ

θ 0.115°

Vac 3.503mV  
Iac 10.15mA

INFORMATION

FREQ	1.0000kHz	SPEED	MED	OPEN	OFF	
V	1.000V	TRIG	INT	SHORT	OFF	
LIMIT	OFF	AVG	OFF	LOAD	OFF	
RANGE	AUTO	1Ω	DELAY	0.0000s	CABLE	Om
LOW Z	OFF	DCBIAS	OFF	SCALE	OFF	
JUDGE	OFF					

ZOOM ON INFO DC



Application Settings

Z 10.4960 Ω

θ -89.988°

Vac 106.1mV  
Iac 10.11mA

SET

BASIC Rdc **ADVANCED**

JUDGE SYNC MEMORY LEVEROVER

IO SET Hi Z LEVCHK

DIGIT DISP BEEP KEYLOCK

2

Application Settings

Z 10.4960 Ω

θ -89.988°

Vac 106.1mV  
Iac 10.11mA

SET

BASIC Rdc ADVANCED

JUDGE SYNC MEMORY LEVEROVER

IO SET Hi Z LEVCHK

DIGIT DISP BEEP KEYLOCK

**PANEL** EXIT

Press **PANEL**.

3

Panel Main Screen

SAVE TYPE ALL LCR:03/30 ANALYZER:1/2 ADJ:003/128

No.	PANEL NAME	MODE	INFORMATION
001	1005231443	LCR+ADJ Z -	-θ -
002	1005231443	ANA+ADJ Z -	θ
003	1005231444	ADJ	
004	----	NO SAVE	----
005	1005231444	LCR	Cs- -D -
006	1005231444	LCR	Z - -θ -
007	----	NO SAVE	----
008	----	NO SAVE	----
009	----	NO SAVE	----
010	----	NO SAVE	----

LOAD SAVE VIEW **OPTION >>** EXIT

Use **▲** or **▼** to select the number of the panel to rename.

Press **OPTION >>**.

**When you want to cancel saving:**

Press **EXIT**.

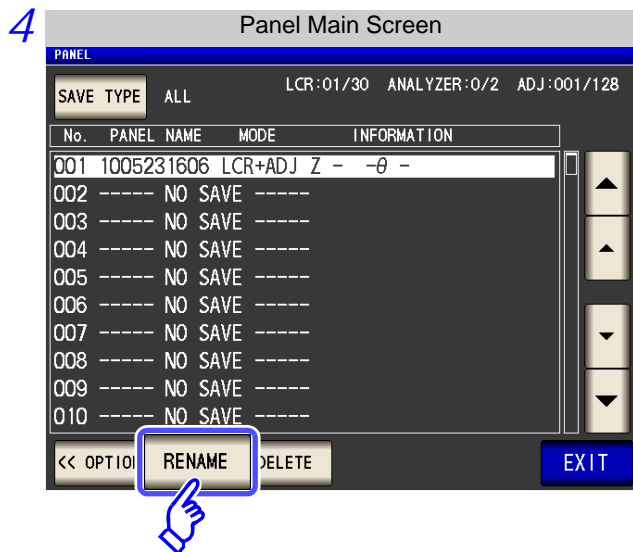

Press **RENAME**.

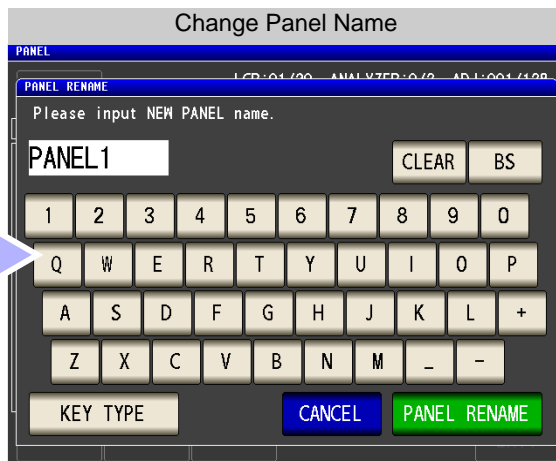
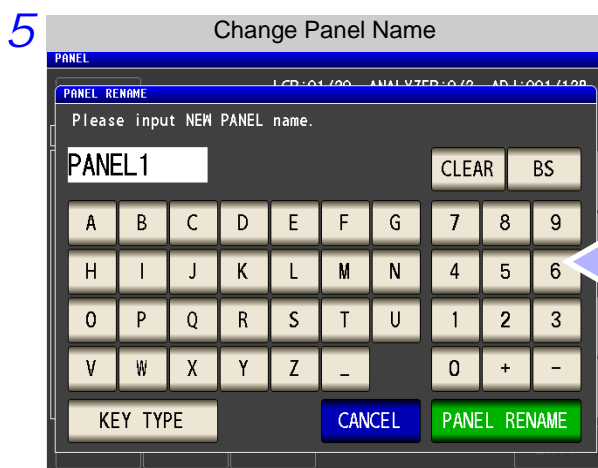

Enter the save name. (Up to 12 characters)

- CLEAR** Deletes all input characters.
- BS** Deletes the last character.
- KEY TYPE** Changes the keyboard type.

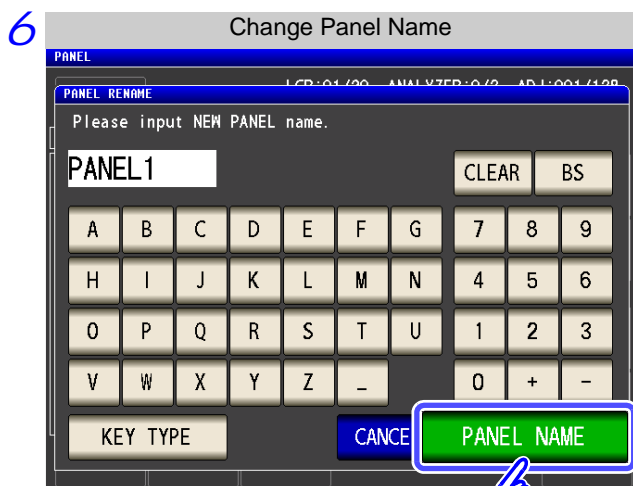

After you enter the new save name, press **PANEL NAME** to confirm the name.

7 Press **EXIT** to close the setting screen.

# 9.4 Deleting a Panel

You can delete a panel saved to the instrument.

**Procedure**

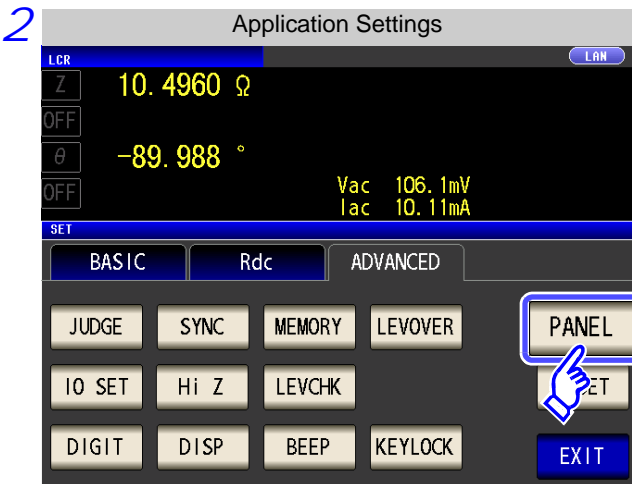
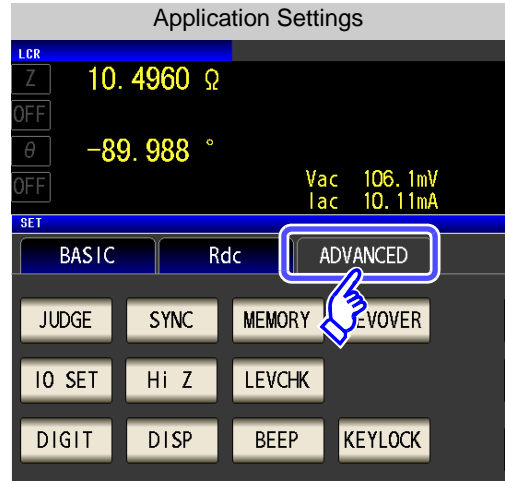
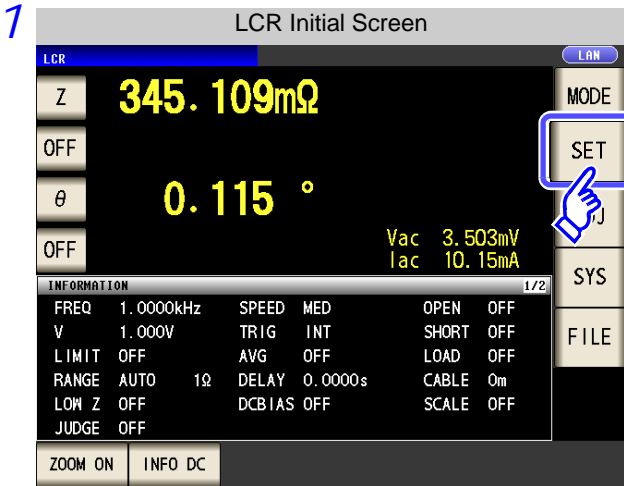

Press **PANEL**.

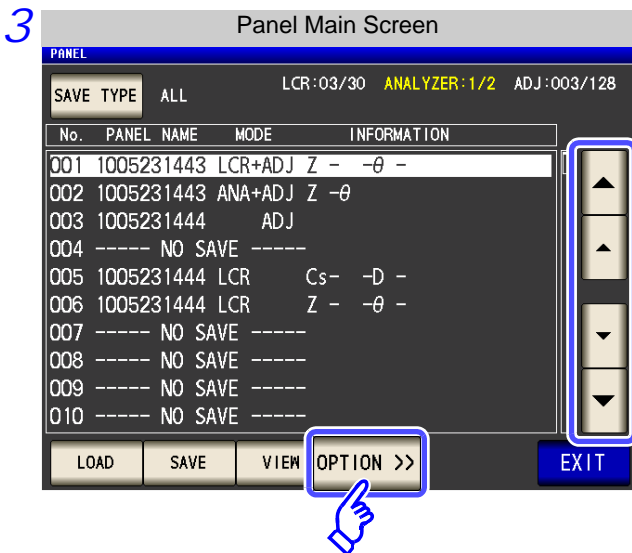

Use **▲** or **▼** to select the number of the panel to delete.

Press **OPTION >>**.

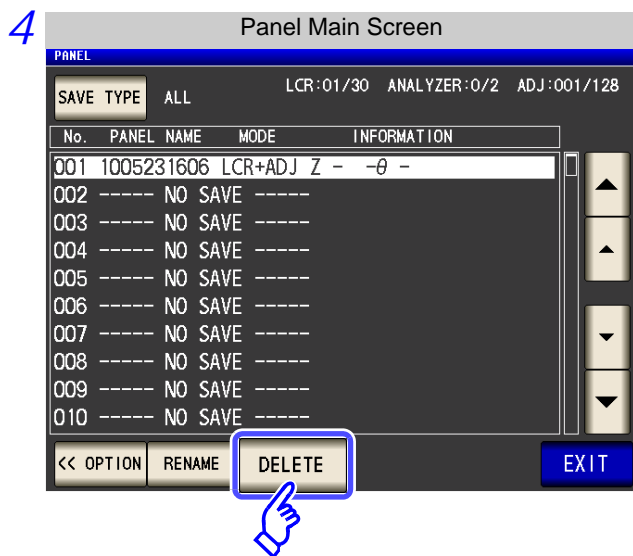

Press **DELETE** .

Some of the information saved to the panel is displayed.

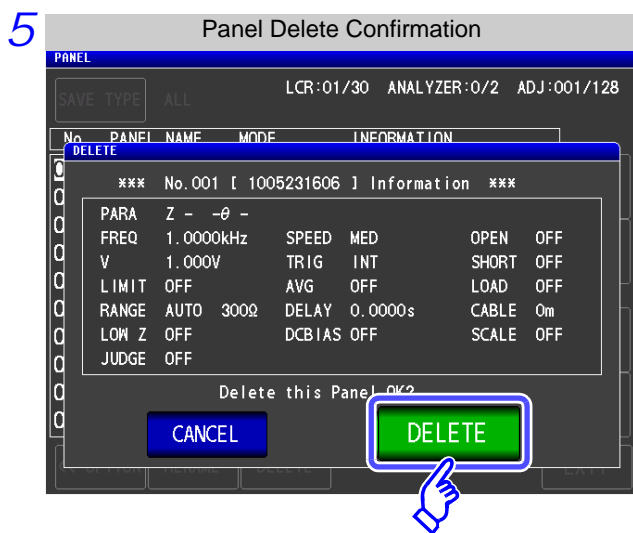

Check the information saved to the panel.

**A panel cannot be restored once it is deleted.**  
**When you want to cancel deletion:**  
 Press **CANCEL** .

Press **DELETE** .

6 Press **EXIT** to close the setting screen.





# Using USB Flash Drive Chapter 10

You can save measurement values to a USB flash drive (commercially available). The instrument settings can also be saved and read.

## Saving Data

- Measurement values, measurement conditions, compensation values, instrument settings (p. 333)
- Currently displayed screen (p. 341)

## Reading Data

- Measurement conditions, compensation values, measurement values, instrument settings (p. 353)
- Saved screen (p. 343)

## File Operations

- Formatting a USB Flash Drive (Initializing) (p. 357)
- Create folders (p. 360)
- Delete files and folders (p. 359)

## USB Specifications

Connector	USB type A
Electrical specification	USB2.0
Power supply	500 mA maximum
No. of ports	1
Compatible USB device	USB Mass Storage Class

## **CAUTION**

- Hioki cannot recover data from damaged or faulty storage media resulting from abnormalities. We are also unable to provide compensation for such data loss, regardless of the contents or cause of the failure or damage. We recommend making a backup of all important data such as a computer.
- Avoid forcing insertion of storage media backwards or in the wrong orientation, as this could damage the media or instrument.
- When a USB flash drive is accessed, the color of the USB icon changes from blue to red. Do not turn off the power of the instrument while the USB flash drive is being accessed. Also, never remove the USB flash drive from the instrument. Doing so may result in the data in the USB flash drive being lost.
- When transporting the instrument, remove the USB flash drive. Failing to do so may result in the instrument or USB flash drive being damaged.
- Do not move the instrument with a USB flash drive installed. Otherwise, the instrument or media could be damaged.
- Some USB flash drives are easily affected by static electricity. Be careful handling the USB flash drive to avoid damage to the drive or instrument malfunctions due to static electricity.
- Some USB flash drives may prevent the instrument from turning on when inserted. In this case, turn the instrument on before inserting the USB flash drive.

## **NOTE**

USB flash drives have a limited usable lifetime. After long-term use, data reading and writing will fail, at which time the USB flash drives must be replaced.

# 10.1 Inserting and Removing USB flash drive

Front

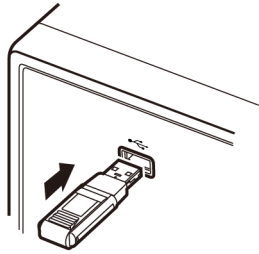

### Inserting a USB Flash Drive

Inert the USB flash drive into the USB port on the front panel of the instrument.

- Do not insert a USB flash drive that is not Mass Storage Class compatible.
- Not all commercially available USB flash drives are compatible.
- If a USB flash drive is not recognized, try using another USB flash drive.

### Removing a USB Flash Drive

Check that the USB flash drive is not being accessed (saving, reading, etc.) by the instrument, and then remove it.



(No remove operation needs to be performed on the instrument.)

## Screen Display when Using USB

When a USB flash drive has been recognized properly, the USB flash drive icon is displayed at the top of the measurement screen.

The icon is red while the USB flash drive is being accessed.



 When the instrument recognizes the USB flash drive  
(Blue)
   
  
 When USB is being accessed  
(Red)

## About File Types

The following files can be handled by the instrument.

Content	Type (file extension)	Indication on instrument
-	Folder	FDR
Measurement data	CSV file	CSV
Screen copy	BMP file	BMP
Instrument settings data	Settings file	SET
Panel save data	Panel settings file	PNL

The instrument cannot display double-byte characters (Japanese, etc.). A double-byte characters is replaced by "??."

# 10.2 About the File Operation Screen

This screen displays a list of the files saved in the USB flash drive. It also allows you to perform file operations such as creating a folder and deleting a file. The instrument can recognize file names of up to 127 single-byte characters. File names that exceed that length are not recognized.

**Procedure**

This operation is possible in any of the **LCR** mode, **ANALYZER** mode.

1 Insert the USB flash drive into the USB port (front panel).

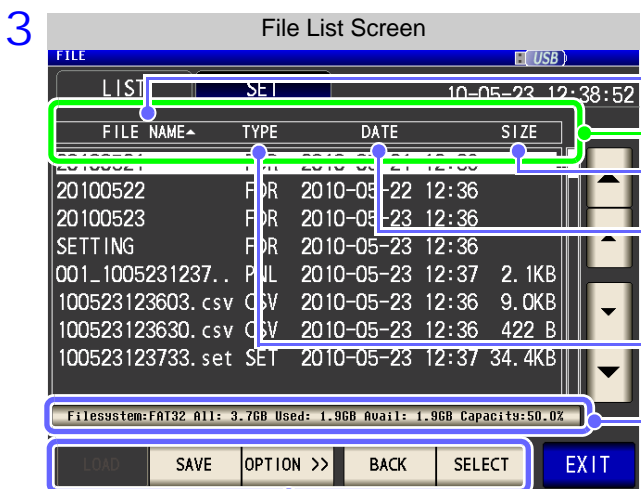
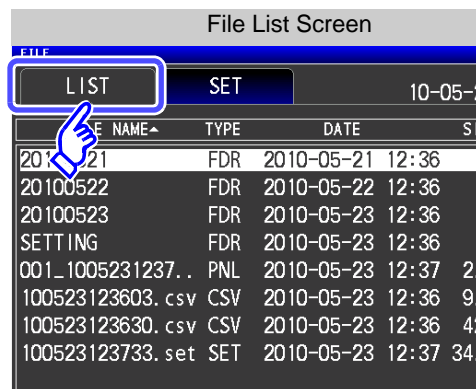
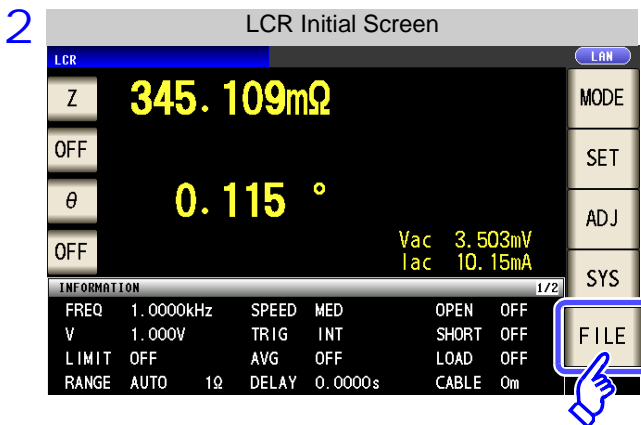

Indicates the file name.

You can press the **[FILE NAME]**, **[DATE]**, and **[SIZE]** parts to change the sorting order.

▲ : Sorts the files in ascending order.

▼ : Sorts the files in descending order.

Indicates the file size.

Indicates file save date and time.

Indicates the file type.

**[FDR]**: Folder  
**[CSV]**: Text data  
**[BMP]**: Screen copy data  
**[SET]**: Instrument settings data  
**[PNL]**: Panel save data

Indicates the information of the USB flash drive. Press the information indication portion to confirm details.

Loads the instrument settings. (p. 353)

Saves the instrument settings. (p. 349)

Moves to the level immediately above.



The indicated key varies depending on the type of the selected file.

- **[FDR]**: **ENTER** (p. 353), (p. 343)
- **[TXT]**, **[CSV]**, **[BMP]**: **VIEW** (p. 343)

Initializes the USB flash drive. (p. 357)

Deletes files and folders. (p. 359)

Creates a folder. (p. 360)

Saves all settings of the instrument. (p. 351)



# 10.3 About the File Save Setting Screen

You can configure settings such as the file save format, save destination, and text save format. Check the settings before using the file save function.

**Procedure** This operation is possible in any of the **LCR** mode, **ANALYZER** mode.

1 Insert the USB flash drive into the USB port (front panel).

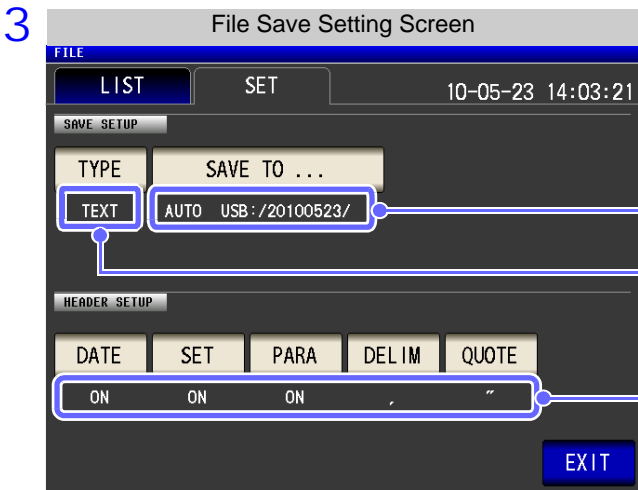
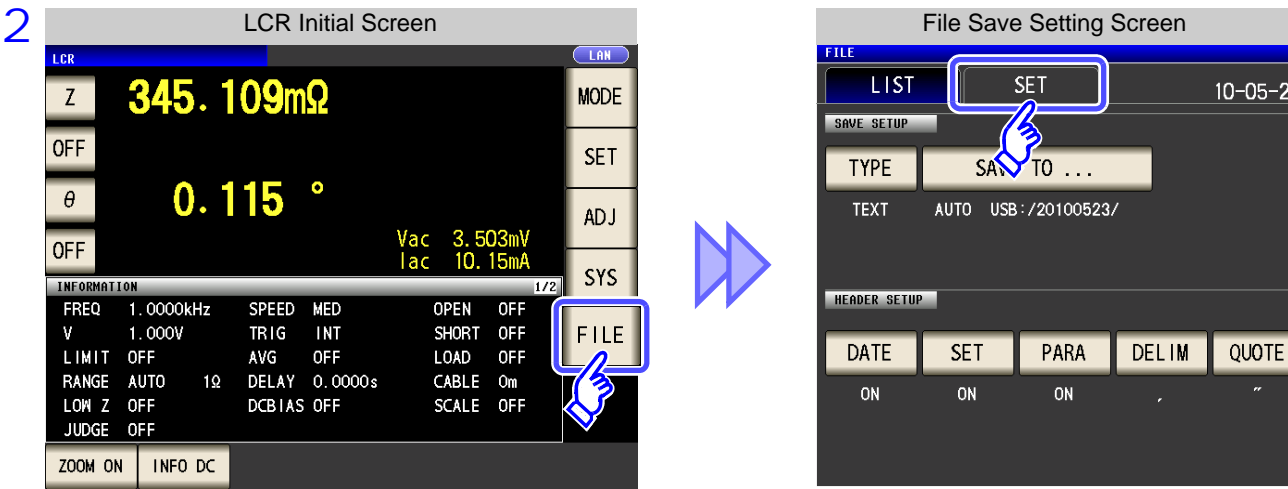

Indicates the save destination folder.

Indicates the save format.

Indicates settings related to saving text.  
(Settings cannot be configured when BMP is selected for the file type.)

# 10.4 Saving Measurement Data

You can save the measurement data to a USB flash drive in CSV format.

- LCR mode** ▶ Saves the measurement values displayed in the current screen in CSV format.
- ANALYZER mode** ▶ Saves the measurement values of one sweep in CSV format.
- CONTINUOUS mode** ▶ Saves the measurement result of each panel in CSV format.

## 1 Saving Measurement Data

### Procedure

1 Insert the USB flash drive into the USB port (front panel).

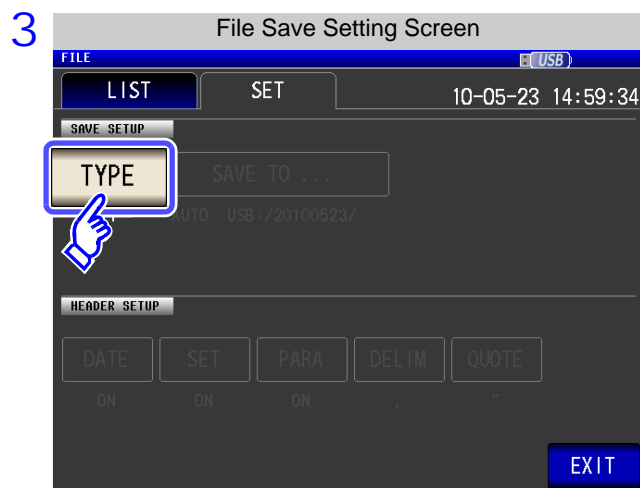
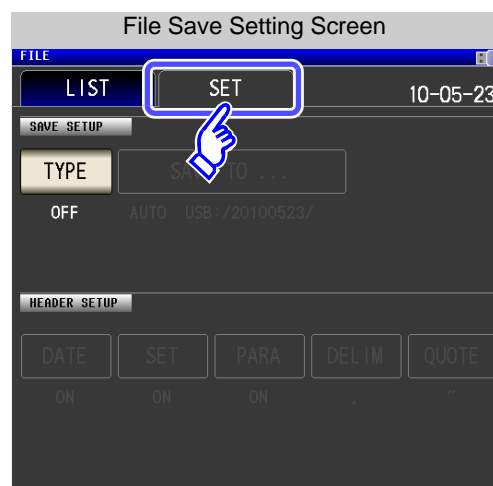
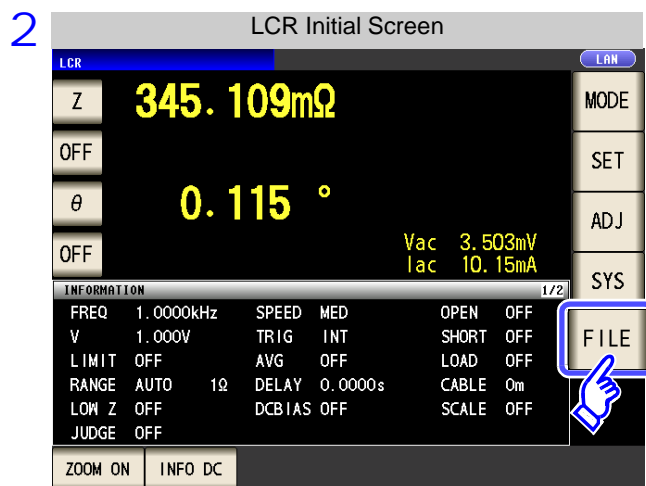

Press TYPE .

## 10.4 Saving Measurement Data

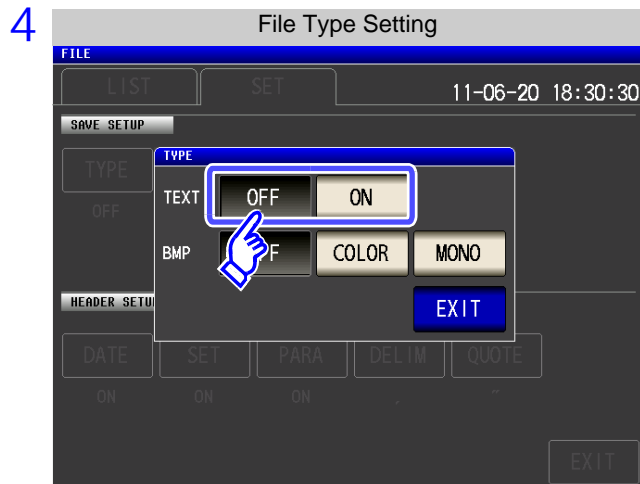

Turn on the text save setting.

OFF Turns off the text save function.

ON Saves measured values as text data.

Press **EXIT**.

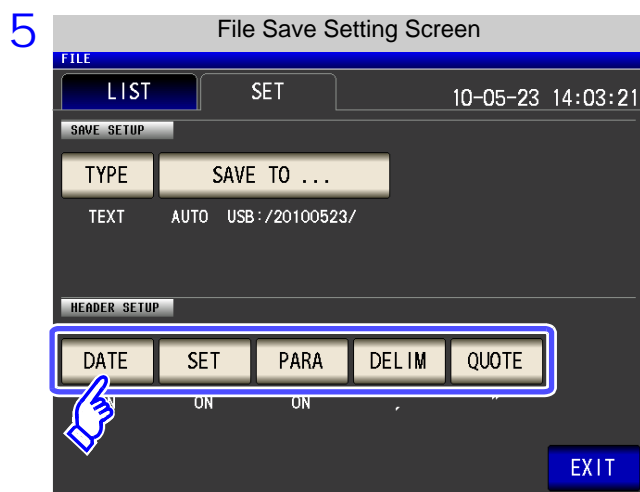

Set the header of the text file.

Select the header setting.

DATE Turns the save date and time ON/ OFF.

SET Turns the measurement condition ON/ OFF.

PARA Turns the measurement parameter ON/ OFF.

DEL IM Sets the delimiter type.

QUOTE Sets the quotation mark type.

DATE

## Save Date and Time Setting

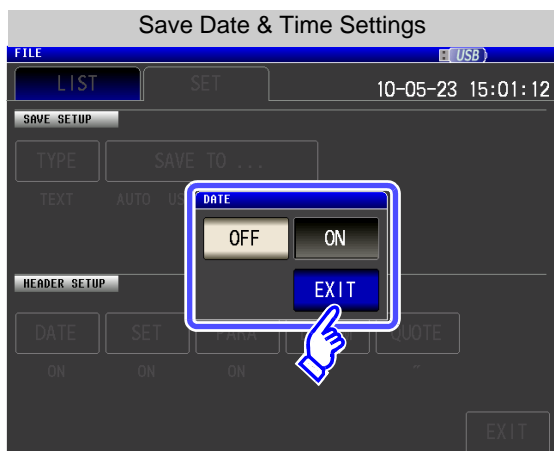

1. Select ON/ OFF for the save date and time.

Does not record the save date and time.

Records the save date and time.

2. Press  to close the setting screen.

## When ON

```
"HIOKI E.E. CORPORATION","IM3570","Ver. 1.00"
```

```
"DATE","10-05-23"
```

```
"TIME","12:35:08"
```

```
"FREQ","1.0000E+03","Hz"
```

```
"V","1.000","V"
```

```
"LIMIT","OFF"
```

## When OFF

```
"HIOKI E.E. CORPORATION","IM3570","Ver. 1.00"
```

```
"FREQ","1.0000E+03","Hz"
```

```
"V","1.000","V"
```

```
"LIMIT","OFF"
```

```
"RANGE","30k","Ω","AUTO"
```

SET

## Measurement Condition Setting

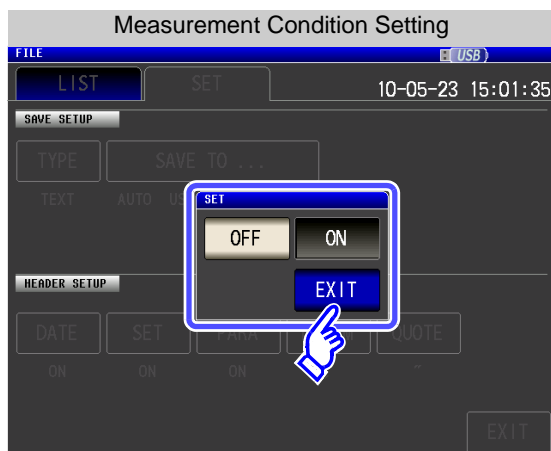

1. Select ON/ OFF for the measurement condition setting.

OFF

Does not record the measurement condition.

ON

Records the measurement condition.

2. Press **EXIT** to close the setting screen.

## When ON

```
"HIOKI E.E. CORPORATION","IM3570","Ver. 1.00"
```

```
"DATE","10-05-23"
```

```
"TIME","12:35:08"
```

```
"FREQ","1.0000E+03","Hz"
```

```
"V","1.000","V"
```

```
"LIMIT","OFF"
```

```
"RANGE","30k","Ω","AUTO"
```

```
"LOW Z","OFF"
```

```
"JUDGE","OFF"
```

```
"SPEED","MED"
```

```
"TRIG","INT"
```

```
"AVE","OFF"
```

```
"DELAY","0.0000","s"
```

```
"DCBIAS","OFF"
```

```
"OPEN","OFF"
```

```
"SHORT","OFF"
```

```
"LOAD","OFF"
```

```
"CABLE","0","m"
```

```
"SCALE","OFF"
```

```
"Z[Ω]","OFF","θ[°]","OFF"
```

```
"16.1504E+03","","-89.992",""
```

## When OFF

```
"HIOKI E.E. CORPORATION","IM3570","Ver. 1.00"
```

```
"DATE","10-05-23"
```

```
"TIME","12:35:27"
```

```
"Z[Ω]","OFF","θ[°]","OFF"
```

```
"16.1505E+03","","-89.992",""
```



PARA Measurement Parameter Setting

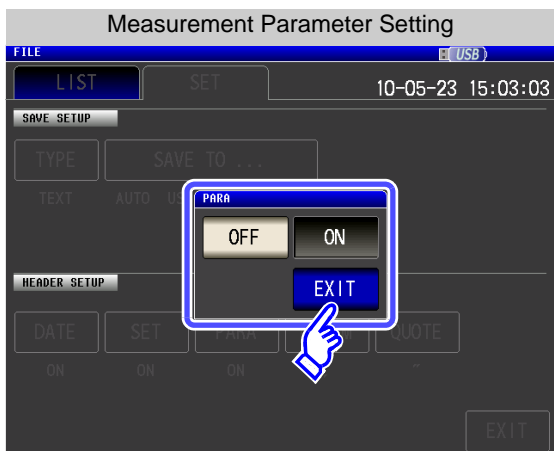

1. Select ON/ OFF for measurement parameter recording.

**OFF** Does not record the measurement parameter.

**ON** Records the measurement parameter.

2. Press **EXIT** to close the setting screen.

When ON

```
"DATE","10-05-23"
"TIME","12:35:08"

"FREQ","1.0000E+03","Hz"
"V","1.000","V"
"LIMIT","OFF"
"RANGE","30k","Ω","AUTO"
"LOW Z","OFF"
"JUDGE","OFF"
"SPEED","MED"
"TRIG","INT"
"AVE","OFF"
"DELAY","0.0000","s"
"DCBIAS","OFF"
"OPEN","OFF"
"SHORT","OFF"
"LOAD","OFF"
"CABLE","0","m"
"SCALE","OFF"
"Z[Ω]","OFF","θ[°]","OFF"
16.1504E+03 , , -89.992 ,
```

When OFF

```
"HIOKI E.E. CORPORATION","IM3570","Ver. 1.00"

"DATE","10-05-23"
"TIME","12:35:35"

"FREQ","1.0000E+03","Hz"
"V","1.000","V"
"LIMIT","OFF"
"RANGE","30k","Ω","AUTO"
"LOW Z","OFF"
"JUDGE","OFF"
"SPEED","MED"
"TRIG","INT"
"AVE","OFF"
"DELAY","0.0000","s"
"DCBIAS","OFF"
"OPEN","OFF"
"SHORT","OFF"
"LOAD","OFF"
"CABLE","0","m"
"SCALE","OFF"

"16.1504E+03","", "-89.992", "
```

## 10.4 Saving Measurement Data

DELIM

### Delimiter Setting

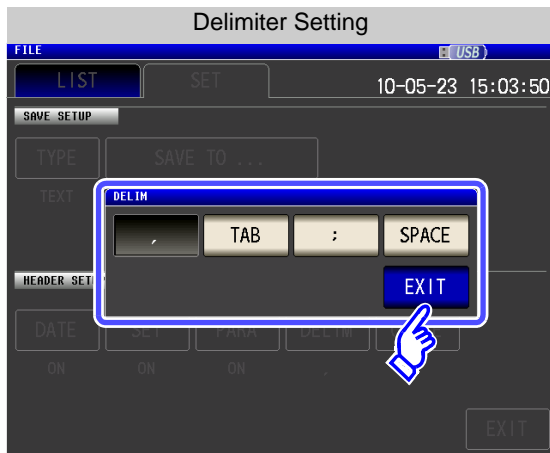

1. Select the delimiter setting.



Sets the delimiter to a comma (,).



Sets the delimiter to a tab.



Sets the delimiter to a semicolon (;).



Sets the delimiter to a space.

2. Press **EXIT** to close the setting screen.

When comma

```
"HIOKI E.E. CORPORATION","IM3570","Ver. 1.00"
"DATE","10-05-23"
"TIME","12:35:08"

"FREQ","1.0000E+03","Hz"
"V","1.000","V"
"LIMIT","OFF"
"RANGE","30k","Ω","AUTO"
"LOW Z","OFF"
"JUDGE","OFF"
"SPEED","MED"
"TRIG","INT"
"AVE","OFF"
"DELAY","0.0000","s"
```

When tab

```
"HIOKI E.E. CORPORATION" "IM3570" "Ver. 1.00"
"DATE" "10-05-23"
"TIME" "12:35:43"

"FREQ" "1.0000E+03" "Hz"
"V" "1.000" "V"
"LIMIT" "OFF"
"RANGE" "30k" "Ω" "AUTO"
"LOW Z" "OFF"
"JUDGE" "OFF"
"SPEED" "MED"
"TRIG" "INT"
"AVE" "OFF"
"DELAY" "0.0000" "s"
"DCBIAS" "OFF"
"OPEN" "OFF"
```

When semicolon

```
"HIOKI E.E. CORPORATION";"IM3570";"Ver. 1.00"
"DATE";"10-05-23"
"TIME";"12:35:48"

"FREQ";"1.0000E+03";"Hz"
"V";"1.000";"V"
"LIMIT";"OFF"
"RANGE";"30k";"Ω";"AUTO"
"LOW Z";"OFF"
"JUDGE";"OFF"
"SPEED";"MED"
"TRIG";"INT"
"AVE";"OFF"
"DELAY";"0.0000";"s"
```

When space

```
"HIOKI E.E. CORPORATION" "IM3570" "Ver. 1.00"
"DATE" "10-05-23"
"TIME" "12:35:55"

"FREQ" "1.0000E+03" "Hz"
"V" "1.000" "V"
"LIMIT" "OFF"
"RANGE" "30k" "Ω" "AUTO"
"LOW Z" "OFF"
"JUDGE" "OFF"
"SPEED" "MED"
"TRIG" "INT"
"AVE" "OFF"
"DELAY" "0.0000" "s"
"DCBIAS" "OFF"
```

## QUOTE Quotation Mark Setting

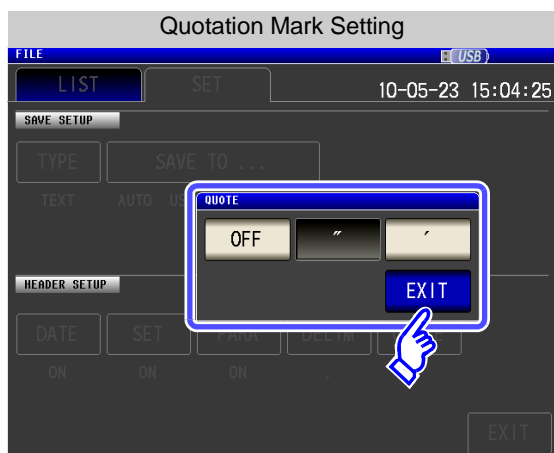

1. Select the quotation mark setting.

OFF	No quotation marks are added.
"	Sets the quotation mark to a double quotation mark (").
'	Sets the quotation mark to a single quotation mark (').

2. Press **EXIT** to close the setting screen.

## When OFF

```
HIOKI E.E. CORPORATION,IM3570,Ver. 1.00
DATE,10-05-23
TIME,12:36:04

FREQ,1.0000E+03,Hz
V,1.000,V
LIMIT,OFF
RANGE,30k,Ω,AUTO
LOW Z,OFF
JUDGE,OFF
SPEED,MED
TRIG,INT
AVE,OFF
DELAY,0.0000,s
```

## When double quotation mark

```
"HIOKI E.E. CORPORATION","IM3570","Ver. 1.00"
"DATE","10-05-23"
"TIME","12:35:08"

"FREQ","1.0000E+03","Hz"
"V","1.000","V"
"LIMIT","OFF"
"RANGE","30k","Ω","AUTO"
"LOW Z","OFF"
"JUDGE","OFF"
"SPEED","MED"
"TRIG","INT"
"AVE","OFF"
"DELAY","0.0000","s"
```

## When single quotation mark

```
'HIOKI E.E. CORPORATION','IM3570','Ver. 1.00'
'DATE','10-05-23'
'TIME','12:36:11'

'FREQ','1.0000E+03','Hz'
'V','1.000','V'
'LIMIT','OFF'
'RANGE','30k','Ω','AUTO'
'LOW Z','OFF'
'JUDGE','OFF'
'SPEED','MED'
'TRIG','INT'
'AVE','OFF'
'DELAY','0.0000','s'
```

## 10.4 Saving Measurement Data

6 Press **EXIT**.

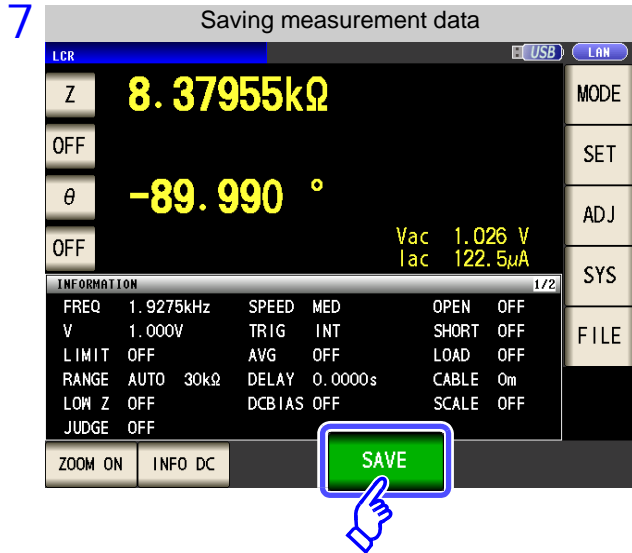

Press **SAVE** in the measurement screen.  
The measurement data is saved.

When **SAVE** is pressed, a folder is automatically created in the USB flash drive and the file is saved.

- The date is used for the name of the folder created when you press **SAVE**.
- The date and time are automatically assigned to the file name.

See "Changing the Save Folder" (p. 344)

### Example of screen copy

When LCR mode

```

HIOKI E.E. IM3570 Ver. 1.00
DATE #####
TIME 12:35:08

FREQ 1.00E+03 Hz
V 1 V
LIMIT OFF
RANGE 30k Ω AUTO
LOW Z OFF
JUDGE OFF
SPEED MED
TRIG INT
AVE OFF
DELAY 0 s
DCBIAS OFF
OPEN OFF
SHORT OFF
LOAD OFF
CABLE 0 m
SCALE OFF

Z[Ω] OFF θ[°] OFF
1.62E+04 -89.992
    
```

When analyzer mode

```

HIOKI E.E. IM3570 Ver. 1.00
DATE #####
TIME 12:53:14

SOURCE FREQ
TRIG REPEAT
DRAW REAL
DELAY 0 s
V 1 V
RANGE 1k Ω AUTO
SPEED MED
AVE OFF
POINT DE 0 s

Point No. FREQUEN Z[Ω] θ[°]
0 1.00E+03 1.62E+04 -89.993
1 1.04E+03 1.56E+04 -89.992
2 1.07E+03 1.51E+04 -89.991
3 1.11E+03 1.46E+04 -89.991
4 1.15E+03 1.41E+04 -89.991
5 1.19E+03 1.36E+04 -89.991
6 1.23E+03 1.31E+04 -89.99
7 1.27E+03 1.27E+04 -89.99
8 1.32E+03 1.23E+04 -89.99
    
```

**2 Saving a Copy of the Screen**

You can save the screen currently displayed to the USB flash drive in bmp file format (256-color or monochrome [2-color]). The file extension is bmp.

**Procedure**

1 Insert the USB flash drive into the USB port (front panel).

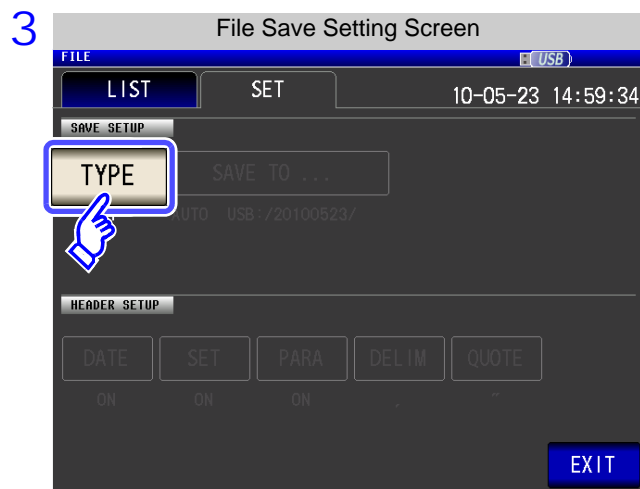
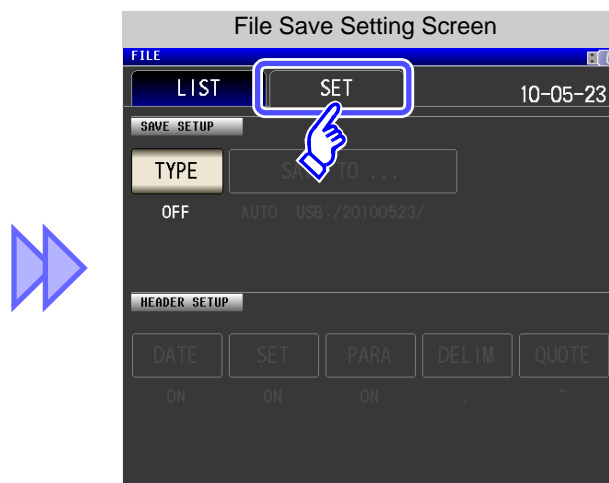
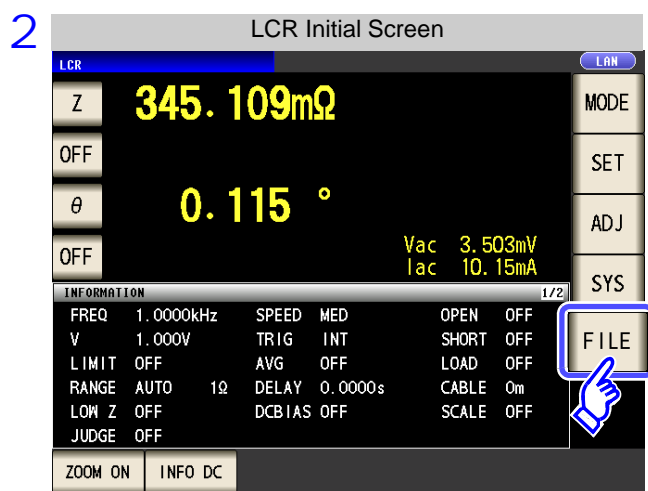

Press **TYPE**.

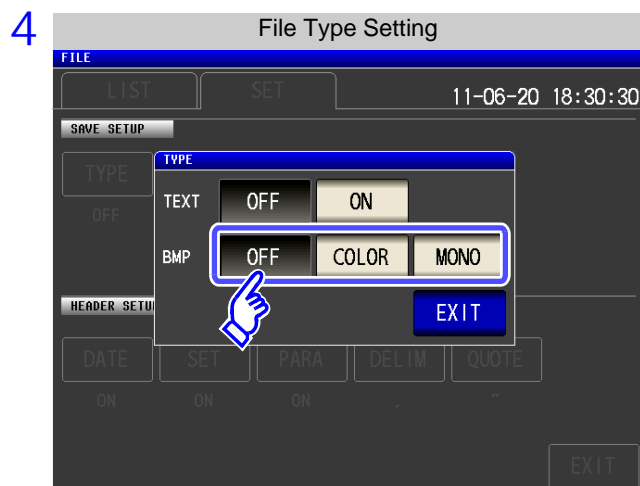

Turn on the BMP save setting.

- OFF** Turns off the screen copy function.
- COLOR** Saves screen copies as 256-color BMP files.
- MONO** Saves screen copies as monochrome (2-color) BMP files.

Press **EXIT** to close the setting screen.

## 10.4 Saving Measurement Data

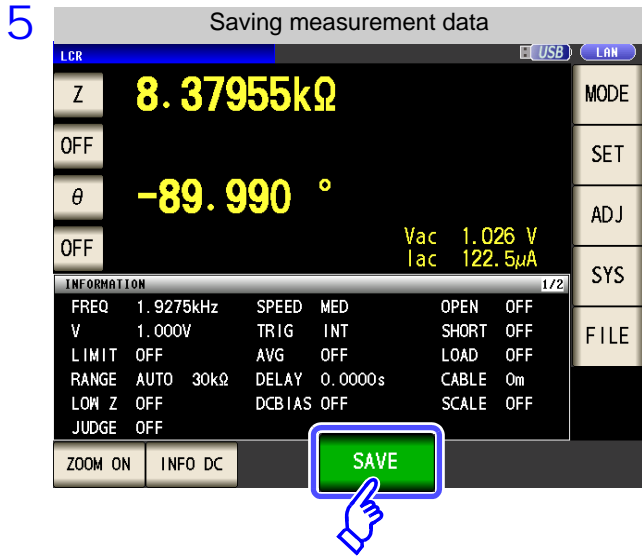

Press **SAVE** in the [Measurement Screen].

A copy of the screen is saved.

When **SAVE** is pressed, a folder is automatically created in the USB flash drive and the file is saved.

- The date is used for the name of the folder created when you press **SAVE**.
- The date and time are automatically assigned to the file name.

See "Changing the Save Folder" (p. 344)

### Example of screen copy

#### When LCR mode

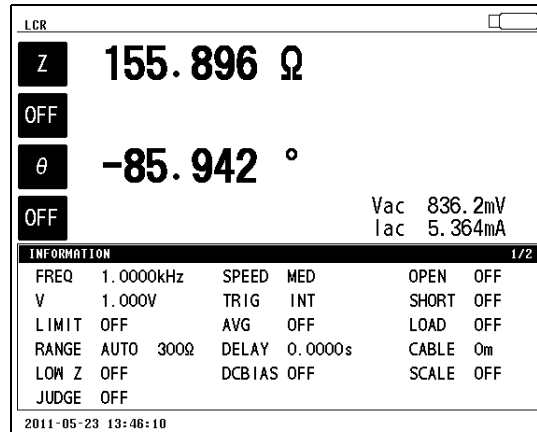
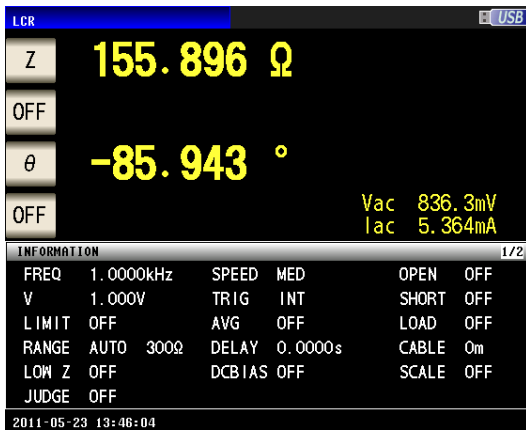

#### When analyzer mode

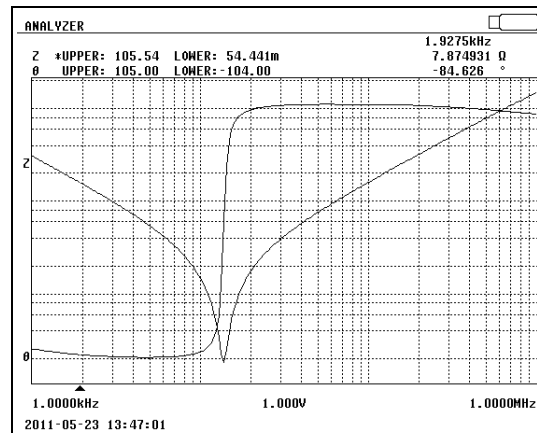
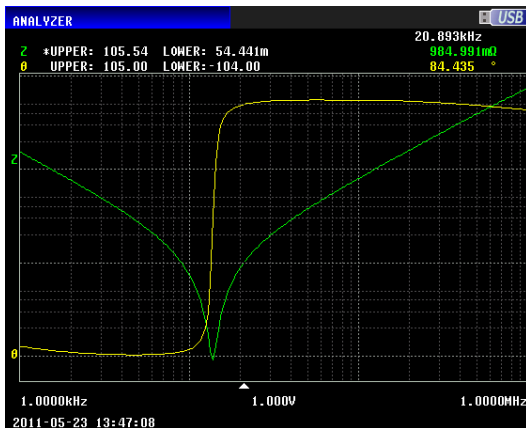

**3** Checking the Contents of Files

You can check files saved to a USB flash drive in text format ([TXT], [CSV]) and BMP format on the screen.

**Procedure**

**1** Insert the USB flash drive into the USB port (front panel).

**2**

LCR Initial Screen

File List Screen

FILE NAME	TYPE	DATE	SIZE
20100521	FDR	2010-05-21 12:36	
20100522	FDR	2010-05-22 12:36	
20100523	FDR	2010-05-23 12:36	
SETTING	FDR	2010-05-23 12:36	

**3**

File Selection

FILE NAME	TYPE	DATE	SIZE
100523150510.csv	CSV	2010-05-23 15:05	422 B
100523152725.bmp	BMP	2010-05-23 15:27	301KB

Use or to select the file to check.

Press to check the file.

The indicated key varies depending on the type of the selected file.

- When [FDR]:
- When [TXT], [CSV], or [BMP]:

CSV File Display

File: 100523150510.csv

"HIOKI E. E. CORPORATION", "IM3570", "Ver. 1.00"

"DATE", "10-05-23"

"TIME", "15:05:10"

"FREQ", "1.9275E+03", "Hz"

"V", "1.000", "V"

"LIMIT", "OFF"

"RANGE", "30k", "Ω", "AUTO"

"LOW Z", "OFF"

"JUDGE", "OFF"

"SPEED", "MED"

"TRIG", "INT"

"AVG", "OFF"

"DELAY", "0.0000", "s"

"DCBIAS", "OFF"

"OPEN", "OFF"

"SHORT", "OFF"

"LOAD", "OFF"

"CABLE", "0", "m"

BMP File Display

ANALYZER

69.183kHz

Z #UPPER: 650.00 LOWER: 73.500

θ #UPPER: 105.00 LOWER: 106.00

34.09277 Ω

-87.476 °

10.000kHz 1.000V

**4** Press to close the setting screen.

## 10.4 Saving Measurement Data

### 4 Changing the Save Folder

You can set the save destination for data automatically or set the desired folder.

#### Procedure

1 Insert the USB flash drive into the USB port (front panel).

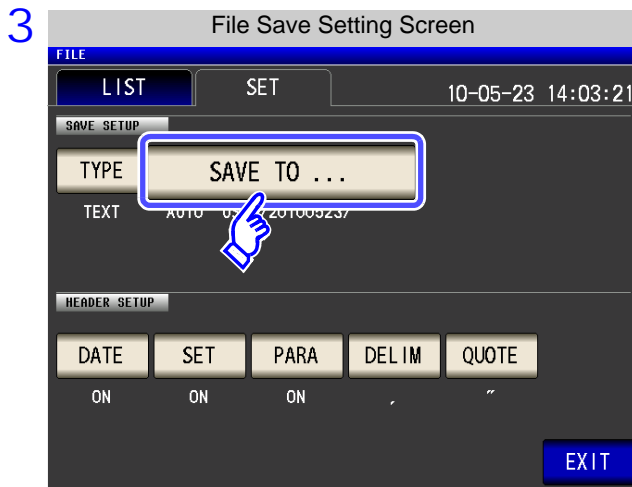
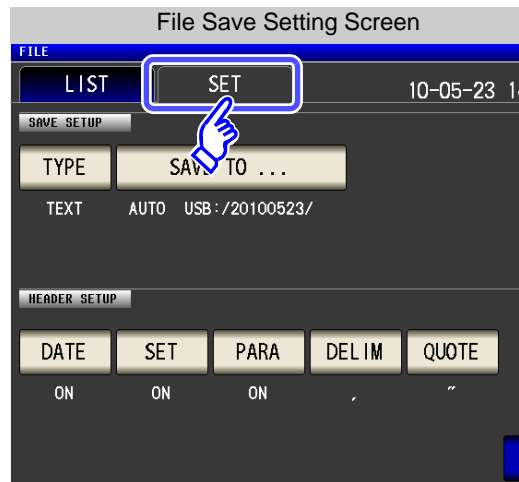
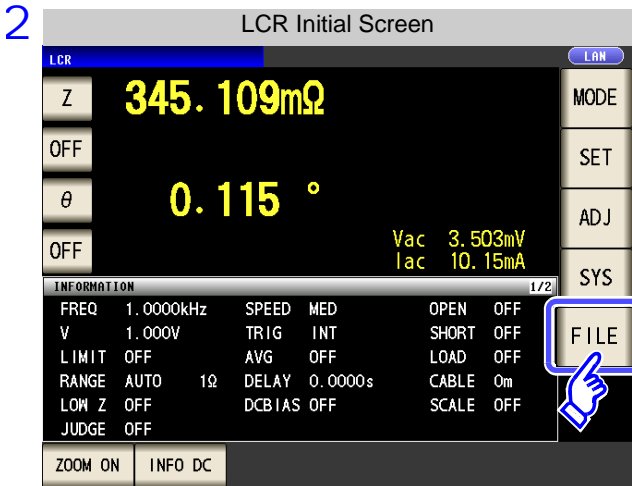

Press .

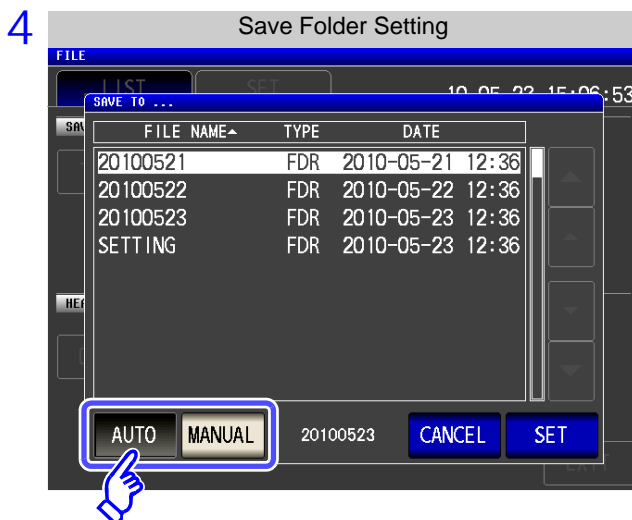

Select the setting procedure of the save folder.

Automatically creates a folder for today's date, and saves the data in the folder.

Allows you to specify any folder and then save the data.

Press to confirm the setting.

When you want to cancel the setting:

Press .



**NOTE** The following restrictions apply to the folder that can be selected with **MANUAL**.

- The folder name must be all single-byte characters (a folder name containing Japanese or other double-byte characters cannot be specified).
- The folder name must be no more than 12 characters.

5 Press **EXIT** to close the setting screen.

**NOTE**

- Only folders in the root directory of the USB flash drive can be selected with **MANUAL**.
- If the folder specified as the save destination folder has been deleted, create a folder when saving files.

### What is the root directory?

The root directory refers to the top-most directory in the hierarchy of the USB flash drive.

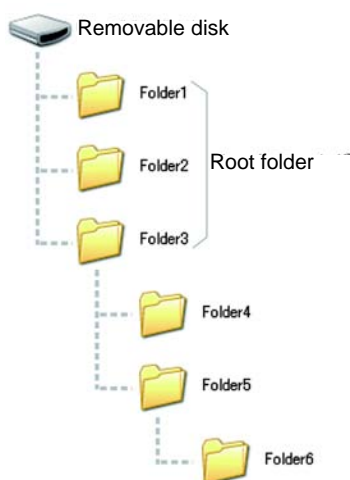

# 10.5 Loading Measurement Data

This section describes how to load analyzer measurement data saved to the instrument's USB memory and display it in graph form or use it to perform equivalent circuit analysis. Since this function only loads measured values, measurement conditions such as measurement parameters and sweep frequencies must be restored to the same conditions that were used when the loaded measurement data was acquired using panel save/load or similar functionality.

**See** "Chapter 9 Saving and Loading Panel Information" (p. 315)  
 "10.4 Saving Measurement Data" (p. 333)  
 "10.7 Reading Setting Conditions" (p. 353)

Parameters for loaded measurement data must be saved in the following format:  
 Z-θ, Cs-D, Cs-Rs, Cp-D, Cp-Rp, Ls-Q, Ls-Rs, Lp-Q, Lp-Rp, Rs-X

- NOTE**
- This functionality can only be used when the IM9000 Equivalent Circuit Analysis Software has been installed.
  - Steps 1 through 4 below can be set by loading measurement conditions saved to the instrument or its USB memory.
- See:** "9.2 Loading Measurement Conditions (Panel Load Function)" (p. 322)  
 "10.7 Reading Setting Conditions" (p. 353)

**Procedure**

- 1 Change the measurement mode to analyzer mode.**  
**See** "1.3.2 Measurement Mode Selection Screen" (p. 13)
- 2 Set the measurement parameters to the same parameters that were used when the loaded measurement data was acquired.**
- 3 Set the trigger mode to sequential sweep or step sweep.**  
**See** "5.2.3 Setting the Trigger" (p. 137)
- 4 Set the sweep frequency, number of sweep points, and other settings to the same conditions that were used when the loaded measurement data was acquired.**
- 5 Insert the USB memory stick into the USB connector (on the front of the instrument).**

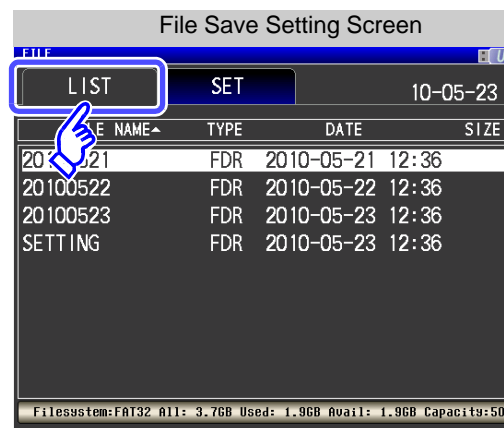
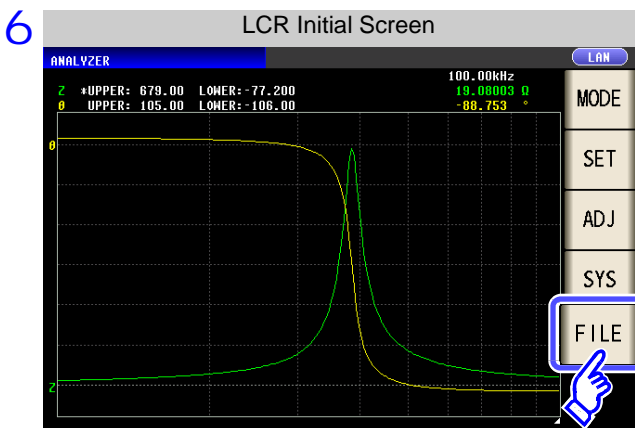

10.5 Loading Measurement Data

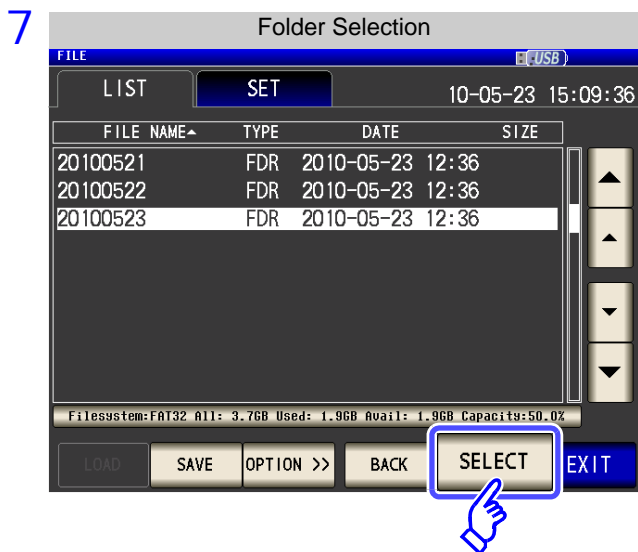

Select the folder in which the measurement data was saved with and .

Press .

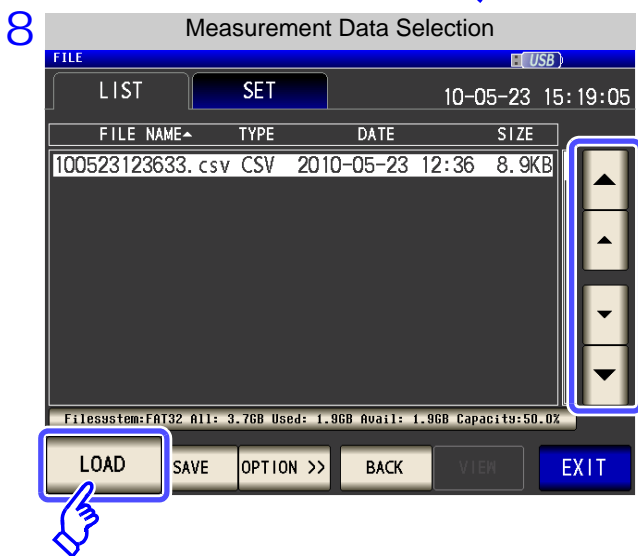

Select the measurement data to load with and .

Press .

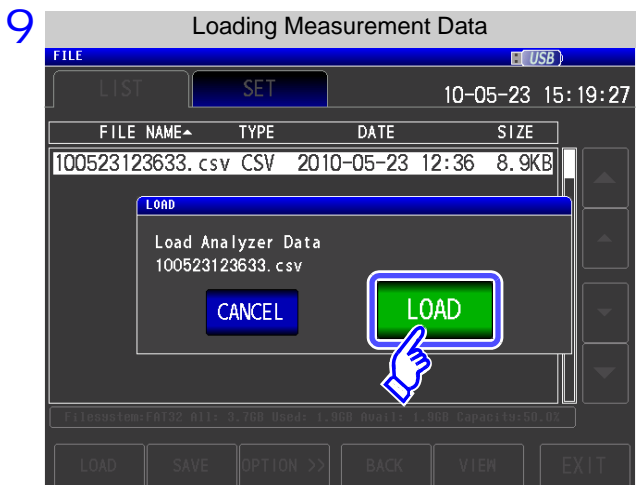

Press on the load confirmation screen. The measurement data will be loaded and applied as measured values.

When you want to cancel the load operation:  
Press .

### When a loading error is displayed

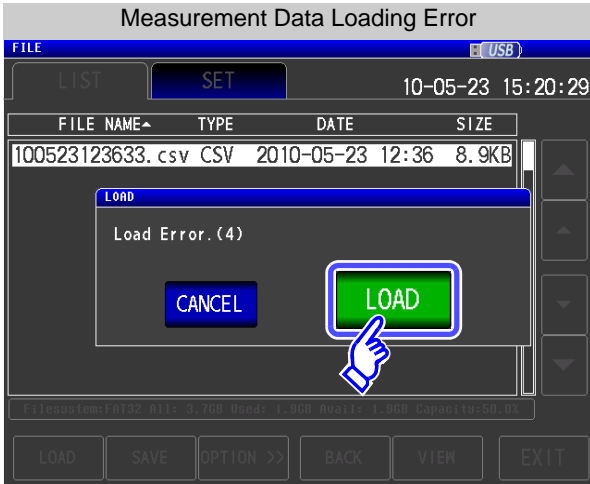

If an error is displayed after you press LOAD, you may be experiencing one of the issues listed below.

Symptom	Check Item, or Cause	Solution/reference
<b>Load Error.(1)</b>	The instrument is not in analyzer mode.	Load measurement data after changing to analyzer mode. <a href="#">See "1.3.2 Measurement Mode Selection Screen" (p. 13)</a>
<b>Load Error.(2)</b>	The trigger settings in analyzer mode have been set to repeat sweep.	Load the measurement data after setting the trigger settings to sequential sweep or step sweep. <a href="#">See "5.2.3 Setting the Trigger" (p. 137)</a>
<b>Load Error.(3)</b>	The measurement data file is corrupt.	Load a file that is not corrupt.
<b>Load Error.(4)</b>	There is no measurement data that can be loaded by the instrument.	Load analyzer data that was saved by the instrument.
<b>Load Error.(5)</b>	The measurement signal setting is not set to frequency sweep.	Load measurement data after setting the sweep parameter to frequency sweep. <a href="#">See "5.2.2 Setting the Sweep Parameter" (p. 135)</a>
<b>Load Error.(6)</b>	Measurement data has been saved in a parameter format that cannot be loaded.	Verify that the measured values being loaded are the following parameters: Z-θ, Cs-D, Cs-Rs, Cp-D, Cp-Rp, Ls-Q, Ls-Rs, Lp-Q, Lp-Rp, Rs-X
<b>Load Error.(7)</b>	The measurement data parameters do not match the current settings.	Load measurement data after configuring the instrument's parameters so that they match the parameters of the measured values being loaded. <a href="#">See "5.2.1 Setting the measurement parameter" (p. 133)</a>
<b>Load Error.(8)</b>	The measurement data includes erroneous values. Example: No measurement after power supply activation: 8888888E+28 Overflow: 9999999E+28	Load measured values that do not contain erroneous values. <a href="#">See Description of communications commands on the included CD (:MEASure?)</a>
<b>Load Error.(9)</b>	Parameter information was not saved with the measurement data.	Load measurement data that includes measurement parameter information. <a href="#">See "10.4 Saving Measurement Data" (p. 333)</a>
<b>Load Error.(10)</b>	The number of sweep points in the measurement data does not match the current setting.	Load measurement data after configuring the settings so that the number of measurement points with which the instrument has been configured matches the number of points in the measured values being loaded. <a href="#">See "5.3.1 Setting Sweep Points" (p. 143)</a>

## 10.6 Saving Instrument Settings

### 1 Saving Instrument Settings

Save various setting information of the instrument as a setting file to the USB flash drive.

The extension of the setting file is ".SET." This function is convenient for when you want to back up the setting state of the instrument.

For the settings that are saved, refer to "Initial Setting List."

#### Procedure

- 1 Insert the USB flash drive into the USB port (front panel).

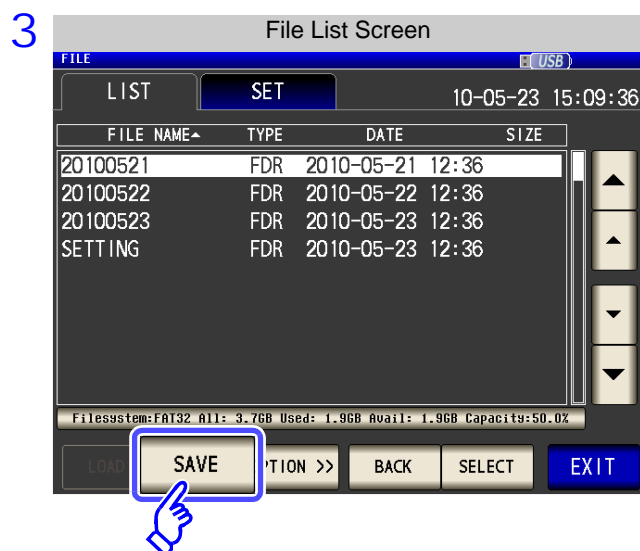
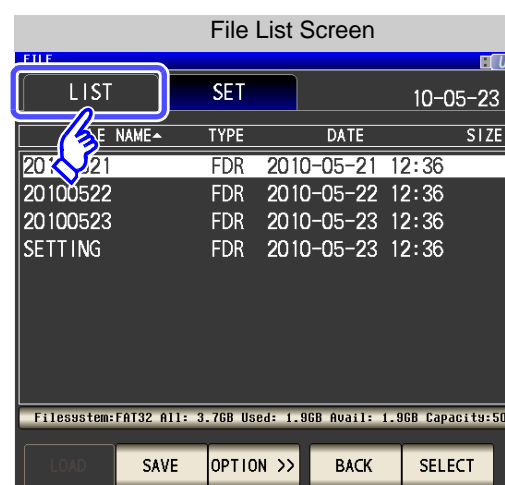
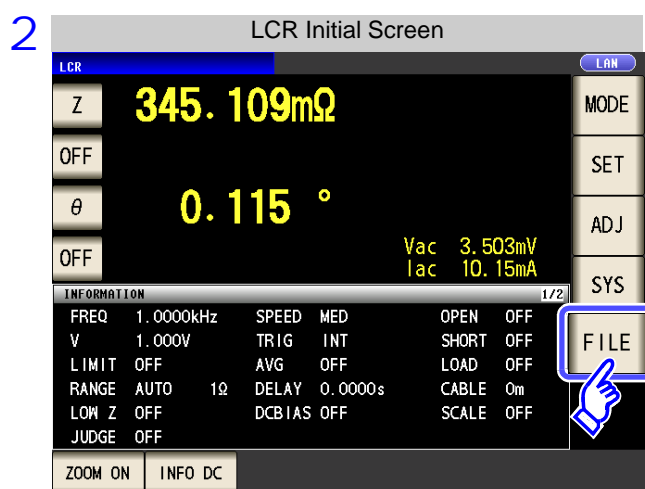

Press  .

## 10.6 Saving Instrument Settings

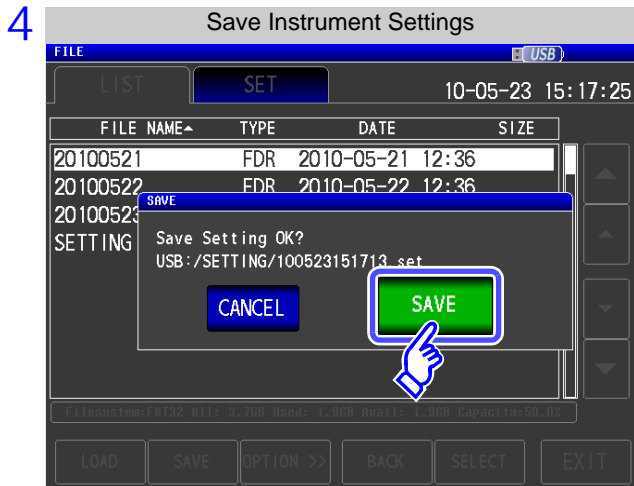

Press **SAVE** in the save confirmation screen.

The measurement data is saved.

- The setting file is saved to the **[SETTING]** folder in the USB flash drive.
- The date and time are automatically assigned to the file name.

### When you want to cancel saving:

Press **CANCEL**.

**2 Saving All Settings of Instrument (ALL SAVE Function)**

Save various setting information of the instrument including the panel save information as a setting file to the USB flash drive.

The extension of the setting file is “.SET.” The extension of the panel save is “.PNL.”  
 For the settings that are saved, refer to "Appendix 12 Initial Settings Table" (p. A17).

**Procedure**

1 Insert the USB flash drive into the USB port (front panel).

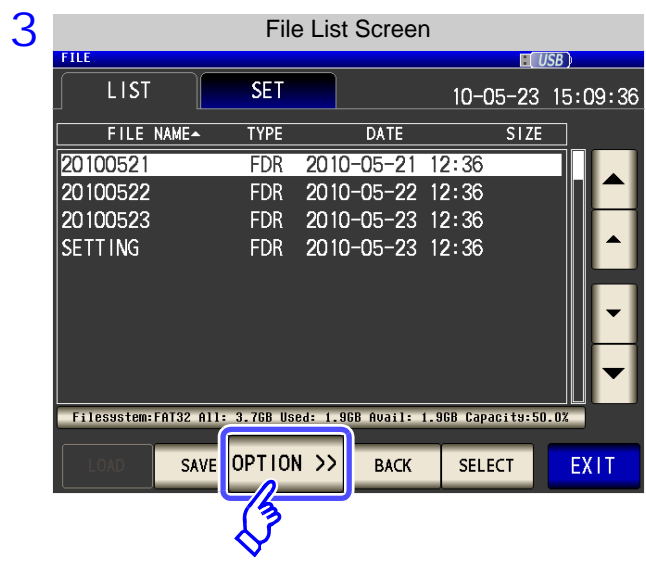
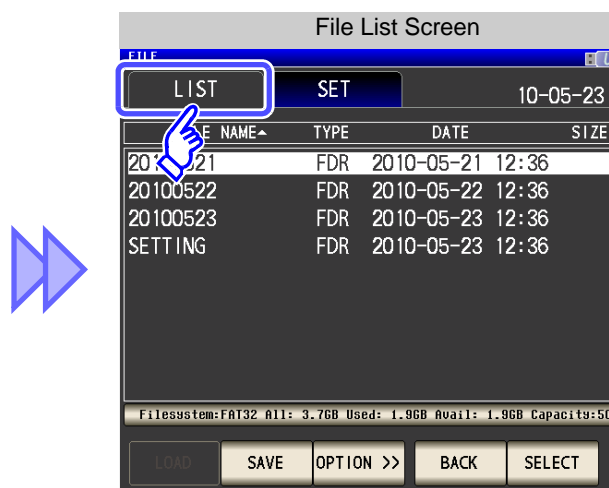
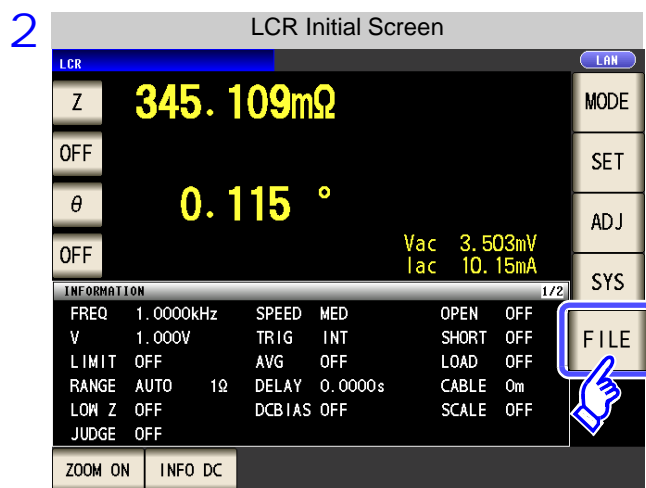

Press **OPTION >>**.

## 10.6 Saving Instrument Settings

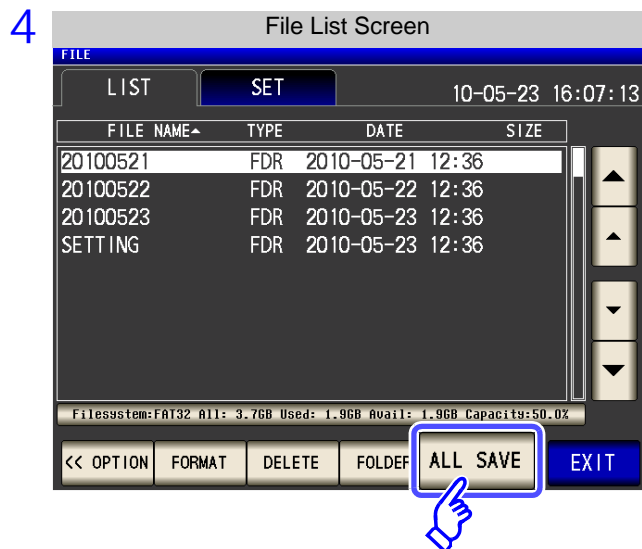

Press **ALL SAVE** .

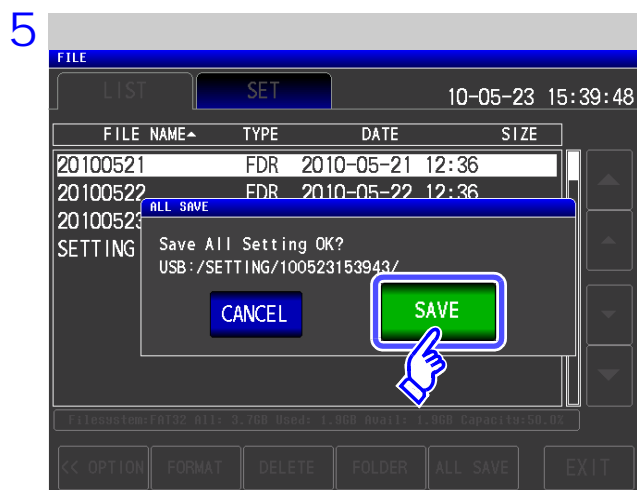

Press **SAVE** in the save confirmation screen.

The measurement data is saved.

- The setting file and panel save data are saved to a folder of the save date and time that is created automatically in the **[SETTING]** folder.
- The date and time are automatically assigned to the folder name and file name.

**When you want to cancel saving:**

Press **CANCEL** .



# 10.7 Reading Setting Conditions

## 1 Loading instrument settings

Read a setting file or panel save file that is saved to the USB flash drive, and restore the settings.

### Procedure

1 Insert the USB flash drive into the USB port (front panel).

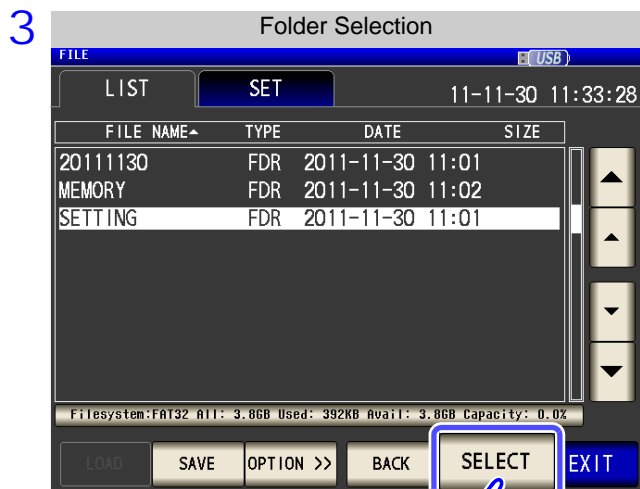
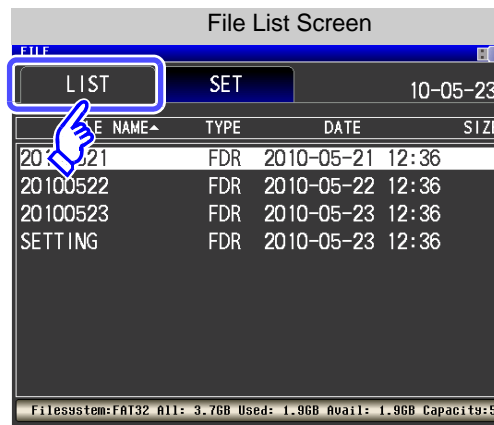
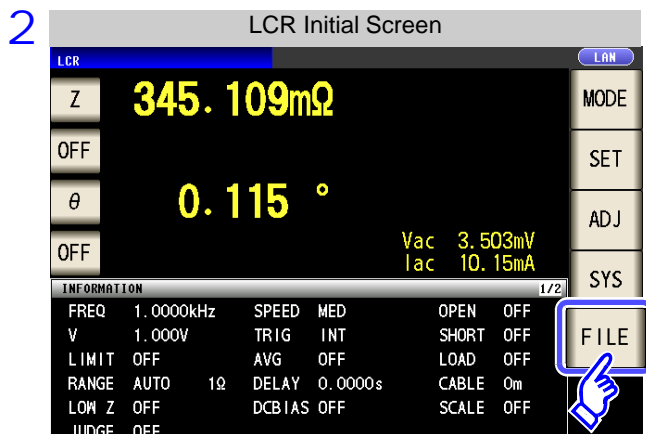

Use or to select the [SETTING] folder.

Press .

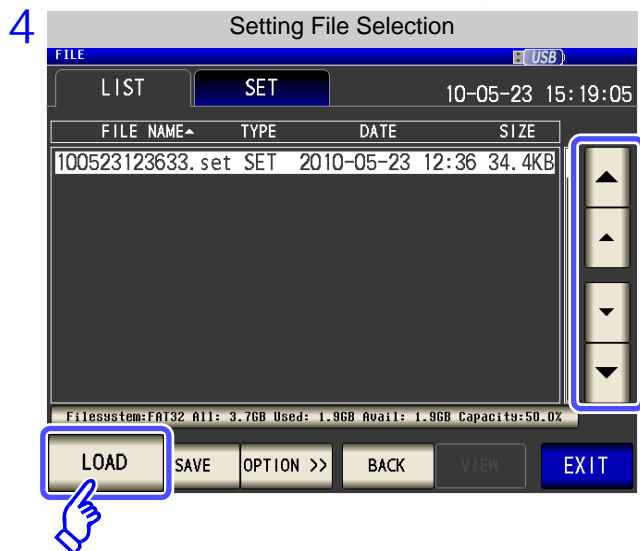

Use or to select the setting file or panel save file to read.

Press .

## 10.7 Reading Setting Conditions

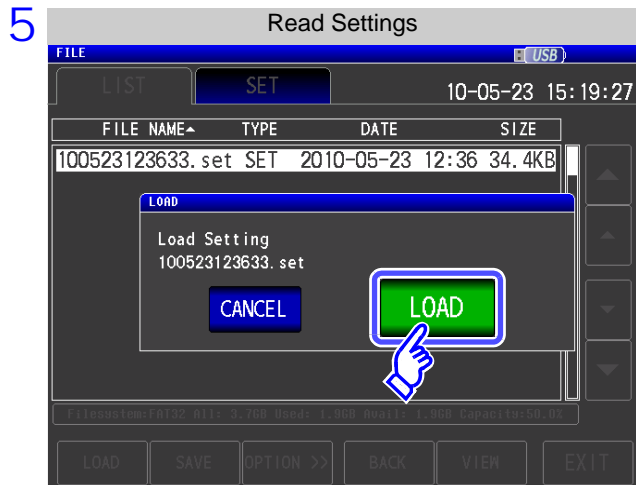

Press **LOAD** in the read confirmation screen.

The measurement data is read, and reflected as the current settings.

**When you want to cancel reading:**

Press **CANCEL**.

### When the Read Confirmation Screen Appears

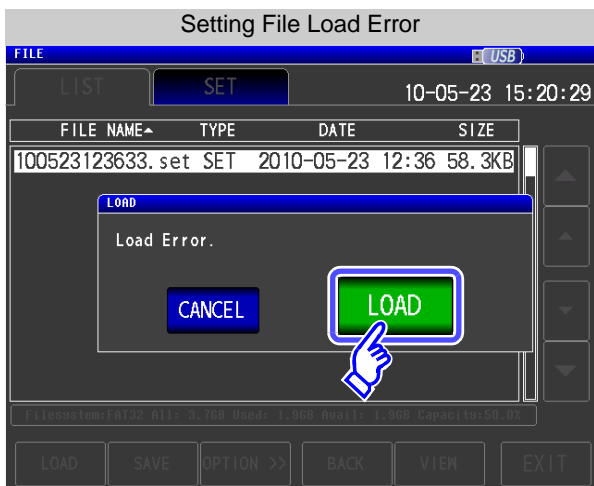

If an error appears when **LOAD** is pressed, one of the following are likely to be cause.

- The setting file is damaged.
- The file is not a setting file that can be read by the instrument.

**When you want to cancel reading:**

Press **CANCEL**.

**2 Loading all settings saved on a USB flash drive (ALL LOAD Function)**

Load and restore instrument settings, including panels saved to USB memory using the all save function.  
**See** "Saving All Settings of Instrument (ALL SAVE Function)" (p. 351)

**Procedure**

**1** Insert the USB flash drive into the USB port (front panel).

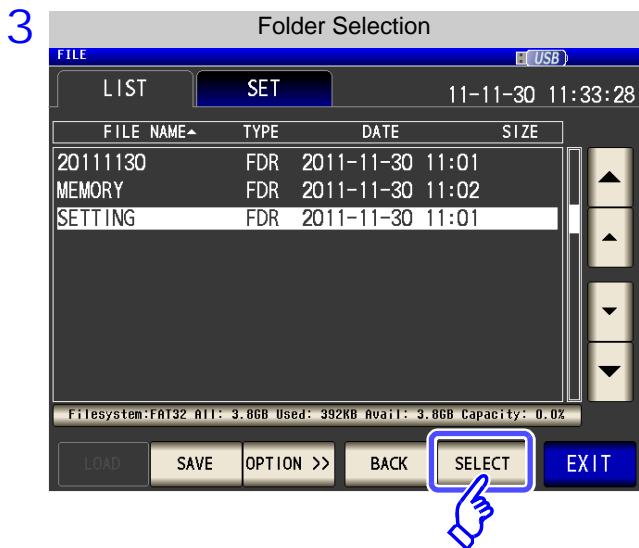
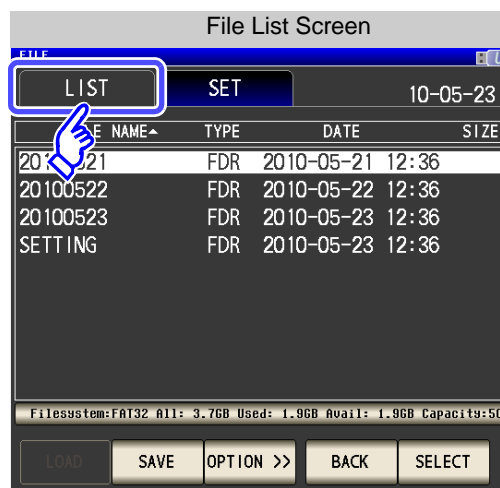
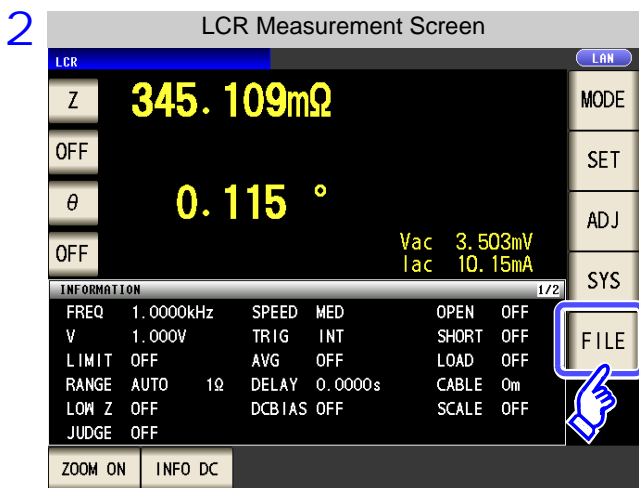

Use or to select the [SETTING] folder.

Press .

## 10.7 Reading Setting Conditions

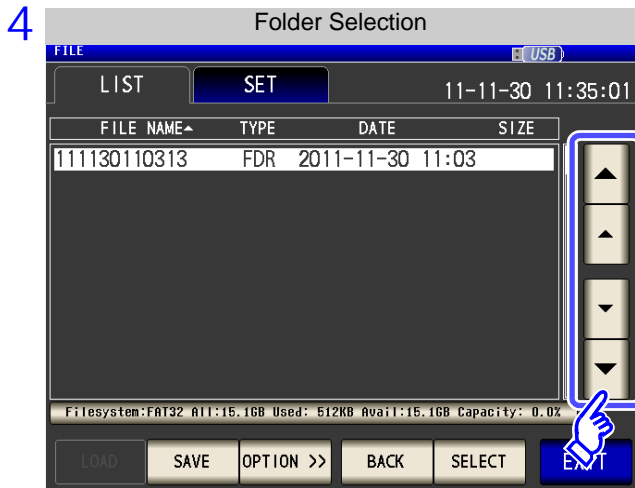

Using the and buttons, select the folder to which settings were saved with the all save function.

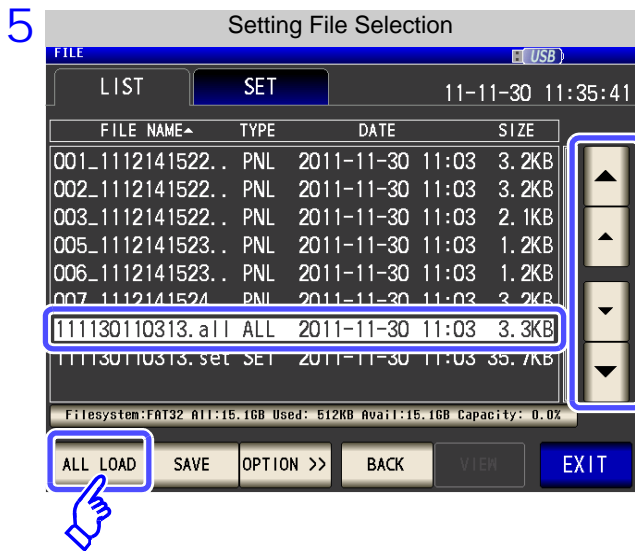

Using the and buttons, set [TYPE] to [ALL] files.

Press .

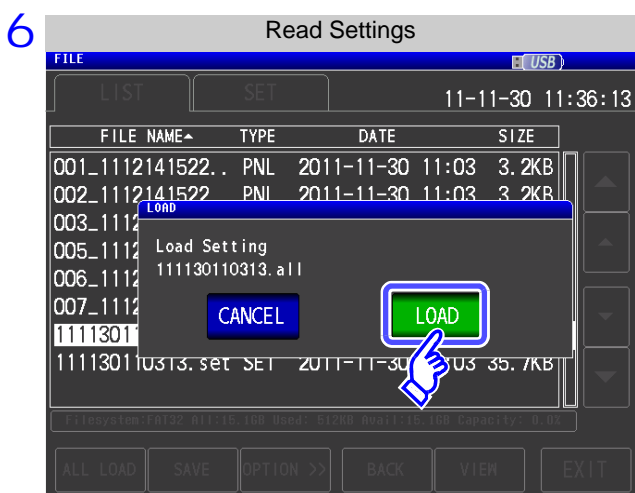

Press in the read confirmation screen.

All measurement data saved in the folder will be loaded and applied to the current settings.

**When you want to cancel reading:**  
Press .

**NOTE** • Selecting [LOAD] will cause the instrument's current settings to be deleted.  
• If the instrument is unable to load the settings file, a beep will sound.

# 10.8 File and Folder Operations

You can edit files and folders saved to the USB flash drive.

## 1 Formatting a USB Flash Drive

Perform this operation if the USB flash drive to be used is not formatted (initialized). Insert the USB flash drive to be formatted into the USB port (on the front panel) (p. 330) and start the format. The IM3570 formats drives using FAT32.

### Procedure

1 Insert the USB flash drive into the USB port (front panel).

2

LCR Initial Screen

LCR

Z 345.109mΩ

OFF

θ 0.115 °

OFF

Vac 3.503mV  
Iac 10.15mA

INFORMATION

FREQ	1.0000kHz	SPEED	MED	OPEN	OFF	
V	1.000V	TRIG	INT	SHORT	OFF	
LIMIT	OFF	AVG	OFF	LOAD	OFF	
RANGE	AUTO	1Ω	DELAY	0.0000s	CABLE	0m
LOW Z	OFF	DCBIAS	OFF	SCALE	OFF	
JUDGE	OFF					

MODE  
SET  
ADJ  
SYS

FILE

File List Screen

FILE

LIST SET 10-05-23 13

FILE NAME~	TYPE	DATE	SIZE
20100521	FDR	2010-05-21 12:36	
20100522	FDR	2010-05-22 12:36	
20100523	FDR	2010-05-23 12:36	
SETTING	FDR	2010-05-23 12:36	

Filesystem:FAT32 All: 3.7GB Used: 1.9GB Avail: 1.9GB Capacity:50.0%

LOAD SAVE OPTION >> BACK SELECT

3

File List Screen

FILE

LIST SET 10-05-23 15:09:36

FILE NAME~	TYPE	DATE	SIZE
20100521	FDR	2010-05-21 12:36	
20100522	FDR	2010-05-22 12:36	
20100523	FDR	2010-05-23 12:36	
SETTING	FDR	2010-05-23 12:36	

Filesystem:FAT32 All: 3.7GB Used: 1.9GB Avail: 1.9GB Capacity:50.0%

LOAD SAVE OPTION >> BACK SELECT EXIT

Press **OPTION >>**.

10.8 File and Folder Operations

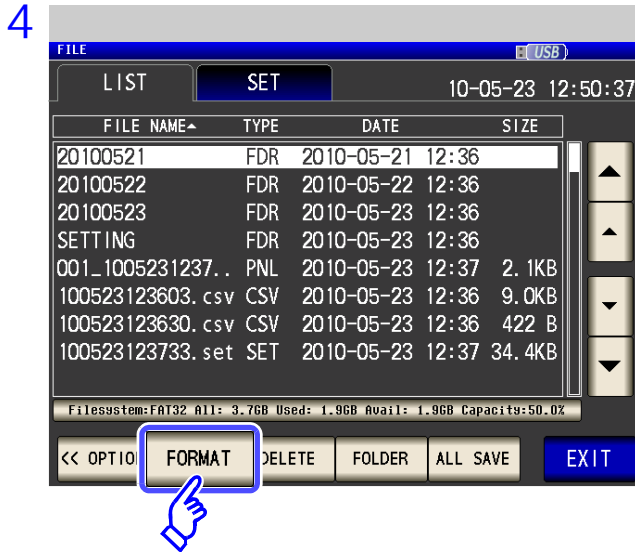

Press **FORMAT** .

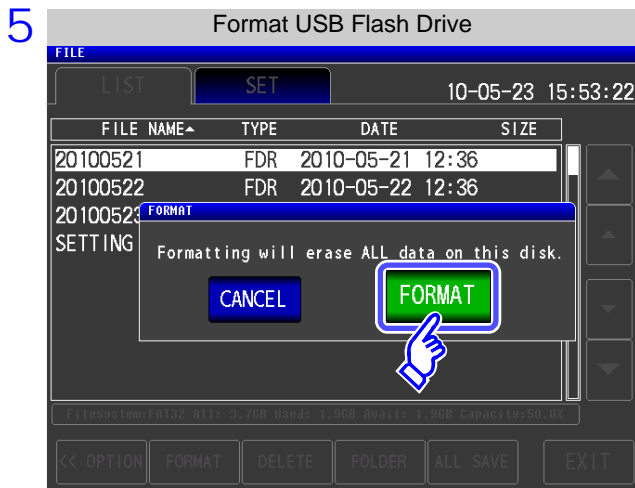

A confirmation screen appears.

Press **FORMAT** .

**When you want to cancel the format:**  
Press **CANCEL** .

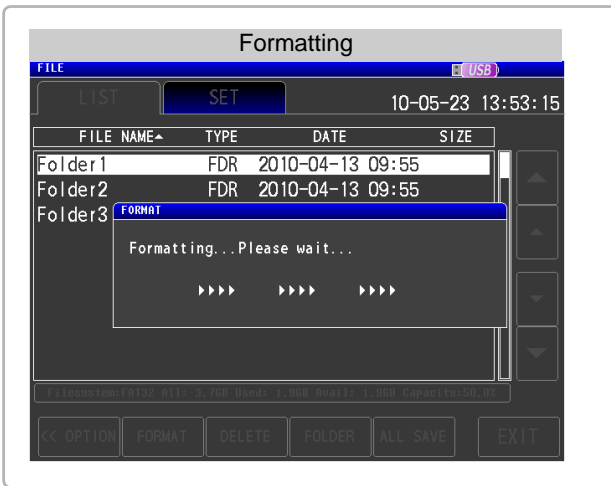

No operation is possible during formatting.

When formatting ends, the file list screen is redisplayed.

**NOTE**

- When you perform a format, all of the data saved to the USB flash drive is deleted and cannot be restored. Carefully check the contents before you perform a format.
- We recommend making a backup of any important data on a USB flash drive.
- When formatting is performed with the instrument, the volume label of the USB flash drive becomes **[NO NAME]**.

What is a Volume Label?

A name that is assigned to a drive such as a USB flash drive.  
In Windows, you can check the volume label of each drive in My Computer.

2 Deleting Files and Folders

You can delete a file or folder saved to the USB flash drive.

Procedure

1 Insert the USB flash drive into the USB port (front panel).

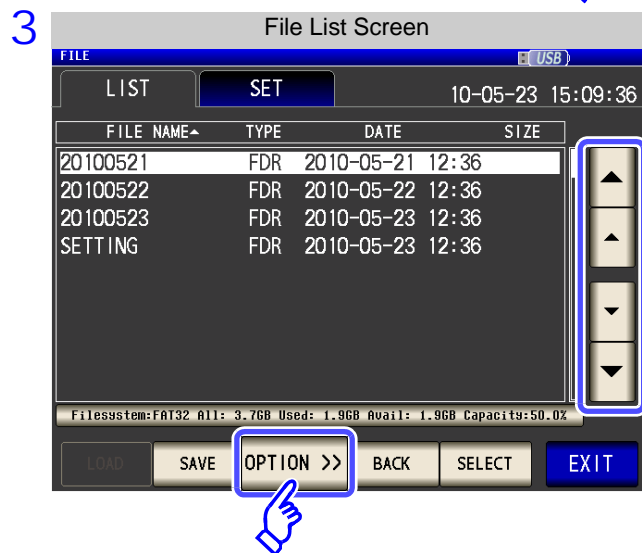
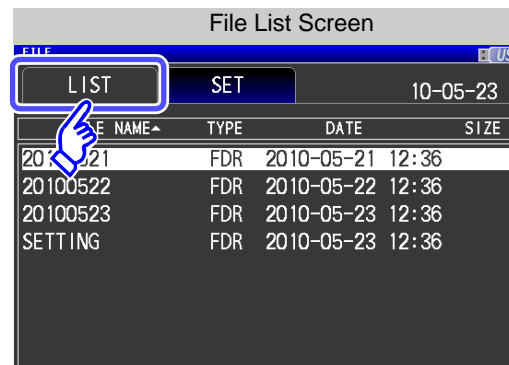
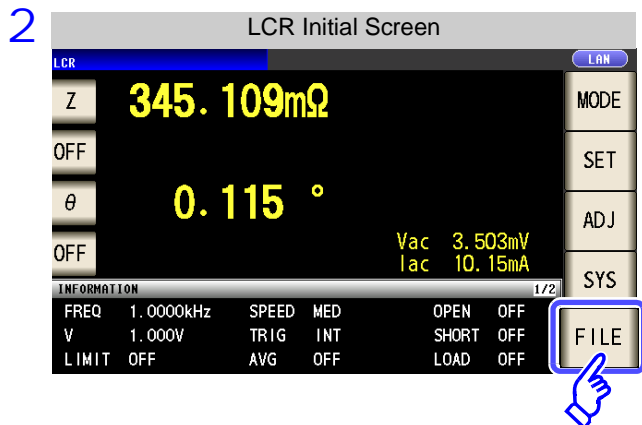

Use or to select the file or folder you want to delete.

Press .

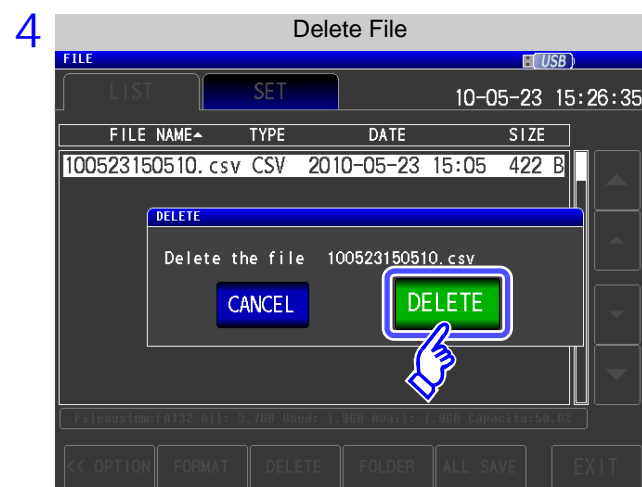

A deleted file or folder cannot be restored once it is deleted.

Confirm the file or folder to be deleted, and then press .

When you want to cancel deletion:  
Press .

**NOTE**

If the folder to be deleted contains a file, it cannot be deleted. To delete the folder, delete all of the files in the folder.

3 Creating Folders

Procedure

1 Insert the USB flash drive into the USB port (front panel).

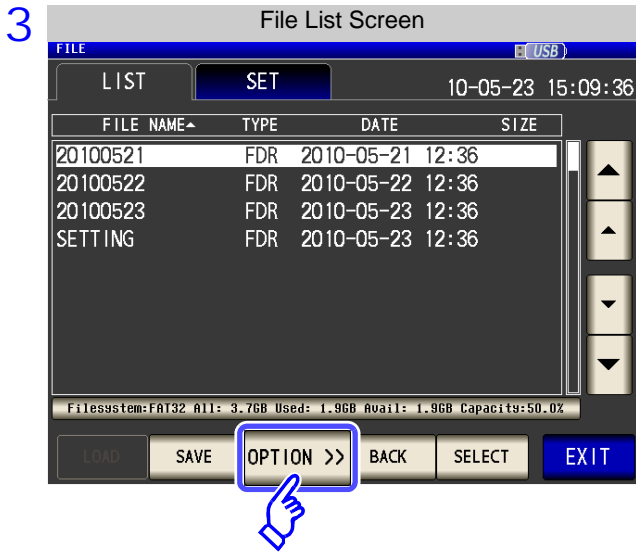
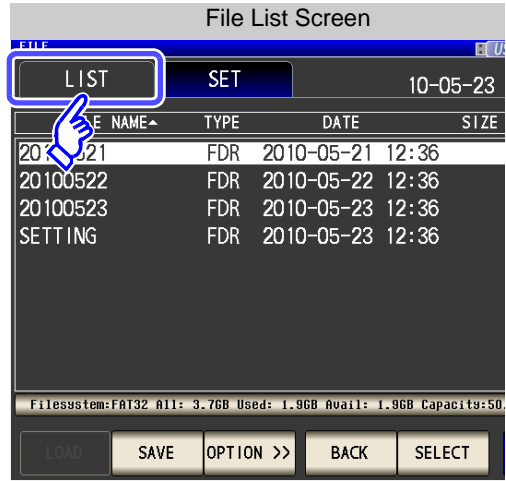
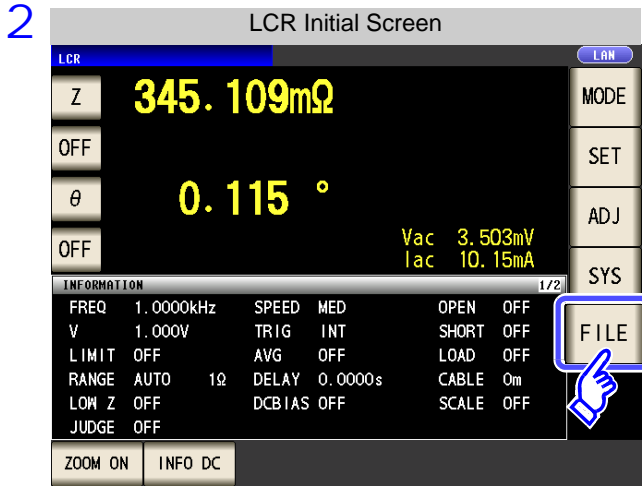

Press OPTION >> .

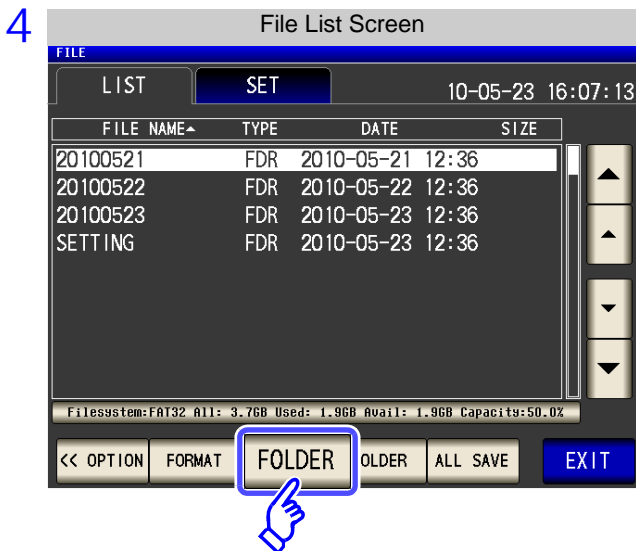

Press FOLDER .



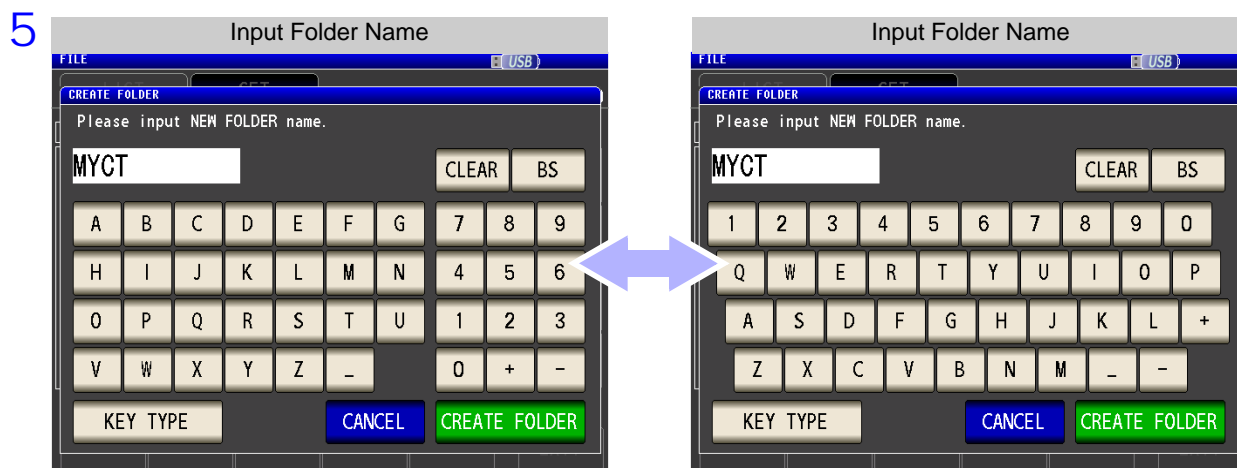

Enter the save name. (Up to 12 characters)

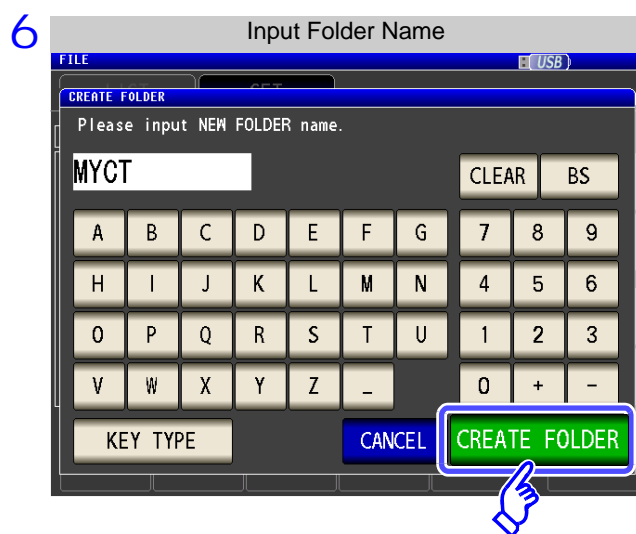
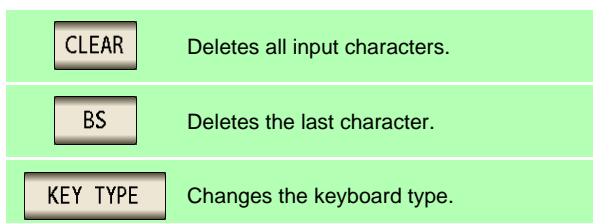

Press **CREATE FOLDER** to create a folder.

7 Press **EXIT** to close the setting screen.

## 10.8 File and Folder Operations

### 4 Displaying the USB Flash Drive Information

You can check the usage rate and file system of the USB flash drive.

#### Procedure

1 Insert the USB flash drive into the USB port (front panel).

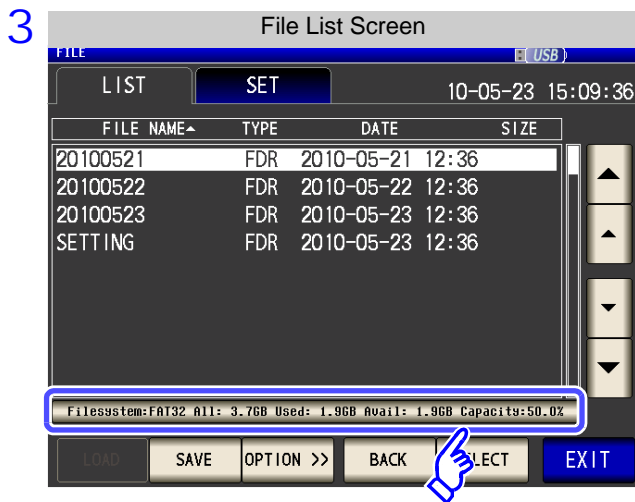
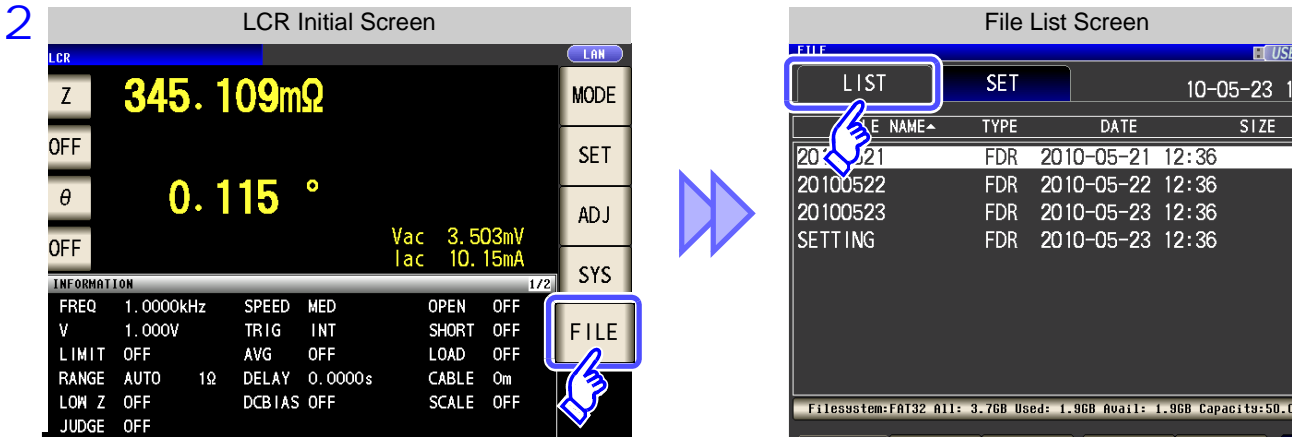

Press the part indicating the disc information.

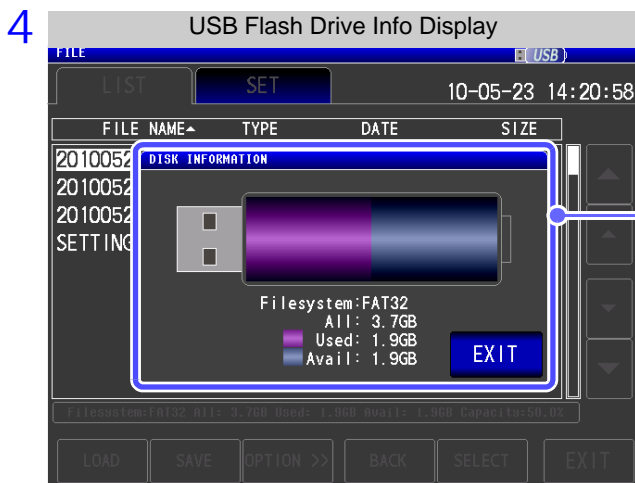

[Filesystem]: File system type  
 [All]: Total size  
 [Used]: Space used  
 [Avail]: Space free

5 Press **EXIT** to close the setting screen.

# External Control Chapter 11

The EXT I/O connector on the rear of the instrument supports external control by providing output of the end-of-measurement and comparator decision signals, and accepting input of measurement trigger and panel load signals. All signals are isolated by optocouplers (inputs and outputs share a common signal ground (ISO\_COM signal ground).)

Confirm input and output ratings, understand the safety precautions for connecting a control system, and use accordingly.

Connect the instrument's EXT I/O connector to the signal output or input device.

Make instrument settings

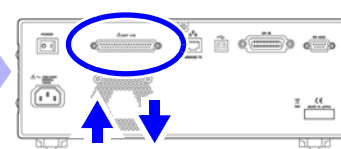

Signal input/output

## 11.1 External Input/Output Connector and Signals



### **WARNING**

To avoid electric shock or damage to the equipment, always observe the following precautions when connecting to the EXT I/O terminals.

- Always turn off the power to the instrument and to any devices to be connected before making connections.
- During operation, a wire becoming dislocated and contacting another conductive object can be serious hazard. Make sure that connections are secure and use screws to secure the external connectors.
- Ensure that devices and systems to be connected to the EXT I/O terminals/ are properly isolated.

### **CAUTION**

To avoid damage to the instrument, observe the following cautions:

- Do not apply voltage or current to the EXT I/O terminals that exceeds their ratings.
- When driving relays, be sure to install diodes to absorb counter-electromotive force.
- Be careful not to short-circuit ISO\_5V to ISO\_COM.

See "Connector Type and Signal Pinouts" (p. 364)

Connector Type and Signal Pinouts

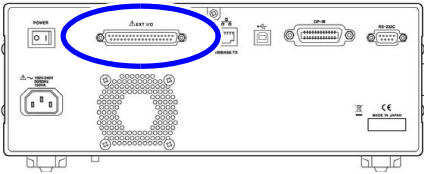

Connector: (Instrument Side)

- 37-pin D-sub female with #4-40 screws

Mating Connectors:

- DC-37P-ULR (solder type)
  - DCSP-JB37PR (pressure weld type)
- Japan Aviation Electronics Industry Ltd.

LCR Mode

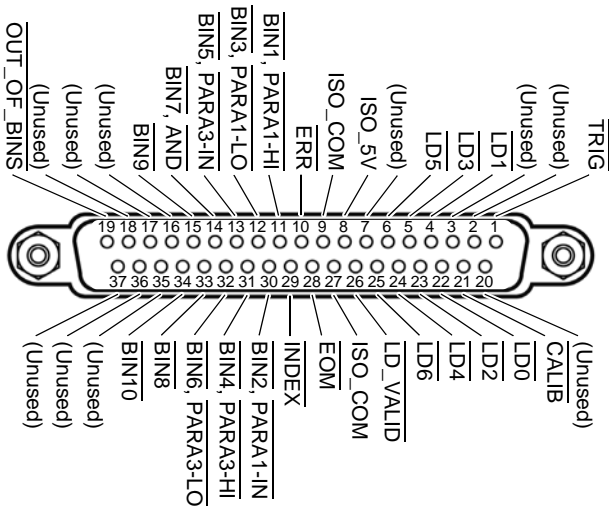

Analyzer Mode

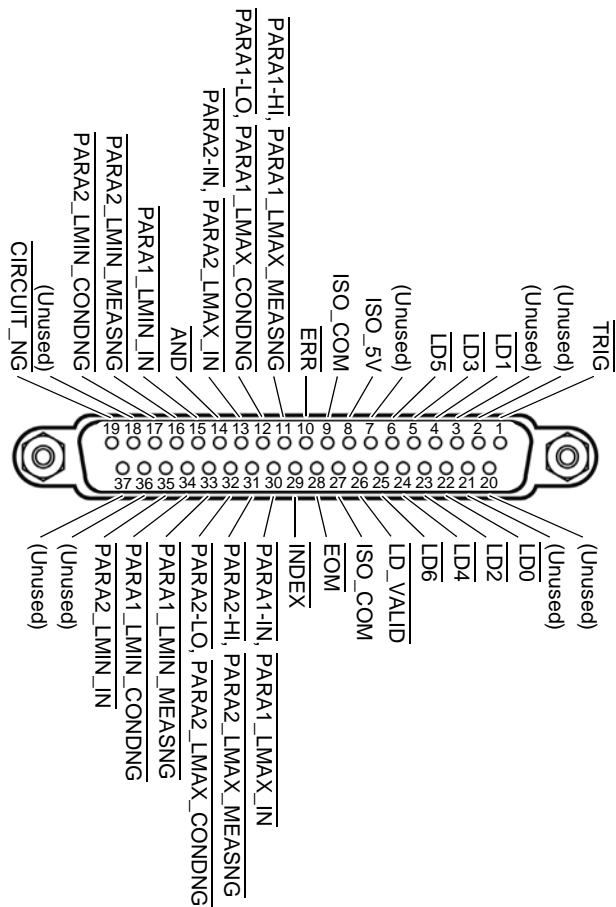

EXT I/O Connector (Instrument Side)

**NOTE**

The connector shell is conductively connected to the metal instrument chassis and the protective earth pin of the power plug. Be aware that it is not isolated from ground.

## 11.1 External Input/Output Connector and Signals

Pin	I/O	LCR Mode		ANALYZER Mode		Logic	
		Signal name	Function	Signal name	Function		
1	IN	$\overline{\text{TRIG}}$	External trigger	$\overline{\text{TRIG}}$	External trigger	Pos	Edge
2	-	(Unused)	-	(Unused)	-	-	-
3	-	(Unused)	-	(Unused)	-	-	-
4	IN	$\overline{\text{LD1}}$	Select panel number	$\overline{\text{LD1}}$	Select panel number	Neg	Level
5	IN	$\overline{\text{LD3}}$	Select panel number	$\overline{\text{LD3}}$	Select panel number	Neg	Level
6	IN	$\overline{\text{LD5}}$	Select panel number	$\overline{\text{LD5}}$	Select panel number	Neg	Level
7	-	(Unused)	-	(Unused)	-	-	-
8	-	ISO_5V	Isolated 5 V power output	ISO_5V	Isolated 5 V power output	-	-
9	-	ISO_COM	Isolated common signal ground	ISO_COM	Isolated common signal ground	-	-
10	OUT	$\overline{\text{ERR}}$	Measurement fault	$\overline{\text{ERR}}$	Measurement fault	Neg	Level
11	OUT	$\overline{\text{BIN1}}$ , $\overline{\text{PARA1-HI}}$	BIN judgment results Comparator judgment results of the first parameter	$\overline{\text{PARA1-HI}}$ , $\overline{\text{PARA1\_LMAX\_MEASNG}}$	Analyzer comparator results of the first parameter in AREA mode (Output if even one HI judgment) Analyzer comparator results for the local maximum value of the first parameter in PEAK mode (Output if the vertical axis (measurement value) is out of the range or there is no comparison peak)	Neg	Level
12	OUT	$\overline{\text{BIN3}}$ , $\overline{\text{PARA1-LO}}$	BIN judgment results Comparator judgment results of the first parameter	$\overline{\text{PARA1-LO}}$ , $\overline{\text{PARA1\_LMAX\_CONDNG}}$	Analyzer comparator results of the first parameter in AREA mode (Output if even one LO judgment) Analyzer comparator results for the local maximum value of the first parameter in PEAK mode (Output if the horizontal axis (sweep setting) is out of the range or there is no comparison peak)	Neg	Level
13	OUT	$\overline{\text{BIN5}}$ , $\overline{\text{PARA3-IN}}$	BIN judgment results Comparator judgment results of the third parameter	$\overline{\text{PARA2-IN}}$ , $\overline{\text{PARA2\_LMAX\_IN}}$	Analyzer comparator results of the second parameter in AREA mode (Output if all judgment results are IN) Analyzer comparator results for the local maximum value of the second parameter in PEAK mode (Output if PEAK is IN)	Neg	Level
14	OUT	$\overline{\text{BIN7}}$ , $\overline{\text{AND}}$	BIN judgment results Comparator judgment results AND	$\overline{\text{AND}}$	Comparator judgment result AND	Neg	Level
15	OUT	$\overline{\text{BIN9}}$	BIN judgment results	$\overline{\text{PARA1\_LMIN\_IN}}$	Analyzer comparator results for the local minimum value of the first parameter in PEAK mode (Output if PEAK is IN)	Neg	Level
16	OUT	(Unused)	-	$\overline{\text{PARA2\_LMIN\_MEASNG}}$	Analyzer comparator results for the local minimum value of the second parameter in PEAK mode (Output if the vertical axis (measurement value) is out of the range or there is no comparison peak)	Neg	Level
17	OUT	(Unused)	-	$\overline{\text{PARA2\_LMIN\_CONDNG}}$	Analyzer comparator results for the local minimum value of the second parameter in PEAK mode (Output if the horizontal axis (sweep setting) is out of the range or there is no comparison peak)	Neg	Level
18	-	(Unused)	-	(Unused)	-	-	-

## 11.1 External Input/Output Connector and Signals

Pin	I/O	LCR Mode		ANALYZER Mode		Logic	
		Signal name	Function	Signal name	Function		
19	OUT	$\overline{\text{OUT\_OF\_BINS}}$	BIN judgment results	$\overline{\text{CIRCUIT\_NG}}$	Equivalent circuit analysis comparator judgment result output (output when logical AND of judgment results is FAIL)	Neg	Level
20	-	(Unused)	-	(Unused)	-	-	-
21	IN	$\overline{\text{CALIB}}$	DC adjustment request	(Unused)	-	Neg	Level
22	IN	$\overline{\text{LD0}}$	Select panel number	$\overline{\text{LD0}}$	Select panel number	Neg	Level
23	IN	$\overline{\text{LD2}}$	Select panel number	$\overline{\text{LD2}}$	Select panel number	Neg	Level
24	IN	$\overline{\text{LD4}}$	Select panel number	$\overline{\text{LD4}}$	Select panel number	Neg	Level
25	IN	$\overline{\text{LD6}}$	Select panel number	$\overline{\text{LD6}}$	Select panel number	Neg	Level
26	IN	$\overline{\text{LD\_VALID}}$	Execute panel load	$\overline{\text{LD\_VALID}}$	Execute panel load	Neg	Level
27	-	ISO_COM	Isolated common signal ground	ISO_COM	Isolated common signal ground	-	-
28	OUT	$\overline{\text{EOM}}$	End of measurement	$\overline{\text{EOM}}$	End of measurement	Neg	Edge
29	OUT	$\overline{\text{INDEX}}$	Analog measurement finished	$\overline{\text{INDEX}}$	Analog measurement finished	Neg	Edge
30	OUT	$\overline{\text{BIN2, PARA1-IN}}$	BIN judgment results Comparator judgment results of the first parameter	$\overline{\text{PARA1-IN, PARA1\_LMAX\_IN}}$	Analyzer comparator results of the first parameter in AREA mode (Output if all judgment results are IN) Analyzer comparator results for the local maximum value of the first parameter in PEAK mode (Output if PEAK is IN)	Neg	Level
31	OUT	$\overline{\text{BIN4, PARA3-HI}}$	BIN judgment results Comparator judgment results of the third parameter	$\overline{\text{PARA2-HI, PARA2\_LMAX\_MEASNG}}$	Analyzer comparator results of the second parameter in AREA mode (Output if even one HI judgment) Analyzer comparator results for the local maximum value of the second parameter in PEAK mode (Output if the vertical axis (measurement value) is out of the range or there is no comparison peak)	Neg	Level
32	OUT	$\overline{\text{BIN6, PARA3-LO}}$	BIN judgment results Comparator judgment results of the third parameter	$\overline{\text{PARA2-LO, PARA2\_LMAX\_CONDNG}}$	Analyzer comparator results of the second parameter in AREA mode (Output if even one LO judgment) Analyzer comparator results for the local maximum value of the second parameter in PEAK mode (Output if the horizontal axis (sweep setting) is out of the range or there is no comparison peak)	Neg	Level
33	OUT	$\overline{\text{BIN8}}$	BIN judgment results	$\overline{\text{PARA1\_LMIN\_MEASNG}}$	Analyzer comparator results for the local minimum value of the first parameter in PEAK mode (Output if the vertical axis (measurement value) is out of the range or there is no comparison peak)	Neg	Level
34	OUT	$\overline{\text{BIN10}}$	BIN judgment results	$\overline{\text{PARA1\_LMIN\_CONDNG}}$	Analyzer comparator results for the local minimum value of the first parameter in PEAK mode (Output if the horizontal axis (sweep setting) is out of the range or there is no comparison peak)	Neg	Level
35	OUT	(Unused)	-	$\overline{\text{PARA2\_LMIN\_IN}}$	Analyzer comparator results for the local minimum value of the second parameter in PEAK mode (Output if PEAK is IN)	Neg	Level
36	-	(Unused)	-	(Unused)	-	-	-
37	-	(Unused)	-	(Unused)	-	-	-

## Signal Descriptions

You can select rising or falling for the valid edge of a trigger.

See "Enabling Trigger Input for during Measurement and Setting the Valid Edge of Trigger Input" (p. 117), (p. 228)

## Input

$\overline{\text{TRIG}}$	<ul style="list-style-type: none"> <li>When the trigger setting is the external trigger <input type="checkbox"/> EXT , measurement is performed once with the falling (ON) or rising (OFF) edge of the TRIG signal. The edge direction can be set in the setting screen. (Initial value: Falling (ON)) See: "Enabling Trigger Input for during Measurement and Setting the Valid Edge of Trigger Input" (p. 117), (p. 228)</li> <li>When the trigger source is set to the internal trigger <input type="checkbox"/> INT , trigger measurement is not performed.</li> <li>You can set whether to enable or disable TRIG signal input during measurement (during output of the EOM signal (HI)). See: "Enabling Trigger Input for during Measurement and Setting the Valid Edge of Trigger Input" (p. 117), (p. 228)</li> </ul>																																																																																
$\overline{\text{LD0}}$ to $\overline{\text{LD6}}$	<p>Selects the number of the panel to load. If a trigger signal is input in external trigger mode, the selected panel is loaded and used for measurement.(p. 377)</p> <p>0: (HIGH: 5 V to 24 V), 1: (LOW: 0 V to 0.9 V)</p> <table border="1" data-bbox="502 987 1267 1375"> <thead> <tr> <th>PIN No.</th> <th><math>\overline{\text{LD6}}</math></th> <th><math>\overline{\text{LD5}}</math></th> <th><math>\overline{\text{LD4}}</math></th> <th><math>\overline{\text{LD3}}</math></th> <th><math>\overline{\text{LD2}}</math></th> <th><math>\overline{\text{LD1}}</math></th> <th><math>\overline{\text{LD0}}</math></th> </tr> </thead> <tbody> <tr> <td>Panel 1</td> <td>0</td> <td>0</td> <td>0</td> <td>0</td> <td>0</td> <td>0</td> <td>1</td> </tr> <tr> <td>Panel 2</td> <td>0</td> <td>0</td> <td>0</td> <td>0</td> <td>0</td> <td>1</td> <td>0</td> </tr> <tr> <td>Panel 4</td> <td>0</td> <td>0</td> <td>0</td> <td>0</td> <td>1</td> <td>0</td> <td>0</td> </tr> <tr> <td>Panel 8</td> <td>0</td> <td>0</td> <td>0</td> <td>1</td> <td>0</td> <td>0</td> <td>0</td> </tr> <tr> <td>Panel 16</td> <td>0</td> <td>0</td> <td>1</td> <td>0</td> <td>0</td> <td>0</td> <td>0</td> </tr> <tr> <td>Panel 32</td> <td>0</td> <td>1</td> <td>0</td> <td>0</td> <td>0</td> <td>0</td> <td>0</td> </tr> <tr> <td>Panel 64</td> <td>1</td> <td>0</td> <td>0</td> <td>0</td> <td>0</td> <td>0</td> <td>0</td> </tr> <tr> <td>Panel 127</td> <td>1</td> <td>1</td> <td>1</td> <td>1</td> <td>1</td> <td>1</td> <td>1</td> </tr> <tr> <td>Panel128</td> <td>0</td> <td>0</td> <td>0</td> <td>0</td> <td>0</td> <td>0</td> <td>0</td> </tr> </tbody> </table>	PIN No.	$\overline{\text{LD6}}$	$\overline{\text{LD5}}$	$\overline{\text{LD4}}$	$\overline{\text{LD3}}$	$\overline{\text{LD2}}$	$\overline{\text{LD1}}$	$\overline{\text{LD0}}$	Panel 1	0	0	0	0	0	0	1	Panel 2	0	0	0	0	0	1	0	Panel 4	0	0	0	0	1	0	0	Panel 8	0	0	0	1	0	0	0	Panel 16	0	0	1	0	0	0	0	Panel 32	0	1	0	0	0	0	0	Panel 64	1	0	0	0	0	0	0	Panel 127	1	1	1	1	1	1	1	Panel128	0	0	0	0	0	0	0
PIN No.	$\overline{\text{LD6}}$	$\overline{\text{LD5}}$	$\overline{\text{LD4}}$	$\overline{\text{LD3}}$	$\overline{\text{LD2}}$	$\overline{\text{LD1}}$	$\overline{\text{LD0}}$																																																																										
Panel 1	0	0	0	0	0	0	1																																																																										
Panel 2	0	0	0	0	0	1	0																																																																										
Panel 4	0	0	0	0	1	0	0																																																																										
Panel 8	0	0	0	1	0	0	0																																																																										
Panel 16	0	0	1	0	0	0	0																																																																										
Panel 32	0	1	0	0	0	0	0																																																																										
Panel 64	1	0	0	0	0	0	0																																																																										
Panel 127	1	1	1	1	1	1	1																																																																										
Panel128	0	0	0	0	0	0	0																																																																										
$\overline{\text{LD-VALID}}$	<p>Inputs a negative logic signal from an external device so that the selected panel number is recognized as valid. After <math>\overline{\text{TRIG}}</math> input, maintain a Low level until <math>\overline{\text{INDEX}}</math> is outputted.</p>																																																																																
$\overline{\text{CALIB}}$	<p>When the DC adjustment function for during DC resistance measurement is set to OFF, the offset value generated in the internal circuit can be obtained at the desired timing. After <math>\overline{\text{TRIG}}</math> input, maintain a Low level until <math>\overline{\text{INDEX}}</math> is outputted.</p>																																																																																

## 11.1 External Input/Output Connector and Signals

### Output

$\overline{\text{PARA1-HI}}$ , $\overline{\text{PARA1-LO}}$ , $\overline{\text{PARA1-IN}}$	LCR mode: Outputs the comparator judgment result for the measurement values of the first parameter. Analyzer mode: Outputs the analyzer comparator result of the first parameter in AREA mode.
$\overline{\text{PARA3-HI}}$ , $\overline{\text{PARA3-LO}}$ , $\overline{\text{PARA3-IN}}$	LCR mode: Outputs the comparator judgment result for the measurement values of the third parameter. Analyzer mode: Outputs the analyzer comparator result of the third parameter in AREA mode.
$\overline{\text{PARA1\_LMAX\_MEASNG}}$ , $\overline{\text{PARA1\_LMAX\_CONDNG}}$ G, $\overline{\text{PARA1\_LMAX\_IN}}$	Analyzer mode: Outputs the analyzer comparator result for the local maximum value of the first parameter in PEAK mode. (Outputs $\overline{\text{PARA1\_LMAX\_MEASNG}}$ if the vertical axis (measurement value) is out of the range or there is no comparison peak, outputs $\overline{\text{PARA1\_LMAX\_CONDNG}}$ if the horizontal axis (sweep setting) is out of the range or there is no comparison peak, and outputs $\overline{\text{PARA1\_LMAX\_IN}}$ if the PEAK is IN.)
$\overline{\text{PARA2\_LMAX\_MEASNG}}$ , $\overline{\text{PARA2\_LMAX\_CONDNG}}$ G, $\overline{\text{PARA2\_LMAX\_IN}}$	Analyzer mode: Outputs the analyzer comparator result for the local maximum value of the second parameter in PEAK mode. (Outputs $\overline{\text{PARA2\_LMAX\_MEASNG}}$ if the vertical axis (measurement value) is out of the range or there is no comparison peak, outputs $\overline{\text{PARA2\_LMAX\_CONDNG}}$ if the horizontal axis (sweep setting) is out of the range or there is no comparison peak, and outputs $\overline{\text{PARA2\_LMAX\_IN}}$ if the PEAK is IN.)
$\overline{\text{PARA1\_LMIN\_MEASNG}}$ , $\overline{\text{PARA1\_LMIN\_CONDNG}}$ , $\overline{\text{PARA1\_LMIN\_IN}}$	Analyzer mode: Outputs the analyzer comparator result for the local minimum value of the first parameter in PEAK mode. (Outputs $\overline{\text{PARA1\_LMIN\_MEASNG}}$ if the vertical axis (measurement value) is out of the range or there is no comparison peak, outputs $\overline{\text{PARA1\_LMIN\_CONDNG}}$ if the horizontal axis (sweep setting) is out of the range or there is no comparison peak, and outputs $\overline{\text{PARA1\_LMIN\_IN}}$ if the PEAK is IN.)
$\overline{\text{PARA2\_LMIN\_MEASNG}}$ , $\overline{\text{PARA2\_LMIN\_CONDNG}}$ , $\overline{\text{PARA2\_LMIN\_IN}}$	Analyzer mode: Outputs the analyzer comparator result for the local minimum value of the first parameter in PEAK mode. (Outputs $\overline{\text{PARA2\_LMIN\_MEASNG}}$ if the vertical axis (measurement value) is out of the range or there is no comparison peak, outputs $\overline{\text{PARA2\_LMIN\_CONDNG}}$ if the horizontal axis (sweep setting) is out of the range or there is no comparison peak, and outputs $\overline{\text{PARA2\_LMIN\_IN}}$ if the PEAK is IN.)
$\overline{\text{AND}}$	Outputs the result that takes the AND of the judgment results of the measurement values of the two parameters judged in both LCR mode and analyzer mode. The result is output when both judgment results are IN or if either one of the first and third parameters is not judged and the judgment result of the judged parameter is IN.
$\overline{\text{BIN1}}$ to $\overline{\text{BIN10}}$ $\overline{\text{OUT OF BINS}}$	Outputs the judgment result of BIN measurement.
$\overline{\text{CIRCUIT\_NG}}$	Outputs the equivalent circuit analysis comparator judgment results.
$\overline{\text{INDEX}}$	This is the signal to indicate that A/D conversion in the measurement circuit has ended. When this signal changes from HIGH (OFF) to LOW (ON), the test sample can be changed.
$\overline{\text{EOM}}$	This is the end of measurement signal. At this point in time, the comparator judgment result is confirmed.
$\overline{\text{ERR}}$	Outputs when there is a sampling error, constant voltage/current error, voltage/current limit value exceeded error, contact check error in low Z high accuracy mode, HIGH-Z reject error or monitoring the detection level.



## 11.2 Timing Chart

### 11.2.1 LCR Measurement

If you set the judgment condition for the comparator (the trigger setting is external trigger) and then in that state a trigger signal is input from the EXT I/O or **TRIG** is pressed in the screen, the judgment result is output from the signal line for comparator result output of the EXT I/O after measurement ends.

Furthermore, if the panel number is selected with the panel load signal when a trigger signal is input from the EXT I/O, the measurement condition of that panel number is loaded and then measurement is performed.

The following shows examples of the measurement timing.

(In the timing examples, the valid edge of the TRIG signal is set to falling (ON).)

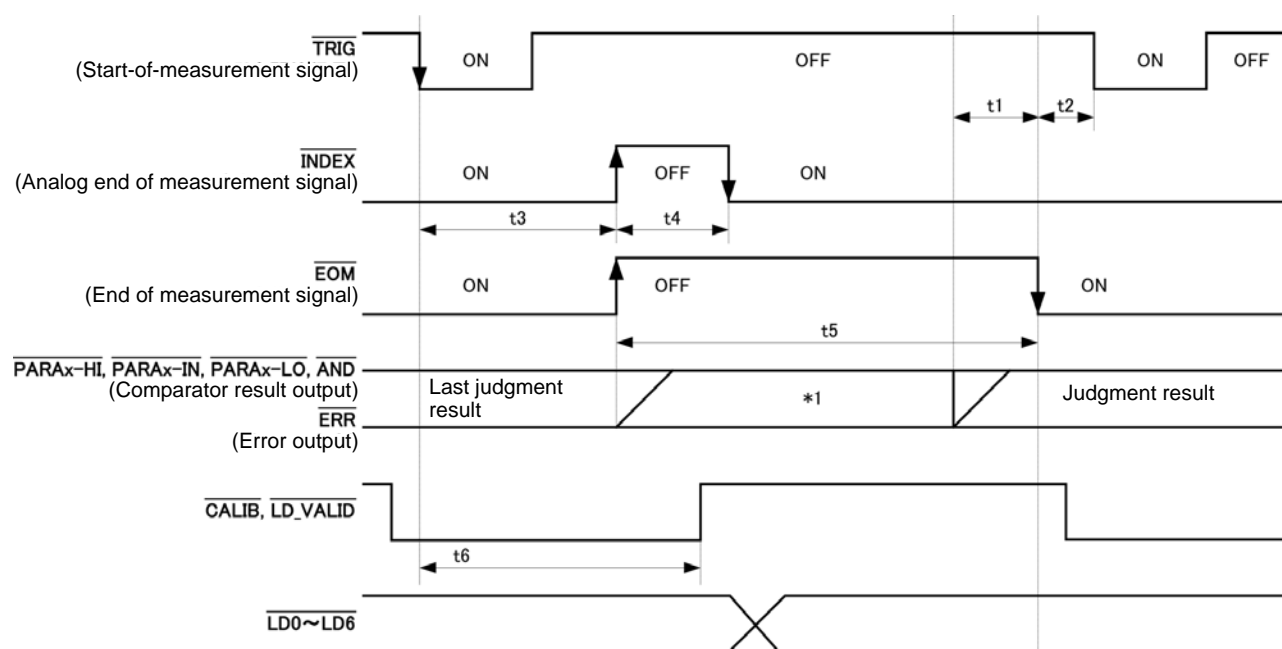

\*1: Reset at the same time as analog measurement starts.: HIGH

Not reset at the same time as analog measurement starts.: Last judgment result remains

**NOTE** Whether the judgment results of comparator and BIN measurement are reset at the time of the measurement start signal or updated at the point in time when measurement ends can be selected on the instrument or by a communication command.

**See** "Setting the Delay Time from the Output of Comparator and BIN Judgment Results until Output of EOM (LOW) and Resetting Judgment Results" (p. 115), (p. 226)  
Description of communications commands on the included CD (**:IO:RESult:RESet**)

## 11.2 Timing Chart

### Timing Chart Interval Descriptions

Interval	Description	Time (Approximate)
t1	From Comparator, BIN Judgement Result to $\overline{\text{EOM}}$ (LOW): Setting value for delay time*1	40 $\mu\text{s}$
t2	From $\overline{\text{EOM}}$ width (LOW) to $\overline{\text{TRIG}}$ (LOW): Minimum time from end of measurement to next trigger*2, 5	400 $\mu\text{s}$
t3	From $\overline{\text{TRIG}}$ (LOW) to $\overline{\text{INDEX}}$ (HIGH): Time from trigger to circuit response*3, 5	700 $\mu\text{s}$
t4	$\overline{\text{INDEX}}$ width (HIGH): Minimum chuck time, switching chuck with $\overline{\text{INDEX}}$ (LOW) is possible*4	220 $\mu\text{s}$
t5	$\overline{\text{EOM}}$ width (HIGH): Measurement time*4	600 $\mu\text{s}$
t6	From $\overline{\text{TRIG}}$ width (LOW) to $\overline{\text{LD-VALID}}$ (HIGH) and $\overline{\text{CALIB}}$ (HIGH): Time to recognize panel number	t3

\*1: There is an approximate error of 100  $\mu\text{s}$  in the delay time entered for Judgement Result  $\leftrightarrow$   $\overline{\text{EOM}}$  for the setting value. t1 is the reference value for when the setting value is 0.0000 s.

\*2: t2 is the reference value for when trigger input for during measurement is disabled.(p. 117), (p. 228)

\*3: • When the panel number is read by the panel load function, the response time is as shown in the table below.

Measurement mode	Load mode	Response time
LCR	LCR+ADJ	12 ms
	HARD	9 ms
	ADJ	4 ms
ANALYZER	ANA+ADJ	120 ms
	HARD	120 ms
	ADJ	8 ms

• When the trigger synchronous output function and trigger delay is enabled, wait times are included.

\*4: Reference value for Measurement frequency: 100 kHz, Measurement speed: FAST, Measurement range: HOLD (p. 399)

\*5: With the conditions shown in the table below, the time is added.

Range	Level	Frequency	Low Z High Accuracy Mode	DC Bias	Time
100 m $\Omega$ , 1 $\Omega$	All levels	DC, 4 Hz to 999.99 Hz	ON	OFF	2 ms

### NOTE

- Since the speed of the rise (LOW  $\rightarrow$  HIGH) of the comparator/BIN judgment result differs depending on the configuration of the circuit connected to the EXT I/O, there is the likelihood of an incorrect judgment if the level of the comparator/BIN judgment result acquired immediately after  $\overline{\text{EOM}}$  output is used. To prevent this from happening, a delay time (t1) between the comparator/BIN judgment result and the  $\overline{\text{EOM}}$  can be set. Furthermore, if the judgment result signal line of the EXT I/O is set to be reset simultaneously with the measurement start signal, and a forced transition to the HIGH level is performed at the same time as TRIG, the transition from LOW to HIGH does not occur when the judgment result is output after measurement ends. As a result, the delay time between the judgment result and the  $\overline{\text{EOM}}$  can be set to the minimum level. However, be careful because the judgment result confirmation interval is until the next trigger is accepted. Furthermore, if the judgment result signal line of the EXT I/O is set to be reset simultaneously with the measurement start signal, and a forced transition to the HIGH level is performed at the same time as  $\overline{\text{TRIG}}$ , the transition from LOW to HIGH does not occur when the judgment result is output after measurement ends. As a result, the delay time between the judgement result output and  $\overline{\text{EOM}}$  can be set to the minimum level. As a result, the delay time between the judgement result output and  $\overline{\text{EOM}}$  can be minimized. However, take note that the evaluation result confirmation range is valid until the following triggers are accepted.
- During measurement, a trigger input from EXT /IO or communicating by interface may lead to a bigger dispersion of delay time between comparator or BIN judgement result output and  $\overline{\text{EOM}}$ . As far as possible, try not to control from external sources when carrying out measurement.

See "Setting the Delay Time from the Output of Comparator and BIN Judgment Results until Output of EOM (LOW) and Resetting Judgment Results" (p. 115),(p. 226)

Description of communications commands on the included CD  
 (:IO:OUTPut:DElay, :IO:RESult:RESet)

**NOTE**

- The higher the measurement frequency, the shorter the time that  $\overline{\text{INDEX}}$  and  $\overline{\text{EOM}}$  are high (off). When the high (off) time is too short due to characteristics of the input circuit, the instrument can be configured to maintain the low (on) state for a preset time once  $\overline{\text{EOM}}$  changes to low (on) before reverting the signal to high (off) after the completion of measurement. When trigger input is received at  $\overline{\text{EOM}}:\text{LOW}$  and  $\overline{\text{INDEX}}:\text{LOW}$ , the signal transitions to high (off) when measurement starts.

Setting the  $\overline{\text{INDEX}}$  and  $\overline{\text{EOM}}$  output method

See "4.5.8 Setting the EOM Output Method" (p. 119)

Description of communications commands on the included CD (: IO: EOM: MODE)

Setting the pulse width for which low (on)  $\overline{\text{EOM}}$  is held

See "4.5.8 Setting the EOM Output Method" (p. 119)

Description of communications commands on the included CD (: IO: EOM: PULSe)

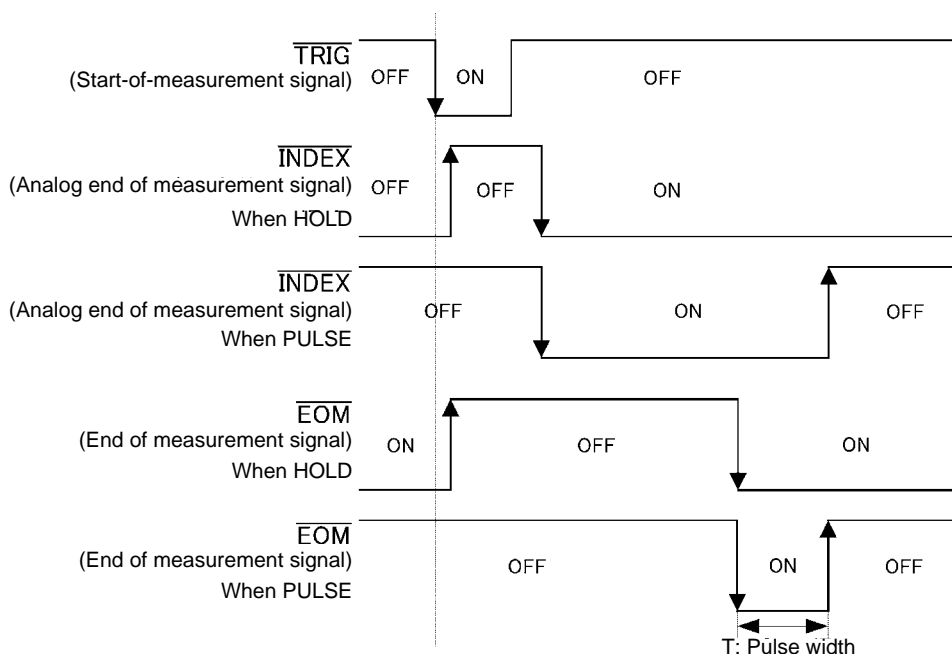

## 11.2.2 Analyzer Measurement

In analyzer mode, if a trigger signal is input from the EXT I/O or **TRIG** is pressed in the screen, the judgment results are output from the signal line for comparator result output of the EXT I/O.

Furthermore, if the panel number is selected with the panel load signal when a trigger signal is input from the EXT I/O, the measurement condition of that panel number is loaded and then measurement is performed.

The following provides an example of measurement timing when the trigger setting is **SEQ** or **REPEAT**. (In the timing examples, the valid edge of the TRIG signal is set to falling (ON).)

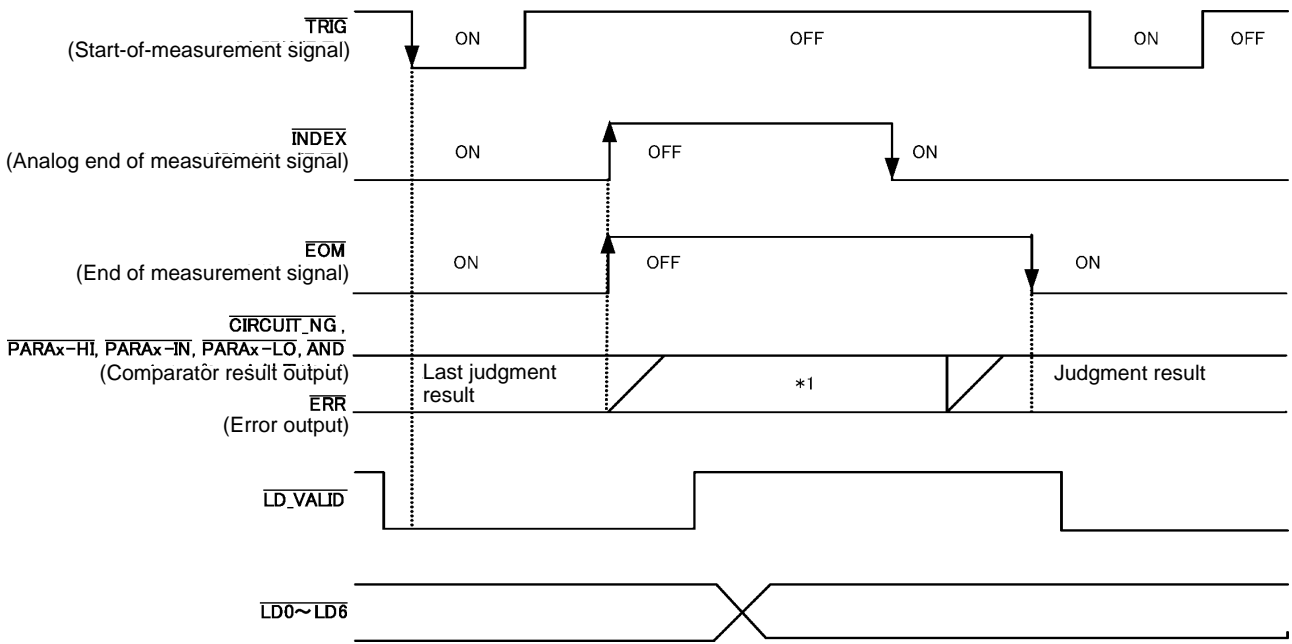

\*1: Reset at the same time as analog measurement starts.: HIGH  
 Not reset at the same time as analog measurement starts.: Last judgment result remains

Signal line	Description
$\overline{\text{INDEX}}$	The transition to HIGH is performed when measurement of the first sweep point starts after trigger signal input and the transition to LOW is performed when the analog measurement of the last sweep point ends. (The HIGH level is maintained during sweep measurement.)
$\overline{\text{EOM}}$	The transition to HIGH is performed when measurement of the first sweep point starts after trigger signal input. Measurement of the last sweep point ends and the transition to LOW is performed after judgment result output. (The HIGH level is maintained during sweep measurement.)

**NOTE**

- If the trigger setting is set to STEP,  $\overline{\text{INDEX}}$  and  $\overline{\text{EOM}}$  transition to LOW every time the measurement for each point ends, and then transition to HIGH when there is trigger input.  $\overline{\text{ERR}}$  also transitions to LOW each time measurement completes if a measurement error occurs.
- Whether the judgment results of comparator measurement are reset at the time of the measurement start signal or updated at the point in time when measurement ends can be selected on the instrument or by a communication command.
  - See: "5.9.4 Setting the Delay Time from the Output of Comparator Judgment Results until Output of EOM (LOW) and Resetting Judgment Results" (p. 226)
  - Description of communications commands on the included CD (**:IO:RESult:RESet**)
- For other timing chart times, refer to "11.2.1 LCR Measurement" (p. 369).

## 11.2.3 Continuous Measurement (Sequential Operation)

With continuous measurement, if a trigger signal is input from the EXT I/O or **TRIG** is pressed in the screen, after measurement of all of the panel numbers set to be executed on the screen is finished, the judgment results are output from the signal line for comparator result output of the EXT I/O.

The following provides an example of measurement timing with the sequential trigger setting.

(In the timing examples, the valid edge of the TRIG signal is set to falling (ON).)

Example: Continuous measurement using panel numbers 1, 2, and 4

Continuous measurement Screen					
CONTINUOUS					
No.	EXEC	PANEL NAME	MODE	PARA	JUDGE
001	ON	1005231606	LCR+ADJ	Z -θ	COMP
002	ON	1004141302	LCR+ADJ	Z -θ	B IN
004	ON	1004151306	ANA+ADJ	Z -θ	AREA

OFF ON ALL OFF ALL ON INFO EXIT

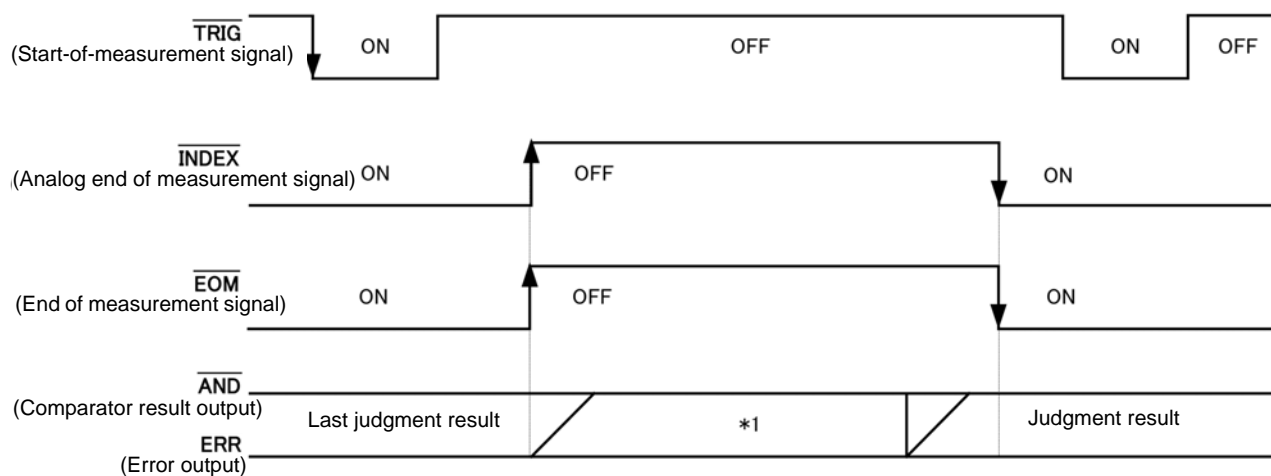

\*1: Reset at the same time as analog measurement starts.: HIGH

Not reset at the same time as analog measurement starts.: When measurement of the first panel number completes,  $\overline{\text{AND}}$  will transition to HIGH, and  $\overline{\text{ERR}}$  will transition to HIGH (if no error) or LOW (if error).

Signal line	Description
$\overline{\text{INDEX}}$ , $\overline{\text{EOM}}$	For both $\overline{\text{INDEX}}$ and $\overline{\text{EOM}}$ , a transition to HIGH is performed when the first panel measurement starts after the trigger signal is input, and a transition to LOW is performed after measurement of the last panel is finished and the judgment result has been output. (The HIGH level is maintained during continuous measurement.)
$\overline{\text{AND}}$	When the judgment results of all panels are IN, LOW is output.

## 11.2 Timing Chart

---

---

**NOTE**

- $\overline{\text{ERR}}$  transitions to LOW each time measurement completes if a measurement error occurs.
  - In the continuous measurement screen, comparator result output signals other than AND and panel load signals ( $\overline{\text{LD-VALID}}$ ,  $\overline{\text{LD0}}$  to  $\overline{\text{LD6}}$ ) cannot be used.  
[See: "Chapter 6 Continuous Measurement Function" \(p. 265\)](#)
  - Whether the judgment results of comparator measurement are reset at the time of the measurement start signal or updated at the point in time when measurement ends can be selected on the instrument or by a communication command.  
[See: "Setting the Delay Time from the Output of Comparator and BIN Judgment Results until Output of EOM \(LOW\) and Resetting Judgment Results" \(p. 115\),\(p. 226\)](#)  
[Description of communications commands on the included CD \(:IO:RESult:RESet\)](#)
  - For other timing chart times, refer to "11.2.1 LCR Measurement" (p. 369).
-

## 11.2.4 Continuous Measurement (Step Operation)

In continuous measurement mode, pressing **TRIG** on the screen asking whether a trigger signal will be input from EXT I/O will cause the judgment result to be output from the EXT I/O comparator result output signal lines after measurement of the panel set to be executed on the screen completes. The following provides an example of measurement timing with the **STEP** trigger setting.

(In this timing example, the TRIG signal active edge is set to the falling edge (ON).)

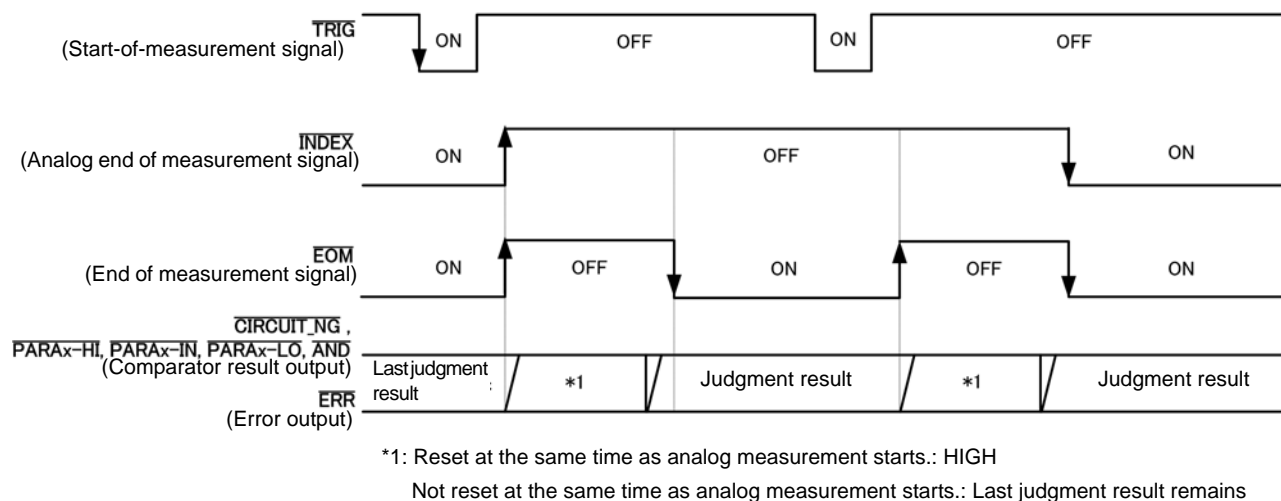

Signal line	Description
$\overline{\text{INDEX}}$	For both $\overline{\text{INDEX}}$ , a transition to HIGH is performed when the first panel measurement starts after the trigger signal is input, and a transition to LOW is performed after measurement of the last panel is finished and the judgment result has been output. (The HIGH level is maintained during continuous measurement.)
$\overline{\text{EOM}}$	$\overline{\text{EOM}}$ transitions to HIGH at the start of measurement after trigger signal input and to LOW each time measurement completes.
Comparator result output	The judgment result and $\overline{\text{ERR}}$ vary according to the measurement state each time measurement completes.

- NOTE**
- Panel load signals ( $\overline{\text{LD-VALID}}$ ,  $\overline{\text{LD0}}$  to  $\overline{\text{LD6}}$ ) cannot be used on the continuous measurement screen.  
**See:** "Chapter 6 Continuous Measurement Function" (p. 265)
  - Comparator judgment results are output just as they are during measurement in LCR or analyzer mode.
  - Whether the judgment results of comparator measurement are reset at the time of the measurement start signal or updated at the point in time when measurement ends can be selected on the instrument or by a communication command.  
**See:** "Setting the Delay Time from the Output of Comparator and BIN Judgment Results until Output of EOM (LOW) and Resetting Judgment Results" (p. 115),(p. 226)  
Description of communications commands on the included CD (**:IO:RESult:RESet**)
  - For other timing chart times, refer to "11.2.1 LCR Measurement" (p. 369).

# 11.3 Internal Circuitry

## Input Circuit

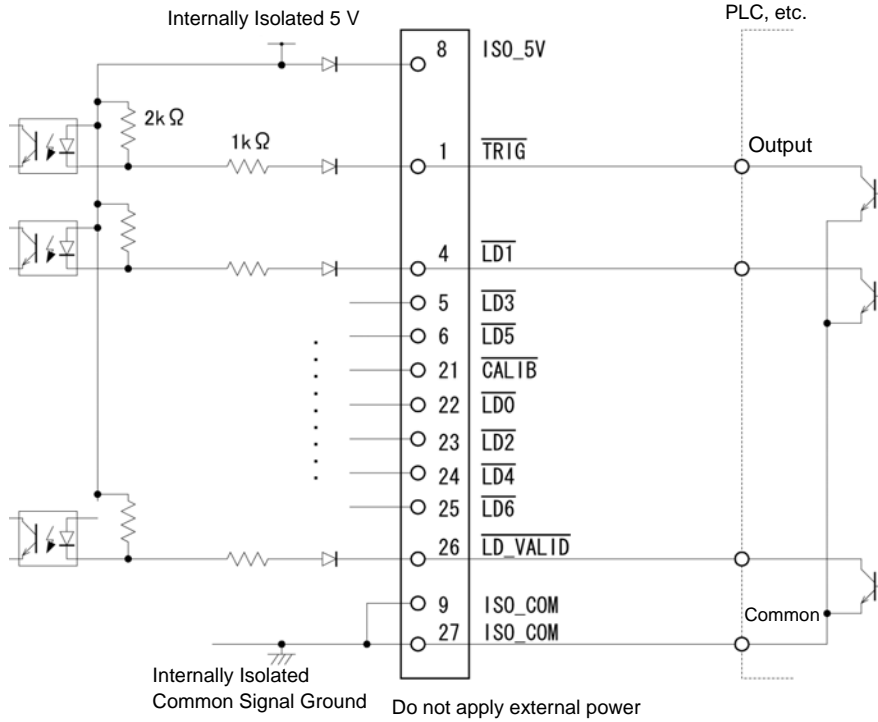

## Output Circuit

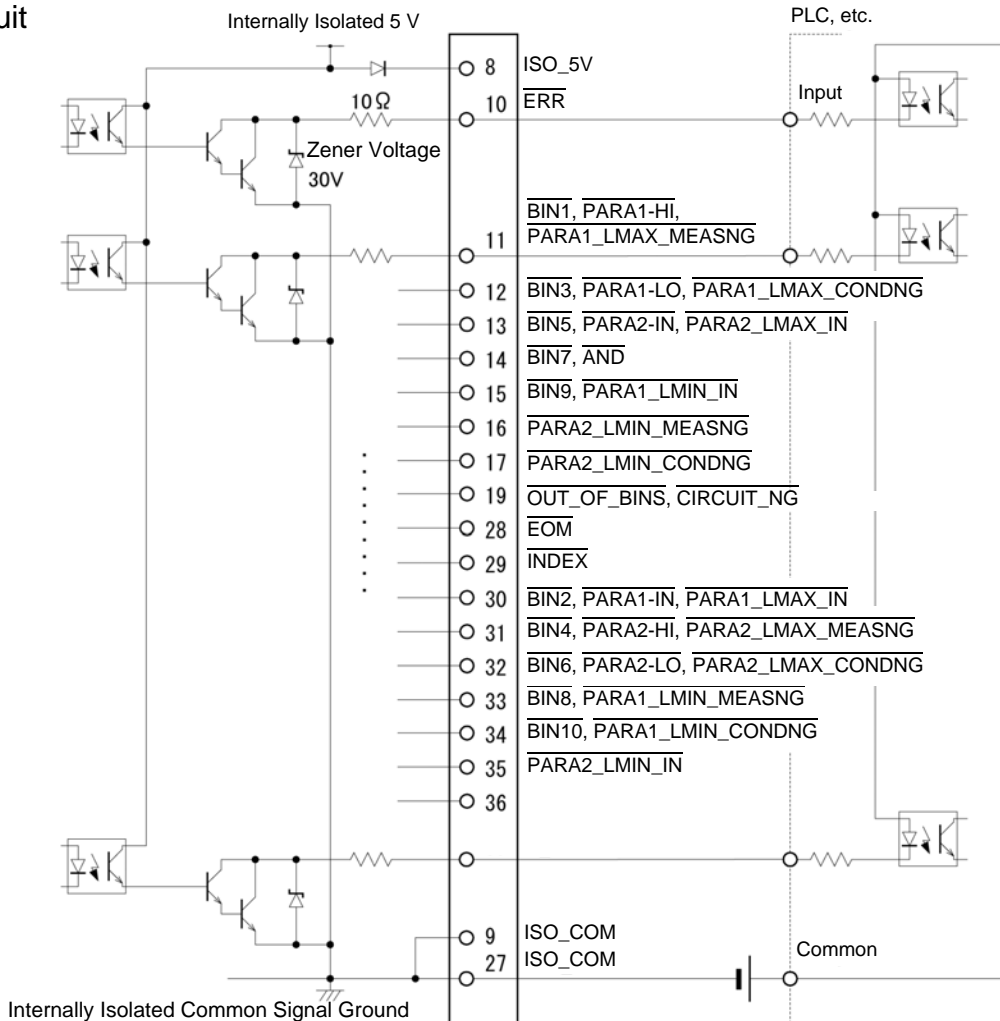



## Electrical Specifications

Input Signals	Input type	Optocoupler-isolated, non-voltage contact inputs (source input, active-low)
	Input asserted (ON) voltage	1 V or less
	Input de-asserted (OFF) voltage	Open or 5 to 30 V
	Input asserted (ON) current	3 mA/ch
	Maximum applied voltage	30 V
Output Signals	Output type	Optocoupler-isolated npn open-collector outputs (current sink, active-low)
	Maximum load voltage	30 V
	Maximum output current	50 mA/ch
	Residual voltage	1 V (10 mA), 1.5 V (50 mA)
Internally Isolated	Power Output	4.5 V to 5.0 V
	Maximum output current	100 mA
	External power input	none

### Connection Examples

#### Input Circuit Connection Examples

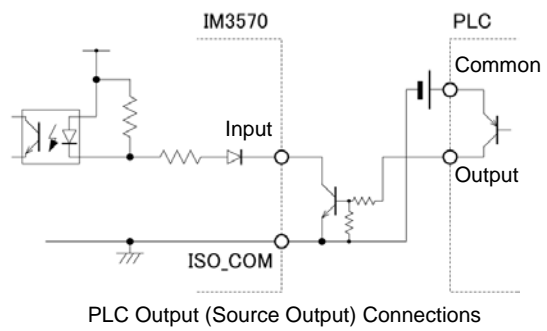
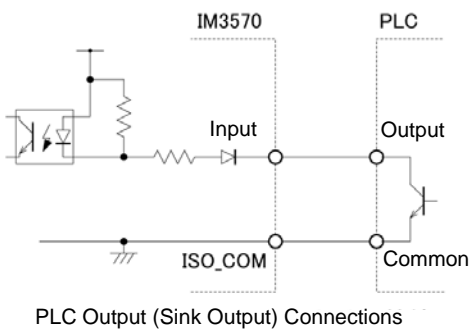
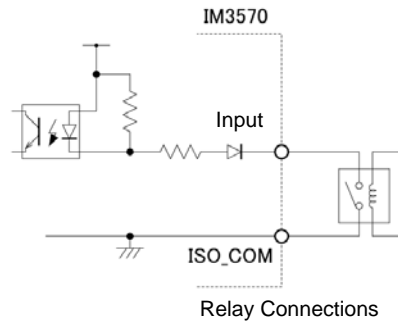
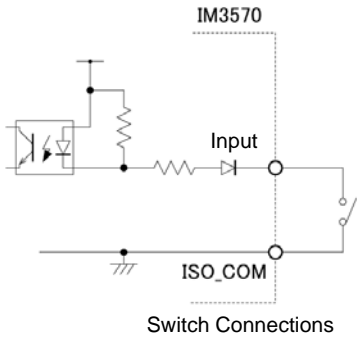

#### Output Circuit Connection Examples

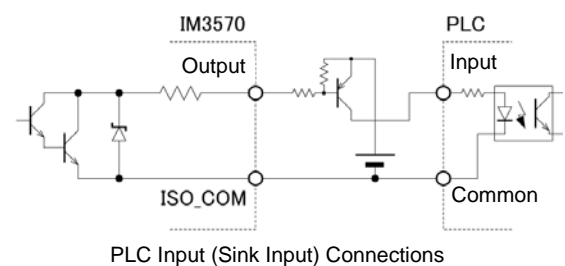
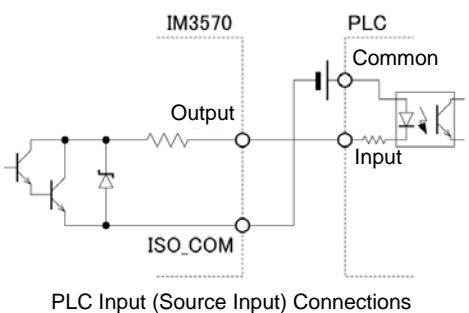
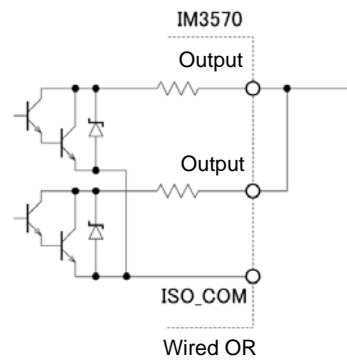
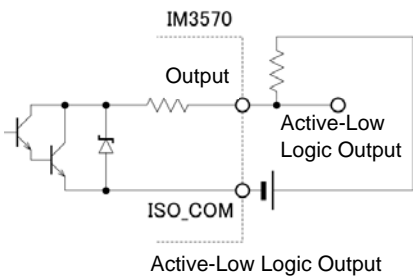
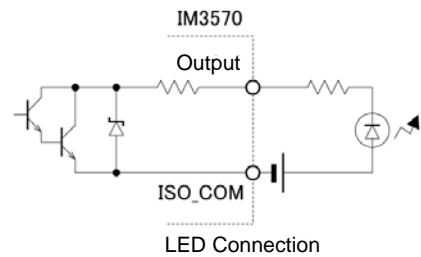
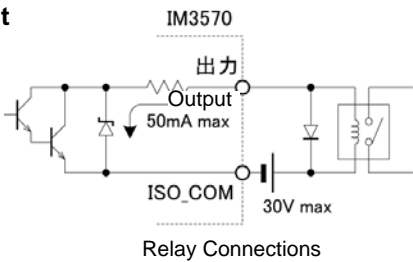

## 11.4 External I/O Settings

There are the following setting items for the output timing of the judgment result output signal and the logic of the trigger signal.

### Setting Delay Time from Output of Comparator and BIN Judgment Results until Output of $\overline{\text{EOM}}$ (LOW)

The delay time for the period from the output of the comparator and BIN judgment results until the output of  $\overline{\text{EOM}}$  (LOW) from the EXT I/O can be set on the instrument or by a communication command.

For the setting procedure, refer to the following.

**See** "Setting the Delay Time from the Output of Comparator and BIN Judgment Results until Output of  $\overline{\text{EOM}}$  (LOW) and Resetting Judgment Results" (p. 115),(p. 226)  
Description of communications commands on the included CD (**:IO:OUTPut:DELay**)

### Setting Reset of Judgment Results

Whether to reset the comparator and BIN judgment results simultaneously with the measurement start signal can be selected on the instrument or by a communication command.

For the setting procedure, refer to the following.

**See** "Setting the Delay Time from the Output of Comparator and BIN Judgment Results until Output of  $\overline{\text{EOM}}$  (LOW) and Resetting Judgment Results" (p. 115),(p. 226)  
Description of communications commands on the included CD (**:IO:RESult:RESet**)

### Enabling Trigger Input for during Measurement

Whether to enable or disable trigger input from the EXT I/O during measurement (during  $\overline{\text{EOM}}$  (HI) output) can be selected on the instrument or by a communication command.

For the setting procedure, refer to the following.

**See** "Enabling Trigger Input for during Measurement and Setting the Valid Edge of Trigger Input" (p. 117), (p. 228)  
Description of communications commands on the included CD (**:IO:TRIGger:ENABle**)

### Setting Valid Edge of Trigger Input

Either the rising edge or falling edge can be selected as the valid edge of trigger input from the EXT I/O. For the setting procedure, refer to the following.

**See** "Enabling Trigger Input for during Measurement and Setting the Valid Edge of Trigger Input" (p. 117), (p. 228)  
Description of communications commands on the included CD (**:IO:TRIGger:EDGE**)

## 11.5 External Control Q&A

Common Questions	Answers
How do I connect external trigger input?	Connect the (active low) $\overline{\text{TRIG}}$ input pin to an ISO_COM pin using a switch or open-collector output.
Which pins are common ground for input and output signals?	The ISO_COM pins.
Are the common (signal ground) pins shared by both inputs and outputs?	Both common ground pins can be shared by inputs and outputs.
How do I confirm output signals?	Confirm <u>voltage waveforms</u> with an oscilloscope. To do this, the output pins such as EOM and comparator decision outputs need to be pulled up (through several k $\Omega$ ).
How do I troubleshoot input (control) signal issues?	For example, if triggering does not operate properly, bypass the PLC and short the $\overline{\text{TRIG}}$ pin directly to an ISO_COM pin. Be careful to avoid power shorts.
Are the comparator decision signals retained during measurement (or can they be off)?	They are initially set to be confirmed at the end of measurement and turned OFF when measurement starts. However, it is possible to change the settings so that the judgment results from last time are also stored during measurement. <a href="#">See "Setting Reset of Judgment Results" (p. 379)</a>
When are measurement error signals displayed?	An error is displayed in the following cases. <ul style="list-style-type: none"> <li>• When sampling error</li> <li>• When constant voltage/constant current error</li> <li>• When voltage/current limit value exceeded error</li> <li>• When contact check error in low Z high accuracy mode</li> <li>• When HIGH-Z reject error</li> </ul>
Is a connector or flat cable for connection provided?	A connector and cable are not supplied, so you need to provide them yourself.
Is direct connection to a PLC possible?	Direct connection is supported for relay or open-collector outputs and positive-ground optocoupler inputs. (Before connecting, confirm that voltage and current ratings will not be exceeded.)
Can external I/O be used at the same time as RS-232C or other communications?	After setting up communications, it is possible to control measurement with the TRIG signal while acquiring measurement data via a communications interface.
How should external power be connected?	The instrument's external I/O input and output signals all operate from an internal isolated power source, so power must not be supplied from the PLC side.

## 11.6 Measurement Using a Computer

You can control the instrument with communication commands from a computer via the GP-IB, RS-232C, USB, and LAN interfaces.

To enable communication, the communication conditions need to be set on the instrument.

For details on the communication condition settings, refer to "8.1 Setting the Interface" (p. 305).

For the details on the communication control procedure, refer to the supplied Communication Instruction Manual (CD).

# Printing

# Chapter 12

Connecting the printer  
to the instrument

Make instrument  
settings (p. 383)

Make printer  
settings

## Printing (p. 384)

- Measurement values and comparator decisions
- Screens

## 12.1 Connecting the Printer

### Connecting the Printer



**WARNING** Because electric shock and instrument damage hazards are present, always follow the steps below when connecting the printer.

- Always turn off the instrument and the printer before connecting.
- A serious hazard can occur if a wire becomes dislocated and contacts another conductor during operation. Make certain connections are secure.

### NOTE

- As much as possible, avoid printing in hot and humid environments. Otherwise, printer life may be severely shortened.
- Use only compatible recording paper in the printer. Using non-specified paper may not only result in faulty printing, but printing may become impossible.
- If the recording paper is skewed on the roller, paper jams may result.

### Recommended printer

The IM3570 has been verified to operate properly with Sanei Electric Inc.'s model SD1-31S thermal printer.

The requirements for a printer to be connected to the instrument are as follows.

Confirm compatibility and make the appropriate settings on the printer before connecting it to the instrument.

See "12.2 Instrument and Printer Settings" (p. 383)

- Interface ..... RS-232C
- Characters per line..... At least 45
- Communication speed . Initial value: 9,600 bps
- Data bits ..... 8bit
- Parity ..... none
- Stop bits ..... 1bit
- Flow control..... none

### NOTE

The communication speed and flow control can be changed with instrument settings. However, the IM3570 and printer must be configured with the same settings.

12.1 Connecting the Printer

Connecting the Printer to the Instrument

Procedure

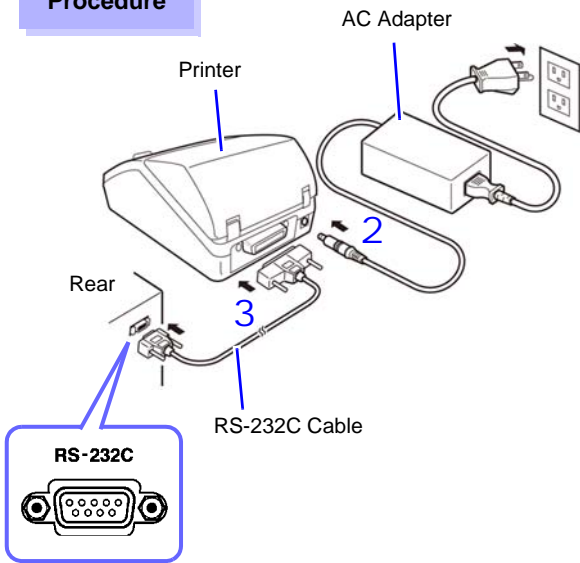

- 1 Confirm that the instrument and printer are turned off.
- 2 Connect the AC adapter to the printer, and insert the power plug into an outlet.
- 3 Connect the RS-232C cable to the RS-232C connectors on the instrument and printer.
- 4 Turn the instrument and printer on.

Connector Pinouts

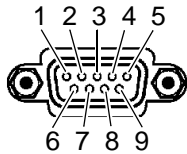

IM3570 (9-pin) Connector

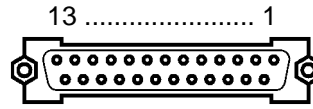

Printer (25-pin) Connector

Function	Signal Name	Pin
Receive Data	RxD	2
Transmit Data	TxD	3
Signal or Common Ground	GND	5
Request to Send	RTS	7
Clear to Send	CTS	8

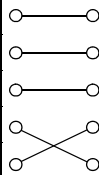

Pin	Signal Name	Function
2	TxD	Transmit Data
3	RxD	Receive Data
7	GND	Signal or Common Ground
4	RTS	Request to Send
5	CTS	Clear to Send

**NOTE**

To use hardware flow control, you will need an RS-232C cable whose RTS and CTS wires are connected (7-pin at instrument to 5-pin at printer or 8-pin at instrument to 4-pin at printer). Hardware flow control cannot be used with cables whose RTS and CTS wires are shorted together.

# 12.2 Instrument and Printer Settings

## Make Instrument Settings

**Procedure**

This operation is possible in any of the **LCR** mode, **ANALYZER** mode.

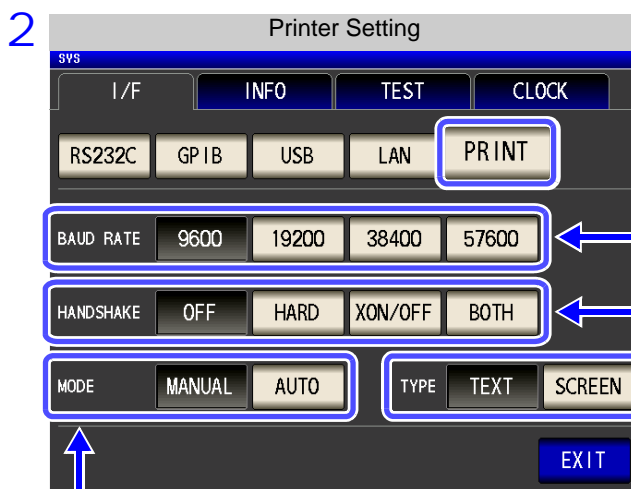
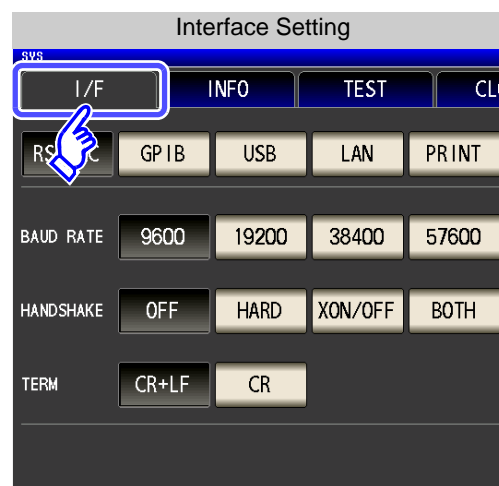
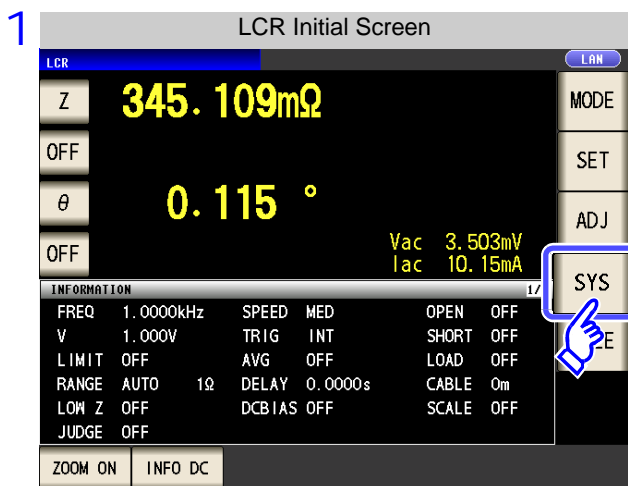

Press **PRINT** and select the printing method.

- BAUD RATE** Communication speed with the printer
- HANDSHAKE** Configuring flow control
- TEXT** Prints the measurement results as text.
- SCREEN** Prints the screen.
- Manual Print**
  - MANUAL** Outputs the measurement values only when **PRINT** of the initial screen is pressed.
  - Auto Print** Outputs the measurement values after measurement finishes.

In analyzer mode, **[TYPE]** cannot be selected. Only the screen can be printed.

3 Select **SET** and check each of the settings, and press **EXIT** to close the setting screen.

The printer's communication speed (baud rate) and flow control settings are the same as the RS-232C settings. If the communication speed is changed, you may need to increase the print speed. It is also necessary to change the printer's communication speed setting. When the communication speed is increased, the printer may be unable to keep up, preventing data from being printed properly. If this occurs, use hardware or software flow control. For more information, see the instruction manual that came with the printer.

# 12.3 Printing

### Before Printing

Verify that the instrument and printer settings (p. 383) are correct.

### When the Printing Method is Set to AUTO

Prints automatically after measurement completes.

### When the Printing Method is Set to MANUAL

Prints the state when PRINT is pressed in the initial screen.

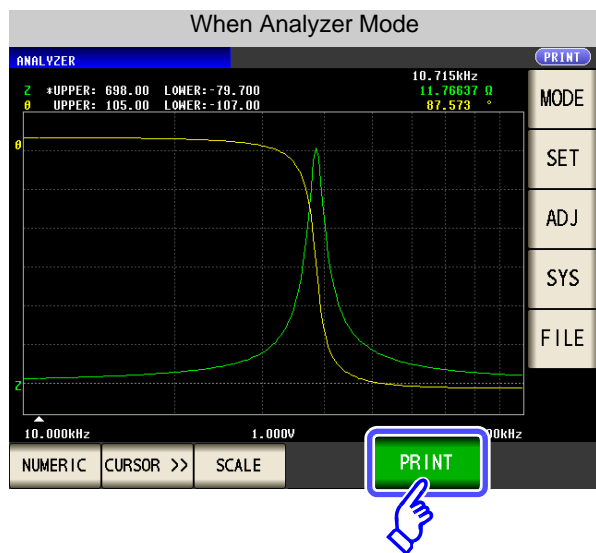
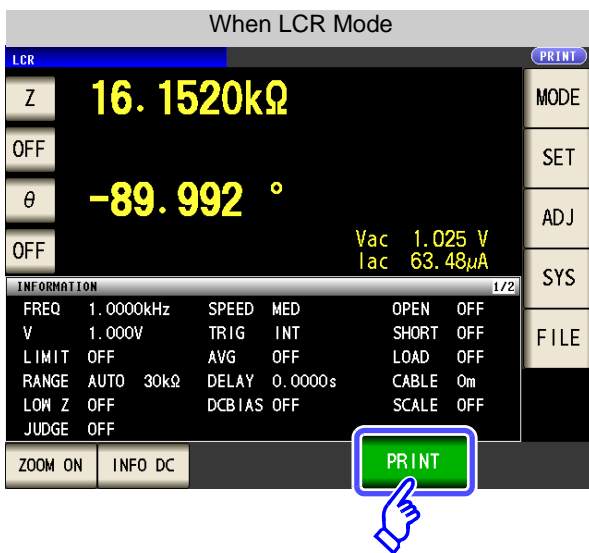



## Example Printouts

The print content varies depending on the printer settings of the instrument.  
 See "12.2 Instrument and Printer Settings" (p. 383)

### When LCR Mode

When the [TYPE] setting is **TEXT**

#### Normal measurement

```
Z 1.84557 ohm
PH 2.024 deg
```

#### Comparator measurement

```
Z 1.85223 ohm IN
PH 2.011 deg HI
```

#### BIN measurement

```
Z 1.85377 ohm
PH 2.010 deg
BIN3
```

When the [TYPE] setting is **SCREEN**

**Z** 350.732mΩ

**OFF**

**θ** 0.416 °

**OFF** Vac 3.559mV  
Iac 10.15mA

INFORMATION				1/2	
FREQ	3.4674kHz	SPEED	MED	OPEN	OFF
V	1.000V	TRIG	INT	SHORT	OFF
LIMIT	OFF	AVG	OFF	LOAD	OFF
RANGE	AUTO 1Ω	DELAY	0.0000s	CABLE	Om
LOW Z	OFF	DCBIAS	OFF	SCALE	OFF
JUDGE	OFF				

**NOTE** When the display is enlarged, the print type is text even when [TYPE] is set to **SCREEN**.

### When Analyzer Mode

In analyzer mode, only printing the screen is available for the print type ([TYPE]).

#### Normal measurement

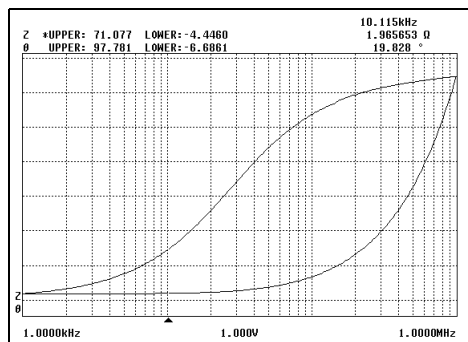

#### Comparator measurement

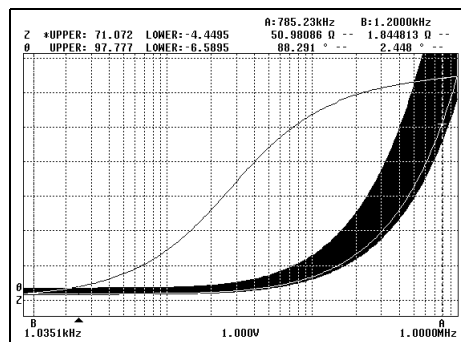

### When Continuous Measurement Mode

The measured value display will be printed in text, or the graph display will be printed as a screen image.

Measured value display

001	Z	SWEEP	PH	SWEEP	NG NG
002	Ls	15.1962mH	D	0.05958	IN HI

Graph display

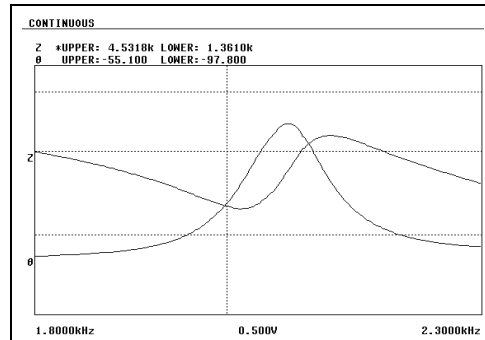

**NOTE** Since printer settings cannot be configured in continuous measurement mode, set the instrument to either LCR mode or analyzer mode in order to changing the printer settings.

# Specifications Chapter 13

## 13.1 General Specifications

### 1. Basic Specifications

Measurement mode	(1) LCR mode: Measurement with single condition (2) Analyzer mode: Measurement frequency sweep, measurement level sweep <ul style="list-style-type: none"> <li>• Measurement points: 2 to 801</li> <li>• Sweep method: Normal sweep/segment sweep                Normal sweep: START-STOP/ CENTER-SPAN/ START-STEP, maximum 801 points                Segment sweep: START-STOP, maximum 20 segments (total of 801 points)</li> <li>• Display: List display/graph display</li> </ul> (3) Continuous measurement mode: Consecutive measurements with saved conditions <ul style="list-style-type: none"> <li>• LCR mode: Up to 30 conditions</li> <li>• Analyzer mode: Up to 2 conditions</li> </ul> * Continuous measurements including a mixture of LCR mode and analyzer mode are possible.
Measurement items	Z (Impedance), Y (Admittance), $\theta$ (Phase angle), Rs (Equivalent series resistance (ESR)), Rp (Parallel equivalent resistance), X (Reactance), G (Conductance), B (Susceptance), Ls (Series equivalent inductance), Lp (Parallel equivalent inductance), Cs (Series equivalent capacitance), Cp (Parallel equivalent capacitance), Q (Q factor), D (Loss coefficient $\tan\delta$ ), Rdc (DC resistance)
Display range	Z, Y, Rs, Rp, Rdc, X, G, B, Ls, Lp, Cs, Cp: $\pm$ (0.000000 (unit) to 9.999999G (unit)) * Absolute value display for Z and Y only  $\theta$ : $\pm$ (0.000 $^\circ$ to 999.999 $^\circ$ ) D: $\pm$ (0.000000 to 9.999999) Q: $\pm$ (0.00 to 99999.99) $\Delta\%$ : $\pm$ (0.0000% to 999.9999%) * DISP OUT is displayed when the upper limit is exceeded.
Measurement frequency	(1) Frequency range 4 Hz to 5 MHz (2) Setting resolution 5-digit resolution (however, the minimum resolution is 10 mHz) (3) Frequency accuracy $\pm 0.01\%$
Output impedance (Hc terminal, when 1 kHz)	Normal mode: $100\ \Omega \pm 10\ \Omega$ Low impedance accuracy mode: Approx. $10\ \Omega$ (100 m $\Omega$ and 1 $\Omega$ ranges of 100 kHz or less) Approx. $100\ \Omega$ (Except for the above)  * The following impedances are connected to the Lc terminal. 1 $\Omega$ range or less (100 kHz or less) when low impedance high accuracy mode: 5 $\Omega$ or less 1 V or less of other than the above: 3 k $\Omega$ range or more.....Approx. 35 $\Omega$ 1 k $\Omega$ range or less.....Approx. 5 $\Omega$  1.001 V or more of other than the above: 30 k $\Omega$ range or more.....Approx. 35 $\Omega$ 10 k $\Omega$ range or less.....Approx. 5 $\Omega$

## 13.1 General Specifications

### 1. Basic Specifications

- Measurement signal level
- (1) Open circuit terminal voltage (V) mode and constant voltage (CV) mode
    - Level range
      - Normal mode: 5 mV to 5 V, maximum 50 mA (up to 1.0000 MHz)
      - 10 mV to 1 V, maximum 10 mA (from 1.0001 MHz)
      - Low Z high accuracy mode: 5 mV to 1 V, maximum 100 mA (up to 100.00 kHz)
    - Setting resolution 1 mV steps
    - Setting accuracy  $\pm 10\%$  of setting  $\pm 10$  mV (up to 1.0000 MHz)
    - $\pm 20\%$  of setting  $\pm 10$  mV (from 1.0001 MHz)
  - (2) Constant current (CC) mode
    - Level range
      - Normal mode: 10  $\mu$ A to 50 mA, maximum 5 V (up to 11.0000 MHz)
      - 10  $\mu$ A to 10 mA, maximum 1 V (from 1.0001 MHz)
      - Low Z high accuracy mode: 10  $\mu$ A to 100 mA, maximum 1 V (100 m $\Omega$  and 1  $\Omega$  ranges of 100 kHz or less)
      - 10  $\mu$ A to 10 mA (other than the above)
    - Setting resolution 10  $\mu$ A steps
    - Setting accuracy  $\pm 10\%$  of setting  $\pm 10$   $\mu$ A (up to 1.0000 MHz)
    - $\pm 20\%$  of setting  $\pm 10$   $\mu$ A (from 1.0001 MHz)

Measurement range

The measurement range is determined according to impedance Z.  
 The values of the other measurement items can be calculated.  
 Ranges: 100 m $\Omega$ , 1  $\Omega$ , 10  $\Omega$ , 300  $\Omega$ , 1 k $\Omega$ , 3 k $\Omega$ , 10 k $\Omega$ , 30 k $\Omega$ , 100 k $\Omega$ , 1 M $\Omega$ , 10 M $\Omega$ , 100 M $\Omega$  (12 ranges)

Measurement range	Guaranteed Accuracy Range	AUTO Ranging Range
100 M $\Omega$	8 M $\Omega$ to 200 M $\Omega$	8 M $\Omega$ to 999.999 M $\Omega$
10 M $\Omega$	800 k $\Omega$ to 100 M $\Omega$	800 k $\Omega$ to 10 M $\Omega$
1 M $\Omega$	80 k $\Omega$ to 10 M $\Omega$	80 k $\Omega$ to 1 M $\Omega$
100 k $\Omega$	24 k $\Omega$ to 1 M $\Omega$	24 k $\Omega$ to 100 k $\Omega$
30 k $\Omega$	8 k $\Omega$ to 300 k $\Omega$	8 k $\Omega$ to 30 k $\Omega$
10 k $\Omega$	2.4 k $\Omega$ to 100 k $\Omega$	2.4 k $\Omega$ to 10 k $\Omega$
3 k $\Omega$	800 $\Omega$ to 30 k $\Omega$	800 $\Omega$ to 3 k $\Omega$
1 k $\Omega$	240 $\Omega$ to 10 k $\Omega$	240 $\Omega$ to 1 k $\Omega$
300 $\Omega$	8 $\Omega$ to 300 $\Omega$	8 $\Omega$ to 300 $\Omega$
10 $\Omega$	800 m $\Omega$ to 10 $\Omega$	800 m $\Omega$ to 10 $\Omega$
1 $\Omega$	80 m $\Omega$ to 1 $\Omega$	80 m $\Omega$ to 1 $\Omega$
100 m $\Omega$	1 m $\Omega$ to 100 m $\Omega$	0 $\Omega$ to 100 m $\Omega$

- The guaranteed accuracy range differs depending on the measurement conditions. (p. 398)
- Out of guaranteed accuracy is displayed when out of the ranging range  
 OVERFLOW or UNDERFLOW is displayed when out of the A/D input range

## 1. Basic Specifications

- Low Z High Accuracy Mode Improves measurement accuracy in the 100 mΩ and 1 Ω ranges of 100 kHz or less.
- The influence of contact resistance is reduced by changing to a circuit configuration that sets the Lp terminal to 0 V.
  - The measurement current is increased (maximum 100 mA, maximum applied voltage 1 V) and the measurement accuracy is improved by setting the output resistance to 10 Ω.
  - A contact check (disconnection detection) can be performed for four terminals.
  - Cable length compensation is for only 0 m and 1 m.

Setting range of low Z high accuracy mode

No	Measurement range	to 1 kHz	to 10 kHz	to 100 kHz	to 1 MHz	to 5 MHz
1	100 MΩ	Normal mode only (setting not possible for low Z high accuracy mode).				None
2	10 MΩ					
3	1 MΩ					
4	100 kΩ					
5	30 kΩ					
6	10 kΩ					
7	3 kΩ					
8	1 kΩ					
9	300 Ω					
10	10 Ω					
11	1 Ω	Low Z high accuracy mode/normal mode				
12	100 mΩ					

Period of guaranteed accuracy	1 year
Warm-up time	At least 60 minutes
Measurement time	Approx. 0.5 ms (100 kHz, representative value, LCD display OFF)
Measurement speed	FAST, MED, SLOW, SLOW2
Terminal structure	4-terminal structure
Backup battery life	Approx. 10 years (25°C (77°F) reference value)
Product warranty period	3 year

## 2. Function

Monitor functions	<p>(1) Monitor voltage</p> <ul style="list-style-type: none"> <li>• Monitor range 0.000 V to 5.000 V</li> <li>• Monitor accuracy ±10% rdg. ±10 mV (up to 1.0000 MHz) ±20% rdg. ±10 mV (from 1.0001 MHz)</li> </ul> <p>(2) Monitor current</p> <ul style="list-style-type: none"> <li>• Monitor range 0.000 mA to 100.0 mA</li> <li>• Monitor accuracy ±10% rdg. ±10 μA (up to 1.0000 MHz) ±20% rdg. ±10 μA (from 1.0001 MHz)</li> </ul>
Limit function	<p>(1) Current limit (when V or CV)</p> <ul style="list-style-type: none"> <li>• Limit range 10 μA to 100.00 mA</li> <li>• Limit accuracy ±10% rdg. ±10 μA (up to 1.0000 MHz) ±20% rdg. ±10 μA (from 1.0001 MHz)</li> </ul> <p>(2) Voltage limit (when CC set)</p> <ul style="list-style-type: none"> <li>• Limit range 0.005 V to 5.000 V</li> <li>• Limit accuracy ±10% rdg. ±10 mV (up to 1.0000 MHz) ±20% rdg. ±10 mV (from 1.0001 MHz)</li> </ul>

## 13.1 General Specifications

### 2.Function

DC bias measurement	<p>Superimposing a DC voltage and then performing measurement is possible.</p> <p>DC voltage Normal mode: 0 V to 2.50 V (10 mV resolution)            Low impedance high accuracy mode: 0 V to 1.00 V (10 mV resolution)            Occurrence accuracy: ±10% of setting ±(V<sub>AC</sub>×0.01+30 mV)            * V<sub>AC</sub>: AC signal voltage setting value [V]</p>
DC resistance measurement	<p>Settable when setting the Rdc measurement item.</p> <p>The measurement condition when DC resistance measurement is settable to other than AC measurement</p> <ul style="list-style-type: none"> <li>• Measurement signal level: Normal mode: 100 mV to 2.50 V (10 mV resolution)            Low impedance high accuracy mode: 100 mV to 1.00 V(10 mV resolution)            Occurrence accuracy: ±10% of setting ±20mV</li> <li>• Measurement range, voltage/current limit, measurement speed, average</li> <li>• DC adjustment setting (measurement of circuit offset, function for cancel)</li> <li>• Delay time (common wait time when level switching, DC and AC switching, and DC adjustment)</li> </ul>
Average	1 to 256 (1 step)
Trigger function	An internal trigger or external trigger can be set.
Trigger delay	0 to 9.9999 s (100 μs resolution)
Interval measurement	Interval 0.0001 s to 10000 s Maximum 801 points
BIN measurement	10 classifications for 2 items, OUT OF BINS Absolute value setting, Δ% setting, % setting
Comparator	<ul style="list-style-type: none"> <li>• LCR mode:            First item: Hi/IN/Lo            Third item: Hi/IN/Lo            Absolute value setting, Δ% setting, % setting</li> <li>• Analyzer mode:            Area judgment: Hi/IN/Lo for each point            Absolute value setting, % setting            Peak judgment: Hi/IN/Lo for local maximum and local minimum frequency and measurement values            Absolute value setting</li> </ul>
Compensation	<ul style="list-style-type: none"> <li>• Open and short circuit compensation</li> <li>• Load circuit compensation</li> <li>• Cable length compensation: 0 m, 1 m (to 5 MHz)            Normal mode: Guaranteed accuracy up to 4 m when cable length compensation of 1 m set            Cable compensation is only 0 m and 1 m when low Z high accuracy mode</li> </ul>
Correlation compensation	Enter the compensation coefficients a and b of the following expression. [Measurement value after compensation] = a × [measurement value] + b
Residual charge protection function (Provides protection against a discharge voltage from a charged capacitor)	$V = \sqrt{\frac{10}{C}}$ <p>C: Capacitance [F] of test sample            However, V = maximum 400 V</p>
Magnification display function	The display of measurement values and comparator judgment results can be magnified.
Continuous measurement	Perform continuous measurement with saved conditions from the screen.
Display digits setting function	The number of display digits for measurement values can be set to 3, 4, 5, 6, and 7. However, the setting differs depending on the parameter. (The initial value is 6 digits)
Display setting function	The LCD can be set to ON/ OFF.
Key-lock function	Can be enabled and disabled by front panel key operation. Can be enabled and disabled by password input
Trigger synchronous output function	Applies a measurement signal during analog measurement only.

## 2.Function

Panel save and load function	LCR mode (single frequency): 30 different measurement conditions can be saved. Sweep measurement: 2 different measurement conditions can be saved. Compensation value only: 128 different measurement conditions can be saved. Any measurement condition can be load by key operation or a control signal via the EXT I/O.
Memory function	32,000 measurement result items can be saved to the instrument. (Reading via RS-232C, GP-IB, USB, and LAN is possible.)
Contact check	(1) 4-terminal contact check (only when low Z high accuracy mode 100 mΩ range, 1 Ω range) Performs a contact (disconnection) check between $H_{CUR}$ and $H_{POT}$ and between $L_{CUR}$ and $L_{POT}$ . When the current monitor value is 0.1 mA or less, a contact error is output. (2) HIGH-Z reject function (detection of OPEN state during 2-terminal measurement) When the measurement value is higher than the judgment reference, a contact error is output. Judgment reference: The impedance Z value can be set to between 0 to 30,000% of the measurement range. Error output: An error is output from the EXT I/O. (3) Detection level monitoring function Detects a contact error (chattering detection). A comparison is made with the effective value of the first waveform that is acquired, and a contact error is output when a variation in the effective value of a subsequent waveform exceeds the judgment reference. Judgment reference: 0.01% to 100.00% (0.01% resolution) relative to the reference value can be set. Error output: An error is displayed on the LCD and output from the EXT I/O.
Print function	The measurement values and graph can be printed. * Requires a printer that supports RS-232C communications.
Buzzer sound	The buzzer for the comparator judgment result (IN or NG) can be set to ON/ OFF. The buzzer sound for key input can be set to ON/ OFF.

## 3.Interface

Display	5.7-inch color TFT
Handler interface	Equipped as standard
RS-232C interface	Equipped as standard
GP-IB interface	Equipped as standard
USB(HI SPEED) interface	Equipped as standard Full-Speed/Hi-Speed supported
LAN interface	Equipped as standard 10BASE-T/100BASE-TX
USB flash drive	The measurement conditions, measurement values, and screen can be saved. The measurement conditions can be load. Saved measurement values and screens can be displayed. File deletion, folder creation, and disk formatting

## 13.1 General Specifications

### 4.Environmental and Safety Specifications

Operating temperature and humidity	0 to 40°C (32 to 104°F),80% RH or less (non-condensating)
Storage temperature and humidity	-10 to 50°C (15 to 122°F) 80% RH or less (non-condensating)
Operating environment	Indoors, Pollution degree 2, altitude up to 2000 m (6562-ft.)
Rated supply voltage	AC90 V to 264 V
Rated supply frequency	50/ 60 Hz
Maximum rated power consumption	150 VA
Dimensions	Approx. 330 W × 119 H × 307 D mm (12.99" W × 4.69" H × 12.09" D) (excluding protrusions)
Mass	Approx. 5.8 kg (204.6 oz.)
Applicable Standards	Safety EN61010 EMC EN61326 Class A EN61000-3-2 EN61000-3-3 Influence of radiation induced by radio frequency electromagnetic fields: Z in 10 V/m: ±5% rdg θ: ±5° Influence of conduction induced by radio-frequency fields: Z in 3 V: ±5% rdg θ: ±5°
Dielectric strength	Between the power wire and ground wire: 1.62 kV AC for 60 seconds

### 5.Accessories, Options

Accessories	Power Cord..... 1 Instruction Manual ..... 1 Communication Instruction Manual (CD)..... 1
Options	Model 9261-10 Test Fixture Model 9262 Test Fixture Model L2001 Pincher Probe Model IM9901 Contact Tips (for model L2001) Model IM9902 Contact Tips (for model L2001) Model 9263 SMD Test Fixture Model 9677 SMD Test Fixture Model 9699 SMD Test Fixture Model 9699 SMD Test Fixture Model IM9100 SMD Test Fixture Model L2000 4-Terminal Probe Model 9140-10 4-Terminal Probe Model 9500-10 4-Terminal Probe Model IM9000 Equivalent Circuit Analysis Firmware Model 9268-10 DC Bias Voltage Unit Model 9269-10 DC Bias Current Unit

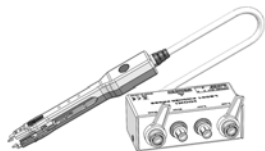

## Options

L2001  
Pincher Probe

Measurable range: DC to 8 MHz  
 Maximum applied voltage:  $\pm 42$  V<sub>peak</sub>(AC+DC)  
 Maximum applied current:  $\pm 1$  A<sub>peak</sub>(AC+DC)  
 Electrode tip spacing: 0.3 to approx. 6 mm  
 IM9901: 0603 to 2220 (EIA)  
 IM9902: 0201 to 2220 (EIA)

9140-10  
4-terminal Probe

Measurable range: DC to 200 kHz  
 Maximum voltage:  $\pm 42$  V<sub>peak</sub> (AC+DC)  
 Maximum current:  $\pm 1$  A<sub>peak</sub> (AC+DC)  
 Measurement terminal hole diameter:  $\phi 0.3$  mm to 5 mm

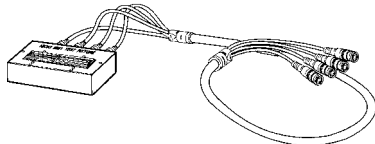
9261-10  
4-terminal Probe

Measurable range: DC to 8 MHz  
 Maximum voltage:  $\pm 42$  V<sub>peak</sub> (AC+DC)  
 Maximum current:  $\pm 1$  A<sub>peak</sub> (AC+DC)  
 Measurement terminal hole diameter: 0.3 mm to 5 mm

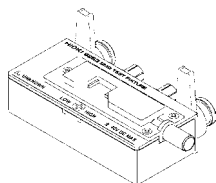
9263  
SMD Test Fixture

▼ This fixture is for measuring chip components. (less than 10 m $\Omega$  residual resistance after zero adjustment)

Measurable range: DC to 8 MHz  
 Maximum applied voltage: DC $\pm 40$  V  
 Test sample dimensions: Test sample width of 1 to 10 mm

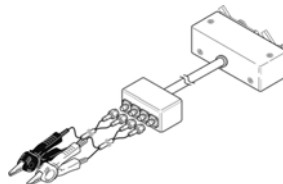
L2000  
4-terminal Probe

▼ Alligator-clip-type measurement probes. These general-purpose dual-electrode clips fit a wide range of conductor thicknesses.

Measurable range: DC to 8 MHz  
 Maximum voltage:  $\pm 42$  V<sub>peak</sub> (AC+DC)  
 Maximum current:  $\pm 1$  A<sub>peak</sub> (AC+DC)  
 Measurement terminal hole diameter: 5 mm or less

9500-10  
4-terminal Probe

Measurable range: DC to 200 kHz  
 Maximum voltage:  $\pm 42$  V<sub>peak</sub> (AC+DC)  
 Maximum current:  $\pm 1$  A<sub>peak</sub> (AC+DC)  
 Measurement terminal hole diameter:  $\phi 0.3$  mm to 2.0 mm

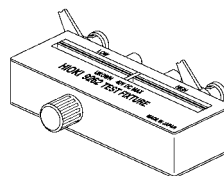
9262  
Test Fixture

▼ This fixture is for measuring lead components. (less than 10 m $\Omega$  residual resistance after zero adjustment)

Measurable range: DC to 8 MHz  
 Maximum applied voltage: DC $\pm 40$  V  
 Test sample dimensions: Lead diameter of 2 mm or less  
 Lead pitch of 5 mm or more

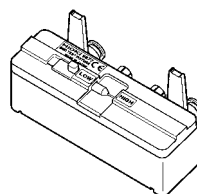
9677  
SMD Test Fixture

Measurable range: DC to 120 MHz  
 Maximum applied voltage: DC $\pm 40$  V  
 Test sample width of 3.5 $\pm 0.5$  mm or less

## 13.1 General Specifications

### 9699 SMD Test Fixture

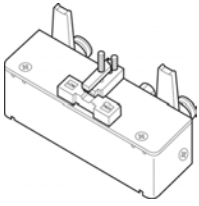

▼ This fixture is for the bottom surface of electrodes.

Measurable range: DC to 120 MHz  
 Maximum applied voltage: DC±40 V  
 Test sample dimensions: Test sample width of 1 to 4 mm  
 Test sample height of 1.5 mm or less

### IM9100 SMD Test Fixture

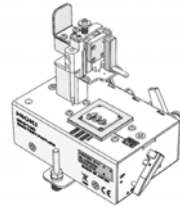

Measurable range: DC to 8 MHz  
 Maximum applied voltage: ±42 V<sub>peak</sub> (AC+DC)  
 Maximum applied current: ±0.15 A rms (±0.15 ADC)  
 Measurement test sample dimensions: 0.4×0.2 mm, 0.6×0.3 mm, 1.0×0.5 mm

### 9268-10 DC Bias Voltage Unit

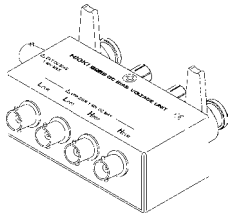

Measurable range: 40 Hz to 5 MHz  
 Maximum applied voltage: DC±40 V

### 9269-10 DC Bias Voltage Unit

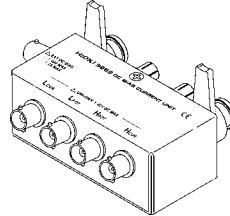

Measurable range: 40 Hz to 2 MHz  
 Maximum applied current: DC2 A

### IM9000 Equivalent Circuit Analysis Firmware

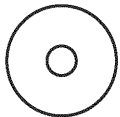

▼ This option enables equivalent circuit analysis and other IM3570 functionality.

- Equivalent circuit analysis (automatic, fixed): 5 patterns
- PASS/FAIL judgments for equivalent circuit elements
- Analysis result simulation
- Cole-cole plot display/admittance circle display

## 13.2 Measurement Range and Accuracy

The measurement accuracy is calculated from a basic accuracy, which is based on the accuracy for impedance  $Z$  (% rdg.) and phase angle  $\theta$  ( $^{\circ}$ ), and the following coefficients.

**Measurement accuracy = Basic accuracy  $\times$  C  $\times$  D  $\times$  E  $\times$  F  $\times$  G**

C: Level coefficient/ D: Measurement speed coefficient/ E: Cable length coefficient/  
F:DC bias coefficient/ G: Temperature coefficient

### Basic accuracy

Measurement conditions of basic accuracy coefficient table

- Using the Model 9262 Test Fixture
- Measurement speed: SLOW2
- Cable length: 0 m
- Operation 60 minutes after the power is turned on.
- Open circuit compensation and short circuit compensation both being performed.
- DC adjustment ON (when DC resistance measurement)
- Temperature and humidity:  $23\pm 5^{\circ}\text{C}$ , 80%RH or less

When the measurement conditions differ from the above, multiply the level coefficient (C), measurement speed coefficient (D), cable length coefficient (E), DC bias coefficient (F), and temperature coefficient (G) by the basic accuracy.

The basic accuracy is calculated by determining coefficient A and B from the basic accuracy coefficient table in accordance with the measurement frequency\*1 and measurement range, and then using the following expression.

The basic accuracy becomes the accuracy [%] of  $Z$  and accuracy [ $^{\circ}$ ] of  $\theta$ .

- \*1 When the measurement frequency is 1.001 MHz or more,  $(f [\text{MHz}] + 3)/4$  must be multiplied to the basic accuracy.

1 k $\Omega$  range or more

$$\text{Basic accuracy} = \pm \left( A + B \times \left| \frac{10 \times Z_x[\Omega]}{\text{Range} [\Omega]} - 1 \right| \right)$$

100  $\Omega$  range or less

$$\text{Basic accuracy} = \pm \left( A + B \times \left| \frac{\text{Range}[\Omega]}{Z_x[\Omega]} - 1 \right| \right)$$

$Z_x$ : Impedance (effective value or value obtained by the following expression) of the test sample

$$\begin{aligned} Z_x[\Omega] &= \omega L [\text{H}] && (\text{when } \theta = 90^{\circ}) \\ &= 1 / \omega C [\text{F}] && (\text{when } \theta = -90^{\circ}) \\ &= R[\Omega] && (\text{when } \theta = 0^{\circ}) \end{aligned}$$

## 13.2 Measurement Range and Accuracy

### Accuracy table

Upper portion: Impedance Z (Unit: %) Lower portion: Phase angle  $\theta$  (Unit:  $^{\circ}$ )

Range	DC	4.00 Hz to 99.99 Hz	100.00 Hz to 999.99 Hz	1.0000 kHz to 10.000 kHz	10.001 kHz to 100.00 kHz	100.01 kHz to 1.0000 MHz	1.0001 MHz to 5.0000 MHz
100 M $\Omega$	A= 4 B= 6	A= 6 B= 5	A= 3 B= 2	A= 3 B= 2	A= 8 B= 4	- -	- -
		A= 5 B= 3	A= 2 B= 2	A= 2 B= 2	A= 3 B= 2	- -	- -
10 M $\Omega$	A= 0.5 B= 0.3	A= 0.8 B= 1	A= 0.5 B= 0.3	A= 0.5 B= 0.3	A= 1 B= 0.7	A= 3 B= 2	- -
		A= 0.8 B= 0.5	A= 0.4 B= 0.2	A= 0.4 B= 0.2	A= 1 B= 0.2	A= 3 B= 1	- -
1 M $\Omega$	A= 0.2 B= 0.1	A= 0.4 B= 0.08	A= 0.3 B= 0.05	A= 0.3 B= 0.05	A= 0.3 B= 0.08	A= 1 B= 0.5	A= 2 B= 1
		A= 0.3 B= 0.08	A= 0.2 B= 0.02	A= 0.2 B= 0.02	A= 0.3 B= 0.08	A= 1 B= 0.5	A= 2 B= 1
100 k $\Omega$	A= 0.1 B= 0.01	A= 0.3 B= 0.01	A= 0.2 B= 0.01	A= 0.15 B= 0.01	A= 0.25 B= 0.04	A= 0.4 B= 0.3	A= 2 B= 0.5
		A= 0.3 B= 0.01	A= 0.1 B= 0.01	A= 0.1 B= 0.01	A= 0.2 B= 0.02	A= 0.3 B= 0.3	A= 2 B= 0.3
30 k $\Omega$	A= 0.1 B= 0.01	A= 0.3 B= 0.01	A= 0.2 B= 0.005	A= 0.12 B= 0.005	A= 0.25 B= 0.01	A= 0.4 B= 0.05	A= 2 B= 0.1
		A= 0.3 B= 0.01	A= 0.1 B= 0.003	A= 0.08 B= 0.003	A= 0.15 B= 0.005	A= 0.3 B= 0.03	A= 2 B= 0.1
10 k $\Omega$	A= 0.1 B= 0.01	A= 0.3 B= 0.01	A= 0.2 B= 0.01	A= 0.12 B= 0.005	A= 0.2 B= 0.02	A= 0.3 B= 0.03	A= 1.5 B= 0.2
		A= 0.3 B= 0.01	A= 0.1 B= 0.005	A= 0.08 B= 0.002	A= 0.08 B= 0.02	A= 0.2 B= 0.05	A= 1 B= 0.2
3 k $\Omega$	A= 0.1 B= 0.01	A= 0.3 B= 0.02	A= 0.2 B= 0.005	A= 0.12 B= 0.005	A= 0.2 B= 0.005	A= 0.3 B= 0.01	A= 1.5 B= 0.02
		A= 0.2 B= 0.01	A= 0.1 B= 0.002	A= 0.08 B= 0.002	A= 0.08 B= 0.005	A= 0.15 B= 0.01	A= 1 B= 0.03
1 k $\Omega$	A= 0.1 B= 0.01	A= 0.3 B= 0.02	A= 0.2 B= 0.01	A= 0.1 B= 0.005	A= 0.2 B= 0.01	A= 0.3 B= 0.01	A= 1.5 B= 0.01
		A= 0.2 B= 0.01	A= 0.1 B= 0.005	A= 0.08 B= 0.002	A= 0.08 B= 0.01	A= 0.15 B= 0.01	A= 1 B= 0.01
300 $\Omega$	A= 0.1 B= 0.02	A= 0.4 B= 0.02	A= 0.3 B= 0.02	A= 0.08 B= 0.02	A= 0.2 B= 0.02	A= 0.3 B= 0.03	A= 1.5 B= 0.05
		A= 0.2 B= 0.01	A= 0.15 B= 0.01	A= 0.05 B= 0.01	A= 0.08 B= 0.02	A= 0.15 B= 0.02	A= 1 B= 0.05
10 $\Omega$	A= 0.2 B= 0.15	A= 0.5 B= 0.2	A= 0.4 B= 0.05	A= 0.3 B= 0.05	A= 0.3 B= 0.05	A= 0.4 B= 0.2	A= 2 B= 1.5
		A= 0.3 B= 0.1	A= 0.3 B= 0.03	A= 0.15 B= 0.03	A= 0.15 B= 0.03	A= 0.3 B= 0.1	A= 2 B= 1
1 $\Omega$	A= 0.3 B= 0.3	A= 2 B= 1	A= 0.6 B= 0.3	A= 0.4 B= 0.3	A= 0.4 B= 0.3	A= 1 B= 1	A= 3 B= 3
		A= 1 B= 0.6	A= 0.5 B= 0.2	A= 0.25 B= 0.2	A= 0.25 B= 0.2	A= 0.7 B= 0.5	A= 3 B= 2
100 m $\Omega$	A= 3 B= 2	A= 10 B= 10	A= 3 B= 3	A= 3 B= 2	A= 2 B= 2	A= 4 B= 3	- -
		A= 6 B= 6	A= 2 B= 2	A= 2 B= 1.5	A= 2 B= 1.5	A= 3 B= 4	- -

### C Level coefficient

The coefficient corresponding to the setting for measurement level is obtained from the measurement level coefficient table and then multiplied by the basic accuracy.

	0.005 V to 0.999 V	1 V to 5 V
Level coefficient	$1 + \frac{0.1}{V}$ (30 k $\Omega$ range or less of other than DCR)	1
	$1 + \frac{0.3}{V}$ (Except for the above)	1

V: Setting value (equivalent to when V mode) [V]

### D Measurement speed coefficient

The coefficient corresponding to the setting for measurement speed is obtained from the measurement speed coefficient table and then multiplied by the basic accuracy.

	FAST	NORMAL	SLOW	SLOW2
Speed coefficient	8	4	2	1

## 13.2 Measurement Range and Accuracy

### E Cable length coefficient

The coefficient corresponding to the setting for measurement cable length is obtained from the measurement cable length table and then multiplied by the basic accuracy.

	0 m	1 m	2 m	4 m
Cable length coefficient	1	1.5	$2 \left( 1 + \frac{f_m}{100} \right)$	$4 \left( 1 + \frac{f_m}{100} \right)$

$f_m$ : Measurement frequency [kHz]

Guaranteed Accuracy Range: 0 m and 1 m = 4 Hz to 5 MHz, 2 m = 4 Hz to 100 kHz, 4 m = 4 Hz to 10 kHz

### F DC bias coefficient

The coefficient corresponding to the setting for ON/ OFF of DC bias is obtained from the DC bias coefficient table and then multiplied by the basic accuracy.

	DC Bias Setting OFF	DC Bias Setting ON
DC bias coefficient	1	$2 \left( 1 + \frac{0.1}{V_{AC}} \right) \times \alpha$

$V_{AC}$ : AC signal voltage setting value [V]

$\alpha$ : This is 2 when 100.01 kHz or more of the 10  $\Omega$  range or less, and 1 in cases other than that.

### G Temperature coefficient

The coefficient corresponding to the operating temperature is obtained from the operating temperature coefficient table and then added to the basic accuracy.

	$0^\circ\text{C} \leq t < 18^\circ\text{C}, 28^\circ\text{C} < t \leq 40^\circ\text{C}$	$18^\circ\text{C} \leq t \leq 28^\circ\text{C}$
Temperature coefficient	$1 + 0.1 \times  t - 23 $	1

When the operating temperature (t) is  $23^\circ\text{C} \pm 5^\circ\text{C}$ , the coefficient is 1.

## 13.2 Measurement Range and Accuracy

### Guaranteed Accuracy Range

The guaranteed accuracy range differs depending on the measurement frequency, measurement signal level, and measurement range.

Range	DC	4.00 Hz to 99.99 Hz	100.00 Hz to 999.99 Hz	1.0000 kHz to 10.000 kHz	10.001 kHz to 100.00 kHz	100.01 kHz to 1.0000 MHz	1.0001 MHz to 5.0000 MHz			
100 MΩ	0.1 V to 2.5 V	0.101 V to 5 V			0.501 V to 5 V					
10 MΩ	0.1 V to 2.5 V	0.050 V to 5 V			0.101 V to 5 V	0.501 V to 5 V				
1 MΩ		0.005 V to 5 V			0.050 V to 5 V	0.101 V to 5 V	0.501 V to 1 V			
100 kΩ					0.050 V to 5 V	0.101 V to 1 V				
30 kΩ										0.05 V to 1 V
10 kΩ										
3 kΩ										
1 kΩ										
300 Ω										
10 Ω										
1 Ω		0.005 V to 5 V *2				0.101 V to 5 V	0.501 V to 1 V			
100 mΩ	0.1 V to 2.5 V *1	0.101 V to 5 V *3			0.501 V to 5 V *3					

The above voltages are the voltage settings equivalent to when V mode.

\*1 The guaranteed accuracy is 10 mΩ or higher

\*2 The guaranteed accuracy for when DC bias is 0.101 to 5 V.

\*3 The guaranteed accuracy for when DC bias is 10 mΩ or higher and 1.001 to 5 V.

### **NOTE**

The above measurement specification was determined using a 1.5C-2 V coaxial cable with an established cable length for the unit.

Using a cable other than a 1.5C-2 V, or a cable that not an established length for the unit in question increases the chance of measurement inaccuracy. A large capacitance between the H terminal and grounding capacitance (GND) or the L terminal and GND may result in measurement inaccuracy. Please set the GND to 10 pF or less.

## 13.3 About Measurement Times and Measurement Speed

Measurement times differ depending on the measurement conditions. Refer to the following values.

**NOTE** All of the values are reference values. Note that they may differ depending on the conditions of use.

### Analog measurement signal (INDEX)

	FAST	MED	SLOW	SLOW2
DC	1 ms+0.6 ms	10 ms+0.6 ms	100 ms+0.6 ms	400 ms+0.6 ms
4.00 Hz to 19.99 Hz	Tf+0.6 ms	2 × Tf+0.6 ms	3 × Tf+0.6 ms	4 × Tf+0.6 ms
20.00 Hz to 100.00 Hz	Tf+0.6 ms	2 × Tf+0.6 ms	8 × Tf+0.6 ms	64 × Tf+0.6 ms
100.01 Hz to 999.99 Hz	Tf+0.6 ms	4 × Tf+0.6 ms	16 × Tf+0.6 ms	128 × Tf+0.6 ms
1.0000 kHz to 3.0000 kHz	Tf+0.2 ms	8 × Tf+0.2 ms	32 × Tf+0.2 ms	256 × Tf+0.2 ms
3.0001 kHz to 10.000 kHz	Tf+0.2 ms	16 × Tf+0.2 ms	64 × Tf+0.2 ms	512 × Tf+0.2 ms
10.001 kHz to 30.000 kHz	4 × Tf+0.2 ms	64 × Tf+0.2 ms	256 × Tf+0.2 ms	2048 × Tf+0.2 ms
30.001 kHz to 100.00 kHz	8 × Tf+0.1 ms	128 × Tf+0.1 ms	512 × Tf+0.1 ms	4096 × Tf+0.1 ms
100.01 kHz to 300.00 kHz	32 × Tf+0.1 ms	512 × Tf+0.1 ms	2048 × Tf+0.1 ms	16384 × Tf+0.1 ms
300.01 kHz to 1.0000 MHz	64 × Tf+0.1 ms	1024 × Tf+0.1 ms	4096 × Tf+0.1 ms	32768 × Tf+0.1 ms
1.0001 MHz to 5.0000 MHz	400 × Tf+0.1 ms	6400 × Tf+0.1 ms	25600 × Tf+0.1 ms	204800 × Tf+0.1 ms

Tolerance:  $\pm 5\% \pm 0.2 \text{ ms}$  Tf [s]=1 ÷ measurement frequency

The DC time is the time when DC adjustment is OFF. The time is about twice as long when DC adjustment is ON.

When there is an external trigger, the corresponding time shown in the table below is added to the analog measurement signal.

Range	Level	Frequency	Low Z High Accuracy Mode	DC Bias	Time
100 mΩ, 1 Ω	All levels	DC, 4 Hz to 999.99 Hz	ON	OFF	5 ms
100 mΩ, 1 Ω	All levels	1 kHz to 5 MHz *	ON	OFF	1 ms
100 mΩ, 1 Ω	All levels	ALL frequency *	ON	ON	1 ms
100 mΩ, 1 Ω	All levels	DC, ALL frequency	OFF	OFF	1 ms
10 Ω	0.005 V to 0.1 V	DC, ALL frequency	OFF	OFF	1 ms
10 Ω	0.101 V to 1 V	DC, 4 Hz to 1 MHz	OFF	OFF	1 ms

\* Low Z high accuracy mode is only valid when the frequency is between 4 Hz and 100 kHz.

### 13.3 About Measurement Times and Measurement Speed

#### Measurement times (EOM)

Measurement times= INDEX + A + B + C + D + E + F

A. Calculation time (no OPEN /SHORT/ LOAD compensation, HOLD range, normal measurement)

	FAST	MED	SLOW	SLOW2
All frequencies	0.5 ms			

Tolerance:  $\pm 10\%$   $\pm 0.1$  ms

B. OPEN/ SHORT/ LOAD compensation

OPEN/ SHORT/ LOAD compensation	
No	0.0 ms
Yes	MAX 0.4 ms

C. Measurement mode

Measurement mode	
Normal measurement	0.0 ms
Comparator measurement	MAX 0.4 ms
BIN measurement	MAX 0.8 ms

D. Screen Display

Screen display	
When no screen display	0.0 ms
When screen display	MAX 0.3 ms

E. Saving to memory

Saving to memory	
Memory function ON/ IN	MAX 0.4 ms
Memory function OFF	0.0 ms

F. Equivalent circuit analysis (optional IM9000)

Equivalent circuit analysis*	
Analysis OFF	0.0 ms
Equivalent circuit model: A to D	MAX 2.5 ms
Equivalent circuit model: E	MAX 3.5 ms

\* Using 201 sweep points, equivalent circuit model selection hold, and auto analysis.



## Wait time

- **When the frequency is changed:**

The wait time differs depending on the frequency changed.

$$\text{Wait time} = \left| \frac{1}{\text{Frequency before change}} - \frac{1}{\text{Frequency after change}} \right|$$

Furthermore, if the range of the measurement frequencies is divided into the following seven categories and the frequency is changed to one in a different range, a wait time of 1 ms is added. However, if the frequency is changed to one that spans 1.0001 MHz, a wait of 3 ms is added.

Range classification	Measurement frequency
1	DC
2	4 Hz to 10 kHz
3	10.001 kHz to 100 kHz
4	100.01 kHz to 1 MHz
5	1.0001 MHz to 5 MHz

- **When switching levels**

When the AC signal level is changed, the wait time is 300  $\mu$ s.

Also, the range of measurement signal levels is divided into the following five categories.

When the level is changed to one in a different range, the wait time is 1 ms.

Range classification	Measurement signal level
1	0.005 V to 0.049 V
2	0.05 V to 0.1 V
3	0.101 V to 0.5 V
4	0.501 V to 1 V
5	1.001 V to 5 V

- **When switching ranges**

When the range is changed, the wait time is 1 ms.

Also, when low Z impedance high accuracy mode is turned ON/ OFF, the wait time is 1 ms.

- **When DC bias**

When DC bias is changed to ON/ OFF and when the DC bias level is changed, the wait time is 300  $\mu$ s.

- **When DC resistance measurement**

When the measurement signal level for DC resistance measurement is changed, the wait time is 300  $\mu$ s. Each time the measurement signal level is changed during DC adjustment, the wait time is 300  $\mu$ s.

When a DC delay is set, that wait time occurs again in order to change the measurement signal level.

- **When panel load**

After all changes are made, the wait time is the sum of the wait time when the frequency is changed and the maximum value of other wait times of the corresponding wait times above.

(If the measurement level and range linked to, for example, a change in the measurement frequency are changed, there is a wait for the maximum value of the corresponding wait time above after all of the linked changes are made.)



# Maintenance and Service

## Chapter 14

### 14.1 Inspection, Repair and Cleaning

Before requesting instrument repair or inspection, please read "Before returning for repair" (p. 405) and Section "Error display" (p. 407).

#### Inspection and Repair

**⚠ WARNING** Do not attempt to modify, disassemble or repair the instrument; as fire, electric shock and injury could result.

#### **NOTE**

- If damage is suspected, check the "Before returning for repair" (p. 405) section before contacting your dealer or Hioki representative.
- If the fuse blows, do not attempt to replace the fuse or repair the instrument: contact your dealer or Hioki representative.
- If damage is suspected, check the "Before returning for repair" (p. 405) section before contacting your dealer or Hioki representative. However, in the following cases, immediately stop using the instrument, unplug the power cord and contact your dealer or Hioki representative.
  - When the nature of the damage is clearly evident
  - When measurement is impossible
  - After long-term storage in adverse conditions such as high temperature or humidity
  - After being subject to severe shock during transport
  - After severe exposure to water, oil, or dust (internal insulation can be degraded by oil or water, causing increase hazard of electric shock or fire)

#### Replaceable Parts

Certain parts require replacement periodically and at the end of their useful life: (Useful life depends on the operating environment and frequency of use. Operation cannot be guaranteed beyond the following periods)

Part	Life	Remarks
Electrolytic Capacitors	Approx. 10 years	The useful life of electrolytic capacitors depends on the operating environment. Periodic replacement is necessary.
Lithium battery	Approx. 10 years	The instrument incorporates a lithium battery for backup. The life of the backup battery is approximately 10 years. If the date and time greatly differ from the actual date and time when the power is turned on or a backup error appears at startup, it is time to replace the battery. Contact your dealer or Hioki representative.
Fan motor	Approx. 50,000 hours	Periodic replacement is necessary.
LCD backlight (to half brightness)	Approx. 50,000 hours	Periodic replacement is necessary.

### Transporting the instrument

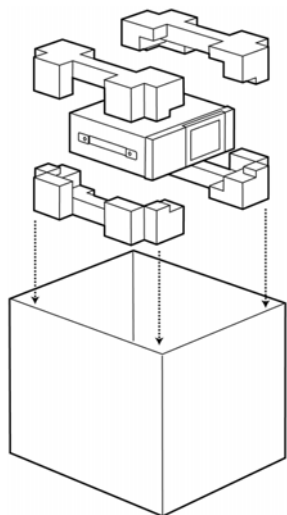

- Pack the instrument so that it will not sustain damage during shipping, and include a description of existing damage. We do not take any responsibility for damage incurred during shipping.
- Use the original packing materials when transporting the instrument, if possible.

### Cleaning

#### **NOTE**

- To clean the instrument, wipe it gently with a soft cloth moistened with water or mild detergent. Never use solvents such as benzene, alcohol, acetone, ether, ketones, thinners or gasoline, as they can deform and discolor the case.
- Wipe the LCD gently with a soft, dry cloth.

## 14.2 Troubleshooting

### Before returning for repair

In the event of the instrument malfunctioning, check the following items.

Symptom	Check Item, or Cause	Remedy and Reference
The display does not appear when you turn the power on.	Is the power cord unplugged? Is it properly connected?	Confirm that the power cord is properly connected. See (p. 29)
Keys do not work.	Are the keys locked?	Disable the key lock. See (p. 121), (p. 230)
	Is the unit being remotely operated from an external device using the communication cable?	Switch to the local state.
A key other than the pressed one is pressed.	Have you performed panel compensation?	Perform panel compensation. See (p. 308)
Cannot print.	Is the recording paper loaded properly? Are the printer settings correct? (Communication speed, interface, etc.) Are the instrument and printer properly connected with a suitable cable?	See (p. 381)
Nothing is displayed on the screen.	The LCD may be set to automatically turn off after a set time. See (p. 127)	Touch the screen.
Key response and screen drawing are slow.	Is the measurement value automatic output function enabled?	When the measurement value automatic output function is enabled, key response and screen drawing may become slow in order to give priority to measurement and measurement value output. See Description of communications commands on the included CD
The measurement values differ when a standard resistor, standard capacitor, or other known test sample is measured. The measurement values differ when a standard resistor, standard capacitor, or other known test sample is measured.	Do the measurement conditions of the known test sample and measurement conditions of the instrument match?	Make sure the measurement conditions match.
	Did you perform open and short compensation properly?	Perform open and short compensation again. See (p. 273)
	Is load compensation set?	Turn load compensation off. See (p. 288)
	Is the wait time for from connecting the test sample until performing measurement insufficient?	Ensure there is an appropriate trigger delay and trigger synchronization output wait time. See (p. 64), (p. 104), (p. 140)
	Is a test sample other than a capacitor being measured using the DC bias function?	Turn the DC bias function OFF.
The LCD appears blurred.	Are you pressing the LCD screen too hard?	Press the LCD screen gently. Slight blurring may occur but this is normal.
Cannot perform measurement correctly.	Is a high-impedance element which is influenced by noise being measured?	Use guarding. See (p.A3)
	Is an element of other than a capacitor being measured using the DC bias function?	Turn the DC bias function OFF. See (p. 57)

## 14.2 Troubleshooting

Symptom	Check Item, or Cause	Remedy and Reference
AUTO ranging is unable to determine a range.	Is a high-impedance element which is influenced by noise being measured?	Use guarding. See (p.A3)
	Is an element of other than a capacitor being measured using the DC bias function?	Turn the DC bias function OFF. See (p. 57)
A contact error is generated even though the connections are correct.	Is an element of other than a capacitor being measured using the DC bias function?	Turn the DC bias function OFF. See (p. 57)
An error beep sound is emitted continuously.	Is the measurement value automatic output function enabled?	When the measurement value automatic output function is enabled, a send error occurs on the measuring instrument side if the receive operation is not performed on the PC side, and a send error sound is emitted continuously when, for example, there is an internal trigger. Perform the receive operation on the PC side and then perform measurement on the measuring instrument side, or disable the measurement value automatic output function. See Description of communications commands on the included CD

### When no apparent cause can be established

Perform a system reset.  
This will return all settings to their factory defaults.  
See (p. 129), (p. 237)

### Full Reset Procedure

Performing a full reset will restore all of the settings to the factory default settings.  
Only perform a full reset in the following cases.

- When the normal reset screen cannot be displayed because of a problem with the instrument.  
(After the full reset, perform a self check to confirm that there are no problems. (p. 307))
- When you have forgotten the passcode for the key lock.

If the instrument still does not operate normally after the full reset, it needs to be repaired.  
Contact your dealer, or a Hioki representative if you are not sure where the instrument was purchased.

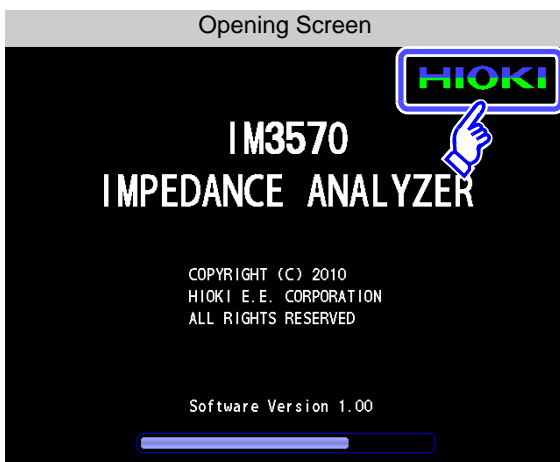





- 1 Connect the power cable.
- 2 Turn ON the switch on the back panel.
- 3 While the opening screen is displayed, press the top right of the screen continuously.
- 4 The full reset is complete when a beeping sound is emitted.



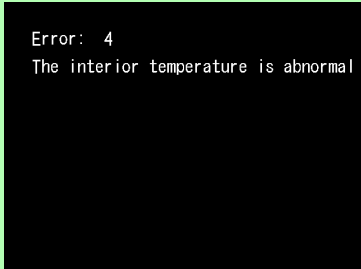
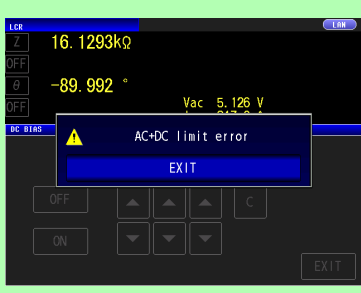

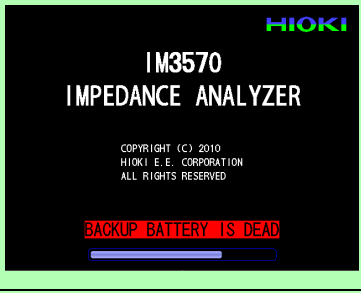





After the full reset, the panel calibration screen is displayed automatically. (p. 308)

## 14.3 Error display

When any of the following indications appear on the screen, check the corresponding reference page.

Error display	Description	Remedy and Reference
	The internal temperature of the instrument is increasing.	Turn off the power and check whether the ventilation holes are blocked. (p. 11)
	The sum of the AC measurement signal and DC measurement signal exceeds the upper limit.	Reduce the AC signal level or DC signal level. (p. 43)
	If the sum of the AC signal level and DC signal level exceeds the upper limit when the signal level mode is changed, the AC signal level is forcefully controlled so that it becomes within the setting range.	Reduce the AC signal level or DC signal level. (p. 43)
	The life of the RAM backup battery has ended.	The instrument needs to be repaired. Contact your dealer or Hioki representative.
	This is displayed when a measurement value is outside of the guaranteed accuracy range.	Increase the measurement signal level or change the measurement range to one that matches the impedance of the element to be measured.(p. 43), (p. 49)
	<ul style="list-style-type: none"> <li>This is displayed when load compensation is enabled and the load compensation frequency does not match the current measurement frequency.</li> <li>This is displayed when constant voltage measurement and constant current measurement cannot be performed.</li> </ul>	<ul style="list-style-type: none"> <li>When load compensation: Match the current measurement frequency to the compensation frequency.(p. 288)</li> <li>When constant voltage measurement or constant current measurement: Reduce the constant voltage level or constant current level. (p. 45)</li> </ul>

## 14.3 Error display

Error display	Description	Remedy and Reference
	This is displayed when a signal level that is lower than the set value is applied to the test sample as a result of the voltage/current limit value setting.	Set the limit value again or change the measurement signal level so that the limit value is not exceeded. (p. 60)
	This is displayed when load compensation is enabled and a load compensation condition other than the frequency does not match the current measurement condition.	Match the current measurement condition to the load compensation condition. (p. 288)
	This is displayed when the measurement results for the setting values are stored in the memory of the instrument.	Load or clear them from the memory of the instrument.(p. 219)
	This is displayed when a measurement value is outside of the screen display range.	Change the measurement range to one that matches the impedance of the element to be measured. (p. 49)
	This is displayed when measurement does not end because of an internal circuit error.	The instrument needs to be repaired. Contact your dealer or Hioki representative.
	This is displayed when a measurement value is at or above the upper limit value of the auto ranging range.	Change the measurement range to a high-impedance range. (p. 49)
	This is displayed when a measurement value is at or below the lower limit value of the auto ranging range.	Change the measurement range to a low-impedance range.(p. 49)
	This is displayed when the terminal of either $L_{POT}$ or $L_{CUR}$ is not connected because of, for example, a broken wire in low impedance high accuracy mode.	<ul style="list-style-type: none"> <li>• Check the connection of each terminal. (p. 54)</li> <li>• This may sometimes be displayed when an element of other than a capacitor is measured when using DC bias. (p. 54)</li> </ul>
	This is displayed when the terminal of either $H_{POT}$ or $H_{CUR}$ is not connected because of, for example, a broken wire in low impedance high accuracy mode.	<ul style="list-style-type: none"> <li>• Check the connection of each terminal. (p. 54)</li> <li>• This may sometimes be displayed when an element of other than a capacitor is measured when using DC bias. (p. 54)</li> </ul>
	This is displayed when a measurement result is high in relation to the judgment reference set for the HIGH-Z reject function.	Check the connection of each terminal. (p. 108)
	This is displayed when a detection level error is detected while the detection level monitoring function is ON.	Check the connection of each terminal. (p. 110)



## 14.4 Discarding the Instrument

When disposing of this instrument, remove the lithium battery and dispose of battery and instrument in accordance with local regulations.



### WARNING

- To avoid electric shock, turn off the power switch and disconnect the power cord and measurement cables before removing the lithium battery.
- Battery may explode if mistreated. Do not short-circuit, recharge, disassemble or dispose of in fire.
- Keep batteries away from children to prevent accidental swallowing.



### CAUTION

If the protective functions of the instrument are damaged, either remove it from service or mark it clearly so that others do not use it inadvertently.

### Lithium Battery Removal

#### Required tools:

- One Phillips screwdriver
- One wire cutter (to remove the lithium battery)

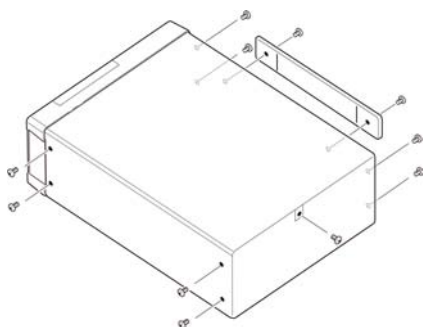

(Overhead View)

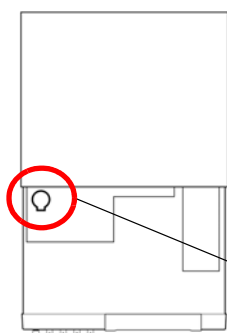

Lithium Battery

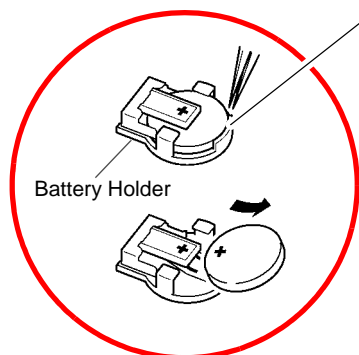

- 1 Verify that the power is off, and remove the connection cables and power cord.
- 2 Remove the six screws from the sides and one screw from the rear.
- 3 Remove the cover.
- 4 Insert the tweezers between the battery and battery holder as shown in the diagram below and lift up the battery.



### CAUTION

Take care not to short the + and -.  
Doing so may cause sparks.

#### CALIFORNIA, USA ONLY

This product contains a CR Coin Lithium Battery which contains Perchlorate Material - special handling may apply. See [www.dtsc.ca.gov/hazardouswaste/perchlorate](http://www.dtsc.ca.gov/hazardouswaste/perchlorate)



## Appendix

## Appendix 1 Measurement Parameters and Arithmetic Expressions

In general, impedance  $Z$  is used to evaluate the characteristics of, for example, circuit components. Measure voltage and current vectors for circuit components relative to AC measurement frequency signals. The unit uses these values to obtain the impedance  $Z$  and phase difference  $\theta$ . The following values can be obtained from impedance  $Z$  by rotating the impedance  $Z$  around the complex plane.

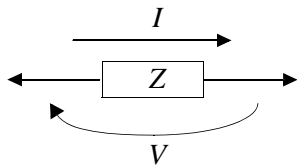

$$Z = R + jX$$

$$\theta = \tan^{-1} \frac{X}{R}$$

$$|Z| = \sqrt{R^2 + X^2}$$

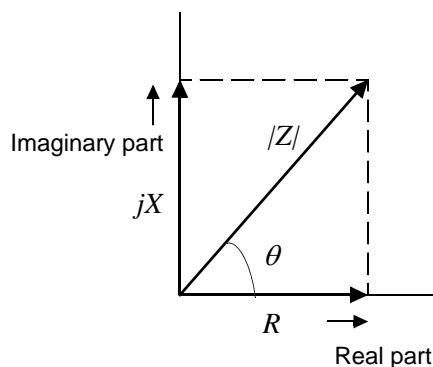

- $Z$  : Impedance ( $\Omega$ )
- $\theta$  : Phase angle (deg)
- $R$  : Resistance ( $\Omega$ )
- $X$  : Reactance ( $\Omega$ )
- $|Z|$  : Absolute value of impedance ( $\Omega$ )

Furthermore, admittance  $Y$  that is the reciprocal of impedance  $Z$  can also be used depending on the characteristics of circuit components. As in the case of impedance  $Z$ , the following values can also be obtained from admittance  $Y$  by rotating the admittance  $Y$  around the complex plane.

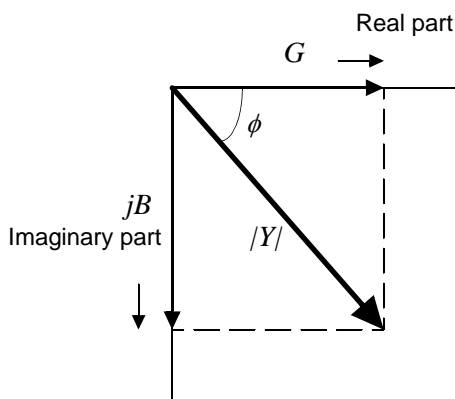

$$Y = G + jB$$

$$\phi = \tan^{-1} \frac{B}{G}$$

$$|Y| = \sqrt{G^2 + B^2}$$

- $Y$  : Admittance (S)
- $\phi$  : Phase angle (deg) =  $-\theta$
- $G$  : Conductance (S)
- $B$  : Susceptance (S)
- $|Y|$  : Absolute value of admittance (S)

# A2

## Appendix 1 Measurement Parameters and Arithmetic Expressions

From the voltage  $V$  which is applied between the terminals of the sample under test, the current  $I$  which flows through the test sample at this time, the phase angle  $\theta$  between this voltage  $V$  and this current  $I$ , and the angular velocity  $\omega$  which corresponds to the test frequency.

**NOTE** The phase angle  $\theta$  is shown based on the impedance  $Z$ . When measuring based on the admittance  $Y$ , the sign of the phase angle  $\theta$  must be reversed.

Item	Series equivalent circuit mode	Parallel equivalent circuit mode
Z	$ Z  = \frac{V}{I} \left( = \sqrt{R^2 + X^2} \right)$	
Y	$ Y  = \frac{I}{ Z } \left( = \sqrt{G^2 + B^2} \right)$	
R	$R_S = ESR =  Z  \cos \theta$	$R_P = \frac{I}{ Y  \cos \phi} \left( = \frac{I}{G} \right)^*$
X	$X =  Z  \sin \theta$	_____
G	_____	$G =  Y  \cos \phi^*$
B	_____	$B =  Y  \sin \phi^*$
L	$L_S = \frac{X}{\omega}$	$L_P = -\frac{I}{\omega B}$
C	$C_S = -\frac{I}{\omega X}$	$C_P = \frac{B}{\omega}$
D	$D = \frac{\cos \theta}{ \sin \theta }$	
Q	$Q = \frac{ \sin \theta }{\cos \theta} \left( = \frac{I}{D} \right)$	

\*  $\phi$ : phase angle of admittance  $Y$  ( $\phi = -\theta$ )

$L_s, R_s, C_s$ : The measured values of  $L, C,$  and  $R$  in series equivalent circuit mode.

$L_p, R_p, C_p$ : The measured values of  $L, C,$  and  $R$  in parallel equivalent circuit mode.

## Appendix 2 Measurement of High Impedance Components

The measured value obtained when testing a high impedance element (such as, for example, a resistor with resistance higher than 100 k $\Omega$ ) is sometimes unreliable, because such an element is vulnerable to the effects of external interference and the like. In this case, reliable testing can be performed by the use of guarding, that is, connecting a metallic plate to the GUARD terminal and carrying out the measurement on the metallic plate.

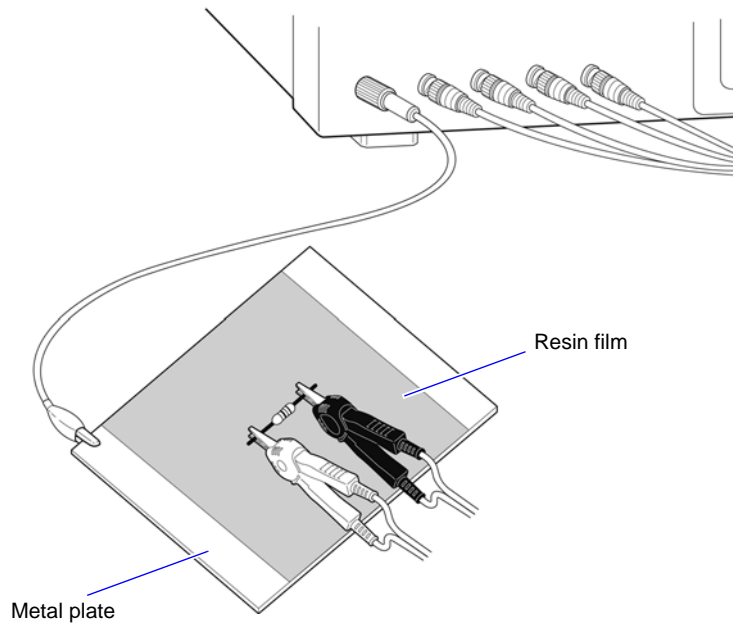

When measuring components on a metal plate, use, for example, resin film as insulation to ensure terminals and the like are not short-circuited.

**NOTE** Open circuit compensation is high impedance measurement, so be sure to use the shielding process. If it is not used, the compensation values may become unstable and affect the measurement values.

### Appendix 3 Measurement of In-circuit Components

Measure an in-circuit component after providing guarding.

$$R = R_2 \cdot \frac{R_3 + R_4}{R_2 + R_3 + R_4}$$

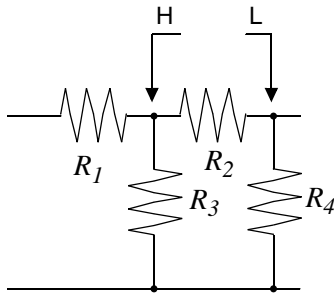

Referring to the following figure, when measuring a resistance value for the resistor  $R_2$ , even if the tips of the two probes are contacted against the ends of the resistor  $R_2$ , considering the sum of the current flowing through the resistor  $R_2$  and the current flowing through the resistors  $R_3$  and  $R_4$ , what is obtained is the resistance value for the parallel combination:

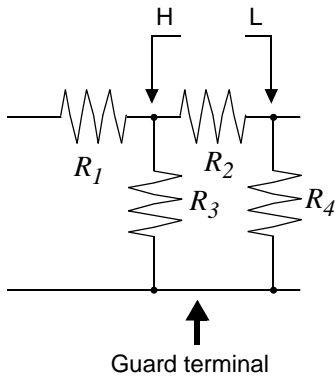

If as shown in the next figure a guard terminal is used, the current flowing through the resistors  $R_3$  (not flowing through  $R_4$ ) is absorbed by this guard terminal, so that the resistance value for the resistor  $R_2$  is accurately measured.

#### **NOTE**

- The accuracy of measurement will not be improved in cases where for example  $R_2 \gg R_3$  and  $R_3$  is close to zero.
- Individual elements cannot be isolated and measured separately in compound circuits consisting of the same element, for example two resistors as shown in the diagram. However, individual elements can be isolated and measured separately in compound circuits such as an inductor and capacitor by using the IM9000 Equivalent Circuit Analysis Firmware (option).

Isolated measurement is supported for five equivalent circuit models.

See "5.10.1 About the Equivalent Circuit Analysis Function" (p. 238)

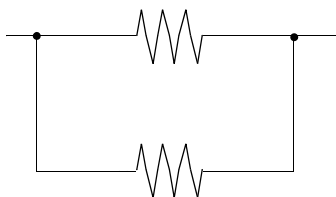

Two resistors in parallel

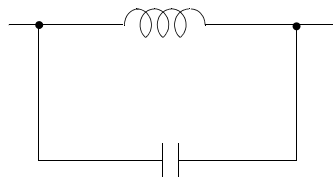

Coil and capacitor in parallel

## Appendix 4 Countermeasures Against Incorporation of External Noise

The unit is designed to be resistant to errors caused by interference from the test cables or the power supply line. However, if the level of the interference is particularly large, this can cause measurement errors or faulty operation.

Refer to the examples given below for examples of countermeasures which can be taken against interference which has caused faulty operation etc.

### Appendix 4.1 Countermeasures Against Incorporation of Noise from the Power Line

You can use the following countermeasures to reduce the effect of noise being incorporated from the power line.

#### Grounding Using a Protective Ground Wire

The unit is structured so that the ground wire of the power cable can be used as protective grounding for the unit. Protective grounding plays an important role in not only the prevention of electrical accidents but also the use of an internal filter to eliminate the incorporation of noise from the power line. Use the supplied power cord.

#### Attaching a Noise Filter to the Power Line

Connect a commercial plug-in noise filter to the power outlet and then connect the unit to the output of the noise filter in order to suppress the incorporation of noise from the power line. Plug-in noise filters are commercially available from various specialist manufacturers.

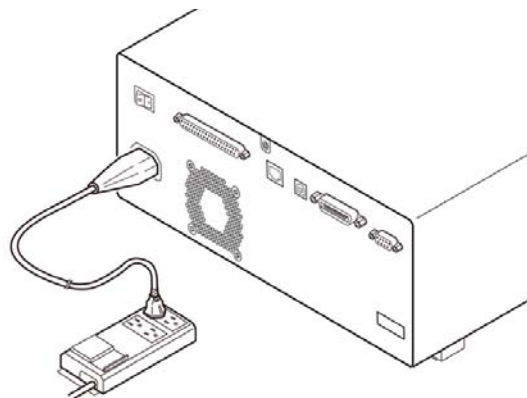

# A6

## Appendix 4 Countermeasures Against Incorporation of External Noise

### Attaching an EMI Suppression Ferrite Core to the Power Cord

Pass the power cord through a commercially available EMI suppression ferrite core and secure the core as close as possible to the AC power inlet of the unit in order to suppress the incorporation of noise from the power line.

Suppression is even more effective if you also attach an EMI suppression ferrite core close to the power plug of the power source.

If a toroidal ferrite core or split ferrite core with a large enough internal diameter is used, the amount of noise suppression can be increased by passing the power cord through the core several times.

EMI ferrite cores and ferrite beads are commercially available from various specialist manufacturers.

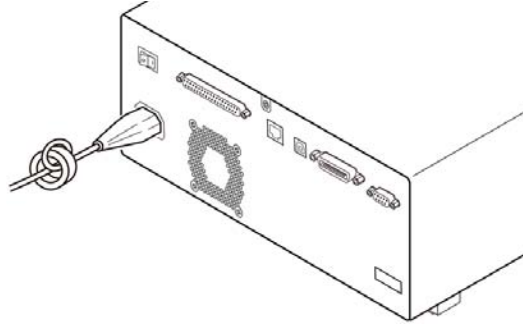

### Appendix 4.2 Countermeasures Against Noise from the measurement Cables

If interference is producing noise in the measurement cables, its influence can be moderated by the following countermeasure.

#### Fitting an anti-interference ferrite core on the measurement cables

Pass the test cables through a commercially available anti-interference ferrite core, and fix it close to the measurement terminals, so as to suppress noise from the measurement cables.

Moreover, if the internal diameter of the ferrite core allows, winding the measurement cables several times around the ferrite core (as with the power cord as described above) may further reduce the amount of noise.

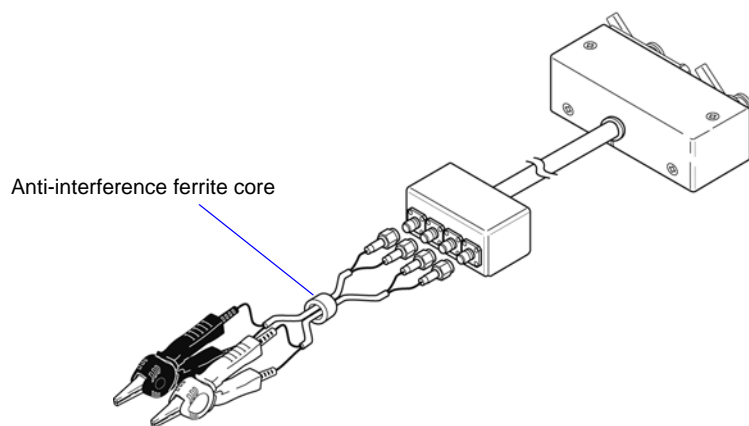



## Appendix 5 Supplying DC Bias

Supplying DC bias means that a DC voltage is supplied as a bias to a sample for test whose characteristics are voltage dependent, such as an electrolytic capacitor or a ceramic capacitor.

Further, a DC current can be supplied as a bias to a sample for test whose characteristics are current dependent, such as a choke coil.

This instrument does not provide a DC bias input terminal. DC bias should be applied using the method described below.

**CAUTION** A voltage must not be applied to the measurement terminals of the instrument from an external source.  
If a voltage is applied from an external source, the instrument may be damaged.

### Appendix 5.1 How to Supply a DC Bias Voltage

When you want to apply a DC voltage bias, refer to the following explanation.

Apply a DC voltage bias to a capacitor or other test sample as shown below.

#### DC Bias Voltage Circuit

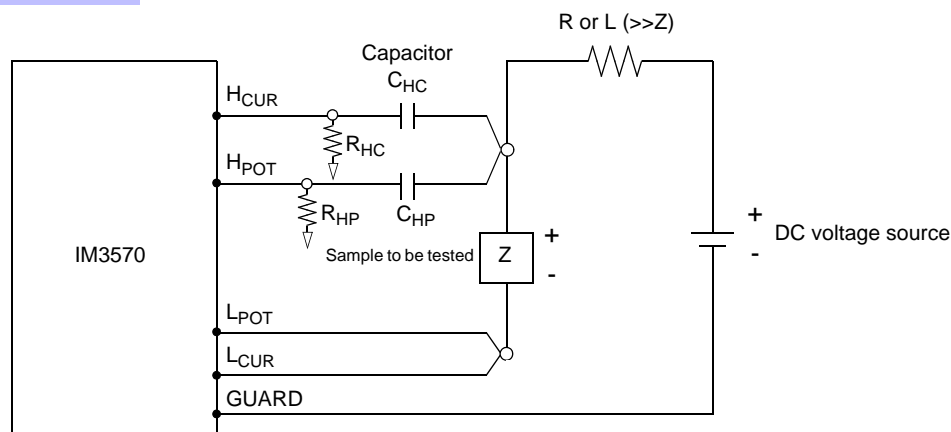

- Use a resistance (R) or inductance (L) which has a large enough impedance with reference to the sample under test (Z).
- A  $H_{CUR}$  side capacitor must have a small enough impedance (i.e. a large enough capacitance) relative to the output resistance ( $100\ \Omega$ ) while a  $H_{POT}$  capacitor must have a small enough impedance to the  $R_{HP}$ .
- Be careful about the polarity when connecting together the probes, the sample to be tested, and the DC voltage source.
- It takes a little time for the DC voltage which is being supplied to the sample under test to reach the set voltage, so you should wait for a certain stabilization time period (which depends upon the sample) before performing
- testing. Be careful, because if you perform testing before this stabilization time period has elapsed, the results will not be reliable.
- After testing is completed, drop the voltage of the DC voltage source to zero, and remove the sample under test from the probes after having discharged any electric charge which may have built up.
- If you have removed the sample under test from the probes without first having discharged the accumulated electric charge, you should be careful to do so immediately.

# A8

## Appendix 5 Supplying DC Bias

---

---

### **CAUTION**

- In order to avoid electric shock accident, be absolutely sure not to touch the test terminals while the DC bias voltage is being supplied to them.
  - If you disconnect the sample under test from the test terminals with the DC bias voltage still being supplied, then the test sample is left charged, which is very dangerous. In order to avoid electric shock accident, be absolutely sure to discharge the test sample.
  - Do not short circuit between the clips of the test probes with the DC bias voltage still being supplied. Doing so may damage the probes or cause a short circuit accident.
  - When measuring the element whose DC resistance is not high enough, DC current will flow to the main unit and the measurement will not be performed properly.
-

## Appendix 5.2 How to Supply a DC Bias Current

When you want to apply a DC current bias, refer to the following explanation.

With regards to a DC current bias for a transformer, choke coil, or other test sample, configure the external bias circuit as shown below.

### DC Bias Current Circuit

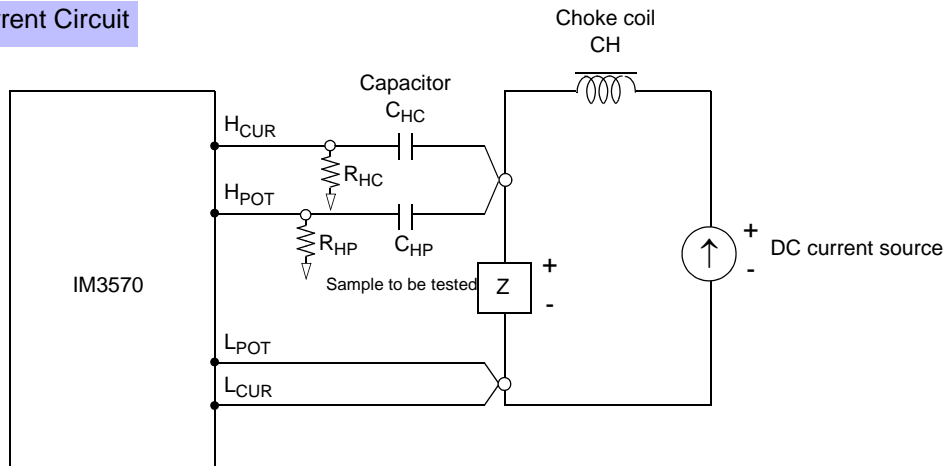

- Connect the sample to the measuring probe and then gradually raise the voltage of the DC source to the specified DC bias level. To disconnect the sample, gradually reduce the voltage of the DC source until the DC bias supplied to the sample is decreased to zero. You may disconnect the sample after this is achieved.
- Use a choke coil (CH) which has a large enough impedance with reference to the sample under test (Z).
- A H<sub>CUR</sub> side capacitor must have a small enough impedance (i.e. a large enough capacitance) relative to the output resistance (100 Ω) while a H<sub>POT</sub> capacitor must have a small enough impedance to the R<sub>HP</sub>.
- Be careful about the polarity when connecting together the probes, the sample to be tested, and the DC current source.
- Be careful not to magnetically saturate the choke coil (CH) with the DC bias current.
- It takes a little time for the DC current which is being supplied to the sample under test to reach the set value, so you should wait for a certain stabilization time period (which depends upon the sample) before performing testing. Be careful, because if you perform testing before this stabilization time period has elapsed, the results will not be reliable.

### **CAUTION**

- In order to avoid electric shock accident, be absolutely sure not to touch the test terminals while the DC bias is being supplied to them.
- Due to the inductance of the coil and the sample, counter electromotive force is generated when the sample is removed or inserted with the DC bias supplied. This may result in damage to the unit or to the DC source.
- When measuring the element whose DC resistance is high (incl. open state), a high voltage occurred on the H side may cause damage on the main unit.

### Appendix 6 The Residual Charge Protection Function

The unit has been enhanced by the incorporation of a residual charge protection function. If by mistake a charged capacitor is connected to the measurement terminals, this function protects the internal circuitry of the unit from discharge of such residual charge.

The maximum voltage from which the unit can be protected by this function is determined from the capacitance value of the sample under test by the following equation:

$$V = \sqrt{\frac{10}{C}}$$

V: voltage (volts) (maximum 400 VDC)

C: capacitance (farads)

#### **CAUTION**

- The quoted maximum voltage from which the unit can be protected by this function is for reference purposes only, and is not a guaranteed value. There may be danger of damage to the unit, depending upon the operational circumstances and upon how often such charged capacitors are connected. In general, you should not rely upon this protection function; be sure to discharge charged capacitors properly before connecting them to the test terminals.
- The residual charge protection function is for protection of the unit against the discharge of voltage present in charged capacitors, and is not capable of protecting the unit against DC voltage which is constantly applied such as a superimposed DC voltage. If this is done, there is a danger of damage to the unit.

**See:** Appendix 5 Supplying DC Bias (p.A7)

## Appendix 7 Series Equivalent Circuit Mode and Parallel Equivalent Circuit Mode

The instrument measures the current flowing to the test sample and the voltage at both ends of the test sample, and determines  $Z$  and  $\theta$ . Other measurement items such as  $L$ ,  $C$ , and  $R$  are calculated from  $Z$  and  $\theta$ . At this time, the mode for calculation becomes series equivalent circuit mode if the resistance components for  $C$  (or  $L$ ) are assumed to be in series, and the mode becomes parallel equivalent circuit mode if the resistance components for  $C$  (or  $L$ ) are assumed to be in parallel. It is, therefore, necessary to select the correct equivalent circuit mode to reduce errors because the calculation expression differs for series equivalent circuit mode and parallel equivalent circuit mode.

Generally, for measurement of a low impedance device (approx. less than  $100\ \Omega$ ) like a large capacitance capacitor or a low inductance, a series equivalent circuit mode will be selected. While, for a high impedance device (approx. more than  $10\ \text{k}\Omega$ ) like a small capacitance capacitor or a high inductance, a parallel equivalent circuit mode will be selected. When you are not sure about selection of circuit mode, please ask the parts maker. (ex. a impedance approx. between  $100\ \Omega$  and  $10\ \text{k}\Omega$ )

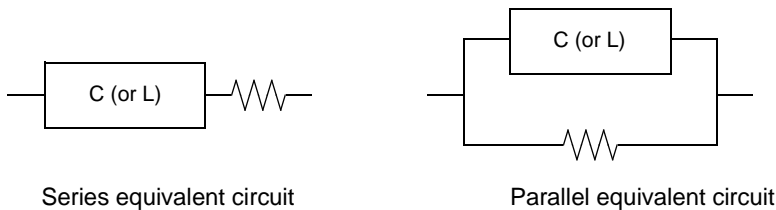

**NOTE** Because measurement value in each equivalent circuit mode is obtained through calculation, measurement values of both modes can be displayed. However, please note that the appropriate equivalent circuit depends on the test sample.

### Appendix 8 Selecting the Equivalent Circuit Model

When using the equivalent circuit function, it is important to select an appropriate equivalent circuit model. The following table provides examples of measurement targets and equivalent circuit models:

Measurement target		Corresponding equivalent circuit model
Inductor	Inductor with high core loss and low ESR	A
	Comparatively high ESR	B
Capacitor	Significant leak resistance effect	C
	Typical capacitor	D
Resistor	Low resistance value, significant inductance effect	B
	High resistance value, significant stray capacitance effect	C
Piezoelectric element	-	E

Since the models for which parameters can be accurately acquired varies with observed values, perform a simulation for estimated results and select the equivalent circuit model based on a comparison with observed values.

When automatically selecting the equivalent circuit model, it will not be possible to select the optimal model when the acquisition of frequency characteristics fails to yield local extreme values. Consequently, set the sweep range so that resonance characteristics can be accurately acquired.

## Appendix 9 Open Circuit Compensation and Short Circuit Compensation

The residual impedance component of the test fixture can be considered in terms of an equivalent circuit as shown in the figure. Further, because the measured value  $Z_m$  for impedance includes this residual component, therefore, in order to obtain the genuine impedance value, it is necessary to compensate the measured value in terms of the open circuit impedance residual component and the short circuit residual component, which accordingly must be obtained.

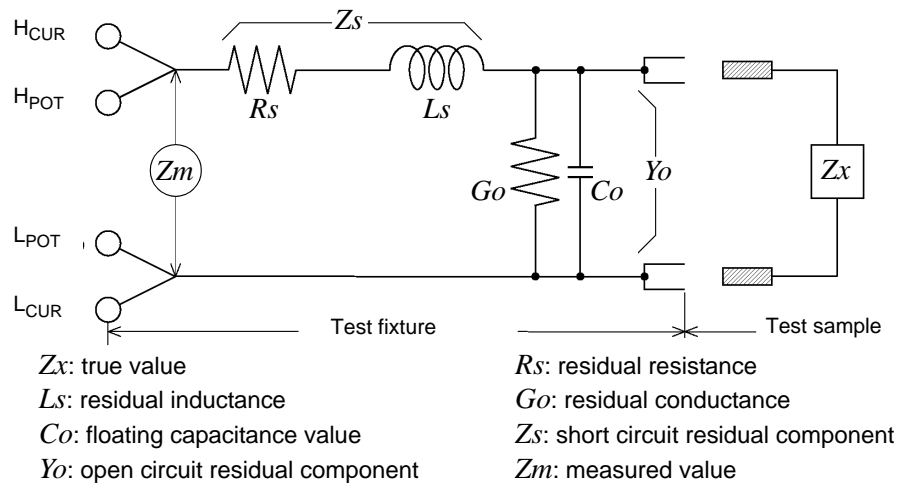

In this case, for the measured value  $Z_m$ :

$$Z_m = Z_s + \frac{1}{Y_o + \frac{1}{Z_x}}$$

The residual components can be determined in the following manner:

- **Open circuit compensation**

The terminals of the test fixture are left separated (open circuited). Because the short circuit residual component  $Z_s$  is now zero, therefore the open circuit residual component  $Y_o$  can be determined.

- **Short circuit compensation**

The terminals of the test fixture are connected together (short circuited).

Because the open circuit residual component  $Y_o$  is now zero, therefore the short circuit residual component  $Z_s$  can be determined.

These residual components thus obtained are recorded as compensation values, and the compensation process may then be performed by substituting them into the above equation.

**NOTE** The determination of test range is performed according to the measured value  $Z_m$  for impedance. Therefore it may happen that testing cannot be performed, when HOLD is on, if the test range is determined merely according to the value of impedance of the sample under test. In this case, you should set the test range in consideration both of the impedance of the test sample and also of the residual impedance components of the test fixture.

Deviations in the measured values can become comparatively large in the following cases:

- **If only short circuit compensation has been performed.**

With short circuit compensation only having been performed, since no compensation can be performed in terms of the open circuit residual component  $Y_o$  (which is not available), thereby deviation in the resultant values will become large if the value of that open circuit residual component  $Y_o$  is relatively large.

- **If only open circuit compensation has been performed.**

With open circuit compensation only having been performed, since no compensation can be performed in terms of the short circuit residual component  $Z_s$  (which is not available), thereby deviation in the resultant values will become large if the value of that short circuit residual component  $Z_s$  is relatively large.

In order to avoid this sort of thing, be sure always to perform both short circuit compensation and also open circuit compensation.

### Appendix 10 Rack Mounting

Rack mounting brackets can be attached to the instrument.



**WARNING** Observe the following precautions regarding the mounting screws to avoid instrument damage and electric shock accidents.

- When installing the Rack Mounting Plate, the screws must not intrude more than 6 mm into either side of the instrument.
- When removing the Rack Mounting Plate to return the instrument to stand-alone use, replace the same screws that were installed originally. (Feet: M3 x 6 mm, Sides: M4 x 6 mm)

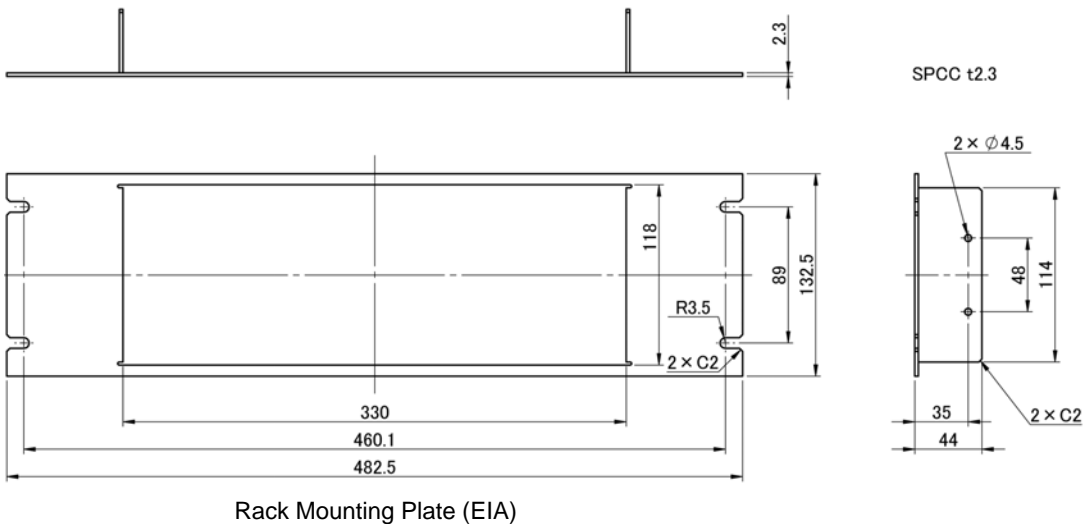
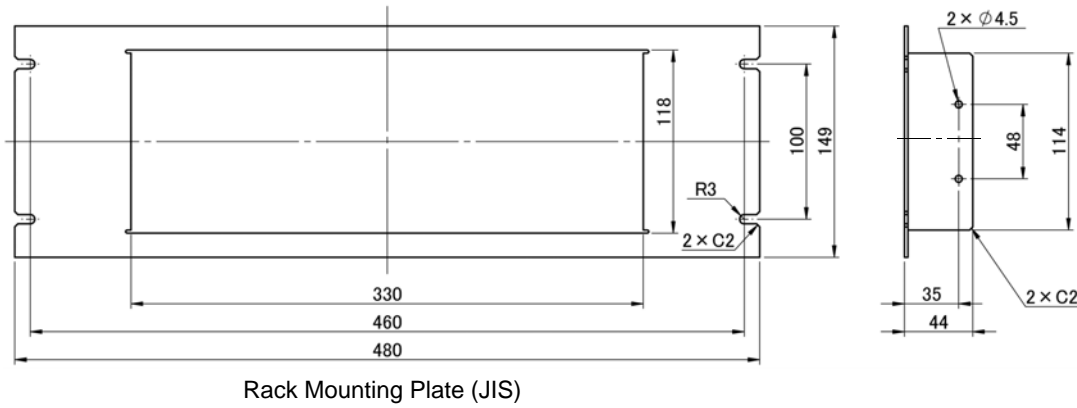
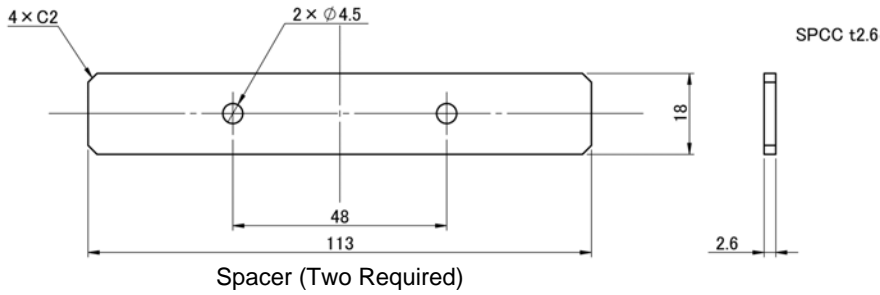



Installation Procedure

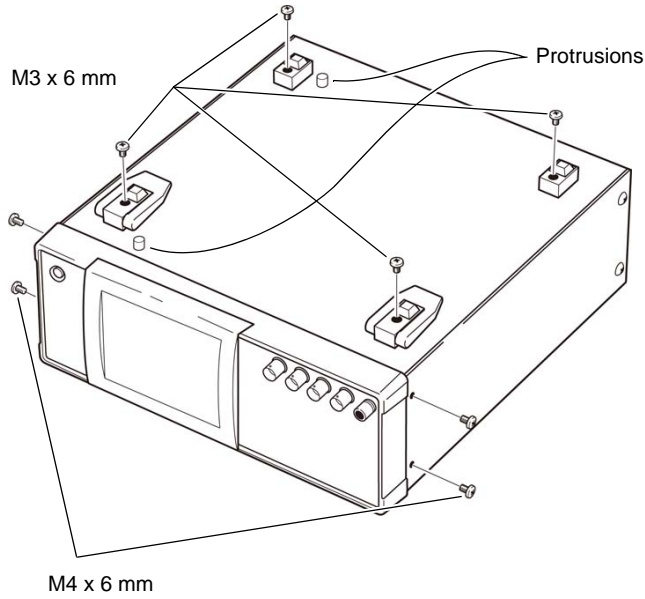

1. Remove the feed from the bottom of the instrument, and the screws from the sides (four near the front).

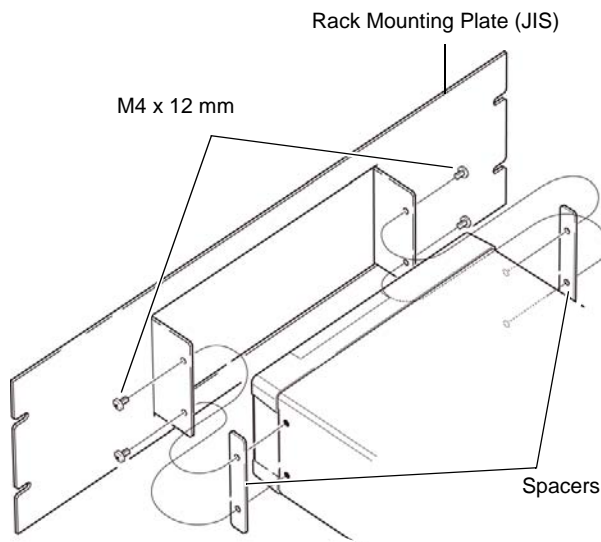

2. Installing the spacers on both sides of the instrument, affix the Rack Mounting Plate with the M4 x 12 mm screws.

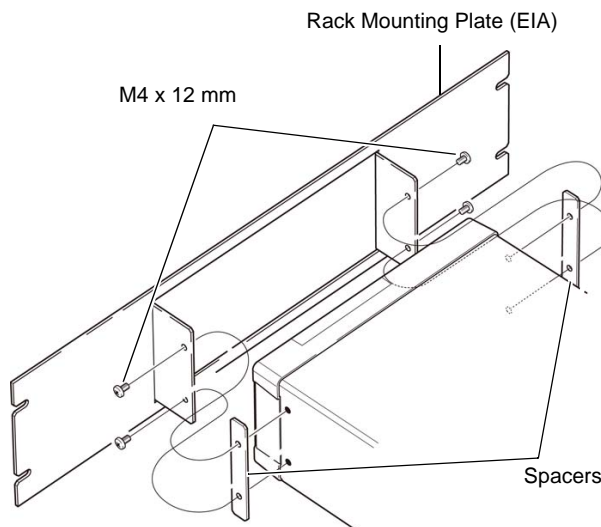

- When installing into the rack, reinforce the installation with a commercially available support stand.
- Please note that protrusions with a diameter of 6 mm protrude from the bottom of the instrument by 4 mm. For details on the positions of the protrusions, refer to the external view on the next page.

# A16

## Appendix 11 Dimensional Diagram

### Appendix 11 Dimensional Diagram

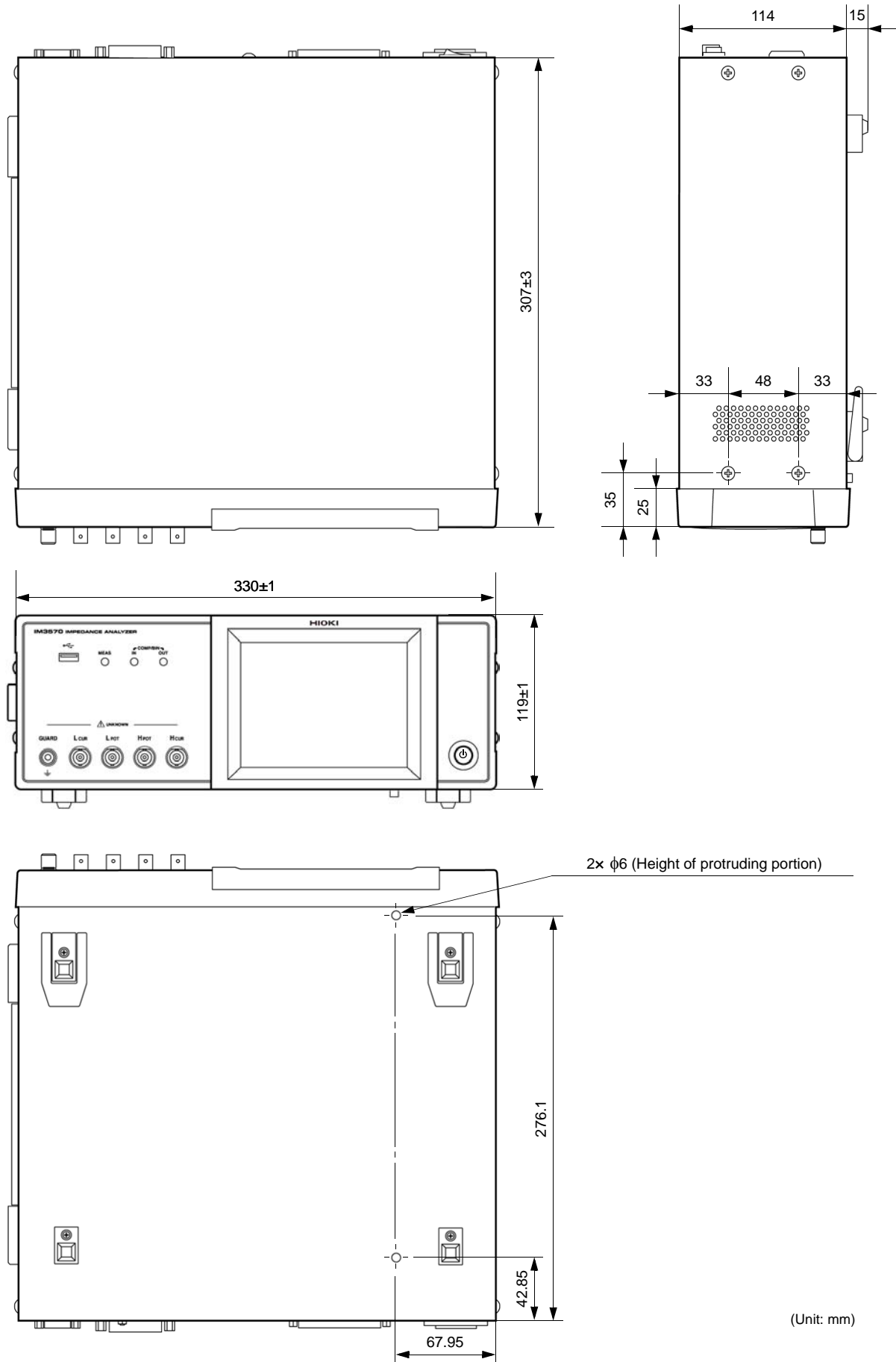

(Unit: mm)

## Appendix 12 Initial Settings Table

The following table shows the initial settings of the instrument.

Yes: Available/ ←: The same as the left/ No: Unavailable

\*1: When TYPE=ALL is set, the items indicated by Yes (ADJ) are also saved.

Setting Items		Initial setting	Unit Reset Operation Full reset	:PRESet	*RST	Return to initial settings when power is turned on	Panel Save/ Load*1		File Save/load	
							LCR mode	ANALYZER mode		
Measurement mode		LCR	←	←	←	No	Yes	Yes	Yes	
Measurement parameter		Z/OFF/θ/OFF	←	←	←	No	Yes	Yes	Yes	
Magnification display		OFF	←	←	←	No	No	No	Yes	
LCR basic settings	Measurement frequency		1 kHz	←	←	←	No	Yes	Yes	Yes
	Measurement signal level	Mode	V	←	←	←	No	Yes	Yes	Yes
		V	1.000 V	←	←	←	No	Yes	Yes	Yes
		CV	1.000 V	←	←	←	No	Yes	Yes	Yes
		CC	10.00 mA	←	←	←	No	Yes	Yes	Yes
	Measurement range	Mode	AUTO	←	←	←	No	Yes	Yes	Yes
		Range	100 Ω	←	←	←	No	Yes	Yes	Yes
		LOW Z	OFF	←	←	←	No	Yes	Yes	Yes
	Trigger mode		INT (Internal Trigger)	←	←	←	No	Yes	Yes	Yes
	DC bias	ON/OFF	OFF	←	←	←	No	Yes	Yes	Yes
		Bias value	0.00 V	←	←	←	No	Yes	Yes	Yes
	Measurement speed		MED	←	←	←	No	Yes	Yes	Yes
	Limit	ON/OFF	OFF	←	←	←	No	Yes	Yes	Yes
		Current limit value	100.00 mA	←	←	←	No	Yes	Yes	Yes
		Voltage limit value	5.000 V	←	←	←	No	Yes	Yes	Yes
	Number of times for average		1	←	←	←	No	Yes	Yes	Yes
Trigger delay		0.0000 s	←	←	←	No	Yes	Yes	Yes	
LCR DC resistance measurement	Measurement signal level	Mode	V	←	←	←	No	Yes	No	Yes
		V	1.00 V	←	←	←	No	Yes	No	Yes
		CV	1.00 V	←	←	←	No	Yes	No	Yes
		CC	10.00 mA	←	←	←	No	Yes	No	Yes
	Measurement range	Mode	AUTO	←	←	←	No	Yes	No	Yes
		Range	100 Ω	←	←	←	No	Yes	No	Yes
		LOW Z	OFF	←	←	←	No	Yes	No	Yes
	DC adjustment		ON	←	←	←	No	Yes	No	Yes
	Measurement speed		MED	←	←	←	No	Yes	No	Yes
	Limit	ON/OFF	OFF	←	←	←	No	Yes	No	Yes
		Current limit value	100.00 mA	←	←	←	No	Yes	No	Yes
		Voltage limit value	2.50 V	←	←	←	No	Yes	No	Yes
Number of times for average		1	←	←	←	No	Yes	No	Yes	
DC delay		0.0003 s	←	←	←	No	Yes	No	Yes	

# A18

## Appendix 12 Initial Settings Table

Yes: Available/ ←: The same as the left/ No: Unavailable  
 \*1: When TYPE=ALL is set, the items indicated by Yes (ADJ) are also saved.

Setting Items		Initial setting	Unit Reset Operation Full reset	:PRESet	*RST	Return to initial settings when power is turned on	Panel Save/ Load*1		File Save/load		
							LCR mode	ANALYZER mode			
Application settings	LCR judgment mode	OFF/COMP/BIN	OFF	←	←	←	No	Yes	Yes	Yes	
	Trigger synchronous output	ON/OFF	OFF	←	←	←	No	Yes	Yes	Yes	
		Trigger time	0.0010 s		←	←	←	No	Yes	Yes	Yes
	Memory	OFF/IN/ON	OFF	←	←	←	No	Yes	Yes	Yes	
		Number of memory items	1000		←	←	←	No	Yes	Yes	Yes
	HIGH-Z Reject	ON/OFF	OFF	←	←	←	No	Yes	Yes	Yes	
		Judgment reference value	1000%		←	←	←	No	Yes	Yes	Yes
	Detection level monitoring	ON/OFF	OFF	←	←	←	No	Yes	Yes	Yes	
		Detection level	10.00%		←	←	←	No	Yes	Yes	Yes
	Detection sensitivity for measurement errors		1		←	←	←	No	No	No	Yes
	Judgment result	Delay between judgment results and EOM	0.0000 s		←	←	←	No	No	No	Yes
		Reset	ON		←	←	←	No	No	No	Yes
	IO trigger	ENABLE	ON		←	←	←	No	No	No	Yes
		Edge	DOWN		←	←	←	No	No	No	Yes
	IO-EOM	Mode	HOLD		←	←	←	No	No	No	Yes
		EOM output time	0.0050 s		←	←	←	No	No	No	Yes
	Key-lock	ON/OFF	OFF		←	←	←	No	No	No	Yes
		Passcode	3570		←	←	←	No	No	No	Yes
	Display digits		6/6/6/6		←	←	←	No	Yes	Yes	Yes
	Backlight		ON		←	←	←	No	No	No	Yes
Beep sound	Judgment result	NG		←	←	←	No	Yes	Yes	Yes	
	Key	ON		←	←	←	No	No	No	Yes	
LCR Comparator	Mode		ABS/ABS	←	←	←	No	Yes	No	Yes	
	Absolute value mode	Upper limit value	OFF/OFF	←	←	←	No	Yes	No	Yes	
		Lower limit value	OFF/OFF		←	←	←	No	Yes	No	Yes
	Percent mode	Reference value	1.000000k/10.00000		←	←	←	No	Yes	No	Yes
		Upper limit value	OFF/OFF		←	←	←	No	Yes	No	Yes
Lower limit value		OFF/OFF		←	←	←	No	Yes	No	Yes	
BIN	Mode		ABS/ABS	←	←	←	No	Yes	No	Yes	
	Absolute value mode	Upper limit value	OFF/OFF	←	←	←	No	Yes	No	Yes	
		Lower limit value	OFF/OFF		←	←	←	No	Yes	No	Yes
	Percent mode	Reference value	1.000000k/10.00000		←	←	←	No	Yes	No	Yes
		Upper limit value	OFF/OFF		←	←	←	No	Yes	No	Yes
		Lower limit value	OFF/OFF		←	←	←	No	Yes	No	Yes

## Appendix 12 Initial Settings Table

Yes: Available/ ←: The same as the left/ No: Unavailable  
 \*1: When TYPE=ALL is set, the items indicated by Yes (ADJ) are also saved.

Setting Items		Initial setting	Unit Reset Operation Full reset	:PRESet	*RST	Return to initial settings when power is turned on	Panel Save/ Load*1		File Save/ load	
							LCR mode	ANALYZER mode		
ANALYZER Basic settings	Sweep parameter	Z-θ	←	←	←	No	No	Yes	Yes	
	Main sweep parameter	FREQ	←	←	←	No	No	Yes	Yes	
	Trigger	REPEAT	←	←	←	No	No	Yes	Yes	
	Display timing	REAL	←	←	←	No	No	Yes	Yes	
	Trigger delay	0.0000 s	←	←	←	No	No	Yes	Yes	
	Segment sweep	OFF	←	←	←	No	No	Yes	Yes	
	Normal sweep	Sweep method	START-STOP	←	←	←	No	No	Yes	Yes
		Sweep start value	1 kHz	←	←	←	No	No	Yes	Yes
		Sweep end value	1 MHz	←	←	←	No	No	Yes	Yes
		Number of points	201	←	←	←	No	No	Yes	Yes
		Setting method of measurement points	LOG	←	←	←	No	No	Yes	Yes
	Sweep signal	1.000 V (V mode)	←	←	←	No	No	Yes	Yes	
	Measurement range	AUTO	←	←	←	No	No	Yes	Yes	
	Measurement speed	MED	←	←	←	No	No	Yes	Yes	
	Number of times for average	1	←	←	←	No	No	Yes	Yes	
	Point delay	0.0000 s	←	←	←	No	No	Yes	Yes	
DC bias	ON/OFF	OFF	←	←	←	No	No	Yes	Yes	
	Bias value	0 V	←	←	←	No	No	Yes	Yes	
Analyzer graph settings	Horizontal	Overwrite	OFF	←	←	←	No	No	Yes	Yes
		Scale	LOG	←	←	←	No	No	Yes	Yes
		Span	SINGLE	←	←	←	No	No	Yes	Yes
	Vertical	Color	1/2	←	←	←	No	No	Yes	Yes
		Scale	LINEAR	←	←	←	No	No	Yes	Yes
		Scale mode	AUTO	←	←	←	No	No	Yes	Yes
Grid display	PARA1	←	←	←	No	No	Yes	Yes		
ANALYZER Comparator settings	Mode	OFF	←	←	←	No	No	Yes	Yes	
	Parameter	PARA1	←	←	←	No	No	Yes	Yes	
	Area display	PARA1	←	←	←	No	No	Yes	Yes	
	Peak No. to judge	Local minimum	1	←	←	←	No	No	Yes	Yes
		Local maximum	1	←	←	←	No	No	Yes	Yes
	Filter for peak search	OFF/ON	ON	←	←	←	No	No	Yes	Yes
	Reference value settings	MEAS VALUE REFERENCE	←	←	←	No	No	Yes	Yes	
	Reference value	1.000000k	←	←	←	No	No	Yes	Yes	
	Area Judgment	Upper limit value	OFF/OFF	←	←	←	No	No	Yes	Yes
		Lower limit value	OFF/OFF	←	←	←	No	No	Yes	Yes
	Peak Judgment	Left limit value	OFF/OFF	←	←	←	No	No	Yes	Yes
		Right limit value	OFF/OFF	←	←	←	No	No	Yes	Yes
Upper limit value		OFF/OFF	←	←	←	No	No	Yes	Yes	
Lower limit value		OFF/OFF	←	←	←	No	No	Yes	Yes	

## Appendix 12 Initial Settings Table

Yes: Available/ ←: The same as the left/ No: Unavailable  
 \*1: When TYPE=ALL is set, the items indicated by Yes (ADJ) are also saved.

Setting Items		Initial setting	Unit Reset Operatio n Full reset	:PRESet	*RST	Return to initial settings when power is turned on	Panel Save/ Load*1		File Save/ load		
							LCR mode	ANALY ZER mode			
Analyzer cursor and search settings	Cursor display	ON/OFF	OFF	←	←	←	No	No	Yes	Yes	
	Cursor to move		A	←	←	←	No	No	Yes	Yes	
	Cursor A	Search mode	L-MAX	←	←	←	No	No	Yes	Yes	
		Parameter	PARA1	←	←	←	No	No	Yes	Yes	
		Target value	0.000000	←	←	←	No	No	Yes	Yes	
	Cursor B	Search mode	L-MAX	←	←	←	No	No	Yes	Yes	
		Parameter	PARA1	←	←	←	No	No	Yes	Yes	
		Target value	0.000000	←	←	←	No	No	Yes	Yes	
Filter	ON/OFF	ON	←	←	←	No	No	Yes	Yes		
Auto search	ON/OFF	OFF	←	←	←	No	No	Yes	Yes		
Equivalent circuit analysis function (optional IM9000)	Model selection method		OFF	←	←	←	No	No	Yes	Yes	
	Equivalent circuit model		A	←	←	←	No	No	Yes	Yes	
	Analysis execution method		MANUAL	←	←	←	No	No	Yes	Yes	
	Analysis start frequency		4 Hz	←	←	←	No	No	Yes	Yes	
	Analysis stop frequency		5 MHz	←	←	←	No	No	Yes	Yes	
	Segment to analyze		ALL	←	←	←	No	No	Yes	Yes	
	Electromechanical coupling coefficient (K)	Oscillation mode		Kr	←	←	←	No	No	Yes	Yes
		Frequency type		fs-fp	←	←	←	No	No	Yes	Yes
		Coefficient a		0.395000	←	←	←	No	No	Yes	Yes
		Coefficient b		0.574000	←	←	←	No	No	Yes	Yes
	Display position		LEFT	←	←	←	No	No	Yes	Yes	
	Estimated value	R1		0.0	←	←	←	No	No	Yes	Yes
L1			0.0	←	←	←	No	No	Yes	Yes	
C1			0.0	←	←	←	No	No	Yes	Yes	
C0			0.0	←	←	←	No	No	Yes	Yes	
Equivalent circuit analysis comparator function (optional IM9000)	Comparator	ON/OFF	OFF	←	←	←	No	No	Yes	Yes	
	R1	Upper limit value	OFF	←	←	←	No	No	Yes	Yes	
		Lower limit value	OFF	←	←	←	No	No	Yes	Yes	
	L1	Upper limit value	OFF	←	←	←	No	No	Yes	Yes	
		Lower limit value	OFF	←	←	←	No	No	Yes	Yes	
	C1	Upper limit value	OFF	←	←	←	No	No	Yes	Yes	
		Lower limit value	OFF	←	←	←	No	No	Yes	Yes	
	C0	Upper limit value	OFF	←	←	←	No	No	Yes	Yes	
Lower limit value		OFF	←	←	←	No	No	Yes	Yes		
Qm	Upper limit value	OFF	←	←	←	No	No	Yes	Yes		
	Lower limit value	OFF	←	←	←	No	No	Yes	Yes		
Continuous measurement	Measurement target	ON/OFF	ON	←	←	←	No	No	No	No	
	Display timing		REAL	←	←	←	No	No	No	Yes	
	Trigger		SEQUENTIAL	←	←	←	No	No	No	Yes	
	Measurement halt at FAIL judgment result		OFF	←	←	←	No	No	No	Yes	
Open circuit compensation	Compensation mode		OFF	←	No Change	OFF	No	Yes (ADJ)	Yes (ADJ)	Yes	
	Parameter type		G-B	←	No Change	G-B	No	Yes (ADJ)	Yes (ADJ)	Yes	
	Correction value	G Correction value		0.0000nS	←	No Change	0.0000 nS	No	Yes (ADJ)	Yes (ADJ)	Yes
		B Correction value		0.0000nS	←	No Change	0.0000 nS	No	Yes (ADJ)	Yes (ADJ)	Yes
	Open compensation conditions		All valid	←	No Change	All valid	No	Yes (ADJ)	Yes (ADJ)	Yes	

## Appendix 12 Initial Settings Table

Yes: Available/ ←: The same as the left/ No: Unavailable  
 \*1: When TYPE=ALL is set, the items indicated by Yes (ADJ) are also saved.

Setting Items		Initial setting	Unit Reset Operation Full reset	:PRESet	*RST	Return to initial settings when power is turned on	Panel Save/ Load*1		File Save/load	
							LCR mode	ANALYZER mode		
Short circuit compensation	Compensation mode		OFF	←	No Change	OFF	No	Yes (ADJ)	Yes (ADJ)	Yes
	Parameter type		Rs-X	←	No Change	Rs-X	No	Yes (ADJ)	Yes (ADJ)	Yes
	Correction value	R Correction value	0.000 mΩ	←	No Change	0 Ω	No	Yes (ADJ)	Yes (ADJ)	Yes
		X Correction value	0.000 mΩ	←	No Change	0 Ω	No	Yes (ADJ)	Yes (ADJ)	Yes
	Short compensation conditions		All valid	←	No Change	All valid	No	Yes (ADJ)	Yes (ADJ)	Yes
Load circuit compensation	ON/OFF		OFF	←	No Change	OFF	No	Yes (ADJ)	Yes (ADJ)	Yes
	Compensation mode		Z-θ	←	No Change	Z-θ	No	Yes (ADJ)	Yes (ADJ)	Yes
	Reference value	Impedance reference value	OFF	←	No Change	OFF	No	Yes (ADJ)	Yes (ADJ)	Yes
		Phase reference value	OFF	←	No Change	OFF	No	Yes (ADJ)	Yes (ADJ)	Yes
	Compensation frequency		OFF	←	No Change	OFF	No	Yes (ADJ)	Yes (ADJ)	Yes
	Compensation signal level	Mode	V	←	No Change	V	No	Yes (ADJ)	Yes (ADJ)	Yes
		V	OFF	←	No Change	OFF	No	Yes (ADJ)	Yes (ADJ)	Yes
		CV	OFF	←	No Change	OFF	No	Yes (ADJ)	Yes (ADJ)	Yes
		CC	OFF	←	No Change	OFF	No	Yes (ADJ)	Yes (ADJ)	Yes
	Compensation range	Range	OFF	←	No Change	OFF	No	Yes (ADJ)	Yes (ADJ)	Yes
		LOW Z	OFF	←	No Change	OFF	No	Yes (ADJ)	Yes (ADJ)	Yes
	Compensation DC bias	ON/OFF	OFF	←	No Change	OFF	No	Yes (ADJ)	Yes (ADJ)	Yes
		Bias value	0.00 V	←	No Change	OFF	No	Yes (ADJ)	Yes (ADJ)	Yes
	Compensation value	Impedance coefficient	OFF	←	No Change	OFF	No	Yes (ADJ)	Yes (ADJ)	Yes
		Phase coefficient	OFF	←	No Change	OFF	No	Yes (ADJ)	Yes (ADJ)	Yes
	Cable length compensation		0 m	←	No Change	0 m	No	Yes (ADJ)	Yes (ADJ)	Yes
	Scaling compensation	ON/OFF		OFF	←	No Change	OFF	No	Yes (ADJ)	Yes (ADJ)
Compensation value		A	1.0000	←	No Change	1.0000	No	Yes (ADJ)	Yes (ADJ)	Yes
		B	0.000000	←	No Change	0.000000	No	Yes (ADJ)	Yes (ADJ)	Yes

## Appendix 12 Initial Settings Table

Yes: Available/ ←: The same as the left/ No: Unavailable  
 \*1: When TYPE=ALL is set, the items indicated by Yes (ADJ) are also saved.

Setting Items		Initial setting	Unit Reset Operation Full reset	:PRESet	*RST	Return to initial settings when power is turned on	Panel Save/ Load*1		File Save/ load	
							LCR mode	ANALYZER mode		
Interface	RS-232C	Baud rate	9600	←	No Change	No Change	No	No	No	Yes
		Terminator	CR+LF	←	No Change	No Change	No	No	No	Yes
		Handshake	OFF	←	No Change	No Change	No	No	No	Yes
	GPIB	Terminator	LF	←	No Change	No Change	No	No	No	Yes
		Address	01	←	No Change	No Change	No	No	No	Yes
	USB	Terminator	CR+LF	←	No Change	No Change	No	No	No	Yes
	LAN	IP address	192.168.000.001	←	No Change	No Change	No	No	No	Yes
		Subnet mask	255.255.255.000	←	No Change	No Change	No	No	No	Yes
		Gateway	OFF	←	No Change	No Change	No	No	No	Yes
		Port	3570	←	No Change	No Change	No	No	No	Yes
		Terminator	CR+LF	←	No Change	No Change	No	No	No	Yes
	Printer	Mode	MANUAL	←	No Change	No Change	No	No	No	Yes
		Type	TEXT	←	No Change	No Change	No	No	No	Yes
	Header		OFF	←	No Change	OFF	Yes	No	No	Yes
	Status Byte register		0	No Change	No Change	No Change	Yes	No	No	Yes
	Event register		0	No Change	No Change	No Change	Yes	No	No	Yes
	Enable register		0	No Change	No Change	No Change	Yes	No	No	Yes
	:MEASure:ITEM		0,0	←	←	←	No	Yes	Yes	Yes
	:MEASure:VALid		14	←	←	←	No	Yes	Yes	Yes
	Automatic output of measurement values		OFF	←	←	←	No	No	No	Yes
Transfer format		ASCII	←	←	←	No	No	No	Yes	
Long format		OFF	←	←	←	No	No	No	Yes	
File	Save Format		OFF	←	←	←	No	No	No	Yes
	Save folder		AUTO	←	←	←	No	No	No	Yes
	Header	Date and time	ON	←	←	←	No	No	No	Yes
		Measurement conditions	ON	←	←	←	No	No	No	Yes
		Measurement parameters	ON	←	←	←	No	No	No	Yes
		Delimiter	, (Comma)	←	←	←	No	No	No	Yes
Quote	" (Double quote)	←	←	←	No	No	No	Yes		
Touch panel compensation		No compensation	←	No Change	No Change	No	No	No	No	
Clock		-	No Change	No Change	No Change	No	No	No	No	
Panel	Save type		ALL	←	←	←	No	No	No	Yes
	Panel		No registration	Clear all data	No Change	Clear all data	No	No	No	Only when ALL SAVE



## Appendix 13 Device Compliance Statement

"Information on compliance to standards" based on the IEEE 488.2 standard

Item	Description
1. IEEE 488.1 interface functions	<b>See</b> Communication Instruction Manual (CD)
2. Operation with a device address other than 0 through 30	Such a setting is not possible.
3. Timing of changed device address recognition	A change of address is recognized immediately after changing.
4. Device settings at power on	The status information is cleared, and all other items are preserved. However, the header on/off setting, and response message separator and terminator are all reinitialized.
5. List of message exchange options	<ul style="list-style-type: none"> <li>• Input buffer capacity and operation</li> </ul> <b>See</b> Included CD  Queries to which multiple response message units are returned :BIN:FLIMit:ABSolute? ..... 2 :BIN:FLIMit:DEVIation? ..... 2 :BIN:FLIMit:PERcent? ..... 2 :BIN:SLIMit:ABSolute? ..... 2 :BIN:SLIMit:DEVIation? ..... 2 :BIN:SLIMit:PERcent? ..... 2 :COMParator:FLIMit:ABSolute? ..... 2 :COMParator:FLIMit:DEVIation? ..... 3 :COMParator:FLIMit:PERcent? ..... 3 :COMParator:SLIMit:ABSolute? ..... 2 :COMParator:SLIMit:DEVIation? ..... 3 :COMParator:SLIMit:PERcent? ..... 3 :CORRection:LOAD:CONDition? ..... 7 :CORRection:LOAD:DCResistance:CONDition? ..... 4 :CORRection:LOAD:REFerence? ..... 3 :CORRection:SCALE:DATA? ..... 2 :FILE:INFOrmation? ..... 5 :MEASure? ..... * :MEASure:ITEM? ..... 2 :MONItor? ..... 4 :SYSTem:DATE? ..... 3 :SYSTem:TIME? ..... 3 :COMParator:AREA:FIX? ..... 4 :COMParator:AREA:LIMit? ..... 2 :COMParator:AREA:MEAS? ..... 3 :COMParator:PEAK? ..... 4 :COMParator:PEAK:NO? ..... 2

## Appendix 13 Device Compliance Statement

Item	Description
	<pre> :GRAPH:VERTical:CENTerdiv? ..... 2 :GRAPH:VERTical:UPPerlower? ..... 2 :LIST:CENTerspan? ..... 3 :LIST:INTerval? ..... 3 :LIST:STARt:STEP? ..... 3 :LIST:STARt:STOP? ..... 4 :MEASure:COMParator:PEAK:MAX? ..... * :MEASure:COMParator:PEAK:MIN? ..... * :SEGment:STARt:STOP? ..... 4 :MEASure:CONTinuous:PEAK? ..... *           </pre> <p>* The number of response messages varies depending on the settings.</p> <ul style="list-style-type: none"> <li>• Queries producing responses as syntax checking is performed: All queries produce responses when syntax checking is performed.</li> <li>• Whether any queries produce responses when read: There are no queries which produce response messages at the instant they are read in by the controller.</li> <li>• Whether any commands are coupled: There are no relevant commands.</li> </ul>
<p>6. Summary of functional elements for use when constructing device specific commands, and whether compound commands or program headers can be used:</p>	<p>The followings can be used</p> <ul style="list-style-type: none"> <li>• Program message</li> <li>• Program message terminator</li> <li>• Program message unit</li> <li>• Program message unit separator</li> <li>• Command message unit</li> <li>• Query message unit</li> <li>• Command program header</li> <li>• Query program header</li> <li>• Program data</li> <li>• Character program data</li> <li>• Decimal program data</li> <li>• Compound commands and program headers</li> </ul>
<p>7. Buffer capacity limitations for block data</p>	<p>Block data is not used.</p>
<p>8. Summary of program data elements used in expressions, and deepest nesting level allowable in sub-expressions, including syntax restrictions imposed by the device.</p>	<p>Sub-expressions are not used. Character data and decimal data are the only program data elements used.</p>
<p>9. Response syntax for queries</p>	<p><a href="#">See</a> Included CD</p>
<p>10. Transmission congestion relating to device-to-device messages which do not conform to the general principles for basic response messages</p>	<p>There are no device to device messages.</p>
<p>11. Response capacity for block data</p>	<p>Block data does not appear in responses.</p>
<p>12. Summary of standard commands and queries used</p>	<p><a href="#">See</a> Included CD</p>
<p>13. Device state after a calibration query has been completed without any problem</p>	<p>The "<a href="#">*CAL?</a>" query is not used.</p>
<p>14. Existence/nonexistence of "<a href="#">*DDT</a>" command</p>	<p>The "<a href="#">*DDT</a>" query is not used.</p>
<p>15. Existence/nonexistence of macro command</p>	<p>Macros are not used.</p>

## Appendix 13 Device Compliance Statement

Item	Description
16. For queries related to identification, explanation of the response to the " <b>*IDN?</b> " query	See Included CD
17. Capacity of the user data storage area reserved for when the " <b>*PUD</b> " command and the " <b>*PUD?</b> " query are being executed	The " <b>*PUD</b> " command and the " <b>*PUD?</b> " query are not used. Further, there is no user data storage area.
18. Resources when the " <b>*RDT</b> " command and the " <b>*RDT?</b> " query are being used	The " <b>*RDT</b> " command and the " <b>*RDT?</b> " query are not used. Further, there is no user data storage area.
19. Conditions which are influenced when " <b>*RST</b> ", " <b>*LRN?</b> ", " <b>*RCL?</b> ", and " <b>*SAV</b> " are used	" <b>*LRN?</b> ", " <b>*RCL?</b> ", and " <b>*SAV</b> " are not used. The " <b>*RST</b> " command returns the unit to its initial state. See Included CD
20. Scope of the self-testing executed as a result of the " <b>*TST?</b> " query	See Included CD
21. Additional organization of the status data used in a device status report	See Included CD
22. Whether commands are overlap or sequential type	All commands except <b>:MEASure?</b> , <b>:MEMory?</b> , <b>:CORrection:OPEN</b> , <b>:CORrection:SHORT</b> , and <b>:CORrection:LOAD</b> are sequence commands.
23. Criterion relating to the functions required at the instant that the termination message is produced, as a response to each command	Termination occurs when the command has been parsed.

# A26

## Appendix 13 Device Compliance Statement

---

---

# Index

## A

Accuracy .....	395
All Compensation .....	274, 282
ANALYZER measurement .....	A131
Area Judgment .....	197
Arithmetic Expressions .....	A1
AUTO .....	49, 69, 160
Average .....	62, 80, 165

## B

Beep Sounds .....	128, 234
BIN .....	93

## C

Cable Length Compensation .....	301
CC .....	43, 66
Changing a Panel Name .....	324
Cleaning .....	403, 404
Comparator .....	86, 197
Constant current .....	43, 66
Constant voltage .....	43, 66
Continuous Measurement .....	265
Copy of the Screen .....	341
Current limit .....	60, 78
Cursor .....	188
Cursor Display .....	189
Cursor Move .....	190
CV .....	43, 66

## D

Date .....	314
DC bias .....	57, A7
DC delay .....	82
DC Resistance .....	65
Deleting a Panel .....	326
Deviation Percentage .....	91, 101
dgt. ....	3
Dimensional Diagram .....	16
Discarding .....	409
Display Timing .....	139, 269
Draw Color .....	181

## E

Editing Judgment Points .....	217
-------------------------------	-----

EMI Suppression .....	6
Enlarging Display .....	126
Equivalent Circuit Analysis .....	238
Error display .....	407
EXT I/O	
Connection Examples .....	378
EXT I/O Connector .....	364
External Control .....	363
Q&A .....	380
External Interference .....	A5
External trigger .....	55

## F

f.s. ....	3
FAST .....	59, 77, 164, 174
File Operation .....	331
Fixture .....	30
Folder .....	344, 360
Format .....	357
Frequency .....	41
Full Reset .....	406

## G

Grid .....	186
Guarding .....	3

## H

High Impedance Components .....	A3
HIGH-Z Reject .....	108, 222
HOLD .....	49, 69, 160
Horizontal Axis Scale .....	177

## I

In-circuit Components .....	A4
Initial Screen .....	12, 38, 132, 265
Initial Settings .....	A17
Initializing .....	129, 237, A17
Inspection and Repair .....	403
Instrument Installation .....	4
Interface .....	305
Internal Circuitry .....	376
Internal Trigger .....	55

---

---

**K**

---

Key-lock Function ..... 121, 230

---

**L**

---

LCD ..... 15, 19, 20, 127, 233, 272

LCR ..... 37

Limit value ..... 60, 78

Load Compensation ..... 288

Low Z High Accuracy Mode ..... 53, 73

---

**M**

---

Manual Scaling ..... 184

Measurement accuracy ..... 395

Measurement Cable ..... 30

Measurement categories ..... 3

Measurement frequency ..... 41

Measurement Mode ..... 13

Measurement Range ..... 49, 69, 395

Measurement signal level ..... 43, 66

Measurement speed ..... 59, 77

Measurement Times ..... 399

MED ..... 59, 77, 164, 174

---

**N**

---

Noise ..... A5

Normal Sweep ..... 143

Number of Display Digits ..... 124

---

**O**

---

Open Circuit Compensation ..... 273, A13

Options ..... 393

Overwrite ..... 176

---

**P**

---

Panel Compensation ..... 308

Panel Load ..... 322

Panel Save ..... 317

Panel Test ..... 307

Parallel Equivalent Circuit Mode ..... A11

Parameter ..... 39, 133

Peak Judgment ..... 208

Percentage ..... 89, 98

Point Delay ..... 166

Power Line ..... A5

Pre-Operation Inspection ..... 28

Printer ..... 381

Printing ..... 384

Probe ..... 30

---

**R**

---

Rack Mounting ..... 14

Range ..... 49, 69, 160

rdg. .... 3

Replaceable Parts ..... A403

Residual Charge Protection ..... A10

ROM/RAM Test ..... 312

---

**S**

---

Saving Measurement Results ..... 106, 219

Scaling ..... 302

Screen Display Test ..... 310

Search ..... 190, 194

Search Target ..... 191

Segment ..... 169

Segment Sweep ..... 169

Self-test ..... 28

Series Equivalent Circuit Mode ..... A11

Set the date and time ..... 314

Setting Continuous Measurement ..... 266

Short Circuit Compensation ..... 280, A13

Signal ..... 367

Signal level ..... 43, 66, 157

Signal Pinouts ..... 364

SLOW ..... 59, 77, 164, 174

SLOW2 ..... 59, 77, 164, 174

Span ..... 179

Specifications ..... 387

Spot Compensation ..... 277, 285

Standby ..... 32

Supply a DC Bias Current ..... A9

Supply a DC Bias Voltage ..... A7

Sweep Parameter ..... 135

Sweep Point ..... 143

System Reset ..... 129, 237

System Settings ..... 22, 305

---

**T**

---

Timing Chart ..... 369

EXT I/O ..... 369

Trigger ..... 55

Trigger Delay ..... 64, 140

Trigger Measurement ..... 55

Trigger Synchronous Output ..... 104, 235

---

**U**

---

USB Flash Drive ..... 329

---

**V**

---

V ..... 43, 66

Version ..... 306

---

---

---

Vertical Axis Scale .....183  
Voltage limit .....60, 78





Key	Description	Reference
A	Cursor A display setting and movement	189
	Compensation coefficient A setting	303
a	Planar oscillation mode coefficient setting	249
A&B	Cursor A and cursor B display settings and movement	189
ABORT	Measurement halt at FAIL judgment result setting	271
ABS	Absolute value mode setting	88, 95
ADD	Add segment	171
ADJ	Compensation settings	21
ADJ	Save only compensation value with panel save function	318
ADJUST	Compensation type setting	274, 282
AFTER	Draw after measurement ends	139, 269
ALL	ALL compensation settings	274, 282
ALL OFF	Remove all panels from the targets for continuous measurement	266
ALL ON	Set all panels as targets for continuous measurement	266
ALL LOAD	Loading all settings saved on a USB flash drive	355
ALL SAVE	Save all saved data	351
ANALYZER	Analyzer measurement	131
AREA SET PARA1	Area judgment range setting of parameter 1	200
AREA	Drawing parameter setting when area judgment	200
	Setting the frequency range for which to perform equivalent circuit analysis	243
AUTO	Auto range setting	49, 69, 161
	Auto setting of save folder	344
	Auto print setting	383
AUTO	Auto setting of draw mode (Automatically set upper and lower limit values from set measurement values)	184

Key	Description	Reference
AUTO SET	To restore the colors of all segments to the initial state	182
AVG	Average setting	62, 80, 165, 169, 174
B	Susceptance (S)	25
	Cursor B movement	190
b	Compensation coefficient B setting	304
	Planar oscillation mode coefficient setting	249
BACK	Display folder immediately above	331
BEEP	Beep settings	128, 234
BIN	BIN function settings	93
BIN	BIN function settings	84
BMP	Save copy of screen	341
BOTH	Set handshake to hardware + software (Refer to the Communication Instruction Manual (CD))	
BS	Delete last character	320, 325, 361
C	Cancel input	
CABLE	Cable length compensation	301
CALIBRATION	Panel compensation	308
CC	Constant current sweep	135
CENTER	Center value of sweep range setting	146
	Center value of vertical axis	185
CENTER-DIV	Center value and width of vertical axis settings	185
CENTER-SPAN	Center value of sweep range and sweep width settings	146
CIRCUIT	Equivalent circuit settings	239
CIRCUIT>>	Configuring and executing equivalent circuit analysis	253
CLEAR	Delete all input characters	320, 325, 361

Key	Description	Reference
<b>CLEAR</b>	Clear all measurement values saved to instrument memory	106, 219
COLOR	Draw color setting	181
	Saves screen copies as 256-color BMP files.	341
COMP	Area judgment setting	197
	Detail display of peak judgment result	208
	Configuring the equivalent circuit analysis comparator	260
CONTINUOUS	Continuous measurement	265
Cp	Static capacitance in parallel equivalent circuit mode (F)	25
CR	Set terminator to CR (Refer to the Communication Instruction Manual (CD))	
CR+LF	Set terminator to CR+LF (Refer to the Communication Instruction Manual (CD))	
Cs	Static capacitance in series equivalent circuit mode (F)	25
CURSOR >>	Cursor settings	188
CV	Constant voltage sweep	135
D	Loss coefficient = $\tan\delta$	25
DATE	Save date and time setting	335
DC ADJ	DC adjustment setting	75
DC BIAS	DC bias setting	57
DC DELAY	Delay time setting	82
DEFINE	Setting circuit element constants	258
DEL	Delete segment	171
DELAY	Trigger delay setting	64
DELETE	Delete selected item	
DELIM	Delimiter type setting	334
DIGIT	Switch numerical input method	41, 158
	Number of display digits setting	124

Key	Description	Reference
DISP	LCD settings	127
DISPLAY & LED TEST	Screen display test	310
DIV	Vertical axis width setting	185
DOWN	Enable falling edge	117
DRAW	Graph and list draw timing setting	139, 269
EDIT	Change segment settings	169
ENTER	Confirm entered numerical values	
<b>EXEC</b>	Start compensation	273, 280, 288
EXIT	Check settings	
	Close setting screen	
EXT	External trigger	56
FAST	High-speed measurement setting	164
FILE	Save settings	315, 329
FILTER	Filter setting	192, 211
FIX VALUE REFERENCE	Judgment area settings (Reference value, upper limit value, and lower limit value settings)	202
FOLDER	Create folder	360
FORMAT	Format USB flash drive	357
FREQ	Frequency setting	41
	Frequency sweep	135
fr-fa	Resonant/anti-resonant frequency setting	248
fs-fp	Series/parallel resonant frequency setting	248
G	Conductance (S)	25
<b>GET</b>	Set current compensation conditions as load compensation conditions	299
GP-IB	GP-IB setting	22

Key	Description	Reference
GRAPH	Waveform graph display	132
GRID	Grid display setting	186
HARD	Save only measurement conditions with panel save function	318
HI	Upper limit value setting	
Hi Z	Hi-Z reject function setting	108, 222
HOLD	HOLD setting	51, 71, 162
IN	Beep sound when result is IN judgment	128, 234
INFO	Display panel information	266
INFO AC	Display measurement conditions for AC measurement	38
INFO BIN	Display BIN settings	38
INFO COMP	Display comparator settings	38
INFO DC	Display measurement conditions for DC measurement	38
INT	Internal trigger	56
INTVL MEAS	Fix sweep parameter and set measurement to be performed at set time interval	147
I/O HANDLER TEST	I/O test	313
IO EOM	EOM output method setting	119, 229
IO JUDGE	I/O judgment	115, 226
IO SET	EXT I/O setting	115, 117
IO TRIG	I/O trigger setting	117, 228
JUDGE	Judgment mode setting	84
K	Electromechanical coupling coefficient setting	247
K15	Shear oscillation electromechanical coupling coefficient	248
K31	Long-side extension oscillation electromechanical coupling coefficient	248

Key	Description	Reference
K33	Longitudinal oscillation electromechanical coupling coefficient	248
Kr	Planar oscillation electromechanical coupling coefficient	248
Kt	Thickness-mode oscillation electromechanical coupling coefficient	248
KEY TYPE	Switch keyboard type	320, 325, 361
KEYLOCK	Key lock function	121, 230
L-MAX	Move cursor to local maximum value of measurement results	190
L-MIN	Move cursor to local minimum value of measurement results	190
LAN	LAN settings	22
LCR	LCR measurement	37
LEFT	Left limit setting	213
	Selecting the equivalent circuit estimation results display position	251
LEVEL	Level setting	43, 66, 157
LEVCHK	Detection level monitoring function setting	110
LEVOVER	Set detection sensitivity for measurement errors	113, 224
LIMIT	Voltage/current limit settings	60, 78
LINEAR	Calculate sweep points linearly	145
	Set horizontal axis of draw type to linear (linear axis)	177
LMT	Comparator function upper and lower limit value settings	86
LO	Lower limit value setting	
LOAD	Load compensation settings	288
LOG	Calculate sweep points logarithmically	145
	Set horizontal axis of draw type to log (logarithmic axis)	177
LOWER	Lower limit value setting	
	Selecting the equivalent circuit estimation results display position	251
Lp	Inductance in parallel equivalent circuit mode (H)	25

Key	Description	Reference
<b>Ls</b>	Inductance in series equivalent circuit mode (H)	25
<b>MANU/AUTO</b>	Setting the equivalent circuit analysis method	241
<b>MANUAL SCALE</b>	Manual scaling setting	184
<b>MANUAL</b>	Set upper and lower limit values manually in draw mode	184
	Specify any folder and then save data	344
	Manual print setting	383
<b>MAX</b>	Move cursor to maximum value of measurement results	190
<b>MEAS VALUE REFERENCE</b>	Judgment area settings (Set upper and lower limit values based on current measurement values)	202
<b>MED</b>	Set normal measurement speed	59, 77, 164, 174
<b>MEMORY</b>	Save measurement results	106, 219
<b>MIN</b>	Move cursor to minimum value of measurement results	190
<b>MODE</b>	Measurement mode setting	13
<b>MODE</b>	Parameter mode setting	291
<b>MODEL</b>	Equivalent circuit model selecting	239
<b>MONO</b>	Saves screen copies as monochrome (2-color) BMP files.	341
<b>NG</b>	Beep sound when result is LO or HI	128, 234
<b>NUM</b>	Sweep point setting	145, 146
	Number of sweep times setting	147
<b>NUMERIC</b>	Display list of numerical values	131
<b>OFF</b>	Set to OFF	
<b>ON</b>	Set to ON	
<b>OPEN</b>	Open compensation settings	273
<b>OPTION &gt;&gt;</b>	Option settings	324, 326, 351, 359

Key	Description	Reference
<b>OVERWRITE</b>	Overwrite save name	321
<b>OVERWRITE</b>	Overwrite setting	176
<b>P1&amp;P2</b>	Set both parameters 1 and 2	
<b>PANEL NAME</b>	Confirm save name	321
<b>PANEL</b>	Panel save function setting	317, 319
	Panel load function setting	322
	Change panel name	324
	Delete panel	326
<b>PARA1</b>	Parameter 1 setting	
<b>PARA2</b>	Parameter 2 setting	
<b>PARA</b>	Parameter settings	133, 199, 209, 334
<b>PASSCODE</b>	Passcode setting	122, 218
<b>PEAK No</b>	Peak number setting	210
<b>PEAK</b>	Peak judgment setting	209
<b>POINT DELAY</b>	Point delay setting	166
<b>POINT</b>	Sweep point setting	218
<b>POSITION</b>	Setting the equivalent circuit analysis results display position	250
<b>PRINT</b>	Print method setting	383
<b>Q</b>	Q factor	25
<b>QUOTE</b>	Quotation mark type setting	334
<b>RANGE</b>	Range setting	
<b>Rdc</b>	DC Resistance( $\Omega$ )	25
<b>REAL</b>	Draw after measurement of each sweep point.	139
<b>REF1</b>	Parameter reference value 1 setting	298
<b>REF2</b>	Parameter reference value 2 setting	298

Key	Description	Reference
REF	Reference value settings	
RENAME	Change save name	320
REPEAT	Repeat sweep setting	138
RESET	System Reset	129, 237
RIGHT	Right limit value setting	213
	Selecting the equivalent circuit estimation results display position	251
ROM/RAM TEST	ROM/RAM test	312
Rp	Effective resistance in parallel equivalent circuit mode ( $\Omega$ )	25
Rs	Effective resistance in series equivalent circuit mode = ESR( $\Omega$ )	25
RS232C	RS-232C setting	22
RUN	Executing equivalent circuit analysis	253
SAVE TO ...	Change save folder	344
SAVE	Save	
SAVE TYPE	Save type setting	318
SCALE	Scale setting	177, 183
	Scaling setting	302
SCALE1	Perform scaling compensation for parameter 1	303
SCALE2	Perform scaling compensation for parameter 2	303
SCALE3	Perform scaling compensation for parameter 3	303
SCALE4	Perform scaling compensation for parameter 4	303
SCREEN	Print hardcopy of screen	383
SEARCH	Search	194
SEG1▶ALL	Apply settings of first segment to all other segments	182, 205

Key	Description	Reference
SEGMENT	Segment settings	142
	Segment span mode setting	179
	Setting the segment for which to perform equivalent circuit analysis	245
SELECT	Check contents of file	343
SEQ	Sequential sweep setting	138
SET	Measurement condition setting	14
SET	Confirm settings	
SET EXT	Use external DC bias unit	57
SHORT	Short compensation	280
SIMULATE	Simulating frequency characteristics	258
SINGLE	Single span mode setting	179
SLOW2	Measurement speed SLOW2 setting	59, 77, 164, 174
	Measurement speed SLOW setting	59, 77, 164, 174
SOURCE	Sweep parameter settings	135
SPACE	Set delimiter to space	338
SPAN	Span Setting	179
SPEED	Measurement speed setting	59, 77, 164, 174
SPOT	Spot compensation settings	277, 285
START	Sweep start value setting	145
START-STEP	Start value of sweep and step width of sweep point settings	146
START-STOP	Start value and end value of sweep settings	145
STEP	Step sweep setting	138
	Step width of sweep point setting	146

Key	Description	Reference
	Sweep end value setting	145
	Sweep point setting	143
	Trigger synchronous output function setting	104, 235
	System settings	22
	Set delimiter to tab	338
	Move cursor to measurement value set in option settings	190
	Save measurement results as text	333
	Panel test	307
	Trigger delay setting	140
	Trigger setting	55, 137
	Setting for type of data to save to USB	333, 341
	Disable key lock	121, 230
	Enable rising edge	117
	Upper limit value setting Selecting the equivalent circuit estimation results display position	251
	Upper and lower limit value settings	185
	USB settings	22
	Open-circuit voltage sweep	135
	Setting for measurement value to find Set upper and lower limit values as absolute values relative to reference value	191 203
	Check file content	343
	Reactance ( $\Omega$ )	25
	Set handshake to software (Refer to the Communication Instruction Manual (CD))	
	Admittance (S)	25

Key	Description	Reference
	Impedance ( $\Omega$ )	25
	Disable enlarged view of measurement values	126
	Enlarge measurement values	126
	Set cable length to 0 m	301
	Set cable length to 1 m	301
	Switch numerical input method	41, 158
	Deviation percentage mode setting	91, 101
	Impedance phase angle ( $^{\circ}$ )	25
	Percent mode setting	89, 98
	Set upper and lower limit values as percentage values relative to reference value	201
	Set measurement frequency to $\times 1/10$	42
	Set measurement frequency to $\times 10$	42
	Set setting value to $\times 1000$	
	Set setting value to $\times 1/1000$	
	Set quotation mark to double quotation mark (")	339
	Set delimiter to comma (,)	338
	Set delimiter to semicolon (;)	338
	Move cursor to left by 1 sweep point	193
	Move cursor to right by 1 sweep point	193
	Select top item	
	Select bottom item	

# Warranty Certificate

# HIOKI

Model	Serial number	Warranty period Three (3) years from date of purchase ( ___ / ___ )
-------	---------------	--

Customer name: \_\_\_\_\_  
Customer address: \_\_\_\_\_

## Important

- Please retain this warranty certificate. Duplicates cannot be reissued.
- Complete the certificate with the model number, serial number, and date of purchase, along with your name and address. The personal information you provide on this form will only be used to provide repair service and information about Hioki products and services.

This document certifies that the product has been inspected and verified to conform to Hioki's standards. Please contact the place of purchase in the event of a malfunction and provide this document, in which case Hioki will repair or replace the product subject to the warranty terms described below.

## Warranty terms

1. The product is guaranteed to operate properly during the warranty period (three [3] years from the date of purchase). If the date of purchase is unknown, the warranty period is defined as three (3) years from the date (month and year) of manufacture (as indicated by the first four digits of the serial number in YYMM format).
2. If the product came with an AC adapter, the adapter is warranted for one (1) year from the date of purchase.
3. The accuracy of measured values and other data generated by the product is guaranteed as described in the product specifications.
4. In the event that the product or AC adapter malfunctions during its respective warranty period due to a defect of workmanship or materials, Hioki will repair or replace the product or AC adapter free of charge.
5. The following malfunctions and issues are not covered by the warranty and as such are not subject to free repair or replacement:
  - 1. Malfunctions or damage of consumables, parts with a defined service life, etc.
  - 2. Malfunctions or damage of connectors, cables, etc.
  - 3. Malfunctions or damage caused by shipment, dropping, relocation, etc., after purchase of the product
  - 4. Malfunctions or damage caused by inappropriate handling that violates information found in the instruction manual or on precautionary labeling on the product itself
  - 5. Malfunctions or damage caused by a failure to perform maintenance or inspections as required by law or recommended in the instruction manual
  - 6. Malfunctions or damage caused by fire, storms or flooding, earthquakes, lightning, power anomalies (involving voltage, frequency, etc.), war or unrest, contamination with radiation, or other acts of God
  - 7. Damage that is limited to the product's appearance (cosmetic blemishes, deformation of enclosure shape, fading of color, etc.)
  - 8. Other malfunctions or damage for which Hioki is not responsible
6. The warranty will be considered invalidated in the following circumstances, in which case Hioki will be unable to perform service such as repair or calibration:
  - 1. If the product has been repaired or modified by a company, entity, or individual other than Hioki
  - 2. If the product has been embedded in another piece of equipment for use in a special application (aerospace, nuclear power, medical use, vehicle control, etc.) without Hioki's having received prior notice
7. If you experience a loss caused by use of the product and Hioki determines that it is responsible for the underlying issue, Hioki will provide compensation in an amount not to exceed the purchase price, with the following exceptions:
  - 1. Secondary damage arising from damage to a measured device or component that was caused by use of the product
  - 2. Damage arising from measurement results provided by the product
  - 3. Damage to a device other than the product that was sustained when connecting the device to the product (including via network connections)
8. Hioki reserves the right to decline to perform repair, calibration, or other service for products for which a certain amount of time has passed since their manufacture, products whose parts have been discontinued, and products that cannot be repaired due to unforeseen circumstances.

**HIOKI E.E. CORPORATION**

<http://www.hioki.com>

18-07 EN-3







**HIOKI**  
**www.hioki.com/**



**All regional  
contact  
information**

**HIOKI E.E. CORPORATION**

81 Koizumi, Ueda, Nagano 386-1192 Japan

2309 EN

Edited and published by HIOKI E.E. CORPORATION

Printed in Japan

- Contents subject to change without notice.
- This document contains copyrighted content.
- It is prohibited to copy, reproduce, or modify the content of this document without permission.
- Company names, product names, etc. mentioned in this document are trademarks or registered trademarks of their respective companies.

**Europe only**

- EU declaration of conformity can be downloaded from our website.
- Contact in Europe: HIOKI EUROPE GmbH  
Helfmann-Park 2, 65760 Eschborn, Germany [hioki@hioki.eu](mailto:hioki@hioki.eu)