

HIOKI

8851

MEMORY Hi CORDER

INSTRUCTION MANUAL

Vol. 1

HIOKI E.E. CORPORATION

Contents

| | |
|--|------|
| Safety Notes | I |
| Introduction..... | II |
| Notes on Use | II |
| Organization of This Manual | III |
| Identification of Controls and Indicators | V |
| Section 1 Overview | 1-1 |
| Section 2 Specifications | 2-1 |
| Section 3 Installation and Preparations | 3-1 |
| Section 4 Basic Display Manipulations | 4-1 |
| Section 5 Memory Recorder Function Operation | 5-1 |
| Section 6 Recorder Function Operation..... | 6-1 |
| Section 7 X-Y Recorder Function Operation..... | 7-1 |
| Section 8 Recorder and Memory Function Operation | 8-1 |
| Section 9 Using the Rear Panel..... | 9-1 |
| Section 10 Printer Operations | 10-1 |
| Section 11 Input Units..... | 11-1 |
| Section 12 Maintenance and Servicing..... | 12-1 |
| Index | |



Safety Notes

This manual includes important directions for safe operation and maintenance of the 8851 unit. Note carefully the following safety points before using the unit.

Safety symbols

| | |
|--|--|
| | Identifies important sections which must be read by the user before carrying out the relevant operation on the unit. |
| | Protective ground connection |
| | Fuse |

The following three levels of heading are also used in this manual to prioritize warnings.

| | |
|---------|--|
| Danger | This indicates points where an error could pose serious danger to the operator. |
| Warning | This indicates points where an error could damage the unit or pose a hazard to the operator. |
| Notes | This indicates important points on operation. |

Danger

- To avoid the danger of electric shock or damage to the unit, never apply more than 450 V (either AC or DC) between a pair of input units or between an input unit and the frame. In particular, if a power line capable of carrying a large current is connected, and applies an excess voltage, there is a danger of a short circuit accident.
- If any metal parts of the input cables are exposed there is a danger of electric shock. Use only the 9574 input cables supplied.
- Normally keep all four input units installed permanently. If the unit is operated with an input unit not in place it poses a shock hazard. (If a unit is not fitted, it must be replaced by a 9509 blanking panel.)

Warning

- The logic inputs are not floating. Although four sets of logic probes can be connected, they all have a common ground with the main unit.

Danger

- To prevent damage to the 8851 unit, never exceed the limits in the table on the right for the various input connections.
- The unit should always be operated in the range of 5°C to 40°C and 35% to 80% relative humidity. Avoid operation in direct sunlight, in dusty conditions or in the presence of corrosive gases.

| Input connection | Maximum capacity |
|-------------------------|--|
| 8944 inputs | 500 V DC+AC peak |
| EXT TRIG, START STOP | -5 V to +10 V |
| TRIG OUT, GO NG | 20 V to +30 V 500 mA max, 200 mW max |

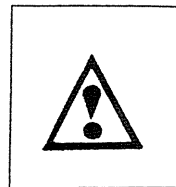

Introduction

Thank you for buying this Hioki 8851 Memory Hi Corder. To get the maximum performance from this unit, and ensure trouble-free operation, read this manual first.

Notes on Use

To ensure safe operation, and in order to exploit its functionality to the full, please follow the directions in this section carefully.

Shipping check

When the unit is delivered, check that it has not been damaged in transit. In particular check panel switches and connectors.

In the event of any damage, or failure to operate according to specification, contact your nearest service representative without delay.

Before powering on

Check that the power supply is correct for the rating of the unit. Also check that the correct fuse is fitted.

Protective grounding

The protective ground terminal must be connected to ground. Alternatively, if a properly grounded three-pin outlet is available, then using the three-core power cord provides automatic grounding.

Using the printer

Using the printer for low-speed printing (the recorder function) in a high-temperature or high-humidity environment should be avoided at all costs. This can seriously reduce the printer life.

Recording paper

This unit uses a thermal printer. The recording paper supplied has characteristics finely tuned for use with the printer. Using recording paper of a different specification may not only result in impaired printing quality, but even prevent the printer from operating. Always use the Hioki specified product.

Storage

If the unit will not be used for a substantial period, to protect the printer head and prevent deformation of the rubber rollers, move the head up/down lever to the head up position.

Shipment

If reshipping the unit, preferably use the original packing. If this is not available, use the following procedure.

- (1) Wrap the unit in plastic sheeting.
- (2) Pack the unit in a cardboard box, of at least 7 mm thickness, providing at least 100 mm of cushioning round the unit.
- (3) After covering the unit with packing, pack the accessories, and add more cushioning, then seal with adhesive tape. If necessary use banding or other fastening on the whole package.

Notes: Before shipping the unit, always remove any floppy disk.
Before shipping the unit, move the head up/down lever to the head up position.

Miscellaneous

In the event of problems with operation, first refer to Section 12-4 "Troubleshooting."

Organization of This Manual

The 8851 Memory Hi Corder documentation comprises two volumes: Volume 1 and Volume 2. Volume 1 includes basic operating instructions for setting up and operating the unit in each of its functions, and other basic information on printer and input unit operations.

Volume 2 includes coverage of the trigger functions, memory division function, waveform decision function, and the calculation functions, which will enable you to get the maximum from the facilities offered by the unit.

This volume, Volume 1, comprises the following twelve sections, arranged for the convenience of new users.

Before Section 1, there is also a schematic illustration of all principal parts of the unit. This includes references to the principal explanations in the text, so can be used as a kind of schematic index. It also includes a summary of the functions of each part.

Section 1 gives an overview of the unit.

Section 2 contains the unit specifications.

Section 3 describes the installation and preparatory work before powering on the unit. This includes important safety notes, and details of the procedures for loading printer paper and replacing fuses.

Section 4 describes standard operating procedures for manipulating the display, which apply to all operating functions.

Sections 5 to 8 describe the operating procedures in each of the four functions of the unit. It includes easy-to-follow examples for all basic applications.

Section 9 covers the operations to do with the rear panel.

Section 10 describes printer operations. This is essential reading.

Section 11 covers both the analog input units and the logic inputs. Take particular note of the limits to the floating voltage which can safely be applied to the input units.

Section 12 covers maintenance and servicing. Follow the maintenance directions to ensure long term trouble-free operation.

The index at the end of the volume allows you to look up both commands and ordinary terms. It will be useful also as a first-level list of commands.

Volume 2 comprises the following eight sections. These generally cover more detailed topics, and should be read after Volume 1.

Section 13 describes the three modes for waveform processing.

Section 14 describes how to use the trigger functions. This is a crucial feature for applications which are to exploit the capabilities of the unit fully.

Section 15 describes the memory division function.

Section 16 covers the waveform decision function.

Section 17 covers the calculation functions.

Section 18 describes operations on the system screen. This includes time settings, scaling settings, comment input, special function settings, GP-IB settings, plotter output settings, and a specification of the self-check functions.

Section 19 covers floppy disk operations.

Section 20 covers operation of the GPIB interface.

The appendices comprise a list of messages output by the unit and a glossary.

Volume 2 also includes the same index as Volume 1.

Identification of Controls and Indicators

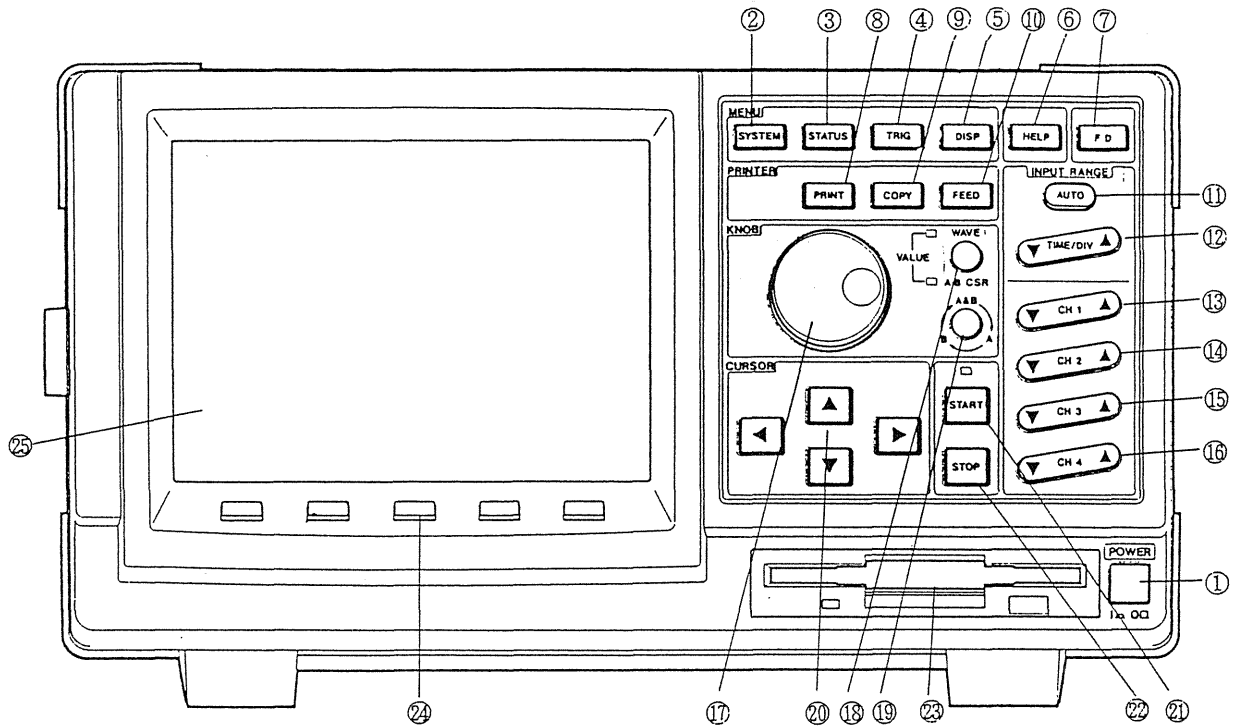

- ① POWER switch
Powers the unit on and off.
- ② SYSTEM key
Switches to the system mode (displays the system screen). (See Section 18 "System Screen.")
- ③ STATUS key
Switches the screen to the status mode, for setting up operations. (See Section 4-1 "Screen Modes.")
- ④ TRIG key
Switches the screen to the trigger mode, for trigger settings. (See Section 4-1 "Screen Modes.")
- ⑤ DISP key
Switches the screen to the display mode, for waveform display. (See Section 4-1 "Screen Modes.")
- ⑥ HELP key
In display mode, displays extra information including the position of the origin on each axis.
- ⑦ FD key
This switches to the floppy disk control mode, providing various functions for saving and reading files on floppy disk. Check that a floppy disk is inserted before switching to this mode. (See Section 19 "Floppy Disk Operations.")
- ⑧ PRINT key
Prints a waveform held in memory. (See Section 10 "Printer Operations.")
- ⑨ COPY key
Prints a copy of the screen (screen dump function). (See Section 10 "Printer Operations.")

- ⑩ FEED key
Holding down this key feeds out the printer paper. (See Section 10 "Printer Operations.")
- ⑪ AUTO key
Auto ranging function. Provides an easy automatic way of setting both time and voltage ranges (in the memory recorder function). (See Section 5-4-17 "Auto Ranging Function.")
- ⑫ TIME/DIV key
Sets the time axis range (time/division). (See Section 4-2-3 "TIME/DIV Key and Range Keys.")
- ⑬ Channel 1 range key
Sets the voltage range for channel 1. (See Section 4-2-3 "TIME/DIV Key and Range Keys.")
- ⑭ Channel 2 range key
Sets the voltage range for channel 2. (See Section 4-2-3 "TIME/DIV Key and Range Keys.")
- ⑮ Channel 3 range key
Sets the voltage range for channel 3. (See Section 4-2-3 "TIME/DIV Key and Range Keys.")
- ⑯ Channel 4 range key
Sets the voltage range for channel 4. (See Section 4-2-3 "TIME/DIV Key and Range Keys.")
- ⑰ Rotary knob
Together with the next control (the knob select key) this allows waveform scrolling, A and B cursor movement, and so forth. Its function depends on which of the two LEDs to the right are lit. (See Section 4-2-2 "Rotary Knob and Knob Select Key.")
- ⑱ Knob select key
Determines the effect of turning the rotary knob. Each time it is pressed, the state of the two LEDs to the left changes. (See Section 4-2-2 "Rotary Knob and Knob Select Key.")
- ⑲ Cursor select key
When the rotary knob is set to control the A and B cursors, this key determines which cursor the knob controls, or whether it moves both.
- ⑳ Cursor keys
These keys move the cursor on the screen. (See Section 4-2-1 "Cursor Keys and Soft Keys.")
- ㉑ START key
Begin measurement operation mode. While operating, the LED above this key lights.
- ㉒ STOP key
End measurement operation mode. This reverses the effect of the START key.
- ㉓ Floppy disk slot
Insert a 3.5-inch floppy disk. (See Section 19 "Floppy Disk Operations.")
- ㉔ Soft keys
The functions of these keys are indicated on the lowest line of the screen. (See Section 4-2-1 "Cursor Keys and Soft Keys.")
- ㉕ Screen

Top view

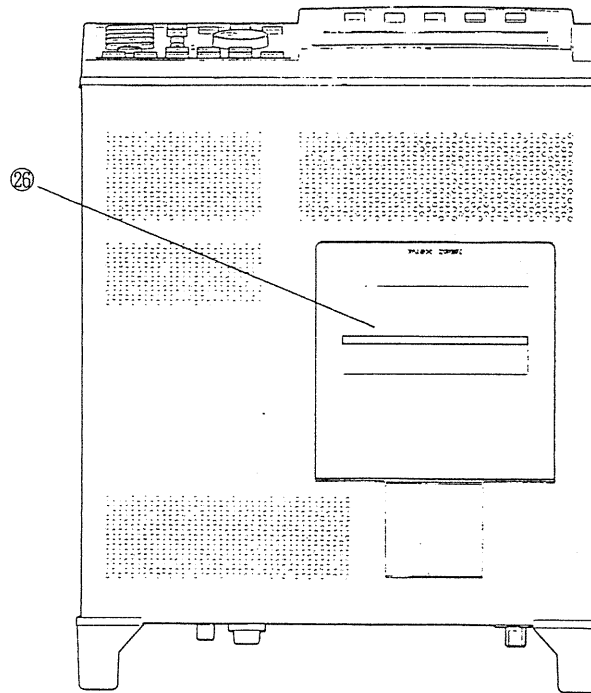

②⑥ Printer

(See Section 10 "Printer Operations.")

Right side view

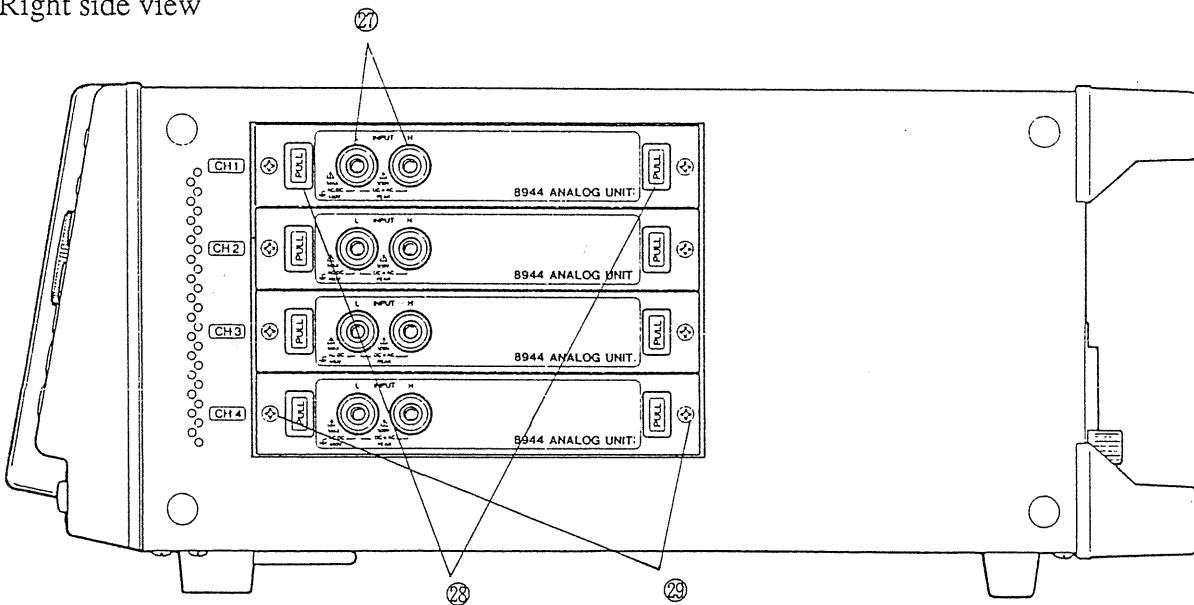

②⑦ Input units (8944 analog input units)

The 8944 input units have unbalanced input terminals.

H: high level input

L: low level input

(See Section 11-2 "8944 Analog Unit.")

②⑧ Handles

Pull the two handles evenly to withdraw the 8944 input unit. (See Section 11-2-4 "Replacement Procedure.")

②⑨ Fixing screws

These retain the input unit. (See Section 11-2-4 "Replacement Procedure.")

Left side view

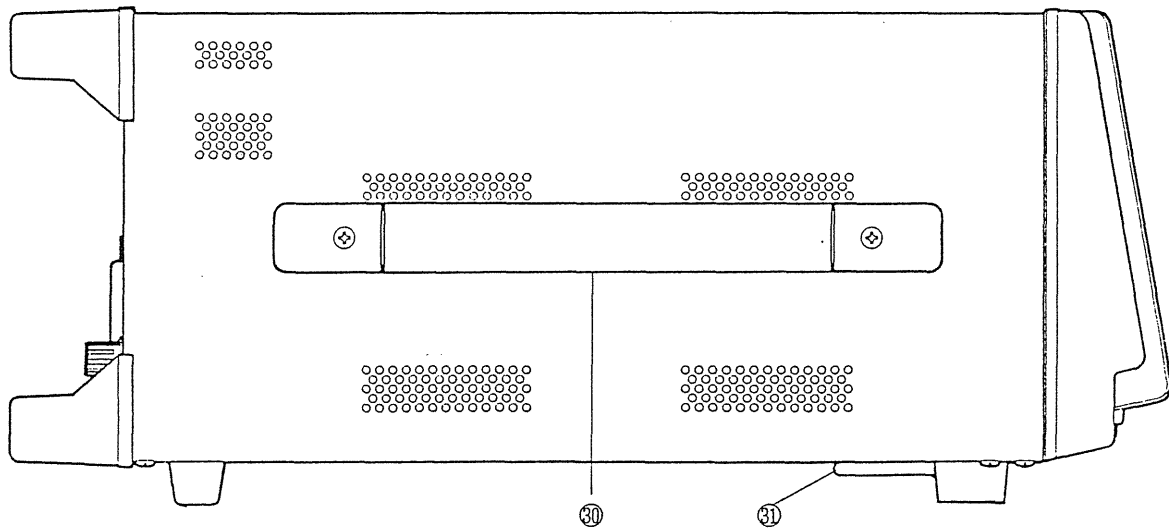

⑩ Handle

This is the carrying handle for the unit. this to incline the unit if convenient.

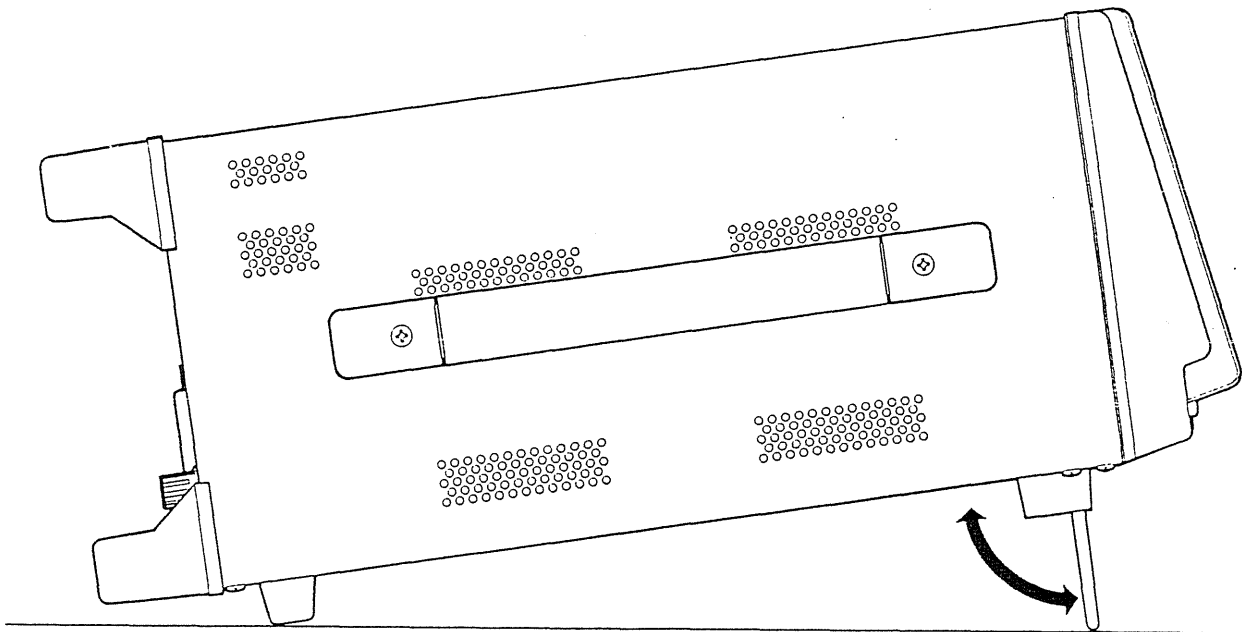

Stand extended position

Read panel

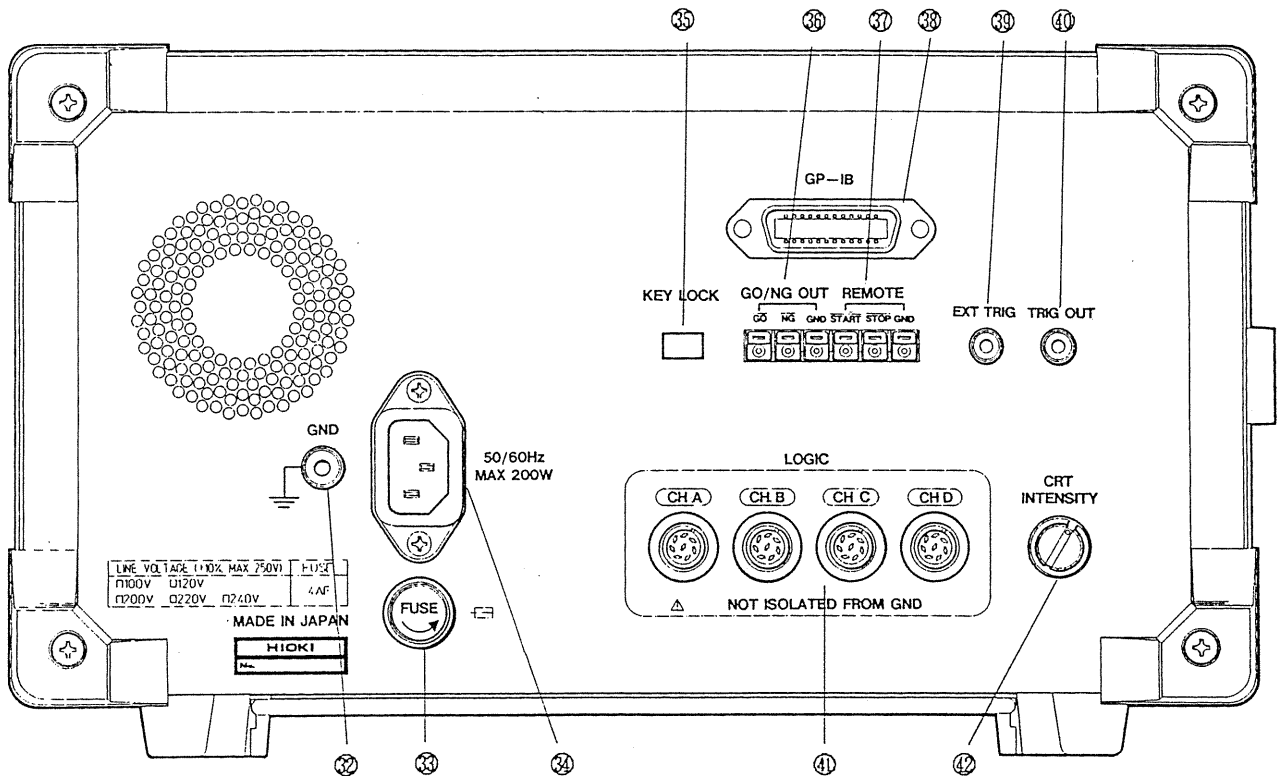

⑫ Protective ground terminal (GND)

⑬ Fuseholder

Holds the main fuse. (See Section 3-1 "Notes on Installation" and Section 12-1 "Fuse Replacement.")

⑭ Power cord connector

Connect the power cord supplied, which has a 3-core grounded cable.

⑮ KEY LOCK key

Press this key to lock the keys on the front panel. Press once more to release the lock.

A GP-IB command can also be used to switch to the key lock state. (See Section 9-3 "Key Lock Function.")

⑯ GO/NG OUT terminals

These output a (pass/fail) waveform decision result or a waveform parameter decision result. (Active low signals) (See Section 16-4 "Using the Pass/Fail Decision Output" and Section 17-3-3 "Waveform Parameter Decision.")

⑰ REMOTE input

This allows external control of start/stop operations. (Active low or short circuit signal)
(See Section 9-2 "External Start/Stop Function.")

⑱ GP-IB connector

Connect the GP-IB cable. (See Section 20 "GP-IB Interface.")

⑲ EXT TRIG input terminal

This inputs the external trigger when it is enabled. (Active low or short circuit signal) (See Section 14-3 "External Trigger.")

⑳ TRIG OUT terminal

This outputs a signal when a trigger occurs. (Active low) (See Section 14-8 "Trigger Output Terminal.")

㉑ Logic probe connectors

These are the connectors for the logic signal inputs, from the special purpose logic probes. A maximum of four sets of logic probes can be connected, identified as four channel groups. (CHA, CHB, CHC, CHD) (See Section 11-1 "Logic Inputs.")

㉒ CRT INTENSITY control

Adjusts the screen brightness. (See Section 3-5 "CRT Intensity.")

Section 1

Overview

Contents

| | |
|-------------------------------|-----|
| 1-1 Product Introduction..... | 1-2 |
| 1-2 System Operation | 1-4 |

1-1 Product Introduction

The 8851 Memory Hi Corder is a new type of waveform recorder, allowing simultaneous measurement and recording.

It provides both analog and logic input channels, and will be ideal for capturing waveform phenomena over a very wide frequency range.

Principal 8851 system features

(1) Powerful waveform capture functions

A/D conversion with a 12-bit resolution (using an 8944 analog input unit), a 1 MS/s sampling rate, and maximum 2M word memory (using one channel) enable complex and rapid waveform variations to be captured.

(2) At-a-glance rapid investigation and observation of waveforms

The gray scale CRT display, in combination with zoom functions to magnify or compress the voltage or time axis, and scroll the waveform display, makes it easy to examine required sections from the large waveform memory.

(3) Record just the required portions

The high-speed thermal printer, with its 1 cm/division high resolution, allows only those sections of the waveform which are needed to be printed.

The printer also provides a handy screen dump function at any time.

(4) Variable number of input channels

Any number from one to four analog input units can be installed. The units are a convenient plug-in type.

(5) Floating input unit potentials

The input units are of the floating type, so that each unit can measure a completely independent voltage.

(6) Logic channels supplied as standard

The sixteen logic input channels are built into the unit as standard. They use a common potential with the main unit.

(7) Four functions to meet a huge range of applications

Memory recorder function (X-Y recording also provided) to capture transients and other high-speed phenomena; recorder function, for extended real time recording; a continuous X-Y recorder; and a combined recorder and memory function, which allows selected sections of data being recorded to be additionally saved in memory.

(8) Flexible trigger functions

The unit uses a digital trigger circuit. This provides a wide range of trigger settings, including 1% step trigger level, trigger slope, trigger filter, and specific trigger functions such as a window trigger, a glitch detection trigger and an event trigger.

(9) Automatic pass/fail waveform decision function

This automatically produces a pass/fail (GO/NG) waveform assessment, based on a user-defined reference area. A convenient graphics editor makes it simple to define the reference area.

(10) Floppy disk drive

The unit has a 3.5 inch floppy disk drive, allowing easy exchange of waveform data and setting information with a personal computer.

(Supports NEC-9801 2HD and IBM PC/AT 2DD MS-DOS disks.)

(11) High-speed intelligent functions

Many auxiliary functions, including memory division, cursor measurements, arithmetic derivations, and fast Fourier transform.

(12) Scaling function

Input values can be scaled and the units specified to correspond to original physical measurement quantities.

(13) GP-IB interface

The GP-IB interface, complying with IEEE-488.2, is fitted as standard. This allows remote control with a wide range of commands.

1-2 System Operation

Fig. 1-1 shows a block diagram of the system.

- The unit is built round a 16-bit microprocessor (CPU) which provides overall control.
- The 9844 analog input unit includes a 12-bit high-speed A/D converter, and uses a photocoupler connection to the main unit. It uses a separate power supply, and is completely electrically isolated from the main unit.
- Data from the A/D converter is transferred through the memory controller and stored in the 2M word RAM.
- The unit uses a digital trigger circuit, and for an internal trigger the value undergoes A/D conversion, and digital comparison with the reference value, to determine whether or not to output a trigger signal.
- Measurement data stored in memory can be processed and displayed or output to the graphics printer. Output to floppy disk or to the GP-IB is also provided.

Fig. 1-1 Block diagram

Analog input units

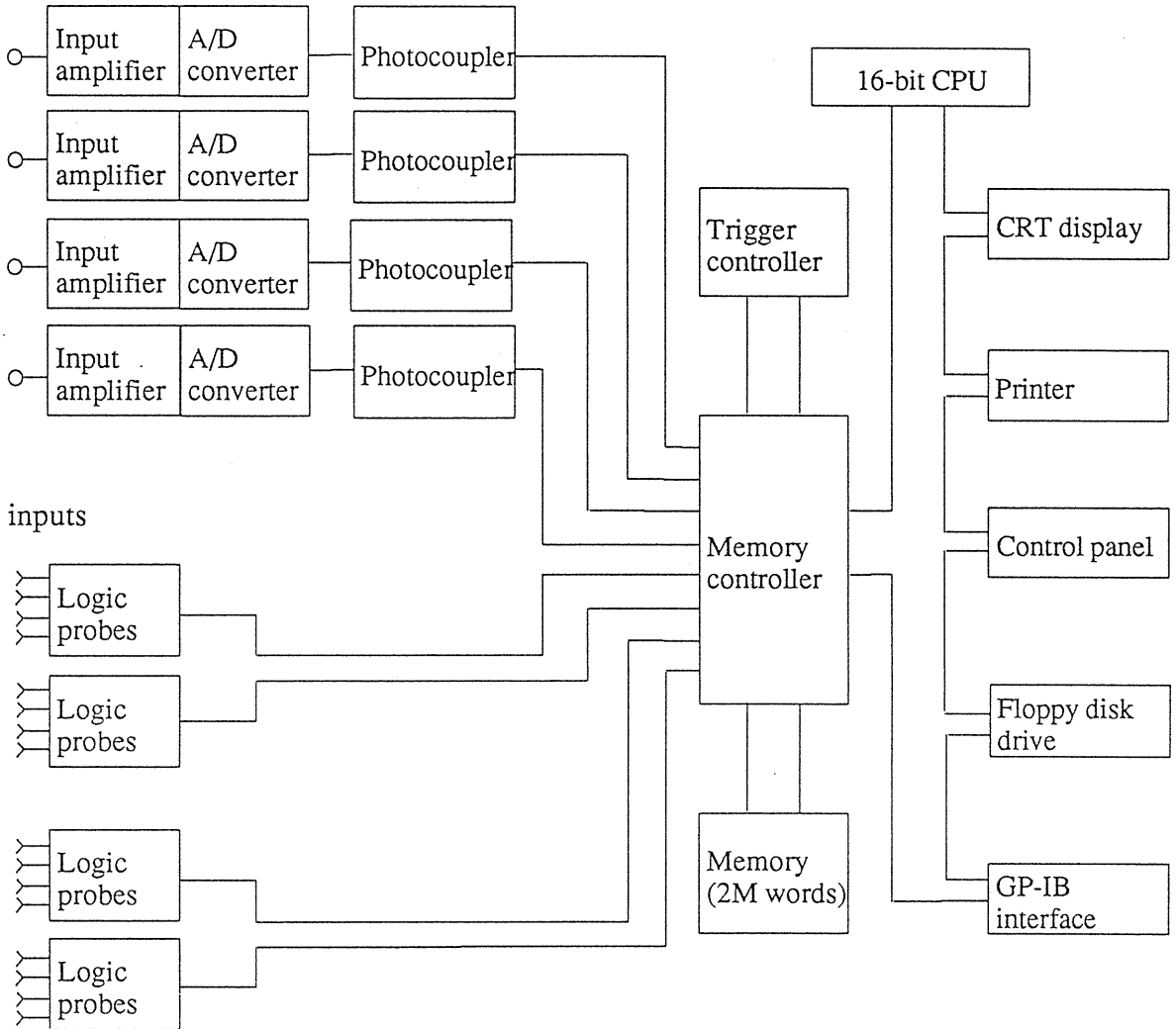

Section 2

Specifications

Contents

| | |
|-----------------------------------|-----|
| 2-1 Main Unit Specifications..... | 2-2 |
| 2-2 Tables | 2-9 |

2-1 Main Unit Specifications

(For analog input unit specifications see Section 11-2-2 "Specifications.")

(1) General specifications

Basic specifications

| | |
|---|---|
| Measurement functions: | Recorder (real time recording) Memory recorder (high-speed data saving) X-Y recorder (continuous X-Y recording) Recorder and memory (combined real time recording and high-speed data saving) |
| Maximum sampling rate: | 1 MS/s |
| Time axis accuracy: | $\pm 0.02\%$ (indicates relative accuracy of scale and real time) |
| Memory capacity: | 12 bits \times 2M words per channel (using channel 1) 12 bits \times 1M words per channel (using channels 1 and 2) 12 bits \times 500K words per channel (using channel 1 to 4) |
| Input: | Plug-in analog input units (floating input) |
| Maximum number of channels: | 4 analog channels + 16 logic channels Logic channels are built into main unit as standard (common ground with main unit) |
| External control connections: | External trigger input, trigger output, start/stop input, GO/NG output |
| Backup battery lifetime: | 10 years (for clock and settings; at 25°C reference value) |
| Operating environment: | Temperature 5°C to 40°C, humidity 35% to 80% R.H. (no condensation) |
| Operating environment to guarantee specification: | Temperature 23°C \pm 5°C, humidity 35% to 80% R.H. (no condensation) |
| Storage: | Temperature -10°C to 50°C, humidity 5% to 90% R.H. (no condensation) |
| Insulation resistance and withstand voltage: | 100 M Ω minimum, 500 V DC/1.5 kV AC, one minute (frame to power supply) 100 M Ω minimum, 500 V DC/2 kV AC, one minute (input units to frame) 100 M Ω minimum, 500 V DC/2 kV AC, one minute (between input units) |
| Power supply: | 100 V AC \pm 10%, 50/60 Hz (120, 200, 220 and 240 V versions available on order) |
| Power consumption: | 200 W maximum (70 W during normal recording) |
| External dimensions: | 170 mm (H) \times 330 mm (W) \times 400 mm (D) (approximate, excluding projections) |
| Weight: | 10.7 kg approx. (main unit only) |

Recording

Recording method: Thermal line-head printer
Recording paper: 110 mm × 30 m roll-type thermal recording paper
Recording width: Overall width 108 mm (864 dots)
Waveform width 100 mm f.s. (1 division = 10 mm)
Recording speed: Maximum 2.5 cm/s approx.
Dimensional accuracy of paper feed: ± 2% (at 25°C, 60% R.H.)

Display

Display type: 7-inch CRT raster scan (gray scale)
Display resolution: Waveform 601 × 256 dots; character display 40 characters × 29 lines

External storage

Storage device: 3.5-inch floppy disk drive
Storage capacity: 1.2M bytes (2HD) for NEC PC9801 series
720K bytes (2DD) for IBM-PC and compatibles
Data format: MS-DOS (*) format
Data stored: Setting state, measurement data, waveform decision area
Measurement data can be saved between cursors A and B

Miscellaneous

Accessories: Power cord
Recording paper (1 roll)
Roll paper spindles (2)
Operation manual (2 volumes: Vol. 1 and Vol. 2)
Spare fuse (ordinary fuse, 4.0 A/250 V, 30 mm × 6.4 mm dia.)
Protective cover
Options: 8944 analog input unit
9509 blanking plate
Chargeable accessories: 9221 recording paper (30 m rolls, 10 rolls per container)
9303 potential transformer
9305 trigger cable
9306 logic probe
9307 line logic probe
9308 line dip detector
9151-02 GP-IB cable (2 m)
9151-04 GP-IB cable (4 m)
220H chart take-up spool
(*) MS-DOS is the registered trademark of Microsoft Corporation.

(2) Trigger functions

| | |
|---------------------|--|
| Trigger type: | Digital comparison |
| Trigger modes: | Memory recorder ... single, repeat, auto Recorder ... single, repeat X-Y recorder ... single Recorder and memory ... single, repeat |
| Trigger sources: | On/off triggers - channel 1 (A), channel 2 (B), channel 3 (C), channel 4 (D), external, or timer If all are off, the system is free running. Analog or logic input can be set for each channel. Timer triggers allow start time, stop time and interval time to be specified. |
| Trigger conditions: | Logical AND or OR of any trigger sources (except timer trigger OR only) |

Trigger types (analog)

| | |
|---------------------------|---|
| Level trigger: | 0 - 100% digital setting, triggered above or below trigger level |
| Event trigger: | Number of events 2 to 4000 (available when level trigger specified) |
| Window trigger: | Specifies upper and lower trigger levels |
| Glitch detection trigger: | Glitch width 2 to 4000 samples |
| Time out trigger: | Setting 2 to 4000 samples |

Trigger types (logic)

| | |
|-------------------------|---|
| Pattern trigger: | Set pattern of 1, 0 and × (don't care); AND/OR settings for each 4 channels; condition met or condition not met |
| Trigger filter: | Filter width 2 to 4000 samples, specifiable when using level trigger or logic trigger |
| Level setting accuracy: | ± 0.4% f.s. |
| Pre-trigger: | 0, 2, 5, 10, 20, 30, 40, 50, 60, 70, 80, 90, 95, 100% -50 to -950% (*) (memory recorder, * depends on recording length) |
| Trigger timing: | Start Stop (recording with recorder, X-Y recorder, or recorder and memory functions) Start and stop (recording with recorder, X-Y recorder, or recorder and memory functions) |
| Trigger output: | Open collector (maximum input voltage 30 V) (with 5 V output, active low, pulse width 1.5 ms approx.) |
| Trigger I/O connectors: | Mini-jack (3.5 mm dia.) |

(3) Memory recorder function

| | |
|--|--|
| Time axis: | 40 μ s, 50 μ s to 5 s / division (17 ranges, 1-2-5 steps, except for 40 μ s) |
| Time axis resolution: | 40 points/division |
| Sampling frequency: | Automatically determined by time axis setting (1/40 of setting) |
| Recording length (shot length): | 15, 30, 75, 150, 300, 750, 1500, 3000, 6000, 12500, 25000 (*1), 50000 (*2) divisions (*1 using channels 1 and 2 only; *2 using channel 1 only) |
| Format: | Single, dual, quad (printer only), X-Y (except when envelope specified) |
| Interpolation function: | Provided, dot/line |
| Overwrite function: | Provided |
| Envelope function: | Provided (sampling 800 kS/s) |
| Waveform magnification and compression: | (time axis) $\times 10, \times 5, \times 2, \times 1, 1/2, 1/5, 1/10, 1/20, 1/50, 1/100,$ $1/200, 1/500, 1/1000, 1/2000, 1/4000$ (voltage axis) $\times 10, \times 5, \times 2, \times 1, 1/2$ |
| Waveform scrolling: | Scrollable left-right and up-down (excluding X-Y display) |
| Grid: | Off, normal and fine |
| Auto print function: | On/off ... automatically stored waveform |
| Manual print function: | Provided |
| Screen dump function: | Provided |
| Partial print function: | Prints the section from cursor A or between cursors A and B. |
| Smoothed print function: | When specified, a smoothed waveform is printed, with twice the density in the time axis direction. |

(4) Recorder function

| | |
|------------------------------------|--|
| Time axis (time per division): | 400 ms, 500 ms, 1 s, 2 s, 5 s, 10 s, 20 s, 1 min, 2 min, 5 min, 10 min, 20 min, 1 hour |
| Time axis resolution: | 80 points/division (400 ms, 500 ms / division) 160 points/division (1 s to 1 hour / division) |
| Sampling rate: | 400 kS/s fixed (high-speed sampling method) |
| Recording length (shot length): | 15, 30, 75, 150, 300, 750 divisions, continuous |
| Format: | Single, dual, quad (printer only) |
| Interpolation function: | Line display only |
| CRT display: | Available (can be used simultaneous with printing) |
| Waveform storage: | Last 750 divisions saved in memory Can be checked by reverse scrolling |
| Printing functions: | On/off and screen dump; re-printing function |
| Data conversion functions: | Measurement data can be converted to data for the memory recorder function. It is then available for various calculations and saving to floppy disk. |

(5) X-Y recorder function

| | | |
|---------------------------------|--|--|
| X channel: | Any of channels 1 to 4 | |
| Y channel: | Any of channels 1 to 4 except x channel (up to 3 combinations) | |
| Effective recording dimensions: | 100 mm × 100 mm (10 × 10 divisions) | |
| Spatial resolution: | Y-axis 25 pixels/division, X-axis 40 pixels/division (display) X and Y axes 80 dots/division (printer output) | |
| Sampling frequency | Dot display (dark and light) | Line display |
| | One channel: 300 μs fixed | 0.3 - 8.5 ms (light) 0.3 - 14 ms (dark) |
| | Two channels: 300 μs fixed (dark) | 0.3 - 16.5 ms (light) 0.3 - 27 ms (dark) |
| | Three channels: 300 μs fixed (dark) | 0.3 - 24.5 ms (light) 0.3 - 40 ms (dark) |
| Recording time: | No limit | |
| Interpolation function: | Provided, dot/line | |
| Monitoring function: | Real time display on CRT | |
| Print functions: | Manual print and screen dump | |

(6) Recorder and memory function

| | | |
|---------------------------------|---|-----------------------|
| Time axis (time per division): | 400 ms - 1 hour (recorder) | |
| | 100 μs - 5 s (memory recorder) | |
| | Note: Being a combination of the time axis settings for the recorder function and memory recorder function, some setting combinations are not possible. | |
| Time axis resolution: | 80 points/division (400 ms, 500 ms / division) | } (recorder function) |
| | 160 points/division (1 s to 1 hour / division) | |
| | 40 points/division (memory recorder function) | |
| Sampling frequency: | 1/40 of memory recorder setting | |
| Recording length (shot length): | 15, 30, 75, 150, 300, 750 divisions, continuous (recorder) | |
| | 15, 30, 75, 150, 300, 750, 1500, 3000, 6000 (memory recorder) | |
| Format: | Single, dual, quad (printer only) | |
| Display: | Switchable between recorder waveform and memory recorder waveform | |
| Printer output: | During measurement operation, recorder waveform only. After data capture, printout of recorder waveform as on display or memory recorder waveform. | |
| Trigger sources: | Timer trigger or off (recorder) | |
| | Channel 1 (A) to channel 4 (D) and external (memory recorder) | |
| Ancillary functions: | Overwriting and sequential save | |

(7) Other functions

Computation functions (memory recorder function)

| | |
|--------------------------------|--|
| Waveform processing functions: | Arithmetic operations (+ - × ÷) absolute value, exponents, common logarithms, square roots, dynamic mean, 1st and 2nd derivatives, 1st and 2nd integrals, time axis parallel shift, upper, lower |
| Waveform parameter extraction: | Maximum, minimum, peak-to-peak value, mean value, rms value, area value, wavelength, frequency, rise time, fall time, XY area value |
| Averaging function: | Sliding average, sampling window variable (4, 8, ... 256 samples) |
| Fast Fourier transform: | Linear spectrum, power spectrum |
| Number of samples: | 800 |
| Frequency range (max.): | 4 Hz to 400 kHz, 500 kHz (×1, ×1/2, ×1/5 setting) |
| Frequency resolution: | 1/400 |
| Dynamic range: | 72 dB (theoretical value) |
| Window: | Rectangular, Hanning |

Special functions (memory recorder functions)

Waveform decision

| | |
|--------------------------------|--|
| ① Waveform area decision: | Waveform decision based on reference area for X-T waveform, X-Y waveform, or FFT results |
| Decision modes: | OUT ... fail if any part of waveform is outside reference area ALL OUT ... fail if whole of waveform is outside reference area |
| Stop mode: | GO (pass) stop, NG (fail) stop, GO & NG stop Printer output or waveform save at stop selectable |
| Decision output: | GO and NG outputs on rear panel ... open collector outputs (maximum input voltage 30 V) (with 5 V output, active low, pulse width 40 ms min.) |
| Decision time: | 50 ms maximum |
| Decision period: | 200 ms approx. (50 μ, 15 divisions; 1 channel, line display. May be delayed when using compressed display or a long recording length.) |
| ② Waveform parameter decision: | Decision based on setting minimum and maximum values for waveform parameter calculation results |
| Graphics editor: | Used for defining an arbitrary reference area for waveform decisions |
| Editor commands: | line, paint, storage, erase, parallel, reverse, clear, all clr, undo, save, end |
| Memory division function: | Memory can be divided among channels |
| Number of divisions: | Maximum 64 (63 divisions usable) ① Memory division (multi-block memory) ② Sequential saving |

Miscellaneous

| | |
|-------------------------------|--|
| Cursor measurement functions: | Time difference, voltage difference or number of cycles between cursors A and B Voltage at cursor A, time from trigger |
| Scaling function: | Specifiable for each channel |
| Comment input function: | Provided |
| Clock functions: | Auto-calendar, automatic leap year calculation, 24-hour system |
| Clock accuracy: | 100 ppm (25°C) |
| List print function: | Settings output after waveform data print (selectable on/off); also output by pressing PRINT key other than in display screen. |
| Remote control: | Start and stop input terminals (TTL levels, active low, or terminal short) |
| Plotter output: | HP-GL plotter output |
| GP-IB: | Complies with mechanical and electrical specifications of IEEE 488.2-1987 Remote control includes input units. |
| Help functions: | In memory recorder function, indicates the position of the screen display with respect to the whole contents of memory. For each channel, in magnified voltage scale mode, indicates the position of the display with respect to the full scale. When using the memory division function, indicates the status of each block. |
| Key lock function: | Locks all keys except the KEY LOCK key (on rear panel). |

2-2 Tables

Memory recorder function and FFT computation

| Time/division | Sampling period | Max. recording length * | FFT frequency range | FFT computation time |
|----------------|-----------------|-------------------------|---------------------|----------------------|
| 40 μ s/DIV | 1 μ s | 2.0s | 500 kHz | 800 μ s |
| 50 | 1.25 | 2.5 | 400 | 1ms |
| 100 | 2.5 | 5.0 | 200 | 2 |
| 200 | 5 | 10 | 100 | 4 |
| 500 | 12.5 | 25 | 40 | 10 |
| 1ms/DIV | 25 | 50 | 20 | 20 |
| 2 | 50 | 1.6min | 10 | 40 |
| 5 | 125 | 4.1 | 4 | 100 |
| 10 | 250 | 8.3 | 2 | 200 |
| 20 | 500 | 16 | 1 | 400 |
| 50 | 1.25ms | 41 | 400Hz | 1s |
| 100 | 2.5 | 1.3hour | 200 | 2 |
| 200 | 5 | 2.7 | 100 | 4 |
| 500 | 12.5 | 6.9 | 40 | 10 |
| 1s/DIV | 25 | 13 | 20 | 20 |
| 2 | 50 | 27 | 10 | 40 |
| 5 | 125 | 69 | 4 | 100 |

Time axis resolution 40 points/division

- When using one channel only (see 18-5-11 "Channel Selection.") The values are truncated to two significant digits.

Recorder function

| Time/division | Chart speed | Time axis resolution | Recording time for one roll of paper (30 m) |
|--|---|----------------------|---|
| 400 ms/DIV 500 | 25 mm/s 20 | 80 points/division | 20 min 25 |
| 1 s/DIV 2 5 10 20 1 min/DIV 2 5 10 20 1 hour/DIV | 10 5 2 1 0.5 10 mm/min 5 2 1 0.5 10 mm/hour | 160 points/DIV | 50 100 250 500 1000 50 hour 100 250 500 1000 3000 |

Recorder and memory function

Settable combinations of time axis ranges

○ = can be set

× = cannot be set

| | | Recorder time axis range (per division) | | | | | | | | | | | | |
|--|----------------------|---|-----------|--------|---|---|----|----|------------------|---|---|----|----|-----------------------|
| | | 400 ms | 500 ms | 1 s | 2 | 5 | 10 | 20 | 1 m i n | 2 | 5 | 10 | 20 | 1 h o u r |
| Memory recorder time axis range (sampling period) | 100 μs/div (2.5 μs) | ○ | ○ | ○ | ○ | ○ | ○ | ○ | ○ | ○ | ○ | ○ | ○ | ○ |
| | 200 μs/div (5 μs) | ○ | ○ | ○ | ○ | ○ | ○ | ○ | ○ | ○ | ○ | ○ | ○ | ○ |
| | 500 μs/div (12.5 μs) | ○ | ○ | ○ | ○ | ○ | ○ | ○ | ○ | ○ | ○ | ○ | ○ | ○ |
| | 1 ms/div (25 μs) | ○ | ○ | ○ | ○ | ○ | ○ | ○ | ○ | ○ | ○ | ○ | ○ | ○ |
| | 2 ms/div (50 μs) | ○ | ○ | ○ | ○ | ○ | ○ | ○ | ○ | ○ | ○ | ○ | ○ | ○ |
| | 5 ms/div (125 μs) | ○ | ○ | ○ | ○ | ○ | ○ | ○ | ○ | ○ | ○ | ○ | ○ | ○ |
| | 10 ms/div (250 μs) | ○ | ○ | ○ | ○ | ○ | ○ | ○ | ○ | ○ | ○ | ○ | ○ | ○ |
| | 20 ms/div (500 μs) | ○ | × | × | ○ | × | ○ | ○ | ○ | ○ | ○ | ○ | ○ | ○ |
| | 50 ms/div (1.25 ms) | ○ | ○ | ○ | ○ | ○ | ○ | ○ | ○ | ○ | ○ | ○ | ○ | ○ |
| | 100 ms/div (2.5 ms) | ○ | × | × | ○ | × | ○ | ○ | ○ | ○ | ○ | ○ | ○ | ○ |
| | 200 ms/div (5 ms) | × | × | × | × | × | × | ○ | ○ | ○ | ○ | ○ | ○ | ○ |
| | 500 ms/div (12.5 ms) | × | × | × | × | × | ○ | ○ | ○ | ○ | ○ | ○ | ○ | ○ |
| | 1 s/div (25 ms) | × | × | × | × | × | × | ○ | ○ | ○ | ○ | ○ | ○ | ○ |
| | 2 s/div (50 ms) | × | × | × | × | × | × | × | × | ○ | × | ○ | ○ | ○ |
| 5 s/div (125 ms) | × | × | × | × | × | × | × | ○ | ○ | ○ | ○ | ○ | ○ | |

Section 3

Installation and Preparations

Contents

| | | |
|-----|-------------------------------|-----|
| 3-1 | Notes on Installation..... | 3-2 |
| 3-2 | Loading Recording Paper..... | 3-3 |
| 3-3 | Care of Recording Paper | 3-5 |
| 3-4 | During Measurements | 3-6 |
| 3-5 | CRT Intensity | 3-6 |

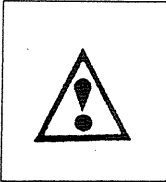

3-1 Notes on Installation

(1) Main power supply and fuse

The power supply voltage for the unit is written on the rear panel. Always check the line voltage before first connecting the unit. The fuse is also indicated on the rear panel. Always use the specified replacement fuse.

| Line voltage ($\pm 10\%$, maximum 250 V) | Fuse rating | Size |
|--|-------------|----------------------------|
| 100 V 120 V | Normal fuse | |
| 200 V 220 V 240 V | 4 A/250 V | 30 mm \times 6.4 mm dia. |

⚠ Warning

Specify the required supply voltage when ordering the unit. Note that the maximum input for the 240 V version is 250 V.

(2) Power cord

Use only the power cord supplied.

(3) Protective grounding

If a grounded power outlet is not available, ensure that the grounding terminal is connected to a satisfactory ground.

(4) Operating environment

The operating environment for the unit should provide a temperature in the range 5°C to 40°C, and 35% to 80% relative humidity. Avoid operation in places where the unit will be exposed to direct sunlight, dust or corrosive gases.

3-2 Loading Recording Paper

- (1) Press the stock cover to release the catch.
Open the stock cover.

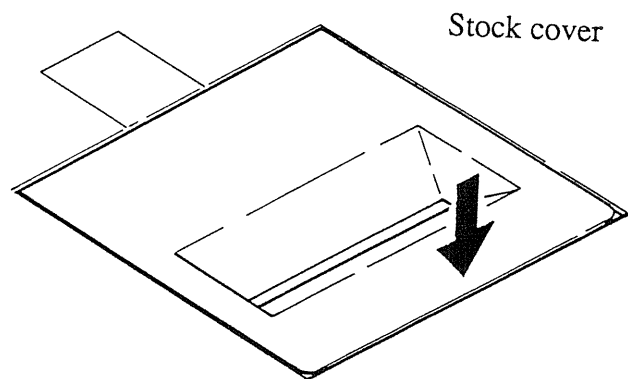

- (2) Raise the head up/down lever.

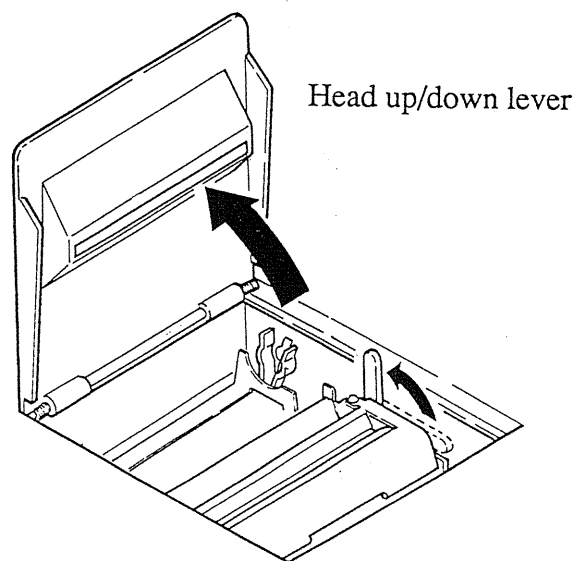

- (3) Insert the spindles into the core of the roll paper, then insert the roll into the retainers.

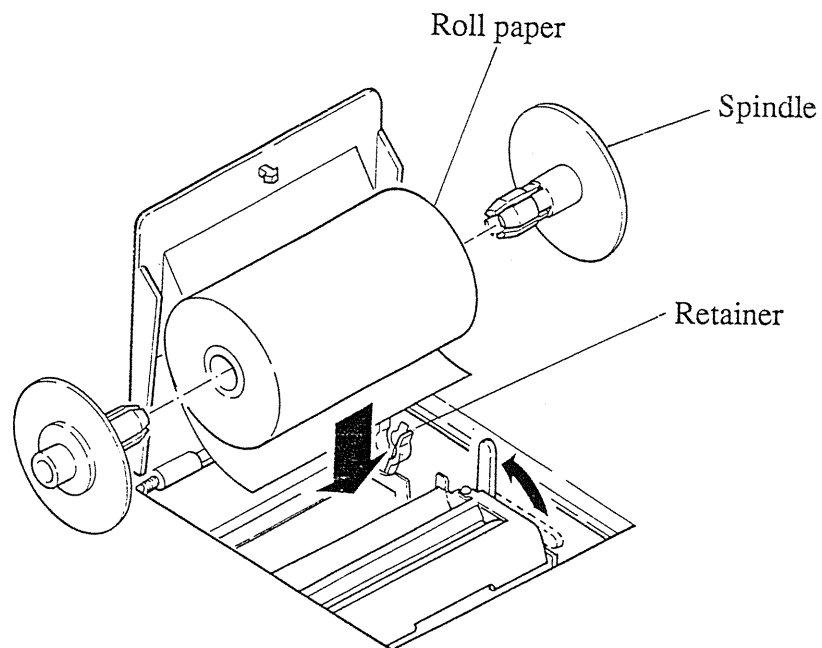

- (4) Insert the end of the paper into the printer slot, and pull out from the other side.

Note: Be careful not to insert the paper between the roller and the black plastic portion.

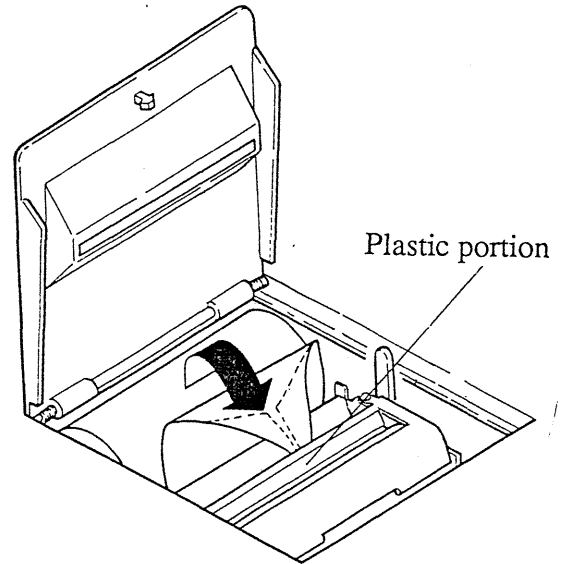

- (5) Pull about 10 cm of paper through, and check that the paper is straight. If the paper does not slide through easily, press the FEED key to feed it through.

Note: Take particular care to get the paper straight, since if it is not properly lined up with the rollers, it is more likely to cause a paper jam.

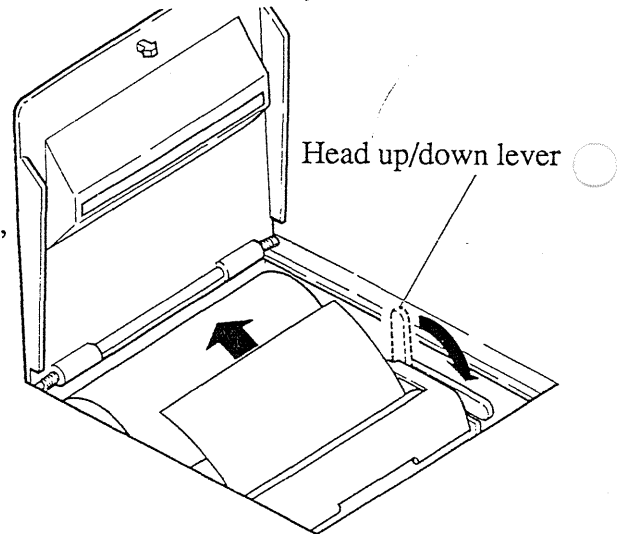

- (6) Lower the head up/down lever.

- (7) Tear off the recording paper on the printer opening, and close the stock cover to complete the operation.

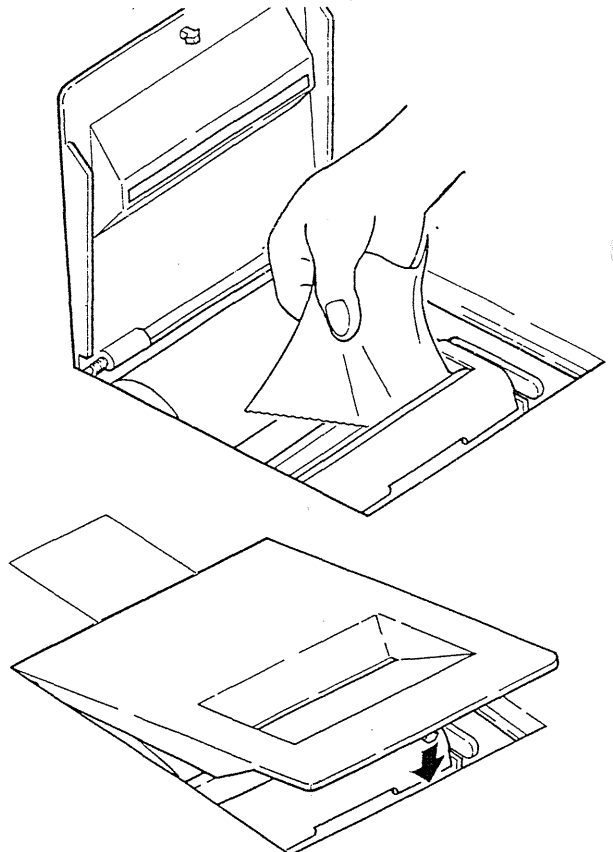

Note

If shipping or storing the unit, always ensure that the printer head is in the raised position. If left with the printer head pressing on the roller for an extended period, the roller may deform, resulting in uneven printing.

The recording paper is not reversible. Ensure that the correct side is facing the printer head.

3-3 Care of Recording Paper

- Unused rolls of thermal recording paper can be stored under normal conditions without problems. For long periods, however, the temperature should not exceed 40°C. Storage at low temperatures presents no problems.
- Over a period of time, strong light will cause the paper to discolor. Once a roll is unwrapped from its protective package, keep it away from any strong light.

Keeping data

The recording technique uses a thermo-chemical reaction. Observe the following when keeping recordings.

- Do not leave recordings where they are exposed to direct sunlight.
- Store at a maximum temperature of 40°C, and not more than 90% relative humidity.
- For keeping permanent copies of recordings, the recommended procedure is to make photocopies.
- Thermal recording paper discolors if brought into contact with volatile organic solvents such as alcohols, esters and ketones.
- Since thermal recording paper absorbs non-volatile organic solvents such as alcohols, esters and ketones, its image-forming characteristics may be impaired, and previous printing may fade. Note particularly that soft PVC film and clear pressure-sensitive adhesive tape both contain non-volatile organic compounds, and should not be used in contact with recordings.
- Do not allow recordings to come into contact with wet diazo copies.

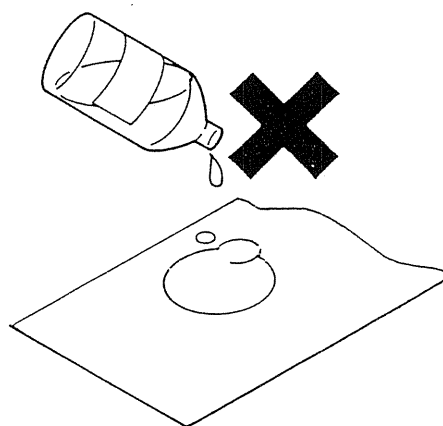
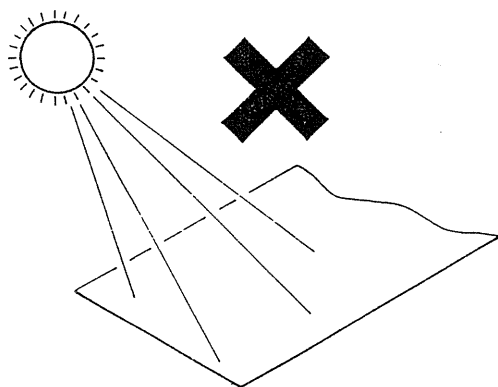

Alcohol

3-4 During Measurements

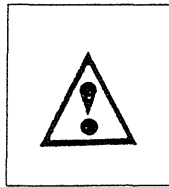

⚠ Danger

- The maximum permitted input voltage to the 8944 analog input unit is 500 V (DC + AC peak). To avoid the danger of electric shock or damage to the unit, ensure that voltages exceeding this limit are never applied to the input terminals.
- The input unit maximum floating voltage is 450 V AC/DC. To avoid the danger of electric shock or damage to the unit, ensure that voltages exceeding this limit are never applied between two channels, or between any channel and the main unit.

⚠ Warning

- The logic inputs all have a common ground with the main unit.

3-5 CRT Intensity

- The display is a gray-scale type. Adjust the intensity for optimum readability.
- To adjust the display turn the CRT INTENSITY knob on the rear panel. The lower the intensity, the longer the CRT itself will last.
- Enabling the screen saver function (screen auto off) prolongs CRT life, by turning the display off automatically if no user operation occurs for 10 minutes.

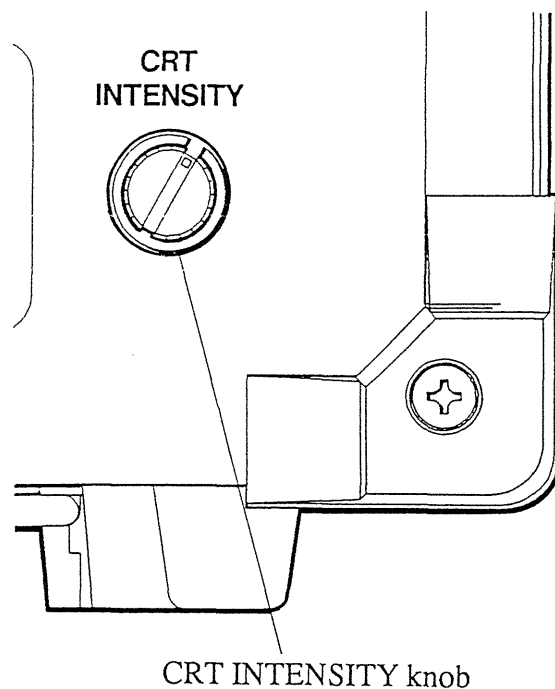

Section 4

Basic Display Manipulations

Contents

| | | |
|-------|--------------------------------------|-----|
| 4-1 | Screen Modes | 4-2 |
| 4-2 | Changing Settings..... | 4-3 |
| 4-2-1 | Cursor Keys and Soft Keys..... | 4-3 |
| 4-2-2 | Rotary Knob and Knob Select Key..... | 4-4 |
| 4-2-3 | TIME/DIV Key and Range Keys..... | 4-5 |
| 4-2-4 | Example Settings | 4-6 |

4-1 Screen Modes

There are four principal screen modes: status, trigger, display and system, plus a floppy disk control mode.

① Status mode

Selected by pressing the STATUS key. Except for the trigger settings, this mode is used for most settings.

② Trigger mode

Selected by pressing the TRIG key. Used for setting trigger conditions for all functions.

③ Display mode

Selected by pressing the DISPLAY key. This mode displays the results of measurement in all functions. The principal settings also appear on this screen.

④ System mode

Selected by pressing the SYSTEM key. This mode is used for setting the real time clock, setting scaling factors, adding comments, special function settings, GP-IB settings, plotter output settings and the self-test function. Except for special functions, these are common to all functions.

⑤ Floppy disk control mode

Selected by pressing the FD key. Used for floppy disk operations including formatting, file display, and deleting, loading and saving files.

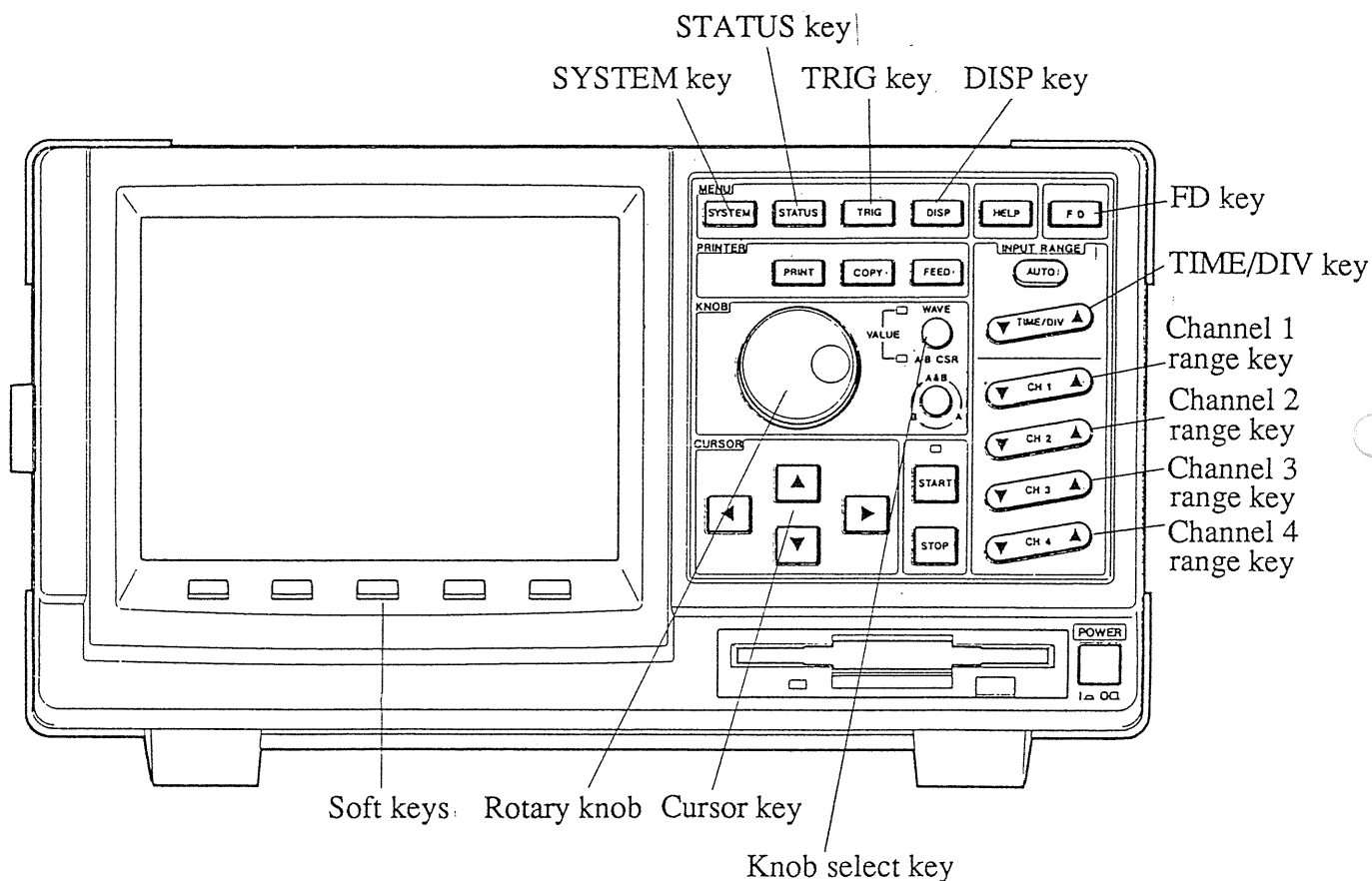

4-2 Changing Settings

Use the following controls to change settings shown on the screen:

- Cursor keys
- Soft keys } All settings can be achieved with just these two keys.
- Rotary knob
- Knob select key

The TIME/DIV key can also be used to set the time axis range.

The range key for each channel can also be used to set the input unit voltage range.



4-2-1 Cursor Keys and Soft Keys

Use the following procedure to change settings on the screen.

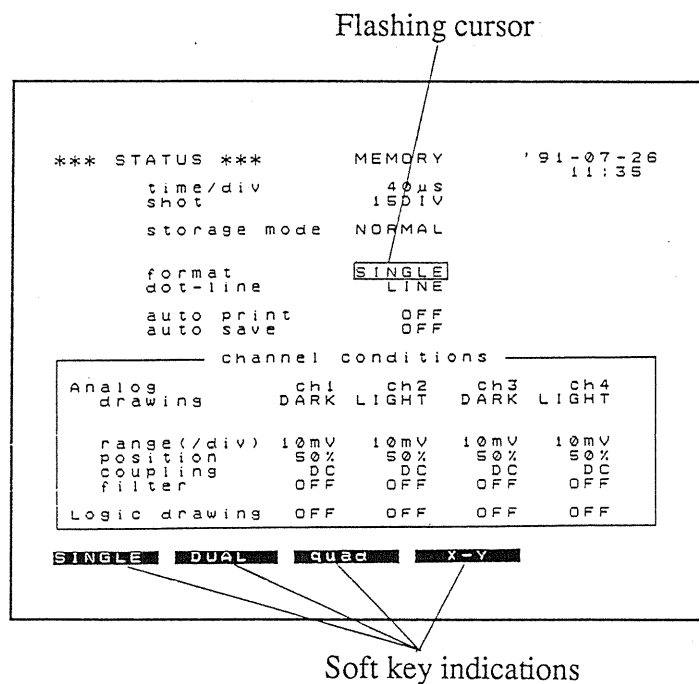
- ① Use the cursor keys to move the flashing cursor on the screen to the item to be changed.
- ② The bottom line of the screen shows the settings assigned to the soft keys. Press the soft key for the required setting.











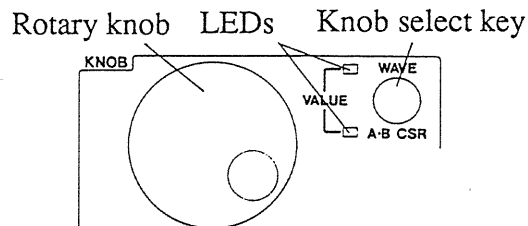

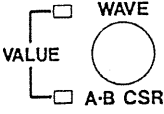
4-2-2 Rotary Knob and Knob Select Key

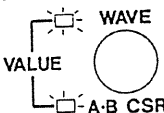
When the soft key indications include  and  you can also use the rotary knob to change the corresponding value. This section explains how the rotary knob, including this adjustment function.

The function of the rotary knob changes each time the knob select key is pressed.

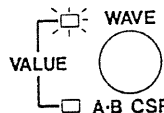
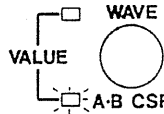
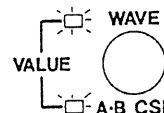
To the left of the knob select key are two LED indicators, one above the other. These indicate the current rotary knob function.

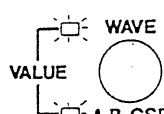

| | LEDs | Rotary knob operation |
|----------------------------------|---|---|
| Status, trigger and system modes |  | Screen scrolling Scrolls the screen vertically. (Except in system mode) Moves the flashing cursor correspondingly. <ul style="list-style-type: none"> Turning the knob clockwise scrolls the screen up. Same effect as the  cursor key. Turning the knob counterclockwise scrolls the screen down. Same effect as the  cursor key. |
| |  | Changing numeric values When the soft key indications include  and  the rotary knob has the same functions. <ul style="list-style-type: none"> Turning the knob clockwise ... same effect as the  soft key. Turning the knob counterclockwise ... same effect as the  soft key. Selecting input characters Allows characters to be selected when inputting comments or scaling units in the system mode. <ul style="list-style-type: none"> Turning the knob clockwise ... moves the flashing cursor to the right. Turning the knob counterclockwise ... moves the flashing cursor to the left. |
| Display mode |  | Waveform scrolling <ul style="list-style-type: none"> Turning the knob clockwise ... scrolls the waveform to the right. Turning the knob counterclockwise ... scrolls the waveform to the left. |
| |  | Moving the A and B cursors and zoom (magnified/compressed) display cursor <ul style="list-style-type: none"> Turning the knob clockwise ... moves the cursor up or to the right. Turning the knob counterclockwise ... moves the cursor down or to the left. |
| |  | Changing numeric values When the soft key indications include  and  the rotary knob has the same functions. <ul style="list-style-type: none"> Turning the knob clockwise ... same effect as the  soft key. Turning the knob counterclockwise ... same effect as the  soft key. |
| Floppy disk control mode |  | Selecting input characters Allows characters to be selected when inputting filenames. <ul style="list-style-type: none"> Turning the knob clockwise ... moves the flashing cursor to the right. Turning the knob counterclockwise ... moves the flashing cursor to the left. |

4-2-3 TIME/DIV Key and Range Keys

- ① You can use the TIME/DIV key to set the time axis range.

For all functions, in the status or display mode:

Pressing the right end of the TIME/DIV key ... makes the recording faster.

Pressing the left end of the TIME/DIV key ... makes the recording slower.

- ② The range key for each channel can also be used to set the input unit voltage range.

For all functions, in the status or display mode:

Pressing the right end of the channel range key ... increases the sensitivity.

Pressing the left end of the channel range key ... decreases the sensitivity.

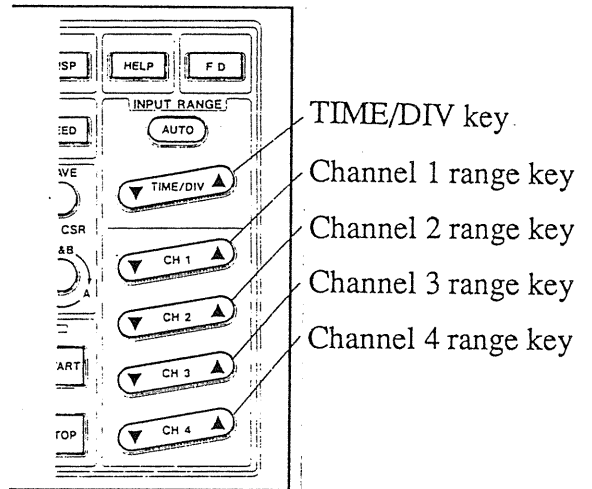

Notes: You can also use the cursor keys and soft keys to set both the time axis range and the input channel voltage ranges.

These settings cannot be carried out in trigger or system mode.

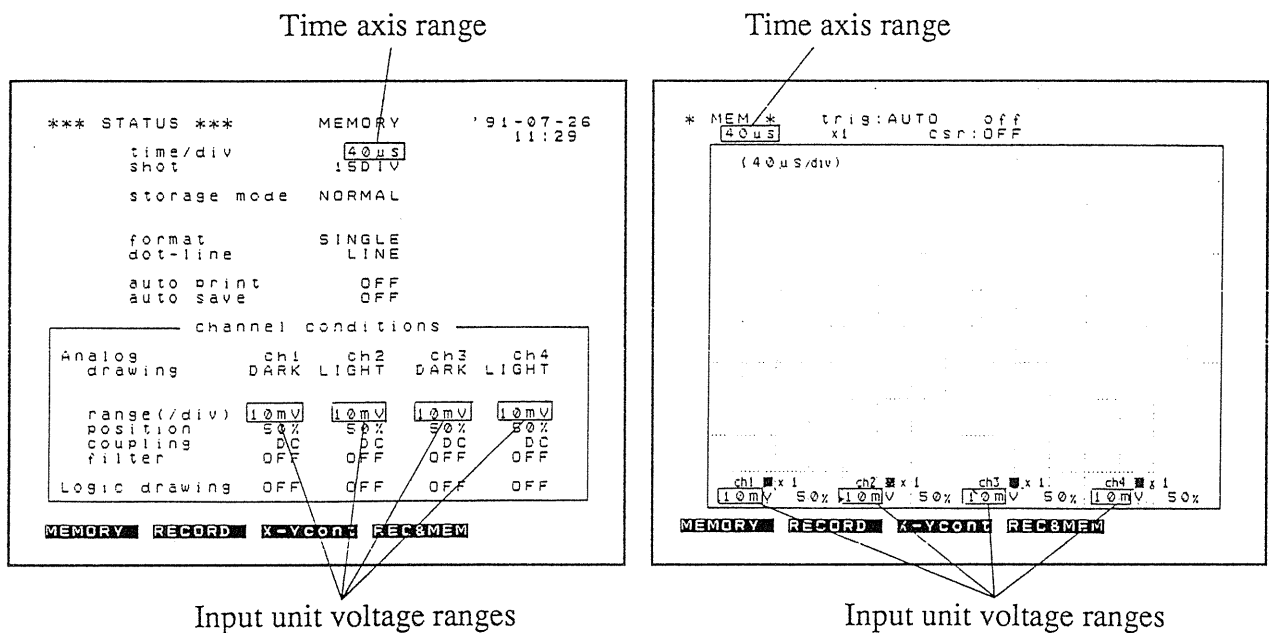

4-2-4 Example Settings

This section illustrates settings for the recorder function in status mode.

(1) Press the STATUS key, to display the status screen.

```

*** STATUS ***      MEMORY      '91-07-26
                        11:15
time/div            100us
shot                1SDIV
storage mode       NORMAL

format              SINGLE
dot-line           LINE
auto print         OFF
auto save          OFF

channel conditions
-----
Analog              ch1  ch2  ch3  ch4
drawing            DARK LIGHT DARK LIGHT

range (/div)       10mV  10mV  10mV  10mV
position           50%   50%   50%   50%
coupling           DC    DC    DC    DC
filter             OFF   OFF   OFF   OFF
Logic drawing      OFF   OFF   OFF   OFF

MEMORY RECORD X-YCONT REC&MEM
  
```

(2) Select the RECORD soft key.

```

*** STATUS ***      RECORDER     '91-07-26
                        11:17
time/div           400ms
shot              1SDIV
format            SINGLE

printer           ON

channel conditions
-----
Analog              ch1  ch2  ch3  ch4
drawing            DARK LIGHT DARK LIGHT

range (/div)       10mV  10mV  10mV  10mV
position           50%   50%   50%   50%
coupling           DC    DC    DC    DC
filter             OFF   OFF   OFF   OFF
Logic drawing      OFF   OFF   OFF   OFF

MEMORY RECORD X-YCONT REC&MEM
  
```

(3) Set the time axis range.

You can use the TIME/DIV key without moving the flashing cursor.

Set the range to 5 seconds.

(It is also possible to move the flashing cursor to the time/div item, and adjust the value with the \uparrow and \downarrow soft keys.)

```

*** STATUS ***      RECORDER     '91-07-26
                        11:19
time/div           5 s
shot              1SDIV
format            SINGLE

printer           ON

channel conditions
-----
Analog              ch1  ch2  ch3  ch4
drawing            DARK LIGHT DARK LIGHT

range (/div)       10mV  10mV  10mV  10mV
position           50%   50%   50%   50%
coupling           DC    DC    DC    DC
filter             OFF   OFF   OFF   OFF
Logic drawing      OFF   OFF   OFF   OFF

MEMORY RECORD X-YCONT REC&MEM
  
```

(4) Set the shot length.

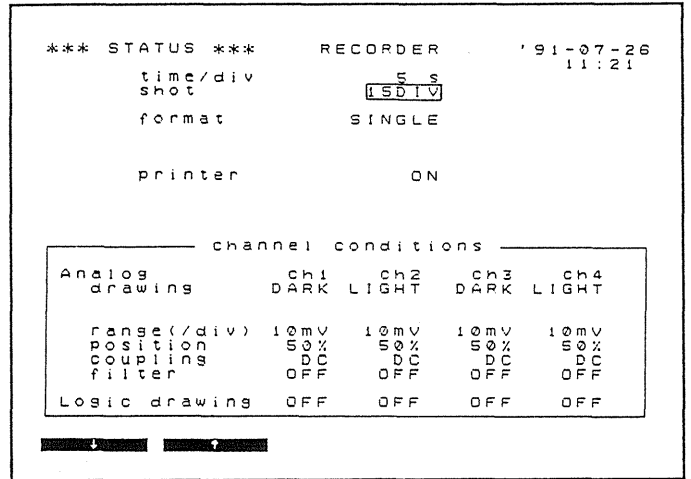

Press the cursor  key to move the flashing cursor to the "shot" item.

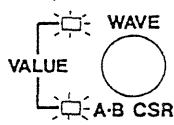

(5) Press the knob select key so that both LEDs are lit.



Turn the rotary knob to set the shot length. Set it to continuous (CONT).

(It is also possible to adjust the value with the  and  soft keys.)

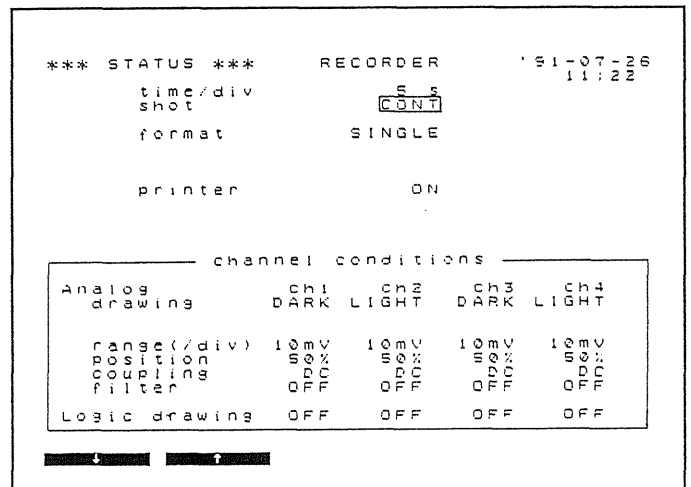

(6) Set the format.

Press the knob select key so that both LEDs are off.

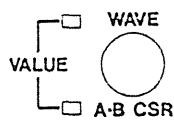

Turn the rotary knob until the flashing cursor is on the "format" item. (Or of course you can use the  cursor key.)

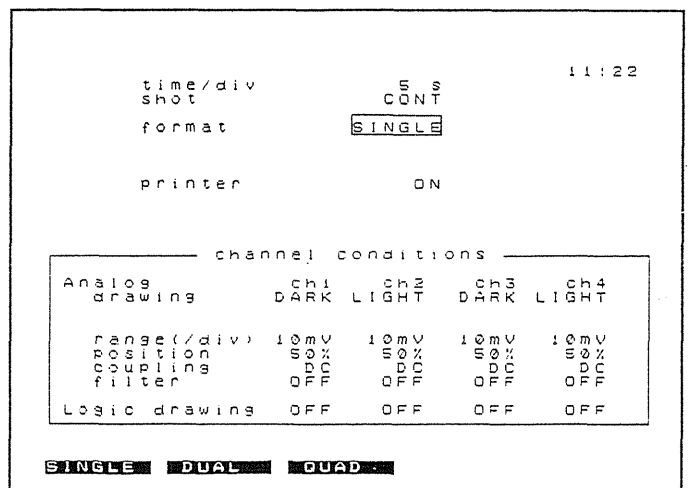

(7) Select the **DUAL** soft key, to select dual format.

```
time/div          S S          11:24
shot              CONT
format            DUAL
printer          ON
```

| channel conditions | | | | |
|--------------------|------|-------|------|-------|
| | ch1 | ch2 | ch3 | ch4 |
| Analog | | | | |
| drawings | DARK | LIGHT | DARK | LIGHT |
| graph | 1 | 2 | 1 | 2 |
| range (/div) | 10mV | 10mV | 10mV | 10mV |
| position | 50% | 50% | 50% | 50% |
| coupling | DC | DC | DC | DC |
| filter | OFF | OFF | OFF | OFF |
| Logic drawings | OFF | OFF | OFF | OFF |

SINGLE **DUAL** **QUAD**

Section 5

Memory Recorder Function Operation

Contents

| | | |
|--------|--|------|
| 5-1 | What is the Memory Recorder Function? | 5-2 |
| 5-1-1 | Introduction..... | 5-2 |
| 5-1-2 | Finding Reference Material in this Manual | 5-5 |
| 5-2 | Screen Modes | 5-5 |
| 5-2-1 | Status Mode | 5-6 |
| 5-2-2 | Trigger Mode | 5-7 |
| 5-2-3 | Display Mode..... | 5-8 |
| 5-3 | Basic Operation Procedure..... | 5-8 |
| 5-3-1 | Operation Sequence | 5-8 |
| 5-3-2 | Operation Example | 5-9 |
| 5-4 | User Operations..... | 5-15 |
| 5-4-1 | Function Selection | 5-15 |
| 5-4-2 | Time Axis Range Setting..... | 5-16 |
| 5-4-3 | Shot Length Selection..... | 5-19 |
| 5-4-4 | Storage Mode Selection..... | 5-20 |
| 5-4-5 | Format Selection..... | 5-21 |
| 5-4-6 | Using X-Y Waveform Plots..... | 5-24 |
| 5-4-7 | Interpolation Setting | 5-28 |
| 5-4-8 | Display and Recording Channel Settings | 5-30 |
| 5-4-9 | Input Unit Range, Position, Coupling and Filter Settings | 5-34 |
| 5-4-10 | Zero Adjustment | 5-37 |
| 5-4-11 | Trigger Settings | 5-38 |
| 5-4-12 | Starting and Stopping Measurement Operation..... | 5-41 |
| 5-4-13 | Using A and B Cursors | 5-42 |
| 5-4-14 | Time Axis Zoom Function..... | 5-49 |
| 5-4-15 | Voltage Axis Zoom Function | 5-51 |
| 5-4-16 | Waveform Scrolling..... | 5-54 |
| 5-4-17 | Auto Ranging Function..... | 5-58 |
| 5-4-18 | Superimposition Function..... | 5-60 |
| 5-4-19 | Printing Waveform Recordings | 5-62 |
| 5-4-20 | Help Function | 5-66 |
| 5-5 | Interpreting Waveform Displays and Recordings..... | 5-70 |

5-1 What is the Memory Recorder Function?

5-1-1 Introduction

This function allows you to carry out a variety of operations on an input signal which has been stored in memory. Since the data is available in memory there are a large number of different ways of exploiting it.

(1) Storing the input signal in memory, then displaying or recording it.

(2) Recording all input channels on the same time axis.

Since the different signals can be overlaid, it is easy to see the relationships among them.

(3) There is a range of 17 time axis scales, from 40 μ s/division to 5 s/division.

(4) Memory capacity is a maximum of 500K words per channel, using four channels.
(Corresponds to 12500 divisions.)

(5) The pre-trigger function allows waveforms leading up to a trigger event to be captured.

(6) Zoom magnification and compression functions are provided for recording, on both time and voltage axes.

Time axis $\times 10, \times 5, \times 2, \times 1, \times 1/2, \times 1/5, \times 1/10, \times 1/20, \times 1/50, \times 1/100, \times 1/200, \times 1/500,$
 $\times 1/1000, \times 1/2000, \times 1/4000$

Voltage axis ... $\times 10, \times 5, \times 2, \times 1, \times 1/2$

(7) Three different display formats, and four different recording formats can be selected.

Time axis waveforms: single, dual and quad (quad recording only)

In addition, X-Y recording and display.

(8) High quality printing

The smooth print function provides a smooth recorded waveform, close to an analog waveform.

(9) Partial printing

The required section of a stored waveform can be extracted and recorded.

(10) Reprint function

Once waveform data is stored, it can be printed as many times as required.

(11) Memory division function

To store recurring intermittent bursts of activity, and reduce dead time. The waveform memory for each channel can be divided into a maximum of 63 blocks, each corresponding to 150 divisions.

(12) Waveform pass/fail decision function allows abnormal waveforms to be detected.

(13) A range of computation functions makes analysis of stored data easy.

(14) Averaging function

The sliding average enables noise components to be removed, and the underlying signal observed.

5-1-2 Finding Reference Material in this Manual

(1) Basic function

See Section 5-4 "User Operations" (Sections 5-4-1 to 5-4-20) for operational details.

(2) Averaging function

See Section 13-2 "Using the Averaging Function" (in Vol. 2).

(3) Envelope function

See Section 13-3 "Using the Envelope Function" (in Vol. 2).

(4) Trigger functions

See Section 14 (Vol. 2). Depending on the application, there is a wide range of trigger types to choose from.

(5) Memory division function

See Section 15 (Vol 2).

The multi-block memory function allows memory to be divided, and the different blocks to be used for different purposes.

The sequential save function allows intermittent phenomena to be recorded sequentially, thus reducing dead time.

(6) Waveform decision functions

See Section 16 (Vol. 2). The input signal waveform decision is based on an arbitrary user-specified area. This allows abnormal waveforms to be detected and recorded.

(7) Computation functions

See Section 17 (Vol. 2). A wide range of functions is provided, from arithmetic operators to fast Fourier transform.

(8) Using floppy disks

See Section 19 (Vol. 2).

The floppy disk drive provides a long-term storage mechanism for setting information, measurement data and waveform decision areas.

Again, using the auto save function, waveform data collected during operation is automatically saved to floppy disk.

(9) Scaling function

See Section 18-3 "Scaling Function" (in Vol. 2). This allows the input voltages to be converted to other values and units, so that the physical quantities originally measured can be read off directly.

(10) Comment function

See Section 18-4 "Adding Comments" (in Vol. 2). This provides a convenient means of annotating printed recordings.

(11) Screen auto off function

(12) Grid setting

The grid can be selected as required, both on the screen and on the printed recording.

} See Section 18-5
"Special Function Settings"
(in Vol. 2)

(13) Start key backup function

If the power supply fails during recording, enabling this function causes recording to restart when the power is restored.

(14) Channel marker function

Prints the channel numbers on the recording.

(15) Audible warning setting

(16) List and gauge functions

Voltage axis scales and listings of settings on printed recordings.

(17) Logic waveform display intensity

Logic channel waveforms can be displayed at two intensities.

(18) Smooth print function

This provides a waveform printout close to analog quality.

(19) Roll mode

This allows waveform display to start as data capture begins after a trigger.

(20) Channel selection

The unit can operate with one, two or four channels in use.

(21) Connection to a computer via the GP-IB interface

See Section 20 (Vol. 2).

(22) Output to an external plotter

See Section 18-7 "Plotter Output" (in Vol. 2).

(23) Self check functions

See Section 18-8 "Self Check Functions" (in Vol. 2). This performs simple tests on the unit's functioning.

See Section 18-5
"Special Function Settings"
(in Vol. 2)

5-2 Screen Modes

This section describes the status, trigger and display modes.

It also shows you where to look in this manual for further explanation of specific items.

See Section 18 for details of the system mode, and see Section 19 for details of the floppy disk control mode.

5-2-1 Status Mode

Press the STATUS key to display the status screen.

Use the rotary knob to scroll the screen, or hold down the cursor  key to see the special function display.

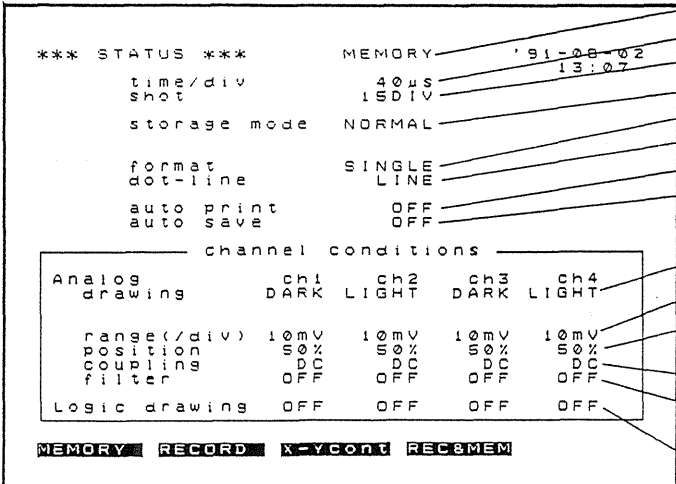

Function selected (See 5-4-1)
 Time axis range (See 5-4-2)
 Shot length (See 5-4-3)
 Storage mode (See 5-4-4)
 Format (See 5-4-5)
 Interpolation function (See 5-4-7)
 Auto print function (See 5-4-19)
 Auto save function (See Section 19)

| channel conditions | | | | |
|--------------------|----------|-----------|----------|-----------|
| Analog drawing | ch1 DARK | ch2 LIGHT | ch3 DARK | ch4 LIGHT |
| range (/div) | 10mV | 10mV | 10mV | 10mV |
| position | 50% | 50% | 50% | 50% |
| coupling | DC | DC | DC | DC |
| filter | OFF | OFF | OFF | OFF |
| Logic drawing | OFF | OFF | OFF | OFF |

Analog waveform display and recording
 Analog voltage range (See 5-4-8)
 Analog waveform origin (See 5-4-9)
 Input unit coupling
 Input unit filter
 Logic waveform display and recording (See 5-4-8)

MEMORY RECORD X-Ycont REC&MEM

Status screen

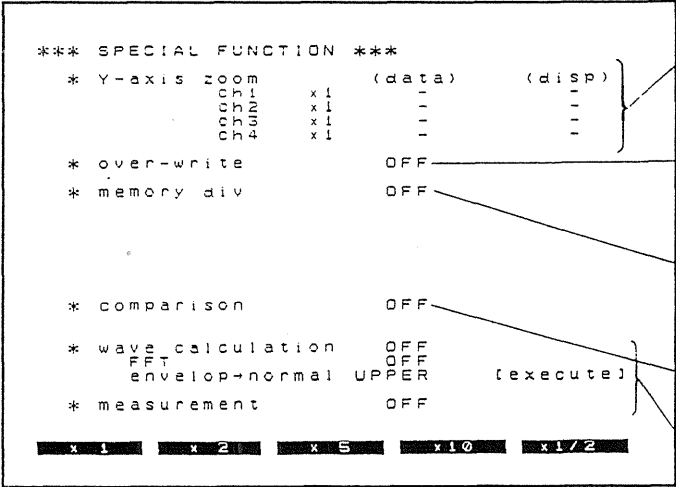

Voltage axis zoom function (See 5-4-15)
 Overwrite function (See 5-4-18)
 Memory division function (See Section 15)
 Waveform decision function (See Section 16)
 Computation functions (See Section 17)

| *** SPECIAL FUNCTION *** | | | |
|--------------------------|--------|--------|-----------|
| * Y-axis zoom | (data) | (disp) | |
| ch1 | x1 | - | - |
| ch2 | x1 | - | - |
| ch3 | x1 | - | - |
| ch4 | x1 | - | - |
| * over-write | OFF | | |
| * memory div | OFF | | |
| * comparison | OFF | | |
| * wave calculation | OFF | | |
| FFT | OFF | | |
| envelop-normal | UPPER | | [execute] |
| * measurement | OFF | | |

x1 x2 x5 x10 x1/2

Special function display

5-2-2 Trigger Mode

Press the TRIG key to display the trigger screen.

Use the rotary knob to scroll the screen, or hold down the cursor  key to see the special trigger display.

See Section 5-4-11 "Trigger Settings" and Section 14 "Trigger Functions" for more details.

| *** TRIG *** | | MEMORY | '91-08-25 |
|--|-------|-----------|---------------------|
| source | OR | | 13:24 |
| ch1(A) | LEVEL | level 50% | } Internal triggers |
| | | slope | |
| | | filter | |
| | | OFF | |
| ch2(B) | OFF | | |
| ch3(C) | OFF | | |
| ch4(D) | OFF | | |
| external | OFF | | } External trigger |
| tris mode | AUTO | | } Trigger mode |
| pre-tris | 0% | | } Pre-trigger |
| <div style="display: flex; justify-content: space-between; border: 1px solid black; padding: 2px;"> OFF LEVEL WINDOW LOGIC (etc) </div> | | | |

Trigger screen.

| *** SPECIAL TRIG *** | | | '91-08-25 |
|---|----|-------------|-----------------|
| | | | 13:25 |
| timer source | ON | | } Timer trigger |
| start | | 08-31 13:00 | |
| stop | | 08-25 15:00 | |
| interval | | 0:10:30 | |
| <div style="display: flex; justify-content: space-between; border: 1px solid black; padding: 2px;"> OFF ON </div> | | | |

Special trigger display

5-2-3 Display Mode

Press the DISP key to enter the display mode.

The figure below illustrates a display in single format. For details of other formats, see Section 5-4-5 "Format Selection" and Section 5-4-6 "Using X-Y Waveform Plots."

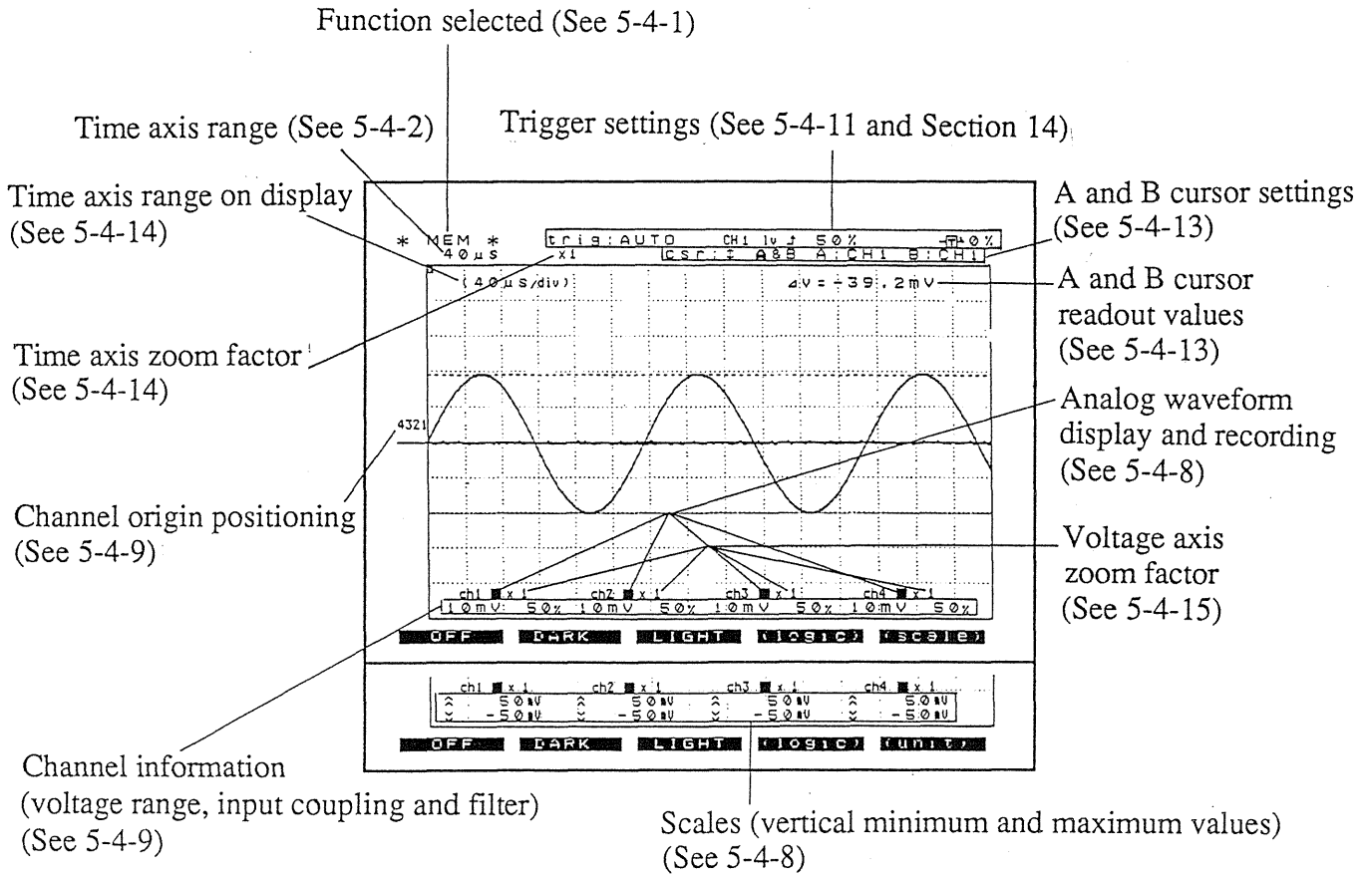

5-3 Basic Operation Procedure

5-3-1 Operation Sequence

The flowchart below illustrates the sequence of operations involved in using the memory recorder function. (The explanation to the right of the flowchart boxes is based on Section 5-3-2 "Operation Example.")

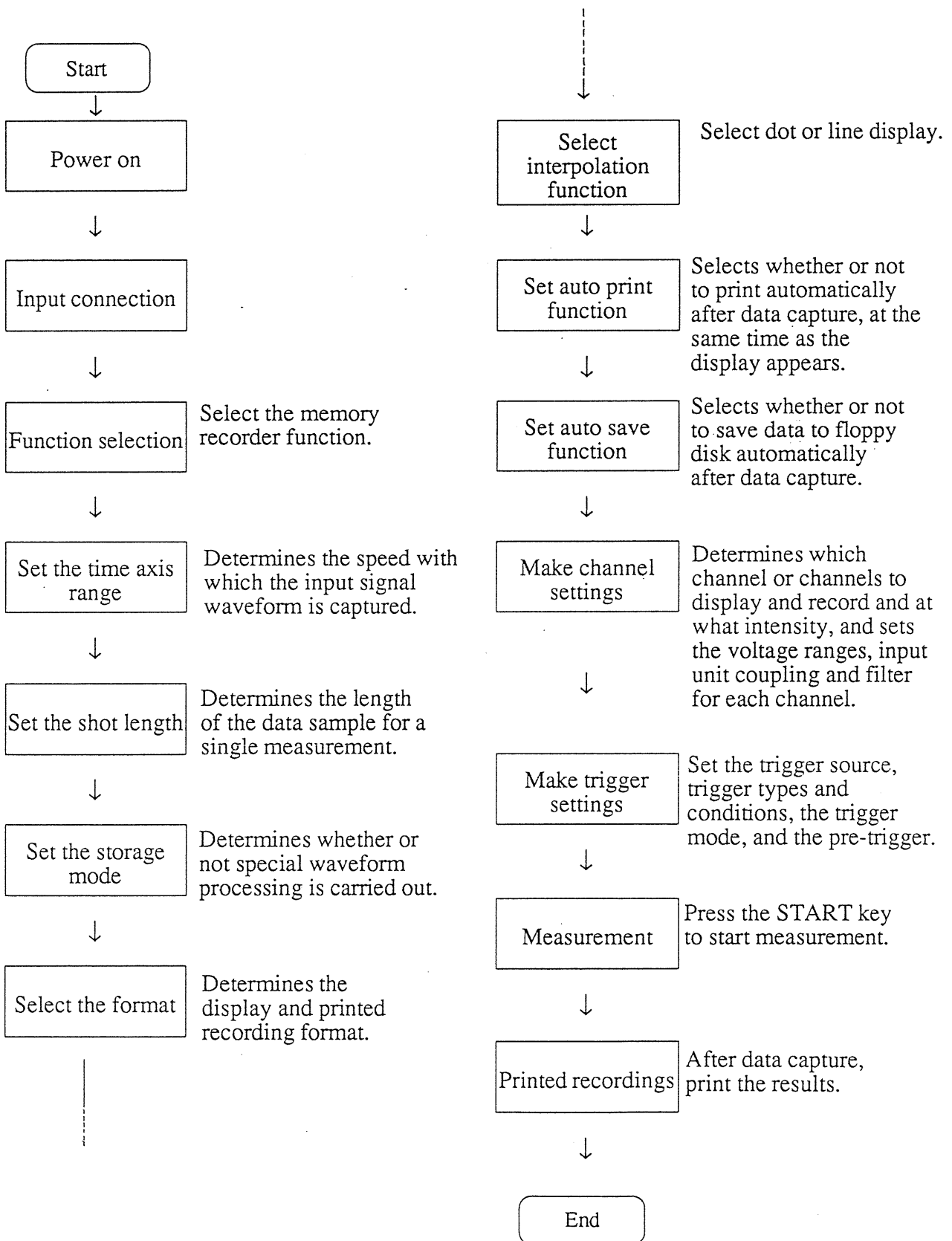

5-3-2 Operation Example

This example illustrates the basic procedure using the memory recorder function to measure a 3 V p-p 1 kHz sine wave input.

(1) Power on the unit

Connect the power cord to the 8851 and press the power switch.

(2) Input connection

Connect a signal generator to the input terminals of channel 1 (the 8944 analog input unit). Set the signal generator so that it outputs a 3 V p-p 1 kHz sine wave.

(3) Select the function

Select the memory recorder function.

1. Press the STATUS key.

2. Move the flashing cursor to the function indication.

3. Press the **MEMORY** soft key.

Flashing cursor

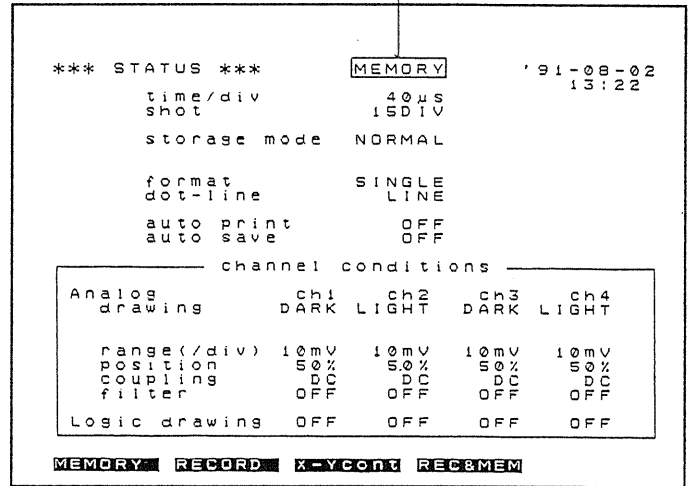

(4) Set the time axis range

Set the time axis range to 500 µs/division.

1. Either use the TIME/DIV key, or move the flashing cursor to the "time/div" item and adjust the value with the **↑** and **↓** soft keys or the rotary knob, so that the setting is 500 µs.

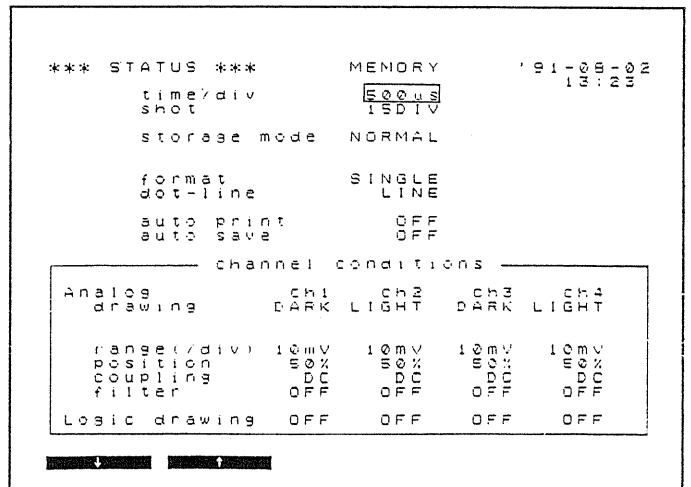

(5) Set the shot length

Set the shot length to 150 divisions.

1. Move the flashing cursor to the "shot" item.
2. Adjust the value with the and soft keys or the rotary knob, so that the setting is 150DIV.

```
*** STATUS ***      MEMORY      '91-08-02
                        13:23
time/div             500us
shot                 150DIV
storage mode         NORMAL

format               SINGLE
dot-line             LINE
auto print           OFF
auto save            OFF

channel conditions
-----
Analog drawing      ch1  ch2  ch3  ch4
                    DARK LIGHT DARK LIGHT
range (/div)       10mV 10mV 10mV 10mV
position           50%  50%  50%  50%
coupling           DC   DC   DC   DC
filter             OFF  OFF  OFF  OFF
Logic drawing      OFF  OFF  OFF  OFF
```

(6) Set the storage mode

Select the normal storage mode so that no special waveform processing is carried out.

1. Move the flashing cursor to the "storage mode" item.
2. Press the soft key.

```
*** STATUS ***      MEMORY      '91-08-02
                        13:27
time/div             500us
shot                 150DIV
storage mode         NORMAL
format               SINGLE
dot-line             LINE
auto print           OFF
auto save            OFF

channel conditions
-----
Analog drawing      ch1  ch2  ch3  ch4
                    DARK LIGHT DARK LIGHT
range (/div)       10mV 10mV 10mV 10mV
position           50%  50%  50%  50%
coupling           DC   DC   DC   DC
filter             OFF  OFF  OFF  OFF
Logic drawing      OFF  OFF  OFF  OFF
```

(7) Select the format

Select the single format: displaying and recording on a single time axis.

1. Move the flashing cursor to the "format" item.
2. Press the soft key.

```
*** STATUS ***      MEMORY      '91-08-02
                        13:27
time/div             500us
shot                 150DIV
storage mode         NORMAL
format               SINGLE
dot-line             LINE
auto print           OFF
auto save            OFF

channel conditions
-----
Analog drawing      ch1  ch2  ch3  ch4
                    DARK LIGHT DARK LIGHT
range (/div)       10mV 10mV 10mV 10mV
position           50%  50%  50%  50%
coupling           DC   DC   DC   DC
filter             OFF  OFF  OFF  OFF
Logic drawing      OFF  OFF  OFF  OFF
```

(8) Select interpolation function

Select the straight line interpolation function (LINE).

1. Move the flashing cursor to the "dot-line" item.
2. Press the **LINE** soft key.

```
*** STATUS ***      MEMORY      '91-08-02
                        13:28
time/div            500us
shot                150DIV
storage mode       NORMAL

format              SINGLE
dot-line           LINE
auto print         OFF
auto save          OFF

channel conditions
-----
Analog              ch1    ch2    ch3    ch4
drawing            DARK  LIGHT DARK  LIGHT

range(/div)        10mV   10mV  10mV  10mV
position           50%    50%   50%   50%
coupling           DC     DC    DC    DC
filter             OFF   OFF   OFF   OFF
Logic drawing      OFF   OFF   OFF   OFF

DOT LINE
```

(9) Set printer output function

Disable the auto print function, so that the printer does not automatically print after displaying a waveform on the screen.

1. Move the flashing cursor to the "auto print" item.
2. Press the **OFF** soft key.

```
*** STATUS ***      MEMORY      '91-08-02
                        13:28
time/div            500us
shot                150DIV
storage mode       NORMAL

format              SINGLE
dot-line           LINE
auto print         OFF
auto save          OFF

channel conditions
-----
Analog              ch1    ch2    ch3    ch4
drawing            DARK  LIGHT DARK  LIGHT

range(/div)        10mV   10mV  10mV  10mV
position           50%    50%   50%   50%
coupling           DC     DC    DC    DC
filter             OFF   OFF   OFF   OFF
Logic drawing      OFF   OFF   OFF   OFF

OFF ON
```

(10) Set floppy disk saving function

Disable the floppy disk auto save function.

1. Move the flashing cursor to the "auto save" item.
2. Press the **OFF** soft key.

```
*** STATUS ***      MEMORY      91-08-02
                        13:31
time/div            500us
shot                150DIV
storage mode       NORMAL

format              SINGLE
dot-line           LINE
auto print         OFF
auto save          OFF

channel conditions
-----
Analog              ch1    ch2    ch3    ch4
drawing            DARK  LIGHT DARK  LIGHT

range(/div)        10mV   10mV  10mV  10mV
position           50%    50%   50%   50%
coupling           DC     DC    DC    DC
filter             OFF   OFF   OFF   OFF
Logic drawing      OFF   OFF   OFF   OFF

OFF ON
```

(11) Make channel settings

Display and record channel 1 only, in high intensity.

Set the voltage range to 500 mV/division, the origin positioning to 50%, input coupling to DC and the input filter off.

1. Flashing cursor ... "ch1 Analog drawing"
Press the **DARK** soft key.
2. Flashing cursor ... "ch1 range"
Set to 500 mV.
You can also use the channel 1 range key, 2 ...
3. Flashing cursor ... "ch1 position"
Set to 50%.
4. Flashing cursor ... "ch1 coupling"
Press the **DC** soft key.
5. Flashing cursor ... "ch1 filter"
Press the **OFF** soft key.
6. Flashing cursor ... "ch1 Logic drawing"
Press the **OFF** soft key.
7. Similarly set the "Analog drawing" and "Logic drawing" items for channels 2, 3 and 4 all off.

*** STATUS *** MEMORY '91-08-02
13:32
time/div 500mV
SHOT 150DIV
storage mode NORMAL
format SINGLE
dot-line LINE
auto print OFF
auto save OFF

channel conditions

| | Ch1 | Ch2 | Ch3 | Ch4 |
|----------------|-------------|-------|------|-------|
| Analog drawing | DARK | LIGHT | DARK | LIGHT |
| range/div | 500mV | 10mV | 10mV | 10mV |
| position | 50% | 50% | 50% | 50% |
| coupling | DC | DC | DC | DC |
| filter | OFF | OFF | OFF | OFF |
| Logic drawing | OFF | OFF | OFF | OFF |

1 ... **OFF** **DARK** **LIGHT**

2 ... **500mV** **10mV**

3 ... **50%** **10%** **10%**

4 ... **GND** **AC** **DC**

5 ... **OFF** **500mV** **5mV**

6 ... **OFF** **ON**

7 ... **OFF** **DARK** **LIGHT**

7 ... **OFF** **ON**

Soft key indications as flashing cursor is moved.

*** STATUS *** MEMORY '91-08-25
14:22
time/div 500mV
SHOT 150DIV
storage mode NORMAL
format SINGLE
dot-line LINE
auto print OFF
auto save OFF

channel conditions

| | Ch1 | Ch2 | Ch3 | Ch4 |
|----------------|-------|------|------|------|
| Analog drawing | DARK | OFF | OFF | OFF |
| range/div | 500mV | 10mV | 10mV | 10mV |
| position | 50% | 50% | 50% | 50% |
| coupling | DC | DC | DC | DC |
| filter | OFF | OFF | OFF | OFF |
| Logic drawing | OFF | OFF | OFF | OFF |

MENU **DEL** **AC** **DC** **OFF** **ON** **RECALL** **RESET**

Screen after settings have been made

(12) Make trigger settings

Use only channel 1 as a trigger source; set the trigger level to 50%, the slope to rising, the filter off, and select the logical OR of the channels.

Set the trigger mode to single, and the pre-trigger to 5%.

Switch off the timer trigger.

1. Press the TRIG key.
2. Flashing cursor ... "source" (at the top)
Press the **OR** soft key.
3. Flashing cursor ... "ch1(A)"
Press the **LEVEL** soft key.
4. Flashing cursor ... "level"
Set to 50%.
5. Flashing cursor ... "slope"
Press the R soft key.
6. Select FILTER/EVENT
Press the **FILTER** soft key.
Note: Refer to the screen appearance after completing settings.
7. Flashing cursor ... "FILTER"
Press the **OFF** soft key.
8. Set all of channels 2 (B), 3 (C) and 4 (D) off.
9. Flashing cursor ... "external"
Press the **OFF** soft key.
10. Flashing cursor ... "trig mode"
Press the **SINGLE** soft key.
11. Flashing cursor ... "pre-trig"
Set to 5%.

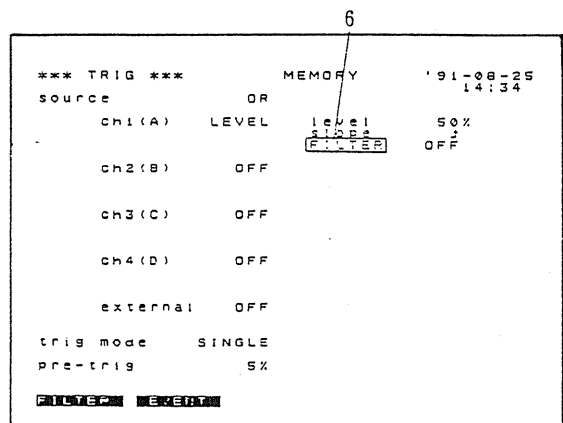
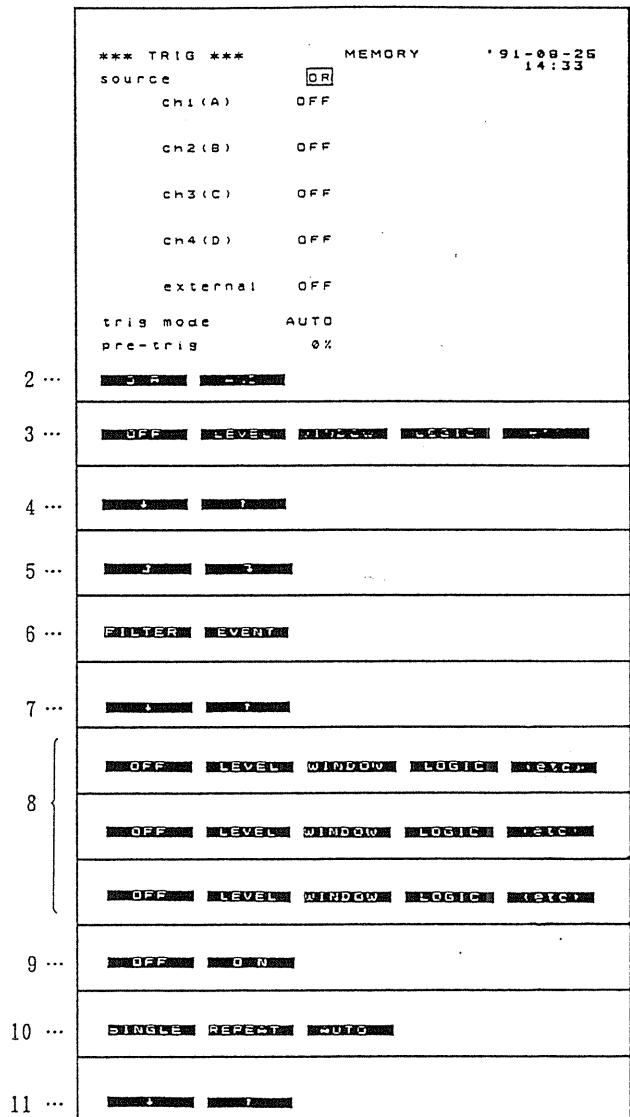

Screen after settings have been made

12. Use the rotary knob to scroll the screen, or hold down the cursor  key to see the special trigger display.

13. Flashing cursor ... "timer source"

Press the  soft key.

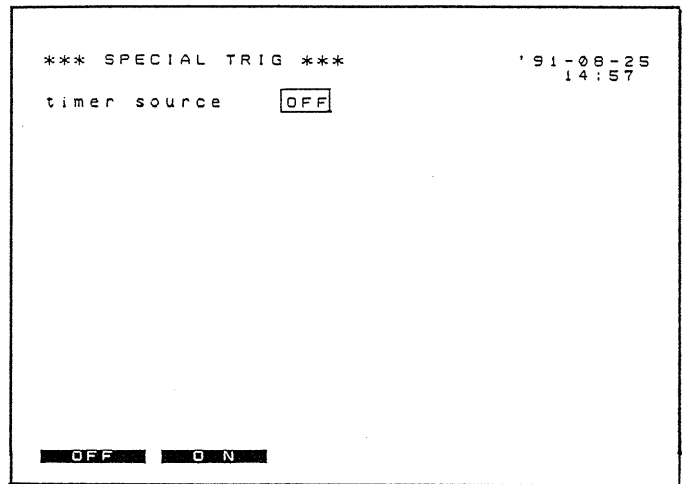

(13) Starting measurement

Press the START key to start measurement. A 75-ms sample of data including the trigger will be captured.

1. Press the START key.

The LED above the START key lights.

In this case the input is already present, so the trigger will take effect immediately. When the 150 divisions of data have been captured, the LED goes off, the unit enters the stop state, and the screen displays the waveform.

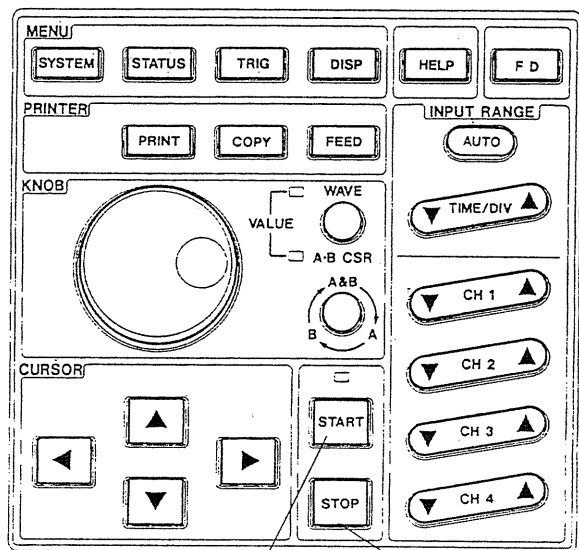

START key

STOP key

(14) Printed recording

Press the COPY and FEED keys simultaneously to copy the displayed waveform to the printer.

1. Press the COPY and FEED keys simultaneously.

The waveform on the screen and the setting information is printed.

Since the printer uses thermally sensitive paper, to keep a permanent copy of the recording, it is recommended to take a photocopy.

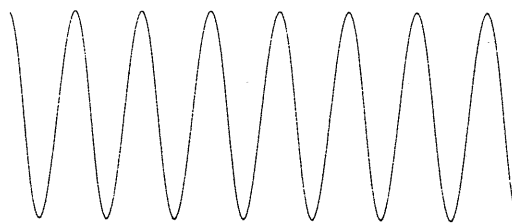

| Function | MEMORY |
|--------------|--------------------|
| time/div | 500 ns |
| | 50 |
| | (500 ns/div) |
| cursor | OFF |
| trigger | SINGLE |
| ch1 LEVEL | 50x |
| pre-trigger | 0x |
| trigger time | |
| | '91-08-25 15:14:10 |
| [CH1] | 100V/DIV DC 50 |
| | pos:50x fit:OFF |
| [CH2] | 100V/DIV DC 50 |
| | pos:50x fit:OFF |
| [CH3] | 100V/DIV DC 50 |
| | pos:50x fit:OFF |
| [CH4] | 100V/DIV DC 50 |
| | pos:50x fit:OFF |
| [CH5] | DARK |
| [CH6] | DARK |
| [CH7] | DARK |
| [CH8] | DARK |

HICKY 8851 MEMORY H. CORDER
91-08-25 15:14

5-4 User Operations

5-4-1 Function Selection

Function

First select the function to be used for measurement. There are four functions: memory recorder, recorder, X-Y recorder, and recorder and memory. In this case, select the memory recorder function.

Procedure

1. Select status mode.
2. Function selection

Press the **MEMORY** soft key.

This selects the memory recorder function.

(MEMORY, RECORDER, X-Ycont,
: REC&MEM)

(Soft key indication is "RECORD".)

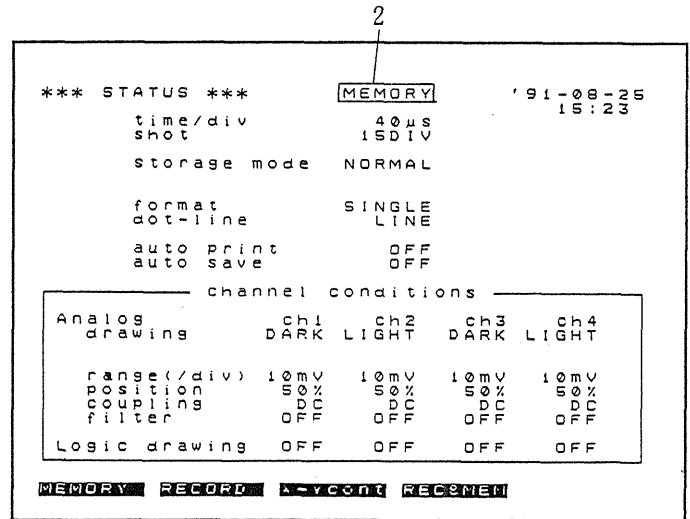

The function selection can be carried out equally in trigger or display mode.

After pressing the TRIG key for the trigger mode, or the DISP key for the display mode, make the function selection in the same way as in the status mode. The soft key indications are the same.

Note: The function indication in the display mode is abbreviated:

MEMORY - MEM
RECORDER - REC

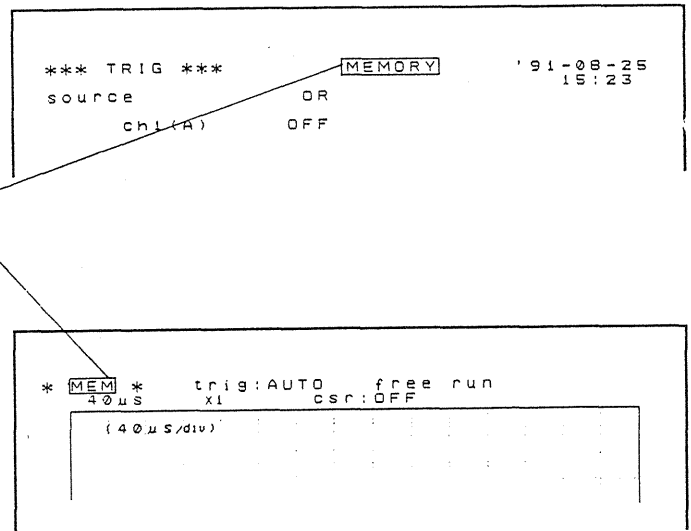

5-4-2 Time Axis Range Setting

Function

This sets the speed at which the input signal waveform is captured.

The "time/div" setting indicates the time for one division on the time axis.

The sampling period is 1/40 of the time axis range setting. (See Section 2-2 "Tables")

Procedure

You can carry out the setting in status mode or display mode.

(1) In status mode

1. Select the status mode.
2. "time/div"

Set the time axis range.

By using the TIME/DIV key, you can set the time axis range without moving the flashing cursor.

(40 μ s, 50 μ s, 100 μ s, 200 μ s, 500 μ s,
1 ms, 2 ms, 5 ms, 10 ms, 20 ms,
50 ms, 100 ms, 200 ms, 500 ms,
1 s, 2 s, 5 s)

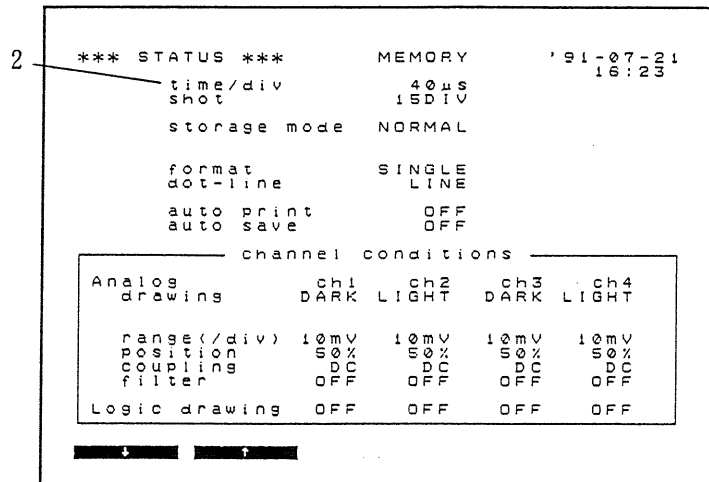

(2) In display mode

After pressing the DISP key to select display mode, carry out the time axis range setting in the same way as in status mode.

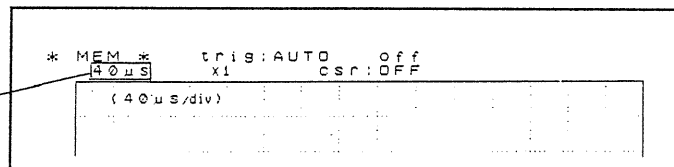

Note

- If the storage mode is set to envelope, the 40 and 50 ms/division settings are not possible. (See Section 13-3 "Using the Envelope Function.")

Related items

Setting the shot length longer makes the measurement time longer.

If using the roll mode function, the waveform display begins at the point that the trigger starts data capture, thus reducing waiting time. For more details, see Section 18-5-10 "Roll Mode" in Vol. 2.

Background

(1) Sampling

The 8851 converts the input signal to a digital value, then carries out all internal processing digitally. This process of converting an analog signal to digital values is termed sampling.

Sampling measures the magnitude of the signal at fixed time intervals.

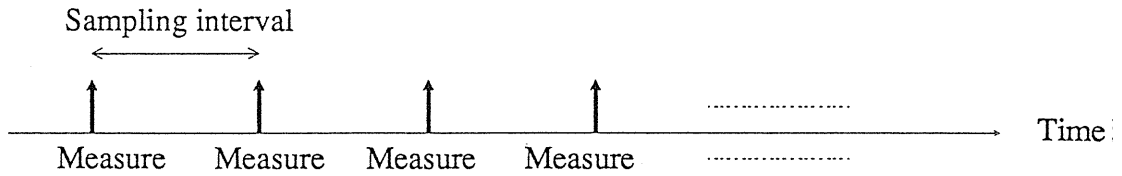

The sampling rate refers to the frequency with which this sampling operation is carried out (expressed in units of samples per second, or S/s). The sampling rate is thus the reciprocal of the sampling period.

(2) Aliasing distortion

If the frequency of the signal being measured is significantly higher than the sampling rate, it is possible for sampling to produce an apparent signal which is actually non-existent.

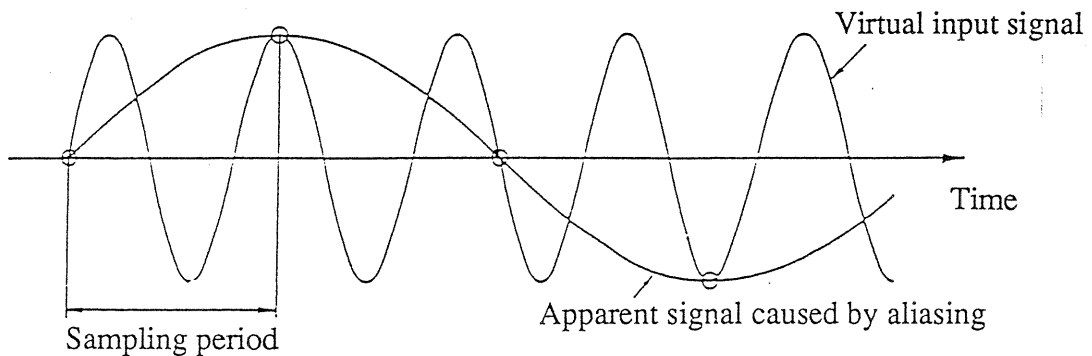

When using the memory recorder function, because of the wide variation in sampling rate, it is not possible to avoid the aliasing problem completely. (When the normal storage mode is used.)

The measurement frequency limit is determined by the setting of the time axis range (see table on next page). In any event, it is always best to use the highest practicable sampling rate.

Setting the storage mode to use the envelope function provides a fixed sampling rate independent of the time axis range, and so is an effective way of avoiding aliasing distortion. For more details see Section 13-3 "Using the Envelope Function."

When measuring a repeating signal, using the auto ranging function is another useful technique. See Section 5-4-17 "Auto Ranging Function."

(3) Measurement frequency limit

As a general rule, to ensure that sampling catches the peaks of a typical sine wave input, 25 samples are required for each input cycle. (8-bit resolution ... the 8851 display)

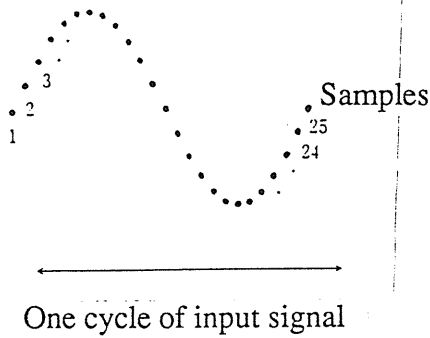

| Time/division | Sampling period | Measurement frequency limit |
|---------------|-----------------|-----------------------------|
| 40 μ s | 1 μ s | 40 kHz |
| 50 μ s | 1.25 μ s | 32 kHz |
| 100 μ s | 2.5 μ s | 16 kHz |
| 200 μ s | 5 μ s | 8 kHz |
| 500 μ s | 12.5 μ s | 3.2 kHz |
| 1 ms | 25 μ s | 1.6 kHz |
| 2 ms | 50 μ s | 800 Hz |
| 5 ms | 125 μ s | 320 Hz |
| 10 ms | 250 μ s | 160 Hz |
| 20 ms | 500 μ s | 80 Hz |
| 50 ms | 1.25 ms | 32 Hz |
| 100 ms | 2.5 ms | 16 Hz |
| 200 ms | 5 ms | 8 Hz |
| 500 ms | 12.5 ms | 3.2 Hz |
| 1 s | 25 ms | 1.6 Hz |
| 2 s | 50 ms | 0.8 Hz |
| 5 s | 125 ms | 0.32 Hz |

Frequencies in each range, computed at 25 samples per cycle

Example: Recording an input sine wave of frequency approximately 1.6 kHz with different time axis ranges

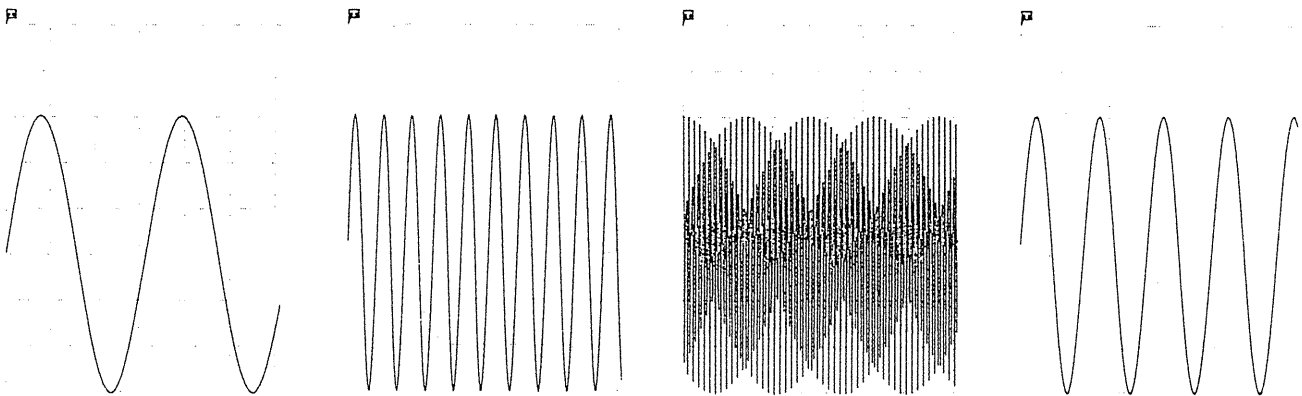

200 μ s/division
Correct waveform

1 ms/division
At the limit of measurement

10 ms/division
Peaks cannot be distinguished

50 ms/division
False signal of approximately 14 Hz,

5-4-3 Shot Length Selection

Function

Sets the recording length (number of divisions) for a single shot measurement.

Procedure

1. Select the status mode.
2. "shot"
Set the shot length.
(15, 30, 75, 150, 300, 750, 1500, 3000, 6000, 12500, 25000 (*1), 50000 (*2))
*1 using channels 1 and 2 only
*2 using channel 1 only
For more details see Section 18-5-11 "Channel Selection" in Vol. 2.

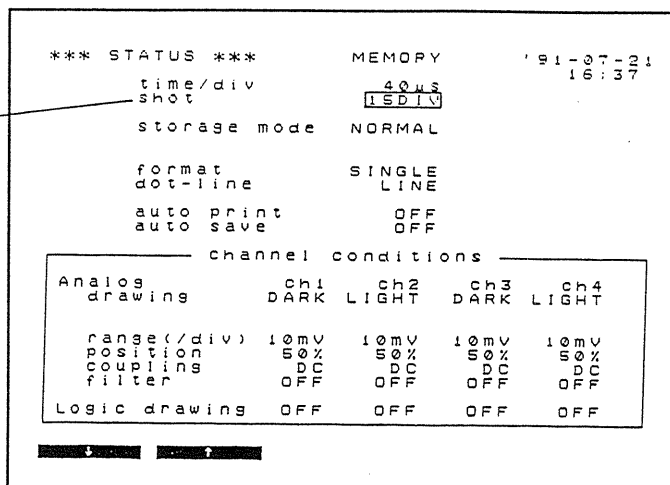

Notes

- If the storage mode is set to use the averaging function, the upper limit on the shot length is 3000 divisions (using four channels). For details see Section 13-2 "Using the Averaging Function" in Vol. 2.
- If the storage mode is set to use the envelope function, the upper limit on the shot length is 6000 divisions (using four channels). For details see Section 13-3 "Using the Envelope Function" in Vol. 2.
- If using waveform calculations, the upper limit on the shot length is 3000 divisions. For details see Section 17-2 "Waveform Processing Calculation" in Vol. 2.

5-4-4 Storage Mode Selection

Function

There are three storage modes, as follows:

NORMAL ... the input signal is displayed without alteration.

AVERAGING ... the input signal is averaged, using a sliding average process.

ENVELOPE ... the envelope of the input signal is displayed.

Procedure

1. Select the STATUS mode.
2. "storage mode"

Select the storage mode.
Select NORMAL mode unless
special processing is required.

(NORMAL, AVERAGE, ENVELOPE)

For details of the averaging and envelope
functions, see Section 13 "Waveform
Processing" in Vol. 2.

```
*** STATUS ***          MEMORY          '91-07-21
                          40µS          16:38
                          1SDIV
                          storage mode  NORMAL
                          format         SINGLE
                          dot-line       LINE
                          auto print     OFF
                          auto save      OFF

                          channel conditions
Analog                    ch1    ch2    ch3    ch4
drawing                   DARK   LIGHT DARK   LIGHT
range(/div)              10mV   10mV  10mV   10mV
position                  50%    50%   50%    50%
coupling                  DC     DC    DC     DC
filter                    OFF    OFF   OFF    OFF
Logic drawing            OFF    OFF   OFF    OFF

NORMAL  AVERAGE  ENVELOPE
```

5-4-5 Format Selection

Function

Selects the format for display and printing. There are four possibilities: single, dual, dual (print quad), and X-Y.

Display and printing formats

(1) Single

The waveforms are displayed or printed superimposed on a single time axis. (Maximum 4 analog waveforms and 16 logic signals)

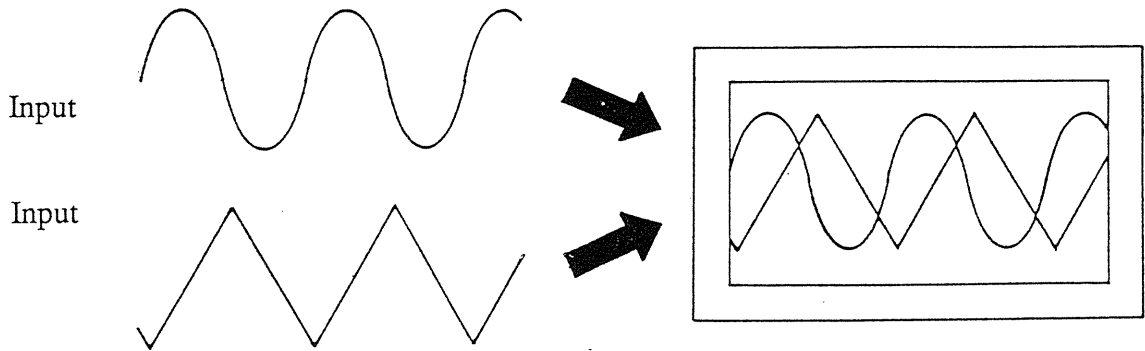

(2) Dual

The waveforms are displayed or printed on two time axes, one above the other. (Maximum 4 analog waveforms and 8 logic signals in each window)

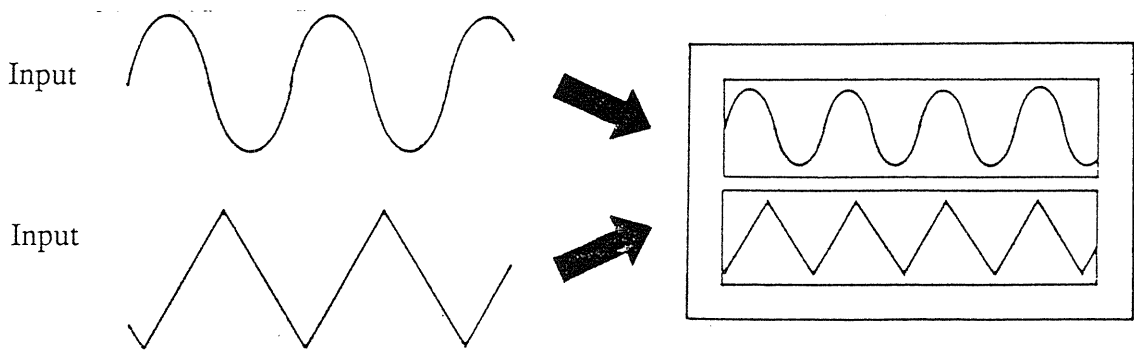

(3) Dual (print quad)

The waveforms are printed on four time axes. (Maximum 1 analog waveform and 4 logic signals on each axis)

The display format is the same as in dual format.

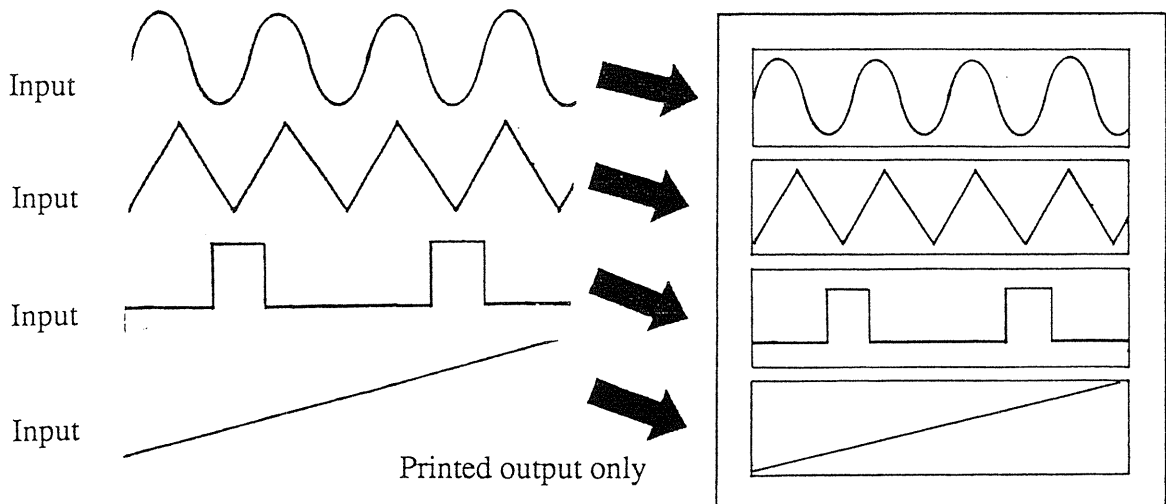

(4) X-Y

The waveforms are printed and displayed as X-Y plots.

(Maximum 3 X-Y combinations. One analog input is assigned to the x-axis.)

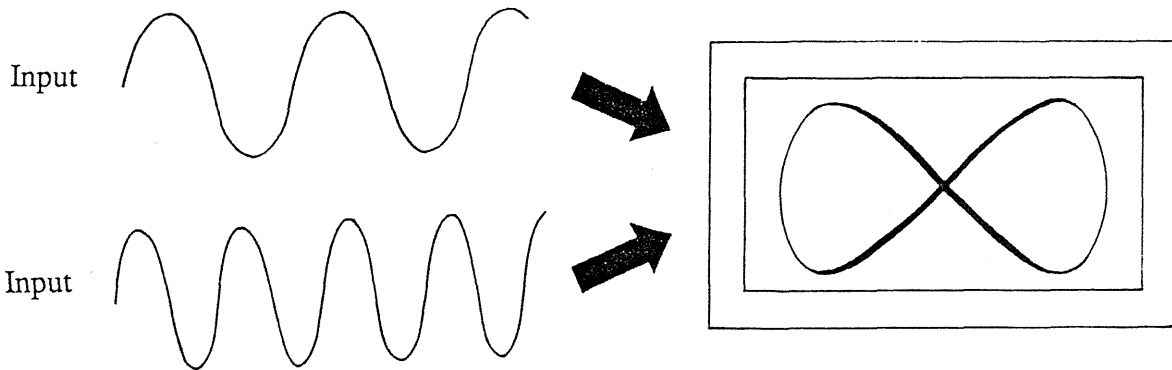

Procedure

1. Select the status mode.

2. "format"

Select the format for display and printing.

(SINGLE, DUAL, DUAL (print quad), X-Y)

Pressing the **quad** soft key selects the DUAL (print quad) format.

Note: For details of the X-Y format, see Section 5-4-6 "Using X-Y Waveform Plots."

3. "graph"

If DUAL or DUAL (print quad) format was selected in step 2, use these settings to assign each analog input to one of the two display windows (1 or 2).

1 .. upper window (time axis)

2 .. lower window (time axis)

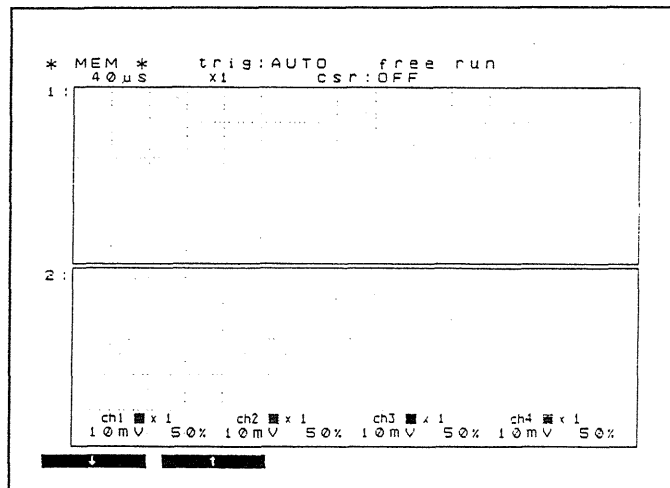
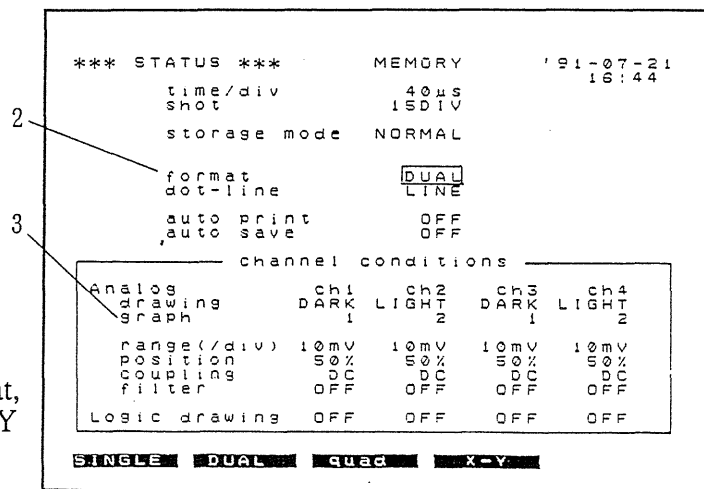

Notes

- In DUAL (print quad) format, the printer automatically assigns the four analog channels one to each of the four time axes, in sequence channel 1 to channel 4.

Display:

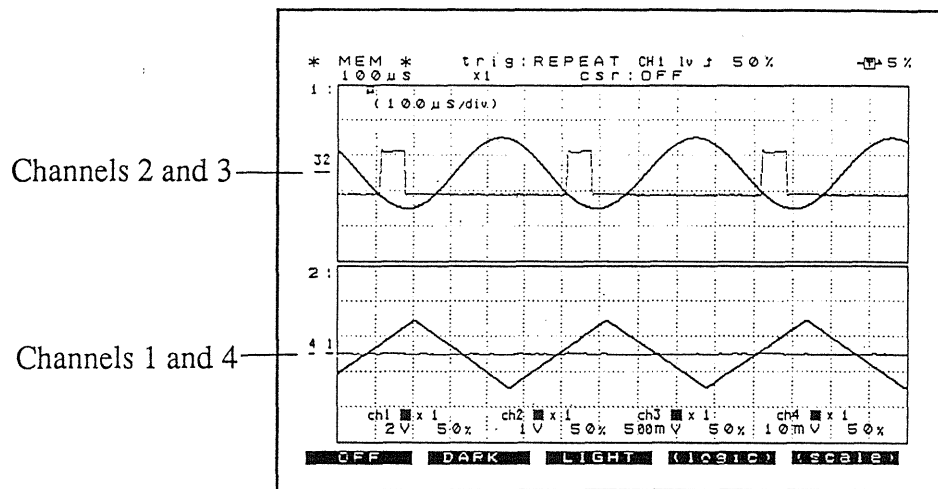

Printed recording:

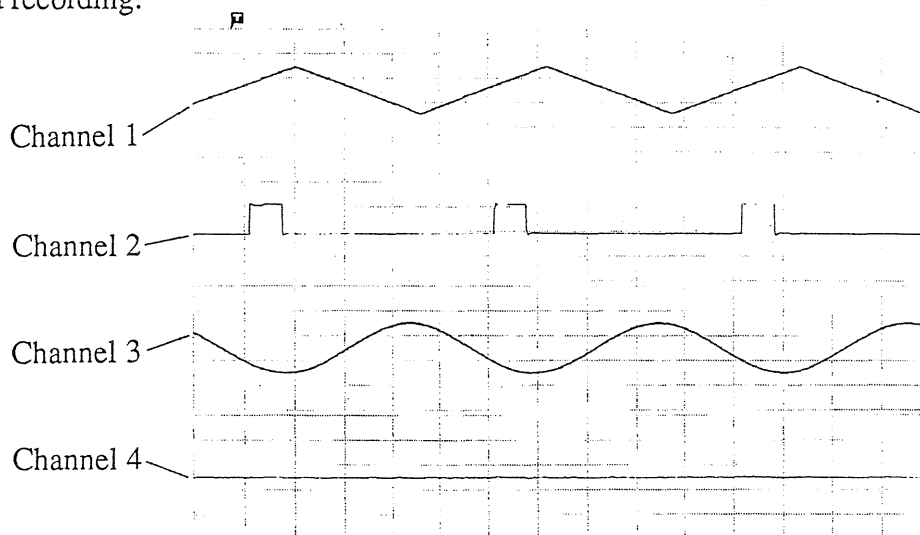

- The logic channel display and recording positions are not variable. See under the Notes heading in Section 5-4-8 "Display and Recording Channel Settings"

5-4-6 Using X-Y Waveform Plots

Function

A maximum of three X-Y plots can be displayed or printed, with one channel assigned to the horizontal axis and three channels assigned to the vertical axis.

The voltage axis zoom function remains in effect in X-Y format. (See Notes below.)

(1) Normal X-Y plot

The X-Y plot is formed using the data for the entire shot length.

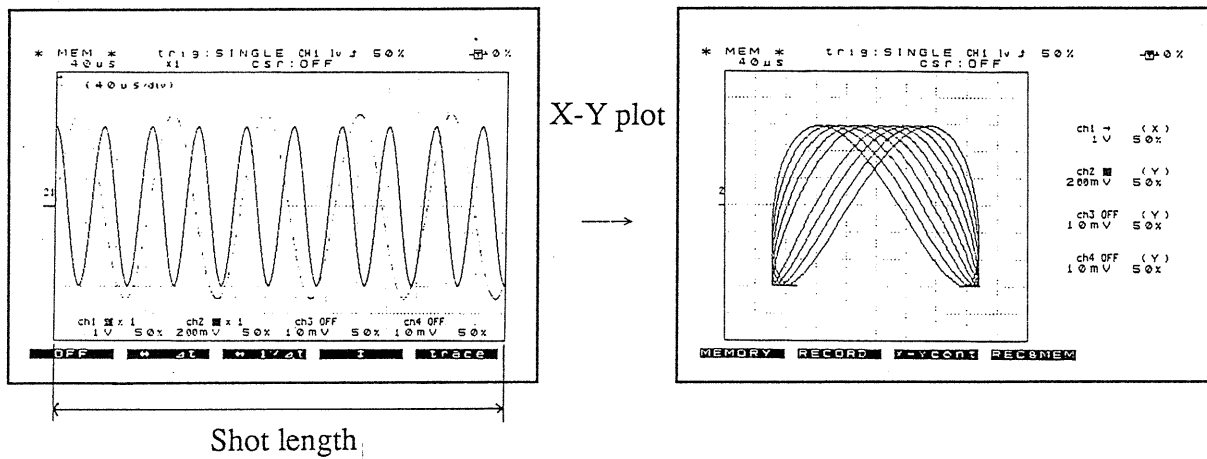

(2) Partial X-Y plot (see Example below)

Use the A and B cursors to define the section of data to be used for the X-Y plot.

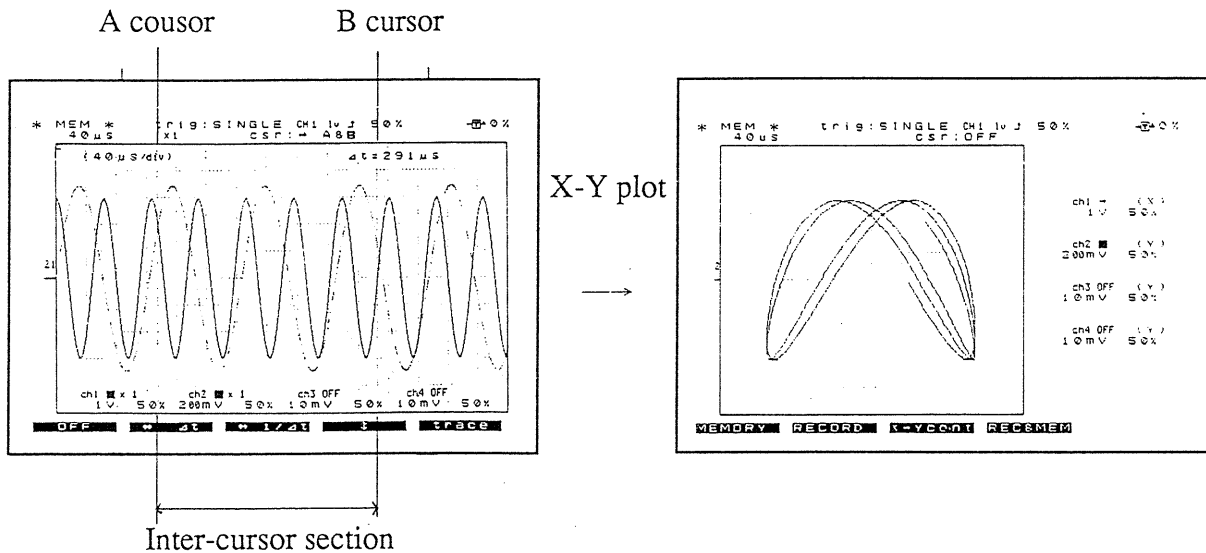

Procedure

1. Select the status mode.

2. "format"

Set the display and recording format to X-Y. (SINGLE, DUAL, DUAL (print quad), X-Y)

3. "axis"

Assign the x- and y-axes.

Assigning the chosen channel to the x-axis automatically assigns the other three channels to the y-axis.

Move the flashing cursor to the channel selected for the x-axis and press the **(X set)** soft key.

Notes: Each X-Y plot is drawn with the "Analog drawing" intensity setting for the respective y-axis channel. For more details see Section 5-4-8 "Display and Recording Channel Settings."

The "Analog drawing" setting for the x-axis channel is indicated as **↓**.

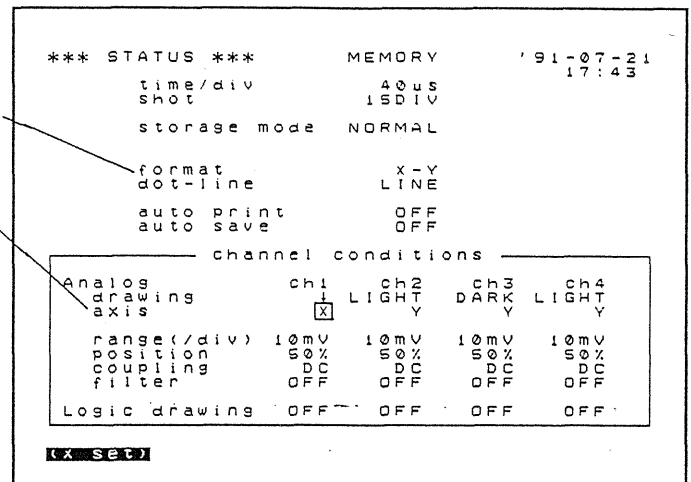

Display screen for X-Y plots

The following figure illustrates the settings shown on the screen in X-Y format.

Trigger settings (See 5-4-11 and Section 14)

Function selected (See 5-4-1)

A and B cursor settings (See 5-4-13 and 7-4-8)

Time axis range (See 5-4-2)

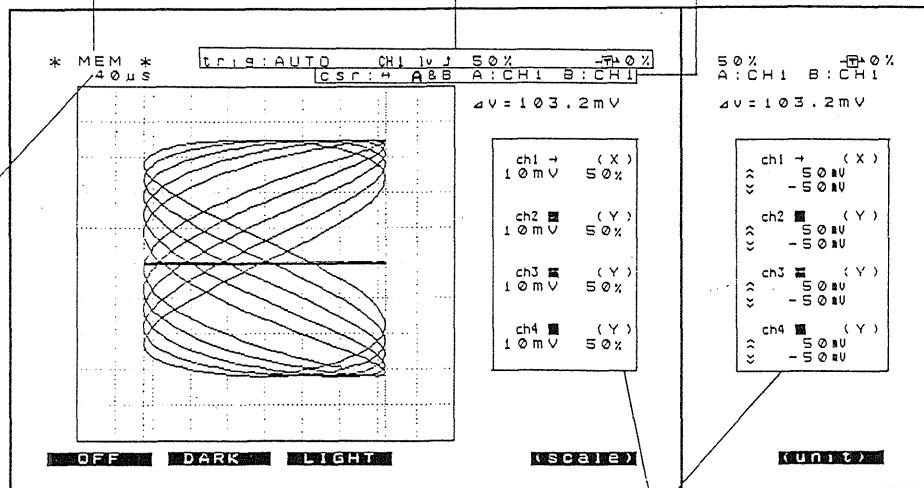

Input unit settings (See 5-4-8 and 5-4-9)

You can switch between the time axis and X-Y displays simply by changing the format setting.

Example

This example uses signals input to channels 1 and 2 to produce an X-Y plot of approximately 100 divisions of a 150-division shot length, with channel 1 on the x-axis.

1. Use the time axis zoom function to compress the display ($\times 1/10$).
(See Section 5-4-14 "Time Axis Zoom Function")
2. Using the A and B cursors, select the section to be used for the X-Y plot.
(See Section 5-4-13 "Using A and B Cursors.")
3. In status mode, select the X-Y format, and assign channel 1 to the x-axis.
4. Select the display mode.

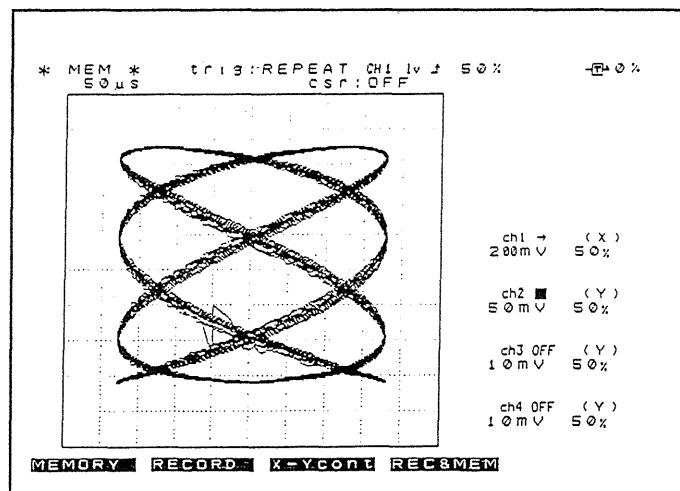
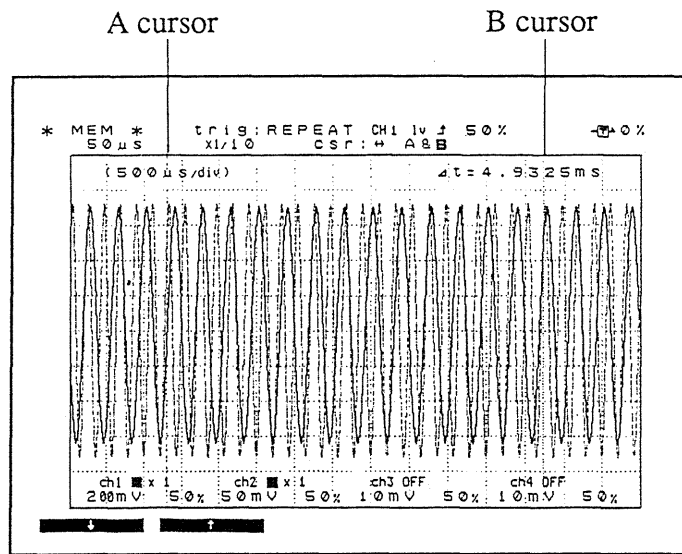

Notes

- Voltage axis zoom function for X-Y plots

In an X-Y plot, there is no significance to the time axis zoom factor, but the voltage axis zoom factor is effective for all channels.

Note, however, that the settings can only be made in status mode, or in display mode when the format is set other than to X-Y. For details of the setting method, see Section 5-4-15 "Voltage Axis Zoom Function."

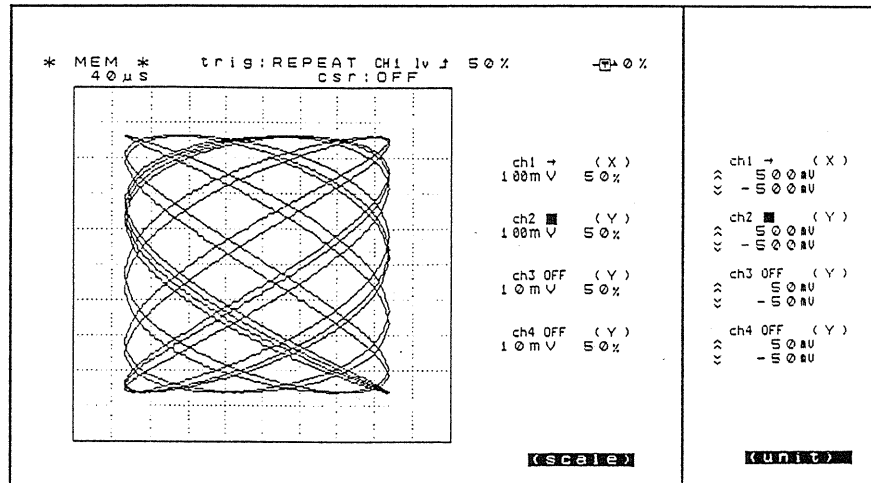

↓ Two times enlargement of x-axis

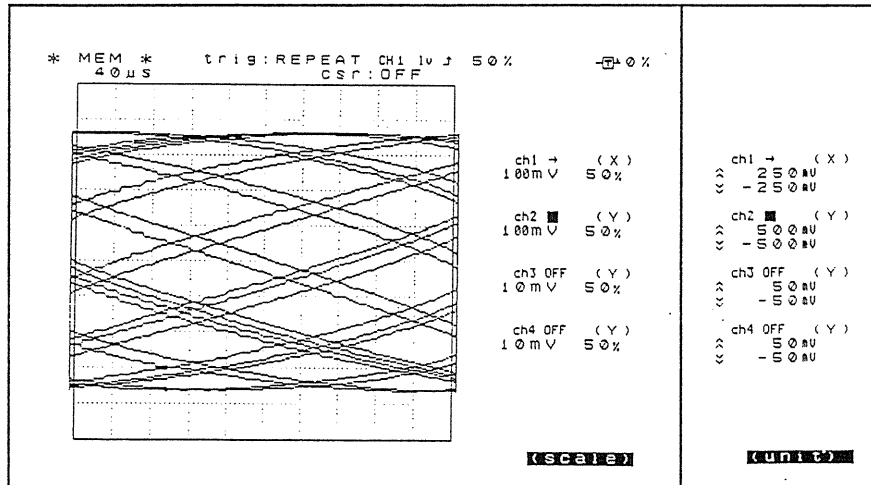

5-4-7 Interpolation Setting

Function

This function determines whether to display and record the sampled data as detached points (dot mode) or with straight-line interpolation (line mode).

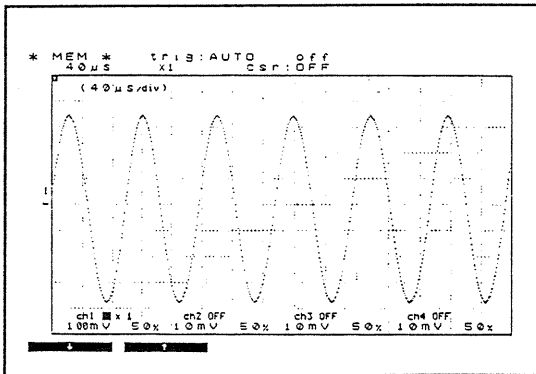

Dot mode

No linear interpolation.
The sampled values are
displayed exactly as
measured.

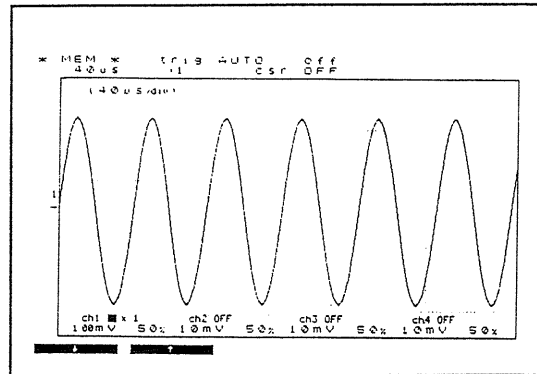

Line mode Linear interpolation.

This gives a more readable display.

Procedure

1. Select the status mode.
2. "dot-line"

Select whether or not to carry out
linear interpolation.

(DOT, LINE)

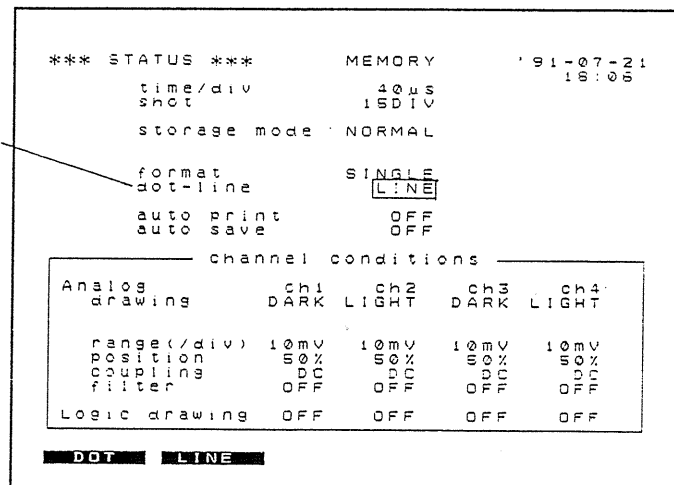

Notes

- This setting affects the display only, and is therefore effective for previously captured data.
- If using a long shot length, and compressing the time axis, drawing in dot mode can take up to one minute approximately.

Changing the display intensity (DARK/LIGHT) or changing the time axis zoom factor can take a similar time.

The recommended procedure is to adjust the display settings using line mode initially, and then switch to dot mode if required.

- Logic channel displays are not affected by this setting. They are always subject to linear interpolation between samples.



5-4-8 Display and Recording Channel Settings

Function

A maximum of four analog channels and 16 logic channels are available on the 8851.

These settings determine which channels are displayed or recorded.

The analog channels can each be set independently, but the logic channels can only be set in groups of four.

Procedure

You can carry out these settings in status mode or display mode.

(1) In status mode

1. Select the status mode.
2. "Analog drawing"

This setting determines for each analog channel whether or not it is displayed and printed, and if so at what intensity.

(OFF, DARK, LIGHT)

OFF no display or recording

DARK high intensity display, bold printed recording

LIGHT low intensity display, fine printed recording

| | | | | | |
|--------------------|------|--------|------|----------|--|
| *** STATUS *** | | MEMORY | | 91-07-21 | |
| time/div | | 40µs | | 18:28 | |
| shot | | 15DIV | | | |
| storage mode | | NORMAL | | | |
| format | | SINGLE | | | |
| dot-line | | LINE | | | |
| auto print | | OFF | | | |
| auto save | | OFF | | | |
| channel conditions | | | | | |
| Analog drawing | ch1 | ch2 | ch3 | ch4 | |
| | DARK | LIGHT | DARK | - | |
| range (/div) | 10mV | 10mV | 10mV | - | |
| position | 50% | 50% | 50% | - | |
| coupling | DC | DC | DC | - | |
| filter | OFF | OFF | OFF | - | |
| Logic drawings | OFF | OFF | OFF | OFF | |

Settings for channel 1

For details of the "range," "position," "coupling," and "filter" settings see Section 5-4-9 "Input Unit Range, Position, Coupling and Filter Settings."

Notes: If an input unit is not installed, the corresponding channel settings will all appear as "-" as in the case of channel 4 in the figure.

In dual or dual (print quad) format, the "graph" item also appears, to show which time axis the channel is assigned to. (See 5-4-5.)

In X-Y format, the "axis" item also appears, indicating the channel which is assigned to the x-axis. (See 5-4-6.)

3. "Logic drawing"

These items switch display or recording for the logic channels on or off. The groups of four channels under channels 1 to 4 correspond to the connectors CHA, CHB, CHC and CHD on the rear panel.



(2) In display mode

1. Select the display mode.
2. For each analog channel or group of four logic channels, select whether or not to display and record.

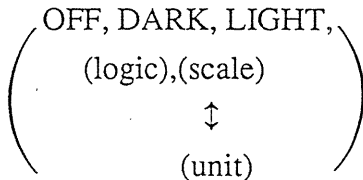
You can also select whether to display input unit information or scale information (top and bottom values).



Screen indications

- OFF ... off
-  ... DARK (high intensity)
-  ... LIGHT (low intensity)

See (1) "In status mode" for details of OFF, DARK, LIGHT.

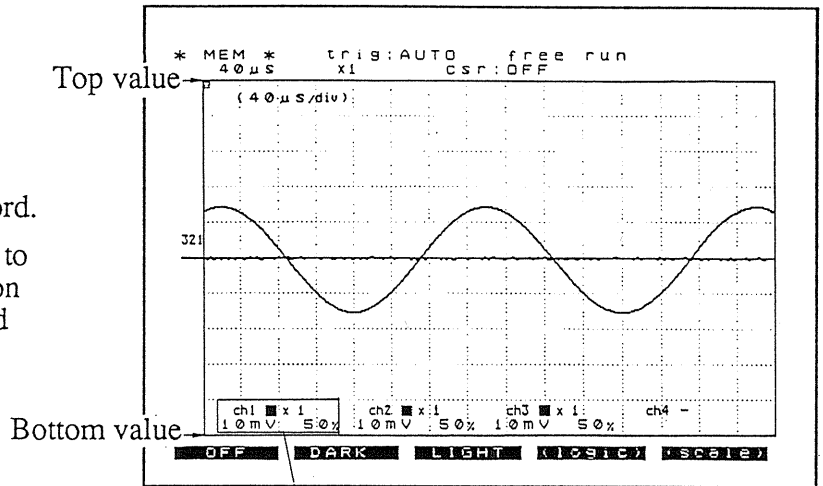

Top value

Bottom value

Taking channel 1 as example

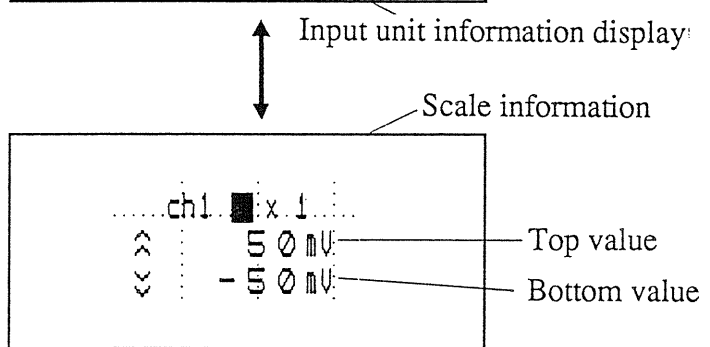
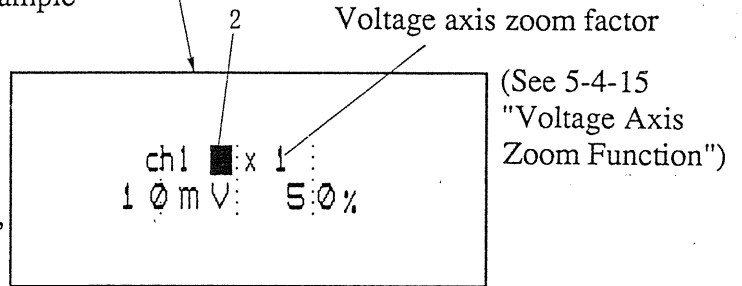

(logic) ... determines whether or not to display and record each group of four logic channels. Pressing the soft key toggles the setting on or off.

The groups of four channels under channels 1 to 4 correspond to the connectors CHA, CHB, CHC and CHD on the rear panel.

(scale) ... pressing the soft key switches to the scale display (showing the top and bottom values on the vertical axis); the soft key indication changes to "(unit)".

(unit) ... pressing the soft key switches to the input unit display (showing the voltage range, input coupling and origin positioning); the soft key indication changes to "(scale)".

Switching between the scale and unit displays affects all channels together.

- When an input unit is not installed

Only the soft keys for setting the logic channel display and recording and for switching between the scale and unit displays are present.

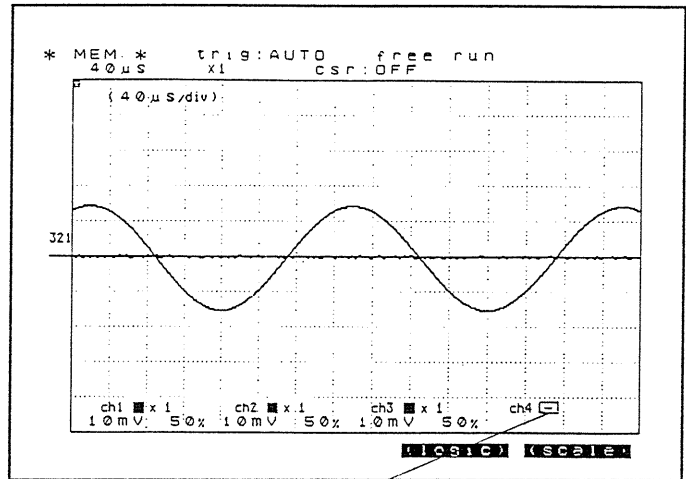
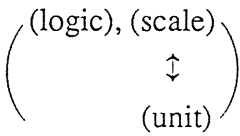

- In X-Y format

- For each channel assigned to the y-axis, select whether or not to display and record the X-Y plot.

You can also select whether to display input unit information or scale information (top and bottom values).

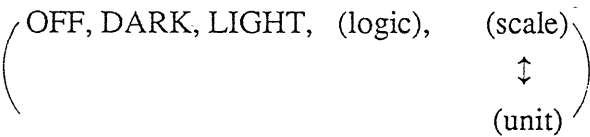

For the channel assigned to the x-axis, only the soft key for switching between the scale and unit displays is present.

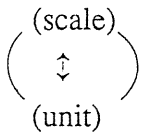

The scale display shows the top and bottom values for the channels assigned to the y-axis, and the leftmost and rightmost values for the channel assigned to the x-axis.

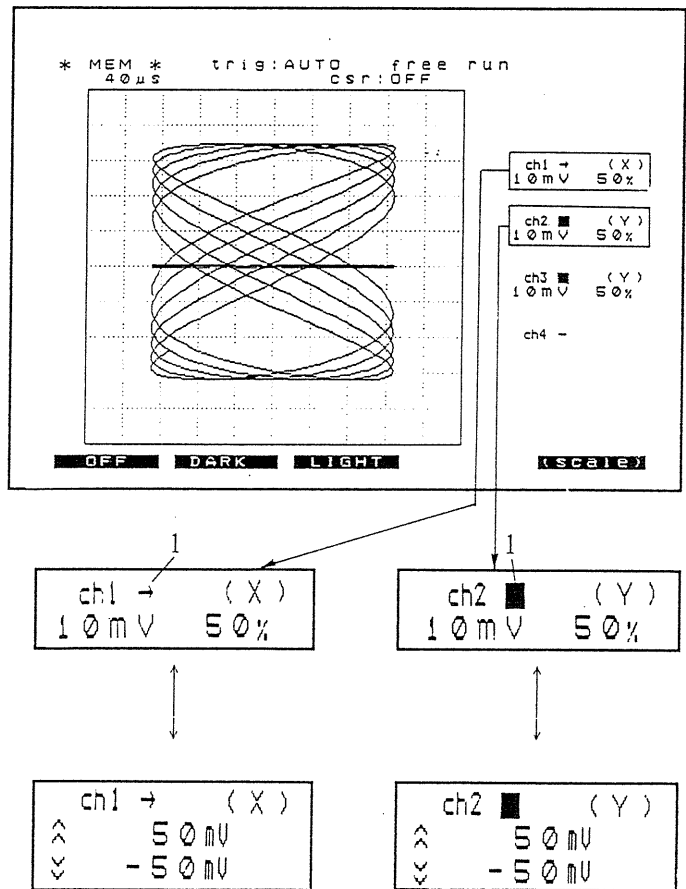

Note: The figure shows an example in which channel 4 is not installed. In this case the indication on the screen is replaced by "-". (The flashing cursor skips this position.)

Notes

- The input unit display shows the voltage range and position settings for the channel, whereas the scale display shows the range of values actually appearing on the screen for the captured waveform data. If, therefore, you change the input unit range and position settings, the values in the scale and unit displays may be different.
- If the scaling function is enabled, the scale display shows the values after scaling. (See Section 18-3 "Scaling Function.")

Position of logic channel displays

As shown in the figures below, the 16 logic channels are displayed in the order A1 to A4, B1 to B4, C1 to C4 and D1 to D4 from top to bottom. (For example channels A1 to A4 correspond to the CHA connector on the rear panel.)

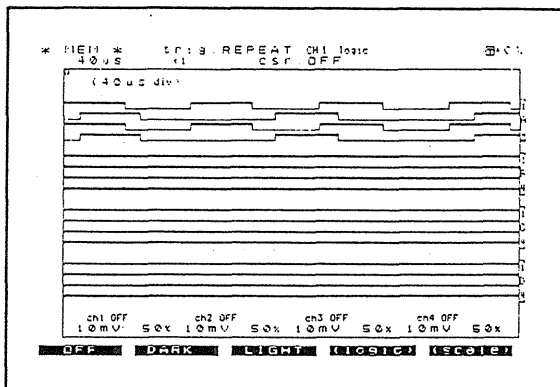

Single format

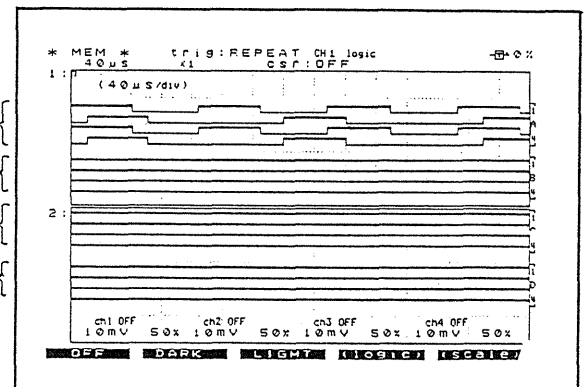

Dual format

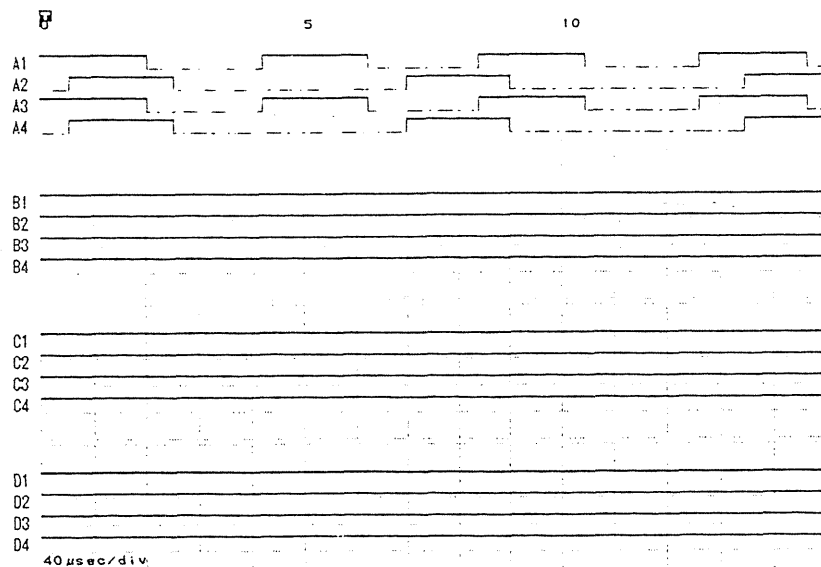

When no logic probe is connected, the signals are always shown as high level.

Dual (print quad) format

5-4-9 Input Unit Range, Position, Coupling and Filter Settings

Function

These settings determine the range, origin positioning, and input unit coupling and filter for each channel.

Procedure

You can carry out the settings in status mode or display mode.

(1) In status mode

1. Select the status mode.

2. "range(/div)"

Set the voltage range.

The value set is the voltage difference for one division on the vertical axis, when the zoom factor is set to $\times 1$.

You can also use the range key for each channel, without moving the flashing cursor.

(10 mV, 20 mV, 50 mV, 100 mV, 200 mV, 500 mV, 1 V, 2 V, 5 V, 10 V, 20 V, 50 V)

| *** STATUS *** | | MEMORY | '91-08-25 | |
|--------------------|------|--------|-----------|-----|
| time/div | | 40μS | 18:35 | |
| shot | | 1SDIV | | |
| storage mode | | NORMAL | | |
| format | | SINGLE | | |
| dot-line | | LINE | | |
| auto print | | OFF | | |
| auto save | | OFF | | |
| channel conditions | | | | |
| Analog drawing | ch1 | ch2 | ch3 | ch4 |
| | DARK | LIGHT | DARK | - |
| range (/div) | 10mV | 10mV | 10mV | - |
| position | 50% | 50% | 50% | - |
| coupling | DC | DC | DC | - |
| filter | OFF | OFF | OFF | - |
| Logic drawing | OFF | OFF | OFF | OFF |

Settings for channel 1

See 5-4-8 "Display and Recording Channel Settings" for details of the "Analog drawing" and "Logic drawing" items.

3. "position"

This determines the position of the zero voltage (from -100% to 100% of the range, in 1% increments).

(See the Background information below.)

The and soft keys change the value in 1% steps; the and soft keys change it by 10% steps.

4. "coupling"

Determines the input unit coupling.

(GND, AC, DC)

GND ...the input unit is not connected.

This enables zero potential checking.

AC ... capacitor in series.

This removes DC components from the input, and measures the AC component only.

DC ... input signal directly connected to amplifier.

This allows measurement from the DC component.

5. "filter"

This determines the low-pass filter setting in the input unit itself.

(OFF, 500Hz, 5Hz)

OFF: no low-pass filter used

500Hz: use a low-pass filter with a cutoff frequency of 500 Hz

5Hz: use a low-pass filter with a cutoff frequency of 5 Hz

Note: As shown for channel 4 in the figure, if no input unit is installed, the settings (2 to 5) are all shown as "-".

(2) In display mode

1. Select the display mode.

If the input unit information is not shown as shown in the figure on the right, move the flashing cursor to the position to the right of one of the channel indications "ch1" to "ch4" and press the **[unit]** soft key.

2. Set the voltage range in the same way as in the status mode (see (1) above).

You can also use the range key for each channel, without moving the flashing cursor.

(10 mV, 20 mV, 50 mV, 100 mV, 200 mV, 500 mV, 1 V, 2 V, 5 V, 10 V, 20 V, 50 V)

In the screen display, the "V" is omitted.

3. Set the input unit coupling.

(GND, AC, DC)

On the screen $\downarrow \downarrow \downarrow$
these appear as ($\overline{||}$, \tilde{v} , v)

See the explanation in (1) "In status mode" above for the significance of these settings.

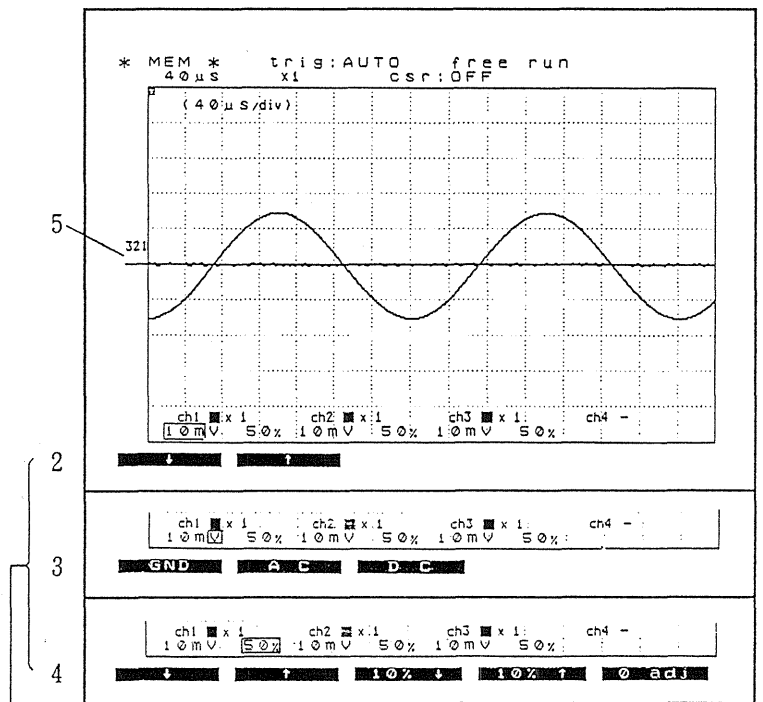

Taking channel 1 as an example

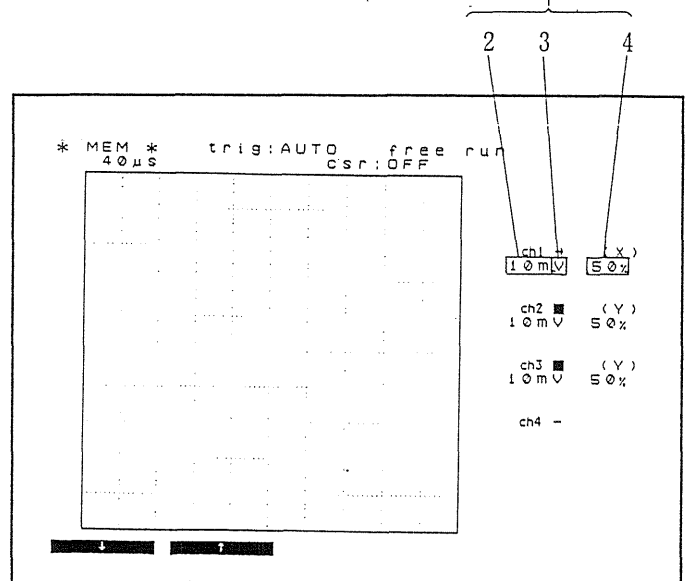

X-Y format

- Set the origin position (the position of the zero voltage). (from -100% to 100% of the range, in 1% increments).

(See the Background information below.)

The $\boxed{\downarrow}$ and $\boxed{\uparrow}$ soft keys change the value in 1% steps; the $\boxed{10\% \downarrow}$ and $\boxed{10\% \uparrow}$ soft keys change it by 10% steps. For an explanation of the $\boxed{0 \text{ adj}}$ soft key, see 5-4-10 "Zero Adjustment."

Note: It is not possible to change the filter setting in the display mode.

- The origin position (the zero voltage position) for the currently captured waveform is shown on the screen. (For example, the label "1" indicates the origin for channel 1.)

Background

- The origin (the zero voltage position) is as follows.

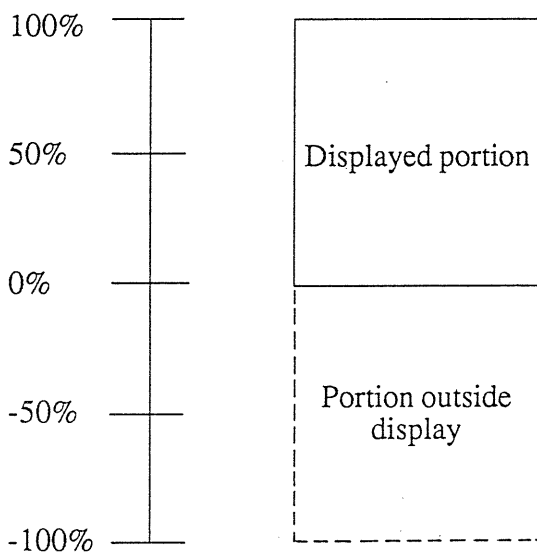

The value of the "position" setting determines the origin. The origin can be inside the display area (0% to 100%) or outside (-100% to 0%) and below it.

In X-Y format

The voltage origins for the x- and y-axes are determined by the "position" settings as shown below.

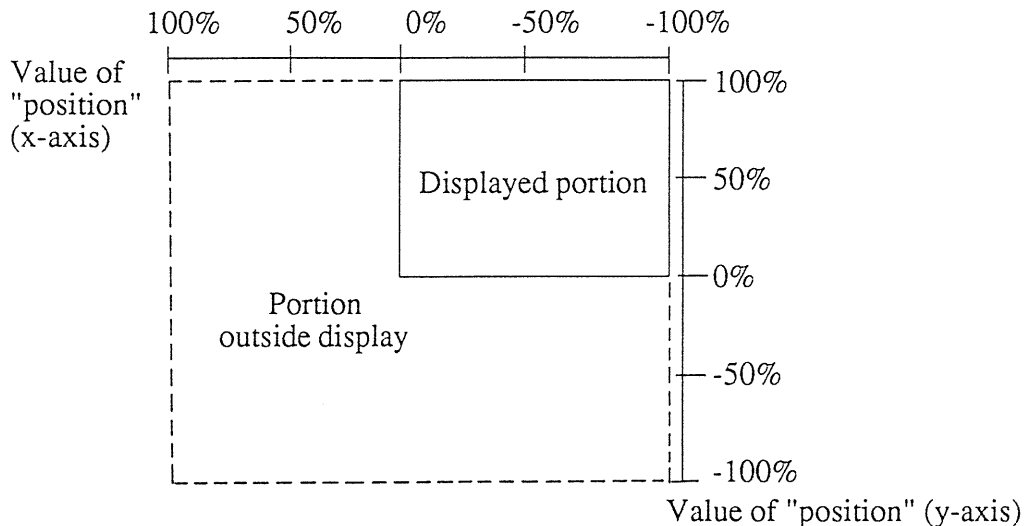

5-4-10 Zero Adjustment

Function

This function provides for accurate adjustment of the waveform to the origin position when a zero voltage is input. Use it for reading precise values from the screen or a printed recording or to ensure accurate results from waveform computations.

Procedure

Always allow at least 30 minutes warming up before carrying out this procedure, to ensure that the internal temperature of the unit has stabilized.

1. Select the display mode.
2. If the input unit information is not shown as shown in the figure on the right, move the flashing cursor to the right of one of the channel indications "ch1" to "ch4" and press the **[unit]** soft key.
3. Press the **[0 adj]** soft key. This carries out the correction for all channels simultaneously. Repeat the process after changing ranges.

Soft keys ... **[↓]**, **[↑]**, **[10%↓]**,
[10%↑], **[0 adj]**)

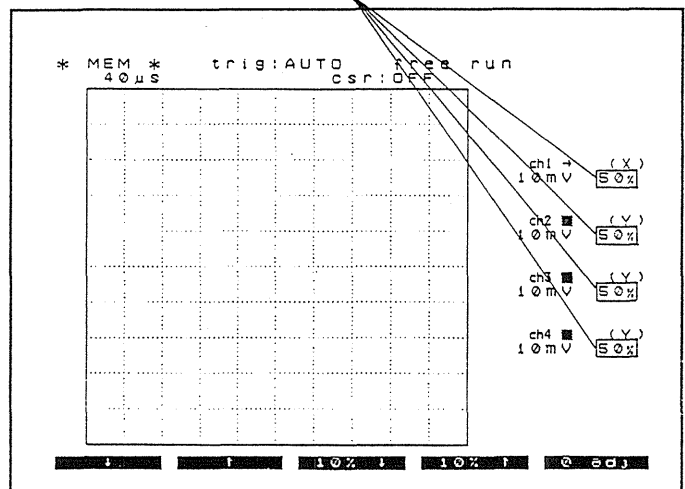
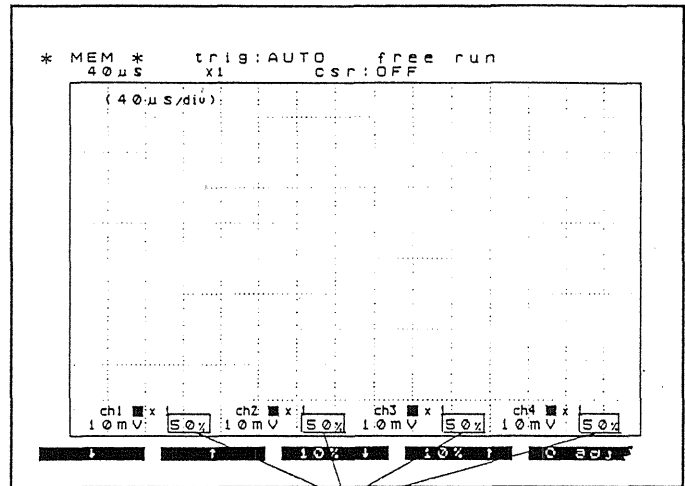

X-Y format

Notes

- Allow at least 30 minutes warming up after powering on before carrying out zero adjustment.
- Zero adjustment is not possible while the unit is measuring.
- The zero adjustment takes effect in the input unit. Always, therefore, repeat zero adjustment after changing input units.

5-4-11 Trigger Settings

Function

This function includes all trigger-related settings.

- Trigger conditions for each channel, and logical operator with external trigger
The trigger conditions for each channel can be set, and AND or OR selected as the logical operator with the external trigger.
- Trigger conditions
The trigger conditions for each channel can be set.
- External trigger
The setting determines whether or not a signal from the external trigger terminal is used as a trigger source.
- Trigger mode
The trigger mode can be set to SINGLE, REPEAT or AUTO.
- Pre-trigger setting
Determines the percentage of the shot length which is before the trigger.
- Timer trigger setting
This allows timer controlled triggering.

Procedure

All settings can be carried out in trigger mode. Basic settings can also be carried out in display mode.

(1) In trigger mode

1. Select the trigger mode.
2. Set the trigger conditions for each channel, and select the logical operator (AND or OR) with the external trigger.
(AND, OR)
See 14-4 "Internal and External Trigger Logical Operator."

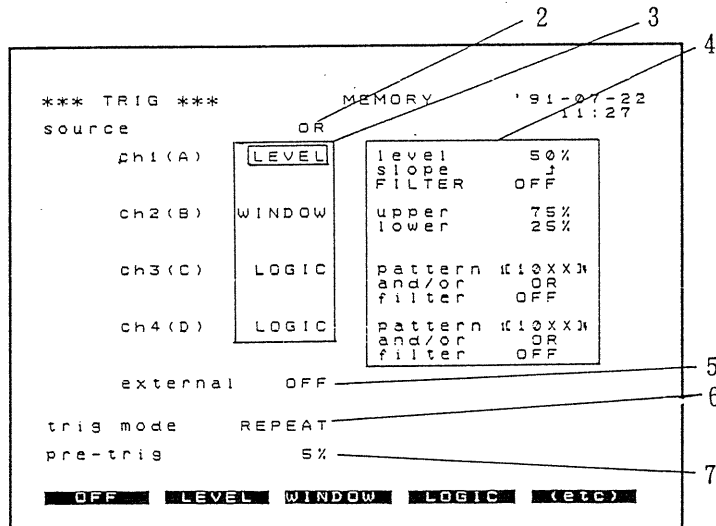

3. Select the trigger type for each channel. (OFF, LEVEL, WINDOW, LOGIC, GLITCH, TIME OUT)

Note: If you set the external and internal trigger logical operator to AND in step 2, some settings are not allowed.

See Section 14-2 "Internal Triggers" (14-2-1 to 14-2-6).

4. Set the detailed conditions for the setting in step 3.

See Section 14-2 "Internal Triggers" (14-2-1 to 14-2-6).

5. "external"

Enable or disable the external trigger. (OFF, ON)

See Section 14-3 "External Trigger".

6. "trig mode"

Set the trigger mode.

(SINGLE, REPEAT, AUTO)

SINGLE the trigger signal is only effective once, after pressing the START key.

REPEAT ... the trigger signal is effective repeatedly.

AUTO the trigger signal is effective repeatedly. If approximately one second elapses without a trigger occurring, a trigger is automatically inserted.

See Section 14-5 "Trigger Modes."

7. "pre-trig"

Set the percentage of the shot length which is to be before the trigger.

(0, 2, 5, 10, 20, 30, 40, 50, 60, 70, 80, 90, 95, 100%, and -50% to -950% in 50% steps)

Note: If the shot length is set to 12500 divisions or more, the lower limit is -100%, not -950%.

(See Section 18-5-11 "Channel Selection" for details on allocating memory to each channel.)

See Section 14-6 "Pre-Trigger and Trigger Timing."

8. Press the cursor key or use the rotary knob to see the special trigger display.

9. "timer source"

Set the timer trigger.

(OFF, ON)

See Section 14-7 "Timer Trigger."

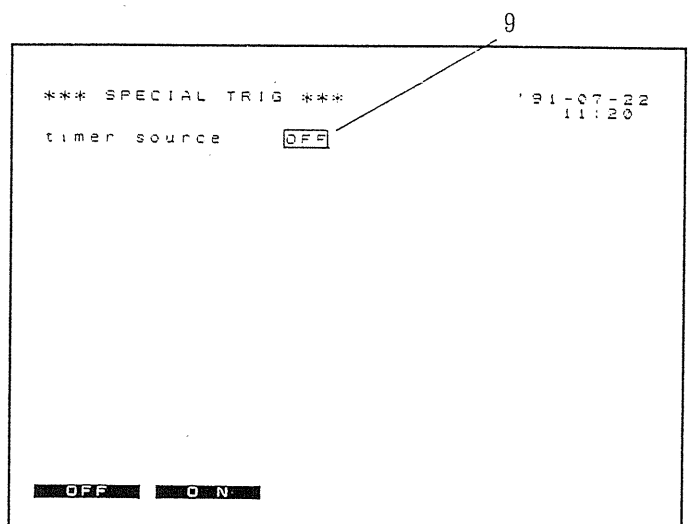

Special trigger display

(2) In display mode

1. Select the display mode.
2. Set the trigger mode.

(SINGLE, REPEAT, AUTO)

See the procedure in trigger mode in (1) above, and Section 14-5 "Trigger Modes."

3. Select the channel.

(CH1, CH2, CH3, CH4)

If all channels are set to "OFF" in trigger mode, the indication "free run" appears.

If, however, the external trigger is enabled the indication is "external", and if the timer trigger is enabled, it is "timer".

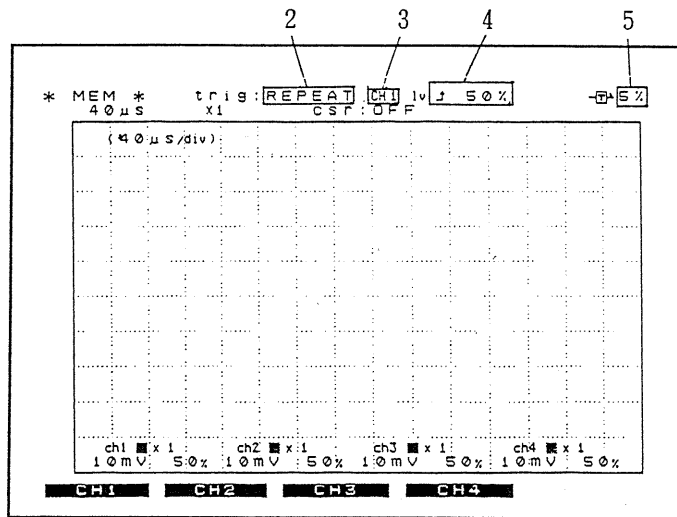

4. Make the detailed settings for the trigger type (other than LOGIC) set for each channel in trigger mode.

Trigger types set in the trigger mode cannot be changed in display mode.

See Section 14-2 "Internal Triggers" (14-2-1 to 14-2-6).

5. Set the percentage of the shot length which is to be before the trigger.

(0, 2, 5, 10, 20, 30, 40, 50, 60, 70, 80, 90, 95, 100%, and -50% to -950% in 50% steps)

Note: If the shot length is set to 12500 divisions or more, the lower limit is -100%, not -950%.

(See Section 18-5-11 "Channel Selection" for details on allocating memory to each channel.)

See Section 14-6 "Pre-Trigger and Trigger Timing."

5-4-12 Starting and Stopping Measurement Operation

Function

The START and STOP keys control the measurement operation mode of the unit. The LED above the START key is lit when in measurement operation mode.

Procedure

1. START
Start measurement operation.
2. STOP
Stop measurement operation.

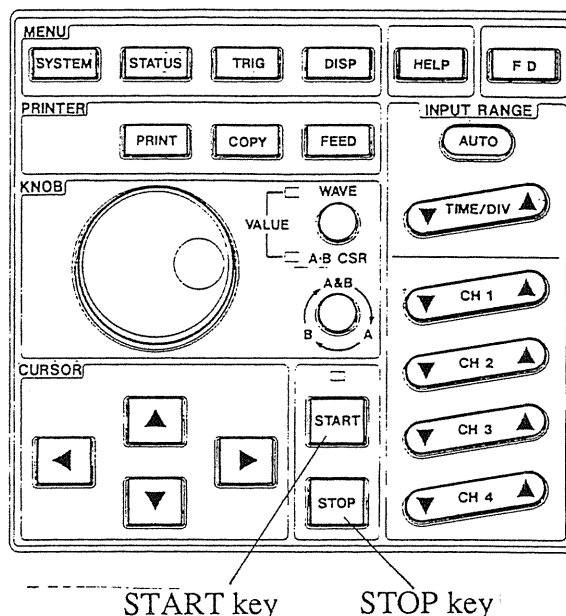

Notes

- The effect of starting and stopping measurement operation mode is different in the three trigger modes.

In trigger SINGLE mode

After pressing START, when the trigger conditions are met, the unit captures data for the specified shot length, and then terminates measurement operation (without the STOP key being pressed).

In trigger REPEAT mode

After pressing START, when the trigger conditions are met, the unit captures data for the specified shot length. It remains in measurement operation mode, and if the conditions are met again, repeats the data capture, each time overwriting memory.

Pressing the STOP key exits from measurement operation mode.

In trigger AUTO mode

After pressing START, when the trigger conditions are met, the unit captures data for the specified shot length. Thereafter it captures data repeatedly, overwriting memory.

Pressing the STOP key exits from measurement operation mode.

- Terminating measurement operation mode

When the STOP key is pressed, the unit completes data capture for the current shot length, then terminates measurement operation mode. The auto save and auto print functions, however, are disabled.

If the STOP key is pressed during data capture, the LED above the START key remains on while the shot length is completed. At this point, pressing the STOP key a second time abandons the data capture. If the trigger mode is REPEAT or AUTO, the previously captured waveform is displayed. If the roll mode function is enabled, the waveform is displayed up to the point of termination (see Section 18-5-10 "Roll Mode.")

If after once pressing the STOP key, you press the START key before the waveform capture is completed, this applies a restart, and the unit is in the same state as when the measurement operation mode was originally started.

5-4-13 Using A and B Cursors

Function

You can use the A and B cursors to measure time or voltage differences (if using the scaling function, the scaled values; see Section 18-3 "Scaling Function"), getting a direct digital readout.

There are two cursor patterns: line and cross-hair.

(1) Line cursor (vertical or horizontal)

Using the A cursor alone, you can use the vertical cursor to measure the time (t) from the trigger position, or the reciprocal of the time ($1/t$), in other words a frequency, and can use the horizontal cursor to read out a voltage (v) with respect to the origin (the 0 V or "position" setting). Using both A and B cursors, you can use the vertical cursors to measure a time difference (Δt), or the reciprocal of the time difference ($1/\Delta t$), in other words a frequency, and can use the horizontal cursors to read out a voltage difference (Δv).

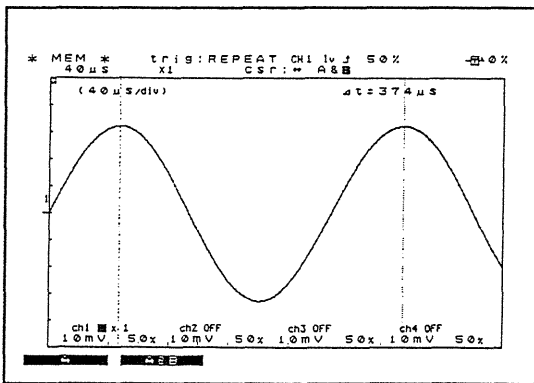

Vertical cursors

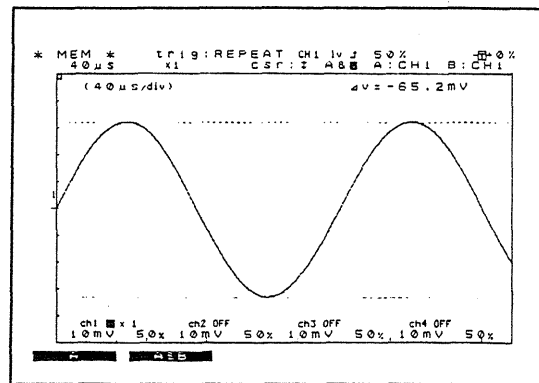

Horizontal cursors

(2) Cross-hair cursor

As the cross-hair cursor is moved, the intersection of the cross hairs traces the waveform of the specified channel. Using the A cursor alone, you can read off the time (t) since the trigger event and the voltage (v) measured from the origin at the intersection. Using both A and B cursors, you can use read off the time difference (Δt) and voltage difference (Δv) between the two intersections.

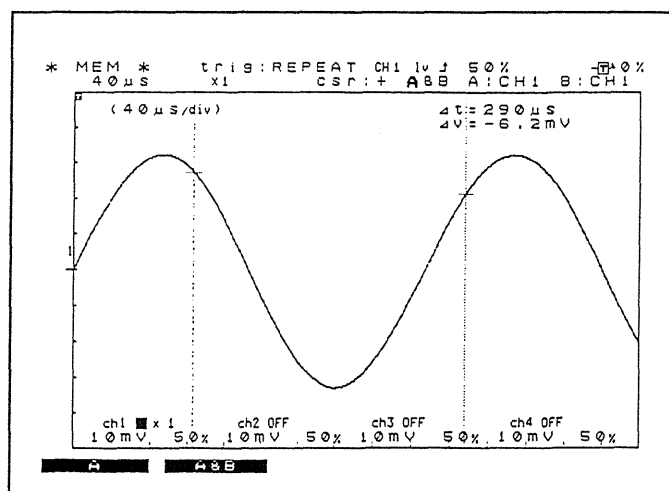

Procedure

(1) Using the line cursors to read waveform data

1. Select the cursor mode.

(OFF, $\leftrightarrow \Delta t$, $\leftrightarrow 1/\Delta$, \updownarrow , trace)

On the screen these are indicated as follows:

($\leftrightarrow \dots \leftrightarrow \Delta t$ or $\leftrightarrow 1/\Delta$)
 + ... trace

OFF ... do not use cursors.

$\leftrightarrow \Delta t$... use line cursors for the time axis (vertical cursors), for reading off time differences.

$\leftrightarrow 1/\Delta$... use line cursors for the time axis (vertical cursors), for reading off frequencies.

\updownarrow use line cursors for the voltage axis (horizontal cursors).

trace use the cross-hair cursors, which trace the waveforms.

Here, select the $\leftrightarrow \Delta t$ $\leftrightarrow 1/\Delta \updownarrow$ or \updownarrow soft key.

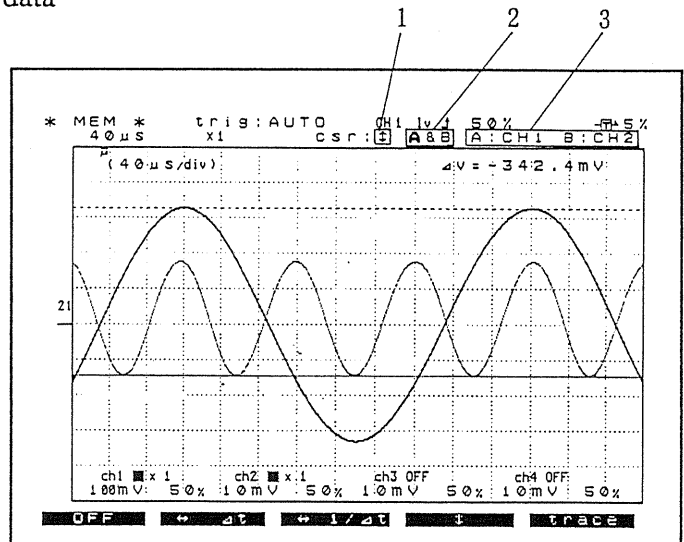

2. Select whether to use the A cursor only, or both cursors.

(A, A&B)

3. If using horizontal line cursors, select which channel voltages are to be read off. You can make independent settings for the A and B cursors.

(CH1, CH2, CH3, CH4)

Notes: Only channels for which waveforms are displayed can be chosen.

If using the A cursor only, the setting for the B cursor is not possible.

This item does not appear when using vertical cursors.

4. ① Using vertical cursors on the time axis

When the $\leftrightarrow \Delta t$ soft key is selected ... using the A cursor only, determines the time (t) from the trigger event to the A cursor; using both A and B cursors, determines the time (Δt) between the A and B cursors.

When the $\leftrightarrow \Delta t$ soft key is selected ... using the A cursor only, determines the reciprocal of the time from the trigger event to the A cursor (1/t); using both A and B cursors, determines the reciprocal of the time between the A and B cursors (1/t).

This function is effective even if both A and B cursors are outside the display area.

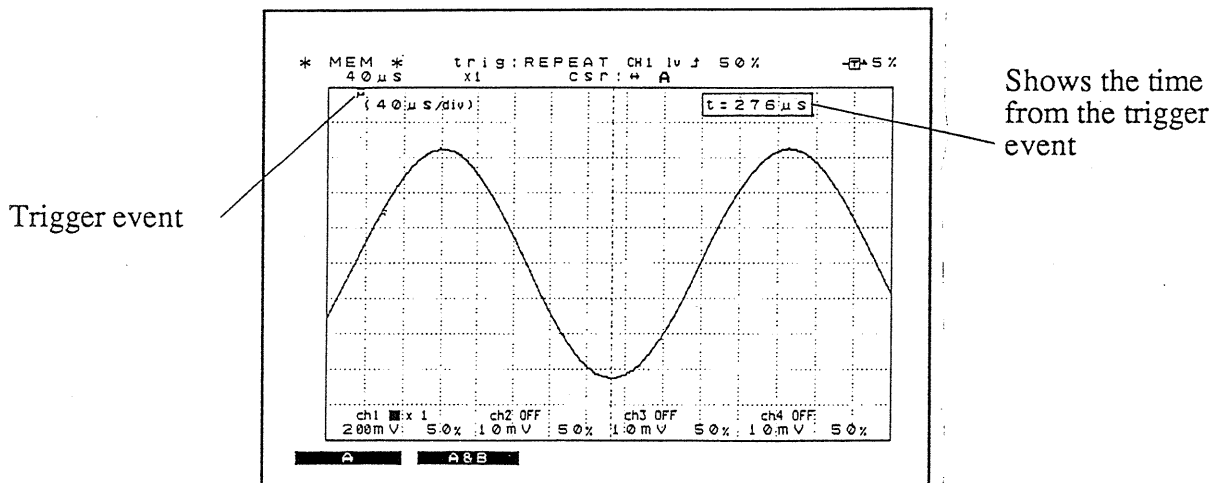

② Using horizontal cursors on the voltage axis

Using the A cursor only, determines the voltage (v) on the specified channel from the origin (the "position" setting, or 0 V); using both A and B cursors, determines the absolute voltage difference (Δv) between the A and B cursors on their respective channels.

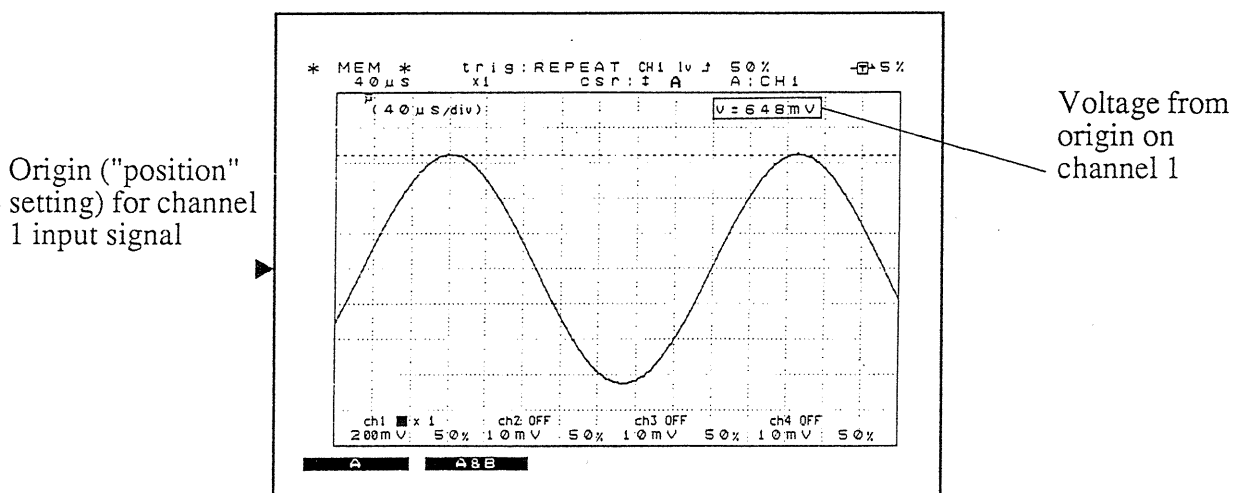

Note: If the scaling function is enabled, you can read the scaled value directly. If, however, the A and B cursors are on different channels, and those channels have different units, then a difference cannot be read off.

(2) Using the cross-hair cursors to read waveform data

1. Select the cursor mode.

Press the **trace** soft key, to select the cross-hair cursor pattern. (For more details see (1) above.)

2. Select whether to use the A cursor only, or both cursors.

(A, A&B)

3. For each cursor, select the channel whose waveform the cross-hair is to trace. You can make independent settings for the A and B cursors.

(CH1, CH2, CH3, CH4)

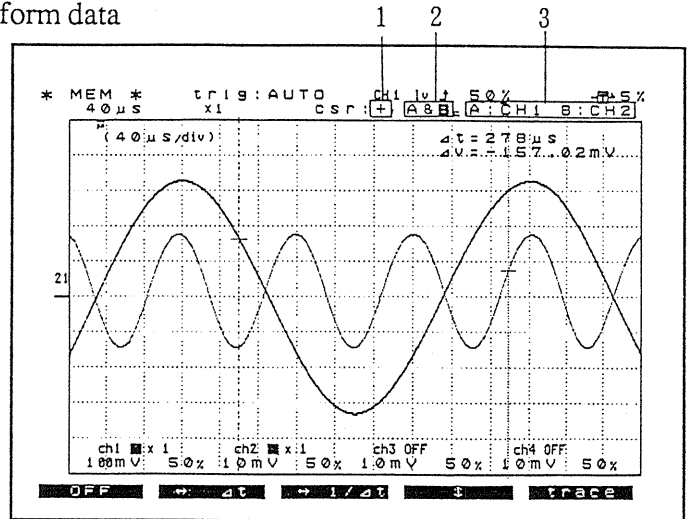

Notes: Only channels for which waveforms are displayed can be chosen.

If using the A cursor only, the setting for the B cursor does not appear.

4. Using the A cursor only determines the time (t) from the trigger event to the cursor position, and the voltage (v) on the specified channel with respect to the voltage origin (0 V). Using both A and B cursors determines the time difference (Δt) and the voltage difference (Δv) between the cross-hair positions of the A and B cursors. If the cursors are on different channels, the correct difference between their absolute voltage values is still shown in addition to the time difference.

This function is effective even if both A and B cursors are outside the display area.

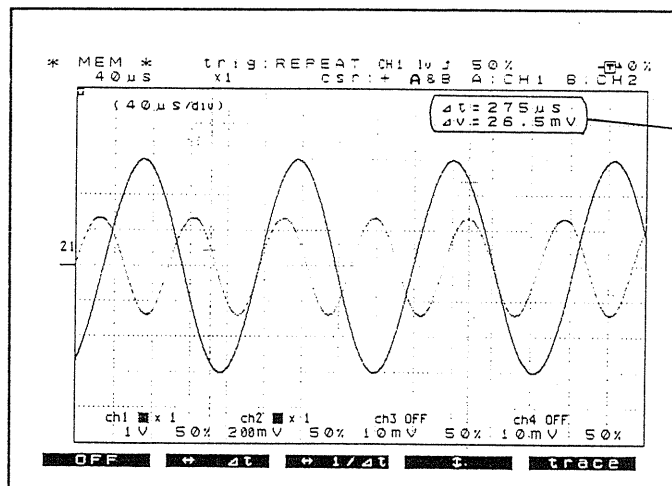

Time and voltage differences between cursor positions on channels 1 and 2.

Note: If the scaling function is enabled, you can read the scaled value directly. If, however, the A and B cursors are on different channels, and those channels have different units, then a difference cannot be read off.

(3) Moving the cursors

1. Press the knob select key so that only the lower LED (A · B CSR) is lit.

In this state, the rotary knob controls the position of the cursors.

Turning the knob clockwise moves the cursors up or to the right.

Turning the knob counterclockwise moves the cursors down or to the left.

Note: See Section 4-2-2 "Rotary Knob and Knob Select Key" for a detailed description of rotary knob operation.

2. Press the cursor select key to select which cursor or cursors to control.

Each time the key is pressed, the display changes as follows:

A move the A cursor only.

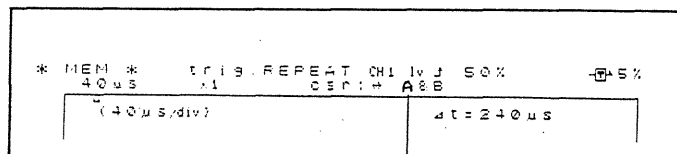
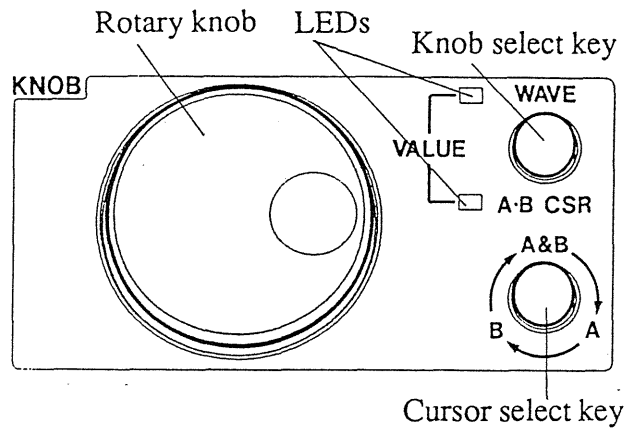

A displayed high intensity

B move the B cursor only.

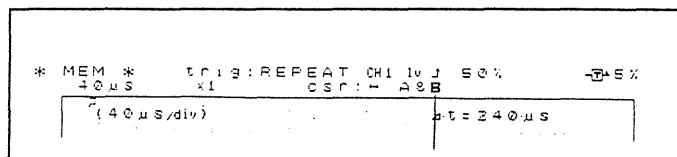

B displayed high intensity

A & B ... move both
A and B cursors.

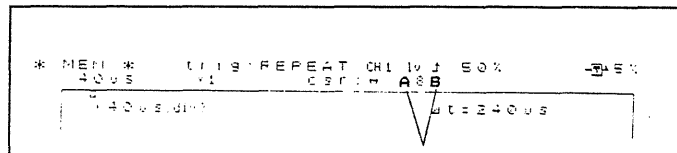

A and B both high intensity

Using either the vertical cursors or the cross-hair cursors, it is possible for the A cursor and/or B cursor to move off the screen when the waveform is scrolled. For details, see the Notes below.

3. If either cursor is off the screen, as soon as you specify cursor movement and start moving it toward the center of the screen, it reappears at the edge.

Notes

- Waveform scrolling and cursor movement

The scrolling and cursor behavior with horizontal cursors is different from that with the vertical or cross-hair cursors.

① Cursor movement when scrolling the waveform

Using the vertical or cross-hair cursors

(The example shows vertical cursors.)

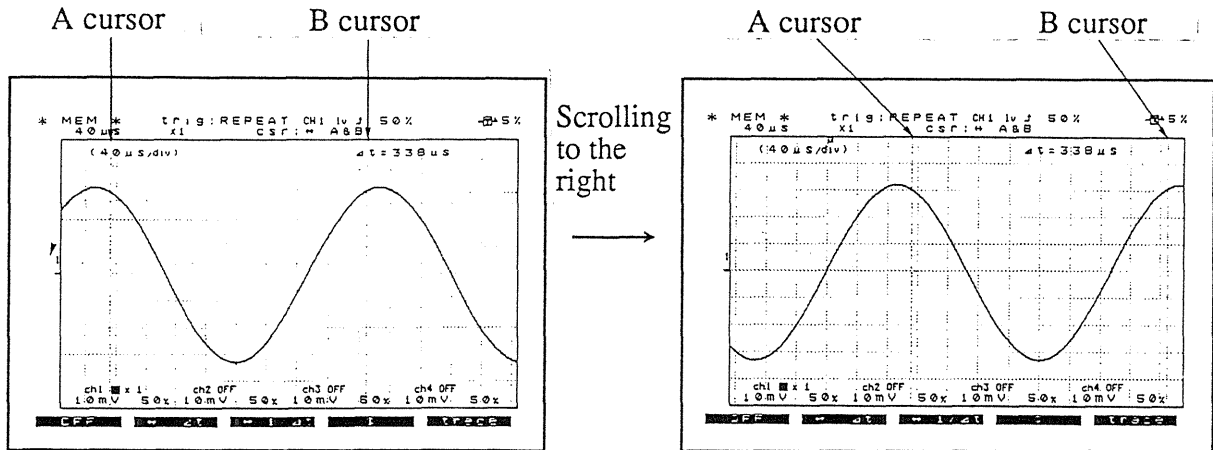

The cursors move with the waveform, disappearing off the edge of the screen

Using horizontal cursors

(The example shows a magnified voltage range.)

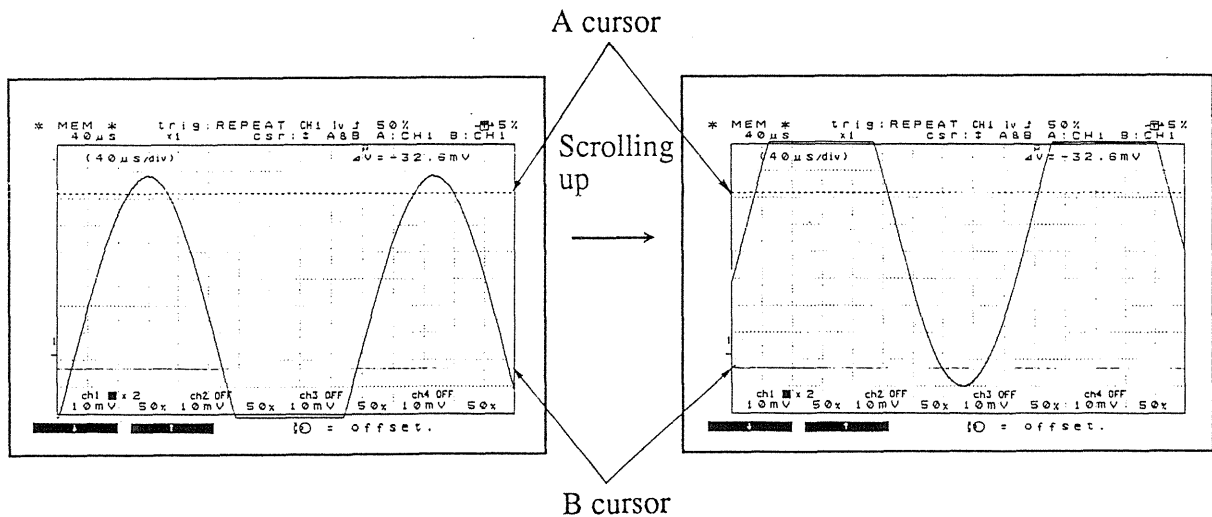

The cursor position on the screen does not change.

- ② Waveform scrolling behavior when moving the cursors
 Using the vertical or cross-hair cursors
 (The example shows cross-hair cursors.)

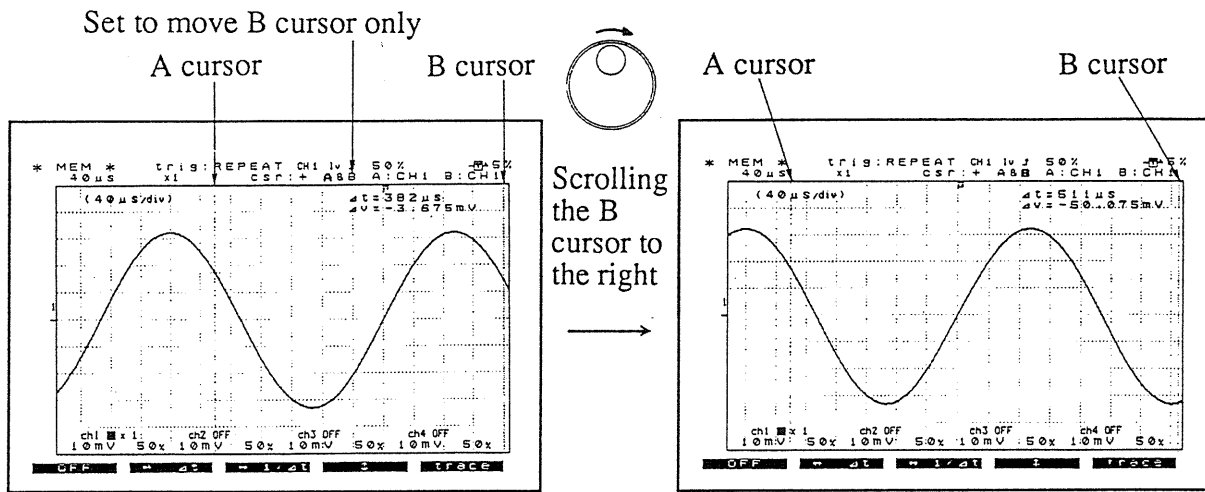

When the B cursor reaches the edge of the screen, the waveform scrolls left, so that the B cursor continues to move relative to the waveform. The A cursor moves with the waveform.

- Using horizontal cursors
 (The example shows a magnified voltage range.)

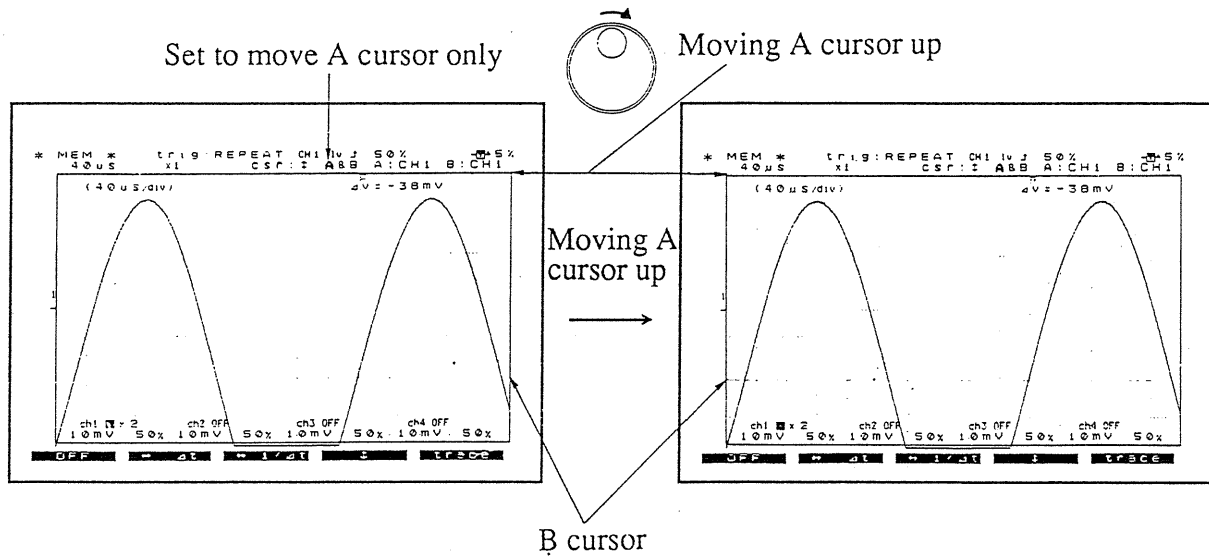

When the A cursor reaches the top of the display area, it stops moving, and the waveform does not scroll.

Related item

When a vertical cursor or cross-hair cursor is outside the display area, it is still possible to tell its approximate location in the total shot length. See Section 5-4-20 "Help Function" for details.

5-4-14 Time Axis Zoom Function

Function

This function allows display and recording with the time axis magnified or compressed.

Magnifying the time axis enables more detailed examination of the waveforms. Compression is useful for getting an overall view of the waveform pattern.

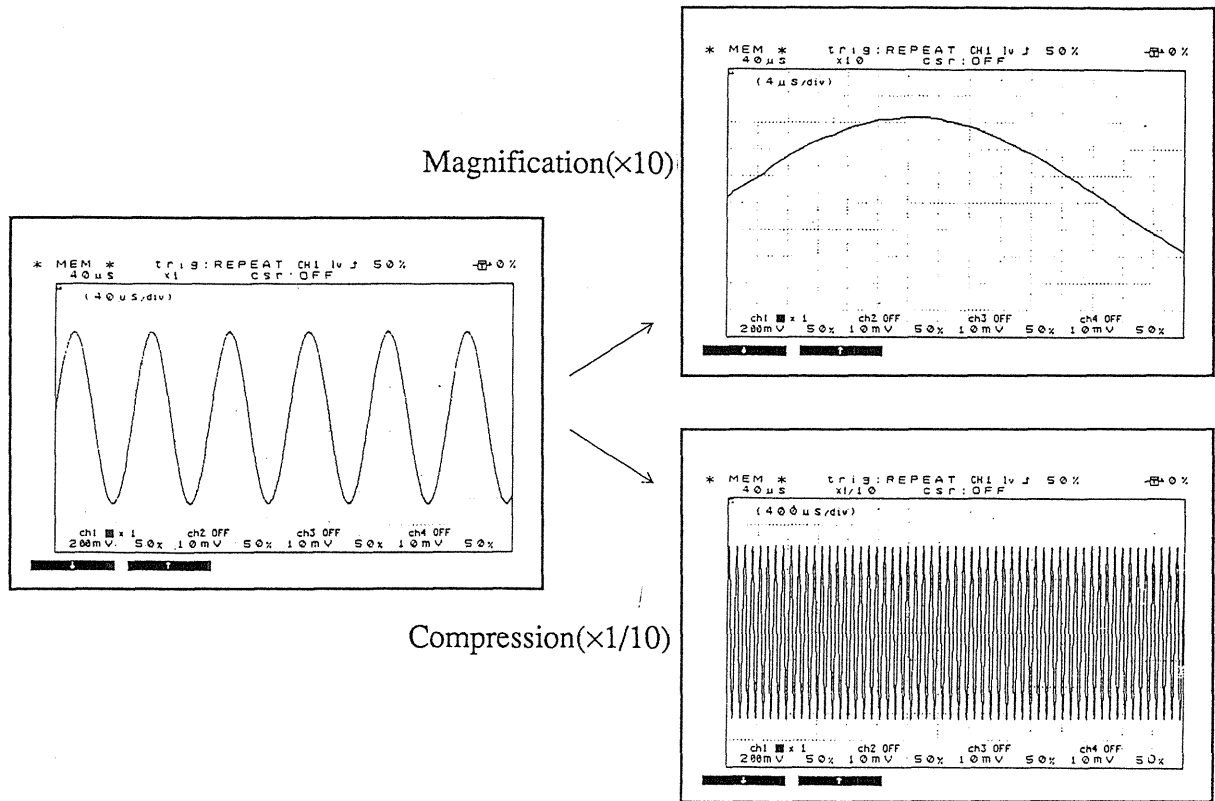

Procedure

1. Select the display mode.
2. Set the magnification or compression factor on the time axis.

($\times 10$, $\times 5$, $\times 2$, $\times 1$, $\times 1/2$,
 $\times 1/5$, $\times 1/10$, $\times 1/20$,
 $\times 1/50$, $\times 1/100$, $\times 1/200$,
 $\times 1/500$, $\times 1/1000$,
 $\times 1/2000$, $\times 1/4000$)

For details see the Notes section below.

3. The display shows the magnified or compressed time axis scale (time per one division).

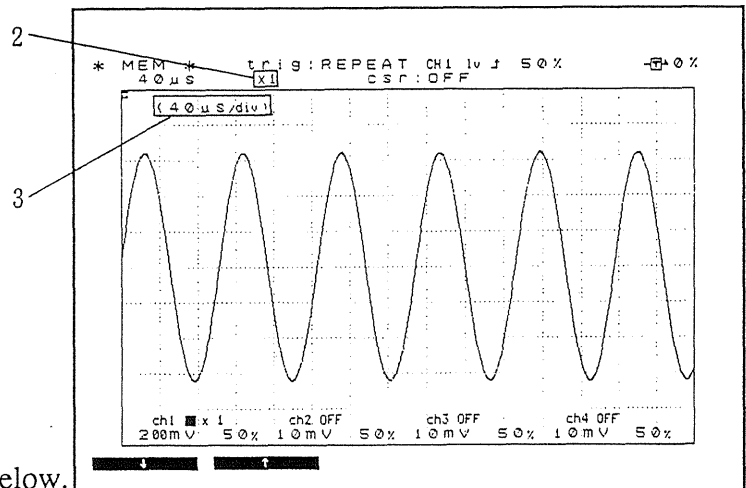

4. The setting of the time axis zoom factor can be carried out either before or after the data is captured. If the data is already displayed on the screen, the display immediately changes to reflect the new setting.

① Reference position when compressing

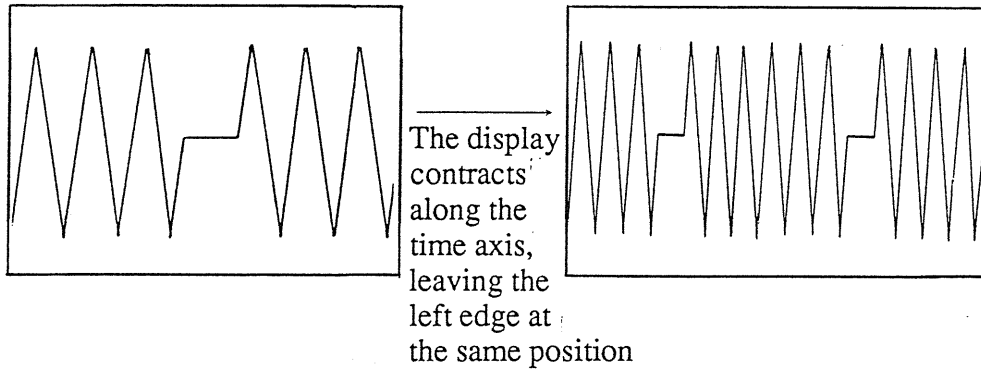

② Reference position when magnifying

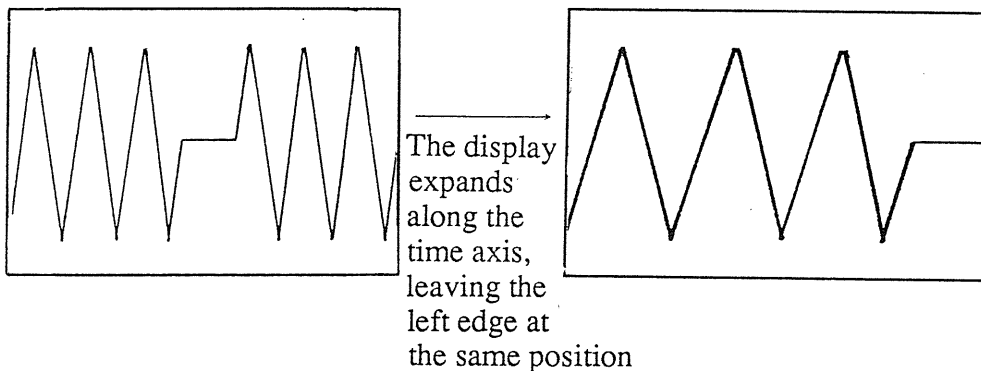

Notes

- If the storage mode is set to enable the envelope function, expansion, and compression by 1/4000 are not possible. (See Section 13-3 "Using the Envelope Function.")
- When showing a long shot length in compressed mode, if the interpolation function is disabled (i.e. set to "DOT"), then display can take up to one minute. The recommended procedure is to set the interpolation function to "LINE". Redisplay after changing the zoom factor takes the same amount of time.

Related item

A scroll bar display is available, to show where the current screen display is in relation to the whole shot length. See Section 5-4-20 "Help Function" for details.

5-4-15 Voltage Axis Zoom Function

Function

The zoom function allows the voltage axis to be magnified or compressed for any channel independently. The magnification function allows you to exploit fully the 12-bit A/D conversion resolution of the unit.

Procedure

You can carry out the setting in display mode or status mode.

(1) In display mode

The procedure varies somewhat, depending on the rotary knob mode.

1. Select the display mode.

Pressing the knob select key changes the rotary knob operating mode. The two LED indicators to the left of the knob select key indicate which mode it is in.

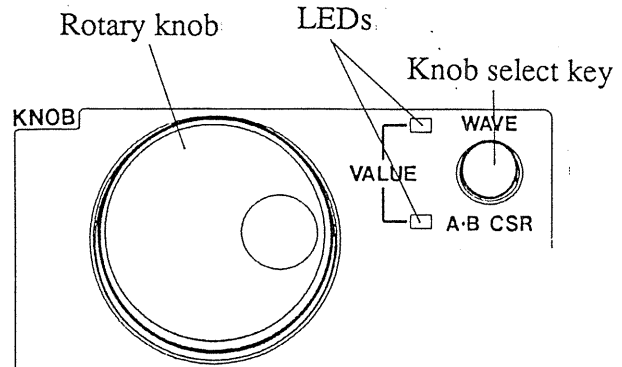

Rotary knob in cursor movement mode

Upper WAVE indicator only lit ... waveform scrolling

Lower A · B CRS indicator only lit ... cursor movement

Both indicators (VALUE) lit ... numeric value setting

2. Set the voltage magnification or compression factor.

($\times 10$, $\times 5$, $\times 2$, $\times 1$, $\times 1/2$)

If the rotary knob is set to carry out waveform scrolling or numerical value adjustment, then at the same time as making the setting, the display expands or contracts vertically about the center.

If the rotary knob is in the waveform scrolling mode, then except when the zoom factor is $\times 1$, it can be used to scroll the waveform vertically.

(See Section 5-4-16 "Waveform Scrolling.")

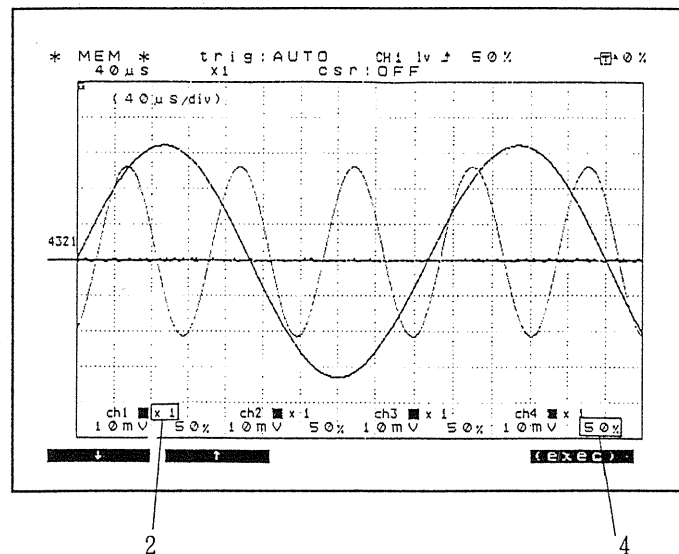

(Move the flashing cursor to the channel to be magnified or compressed.)

Scrolling the waveform allows you to change the portion to be magnified or compressed.

(See Section 5-4-16 "Waveform Scrolling.")

The following explanation assumes the rotary knob is in the cursor movement mode.

3. The magnification indicator cursor or the compression indicator cursor appears on the screen.

Note: The magnification indicator cursor or compression indicator cursor only appears when the flashing cursor is positioned on 2.

Magnification

This section will be expanded to fill the display window vertically.

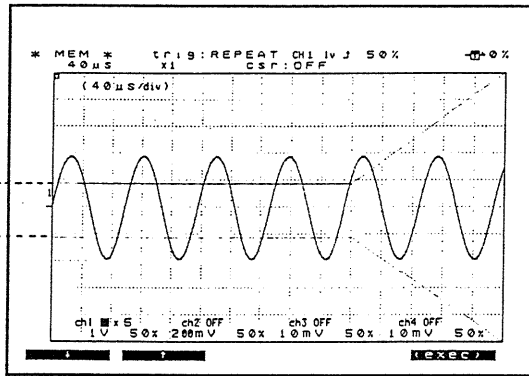

Use the rotary knob to move the magnification indicator cursor over the section to be expanded.

Compression

Use the rotary knob to position the section of the vertical range which corresponds to the current display window position.

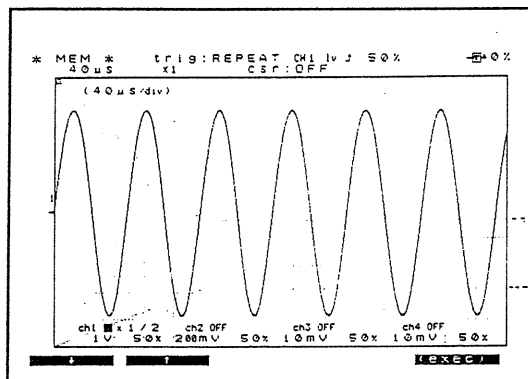

The waveform will be compressed vertically so that the current display window range is in this section.

4. Press the **EXEC** soft key to carry out the zoom function.

The setting of the zoom factor can be carried out either before or after the data is captured. If the data is already displayed on the screen, the display immediately changes to reflect the new setting.

5. After executing the vertical zoom function (other than with a $\times 1$ setting) a cursor appears as shown in the figure on the right, to indicate the position. At this point, use the rotary knob to move the cursor and change the center position of the waveform.

(See Section 5-4-16 "Waveform Scrolling.")

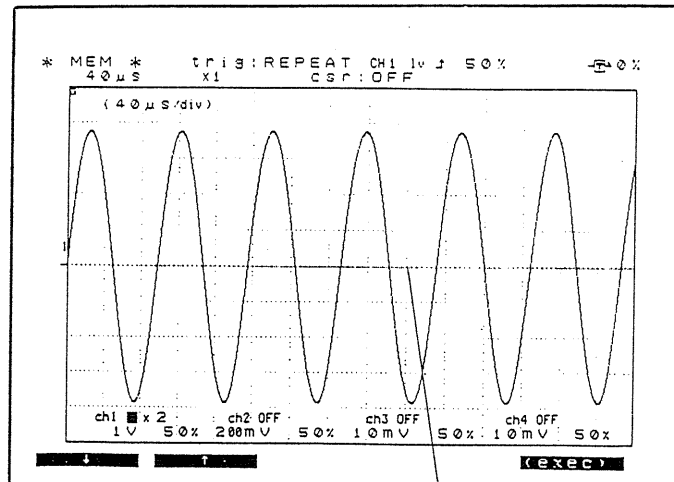

Cursor

(2) In status mode

1. Select the status mode, then use either the  cursor key or the rotary knob to show the special function display.
2. Set the voltage magnification or compression factor for each channel.
($\times 10$, $\times 5$, $\times 2$, $\times 1$, $\times 1/2$)
3. When a magnification factor of $\times 2$, $\times 5$ or $\times 10$ is set, select the portion of the existing $\times 1$ range which is to appear in the screen window.

(If the zoom factor setting is $\times 1$, this appears as "-", and if it is $\times 1/2$, as "Full".)

The position is defined in terms of percentages of the vertical range (100% at the top), as follows:

- $\times 2$... from 0 - 50% to 50 - 100% in 1% steps.
- $\times 5$... from 0 - 20% to 80 - 100% in 1% steps.
- $\times 10$... from 0 - 10% to 90 - 100% in 1% steps.

4. When a compression factor $\times 1/2$ is set, select the position in the compressed display to be occupied by the entire window in the $\times 1$ range.

(If the zoom factor setting is $\times 1$, this appears as "-", and if it is $\times 2$, $\times 5$ or $\times 10$, as "Full".)

The position is defined in terms of percentages of the vertical range (100% at the top), ranging from 0 - 50% to 50 - 100% in 1% steps.

The setting of the zoom factor can be carried out either before or after the data is captured. If the data is already displayed on the screen, the display immediately changes to reflect the new setting.

(When making this setting in status mode, no operation corresponding to the  soft key is required.)

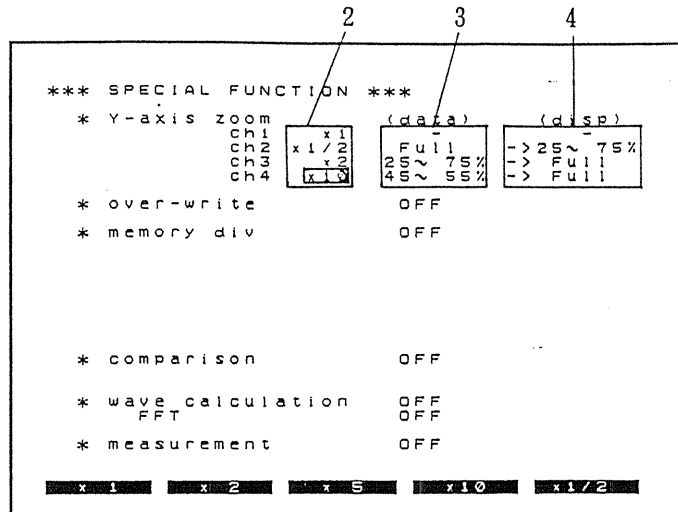

Related item

When using a zoom magnification factor, a scroll bar display is available, to show where the current screen display is in relation to the waveform voltage range (at $\times 1$), and when using the $\times 1/2$ compression setting, to show where the input waveform range is. See Section 5-4-20 "Help Function" for details.

5-4-16 Waveform Scrolling

Function

This function scrolls the waveform display both vertically (when a zoom factor is applied to the voltage axis) and horizontally.

Scrolling on the voltage axis

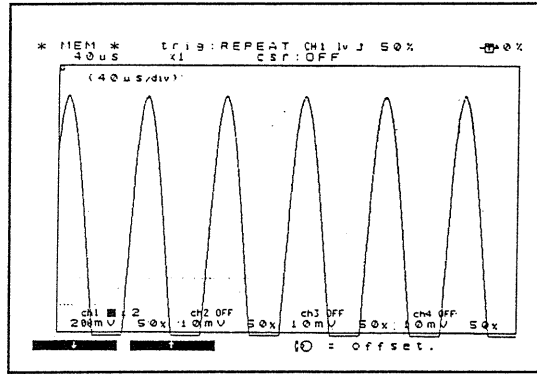
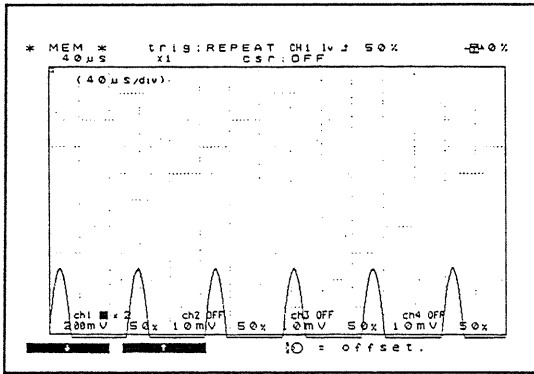

Scrolling on the time axis

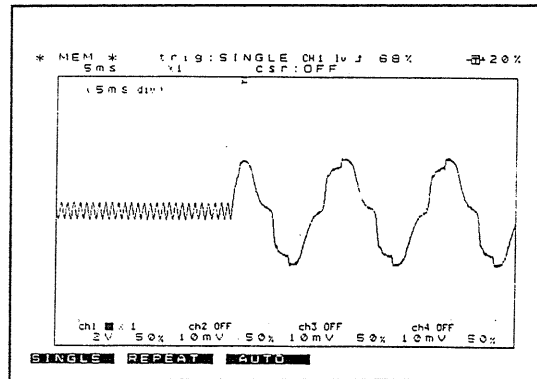
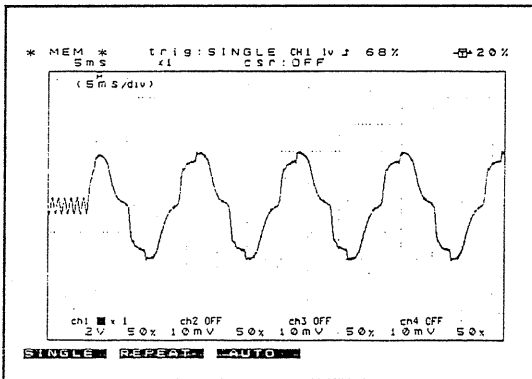

Procedure

(1) Vertical scrolling (voltage axis)

When a magnification ($\times 2$, $\times 5$, $\times 10$) or compression ($\times 1/2$) zoom factor is set for the voltage axis, there are two methods by which the waveform can be scrolled vertically.

a. Normal scrolling

1. Position the flashing cursor as shown in the figure on the right. (Position it on the channel you wish to scroll.)

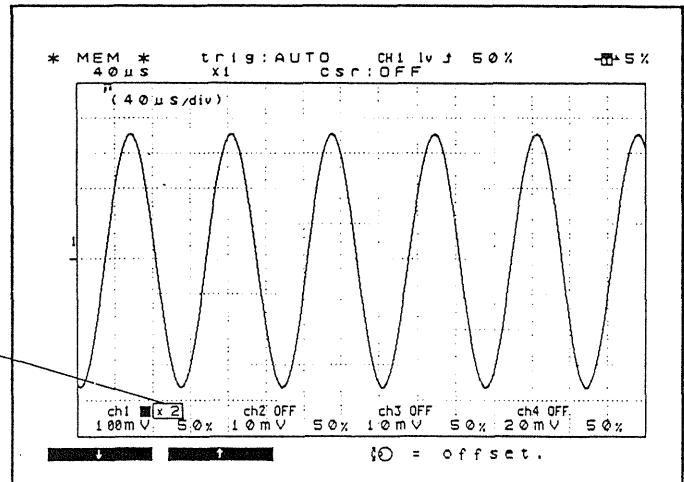

2. Press the knob select key so that only the upper (WAVE) indicator is lit.

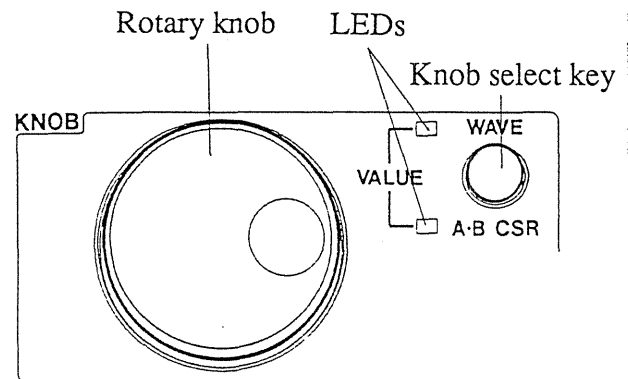

3. Use the rotary knob to scroll the waveform vertically.

b. Scrolling using a horizontal cursor

1. Position the flashing cursor as shown in the figure on the right. (Position it on the channel you wish to scroll.)

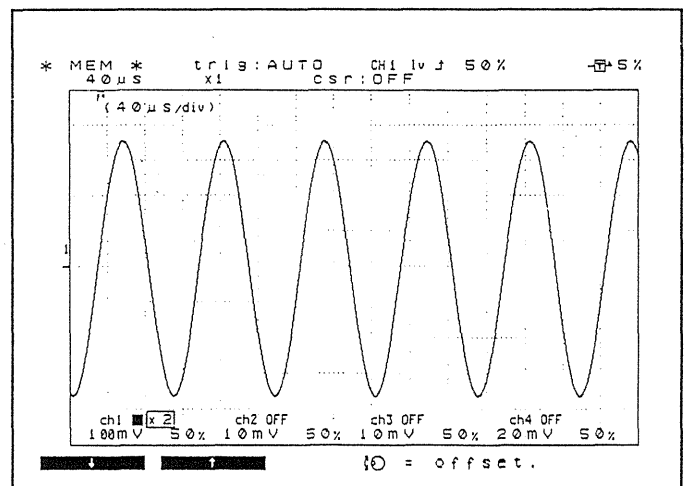

- Press the knob select key so that only the lower (A · B CSR) indicator is lit. (See the figure above for step 2 of a)

The horizontal cursor appears on the screen.

Cursor

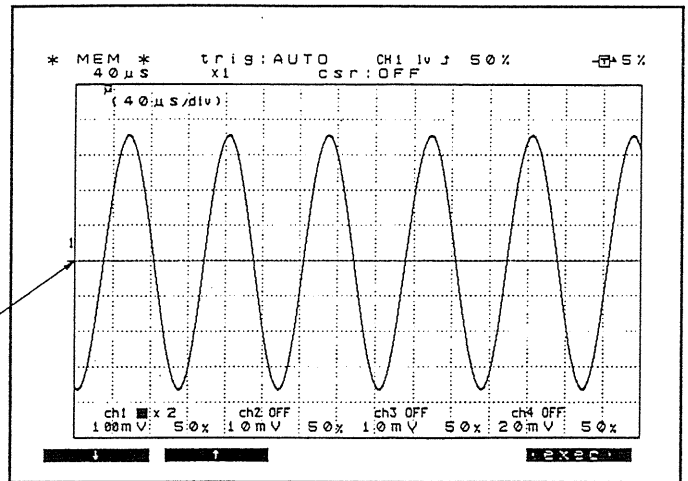

- Use the rotary knob to offset the cursor position by the amount you wish to scroll the waveform. The scroll will move the waveform so that the position where the cursor is now will be in the center.

Scroll direction (down)

Distance moved

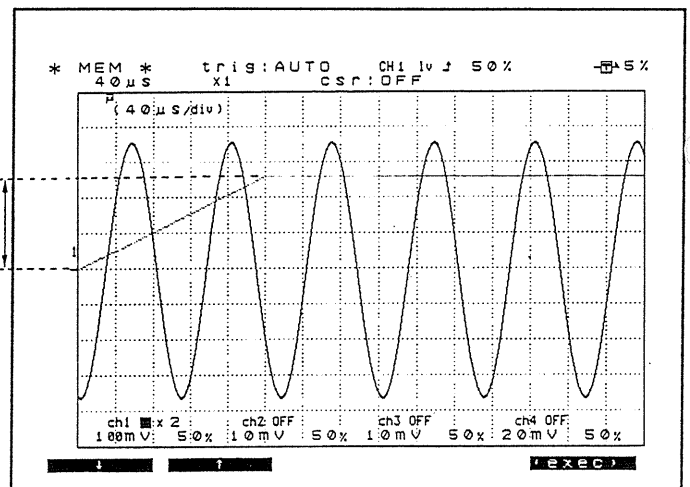

- Press the `(exec)` soft key to carry out the scroll.

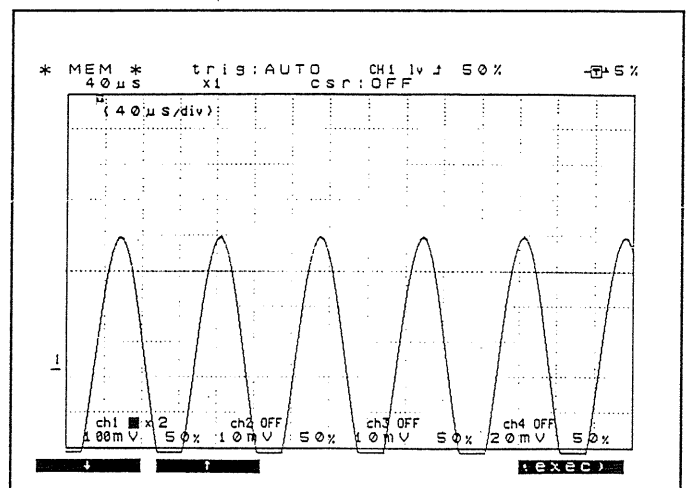

(2) Horizontal scrolling (on the time axis)

1. Press the knob select key so that only the upper (WAVE) indicator is lit.

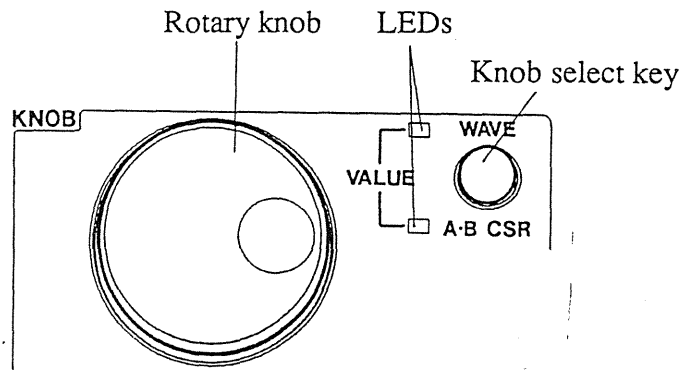

2. Use the rotary knob to scroll the waveform horizontally.

If, however, the flashing cursor is positioned on the voltage axis zoom factor setting, the rotary knob will scroll the waveform vertically. For details see (1) above.

Turning the rotary knob rapidly switches to auto scroll mode, and the waveform continues scrolling automatically.

If the A and B cursors are present as vertical or cross-hair cursors, if you move either cursor to the edge of the display window, and continue moving it, the waveform will scroll in the reverse direction.

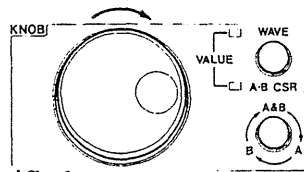

Moving both A and B cursors specified

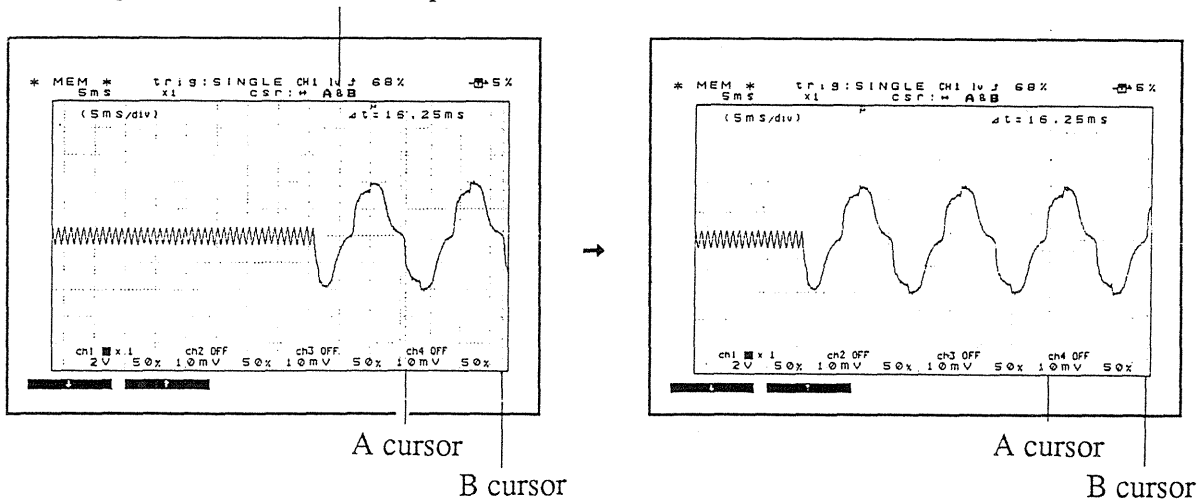

Related item

It is possible to specify the amount to be scrolled as a proportion of the entire shot length for high speed positioning. See Section 5-4-20 "Help Function" for details.

5-4-17 Auto Ranging Function

Function

This function provides a display with automatic setting of the input waveform time range (time/division) and voltage range (volts/division).

Procedure

1. Press the AUTO key, to start measurement using the auto ranging function.

The indicator above the START key lights.

1. AUTO key

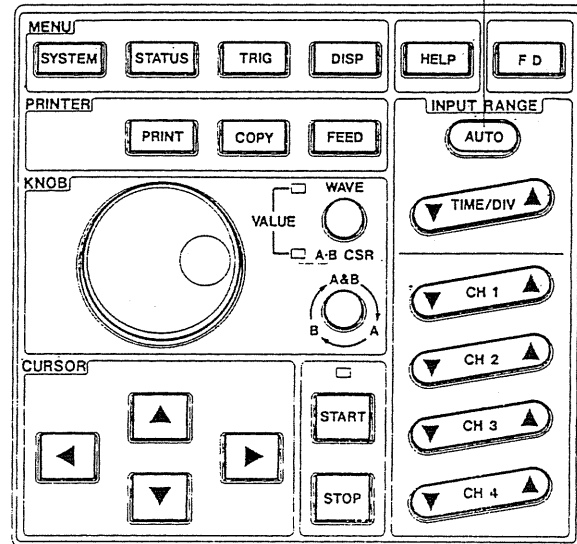

Notes

- Time axis range setting

This is set automatically so that for the lowest numbered channel for which waveform display is enabled, between 1 and 2.5 cycles are recorded for 15 divisions. If, however, the input for the lowest numbered channel has only a small difference between the minimum and maximum values even with the maximum sensitivity voltage range (10 mV/division), then the next channel is used for the setting.

- Starting measurement with the auto ranging function

The setting conditions are as follows (other settings are not changed):

- a. Input unit conditions

Voltage range ... set automatically

Input coupling ... AC

Origin position ... 50%

Low pass filter ... off

} all four channels

- b. Trigger settings

Logical operator (AND/OR) for internal and external triggers ... OR

Internal triggers on for the lowest numbered channel for which waveform display is enabled (provided the difference between minimum and maximum values is large); off for the other three channels

Trigger type ... level

Slope ... J

Level ... automatic setting

Filter ... off

} Channel 1 only

External trigger ... off

Timer trigger ... off

Pre-trigger ... 20%

Trigger mode ... AUTO

c. Status conditions

Time axis range (time/division) ... automatic setting

Storage mode ... normal

Auto print function ... off

Voltage axis zoom factor ... $\times 1$

Memory division function ... off

Waveform pass/fail decision function ... off

Computation functions ... off

5-4-18 Superimposition Function

Function

This function disables clearing of existing waveforms on the screen, allowing waveforms to be superimposed. (When the trigger mode is REPEAT or AUTO.)

Using this function, you can easily make comparisons with the previous waveform.

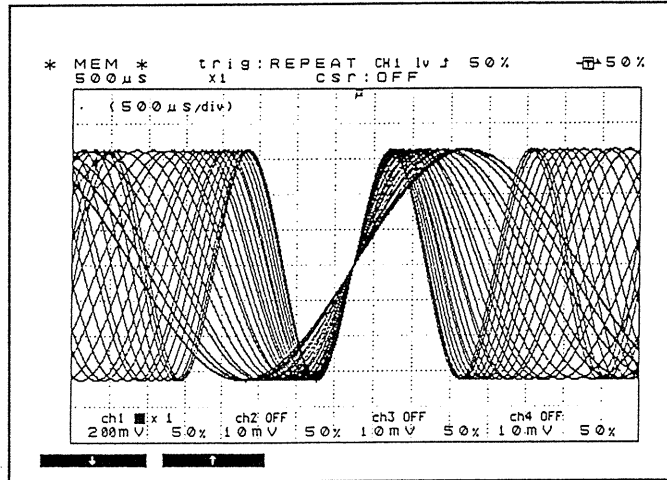

Procedure

1. Select the status mode, then use either the cursor key or the rotary knob to show the special function display.

2. "over-write"

This setting toggles the superimposition function.

(ON, OFF)

```

*** SPECIAL FUNCTION ***
* Y-axis zoom      (data)  (disp)
  ch1      x1      -      -
  ch2      x1      -      -
  ch3      x1      -      -
  ch4      x1      -      -
* over-write       ON
* memory div      OFF

* comparison      OFF

* wave calculation  FFT      OFF
                   FFT      OFF

* measurement      OFF

OFF  ON
    
```

Notes

- The superimposition function has no significance when the trigger mode is set to SINGLE, since data capture then stops after a single shot.
- The following functions are no longer available when using the superimposition function:
Waveform scrolling, plotter output, waveform pass/fail decision function, display zoom factor setting.
Furthermore, the printout function prints only the last captured waveform data.
- After using the superimposition function, all of the following operations delete the superimposition (leaving only the last captured waveform data):
Changing the zoom factor (voltage axis) in status mode
Changing the position on the voltage axis of the waveform in status mode
Changing the format
Changing the interpolation setting
Changing the channel settings for display or printed recording ("Analog drawing" and "Logic drawing")
Changing the x-axis setting in X-Y format
Again, pressing the START key deletes all of the displayed superimposed waveforms. (The most recently captured waveform also disappears.)

5-4-19 Printing Waveform Recordings

Function

There are three methods of printing waveforms:

- (1) Pressing the PRINT key to record the waveform. (The manual print function)

Using the A and B cursors (as vertical or cross-hair cursors), you can select a section of the total shot length to be printed. (Partial print function)

- (2) Pressing the COPY key to print the screen. (The screen dump function)

- (3) Using the auto print function to print a waveform automatically after capture, simultaneously with displaying it on the screen.

Procedure

- (1) Manual print function

- a. When there are no vertical or cross-hair A and B cursors

1. **PRINT**

Print the waveform data from the beginning. If a zoom factor is in effect, it applies from the beginning of the data. Since the data is held in memory, it can be printed as many times as required.

PRINT key, COPY key

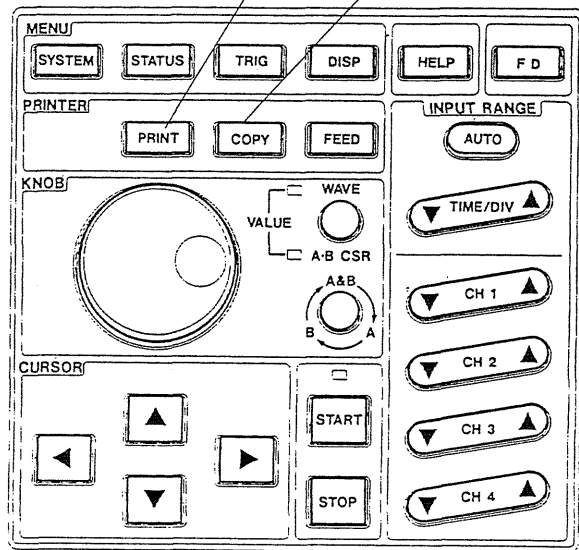

These zoom factors apply to the printed recording as well as to the screen display.

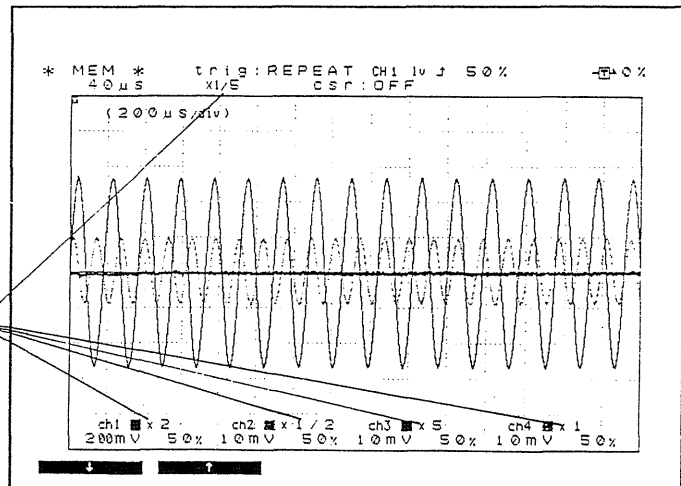

b. Using the A and B cursors (as vertical or cross-hair cursors) for a partial print

1. Display the A cursor or A and B cursors as vertical or cross-hair cursors.

Using the A cursor only, print from the A cursor position to the end of the waveform.

Using both A and B cursors, print the section of waveform between the cursors.

This function is effective even if either cursor is outside the screen area. For more details see the Example below.

2. **PRINT**

Prints the section of waveform defined by the cursors.

If zoom factors are in effect, they are also applied to the printing.

These zoom factors apply to the printed recording as well as to the screen display.

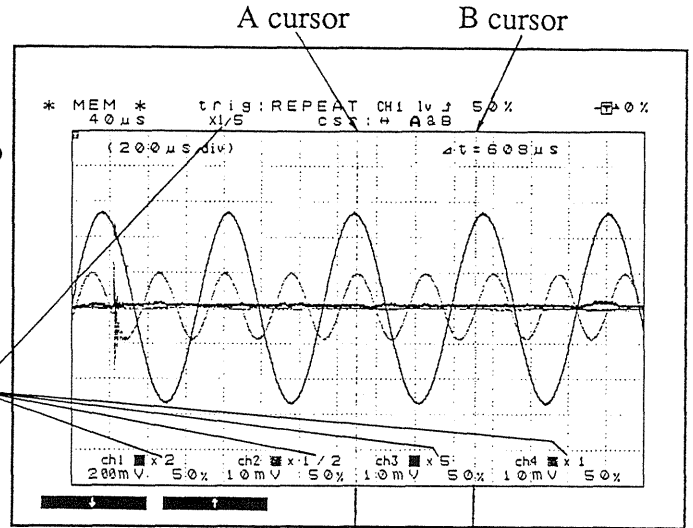

This section is printed.

(2) Screen dump function

1. **COPY**

Prints an exact copy of the screen.

Provided that a waveform is displayed on the screen, pressing the COPY and FEED keys simultaneously prints a copy of the screen, followed by a listing of the settings, as follows.

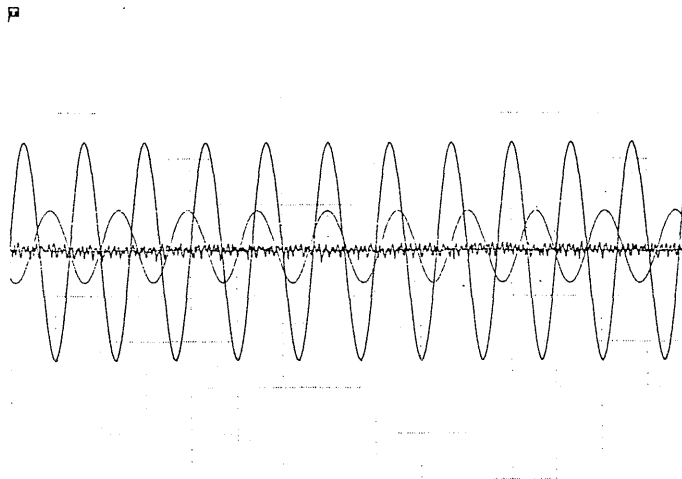

(3) Auto print function

1. Select the status mode.
2. "auto print"
Enable the auto print function.
(OFF, ON)

3. **START**
Start measurement operation.

During measurement operation mode, captured waveforms will automatically be printed at the same time that they are displayed.

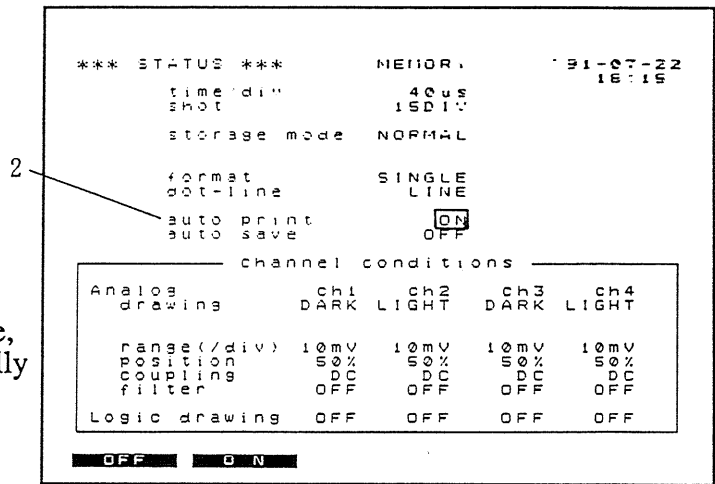

Example

The A and B cursors (vertical or cross-hair) can be used to mark a section of waveform to print, even when either of the cursors is outside the screen area.

1. Use the A cursor to determine the start position.

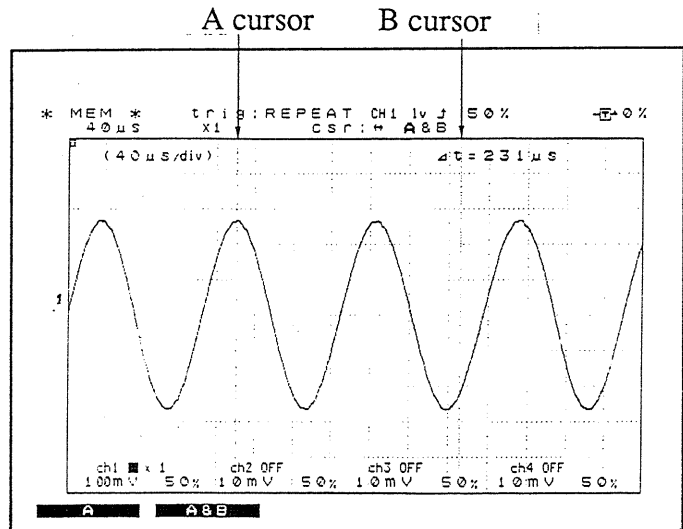

2. Move the B cursor to the right; when it reaches the edge of the display window, the waveform scrolls to the left.

The A cursor scrolls left with the waveform.

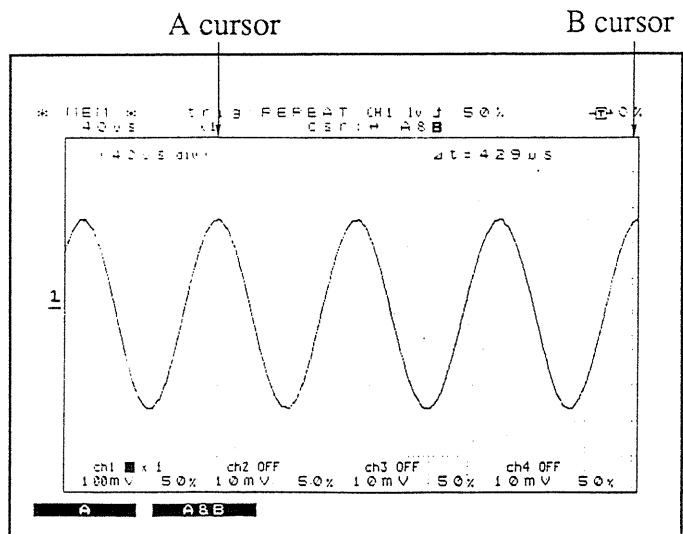

- Determine the end position with the B cursor. At this point, the A cursor has disappeared off the left side of the display window, but pressing the PRINT key still prints the correct section of the waveform.

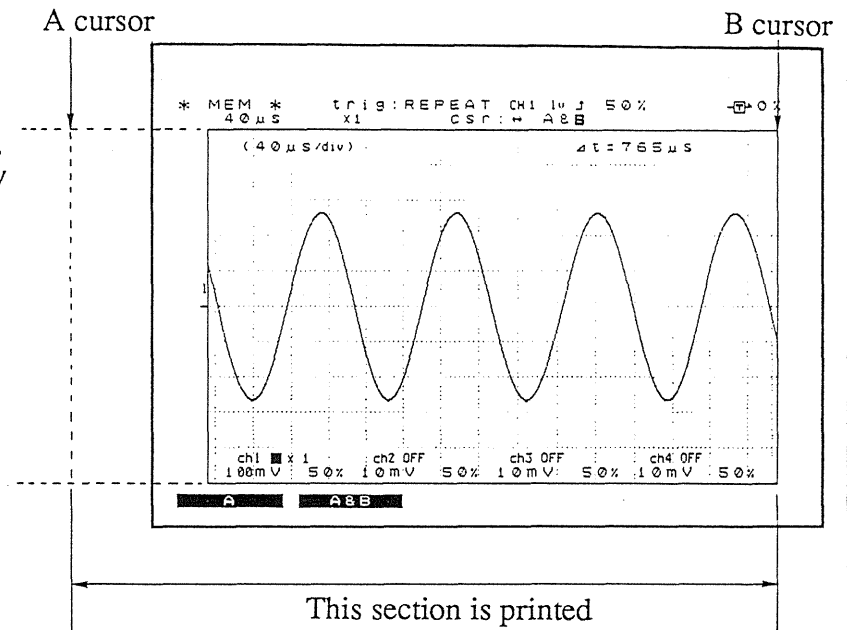

Notes

- When the format is set to DUAL (print quad), then regardless of the allocation of channels to the two display windows on the screen, the channels are printed in order channel 1 to 4. (See the Notes in Section 5-4-5 "Format Selection.")
- When the screen is in other than display mode (excluding the floppy disk control mode), pressing the PRINT key produces a listing of settings. This is the same as the printing following the waveform when the listing function is enabled. (See Section 18-5-7 "Listing and Gauge Functions," and Section 5-5 "Interpreting Waveform Displays and Recordings.")

Related items

You can select whether or not to print voltage scales (gauges) and listings of settings when using either of the manual and auto print functions. (See Section 18-5-7 "Listing and Gauge Functions.")

You can also select the smooth print function, giving a print quality close to an analog recording, or the normal print function, which is twice as fast. The default setting is the smooth print. (See Section 18-5-9 "Smooth Print Function.")

5-4-20 Help Function

In display mode, pressing the HELP key superimposes the information shown in the following figure on the screen. This includes scroll bars, which indicate the position of the display window and the memory block display, used in memory division mode.

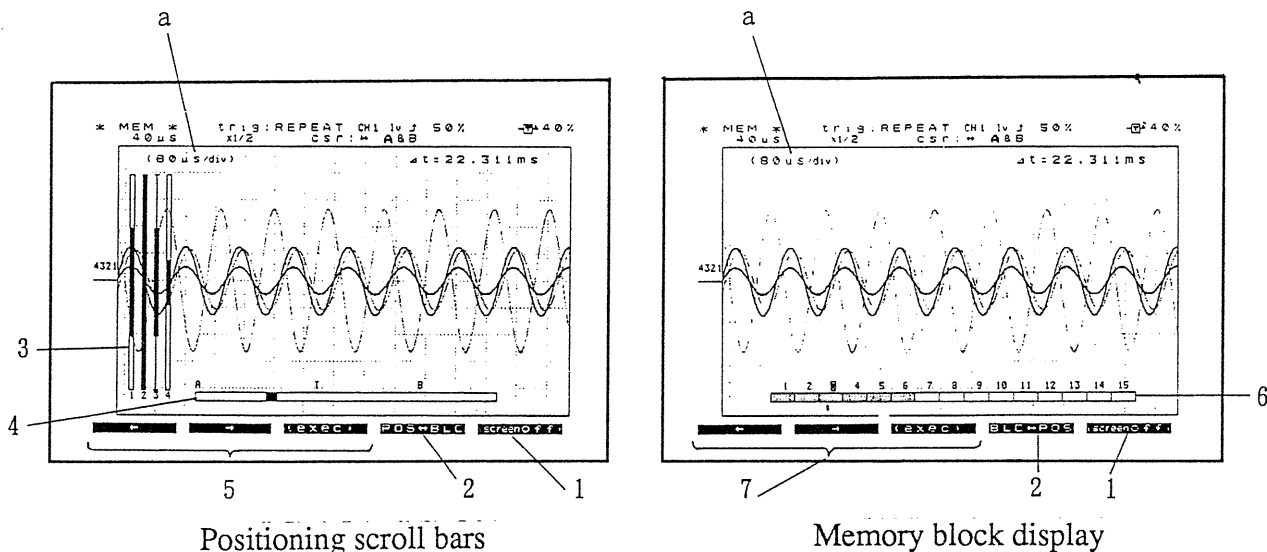

Positioning scroll bars

Memory block display

1. This soft key toggles on and off the display of scroll bars (memory blocks), the other soft key indications, and the time axis scale ('a' in the figure).
2. This soft key toggles between the scroll bar display and the memory block display.
3. The vertical scroll bars indicate the position of the display window on the voltage axis.

There is a scroll bar for each channel for which the display is on. The numeral at the bottom indicates the channel number.

When a magnification zoom factor is set for the voltage axis (including $\times 1$), the scroll bar shows the position on the voltage range occupied by the display window. When the $\times 1/2$ compression factor is set, it uses a different display pattern to show the section of the display window height occupied by the voltage range.

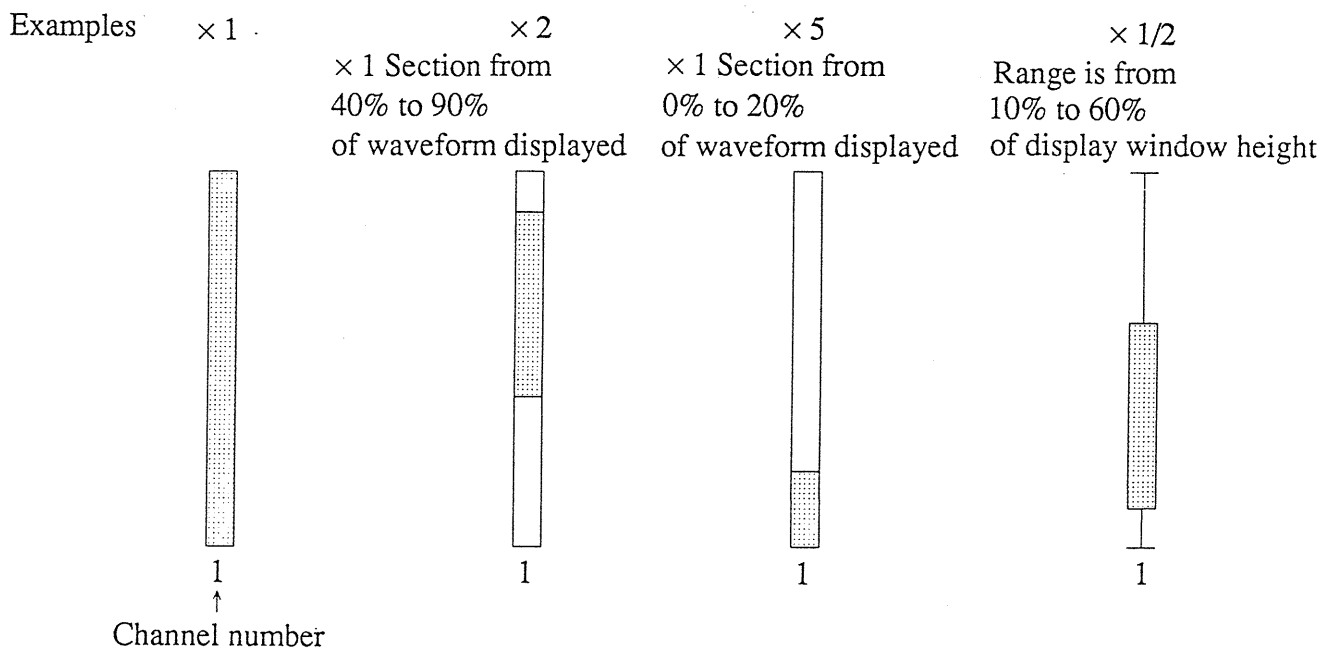

4. The horizontal scroll bar shows the position of the display window in relation to the entire shot length of the data.

It also indicates the positions of the A and B cursors, where appropriate (vertical or cross-hair cursors).

Example

Shot length of 750 divisions, time axis zoom factor set to $\times 1/2$ compression:

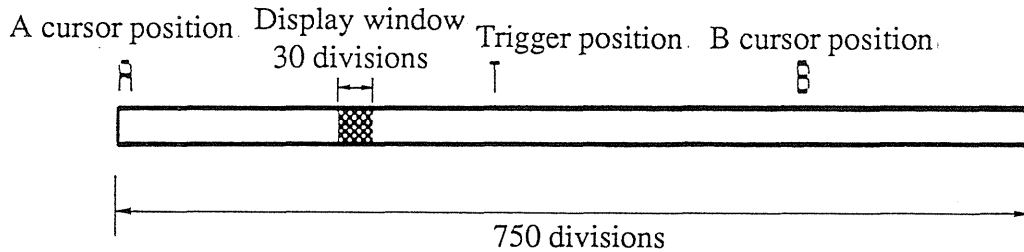

5. These soft keys provide high-speed positioning on the waveform.

Example

- (1) The current display window position is shown.

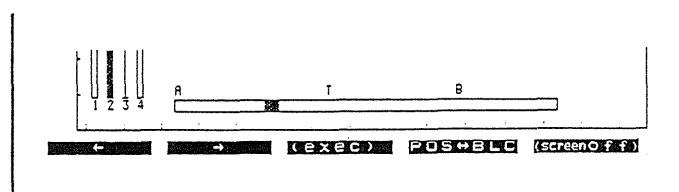

- (2) Press the  soft key to move the faint cursor to the desired new display position.

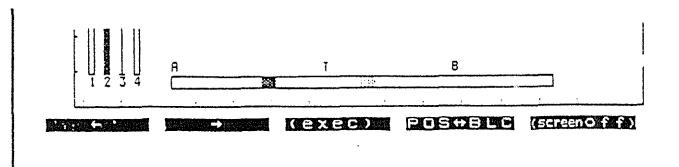

- (3) Press the  soft key to make an instantaneous move to the new position.

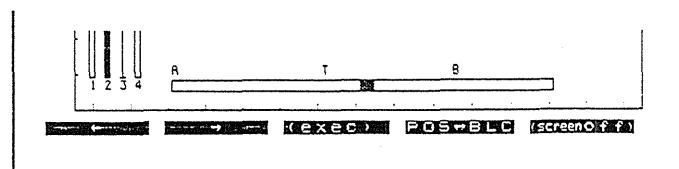

Note: There are a total of nine positions on which you can position the display window cursor: five evenly spaced positions (dividing the shot length into fourths), plus the A and B cursor positions, the trigger position and the current position.

This does not apply, however, if the number of divisions in the display window is greater than the total shot length.

| | | | |
|--|--|------------------|--|
| A cursor position (A cursor in the center of the screen) | Trigger position (trigger position at the left edge of the screen) | Current position | B cursor position (B cursor in the center of the screen) |
| A | T | | B |

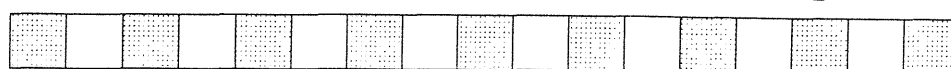

Five points dividing screen into fourths
(except for last point, the dividing point at the left edge of the screen)

6. When using the memory division function, this display indicates which memory blocks are in use. (See the next page for details when the memory division function is not in use.)

Example

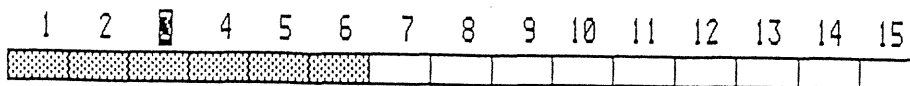

The asterisk indicates the currently displayed memory block.

The asterisk indicates the currently displayed memory block

Except for the asterisk indicating the current memory block, this display is the same as in the memory division setting operation in the special function display. See Section 15 "Memory Division Function."

7. Use these soft keys to change the memory block to be displayed.

Example

- (1) The current memory block is indicated.

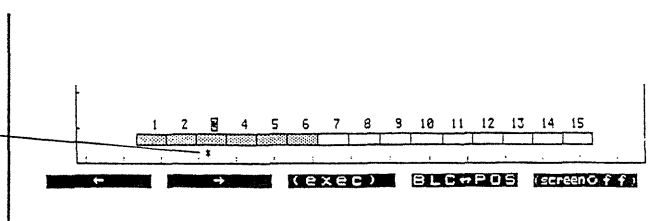

- (2) Press the  soft key to move the asterisk to the new block to be displayed.

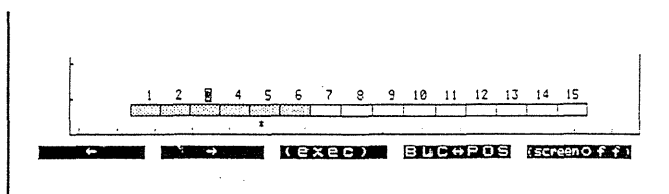

- (3) Press the  soft key to switch to the new memory block.

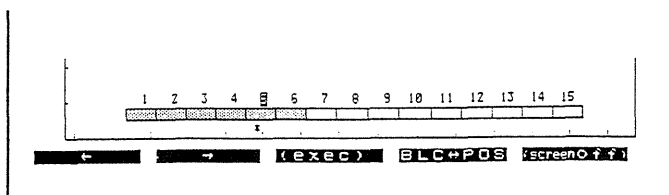

Block indication when not using the memory division function
 (When the trigger mode is REPEAT or AUTO)

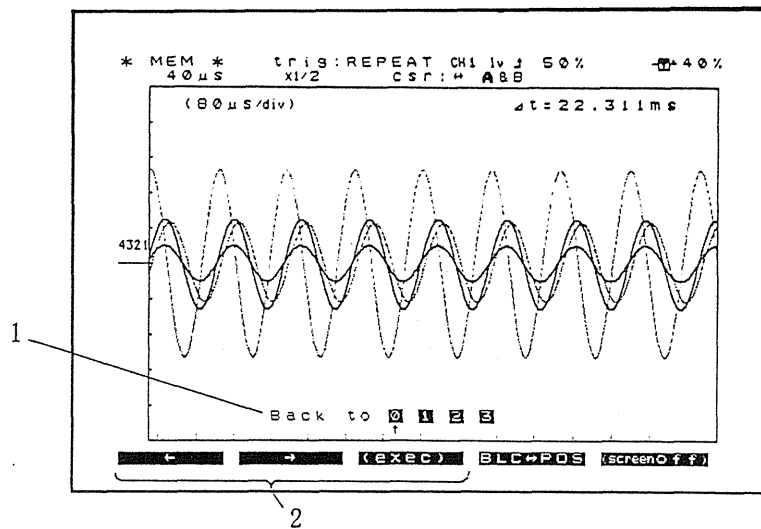

1. In addition to the most recently captured set of data, the three previous set are also held in memory.

The four reverse video numerals refer to the latest set of data (0), and the previous three (1 is the immediately previous, and 3 the oldest). The up-arrow under the numerals indicates the currently displayed data set.

Note: Depending on the shot length, it may not be possible to store all four sets of data. In this case the display appears as in 3. Again, when the trigger mode is SINGLE, the display appears as "Single wave."

2. Use these soft keys to change the waveform displayed.

When you press either of the \leftarrow and \rightarrow soft keys, an asterisk appears; move this to the required set of data.

Press the $(exec)$ soft key to change the display.

Notes: In X-Y format, only the block indication appears.

5-5 Interpreting Waveform Displays and Recordings

This section illustrates the display and printed recording (manual print, pressing COPY and FEED simultaneously) in each of the formats.

- SINGLE format Display

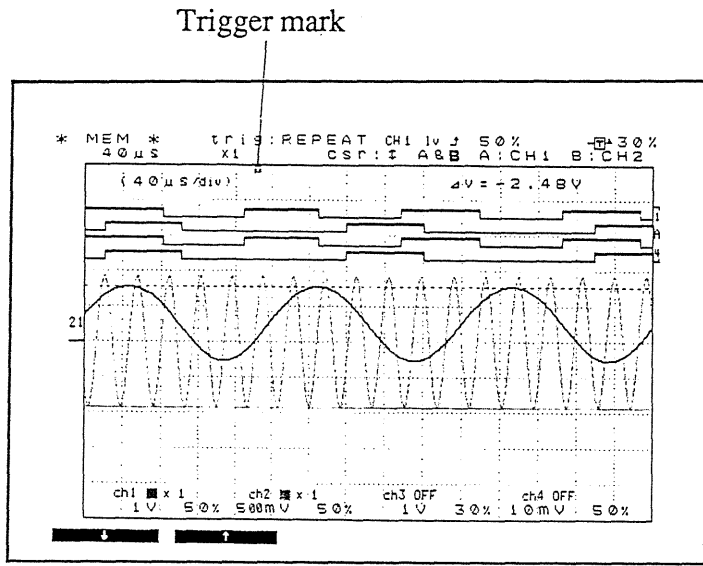

Pressing COPY and FEED simultaneously

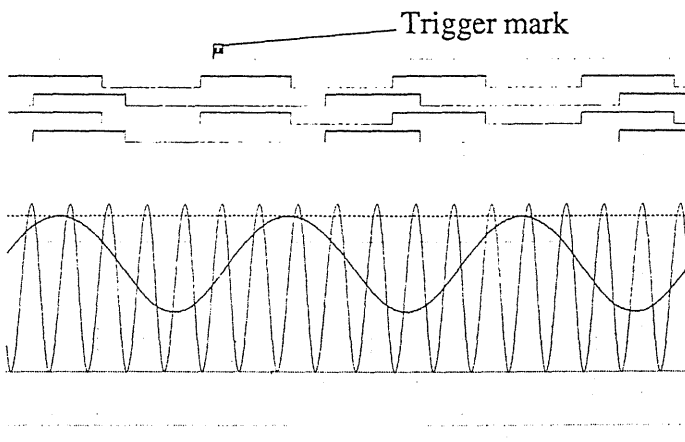

Listing of settings

```

function : MEMORY
time/div : 40µs
(40µs/div)
cursor: 01 A: CH1 B: CH2
dv: -2.48V

trigger : REPEAT
ch1: LEVEL 1 50%
pre-trigger: 30%
trigger time
'91-09-08 12:49:42

[CH1] 1V/DIV DC X1
DARK pos: 50% fil: OFF
-5V -5V

[CH2] 500µV/DIV DC X1
LIGHT pos: 50% fil: OFF
-2.5V -2.5V

[CH3] 1V/DIV DC X1
OFF pos: 30% fil: OFF

[CH4] 10mV/DIV DC X1
OFF pos: 50% fil: OFF

[Log, d] : DARK
A: ON
B: OFF
C: OFF
D: OFF

HIKI 8851 MEMORY H1 CORDER
'91-09-08 23:44
    
```

Trigger time

Filter

Setting of "position"

Manual print

Gauges

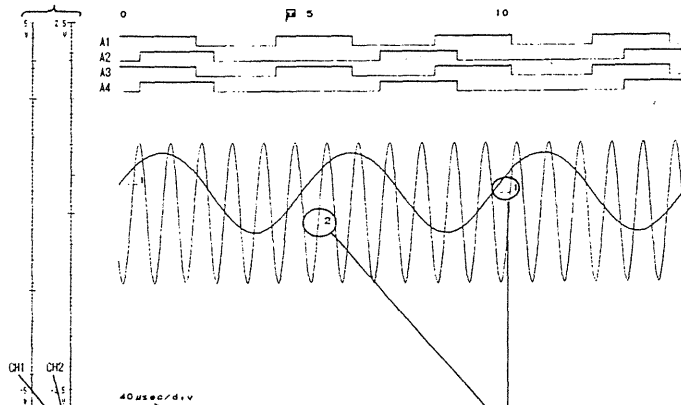

Channel number of gauge

Time axis scale

Channel marks

Trigger settings

listing

| | | |
|---|---|--|
| Trigger time | | |
| <pre> function : MEMORY time/div : 40µs (40µs/div) shot : 1SDIV str mode : NORMAL format : SINGLE dot-line : LINE auto print : OFF auto save : OFF [CH1] 1V/DIV DC X1 DARK pos: 50% fil: OFF -5V -5V [CH2] 500µV/DIV DC X1 LIGHT pos: 50% fil: OFF -2.5V -2.5V [CH3] 1V/DIV DC X1 OFF pos: 30% fil: OFF [CH4] 10mV/DIV DC X1 OFF pos: 50% fil: OFF -50µV -50µV [Log, d] : DARK A: ON B: OFF C: OFF D: OFF HIKI 8851 MEMORY H1 CORDER '91-09-08 23:44 </pre> | <pre> *** TRIGGER *** trigger time '91-09-08 12:49:42 source : OR cha : LOGIC #(1) #(2) OR #filter: 0 ch2 : OFF ch3 : OFF ch4 : OFF external: OFF trig mode : AUTO pre-trigger: 0x trigger source: OFF </pre> | <pre> *** SPECIAL FUNCTION *** x over-write : OFF x memory div : OFF x comparison : OFF x wave calculation: OFF x measurement : OFF *** SYSTEM *** V 0.20 screen auto off : ON grid type : NORMAL start key backup: OFF ch-marker : ON beep sound : ON list & gauge : L & G logic drawing : DARK smooth print : ON roll mode : OFF using unit : 4ch </pre> |

Settings on special function display

Settings in system mode

- DUAL format Display

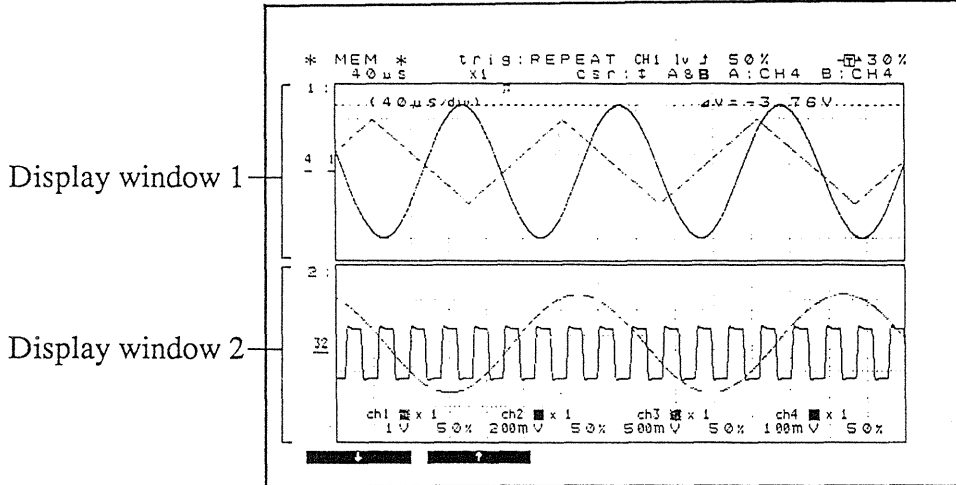

Pressing COPY and FEED simultaneously

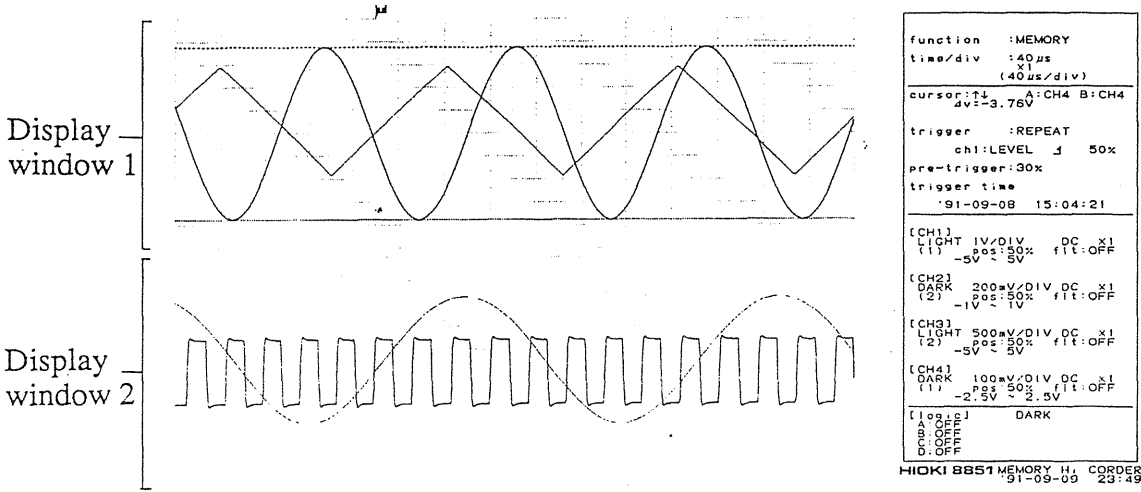

Manual print

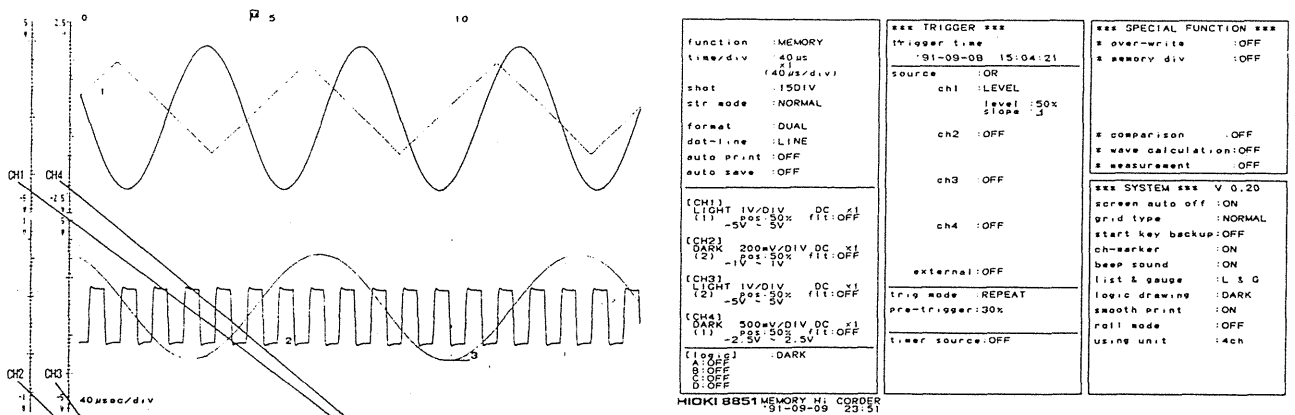

Channel numbers for display window 2

Channel numbers for display window 1

- DUAL (print quad) format
Display

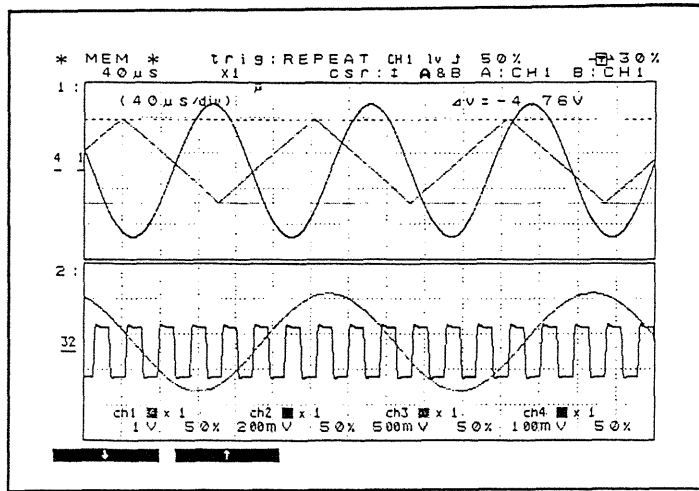

Pressing COPY and FEED simultaneously

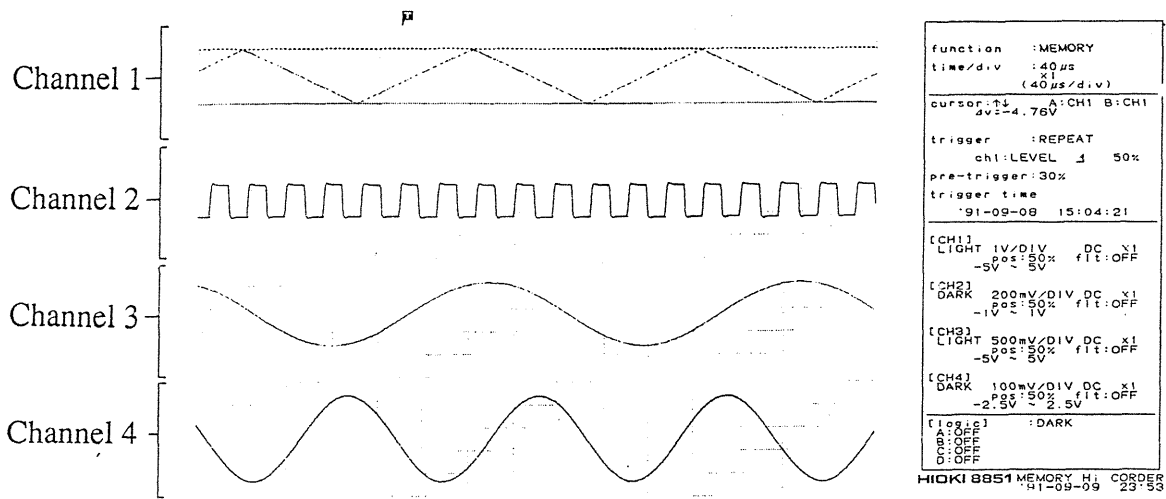

Manual print

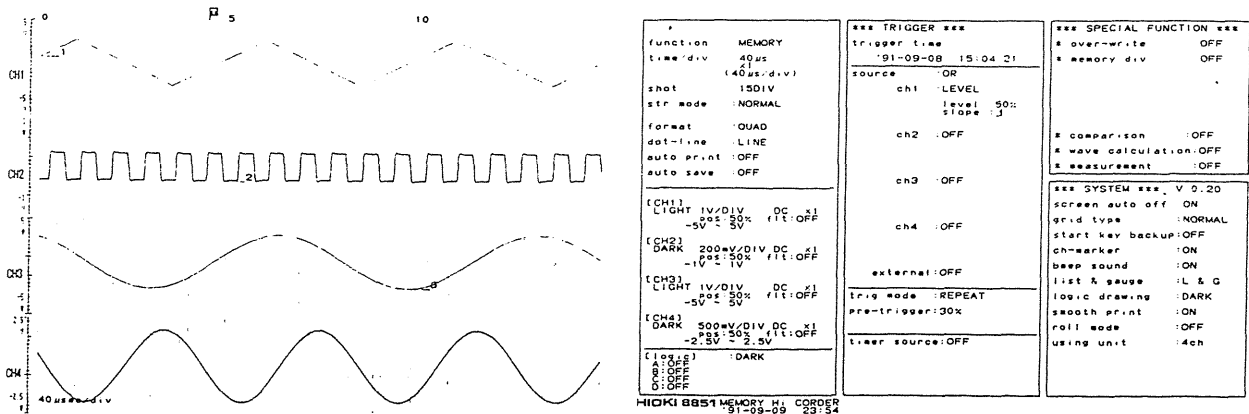

- X-Y format Display

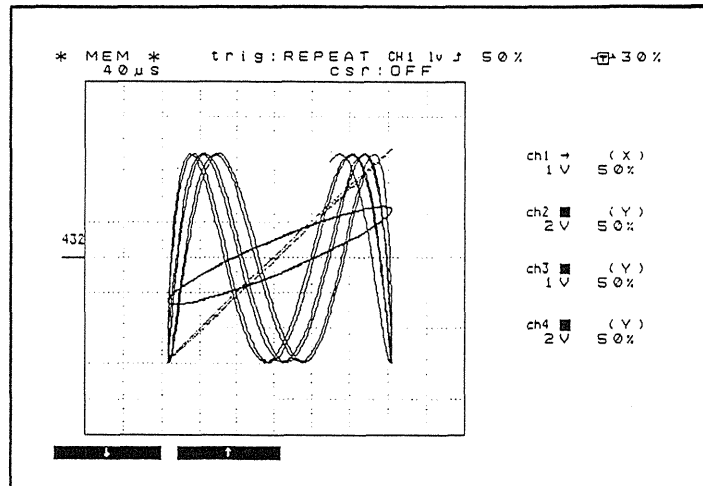

Pressing COPY and FEED simultaneously

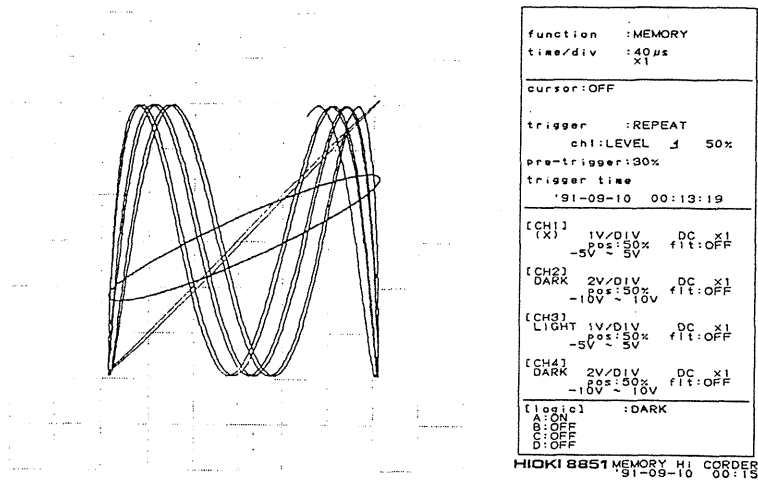

Manual print

Gauges (for the x-axis, read as though rotated clockwise through 90 degrees)

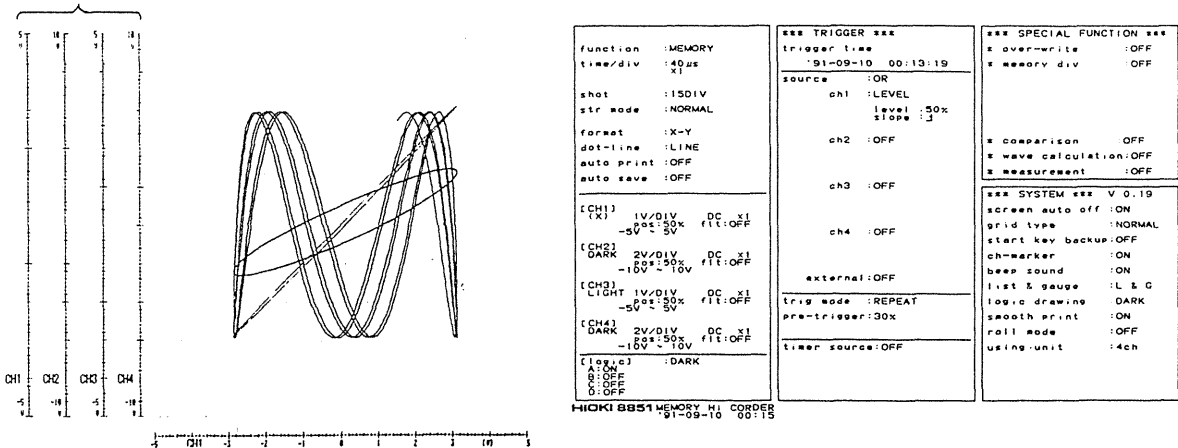

Section 6

Recorder Function Operation

Contents

| | | |
|--------|--|------|
| 6-1 | What is the Recorder Function? | 6-2 |
| 6-1-1 | Introduction..... | 6-2 |
| 6-1-2 | Finding Reference Material in this Manual | 6-3 |
| 6-2 | Screen Modes | 6-4 |
| 6-2-1 | Status Mode | 6-4 |
| 6-2-2 | Trigger Mode | 6-5 |
| 6-2-3 | Display Mode..... | 6-6 |
| 6-3 | Basic Operation Procedure..... | 6-7 |
| 6-3-1 | Operation Sequence | 6-7 |
| 6-3-2 | Operation Example | 6-8 |
| 6-4 | User Operations..... | 6-13 |
| 6-4-1 | Function Selection | 6-13 |
| 6-4-2 | Time Axis Range Setting..... | 6-14 |
| 6-4-3 | Shot Length Selection..... | 6-15 |
| 6-4-4 | Format Selection..... | 6-16 |
| 6-4-5 | Display and Recording Channel Settings | 6-19 |
| 6-4-6 | Input Unit Range, Position, Coupling and Filter Settings | 6-23 |
| 6-4-7 | Zero Adjustment | 6-26 |
| 6-4-8 | Trigger Settings | 6-27 |
| 6-4-9 | Starting and Stopping Measurement Operation | 6-30 |
| 6-4-10 | Using A and B Cursors | 6-31 |
| 6-4-11 | Voltage Axis Zoom Function | 6-36 |
| 6-4-12 | Waveform Scrolling..... | 6-38 |
| 6-4-13 | Printing Waveform Recordings | 6-40 |
| 6-4-14 | Converting Data for the Memory Recorder Function..... | 6-44 |
| 6-4-15 | Help Function | 6-46 |
| 6-5 | Interpreting Waveform Displays and Recordings | 6-47 |

6-1 What is the Recorder Function?

6-1-1 Introduction

This function provides real time display and printing of the input signal.

(1) Real time continuous recording of the input signal.

(2) Recording all input channels on the same time axis.

Since the different signals can be overlaid, it is easy to see the relationships among them.

(3) There is a range of 13 chart speeds, from 400 ms/division to 1 hour/division.

(4) High-speed sampling

Independent of the chart speed, sampling is carried out at 400 kS/s, thus allowing the envelope function to be used.

(5) Scrollable display

Although this is real time recording, 750 divisions of the waveform (including the screen portion) are held in memory. It is thus possible to scroll back for easy review of the waveform.

(6) Two display formats and three formats for printed recordings selectable.

Single, dual, and quad(printing only) formats are available for the time axis.

(7) High quality printed recordings

The high time axis resolution of the printing yields results close to those of an analog recorder.

400 ms or 500 ms/division ... 80 points/division

1 s to 1 hour/division ... 160 points/division

(8) Reprint function

The waveform data held in memory (the most recent 750 divisions, including the section displayed) can be printed as many times as required.

(9) Measurement data can be converted to memory recorder data. This allows the data to be saved to a floppy disk, among many other functions.

6-1-2 Finding Reference Material in this Manual

(1) Basic function

See Section 6-4 "User Operations" (Sections 6-4-1 to 6-4-15) for operational details.

(2) Trigger functions

See Section 14 (Vol. 2). Depending on the application, there is a wide range of trigger types to choose from.

(3) Using floppy disks

See Section 19 (Vol. 2).

The floppy disk drive provides a long-term storage mechanism for setting information.

(4) Scaling function

See Section 18-3 "Scaling Function" (in Vol. 2). This allows the input voltages to be converted to other values and units, so that the physical quantities originally measured can be read off directly.

(5) Comment function

See Section 18-4 "Adding Comments" (in Vol. 2). This provides a convenient means of annotating printed recordings.

(6) Screen auto off function

(7) Grid setting

The grid for the printed recording can be selected as required.

(8) Start key backup function

If the power supply fails during recording, enabling this function causes recording to restart when the power is restored.

(9) Channel marker function

Prints the channel numbers on the recording.

(10) Audible warning setting

(11) List and gauge functions

Voltage axis scales and listings of settings on printed recordings.

(12) Logic waveform display intensity

Logic channel waveforms can be displayed at two intensities.

(13) Connection to a computer via the GP-IB interface

See Section 20 (Vol. 2).

(14) Output to an external plotter

See Section 18-7 "Plotter Output" (in Vol. 2).

(15) Self check functions

See Section 18-8 "Self Check Functions" (in Vol. 2). This performs simple tests on the unit's functioning.

See Section 18-5
"Special Function
Settings"
(in Vol. 2)

6-2 Screen Modes

This section describes the status, trigger and display modes.

It also shows you where to look in this manual for further explanation of specific items.

See Section 18 for details of the system mode, and see Section 19 for details of the floppy disk control mode.

6-2-1 Status Mode

Press the STATUS key to display the status screen.

Use the rotary knob to scroll the screen, or hold down the cursor  key to see the special function display.

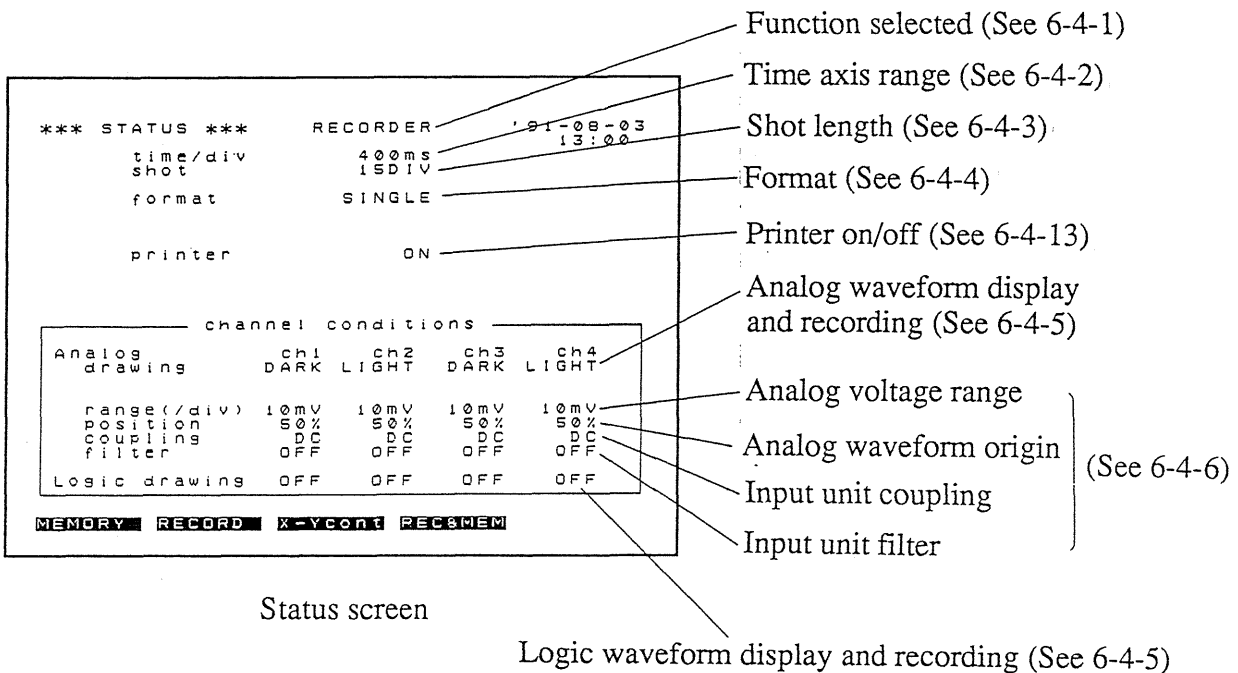

The Status screen displays the following information:

```

*** STATUS ***
time/div      400ms
shot          1SDIV
format        SINGLE
printer       ON

channel conditions
Analog drawing  ch1 DARK ch2 LIGHT ch3 DARK ch4 LIGHT
range(/div)    10mV  10mV  10mV  10mV
position       50%   50%   50%   50%
couplings      DCF   DCF   DCF   DCF
filter         OFF   OFF   OFF   OFF
Logic drawing  OFF   OFF   OFF   OFF
    
```

Callouts from the right side of the image point to the following elements:

- Function selected (See 6-4-1)
- Time axis range (See 6-4-2)
- Shot length (See 6-4-3)
- Format (See 6-4-4)
- Printer on/off (See 6-4-13)
- Analog waveform display and recording (See 6-4-5)
- Analog voltage range
- Analog waveform origin (See 6-4-6)
- Input unit coupling
- Input unit filter
- Logic waveform display and recording (See 6-4-5)

At the bottom of the screen, there are indicators for MEMORY, RECORD, X-YCONT, and REC&MEM.

Status screen

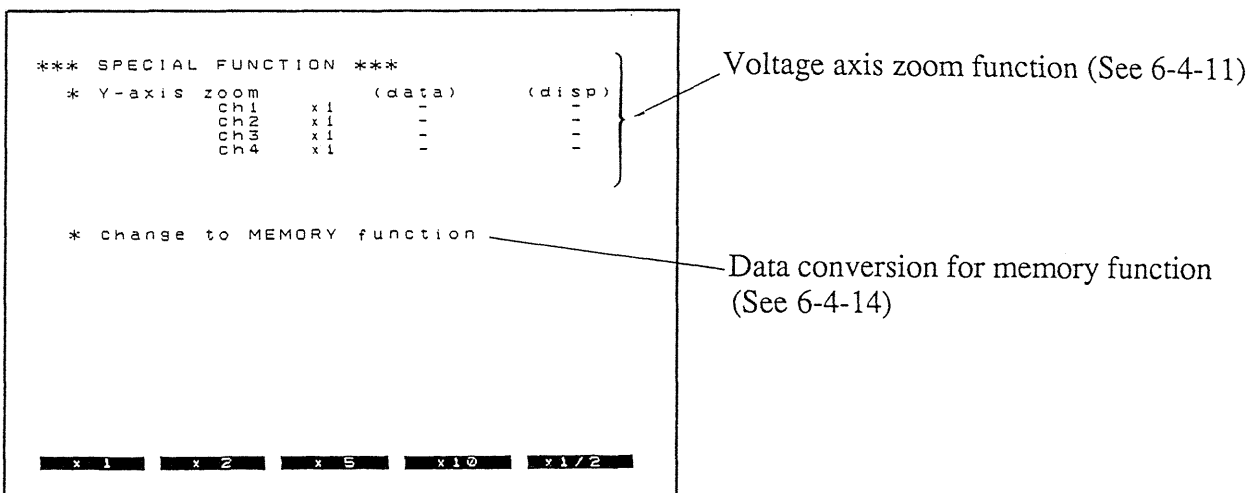

The Special function display shows the following information:

```

*** SPECIAL FUNCTION ***
* Y-axis zoom (data) (disp)
  ch1 x1 - -
  ch2 x1 - -
  ch4 x1 - -
* change to MEMORY function
    
```

Callouts from the right side of the image point to the following elements:

- Voltage axis zoom function (See 6-4-11)
- Data conversion for memory function (See 6-4-14)

At the bottom of the screen, there are indicators for zoom levels: x1, x2, x5, x10, and x1/2.

Special function display

6-2-2 Trigger Mode

Press the TRIG key to display the trigger screen.

Use the rotary knob to scroll the screen, or hold down the cursor  key to see the special trigger display.

See Section 6-4-8 "Trigger Settings" and Section 14 "Trigger Functions" for more details.

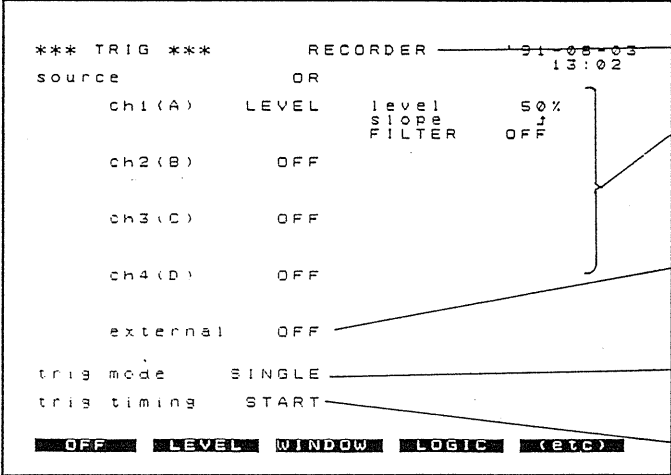

```

*** TRIG ***          RECORDER  '91-08-03
source                OR          13:02
  ch1(A)  LEVEL      level  50%
                   SLOPE  J
                   FILTER  OFF
  ch2(B)   OFF
  ch3(C)   OFF
  ch4(D)   OFF
  external OFF
  trig mode SINGLE
  trig timing START
  OFF  LEVEL WINDOW LOGIC (etc)
  
```

Function selected (See 6-4-1)

Internal triggers

External trigger

Trigger mode

Trigger timing

Trigger screen

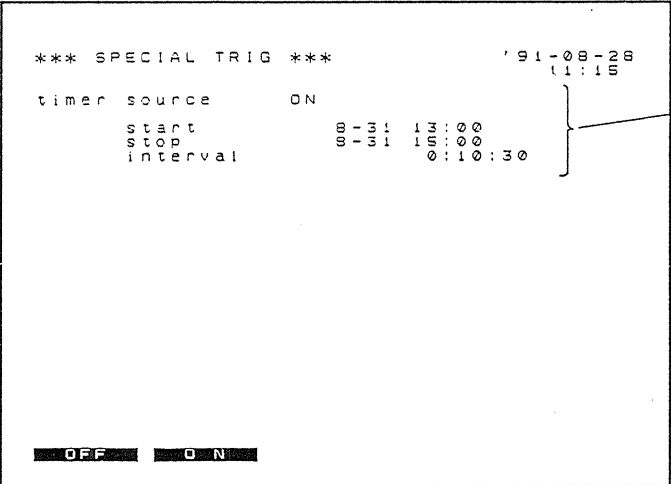

```

*** SPECIAL TRIG ***          '91-08-28
timer source                ON          11:15
  start  8-31 13:00
  stop   8-31 15:00
  interval 0:10:30
  OFF  ON
  
```

Timer trigger

Special trigger display

6-2-3 Display Mode

Press the DISP key to enter the display mode.

The figure below illustrates a display in single format. (See Section 6-4-4 "Format Selection.")

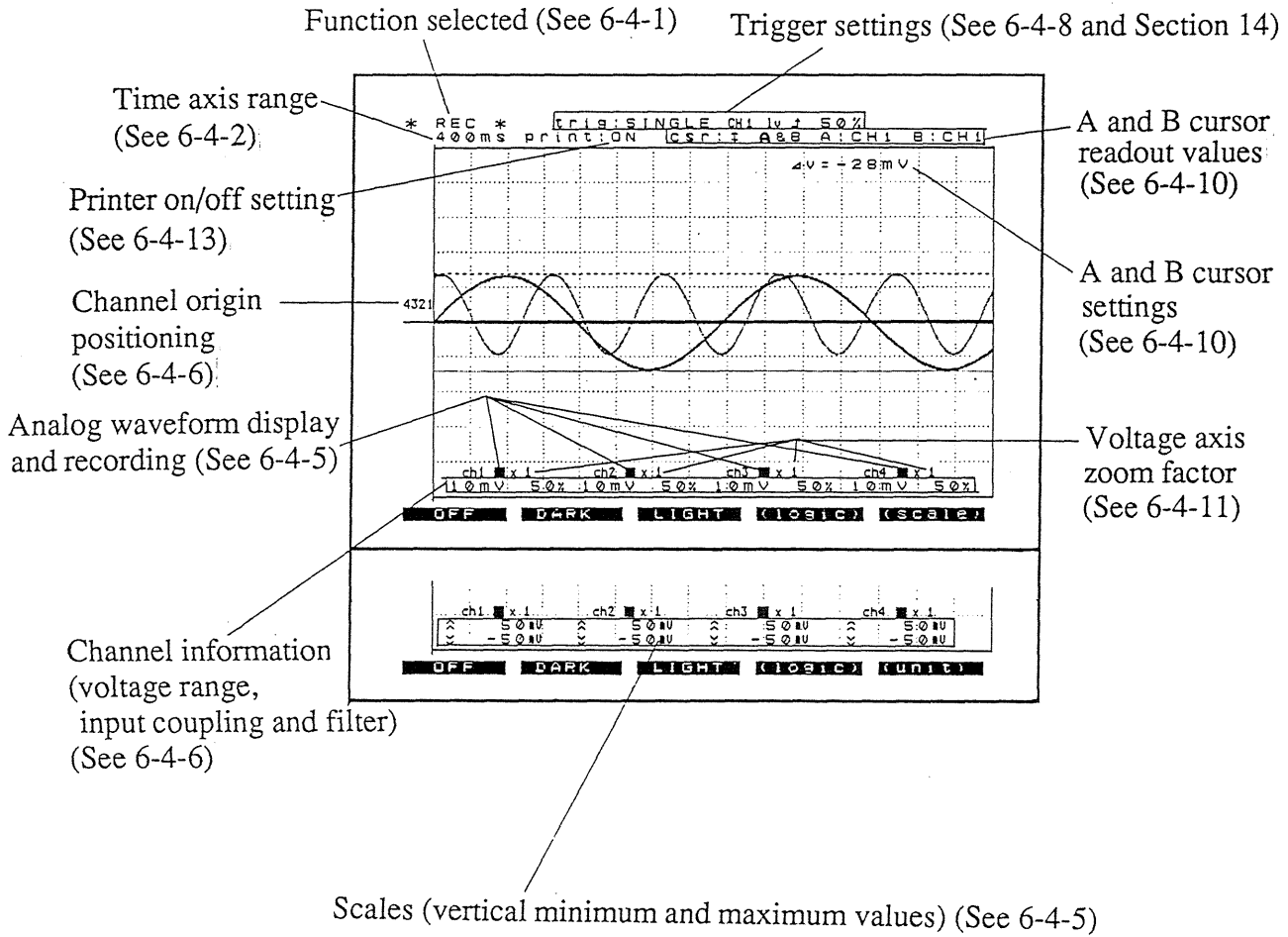

6-3 Basic Operation Procedure

6-3-1 Operation Sequence

The flowchart below illustrates the sequence of operations involved in using the recorder function. (The explanation to the right of the flowchart boxes is based on Section 6-3-2 "Operation Example.")

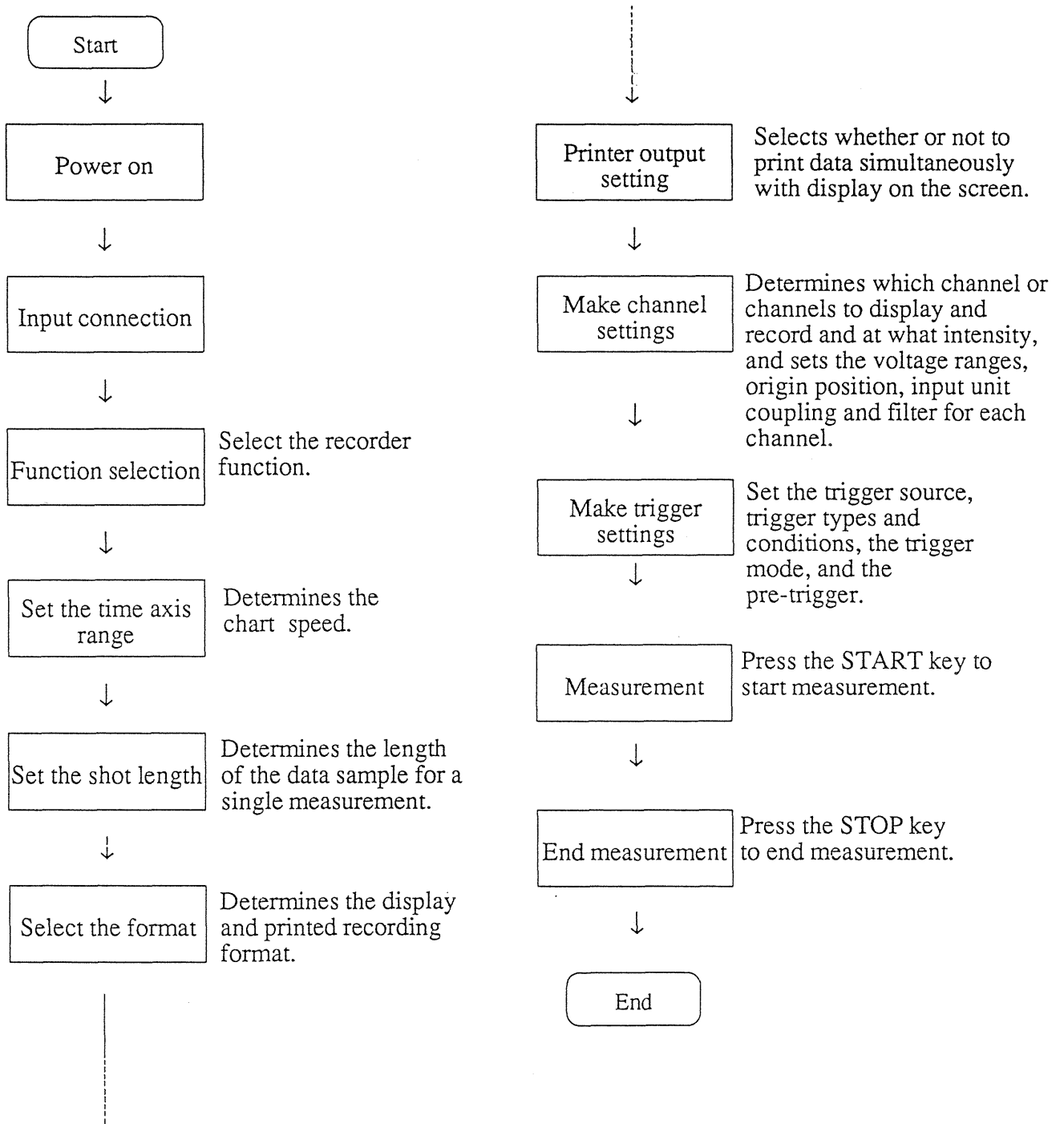

6-3-2 Operation Example

This example illustrates the basic procedure using the recorder function to measure a 3 V p-p 1 kHz sine wave input.

(1) Power on the unit

Connect the power cord to the 8851 and press the power switch.

(2) Input connection

Connect a signal generator to the input terminals of channel 1 (the 8944 analog input unit). Set the signal generator so that it outputs a 3 V p-p 1 kHz sine wave.

(3) Select the function

Select the recorder function.

1. Press the STATUS key.
2. Move the flashing cursor to the function indication.
3. Press the **RECORD** soft key.

Flashing cursor

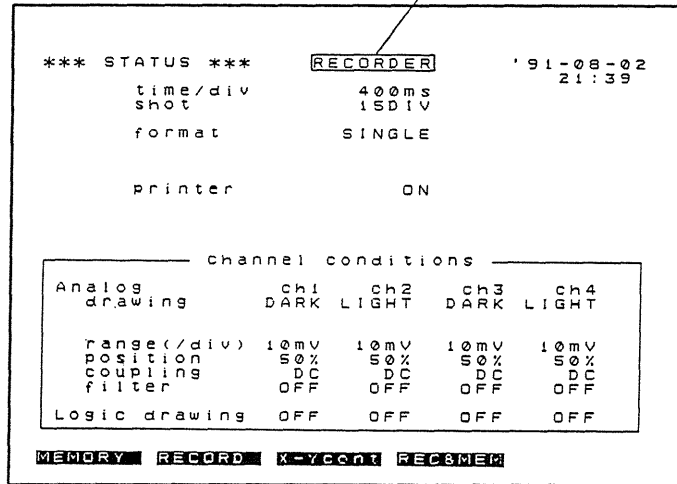

(4) Set the time axis range

Set the time axis range to 500 ms/division.

1. Either use the TIME/DIV key, or move the flashing cursor to the "time/div" item and adjust the value with the **↑** and **↓** soft keys or the rotary knob, so that the setting is 500 ms.

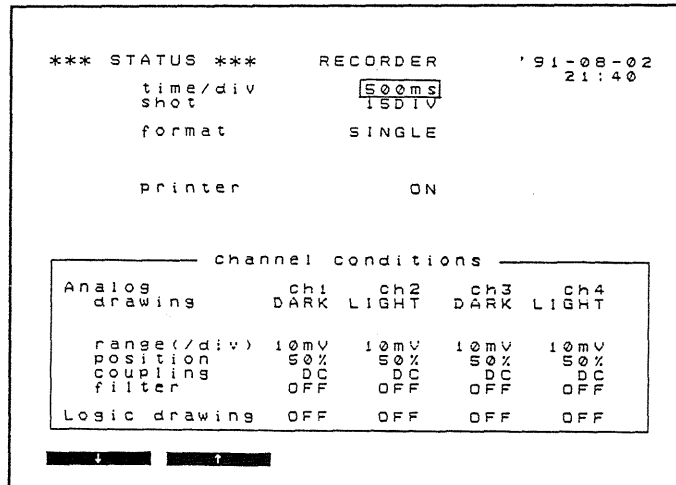

(5) Set the shot length

Set the shot length to "CONT" for continuous recording until you press the STOP key or the paper runs out.

1. Move the flashing cursor to the "shot" item.
2. Adjust the value with the and soft keys or the rotary knob, so that the setting is CONT.

```
*** STATUS ***      RECORDER      '91-08-02
                        21:44
time/div            500ms
shot                CONT
format              SINGLE

printer             ON

channel conditions
-----
Analog              ch1  ch2  ch3  ch4
drawing             DARK LIGHT DARK LIGHT

range(/div)        10mV  10mV  10mV  10mV
position            50%   50%   50%   50%
coupling            DC    DC    DC    DC
filter              OFF   OFF   OFF   OFF
Logic drawing      OFF   OFF   OFF   OFF
```

(6) Select the format

Select the single format: displaying and recording on a single time axis.

1. Move the flashing cursor to the "format" item.
2. Press the soft key.

```
*** STATUS ***      RECORDER      '91-08-02
                        21:45
time/div            500ms
shot                CONT
format              SINGLE
printer             ON

channel conditions
-----
Analog              ch1  ch2  ch3  ch4
drawing             DARK LIGHT DARK LIGHT

range(/div)        10mV  10mV  10mV  10mV
position            50%   50%   50%   50%
coupling            DC    DC    DC    DC
filter              OFF   OFF   OFF   OFF
Logic drawing      OFF   OFF   OFF   OFF
```

(7) Set printer output function

Set the printer output function to print during measurement.

1. Move the flashing cursor to the "print" item.
2. Press the soft key.

```
*** STATUS ***      RECORDER      '91-08-02
                        21:45
time/div            500ms
shot                CONT
format              SINGLE
printer             ON

channel conditions
-----
Analog              ch1  ch2  ch3  ch4
drawing             DARK LIGHT DARK LIGHT

range(/div)        10mV  10mV  10mV  10mV
position            50%   50%   50%   50%
coupling            DC    DC    DC    DC
filter              OFF   OFF   OFF   OFF
Logic drawing      OFF   OFF   OFF   OFF
```

(8) Make channel settings

Display and record channel 1 only, in high intensity.

Set the voltage range to 500 mV/division, the origin position to 50%, input coupling to DC and the input filter off.

1. Flashing cursor ... "ch1 Analog drawing"
Press the **DARK** soft key.
2. Flashing cursor ... "ch1 range"
Set to 500 mV.
You can also use the channel 1 range key, without moving the flashing cursor.
3. Flashing cursor ... "ch1 position"
Set to 50%.
4. Flashing cursor ... "ch1 coupling"
Press the **DC** soft key.
5. Flashing cursor ... "ch1 filter"
Press the **OFF** soft key.
6. Flashing cursor ... "ch1 Logic drawing"
Press the **OFF** soft key.
7. Similarly set the "Analog drawing" and "Logic drawing" items for channels 2, 3 and 4 all off.

```

*** STATUS ***      RECORDER      '91-08-28
                        11:22
time/div            500ms
shot                CONT
format              SINGLE

printer             ON

channel conditions
Analog drawing     ch1 ch2 ch3 ch4
                  DARK LIGHT DARK LIGHT
range(/div)        10mV 10mV 10mV 10mV
position           50%  50%  50%  50%
coupling           DC   DC   DC   DC
filter             OFF  OFF  OFF  OFF
Logic drawing      OFF  OFF  OFF  OFF
    
```

1... **OFF** **DARK** **LIGHT**

2... **OFF** **DARK** **LIGHT**

3... **OFF** **DARK** **LIGHT**

4... **GND** **AC** **DC**

5... **OFF** **500HZ** **5HZ**

6... **OFF** **ON**

7... **OFF** **DARK** **LIGHT**

OFF **ON**

```

*** STATUS ***      RECORDER      '91-08-28
                        11:24
time/div            500ms
shot                CONT
format              SINGLE

printer             ON

channel conditions
Analog drawing     ch1 ch2 ch3 ch4
                  DARK OFF  OFF  OFF
range(/div)        500mV 10mV 10mV 10mV
position           50%  50%  50%  50%
coupling           DC   DC   DC   DC
filter             OFF  OFF  OFF  OFF
Logic drawing      OFF  OFF  OFF  OFF
    
```

MEMORY **RECORD** **X-YCONT** **RECSMEM**

Screen after settings have been made

(9) Make trigger settings

Use only channel 1 as a trigger source; set the trigger level to 50%, the slope to rising, the filter off, and select the logical OR of the channels.

Set the trigger mode to single, the trigger timing to START, and switch off the timer trigger.

1. Press the TRIG key.
2. Flashing cursor ... "source" (at the top)

Press the **OR** soft key.

3. Flashing cursor ... "ch1(A)"

Press the **LEVEL** soft key.

4. Flashing cursor ... "level"

Set to 50%.

5. Flashing cursor ... "slope"

Press the **↑** soft key.

6. Select FILTER/EVENT

Press the **FILTER** soft key.

Note: Refer to the screen appearance after completing settings.

7. Flashing cursor ... "FILTER"

Press the **OFF** soft key.

8. Set all of channels 2 (B), 3 (C) and 4 (D) off.

9. Flashing cursor ... "external"

Press the **OFF** soft key.

10. Flashing cursor ... "trigger mode"

Press the **OFF** soft key.



11. Flashing cursor ... "trigger timing"

Press the **START** soft key.

| | | | |
|-------|---------------|---------------|----------------------------------|
| 2... | *** TRIG *** | RECORDER | '91-08-28 |
| | source | OR | 11:28 |
| | ch1(A) | OFF | |
| | ch2(B) | OFF | |
| | ch3(C) | OFF | |
| | ch4(D) | OFF | |
| | external | OFF | |
| | trig mode | SINGLE | |
| | trig timing | START | |
| 3... | OFF | AND | |
| 4... | OFF | LEVEL | WINDOW LOGIC (etc) |
| 5... | ↓ | ↑ | |
| 6... | ↓ | ↑ | |
| 7... | FILTER | EVENT | |
| 8 | OFF | ON | |
| | OFF | LEVEL | WINDOW LOGIC (etc) |
| | OFF | LEVEL | WINDOW LOGIC (etc) |
| | OFF | LEVEL | WINDOW LOGIC (etc) |
| 9... | OFF | ON | |
| 10... | SINGLE | REPEAT | |
| 11... | START | STOP | - 8 - |

| | | | |
|---|---------------|---------------|-----------|
| 6 | *** TRIG *** | RECORDER | '91-08-28 |
| | source | OR | 11:30 |
| | ch1(A) | LEVEL | level 50% |
| | | | slope ↑ |
| | | FILTER | OFF |
| | ch2(B) | OFF | |
| | ch3(C) | OFF | |
| | ch4(D) | OFF | |
| | external | OFF | |
| | trig mode | SINGLE | |
| | trig timing | START | |
| | FILTER | EVENT | |

Screen appearance after completing settings

12. Use the rotary knob to scroll the screen, or hold down the cursor  key to see the special trigger display.
13. Flashing cursor ... "timer source"
Press the  soft key.

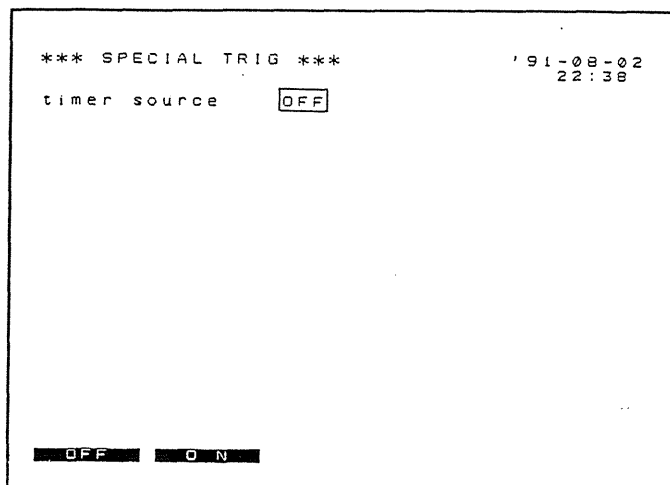

Special trigger display

(10) Starting measurement

On pressing the START key, the waveform display will appear on the screen, and the printer simultaneously start producing a recording output.

1. Press the START key.

The LED above the START key lights.

In this case the input is already present, so the trigger will take effect immediately, and both waveform display and printed recording start.

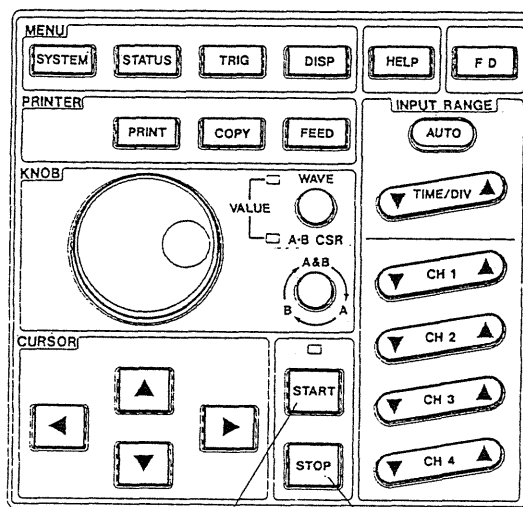

START key STOP key

(11) Ending measurement

Since the shot length is set to "CONT" the recording continues until the printer paper runs out or the STOP key is pressed.

1. Press the STOP key.

The LED above the START key goes off, and measurement ends.

Note: Since the printer uses thermally sensitive paper, to keep a permanent copy of the recording, it is recommended to take a photocopy.

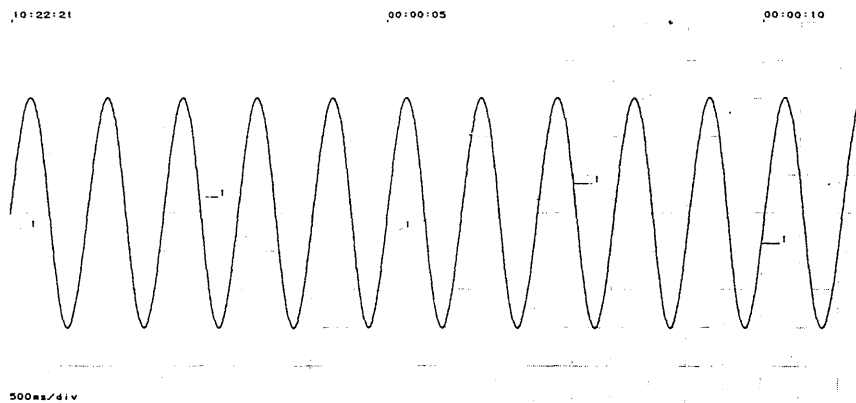

6-4 User Operations

6-4-1 Function Selection

Function

First select the function to be used for measurement. There are four functions: memory recorder, recorder, X-Y recorder, and recorder and memory. In this case, select the recorder function.

Procedure

1. Select status mode.
2. Function selection

Press the **RECORD** soft key.

This selects the recorder function.

(MEMORY, RECORDER, X-Ycont, REC&MEM)

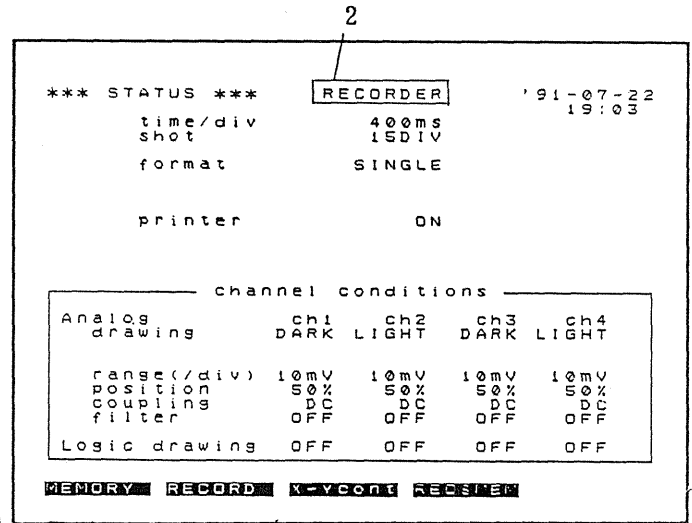

(Soft key indication is "RECORD".)

The function selection can be carried out equally in trigger or display mode.

After pressing the TRIG key for the trigger mode, or the DISP key for the display mode, make the function selection in the same way as in the status mode. The soft key indications are the same.

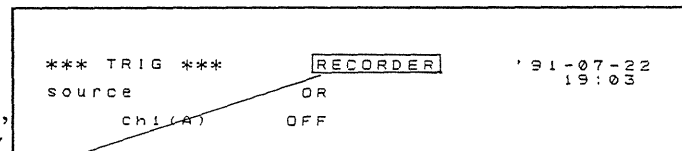

Note: The function indication in the display mode is abbreviated:

MEMORY - MEM

RECORDER - REC

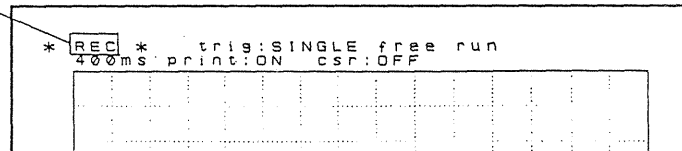

6-4-2 Time Axis Range Setting

Function

This sets the chart speed.

The "time/div" setting indicates the time for one division on the time axis.

The sampling period is fixed at 400 kS/s, regardless of the time axis range setting.
(See Background in Section 5-4-2.)

Procedure

You can carry out the setting in status mode or display mode.

(1) In status mode

1. Select the status mode.
2. "time/div"

Set the time axis range.

By using the TIME/DIV key, you can set the time axis range without moving the flashing cursor.

(400 ms, 500 ms, 1 s, 2 s, 5 s, 10 s, 20 s, 1 min, 2 min, 5 min, 10 min, 20 min, 1 hour)

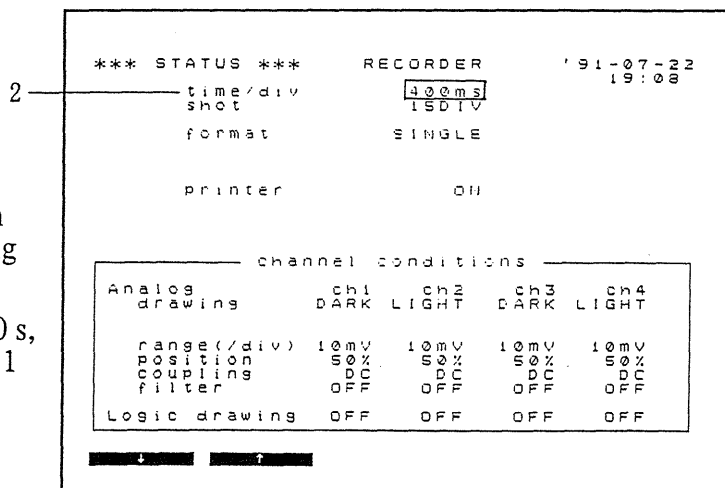

(2) In display mode

After pressing the DISP key to select display mode, carry out the time axis range setting in the same way as in status mode.

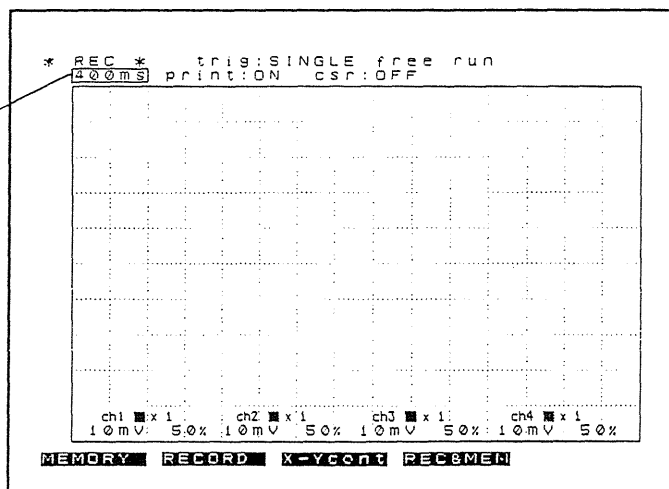

6-4-3 Shot Length Selection

Function

Sets the recording length (number of divisions) for a single shot measurement.

The CONT (continuous) setting causes the measurement to continue until the STOP key is pressed, or the printer runs out of paper.

Procedure

1. Select the status mode.
2. "shot"
Set the shot length.
(15, 30, 75, 150, 300, 750DIV, CONT)

| | | |
|----------------|--------------|-----------|
| *** STATUS *** | RECORDER | '91-07-22 |
| time/div | 400ms | 19:12 |
| shot | <u>15DIV</u> | |
| format | SINGLE | |
| Printer | ON | |

| channel conditions | | | | |
|--------------------|------|-------|------|-------|
| Analog | ch1 | ch2 | ch3 | ch4 |
| drawing | DARK | LIGHT | DARK | LIGHT |
| range (/div) | 10mV | 10mV | 10mV | 10mV |
| position | 50% | 50% | 50% | 50% |
| coupling | DC | DC | DC | DC |
| filter | OFF | OFF | OFF | OFF |
| Logic drawings | OFF | OFF | OFF | OFF |

Notes

- When the shot length is set to any of the values from 15 to 750 divisions the entire measurement data is held in memory. On the continuous setting, the most recent 750 divisions of data are always retained in memory.

6-4-4 Format Selection

Function

Selects the format for display and printing. There are three possibilities: SINGLE, DUAL, and DUAL (print quad).

Display and printing formats

(1) Single

The waveforms are displayed or printed superimposed on a single time axis. (Maximum 4 analog waveforms and 16 logic signals)

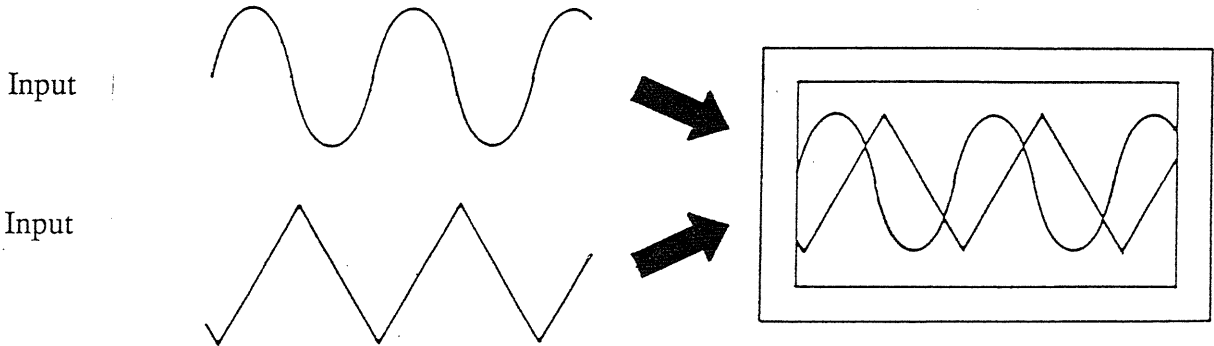

(2) Dual

The waveforms are displayed or printed on two time axes, one above the other. (Maximum 4 analog waveforms and 8 logic signals in each window)

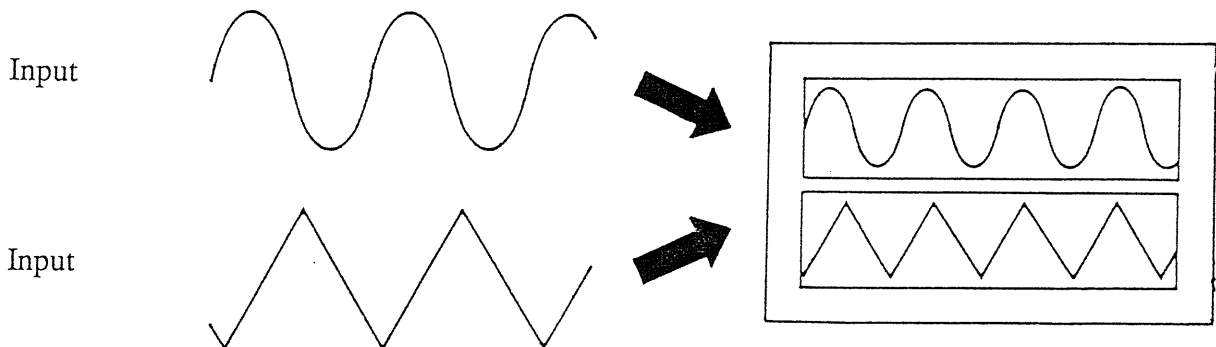

(3) Dual (print quad)

The waveforms are printed on four time axes. (Maximum 1 analog waveform and 4 logic signals on each axis)

The display format is the same as in dual format.

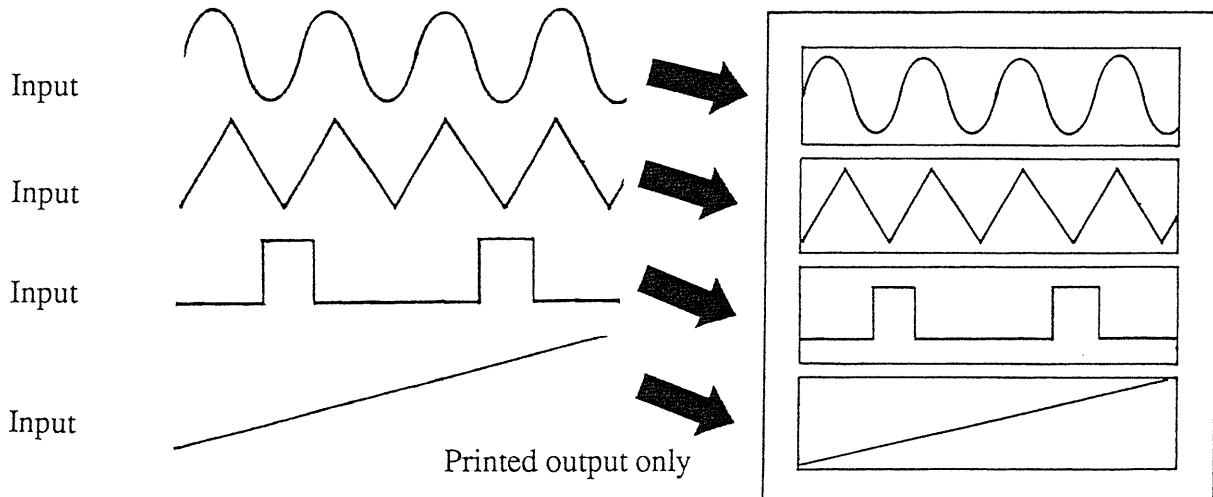

Procedure

1. Select the status mode.
2. "format"

Select the format for display and printing.

Pressing the **quad** soft key selects the DUAL (print quad) format.

(SINGLE, DUAL, DUAL (print quad))

3. "graph"

If DUAL or DUAL (print quad) format was selected in step 2, use these settings to assign each analog input to one of the two display windows (1 or 2).

- 1 .. upper window (time axis)
- 2 .. lower window (time axis)

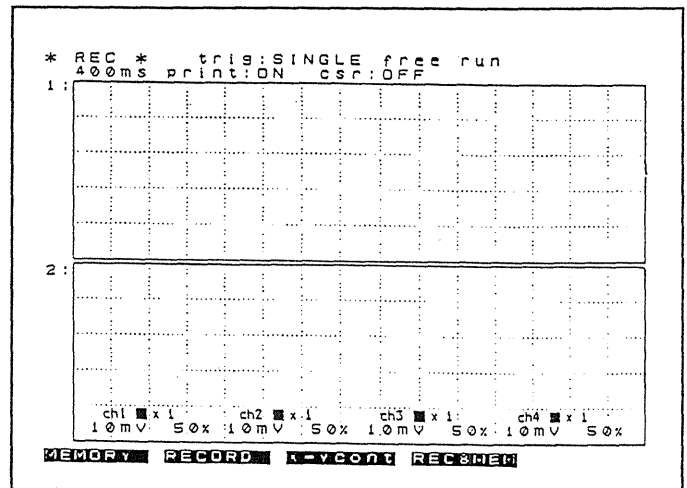
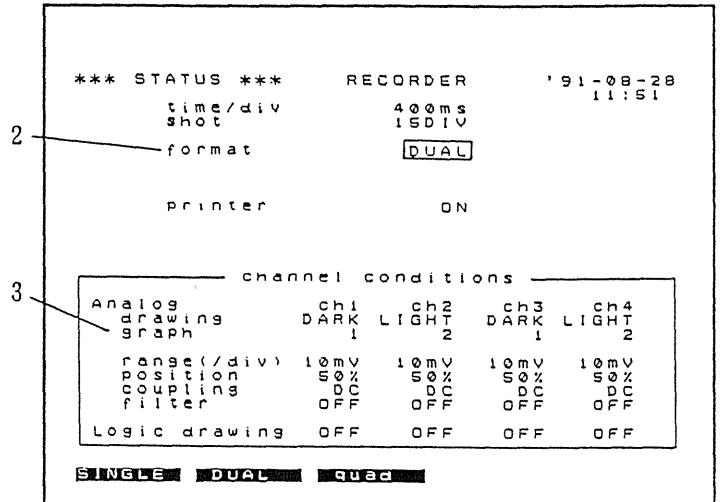

Notes

- In DUAL (print quad) format, the printer automatically assigns the four analog channels one to each of the four time axes, in sequence channel 1 to channel 4.

Display:

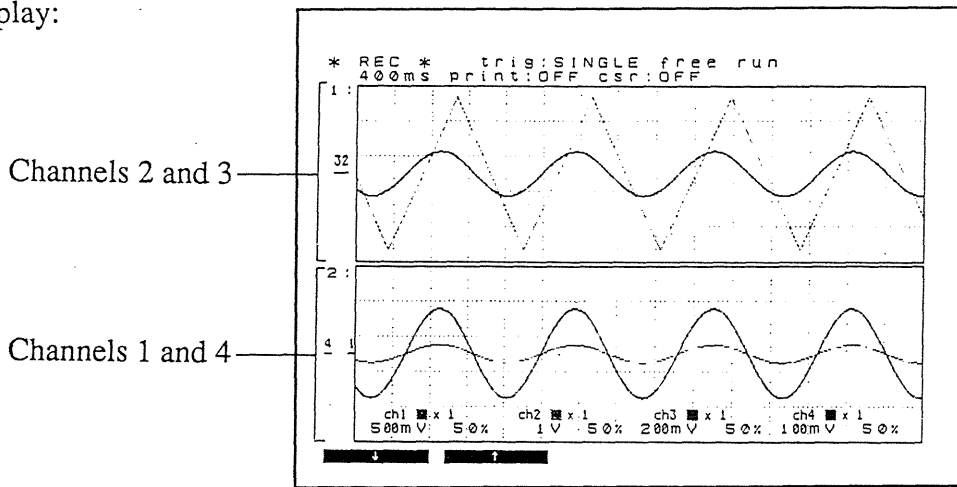

Printed recording:

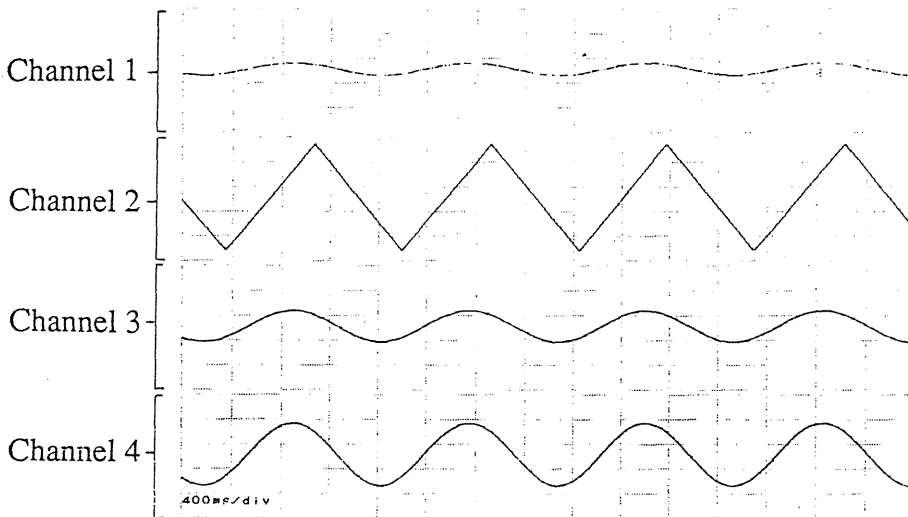

- The logic channel display and recording positions are not variable.
See under the Notes heading in Section 6-4-5 "Display and Recording Channel Settings"

6-4-5 Display and Recording Channel Settings

Function

A maximum of four analog channels and 16 logic channels are available on the 8851.

These settings determine which channels are displayed or recorded.

The analog channels can each be set independently, but the logic channels can only be set in groups of four.

Procedure

You can carry out these settings in status mode or display mode.

(1) In status mode

1. Select the status mode.

2. "Analog drawing"

This setting determines for each analog channel whether or not it is displayed and printed, and if so at what intensity.

(OFF, DARK, LIGHT)

OFF ... no display or recording

DARK ... high intensity display, bold printed recording

LIGHT ... low intensity display, fine printed recording

| | | ch1 | ch2 | ch3 | ch4 |
|----------------|--|------|-------|------|-------|
| Analog drawing | | DARK | LIGHT | DARK | LIGHT |
| range (/div) | | 10mV | 10mV | 10mV | 10mV |
| position | | 50% | 50% | 50% | 50% |
| coupling | | DC | DC | DC | DC |
| filter | | OFF | OFF | OFF | OFF |
| Logic drawing | | OFF | OFF | OFF | OFF |

Legend: OFF DARK LIGHT

Settings for channel 1

For details of the "range," "position," "coupling," and "filter" settings see Section 6-4-6 "Input Unit Range, Position, Coupling and Filter Settings."

Notes: If an input unit is not installed, the corresponding channel settings will all appear as "-" as in the case of channel 4 in the figure.

In dual or dual (print quad) format, the "graph" item also appears, to show which time axis the channel is assigned to. (See 6-4-4.)

3. "Logic drawing"

These items switch display or recording for the logic channels on or off. The groups of four channels under channels 1 to 4 correspond to the connectors CHA, CHB, CHC and CHD on the rear panel.

(2) In display mode

1. Select the display mode.
2. For each analog channel or group of four logic channels, select whether or not to display and record.

You can also select whether to display input unit information or scale information (top and bottom values).

(OFF, DARK, LIGHT, (logic), (scale))

(unit)

Screen indications

OFF ... off

■ ... DARK (high intensity)

▨ ... LIGHT (low intensity)

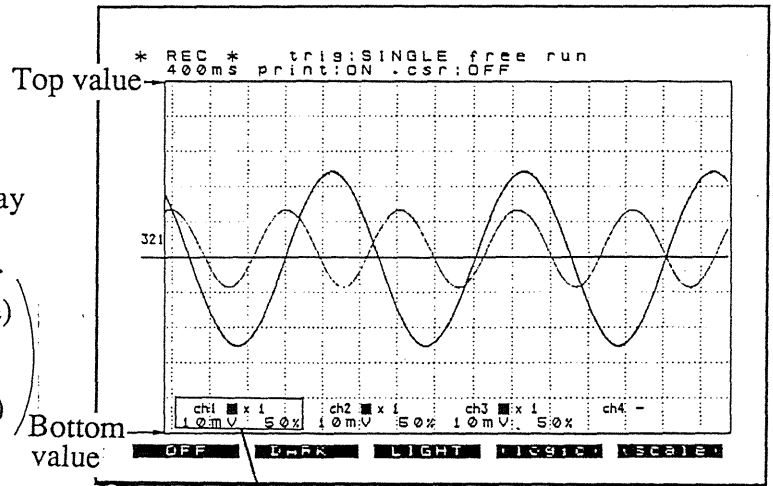

Top value

Bottom value

Taking channel 1 as example

Voltage axis zoom factor!
(See 6-4-11
"Voltage Axis Zoom Function")

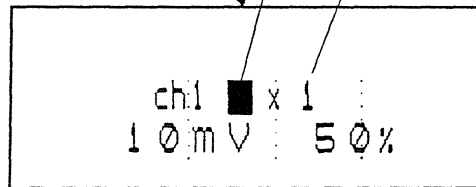

Input unit information display

Scale information

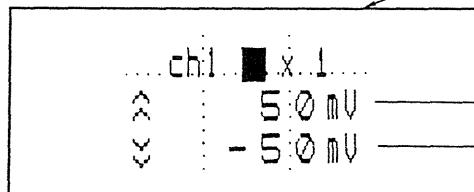

(logic) ... determines whether or not to display and record each group of four logic channels. Pressing the soft key toggles the setting on or off.

The groups of four channels under channels 1 to 4 correspond to the connectors CHA, CHB, CHC and CHD on the rear panel.

(scale) ... pressing the soft key switches to the scale display (showing the top and bottom values on the vertical axis); the soft key indication changes to "(unit)".

(unit) ... pressing the soft key switches to the input unit display (showing the voltage range, input coupling and origin positioning); the soft key indication changes to "(scale)".

Switching between the scale and unit displays affects all channels together.

When an input unit is not installed

Only the soft keys for setting the logic channel display and recording and for switching between the scale and unit displays are present.

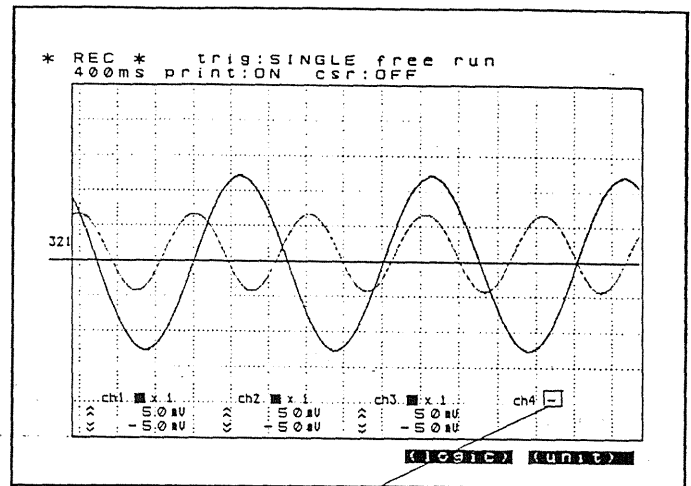
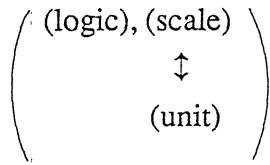

Flashing cursor

Notes

- The input unit display shows the voltage range and position settings for the channel, whereas the scale display shows the range of values actually appearing on the screen for the captured waveform data. If, therefore, you change the input unit range and position settings, the values in the scale and unit displays may be different.
- If the scaling function is enabled, the scale display shows the values after scaling. (See Section 18-3 "Scaling Function")

Position of logic channel displays

As shown in the figures below, the 16 logic channels are displayed in the order A1 to A4, B1 to B4, C1 to C4 and D1 to D4 from top to bottom. (For example channels A1 to A4 correspond to the CHA connector on the rear panel.)

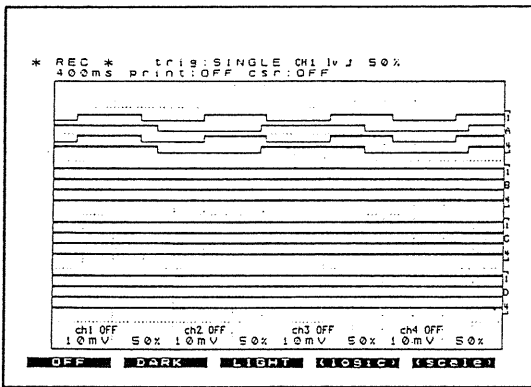

Single format

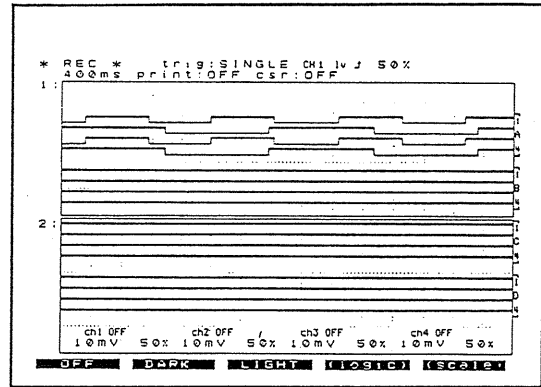

Dual format

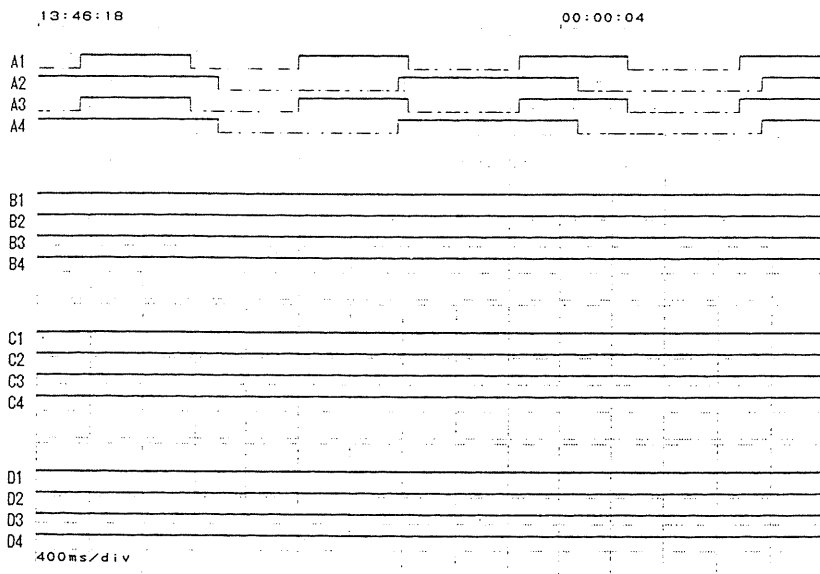

When no logic probe is connected, the signals are always shown as high level.

Dual (print quad) format (printed recording)

6-4-6 Input Unit Range, Position, Coupling and Filter Settings

Function

These settings determine the range, origin positioning, and input unit coupling and filter for each channel.

Procedure

You can carry out the settings in status mode or display mode.

(1) In status mode

1. Select the status mode.
2. "range(/div)"

Set the voltage range.

The value set is the voltage difference for one division on the vertical axis, when the zoom factor is set to $\times 1$.

You can also use the range key for each channel, without moving the flashing cursor.

(10 mV, 20 mV, 50 mV, 100 mV, 200 mV, 500 mV, 1 V, 2 V, 5 V, 10 V, 20 V, 50 V)

| *** STATUS *** | | RECORDER | '91-08-28 | |
|--------------------|----------|-----------|-----------|-------|
| time/div | | 400ms | 19:01 | |
| shot | | 1SDIV | | |
| format | | SINGLE | | |
| printer | | ON | | |
| channel conditions | | | | |
| Analog drawing | ch1 DARK | ch2 LIGHT | ch3 DARK | ch4 - |
| range(/div) | 10mV | 10mV | 10mV | - |
| position | 50% | 50% | 50% | - |
| coupling | DC | DC | DC | - |
| filter | OFF | OFF | OFF | - |
| Logic drawing | OFF | OFF | OFF | OFF |

Settings for channel 1

See 6-4-5 "Display and Recording Channel Settings" for details of the "Analog drawing" and "Logic drawing" items.

3. "position"

This determines the position of the zero voltage (from -100% to 100% of the range, in 1% increments).

(See the Background information below.)

The \uparrow and \downarrow soft keys change the value in 1% steps; the $10\% \downarrow$ and $10\% \uparrow$ soft keys change it by 10% steps.

4. "coupling"

Determines the input unit coupling.

(GND, AC, DC)

GND.. the input unit is not connected.

This enables zero potential checking.

AC ... capacitor in series.

This removes DC components from the input, and measures the AC component only.

DC ... input signal directly connected to amplifier.

This allows measurement from the DC component.

5. "filter"

This determines the low-pass filter setting in the input unit itself.

(OFF, 500Hz, 5Hz)

OFF: no low-pass filter used

500Hz: use a low-pass filter with a cutoff frequency of 500 Hz

5Hz: use a low-pass filter with a cutoff frequency of 5 Hz

Note: As shown for channel 4 in the figure, if no input unit is installed, the settings (2 to 5) are all shown as "-".

(2) In display mode

1. Select the display mode.

If the input unit information is not shown as shown in the figure on the right, move the flashing cursor to the position to the right of one of the channel indications "ch1" to "ch4" and press the [unit] soft key.

2. Set the voltage range in the same way as in the status mode (see (1) above).

You can also use the range key for each channel, without moving the flashing cursor.

(10 mV, 20 mV, 50 mV, 100 mV, 200 mV, 500 mV, 1 V, 2 V, 5 V, 10 V, 20 V, 50 V)

In the screen display, the "V" is omitted.

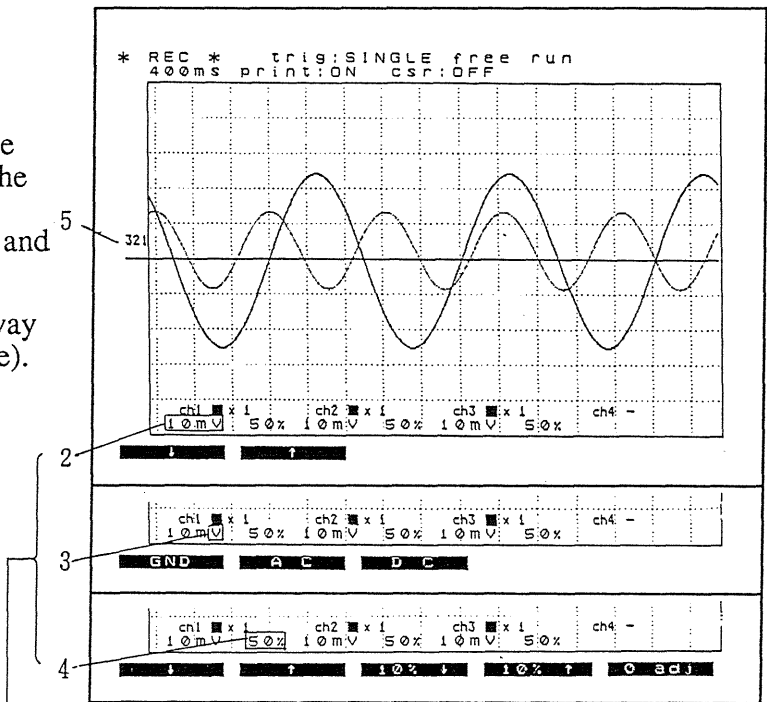

Taking channel 1 as an example

3. Set the input unit coupling.

(GND, AC, DC)

On the screen ↓ ↓ ↓
 these appear as ($\overline{\text{GND}}$, $\overline{\text{AC}}$, $\overline{\text{DC}}$)

See the explanation in (1) "In status mode" above for the significance of these settings.

4. Set the origin position (the position of the zero voltage). (from -100% to 100% of the range, in 1% increments).

(See the Background information below.)

The and soft keys change the value in 1% steps; the and soft keys change it by 10% steps. For an explanation of the soft key, see 6-4-7 "Zero Adjustment."

Note: It is not possible to change the filter setting in the display mode.

5. The origin position (the zero voltage position) for the currently captured waveform is shown on the screen. (For example, the label "1" indicates the origin for channel 1.)

Background

- The origin (the zero voltage position) is as follows.

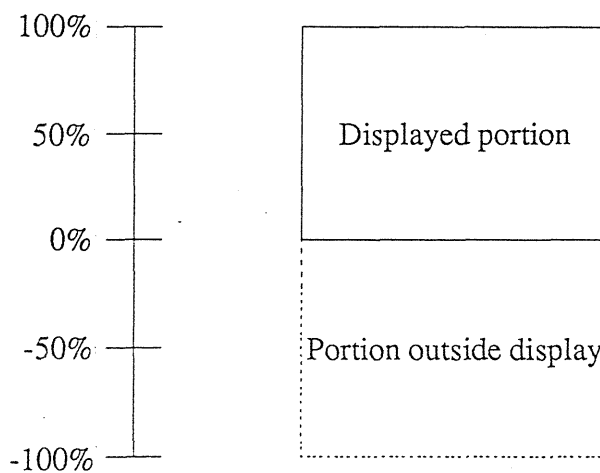

The value of the "position" setting determines the origin. The origin can be inside the display area (0% to 100%) or outside (-100% to 0%) and below it.

6-4-7 Zero Adjustment

Function

This function provides for accurate adjustment of the waveform to the origin position when a zero voltage is input. Use it for reading precise values from the screen or a printed recording.

Procedure

Always allow at least 30 minutes warming up before carrying out this procedure, to ensure that the internal temperature of the unit has stabilized.

1. Select the display mode.
2. If the input unit information is not shown as shown in the figure on the right, move the flashing cursor to the position to the right of one of the channel indications "ch1" to "ch4" and press the (unit) soft key.

3. Press the (0 adj) soft key. This carries out the correction for all channels simultaneously. Repeat the process after changing ranges.

Soft keys ... (↓), (↑), (10% ↑), (10% ↓), (0 adj)

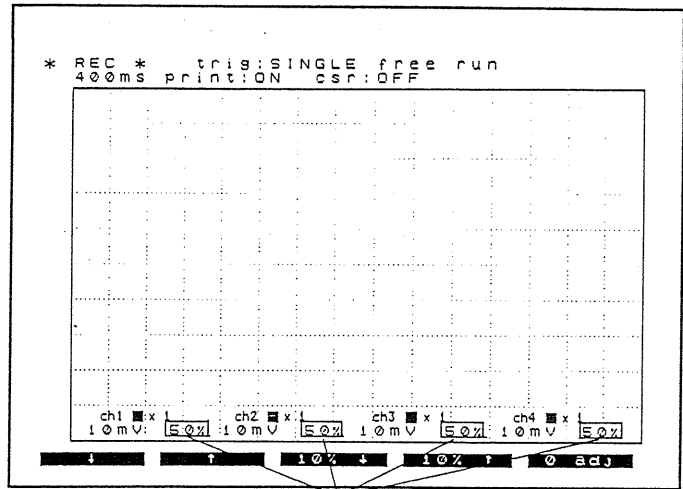

Notes

- Allow at least 30 minutes warming up after powering on before carrying out zero adjustment.
- Zero adjustment is not possible while the unit is measuring.
- The zero adjustment takes effect in the input unit. Always, therefore, repeat zero adjustment after changing input units.

6-4-8 Trigger Settings

Function

This function includes all trigger-related settings.

- Trigger conditions for each channel, and logical operator with external trigger
The trigger conditions for each channel can be set, and AND or OR selected as the logical operator with the external trigger.
- Trigger conditions
The trigger conditions for each channel can be set.
- External trigger
The setting determines whether or not a signal from the external trigger terminal is used as a trigger source.
- Trigger mode
The trigger mode can be set to SINGLE or REPEAT.
- Trigger timing setting
Determines whether measurement starts or stops when the trigger occurs.
- Timer trigger setting
This allows timer controlled triggering.

Procedure

All settings can be carried out in trigger mode. Basic settings can also be carried out in display mode.

(1) In trigger mode

1. Select the trigger mode.
2. Set the trigger conditions for each channel, and select the logical operator (AND or OR) with the external trigger.

(AND, OR)

See 14-4 "Internal and External Trigger Logical Operator."

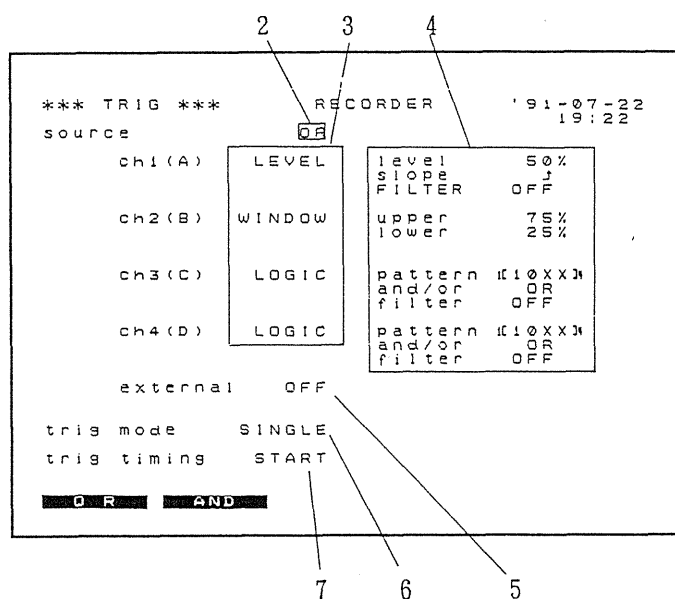

3. Select the trigger type for each channel. (OFF, LEVEL, WINDOW, LOGIC, GLITCH, TIME OUT)

Note: If you set the external and internal trigger logical operator to AND in step 2, some settings are not allowed.

See Section 14-2 "Internal Triggers" (14-2-1 to 14-2-6).

4. Set the detailed conditions for the setting in step 3.

See Section 14-2 "Internal Triggers" (14-2-1 to 14-2-6).

5. "external"

Enable or disable the external trigger. (OFF, ON)

See Section 14-3 "External Trigger".

6. "trig mode"

Set the trigger mode.

(SINGLE, REPEAT)

SINGLE ... the trigger signal is only effective once, after pressing the START key.

REPEAT ... the trigger signal is effective repeatedly.

See Section 14-5 "Trigger Modes."

7. "trig timing"

Make the trigger timing setting. (START, STOP, START&STOP)

⋮

Soft key indication is "- & -".

START: recording starts when the trigger is applied.

STOP: recording starts when the START key is pressed, and stops when the trigger is applied.

START&STOP: recording starts when the trigger is applied, and stops when the trigger is next applied.

See Section 14-6 "Pre-Trigger and Trigger Timing."

8. Press the cursor key or use the rotary knob to see the special trigger display.

9. "timer source"

Set the timer trigger.

(OFF, ON)

See Section 14-7 "Timer Trigger."

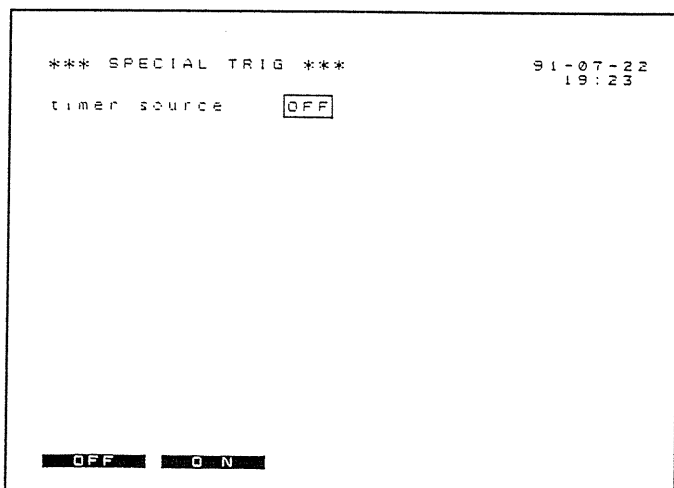

Special trigger display

(2) In display mode

1. Select the display mode.
2. Set the trigger mode.

(SINGLE, REPEAT)

See the procedure in trigger mode in (1) above, and Section 14-5 "Trigger Modes."

3. Select the channel.

(CH1, CH2, CH3, CH4)

If all channels are set to "OFF" in trigger mode, the indication "free run" appears.

If, however, the external trigger is enabled the indication is "external", and if the timer trigger is enabled, it is "timer".

4. Make the detailed settings for the trigger type (other than LOGIC) set for each channel in trigger mode.

Trigger types set in the trigger mode cannot be changed in display mode.

See Section 14-2 "Internal Triggers" (14-2-1 to 14-2-6).

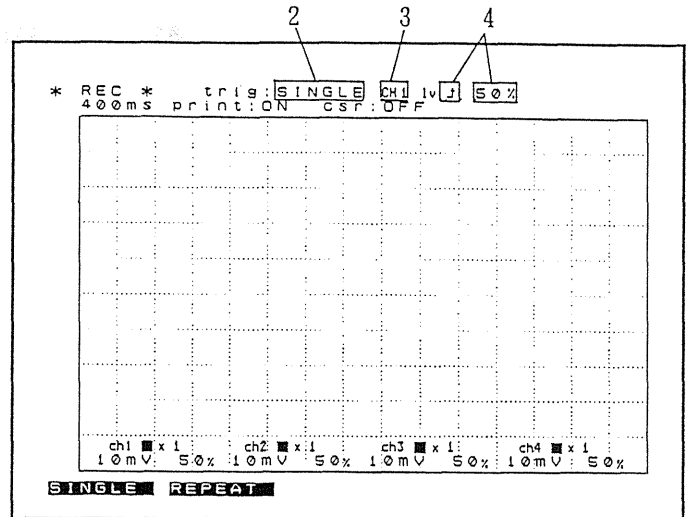

6-4-9 Starting and Stopping Measurement Operation

Function

The START and STOP keys control the measurement operation mode of the unit. The LED above the START key is lit when in measurement operation mode.

Procedure

1. **START**
Start measurement operation.
2. **STOP**
Stop measurement operation.

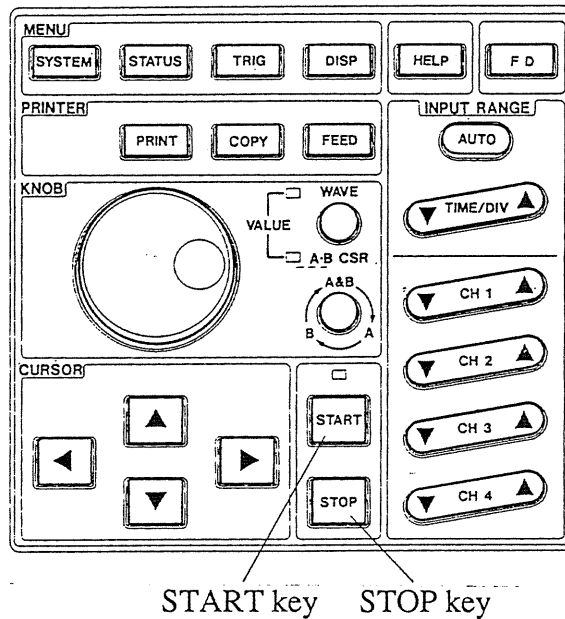

Note

- If the trigger mode is set to REPEAT, or the shot length is set to CONT, then recording will not automatically stop. It is therefore necessary to press the STOP key to end recording.

6-4-10 Using A and B Cursors

Function

You can use the A and B cursors to measure time or voltage differences (if using the scaling function, the scaled values; see Section 18-3 "Scaling Function"), getting a direct digital readout.

The recorder function allows either vertical or horizontal line cursors to be used; it does not support cross-hair cursors.

Using the A cursor alone, you can use the vertical cursor to measure the time (t) from the trigger position, or the reciprocal of the time ($1/t$), in other words a frequency, and can use the horizontal cursor to read out a voltage (v) with respect to the origin (the 0 V or "position" setting). Using both A and B cursors, you can use the vertical cursors to measure a time difference (Δt), or the reciprocal of the time difference ($1/\Delta t$), in other words a frequency, and can use the horizontal cursors to read out a voltage difference (Δv).

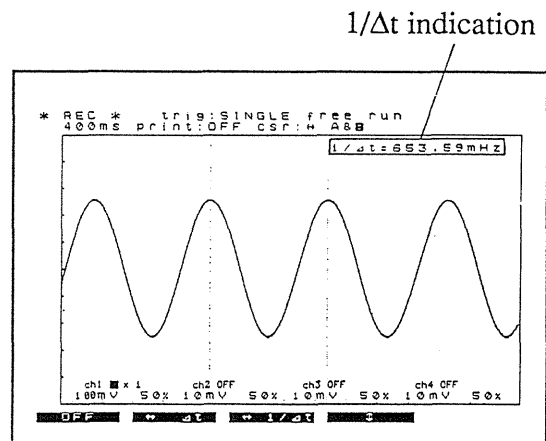
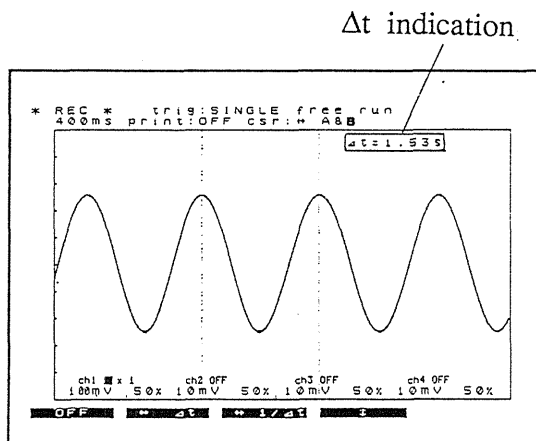

Vertical cursors

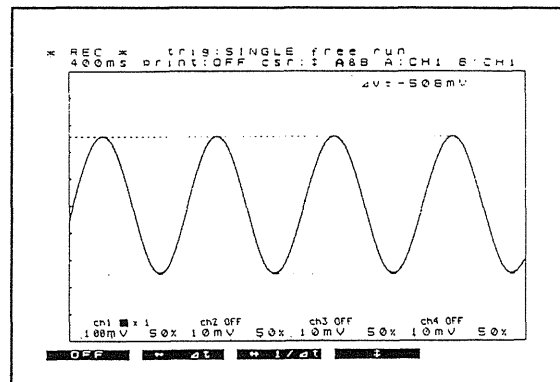

Horizontal cursors

Procedure

(1) Using the cursors to read waveform data

1. Select the cursor mode.

On the screen these are indicated as follows:

\leftrightarrow \leftrightarrow Δt or \leftrightarrow $1/\Delta t$

(OFF, \leftrightarrow Δt , \leftrightarrow $1/\Delta t$, \updownarrow)

OFF ... do not use cursors.

\leftrightarrow Δt ... use cursors for the time axis (vertical cursors), for reading off time differences.

\leftrightarrow $1/\Delta t$... use cursors for the time axis (vertical cursors), for reading off frequencies.

\updownarrow ... use cursors for the voltage axis (horizontal cursors).

2. Select whether to use the A cursor only, or both cursors.

(A, A&B)

3. If using horizontal line cursors, select which channel voltages are to be read off. You can make independent settings for the A and B cursors.

(CH1, CH2, CH3, CH4)

Notes: Only channels for which waveforms are displayed can be chosen.

If using the A cursor only, the setting for the B cursor is not possible.

This item does not appear when using vertical cursors.

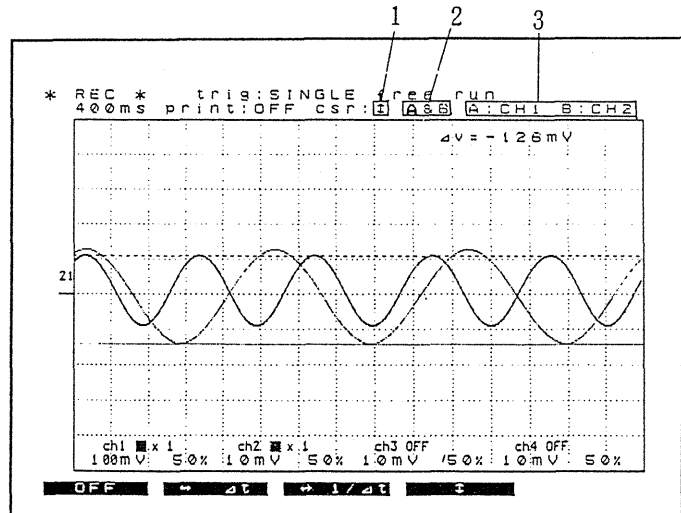

4. ① Using vertical cursors on the time axis

When the $\leftrightarrow \Delta t$ soft key is selected ... using the A cursor only, determines the time (t) from the beginning of the recording to the A cursor; using both A and B cursors, determines the time (Δt) between the A and B cursors.

When the $\leftrightarrow 1/\Delta t$ soft key is selected ... using the A cursor only, determines the reciprocal of the time from the beginning of the recording to the A cursor (1/t); using both A and B cursors, determines the reciprocal of the time between the A and B cursors (1/ Δt).

This function is effective even if both A and B cursors are outside the display area.

Shows the time from the beginning of the recording

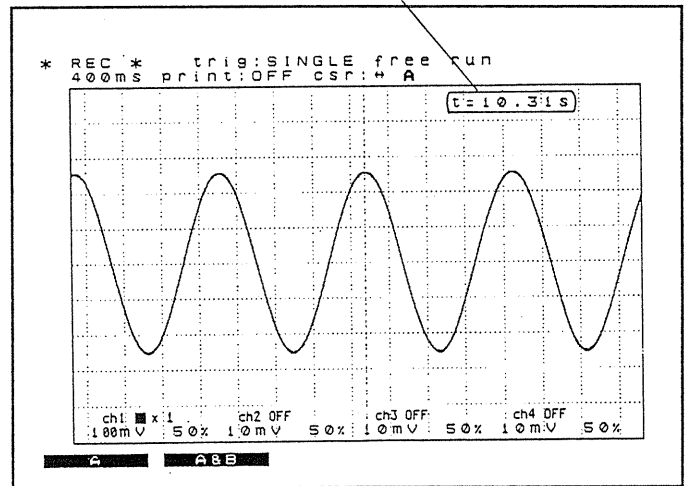
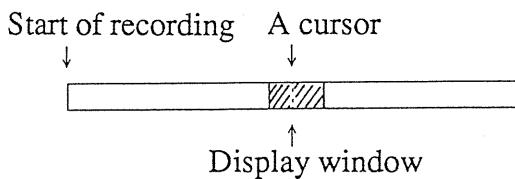

② Using horizontal cursors on the voltage axis

Using the A cursor only, determines the voltage (V) on the specified channel from the origin (the "position" setting, or 0 V); using both A and B cursors, determines the absolute voltage difference (ΔV) between the A and B cursors on their respective channels.

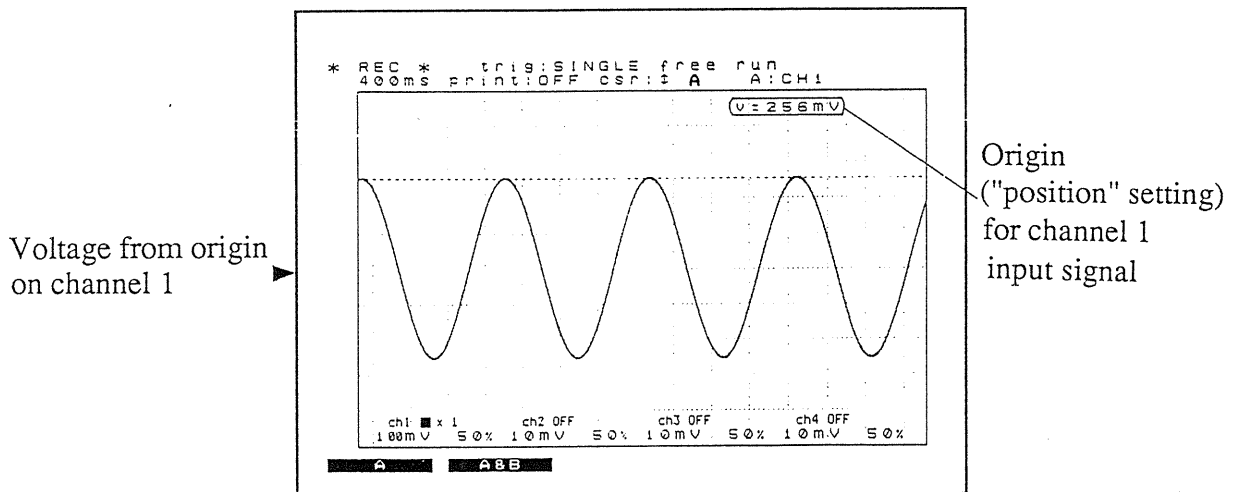

Note: If the scaling function is enabled, you can read the scaled value directly. If, however, the A and B cursors are on different channels, and those channels have different units, then a difference cannot be read off.

(2) Moving the cursors

1. Press the knob select key so that only the lower LED (A · B CSR) is lit.

In this state, the rotary knob controls the position of the cursors.

Turning the knob clockwise moves the cursors up or to the right.

Turning the knob counterclockwise moves the cursors down or to the left.

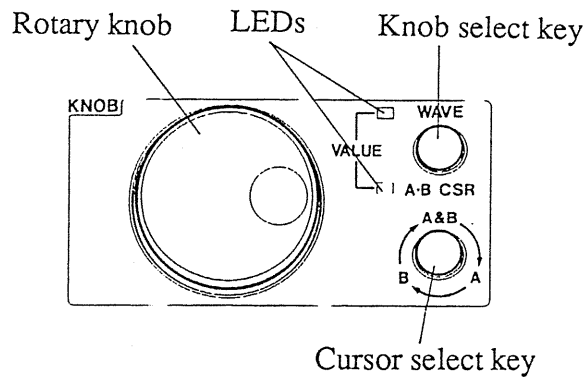

Note: See Section 4-2-2 "Rotary Knob and Knob Select Key" for a detailed description of rotary knob operation.

2. Press the cursor select key to select which cursor or cursors to control.

Each time the key is pressed, the display changes as follows:

A ... move the A cursor only.

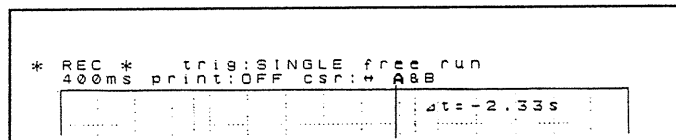

B ... move the B cursor only.

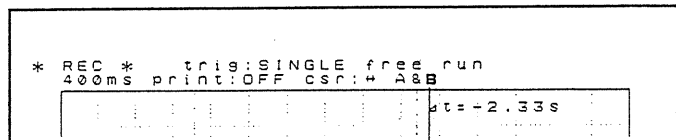

A & B ... move both A and B cursors.

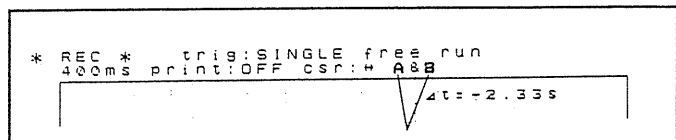

3. Using the vertical cursors

It is possible for the A cursor and/or the B cursor to move off the screen when the waveform is scrolled. For details, see the Notes below.

4. If either cursor is off the screen, as soon as you specify cursor movement and start moving it toward the center of the screen, it reappears at the edge.

Notes

- Waveform scrolling and cursor movement

The recorder function only supports scrolling along the time axis.

- When scrolling the waveform, the vertical cursors move with the waveform.

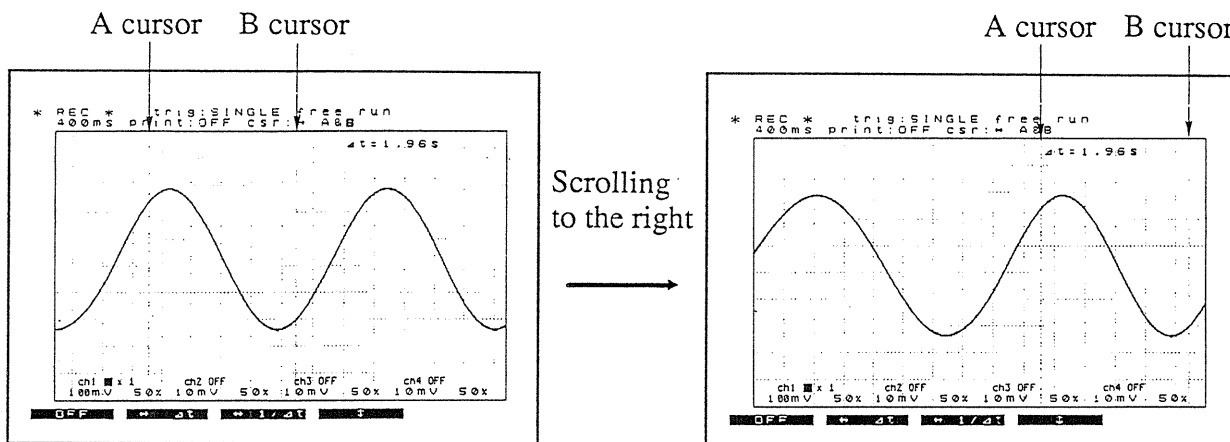

The cursors move with the waveform, disappearing off the edge of the screen if necessary.

- When moving the vertical cursors, if the cursor reaches the edge of the display window, the waveform scrolls.

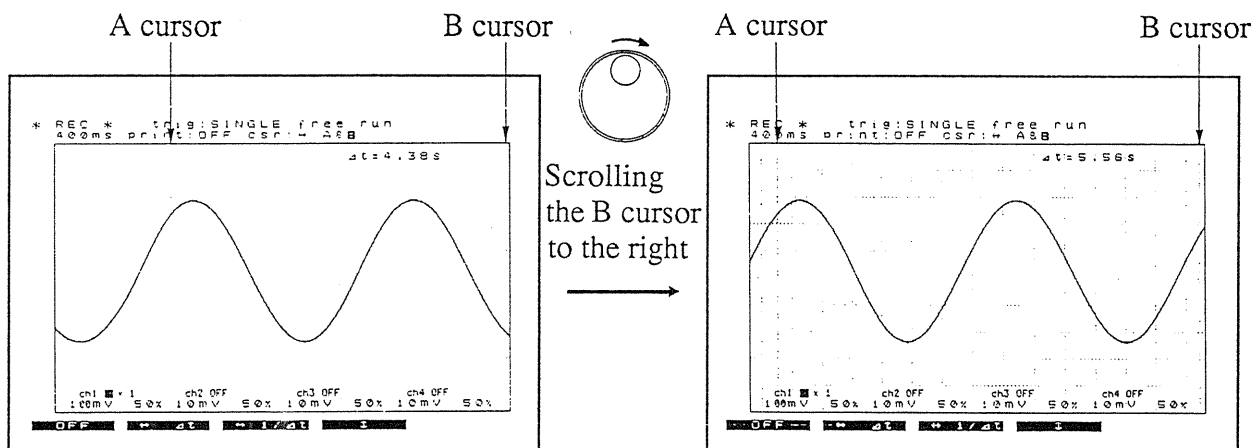

When the B cursor reaches the edge of the screen, the waveform scrolls left, so that the B cursor continues to move relative to the waveform.

Related item

When a vertical cursor is outside the display area, it is still possible to tell its approximate location in the total shot length. See Section 6-4-15 "Help Function" for details.

6-4-11 Voltage Axis Zoom Function

Function

The zoom function allows the voltage axis to be magnified or compressed for any channel independently. The magnification function allows you to exploit fully the 12-bit A/D conversion resolution of the unit.

Procedure

1. Select the status mode, then use either the  cursor key or the rotary knob to show the special function display.
2. Set the voltage magnification or compression factor for each channel.
($\times 10$, $\times 5$, $\times 2$, $\times 1$, $\times 1/2$)
3. When a magnification factor of $\times 2$, $\times 5$ or $\times 10$ is set, select the portion of the $\times 1$ range which is to appear in the screen window.

(If the zoom factor setting is $\times 1$, this appears as "-", and if it is $\times 1/2$, as "Full".)

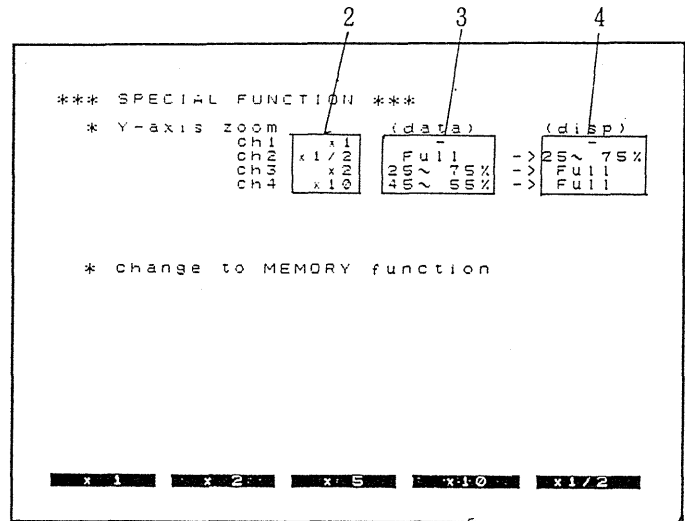

The position is defined in terms of percentages of the vertical range (100% at the top); as follows:

$\times 2$... from 0 - 50% to
50 - 100% in 1% steps.

$\times 5$... from 0 - 20% to
80 - 100% in 1% steps.

$\times 10$... from 0 - 10% to
90 - 100% in 1% steps.

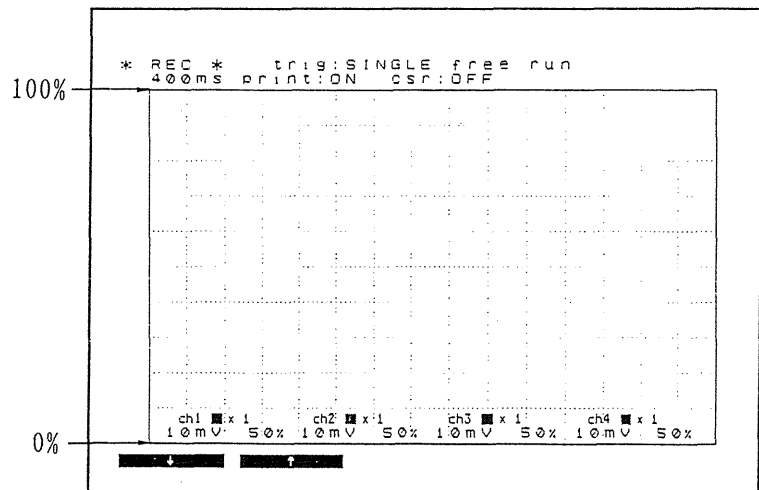

4. When a compression factor $\times 1/2$ is set, select the position in the compressed display to be occupied by the entire window in the $\times 1$ range.

(If the zoom factor setting is $\times 1$, this appears as "-", and if it is $\times 2$, $\times 5$ or $\times 10$, as "Full".)

The position is defined in terms of percentages of the vertical range (100% at the top), ranging from 0 - 50% to 50 - 100% in 1% steps.

The setting of the zoom factor can be carried out either before or after the data is captured. If the data is already displayed on the screen, the display immediately changes to reflect the new setting.

Note

- Although the magnification or compression takes effect on the display screen, unlike the memory recorder function, the recorder function does not allow the zoom setting to be changed while in display mode.

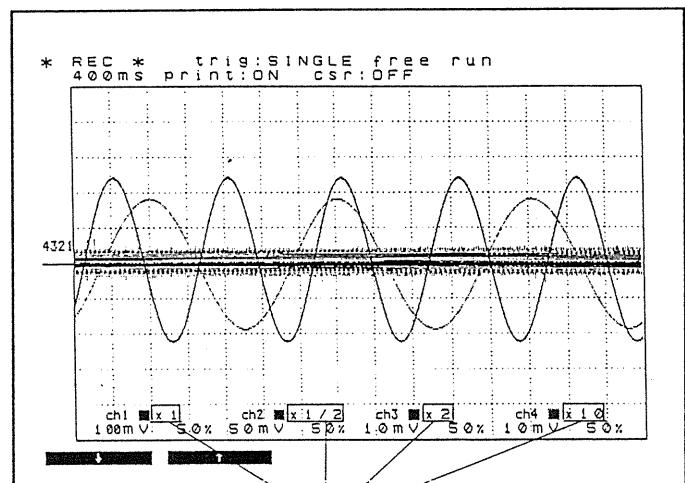

Indication

Related item

When using a zoom magnification factor, a scroll bar display is available, to show where the current screen display is in relation to the waveform voltage range (at $\times 1$), and when using the $\times 1/2$ compression setting, to show where the input waveform range is. See Section 6-4-15 "Help Function" for details.

6-4-12 Waveform Scrolling

Function

Although this function provides real time recording, it is possible to scroll back over the most recently recorded 750 divisions of the time axis.

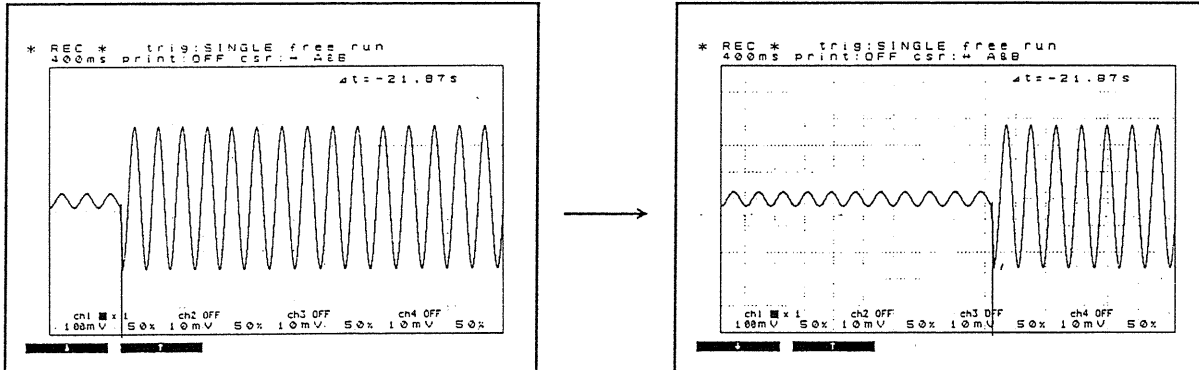

Procedure

1. Press the knob select key so that only the upper (WAVE) indicator is lit.

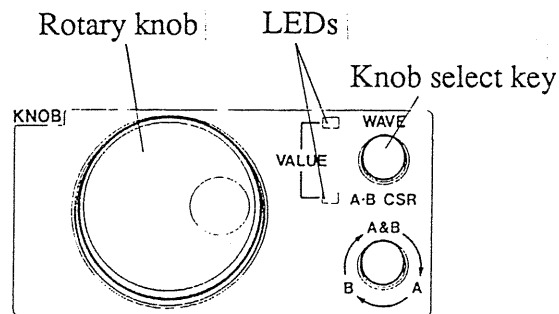

2. Use the rotary knob to scroll the waveform horizontally.

Turning the rotary knob rapidly switches to auto scroll mode, and the waveform continues scrolling automatically.

- If the A and B cursors are present as vertical or cross-hair cursors, if you move either cursor to the edge of the display window, and continue moving it, the waveform will scroll in the reverse direction.

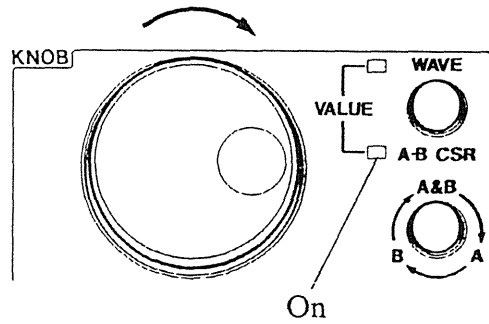

Moving both A and B cursors specified

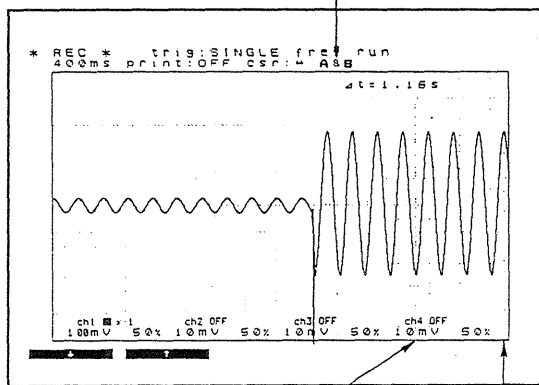

A cursor B cursor

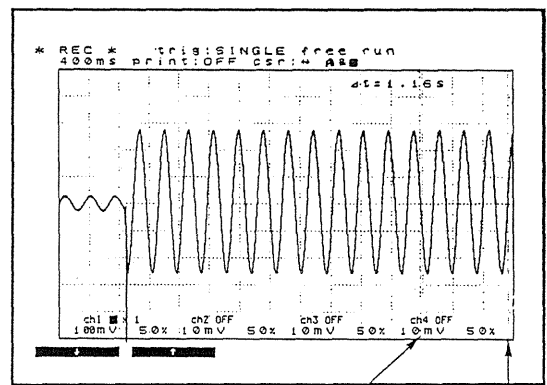

A cursor B cursor



6-4-13 Printing Waveform Recordings

Function

There are three methods of printing waveforms:

- (1) Normal real time recording. This outputs a printed recording as data is captured, simultaneously with the screen display.
- (2) Although this function provides real time recording, the most recently recorded 750 divisions of data are held in memory. Pressing the PRINT key outputs this a record of this stored data. (The manual print function)

Using the A and B cursors (as vertical cursors), you can select a section of the stored data to be printed. (Partial print function)

- (3) Pressing the COPY key to print the screen. (The screen dump function)

Note

As far as possible, avoid low-speed printing in a high-temperature or high-humidity environment. This may sharply reduce printer life.

Procedure

- (1) Normal real time recording

1. Select the status mode.

2

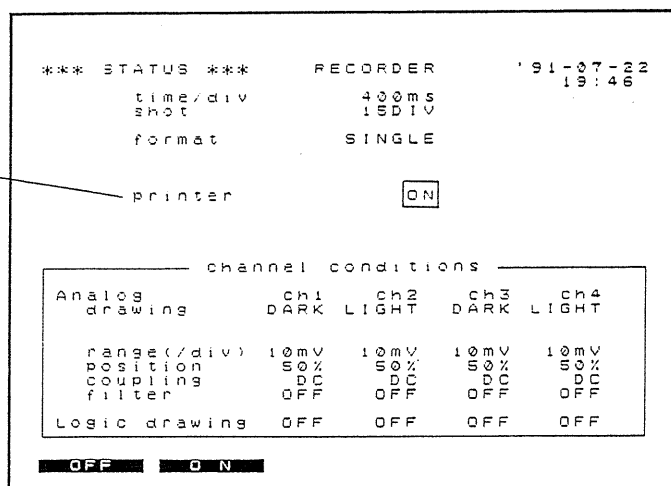

2. "printer"

Select whether or not to print in real time simultaneously with the display. (OFF, ON)

Set this to ON.

(You can also make this setting in display mode. Press DISP to select the display screen, then make the setting in the same way.)

3. **START**

Start measurement operation. The printed record appears as the data is captured.

If a voltage zoom factor is in effect, it applies to the printed recording as well as to the screen display.

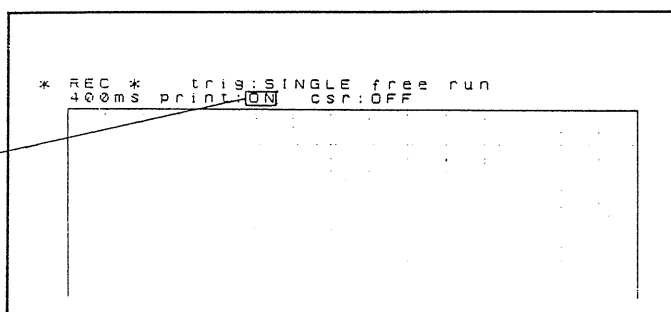

(2) Manual print function

When there are no (vertical) A and B cursors

1. **PRINT**

Print the stored waveform data from the beginning.

(Maximum 750 divisions)

If a zoom factor is in effect, it applies from the beginning of the data. Since the data is held in memory, it can be printed as many times as required.

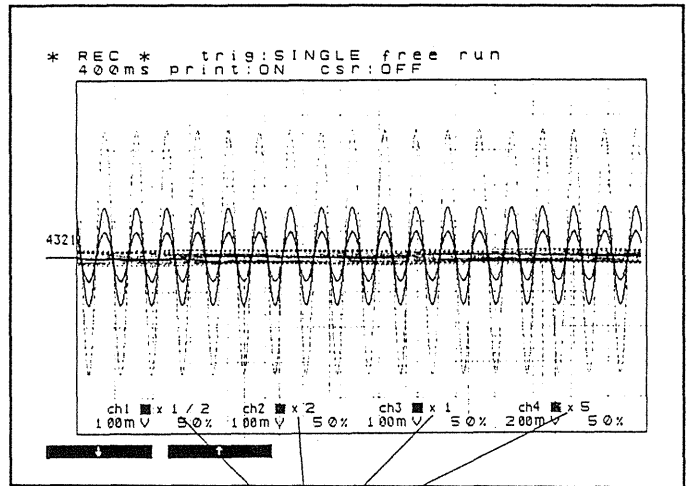

These zoom factors apply to the printed recording as well as to the screen display.

Using the A and B cursors (as vertical cursors) for a partial print

1. Display the A cursor or A and B cursors as vertical or cross-hair cursors.

- ① Using the A cursor only, print from the A cursor position to the end of the waveform.
- ② Using both A and B cursors, print the section of waveform between the cursors.

This function is effective even if either cursor is outside the screen area. For more details see the Example below.

2. **PRINT**

Prints the section of waveform defined by the cursors.

If zoom factors are in effect, they are also applied to the printing.

These zoom factors apply to the printed recording as well as to the screen display.

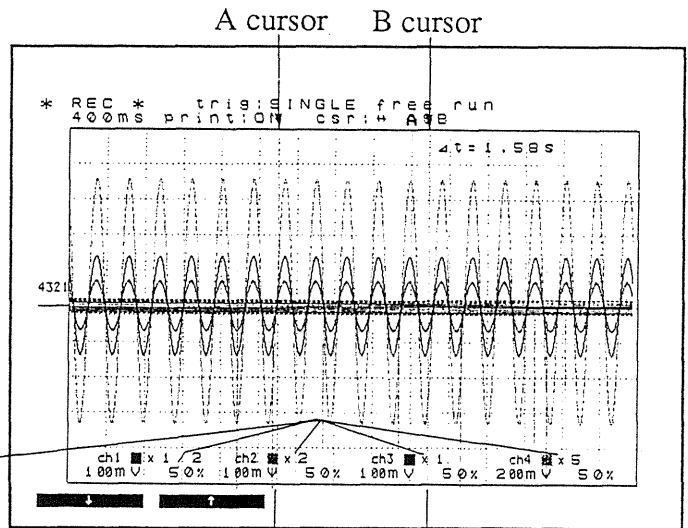

This section is printed.

(3) Screen dump function

1. **COPY**

Prints an exact copy of the screen.

Provided that a waveform is displayed on the screen, pressing the COPY and FEED keys simultaneously prints a copy of the screen, followed by a listing of the settings, as follows.

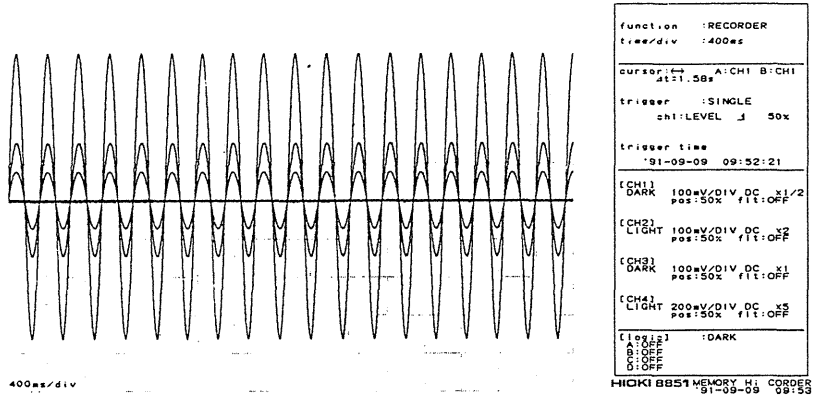

Example

The A and B (vertical) cursors can be used to mark a section of waveform to print, even when either of the cursors is outside the screen area.

1. Use the A cursor to determine the start position.

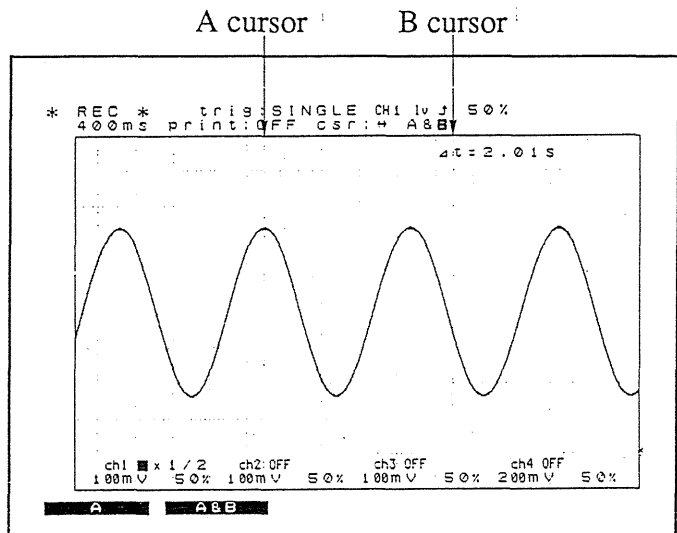

2. Move the B cursor to the right; when it reaches the edge of the display window, the waveform scrolls to the left.

The A cursor scrolls left with the waveform.

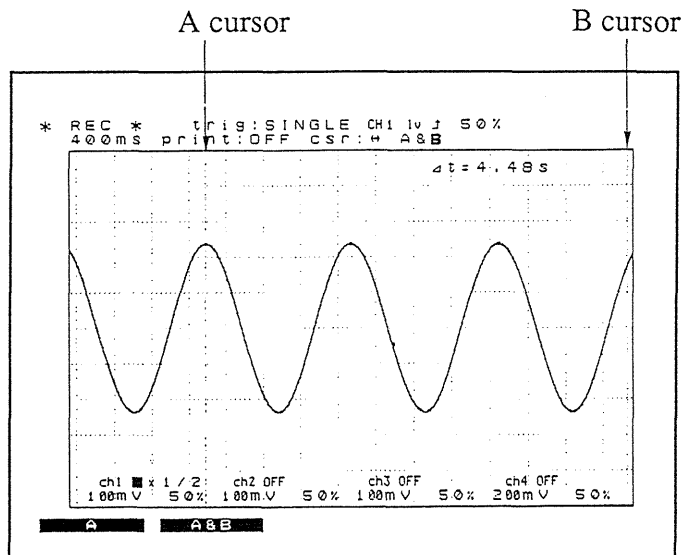

- Determine the end position with the B cursor. At this point, the A cursor has disappeared off the left side of the display window, but pressing the PRINT key still prints the correct section of the waveform.

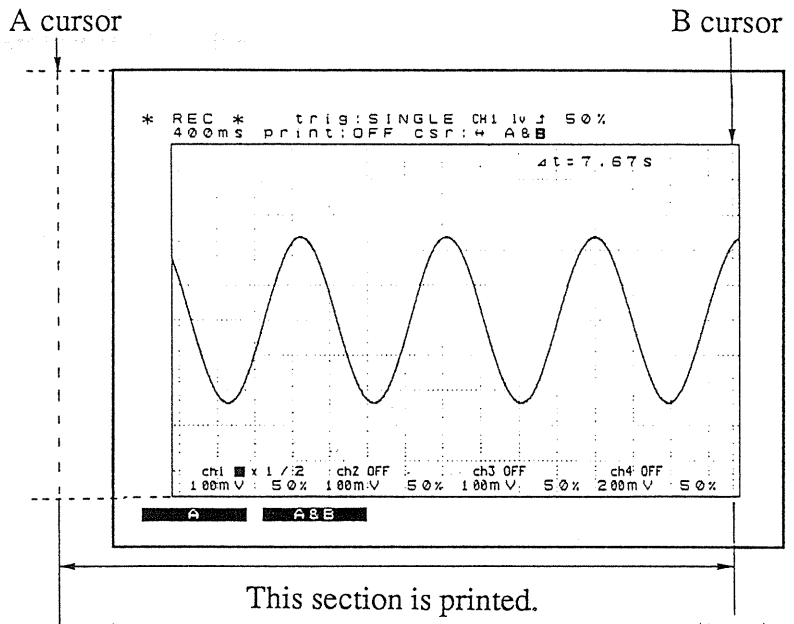

Notes

- When the format is set to DUAL (print quad), then regardless of the allocation of channels to the two display windows on the screen, the channels are printed in order channel 1 to 4. (See the Notes in Section 6-4-4 "Format Selection.")
- When the screen is in other than display mode (excluding the floppy disk control mode), pressing the PRINT key produces a listing of settings. This is the same as the printing following the waveform when the listing function is enabled. (See Section 18-5-7 "Listing and Gauge Functions," and Section 6-5 "Interpreting Waveform Displays and Recordings.")

Related items

You can select whether or not to print voltage scales (gauges) and listings of settings when using either normal real time recording or the manual print function. (See Section 18-5-7 "Listing and Gauge Functions.")



6-4-14 Converting Data for the Memory Recorder Function

Function

After data capture, if the shot length was set to 750 divisions or less the entire measurement data is held in memory. If the shot length was set to CONT, then the most recently recorded 750 divisions of data is held.

This stored data can be converted for use by the memory recorder function; it can then be processed as required, and saved to floppy disk.

Procedure

1. Capture the waveform data.
2. Select the status mode, then use either the  cursor key or the rotary knob to show the special function display.
3. Move the flashing cursor to the position in the figure on the right, and press the  soft key to convert the data and switch to the memory recorder function.

Note: An attempt to make this selection when there is no data captured results in an error.

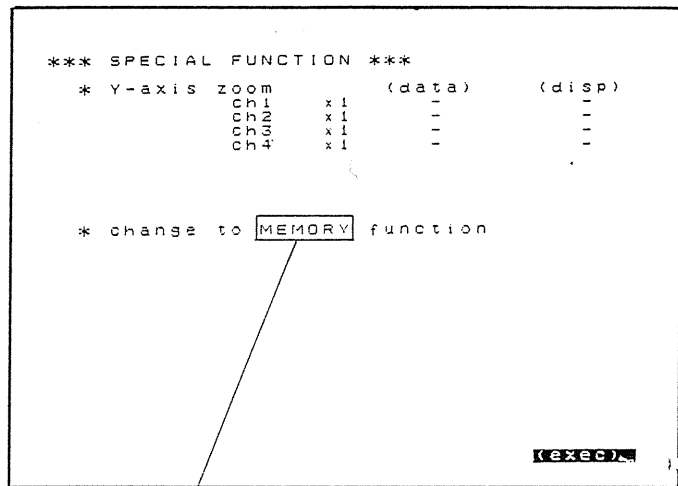

Conversion operation

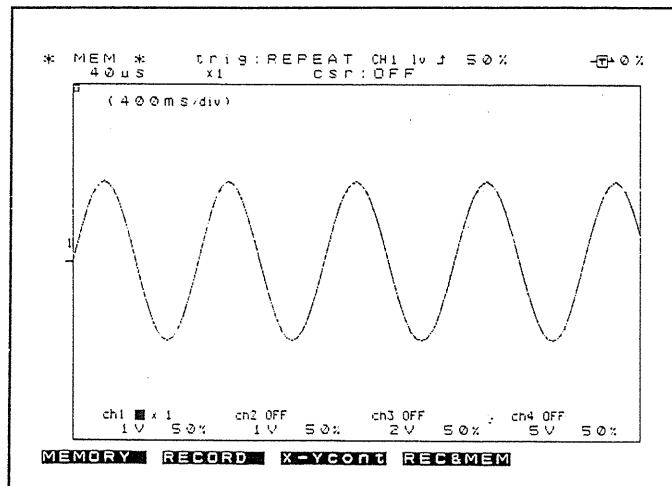

Notes

- Conversion conditions

After converting recorder function data to the memory recorder function, the following settings apply.

The shot length is set to 750 divisions. If the amount of data in memory falls short of 750 divisions, the remainder is set to zero (or the lowest value).

If the storage mode was originally set to AVERAGE, it changes to NORMAL. Otherwise the setting is unchanged. The converted data is, however, treated as an envelope waveform.

The interpolation setting switches to LINE.

Other memory recorder function settings remain unchanged.

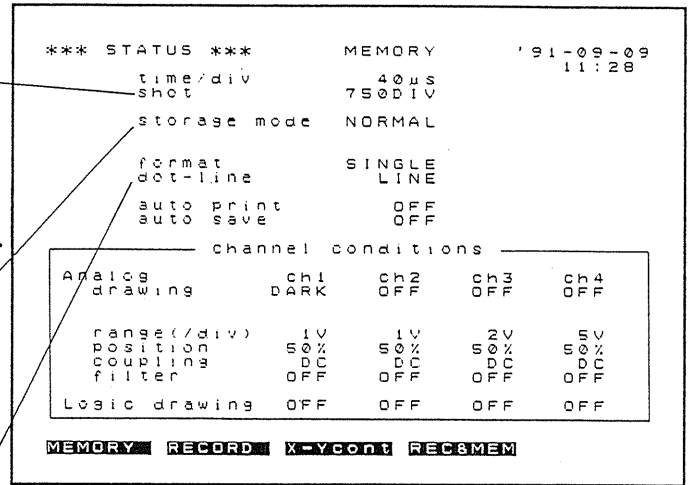

Status screen

Time axis range setting from the recorder function

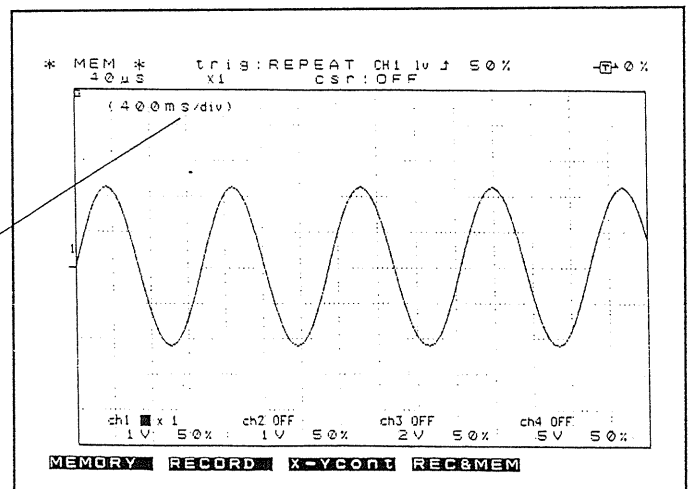

Display screen

6-4-15 Help Function

In display mode, pressing the HELP key superimposes the information shown in the following figure on the screen.

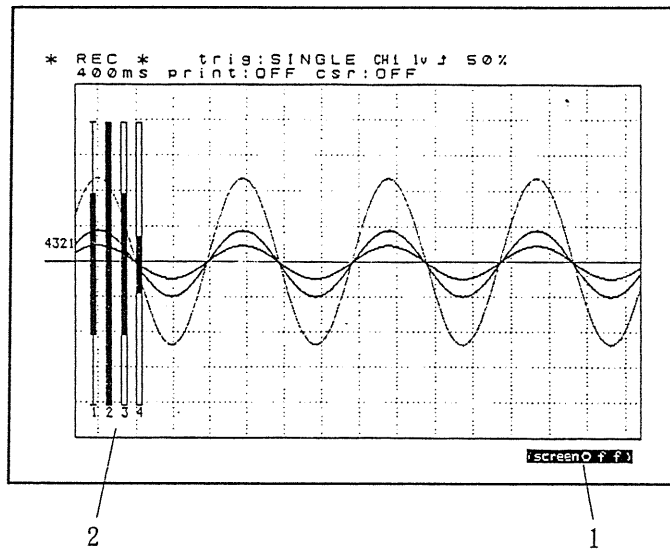

1. This soft key toggles on and off the display indicating the vertical position of the display window.
2. The vertical scroll bars indicate the position of the display window on the voltage axis.

There is a scroll bar for each channel for which the display is on. The numeral at the bottom indicates the channel number.

When a magnification zoom factor is set for the voltage axis (including $\times 1$), the scroll bar shows the position on the voltage range occupied by the display window. When the $\times 1/2$ compression factor is set, it uses a different display pattern to show the section of the display window height occupied by the voltage range.

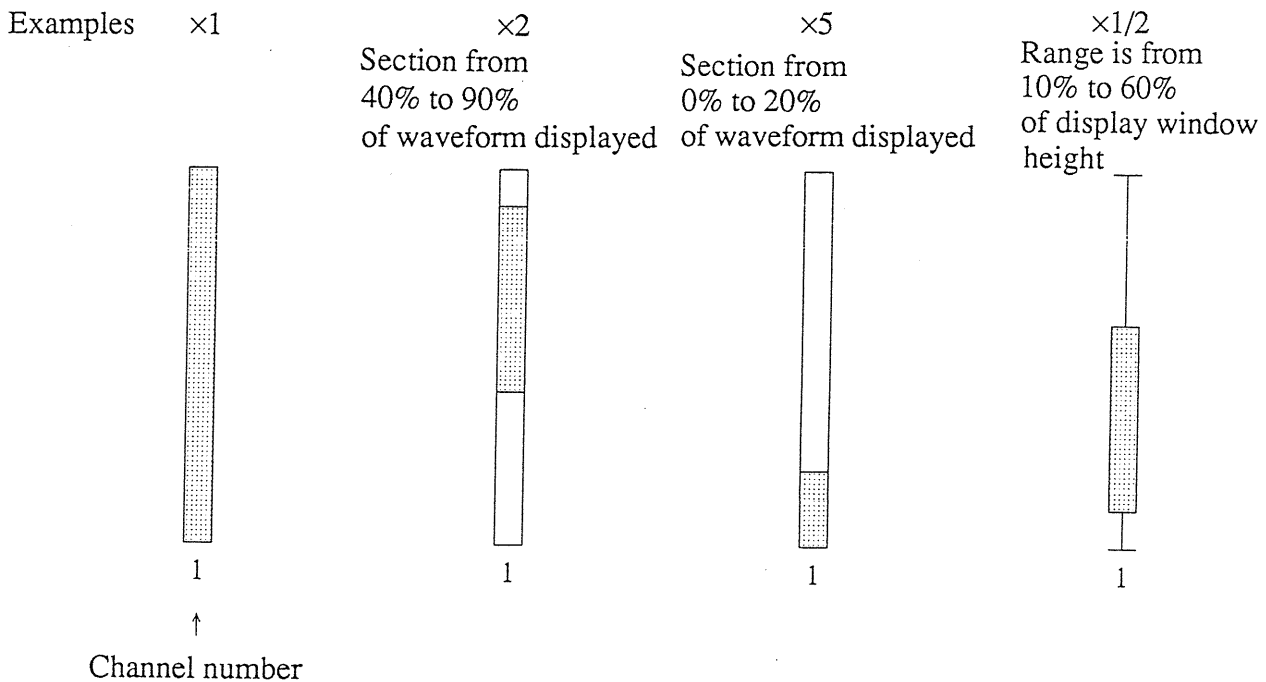

6-5 Interpreting Waveform Displays and Recordings

- SINGLE format Display

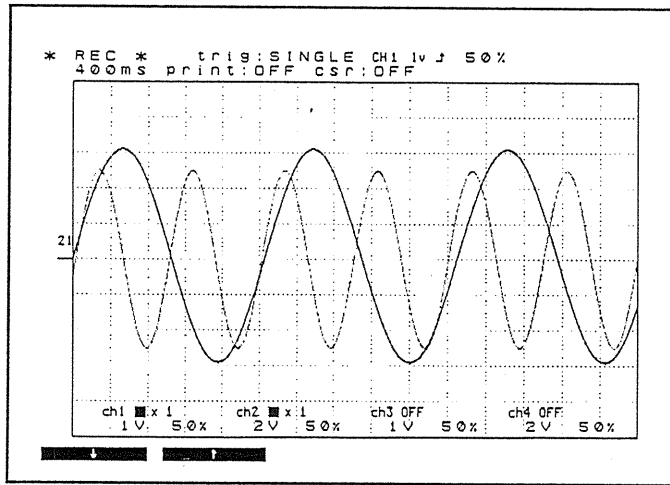

Pressing COPY and FEED simultaneously

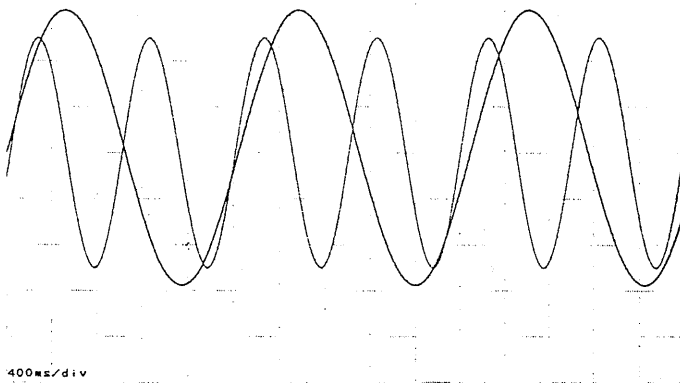

Listing of settings:

| | |
|--------------|----------------------|
| function | : RECORDER |
| time/div | : 400ms |
| cursor | : OFF |
| trigger | : SINGLE |
| ch1 | : LEVEL J 50% |
| trigger time | : '91-09-10 00:29:04 |
| [CH1] | 1V/DIV DC x1 |
| DARK | -50% 50% fll:OFF |
| [CH2] | 2V/DIV DC x1 |
| LIGHT | 80% 50% fll:OFF |
| -10V -10V | |
| [CH3] | 1V/DIV DC x1 |
| OFF | pos:50% fll:OFF |
| [CH4] | 2V/DIV DC x1 |
| OFF | pos:50% fll:OFF |
| [log:s] | : DARK |
| A | : OFF |
| B | : OFF |
| C | : OFF |
| D | : OFF |
| HIOKI 8851 | MEMORY HI CORDER |
| '91-09-10 | 00:29 |

Trigger time (if the trigger sources all set off, pressing the START key determines the trigger time)

Setting of "position" Filter

Manual print

Listing

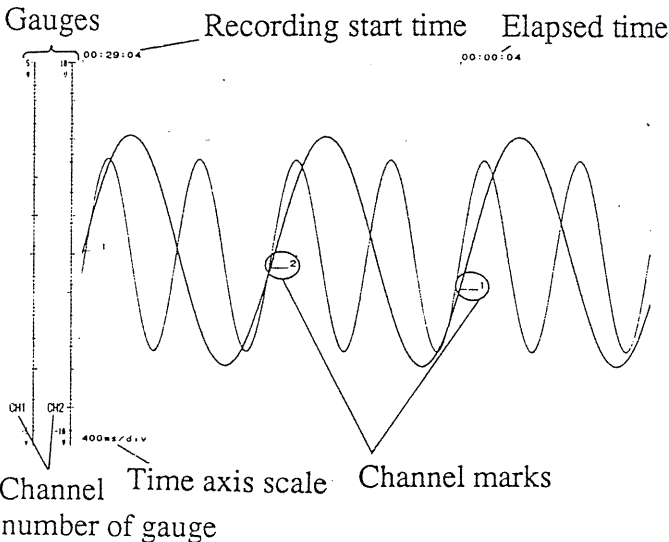

| | |
|------------|-------------------|
| function | : RECORDER |
| time/div | : 400ms |
| shot | : 1501V |
| format | : SINGLE |
| printer | : OFF |
| [CH1] | 1V/DIV DC x1 |
| DARK | -50% 50% fll:OFF |
| [CH2] | 2V/DIV DC x1 |
| LIGHT | 80% 50% fll:OFF |
| -10V -10V | |
| [CH3] | 1V/DIV DC x1 |
| OFF | pos:50% fll:OFF |
| [CH4] | 2V/DIV DC x1 |
| OFF | -100% 50% fll:OFF |
| [log:s] | : DARK |
| A | : OFF |
| B | : OFF |
| C | : OFF |
| D | : OFF |
| HIOKI 8851 | MEMORY HI CORDER |
| '91-09-10 | 00:30 |

| | |
|-----------------|----------------------|
| *** TRIGGER *** | |
| trigger time | : '91-09-10 00:29:04 |
| source | : OR |
| ch1 | : LEVEL |
| level | : 50% |
| slope | : J |
| ch2 | : OFF |
| ch3 | : OFF |
| ch4 | : OFF |
| external | : OFF |
| trig mode | : SINGLE |
| trig time | : START |
| timer source | : OFF |

| | |
|------------------|----------|
| *** SYSTEM *** | |
| V 0.19 | |
| screen auto off | : ON |
| grid type | : NORMAL |
| start key backup | : OFF |
| ch-warker | : ON |
| beep sound | : ON |
| list X gauge | : L & G |
| log:c drawing | : DARK |

Trigger time

Trigger settings

Settings in system mode

- DUAL format Display

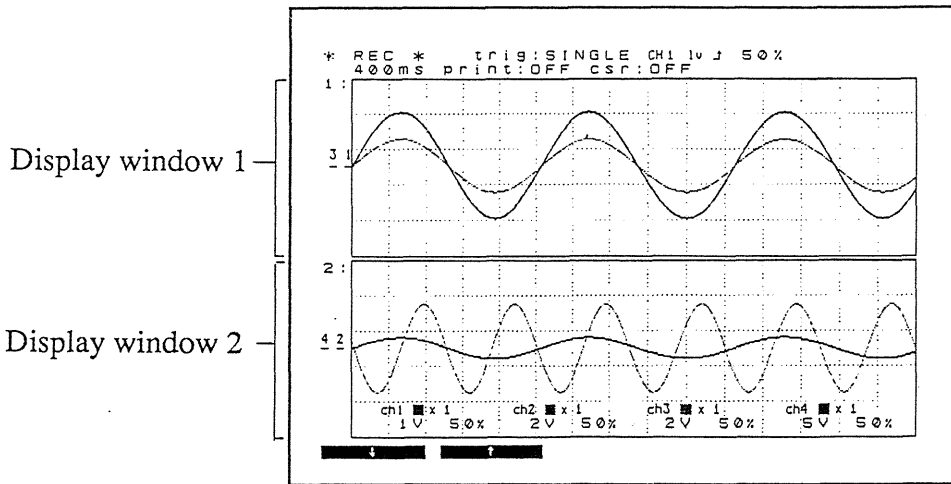

Pressing COPY and FEED simultaneously

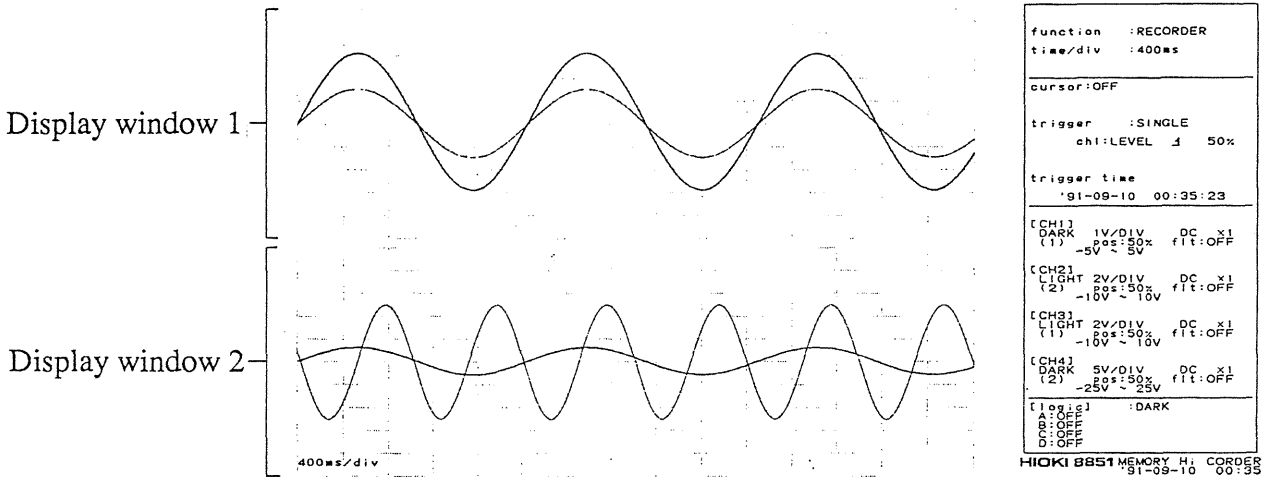

Manual print

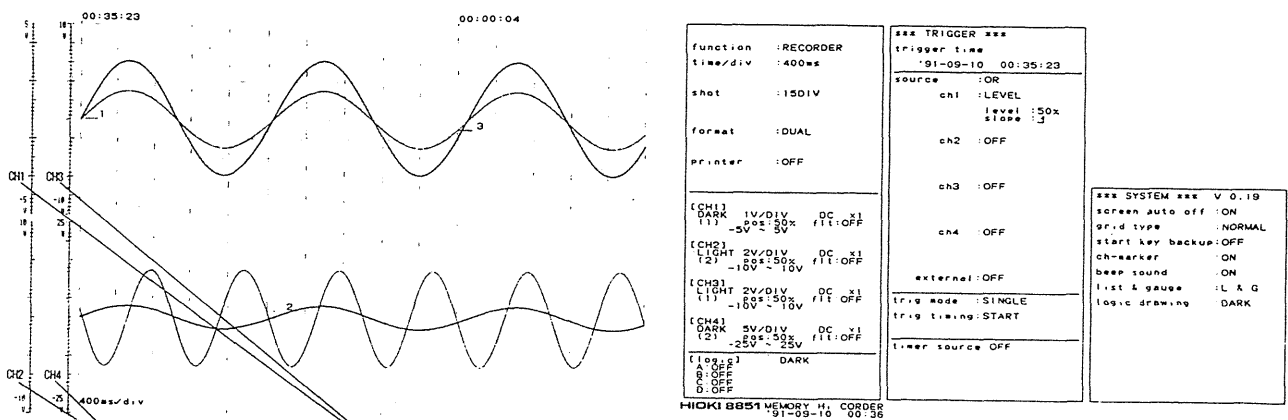

Channel numbers for display window 2

Channel numbers for display window 1

- DUAL (print quad) format
Display

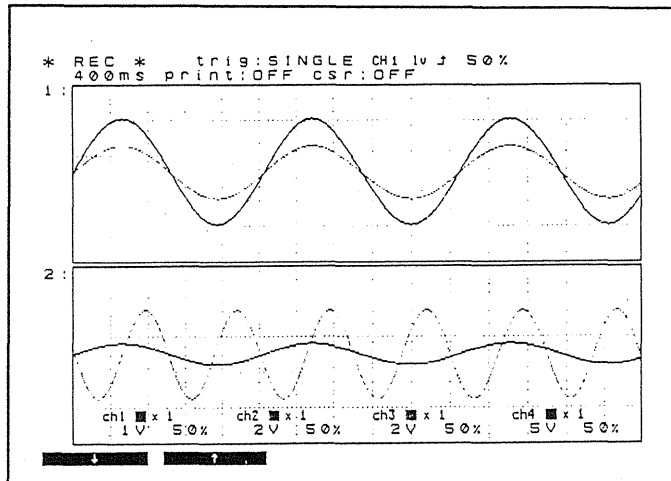

Pressing COPY and FEED simultaneously

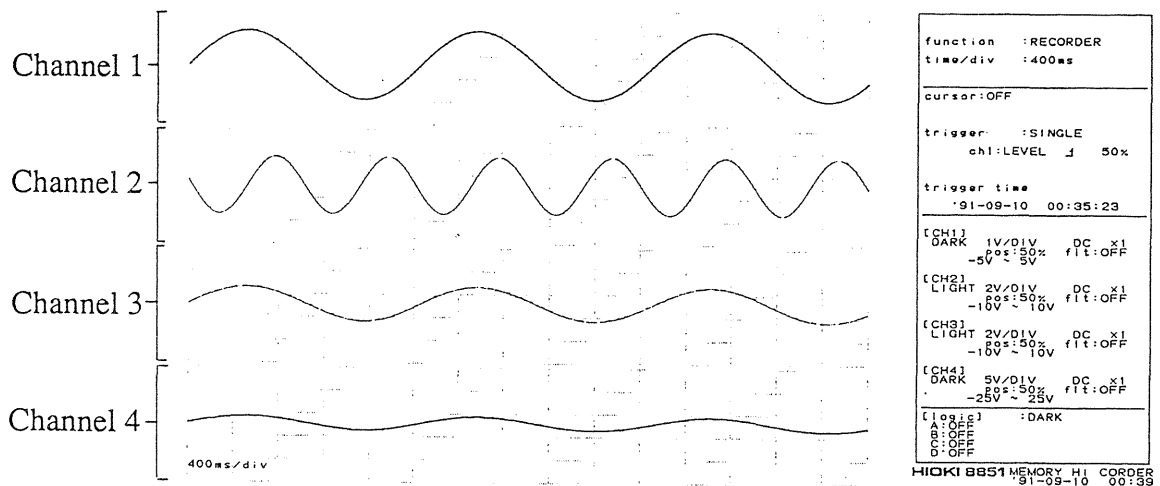

Manual print

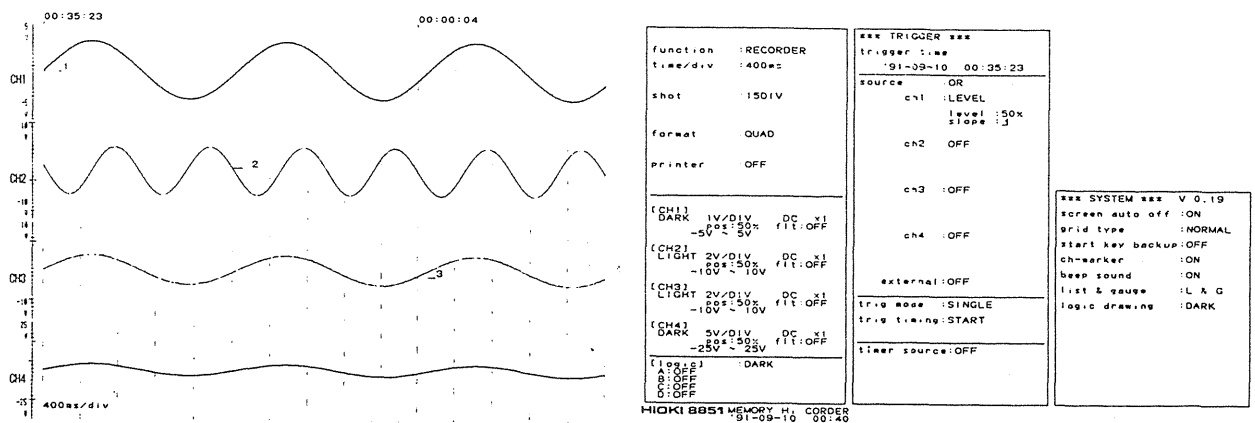

Section 7

X-Y Recorder Function Operation

Contents

| | |
|---|------|
| 7-1 What is the X-Y Recorder Function?..... | 7-2 |
| 7-1-1 Introduction..... | 7-2 |
| 7-1-2 Finding Reference Material in this Manual | 7-3 |
| 7-2 Screen Modes..... | 7-4 |
| 7-2-1 Status Mode | 7-4 |
| 7-2-2 Trigger Mode | 7-5 |
| 7-2-3 Display Mode..... | 7-6 |
| 7-3 Basic Operation Procedure..... | 7-7 |
| 7-3-1 Operation Sequence | 7-7 |
| 7-3-2 Operation Example | 7-8 |
| 7-4 User Operations..... | 7-12 |
| 7-4-1 Function Selection | 7-12 |
| 7-4-2 Interpolation Setting | 7-13 |
| 7-4-3 Display Clear Function | 7-14 |
| 7-4-4 Input Unit Settings..... | 7-15 |
| 7-4-5 Zero Adjustment | 7-19 |
| 7-4-6 Trigger Settings | 7-20 |
| 7-4-7 Starting and Stopping Measurement Operation | 7-22 |
| 7-4-8 Using A and B Cursors | 7-23 |
| 7-4-9 Printing Waveform Recordings | 7-26 |
| 7-5 Interpreting Waveform Displays and Recordings..... | 7-27 |

7-1 What is the X-Y Recorder Function?

7-1-1 Introduction

This function displays real time X-Y plots of pairs of input signals.

- (1) Normal X-Y recorder function, displaying the relationships between pairs of input signals.
- (2) Unlike the X-Y plot format in the memory recorder function, the system does not store the time axis waveforms for each channel.
- (3) The X-Y waveforms are saved in memory.
- (4) One of the four channels can be selected for the x-axis, and the remaining three channels are automatically assigned to the y-axis.

(5) High-speed sampling

With one y-axis channel, in dot display mode the sampling period is 300 μ s, and in line display mode it is 40 ms.

(6) No limit on recording time

In principle, as with a conventional X-Y recorder, recording can continue indefinitely.

(7) Superimposition function

If the "display clear" setting is disabled, the waveform is superimposed.

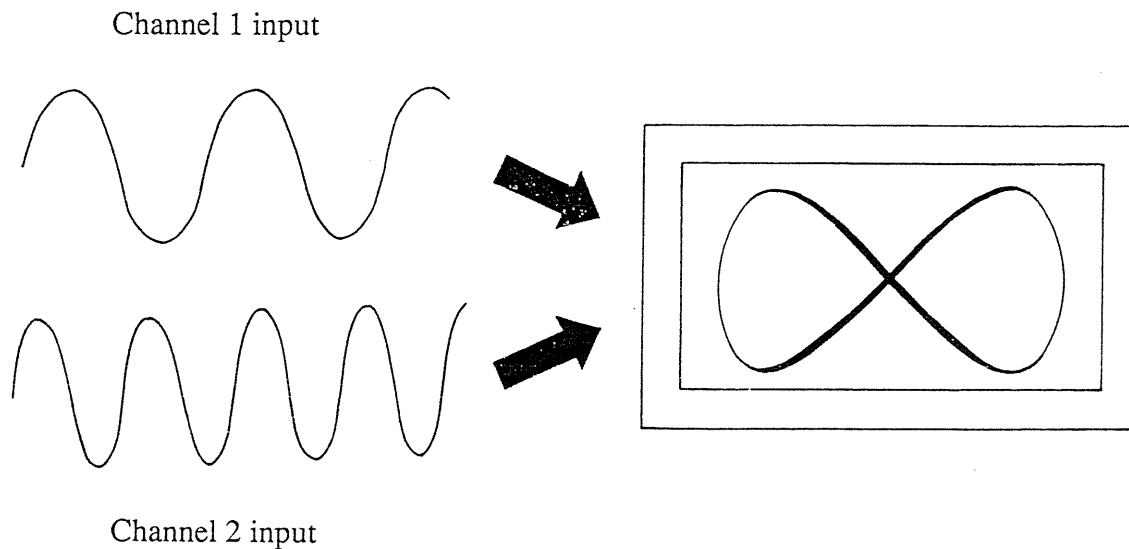

7-1-2 Finding Reference Material in this Manual

(1) Basic function

See Section 7-4 "User Operations" (Sections 7-4-1 to 7-4-9) for operational details.

(2) Trigger functions

See Section 14 (Vol. 2). Depending on the application, there is a wide range of trigger types to choose from.

(3) Using floppy disks

See Section 19 (Vol. 2).

The floppy disk drive provides a long-term storage mechanism for setting information.

(4) Scaling function

See Section 18-3 "Scaling Function" (in Vol. 2). This allows the input voltages to be converted to other values and units, so that the physical quantities originally measured can be read off directly.

(5) Comment function

See Section 18-4 "Adding Comments" (in Vol. 2). This provides a convenient means of annotating printed recordings.

(6) Screen auto off function

(7) Grid setting

The grid for the printed recording can be selected as required.

(8) Start key backup function

If the power supply fails during recording, enabling this function causes recording to restart when the power is restored.

(9) Channel marker function

Prints the origin positions of the y-axis channels on the recording.

(10) Audible warning setting

(11) List and gauge functions

Voltage axis scales and listings of settings on printed recordings.

(12) Connection to a computer via the GP-IB interface

See Section 20 (Vol. 2).

(13) Self check functions

See Section 18-8 "Self Check Functions" (in Vol. 2). This performs simple tests on the unit's functioning.

See Section 18-5
"Special Function
Settings"
(in Vol. 2)

7-2 Screen Modes

This section describes the status, trigger and display modes.

It also shows you where to look in this manual for further explanation of specific items.

See Section 18 for details of the system mode, and see Section 19 for details of the floppy disk control mode.

7-2-1 Status Mode

Press the STATUS key to display the status screen.

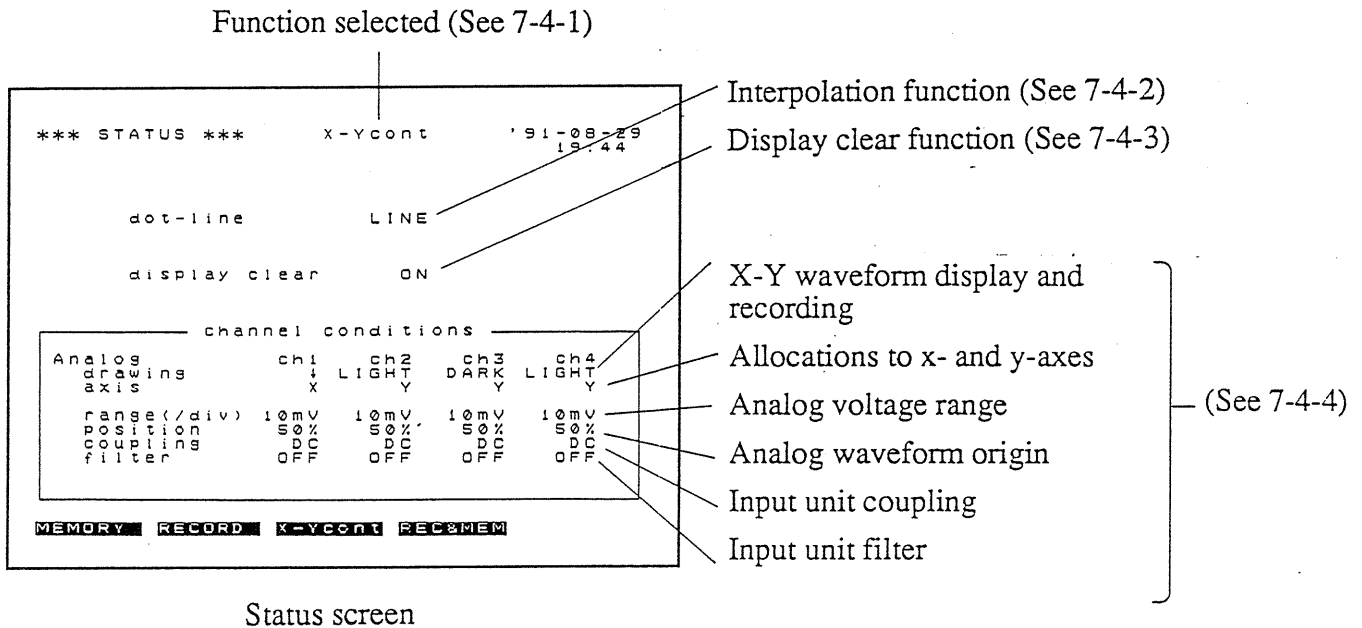

7-2-2 Trigger Mode

Press the TRIG key to display the trigger screen.

Use the rotary knob to scroll the screen, or hold down the cursor  key to see the special trigger display.

See Section 7-4-6 "Trigger Settings" and Section 14 "Trigger Functions" for more details.

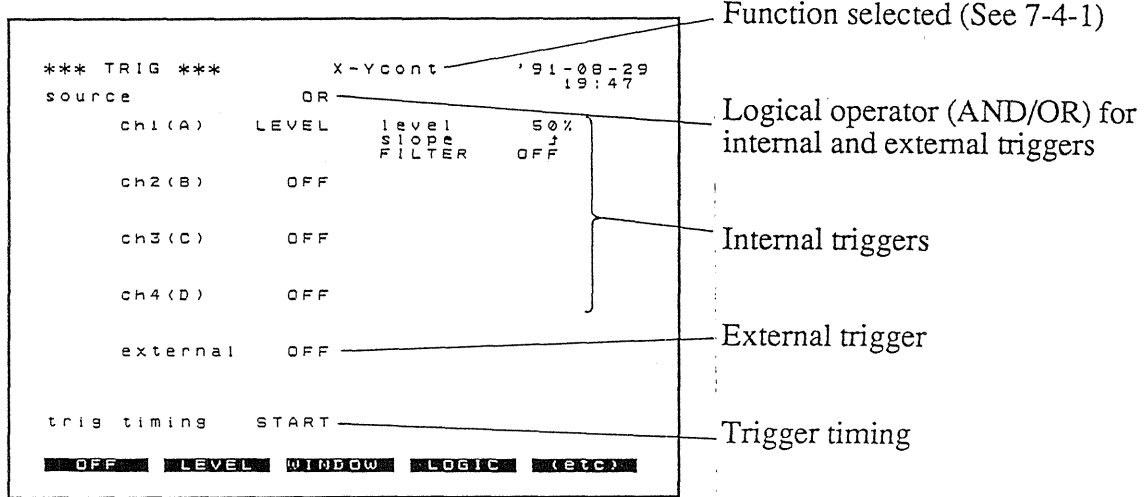

```

*** TRIG ***
source      OR      X-Ycont      '91-08-29
                                19:47
ch1(A)     LEVEL   level      50%
                                SLOPE
                                FILTER      OFF
ch2(B)     OFF
ch3(C)     OFF
ch4(D)     OFF
external   OFF
trig timing START
OFF  LEVEL WINDOW LOGIC (Etc.)
  
```

Trigger screen

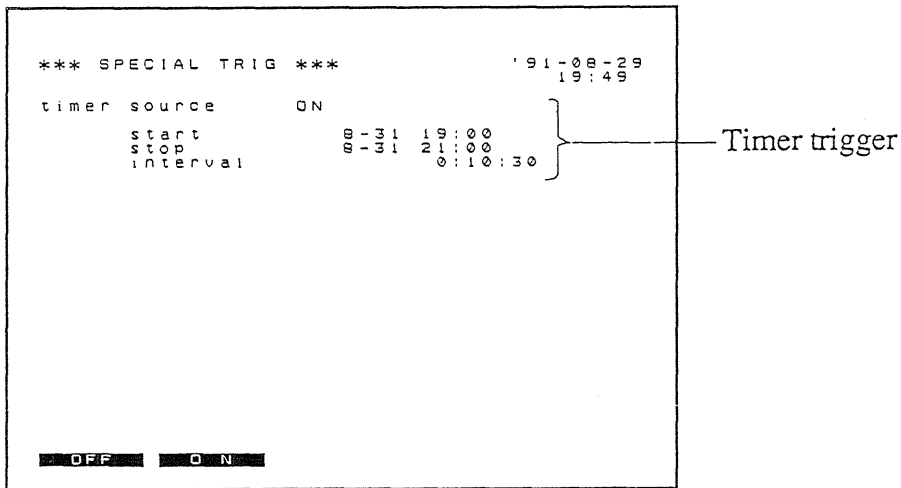

```

*** SPECIAL TRIG ***
timer source  ON      '91-08-29
                                19:49
start        88-31 19:00
stop         88-31 21:00
interval     0:10:30
OFF  ON
  
```

Special trigger display

7-2-3 Display Mode

Press the DISP key to enter the display mode.

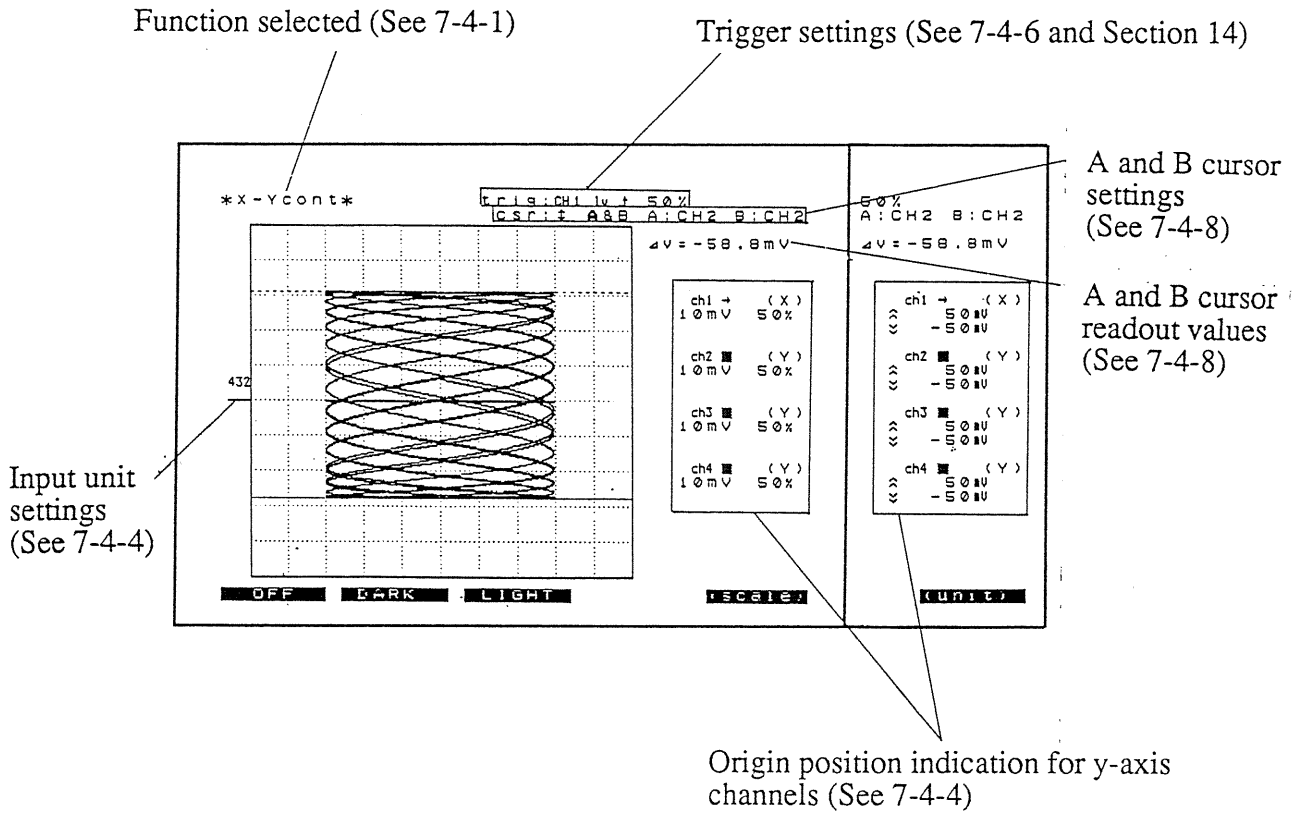

7-3 Basic Operation Procedure

7-3-1 Operation Sequence

The flowchart below illustrates the sequence of operations involved in using the X-Y recorder function. (The explanation to the right of the flowchart boxes is based on Section 7-3-2 "Operation Example.")

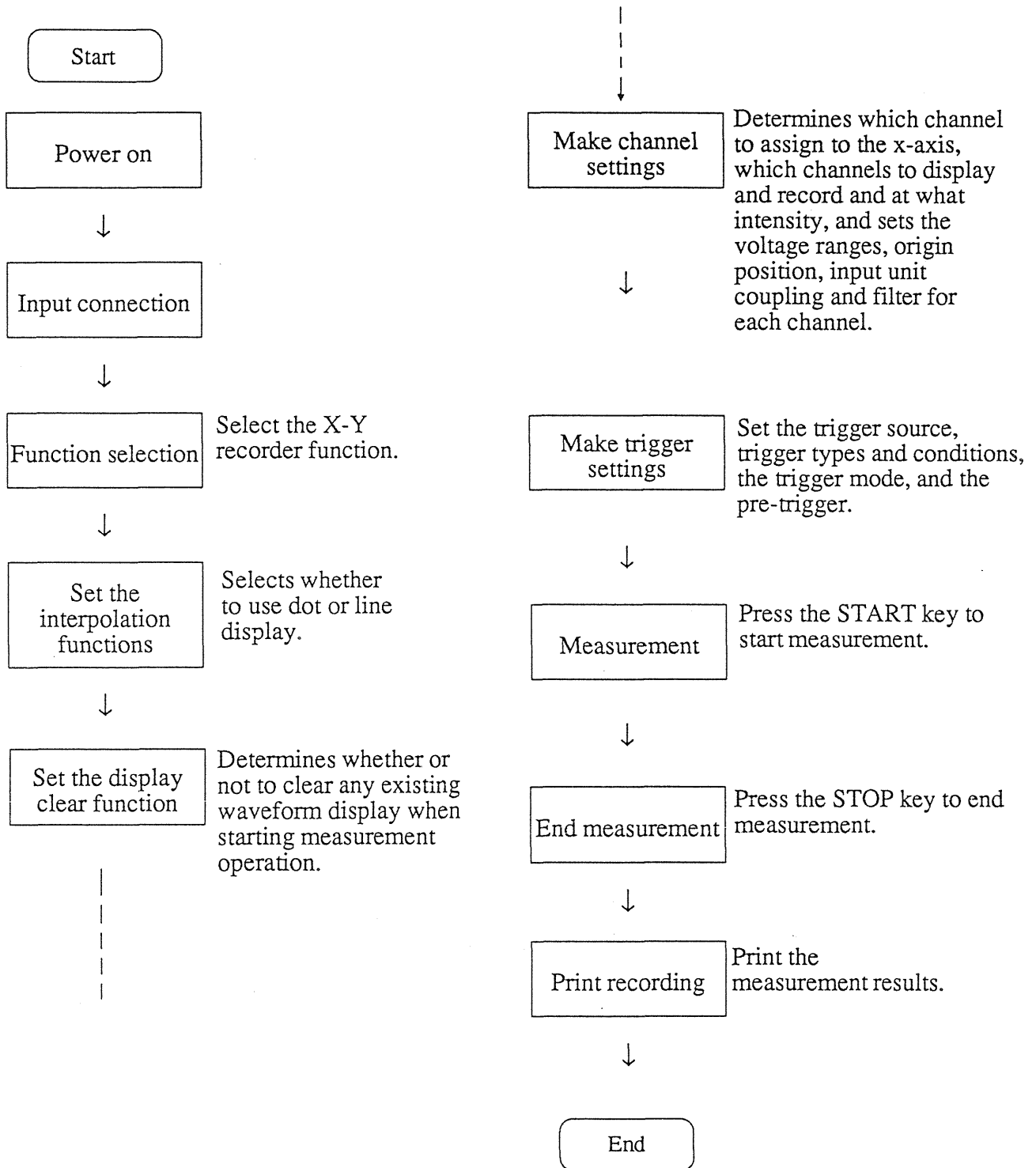

7-3-2 Operation Example

This example illustrates the basic procedure using the X-Y recorder function to plot the Lissajous's figure resulting from two 3 V p-p sine wave inputs, one of frequency 1 Hz, and the other 2 Hz.

(1) Power on the unit

Connect the power cord to the 8851 and press the power switch.

(2) Input connection

Connect signal generators to the input terminals of channels 1 and 2 (both 8944 analog input units). Set the signal generators to output the following signals:

Channel 1 ... 3 V p-p 1 Hz sine wave

Channel 2 ... 3 V p-p 2 Hz sine wave

(3) Select the function

Select the X-Y recorder function.

1. Press the STATUS key.
2. Move the flashing cursor to the function indication.
3. Press the **X-Ycont** soft key.

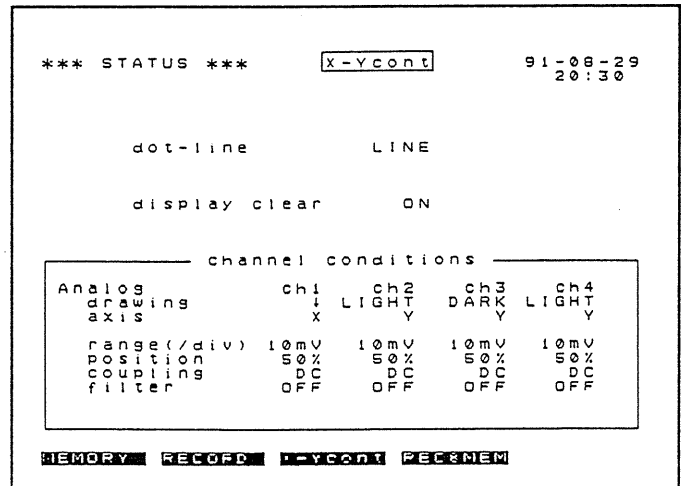

(4) Set the interpolation function

Set this to LINE, for linear interpolation.

1. Move the flashing cursor to the "dot-line" item.
2. Press the **LINE** soft key.

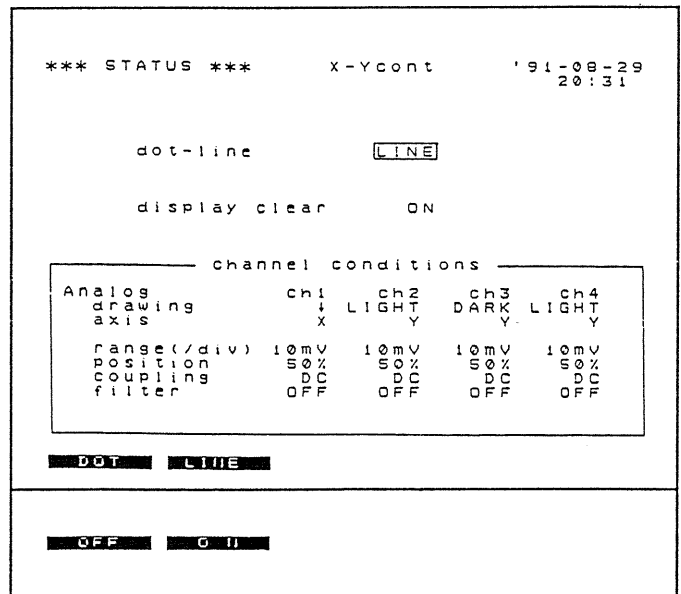

(5) Set the display clear function

Set this to clear the screen of any existing X-Y plot when the START key is pressed.

1. Move the flashing cursor to the "display clear" item.
2. Press the **ON** soft key.

(5)...

(6) Make channel settings

Display and record with channel 1 on the x-axis and channel 2 on the y-axis, in high intensity.

For both channels 1 and 2, set the voltage range to 500 mV/division, the origin position to 50%, input coupling to DC and the input filter off.

1. Flashing cursor ... "ch1 axis"

Press the **(X set)** soft key.

2. Flashing cursor ... "ch1 range"

Set to 500 mV.

You can also use the channel 1 range key, without moving the flashing cursor.

3. Flashing cursor ... "ch1 position"

Set to 50%.

4. Flashing cursor ... "ch1 coupling"

Press the **(DC)** soft key.

5. Flashing cursor ... "ch1 filter"

Press the **(OFF)** soft key.

6. Flashing cursor ... "ch2 Analog drawing"

Press the **(DARK)** soft key.

7. Flashing cursor ... "ch2 range"

Set to 500 mV.

You can also use the channel 2 range key, without moving the flashing cursor.

8. Flashing cursor ... "ch2 position"

Set to 50%.

9. Flashing cursor ... "ch2 coupling"

Press the **(DC)** soft key.

10. Flashing cursor ... "ch2 filter"

Press the **(OFF)** soft key.

11. Similarly set the "Analog drawing" items for channels 3 and 4 both off.

- 1 ...
- 2 ...
- 3 ...
- 4 ...
- 5 ...
- 6 ...
- 7 ...
- 8 ...
- 9 ...
- 10 ...
- 11 {

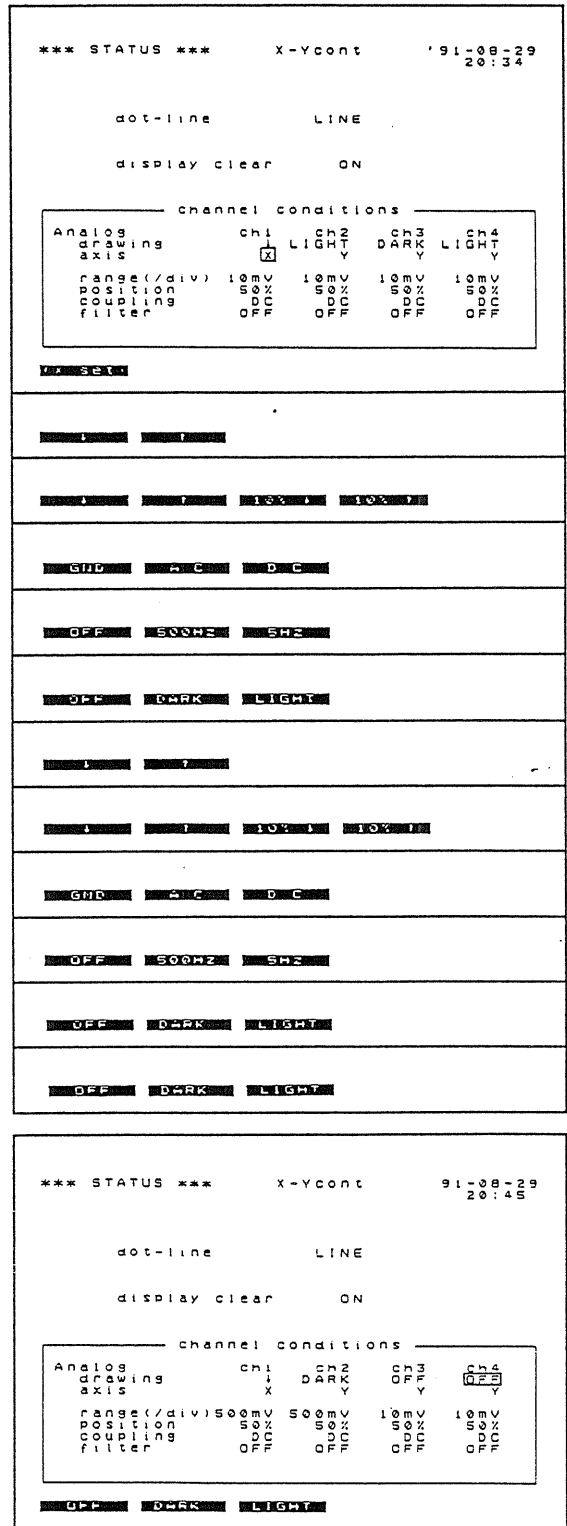

Screen after settings have been made

(7) Make trigger settings



Use only channel 1 as a trigger source; set the trigger level to 50%, the slope to rising, the filter off, and select the logical OR of the channels.

Set the trigger timing to START, and switch off the timer trigger.

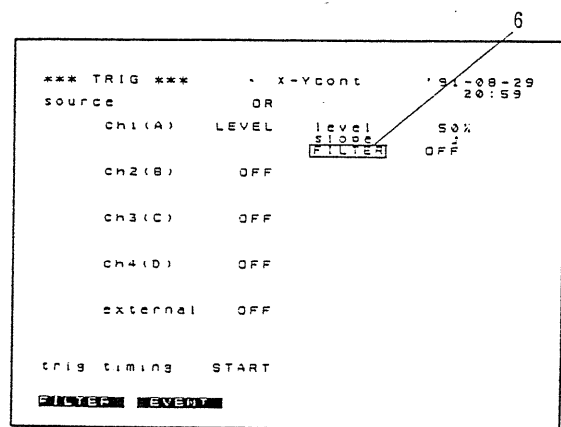
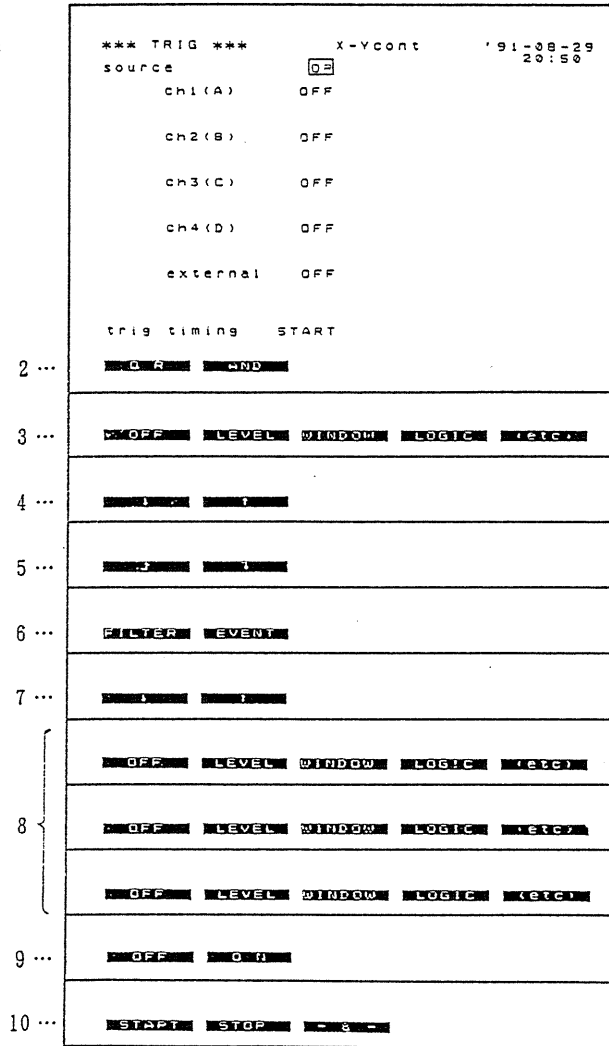
1. Press the TRIG key.
2. Flashing cursor ... "source" (at the top)
Press the **OR** soft key.
3. Flashing cursor ... "ch1(A)"
Press the **LEVEL** soft key.
4. Flashing cursor ... "level"
Set to 50%.
5. Flashing cursor ... "slope"
Press the **↓** soft key.
6. Select FILTER/EVENT
Press the **FILTER** soft key.
- Note:** Refer to the screen appearance after completing settings.
7. Flashing cursor ... "FILTER"
Press the **OFF** soft key.
8. Set all of channels 2 (B), 3 (C) and 4 (D) off.
9. Flashing cursor ... "external"
Press the **OFF** soft key.
10. Flashing cursor ... "trig timing"
Press the **START** soft key.



Screen after settings have been made

11. Use the rotary knob to scroll the screen, or hold down the cursor  key to see the special trigger display.
12. Flashing cursor ... "timer source"
Press the  soft key.

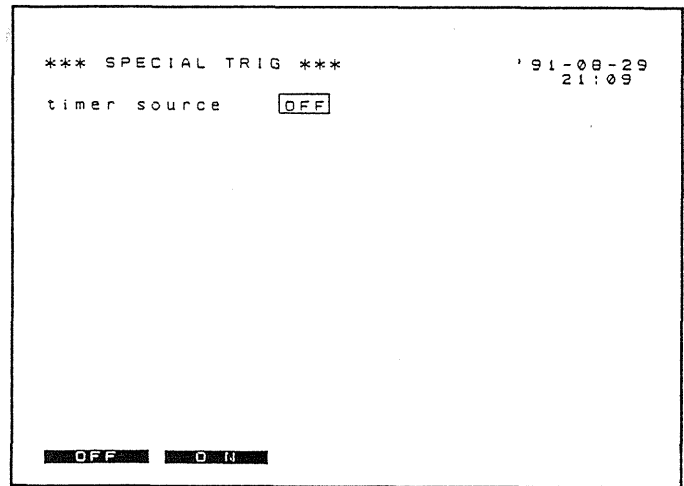

(8) Starting measurement

On pressing the START key, the display screen appears, and the waveform is displayed.

1. Press the START key.

The LED above the START key lights.

In this case the input is already present, so the trigger takes effect immediately, and the waveform display starts.

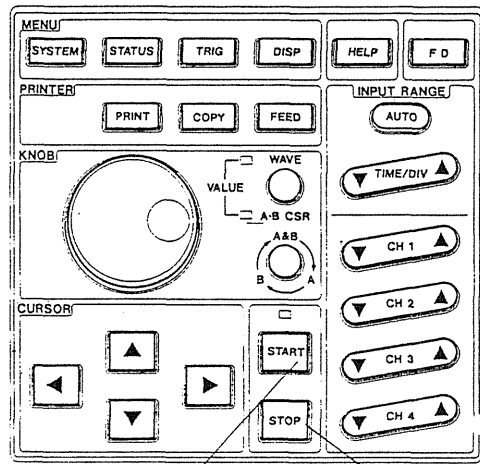

START key

STOP key

(9) Ending measurement

The display continues indefinitely until the STOP key is pressed.

1. Press the STOP key.

The LED above the START key goes off, and measurement ends.

(10) Printed recording

Press the COPY and FEED keys simultaneously to copy the displayed Lissajous's figure to the printer.

1. Press the COPY and FEED keys simultaneously. The screen display and the setting information is printed.

Since the printer uses thermally sensitive paper, to keep a permanent copy of the recording, it is recommended to take a photocopy.

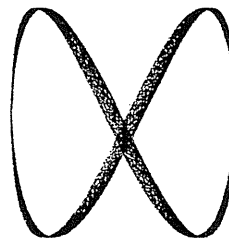

| | |
|--------------|------------------------------------|
| function | :X-Ycont |
| cursor | :OFF |
| trigger | : ch1:LEVEL 1 50x |
| trigger time | : 91-08-30 11:29:00 |
| [CH1] | 500mV/DIV DC x1 pos:50% fit:OFF |
| [CH2] | 500mV/DIV DC x1 pos:50% fit:OFF |
| [CH3] | 10mV/DIV DC x1 pos:50% fit:OFF |
| [CH4] | 10mV/DIV DC x1 pos:50% fit:OFF |
| [A&B] | :DARK |
| A: | :OFF |
| B: | :OFF |
| C: | :OFF |
| D: | :OFF |

HIOKI 9851 MEMORY H. CORDER
91-08-30 11:30

7-4 User Operations

7-4-1 Function Selection

Function

First select the function to be used for measurement. There are four functions: memory recorder, recorder, X-Y recorder, and recorder and memory. In this case, select the X-Y recorder function.

Procedure

1. Select status mode.
2. Function selection

Press the **X-Ycont** soft key.

This selects the X-Y recorder function.

(MEMORY, RECORDER, X-Ycont, REC&MEM)

(Soft key indication is "RECORD".)

The function selection can be carried out equally in trigger or display mode.

After pressing the TRIG key for the trigger mode, or the DISP key for the display mode, make the function selection in the same way as in the status mode.

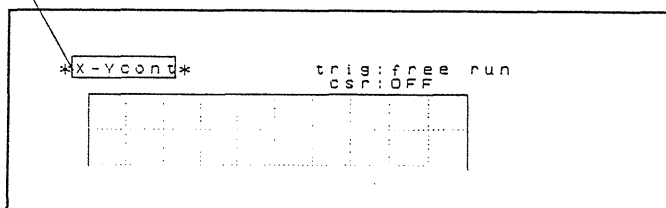
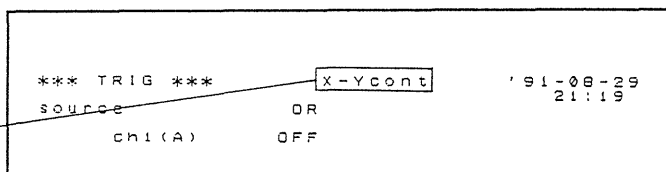
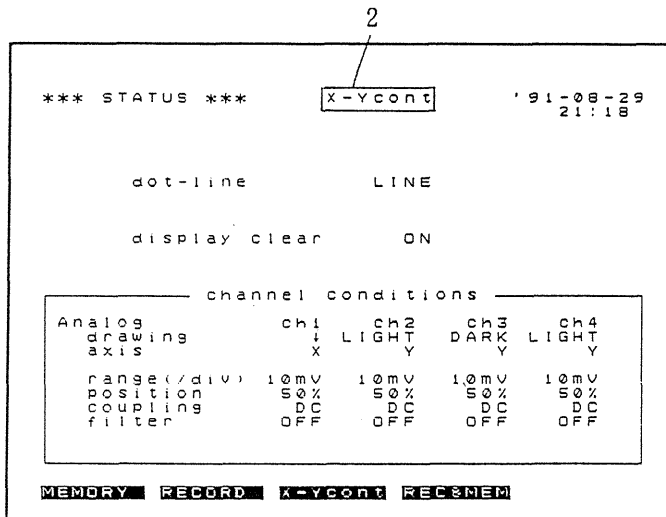

Notes

- The function indication in the display mode is abbreviated:
MEMORY - MEM
RECORDER - REC
- In the display mode, switching to any other function clears the X-Y plot from the screen. Even if you switch back to the X-Y recorder function, no X-Y plot remains on the screen.

7-4-2 Interpolation Setting

Function

This function determines whether to display and record the sampled data as detached points (dot mode) or with straight-line interpolation (line mode).

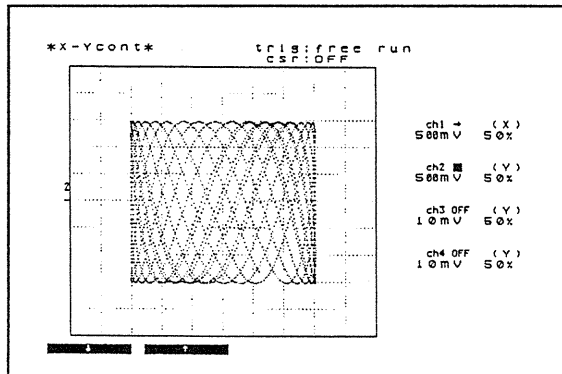

Dot mode

No linear interpolation. The sampled values are displayed exactly as measured.

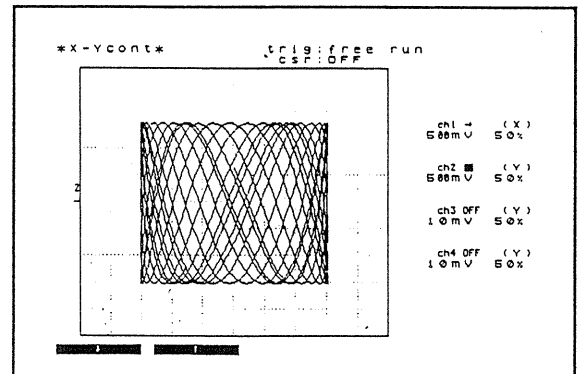

Line mode

Linear interpolation.

This gives a more readable display. The sampling rate is reduced, however, compared with the dot mode.

Procedure

1. Select the status mode.
2. "dot-line"

Select whether or not to carry out linear interpolation.

(DOT, LINE)

2

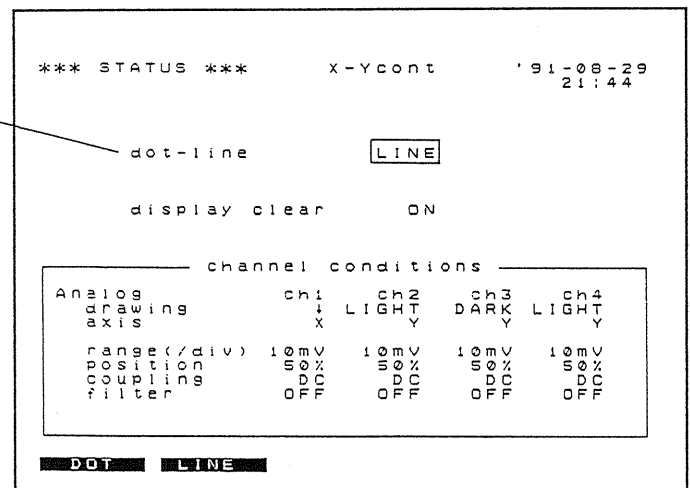

Notes

- Changing the setting after capturing data has no effect on the X-Y display.
- Using the linear interpolation mode (line), the sampling rate depends on the number of channels, and the amplitude and density of the displayed X-Y plots. For details, see the specifications for the X-Y recorder function in Section 2-1.

7-4-3 Display Clear Function

Function

This function determines whether or not an existing X-Y display is cleared when you press the START key to start recording.

If the function is not set to clear, the new X-Y plot is superimposed on the existing one.

Procedure

1. Select the status mode.
2. "display clear"

Select whether or not the START key should clear any existing X-Y plot.

(OFF, ON)

OFF ... pressing the START key does not clear the display window. The new recording is superimposed on the existing one.

ON Pressing the START key clears the display window.

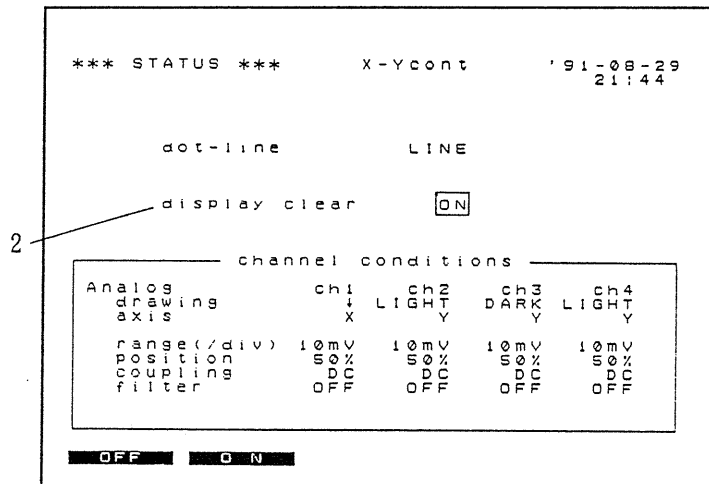

7-4-4 Input Unit Settings

Function

This function provides the following settings for each input unit.

- Axis assignment
Determines which channel is allocated to the x-axis. The remaining channels are automatically allocated to the y-axis.
- Display settings
These determine which channels are displayed, and at what intensity.
- Range, origin positioning, and input unit coupling and filter for each channel.

Procedure

You can carry out most of the settings in status mode or display mode. The only restriction is that the axis assignment and input unit filter settings cannot be carried out in display mode.

(1) In status mode

1. Select the status mode.
2. "axis"

Select one of channels 1 to 4 to assign to the x-axis. Press the **(X set)** soft key on the required channel. The remaining channels are automatically allocated to the y-axis.

Note: The x-axis can be selected even for a channel for which "Analog drawing" is set to OFF.

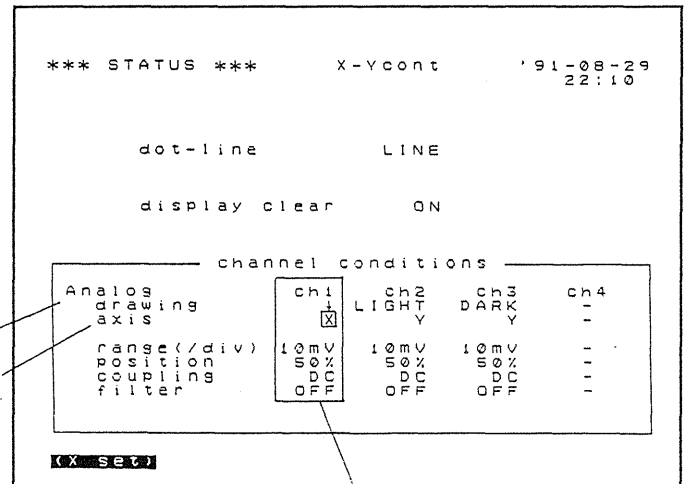

Settings for channel 1

3. "Analog drawing"

For the channels assigned to the y-axis, this setting determines whether or not the corresponding X-Y plot is displayed, and at what intensity.

(OFF, DARK, LIGHT)

OFF do not display

DARK display at high intensity

LIGHT display at low intensity

Note: For the channel assigned to the x-axis, this setting is shown as ↓.

4. "range(/div)"

Set the voltage range for each channel.

You can also use the range key for each channel, without moving the flashing cursor.

(10 mV, 20 mV, 50 mV, 100 mV, 200 mV, 500 mV, 1 V, 2 V, 5 V, 10 V, 20 V, 50 V)

5. "position"

This determines the position of the voltage origin (from -100% to 100% of the range, in 1% increments).

(See the Background information below.)

The and soft keys change the value in 1% steps; the and soft keys change it by 10% steps.

6. "coupling"

Determines the input unit coupling.

(GND, AC, DC)

GND ... the input unit is not connected.

This enables zero potential checking.

AC ... capacitor in series.

This removes DC components from the input, and measures the AC component only.

DC ... input signal directly connected to amplifier.

This allows measurement from the DC component.

7. "filter"

This determines the low-pass filter setting in the input unit itself.

(OFF, 500Hz, 5Hz)

OFF: no low-pass filter used

500Hz: use a low-pass filter with a cutoff frequency of 500 Hz

5Hz: use a low-pass filter with a cutoff frequency of 5 Hz

Note: As shown for channel 4 in the figure, if no input unit is installed, the settings (2 to 7) are all shown as "-".

(2) In display mode

1. Select the display mode.
2. For each of the y-axis channels, select whether to display or not, and at what intensity. Also select whether to show input unit information or scaling information on the screen.

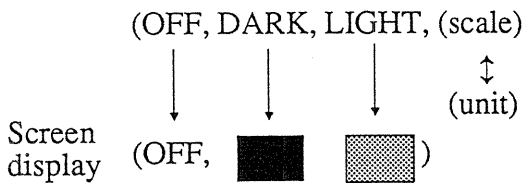

For the x-axis channel, select whether to show input unit information or scaling information.

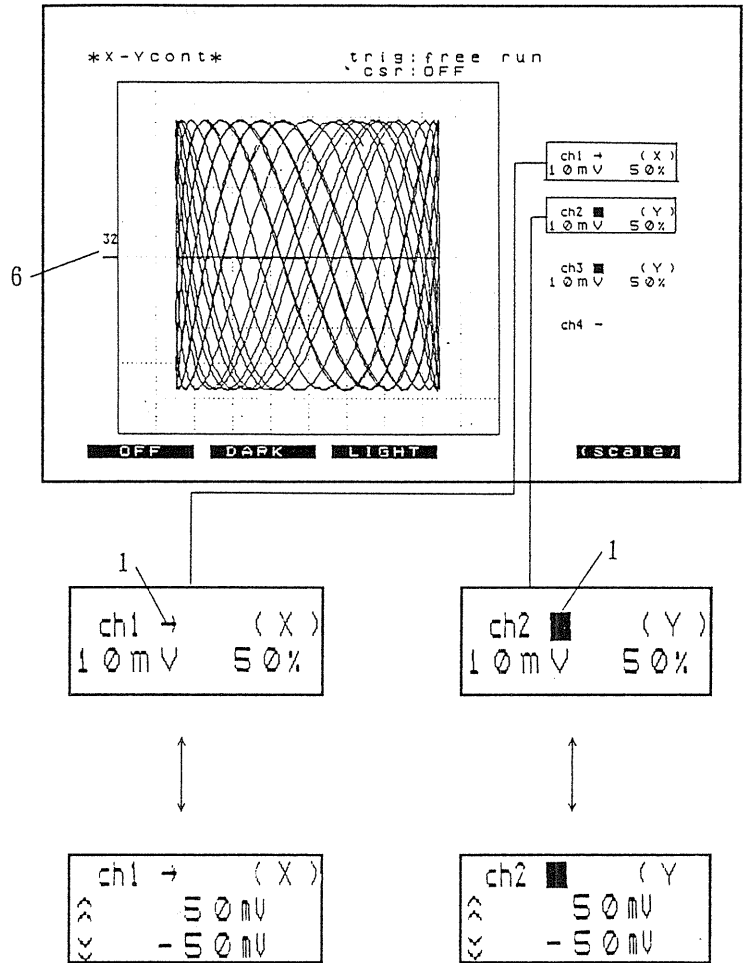
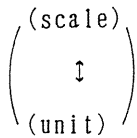

See the note above on the interpretation of OFF, DARK, and LIGHT.

- (scale) ... pressing the soft key switches to the scale display (showing the top and bottom values on the y-axis, and the leftmost and rightmost values on the x-axis);
- ↑↓ the soft key indication changes to "(unit)".
- (unit) ... pressing the soft key switches to the input unit display (showing the voltage range, input coupling and origin positioning); the soft key indication changes to "(scale)".

Switching between the scale and unit displays affects all channels together.

Note: As shown for channel 4 in the figure, if no input unit is installed, the settings (2 to 7) are all shown as "-", and the flashing cursor skips these items.

- Set the voltage range for each channel. You can also use the range key for each channel, without moving the flashing cursor.

(10 mV, 20 mV, 50 mV, 100 mV, 200 mV, 500 mV, 1 V, 2 V, 5 V, 10 V, 20 V, 50 V)

In the screen display, the "V" is omitted.

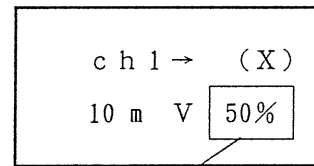
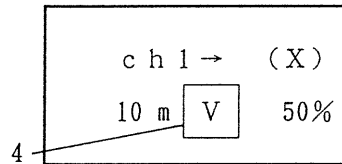
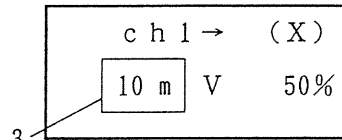

- Set the input unit coupling.

(GND, AC, DC)

On the screen
these appear as ($\overline{\text{m}}$, $\overline{\text{V}}$, V)

See the explanation in (1) "In status mode" above for the significance of these settings.

- Set the origin position (the position of the zero voltage). (from -100% to 100% of the range, in 1% increments).

(See the Background information below.)

The \downarrow and \uparrow soft keys change the value in 1% steps; the \downarrow and \uparrow soft keys change it by 10% steps. For an explanation of the 0 adj soft key, see 7-4-5 "Zero Adjustment."

- The origin position on the y-axis (the zero voltage position) for the currently displayed X-Y plot is shown on the screen.

(For example, the label "2" indicates the origin for channel 2.)

Background

The voltage origins for the x- and y-axes are determined by the "position" settings as shown below.

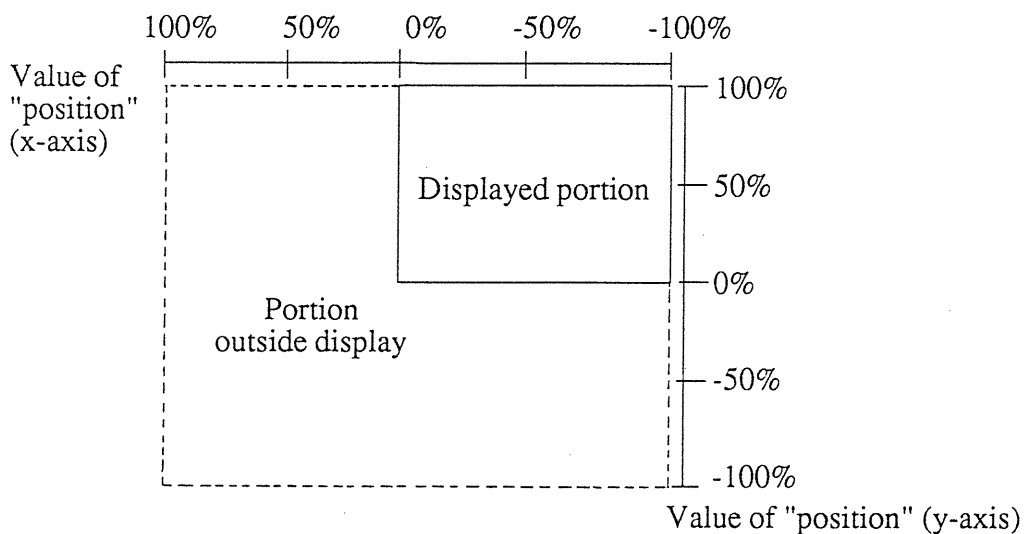

The value of the "position" setting determines the origin. The origin can be inside the display area (0% to 100%) or outside (-100% to 0%) and below or to the left of it.

7-4-5 Zero Adjustment

Function

This function provides for accurate adjustment of the waveform to the origin position when a zero voltage is input. Use it for reading precise values from the screen or a printed recording.

Procedure

Always allow at least 30 minutes warming up before carrying out this procedure, to ensure that the internal temperature of the unit has stabilized.

1. Select the display mode.
2. If the input unit information is not shown as shown in the figure on the right, move the flashing cursor to the position to the right of one of the channel indications "ch1" to "ch4" and press the (unit) soft key.
3. Press the [0 adj] soft key. This carries out the correction for all channels simultaneously. Repeat the process after changing ranges.

Soft keys ... (↓, ↑, 10%↓, 10%↑, 0 adj)

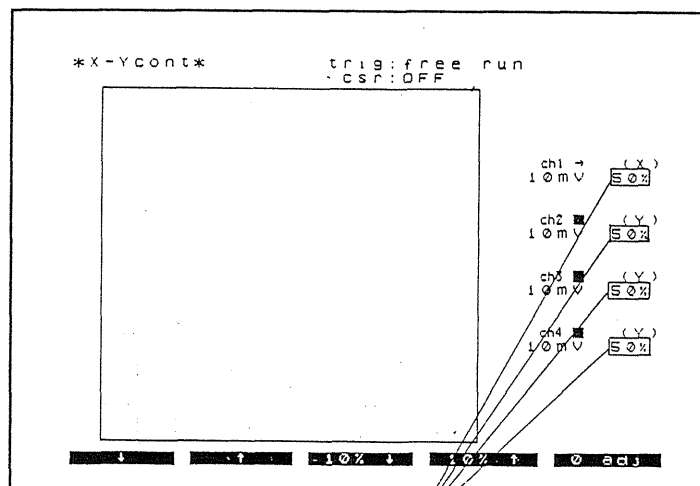

Notes

- Allow at least 30 minutes warming up after powering on before carrying out zero adjustment.
- Zero adjustment is not possible while the unit is measuring.
- The zero adjustment takes effect in the input unit. Always, therefore, repeat zero adjustment after changing input units.

7-4-6 Trigger Settings

Function

This function includes all trigger-related settings.

- Trigger conditions for each channel, and logical operator with external trigger
The trigger conditions for each channel can be set, and AND or OR selected as the logical operator with the external trigger.
- Trigger conditions
The trigger conditions for each channel can be set.
- External trigger
The setting determines whether or not a signal from the external trigger terminal is used as a trigger source.
- Trigger timing setting
Determines whether measurement starts or stops when the trigger occurs.
- Timer trigger setting
This allows timer controlled triggering.

Procedure

All settings can be carried out in trigger mode. Basic settings can also be carried out in display mode.

(1) In trigger mode

1. Select the trigger mode.
2. Set the trigger conditions for each channel, and select the logical operator (AND or OR) with the external trigger.
(AND, OR)
See 14-4 "Internal and External Trigger Logical Operator."
3. Select the trigger type for each channel.
(OFF, LEVEL, WINDOW, LOGIC, GLITCH, TIME OUT)

Note: If you set the external and internal trigger logical operator to AND in step 2, some settings are not allowed.

See Section 14-2 "Internal Triggers" (14-2-1 to 14-2-6).

4. Set the detailed conditions for the setting in step 3.
See Section 14-2 "Internal Triggers" (14-2-1 to 14-2-6).
5. "external"
Enable or disable the external trigger. (OFF, ON)
See Section 14-3 "External Trigger".

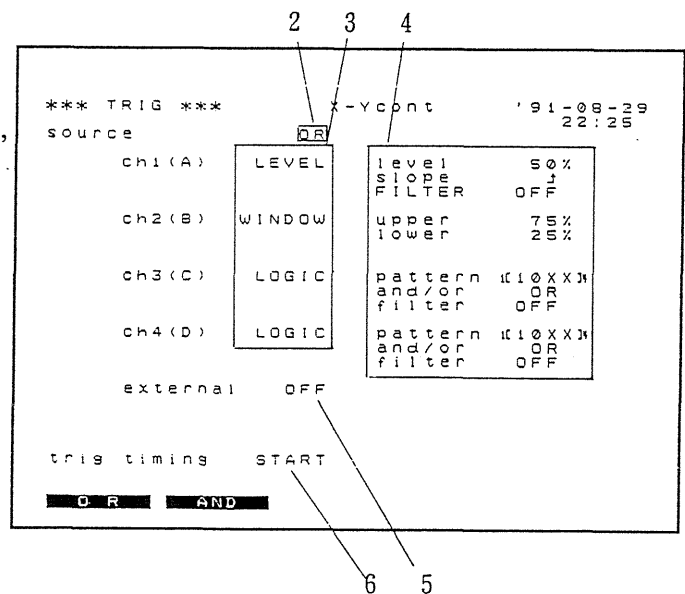

6. "trig timing"

Make the trigger timing setting.

(START, STOP, START&STOP)

⋮

Soft key indication is "- & -".

START: recording starts when the trigger is applied.

STOP: recording starts when the START key is pressed, and stops when the trigger is applied.

START&STOP: recording starts when the trigger is applied, and stops when the trigger is next applied.

See Section 14-6 "Pre-Trigger and Trigger Timing."

7. "timer source"

Set the timer trigger.

(OFF, ON)

See Section 14-7 "Timer Trigger."

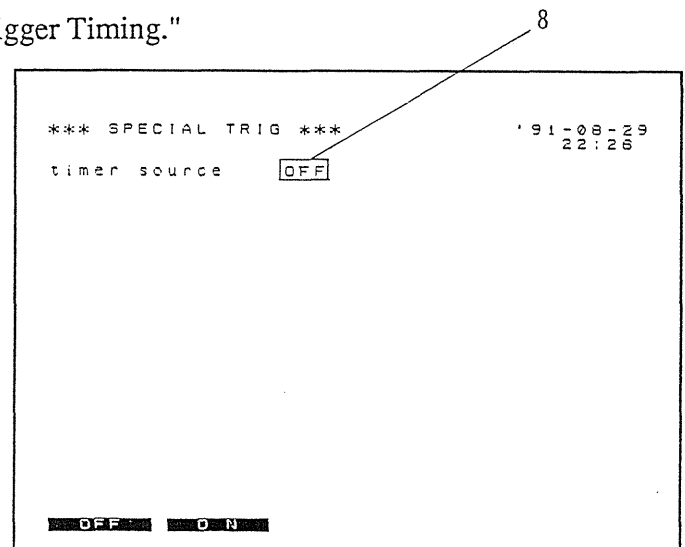

(2) In display mode

1. Select the display mode.

2. Select the channel.

(CH1, CH2, CH3, CH4)

If all channels are set to "OFF" in trigger mode, the indication "free run" appears.

If, however, the external trigger is enabled the indication is "external", and if the timer trigger is enabled, it is "timer".

3. Make the detailed settings for the trigger type (other than LOGIC) set in trigger mode.

Trigger types set in the trigger mode cannot be changed in display mode.

See Section 14-2 "Internal Triggers" (14-2-1 to 14-2-6).

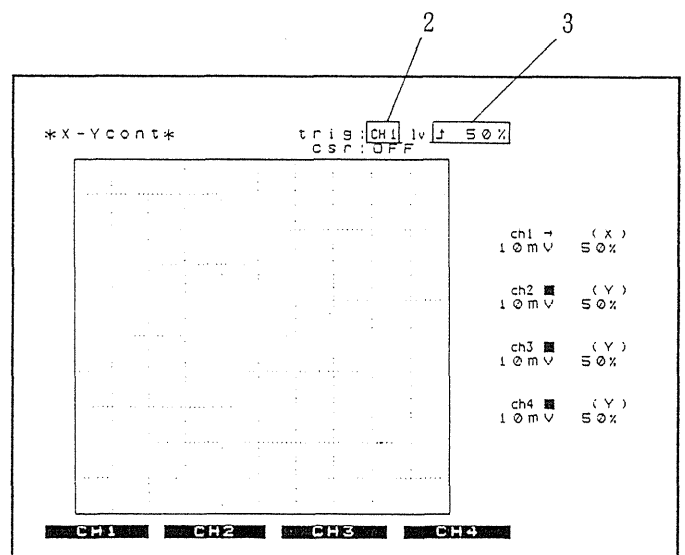

7-4-7 Starting and Stopping Measurement Operation

Function

The START and STOP keys control the measurement operation mode of the unit. The LED above the START key is lit when in measurement operation mode.

Procedure

1. **START**
Start measurement operation.
2. **STOP**
Stop measurement operation.

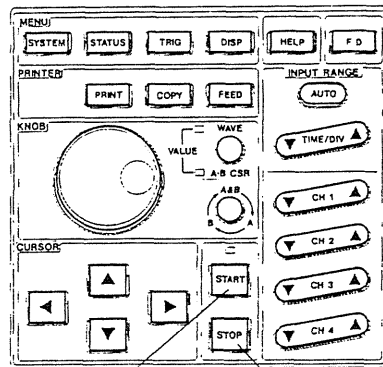

1. START key
2. STOP key

Note

- Operation is the same as that of a conventional X-Y recorder: pressing START begins recording, which continues until the STOP key is pressed. If, however, the trigger timing is set to STOP or START&STOP, then recording will stop automatically if the trigger occurs.

7-4-8 Using A and B Cursors

Function

You can use the A and B cursors to measure voltage differences (if using the scaling function, the scaled values; see Section 18-3 "Scaling Function"), getting a direct digital readout.

You can use the A cursor alone, to read out a voltage (v) with respect to the origin (the 0 V or "position" setting), or use both A and B cursors to read out a voltage difference (Δv). When using horizontal cursors, the A and B cursors can be attached to different y-axis channels.

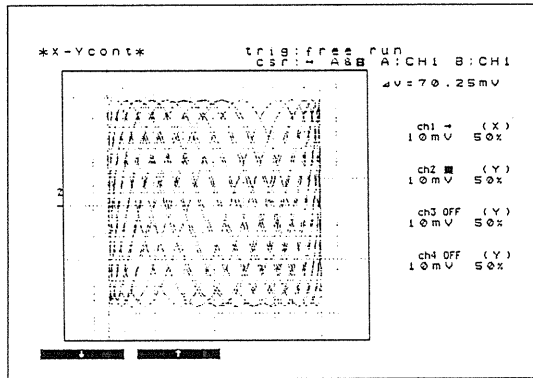

Vertical cursors for the x-axis

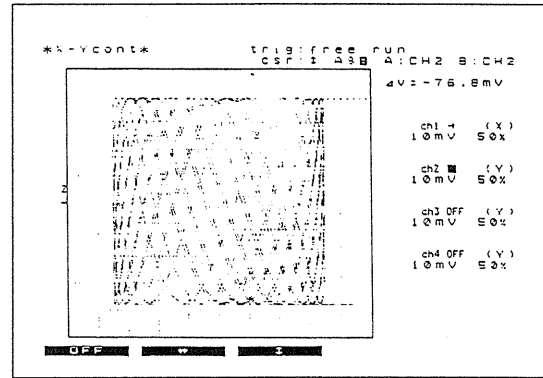

Horizontal cursors for the y-axis

Procedure

- Select the cursor mode.
(OFF, \leftrightarrow , \updownarrow)
OFF ... do not use cursors.
 \leftrightarrow use vertical cursors for the x-axis.
 \updownarrow use horizontal cursors for the y-axis.
- Select whether to use the A cursor only, or both cursors.
(A, A&B)
- If using horizontal line cursors, select which y-axis channel voltages are to be read off. You can make independent settings for the A and B cursors.
(CH1, CH2, CH3, CH4)

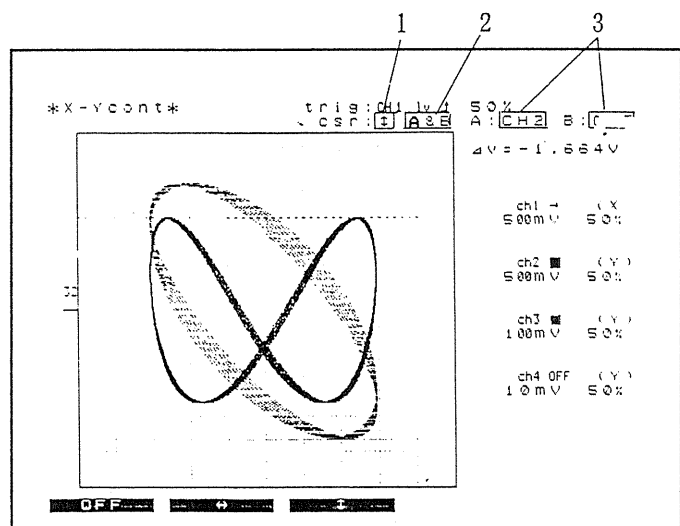

Notes: Only channels for which waveforms are displayed can be chosen.
If using the A cursor only, the setting for the B cursor is not possible.
If using vertical cursors, the x-axis channel appears.

4. ① Using vertical cursors on the x-axis

Using the A cursor only, determines the voltage (V) on the x-axis channel from the origin (the "position" setting, or 0 V); using both A and B cursors, determines the voltage difference (ΔV) between the A and B cursors.

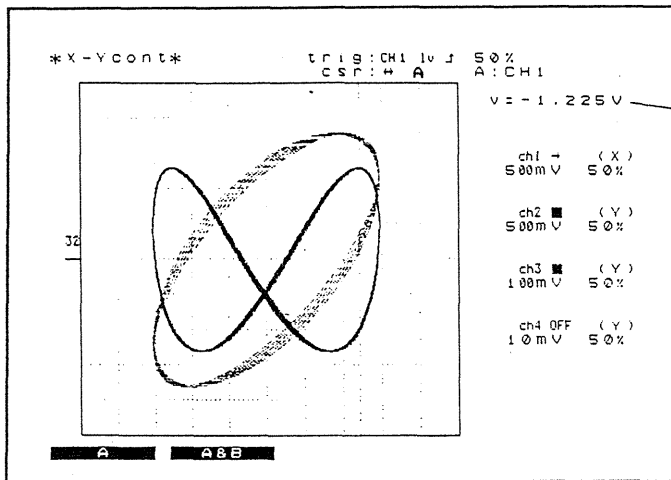

Voltage from origin on channel 1

Origin ("position" setting) for channel 1 input signal

② Using horizontal cursors on the y-axis

Using the A cursor only, determines the voltage (V) on the specified channel from the origin (the "position" setting, or 0 V); using both A and B cursors, determines the absolute voltage difference (ΔV) between the A and B cursors on their respective channels.

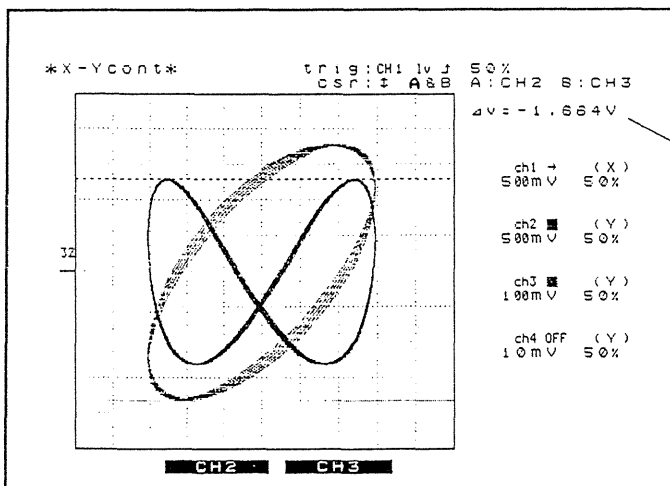

Finds voltage difference between cursors even when they are assigned to different channels

Note: In both cases ① and ② above, if the scaling function is enabled, you can read the scaled value directly. If, however, the A and B cursors are on different channels on the y-axis, and those channels have different units, then a difference cannot be read off.

5. Moving the cursors

- ① Press the knob select key so that only the lower LED (A · B CSR) is lit. In this state, the rotary knob controls the position of the cursors. Turning the knob clockwise moves the cursors up or to the right. Turning the knob counterclockwise moves the cursors down or to the left.

Note: See Section 4-2-2 "Rotary Knob and Knob Select Key" for a detailed description of rotary knob operation.



- ② Press the cursor select key to select which cursor or cursors to control.

Each time the key is pressed, the display changes as follows:

- A ... move the A cursor only.
- B ... move the B cursor only.
- A & B ... move both A and B cursors.

A displayed high intensity

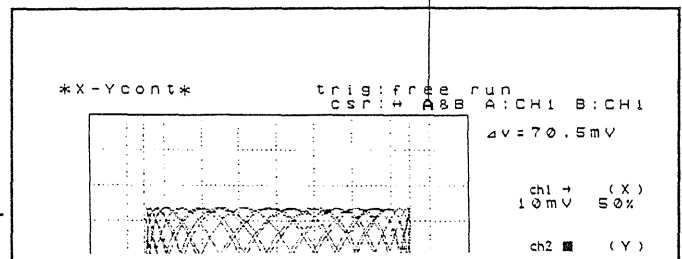

- A ... move the A cursor only. -----

B displayed high intensity

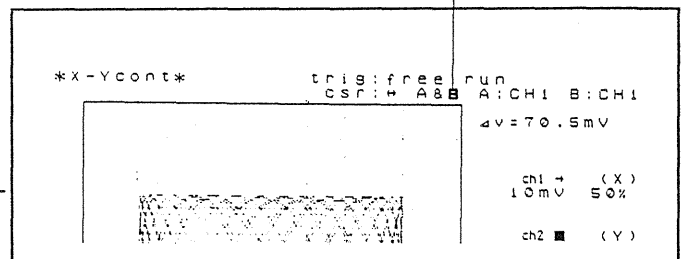

- B ... move the B cursor only. -----

A and B both high intensity

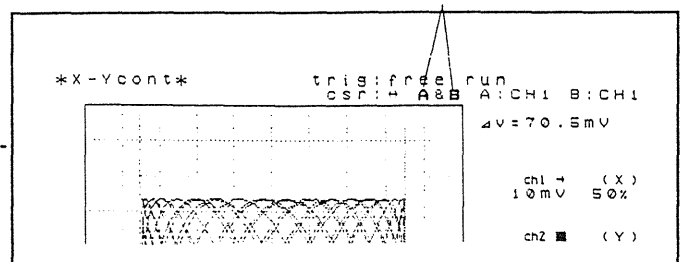

- A & B ... move both A and B cursors. -----

7-4-9 Printing Waveform Recordings

Function

There are two methods of printing

- (1) Pressing the PRINT key to print the X-Y plot. (The manual print function)
- (2) Pressing the COPY key to print the screen. (The screen dump function)

Procedure

(1) Manual print function

1. **PRINT**

Print the X-Y plot on the screen.

The A and B cursors have no effect on the printing (and do not appear on the recording).

(2) Screen dump function

1. **COPY**

Prints an exact copy of the screen.

Provided that an X-Y plot is displayed on the screen, pressing the COPY and FEED keys simultaneously prints a copy of the screen, followed by a listing of the settings, as follows.

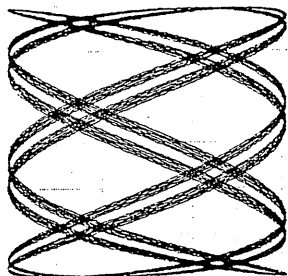
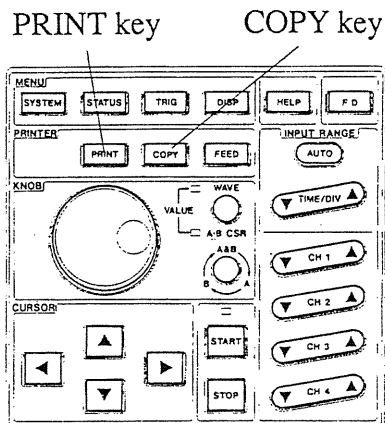

```

function :X-Ycont
-----
cursor:OFF
trigger :
  chl:LEVEL  50%
trigger time
  '91-08-30 10:35:52
-----
[CH1]  1V/DIV  DC x1
  (X)  pos:50%  fit:OFF
[CH2]  1V/DIV  DC x1
  DARK pos:50%  fit:OFF
[CH3]  10mV/DIV DC x1
  OFF  pos:50%  fit:OFF
[CH4]  10mV/DIV DC x1
  OFF  pos:50%  fit:OFF
-----
[log.e] :DARK
A:OFF
B:OFF
G:OFF
HIOKI 8851 MEMORY H1 CORDER
  '91-08-30 10:45
  
```

Notes

- When the screen is in other than display mode (excluding the floppy disk control mode), pressing the PRINT key produces a listing of settings. This is the same as the printing following the X-Y plot when the listing function is enabled. (See Section 18-5-7 "Listing and Gauge Functions," and Section 7-5 "Interpreting Waveform Displays and Recordings.")

Related items

You can select whether or not to print voltage scales (gauges) and listings of settings when using the manual print function. (See Section 18-5-7 "Listing and Gauge Functions" and Section 7-5 "Interpreting Waveform Displays and Recordings.")

7-5 Interpreting Waveform Displays and Recordings

- Display

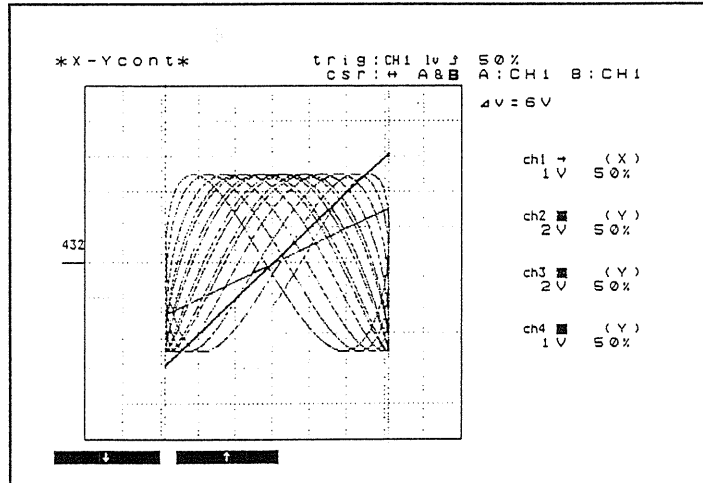

- Pressing COPY and FEED simultaneously

Listing of settings

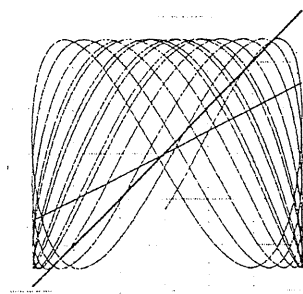

```

function :X-Ycont
-----
cursor: (→) A:CH1 B:CH1
Δv:6V
trigger
  ch1:LEVEL J 50%
trigger time
  '91-09-10 00:45:32
[CH1] 1V/DIV DC X1
(X) pos:50% filt:OFF
  -5V ~ 5V
[CH2] 2V/DIV DC X1
LIGHT pos:50% filt:OFF
  -10V ~ 10V
[CH3] 2V/DIV DC X1
LIGHT pos:50% filt:OFF
  -10V ~ 10V
[CH4] 1V/DIV DC X1
DARK pos:50% filt:OFF
  -5V ~ 5V
[log:1] :DARK
A:OFF
B:OFF
C:OFF
D:OFF
HIOKI 8851 MEMORY HI CORDER
          91-09-10 00:47
    
```

Trigger time (if the trigger sources all set off, pressing the START key determines the trigger time)

- Manual print

Setting of "position" Filter

Gauges (for the x-axis, read as though rotated clockwise through 90 degrees)

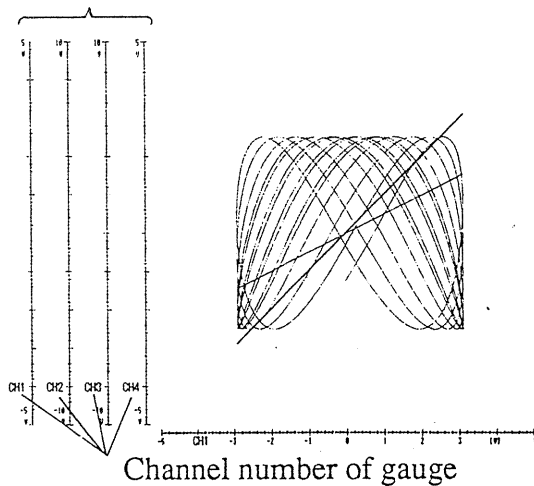

Listing

```

function X-Ycont
*** TRIGGER ***
trigger time
  '91-09-10 00:45:32
source
  OR
  ch1 :LEVEL
    level:50%
    slope:J
  ch2 :OFF
  ch3 :OFF
  ch4 :OFF
  external:OFF
trig timing:START
trigger source:OFF
-----
[log:1] :DARK
A:OFF
B:OFF
C:OFF
D:OFF
HIOKI 8851 MEMORY HI CORDER
          91-09-10 00:47
    
```

Trigger settings

Settings in system mode.

Section 8

Recorder and Memory Function Operation

Contents

| | | |
|--------|---|------|
| 8-1 | What is the Recorder and Memory Function? | 8-2 |
| 8-1-1 | Introduction..... | 8-2 |
| 8-1-2 | Finding Reference Material in this Manual | 8-3 |
| 8-2 | Screen Modes | 8-5 |
| 8-2-1 | Status Mode | 8-5 |
| 8-2-2 | Trigger Mode | 8-6 |
| 8-2-3 | Display Mode..... | 8-7 |
| 8-3 | Basic Operation Procedure..... | 8-9 |
| 8-3-1 | Operation Sequence | 8-9 |
| 8-3-2 | Operation Example | 8-10 |
| 8-4 | User Operations..... | 8-17 |
| 8-4-1 | Function Selection | 8-17 |
| 8-4-2 | Time Axis Range Setting..... | 8-19 |
| 8-4-3 | Shot Length Selection..... | 8-21 |
| 8-4-4 | Switching Between Recorder and Memory Recorder Waveform Displays..... | 8-22 |
| 8-4-5 | Format Selection | 8-23 |
| 8-4-6 | Interpolation Setting | 8-25 |
| 8-4-7 | Display and Recording Channel Settings | 8-27 |
| 8-4-8 | Input Unit Range, Position, Coupling and Filter Settings | 8-30 |
| 8-4-9 | Zero Adjustment | 8-33 |
| 8-4-10 | Trigger Settings | 8-34 |
| 8-4-11 | Starting and Stopping Measurement Operation | 8-38 |
| 8-4-12 | Using A and B Cursors | 8-39 |
| 8-4-13 | Memory Recorder Time Axis Zoom Function | 8-40 |
| 8-4-14 | Voltage Axis Zoom Function (See Sections 5-4-15 and 6-4-11)..... | 8-42 |
| 8-4-15 | Waveform Scrolling (See Sections 5-4-16 and 6-4-12)..... | 8-42 |
| 8-4-16 | Superimposition Function..... | 8-43 |
| 8-4-17 | Printing Waveform Recordings | 8-45 |
| 8-5 | Interpreting Waveform Displays and Recordings | 8-50 |

8-1 What is the Recorder and Memory Function?

8-1-1 Introduction

This function combines the recorder and memory recorder functions - while the recorder function is operating, a trigger event can start the memory recorder function, capturing required data and saving it to memory.

- When using the recorder function and envelope function to capture high-speed transient phenomena, it is still possible to use the memory recorder function to capture a section of the data at high resolution on the time axis.
- Simultaneous recorder and memory recorder operation
While the printer is producing a continuous record, you can use the memory recorder function for detailed waveform inspection on the screen.
- Reprinting
Whether waveform is held as recorder data (maximum 750 divisions) or memory recorder data (maximum 6000 divisions) it can be printed as many times as required.

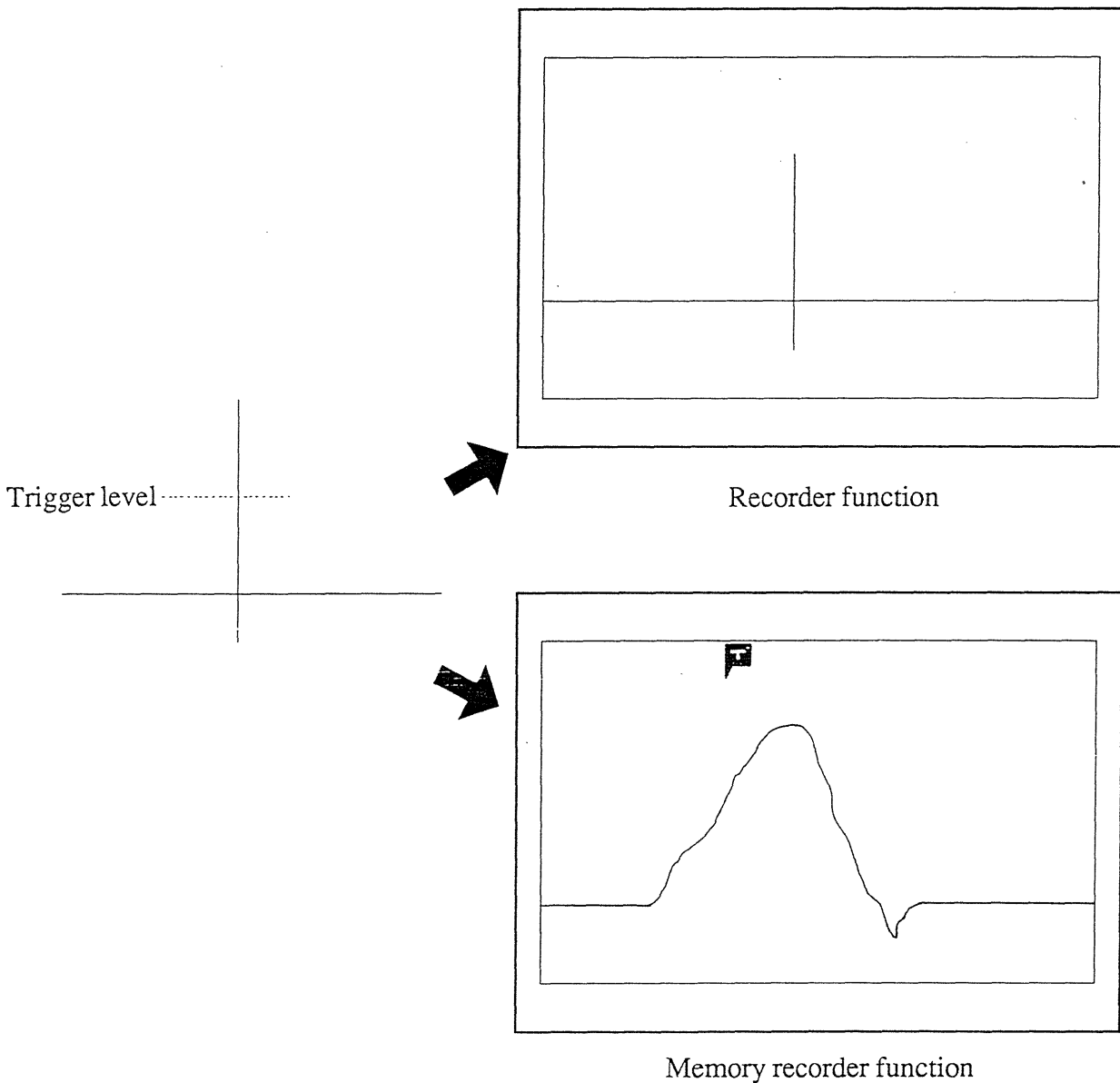

8-1-2 Finding Reference Material in this Manual

(1) Basic function

See Section 8-4 "User Operations" (Sections 8-4-1 to 8-4-17) for operational details.

(2) Trigger functions

See Section 14 (Vol. 2). Depending on the application, there is a wide range of trigger types to choose from.

(3) Memory division function

See Section 15 (Vol. 2).

The sequential save function allows a number of transient phenomena to be captured by the memory recorder function, even while the recorder is continuing to operate.

(4) Using floppy disks

See Section 19 (Vol. 2).

The floppy disk drive provides a long-term storage mechanism for setting information.

(5) Scaling function

See Section 18-3 "Scaling Function" (in Vol. 2). This allows the input voltages to be converted to other values and units, so that the physical quantities originally measured can be read off directly.

(6) Comment function

See Section 18-4 "Adding Comments" (in Vol. 2). This provides a convenient means of annotating printed recordings.

(7) Screen auto off function

(8) Grid setting

The grid can be selected as required, both on the screen and on the printed recording.

(9) Start key backup function

If the power supply fails during recording, enabling this function causes recording to restart when the power is restored.

(10) Channel marker function

Prints the channel numbers on the recording.

(11) Audible warning setting

(12) List and gauge functions

Voltage axis scales and listings of settings on printed recordings.

(13) Logic waveform display intensity

Logic channel waveforms can be displayed at two intensities.

(14) Smooth print function

This provides a memory recorder waveform printout close to analog quality.

See Section 18-5 "Special Function Settings" (in Vol. 2)

(15) Connection to a computer via the GP-IB interface

See Section 20 (Vol. 2).

(16) Output to an external plotter

See Section 18-7 "Plotter Output" (in Vol. 2).

(17) Self check functions

See Section 18-8 "Self Check Functions" (in Vol. 2). This performs simple tests on the unit's functioning.

(18) By switching functions, the full range of memory recorder processing functions is available for a captured waveform. Saving to floppy disk is also possible.

8-2 Screen Modes

This section describes the status, trigger and display modes.

It also shows you where to look in this manual for further explanation of specific items.

See Section 18 for details of the system mode, and see Section 19 for details of the floppy disk control mode.

8-2-1 Status Mode

Press the STATUS key to display the status screen.

Use the rotary knob to scroll the screen, or hold down the cursor  key to see the special function display.

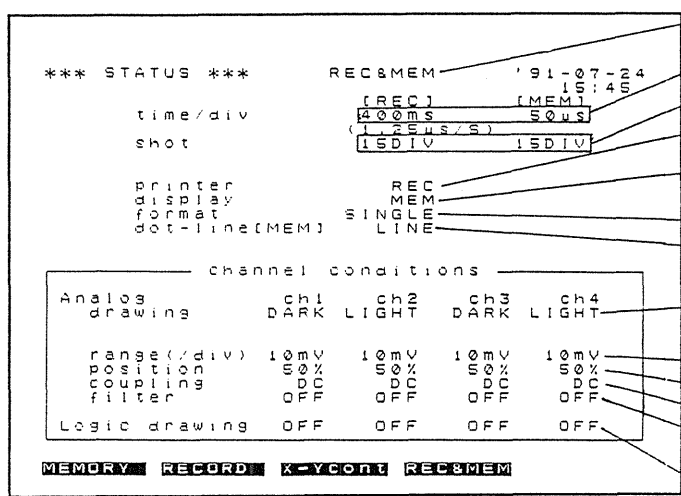

Function selected (See 8-4-1)
 Time axis range (See 8-4-2)
 Shot length (See 8-4-3)
 Recorder waveform printing (on/off)
 Displayed waveform setting (See 8-4-17)
 (See 8-4-4)
 Format (See 8-4-5)
 Memory recorder interpolation function
 Analog waveform display (See 8-4-6)
 and recording (See 8-4-7)
 Analog voltage range
 Analog waveform origin
 Input unit coupling
 Input unit filter
 (See 8-4-8)
 Logic waveform display
 and recording (See 8-4-7)

```

*** STATUS ***
REC&MEM          '91-07-24
                  15:45
time/div         [REC] [MEM]
shot            400ms 50us
                1.25us/S 1SDIV
Printer
display
format
dot-line(MEM)   REC
                  MEM
                  SINGLE
                  LINE

channel conditions
Analog drawing  DARK LIGHT DARK LIGHT
range(/div)    10mV 10mV 10mV 10mV
position       50% 50% 50% 50%
coupling       OFF DC  OFF DC  OFF DC  OFF DC
filter         OFF  OFF  OFF  OFF
Logic drawing  OFF  OFF  OFF  OFF

MEMORY RECORD K-YCONT REC&MEM
    
```

Status screen

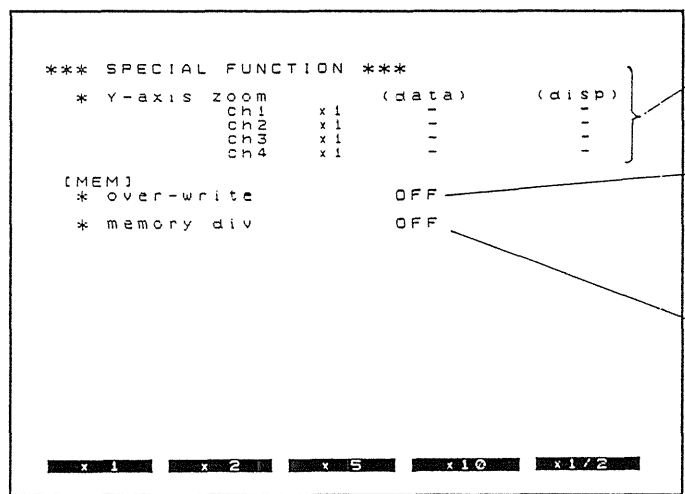

Voltage axis zoom function
 (See 8-4-14)
 Superimposition function
 (See 8-4-16)
 Memory recorder
 function
 Memory division function
 (See Section 15)

```

*** SPECIAL FUNCTION ***
* Y-axis zoom (data) (disp)
  ch1      x1      -
  ch2      x1      -
  ch3      x1      -
  ch4      x1      -
[MEM]
* over-write      OFF
* memory div      OFF

x1 x2 x5 x10 x1/2
    
```

Special function display

8-2-2 Trigger Mode

Press the TRIG key to display the trigger screen.

Use the rotary knob to scroll the screen, or hold down the cursor  key to see the recorder function trigger setting display.

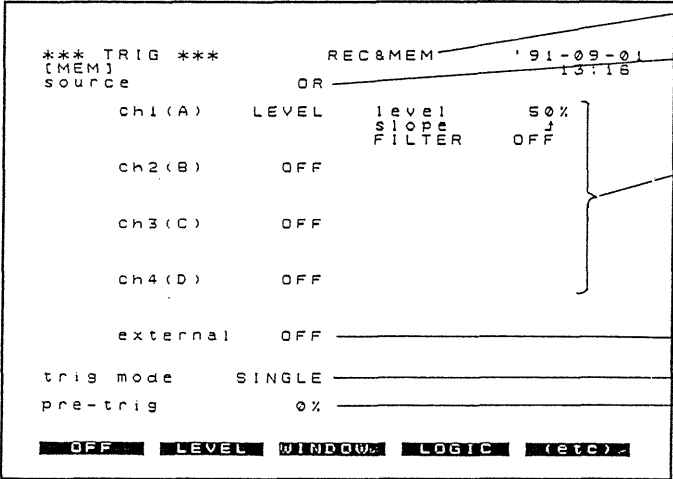

Function selected (See 8-4-1)

Logical operator (AND/OR) for internal and external triggers

Internal triggers

External trigger

Trigger mode

Pre-trigger

```

*** TRIG ***
[MEM]
source
  ch1(A)  LEVEL  level  50%
           OR    slope  4%
           OR    filter OFF
  ch2(B)  OFF
  ch3(C)  OFF
  ch4(D)  OFF
  external OFF
  tris mode SINGLE
  pre-trig 0%
  OFF  LEVEL WINDOW LOGIC (etc)
  
```

Memory recorder trigger settings

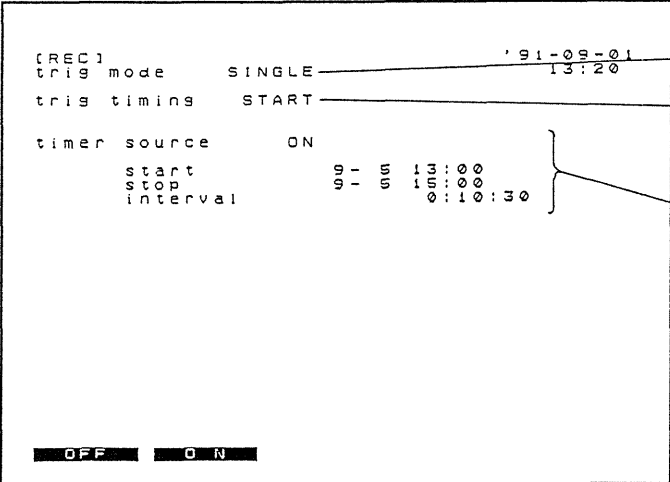

Trigger mode

Trigger timing

Timer trigger

```

[REC]
tris mode SINGLE
tris timing START
timer source ON
  start 00 11 00 13:00
  stop 00 11 00 15:00
  interval 0:10:30
  OFF  ON
  
```

Recorder trigger settings

8-2-3 Display Mode

Press the DISP key to enter the display mode.

The following figures illustrate the display for both a recorder waveform display and a memory recorder waveform display. (See Section 8-4-4 "Switching Between Recorder and Memory Recorder Waveform Displays.")

The examples here show the display in single format. (See Section 8-4-5 "Format Selection.")

Recorder waveform display

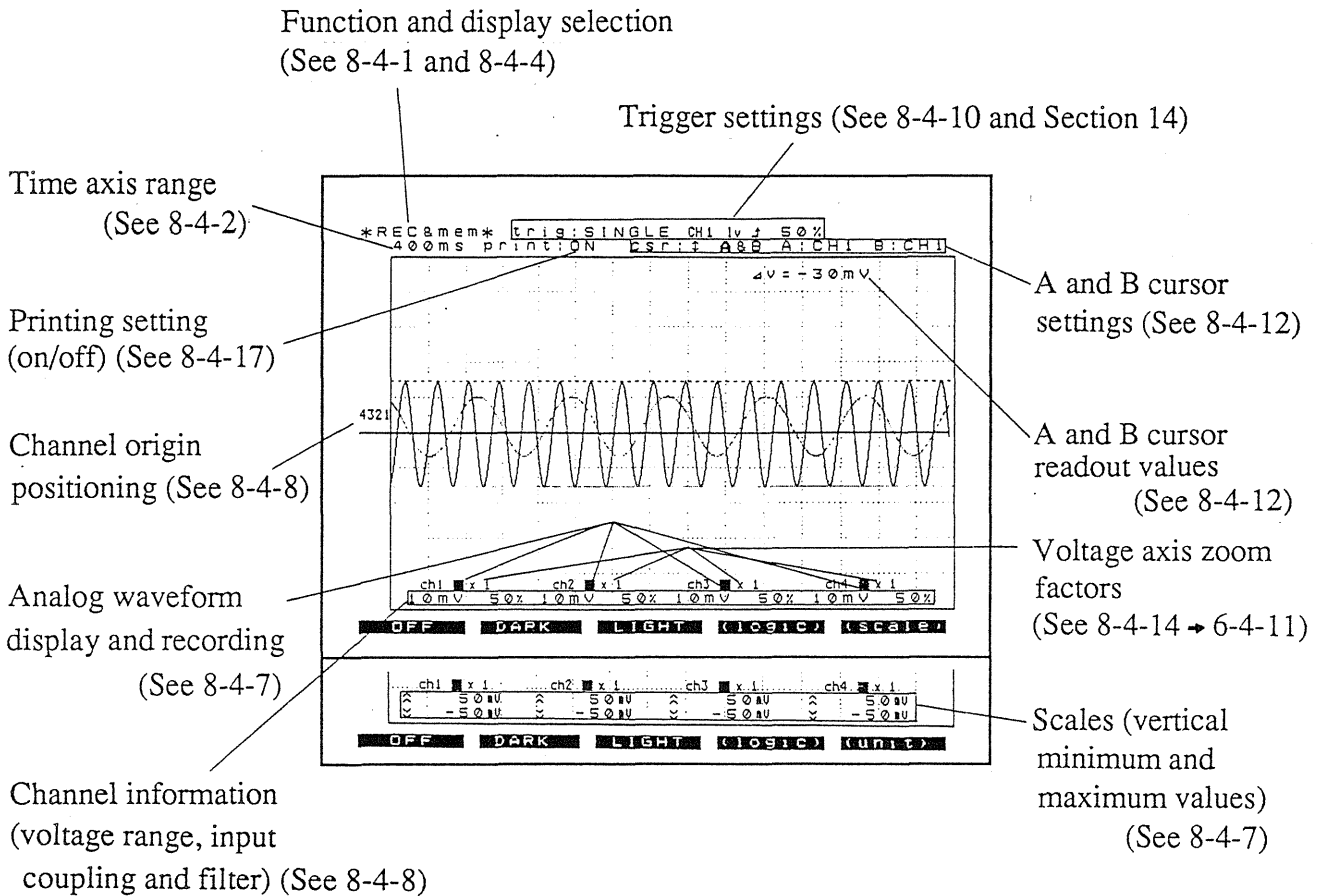

Memory recorder waveform display

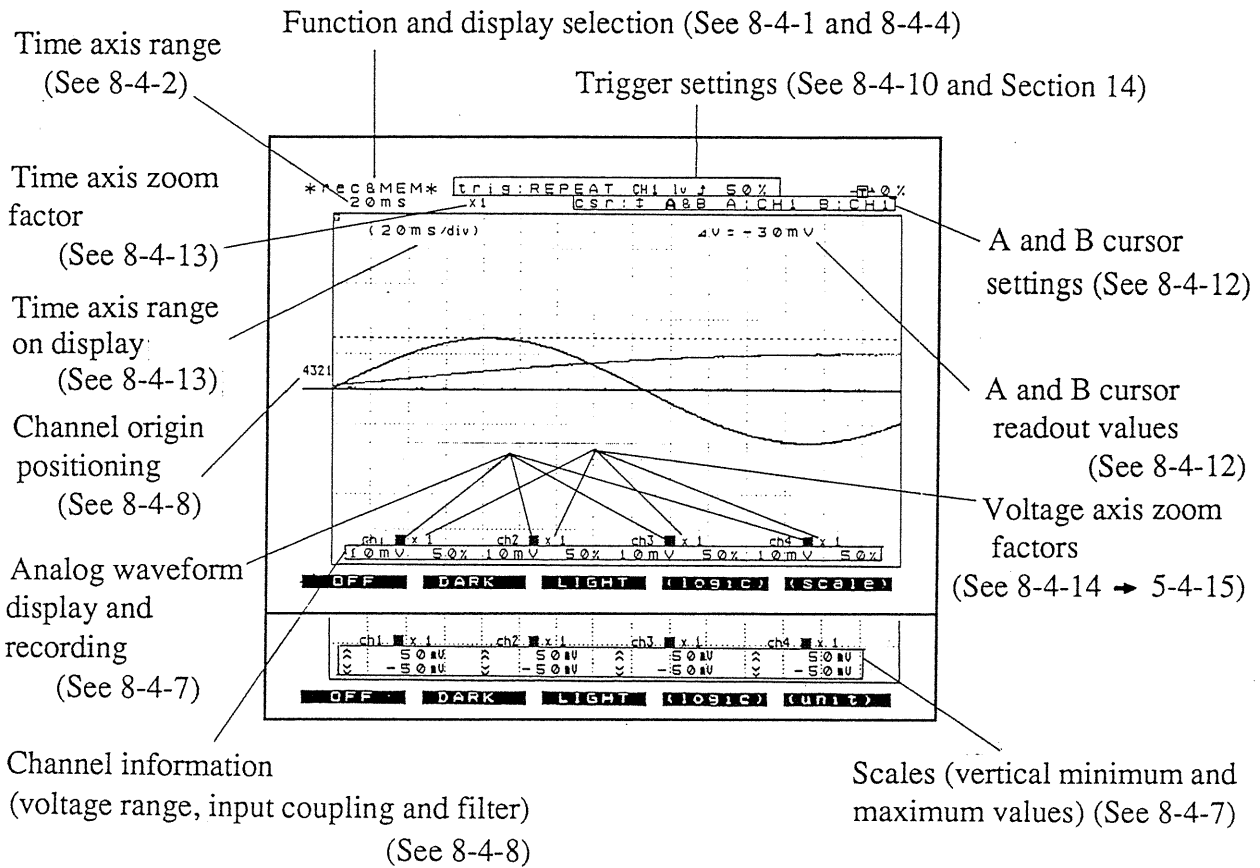

8-3 Basic Operation Procedure

8-3-1 Operation Sequence

The flowchart below illustrates the sequence of operations involved in using the memory recorder function. (The explanation to the right of the flowchart boxes is based on Section 8-3-2 "Operation Example.")

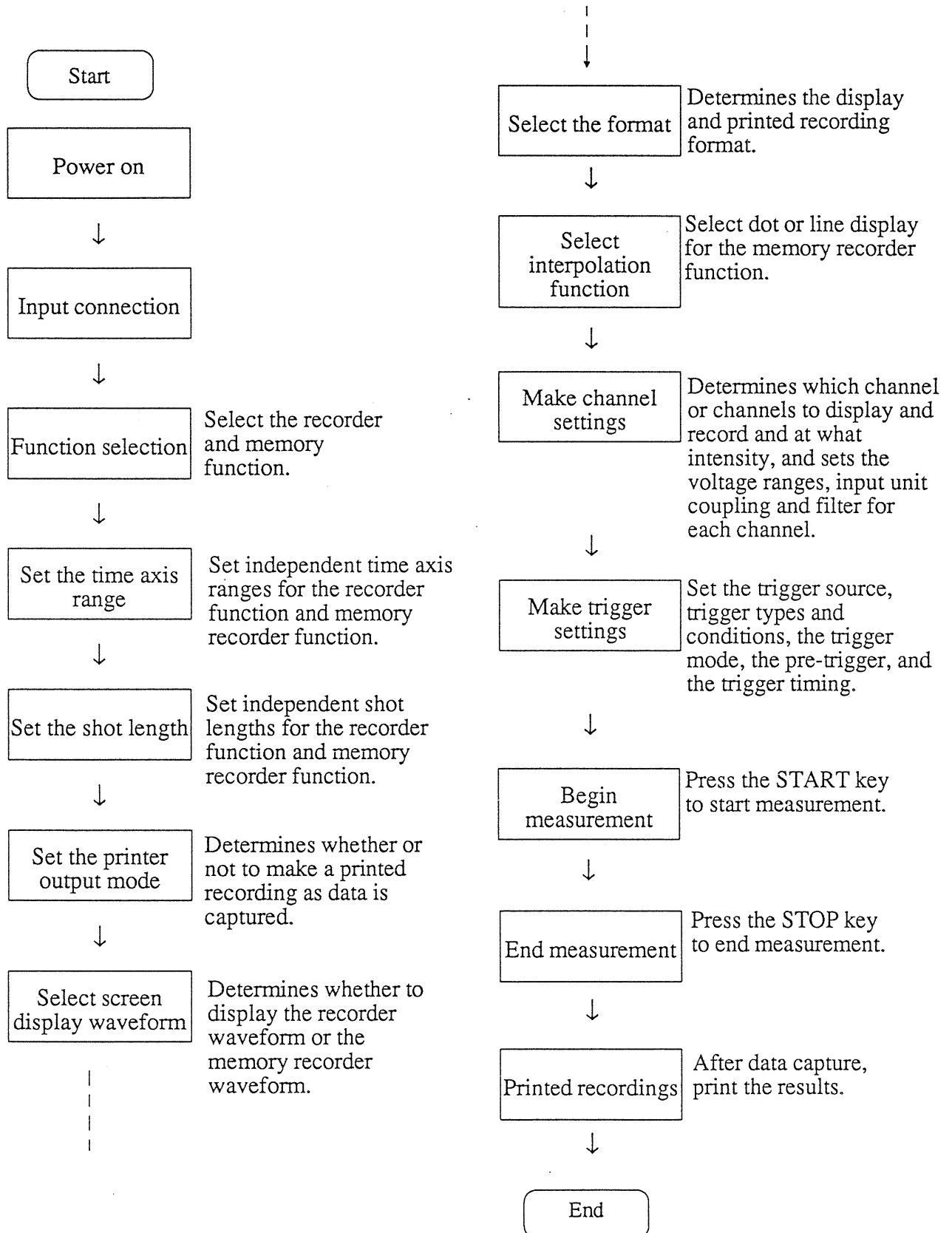

8-3-2 Operation Example

This example illustrates the basic procedure for using the recorder and memory function; as an example, the 8851 is connected to a signal generator, and we capture the waveform when the signal generator is powered on.

(1) Power on the unit

Connect the power cord to the 8851 and press the power switch.

(2) Input connection

Connect a signal generator to the input terminals of channel 1 (the 8944 analog input unit). Set the signal generator so that it outputs a 8 V p-p 1 kHz sine wave. After setting, power off the signal generator.

(3) Select the function

Select the recorder and memory function.

1. Press the STATUS key.
2. Move the flashing cursor to the function indication.
3. Press the **REC&MEM** soft key.

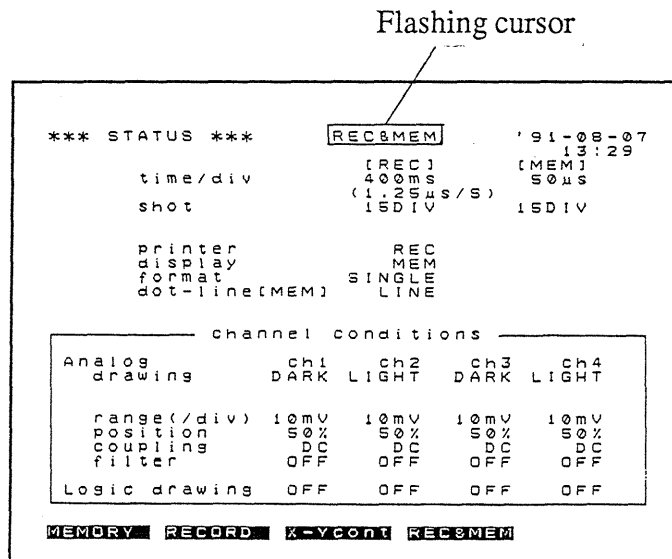

(4) Set the time axis range

Set the time axis range to 1 s/division for the recorder function (chart speed 1 cm/s) and to 1 ms/division for the memory recorder function.

1. Either use the TIME/DIV key, or move the flashing cursor to the "time/div [REC]" item and adjust the value with the **↑** and **↓** soft keys or the rotary knob, so that the setting is 1 s.
2. Move the flashing cursor to the "time/div [MEM]" item and adjust the value with the **↑** and **↓** soft keys or the rotary knob, so that the setting is 1 ms.

Note: The value in parenthesis under the "time/div [REC]" item is the sampling period.

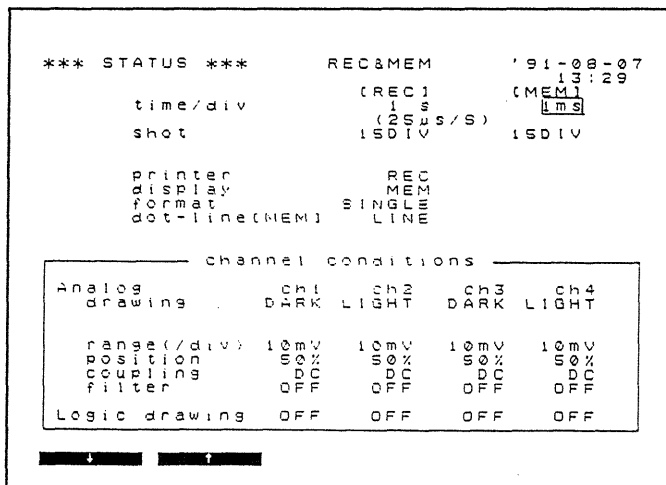

(5) Set the shot length

Set a continuous shot length for the recorder function, and the shot length for the memory recorder to 30 divisions.

1. Move the flashing cursor to the "shot [REC]" item, and adjust the value with the and soft keys or the rotary knob, so that the setting is CONT.
2. Move the flashing cursor to the "shot [MEM]" item, and adjust the value with the and soft keys or the rotary knob, so that the setting is 30DIV.

```
*** STATUS ***      REC&MEM      '91-08-07
                    [REC]      [MEM]
                    1 S      1ms
                    (25μs/S)
                    CONT      30DIV

printer            REC
display           MEM
format            SINGLE
dot-line(MEM)    LINE

channel conditions
-----
Analog            ch1   ch2   ch3   ch4
drawing          DARK  LIGHT  DARK  LIGHT

range(/div)     10mV  10mV  10mV  10mV
position        50%   50%   50%   50%
coupling        DC    DC    DC    DC
filter          OFF   OFF   OFF   OFF
Logic drawing   OFF   OFF   OFF   OFF
```

(6) Set the printer output mode

Set the printer output mode so that as soon as the recorder function is started by the START key, printed recording begins.

1. Move the flashing cursor to the "printer" item.
2. Press the soft key.

```
*** STATUS ***      REC&MEM      '91-08-07
                    [REC]      [MEM]
                    1 S      1ms
                    (25μs/S)
                    CONT      30DIV

printer            REC
display           MEM
format            SINGLE
dot-line(MEM)    LINE

channel conditions
-----
Analog            ch1   ch2   ch3   ch4
drawing          DARK  LIGHT  DARK  LIGHT

range(/div)     10mV  10mV  10mV  10mV
position        50%   50%   50%   50%
coupling        DC    DC    DC    DC
filter          OFF   OFF   OFF   OFF
Logic drawing   OFF   OFF   OFF   OFF

OFF      REC
```

(7) Select screen display waveform

Set the screen to display the memory recorder waveform.

1. Move the flashing cursor to the "display" item.
2. Press the soft key.

```
*** STATUS ***      REC&MEM      '91-08-07
                    [REC]      [MEM]
                    1 S      1ms
                    (25μs/S)
                    CONT      30DIV

printer            REC
display           MEM
format            SINGLE
dot-line(MEM)    LINE

channel conditions
-----
Analog            ch1   ch2   ch3   ch4
drawing          DARK  LIGHT  DARK  LIGHT

range(/div)     10mV  10mV  10mV  10mV
position        50%   50%   50%   50%
coupling        DC    DC    DC    DC
filter          OFF   OFF   OFF   OFF
Logic drawing   OFF   OFF   OFF   OFF

REC      MEM
```

(8) Select the format

Select the single format: displaying and recording on a single time axis.

1. Move the flashing cursor to the "format" item.
2. Press the **SINGLE** soft key.

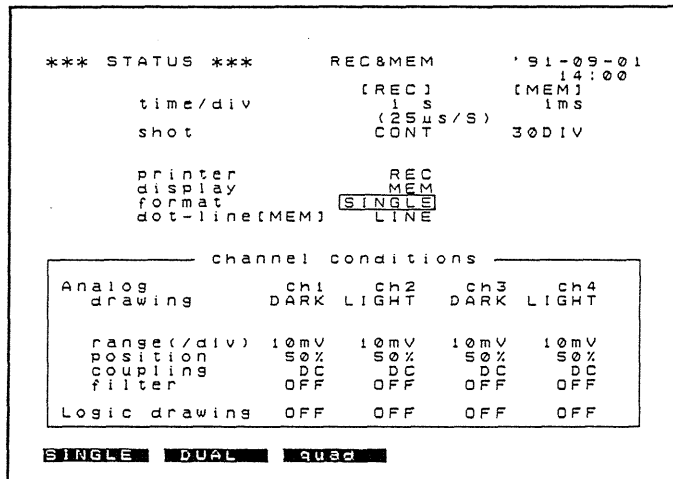

(9) Select interpolation function

Select the straight line interpolation function (LINE).

1. Move the flashing cursor to the "dot-line [MEM]" item.
2. Press the **LINE** soft key.

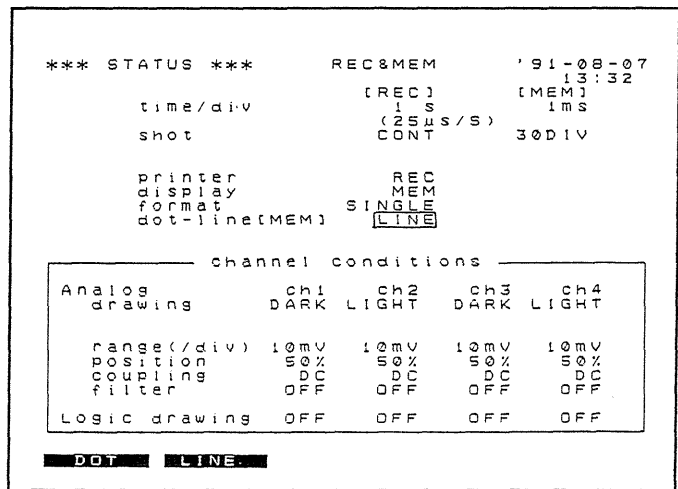

(10) Make channel settings

Display and record channel 1 only, in high intensity. Set the voltage range to 5 V/division, the origin positioning to 50%, input coupling to DC and the input filter off.

1. Flashing cursor ... "ch1 Analog drawing"
Press the **DARK** soft key.
2. Flashing cursor ... "ch1 range"
Set to 5 V.
You can also use the channel 1 range key, without moving the flashing cursor.
3. Flashing cursor ... "ch1 position"
Set to 50%.
4. Flashing cursor ... "ch1 coupling"
Press the **DC** soft key.
5. Flashing cursor ... "ch1 filter"
Press the **OFF** soft key.
6. Flashing cursor ... "ch1 Logic drawing"
Press the **OFF** soft key.
7. Similarly set the "Analog drawing" and "Logic drawing" items for channels 2, 3 and 4 all off.

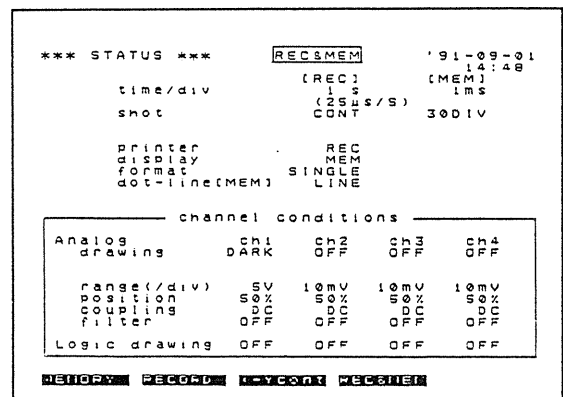
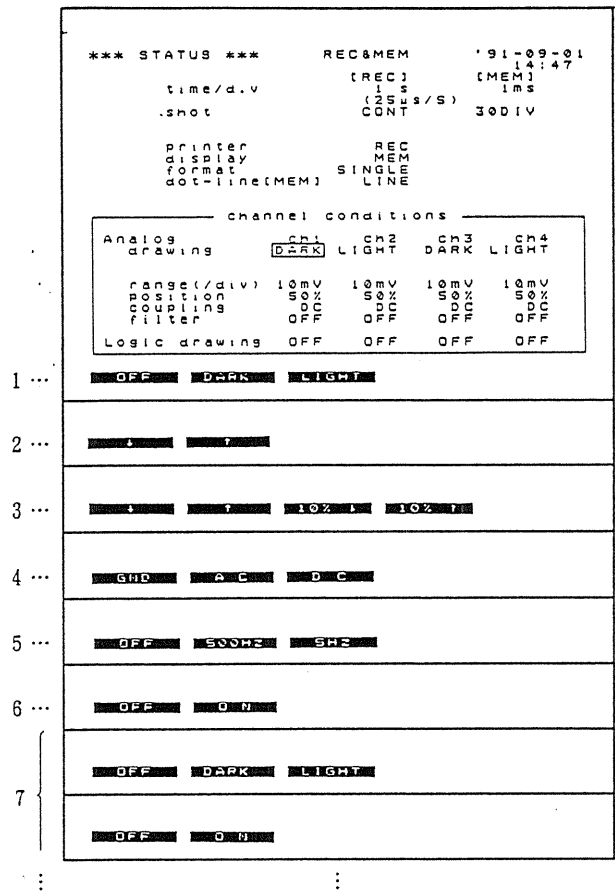

Screen after settings have been made

(11) Make trigger settings

Memory recorder function ... use only channel 1 as a window trigger source; set the upper level to 55%, the lower level to 45%, and select the logical OR of the channels. Set the trigger mode to single, and the pre-trigger to 10%.

Recorder function ... set the trigger mode to single, the trigger timing to START, and the timer trigger off.

Switch off the timer trigger.

1. Press the TRIG key.

First make the memory recorder settings.

2. Flashing cursor ... "source" (at the top)

Press the **OR** soft key.

3. Flashing cursor ... "ch1(A)"

Press the **WINDOW** soft key.

4. Flashing cursor ... "upper"

Set to to 55%.

5. Flashing cursor ... "lower"

Set to to 45%.

6. Set all of channels 2 (B), 3 (C) and 4 (D) off.

7. Flashing cursor ... "external"

Press the **OFF** soft key.

8. Flashing cursor ... "trig mode"

Press the **SINGLE** soft key.

9. Flashing cursor ... "pre-trig"

Set to 10%.

```

*** TRIG ***          RECSMEM          '91-09-01
(MEM) source          OR              14:51
ch1(A)               OFF
ch2(B)               OFF
ch3(C)               OFF
ch4(D)               OFF
external              OFF

trig mode            SINGLE
pre-trig              0%

2...  OR      AND
3...  OFF     LEVEL WINDOW LOGIC  TRIG
4...  OFF     TRIG
5...  OFF     TRIG
6...  OFF     LEVEL WINDOW LOGIC  TRIG
7...  OFF     LEVEL WINDOW LOGIC  TRIG
8...  OFF     ON
9...  SINGLE REPEAT
10... SINGLE REPEAT
11... START  STOP  -  -  -
12... OFF     ON
    
```

```

*** TRIG ***          RECSMEM          '91-09-01
(MEM) source          OR              14:59
ch1(A) WINDOW        upper          55%
                     lower          45%
ch2(B)               OFF
ch3(C)               OFF
ch4(D)               OFF
external              OFF

trig mode            SINGLE
pre-trig              10%

RECORD RECORD RECORD RECORD
    
```

Screen after settings have been made

Screen appearance after completing settings

Next make the recorder trigger settings.
(The soft key indications are shown on the previous page.)

10. Flashing cursor ... "trig mode"

Press the **SINGLE** soft key.

11. Flashing cursor ... "trig timing"

Press the **START** soft key.

12. Flashing cursor ... "timer source"

Press the **OFF** soft key.

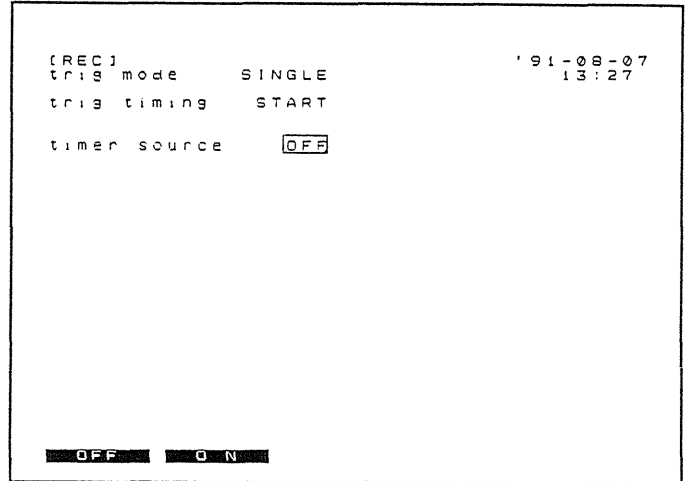

Screen after settings have been made

(12) Starting measurement

Press the START key to start measurement operation. The printer will begin to output the waveform from the recorder function.

1. Press the START key.

The LED above the START key lights.

2. After about five seconds, power on the signal generator.

As the output of the signal generator comes on, the memory recorder function captures 30 divisions of data. When this data capture is complete, the waveform is displayed on the screen.

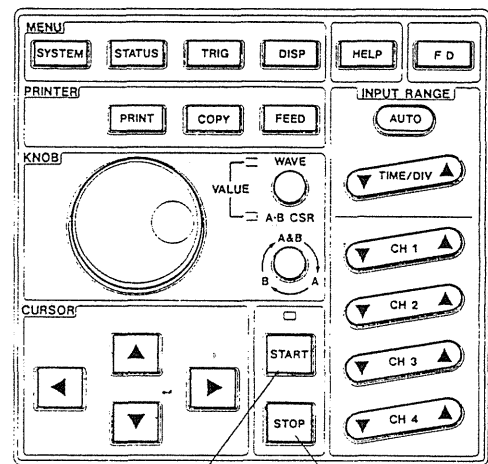

START key

STOP key

(13) Ending measurement

Since the recorder function shot length is set to continuous, the unit will continue to record until you press the STOP key.

1. Press the STOP key.

The LED above the START key goes off.

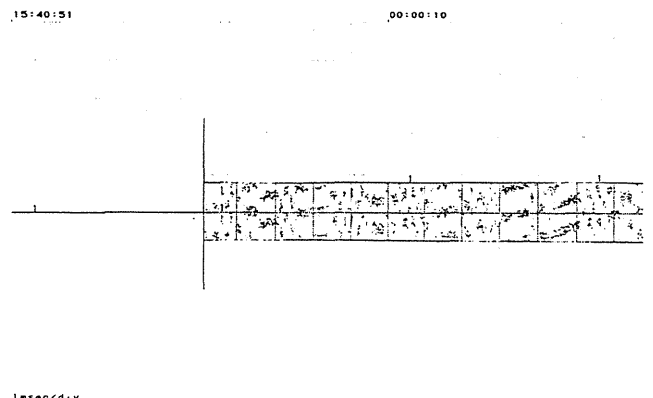

Recorder function waveform

(14) Printing the memory recorder waveform

Press the COPY and FEED keys simultaneously to copy the displayed memory recorder waveform to the printer.

1. Press the COPY and FEED keys simultaneously.

The waveform on the screen and the setting information is printed.

Since the 8851 uses thermally sensitive paper, to keep a permanent copy of the recording, it is recommended to take a photocopy.

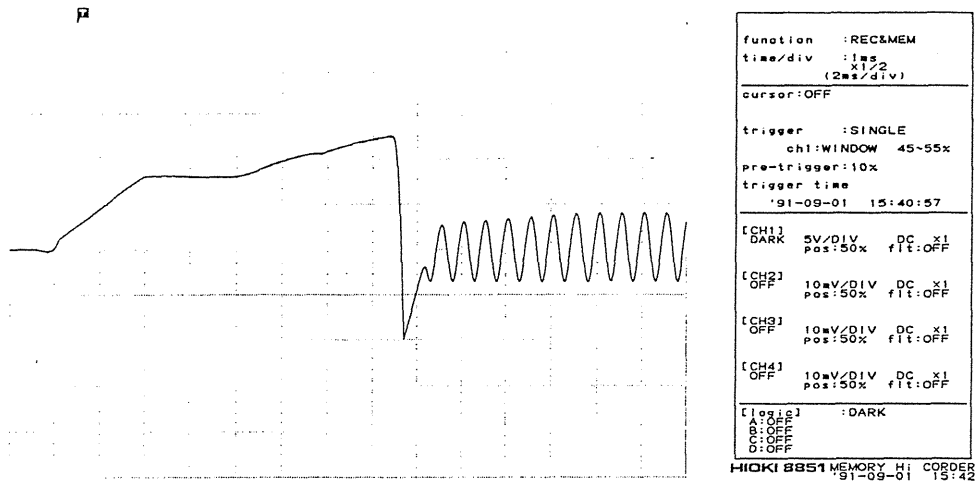

Memory recorder waveform

(With X1/2 compression factor applied to the time axis)

8-4 User Operations

8-4-1 Function Selection

Function

First select the function to be used for measurement. There are four functions: memory recorder, recorder, X-Y recorder, and recorder and memory. In this case, select the recorder and memory function.

Procedure

You can carry out the setting in status mode, trigger mode or display mode.

(1) In status mode

1. Select status mode.

2. Function selection

Press the **REC&MEM** soft key.

This selects the recorder and memory function.

(MEMORY, RECORDER, X-Ycont, REC&MEM)

(Soft key indication is "RECORD".)

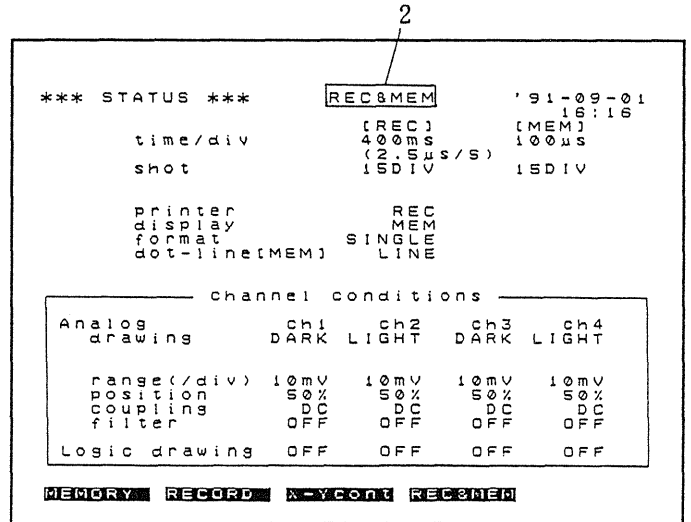

(2) In trigger mode

After pressing the TRIG key for the trigger mode, make the function selection in the same way as in the status mode. The soft key indications are the same.

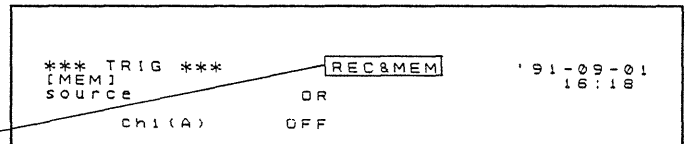

(3) In display mode

1. Select the display mode.
2. Select the function, and the waveform display.

Press the **REC&MEM** soft key to select the recorder and memory function in the same way as in the status mode. At this time the soft key indications change, to **REC&mem** and **rec&MEM**, indicating the waveform to be displayed in capitals.

(MEM, REC, X-Ycont, REC&mem, rec&MEM)

MEM: short for MEMORY

REC: short for RECORDER.

Soft key indication is RECORD.

REC&mem: display recorder waveform.

rec&MEM: display memory recorder waveform.

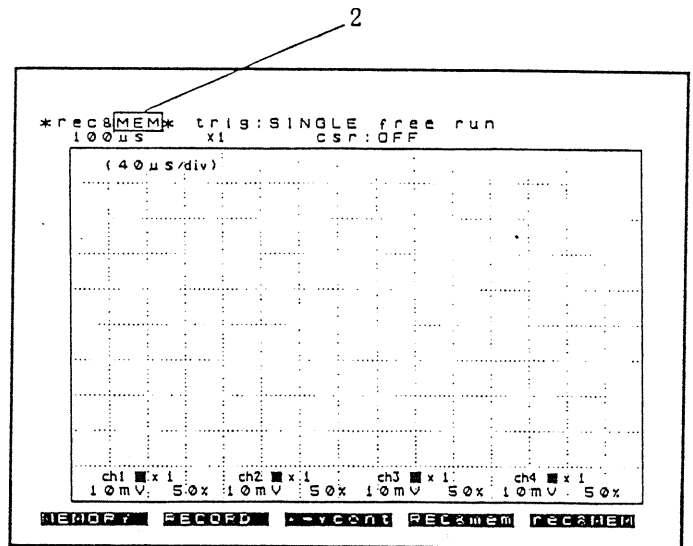

8-4-2 Time Axis Range Setting

Function

This sets the speed at which the input signal waveform is captured (memory recorder function) and the chart speed (recorder function).

The "time/div" setting indicates the time for one division on the time axis.

For both recorder and memory recorder functions, the sampling period is 1/40 of the memory recorder time axis range setting.

Procedure

You can carry out the setting in status mode or display mode.

(1) In status mode

1. Select the status mode.
2. "time/div" [REC] [MEM]

Set the time axis range for each of the two functions.

By using the TIME/DIV key, you can set the time axis range for the recorder function without moving the flashing cursor.

[REC] ... (400 ms, 500 ms, 1 s, 2 s, 5 s, 10 s, 20 s, 1 min, 2 min, 5 min, 10 min, 20 min, 1 hour)

[MEM] ... (100 μ s, 200 μ s, 500 μ s, 1 ms, 2 ms, 5 ms, 10 ms, 20 ms, 50 ms, 100 ms, 200 ms, 500 ms, 1 s, 2 s, 5 s)

Note: Some combinations of recorder and memory recorder time axis settings are not possible. See Section 2-2 "Tables" for details. Changing the recorder time axis setting may, therefore, automatically change the memory recorder time axis setting.

3. The value in parenthesis under the "time/div [REC]" item indicates the sampling period. This is 1/40 of the memory recorder time axis setting.

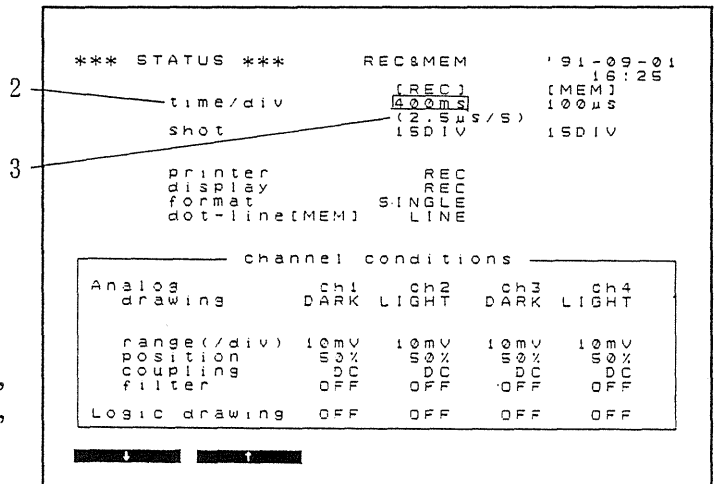

(2) In display mode

1. Select the display mode.
2. Set the time axis range for the recorder function.

By using the TIME/DIV key, you can set the time axis range without moving the flashing cursor.

(400 ms, 500 ms, 1 s, 2 s, 5 s, 10 s, 20 s, 1 min, 2 min, 5 min, 10 min, 20 min, 1 hour)

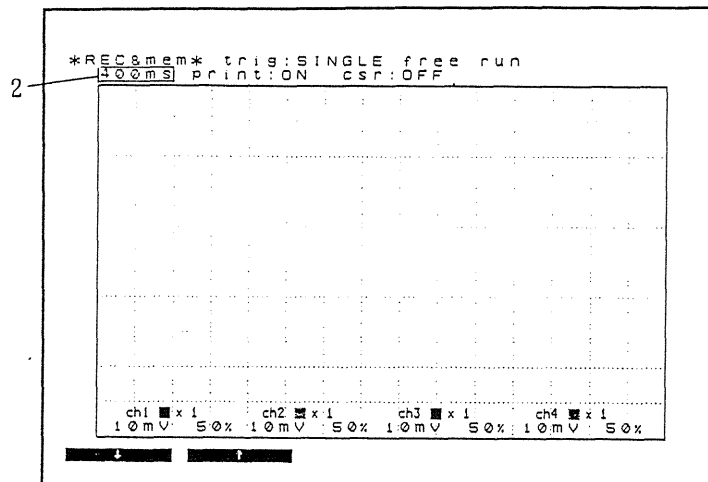

Recorder waveform display

3. Set the time axis range for the memory recorder function.

By using the TIME/DIV key, you can set the time axis range without moving the flashing cursor.

(100 μ s, 200 μ s, 500 μ s, 1 ms, 2 ms, 5 ms, 10 ms, 20 ms, 50 ms, 100 ms, 200 ms, 500 ms, 1 s, 2 s, 5 s)

See the procedure in status mode (1) above and Section 2-2 "Tables" for details of the relationship between the two time axis settings.

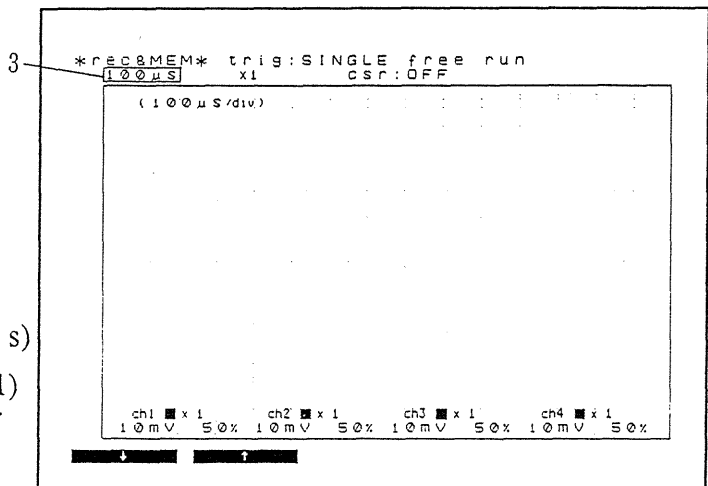

Memory recorder waveform display

Note: See Section 8-4-4 "Switching Between Recorder and Memory Recorder Waveform Displays" for more details.

8-4-3 Shot Length Selection

Function

Sets the recording length (number of divisions) for a single shot measurement of both recorder and memory recorder functions.

Procedure

1. Select the status mode.

2. "shot" [REC] [MEM]

Set the two shot lengths.

[REC] (15, 30, 75, 150, 300,
750DIV, CONT)

[MEM](15, 30, 75, 150, 300,
750, 1500, 3000, 6000DIV)

```
*** STATUS ***      REC&MEM      '91-09-01
                    [REC]         16:59
                    400ms         [MEM]
                    (2 S/s)       100us
                    15DIV         15DIV

printer            REC
display           MEM
format            SINGLE
dot-line(MEM)    LINE
```

| channel conditions | | | | |
|--------------------|------|-------|------|-------|
| Analog | ch1 | ch2 | ch3 | ch4 |
| drawing | DARK | LIGHT | DARK | LIGHT |
| range(/div) | 10mV | 10mV | 10mV | 10mV |
| position | 50% | 50% | 50% | 50% |
| coupling | DC | DC | DC | DC |
| filter | OFF | OFF | OFF | OFF |
| Logic drawing | OFF | OFF | OFF | OFF |

8-4-4 Switching Between Recorder and Memory Recorder Waveform Displays

Function

This function switches the screen display between the recorder waveform and the memory recorder waveform.

Procedure

You can switch in status mode or display mode.

(1) In status mode

1. Select the status mode.
2. "display"

Select whether to show the recorder waveform or the memory recorder waveform in the display mode.

(REC, MEM)

REC display recorder waveform.

MEM display memory recorder waveform.

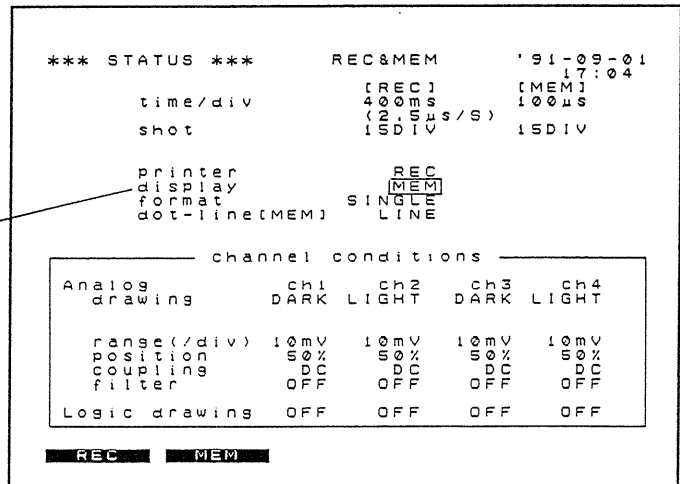

(2) In display mode

1. Select the display mode.
2. Select whether to show the recorder waveform or the memory recorder waveform.

You can also switch to a different function.

(MEMORY, RECORD, X-Ycont, REC&mem, rec&MEM)

REC&mem: display recorder waveform.

rec&MEM: display memory recorder waveform.

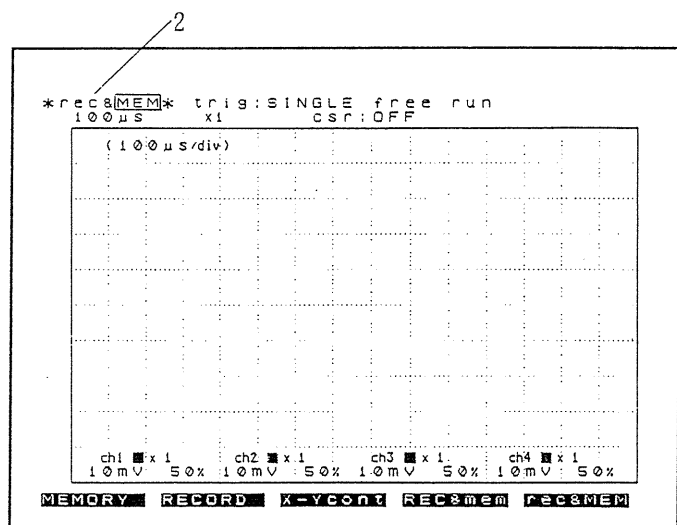

8-4-5 Format Selection

Function

Selects the format for display and printing. There are three possibilities: single, dual, and dual (print quad).

The recorder and memory recorder functions both use the same setting.

Display and printing formats

(1) Single

The waveforms are displayed or printed superimposed on a single time axis. (Maximum 4 analog waveforms and 16 logic signals)

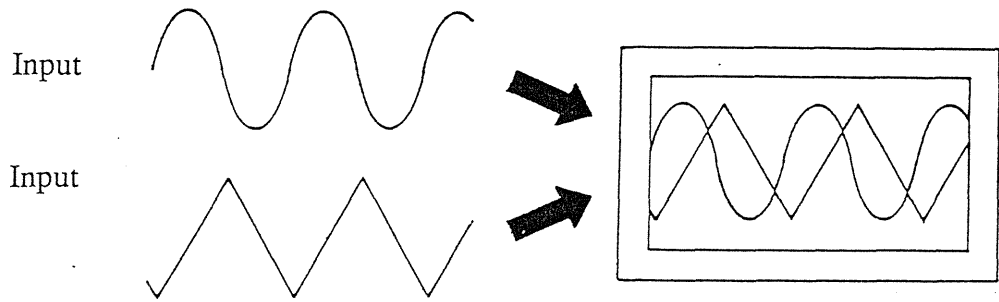

(2) Dual

The waveforms are displayed or printed on two time axes, one above the other. (Maximum 4 analog waveforms and 8 logic signals in each window)

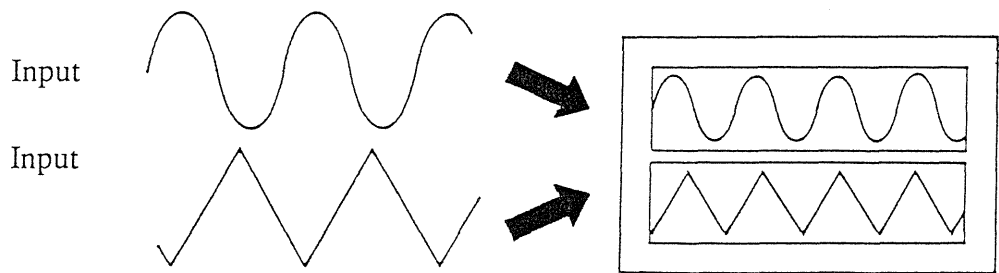

(3) Dual (print quad)

The waveforms are printed on four time axes. (Maximum 1 analog waveform and 4 logic signals on each axis)

The display format is the same as in dual format.

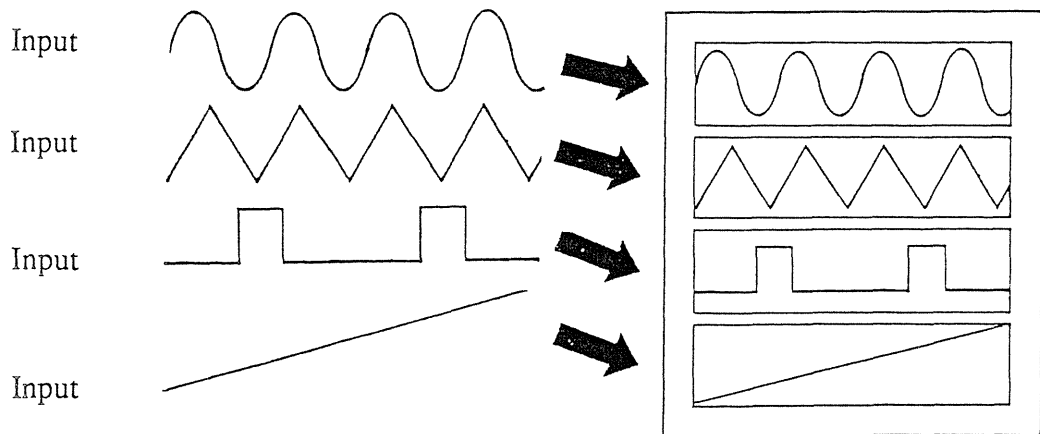

Printed output only

Procedure

1. Select the status mode.

2. "format"

Select the format for display and printing.

Pressing the **quad** soft key selects the **DUAL** (print quad) format.

(SINGLE, DUAL, DUAL (print quad))

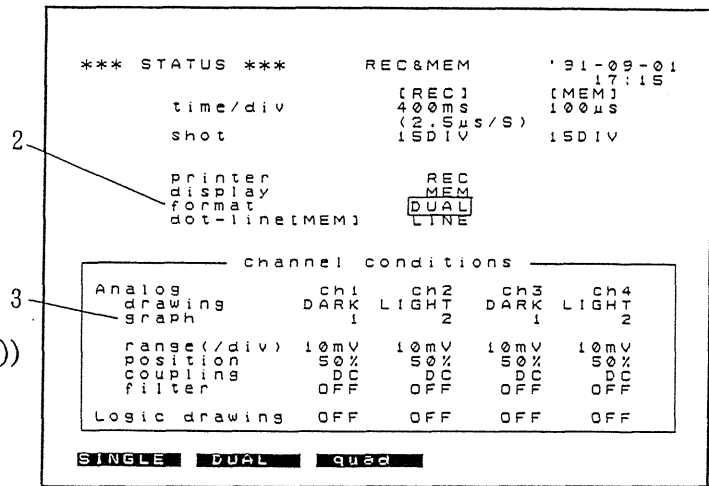

3. "graph"

If DUAL or DUAL (print quad) format was selected in step 2, use these settings to assign each analog input to one of the two display windows (1 or 2).

1 .. upper window (time axis)

2 .. lower window (time axis)

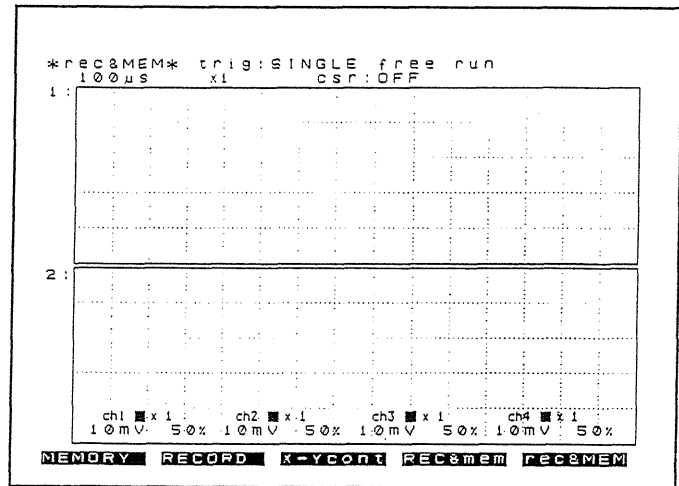

Notes

- In DUAL (print quad) format, the printer automatically assigns the four analog channels one to each of the four time axes, in sequence channel 1 to channel 4. See the **Notes** on format selection in Sections 5-4-5 and 6-4-4.
- The logic channel display and recording positions are not variable. See the **Notes** on display and recording channel settings in Sections 5-4-8 and 6-4-5.
- When using the recorder and memory function, the memory recorder X-Y format is not available.

8-4-6 Interpolation Setting

Function

This function determines whether to display and record the memory recorder sampled data as detached points (dot mode) or with straight-line interpolation (line mode).

The recorder function display is not affected by this setting, and always uses straight-line interpolation.

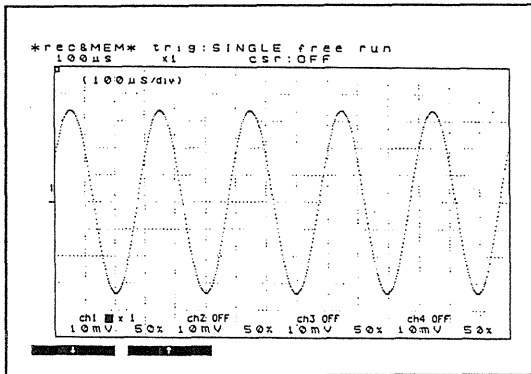

Dot mode

No linear interpolation.
The sampled values are displayed exactly as measured.

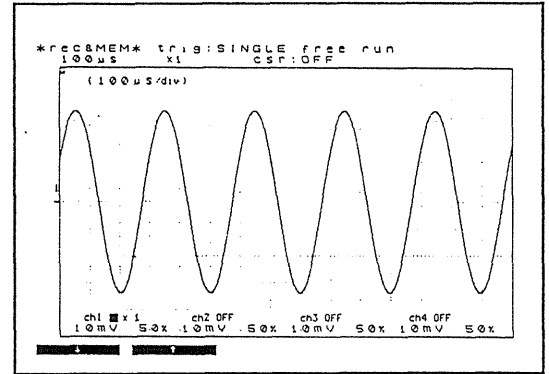

Line mode

Linear interpolation.
This gives a more readable display.

Procedure

1. Select the status mode.
2. "dot-line" [MEM]
Select whether or not to carry out linear interpolation on the memory recorder data.
(DOT, LINE)

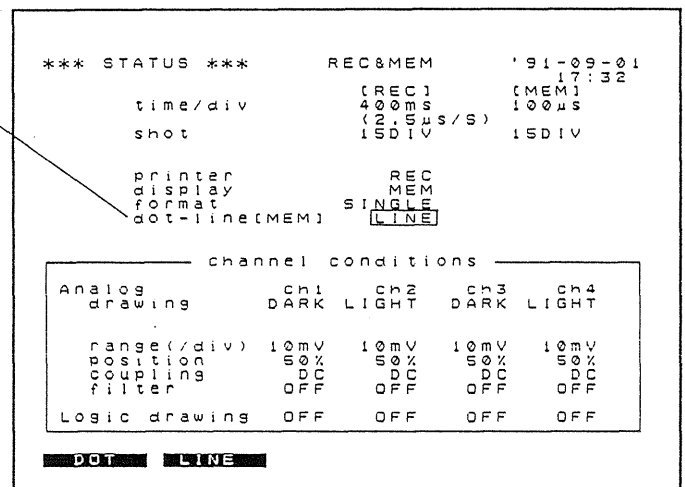

Notes

- This setting affects the display only, and is therefore effective for previously captured data.
- If using a long shot length, and compressing the time axis, any setting which requires the screen to be redrawn (such as scrolling on the voltage axis) can take an appreciable time.
- Logic channel displays are not affected by this setting. They are always subject to linear interpolation between samples.

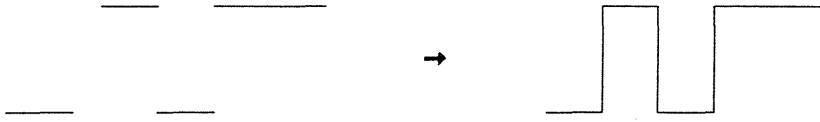

8-4-7 Display and Recording Channel Settings

Function

A maximum of four analog channels and 16 logic channels are available on the 8851.

These settings determine which channels are displayed or recorded.

The analog channels can each be set independently, but the logic channels can only be set in groups of four.

Procedure

You can carry out these settings in status mode or display mode.

(1) In status mode

1. Select the status mode.

2. "Analog drawing"

This setting determines for each analog channel whether or not it is displayed and printed, and if so at what intensity.

(OFF, DARK, LIGHT)

OFF no display or recording

DARK high intensity display, bold printed recording

LIGHT low intensity display, fine printed recording

| | | ch1 | ch2 | ch3 | ch4 |
|----------------|--|------|-------|------|-----|
| Analog drawing | | DARK | LIGHT | DARK | - |
| range (/div) | | 10mV | 10mV | 10mV | - |
| position | | 50% | 50% | 50% | - |
| coupling | | DC | DC | DC | - |
| filter | | OFF | OFF | OFF | - |
| Logic drawing | | OFF | OFF | OFF | OFF |

Legend: OFF DARK LIGHT

Settings for channel 1

For details of the "range," "position," "coupling," and "filter" settings see Section 8-4-8 "Input Unit Range, Position, Coupling and Filter Settings."

For details of the "range," "position," "coupling," and "filter" settings see Section 8-4-8 "Input Unit Range, Position, Coupling and Filter Settings."

Notes: If an input unit is not installed, the corresponding channel settings will all appear as "-" as in the case of channel 4 in the figure.

In dual or dual (print quad) format, the "graph" item also appears, to show which time axis the channel is assigned to. (See 8-4-5.)

3. "Logic drawing"

These items switch display or recording for the logic channels on or off. The groups of four channels under channels 1 to 4 correspond to the connectors CHA, CHB, CHC and CHD on the rear panel.

(2) In display mode

1. Select the display mode.

The setting procedure is the same, whether the recorder waveform or the memory recorder waveform is displayed.

2. For each analog channel or group of four logic channels, select whether or not to display and record.

You can also select whether to display input unit information or scale information (top and bottom values).

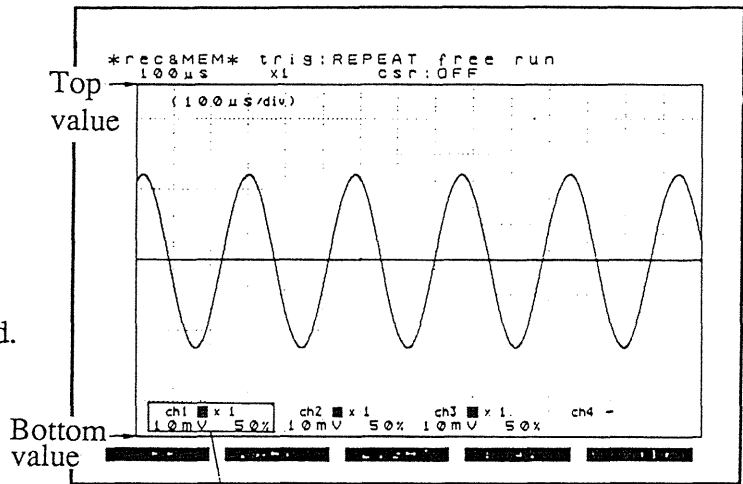

OFF, DARK, LIGHT, (logic), (scale)

↑
(unit)

Screen indications

OFF ... off

■ ... DARK (high intensity)

▒ ... LIGHT (low intensity)

Taking channel 1 as example

Voltage axis zoom factor (See 8-4-14 "Voltage Axis Zoom Function")

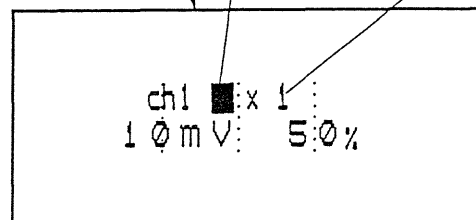

Input unit information display

Scale information

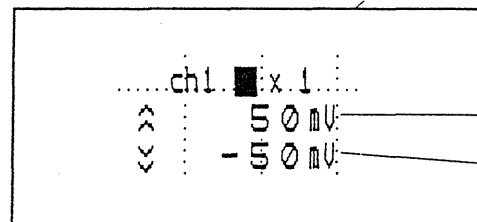

(logic) ... determines whether or not to display and record each group of four logic channels. Pressing the soft key toggles the setting on or off.

The groups of four channels under channels 1 to 4 correspond to the connectors CHA, CHB, CHC and CHD on the rear panel.

(scale) ... pressing the soft key switches to the scale display (showing the top and bottom values on the vertical axis); the soft key indication changes to "(unit)".

(unit) ... pressing the soft key switches to the input unit display (showing the voltage range, input coupling and origin positioning); the soft key indication changes to "(scale)".

Switching between the scale and unit displays affects all channels together.

- When an input unit is not installed
Only the soft keys for setting the logic channel display and recording and for switching between the scale and unit displays are present.

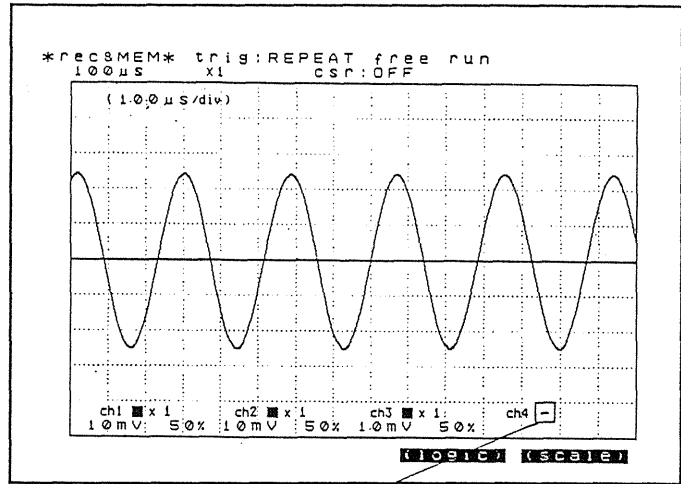
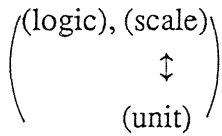

Flashing cursor

Notes

- The input unit display shows the voltage range and position settings for the channel, whereas the scale display shows the range of values actually appearing on the screen for the captured waveform data. If, therefore, you change the input unit range and position settings, the values in the scale and unit displays may be different.
- If the scaling function is enabled, the scale display shows the values after scaling. (See Section 18-3 "Scaling Function.")
- For details of the setting and positioning of logic channel displays, see the **Notes** in Sections 5-4-8 and 6-4-5.

8-4-8 Input Unit Range, Position, Coupling and Filter Settings

Function

These settings determine the range, origin positioning, and input unit coupling and filter for each channel.

Procedure

You can carry out the settings in status mode or display mode.

(1) In status mode

1. Select the status mode.

2. "range(/div)"

Set the voltage range.

The value set is the voltage difference for one division on the vertical axis, when the zoom factor is set to $\times 1$.

You can also use the range key for each channel, without moving the flashing cursor.

(10 mV, 20 mV, 50 mV, 100 mV, 200 mV, 500 mV, 1 V, 2 V, 5 V, 10 V, 20 V, 50 V)

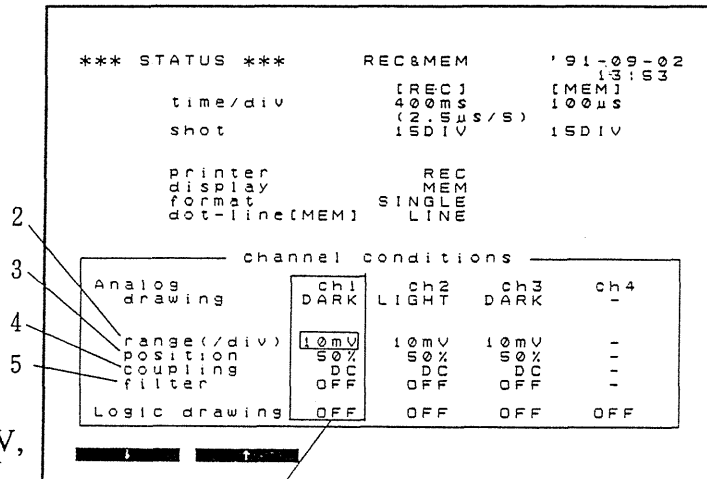

Settings for channel 1

See 8-4-7 "Display and Recording Channel Settings" for details of the "Analog drawing" and "Logic drawing" items.

3. "position"

This determines the position of the zero voltage (from -100% to 100% of the range, in 1% increments).

(See the Background information below.)

The \downarrow and \uparrow soft keys change the value in 1% steps; the $10\% \downarrow$ and $10\% \uparrow$ soft keys change it by 10% steps.

4. "coupling"

Determines the input unit coupling.

(GND, AC, DC)

GND the input unit is not connected.

This enables zero potential checking.

AC capacitor in series.

This removes DC components from the input, and measures the AC component only.

DC input signal directly connected to amplifier.

This allows measurement from the DC component.

5. "filter"

This determines the low-pass filter setting in the input unit itself.

(OFF, 500Hz, 5Hz)

OFF: no low-pass filter used

500Hz: use a low-pass filter with a cutoff frequency of 500 Hz

5Hz: use a low-pass filter with a cutoff frequency of 5 Hz

Note: As shown for channel 4 in the figure, if no input unit is installed, the settings (2 to 5) are all shown as "-".

(2) In display mode

1. Select the display mode.

The setting procedure is the same, whether the recorder waveform or the memory recorder waveform is displayed.

If the input unit information is not shown as shown in the figure on the right, move the flashing cursor to the position to the right of one of the channel indications "ch1" to "ch4" and press the unit soft key.

2. Set the voltage range in the same way as in the status mode (see (1) above).

You can also use the range key for each channel, without moving the flashing cursor.

(10 mV, 20 mV, 50 mV, 100 mV, 200 mV, 500 mV, 1 V, 2 V, 5 V, 10 V, 20 V, 50 V)

In the screen display, the "V" is omitted.

3. Set the input unit coupling.

(GND, AC, DC)

On the screen
 these appear as \downarrow \downarrow \downarrow
 ($\overline{\text{H}}$, $\tilde{\text{V}}$, v)

See the explanation in (1) "In status mode" above for the significance of these settings.

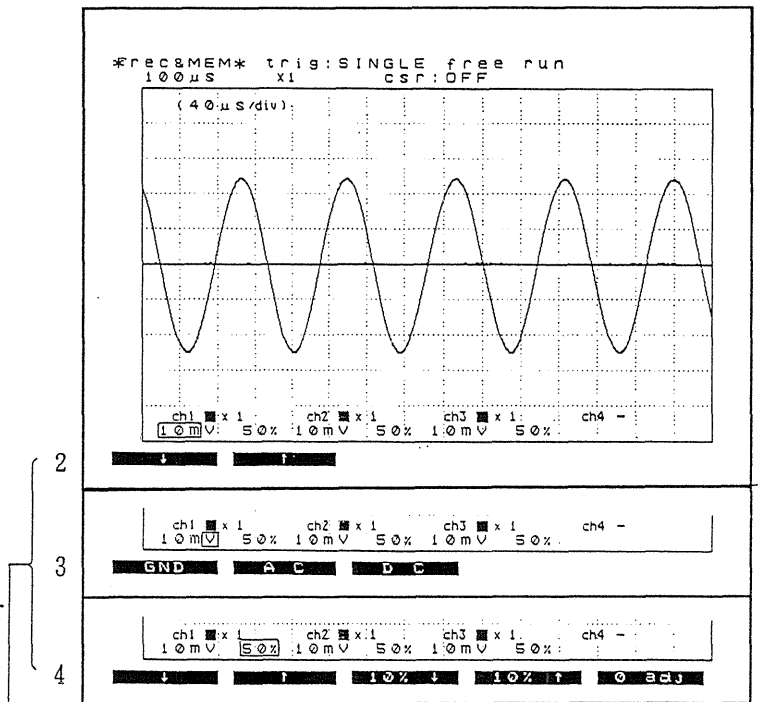

Taking channel 1 as an example

4. Set the origin position (the position of the zero voltage). (from -100% to 100% of the range, in 1% increments).

(See the Background information below.)

The $\boxed{\downarrow}$ and $\boxed{\uparrow}$ soft keys change the value in 1% steps; the $\boxed{10\% \downarrow}$ and $\boxed{10\% \uparrow}$ soft keys change it by 10% steps. For an explanation of the $\boxed{0 \text{ adj}}$ soft key, see 8-4-9 "Zero Adjustment."

Note: It is not possible to change the filter setting in the display mode.

5. The origin position (the zero voltage position) for the currently captured waveform is shown on the screen. (For example, the label "1" indicates the origin for channel 1.)

Background

The origin (the zero voltage position) is as follows.

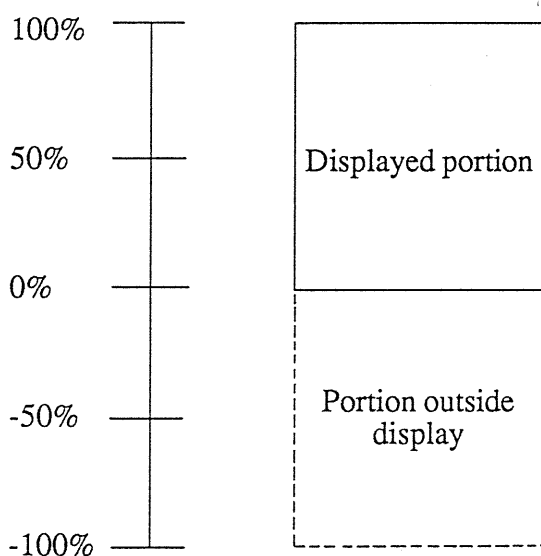

The value of the "position" setting determines the origin. The origin can be inside the display area (0% to 100%) or outside (-100% to 0%) and below it.

8-4-9 Zero Adjustment

Function

This function provides for accurate adjustment of the waveform to the origin position when a zero voltage is input. Use it for reading precise values from the screen or a printed recording.

Procedure

Always allow at least 30 minutes warming up before carrying out this procedure, to ensure that the internal temperature of the unit has stabilized.

1. Select the display mode.
2. If the input unit information is not shown as shown in the figure on the right, move the flashing cursor to the position to the right of one of the channel indications "ch1" to "ch4" and press the **(unit)** soft key.
3. Press the **0 adj** soft key. This carries out the correction for all channels simultaneously. Repeat the process after changing ranges.

Soft keys ... (**↓**, **↑**, **10%↓**,
10%↑, **0 adj**)

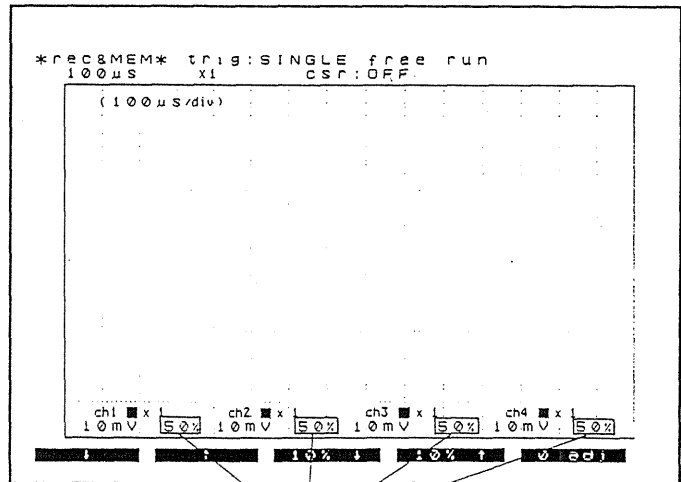

Notes

- Allow at least 30 minutes warming up after powering on before carrying out zero adjustment.
- Zero adjustment is not possible while the unit is measuring.
- The zero adjustment takes effect in the input unit. Always, therefore, repeat zero adjustment after changing input units.

8-4-10 Trigger Settings

Function

This function includes all trigger-related settings.

Different sets of trigger functions are available for the recorder and memory recorder functions.

Memory recorder function

- Trigger conditions for each channel, and logical operator with external trigger
The trigger conditions for each channel can be set, and AND or OR selected as the logical operator with the external trigger.
- Trigger conditions
The trigger conditions for each channel can be set.
- External trigger
The setting determines whether or not a signal from the external trigger terminal is used as a trigger source.
- Trigger mode
- Pre-trigger setting
Determines the percentage of the shot length which is before the trigger.

Recorder function

- Trigger mode
- Trigger timing setting
This determines whether a trigger starts or stops recording, or both.
- Timer trigger setting
This allows timer controlled triggering.

Procedure

All settings can be carried out in trigger mode. Basic settings can also be carried out in display mode.

(1) In trigger mode

1. Select the trigger mode.

First make the settings for the memory recorder function.

2. Set the trigger conditions for each channel, and select the logical operator (AND or OR) with the external trigger.

(AND, OR)

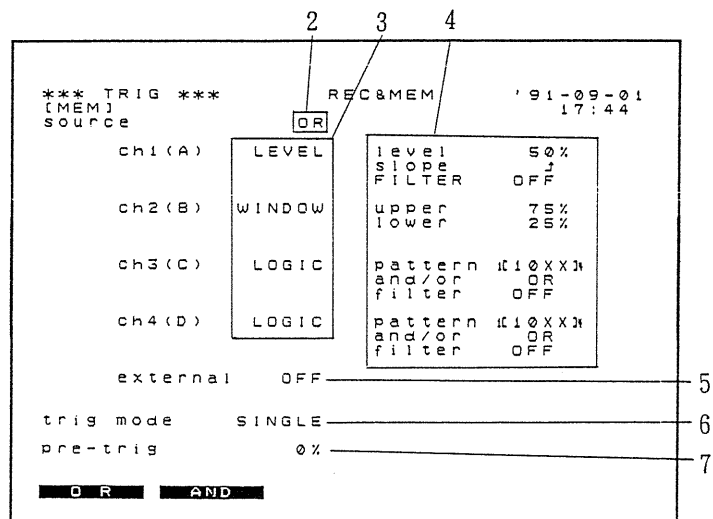

3. Select the trigger type for each channel.
(OFF, LEVEL, WINDOW, LOGIC, GLITCH, TIME OUT)
See Section 14-2 "Internal Triggers" (14-2-1 to 14-2-6).
Note: If you set the external and internal trigger logical operator to AND in step 2, some settings are not allowed.
4. Set the detailed conditions for the setting in step 3.
See Section 14-2 "Internal Triggers" (14-2-1 to 14-2-6).
5. "external"
Enable or disable the external trigger. (OFF, ON)
See Section 14-3 "External Trigger".
6. "trig mode"
Set the trigger mode.
(SINGLE, REPEAT)
SINGLE ... the trigger signal is only effective once, after pressing the START key.
REPEAT ... the trigger signal is effective repeatedly.
See Section 14-5 "Trigger Modes."
7. "pre-trig"
Set the percentage of the shot length which is to be before the trigger.
(0, 2, 5, 10, 20, 30, 40, 50, 60, 70, 80, 90, 95, 100%, and -50% to -950% in 50% steps)
Note: When a positive pre-trigger setting (2% to 100%) is made, if a trigger occurs before the pre-trigger interval has elapsed, the trigger applies immediately.
(No-wait operation)

See Section 14-6 "Pre-Trigger and Trigger Timing."

Next make the settings for the recorder function.

8. "trig mode"
Set the trigger mode.
(SINGLE, REPEAT)
SINGLE ... the trigger signal is only effective once, after pressing the START key.
REPEAT ... the trigger signal is effective repeatedly.
See Section 14-5 "Trigger Modes."

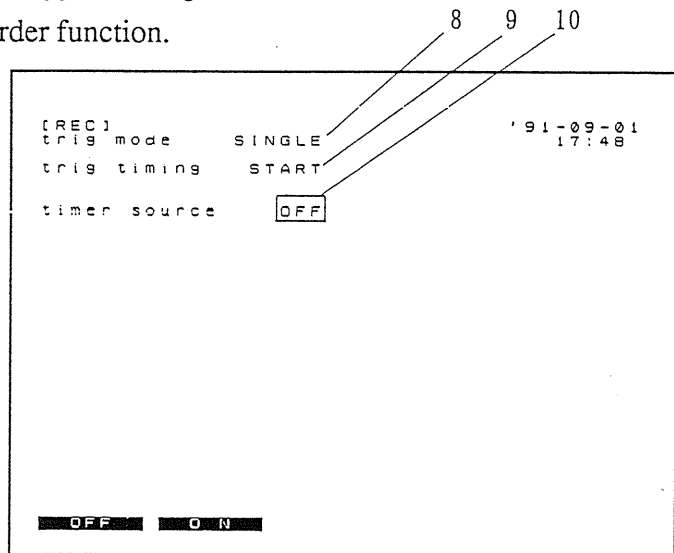

9. "trig timing"

Make the trigger timing setting.

(START, STOP, START&STOP)

·
·
·

Soft key indication is "- & -".

START: recording starts when the trigger is applied.

STOP: recording starts when the START key is pressed, and stops when the trigger is applied.

START&STOP: recording starts when the trigger is applied, and stops when the trigger is next applied.

See Section 14-6 "Pre-Trigger and Trigger Timing."

10. "timer source"

Set the timer trigger.

(OFF, ON)

See Section 14-7 "Timer Trigger."

(2) In display mode

1. Select the display mode.

When the memory recorder waveform is displayed:

2. Set the trigger mode for the memory recorder function.

(SINGLE, REPEAT)

See the procedure in trigger mode in (1) above, and Section 14-5 "Trigger Modes."

3. Select the channel.

(CH1, CH2, CH3, CH4)

If all channels are set to "OFF" in trigger mode, the indication "free run" appears.

If, however, the external trigger is enabled the indication is "external", and if the timer trigger is enabled, it is "timer".

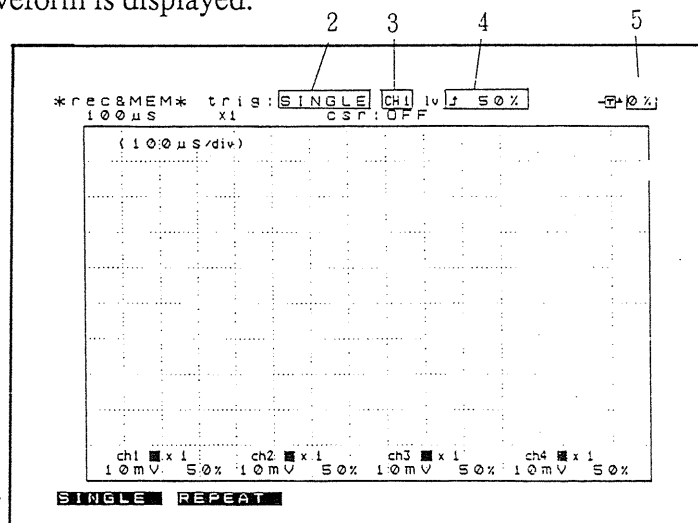

4. Make the detailed settings for the trigger type (other than LOGIC) set for each channel in trigger mode.

Trigger types set in the trigger mode cannot be changed in display mode.

See Section 14-2 "Internal Triggers" (14-2-1 to 14-2-6).

5. Set the percentage of the shot length which is to be before the trigger.
(0, 2, 5, 10, 20, 30, 40, 50, 60, 70, 80, 90, 95, 100%, and -50% to -950% in 50% steps)
See the procedure in trigger mode in (1) above, and Section 14-6 "Pre-Trigger and Trigger Timing."

When the recorder waveform is displayed:

6. Set the trigger mode for the recorder function.
(SINGLE, REPEAT)

See the procedure in trigger mode in (1) above, and Section 14-5 "Trigger Modes."

7. Same as 3.
8. Same as 4.

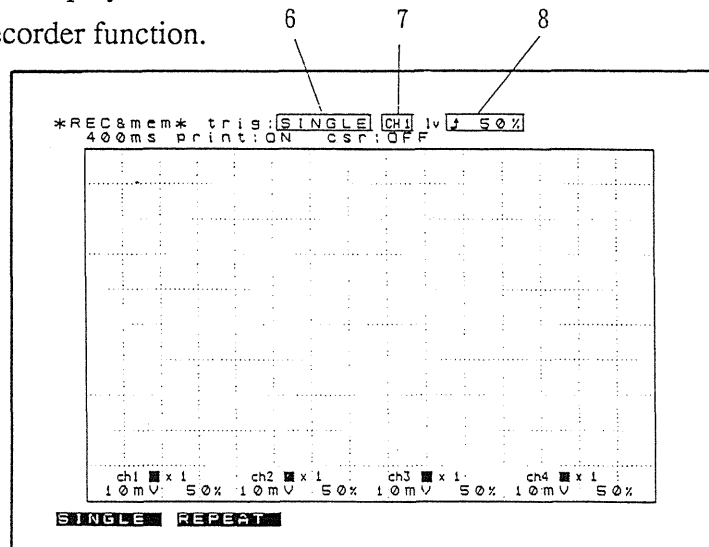

8-4-11 Starting and Stopping Measurement Operation

Function

The START and STOP keys control the measurement operation mode of the unit. The LED above the START key is lit when in recorder measurement operation mode.

Procedure

1. **START**
Start measurement operation.
2. **STOP**
Stop measurement operation.

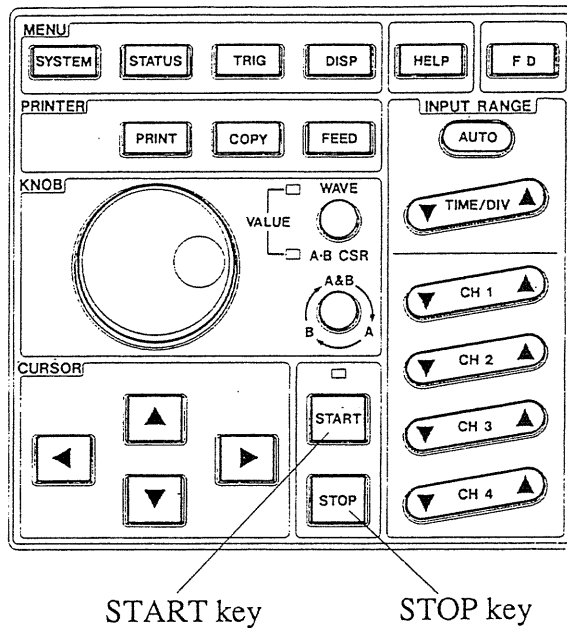

Notes

- The recorder function is the principal operation in the memory and recorder mode. Even if the memory recorder trigger conditions never hold, once the conditions for stopping the recorder function hold, it stops, without necessarily capturing any memory recorder data.
- If the trigger mode is set to REPEAT, or the shot length is set to CONT, then recording will not automatically stop. It is therefore necessary to press the STOP key to end recording.

8-4-12 Using A and B Cursors

Function

You can use the A and B cursors to measure time or voltage differences, getting a direct digital readout.

The method of operation is the same as that in the recorder function or memory recorder function, depending on which part of the recorder and memory function you are using. See Sections 6-4-10 and 5-4-13 respectively for descriptions for the recorder and memory recorder functions.

Related item

When the memory recorder waveform is displayed, even when a vertical cursor or cross-hair cursor is outside the display area, it is still possible to determine its approximate location in the total shot length. See Section 5-4-20 "Help Function" for details.

8-4-13 Memory Recorder Time Axis Zoom Function

Function

When the memory recorder waveform is displayed, this function allows a zoom factor to be applied to the time axis.

Magnifying the time axis enables more detailed examination of the waveforms. Compression is useful for getting an overall view of the waveform pattern.

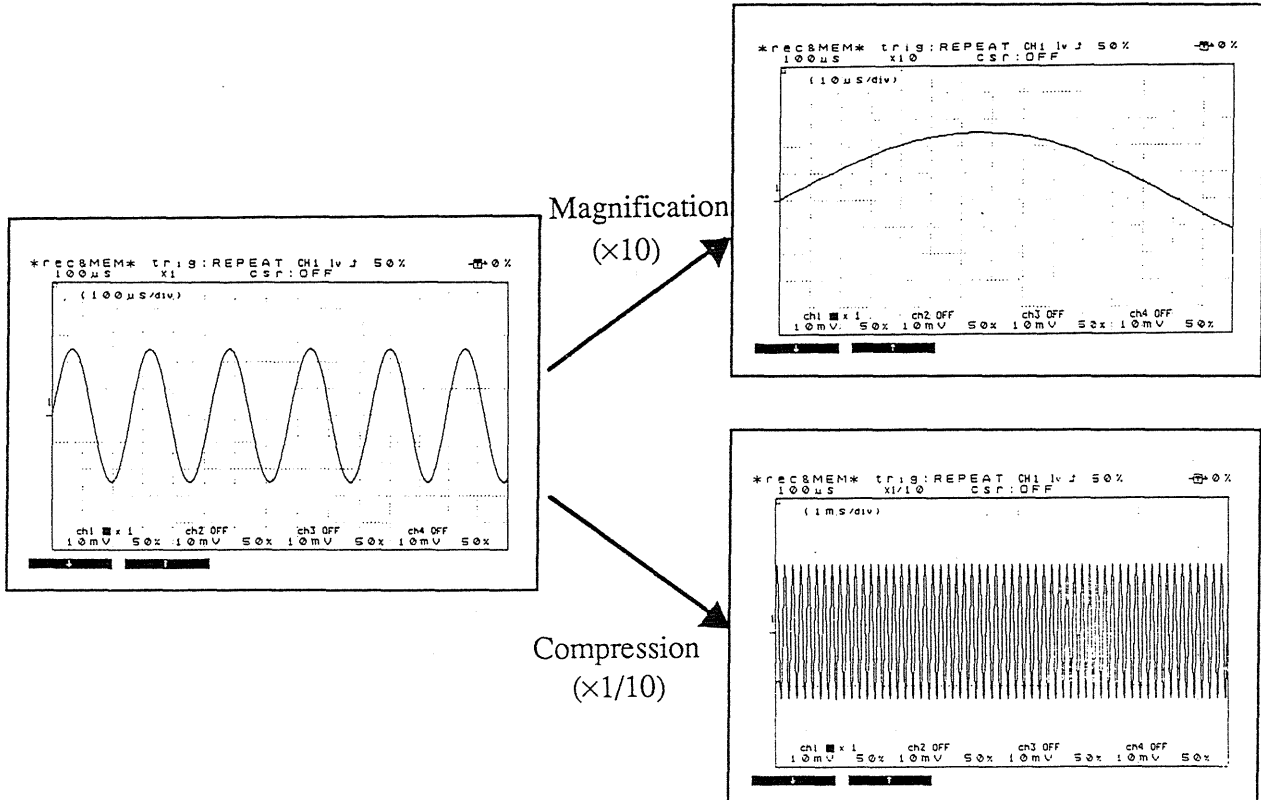

Procedure

1. Select the display mode.
2. Select the **rec&MEM** soft key, so that the memory recorder waveform is displayed.
(MEMORY, RECORD, X-Ycont, REC&mem, rec&MEM)
3. Set the magnification or compression factor on the time axis.
($\times 10$, $\times 5$, $\times 2$, $\times 1$, $\times 1/2$, $\times 1/5$, $\times 1/10$, $\times 1/20$, $\times 1/50$, $\times 1/100$, $\times 1/200$, $\times 1/500$, $\times 1/1000$, $\times 1/2000$, $\times 1/4000$)

Note: The setting is always reinitialized to $\times 1$ when you start measurement operation.

4. The display shows the magnified or compressed time axis scale (time per one division).

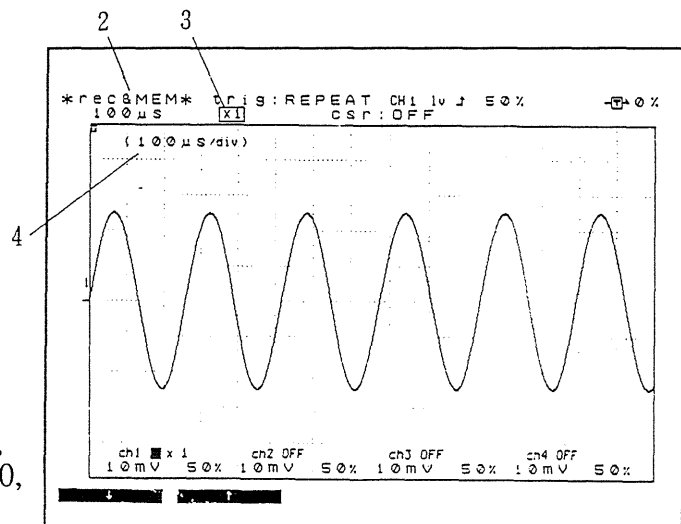

5. If you change the zoom factor after data capture, when it is already displayed on the screen, the display immediately changes to reflect the new setting.

① Reference position when compressing

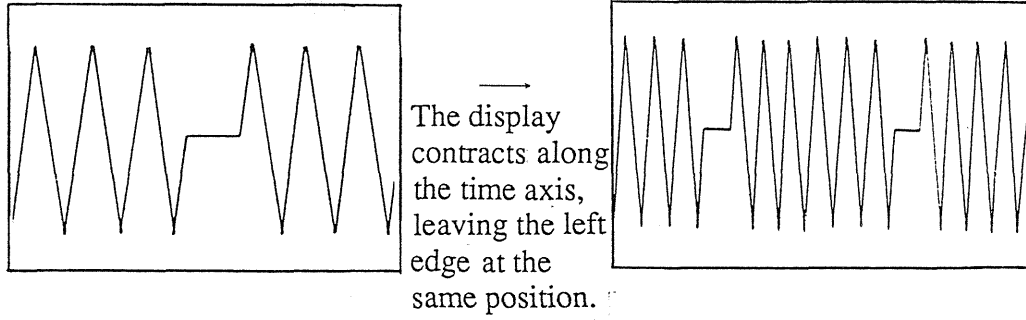

② Reference position when magnifying

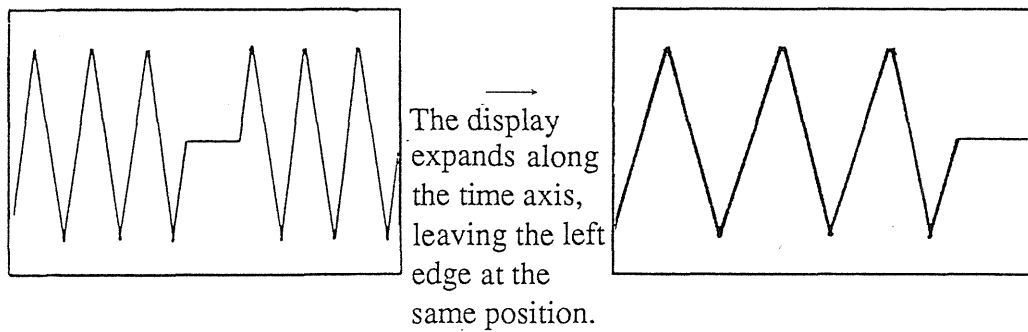

Notes

- When showing a long shot length in compressed mode, if the interpolation function is disabled (i.e. set to "DOT"), then display can take an appreciable time.

Related item

A scroll bar display is available, to show where the current screen display is in relation to the whole shot length. See Section 5-4-20 "Help Function" for details.

8-4-14 Voltage Axis Zoom Function

Function

The zoom function allows the voltage axis to be magnified or compressed for any channel independently.

The method of operation is the same as that in the recorder function or memory recorder function, depending on which display you are using. See Sections 6-4-11 and 5-4-15 respectively for descriptions for the recorder and memory recorder functions.

8-4-15 Waveform Scrolling

Function

When the recorder waveform is displayed, the screen scrolls left and right as in the recorder function.

When the memory recorder waveform is displayed, the screen scrolls both vertically (when a zoom factor is applied to the voltage axis) and horizontally.

See Sections 6-4-12 and 5-4-16 respectively for descriptions for the recorder and memory recorder functions.

8-4-16 Superimposition Function

Function

When the memory recorder waveform is displayed, this function disables clearing of existing waveforms on the screen, and allows them to be superimposed. (When the trigger mode is REPEAT.)

Using this function, you can easily make comparisons with the previous waveform.

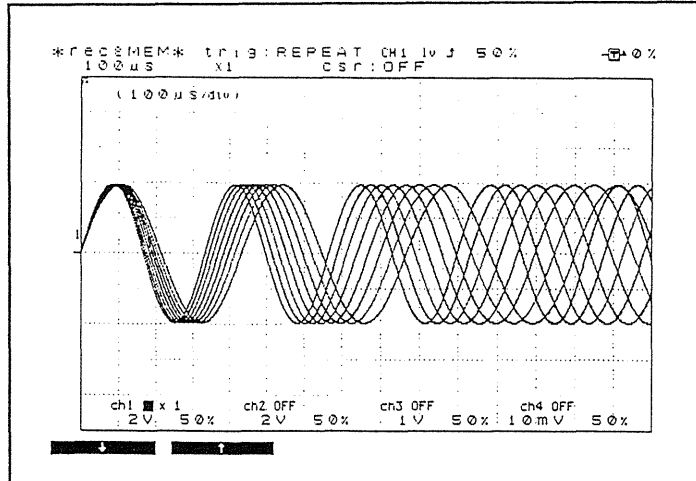

Procedure

1. Select the status mode, then use either the cursor key or the rotary knob to show the special function display.
2. "over-write"

This setting toggles the superimposition function.
(ON, OFF)

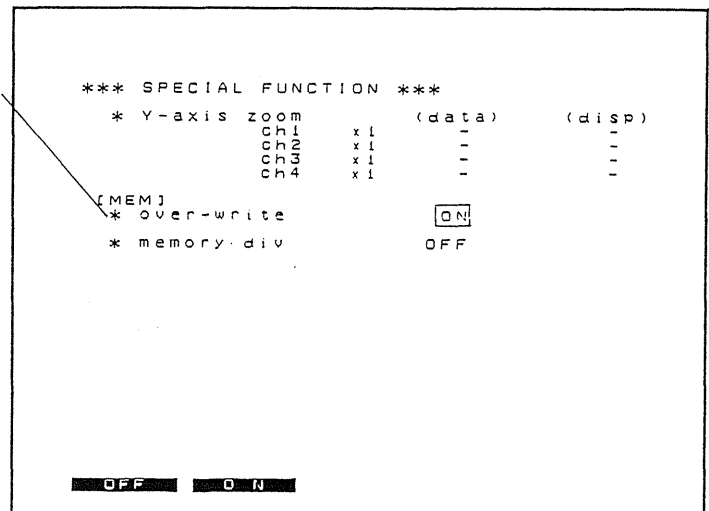

Notes

- The superimposition function has no significance when the trigger mode for memory recorder waveforms is set to SINGLE, since data capture then stops after a single shot.
- When using the superimposition function, it is no longer possible to scroll the waveform or change the display zoom factor setting.

Furthermore, the printout function prints only the last captured waveform data.

- After using the superimposition function, all of the following operations delete the superimposition (leaving only the last captured waveform data):

Changing the zoom factor (voltage axis) in status mode

Changing the position on the voltage axis of the waveform in status mode

Changing the format

Changing the interpolation setting

Changing the channel settings for display or printed recording ("Analog drawing" and "Logic drawing")

Again, pressing the START key deletes all of the displayed superimposed waveforms. (The most recently captured waveform also disappears.)

8-4-17 Printing Waveform Recordings

Function

There are three methods of printing waveforms:

- (1) Normal real time recording. This outputs a printed recording of the recorder waveform as data is captured, simultaneously with the screen display. (See notes on page 8-49 below.)
- (2) Pressing the PRINT key to record the waveform of either the recorder function or the memory recorder function. (The manual print function)

Using the A and B cursors, you can select a section of the waveform held in memory to be printed. (Partial print function)

- (3) Pressing the COPY key to print the screen. (The screen dump function)

Procedure

- (1) Normal real time recording

1. Select the status mode.
2. "printer"

Select whether or not to print the recorder waveform in real time simultaneously with the display. (OFF, REC)

OFF ... no printed recording.

REC ... print recording.

Here, select the **REC** soft key.

You can also make this setting in display mode.

- a. Select display mode.
- b. Select the **REC&mem** soft key, displaying the recorder waveform. (MEMORY, RECORD, X-Ycont, REC&mem, rec&MEM)
- c. Select the **ON** soft key. (OFF, ON)

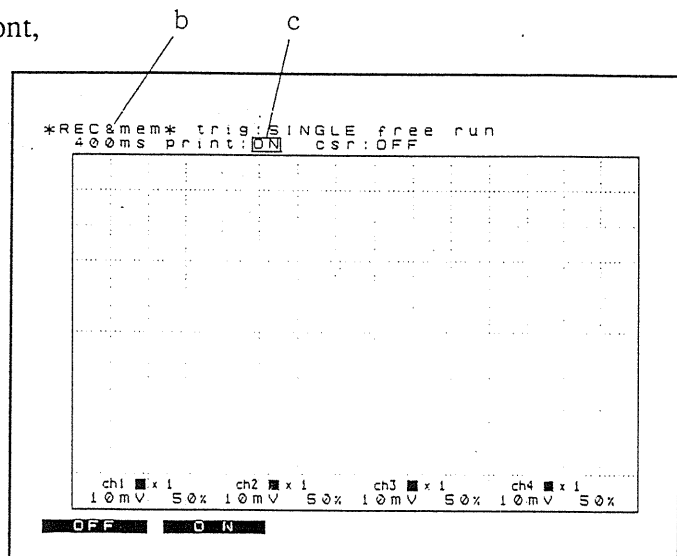
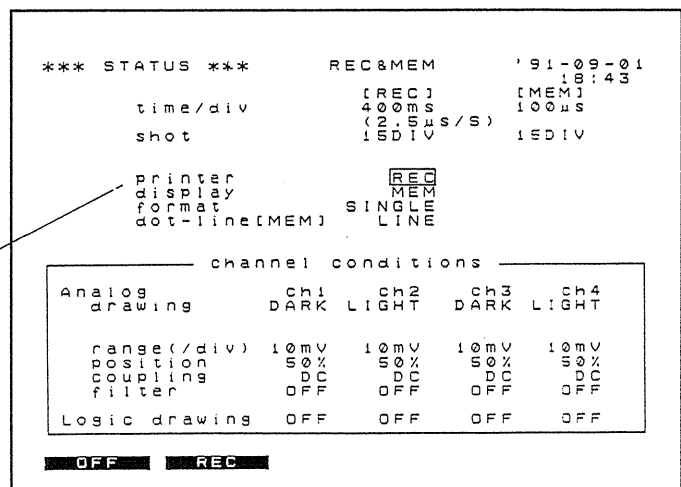

3. **START**

Start measurement operation. The printed record appears as the recorder waveform data is captured.

(2) Manual print function

First select whether to print the recorder waveform or the memory recorder waveform.

To print the recorder waveform ... in display mode, select the recorder waveform display.

To print the memory recorder waveform ... in display mode, select the memory recorder waveform display.

See Section 8-4-4 "Switching Between Recorder and Memory Recorder Waveform Displays" for details.

a. When there are no vertical or cross-hair A and B cursors

1. **PRINT**

Print the waveform data from the beginning.

Recorder function ...
maximum 750 divisions

Memory recorder function ...
maximum 6000 divisions

If a zoom factor is in effect, it applies to the printing.

The waveform can be printed as many times as required.

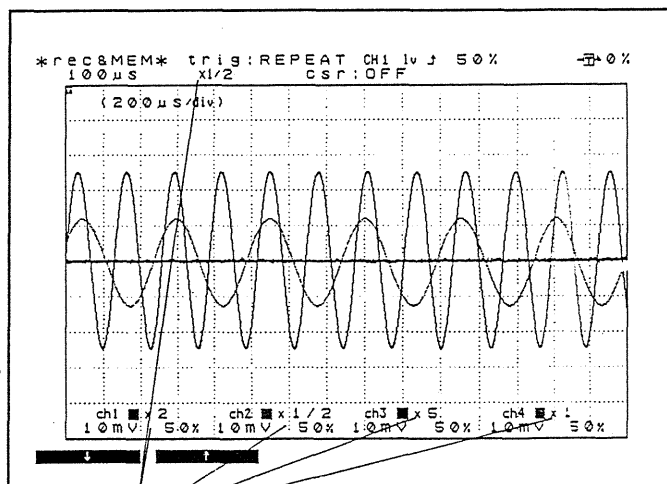

These zoom factors apply to the printed recording as well as to the screen display. (A zoom factor can only be applied to the time axis for the memory recorder function.)

Note: If the recorder shot length is set to continuous, and more than 750 divisions are recorded, only the most recently recorded 750 divisions are retained in memory. Data preceding those 750 divisions cannot be printed.

b. Using the A and B cursors (as vertical or cross-hair cursors) for a partial print

1. Display the A cursor or A and B cursors as vertical or cross-hair cursors.

(Cross-hair cursors can only be used in the memory recorder function.)

① Using the A cursor only, print from the A cursor position to the end of the waveform.

② Using both A and B cursors, print the section of waveform between the cursors.

This function is effective even if either cursor is outside the screen area. For more details see the Example below.

2. **PRINT**

Prints the section of waveform defined by the cursors.

If zoom factors are in effect, they are also applied to the printing.

These zoom factors apply to the printed recording as well as to the screen display. (A zoom factor can only be applied to the time axis for the memory recorder function.)

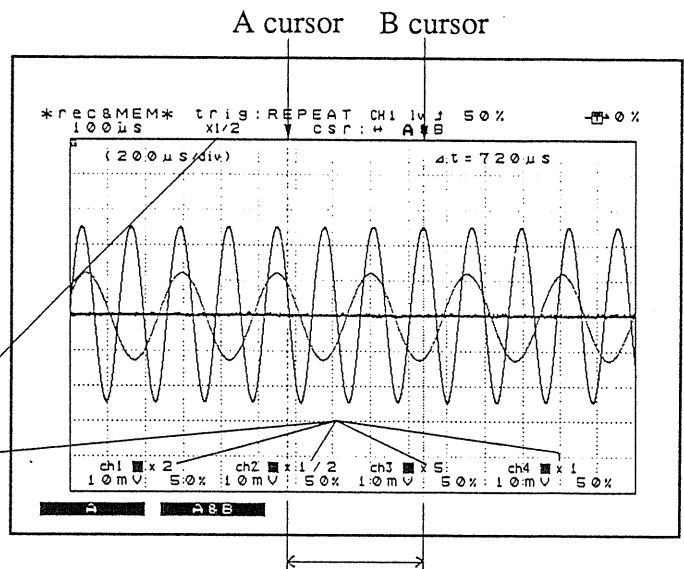

This section is printed.

(3) Screen dump function

1. **COPY**

Prints an exact copy of the screen.

Provided that a waveform is displayed on the screen, pressing the COPY and FEED keys simultaneously prints a copy of the screen, followed by a listing of the settings, as follows.

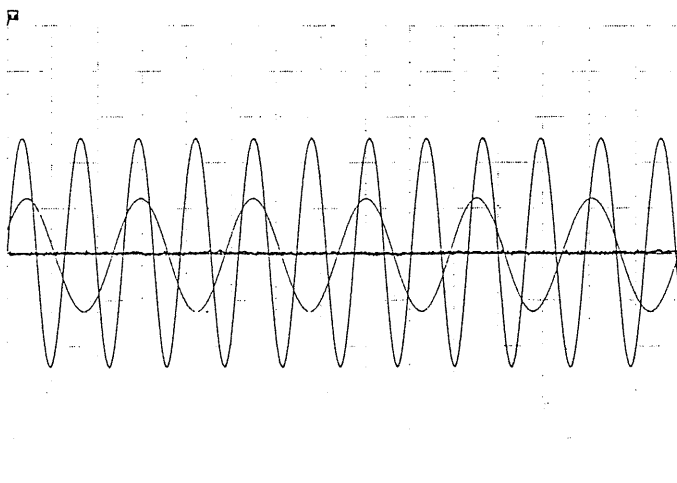

```

function : REC&MEM
time/div : 100 μs
           (200 μs/div)
cursor: (←) A: CH1 B: CH1
          dt: 720 μs

trigger : REPEAT
ch1: LEVEL 1 50%
pre-trigger: 0x
trigger time
          '91-09-01 19:18:27

[CH1]
DARK 10mV/DIV DC X2
pos: 50% flt: OFF

[CH2]
LIGHT 10mV/DIV DC X1/2
pos: 50% flt: OFF

[CH3]
DARK 10mV/DIV DC X5
pos: 50% flt: OFF

[CH4]
LIGHT 10mV/DIV DC X1
pos: 50% flt: OFF

[10xlg] : DARK
A: OFF
B: OFF
C: OFF
D: OFF

HIKI 8851 MEMORY HI CORDER
          '91-09-01 19:20
    
```

Example

The A and B cursors (vertical or cross-hair) can be used to mark a section of waveform to print, even when either of the cursors is outside the screen area. (Cross-hair cursors can only be used in the memory recorder function.)

1. Use the A cursor to determine the start position.

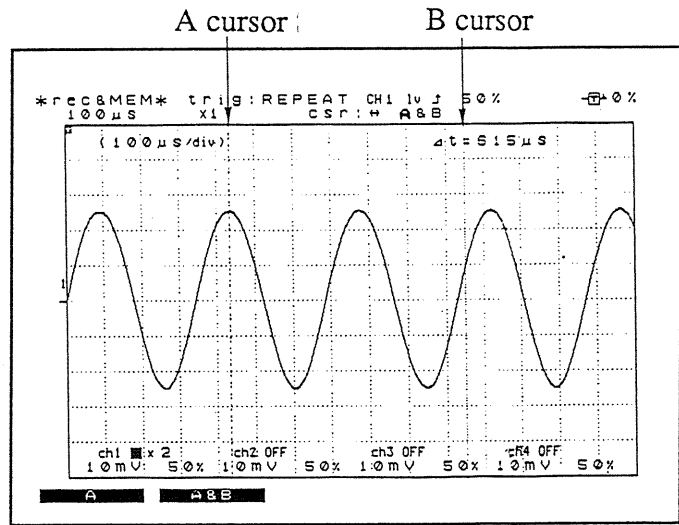

2. Move the B cursor to the right; when it reaches the edge of the display window, the waveform scrolls to the left.

The A cursor scrolls left with the waveform.

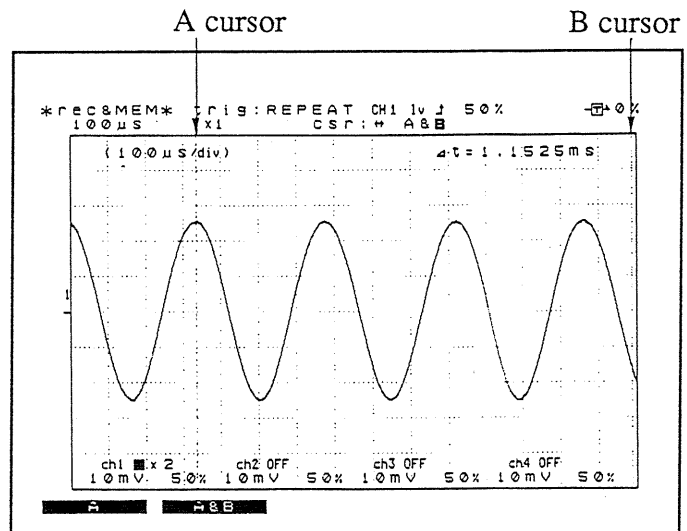

3. Determine the end position with the B cursor.

At this point, the A cursor has disappeared off the left side of the display window, but pressing the PRINT key still prints the correct section of the waveform.

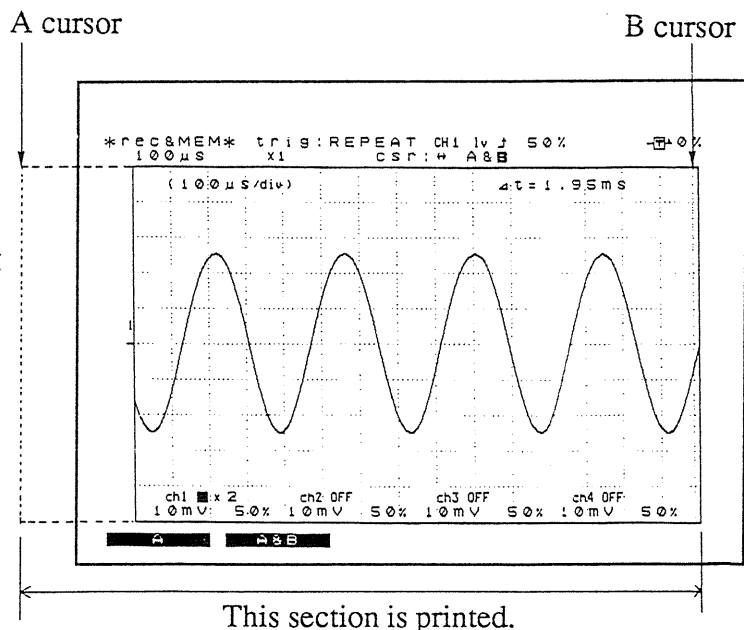



Notes

- When the format is set to DUAL (print quad), then regardless of the allocation of channels to the two display windows on the screen, the channels are printed in order channel 1 to 4. (See Section 5-4-5 "Format Selection and Section 6-4-4 "Format Selection.")
- When the screen is in other than display mode (excluding the floppy disk control mode), pressing the PRINT key produces a listing of settings. This is the same as the printing following the waveform when the listing function is enabled. (See Section 18-5-7 "Listing and Gauge Functions," and Section 8-5 "Interpreting Waveform Displays and Recordings.")

Note

For normal real time recording, as far as possible avoid low-speed printing in a high-temperature or high-humidity environment. This may sharply reduce printer life.

Related items

You can select whether or not to print voltage scales (gauges) and listings of settings when using either normal real time recording or the manual print function.

(See Section 18-5-7 "Listing and Gauge Functions," and Section 8-5 "Interpreting Waveform Displays and Recordings.")

When printing the memory recorder waveform, you can also select the smooth print function, giving a print quality close to an analog recording, or the normal print function, which is twice as fast. The default setting is the smooth print. (See Section 18-5-9 "Smooth Print Function.")

8-5 Interpreting Waveform Displays and Recordings

- SINGLE format (recorder waveform display)

Display

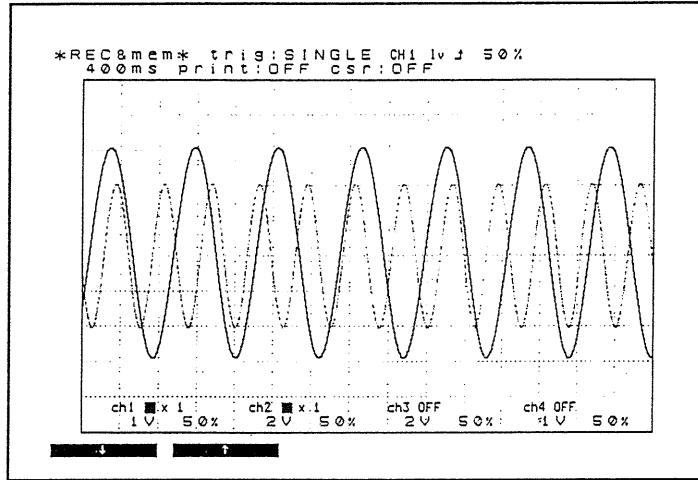

Pressing COPY and FEED simultaneously

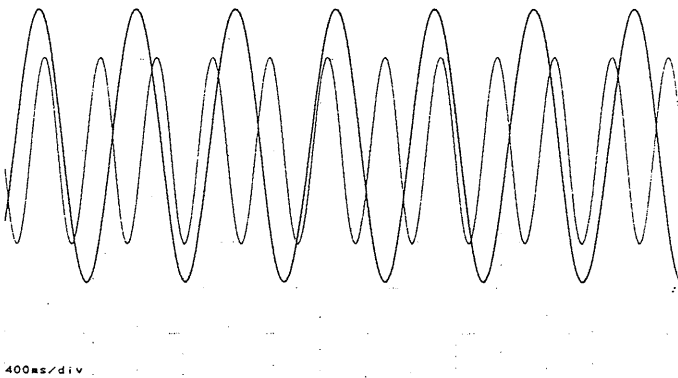

Listing of settings

| | |
|-----------------------------|--------------|
| function | : RECMEM |
| time/div | : 400ms |
| cursor: OFF | |
| trigger | : SINGLE |
| ch1: LEVEL | : 50% |
| trigger time | |
| : '91-09-10 00:53:27 | |
| [CH1] DARK | 1V/DIV DC X1 |
| pos: 50% | fit: OFF |
| -5V | |
| [CH2] LIGHT | 2V/DIV DC X1 |
| -180 | fit: OFF |
| pos: 50% | |
| [CH3] OFF | 2V/DIV DC X1 |
| | fit: OFF |
| [CH4] OFF | 1V/DIV DC X1 |
| | fit: OFF |
| [log] : | : DARK |
| A: OFF | |
| B: OFF | |
| C: OFF | |
| D: OFF | |
| HIOKI 8851 MEMORY HI CORDER | |
| : '91-09-10 00:54 | |

Trigger time (if the trigger sources all set off, pressing the START key determines the trigger time)

Setting of "position" Filter

Manual print

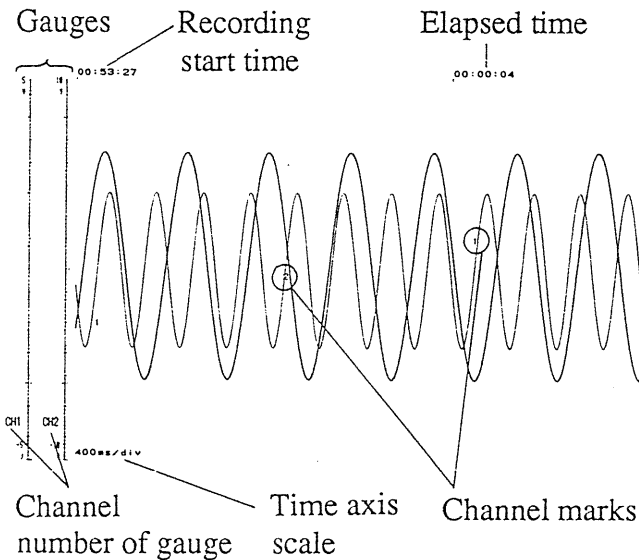

Listing

| | | |
|-----------------------------|---------------|------------------------|
| Trigger time | | |
| function | : RECMEM | *** TRIGGER *** |
| time/div | : 400ms [REC] | trigger time |
| 100ms [MEM] | | : '91-09-10 00:53:27 |
| shot | : 150V [REC] | source |
| 150V [MEM] | | OR |
| printer | : OFF | ch1 LEVEL |
| display | : REC | level 50% |
| format | : SINGLE | stop J |
| dot-line | : LINE [MEM] | ch2 OFF |
| [CH1] DARK | 1V/DIV DC X1 | ch3 OFF |
| pos: 50% | fit: OFF | ch4 OFF |
| -5V | | external OFF |
| [CH2] LIGHT | 2V/DIV DC X1 | INMODE SINGLE |
| -180 | fit: OFF | INMODE SINGLE |
| pos: 50% | | pre-trig: 0x [MEM] |
| [CH3] OFF | 2V/DIV DC X1 | trig time: START [REC] |
| -180 | fit: OFF | user source OFF |
| pos: 50% | | |
| [CH4] OFF | 1V/DIV DC X1 | *** SYSTEM *** V 0.19 |
| | fit: OFF | screen auto off ON |
| [log] : | : DARK | grid type NORMAL |
| A: OFF | | start key backup OFF |
| B: OFF | | ch-marker ON |
| C: OFF | | beep sound ON |
| D: OFF | | list & gauge L & G |
| | | logic drawing DARK |
| | | smooth print ON |
| | | roll mode OFF |
| | | using unit 4ch |
| HIOKI 8851 MEMORY HI CORDER | | |
| : '91-09-10 01:00 | | |

Trigger settings

Settings on special function display

Settings in system mode

- SINGLE format (memory recorder waveform display)
Display

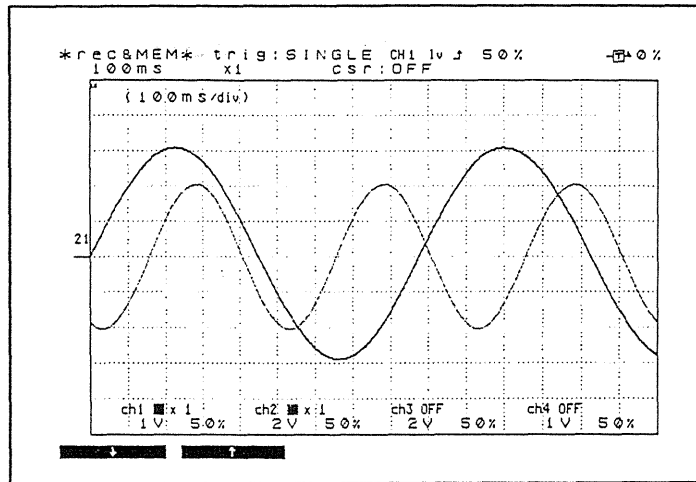

Pressing COPY and FEED simultaneously

Trigger mark

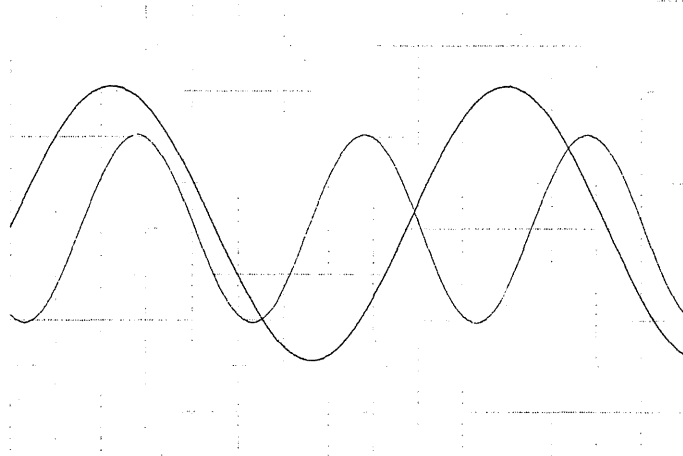

Listing of settings

| | |
|--------------|----------------------|
| function | :REC&MEM |
| time/div | :40μs (100ms/div) |
| cursor | :OFF |
| trigger | :SINGLE |
| ch1:LEVEL | :50% |
| pre-trigger | :0x |
| trigger time | :91-09-10 00:53:28 |
| [CH1] | DARK 1V/DIV DC:z1 |
| | pos:50% ffit:OFF |
| [CH2] | LIGHT 2V/DIV DC:x1 |
| | pos:50% ffit:OFF |
| [CH3] | OFF 2V/DIV DC:x1 |
| | pos:50% ffit:OFF |
| [CH4] | OFF 1V/DIV DC:x1 |
| | pos:50% ffit:OFF |
| [log:z] | :DARK |
| A: | OFF |
| B: | OFF |
| C: | OFF |
| D: | OFF |

HIOKI 8851 MEMORY HI CORDES
91-09-10 01:07

Manual print

Trigger mark

Number of divisions

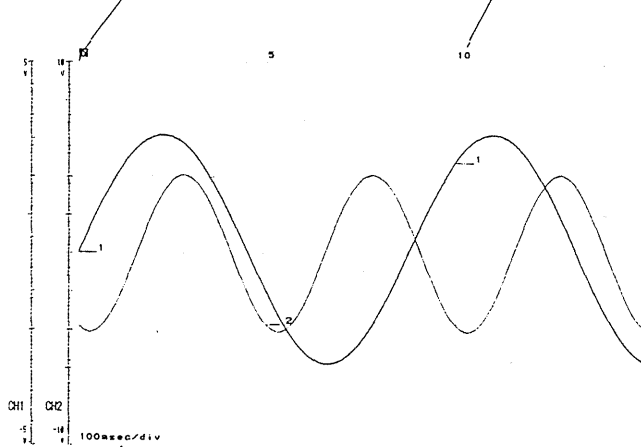

Time axis scale

| | | | |
|----------|-----------------------------------|-------------------------|--------------------------|
| function | :REC&MEM | *** TRIGGER *** | *** SPECIAL FUNCTION *** |
| time/div | :400μs [REC] (100ms/div) [MEM] | trigger time | s over-write :OFF |
| shot | :150DIV [REC] 150DIV [MEM] | :91-09-10 00:53:28 | s memory div :OFF |
| printer | :OFF | source | |
| display | :MEM | ch1 :LEVEL | |
| format | :SINGLE | level :50% | |
| dot-line | :LINE [MEM] | scope :3 | |
| [CH1] | DARK 1V/DIV DC:z1 | ch2 :OFF | |
| | pos:50% ffit:OFF | ch3 :OFF | |
| [CH2] | LIGHT 2V/DIV DC:z1 | ch4 :OFF | |
| | pos:50% ffit:OFF | | |
| [CH3] | OFF 2V/DIV DC:x1 | external:OFF | |
| | pos:50% ffit:OFF | [REC]mode :SINGLE | *** SYSTEM *** V 0.19 |
| [CH4] | OFF 1V/DIV DC:z1 | [MEM]mode :SINGLE | screen auto off :ON |
| | pos:50% ffit:OFF | pre-trigger:0x [MEM] | grid type :NORMAL |
| [log:z] | :DARK | trig timing:START [REC] | start key backup:OFF |
| A: | OFF | timer source:OFF | ch-marker :ON |
| B: | OFF | | beep sound :ON |
| C: | OFF | | list & gauge :L & G |
| D: | OFF | | logic drawing :DARK |
| | | | smooth print :ON |
| | | | roll mode :OFF |
| | | | using unit :4ch |

HIOKI 8851 MEMORY HI CORDES
91-09-10 01:07

- DUAL format (recorder waveform display)
Display

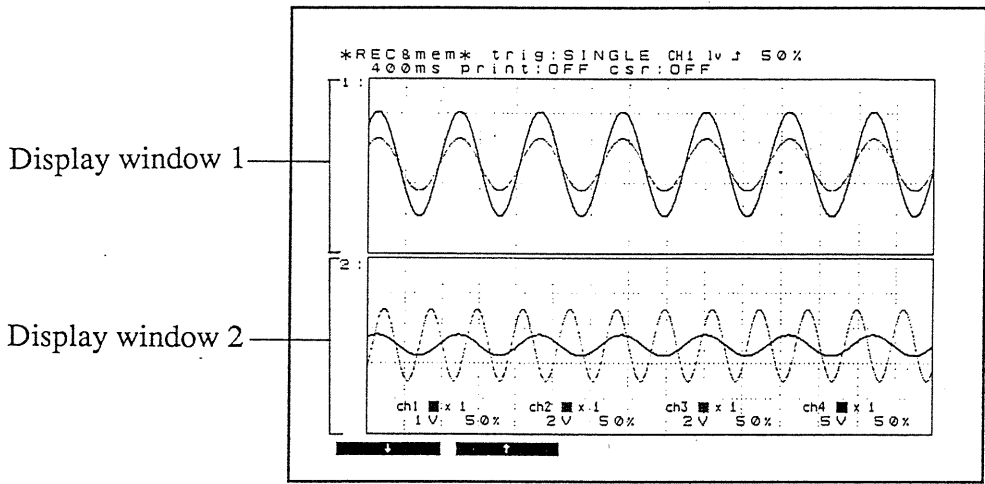

Pressing COPY and FEED simultaneously

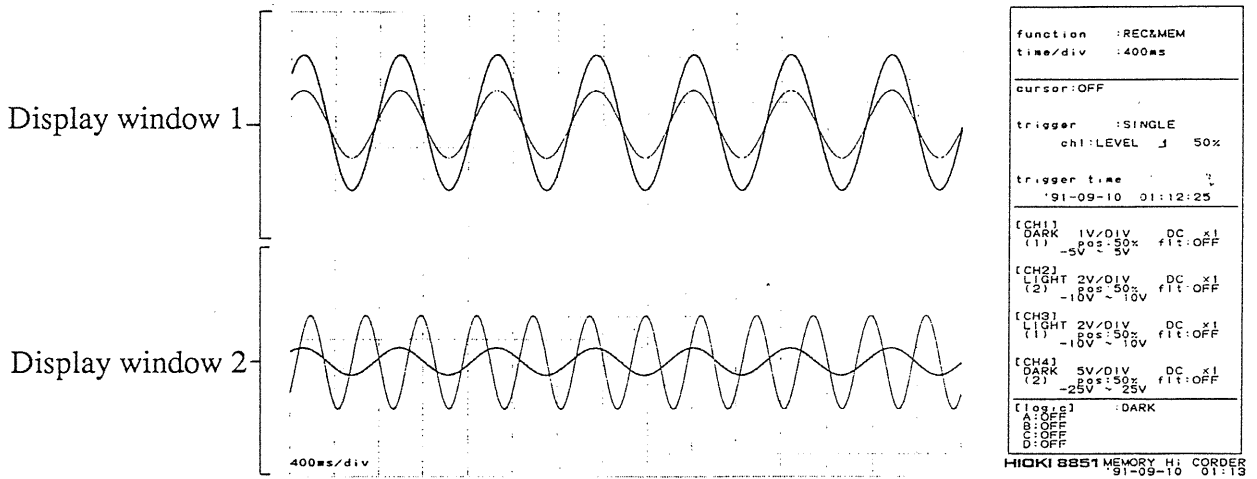

Manual print

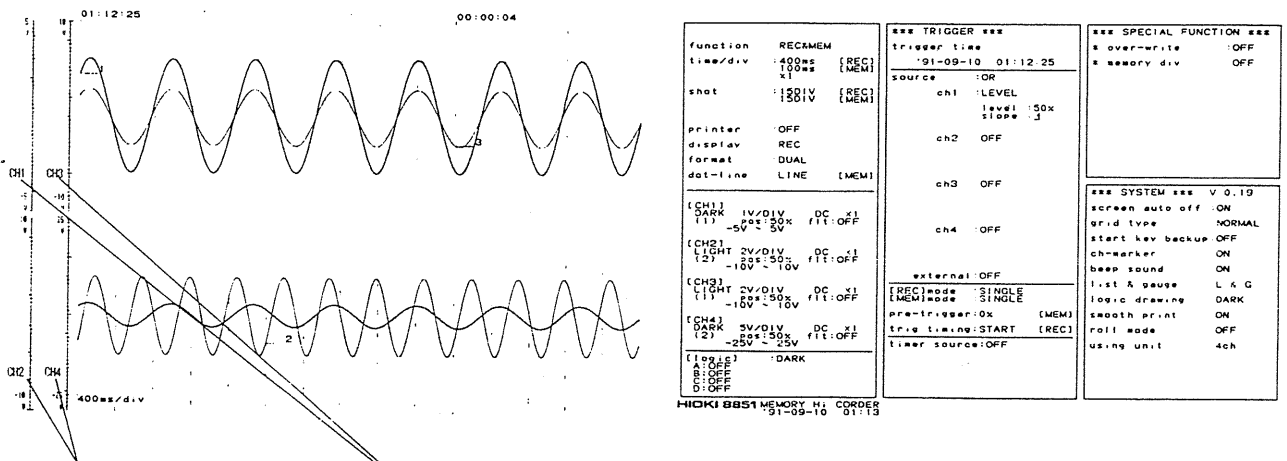

Channel numbers for display window 2

Channel numbers for display window 1

DUAL format (memory recorder waveform display)

Display

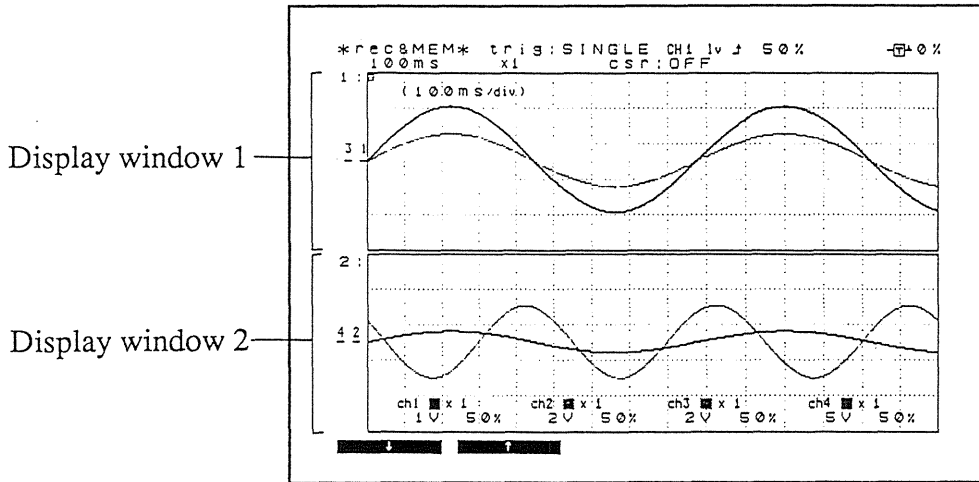

Display window 1

Display window 2

Pressing COPY and FEED simultaneously

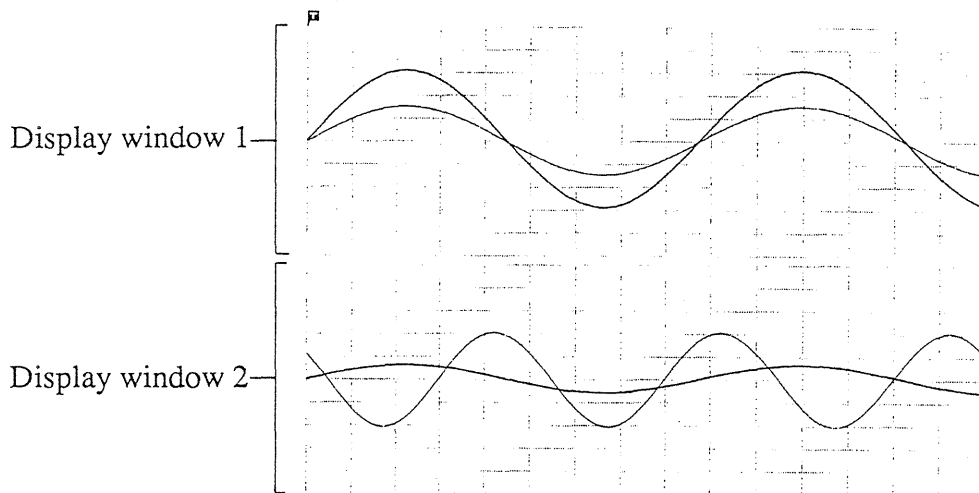

Display window 1

Display window 2

| | |
|-----------------------------|----------------------|
| function | : REC&MEM |
| time/div | : 40us |
| | (100us/div) |
| cursor | : OFF |
| trigger | : SINGLE |
| ch1:LEVEL | ↓ 50% |
| pre-trigger | : 0x |
| trigger time | : '91-09-10 01:12:27 |
| [CH1] | DARK 1V/DIV DC x1 |
| (1) | -50s:50% fll:OFF |
| | -5V ~ 5V |
| [CH2] | LIGHT 2V/DIV DC x1 |
| (2) | -10s:50% fll:OFF |
| | -10V ~ 10V |
| [CH3] | LIGHT 2V/DIV DC x1 |
| (1) | -10s:50% fll:OFF |
| | -10V ~ 10V |
| [CH4] | DARK 5V/DIV DC x1 |
| (2) | -25V ~ 25V fll:OFF |
| [log]1 | : DARK |
| A | : OFF |
| B | : OFF |
| C | : OFF |
| HIOKI 8851 MEMORY H: CORDER | |
| '91-09-10 01:17 | |

Manual print

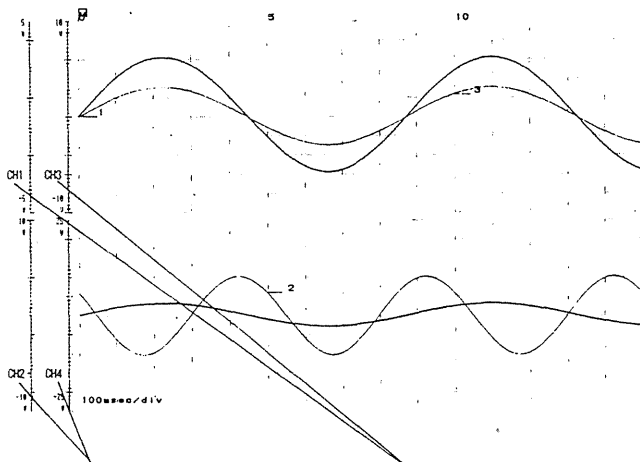

Channel numbers for display window 2

Channel numbers for display window 1

| | | | |
|-----------------------------|---------------------------|--------------------------|--------------------------|
| function | : REC&MEM | *** TRIGGER *** | *** SPECIAL FUNCTION *** |
| time/div | : 400us (100us/div) [REG] | trigger time | z over-write : OFF |
| shot | : 100V [REG] | '91-09-10 01:12:27 | z memory div : OFF |
| printer | : OFF | source | |
| display | : MEM | ch1 : LEVEL | |
| format | : DUAL | level : 50% | |
| dot-line | : LINE [MEM] | slope : ↓ | |
| | | ch2 : OFF | |
| [CH1] | DARK 1V/DIV DC x1 | ch3 : OFF | |
| (1) | -50s:50% fll:OFF | ch4 : OFF | |
| | -5V ~ 5V | external: OFF | |
| [CH2] | LIGHT 2V/DIV DC x1 | [REC] mode : SINGLE | *** SYSTEM *** V 0.19 |
| (2) | -10s:50% fll:OFF | [MEM] mode : SINGLE | screen auto off : ON |
| | -10V ~ 10V | pre-trigger: 0x [MEM] | grid type : NORMAL |
| [CH3] | LIGHT 2V/DIV DC x1 | trig timing: START [REC] | start key backup: OFF |
| (1) | -10s:50% fll:OFF | trigger source: OFF | ch-marker : ON |
| | -10V ~ 10V | | beep sound : ON |
| [CH4] | DARK 5V/DIV DC x1 | | list & gauge : L & Q |
| (2) | -25V ~ 25V fll:OFF | | logic drawing : DARK |
| [log]1 | : DARK | | smooth print : ON |
| A | : OFF | | roll mode : OFF |
| B | : OFF | | using unit : 4ch |
| C | : OFF | | |
| HIOKI 8851 MEMORY H: CORDER | | | |
| '91-09-10 01:18 | | | |

- DUAL (print quad) format (recorder waveform display)

Display

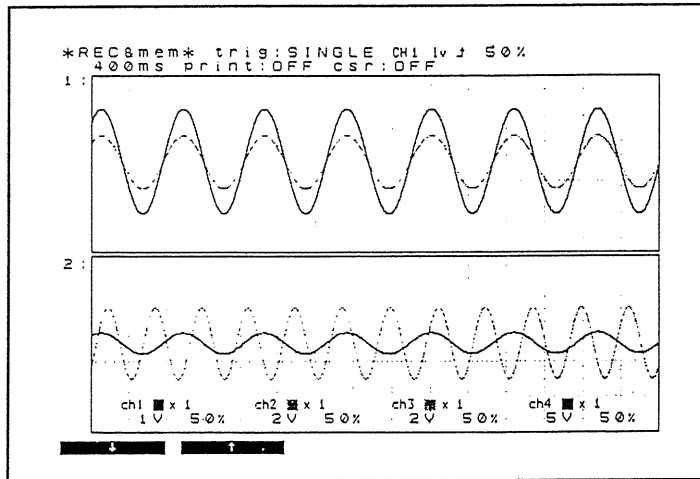

Pressing COPY and FEED simultaneously

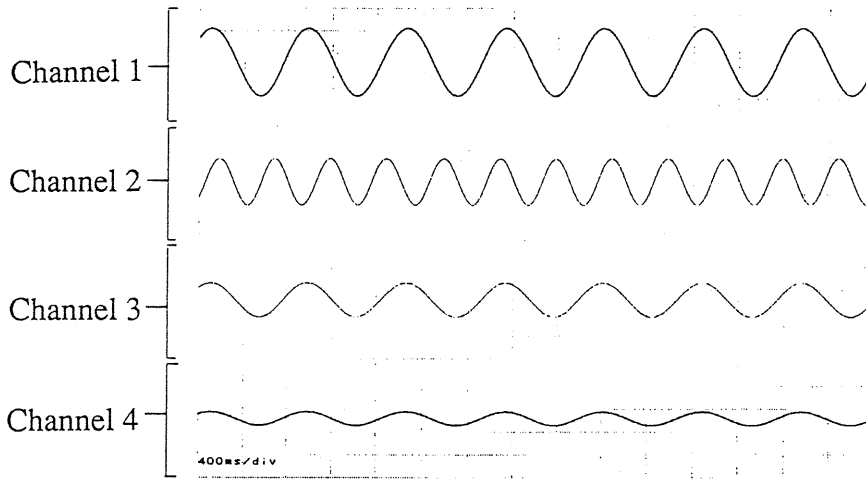

| | |
|--------------|--------------------|
| function | REC&MEM |
| time/div | 400ms |
| cursor | OFF |
| trigger | SINGLE |
| ch1:LEVEL | J 50% |
| trigger time | 91-09-10 01:12:25 |
| [CH1] | DARK 1V/DIV DC X1 |
| | -50% 50% filt:OFF |
| | -10V -10V |
| [CH2] | LIGHT 2V/DIV DC X1 |
| | 50% 50% filt:OFF |
| | -10V -10V |
| [CH3] | LIGHT 2V/DIV DC X1 |
| | 50% 50% filt:OFF |
| | -10V -10V |
| [CH4] | DARK 5V/DIV DC X1 |
| | -25V -25V filt:OFF |
| [log] | DARK |
| A | OFF |
| B | OFF |
| C | OFF |
| D | OFF |

HIOKI 8851 MEMORY H: CORDER
91-09-10 01:20

Manual print

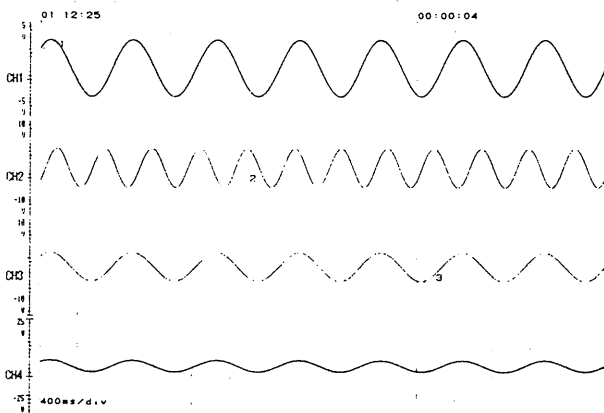

| | | | |
|----------|--------------------|--------------------------|--------------------------|
| function | REC&MEM | *** TRIGGER *** | *** SPECIAL FUNCTION *** |
| time/div | 400ms [REC] | trigger time | a over-write OFF |
| | 100ms [MEM] | '91-09-10 01:12:25 | a memory div OFF |
| shot | 120DIV [REC] | source | |
| | 15DIV [MEM] | ch1 LEVEL | |
| printer | OFF | level 50% | |
| display | REC | slope J | |
| format | QUAD | ch2 OFF | |
| dot-line | LINE [MEM] | ch3 OFF | |
| [CH1] | DARK 1V/DIV DC X1 | ch4 OFF | |
| | -50% 50% filt:OFF | external OFF | |
| | -10V -10V | [REC]mode SINGLE | *** SYSTEM *** V 0.19 |
| [CH2] | LIGHT 2V/DIV DC X1 | [MEM]mode SINGLE | screen auto off ON |
| | 50% 50% filt:OFF | pre-trigger 0x [MEM] | grid type NORMAL |
| | -10V -10V | trigger time START [REC] | start key backup OFF |
| [CH3] | LIGHT 2V/DIV DC X1 | timer source OFF | ch-marker ON |
| | 50% 50% filt:OFF | | beep sound ON |
| | -10V -10V | | list & gauge L & G |
| [CH4] | DARK 5V/DIV DC X1 | | logic drawing DARK |
| | -25V -25V filt:OFF | | smooth print ON |
| [log] | DARK | | roll mode OFF |
| A | OFF | | using unit 4ch |
| B | OFF | | |
| C | OFF | | |
| D | OFF | | |

HIOKI 8851 MEMORY H: CORDER
91-09-10 01:21

- DUAL (print quad) format (memory recorder waveform display)
Display

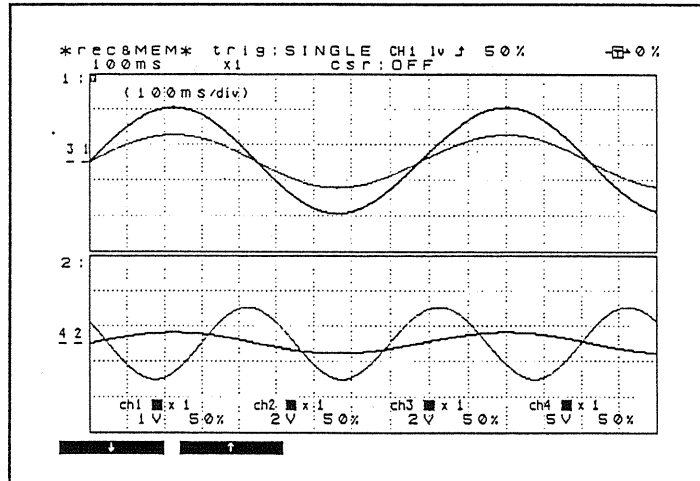

Pressing COPY and FEED simultaneously

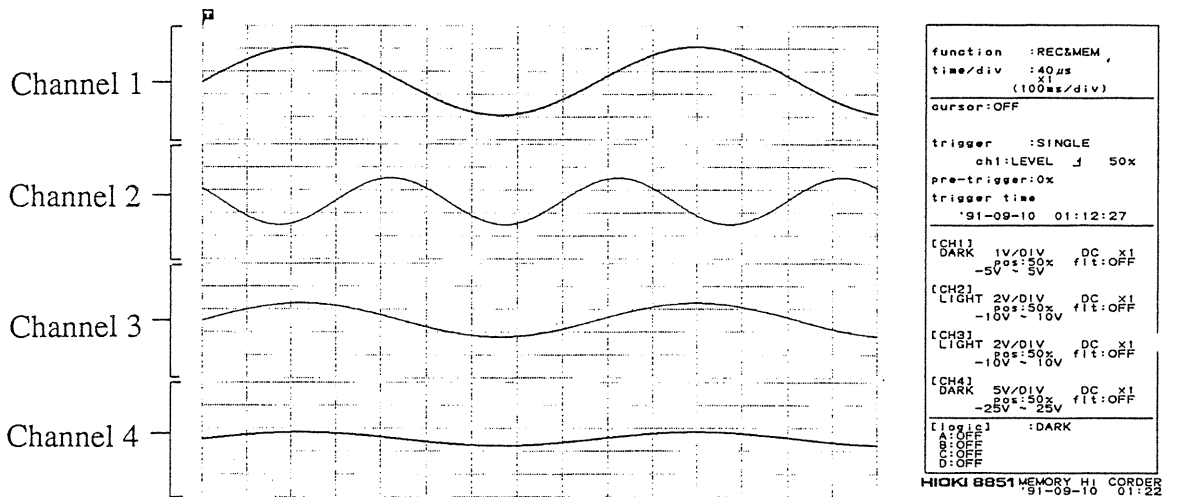

Manual print

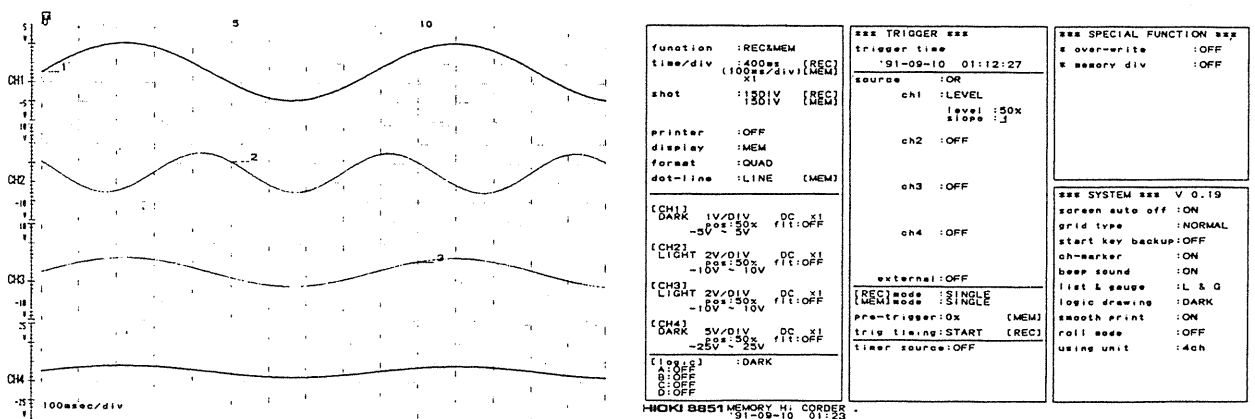

Section 9

Using the Rear Panel

Contents

| | |
|--|-----|
| 9-1 Overview | 9-2 |
| 9-2 External Start/Stop Function | 9-2 |
| 9-3 Key Lock Function | 9-4 |

9-1 Overview

The section "Identification of Controls and Indicators" at the beginning of this volume lists the various connections which can be made to the rear panel. Refer to the sections cross-referenced there for detailed descriptions of the functions of the connectors.

Section 9 deals with the external start/stop function and the key lock function.

9-2 External Start/Stop Function

The external control terminals on the rear panel provide start and stop functions for recording in all functions.

- START:** Uses a TTL level input signal low (0.7 V or less) between the START and GND terminals, or a terminal short.
- STOP:** Uses a TTL level input signal low (0.7 V or less) between the STOP and GND terminals, or a terminal short.

Maximum input voltage -5 V to +10 V

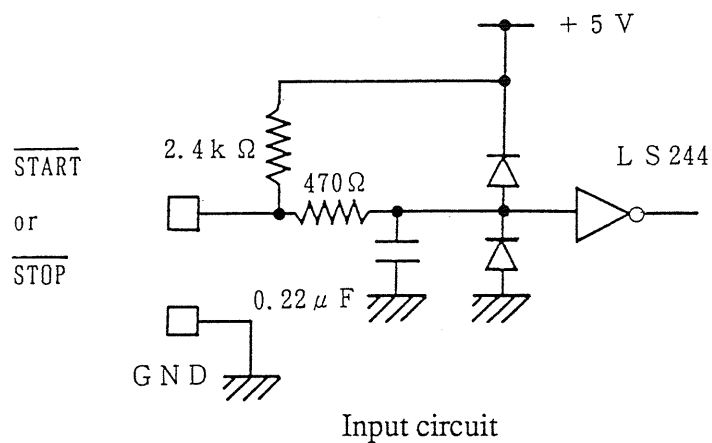

Connections to the external start/stop input terminals

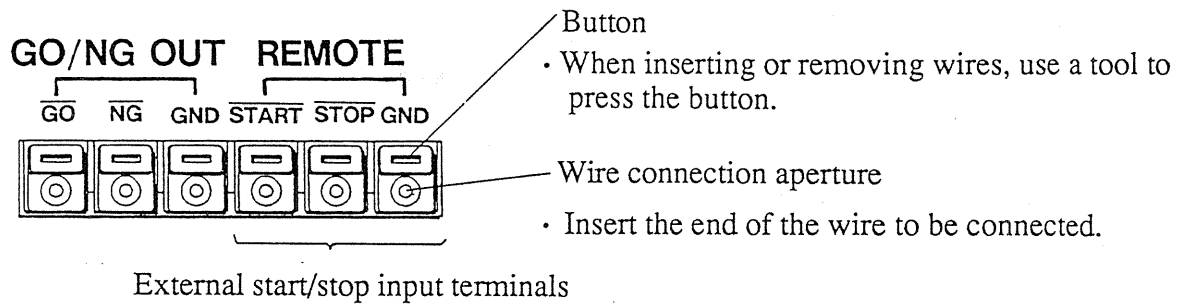

Connecting wires and tools

| | |
|---------------------------------------|---|
| Recommended wire size: | Single strand, 1.0 mm dia. (AWG 18), multi-strand 0.75 mm ² . |
| Usable wire sizes: | Single strand, 0.4 to 1.0 mm dia. (AWG 26 to 18), multi-strand 0.3 to 0.75 mm ² (AWG 22 to 20). Minimum strand diameter 0.18 mm |
| Standard insulation stripping length: | 10 mm |
| Button pressing tool: | Blade screwdriver (tip width 2.6 mm) |

9-3 Key Lock Function

The KEY LOCK key switches to the key lock state. In this state, the message "KEY LOCK" appears on the screen, and all keys on the front panel are disabled.

This function can be used to prevent inadvertent operation of the controls during recording.

The key lock state does not change even if the unit is powered off and on again.

To release the key lock state, press the KEY LOCK key again.

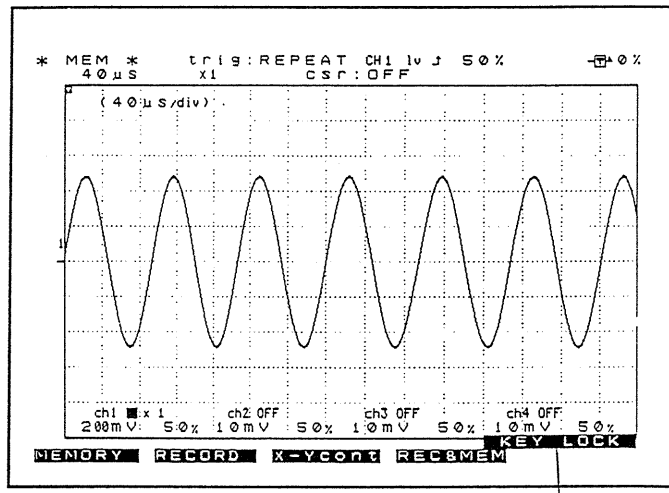
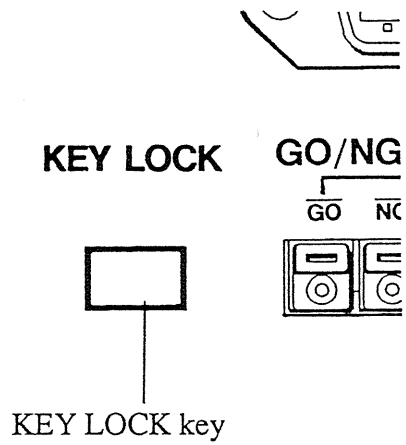

Key lock indication

Note: When using external remote control through the GP-IB interface, all keys, including the KEY LOCK key, are disabled, except for the **LCL** soft key.

If, however, the unit was previously in the key lock state, then even the **LCL** soft key is disabled.

Section 10

Printer Operations

Contents

| | |
|--|------|
| 10-1 Head Up and Paper End | 10-2 |
| 10-2 Screen Dump Function | 10-2 |
| 10-3 Manual Print Function..... | 10-3 |
| 10-4 Feed Function | 10-3 |
| 10-5 Head Temperature Protection Function..... | 10-4 |
| 10-6 Low-Speed Printing..... | 10-4 |

10-1 Head Up and Paper End

- When the printer head is up, the printer will not operate.
An attempt to carry out a printing operation produces the following error message:
"ERROR 2: Set printer lever."
Lower the head up/down lever.
- If the printer paper runs out, printing stops.
The next attempt to carry out a printing operation produces the following error message:
"ERROR 1: Set printer paper."
See Section 3-2 "Loading Recording Paper" for the procedure for reloading printer paper.

10-2 Screen Dump Function

Except during recording, this function provides a hard copy of the screen.

Provided that a waveform is displayed on the screen, pressing the COPY and FEED keys simultaneously prints a copy of the screen, followed by a listing of the settings, as follows.

Display screen

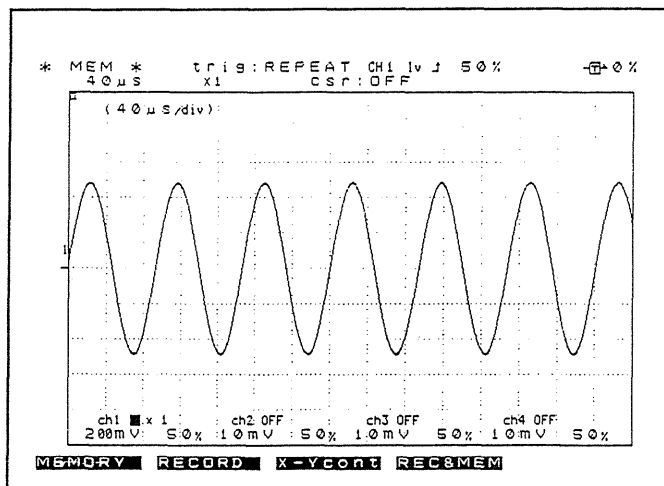

COPY

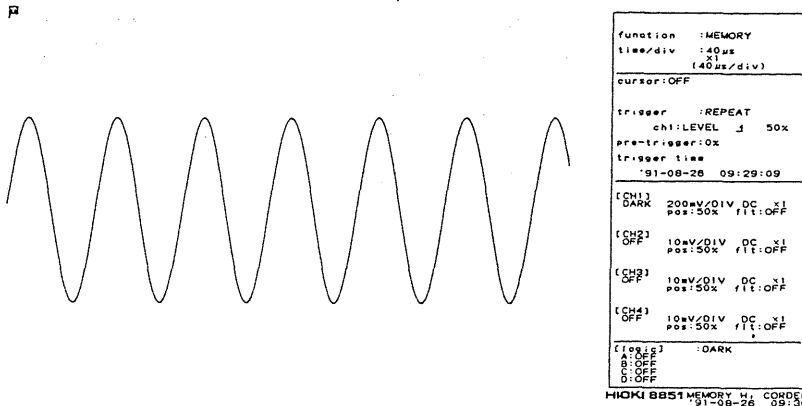

10-3 Manual Print Function

Waveform data held in memory can be printed as many times as required by pressing the PRINT key.

If the list and gauge functions are enabled on the system screen, listings of settings and gauges or the axes can also be printed.

In the memory recorder function, the smooth print function setting provides either waveform printing close to analog quality, or lesser quality but double speed printing.

10-4 Feed Function

Except during recording, pressing the FEED key feeds the printer paper.

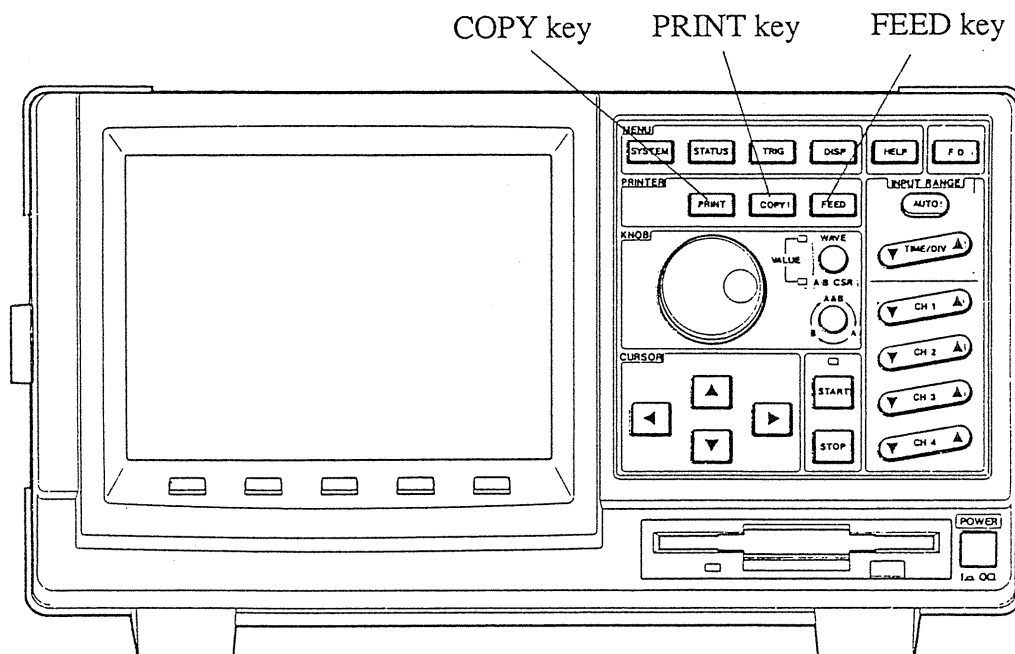



10-5 Head Temperature Protection Function

The printer has a thermal head equipped with a temperature protection circuit. This cuts out operation of the printer if the head temperature reaches a certain level. It is therefore possible for the printer to stop operating while in use, and temporarily feed blank paper.

The tendency of the head temperature to rise is exacerbated by a greater black area being printed, and by a faster paper feed speed. Additionally, higher ambient temperatures make it more likely that the head temperature will rise and trip the protective mechanism.

When the temperature protection circuit operates, disabling printing, once the head temperature has cooled appropriately printing is once more possible.

If printing stops repeatedly, it may be advisable to adjust the input unit ranges to reduce the area of black printed, or to change the recording style using LIGHT or DOT settings.

10-6 Low-Speed Printing

Note

As far as possible, avoid low-speed printing (recorder function or recording with the recorder and memory function) in a high-temperature or high-humidity environment. This may sharply reduce printer life.

Section 11

Input Units

Contents

| | |
|---|-------|
| 11-1 Logic Inputs..... | 11-2 |
| 11-1-1 Logic Input Units | 11-2 |
| 11-1-2 Logic Probes | 11-3 |
| 11-2 8944 Analog Unit..... | 11-4 |
| 11-2-1 Overview..... | 11-4 |
| 11-2-2 Specifications..... | 11-4 |
| 11-2-3 Safety Precautions..... | 11-5 |
| 11-2-4 Replacement Procedure | 11-6 |
| 11-2-5 Input Cables | 11-7 |
| 11-2-6 Functional Description..... | 11-7 |
| (1) Voltage range..... | 11-7 |
| (2) Origin position | 11-7 |
| (3) Zero adjustment | 11-8 |
| (4) Input coupling..... | 11-8 |
| (5) Filter setting | 11-9 |
| 11-2-7 Measurement Errors Caused by Signal Source Internal Resistance | 11-10 |



11-1 Logic Inputs

The 8851 has logic input units built-in, and provides a maximum of 16 logic channel recordings. For operation details, see Sections 5-4-8, 6-4-5 and 8-4-7 "Display and Recording Channel Settings" and Section 14 "Trigger Functions."

11-1-1 Logic Input Units

The logic input units are on the rear panel.

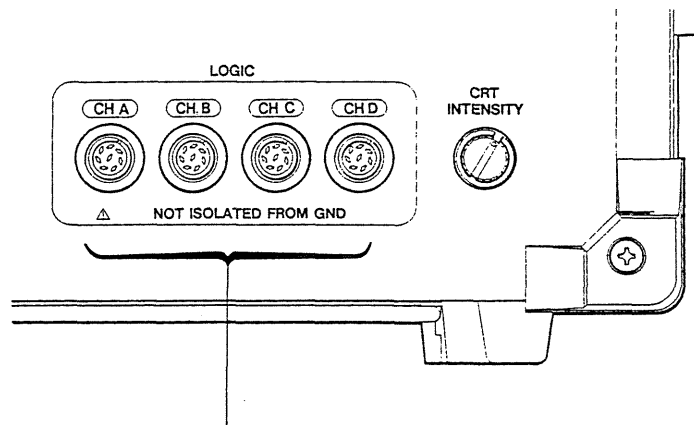

The logic input units have a common ground with the 8851 GND.

Note: If no logic probe is connected, the corresponding logic waveform is displayed on the screen as high level.

⚠ Warning

Each logic input unit allows four probes to be connected, but these are not floating, having a common ground with the main unit.

Do not connect logic probes other than those supplied by Hioki to the logic input units.

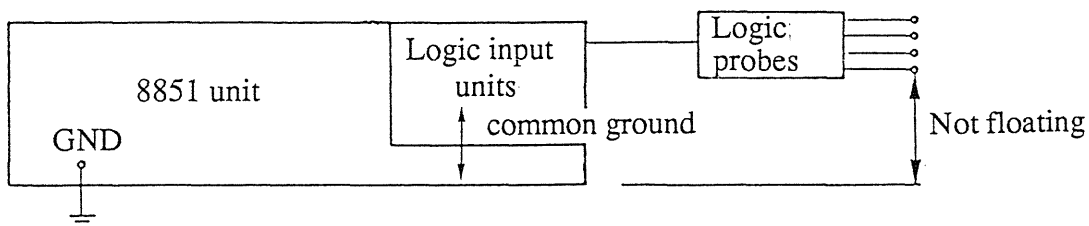



11-1-2 Logic Probes

(1) Using the 9306 logic probe

Switchable between voltage input and contact input. Allows a wide range of measurements from electronic circuits to relay timings.

⚠ Warning

The 8851 allows a maximum of four 9306 units to be connected, but in this case the units have a common ground.

Refer to the documentation for the 9306.

(2) Using the 9307 line logic probe

Can detect the on/off state of an AC line. Since a line voltage up to 250 V can be input, this allows timing measurement of relay sequencers and so forth.

⚠ Danger

Insulation is provided in the probes between the input and output, and between channels. To avoid the danger of electric shock or damage to the equipment, ensure that the applied voltage never exceeds the maximum floating voltage.

Refer to the documentation for the 9307.

If using an early model (serial number 1987 191974 and earlier), when connected to the 8851 the indicator does not light. (All other functions operate correctly.)

(3) Using the 9308 line dip detector

Detects instantaneous dips on a commercial power line (100 or 120 V AC).

The dip level is switchable between approximately 80% and 90%.

⚠ Danger

The low side banana plug (black) is directly connected to the input grip (black); take care to avoid electric shock.

An 8944 analog unit is required.

Refer to the documentation for the 9308.

Note: Can also be carried out in the same way using the timeout trigger of the 8851.

11-2 8944 Analog Unit

This section describes the 8944 analog unit and input cables.

Follow carefully the advice of Section 11-2-3 "Safety Precautions."

11-2-1 Overview

The 8944 analog unit is the analog unit for the 8851 Memory Hi Corder.

The 8944 allows line voltages up to 100 V AC systems to be recorded directly.

11-2-2 Specifications

(Accuracy at $23^{\circ}\text{C} \pm 5^{\circ}\text{C}$, after 30 minutes warming-up time) Accuracy guaranteed for six months.

| | |
|----------------------------------|---|
| Measurement ranges: | 10 mV/DIV to 50 V/DIV, 12 ranges, in 1-2-5 steps |
| DC amplitude accuracy: | $\pm 0.25\%$ f.s. |
| Zero position adjustment: | -100% to +100%, adjustable in 1% steps, with zero adjust function |
| Zero position accuracy: | $\pm 0.1\%$ f.s. (after zero adjustment) |
| Temperature characteristics: | Gain $\pm 0.025\%$ f.s./ $^{\circ}\text{C}$ Zero position $\pm 0.015\%$ f.s./ $^{\circ}\text{C}$ (after zero adjustment) |
| Frequency characteristics: | DC to 500 kHz ± 3 dB (DC coupling) Approx. 7 Hz to 500 kHz ± 3 dB (AC coupling) |
| Noise: | 350 μ Vp-p (typical); maximum sensitivity range, with input shorted |
| Common mode exclusion ratio: | 90 dB minimum (50 Hz or 60 Hz, signal source resistance 100 Ω maximum) |
| Low pass filter: | Cut off frequency approximately 5 Hz or 500 Hz, switchable on/off |
| Input type: | Unbalanced (floating) |
| Input RC: | 1 M Ω $\pm 1\%$, 30 pF approx. (at 100 kHz) |
| Input coupling: | AC, GND, DC |
| A/D resolution: | 12-bit |
| Maximum sampling rate: | 1 MS/s |
| Input terminals: | 2 terminals (banana plugs) |
| Maximum permitted input voltage: | 500 V (DC + AC peak) |
| Maximum floating voltage: | 450 V AC/DC (between input unit and frame or between input units) |
| Dimensions and weight: | 30 mm (H) \times 160 mm (W) \times 110 mm (D) approx. (excluding projections); 300 g approx. |
| Accessories: | 9574 input cable (1) |

11-2-3 Safety Precautions



⚠ Danger

If any metallic portions of the input cables are exposed, there is a danger of electric shock. Use only the 9574 input cables supplied.

⚠ Danger

The 8944 input and the 8851 frame are insulated.

The maximum floating voltage between the 8944 input and the 8851 frame or with other analog units is 450 V AC/DC. To avoid the danger of electric shock or damage to the equipment, ensure that the applied voltage never exceeds the maximum floating voltage.

The maximum floating voltage does not change even when using an attenuator with the input, for example.

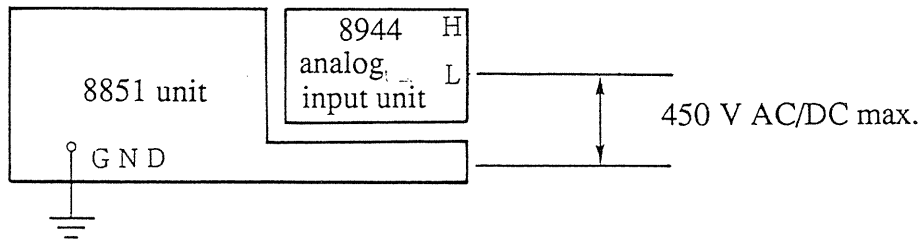

⚠ Danger

The maximum permitted input to the 8944 is 500 V (DC + AC peak). To avoid the danger of electric shock or damage to the equipment, ensure that the applied voltage never exceeds this level.

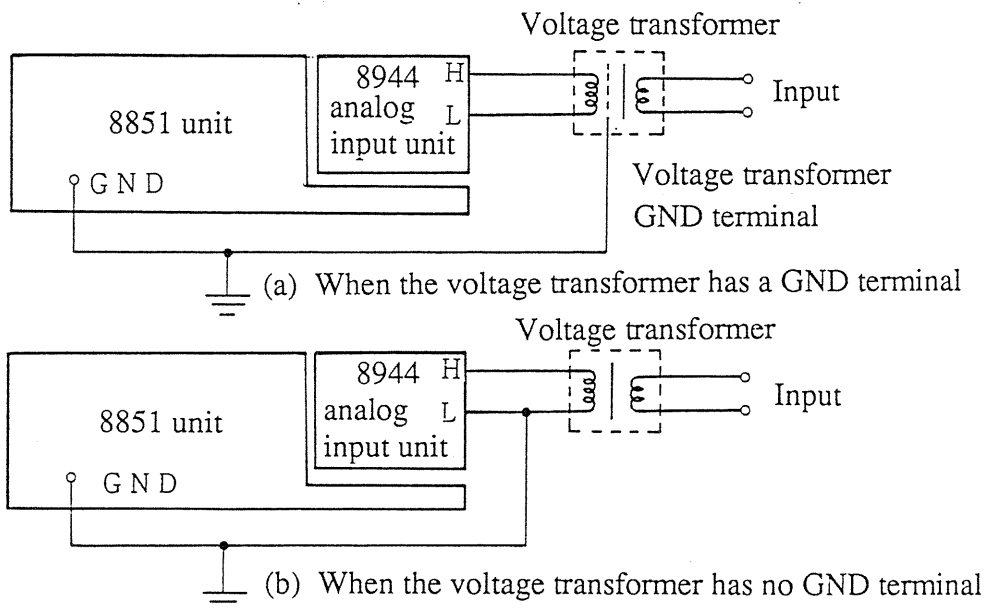



11-2-4 Replacement Procedure

This section describes how to replace the analog input units.

The following procedure describes how to remove an analog input unit; reverse the procedure to insert the replacement.

- ① Remove the input cable from each of the input units.
- ② Power off the 8851 main unit, and disconnect the power cord.

⚠ Danger

To avoid the danger of electric shock, always disconnect the input cables and the power cord before replacing input units.

- ③ Remove the two fixing screws with a phillips screwdriver, as shown in the figure below.
- ④ Holding the handles at each end of the input unit, withdraw it from the main unit.

⚠ Warning

Pull both handles evenly; pulling the input unit out by one handle can damage it.

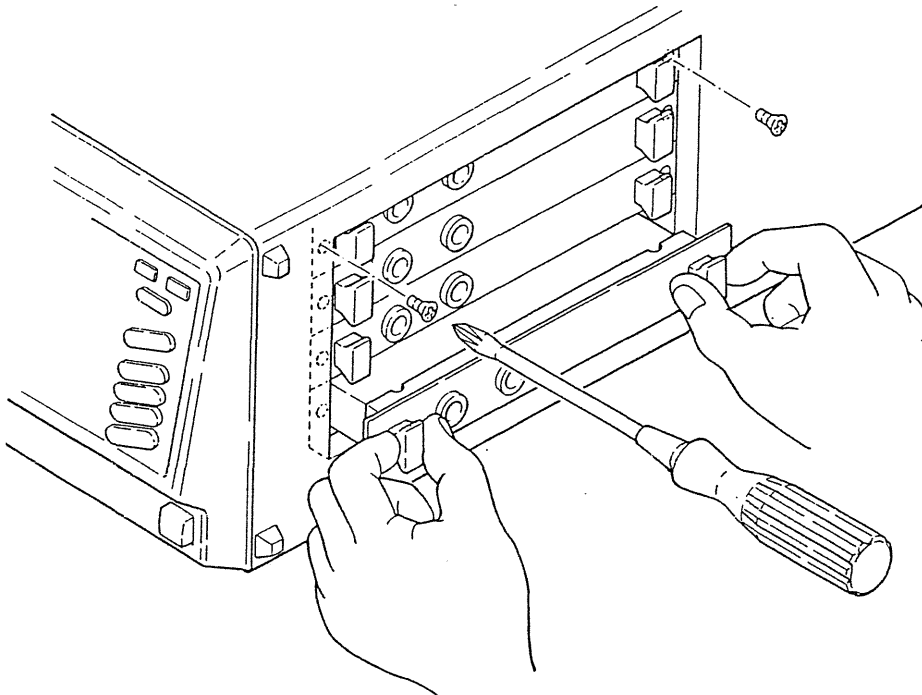

⚠ Danger

To avoid the danger of electric shock, never operate the 8851 unit with an input unit removed.

If you should wish to use the unit after removing an input unit, fit a 9509 blanking panel (available separately).

11-2-5 Input Cables



⚠ Danger

If any metal parts of the input cables are exposed, there is a danger of electric shock.
Use only the special-purpose 9574 input cables with the 8944 input unit.

The cables have a length of 1.7 m, and the portion which plugs into the 8944 has a plastic cover for added safety.

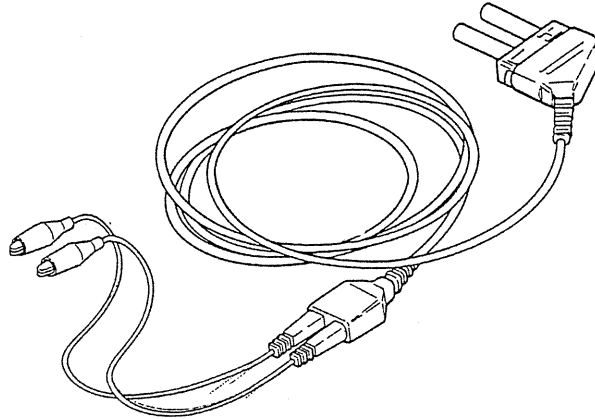

11-2-6 Functional Description

This section covers the voltage range, origin position, input coupling, and filter settings of the 8944 input unit.

(1) Voltage range

This indicates the voltage corresponding to one division of the recording paper on the voltage axis. Since the voltage axis is 10 divisions, the maximum voltage value which can be recorded is ten times this value. (100 mV to 500 V)

Settable range ... 10 mV to 50 V / division

(1-2-5 steps)

12 ranges

(2) Origin position

The position setting indicates the location of the origin (0 V) on both the display and printed recordings.

Settable range ... -100% to 100%

1% steps

The figure on the right illustrates this.

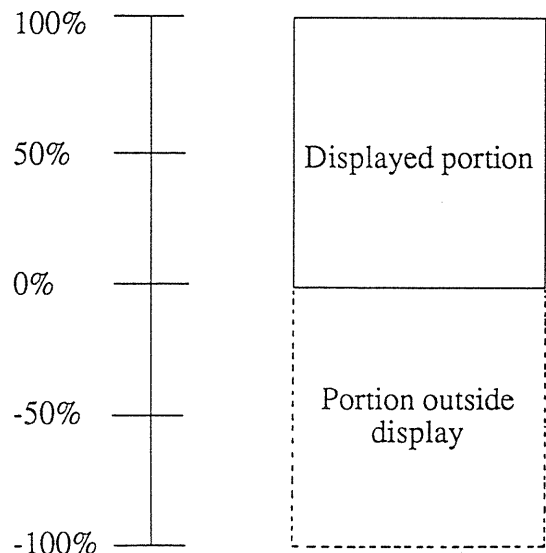

(3) Zero adjustment

Because of thermally dependent drift of components in the input units and other factors, it is possible for the position of the waveform with a zero input to vary somewhat.

The zero adjustment function provides for accurate adjustment of the waveform to the origin position when a zero voltage is input, to cancel this effect.

Notes: Allow at least 30 minutes warming up after powering on before carrying out zero adjustment.

The origin position may be affected by changing input units. Always, therefore, repeat zero adjustment after changing input units.

In particular, if using the waveform calculation functions, to ensure accurate results, carry out zero adjustment first.

(4) Input coupling

This indicates the method of coupling the input signal.

(a) GND

No input signal is connected, and the effect is the same as if 0 V were applied.

(b) AC coupling

The input signal is connected with a capacitor in series, cutting any DC component. This allows only the AC component to be measured.

Frequency characteristics: approximately 7 Hz to 500 kHz ± 3 dB

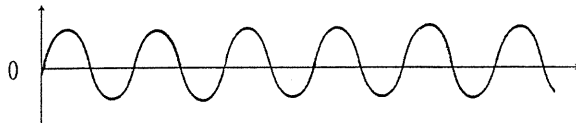

(c) DC coupling

The input signal is connected directly to the amplifier, allowing both AC and DC components to be measured.

Frequency characteristics: DC to 500 kHz ± 3 dB

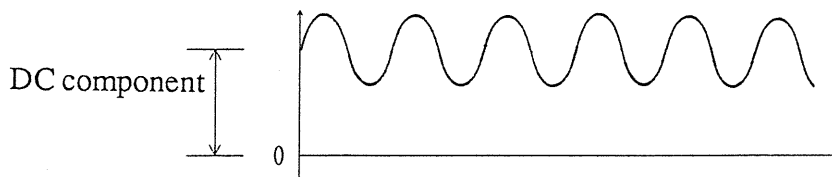

(5) Filter setting

This controls the frequency band of the built-in low pass filter.

Attenuation -6 dB/oct

Cut-off frequency: approximately 5 Hz or 500 Hz

This is effective for countering the following phenomena:

- When using the recorder function for recording the level of some signal, the combination of high sampling rate and high band amplifier can cause ripple or noise on the signal to make the recording trace into a broad line.
- Ripple in the output of a transducer can make the recording trace into a broad line.

11-2-7 Measurement Errors Caused by Signal Source Internal Resistance

This problem only arises if the internal resistance of the signal source is not sufficiently low compared to the internal resistance of the 8851 unit. If it is high, it can lead to measurement errors.

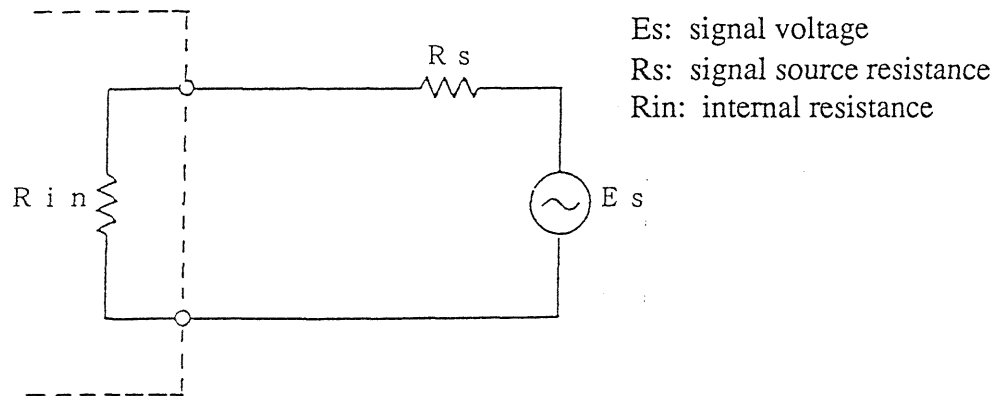

$$\text{Measurement error} = E_s \left(1 - \frac{R_{in}}{R_s + R_{in}} \right)$$

Example: The internal resistance of the 8851 is approximately 1 M Ω , and therefore if the signal source resistance is 1k Ω the error is increased by approximately 0.1%.

Section 12

Maintenance and Servicing

Contents

| | |
|--------------------------------------|------|
| 12-1 Fuse Replacement | 12-2 |
| 12-2 Cleaning the Printer Head | 12-3 |
| 12-3 Cleaning the CRT Screen..... | 12-5 |
| 12-4 Troubleshooting | 12-6 |

12-1 Fuse Replacement



⚠ Danger

To avoid the danger of electric shock, always disconnect the power cord and input cables from the 8851 before removing or replacing input units or changing the fuse. To ensure safe operation, use only a fuse with the correct voltage and current rating as shown on the rear panel.

⚠ Danger

If the fuse has blown, there is a possibility of an internal 8851 failure. Check the cause of the fault carefully before replacing the fuse.

To avoid the danger of electric shock, always remove the power cord from the connector and disconnect the input cables from the 8851 before replacing the fuse.

To ensure safe operation, use only a fuse of the correct rating.

Ordinary fuse 4.0 A / 250 V, size 30 mm × 6.4 mm dia.

- ① Turn off the power switch on the 8851.
- ② Remove the 8851 power cord.
- ③ Remove the fuse from the fuseholder.
- ④ Replace with the specified fuse.
- ⑤ Reconnect the power cord.

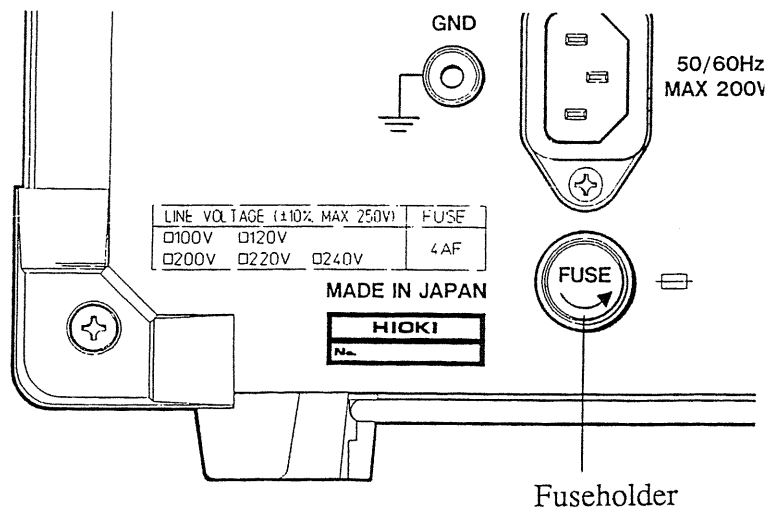

12-2 Cleaning the Printer Head

The printer does not normally require any maintenance. With extended use, however, it is possible for dirt or paper dust to adhere to the thermal printer head, causing the printing to be faint or otherwise indistinct. If this occurs, use the following procedure to clean the printer head.

- ① Open the printer cover

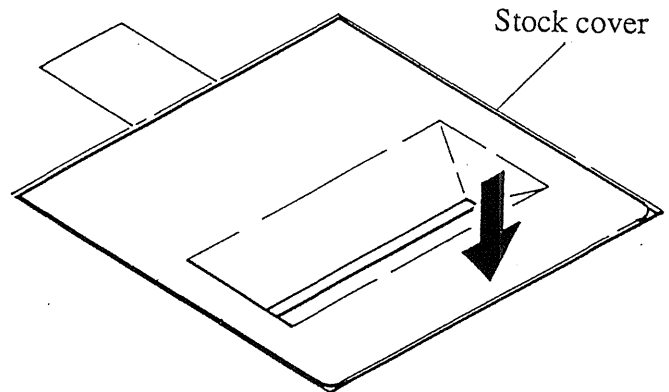

- ② Raise the head up/down lever, then use a phillips screwdriver to remove the two screws. (Leave the screws and the plastic washers in the metal part containing the head.)

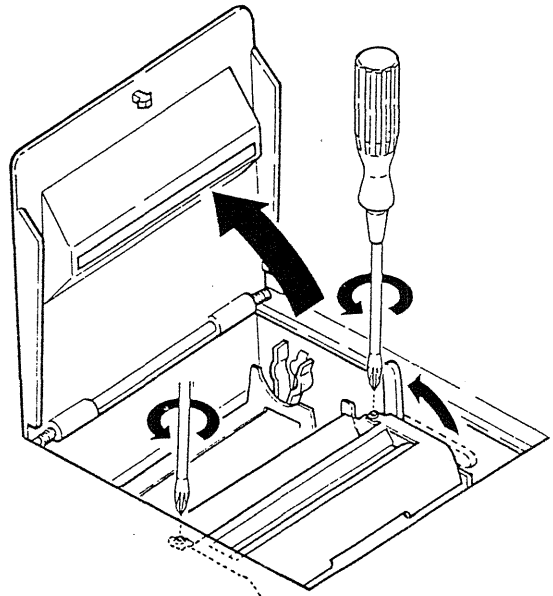

- ③ Reverse the metal part containing the head. Do not hold the roller and pull up, or the entire mechanism including the gears will come out. This can cause printer failure.

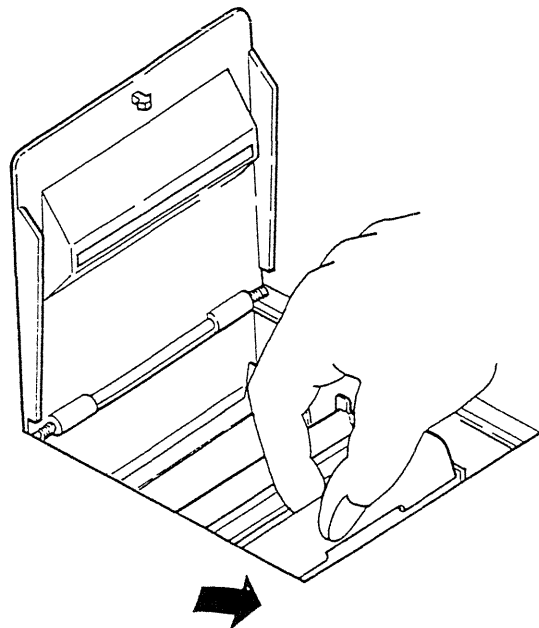

- ④ Apply some neat alcohol to a cotton swab, and use it to remove the dirt and dust from the head.
- ⑤ Reverse the disassembly procedure to reassemble the printer.

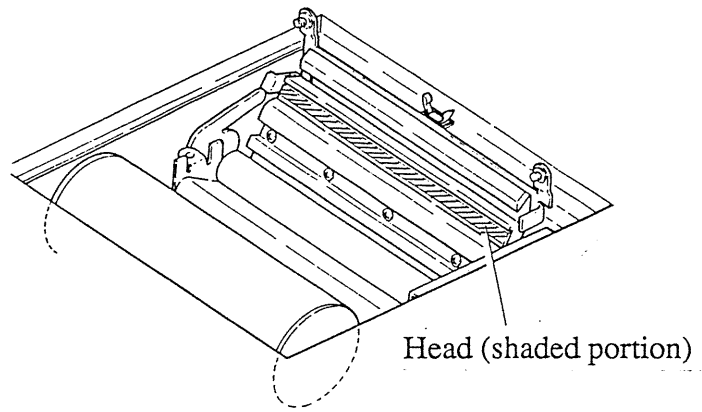

⚠ Warning

Avoid any more than the minimum necessary adjustments or dismantling of the printer. This can lead to printer failure.

Do not use thinners, benzine or other organic solvents.

After using alcohol, be sure that the printer is completely dry.

12-3 Cleaning the CRT Screen

The screen has a cover to prevent dirt from getting at it. However, depending on the conditions under which the unit is used, dirt may penetrate the small gap around the cover, and stick to the screen, impairing readability. If this occurs, use the following procedure to clean the screen.

- ① Press gently on the top left and right corners of the screen cover, sliding the cover upwards. The cover can then be detached from the bottom.

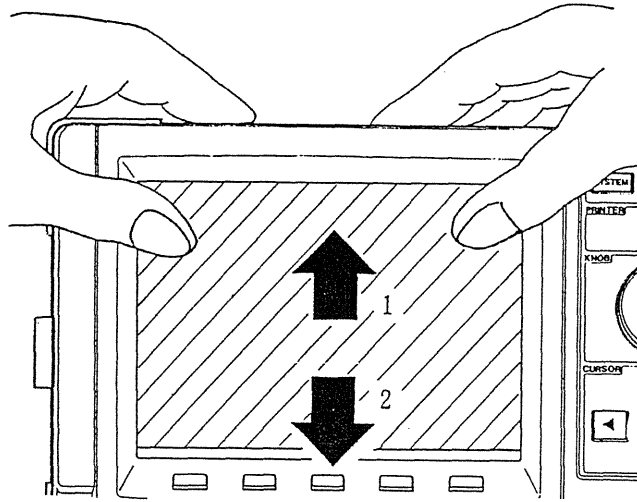

- ② After removing the cover, clean the screen and both surfaces of the cover with a tissue or soft cloth steeped in neat alcohol, to remove dust and dirt. (You can use an anti-static preparation on both cover and screen to reduce the incidence of dust.)

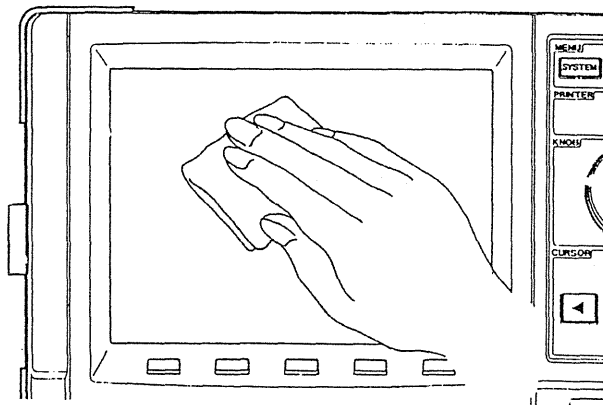

- ③ Holding the left and right sides of the cover, and taking care not to pull the bottom toward you, slide the cover up in the rails. The bottom should click into place when the cover is properly positioned. (If you pull the bottom toward you while inserting the cover, it may not fit correctly into place.)

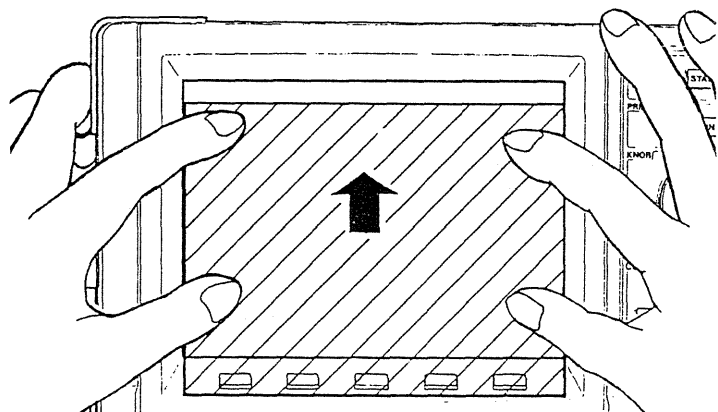

⚠ Warning

Do not use thinners, benzine or other organic solvents.

After using alcohol or anti-static preparation, be sure that the parts are completely dry before operating the unit.

12-4 Troubleshooting

If the unit is not functioning normally, check the following items before sending it for repair.

| | |
|--|--|
| The screen and indicators do not light when powered on. | <ul style="list-style-type: none"> • Is the power cord correctly connected? • Has the fuse blown? • Try adjusting the brightness control. |
| The screen shows nothing. | <ul style="list-style-type: none"> • Is the screen saver function (screen auto off) function enabled? Press any key to check whether the display comes back to life. |
| No waveform appears on the display when the START key is pressed. | <ul style="list-style-type: none"> • Has the "pre-trig wait." message appeared? When recording before the trigger, until the corresponding time interval has elapsed, a trigger is not accepted. • Has the "wait for trig." message appeared? Check the trigger settings. • Are all of the channels switched off? |
| There is absolutely no variation in the recorded waveform. | <ul style="list-style-type: none"> • Is the measurement range setting correct? • Is the input coupling set to GND? • Is the low-pass filter set to 5 Hz or 500 Hz? |
| The printed recording is very faint or non-existent. | <ul style="list-style-type: none"> • Is the recording paper back to front? • Are you using the correct recording paper? |
| During memory recorder operation, the apparent frequency of the recording is much lower than the expected frequency. | <ul style="list-style-type: none"> • This is likely to be an aliasing error. • Either switch to envelope mode, or make the TIME/DIV setting faster. For more details see the background information on aliasing distortion in Section 5-4-2 "Time Axis Range Setting." |
| In the recorder function, the recording line is very thick. | <ul style="list-style-type: none"> • A ripple component in the input signal may be the cause. Set the filter setting for the input unit to 5 Hz or 500 Hz. |
| The screen display is unstable. | <ul style="list-style-type: none"> • Is the unit close to something producing a powerful magnetic field? • Is the power supply voltage fluctuating? |
| The keys on the front panel do not operate. | <ul style="list-style-type: none"> • Is the unit in the key lock state? (If so the message "KEY LOCK" will appear.) Press the KEY LOCK key to release the lock. • Is the unit being remotely controlled through the GP-IB interface? |

If other operating problems occur which cannot be solved immediately, try carrying out a system reset. This returns all settings to their default values at shipment. Then make all required settings again, and check whether performance is normal.

System reset
Power on the unit while holding down the STOP key.

INDEX

A

| | |
|---------------------------------------|---------------------|
| A/D..... | Glossary 2 |
| ABS..... | 17-5,17-10 |
| Absolute value..... | 17-9 |
| address..... | 20-7 |
| all clr..... | 16-12 |
| all clear..... | 16-12 |
| Analog drawing..... | 5-31,6-20,7-15,8-28 |
| analog trigger..... | 14-3 |
| and/or..... | 14-14 |
| AND/OR..... | 14-18 |
| AND..... | 14-15,14-18 |
| Anti-aliasing filter..... | 17-45 |
| Area value..... | 17-27 |
| Area..... | 17-22,17-28 |
| AREA..... | 19-3 |
| auto save..... | 19-17 |
| auto print..... | 5-66 |
| Auto Setup Function..... | 19-17 |
| Auto Save Function..... | 19-16 |
| AUTO..... | 5-60,14-20 |
| Automatic creation of file names..... | 19-10 |
| Average value..... | 17-26 |
| Average..... | 17-22,17-27 |
| AVERAGE..... | 5-21,13-2 |
| averaging process..... | 13-2 |
| Averaging Function..... | 13-2 |
| axis..... | 5-26,7-15 |

B

| | |
|-----------------|-------------|
| beep sound..... | 18-13,18-16 |
| Beep Sound..... | 18-14 |

C

| | |
|----------------------------|---------------------|
| Calculation Functions..... | 17-1 |
| calculation screen..... | 17-4 |
| CALCULATION..... | 17-5 |
| ch - marker..... | 18-13,18-15 |
| CH1 - CH4..... | 4-5 |
| ch1 (A) - ch4 (D)..... | 14-3 |
| CHA - CHD..... | 5-31,6-20,8-28,11-2 |

| | |
|---------------------------------|--------------------------|
| change to MEMORY function | 6-45 |
| Channel Marker Function..... | 18-13 |
| clear | 16-12 |
| Clock Function | 18-3 |
| Command tree | 20-8 |
| Command program headers..... | 20-7 |
| COMMENT..... | 18-11 |
| Comments..... | 18-8 |
| Common logarithm | 17-11 |
| comparison | 16-2,17-23 |
| COPY | 5-64,6-41,7-26,8-46,10-1 |
| coupling..... | 5-35,6-24,7-16,8-31,11-8 |
| CRT INTENSITY | 3-6 |
| CRT screen check..... | 18-26 |
| cursor..... | 19-9 |
| CURSOR..... | 4-3 |

D

| | |
|------------------------|----------------------|
| DARK..... | 5-31,6-20,7-15,8-28 |
| DATA..... | 17-35 |
| Decision Mode | 16-2 |
| DELETE..... | 19-14 |
| delimiter..... | 20-7 |
| DIF | 17-5,17-15 |
| DIF2 | 17-5,17-15 |
| DISP | 4-2,5-8,6-7,7-6,8-8 |
| display clear..... | 7-14 |
| Display..... | 18-27 |
| display | 8-23 |
| DIV | Glossary 2 |
| dot-line (MEM) | 8-26 |
| dot-line..... | 5-29,7-13 |
| DOT..... | 5-29,7-13,8-26 |
| DUAL (print quad)..... | 5-22,6-17,8-24 |
| DUAL..... | 5-22,6-17,8-24,17-35 |
| Dynamic range | 17-30 |

E

| | |
|---|------------|
| Effective value | 17-26 |
| end..... | 16-13 |
| Envelope Function | 13-5 |
| envelope → normal..... | 17-30 |
| Envelope To Normal Conversion Calculation | 17-29 |
| ENVELOPE..... | 5-21,13-5 |
| erase | 16-11 |
| ERROR | Glossary 1 |
| Event Status register..... | 20-15 |
| Event trigger..... | |
| EVENT | 14-8 |
| EXP | 17-5,17-11 |
| Exponential | 17-10 |
| EXT TRIG | 14-17 |
| External Trigger | 14-17 |
| external..... | 14-17 |

F

| | |
|------------------------------------|----------------------------------|
| Fall Time | 17-27 |
| Fall time | 17-22,17-28 |
| FD | 4-2,19-1 |
| FEED..... | 10-3 |
| FFT..... | 17-33 |
| FFT..... | 17-42 |
| FFT analyzers..... | 17-43 |
| FFT calculation | 17-30 |
| FFT screen | 17-33 |
| file | 19-9 |
| FILTER..... | 14-4 |
| filter..... | 5-36,6-25,7-16,8-32,11-9,14-14 |
| Floppy Disk Control Screen..... | 19-5 |
| Floppy Disk..... | 19-1 |
| FORMAT..... | 19-7 |
| format..... | 5-22,6-17,8-24,17-34, Glossary 2 |
| four arithmetical operations | 17-8 |
| Frequency range..... | 17-30 |
| Frequency..... | 17-22,17-28 |
| Frequency..... | 5-44,6-32 |
| FUNC..... | 19-3 |
| FUSE..... | 3-2,12-2 |

G

| | |
|--------------------------------|----------------|
| Gauge | 18-14 |
| gl..... | 14-11 |
| glid type..... | 18-13,18-14 |
| Glitch Dectection Trigger..... | 14-10 |
| GLITCH | 14-10 |
| GND | 3-2 |
| GO/NG OUT | 16-14,17-24 |
| GP-IB | 18-21,20-1 |
| GP-IB Interface | 20-1 |
| graph..... | 5-23,6-18,8-25 |
| Graphic Editor | 16-6 |
| GRAPHIC EDITOR..... | 16-6 |
| Grid..... | 18-14 |

H

| | |
|---------------|-----------|
| HANNING | 17-34 |
| header | 20-7 |
| HELP..... | 5-68,6-47 |

I

| | |
|---------------------------|------------|
| infor. | 19-15 |
| INT | 17-5,17-16 |
| INT2 | 17-5,17-16 |
| Integration | 17-17 |
| Integration | 17-15 |
| Internal File Format..... | 19-24 |
| Internal Triggers | 14-3 |
| interval..... | 14-25 |

K

| | |
|---------------------|-------|
| KEY LOCK..... | 9-4 |
| Key Board..... | 18-26 |
| keyboard check..... | 18-24 |
| KNOB..... | 4-4 |

L

| | |
|--------------------|-----------------------|
| LED | 18-24,Glossary 2 |
| LED check..... | 18-22 |
| Level Trigger..... | 14-4 |
| level | 14-4,14-9,14-10,14-12 |
| LEVEL | 14-4,14-9 |

| | |
|----------------------|---------------------|
| LIGHT..... | 5-31,6-20,7-15,8-28 |
| LIN-RAL..... | 17-36,17-40,17-42 |
| LIN-IMG..... | 17-36,17-40,17-42 |
| LIN-MAG..... | 17-36,17-39,17-42 |
| LIN..... | 17-36 |
| LINE VOLTAGE..... | 3-2 |
| line..... | 16-7 |
| LINE..... | 5-29,7-13,8-26 |
| Linear Spectrum..... | 17-44 |
| list & gauge..... | 18-13,18-16 |
| Listing..... | 18-14 |
| lo..... | 17-36 |
| LOAD..... | 19-11 |
| LOG..... | 17-5,17-12,17-36 |
| logic drawing..... | 18-13,18-16 |
| Logic drawing..... | 5-31,6-20,8-28 |
| Logic Trigger..... | 14-14 |
| LOGIC..... | 11-2,14-14 |
| lower..... | 14-6,17-30 |
| lv..... | 14-5 |

M

| | |
|-------------------------------|-------------|
| Max..... | 17-22,17-27 |
| Maximum value..... | 17-26 |
| Measurement data..... | 19-3 |
| measurement..... | 17-21 |
| MEASUREMENT..... | 17-22 |
| MEM..... | 5-1 |
| Memory Division Function..... | 15-1 |
| memory div..... | 15-1 |
| MEMORY..... | 5-1 |
| Messages..... | 20-7 |
| Min..... | 17-22,17-27 |
| Minimum value..... | 17-26 |
| mode..... | 20-7 |
| MOV..... | 17-5,17-14 |
| Moving average..... | 17-13 |
| MS-DOS..... | Glossary 2 |
| MULTI-BLOCK..... | 15-4 |
| Multi-Block Function..... | 15-2 |

N

| | |
|-------------------------|-----------|
| natural logarithm | 17-11 |
| No-wait operation | 14-23 |
| NONE | 17-7 |
| NORMAL | 5-21,13-2 |
| Nyquist frequency | 17-45 |

O

| | |
|-----------------------|-------------|
| Offset | 17-5 |
| OR | 14-15,14-19 |
| Output Terminal | 14-26,17-23 |
| Output Queue | 20-16 |
| over-write | 5-62,8-44 |

P

| | |
|---|---|
| paint | 16-8 |
| paral | 16-10 |
| Parallel displacement along the time axis | 17-19 |
| parallel | 16-10 |
| Partial Save Function | 19-15 |
| Pass/Fail Decision Output | 16-14,17-24 |
| pattern | 14-14 |
| Peak to Peak | 17-22,17-27 |
| Peak to peak value | 17-26 |
| PEAK | 17-35 |
| Period | 17-27 |
| Period | 17-22,17-28 |
| Plotter Output | 18-17 |
| PLOTTER | 18-19 |
| position | 5-35,6-24,7-16,8-31,11-7 |
| Power Spectrum | 17-44 |
| POWER | Identification of Controls and Indicators |
| Pre-Trigger | 14-21 |
| pre-trig | 14-21 |
| PRINT | 5-64,6-41,7-26,8-46,10-1 |
| print | 6-41,17-21 |
| Printer Check | 18-23 |
| printer | 6-41,8-46,18-25 |
| PSP-MAG | 17-36,17-39,17-41 |
| PSP-MdB | 17-36,17-38,17-41 |
| PT | Glossary 2 |

R

| | |
|-------------------------|--------------------------|
| range..... | 5-35,6-24,7-16,8-31,11-7 |
| REC..... | 6-1 |
| REC&MEM..... | 8-1 |
| REC&mem..... | 8-23 |
| rec&MEM..... | 8-23 |
| RECORDER..... | 6-1 |
| RECTANG..... | 17-34 |
| REMOTE..... | 9-2 |
| REPEAT..... | 14-20 |
| Response messages..... | 20-8 |
| reverse..... | 16-9 |
| Rise Time..... | 17-27 |
| Rise-time..... | 17-22,17-28 |
| RMS..... | 17-22,17-27,17-35 |
| roll mode..... | 18-13,18-17 |
| Roll Mode..... | 18-15 |
| ROM/RAM..... | 18-23 |
| ROM and RAM checks..... | 18-21 |

S

| | |
|-------------------------------|--------------------------|
| save..... | 16-13 |
| SAVE..... | 19-8 |
| Scaling Function..... | 18-3 |
| SCALING..... | 18-4 |
| screen auto off..... | 18-14 |
| screen auto off..... | 18-13,18-14 |
| SELF-CHECK..... | 18-22 |
| self-check..... | 18-22 |
| Separators..... | 20-9 |
| Sequential Save Function..... | 15-6 |
| SEQUENTIAL SAVE..... | 15-8 |
| Setting state..... | 19-3 |
| SETUP..... | 18-13 |
| shot..... | 5-20,6-16,8-22 |
| SINGLE..... | 5-22,6-17,8-24,140,17-35 |
| SLI..... | 17-5,17-19 |
| Sliding averaging..... | 13-4 |
| slope..... | 14-4,14-9,14-10,14-12 |
| Smooth Print Function..... | 18-15 |
| smooth print..... | 18-13,18-17 |

| | |
|--------------------------------------|---------------------------|
| Special Function Settings | 18-11 |
| spectrum analyzer | 17-43 |
| SQR | 17-5,17-13 |
| Square root | 17-12 |
| Standard event status register | 20-15 |
| Standards | 20-3 |
| STARPU | 19-19 |
| start key backup | 18-13,18-15 |
| Start Key Backup Function | 18-13 |
| start | 14-25 |
| START | 5-42,6-31,7-22,8-39,14-24 |
| START&STOP | 14-24 |
| STARTUPA | 19-19 |
| Status byte | 20-14 |
| STATUS | 4-2,5-6,6-5,7-4,8-6 |
| Stop Mode | 16-4 |
| stop mode | 16-14 |
| stop | 14-25 |
| STOP | 5-42,6-31,7-22,8-39,14-24 |
| storage mode | 5-21,13-1 |
| storage | 16-9 |
| STORAGE | 17-36,17-38,17-41 |
| System Screen | 18-1 |
| SYSTEM | 4-2,18-1 |

T

| | |
|------------------------|-----------------------|
| Terminator | 20-9 |
| ti | 14-13 |
| TIME/DIV | 4-5,5-17,6-15,8-20 |
| time/div | 5-17,6-15,8-20 |
| TIME OUT | 14-12 |
| Time Out Trigger | 14-12 |
| TIME | 18-3 |
| timer source | 14-25 |
| Timer Trigger | 14-25 |
| TRIG OUT | 14-27 |
| trig timing | 14-24 |
| trig mode | 14-20 |
| TRIG | 4-2,5-7,6-6,7-5,8-7 |
| trigger slope | 14-5,14-9,14-10,14-12 |
| trigger timing | 14-24 |

| | |
|------------------------|----------------------------|
| Trigger level..... | 14-4,14-6,14-9,14-10,14-12 |
| trigger pattern..... | 14-14 |
| Trigger Functions..... | 14-1 |
| Trigger Modes..... | 14-20 |
| trigger filter..... | 14-5,14-15 |
| Trigger..... | 14-2 |

U

| | |
|-----------------|-------------|
| undo..... | 16-13 |
| up..... | 17-36 |
| upper..... | 14-6,17-30 |
| using unit..... | 18-13,18-18 |

W

| | |
|--------------------------------------|-------------|
| WARNING..... | Glossary 1 |
| wave calculation..... | 17-3 |
| WAVE..... | 17-35,19-3 |
| Waveform Processing Calculation..... | 17-3 |
| Waveform Processing..... | 13-1 |
| Waveform decision area..... | 19-3 |
| Waveform Parameter Decision..... | 17-22 |
| Waveform Parameter Calculation..... | 17-19 |
| Waveform Data Listing..... | 17-40 |
| Waveform Decision Function..... | 16-1 |
| wd..... | 14-7 |
| width..... | 14-10,14-12 |
| Window Trigger..... | 14-6 |
| WINDOW..... | 14-6 |
| window..... | 17-34 |
| write-protect..... | 19-16 |
| X-Y..... | 5-22,5-25 |

X

| | |
|---------------|-------------|
| X-Y Area..... | 17-22,17-29 |
| X-Y area..... | 17-28 |
| X-Ycont..... | 7-1 |

Y

| | |
|------------------|-----------|
| Y-axis zoom..... | 5-55,6-37 |
|------------------|-----------|

HIOKI E.E. CORPORATION

81 Koizumi, Ueda, Nagano 386-11, Japan
TEL 0268-28-0562 FAX 0268-28-0568
TLX: 3327508 HIOKI J CABLE: HEWLOV, Ueda