

# MR6000

# HIOKI

# MR6000-01

Instruction Manual

# MEMORY HiCORDER



**Read carefully before use.  
Keep for future reference.**

The latest edition of the  
instruction manual



# EN

June 2024 Revised edition 7  
MR6000A966-07





# Contents

Introduction.....	1
Notations.....	1
How to Use This Document.....	2

## 1 Measurement Method 3

1.1 Measurement Procedure.....	3
1.2 Setting Measurement Conditions.....	5
Sampling rate setting guideline.....	7
Using the envelope.....	9
1.3 Configuring the Input Channel Settings.....	11
Analog channels.....	13
Logic channels.....	17
1.4 Configuring the Sheet Settings.....	19
Switching sheets on the waveform screen.....	24
Generating XY composite waveforms.....	25
1.5 Starting/Stopping a Measurement.....	28

## 2 Operating the Waveform Screen and Analyzing Data 29

2.1 Reading Measured Values (Trace Cursors, Horizontal Cursors).....	30
2.2 Specifying the Waveform Range (Section Cursor).....	35
Changing the display magnification of the waveforms while moving the section cursor.....	36
2.3 Displaying Vertical Scales (Gauge Function).....	37
2.4 Scrolling Through Waveforms.....	39
Scrolling through waveforms.....	39
Checking a position of waveforms with the scroll bar.....	40
2.5 Changing the Display Position and Display Magnification of Waveforms.....	41
Differentiating a waveform display position and display magnification from those of other analog channels.....	42
2.6 Operating the Rotary Knobs.....	45
2.7 Enlarging a Part of the Waveform (Zoom Function).....	46
2.8 Generating XY Composite Waveforms (XY Composite).....	47
2.9 Displaying Measured Values.....	49
2.10 Viewing Block Waveforms.....	51

## 3 Advanced Functions 53

3.1 Overlaying New Waveforms With Previously Acquired Waveforms.....	54
3.2 Converting Input Values (Scaling Function).....	56
When using Model U8969 Strain Unit.....	61
3.3 Adjusting the Waveform Display Positions (Variable Function).....	62
3.4 Fine-Adjusting Input Values (Vernier Function).....	64
3.5 Inverting a Waveform (Invert Function).....	65
3.6 Copying Settings (Copy Function).....	66
3.7 Configuring Measurement Module-Specific Settings.....	67
Configuring Model 8968 High Resolution Unit settings.....	67
Configuring Model 8967 Temp Unit settings.....	68
Configuring Model U8969 Strain Unit settings.....	70
Configuring Model 8970 Freq Unit settings.....	72
Configuring Model 8971 Current Unit settings.....	75
Configuring Model 8972 DC/RMS Unit settings.....	77
Configuring Model MR8990 Digital Voltmeter Unit settings.....	78
Configuring Model U8974 High Voltage Unit settings.....	80
Configuring Model U8977 3CH Current Unit Settings.....	81
Configure Model U8979 Charge Unit Settings.....	83
3.8 Configuring Generator Module-Specific Settings.....	86
Generating signals from Model MR8790 Waveform Generator Unit.....	86
Configuring Model MR8790 Waveform Generator Unit settings.....	88
Generating signals from Model MR8791 Pulse Generator Unit.....	90
Configuring Model MR8791 Pulse Generator Unit settings.....	92
Generating signals from Model U8793 Arbitrary Waveform Generator Unit.....	97
Configuring Model U8793 Arbitrary Waveform Generator Unit.....	99
Registering arbitrary waveforms in the U8793 Arbitrary Waveform Generator Unit.....	102

1

2

3

Index

Editing arbitrary waveforms for Model U8793 Arbitrary Waveform Generator Unit .....	106
Editing programs of Model U8793 Arbitrary Waveform Generator Unit.....	107
Installing Model SF8000 Wave Marker software .....	110

## **4 Saving/Loading Data and Managing Files** 115

4.1 Data That Can Be Saved and Loaded .....	116
4.2 Saving Data.....	118
Saving types and setting procedure.....	118
Structure of the save destination folders .....	119
Automatically saving waveform data.....	120
Real-time saving.....	124
Freely choosing data items to be saved and save files (SAVE key) .....	127
4.3 Loading Data.....	131
Data loading procedure.....	131
Loading waveform data in a batch .....	134
Automatically loading the settings (Automatic setup function).....	135
Loading numerical calculation settings.....	135
4.4 Managing Files .....	136

## **5 Configuring the Trigger Settings** 137

5.1 Trigger Setting Procedure .....	138
5.2 Enabling the Trigger Function.....	139
5.3 Configuring the Trigger Timing Setting .....	140
5.4 Configuring the Pre-trigger and Post-trigger Settings .....	142
To observe an input waveform while the instrument is waiting for a trigger .....	146
5.5 Setting the Trigger Satisfaction Conditions (AND/OR Operation) Among Trigger Sources.....	147
5.6 Triggering the Instrument Using Analog Signals (Analog Trigger) .....	149
5.7 Triggering the Instrument Using Logic Signals (Logic Trigger) .....	158
5.8 Triggering the Instrument at Regular Intervals (Interval Trigger) .....	160
5.9 Externally Triggering the Instrument (External Trigger).....	162

5.10 Manually Triggering the Instrument (Forcible Trigger) .....	162
5.11 Triggering the Instrument Using CAN Signals (CAN Trigger) .....	163

## **6 Search Function** 167

6.1 Searching For Peak Values .....	168
6.2 Searching For Positions Where a Trigger Condition Is Satisfied.....	171
6.3 Searching For Differences from a Fundamental Wave (Memory HiConcierge).....	176
6.4 Jumping to the Specified Position .....	179

## **7 Numerical Calculation Function** 181

7.1 Numerical Calculation Procedure ....	182
7.2 Configuring the Numerical Calculation Settings .....	184
Displaying numerical calculation results .....	195
7.3 Evaluating Calculation Results on a Pass/Fail Basis .....	197
Displaying evaluation results and externally outputting signals .....	200
7.4 Numerical Calculation Types and Descriptions.....	201

## **8 Waveform Calculation Function** 209

8.1 Waveform Calculation Procedure ....	211
8.2 Configuring the Waveform Calculation Settings .....	213
8.3 Defining Constants.....	220
8.4 Operators of the Waveform Calculation and Calculation Results .....	222
8.5 Examples of Configuring Waveform Calculation Settings .....	230
Obtaining an RMS waveform from an instantaneous waveform .....	230
FIR filter .....	233
IIR filter.....	237
8.6 Explanations of Filter Calculation ....	242
Filter type .....	242
Filter configuration .....	243
8.7 Setting Power Calculation Conditions.....	244





Configuring the FTP client setting with the instrument.....365

14.4 Operating the Instrument With a Browser Installed in a Computer .....367

Connecting your computer to the instrument with a web browser .....368

Remotely operating the instrument .....369

Starting/Stopping measurement .....370

Configuring the comment setting .....371

Acquiring data from the instrument .....372

Setting the clock .....373

Handling files.....373

14.5 Sending Email messages.....374

Configuring the basic setting for sending email messages.....375

Configuring the email contents settings.....376

Configuring the authentication, compression, and encryption settings for email messages to be sent.....377

14.6 Controlling the Instrument With Command Communications (LAN).....379

14.7 Connecting to a Network Drive.....381

Host PC settings.....381

MR6000 settings.....383

Power equation.....420

Wiring specifications .....421

**Index** 425

**15 Externally Controlling the Instrument** 385

15.1 External Input and Output .....386

External input (IN1), (IN2) .....386

External output (OUT1), (OUT2).....387

Trigger output (TRIG.OUT).....389

External trigger terminal (EXT.TRIG) .....391

15.2 External Sampling (EXT.SMPL) .....394

**16 Appendix** 395

16.1 Information for Reference

Purposes.....395

Waveform file size (values for reference purposes) .....395

Maximum recordable time when the real-time saving is enabled (values for reference purposes).....399

Scaling method for strain gauges .....405

Example of a waveform text file .....407

File saving rates (values for reference purposes).....408

16.2 FFT Definitions.....409

16.3 Dual Sampling.....419

16.4 Power Equations and Wiring Specifications .....420

## Introduction

Thank you for choosing the Hioki MR6000, MR6000-01 Memory HiCorder. Preserve this manual carefully and keep it handy to make full use of this instrument for a long time.

Model MR6000-01 Memory HiCorder is an upper model of Model MR6000, which is equipped with the following calculation functions:

- Digital filter calculation
- Real-time waveform calculation

### The latest edition of the instruction manual

The contents of this manual are subject to change, for example as a result of product improvements or changes to specifications.

The latest edition can be downloaded from Hioki's website.

<https://www.hioki.com/global/support/download>



### Product registration

Register your product in order to receive important product information.

<https://www.hioki.com/global/support/myhioki/registration/>



Following manuals are provided along with these models. See manuals relevant to your purpose.

Type	Contents	Printed	CD-stored file name
<b>Operating Precautions</b>	Information on the instrument for safe operation	✓	–
<b>Quick Start Manual</b>	Basic instructions and specifications of the instrument	✓	✓ MR6000A965-XX.pdf
<b>Instruction Manual (this document)</b>	Functions and instructions for the instrument	–	✓ MR6000A966-XX.pdf
<b>MR6000-01 Dedicated Functions</b>	Method to use functions including the calculation available with Model MR6000-01	–	✓ MR6000A968-XX.pdf
<b>U8793, MR8790, MR8791 Instruction Manual</b>	Functions, specifications, and instructions of Models U8793, MR8790, and MR8791	–	✓ U8793A981-XX.pdf

## Notations

*	Additional information is presented below.
☑	Indicates the initial setting values of the items. Initializing the instrument restores settings to each of these values.
(p. )	Indicates the location of reference information.
<b>START</b> (Bold-faced)	Names and keys on the screen are indicated in boldface.
[ ]	Menus, dialog boxes, buttons in a dialog box, and other names on the screen are indicated in blue brackets.
Windows	Unless otherwise specified, "Windows" represents Windows 7, Windows 8, and Windows 10.

Current sensor	Sensors measuring current are referred to as “current sensor.”
S/s	The number of times per second the analog input signals are digitized by the instrument is expressed in terms of “samples per second (S/s).” Example: “20 MS/s” (20 megasamples per second) indicates that the signal is digitized $20 \times 10^6$ times per second.

**Accuracy**

We define measurement tolerances in terms of f.s. (full scale), rdg. (reading), and setting values, with the following meanings:

f.s.	(maximum display value or scale length) The maximum displayable value or scale length.
rdg.	(displayed value) The value currently being measured and displayed on the measuring instrument.
Setting	(set value) Indicates the set value, such as voltage and current, that the instrument has been configured to output.

# How to Use This Document

**How to open a screen** .....

Indicates the order of tapping the screens.

The button  represents the setting key.

**Procedure numbers** .....

Numbered same as a corresponding step-by-step instruction.

**Options and explanations** .....

Describes options available when an item is tapped.

The icon  indicates the default setting of the item.

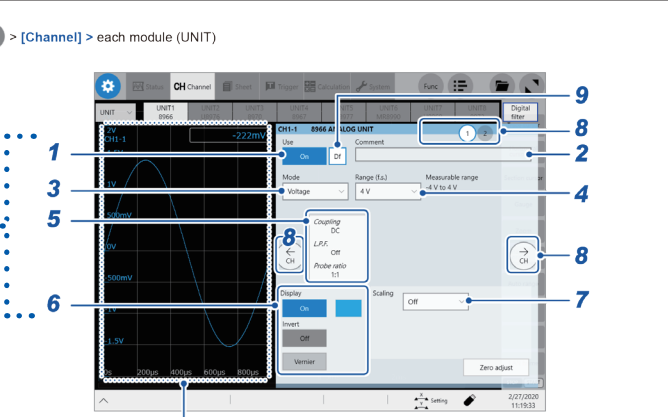

 > [Channel] > each module (UNIT)

The instrument displays the waveform screen during measurement.  
When the instrument does not perform measurement, it displays the presently inputted waveforms on the monitor.

- Tap the [Use] button to set it to [On] or [Off].

On <sup>☑</sup>	Measures waveforms through this module.
Off	Does not measure any waveform through this module. Since no data is acquired, the instrument displays or saves nothing.

- Enter a comment in the [Comment] box.  
Number of characters that can be entered: up to 40
- Tap the [Mode] box, and then choose a measurement mode from the list.

Voltage <sup>☑</sup>	Measures a waveform in voltage mode.
Temperature	Measures a waveform in temperature mode.

Selectable modes vary depending on the installed modules.  
See “3.6 Configuring Module-Specific Settings” (p. 61).

## 1.1 Measurement Procedure

## Inspecting the instrument before measurement



## Configuring the basic settings for measurement

Choose a sampling rate.

(p. 5)

Choose a recording length.

(p. 6)

**Advanced settings**

“Using the envelope”

(p. 9)

“3.1 Overlaying New Waveforms With Previously Acquired Waveforms”

(p. 54)

## Configuring the input channel settings

(p. 11)

Configure the analog channel settings.

(p. 13)

Specify the logic channel settings.

(p. 17)

**Advanced settings**

“3.2 Converting Input Values (Scaling Function)”

(p. 56)

“3.3 Adjusting the Waveform Display Positions (Variable Function)”

(p. 62)

“3.4 Fine-Adjusting Input Values (Vernier Function)”

(p. 64)

“3.5 Inverting a Waveform (Invert Function)”

(p. 65)

## Configuring the sheet settings



Choose a display format of waveforms.

(p. 19)

## Configuring the trigger settings

(p. 137)



## Starting a measurement

(p. 28)



## Finishing the measurement

**Advanced operation**

“2.2 Specifying the Waveform Range (Section Cursor)”

(p. 35)

“Scrolling through waveforms”

(p. 39)

“2.5 Changing the Display Position and Display Magnification of Waveforms”

(p. 41)

“4 Saving/Loading Data and Managing Files”

(p. 115)

“7 Numerical Calculation Function”

(p. 181)

### To configuring measurement settings automatically

Tapping **[Auto range]** on the waveform screen automatically specifies the sampling rate, measurement range, and zero position of the input waveform and start a measurement. See “3.7 Measuring Signals With the Auto-range Setting” in the Quick Start Manual.

### To load settings registered previously

Load the settings file on the file screen.  
See “4.3 Loading Data” (p. 131).

### To automatically load saved settings at the time of startup

Configure the setting for the instrument so as to load the file containing the instrument settings at the time of startup.  
See “Automatically loading the settings (Automatic setup function)” (p. 135).

### Initializing the instrument (Restoring the basic settings)



Select > **[System]** > **[Initialize]** to restore the instrument settings to the factory default.

The setting after the initialization is suitable for simple measurement.

Initialize the instrument when you have found any unexpected or complicated operation.

See “6.2 Initializing the Instrument” in the Quick Start Manual.

## 1.2 Setting Measurement Conditions

You have to set conditions required for measurement, such as the sampling rate ([Sampling]) and recording length ([Shot]).

 > [Status] > [Condition]

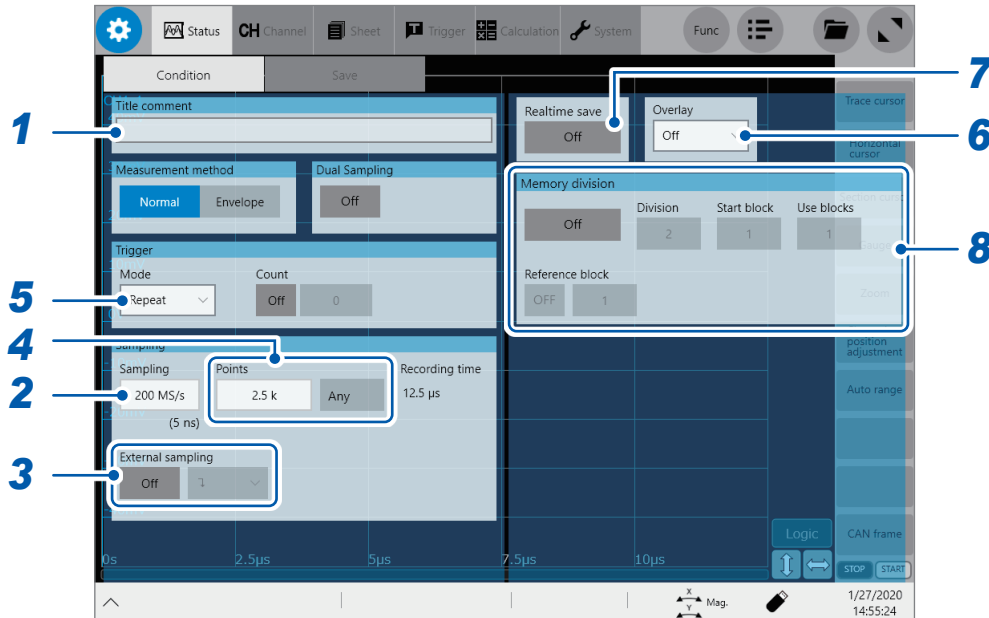

**1** Enter a comment in the [Title comment] box.  
Number of characters that can be entered: up to 40

**2** Tap the [Sampling] box, and then choose a sampling rate from the list.  
See "Sampling rate setting guideline" (p. 7).

200 MS/s, 100 MS/s, 50 MS/s, 20 MS/s, 10 MS/s, 5 MS/s, 2 MS/s, 1 MS/s,  
500 kS/s, 200 kS/s, 100 kS/s, 50 kS/s, 20 kS/s, 10 kS/s, 5 kS/s, 2 kS/s, 1 kS/s,  
500 S/s, 200 S/s, 100 S/s, 50 S/s, 20 S/s, 10 S/s, 5 S/s, 2 S/s, 1 S/s

The instrument can measure signals at a sampling rate of 200 MS/s even with several modules other than Model U8976 installed together. However, the data refresh rate does not exceed the maximum sampling rate of each module.

When the real-time waveform calculation (Model MR6000-01 only) is set to [On], you cannot choose a sampling rate of 200 MS/s.

When the real-time saving is set to [On], due to the combination of the number of channels to be used and save destinations, the maximum sampling rate that can be set varies as follows:

Number of channels to be used	Maximum sampling rate that can be chosen		
	SSD	HDD	USB flash drive SD Card FTP transmission
1 channel to 2 channels	20 MS/s	10 MS/s	5 MS/s
3 channel to 4 channels	10 MS/s	5 MS/s	2 MS/s
5 channel to 8 channels	5 MS/s	2 MS/s	1 MS/s
9 channel to 16 channels	2 MS/s	1 MS/s	500 kS/s
17 channel to 32 channels	1 MS/s	500 kS/s	200 kS/s

Only if the following Hioki-designated options are used, the real-time saving operation with the instrument is guaranteed:

- Model U8332 SSD Unit
- Model U8333 HD Unit
- Model Z4006 USB Drive
- Model Z4001 and Model Z4003 SD Memory Card

**3 Tap the [External sampling] button to set it to [On] or [Off].**

The external sampling is cannot be set when the envelope is used.

<b>Off</b> <sup>☑</sup>	Disables the external sampling function.
<b>On</b>	Choose this option to sample data at a sampling rate defined by a signal inputted into the external sampling terminal (EXT.SMPL).

<b>↑</b>	Samples data at rising edges of the input signal.
<b>↓</b> <sup>☑</sup>	Samples data at falling edges of the input signal.
<b>↑ &amp; ↓</b>	Samples data at both rising and falling edges of the input signal.

**4 Tap the [Points] box, and then from the list, choose an option for the number of points to be measured.**

<b>2.5 k</b> <sup>☑</sup> , 5 k, 10 k, 20 k, 50 k, 100 k, 200 k, 500 k, 1 M, 2 M, 5 M, 10 M, 20 M, 50 M, 100 M, 200 M, 500 M, 1 G
---

Tap **[Any]** to enable it, and then tap **[Points]**, which allows you to enter the number of points in 100 increments.

When the real-time saving is set to **[On]**, you cannot specify the recording length in the **[Points]** box. Choose **[Save]**, and enter the recording length in the **[Recording time]** box. (p. 125)

The maximum recording length you can set varies depending on the number of channels to be measured.

**5 Tap the [Mode] box, and then choose a recording mode from the list.**

<b>Single</b>	Measures waveforms only once. Pressing the <b>START</b> key starts recording waveforms, and then stops when the specified recording length of the waveforms have been acquired.
<b>Repeat</b> <sup>☑</sup>	Measures waveforms repeatedly. Pressing the <b>STOP</b> key stops the measurement in progress.

When you choose **[Repeat]** and set **[Count]** to **[On]**, measurements repeat the number of times entered in the **[Count]** box.

When **[Realtime save]** is set to **[On]**, you can choose **[Single]** mode only.

**6 Configure the overlay setting.**

See “3.1 Overlaying New Waveforms With Previously Acquired Waveforms” (p. 54).

**7 Tap the [Realtime save] button to set it to [On].**

The instrument can record data in an optional storage device while measuring waveforms.

See “Real-time saving” (p. 124).

**8 Configuring the memory division settings**

The instrument can divide the internal memory into several blocks and store waveforms into them.

See “10 Memory Division Function” (p. 289).



## Sampling rate setting guideline

Choose a sampling rate using the following table as a guideline.

Maximum display frequency	Sampling rate	Maximum display frequency	Sampling rate
8 MHz	200 MS/s	400 Hz	10 kS/s
4 MHz	100 MS/s	200 Hz	5 kS/s
2 MHz	50 MS/s	80 Hz	2 kS/s
800 kHz	20 MS/s	40 Hz	1 kS/s
400 kHz	10 MS/s	20 Hz	500 S/s
200 kHz	5 MS/s	8 Hz	200 S/s
80 kHz	2 MS/s	4 Hz	100 S/s
40 kHz	1 MS/s	2 Hz	50 S/s
20 kHz	500 kS/s	0.8 Hz	20 S/s
8 kHz	200 kS/s	0.4 Hz	10 S/s
4 kHz	100 kS/s	0.2 Hz	5 S/s
2 kHz	50 kS/s	0.08 Hz	2 S/s
800 Hz	20 kS/s	0.04 Hz	1 S/s

### If the instrument plots false waveforms (aliasing)

If a measured signal oscillates at a higher frequency compared to the sampling rate you chose, the instrument may plot false waveforms oscillating at a frequency lower than that of the actual signal once the signal frequency reaches a certain level. This phenomenon is called aliasing.

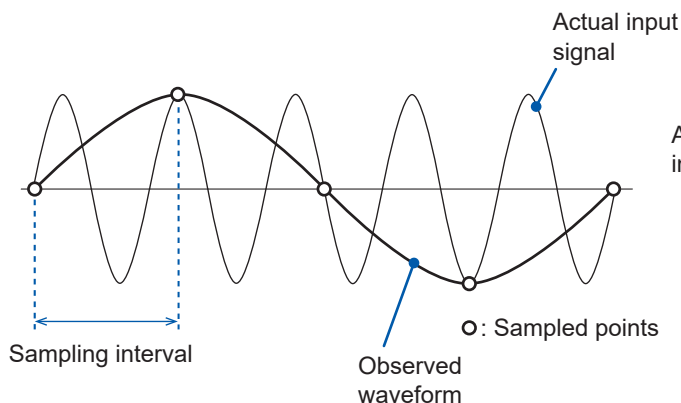

A sampling interval longer than the cycle of the input signal causes aliasing.

To plot a sign wave that allows you to observe the peaks without any aliasing, the instrument needs to sample the waveform at a minimum of 25 points per cycle.

### To set the sampling rate automatically

See “3.7 Measuring Signals With the Auto-range Setting” in the Quick Start Manual.

## Update rate of each module

The data refresh rate is not allowed to exceed the maximum sampling rate of each module.

The instrument measures the same data until the data gets updated, causing the instrument to plot a stair-step waveform.

In addition, even though the instrument measures the same signal simultaneously, values may vary due to differences in the sampling rate, frequency range, and frequency characteristics of modules.

Modules	Maximum sampling rate or data update rate	Reference
Model 8966 Analog Unit	20 MS/s (50 ns)	–
Model 8967 Temp Unit	Depends on the data refresh setting.	p. 68
Model 8968 High Resolution Unit	1 MS/s (1 $\mu$ s)	–
Model U8969 Strain Unit	200 kS/s (5 $\mu$ s)	–
Model 8970 Freq Unit	Depends on the setting.	p. 72
Model 8971 Current Unit	1 MS/s (1 $\mu$ s)	–
Model 8972 DC/RMS Unit	Depends on the response setting.	p. 77
Model 8973 Logic Unit	20 MS/s (50 ns)	–
MR8990 Digital Voltmeter Unit	Depends on the NPLC setting.	p. 78
Model U8974 High Voltage Unit	Depends on the response setting.	p. 80
Model U8975 4ch Analog Unit	5 MS/s (200 ns)	–
Model U8976 High Speed Analog Unit	200 MS/s (5 ns)	–
Model U8977 3CH Current Unit	5 MS/s (200 ns)	–
Model U8978 4CH Analog Unit	5 MS/s (200 ns)	–
U8979 Charge Unit	200 kS/s (5 $\mu$ s)	–

## Using the envelope

 > [Status] > [Condition]

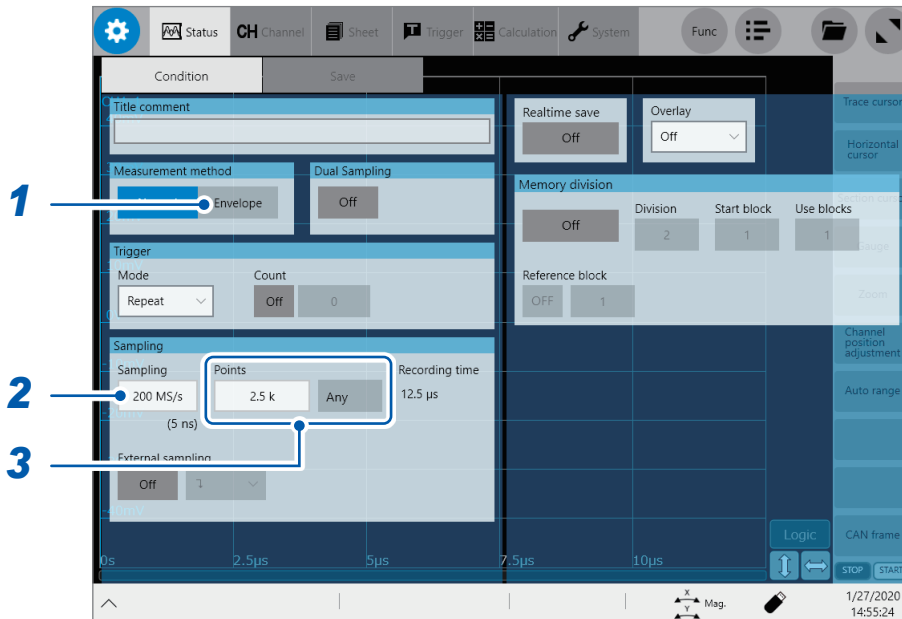

1

Measurement Method

**1** Under [Measurement method], tap [Envelope] to use the envelop.

<b>Normal</b> <sup>□</sup>	Does not use the envelope.
<b>Envelope</b>	Uses the envelope.

- What is *Normal*?  
The instrument records data at the specified sampling rate.
  - What is *Envelope*?  
At the specified recording interval, the instrument records the maximum and minimum values among data points sampled within each specified recording interval by sampling an input signal at an over-sampling rate\* of 100 MS/s. Hence, even though a relatively longer recording interval is specified, peaks of fluctuations can be recorded without being missed.
- \*: Over-sampled data (indicated by blue dots ● in the figure) are not saved.
- Values to be acquired using the envelope

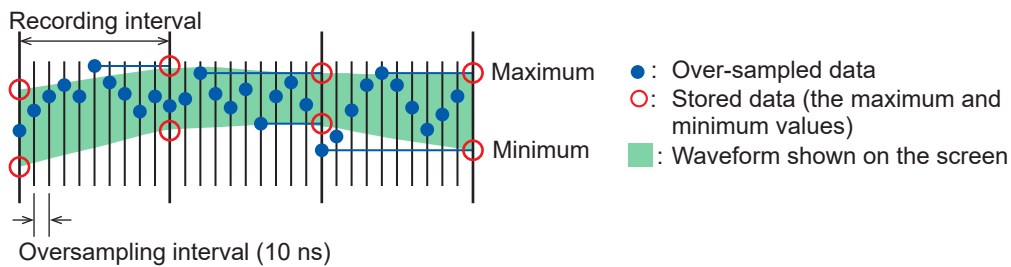

A set of sampled data acquired using the envelope consists of two values: the maximum value and the minimum value. These values are taken from the measured values acquired by sampling an input signal at an over-sampling rate during the recording interval chosen in the [Sampling] box. The screen displays a vertically wide waveform line. When saved in an external storage device, the data set that consists of the maximum and minimum values is stored for a single instance of measurement.

**2** Tap the **[Sampling]** box, and then choose a sampling rate from the list.

The following are the sampling rates you can choose when the envelope is used.

10 MS/s<sup>□</sup>, 5 MS/s, 2 MS/s, 1 MS/s, 500 kS/s, 200 kS/s, 100 kS/s, 50 kS/s, 20 kS/s, 10 kS/s, 5 kS/s, 2 kS/s, 1 kS/s, 500 S/s, 200 S/s, 100 S/s, 50 S/s, 20 S/s, 10 S/s, 5 S/s, 2 S/s, 1 S/s, 30 S/min, 12 S/min, 6 S/min, 2 S/min, 1 S/min

**3** Tap the **[Points]** box, and then from the list, choose an option for the number of points to be measured.

2.5 k<sup>□</sup>, 5 k, 10 k, 20 k, 50 k, 100 k, 200 k, 500 k, 1 M, 2 M, 5 M, 10 M, 20 M, 50 M, 100 M, 200 M, 500 M, 1 G

Tap **[Any]** to enable it, and then tap the **[Points]** box, which allows you to enter the number of points in 100 increments.

When the real-time saving is set to **[On]**, you cannot specify the recording length in the **[Points]** box. Choose **[Save]**, and enter the recording length in the **[Recording time]** box. (p. 125)

The maximum recording length you can specify varies depending on the number of channels to be measured.

## 1.3 Configuring the Input Channel Settings

Configure the settings of the analog and logic channels.

 > [Channel]

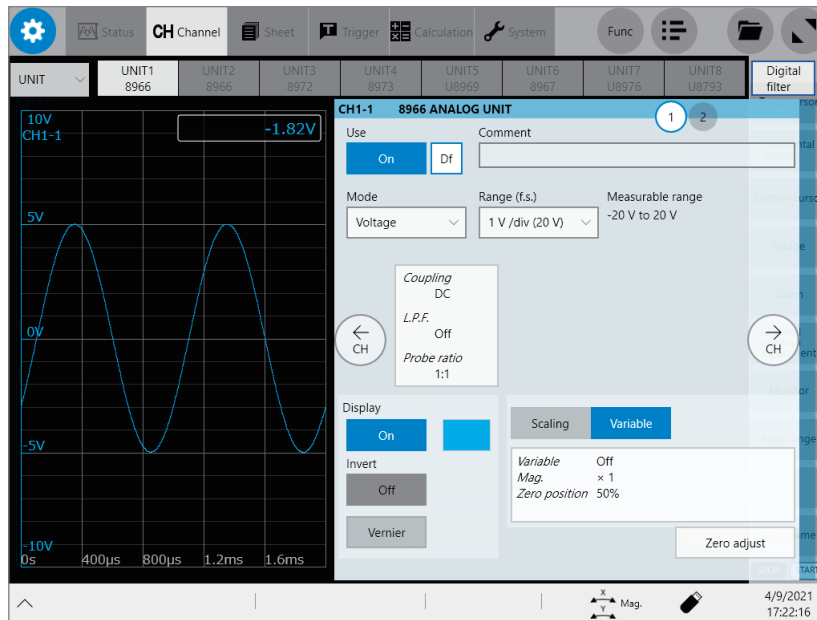

### Operation available on the [Channel] screen

- Adding a comment to each channel
- Setting measurement conditions for each channel
- Specifying the display method setting for waveforms
- Converting measured values into physical quantities and displaying them

When a CAN/LIN interface is connected, you can toggle between [UNIT] and [CAN/LIN]. To configure the input channel settings, select [UNIT].

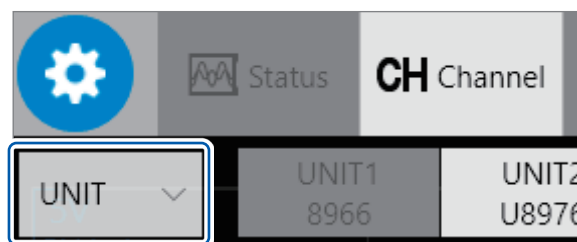

## Channel setting procedure

### Analog channels (CH1 through CH32) setting procedure

#### Configuring the input settings

- 
- Choose a measurement mode. (p. 13)
  - Choose a measurement range for each measurement target. (p. 14)
  - Convert input values (scaling function). (p. 15)
  - Choose an input coupling method. (p. 15)
  - Choose a low-pass filter cutoff frequency (if noise is present). (p. 15)

#### Configuring the display settings

- 
- Choose a waveform display color. (p. 15)
  - Convert input values (scaling function). (p. 15)

### Logic channels (Model 8973 Logic Unit) setting procedure

#### Configuring the display settings

- 
- Choose a logic recording width. (p. 17)
  - Specify the display position of the waveform. (p. 17)
  - Choose a waveform display color. (p. 17)

When the sheet display format is set to XY composite waveforms or FFT waveforms, no logic waveforms are displayed.

## Analog channels

For details on configuring each module setting, refer to “3.7 Configuring Measurement Module-Specific Settings” (p. 67).

 > [Channel] > each module (UNIT)

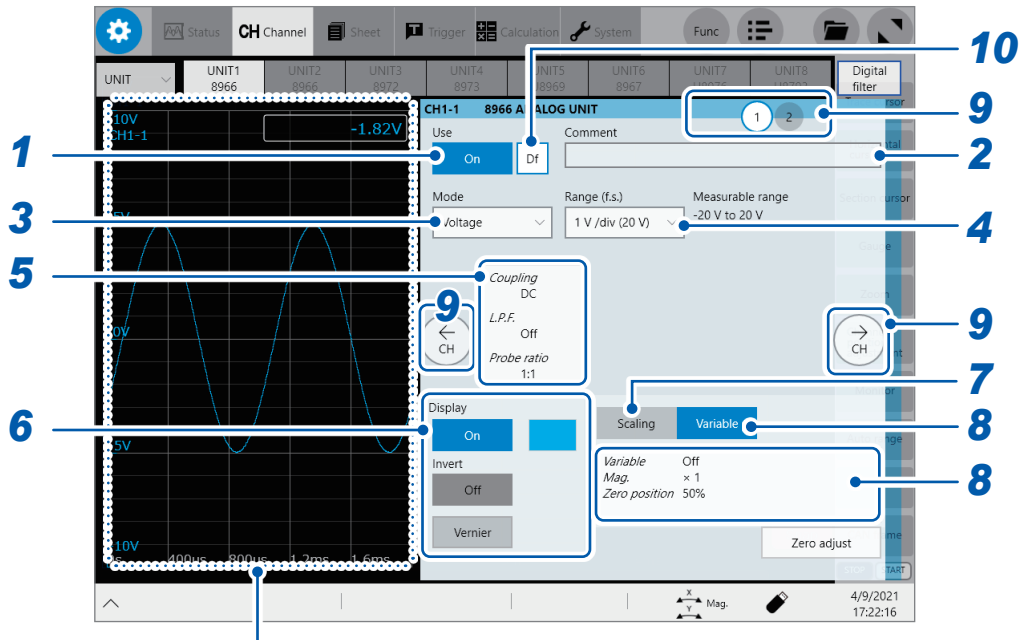

The instrument displays the waveform screen during measurement.  
When the instrument does not perform measurement, it displays the presently inputted waveforms on the monitor.

**1** Tap the [Use] button to set it to [On] or [Off].

<b>On</b> <input checked="" type="checkbox"/>	Measures waveforms through this module.
<b>Off</b> <input type="checkbox"/>	Does not measure any waveform through this module. Since no data is acquired, the instrument displays or saves nothing.

**2** Enter a comment in the [Comment] box.

Number of characters that can be entered: up to 40

**3** Tap the [Mode] box, and then choose a measurement mode from the list.

<b>Voltage</b> <input checked="" type="checkbox"/>	Measures a waveform in voltage mode.
<b>Temperature</b> <input type="checkbox"/>	Measures a waveform in temperature mode.

Selectable modes vary depending on the installed modules.  
See “3.7 Configuring Measurement Module-Specific Settings” (p. 67).

**4 Tap the [Range (f.s.)] box, and then choose a measurement range from the list.**

The value of the range represents its maximum displayable value (f.s.).

See the following table for the full-scale resolution of each module.

If the input voltage exceeds the measurable range (overrange occurs), change the measurement range to one with a lower sensitivity.

After changing measurement ranges, check values including level, upper, lower of the trigger, search, and numerical calculation functions.

Modules	Resolution (LSB)
Model 8966 Analog Unit, Model 8971 Current Unit, Model 8972 DC/RMS Unit	2,000
Model 8967 Temp Unit	20,000
Model 8968 High Resolution Unit, Model U8974 High Voltage Unit, Model U8975 4ch Analog Unit, Model U8977 3CH Current Unit, Model U8978 4CH Analog Unit	32,000
Model U8976 High Speed Analog Unit	1,600
Model U8969 Strain Unit, Model U8979 Charge Unit	25,000
Model 8970 Freq Unit (Power frequency mode)	2,000
Model 8970 Freq Unit (Count mode)	40,000
Model 8970 Freq Unit (Frequency mode, rotation speed mode, duty ratio mode, pulse width mode)	10,000
Model MR8990 Digital Voltmeter Unit	1,000,000

\*: For the Model 8967 Temp Unit, the valid range varies depending on the thermocouples. For more information about resolution, refer to “Model 8967 Temp Unit” in “5.2 Specifications of the Options” in the Quick Start Manual.

**5 Configure the input coupling, low-pass filter, and probe ratio settings.**

Tapping the area that includes [Coupling] allows the setting dialog box to appear.

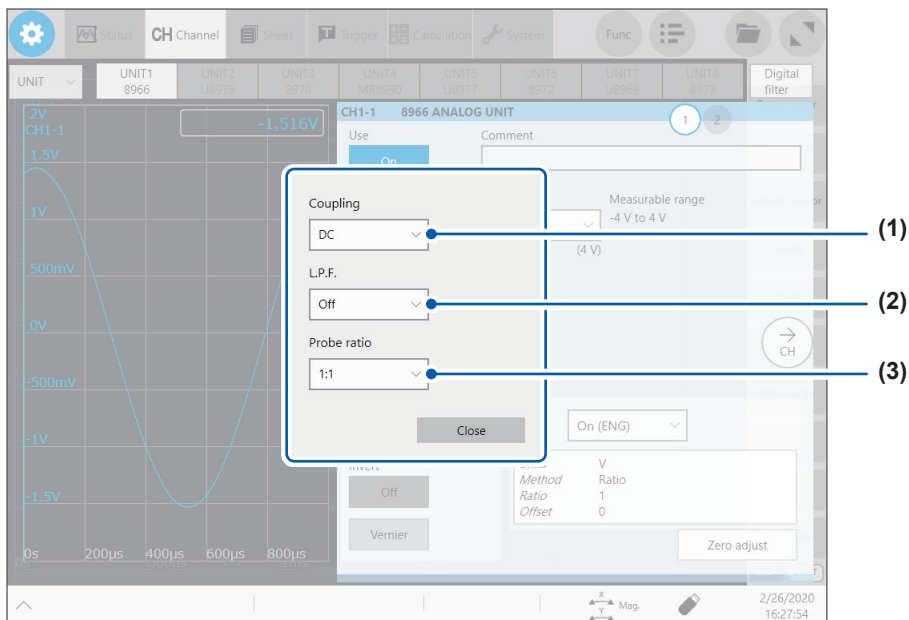



**(1) Tap the [Coupling] box, and then choose a coupling method for an input signal from the list.**

In general, use the DC coupling.

<b>DC</b>	Measures both DC and AC components of an input signal.
<b>AC</b>	Measures an AC component only of an input signal. A DC component can be eliminated.
<b>GND</b>	Connects the input terminal to the ground (which allows you to check the zero position).

**(2) Tap the [L.P.F] box, and then choose a cutoff frequency of the low-pass filter from the list.**

Enabling the low-pass filter installed in the module can eliminate unwanted high-frequency components. Cutoff frequencies available vary depending on the module types. Choose an adequate cutoff frequency depending on the characteristics of an input signal.

Example: Model 8966 Analog Unit

<b>Off</b> , 5 Hz, 50 Hz, 500 Hz, 5 kHz, 50 kHz, 500 kHz
--

**(3) Tap the [Probe ratio] box, and then choose a probe ratio from the list.**

Choose any of the ratios when the measurement involves use of a connection cord or probe.

<b>1:1</b>	Choose this ratio when using Model L9197, Model L9198, Model L9790, or Model L9217 Connection Cord.
<b>1:10</b>	Choose this ratio when using Model 9665 10:1 Probe.
<b>1:100</b>	Choose this ratio when using Model 9666 100:1 Probe, Model P9000-01 Differential Probe, or Model P9000-02 Differential Probe.
<b>1:1000</b>	Select this ratio when using Model 9322 Differential Probe, Model P9000-01 Differential Probe, or Model P9000-02 Differential Probe.

**6 Tap the [Display] button to set it to [On] or [Off].**

<b>On</b>	Displays the waveform on the waveform screen.	
	Color	Allows you to choose a display waveform of each waveform. You can also select the same color as other lines.
	<b>Invert</b> (Off, On)	When the signs of displayed waveforms are reversed, the waveforms can be inverted. See "3.5 Inverting a Waveform (Invert Function)" (p. 65).
	<b>Vernier</b>	Allows you to freely fine-adjust the input voltage on the waveform screen (display adjustment only). When recording physical values such as noise, temperature, and acceleration with sensors, you can adjust those amplitudes, facilitating calibration. See "3.4 Fine-Adjusting Input Values (Vernier Function)" (p. 64).
<b>Off</b>	Does not display any waveform.	

**7 Configure the scaling settings.**

See "3.2 Converting Input Values (Scaling Function)" (p. 56).

## 8 Tap the [Variable] button to set it to [Off] or [On].

<b>Off</b>	Does not use the variable function but the [Magnification] box and the [Zero position] button to adjust the waveform positions.
<b>On</b> <input checked="" type="checkbox"/>	Uses the variable function. See “3.3 Adjusting the Waveform Display Positions (Variable Function)” (p. 62).

You can use the [Variable] button when [Fix grid] is set to [On].  
See “13 Configuring the System Environment Settings” (p. 343).

If [Variable] is set to [Off], tap the [Magnification] box, and then from the list, choose a magnification.

You can choose a magnification in the direction of the vertical axis (voltage axis).

**×100, ×50, ×20, ×10, ×5, ×2, ×1<sup>□</sup>, ×1/2, ×1/5, ×1/10**

You can use the [Magnification] box when [Fix grid] is set to [On].  
See “13 Configuring the System Environment Settings” (p. 343).

If [Variable] is set to [Off], tap the [Zero position] button, and then set the zero position.

You can specify where the zero-volt level is on the vertical axis.

Waveforms are magnified/demagnified with respect to the zero position. Although ranges of voltage shown on the waveform screen vary according to the magnification, the measurable ranges do not vary. Besides, input signals are not DC-biased but merely moved visually.

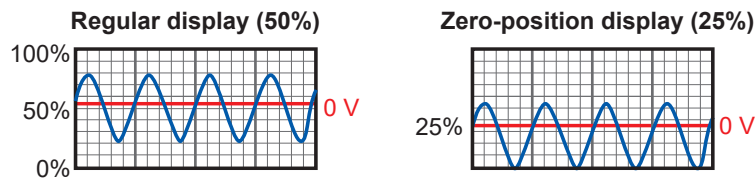

You can use the [Variable] button when [Fix grid] is set to [On].  
See “13 Configuring the System Environment Settings” (p. 343).

## 9 Switch the channels.

Tap the corresponding location to switch the channels, and then set the measurement conditions by following the procedure described above.

## 10 Configuring the digital filter setting for each channel. (Model MR6000-01 only)

The [Df] setting is displayed for only channels with [Digital filter] set to [On], allowing you to configure the digital filter setting for each channel.

For more information, refer to “Setting the Digital Filter Calculation” in MR6000-01 Dedicated Functions.

## Logic channels

The logic sheet appears when the screen is in Single, Dual, Quad, Octa, or Hexadeca mode.

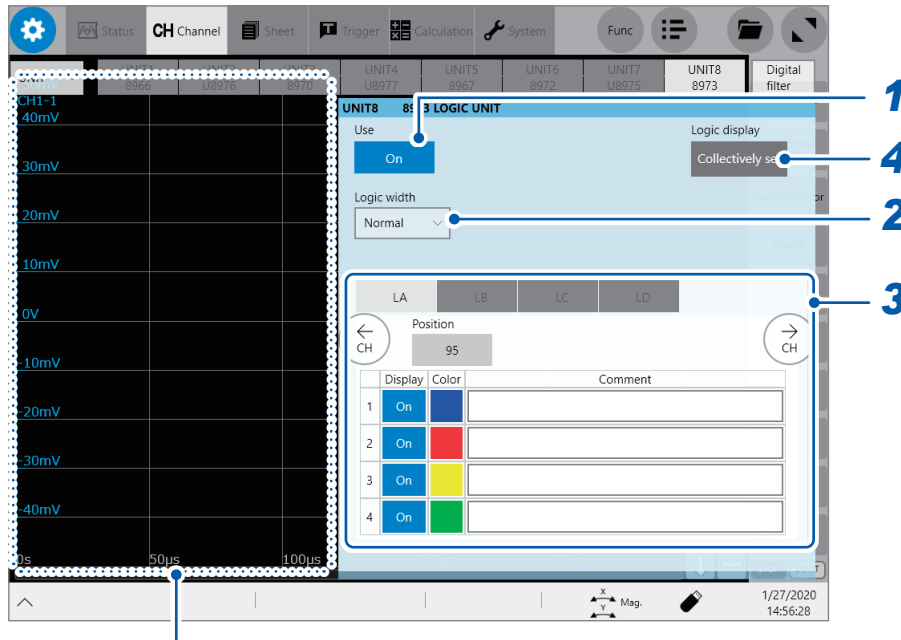

The instrument displays the waveform screen when a logic channel is chosen. You can check display positions of the logic signals.

### 1 Tap the [Use] button to set it to [On] or [Off].

<b>On</b> <input checked="" type="checkbox"/>	Measures a waveform through this module.
<b>Off</b> <input type="checkbox"/>	Does not measure any waveform through this module. Since no data is acquired, the instrument displays or saves nothing.

### 2 Tap the [Logic width] box, and then choose a display width for logic waveforms from the list.

Making waveforms narrower can enhance the readability of a display that contains a large number of waveforms.

This setting is a cross-module for all logic modules installed in the instrument.

<b>Wide</b>	Increases the width of the waveforms.
<b>Normal</b> <input checked="" type="checkbox"/>	Displays the waveforms in normal width.
<b>Narrow</b>	Reduces the width of the waveforms.

### 3 Choose a display method for each probe (LA through LD).

<b>Position</b>	Allows you to specify a numeral that represents a logic waveforms position on the screen in one percent point increments. This setting is a cross-probe for all probes (LA through LD). You can display logic waveforms in a desired position.
<b>Display</b>	Allows you to choose whether to display logic waveform.
<b>Color</b>	Allows you to choose a display waveform of each waveform. You can also choose the same color as the lines acquired across other channels.
<b>Comment</b>	Allows you to type a comment for each channel. Number of characters that can be entered: up to 40

- 4** Under **[Logic display]**, tap **[Collectively set]**, and then from the list, select the logic waveform display setting.

<b>All logic On</b>	Displays all logic waveforms.
<b>All logic Off</b>	Hides any logic waveforms.
<b>Unit On</b>	Sets all the logic waveforms acquired with the enabled modules to display altogether.
<b>Unit Off</b>	Sets all the logic waveforms acquired with the enabled modules to hide together.
<b>Probe On</b>	Sets all the logic waveforms acquired with the chosen probes to display altogether.
<b>Probe Off</b>	Sets all the logic waveforms acquired with the chosen probes to hide altogether.

# 1.4 Configuring the Sheet Settings

You can define the display format of waveforms on the sheet. You can define different display formats for each of the 16 sheets. You can also switch sheets to be displayed on the waveform screen.

You can configure the XY composite waveform settings.

See “2.8 Generating XY Composite Waveforms (XY Composite)” (p. 47)

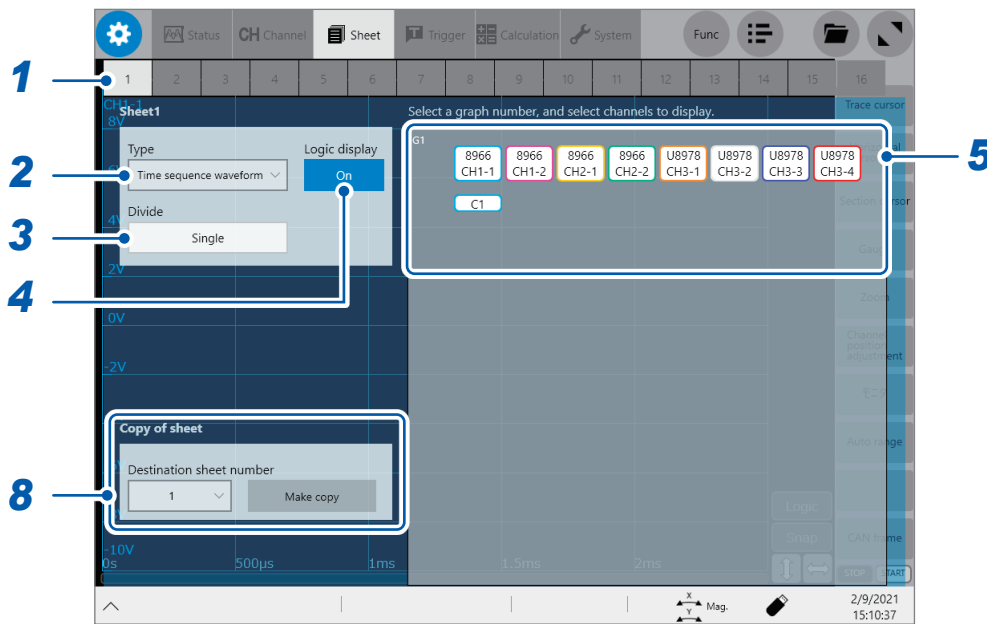

- 1 Choose a sheet.
- 2 Tap the [Type] box, and then choose a display format from the list.

<b>Time sequence waveform</b> <input checked="" type="checkbox"/>	Displays time-sequence waveforms.
<b>XY composite waveform</b>	Displays XY composite waveforms.
<b>FFT waveform</b>	Displays FFT-calculated waveforms.

**3** Tap the **[Divide]** box, and then from the list, choose an option for the number of screens to be divided.

You can split the screen into multiple screens (graphs).

When you choose **[Time sequence waveform]** in the **[Type]** box

Single , Dual, Triangle, Quad, Hexagon, Octa, Nonagon, Hexadeca

When you choose **[XY composite waveform]** in the **[Type]** box

XY Single , XY Dual, XY Quad, Time sequence + XY Dual

When you choose **[FFT waveform]** in the **[Type]** box

FFT Single , FFT dual, FFT quad, Time sequence + FFT single, Time sequence + FFT dual, Time sequence + FFT quad

**4** (When you choose **[Time sequence waveform]** in the **[Type]** box)

Tap the **[Logic display]** button to set it to **[On]** or **[Off]**.

Off	Does not display logic waveforms.
On <input checked="" type="checkbox"/>	Displays logic waveforms.

**5** Tap the display panel of each graph.

The **[Select the channel]** dialog box opens.

**6** Choose channels to be displayed on the graph.

All channels are chosen in the default setting. Tapping a button deselects a channel (Tap it again to select it). Every time you tap **[All]**, all waveform calculation channels is collectively selected or deselected.

Example: Selection screen for time series waveforms

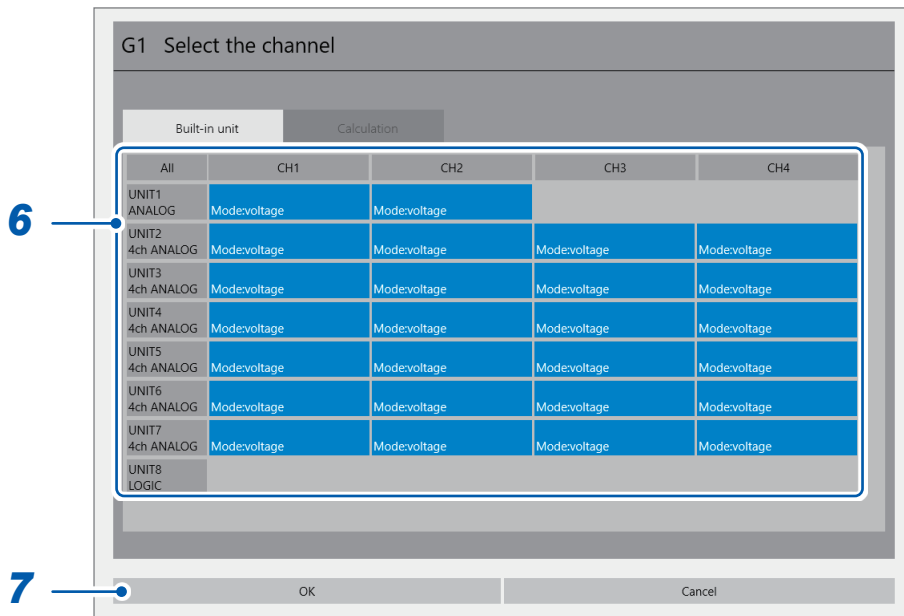

Example: Selection screen for XY composite waveforms

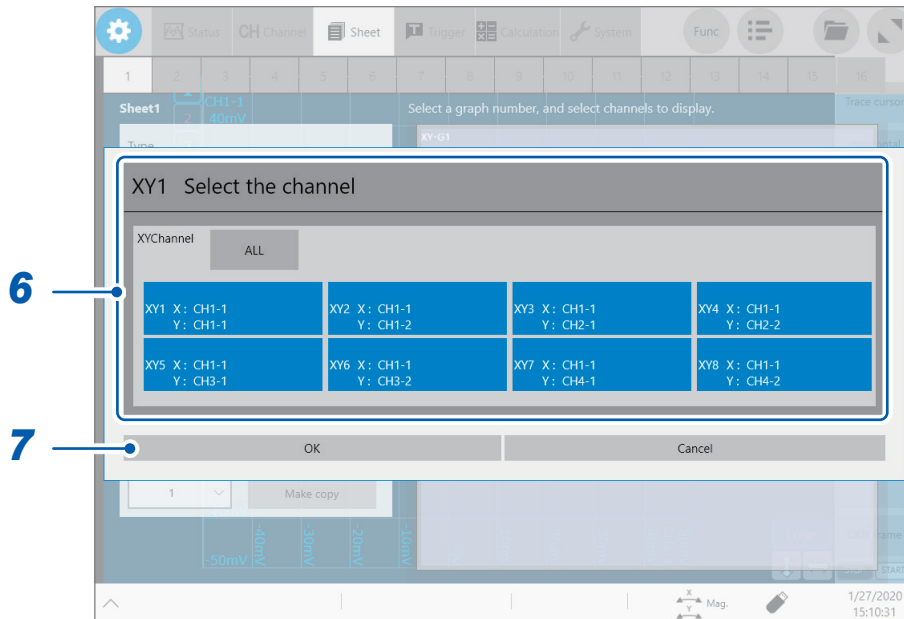

Example: Selection screen for FFT waveforms

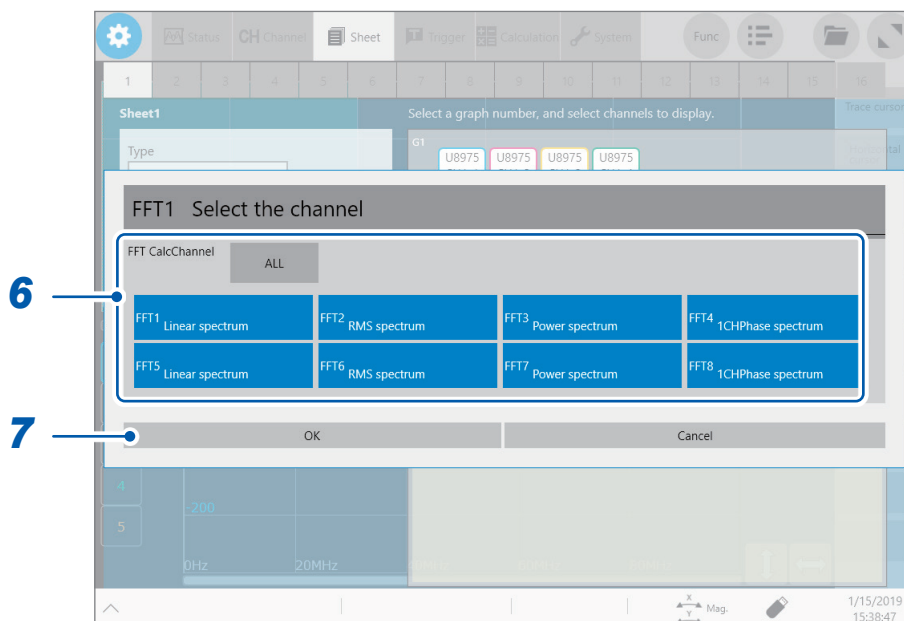

**7** Tap [OK].

Your selection is confirmed.

Tapping [Cancel] closes the dialog box without your selection confirmed.

**8** (When you choose [Time sequence waveform] or [FFT waveform] in the [Type] box)

Tap [Destination sheet number] to choose a sheet number, and then tap the [Make copy] button.

The settings configured from steps 1 to 6 affect the copy destination sheet. The sheet settings have been finished.

(When you choose [XY composite waveform] in the [Type] box)

Go on to step 9.

- 9** (When you choose [XY composite waveform] in the [Type] box)  
Tap the [X:Y: Settings].

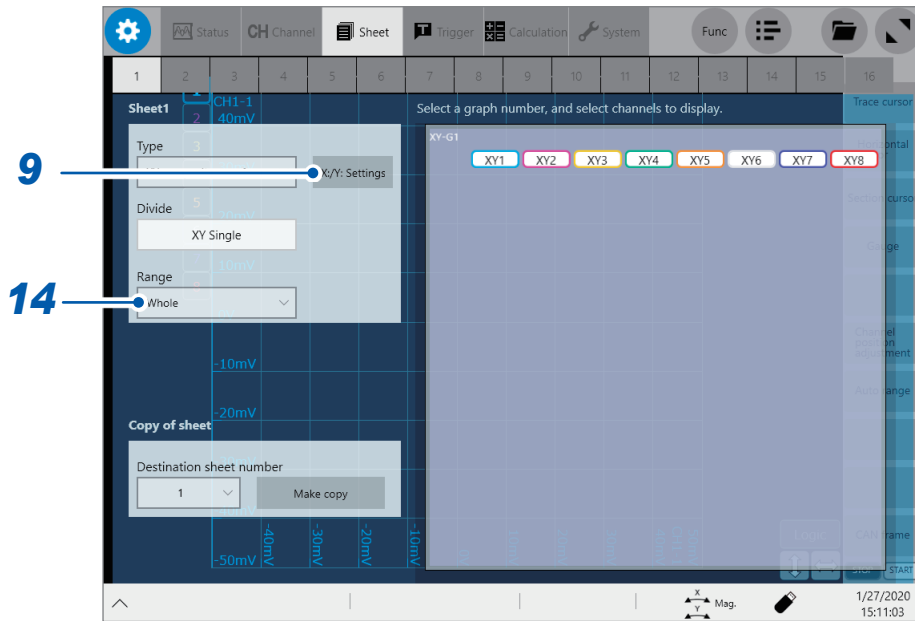

The [XY composite channel settings] dialog box is displayed.

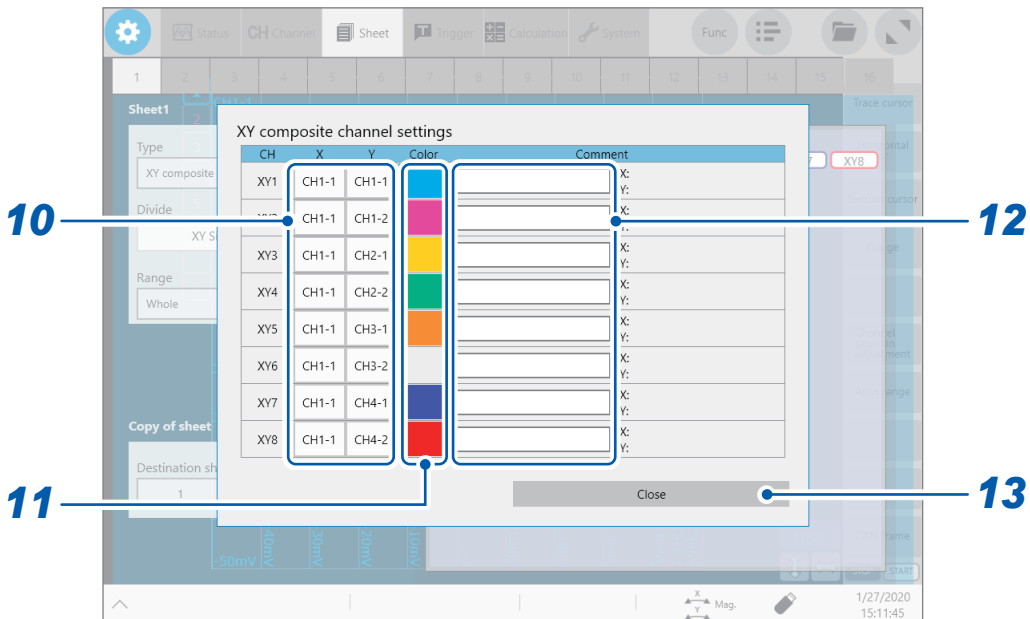

- 10** Tap a channel number button, and then from the list, choose channels to be assigned to the X and Y axes of the XY channel you chose.

- 11** Tap the color button, and then from the color pallet, choose a display color of the XY channel you chose.

You can choose the same color as lines acquired across other channels.

- 12** Enter a comment in the [Comment] box.

Number of characters that can be entered: up to 40



**13** Tap **[Close]**.

The **[XY composite channel settings]** dialog box closes.

**14** Tap the **[Range]** box, and then from the list, choose an option for a range of waveforms to be used for generating XY composite waveforms.

<b>Whole</b> <input type="checkbox"/>	Generates XY composite waveforms using waveforms spanning the whole range.
<b>Segment 1</b>	Generates XY composite waveforms using the waveforms of the scope specified as Segment 1.
<b>Segment 2</b>	Generates XY composite waveforms using the waveforms of the scope specified as Segment 2.

## Switching sheets on the waveform screen



Choose sheet numbers to be displayed.

## Generating XY composite waveforms

During or after measurement, you can generate XY composite waveforms using waveform acquired across user-defined channels.

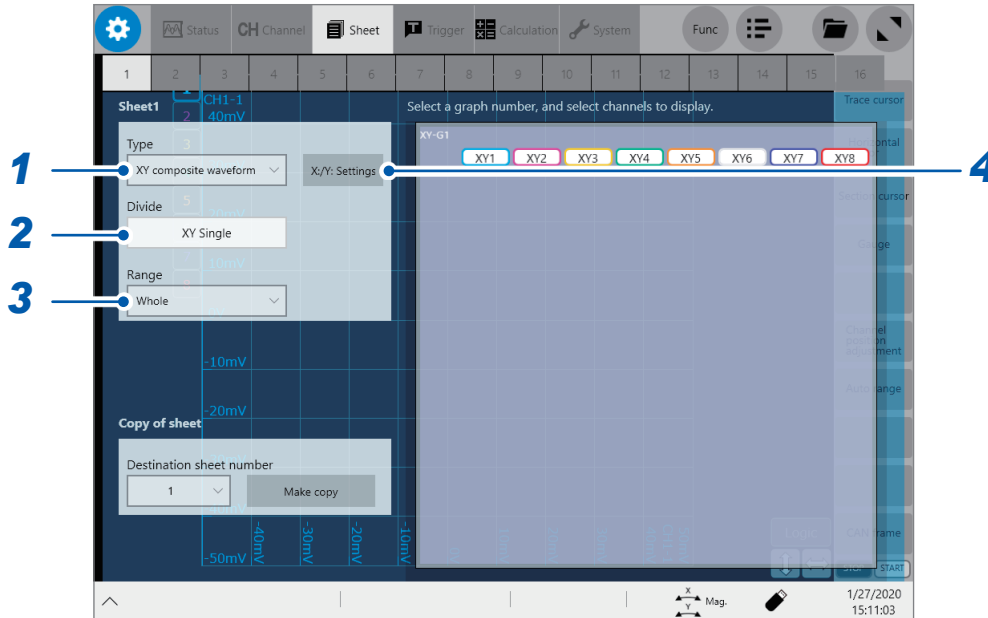

**1** Tap the [Type] box, and then from the list, select [XY composite waveform].

**2** Tap the [Divide] box, and then from the list, choose an option for the number of screens to be divided.

XY Single, XY Dual, XY Quad, Time sequence + XY Dual

**3** Tap the [Range] box, and then from the list, choose an option for a range of waveforms to be used for generating XY composite waveforms.

<b>Whole</b>	Generates XY composite waveforms using the whole waveforms.
<b>Segment 1</b> <b>Segment 2</b>	Generates XY composite waveforms using the waveforms between the specified section cursors. How to specify section cursors See "2.2 Specifying the Waveform Range (Section Cursor)" (p. 35).

#### 4 Tap the [X:Y: setting].

The [XY composite channel settings] dialog box is displayed.

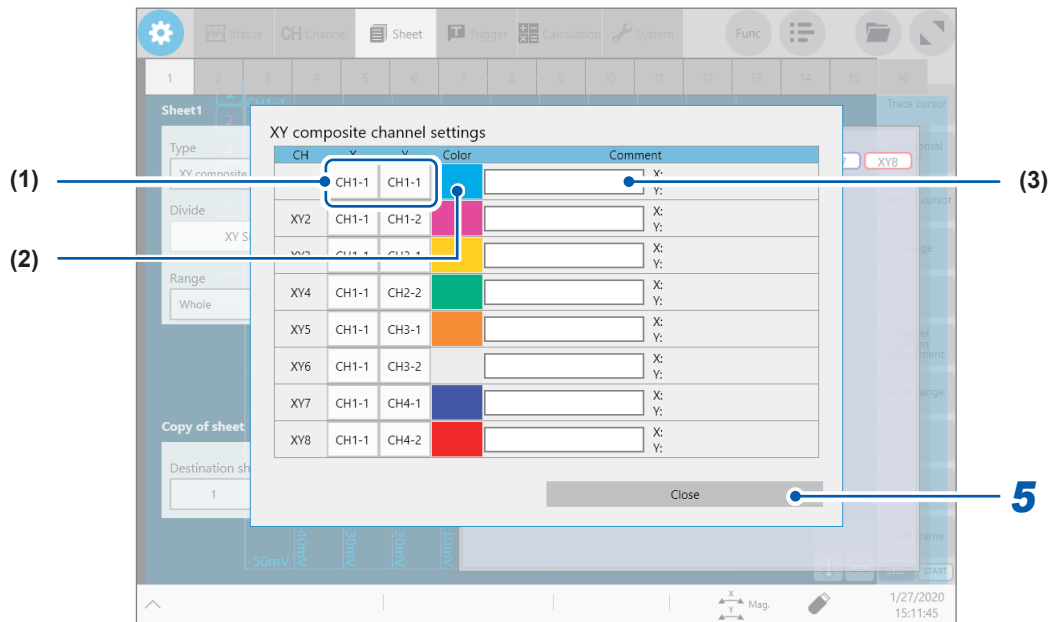

- (1) Tap a cell in the [X] and [Y] columns, and then from the list, choose channels to be used for generating XY composite waveforms. Up to eight XY composite waveforms can be generated.
- (2) Tap a color button in the [Color] column, and then choose a color for XY composite waveforms.
- (3) In the [Comment] box, enter a comment for the XY composite waveform.

#### 5 Tap [Close].

The [XY composite channel settings] dialog box closes.

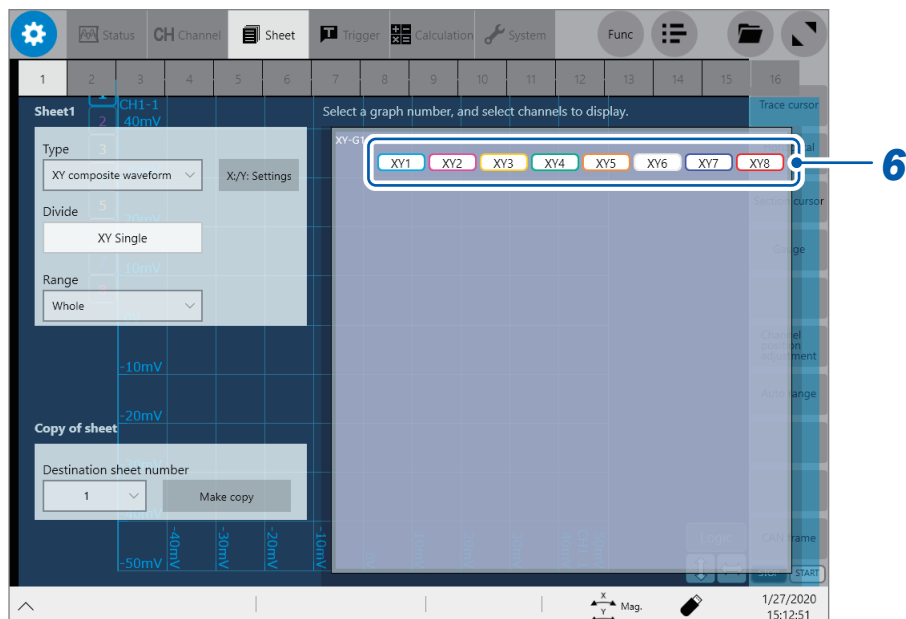

**6** Tap the display panel of each graph.

The **[XY Select the channel]** dialog box is displayed.

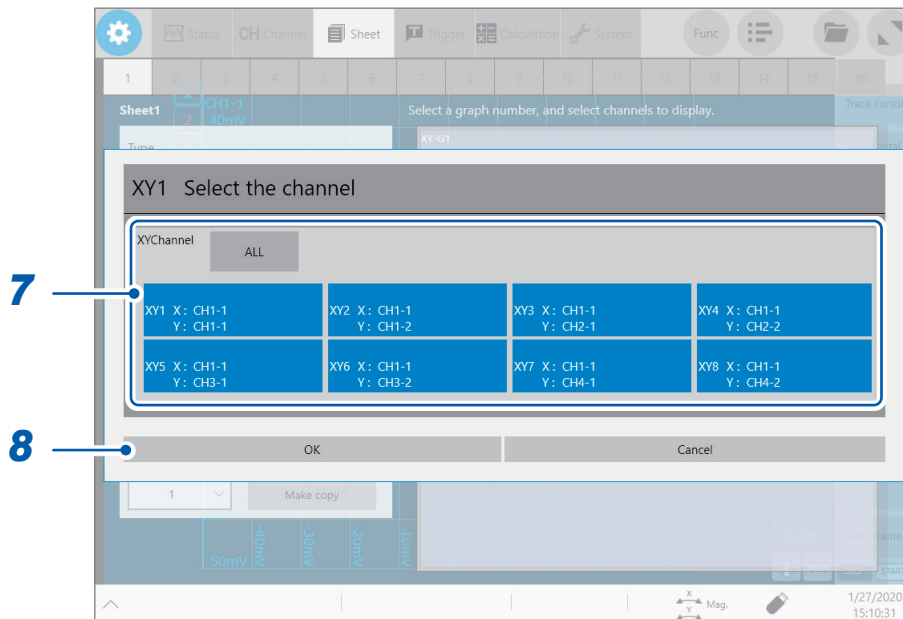
**7** Tap the XY channel to be displayed.

- If you save a setting file, the settings for all the displayed sheet are saved.
- If you save a waveform file, the settings of the displayed sheet are saved as configured at the time of saving. Even when a waveform file is loaded, no sheets except the sheet displayed at the time of saving are loaded.

**8** Tap [OK].

The **[XY Select the channel]** dialog box closes.

## 1.5 Starting/Stopping a Measurement

### Starting a measurement

Pressing the **START** key starts a measurement.

- Waveforms shown on the screen are cleared once the measurement starts.
- You can also start a measurement by inputting a signal into the external control terminal.  
See “15 Externally Controlling the Instrument” (p. 385).

### Waveform display during measurement

In general, the waveforms appear after data with the specified recording length has been acquired. When the measurement speed is relatively slow, the instrument displays waveforms while it is acquiring the data.

However, even if a slow-speed range is set, the instrument may display waveforms after it has been acquired the data of the whole waveform, depending on the overlay or magnification setting.

### To save data automatically during measurement

When waveforms of the specified recording have been acquired, the waveform data is automatically stored.

See “Automatically saving waveform data” (p. 120).

### To save data during measurement in real time

The instrument can store data on a storage device during measurement in real time.

See “Real-time saving” (p. 124).

### Stopping the measurement

Pressing the **STOP** key once stops the measurement after the waveforms of the specified recording length have been acquired.

Pressing the **STOP** key twice stops the measurement immediately.

### Operation on the waveform screen

When you operate a USB mouse connected to the instrument, the **[START]** and **[STOP]** buttons appear at the bottom right of the screen.

You can use the mouse in the same manner as the **START** and **STOP** keys on the instrument.

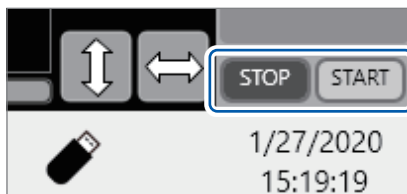

# 2

## Operating the Waveform Screen and Analyzing Data

You can analyze measured data with various functions including trace cursor measurement of input waveforms and searches on the waveform screen. You can also change measurement conditions or other settings on this screen.



### Operation available on the waveform screen

#### Using the trace cursors and horizontal cursors

- Reading measured values (p. 30)

#### Using the section cursors

- Specifying the waveform range (p. 35)

#### Moving the waveform display position

- Dragging waveforms
- Moving waveforms with the scroll bar

#### Changing the display magnification of waveforms

- Magnifying/demagnifying waveforms (p. 41)
- Magnifying a part of waveforms horizontally (p. 46)

#### Generating XY composite waveforms

- Generating composite waveforms (p. 47)

## 2.1 Reading Measured Values (Trace Cursors, Horizontal Cursors)

You can read measured values (scaled values when the scaling is used) using trace cursors on the waveform screen. The instrument can simultaneously display up to eight trace cursors. You can read differences in times and measured values between any two cursors you choose from among all cursors. You can also read measured values of trace cursors on X-Y waveforms.

**1** Tap [Trace cursor] on the wave screen.

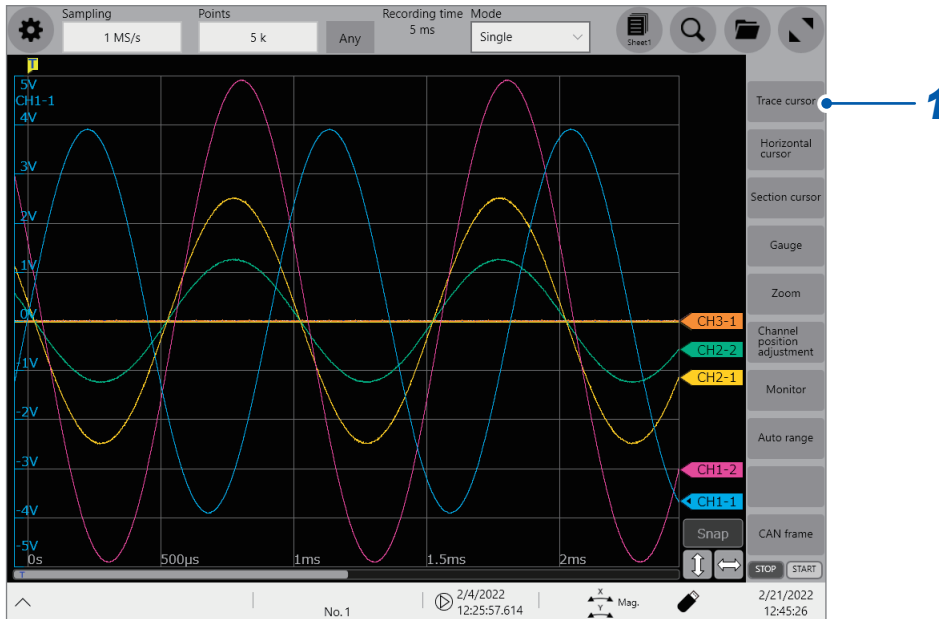

**2** Choose one or more cursors to be displayed from among [Trace cursor A] through [Trace cursor H] by tapping them.

The chosen trace cursors are displayed on the waveform screen. You can drag trace cursors on the time-series waveform screen.

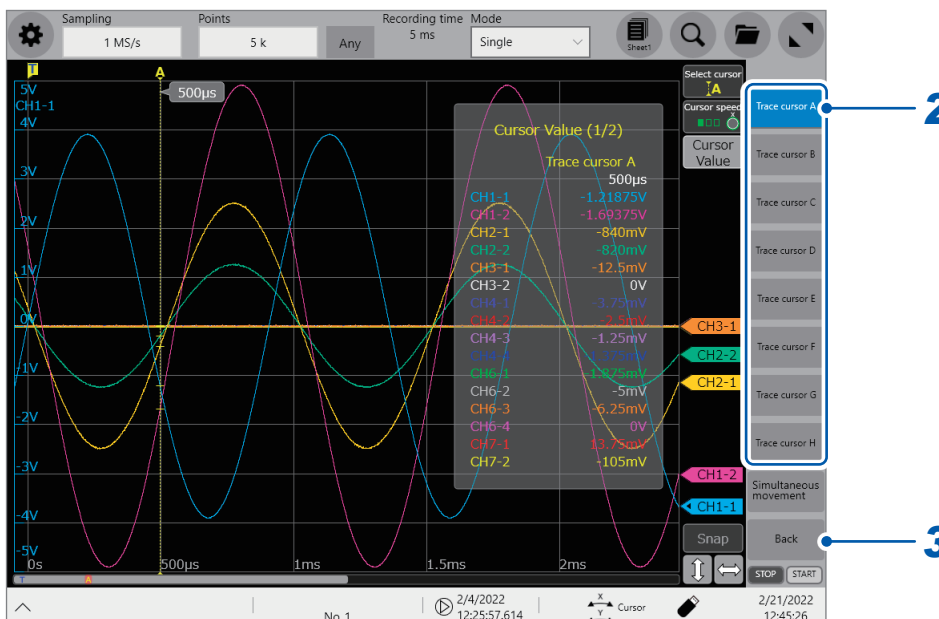

**3** Tap [Back].



#### 4 Tap [Cursor Value].

You can switch between on and off for the cursor value display every time you tap [Cursor Value].

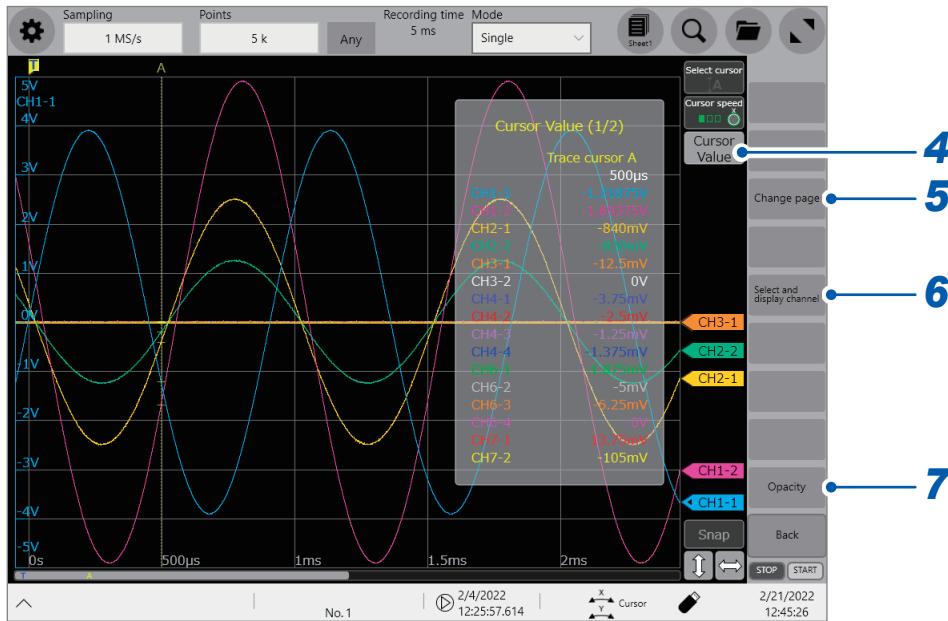

#### 5 Tap [Change page].

When the instrument displays multiple channels, you can switch the pages to check cursor values of each channel. Every time you tap it, the pages are switched.

#### 6 Tap [Select and display channel].

The function buttons switch.

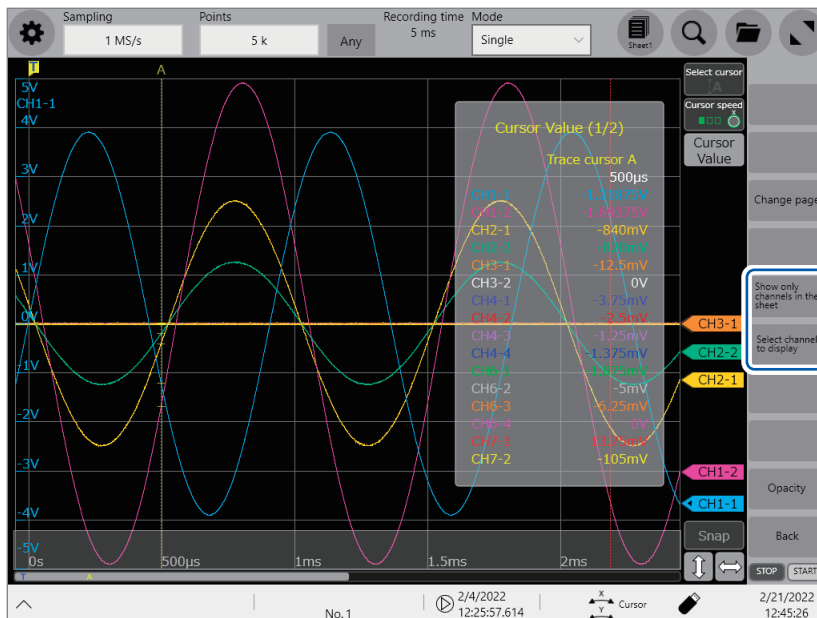

Tapping [Show only channels in the sheet] can only display channels in the present sheet.

Tapping [Select channel to display] allows you to select channels of which you want to display cursor values.

## 7 Tap [Opacity].

The function buttons switch.



Tapping [▲] or [▼] allows you to change the opacity of the screen background between 0% and 100% in 10 percent points increments.

## 8 Tap [1: Trace cursor A] or [2: Trace cursor B].

The waveform screen has two areas where cursor values of trace cursors (trace cursor value 1 and Trace cursor value 2) appear.

Every time you tap [1: Trace cursor A], you can toggle the trace cursors displayed on the values of cursor values 1.

Every time you tap [2: Trace cursor B], you can toggle the trace cursors displayed on the values of cursor values 2.

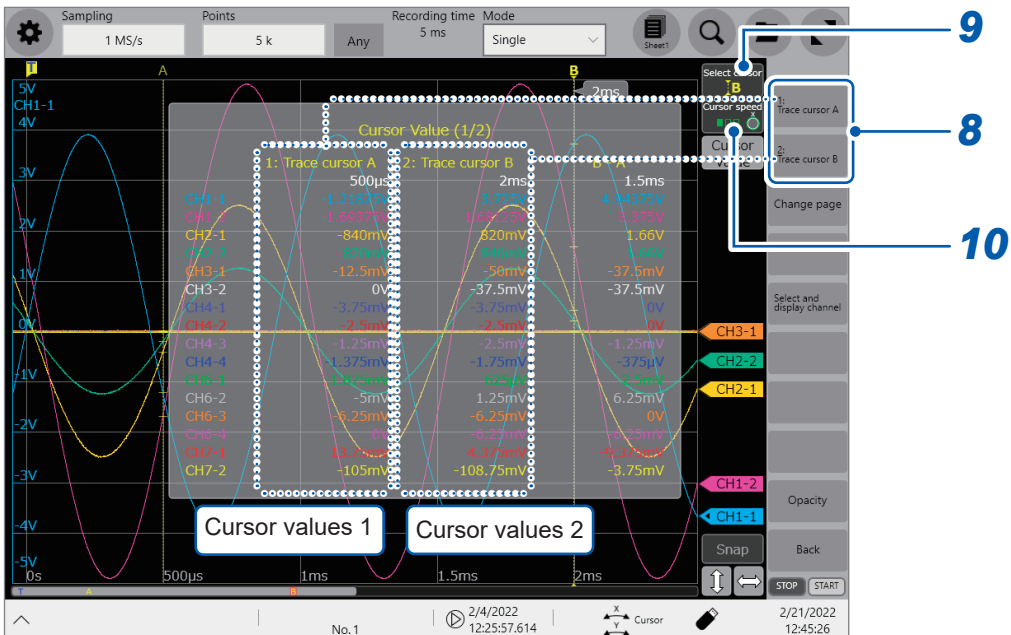

**9 Tap [Select cursor].**

Every time you tap it when the instrument displays multiple trace cursors, a cursor is activated one by one in sequence. In addition, you can activate any one of the cursors displayed on the screen by tapping it.

While you are operating the cursors on the waveform screen, the instrument may not display [Cursor Value] and [Select cursor] depending on the screen operation.

In this case, tap the waveform plotting field to redisplay the [Cursor Value] and [Select cursor] button.

**10 Tap [Cursor speed].**

You can switch the cursor moving speed on the rotary knob X on three levels every time you tap it.

**Changing the display magnification of time-series waveforms while moving the trace cursor**

Sliding your finger upward on the screen while dragging the trace cursor enlarges the time-series waveform display centered around the trace cursor in proportion to the dragging distance. Sliding your finger downward compresses the waveform display.

Once you have adjusted the display to a suitable size, move the trace cursor along the horizontal axis to change the display position.

Releasing your finger from the screen reverts the display to the original magnification.

**To move the trace cursor using the rotary knob X**

When [Cursor] is assigned to the rotary knob, you can move the active trace cursor with the rotary knob X.

Tapping [Cursor speed] allows you to switch the cursor moving distance on the rotary knob X on three levels.

The moving distance on the rotary knob Y is fixed at one.

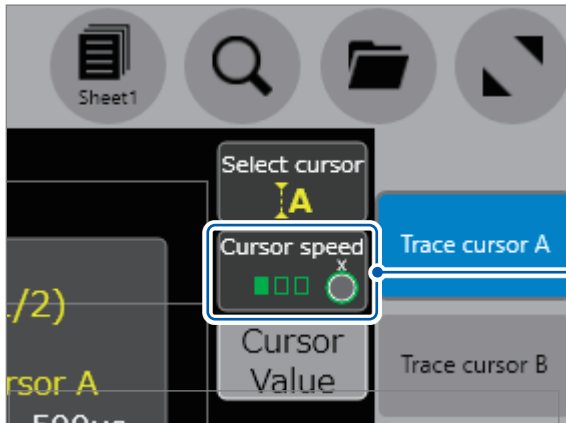

The moving distance switches every time you tap it.

**If no trace cursors appear on the screen even though the trace cursors are enabled**

You can check the trace cursors positions on the scroll bar. (p. 40)

## Reading measured values on the waveform screen

When the trace cursor is chosen

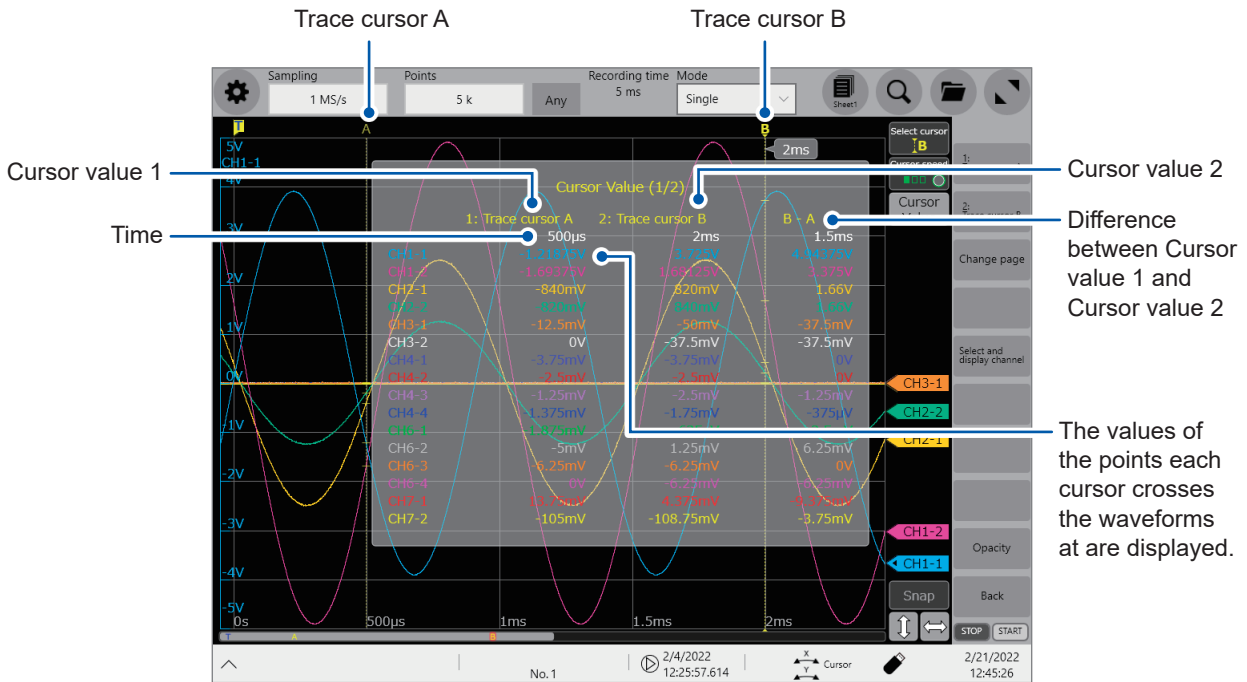

### When the horizontal cursor is selected

The measured value at each cursor and the difference in the measured value between cursors.

The display of the cursor values varies depending on the chosen cursor type.

Cursor type	Cursor value
<b>Trace cursor</b>	<p>When trace cursor A is assigned to cursor value 1; and trace cursor B, to cursor value 2.</p> <p>Time: A period of time from the trigger point or recording starting point until the trace cursor assigned to cursor value 1 or cursor value 2</p> <p>B - A: Difference in measured values between trace cursor A and trace cursor B</p>
<b>Horizontal cursor</b>	<p>When horizontal cursor A is assigned to cursor value 1; and horizontal cursor B, to cursor value 2</p> <p>Cursor value 1 or cursor value 2: Measured value at the specified cursor</p> <p>B - A: Difference in measured values between horizontal cursor A and horizontal cursor B</p>

When the external sampling is used, the time is represented in the number of samples.

## 2.2 Specifying the Waveform Range (Section Cursor)

You can specify the range using section cursors.

The specified range is applicable for saving files, making numerical calculation and searches and creating XY composite waveforms. The range selection remains unchanged even when you change the waveform display format.

### 1 Tap [Section cursor].



## 2 Tap [Section cursor 1] or [Section cursor 2].

The cursor is displayed on the left side of the screen.  
 Drag the section cursors on the waveform screen.  
 You can drag the section after tapping it to select.

<b>Section cursor 1</b>	Specifies the section with cursor 1A and cursor 1B.
<b>Section cursor 2</b>	Specifies the section with cursor 2A and cursor 2B.

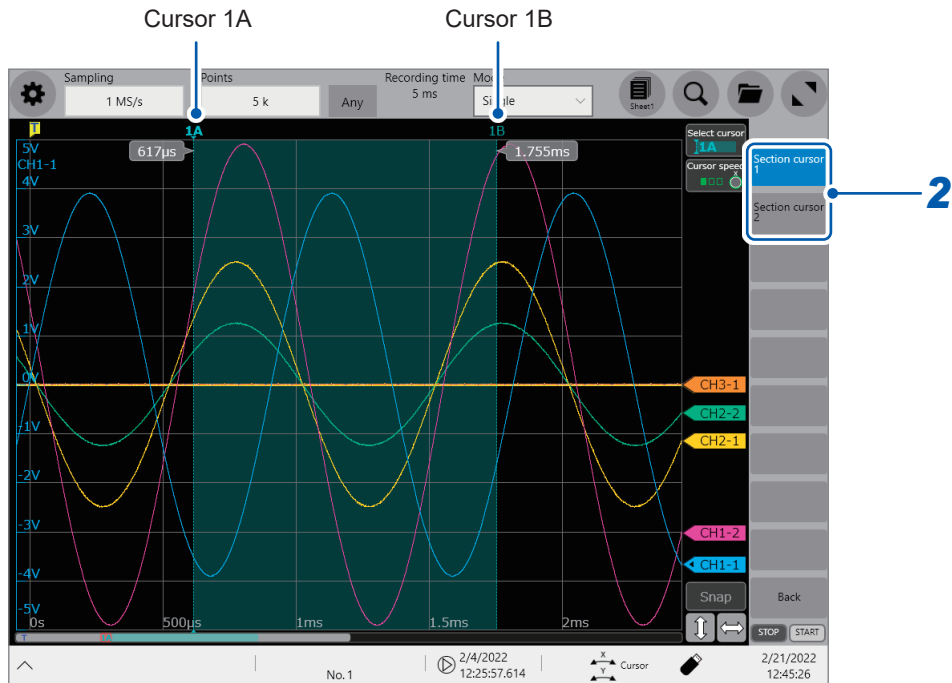

## Changing the display magnification of the waveforms while moving the section cursor

Sliding your finger upward on the screen while dragging the section cursor enlarges the waveform display centered around the section cursor in proportion to the dragging distance (Sliding your finger downward compresses the waveform display.).

Once you have adjusted the display to a suitable size, move the section cursor along the horizontal axis to change the display position.

Releasing your finger from the screen reverts the display to the original magnification.

## 2.3 Displaying Vertical Scales (Gauge Function)

Using the gauge function enables the vertical scales (for convenience, hereafter referred to as “gauges”) to be displayed overlapping waveforms.

### 1 Tap [Gauge].

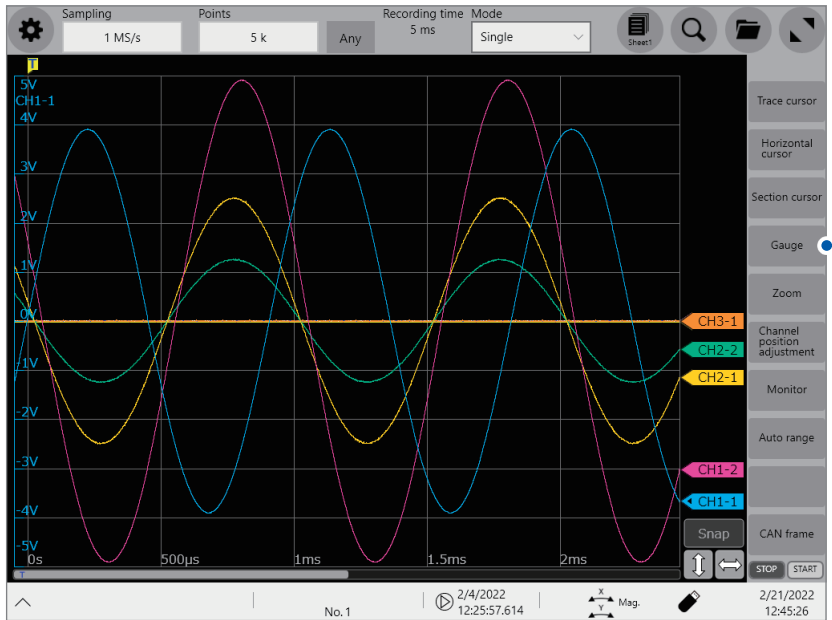

### 2 Choose gauges to be displayed from among [Gauge A] through [Gauge H].

The screen display the gauges at the left. You can drag a gauge after tapping it to select.



Tapping [Left-justified] aligns the gauges to the left.

## 2

**3** Tap [CH ▲] or [CH ▼] to choose a channel to be displayed.

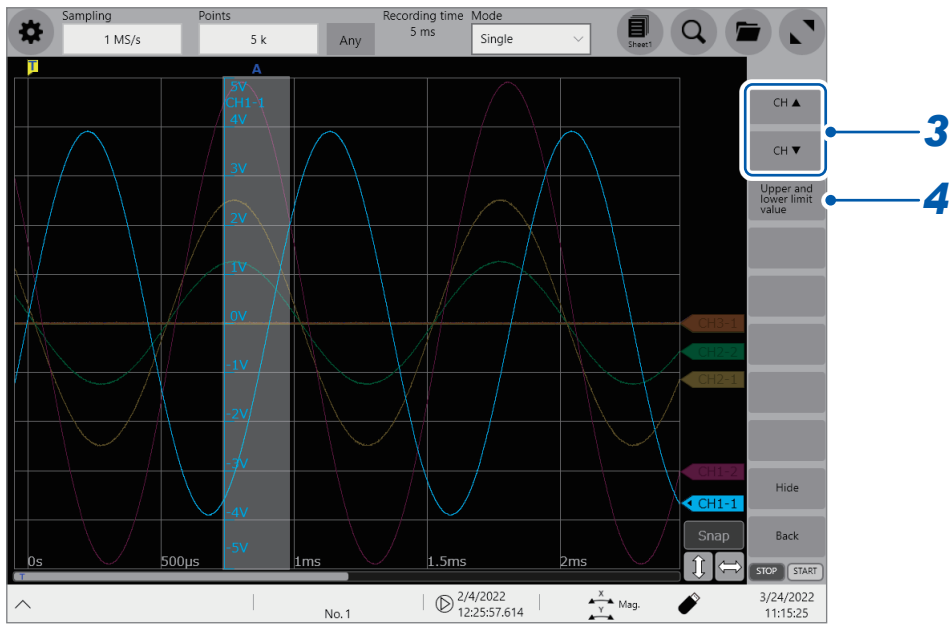

Tapping [Hide] hides the gauges.

**4** Tap [Upper and lower limit value].

The setting dialog box appears. You can enter numbers that represent the display range of each channel. Enter an upper and lower values in the [Upper] and [Lower] boxes, respectively, and then tap [OK].

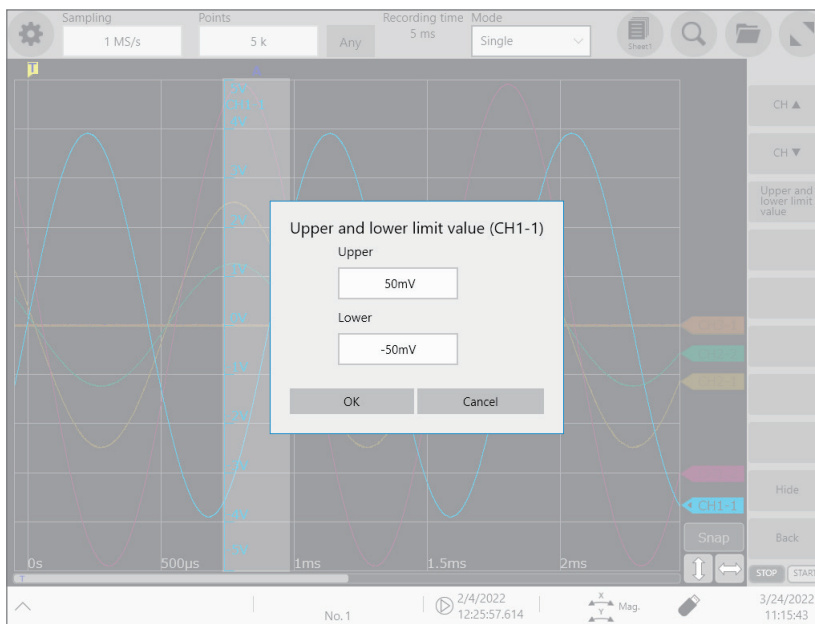



# 2.4 Scrolling Through Waveforms

## Scrolling through waveforms

Dragging the waveform screen scrolls through waveforms that are being measured or existing waveforms.

### Scrolling direction

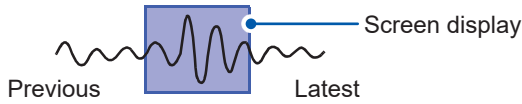

Dragging the waveform rightward:  
Scrolls through the waveform backward from the present.



Dragging the waveform leftward:  
Scrolls through the waveform forward from the present.



### To quickly scroll waveforms sideways

When dragging the scroll bar, you can quickly scroll waveforms sideways. The longer distance you drag the scroll bar, the more quickly waveforms scroll through. Once you remove your finger from the screen, the scrolling waveforms stop.

### To observe waveforms previously obtained during slow-speed measurement

When the waveforms are being displayed during a slow-speed measurement, dragging the waveform screen rightward allows you to observe waveforms previously obtained. To observe the waveforms being measured presently again, tap **▶▶▶** on the screen.

### To anchor the waveforms vertically

Tap the button to deselect it as the scroll direction.

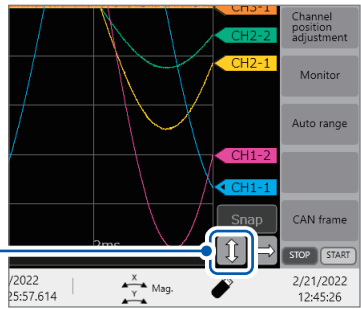

### To anchor the waveforms horizontally

Tap the button to deselect it as the scroll direction.

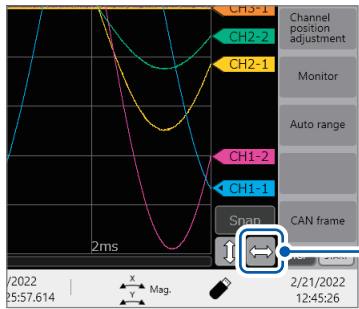

## Checking a position of waveforms with the scroll bar

The scroll bar provides the position and size of the displayed part of the waveforms relative to the entire recording length of the waveforms. It also shows the positions of the trigger point, trace cursors, and section cursors.

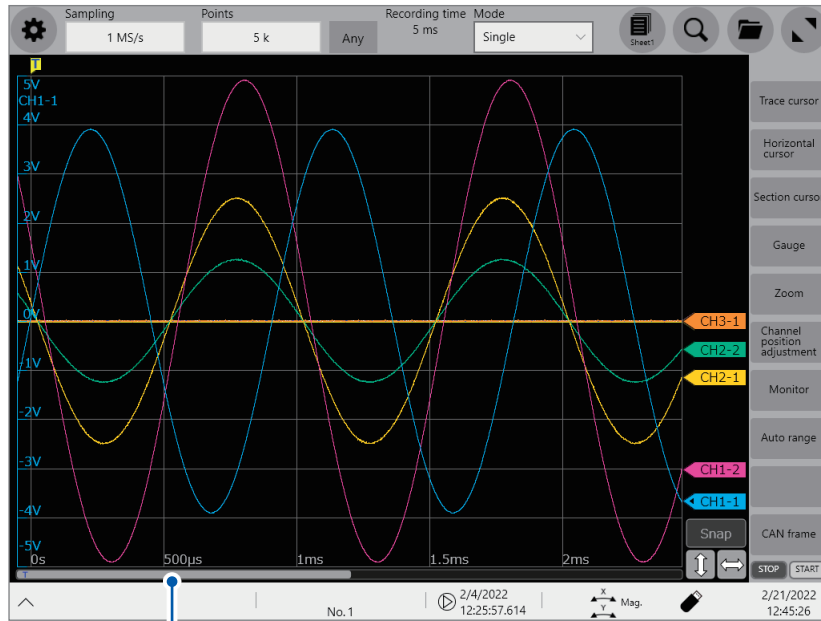

Scroll bar

## Checking the positions of the trigger point and cursors on the scroll bar

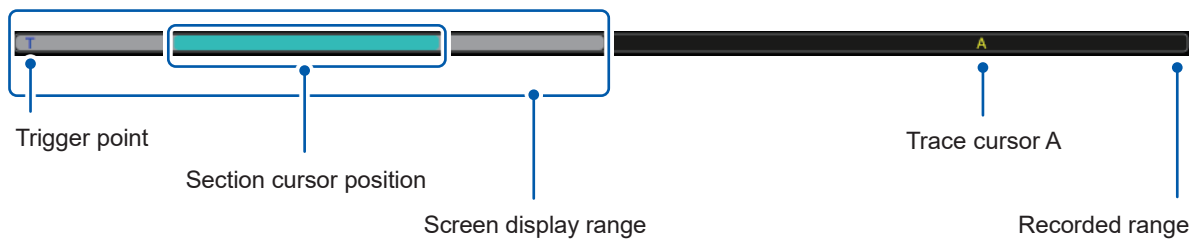

With the display zoomed in, the scroll bars are displayed at both the top and bottom.



### To move the display position when **[Memory division]** is set to **[On]**

You can move a block by directly specifying a block number to be displayed.

## 2.5 Changing the Display Position and Display Magnification of Waveforms

Horizontally pinching in the waveform screen compresses waveforms horizontally, and pinching out enlarges.

Vertically pinching in the waveform screen compresses waveforms vertically, and pinching out enlarges.

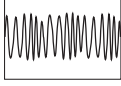
	<b>Pinch out</b>		Zooms in the waveforms.
	<b>Pinch in</b>		Zooms out the waveforms.

### To toggle snap mode

When **[Snap]** has been enabled by tapping it, waveforms can scroll and enlarge/compress snapping the grid lines onto the edges.

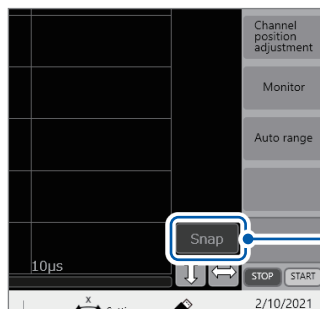

Tap the button to select or deselect it.

### To change the display position of logic channels in a batch

You can drag logic channels only after tapping **[Logic]** to select. When **[Logic]** is not chosen, you can drag analog channels only.

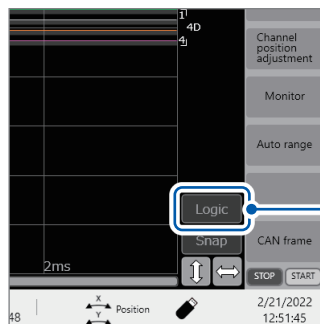

Tap the button to select or deselect it.

## Differentiating a waveform display position and display magnification from those of other analog channels

1 Tap [Channel position adjustment].



The channel position adjustment screen is displayed.

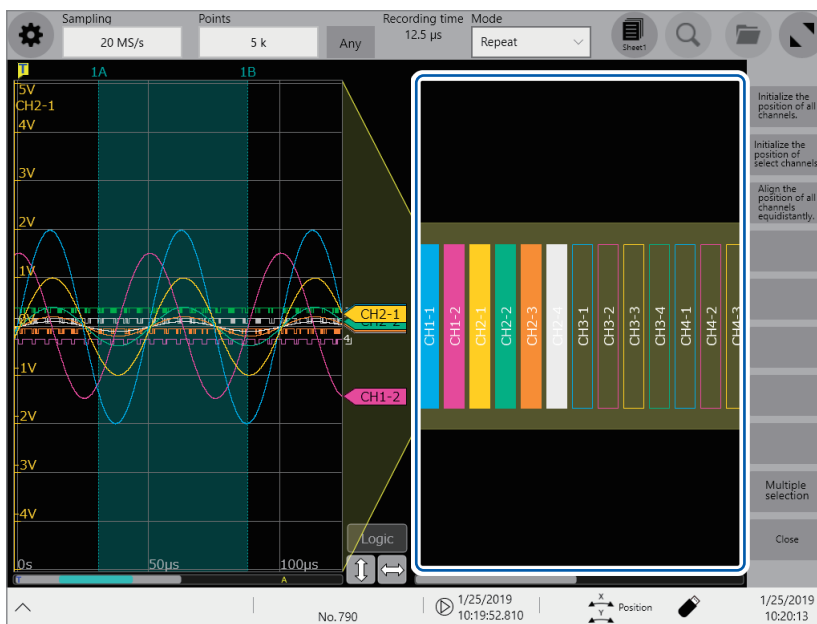

The yellow area shows the display range of the waveform screen.

- 2 Tap a channel number you want to move to choose and drag the chosen area.**  
The display position of the channel is moved.

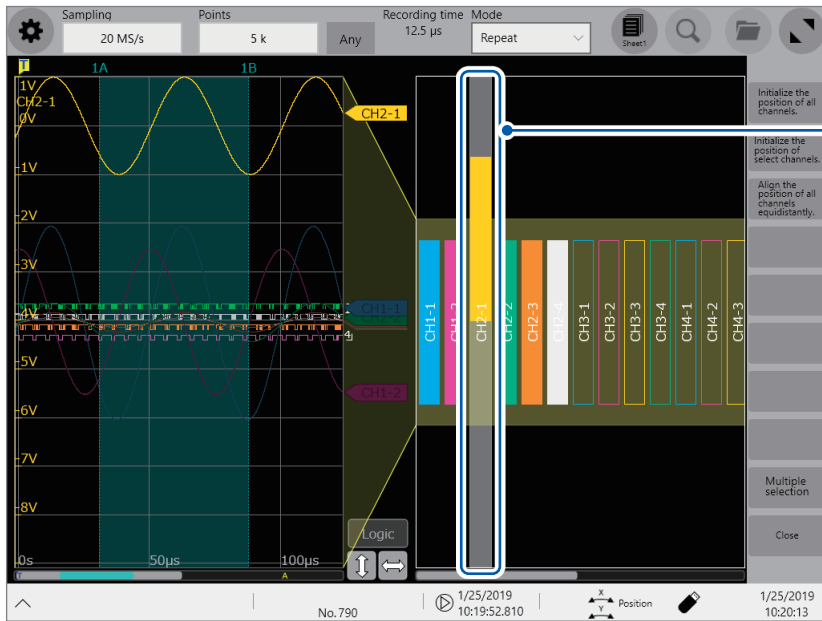

- 3 Tap a channel number you want to magnify/demagnify to choose and pinch in/out the chosen area.**  
The channel is magnified/demagnified.

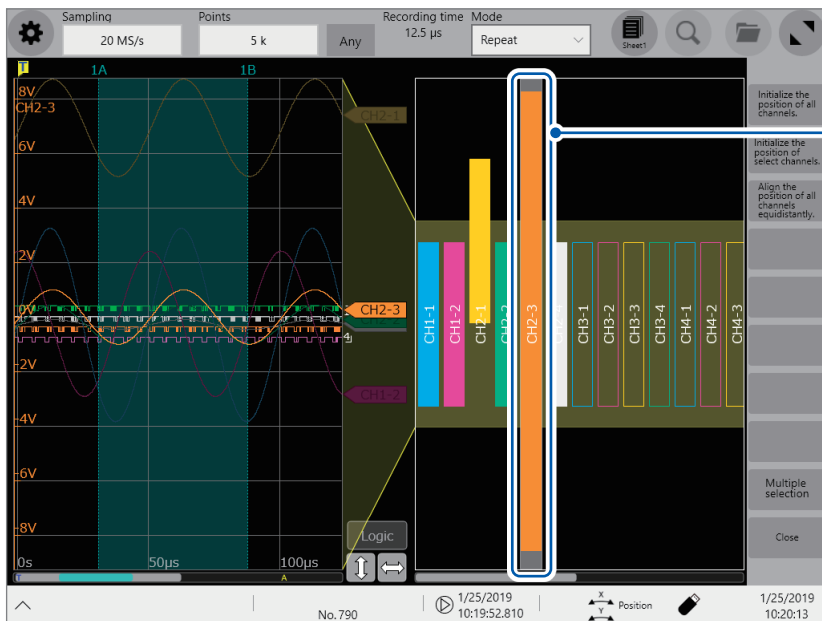

## 4 Adjust the display position and magnification.

The display can be adjusted as follows depending on the selected state.

<b>Initialize the position of all channels.</b>	Restores all the channels to the initial positions and displays them at the default magnifications.
<b>Initialize the position of select channels.</b>	Restores selected channels only to the initial positions and displays them at the default magnifications.
<b>Align the position of all channels equidistantly.</b>	Adjusts the display positions and magnifications of all channels such that they are aligned at the same intervals.
<b>Multiple selection</b>	Allows you to choose several channels to adjust the displays simultaneously.



## 2.6 Operating the Rotary Knobs

Push a rotary knob to choose an action and turn the knob to perform the action.

### Operation of the rotary knob X

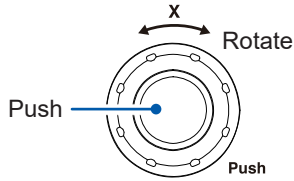

Each time you push the rotary knob X, the following actions are chosen one after another.

<b>Magnification/demagnification ratio</b>	Changes the magnification/demagnification ratio of waveforms acquired across all channels in the horizontal axis direction.
<b>Position</b>	Changes the display position of waveforms acquired across all channels in the horizontal axis direction.
<b>Cursor</b>	Moves the chosen cursor.
<b>Setting</b>	Changes the sampling rate. This operation can be used on the waveform screen only.

### Operation for the rotary knob Y

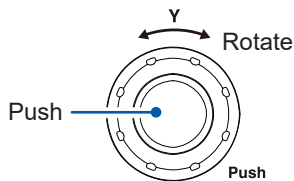

Each time you push the rotary knob X, the following actions are chosen one after another.

<b>Magnification/demagnification ratio</b>	Changes the display magnification of the chosen channel in the vertical axis direction.
<b>Position</b>	Changes the display position of the chosen channel in the vertical axis direction.
<b>Cursor</b>	Moves the selected cursor by one sample.
<b>Setting</b>	Changes the measurement range. This operation can be used on the waveform screen only.

When you operate a rotary knob, the channel selection panel appears, which allows you to choose an channel to be operated by tapping the [←] or [→] button. In addition, you can directly choose an channel to be operated by tapping a channel marker.

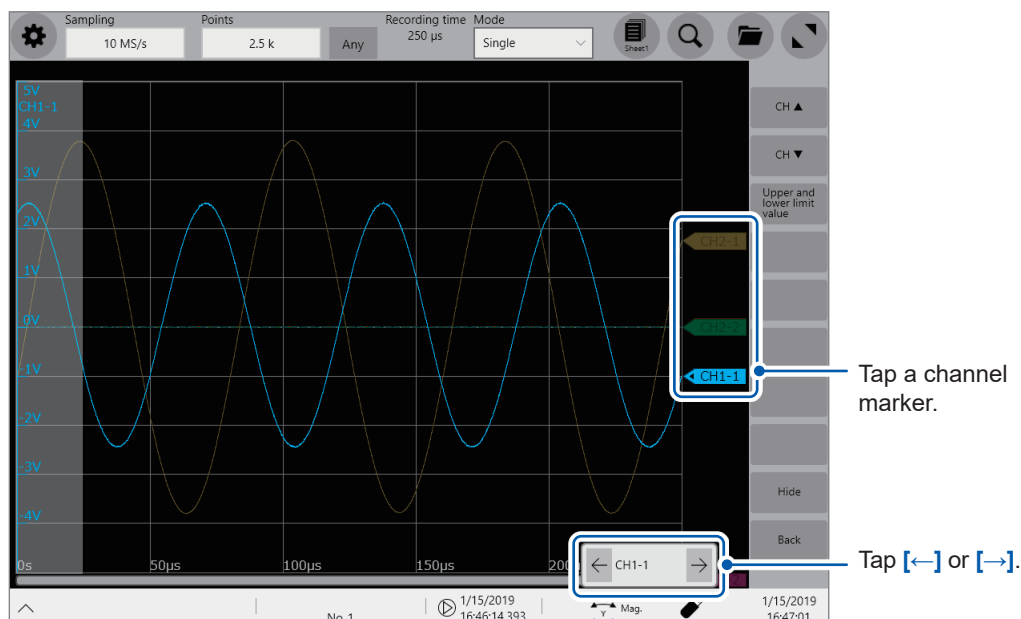

## 2.7 Enlarging a Part of the Waveform (Zoom Function)

Using the zoom function allows you to enlarge a part of waveforms.

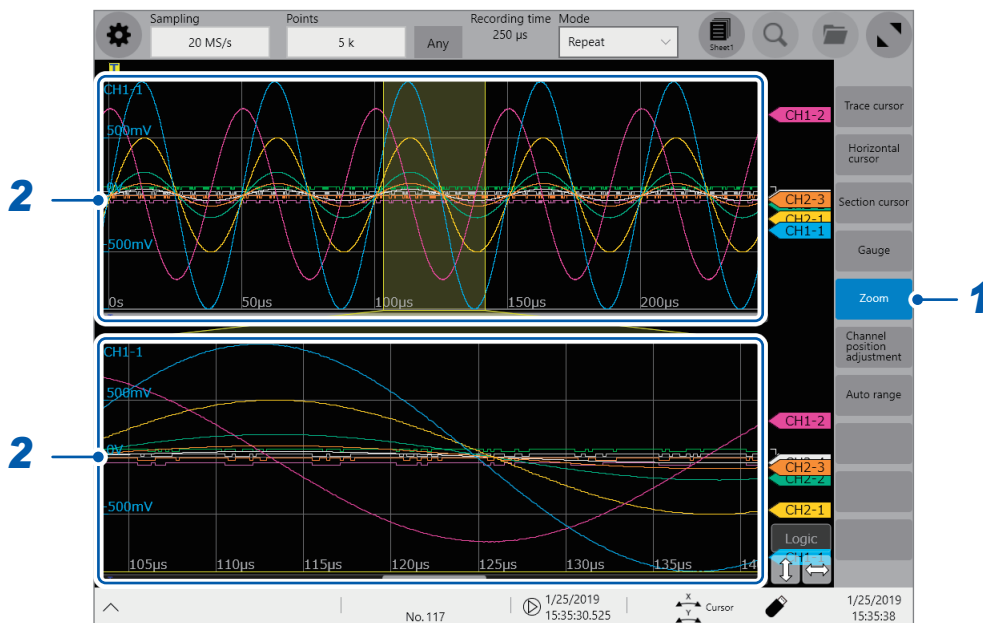
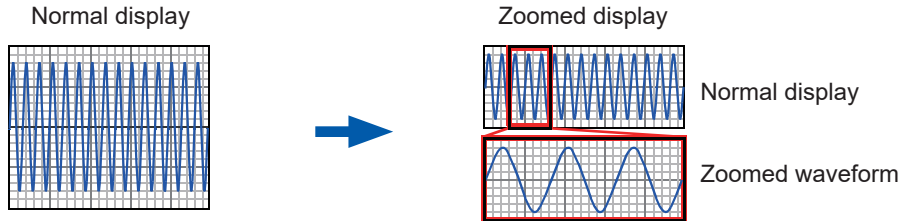

### 1 Tap [Zoom].

The screen splits into two, upper and lower, which enable the zoom function.

Upper screen: Displays the waveforms in the magnification specified before the zoom function was applied.

The part of the waveforms enclosed by the yellow frame represents the zoomed display range shown in the lower screen.

Lower screen: Displays the zoomed-in waveform

### 2 Pinch in or out each screen to change the display magnification of waveforms on each screen.

### 3 Drag waveforms to scroll through them on each screen.

### To cancel the zoomed display

Tap [Zoom] on the screen to cancel the zoomed display. When you cancel the zoomed display, the display (the upper screen) is restored to that with the normal magnification.



## 2.8 Generating XY Composite Waveforms (XY Composite)

During or after measurement, you can generate XY composite waveforms using waveforms acquired across user-defined channels.

Up to eight channels can be chosen from among analog channels, real-time calculation channels, and waveform calculation channels for generating XY composite waveforms.

No waveforms that have been acquired with the measurement method set to **[Envelope]** can be used for generating XY composite waveforms.

You can use the sheet setting screen to configure the display format, channels assigned to the X and Y axes, and the composite range settings.

To generate XY composite waveforms during measurement, you have to configure settings beforehand.

See “1.4 Configuring the Sheet Settings” (p. 19).

2

Operating the Waveform Screen and Analyzing Data

### Operation on the waveform screen

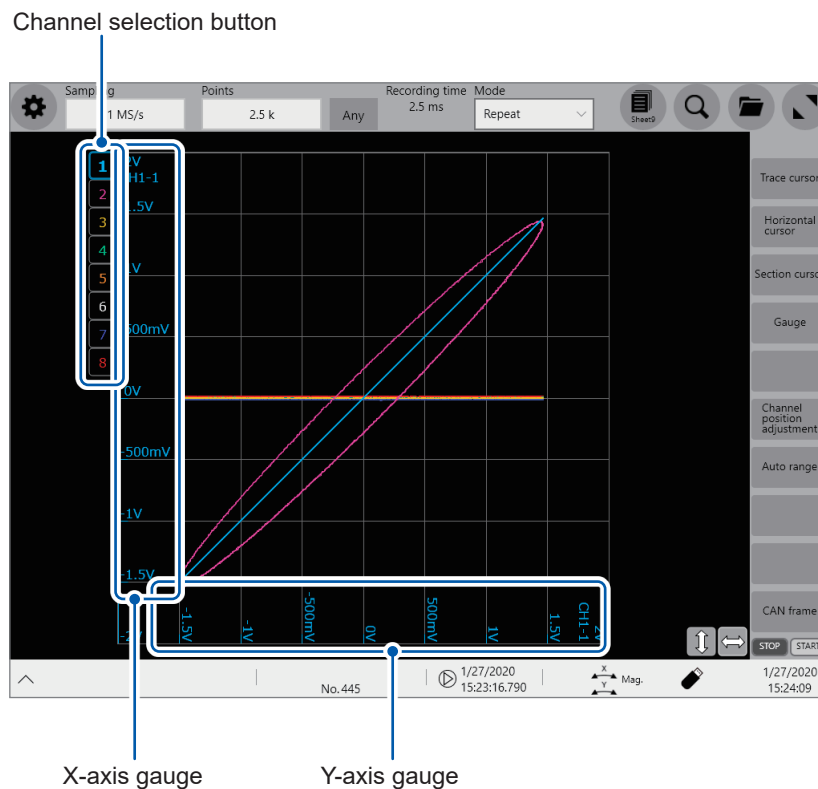

The X-axis and Y-axis gauges indicate the values of channels of each axis assigned to the chosen composite channel.

#### Dragging the waveform screen

Scrolls through displayed waveforms that are being measured or that have already existed.

#### Pinching in and out the waveform screen

Enlarges and compresses the waveforms.

#### Tapping the channel selection button

Switching the composite channels to be brought in front of others.

## Generating XY composite waveforms using partial waveforms on the time sequence + XY dual mode screen

When the division setting is configured to [Time sequence + XY Dual] and the save range setting is configured to [Segment 1] or [Segment 2] on the sheet setting screen, you can directly specify the XY composite range by moving the section cursor on the time-series waveforms.

Present composite range

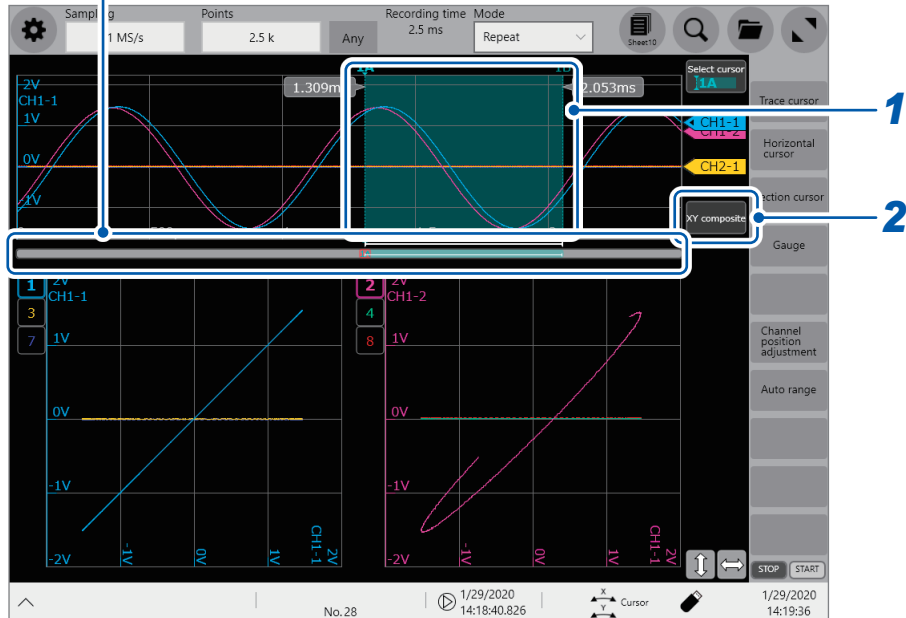

**1** Drag the section cursor to specify the XY composite range.

**2** Tap the [XY composite] button.

The XY composite waveforms are generated using the specified range.

## 2.9 Displaying Measured Values

This section explains how to configure the display settings to display measured values as well as waveforms.

While not performing measurement, the instrument will update the value of each channel every 0.5 s.

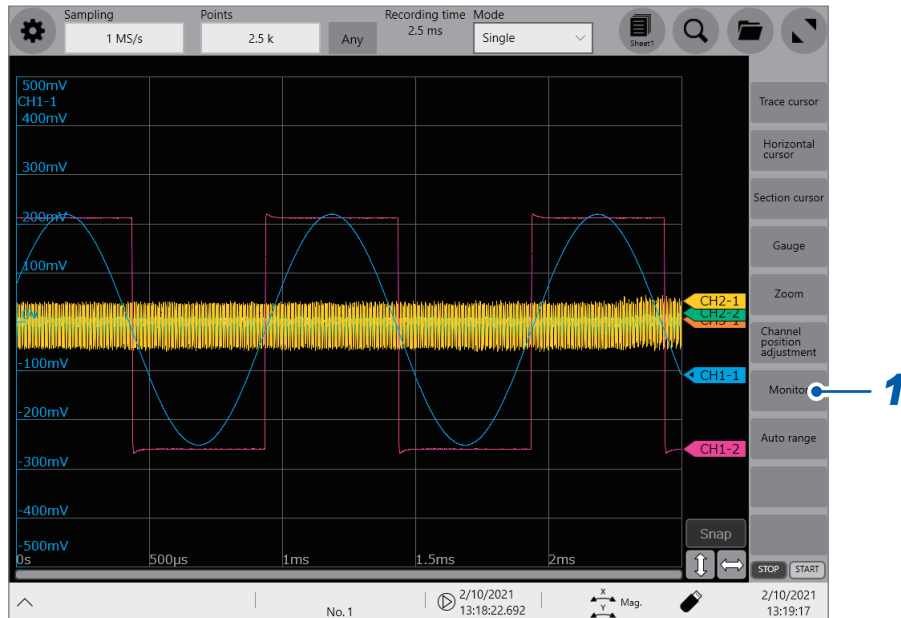

### 1 Tap [Monitor].

The numerical value display screen appears.

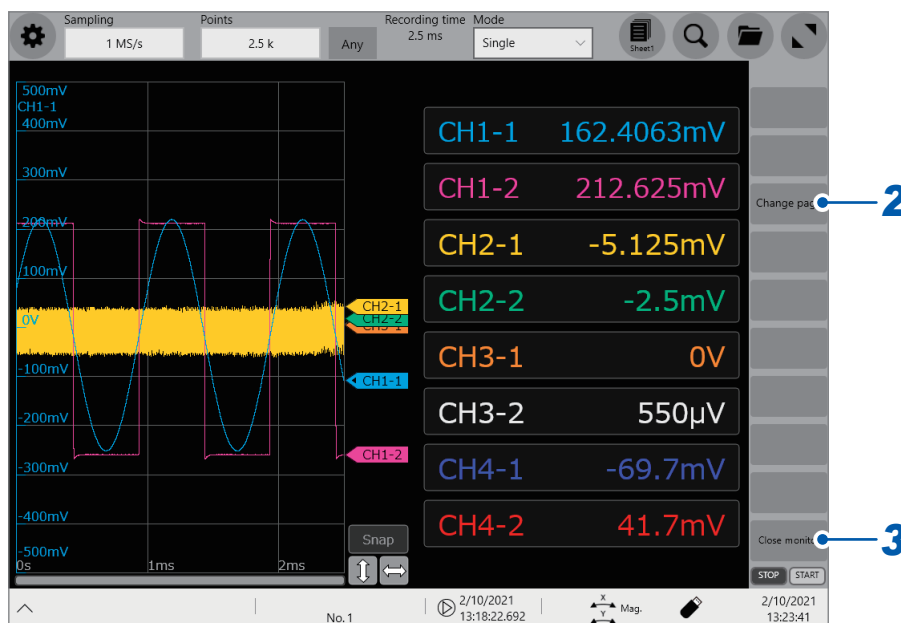

### 2 Tap [Change page].

If the instrument does not display some of the channels on a single screen, you can switch over the page. Every time you tap [Change page], the page switches over to another.

### 3 Tap [Close waveform monitor].

The numerical value display screen closes.

While the instrument does not perform measurement, tapping a value can display the waveform acquired across its channel.

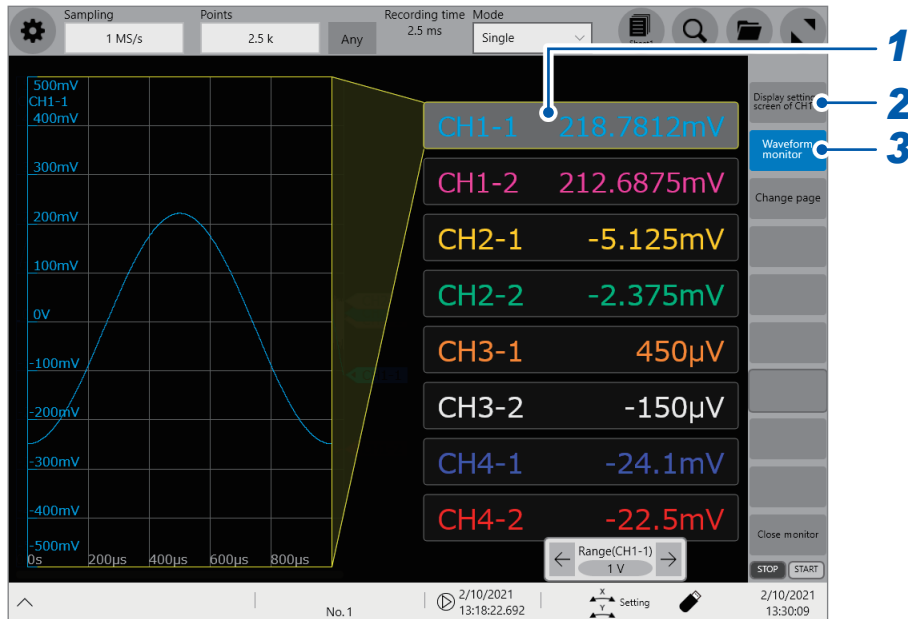

- 1** Tap the value of the channel whose waveform you wish to display.
- 2** Tap **[Display setting screen of CH□-□]**.  
The setting screen of the channel you chose in step **1** appears.
- 3** Tap **[Waveform monitor]**.  
Every time you tap **[Waveform monitor]**, the waveform monitor appears or hides.

## 2.10 Viewing Block Waveforms

This section describes how to select blocks and view waveforms recorded using the instrument's memory division function.

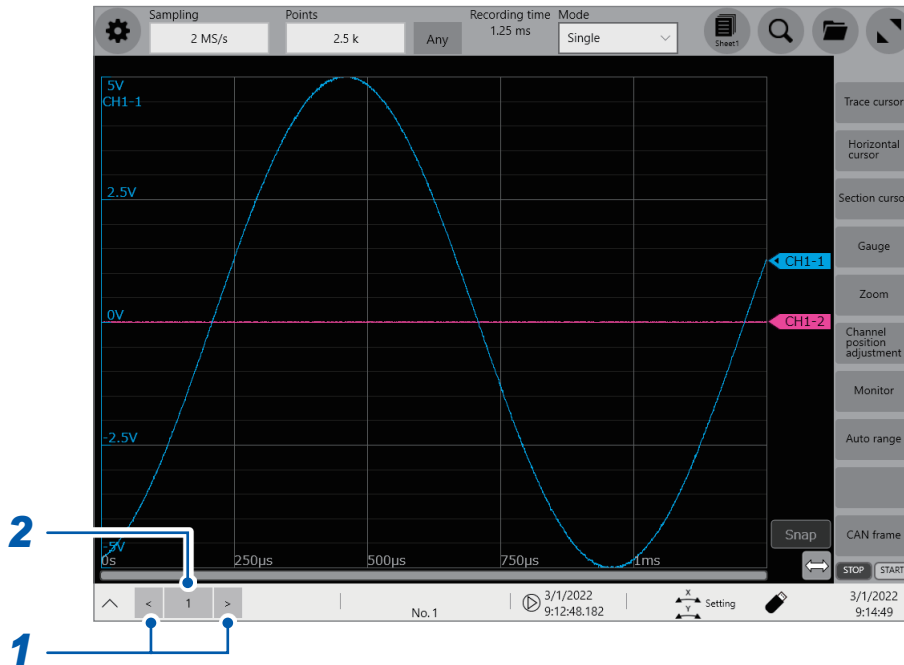

- 1** Tap the [**<**] and [**>**] keys to cycle through the block number shown on the waveform screen.
- 2** Tap the number box.  
A window allowing you to change blocks will be displayed.

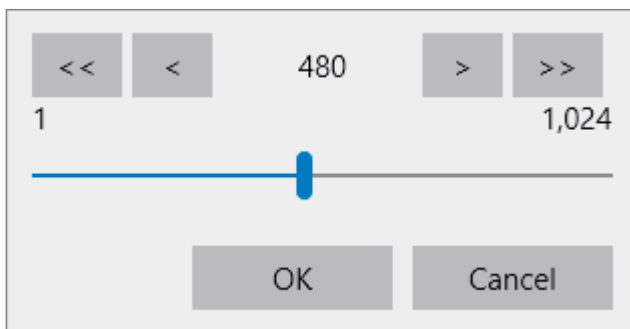

- 3** Select a block number using the arrow keys ([**<**] and [**>**]), the double-arrow keys ([**<<**] and [**>>**]), or the slider and tap [**OK**].  
The waveform for the selected block will be displayed.



Converting input values (scaling)

(p. 56)

Adjusting the Waveform Display Positions  
(Variable Function)

(p. 64)

Fine-adjusting input values

(p. 64)

Inverting a waveform

(p. 65)

Copying a setting to another channel

(p. 66)

**Advanced measurements and settings**

- Overlaying new waveforms with previously acquired waveforms (p. 54)

**Detailed module settings** (p. 67)

- Anti-aliasing filter
- Thermocouple type
- Reference junction compensation
- Wire break detection
- Data refresh
- Executing automatic balancing
- Probe division ratio
- Response time
- Measurement mode

# 3.1 Overlaying New Waveforms With Previously Acquired Waveforms

New waveforms can be overlaid with the presently displayed waveforms.

- You can compare the new waveforms with those recorded before. (When **[Mode]** is set to **[Repeat]**) (p. 6)
- Two methods are available to overlay waveforms: the automatic overlaying during measurement and the manual overlaying.

 > **[Status]** > **[Condition]**

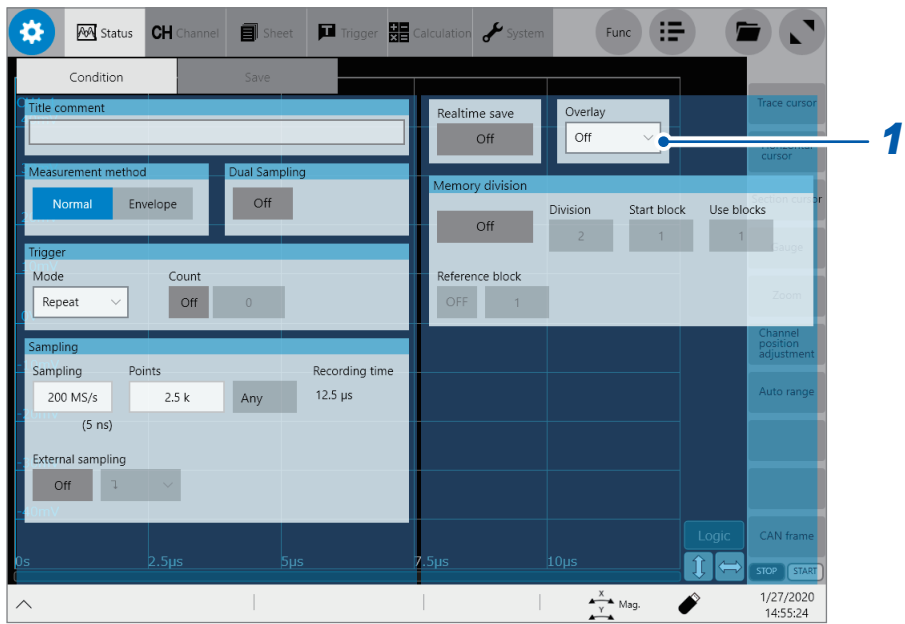

**1** Tap the **[Overlay]** box, and then choose an overlaying method from the list.

<b>Off</b> <input checked="" type="checkbox"/>	Does not overlay the waveforms.
<b>Auto</b>	Overlays waveforms newly acquired with the presently displayed waveforms every time the instrument acquires new ones. When <b>[Mode]</b> is set to <b>[Repeat]</b> , the instrument overlays the new waveforms with the presently displayed waveforms beginning from the start until the stop of the measurement.
<b>Manual</b>	Manually overlays the new waveforms with the presently displayed waveforms. See step <b>3</b> “Overlay the waveforms manually (leaving any waveforms to be displayed on the screen).” (p. 55).

See “When the overlay function is enabled (When **[Overlay]** is set to **[Auto]** or **[Manual]**)” (p. 55).



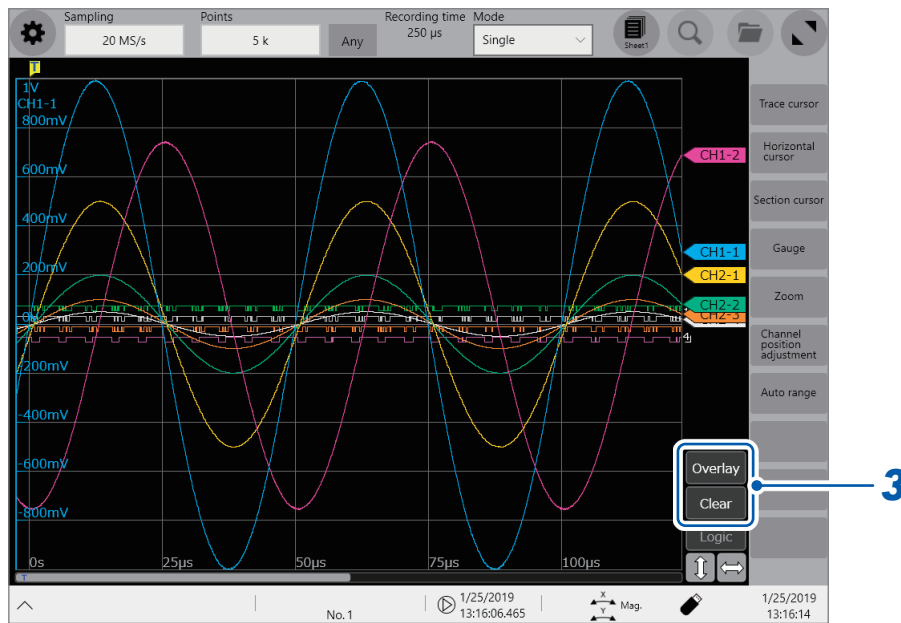

2 Tap the button  to switch over the display to the waveform screen.



3 Overlay the waveforms manually (leaving any waveforms to be displayed on the screen). Tap the button on the right side of the waveform screen.

<b>Overlay</b>	Leaves the acquired waveforms displayed on the screen. The overlay setting continues to be available until the waveforms are cleared.
<b>Clear</b>	Clears all the overlaid waveforms displayed on the screen. No cleared waveforms can be displayed again.

**When the overlay function is enabled (When [Overlay] is set to [Auto] or [Manual])**

- The instrument displays the waveforms always after the data has been acquired.
- The trace cursors show the measured values of the waveforms most recently acquired.
- The following operation is not available on the waveform screen:  
Scrolling through waveforms, switching the zoom function between on and off, changing the magnification, and changing the zero position.
- The instrument leaves the waveforms most recently displayed only and clears the others in the following cases:
  - After selecting  > [Sheet] and changing its setting
  - After selecting  > [Channel] and changing the waveform display settings (switching between on and off for the display setting or changing a waveform color)
  - After executing the search.

## 3.2 Converting Input Values (Scaling Function)

### About the scaling function

The scaling function enables you to convert voltage outputted from measuring devices such as sensors into physical quantities of measurement targets.

Hereafter, the term “scale” refers to converting numerical values using the scaling function.

Gauge scales, scaled values (upper and lower limits of the vertical axis or voltage axis), and measured values using trace cursors are represented as scaled values in the specified units. You can configure different scale settings for each channel.

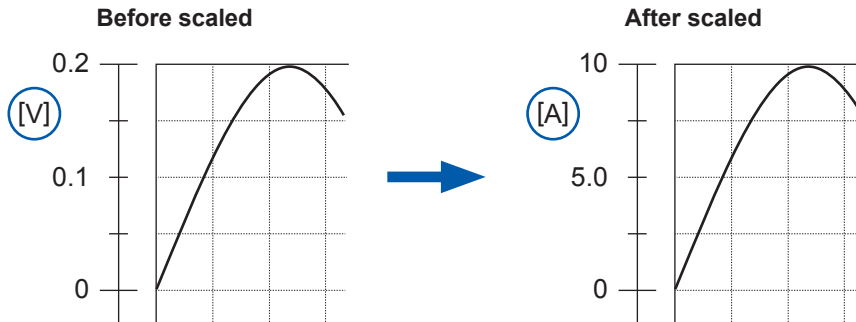

### Scaling methods

The following six methods are available:

- Specifying a conversion ratio and offset
- Specifying two points
- Choosing a model name of a connected current sensor or differential probe
- Choosing an output rate
- Specifying an input value in decibels and value after scaled
- Specifying a rated capacity and rated output according to an inspection record of a strain gauge converter (for Model U8969 Strain Unit only)

 > [Channel]

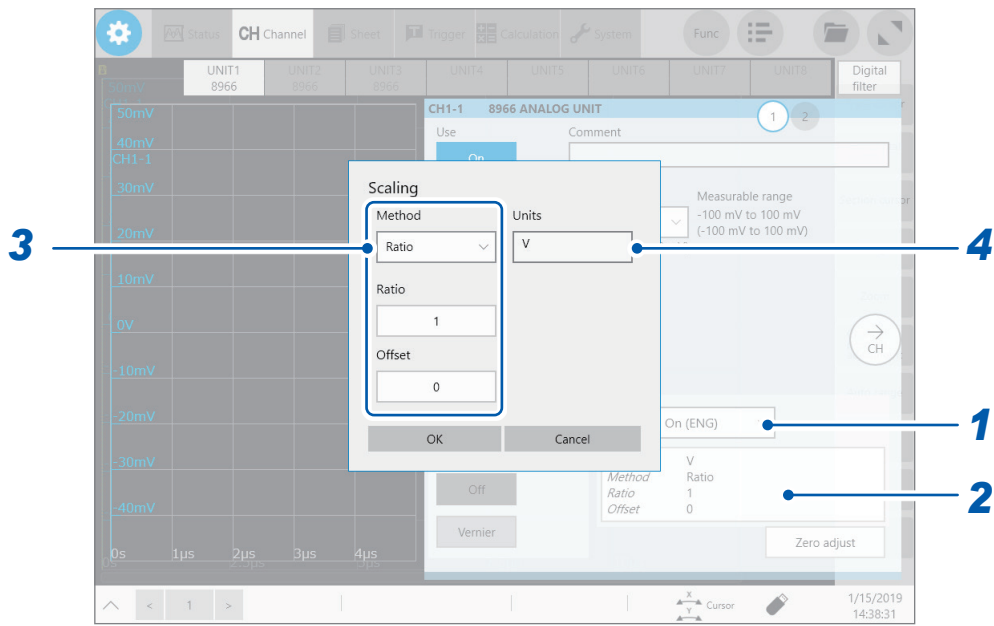

**1** Tap the [Scaling] box, and then choose a scaling setting from the list.

<b>Off</b> <sup>EN</sup>	Does not scale any values.
<b>On (ENG)</b>	Displays values in decimal notation with a unit prefix (such as m and k).
<b>On (SCI)</b>	Displays values in scientific notation (as a power of 10).

**2** Tap the setting items area.  
The setting dialog box appears.

**3**

Advanced Functions

**3** Tap the **[Method]** box, and then choose a setting method from the list.

<b>Ratio</b> <sup>□</sup>	Allows you to specify a conversion ratio and an offset.
<b>2-Point</b>	Allows you to specify two scaling-reference points.
<b>Sensor</b>	Allows you to choose a model name and measurement range of a connected current sensor or differential probe.
<b>Output rate</b>	Allows you to choose an output rate (ratio) of a current sensor or a division ratio of a voltage dividing probe.
<b>dB</b>	Allows you to specify an input value in decibels and value after scaled.
<b>Rating</b>	Allows you to specify a rated capacity and rated output according to an inspection record of a strain gauge converter to be used. (For Model U8969 Strain Unit only)

**When using [Ratio]**

Enter a conversion ratio in the **[Ratio]** box.

**-9.9999E+9 to 9.9999E+9**

Enter an offset value in the **[Offset]** box.

**-9.9999E+19 to 9.9999E+19**

**To convert inputted voltage values into current values**

Specify a physical quantity per one volt of an inputted signal (conversion ratio: eu/V), an offset value, and a measurement unit to be used. The instrument converts (scales) measured values acquired in volts into that in the specified measurement unit. (eu: engineering unit)

Example:  
 Ratio: Change in amperes per volt; offset value: B  
 Unit: A

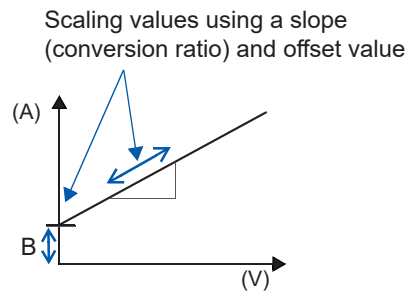

**When using [2-Point]**

Enter a value in each of the following fields: **[Input1]**, **[Input2]**, **[Scale1]**, **[Scale2]**.  
 Enter two voltage values of an inputted signal in the **[Input1]** and **[Input2]** boxes.  
 Enter each of two scaled value in the **[Scale1]** and **[Scale2]** boxes.

**-9.9999E+29 to 9.9999E+29**

The instrument converts (scales) measured values in volts into values in the specified measurement unit.

Example:

<b>Input1, Input2</b>	<b>Scale1, Scale2</b>
V <sub>H</sub> : Higher potential point	A <sub>H</sub> : Value for the higher potential point
V <sub>L</sub> : Lower potential point	A <sub>L</sub> : Value for the lower potential point

Unit: A

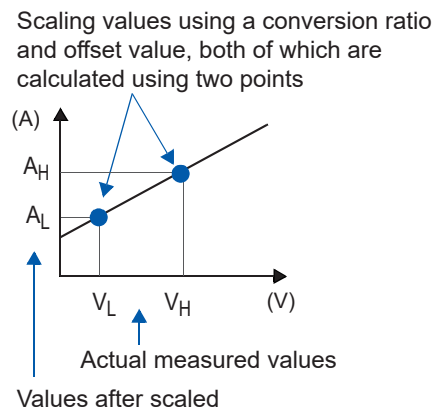

When changing the value with the **[Ratio]** setting, the instrument does not change the values for V<sub>L</sub> or V<sub>H</sub>, but the values for A<sub>L</sub> and A<sub>H</sub>, all of which have been specified with **[Method]** set to **[2-Point]**.

**When using [Sensor]**

Tap the [Sensor] box, and then choose a model name of a current sensor or differential probe from the list.

Tap the [Range (f.s.)] box, and then choose a measurement range from the list.

Sensor	Measurement range
Model 3273-50	30 A
Model 3274	150 A
Model 3275	500 A
Model 3276	30 A
Model 3283 <sup>□</sup>	10 mA <sup>□</sup> , 100 mA, 1 A, 10 A, 200 A
Model 3284	20 A <sup>□</sup> , 200 A
Model 3285	200 A <sup>□</sup> , 2000 A
Model 9010-50	10 A <sup>□</sup> , 20 A, 50 A, 100 A, 200 A, 500 A
Model 9018-50	10 A <sup>□</sup> , 20 A, 50 A, 100 A, 200 A, 500 A
Model 9132-50	20 A <sup>□</sup> , 50 A, 100 A, 200 A, 500 A, 1000 A
Model 9322	–
Model 9657-10	10 A
Model 9675	10 A
Model CT6700	5 A
Model CT6701	5 A
Model CT6710	500 mA, 5 A, 30 A
Model CT6711	500 mA, 5 A, 30 A

Setting example:

To display values measured with Model 9018-50 Clamp on Probe using the 10 A range as values in amperes (A)

**Sensor:** Model 9018-50

**Range:** 10 A

**Unit:** A

**When using [Output rate]**

Tap the [Output rate] box, and then choose a current value per one volt outputted the current sensor from the list.

Otherwise, choose a voltage value per a one volt outputted from the differential probe.

10 mA<sup>□</sup>, 100 mA, 1 A, 10 A, 20 A, 50 A, 100 A, 200 A, 250 A, 500 A, 1000 A, 2000 A, 2500 A, 5000 A, 1000 V

**When using [dB]: Specify a physical quantity per input signal (ratio) in decibels.**

Tap the **[Input dB]** box, and then enter an inputted signal value in decibels.

Tap the **[Output dB]** box, and then enter an scaled value in decibels.

**-200 to +200**

You can specify values to five or less significant figures.

Setting example:

Converting (scaling) an input value of 40 dB into 60 dB

**Input dB:** 40

**Output dB:** 60

The instrument specifies a conversion ratio corresponding to inputted values in decibels. The offset value is set at zero.

**When using [Rating]**

(for Model U8969 Strain Unit only)

Tap the **[Capacity]** box, and then enter the rated capacity of a strain gauge converter to be used.

Tap the **[Output]** box, and then enter a rated output of a strain gauge converter to be used.

**+1.0000E-9 to +9.9999E+9**

You can specify values to five or less significant figures.

Specify the parameters such that the quotient of the rated capacity divided by two times the rated output is less than or equal to 9.9999E+9.

For the rated capacity and rated output, see an inspection record of a strain gauge converter to be used.

Setting example: To display results measured with a strain gauge converter that has a rated capacity of 20 G and rated output of 1000  $\mu\text{V/V}$  as figures in gravities (G)

Unit: G

Rated capacity: 20

Rated output: 1000

The upper and lower display values of a waveform also automatically change according to the changes made in the scaling settings.

**4 Tap the [Units] box, and then enter a unit used for scaled values.**

(Number of characters: up to 7)

**To copy the scaling setting to another channel**

See "3.6 Copying Settings (Copy Function)" (p. 66).

## When using Model U8969 Strain Unit

### When an inspection record of a strain gauge converter provides a calibration factor

**Example:** To display waveform data measured with a strain gauge converter that has a calibration factor of  $0.001442 \text{ G}/1 \times 10^{-6} \text{ strain}^*$  as figures in gravities (G)

(\*:  $10^{-6} \text{ strain} = \mu\epsilon$ )

<b>Scaling</b>	On (ENG)
<b>Method</b>	Ratio
<b>Units</b>	G
<b>Ratio</b>	0.001442 [G] (Displayed as "1.4420 m")

### When an inspection record of a strain gauge converter provides the rated capacity and rated output

See "When using the [Rating] setting" in "3.2 Converting Input Values (Scaling Function)"(p. 60).

### When using a strain gauge that has a gauge factor of other than 2.0

Model U8969 Strain Unit measures outputs of the gauge supposing that the gauge factor stands at 2.0.

When a strain gauge that has a gauge factor of other than 2.0 is used, you need to convert its gauge factor into a conversion ratio.

For example, if the gauge factor stands at 2.1, the conversion ratio will be  $0.952 (\approx 2 / 2.1)$ .

**Example:** To display waveform data measured with a strain gauge (gauge factor: 2.1) as figures in gravities (G)

Converting output into physical quantities requires the two scaling (s) calculations: multiplying output by the gauge ratio and by a conversion ratio. In this case, enter the product of the conversion ratios of the gauge factor and the scaling conversion ratio as the conversion ratio.

Where the conversion ratio of the gauge factor is 0.952, and the conversion ratio to convert data into physical quantities is 0.001442\*.

Conversion ratio =  $0.952 \times 0.001442 = 0.0013728$

Enter [0.0013728] as the conversion ratio.

\*: To convert values measured with a strain gauge into physical quantities, calculate the conversion ratio based on Young's modulus or Poisson's ratio of a measurement object. The conversion method varies depending on the conditions the strain gauge is used in.

See "Scaling method for strain gauges" (p. 405).

### 3.3 Adjusting the Waveform Display Positions (Variable Function)

This section describes how to adjust display ranges and waveform display positions in the direction of the vertical (voltage) axis, according to your preferences.

You can specify each waveform's upper and lower limit values for the vertical (voltage) axis to display the waveform enlarging it to fill the screen.

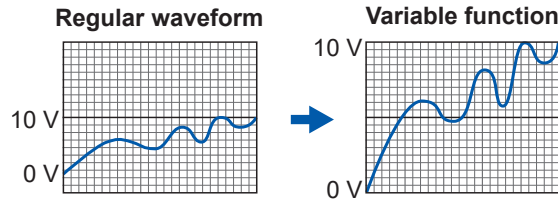

#### Before using the variable function

- Make sure that the vertical-axis (voltage-axis) range is suitably set for the input signal.
- You can specify the upper and lower limit values when **[Fix grid]** is set to **[On]**. See “13 Configuring the System Environment Settings” (p. 343).

> **[Channel]**

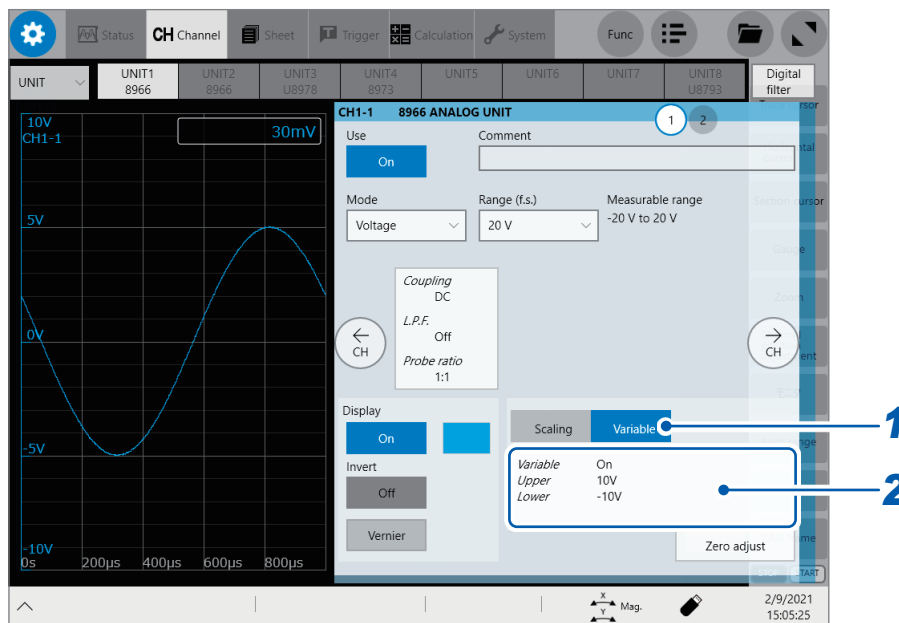

**1** Tap **[Variable]**.



**2** Tap the variable setting item field.

The **[Variable]** dialog box appears.

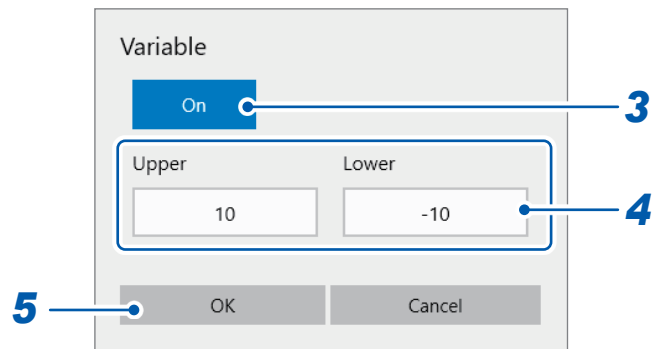
**3** Tap **[On]**.

If **[Variable]** is set to **[On]**, use the **[Magnification]** box and the **[Zero position]** button to adjust the waveform positions. (p. 16)

**4** Tap the **[Up]** and **[Low]** boxes, and enter the value in each box.**5** Tap **[OK]**.

# 3.4 Fine-Adjusting Input Values (Vernier Function)

You can freely fine-adjust input voltage on the waveform screen. When recording physical values, such as noise, temperature, and acceleration, with sensors, you can adjust those amplitudes, which facilitates calibration.

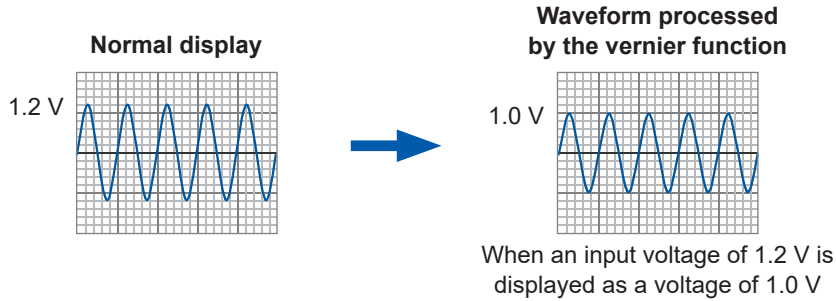

> [Channel]

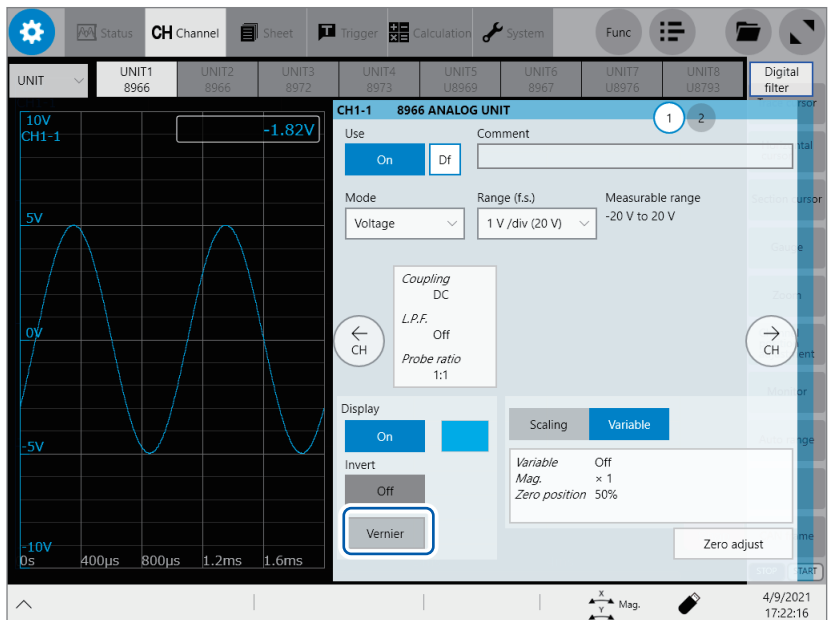

- 1 Tap [Vernier].  
The adjustment keypad appears.
- 2 While observing the waveform, you can fine-adjust its amplitude by tapping [--], [-], [+], and [++].  
Tap [C] to revert the fine -adjusted amplitude to its original.

- The adjustable range is from 50% to 250% of an original waveform.
- Using the vernier function turns the sides of [Vernier] blue.

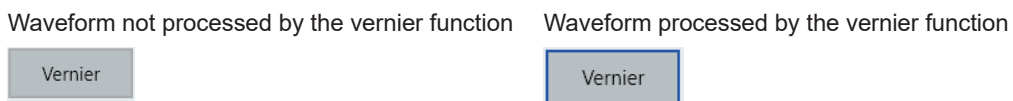

- Waveform data (data saved as files) is that adjusted by the vernier function.

## 3.5 Inverting a Waveform (Invert Function)

You can invert a waveform relative to the X axis. This function can be used for analog channels only.

Measured data saved in files is that inverted by the invert function.

Example:

- When a signal is inputted with spring-pulling force negative and spring-compressing force positive; however, you would like to display the results with spring-pulling force positive and spring-compressing force negative
- When a current sensor is clamped around a wire with its current direction mark mistakenly in the direction opposite to the current flow

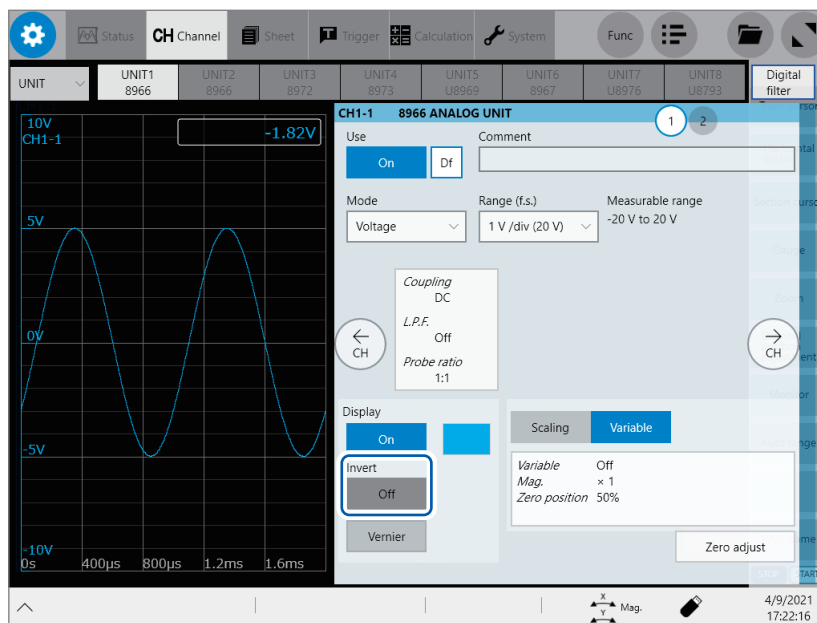

Tap the **[Invert]** button to set it to **[On]**.

This setting is not available for Model 8967 Temp Unit, Model 8970 Freq Unit, and Model 8973 Logic Unit.

## 3.6 Copying Settings (Copy Function)

You can copy settings of other channels, as well as the trigger settings and the real-time waveform calculation settings (Model MR6000-01 only).

The following procedure explains how to copy settings of another channel.

 > **[Func]** > **[Copy]** > **[Channel]**

The **[Copy settings]** dialog box appears.

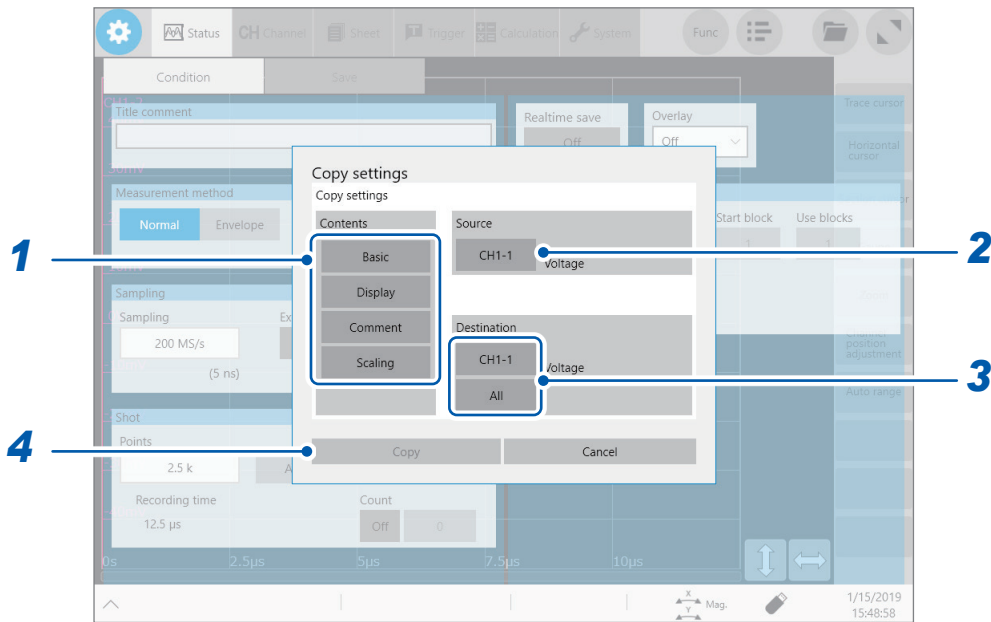

### 1 In the **[Contents]** area, tap one or more of items that you want to copy.

Depending on module types, some items may not be able to be copied.

<b>Basic</b>	Copies the mode, measurement range, coupling, L.P.F., division ratio, and module-specific settings.
<b>Display</b>	Copies the display setting (excluding comments).
<b>Comment</b>	Copies a comment.
<b>Scaling</b>	Copies the scaling setting.

### 2 Tap the **[Source]** box, and then choose a source channel from the list.

### 3 Tap the **[Destination]** box, and then choose a destination channel from the list.

Otherwise, tap **[All]**.

<b>CH1-1</b> <input checked="" type="checkbox"/> (Channel selection)	Tap this option when you would like to copy the settings to any one of the channels, and then choose a destination channel from the list.
<b>All</b>	Copies settings to UNIT 1 through UNIT 8.

### 4 Tap **[Copy]**.

After copying the settings, check that the measurement range, as well as setting values, such as the level, upper, and lower values, of the trigger function, the search function, and the numerical calculation function are appropriate.

## 3.7 Configuring Measurement Module-Specific Settings

You can configure advanced settings for each module.

### Configuring Model 8968 High Resolution Unit settings

 > [Channel] > [8968]

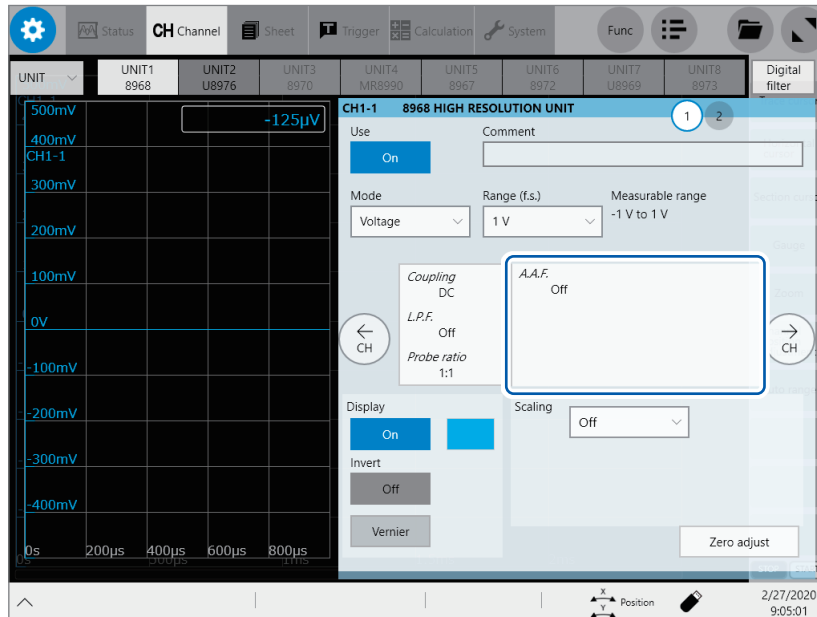

**1** Tap the area that includes **[A.A.F.]**.  
The **[A.A.F.]** setting dialog box appears.

**2** Tap the **[A.A.F.]** box, and then choose **[On]** or **[Off]** from the list for the anti-aliasing filter setting.  
Enabling the anti-aliasing filter prevents aliasing distortion from influencing FFT calculations. The cutoff frequency automatically changes according to the sampling rate or frequency range (for the FFT function) settings.

<b>Off</b>	Disables the anti-aliasing filter.
<b>On</b>	Enables the anti-aliasing filter. (Disabled when the external sampling is used, or the sampling rate is set at 100 kS/s or faster)

**3** Tap **[Close]**.  
The setting dialog box closes.

## Configuring Model 8967 Temp Unit settings

 > [Channel] > [8967]

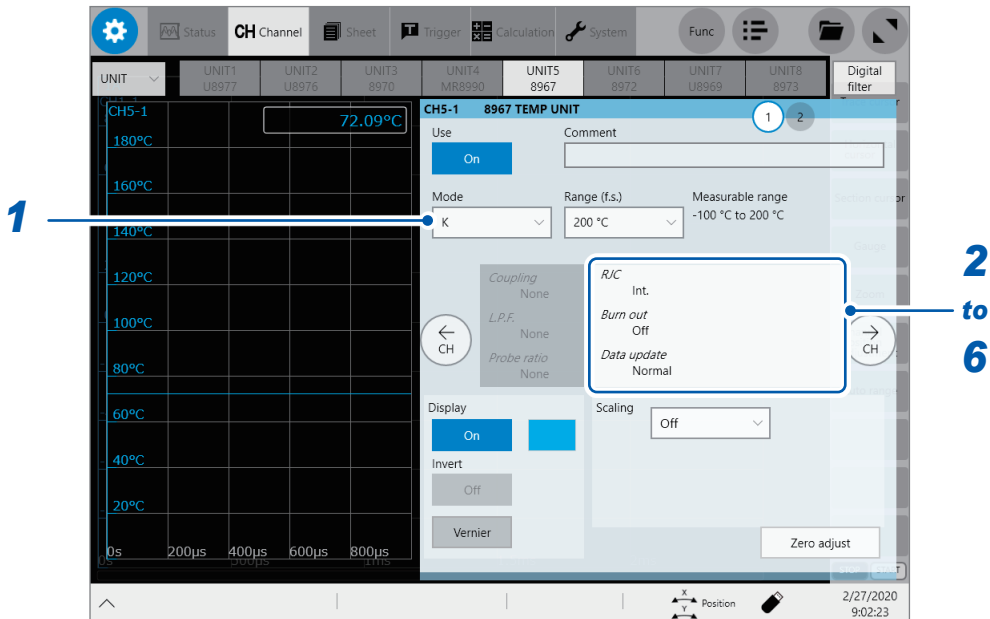

### 1 Tap the [Mode] box, and then choose a thermocouple type from the list.

Choose an option depending on the type of a thermocouple to be used.

Mode	Measurable range	Mode	Measurable range
<b>K</b> <input checked="" type="checkbox"/>	-200°C to 1350°C	<b>R</b>	0°C to 1700°C
<b>J</b>	-200°C to 1100°C	<b>S</b>	0°C to 1700°C
<b>E</b>	-200°C to 800°C	<b>B</b>	400°C to 1800°C
<b>T</b>	-200°C to 400°C	<b>W</b>	0°C to 2000°C
<b>N</b>	-200°C to 1300°C		

### 2 Tap the area that includes [RJC].

The setting dialog box appears.

### 3 Tap the [RJC] box, and then choose between [Int.] and [Ext.] from the list for reference junction compensation.

<b>Int.</b> <input checked="" type="checkbox"/>	Execute the reference junction compensation inside the module. (Measurement accuracy: The sum of the accuracy of the temperature measurement and that of the reference junction compensation)
<b>Ext.</b>	Does not execute the reference junction compensation inside the module. (Measurement accuracy: The accuracy of the temperature measurement only)

When connecting a thermocouple directly to the module, choose **[Int.]**.

When connecting a thermocouple via a reference junction device (e.g., zero-point bath), choose **[Ext.]**.

#### 4 Tap the **[Burn out]** box, and then choose between **[On]** and **[Off]** from the list for the wire break detection setting.

You can detect a broken thermocouple wire during temperature measurement. If a thermocouple wire breaks, measured values will fluctuate.

<b>Off</b> <sup>□</sup>	Does not check wires for a break.
<b>On</b>	Check wires for a break by flowing about 100 nA of minuscule current through the thermocouple.

If the thermocouple wires are long or have a relatively high resistance, set **[Burn out]** to **[Off]** to avoid measurement errors.

#### 5 Tap the **[Data update]** box, and then choose a data update interval from the list.

<b>Fast</b>	Updates data about every 1.2 ms. Choose this option for a quicker response. However, choosing this option causes some increase in noise superimposed on input signals.
<b>Normal</b> <sup>□</sup>	Updates data about every 100 ms. Choosing this option eliminates noise, leading to stable measurement.
<b>Slow</b>	Updates data about every 500 ms. Choosing this option leads to stabler measurement.

#### 6 Tap **[Close]**.

The setting dialog box closes.

## Configuring Model U8969 Strain Unit settings

Model U8969 Strain Unit can execute automatic balancing.

Executing automatic balancing regulates the reference output level of a transducer at the specified zero position. Automatic balancing is available for Model U8969 Strain Unit only.

You can use Model 8969 Strain Unit you own with this instrument. The instrument displays the model name of Model 8969 Strain Unit as **[U8969]**.

### Before executing automatic balancing

- Turn on the instrument and leave it for 30 minutes to allow the internal temperature of the module to stabilize.
- After properly connecting a strain gauge converter to the module and a measuring object, execute automatic balancing without any input including distortion.
- You cannot execute automatic balancing during measurement.
- No key operation is accepted during automatic balancing.

### To execute automatic balancing on the channel screen of each channel

 > **[Channel]** > **[U8969]**

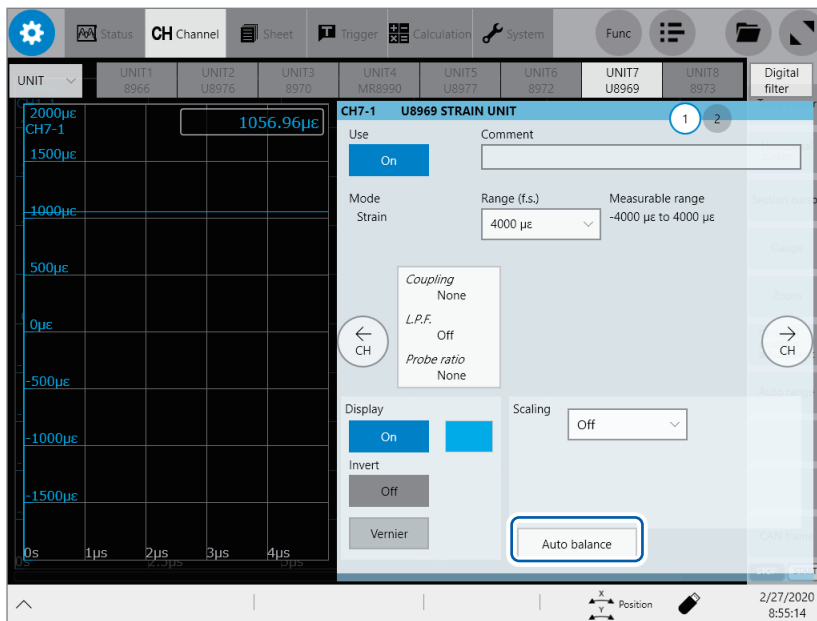

Tap **[Auto balance]**, and then choose an automatic balancing setting from the list.

<b>One channel only</b>	Executes automatic balancing for only a channel displayed on the channel screen.
<b>All</b>	Executes automatic balancing for all of the channels Model U8969 is installed in.



## To execute automatic balancing on the list screen

 > [Channel] >  > [Operate] > [Auto balance]

Executes automatic balancing for all channels of Strain Units installed in the instrument.

In the following cases, execute automatic balancing again.

- After changing the vertical axis (strain axis) range
- After replacing any modules
- After replacing the strain gauge converter
- After cycling the instrument
- After initializing the instrument
- When the ambient temperature has changed significantly (the zero position may drift)

### If automatic balancing fails

Check the following items, and re-execute automatic balancing.

- Is the strain gauge converter not subjected to any load?  
(Make sure that the strain gauge converter is not subjected to vibration, etc.)
- Is the strain gauge converter connected to the measurement target properly?

## Configuring Model 8970 Freq Unit settings

 > [Channel] > [8970]

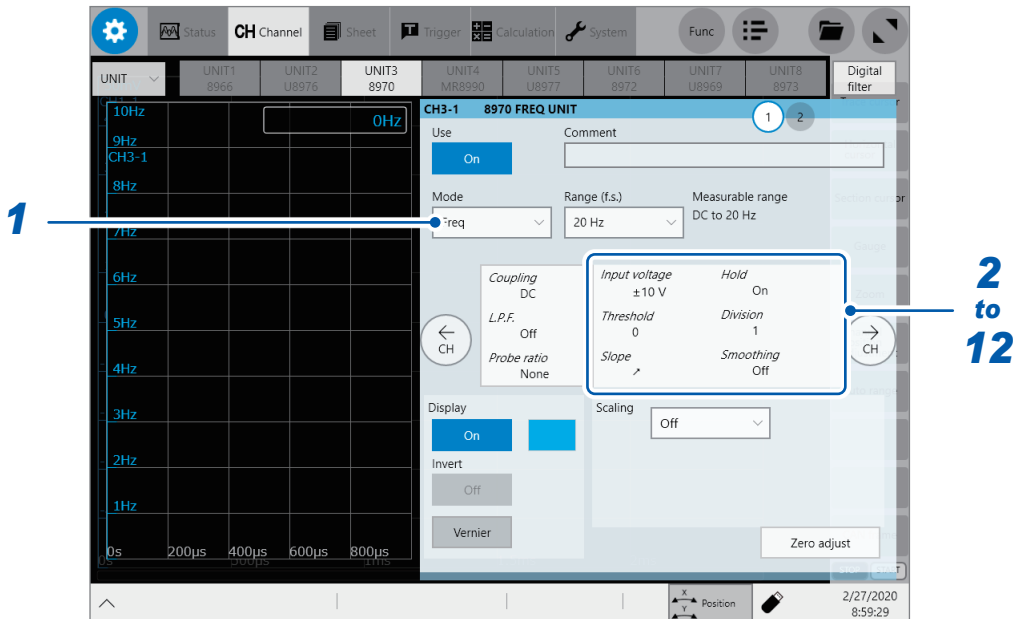

**1** Tap the [Mode] box, and then choose a measurement mode from the list.

<b>Freq</b> <input checked="" type="checkbox"/>	Measures frequency of a waveform (in hertz [Hz]).
<b>Rotation speed</b>	Measures the number of rotations of a measuring object (in rotations per minute [r/min]).
<b>Power frequency</b>	Measures power frequency fluctuation (in hertz [Hz]).
<b>Count</b>	Accumulates the number of input pulses.
<b>Duty ratio</b>	Measures duty ratios of a waveform to be measured (in percent [%]).
<b>Pulse width</b>	Measures pulse widths (in second [s]).

A pulse that rises during the dead time (during a calculation) cannot be measured (with a frequency of 25 kHz or higher).

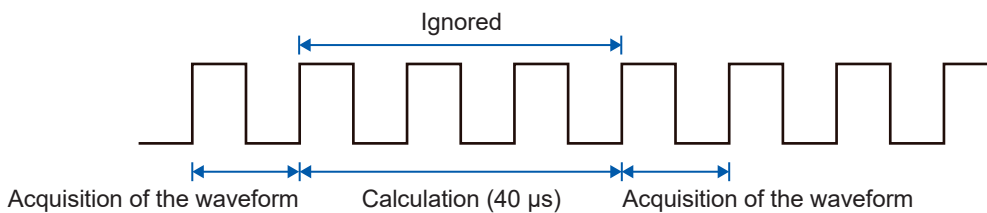

**2** Tap the area that includes [Input voltage].

The setting dialog box appears.

**3** Tap the [Input voltage] box, and then choose an option for the maximum level of an input signal from the list.

±10 V,  ±20 V,  ±50 V,  ±100 V,  ±200 V,  ±400 V

**4 Tap the [Threshold] box, and then enter a threshold value.**



- Measured values are acquired based on the following: the interval between the subsequent two points when measured waveform exceeds (or falls below) the threshold value, and the number of times when the waveform exceeds (or falls below) the threshold value.
- The upper and lower limits of the threshold value and the increment in the threshold value vary depending on the input voltage setting.

To prevent measurement errors due to noise, a hysteresis width of about 3% of the input voltage is tolerated for the threshold.

(When [Input voltage] is set to  $[\pm 10 \text{ V}]$ , it stands at about  $\pm 0.3 \text{ V}$ .)

Specify a threshold allowing for tolerance that exceeds the hysteresis width relative to a peak voltage.

**5 Tap the [Slope] box, and then from the list, choose a signal direction to be detected.**

	Detects a waveform when it exceeds the specified threshold value (while rising).
	Detects a waveform when it falls below the specified threshold value (while falling).

**6 Tap the [Division] box, and then enter a pulse count used for calculating frequency.**

1 to 4,096

Example: For an encoder that outputs 360 pulses per rotation, set [Division] at [360] to measure a frequency each rotation. When [Division] is not used, set it at [1].

**7 Tap the [Timing] box, and then from the list, choose a condition used for starting a count.**

Only when [Mode] is set to [Count], this setting is available.

Start	Starts a count when you press the <b>START</b> key.
Trigger	Starts a count when the instrument is triggered.

- With the [Start] setting, some internal processing time is required between the time when you press the **START** key and the start of measurement. Thus, the count value is not zero at the start point.
- With the [Timing] setting, an input that exceeds the trigger level does not trigger the instrument during pre-trigger latency. Furthermore, the time for internal processing at the start and the trigger priority setting may not cause the instrument to trigger even when the input signal exceeds the specified trigger level.
- The memory division may cause the last data of the previous block to remain in the top of the block.

**8 Tap the [Count over] box, and then from the list, choose an action to be performed when a count number is saturated.**

Only when [Mode] is set to [Count], this setting is available.

Hold	Counts pulses and stops counting when the pulse count reaches the upper limit (65535 for the 40 k range).
Back	Starts counting pulses and brings the count back to zero when the pulse count reaches 25 times of the range figure (50000 for the 40 k range).

**9 Tap the [Level] box, and then from the list, choose a side of the threshold level to be detected for pulse width measurement and duty ratio measurement.**

Only when [Mode] is set to [Pulse width] or [Duty ratio], this setting is available.

High	Detects pulses on the upper side of the threshold level.
Low	Detects pulses on the lower side of the threshold level.

**10** Tap the **[Smoothing]** box, and then choose a scaling setting from the list.

Only when **[Mode]** is set to **[Freq]** or **[Revolution]**, this setting is available.

<b>Off</b> <input type="checkbox"/>	Records measured data without smoothing (resulting in a step-like waveform).
<b>On</b>	Interpolates measured data to smooth a waveform and outputs it. (Upper limit: 10 kHz; outputting data with this setting set to on lags behind that with this setting set to off)

**11** Tap the **[Hold]** box, and then choose a measured-value retaining setting from the list.

Only when **[Mode]** is set to **[Freq]** or **[Revolution]**, this setting is available.

<b>Off (1 Hz),</b> <b>Off (0.5 Hz),</b> <b>Off (0.2 Hz),</b> <b>Off (0.1 Hz)</b>	When the instrument cannot determine a measured value even when the frequency reaches a value in the brackets, the instrument determines the measurement to stop and regards the measured value as 0 Hz (0 rpm).
<b>On</b> <input type="checkbox"/>	Retains the value confirmed the last time.

**12** Tap **[Close]**.

The setting dialog box closes.

## Configuring Model 8971 Current Unit settings

 > [Channel] > [8971]

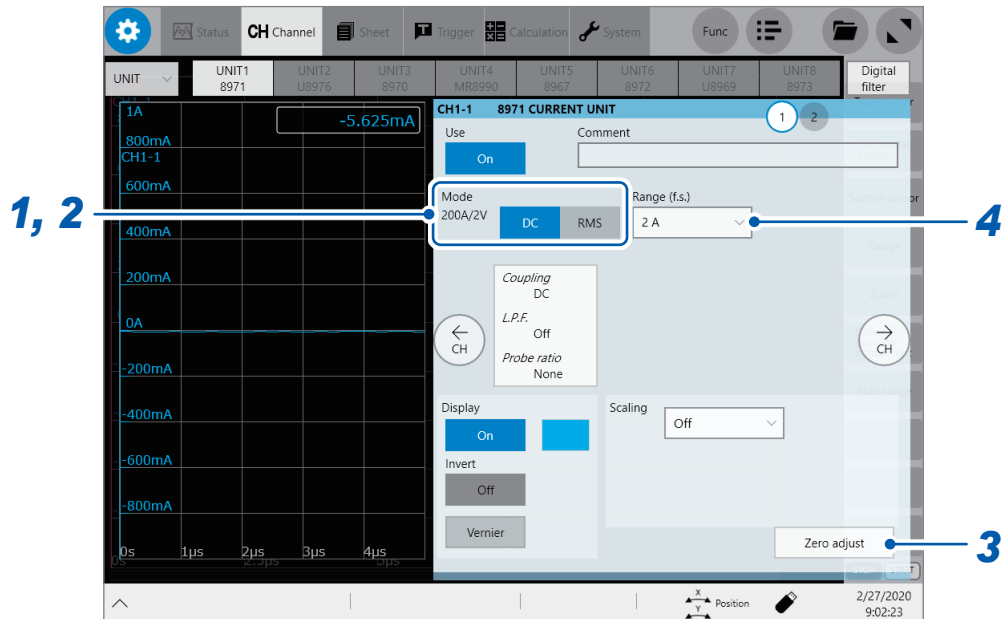

### 1 Confirm the output rate displayed in the [Mode] area.

The instrument automatically recognizes a current sensor connected to Model 8971 Current Unit and displays it as follows:

<b>20A/2V</b>	When one of the following current sensors is connected: Models 9272-10 (20 A range), 9277, and CT6841.
<b>200A/2V</b>	When one of the following current sensors is connected: Models 9272-10 (200 A range), 9278, CT6843, and CT6863.
<b>50A/2V</b>	When Model CT6862 AC/DC Current Sensor is connected
<b>500A/2V</b>	When one of the following current sensors is connected: Models 9279, 9709, CT6844, CT6845, CT6846*, and CT6865*.
<b>None</b>	When no current sensor is connected.

#### IMPORTANT

\*: When Model CT6846 or Model CT6865 connects to Model 8971 Current Unit via Model 9318 Conversion Cable, the instrument recognizes the sensor as a 500 A AC/DC sensor. Set the conversion ratio at 2.00 in the scaling setting.

### 2 In the [Mode] area, tap the [DC] or [RMS] to choose a measurement mode.

<b>DC</b>	For current measurement
<b>RMS</b>	For RMS measurement

### 3 (When you have changed the measurement mode) Tap [Zero adjust].

The instrument performs zero-adjustment. Execute zero-adjustment without any input.

**4 Tap the [Range (f.s.)] box, and then choose a measurement range from the list.**

You can choose a measurement range from among the options, which have been scaled for the current sensor detected automatically.

**IMPORTANT**

The figure of each measurement range name represents the maximum current that Model 8971 can measure using the range. However, the instrument cannot measure currents that exceed the rated current of a connected current sensor. Check the specifications of the current sensor used.

## Configuring Model 8972 DC/RMS Unit settings

 > [Channel] > [8972]

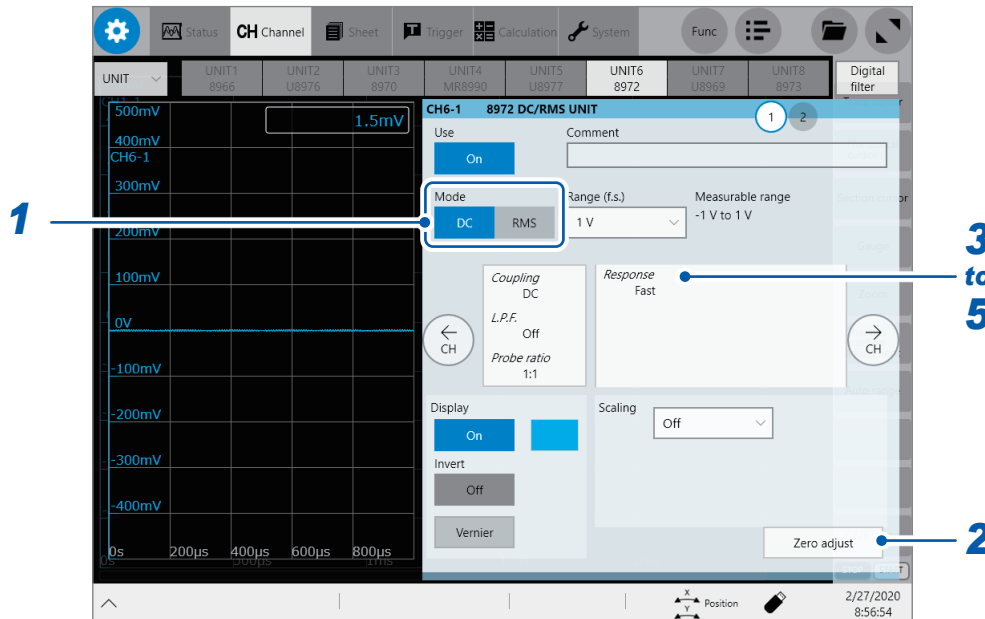

**1** In the [Mode] area, tap the [DC] or [RMS] to choose a measurement mode.

<b>DC</b> <sup>☑</sup>	For voltage measurement
<b>RMS</b>	For RMS measurement

**2** (When you have changed the measurement mode) Tap [Zero adjust].  
The instrument performs zero-adjustment. Execute zero-adjustment without any input.

**3** Tap the area that includes [Response].  
The setting dialog box appears.

**4** Tap the [Response] box, and then from the list, choose a response time for RMS measurement.

<b>Fast</b> <sup>☑</sup>	Sets the response time to about 100 ms.
<b>Normal</b>	Sets the response time to about 800 ms.
<b>Slow</b>	Sets the response time to about 5 seconds.

Usually, choose [Fast]. Setting the response time to [Normal] or [Slow] can stabilize the measured values if the frequency is relatively low or the voltage fluctuates severely.

**5** Tap [Close].  
The setting dialog box closes.

## Configuring Model MR8990 Digital Voltmeter Unit settings

 > [Channel] > [MR8990]

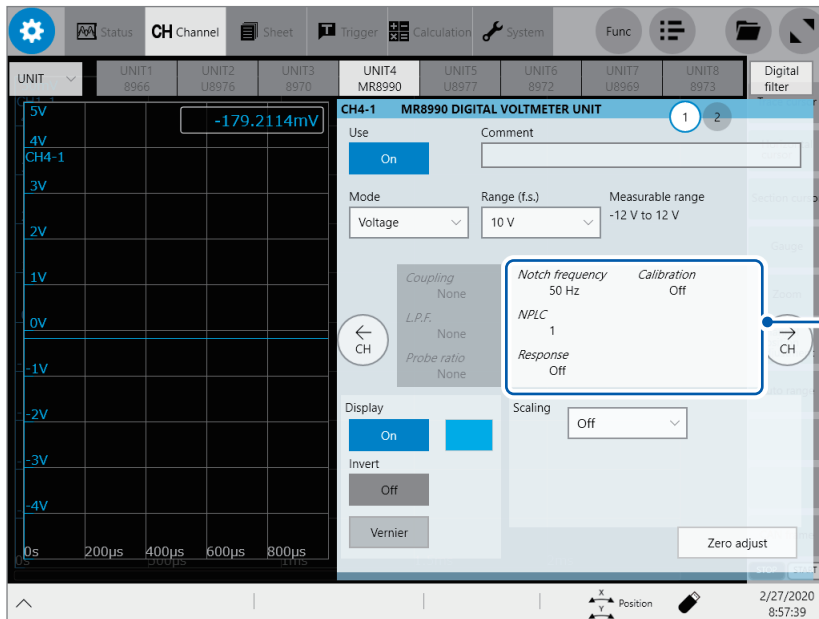

**1** Tap the area that includes [Notch frequency].

The setting dialog box appears.

**2** Tap the [Notch frequency] box, and then choose a power frequency from the list.

Choose a power frequency of your region.

50 Hz	Sets the period to 20 ms.
60 Hz	Sets the period to 16.67 ms.

An incorrect power frequency setting causes measured values to be unstable.

**3** Tap the [NPLC] box, and then enter an integration time.

Define an integration time based on the power line cycle (PLC), which is the time equivalent to one period of the power frequency.

0.1 to 0.9, 1 to 10, 20, 30, 40, 50, 60, 70, 80, 90, 100
--

Example: When the power frequency is 50 Hz and NPLC is set at 10, the integration time is calculated to be 200 ms (= 20 ms × 10).

The instrument updates waveform data every 200 ms.

**4** Tap the [Response] box, and then choose a data update interval from the list.

Off	Updates data at intervals of the integration time entered in the [NPLC] box.
On	Updates the data at high speed by calculating moving averages. <ul style="list-style-type: none"> <li>• Updates data at intervals of 0.1 PLC when NPLC is set at 9 or less.</li> <li>• Updates data at intervals of 1 PLC when NPLC is set at 10 or more.</li> </ul>



## 5 Tap the **[Calibration]** box, and then choose a calibration setting from the list.

Enabling this setting automatically calibrates the module or synchronizes the channels at the start of measurement. The synchronization between channels allows integration calculations to synchronize with each other.

<b>Off</b> <sup>□</sup>	Does not calibrate the module nor synchronize the channels.
<b>On</b>	Calibrates the instrument and synchronizes the channels.
<b>Synchronization</b>	Only synchronizes the channels.

- It takes about 150 ms to calibrate the module. The instrument cannot measure any input signals during calibration.
- If the channels are synchronized, the instrument sends a signal that interrupts the integration to each module at the start of measurement; thus, the instrument has to wait until the first integration finishes. The wait time required for this process stands at the sum of 10 ms and integration time\*.

\*: The integration time varies depending on the NPLC setting.

Even when synchronization is not performed, the wait time described above is required for measurement performed immediately after the settings of Model MR8990 Digital Voltmeter Unit has been changed. No wait time is required when the measurement is performed without any setting changes

- When **[Calibration]** is set to **[Off]** (default setting), execute calibration manually. See “2.12 Executing Calibration (For the Instrument With Model MR8990 Installed)” in the Quick Start Manual.

## 6 Tap **[Close]**.

The setting dialog box closes.

## Configuring Model U8974 High Voltage Unit settings

 > [Channel] > [U8974]

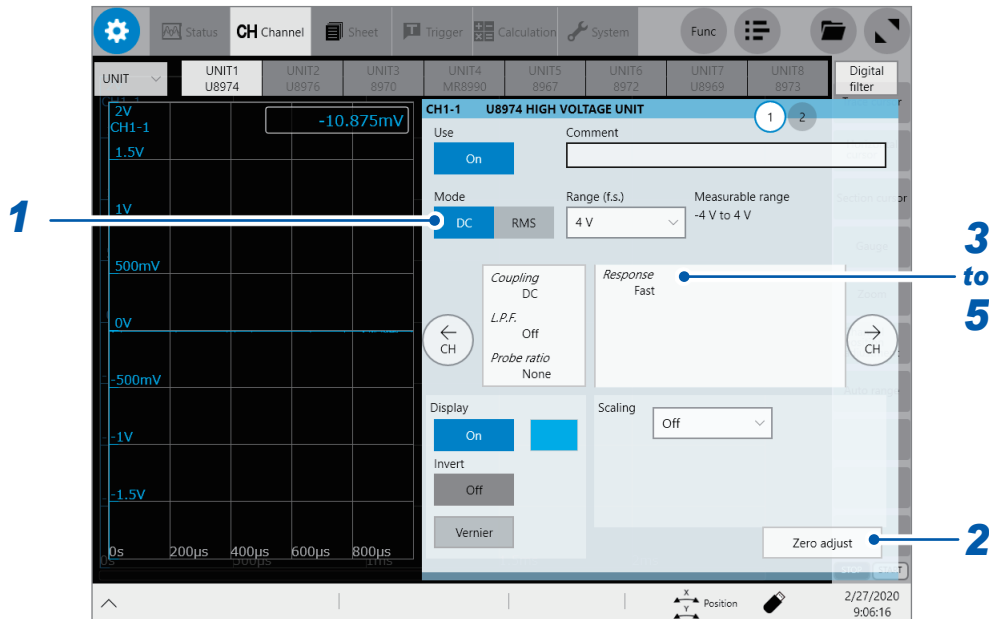

**1** In the [Mode] area, tap the [DC] or [RMS] to choose a measurement mode.

<b>DC</b> <input checked="" type="checkbox"/>	For voltage measurement
<b>RMS</b>	For RMS measurement

**2** (When you have changed the measurement mode) Tap [Zero adjust].

The instrument performs zero-adjustment. Execute zero-adjustment without any input.

**3** Tap the area that includes [Response].

The setting dialog box appears.

**4** Tap the [Response] box, and then from the list, choose a response time for RMS measurement.

<b>Fast</b> <input checked="" type="checkbox"/>	Sets the response time to 150 ms.
<b>Normal</b>	Sets the response time to 500 ms.
<b>Slow</b>	Sets the response time to 2.5 seconds.

Setting the response time to [Slow] can stabilize measured values if frequency is relatively low or voltage fluctuates severely.

**5** Tap [Close].

The setting dialog box closes.

## Configuring Model U8977 3CH Current Unit Settings

Each of Model 9709, Model CT6860 series, and Model CT6840 consists of a current sensor with the sub model-number “-05,” which has a metal connector, and that without the sub model-number “-05,” which has a black plastic connector.

You can directly connect a current sensor that has the sub model-number “-05,” which has a metal connector, with Model U8977 3CH Current Unit. Using Model CT9900 Conversion Cable, you can connect a current sensor without the sub model-number “-05,” which has a black plastic connector, to Model U8977 3CH Current Unit.

 > [Channel] > [U8977]

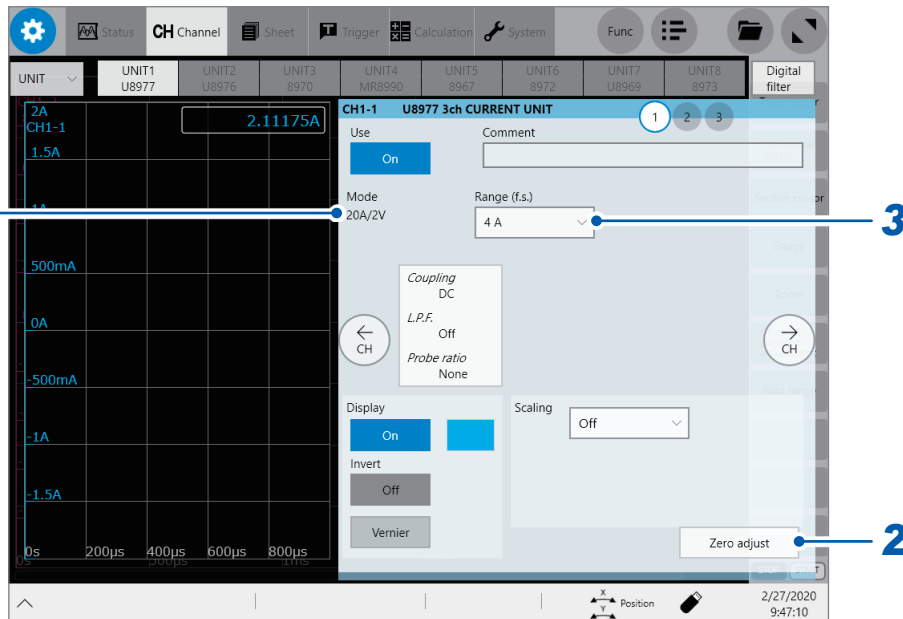

Current sensors to be connected determine whether the instrument automatically recognizes mode or whether you have to choose a current sensor setting.

### 1 (When the instrument automatically recognizes the sensors connected) Confirm the output rate displayed in the [Mode] area.

Available measurement ranges, which depend on automatically recognized output rates, are as follows:

<b>2A/2V</b>	200 mA, 400 mA, 1 A, 2 A, 4 A, 10 A
<b>20A/2V</b>	2 A, 4 A, 10 A, 20 A, 40 A, 100 A
<b>50A/2V</b>	4 A, 10 A, 20 A, 40 A, 100 A, 200 A
<b>200A/2V</b>	20 A, 40 A, 100 A, 200 A, 400 A, 1000 A
<b>500A/2V*</b>	40 A, 100 A, 200 A, 400 A, 1000 A, 2000 A
<b>1000A/2V</b>	100 A, 200 A, 400 A, 1000 A, 2000 A, 4000 A
<b>2000A/2V</b>	200 A, 400 A, 1000 A, 2000 A, 4000 A, 10000 A
<b>None</b>	When no current sensor is connected.

\*: When Model CT6846 or Model CT6865 connects via Model CT9900 Conversion Cable, the instrument recognizes the sensor as a 500 AAC/DC sensor. Set the conversion ratio at 2.00 in the scaling setting.

**(When you have to choose a current sensor setting) Tap the [Mode] box, and then choose a connected current sensor.**

Available measurement ranges, which depend on chosen current sensors, are as follows:

<b>CT7631/CT7731</b>	200 A
<b>CT7636/CT7736</b>	200 A, 400 A, 1000 V
<b>CT7642/CT7742</b>	2000, 4000
<b>CT7044/CT7045/ CT7046</b>	2000, 4000, 10000
<b>0.1mV/A</b>	2000, 4000, 10000, 20000, 40000, 100000
<b>1mV/A</b>	200, 400, 1000, 2000, 4000, 10000
<b>10mV/A</b>	20, 40, 100, 200, 400, 1000
<b>100mV/A</b>	2, 4, 10, 20, 40, 100
<b>1000mV/A</b>	0.2, 0.4, 1, 2, 4, 10

**IMPORTANT**

When a current sensor included in Model CT6700 series connects via Model CT9920 Conversion Cable, set a current sensor model name or its output rate.

**2 (When you have changed the measurement mode) Tap [Zero adjust].**

The instrument performs zero-adjustment. Execute zero-adjustment without any input.

**3 Tap the [Range (f.s.)] box, and then choose a measurement range from the list.**

The instrument automatically configures the scaling setting for a measurement range according to a recognized current sensor.

**IMPORTANT**

The figure of each measurement range name represents the maximum current that Model U8977 can measure using the range. However, the instrument cannot measure currents that exceed the rated current of the connected current sensor. Check the specifications of the current sensor used.

## Configure Model U8979 Charge Unit Settings

This setting allows you to choose between voltage measurement and acceleration measurement (charge-output or built-in pre-amplifier) for a channel.

**[Voltage]** mode and **[Preamp]** mode use BNC connectors, whereas **[Charge]** mode uses miniature connectors.

A channel can measure either one of them.

Model U8979 can automatically recognize TEDS-compliant\* sensors.

\*: Transducer electronic data sheet

### WARNING



Setting the measurement mode to **[Preamp]** allows Model U8979 Charge Unit to constantly provide power (3.0 mA, 22 V) to sensors. Set any measurement mode other than **[Preamp]** or turn off the instrument before connecting a sensor or probe with a BNC terminal to avoid an electric shock or damage to the measurement target.

3

Advanced Functions

> [Channel] > [U8979]

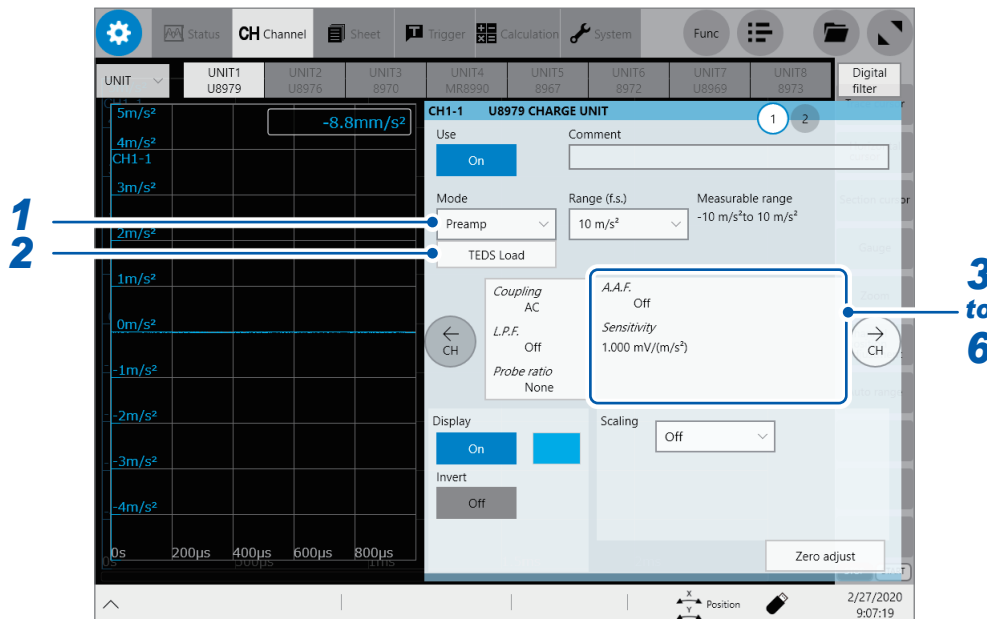

**1** Tap the **[Mode]** box, and then choose a measurement mode from the list.

Mode	Measurement target	Measurement sensitivity
<b>Voltage</b>	Voltage	—
<b>Charge</b>	Charge-output acceleration sensor	0.1 pC/(m/s <sup>2</sup> ) to 10 pC/(m/s <sup>2</sup> )
<b>Preamp</b>	Acceleration sensor with a built-in pre-amplifier	0.1 mV/(m/s <sup>2</sup> ) to 10 mV/(m/s <sup>2</sup> )

**2** (When setting mode to **[Preamp]**) Tap **[TEDS Load]**.

Acquires sensitivity of a connected sensor. However, the instrument can acquire sensitivity of TEDS-compliant acceleration sensors with a built-in pre-amplifier only.

When sensor sensitivity has been acquired, it is automatically set.

**3 Tap the area that includes [A.A.F].**

The setting dialog box appears.

**4 Tap the [A.A.F.] box, and then choose a anti-aliasing filter setting from a list.**

The anti-aliasing filter can prevent aliasing distortion that may be produced during FFT calculation. The cutoff frequency automatically changes according to the sampling rates or frequency range (for the FFT function) settings.

Off <input checked="" type="checkbox"/>	Disables the anti-aliasing filter.
On	Enables the anti-aliasing filter. (Disabled when the external sampling is used, or the sampling rate is set at 100 kS/s or faster)

**5 Tap [Sensitivity] box, and then enter sensor sensitivity.**

You can enter sensor sensitivity to two decimal places. For a charge-output acceleration sensor or non-TEDS-compliant sensor, enter its sensitivity marked on the sensor, which represents sensitivity per meter per second squared.

**6 Tap [Close].**

The setting dialog box closes.

**Setting example for sensor sensitivity**

**Example 1**

For a sensor with its sensor sensitivity per meter per second squared marked

Sensor sensitivity	(setting value)
1.08 pC/(m/s <sup>2</sup> )	1.08

**Example 2**

For a sensor with its sensor sensitivity per gee (G) marked.

For a sensor with its sensitivity marked, enter a quotient of the marked sensitivity divided by 9.8 m/s<sup>2</sup>.

Sensor sensitivity	(setting value)
For sensor sensitivity of 64 pC/G 64.0 / 9.8 = 6.53061 ... pC/(m/s <sup>2</sup> )	6.531 (to two decimal places)

**To convert a unit from meter per second squared into gee (G)**

The instrument measure charge quantities per meter per second squared. You can convert such charge quantities into those per gee (G) using the scaling function.

See “3.2 Converting Input Values (Scaling Function)” (p. 56).

Configure the scaling setting as follows;

**Example 1**

Specifying a conversion ratio

Ratio	0.1020E+00 (= 1/9.8)
Offset	0.0000E+00
Units	G

**Example 2**

Specifying two points

Input1	9.8000E+00	Scale1	1.0000E+00
Input2	0.0000E+00	Scale2	0.0000E+00
Units	G		

## When using an out-of-setting-range current sensor

You can use an out-of-setting-range current sensor using the scaling function.  
See “Automatically saving waveform data” (p. 120).

### 1 Tap the area that includes [Sensitivity].

The setting dialog box appears.

### 2 Tap [Sensitivity] box, and then enter sensor sensitivity.

Multiply the sensor sensitivity of a sensor to be used by a certain value to allow a product to fall within the setting range (0.1 to 10), and enter the product.

### 3 Tap [Close].

The setting dialog box closes.

### 4 Tap the [Scaling] box, and then configure the scaling setting.

Configure the scaling setting so that a scaling ratio is the same value as the number you multiplied the sensor sensitivity by.

#### Example 1

##### For sensor sensitivity of 23.4 pC/(m/s<sup>2</sup>)

Specify 10 pC/(m/s<sup>2</sup>), which results from multiplying the sensor sensitivity by 1/2.34, as the sensor sensitivity. To display measured values after multiplying them by 1/2.34, configure the scaling setting as follows:

To configure the scaling setting using the conversion ratio method

Ratio	0.4274E+00 (= 10/23.4)		
Offset	0.0000E+00		
Units	m/s <sup>2</sup>		

To configure the scaling setting using the 2-point method

Input1	2.3400E+00	Scale1	1.0000E+00
Input2	0.0000E+00	Scale2	0.0000E+00
Units	m/s <sup>2</sup>		

#### Example 2

##### For sensor sensitivity of 0.05 pC/(m/s<sup>2</sup>)

Specify 0.1 pC/(m/s<sup>2</sup>), which results from multiplying the sensor sensitivity by two, as the sensor sensitivity. To display measured values after multiplying them by two, configure the scaling setting as follows:

To configure the scaling setting using the conversion ratio method

Ratio	2.0000E+00 (= 0.1/0.05)		
Offset	0.0000E+00		
Units	m/s <sup>2</sup>		

To configure the scaling setting using the 2-point method

Input1	0.0500E+00	Scale1	1.0000E+00
Input2	0.0000E+00	Scale2	0.0000E+00
Units	m/s <sup>2</sup>		

## 3.8 Configuring Generator Module-Specific Settings

This section describes how to configure settings related to the MR8790 Waveform Generator Unit, MR8791 Pulse Generator Unit, and U8793 Arbitrary Waveform Generator Unit.

### Generating signals from Model MR8790 Waveform Generator Unit

For detailed information, see the Instruction Manual that came with the U8793, MR8790, and MR8791.

This section describes how to configure sync control and set the configuration method for signals generated by the MR8790 Waveform Generator Unit.

 > [Channel] > [MR8790]

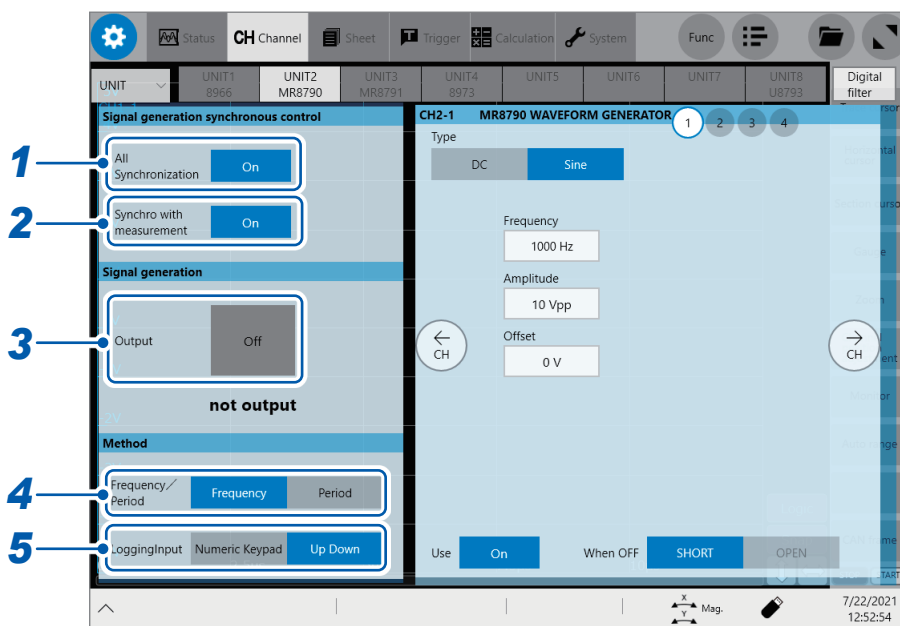

**1** Tap the [All Synchronization] button and set it to [On] or [Off].

On	Controls signal generation for all units and channels simultaneously.
Off 	Controls signal generation for channels set on this screen only.

**2** Tap the [Synchro with measurement] button and set to [On] or [Off].

On	Synchronizes signal output with measurement start and stop events. Signal output will start when measurement starts and stop when measurement stops.
Off 	Disables synchronization of signal output with measurement start and stop events. Signal generation must be controlled manually.

**3** Tap the [Output] button and set it to [On] or [Off].

On	Generates the signal.
Off 	Stops the signal.



**4** Tap **[Frequency]** or **[Period]** and select the signal configuration method.

<b>Frequency</b> <input checked="" type="checkbox"/>	Use the frequency.
<b>Period</b>	Use the period.

**5** Tap **[Numeric Keypad]** or **[Up Down]** to select how to enter values.

<b>Numeric keypad</b> <input checked="" type="checkbox"/>	Enter numerals using the numeric keypad.
<b>Up Down</b>	Enter numerals using the “Up” and “Down” buttons.

Numeric keypad

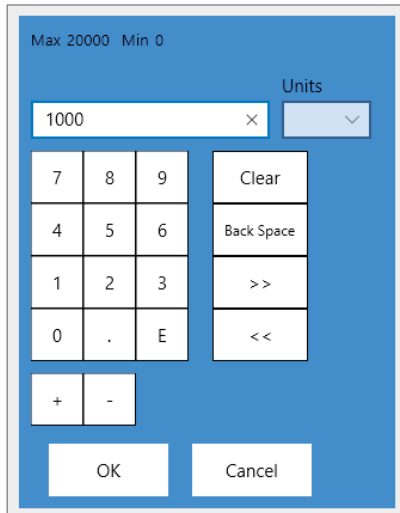

Up/down keys

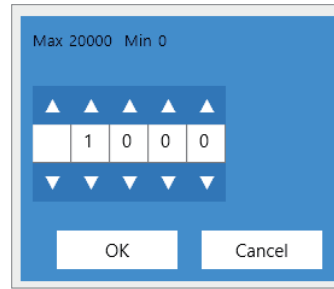

## Configuring Model MR8790 Waveform Generator Unit settings

This section describes how to configure MR8790 Waveform Generator Unit settings.

 > [Channel] > [MR8790]

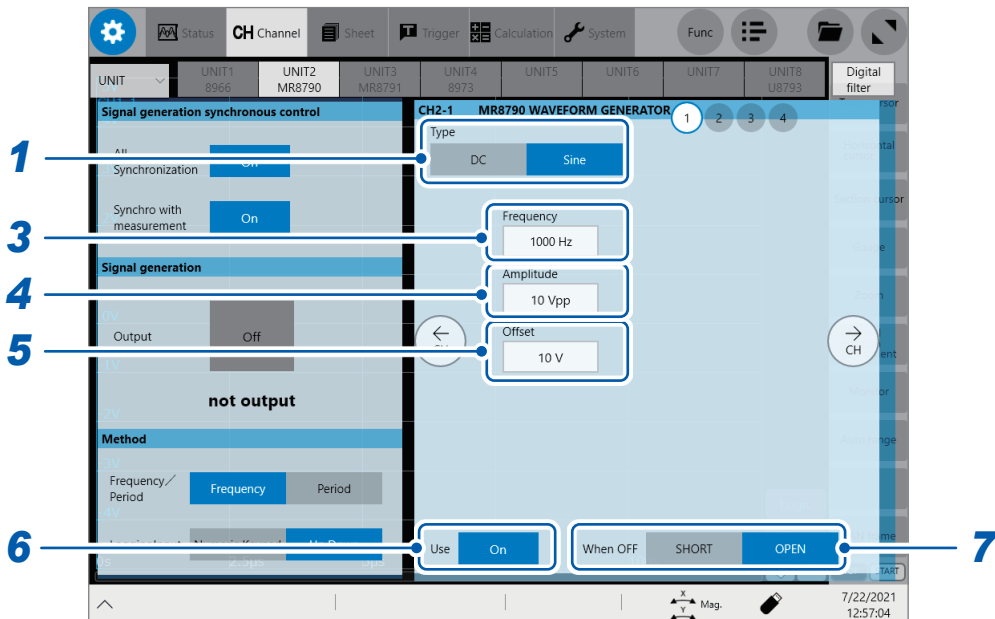
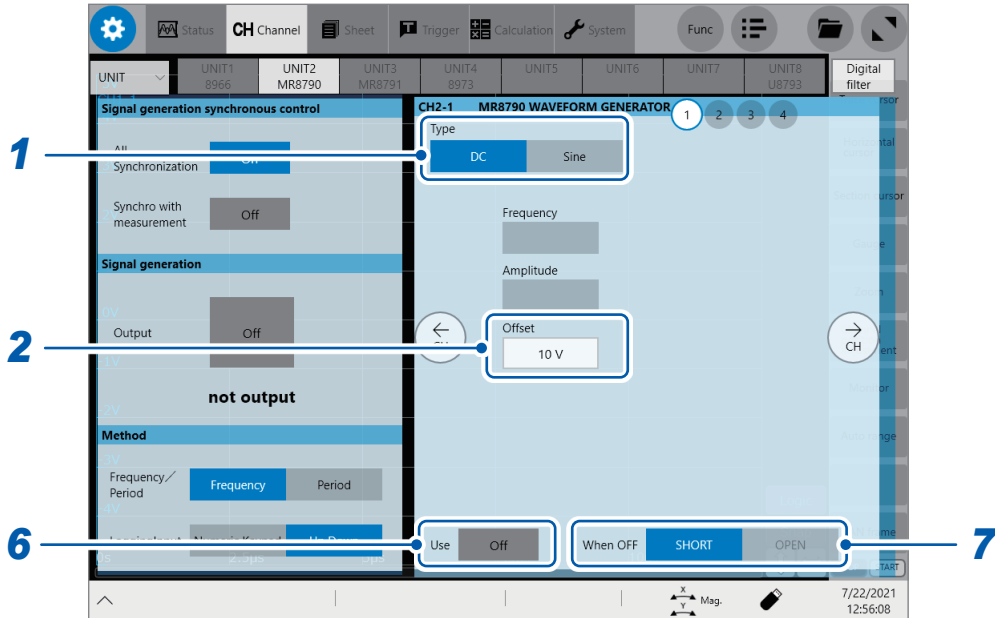

**1** Tap the [Type] button and select the waveform type.

DC <input checked="" type="checkbox"/>	DC output
Sine wave <input type="checkbox"/>	Sine wave output

**2** (For DC output) Tap the [Offset] box and enter the output voltage.

-10.000 V to +10.000 V

**3** (For sine wave output) Tap the **[Frequency]** box and enter the frequency.

0 Hz to 20000 Hz

**4** (For sine wave output) Tap the **[Amplitude]** box and enter the amplitude.

Accuracy of output voltages (obtained by adding the offset to the amplitude) is guaranteed within the following range: -10 V to +10 V.

If the value obtained by adding the offset to the amplitude exceeds the accuracy guarantee range, output waveforms will be clamped to an upper limit of approximately +14 V and a lower limit of approximately -14 V.

0.000 Vpp to 20.000 Vpp

**5** (For sine wave output) Tap the **[Offset]** box and enter the offset voltage.

Accuracy of output voltages (obtained by adding the offset to the amplitude) is guaranteed within the following range: -10 V to +10 V.

If the value obtained by adding the offset to the amplitude exceeds the accuracy guarantee range, output waveforms will be clamped to an upper limit of approximately +14 V and a lower limit of approximately -14 V.

-10.000 V to +10.000 V

**6** (If **[All Synchronization]** is On) Tap the **[Use]** button to set output for each channel to **[On]** or **[Off]**.

<b>On</b>	Generates output from this channel.
<b>Off</b> <sup>□</sup>	Does not generate output from this channel.

**7** Tap the **[When OFF]** button and select the pin state when not outputting a waveform.

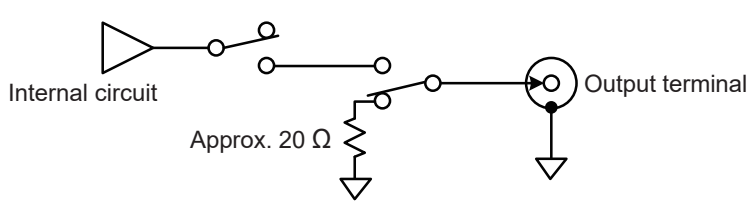
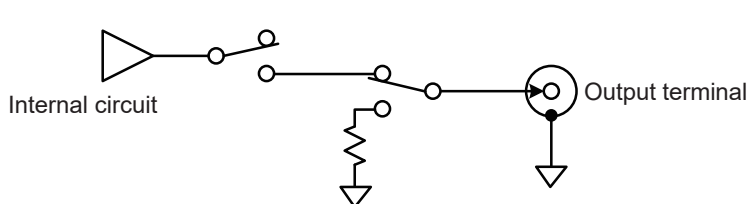
<b>SHORT</b> <sup>□</sup>	<p>Shorts the output pin via a resistor.</p> 
<b>OPEN</b>	<p>Leaves the output pin open.</p> 

## Generating signals from Model MR8791 Pulse Generator Unit

For detailed information, see the Instruction Manual that came with the U8793, MR8790, and MR8791.

This section describes how to configure sync control and set the configuration method for signals generated by the MR8791 Pulse Generator Unit.

 > [Channel] > [MR8791]

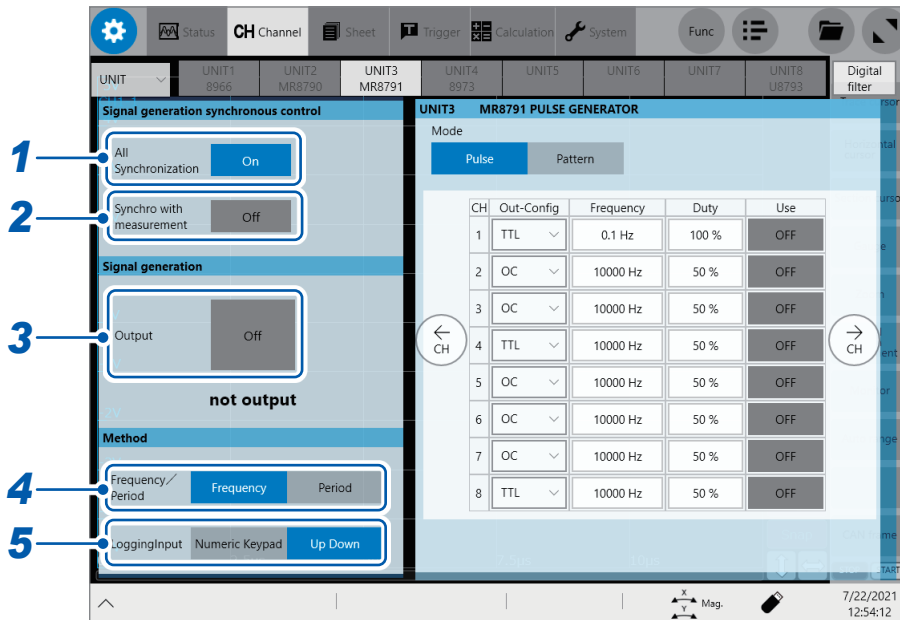

### 1 Tap the [All Synchronization] button and set it to [On] or [Off].

The MR8791 Pulse Generator Unit can be used by setting [All Synchronization] to On.

On	Controls signal generation for all units and channels simultaneously.
Off <sup>□</sup>	Controls signal generation for channels set on this screen only.

### 2 Tap the [Synchro with measurement] button and set to [On] or [Off].

On	Synchronizes signal output with measurement start and stop events. Signal output will start when measurement starts and stop when measurement stops.
Off <sup>□</sup>	Disables synchronization of signal output with measurement start and stop events. Signal generation must be controlled manually.

### 3 Tap the [Output] button and set it to [On] or [Off].

On	Generates the signal.
Off <sup>□</sup>	Stops the signal.

### 4 Tap [Frequency] or [Period] and select the signal configuration method.

Frequency <sup>□</sup>	Set by frequency.
Period	Set by period.

**5** Tap **[Numeric Keypad]** or **[Up Down]** to select how to enter values.

<b>Numeric keypad</b> 	Enter numerals using the numeric keypad.
<b>Up Down</b>	Enter numerals using the “Up” and “Down” buttons.

Numeric keypad

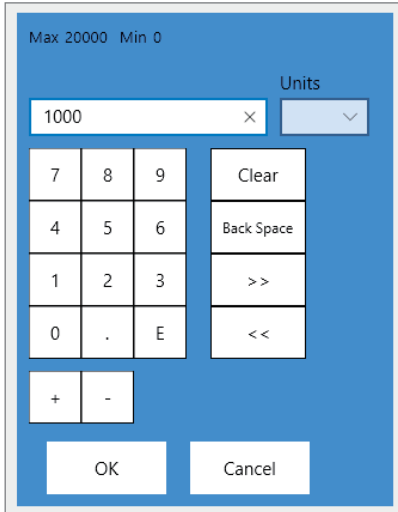

Up/down keys

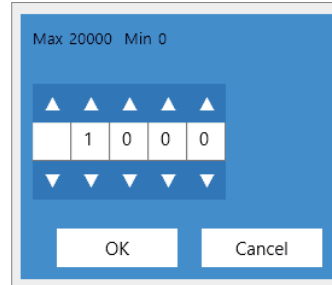

## Configuring Model MR8791 Pulse Generator Unit settings

This section describes how to configure MR8791 Pulse Generator Unit settings.

 > [Channel] > [MR8791]

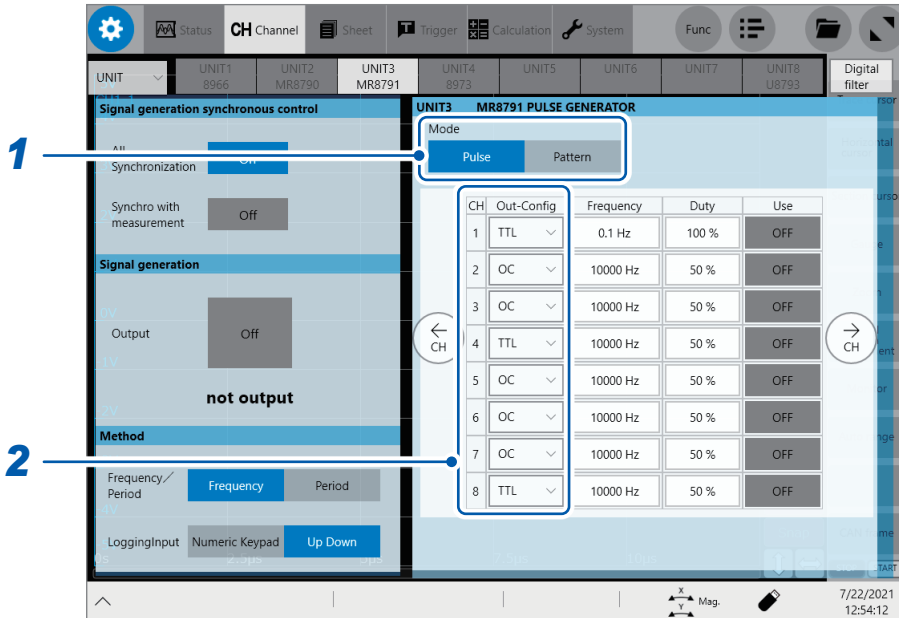

**1** Tap the [Mode] button and select the output waveform type.

<b>Pulse</b>	Pulse output
<b>Pattern</b> <input checked="" type="checkbox"/>	Pattern output

**2** Tap the [Out-Config] box and select the output configuration.

<b>TTL</b>	TTL (amplitude 0 to 5 V) output
<b>OC</b> <input checked="" type="checkbox"/>	Open collector output

Channels share the same ground and are not isolated.

When using open collector output

- Set the voltage applied between the collector and emitter to 50 V or less.
- Response time (10% to 90%): Max. approx. 5  $\mu$ s (reference value: with a load capacitance of 1000 pF and pull-up resistance of 1 k $\Omega$ )

## Pulse output settings

If you set the output type to **[Pulse]**, configure the following settings:

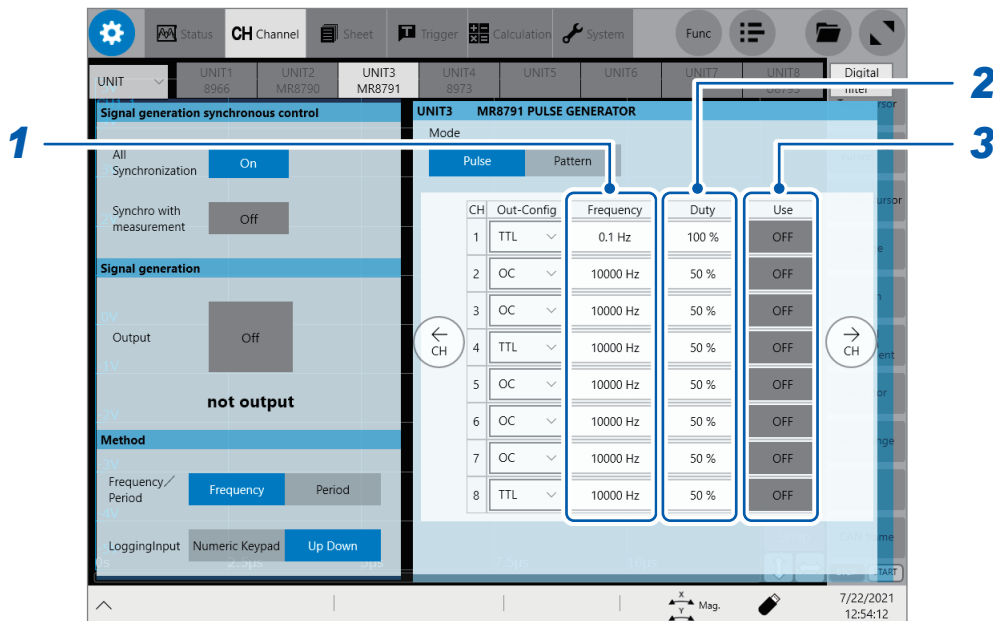

- 1 Tap the **[Frequency]** box and enter the frequency (in 0.1 Hz increments).

0 Hz to 20000 Hz

- 2 Tap the **[Duty]** box and enter the duty ratio (in 0.1% increments).

0% to 100%

- The output signal will be set to L level when set to 0% and to H level when set to 100%, causing no pulse to be output.
- When set to 100%, an H level signal will be output, even if the output setting is off.
- The pulse may disappear if the output pulse width is less than 1  $\mu$ s as a result of the frequency and duty ratio settings.

- 3 Tap the **[Use]** button and set pulse output to **[On]** or **[Off]**.

<b>On</b>	Outputs a pulse.
<b>Off</b>	Does not output a pulse.

## Pattern output settings

If you set the output type to **[Pattern]**, configure the following settings:

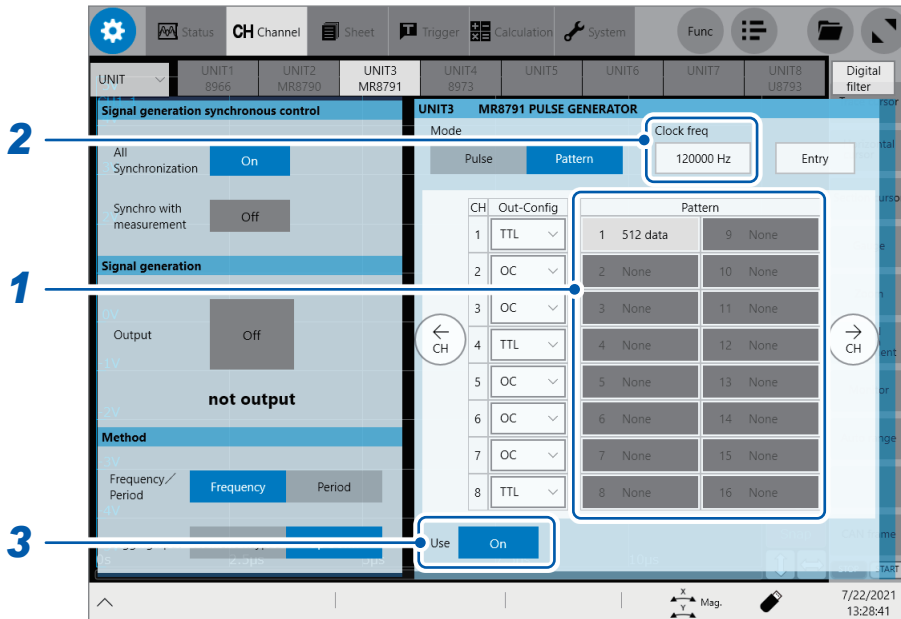

### 1 Tap the pattern you wish to use to select it.

If output is in the stopped state, the registered pattern's initial pattern will be output. Pattern data will be cleared when the instrument is turned off. Register pattern data again after turning the instrument on.

### 2 Tap the **[Clock freq]** box and enter the clock frequency (in 10 Hz increments).

0 Hz to 120000 Hz

### 3 (If **[All Synchronization]** is On) Tap the **[Use]** button to set output for each channel to **[On]** or **[Off]**.

On	Generates output from this channel.
Off <input checked="" type="checkbox"/>	Does not generate output from this channel.



## Pattern registration

Before performing this procedure, insert recording media containing the pattern data (with the extension .pls).

Up to 16 sets of pattern data can be registered.

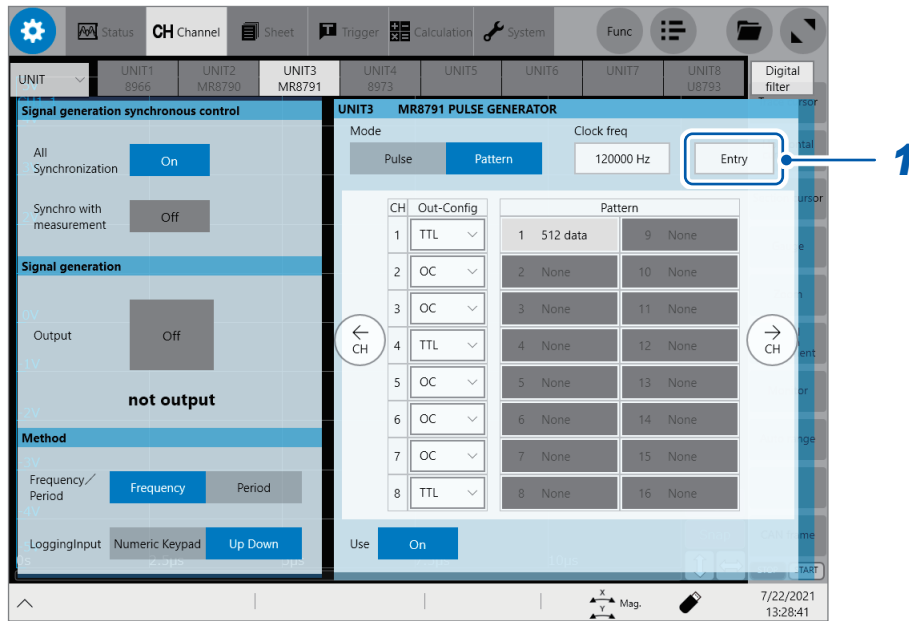

3

Advanced Functions

### 1 Tap [Entry].

A window will open allowing you to select a file.

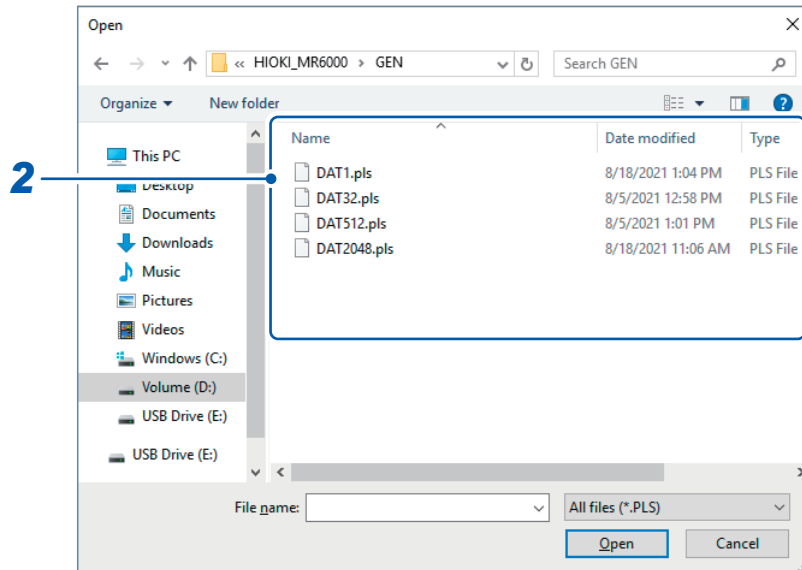

**2** Select the file you wish to register.

The **[Entry from File]** dialog box will be displayed.

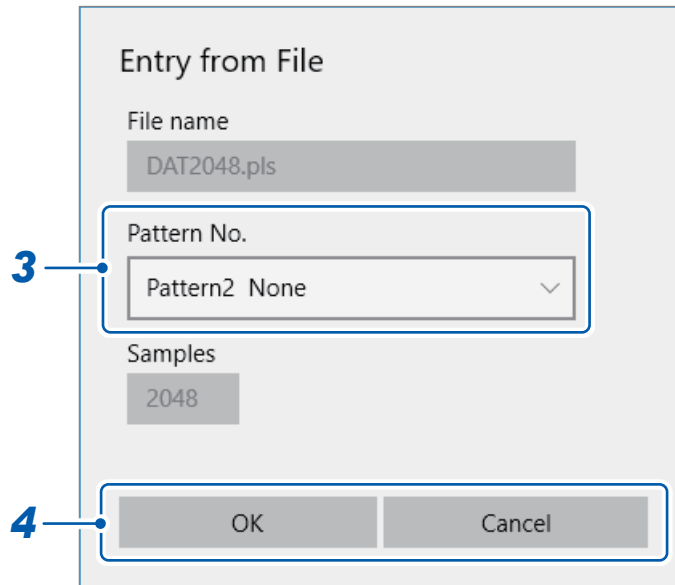

**3** Tap the **[Pattern No.]** box and select a pattern.

**4** Tap **[OK]** to register the pattern.

Tap **[Cancel]** to close the dialog box without registering the pattern.

## Generating signals from Model U8793 Arbitrary Waveform Generator Unit

For details, see the Instruction Manual that came with the U8793, MR8790, and MR8791. This section describes how to select the Arbitrary Waveform Generator Unit's output synchronization control and setting method.

 > [Channel] > [U8793]



3

Advanced Functions

**1** Tap the [All Synchronization] button to set it to [On] or [Off].

<b>On</b>	Controls the signal generation of all modules' all channels simultaneously.
<b>Off</b> <sup>☑</sup>	Controls the signal generation of the channels only set on this screen.

**2** Tap the [Synchro with measurement] button to set it to [On] or [Off].

<b>On</b>	Synchronizes signal outputting with the start/stop of measurements. The signals outputs and stops respectively in sync with the the start and stop of measurements.
<b>Off</b> <sup>☑</sup>	Does not synchronize signal outputting with the start/stop of measurements. You can manually control signal outputting.

**3** Tap the [Output] button to set it to [On] or [Off].

<b>On</b>	Outputs the signals.
<b>Off</b> <sup>☑</sup>	Stops outputting the signals.

**4** Tap **[Frequency]** or **[Period]** to set what parameter is used to set the oscillation speed.

<b>Frequency</b> <sup>☑</sup>	Uses the frequency.
<b>Period</b>	Uses the period.

**5** Tap **[Numeric Keypad]** or **[Up Down]** to choose a way of entering values.

<b>Numeric Keypad</b> <sup>☑</sup>	Lets you use the numerical key pad.
<b>Up Down</b>	Lets you use the Up Arrow and Down Arrow keys.

Key pad

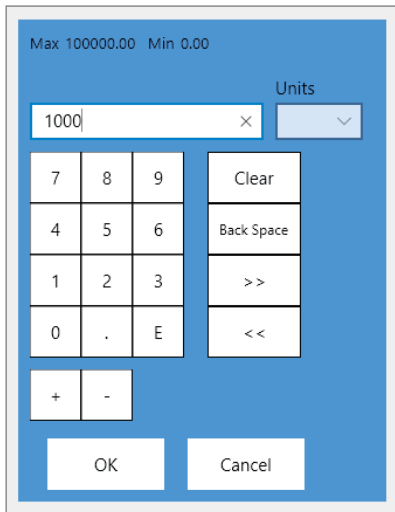

Up Arrow and Down Arrow keys

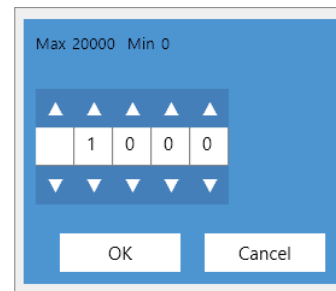

## Configuring Model U8793 Arbitrary Waveform Generator Unit

This section describes how to configure the settings specific to the U8793 Arbitrary Waveform Generator Unit.

 > [Channel] > [U8793]

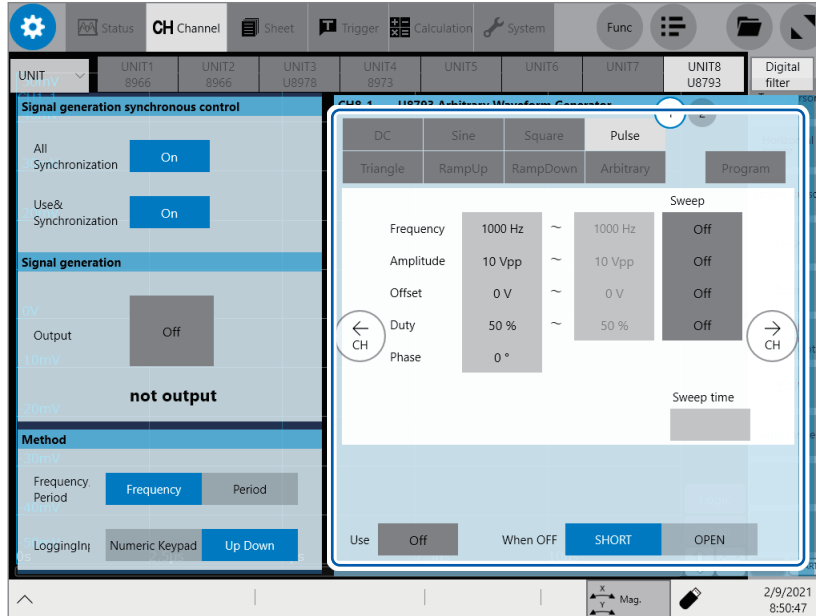

List of parameters than can be displayed and set.

✓: Displayed, -: Not displayed

Type	DC	Sine	Square	Pulse	Triangle	Ramp-Up	Ramp-Down	Arbitrary
<b>Frequency or Period</b> 0.00 to 100,000.00 (Hz) 0.00 to 100.00 (s)	-	✓	✓	✓	✓	✓	✓	-
<b>Clock frequency or Clock period</b> 0.00 to 20,000,000.00 (Hz) 0.00 to 100.00 (s)	-	-	-	-	-	-	-	✓
<b>Amplitude</b> 0.000 to 20.000 (Vpp)	-	✓	✓	✓	✓	✓	✓	-
<b>Amp. Adjust.</b> 0.000× to 2.000×	-	-	-	-	-	-	-	✓
<b>Offset</b> -10.000 to 15.000 (V)	✓	✓	✓	✓	✓	✓	✓	✓
<b>Duty</b> 0.1 to 99.9 (%)	-	-	-	✓	-	-	-	-
<b>Phase</b> -360.0 to 360.0 (°)	-	✓	✓	✓	✓	✓	✓	-
<b>Delay</b> -250000 to 250000 (Can be set in the number of samples)	-	-	-	-	-	-	-	✓

✓: Displayed, –: Not displayed

Type	DC	Sine	Square	Pulse	Triangle	Ramp-Up	Ramp-Down	Arbitrary
<b>Loop times</b> 1 to 50000 (Infinity when set to zero)	–	–	–	–	–	–	–	✓
<b>Filter</b>	–	–	–	–	–	–	–	✓
<b>Sweep</b> (On/Off)	–	✓	✓	✓	✓	✓	✓	✓
<b>Sweep time</b> 10 μ to 1000 (s)	–	✓	✓	✓	✓	✓	✓	✓

- See “Editing programs of Model U8793 Arbitrary Waveform Generator Unit” for the **[Program]** settings.
- The least significant digit displayed in the valid setting range indicates the setting resolution.

Type	Function
<b>DC</b>	Outputs a DC signal.
<b>Sine</b>	Outputs a sine wave.
<b>Square</b>	Outputs a square wave with a duty ratio of 50%.
<b>Pulse</b>	Outputs a pulse wave with a previously set duty ratio.
<b>Triangle</b>	Outputs a triangular wave.
<b>RampUp</b>	Outputs a ramp-up wave.
<b>RampDown</b>	Outputs a ramp-down wave.
<b>Arbitrary</b>	Outputs a created arbitrary wave. See “Registering arbitrary waveforms in the U8793 Arbitrary Waveform Generator Unit” (p. 102).
<b>Program</b>	Outputs a waveform according to a previously edited program. See “Editing programs of Model U8793 Arbitrary Waveform Generator Unit” (p. 107).

Parameter	Function
<b>Frequency</b>	Allows you to enter the frequency or period of the output waveform.
<b>Clock frequency</b>	Allows you to enter the frequency or period if you chose the arbitrary waveform setting.
<b>Amplitude</b>	Allows you to enter the amplitude of the output waveform.
<b>Amp. Adjust.</b>	Allows you to adjust the amplitude if you chose the arbitrary waveform setting.
<b>Offset</b>	Allows you to enter the offset voltage of the output waveform. Allows you to enter the DC voltage if you chose the DC voltage setting.
<b>Duty</b>	Allows you to enter the duty ratio if you chose the pulse wave setting.
<b>Phase</b>	Allows you to enter the phase.
<b>Delay</b>	Allows you to enter the delay time if you chose the arbitrary waveform setting.
<b>Loop times</b>	Allows you to enter the number of looping times if you chose the arbitrary waveform setting. If you enter zero, the instrument displays the sign <b>[∞]</b> and continues outputting the signal repeatedly until you stop the output. The <b>[Loop times]</b> setting cannot be configured if the <b>[Sweep]</b> is set to <b>[On]</b> .
<b>Filter</b>	Allows you to choose the frequency used to filter the arbitrary waveform. <b>Off</b> , 50, 100, 200, 500, 1 k, 2 k, 5 k, 10 k, 20 k, 50 k, 100 k, 200 k, 500 k, 1M [Hz]





Parameter	Function				
<b>Sweep</b>	Allows you to set the sweep function to on or off. You can set multiple parameters to on. However, either the frequency sweep or the duty ratio sweep, but not both, can be set to on.				
<b>Sweep time</b>	Allows you to set the sweeping time. Every parameter uses the common sweeping time.				
<b>Use</b>	This setting will appear when the <b>[All Synchronization]</b> has been set to <b>[On]</b> . <table border="1" data-bbox="507 443 1428 533"> <tr> <td><b>On</b></td> <td>Uses the channel as the output target.</td> </tr> <tr> <td><b>Off</b><sup>☐</sup></td> <td>Does not use the channel as the output target.</td> </tr> </table>	<b>On</b>	Uses the channel as the output target.	<b>Off</b> <sup>☐</sup>	Does not use the channel as the output target.
<b>On</b>	Uses the channel as the output target.				
<b>Off</b> <sup>☐</sup>	Does not use the channel as the output target.				
<b>When OFF</b>	Allows you to choose an option used when the output is set to off. <table border="1" data-bbox="507 600 1428 689"> <tr> <td><b>SHORT</b><sup>☐</sup></td> <td>Short-circuits the output terminal.</td> </tr> <tr> <td><b>OPEN</b></td> <td>Opens the output terminal.</td> </tr> </table>	<b>SHORT</b> <sup>☐</sup>	Short-circuits the output terminal.	<b>OPEN</b>	Opens the output terminal.
<b>SHORT</b> <sup>☐</sup>	Short-circuits the output terminal.				
<b>OPEN</b>	Opens the output terminal.				

## Registering arbitrary waveforms in the U8793 Arbitrary Waveform Generator Unit

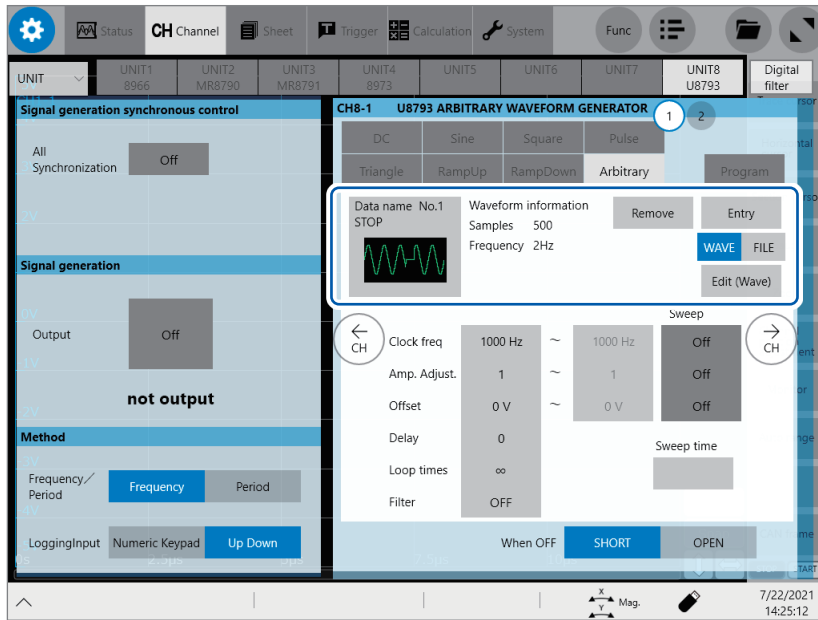
This section describes how to register, display, and delete arbitrary waveform data.

 > [Channel] > [U8793]



<p>Display</p>	<p>Displays the arbitrary waveform data set chosen from among registered data sets.</p> <p>Tap  to choose or check the registered arbitrary waveform data sets.</p>				
<p>Remove</p>	<p>Deletes the chosen arbitrary waveform data set.</p> <p>When the U8793 contains eight registered waveforms, delete any one of them before registering a waveform.</p>				
<p>Entry</p>	<p>Registers the arbitrary waveform in a vacant number (up to eight waveforms). It will take about 40 s to register a waveform consisting of 250,000 samples.</p> <table border="1" data-bbox="470 1379 1390 1561"> <tr> <td data-bbox="470 1379 699 1482"> <p><b>WAVE</b> </p> </td> <td data-bbox="707 1379 1390 1482"> <p>Registers the waveform data the instrument has acquired. See “To register the arbitrary waveform using measured data” (p. 103).</p> </td> </tr> <tr> <td data-bbox="470 1489 699 1561"> <p><b>FILE</b></p> </td> <td data-bbox="707 1489 1390 1561"> <p>Reads the waveform data from a file and registers it. See “To register the arbitrary waveform using a file” (p. 104).</p> </td> </tr> </table>	<p><b>WAVE</b> </p>	<p>Registers the waveform data the instrument has acquired. See “To register the arbitrary waveform using measured data” (p. 103).</p>	<p><b>FILE</b></p>	<p>Reads the waveform data from a file and registers it. See “To register the arbitrary waveform using a file” (p. 104).</p>
<p><b>WAVE</b> </p>	<p>Registers the waveform data the instrument has acquired. See “To register the arbitrary waveform using measured data” (p. 103).</p>				
<p><b>FILE</b></p>	<p>Reads the waveform data from a file and registers it. See “To register the arbitrary waveform using a file” (p. 104).</p>				
<p>Save</p>	<p>Press the <b>SAVE</b> key to save arbitrary waveform data registered in the U8793 as files. See “Freely choosing data items to be saved and save files (SAVE key)” (p. 127).</p>				

Initializing the instrument will not cause loss of registered waveform data.



To register the arbitrary waveform using measured data

> [Channel] > [U8793]

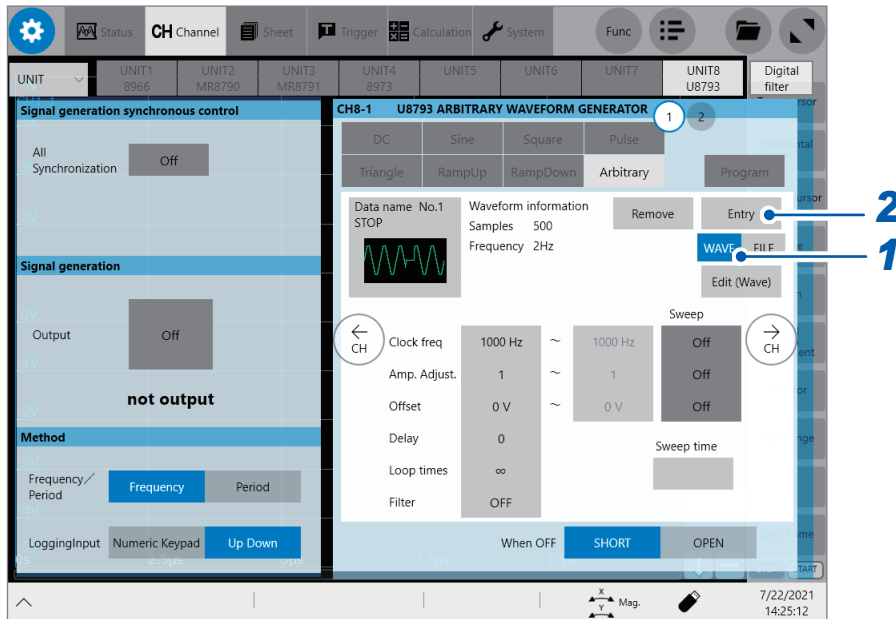

3 Advanced Functions

1 Tap [WAVE].

2 Tap [Entry].

The [Entry from Measured] dialog box appears.

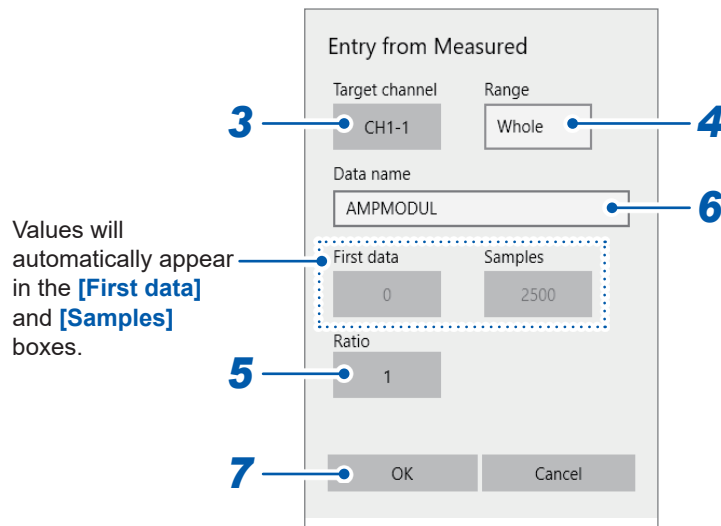

3 Tap the [Target channel] button to choose a channel you wish to register.

You can choose a channel to register from internal modules and waveform-calculation channels.

4 Tap the [Range] box, and then from the list, choose a registration range option.

Whole , Segment 1, Segment 2

Values will appear based on the specified range in [First data] and [Samples]. If you wish to register the measured data partly, specified the range to register by using [Section cursor].

See "2.2 Specifying the Waveform Range (Section Cursor)" (p. 35).

**5** Tap the **[Ratio]** button to enter the conversion ratio.

Measured data will be registered after amplifying/attenuating its voltage.

0.001 to 100.000 times (1.000<sup>□</sup> time)

**6** Enter a data name in the **[Data name]** box.

A data name can be up to 16 characters long. If you enter the name same as a registered data, the existing data will be overwritten.

**7** Tap **[OK]**.

**To register the arbitrary waveform using a file**

 > **[Channel]** > **[U8793]**



**1** Tap **[FILE]**.

**2** Tap [Entry].

The file selection screen appears.

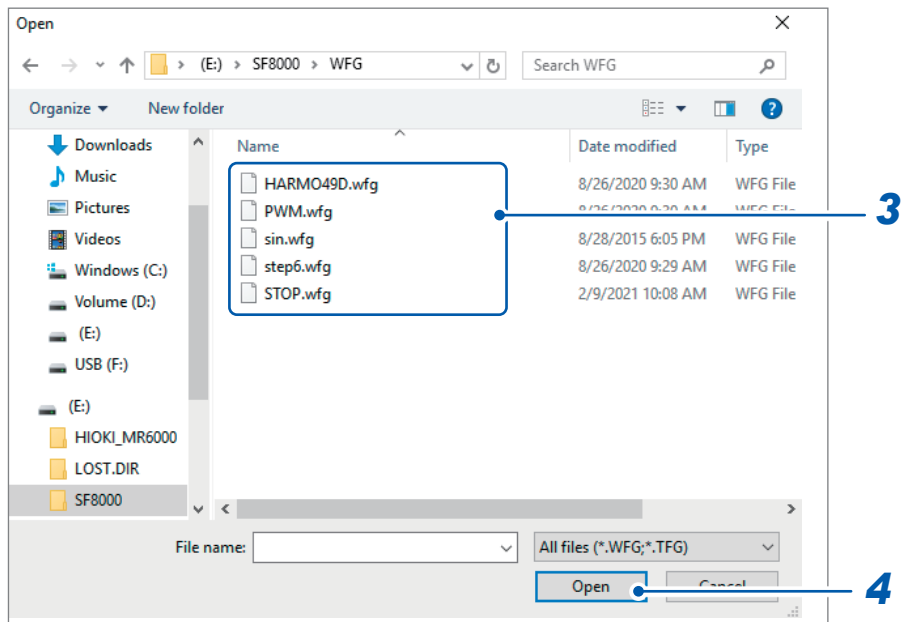

**3** Choose a file you wish to register (\*.WFG, \*.TFG, \*.CSV, or \*.TXT).

**4** Tap [Open].

The [Enter from File] dialog box appears.

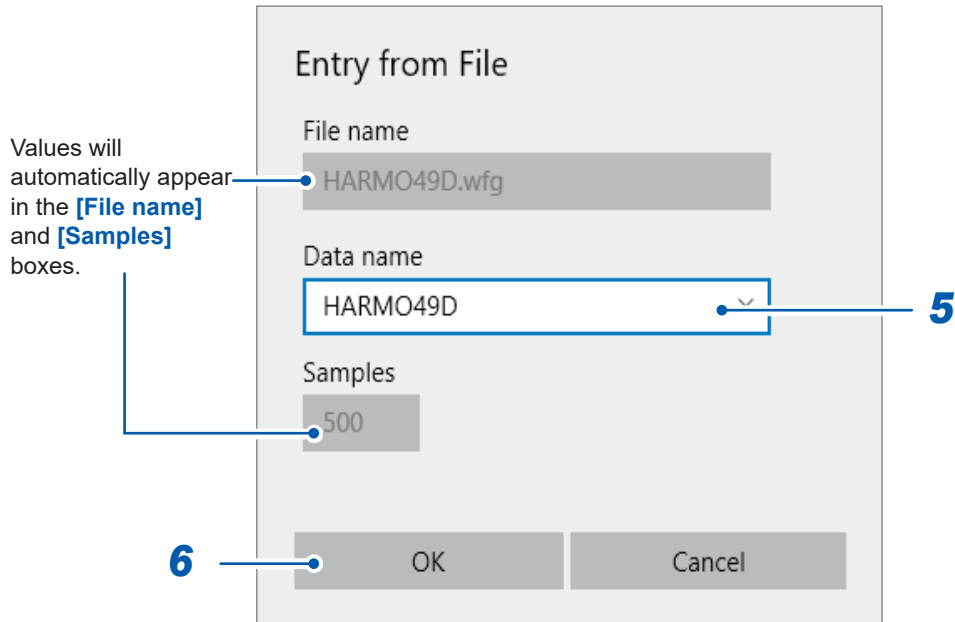

**5** Enter a data name in the [Data name] box.

A data name can be up to 16 characters long. If you enter the name same as a registered data, the existing data will be overwritten.

**6** Tap [OK].

## Editing arbitrary waveforms for Model U8793 Arbitrary Waveform Generator Unit

This section describes how to edit arbitrary waveforms using the SF8000 Waveform Maker software.

You must first install the SF8000 software.

See “Installing Model SF8000 Wave Marker software” (p. 110).

 > [Channel] > [U8793]

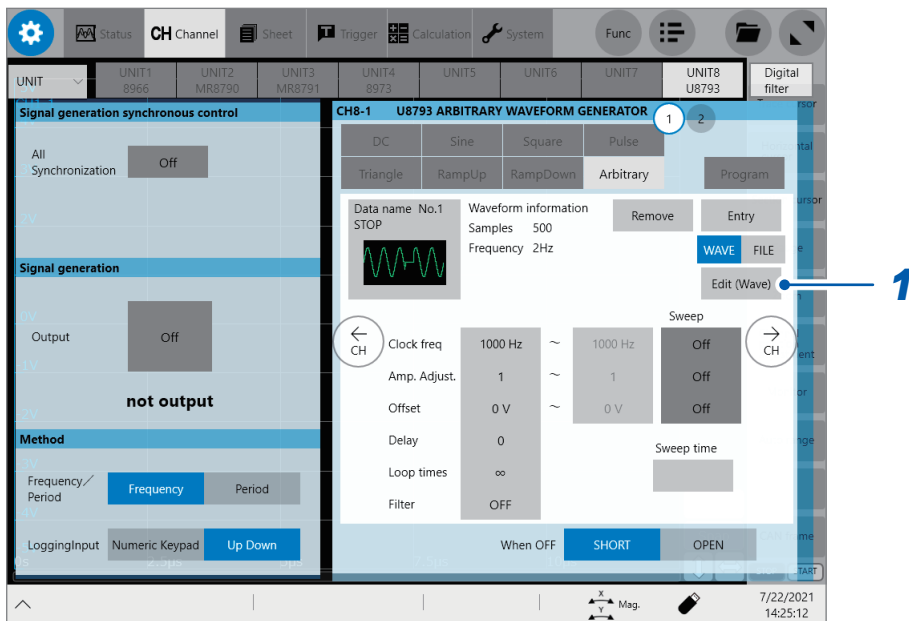

### 1 Tap [Edit (Wave)].

The SF8000 software will launch. Edit and save an arbitrary waveform.

For more information about how to use the SF8000, see the Instruction Manual that came with the U8793, MR8790, and MR8791.

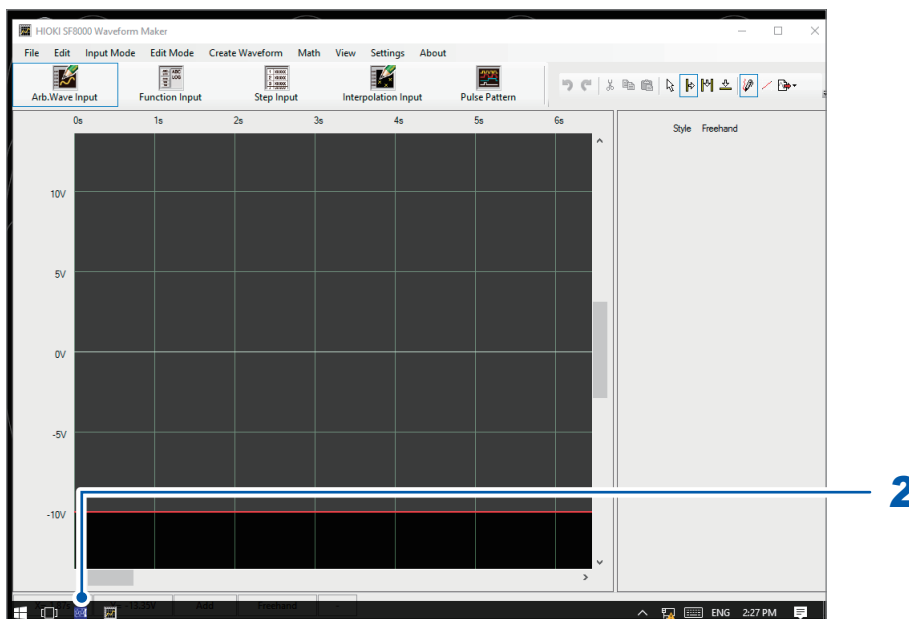

### 2 Tap the blue icon at the bottom left corner of the screen.

The screen returns to the MR6000 software.

## Editing programs of Model U8793 Arbitrary Waveform Generator Unit

You can use the program function to output a waveform generated by piecing up to 128 steps together.

### Setting up the whole program list

This section describes how to load and edit a program list and configure the whole program list.

 > [Channel] > [U8793]

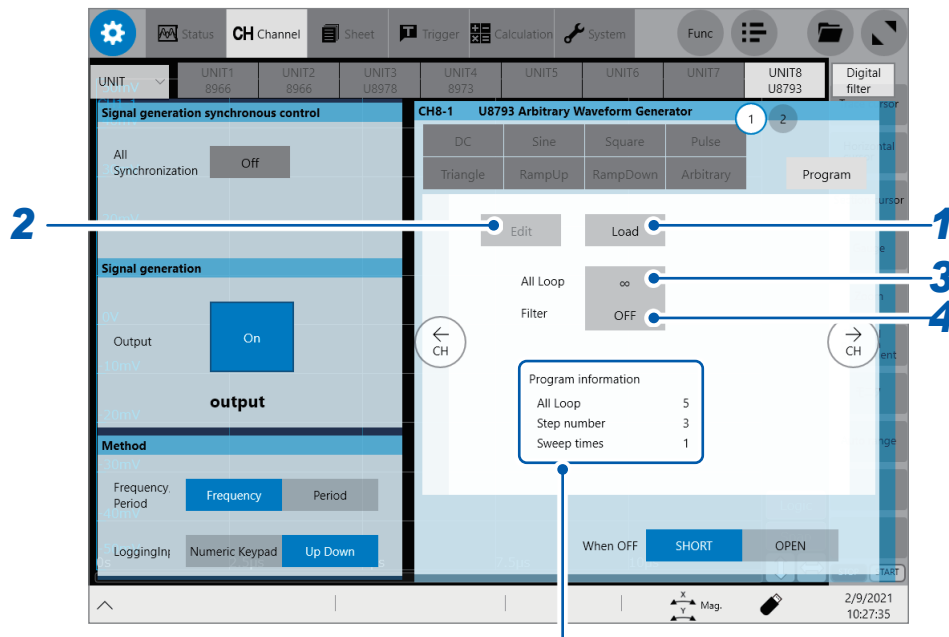

Displays the looping count, step number, and sweeping count of the still-in-progress process.  
When you have set the whole looping times to infinity, the instrument will show [∞] as the entire looping count of the still-in-progress process repeating more than 50,000 times.

- 1** Tap [Load] to load a program list into the instrument.
- 2** Tap [Edit] to edit the program list with the instrument.  
See "Editing the program list" (p. 108).
- 3** Tap the [All Loop] button to enter the number of repetitions the whole program is executed.  
If you enter zero, the instrument displays the sign [∞] and continues outputting the signal repeatedly until you stop the output.

1 to 50000, ∞

- 4** Tap the [Filter] button to specify a filter frequency commonly used for every step.

OFF, 50, 100, 200, 500, 1 k, 2 k, 5 k, 10 k, 20 k, 50 k, 100 k, 200 k, 500 k, 1M [Hz]

### Editing the program list

You can edit and display programs with up to 128 steps. Even if resetting the instrument, you cannot delete the program list.

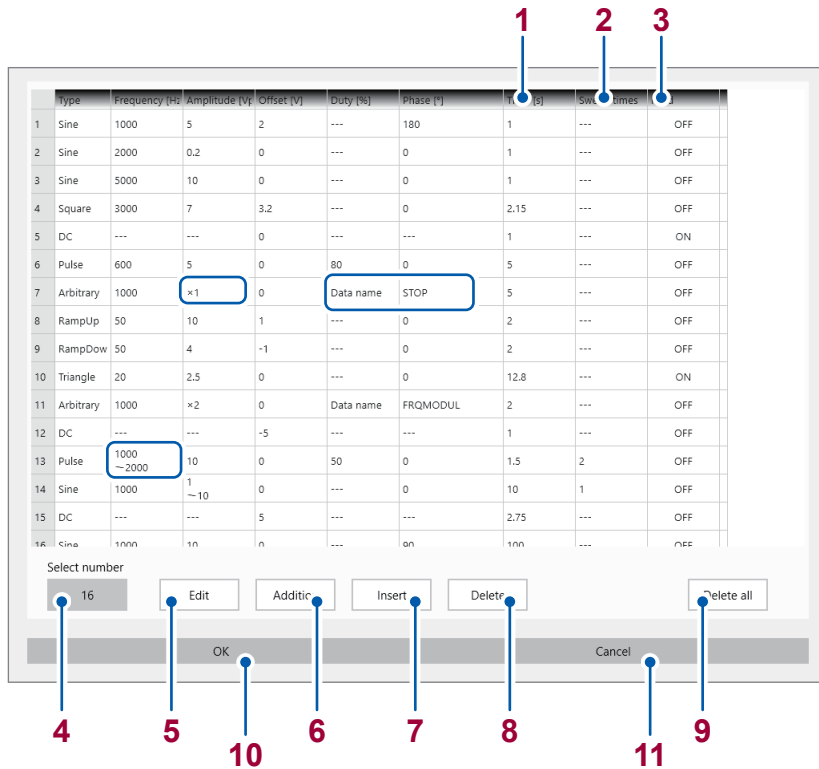

- When the [Type] is set to [Arbitrary], the clock frequency (Hz) will be displayed in the [Frequency [Hz]] column.
- When the [Type] is set to [Arbitrary], the amplitude adjustment factor, such as [x1], will be displayed in the [Amplitude [V]] column.
- When the [Type] is set to [Arbitrary], the data names, such as [Data name] and [STOP] respectively, will be displayed in the [Duty [%]] and [Phase [°]] columns.
- Parameters whose sweep setting is set to [On] will be spread over two lines as follows:

[1000  
to 2000]

No.	Element	Function
1	Time [s]	Allows you to set the generating time when the sweep is set to [Off]. <div style="border: 1px solid black; padding: 2px; margin: 5px 0;">1 to 1000</div> Allows you to set the sweeping time when the sweep is set to [On]. <div style="border: 1px solid black; padding: 2px; margin: 5px 0;">1 to 1000</div>
2	Sweep times	Allows you to set the sweeping count when the sweep is set to [On]. <div style="border: 1px solid black; padding: 2px; margin: 5px 0;">1 to 1000</div>
3	Hold	When you set this column to [Off], the instrument moves on to the next step after the time specified in the [Time [s]] column has elapsed. When you set this column to [On], after the time specified in the [Time [s]] column has elapsed, the instrument continues outputting the signal while an IN signal of high level is being input into the U8793's external control terminal. It will move on to the next step when the IN signal of low level is input.

No.	Element	Function
4	Select number	Displays the number you chose. The step will be used as the reference step to execute steps 5 through 8.
5	Edit	<p>Allows you to edit the chosen step.</p> <p>Use the <b>[Setting program step]</b> dialog to enter parameters you wish to edit. Tap <b>[OK]</b> to confirm your entries by overwriting the existing step.</p> <div data-bbox="852 472 1270 920" data-label="Image"> </div> <ul style="list-style-type: none"> <li>• When you set the <b>[Sweep]</b> column to <b>[On]</b>, the dialog will display the string <b>[Sweeping times]</b>; when <b>[Off]</b>, the string instead.</li> <li>• The <b>[Sweep times]</b> setting cannot be configured if the <b>[Sweep]</b> column is set to <b>[Off]</b>.</li> </ul>
6	Addition	Adds a step after the last step.
7	Insert	Inserts a step before the chosen step.
8	Delete	Deletes the chosen step.
9	Delete all	Deletes all steps.
10	OK	Registers the program list.
11	Cancel	Does not update the program list. Your entry will be discarded.

For information on other user-interface elements and their functions, see “Configuring Model U8793 Arbitrary Waveform Generator Unit” (p. 99).

## Installing Model SF8000 Wave Marker software

### 1 Copy the SF8000 installer to a USB drive.

Copy the [setup] folder in [SF8000\ENGLISH] on the included application disc to a USB drive.

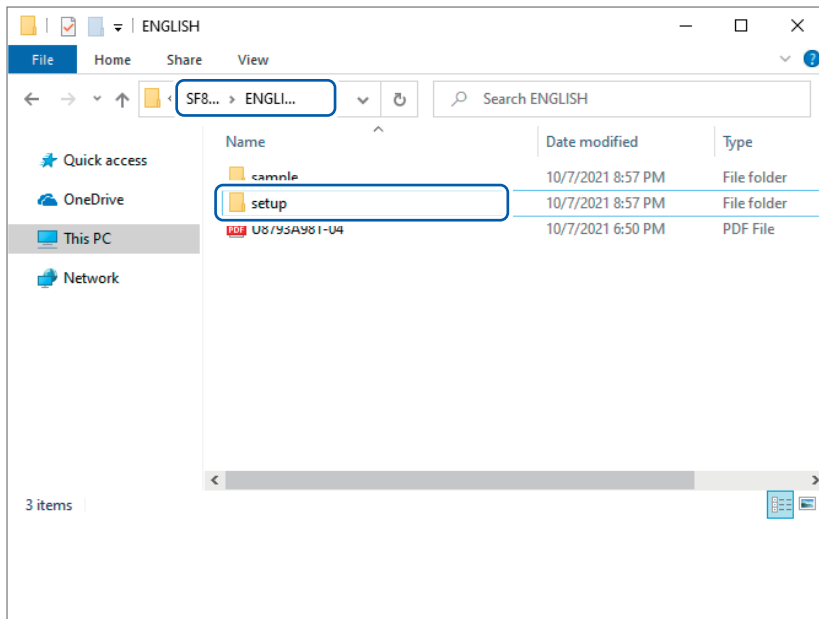

### 2 Turn on the instrument and connect the USB drive to the MR6000's USB connector.

### 3 Open Explorer.

(1) Tap [Func].

(2) Select [Explorer].

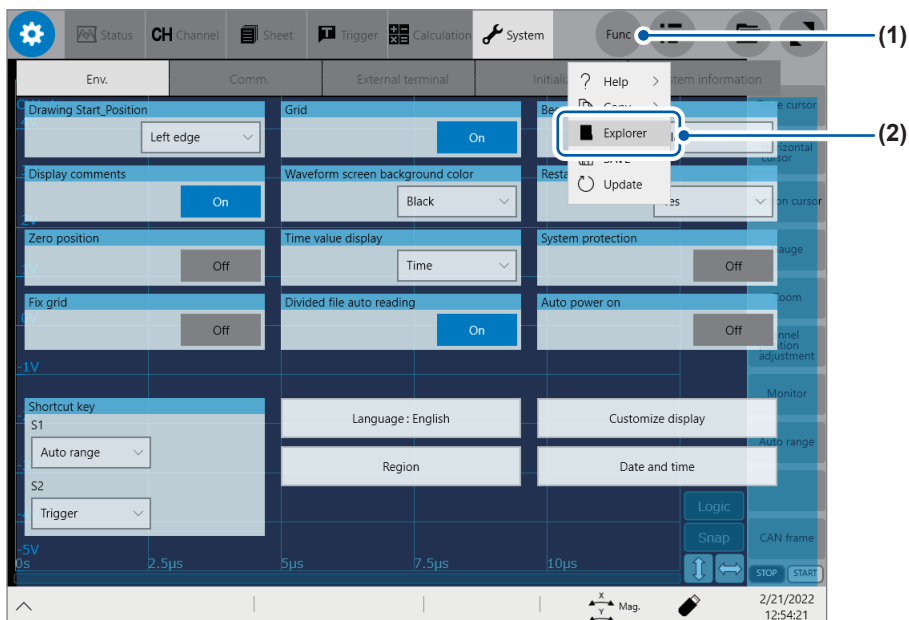



**4** Execute [setup] inside the [setup] folder that you copied to the USB drive.

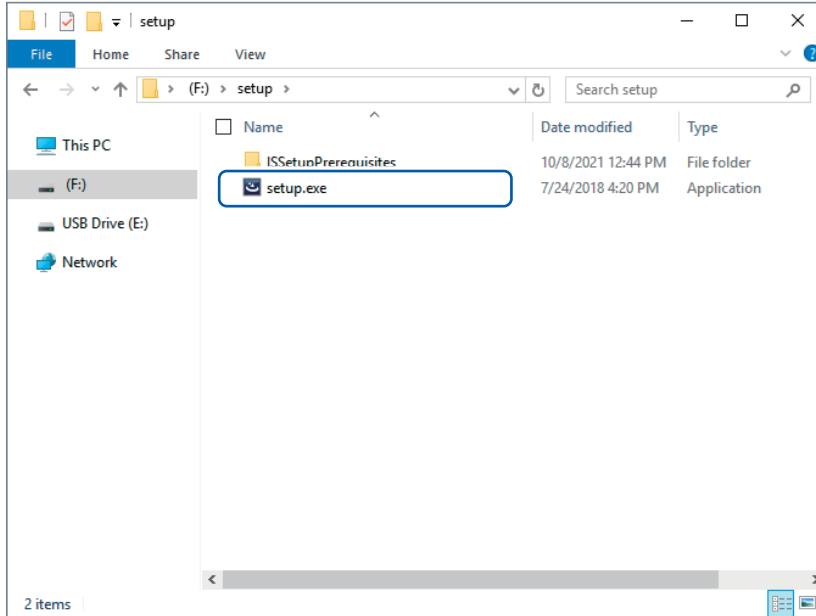

**5** Tap [Next].

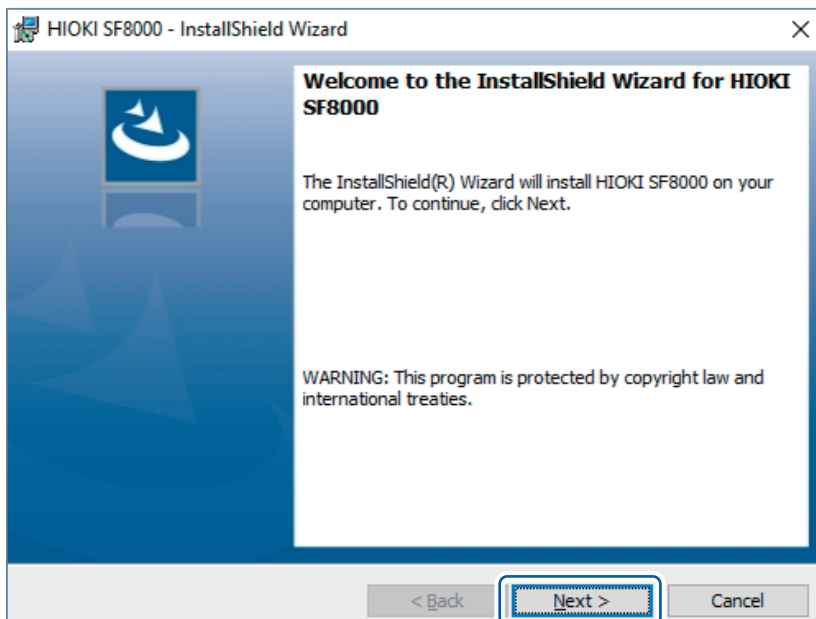

**6** Accept the License Agreement and tap **[Next]**.



**7** Leaving the destination folder unchanged, tap **[Next]**.

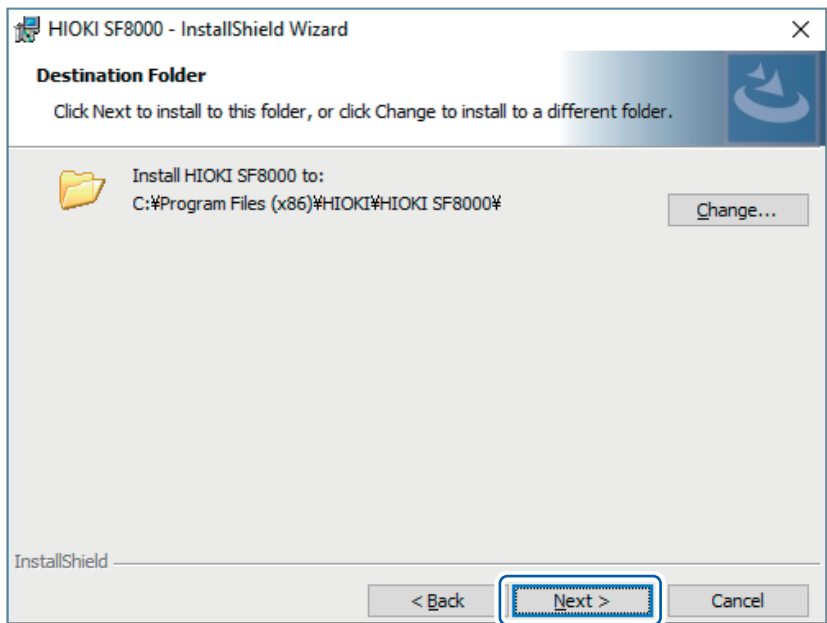

**8** Tap [Install].

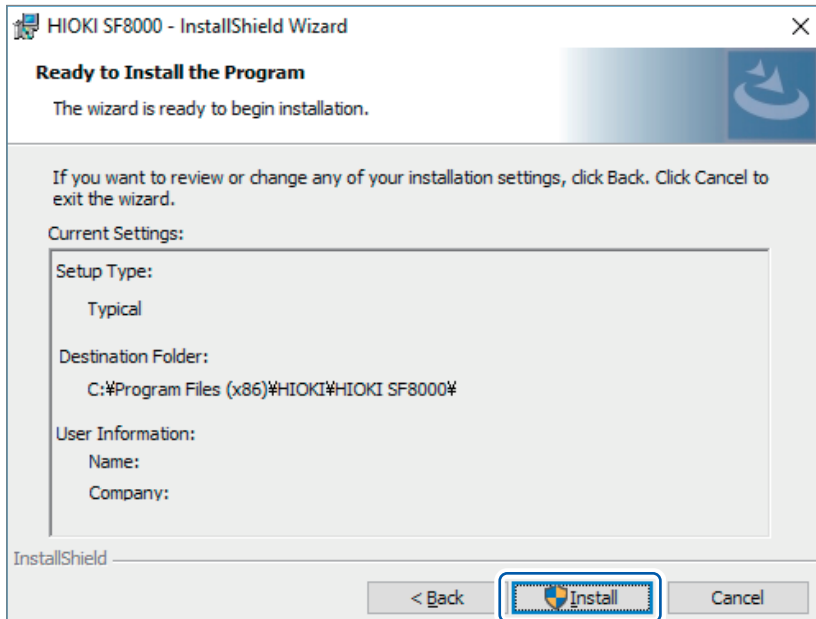

**9** Tap [Finish].

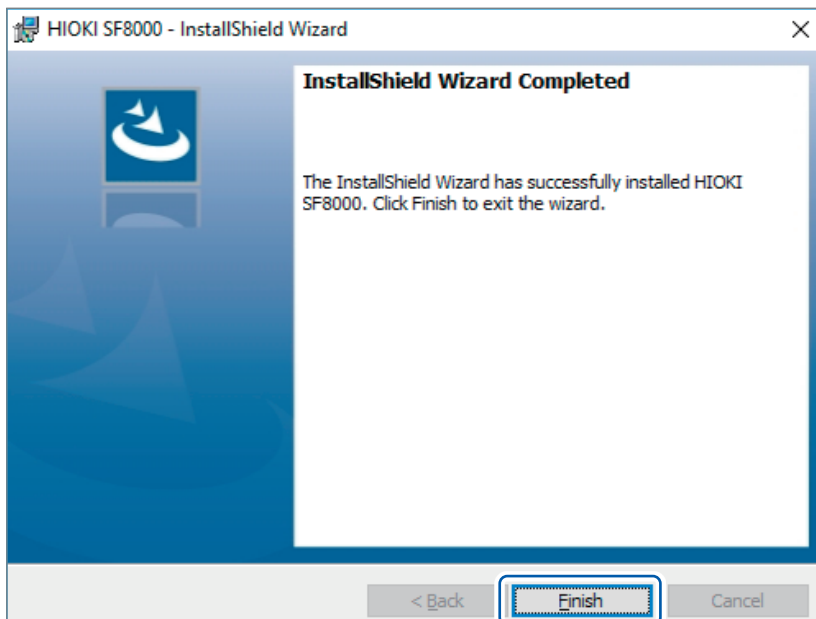

The installation is complete.

**10** Tap the blue icon at the lower-left corner of the screen.

The screen goes back to the MR6000's screen.



# 4

# Saving/Loading Data and Managing Files

This chapter explains how to save and load data and manage files.

Before saving data, select **[Status] > [Save]**, and configure the save setting.

The file screen allows you to load data.

Explorer allows you to manage files.

You can use Explorer to control filing, including copying and moving files, and to check files not supported by the instrument.

See “4.4 Managing Files” (p. 136).

 **> [Status] > [Save]**

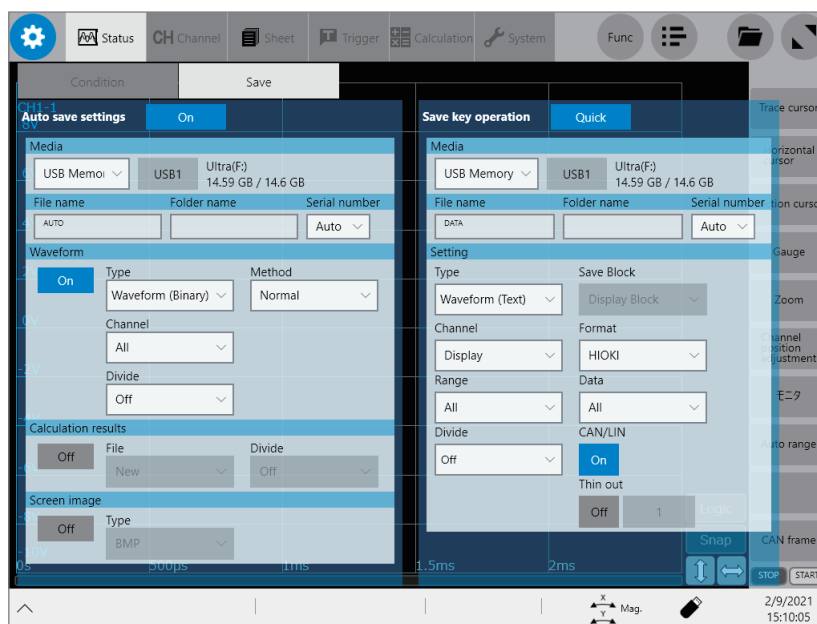

## Operation available on the **[Save]** screen

### Automatic saving

Configuring the automatic saving method settings for measured data (p. 120)

### Real-time saving

Setting the method of saving waveform data in real time (p. 124)

### SAVE key operation

- Setting the operation implemented when the **SAVE** key is pressed (p. 127)
- Specifying contents to be saved when **[Quick]** is selected (p. 127)

## 4.1 Data That Can Be Saved and Loaded

Data saved with another instrument cannot be loaded onto the instrument.

✓: Enable, –: Disable

File type	File format	File extension and description		Saving		Loading	Loading on a PC
				Auto	Manual		
Setting data* <sup>1</sup>	Binary	SET	Setting data (measurement conditions)	–	✓	✓	–
Waveform data* <sup>2</sup> Data of whole waveforms acquired in the instrument or a part of waveforms within the range between the section cursors	Binary	MEM	Normal waveform data	✓	✓	✓	– * <sup>3</sup>
		REC	Envelope waveform data	✓	✓	✓	– * <sup>3</sup>
		FLT	Waveform data in floating-point format	✓	✓	–	–
		MDF	MDF format waveform data (MDF 3.0 format)	✓	✓	✓	✓
		MF4	MDF format waveform data (MDF 4.0 format)	✓	✓	✓	✓
	Text	CSV, TXT* <sup>6</sup>	Text data	✓	✓	–	✓
		CFG, DAT	COMTRADE data	✓	✓	–	✓
Waveform managing data* <sup>4</sup> (When division save, memory division save, dual-sampling save, or CAN frame data save is used)	(Index file)	IDX	Index data of the division save	✓	✓	✓	–
		SEQ	Index data of the memory division save (automatically created at a batch save)	✓	✓	✓	–
		R_M	Index data of dual-sampling batch save	✓	✓	✓	–
		IXC	Index data when CAN frame data saved	✓	✓	✓	–
Screenshot, waveform image	BMP* <sup>5</sup>	BMP	Image data	✓	✓	–	✓
	PNG* <sup>5</sup>	PNG	Image data (PNG format)	✓	✓	–	✓
	JPEG* <sup>5</sup>	JPEG	Image data (JPEG format)	✓	✓	–	✓
Numerical calculation result	Text	CSV, TXT* <sup>6</sup>	Text data	✓	✓	–	✓
CAN frame data	Binary	CLG	Saves waveform file and index file together.	✓	✓	✓	–
	Text	CSV, TXT	Text data	–	✓	–	✓
Waveform generation data	Binary	WFG	Arbitrary waveform data (for U8973)	–	✓	✓	–
	Text	TFG, CSV, TXT	Arbitrary waveform data (for U8973)	–	–	✓	✓
	Program	FGP	Waveform generating program data (for U8973)	–	✓	✓	–

- \*1: The instrument automatically loads data at the time of startup. (p. 135)
- \*2: To load data with the instrument: Save the data in binary format. Waveform data and a part of measurement settings data are saved.  
To load data on your computer: Save the data in text format. (p. 118)  
To save a part of waveforms: Specify the saving range with section cursors. (p. 30, p. 35)
- \*3: Data can be loaded with Wave Viewer (Wv).
- \*4: To load all blocks when the memory division is used  
Save waveform data using **[All block]**. The instrument automatically creates a directory, waveform data of each block, and index data (SEQ). To load waveform data of each block, load this index data.  
To load divided waveform data, load the index data (IDX).
- \*5: BMP format: This is one of the standard Windows® image file format. Various graphics programs can open these files.  
PNG format: Internationally standardized image file format conforming to ISO/IEC15948  
JPEG format: Internationally standardized image format conforming to ISO/IEC10918
- \*6: When you choose a separator other than **[Comma ,]** in **[Region]**, files are saved with the .TXT extension. (p. 348)

## 4.2 Saving Data

### Saving types and setting procedure

Three ways are available to save data.

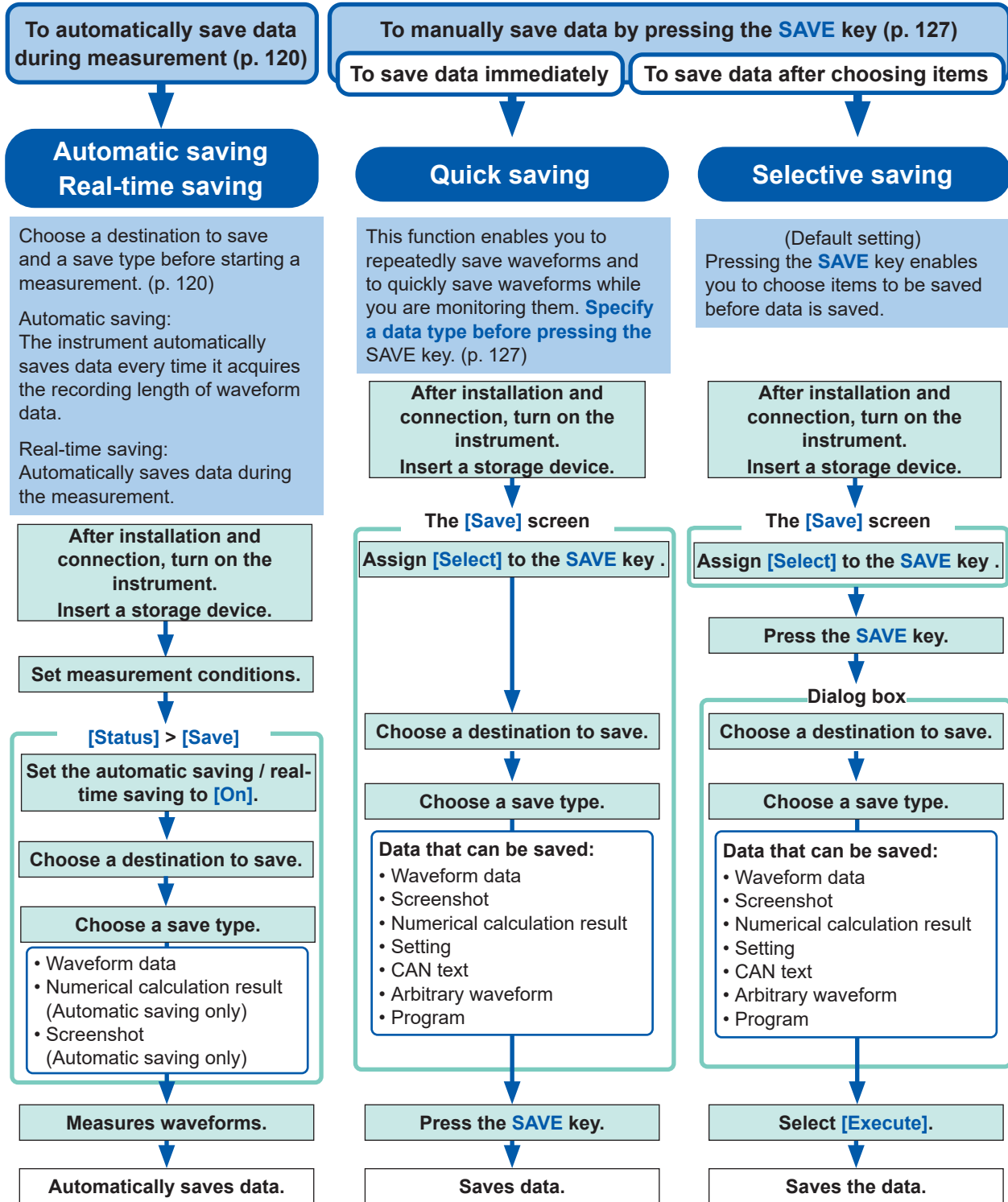

**Check the following before saving data:**

- Have you already inserted and initialized a storage device?  
See “Formatting storage devices” in “2.7 Preparing Storage Devices (Recording Media)” in the Quick Start Manual.
- Is the save destination specified correctly?
- When the automatic saving is used, is [Auto save settings] set to [On]?



## Structure of the save destination folders

The instrument will automatically create the *HIOKI\_MR6000* folder immediately under the storage device and sub-folders according to saving type.

When you specified a save destination folder, the instrument will save files in the folder regardless of the file type.

Folder name	File type
WAVE	Waveform (binary), waveform (text), waveform (MDF), waveform (float), CAN text
CONFIG	Setting
MEASURE	Numerical calculation result
PICT	Scenshots
GEN	Arbitrary waveform, program
User-definable folder	Destination location to save when specified

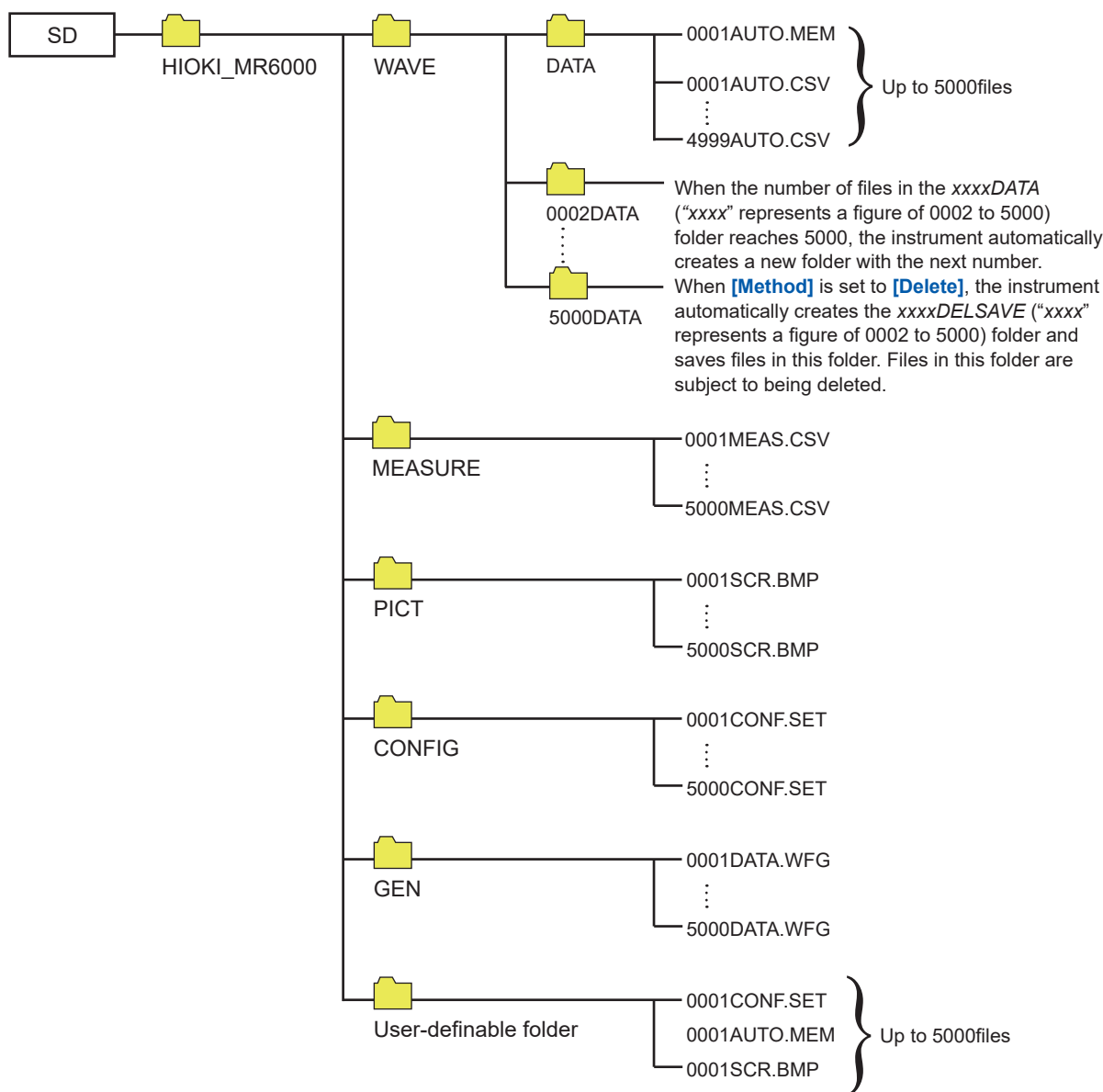

## Automatically saving waveform data

The instrument automatically saves data every time it acquires a recording length of waveform data. Specify a save destination and items to be saved before starting a measurement.

 > [Status] > [Save]

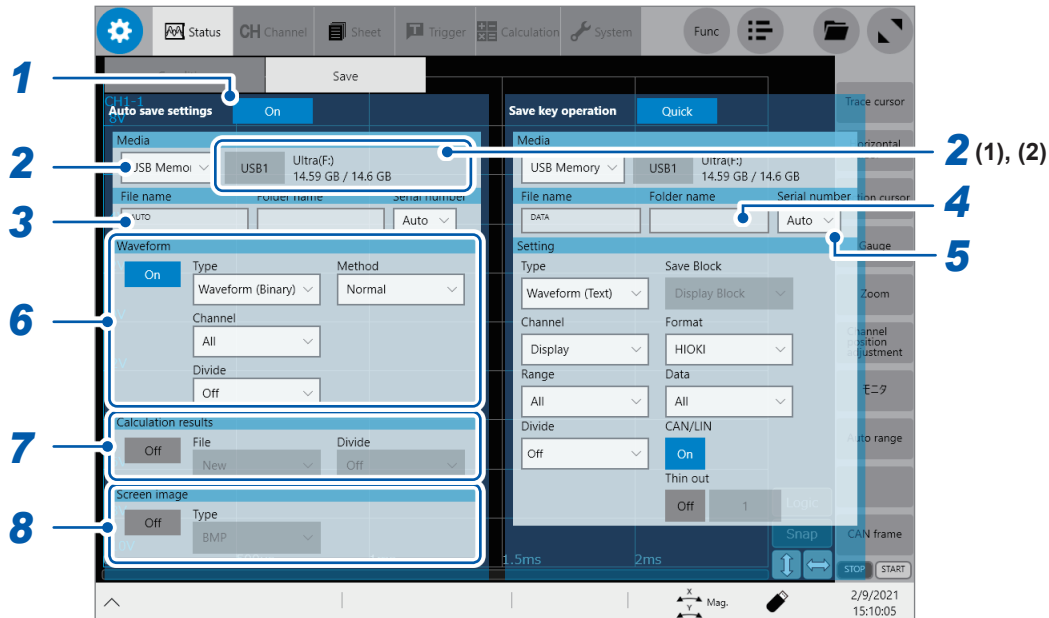

**1** Tap the [Auto save settings] button to set it to [On].

**2** Tap the [Media] box, and then from the list, choose a destination to save.

<b>SSD/HDD</b>	Saves data onto the built-in drive.
<b>SD Card</b>	Saves data on an SD memory card.
<b>USB Memory</b> <input checked="" type="checkbox"/>	Saves data on a USB flash drive.
<b>Mail</b>	Sends email messages with waveform data attached to computers in your network or to remote computers.
<b>FTP</b>	Sends waveform data to a computer connected to your network
<b>Network</b>	Saves data in a shared folder of a Windows <sup>®</sup> -based computer connected to your local network.

- (1) When you choose a save destination, the state of the storage device such as its drive letter and capacity appears on the right of the [Media] box. If no storage device is inserted, the string [None] appears.
  - (2) When you choose [USB Memory] as the save destination, choose a USB flash drive you would like to use as a save destination from among all attached USB flash drives.
- If selecting [Network], [Mail], or [FTP], you can set a backup-file saving destination used for communication failure. When a backup is enabled, choose from SSD/HDD, SD card, and USB flash drive for the destination to save.

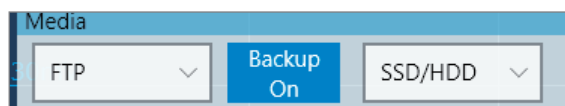

- If selecting [Network], configure the shared folder and network drive settings. See "14.7 Connecting to a Network Drive" (p. 381).
- When you choose [FTP], configure the LAN and FTP client function settings. See "Configuring the LAN settings with the instrument" (p. 351) and "14.3 Sending Data to a Computer With the FTP Client Function" (p. 359).
- For protecting data, use the following Hioki's options:  
Model U8332 SSD Unit, Model U8333 HD Unit, Model Z4006 USB Drive, Model Z4001 SD Memory Card (2 GB), and Z4003 SD Memory Card (8 GB).

**3** Enter the file name in the **[File name]** box.

- Number of characters for a file name: Up to 100 characters
- The maximum length of a file name that includes its path: Up to 255 characters

**4** Enter a folder name in the **[Folder name]** box.

If you wish to choose a destination folder, enter a folder name. If you leave the box blank, the instrument will sort files into folders based on the file type.

- Folder name: up to 32 characters

**5** Tap the **[Serial number]**, and then from the list, choose a format of sequential number to be added to folder/file names.

<b>Previous</b> <sup>☑</sup>	Prefixes a sequential number to each folder/file name.
<b>Tail</b>	Suffixes a sequential number to each folder/file name.
<b>Auto</b>	Saves folders/files without sequential numbers. Suffixes a sequential number to each folder/file name if a folder/file with the same name has already existed.

**6** In the **[Waveform]** area, tap **[On]** or **[Off]** to configure the waveform save setting.

<b>Off</b> <sup>☑</sup>	Does not save any waveforms.
<b>On</b>	Saves waveforms.

Tap the **[Type]** box, and then choose a save format from the list.

<b>Waveform (Binary)</b> <sup>☑</sup>	Saves waveform data in binary format. (Only data saved in binary format can be loaded onto the instrument)
<b>Waveform (Text)</b>	Saves waveform data in text format. (The instrument decimates the data and saves the remaining data as a file. The files can be opened with editors and spreadsheet software installed in computers; however, they cannot be loaded onto the instrument.)
<b>Waveform (MDF)</b>	Saves waveform data in MDF format. (You can use an MDF-capable waveform viewer installed in a computer to load MDF waveform data.)

Tap the **[Method]** box, and then from the list, choose an action to be taken if the size of waveform data to be saved exceeds the capacity of the storage device.

<b>Normal</b> <sup>☑</sup>	Stops the automatic saving if the storage device is full.
<b>Delete</b>	Deletes older files and continues the automatic saving even when the storage device is full (waveform files only). The instrument deletes files only created after the measurement has started. It does not delete previously existing files.

Tap the **[Channel]** box, and then from the list, choose an option for channels to be saved.

<b>All</b> <sup>☑</sup>	Saves data acquired across all measured channels (channels with measurement set to <b>[On]</b> ). The instrument also saves data acquired across channels with the waveform display set to <b>[Off]</b> .
<b>Display</b>	Saves data acquired across channels with the waveform display set to <b>[On]</b> on all sheets.

(When you choose **[Waveform (Binary)]** in the **[Type]** box)

Tap the **[Divide]** box, and then from the list, choose a size of each file.

<b>Off</b>	Saves a file without dividing it.
<b>16 MB, 32 MB, 64 MB</b>	Choose this option to divide a large file into several files and save them. A file is divided into several files each of which has the specified size. The instrument creates a folder with the specified name, divides a file into several files, and then saves them in the folder.

Even if the **[Divide]** has been set to **[Off]**, the instrument automatically divides files more than 512 MB in size, which can be generated in some measurement conditions. When the instrument needs to divide a file, it automatically creates a folder to save divided files and an index file with the extension .INX. Loading the IDX file allows the waveform files to be loaded in a batch.

When using the memory division function, you cannot use the division save function.

See “Loads divided files in a batch.” (p. 134) and “10 Memory Division Function” (p. 289).

(When you choose **[Waveform (Text)]** in the **[Type]** box)

Tap the **[Divide]** box, and then from the list, choose an option for the number of lines of each file.

<b>Off</b>	Saves a file without dividing it.
<b>60,000 data, 1,000,000 Data</b>	Divides a file according to data points (row) you specify.

Even if the **[Divide]** has been set to **[Off]**, the instrument automatically divides files more than 512 MB in size, which can be generated in some measurement conditions.

When using the memory division function, you cannot use the division save function.

See “10 Memory Division Function” (p. 289).

(When you choose **[Waveform (Text)]** in the **[Type]** box)

Tap the **[Thin out]** button to set it to **[On]** or **[Off]**.

When you choose **[On]**, tap the number box on the right, and then enter the number of samples out of which a data point is retained

Storing files in text format requires a lot of storage space. Data decimation can reduce file sizes.

<b>Off</b>	No data is decimated.
<b>On (2 to 1,000)</b>	Allows you to enter the decimation number. The instrument retains one data point out of the specified number of data points.

Example

When you enter **[3]**, the instrument retains one data point out of three consecutive data points: it decimates the two other points. The number of samples is reduced by one third of the original number.

## 7 In the **[Calculation result]** area, tap **[On]** or **[Off]** to configure the numerical calculation result setting.

<b>Off</b>	Does not any save numerical calculation results.
<b>On</b>	Saves numerical calculation results.

Tap the **[File]** box, and then from the list, choose an option for saving data to files.

<b>New</b>	Creates a new file for each measurement and saves it.
<b>Append</b>	Appends data to an existing file and saves it.

Tap the **[Divide]** box, and then choose a file division setting from the list.

<b>Off</b>	Does not divide any files.
<b>Split by Calc. No.</b>	Creates a file for each calculation number.

- 8** In the [Screen image] area, tap [On] or [Off] to configure the display image saving setting.

Off <sup>☑</sup>	Does not save any screenshot.
On	Saves a screenshot.

Tap the [Type] box, and then choose a save format of images from the list.

BMP<sup>☑</sup>, PNG, JPEG

### When you choose data in text format or numerical calculation results to be saved

Characters or display items used on the instrument are converted as follows:

Character used on the instrument	Saved character
<sup>2</sup>	^2
<sup>3</sup>	^3
μ	~u
Ω	~o
ε	~e
°	~c
±	~+

### Waveform data

The instrument automatically divides large-size waveform data files (.MEM or .REC) before saving.

## Real-time saving

Since setting the real-time saving to **[On]** allows data to be saved in a storage device simultaneously with measurement, the instrument can perform measurement for a long period of time regardless of the capacity of the internal memory.

The measurement condition settings are different between setting the real-time saving to **[On]** and **[Off]**.

- When setting the real-time saving to **[On]**, you cannot use the following functions: Automatic saving, trigger function, waveform calculation function, and memory division function.
- No storage device can be removed or replaced during the real-time saving.
- If displaying the message, Error No. 235 **[Real-time saving could not be completed within available time.]**, the instrument may record abnormal data in a waveform file saved in a storage device.
- The operation may be automatically restricted if there is a risk that saving data cannot be completed in time during the real-time saving.
- When any numerical calculation is set, only manual calculation can be executed.  
After the measurement has been complete, select  > **[Calculation]** > **[Numerical calculation]**, and then tap **[Execute]**.
- Configuring the waveform display setting with the higher vertical compression ratio may cause saving data not to be completed in time during the real-time saving. Lower the compression ratio such a case.
- For real-time saving, use the following Hioki's options:  
Model U8332 SSD Unit, Model U8333 HD Unit, and Model Z4006 USB Drive  
Model Z4001 SD Memory Card (2 GB), Model Z4003 SD Memory Card (8 GB)
- When using Model Z4006 USB Drive for real-time saving, connect the drive to the USB 3.0 connector on the right side of the instrument. Connecting the drive to the USB 2.0 connector cannot deliver the real-time saving speed specified in the product specifications.

### Maximum recording time

- When the real-time saving is set to **[On]**, the maximum recording time is determined based on the recording interval, the remaining capacity of a storage device, and the number of channels to be used.
- When the sampling rate is set at a slow rate, the recording time is set to a long period of time (one year or more) depending on a condition. The operation cannot be guaranteed because the warranty period or product life may disturb it.
- When the external sampling is used, the instrument calculates the maximum recording time assuming a recording interval of 10 MS/s.

See "Maximum recordable time when the real-time saving is enabled (values for reference purposes)" (p. 399).

### Waveform data

When recording waveforms with the real-time saving set to **[On]**, the instrument directly saves measured waveform data (.MEM or .REC) onto a storage device. If the file size is large, the instrument automatically divides the file into several files each of which has 512 MB and saves them.

### Deleting and saving files when saving data in real time

- If the capacity of the storage device becomes full while the instrument is storing files, it automatically deletes waveform files created after the measurement has started beginning from the oldest, securing free space in the storage device. However, when free space in a storage device is less than the sum of the created file size and 512 MB before starting a measurement, the instrument cannot overwrite any new files over the older files. Use a storage device with as much free space as possible.
- The instrument does not delete waveform files saved in the past.

- When **[Method]** is set to **[Delete]**, the recording length can be set at 10000 days at a maximum; however, data the instrument retains after the measurement is limited to a free space size of a storage device at the start of recording (recording time of the normal saving).

 > **[Status]** > **[Save]**

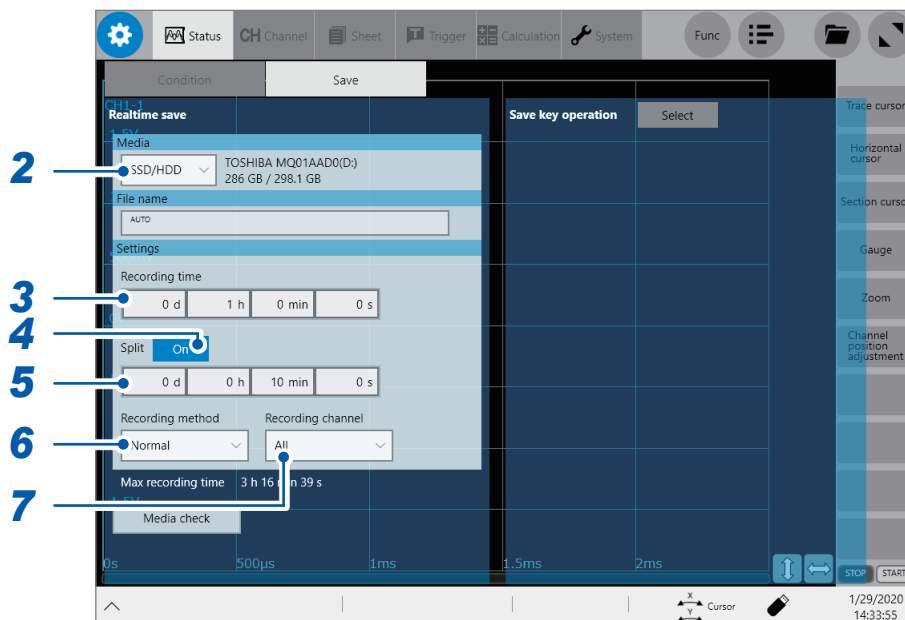

**1** On the **[Condition]** screen, configure the realtime save and sampling settings. See “1.2 Setting Measurement Conditions” (p. 5).

**2** Tap the **[Media]** box, and then choose a destination to save from the list. When selecting **[FTP]** as the destination to save, you can specify another backup destination used if the communication fails. When a backup is enabled, choose from SSD/HDD, SD card, and USB flash drive for the destination to save.

**3** Tap the **[Recording time]** box, and then enter a recording time.

<b>d</b>	0 to 10000 (days)
<b>h</b>	0 to 23 (hours)
<b>min</b>	0 to 59 (minutes)
<b>s</b>	0 to 59 (seconds)

**4** Tap the **[Split]** button to specify whether to divide a file before it is saved.

<b>Off</b>	Does not divide a file.
<b>On</b>	Divides a file.

**4**

Saving/Loading Data and Managing Files

**5** (When the **[Split]** button is set to **[On]**)

Tap the time entry boxes under **[Split]** to enter the length of time each divided file has.

<b>d</b>	0 to 100 (days)
<b>h</b>	0 to 23 (h)
<b>min</b>	0 to 59 (min.)
<b>s</b>	0 to 59 (s)

If the file size exceeds 512 MB before the set division time has elapsed, the file is divided at the time, and 512 MB of the recorded data is saved.

**6** Tap the **[Method]** box, and then from the list, choose a way to handle if a space of a storage device is insufficient.

<b>Normal</b> <sup>☑</sup>	Stops the real-time saving and measurement if the storage device is full.
<b>Delete</b>	Deletes older files and saves files in real time if the storage device is full (waveform files only). The instrument deletes files only created after the measurement has started. It does not delete previously existing files.

Setting **[Media]** to **[FTP]** forces this setting into **[Normal]**.

**7** Tap the **[Recording channel]** box, and then choose a channel to be saved.

<b>All</b> <sup>☑</sup>	Saves data acquired across all the channels that have performed measurement (whose measurement settings are <b>[On]</b> ).
<b>Display</b>	Saves data acquired across all the channels whose display settings are <b>[On]</b> .

**8** Check settings that include the input channel settings, and then press the **START** key to start a measurement.

The instrument saves data onto a storage device in real time during measurement.



## Freely choosing data items to be saved and save files (SAVE key)

You can configure saving action setting the instrument performs when you press the **SAVE** key.

**Selective save:** After you press the **SAVE** key, the instrument allows you to configure the save settings before saving data.

**Quick save:** Pressing the **SAVE** key causes the instrument to save data that consists of pre-specified items.

You can save the following types of data:

- Waveform data
- Screenshot
- Numerical calculation result
- Setting
- CAN text
- Arbitrary waveforms
- Program

 > [Status] > [Save]

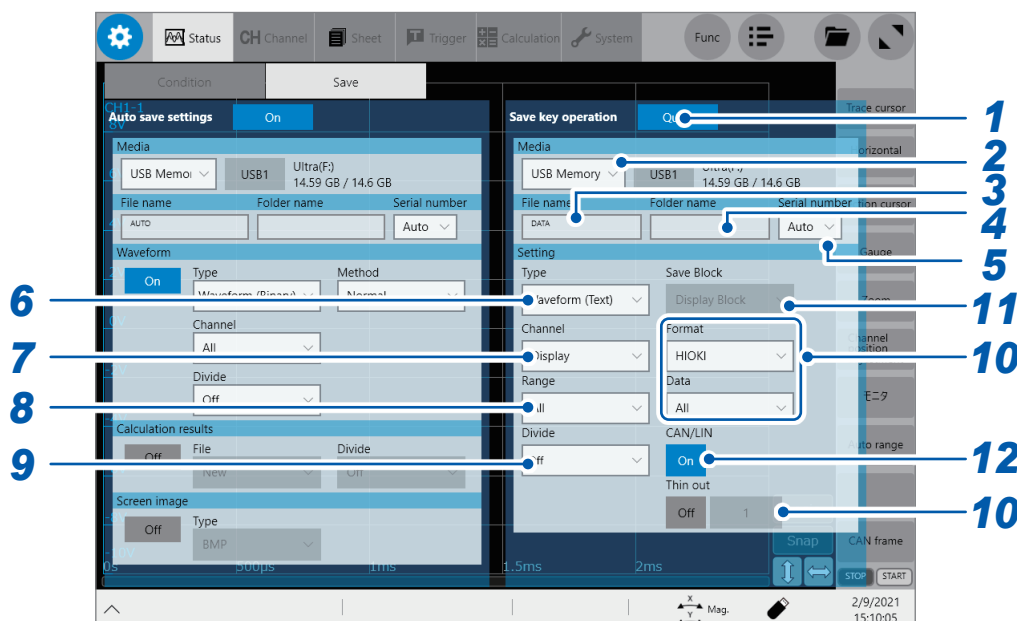

**1** Tap the **[Save key operation]** button, and then choose a save method adopted when you press the **SAVE** key.

<p><b>Select</b> <input checked="" type="checkbox"/></p>	<p>Displays the dialog box to allow you to choose items to be saved and saves them. The instrument displays the dialog box when you press the <b>SAVE</b> key to start a measurement, which allows you to configure subsequent settings. This operation cannot be executed if another dialog box is open. See “Selective saving” (p. 118).</p>
<p><b>Quick</b></p>	<p>Immediately saves data consisting of pre-specified items. See “Quick saving” (p. 118).</p>

**2** Tap the **[Media]** box, and then choose a destination to save from the list. (See p. 120.)

**3** Tap the **[File name]** box, and then enter a file name.

- Number of characters for a file name: Up to 100 characters
- The maximum length of a file name that includes its path: Up to 255 characters

#### 4 Enter a folder name in the **[Folder name]** box.

If you wish to choose a destination folder, enter a folder name. If you leave the box blank, the instrument will sort files into folders based on the file type.

- Folder name: up to 32 characters

#### 5 Tap the **[Serial number]**, and then from the list, choose a format of sequential number to be added to folder/file names.

<b>Previous</b> <sup>☑</sup>	Prefixes a sequential number to each folder/file name.
<b>Tail</b>	Suffixes a sequential number to each folder/file name.
<b>Auto</b>	Saves folders/files without sequential numbers. Suffixes a sequential number to each folder/file name if a folder/file with the same name has already existed.

#### 6 Tap the **[Type]** box, and then choose a save format from the list.

<b>Waveform (Binary)</b> <sup>☑</sup>	Saves waveform data in binary format. Choose this option to reload the waveforms into the instrument.
<b>Waveform (Text)</b>	Saves waveform data in text format. Choose this option to load the waveforms with a computer.
<b>Waveform (MDF)</b>	Saves waveform data in MDF format. Choose this option to load the data using an MDF-capable waveform viewer installed in a computer.
<b>Waveform (Float)</b>	Saves waveform data in binary format (32-bit floating point). Choose this option to load the waveforms with a computer.
<b>Screen image</b>	Saves screenshots. The data saved can be viewed on a computer with image viewing software.
<b>Numerical calculation result</b>	Saves numerical calculation results.
<b>Setting</b>	Saves the present measurement conditions.
<b>Arbitrary waveform</b>	Saves arbitrary waveform data.
<b>Program</b>	Saves a waveform generation program.
<b>CAN text</b>	Saves CAN frame data in text format.

#### 7 Tap the **[Channel]** box, and then choose an option for channels to be saved.

When **[Type]** is set to **[Waveform (Binary)]** or **[Waveform (Text)]**

<b>All</b>	Saves data acquired across all measured channels (channels with measurement set to <b>[On]</b> ). Saves the data acquired across the channels with the display setting set to <b>[Off]</b> .
<b>Display</b> <sup>☑</sup>	Saves data acquired across the channels with the display setting set to <b>[On]</b> on all sheets.

#### 8 Tap the **[Range]** box, and then choose an option for the save range from the list.

When **[Type]** is set to **[Waveform (Binary)]** or **[Waveform (Text)]**

<b>All</b> <sup>☑</sup>	Saves all data written in the memory.
<b>Segment 1</b>	Saves data in the section between section cursors <b>[1A]</b> and <b>[1B]</b> .
<b>Segment 2</b>	Saves data in the section between section cursors <b>[2A]</b> and <b>[2B]</b> .

The instrument saves data acquired across the channels displayed on the screen.

See “2.2 Specifying the Waveform Range (Section Cursor)” (p. 35).

When no target section cursors are set, whole data is saved regardless of the **[Segment 1]** or **[Segment 2]** setting.

## 9 Tap the **[Divide]** box, and then from the list, choose an option for a file size of each file.

When **[Type]** is set to **[Waveform (Binary)]**.

<b>Off</b>	Saves a file without dividing it.
<b>16 MB, 32 MB</b>	Choose this option to divide a large file into several files and save them. A file is divided into several files each of which has the specified size. The instrument creates a folder with the specified name, divides a file into several files, and then saves them in the folder.

Even if the **[Divide]** has been set to **[Off]**, the instrument automatically divides files more than 512 MB in size, which can be generated in some measurement conditions. When the instrument needs to divide a file, it automatically creates a folder to save divided files and an index file with the extension .INX. Loading the IDX file allows the waveform files to be loaded in a batch.

When using the memory division function, you cannot use the division save function.

See “Loads divided files in a batch.” (p. 134) and “10 Memory Division Function” (p. 289).

When **[Type]** is set to **[Waveform (Text)]**.

<b>Off</b>	Saves a file without dividing it.
<b>60,000 Data 1,000,000 Data</b>	The instrument divides a file into several files each of which contains the specified number of data points.

Even if the **[Divide]** has been set to **[Off]**, the instrument automatically divides files more than 512 MB in size, which can be generated in some measurement conditions.

When using the memory division function, you cannot use the division save function.

See “10 Memory Division Function” (p. 289).

## 10 Configure advanced save settings according to the **[Type]** box setting.

Saving format	Setting		Description
<b>Waveform (Text)</b>	<b>Format</b>	<b>HIOKI</b>	Saves data in commonly used text format.
		<b>COMTRDE</b>	Saves data in COMTRADE-compliant format.
	<b>Data</b>	<b>All</b>	Saves all data in .
		<b>Event</b>	Saves only the data points at event marks.
<b>Thin out</b>	<b>Off</b> , <b>On (2 to 1,000)</b>	A large amount of space is required to save files in text format. Decimating data points before saving a file can reduce the file size. This setting allows you to specify the decimation number (the instrument retains a data point out of the decimation number of data points). Example: When you specify <b>[10]</b> , the instrument saves one out of every 10 consecutive data points and disregards nine others. The number of samples is reduced to one-tenth of the original amount.	
<b>Screen image</b> (screenshot)	<b>Type</b>	<b>BMP</b> , <b>PNG</b> , <b>JPEG</b>	Allows you to choose a type for saving image files.
<b>Numerical calculation result</b>	<b>File designation</b>	<b>New</b>	Saves files with a new file name each time. The instrument allocates sequence numbers when the same name is given.
		<b>Append</b>	Appends data to the same file and saves it.
	<b>File division</b>	<b>Off</b>	Saves all calculations in a single file.
		<b>Split by Calc. No.</b>	Creates a new folder, divides a file into several files according to calculation number, and save them in the folder. The instrument appends the string “_K + sequential number” following each file name.

Saving format	Setting		Description
Arbitrary	Channel		Select a channel number of the measured waveform to be saved or that of the U8793 with the arbitrary waveform registered.
	Data name		Allows you to enter a data name to be saved (for measured waveforms) or that of an arbitrary waveform data name to be saved (for the U8793).
Program	Channel		Allows you to choose the channel number of the U8793 where the program you wish to save has been registered.
Waveform (MDF)	Format	MDF3.0	Saves data in MDF 3.0 format with the MDF extension.
		MDF4.0	Saves data in MDF 4.0 format with the MF4 extension.

**11** (When using the memory division function or the dual sampling function)

Tap **[Save Block]** box, and then from the list, choose an option for blocks to be saved.

Display block <input checked="" type="checkbox"/>	Saves waveforms included in displayed blocks.
All block	(When using the memory division function) Saves all blocks specified by the “use blocks” setting, starting with the start block.
	(When using the dual sampling function) Saves all trend and instantaneous waveform blocks.

**12** (When CAN signals are recorded)

Tap the **[CAN/LIN]** button to configure the simultaneous-save setting of the waveform file and the CAN binary file.

Off <input checked="" type="checkbox"/>	Saves the waveform file only.
On	Saves the CAN log file and index file as well as the waveform file.

Whenever you press the **SAVE** key, the instrument saves data that consists of specified items.

**File division**

The instrument automatically divides a large-size data file into several files each of which is 512 MB in size before saving.

**Performing the SAVE key operation using the screen**

You can use the screen to perform the **SAVE** key operation.

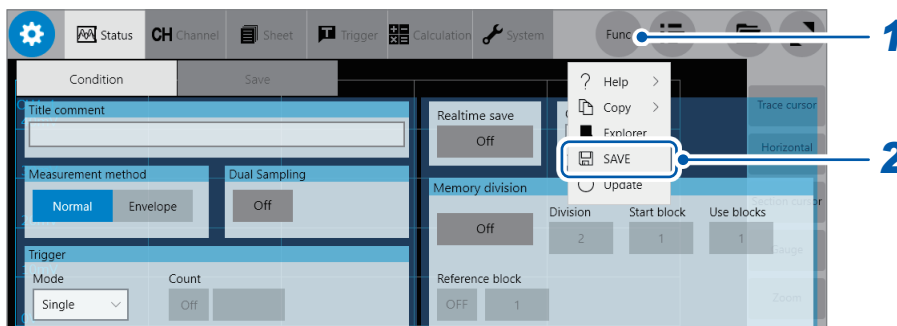

**1** Tap **[Func]**.

**2** Select **[SAVE]**.

## 4.3 Loading Data

You can load data saved in a storage device or written in the internal memory of the instrument.

### Data loading procedure

Before attempting to load the data, make sure that a storage device is inserted, and the save destination is correctly specified.

Open the file screen, choose a storage device, and double-tap a file you want to load.

Waveform and settings files saved in waveform (binary) format can be loaded on the instrument.

The instrument displays only loadable files on the file screen.

You can use Explorer to check files not supported by the instrument, including those in text and BMP formats.

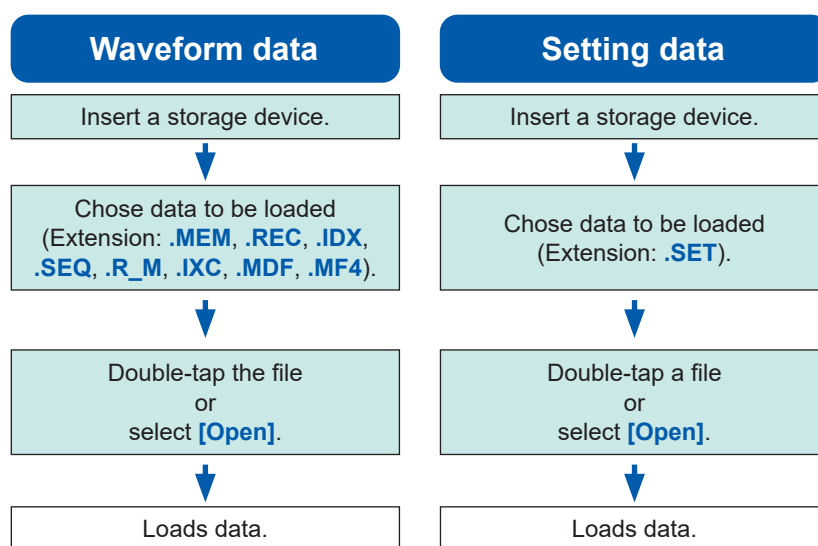



## To display the file screen

### IMPORTANT

The file screen lets you to choose files to load. It will not display files the instrument cannot load. You can use Explorer to control files, including copying and moving them, and to check files not supported by the instrument.

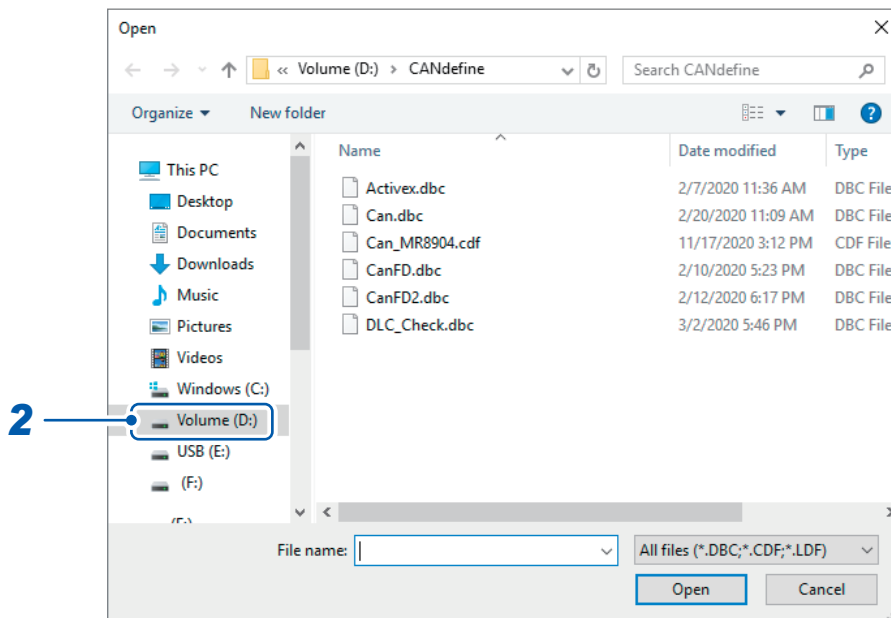
See “4.4 Managing Files” (p. 136).



**1** Tap  on the waveform screen. A window will open allowing you to select a file.

**2** Choose a storage device to be operated.

## When loading data from a storage device

Insert a storage device before choosing it.

### Others

- The MR6000 can load data saved with the MR6000, MR8847, MR8827, MR8740, and MR8741 Memory HiCorder. Data saved with other recorders cannot be loaded onto the MR6000.
- The MR6000 cannot load some settings when loading data saved with the MR8847, MR8827, MR8740, and MR8741.
- Loading a waveform file changes the settings of the instrument to those when the waveform file was saved. When a measurement starts with this state, the instrument measures waveforms with the settings of the loaded waveform file; however, the settings of the modules are restored to those set before the waveform file was loaded. To discard the module settings of the loaded waveform file, execute **[Initialize waveform data]** (See “6.2 Initializing the Instrument” in the Quick Start Manual.).
- Loading a waveform file suspends the waveform monitor until one of the following actions is performed:
  - Start a measurement.
  - Initializing the instrument by executing **[Initialize waveform data]**, **[Initialize Settings]**, or **[Initialize all]**
  - Loading a setting file

## Loading waveform data in a batch

Loading one of the following index files allows waveform data to be loaded in a batch. Configuring the following settings allows the instrument to create an index files and waveform file together.

Extension	Content
<b>IDX</b>	<p>Loads divided files in a batch.</p> <p>The instrument with the file division setting creates an index file (the file division setting is included in the automatic saving or the <b>SAVE</b> key operation settings). However, when <b>[Type]</b> is set to any type other than <b>[Waveform (Binary)]</b>, the instrument does not create any index file.</p> <p>See “Automatically saving waveform data” (p. 120) and “Freely choosing data items to be saved and save files (SAVE key)” (p. 127).</p>
<b>SEQ</b>	<p>(When using the memory division function)</p> <p>The instrument loads waveforms of all blocks at a time.</p> <p>The instrument creates an index file when the instrument with the memory division function enabled automatically save data or you press the <b>SAVE</b> key to save data of all blocks (p. 130). See “Freely choosing data items to be saved and save files (SAVE key)” (p. 127) and “Automatic saving for the memory division setting” (p. 293).</p>
<b>R_M</b>	<p>(When using the dual sampling function)</p> <p>Loads all trend and instantaneous waveform files at once.</p> <p>Index files are created when saving data automatically during dual sampling measurement and when saving all blocks with the <b>SAVE</b> key.</p> <p>See “Freely choosing data items to be saved and save files (SAVE key)” (p. 127) and “11.5 Files” (p. 308).</p>
<b>IXC</b>	<p>(When using CAN/LIN channels)</p> <p>Loads waveforms and CAN frame data at once.</p> <p>Index files are created when automatically saving data while using CAN/LIN channels and when saving CAN binary files simultaneously with the <b>SAVE</b> key.</p> <p>See “Freely choosing data items to be saved and save files (SAVE key)” (p. 127) and “12.8 Saving Data” (p. 342).</p>

## Loading waveform generating data (registration)

The instrument can load data for signal generating modules.

The signal generating screen in the channel screen can be used to load such data.

See the Instruction Manual that came with the U8793, MR8790, and MR8791.

Extension	Content
<b>WFG, TFG, CSV, TXT</b>	<p>Loads waveform generator data to the specified channel of the arbitrary waveform generator module. (registration)</p> <p>The instrument will output the signal of the loaded (registered) waveform data from the U8793 Arbitrary Waveform Generator Unit.</p> <p>See “Registering arbitrary waveforms in the U8793 Arbitrary Waveform Generator Unit” (p. 102).</p> <p>Only CSV and TXT files that include one generator data value per line in text format are valid.</p>
<b>PLS</b>	<p>Loads pulse pattern data to the specified channel of the pulse generator module. (loading)</p> <p>The instrument will output a pulse pattern waveform of the loaded pulse pattern data from the MR8791 Pulse Generator Unit.</p> <p>See “Configuring Model MR8791 Pulse Generator Unit settings” (p. 92).</p>
<b>FGP</b>	<p>Loads an FGP waveform generator program file to the specified channel of the arbitrary waveform generator module. (registration)</p> <p>See “Editing programs of Model U8793 Arbitrary Waveform Generator Unit” (p. 107).</p>



## Automatically loading the settings (Automatic setup function)

The instrument can load a setting file with the file name "STARTUP" in the [CONFIG] folder in the [HIOKI\_MR6000] folder at the time of startup.

The instrument searches the drives beginning from drive D in alphabetical order for the file "STARTUP.SET," loading the file found first.

## Loading numerical calculation settings

When loading a waveform file during the numerical calculation setting enabled, you can choose whether to overwrite the existing numerical calculation settings with those of the waveform file.

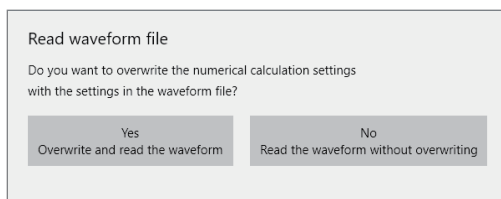

Read waveform file

Do you want to overwrite the numerical calculation settings with the settings in the waveform file?

Yes  
Overwrite and read the waveform

No  
Read the waveform without overwriting

## 4.4 Managing Files

Opening Explorer allows you to manage data saved in storage devices.

### Operation available on Explorer

Changing storage devices	Storage devices can be changed.
Sorting files	Files on a file list can be sorted based on the chosen basis.
Moving files to a folder	Files can be moved to a folder of your choice.
Copying files	Files can be copied to a specified folder. When you choose folders to be copied, the chosen folders are copied to the specified folder.
Creating a folder	A new folder can be created.
Renaming a file	A file or folder can be renamed.
Deleting files	Files and folders can be deleted.
Format	A storage device can be formatted.

### To open the explorer

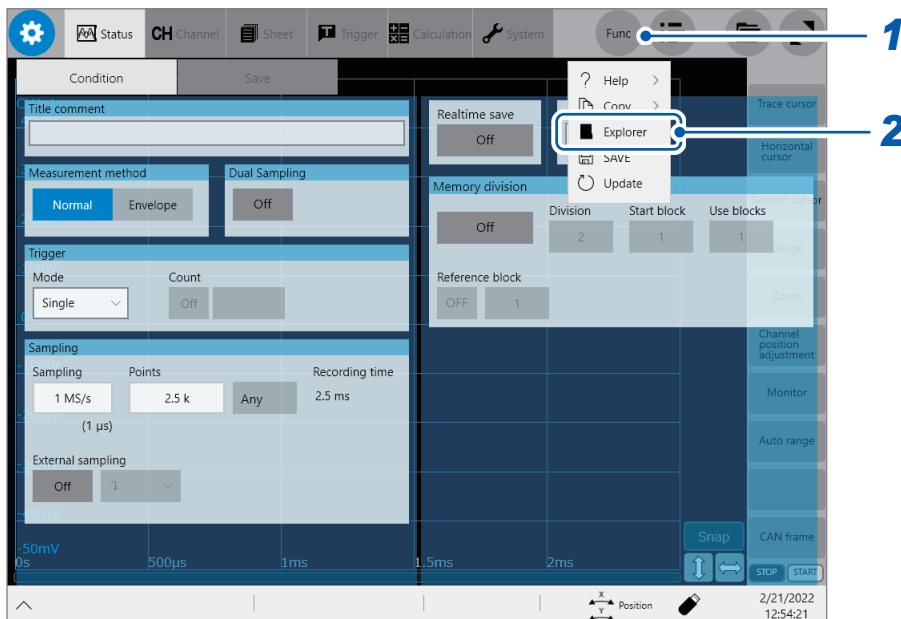

**1** Tap [Func].

**2** Select [Explorer].

Explorer appears.

Choose a storage device to be operated.

# 5

# Configuring the Trigger Settings

The trigger function allows you to start and stop measurement using specific signals. When recording is started or stopped by specific signals, it is called “The instrument is triggered.”

When the real-time saving is set to **[On]**, you cannot use the trigger function.

In this chapter, the mark **T** represents the point the start trigger is activated; the mark **T** represents the point the stop trigger is activated.

In the descriptions of each trigger source, the mark **T** represents a point each trigger condition is satisfied and a point each trigger is generated.

 > **[Trigger]** > **[Common]**

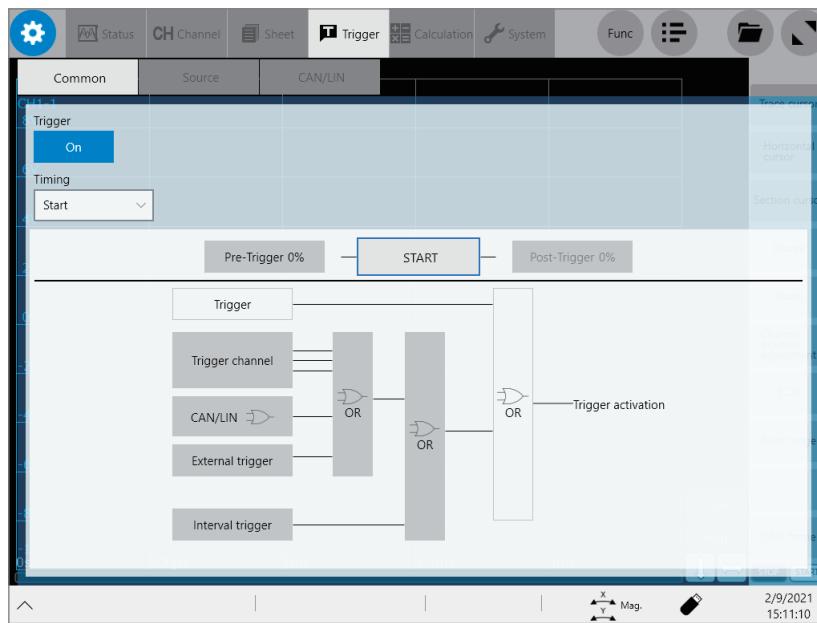

## Operation available on the **[Trigger]** screen

### Configuring the trigger setting

- Trigger timing (p. 140)
- Pre-trigger, post-trigger (p. 142)
- Trigger satisfaction condition (logical AND or OR operation) among the trigger sources (p. 147)

### Configuring the trigger source settings

#### Configuring the analog trigger settings (p. 149)

- Level trigger
- Window trigger
- Period trigger
- Glitch trigger
- Voltage drop trigger

#### Configuring the interval trigger settings (p. 160)

#### Configuring the external trigger settings (p. 162)

#### Forcible trigger (p. 162)

#### Configuring the logic trigger settings (p. 158)

- Logic-trigger satisfaction conditions
- Trigger filter
- Trigger pattern

#### CAN trigger (p. 163)

You can configure the trigger setting so that the instrument can output an signal from the external control terminals when the trigger activates.

See “External trigger terminal (EXT.TRIG)” (p. 391).

## 5.1 Trigger Setting Procedure

- The instrument is triggered based on trigger satisfaction conditions (logical AND or OR operation) among trigger sources except for the forcible trigger. (p. 147)
- When triggered, the instrument outputs the TRIG.OUT signal from the external control terminal. (p. 389)

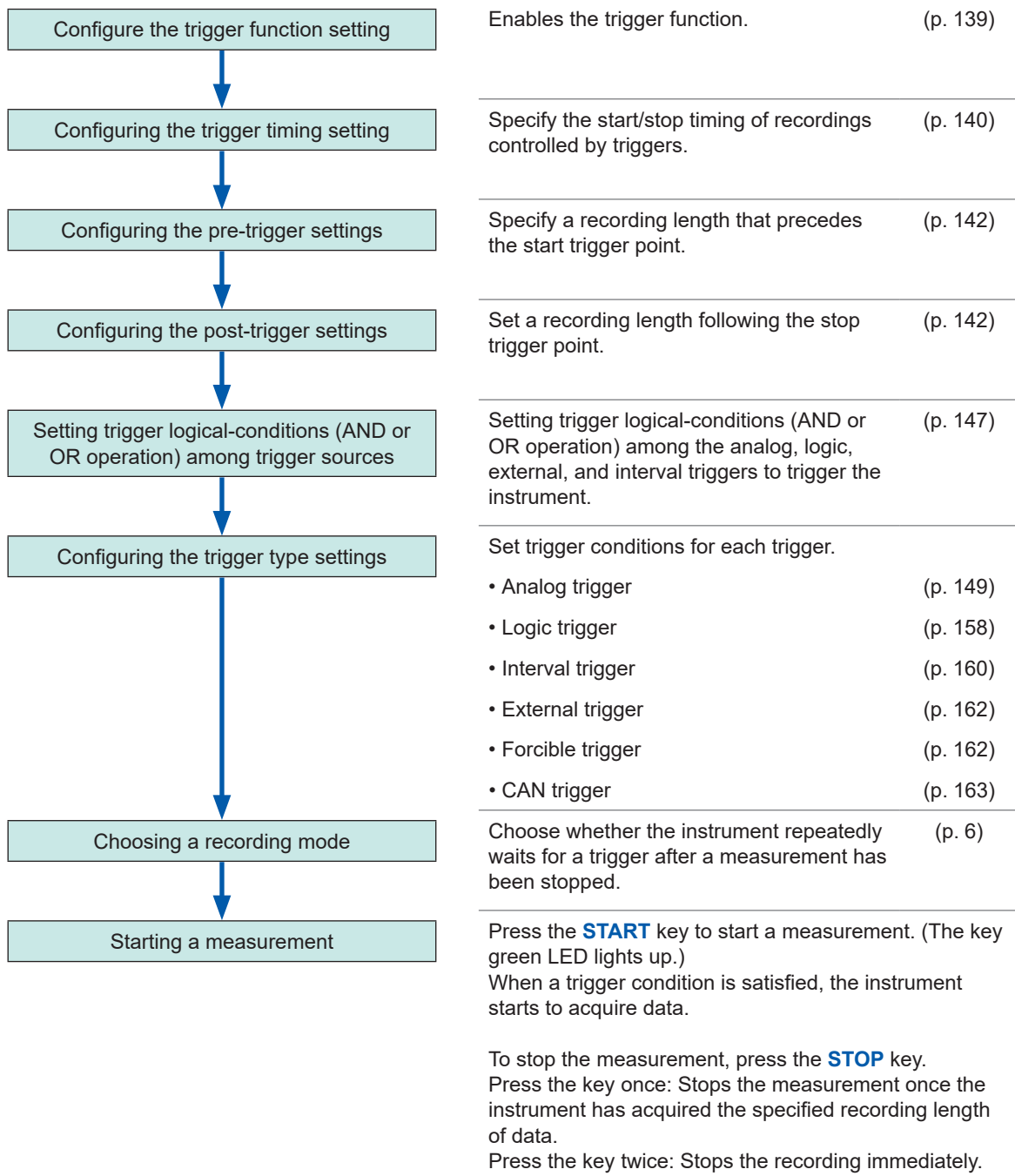

# 5.2 Enabling the Trigger Function

> [Trigger] > [Common]

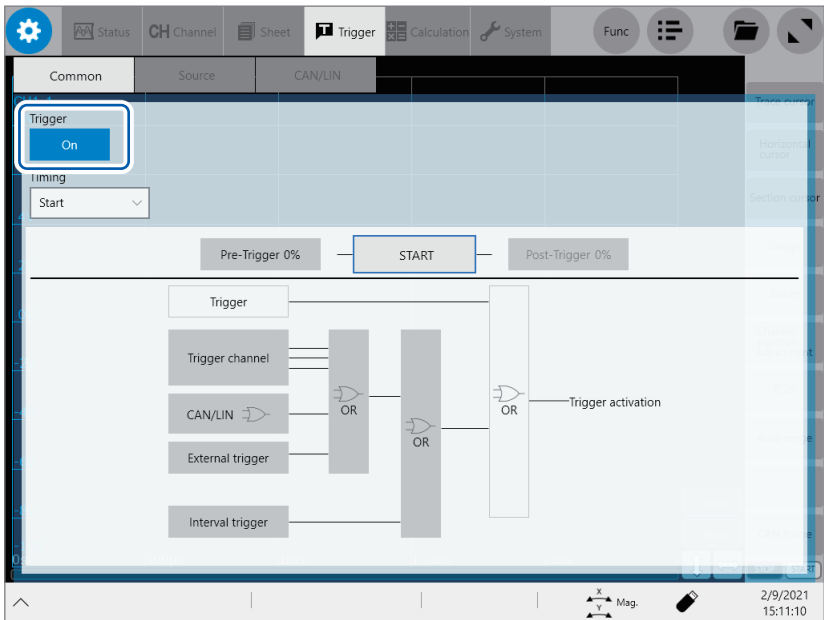

Tap the [Trigger] button to set it to [On].

<b>Off</b>	Disables the trigger function.
<b>On</b>	Enables the trigger function.

### To copy settings to other channels

You can copy settings on the analog trigger setting screen. See "3.6 Copying Settings (Copy Function)" (p. 66).

## 5.3 Configuring the Trigger Timing Setting

Configure the waveform recording settings the instrument follows when it is triggered.

 > [Trigger] > [Common]

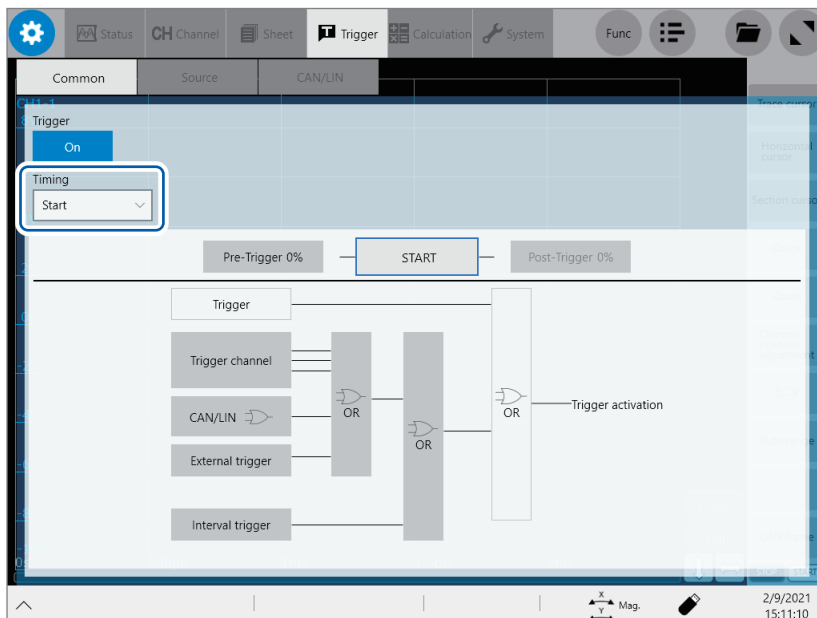

**1** Tap the [Timing] box, and then choose a trigger recording method from the list.

<b>Start</b> <sup>☑</sup>	Starts recording when the instrument is triggered, and stops the recording after the instrument has acquired the recording length of waveforms.
<b>Stop</b>	Starts recording when you press the <b>START</b> key, and stops the recording when the instrument is triggered.
<b>Start/Stop</b>	Starts recording when a start trigger is activated and records data until a stop trigger is activated.

When Model U8975 4ch Analog Unit or MR8990 Digital Voltmeter Unit or both are included in the measurement modules, the displayed trigger point may lag behind the actual trigger point by one sample.

## Trigger timing

Behavior varies depending on the recording mode.

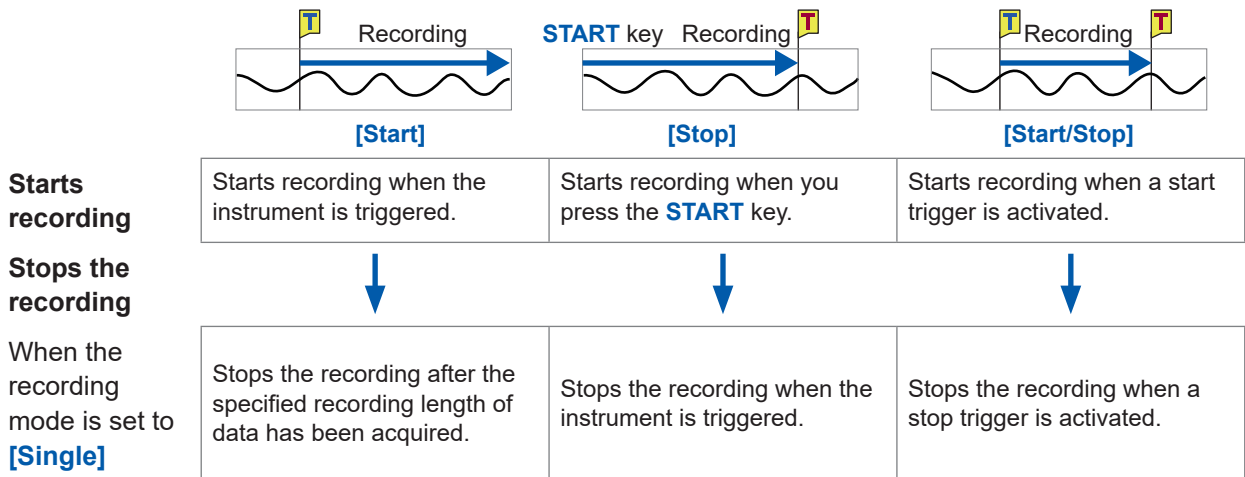

**When the instrument is not triggered even after the specified recording length has elapsed**

**[Stop]** or **[Start/Stop]**: Stops the recording after acquiring the specified recording length of data.

When the recording mode is set to **[Repeat]**

Starts recording, stops the recording after the specified recording length of data has been acquired, and then waits for a trigger. When triggered again, starts recording, stops the recording after the specified recording length of data has been acquired, and then waits for a trigger (repeats this sequence).	When triggered, stops the recording, and then starts another recording. (repeats this sequence).	When a stop trigger is activated, stops the recording, and then waits for a start trigger. When the start trigger is activated again, starts another recording until the stop trigger is activated one more time (repeats this sequence).
---	--	---

**When the instrument is not triggered even after the specified recording length has elapsed**

**[Stop]**: After having acquired the specified recording length of data, the instrument starts another recording. The instrument repeats this sequence until it is triggered.

**[Start/Stop]**: Starts recording, stops the recording after having acquired the specified recording length of data, and then waits for a start trigger.

### Example of trigger timing

When the trigger type is set to the level trigger; level, level, at 0.000 V; and slope, to positive [↗]

Setting of **[Timing]**

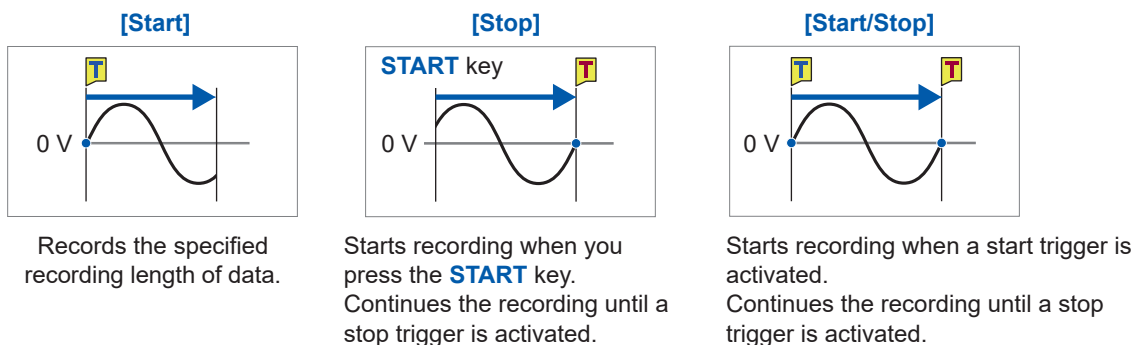

The above processes are repeated when the recording mode is set to **[Repeat]**.

## 5.4 Configuring the Pre-trigger and Post-trigger Settings

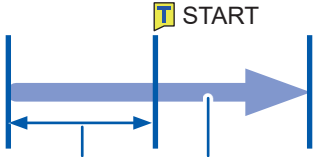
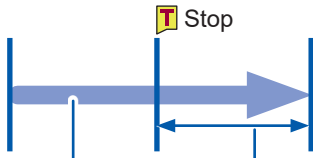
<p><b>Pre-Trigger</b></p>	<p>You can record not only waveforms that appear after a start trigger has been activated, but also those that appear before the trigger is activated.</p> <p>Setting of timing:  <b>[Start], [Start/Stop]</b></p>	<p><b>Also records data before the start trigger.</b></p>  <p>Specified pre-trigger      Recording length or recording time</p>
<p><b>Post-Trigger</b></p>	<p>You can also record waveforms that appear after the specified recording length elapses from the stop trigger point.</p> <p>Setting of timing:  <b>[Stop], [Start/Stop]</b></p>	<p><b>Also records data after the stop trigger.</b></p>  <p>Recording length or recording time      Specified post-trigger length</p>

The pre-trigger and post-trigger are expressed as a percentage of the recording length (unit: percent).

- Setting all the trigger sources (including analog and interval triggers) to **[Off]** disables pre-trigger and post-trigger settings.
- The setting of the recording length or the recording time is prioritized over the post-trigger setting.

Example

When the recording length is set at 10,000 points and the post-trigger length at 30%, and the stop trigger is activated after the instrument measures 8000 points of waveforms, the instrument records only 2000 points of the waveforms after the stop trigger has been activated.



> [Trigger] > [Common]

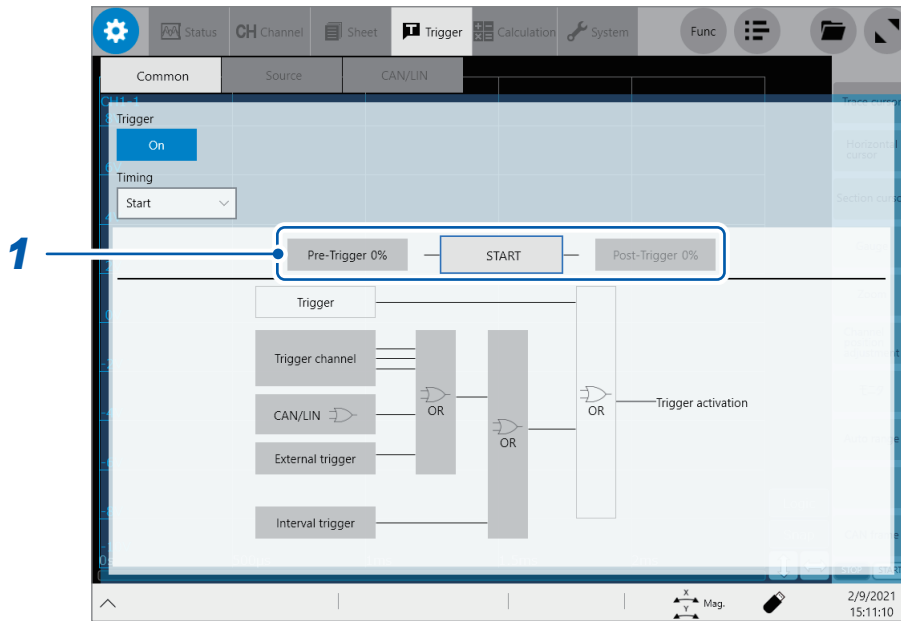

- 1 Tap [Pre-Trigger 0%] or [Post-Trigger 0%].  
The setting dialog box appears.

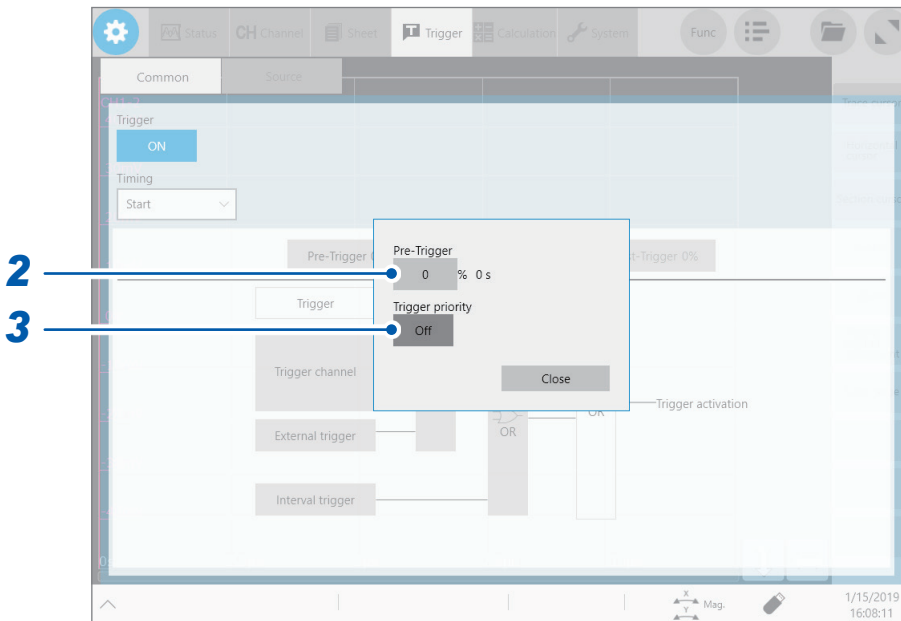

- 2 Tap the [Pre-trigger] or [Post-trigger] boxes, and then enter a pre- or post-trigger length.

<b>Pre-Trigger</b>	0% <input checked="" type="checkbox"/> to 100%
<b>Post-Trigger</b>	0% <input checked="" type="checkbox"/> to 40%

See “For saving data acquired without using the envelope on Model U8333 HD Unit” (p. 400).  
When setting both [Pre-Trigger] and [Post-Trigger] in combination, make sure that the total percentage points of [Pre-Trigger] and [Post-Trigger] is 80% or less.

**Difference between [Waiting for Pre-Trigger] and [Waiting for Trigger]**

When starting a measurement, the instrument starts filling the pre-trigger memory. During this period, the instrument displays the message [Waiting for Pre-Trigger]. After having filled the pre-trigger memory, the instrument displays the message [Waiting for Trigger] until it is triggered. While displaying [Waiting for Pre-Trigger], the instrument is not triggered even when a trigger condition is satisfied.

**Pre-trigger, post-trigger, and recording range**

- Using the pre-trigger along with the start trigger setting

When the pre-trigger length is set at 95%:  
Records the recording length of waveforms, 95% of which appear before the start trigger point.

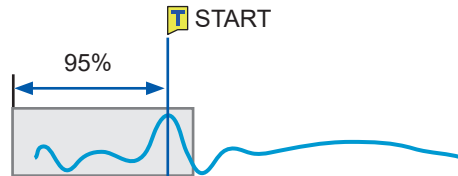

When the pre-trigger length is set at 50%:  
Records the recording length of waveforms, 50% of which appear before the start trigger point.

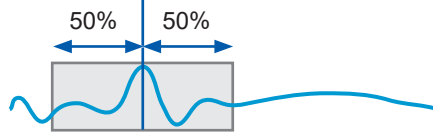

- Using the post-trigger along with the stop trigger setting

When the post-trigger length is set at 20%:  
Also records data after the stop trigger.

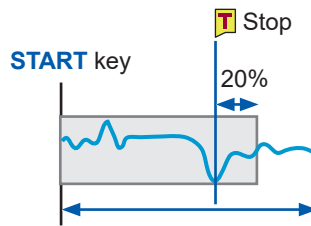

Period of time shorter than the specified recording length or recording time

- Using the pre-trigger and post-trigger along with the Start/Stop triggers setting

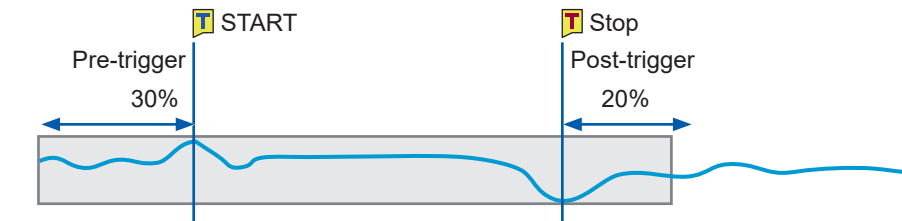

Records 30% of the recording length of waveforms that appear before the start trigger point.

Also records 20% of the recording length of waveforms that appear after the stop trigger point.

**3** Tap the **[Trigger priority]** button to choose a way to handle triggers activated while the instrument is filling the pre-trigger memory.

You can choose whether the instrument is triggered when the trigger conditions are satisfied while the instrument is filling the pre-trigger memory.

<b>Off</b>	Ignores triggers while filling the pre-trigger memory.
<b>On</b>	Accepts a trigger while filling the pre-trigger memory.

**When the trigger conditions are satisfied while the message **[Waiting for Pre-Trigger]** is being displayed**

Example: When the pre-trigger length is set to 50%

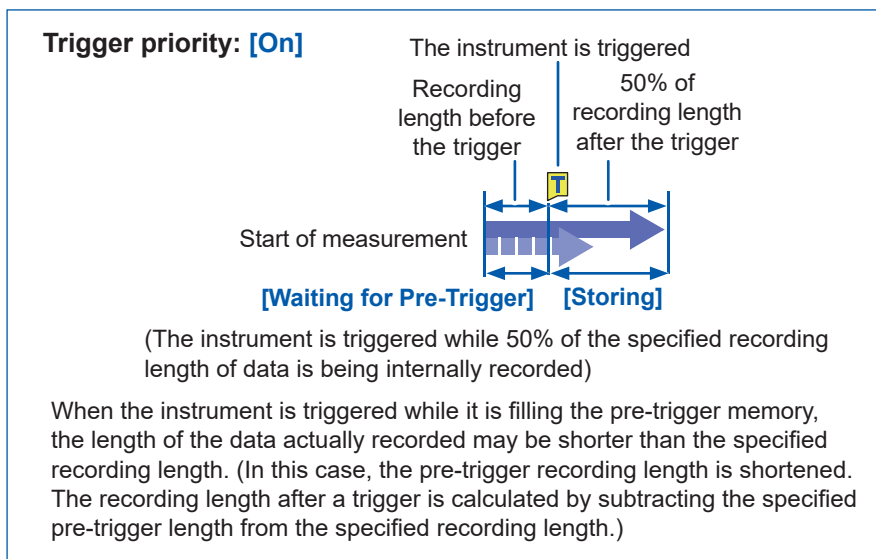
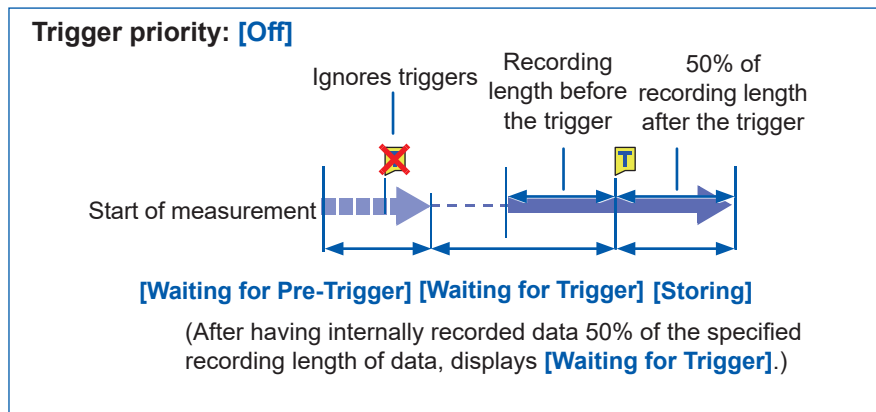

## To observe an input waveform while the instrument is waiting for a trigger

### 1 Tap [Waveform monitor].

A waveform acquired across one of any channels is displayed.



### 2 Tap [CH $\blacktriangle$ ] or [CH $\blacktriangledown$ ] to choose a channel to be displayed.

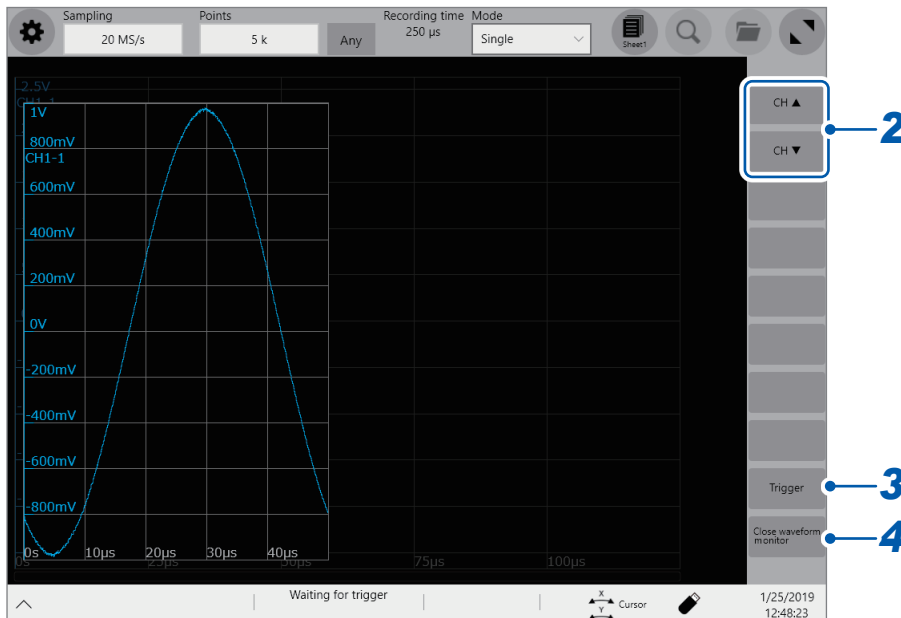

### 3 Tap [Trigger].

You can forcibly trigger the instrument.

### 4 Tap [Close waveform monitor].

The screen restores to the waveform screen.

## 5.5 Setting the Trigger Satisfaction Conditions (AND/OR Operation) Among Trigger Sources

Set the trigger satisfaction conditions among the analog, logic, CAN, external, and interval triggers by choosing between logical AND or OR operation.

The forcible trigger triggers the instrument regardless of the trigger satisfaction conditions setting. If all trigger sources are set to off (i.e., with no trigger setting), recording starts immediately (free run).

 > [Trigger] > [Common]

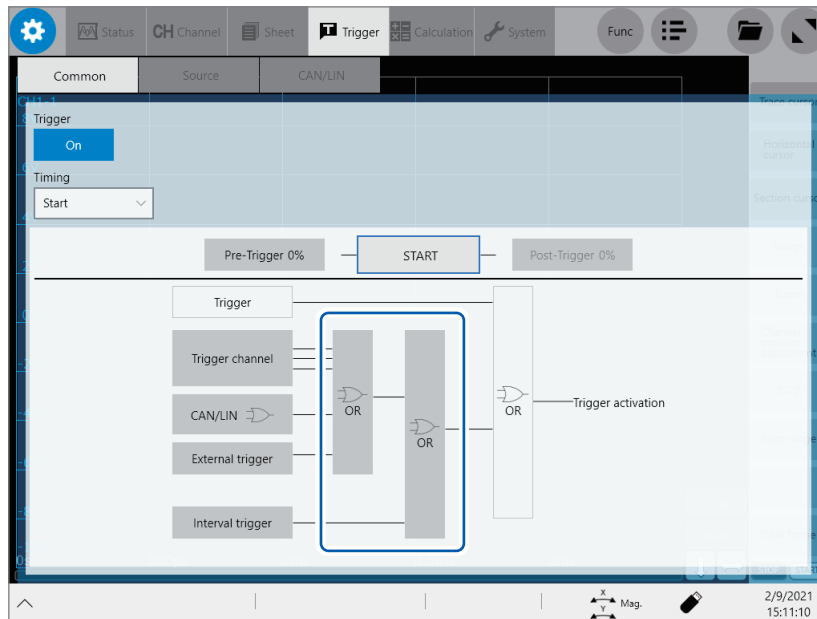

Tap **[AND]** or **[OR]**, whichever is displayed, to switch to the other.

<b>OR</b> <sup>□</sup>	When any one of the specified trigger conditions changes from not being satisfied to being satisfied (at a changing point), the instrument is triggered. Thus, even though a trigger condition has been already satisfied at the start of waiting for a trigger, the instrument is not triggered until a changing point is detected.
<b>AND</b>	Only when all of the specified trigger conditions are satisfied, the instrument is triggered. Thus, if all the specified trigger conditions have been already satisfied at the start of waiting for a trigger, the instrument is immediately triggered.

**Setting example: To trigger the instrument when a waveform crosses the zero-volt level while rising ([↗]\*)**

The instrument is triggered based on whether the trigger satisfaction condition is set to AND or OR operation in the following ways:

Channel	Trigger	Level	Slope	Filter
CH1, CH2	Level	0.00 V	↗*	Off

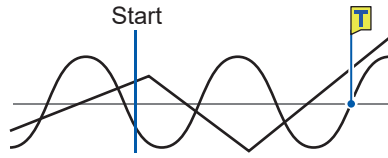

**[AND]**

One waveform is above 0 V, and the other is also above 0 V.

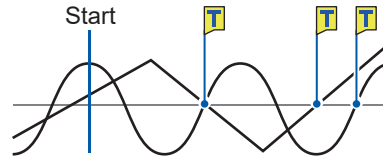

**[OR]**

Either waveform crosses 0 V upwards.

When the trigger timing is set to **[Start/Stop]**, the instrument determines that a logical AND or OR operation is satisfied in a set of trigger sources assigned to the start trigger or those assigned to the stop trigger.

\*: With the **[AND]** setting, the slope setting item appears as **[HIGH]**.

## 5.6 Triggering the Instrument Using Analog Signals (Analog Trigger)

This section explains how to configure the analog trigger settings and types of the analog triggers.

 > [Trigger] > [Source]

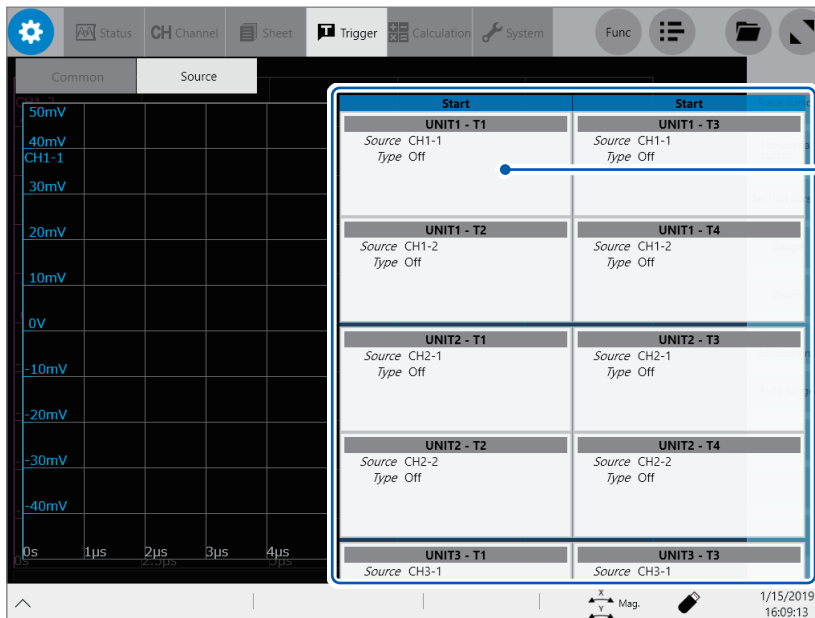

- 1 Tap a trigger source to be set.  
The setting dialog box appears.

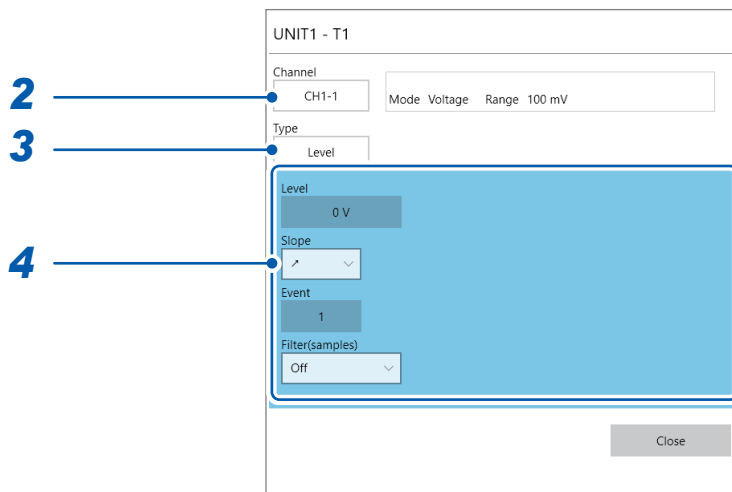

- 2 Tap the [Channel] box, and then from the list, choose a channel you want to set a trigger condition for.  
See "Settable channels for each trigger source" (p. 150).

- 3 Tap the [Type] box, and then choose a trigger type from the list.

Off, Level, In, Out, Voltage drop, Period-in, Period-out, Glitch

- 4 Configure each trigger-type-specific setting.

### Settable channels for each trigger source

Trigger source	Module (UNIT) channel	Calculation channel
UNIT1 – T1, T3	Channels of UNIT1	W1
UNIT1 – T2, T4		W2
UNIT2 – T1, T3	Channels of UNIT2	W3
UNIT2 – T2, T4		W4
UNIT3 – T1, T3	Channels of UNIT3	W5
UNIT3 – T2, T4		W6
UNIT4 – T1, T3	Channels of UNIT4	W7
UNIT4 – T2, T4		W8
UNIT5 – T1, T3	Channels of UNIT5	W9
UNIT5 – T2, T4		W10
UNIT6 – T1, T3	Channels of UNIT6	W11
UNIT6 – T2, T4		W12
UNIT7 – T1, T3	Channels of UNIT7	W13
UNIT7 – T2, T4		W14
UNIT8 – T1, T3	Channels of UNIT8	W15
UNIT8 – T2, T4		W16



### 1. [Level] trigger

When an input signal crosses the specified level in the positive or negative direction, an analog trigger is generated.

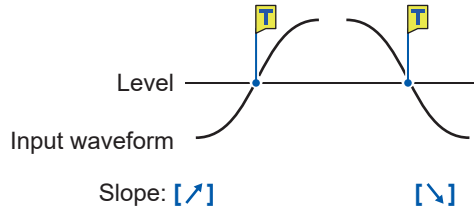

Setting		Description	
<b>Level</b>	-f.s. to +f.s. Default: 0	Allows you to enter a level of the level trigger.	
<b>Slope</b>	<b>With OR</b>	↗	The level-trigger condition is satisfied when a waveform crosses the threshold value (level) while rising.
		↘	The level-trigger condition is satisfied when a waveform crosses the threshold value (level) while falling.
	<b>With AND</b>	<b>HIGH</b>	The level-trigger condition is satisfied when a waveform is higher than the threshold value (level).
		<b>LOW</b>	The level-trigger condition is satisfied when a waveform is lower than the threshold value (level).
<b>Event</b>	<b>With OR</b>	1 to 4,000	Allows you to enter the number of events. The instrument counts the number of times the level-trigger condition is satisfied. An analog trigger is generated when the count reaches the specified number of events.
	<b>With AND</b>		Not available
<b>Filter</b>	<b>Off</b> , 10 to 10,000		Allows you to enter a filter width in the number of samples. Only after the level-trigger condition is continuously satisfied during the specified period, an analog trigger is generated. Specifying this option prevents the instrument from being unintentionally triggered due to noise.
	<b>Off</b> , 1 ms, 10 ms		Allows you to enter a filter width in milliseconds when the envelope is used.

#### With the [Filter] setting

Specifying the filter width prevents analog triggers from being unintentionally generated due to noise, allowing it to be generated only after the level-trigger condition is continuously satisfied during the specified width or longer.

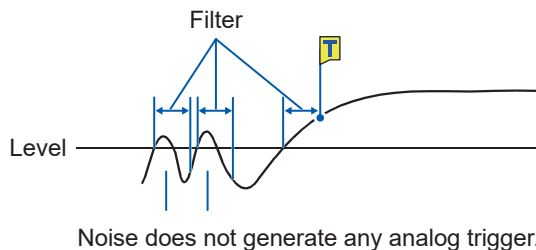

**With the [Event] setting**

If the trigger condition is repeatedly satisfied, setting the number of events prevents an analog trigger from being generated until the number of times the level-trigger condition is satisfied reaches the specified number of counts.

Example: When the number of events is set to [4] (Slope: [↗]).

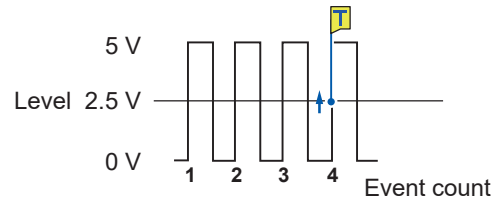

## 2. [In] trigger, [Out] trigger

When an input signal falls within ([In]) or exits of a range ([Out]), which is determined by specifying upper and lower values, an analog trigger is generated. These triggers are disabled when the sampling rate is set at 200 MS/s.

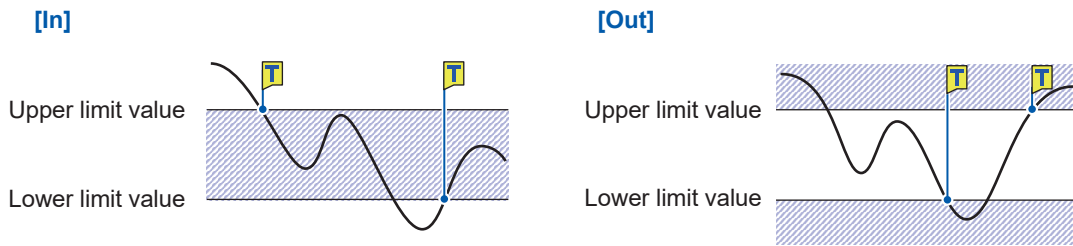

Setting			Description
Event	With OR	1 <sup>□</sup> to 4,000	Allows you to enter the number of events. The instrument counts the number of times the window-trigger condition is satisfied. Only after the count reaches the specified number of events, an analog trigger is generated.
	With AND		Not available
Filter	Off <sup>□</sup> , 10 to 10,000		Allows you to enter a filter width in the number of samples. Only after the window-trigger condition is continuously satisfied during the specified period, the analog trigger is generated. Specifying this option prevents the instrument from being unintentionally triggered due to noise.
	Off <sup>□</sup> , 1 ms, 10 ms		Allows you to enter a filter width in milliseconds when the envelope is used.
Upper	-f.s. to +f.s.		Allows you to enter an upper limit value.
Lower	-f.s. to +f.s.		Allows you to enter a lower limit value.

Behavior with the in trigger and out trigger settings varies depending on the trigger satisfaction conditions (AND and OR operations).

With OR	In	The window-trigger condition is satisfied when an input signal crosses the upper or lower limit value of the threshold (level) and thereby falls within the range, which is specified by the upper and lower limit values of the threshold (level).
	Out	The window-trigger condition is satisfied when an input signal crosses the upper or lower limit value of the threshold (level) and thereby exits the range, which is specified by the upper and lower limit values of the threshold (level).
With AND	In	The window-trigger condition is satisfied when an input signal is inside the range, which is specified by the upper and lower limit values of the threshold (level).
	Out	The window-trigger condition is satisfied when an input signal is outside the range, which is specified by the upper and lower limit values of the threshold (level).

### 3. [Voltage drop] trigger

When a voltage peak is continuously lower than a specified level for a time of half a period or more, the voltage-drop-trigger condition is satisfied. The sampling rate can be set at a figure in the range of 2 kS/s to 100 MS/s.

The external sampling is cannot be set when the envelope is used. These triggers cannot be set either when Model MR8990 or Model 8970 is used.

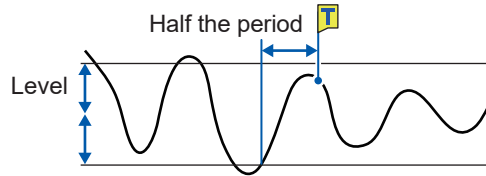

Setting		Description	
<b>Level</b>	0 to +f.s. (100 V <sup>□</sup> )	Allows you to enter a level to be used to check for voltage drops.	
<b>Frequency</b>	50 Hz <sup>□</sup> , 60 Hz	Allows you to choose the frequency of the power to be measured.	
<b>RMS (root-mean-square value)</b>	Varies in conjunction with the level settings	Displays a rough indication of the RMS value.	
<b>Event</b>	<b>With OR</b>	1 <sup>□</sup> to 4,000	Allows you to enter the number of events. The instrument counts the number of times the voltage-drop-trigger condition is satisfied. Only after the count reaches the specified number of events, an analog trigger is generated.
	<b>With AND</b>		

Behavior of the voltage drop trigger varies depending on the trigger satisfaction conditions (AND and OR operations).

<b>With OR</b>	As soon as the instrument determines that a voltage peak became lower than a specified level for a time of half a period or more, the voltage-drop-trigger condition is satisfied.
<b>With AND</b>	While a voltage peak is lower than a specified level for a time of half a period or more, the voltage-drop-trigger condition is continuously satisfied.

#### 4. [Period-in] trigger and [Period-out] trigger

The instrument measures periods of an input waveform, which are time lags between consecutive two points at which an input voltage crosses the specified level in the positive or negative direction. The period-trigger condition is satisfied when a period is inside the specified range (In) or outside the specified range (Out).

An trigger point lags behind the actual trigger point by one sample. These triggers are disabled when the sampling rate is set at 200 MS/s.

The external sampling is cannot be set when the envelope is used. These triggers cannot be set either when Model MR8990 and Model 8970 is used.

See “Setting of the period range” and “[Period-out] trigger” (p. 156).

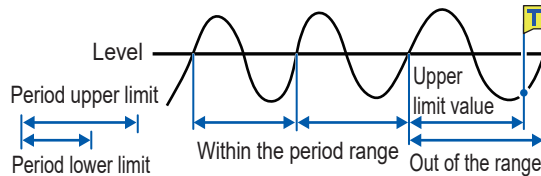

Setting		Description	
Level	-f.s. to +f.s. Default: 0	Allows you to enter a level for detecting the rising or falling slopes of a signal.	
Slope	↗, ↘	Allows you to choose which of the following points to use to calculate periods: two consecutive points at which a signal crosses the specified level while rising; or those while falling.	
Period lower limit*	Zero or 5 times the sampling period or more	The lower limit of periods cannot be set to a value higher than that in the [Period upper limit] box. When the lower limit of periods is set to [0], the instrument ignores the value in the [Period lower limit] box, and the period-trigger condition is satisfied using the value in the [Period upper limit] box only.	
Period upper limit*	20,000 times or less of the sampling period	The higher limit of periods cannot be set to a value lower than that in the [Period lower limit] box.	
Event	With OR	1 to 4,000	Allows you to enter the number of events. The instrument counts the number of times the period-trigger condition is satisfied. Only after the count reaches the specified number of events, an analog trigger is generated.
	With AND		Not available
Filter	Off, 10 to 10,000	Allows you to enter a filter width in the number of samples. Only after the period-trigger condition is continuously satisfied during the specified period, an analog trigger is generated. Specifying this option prevents the instrument from being unintentionally triggered due to noise.	

\*: Configurable ranges of the period lower limit and period upper limit vary according to the sampling rates (periods).

## Setting of the period range

The period range settings of the period trigger vary depending on the sampling periods (sampling rates).

(The setting value of the period range also changes in conjunction with the sampling period [sampling rate] setting.)

Select [Status] > [Condition] > [Sampling] and check the sampling rate setting.

### To set the period-trigger condition such that it is satisfied when an input frequency exceeds the upper limit value (when the period becomes shorter)

Set [Type] to [Period-in] and set [Period lower limit] at [0]. The instrument ignores a value in the [Period lower limit] box, and the period-trigger condition is satisfied when an input frequency exceeds a value in the [Period upper limit] box.

### To set the period-trigger condition such that only when an input frequency falls below the upper limit value (when the period becomes longer):

Set [Type] to [Period-out] and set [Period lower limit] at [0]. The instrument ignores a value in the [Period lower limit] box, and the period-trigger condition is satisfied when an input frequency falls below a value in the [Period upper limit] box.

## [Period-out] trigger

The instrument calculates periods by monitoring times when an input signal crosses the specified level in the positive or negative direction, and the period-trigger condition is satisfied when a period exits the specified period range.

Points at which the period-trigger condition is satisfied varies depending on the specified period range and the period of a measuring object.

### When an input signal period is shorter than the specified lower limit of periods (with the slope set to positive [↗]).

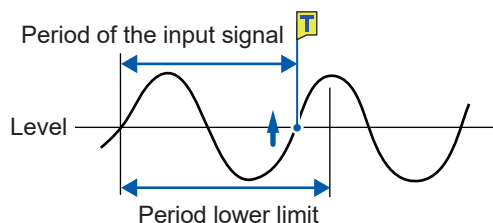

The period-trigger condition is satisfied when a rising slope of an input signal crosses the specified level before the lower limit of periods elapses.

### When an input signal period is longer than the specified upper limit of periods (with the slope set to positive [↗]).

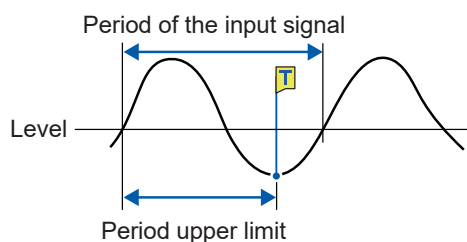

The period-trigger condition is satisfied when the upper limit of periods elapses before a rising slope of an input signal crosses the reference voltage level.

Thus, points at which the period-out-trigger condition is satisfied varies depending on the upper limit of a period range.

### 5. [Glitch] trigger

The glitch-trigger condition is satisfied when a pulse width of an input signal that has crossed the specified level is shorter than the specified width. These triggers are disabled when the sampling rate is set at 200 MS/s.

The external sampling is cannot be set when the envelope is used. This trigger cannot be set when Model MR8990 is used.

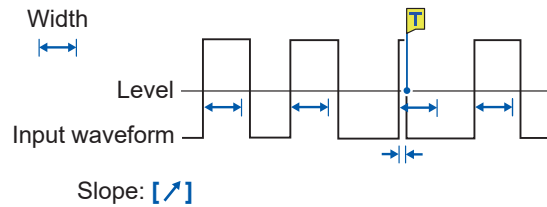

Setting		Description
<b>Level</b>	<b>-f.s. to +f.s.</b> Default: 0	Allows you to specify a level for detecting glitches.
<b>Slope</b>	↗, ↘	Allows you to choose which of the following points to use to detect glitches: two consecutive points at which a signal crosses the specified level while rising; or those while falling.
<b>Event</b>	<b>With OR</b> 1 to 4,000	Allows you to enter the number of events. The instrument counts the number of times the glitch-trigger condition is satisfied. An analog trigger is generated only after the count reaches the specified number of events.
	<b>With AND</b>	Not available
<b>Width</b>	<b>2 times to 4000 times of the sampling period</b>	Allows you to enter a pulse width (time), which is used to determine a glitch. The glitch-trigger condition is satisfied when a pulse width is shorter than the specified width. (The available setting range varies depending on the sampling periods. Lower limit: 2 times sampling period or more; Upper limit: 4000 times sampling period or less)

## 5.7 Triggering the Instrument Using Logic Signals (Logic Trigger)

The section explains the logic trigger function.

- Input signals acquired across the logic channels serve as a trigger source.
- You can set a trigger pattern and trigger satisfaction condition by choosing between logical AND and OR operations. When the logic-trigger conditions are satisfied, a logic trigger is generated.
- With the trigger filter setting, no logic triggers are generated until the logic-trigger condition is continuously satisfied during the specified filter.

 > [Trigger] > [Source]

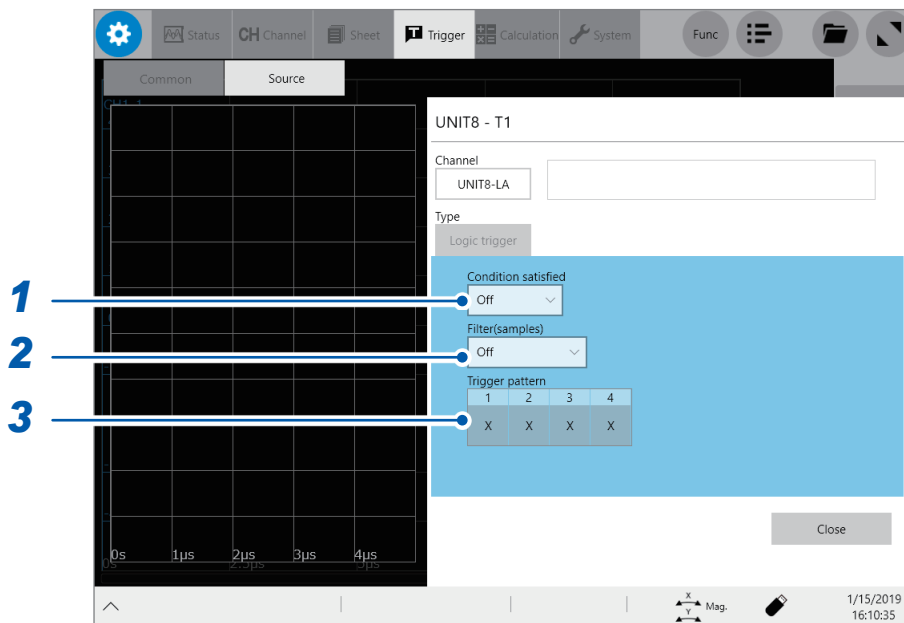

**1** Tap the [Condition satisfied] box, and then choose a logic-trigger satisfaction condition from the list.

<b>Off</b> <input checked="" type="checkbox"/>	Disables the logic trigger.
<b>OR</b>	The logic-trigger condition is satisfied when any one of logic input signals matches the trigger pattern.
<b>AND</b>	The logic-trigger condition is satisfied when all logic input signals match the trigger pattern.

**2** Tap the [Filter] box, and then choose a sampling count of the filter from the list.

Only after the level-trigger condition is continuously satisfied during the specified period, an analog trigger is generated. Configuring the trigger filter setting prevents a logic trigger from being unintentionally generated due to noise. (p. 151)

<b>Off</b> <input checked="" type="checkbox"/>	Disables the trigger filter.
<b>10 to 10000</b>	Enables the trigger filter. Allows you to enter a filter width in the number of samples.

When the envelope is used

<b>Off</b> <input checked="" type="checkbox"/>	Disables the trigger filter.
<b>1 ms, 10 ms</b>	Enables the trigger filter.



**3** Tap each of the signals under [Trigger pattern] to set a logic-trigger pattern.

X	Ignores a signal.
0	The logic-trigger condition for each logic signal is satisfied when the signal is at a low level.
1	The logic-trigger condition for each logic signal is satisfied when the signal is at a high level.

**Setting example**

The logic-trigger conditions differ depending on the combination of the [Condition satisfied] setting (logical OR or AND operation) and the [Trigger pattern] setting as follows:

**OR**

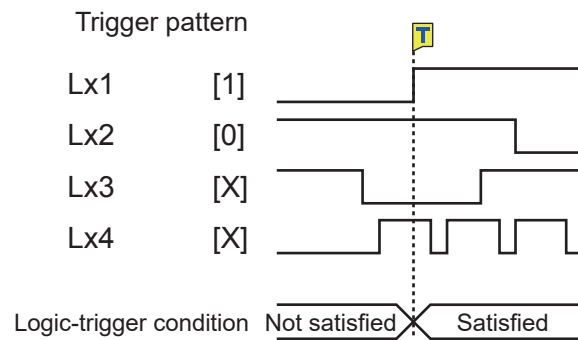

**AND**

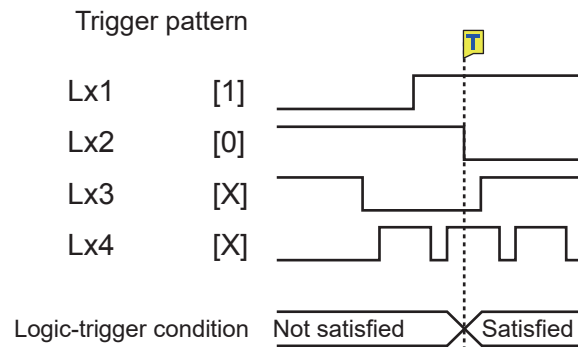

## 5.8 Triggering the Instrument at Regular Intervals (Interval Trigger)

Start triggers can be activated at specified intervals. Setting the recording mode to **[Repeat]** allows the instrument to record waveforms at regular intervals.

- When using the pre-trigger, the instrument starts monitoring interval-trigger times after the first pre-trigger time elapses since the start of measurement.
- No start triggers are activated by any interval triggers while the instrument is filling the pre-trigger memory. An interval trigger triggers the instrument while the instrument is waiting for a trigger after the instrument has filled the pre-trigger memory.
- Since the clock is internally corrected, displayed trigger times may not synchronize with the intervals of the interval trigger.

 > **[Trigger]** > **[Common]**

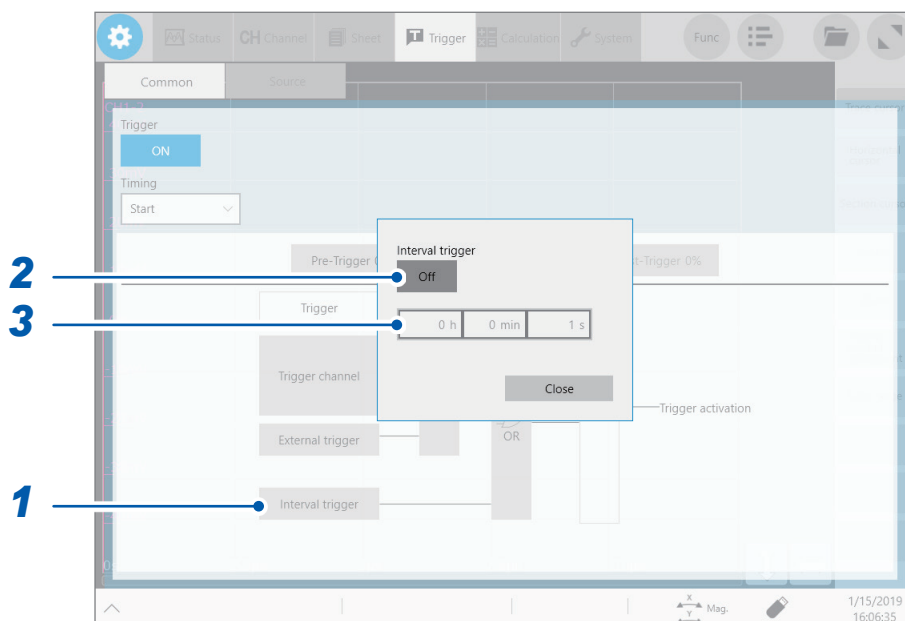

**1** Tap **[Interval trigger]**.

**2** Tap **[Interval trigger]** to set it to **[On]**.

**3** Tap the **[h]**, **[min]**, and **[s]** boxes, and then enter a period of time for interval triggers.

An internal trigger is generated at the start of measurement, and triggers are repeatedly generated at the specified intervals.

### Acquiring data at regular intervals (relation between a time interval and a recording length or recording time)

The instrument is not triggered until having acquired data that has the specified recording length or recording interval.

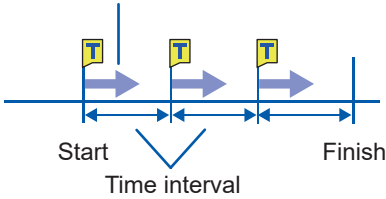
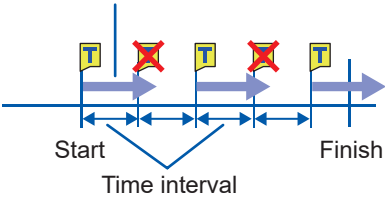
When a recording length or recording time is shorter than a time interval	When a recording length or recording time is longer than a time interval
<p>The instrument records data that has the specified recording length or recording time.</p> 	<p>The instrument records data that has the specified recording length or recording time.</p> 

## 5.9 Externally Triggering the Instrument (External Trigger)

External signals applied to the external control terminals can serve as trigger sources. External signals can also be used to operate multiple instruments in synchronization with each other.

See “External trigger terminal (EXT.TRIG)” (p. 391).

## 5.10 Manually Triggering the Instrument (Forcible Trigger)



Tapping **[Trigger]** on the right side of the waveform screen allows you to manually trigger the instrument while the instrument is waiting for a trigger.

The forcible trigger triggers the instrument regardless of other trigger source settings.

To stop the recording, press the **STOP** key.

Press the key once: Stops the measurement once the instrument has acquired the specified recording length of data.

Press the key twice: Stops the recording immediately.

## 5.11 Triggering the Instrument Using CAN Signals (CAN Trigger)

The instrument can be triggered using CAN signals as a trigger source.  
The instrument is triggered when the CAN signal that meets the set type and ID is inputted.

 > [Trigger] > [CAN]

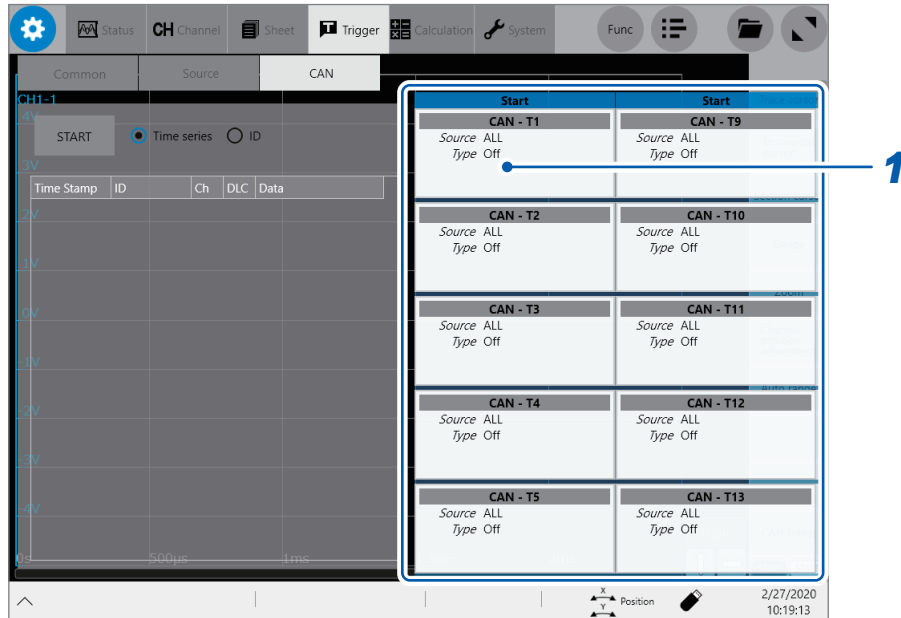

- 1 Tap a trigger source area you wish to configure.  
The setting dialog box is displayed.

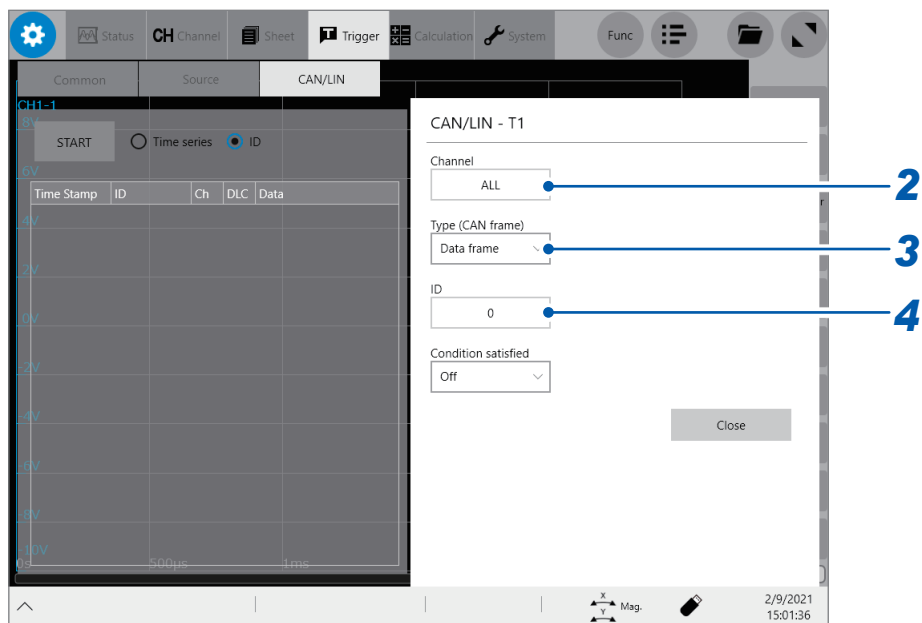

- 2 Tap the [Channel] box, and then from the list, choose a channel of which you wish to configure trigger conditions.  
When [ALL] is selected, CAN signals inputted across any channels can trigger the instrument.

**3** Tap the **[Type]** box, and then from the list, choose a trigger type.

Off , Data frame, Error frame, Remote frame

**4** (When **[Data frame]** or **[Remote frame]** is set in the **[Type]** box)

In the **[ID(HEX)]** box, enter a message ID set as the trigger source in hexadecimal.

Hexadecimal is a positional system that represents numbers using a base of 16. In addition to the ten numbers, 0 to 9, it uses the alphabets, A to F to represent values ten to fifteen, respectively.

Decimal	0	1	2	3	4	5	6	7	8	9	10	11	12	13	14	15	16	...
Hexadecimal	0	1	2	3	4	5	6	7	8	9	A	B	C	D	E	F	10	...

**5** (When you choose **[Data frame]** in the **[Type]** box)

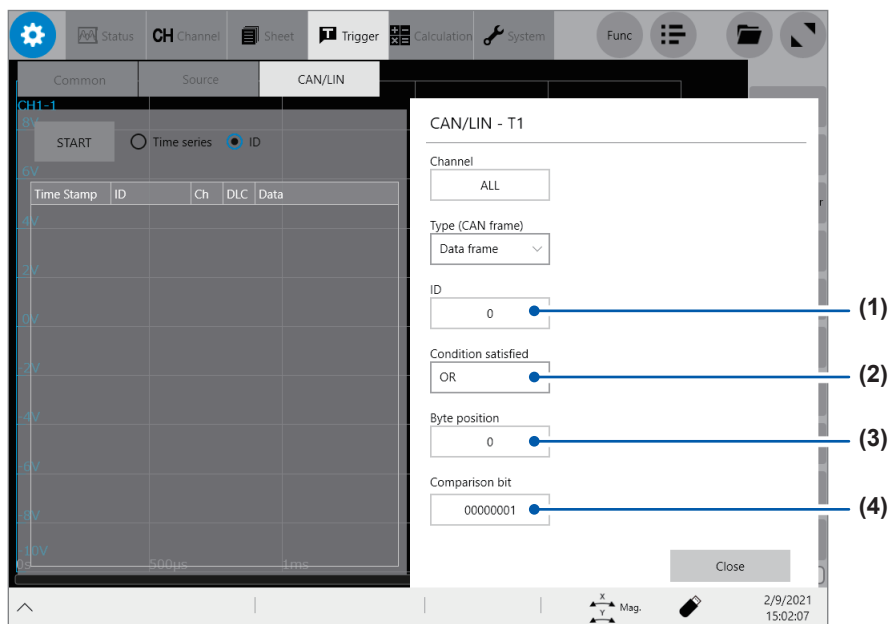

(1) Tap the **[ID]** box, and then set the message ID you wish to use as the trigger source. Use hexadecimal notation.

(2) Tap the **[Condition satisfied]** box, and then from the list, choose a CAN-trigger satisfaction condition.

Off <input checked="" type="checkbox"/>	Does not use the trigger pattern. The CAN-trigger condition is satisfied when a signal of the specified ID is input.
OR	The CAN-trigger condition is satisfied when any one of CAN input signals matches the trigger pattern.
AND	The CAN-trigger condition is satisfied when all CAN input signals match the trigger pattern.

(3) Tap the **[Byte position]** box, and then specify the byte location you wish to use as the trigger source.

0 to 63

(4) Tap the **[Comparison bit]** box, and then set the CAN-trigger pattern.

<b>X</b>	Ignores a signal.
<b>0</b>	The CAN-trigger condition for each CAN signal is satisfied when the signal is at a low level.
<b>1</b>	The CAN-trigger condition for each CAN signal is satisfied when the signal is at a high level.

The CAN-trigger conditions are defined, as with the logic-trigger conditions, depending on the combination of the condition setting of satisfaction and the trigger pattern setting. See “5.7 Triggering the Instrument Using Logic Signals (Logic Trigger)” (p. 158).

You can monitor CAN bus states by tapping **[START]** on the CAN trigger setting screen.

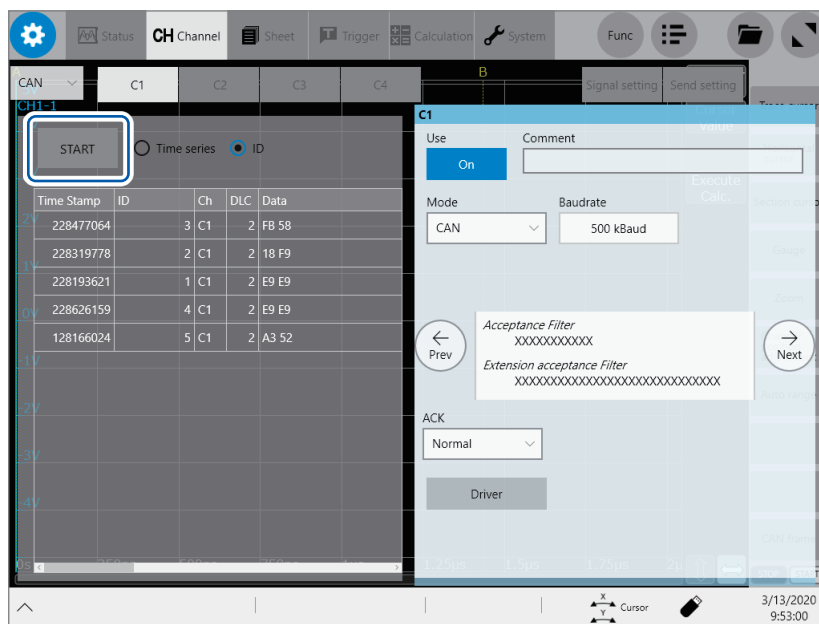

See “Monitor the state of the CAN/LIN bus.” (p. 323).





# 6 Search Function

Using the search function allows you to search measured data for positions where user-defined search conditions have been satisfied and displays search results.

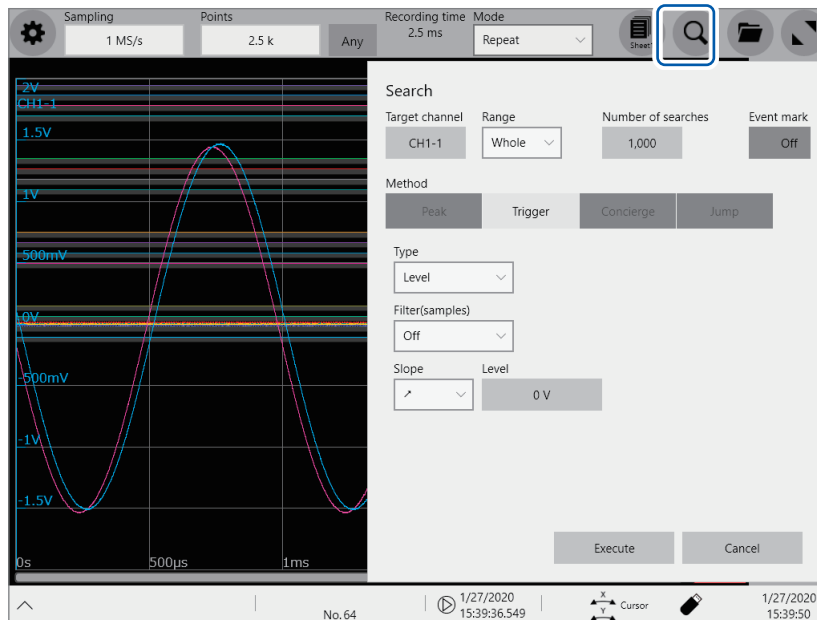

## Operation available on the search screen

### Peak search

You can choose from the maximum, minimum, local maximum (maximal), and local minimum (minimal) value to search for it. (p. 168)

### Trigger search

You can set a trigger condition to search for positions where the condition is satisfied. (p. 171)

### Memory HiConcierge

You can specify a fundamental wave to automatically detect differences from the fundamental wave based on a histogram or standard deviation. (p. 176)

### Jump

You can jump to the specified time, trace cursor position, section cursor position, event number, trigger point, or search mark. (p. 179)

## 6.1 Searching For Peak Values

You can choose any one of the maximum, minimum, maximal, and minimal values and search measured data for it.

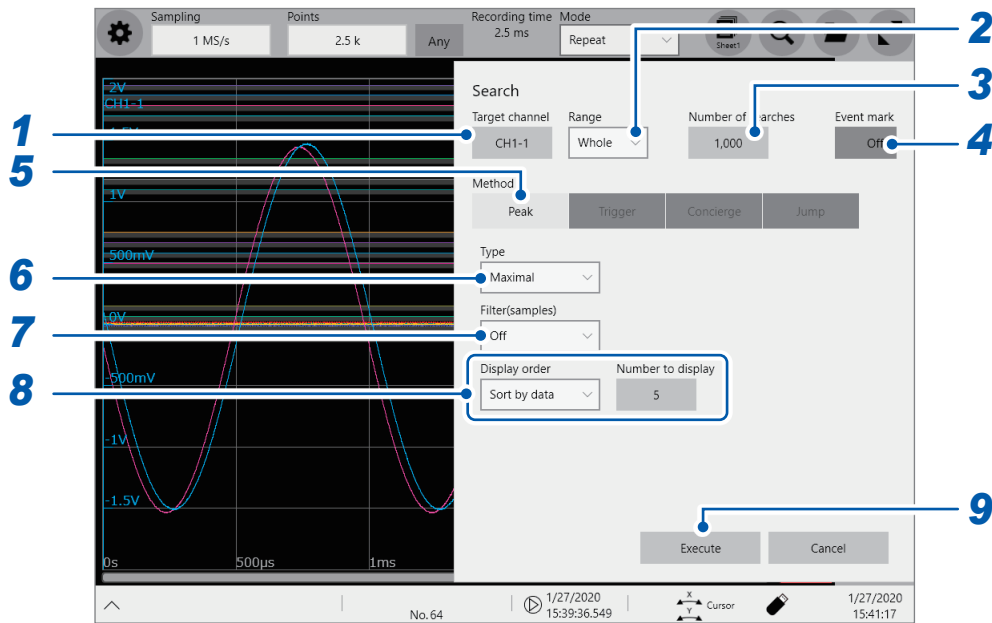

**1** Tap the [Target channel] box, and then from the channel setting dialog box, choose a channels to be searched for values.

**2** Tap the [Range] box, and then choose an option for the search range from the list.

Whole <input checked="" type="checkbox"/>	Searches whole waveform for values.
Segment 1, Segment 2	Search a range specified as Segment 1 or Segment 2 for values.

See “2.2 Specifying the Waveform Range (Section Cursor)” (p. 35).

**3** Tap the [Number of searches] box, and then enter the number of search results.

**4** Tap the [Event mark] box to set whether to display event marks at positions where user-defined search conditions have been satisfied.

On <input checked="" type="checkbox"/>	Displays event marks.
Off	Does not display event marks.

**5** In the [Method] area, tap [Peak] to choose a search method for searching for peak values.

## 6 Tap the **[Type]** box, and then from the list, choose a value type to be searched for.

<b>Maximum</b> <input type="checkbox"/>	Allows you to search for the maximum value.
<b>Minimum</b>	Allows you to search for the minimum value.
<b>Maximal</b>	Allows you to search for maximal values. When the envelope is used, the instrument searches maximum value data for maximal values.
<b>Minimal</b>	Allows you to search for minimal values. When the envelope is used, the instrument searches minimum value data for minimal values.

- If search results have two or more maximum or minimum values, the instrument displays any one of them as a representative value among the search results.
- Search results have multiple maximal or minimal values

## 7 (When you choose **[Maximal]** or **[Minimal]** in the **[Type]** box)

Tap the **[Filter(samples)]** box, and then from the list, choose a decision condition for maximal or minimal values.

<b>Off</b> <input type="checkbox"/>	Regards a value as a maximal value when it is larger than the values found one point before and after, and a minimal value when it is smaller.
<b>10 to 10,000</b>	Regards a value as a maximal value when it is larger than any other value in the range between the specified points before and after, and a minimal value when it is smaller.

## 8 (When you choose **[Maximal]** or **[Minimal]** in the **[Type]** box)

Tap the **[Display order]** box, and then from the list, choose a sequence to sort.

<b>Sort by time</b> <input type="checkbox"/>	Displays the search results in chronological order. You cannot set the <b>[Number to display]</b> box. The instrument handles up to 1000 search results. The instrument stops the search if it retrieves more than 1000 results.
<b>Sort by data</b>	With the <b>[Maximal]</b> setting, displays search results the number of which is specified in the <b>[Number to display]</b> box in descending order. With the <b>[Minimal]</b> setting, displays them in ascending order.

(When you choose **[Sort by data]** in the **[Display order]** box)

Tap the **[Number to display]** box, and then enter the number of search results to be displayed.

## 9 Tap **[Execute]**.

The instrument puts search marks (  ) on positions where the search condition is satisfied. The **[Search Pos.]** switching panel appears on the waveform screen.

**To stop the search**

Press the **STOP** key.

**10** Change retrieved positions using the [Search Pos.] switching panel and check the search results.

You can change retrieved positions by tapping [**<**] or [**>**].  
The display order follows the setting in the [Display order] box.

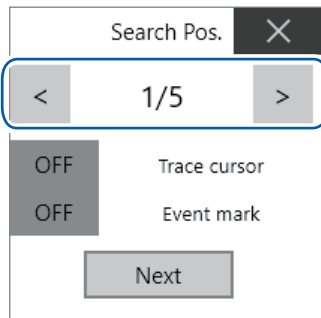

**[Trace cursor]**

Set to [**On**] to move the trace cursor H to the retrieved positions.

**[Event mark]**

Set to [**On**] to place event marks (E) to the retrieved positions.

Tapping [**Next**] executes another search beginning from the next point of the retrieved position presently displayed. The instrument discards a previous search result.

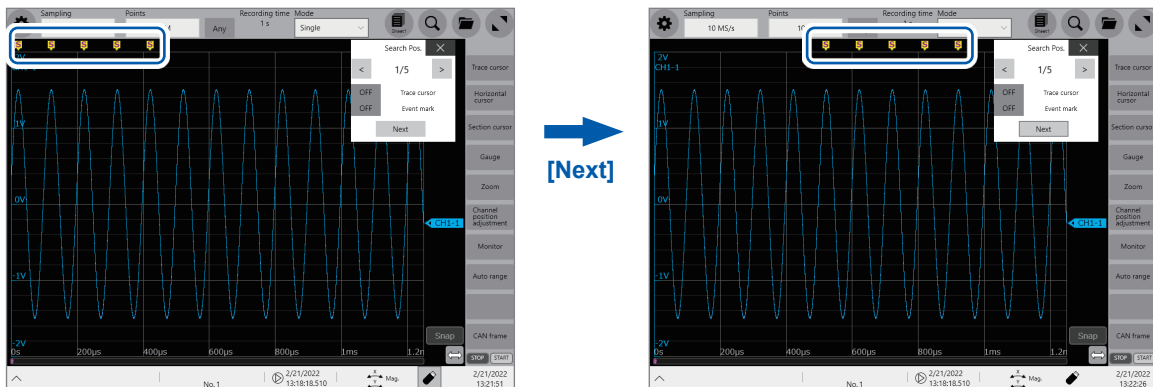

**To specify a retrieved position and jump there**

As described in “6.4 Jumping to the Specified Position” (p. 179), choose [Search number] in the [Type] box, and then tap [Execute].

## 6.2 Searching For Positions Where a Trigger Condition Is Satisfied

Setting a trigger condition allows you to search measured data for positions where the trigger condition is satisfied.



- 1 Tap the [Target channel] box, and then from the channel setting dialog box, choose a channel to be searched for positions where a trigger condition is satisfied.

When you choose an analog channel

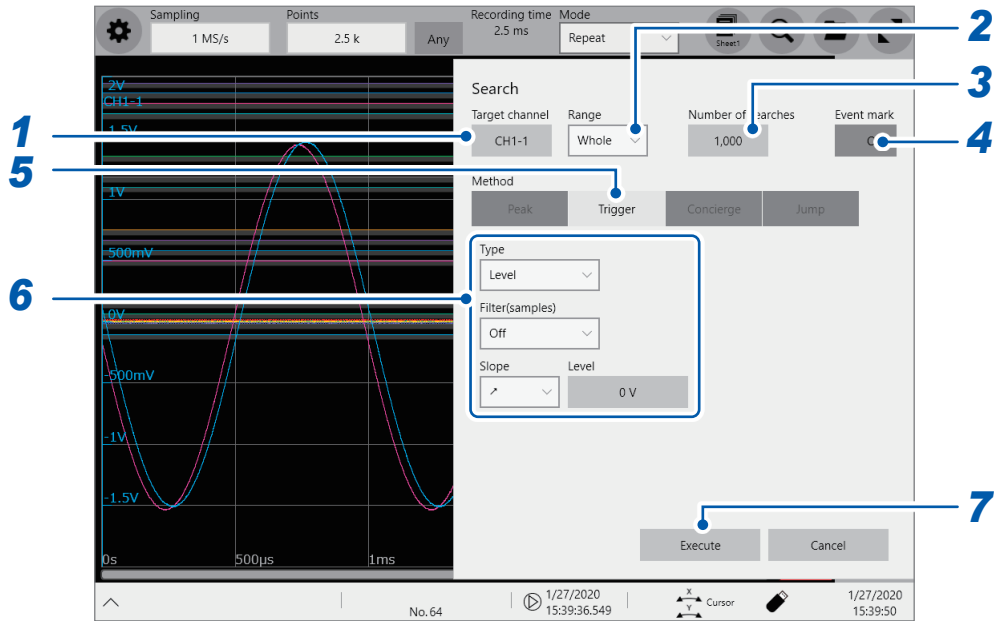

When you choose an logic channel

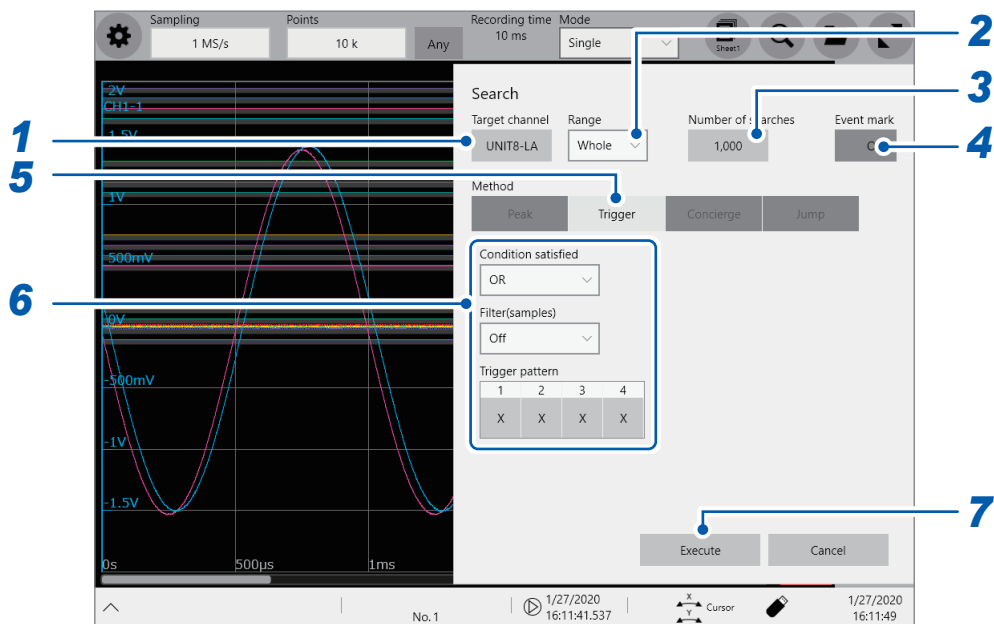

**2** Tap the **[Range]** box, and then from the list, choose an option for a range to be searched for positions where a trigger condition is satisfied

<b>Whole</b> <sup>☑</sup>	Allows you to search whole waveform.
<b>Segment 1, Segment 2</b>	Allows you to search the scope specified as Segment 1 or Segment 2.

**3** Tap the **[Number of searches]** box, and then enter the number of search results.

**4** Tap the **[Event mark]** box to set whether to display event marks at positions where user-defined search conditions have been satisfied.

<b>On</b> <sup>☑</sup>	Displays event marks.
<b>Off</b>	Does not display event marks.

**5** In the **[Method]** area, tap **[Trigger]** to choose a search method for searching for triggers.

**6** Set a search condition.

-1. When you choose an analog channel under **[Target channel]**

Tap the **[Type]** box, and then from the list, choose a trigger type to be searched for.

<b>Level</b> <sup>☑</sup>	Allows you to enter a level and search for positions where a waveform crosses the level.
<b>In</b>	Allows you to enter an upper and lower limit values to specify a range and search for positions where a waveform falls within the range.
<b>Out</b>	Allows you to enter an upper and lower limit values to specify a range and search for positions where a waveform exits the range.

**Setting a search condition.**

Items to be set may vary depending on trigger types.

(1) When you choose **[Level]**

Measurement method: **[Normal]**

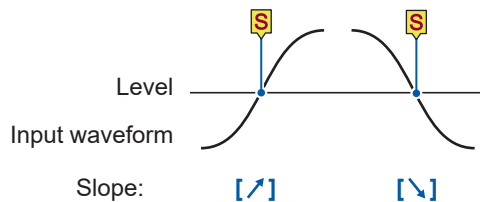

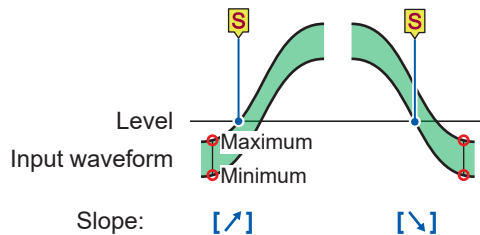

Measurement method: **[Envelope]**



The point where the max. crosses the level

The point where the min. crosses the level

Setting	Description
<b>Filter</b>	<b>Off</b> , <b>10 to 10,000</b>
<b>Slope</b>	 , 
<b>Level</b>	<b>-3.4028E+38 to 3.4028E+38</b> <b>Default: 0</b>

(2) With the [In] or [Out] setting

Measurement method: [Normal]

[In]

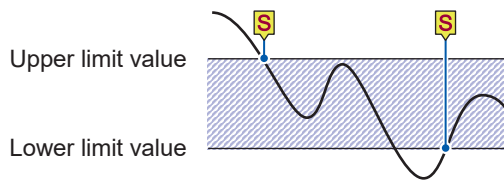

[Out]

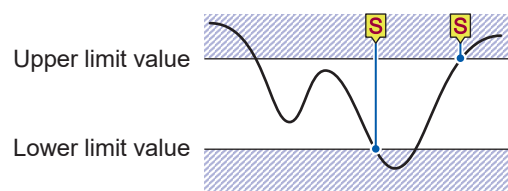

Measurement method: [Envelope]

[In]

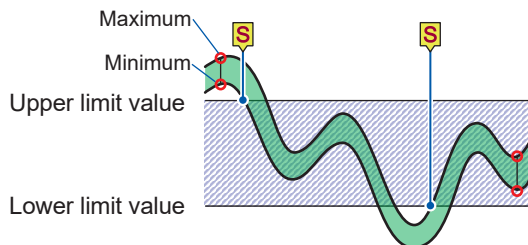

The points where either the max. or min. value falls within the range.

[Out]

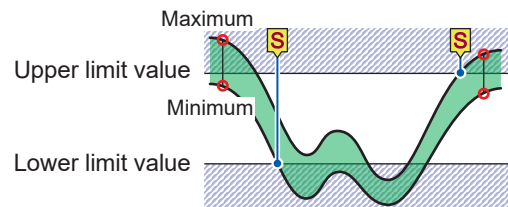

The points where either the max. or min. value gets outside the range.

Setting	Description
<b>Filter</b>	<b>Off</b> , <b>10 to 10,000</b>
<b>Upper limit value</b>	<b>-3.4028E+38 to 3.4028E+38</b> <b>Default: 0.2</b>
<b>Lower limit value</b>	<b>-3.4028E+38 to 3.4028E+38</b> <b>Default: -0.2</b>

**-2. When you choose a logic channel under [Target channel]**

The instrument searches for positions where signals match the specified pattern. You cannot use this function when the envelope function is used.

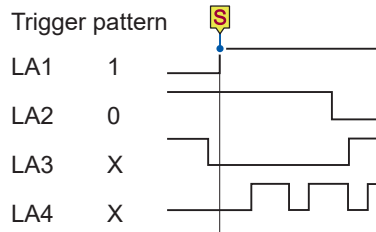

Setting		Description
Condition satisfied	OR <input checked="" type="checkbox"/>	Positions where any one of the signals matches the specified search patterns are determined to be retrieved positions.
	AND	Positions where all signals match the specified patterns are determined to be retrieved positions.
Filter	Off <input checked="" type="checkbox"/> , 10 to 10,000	Allows you to enter a filter width in the number of samples. Positions where a search condition is continuously satisfied during the specified period are determined to be the retrieved positions.
Trigger pattern	X <input checked="" type="checkbox"/>	Ignores data.
	0	Searches for low-level positions.
	1	Searches for high-level positions.

For the logic search, a retrieved position is a point where a condition that has not been satisfied changes to being satisfied. Thus, even if signals match a search pattern at the start of a search, it is not regarded as a retrieved position.

**7 Tap [Execute].**

The instrument puts search marks (S) at positions where a search condition is satisfied. Up to 1000 positions can be retrieved. The instrument stops the search if it finds more than 1000 positions. The retrieved position switching panel appears on the waveform screen.

**To stop the search**

Press the **STOP** key.



**8** Change retrieved positions using the [Search Pos.] switching panel to check search results.

You can change retrieved positions by tapping [**<**] or [**>**].  
The display order follows the setting in [Display order].

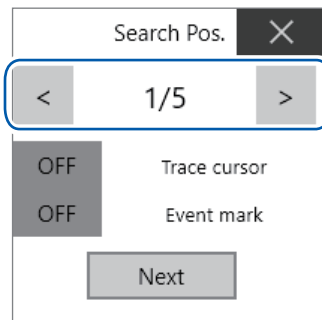

**[Trace cursor]**

Set to **[On]** to move the trace cursor H to the retrieved positions.

**[Event mark]**

Set to **[On]** to place event marks (E) to the retrieved positions.

Tapping **[Next]** executes another search beginning from the next point of the retrieved position presently displayed. The previous search result is discarded.

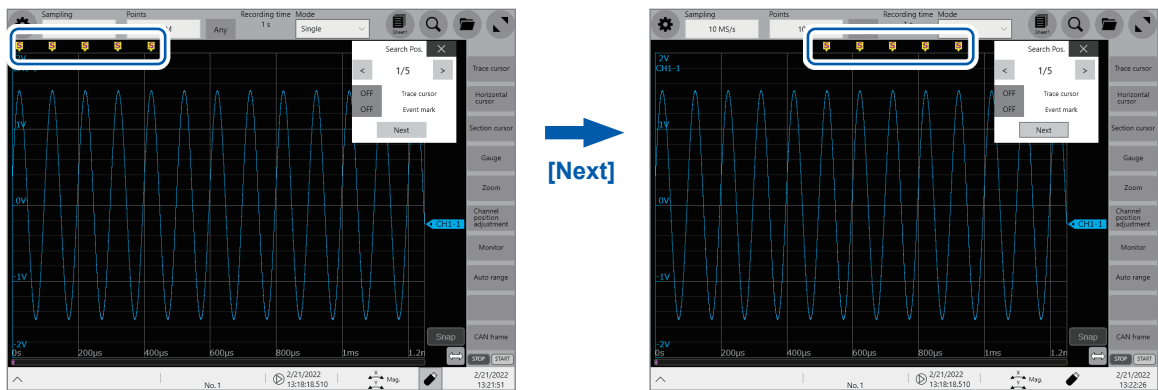

**To jump to a specified retrieved position**

As described in “6.4 Jumping to the Specified Position” (p. 179), choose [Search number] in the [Type] box, and then tap [Execute].

## 6.3 Searching For Differences from a Fundamental Wave (Memory HiConcierge)

You cannot use this function when the envelope function is used.

Using Memory HiConcierge allows you to detect differences from the specified fundamental waveform based on a histogram or standard deviation.

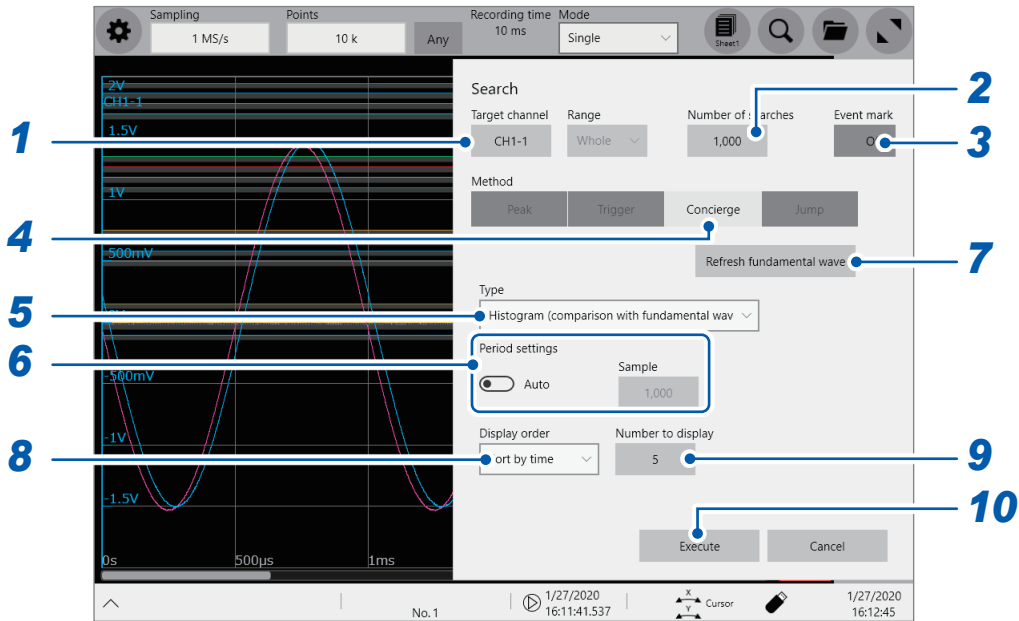

- 1 Tap the [Target channel] box, and then from the channel setting dialog box, choose a channel to be searched for differences.
- 2 Tap the [Number of searches] box, and then enter the number of search results.
- 3 Tap the [Event mark] box to set whether to display event marks at positions where user-defined search conditions have been satisfied.

On <input checked="" type="checkbox"/>	Displays event marks.
Off <input type="checkbox"/>	Does not display event marks.

- 4 In the [Method] area, tap [Concierge] to set the search method to Concierge.

**5** Tap the **[Mode]** box, and then from the list, choose a type to be searched for.

<b>Histogram (comparison with fundamental wave)</b> <sup>☑</sup>	Searches for differences from the specified fundamental wave based on a histogram.
<b>Histogram (comparison with previous waveform)</b>	Searches for differences from the previous waveform based on a histogram.
<b>Standard deviation (comparison with fundamental wave)</b>	Searches for differences from the specified fundamental wave based on a standard deviation.
<b>Standard deviation (Compared with previous waveform)</b>	Search for differences from the previous waveform based on a standard deviation.

Memory HiConcierge searches a whole measured waveform for differences. You cannot specify a segment to be searched.

**6** Use the **[Period settings]** toggle switch to choose a period setting used for searches.

<b>Auto</b> <sup>☑</sup>	Automatically detects the period.
<b>Any</b>	Allows you to tap the <b>[Sample]</b> box to enter the number of samples, which specifies a period.

With the **[Auto]** setting, the instrument may not be able to determine a period depending on measured waveforms. If a fundamental wave have an unintended form, change this setting to **[Any]** and specify a period in terms of the number of samples in the **[Sample]** box.

**7** Tap **[Refresh fundamental wave]** to display a fundamental wave.

The instrument extracts a fundamental wave from the specified period and displays the wave on the screen.

**8** Tap the **[Display order]** list and choose a display order from the list.

<b>Sort by time</b> <sup>☑</sup>	Displays retrieved positions in chronological order.
<b>Sort by data</b>	Displays retrieved positions in order of decreasing difference from a comparison target (fundamental wave or previous waveform).

**9** Tap **[Number to display]** box and enter the number of retrieved points to be displayed.

**10** Tap **[Execute]**.

The instrument puts search marks (**[S]**) at positions where a search condition is satisfied. The retrieved position switching panel appear on the waveform screen.

**To stop the searching**

Press the **STOP** key.

## 11 Change retrieved positions using the [Search Pos.] switching panel to check search results.

You can change the retrieved positions by tapping [**<**] or [**>**].  
The display order follows the setting in [Display order].

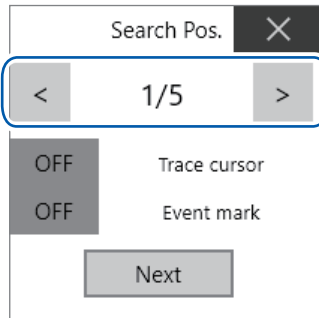

### [Trace cursor]

Set to [On] to move the trace cursor H to the retrieved positions.

### [Event mark]

Set to [On] to place event marks (E) to the retrieved positions.

Tapping [Next] executes another search beginning from the next point of the search result. The previous search result is discarded.

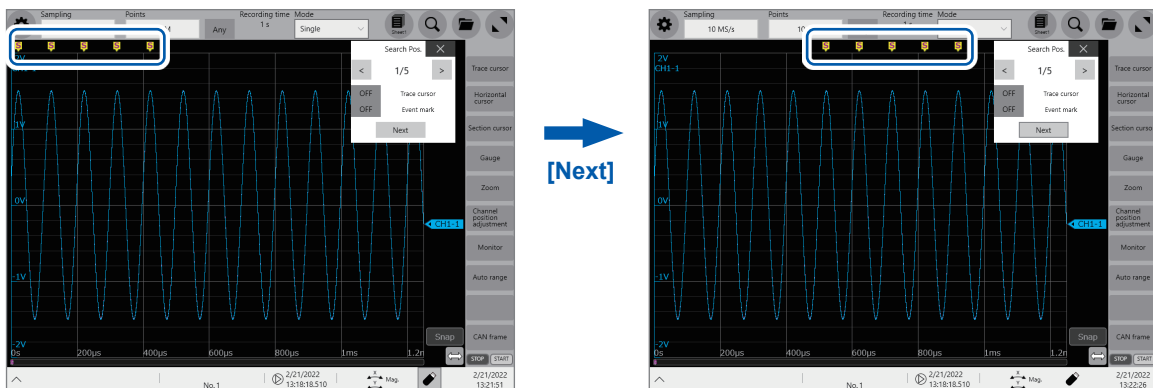

### To jump to a specified retrieved position

As described in “6.4 Jumping to the Specified Position” (p. 179), choose [Search number] in the [Type] box, and then tap [Execute].

## 6.4 Jumping to the Specified Position

You can jump to the specified time, trace cursor position, section cursor position, event number, trigger point, or search mark.

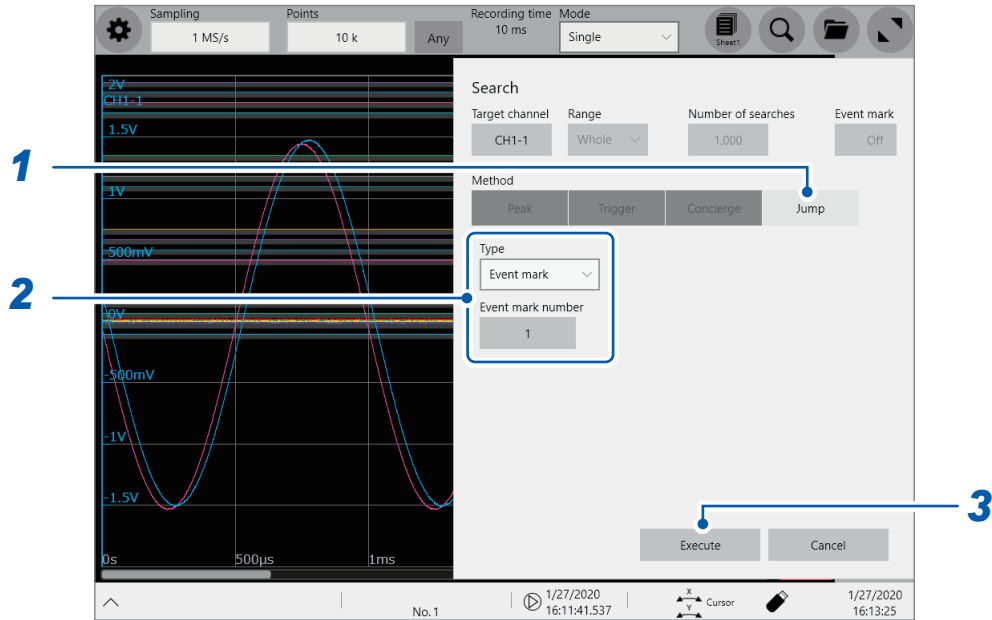

- 1 In the [Method] area, tap [Jump] to set the search method to the jump method.
- 2 Tap the [Type] box, and then from the list, choose a type to jump to.

<b>Event mark</b> <sup>□</sup>	Allows you to enter an event number to jump to in the [Event mark number] box.	
<b>Cursor</b>	Allows you to choose a position, at which a trace cursor or section cursor is specified, to jump to.	
<b>Time</b>	<b>Time</b>	Allows you to enter an absolute time to jump to when ([System] > [Env.] >) [Time value display] is set to [Date].
	<b>Time from trigger point</b>	Allows you to enter a time relative to the trigger point to jump to when ([System] > [Env.] >) [Time value display] is set to [Time] or [Mod 60].
	<b>Points</b>	Allows you to enter the number of points to jump to in the [Points] box when measurement is performed using the external sampling or when ([System] > [Env.] >) [Time value display] is set to [Samples].
<b>Trigger</b>	Jumps to the start or stop trigger point.	
<b>Search number</b>	Allows you to enter a search number to jump to in the [Search number] box.	

### 3 Tap [Execute].

The instrument put search marks (S) at positions where the search condition is satisfied.

When [Type] is set to [Event mark], you can jump to an event mark (E) position.

When [Type] is set to [Search number], you can jump to a search mark (S) position.

The jump-destination switching panel appears on the waveform screen.

### 4 Change jump destinations using the [Search Pos.] switching panel to check jump results.

You can change the retrieved positions by tapping [<] or [>].

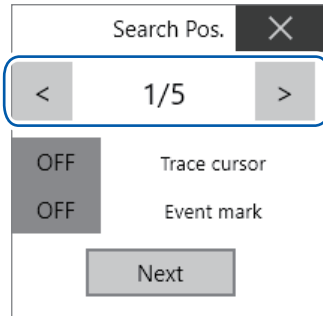

#### [Trace cursor]

Set to [On] to move the trace cursor H to the retrieved positions.

#### [Event mark]

Set to [On] to place event marks to the retrieved positions.

# 7

# Numerical Calculation Function

The instrument performs calculations using acquired waveform data to numerically displays calculation results on the waveform screen. The instrument can evaluate these calculation results on a pass/fail basis.

No numerical calculation is available when the envelope is used.

 > [Calculation] > [Numerical calculation]

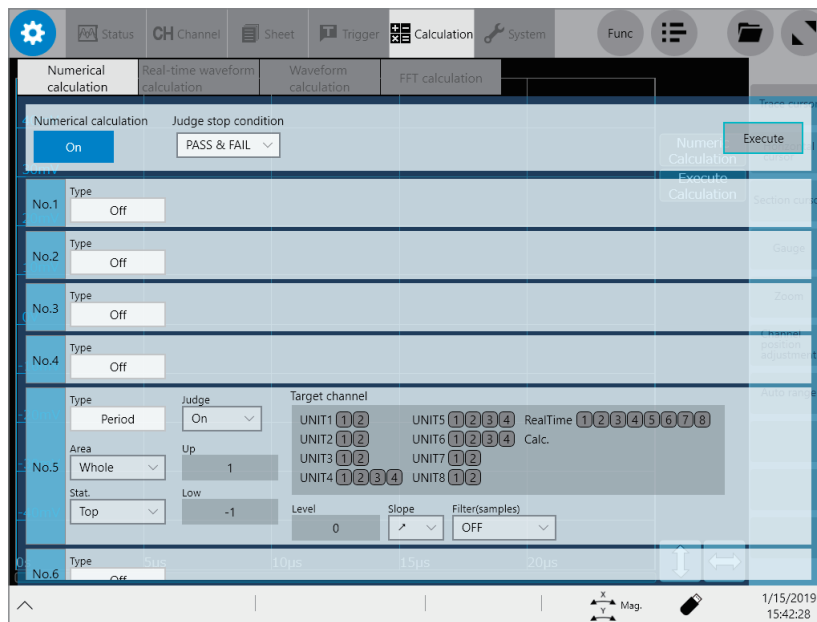

## Operation available on the [Numerical calculation] screen

### Numerical calculation

- Average
- RMS
- P-P
- Maximum
- Time to maximum
- Minimum
- Time to minimum
- Period
- Frequency
- Rise time
- Fall time
- Standard deviation
- Area
- X-Y area
- Time to level
- Level at time
- Pulse width
- Duty ratio
- Pulse count
- Arithmetic operations
- Time difference
- Phase contrast
- High level
- Low level
- Intermediate value
- Amplitude
- Overshoot
- Undershoot
- +Width
- -Width
- Burst width
- Accumulation
- Angle of XY waveform
- CAN statistics (33 types in total)

Calculation using data between section cursors  
Numerical calculations can be performed for data within the range specified with section cursors.

For details on arithmetic expressions, refer to “Calculation target channels and setting contents of calculation conditions for each calculation type” (p. 187).

### Evaluating numerical calculation results on a pass/fail basis(p. 197)

Evaluating numerical calculation results by comparing them with specified reference ranges, giving pass or fail judgments.

The instrument can simultaneously execute up to 32 types of numerical calculations. When the scaling function is enabled, the instrument performs calculations using scaled values.

# 7.1 Numerical Calculation Procedure

The following two methods are available:

Automatically performing calculations after measurement	The numerical calculation settings must be configured before starting a measurement (not available when the real-time saving is set to on).
Performing calculations using existing data	The instrument can perform calculations using waveform data that has already been acquired and that saved on storage devices.

## Performing calculation during measurement

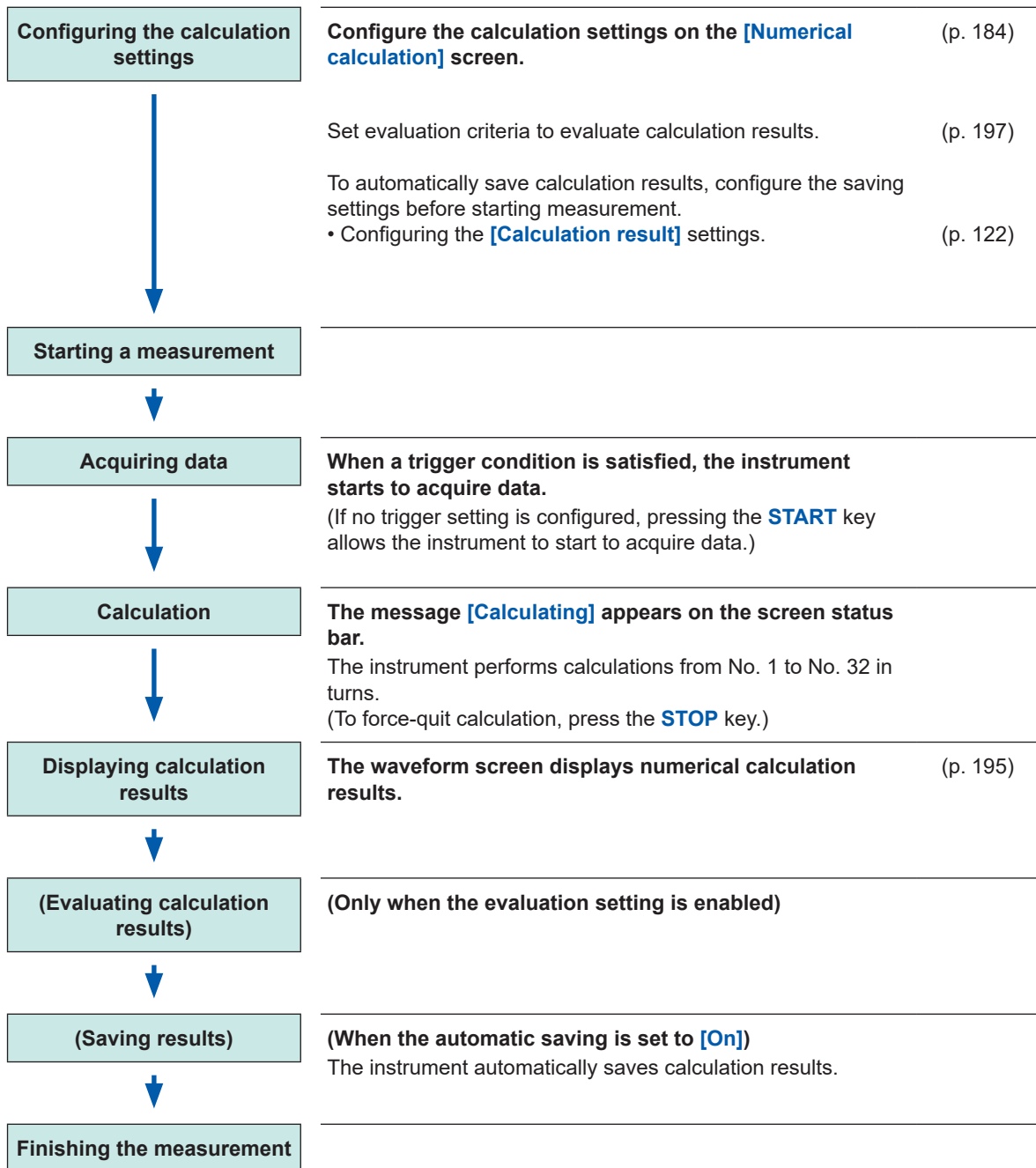



## Performing calculations using existing data

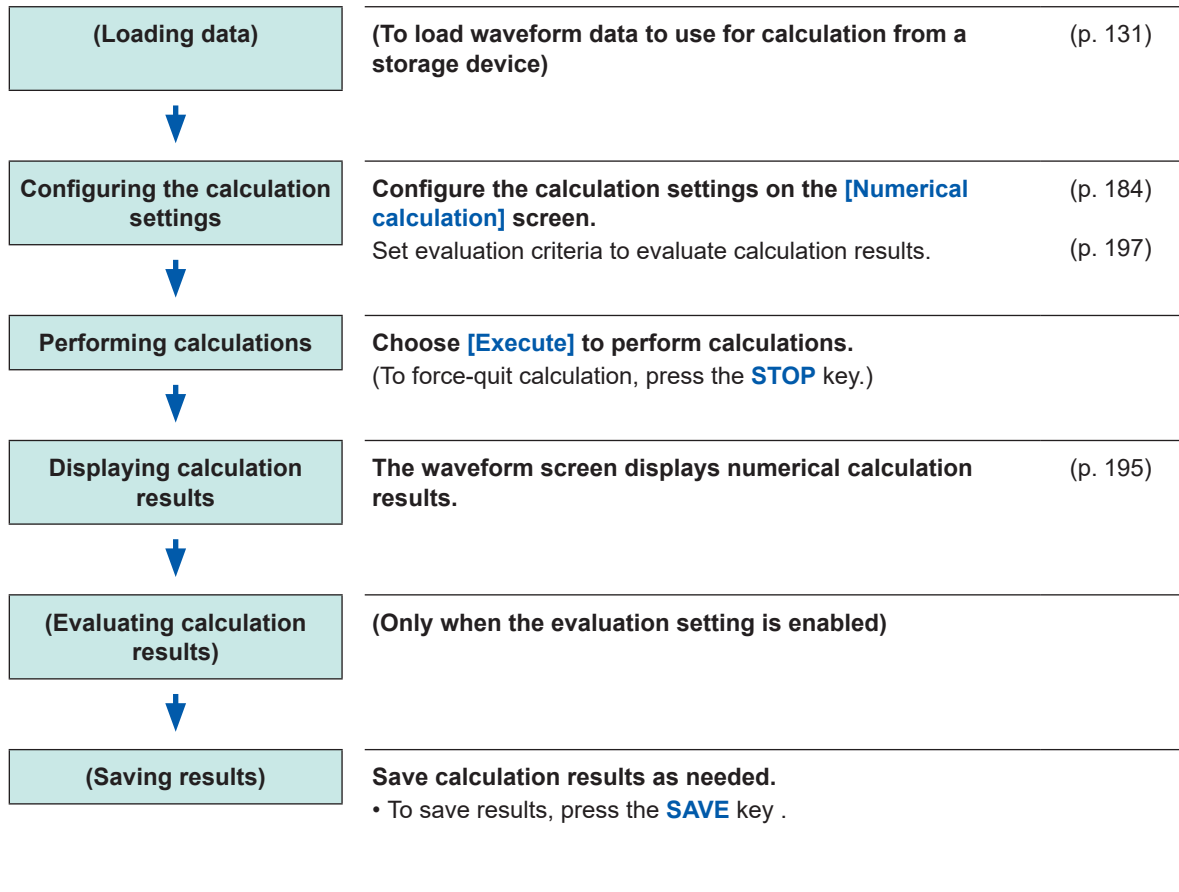

### To specify a calculation range and perform calculation

Before performing calculation, specify a calculation range using section cursors on the waveform screen. Set **[Area]** to **[Segment 1]** or **[Segment 2]** on the **[Numerical calculation]** screen. See “2.2 Specifying the Waveform Range (Section Cursor)” (p. 35) and “7.2 Configuring the Numerical Calculation Settings” (p. 184)

## 7.2 Configuring the Numerical Calculation Settings

 > [Calculation] > [Numerical calculation]

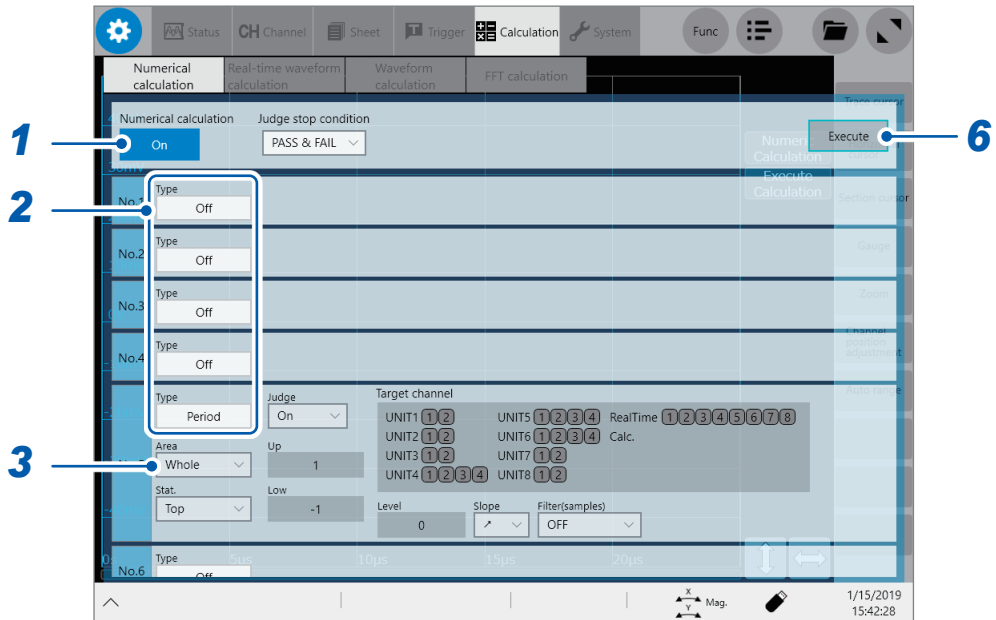

**1** Tap the [Numerical calculation] button to set it to [On].

## 2 Tap the [Type] box, and then choose a calculation type from the list.

<b>Off</b> <sup>☑</sup>	The instrument does not perform any calculation.
<b>Average</b>	Average value of waveform data
<b>RMS</b>	RMS value of waveform data
<b>P-P</b>	Peak-to-peak value of waveform data
<b>Maximum</b>	Maximum value of waveform data
<b>Time to maximum</b>	Period of time elapsed from a trigger point to the time of the maximum value
<b>Minimum</b>	Minimum value of waveform data
<b>Time to minimum</b>	Period of time elapsed from a trigger point to the time of the minimum value
<b>Period</b> <sup>*2</sup>	Period of waveform data
<b>Frequency</b> <sup>*2</sup>	Frequency of waveform data
<b>Rise time</b> <sup>*1</sup>	Rise time of waveform data
<b>Fall time</b> <sup>*1</sup>	Fall time of waveform data
<b>Standard deviation</b>	Standard deviation of waveform data
<b>Area</b>	Area enclosed by the horizontal axis and waveform data
<b>X-Y area</b>	Area enclosed by an XY composite curve
<b>Time to level</b> <sup>*2</sup>	Period of time elapsed from a trigger point to the time when waveform data reached the specified level
<b>Level at time</b> <sup>*2</sup>	Measured value when the specified time has elapsed from a trigger point
<b>Pulse width</b> <sup>*2</sup>	Pulse width of waveform data
<b>Duty ratio</b> <sup>*2</sup>	Duty ratio of waveform data
<b>Pulse count</b> <sup>*2</sup>	Pulse count of waveform data
<b>Arithmetic operations</b>	Four arithmetic operations of numerical calculation results
<b>Time difference</b> <sup>*2</sup>	Time lag between phenomena A and B
<b>Phase contrast</b> <sup>*2</sup>	Time lag between phenomena A and B represented as a phase difference
<b>High level</b> <sup>*1</sup>	High level of waveform data
<b>Low level</b> <sup>*1</sup>	Low level of waveform data
<b>Intermediate value</b>	Intermediate value of waveform data
<b>Amplitude</b> <sup>*1</sup>	Amplitude value of waveform data
<b>Overshoot</b> <sup>*1</sup>	Overshoot value of waveform data
<b>Undershoot</b> <sup>*1</sup>	Undershoot value of waveform data
<b>+Width</b> <sup>*1</sup>	Time value above the intermediate level
<b>-Width</b> <sup>*1</sup>	Time value below the intermediate level
<b>Burst width</b> <sup>*2</sup>	Burst width of waveform data
<b>Accumulation</b>	Accumulated value of waveform data
<b>Angle of XY waveform</b>	Slope angle of a regression line on an XY composite curve
<b>CAN statistics</b>	Average, minimum, and maximum values of CAN signals' arrival time intervals

\*1: Unable to perform any calculations using data acquired across the measurement channels of Model MR8990 Digital Voltmeter Unit.

\*2: The settings can also be configured for the logic channels.

See "Calculation target channels and setting contents of calculation conditions for each calculation type" (p. 187).

**3 Tap the [Area] box, and then from the list, choose an option for a save range.**

You can specify a calculation range for each calculation.

<b>Whole</b> <sup>□</sup>	Performs calculations using whole waveforms.
<b>Segment 1</b>	Performs calculations using waveforms between cursors of Segment 1.
<b>Segment 2</b>	Performs calculations using waveforms between cursors of Segment 2.
<b>After Trigger</b>	Performs calculations using waveforms obtained after the trigger.

When choosing **[Segment 1]** or **[Segment 2]**, specify a calculation range with section cursors on the waveform screen.

See “2.2 Specifying the Waveform Range (Section Cursor)” (p. 35).

When the instrument does not acquire any waveforms, perform another measurement and specify a range. Doing so allows you to perform calculations using data acquired within the specified range from the next measurement.

**4 Tap a calculation target channel.**

The channel selection screen appears.

See “Calculation target channels and setting contents of calculation conditions for each calculation type” (p. 187).

**5 Set calculation conditions.**

See “Calculation target channels and setting contents of calculation conditions for each calculation type” (p. 187).

**6 (To perform calculation using existing data)**



Tap **[Execute]**.

**(To automatically perform calculation using acquired data after measurement)**

Press the **START** key.

### Calculation target channels and setting contents of calculation conditions for each calculation type

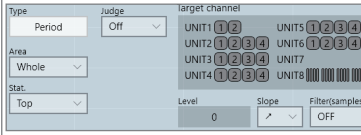

Type	Setting	Description	Sample screen
Average RMS P-P Maximum Time to maximum Minimum Time to minimum Standard deviation Area High level Low level Intermediate value Amplitude Overshoot Undershoot Accumulation	<b>Target channel</b> (Analog, real-time calculation, waveform calculation)	Allows you to specify calculation target channels.	
With the <b>[Area]</b> or <b>[Accumulation]</b> setting, set <b>[Method]</b> . ( <b>Total</b> , <b>Absolute value</b> , <b>Positive</b> , <b>Negative</b> )	Calculates an area or accumulation according to the method you specify here.		

Type	Setting	Description	Sample screen	
<b>Period</b> <b>Frequency</b> <b>Pulse width</b> <b>Duty ratio</b>	<b>Target channel</b> (Analog, logic, real-time calculation, waveform calculation)	Allows you to specify channels as calculation targets.		
	<b>Level*</b>	The instrument performs calculations using values based on a period of time when a waveform crossed the level specified here. No setting is available for logic channels.		
	<b>Slope</b>  No slope can be specified for calculating the duty ratio.			Performs calculations using values based on a period of time when a waveform crossed the specified level while rising.
				Performs calculations using values based on a period of time when a waveform crossed the specified level while falling.
	<b>Filter(samples)</b> (Off <sup>☑</sup> , 10 to 10,000)	Allows you to enter duration used to determine that a waveform crosses the specified level.  Only after a waveform has crossed the level and has never crossed the level again during the specified filter duration, the instrument determines that the waveform has crossed the level.  This is useful to eliminate false level-crossing events caused by noise.		
	<b>Stat.</b>	<b>Top</b> <sup>☑</sup>		Detects a value obtained first from the beginning within the specified range.
		<b>Average</b>		Calculates the average, maximum, or minimum value for each parameter within the specified range.
		<b>Max</b>		
<b>Min</b>				
<b>Times</b>	Calculates the value when the number of times a waveform crosses the level reaches the specified number from the beginning within the specified range.			

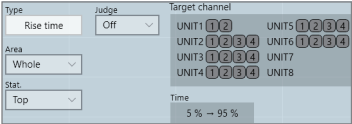
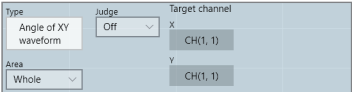
\*: You can set a level within the range of  $-9.9999E+29$  to  $-1.0000E29$ , at zero, within the range of  $+1.0000E29$  to  $+9.9999E+29$ . A value to five significant figures can be specified (a value to 10 significant figures can be specified for a time of the level at time setting).

Type	Setting	Description	Sample screen	
<b>Rise time</b> <b>Fall time</b>	<b>Target channel</b> (Analog, real-time calculation, waveform calculation)	Allows you to specify calculation target channels.		
	<b>Time (%)</b> (5%→95% to 30% → 70% or 95% → 5% to 70%→30%)	Allows you to specify which part of a waveform between the upper and lower limits is used for calculating the rise time (or fall time). A rise time (or fall time) is calculated based on the percentage, which is specified here, of the range between the upper and lower limit values.		
	<b>Stat.</b>	<b>Top</b> <b>Average</b> <b>Max</b> <b>Min</b>		Detects the value obtained first from the beginning within the specified range. Calculates the average, maximum, or minimum value for each parameter within the specified range.
	<b>Times</b>	Calculates the value when the number of times a waveform crosses the level reaches the specified number from the beginning within the specified range.		
<b>X-Y area</b> <b>Angle of XY waveform</b>	<b>Target channel (X, Y)</b> (Analog, real-time calculation, waveform calculation)	Allows you to assign channels to the X- and Y-axis.		
	With the [X-Y area] setting, set [Method]. (Coordinate method, Trapezoidal approximation)	Calculates an XY area according to a calculation method.		

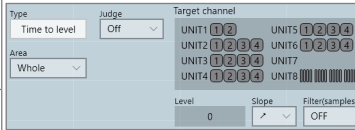
7

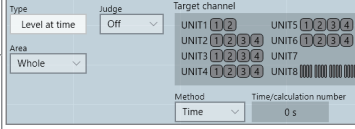
Type	Setting	Description	Sample screen			
Time to level Pulse count	<b>Target channel</b> (Analog, logic, real-time calculation, waveform calculation)	Allows you to specify calculation target channels.				
	<b>Times</b> (Phase contrast only)	Detects the time when the number of times a waveform crossed the specified level reaches the specified number.				
	<b>Level*</b>	Detects the time when a waveform crossed the level specified here or a pulse count that crossed the level. No setting is available for logic channels.				
	<b>Slope</b>	<div style="display: flex; justify-content: space-between;"> <div style="width: 45%;">  </div> <div style="width: 45%;"> <p>Detects a time when a waveform crossed the level specified here while rising or a pulse count that crossed the level while rising.</p> </div> </div> <div style="display: flex; justify-content: space-between;"> <div style="width: 45%;">  </div> <div style="width: 45%;"> <p>Detects the time when a waveform crossed the level specified here while falling or a pulse count that crossed the level while falling.</p> </div> </div>				
	<b>Filter(samples)</b> (Off <sup>☑</sup> , 10 to 10,000)	<p>Allows you to enter duration used to determine that a waveform crosses the specified level.</p> <p>Only after a waveform has crossed the level and does not cross the level again within the specified filter duration, the waveform is considered to have crossed the level.</p> <p>This is useful to eliminate false level-crossing events caused by noise.</p>				
Level at time	<b>Target channel</b> (Analog, logic, real-time calculation, waveform calculation)	Allows you to specify calculation target channels.				
	<b>Method</b>	Allows you to set the time-specifying method.				
	<table border="1" style="width: 100%; border-collapse: collapse;"> <tr> <td style="width: 20%;"><b>Time</b><sup>☑</sup></td> <td style="width: 20%;"><b>Time</b></td> <td>Allows you to enter a time for obtaining a measured value with the trigger point position fixed at zero.</td> </tr> <tr> <td><b>Calc. No.</b></td> <td><b>Calculation No.</b></td> <td> <p>Allows you to choose a calculation number when you use numerical calculation results.</p> <p>You cannot specify any number equal to or more than the calculation number you specified.</p> <p>Specifying a range using Segment 1 and Segment 2 is not available.</p> </td> </tr> </table>	<b>Time</b> <sup>☑</sup>		<b>Time</b>	Allows you to enter a time for obtaining a measured value with the trigger point position fixed at zero.	<b>Calc. No.</b>
<b>Time</b> <sup>☑</sup>	<b>Time</b>	Allows you to enter a time for obtaining a measured value with the trigger point position fixed at zero.				
<b>Calc. No.</b>	<b>Calculation No.</b>	<p>Allows you to choose a calculation number when you use numerical calculation results.</p> <p>You cannot specify any number equal to or more than the calculation number you specified.</p> <p>Specifying a range using Segment 1 and Segment 2 is not available.</p>				



\*: You can set a level within the range of  $-9.9999E+29$  to  $-1.0000E29$ , at zero, within the range of  $+1.0000E29$  to  $+9.9999E+29$ . A value to five significant figures can be specified (a value to 10 significant figures can be specified for a time of the level at time setting).

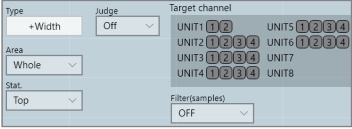

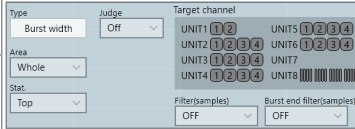
Type	Setting	Description	Sample screen	
+Width -Width	<b>Target channel</b> (Analog, real-time calculation, waveform calculation)	Allows you to specify calculation target channels.		
	<b>Filter(samples)</b> (Off <sup>□</sup> , 10 to 10,000)	Allows you to enter duration used to determine that a waveform crosses the specified level. Only after a waveform has crossed the level and does not cross the level again within the specified filter duration, the waveform is considered to have crossed the level. This is useful to eliminate false level-crossing events caused by noise.		
	<b>Stat.</b>	<b>Top</b> <sup>□</sup>		Detects the value obtained first from the beginning within the specified range.
		<b>Average</b>		Calculates the average, maximum, or minimum value for each parameter within the specified range.
		<b>Max</b>		
<b>Min</b>				
<b>Times</b>		Calculates the value when the number of times a waveform crosses the level reaches the specified number from the beginning within the specified range.		

Type	Setting	Description	Sample screen
Burst width	<b>Target channel</b> (Analog, logic, real-time calculation, waveform calculation)	Allows you to specify calculation target channels.	
	<b>Slope</b> (Logic channels only)	<input checked="" type="checkbox"/> Detects rising edges and calculates a burst width. <input type="checkbox"/> Detects falling edges and calculates a burst width.	
	<b>Filter(samples)</b> (Off <sup>□</sup> , 10 to 10,000)	Allows you to enter duration used to determine that a waveform crosses the specified level. Only after a waveform has crossed the level and does not cross the level again within the specified filter duration, the waveform is considered to have crossed the level. This is useful to eliminate false level-crossing events caused by noise.	
	<b>Burst end filter(samples)</b> (Off <sup>□</sup> , 10 to 10,000)	Allows you to set duration used to determine whether a waveform is a burst signal. If a waveform falls within the window level range and remains in the range longer than the specified filter duration, the instrument determines the detected period to be a burst duration.	
	<b>Window-level range*</b> (Up, Low)	Allows you to enter an upper and lower limit values used to determine whether a waveform is a burst signal.	
	<b>Stat.</b>	<input checked="" type="checkbox"/> <b>Top</b> Average Max Min	
	<b>Times</b>	Calculates the value when the number of times a waveform crosses the level reaches the specified number from the beginning within the specified range.	

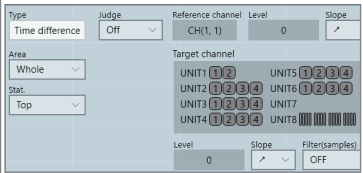
\*: You can set a level within the range of  $-9.9999E+29$  to  $-1.0000E29$ , at zero, within the range of  $+1.0000E29$  to  $+9.9999E+29$ . A value to five significant figures can be specified (a value to 10 significant figures can be specified for a time of the level at time setting).

Type	Setting	Description	Sample screen	
Time difference Phase contrast	<b>Reference channel, Target channel</b> (Analog, logic, real-time calculation, waveform calculation)	Allows you to specify the reference channel and the target channel.		
	<b>Level*</b>	The instrument calculates values based on times when a waveform crossed the level specified here. This setting is not available for logic channels.		
	<b>Slope</b>			Performs calculations using values based on a period of time when a waveform crossed the specified level while rising.
				Performs calculations using values based on a period of time when a waveform crossed the specified level while falling.
	<b>Filter(samples)</b> (Off, 10 to 10,000)	Allows you to enter duration used to determine that a waveform crosses the specified level. Only after a waveform has crossed the level and does not cross the level again within the specified filter duration, the waveform is considered to have crossed the level. This is useful to eliminate false level-crossing events caused by noise.		
	<b>Method</b> (Phase contrast only)	0° to 360°		Displays phase difference using the angle range of 0° to 360°.
		-180° to 180°		Displays phase difference using the angle range of -180° to 180°.
	<b>Stat.</b>	<b>Top</b>		Detects the value obtained first from the beginning within the specified range.
		<b>Average</b>		Calculates the average, maximum, or minimum value for each parameter within the specified range.
		<b>Max</b>		
<b>Min</b>				
<b>Times</b>				

\*: You can set a level within the range of -9.9999E+29 to -1.0000E29, at zero, within the range of +1.0000E29 to +9.9999E+29. A value to five significant figures can be specified (a value to 10 significant figures can be specified for a time of the level at time setting).

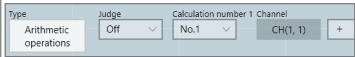
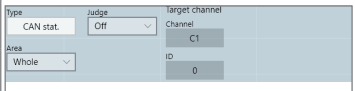
Type	Setting	Description	Sample screen
Arithmetic operations	Calculation number 1, Calculation number 2 (No. 1 to No. 15)	Allows you to specify two numerical calculation numbers to use for calculations.	
	Target channel	Allows you to specify a target channel that has a numerical calculation number to use for calculations.	
	Operator (+, -, ×, ÷)	Allows you to choose among the four basic arithmetic operations.	
CAN stat.	Target channel (C1 to C4)	Allows you to specify a CAN channel used as the calculation target.	
	ID (0 to 1FFFFFFF)	Allows you to specify a CAN channels as calculation targets in hexadecimal notation.	

- With the **[Period]**, **[Frequency]**, **[Rise time]**, and **[Fall time]** calculations, the instrument may not be able to perform calculations depending on the condition of waveform data.
  - With the **[Period]** and **[Frequency]** calculation, correct measurement results may not be obtained if the filter setting is close to half the period (an integer multiple of an actual period may be calculated).
  - When the scaling is enabled, the instrument scales waveform data before calculation. Units for parameter values are those set in the scaling function.
  - If a waveform across a calculation target channel exceeds the measurable range (overrange waveform), the instrument substitutes the upper or lower measurement limit for values that exceed the measurable range before calculation.
- See “3.2 Converting Input Values (Scaling Function)” (p. 56).

### Settings: Calculations for which **[Stat.]** can be set

Period, frequency, rise time, fall time, pulse width, duty ratio, time lag, phase contrast, +Width, -Width, and burst width

<b>Top</b> <sup>☑</sup>	Performs calculations within the calculation range in the initial condition.
<b>Average</b>	Calculates the average value of calculation results for data within the calculation range.
<b>Max</b>	Calculates the maximum value of calculation results for data within the calculation range.
<b>Min</b>	Calculates the minimum value of calculation results for data within the calculation range.
<b>Times</b>	Calculates the value when the number of times a waveform crosses the level reaches the specified number for data within the calculation range.

## Displaying numerical calculation results

This section describes how to check calculation results on the waveform screen.

### > [Numerical calculation]

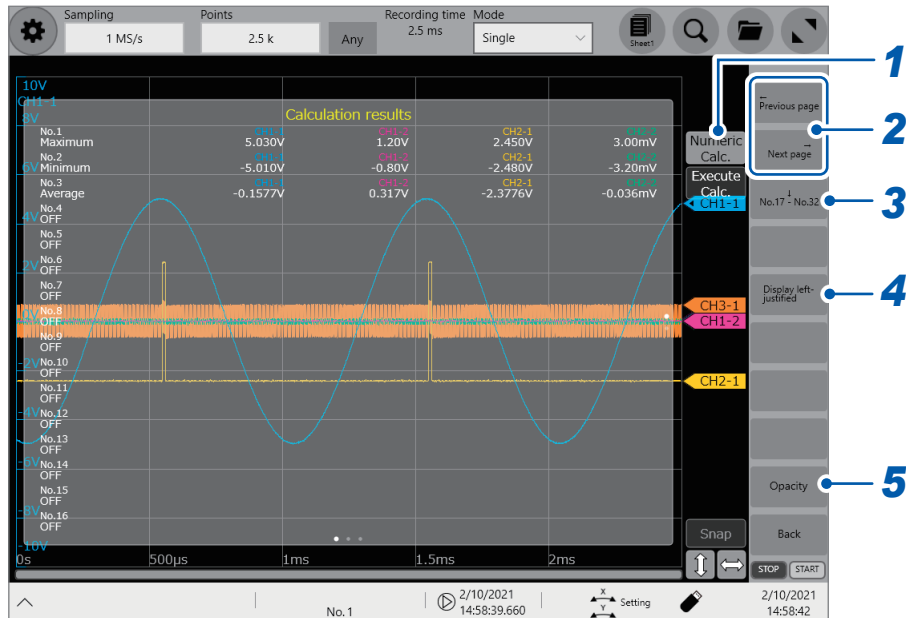

### 1 Tap [Numerical calculation].

Every time you tap it, the numerical calculation result screen appears or hides.

If the instrument cannot calculate the periods or discontinue the calculations, results are expressed as the string [\*\*\*\*\*].

The results of channels not set as calculation targets are expressed as the sign [-].

### 2 Tap [Previous page] or [Next page].

If the instrument cannot display some of the results of all channels' numerical calculations on a single screen, you can switch over the page.

### 3 Tap [No.1 – No.16] or [No.17 – No.32].

A single screen can display 16 types of numerical calculation results. Every time you tap either, the numerical calculation results switches between those for Nos. 1 through 16 and those for Nos. 17 through 32.

### 4 Tap [Align the columns of channels] or [Display left-justified].

Every time you tap either, alignment of numerical calculation results is switched.

If you choose [Align the columns of channels], the results including those of channels not set as calculation targets are displayed as well.

If you choose [Display left-justified], results of channels only set as calculation targets are displayed in left alignment.

**5** Tap [Opacity].

The function keys switch over to those for opacity adjustment of the numerical calculation result screen's background.

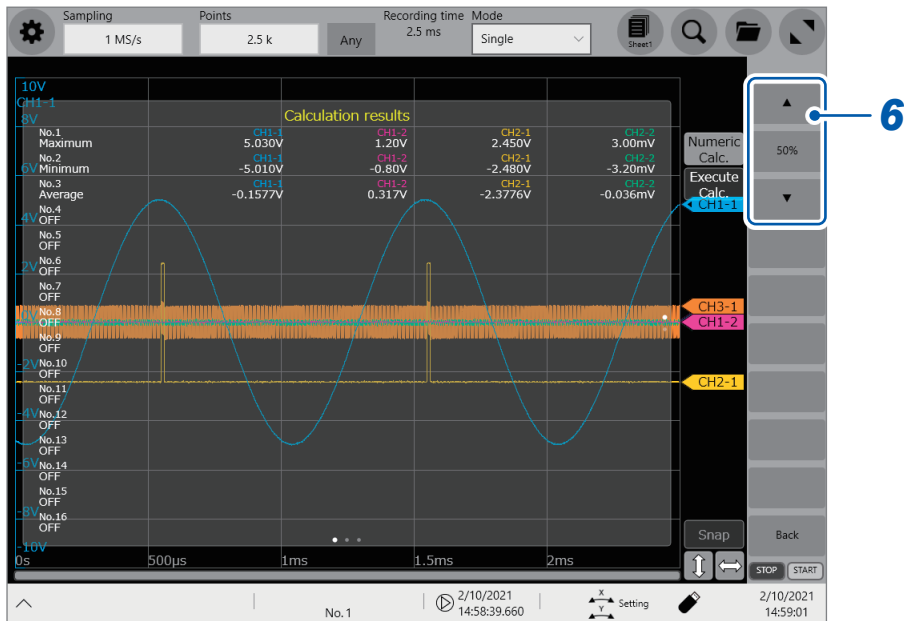

**6** Tap [▲] or [▼].

Pressing either key can adjust the opacity of the numerical calculation result screen's background between 0% and 100% in step of 10 percent points.

**To save the calculation results after the measurement**

See “Freely choosing data items to be saved and save files (SAVE key)” (p. 127).

## 7.3 Evaluating Calculation Results on a Pass/Fail Basis

You can specify evaluation criteria ([Up] and [Low]) to evaluate numerical calculation results on a pass/fail basis.

Each numerical calculation can have different evaluation criteria.

The waveform acquisition process varies depending on the recording mode setting ([Single] or [Repeat]) and the stop condition specified to stop measurement according to an evaluation ([PASS], [FAIL], or [PASS & FAIL]).

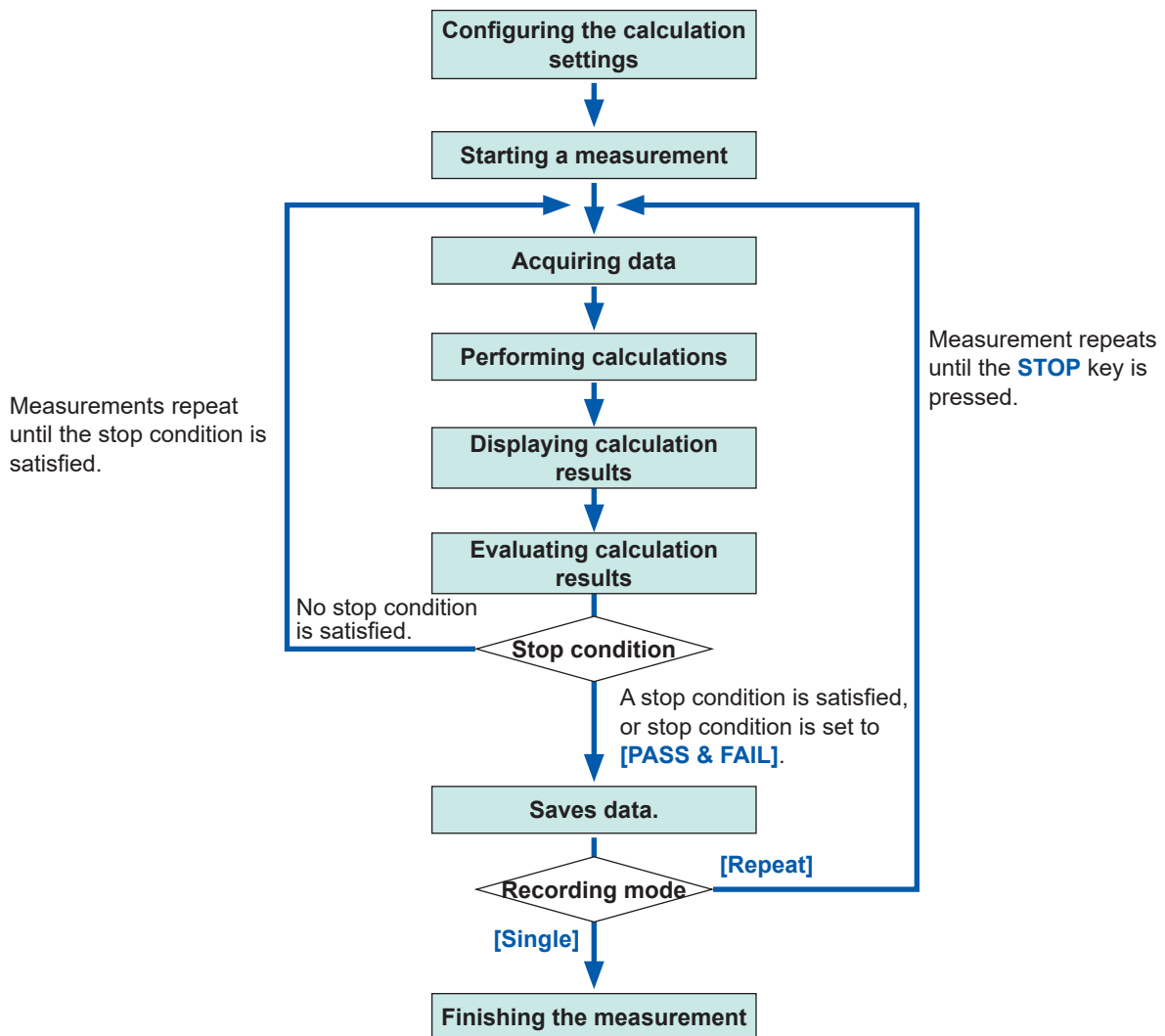

Automatic saving is not carried out until the stop condition is satisfied at the end of calculation evaluation.

 > [Calculation] > [Numerical calculation]

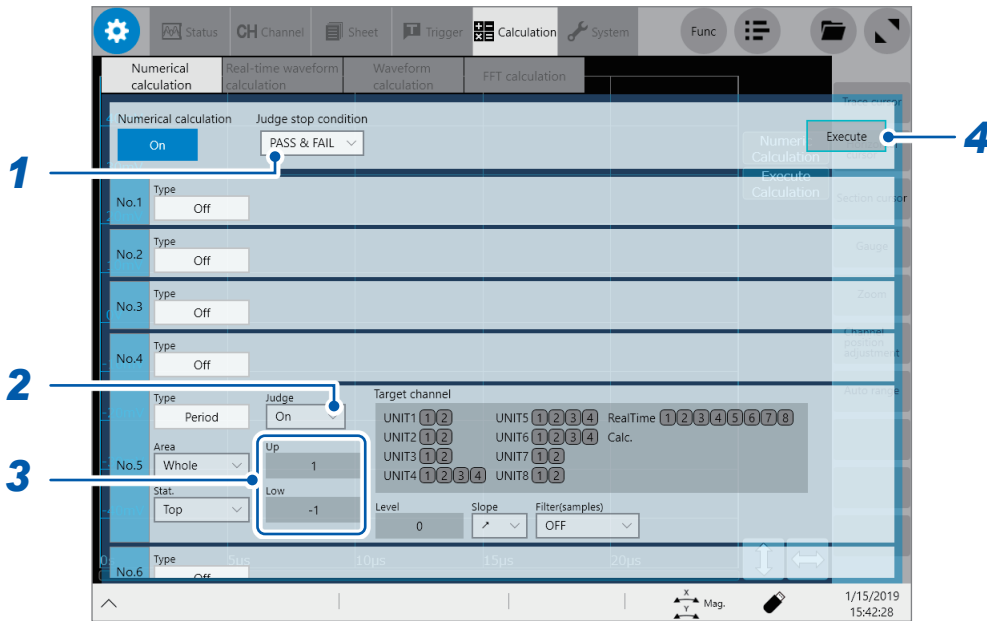

**1** Tap the [Judge stop condition] box, and then from the list, choose a stopping condition applied according to judgments.

<b>PASS</b>	Stops measurement when a calculation result falls within a criteria range (pass judgment).
<b>FAIL</b>	Stops measurement when a calculation result is outside a criteria range (fail judgment).
<b>PASS &amp; FAIL</b> <input checked="" type="checkbox"/>	Stops measurement regardless whether a pass or fail judgment is given.

**2** Tap the [Judge] box, and then from the list, choose whether or not to evaluate calculation results.

<b>Off</b> <input checked="" type="checkbox"/>	Evaluates calculation results.
<b>On</b>	Yields a FAIL judgment if a result is outside a criteria range. Calculated values in a channel with the FAIL judgment are highlighted in red.

**3** Tap the [Up] and [Low] boxes in turn, and then enter evaluation criteria values in each of them.

Enterable range:  $-9.9999E+29$  to  $-1.0000E+29$ ,  $0$ ,  $+1.0000E+29$  to  $+9.9999E+29$

**4** (To evaluate existing data)

Tap [Execute].

(To automatically execute evaluation after measurement)

**START** key



**About upper and lower limit values**

You cannot specify an upper limit value lower than a lower limit value.  
Neither can you specify a lower limit value higher than an upper limit value.

**To record all calculation results**

Choose **[PASS & FAIL]** for the stopping condition.

**Judging method of CAN statistics**

The instrument makes CAN statistics judgments by comparing the following values:

- The maximum value of the CAN statistics with the upper limit of the evaluation criterion
- The minimum value of the CAN statistics with the lower limit of the evaluation criterion .

## Displaying evaluation results and externally outputting signals

The numerical calculation result screen of the waveform screen displays numerical calculation evaluation results.

Values that fall within an evaluation criteria range: Pass judgment

Values outside an evaluation criteria range: Fail judgment (highlighted in red)

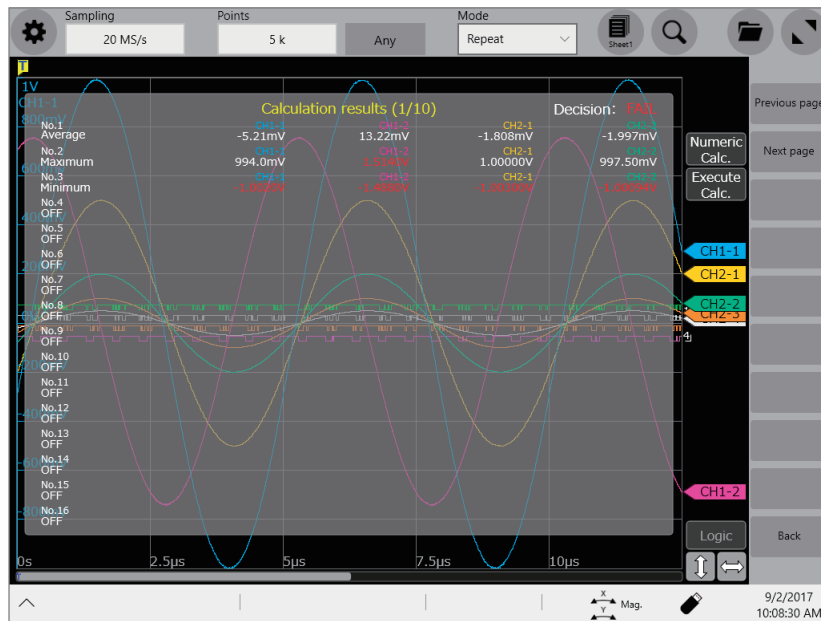

### When a pass judgment is given

When the external output terminals (OUT 1, OUT 2) are set to **[Judge(Pass)]**, a PASS signal is output from the external output terminals (OUT 1, OUT 2).

### When a fail judgment is given

When the external output terminals (OUT 1, OUT 2) are set to **[Judge(Fail)]**, a FAIL signal is output from the external output terminals (OUT 1, OUT 2). A fail judgment is given when any one of the channels is judged to be a fail.

# 7.4 Numerical Calculation Types and Descriptions

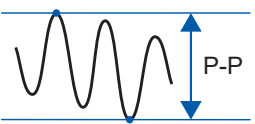
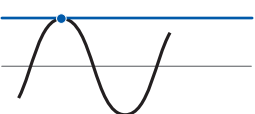
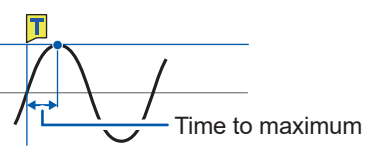
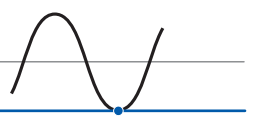
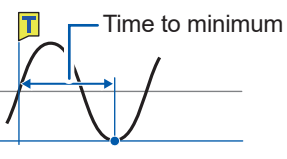
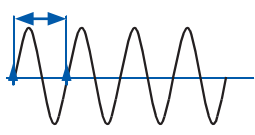
Calculation type	Description	
<b>Average</b>	<p>Calculates an average value of waveform data.</p> $AVE = \frac{1}{n} \sum_{i=1}^n di$ <p><i>AVE</i>: Average  <i>n</i>: Number of data points  <i>di</i>: <i>i</i>th-point data acquired across a channel</p>	
<b>RMS</b>	<p>Calculates an RMS value of waveform data. When the scaling is enabled, the instrument scales waveform data before calculation.</p> $RMS = \sqrt{\frac{1}{n} \sum_{i=1}^n di^2}$ <p><i>RMS</i>: Root-mean-square value  <i>n</i>: Number of data points  <i>di</i>: <i>i</i>th-point data acquired across a channel</p>	
<b>P-P</b>	<p>Calculates a difference (peak-to-peak value) between the maximum and minimum values of waveform data.</p>	<p>Maximum </p> <p>Minimum</p>
<b>Maximum</b>	<p>Calculates the maximum value of waveform data.</p>	<p>Maximum </p>
<b>Time to maximum</b>	<p>Calculates a period of time (unit: s) from a trigger point to the maximum value. When waveform has two or more points of the maximum value, the instrument determines the first of them in the waveform used for a calculation to be the maximum value.</p>	<p>Maximum </p>
<b>Minimum</b>	<p>Calculates the minimum value of waveform data.</p>	<p>Minimum </p>
<b>Time to minimum</b>	<p>Calculates a period of time (unit: s) from a trigger point to the minimum value. When waveform has two or more points of the minimum value, the instrument determines the first of them in the waveform used for a calculation to be the minimum value.</p>	<p>Minimum </p>
<b>Period Frequency</b>	<p>Displays a period (unit: s) and frequency (unit: Hz) of a signal waveform. Calculates a period and frequency based on a time lag between the time when a waveform crossed the specified level in the positive (or negative) direction the first time and the time when it next crossed the specified level.                      Settings: <b>Level</b>, <b>Slope</b>, <b>Filter</b>, <b>Stat</b>.</p>	
	<p>Level </p>	

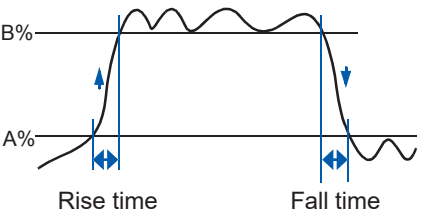
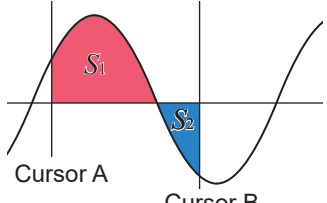
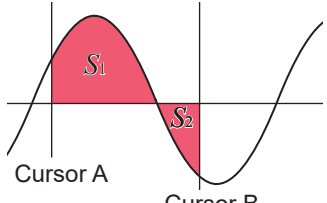
Calculation type	Description	
<p><b>Rise time</b> <b>Fall time</b></p>	<p>Calculates a A%-to-B% rise time (or a B%-to-A% fall time; unit: s) based on the 0% and 100% levels based on a histogram (frequency distribution) of acquired waveform data.</p> <p>The instrument calculates a rise time (or fall time) of the first rising (or falling) slope that appears in acquired waveform data.</p> <p>When a range is specified with section cursors, the instrument calculates a rise time (or fall time) of the first rising (or falling) slope that appears between cursors.</p> <p>You can specify values of A and B in percent. The values of A and B varies along with each other. When the value of A is 5%, the value of B is specified at 95%; when the value of A is 30%, the value of B is specified at 70%.</p> <p>Settings: <b>Rise time</b> (A% to B%) and <b>Fall time</b> (B% to A%) values in percent, <b>Stat</b>.</p>	 <p>Rise time                      Fall time</p> <p>A: 5% to 30% B: 95% to 70%</p>
<p><b>Standard deviation</b></p>	<p>Calculates a standard deviation of waveform data.</p> $\sigma = \sqrt{\frac{1}{n} \sum_{i=1}^n (d_i - AVE)^2}$ <p><math>\sigma</math>: Standard deviation <math>AVE</math>: Average <math>n</math>: Number of data points <math>d_i</math>: <math>i</math>th-point acquired across a channel</p>	
<p><b>Area</b> <b>Method: Total</b></p>	<p>Calculates an area by subtracting an area (unit: V·s) enclosed by the zero-level (zero-potential) line and the negative-amplitude part of a signal waveform from an area (unit: V·s) enclosed by the zero-level (zero-potential) line and the positive-amplitude part of the signal waveform.</p> <p>When a calculation range is specified with section cursors, the instrument calculates an area between the cursors.</p> <p><math>S</math>: Area <math>n</math>: Number of data points <math>d_i</math>: <math>i</math>th-point data acquired across a channel <math>h = \Delta t</math>: Sampling interval</p> $S = \sum_{i=1}^n d_i \cdot h$	 <p>Cursor A                      Cursor B</p> <p><math>S = S_1 - S_2</math></p>
<p><b>Area</b> <b>Method: Absolute value</b></p>	<p>Calculates an area value (unit: V·s) enclosed by the zero-level (zero-potential) line and a signal waveform.</p> <p>When a calculation range is specified with section cursors, the instrument calculates an area between the cursors.</p> <p><math>S</math>: Area <math>n</math>: Number of data points <math>d_i</math>: <math>i</math>th-point data acquired across a channel <math>h = \Delta t</math>: Sampling interval</p> $S = \sum_{i=1}^n  d_i  \cdot h$	 <p>Cursor A                      Cursor B</p> <p><math>S = S_1 + S_2</math></p>

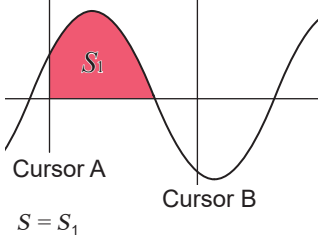
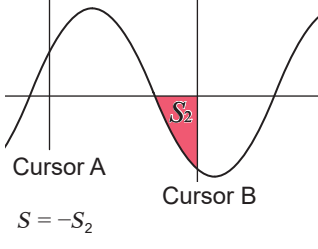
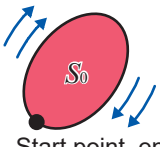
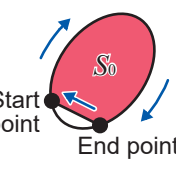
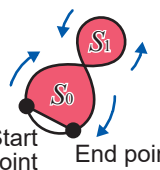
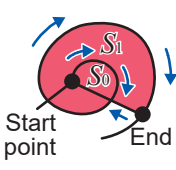
Calculation type	Description	
<p><b>Area Method: Positive</b> (Only the positive-amplitude part)</p>	<p>Calculates an area enclosed by the zero-level (zero-potential) line and the positive-amplitude part of a signal waveform. When a range is specified with section cursors, the instrument calculates an area between the cursors.</p> $S = \sum_{i=1, di > 0}^n di \cdot h$ <p><i>S</i>: Area  <i>n</i>: Number of data points  <i>di</i>: <i>i</i>th-point data acquired across a channel  <i>h</i> = Δ<i>t</i>: Sampling interval</p>	 <p>Cursor A Cursor B <math>S = S_1</math></p>
<p><b>Area Method: Negative</b> (Only the negative-amplitude part)</p>	<p>Calculates an area enclosed by the zero-level (zero-potential) line and the negative-amplitude part of a signal waveform. When a calculation range is specified with section cursors, the instrument calculates an area between the cursors.</p> $S = \sum_{i=1, di < 0}^n di \cdot h$ <p><i>S</i>: Area  <i>n</i>: Number of data points  <i>di</i>: <i>i</i>th-point data acquired across a channel  <i>h</i> = Δ<i>t</i>: Sampling interval</p>	 <p>Cursor A Cursor B <math>S = -S_2</math></p>
<p><b>X-Y area Method: Coordinate method</b></p>	<p>Calculates an area (unit: V<sup>2</sup>) enclosed by an XY composite curve. The instrument calculates an area enclosed by the lines as illustrated below. An area can be calculated even when no XY composite curve is displayed. You can specify a calculation range on a horizontal-axis (time-axis) waveform of each channel using section cursors. The instrument calculates an area of an XY composite curve within the specified range (you cannot directly specify a range on an XY waveform using section cursors). See "2.1 Reading Measured Values (Trace Cursors, Horizontal Cursors)" (p. 30).</p> <div style="display: flex; justify-content: space-around;"> <div data-bbox="472 1205 885 1422"> <p><b>When multiple loops are plotted</b></p>  <p><math>S = n \times S_0</math>  <i>S</i>: Area  <i>n</i>: Number of loops</p> </div> <div data-bbox="917 1205 1428 1444"> <p><b>When an open curve is plotted</b></p>  <p><math>S = S_0</math>  <i>S</i>: Area                      (Closed area is created by connecting the start and end points with a straight line)</p> </div> </div> <div style="display: flex; justify-content: space-around; margin-top: 10px;"> <div data-bbox="472 1444 885 1668"> <p><b>When a figure of eight is plotted</b></p>  <p><math>S =  S_0 - S_1 </math>  <i>S</i>: Area</p> </div> <div data-bbox="917 1444 1428 1668"> <p><b>When a spiral loop is plotted</b></p>  <p><math>S = S_0 \times 2 + S_1</math>  <i>S</i>: Area                      (The number of overlapping segments increases with a loop count)</p> </div> </div>	

Calculation type	Description	
<p><b>X-Y area</b>  <b>Method:</b>  <b>Trapezoidal approximation</b></p>	<p>Calculates an area (unit: <math>V^2</math>) enclosed by an XY composite curve using the trapezoidal approximation method. The instrument calculates an area enclosed by the lines as illustrated below. An area can be calculated even when no XY composite curve is displayed.</p> <p>You can specify a calculation range on a horizontal-axis (time-axis) waveform of each channel using section cursors. The instrument calculates an area of an XY composite curve within the specified range (you cannot directly specify a range on an XY waveform using section cursors).</p>	
<p><b>When a Y data set corresponds to an X data set</b></p>		
<p>The diagrams illustrate four cases for area calculation when a Y data set corresponds to an X data set:</p> <ul style="list-style-type: none"> <li><b>Case 1:</b> A positive waveform above the X-axis (Y=0). The area is labeled <math>S_0</math>. The formula is <math>Area\ S = S_0</math>.</li> <li><b>Case 2:</b> A negative waveform below the X-axis (Y=0). The area is labeled <math>S_0</math>. The formula is <math>Area\ S = -S_0</math>.</li> <li><b>Case 3:</b> A positive waveform above the X-axis (Y=0). The area is labeled <math>S_0</math>. The formula is <math>Area\ S = S_0</math>.</li> <li><b>Case 4:</b> A negative waveform below the X-axis (Y=0). The area is labeled <math>S_0</math>. The formula is <math>Area\ S = -S_0</math>.</li> </ul>		
<p><b>When a waveform includes negative amplitude</b></p>		
<p>The diagrams illustrate two cases for area calculation when a waveform includes negative amplitude or multiple Y data sets:</p> <ul style="list-style-type: none"> <li><b>Case 1:</b> A waveform crossing the X-axis (Y=0). The area above the axis is <math>S_0</math> and the area below is <math>S_1</math>. The formula is <math>Area\ S = S_0 - S_1</math>.</li> <li><b>Case 2:</b> A complex waveform with multiple Y data sets. The area is labeled <math>S_0</math>. The formula is <math>Area\ S = S_0</math>.</li> <li><b>Case 3:</b> A complex waveform with multiple Y data sets, including a shaded region <math>S_2</math>. The formula is <math>Area\ S = S_0 + 2 \times S_1 + S_2</math>.</li> </ul>		
<p><b>Time to level</b></p>	<p>Searches a calculation range from the beginning for the time when a signal crossed the specified level and calculates a period of time from a trigger point to a point searched for.</p> <p>Settings: <b>Level, Slope, Filter</b></p>	<p>A graph showing a signal crossing a specified level. A vertical line marks the trigger point, and a horizontal line marks the level. A double-headed arrow indicates the time interval T from the trigger point to the level crossing.</p>
<p><b>Level at time</b></p>	<p>Calculates a level when the specified time has elapsed from a trigger point.</p> <p>You can also specify a time based on previously calculated results.</p> <p>Settings: <b>Method (Time, Calc. No.), Time/calculation number (No. 1 to No. 16)</b></p>	<p>A graph showing a signal at a specific time T. A vertical line marks the time T, and a horizontal line marks the level at that time.</p>
<p><b>Pulse width</b></p>	<p>Calculates a pulse width based on a time lag between the time when a waveform crossed the specified level in the positive (or negative) direction and the time when it next crossed the specified level in the opposite direction.</p> <p>Settings: <b>Level, Slope, Filter, Stat.</b></p>	<p>A graph showing a square wave. A horizontal line marks the level. A double-headed arrow indicates the pulse width between two consecutive crossings of the level.</p>

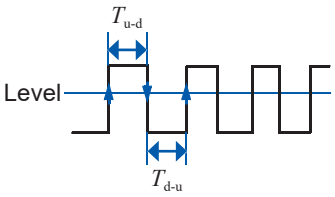
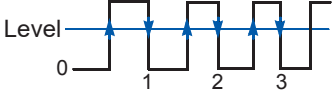
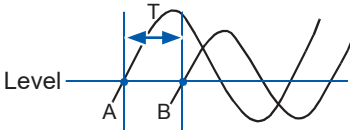
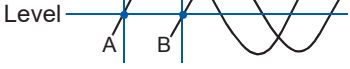
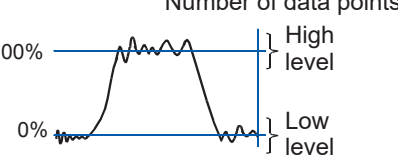
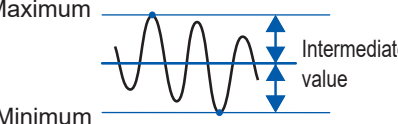
Calculation type	Description	
<p><b>Duty ratio</b></p>	<p>Calculates a duty ratio based on a time lag between the time when a waveform crossed the specified level while rising and the time when it next crossed the specified level in the opposite direction, and a time lag between the time when the waveform crossed the specified level while falling and the time when it next crossed the specified level while rising.</p> $\text{Duty ratio} = \frac{T_{u-d}}{T_{u-d} + T_{d-u}} \times 100 [\%]$ <p><math>T_{u-d}</math>: Time from rising edge to falling edge (unit: s)  <math>T_{d-u}</math>: Time from falling edge to rising edge (unit: s)                      Settings: <b>Level, Filter, Stat.</b></p>	
<p><b>Pulse count</b></p>	<p>Counts the number of pulses that crossed the specified level in the positive (or negative) direction. For the pulse counts, it is considered as one count that a period between the point when a pulse crossed the level while rising and the point when the pulse crossed the level while falling (otherwise, between that while falling and while rising).                      Settings: <b>Level, Slope, Filter</b></p>	
<p><b>Arithmetic operations</b></p>	<p>Allows you to freely choose numerical calculation results and the instrument performs arithmetic operations of the results of your choice.                      Settings: <b>Calculation number 1</b>, Arithmetic operations (+, -, ×, ÷), <b>Calculation number 2</b></p>	
<p><b>Time difference</b></p>	<p>Calculates a time lag T (unit: s) between the time when waveform A crossed the specified level in the positive (or negative) direction and the time when waveform B crossed it in the same direction.                      (Time lag T) = (Time when waveform B crossed the level) - (Time when waveform A crossed the level)                      Settings: Waveform A (<b>Reference channel, Level, Slope, Filter</b>); Waveform B (<b>Target channel, Level, Slope, Filter</b>)</p>	
<p><b>Phase contrast</b></p>	<p>Calculates a phase difference (unit: degree) with reference to waveform A based on a time lag between the time when waveform A crossed the specified level in the positive (or negative) direction and the time when waveform B crossed it in the same direction.  <math display="block">\text{Phase difference} = \frac{\text{Time lag between waveforms A and B (T)}}{\text{Period of waveform A}} \times 360 [^\circ]</math>                     Settings: Waveform A (<b>Reference channel, Level, Slope, Filter</b>); Waveform B (<b>Target channel, Level, Slope, Filter</b>)</p>	
<p><b>High level Low level</b></p>	<p>Calculates a low and high levels letting 0% and 100% of acquired waveform data be them, respectively, based on a histogram (frequency distribution).</p>	
<p><b>Intermediate value</b></p>	<p>Calculates the average of the maximum and minimum values of waveform data.  <math display="block">[(\text{Maximum value}) + (\text{Minimum value})] / 2</math></p>	

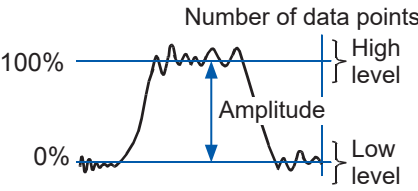
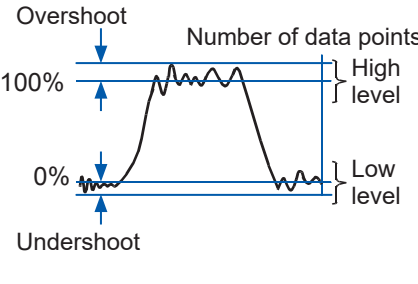
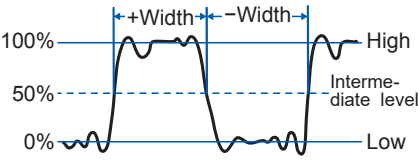
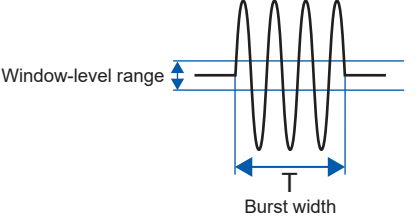
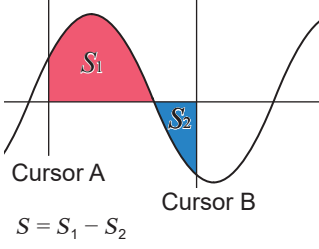
Calculation type	Description	
<p><b>Amplitude</b></p>	<p>Calculates a value (amplitude) between a low and high levels letting 0% and 100% of acquired waveform data be them, respectively, based on a histogram (frequency distribution). (High level) – (Low level)</p>	
<p><b>Overshoot Undershoot</b></p>	<p>Calculates a ratio of a difference between the maximum (or minimum) value and a high (or low) level to a difference between a high and low levels, which are calculated letting 0% and 100% of acquired waveform data be them, respectively, based on a histogram (frequency distribution).  <math display="block">\frac{[(\text{Maximum value}) - (\text{High level})]}{[(\text{High level}) - (\text{Low level})]} \times 100</math> <math display="block">\frac{[(\text{Low level}) - (\text{Minimum value})]}{[(\text{High level}) - (\text{Low level})]} \times 100</math></p>	
<p><b>+Width</b> (Period during which a waveform is above the intermediate level) <b>-Width</b> (Period during which a waveform is below the intermediate level)</p>	<p>Calculates a time lag between the time when a waveform crossed the intermediate line level (50%) in the positive (or negative) direction and the time when it next crossed the intermediate level in the opposite direction. Settings: <b>Filter, Stat.</b></p>	
<p><b>Burst width</b></p>	<p>Calculates a time during which a burst signal is outputted. Settings: <b>Filter, Burst end filter, Window (Up, Low), Stat.</b></p>	
<p><b>Accumulation Method: Total</b></p>	<p>Calculates an accumulation by subtracting an accumulation (V) enclosed by the zero-level (zero-potential) line and the negative-amplitude part of a signal waveform from an accumulation (unit: V) enclosed by the zero-level (zero-potential) line and the positive-amplitude part of a signal waveform. When a calculation range is specified with section cursors, the instrument calculates an accumulation between the cursors.</p> $S = \sum_{i=1}^n di$ <p>S: Accumulation n: Number of data points di: ith-point data acquired across a channel</p>	

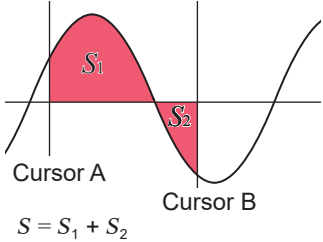
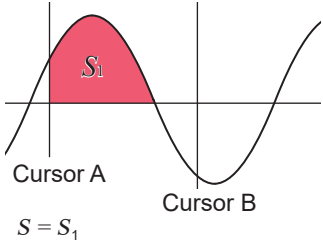
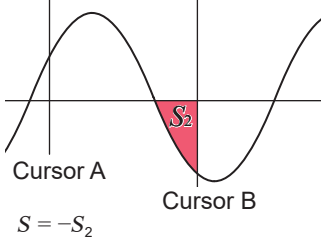
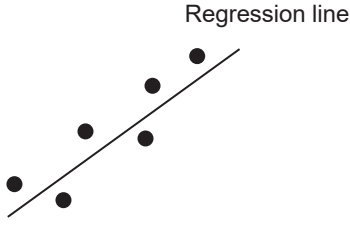
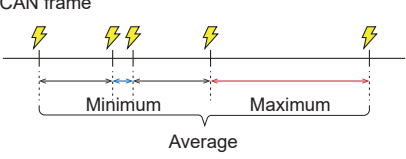

Calculation type	Description	
<p><b>Accumulation Method: Absolute value</b></p>	<p>Calculates an accumulation (unit: V) enclosed by the zero-level (zero-potential) line and a signal waveform.</p> <p>When a calculation range is specified with section cursors, the instrument calculates an accumulation between the cursors.</p> $S = \sum_{i=1}^n  di $ <p>S: Accumulation  n: Number of data points  di: ith-point data acquired across a channel</p>	
<p><b>Accumulation Method: Positive</b> (Only the positive-amplitude part)</p>	<p>Calculates an accumulation (unit: V) enclosed by the zero-level (zero-potential) line and the positive-amplitude part of a signal waveform.</p> <p>When a calculation range is specified with section cursors, the instrument calculates an accumulation between the cursors.</p> $S = \sum_{i=1, di > 0}^n di$ <p>S: Accumulation  n: Number of data points  di: ith-point data acquired across a channel</p>	
<p><b>Accumulation Method: Negative</b> (Only the negative-amplitude part)</p>	<p>Calculates an accumulation (unit: V) enclosed by the zero-level (zero-potential) line and the negative-amplitude part of a signal waveform.</p> <p>When a calculation range is specified with section cursors, the instrument calculates an accumulation between the cursors.</p> $S = \sum_{i=1, di < 0}^n di$ <p>S: Accumulation  n: Number of data points  di: ith-point data acquired across a channel</p>	
<p><b>Angle of XY waveform</b></p>	<p>Calculates a regression line of an XY composite curve, and then a slope angle.</p> $SLOPE = \frac{\sum_{i=1}^n (x_i - \bar{x}) \cdot (y_i - \bar{y})}{\sum_{i=1}^n (x_i - \bar{x})^2}$ $\theta = \arctan (SLOPE) \cdot \frac{180}{\pi} [^\circ]$ <p>xi: ith-point data acquired across the X-axis channel  yi: ith-point data acquired across the Y-axis channel  x̄: Average value of the X-axis channel  ȳ: Average value of the Y-axis channel</p> 	
<p><b>CAN statistics</b></p>	<p>Calculates average, maximum, and minimum values of CAN signals' arrival time intervals.</p> 	



# 8

# Waveform Calculation Function

The instrument performs calculations using acquired waveform data and pre-defined arithmetic expressions to numerically display calculation results on the waveform screen. Up to 16 calculations are simultaneously available.

No waveform calculation is available when the envelope is used.

- When the envelope is used
- When the real-time saving is set to **[On]**

 > **[Calculation]** > **[Waveform calculation]**

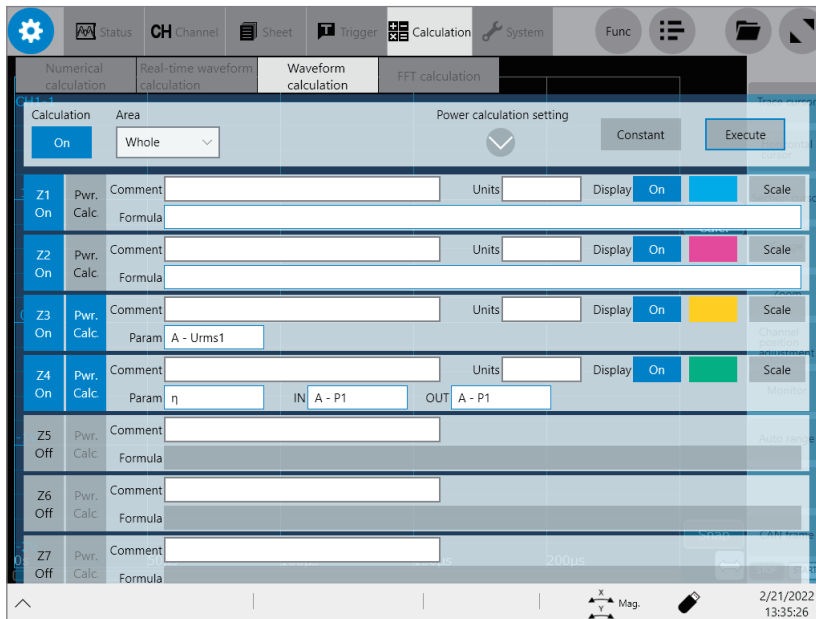

## Operation available on the [Waveform calculation] screen

### Waveform Calculation

- **Four arithmetic operations**

Addition (+), subtraction (-), multiplication ( $\times$ ), division ( $\div$ )

- **Basic**

Absolute value, exponent, common logarithm, moving average, differential, integral, square root, cubic root, parallel move

- **Waveform parameter**

Average, maximum value, minimum value, level at time

- **Averaging**

Simple average, exponential average

- **Period**

Half-wave average, half-wave period, half-wave frequency, half-wave RMS value, full-wave average, full-wave period, full-wave frequency, full-wave RMS value, polarity, encoder, resolver, reminder

- **FIR filter, IIR filter**

Low-pass, high-pass, band-pass, band-stop, binarization

- **Trigonometric function**

Sine, cosine, tangent, arc sine, arc cosine, arc tangent

- **CAN**

CAN conversion

### Power calculation

- **Voltage, current**

RMS value, average value, simple average value

- **Power**

Effective power, apparent power, reactive power, power factor, power phase angle

- **Others**

Efficiency, loss

- For details on arithmetic expressions, see “8.4 Operators of the Waveform Calculation and Calculation Results” (p. 222).
- For details on power calculation expressions, see “16.4 Power Equations and Wiring Specifications” (p. 420).
- Section-cursor range calculation: You can perform calculations using waveforms within a range specified with section cursors.
- When the scaling function is enabled, the instrument performs calculations using scaled values.
- You can enter each value of numerical calculation results in arithmetic calculations of waveform parameter.
- Up to 16 operations (Z1 to Z16) can be performed simultaneously; only one waveform or power operation can be performed per one operation among Z1 to Z16.

The power calculation results may not match those of other measuring instruments such as wattmeters. This is due to differences in measurement principles, accuracy, and frequency characteristics.

See “8.8 Types of Power Calculations and Explanations” (p. 252) for more information on each calculation.

## 8.1 Waveform Calculation Procedure

The following two methods are available:

Performing calculation during measurement	You have to configure the waveform calculation settings before starting measurement.
Performing calculations using existing data	The instrument can perform calculations using waveform data that has already been acquired and that saved on storage devices.

### Performing calculation during measurement

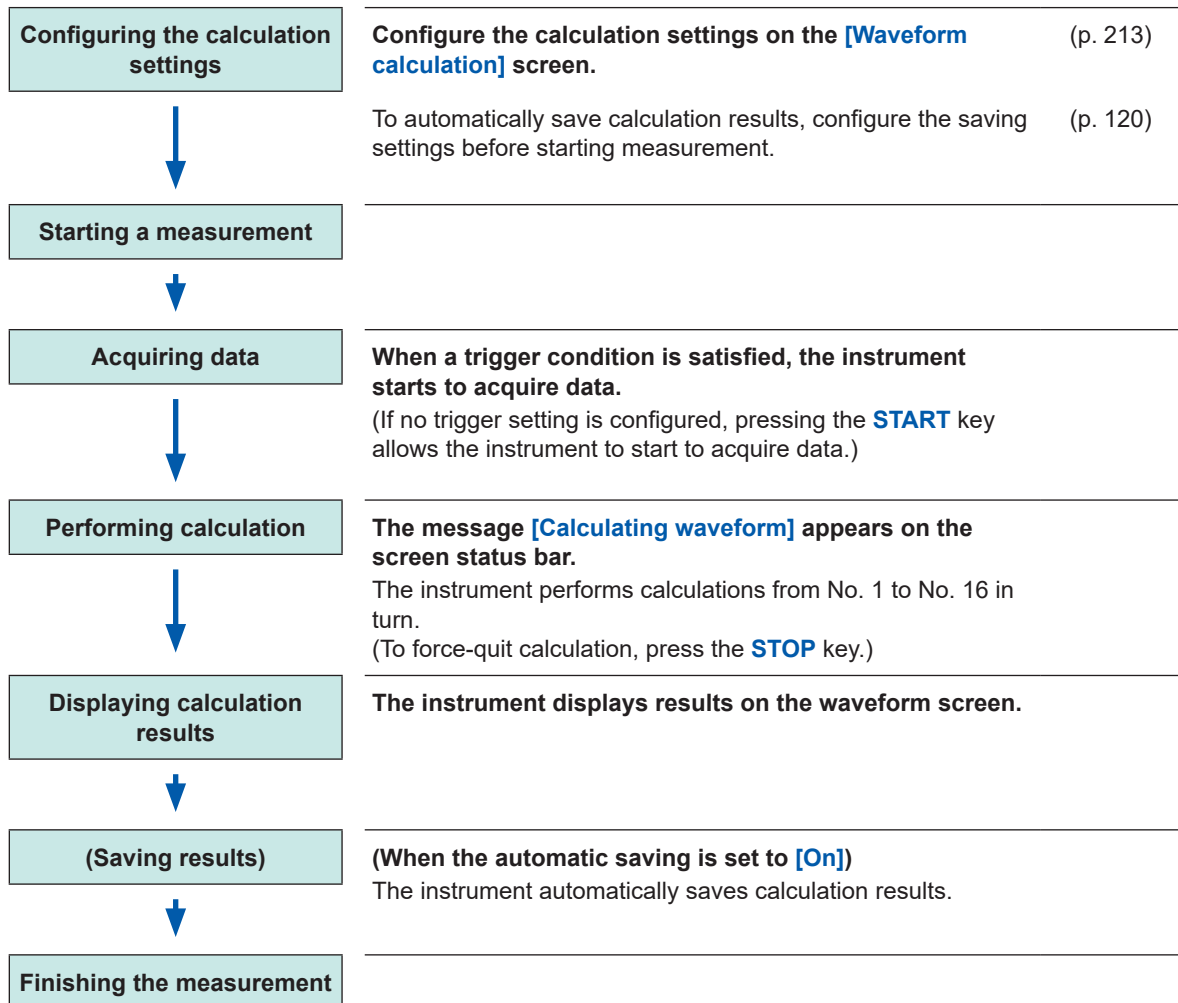

## Performing calculations using existing data

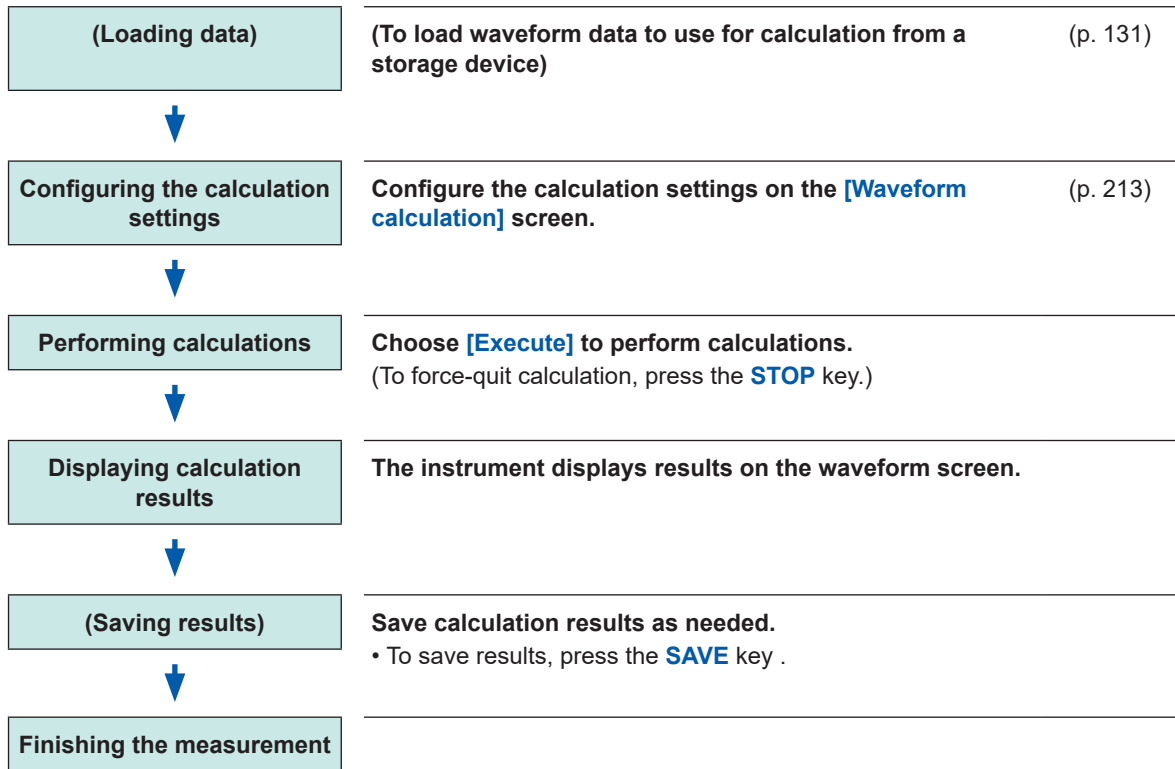

- The instrument can perform calculations using waveforms with a length of up to 5,000,000 points. To perform a calculation using a longer length of waveforms, partly save the waveforms with a length of less than 5,000,000 points and then reload the waveforms to perform another calculation.
- Using the memory division function allows the instrument to display calculation results of the last measured block.
- When the instrument perform a calculation using waveforms during measurement, force-quitting calculation prohibits the instrument from displaying calculation results.
- To restart the calculation, choose **[Execute]** in the **[Waveform calculation]** screen.

### To specify a range for calculation

Before calculation, specify a calculation range using section cursors on the waveform screen. Set **[Area]** to **[Segment 1]** or **[Segment 2]** on the **[Waveform calculation]** screen.  
See "8.2 Configuring the Waveform Calculation Settings" (p. 213).

### To automatically save waveform calculation results after measurement

See "Automatically saving waveform data" (p. 120).

## 8.2 Configuring the Waveform Calculation Settings

 > [Calculation] > [Waveform calculation]

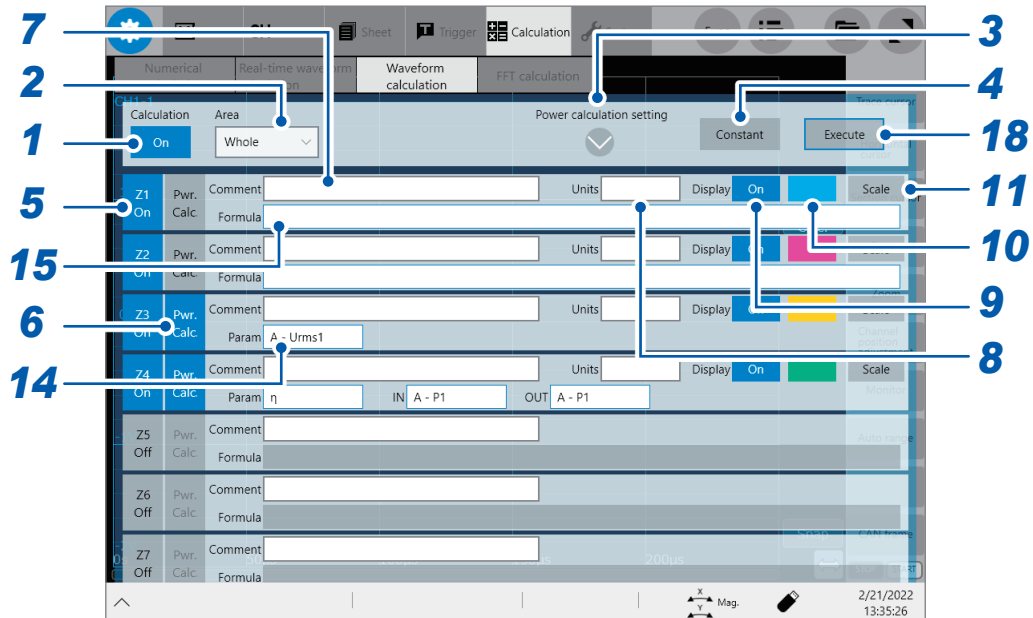

- 1** Tap the [Calculation] button to set it to [On].
- 2** Tap the [Area] box, and then from the list, choose an option for a waveform calculation range.

<b>Whole</b> <input checked="" type="checkbox"/>	Performs calculations using whole waveforms.
<b>Segment 1</b>	Performs calculations using waveform between cursors of Segment 1.
<b>Segment 2</b>	Performs calculations using waveform between cursors of Segment 2.

When choosing [Segment 1] or [Segment 2], specify a calculation range with section cursors on the waveform screen. When the instrument has not acquired any waveforms, perform another measurement and specify a range. Doing so allows you to perform calculations using data acquired within the specified range from the next measurement.

- 3** (When configuring the power calculation settings) Tap the open mark under [Power calculation setting].  
See "8.7 Setting Power Calculation Conditions" (p. 244).
- 4** Tap [Constant], and then specify constants to be used for calculation.  
See "8.3 Defining Constants" (p. 220).
- 5** Tap any of the channels, [Z1] through [Z16], you want to specify a arithmetic calculation to set it to [On].
- 6** (When configuring the power calculation settings) Tap [Pwr. Calc.] to enable the power calculation.
- 7** Enter a comment in the [Comment] box.
- 8** Enter a unit symbol in the [Units] box.

**9** Tap the **[Display]** button to set it to **[On]** or **[Off]**.

<b>On</b> <input checked="" type="checkbox"/>	Displays a calculated waveform.
<b>Off</b>	Does not display any calculated waveform.

**10** Tap the color button to the right of the **[Display]** button, and then choose a display color of the channel from the color pallet.

You can also choose the same color as lines acquired across other channels.

**11** Tap **[Scale]** to the right of the color button.

The **[Scale Settings]** dialog box appears.

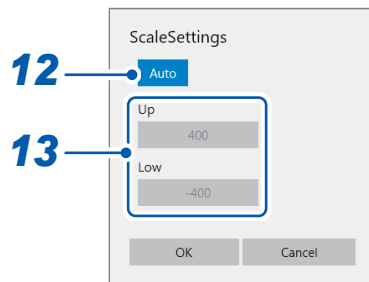

**12** Tap the **[Scale Settings]** button to set the scale setting of calculation results to **[Auto]** or **[Manual]**.

<b>Auto</b> <input checked="" type="checkbox"/>	Automatically scales a calculation result.
<b>Manual</b>	Allows you to change the scale settings.

**13** (When you choose **[Manual]** in the **[Scale Settings]** box.)

Tap the **[Up]** or **[Low]** box.

The numerical value entry dialog box appears.

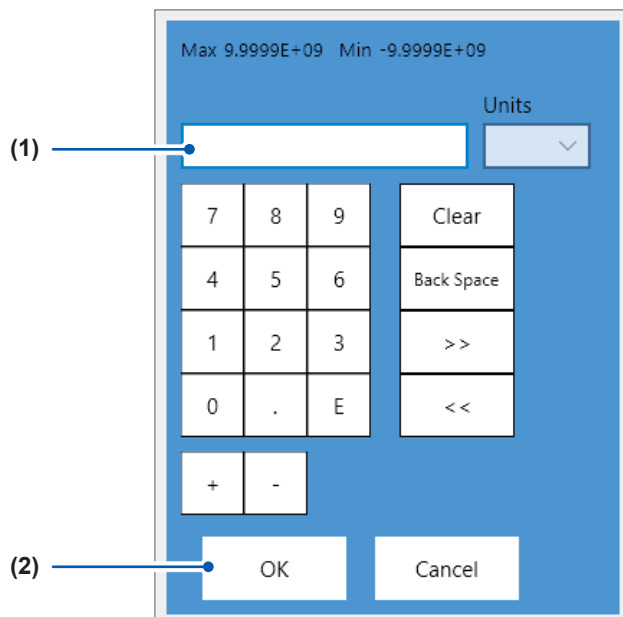

**(1) Enter an upper and lower value in each box.**

Use the numerical keypad, **[+]** button, and **[-]** button to enter.

**-9.9999E+19 to 9.9999E+19**



**(2) Tap [OK].**

The numerical value entry dialog box closes.

**14 (When configuring the power calculation settings) Tap the [Param] box.**

See “8.8 Types of Power Calculations and Explanations” (p. 252).

This completes the power calculation settings. Follow the steps below to continue the waveform calculation settings.

**15 Tap the [Formula] box.**

The arithmetic expression setting dialog box appears.

**16 Enter an arithmetic expression.**

You can specify an arithmetic expression by combining numerical values, operators that includes the four arithmetic operations, calculation target channels, and constants

See “8.5 Examples of Configuring Waveform Calculation Settings” (p. 230).

The arithmetic expression you have specified appears in the screen.

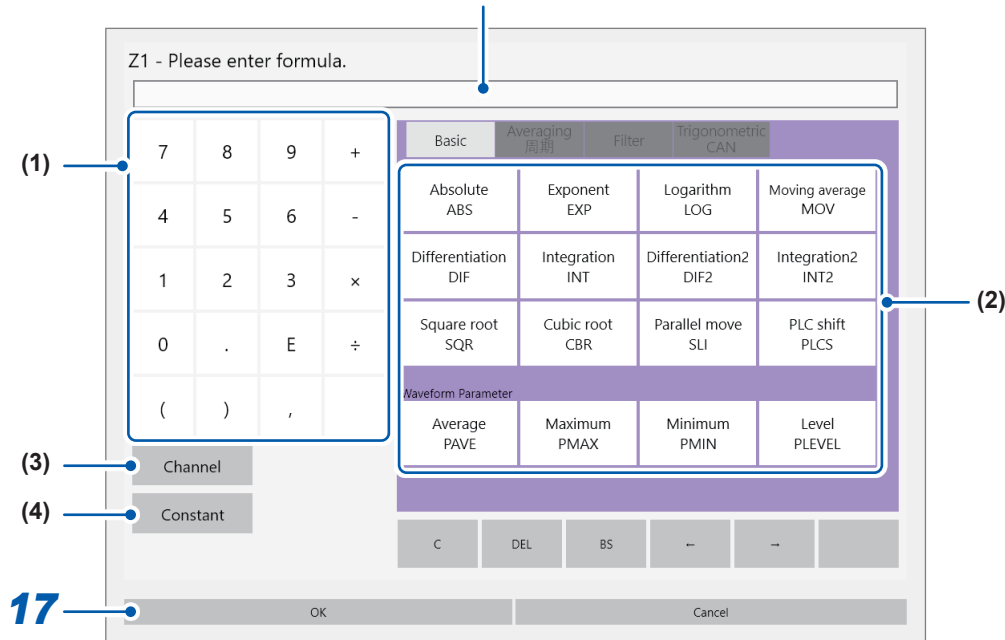

- (1) Numbers, four arithmetic operations
- (2) Operators
- (3) Allows you to choose calculation target channels.
- (4) Allows you to enter constants (5-digit numbers).

**17 Tap [OK].**

The arithmetic expression you have specified appears in the [Formula] box.

**18 (To perform calculations using existing data)**

Tap [Execute].

(To perform calculations during measurement)

**START** key

A measurement starts.

**To automatically save waveform calculation results after measurement**

See “Automatically saving waveform data” (p. 120).

**To allocate a calculation result waveform on a sheet**

See “1.4 Configuring the Sheet Settings” (p. 19).

**To switch sheets on the waveform screen**

See “Switching sheets on the waveform screen” (p. 24).

**Arithmetic expressions**

Name	Operator
Absolute value	ABS
Exponent	EXP
Common logarithm	LOG
Moving average	MOV
Differential	DIF
Integration	INT
2nd-order differential	DIF2
2nd-order integration	INT2
Square root	SQR
Cubic root	CBR
Parallel move	SLI
PLC shift	PLCS
Average value	PAVE
Maximum value	PMAX
Minimum value	PMIN
Level at time	PLEVEL
Simple average	AVESIM
Exponential average	AVEEXP
Half-wave average	AVEH
Half-wave period	PRDH
Half-wave frequency	FRQH
Half-wave RMS value	RMSH
Full-wave average	AVEF
Full-wave period	PRDF
Full-wave frequency	FRQF
Full-wave RMS value	RMSF
Polarity	POLE
Encoder	ABZ
Resolver	RSLV
Reminder	MOD

Name	Operator
FIR low-pass filter	LPFFIR
FIR high-pass filter	HPFFIR
FIR band-pass filter	BPFFIR
FIR band-stop filter	BSFFIR
IIR low-pass filter	LPFIIR
IIR high-pass filter	HPFIIR
IIR band-pass filter	BPFIIR
IIR band-stop filter	BSFIIR
Sine	SIN
Cosine	COS
Tangent	TAN
Arc sine	ASIN
Arc cosine	ACOS
Arc tangent	ATAN
2-argument arc tangent	ATAN2
CAN conversion	CAN

### Arithmetic expression entry

- The length of each arithmetic expression is limited to 80 characters.
- You can directly enter a 30-digit numbers or less in arithmetic expressions (for constants, 5-digit number or less ).
- If an expression you enter includes an error (its frame is filled with red), all calculation results become zero.
- Entering a complex, long arithmetic expression causes a red frame to enclose the entry box. Divide an expression into two or more.

$$\underbrace{\text{ABS}(\text{CH}(1,1))}_{1} + \underbrace{\text{CH}(1,2) \times \text{CH}(1,3)}_{2} - \underbrace{(\text{CH}(2,1) + \text{CH}(2,2)) \times \text{ABS}(\text{CH}(2,1))}_{3} / \text{DIF}(\text{CH}(1,1),1)$$

- You can use calculation result Zi in other arithmetic expressions. However, expression Zn can include only result Zn-1 or earlier.  
Example: Expression Z4 can include result Z1 through Z3.

**When an expression includes any one of the following operators: MOV, SLI, DIF, DIF2, PLEVEL, ATAN2, AVEEXP, and MOD.**

The operators above require a comma and second parameter to follow the first parameter, which is enclosed in parentheses.

Operator	Setting	Setting example
<b>MOV</b> (moving average) <b>SLI</b> (parallel move)	Specify the number of points to be moved. Setting range <b>MOV</b> (moving average): 1 to 5000 <b>SLI</b> : -5000 to 5000 If you omit the second parameter, the instrument specifies <b>[1]</b> to perform calculations.	To calculate a 10-point moving average of the CH1-1 waveform <b>MOV(CH(1,1),10)</b>
<b>DIF</b> (Differential) <b>DIF2</b> (2nd-order differential)	Specify a sampling interval for differentials Usually specify "1." To acquire amplitudes of a slowly fluctuating waveform, specify a greater number. Setting range <b>DIF</b> , <b>DIF2</b> : 1 to 5000 If you omit the second parameter, the instrument specifies <b>[1]</b> to perform calculations.	To differentiate the CH1-2 waveform every 20 sampling points <b>DIF(CH(1,2),20)</b>
<b>PLEVEL</b> (level at time)	Specify a period of time from a trigger in second. If you omit the second parameter, the instrument specifies <b>[0]</b> to perform calculations.	To obtain a level 1 ms after a trigger yielded from CH1-3 <b>PLEVEL(CH(1,3),0.001)</b>
<b>ATAN2</b> (2-argument arc tangent)	Entering " <b>ATAN2(y,x)</b> " allows the instrument to solve <b>TAN(y/x)</b> . (p. 224) If you omit parameter x, the instrument specifies 1.0 to perform calculations. For parameter x, you cannot specify any functions or expressions, but CH, W, or Z.	To calculate 2-argument arc tangent of (CH1-1) / (CH1-2) <b>ATAN2(CH(1,1),CH(1,2))</b>
<b>AVEEXP</b> (exponential average)	Specify an attenuation constant for an exponential average calculation. Setting range: 2 to 1000 Omitting an attenuation constant causes an error.	To calculate an exponential average of the CH1-4 waveform using an attenuation constant of 40 <b>AVEEXP(CH(1,4),40)</b>
<b>MOD</b> (Reminder)	Specify a reminder. Omitting a reminder causes an error.	To obtain the remainder of the value of Z1 divided by 360 <b>MOD(Z1,360)</b>

When an expression includes any one of the following operators: **AVEH**, **PRDH**, **FRQH**, **RMSH**, **AVEF**, **PRDF**, **FRQF**, **RMSF**, and **POLE**.

Operator	Setting	Setting example
<b>AVEH</b> (half-wave average) <b>RMSH</b> (half-wave RMS value) <b>AVEF</b> (full-wave average) <b>RMSF</b> (full-wave RMS value)	Specify the reference channel, hysteresis threshold, the forcibly averaging time. If you omit to enter the forcibly averaging time, the instrument performs calculation without using the forcibly averaging. If you omit to enter the hysteresis threshold and the forcibly averaging time, the instrument performs calculation specifying zero for the hysteresis threshold without using the forcibly averaging. Omitting to enter the reference channel causes an error.	To calculate an average of the CH1-1 waveform every half cycle defined by the zero-crossings of the CH1-2 waveform with a hysteresis threshold of 100 mV and a forcibly average time of 500 ms <b>AVEH(CH(1,1),CH(1,2),0.1,0.5)</b>
<b>PRDH</b> (half-wave period) <b>FRQH</b> (half-wave frequency) <b>PRDF</b> (full-wave period) <b>FRQF</b> (full-wave frequency)	Specify the hysteresis threshold. If you omit to enter the hysteresis threshold, the instrument specifies zero for it and performs calculation.	To calculate the period of the CH1-3 waveform on the basis of the zero-crossings that occur every half cycle with a hysteresis threshold of 100 mV <b>PRDH(CH(1,3),0.1)</b>
<b>POLE</b> (polarity)	Specify the reference channel and hysteresis threshold. Omitting to enter the reference channel causes an error. If you omit to enter the hysteresis threshold, the instrument performs calculation specifying zero for it.	To obtain the polarity of the CH1-1 waveform in reference to the CH1-2 waveform with a hysteresis threshold of 100 mV <b>POLE(CH(1,1),CH(1,2),0.1)</b>

When using the **ABZ** operator in equations

Operator	Setting	Setting example
<b>ABZ</b> (encoder)	Sets the A-phase channel, B-phase channel, Z-phase channel, low threshold value, and high threshold value. Omitting the channels and thresholds will result in an error.	To calculate the rotary encoder angle for a low threshold value of 0.5 V, a high threshold value of 4.5 V, and A-, B-, and Z-phase channels of CH1-1, CH1-2, and CH1-3, respectively: <b>ABZ(CH(1,1),CH(1,2),CH(1,3),0.5,4.5)</b>

When using the **RSLV** operator in equations

Operator	Setting	Setting example
<b>RSLV</b> (resolver)	Sets the excitation wave channel, cos wave channel, sin wave channel, hysteresis, and pole pairs. Omitting the channels and hysteresis will result in an error. If the number of pole pairs is omitted, a pole pair value of 1 will be used in calculations.	To calculate the resolver error with a hysteresis threshold value of 100 mV, 4 pole pairs, and an excitation wave, cos wave, and sin wave of CH1-1, CH1-2, and CH1-3, respectively: <b>RSLV(CH(1,1),CH(1,2),CH(1,3),0.1,4)</b>

### When a filter calculation is used in an arithmetic expression

Operator	Setting	Setting example
<b>LPFFIR</b> (FIR low-pass filter) <b>HPFFIR</b> (FIR high-pass filter)	Specify a cutoff frequency, the order of a filter, and a Kaiser window coefficient. Setting range Cutoff frequency: See p. 241. Order of a filter: 2 to 400 Kaiser window coefficient: 0 to 20	To pass the CH1-1 waveform through the 128th-order FIR low-pass filter with a cutoff frequency of 100 kHz and a Kaiser window coefficient of 10 <b>LPFFIR(CH(1,1),100000,128,10)</b>
<b>BPFFIR</b> (FIR band-pass filter) <b>BSFFIR</b> (FIR band-stop filter)	Specify a lower and higher cutoff frequencies, the order of a filter, and a Kaiser window coefficient. Setting range Cutoff frequency: See p. 241. Order of a filter: 2 to 400 Kaiser window coefficient: 0 to 20	To pass the CH1-1 waveform through the 128th-order FIR band-pass filter with a lower cutoff frequency of 100 kHz, a higher cutoff frequency of 200 kHz, and a Kaiser window coefficient of 10 <b>BPFFIR(CH(1,1),100000,200000,128,10)</b>
<b>LPFIIR</b> (IIR low-pass filter) <b>HPFIIR</b> (IIR high-pass filter)	Specify a cutoff frequency and the order of a filter. Setting range Cutoff frequency: See p. 241. Order of a filter: 1 to 64	To pass the CH1-1 waveform through the 2nd-order IIR high-pass filter with a cutoff frequency of 100 kHz <b>HPFIIR(CH(1,1),100000,2)</b>
<b>BPFIIR</b> (IIR band-pass filter) <b>BSFIIR</b> (IIR band-stop filter)	Specify a lower and higher cutoff frequencies, and the order of a filter. Setting range Cutoff frequency: See p. 241. Order of a filter: 1 to 64	To pass the CH1-1 waveform through the 2nd-order IIR band-stop filter with a lower cutoff frequency of 100 kHz and a higher cutoff frequency of 200 kHz <b>BSFIIR(CH(1,1),100000,200000,2)</b>
<b>BIN</b> (Binarization)	Specify a lower and a higher thresholds. Omitting to enter the thresholds causes an error.	To binarize the CH1-1 waveform using the lower thresholds of 1.5 V and higher of 3.5 V <b>BIN(CH(1,1),1.5,3.5)</b>

### If a calculation result overflows

- The instrument regards a calculation result that falls within the following range as an overflow.
  1. Greater than +9.9999E+29
  2. Less than -9.9999E+29
- The instrument assigns +9.9999E+29 to positive overflows, and -9.9999E+29 to negative overflows.
- Trace cursors (A through H) read +9.9999E+29 at a positively overflowing point, and -9.9999E+29 at a negatively overflowing point.

## 8.3 Defining Constants

You can previously define constants to use in arithmetic expressions.

 > [Calculation] > [Waveform calculation]

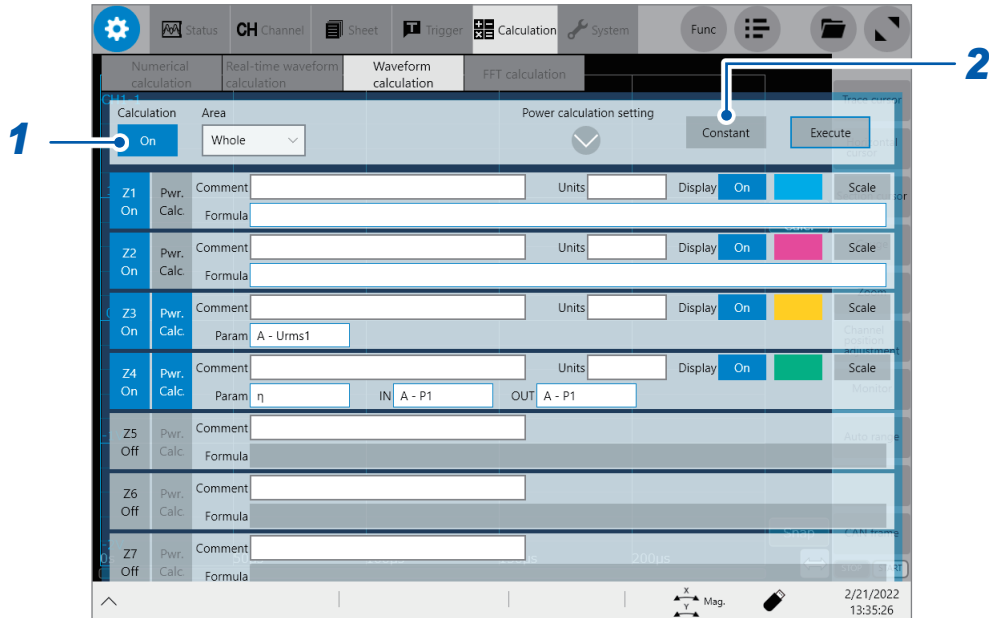

**1** Tap the [Calculation] button to set it to [On].

**2** Tap [Constant].

The constant entry dialog box appears.

**3** Tap a box that has an alphabet you want to allocate a constant to.

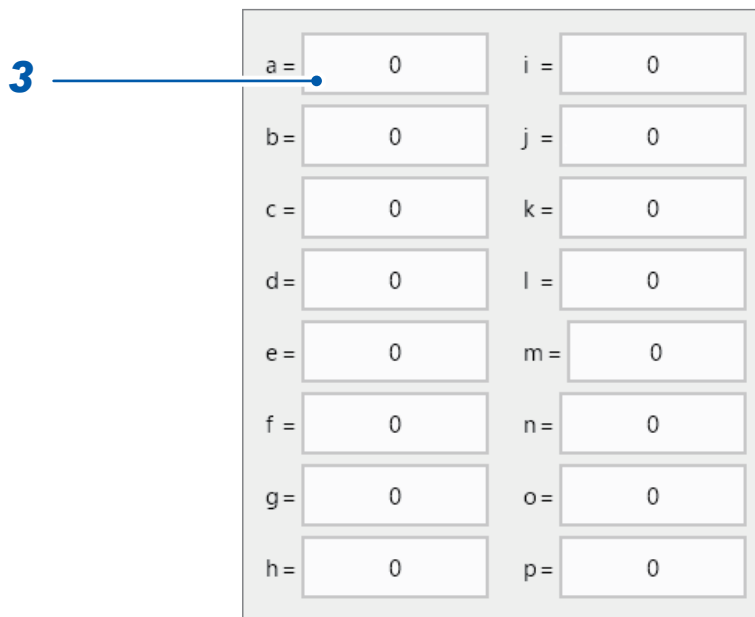

The numerical value entry dialog box appears.

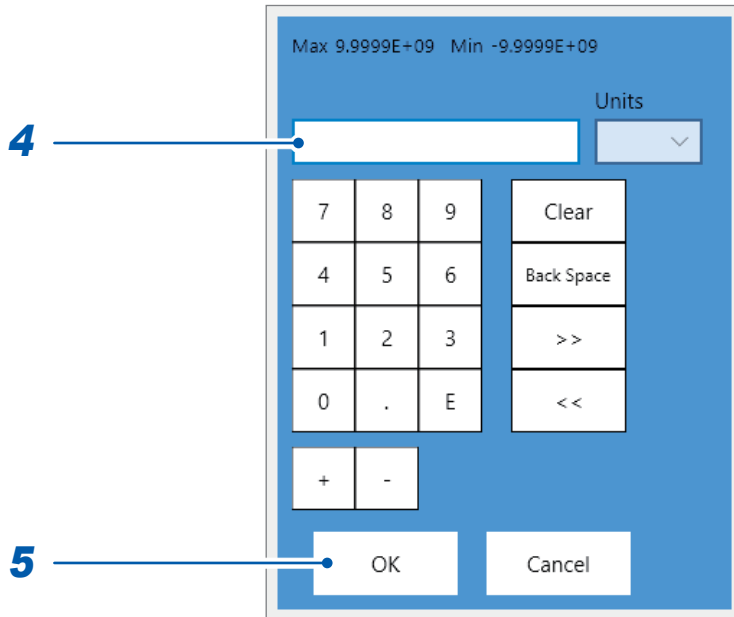
**4** Enter a constant.

**-9.9999E+29 to -1.0000E-29, 0, +1.0000E-29 to +9.9999E+29**

You can specify a value to five or less significant figures.

Use the numerical keypad, **[+]** button, and **[-]** button to enter.

The instrument feeds constants you have defined to the constant display on the arithmetic expression setting dialog box.

**5** Tap **[OK]**.

The numerical value entry dialog box closes.

## 8.4 Operators of the Waveform Calculation and Calculation Results

$b_i$ :  $i$ th-point data in calculation results,  $d_i$ :  $i$ th-point data acquired across the source channel

Waveform calculation type	Description
<b>Four arithmetic operations (+, -, ×, ÷)</b>	Performs calculations using operators specified from the four arithmetic operations, which consists of addition (+), subtraction (-), multiplication (×), and division (÷). Multiplication signs (×) and division signs (÷) are represented as asterisks (*) and slashed (/), respectively.
<b>Absolute value (ABS)</b>	$b_i =  d_i $ ( $i = 1, 2, \dots, n$ )
<b>Exponent (EXP)</b>	$b_i = \exp(d_i)$ ( $i = 1, 2, \dots, n$ )
<b>Common logarithm (LOG)</b>	<p>For <math>d_i &gt; 0</math> <math>b_i = \log_{10} d_i</math>                      For <math>d_i = 0</math> <math>b_i = -\infty</math> (Outputs overflowing values)                      For <math>d_i &lt; 0</math> <math>b_i = \log_{10}  d_i </math> (<math>i = 1, 2, \dots, n</math>)</p> <p>Note: Using the following equations can convert a common logarithm into a natural logarithm.  <math>\ln X = \log_e X = \log_{10} X / \log_{10} e</math>  <math>1 / \log_{10} e \approx 2.30</math></p>
<b>Square root (SQR)</b>	<p>For <math>d_i \geq 0</math> <math>b_i = \sqrt{d_i}</math>                      For <math>d_i &lt; 0</math> <math>b_i = -\sqrt{ d_i }</math> (<math>i = 1, 2, \dots, n</math>)</p>
<b>Cubic root (CBR)</b>	$b_i = \sqrt[3]{d_i}$
<b>Moving average (MOV)</b>	<p>This function requires the number of moving points to be specified in the second parameter <math>k</math>.                      When <math>k</math> is an odd number <span style="margin-left: 150px;">When <math>k</math> is an even number</span></p> $b_i = \frac{1}{k} \sum_{t=i-\frac{k-1}{2}}^{i+\frac{k-1}{2}} d_t \quad (i=1, 2, \dots, n)$ $b_i = \frac{1}{k} \sum_{t=i-\frac{k}{2}+1}^{i+\frac{k}{2}} d_t \quad (i=1, 2, \dots, n)$ <p><math>d_i</math>: <math>i</math>th-point data acquired across the source channel  <math>k</math>: Number of moving point (1 to 5000)</p> <p>Specify the constant <math>k</math> following a comma. Example: Calculating 100-point moving averages of the Z1 waveform MOV(Z1,100)                      For each <math>k/2</math> points of data at the beginning and end of the calculation interval, the instrument performs calculations by plugging in zero for data-missing parts.</p>
<b>Parallel move in the time axis direction (SLI)</b>	<p>This function requires the number of moving points to be specified in the second parameter <math>k</math>.                      The instrument translates a waveform in the time-axis direction by the specified moving points.</p> $b_i = d_{i-k} \quad (i = 1, 2, \dots, n)$ <p><math>k</math>: Number of moving points (-5000 to 5000)</p> <p>Specify the constant <math>k</math> following a comma. Example: Translating the Z1 waveform by 100 points SLI(Z1,100)</p> <p>Note: If the instrument finds non-data parts at the beginning or end of the calculation interval after translating a waveform, the instrument specifies zero-volt voltage there.</p>



$b_i$ :  $i$ th-point data in calculation results,  $d_i$ :  $i$ th-point data acquired across the source channel

Waveform calculation type	Description
<b>Waveform shifting by a PLC delay time specified in a digital voltmeter module (PLCS)</b>	<p>The instrument shifts a waveform by a frequency (PLC) and delay time of PLCS, which are configured in the setting for Model MR8990 Digital Voltmeter Unit. Since digital voltmeter modules calculate averages of data acquired during periods specified in the NPLC setting, an observed waveform will lag behind waveforms acquired with Model 8966 Analog Unit by a half of the NPLC setting. The PLCS calculation advances a waveform acquired with the digital voltmeter module by the delay time to compensate for the lag behind a waveform acquired with Model 8966.</p> <p>Note If the instrument find non-data part at the end of the calculation result, the instrument specifies zero volt there.</p>
<b>Sine (SIN)</b>	$b_i = \sin(d_i) \quad (i = 1, 2, \dots, n)$ <p>For the trigonometric and inverse trigonometric functions, specify numbers in radians (rad).</p>
<b>Cosine (COS)</b>	$b_i = \cos(d_i) \quad (i = 1, 2, \dots, n)$ <p>For the trigonometric and inverse trigonometric functions, specify numbers in radians (rad).</p>
<b>Tangent (TAN)</b>	$b_i = \tan(d_i) \quad (i = 1, 2, \dots, n)$ <p>For the trigonometric and inverse trigonometric functions, specify numbers in radians (rad).</p>
<b>Arc sine (ASIN)</b>	<p>For <math>d_i &gt; 1</math>                      <math>b_i = \pi / 2</math>  For <math>-1 \leq d_i \leq 1</math>              <math>b_i = \arcsin(d_i)</math>  For <math>d_i &lt; -1</math>                      <math>b_i = -\pi / 2</math> (<math>i = 1, 2, \dots, n</math>)</p> <p>For the trigonometric and inverse trigonometric functions, specify numbers in radians (rad).</p>
<b>Arc cosine (ACOS)</b>	<p>For <math>d_i &gt; 1</math>                      <math>b_i = 0</math>  For <math>-1 \leq d_i \leq 1</math>              <math>b_i = \arccos(d_i)</math>  For <math>d_i &lt; -1</math>                      <math>b_i = \pi</math> (<math>i = 1, 2, \dots, n</math>)</p> <p>For the trigonometric and inverse trigonometric functions, specify numbers in radians (rad).</p>
<b>Arc tangent (ATAN)</b>	$b_i = \arctan(d_i) \quad (i = 1, 2, \dots, n)$ <p>For the trigonometric and inverse trigonometric functions, specify numbers in radians (rad).</p>
<b>2-argument arc tangent (ATAN2(y, x))</b>	<p>Responses arc tangent of <math>(y/x)</math> in the range of <math>[-\pi, \pi]</math>. Specify numbers in radians (rad).  <math>ATAN2(y, x) =</math>  For <math>x \geq 0</math>                      <math>ATAN(y/x)</math>  For <math>x &lt; 0</math> and <math>y \geq 0</math>              <math>ATAN(y/x) + \pi</math>  For <math>x &lt; 0</math> and <math>y &lt; 0</math>              <math>ATAN(y/x) - \pi</math></p>

$b_i$ :  $i$ th-point data in calculation results,  $d_i$ :  $i$ th-point data acquired across the source channel

Waveform calculation type	Description
<p><b>1st-order differential (DIF)</b></p> <p><b>2nd-order differential (DIF2)</b></p>	<p>The instrument makes 1st-order differential and 2nd-order differential calculations using 5th-order Lagrange interpolation formula to obtain 1-point data from 5-point values that includes before and after the point. The instrument differentiates data <math>d_1</math> to <math>d_n</math> considering them as the corresponding data for the sampling time <math>t_1</math> to <math>t_n</math>.</p> <p>Note: Differentiating a slowly oscillating waveform causes an increase in calculation results variation. In such a case, raise the second parameter of the function. The following equations hold when the second parameter equals one.</p> <p><b>Arithmetic expressions of 1st-order differential</b></p> <p>Point <math>t_1</math> <math>b_1 = (-25d_1 + 48d_2 - 36d_3 + 16d_4 - 3d_5) / 12h</math>            Point <math>t_2</math> <math>b_2 = (-3d_1 - 10d_2 + 18d_3 - 6d_4 + d_5) / 12h</math>            Point <math>t_3</math> <math>b_3 = (d_1 - 8d_2 + 8d_4 - d_5) / 12h</math>            ↓            Point <math>t_i</math> <math>b_i = (d_{i-2} - 8d_{i-1} + 8d_{i+1} - d_{i+2}) / 12h</math>            ↓            Point <math>t_{n-2}</math> <math>b_{n-2} = (d_{n-4} - 8d_{n-3} + 8d_{n-1} - d_n) / 12h</math>            Point <math>t_{n-1}</math> <math>b_{n-1} = (-d_{n-4} + 6d_{n-3} - 18d_{n-2} + 10d_{n-1} + 3d_n) / 12h</math>            Point <math>t_n</math> <math>b_n = (3d_{n-4} - 16d_{n-3} + 36d_{n-2} - 48d_{n-1} + 25d_n) / 12h</math></p> <p><math>b_1</math> to <math>b_n</math>: Calculation result data  <math>h = \Delta t</math>: Sampling period</p> <p><b>Arithmetic expressions of 2nd-order differential</b></p> <p>Point <math>t_1</math> <math>b_1 = (35d_1 - 104d_2 + 114d_3 - 56d_4 + 11d_5) / 12h^2</math>            Point <math>t_2</math> <math>b_2 = (11d_1 - 20d_2 + 6d_3 + 4d_4 - d_5) / 12h^2</math>            Point <math>t_3</math> <math>b_3 = (-d_1 + 16d_2 - 30d_3 + 16d_4 - d_5) / 12h^2</math>            ↓            Point <math>t_i</math> <math>b_i = (-d_{i-2} + 16d_{i-1} - 30d_i + 16d_{i+1} - d_{i+2}) / 12h^2</math>            ↓            Point <math>t_{n-2}</math> <math>b_{n-2} = (-d_{n-4} + 16d_{n-3} - 30d_{n-2} + 16d_{n-1} - d_n) / 12h^2</math>            Point <math>t_{n-1}</math> <math>b_{n-1} = (-d_{n-4} + 4d_{n-3} + 6d_{n-2} - 20d_{n-1} + 11d_n) / 12h^2</math>            Point <math>t_n</math> <math>b_n = (11d_{n-4} - 56d_{n-3} + 114d_{n-2} - 104d_{n-1} + 35d_n) / 12h^2</math></p>

$b_i$ :  $i$ th-point data in calculation results,  $d_i$ :  $i$ th-point data acquired across the source channel

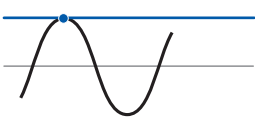
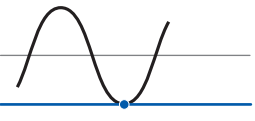
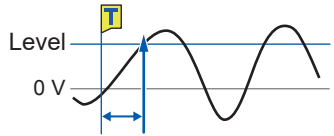
Waveform calculation type	Description	
<p><b>1st-order integration (INT)</b> <b>2nd-order integration (INT2)</b></p>	<p>To calculate values of 1st-order and 2nd-order integration, the instrument uses the trapezoidal formula. The instrument integrates data <math>d_1</math> to <math>d_n</math> considering them as the corresponding data for the sampling time <math>t_1</math> to <math>t_n</math>.</p> <p><b>Arithmetic expressions of 1st-order integration</b> Point <math>t_1</math> <math>I_1 = 0</math> Point <math>t_2</math> <math>I_2 = (d_1 + d_2) h / 2</math> Point <math>t_3</math> <math>I_3 = (d_1 + d_2) h / 2 + (d_2 + d_3) h / 2 = I_2 + (d_2 + d_3) h / 2</math> ↓ Point <math>t_n</math> <math>I_n = I_{n-1} + (d_{n-1} + d_n) h / 2</math></p> <p><math>I_1</math> to <math>I_n</math>: Calculation result data <math>h = \Delta t</math>: Sampling period</p> <p><b>Arithmetic expressions of 2nd-order integration</b> Point <math>t_1</math> <math>II_1 = 0</math> Point <math>t_2</math> <math>II_2 = (I_1 + I_2) h / 2</math> Point <math>t_3</math> <math>II_3 = (I_1 + I_2) h / 2 + (I_2 + I_3) h / 2 = II_2 + (I_2 + I_3) h / 2</math> ↓ Point <math>t_n</math> <math>II_n = II_{n-1} + (I_{n-1} + I_n) h / 2</math></p> <p><math>II_1</math> to <math>II_n</math>: Calculation result data Note Integration is susceptible to minor deviation of the zero-position. Be sure to execute zero-adjustment before performing measurement. In addition, zero-point offset correction may be required. Example: To adjust the zero point by 0.124 mV <math>Z1 = INT (CH(1,1)-0.000124)</math></p>	
<p><b>Average value (PAVE)</b></p>	<p>Calculates an average value of waveform data to use this numerical calculation result for waveform calculations.</p> $AVE = \frac{1}{n} \sum_{i=1}^n d_i$ <p><math>AVE</math>: Average <math>n</math>: Number of data points <math>d_i</math>: <math>i</math>th-point data acquired across a channel</p>	
<p><b>Maximum value (PMAX)</b></p>	<p>Calculates the maximum value of waveform data to use this numerical calculation result for waveform calculations.</p>	<p>Maximum value </p>
<p><b>Minimum value (PMIN)</b></p>	<p>Calculates the minimum value of waveform data to use this numerical calculation result for waveform calculations.</p>	<p>Minimum value </p>
<p><b>Level at time (PLEVEL)</b></p>	<p>Calculates a measured value at the time a specified time has elapsed from a trigger point to use this numerical calculation result for waveform calculations.</p> 	
<p><b>Simple average (AVESIM)</b></p>	<p>Calculates a simple average of repeatedly measured waveform data sets.</p> $A_{m,i} = \frac{1}{m} \sum_{j=1}^m d_{j,i}$ <p><math>m</math>: Number of repeated measurements <math>A_{m,i}</math>: <math>i</math>th-point data in simple average results of the <math>m</math>th measurement among repeated measurements <math>d_{j,i}</math>: <math>i</math>th-point data acquired across a channel of the <math>j</math>th measurement among repeated measurements</p> <p>A simple average expression occupies three expressions (two expressions immediately following the calculation number the simple average is specified to are not available).</p>	

$b_i$ :  $i$ th-point data in calculation results,  $d_i$ :  $i$ th-point data acquired across the source channel

Waveform calculation type	Description
<p><b>Exponential average (AVEEXP)</b></p>	<p>This function requires an attenuation constant to be specified in the second parameter <math>k</math>. Calculates an exponential average of repeatedly measured waveform data sets. (First of repeated measurements)</p> $A_{1,i} = d_{1,i}$ <p style="margin-left: 40px;"><math>A_{1,i}</math>: <math>i</math>th-point data in exponential average results of the first measurement among repeated measurements</p> <p style="margin-left: 40px;"><math>d_{1,i}</math>: <math>i</math>th-point data obtained across a channel of the first measurement among repeated measurements</p> <p>(Second or later of repeated measurements)</p> $A_{m,i} = (d_{m,i} + (k - 1) A_{m-1,i}) / k$ <p style="margin-left: 40px;"><math>m</math>: Number of repeated measurements</p> <p style="margin-left: 40px;"><math>A_{m,i}</math>: <math>i</math>th-point data in exponential average results of the <math>m</math>th measurement among repeated measurements</p> <p style="margin-left: 40px;"><math>d_{m,i}</math>: <math>i</math>th-point data acquired across a channel of the <math>m</math>th measurement among repeated measurements</p> <p style="margin-left: 40px;"><math>k</math>: Attenuation constant</p> <p>Use an exponential average independently. Concurrent use with other calculations causes an error.</p>

$b_i$ :  $i$ th-point data in calculation results,  $a_i$ :  $i$ th-point data acquired across the source channel

Waveform calculation type	Description
<p><b>Half-wave average (AVEH)</b>  <b>Full-wave average (AVEF)</b>  <b>Half-wave RMS value (RMSH)</b>  <b>Full-wave RMS value (RMSF)</b></p>	<p>Detects the points where the signal acquired across the reference channel has no voltage (zero-crossings), and calculates averages or RMS values of the signal acquired across the target channel during each time period specified by the zero-crossings. During each time period, the displayed period or frequency remains unchanged.</p> <p><b>Time period for half-wave average and half-wave RMS value</b>                      Time periods are defined by the zero-crossings that occur while the signal is both rising and falling (● marks), thus consisting of two parts: one from when the signal crosses the zero-volt level while rising to when it crosses the zero-volt level while falling, and vice versa.</p> <p><b>Time period for full-wave average and full-wave RMS value</b>                      Time periods are defined by the zero-crossings that occur while the signal is rising only (● marks).</p> <p>Once a zero-crossing (● mark) has been detected, the instrument will not honor subsequent zero-crossings (○ marks) when the signal crosses the zero-volt level before exiting the threshold range, which is between the positive and negative threshold values.</p> <p>When the forced-average setting is enabled, the instrument calculates averages or RMS values of the signal acquired during the period until the user-specified forced-average time has elapsed after detecting zero-crossings (● marks).</p>

$b_i$ :  $i$ th-point data in calculation results,  $d_i$ :  $i$ th-point data acquired across the source channel

Waveform calculation type	Description	
<p>Half-wave period (PRDH)                      Half-wave frequency (FRQH)                      Full-wave period (PRDF)                      Full-wave frequency (FRQF)</p>	<p>Detects the points where the signal acquired across the reference channel has no voltage (zero-crossings), and calculates the periods and frequencies of a signal for each time period. During each time period, the displayed period or frequency remains unchanged.</p> <p><b>Time periods for calculating half-wave periods and frequencies</b>                      Time periods are defined by the zero-crossings that occur while the signal is both rising and falling (● marks), thus consisting of two parts: one from when the signal crosses the zero-volt level while rising to when it crosses the zero-volt level while falling, and vice versa.</p> <p><b>Time periods for calculating full-wave periods and frequencies</b>                      Time periods are defined by the zero-crossings that occur while the signal is rising only (● marks).</p> <p>Once a zero-crossing (● mark) has been detected, the instrument will not honor subsequent zero-crossings (○ marks) when the signal crosses the zero-volt level before exiting the threshold range, which is between the positive and negative threshold values.</p>	
<p>Polarity (POLE)</p>	<p>If the waveform acquired across the target channel leads that acquired across the reference channel, the instrument displays the figure +1; if lags, the figure -1.</p>	<p>Lead (+1)</p>

$b_i$ :  $i$ th-point data in calculation results,  $d_i$ :  $i$ th-point data acquired across the source channel

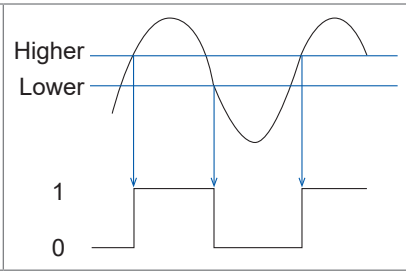
Waveform calculation type	Description
<b>Encoder (ABZ)</b>	<p>Cumulatively adds the pulses of an incremental-type rotary encoder. Values cannot be converted for absolute-type rotary encoders. This function uses 4× operation in which both the rising and falling edges are counted for A-phase and B-phase channels. The angle is incremented (decremented) by 1 when the A-phase leads (lags) the B-phase. Values are interpolated linearly for each angle count. The angle is reset to 0 at the Z-phase channel pulse's rising edge. The value 0 is output until the first Z-phase pulse is detected.</p>
<b>Resolver (RSLV)</b>	<p>When <b>RSLV(CH<sub>EXC</sub>, CH<sub>COS</sub>, CH<sub>SIN</sub>, hys)</b> is entered into an equation, the calculation shown below is performed to calculate the resolver angle (in degrees). The output range is 0 to 360. <math>Z_{RSLV}</math> is output to the waveform calculation channel.</p> $Z_{COS} = AVEH(CH_{EXC} * CH_{COS}, CH_{EXC}, hys)$ $Z_{SIN} = AVEH(CH_{EXC} * CH_{SIN}, CH_{EXC}, hys)$ $Z_{RSLV} = ATAN2(Z_{SIN}, Z_{COS}) * 180 / \pi$ <p>CH<sub>EXC</sub>: Excitation wave channel                      CH<sub>COS</sub>: cos wave channel                      CH<sub>SIN</sub>: sin wave channel                      hys: Hysteresis threshold value                      AVEH: Half-cycle average operator                      ATAN2: Arc tangent operator</p>
<b>Remainder (MOD)</b>	<p>When <math>d_i \geq 0</math>                      <math>b_i = d_i \text{ mod } m</math>                      <math>m</math>: Divisor                      When <math>d_i &lt; 0</math>                      <math>b_i = m - ( d_i  \text{ mod } m)</math></p>
<b>Low-pass filter (FIRLPF)</b>	Passes a waveform through an FIR low-pass filter.
<b>High-pass filter (FIRHPF)</b>	Passes a waveform through an FIR high-pass filter.
<b>Band-pass filter (FIRBPF)</b>	Passes a waveform through an FIR band-pass filter.
<b>Band-stop filter (FIRBSF)</b>	Passes a waveform through an FIR band-stop filter.
<b>Low-pass filter (IIRLPF)</b>	Passes a waveform through an IIR low-pass filter.
<b>High-pass filter (IIRHPF)</b>	Passes a waveform through an IIR high-pass filter.
<b>Band-pass filter (IIRBPF)</b>	Passes a waveform through an IIR band-pass filter.
<b>Band-stop filter (IIRBSF)</b>	Passes a waveform through an IIR band-stop filter.
<b>Binarization (BIN)</b>	<p>If the signal crosses the higher threshold while rising, the instrument displays the figure +1; if the lower while falling, the figure -1.</p> 
<b>CAN</b>	<p>Converts CAN signals into waveforms on the basis of CAN definition data. See "12.7 Choosing Data To Be Displayed as Waveforms (When Using the Waveform Calculation Function)" (p. 339).</p>

## 8.5 Examples of Configuring Waveform Calculation Settings

### Obtaining an RMS waveform from an instantaneous waveform

This section explains how to display a RMS waveform obtained through a calculation using a constantly oscillating waveform acquired across the analog channel (CH1-1). The instrument provides no calculations to obtain an RMS waveform from a waveform with a variable period. This example demonstrates a calculation for a waveform data with a period of 200 samples.

 > [Calculation] > [Waveform calculation]

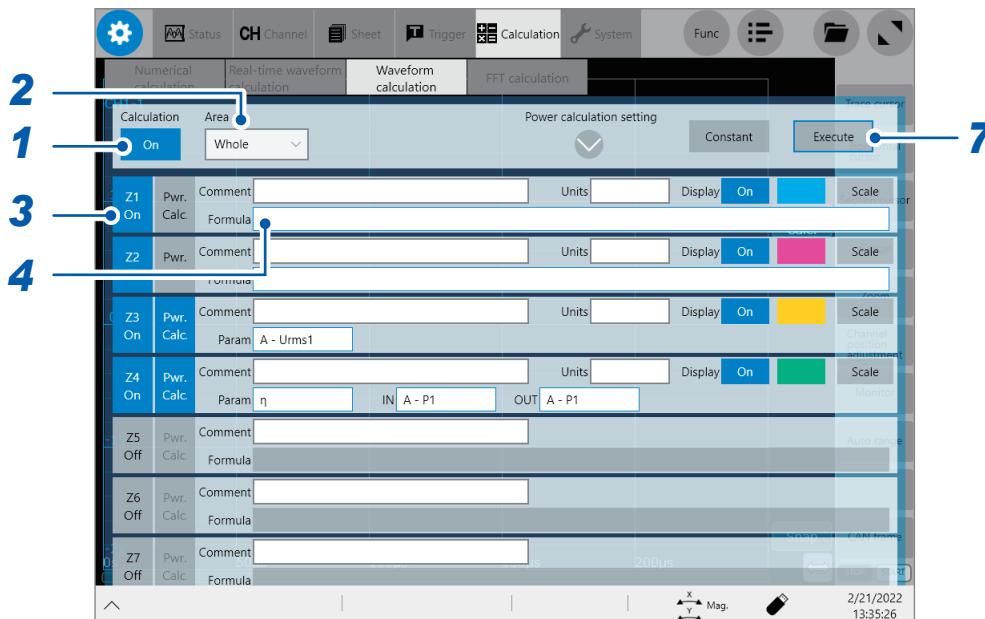

- 1 Tap the [Calculation] button to set it to [On].
- 2 Tap the [Area] box, and then choose [Whole].
- 3 Tap the channel to use for calculation, [Z1], to set it to [On].
- 4 Specify an arithmetic expression.  
Tap the [Formula] box of [Z1] to open the arithmetic expression setting dialog box.



**5** Enter an arithmetic expression.

`SQR(MOV(CH(1,1)*CH(1,1),200))`

Number of sampling per period  
(Specify 200 when measuring 50-Hz commercial power with a sampling rate of 10 kS/s)

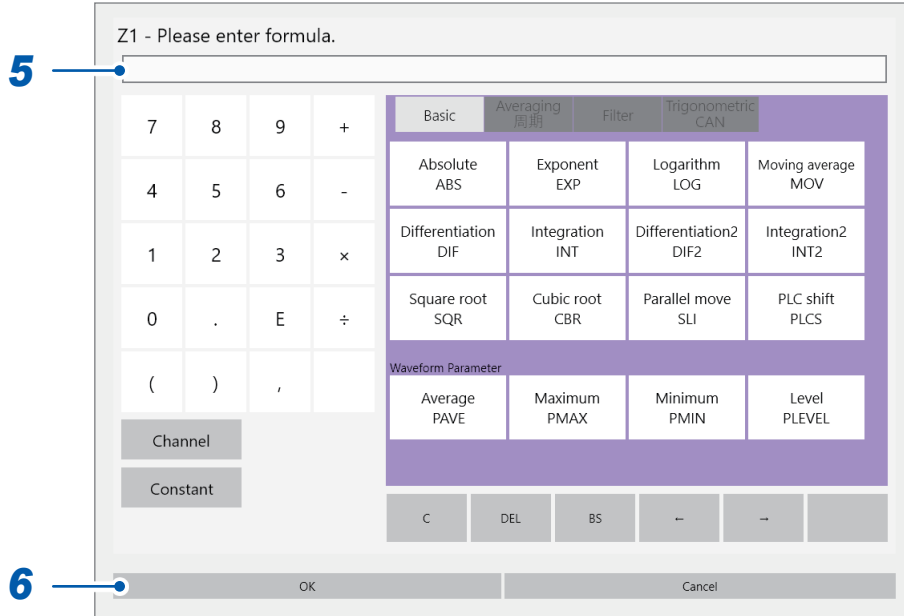

**6** Tap [OK].

The arithmetic expression setting dialog box closes and the arithmetic expression you have entered appears.

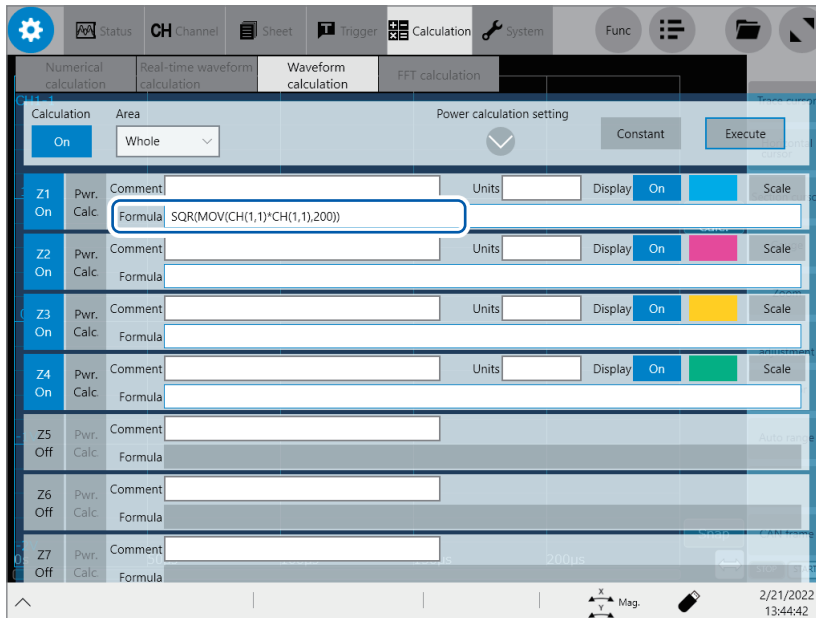

**7** Tap [Execute] to execute the calculation.

**8** Press the **START** key to start a measurement.

The instrument have acquired a waveform, then displaying the calculated waveform.

## To perform calculations using previously acquired data

Tap **[Execute]** in the waveform calculation screen.

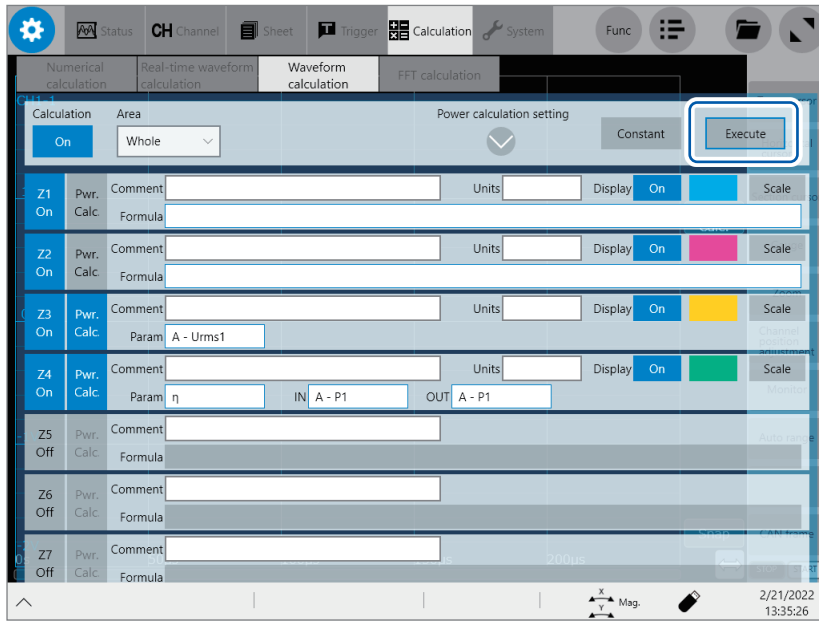

## FIR filter

### How to configure the FIR filter setting

For LPFFIR and HPFFIR, specify a channel number, cutoff frequency (default: 50 Hz), the order of a filter, and a Kaiser window coefficient in an arithmetic expression as follows.

For LPFFIR: LPFFIR(CH(1,1),100000,128,10)

For HPFFIR: HPFFIR(CH(1,1),200000,128,10)

For BPFIR and BSFFIR, specify a channel number, a lower and higher cutoff frequencies (default: 40 Hz and 60 Hz, respectively), the order of a filter, and a Kaiser window coefficient in an arithmetic expression as follows.

For BPFIR: BPFIR(CH(1,1),100000,200000,128,10)

For BSFFIR: BSFFIR(CH(1,1),100000,200000,128,10)

- See Table A (p. 241) for settable upper limits of cutoff frequencies (you can specify a value less than half a sampling frequency, which depends on the time-axis settings).
- For BPFIR and BSFFIR, specify a lower cutoff frequency lower than higher cutoff frequency.
- Specify the order of the FIR filter in the range of 2 to 400 (default: 128). Higher-order filters exhibit steeper cutoff characteristics; however, calculation requires a longer time.
- Specify a Kaiser window coefficient in the range of 0.0 to 20.0 (default: 10.0). Specifying 0.0 exhibits no Kaiser window effect. A greater Kaiser window coefficient can reduce pass-band ripples due to filter amplitude characteristics, allowing a greater out-of-pass-band attenuation.

### Example of an FIR low-pass filter (LPF) setting

This section explains how to configure the Z1 calculation setting to pass the CH1-1 data through a 128th-order FIR low-pass filter with a cutoff frequency of 100 kHz (100000 Hz) and a Kaiser window coefficient of 10.

(With a sampling rate of 500 kHz, which means a sampling period of 200 μs)

 > [Calculation] > [Waveform calculation]

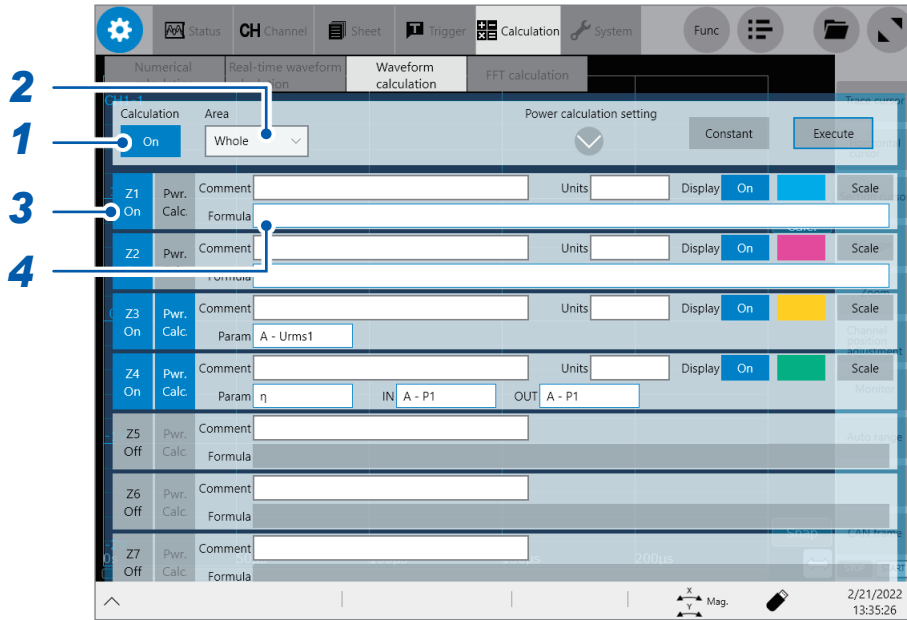

- 1 Tap the [Calculation] button to set it to [On].
- 2 Set [Area] to [Whole].
- 3 Tap the channel to use for calculation, [Z1], to set it to [On].
- 4 Specify an arithmetic expression.  
Tap the [Formula] box of [Z1] to display the arithmetic expression setting dialog box.

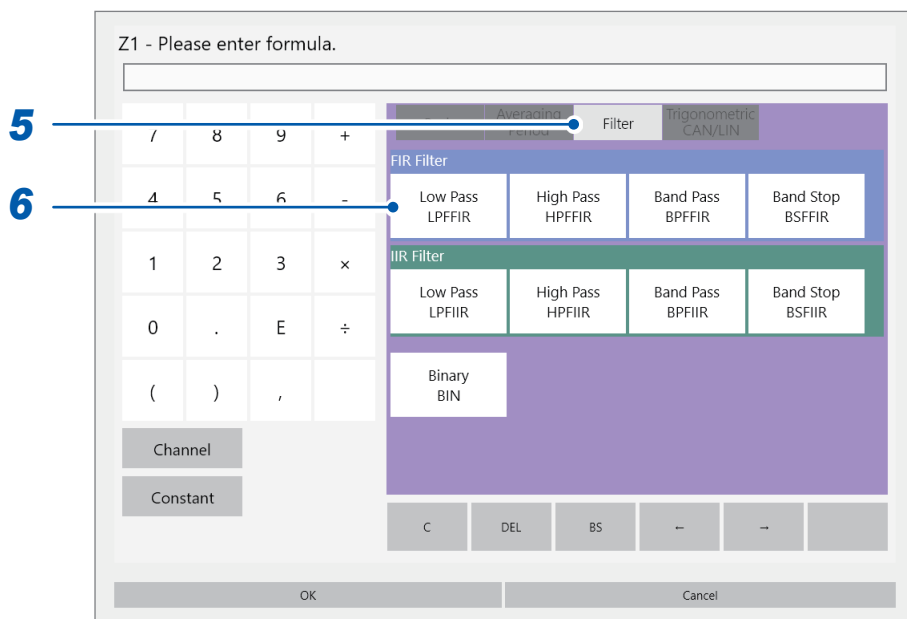

**5** Tap the **[Filter]** tab.  
The filter setting list appears.

**6** Tap **[Low Pass LPFFIR]** of the calculation items.  
The **[FIR Low Pass Filter]** setting dialog box appears.

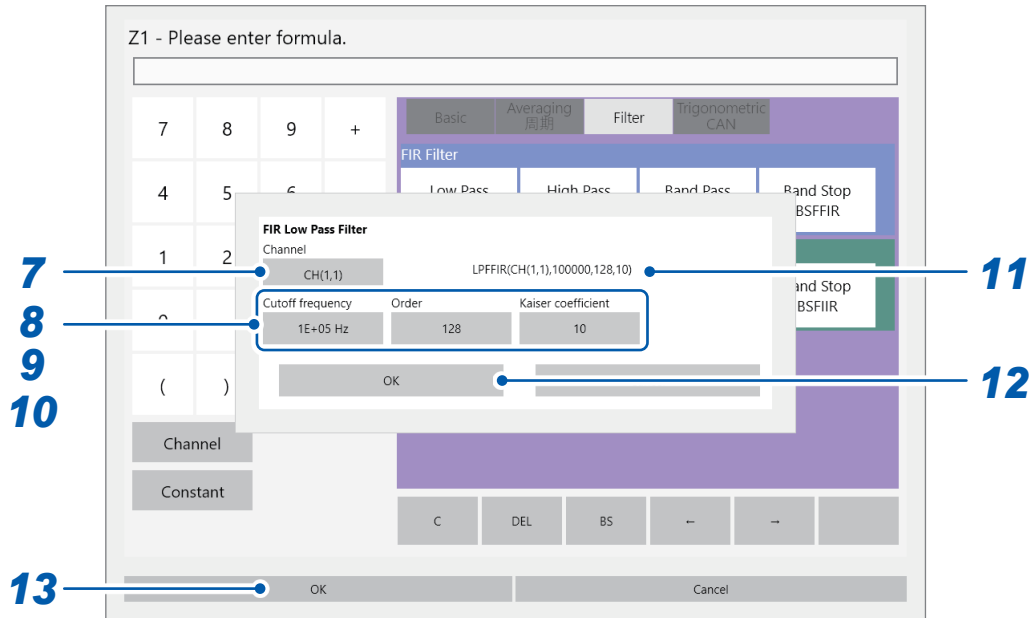

**7** Tap the **[Channel]** box, and then choose a calculation target channel from the list (choose "UNIT1-CH1" of built-in modules).

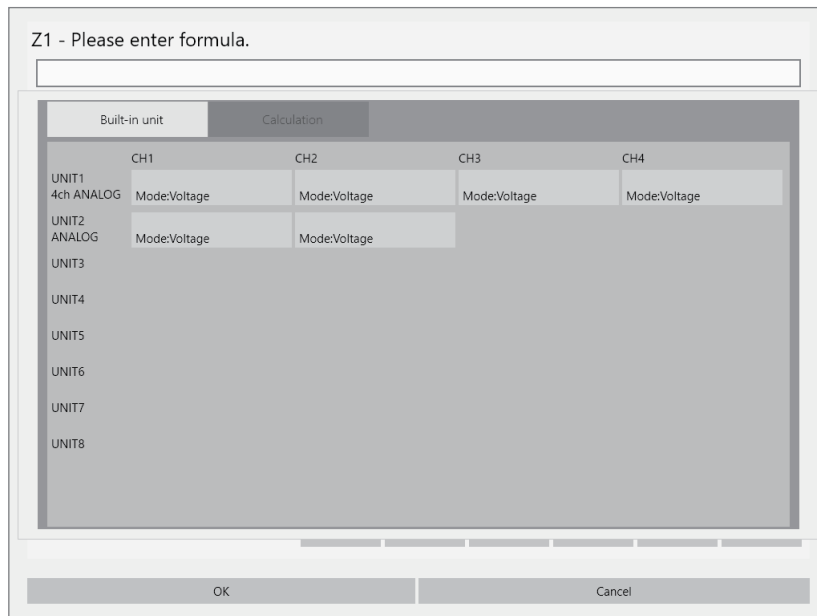

**8** Tap the **[Cutoff frequency]** box, and then specify "100E3" for a unit symbol.

**9** Tap the **[Order]** box, and then specify "128." for a number and "k" for a unit symbol.

**10** Tap the **[Kaiser coefficient]** box, and then specify "10."

**11** Check the arithmetic expressions you entered.

### 12 Tap [OK].

The [FIR Low Pass Filter] setting dialog box closes.  
The arithmetic expression you have specified appears in the screen.

### 13 Tap [OK].

The instrument closes the arithmetic expression setting dialog box, redisplaying the [Waveform calculation] screen.  
The arithmetic expression you have specified appears in [Formula] box of [Z1].

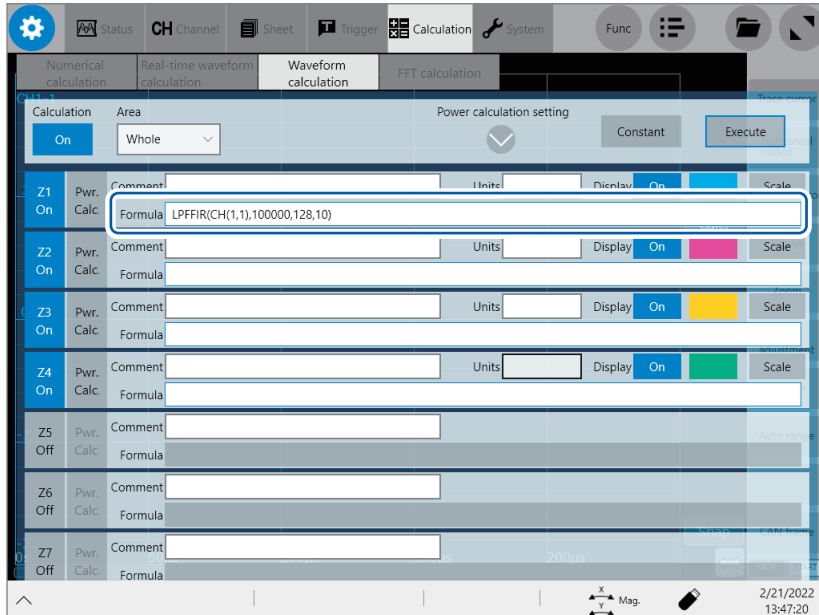

## IIR filter

---

### How to configure the IIR filter setting

For LPFIIR and HPFIIR, specify a channel number, cutoff frequency (default: 50 Hz), the order of a filter in an arithmetic expression as follows.

For LPFIIR: LPFIIR(CH(1,1),100000,2)

For HPFIIR: HPFIIR(CH(1,1),200000,2)

For BPFIIIR and BSFIIR, specify a channel number, a lower and higher cutoff frequencies (default: 40 Hz and 60 Hz, respectively), the order of a filter in an arithmetic expression as follows.

For BPFIIIR: BPFIIIR(CH(1,1),100000,200000,2)

For BSFIIR: BSFIIR(CH(1,1),100000,200000,2)

- See Table A (p. 241) for settable upper limits of cutoff frequencies (you can specify a value less than half a sampling frequency, which depends on the time-axis settings).
- For BPFIIIR and BSFIIR, specify a lower cutoff frequency lower than higher cutoff frequency.
- Specify the order of the IIR filter in the range of 1 to 64 (default: 2). Higher-order filters exhibit steeper cutoff characteristics.

### Example of an IIR low-pass filter (LPF) setting

This section explains how to configure the Z1 calculation setting to pass the CH1-1 data through a 2nd-order IIR low-pass filter with a cutoff frequency of 100 kHz (100000 Hz).  
(With a sampling rate of 500 kHz, which means a sampling period of 2  $\mu$ s)

 > [Calculation] > [Waveform calculation]

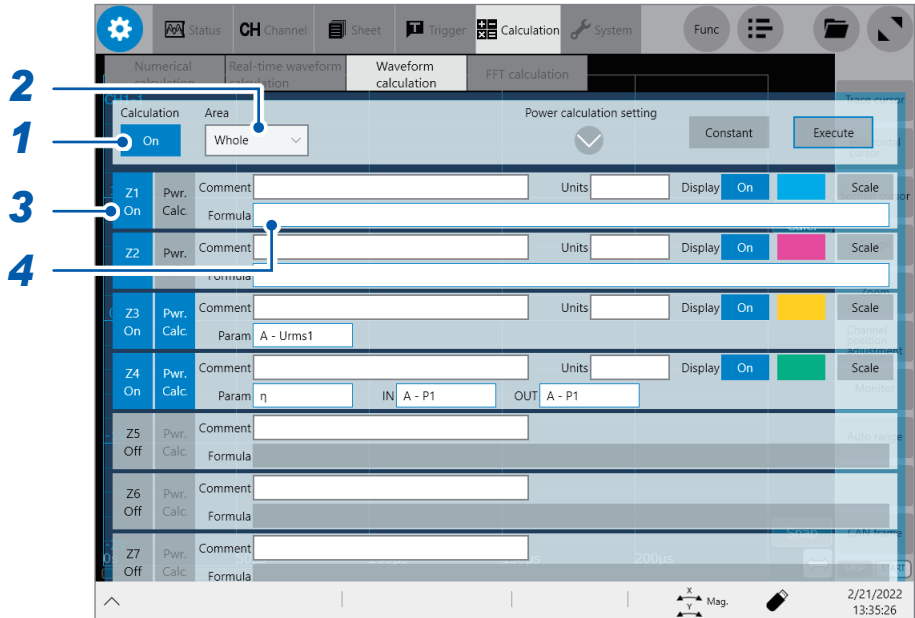

- 1 Tap the [Calculation] button to set it to [On].
- 2 Set [Area] to [Whole].
- 3 Tap the channel to use for calculation, [Z1], to set it to [On].
- 4 Specify an arithmetic expression.

Tap the [Formula] box of [Z1] to display the arithmetic expression setting dialog box.

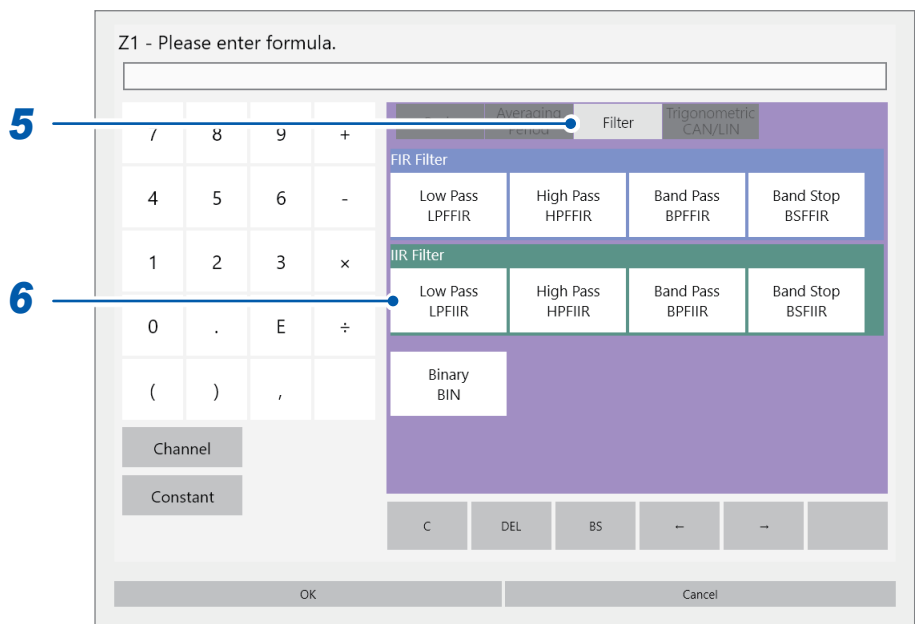



**5** Tap the **[Filter]** tab.  
The filter setting list appears.

**6** Tap **[Low Pass LPFIIR]** of the calculation items.  
The **[IIR Low Pass Filter]** setting dialog box appears.

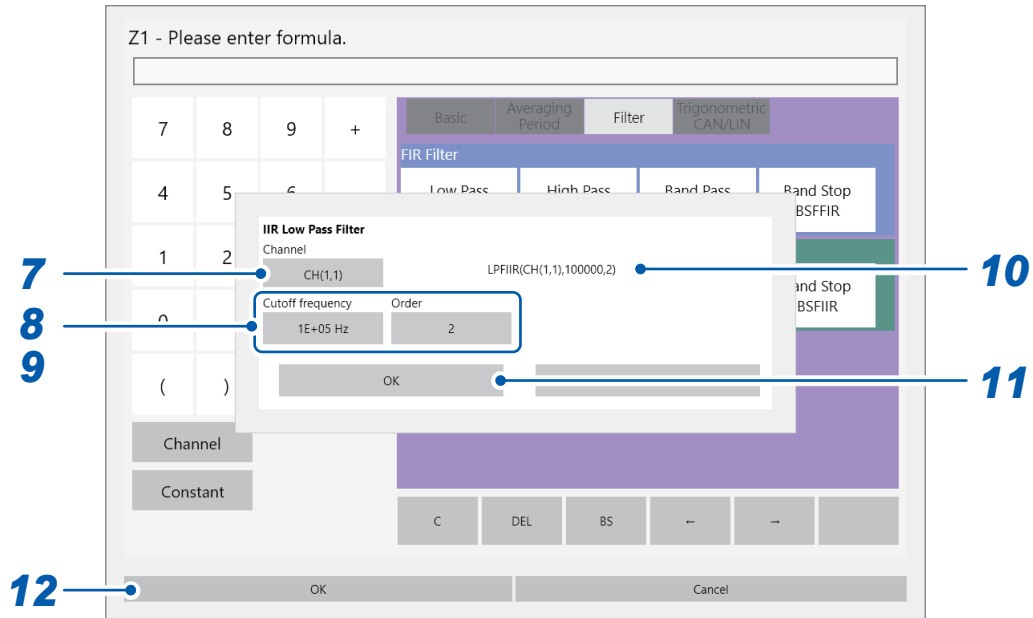

**7** Tap the **[Channel]** box, and then choose a calculation target channel from the list (choose "UNIT1-CH1" of built-in modules).

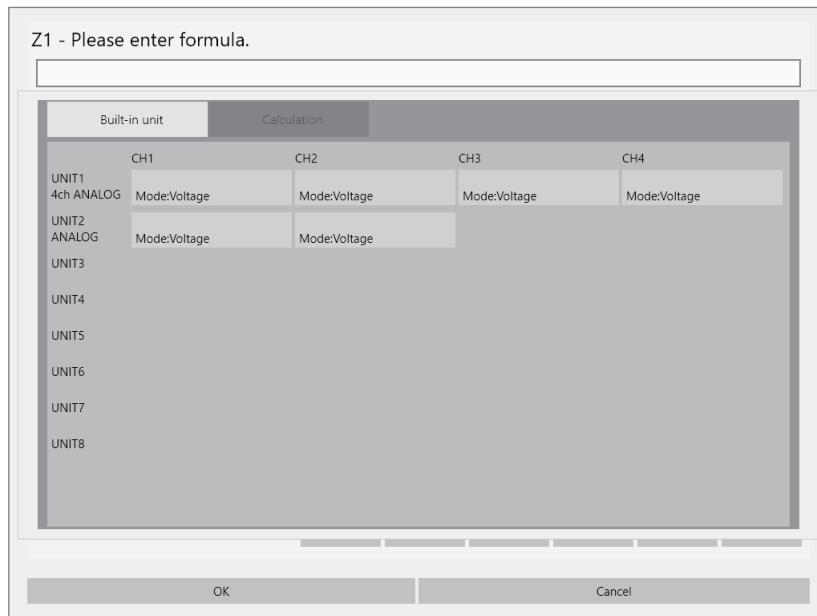

**8** Tap the **[Cutoff frequency]** box, and then specify "100E3" for a unit symbol.

**9** Tap the **[Order]** box, and then specify "2." for a number and "k" for a unit symbol.

**10** Check the arithmetic expressions you entered.

**11** Tap [OK].

The [IIR Low Pass Filter] setting dialog box closes.  
The arithmetic expression you have specified appears in the screen.

**12** Tap [OK].

The instrument closes the arithmetic expression setting dialog box, redisplaying the [Waveform calculation] screen.  
The arithmetic expression you have specified appears in [Formula] box of [Z1].

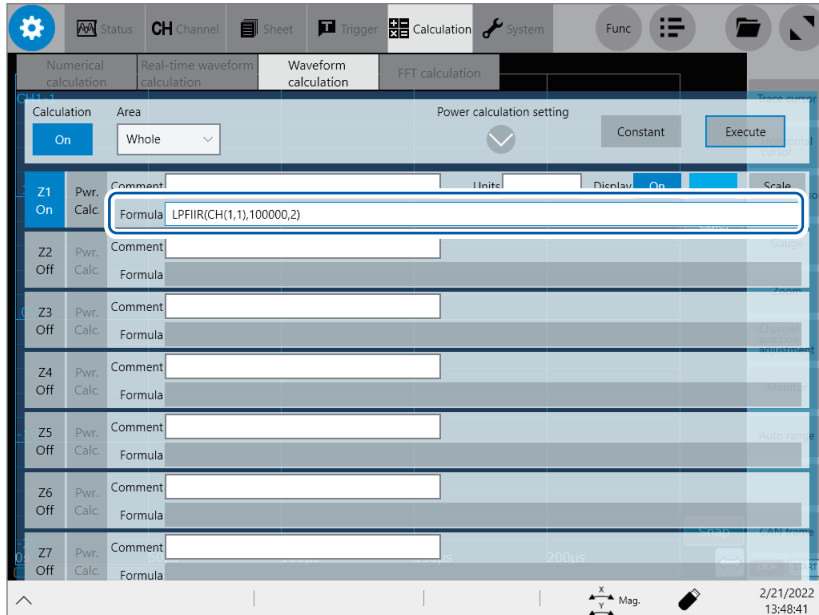

**Table A Relationship among sampling rates, sampling frequencies, cutoff frequencies, and setting resolutions of cutoff frequencies (for both FIR and IIR filters)**

Sampling rate	Sampling period	Sampling frequency	Upper limit of cutoff frequency (Value less than this frequency can be set)	Cutoff frequency setting resolution
200 MS/s	5 ns	200 MHz	100 MHz	200 kHz
100 MS/s	10 ns	100 MHz	50 MHz	100 kHz
50 MS/s	20 ns	50 MHz	25 MHz	50 kHz
20 MS/s	50 ns	20 MHz	10 MHz	20 kHz
10 MS/s	100 ns	10 MHz	5 MHz	10 kHz
5 MS/s	200 ns	5 MHz	2.5 MHz	5 kHz
2 MS/s	500 ns	2 MHz	1 MHz	2 kHz
1 MS/s	1 $\mu$ s	1 MHz	500 kHz	1 kHz
500 kS/s	2 $\mu$ s	500 kHz	250 kHz	500 Hz
200 kS/s	5 $\mu$ s	200 kHz	100 kHz	200 Hz
100 kS/s	10 $\mu$ s	100 kHz	50 kHz	100 Hz
50 kS/s	20 $\mu$ s	50 kHz	25 kHz	50 Hz
20 kS/s	50 $\mu$ s	20 kHz	10 kHz	20 Hz
10 kS/s	100 $\mu$ s	10 kHz	5 kHz	10 Hz
5 kS/s	200 $\mu$ s	5 kHz	2.5 kHz	5 Hz
2 kS/s	500 $\mu$ s	2 kHz	1 kHz	2 Hz
1 kS/s	1 ms	1 kHz	500 Hz	1 Hz
500 S/s	2 ms	500 Hz	250 Hz	500 mHz
200 S/s	5 ms	200 Hz	100 Hz	200 mHz
100 S/s	10 ms	100 Hz	50 Hz	100 mHz
50 S/s	20 ms	50 Hz	25 Hz	50 mHz
20 S/s	50 ms	20 Hz	10 Hz	20 mHz
10 S/s	100 ms	10 Hz	5 Hz	10 mHz
5 S/s	200 ms	5 Hz	2.5 Hz	5 mHz
2 S/s	500 ms	2 Hz	1 Hz	2 mHz
1 S/s	1 s	1 Hz	0.5 Hz	1 mHz

- Stating a measurement and waveform calculation with the instrument having no waveform data allows the sampling rate setting on the measurement setting screen or the waveform screen to define a settable upper limit of a cutoff frequency.
- Tapping **[Execute]** on the waveform calculation screen to perform calculations using waveform data previously acquired in the instrument allows the sampling rate setting to define a settable upper limit of a cutoff frequency.
- The instrument with the external sampling clock setting performs calculations with one sample fixed at 1 Hz.

## 8.6 Explanations of Filter Calculation

### Filter type

Filter name	Description
<b>FIRLPF</b> (Finite impulse response low-pass filter) <b>IIRLPF</b> (Infinite impulse response low-pass filter)	Allows low-frequency components to pass, thus eliminating high-frequency-component noise.
<b>FIRHPF</b> (Finite impulse response high-pass filter) <b>IIRHPF</b> (Infinite impulse response high-pass filter)	Allows high-frequency components to pass, thus eliminating low-frequency-component noise.
<b>FIRBPF</b> (Finite impulse response band-pass filter) <b>IIRBPF</b> (Infinite impulse response band-pass filter)	Allows specified frequency-band components to pass, thus eliminating low- and high-frequency-component noise.
<b>FIRBSF</b> (Finite impulse response band-stop filter) <b>IIRBSF</b> (Infinite impulse response band-stop filter)	Allows low- and high-frequency components to pass, thus eliminating specified-frequency-band-component noise.

#### FIR filters (LPF, HPF, BPF, BSF)

The finite impulse response filter is a digital filter whose impulse response is of finite duration.

**Advantages:** The filter has linear-phase characteristics (a phase difference is proportional to a frequency), reducing phase distortion (phase delay). Since input signals that have not been involved in any calculations are used for the filter calculation, calculated output signals do not diverge, resulting in stable output signals.

**Disadvantages:** A higher order filter is required to obtain steep cutoff characteristics. However, calculation requires a longer time.

#### IIR filters (LPF, HPF, BPF, BSF)

The infinite impulse response filter is a digital filter whose impulse response continues indefinitely. The instrument uses a Butterworth IIR digital filter, which has flat pass-band characteristics, for calculation.

**Advantages:** A lower-order filter is sufficient to obtain sharp cutoff characteristics. A lower-order filter requires a shorter period of calculation time.

**Disadvantages:** A filter has non-linear phase characteristics (a phase difference is not proportional to a frequency), causing greater phase distortion (phase delay). Since input signals that have not been involved in any calculations are used for the filter calculation, calculated output signals may diverge, resulting in unstable output signals.

## Filter configuration

**FIR filter configuration (nth-order FIR filter)**

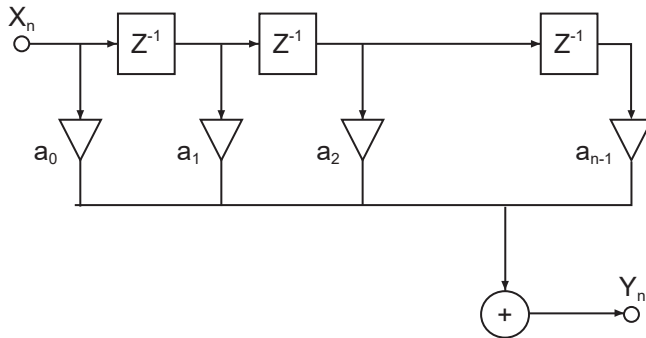

**IIR filter configuration (4th-order IIR filter)**

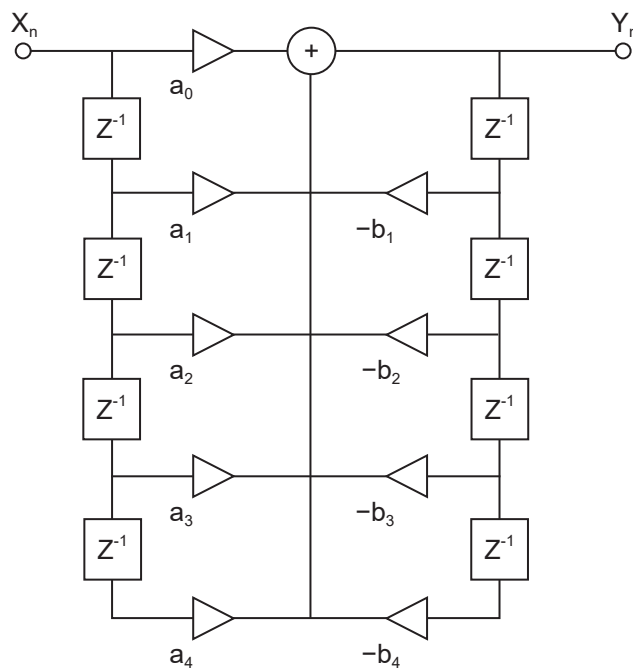

### Delayer

A component that delays input signals by one sampling time

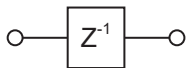

### Adder

A component that outputs the sum of two input signals

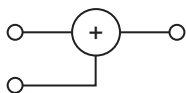

### Multiplier

A component that outputs multiplication of a input signal by constant a

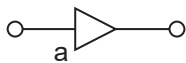

## 8.7 Setting Power Calculation Conditions

### Detailed power calculation settings

This section describes how to set calculation conditions for each of the four circuits.

 > [Calculation] > [Waveform calculation] > [Power calculation setting]

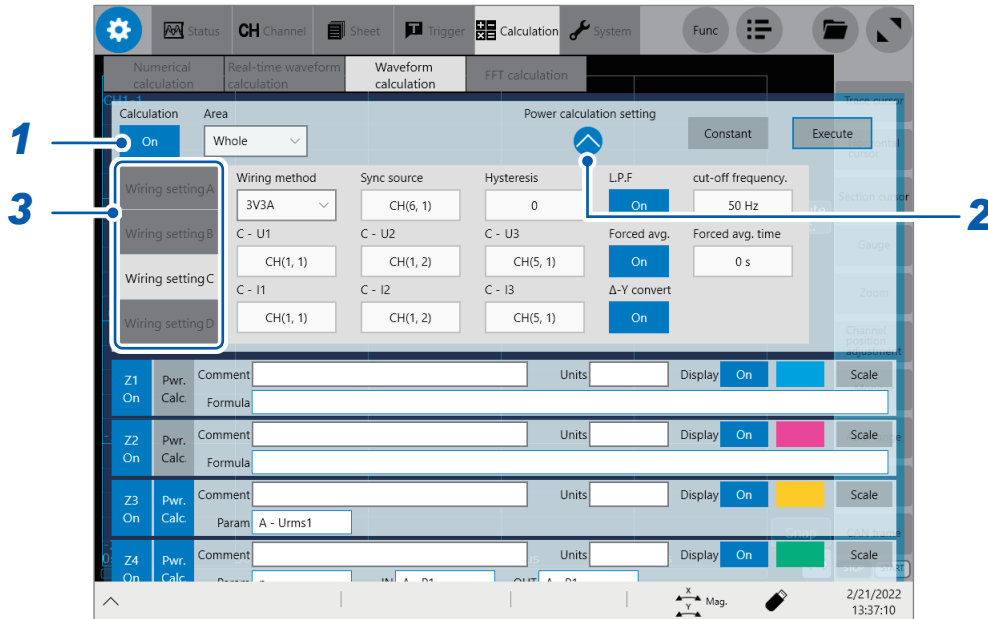

**1** Tap the [Calculation] button and set it to [On].

**2** Tap the “Open” mark underneath [Power Calculation Setting].

A screen of detailed power calculation settings will open.

**3** Tap [Wiring setting A], [Wiring setting B], [Wiring setting C], or [Wiring setting D] and set the desired conditions.

The settings described below can be configured for [Wiring setting A], [Wiring setting B], [Wiring setting C], and [Wiring setting D].

## Wiring method settings

This section describes how to set the wiring method.

 > [Calculation] > [Waveform calculation] > [Power calculation setting]



**1** Tap the [Wiring method] box and select the wiring method.

Wiring method		Example settings
<b>1P2W</b>	1-phase/2-wire	Configures the instrument for 1-phase/2-wire (1P2W) measurement and calculations.
<b>1P3W</b>	1-phase/3-wire	Configures the instrument for 1-phase/3-wire (1P3W) measurement and calculations.
<b>3P3W</b>	3-phase/3-wire	Configures the instrument for 3-phase/3-wire (3P3W) measurement and calculations. In this wiring method, the two channels of the 3-phase delta wiring line are used to perform two-power-meter measurement. It can be used to measure active power accurately even if the waveforms are distorted due to unbalance.
<b>3V3A</b>	3-phase/3-wire	Configures the instrument for 3-phase/3-wire (3V3A) measurement and calculations. In this wiring method, the three channels of the 3-phase delta wiring line are used to perform two-power-meter measurement. It can be used to measure not only active power, but also apparent power, reactive power, and power factor accurately even if the lines are unbalanced.
<b>3P4W</b>	3-phase/4-wire	Configures the instrument for 3-phase/4-wire (3P4W) measurement and calculations. In this wiring method, the three channels of the 3-phase Y (star) wiring line are used to perform three-power-meter measurement.

See "16 Power Equations and Wiring Specifications" (p. 420).

**2** Tap the voltage boxes ([U1] to [U3]) and set the voltage channel for each phase.

Set built-in unit and real-time calculation channels.

### **3 Tap the current boxes ([I1] to [I3]) and set the current channel for each phase.**

Set built-in unit and real-time calculation channels.

Which voltage boxes ([U1] to [U3]) and current boxes ([I1] to [I3]) are displayed depends on the wiring method.

- Check the unit input and wiring method before measurement. Incorrect wiring will prevent proper measurement and calculation.
- Selecting either 3P3W or 3V3A when performing 3-phase/3-wire measurement will result in the same power waveform, since both methods use the same power waveform (P) measurement method.



## Configuring zero-cross settings

A zero-cross event occurs when an input signal crosses the zero level. In power waveform calculations, the interval from one zero-cross to the next zero-cross when the signal crosses the zero level in the same direction is defined as 1 cycle, and calculations are performed for each cycle.

 > [Calculation] > [Waveform calculation] > [Power calculation setting]

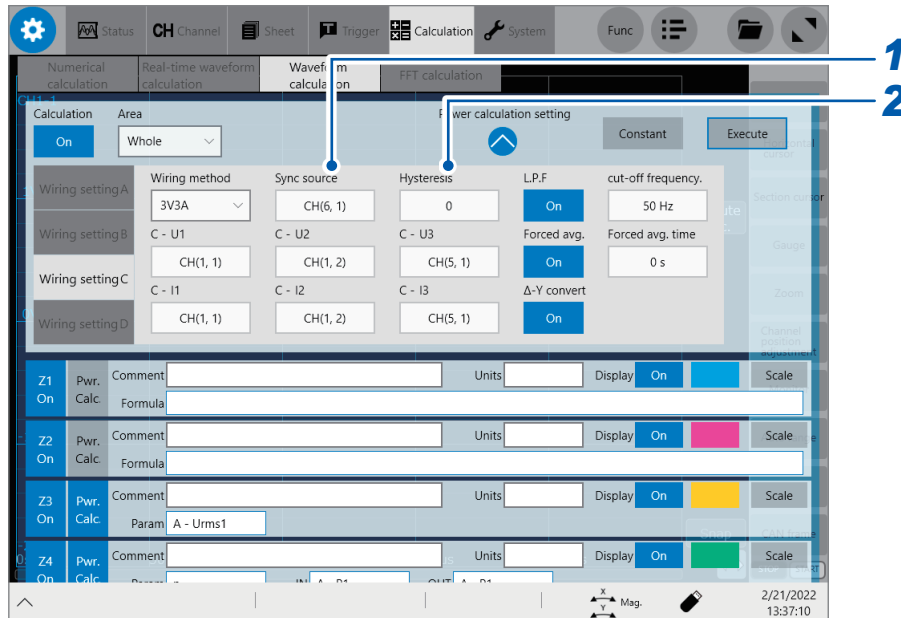

### 1 Tap the [Sync source] box and set the channel to use as the basis for cycles.

Set built-in unit and real-time calculation channels.

Set the source channel (zero-cross detection channel) to use in order to determine the cycle (zero-cross interval), which provides the basis for calculations.

Calculations will be performed from the first zero-cross point in captured waveforms to the last zero-cross point.

If specifying the interval with [Area], the calculation scope will be defined as the interval from the first zero-cross point that falls within the specified range to the last zero-cross point in that range.

### 2 Tap the [Hysteresis] box and set the threshold.

0 V to 9.9999E+29 V

### Sync source

Set the source channel (zero-cross detection channel) to use in order to determine the cycle (zero-cross interval), which provides the basis for calculations.

Calculations will be performed from the first zero-cross point in captured waveforms to the last zero-cross point.

If specifying the interval with [Area], the calculation scope will be defined as the interval from the first zero-cross point that falls within the specified range to the last zero-cross point in that range.

## Hysteresis

The cycle that provides the basis for calculations is the zero-cross interval for the sync source channel. If there is noise near this zero-cross, the instrument won't be able to detect one cycle accurately.

Hysteresis prevents erroneous calculations due to noise near the zero-cross by allowing you to set a threshold value.

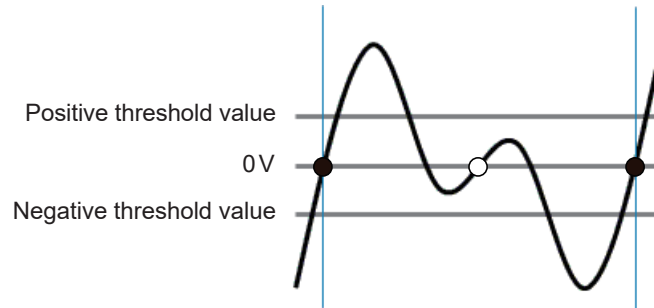

After a zero-cross point is detected (● mark), points at which 0 V is crossed (○ mark) will not be treated as the next zero-cross point unless the signal has exceeded the hysteresis width (the range between the positive hysteresis threshold value and the negative hysteresis threshold value).

## Low-pass filter settings

This section describes how to apply the IIR low-pass filter.

 > [Calculation] > [Waveform calculation] > [Power calculation setting]

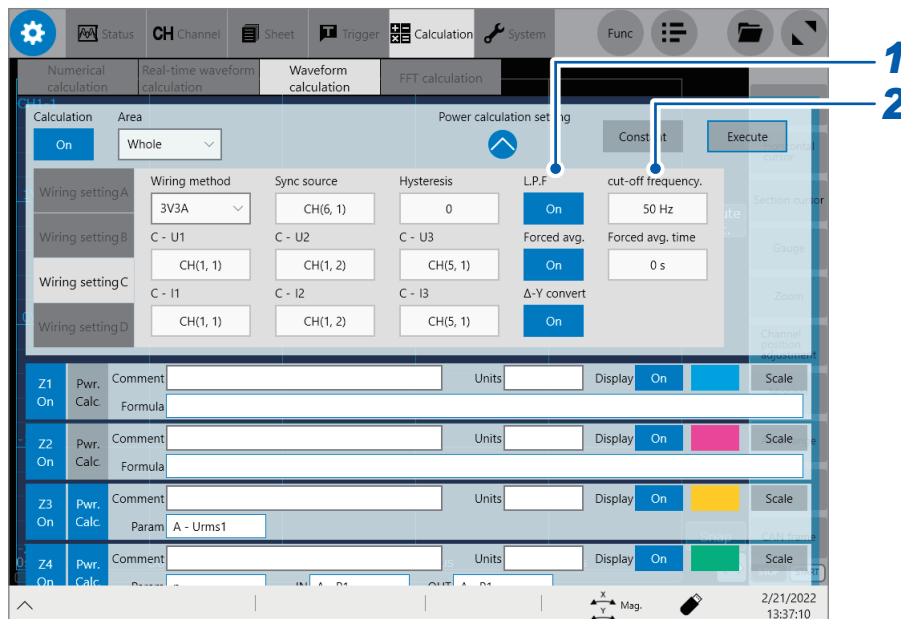

**1** Tap the [L.P.F] button and set it to [On].

**2** (If the [L.P.F] button is set to [On])

Tap the low-pass filter's [cut-off frequency] box and set the frequency.

0 Hz <sup>□</sup> to 1E+8 Hz

### Low-pass filter

You can set an IIR low-pass filter to limit the frequency band.

This filter can be used to reject high-frequency components and unnecessary external noise components that exceed the set frequency.

For more information about the maximum cutoff frequencies that can be set, see Table A (p. 241).

(The maximum cutoff frequency is half the sampling frequency, which is determined by the time width setting.)

## Forced average time setting

This section describes how to force the instrument to perform calculations once a specified time elapses.

 > [Calculation] > [Waveform calculation] > [Power calculation setting]

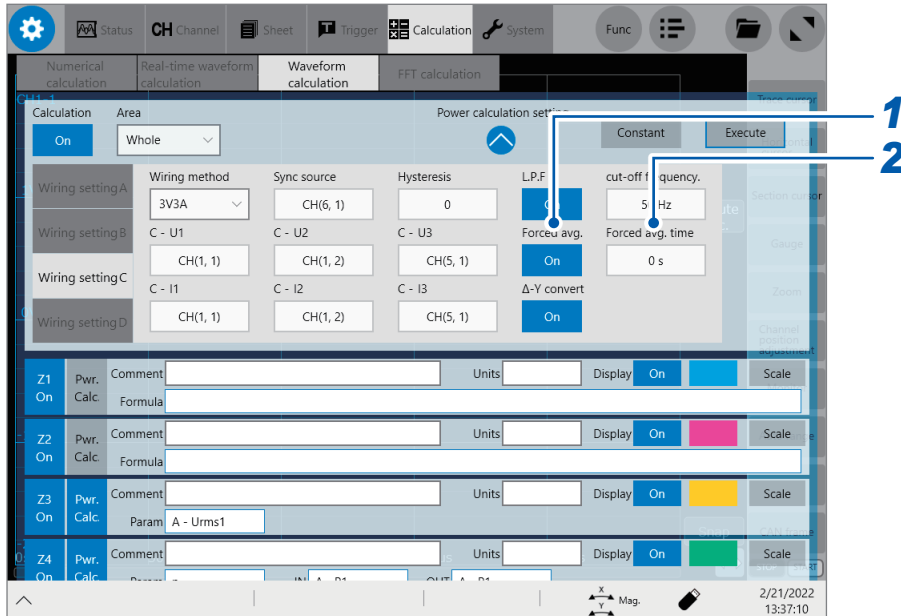

**1** Tap the [Forced avg.] button and set it to [On].

**2** (If the [Forced avg.] button is set to [On])

Tap the [Forced avg. time] box and set the forced average time.

0 s  to 9.9999E+29 s

## Δ-Y conversion setting

This section describes how to convert Δ (delta) wiring to Y (star) wiring for a 3-phase measurement line.

This function is valid when the [Wiring method] is [3V3A].

 > [Calculation] > [Waveform calculation] > [Power calculation setting]

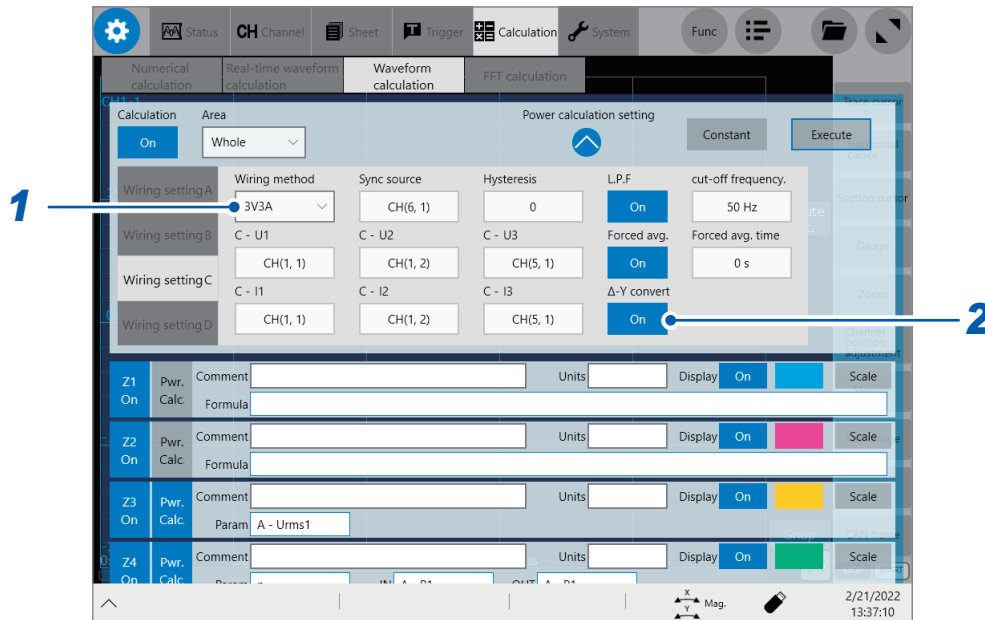

**1** Tap the [Wiring method] box and select [3V3A].

**2** Tap the [Δ-Y convert] button and set it to [On].

### Δ-Y conversion

This function lets you perform measurement using the phase voltage applied to the motor coil as Y wiring even when using delta wiring when you can't access the neutral point in a motor that uses Y wiring internally.

Although voltage waveform, voltage measured value, and harmonic voltage input all use line-to-line voltages, calculations are made using phase voltages.

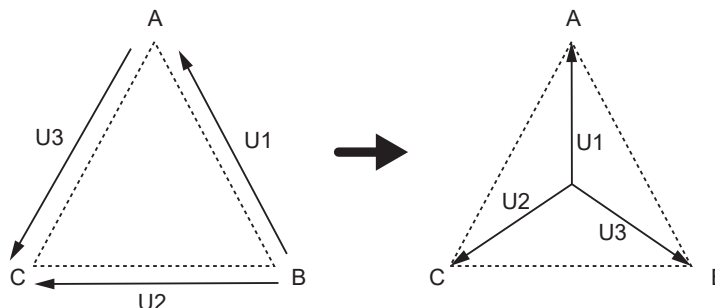

- With Δ-Y conversion, a virtual neutral point is used to convert voltage waveforms to vectors for use in analysis.
- Results may differ from actual phase voltages.
- Whereas active power for 3V3A wiring uses the two-power-meter method, after conversion the three-power-meter method will be used.

## 8.8 Types of Power Calculations and Explanations

This section describes how to set the types of power calculations to perform.

 > [Calculation] > [Waveform calculation]

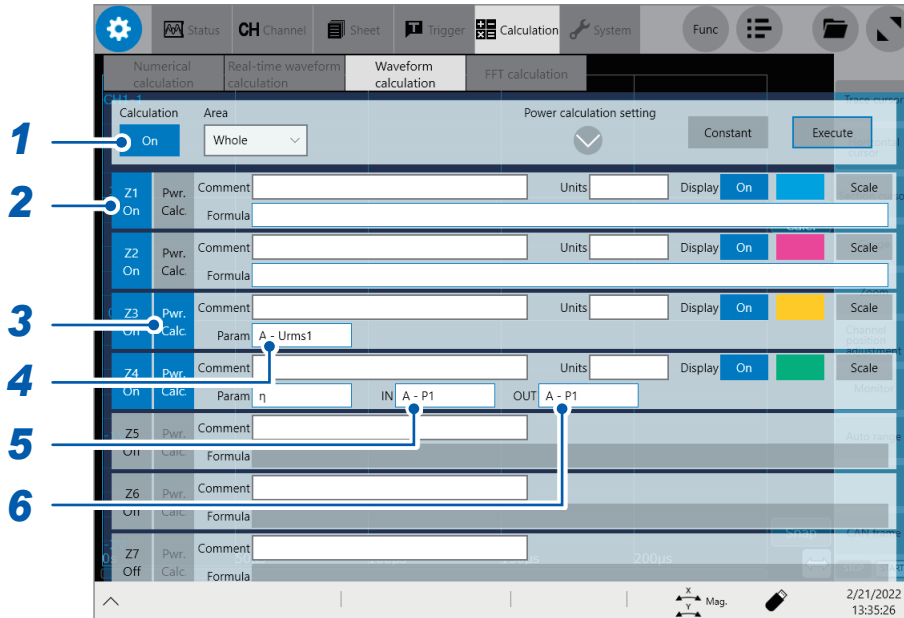

- 1 Tap the [Calculation] button and set it to [On].
- 2 Tap the calculation channel you wish to configure ([Z1] to [Z16]) and set it to [On].
- 3 (When setting a power calculation) Tap [Power Calc.] to enable power calculations.
- 4 Tap the [Param] box and select the type of calculation.

Parameter	Types
Voltage (U)	RMS value ( $U_{rms}$ ), mean value ( $U_{mn}$ ), simple average value ( $U_{dc}$ )
Current (I)	RMS value ( $I_{rms}$ ), mean value ( $I_{mn}$ ), simple average value ( $I_{dc}$ )
Power (P)	Active power ( $P$ ), apparent power ( $S$ ), reactive power ( $Q$ ), power factor ( $\lambda$ ), phase ( $\phi$ )
Other	Efficiency ( $\eta$ ), loss (loss)

- 5 (If [Param] is [ $\eta$ ] (efficiency) or [Loss])  
Tap the [IN] box and select the input-side power value.
- 6 (If [Param] is [ $\eta$ ] (efficiency) or [Loss])  
Tap the [OUT] box and select the output-side power value.

## U (voltage) and I (current)

These waveforms are generated by calculating the value each time voltage and current waveforms cross the zero level and then graphing the results.

A 1P2W	B 3P3W	C 3V3A	D 3P4W	
U	I	P	Others	
Voltage RMS value				
D - Urms1	D - Urms2	D - Urms3	D - Urms12	D - Urms123
Voltage mean value				
D - Umn1	D - Umn2	D - Umn3	D - Umn12	D - Umn123
Voltage simple average				
D - Udc1	D - Udc2	D - Udc3		

A 1P2W	B 3P3W	C 3V3A	D 3P4W	
U	I	P	Others	
Current RMS value				
D - Irms1	D - Irms2	D - Irms3	D - Irms12	D - Irms123
Current mean value				
D - Imn1	D - Imn2	D - Imn3	D - Imn12	D - Imn123
Current simple average				
D - Idc1	D - Idc2	D - Idc3		

### Voltage RMS value (Urms), current RMS value (Irms)

Calculates the true RMS value of the voltage or current.

$$U_{rms} = \sqrt{\frac{1}{n} \sum_{i=1}^n (U_i)^2}$$

$$I_{rms} = \sqrt{\frac{1}{n} \sum_{i=1}^n (I_i)^2}$$

$n$ : Number of data points  
 $U_i$ : Voltage input waveform  
 $I_i$ : Current input waveform

### Voltage mean value (Umn), current mean value (Imn)

Calculates the average value of the voltage or current.

$$U_{mn} = \frac{\pi}{2\sqrt{2}} \cdot \frac{1}{n} \sum_{i=1}^n |U_i|$$

$$I_{mn} = \frac{\pi}{2\sqrt{2}} \cdot \frac{1}{n} \sum_{i=1}^n |I_i|$$

$n$ : Number of data points  
 $U_i$ : Voltage input waveform  
 $I_i$ : Current input waveform

### Voltage simple average value (Udc), current simple average value (Idc)

Calculates the simple average value of the voltage or current.

$$U_{dc} = \frac{1}{n} \sum_{i=1}^n U_i$$

$$I_{dc} = \frac{1}{n} \sum_{i=1}^n I_i$$

$n$ : Number of data points  
 $U_i$ : Voltage input waveform  
 $I_i$ : Current input waveform

## P (power)

These waveforms are generated by detecting voltage and current zero-cross events, calculating values for each zero-cross event, and graphing the results.

A 1P2W	B 3P3W	C 3V3A	D 3P4W	
U	I	P	Others	
Active power				
D - P1	D - P2	D - P3	D - P12	D - P123
Apparent power				
D - S1	D - S2	D - S3	D - S12	D - S123
Reactive power				
D - Q1	D - Q2	D - Q3	D - Q12	D - Q123
Power factor				
D - λ1	D - λ2	D - λ3	D - λ12	D - λ123
Power phase angle				
D - φ1	D - φ2	D - φ3	D - φ12	D - φ123

### Active power (P)

Calculates the active power from the average product of the voltage and current waveforms.

$$P = \frac{1}{n} \sum_{i=1}^n (U_i \cdot I_i)$$

$n$ : Number of data points  
 $U_i$ : Voltage input waveform  
 $I_i$ : Current input waveform

### Apparent power (S)

Calculates the apparent power from voltage RMS values ( $U_{rms}$ ) and current RMS values ( $I_{rms}$ ).

$$S = U_{rms} \cdot I_{rms}$$

### Reactive power (Q)

Calculates the reactive power from the active power (P) and apparent power (S).

$$Q = \sqrt{(S^2 - P^2)}$$

### Power factor ( $\lambda$ )

Calculates the reactive power from the active power (P) and apparent power (S).

$$\lambda = \left| \frac{P}{S} \right|$$

### Power phase angle ( $\phi$ )

Calculates the reactive power from the active power (P) and apparent power (S).

$$\phi = \cos^{-1} \left( \left| \frac{P}{S} \right| \right)$$



## Others (efficiency, loss)

The instrument can calculate and display efficiency ( $\eta$ ) [%] and loss [W] using the active power value and motor power value.



### Efficiency ( $\eta$ ) and loss (loss)

Calculates the efficiency ( $\eta$ ) and loss from the input-side power value ( $P_{in}$ ) and the output-side power value ( $P_{out}$ ).

Input side	<b>[IN]:</b>	$P_{in}$
Output side	<b>[OUT]:</b>	$P_{out}$
Efficiency	<b>[<math>\eta</math>]:</b>	$100 \times  P_{out}  /  P_{in} $
Loss	<b>[Loss]:</b>	$ P_{in}  -  P_{out} $



Using the FFT function allows you to analyze input signal data with respect to frequency through the FFT calculation.

This function is useful to perform frequency analysis of a variety of signals, such as those from rotating objects, vibration, and sound.

See “16.2 FFT Definitions” (p. 409).

The instrument can perform FFT calculation using data previously obtained and processed through waveform calculation, as well as that being acquired concurrently with measurement.

Using Model 8968 High Resolution Unit or Model 8979 Charge Unit, which are equipped with an anti-aliasing filter, allows a cutoff frequency to automatically be set in conjunction with the frequency range setting.

The FFT calculation function is not available in the following occasions:

- When the envelope is used
- When the real-time saving is set to **[On]**

### Major features

- FFT calculation frequency range: 500 mHz to 100 MHz
- FFT calculation types (eight calculations)

FFT calculation type	
Linear spectrum	RMS spectrum
Power spectrum	1CH Phase spectrum
Cross power spectrum	Transfer function
Coherence function	2CH Phase spectrum

- For FFT calculation using signals outputted from a sound level or vibration meter connected with the instrument, you can directly read values in decibels processed through calibration by configuring the scaling setting in the channel setting screen.  
See “3.2 Converting Input Values (Scaling Function)” (p. 56).

#### To perform FFT calculations without being affected by aliasing distortion due to sampling

- Using an input module equipped with a anti-aliasing filter is recommended.  
See “16.2 FFT Definitions” (p. 409), “Aliasing” (p. 411), and “Anti-aliasing filter” (p. 412).
- For more information about the specifications of the FFT calculation function, refer to Quick Start Manual.

# 9.1 Operating Procedure

The following two methods are available:

Newly performing measurement before calculation.	You have to configure the FFT calculation settings before starting measurement.
Performing calculations using existing data	The instrument can perform calculations using waveform data that has already been acquired or that saved on storage devices.

## Newly performing measurement and calculation

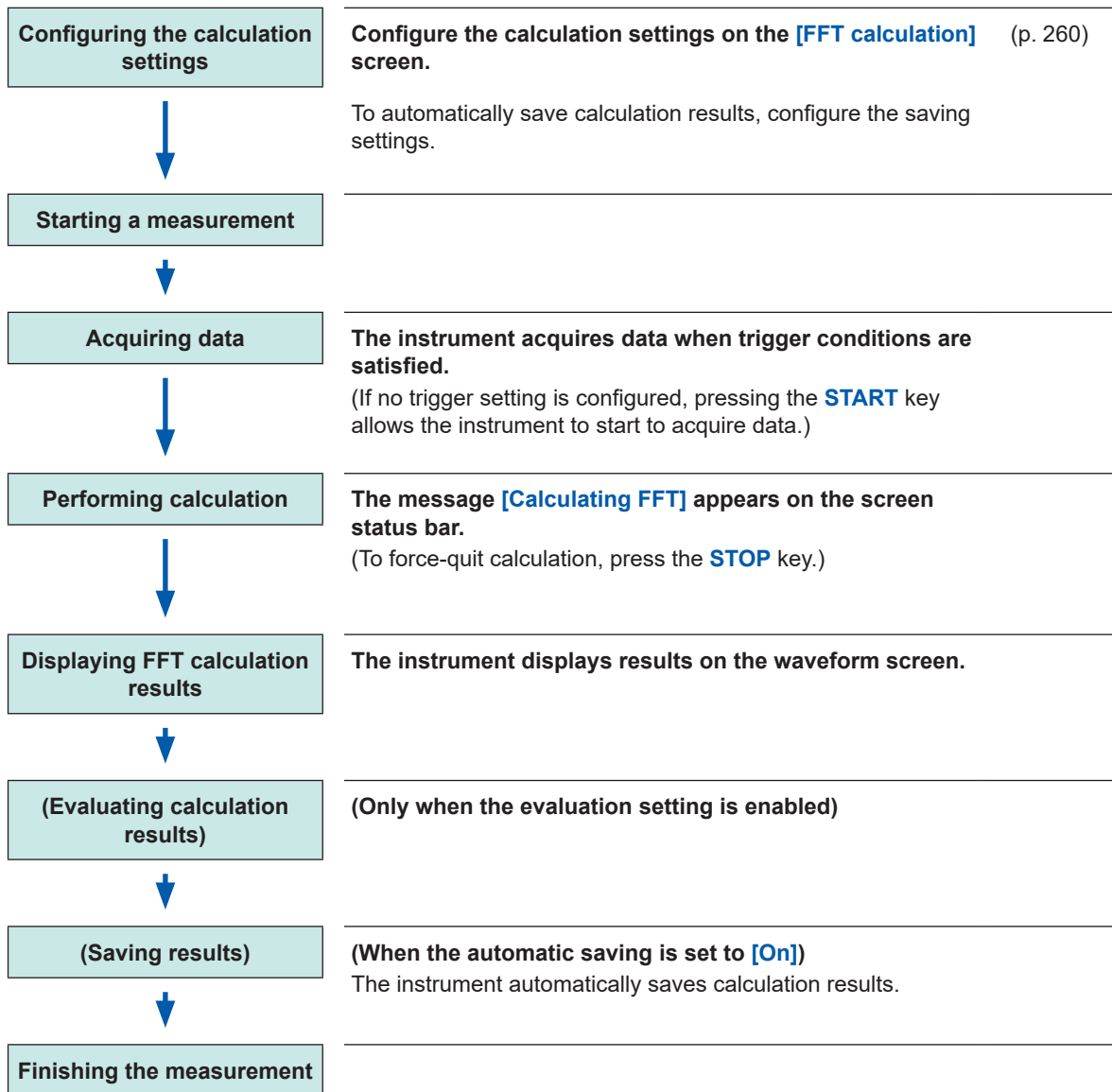

## Performing calculations using existing data

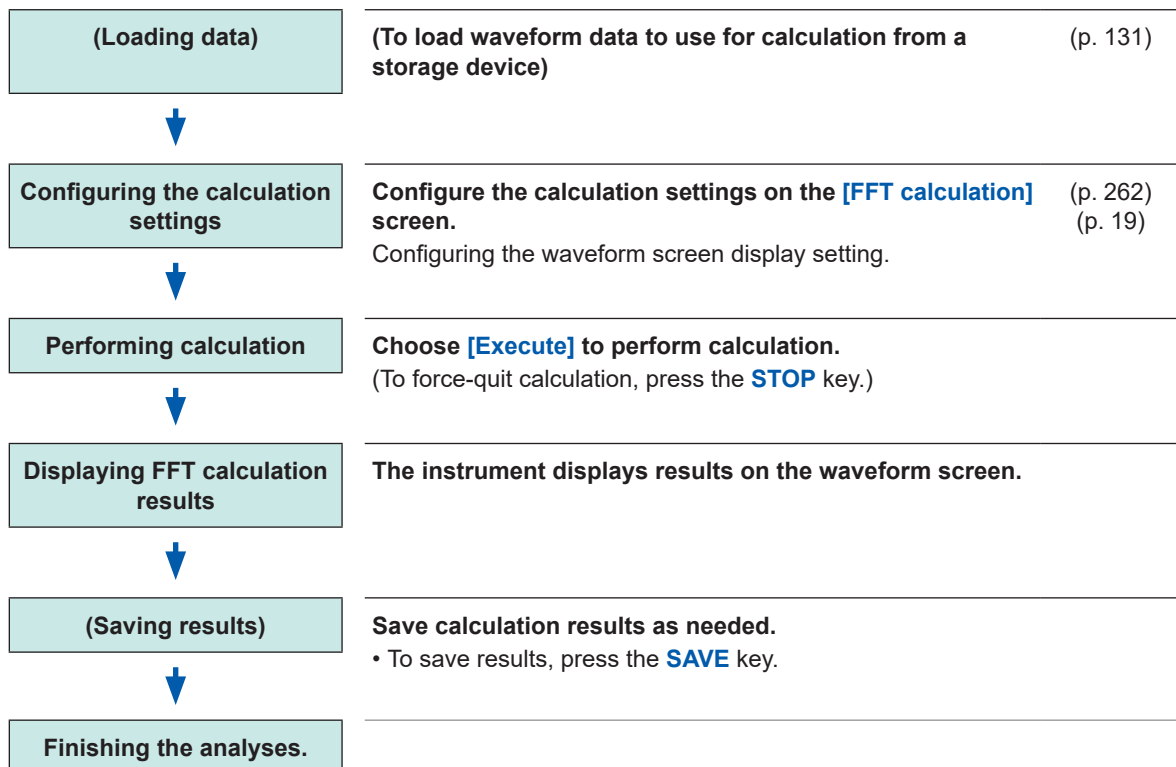

### To specify a calculation range and perform calculation

You can specify a calculation range on the waveform screen.  
See “9.4 Performing Calculations on the Waveform Screen” (p. 276).

### To automatically save waveform calculation results after measurement

See “Automatically saving waveform data” (p. 120).

## 9.2 Enabling the FFT Calculation Settings

 > [Calculation] > [FFT calculation]

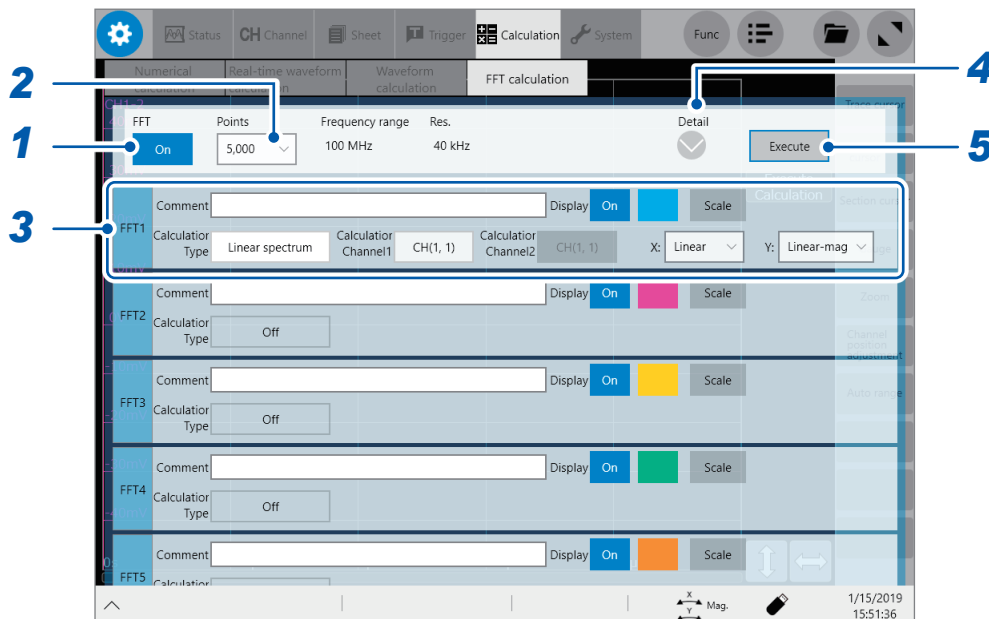

**1** Tap the **[FFT]** button to set it to **[On]**.

**2** Tap the **[Points]** box, and then from the list, choose an option for the number of calculation points.

See “Specifying the number of calculation points” (p. 262).

**3** Configure the basic FFT calculation settings.

The settings includes an FFT calculation type, channels, vertical- and horizontal-axes display preference, and display color.

See “FFT calculation advanced settings” (p. 272).

**4** Configure the advanced FFT calculation settings.

The settings includes an averaging method, the number of acquisitions for averaging, window function, attenuation rate, correction method, correction factor, and peak value display method.

See “Averaging calculation results” (p. 268).

See “Configuring the window function settings” (p. 265).

See “Configuring the calculation result peak value settings” (p. 267).

**5** (To newly perform measurement before calculation)

Press the **START** key

The instrument starts a measurement to acquire data that contains the number of calculation points specified in the **[Points]** box (p. 262), and performs an FFT calculation.

(To perform calculations using existing data)

Tap **[Execute]**.

The instrument performs a calculation using data displayed on the waveform screen (previously measured data stored in the internal buffer memory or data loaded from storage devices) that contains the number of calculation points specified in the **[Points]** box (p. 262).

You cannot change a frequency range. The instrument automatically set a frequency range according to a time-axis range and the point count setting.

See “Relationship among frequency ranges, frequency resolutions, and the number of calculation points” (p. 263).

**To automatically save waveform calculation results after measurement**

See “Automatically saving waveform data” (p. 120).

**To allocate a calculation result waveform on a sheet**

See “1.4 Configuring the Sheet Settings” (p. 19).

**To toggle sheets on the waveform screen**

See “Switching sheets on the waveform screen” (p. 24).

## 9.3 Setting FFT Calculation Conditions

This section describes how to configure the calculation condition setting.

### Specifying the number of calculation points

You can specify the number of samples to be used for an FFT calculation.

 > [Calculation] > [FFT calculation]

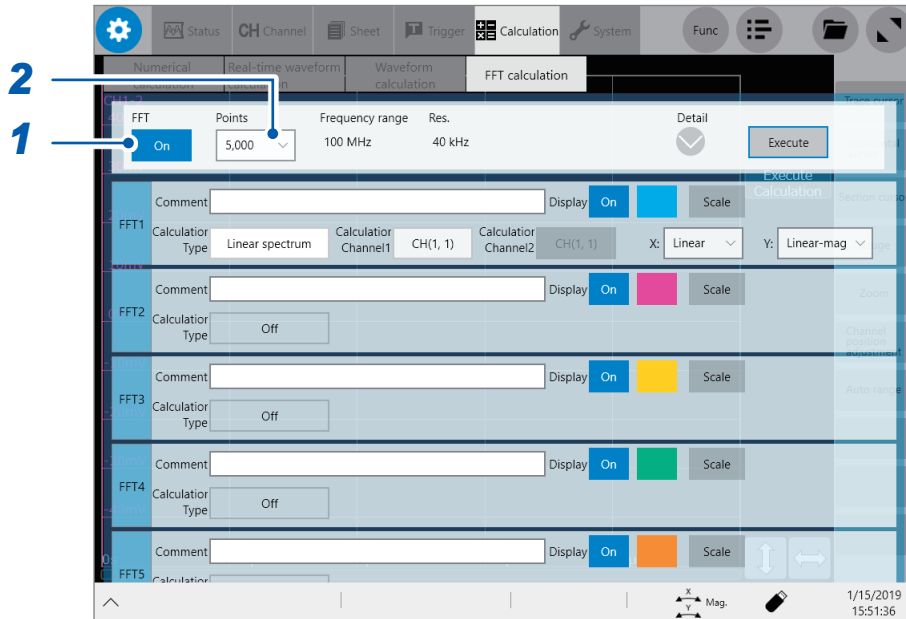

- This calculation point setting automatically decides the frequency range and frequency resolution, See “Relationship among frequency ranges, frequency resolutions, and the number of calculation points” (p. 263).
- Increasing the number of calculation points enhances the frequency resolution; however, it also increases the time required for calculation.

### To perform calculation with the external sampling

Set the external sampling to **[On]**. (p. 6)

- 1 Tap the **[FFT]** button to set it to **[On]**.
- 2 Tap the **[Points]** box, and then from the list, choose an option for the number of calculation points.

1000<sup>□</sup>, 2000, 5000, 10000, 20000, 50000, 100000



## Relationship among frequency ranges, frequency resolutions, and the number of calculation points (1000 points to 10000 points)

Sampling rate (S/s)	Sampling period	Frequency range (Hz)	Number of FFT calculation points							
			1000		2000		5000		10000	
			Resolution (Hz)	Acquisition period	Resolution (Hz)	Acquisition period	Resolution (Hz)	Acquisition period	Resolution (Hz)	Acquisition period
200 M	5 ns	100 M <sup>*1</sup>	200 k	5 μs	100 k	10 μs	40 k	25 μs	20 k	50 μs
100 M	10 ns	50 M <sup>*1</sup>	100 k	10 μs	50 k	20 μs	20 k	50 μs	10 k	100 μs
50 M	20 ns	25 M <sup>*1</sup>	50 k	20 μs	25 k	40 μs	10 k	100 μs	5 k	200 μs
20 M	50 ns	10 M <sup>*1</sup>	20 k	50 μs	10 k	100 μs	4 k	250 μs	2 k	500 μs
10 M	100 ns	5 M <sup>*1</sup>	10 k	100 μs	5 k	200 μs	2 k	500 μs	1 k	1 ms
5 M	200 ns	2.5 M <sup>*1</sup>	5 k	200 μs	2.5 k	400 μs	1 k	1 ms	500	2 ms
2 M	500 ns	1 M <sup>*1</sup>	2 k	500 μs	1 k	1 ms	400	2.5 ms	200	5 ms
1 M	1 μs	500 k <sup>*1</sup>	1 k	1 ms	500	2 ms	200	5 ms	100	10 ms
500 k	2 μs	250 k <sup>*1</sup>	500	2 ms	250	4 ms	100	10 ms	50	20 ms
200 k	5 μs	100 k <sup>*1</sup>	200	5 ms	100	10 ms	40	25 ms	20	50 ms
100 k	10 μs	50 k	100	10 ms	50	20 ms	20	50 ms	10	100 ms
50 k	20 μs	25 k	50	20 ms	25	40 ms	10	100 ms	5	200 ms
20 k	50 μs	10 k	20	50 ms	10	100 ms	4	250 ms	2	500 ms
10 k	100 μs	5 k	10	100 ms	5	200 ms	2	500 ms	1	1 s
5 k	200 μs	2.5 k	5	200 ms	2.5	400 ms	1	1 s	500 m	2 s
2 k	500 μs	1 k	2	500 ms	1	1 s	400 m	2.5 s	200 m	5 s
1 k	1 ms	500	1	1 s	500 m	2 s	200 m	5 s	100 m	10 s
500	2 ms	250	500 m	2 s	250 m	4 s	100 m	10 s	50 m	20 s
200	5 ms	100	200 m	5 s	100 m	10 s	40 m	25 s	20 m	50 s
100	10 ms	50	100 m	10 s	50 m	20 s	20 m	50 s	10 m	100 s
50	20 ms	25	50 m	20 s	25 m	40 s	10 m	100 s	5 m	200 s
20	50 ms	10 <sup>*2</sup>	20 m	50 s	10 m	100 s	4 m	250 s	2 m	500 s
10	100 ms	5 <sup>*2</sup>	10 m	100 s	5 m	200 s	2 m	500 s	1 m	1 ks
5	200 ms	2.5 <sup>*2</sup>	5 m	200 s	2.5 m	400 s	1 m	1 ks	500 μ	2 ks
2	500 ms	1 <sup>*2</sup>	2 m	500 s	1 m	1 ks	400 μ	2.5 ks	200 μ	5 ks
1	1 s	500 m <sup>*2</sup>	1 m	1 ks	500 μ	2 ks	200 μ	5 ks	100 μ	10 ks

\*1: The anti-aliasing filter of a module is set to off.

\*2: The anti-aliasing filter cutoff frequency of a module is set at 20 Hz.

### Relationship among frequency ranges, frequency resolutions, and the number of calculation points

(20000 points to 100000 points)

Sampling rate (S/s)	Sampling period	Frequency range (Hz)	Number of FFT calculation points					
			20000		50000		100000	
			Resolution (Hz)	Acquisition period	Resolution (Hz)	Acquisition period	Resolution (Hz)	Acquisition period
200 M	5 ns	100 M <sup>*1</sup>	10 k	100 μs	4 k	250 μs	2 k	500 μs
100 M	10 ns	50 M <sup>*1</sup>	5 k	200 μs	2 k	500 μs	1 k	1 ms
50 M	20 ns	25 M <sup>*1</sup>	2.5 k	400 μs	1 k	1 ms	500	2 ms
20 M	50 ns	10 M <sup>*1</sup>	1 k	1 ms	400	2.5 ms	200	5 ms
10 M	100 ns	5 M <sup>*1</sup>	500	2 ms	200	5 ms	100	10 ms
5 M	200 ns	2.5 M <sup>*1</sup>	250	4 ms	100	10 ms	50	20 ms
2 M	500 ns	1 M <sup>*1</sup>	100	10 ms	40	25 ms	20	50 ms
1 M	1 μs	500 k <sup>*1</sup>	50	20 ms	20	50 ms	10	100 ms
500 k	2 μs	250 k <sup>*1</sup>	25	40 ms	10	100 ms	5	200 ms
200 k	5 μs	100 k <sup>*1</sup>	10	100 ms	4	250 ms	2	500 ms
100 k	10 μs	50 k	5	200 ms	2	500 ms	1	1 s
50 k	20 μs	25 k	2.5	400 ms	1	1 s	500 m	2 s
20 k	50 μs	10 k	1	1 s	400 m	2.5 s	200 m	5 s
10 k	100 μs	5 k	500 m	2 s	200 m	5 s	100 m	10 s
5 k	200 μs	2.5 k	250 m	4 s	100 m	10 s	50 m	20 s
2 k	500 μs	1 k	100 m	10 s	40 m	25 s	20 m	50 s
1 k	1 ms	500	50 m	20 s	20 m	50 s	10 m	100 s
500	2 ms	250	25 m	40 s	10 m	100 s	5 m	200 s
200	5 ms	100	10 m	100 s	4 m	250 s	2 m	500 s
100	10 ms	50	5 m	200 s	2 m	500 s	1 m	1 ks
50	20 ms	25	2.5 m	400 s	1 m	1 ks	500 μ	2 ks
20	50 ms	10 <sup>*2</sup>	1 m	1 ks	400 μ	2.5 ks	200 μ	5 ks
10	100 ms	5 <sup>*2</sup>	500 μ	2 ks	200 μ	5 ks	100 μ	10 ks
5	200 ms	2.5 <sup>*2</sup>	250 μ	4 ks	100 μ	10 ks	50 μ	20 ks
2	500 ms	1 <sup>*2</sup>	100 μ	10 ks	40 μ	25 ks	20 μ	50 ks
1	1 s	500 m <sup>*2</sup>	50 μ	20 ks	20 μ	50 ks	10 μ	100 ks

\*1 The anti-aliasing filter of a module is set to off.

\*2 The anti-aliasing filter cutoff frequency of a module is set at 20 Hz.

## Configuring the window function settings

You can choose a window function by which the instrument multiplies an acquired input signal. Using a window function reduces a leakage error. See “Window function” (p. 415).

The window functions fall into three major groups.

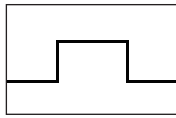

• Rectangular window

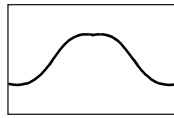

- Hann window
- Hamming window
- Blackman window
- Blackman Harris window
- Flat-top window

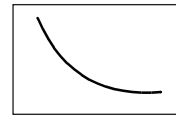

• Exponential window

Using a non-rectangular window function generally attenuates FFT calculation results. Compensating this attenuation for effect of the use of a non-rectangular window function can correct calculation results to an equivalent level of those multiplied by a rectangular window.

> [Calculation] > [FFT calculation]

**1** Tap the [FFT] button to set it to [On].

**2** Tap the open mark under [Detail].  
The FFT calculation advanced setting window appears.

**3** Tap the [Window] box, and then choose a window function from the list.

Rectangular , Hanning, Hamming, Blackman, Blackman Harris, Flat-top, Exponential

See “Window function” (p. 415).

**4** (When you choose **[Exponential]** in the **[Window]** box)

Tap the **[Attenuation ratio]** box, and then enter an attenuation rate.

0.1% to 99.9%

Noise superimposing on attenuating waveform is mitigated.

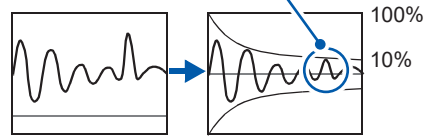

Attenuation rate: 10%

**5** Tap the **[Compensation]** box, and then choose a compensation method for an attenuation from the list.

The instrument compensates an attenuation of a calculation result for effect of the use of a non-rectangular window function.

<b>None</b>	Does not compensate any attenuation for effect of the use of a window function.
<b>Power</b>	Compensates an attenuation for effect to correct energy of time-domain waveform to an equivalent level of energy generated when multiplied by a rectangular window.
<b>Average</b>	Compensates an attenuation for effect to correct an average of a time-domain waveform to an equivalent level of an average calculated when multiplied by a rectangular window.

Choosing **[Rectangular]** in the **[Window]** box fixes a correction value to a factor of one (0 dB).

## Configuring the calculation result peak value settings

The instrument can display global or local maximum values of input signals and calculation results on the waveform screen.

 > [Calculation] > [FFT calculation]

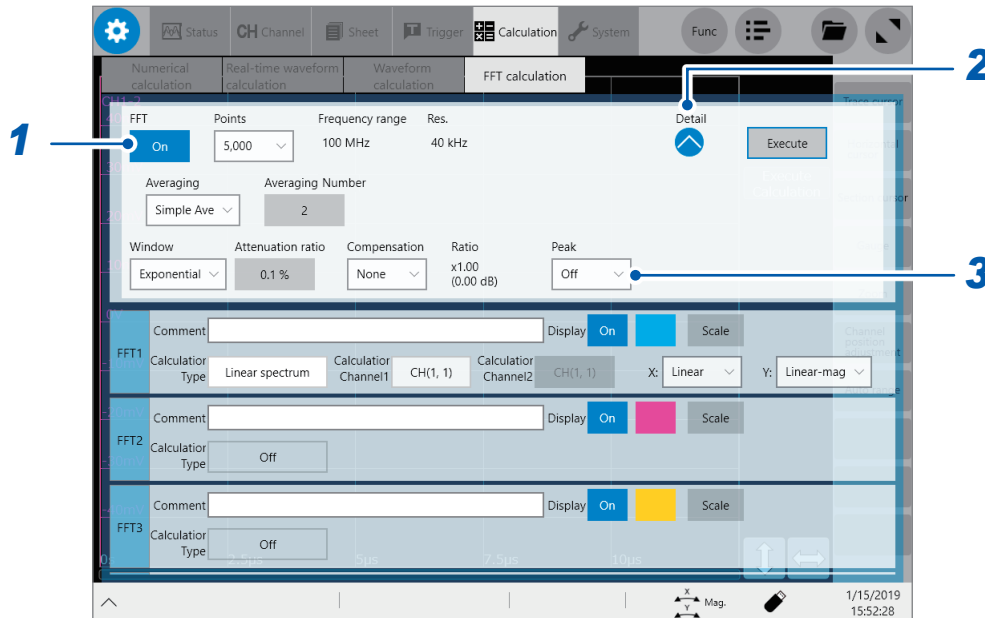

- 1** Tap the [FFT] button to set it to [On].
- 2** Tap the open mark under [Detail].  
The FFT calculation advanced setting window appears.
- 3** Tap the [Peak] box, and then from the list, choose a peak value type to be displayed.

<b>Off</b>	Does not display any peak values.
<b>Maximal</b>	Displays the ten greatest values among maximal values. When a value of a data point is greater than values of both the adjacent points, the instrument determines that the point is a local maximum.
<b>Maximum</b>	Displays the ten greatest values.

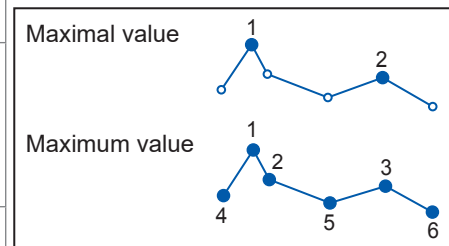

- When the instrument does not find any peak values, it displays no values.
- The instrument can display peak values on the waveform screen, but no peak values can be stored in text-form files.
- Some split screens does not always display ten peak values. Such a screen displays as many values as possible in decreasing order.

## Averaging calculation results

The averaging is a series of processes that include repeatedly acquiring waveforms, and then averaging them to perform calculations using the averaged waveform. Using this function mitigates the effect of noise superimposed on waveforms and unstable factors.

 > [Calculation] > [FFT calculation]

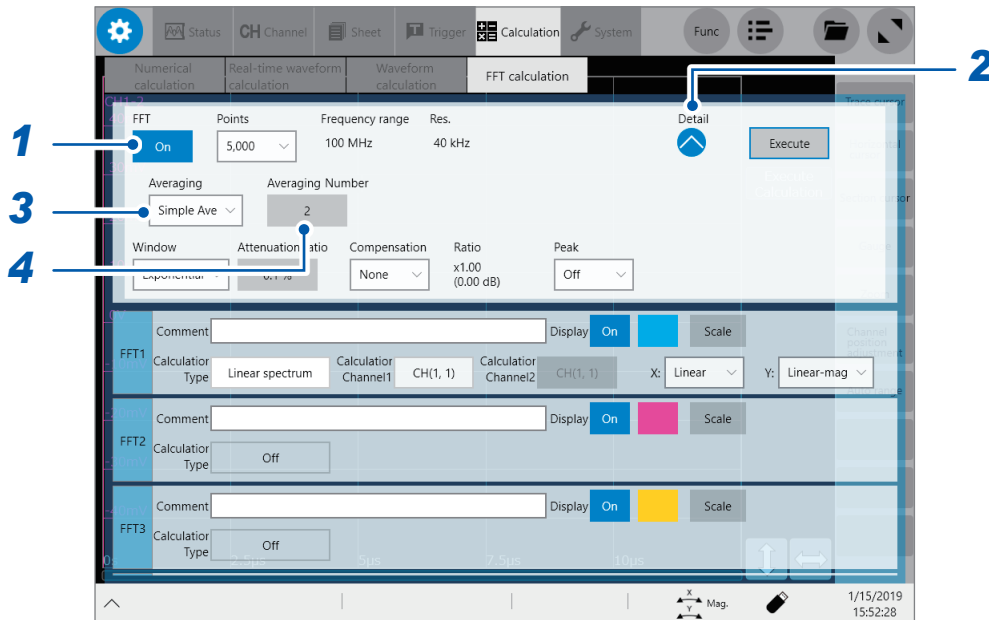

- 1 Tap the [FFT] button to set it to [On].
- 2 Tap the open mark under [Detail].  
The FFT calculation advanced setting window appears.
- 3 Tap the [Averaging] box, and then choose a averaging method from the list.

Off 	Does not perform any averaging.
Simple Ave	Calculates a simple average of a frequency-domain waveform to output a calculation result.
Exp Ave	Calculates an exponential average of a frequency-domain waveform to output a calculation result.
Freq-peak hold	Continues to display the maximum value of a frequency-domain waveforms.

See “Averaging” (p. 414).

See “Relationship between recording modes and averaging types” (p. 270).

- 4 Tap the [Averaging Number] box, and then enter the number of times the instrument acquires a waveforms used for an averaging process.

 to 10,000

## Relationship between FFT calculation types and averaging types

✓: Enable, -: Disable

Calculation type	Averaging		
	Simple	Exponential	Peak hold
Off	-	-	-
Linear spectrum	✓	✓	✓
RMS spectrum	✓	✓	✓
Power spectrum	✓	✓	✓
1CH Phase spectrum	-	-	-
Cross power spectrum	✓	✓	✓
Transfer function	✓	✓	✓
Coherence function	✓	✓	-
2CH Phase spectrum	-	-	-

## Relationship between recording modes and averaging types

### When the recording mode is set to [Single]

Repeatedly measures a waveform until the waveform acquisition count reaches the number specified in the [Averaging Number] box.

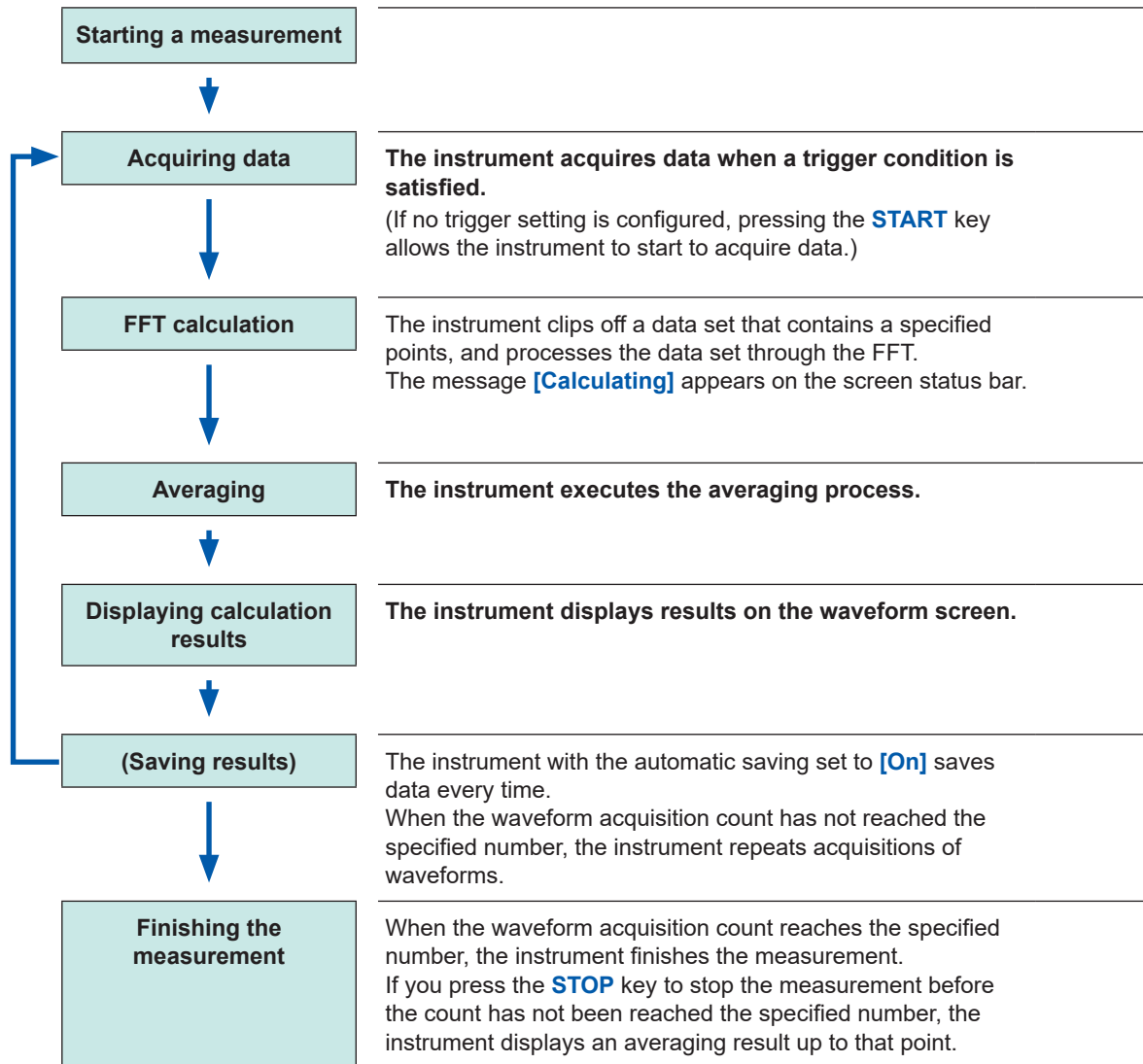



**When the recording mode is set to [Repeat]**

The instrument continues the measurement even if the waveform acquisition count has reached the number specified in the [Averaging Number] box.

When the waveform acquisition count reaches, the instrument re-executes the averaging process and repeats measurements until you press the **STOP** key.

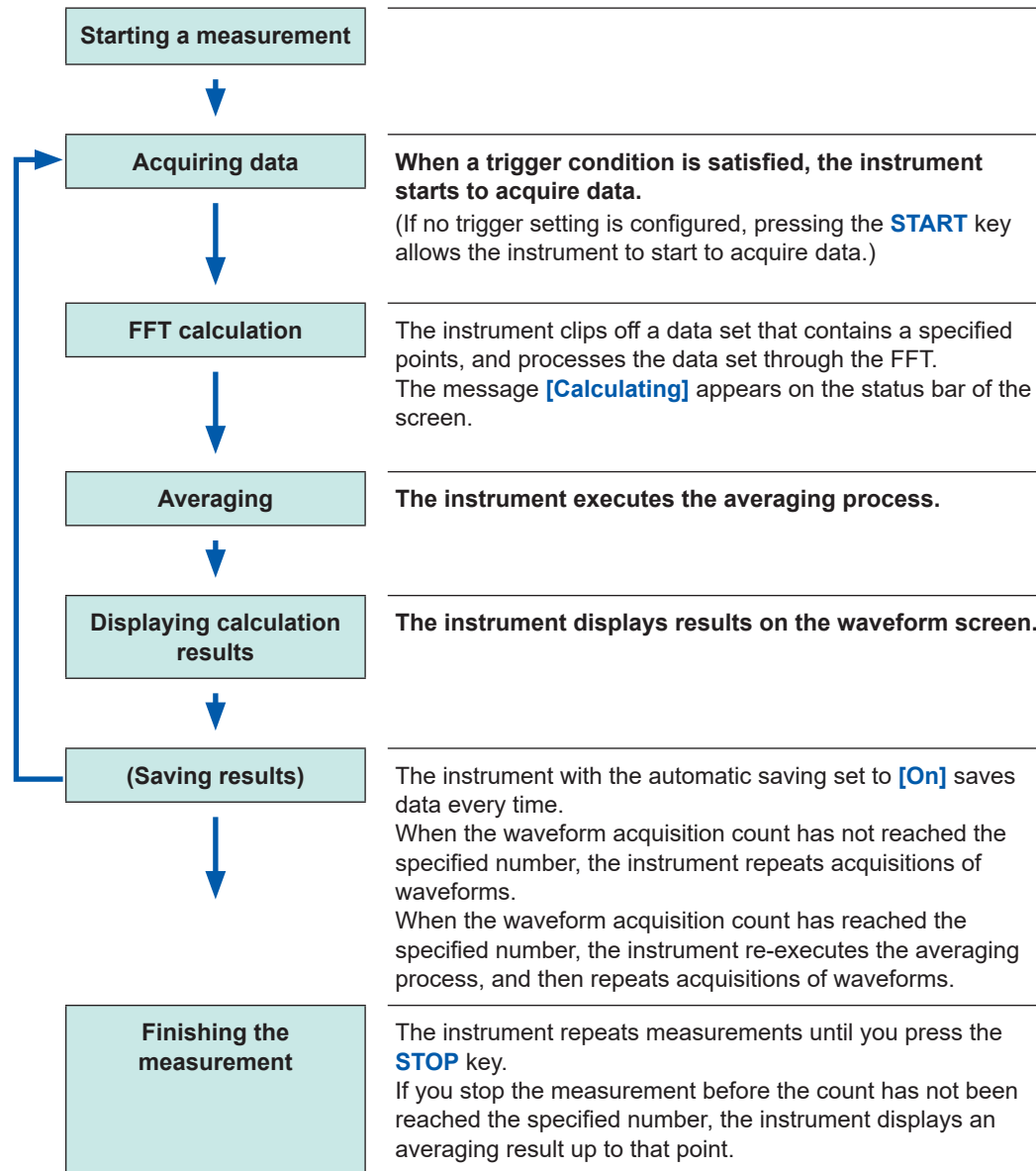

## FFT calculation advanced settings

You can configure the FFT analysis setting that includes a type, channels, a waveform display color, and X- and Y-axes.

 > [Calculation] > [FFT calculation]

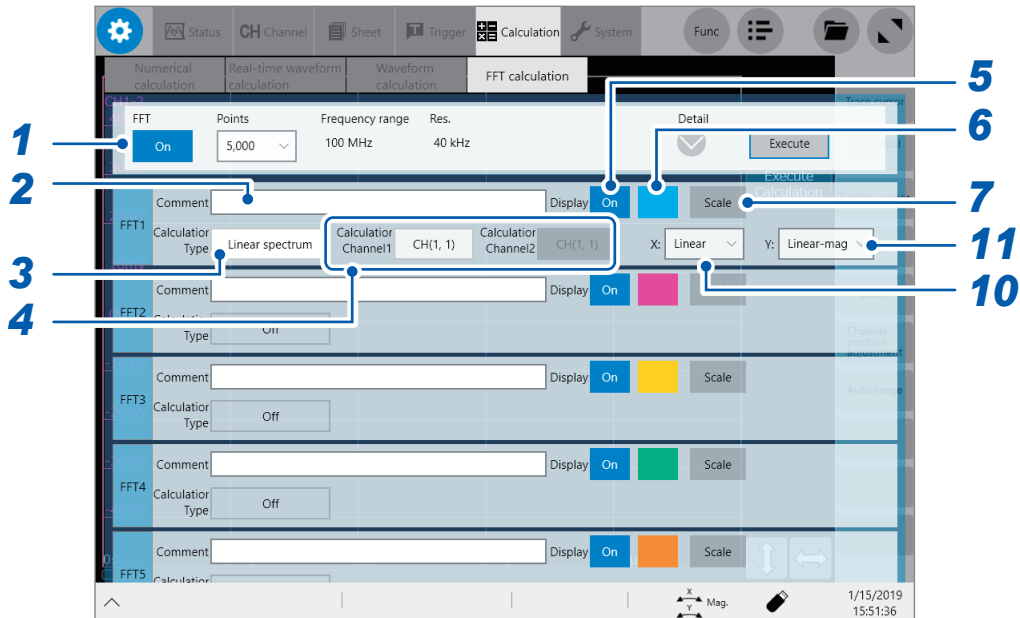

**1** Tap the [FFT] button to set it to [On].

**2** Enter a comment in the [Comment] box.  
Number of characters that can be entered: up to 40

**3** Tap the [Calculation Type] box, and then choose a calculation type from the list.

Off <input checked="" type="checkbox"/>	Does not perform any calculations.
Linear spectrum	(p. 279)
RMS spectrum	(p. 281)
Power spectrum	(p. 283)
1CH Phase spectrum	(p. 284)
Cross power spectrum	(p. 285)
Transfer function	(p. 286)
Coherence	(p. 287)
2CH Phase spectrum	(p. 284)

See “Calculation types and internal calculation formulas” (p. 288).

**4** Tap the [Calculation Channel 1] and [Calculation Channel 2] boxes in turn, and then from the list, choose channels to use for a calculation.  
Target: built-in modules, calculations

**5** Tap the [Display] button of the FFT calculation results to set it to [On].

**6** Tap the color button to the right of the **[Display]** button, and then choose a display color of the channel from the color pallet.

**7** Tap **[Scale]** to the right of the color button.

The **[Scale Settings]** dialog box appears.

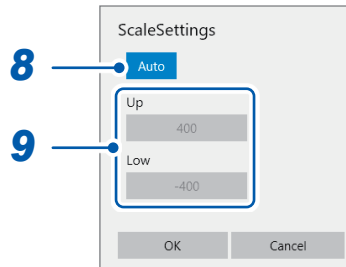

**8** Tap the **[Scale Settings]** button to choose a Y-axis scale setting method.

<b>Auto</b> <input checked="" type="checkbox"/>	Automatically set the Y-axis (vertical axis) scale from a calculation result.
<b>Manual</b>	Allows you to set the Y-axis (vertical axis) scale depending on your purpose. This is useful to enlarge or reduce an amplitude and to shift the waveform upward or downward.

**9** (When you choose **[Manual]** in the **[Scale Settings]** box.)

Tap the **[Up]** or **[Low]** box.

The numerical value entry dialog box appears.

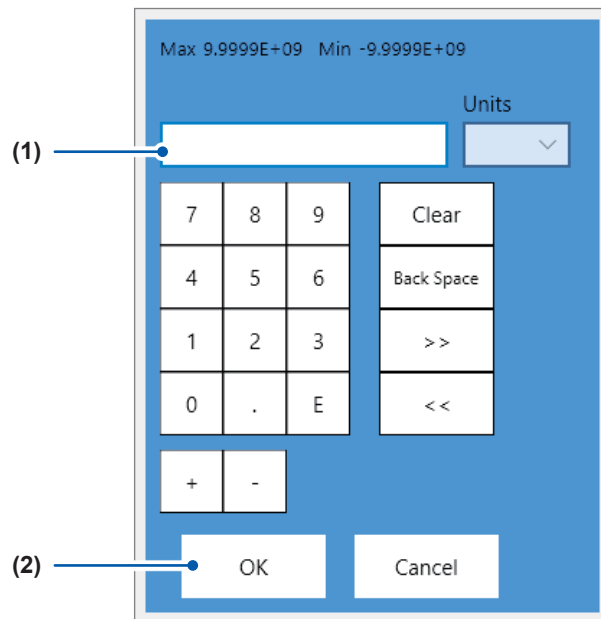

**(1) Enter an upper and lower value in each box.**

Use the numerical keypad, **[+]** button, and **[-]** button to enter.

**-9.9999E+19** to **9.9999E+19**

**(2) Tap [OK].**

The numerical value entry dialog box closes.

**10** Tap the [X:] box, and then choose a X-axis scale from the list.

<b>Linear</b> <sup>☑</sup>	Indicates a frequency on the linear-scaled horizontal axis.
<b>Log</b>	Indicates a frequency on the logarithmic-scaled horizontal axis. You can observe signals, such as sound and vibration, with the emphasis on a lower frequency range.

When the instrument performs calculations using the external sampling, it displays the x-axis in terms with the number of samples.

**11** Tap the [Y:] box, and then from the list, choose an option for calculation data the Y-axis indicates.

Selectable contents vary depending on calculation types.  
See “Calculation types and settable items on the X- and Y-axes” (p. 274).

<b>Linear-mag</b> <sup>☑</sup>	Plots analyzed data on a linear scale.
<b>Log-mag</b>	Plots a level of analyzed data (a logarithm of the ratio of a value to a reference value) in decibels. The reference value is 1 eV. Example: For voltage, the level of 1 V is 0 dB.
<b>Linear-real</b>	Plots the real part of analyzed data on a linear scale.
<b>Linear-imag</b>	Plots the imaginary part of analyzed data on a linear scale.

**Calculation types and settable items on the X- and Y-axes**

✓: Enable, –: Disable

Calculation type	X-axis		Y-axis			
	Linear	Logarithmic	Amplitude (Linear)	Amplitude (dB)	Real (Linear)	Imaginary (linear)
<b>Off</b>	–	–	–	–	–	–
<b>Linear spectrum</b>	✓	✓	✓	✓	✓	✓
<b>RMS spectrum</b>	✓	✓	✓	✓	✓	✓
<b>Power spectrum</b>	✓	✓	✓	✓	–	–
<b>Phase spectrum</b>	✓	✓	✓	–	–	–
<b>Cross power spectrum</b>	✓	✓	✓	✓	✓	✓
<b>Transfer function</b>	✓	✓	✓	✓	✓	✓
<b>Coherence function</b>	✓	✓	✓	–	–	–

## Total harmonic distortion factor (THD)

When the calculation is set to one of the following types and the cursors are enabled, the distortion factor is calculated.

(Linear spectrum, RMS spectrum, power spectrum)

The distortion factor is calculated regarding the cursor position as the fundamental wave. When displaying the two cursors, the instrument regards the A cursor as the fundamental wave to calculate the distortion factor.

When no results have been obtained, the instrument displays the string [---%].

Incidentally, the total harmonic distortion factor may significantly vary depending on the window function setting.

$$\text{THD} = \sqrt{\frac{\sum (V_n)^2}{(V_0)^2}} \times 100 \text{ [%]}$$

$V_0$  = Fundamental wave

$V_n$  =  $n$ th harmonic

# 9.4 Performing Calculations on the Waveform Screen

## To specify a range before calculation

You can specify an FFT calculation range on acquired data.  
 The default calculation range is the number of the FFT calculation points from the start of measurement.

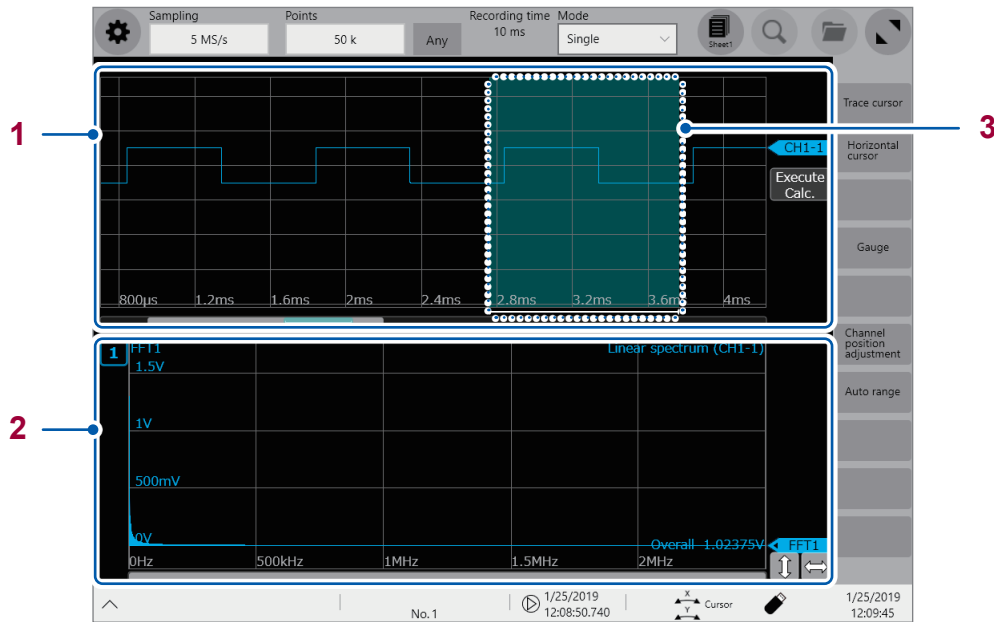

1	T-Y waveform	Acquired time series waveform
2	FFT waveform	FFT calculation result
3	FFT calculation selection cursor	Specifies an FFT calculation range on the displayed T-Y waveform.

You can specify a calculation range using the display format and split settings.  
 See "1.4 Configuring the Sheet Settings" (p. 19).

✓: Enable, -: Disable

Display format	Split number	Range specification
Time series waveform	T-Y waveform on single screen	— *1
	T-Y waveform on 2-split screen	— *1
	T-Y waveform on 4-split screen	— *1
	T-Y waveform on 8-split screen	— *1
	T-Y waveform on 16-split screen	— *1
FFT waveform	FFT waveform on single screen	— *1
	FFT waveform on 2-split screen	— *1
	FFT waveform on 4-split screen	— *1
	T-Y and FFT waveforms on single screen	✓ *2
	T-Y and FFT waveforms on 2-split screen	✓ *2
	T-Y and FFT waveforms on 4-split screen	✓ *2

\*1: An FFT calculation starts at a measurement starting position.

\*2: When you choose the “T-Y and FFT waveforms on single screen,” “T-Y and FFT waveforms on 2-split screen,” or “T-Y and FFT waveforms on 4-split single screen” for the split number setting and specify a calculation range on any sheet, the specified range also applies to FFT calculations on other sheet.

**1** Tap the FFT calculation selection cursor displayed on T-Y waveform.

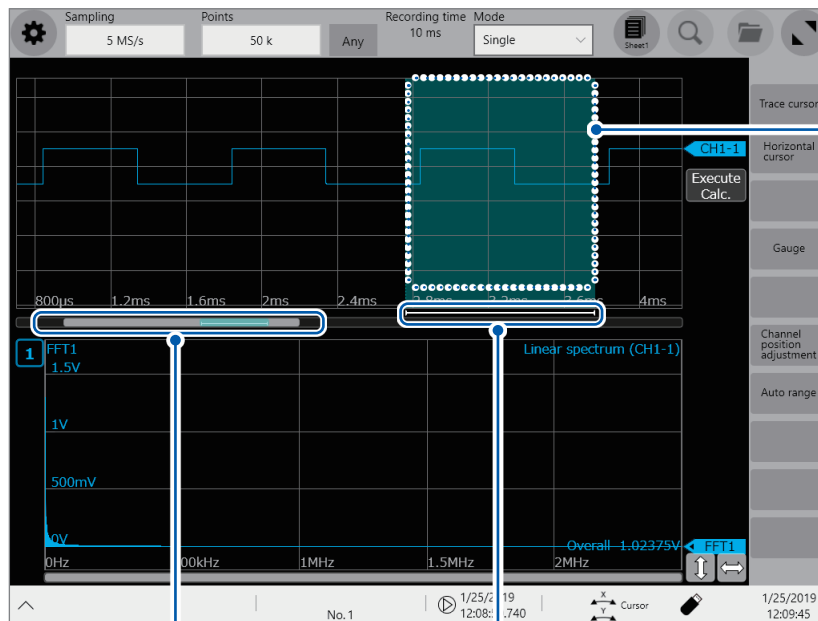

White line: Range of source data used for FFT calculation in proportion to displayed T-Y waveform

Bar indicating the range being displayed in proportion to whole acquired data

Gray bar: T-Y waveform position

Blue bar: FFT calculation selection cursor position

White line: Range of source data used for FFT calculation

## 2 Drag the FFT calculation selection cursor.

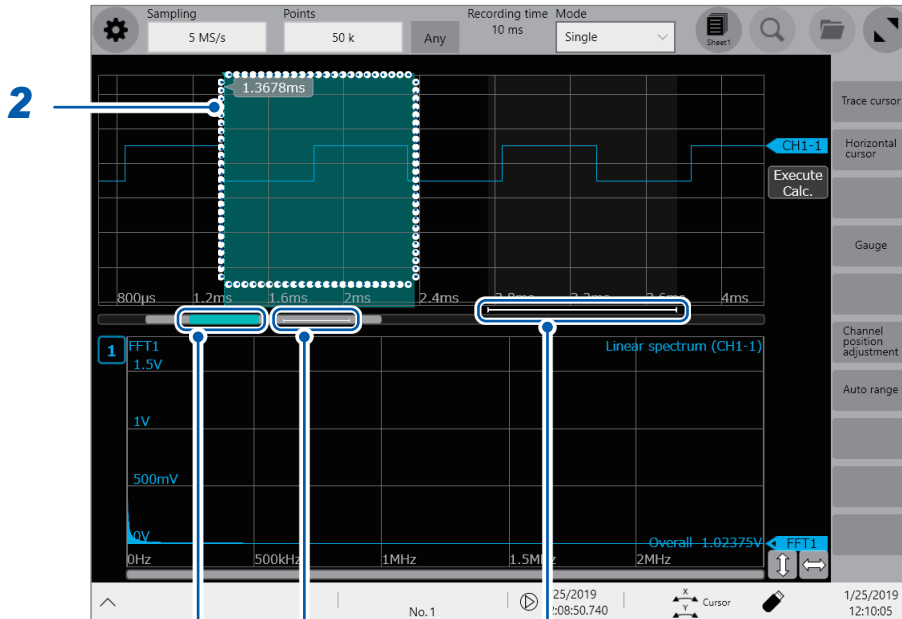

White line: Range of source data used for FFT calculation in proportion to displayed T-Y waveform

White line: Range of source data used for FFT calculation in proportion to the whole acquired data

Blue bar: FFT calculation selection cursor position

## 3 Perform an FFT calculation within a range specified with the FFT calculation selection cursor.

Any one of the following actions allows the instrument to perform an FFT calculation within a range newly specified with the FFT calculation selection cursor.

- Tap **[Execute]** on the waveform screen.
- Tap **[Execute]** on the FFT calculation screen.
- Press the **START** key



# 9.5 FFT Calculation Types

## Calculation types and display examples

### Linear spectrum

The instrument performs a calculation using strength of input signals within each frequency band to plot it on a frequency-domain graph.

**Main uses:**

To analyze peaks of frequency components of a waveform

See "Calculation types and internal calculation formulas" (p. 288).

Axis	Display type	Description
Horizontal axis (X-axis)	Linear	Indicates a frequency on a linear scale.
	Logarithmic	Indicates a frequency on a logarithm scale.
Vertical axis (Y-axis)	Amplitude (linear)	Indicates analyzed data on a linear scale.
	Amplitude (decibel)	Indicates analyzed data in decibels. (Reference of 0 dB: 1 eu)*
	Real part (linear)	Indicates the real part of analyzed data.
	Imaginary (linear)	Indicates the imaginary part of analyzed data.

\*(Eu: engineering unit) The level is calculated using a reference value in terms with an engineering unit presently set.  
 (For example, when the unit is set to volts, 0 dB is equivalent to 1 V.)

### Examples of waveforms

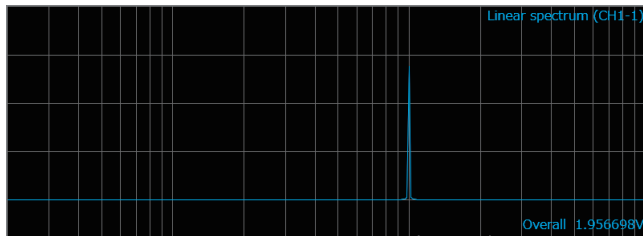

**Normal display**  
 Horizontal axis: logarithmic  
 Vertical axis: amplitude (linear)

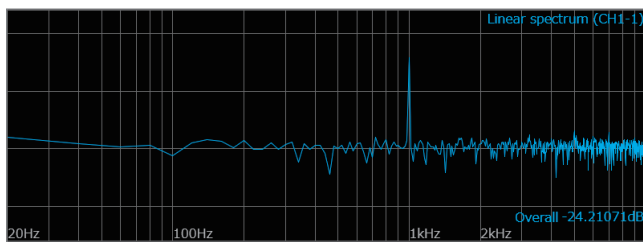

**Normal display**  
 Horizontal axis: logarithmic  
 Vertical axis: amplitude (decibel)

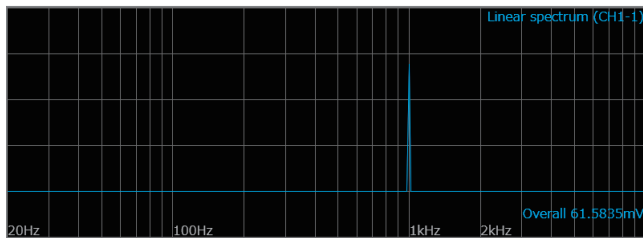

**Normal display**  
 Horizontal axis: logarithmic  
 Vertical axis: real part (linear)

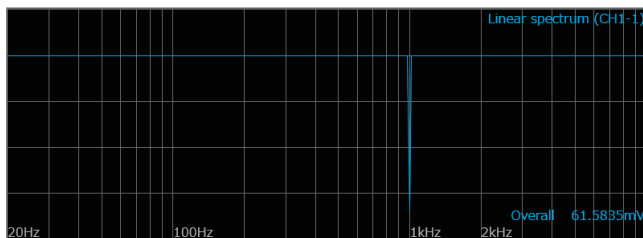

**Normal display**  
 Horizontal axis: logarithmic  
 Vertical axis: imaginary (linear)

- The instrument with a cursor enabled displays the total harmonic distortion factor (THD) regarding the cursor position as the fundamental wave. When displaying the two cursors, the instrument regards the A cursor as the fundamental wave. When no results have been obtained, the instrument displays the string [---%].
- When a sine wave is only inputted, the component level becomes approximately 1.4 times (3 dB) the overall value. To measure a signal using the same reference as the overall value, analyze it through the RMS spectrum or power spectrum.

See “RMS spectrum” (p. 281) and “Power spectrum” (p. 283).

## RMS spectrum

The RMC spectrum calculates an input signal amplitude (RMS values) of each frequency band and plots the calculation results on a graph with a horizontal axis that indicates a frequency. The RMS spectrum shows the same calculation result as the power spectrum that logarithmically describes amplitudes in decibels.

### Main uses:

To analyze an RMS value of each frequency component included in a waveform.

See “Calculation types and internal calculation formulas” (p. 288).

Axis	Display type	Description
Horizontal axis (X-axis)	Linear	Indicates a frequency on a linear scale.
	Logarithmic	Indicates a frequency on a logarithm scale.
Vertical axis (Y-axis)	Amplitude (linear)	Indicates analyzed data on a linear scale.
	Amplitude (decibel)	Indicates analyzed data in decibels. (Reference of 0 dB: 1 eu)*
	Real part (linear)	Indicates the real part of analyzed data.
	Imaginary (linear)	Indicates the imaginary part of analyzed data.

\*(Eu: engineering unit) The level is calculated using a reference value in terms with an engineering unit presently set.  
(For example, when the unit is set to volts, 0 dB is equivalent to 1 V.)

### Examples of waveforms

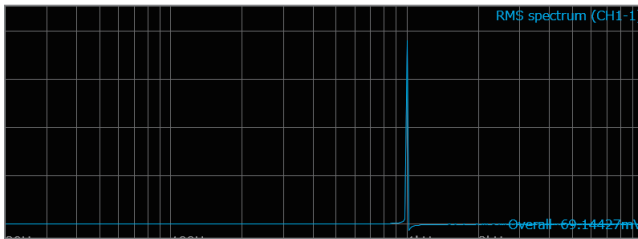

#### Normal display

Horizontal axis: logarithmic  
Vertical axis: amplitude (linear)

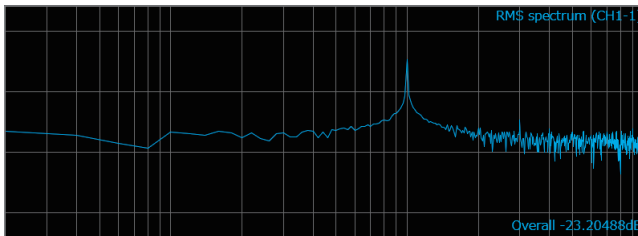

#### Normal display

Horizontal axis: logarithmic  
Vertical axis: amplitude (decibel)

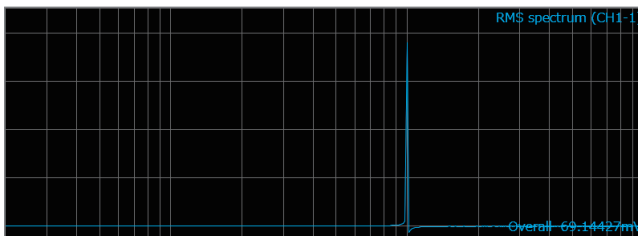

#### Normal display

Horizontal axis: logarithmic  
Vertical axis: real part (linear)

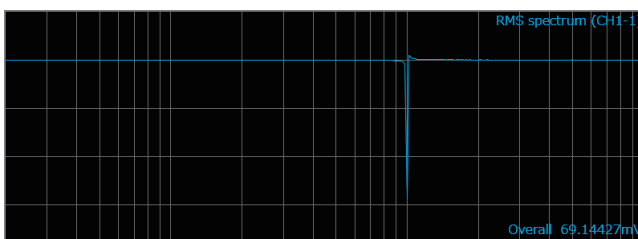

#### Normal display

Horizontal axis: logarithmic  
Vertical axis: imaginary (linear)

The instrument with a cursor enabled displays the total harmonic distortion factor (THD) regarding the cursor position as the fundamental wave. When displaying the two cursors, the instrument regards the A cursor as the fundamental wave. When no results have been obtained, the instrument displays the string [---%].

## Power spectrum

The power spectrum calculates an input signal power of each frequency band and plots the calculation results on a graph with a horizontal axis that indicates a frequency.

### Main uses:

- To analyze peaks of frequency components of a waveform
- To analyze power levels of each frequency component

See "Calculation types and internal calculation formulas" (p. 288).

Axis	Display type	Description
Horizontal axis (X-axis)	Linear	Indicates a frequency on a linear scale.
	Logarithmic	Indicates a frequency on a logarithm scale.
Vertical axis (Y-axis)	Amplitude (linear)	Indicates a square of analyzed data. It represents power components.
	Amplitude (decibel)	Indicates analyzed data in decibels. (Reference of 0 dB: 1 eu <sup>2</sup> )*

\*(Eu: engineering unit) The level is calculated using a reference value in terms with an engineering unit presently set.

(For example, when the unit is set to volts, 0 dB is equivalent to 1 V<sup>2</sup>.)

### Examples of waveforms

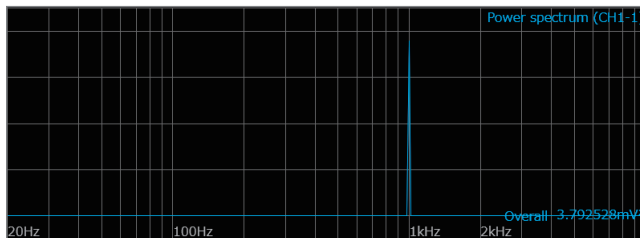

#### Normal display

Horizontal axis: logarithmic  
Vertical axis: amplitude (linear)

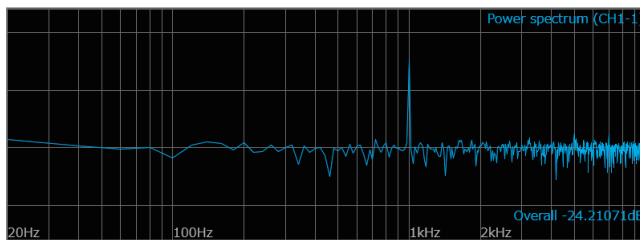

#### Normal display

Horizontal axis: logarithmic  
Vertical axis: amplitude (decibel)

The instrument with a cursor enabled displays the total harmonic distortion factor (THD) regarding the cursor position as the fundamental wave. When displaying the two cursors, the instrument regards the A cursor as the fundamental wave. When no results have been obtained, the instrument displays the string [---%].

## Phase spectrum

The phase spectrum analyzes phase characteristics of an input signal.

### Main uses:

- To analyze the phase spectrum of channel 1 The phase of a cosine waveform is indicated using a reference of 0°.
- To analyze the phase difference between channels 1 and 2  
See “Calculation types and internal calculation formulas” (p. 288).

- 1ch FFT: The 1ch FFT displays the phase of a signal obtained across channel 1. The phase of a cosine waveform is indicated using a reference of 0°. A non-synchronized time-domain waveform causes phase values to be unstable.
- 2ch FFT: The 2ch FFT displays the phase difference between channels 1 and 2. Positive values indicate that the phase of channel 2 leads channel 1.

Axis	Display type	Description
Horizontal axis (X-axis)	Linear	Indicates a frequency on a linear scale.
	Logarithmic	Indicates a frequency on a logarithm scale.
Vertical axis (Y-axis)	Amplitude (linear)	Indicates analyzed data on a linear scale.

### Examples of waveforms

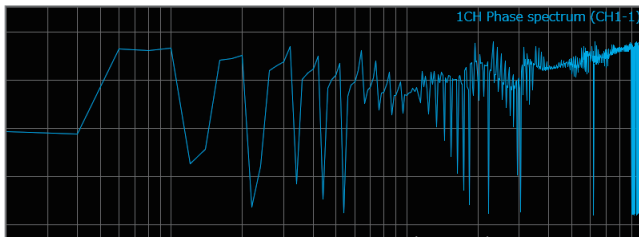

1ch FFT  
Horizontal axis: logarithmic  
Vertical axis: amplitude (linear)

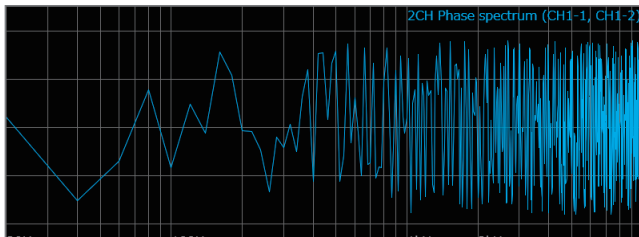

2ch FFT  
Horizontal axis: logarithmic  
Vertical axis: amplitude (linear)

The instrument with a cursor enabled displays the total harmonic distortion factor (THD) regarding the cursor position as the fundamental wave. When displaying the two cursors, the instrument regards the A cursor as the fundamental wave. When no results have been obtained, the instrument displays the string [---%].

## Cross power spectrum

The cross power spectrum finds a product of two input signal spectra. Common frequency components to both two signals can also be obtained.

You can input a voltage waveform and current waveform to calculate power (active power, reactive power, apparent power) of each frequency band.

### Main uses:

To analyze common frequency components to two signals  
See "Calculation types and internal calculation formulas" (p. 288).

Axis	Display type	Description
Horizontal axis (X-axis)	Linear	Indicates a frequency on a linear scale.
	Logarithmic	Indicates a frequency on a logarithm scale.
Vertical axis (Y-axis)	Amplitude (linear)	Indicates a square of an amplitude component of analyzed data on a linear scale.
	Amplitude in decibels (logarithmic)	Indicates an amplitude component in decibels. (Reference of 0 dB: 1 eu <sup>2</sup> )*
	Real part (linear)	Indicates a square of the real part of analysis data on a linear scale.
	Imaginary (linear)	Indicates a square of the imaginary part of analyzed data on a linear scale.

\*(Eu: engineering unit) The level is calculated using a reference value in terms with an engineering unit presently set.

(For example, when the unit is set to volts, 0 dB is equivalent to 1 V<sup>2</sup>.)

### Examples of waveforms

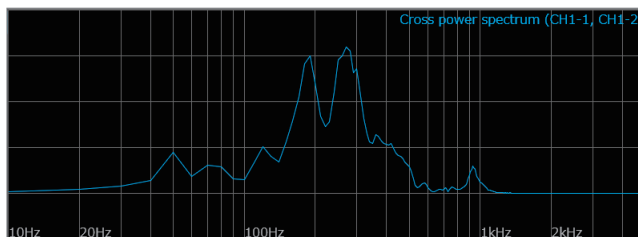

#### Normal display

Horizontal axis: logarithmic  
Vertical axis: amplitude (linear)

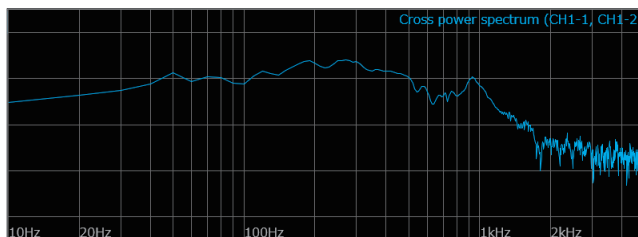

#### Normal display

Horizontal axis: logarithmic  
Vertical axis: amplitude (decibel)

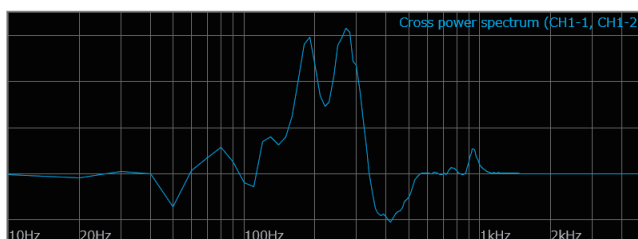

#### Normal display

Horizontal axis: logarithmic  
Vertical axis: real part (linear)

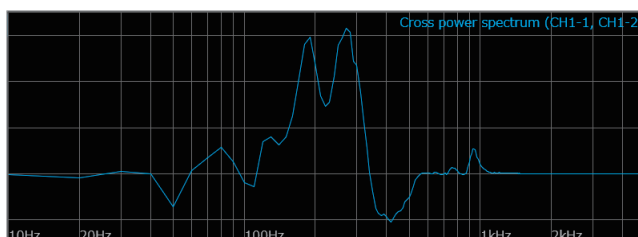

#### Normal display

Horizontal axis: logarithmic  
Vertical axis: Imaginary (linear)

## Transfer function

The instrument can obtain the transfer function (frequency characteristic) of a measurement system from an input and output signals.

### Main uses:

- To analyze frequency characteristics of a filter
  - To analyze stability of a feedback control system
  - To analyze a resonance frequency of an object using an impulse hammer and pick-up sensor
- See “Calculation types and internal calculation formulas” (p. 288) and “Linear time-invariant system” (p. 410).

Axis	Display type	Description
Horizontal axis (X-axis)	Linear	Indicates a frequency on a linear scale.
	Logarithmic	Indicates a frequency on a logarithm scale.
Vertical axis (Y-axis)	Amplitude (linear)	Indicates an input-to-output ratio on a linear scale. (no units)
	Amplitude in decibels (logarithmic)	Indicates an input-to-output ratio in decibels.
	Real part (linear)	Indicates the real part of an input-to-output ratio. (no units)
	Imaginary (linear)	Indicates the imaginary part of an input-to-output ratio. (no units)

### Examples of waveforms

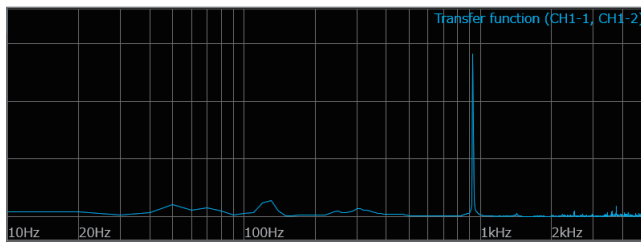

#### Normal display

Horizontal axis: logarithmic  
Vertical axis: amplitude (linear)

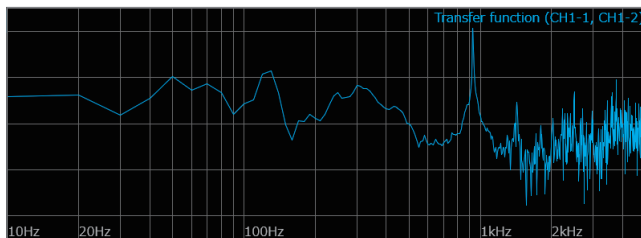

#### Normal display

Horizontal axis: logarithmic  
Vertical axis: amplitude (decibel)

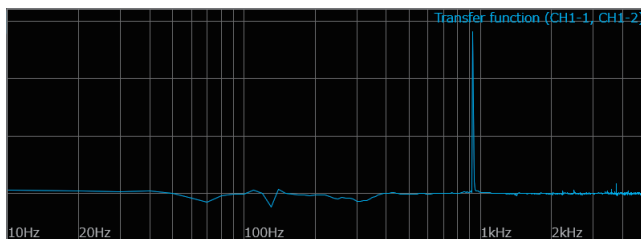

#### Normal display

Horizontal axis: logarithmic  
Vertical axis: real part (linear)

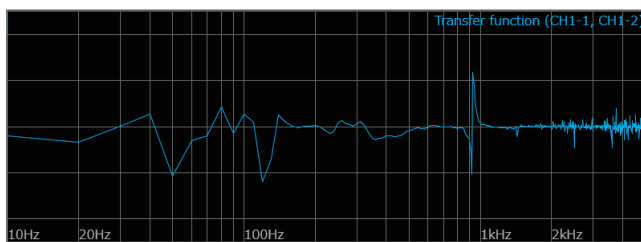

#### Normal display

Horizontal axis: logarithmic  
Vertical axis: imaginary (linear)



## Coherence function

This function shows a ratio of components that have coherence with an input signal to whole components of an output signal. Values ranges zero to one. A coherence function of one shows that an input signal does not affect the frequency of an output signal.

### Main uses:

- To analyze a transfer function
- To analyze effects of each input signal on an output signals for a multi-input system.

See “Calculation types and internal calculation formulas” (p. 288).

Axis	Display type	Description
Horizontal axis (X-axis)	Linear	Indicates a frequency on a linear scale.
	Logarithmic	Indicates a frequency on a logarithm scale.
Vertical axis (Y-axis)	Amplitude (linear)	Indicates a cause-and-effect relationship of relevance ratio between two input signals, degree of which are presented by a numerical value that ranges zero to one. (non-dimensional)

### Examples of waveforms

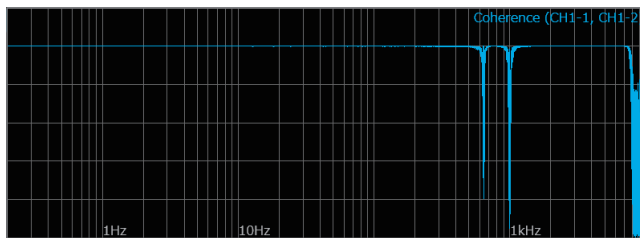

#### Normal display

Horizontal axis: logarithmic  
Vertical axis: amplitude (linear)

- A single measurement causes the coherence function to be one across the entire frequency range. Always execute the averaging process of the FFT function before measurement.
- The coherence function has two general definition formulas. For the definition formulas, refer to “Calculation types and internal calculation formulas” (p. 288).

## Calculation types and internal calculation formulas

Calculation type	Internal calculation formula (real: real part, imag: imaginary part, log: logarithm)
<b>Off</b>	Does not perform any calculation.
<b>Linear spectrum</b>	$X(k) = \sum_{n=0}^{N-1} x(n)W^{kn} \quad F(k) = CX(k) \quad C = \begin{cases} 1/N (DC) \\ 2/N (AC) \end{cases}$ $linear =  F(k)  \quad real = \text{Re}\{F(k)\} \quad imag = \text{Im}\{F(k)\} \quad log = 20\log F(k) $
<b>RMS spectrum</b>	$F'(k) = C'F(k) \quad C' = \begin{cases} 1 (DC) \\ 1/\sqrt{2} (AC) \end{cases}$ $linear =  F'(k)  \quad real = \text{Re}\{F'(k)\} \quad imag = \text{Im}\{F'(k)\} \quad log = 20\log F'(k) $
<b>Power spectrum</b>	$P(k) = a F(k) ^2 \quad a = \begin{cases} 1 (DC) \\ 1/2 (AC) \end{cases}$ $linear = P(k) \quad log = 10\log P(k) $
<b>Phase spectrum</b>	$\theta(k) = 180/\pi \times \tan^{-1}(\text{Im}(F'(k))/\text{Re}(F'(k)))$ $\theta(k) = 180/\pi \times \tan^{-1}(\text{Im}(S_{yx}(k))/\text{Re}(S_{yx}(k)))$
<b>Cross power spectrum</b>	$S_{yx}(k) = X^*(k)Y(k): \text{Cross spectrum}$ $X_{power}(k) = AS_{yx}(k) \quad A = \begin{cases} 1/N^2 (DC) \\ 2/N^2 (AC) \end{cases}$ $linear =  X_{power}(k)  \quad real = \text{Re}\{X_{power}(k)\}$ $imag = \text{Im}\{X_{power}(k)\} \quad log = 10\log X_{power}(k) $
<b>Transfer function</b>	$H(k) = Y(k)/X(k)$ $linear =  H(k)  \quad real = \text{Re}\{H(k)\} \quad imag = \text{Im}\{H(k)\} \quad log = 20\log H(k) $
<b>Coherence function</b>	$coh(k) = \sqrt{\frac{S_{yx}(k)S_{yx}^*(k)}{S_{xx}(k)S_{yy}(k)}}$

# 10 Memory Division Function

You can divide the internal memory into multiple blocks and store waveforms into them.

- Start block:** Specifying a start block allows a waveform to be stored in other blocks without deleting previously measured waveforms.
- Reference block:** You can overlay a newly acquired waveform with those retained in other blocks.
- Blocks to be used:** Storing waveforms into multiple blocks can shorten dead times between blocks.

The memory can be divided into up to 1024 blocks (the more blocks you divide the memory into, the shorter the recording length is).

## Normal

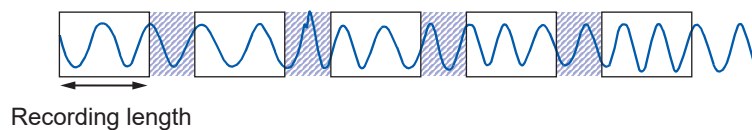

## Memory division

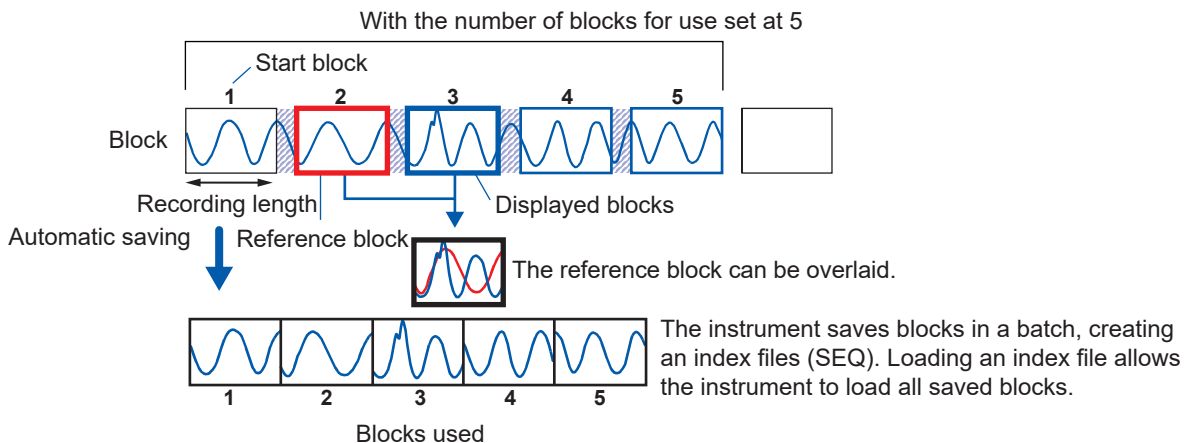

For manual save, you can choose whether to collectively save blocks used or to save only displayed blocks before saving data. (p. 127)

You cannot use the following functions concurrently with the memory division function.

- Real-time saving (See p. 124.)
- Stop trigger (See p. 140.)

During use of the memory division, the instrument may switch the trigger output (TRIG.OUT terminal) to a low level or irregularly output signals.

- The trigger output method is set to pulse.
- The recording length is set at 3 ms or less

# 10.1 Configuring the Memory Division Settings

 > [Status] > [Condition]

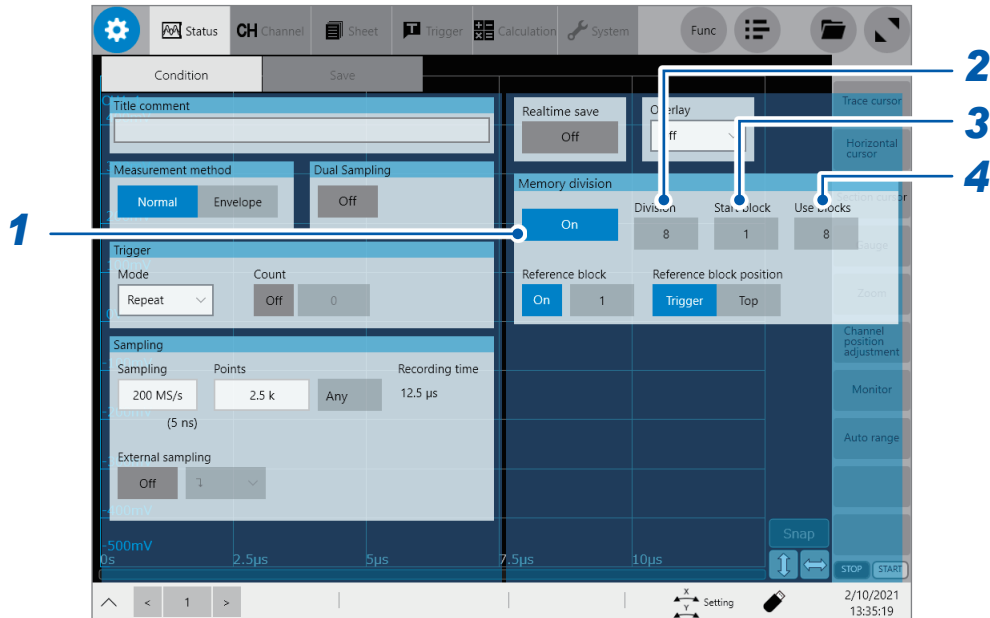

- 1** Tap the **[Memory division]** button to set it to **[On]**.
- 2** Tap the **[Division]** box, and then enter the number of blocks the memory capacity is divided into.  
Default setting: 2
- 3** Tap the **[Start block]** box, and then enter the start block number.  
Default setting: 1  
Figures you can set in **[Start block]** varies according to the settings in the **[Division]** box.
- 4** Tap the **[Use blocks]** box, and then enter the number of blocks to be used.  
Default setting: 1  
The maximum value that can be set is equivalent to a figure in the **[Division]** box.

The instrument defines a block to use for the next measurement according to the settings specified in the **[Start block]** and **[Use blocks]** boxes. The instrument clears a waveform in this block at the start of measurement if retained.

## When the number of block for use is set at one

- The number of blocks for use is set at one.
- The recording mode is set to **[Repeat]**.
- The trigger setting is enabled.

While the instrument is waiting for a trigger or filling the pre-trigger memory in the conditions above, halting measurement causes any waveform data to vanish.

Either of the following settings allows waveforms acquired before the instrument starts to wait for a trigger to remain in blocks the number of which, at a maximum, is the specified block number for use minus one.

The instrument can leave blocks, the number of which is one less than blocks used, that contains waveforms acquired before entering trigger standby mode with either one of the following settings:

- The recording mode is set to **[Single]** to perform measurement one after another.
- The recording mode is set to **[Repeat]** and the number of blocks to be used to be two or more.

## 10.2 Configuring the Display Settings

 > [Status] > [Condition]

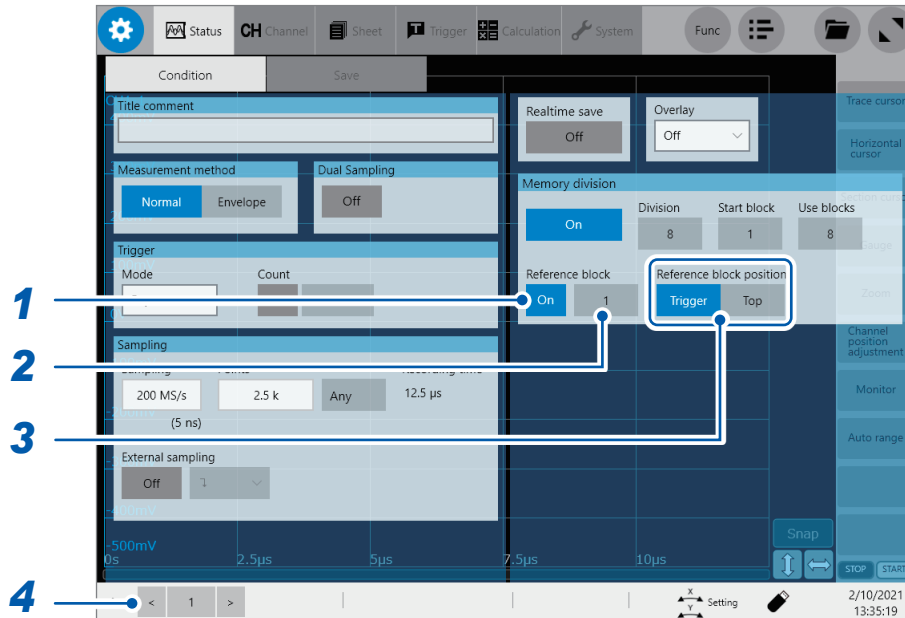

- 1** Tap the **[Reference block]** button to set it to **[On]**.  
 You can overlay waveforms stored in other blocks with the waveform stored in the displayed block.
- 2** Tap the box to the right of the **[Reference block]** box, and then to choose a reference block number from the list.  
 Default setting: 1  
 You can choose a reference block number less than or equal to the figure specified in the **[Division]** box
- 3** Tap the **[Reference block position]** box, and then from the list, choose an option for the fiducial point to display the reference waveform.

<b>Trigger</b>	Arranges the reference waveform so that its trigger point is aligned with that of the displayed block waveform.
<b>Top</b>	Arranges the reference waveform so that its start point is aligned with that of the displayed block waveform.

- 4** (When waveforms are stored in blocks after measurement)  
 Tap **[<]** and **[>]** or the number box to choose a block number to be displayed.  
 You can also choose a block on the waveform screen.

## Dead time (period during the instrument cannot sample data)

### When the memory division set is [Off]

The instrument performs internal processes that include performing calculations, displaying waveforms, and saving data at every waveform acquisition.

These processes require a certain period of time as a dead time.

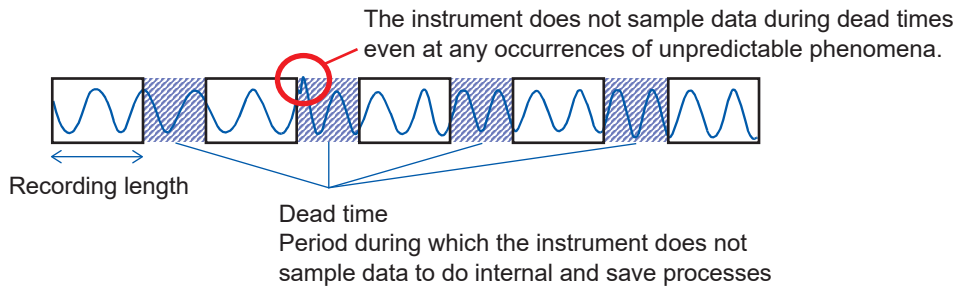

### When the memory division set to [On]

The instrument acquires waveforms in blocks in a sequential order to save time the internal processes requires at every waveform acquisition.

Dead times can shorten because the instrument displays and saves waveforms after acquiring them.

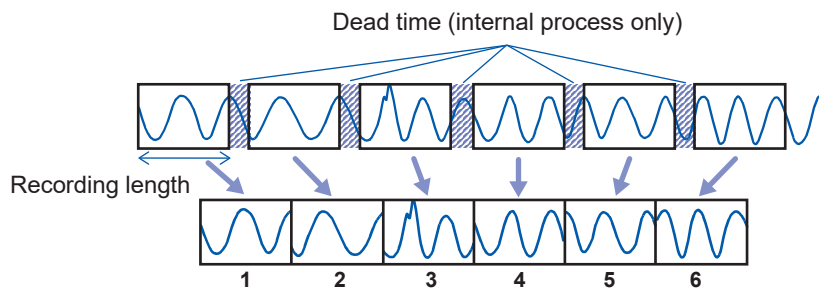

The instrument records a recording length of waveform data once per block.

- The relationships between dead times with the memory division setting and sampling rates are as follows.  
10 MS/s to 200 MS/s: 1 to 4 samples  
Sampling rate slower than 10 MS/s: 1 sample
- Measurement using Model 8970 Freq Unit in accumulation mode causes the last data set stored in the previous block to remain at the beginning of acquired data.
- When the instrument is frequently triggered, even pressing the **STOP** key may not stop measurement until the instrument has been acquired the specified number of blocks.
- Even the memory division is set to **[On]**, the following conditions require the instrument to perform processes that include performing calculations, displaying waveforms, and saving data at every waveform acquisition.
  - The numerical calculation is set to **[On]**.
  - The waveform calculation is set to **[On]**.
  - The FFT calculation is set to **[On]**.

However, the instrument performs multiple-block measurement, it displays a calculation result of the last block after measurement. To display calculation results of other blocks, re-execute a calculation.

## Automatic saving for the memory division setting

Measurement conditions	Automatic saving action
<ul style="list-style-type: none"> <li>The numerical calculation is set to <b>[On]</b>.</li> <li>The waveform calculation is set to <b>[On]</b>.</li> <li>The FFT calculation is set to <b>[On]</b>.</li> </ul>	Performs various calculations, automatically saves data, and displays waveforms at every 1-block measurement
<ul style="list-style-type: none"> <li>Sampling rate: 200 MS/s</li> </ul>	Automatically saves data after a all-block measurement.
Other than above	Automatically saves data and displays waveforms during measurement.





# 11 Dual Sampling

Dual sampling is a function that performs high-speed sampling in combination with low-speed sampling; the high-speed sampling can capture abnormal phenomena using triggers to record instantaneous waveforms while the low-speed sampling is continuously recording normal-state trend waveforms.

Multiple abnormal phenomena can be recorded using the memory division function.

## Trend waveform

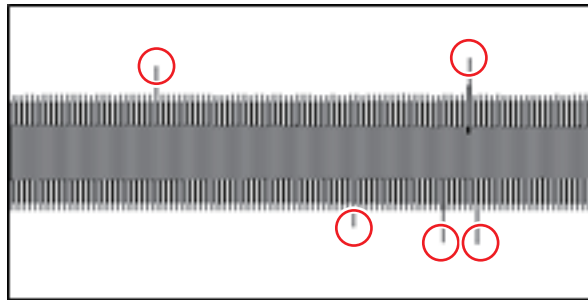

By observing trend waveforms, you can roughly check variation of waveforms under measurement. Instantaneous waveforms can be captured by configuring trigger settings, allowing you to examine abnormal phenomena (circled) closely.

## Instantaneous waveform

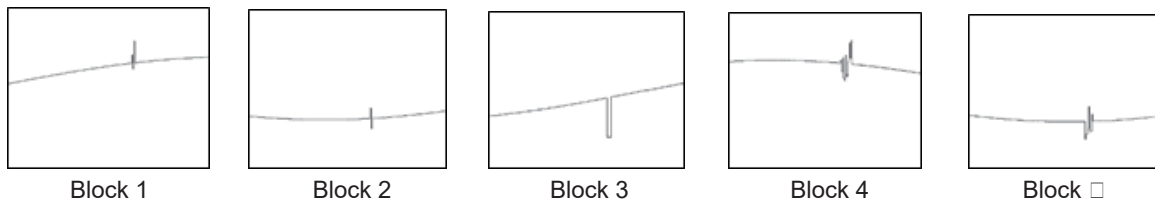

By pressing the **START** key, you can start recording trend waveforms. When trigger conditions are met, instantaneous waveform recording can start.

After measurement has finished, you can use instantaneous waveforms for numerical calculation, waveform calculation, and FFT calculation.

## 11.1 Dual Sampling Procedure

<p><b>Configuring dual sampling settings</b></p>	<p>Enable the dual sampling function. (p. 297)</p>
<p><b>Configuring settings for capturing trend waveforms</b></p>	<p>Set the recording mode. (p. 297) Set the sampling speed and the number of points for the trend waveforms. (p. 297)</p>
<p><b>Configuring settings for acquiring instantaneous waveforms</b></p>	<p>Set the sampling speed and the number of points for instantaneous waveforms. (p. 297) Configure the memory division settings. (p. 298)</p>
<p><b>Configuring the input channel settings</b></p>	<p>Configure the analog and logic channels settings. (p. 11)</p>
<p><b>Configuring the trigger settings</b></p>	<p>Configure the timing settings for acquiring instantaneous waveforms (p. 137)</p>
<p><b>Configuring automatic saving settings</b></p>	<p>Configure the settings so that waveform data can be automatically stored while being acquired. (p. 120)</p>
<p><b>Starting measurement</b></p>	<p>Press the <b>START</b> key to start recording trend waveforms.</p>
<p><b>Measurement in progress</b></p>	<p>When a trigger activates, the instrument starts recording instantaneous waveforms. When the memory division is enabled, the instrument records instantaneous waveforms every time the trigger activates. When the automatic saving is enabled, the instrument automatically stores instantaneous waveforms every time it acquires waveforms.</p>
<p><b>Finishing measurement</b></p>	<p>The instrument finishes measurement after it has acquired all the trend waveforms each of which contains set data points. When the automatic saving is enabled, the instrument stores instantaneous waveforms automatically. (p. 306) After measurement, you can perform various calculations using instantaneous waveforms.</p>

# 11.2 Configuring Dual Sampling Settings

> [Status] > [Condition]

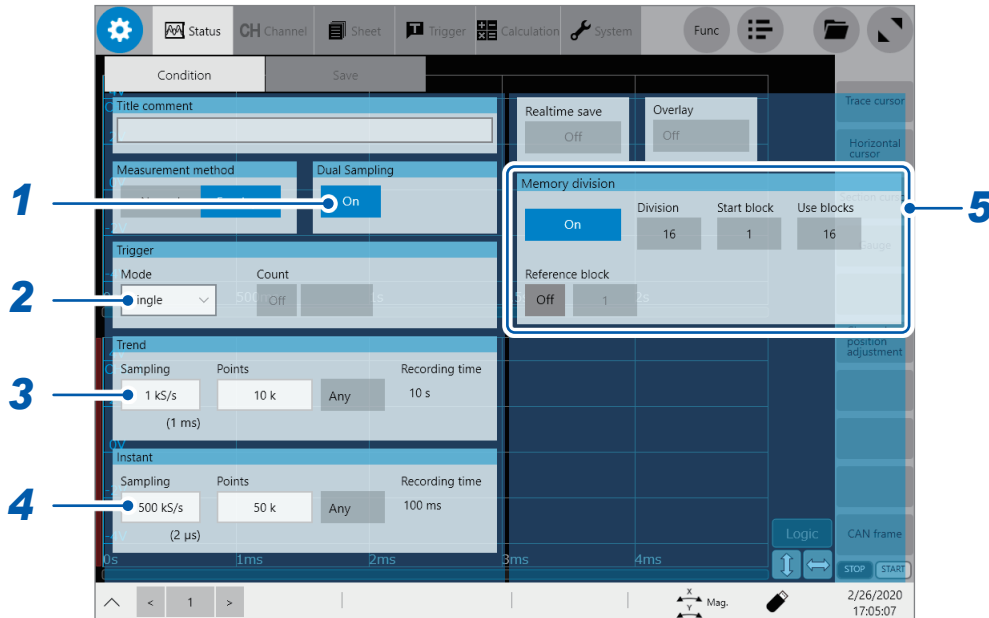

**1** Tap the [Dual Sampling] box to set to [On].

The following settings change automatically.

<b>Measurement method</b>	Envelope
<b>Realtime save</b>	Off
<b>Memory division</b>	On
<b>Overlay</b>	Off

**2** Tap the [Mode] box, and then from the list, choose a recording mode (behavior after finishing trend waveforms).

<b>Single</b>	Finishes recording after the set recording length of trend waveforms has been recorded.
<b>Repeat</b>	Clears waveforms after the recording length of trend waveforms have been recorded and records waveforms once again from the beginning. At this time, instantaneous waveforms are also recorded from the start block. You can stop recording by pressing the <b>STOP</b> key

**3** Set the sampling speed and the number of points for the trend waveforms.

The instrument measures trend waveforms using the envelope method (records the maximum and minimum values per sample).  
 At this time, it performs oversampling of the input signals at the sampling speed specified for the instantaneous waveform recording.  
 See "Using the envelope" (p. 9).

#### 4 Set the sampling speed and the number of points for instantaneous waveforms.

The instrument measures instantaneous waveforms using the normal method (acquiring one data point per sample). Choose a sampling rate faster than that chosen for trend waveforms. See the following page for the sampling speeds that can be set.  
See “Linear time-invariant system” (p. 410).

#### 5 Configure the memory division settings.

Instantaneous waveforms can be acquired into multiple blocks.  
By setting the dual sampling to **[On]**, the memory division is also set to **[On]** automatically, allowing you to set the number of blocks, start block number, and the number of blocks to be used.  
See “10 Memory Division Function” (p. 289).

#### 6 Configure the input channel settings.

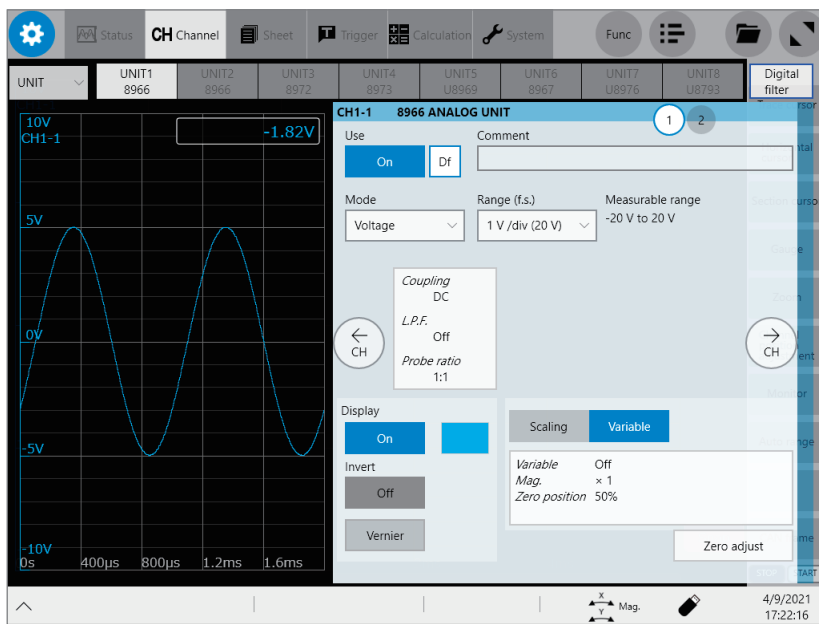

Configure the analog and logic channels settings.  
See “1.3 Configuring the Input Channel Settings” (p. 11).

## 7 Configure the trigger settings.

 > [Trigger]

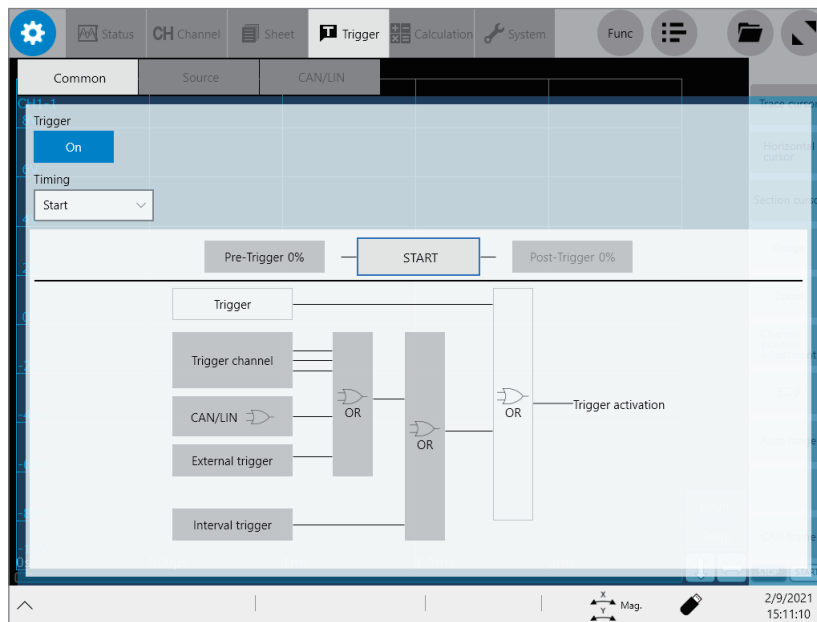

The instrument can record instantaneous waveforms using triggers under certain conditions only. See “5 Configuring the Trigger Settings” (p. 137).

### IMPORTANT

The following trigger functions are disabled when the dual sampling is set to **[Off]**.

- Trigger timing (**[Stop]**, **[Start/Stop]**)
- Post trigger

### Trend waveform and instantaneous waveform

- Recording trend waveforms can immediately start by pressing the **START** key. Instantaneous waveforms, which can use the memory division, are recorded into a different block one after another every time the instrument is triggered. Even if blocks run out for recording instantaneous waveforms, the instrument continues to record waveforms until the recording length specified for trend waveforms elapses.

**Example**

When an instantaneous waveform is recorded with 2-memory-division setting  
The waveform is recorded into two or fewer blocks.

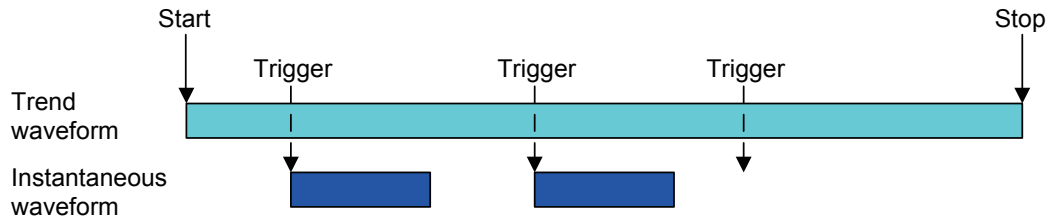

- Once the recording of trend waveforms finishes, recording of instantaneous waveforms is also finished.

**Example**

When an instantaneous waveform is recorded with 2-memory-division setting

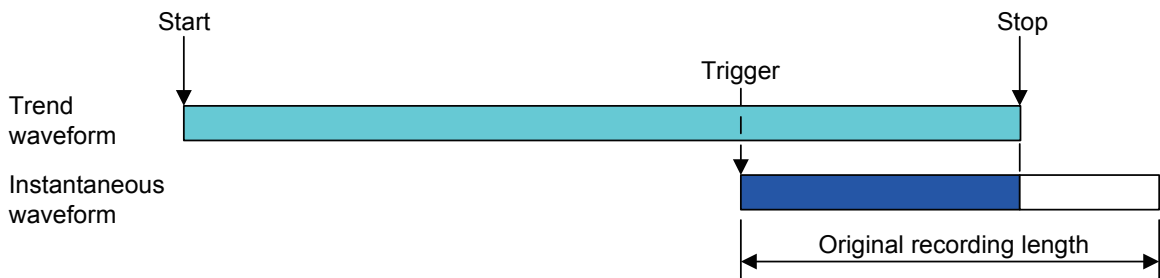

- For repetitive measurements, the instrument clears waveforms every time it finishes recording of trend waveforms, and then restarts recording waveforms from the beginning. At this time, instantaneous waveforms are also recorded from the start block. You can stop recording by pressing the **STOP** key

**Example**

When pressing the **STOP** key during the third measurement of instantaneous waveform recordings with the recording mode set to repeat and the number of the memory division set to four

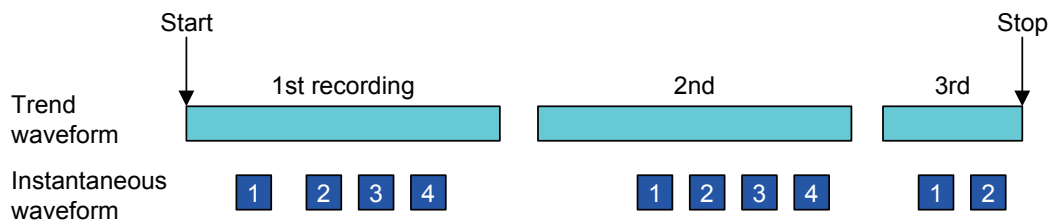

# 11.3 Operating the Waveform Screen for Analyzing Waveforms

You can use the waveform screen to toggle between the trend waveform setting and the instantaneous setting, switch the display, and analyze waveforms with the trace cursors.

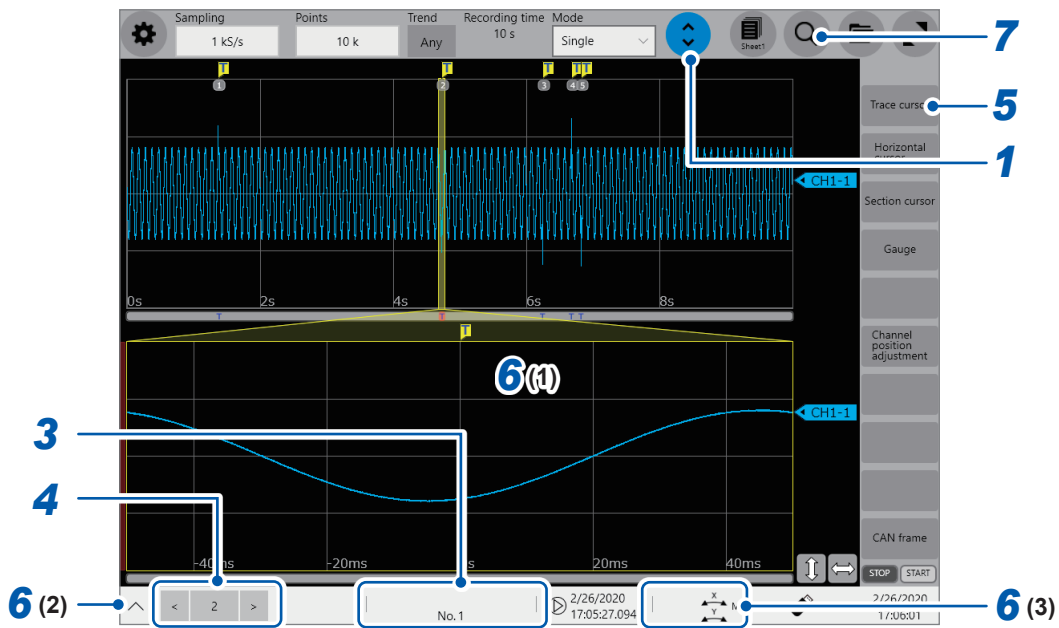

**1** Tap (blue) button or (gray) button.

Every time you tap the button, it changes in color, and the settable items are toggled.

**When the button color is blue**

The setting is of trend waveforms.

You can set the sampling speed, the number of measurement points, and the recording mode.

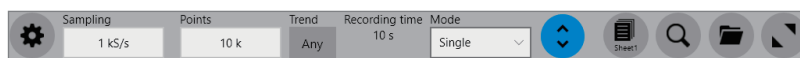

**When the button color is gray**

The setting is of instantaneous waveforms.

You can set the sampling speed, the number of measurement points, and the waveform type to be displayed on the screen,

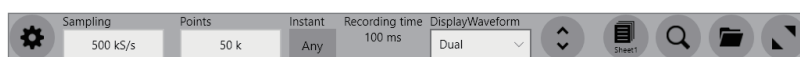



**2** Tap the **[DisplayWaveform]** box, and then from the list, choose a waveform type to be displayed on the waveform screen.

<b>Dual</b>	Displays trend waveforms on the upper split-screen and instantaneous waveforms on the lower split-screen.
<b>Trend</b>	Displays trend waveforms You can use the sheet setting to choose a screen spit setting.
<b>Instantaneous</b>	Displays Instantaneous waveforms. You can use the sheet setting to choose a screen spit setting.

See “1.4 Configuring the Sheet Settings” (p. 19).

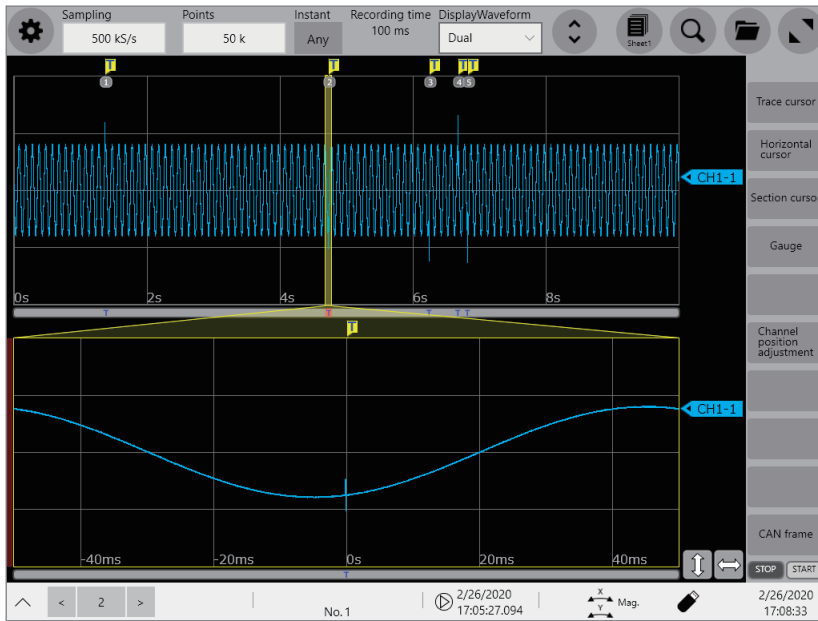
**When choosing [Dual]**



The trend waveforms (on the upper screen) have the trigger marks  and block numbers that indicate the positions of the instantaneous waveforms.

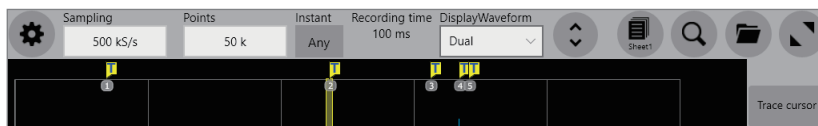

The instantaneous waveforms (on the lower screen) have the trigger marks  that indicate the positions of the trigger positions.

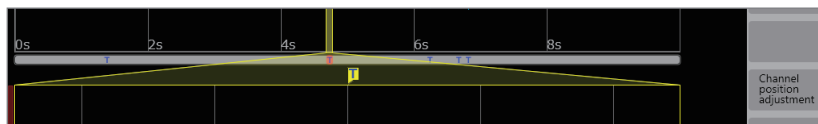



When choosing [Trend]

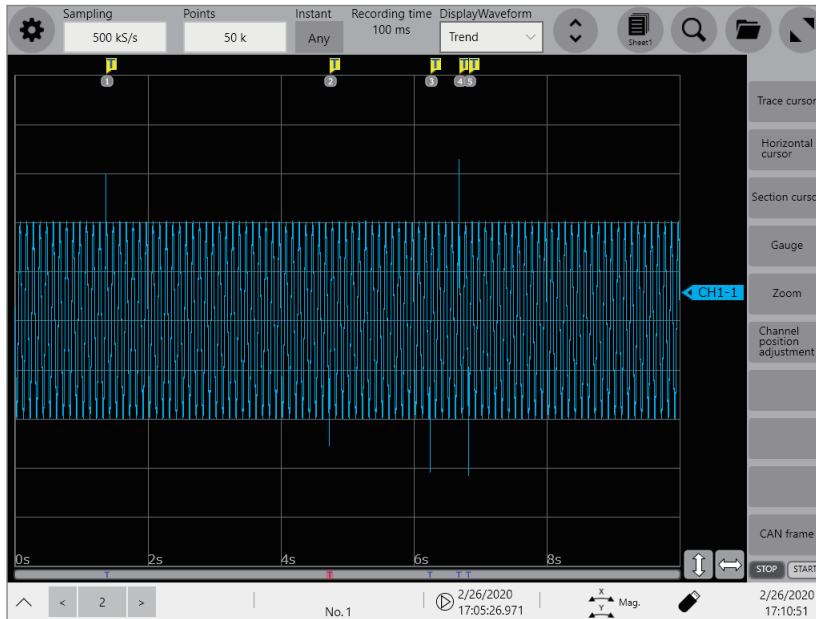

When choosing [Instantaneous]

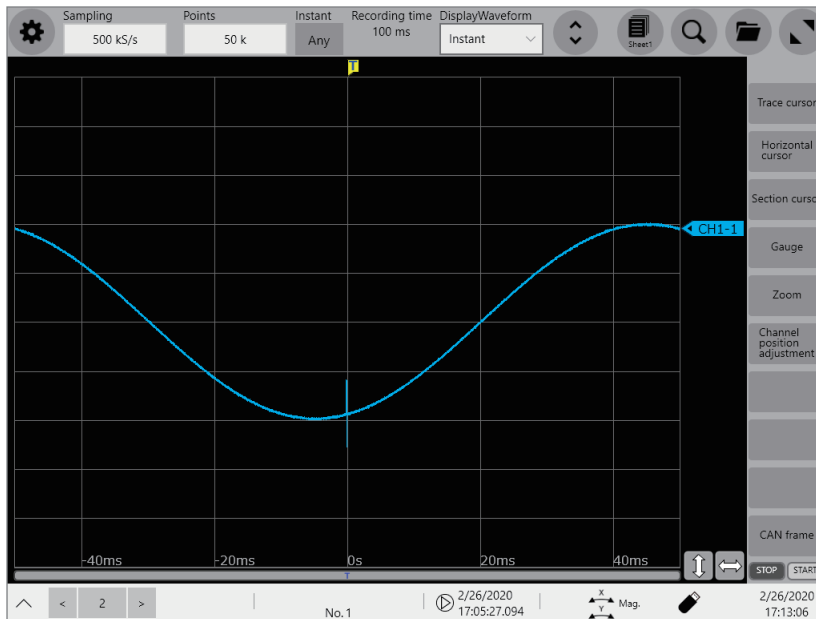

3 Check on the measurement state.

During measurement, the recording states of the trend waveforms and instantaneous waveforms are indicated using characters and the progress bar.

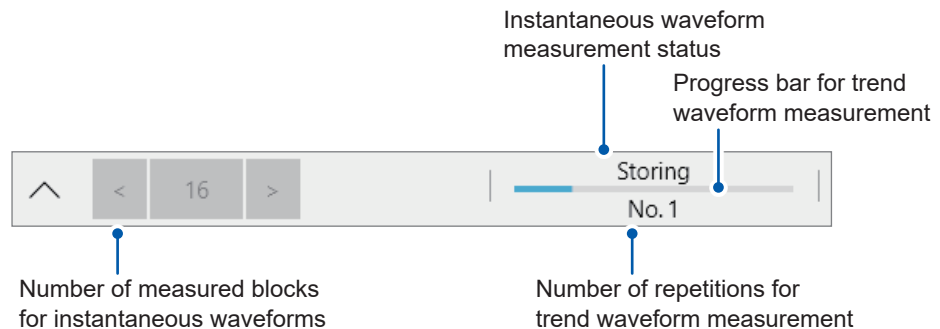

**4** (When the displayed waveforms are set to **[Dual]** or **[Instantaneous]**)

After measurement has finished, tap **[<]** and **[>]** to choose a block number of instantaneous waveforms to be displayed.

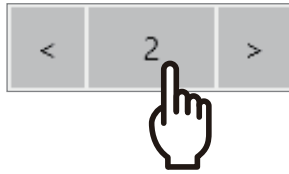

Tapping the number can display the block switching window.



Use the arrow keys, two-headed arrow keys, and slider to select a block number, and tap **[OK]** to display instantaneous waveforms contained in the selected-numbered block.

When the displayed waveforms are set to **[Dual]**, you can switch the block number to be displayed by tapping the number of the instantaneous waveform position mark.



**5** Tap the **[Trace cursor]** button to display the cursor to read off measured values.

See “2.1 Reading Measured Values (Trace Cursors, Horizontal Cursors)” (p. 30).

Trace cursors retain their positions on both trend waveforms and instantaneous waveforms.

When the displayed waveforms are set to **[Dual]**, the cursors for instantaneous waveforms are displayed, allowing you to operate the cursors.

## 6 Move and zoom in/out waveforms.

You can move and zooming in/out waveform using the following four ways:

- (1) Pinch in the waveform screen to zoom out waveforms, and pinch out to zoom in.
- (2) Use the quick access menu to zoom in/out waveforms.

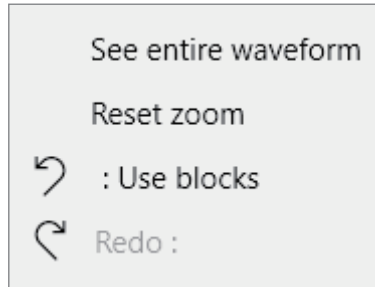

See to “1.4 Supplying Power to the Instrument” in the Quick Start Manual.

- (3) Press the rotary knob to choose an item you wish to operate and rotate the knob to change the display setting.

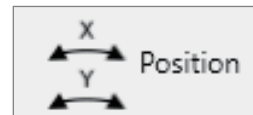
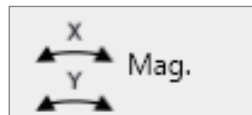

See “2.6 Operating the Rotary Knobs” (p. 45).

- (4) Use the shortcut keys to zoom in/out waveforms.



See “13 Configuring the System Environment Settings” (p. 343).

When the displayed waveforms are set to **[Dual]**, you can toggle waveforms to operate by tapping the screen.

You can operate waveforms that have the red bar at the left edge.

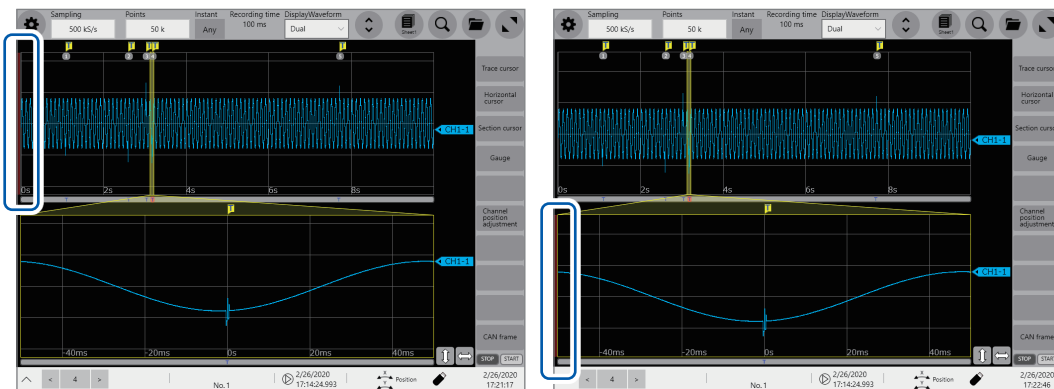

When the trend waveforms can be operated    When the instantaneous waveforms can be operated

## 7 Search the instantaneous waveforms for the positions where the specified conditions are met.

Tap **[Search]** button to enter the conditions. The instrument searches the waveforms for the positions where the conditions are met.

See “6 Search Function” (p. 167).

You can jump to event marks on trend waveforms only. Other searches and jumps can be performed on instantaneous waveforms only regardless of the waveform display setting.

# 11.4 Calculation Function

After measurement has finished, you can perform various calculations using instantaneous waveforms.

## 1 Configure various calculation settings.

The following calculations are available:

- Numerical calculation See "7 Numerical Calculation Function" (p. 181).
- Waveform calculation See "8 Waveform Calculation Function" (p. 209).
- FFT calculation See "9 FFT Calculation Function" (p. 257).

## 2 Tap the button.

The waveform screen is displayed.

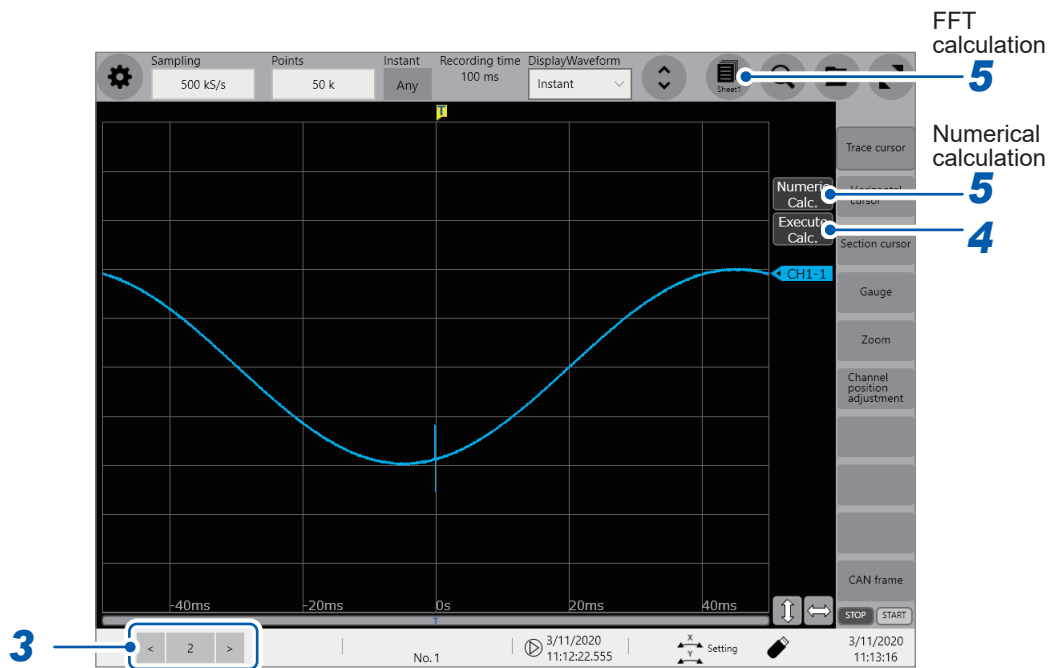

## 3 When the displayed waveforms are set to [Dual] or [Instantaneous]

Tap [**<**] and [**>**] to choose a block number of instantaneous waveforms to be used for calculation.

When the displayed waveforms are set to [Dual], you can also choose a block number by tapping the position number of the instantaneous waveform position marks.

## 4 Tap [Execute Calc.].

The calculation is executed.

When all calculations are set to [Off], [Execute Calc.] does not appear.

- For the numerical calculation  
Tap **[Numeric Calc.]** to check on the calculation results displayed on the waveform screen.

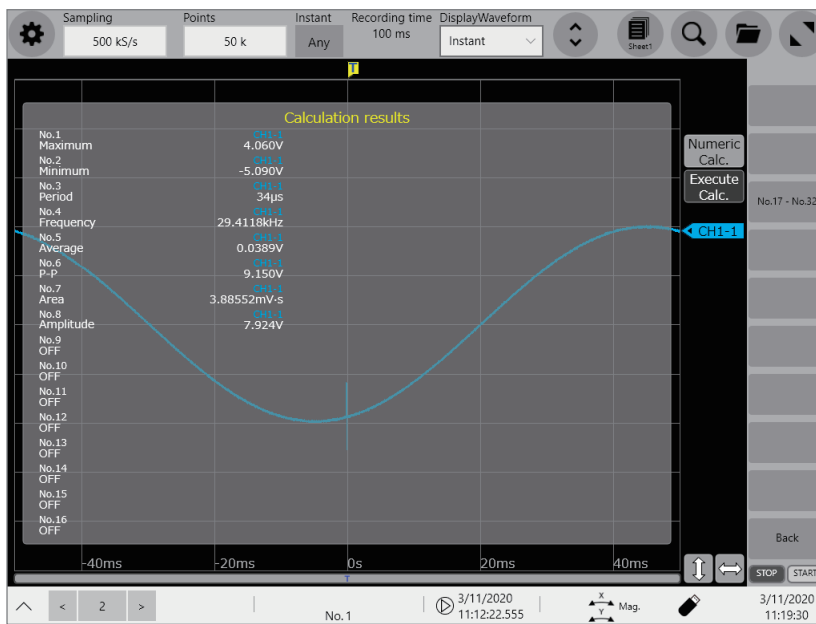

For waveform calculation

Check on the calculation results displayed as waveforms on the waveform screen.

For FFT calculation

Tap the **[Sheet]** button, which can switch over to the sheet with the display form set to FFT waveforms, to check on the calculation results.

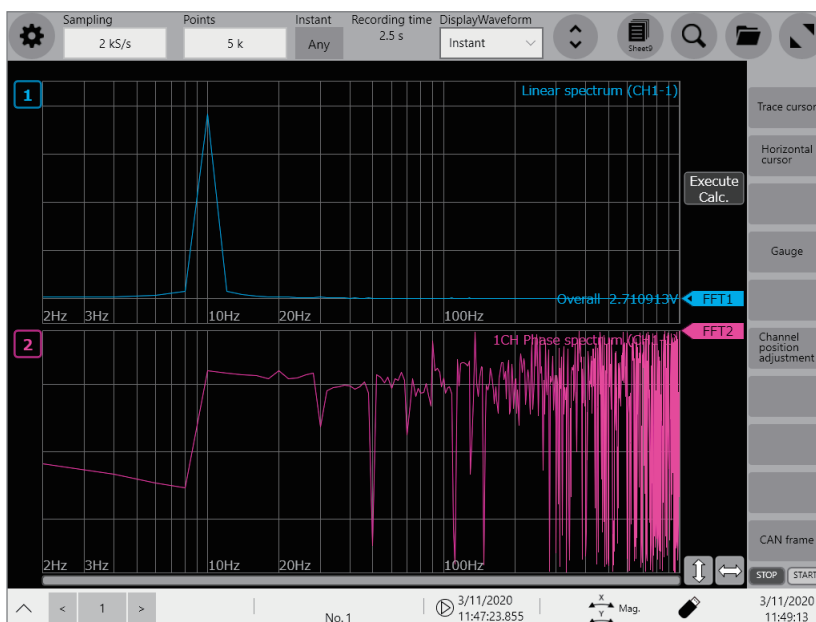

**IMPORTANT**

Even if the calculation is set to **[On]**, no calculation is automatically performed during measurement.

After measurement has finished, tap **[Execute Calc.]** to perform calculation.

## 11.5 Files

You can save and load dual sampling waveform files.

Arranges the reference waveform so that its start point is aligned with that of the displayed block waveform.

The instrument saves instantaneous waveforms at the moment when finishing the measurement of each block, which is specified by the number of blocks you wish to use in the memory division settings.

When it has saved instantaneous waveforms of all blocks during measurement, it subsequently starts to save trend waveforms. When instantaneous waveforms of some blocks have been left unsaved on the completion of the measurement, the instrument starts to save trend waveforms at that moment.

The automatic saving function requires you to configure the settings, including save destinations and saving types, in advance of measurement.

See “4 Saving/Loading Data and Managing Files” (p. 115).

When the automatic saving function is enabled, the instrument saves trend waveforms and instantaneous waveforms of all blocks in a batch. An index file is also saved simultaneously.

### Dual sampling waveform files you can save and load

✓: enabled, –: disabled

File type	File format	Extension	Content	Automatic saving	Manual save	Load onto MR6000	Load onto computer
Waveform data	Binary	MEM	Instantaneous waveform measured data	✓	✓	✓	✓ <sup>*1</sup>
		REC	Trend waveform measured data	✓	✓	✓	✓ <sup>*1</sup>
	Text	REC	Text data	✓	✓	–	✓
	Float	CSV, TXT	Floating point data	–	✓	–	–
Management data <sup>*2</sup>	Index	R_M	Binary batch-save management data	✓	✓	✓	–

\*1 Loadable with Waveform Viewer (Wv)

\*2 Automatically created when all binary files are collectively saved.

## Hierarchical destination folders

The instrument automatically creates folders on recording media to save various files. One folder can contain up to 5000 files and folders, collectively.

Example of the folder hierarchy when the waveform file is named *MRDAT*

The shaded folders are created when recording media is inserted; the filled folders are created depending on a saving state.

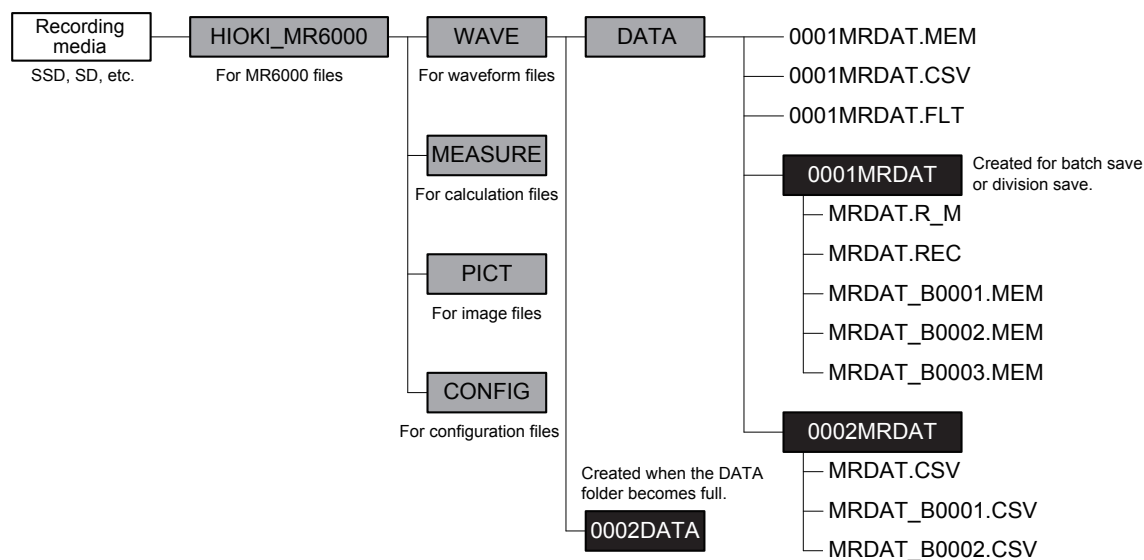

When dual-sampling waveforms are collectively saved or divided before saved into display blocks, the instrument newly creates the folder with the name of the waveform file name preceded by a running number and saves all the files in the folder.

For instantaneous waveform files, a block number is added to file names.

## Automatically saving waveform data

The instrument automatically saves waveform data while being acquired. You have to specify a destination to save and a file type before starting measurement.

See “Automatically saving waveform data” (p. 120).

All blocks containing trend waveforms and instantaneous waveforms are collectively saved. An index file is also saved simultaneously.

## Freely choosing data items to be saved and save files (SAVE key)

You can save waveform data by pressing the **SAVE** key.

See “Freely choosing data items to be saved and save files (SAVE key)” (p. 127).

**Manual save**

Media  
 SSD/HDD ▼ TOSHIBA MQ01AAD0(D:)  
 286.2 GB / 298.1 GB

File name  
 DATA

Type  
 Waveform (Binary) ▼

Save Block  
 Display Block ▼

Channel  
 Display ▼

CAN  
 Off

Range  
 All ▼

Divide  
 Off ▼

Execute Cancel

### 1 Press the **SAVE** key.

The **[Manual save]** dialog box is displayed.

### 2 Tap the **[Save Block]** box, and then from the list, choose a block in which data is saved.

<b>Display Block</b> <sup>☑</sup>	Saves waveforms included in displayed blocks.
<b>All Block</b>	Saves waveforms included in the specified number of blocks being used counting from the start block.

### 3 Tap **[Execute]**.

Waveforms included in displayed blocks are saved.

## Loading waveform data

You can load files saved in recording media onto the instrument.

See “Loading Data” (p. 131).

Extension	Measurement target
R_M	Loads trend waveforms and instantaneous waveforms included in all blocks to restore the waveforms to those measured with the dual sampling set to <b>[On]</b> .
REC	Loads trend waveforms only. The dual sampling setting is set to <b>[Off]</b> .
MEM	Loads instantaneous waveforms included in only one block. The dual sampling is set to <b>[Off]</b> .



Using the CAN/LIN measurement function, the instrument can record all CAN/LIN signals that transmit through a CAN/LIN bus and display user-selected signals as waveforms. To use this function, the Vector VN1600 interface is required.

The CAN/LIN measurement function cannot be used in the following conditions:

- When the memory division is set to **[On]**
- When the dual sampling is set to **[On]**
- When the external sampling is set to **[On]**

Up to 1,000,000 frames can be obtained through the CAN/LIN measurement. If the number of obtained frames reaches this number during measurement, the instrument will stop obtaining following frames, but continue the measurement until the set recording time has elapsed.

### Main features

- All CAN signals transmitting through a CAN bus can be recorded.
- All LIN signals transmitting through a LIN bus can be recorded.
- CAN FD, CAN, and LIN are supported.
- All of hardware configuration you have to do to record CAN/LIN signals is connecting the Vector VN1600 interface to the instrument's USB port. You do not need to change the existing input module configuration. The instrument becomes capable of recording CAN/LIN signals without removing inserted input modules.
- The instrument, which has four ports independent from one another, can connect to networks of various CAN/LIN bus types or baud rates.
- You can choose signals to be displayed as waveforms from recorded CAN/LIN signals. Up to 16 CAN/LIN signals can be simultaneously displayed as waveforms.
- Up to 300 CAN/LIN definition data sets can register for displaying CAN/LIN signals as waveforms.
- Files (DBC/LDF files) created with the Vector database CANdb can be directory loaded. Loaded definition data can be used without any process. You can also modify definition data contents.
- The instrument can send CAN messages and acknowledgments responding (ACK) to CAN messages, allowing you to perform a simple simulation.
- You can configure all the settings with the instrument.

## 12.1 CAN/LIN Measurement Procedure

Two methods are available for CAN/LIN measurement.

You can choose an optimal method depending on your purpose (concurrent use is available).

Method	Advantage
Using waveform processing calculations	<ul style="list-style-type: none"> <li>Waveforms can be displayed after measurement.</li> <li>The waveform processing calculations are used.</li> <li>Waveforms can be computed.</li> <li>Up to 16 channels are available.</li> </ul>
Displaying waveforms during measurement	<ul style="list-style-type: none"> <li>Waveforms can be displayed during measurement.</li> <li>The waveform display settings are used.</li> <li>Up to 64 channels are available.</li> </ul> (Waveforms cannot be computed.)

### Using waveform processing calculations

Connecting interfaces	Connect CAN/LIN interfaces to the instrument's USB ports. (p. 314) (When the CAN/LIN measurement function has been added by installing updated firmware, you first need to install the driver)
Configuring the interface settings	Set a CAN/LIN bus mode and a baud rate for each interface. (p. 314)
Configuring settings for displaying signals as waveforms	Set definition data for displaying CAN/LIN signals as waveforms. You can choose definition data by loading a DBC/LDF file. (p. 325) Configure the waveform calculation settings to choose data sets to be displayed as waveforms.
(Configuring the CAN/LIN trigger settings)	When a specific CAN/LIN frame is inputted, the instrument starts to acquire data. (p. 163)
(Configuring the transmission function settings)	During measurement, the instrument can transmit CAN messages at pre-set timings. (p. 333)
Acquiring data	Press the <b>START</b> key to start measurement. The instrument starts recording all CAN/LIN signals that transmit through a bus as well as acquiring data with the instrument's input modules.
Performing calculation	When finishing acquisition of data, the instrument shows the message <b>[Calculating Waveform]</b> on the screen status bar. (p. 339) You can choose a definition data set from among CAN/LIN signals recorded to search for to display them as waveforms.
Displaying results	The waveform screen displays results. The displayed results consist of data measured with measurement modules and CAN/LIN signals displayed as waveforms.

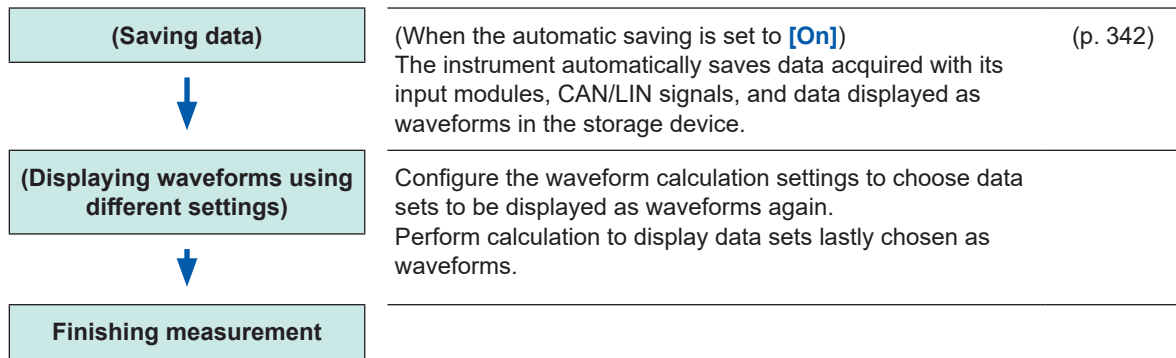

## Displaying waveforms during measurement

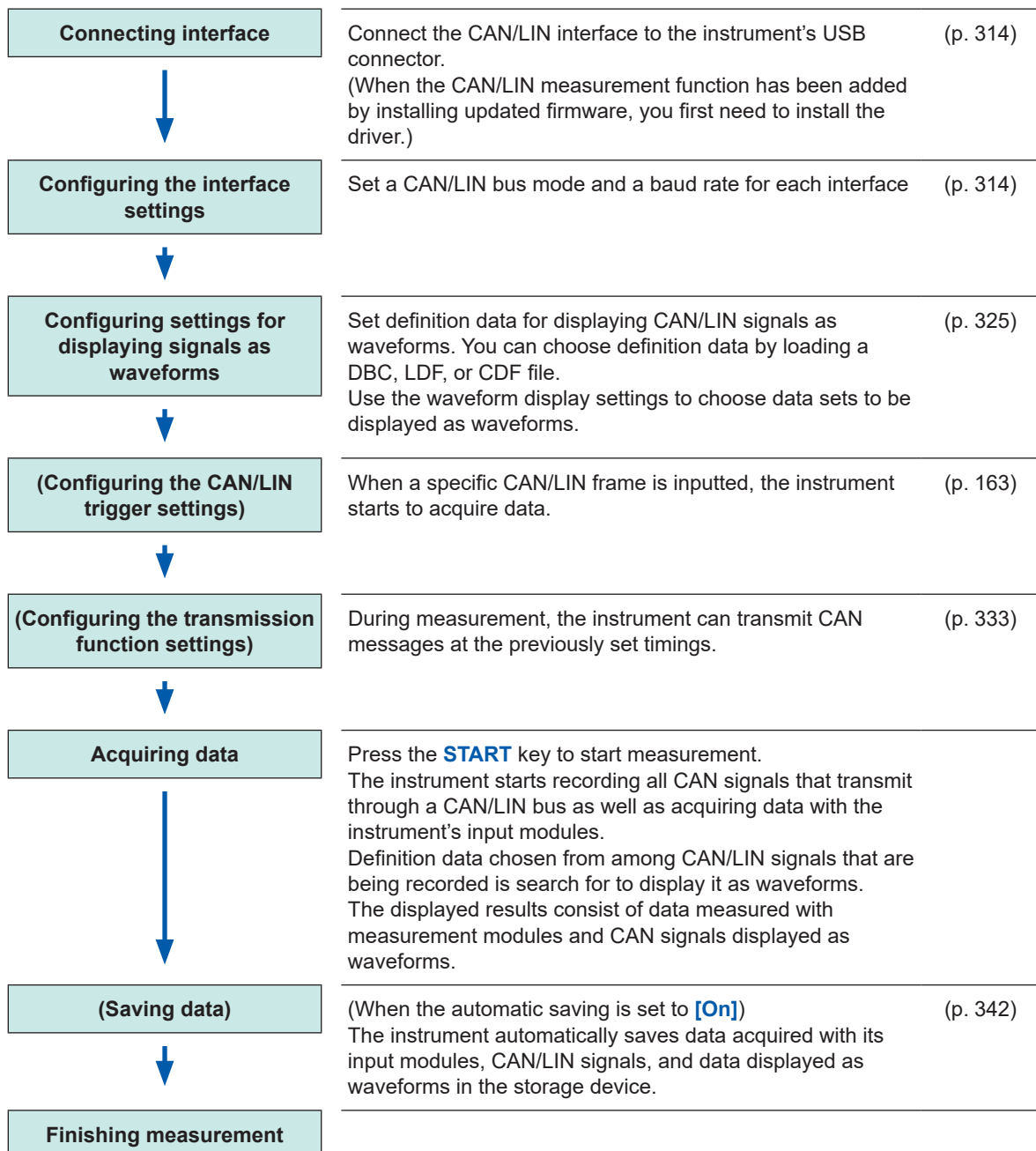

# 12.2 Connecting CAN/LIN Interfaces

**1 Connect CAN/LIN interfaces to the instrument using a USB cable.**

Any USB ports of the instrument are available to connect CAN/LIN interfaces. Only one CAN interface can be connected to the instrument. Do not connect more than one CAN interface. Some CAN interfaces can perform measurement involving up to four channels (C1 to C4). The CAN interfaces are assigned the channel numbers C1, C2, C3, and C4 in the order in which they are detected.

Hioki has verified proper operation of the following CAN/LIN interfaces:

- VN1630, VN1640 (CANpiggy 1051cap/1057Gcap): CAN FD, High-speed CAN (up to 4 ports)
- VN1610: CAN FD, High-speed CAN (2 ports)
- VN1611: LIN, High-speed CAN

**2 Turn on the instrument.**

**3 Disable the system protection function.**

See “13 Configuring the System Environment Settings” (p. 343).

**4 (Only when connecting CAN/LIN interfaces for the first time)**

**Open Explorer and use the Vector Driver Disk, which came with the CAN/LIN interface (VN1600 interface), to install the CAN/LIN driver on the instrument.**

See the instruction manual that came with the interface to install the driver.

**5 Connect a USB mouse to the USB port.**

From this time through step 17, you can use the USB mouse for settings.

**6 Tap  > [Channel] > [UNIT] > [CAN/LIN] > [Driver].**

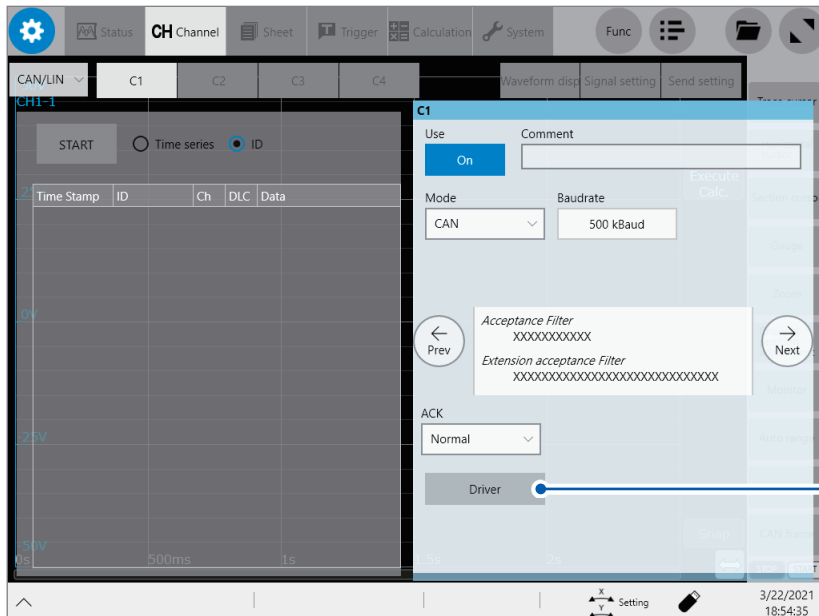

The **[Vector Hardware Config]** window appears.

If the **[Vector Hardware Config]** window does not appear, click the Windows button at the lower left corner of the screen with the mouse and choose **[Vector Hardware Configuration]** from the Start menu.

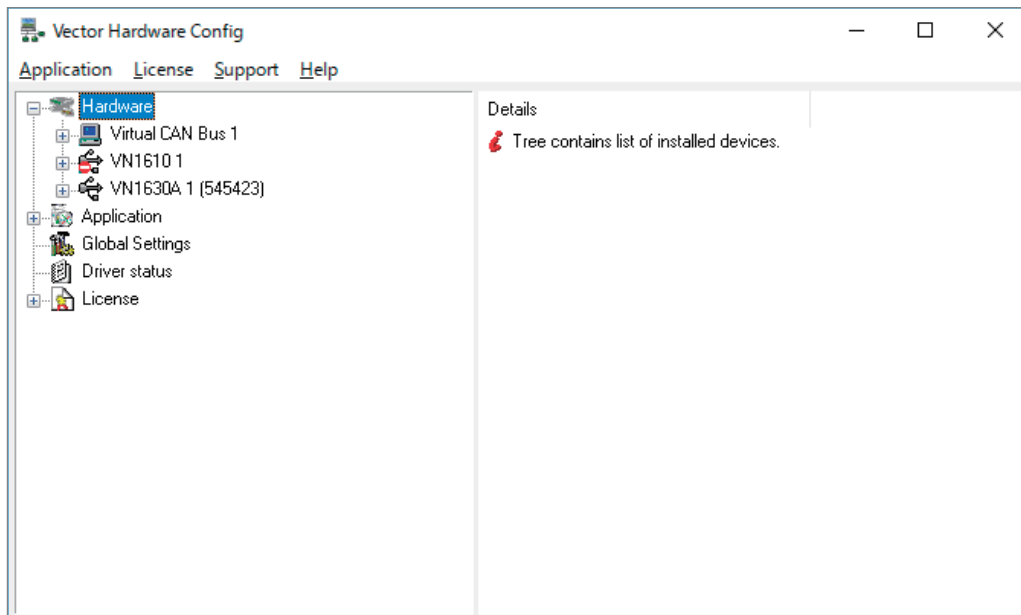

## 7 Check if the connected CAN interface has detected.

Under **[Hardware]**, the connected CAN interface appears. If the instrument cannot correctly detect the CAN interface, an error mark appears on the icon,

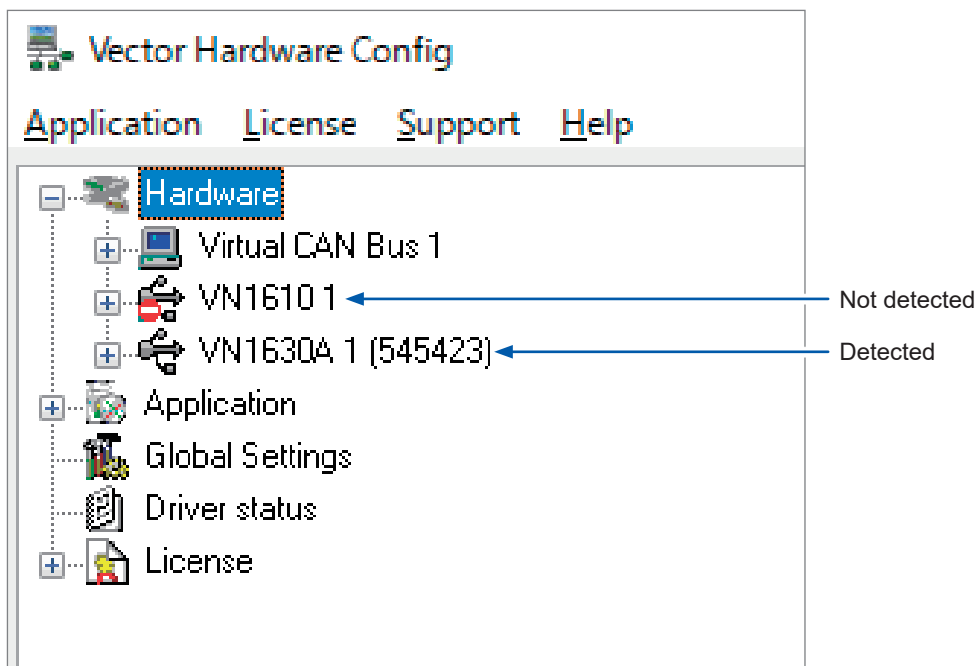

- 8** Right-click **[Application]**, and then from the shortcut menu, select **[Add application]**.

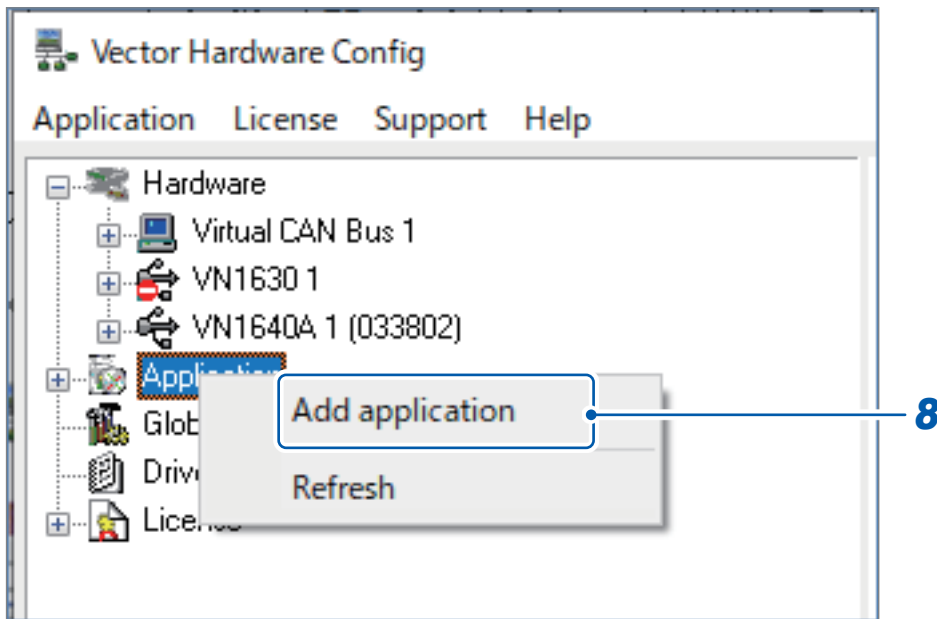

The **[Application settings]** appears.

- 9** In the **[Application name]** box, enter the string **[hiokiCANcontrol]**.  
Exercise care as the software won't be able to connect if even one character differs.

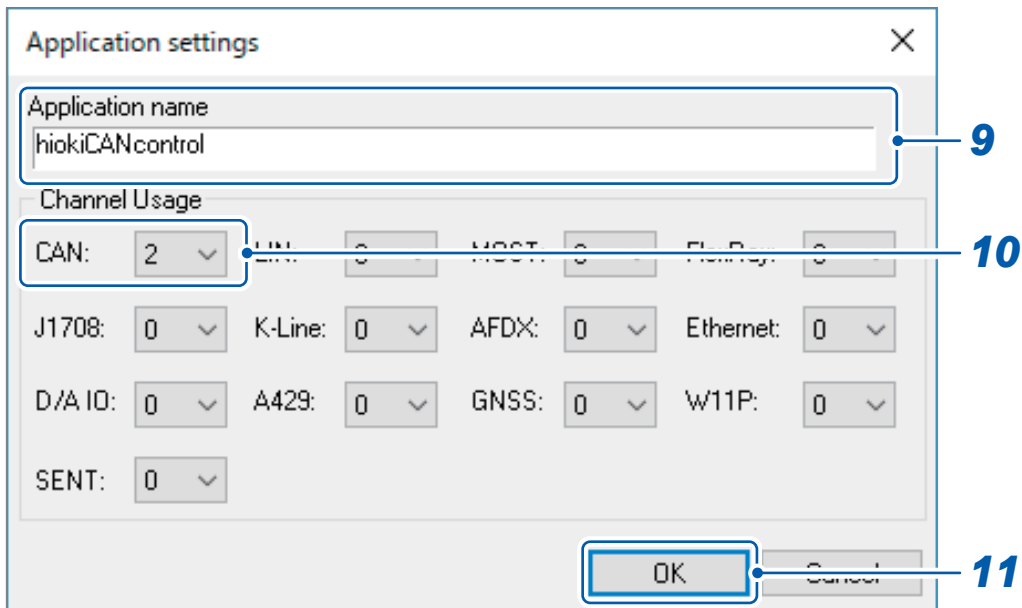

- 10** Click the **[CAN:]** box, and then from the list, choose the number of the connected CAN interfaces.

- 11** Click **[OK]**.  
The **[Application settings]** dialog box closes.

- 12** On the left pane of the [Vector Hardware Config] window, click the plus sign next to [Hardware].

The tree structure consisting of the connected CAN interfaces expands.

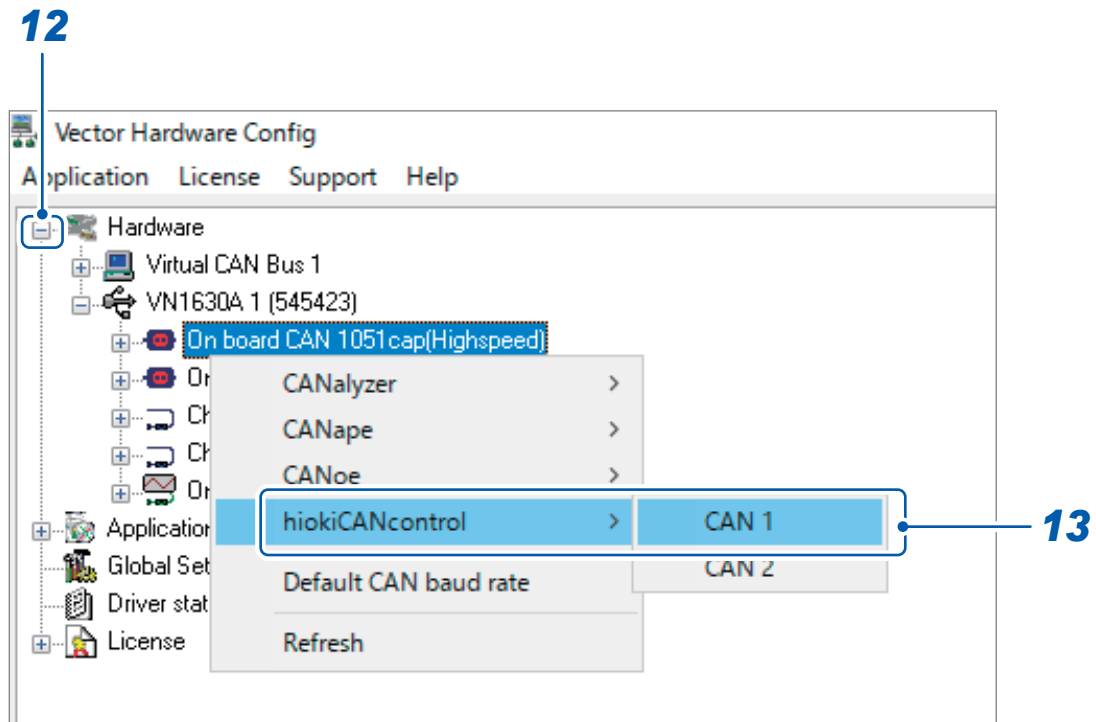

12

CAN/LIN Measurement Function

- 13** Right-click a CAN interface of your choice, click [hiokiCANcontrol] on the shortcut menu, and then choose a CAN channel number (such as [CAN 1]).

Assign channel numbers to all of the CAN interfaces actually connected. When you click a plus sign, the tree structure expands; a minus sign, collapses.

- 14** Click the plus sign next to [Application].

The node expands.

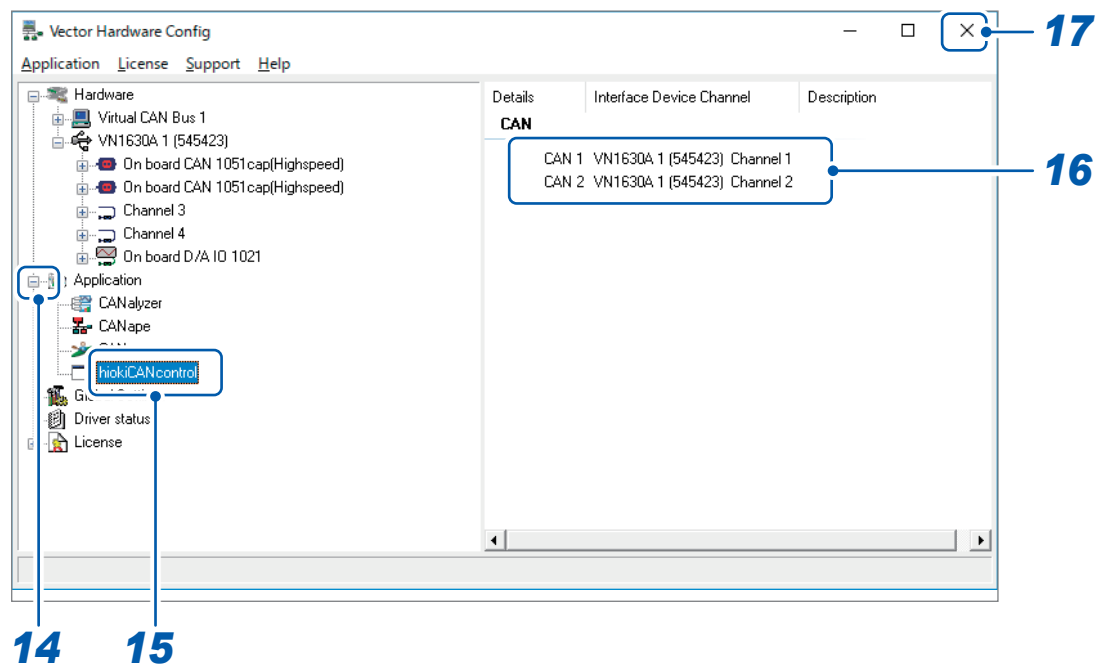

**15** Click **[hiokiCANcontrol]**.

On the right pane of the window, the state of assigned CAN channels is displayed. For channels not assigned correctly, the string **[Not assigned]** appears.

**16** Check if channel numbers are assigned to the CAN interfaces as intended.

**17** Tap the **[Close]** button.

The **[Vector Hardware Config]** window closes; the screen returns to the recorder application.

**18** Cycle the instrument.

Refer to “2.9 Supplying Power to the Instrument” in the Quick Start Manual.



# 12.3 Configuring the CAN/LIN Interface Settings

This section describes how to configure condition settings required for measurement, such as the baud rate and packet filter.

 > [Channel] > [UNIT] > [CAN/LIN]

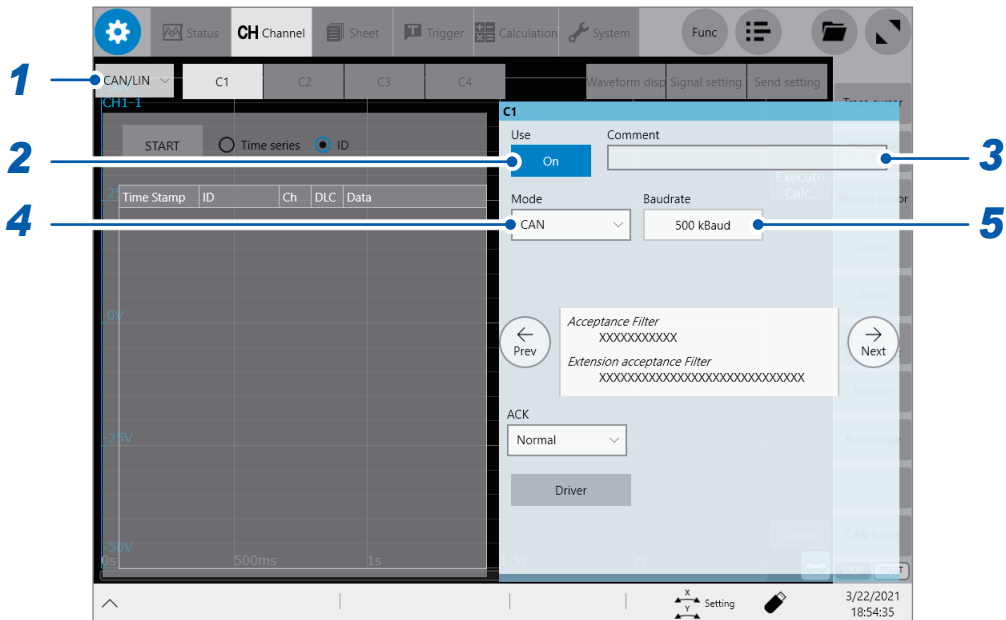

**1** Tap the box that can toggle between [Unit] and [CAN/LIN] to select [CAN/LIN].

**2** Tap the [Measurement] button to set it to [On] or [Off].

Off 	Does not designate the channel as a measuring target. The instrument does not acquire any data; nothing is displayed or saved.
On	Designates the channel as a measuring target.

**3** Enter a comment in the [Comment] box.

Number of characters that can be entered: up to 40

**4** Tap the [Mode] box, and then from the list, choose a CAN mode (setting common to C1 through C4).

CAN 	Enters CAN mode.
CAN FD	Enters CAN FD mode.
LIN	Enters LIN mode.

**5** Tap the [Baudrate] box, and then from the list, choose a baud rate.

CAN, CAN FD	33.3 k, 50 k, 83.3 k, 100 k, 125 k, 250 k, 500 k  , 1 M (Baud)
LIN	2.4 k  , 9.6 k, 14.4 k, 19.2 k (Baud)

## 6 (When you set [Mode] to [CAN FD])

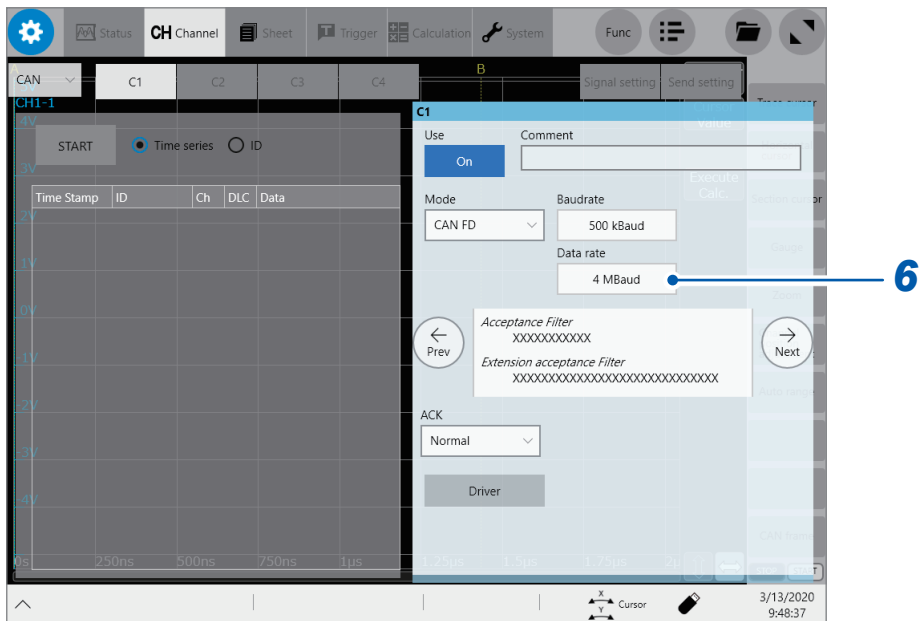

Tap the [Data rate] box, and then from the list, choose a baud rate used in the data phase.

33.3 k, 50 k, 83.3 k, 100 k, 125 k, 250 k, 500 k, 1 M , 2 M, 4 M (Baud)

## 7 (When you set [Mode] to [LIN])

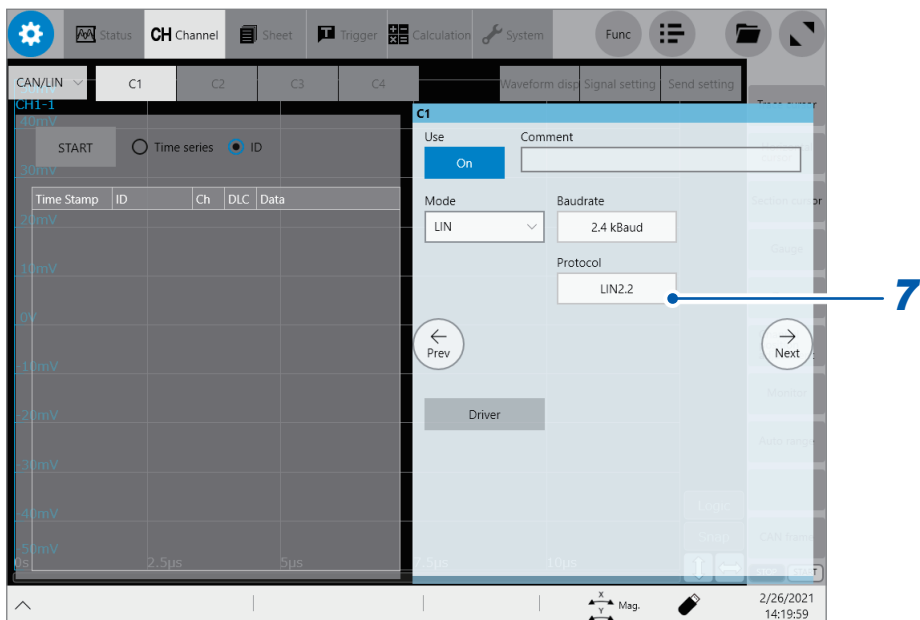

Tap the [Protocol] box, and then from the list, choose a protocol you wish to use.

LIN2.2 , LIN2.1, LIN2.0, LIN1.3

8 (When you set [Mode] to [CAN] or [CAN FD])

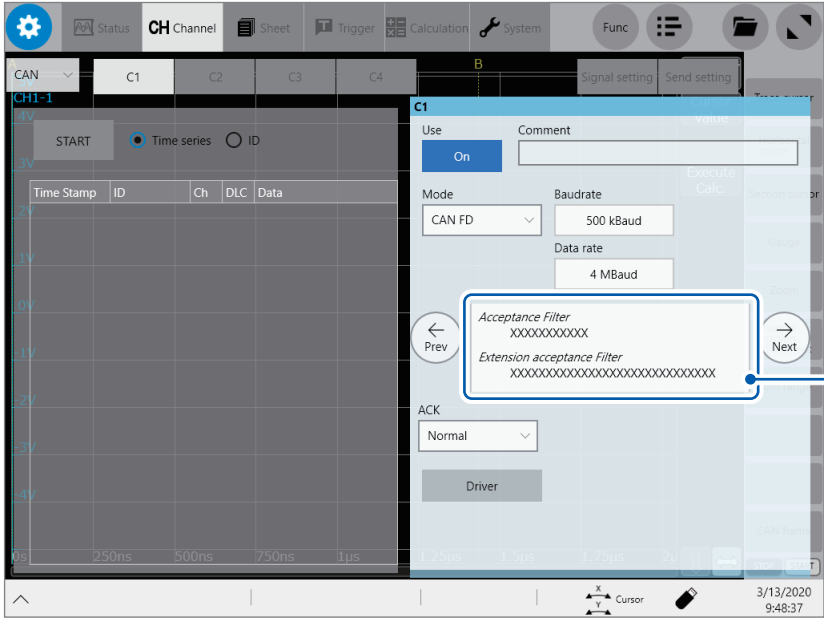

Tap the area that includes [Acceptance Filter].  
 The [Acceptance Filter/Extension acceptance Filter] dialog box appears.  
 Use this dialog box to set which message is filtered to perform measurement.

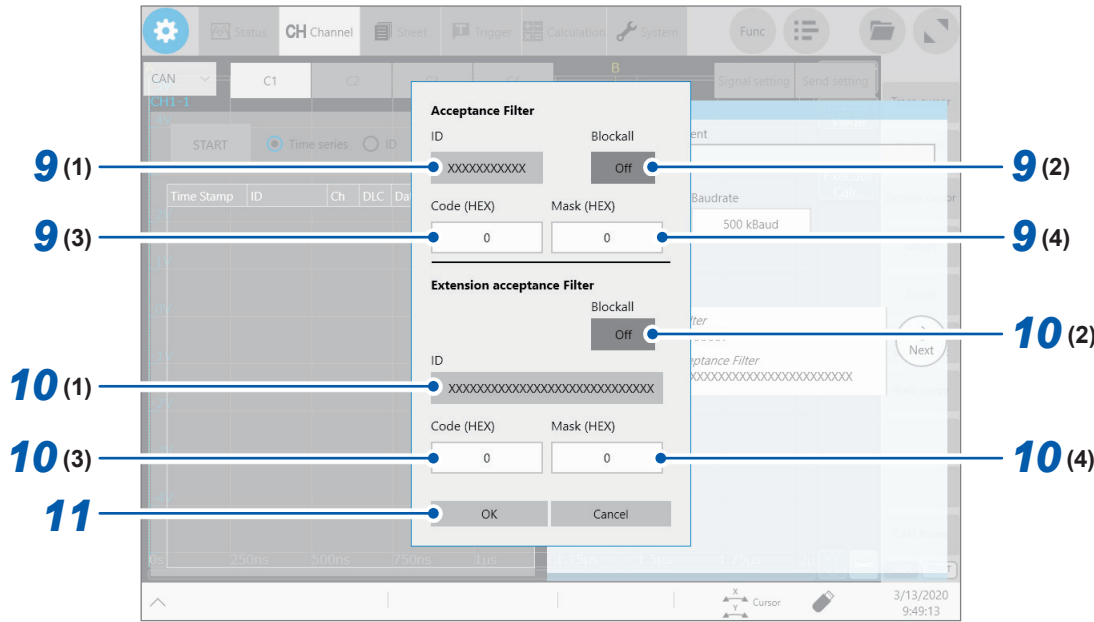

## 9 Configuring the receiving filter settings.

- (1) Under **[Acceptance Filter]**, tap the **[ID]** box, and then enter a filter ID.  
The instrument blocks a message of a bit whose filter ID does not match the ID bit of each signal. Bits whose bit mask to which the character X has been set pass all messages. The bit mask automatically calculates a code and mask.
- (2) Tap the **[Blockall]** button to set it to **[On]** or **[Off]**.

<b>Off</b> <sup>☑</sup>	Passes all messages.
<b>On</b>	Blocks any messages. <b>[Blockall]</b> of <b>[Extension acceptance Filter]</b> is set to <b>[Off]</b> .

- (3) Tap the **[Code (HEX)]** box, and then enter a filter code.
- (4) Tap the **[Mask (HEX)]** box, and then enter a filter mask.

Example 1 Code: arbitrary, Mask: 000  
Passes all messages.

Example 2 Code: 001, Mask: 7FE  
Passes messages only with the ID whose first bit is one or zero (ID = 0, ID = 1).

## 10 Configuring the extended receiving filter settings.

- (1) Under **[Extension acceptance Filter]**, tap the **[ID]** box, and then enter a filter ID.  
The instrument blocks a message of a bit whose filter ID does not match the ID bit of each signal. Bits whose bit mask to which the character X has been set pass all messages. The bit mask automatically calculates a code and mask.
- (2) Tap the **[Blockall]** button to set it to **[On]** or **[Off]**.

<b>Off</b> <sup>☑</sup>	Passes all messages.
<b>On</b>	Blocks any messages. <b>[Blockall]</b> of <b>[Acceptance Filter]</b> is set to <b>[Off]</b> .

- (3) Tap the **[Code (HEX)]** box, and then enter a filter code.
- (4) Tap the **[Mask (HEX)]** box, and then enter a filter mask.

## 11 Tap [OK].

The **[Acceptance Filter/Extension acceptance Filter]** dialog box appears.

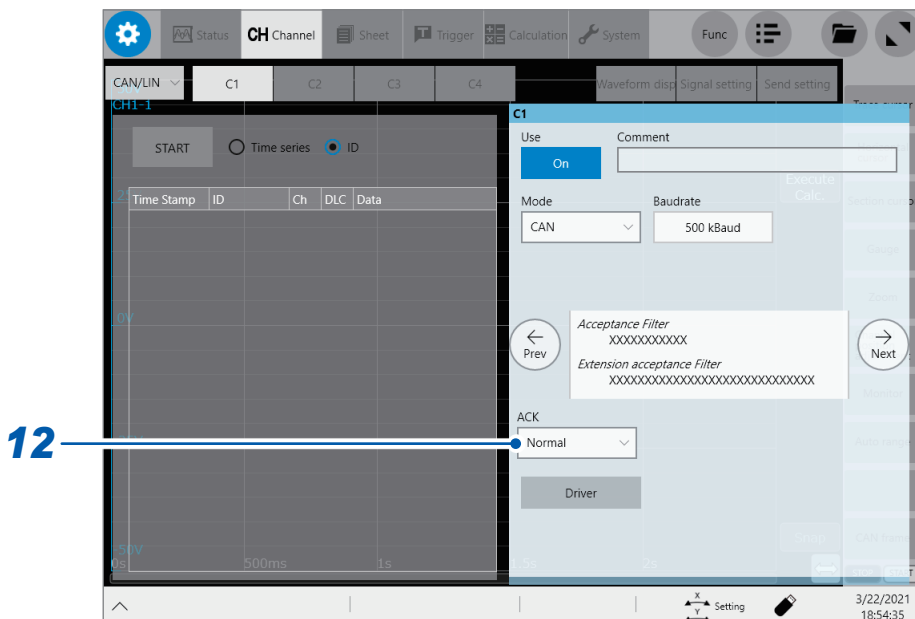

**12** Tap the **[ACK]** box, and then from the list, choose an **ACK** measurement setting.

<b>Normal</b> <input checked="" type="checkbox"/>	The CAN controller participates in bus communication. The instrument sends acknowledgments.
<b>ACK OFF</b>	The bus is influenced by the measurement since the CAN controller on the interface card represents the interface between the analysis software and the CAN bus. Particularly the CAN controller sends its acknowledge for correctly recognized messages by sending a dominant level (on the bus) in the corresponding slot of the CAN message. To reduce the influence on the system you can switch off this functionality. Thereby the node is no longer visible on the bus. Please keep in mind that - when you switched off acknowledge - communication on the bus only may happen if at least one other network node sends an acknowledge.

Excerpt from CANoeCANalyzer.chm of Vector CANalyzer (Vector Infomatic)

When **[ACK OFF]** is selected, the CAN transmission function is disabled.

**13** Monitor the state of the CAN/LIN bus.

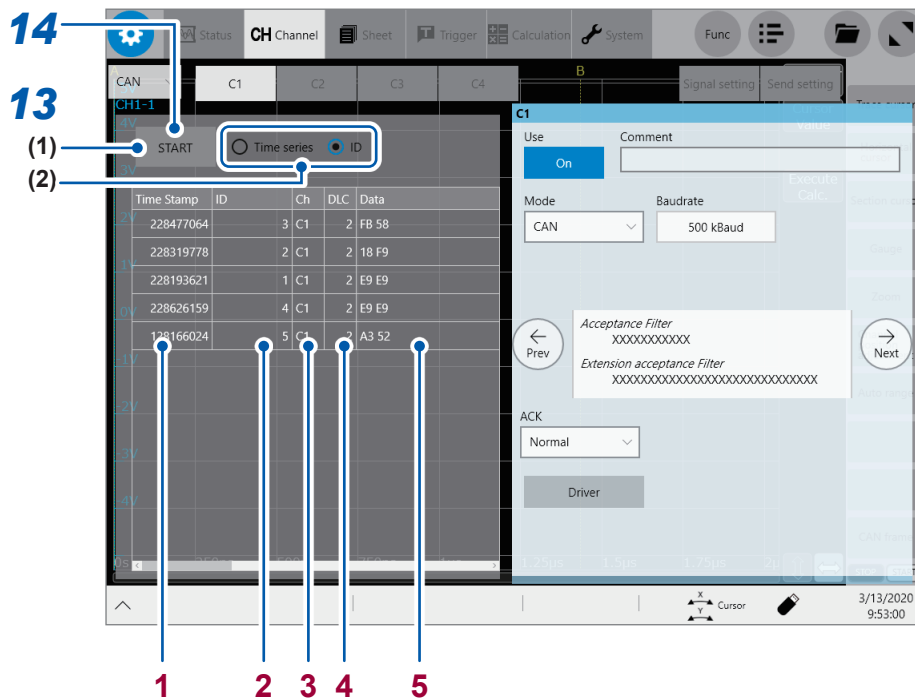

- (1) Tap **[START]**.  
The monitor value table is displayed on the left half of the screen.

No.	Name	Function
1	<b>Time Stamp</b>	Displays time stamps.
2	<b>ID</b>	Displays message IDs in hexadecimal notation.
3	<b>Ch</b>	Displays channel numbers (C1 through C4).
4	<b>DLC</b>	Displays the numbers of bytes of the received data.
5	<b>Data</b>	Displays data in hexadecimal notation.

- (2) Tap **[Time series]** or **[ID]** to change the order of monitor values.

<b>Time series</b> <input checked="" type="checkbox"/>	Displays monitor values in the acquired order.
<b>ID</b>	Displays monitor values in the order of IDs.

**14** Tap **[START]** to hide the monitor values.

The monitor table can be displayed on the waveform screen.

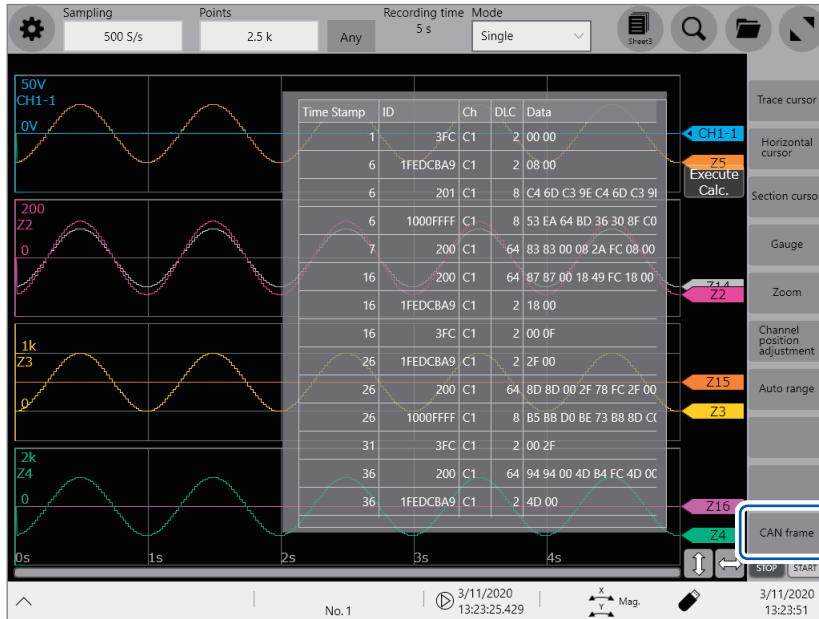

If you tap **[CAN frame]** on the waveform screen, the monitor table appears, allowing you to check monitor values during measurement.

Tapping **[CAN frame]** once more closes the monitor table.

## 12.4 Configuring the CAN/LIN Definition Data Settings

This chapter describes how to set definition data for displaying CAN/LIN signals as waveforms. In CAN measurement mode, loading a DBC file or a CDF file can choose CAN definition data. In LIN measurement mode, loading a LDF file, which stands for LIN description file, can choose LIN definition data.

 > [Channel] > [UNIT] > [CAN/LIN] > [Signal setting]

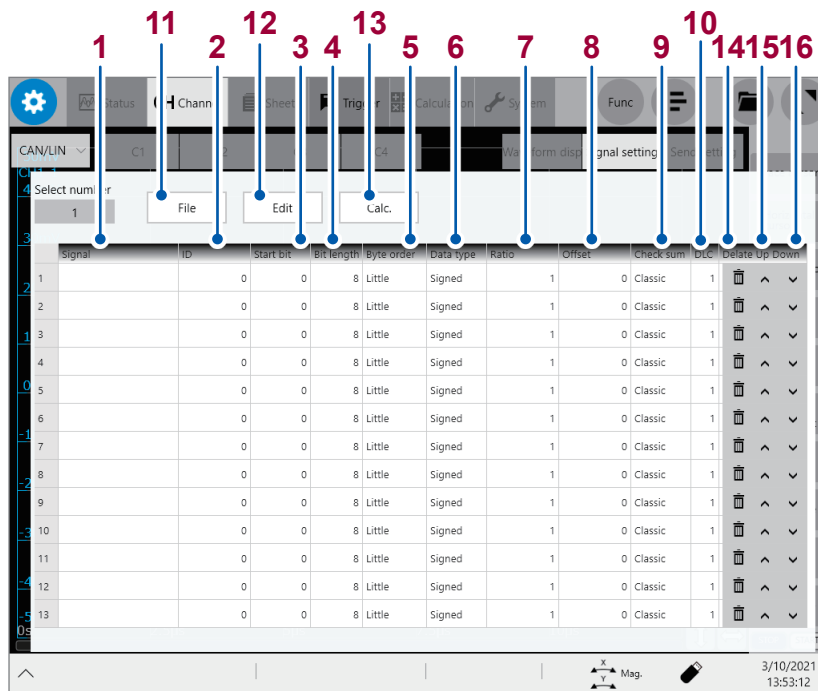





No.	Name	Function
1	Signal	Allows you to enter a signal name for the data concerned. Number of characters that can be entered: up to 32
2	ID	Allows you to enter a message ID, in hexadecimal notation (p. 331), of a message that includes data you wish to allocate to a channel. Both 11-bit base IDs and 29-bit extended IDs are supported. <b>0 to 1FFFFFF</b>
3	Start bit	Allows you to enter the data starting address on the message frame. Specify the least significant bit (LSB) of a signal you wish to capture. <b>0 to 63</b> See “To find out the data starting address ([Start bit])” (p. 329).
4	Bit length	Allows you to enter the data size, in bits, of a signal you wish to capture. <b>1 to 64, default setting: 8</b>

No.	Name	Function								
5	Byte order	Allows you to choose between big-endian ordering and little-endian ordering for the data concerned,								
		<table border="1"> <tr> <td>Big<sup>☑</sup></td> <td>Sends the most significant byte first (Motorola order).</td> </tr> <tr> <td>Little</td> <td>Sends the least significant byte first (Intel order).</td> </tr> </table>	Big <sup>☑</sup>	Sends the most significant byte first (Motorola order).	Little	Sends the least significant byte first (Intel order).				
		Big <sup>☑</sup>	Sends the most significant byte first (Motorola order).							
Little	Sends the least significant byte first (Intel order).									
See "Data allocation ([Byte order])" (p. 330).										
6	Data type	Allows you to choose a data type for the data concerned.								
		<table border="1"> <tr> <td>Signed<sup>☑</sup></td> <td>Signed integral type</td> </tr> <tr> <td>Unsigned</td> <td>Unsigned integral type</td> </tr> <tr> <td>Float</td> <td>Single-precision floating-point data type</td> </tr> <tr> <td>Double</td> <td>Double-precision floating-point data type</td> </tr> </table>	Signed <sup>☑</sup>	Signed integral type	Unsigned	Unsigned integral type	Float	Single-precision floating-point data type	Double	Double-precision floating-point data type
		Signed <sup>☑</sup>	Signed integral type							
		Unsigned	Unsigned integral type							
Float	Single-precision floating-point data type									
Double	Double-precision floating-point data type									
7	Ratio	Allows you to enter a conversion ratio								
8	Offset	Physical values can be obtained from the following expression. (Physical value) = (Conversion ratio) × (Data value [bit]) + (Offset) (Default conversion ratio: 1.0, default offset value: 0.0)								
9	Check sum	Allows you to choose a checksum concept for every frame ID when performing LIN measurement.								
		<table border="1"> <tr> <td>Classic<sup>☑</sup></td> <td>Standard checksum</td> </tr> <tr> <td>Enhanced</td> <td>Enhanced checksum</td> </tr> </table>	Classic <sup>☑</sup>	Standard checksum	Enhanced	Enhanced checksum				
		Classic <sup>☑</sup>	Standard checksum							
Enhanced	Enhanced checksum									
10	DLC	Allows you to enter a data length code (DLC) for every frame ID when performing LIN measurement. (Default: 1)								



Data manipulations

No.	Name	Function
11	File	<p>Select the rows where you wish to add data, and then tap <b>[File]</b> to display the file selection dialog box. You can add data to multiple rows in a batch. Choose items you wish to add, and then tap <b>[OK]</b>. The chosen columns are overwritten in ascending order. See “Choosing CAN definition data” (p. 331).</p>
12	Edit	<p>Select the rows you wish to edit, and then tap <b>[Edit]</b> to display the <b>[Signal setting]</b> dialog box. You can add data to multiple rows in a batch. Enter items you wish to edit, and then tap <b>[OK]</b>. The edited items are overwritten.</p> <div data-bbox="826 593 1244 1153" style="border: 1px solid gray; padding: 10px; margin: 10px auto; width: fit-content;"> <p>Signal setting</p> <p>Signal  <input style="width: 100%;" type="text"/></p> <p>ID                      Start bit                      Bit length</p> <p><input type="text" value="0"/>                      <input type="text" value="0"/>                      <input type="text" value="8"/></p> <p>Byte order                      Data type</p> <p><input type="text" value="Little"/>                      <input type="text" value="Signed"/></p> <p>Ratio                      Offset</p> <p><input type="text" value="1"/>                      <input type="text" value="0"/></p> <p>Check sum                      DLC</p> <p><input type="text" value="Classic"/>                      <input type="text" value="1"/></p> <p><input type="button" value="OK"/>                      <input type="button" value="Cancel"/></p> </div>

No.	Name	Function																														
13	Calc.	<p>Tap <b>[Calc.]</b> to display the <b>[CAN calculation]</b> setting dialog box. Enter arithmetic expressions, and then tap <b>[OK]</b>. The arithmetic expressions will be confirmed.</p> <div data-bbox="868 344 1342 1075" style="border: 1px solid gray; padding: 10px; margin: 10px 0;"> <p><b>CAN calculation</b></p> <p>Channel: C1      Signal No.: S1      Calc. number: Z2</p> <p>Calculation: <b>On</b>      Formula: <b>CAN(C1,S1)</b>      Set formula: SET to Z2</p> <p>Tap the formula to move to the waveform calc. display</p> <table border="1" style="width: 100%; border-collapse: collapse;"> <tr> <td style="text-align: center;">Z1 On</td> <td style="text-align: center;">Pwr. Calc.</td> <td>Comment: _____</td> <td>Formula: CH(1,1)</td> </tr> <tr> <td style="text-align: center;">Z2 On</td> <td style="text-align: center;">Pwr. Calc.</td> <td>Comment: _____</td> <td>Formula: _____</td> </tr> <tr> <td style="text-align: center;">Z3 On</td> <td style="text-align: center;">Pwr. Calc.</td> <td>Comment: _____</td> <td>Param: A - Urms1</td> </tr> <tr> <td style="text-align: center;">Z4 On</td> <td style="text-align: center;">Pwr. Calc.</td> <td>Comment: _____</td> <td>Param: η      IN: A - P1</td> </tr> </table> <p style="text-align: center;">OK      Cancel</p> </div> <div style="margin-left: 20px;"> <p>Waveform calculation list</p>  </div> <table border="1" style="width: 100%; border-collapse: collapse; margin-top: 10px;"> <tr> <td style="width: 20%;"><b>Channel</b></td> <td>Allows you to choose a channel number (C1 to C4).</td> </tr> <tr> <td><b>Signal No.</b></td> <td>Allows you to choose a signal number (S1 to S300).</td> </tr> <tr> <td><b>Calc. number</b></td> <td>Allows you to choose a calculation number (Z1 to Z16).</td> </tr> <tr> <td><b>Calculation</b></td> <td>Tap to set to <b>[On]</b> to display the waveform calculation list. See “12.7 Choosing Data To Be Displayed as Waveforms (When Using the Waveform Calculation Function)” (p. 339).</td> </tr> <tr> <td><b>Formula</b></td> <td>Displays the formula set in <b>[Channel]</b> and <b>[Signal No.]</b>.</td> </tr> <tr> <td><b>Set formula</b></td> <td>Assigns the formula to the calculation number chosen in <b>[Calc.number]</b>.</td> </tr> <tr> <td>Waveform calculation list</td> <td>You can scroll the list upward and downward. Tapping the <b>[Formula]</b> box can display the formula setting dialog box.</td> </tr> </table>	Z1 On	Pwr. Calc.	Comment: _____	Formula: CH(1,1)	Z2 On	Pwr. Calc.	Comment: _____	Formula: _____	Z3 On	Pwr. Calc.	Comment: _____	Param: A - Urms1	Z4 On	Pwr. Calc.	Comment: _____	Param: η      IN: A - P1	<b>Channel</b>	Allows you to choose a channel number (C1 to C4).	<b>Signal No.</b>	Allows you to choose a signal number (S1 to S300).	<b>Calc. number</b>	Allows you to choose a calculation number (Z1 to Z16).	<b>Calculation</b>	Tap to set to <b>[On]</b> to display the waveform calculation list. See “12.7 Choosing Data To Be Displayed as Waveforms (When Using the Waveform Calculation Function)” (p. 339).	<b>Formula</b>	Displays the formula set in <b>[Channel]</b> and <b>[Signal No.]</b> .	<b>Set formula</b>	Assigns the formula to the calculation number chosen in <b>[Calc.number]</b> .	Waveform calculation list	You can scroll the list upward and downward. Tapping the <b>[Formula]</b> box can display the formula setting dialog box.
Z1 On	Pwr. Calc.	Comment: _____	Formula: CH(1,1)																													
Z2 On	Pwr. Calc.	Comment: _____	Formula: _____																													
Z3 On	Pwr. Calc.	Comment: _____	Param: A - Urms1																													
Z4 On	Pwr. Calc.	Comment: _____	Param: η      IN: A - P1																													
<b>Channel</b>	Allows you to choose a channel number (C1 to C4).																															
<b>Signal No.</b>	Allows you to choose a signal number (S1 to S300).																															
<b>Calc. number</b>	Allows you to choose a calculation number (Z1 to Z16).																															
<b>Calculation</b>	Tap to set to <b>[On]</b> to display the waveform calculation list. See “12.7 Choosing Data To Be Displayed as Waveforms (When Using the Waveform Calculation Function)” (p. 339).																															
<b>Formula</b>	Displays the formula set in <b>[Channel]</b> and <b>[Signal No.]</b> .																															
<b>Set formula</b>	Assigns the formula to the calculation number chosen in <b>[Calc.number]</b> .																															
Waveform calculation list	You can scroll the list upward and downward. Tapping the <b>[Formula]</b> box can display the formula setting dialog box.																															
14	Delete	Tap the  icon in the row you wish to delete. The values return to the default values.																														
15	Up	Tap the  icon in the row you wish to move upward.																														
16	Down	Tap the  icon in the row you wish to move downward.																														

**Bit addressing**

1. Configure the least significant bit (LSB) of the first byte data in the data frame at address 0. Allocate addresses to every bit toward the most significant bit (MSB), incrementing by one.
2. When the MSB is addressed, allocate the following addresses to the next byte data beginning from the LSB toward the MSB, incrementing by one as with the first byte (byte 0).
3. A data frame can have a size of eight bytes (64 bits) at most. The MSB of the eighth byte (byte 7) is configured at address 63.

		MSB ←							→ LSB
		Bit 7	Bit 6	Bit 5	Bit 4	Bit 3	Bit 2	Bit 1	Bit 0
First ↓ Last	Byte 0	7	6	5	4	3	2	1	0
	Byte 1	15	14	13	12	11	10	9	8
	Byte 2	23	22	21	20	19	18	17	16
	Byte 3	31	30	29	28	27	26	25	24
	Byte 4	39	38	37	36	35	34	33	32
	Byte 5	47	46	45	44	43	42	41	40
	Byte 6	55	54	53	52	51	50	49	48
	Byte 7	63	62	61	60	59	58	57	56

**To find out the data starting address ([Start bit])**

When you wish to capture 8-bit data of the second byte from the first (byte 1), configure the LSB at address 8.

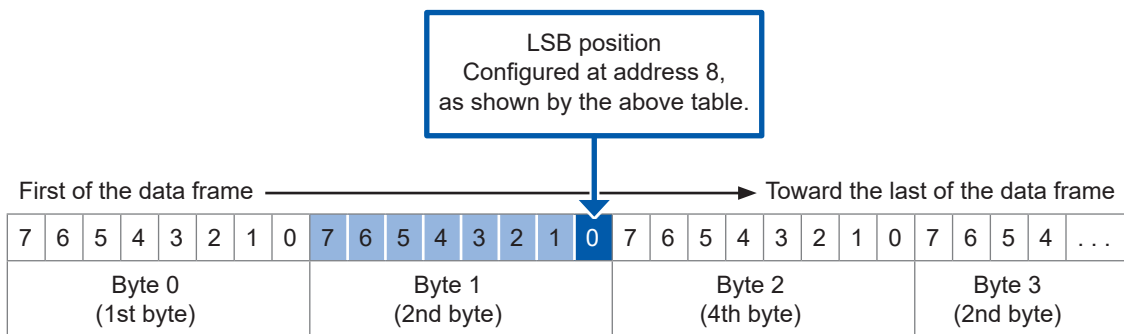

**Data allocation ([Byte order])**

Captured data using a big-endian ordering differs from those using a little-endian ordering although the same data starting address ([Start bit]) and the same bit length ([Bit length]) are used. In the following figure, the shaded cells indicate the pieces of data to be captured when a bit length of 10 and a data starting address (LSB position) of bit 16 are configured.

**Big-endian ordering**

The MSB is configured at address 9.

	Bit 7	Bit 6	Bit 5	Bit 4	Bit 3	Bit 2	Bit 1	Bit 0
Byte 0	7	6	5	4	3	2	1	0
Byte 1	15	14	13	12	11	10	9	8
Byte 2	23	22	21	20	19	18	17	16
Byte 3	31	30	29	28	27	26	25	24

**Little-endian ordering**

The MSB is configured at address 25.

	Bit 7	Bit 6	Bit 5	Bit 4	Bit 3	Bit 2	Bit 1	Bit 0
Byte 0	7	6	5	4	3	2	1	0
Byte 1	15	14	13	12	11	10	9	8
Byte 2	23	22	21	20	19	18	17	16
Byte 3	31	30	29	28	27	26	25	24

In the following figure, assuming that byte 0 and byte 1 have 16-bit data of FF and 00, respectively. The following 16-bit data sets are captured:

Big-endian ordering (MSB first): FF00 (Data starting address: 8)

Little-endian ordering (LSB first): 00FF (Data starting address: 0)

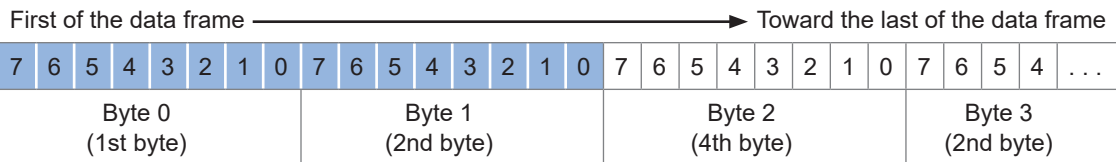

## Choosing CAN definition data

Loading a DBC file can set CAN definition data.

 > [Channel] > [UNIT] > [CAN/LIN] > [Signal setting]

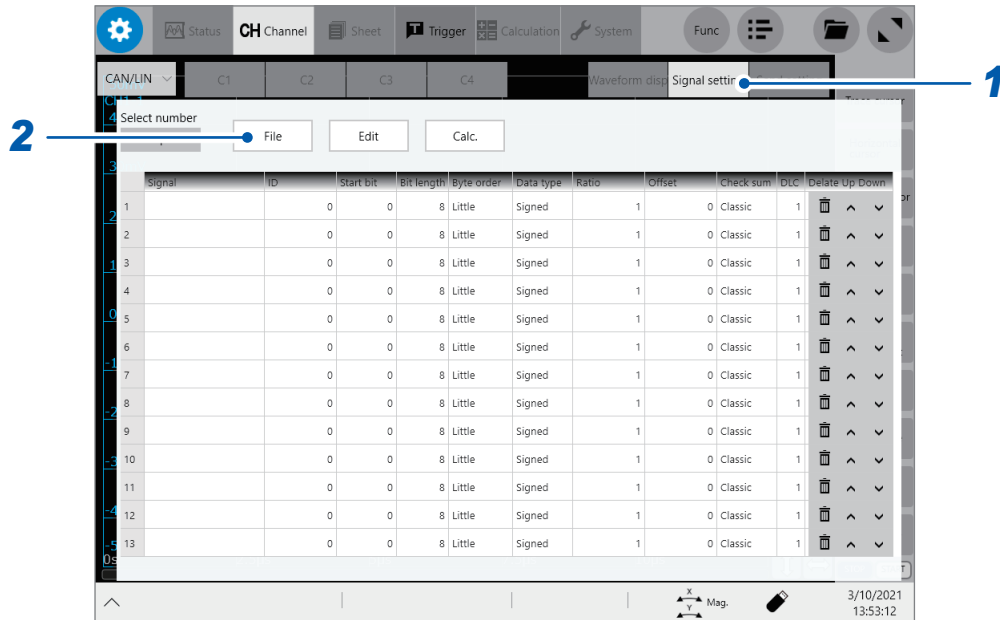

12

CAN/LIN Measurement Function

**1** Tap [Signal setting].

**2** Tap [File].

The file selection dialog box is displayed.

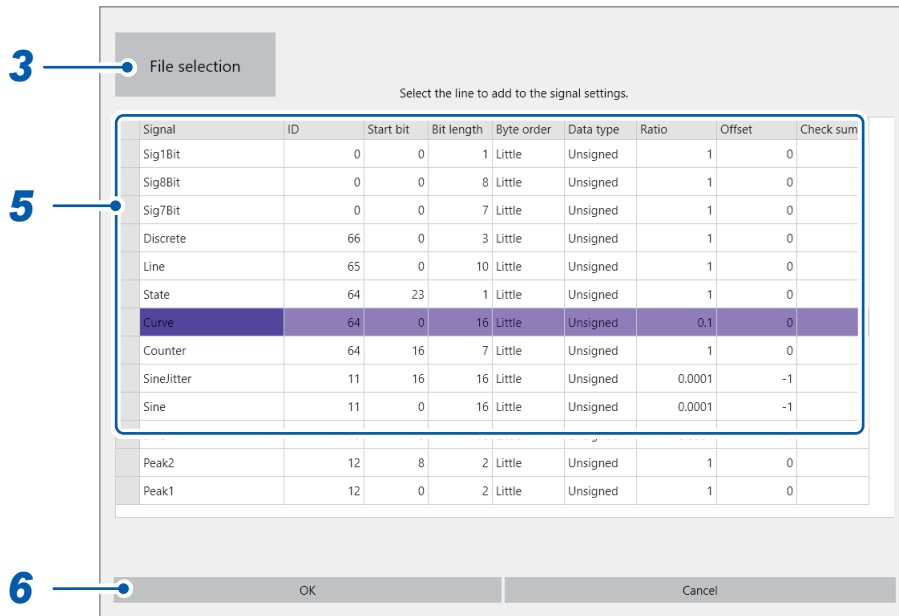

**3** Tap **[File selection]**.

The file selection dialog box is displayed.

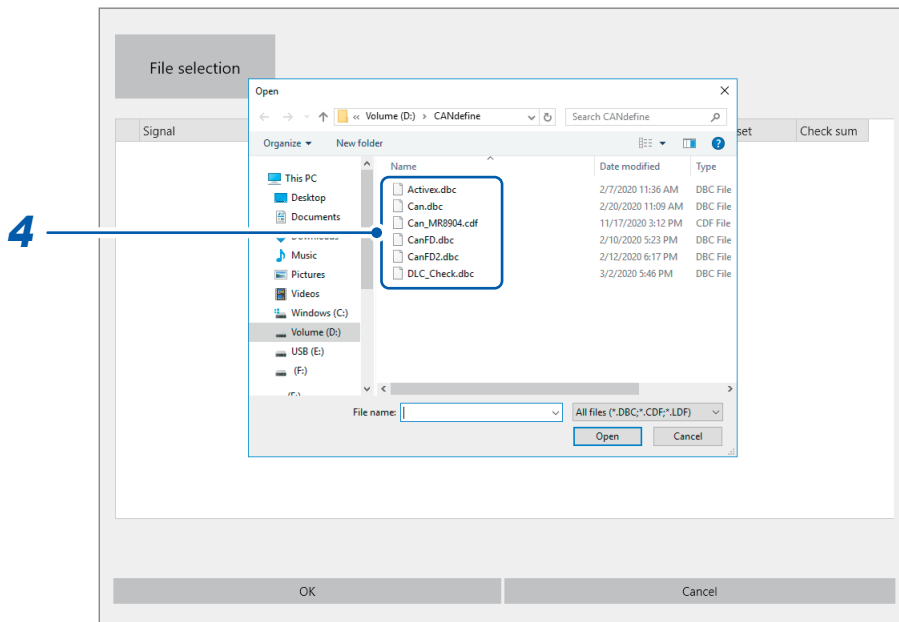

**4** Select a file and tap **[Open]**.

The contents of the file you chose are displayed.

**5** Tap data sets (rows) to be analyzed.

The chosen rows turn blue. You can choose multiple rows. Tap a chose data again to put it into unselected.

**6** Tap **[OK]**.

The file selection dialog box closes, and the chosen data (rows) appear on the **[Signal setting]** screen.



## 12.5 Configuring the Transmission Function Settings (Creating a Transmission List)

This section describes how to set data to be transmitted from the instrument to a CAN bus and transmission timing.

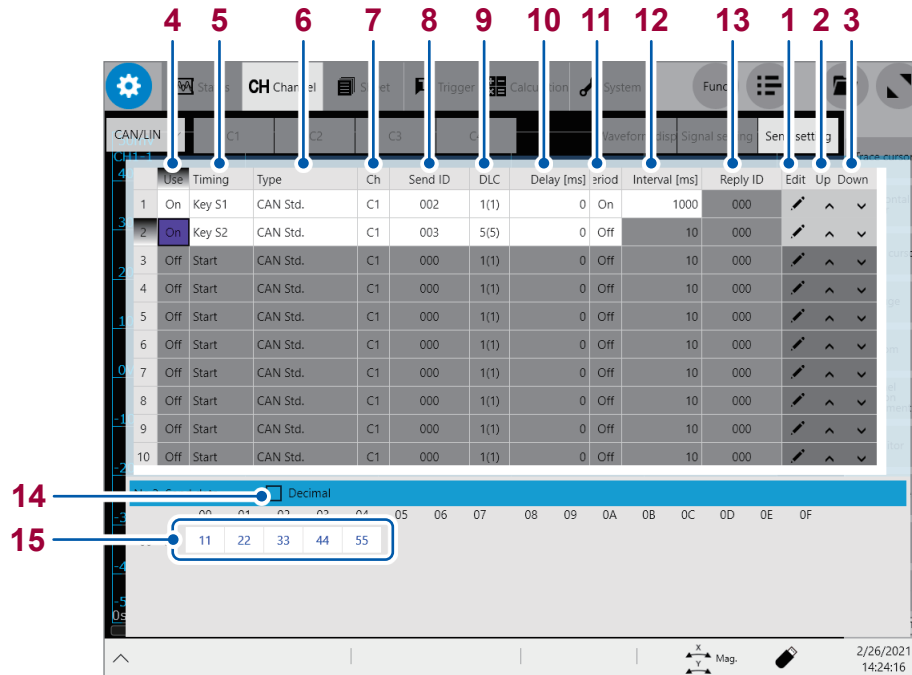
 > [Channel] > [CAN/LIN] > [Send setting]



### Operation of the transmission list

No.	Name	Function
1	Edit	Tap the  icon in a row you wish to edit. The DBC file selection dialog box appears. Enter items you wish to edit, and then tap [OK]. The edited items are overwritten.
2	Up	Tap the  icon in the row you wish to move upward.
3	Down	Tap the  icon in the row you wish to move downward.

Tapping the transmission list displays the data, at the bottom, to be transmitted of the number you tapped.

Settings of the transmission list

No.	Name	Function																
4	Use	Allows you to choose whether to transmit the data concerned.																
		<table border="1"> <tr> <td>Off <input type="checkbox"/></td> <td>Does not transmit the data.</td> </tr> <tr> <td>On</td> <td>Transmit the data.</td> </tr> </table>	Off <input type="checkbox"/>	Does not transmit the data.	On	Transmit the data.												
		Off <input type="checkbox"/>	Does not transmit the data.															
On	Transmit the data.																	
5	Timing	Allows you to set when to transmit the data concerned.																
		<table border="1"> <tr> <td>Key S1</td> <td>When you press the <b>S1</b> key</td> </tr> <tr> <td>Key S2</td> <td>When you press the <b>S2</b> key</td> </tr> <tr> <td>Start <input type="checkbox"/></td> <td>When you press the <b>START</b> key Otherwise, when you send the <b>:START</b> command to start measurement</td> </tr> <tr> <td>Trigger</td> <td>When the trigger activates</td> </tr> <tr> <td>Reply</td> <td>When the instrument receives a message ID set in <b>[Reply ID]</b> during measurement. (The instrument does not reply any response while no measurement is being performed.)</td> </tr> <tr> <td>Pass</td> <td>When a pass judgment is yielded for the numerical calculation</td> </tr> <tr> <td>Fail</td> <td>When a fail judgment is yielded for the numerical calculation</td> </tr> <tr> <td>Error</td> <td>When an error occurs or a warning is issued</td> </tr> </table>	Key S1	When you press the <b>S1</b> key	Key S2	When you press the <b>S2</b> key	Start <input type="checkbox"/>	When you press the <b>START</b> key Otherwise, when you send the <b>:START</b> command to start measurement	Trigger	When the trigger activates	Reply	When the instrument receives a message ID set in <b>[Reply ID]</b> during measurement. (The instrument does not reply any response while no measurement is being performed.)	Pass	When a pass judgment is yielded for the numerical calculation	Fail	When a fail judgment is yielded for the numerical calculation	Error	When an error occurs or a warning is issued
		Key S1	When you press the <b>S1</b> key															
		Key S2	When you press the <b>S2</b> key															
		Start <input type="checkbox"/>	When you press the <b>START</b> key Otherwise, when you send the <b>:START</b> command to start measurement															
		Trigger	When the trigger activates															
		Reply	When the instrument receives a message ID set in <b>[Reply ID]</b> during measurement. (The instrument does not reply any response while no measurement is being performed.)															
		Pass	When a pass judgment is yielded for the numerical calculation															
Fail	When a fail judgment is yielded for the numerical calculation																	
Error	When an error occurs or a warning is issued																	
6	Type	Allows you to choose a data type to be transmitted.																
		<table border="1"> <tr> <td>CAN Std. <input type="checkbox"/></td> <td>CAN data frame in the base format</td> </tr> <tr> <td>CAN Ext.</td> <td>CAN data frame in the extended format</td> </tr> <tr> <td>CAN Remote Std.</td> <td>CAN remote frame in the base format</td> </tr> <tr> <td>CAN Remote Ext.</td> <td>CAN remote frame in the extended format</td> </tr> <tr> <td>CAN FD Std.</td> <td>CAN FD data frame in the base format</td> </tr> <tr> <td>CAN FD Ext.</td> <td>CAN FD data frame in the extended format</td> </tr> </table>	CAN Std. <input type="checkbox"/>	CAN data frame in the base format	CAN Ext.	CAN data frame in the extended format	CAN Remote Std.	CAN remote frame in the base format	CAN Remote Ext.	CAN remote frame in the extended format	CAN FD Std.	CAN FD data frame in the base format	CAN FD Ext.	CAN FD data frame in the extended format				
		CAN Std. <input type="checkbox"/>	CAN data frame in the base format															
		CAN Ext.	CAN data frame in the extended format															
		CAN Remote Std.	CAN remote frame in the base format															
		CAN Remote Ext.	CAN remote frame in the extended format															
		CAN FD Std.	CAN FD data frame in the base format															
CAN FD Ext.	CAN FD data frame in the extended format																	
Some types of data cannot be sent depending on the CAN mode-setting (p. 319).																		
<ul style="list-style-type: none"> <li>• In CAN mode, data set to <b>[CAN FD Std.]</b> or <b>[CAN FD Ext.]</b> cannot be sent.</li> <li>• In CAN FD mode, data set to <b>[CAN Remote Std.]</b> or <b>[CAN Remote Ext.]</b> cannot be sent.</li> </ul>																		
7	Ch	Allows you to specify a CAN channel for use in transmission.																
		<table border="1"> <tr> <td>C1 <input type="checkbox"/>, C2, C3, C4, All</td> </tr> </table> <p>When you choose <b>[All]</b>, the instrument transmits the same data for all channels.</p>	C1 <input type="checkbox"/> , C2, C3, C4, All															
C1 <input type="checkbox"/> , C2, C3, C4, All																		
8	Send ID	Allows you to enter a message ID of the data to be transmitted. Use hexadecimal notation.																
		<p><b>For the base format</b></p> <table border="1"> <tr> <td>0 to 7FF</td> </tr> </table>	0 to 7FF															
		0 to 7FF																
<p><b>For the extended format</b></p> <table border="1"> <tr> <td>0 to 1FFFFFFF</td> </tr> </table>	0 to 1FFFFFFF																	
0 to 1FFFFFFF																		



No.	Name	Function				
9	DLC	<p>Allows you to enter the DLC and the number of bytes of the data to be transmitted.</p> <p><b>For CAN</b></p> <p>0(0) to 8(8)</p> <p><b>For CAN FD</b></p> <p>0(0) to 8(8), 9(12), 10(16), 11(20), 12(24), 13(32), 14(48), 15(64)</p>				
10	Delay [ms]	<p>Allows you to enter a delay time, a period of time from when the condition set in [Timing] is met to when the data is transmitted (unit: ms).</p> <p>0 to 10000</p>				
11	Period	<p>Allows you to choose whether to transmit data only once or at regular intervals.</p> <p>This setting is available when you chose [Key S1], [Key S2], or [Start] in [Timing].</p> <table border="1"> <tr> <td>Off <input type="checkbox"/></td> <td>Transmits data only once.</td> </tr> <tr> <td>On <input type="checkbox"/></td> <td>Transmits data at regular intervals.</td> </tr> </table> <p><b>When [Timing] is set to [Key S1] or [Key S2]</b> Pressing the same key again can stop transmission.</p> <p><b>When [Timing] is set to [Start]</b> Transmission stops once measurement has finished, and the <b>START</b> key indication has been turned off. During repetitive measurement, pressing the <b>STOP</b> key can stop transmission as well as measurement.</p>	Off <input type="checkbox"/>	Transmits data only once.	On <input type="checkbox"/>	Transmits data at regular intervals.
Off <input type="checkbox"/>	Transmits data only once.					
On <input type="checkbox"/>	Transmits data at regular intervals.					
12	Interval [ms]	<p>Allows you to enter a transmission interval (unit: ms) when you set [Period] to [On].</p> <p>0 to 10000</p>				
13	Reply ID	<p>Allows you to enter a message ID in hexadecimal notation when you set [Timing].to [Reply].</p> <p><b>For the base format</b></p> <p>0 to 7FF</p> <p><b>For the extended format</b></p> <p>0 to 1FFFFFFF</p>				

Editing data to be transmitted

No.	Name	Function				
14	Decimal	<p>Allows you to choose whether to display data in decimal or hexadecimal notation.</p> <table border="1"> <tr> <td><input type="checkbox"/></td> <td>Displays it in hexadecimal notation.</td> </tr> <tr> <td><input checked="" type="checkbox"/></td> <td>Displays it in decimal notation.</td> </tr> </table>	<input type="checkbox"/>	Displays it in hexadecimal notation.	<input checked="" type="checkbox"/>	Displays it in decimal notation.
<input type="checkbox"/>	Displays it in hexadecimal notation.					
<input checked="" type="checkbox"/>	Displays it in decimal notation.					
15	Editing data	Allows you to edit data. (p. 336)				

## How to edit data to be transmitted

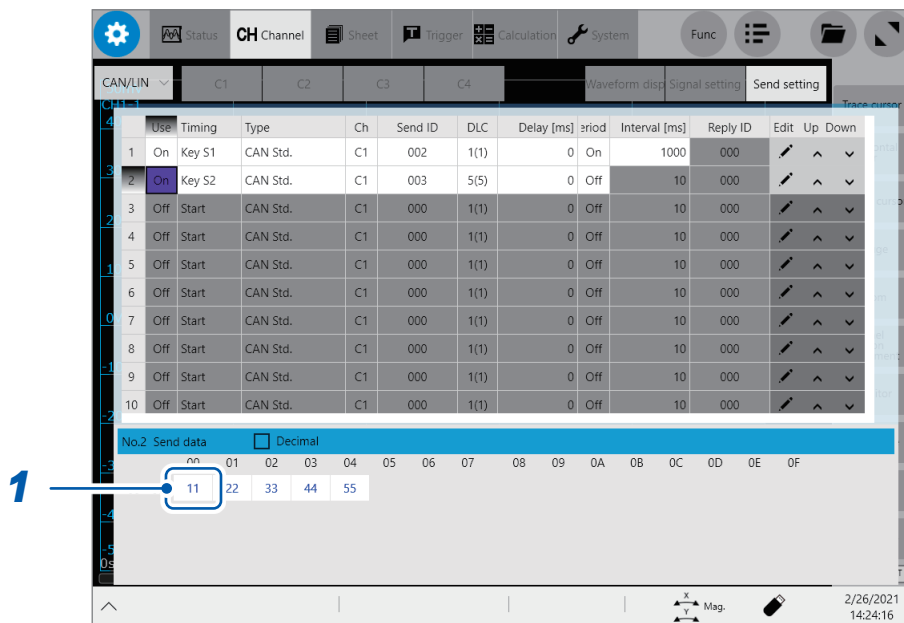

### 1 Tap data item you wish to modify.

The tapped data item turns red, and the editing dialog box appears.

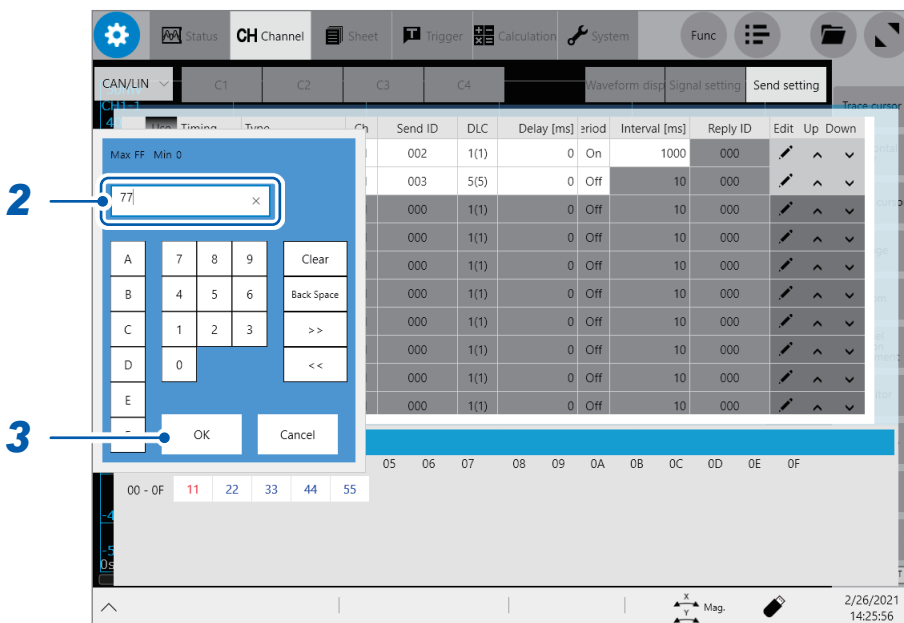

### 2 Enter values in the editing dialog box.

For hexadecimal notation

0 to FF

For decimal notation

0 to 255

**3** Tap [OK].

The editing dialog box closes. The edited data is displayed.

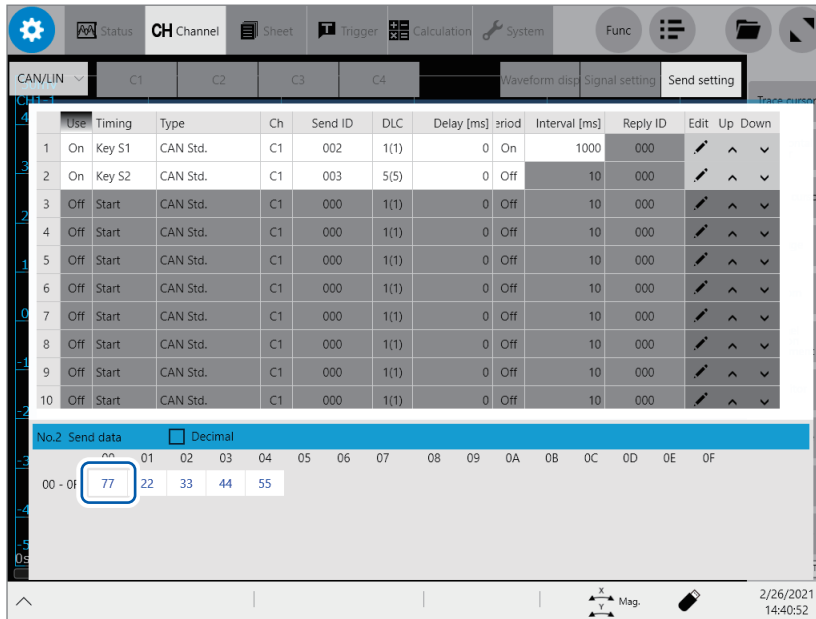

## 12.6 Choosing Data Sets to Be Displayed as Waveforms (When Displaying Waveforms During Measurement)

This section describes how to use the waveform display settings to display CAN/LIN waveforms during measurement.

The instrument converts CAN signals based on CAN definition data before displaying waveforms.

 > [Channel] > [UNIT] > [CAN/LIN] > [Waveform disp]

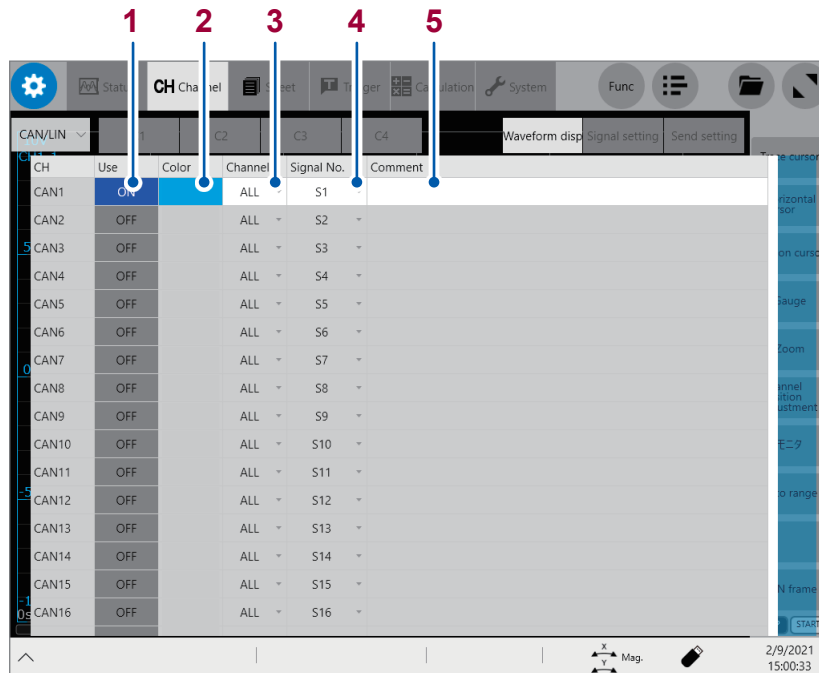

No.	Element	Function
1	Use	Set the column to [On] or [Off].
2	Color	Set a waveform color.
3	Channel	Tap the button to choose a channel. If you choose [ALL], all channels' signals are converted.
4	Signal No.	Choose a signal number.
5	Comment	Displays the signal name entered in [Signal setting].

## 12.7 Choosing Data To Be Displayed as Waveforms (When Using the Waveform Calculation Function)

You can use the waveform calculation function to convert CAN signals on the basis of CAN definition data.

This section describes how to perform calculation for CAN channel C1 on the basis of definition data S1.

 > [Calculation] > [Waveform calculation]

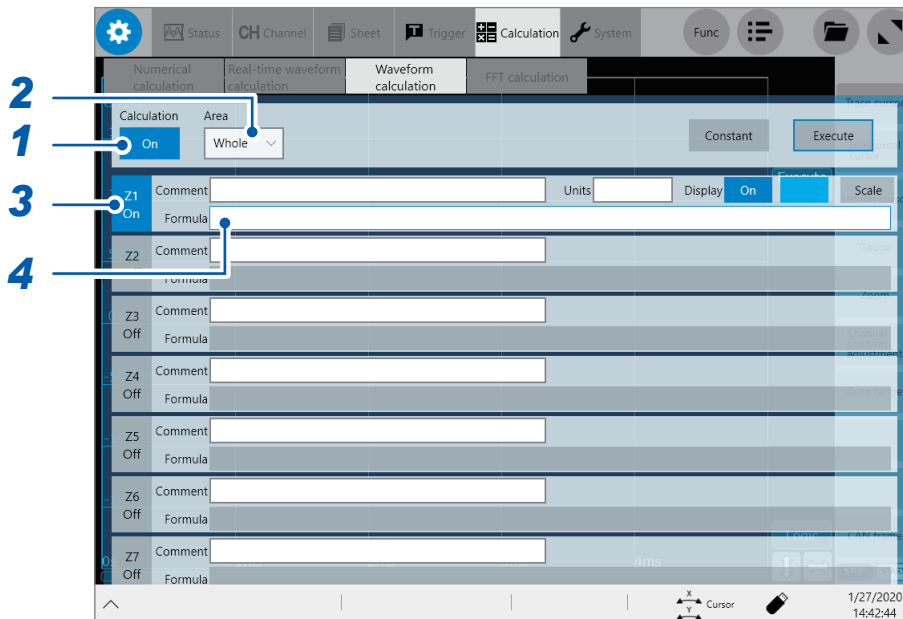

- 1** Tap the [Calculation] button to set it to [On].
- 2** Tap the [Area] button, and then from the list, select [Whole].
- 3** Tap [Z1], which you wish to set, to set to [On].

- 4 Tap the **[Formula]** box of **[Z1]**.  
The expression setting dialog box is displayed.

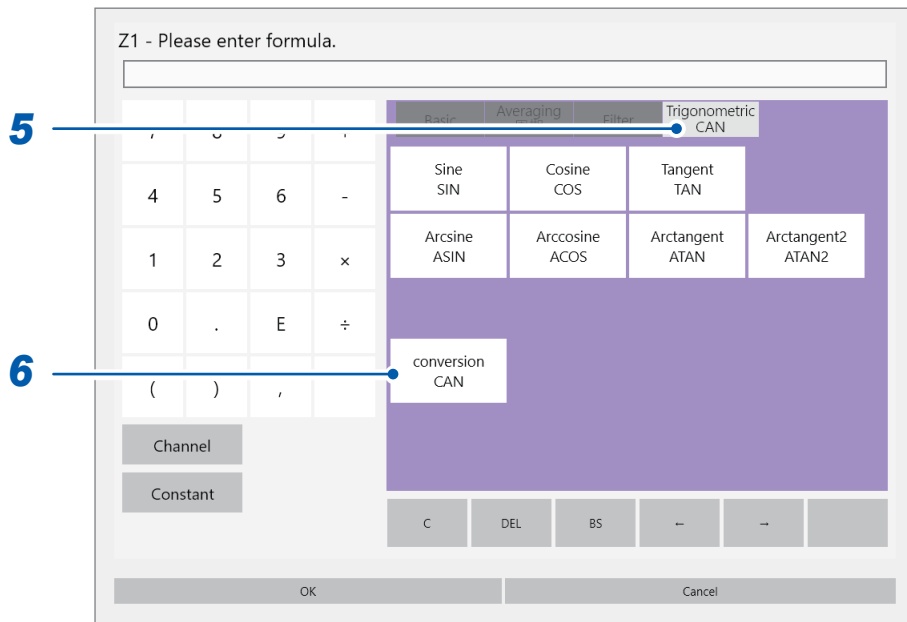

- 5 Tap the **[Trigonometric/CAN]** tab.
- 6 Tap **[conversion CAN]**.  
The **[setting CAN]** dialog box appears.

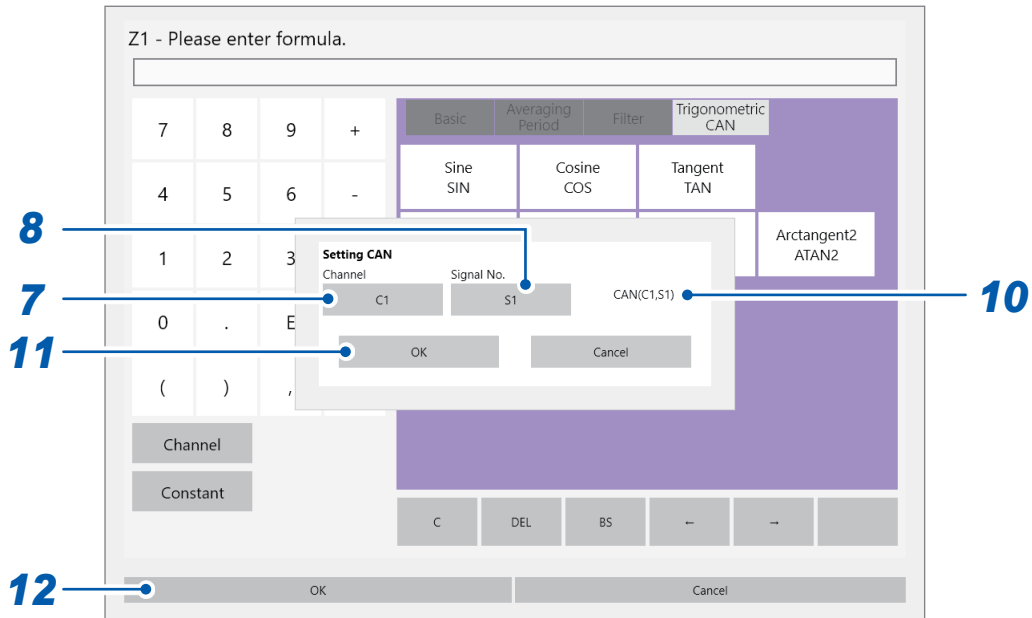

- 7 Tap the **[Channel]** box, and then from the list, select **[C1]**.

- 8** Tap the [Signal No.] box.  
The definition data list is displayed.

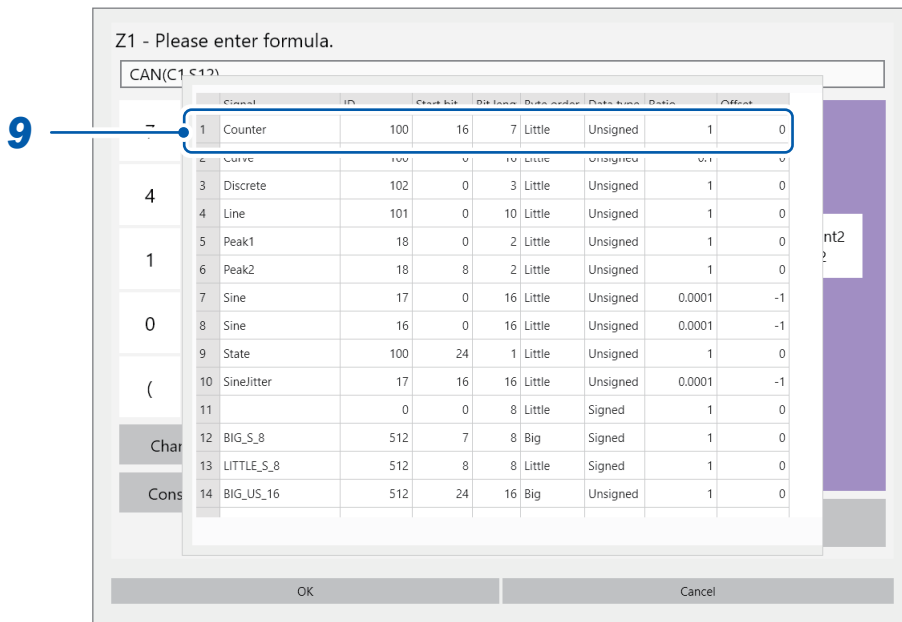

- 9** Tap the definition data set you wish to use from the list (choose the first row, definition data S1).  
The definition data list closes.

- 10** Check if the selected expression is displayed.

- 11** Tap [OK] in the [Setting CAN] dialog box.  
The [Setting CAN] dialog box closes.  
The selected expression is displayed.

- 12** Tap [OK] in the expression setting dialog box.  
The expression setting dialog box closes.  
The selected expression is displayed in the [Formula] box of [Z1].

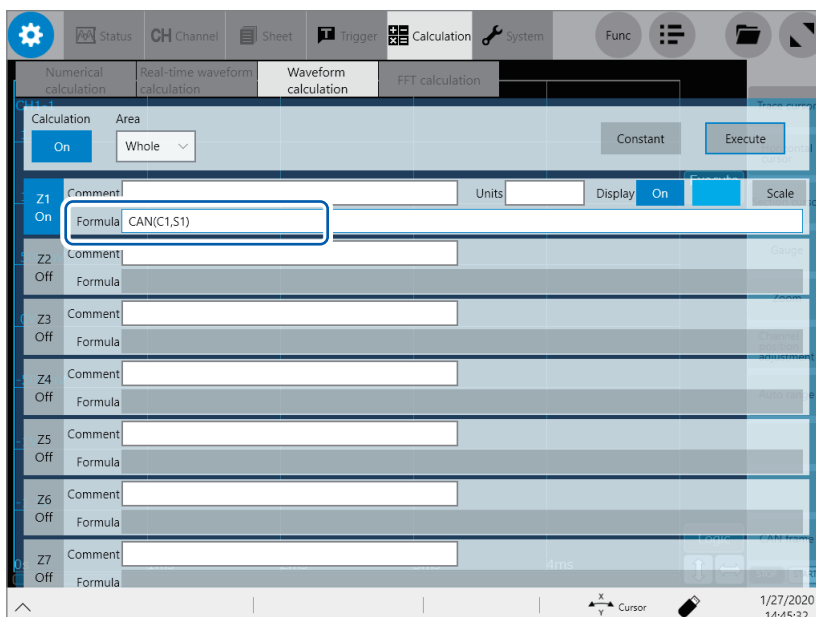

## 12.8 Saving Data

You can save all CAN frame data measured.

### File format

CAN frame data is saved as files different from waveform files. Data can be saved in binary form or text form.

Type	Form	Extension	Description
CAN binary	Binary	CLG	CAN frame data is saved as a binary file.
CAN text	Text	CSV, TXT	CAN frame data is saved as a text file. Only manually saving is available.
CAN index	Index	IXC	These files are used to manage waveform binary files and CAN binary files. They are saved along with CAN binary files. When a CAN index file is loaded, the waveform and CAN frame data are read into the instrument's internal memory at the same time.

### CAN binary file

#### (1) Saving by pressing the **SAVE** key (manual save)

When a CAN binary file is saved, a CAN binary file can be simultaneously saved.

Tap the **[CAN]** button to specify the file to be saved.

<b>Off</b> <input type="checkbox"/>	Saves the waveform file only.
<b>On</b> <input type="checkbox"/>	When the CAN frame data exists, the CAN binary file and CAN index file, as well as the waveform binary file, are saved.

#### (2) Automatic saving, real-time saving

When CAN frame data exists, a CAN binary file and CAN index file are automatically saved along with the waveform binary file.

### CAN text file

CAN text files can be saved by pressing the **SAVE** key (manual save) only.

Tap the **[Type]** button, and choose **[CAN(Text)]**.



# 13

## Configuring the System Environment Settings

You can configure the system environment settings for the instrument.

### IMPORTANT

Do not change any Windows® setting unless otherwise indicated in this document. Doing so may cause unstable system operation.

 > [System] > [Env.]



- 1 Tap the [Drawing Start\_Position] box, and then choose a start position of the scrolling display from the list.

Left edge <input checked="" type="checkbox"/>	Starts scrolling through waveforms from the left side of the waveform screen.
Right edge	Starts scrolling through waveforms from the right side of the waveform screen.

- 2 Tap the [Display comments] button to choose a comment display setting.

You can display a title comment and each channel comment on the waveform screen. Each channel comment appears along with each input-channel marker.

On <input checked="" type="checkbox"/>	Displays comments.
Off	Does not display any comments.

- 3 Tap the [Zero position] button to choose a zero-position marker display setting.

You can display markers at the zero position of each input channel on the time-axis waveform display.

Off <input checked="" type="checkbox"/>	Does not display any markers.
On	Displays markers at the zero positions on the left side of the waveform screen.

#### 4 Tap the **[Fix grid]** button to choose waveform operation mode.

Entering this mode prohibits you from using the touch panel to scroll, enlarge, or compress waveforms in the voltage-axis direction by anchoring the waveform display position.

<b>Off</b> <sup>☑</sup>	Allows you to scroll, enlarge, and compress waveforms in the voltage-axis direction.
<b>On</b>	Prohibits you from scrolling, enlarging, and compressing waveforms in the voltage-axis direction.

#### 5 Tap the **[Grid]** button to choose a grid display setting of the waveform screen.

<b>On</b> <sup>☑</sup>	Displays the solid-line grid.
<b>Off</b>	Does not display any grids.

#### 6 Tap the **[Waveform screen background color]** box, and then from the list, choose a background color of the waveform screen.

<b>Black</b> <sup>☑</sup>	Sets the background color of the waveform screen to black.
<b>White</b>	Sets the background color of the waveform screen to white.

#### 7 Tap the **[Time value display]** box, and then from the list, choose a display format for the lapse time from a trigger point.

<b>Time</b> <sup>☑</sup>	Displays the lapse time from the trigger point (the unit is fixed).
<b>Mod 60</b>	Displays the lapse time from the trigger point (in the sexagesimal <b>[base 60]</b> system).
<b>Date</b>	Displays the time when the instrument acquired a waveform.
<b>Samples</b>	Displays the number of samples acquired during the period from the trigger point.

- During the external sampling, this setting is fixed to **[Samples]**.
- These settings also apply to values of the trace cursors.

#### 8 Tap the **[Divided file auto reading]** button to choose a operation mode for loading divided files.

<b>Off</b> <sup>☑</sup>	Clears the instrument's internal memory and loads the specified file only. To load divided files consecutively, load an IDX file.
<b>On</b>	When you choose the file adjacent to the end of a waveform saved in the instrument's internal memory, the instrument will additionally load files while leaving the waveforms in the internal memory (The waveform's portion of loaded length at the other end is deleted). If you specify files other than those adjacent, the instrument clears the internal memory and consecutively loads the divided files adjacent to the specified file until the internal memory becomes full.

##### Example of automatic loading of divided files

1. If the storage media contains eight divided individual files 512 MB in size.

Data in file 1 (512 MB)	Data in file 2 (512 MB)	Data in file 3 (512 MB)	Data in file 4 (512 MB)	Data in file 5 (512 MB)	Data in file 6 (512 MB)	Data in file 7 (512 MB)	Data in file 8 (512 MB)
-------------------------	-------------------------	-------------------------	-------------------------	-------------------------	-------------------------	-------------------------	-------------------------

2. If the instrument loads file 3 with its internal memory (2 GB) containing no waveforms, the files until file 6 are loaded.

		Data in file 3 (512 MB)	Data in file 4 (512 MB)	Data in file 5 (512 MB)	Data in file 6 (512 MB)		
--	--	-------------------------	-------------------------	-------------------------	-------------------------	--	--

3. If the instrument loads file 7 in this state, it is additionally loaded and the data portion of file 3 is deleted from the internal memory.

			Data in file 4 (512 MB)	Data in file 5 (512 MB)	Data in file 6 (512 MB)	Data in file 7 (512 MB)	
--	--	--	-------------------------	-------------------------	-------------------------	-------------------------	--

4. If the instrument loads file 2 in this state furthermore, the internal memory is cleared and file 2 through file 6 are automatically loaded.

	Data in file 2 (512 MB)	Data in file 3 (512 MB)	Data in file 4 (512 MB)	Data in file 5 (512 MB)			
--	-------------------------	-------------------------	-------------------------	-------------------------	--	--	--

**9** Tap the **[Beep sound]** box, and then choose a beep setting from the list.

<b>Off</b>	Does not allow the instrument to beep.
<b>Alert</b> <sup>☑</sup>	Allows the instrument to beep in the following cases: <ul style="list-style-type: none"> <li>• If an error message or warning appears</li> <li>• If a fail judgment is given</li> </ul>
<b>Alert+Action</b>	Allows the instrument to beep when the instrument starts a measurement, is triggered, stops the measurement, and completes auto-saving, in addition to the cases described above.

**10** Tap the **[Restart]** box, and then from the list, choose whether to immediately restart the measurement after changing a setting that affects measurement during the measurement.

<b>No</b>	Does not restart any measurement. You cannot change any settings during measurement.
<b>Yes</b> <sup>☑</sup>	If you change a setting during measurement, the instrument confirms the changes and then restart the measurement.

**11** Tap the **[System protection]** box to choose a system protection function setting for power outage.

<b>On</b> <sup>☑</sup>	Protects the system from unexpected power interruptions.
<b>Off</b>	Does not protect the system from unexpected power interruptions.

This system protection function uses the UWF (unified write filter) feature installed in Windows®. If the system is continuously running for one month or more, we recommend you to turn off this function and prepare an external UPS.

**IMPORTANT**

If the instrument is shut down while saving files onto an external storage device, it cannot save data correctly.  
See “2.9 Supplying Power to the Instrument” in the Quick Start Manual.

**12** Tap the **[Auto power on]** button to set whether or not to use the automatic startup function.

<b>Off</b> <sup>□</sup>	Does not use the automatic startup function.
<b>On</b>	Uses the automatic startup function. Supplying power to the instrument can automatically start running Windows®, allowing you to start measurement. You do not need to use the power key.

**13** In the **[Shortcut key]** area, tap the **[S1]** and **[S2]** boxes in turn, and then from the list, choose an action allocated to each of the **S1** and **S2** keys.

<b>Off</b>	Does not execute any action.
<b>Auto range</b> <sup>□</sup>	Executes the automatic ranging. (Default setting for the <b>S1</b> key)
<b>Trigger</b> <sup>□</sup>	Executes the forcible trigger. (Default setting for the <b>S2</b> key)
<b>See entire waveform</b>	Displays the recording length of waveforms so that they fit the single screen width. A relatively long recording length may require a lot of time for displaying waveforms.
<b>Reset zoom</b>	Displays waveforms at the default display magnification.
<b>Execute</b>	Performing calculation using existing data.
<b>Send CAN data</b>	Sends data whose the CAN transmission <b>[Timing]</b> setting configured to <b>[Key S1]</b> or <b>[Key S2]</b> . When the <b>[Period]</b> setting is configured to <b>[On]</b> , pressing S1 or S2 key can start regular transmission. Pressing the same key can stop periodic transmission.
<b>Undo</b>	Cancels the previous action, which restores the instrument to the previous setting.
<b>Redo</b>	Performs the action canceled by tapping <b>[Undo]</b> .

## 14 Tap [Customize display].

The settings screen appears.

### To adjust the brightness

- (1) Drag the [Adjust brightness level] slider to adjust the brightness.

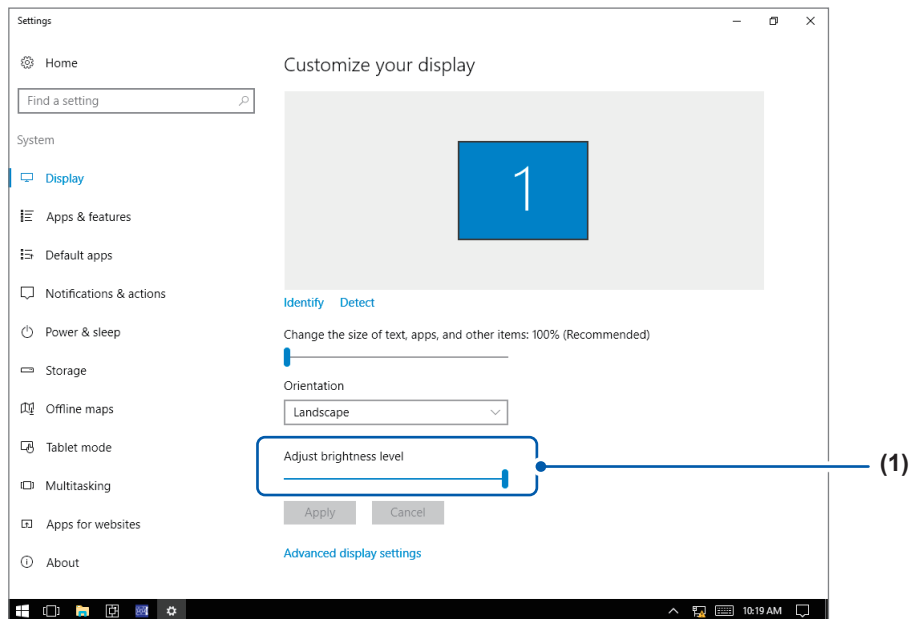

### To automatically turn off the display (to blank the screen)

- (2) Tap [Power & sleep].
- (3) In the [Screen] area, tap the list box to choose a length of time after which the screen is blanked.

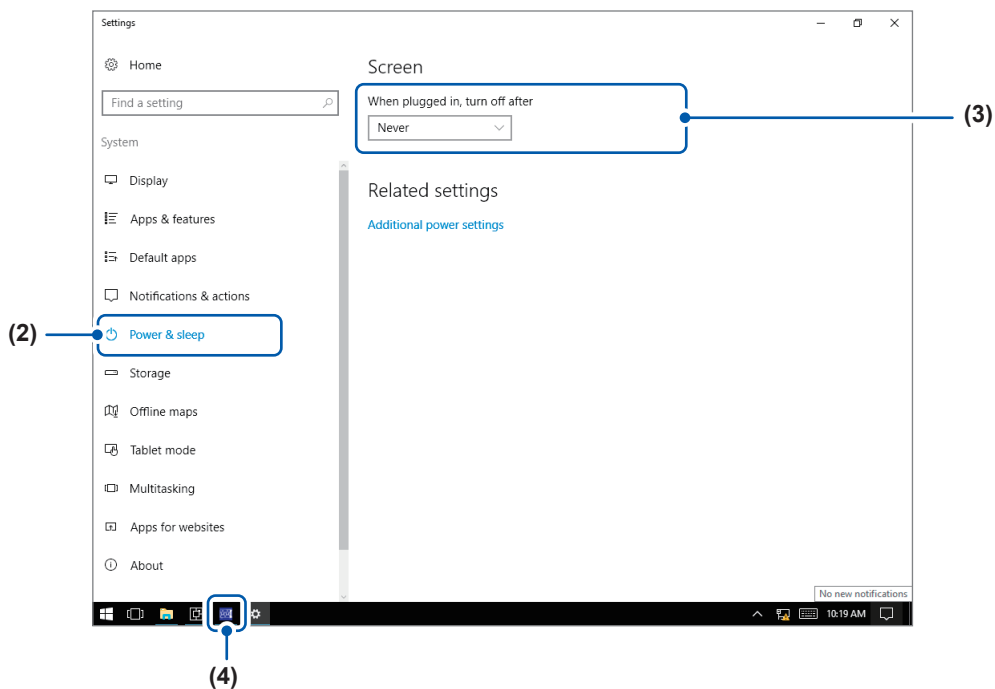

- (4) Tap the icon  on the taskbar to restore the display to the [Env.] screen of the Recorder.

**15** Tap **[Date and time]**, and then set the clock.  
See “2.10 Setting the Clock” in the Quick Start Manual.

**16** Change the user interface languages.

- (1) Tap **[Language: English]**.  
The setting dialog box appears.

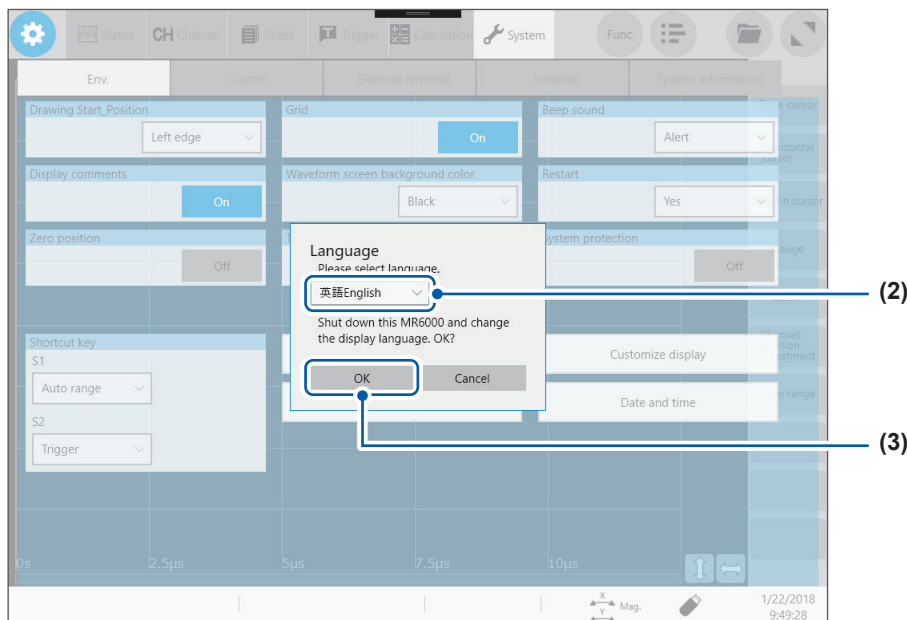

(2) Tap the **[Language]** box, and then choose a user interface language from the list.

**English** , **Japanese**, **Chinese**

(3) Tap **[OK]**.  
The instrument is turned off.

(4) **Press the power key.**  
The instrument starts up with the display in the chosen language.

**17** Tap **[Region]**.

Choose characters that represent the decimal symbol and the separator used in data included in waveform files (text format) and numerical calculation result files.

Tap the **[Decimal point]**, and then from the list, choose a character that represents the decimal symbol.

<b>Period</b> <input checked="" type="checkbox"/>	Designates the period (.) as the decimal point.
<b>Comma</b> <input type="checkbox"/>	Designates the comma (,) as the decimal point.

Tap the **[Decimal point]**, and then from the list, choose a character that represents the separator.

<b>Comma</b> <input checked="" type="checkbox"/>	Designates the comma (,) as the separator.
<b>Space</b>	Designates the space symbol as the separator.
<b>Tab</b>	Designates the tab symbol as the separator.
<b>Semicolon</b> ;	Designates the semicolon (;) as the separator.

- Either the decimal symbol or separator, but not both, can be set to **[Comma ,]**.
- Filenames have the .CSV extension with the **[Comma ,]** separator setting; the .TXT extension with a separator settings other than **[Comma ,]**.

# 14

## Connecting the Instrument to Computers

Familiarize yourself with the section “Before connecting to an external device” in “Operation Precautions” in the Quick Start Manual.

This instrument is equipped with the Ethernet 1000BASE-T interface for LAN communications. You can control the instrument using computers or other devices connected to your network with 10BASE-T or 100BASE-TX or 1000BASE-T cable.

 > [System] > [Comm.]

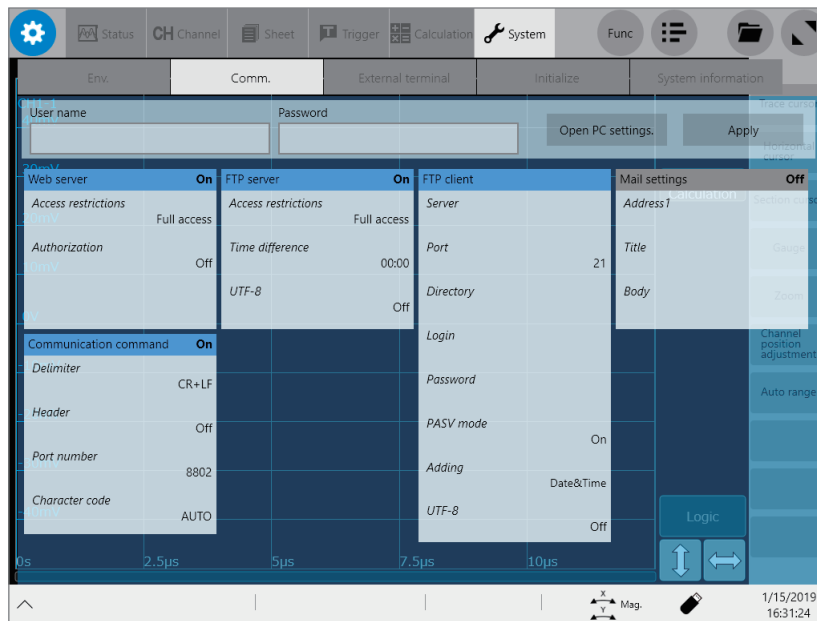

## Operation available on the [Comm.] screen

### Configuring the LAN settings and connecting the instrument via LAN (p. 351)

- Connecting the instrument to your computer via the network

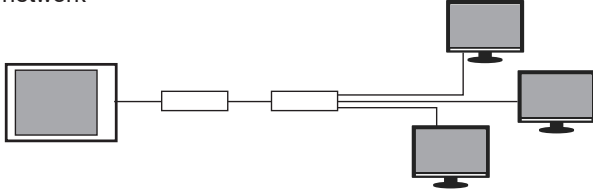

- Directly connecting the instrument to your computer



### Remotely controlling the instrument with a web browser (p. 367)

### Sending email messages (p. 374)

### FTP server function (p. 356)

Using an FTP client software installed on your computer allows you to transfer files from a storage device inserted to the instrument to the computer, and handle the files.

### FTP client function (p. 359)

Using this function allows you to send data to the FTP server of the computer. The instrument can send waveform data on completion of each measurement. You can also send data manually.

### Controlling the instrument with the command communications (p. 379)

You can control the instrument using programs you have created after connecting your computer to the command communications port using the TCP.

For more information about the communication commands, refer to the Communications Command Instruction Manual on the accompanying application disc.



# 14.1 Configuring the LAN Settings and Connecting the Instrument to the Network

This section describes how to configure the LAN settings of the instrument and how to connect the instrument to your computer with a LAN cable before using the FTP or web browser with a computer or command-communicating.

Be sure to configure the LAN settings before connecting the instrument to the network. When you change the settings while the instrument is connecting to the network, the IP addresses may fail to be unique or invalid address data may be transmitted over the network.

For more information on how to connect the instrument to computers, refer to “2.6 Connecting the Instrument With Computers” in the Quick Start Manual.

When the system protection function (p. 345) is enabled, you cannot change the LAN settings.

**IMPORTANT**

Do not change any Windows® setting unless otherwise indicated in this document. Doing so may cause unstable system operation.

## Configuring the LAN settings with the instrument

### Items to be checked before configuring the LAN settings

The required settings are different depending on whether to connect the instrument to an existing network or whether to establish a new network consisting of only the instrument and a computer.

**When connecting the instrument to the existing network**

Ask your network administrator to assign the following items in advance. Be sure that there is no conflict with other devices.

• **The computer name and address of the instrument**

Computer name (up to 15 characters): \_\_\_\_\_

IP address: .....:.....:.....:.....

Subnet mask: .....:.....:.....:.....

• **Gateway**

Whether to use a gateway: ..... Yes/No

IP address (When used): .....:.....:.....:.....

**When establishing a new network consisting of the instrument and a computer**

(Using the instrument on the local network not connect to any external networks)

When no administrator exists for your network or you are entrusted with the settings, the following addresses are recommended.

Setting example:

```

IP Address
Computer:           192.168.0.1
Recorder 1: 192.168.0.2
Recorder 2: 192.168.0.3 . . . Assign numbers in a sequential order.

      ↓                ↓
Computer name.....Any name (must be unique)
Subnet mask.....255.255.255.0
Gateway .....Off
    
```

## Setting items

 > [System] > [Comm.]

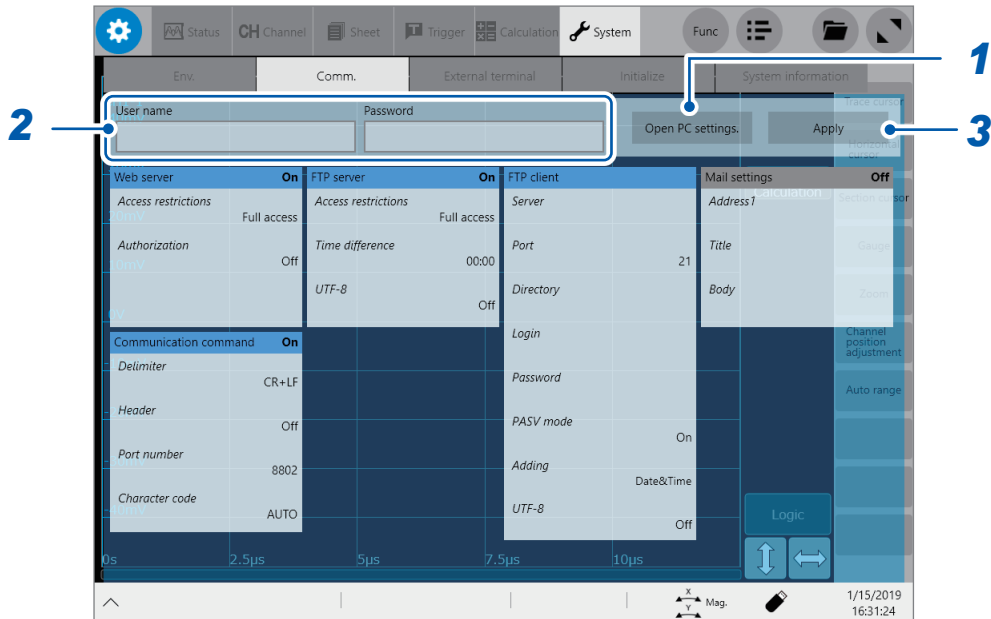

### 1 Tap [Open PC settings.].

The Ethernet settings screen appears.

### (1) Tap [Ethernet Properties].

The [Network Connections] window appears.

### (2) Tap [Ethernet].

### (3) Tap [Change settings of this connection].

The [Ethernet Properties] window appears.

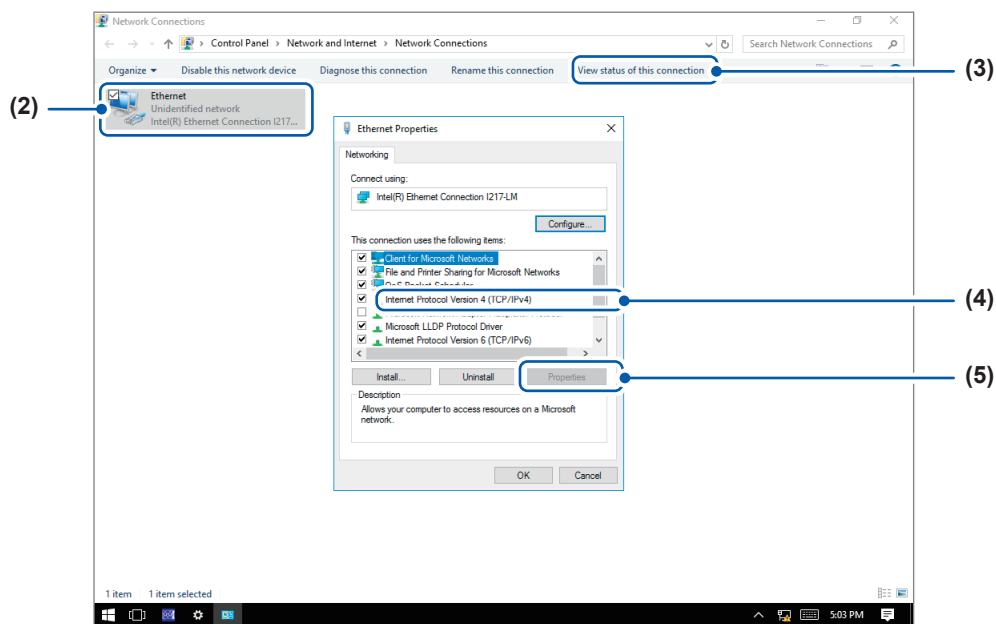

### (4) Tap [Internet Protocol Version 4 (TCP/IPv4)].

### (5) Tap [Properties].

The [Internet Protocol Version 4 (TCP/IPv4) Properties].

**(6) Enter the necessary information.**

<b>IP address</b>	The IP addresses identify individual devices on the network. Assign a unique address different from that of other devices.
<b>Subnet mask</b>	The subnet mask divides the IP address into the network address and the host address. Configure the subnet mask settings in the same way as those of other devices on the network.
<b>Default gateway</b>	For network connection When your computer to be used (host device) connects to another network than the instrument, specify a gateway device. When your computer connects to the same network, usually assign the same address as the default gateway in the computer communications settings.

**(7) Tap [OK].****(8) In the [Ethernet Properties] window, tap [OK].****(9) Tap the [Close] ([x]) button to close the [Network Connections] window.****(10) Tap the icon  on the taskbar to restore the display to the [Comm.] screen of the Recorder.****2 Tap the [User name] and [Password] boxes in turn, and then enter your authorization user name and password in each box**

These are used when you log in to the FTP of the instrument or use the web browser installed in the computer (When the authorization setting is set to **[On]**).

With the authorization setting configured, you can log in only when you enter the user name and password same as those specified. Configuring this setting is recommended when you would like to limit the users.

The password entered in the **[Password]** box is hidden behind the asterisks (\*).

Characters you can use: Alphabetic characters and symbols (however, the colon **[:]** is prohibited.)

When you would like to allow anyone to access the network or log in as an “anonymous” FTP client, leave the **[User name]** box and **[Password]** boxes blank.

**3 Tap [Apply].**

Tap **[OK]** to confirm the settings.

## Renaming the computer

This name in the **[Current PC name]** box identifies the instrument on the network. If necessary, change the computer name to a unique one among the network devices.

 > **[System]** > **[Comm.]**

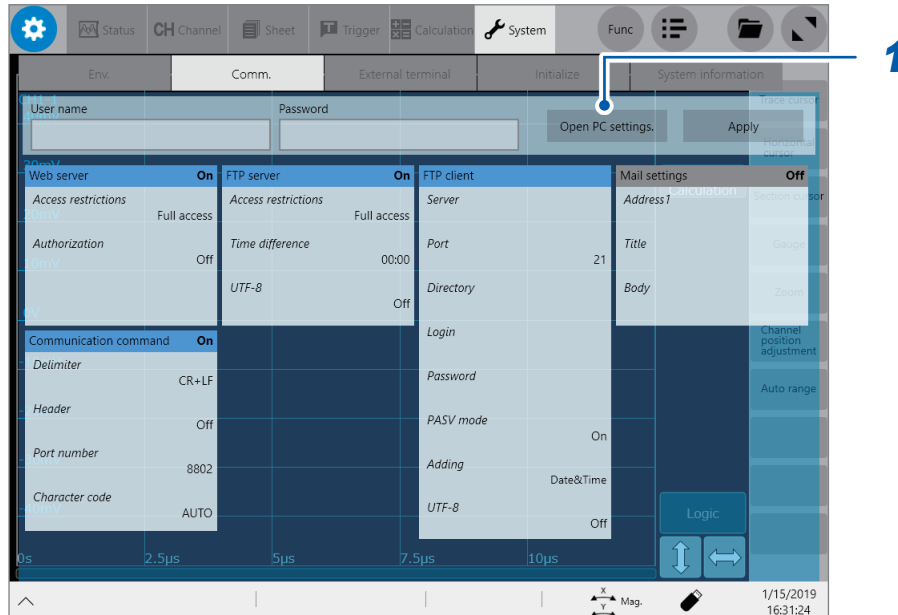

- 1** Tap **[Open PC settings.]**.  
The Ethernet settings screen appears.
- 2** Tap **[Home]**.  
The Windows® settings screen appears.
- 3** Tap **[System]**.
- 4** Tap **[About]** under **System**.
- 5** Tap **[Rename PC]**, and then enter another name in the **[Current PC name]** box.
- 6** Tap **[Next]**.  
Restarting the instrument is required.
- 7** Tap **[Restart now]**.

## How to configure the LAN settings

Follow this procedure in accordance with the intended usage.

For details on each setting, refer to “Setting items” (p. 352).

For details on your network including the IP address, contact your network administrator.

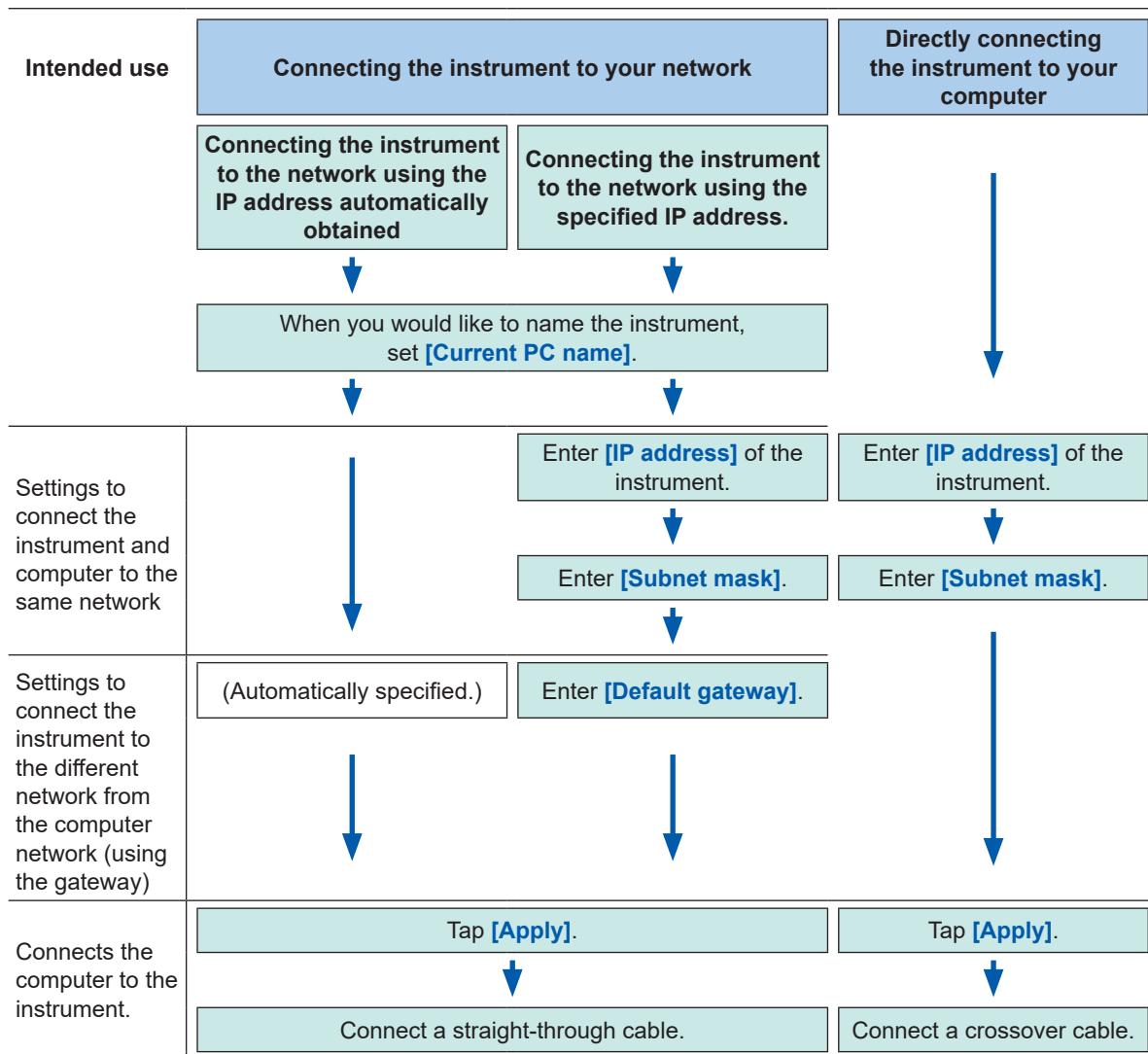

## 14.2 Managing Data in the Instrument With the FTP Server Function

Using the FTP client software installed in your computer allows you to transfer files from storage devices in the instrument to the computer, and manage the files with the computer.

- The instrument is equipped with an FTP server.
- You can operate the instrument using Explorer or various free software.

### Precautions when the FTP is used

- The FTP server of the instrument allows only one connection. Multiple computers cannot simultaneously access the server.
- If no command is sent from the computer for more than one minute after the FTP connection has been established, the FTP session may time out. If a timeout occurs, reconnect the computer via the FTP.
- The instrument interrupts an FTP session during real-time saving (during measurement).
- Before inserting or removing an SD memory card or a USB flash drive, terminate the FTP connection first.
- Do not handle any files during an FTP session.
- With Internet Explorer®, updated dates of files may not match those saved in the instrument.
- With Internet Explorer®, temporary Internet files created during the previous access are retained; thus, the previous data may be acquired instead of the latest data.
- If you cancel the transfer of selected files or folders before its completion, some FTP client/browser programs may delete all of them from the source regardless of whether they have been transferred. Avoid moving files and folders. Download files and folders using the copy function, and then delete them.
- Be careful that the user name and password themselves will get transmitted via the network when the FTP server is used.
- When you upload a file, the time stamp on the file will change to the uploading time.
- Each storage device appears as a directory on the FTP server.

<b>/STORAGE</b>	Waveform data written in the instrument (Writing data is prohibited.)
<b>/D through /Z</b>	Storage devices serving as drives

## Configuring the FTP sever setting with the instrument

 > [System] > [Comm.]

**1** Tap [FTP server].

The setting dialog box appears.

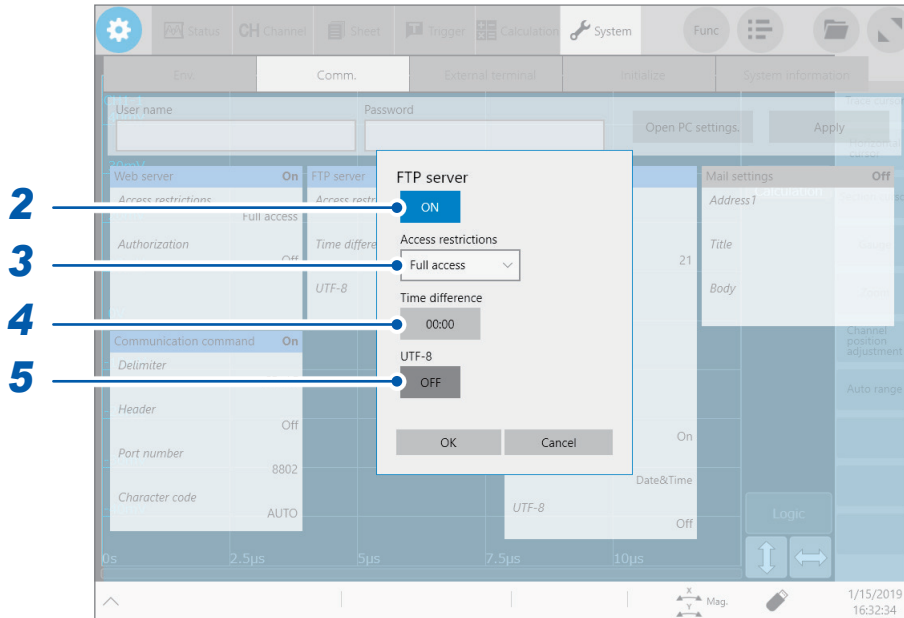

**2** Tap the [FTP server] button to set it to [On].

**3** Tap the [Access restrictions] box, and then from the list, choose an access restriction setting.

<b>Read only</b>	Enables you to read files only. Choosing this option prevents files from being deleted or changed from outside the instrument.
<b>Full access</b> 	Enables you to write (upload) files on storage devices, as well as delete and rename files.

**4** Tap the [Time difference] box, and then enter a time correction.

In general, leave it at [00:00].

**Setting the time difference between files**

With some versions of Internet Explorer®, time stamps may differ between those on files in your computer and the instrument to a certain extent. In this case, you can correct the time stamps by specifying the time difference. However, the corrected time stamps will differ from those on files in any FTP clients other than Internet Explorer®.

Example: -9:00

**5** Tap the [UTF-8] button to choose an UFT-8 support setting.

## Operating the instrument with your computer (FTP server function)

The following example shows how to operate the instrument with File Explorer on Windows 10.



### 1 Run File Explorer on your computer.

Click the File Explorer icon on the Windows 10 taskbar to start File Explorer.

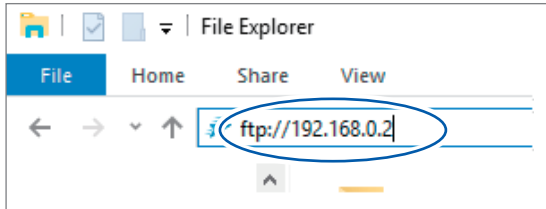

### 2 Enter an IP address.

Click the address bar in File Explorer and enter an IP address.  
Enter the character string **[ftp://]** followed by the IP address.

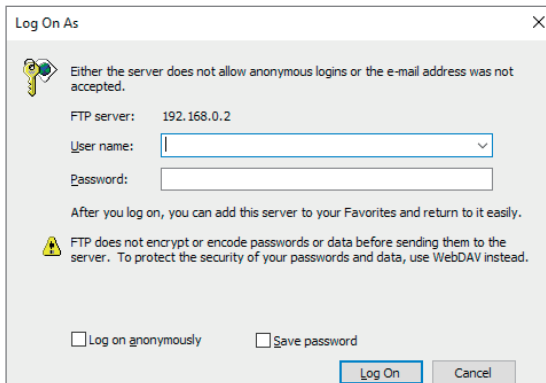

### 3 Log on to the FTP server.

The Log On As screen appears when you have been registered your authentication user name and password in the communication screen or the instrument. Enter your user name and password to log on,

Drag

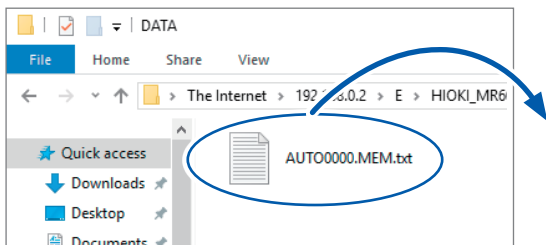

### 4 Download a file.

Choose a file you would like to download from the file list. Drag the file to the download destination (press and hold the mouse left button on the file, move it to the intended location while pressing the button, and then release the button).

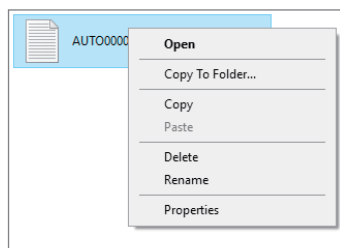

### 5 Delete or rename a file.

Right-click a file in the FTP folder list, and select **[Delete]** or **[Rename]** from the shortcut menu.



## 14.3 Sending Data to a Computer With the FTP Client Function

The instrument is equipped with the FTP transmission function (FTP client). You can send data to the FTP server on the network.

### FTP transmission method

Real-time saving data transmission	Automatically sends waveform data during measurement. Configure the real-time saving settings and specify the save destination to <b>[FTP]</b> .
Automatic saving data transmission	Automatically sends save target data on completion of the measurement, according to the automatic saving settings. Configure the automatic saving settings and specify the save destination to <b>[FTP]</b> .
Transmission with the SAVE key	Press the SAVE key automatically sends save target data. With the manual save settings, specify the save destination to <b>[FTP]</b> .

- The date of a file sent to the computer is set at when the file was sent.
- Transmission to all FTP servers is not necessarily guaranteed due to differences among servers.
- If a file with the same name exists in the destination, the file is overwritten.

## Configuring an FTP server setting on a computer

The following example shows how to configure the FTP server settings on Windows 10. The Microsoft® Windows® Home Edition does not include any FTP server. Use free software such as the FileZilla (trademark of another company) Server.

- The setting contents may vary with environment. When necessary, refer to the help topics of the FTP server or consult your network administrator.
- Microsoft® Windows® administrator privileges are required for setup.

### Enabling the FTP

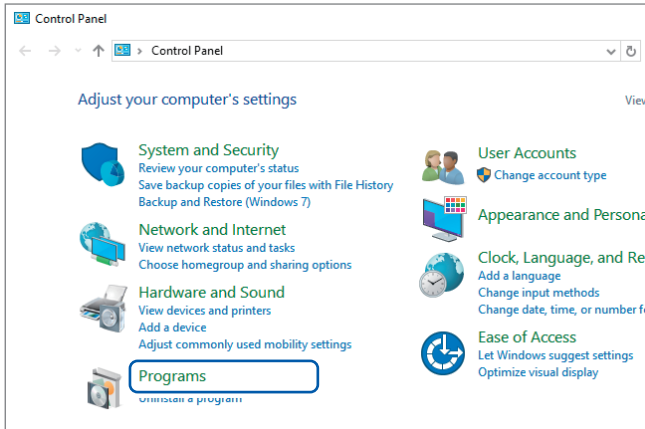

**1** Click [Programs] on [Control Panel].

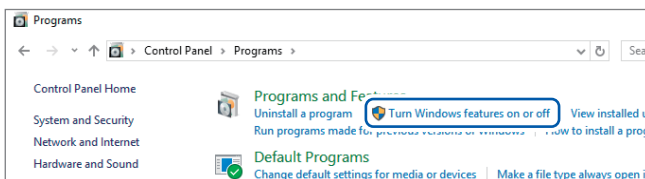

**2** Click [Turn Windows features on or off].

The [Windows Features] dialog box appear.

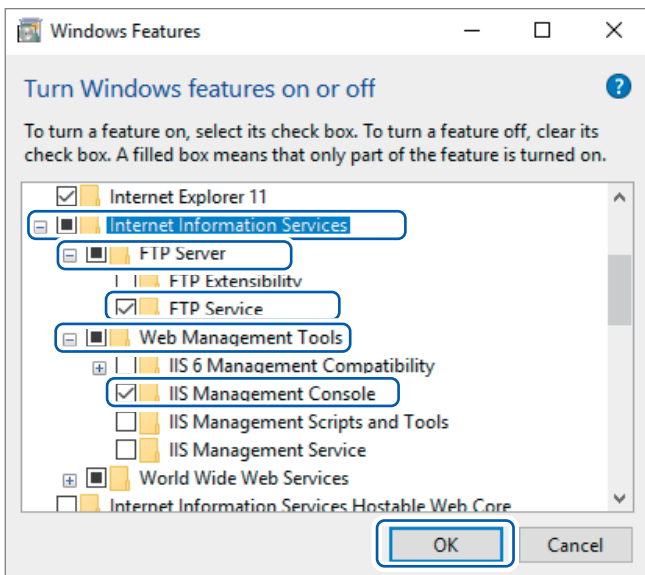

**3** Click [+] on the left of [Internet Information Services] to expand it.

Click [+] on the left of [FTP Server] to expand it, and then select [FTP Service].

Click [+] on the left of [Web Management Tools] to expand it, and then select [IIS Management Console].

Click [OK].

## Configuring the FTP settings

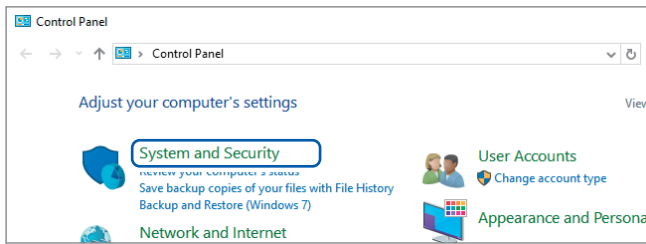

**4** Click **[System and Security]** on **[Control Panel]**.

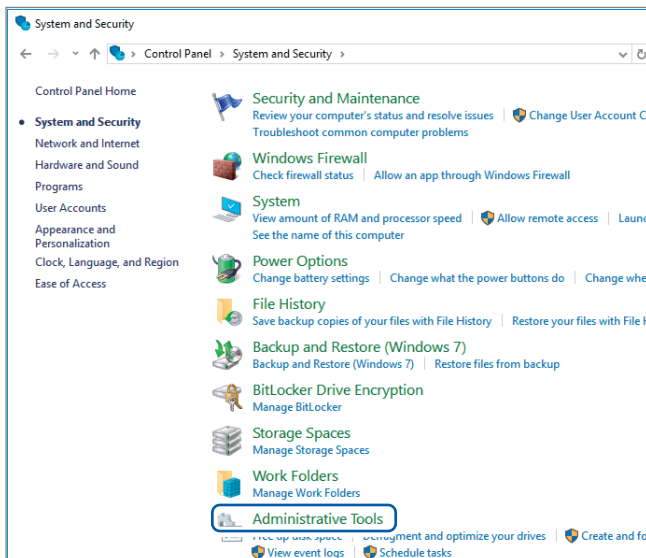

**5** Click **[Administrative Tools]**.

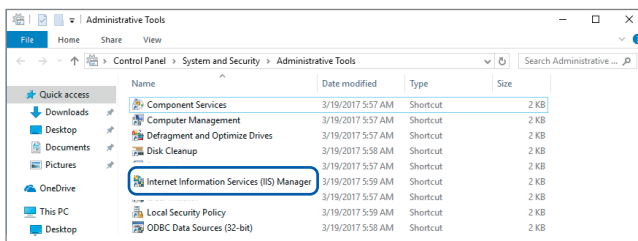

**6** Double-click **[Internet Information Services (IIS) Manager]**.

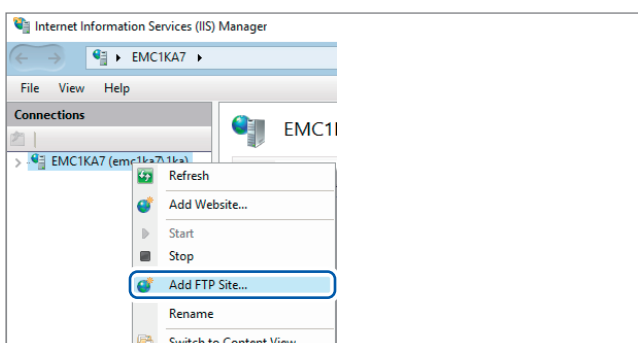

**7** Right-click on the item displayed under **[Connections]** on the left side of the screen to display the shortcut menu, and then click **[Add FTP Site]**.

Communication may be blocked depending on the settings of the computer protecting software (example: firewall).

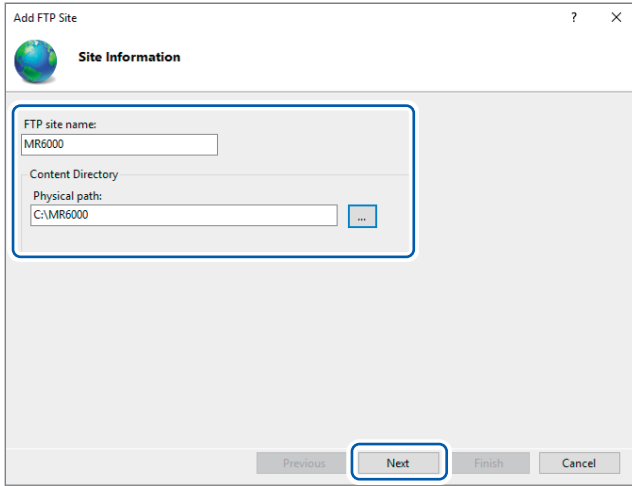

**8 Enter site information.**

Example:

**[FTP site name]: [MR6000]**

**[Content Directory]:**

Specify a directory in which data from the FTP client will be saved.

Click **[Next]**.

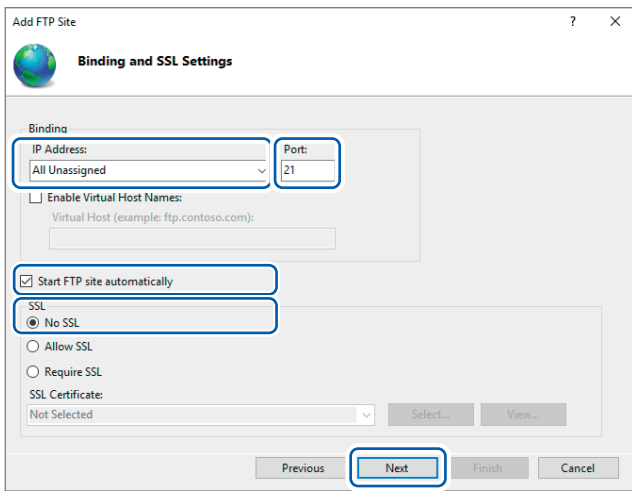

**9 Specify the [Binding] and [SSL] settings as follows:**

<b>[IP Address]</b>	<b>[All Unassigned]</b>
<b>[Port]</b>	<b>[21]</b>
<b>[Start FTP site automatically]</b>	Select
<b>[SSL]</b>	<b>[No SSL]</b>

Click **[Next]**.

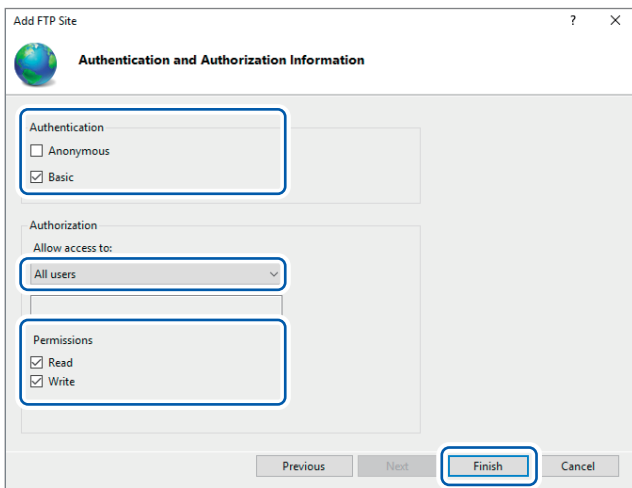

**10 Specify [Authentication and Authorization Information] as follows:**

<b>[Authentication]</b>	Select <b>[Basic]</b> .
<b>[Authorization]</b>	<b>[All users]</b>
<b>[Permissions]</b>	Select both <b>[Read]</b> and <b>[Write]</b> .

Click **[Finish]**.

## Configure the access user setting

Enter an FTP user name and password.

Enter the user name and password specified here in the **[Login]** and **[Password]** boxes, respectively, of the FTP client setting screen of the instrument (see step 4 “Enter a login name and password to use for logging in to the FTP server in the **[Login]** and **[Password]** box, respectively.” in p. 365).

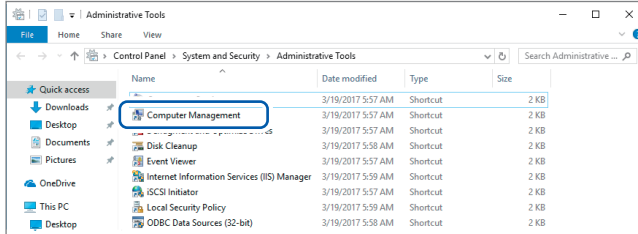

**11** Select **[Computer Management]** in **[Administrative Tools]** mentioned in step 5 (p. 361).

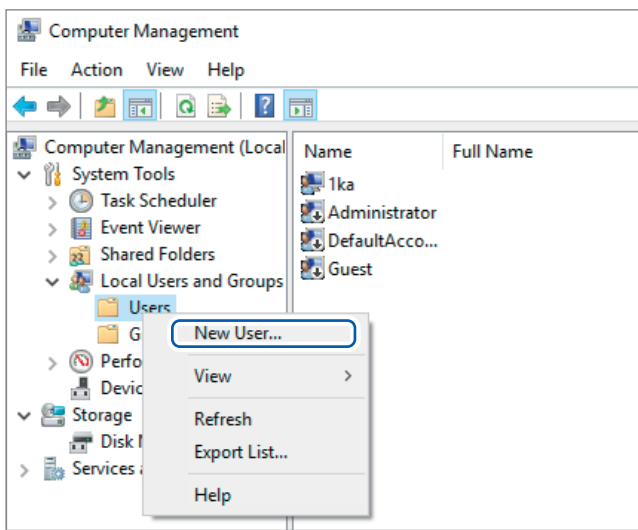

**12** Right-click **[Users]** under **[Local Users and Groups]**, then select **[New User]**.

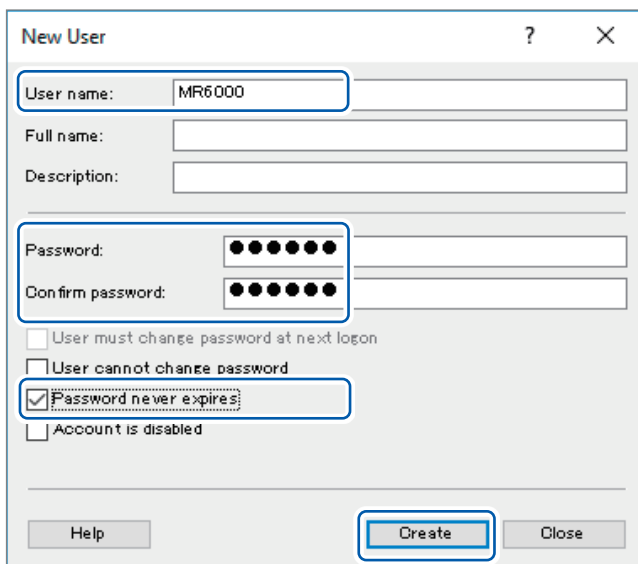

**13** Enter your user name, password, and the same password entered in the **[User name]**, **[Password]**, and **[Confirm password]** boxes, respectively, then select **[Password never expires]**.

**14** Click **[Create]**.

## Configuring the Windows® firewall settings

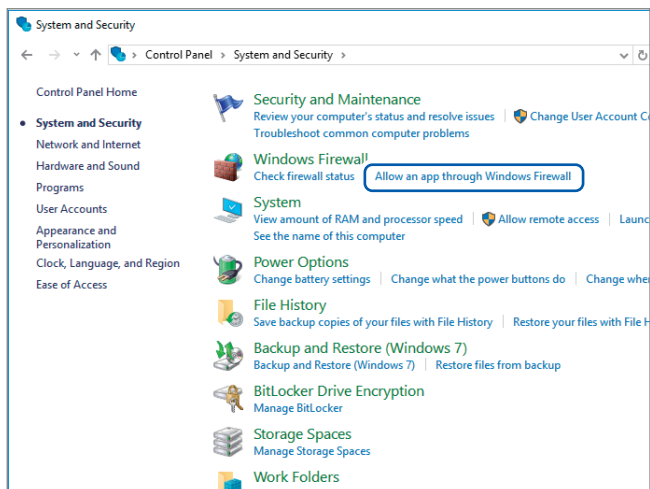

**15** Follow step 4 (p. 361), and then select [System and Security] > [Allow an app through Window Firewall].

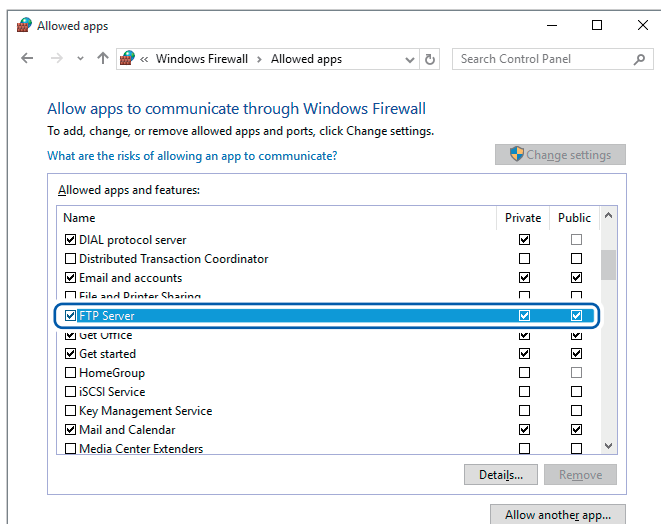

**16** Select [FTP Server].  
Select private or public, whichever connects with Model MR6000.

## Configuring the FTP client setting with the instrument

 > [System] > [Comm.]

### 1 Tap [FTP Client].

The setting dialog box appears.

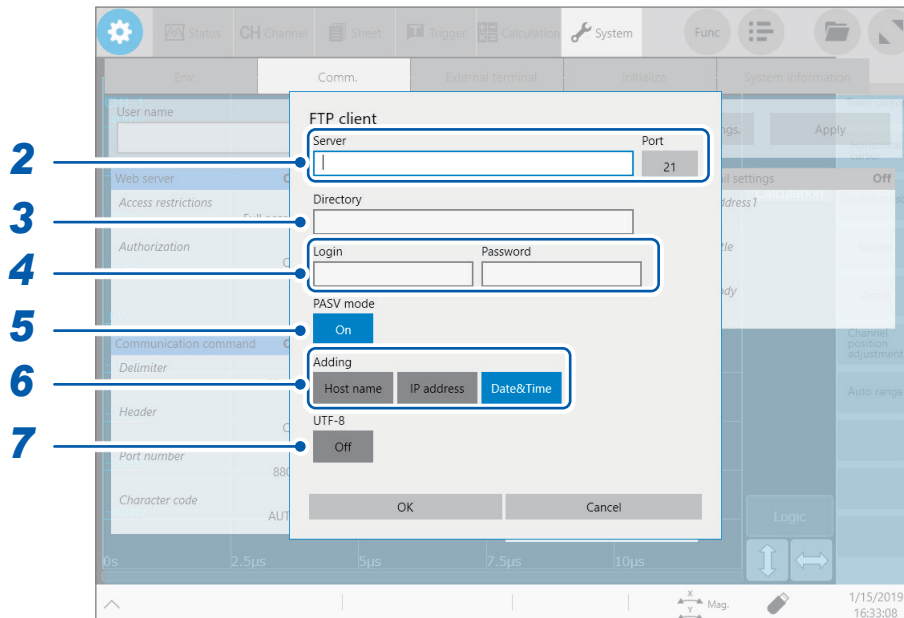

### 2 Tap the [Server] box and the [Port] button in turn.

The key pad and numerical value entry dialog box appears.

Enter a computer name or an IP address in the [Server] box. In the [Port] box, enter a port number with which the FTP server is operating if the number is not the standard number of 21.

### 3 Enter a directory name in the [Directory] box.

When the directory is left blank, the instrument stores the file in the contents directory of the FTP site specified in step 8 on p. 362.

If you wish to specify a directory of the contents directory to store files, enter the directory path in the [Directory] box.

Setting example

If you have specified the C:\MR6000 folder as the contents directory in step 8 on p. 362 and have left the directory name blank in this step, the file is stored in the C:\MR6000 folder.

If you enter WAVE for the contents directory, the file is stored in the C:\MR6000\wave folder.

Do not enter an absolute path beginning with a drive letter.

### 4 Enter a login name and password to use for logging in to the FTP server in the [Login] and [Password] box, respectively.

Enter the user name and password specified for the FTP server of the computer.

See "Configure the access user setting" (p. 363).

### 5 Tap the [PASV Mode].button to choose a PASV mode setting.

To establish communications in PASV mode, set it to [On].

**6** Tap any of the buttons in the **[Adding]** area,

Tap a button to add identifiers to file names.

- No identifies is added when you choose a file on the file screen to send it. Files with the same name are overwritten.
- When you have configured the setting to append numerical calculation results to existing files (when you set the **[Calculation result]** button to **[On]** or choose **[Append]** in the **[File]** box), no identifiers representing time of day are added. Moreover, if a file with the same name exists, the instrument attempts to append data to the file.
- No button in the **[Adding]** area is enabled, a file with the same name is overwritten when it exists. Note that all files with the same name will be overwritten if **[Date&Time]** is disabled with the continuous measurement setting and some others.

**7** Tap the **[UTF-8]** button to choose an UFT-8 support setting.



## 14.4 Operating the Instrument With a Browser Installed in a Computer

You can configure the instrument settings, operate the instrument, and acquire data from a computer with a web browser. Internet Explorer® Version 8 or later or Microsoft Edge® is recommended.

 > [System] > [Comm.]

### 1 Tap [Web server].

The setting dialog box appears.

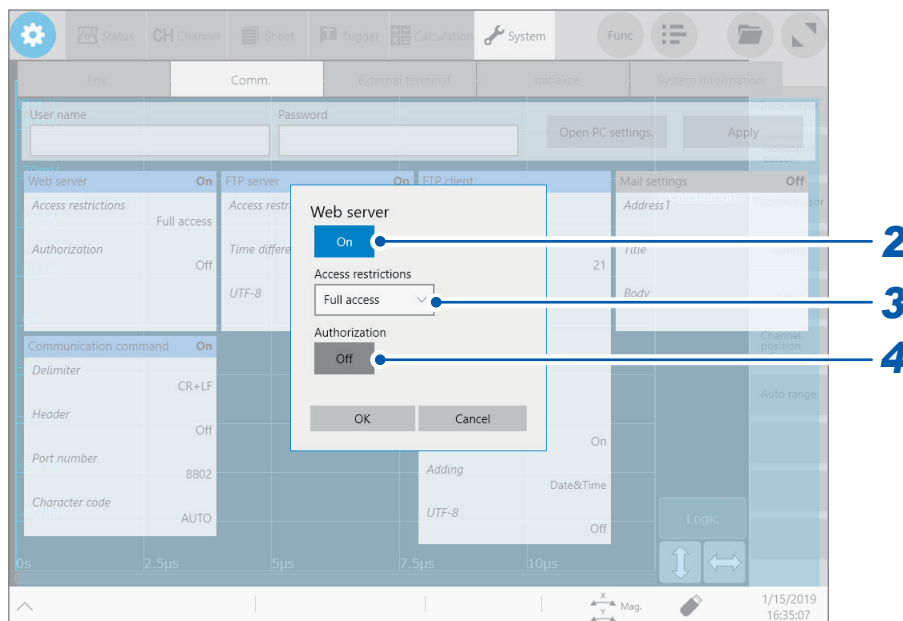

### 2 Tap the [Web server] button to set it to [On].

### 3 Tap the [Access restrictions] box, and then from the list, choose an access restriction setting.

<b>Monitor only</b>	Allows you to browse only the screen and status from the browser (you can obtain waveform data).
<b>Full access</b> <sup>□</sup>	Allows you to operate the instrument and configure settings from the browser.

### 4 Tap the [Authentication] button to choose a web-server authentication setting.

<b>Off</b> <sup>□</sup>	Allows you to operate the instrument without the web server authentication.
<b>On</b>	Allows you to operate the instrument with the web server authentication.

## Connecting your computer to the instrument with a web browser

The following example describes how to connect your computer to the instrument with Internet Explorer® on Windows 10.

Start Internet Explorer® on the computer and enter the character string [http://] followed by the IP address or the computer name in the address bar.

### When the IP address of the instrument is “192.168.0.3”

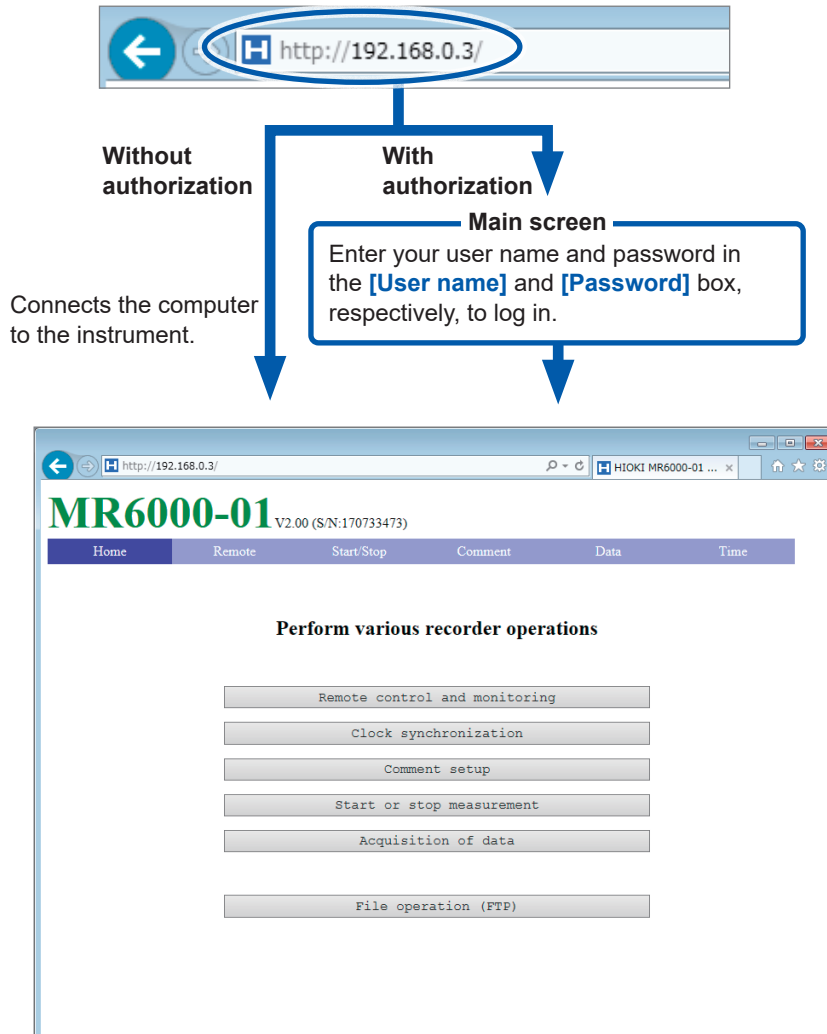

## Remotely operating the instrument



**1** Click **[Remote]** on the menu.

The screen switches to the remote operation screen, and the screen displayed on the instrument appears as it is on the browser.

The operation panel buttons conform to the buttons on the instrument. Clicking the screen with a mouse (same as tapping the screen of the instrument) allows you to remotely operate the instrument.

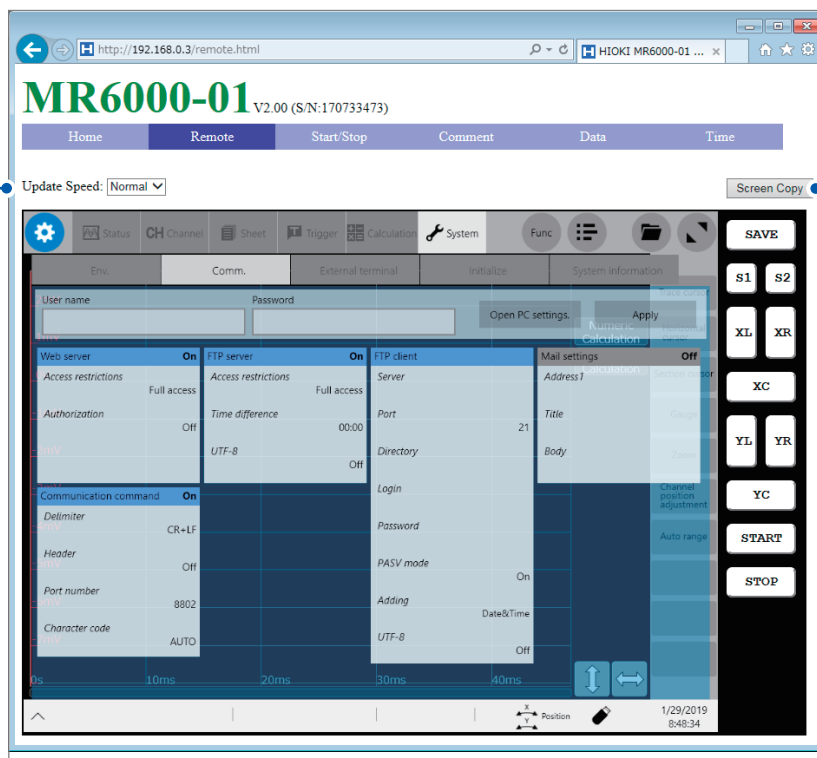

**2** Choose a screen update speed from the **[Update Speed]** list box.

**3** To save a screenshot, click **[Screen Copy]**.

## Starting/Stopping measurement

You can start and stop measurement



- 1 Click **[Start/Stop]** on the menu.  
The **[Measurement Start/Stop]** screen appears.

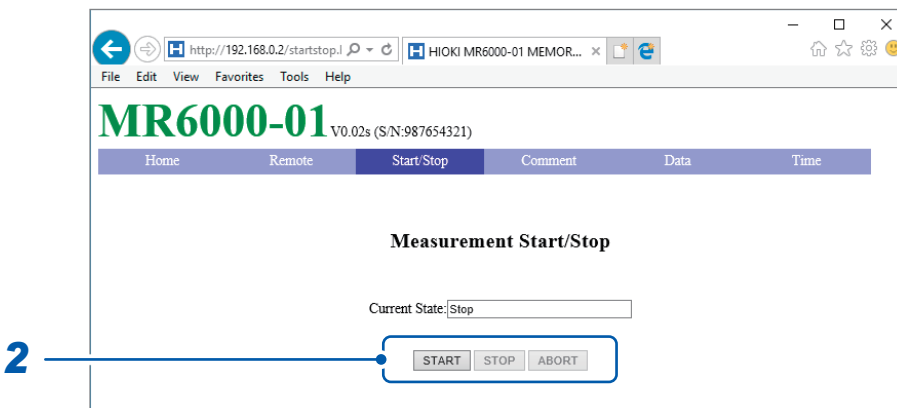

- 2 Choose an action.

<b>START</b>	Starts a measurement.
<b>STOP</b>	Stops the measurement.
<b>ABORT</b>	Forcibly stops the measurement.

No post-measurement processes such as numerical calculations and automatic saving are performed.

## Configuring the comment setting

You can configure the comment setting.

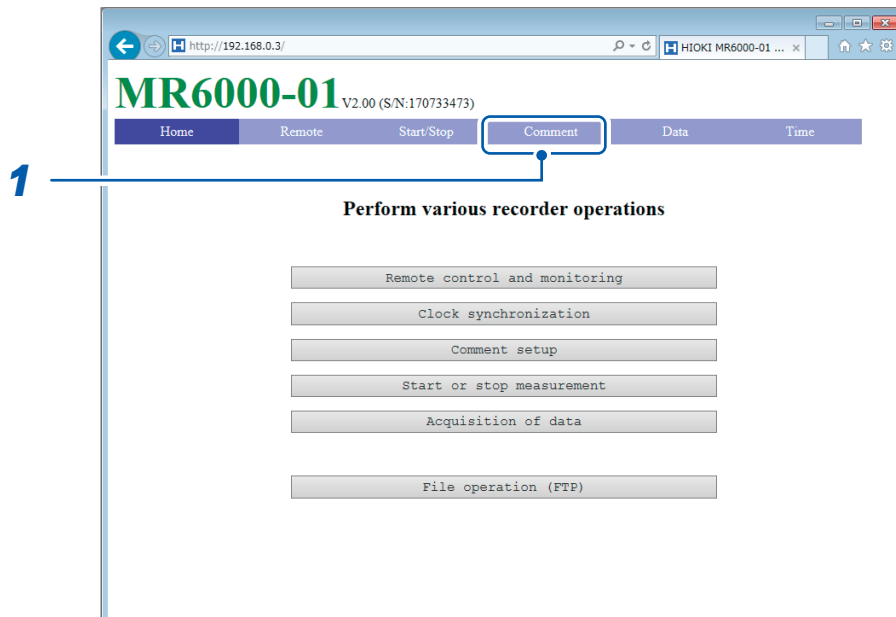

- 1 Click **[Comment]** on the menu.  
The **[Comment setup]** screen appears.

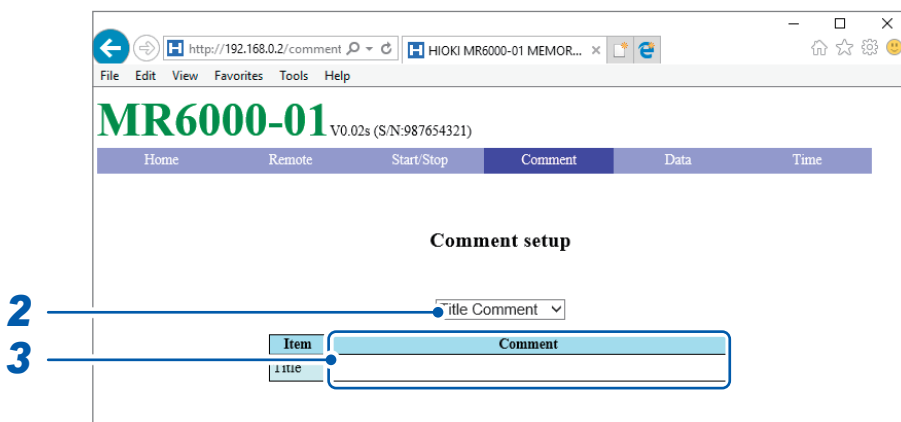

- 2 From the **[Comment setup]** list box, choose a comment type.  
You can enter the following comments:

**Title Comment** , **Analog Channel**, **Logic Channel**, **Real-time Waveform Calculation**, **Waveform Calculation Comment**, **FFT Calculation Comment**

- 3 Enter a comment in the **[Comment]** box.

## Acquiring data from the instrument

Data written in the memory of the instrument can be acquired.



- 1 Click **[Data]** on the menu.  
The **[Acquisition of measurement data]** screen appears.

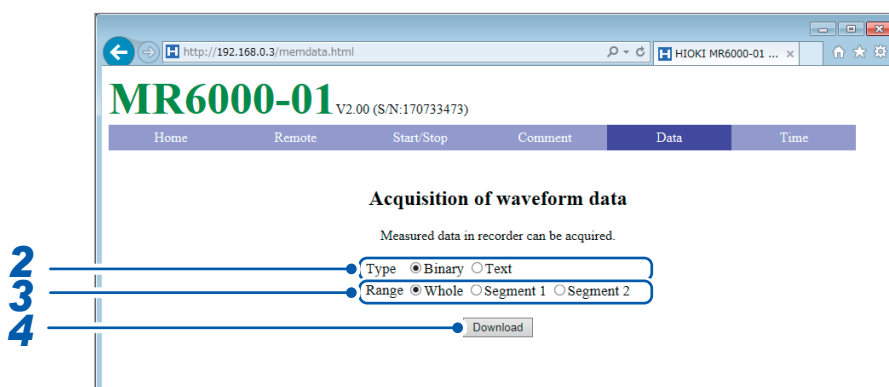

- 2 Choose a data type.  
**Binary, Text**
- 3 Choose a data range (**[Section cursor]**).  
**Whole, Segment 1, Segment 2**
- 4 Click **[Download]**.

## Setting the clock

The time of the clock on your computer can be set by that in the instrument. You cannot the clock during measurement.

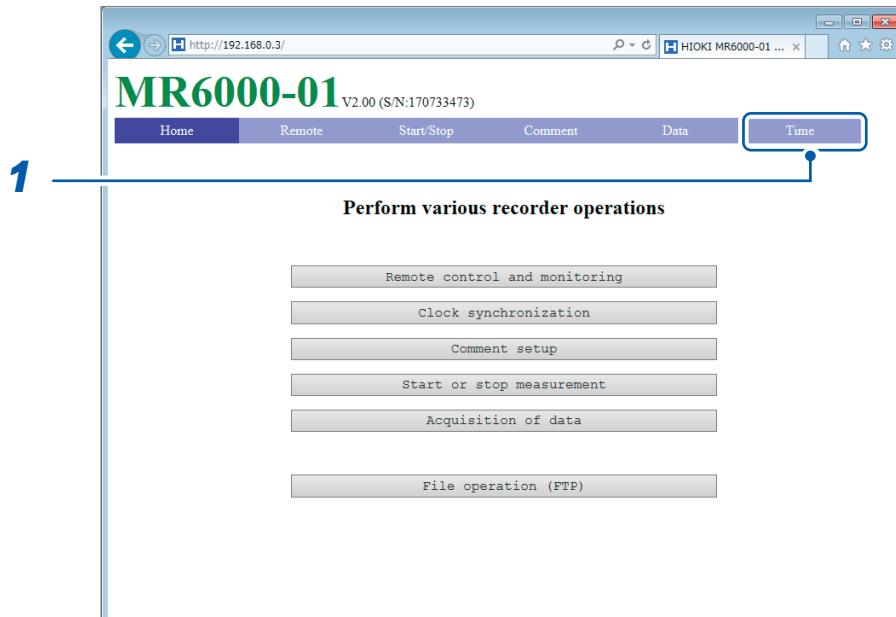

### 1 Click [Time] on the menu.

The [Synchronization] screen appears, and the time of the clock on the computer and the recorder (instrument) appear.

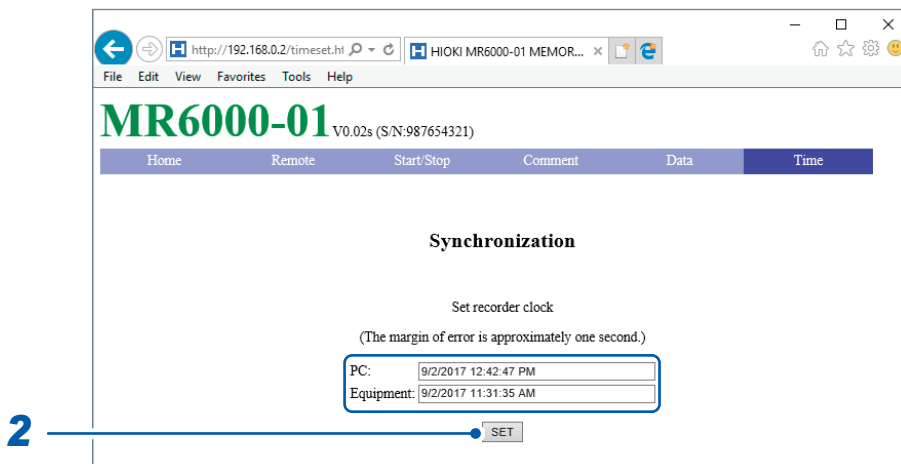

### 2 Click [SET].

The time of the clock on the computer is set by that in the recorder (instrument). However, an error of one second may occur.

## Handling files

You can transfer files in the instrument.

See “14.2 Managing Data in the Instrument With the FTP Server Function” (p. 356).

## 14.5 Sending Email messages

The instrument is equipped with the email transmission function. You can send email messages to computers in the network or to those installed in remote locations via the SMTP server. Moreover, you can install the instrument in a remote location and collect waveform data through an email attachment.

### How to send email messages

Automatic saving email message	Automatically sends an email message with data saved on completion of measurement attached, according to the automatic saving settings. Set <b>[Auto save settings]</b> to <b>[On]</b> and choose <b>[Mail]</b> in the <b>[Media]</b> box in advance. (p. 120)
Manual email transmission with the SAVE key	Pressing the <b>SAVE</b> key automatically allows an email message to be sent with saved data attached. Set the <b>[Media]</b> box of the manual save setting to <b>[Mail]</b> in advance. (p. 127)
Test email message	Checks if an email message is successfully sent.

### Encryption of email attachments

You can encrypt email attachments, such as screen data and waveform data, to prevent it from getting into outsiders.

- If transmission conditions are frequently satisfied, email messages will also be sent frequently.
- Data size of an email attachment may get extremely large. Depending on the communication environment, an email message cannot correctly be sent if the size is extremely large.
- Email attachment data is encrypted in ZIP format by WinZip 128-bit AE-2 / AES encryption. Encrypted files can be unzipped by Corel WinZip (trademark of another company) or free software such as 7z. (The WinZip AES encryption is stronger and securer than the standard ZIP encryption; however, supporting software is limited. The built-in ZIP feature of Microsoft® Windows® cannot unzip encrypted files in this format.)
- Files are encrypted by 128-bit AES encryption. Presently, this encryption method is sufficiently strong; however, Hioki does not guarantee that files are never decrypted.
- Handle your encryption password so that outsiders could know. Note that you cannot decrypt any files if you forget your password or enter an invalid password.
- When you have set or changed the password, send a test email message first to check whether you can unzip an attachment before actual use.
- Encrypted ZIP files are not compressed.
- When files are encrypted and zipped, sending email messages require a long time due to conversion time.
- The instrument supports pop-before-smtp and smtp-auth (PLAIN, LOGIN, CRAM-MD5) as the SMTP authentication (since the instrument does not support IMAP, SSL, or STARTTLS, you cannot send email messages to some mail servers, such as Gmail).
- We cannot guarantee transmission to all SMTP servers due to differences among servers.
- AES is the encryption standard specified in the U.S. Federal Information Processing Standard (FIPS) PUB 197.
- The instrument have no email reception function but the transmission function.
- You cannot load any compressed and encrypted data as it is on the instrument or on the Wave Viewer (Wv).



## Configuring the basic setting for sending email messages

 > [System] > [Comm.]

### 1 Tap [Mail settings].

The setting dialog box appears.

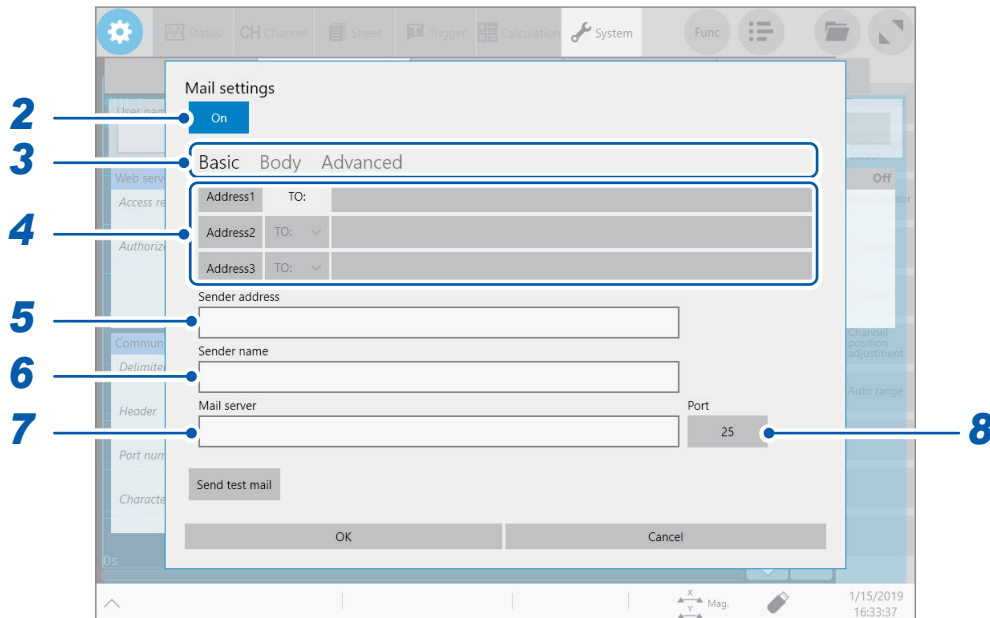

### 2 Tap the [Mail settings] button to set it to [On].

### 3 Tap [Basic].

### 4 Tap [Address1] to choose it, and then enter an email address in the blank box.

To send email messages to multiple destinations, enter other email addresses in the [Address2] and [Address3] boxes in the same manner.

Specify a recipient type ([To] or [Bcc]) for [Address2] and [Address3].

### 5 Tap the [Sender address] box, and then enter a sender address.

### 6 Tap the [Sender name] box, and then enter a name so that the recipients identify email messages received from the instrument.

### 7 Tap the [Server] box, and then enter a computer name or computer address.

### 8 (When the SMTP server is operating with the number other than the standard number, 25.) Tap [Port] button, and then enter a port number.

## Configuring the email contents settings

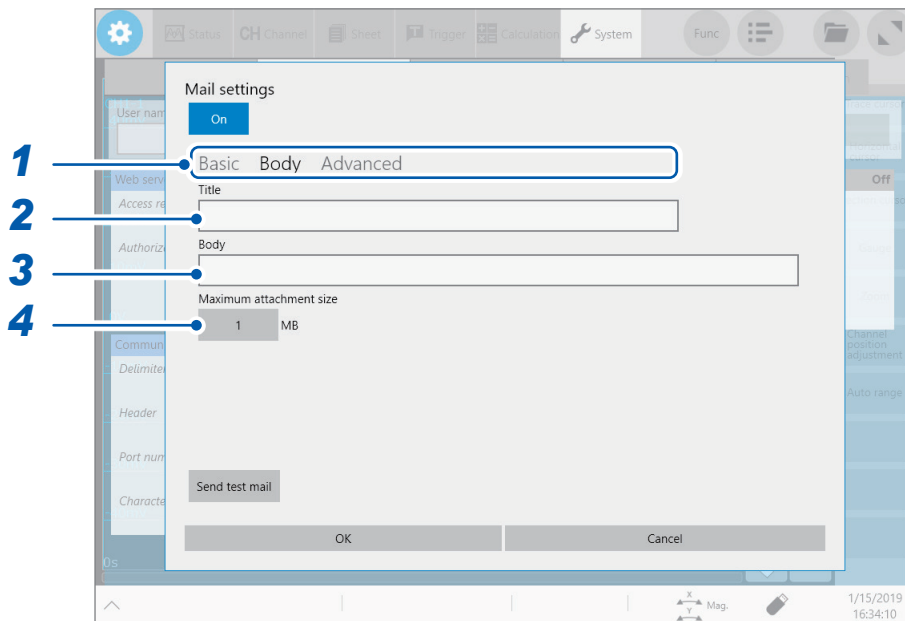

- 1** Tap **[Body]**.
- 2** Tap the **[Title]** box, and then enter a mail title.
- 3** Tap the **[Body]** box, and then enter an email body.
- 4** Tap the **[Maximum attachment size]** button, and then enter the maximum attachment size.

1<sup>□</sup> to 2048

Specify the maximum file size so that no large-size data is sent to the mail server. If a measured data size automatically saved is larger than the specified size, the instrument does not send email messages.

- Data with the specified file size or less may also not be sent due to server restrictions.
- Data is converted (encoded by Base64, compressed, encrypted) for attachment; however, the maximum file size is determined in terms of the size before conversion. Thus, the actually sent data may be larger (approximately 1.3 times) than the size limitation.

## Configuring the authentication, compression, and encryption settings for email messages to be sent

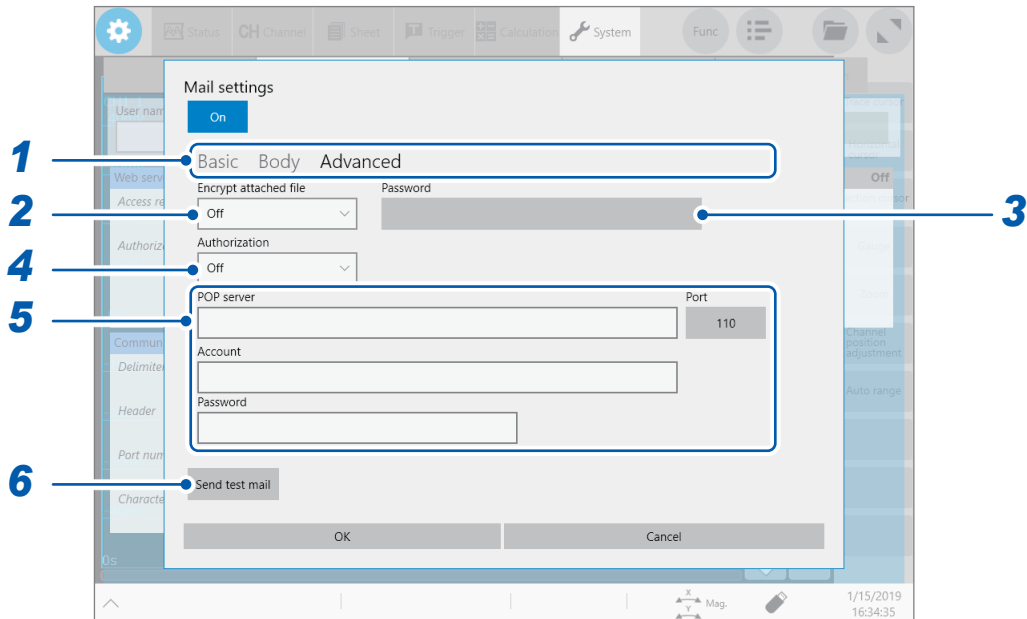

- 1** Tap **[Advanced]**.
- 2** Tap the **[Encrypt attached file]** box, and then choose an attachment setting from the list.

<b>Off</b>	Attaches files in original format.
<b>ZIP</b>	Attaches ZIP-compressed files.
<b>ZIP+AES</b>	Attaches files in encrypted ZIP format. The instrument does not compress files.

- 3** (To encrypt attachments)  
Enter an encryption password in the **[Password]** box.  
Number of characters: up to 16

- 4** (When a user authentication is required)  
Tap the **[Authentication]** box, and then choose a authentication method from the list.

<b>Off</b>	Sends mails with no user authentication.
<b>POP</b>	Sends mails using POP (APOP) before SMTP.
<b>SMTP</b>	Sends mails using SMTP (supports CRAM-MD5, PLAIN, and LOGIN).

## 5 Configure the authorization information settings.

- When using POP authentication  
Tap the **[POP server]** box and the **[Port]** button in turn, and then enter a POP server name and its port number, respectively.  
When the **[POP server]** is left blank, the instrument uses the figure entered in the **[Mail server]** box.  
Tap the **[Account]** and **[Password]** boxes in turn, and then enter an authentication user name and password, respectively.
- When using SMTP authentication  
Tap the **[SMTP Server]** box and the **[Port]** button in turn, and then enter a POP server name and its port number, respectively.  
Tap the **[Account]** and **[Password]** boxes in turn, and then enter an authentication user name and password, respectively.

## 6 Check if an email message can normally be sent.

Tap **[Send test mail]**.

The instrument send a test email message that contains specified contents.

Check if the specified destination can correctly receive the email message. If the specified destination cannot receive the email message, review your settings.

If the attachment encryption setting is enabled, the instrument encrypts the test email image.

Be sure to decompress the attachment to check whether the password is correctly set.

## 14.6 Controlling the Instrument With Command Communications (LAN)

You can externally control the instrument using commands via the communication interface. Communications can be established with a LAN connection. For details, refer to the Communication Command Instruction Manual on the accompanying application disc.

Configure the LAN settings and connect the instrument before using the command communications. See “14.1 Configuring the LAN Settings and Connecting the Instrument to the Network” (p. 351).

 > [System] > [Comm.]

### 1 Tap [Communication command].

The setting dialog box appears.

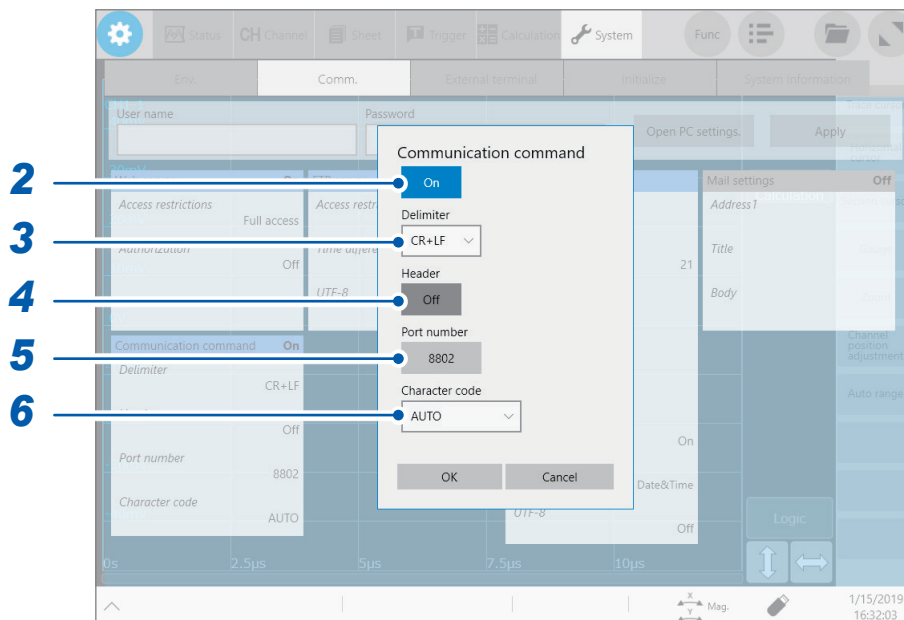

### 2 Tap the [Communication command] button to set it to [On].

### 3 Tap the [Delimiter] box, and then choose a character code (line feed code) that represents the data delimiter.

<b>CR+LF</b> <sup>☑</sup>	Sends the character codes 0x0d and 0x0a.
<b>LF</b>	Sends the character code 0x0a.

### 4 Tap the [Header] to choose whether to prefix a header to command responses.

<b>Off</b> <sup>☑</sup>	Does not prefix any header to response data.
<b>On</b>	Prefixes a header to response data.

- 5** Tap the **[Port number]** box, and enter a port number in the range of 1002 to 49002.  
The last digit is fixed at **[2]**.

- 6** Tap the **[Character code]** box, and then choose a character code setting from the list.

<b>AUTO</b> <input type="checkbox"/>	Automatically sets the character code.
<b>SJIS</b>	Sets the character code to SJIS.
<b>UTF-8</b>	Sets the character code to UTF-8.

## 14.7 Connecting to a Network Drive

This section describes how to allocate a folder on a networked PC as a network drive and use it as if it were connected to the instrument. First, it's necessary to share the folder on the host PC.

### Host PC settings

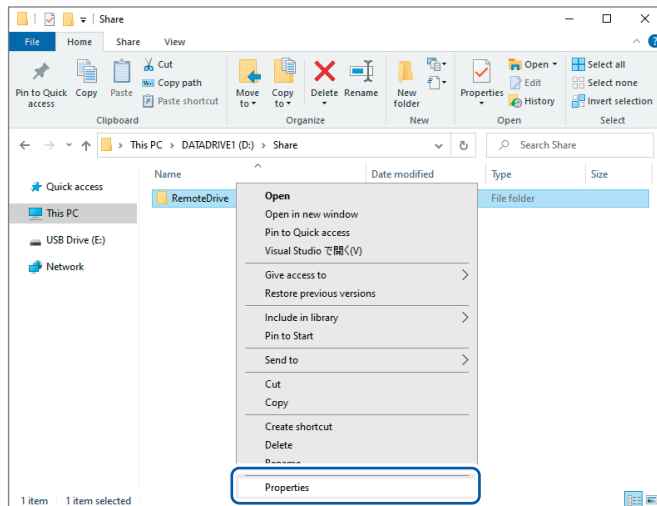

- 1 Right-click on the folder you wish to share, select the **[Properties]** menu.

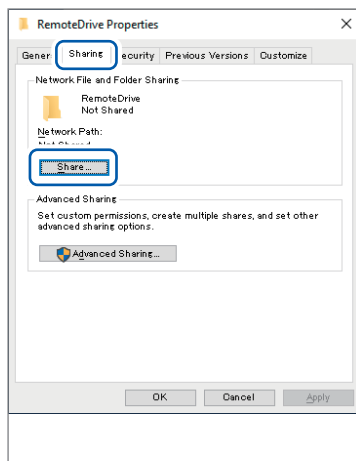

- 2 Click the **[Sharing]** tab.

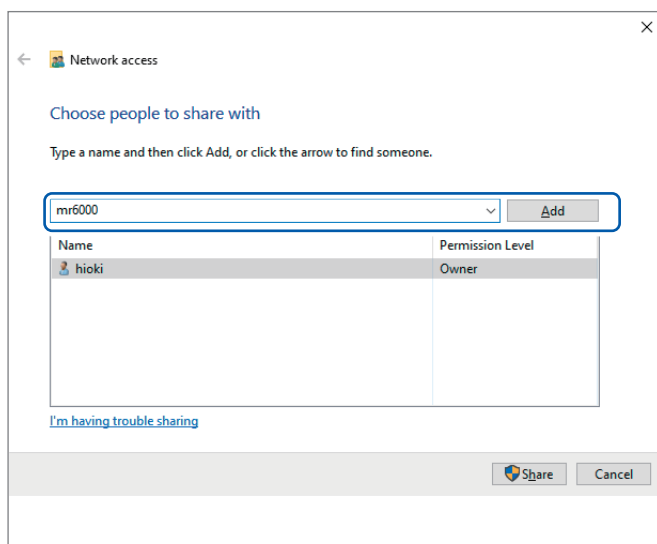

- 3 Enter the username with which you'll connect from the MR6000 and click **[Add]**.

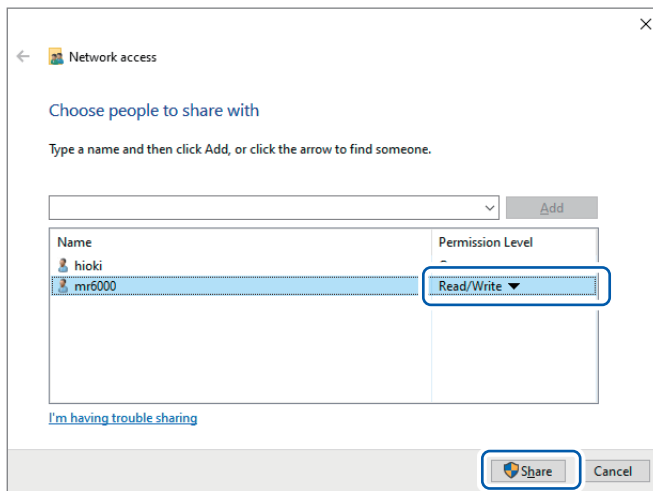

**4** Set the access privileges for the newly added user to **[Read/Write]** and click **[Share]**.

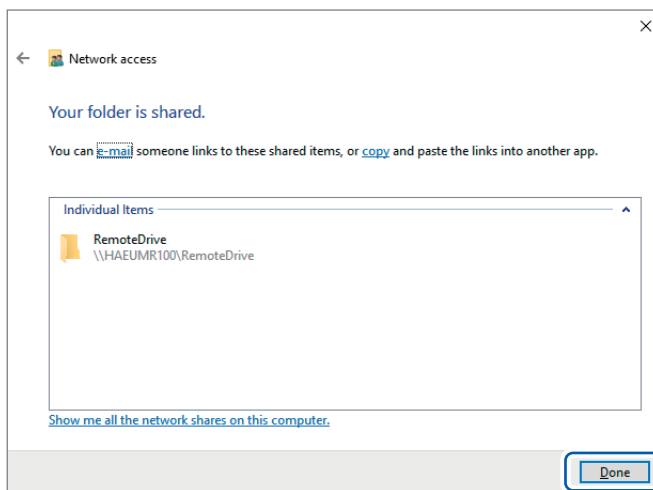

**5** Click **[Done]**.



## MR6000 settings

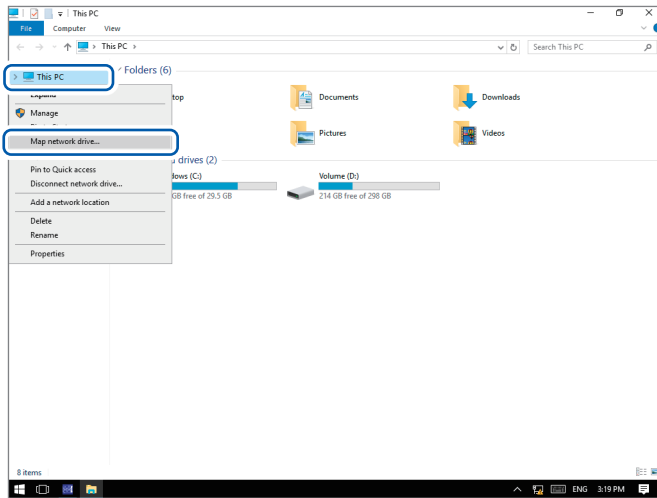

- 1 Open Explorer and configure **[Map network drive]**.

Right-click **[This PC]** on the left pane and select **[Map network drive]**.

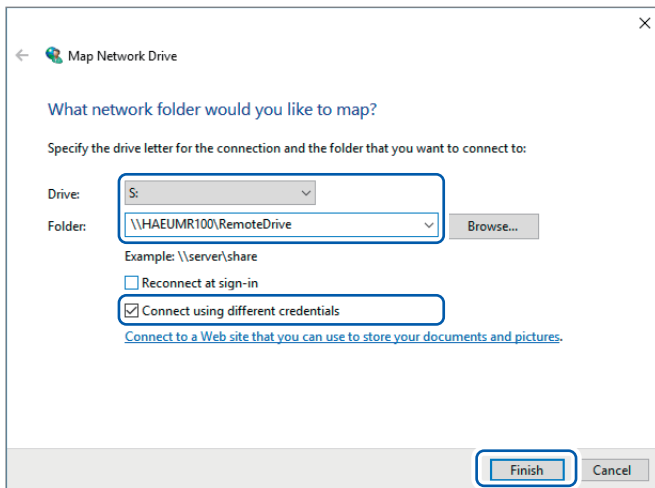

- 2 Enter the network information and tap **[Finish]**.

Enter the drive and folder (network path) and select the **[Connect using different credentials]** checkbox.

If you select the **[Reconnect at sign-in]** checkbox, the instrument will automatically connect to the network drive when it starts up, but the startup process will take longer if the drive is not found.

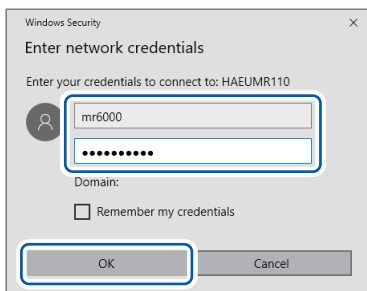

- 3 Enter the username and password and tap **[OK]**.

Select the **[Remember my credentials]** checkbox if you wish.

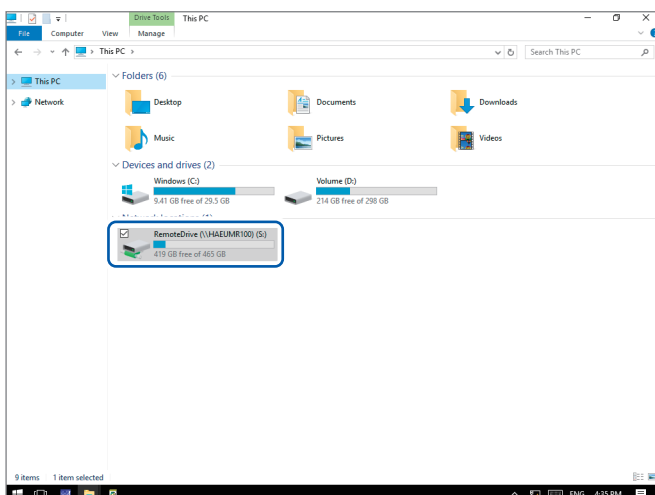

The instrument will connect to the network drive.



# Externally Controlling the Instrument

Read the section “Before connecting to an external device” in “Operation Precautions” in the Quick Start Manual carefully.

Connecting the external control terminals with external devices allows the instrument to start and stop measurement.

This section describes the procedure and the external control terminal function to externally control the instrument.

The terminals are referred to collectively as “external control terminals.”

Signals inputted into the external control terminals can operate the instrument even when the key lock function is enabled.

For more information about the specifications of the FFT calculation function, refer to Quick Start Manual.

# 15.1 External Input and Output

## External input (IN1), (IN2)

Externally inputting signals can start and stop measurement as well as save data. In factory default settings, the START signal is assigned to the IN1 terminal, and the STOP signal to the IN2 terminal.

### How to input signals

- 1 Connect each of the IN1, IN2, and GND terminals to an external signal-outputting device with wires.

See “2.5 Connecting the External Control Terminals” in the Quick Start Manual.

- 2  > [System] > [External terminal]

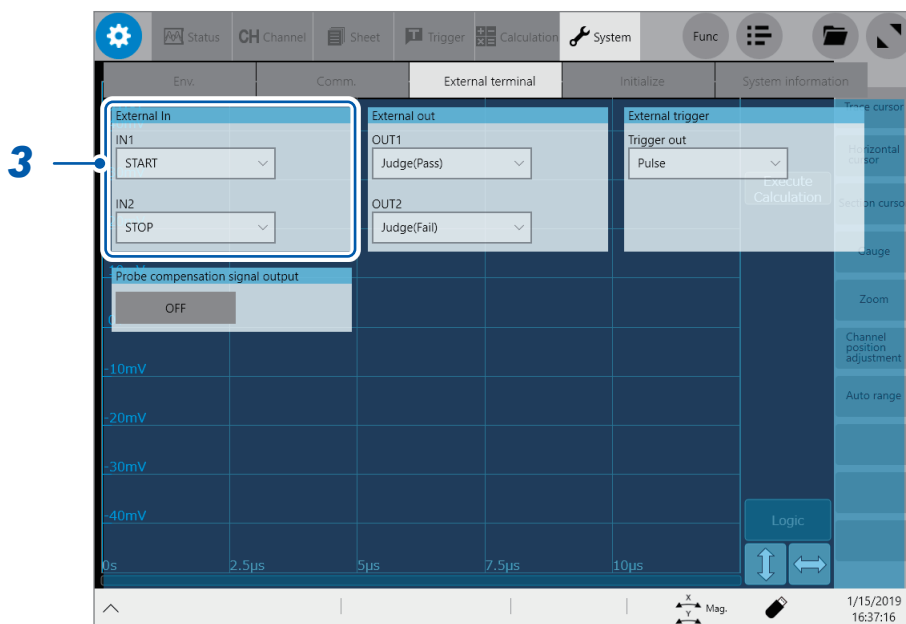

- 3 Tap the [IN1] and [IN2] boxes in the [External In] area in turn, and then from the list, choose an action performed when an input signal is inputted.

<b>START</b>	Starts a measurement.
<b>STOP</b>	Stops the measurement (post-measurement processes such as numerical calculations and automatic saving are performed).
<b>START/STOP</b>	Starts a measurement when the low-level signal is inputted; stops the measurement when the high-level signal is inputted.
<b>SAVE</b>	Saves data on the specified conditions into a storage device that is specified in ([Status] > [Save] > [Save key operation] >) [Quick].
<b>ABORT</b>	Forcibly terminates the measurement. (No post-measurement processes such as numerical calculation or automatic saving are performed. However, the instrument automatically saves a waveform file that contains data acquired until the forcible termination).
<b>EVENT</b>	Puts on an event mark. The event marks are put on the waveform screen. You can put event marks by pressing the <b>START</b> key during measurement.

**4** Connect the terminal and the GND terminal with each other, or input pulse waves or square waves to the terminal. The signal have to be with a high-level voltage of between 2.5 V and 10 V, and a low-level voltage of between 0 V and 0.8 V.

The low level of the input waveform controls the instrument.

Available voltage range	High level: 2.5 V to 10 V; low level: 0 V to 0.8 V
Pulse width	High-level period: 50 ms or more; low-level period: 50 ms or more
Pulse interval	200 ms or more
Maximum input voltage	10 V DC

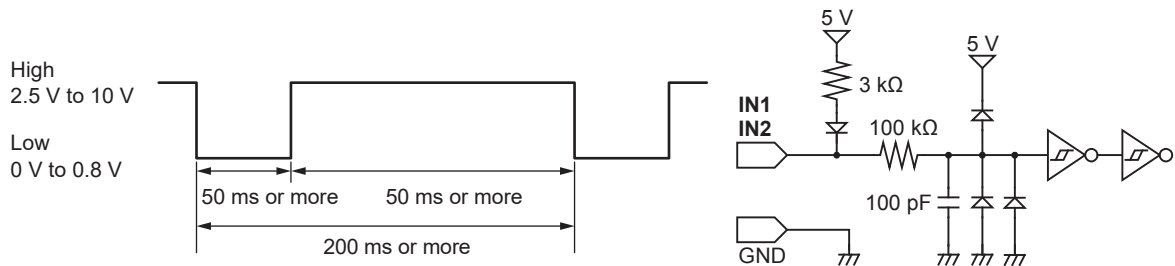

**External output (OUT1), (OUT2)**

The instrument can output various DC signals depending on its state.

**How to output signals**

- 1** Connect each of the OUT1, OUT2, and GND terminals to an external signal-inputting device with wires.

See “2.5 Connecting the External Control Terminals” in the Quick Start Manual.

- 2** > [System] > [External terminal]

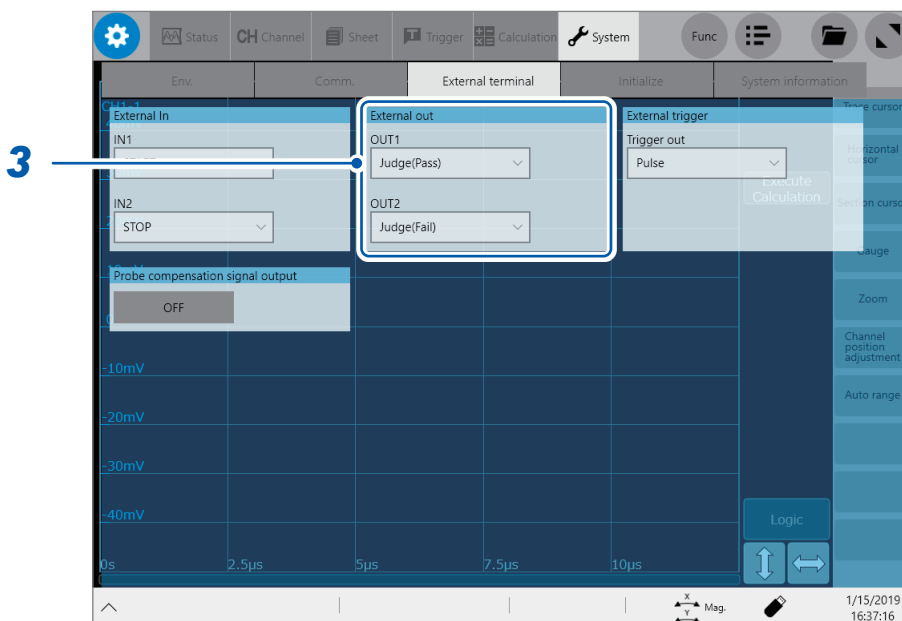

**3** Tap the [OUT1] and [OUT2] boxes in the [External out] area in turn, and then from the list, choose a signal output action.

Choose a condition under which the instrument outputs a signal.

<b>Judge(Pass)</b>	Outputs a low-level signal when a pass judgment is given for the numerical calculation result.
<b>Judge(Fail)</b>	Outputs a low-level signal when a fail judgment is given for the numerical calculation result.
<b>Error</b>	Outputs a low-level signal when some kind of error or warning occurs.
<b>Busy</b>	Outputs a low-level signal while rejecting a START signal because the instrument is in the busy state such as performing a measurement and saving data.
<b>[Waiting for Trigger]</b>	Outputs a low-level signal while waiting for a trigger.

The instrument continues outputting the signal for a pass/fail judgment (low-level output) until it starts the next measurement.

The instrument can output various signals depending on its state.

Output signal	Open-drain output (with voltage output), active low
Output voltage range	High level: 4.0 V to 5.0 V Low level: 0 V to 0.5 V
Maximum input voltage	50 V DC, 50 mA, 200 mW

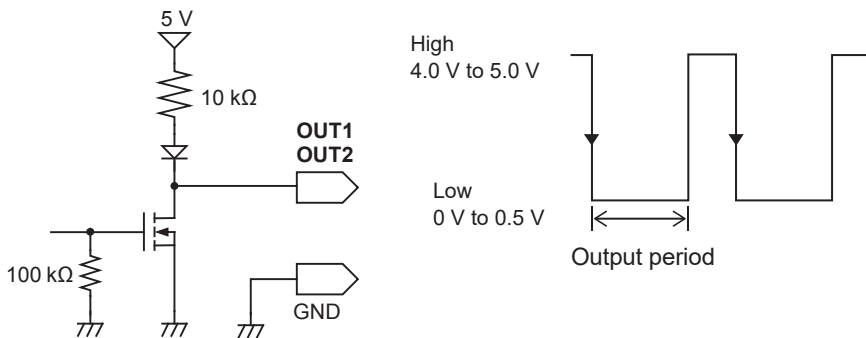

## Trigger output (TRIG.OUT)

The instrument outputs a signal when it is triggered. You can use this signal to control multiple instruments, achieving synchronous operation.

### How to output signals

- 1 Connect each of the TRIG OUT and GND terminals to an external signal-inputting device with wires.

See “2.5 Connecting the External Control Terminals” in the Quick Start Manual.

- 2  > [System] > [External terminal]

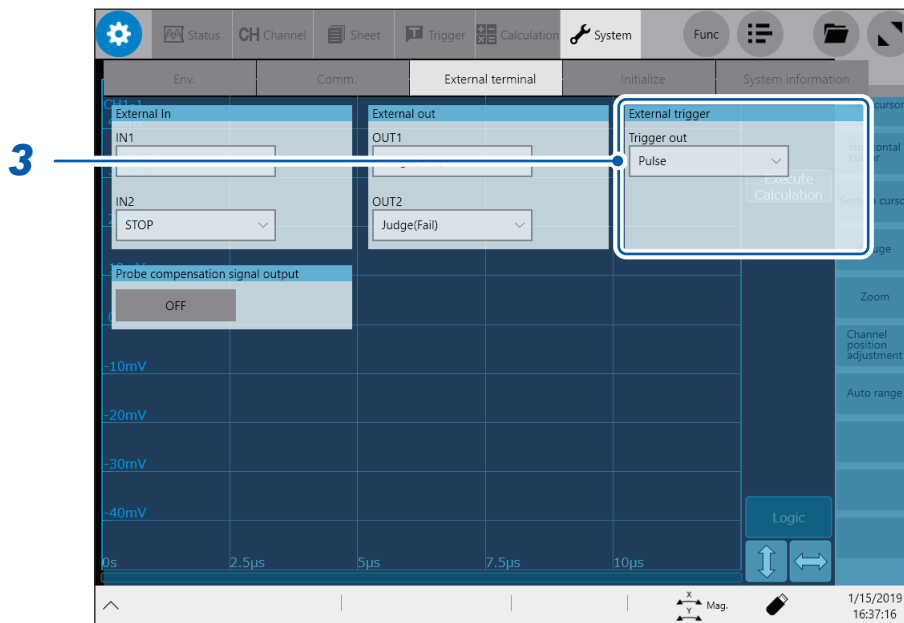

- 3 In the [External trigger] area, tap the [Trigger out] box, and then from the list, choose a signal output method (the signal is outputted through the trigger output terminal).

<b>Pulse</b> <input checked="" type="checkbox"/>	Outputs a low-level signal, and then switches it to the high level after the specified time has elapsed.
<b>Level</b>	Continuously outputs a low-level signal after triggered during the measurement..

When triggered, the instrument outputs a pulse wave, which switches from the high level (4.0 V to 5.0 V) to the low level (0 V to 0.5 V).

Output signal	Open-drain output (with voltage output), active low*
Output voltage range	High level: 4.0 V to 5.0 V Low level: 0 V to 0.5 V
Pulse width	With the pulse setting: 2 ms ± 1 ms When the level setting: (Sampling rate) × (Number of data points after trigger) or longer
Maximum input voltage	50 V DC, 50 mA, 200 mW

\*: The instrument is triggered when the signal voltage level switches from the high level to the low level.

## External Input and Output

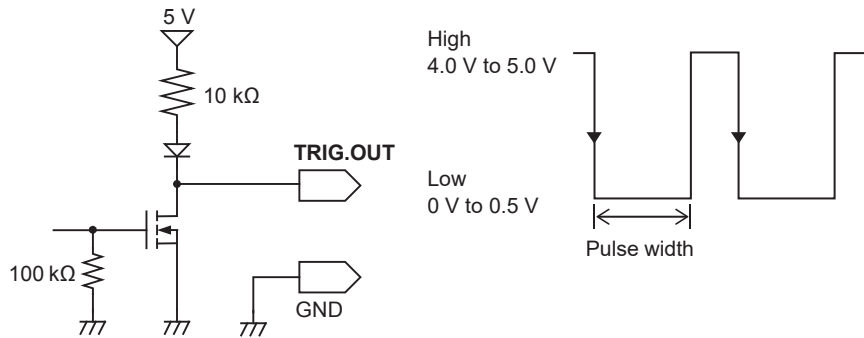

When the auto-range function is used, the instrument is triggered, outputting the TRIG.OUT signal. Be careful when performing auto-range measurement while using the TRIG.OUT signals.

During use of the memory division, the instrument may switch the trigger output (output signal from the TRIG\_OUT terminal) to the low level, or irregularly output signals.

- Sampling rate: 200 MS/s to 1 MS/s
- Recording (measuring) length: 5 ms or less



## External trigger terminal (EXT.TRIG)

Externally inputting the trigger signal can trigger the instrument. You can use this signal to control multiple instruments, achieving synchronous operation.

### How to an input signal

- 1 Connect each of the EXT.TRIG and GND terminals to an external signal-outputting device with wires.  
See "2.5 Connecting the External Control Terminals" in the Quick Start Manual.
- 2  > [Trigger] > [Common]
- 3 Tap the [Trigger] button to set it to [On].

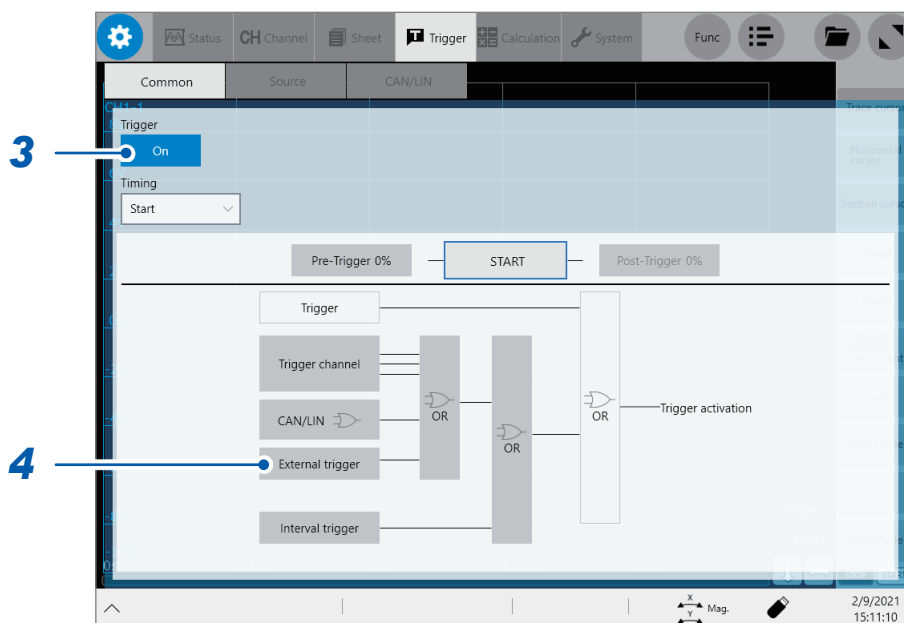

#### 4 Tap [External trigger].

The setting dialog box appears.

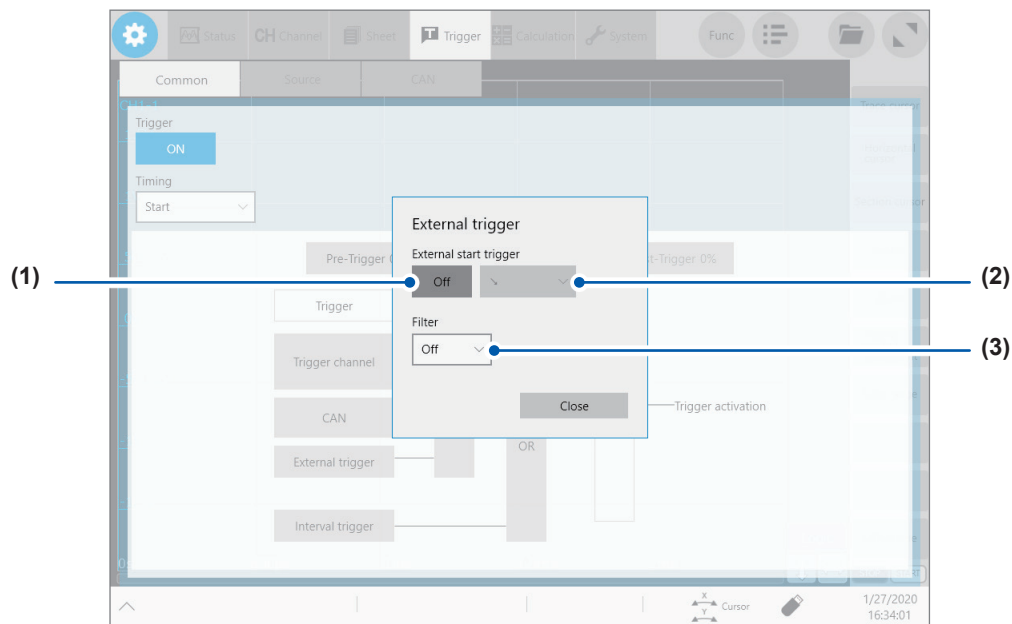

- (1) Tap the **[External start trigger]** button to set it to **[On]**.
  - (2) Tap the box to the right of the **[External start trigger]** box, and then from the list, choose which direction to used for reception of the external trigger.  
 To accept a rising edge: **[↗]**\*  
 To accept a falling edge: **[↘]**\*  
 To accept both a rising edge and falling edge: **[↗ & ↘]**\*
- \*: When the trigger satisfaction condition is set to **[AND]**, the instrument displays **[HIGH]** or **[LOW]** instead of them. You cannot set the trigger satisfaction condition to **[High or Low]**.
- (3) Tap the **[Filter]** box, and then from the list, choose a filter setting.  
 This setting can prevent noise and chattering from triggering the instrument unintentionally. Always set this setting to **[Off]** to synchronize multiple instruments using the external trigger.

<b>Off</b> <sup>□</sup>	Enables the chattering prevention filter.
<b>On</b>	Disables the chattering prevention filter.

**5** Connect the EXT.TRIG terminal and GND terminal with each other, or input pulse waves or square waves to the EXT.TRIG terminal. The wave have to be with a high-level voltage of between 2.5 V and 10 V and a low-level voltage of between 0 V and 0.8 V.

The instrument accepts an external trigger on the rising or falling edge of the input waveform.

Available voltage range	High level: 2.5 V to 10 V; low level: 0 V to 0.8 V	
Pulse width	Whit the filter disabled	High level: 1 ms or more; Low level: 2 $\mu$ s or more
	With the filter enabled	High and low level: 2.5 ms or more
Maximum input voltage	10 V DC	

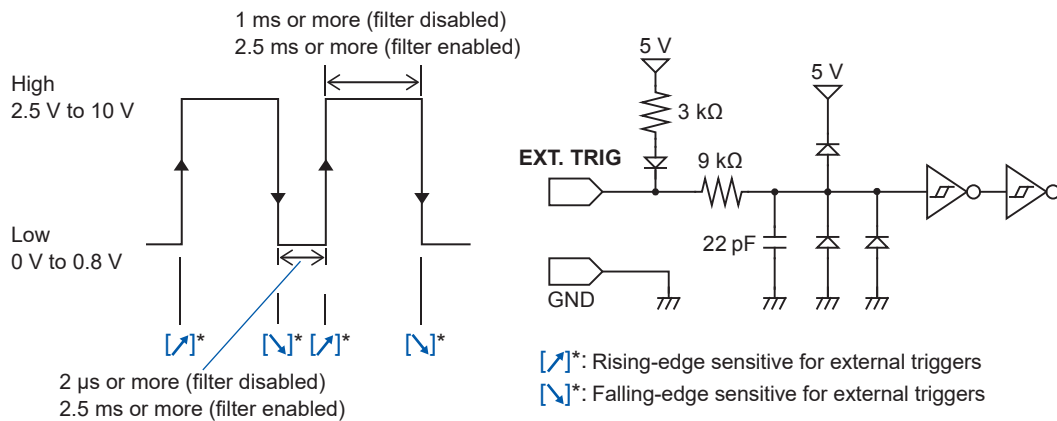

# 15.2 External Sampling (EXT.SMPL)

Externally inputting the signal allows you to set the sampling rate at any value.

## How to an input signal

**1** Connect the external sampling terminal of the instrument and the sampling signal-outputting device with the SMB cable.  
See “2.4 External Sampling (EXT.SMPL)” in the Quick Start Manual.

**2**  > [Status] > [Condition]

**3** Tap the [External sampling] button to set it to [On].

**4** Tap the box to the right of the [External sampling] box, and then from the list, choose which direction to used for reception of the external sampling signal.

To accept a rising edge: [↑]

To accept a falling edge: [↓]

To accept both a rising edge and falling edge: [↑&↓]

**5** Input pulse waves or square waves to the EXT.SMPL terminal. The waves have to be with a high-level voltage of between 2.5 V and 10 V and a low-level voltage of between 0 V and 0.8 V.

Available voltage range	High level: 2.5 V to 10 V; low level: 0 V to 0.8 V
Pulse width	High and low level: 50 ns or more
Response frequency	10 MHz or less
Maximum input voltage	10 V DC

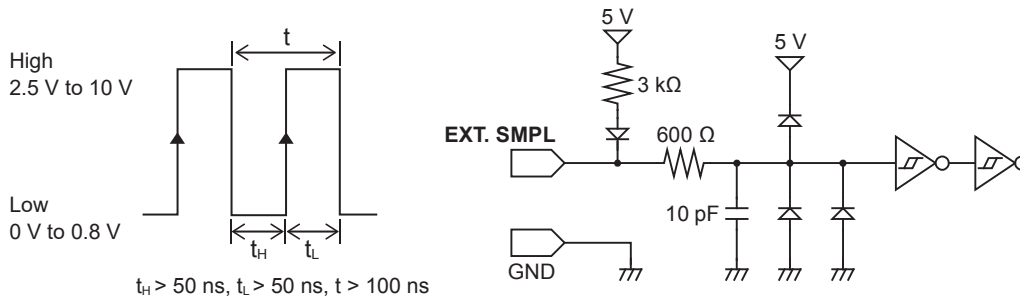

- If a sampling signal with 5 MHz or more is inputted, trigger points are delayed by one sample.
- Using Model 8968 High Resolution Unit disables the anti-aliasing filter even when you set [A.A.F.] to [On].

# 16 Appendix

## 16.1 Information for Reference Purposes

### Waveform file size (values for reference purposes)

#### MEM file size (waveforms acquired without using the envelope)

<p><b>(MEM file size) = (Setting part size) + (Data part size)</b>            (Setting part size) = 187392 + 512 × [(Number of analog channels) + 4 × (Number of logic channels) + (Number of real-time calculation channels)]            (Data part size) = {2 × [(Number of analog channels other than Model MR8990) + (Number of logic modules)] + 4 × [(Number of Model MR8990 channels) + (Number of real-time calculation channels)]} × (Number of data points)</p>
---

Recording length (Points)	Number of channels used					
	1	2	4	8	16	32
2.5 k	192 KB	198 KB	209 KB	231 KB	275 KB	363 KB
5 k	197 KB	208 KB	229 KB	271 KB	355 KB	523 KB
10 k	207 KB	228 KB	269 KB	351 KB	515 KB	843 KB
20 k	227 KB	268 KB	349 KB	511 KB	835 KB	1.5 MB
50 k	287 KB	388 KB	589 KB	991 KB	1.8 MB	3.4 MB
100 k	387 KB	588 KB	989 KB	1.8 MB	3.4 MB	6.6 MB
200 k	587 KB	988 KB	1.8 MB	3.4 MB	6.6 MB	13 MB
500 k	1.2 MB	2.2 MB	4.2 MB	8.2 MB	16.2 MB	32.2 MB
1 M	2.2 MB	4.2 MB	8.2 MB	16.2 MB	32.2 MB	64.2 MB
2 M	4.2 MB	8.2 MB	16.2 MB	32.2 MB	64.2 MB	128.2 MB
5 M	10.2 MB	20.2 MB	40.2 MB	80.2 MB	160.2 MB	320.2 MB
10 M	20.2 MB	40.2 MB	80.2 MB	160.2 MB	320.2 MB	640.2 MB
20 M	40.2 MB	80.2 MB	160.2 MB	320.2 MB	640.2 MB	1.28 GB
50 M	100.2 MB	200.2 MB	400.2 MB	800.2 MB	1.6 GB	–
100 M	200.2 MB	400.2 MB	800.2 MB	1.6 GB	–	–
200 M	400.2 MB	800.2 MB	1.6 GB	–	–	–
500 M	1 GB	2 GB	–	–	–	–
1 G	2 GB	–	–	–	–	–

- These sizes are of files that contain data acquired using analog channels (other than Model MR8990) and can be used only as a reference. Any number of logic channels on one module occupies one channel; one analog channel (Model MR8990) and one real-time calculation channel occupies two channels each.
- The instrument divides files with a size that exceeds 512 MB into multiple files of about 512 MB each to save them (except when the memory division is enabled).

**REC file size (waveforms acquired by using the envelope)**

<p><b>(REC file size) = (Setting part size) + (Data part size)</b>          (Setting part size) = 187392 + 512 × [(Number of analog channels) + 4 × (Number of logic channels) + (Number of real-time calculation channels)]          (Data part size) = {2 × [(Number of analog channels other than Model MR8990) + (Number of logic modules)] + 4 × [(Number of Model MR8990 channels) + (Number of real-time calculation channels)]} × (Number of data points) × 2</p>
---

Recording length (Points)	Number of channels used					
	1	2	4	8	16	32
2.5 k	197 KB	208 KB	229 KB	271 KB	355 KB	523 KB
5 k	207 KB	228 KB	269 KB	351 KB	515 KB	843 KB
10 k	227 KB	268 KB	349 KB	511 KB	835 KB	1.5 MB
20 k	267 KB	348 KB	509 KB	831 KB	1.5 MB	2.8 MB
50 k	387 KB	588 KB	989 KB	1.8 MB	3.4 MB	6.6 MB
100 k	587 KB	988 KB	1.8 MB	3.4 MB	6.6 MB	13 MB
200 k	987 KB	1.8 MB	34 MB	6.6 MB	13 MB	25.8 MB
500 k	2.2 MB	4.2 MB	8.2 MB	16.2 MB	32.2 MB	64.2 MB
1 M	4.2 MB	8.2 MB	16.2 MB	32.2 MB	64.2 MB	128.2 MB
2 M	8.2 MB	16.2 MB	32.2 MB	64.2 MB	128.2 MB	256.2 MB
5 M	20.2 MB	40.2 MB	80.2 MB	160.2 MB	320.2 MB	640.2 MB
10 M	40.2 MB	80.2 MB	160.2 MB	320.2 MB	640.2 MB	1.28 GB
20 M	80.2 MB	160.2 MB	320.2 MB	640.2 MB	1.28 GB	–
50 M	200.2 MB	400.2 MB	800.2 MB	1.6 GB	–	–
100 M	400.2 MB	800.2 MB	1.6 GB	–	–	–
200 M	800.2 MB	1.6 GB	–	–	–	–
500 M	2 GB	–	–	–	–	–

- These sizes are of files that contain data acquired using analog channels (other than Model MR8990) and can be used only as a reference. Any number of logic channels on one module occupies one channel; one analog channel (Model MR8990) and one real-time calculation channel occupies two channels each.
- The instrument divides files with a size that exceeds 512 MB into multiple files of about 512 MB each to save them (except when the memory division is enabled).

## Waveform (text) file size

### Size of files that contain data acquired without using the envelope

**(Text file size) = (Header part size) + (Data part size)**  
 (Header part size) = (About 14 KB at a maximum) (varies depending on the setting condition)  
 (Data part size) =  $[24 + 14 \times (\text{Number of analog channels}) + 32 \times (\text{Number of logic modules}) + 14 \times (\text{Number of real-time calculation channels})] \times (\text{Number of data points})$

Recording length (Points)	Number of channels used					
	1	2	4	8	16	32
2.5 k	235 KB	270 KB	340 KB	480 KB	760 KB	1.4 MB
5 k	330 KB	400 KB	540 KB	820 KB	1.4 MB	2.5 MB
10 k	520 KB	660 KB	940 KB	1.5 MB	2.7 MB	4.9 MB
20 k	900 KB	1.2 MB	1.8 MB	2.9 MB	5.1 MB	9.6 MB
50 k	2 MB	2.8 MB	4.2 MB	7 MB	12.6 MB	23.8 MB
100 k	4 MB	5.4 MB	8.2 MB	13.8 MB	25 MB	47.4 MB
200 k	7.8 MB	10.6 MB	16.2 MB	27.4 MB	49.8 MB	94.6 MB
500 k	19.2 MB	26.2 MB	40.2 MB	68.2 MB	124.2 MB	236.2 MB
1 M	38.2 MB	52.2 MB	80.2 MB	136.2 MB	248.2 MB	472.2 MB
2 M	76.2 MB	104.2 MB	160.2 MB	272.2 MB	496.2 MB	944.2 MB
5 M	190.2 MB	260.2 MB	400.2 MB	680.2 MB	1.24 GB	2.36 GB
10 M	380.2 MB	520.2 MB	800.2 MB	1.36 GB	2.48 GB	4.72 GB
20 M	760.2 MB	1.04 GB	1.6 GB	2.72 GB	4.96 GB	9.44 GB
50 M	1.9 GB	2.6 GB	4 GB	6.8 GB	12.4 GB	–
100 M	3.8 GB	5.2 GB	8 GB	13.6 GB	–	–
200 M	7.6 GB	10.4 GB	16 GB	–	–	–
500 M	19 GB	26 GB	–	–	–	–
1 G	38 GB	–	–	–	–	–

- These sizes are of files that contain data acquired using analog channels (other than Model MR8990) and can be used only as a reference.
- Depending on the setting conditions, the size may slightly differ from those provided in the above table. Allow 20% of the size provided in the above table for margin.
- The instrument divides files with a size that exceeds 512 MB into multiple files of about 512 MB each to save them.

**Size of files that contain acquired by using the envelope**

**(Text file size) = (Header part size) + (Data part size)**  
 (Header part size) = (About 14 KB at a maximum) (varies depending on the setting condition)  
 (Data part size) =  $24 + [14 \times (\text{Number of analog channels}) + 32 \times (\text{Number of logic modules}) + 14 \times (\text{Number of real-time calculation channels}) \times 2] \times (\text{Number of data points})$

Recording length (Points)	Number of channels used					
	1	2	4	8	16	32
2.5 k	270 KB	340 KB	480 KB	760 KB	1.4 MB	2.5 MB
5 k	400 KB	540 KB	820 KB	1.4 MB	2.5 MB	4.8 MB
10 k	660 KB	940 KB	1.5 MB	2.7 MB	4.9 MB	9.4 MB
20 k	1.2 MB	1.8 MB	2.9 MB	5.1 MB	9.6 MB	18.6 MB
50 k	2.8 MB	4.2 MB	7 MB	12.6 MB	23.8 MB	46.2 MB
100 k	5.4 MB	8.2 MB	13.8 MB	25 MB	47.4 MB	92.2 MB
200 k	10.6 MB	16.2 MB	27.4 MB	49.8 MB	94.6 MB	184.2 MB
500 k	26.2 MB	40.2 MB	68.2 MB	124.2 MB	236.2 MB	460.2 MB
1 M	52.2 MB	80.2 MB	136.2 MB	248.2 MB	472.2 MB	920.2 MB
2 M	104.2 MB	160.2 MB	272.2 MB	496.2 MB	944.2 MB	1.84 GB
5 M	260.2 MB	400.2 MB	680.2 MB	1.24 GB	2.36 GB	4.6 GB
10 M	520.2 MB	800.2 MB	1.36 GB	2.48 GB	4.72 GB	9.2 GB
20 M	1.04 GB	1.6 GB	2.72 GB	4.96 GB	9.44 GB	–
50 M	2.6 GB	4 GB	6.8 GB	12.4 GB	–	–
100 M	5.2 GB	8 GB	13.6 GB	–	–	–
200 M	10.4 GB	16 GB	–	–	–	–
500 M	26 GB	–	–	–	–	–

- These sizes are of files that contain data acquired using analog channels (other than Model MR8990) and can be used only as a reference.
- Depending on the setting conditions, the size may slightly differ from those provided in the above table. Allow 20% of the size provided in the above table for margin.
- The instrument divides files with a size that exceeds 512 MB into multiple files of about 512 MB each to save them.



## Maximum recordable time when the real-time saving is enabled (values for reference purposes)

The maximum recordable time is expressed in the following equation.

$$\begin{aligned}
 \text{(Maximum recordable time)} &= \frac{\text{[(Recording capacity) } \times \text{ (Sampling time)]}}{\text{[(Number of channels used) } \times \text{ 2]}} \\
 \text{(Number of channels used)} &= \text{[(Number of analog channels other than Model MR8990)} \\
 &\quad + \text{ (Number of logic modules) + (Number of Model MR8990 channels)] } \times \text{ 2} \\
 &\quad + \text{ (Number of real-time calculation channels) } \times \text{ 2}
 \end{aligned}$$

The maximum recordable times for saving data to each storage device are shown in the following table (assume that each storage device is empty). Since no capacity of the header of a waveform file is included, use about 90% of the recordable time provided in the table as a reference. Some conditions allow a long-term recordable time (1 year or more, shaded areas in the tables) to be set; however, the operation cannot be guaranteed because the warranty period or product life may disturb it.

### For saving data acquired without using the envelope on Model U8332 SSD Unit

d: days, h: hours, min: minutes, s: seconds

Sampling rate	Number of channels used				
	2	4	8	16	32
20 MS/s	53 min 20 s	–	–	–	–
10 MS/s	1 h 46 min 40 s	53 min 20 s	–	–	–
5 MS/s	3 h 33 min 20 s	1 h 46 min 40 s	53 min 20 s	–	–
2 MS/s	8 h 53 min 20 s	4 h 26 min 40 s	2 h 13 min 20 s	1 h 6 min 40 s	–
1 MS/s	17 h 46 min 40 s	8 h 53 min 20 s	4 h 26 min 40 s	2 h 13 min 20 s	1 h 6 min 40 s
500 kS/s	1 d 11 h 33 min 20 s	17 h 46 min 40 s	8 h 53 min 20 s	4 h 26 min 40 s	2 h 13 min 20 s
200 kS/s	3 d 16 h 53 min 20 s	1 d 20 h 26 min 40 s	22 h 13 min 20 s	11 h 6 min 40 s	5 h 33 min 20 s
100 kS/s	7 d 9 h 46 min 40 s	3 d 16 h 53 min 20 s	1 d 20 h 26 min 40 s	22 h 13 min 20 s	11 h 6 min 40 s
50 kS/s	14 d 19 h 33 min 20 s	7 d 9 h 46 min 40 s	3 d 16 h 53 min 20 s	1 d 20 h 26 min 40 s	22 h 13 min 20 s
20 kS/s	37 d 0 h 53 min 20 s	18 d 12 h 26 min 40 s	9 d 6 h 13 min 20 s	4 d 15 h 6 min 40 s	2 d 7 h 33 min 20 s
10 kS/s	74 d 1 h 46 min 40 s	37 d 0 h 53 min 20 s	18 d 12 h 26 min 40 s	9 d 6 h 13 min 20 s	4 d 15 h 6 min 40 s
5 kS/s	148 d 3 h 33 min 20 s	74 d 1 h 46 min 40 s	37 d 0 h 53 min 20 s	18 d 12 h 26 min 40 s	9 d 6 h 13 min 20 s
2 kS/s	370 d 8 h 53 min 20 s	185 d 4 h 26 min 40 s	92 d 14 h 13 min 20 s	46 d 7 h 6 min 40 s	23 d 3 h 33 min 20 s
1 kS/s	740 d 17 h 46 min 40 s	370 d 8 h 53 min 20 s	185 d 4 h 26 min 40 s	92 d 14 h 13 min 20 s	46 d 7 h 6 min 40 s
500 S/s	1481 d 11 h 33 min 20 s	740 d 17 h 46 min 40 s	370 d 8 h 53 min 20 s	185 d 4 h 26 min 40 s	92 d 14 h 13 min 20 s
200 S/s	3703 d 16 h 53 min 20 s	1851 d 20 h 26 min 40 s	925 d 22 h 13 min 20 s	462 d 23 h 6 min 40 s	231 d 11 h 33 min 20 s
100 S/s	7407 d 9 h 46 min 40 s	3703 d 16 h 53 min 20 s	1851 d 20 h 26 min 40 s	925 d 22 h 13 min 20 s	462 d 23 h 6 min 40 s
50 S/s	10000 d	7407 d 9 h 46 min 40 s	3703 d 16 h 53 min 20 s	1851 d 20 h 26 min 40 s	925 d 22 h 13 min 20 s
20 S/s	10000 d	10000 d	9259 d 6 h 13 min 20 s	4629 d 15 h 6 min 40 s	2314 d 19 h 33 min 20 s
10 S/s	10000 d	10000 d	10000 d	9259 d 6 h 13 min 20 s	4629 d 15 h 6 min 40 s
5 S/s	10000 d	10000 d	10000 d	10000 d	9259 d 6 h 13 min 20 s
2 S/s	10000 d	10000 d	10000 d	10000 d	10000 d
1 S/s	10000 d	10000 d	10000 d	10000 d	10000 d

## For saving data acquired without using the envelope on Model U8333 HD Unit

d: days, h: hours, min: minutes, s: seconds

Sampling rate	Number of channels used				
	2	4	8	16	32
10 MS/s	2 h 12 min 48 s	–	–	–	–
5 MS/s	4 h 25 min 36 s	2 h 12 min 48 s	–	–	–
2 MS/s	11 h 4 min 0 s	5 h 32 min 0 s	2 h 46 min 0 s	–	–
1 MS/s	22 h 8 min 1 s	11 h 4 min 0 s	5 h 32 min 0 s	2 h 46 min 0 s	–
500 kS/s	1 d 20 h 16 min 3 s	22 h 8 min 1 s	11 h 4 min 0 s	5 h 32 min 0 s	2 h 46 min 0 s
200 kS/s	4 d 14 h 40 min 8 s	2 d 7 h 20 min 4 s	1 d 3 h 40 min 2 s	13 h 50 min 1 s	6 h 55 min 0 s
100 kS/s	9 d 5 h 20 min 17 s	4 d 14 h 40 min 8 s	2 d 7 h 20 min 4 s	1 d 3 h 40 min 2 s	13 h 50 min 1 s
50 kS/s	18 d 10 h 40 min 35 s	9 h 20 min 17 s	4 d 14 h 40 min 8 s	2 d 7 h 20 min 4 s	1 d 3 h 40 min 2 s
20 kS/s	46 d 2 h 41 min 29 s	23 d 1 h 20 min 44 s	11 d 12 h 40 min 22 s	5 d 18 h 20 min 11 s	2 d 21 h 10 min 5 s
10 kS/s	92 d 5 h 22 min 59 s	46 d 2 h 41 min 29 s	23 d 1 h 20 min 44 s	11 d 12 h 40 min 22 s	5 d 18 h 20 min 11 s
5 kS/s	184 d 10 h 45 min 59 s	92 d 5 h 22 min 59 s	46 d 2 h 41 min 29 s	23 d 1 h 20 min 44 s	11 d 12 h 40 min 22 s
2 kS/s	461 d 2 h 54 min 57 s	230 d 13 h 27 min 28 s	115 d 6 h 43 min 44 s	57 d 15 h 21 min 52 s	28 d 19 h 40 min 56 s
1 kS/s	922 d 5 h 49 min 55 s	461 d 2 h 54 min 57 s	230 d 13 h 27 min 28 s	115 d 6 h 43 min 44 s	57 d 15 h 21 min 52 s
500 S/s	1844 d 11 h 39 min 50 s	922 d 5 h 49 min 55 s	461 d 2 h 54 min 57 s	230 d 13 h 27 min 28 s	115 d 6 h 43 min 44 s
200 S/s	4611 d 5 h 9 min 35 s	2305 d 14 h 34 min 47 s	1152 d 19 h 17 min 23 s	576 d 9 h 38 min 41 s	288 d 4 h 49 min 20 s
100 S/s	9222 d 10 h 19 min 10 s	4611 d 5 h 9 min 35 s	2305 d 14 h 34 min 47 s	1152 d 19 h 17 min 23 s	576 d 9 h 38 min 41 s
50 S/s	10000 d	9222 d 10 h 19 min 10 s	4611 d 5 h 9 min 35 s	2305 d 14 h 34 min 47 s	1152 d 19 h 17 min 23 s
20 S/s	10000 d	10000 d	10000 d	5764 d 0 h 26 min 59 s	2882 d 0 h 13 min 29 s
10 S/s	10000 d	10000 d	10000 d	10000 d	5764 d 0 h 26 min 59 s
5 S/s	10000 d	10000 d	10000 d	10000 d	10000 d
2 S/s	10000 d	10000 d	10000 d	10000 d	10000 d
1 S/s	10000 d	10000 d	10000 d	10000 d	10000 d

## For saving data acquired without using the envelope on Model Z4006 USB Drive

d: days, h: hours, min: minutes, s: seconds

Sampling rate	Number of channels used				
	2	4	8	16	32
5 MS/s	13 min 25 s	–	–	–	–
2 MS/s	33 min 32 s	16 min 46 s	–	–	–
1 MS/s	1 h 7 min 5 s	33 min 32 s	16 min 46 s	–	–
500 kS/s	2 h 14 min 10 s	1 h 7 min 5 s	33 min 32 s	16 min 46 s	–
200 kS/s	5 h 35 min 26 s	2 h 47 min 43 s	1 h 23 min 51 s	41 min 55 s	20 min 57 s
100 kS/s	11 h 10 min 53 s	5 h 35 min 26 s	2 h 47 min 43 s	1 h 23 min 51 s	41 min 55 s
50 kS/s	22 h 21 min 47 s	11 h 10 min 53 s	5 h 35 min 26 s	2 h 47 min 43 s	1 h 23 min 51 s
20 kS/s	2 d 7 h 54 min 28 s	1 d 3 h 57 min 14 s	13 h 58 min 37 s	6 h 59 min 18 s	3 h 29 min 39 s
10 kS/s	4 d 15 h 48 min 57 s	2 d 7 h 54 min 28 s	1 d 3 h 57 min 14 s	13 h 58 min 37 s	6 h 59 min 18 s
5 kS/s	9 d 7 h 37 min 55 s	4 d 15 h 48 min 57 s	2 d 7 h 54 min 28 s	1 d 3 h 57 min 14 s	13 h 58 min 37 s
2 kS/s	23 d 7 h 4 min 49 s	11 d 15 h 32 min 24 s	5 d 19 h 46 min 12 s	2 d 21 h 53 min 6 s	1 d 10 h 56 min 33 s
1 kS/s	46 d 14 h 9 min 38 s	23 d 7 h 4 min 49 s	11 d 15 h 32 min 24 s	5 d 19 h 46 min 12 s	2 d 21 h 53 min 6 s
500 S/s	93 d 4 h 19 min 17 s	46 d 14 h 9 min 38 s	23 d 7 h 4 min 49 s	11 d 15 h 32 min 24 s	5 d 19 h 46 min 12 s
200 S/s	232 d 22 h 48 min 14 s	116 d 11 h 24 min 7 s	58 d 5 h 42 min 3 s	29 d 2 h 51 min 1 s	14 d 13 h 25 min 30 s
100 S/s	465 d 21 h 36 min 28 s	232 d 22 h 48 min 14 s	116 d 11 h 24 min 7 s	58 d 5 h 42 min 3 s	29 d 2 h 51 min 1 s
50 S/s	931 d 19 h 12 min 56 s	465 d 21 h 36 min 28 s	232 d 22 h 48 min 14 s	116 d 11 h 24 min 7 s	58 d 5 h 42 min 3 s
20 S/s	2329 d 12 h 2 min 20 s	1164 d 18 h 1 min 10 s	582 d 9 h 0 min 35 s	291 d 4 h 30 min 17 s	145 d 14 h 15 min 8 s
10 S/s	4659 d 0 h 4 min 41 s	2329 d 12 h 2 min 20 s	1164 d 18 h 1 min 10 s	582 d 9 h 0 min 35 s	291 d 4 h 30 min 17 s
5 S/s	9318 d 0 h 9 min 23 s	4659 d 0 h 4 min 41 s	2329 d 12 h 2 min 20 s	1164 d 18 h 1 min 10 s	582 d 9 h 0 min 35 s
2 S/s	10000 d	10000 d	5823 d 18 h 5 min 52 s	2911 d 21 h 2 min 56 s	1455 d 22 h 31 min 28 s
1 S/s	10000 d	10000 d	10000 d	5823 d 18 h 5 min 52 s	2911 d 21 h 2 min 56 s

- When saving data in Model Z4003 SD memory card, consider the recordable time to be about half the time provided in the above table as a reference.
- When saving data in Model Z4001 SD memory card, consider the recording to be about 1/8 of the time provided in the above table as a reference.

### For saving data acquired by using the envelope on Model U8332 SSD Unit

d: days, h: hours, min: minutes, s: seconds

Sampling rate	Number of channels used				
	2	4	8	16	32
10 MS/s	53 min 20 s	–	–	–	–
5 MS/s	1 h 46 min 40 s	53 min 20 s	–	–	–
2 MS/s	4 h 26 min 40 s	2 h 13 min 20 s	1 h 6 min 40 s	–	–
1 MS/s	8 h 53 min 20 s	4 h 26 min 40 s	2 h 13 min 20 s	1 h 6 min 40 s	–
500 kS/s	17 h 46 min 40 s	8 h 53 min 20 s	4 h 26 min 40 s	2 h 13 min 20 s	1 h 6 min 40 s
200 kS/s	1 d 20 h 26 min 40 s	22 h 13 min 20 s	11 h 6 min 40 s	5 h 33 min 20 s	2 h 46 min 40 s
100 kS/s	3 d 16 h 53 min 20 s	1 d 20 h 26 min 40 s	22 h 13 min 20 s	11 h 6 min 40 s	5 h 33 min 20 s
50 kS/s	7 d 9 h 46 min 40 s	3 d 16 h 53 min 20 s	1 d 20 h 26 min 40 s	22 h 13 min 20 s	11 h 6 min 40 s
20 kS/s	18 d 12 h 26 min 40 s	9 d 6 h 13 min 20 s	4 d 15 h 6 min 40 s	2 d 7 h 33 min 20 s	1 d 3 h 46 min 40 s
10 kS/s	37 d 0 h 53 min 20 s	18 d 12 h 26 min 40 s	9 d 6 h 13 min 20 s	4 d 15 h 6 min 40 s	2 d 7 h 33 min 20 s
5 kS/s	74 d 1 h 46 min 40 s	37 d 0 h 53 min 20 s	18 d 12 h 26 min 40 s	9 d 6 h 13 min 20 s	4 d 15 h 6 min 40 s
2 kS/s	185 d 4 h 26 min 40 s	92 d 14 h 13 min 20 s	46 d 7 h 6 min 40 s	23 d 3 h 33 min 20 s	11 d 13 h 46 min 40 s
1 kS/s	370 d 8 h 53 min 20 s	185 d 4 h 26 min 40 s	92 d 14 h 13 min 20 s	46 d 7 h 6 min 40 s	23 d 3 h 33 min 20 s
500 S/s	740 d 17 h 46 min 40 s	370 d 8 h 53 min 20 s	185 d 4 h 26 min 40 s	92 d 14 h 13 min 20 s	46 d 7 h 6 min 40 s
200 S/s	1851 d 20 h 26 min 40 s	925 d 22 h 13 min 20 s	462 d 23 h 6 min 40 s	231 d 11 h 33 min 20 s	115 d 17 h 46 min 40 s
100 S/s	3703 d 16 h 53 min 20 s	1851 d 20 h 26 min 40 s	925 d 22 h 13 min 20 s	462 d 23 h 6 min 40 s	231 d 11 h 33 min 20 s
50 S/s	7407 d 9 h 46 min 40 s	3703 d 16 h 53 min 20 s	1851 d 20 h 26 min 40 s	925 d 22 h 13 min 20 s	462 d 23 h 6 min 40 s
20 S/s	10000 d	9259 d 6 h 13 min 20 s	4629 d 15 h 6 min 40 s	2314 d 19 h 33 min 20 s	1157 d 9 h 46 min 40 s
10 S/s	10000 d	10000 d	9259 d 6 h 13 min 20 s	4629 d 15 h 6 min 40 s	2314 d 19 h 33 min 20 s
5 S/s	10000 d	10000 d	10000 d	9259 d 6 h 13 min 20 s	4629 d 15 h 6 min 40 s
2 S/s	10000 d	10000 d	10000 d	10000 d	10000 d
1 S/s	10000 d	10000 d	10000 d	10000 d	10000 d
30 S/min	10000 d	10000 d	10000 d	10000 d	10000 d
12 S/min	10000 d	10000 d	10000 d	10000 d	10000 d
6 S/min	10000 d	10000 d	10000 d	10000 d	10000 d
2 S/min	10000 d	10000 d	10000 d	10000 d	10000 d
1 S/min	10000 d	10000 d	10000 d	10000 d	10000 d

**For saving data acquired without using the envelope on Model U8333 HD Unit**

d: days, h: hours, min: minutes, s: seconds

Sampling rate	Number of channels used				
	2	4	8	16	32
5 MS/s	2 h 12 min 48 s	–	–	–	–
2 MS/s	5 h 32 min 0 s	2 h 46 min 0 s	–	–	–
1 MS/s	11 h 4 min 0 s	5 h 32 min 0 s	2 h 46 min 0 s	–	–
500 kS/s	22 h 8 min 1 s	11 h 4 min 0 s	5 h 32 min 0 s	2 h 46 min 0 s	–
200 kS/s	2 d 7 h 20 min 4 s	1 d 3 h 40 min 2 s	13 h 50 min 1 s	6 h 55 min 0 s	3 h 27 min 30 s
100 kS/s	4 d 14 h 40 min 8 s	2 d 7 h 20 min 4 s	1 d 3 h 40 min 2 s	13 h 50 min 1 s	6 h 55 min 0 s
50 kS/s	9 d 5 h 20 min 17 s	4 d 14 h 40 min 8 s	2 d 7 h 20 min 4 s	1 d 3 h 40 min 2 s	13 h 50 min 1 s
20 kS/s	23 d 1 h 20 min 44 s	11 d 12 h 40 min 22 s	5 d 18 h 20 min 11 s	2 d 21 h 10 min 5 s	1 d 10 h 35 min 2 s
10 kS/s	46 d 2 h 41 min 29 s	23 d 1 h 20 min 44 s	11 d 12 h 40 min 22 s	5 d 18 h 20 min 11 s	2 d 21 h 10 min 5 s
5 kS/s	92 d 5 h 22 min 59 s	46 d 2 h 41 min 29 s	23 d 1 h 20 min 44 s	11 d 12 h 40 min 22 s	5 d 18 h 20 min 11 s
2 kS/s	230 d 13 h 27 min 28 s	115 d 6 h 43 min 44 s	57 d 15 h 21 min 52 s	28 d 19 h 40 min 56 s	14 d 9 h 50 min 28 s
1 kS/s	461 d 2 h 54 min 57 s	230 d 13 h 27 min 28 s	115 d 6 h 43 min 44 s	57 d 15 h 21 min 52 s	28 d 19 h 40 min 56 s
500 S/s	922 d 5 h 49 min 55 s	461 d 2 h 54 min 57 s	230 d 13 h 27 min 28 s	115 d 6 h 43 min 44 s	57 d 15 h 21 min 52 s
200 S/s	2305 d 14 h 34 min 47 s	1152 d 19 h 17 min 23 s	576 d 9 h 38 min 41 s	288 d 4 h 49 min 20 s	144 d 2 h 24 min 40 s
100 S/s	4611 d 5 h 9 min 35 s	2305 d 14 h 34 min 47 s	1152 d 19 h 17 min 23 s	576 d 9 h 38 min 41 s	288 d 4 h 49 min 20 s
50 S/s	9222 d 10 h 19 min 10 s	4611 d 5 h 9 min 35 s	2305 d 14 h 34 min 47 s	1152 d 19 h 17 min 23 s	576 d 9 h 38 min 41 s
20 S/s	10000 d	10000 d	5764 d 0 h 26 min 59 s	2882 d 0 h 13 min 29 s	1441 d 0 h 6 min 44 s
10 S/s	10000 d	10000 d	10000 d	5764 d 0 h 26 min 59 s	2882 d 0 h 13 min 29 s
5 S/s	10000 d	10000 d	10000 d	10000 d	5764 d 0 h 26 min 59 s
2 S/s	10000 d	10000 d	10000 d	10000 d	10000 d
1 S/s	10000 d	10000 d	10000 d	10000 d	10000 d
30 S/min	10000 d	10000 d	10000 d	10000 d	10000 d
12 S/min	10000 d	10000 d	10000 d	10000 d	10000 d
6 S/min	10000 d	10000 d	10000 d	10000 d	10000 d
2 S/min	10000 d	10000 d	10000 d	10000 d	10000 d
1 S/min	10000 d	10000 d	10000 d	10000 d	10000 d

## For saving data acquired by using the envelope on Model Z4006 USB Drive

d: days, h: hours, min: minutes, s: seconds

Sampling rate	Number of channels used				
	2	4	8	16	32
2 MS/s	17 m 53 s	–	–	–	–
1 MS/s	35 m 47 s	17 m 53 s	–	–	–
500 kS/s	1 h 11 m 34 s	53 m 47 s	17 m 53 s	–	–
200 kS/s	2 h 58 m 57 s	1 h 29 m 28 s	44 m 44 s	22 m 22 s	–
100 kS/s	5 h 57 m 54 s	2 h 58 m 57 s	1 h 29 m 28 s	44 m 44 s	22 m 22 s
50 kS/s	11 h 55 m 49 s	5 h 57 m 54 s	2 h 58 m 57 s	1 h 29 m 28 s	44 m 44 s
20 kS/s	1 d 5 h 49 m 34 s	14 h 54 m 47 s	7 h 27 m 23 s	3 h 43 m 41 s	1 h 51 m 50 s
10 kS/s	2 d 11 h 39 m 8 s	1 d 5 h 49 m 34 s	14 h 54 m 47 s	7 h 27 m 23 s	3 h 43 m 41 s
5 kS/s	4 d 23 h 18 m 16 s	2 d 11 h 39 m 8 s	1 d 5 h 49 m 34 s	14 h 54 m 47 s	7 h 27 m 23 s
2 kS/s	12 d 10 h 15 m 41 s	6 d 5 h 7 m 50 s	3 d 2 h 33 m 55 s	1 d 13 h 16 m 57 s	18 h 38 m 28 s
1 kS/s	24 d 20 h 31 m 23 s	12 d 10 h 15 m 41 s	6 d 5 h 7 m 50 s	3 d 2 h 33 m 55 s	1 d 13 h 16 m 57 s
500 S/s	49 d 17 h 2 m 47 s	24 d 20 h 31 m 23 s	12 d 10 h 15 m 41 s	6 d 5 h 7 m 50 s	3 d 2 h 33 m 55 s
200 S/s	124 d 6 h 36 m 58 s	62 d 3 h 18 m 29 s	31 d 1 h 39 m 14 s	15 d 12 h 49 m 37 s	7 d 18 h 24 m 48 s
100 S/s	248 d 13 h 13 m 56 s	124 d 6 h 36 m 58 s	62 d 3 h 18 m 29 s	31 d 1 h 39 m 14 s	15 d 12 h 49 m 37 s
50 S/s	497 d 2 h 27 m 52 s	248 d 13 h 13 m 56 s	124 d 6 h 36 m 58 s	62 d 3 h 18 m 29 s	31 d 1 h 39 m 14 s
20 S/s	1242 d 18 h 9 m 42 s	621 d 9 h 4 m 51 s	310 d 16 h 32 m 25 s	155 d 8 h 16 m 12 s	77 d 16 h 8 m 6 s
10 S/s	2485 d 12 h 19 m 24 s	1242 d 18 h 9 m 42 s	621 d 9 h 4 m 51 s	310 d 16 h 32 m 25 s	155 d 8 h 16 m 12 s
5 S/s	4971 d 0 h 38 m 49 s	2485 d 12 h 19 m 24 s	1242 d 18 h 9 m 42 s	621 d 9 h 4 m 51 s	310 d 16 h 32 m 25 s
2 S/s	10000 d	6213 d 18 h 48 m 32 s	3106 d 21 h 24 m 16 s	1553 d 10 h 42 m 8 s	776 d 17 h 21 m 4 s
1 S/s	10000 d	10000 d	6213 d 18 h 48 m 32 s	3106 d 21 h 24 m 16 s	1553 d 10 h 42 m 8 s
30 S/min	10000 d	10000 d	10000 d	6213 d 18 h 48 m 32 s	3106 d 21 h 24 m 16 s
12 S/min	10000 d	10000 d	10000 d	10000 d	7767 d 5 h 30 m 40 s
6 S/min	10000 d	10000 d	10000 d	10000 d	10000 d
2 S/min	10000 d	10000 d	10000 d	10000 d	10000 d
1 S/min	10000 d	10000 d	10000 d	10000 d	10000 d

- When saving data in Model Z4003 SD memory card, consider the recordable time to be about 1/2 of the time provided in the above table as a reference.
- When saving data in Model Z4001 SD memory card, consider the recording to be about 1/8 of the time provided in the above table as a reference.

## Scaling method for strain gauges

This section describes how to determine the scaling conversion ratio when measurement is performed with strain gauges and Model U8969 Strain Unit.

The appropriate conversion equation into stress varies depending on how the strain gauges are used.

Three methods are available: the 1-gauge (for a gauge), 2-gauge (for two gauges), and 4-gauge methods (for four gauges). The 2-gauge method is used for strain measurement involving temperature compensation.

E: Young's modulus,  $\nu$ : Poisson's ratio,  $\varepsilon$ : Measured strain value

### Measuring tensile and compressive stress: $\text{Stress } (\sigma) = E \times \varepsilon$

When 2- or 4-gauge method measurement is performed involving temperature compensation, position the gauges perpendicularly to each other.

The stress ( $\sigma$ ) is multiplied by  $1 / (1 + \nu)$  for the 2-gauge method, and  $1 / [2 (1 + \nu)]$  for the 4-gauge method.

### Measuring bending stress: $\text{Stress } (\sigma) = E \times \varepsilon$

When 2- or 4-gauge measurement is performed involving temperature compensation, the stress ( $\sigma$ ) is multiplied by 1/2 or 1/4, respectively.

### Measuring torsional stress: $\text{Stress } (\sigma) = E / [2 (1 + \nu)] \times \varepsilon$ (2-gauge method)

When the 4-gauge method is used, the stress is halved.

See the instruction manual of the strain gauge for how to combine strain gauges for each measurement.

Example: Measuring compressive stress

Using the 1-gauge method, material of measured object: aluminum, Young's modulus: 73 (GPa)  
(See the table below.)

$$\sigma = 73 \times 10^9 \times (\text{Measured value}) \times 10^{-6} \quad (\text{unit of measured value: } \mu\varepsilon)$$

$$= 73 \times (\text{Measured value}) \quad (\text{unit: kPa})$$

$$= 7.44^* \times (\text{Measured value}) \quad (\text{unit: gf/mm}^2)$$

$$*: 1 \text{ Pa} = 1.01971621 \times 10^{-7} \text{ kgf/mm}^2 = 1 \text{ N/m}^2$$

Conversion ratio: 7.44, unit: gf/mm<sup>2</sup>

Enter this value as the scaling conversion ratio.

**Mechanical properties of industrial materials**

Material	Modulus of longitudinal elasticity (Young's modulus)	Poisson's ratio
	E (GPa)	$\nu$
Carbon steel (Carbon content: 0.1% to 0.25%)	205	0.28 to 0.3
Carbon steel (Carbon content: 0.25% or more)	206	0.28 to 0.3
Spring steel (Quenched)	206 to 211	0.28 to 0.3
Nickel steel	205	0.28 to 0.3
Cast iron	98	0.2 to 0.29
Brass (Cast)	78	0.34
Phosphor bronze	118	0.38
Aluminum	73	0.34
Concrete	20 to 29	0.1

See "3.2 Converting Input Values (Scaling Function)" (p. 56).



## Example of a waveform text file

The waveform text file consists of a header and data.  
The header includes the following information:

- (1) **Title comment**
- (2) **Recording length, sampling rate, trigger time**
- (3) **Channel number, module type, measurement range, LPF, channel comment, scaling (setting, conversion ratio, offset), invert**

## Example of a saved file (data acquired without using the envelope)

```
"Title comment"..... (1)
"Rec length","Sampling","Trigger Time"
"2500 sample","1MS/s","17/09/20 16:42:07.044" ..... (2)

"Channel","Mode","Range(f.s.)","L.P.F.","Comment","Scaling","Ratio","Offset","Invert"
"CH1-1","VOLTAGE","10V","OFF","Analog 1-1","OFF","-","-","OFF" ..... (3)
"CH1-2","VOLTAGE","100mV","OFF","Analog 1-2","OFF","-","-","OFF"
"CH2-1","K","200^cC","---","Temperature 1","ON(SCI)","2.1568E+00","4.9874E+00","OFF"
"CH2-2","K","200^cC","---","Temperature 2","OFF","-","-","ON"
"CH3-1","VOLTAGE","10V","---","Digital Voltmeter Unit 3-1","ON(ENG)","2.4178E+00","1.0254E+01","OFF"
"CH3-2","VOLTAGE","10V","---","Digital Voltmeter Unit 3-2","OFF","-","-","ON"
"L4 A1","-","-","-","4LA1","-","-","-","-"
"L4 A2","-","-","-","4LA2","-","-","-","-"
"L4 A3","-","-","-","4LA3","-","-","-","-"
"L4 A4","-","-","-","4LA4","-","-","-","-"

"Time[s]","CH1-1[V]","CH1-2[V]","CH2-1[^cC]","CH2-2[^cC]","CH3-1[V]","CH3-2[V]","L4A1","L4A2","L4A3","L4A4"
+0.000000000E+00,+1.510000E+00,-3.000000E-04,+3.997600E+02,+3.997600E+02,-9.997559E-03,-9.340576E-02,1,1,1,1,1
+1.000000000E-06,+1.510000E+00,-2.500000E-04,+3.997600E+02,+3.997600E+02,-9.997559E-03,-9.340576E-02,1,1,1,1,1
0.000000000E-06,+1.510000E+00,-3.000000E-04,+3.997600E+02,+3.997600E+02,-9.997559E-03,-9.340576E-02,1,1,1,1,1
+3.000000000E-06,+1.440000E+00,+3.500000E-04,+3.997600E+02,+3.997600E+02,-9.997559E-03,-9.340576E-02,1,1,1,1,1
+4.000000000E-06,+1.430000E+00,+2.000000E-04,+3.997600E+02,+3.997600E+02,-9.997559E-03,-9.340576E-02,1,1,1,1,1
```

## File saving rates (values for reference purposes)

The instruments can save waveform binary files onto either of Hioki's optional storage devices or through LAN at the following saving rates:

Storage device	Saving rate (value for reference purposes)
Model U8332 SSD Unit	40 MB/s
Model U8333 HD Unit	20 MB/s
Model Z4006 USB Drive (using USB 3.0 connector)	12 MB/s
Model Z4006 USB Drive (using USB 2.0 connector)	10 MB/s
Z4001 SD Memory Card (2 GB)	12 MB/s
Z4003 SD Memory Card (8 GB)	20 MB/s
LAN (FTP client)	8 MB/s

- When saved files containing two channels of data, the instrument can save them at the rates on the table. As the number of channels increases, the size of a data set increases. Although saving the data set requires longer, the saving rate will increase because a more extensive data set can be transferred at once.
- When LAN is used, the saving rate is greatly impacted by connection conditions.

## 16.2 FFT Definitions

The FFT, which stands for fast Fourier transform, is an efficient method to compute the DFT (discrete Fourier transform) from a time-domain waveform. The reverse process of transforming frequency data obtained through the FFT into its original time-domain waveform is called the IFFT (Inverse FFT). The FFT function performs various analyses using FFT and IFFT.

### Time and frequency domain considerations

All signals inputted to the instrument are functions of time. These functions can be considered as a combination of sine waves at various frequencies, such as in the following diagram. Although observing a signal only as a the time-domain waveform may be difficult to analyze, you can easily understand its characteristics by transforming it into a frequency-domain graph.

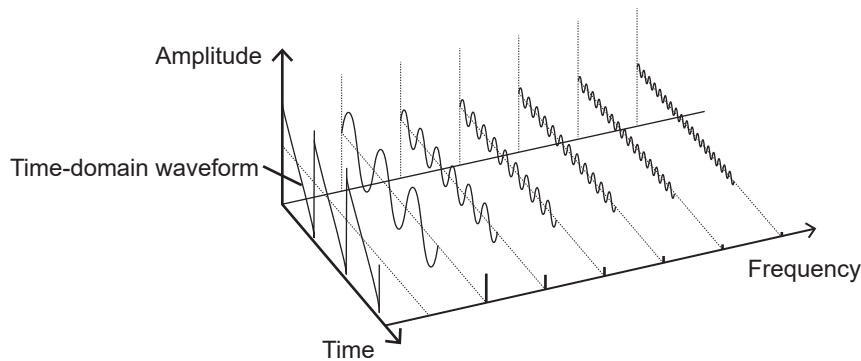

### Discrete Fourier transform and inverse discrete Fourier transform

Let  $x(n)$  denote a discrete signal,  $X(k)$  denote its discrete Fourier transform (DFT), and  $N$  denote the number of calculation points. The relationships among them are as follows:

$$X(k) = DFT\{x(n)\} = \sum_{n=0}^{N-1} x(n)W_N^{kn} \dots\dots\dots(1)$$

$$x(n) = IDFT\{X(k)\} = \frac{1}{N} \sum_{k=0}^{N-1} X(k)W_N^{-kn} \dots\dots\dots(2)$$

$$W_N = \exp\left(-j\frac{2\pi}{N}\right) \dots\dots\dots(3)$$

The discrete signal  $X(k)$  is typically a complex number, thus expression (1) can be transformed again and written as follows:

$$F(k) = |F(k)|\exp\{j\phi(k)\} = |F(k)|\angle\phi(k) \dots\dots\dots(4)$$

$$\phi(k) = \tan^{-1} \frac{\text{Im}\{X(k)\}}{\text{Re}\{X(k)\}} \dots\dots\dots(5)$$

$|F(k)|$  : Altitude spectrum,  $\phi(k)$  : Phase spectrum

The above relationships are represented on the following complex plane.

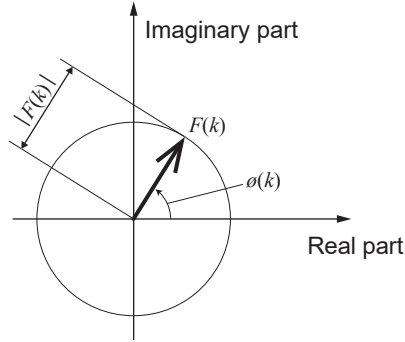

**Linear time-invariant system**

Consider a linear time-invariant (LTI) system that produces a response  $y(n)$  to a discrete time-domain signal  $x(n)$ .

The linear time-invariant system (hereafter referred to as LTI system) is a system in which the following expression holds for any integer  $A_i$  where the equation  $y_i(n) = L[x_i(n)]$  is the response to  $x_i(n)$ .

$$L[A_1x_1(n) + A_2x_2(n)] = A_1y_1(n) + A_2y_2(n) \dots \dots \dots (6)$$

Let  $h(n)$  denote a system function of the LTI system, the relationship between an input and output is given by the following expression.

$$y(n) = \sum_{m=0}^{\infty} h(m)x(n - m) = \sum_{m=-\infty}^{\infty} h(n - m)x(m) \dots \dots \dots (7)$$

Assign a unit impulse  $\delta(n)$  (1 for  $n = 0$ , 0 for other numbers) to  $x(n)$ , and the following expression holds.

$$y(n) = h(n) \dots \dots \dots (8)$$

Thus, applying the unit impulse to the input signal allows the LTI system characteristics to absolutely outputs. The response waveform of a system to a unit impulse is called the impulse response.

On the other hand, where the discrete Fourier transforms of  $x(n)$ ,  $y(n)$ , and  $h(n)$  are  $X(k)$ ,  $Y(k)$ , and  $H(k)$ , respectively, expression (7) can be written as follows:

$$Y(k) = X(k)H(k) \dots \dots \dots (9)$$

The function  $H(k)$  is also called the transfer function, which is calculated from  $X(k)$  and  $Y(k)$ . Also, the inverse discrete Fourier transform function of  $H(k)$  is the unit impulse response  $h(n)$  of the LTI system.

The instrument calculates an impulse response and a transfer function using the relationships of expression (9).

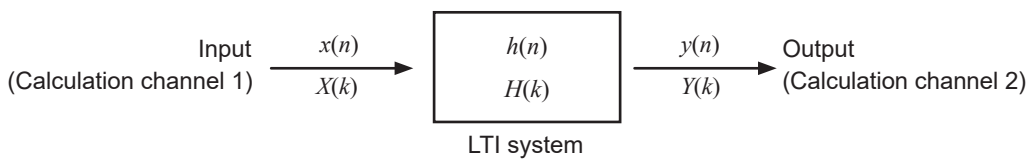

## Aliasing

When a measured signal oscillates at a higher frequency compared to the sampling rate you have chosen, the instrument may plot a false waveform oscillating lower than the actual signal with respect to a frequency once the signal frequency reaches a certain level. This phenomena, which occurs when a signal is sampled at a lower frequency than that defined by the Nyquist-Shannon sampling theorem, is called aliasing.

Let  $f_{max}$  denote the highest frequency component of an input signal, and  $f_s$  denote a sampling frequency. The following expression have to stand.

$$f_s = 2f_{max} \dots\dots\dots (10)$$

Thus, if the input includes frequency components higher than  $f_s / 2$ , a lower frequency component folds higher frequency components, resulting in an occurrence of false frequency components.

The following figures show the results of spectrum analysis of composite waveforms that have components of 1 kHz and 3 kHz, and of 1 kHz and 7 kHz.

If the instrument samples a signal that has frequency components of above 5 kHz (in this case, 7 kHz) at the sampling frequency  $f_s$  of 10 kHz, folded spectral components of 5 kHz or lower are observed.

This example demonstrates that the difference between the 3 kHz and 7 kHz components is indistinguishable from one another.

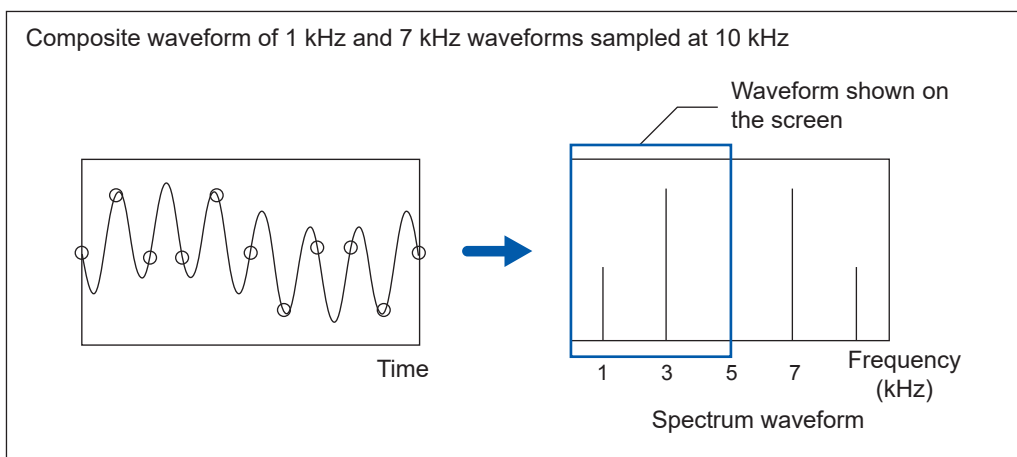
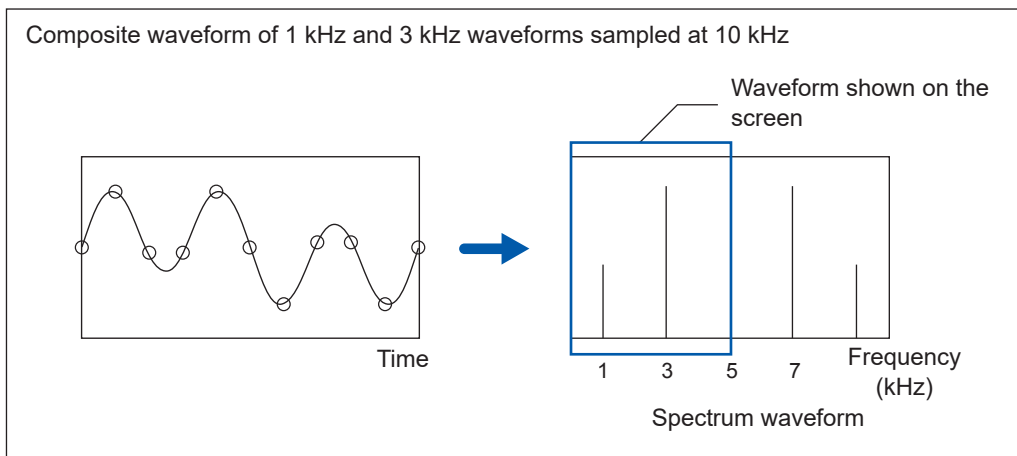

### Anti-aliasing filter

An input signal causes aliasing if it includes the maximum frequency component higher than half the sampling frequency. Countermeasures against aliasing includes using a low-pass filter that eliminates frequency components higher than half the sampling frequency. This low-pass filter is called the anti-aliasing filter.

The figures below shows the effect of use of an anti-aliasing filter for a square wave input waveform.

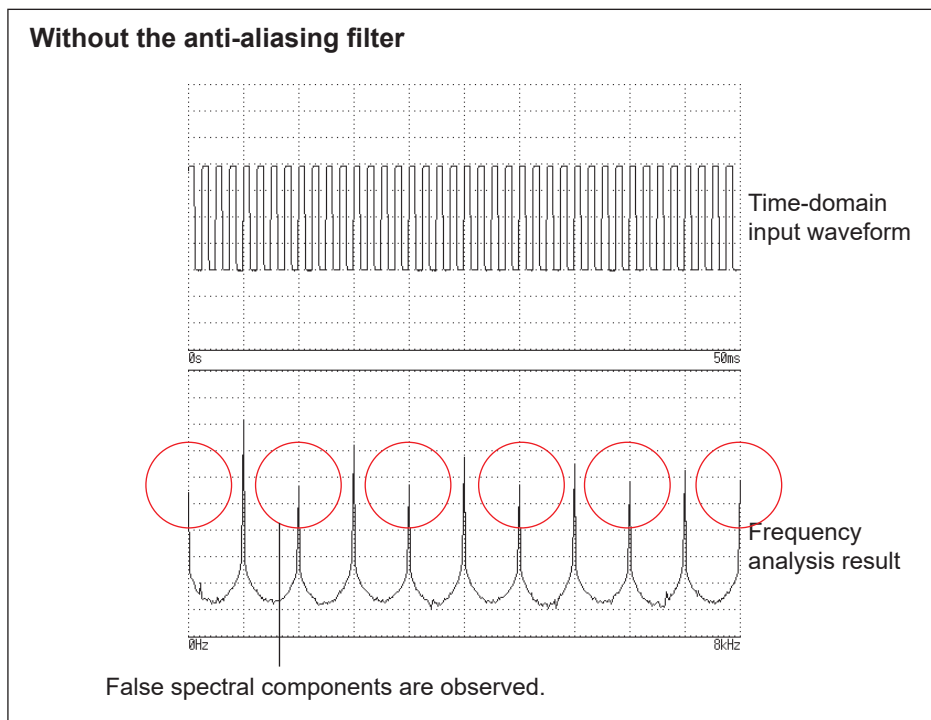
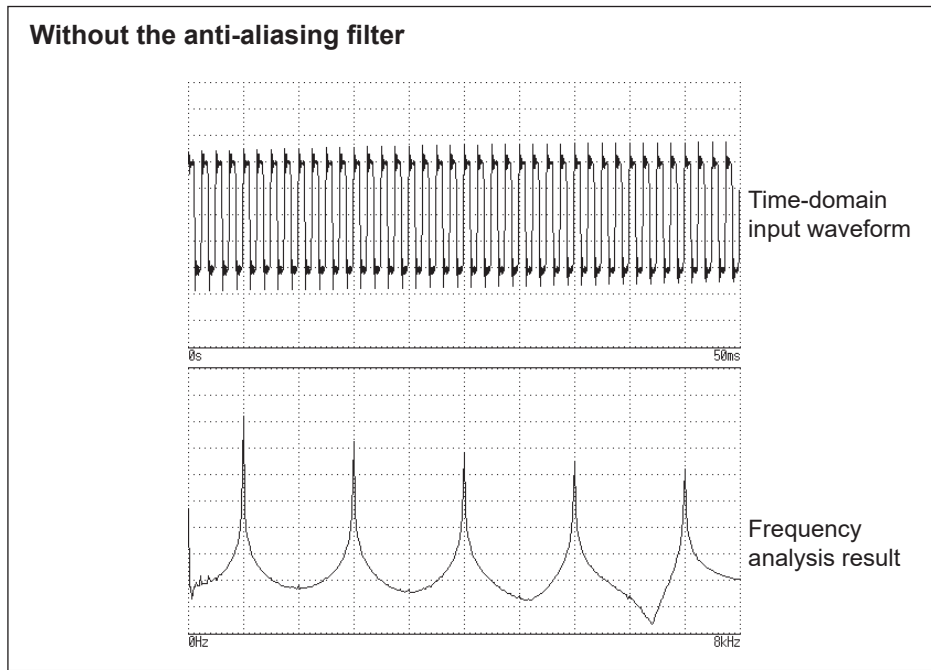

## Imaging

If the instrument is configured with a frequency range that exceeds the maximum sampling frequency defined for each unit, multiple sampled data points will be arrayed and interpolated by creating intermediate data. In this case, the time-axis waveform will exhibit a stepped shape. If FFT analysis is performed under these conditions, spectra that do not actually exist will be observed at high frequencies. This phenomenon, known as imaging, is caused by 0-order hold characteristics.

The figure below depicts the time-axis waveform and spectra when a sine wave is applied to the 8968 High Resolution Unit.

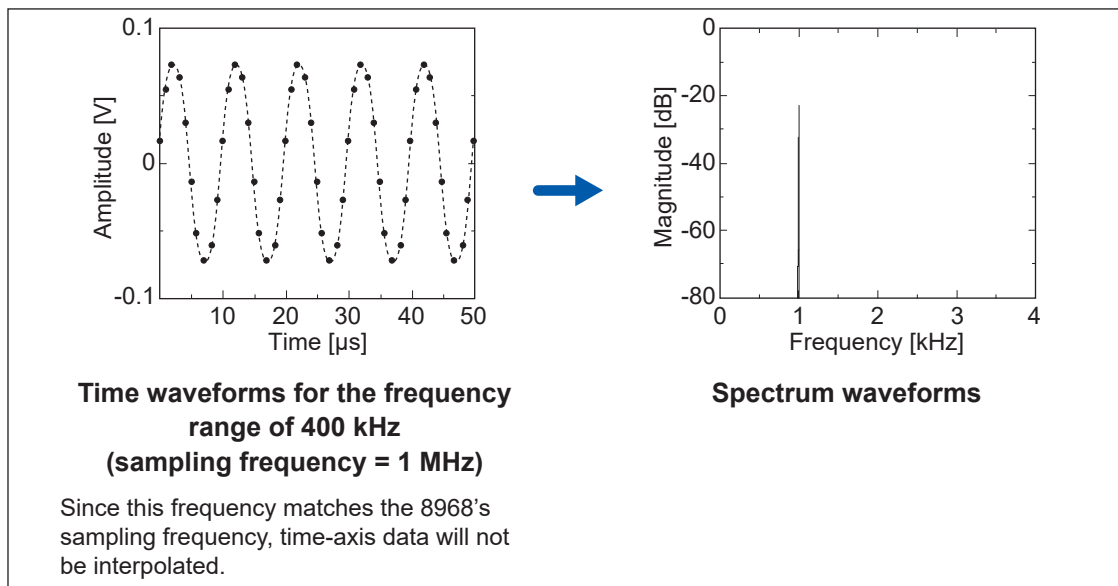
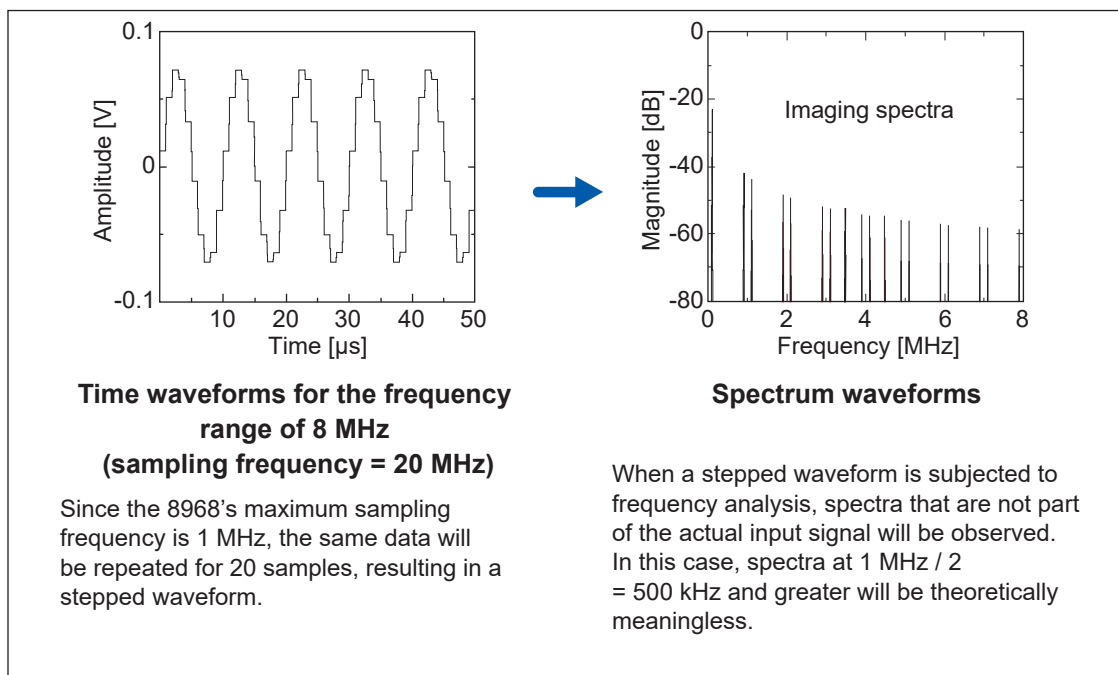

To prevent the imaging phenomenon when analyzing waveforms using the FFT function, be sure to check the unit's maximum sampling frequency prior to measurement.

## Averaging

With the FFT function, averaging used the following expressions.

### (1) Simple average

Add acquired data sets in series and divides the sum by a acquisition count.

$$A_n = \frac{(n - 1)A_{n-1} + Z_n}{n} \dots\dots\dots (11)$$

$n$ : Acquisition count for averaging

$A_n$ :  $n$ th averaging result

$Z_n$ :  $n$ th waveform data set

### (2) Exponential average

Calculates an weighted average such that newer data points contribute more than others.

$$A_n = \frac{(N - 1)A_{n-1} + Z_n}{N} \dots\dots\dots (12)$$

$N$ : Specified number of acquisition for averaging

$n$ : Acquisition count for averaging ( $n \geq 2$ )

$A_n$ :  $n$ th averaging result ( $A_1 = Z_1$ )

$Z_n$ :  $n$ th waveform data set

## Overall value

The overall value shows the sum of power spectra of each frequency. This value is nearly equal to the sum of the squares of an input signal (square of RMS value)(except when frequency averaging is performed). With the FFT function, the instrument displays RMS values for stored waveforms, or overall values for frequency-domain waveforms calculated using the sum of power spectra. Any FFT analysis modes other than the power spectrum, however, take the root square of the overall value to match the unit.

With the FFT analysis mode set to the power spectrum

$$(Over\ all) = \sum_{i=0} P_i \dots\dots\dots (13-1)$$

With the FFT analysis mode set to the histogram, linear spectrum, RMS spectrum, impulse response, 1/1 octave analysis, or 1/3 octave analysis

$$(Over\ all) = \sqrt{\sum_{i=0} P_i} \dots\dots\dots (13-2)$$

$P_i$ :  $i$ th power spectrum

## Total harmonic distortion factor (THD)

The total harmonic distortion factor (THD) indicates a percentage of the total harmonic to the fundamental.

The more severely the waveform distorts, the larger the value becomes.

$$THD = \sqrt{\frac{\sum(V_n)^2}{(V_o)^2}} \times 100 \text{ [%]} \dots\dots\dots (14)$$

$V_o$ : Fundamental wave

$V_n$ :  $n$ th order harmonic



### Window function

The Fourier transform of a continuous system is defined to be the integral from negative infinity to positive infinity with respect to time as expression (15) provides.

$$X(f) = \int_{-\infty}^{\infty} x(t) \varepsilon^{-2\pi f t} dt \dots\dots\dots(15)$$

However, since expression (15) cannot apply to actual measurement, a certain finite interval is used for calculation. Extracting a segment of a waveform is called window processing. The FFT function performs a calculation assuming that this finite interval of a waveform segment repeats periodically (as shown below).

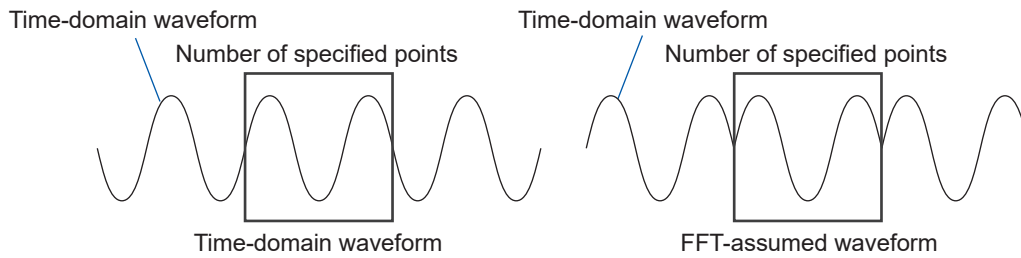

When the number of FFT calculation points is equal to an integer multiple of the input signal frequency, a single line spectrum is obtained. However, if the number is unequal to an integer multiple of the frequency (with the result that the FFT-assumed waveform has discontinuous points), spectral lines spread, resulting in failure of production of a line spectrum. This phenomenon is called the leakage error (as shown below).

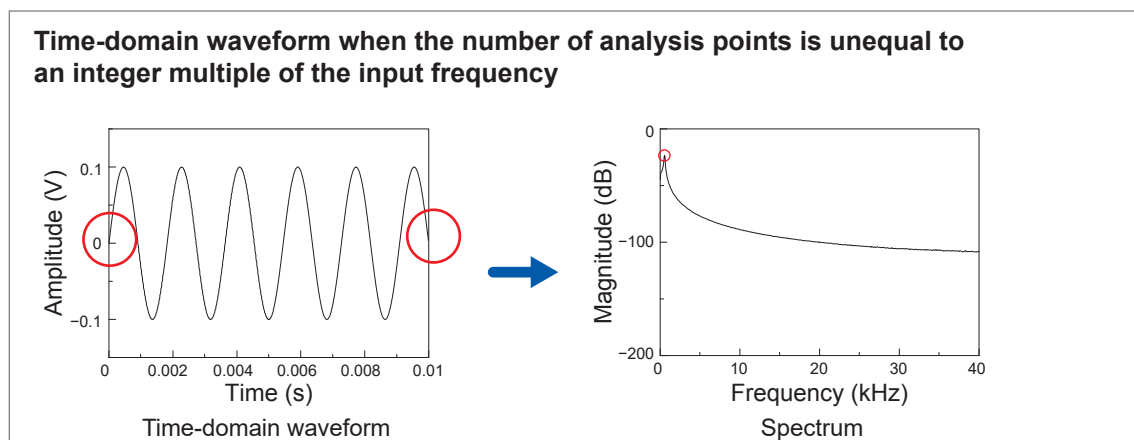
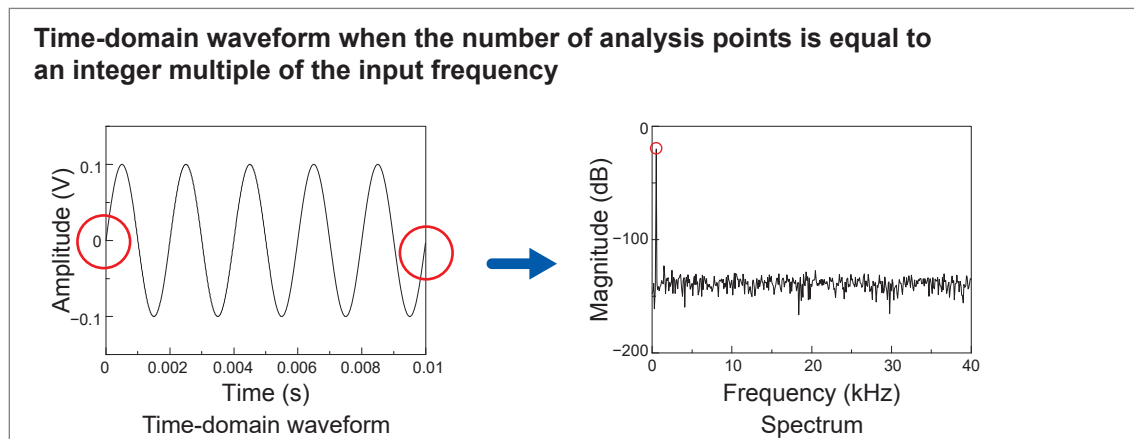

The window function has been created to suppress such leakage errors. The window function smoothly connects each cropped end of a time-domain waveform.

The following figure presents an example of spectral analysis of a time-domain waveform multiplied by a window function.

Multiplying the time-domain waveform by the window function eliminates discontinuous points on the waveform, obtaining the spectrum with a lobe similar to the line spectrum.

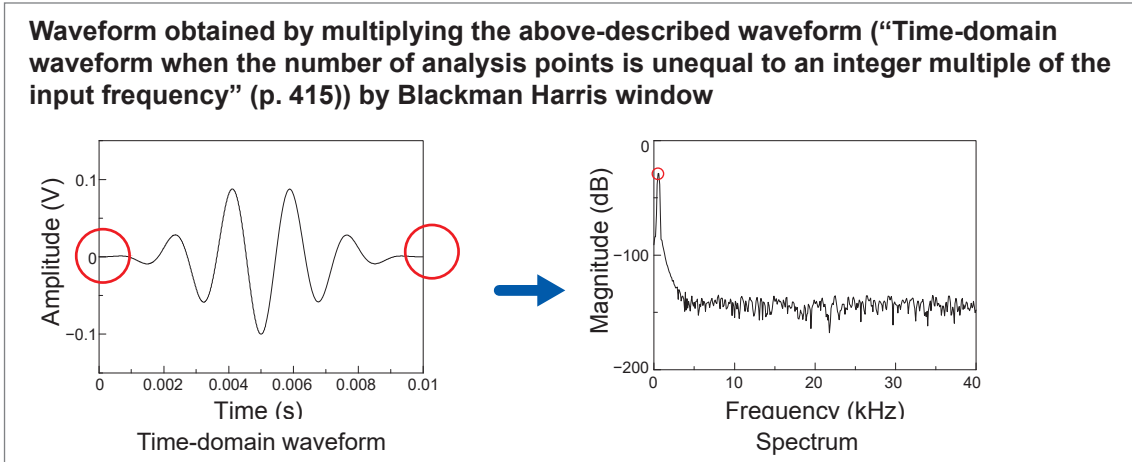

The following figure illustrate the time-domain waveform multiplied by the window function and its spectrum.

Each spectrum shows a highest peak at a low frequency, and many lower peaks at higher frequencies. The highest peak is called the main lobe, and the smaller peaks are the side lobes. A narrower width of the main lobe and lower lobes lead to accurate results of FFT analyses; however, the conditions are incompatible with one another. Thus, if you wish to emphasize altitudes, use a window function that has a wider main lobe. If you wish to observe spectra adjacent to each other, use a window function that has a narrower main lobe. If you wish to eliminate the effect of the adjacent spectra, use a window function that has smaller side lobe values.

Since the main lobe width is proportional to the width of the window ( $1/W$ ), increasing the number of analysis points increases the frequency resolution.

**Rectangular window**

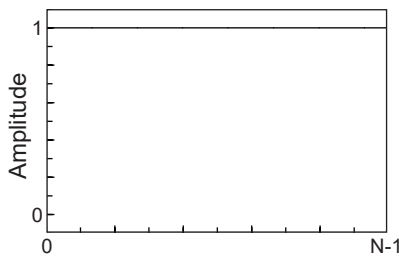

Time-domain waveform

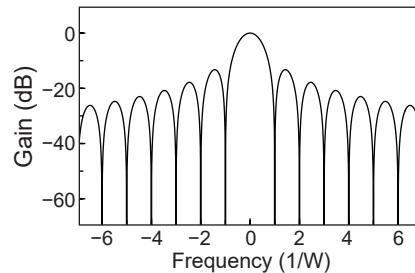

Spectrum

**Hann (also referred to as Hanning) window**

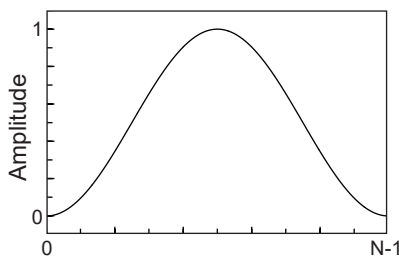

Time-domain waveform

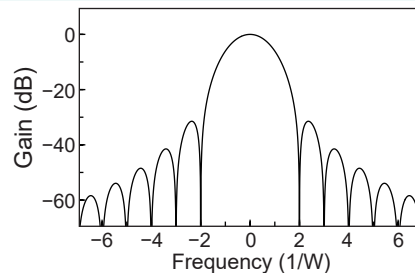

Spectrum

**Hamming window**

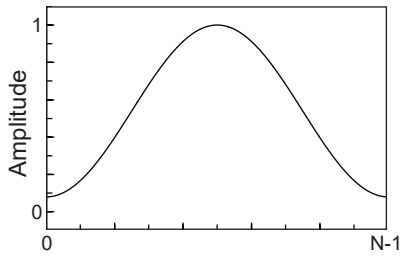

Time-domain waveform

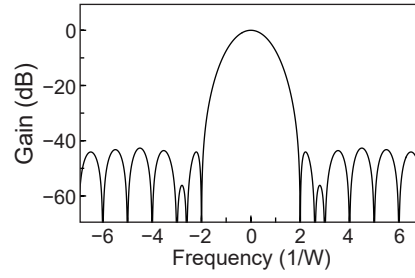

Spectrum

**Blackman window**

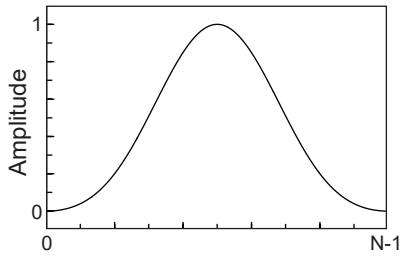

Time-domain waveform

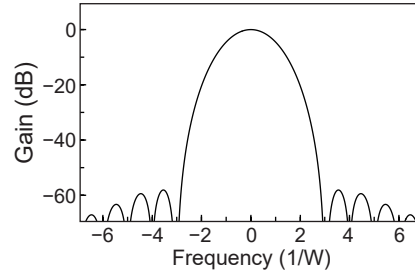

Spectrum

**Blackman Harris window**

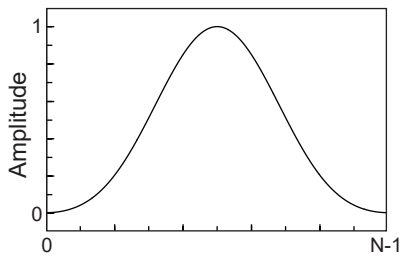

Time-domain waveform

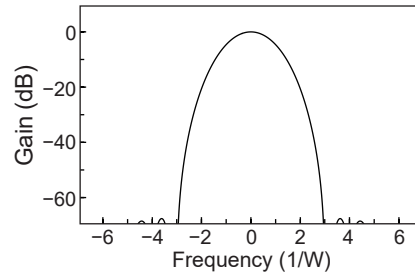

Spectrum

**Flat-top window**

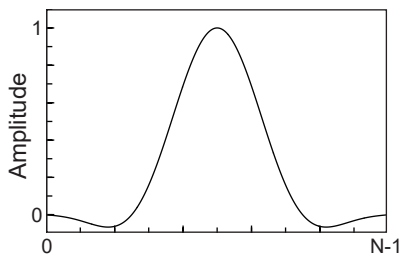

Time-domain waveform

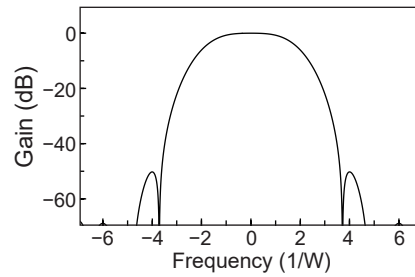

Spectrum

**Exponential window**

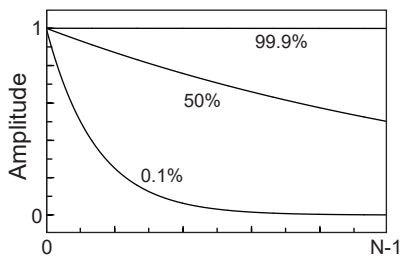

Time-domain waveform

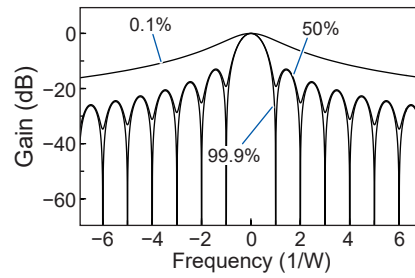

Spectrum

The following example shows the analyses of input sine waves, which has a frequency of 1050 Hz and 1150 Hz, with different window functions.

In this example, since the frequencies are close to each other, the rectangular window, which can yield a narrow main lobe, can separately display both frequencies; the Hann (also referred to as Hanning) window, however, which yields a wide main lobe, displays the two frequency component as a single component.

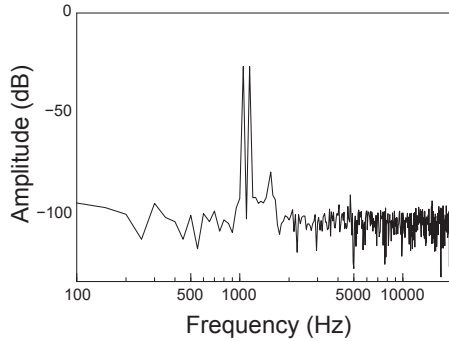

Analysis using the rectangular window

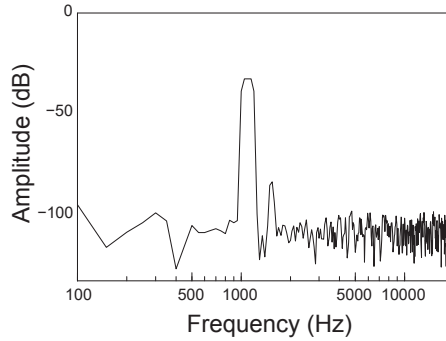

Analysis using the Hann window

## 16.3 Dual Sampling

### Sampling speed combination that can be set

✓: Selectable, –: Not selectable

		Sampling speed for trend waveforms																										
		10 MS/s	5 MS/s	2 MS/s	1 MS/s	500 kS/s	200 kS/s	100 kS/s	50 kS/s	20 kS/s	10 kS/s	5 kS/s	2 kS/s	1 kS/s	500 S/s	200 S/s	100 S/s	50 S/s	20 S/s	10 S/s	5 S/s	2 S/s	1 S/s	30 S/min	12 S/min	6 S/min	2 S/min	1 S/min
Sampling speed for instantaneous waveforms	100 MS/s	✓	✓	✓	✓	✓	✓	✓	✓	✓	✓	✓	✓	✓	✓	✓	✓	✓	✓	✓	✓	✓	✓	✓	✓	✓	✓	✓
	50 MS/s	–	✓	–	✓	✓	✓	✓	✓	✓	✓	✓	✓	✓	✓	✓	✓	✓	✓	✓	✓	✓	✓	✓	✓	✓	✓	✓
	20 MS/s	–	–	✓	✓	✓	✓	✓	✓	✓	✓	✓	✓	✓	✓	✓	✓	✓	✓	✓	✓	✓	✓	✓	✓	✓	✓	✓
	10 MS/s	–	–	–	✓	✓	✓	✓	✓	✓	✓	✓	✓	✓	✓	✓	✓	✓	✓	✓	✓	✓	✓	✓	✓	✓	✓	✓
	5 MS/s	–	–	–	–	✓	–	✓	✓	✓	✓	✓	✓	✓	✓	✓	✓	✓	✓	✓	✓	✓	✓	✓	✓	✓	✓	✓
	2 MS/s	–	–	–	–	–	✓	✓	✓	✓	✓	✓	✓	✓	✓	✓	✓	✓	✓	✓	✓	✓	✓	✓	✓	✓	✓	✓
	1 MS/s	–	–	–	–	–	–	✓	✓	✓	✓	✓	✓	✓	✓	✓	✓	✓	✓	✓	✓	✓	✓	✓	✓	✓	✓	✓
	500 kS/s	–	–	–	–	–	–	–	✓	–	✓	✓	✓	✓	✓	✓	✓	✓	✓	✓	✓	✓	✓	✓	✓	✓	✓	✓
	200 kS/s	–	–	–	–	–	–	–	–	✓	✓	✓	✓	✓	✓	✓	✓	✓	✓	✓	✓	✓	✓	✓	✓	✓	✓	✓
	100 kS/s	–	–	–	–	–	–	–	–	–	✓	✓	✓	✓	✓	✓	✓	✓	✓	✓	✓	✓	✓	✓	✓	✓	✓	✓
	50 kS/s	–	–	–	–	–	–	–	–	–	–	✓	–	✓	✓	✓	✓	✓	✓	✓	✓	✓	✓	✓	✓	✓	✓	✓
	20 kS/s	–	–	–	–	–	–	–	–	–	–	–	✓	✓	✓	✓	✓	✓	✓	✓	✓	✓	✓	✓	✓	✓	✓	✓
	10 kS/s	–	–	–	–	–	–	–	–	–	–	–	–	✓	✓	✓	✓	✓	✓	✓	✓	✓	✓	✓	✓	✓	✓	✓
	5 kS/s	–	–	–	–	–	–	–	–	–	–	–	–	–	✓	–	✓	✓	✓	✓	✓	✓	✓	✓	✓	✓	✓	✓
	2 kS/s	–	–	–	–	–	–	–	–	–	–	–	–	–	–	✓	✓	✓	✓	✓	✓	✓	✓	✓	✓	✓	✓	✓
	1 kS/s	–	–	–	–	–	–	–	–	–	–	–	–	–	–	–	✓	✓	✓	✓	✓	✓	✓	✓	✓	✓	✓	✓
	500 S/s	–	–	–	–	–	–	–	–	–	–	–	–	–	–	–	–	✓	–	✓	✓	✓	✓	✓	✓	✓	✓	✓
	200 S/s	–	–	–	–	–	–	–	–	–	–	–	–	–	–	–	–	–	✓	✓	✓	✓	✓	✓	✓	✓	✓	✓
	100 S/s	–	–	–	–	–	–	–	–	–	–	–	–	–	–	–	–	–	–	✓	✓	✓	✓	✓	✓	✓	✓	✓
	50 S/s	–	–	–	–	–	–	–	–	–	–	–	–	–	–	–	–	–	–	–	✓	–	✓	✓	✓	✓	✓	✓
20 S/s	–	–	–	–	–	–	–	–	–	–	–	–	–	–	–	–	–	–	–	–	✓	✓	✓	✓	✓	✓	✓	
10 S/s	–	–	–	–	–	–	–	–	–	–	–	–	–	–	–	–	–	–	–	–	–	✓	✓	✓	✓	✓	✓	
5 S/s	–	–	–	–	–	–	–	–	–	–	–	–	–	–	–	–	–	–	–	–	–	–	–	✓	✓	✓	✓	
2 S/s	–	–	–	–	–	–	–	–	–	–	–	–	–	–	–	–	–	–	–	–	–	–	–	–	✓	✓	✓	
1 S/s	–	–	–	–	–	–	–	–	–	–	–	–	–	–	–	–	–	–	–	–	–	–	–	–	–	✓	✓	

Trend waveforms are measured using the envelop method (the maximum and minimum values are recorded per sample).

At this time, the instrument performs oversampling at a sampling speed set for instantaneous waveform recording.

Although the sampling speed for trend waveform recording has been fixed at a specific value, measurement results of trend waveforms differ according to the sampling speed for instantaneous waveform recording.

# 16.4 Power Equations and Wiring Specifications

## Power equation

Wiring setting Item	1P2W	1P3W	3P3W	3V3A	3P4W
Voltage RMS value	$U_{rms1} = \sqrt{\frac{1}{n} \sum_{i=1}^n (U_{1i})^2}$	$U_{rms12} = \frac{1}{2} (U_{rms1} + U_{rms2})$		$U_{rms123} = \frac{1}{3} (U_{rms1} + U_{rms2} + U_{rms3})$	
Voltage mean value	$U_{mn1} = \frac{\pi}{2\sqrt{2}} \frac{1}{n} \sum_{i=1}^n  U_{1i} $	$U_{mn12} = \frac{1}{2} (U_{mn1} + U_{mn2})$		$U_{mn123} = \frac{1}{3} (U_{mn1} + U_{mn2} + U_{mn3})$	
Voltage simple average value	$U_{dc} = \frac{1}{n} \sum_{i=1}^n U_i$				
Current RMS value	$I_{rms1} = \sqrt{\frac{1}{n} \sum_{i=1}^n (I_{1i})^2}$	$I_{rms12} = \frac{1}{2} (I_{rms1} + I_{rms2})$		$I_{rms123} = \frac{1}{3} (I_{rms1} + I_{rms2} + I_{rms3})$	
Current mean value	$I_{mn1} = \frac{\pi}{2\sqrt{2}} \frac{1}{n} \sum_{i=1}^n  I_{1i} $	$I_{mn12} = \frac{1}{2} (I_{mn1} + I_{mn2})$		$I_{mn123} = \frac{1}{3} (I_{mn1} + I_{mn2} + I_{mn3})$	
Current simple average value	$I_{dc} = \frac{1}{n} \sum_{i=1}^n I_i$				
Active power	$P_1 = \frac{1}{n} \sum_{i=1}^n (U_{1i} \times I_{1i})$	$P_{12} = P_1 + P_2$		$P_{123} = P_1 + P_2$	$P_{123} = P_1 + P_2 + P_3$
Apparent power	$S_1 = U_{rms1} \times I_{rms1}$	$S_{12} = S_1 + S_2$	$S_{12} = \frac{\sqrt{3}}{2} (S_1 + S_2)$	$S_{123} = \frac{\sqrt{3}}{3} (S_1 + S_2 + S_3)$	$S_{123} = S_1 + S_2 + S_3$
Reactive power	$Q_1 = \sqrt{S_1^2 - P_1^2}$	$Q_{12} = \sqrt{S_{12}^2 - P_{12}^2}$		$Q_{123} = \sqrt{S_{123}^2 - P_{123}^2}$	
Power factor	$\lambda_1 = \left  \frac{P_1}{S_1} \right $	$\lambda_{12} = \left  \frac{P_{12}}{S_{12}} \right $		$\lambda_{123} = \left  \frac{P_{123}}{S_{123}} \right $	
Power phase angle	$\phi_1 = \cos^{-1}  \lambda_1 $	$\phi_{12} = \cos^{-1}  \lambda_{12} $		$\phi_{123} = \cos^{-1}  \lambda_{123} $	
<i>n</i> : Number of data points; <i>i</i> : <i>i</i> th data point When using 3V3A wiring, 3P4W equations are used for Δ-Y conversion.					

### Wiring specifications

#### 1-phase/2-wire (1P2W)

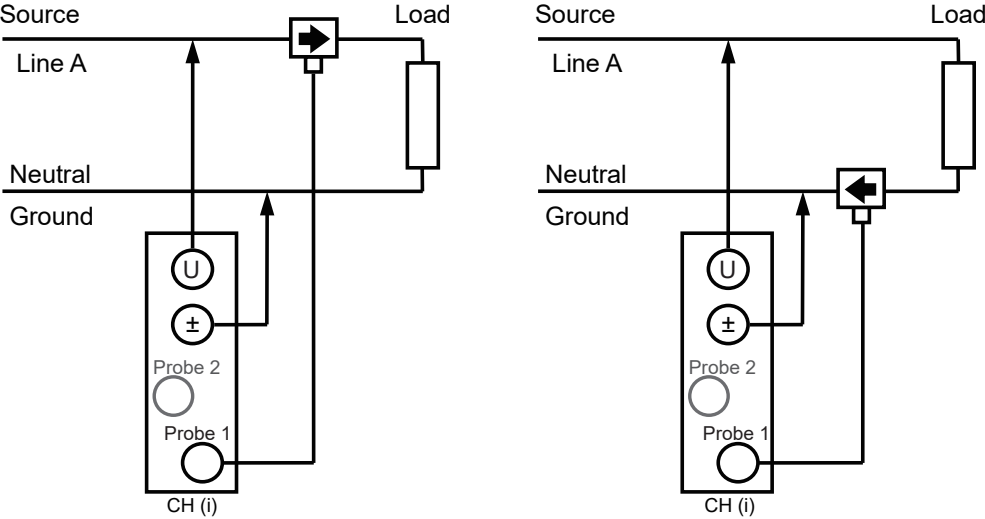

#### 1-phase/3-wire (1P3W)

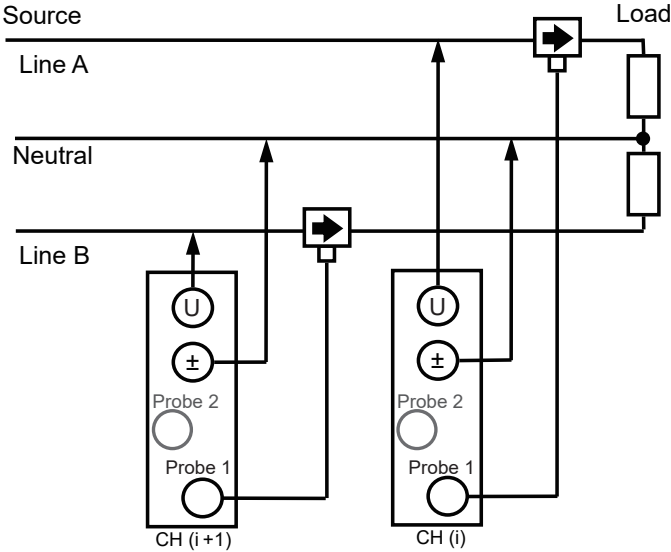

### 3-phase/3-wire (3P3W)

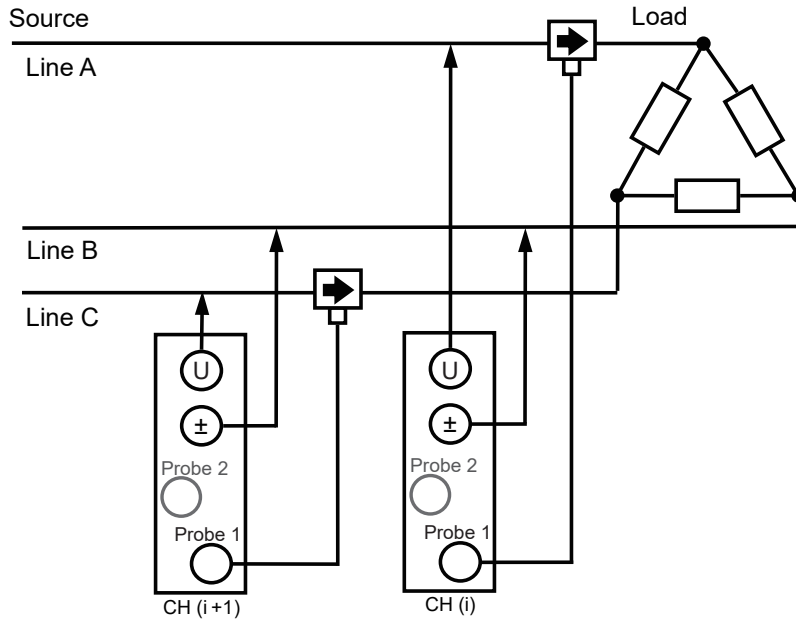

### 3-phase/3-wire (3V3A)

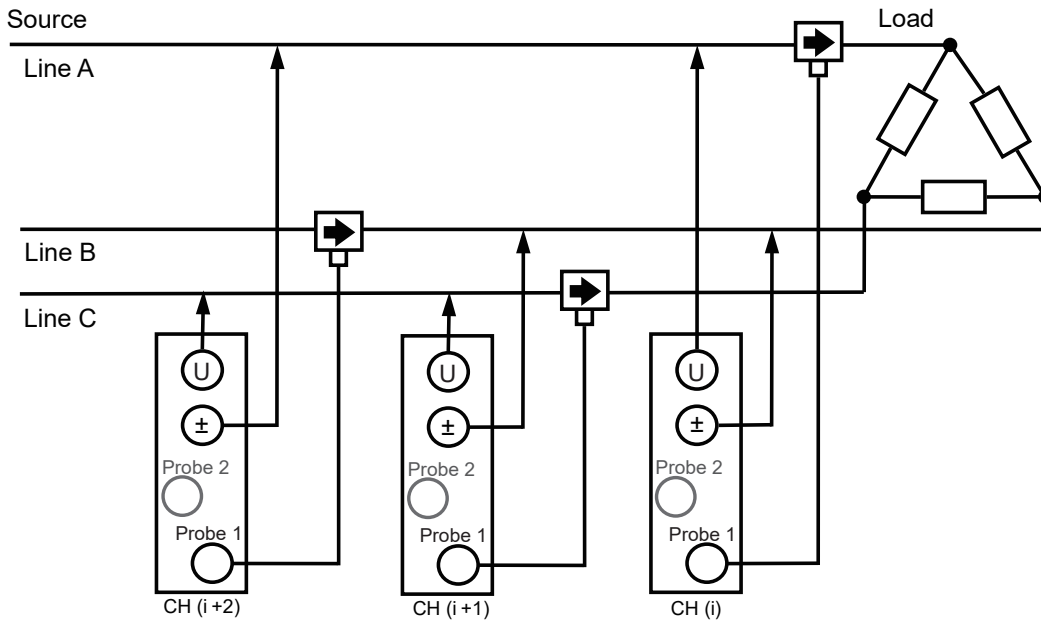



### 4-phase/3-wire (3P4W)

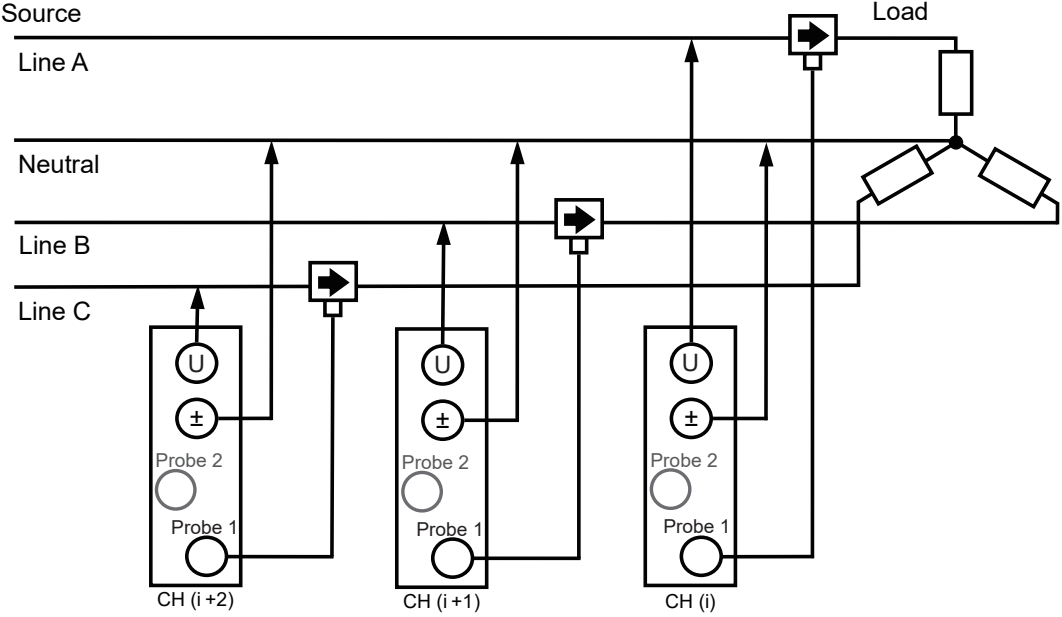



# Index

When the reference pages of an index entry include “Quick,” please also see the Index pages of the Quick Start Manual.

## Symbol

+Width .....	185, 191, 206
–Width .....	185, 191, 206
$\Delta$ -Y conversion .....	251

## 0-9

2-point setting .....	58
-----------------------	----

## A

A.A.F. ....	67, 84
Accumulation .....	185, 187, 206
Acquisition period .....	263, 264
Aliasing .....	7, 411
Amplitude .....	185, 187, 206
Analog channel .....	13
Analog trigger .....	149
Angle of XY waveform .....	185, 189, 207
Anti-aliasing filter .....	67, 84, 412
Area .....	185, 187, 202
Absolute value .....	202
Only the negative-amplitude part .....	203
Only the positive-amplitude part .....	203
Total .....	202
Attenuation rate .....	266
Automatic balancing .....	70
Automatic ranging .....	Quick
Automatic saving .....	118, 120
Automatic setup .....	135
Automatic startup function .....	346
Average .....	185, 187, 201
Averaging .....	268, 414

## B

Beep .....	345
Binary .....	116, 121
Blackman Harris window .....	265, 417
Blackman window .....	265, 417
Block to be used .....	290
BMP .....	116
Burst width .....	185, 192, 206

## C

Calculation starting point .....	276
Calculation type .....	272, 274, 288
Calibration .....	79
CAN interface .....	319
CAN/LIN definition data .....	325
CAN/LIN measurement function .....	311

CAN statistics .....	185, 194, 207
CAN transmission function .....	333
CAN trigger .....	163
Character code .....	380
Clock .....	Quick
Coherence function .....	287
Command .....	379
Comment .....	5, 13, 17
Communications .....	349
Command communications .....	379
Computer name .....	354
Gateway .....	353
IP address .....	353
Subnet mask .....	353
Computer name .....	354
Concierge .....	176
Conversion ratio .....	58
Copy function .....	66
Cross power spectrum .....	285
Cursor value .....	30

## D

DBC file .....	331
Dead time .....	292
Decibels (dB) .....	60
Delimiter .....	379
Display magnification	
Waveform .....	41
Zoom function .....	46
Display position	
Waveform .....	41
Display setting .....	347
Dual sampling .....	295
Duty ratio .....	185, 188, 205

## E

Email transmission .....	374
Envelope .....	9
Evaluation .....	197
Event count .....	152
Event mark .....	386
Explorer .....	136
Exponential average .....	414
Exponential window .....	265, 417
External control .....	385
External control terminal .....	385
External sampling .....	262, 394
External trigger .....	391
EXT.SMPL .....	394, Quick
EXT.TRIG .....	391, Quick

**F**

Fall time .....	185, 189, 202
FFT .....	409
FFT calculation function .....	257
FFT calculation type .....	279
FFT internal calculation formula .....	288
File	
File type.....	116
File screen.....	131
File size	
MEM file .....	395
REC file .....	396
Waveform (text) file .....	397
Filter.....	151, 153, 155, 158
Flat-top window .....	265, 417
Forced average time.....	250
Forcible trigger.....	162
Format .....	136
Formatting storage devices .....	136, Quick
Four arithmetic operations.....	185, 194, 205
Fourier transform .....	409
Frequency.....	185, 188, 201
Frequency resolution .....	263, 264
FTP .....	356, 359

**G**

Gateway .....	353
Gauge (vertical scale).....	37
Glitch trigger .....	157

**H**

Hamming window .....	265, 417
Hann window .....	265, 416
Header.....	379
High level.....	185, 187, 205
High-speed response .....	78
Horizontal cursor .....	34
How to connect a computer.....	Quick
Hysteresis.....	248

**I**

Imaging.....	413
Impulse response .....	410
IN1 .....	386, Quick
IN2.....	386 Quick
Initializing the instrument.....	4
Input coupling .....	15
Instantaneous waveform .....	295, 300
Intermediate value.....	185, 187, 205
Internal calculation formula.....	288
Interval trigger.....	160
In trigger .....	153
Invert.....	65

IP address .....	353
------------------	-----

**K**

Key check .....	Quick
Key lock.....	Quick

**L**

LAN.....	351, 379
Language.....	348
Level at time .....	185, 190, 204
Level trigger.....	151
Linear spectrum.....	279
Linear time-invariant system.....	410
Loading data.....	131
File type.....	116
Logical AND/OR operation .....	147
Logic channel .....	17
Logic trigger.....	158
Low level.....	185, 187, 205
Low-pass filter .....	15, 249
L.P.F.....	15
LTI system .....	410

**M**

Managing files .....	136
Manual saving .....	127
Maximal value.....	168, 267
Maximum value .....	185, 187, 201, 267
Measurement mode.....	13
Measurement range .....	14
Memory HiConcierge.....	176
Minimal value.....	168
Minimum value .....	185, 187, 201
Module-specific setting.....	67, 86

**N**

Network drive.....	381
Normal .....	9
NPLC .....	78
Numerical calculation .....	181
Evaluation .....	197
Numerical calculation result .....	195
Setting .....	184

**O**

Offset .....	58
Option.....	Quick
OUT1 .....	387
OUT2.....	387
Out trigger.....	153
Overall value.....	414

Overlay ..... 54  
 Overshoot ..... 185, 187, 206

## P

Peak-to-peak value ..... 185, 187, 201  
 Period ..... 185, 188, 201  
 Period-in trigger ..... 155  
 Period-out trigger ..... 155  
 Phase contrast ..... 185, 193, 205  
 Phase spectrum ..... 284  
 Port number ..... 380  
 Post-trigger ..... 142  
 Power calculation ..... 210  
 Power equations ..... 420  
 Power spectrum ..... 283  
 Pre-trigger ..... 142  
   Trigger priority ..... 145  
 Probe ratio ..... 15  
 Pulse count ..... 185, 190, 205  
 Pulse width ..... 185, 188, 204

## Q

Quick saving ..... 118, 127

## R

Real-time saving ..... 124  
 Recordable time ..... 399  
 Recording length ..... 6  
 Recording method ..... 9  
   Envelope ..... 9  
   Normal ..... 9  
 Recording mode ..... 6, 297  
 Rectangular window ..... 265, 416  
 Reference block ..... 291  
 Remote operation ..... 369  
 Response ..... 77, 80  
 Response time ..... 77, 80  
 Rise time ..... 185, 189, 202  
 RMS ..... 185, 187, 201  
 RMS spectrum ..... 281  
 Rotary knob ..... 45

## S

S1 key ..... 346  
 S2 key ..... 346  
 Sampling rate ..... 5  
 SAVE key ..... 118, 127  
 Saving data ..... 115, 118  
   Automatic saving ..... 118, 120  
   File type ..... 116  
   Quick saving ..... 118, 127  
   Selective saving ..... 118, 127

Saving type ..... 118, 121, 128  
 Scaling ..... 56  
   Using Model U8969 Strain Unit ..... 61  
   Using strain gauge ..... 61, 405  
 Screenshot ..... 116, 123  
   Saving data ..... 127  
 Scrolling through waveforms ..... 39  
 Search ..... 167  
 Section cursor ..... 35  
 Selective save ..... 118, 127  
 Setting  
   Automatically loading ..... 135  
   Input channel ..... 11  
   Measurement condition ..... 5  
   Numerical calculation ..... 184  
   Saving data ..... 118  
   Trigger ..... 138  
 SF8000 ..... 110  
 Sheet ..... 19  
 Shortcut key ..... 346  
 Simple average ..... 414  
 Standard deviation ..... 185, 187, 202  
 Start block ..... 290  
 Starting measurement ..... 28  
 STARTUP ..... 135  
 Subnet mask ..... 353  
 Sync source ..... 247  
 System protection function ..... 345

## T

Text ..... 116, 121  
 Thermocouple ..... 68  
 Time  
   Time to maximum ..... 185, 187, 201  
   Time to minimum ..... 185, 187, 201  
 Time difference (Time lag) ..... 185, 193, 205  
 Time to level ..... 185, 190, 204  
 Trace cursor ..... 30  
 Transfer function ..... 286  
 Trend waveform ..... 295, 300  
 Trigger ..... 137  
   CAN trigger ..... 163  
   Glitch ..... 157  
   In ..... 153  
   Level ..... 151  
   Out ..... 153  
   Period-in ..... 155  
   Period-out ..... 155  
   Voltage drop ..... 154  
 Trigger filter ..... 151, 153, 155  
 Trigger output ..... 389  
 Trigger priority ..... 145  
 Trigger setting ..... 138  
 Trigger source (AND/OR operation) ..... 147  
 TRIG.OUT ..... 389

**U**

---

Undershoot ..... 185, 187, 206

**V**

---

Vernier ..... 64  
Voltage drop trigger ..... 154

**W**

---

Warning ..... Quick  
Waveform  
  Display magnification ..... 41  
  Display position ..... 41  
  Range specification ..... 35  
  Zoom-in/zoom-out ..... 46  
Waveform calculation ..... 210  
  Operator ..... 222  
Waveform file size ..... 395  
Waveform generation ..... 86, Quick  
Waveform image ..... 116  
Waveform screen ..... 276  
Wave marker software ..... 110  
Web browser ..... 367  
Window function ..... 265, 415  
Wiring method ..... 245  
Wiring specifications ..... 420

**X**

---

XY area ..... 185, 189, 203  
  Coordinate method ..... 203  
  Trapezoidal approximation method ..... 204  
XY composite ..... 25, 47

**Z**

---

Zero-cross ..... 247  
Zoom function ..... 46

**HIOKI**  
**www.hioki.com/**



**All regional  
contact  
information**

**HIOKI E.E. CORPORATION**

81 Koizumi, Ueda, Nagano 386-1192 Japan

2402 EN

Edited and published by HIOKI E.E. CORPORATION

Printed in Japan

- Contents subject to change without notice.
- This document contains copyrighted content.
- It is prohibited to copy, reproduce, or modify the content of this document without permission.
- Company names, product names, etc. mentioned in this document are trademarks or registered trademarks of their respective companies.

**Europe only**

• EU declaration of conformity can be downloaded from our website.

• Contact in Europe: HIOKI EUROPE GmbH

Helfmann-Park 2, 65760 Eschborn, Germany

hioki@hioki.eu