

U8793
MR8790
MR8791

HIOKI

Instruction Manual

**ARBITRARY WAVEFORM
GENERATOR UNIT**

**WAVEFORM
GENERATOR UNIT**

PULSE GENERATOR UNIT

EN

Apr. 2022 Revised edition 5
U8793A981-05 22-04H



Contents

Introduction.....	1
Verifying Package Contents	2
Safety Information	2
Operating Precautions	5

1 Overview 7

1.1 Features	7
1.2 Part Names and Functions	8
1.3 Inspecting the Module before Use..	9

2 Connecting the Module 11

2.1 Installing the Module in and Removing the Module from a Memory HiCorder	11
Installing the module	11
Removing the module	11
2.2 Connecting Cables to the Output Terminals.....	12
2.3 Output Terminals.....	13
2.4 Connecting Wires to the External Control Terminals (U8793)	14

3 Signal Generation Settings Screen 15

Method for copying and pasting channel settings	16
---	----

4 Waveform Settings (U8793 and MR8790) 19

Method for setting values.....	20
4.1 Setting the Waveform Type	24
4.2 Setting the Frequency	26
4.3 Setting the Amplitude	28
4.4 Setting the Offset	30
4.5 Setting the Duty Cycle (Pulse Wave Output Only)	32
4.6 Setting the Phase	34
4.7 Setting the Output to On or Off (MR8847A, MR8827, MR8740, and MR8741)	36
4.8 Setting the Sync Use to On or Off (MR6000 and MR8740T)	38
4.9 Setting Behavior When Output is Off	39

5 Setting Pulse and Pattern Output (MR8791) 41

5.1 Setting the Mode	41
5.2 Setting the Pulse Mode.....	43
Setting the frequency.....	43
Setting the duty cycle.....	45
Setting the output configuration	47
Setting output (MR8847A, MR8827, MR8740, and MR8741)	49
Setting the Use to On or Off (for MR6000 and MR8740T).....	50
5.3 Setting the Pattern Mode.....	51
Setting the output configuration	51
Setting the pattern to use.....	53
Method for registering a pattern.....	55
Setting the clock frequency.....	59
Setting output (MR8847A, MR8827, MR8740, and MR8741)	61
Setting the Use to On or Off (for MR6000 and MR8740T).....	62

6 Sweep Setting (U8793) 63

6.1 Selecting the Sweep Type	63
6.2 Setting the Start Value	65
6.3 Setting the End Value	67
6.4 Setting the Sweep Time	69

7 Arbitrary Waveform Settings (U8793) 71

7.1 Setting the Waveform Type	71
7.2 Registering a Waveform	73
Registering data measured with a Memory HiCorder	76
Registering data created with the SF8000 Waveform Maker	81
7.3 Setting the Clock Frequency.....	85
7.4 Setting Amplitude Adjustment.....	88
7.5 Setting the Offset	90
7.6 Setting the Delay	92
7.7 Setting the Iteration Count for the Loop (When Sweep Is Disabled).....	94
7.8 Setting the Filter	96
7.9 Setting the Output to On or Off (MR8847A, MR8827, MR8740, and MR8741)	98
7.10 Setting the Sync Use to On or Off (MR6000 and MR8740T)	100
7.11 Setting Behavior When Output is Off	101

7.12 Saving the Arbitrary Waveform (MR6000 and MR8740T) 103

7.13 Editing the Arbitrary Waveform (MR6000) 104

8 Program Settings (U8793) 105

8.1 Switching to the Program Settings Screen 105

8.2 Editing the Program 107

 Opening the Edit screen 107

 Configuring each step 110

 Ending program editing 115

8.3 Setting the Overall Number of Loops 116

8.4 Setting the Filter 118

8.5 Saving/Loading the Edited Program 120

8.6 Checking Program Progress 125

9 Outputting Signals 127

9.1 Setting the Control Method 127

9.2 Setting Output When Measurement Completes 130

9.3 Controlling Signal Output 131

10 Configuring Settings on the Waveform Screen (MR8847A, MR8827, MR8740, and MR8741) 135

10.1 Setting Output Waveform Parameters 135

 To display the waveform and output parameter settings in separate windows .. 136

10.2 Waveform Type and Output Status Display 138

11 Self-test Function (MR8847A, MR8827, MR8740, and MR8741) 139

11.1 Monitoring Output Values with Test Output 139

12 External Control Terminal (U8793) 143

12.1 External Input 144

12.2 External Output 145

13 Waveform Maker 147

13.1 Overview of the SF8000 Waveform Maker 147

 Operating environment 147

 Functional specifications 147

13.2 Installing the SF8000 Application 149

13.3 Launching and Exiting the SF8000 Application 151

 Launching the application 151

 Exiting the application 152

13.4 Uninstalling the SF8000 Application 153

13.5 SF8000 Screen 154

 Setting the display format 155

 Setting the time axis range 156

 Input mode screens 156

13.6 Arbitrary Waveform Input Mode.. 158

 Basic instructions 158

 Editing mode 159

 Waveform creation 160

 Properties 162

 Calculations using previously input waveforms 163

13.7 Function Input Mode 164

 Basic instructions 164

 Example of program creation 164

 Expressions and operations 165

 Control words 166

 Functions 168

 Usable characters 171

13.8 Step Input Mode 172

 Basic instructions 172

 Example of waveform creation 172

 Start and end point settings 172

 Waveform type and settings 172

 Editing steps 173

 Reordering the display 173

13.9 Interpolation Input Mode 174

 Basic instructions 174

 Editing mode 176

 Dot data list 177

 Interpolation method 178

13.10 Pulse Pattern Mode 179

 Basic instructions 179

 Example of waveform creation 180

13.11 Transferring Data 181

13.12 Saving and Loading Data 183

Saving and loading all data..... 183
 Saving and loading data for an individual input mode (import, export)..... 184

14 Specifications 187

14.1 U8793 Arbitrary Waveform Generator Unit 187
 General specifications 187
 Output specifications 187
 Sweep function specifications..... 189
 Program functional specifications 189
 Other specifications 190

14.2 MR8790 Waveform Generator Unit 191
 General specifications 191
 Voltage output specifications 192

14.3 MR8791 Pulse Generator Unit..... 193
 General specifications 193
 Pulse output specifications 194
 Pattern output specifications..... 194
 Output connector specifications..... 194

15 Maintenance and Service 197

15.1 Cleaning the Module 197
 15.2 Troubleshooting 198
 15.3 Error Messages 199

Index 201

Introduction

Thank you for purchasing the Hioki U8793 Arbitrary Waveform Generator Unit, MR8790 Waveform Generator Unit and MR8791 Pulse Generator Unit. To obtain maximum performance from the module, please read this manual first, and keep it handy for future reference.

Latest edition of instruction manual

The contents of this manual are subject to change, for example as a result of product improvements or changes to specifications.

The latest edition can be downloaded from Hioki's website.

<https://www.hioki.com/global/support/download>



Trademark

Windows is a registered trademark or a trademark of Microsoft Corporation in the United States and other countries.

Verifying Package Contents

When you receive the module, inspect it carefully to ensure that no damage occurred during shipping. In particular, check the connectors. If damage is evident, or if it fails to operate according to the specifications, contact your authorized Hioki distributor or reseller. Store the packaging in which the module was delivered, as you will need it when transporting the module.

Safety Information

This module is designed to conform to IEC 61010 Safety Standards, and has been thoroughly tested for safety prior to shipment. However, using the module in a way not described in this manual may negate the provided safety features.

Before using the module, be certain to carefully read the following safety notes.

DANGER



Mishandling during use could result in injury or death, as well as damage to the module. Be certain that you understand the instructions and precautions in the manual before use.







WARNING







With regard to the electricity supply, there are risks of electric shock, heat generation, fire, and arc discharge due to short circuits. If persons unfamiliar with electrical measuring instrument are to use the instrument, another person familiar with such instruments must supervise operations.

Notations

In this manual, the risk seriousness and the hazard levels are classified as follows.

 DANGER	Indicates an imminently hazardous situation that will result in death or serious injury to the operator.
 WARNING	Indicates a potentially hazardous situation that may result in death or serious injury to the operator.
 CAUTION	Indicates a potentially hazardous situation that may result in minor or moderate injury to the operator or damage to the module or malfunction.
IMPORTANT	Indicates information related to the operation of the module or maintenance tasks with which the operators must be fully familiar.
	Indicates a high voltage hazard. If a particular safety check is not performed or the module is mishandled, this may give rise to a hazardous situation; the operator may receive an electric shock, may get burnt or may even be fatally injured.
	Indicates a prohibited action.
	Indicates the action which must be performed.
(p.)	Indicates the location of reference information.
CURSOR (bold)	Bold alphanumeric characters in this text show characters appeared on the operation keys.
[]	Menus, commands, dialogs, buttons in a dialog, and other names on the screen are indicated in brackets .
*	Additional information is presented below.

Symbols on the module

	Indicates cautions and hazards. When the symbol is printed on the module, refer to a corresponding topic in the Instruction Manual.
	Indicates a fuse.
	Indicates a grounding terminal.
	Indicates DC (Direct Current).
	Indicates AC (Alternating Current).

Symbols for standards

	Indicates that the product conforms to regulations required by the EU Directive.
---	--

Accuracy

The instrument accuracy is expressed by defining a percentage of the setting.

Setting	Indicates the voltage, current, or other value that the instrument has been configured to output. Limit values for setting errors are expressed as a percentage of the setting (“% of setting”).
---------	--

Measurement categories

To ensure safe operation of measuring instruments, IEC 61010 establishes safety standards for various electrical environments, categorized as CAT II to CAT IV, and called measurement categories.

DANGER



- Using a measuring instrument in an environment designated with a higher-numbered category than that for which the instrument is rated could result in a severe accident, and must be carefully avoided.
- Using a measuring instrument without categories in an environment designated with the CAT II to CAT IV category could result in a severe accident, and must be carefully avoided.

- CAT II: When directly measuring the electrical outlet receptacles of the primary electrical circuits in equipment connected to an AC electrical outlet by a power cord (portable tools, household appliances, etc.).
- CAT III: When measuring the primary electrical circuits of heavy equipment (fixed installations) connected directly to the distribution panel, and feeders from the distribution panel to outlets.
- CAT IV: When measuring the circuit from the service drop to the service entrance, and to the power meter and primary overcurrent protection device (distribution panel).

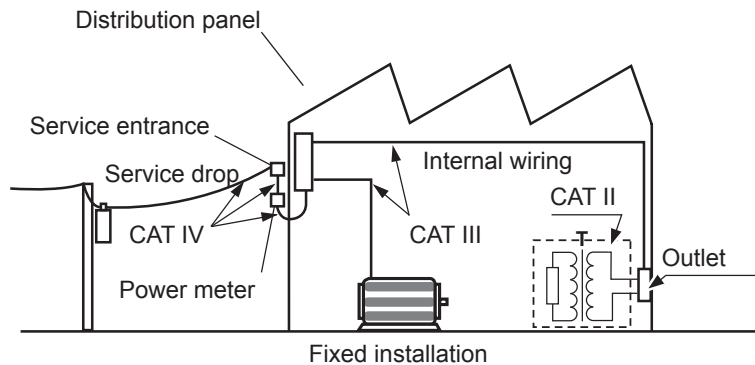

Operating Precautions

Check before use

Use of the devices should confirm not only to their specifications, but also to the specifications of all options and other equipment in use.

DANGER

If the connecting cable or the module is damaged, there is a risk of electric shock. Before using the module perform the following inspection.



- Before using the module, make sure that the insulation on the cables are undamaged and that no bare conductors are improperly exposed. If there is any damage on the cable, replace it with those specified by our company.
- Before using the module for the first time, verify that it operates normally to ensure that no damage occurred during storage or shipping. If you find any damage, contact your authorized Hioki distributor or reseller.

Module installation

WARNING

Installing the module in inappropriate locations may cause a malfunction of module or may give rise to an accident. Avoid the following locations.



- Exposed to direct sunlight or high temperature
- Exposed to corrosive or combustible gases
- Exposed to a strong electromagnetic field or electrostatic charge
- Near induction heating systems (such as high-frequency induction heating systems and IH cooking equipment)
- Susceptible to vibration
- Exposed to water, oil, chemicals, or solvents
- Exposed to high humidity or condensation
- Exposed to high quantities of dust particles

Handling of the module

DANGER



- Do not exceed the module or cable ratings or specifications range.
- To avoid electric shock, do not remove the module's case.
The internal components of the module carry high voltages and may become very hot during operation.

WARNING



- To avoid electric shock accident, before removing or replacing the module, confirm that the Memory HiCorder is turned off and that the connection cables are disconnected.
- To avoid the danger of electric shock, never operate the Memory HiCorder with the module removed. Install a blank panel in the Memory HiCorder after removing the module.
- To avoid damage to the module or electric shock accident, use original screws from the factory shipment for fastening the module.
If any of the screws is lost or there is any damage on the module, contact your authorized Hioki distributor or reseller.

CAUTION



- To avoid damage to the module, do not touch the connectors to be inserted into the Memory HiCorder.
- Do not perform measurements when the blank panel of the Memory HiCorder has been removed. This condition will cause unstable temperature in the module and does will not satisfy the specifications.



- To avoid damage to the module, protect it from physical shock when transporting and handling. Be especially careful to avoid physical shock from dropping.
- The mounting screws must be firmly tightened or the module may not perform to specifications, or may even fail.

This module may cause interference if used in residential areas. Such use must be avoided unless the user takes special measures to reduce electromagnetic emissions to prevent interference to the reception of radio and television broadcasts.

Precautions during transportation

Store the packaging in which the module was delivered, as you will need it when transporting the module.

1.1 Features

The U8793, MR8790, and MR8791 are Memory HiCorder modules designed to output basic waveforms such as sine waves and rectangular waves, user-created waveforms, logic patterns, and other signals. (Models vary by the type of waveform they can output.) Since a single Memory HiCorder can accommodate the U8793, MR8790, or MR8791 along with one or more measurement modules, it is possible to both measure and generate waveforms with one instrument.

U8793 Arbitrary Waveform Generator Unit

Isolated-channel output

Each module provides two channels of output. Since output channels are isolated from the host Memory HiCorder's chassis as well as from each other, the instrument can be connected to other devices that operate at a different potential. (The maximum rated terminal-to-ground voltage is limited to 30 V AC RMS or 60 V DC.)

Maximum output voltage of 15 V

The module can output up to 15 V. This capability eliminates the need to connect the module's output to an external amplifier prior to simulating a signal from an automotive sensor or other device, enabling output signals to be applied directly.

Channel synchronization

Phase can be set between channels on the same module and between channels on different modules.

Sweep functionality

Sweep functionality is provided for frequency, amplitude, offset, and duty cycle (pulse waves only).

Program function

Users can set an output waveform type, generation duration, and the iteration count for the loop for each step.

Observed waveform output

The module can load waveform data measured by the Memory HiCorder and then output a waveform that is identical to the observed waveform, enabling use in applications such as reproduction testing.

MR8790 Waveform Generator Unit

Isolated-channel output

Each module provides four channels of output. Since output channels are isolated from the host Memory HiCorder's chassis as well as from each other, the instrument can be connected to other devices that operate at a different potential. (The maximum rated terminal-to-ground voltage is limited to 30 V AC RMS or 60 V DC.)

High-precision DC output

Thanks to its ability to generate high-precision DC output with an output accuracy of ± 0.6 mV, the MR8790 can generate output simulating the minuscule voltage variations of sensor output.

MR8791 Pulse Generator Unit

Multichannel output

Each module provides eight channels of output. Output channels are isolated from the host Memory HiCorder's chassis. (Output channels are not isolated from each other.) (The maximum rated terminal-to-ground voltage is limited to 30 V AC RMS or 60 V DC.)

Wide selection of output modes

Depending on the configuration, each channel can generate independent pulse output, or all channels can generate synchronized pattern output. In addition, users can select either TTL level logic output or open-collector output as the output type (for each channel).

1.2 Part Names and Functions

Front (U8793)

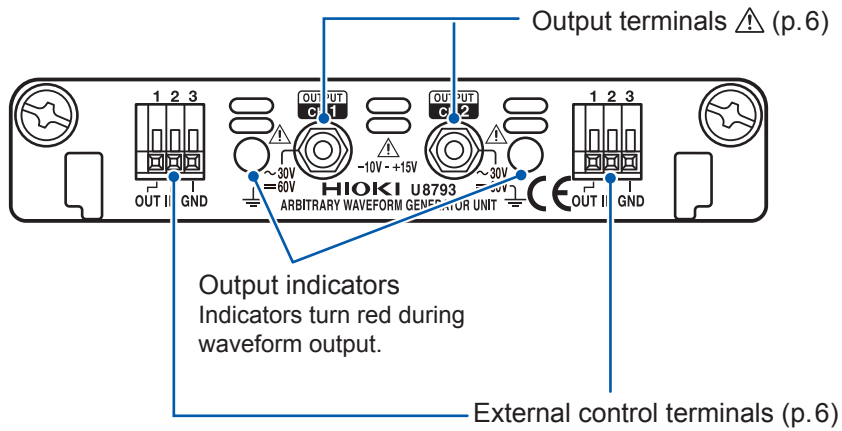

Front (MR8790)

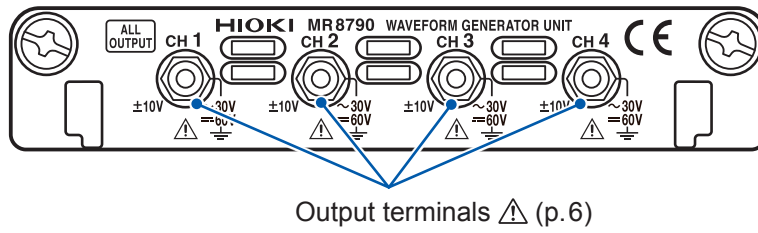

Front (MR8791)

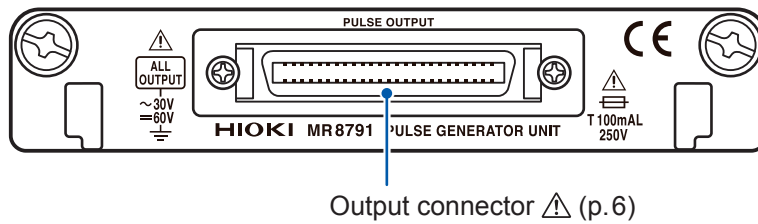

1.3 Inspecting the Module before Use

Before using the module, inspect it to ensure that it did not sustain any damage during storage or transport and that it is operating properly. If you discover any damage, contact your authorized Hioki distributor or reseller.

(1) Inspecting connection cables

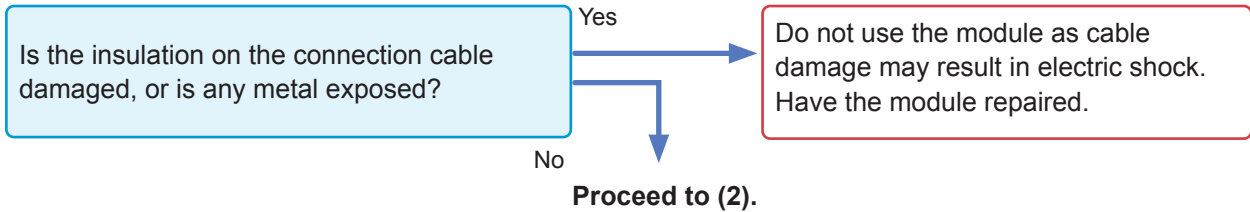

(2) Inspecting the module

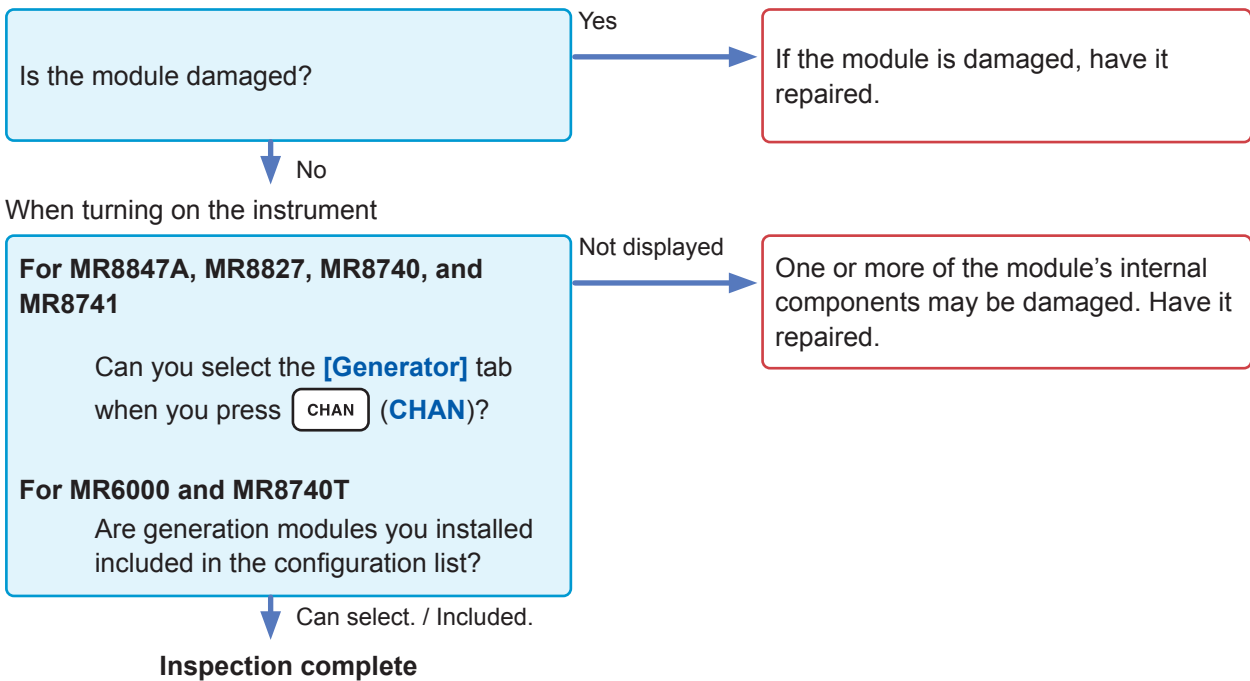

2

Connecting the Module

2.1 Installing the Module in and Removing the Module from a Memory HiCorder

For more information about how to install the module, see the Memory HiCorder's instruction manual.

You will need: Phillips head screwdriver (No. 2)

2

Installing the module

Example: U8793

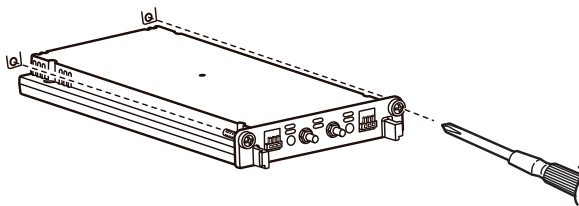

- 1** Turn off the Memory HiCorder into which you will install the module.
- 2** Exercising care to orient the module properly, insert it firmly as far as it will go. Orient the module so that the lettering on its front faces the same direction as the lettering on the host Memory HiCorder.
- 3** Securely tighten the fastening screws on the module with the Phillips head screwdriver.

Removing the module

Example: U8793

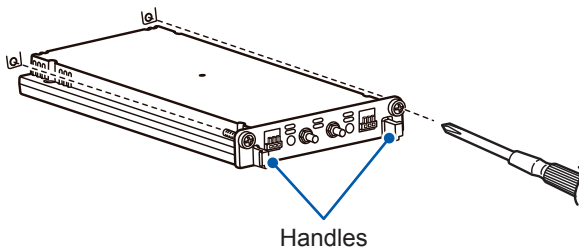

- 1** Turn off the Memory HiCorder from which you will remove the module.
- 2** Disconnect all connection cables, thermocouples, and other devices that are connected to the module.
- 3** Loosen the fastening screws on the module with the Phillips head screwdriver.
- 4** Gripping the handles, pull the module towards you.
- 5** Attach the blank panel to cover the opening on the Memory HiCorder from which you removed the module.

2.2 Connecting Cables to the Output Terminals

Be sure to use only Hioki-specified connection cables with the module. Use of other cables may prevent the module from generating waveforms accurately due to poor contact or other issues.

U8793 and MR8790

You will need: L9795-01 Connection Cable or L9795-02 Connection Cable

Example: U8793

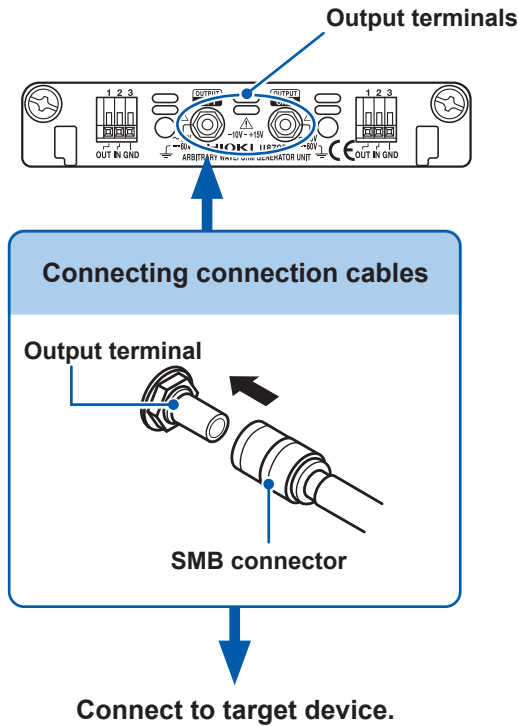

1 Insert the connection cable's SMB connector into the module's output terminal until you hear it click into place.

2 Connect the target device to the clip side of the connection cable.

Disconnecting cables from the output terminals

Grip the cable by the SMB connector (not the cable itself) and pull toward you to disconnect the cable.

MR8791

You will need: Connection cable

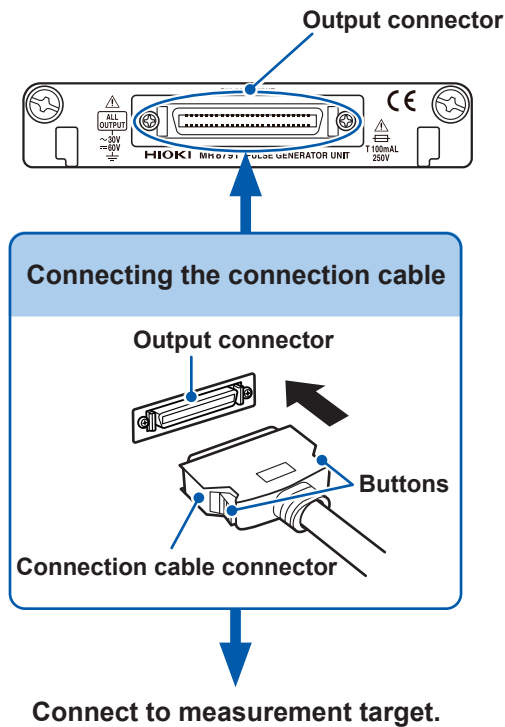

- 1** Connect the connection cable's connector to the module's output connector.
- 2** Connect the connection cable to the device being measured.

To disconnect the cable from the output terminal

Pull the connection cable's connector toward you while depressing the buttons on the connector to disconnect the cable.

2

Connecting the Module

2.3 Output Terminals

⚠ WARNING



The allowable load resistance for the module's analog output terminals is 1.5 k Ω or greater (U8793) or 2 k Ω or greater (MR8790). Do not connect a load whose resistance is less than the allowable load resistance or short the module's outputs. Doing so may damage the module or cause a fire.

⚠ CAUTION



Do not apply a voltage from outside the device to the analog output terminals. Doing so may damage the module.

2.4 Connecting Wires to the External Control Terminals (U8793)

The following describes how to connect wires to the module's external control terminals.

Procedure

You will need

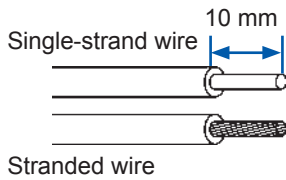

- Compatible wires: Single-strand wire $\phi 0.65$ mm (22 AWG)
 Twisted wire 0.32 mm² (22 AWG)
- Usable wire: Single-strand wire $\phi 0.32$ to $\phi 0.65$ mm (28 to 22 AWG)
 Stranded wire 0.08 to 0.32 mm² (28 to 22 AWG)
 Strand diameter $\phi 0.12$ mm (per strand)
- Standard stripped wire length: 9 to 10 mm
- Tool for manipulating terminal buttons: Flat-head screwdriver (with a shaft diameter of $\phi 3$ mm and a tip width of 2.6 mm)

Connection method

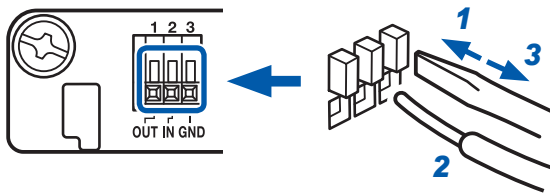

- 1** Press the terminal button with a flathead screwdriver or other tool.
- 2** Insert the wire into the wire connection hole while continuing to depress the button.
- 3** Release the button.
The wire will be locked in place.



Terminal no.	Operation
1	OUT: Outputs a low-level signal during waveform output.
2	IN: When using the program function, inputting a low-level signal from an external device will cause the module to cancel the hold state and transition to the next step.
3	GND terminal (same potential as the Memory HiCorder's GND)

3

Signal Generation Settings Screen

Switch to the Generator screen (signal generation settings screen) and set the output channel.

When the module is installed in a Memory HiCorder, the instrument will display the Generator screen.

For MR8847A, MR8827, MR8740, and MR8741

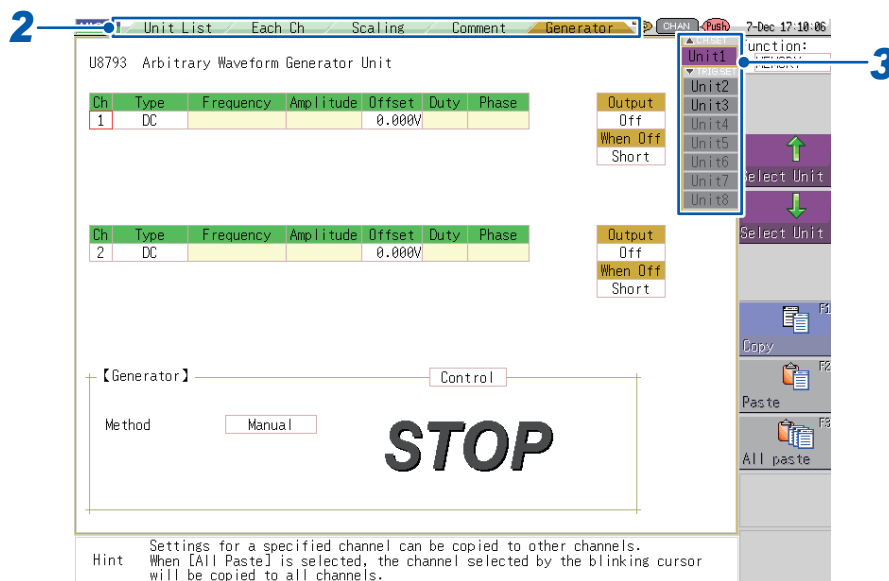

- 1 Press **CHAN** (**CHAN**).
- 2 Select the **[Generator]** tab.
- 3 Press **CH.SET** (**CH.SET**) or **TRIG.SET** (**TRIG.SET**) and select the module.

3

Method for copying and pasting channel settings

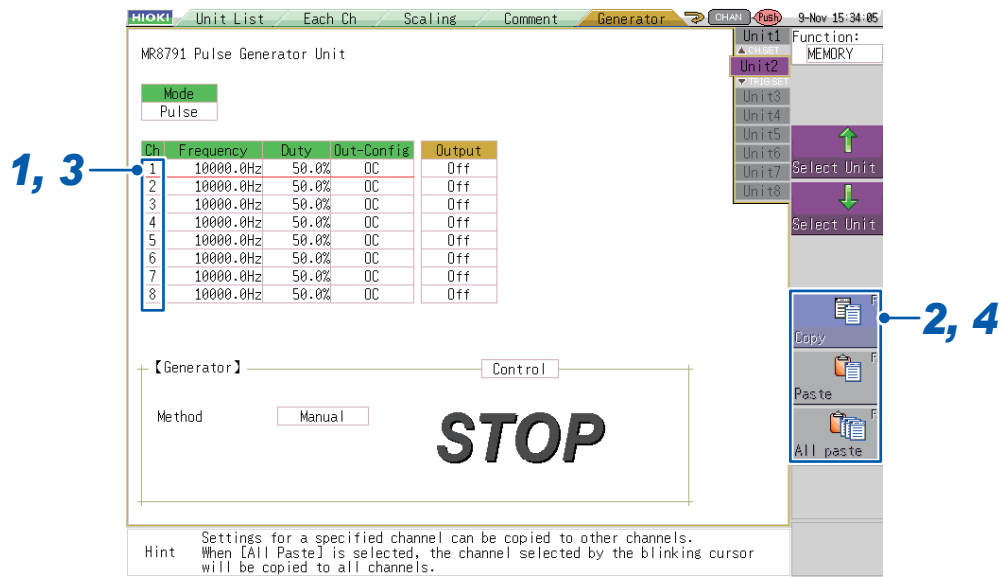

- 1** Select the source channel's [Ch] setting.
- 2** Press a function key (F1 to F5) or select [Copy] with the mouse.
- 3** Move the cursor to the [Ch] setting to which you wish to paste the settings.
- 4** Press a function key (F1 to F5) or select a button with the mouse.

Copy	Copies the settings.
------	----------------------

Paste	Pastes the copied settings.
Paste All	Pastes the settings to all channels.

For MR6000 and MR8740T

 > [Channel]

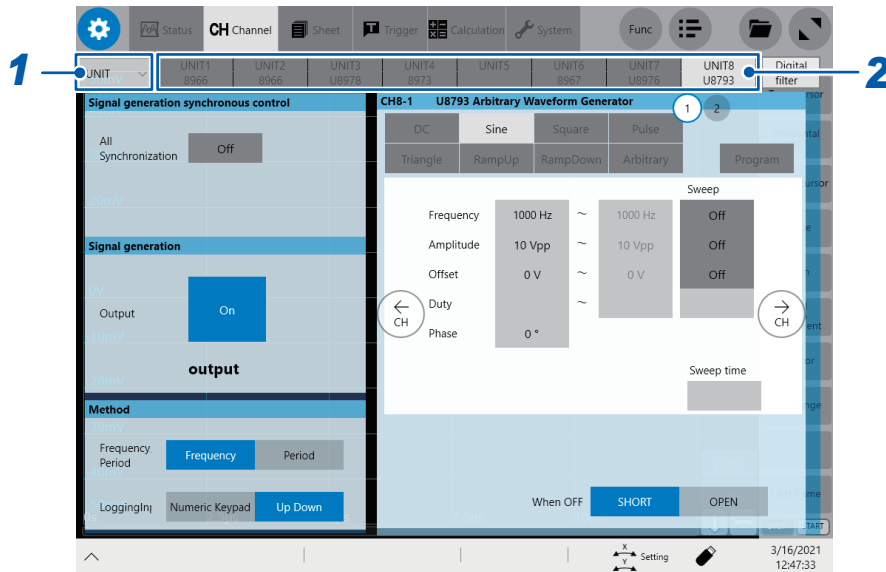

- 1** (MR6000 only)
If the CAN/LIN interface is connected, tap the UNIT/CAN switching box, and then from the list, choose [UNIT].
- 2** Tap the unit number's tab where a Generator Unit has been installed.

3

Signal Generation Settings Screen

4

Waveform Settings (U8793 and MR8790)

This section describes the settings that are available when a U8793 Arbitrary Waveform Generator Unit or an MR8790 Waveform Generator Unit is selected on the Generator screen (signal generation settings screen) (p. 15).

The following parameters can be set (except with the two waveform types: **[Arbitrary]** and **[Program]**):

Type	Selects the type of waveform.	p.24
Frequency	Sets the frequency.	p.26
Amplitude	Sets the amplitude.	p.28
Offset	Sets the offset.	p.30
Duty cycle	Sets the duty cycle.	p.32
Phase	Sets the phase.	p.34
When Off	Sets the output terminal state to use when waveform output is stopped.	p.36
Output	Turns output on or off.	p.39

(When the sweep setting is enabled)

Sweep Time	Sets the sweep time.	p.69
------------	----------------------	------

Method for setting values

For MR8847A, MR8827, MR8740, and MR8741

Parameters that are set as values can be entered using either the [Up-Down] (arrow key input) method or the [Tenkey entry] (numeric input) method.

After selecting the [Up-Down] method

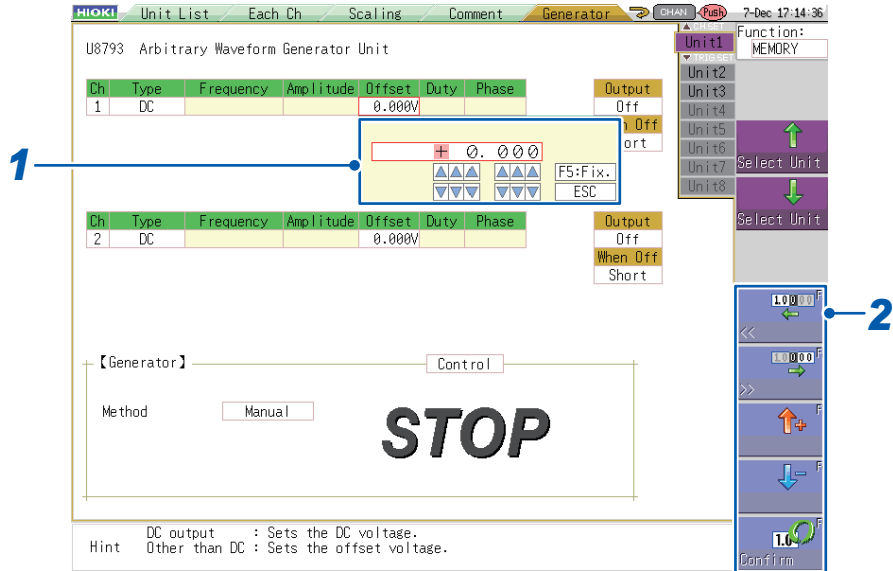

1 Press a function key (F1 to F5) or select a button with the mouse.

	Moves one digit to the left.
	Moves one digit to the right.
	Increases the value.
	Decreases the value.
	Accepts the value.

After selecting [Tenkey entry]

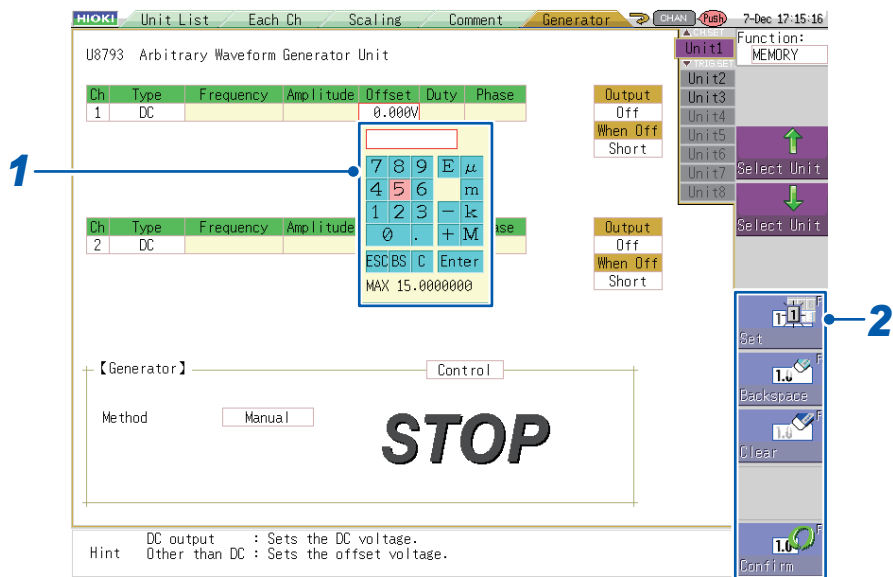

1 Press a function key (F1 to F5) or select a button with the mouse.

Set	Enters the selected value, unit, etc.
Backspace	Deletes the most recently entered value, unit, etc.
Clear	Deletes all entered values.
Confirm	Accepts the value.

For MR6000 and MR8740T

You can enter values using the numeric keypad (**[Numeric Keypad]**) or the Up Arrow and Down Arrow keys (**[Up Down]**).

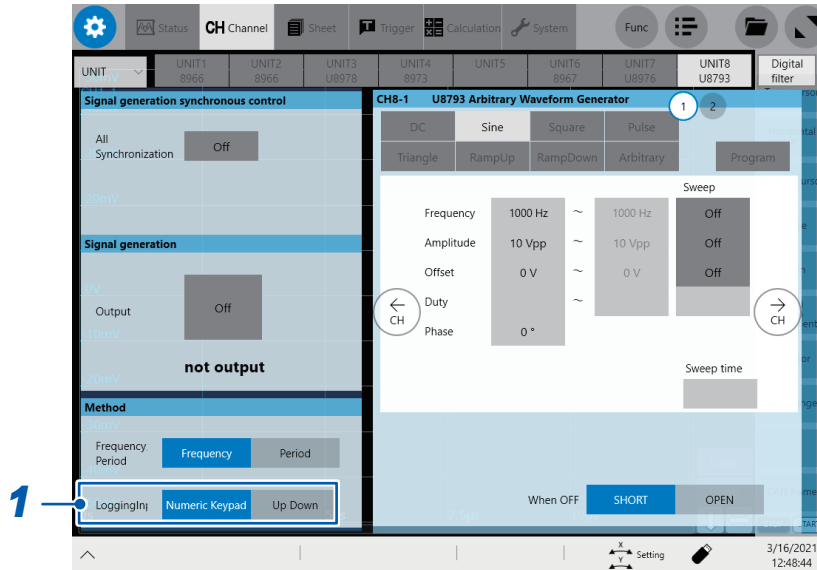

- 1 Tap a button under **[LoggingIn]** to choose a way of entering values.

Numeric keypad	Lets you use the numeric keypad.
Up Down	Lets you use the Up Arrow and Down Arrow keys

When you choose **[Up Down]**



- 1 Tap a parameter you wish to change its value.
The window including the Up Arrow and Down Arrow keys will be displayed.
- 2 Change the value.
Tap the ▲ and ▼ keys respectively to increase and decrease the value. When the output is set to on, the change in the value will immediately be applied to the output.
- 3 Tap **[OK]** to confirm the set value.
If you do not wish to change it, tap **[Cancel]**.

When you choose [Numeric keypad]

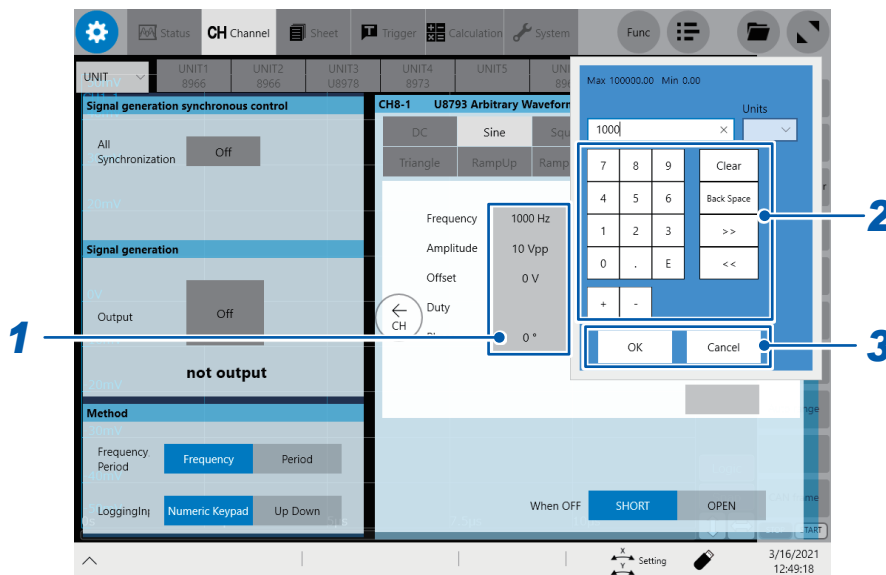

- 1** Tap a parameter you wish to change its value.
The numeric keypad will be displayed.
- 2** Change the value.
- 3** Tap **[OK]** to confirm the set value.
If you do not wish to change it, tap **[Cancel]**.

You can enter a value given to five significant figures using the frequency setting's numeric keypad.
If you wish to enter a value given to more significant figures, use the Up Arrow and Down Arrow keys.

4.1 Setting the Waveform Type

For MR8847A, MR8827, MR8740, and MR8741

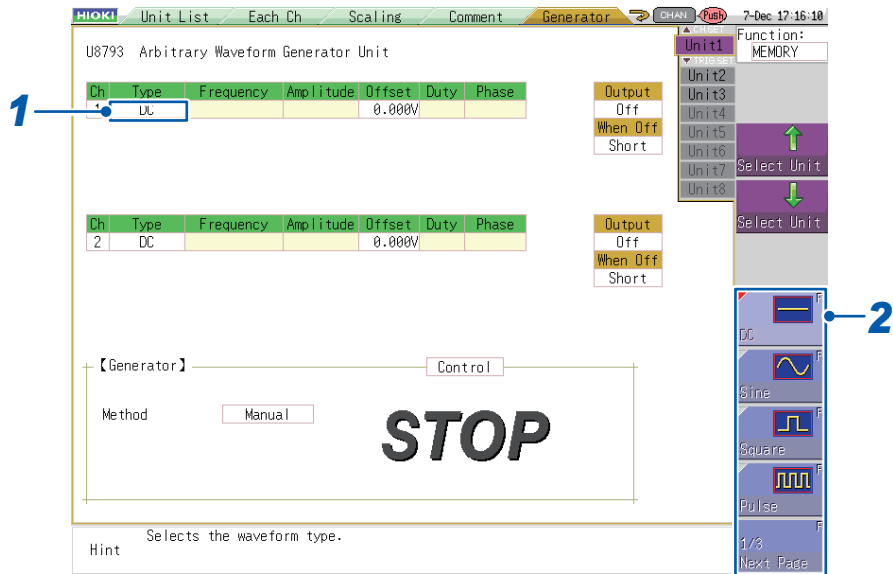

- 1** Select the [Type] setting.
- 2** Press a function key (F1 to F5) or select a button with the mouse.

DC	Outputs a DC waveform.
Sine	Outputs a sine wave.
Square	Outputs a rectangular wave with a fixed duty cycle of 50% (U8793 only).
Pulse	Outputs a pulse wave with variable duty cycle (U8793 only).
Triangle	Outputs a triangular wave (U8793 only).
Ramp-up	Outputs a ramp-up wave (U8793 only).
Ramp-down	Outputs a ramp-down wave (U8793 only).
Arbitrary	Outputs a user-created waveform (U8793 only). (p. 71)
Program	Outputs a waveform in accordance with the edited program (U8793 only). (p. 105)

Examples of waveforms that can be output

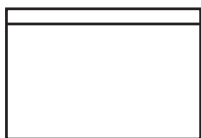

DC

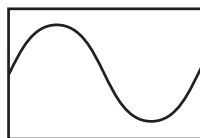

Sine wave

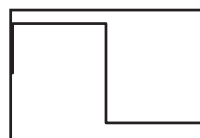

Square wave

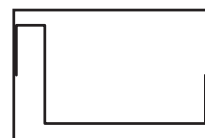

Pulse wave

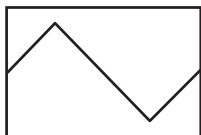

Triangular wave

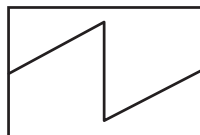

Ramp-up wave

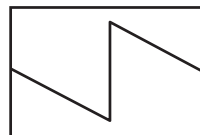

Ramp-down wave

For MR6000 and MR8740T

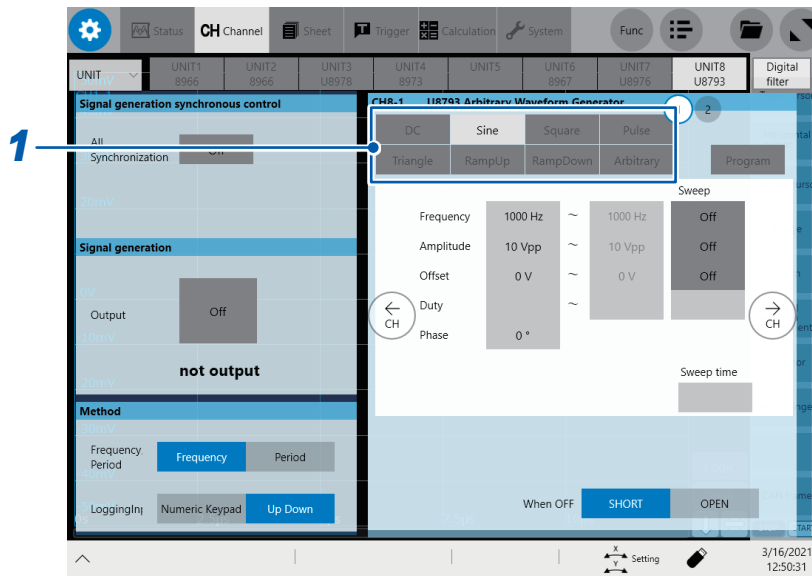

4

1 Tap a waveform type you wish to generate.

DC	Outputs a DC signal.
Sine	Outputs a sine wave.
Square	Outputs a square wave with a duty cycle of 50% (U8793 only).
Pulse	Outputs a pulse wave whose duty cycle is adjustable (U8793 only).
Triangle	Outputs a triangular wave (U8793 only).
RampUp	Outputs a ramp-up wave (U8793 only).
RampDown	Outputs a ramp-down wave (U8793 only).
Arbitrary	Outputs a created arbitrary waveform (U8793 only). (p.71)
Program	Outputs a waveform according to a previously edited program (U8793 only). (p.105)

Waveforms that can be output

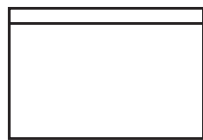

DC

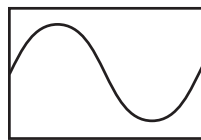

Sine

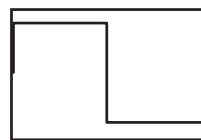

Square



Pulse

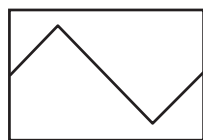

Triangle

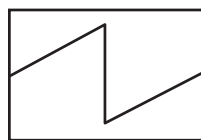

Ramp-up

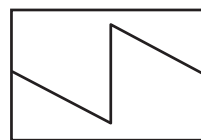

Ramp-down

Waveform Settings (U8793 and MR8790)

4.2 Setting the Frequency

For MR8847A, MR8827, MR8740, and MR8741

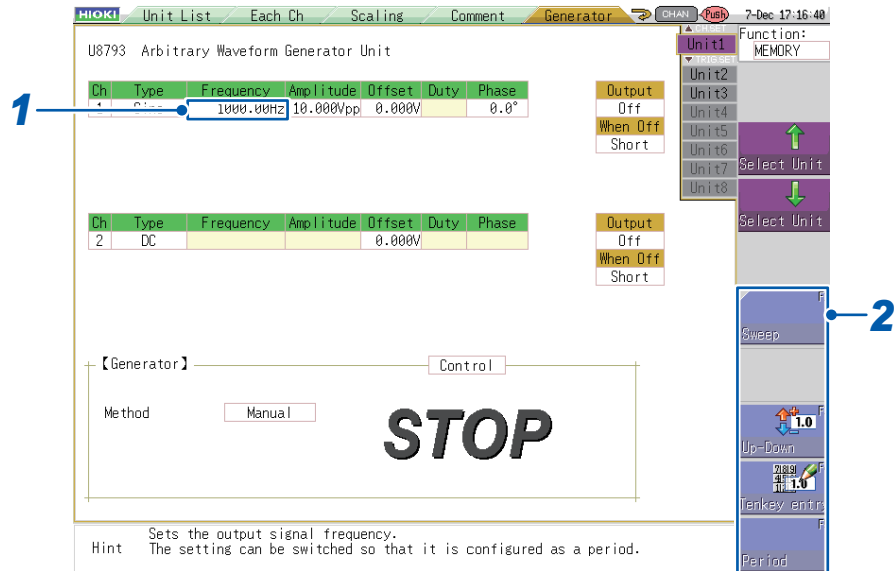

1 Select the **[Frequency]** setting.

2 Press a function key (**F1** to **F5**) or select a button with the mouse.

Sweep	p.63
Up-Down	p.20
Tenkey entry	p.21
Period	Allows you to enter the setting as a period instead of a frequency. This value can be set only by means of numeric keypad input. (p.21)

Valid frequency setting range:

U8793: 0 Hz to 100 kHz (in 0.01 Hz increments)

MR8790: 0 Hz to 20 kHz (in 1 Hz increments)

Valid period setting range:

U8793: 0 sec. to 100 sec.

MR8790: 0 sec. to 1 sec.

The period can be set as desired within the above range. However, the period of the waveform that is actually output will be the period of the waveform corresponding to the valid frequency setting that would produce the period closest to the user-entered period value.

For MR6000 and MR8740T

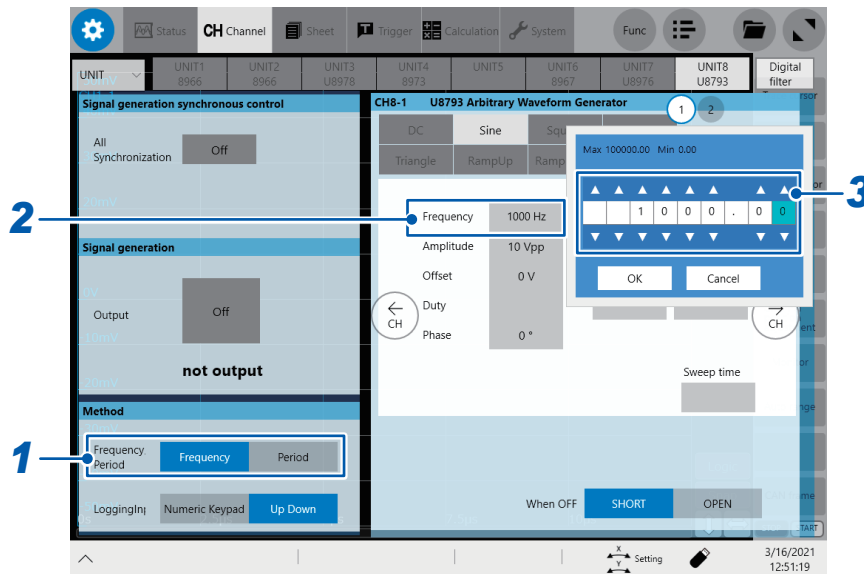

- 1** Tap **[Frequency]** or **[Period]** to choose.
You can enter the frequency or period of the output waveform. The displayed items differ between **[Frequency]** and **[Period]**.
- 2** Tap the **[Frequency]** setting (the **[Period]** setting if you choose period).
- 3** Enter the frequency using the Up Arrow and Down Arrow keys or the numeric keypad.

Valid frequency setting range:

U8793: 0 Hz to 100 kHz (in 0.01 Hz increments)

MR8790: 0 Hz to 20 kHz (in 1 Hz increments)

Valid period setting range:

U8793: 0 sec. to 100 sec.

MR8790: 0 sec. to 1 sec.

You can enter any period within the range mentioned above. However, the actual output waveform will have a period rounded off to the nearest valid value in frequency.

4

Waveform Settings (U8793 and MR8790)

4.3 Setting the Amplitude

For MR8847A, MR8827, MR8740, and MR8741

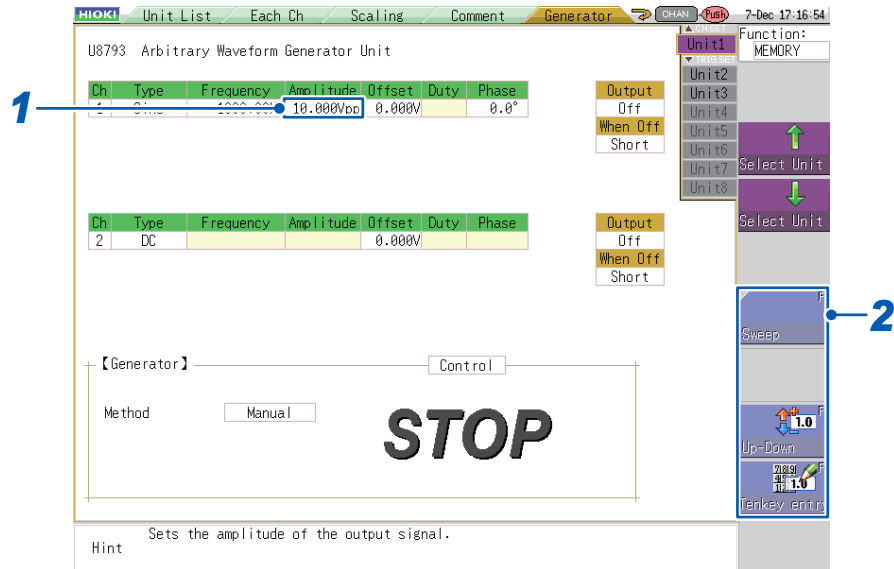

1 Select the [Amplitude] setting.

2 Press a function key (F1 to F5) or select the sweep setting and numerical entry method with the mouse.

Sweep	p.63
Up-Down	p.20
Tenkey entry	p.21

Valid amplitude setting range: 0 V p-p to 20 V p-p (in 1 mV p-p increments)

The output voltage (amplitude + offset) range for which accuracy is guaranteed for each module is as follows:

U8793: -10 V to +15 V

MR8790: -10 V to +10 V

If the sum of the amplitude and offset is set to out of the accuracy guarantee range, the output waveform will partly be clamped on the following limits:

U8793: Upper limit of about +16 V, lower limit of about -11 V

MR8790: Upper limit of about +14 V, lower limit of about -14 V

For MR6000 and MR8740T

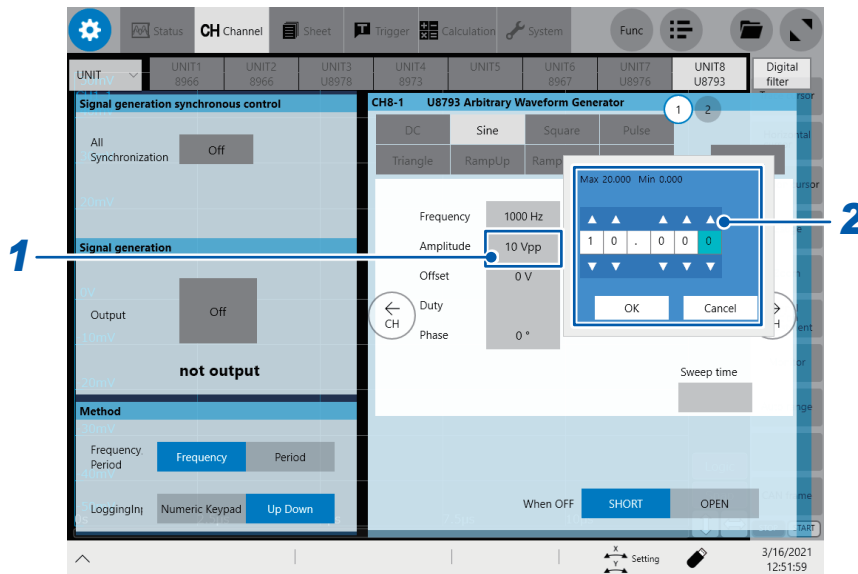

1 Tap the [Amplitude] setting.

2 Enter the amplitude using the Up Arrow and Down Arrow keys or the numeric keypad.

Valid amplitude setting range: 0 V p-p to 20 V p-p (in 1 mV p-p increments)

Each module's accuracy of output voltage, which is the sum of the amplitude and offset, is guaranteed only if the voltage falls within the following range:

U8793: -10 V to +15 V

MR8790: -10 V to +10 V

If the sum of the amplitude and offset is set to out of the accuracy guarantee range, the output waveform will partly be clamped on the following limits:

U8793: Upper limit of about +16 V, lower limit of about -11 V

MR8790: Upper limit of about +14 V, lower limit of about -14 V

4

Waveform Settings (U8793 and MR8790)

4.4 Setting the Offset

For MR8847A, MR8827, MR8740, and MR8741

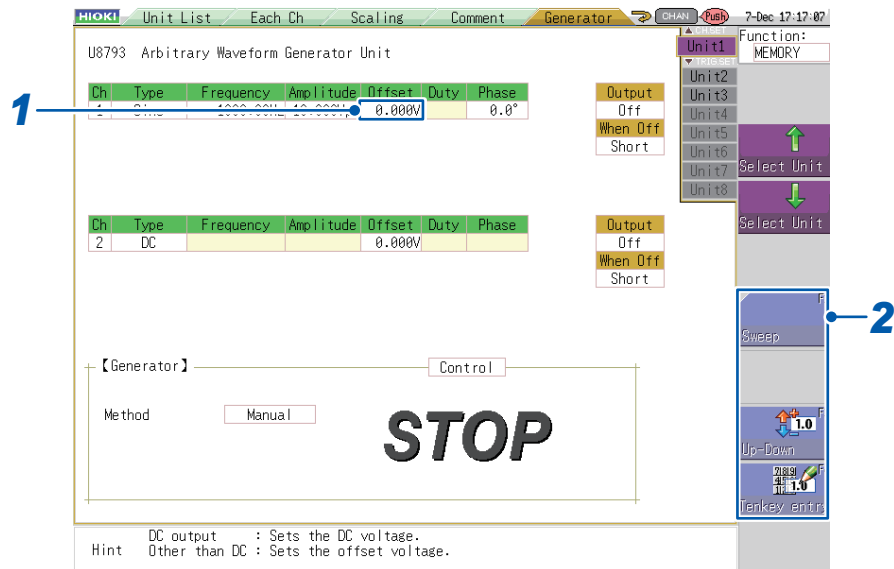

- 1** Select the **[Offset]** setting.
- 2** Press a function key (**F1** to **F5**) or select a button with the mouse.

Sweep	p.63
Up-Down	p.20
Tenkey entry	p.21

Valid offset setting range: -10 V to +15 V (in 1 mV increments) (U8793)
 -10 V to +10 V (in 1 mV increments) (MR8790)

When the waveform type is set to DC, the set offset value determines the DC voltage that is output.

Each module's accuracy of output voltage, which is the sum of the amplitude and offset, is guaranteed only if the voltage falls within the following range:

U8793: -10 V to +15 V
 MR8790: -10 V to +10 V

If the sum of the amplitude and offset is set to out of the accuracy guarantee range, the output waveform will partly be clamped on the following limits:

U8793: Upper limit of about +16 V, lower limit of about -11 V
 MR8790: Upper limit of about +14 V, lower limit of about -14 V

For MR6000 and MR8740T

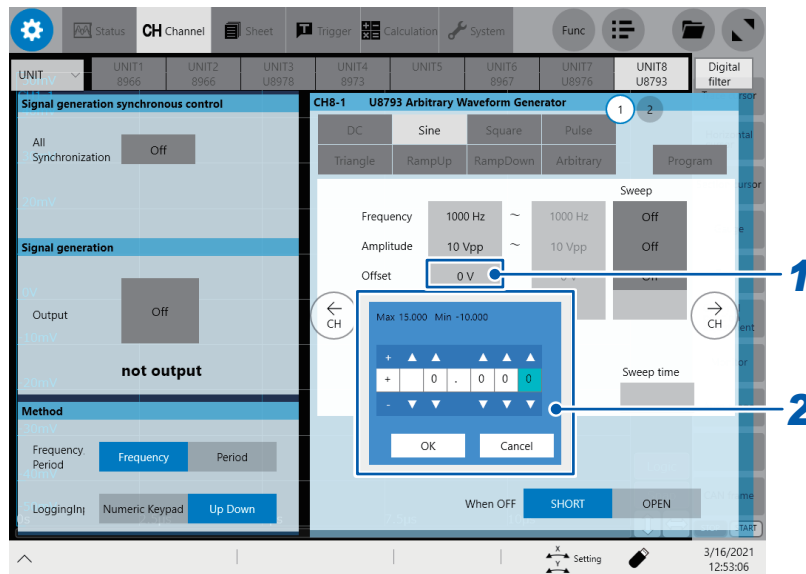

- 1** Tap the **[Offset]** setting.
- 2** Enter the offset using the **Up Arrow** and **Down Arrow** keys or the numeric keypad.

Valid offset setting range: -10 V to $+15\text{ V}$ (in 1 mV increments)

If you set the waveform type to DC, the DC with a voltage of the set offset value will be output. Each module's accuracy of output voltage, which is the sum of the amplitude and offset, is guaranteed only if the voltage falls within the following range:

U8793: -10 V to $+15\text{ V}$

MR8790: -10 V to $+10\text{ V}$

If the sum of the amplitude and offset is set to out of the accuracy guarantee range, the output waveform will partly be clamped on the following limits:

U8793: Upper limit of about $+16\text{ V}$, lower limit of about -11 V

MR8790: Upper limit of about $+14\text{ V}$, lower limit of about -14 V

4.5 Setting the Duty Cycle (Pulse Wave Output Only)

For MR8847A, MR8827, MR8740, and MR8741

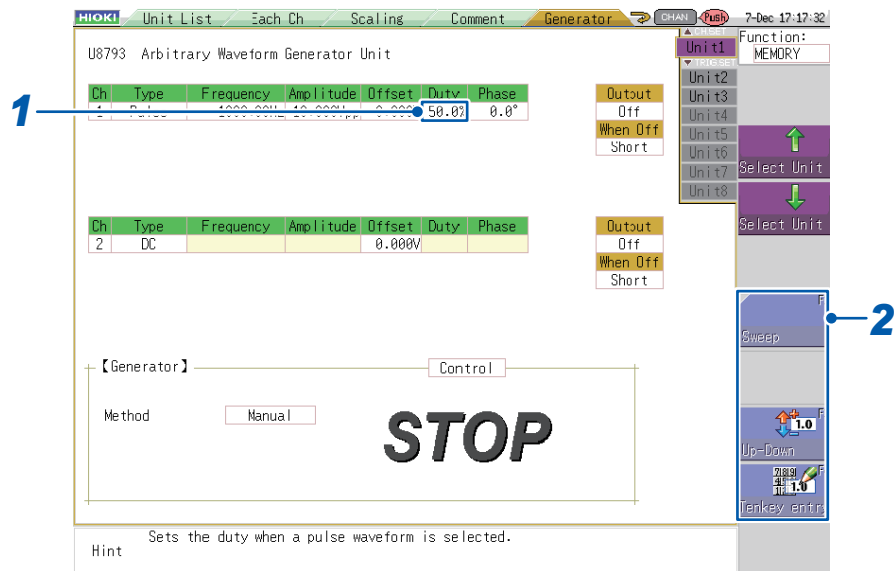

- 1** Select the [Duty] setting.
- 2** Press a function key (F1 to F5) or select a button with the mouse.

Sweep	p.63
Up-Down	p.20
Tenkey entry	p.21

Valid duty cycle setting range: 0.1% to 99.9% (in 0.1% increments)
 A pulse width of less than 500 ns in length, resulting from some combinations of the frequency and duty cycle settings, can cause the output pulse to deform or disappear.

For MR6000 and MR8740T



- 1** Tap the [Duty] setting.
- 2** Enter the duty cycle using the Up Arrow and Down Arrow keys or the numeric keypad.

Valid duty cycle setting range: 0.1% to 99.9% (in 0.1 percent points increments)
 A pulse width of less than 500 ns in length, resulting from some combinations of the frequency and duty cycle settings, can cause the output pulse to deform or disappear.

4.6 Setting the Phase

For MR8847A, MR8827, MR8740, and MR8741

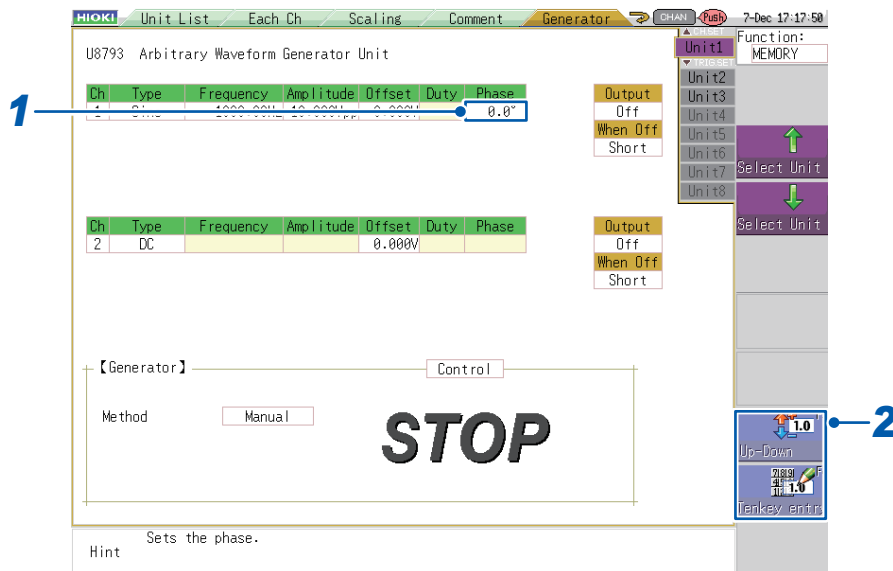

1 Select the **[Phase]** setting.

2 Press a function key (**F1 to F5**) or select a button with the mouse.

Up-Down	p.20
Tenkey entry	p.21

Valid phase setting range: -360° to $+360^{\circ}$ (in 0.1° increments)

- The U8793, which can output signals in sync with each other in a single module or with other modules, can output a signal with a phase difference set for each channels.

Example

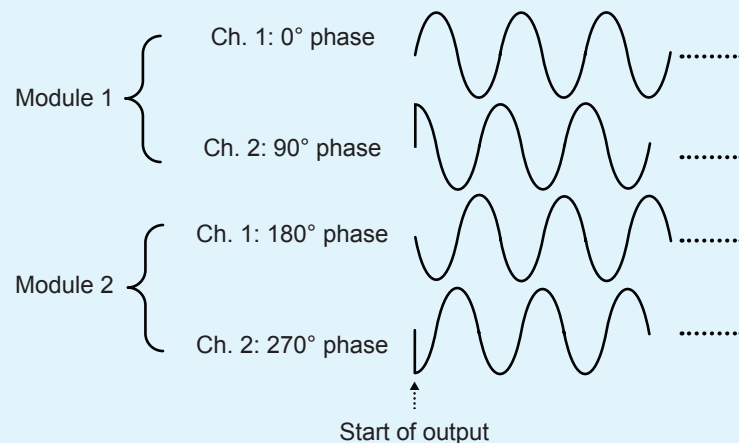

- Phase synchronization cannot be performed while using the sweep setting (p.63) or program setting (p.105).
- The MR8790 cannot generate output that is synchronized between channels on the same module, between channels on different modules, or with output from a U8793 or MR8791 module.
- The MR8791 cannot generate output that is synchronized with output from a U8793 or MR8790 module.

For MR6000 and MR8740T



- 1 Tap the [Phase] setting.
- 2 Enter the phase using the Up Arrow and Down Arrow keys or the numeric keypad.

Valid phase setting range: -360° to $+360^{\circ}$ (in 0.1° increments)

- The U8793, which can output signals in sync with each other in a single module or with other modules, can output a signal with a phase difference set for each channels.

Example

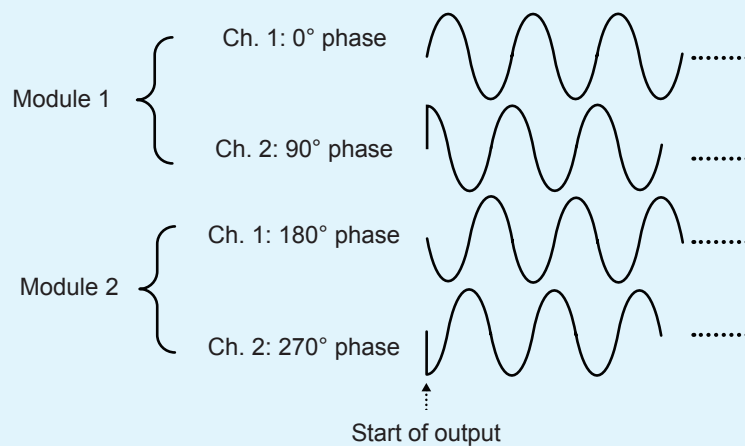

- Phase synchronization cannot be performed while using the sweep setting (p.63) or program setting (p. 105).
- To sync phases between channels, set [All synchronization] to [On].

4.7 Setting the Output to On or Off (MR8847A, MR8827, MR8740, and MR8741)

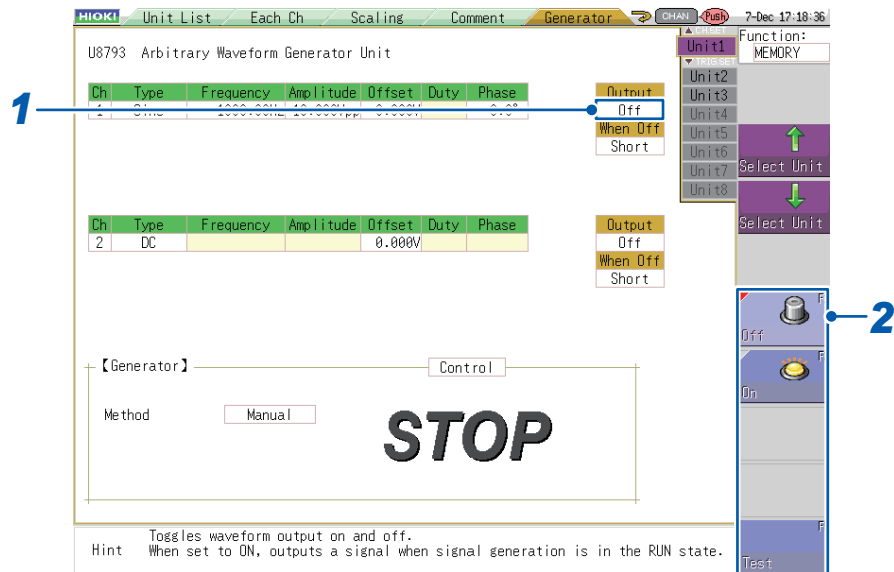

- 1** Select the **[Output]** setting.
- 2** Press a function key (**F1** to **F5**) or select a button with the mouse.

Off	Does not output a waveform, regardless of the state of Generator Control (p. 131). (Output indicator: Off)
On	Outputs a waveform when Generator Control (p. 131) is [RUN] . (Output indicator: Red)
Test	Generates test output of the set waveform. (Output indicator: Red)

After selecting [Test]

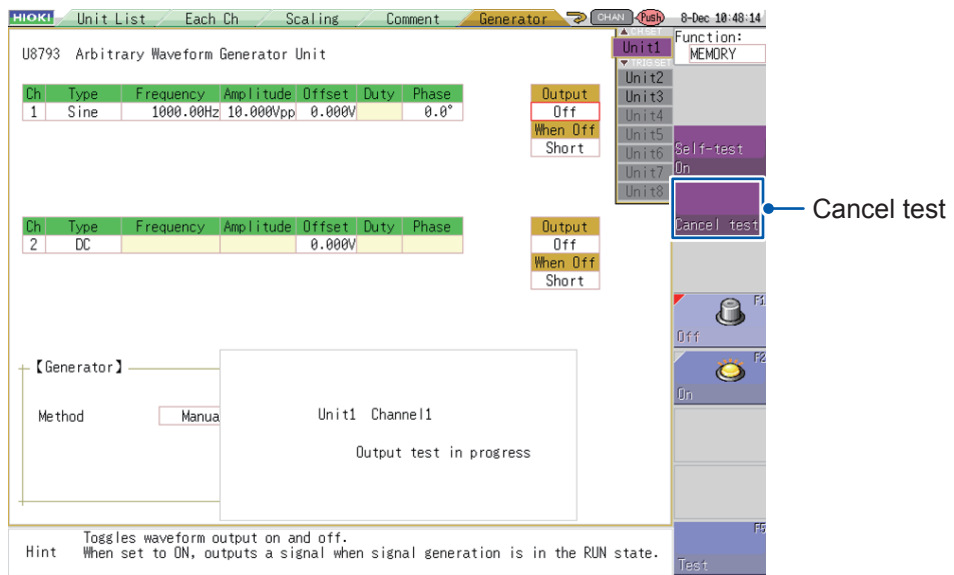

Pressing **TRIG.SET** (**TRIG.SET**) stops test output.

This test mode does not provide functionality for judging test results with the module. You are responsible for determining whether the set waveform is being properly output during the output test.

4.8 Setting the Sync Use to On or Off (MR6000 and MR8740T)

You can configure this setting if the **[All synchronization]** setting is set to **[On]** by following the instructions in “9.1 Setting the Control Method” (p. 127)

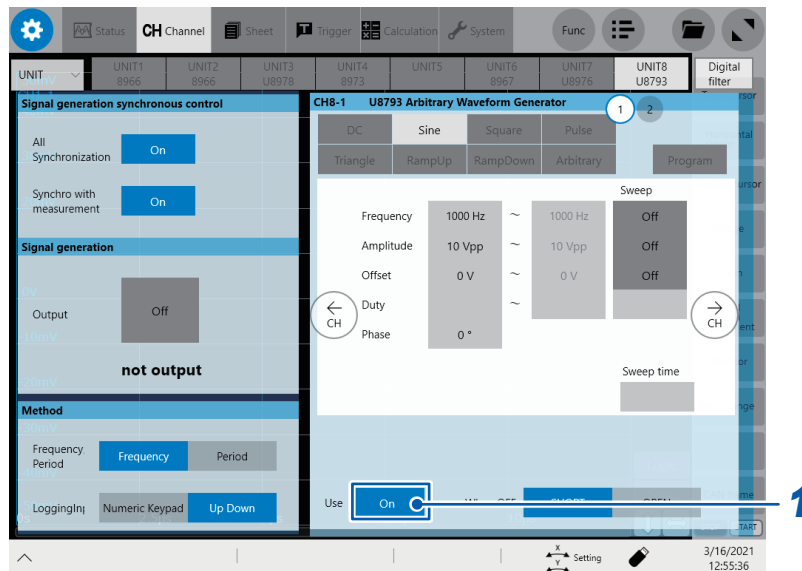

1 Tap the **[Use]** button to set it **[On]** or **[Off]**.

Off	Does not output a waveform regardless of the signal generation outputting setting (p. 133). (Output indicator: Off)
On	Outputs a waveform when the signal generation outputting (p. 133) is set to [On] . (Output indicator: Red)

4.9 Setting Behavior When Output is Off

For MR8847A, MR8827, MR8740, and MR8741

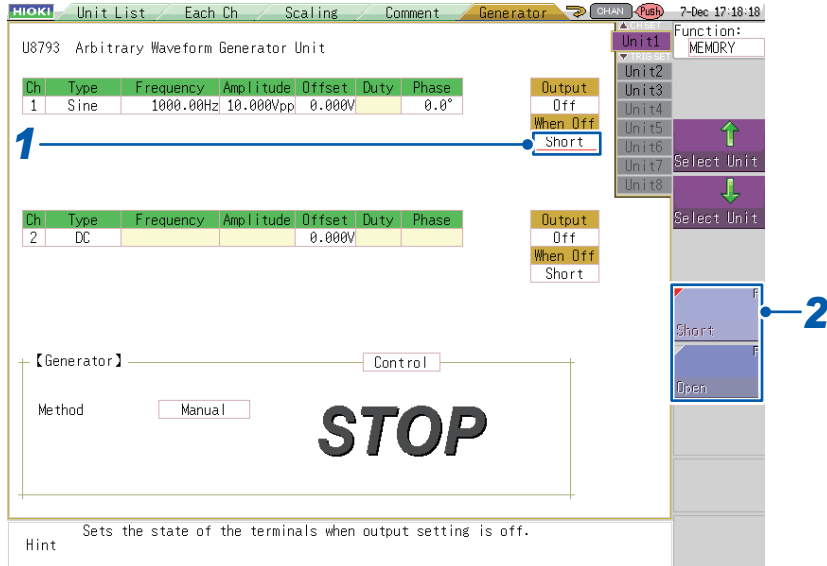

- 1** Select the **[When Off]** setting.
- 2** Press a function key (**F1 to F5**) or select a button with the mouse.

Short	<p>When the output (p. 36) is off, places the output terminal in a shorted state by separating it from the module's internal circuitry and introducing resistance.</p>
Open	<p>When the output (p. 36) is off, places the output terminal in an open state by separating it from the module's internal circuitry.</p>

For MR6000 and MR8740T

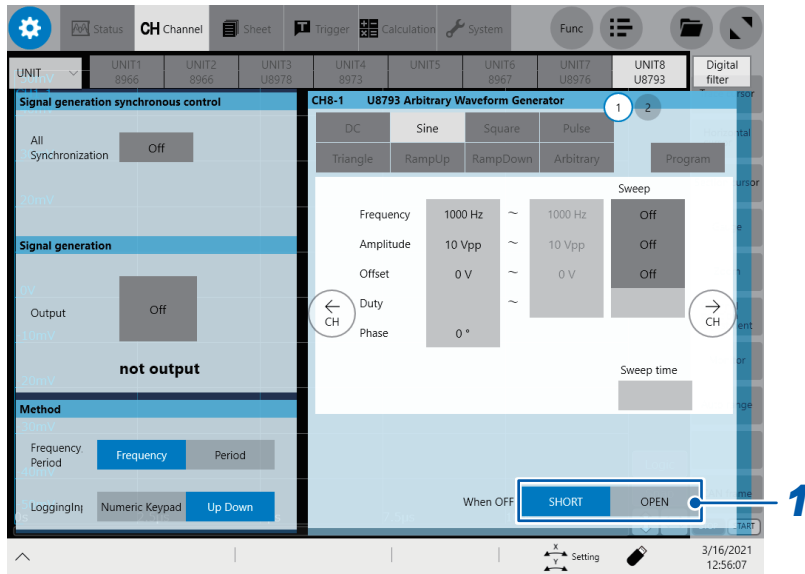

1 Tap the [When OFF] button to set it [Short] or [Open].

Short	<p>Disconnects the output terminal from the internal circuit and shorts the terminal using a resistance when the signal outputting (p. 133) is set to off.</p> <p style="margin-left: 40px;">Internal circuit</p> <p style="margin-left: 40px;">U8793: approx. 100 Ω MR8790: approx. 20 Ω</p> <p style="margin-left: 40px;">Output terminal</p>
Open	<p>Disconnects the output terminal from the internal circuit and opens the terminal when the signal output setting (p. 133) is set to off.</p> <p style="margin-left: 40px;">Internal circuit</p> <p style="margin-left: 40px;">Output terminal</p>

5

Setting Pulse and Pattern Output (MR8791)

This section describes the settings that are available when an MR8791 Pulse Generator Unit is selected on the Generator screen (signal generation settings screen) (p. 15).

5.1 Setting the Mode

For MR8847A, MR8827, MR8740, and MR8741

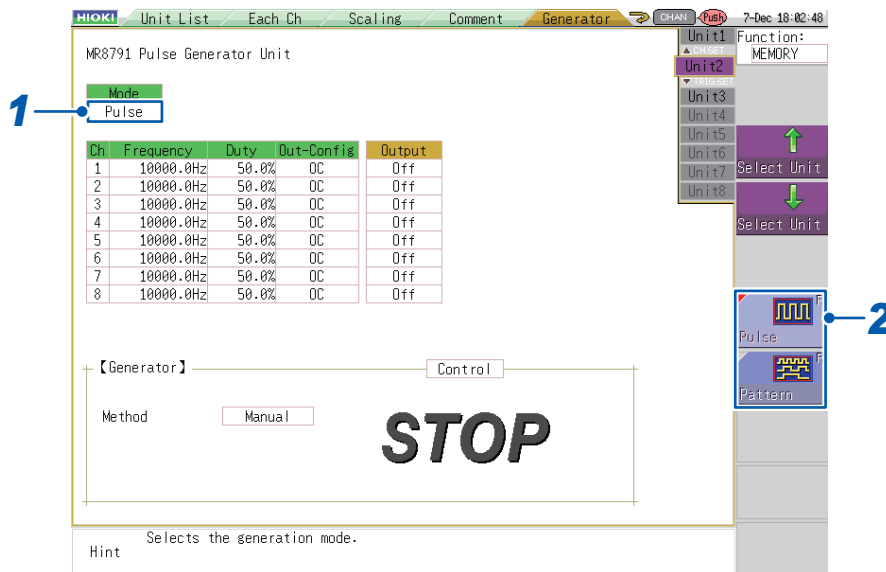

- 1 Select the **[Mode]** setting.
- 2 Press a function key (F1 to F5) or select a button with the mouse.

Pulse	Outputs continuous pulse waveforms. (p.43) The frequency and duty cycle can be set separately for each channel.
Pattern	Outputs user-edited patterns. (p.51) Patterns are edited using the SF8000 Waveform Maker. For information about how to edit, see “13.10 Pulse Pattern Mode” (p. 179).

The Pattern setting can only be selected when the Channels to use setting on the Memory HiCorder in which the MR8791 is installed is set to the maximum number of channels. The Channels to use setting can be configured under **[Basic Setting]** on the **[STATUS]** screen. For more information, see the instruction manual for the Memory HiCorder in which the module is installed.

For MR6000 and MR8740T

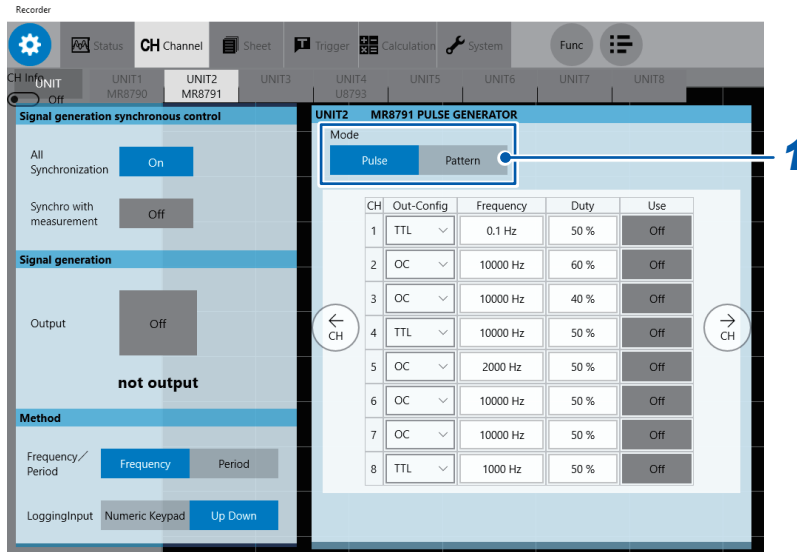

1 Click a button under **[Mode]** to choose an output mode of the MR8791 Pulse Generator Unit.

Pulse	Outputs continuous pulse waveforms. (p.44) The frequency and duty cycle can be set separately for each channel.
Pattern	Outputs a user-edited pattern. (p.52) Patterns are edited using the SF8000 Waveform Maker. For information about how to edit, see “13.10 Pulse Pattern Mode” (p.179).

5.2 Setting the Pulse Mode

Setting the frequency

For MR8847A, MR8827, MR8740, and MR8741

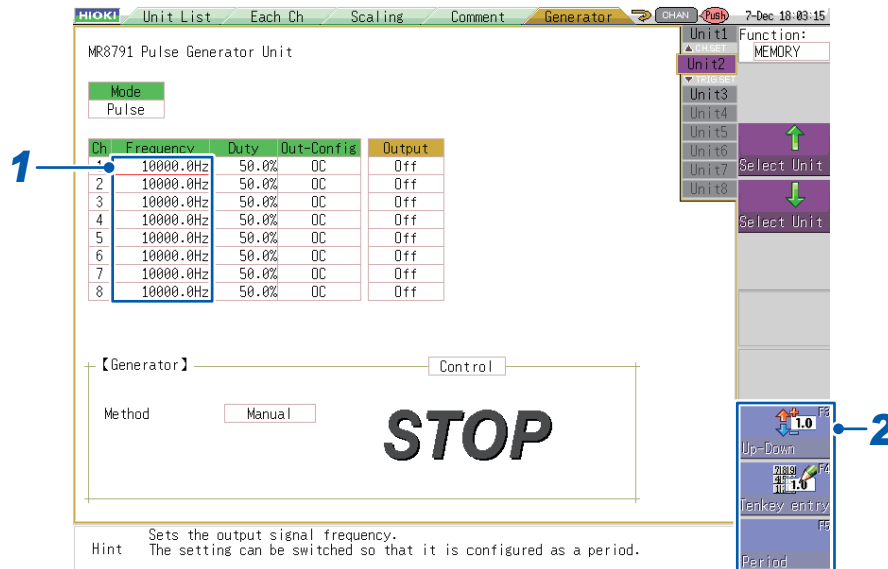

- 1 Select the **[Frequency]** setting.
- 2 Press a function key (**F1 to F5**) or select a button with the mouse.

Up-Down	p.20
Tenkey entry	p.21
Period	Allows you to enter the setting as a period instead of a frequency. This value can be set only by means of numeric keypad input. (p.21)

Valid frequency setting range: 0 Hz to 20 kHz (in 0.1 Hz increments)

Valid period setting range: 0 sec. to 10 sec.

The period can be set as desired within the above range. However, the period of the waveform that is actually output will be the period of the waveform corresponding to the valid frequency setting that would produce the period closest to the user-entered period value.

For MR6000 and MR8740T

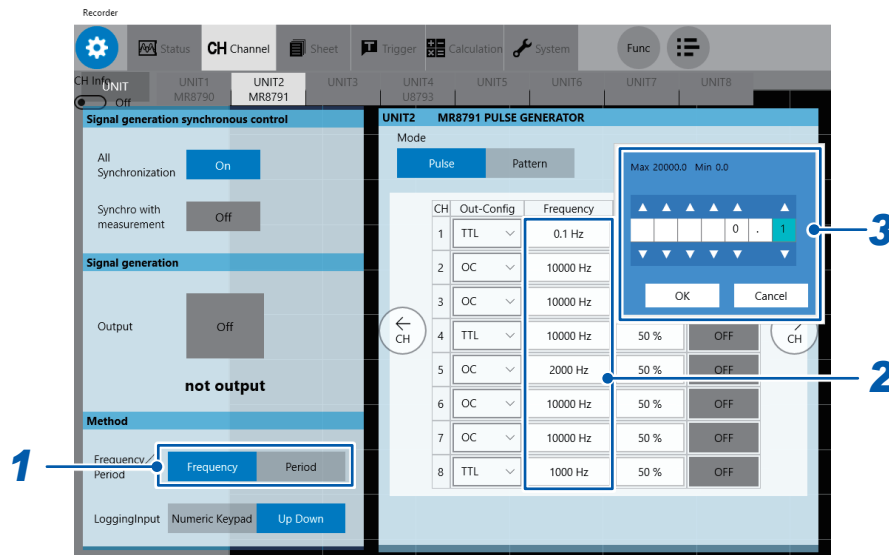

- 1** Click **[Frequency]** or **[Period]** to choose.
Display items will vary between **[Frequency]** and **[Period]**.
- 2** Click a box in the **[Frequency]** column (or the **[Period]** column when you chose **[Period]**).
- 3** Set the frequency (or period) using the up and down arrow keys or numerical keypad.

Valid frequency setting range: 0 Hz to 20 kHz (in 0.1 Hz increments)
 Valid period setting range: 0 s to 10 s
 You can enter any period within the range mentioned above. However, the actual output waveform will have a period rounded off to the nearest valid value in frequency.

Setting the duty cycle

For MR8847A, MR8827, MR8740, and MR8741

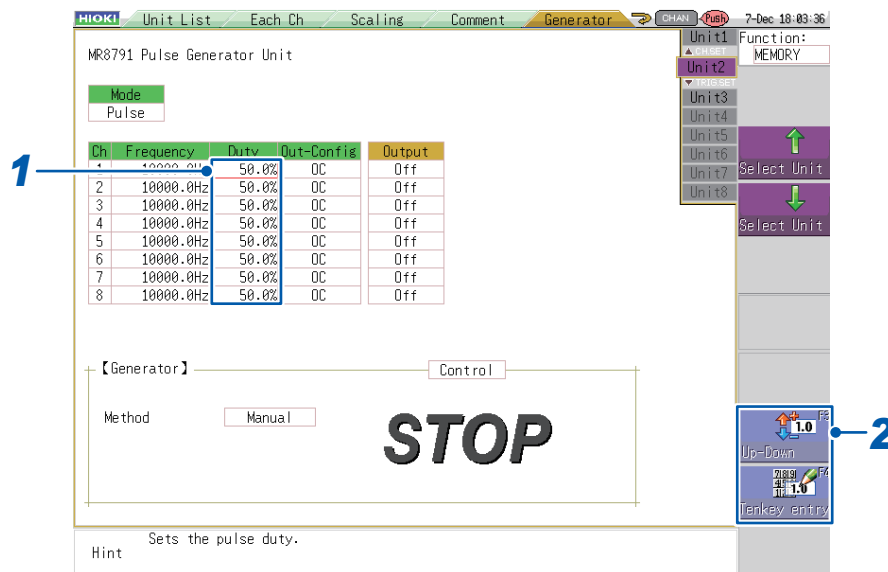

- 1** Select the **[Duty]** setting.
- 2** Press a function key (**F1** to **F5**) or select a button with the mouse.

Up-Down	p.20
Tenkey entry	p.21

Valid duty cycle setting range: 0% to 100% (in 0.1% increments)

- Entering a setting of 0% will fix the output level to low, while entering a setting of 100% will fix the output level to high. The module will not generate pulse output in either case.
- When the duty cycle is set to 100%, the output waveform will be fixed at the high level, even when output is set to off (p.49).
- A pulse width of less than 500 ns in length, resulting from some combinations of the frequency and duty cycle settings, can cause the output pulse to deform or disappear.

For MR6000 and MR8740T

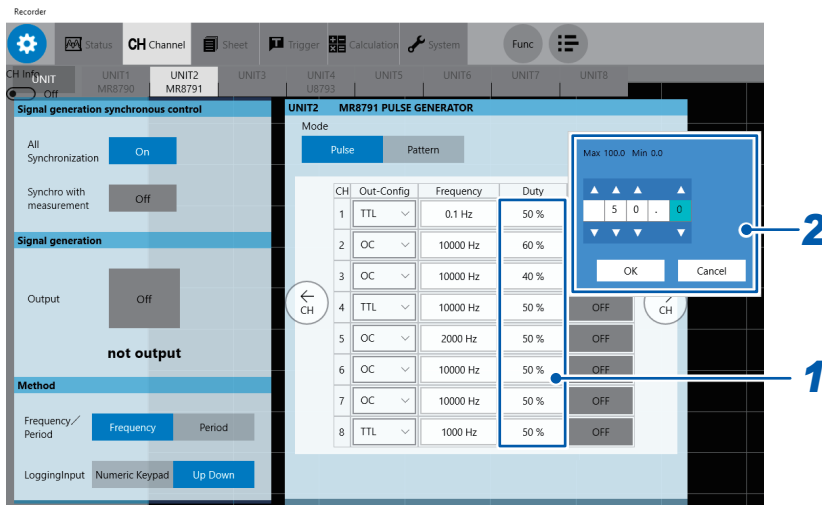

- 1 Click a box in the [Duty] column.
- 2 Set the duty cycle using the up and down arrow keys or numerical keypad.

Valid duty cycle setting range: 0% to 100% (in 0.1 percent point increments)

- Entering a setting of 0% will fix the output level to low, while entering a setting of 100% will fix the output level to high. The module will not generate pulse output in either case.
- When the duty cycle is set to 100%, the output waveform will be fixed at the high level, even when the output is set to [Off]. (p. 133)
- A pulse width of less than 1 μ s in length, resulting from some duty cycle settings, can cause the output pulse to disappear.

Setting the output configuration

For MR8847A, MR8827, MR8740, and MR8741

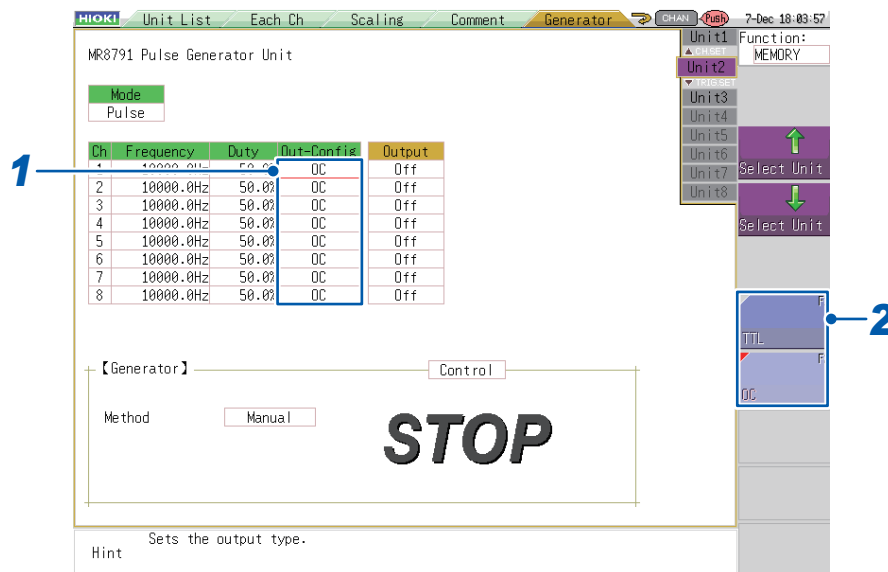

- 1 Select the **[Out-Config]** setting.
- 2 Press a function key (**F1 to F5**) or select a button with the mouse.

TTL	Selects a TTL-level pulse waveform (0 to 5 V of amplitude).
OC	Selects a pulse waveform consisting of open-collector output.

- All channels share the same ground and are not isolated from one another.

Open-collector output

- The voltage applied between the collector and emitter must be 50 V or less.
- The maximum response time (10% to 90%) is approximately 5 μ s (with a load capacitance of 1000 pF and a pull-up resistance of 1 k Ω) (reference value).

For MR6000 and MR8740T

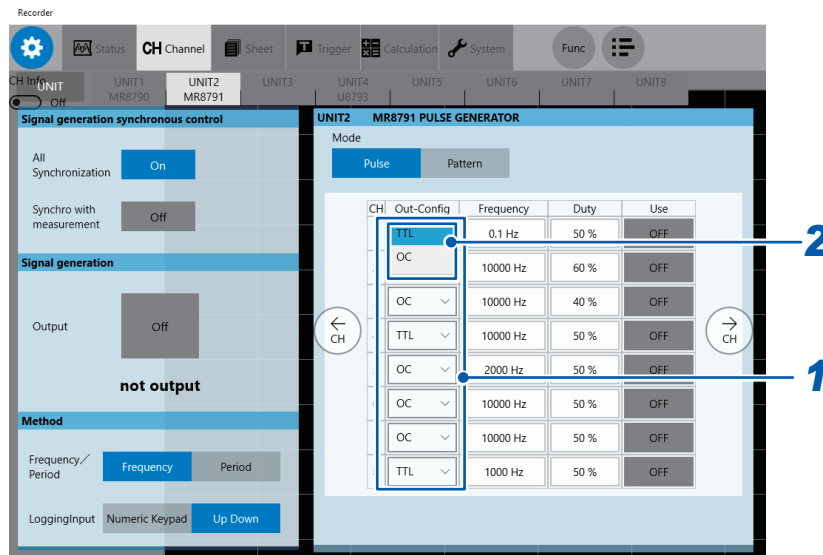

1 Click a box in the [Out-Config] column.

2 Choose between [TTL] and [OC].

TTL	Outputs a TTL pulse waveform (altitude: 0 to 5 V).
OC	Outputs an open-collector pulse waveform.

- All channels share the same ground and are not isolated from one another.

Open-collector output

- The voltage applied between the collector and emitter must be 50 V or less.
- The maximum response time (10% to 90%) is approximately 5 μ s (with a load capacitance of 1000 pF and a pull-up resistance of 1 k Ω) (reference value).

Setting output (MR8847A, MR8827, MR8740, and MR8741)

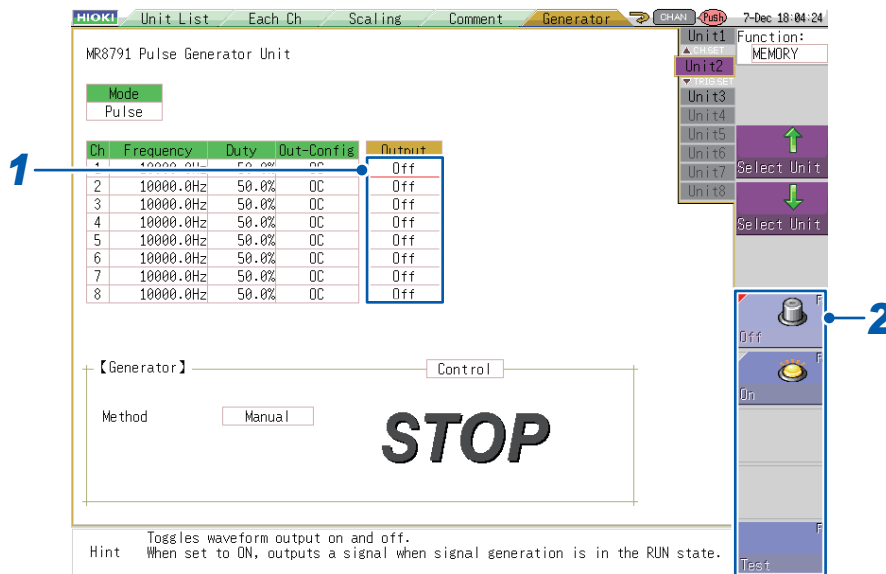

- 1 Select the **[Output]** setting.
- 2 Press a function key (**F1 to F5**) or select a button with the mouse.

Off	Does not output a waveform, regardless of the state of Generator Control (p. 131).
On	Outputs the set pulse waveform when Generator Control (p. 131) is [RUN] .
Test	Generates test output of the set waveform.

A high-level signal may be output momentarily when the power is turned on or off.

After selecting [Test]

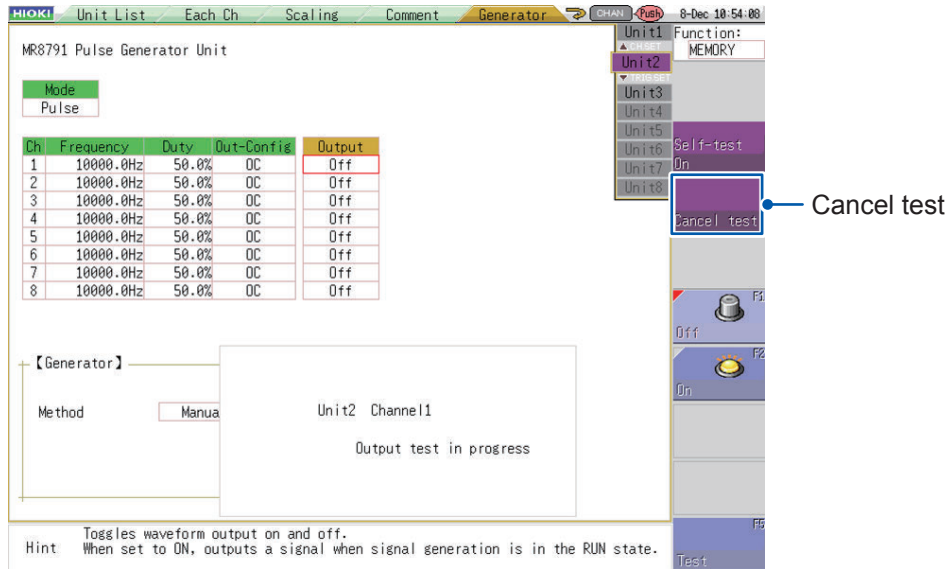

Pressing **TRIG.SET** (**TRIG.SET**) stops test output.

This test mode does not provide functionality for judging test results with the module. You are responsible for determining whether the set pulse waveform is being properly output during the output test.

Setting the Use to On or Off (for MR6000 and MR8740T)

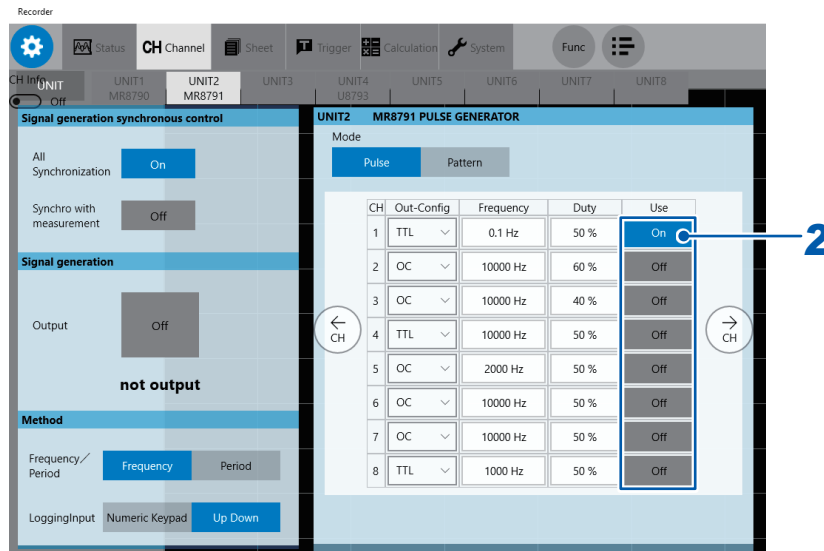

1 Click the **[Use]** button to set it to **[On]** or **[Off]**.

On	Outputs waveforms when the [Output] button under [Signal generation] (p. 133) is set to [On] .
Off	Does not output a waveform regardless of the state of the [Output] button under [Signal generation] (p. 133).

5.3 Setting the Pattern Mode

Setting the output configuration

For MR8847A, MR8827, MR8740, and MR8741

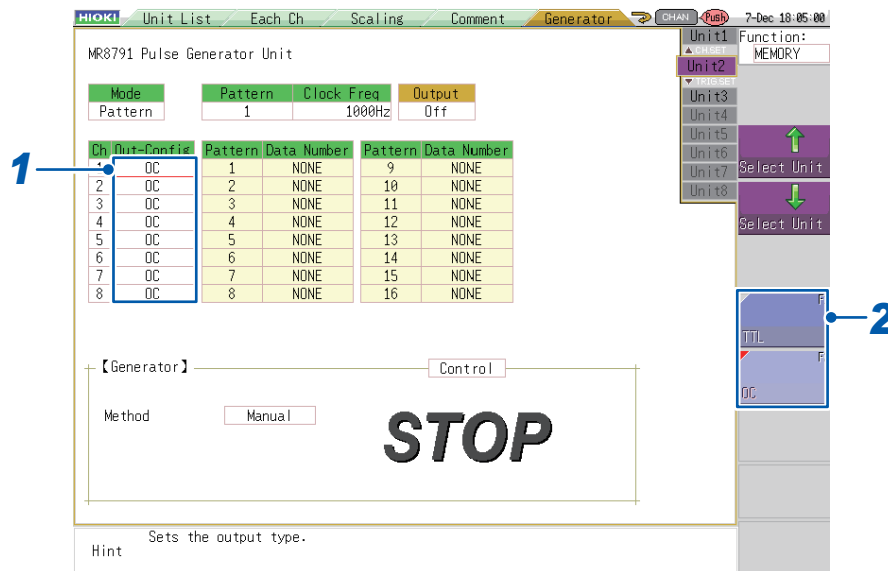

- 1 Select the **[Out-Config]** setting.
- 2 Press a function key (**F1 to F5**) or select a button with the mouse.

TTL	Selects a TTL-level pulse waveform (0 to 5 V of amplitude).
OC	Selects a pulse waveform consisting of open-collector output.

- All channels share the same ground and are not isolated from one another.

Open-collector output

- The voltage applied between the collector and emitter must be 50 V or less.
- The maximum response time (10% to 90%) is approximately 5 μ s (with a load capacitance of 1000 pF and a pull-up resistance of 1 k Ω) (reference value).

For MR6000 and MR8740T

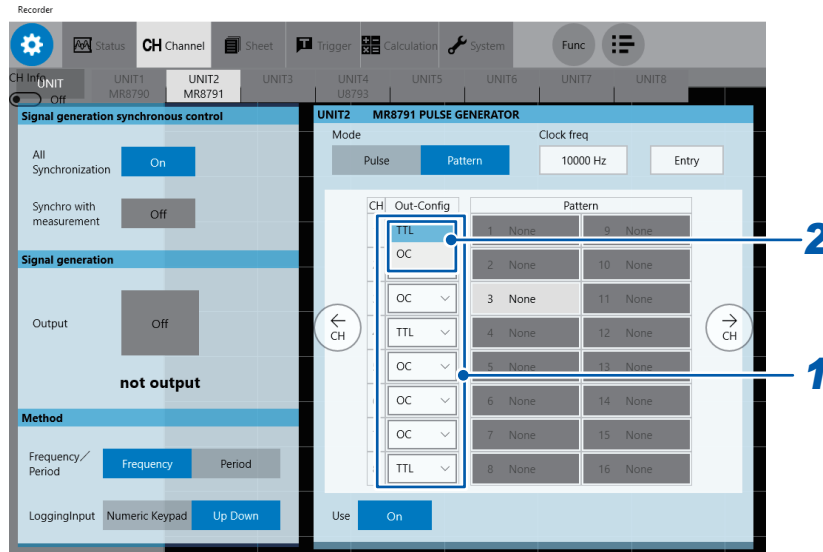

1 Click a box in the [Out-Config] column.

2 Choose between [TTL] and [OC].

TTL	Outputs a TTL pulse waveform (altitude: 0 to 5 V).
OC	Outputs an open-collector pulse waveform.



- All channels share the same ground and are not isolated from one another.
- Open-collector output**
- The voltage applied between the collector and emitter must be 50 V or less.
 - The maximum response time (10% to 90%) is approximately 5 μ s (with a load capacitance of 1000 pF and a pull-up resistance of 1 k Ω) (reference value).

Setting the pattern to use

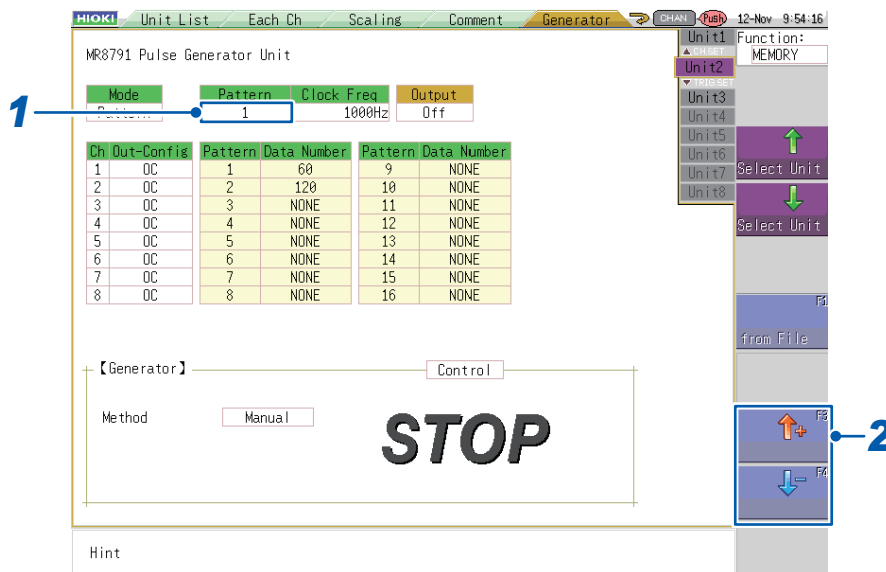
For MR8847A, MR8827, MR8740, and MR8741

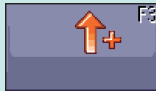

- 1 Select the **[Pattern]** setting.
- 2 Press a function key (**F1 to F5**) or select a button with the mouse.

Register: From file	Select this function key when registering the pattern. (p.55)
	Selects the pattern number to use.
	

- When output is in the stopped state, the first registered pattern will be output.
- Registered patterns will be erased if the **[Channels to use]** setting on the Memory HiCorder in which the MR8791 is installed is changed to any value other than the maximum number of channels.
- Pattern data will be erased if the instrument is turned off. Register pattern data again after turning the instrument on again.

The Channels to use setting can be configured under **[Basic Setting]** on the **[STATUS]** screen. For more information, see the instruction manual for the Memory HiCorder in which the module is installed.

For MR6000 and MR8740T

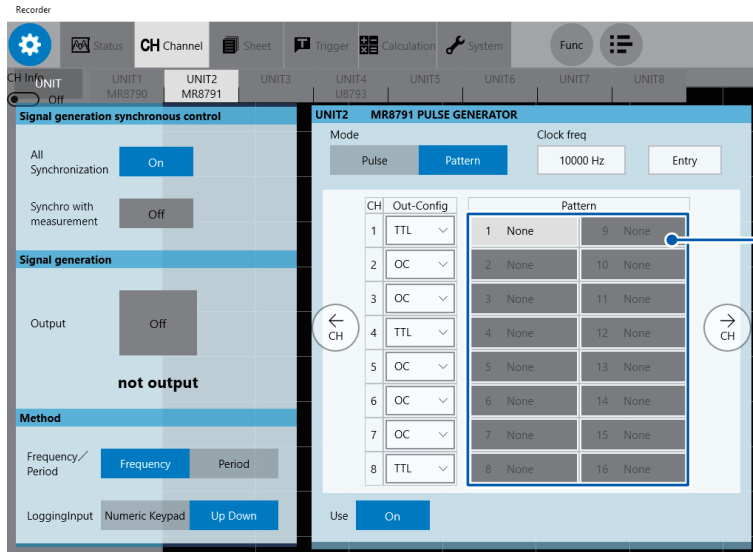

1 Click a box in the [Pattern] column.

- When the output is in the stopped state, the first registered pattern will be output.
- Pattern data will be erased if the instrument is turned off. Register pattern data again after turning the instrument on again

Method for registering a pattern

For MR8847A, MR8827, MR8740, and MR8741

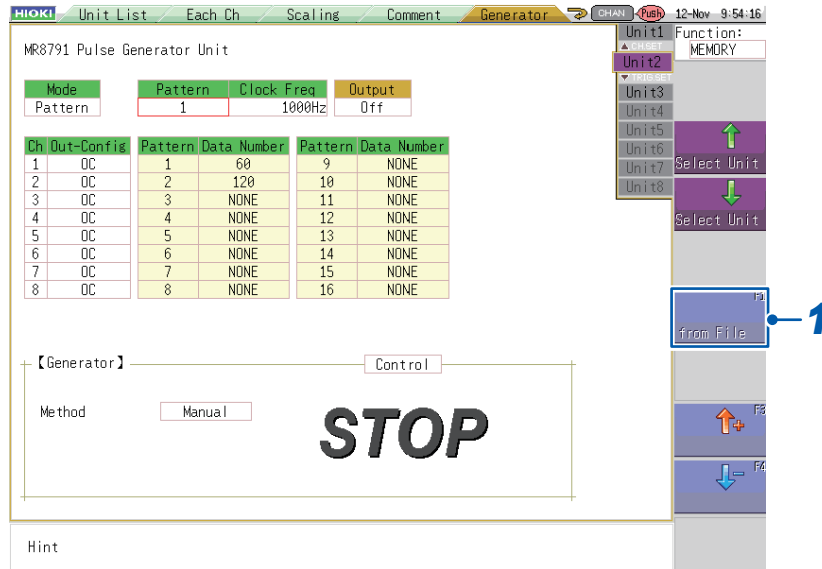

- 1 Press the function key (F1) or select [from File] with the mouse to display the File screen in accordance with the guidance on the screen.

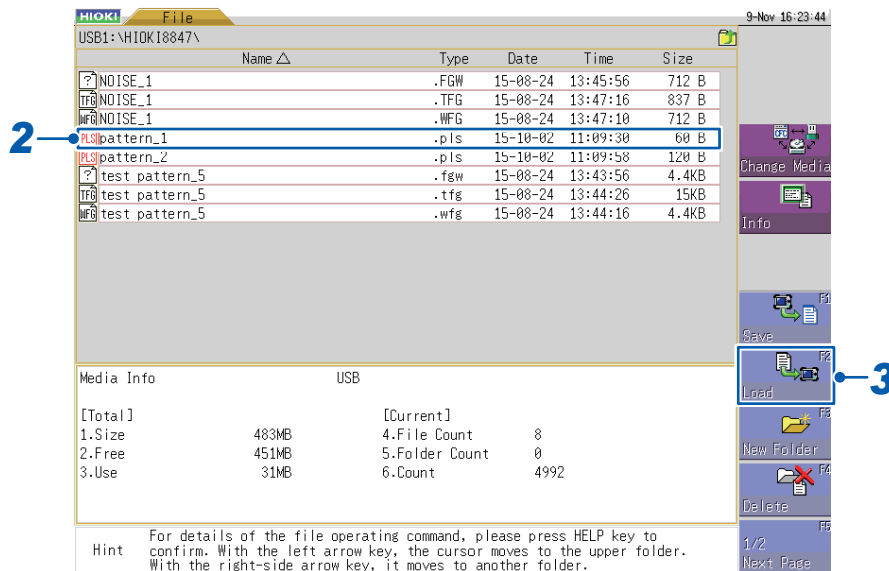

- 2 Select the file to register (with an extension of “.pls”).

- 3** Press the function key (F2) or select [Load] with the mouse.
The register settings screen will be displayed.

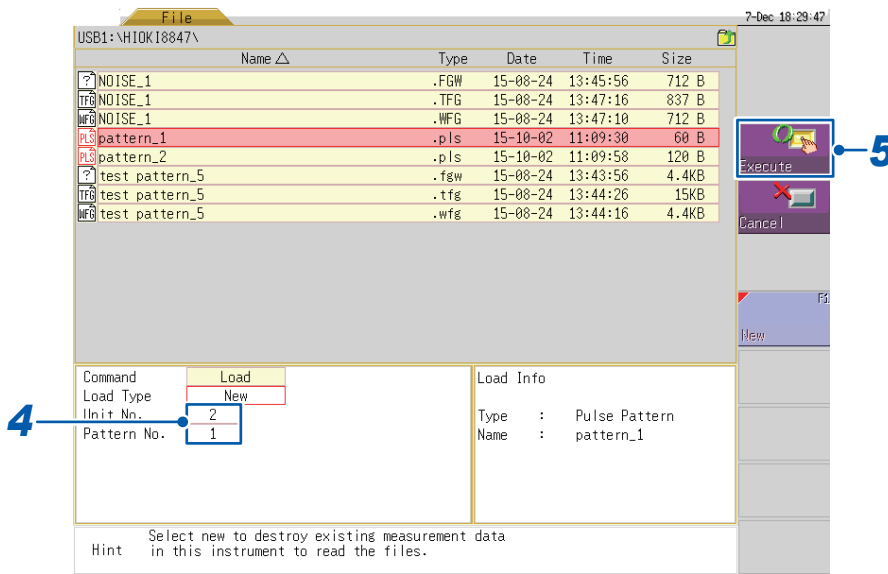

- 4** Set the target unit number and pattern number.

- 5** Press **CH.SET** (**CH.SET**)
The file will be registered.

- Insert the media before performing any operations on the File screen.
- Up to 16 pattern files can be registered.
- To cancel the file register operation, press **TRIG.SET** (**TRIG.SET**) or **ESC** (**ESC**).
- The extension for pattern files is “.pls.”

For MR6000 and MR8740T

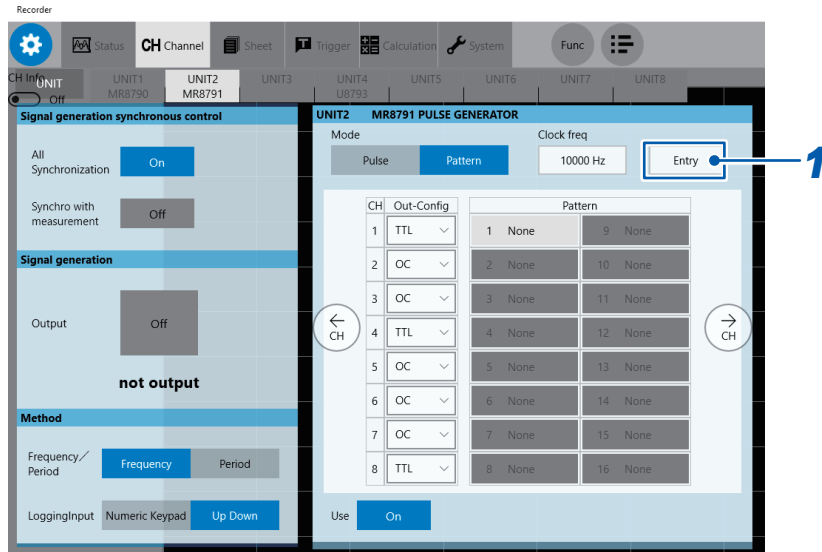

- 1 Click the [Entry] box.
The open window is displayed.

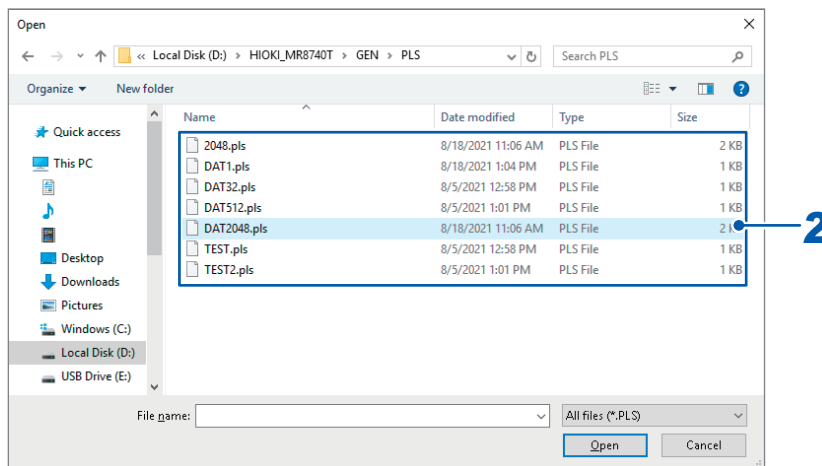

- 2 Choose a file you wish to entry.
The [Entry from File] dialog box will be displayed.

5 Setting Pulse and Pattern Output (MR8791)

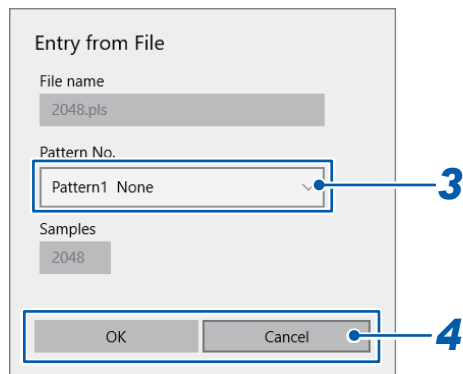

3 Click the **[Pattern No.]** box to choose a pattern.

4 **Entry the pattern.**
Clicking **[OK]** will register the pattern of your choice.
If you do not wish to register, click **[Cancel]**.

- Insert a storage device before using the open window.
- You can register up to 16 pattern data sets.
- Pattern data will be stored in .pls files.

Setting the clock frequency

For MR8847A, MR8827, MR8740, and MR8741

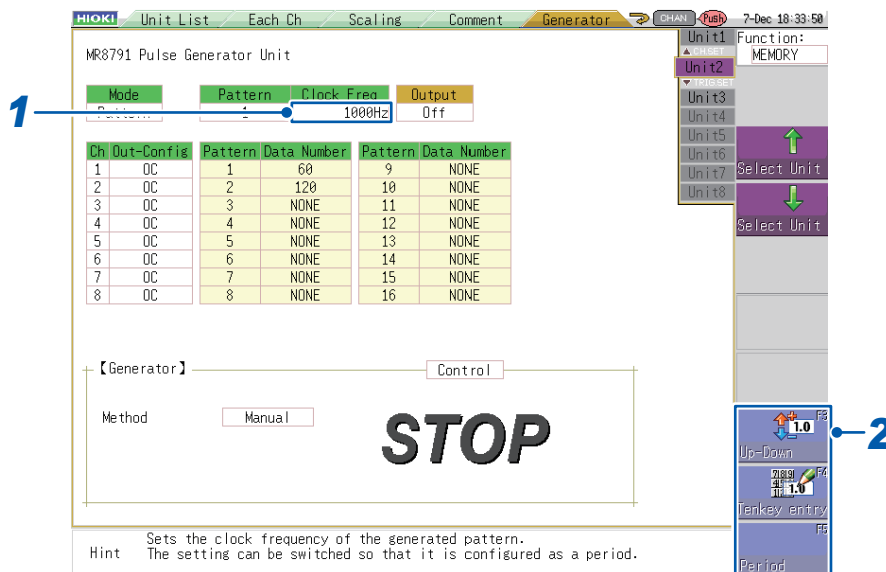

- 1** Select the **[Clock Freq]** setting.
- 2** Press a function key (**F1 to F5**) or select a button with the mouse.

Up-Down	p.20
Tenkey entry	p.21
Period	Allows you to enter the setting as a period instead of a frequency. This value can be set only by means of numeric keypad input. (p.21)

Valid clock frequency setting range: 0 Hz to 120 kHz (in 10 Hz increments)
 Valid clock period setting range: 0 sec. to 0.1 sec.

The clock period can be set as desired within the above range. However, the clock period of the waveform that is actually output will be the clock period of the waveform corresponding to the valid clock frequency setting that would produce the clock period closest to the user-entered clock period value.

For MR6000 and MR8740T

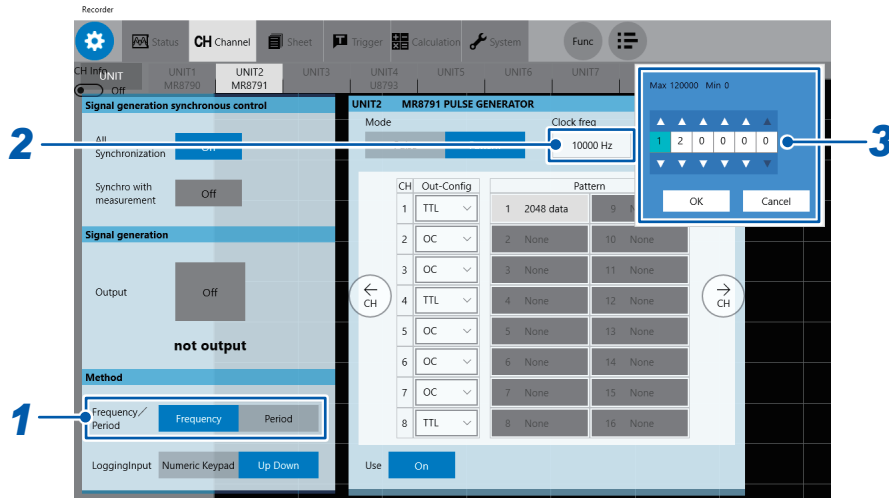

- 1** Click **[Frequency]** or **[Period]** to choose.
You can enter the frequency or period of the output waveform. Display items will vary between **[Frequency]** and **[Period]**.
- 2** Click the **[Clock freq]** box.
- 3** Set the clock frequency using the up and down arrow keys or numerical keypad.

Valid clock frequency setting range: 0 Hz to 120 kHz (in 10 Hz increments)
 Valid clock period setting range: 0 s to 0.1 s
 You can enter any clock period within the range mentioned above. However, the actual output waveform will have a clock period rounded off to the nearest valid value in clock frequency.

Setting output (MR8847A, MR8827, MR8740, and MR8741)

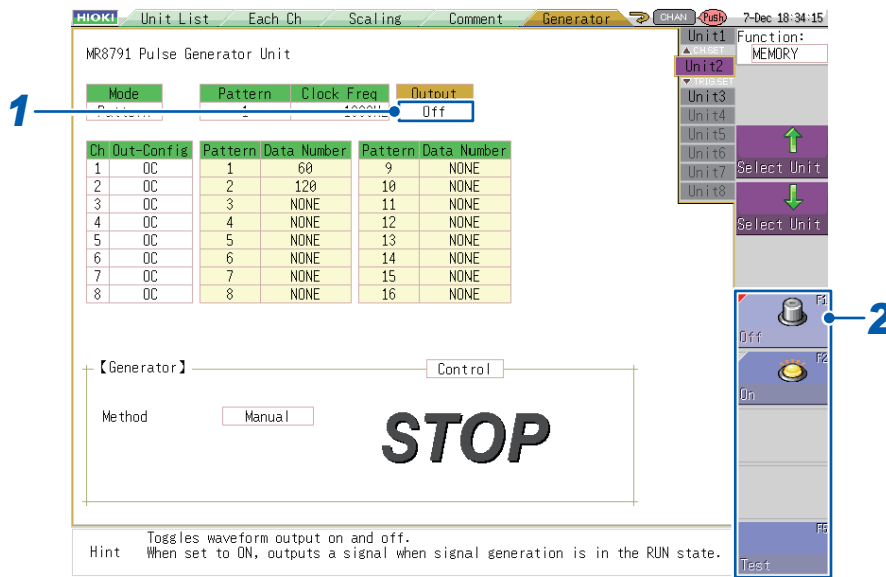

- 1 Select the **[Output]** setting.
- 2 Press a function key (**F1 to F5**) or select a button with the mouse.

Off	Does not output a waveform, regardless of the state of Generator Control (p. 131).
On	Outputs the set pulse waveform when Generator Control (p. 131) is [RUN] .
Test	Generates test output of the set waveform.

After selecting **[Test]**

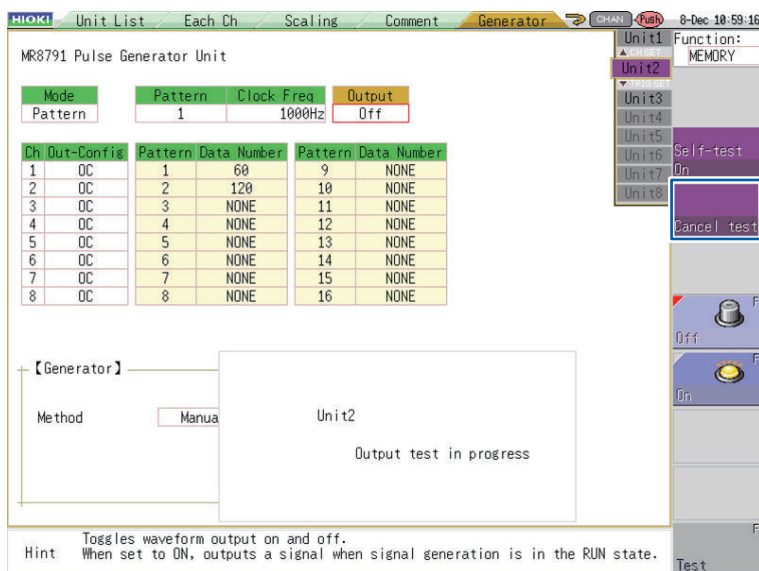

Pressing **(TRIG.SET)** (**TRIG.SET**) stops test output.

This test mode does not provide functionality for judging test results with the module. You are responsible for determining whether the selected pattern waveform is being properly output during the output test.

Setting the Use to On or Off (for MR6000 and MR8740T)

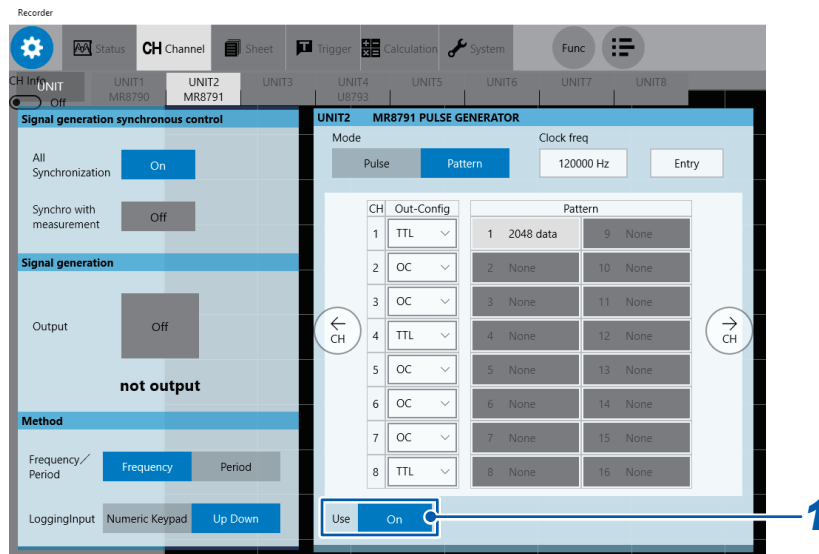

1 Click the **[Use]** button to set it to **[On]** or **[Off]**.

On	Outputs waveforms when the [Output] button under [Signal generation] (p. 133) is set to [On] .
Off	Does not output a waveform regardless of the state of the [Output] button under [Signal generation] (p. 133).

6

Sweep Setting (U8793)

6.1 Selecting the Sweep Type

For MR8847A, MR8827, MR8740, and MR8741

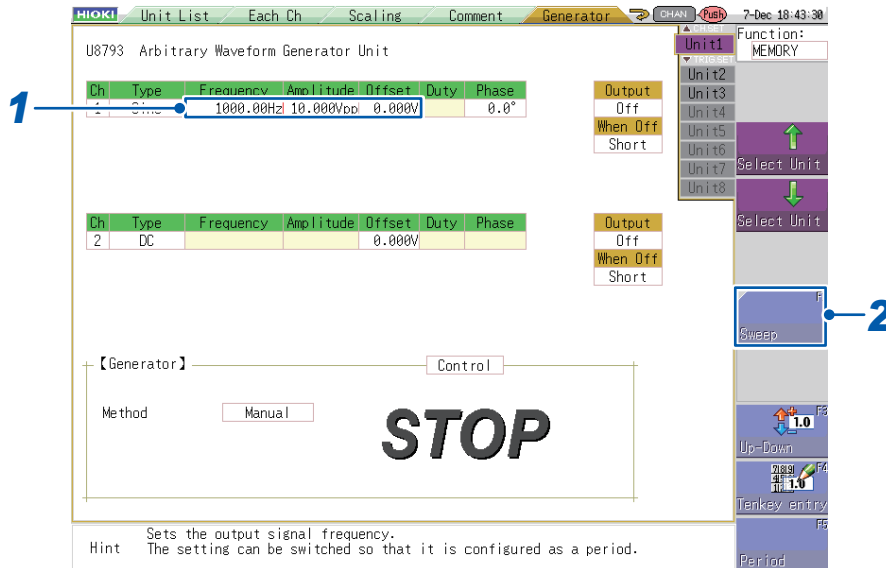

1 Select the type of sweep operation you wish to perform.

Type	Selectable settings
DC	n/a
Sine Square Triangle Ramp-up Ramp-down	Frequency, amplitude, offset (Simultaneous sweep is supported.)
Pulse	Frequency, amplitude, offset, duty cycle (Simultaneous sweep is supported. However, frequency and duty cycle cannot be set at the same time.)
Arbitrary	Clock frequency, amplitude adjustment, offset (Simultaneous sweep is supported.)

2 Press the function key (F1) or select [Sweep] with the mouse.

When [Sweep] is selected, you will be able to enter the end value (p.67) underneath the selected setting.

Canceling the sweep setting

The sweep setting can be canceled by pressing the function key (F1) again or by selecting [Sweep] with the mouse.

For MR6000 and MR8740T



1 Tap the **[Sweep]** button you wish to apply the sweep to set it to **[On]**.
Every time you tap the button, it toggles between **[Off]** and **[On]**.

Type	Parameters to which the sweep can be applied
DC	—
Sine Square Triangle RampUp RampDown	Frequency, amplitude, offset (Instantaneous sweep can be performed.)
Pulse	Frequency, amplitude, offset, duty cycle (Instantaneous sweep can be performed. However, either the frequency sweep or the duty cycle sweep, but not both, can be set.)
Arbitrary	Clock frequency, amplitude adjustment, offset (Instantaneous sweep can be performed.)

Setting **[Sweep]** to **[On]** lets you to set the start value, end value, and sweeping time.

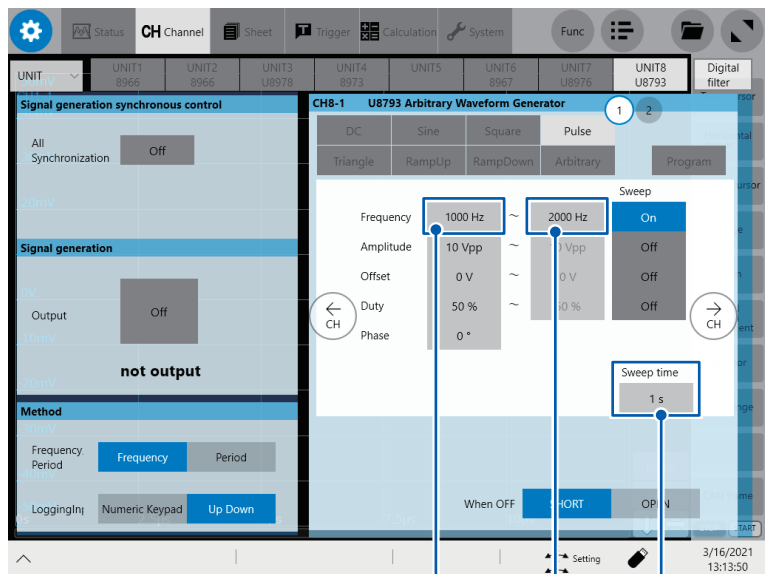

Start value End value Sweeping time

6.2 Setting the Start Value

For MR8847A, MR8827, MR8740, and MR8741

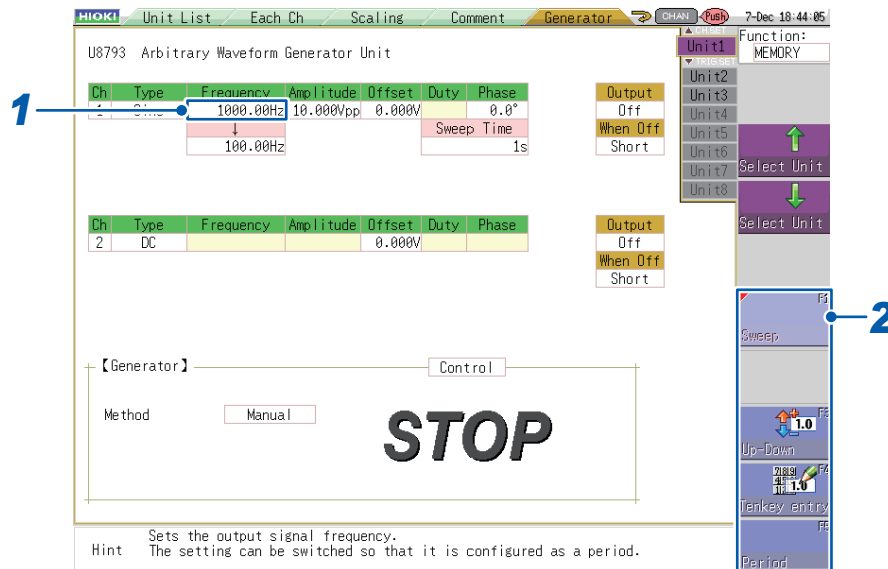

- 1 Select the start value setting.
- 2 Press a function key (F1 to F5) or select a button with the mouse.

Up-Down	p.20
Tenkey entry	p.21
Period	Allows you to enter the setting as a period instead of a frequency. This value can be set only by means of numeric keypad input. (p.21)

When the frequency is set to the sweep setting, you can set the period with the function key (F5). When you do so, the end value will also switch to the period setting. Values can only be set with numeric key input.

Valid frequency setting range: 0 Hz to 100 kHz (in 0.01 Hz increments)

Valid period setting range: 0 sec. to 100 sec.

The period can be set as desired within the above range. However, the period of the waveform that is actually output will be the period of the waveform corresponding to the valid frequency setting that would produce the period closest to the user-entered period value.

For duty-cycle sweeping, an error may become larger between a duty-cycle-starting value of a pulse waveform outputted and the set value.

The smaller the difference is between the period of the set pulse waveform and the sweeping time, the larger the error becomes.

For MR6000 and MR8740T

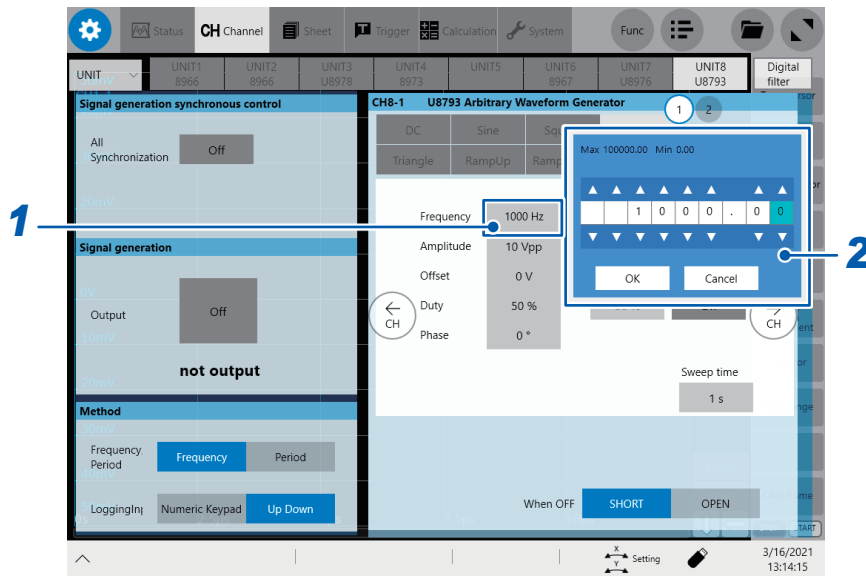

- 1 Tap the box of which you wish to set the start value.
- 2 Enter the start value using the Up Arrow and Down Arrow keys or the numeric keypad.

6.3 Setting the End Value

For MR8847A, MR8827, MR8740, and MR8741

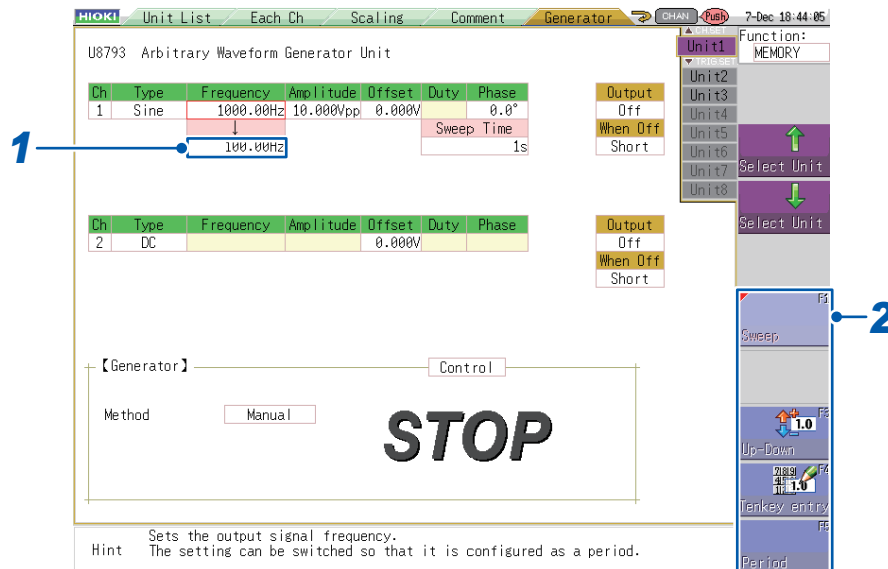

- 1** Select the end value setting.
- 2** Press a function key (F1 to F5) or select a button with the mouse.

Up-Down	p.20
Tenkey entry	p.21
Period	Allows you to enter the setting as a period instead of a frequency. This value can be set only by means of numeric keypad input. (p.21)

Valid frequency setting range: 0 Hz to 100 kHz (in 0.01 Hz increments)
Valid period setting range: 0 sec. to 100 sec.

The period can be set as desired within the above range. However, the period of the waveform that is actually output will be the period of the waveform corresponding to the valid frequency setting that would produce the period closest to the user-entered period value.

For duty-cycle sweeping, an error may become larger between a duty-cycle-ending value of a pulse waveform outputted and the set value.
The smaller the difference is between the period of the set pulse waveform and the sweeping time, the larger the error becomes.

For MR6000 and MR8740T



- 1 Tap the box of which you wish to set the end value.
- 2 Enter the end value using the Up Arrow and Down Arrow keys or the numeric keypad.

6.4 Setting the Sweep Time

For MR8847A, MR8827, MR8740, and MR8741

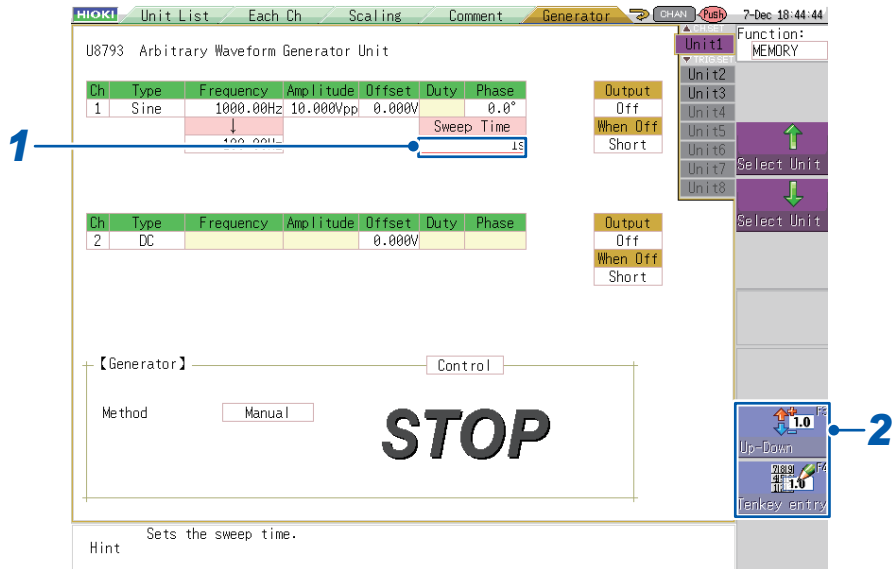

- 1** Select the [Time] setting.
- 2** Press a function key (F1 to F5) or select a button with the mouse.

Up-Down	p.20
Tenkey entry	p.21

Valid sweep time setting range: 0.01 ms to 1000 sec. (in 0.01 ms increments)

6

Sweep Setting (U8793)

For MR6000 and MR8740T



- 1 Tap the [Sweep time] box.
- 2 Enter the sweeping time using the Up Arrow and Down Arrow keys or the numeric keypad.

7

Arbitrary Waveform Settings (U8793)

This chapter describes what you need to set when the waveform type is set to **[Arbitrary]**.

7.1 Setting the Waveform Type

For MR8847A, MR8827, MR8740, and MR8741

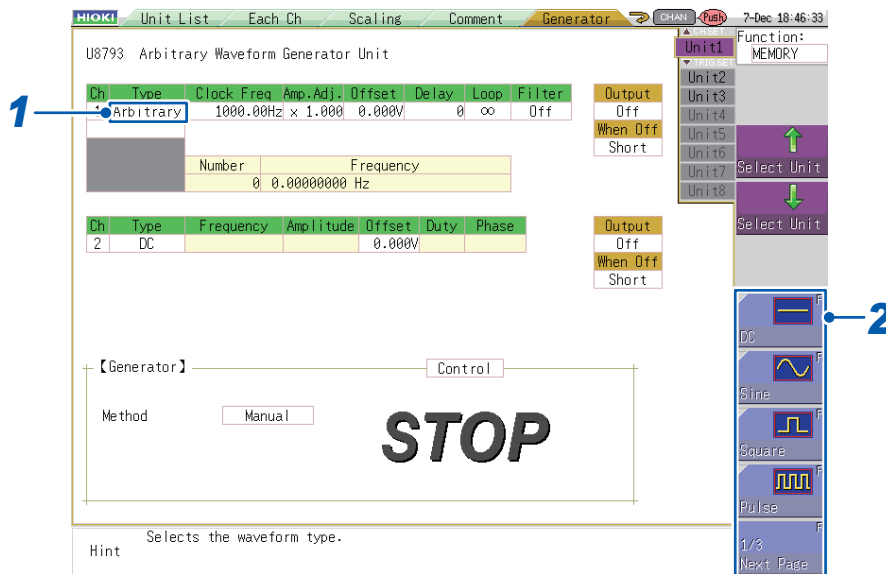

- 1 Select the **[Type]** setting.
- 2 Press a function key (F1 to F5) or select the **[Arbitrary]** button (page 2/3) with the mouse.

For MR6000 and MR8740T



1 Tap [Arbitrary] under the waveform types.

7.2 Registering a Waveform

This section describes how to register the desired waveform data in the U8793's memory. You can register either data created using the SF8000 Waveform Maker or data measured with a Memory HiCorder. For more information about how to create waveforms with the SF8000 Waveform Maker, see "13 Waveform Maker" (p. 147).

For MR8847A, MR8827, MR8740, and MR8741

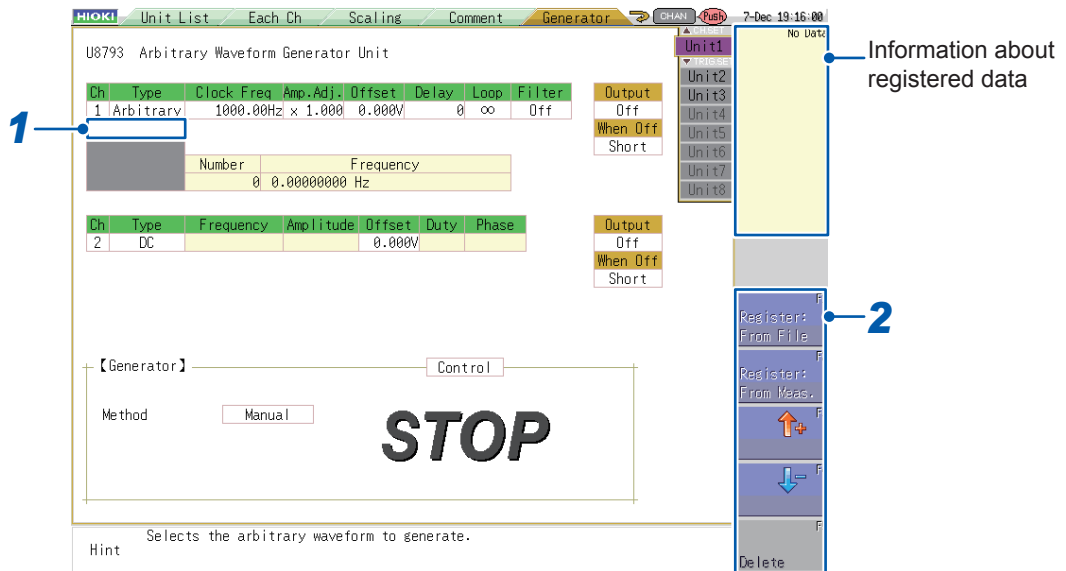

- 1** Select the setting under [Type].
- 2** Press a function key (F1 to F5) or select a button with the mouse.

Register: From File	Registers data saved on external media. (p. 81)
Register: From Meas.	Registers data measured using the memory function. The data can be registered once the MEM file is loaded into the Memory HiCorder from external media. (p. 76)
Delete	Deletes data that has been registered in the U8793's memory. If the maximum eight waveforms have already been registered, you must delete one of the previously registered waveforms before you can register a new waveform.

- Data for up to eight arbitrary waveforms can be registered for each channel.
- If deleted arbitrary waveform data is used in program function (p. 105) steps, those steps will also be deleted.

For MR6000 and MR8740T

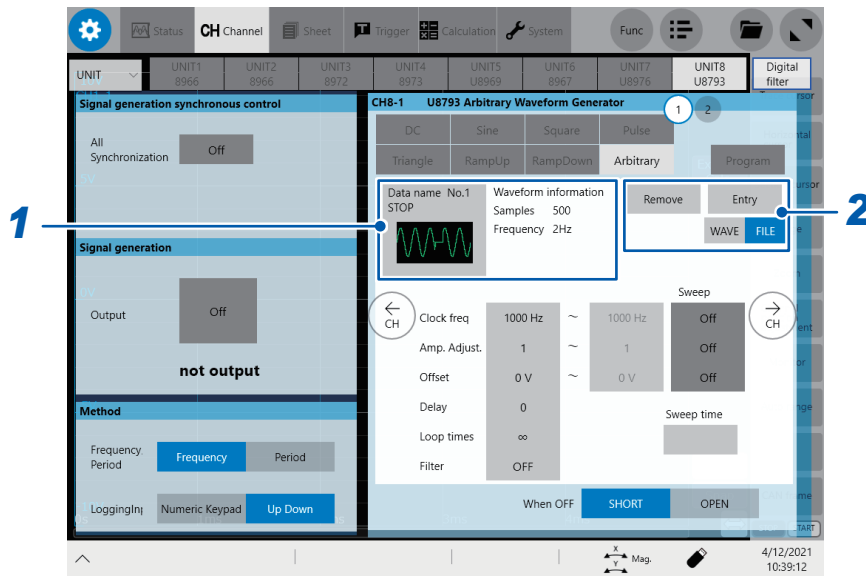

1 Select or confirm arbitrary waveform data sets.

The arbitrary waveform selection button has the chosen waveform thumbnail. On its right are the number of samples ([Samples]) and the frequency ([Frequency]). Tapping the arbitrary waveform selection button will show the list of the registered arbitrary waveforms.

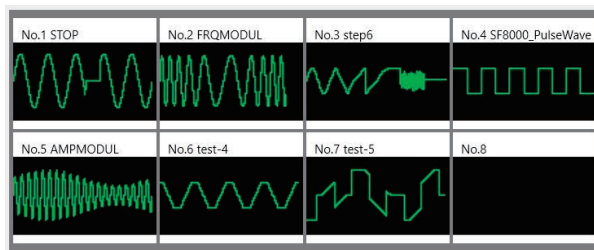

You can register up to eight waveforms per channel.

Follow the instruction described below to change the arbitrary waveform data set to be output.

(1) Tap the waveform thumbnail.

The list of the registered arbitrary waveform data sets will be displayed.

(2) Tap the waveform thumbnail you wish to output.

2 Register or delete an arbitrary waveform data set.

If eight waveform data sets have already been registered, you cannot register another data set. Delete waveforms with any numbers before registration. The destination number is automatically chosen from among vacant numbers.

Wave	Allows you to register a measured data set (Envelope waveforms cannot be registered). You can also load a MEM file from a storage device onto the instrument before registration.
File	Registers the saved data.
Entry	Registers the data set following the method you chose. If the data set with the same name exists in the registration destination, the instrument will save the new data set by overwriting the existing one. It will take about 40 s to register a data set that consists of 250,000 samples.
Remove	Removes the data set registered in the U8793 memory. When the U8793 already contains eight registered waveforms, delete any one of them before registering a waveform.

Registering data measured with a Memory HiCorder

For MR8847A, MR8827, MR8740, and MR8741

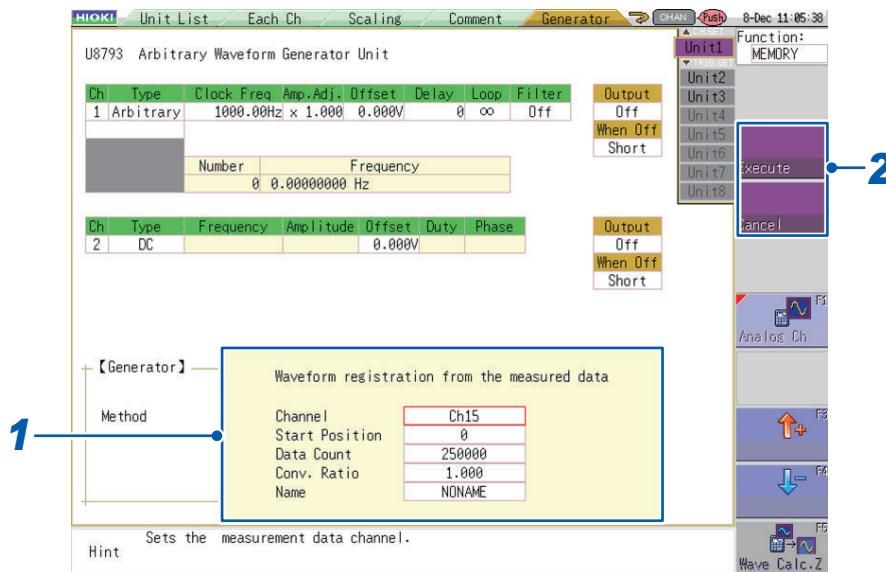

1 Set information about the measurement data to be registered.

Channel	Sets the measurement channel number for the measurement data being registered (Analog waveform: Ch, Waveform calculation: Z). This parameter can be set by function key (F3 , F4).
Start Position	Sets the start position for the range of measurement data to be registered. This parameter can be set by function key (F1 : entire waveform; F2 : waveform between A and B; F3 : up-down; F4 : numeric keypad input). Selecting [F1 : Entire waveform] will cause the start position to be set to 0, while selecting [F2 : Waveform between A and B] will cause the start position to be set to the position of the A cursor.
Data Count	Sets the number of samples in the measurement data to be registered. This parameter can be set by function key (F1 : entire waveform; F2 : waveform between A and B; F3 : up-down; F4 : numeric keypad input). Selecting [F1 : Entire waveform] will cause the data count to be set to the total number of measured samples, while selecting [F2 : Waveform between A and B] will cause the data count to be set to the number of samples between the A and B cursors (or if only the A cursor is displayed, the number of samples occurring after the A cursor).
Conv. Ratio	Sets the scaling factor to apply to the voltage values in the measurement data to be registered when registering the data. The valid setting range for this parameter is 0.001× to 100.000×. The parameter can be set by function key (F3 : up-down; F4 : numeric keypad input).
Name	Sets the name of the data. Up to 16 single-byte characters or 8 double-byte characters can be entered.

2 Press **CH.SET** (**CH.SET**)

The data will be registered in the module's memory.

To cancel the operation without registering any data, press **TRIG.SET** (**TRIG.SET**) or **ESC** (**ESC**).

After registering data

Name of the registered arbitrary waveform

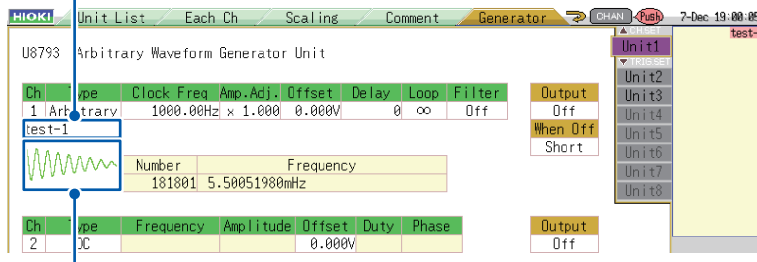
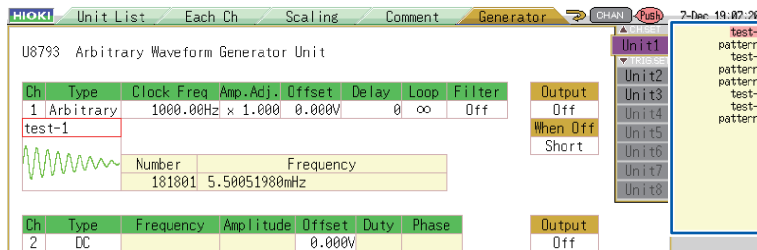

Image of the registered waveform

To change the arbitrary waveform data that is output, select the desired waveform from the list of registered arbitrary waveform data. To do so, move the cursor to the data name field and press a function key (**F3**, **F4**).



It takes approximately 30 seconds to register arbitrary waveform data with 250,000 samples.

About the data count

Measurement data containing up to 250,000 samples can be registered. If you attempt to register measurement data containing more than this maximum number of samples, only 250,000 samples will be registered.

About the conversion ratio

The range of voltages that can be output by the U8793 is -10 V to 15 V. If the measurement data being registered contains voltage values that exceed this range, a conversion ratio can be set so that the registered waveform remains within the -10 V to 15 V range.

Example:

You wish to register measurement data describing an anomalous waveform for a 100 V AC power supply and then output it via an amplifier connected to the U8793's output.

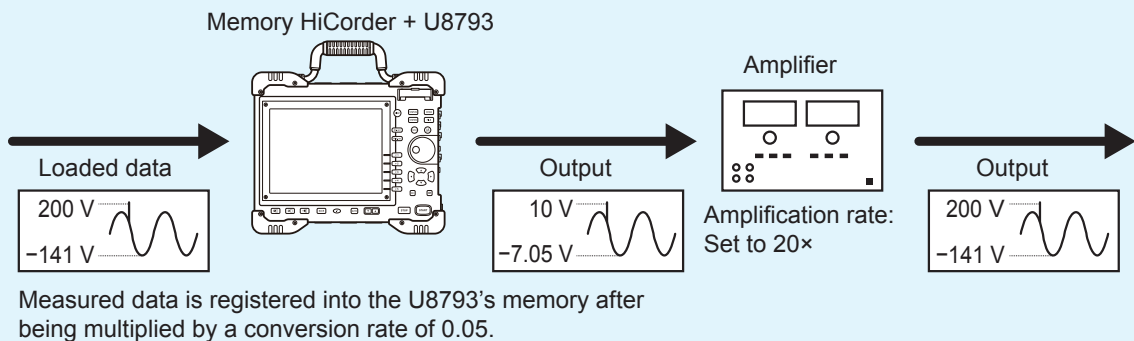

Measured data is registered into the U8793's memory after being multiplied by a conversion rate of 0.05.

(Use an amplifier with an input resistance of at least 2 kΩ for external signal input.)

For MR6000 and MR8740T

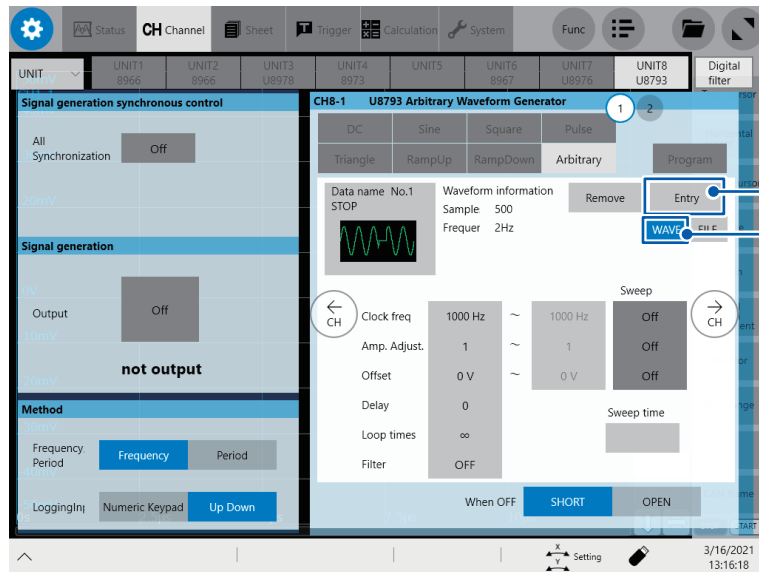

1 Tap [Wave].

2 Tap [Entry].
The [Entry from Measured] dialog box will be displayed.

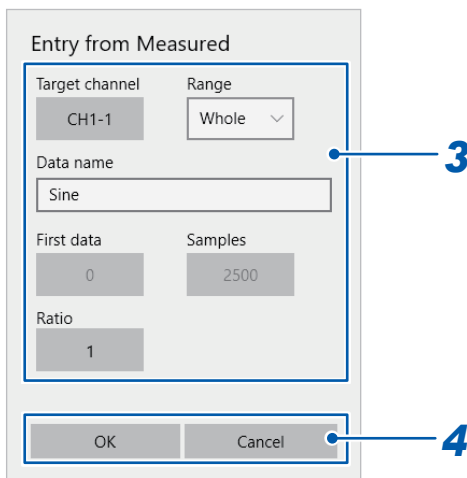

3 Set the items of the measured data set to be registered.
Tap each item to set.

Target channel	Allows you to enter the channel number of the data set you wish to register.
Range	Allows you to choose a registration range from Whole, Segment 1, and Segment 2. If you choose Segment 1 or Segment 2, samples defined by the section cursors will be registered.
Data name	Allows you to enter a data name. A data name can be up to eight characters long. If you leave the box blank, the data set will be named <i>NONAME</i> . If you enter the name same as that of the already registered arbitrary waveform data set, the instrument will save the new data set by overwriting the existing one.
First data	Displays the first location in the data range.
Number	Displays the number of the samples to be registered.
Ratio	Allows you to enter a ratio by which you wish to multiply the voltage in the data set to be registered. Valid setting range: 0.001× to 100.000×

4 Register the arbitrary waveform.

Tapping **[OK]** can register the waveform in a vacant block. If eight waveforms have been already registered, you cannot register another. Delete any one of them before registering a waveform.

If you do not wish to register it, tap **[Cancel]**

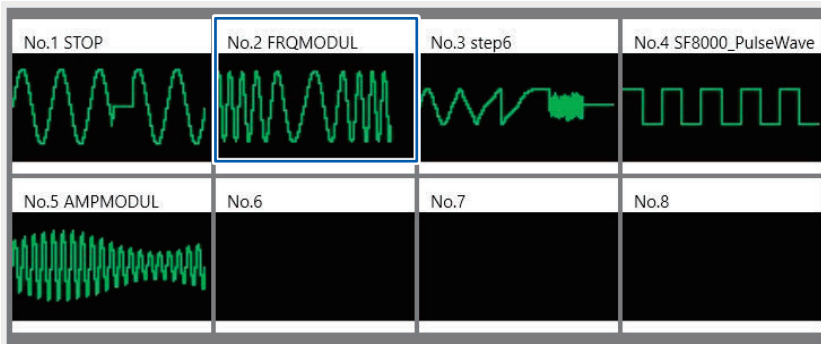

Registering data created with the SF8000 Waveform Maker

For MR8847A, MR8827, MR8740, and MR8741

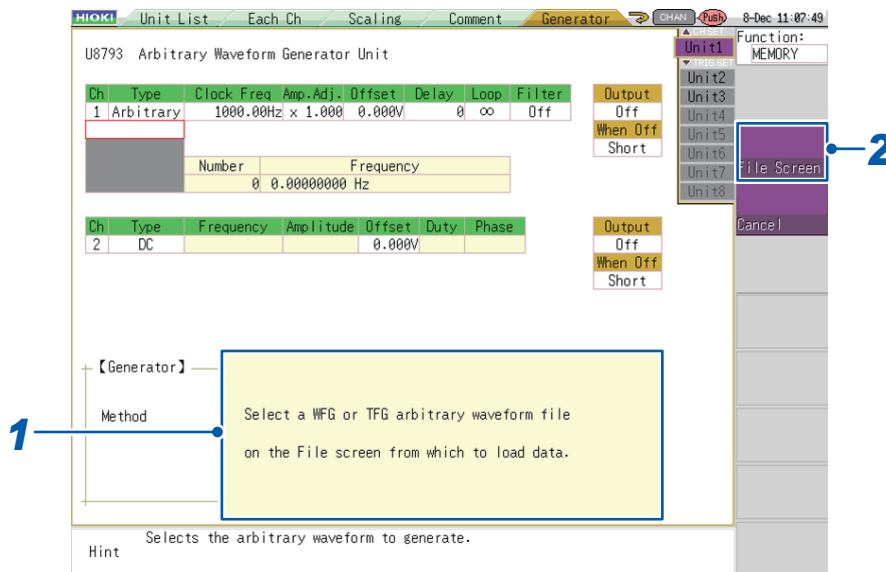

1 Verify that the confirmation window is being displayed.

2 Press **CH.SET** (**CH.SET**).
The file screen will be displayed.

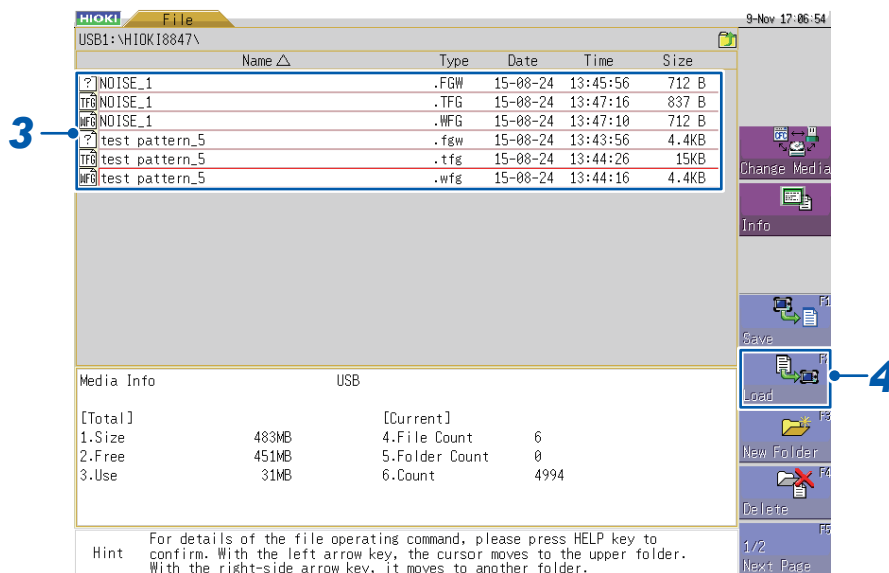

3 Select the data you wish to register.

7

Arbitrary Waveform Settings (U8793)

- 4** Press the function key (F2) or select [Load] with the mouse.
The register settings screen will be displayed.

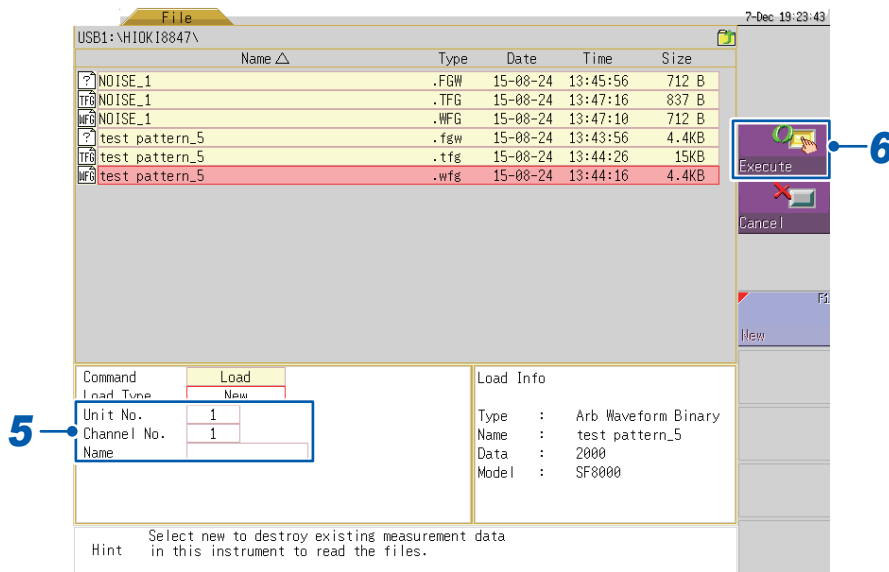

- 5** Select the target unit number and channel number and enter the data name.

- 6** Press **CH.SET** (**CH.SET**).
The data will be registered.

- Insert the media before performing any operations on the File screen.
- It will take about 30 s to register a data set that consists of 250,000 samples.
- To cancel the data register operation, press **TRIG.SET** (**TRIG.SET**) or **ESC** (**ESC**).
- Only data with the extension “.wfg” or “.tfg” can be registered into the U8793’s memory. Files with the extension “.wfg” contain binary data, while files with the extension “.tfg” contain text data. Files with the extension “.fgw” can only be registered using the SF8000 Waveform Maker.

For MR6000 and MR8740T



- 1 Tap [FILE].
- 2 Tap [Entry].
The file screen will be displayed.

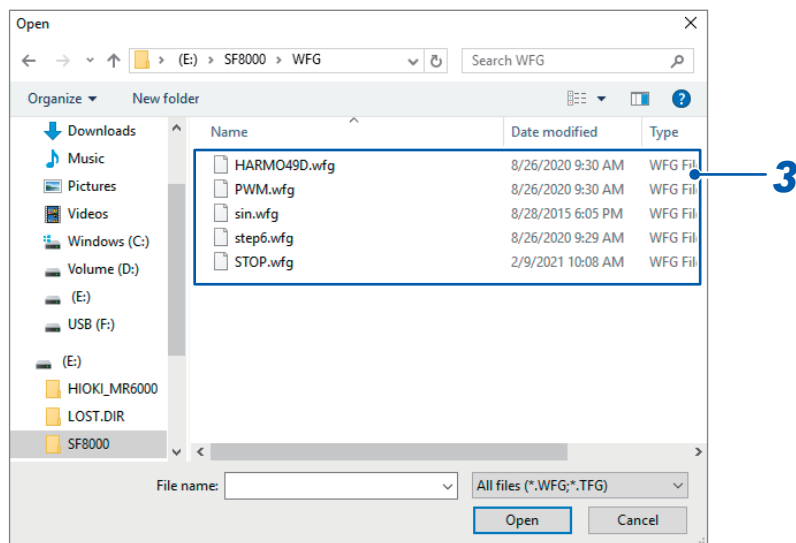

7

Arbitrary Waveform Settings (U8793)

- 3 Choose a file you wish to register using the file screen.**
 After choosing a file, the **[Entry from File]** dialog box will be displayed.

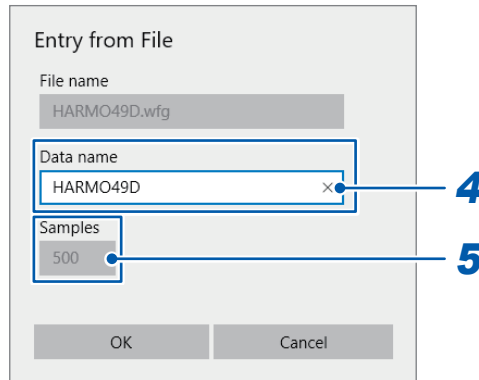

- 4 Enter a data name in the [Data name] box.**
 A data name can be up to eight characters long.
 If you leave the box blank, the data set will be named *NONAME*.
 If you enter the name same as that of the already registered arbitrary waveform data, the instrument will save the new data set by overwriting the existing one.

- 5 Register the arbitrary waveform.**
 Tapping **[OK]** can register the waveform in a vacant block. If eight waveforms have been already registered, you cannot register another. Delete any one of them before registering a waveform.
 If you do not wish to register it, tap **[Cancel]**.

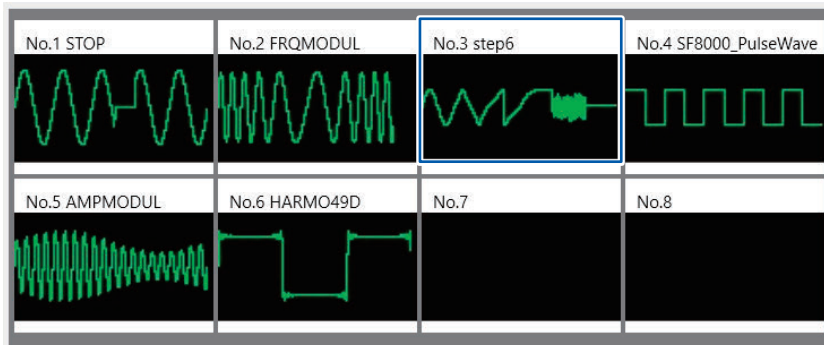

- It will take about 40 s to register a data set that consists of 250,000 samples.
- You can register data sets with only the extension .WFG or .tfg on the U8793's memory. (Data with the extension .WFG is binary, while that with .tfg is of text.)
 Only SF8000 Waveform Maker can read data with the extension .fgw.

7.3 Setting the Clock Frequency

This section describes how to set the conversion clock frequency for the D/A converter when converting arbitrary waveform data to an analog signal with a D/A converter. The sweep setting may also be used. (p.63)

The frequency of the arbitrary waveform that is output is determined by the clock frequency and arbitrary waveform data count.

For MR8847A, MR8827, MR8740, and MR8741

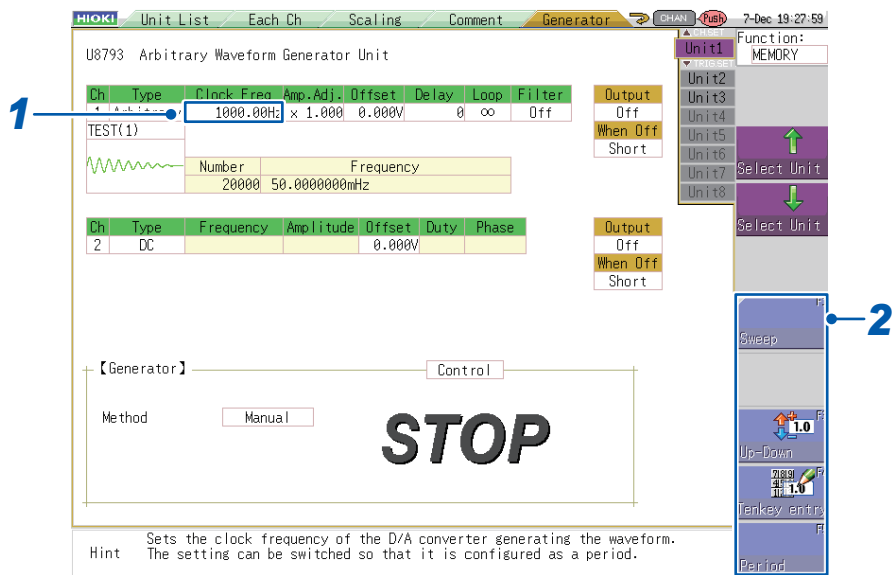

- 1** Select the **[Clock Freq.]** setting.
- 2** Press a function key (**F1 to F5**) or select a button with the mouse.

Sweep	p.63
Up-Down	p.20
Tenkey entry	p.21
Period	Allows you to enter the setting as a period instead of a frequency. This value can be set only by means of numeric keypad input. (p.21)

- A low clock frequency may result in a stepped output waveform, which can be smoothed by applying a filter. (p.96)

Valid clock frequency setting range: 0 Hz to 2 MHz (in 0.01 Hz increments)

Valid clock period setting range: 0 sec. to 100 sec.

- The clock period can be set as desired within the above range. However, the clock period of the waveform that is actually output will be the clock period of the waveform corresponding to the valid clock frequency setting that would produce the clock period closest to the user-entered clock period value.
- Because the maximum clock frequency that can be set is 2 MHz (clock period: 500 ns), outputting measurement data that was measured at sampling speed of greater than 500 ns/S will cause the frequency of the output waveform to be less than the frequency of the measurement waveform.

For MR6000 and MR8740T

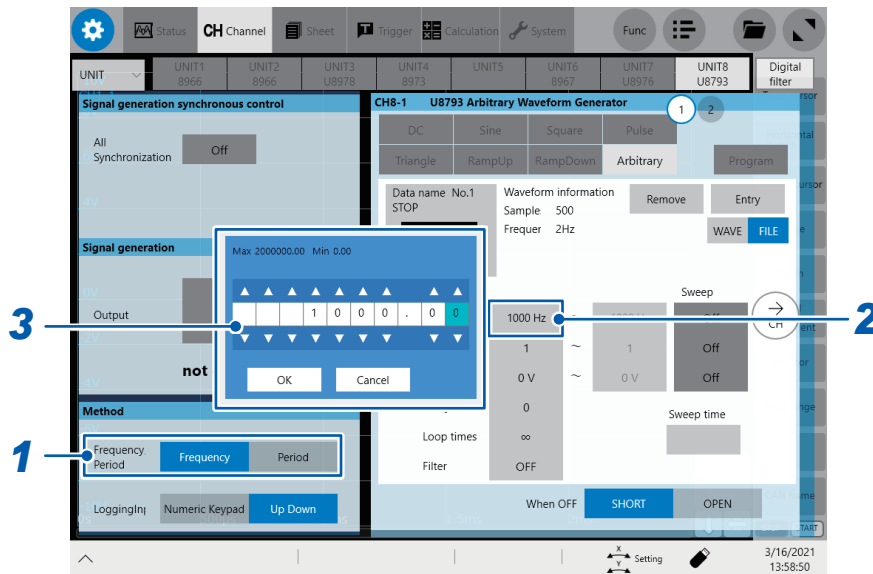

- 1** Tap **[Frequency]** or **[Period]** to choose.
You can enter the frequency or period of the output waveform. The displayed items differ between **[Frequency]** and **[Period]**.
- 2** Tap the **[Clock freq]** item (the **[Clock period]** item when you choose period).
- 3** Enter the clock frequency using the Up Arrow and Down Arrow keys or the numeric keypad.

Setting a lower clock frequency will make the output waveform jagged. Filtering such a waveform can smooth it out. (p.96)

Valid clock frequency setting range: 0 Hz to 2 MHz (in 0.01 Hz increments)

Valid clock period setting range: 0 s to 100 s

You can enter any clock period within the range mentioned above. However, the actual output waveform will have a clock period rounded off to the nearest valid value clock frequency.

The instrument has the highest valid clock frequency of 2 MHz (clock period of 500 ns). Even if it is set to output a waveform sampled at a sampling speed of 500 ns/S or faster, the output waveform will have a frequency lower than that of the measured waveform.

7.4 Setting Amplitude Adjustment

This section describes how to set the amplitude of the arbitrary waveform being output. The amplitude can be adjusted prior to output, for example when you wish to vary the amplitude minutely. A sweep setting may also be used. (p.63)

For MR8847A, MR8827, MR8740, and MR8741

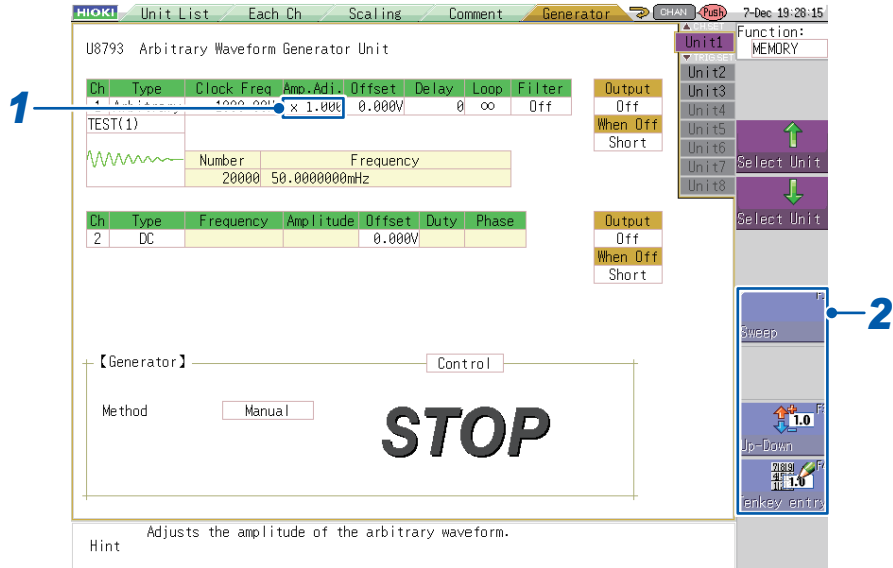

- 1** Select the [Amp. Adj.] setting.
- 2** Press a function key (F1 to F5) or select a button with the mouse.

Sweep	p.63
Up-Down	p.20
Tenkey entry	p.21

Valid amplitude adjustment setting range: $\times 0$ to $\times 2$ (in 0.001 increments)

- For the U8793, accuracy is guaranteed for output voltages within the range of -10 V to $+15\text{ V}$. If the amplitude of the arbitrary waveform to be output is increased using amplitude adjustment so that the range within which accuracy is guaranteed is exceeded, part of the output waveform will be clamped as follows:
Upper limit of $+16\text{ V}$, lower limit of -11 V

For MR6000 and MR8740T

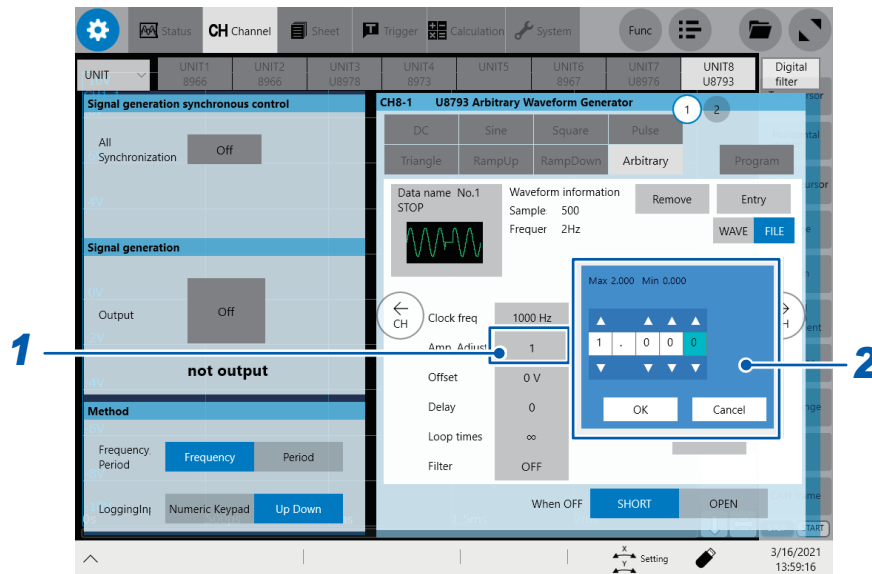

- 1 Tap the [Amp. Adjust.] setting.
- 2 Enter the amplitude adjustment using the Up Arrow and Down Arrow keys or the numeric keypad.

Valid amplitude adjustment setting range: 0× to 2× (in 0.001 increments)

The accuracy of the U8793's output voltage is guaranteed within the range of -10 V to +15 V. If the amplitude of an arbitrary waveform to be output during the amplitude adjustment falls outside the accuracy guarantee range even if you set a larger one, the output waveform will be partly clamped on the upper voltage of about +16 V and the lower voltage of about -11 V.

7

Arbitrary Waveform Settings (U8793)

7.5 Setting the Offset

This section describes how to set the offset for registered arbitrary waveform data. The offset is added to the arbitrary waveform data before it is output. The sweep setting may also be used. (p. 63)

For MR8847A, MR8827, MR8740, and MR8741

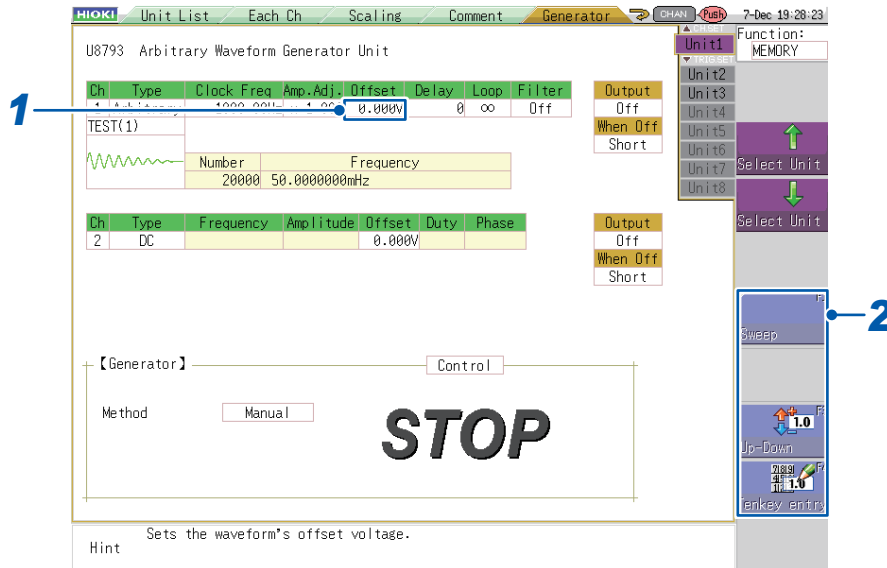

- 1** Select the **[Offset]** setting.
- 2** Press a function key (**F1** to **F5**) or select a button with the mouse.

Sweep	p. 63
Up-Down	p. 20
Tenkey entry	p. 21

Valid offset setting range: -10 V to +15 V (in 1 mV increments)

- For the U8793, accuracy is guaranteed for output voltages within the range of -10 V to +15 V. If the value obtained by adding the arbitrary waveform amplitude and offset exceeds the range within which accuracy is guaranteed, part of the output waveform will be clamped as follows:
Upper limit of +16 V, lower limit of -11 V

For MR6000 and MR8740T

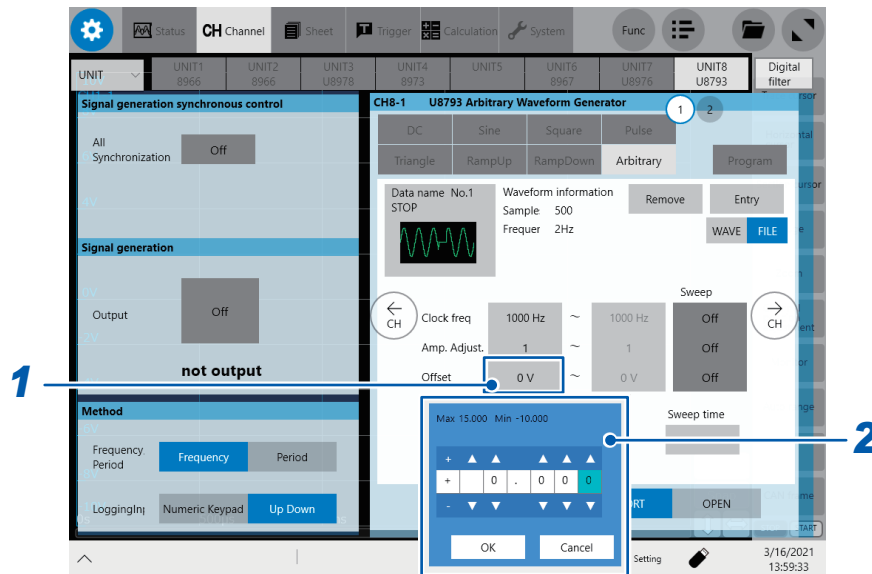

- 1** Tap the [Offset] setting.
- 2** Enter the offset using the Up Arrow and Down Arrow keys or the numeric keypad.

Valid offset setting range: -10 V to +15 V (in 1mV increments)

The accuracy of the U8793's output voltage is guaranteed within the range of -10 V to +15 V. If the sum of the amplitude and offset is set to out of the accuracy guarantee range, the output waveform will be partly clamped on the upper voltage of about +16 V and the lower voltage of about -11 V.

7.6 Setting the Delay

This section describes how to set the delay (phase) for the arbitrary waveform being output as a data position. Output will start from the set data position.

For MR8847A, MR8827, MR8740, and MR8741

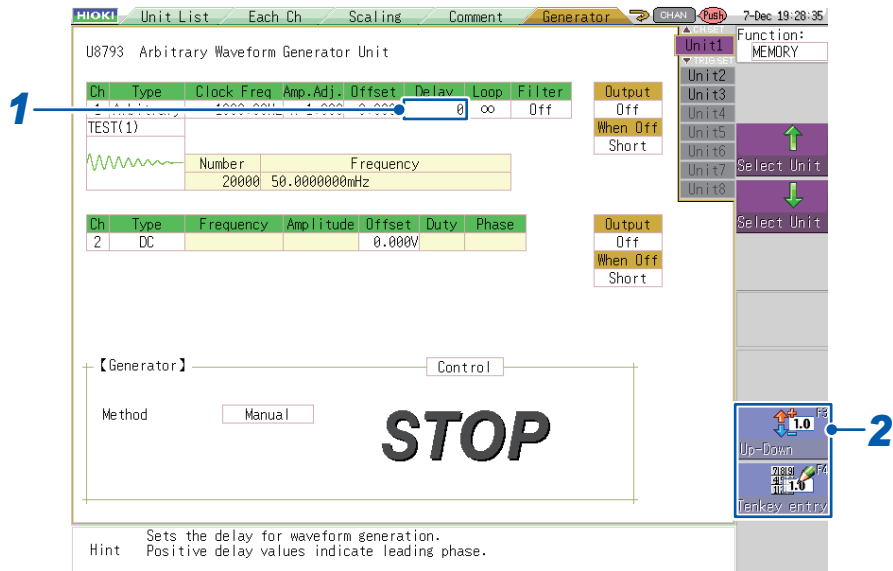

- 1** Select the [Delay] setting.
- 2** Press a function key (F1 to F5) or select a button with the mouse.

Up-Down	p.20
Tenkey entry	p.21

The delay can be set within the range of -250,000 to 250,000 in increments of 1 sample. Positive delay values indicate leading phase.

Registered arbitrary waveform data

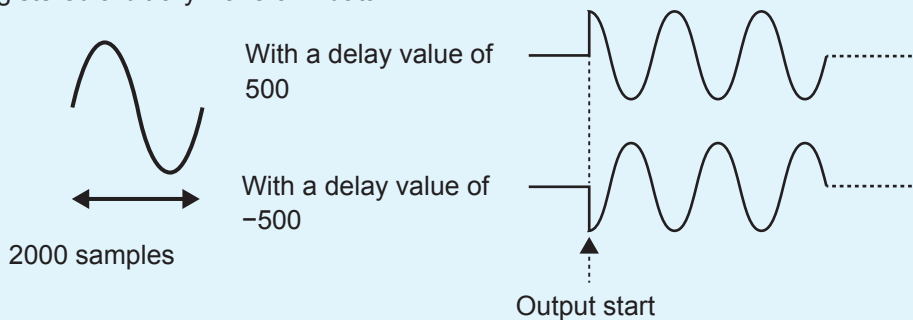

For MR6000 and MR8740T

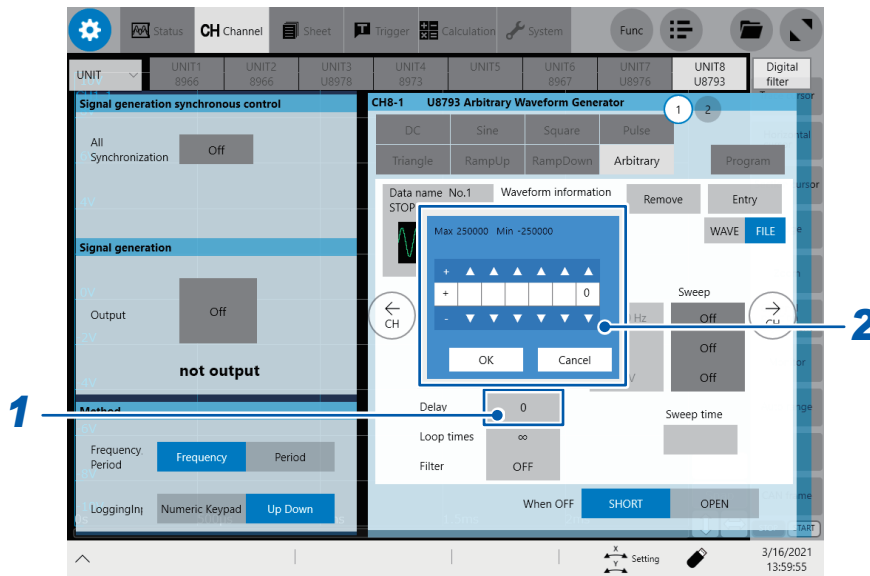

- 1 Tap the [Delay] setting.
- 2 Enter the delay using the Up Arrow and Down Arrow keys or the numeric keypad.

You can set the delay within the range of -250,000 to 250,000 in 1 sample increments. A positive delay value indicates the phase lead.

Registered arbitrary waveform data

7.7 Setting the Iteration Count for the Loop (When Sweep Is Disabled)

This section describes how to set the number of times to repeat the arbitrary waveform being output. Once output starts, the waveform will be output the set number of times.

For MR8847A, MR8827, MR8740, and MR8741

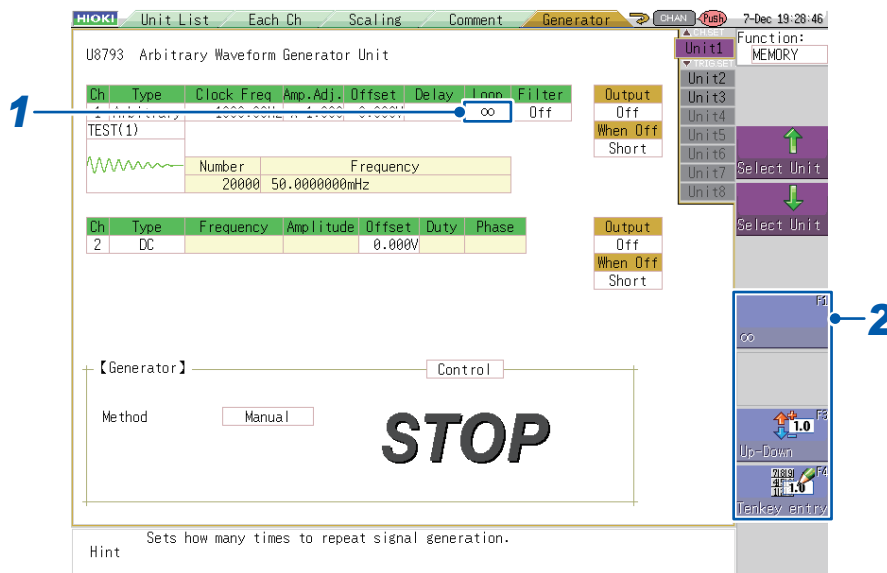

1 Select the [Loop] setting.

2 Press a function key (F1 to F5) or select a button with the mouse.

∞	Continues to repeat the arbitrary waveform until output is stopped.
Up-Down	p.20
Tenkey entry	p.21

- Valid number of loops setting range: 1 to 50,000
- After the waveform is output the set number of times, a 0 V signal will be output.
- If the clock frequency, amplitude adjustment, or offset is set to sweep, the number of loops setting cannot be configured.
- If a delay has been set, the repeat output waveform will be generated as follows:

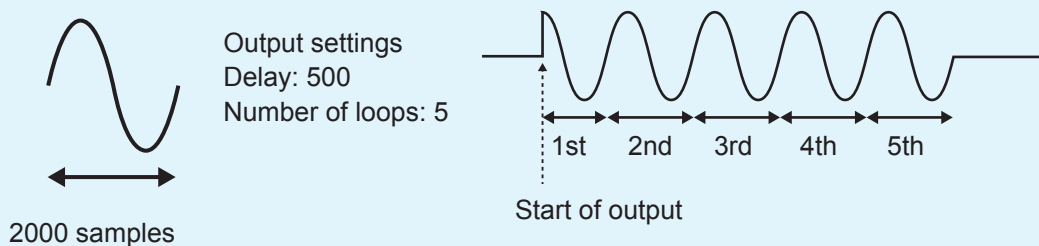

For MR6000 and MR8740T

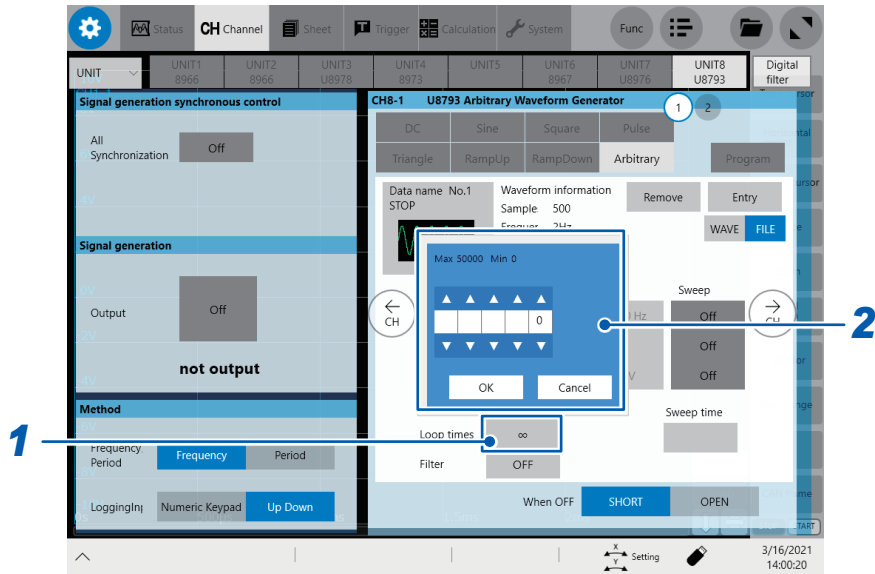

- 1 Tap the [Loop times] setting.
- 2 Enter the iteration count for the loop using the Up Arrow and Down Arrow keys or the numeric keypad.
Entering zero will set the number of looping time to infinity (∞).

- Valid range of the iteration count for the loop: 1 to 50,000
- After executing the output for a specified number of iterations, the instrument outputs zero volts.
- If the sweeping is set for any one of the clock frequency, amplitude adjustment, or offset, you cannot set the iteration count for the loop.
- If the delay is set, the repeatedly output waveform will look like the following figure.



2000 samples

For the following output settings:
Delay: 500
Iteration count for the loop

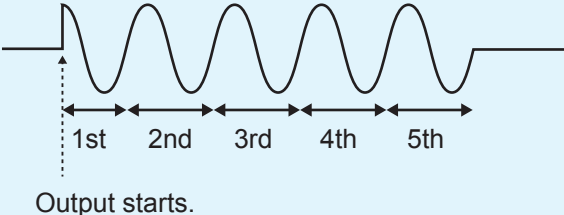

Output starts.

7.8 Setting the Filter

For MR8847A, MR8827, MR8740, and MR8741

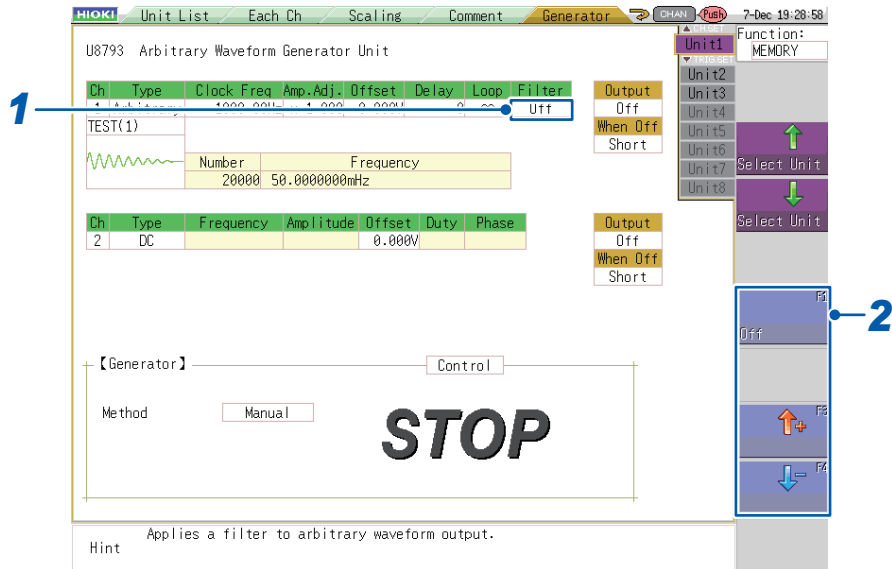

- 1** Select the **[Filter]** setting.
- 2** Press a function key (**F1** to **F5**) or select **[Off]** with the mouse.

OFF (default value), **50 Hz**,
100 Hz, **200 Hz**, **500 Hz**,
1 kHz, **2 kHz**, **5 kHz**,
10 kHz, **20 kHz**, **50 kHz**,
100 kHz, **200 kHz**, **500 kHz**,
1 MHz

- The module provides a two-stage low-pass filter.
- The tighter the set filter (i.e., the lower the cutoff frequency), the smaller the amplitude of the waveform that is actually output will be compared to the arbitrary waveform data's amplitude value.
- The filter setting is not available when the generator control (p. 131) is set to **[RUN]** or **[PAUSE]**.

For MR6000 and MR8740T

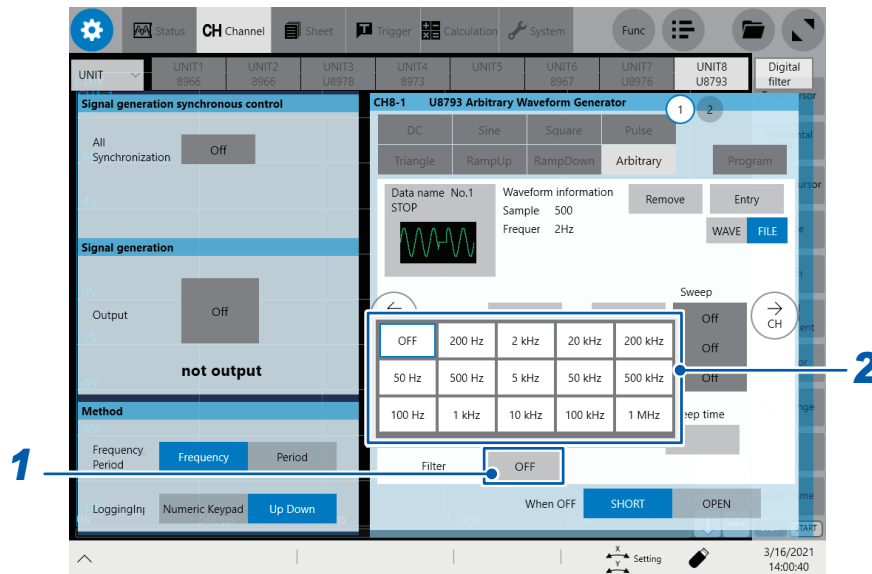

- 1 Tap the **[Filter]** setting.
- 2 Select the filter setting.

- The instrument is equipped with a second-order low-pass filter.
- The steeper filter (the lower the cut-off frequency) you set, the smaller amplitude of the waveform will be output compared with that of the arbitrary waveform data.
- If the generator control (p.133) is set to **[On]**, you cannot configure the filter setting.

7.9 Setting the Output to On or Off (MR8847A, MR8827, MR8740, and MR8741)

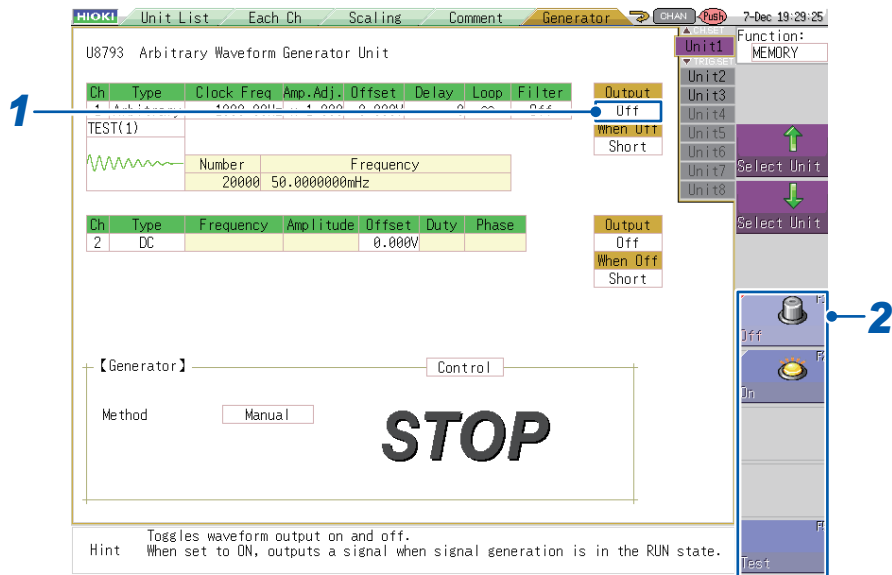

1 Select the **[Output]** setting.

2 Press a function key (**F1** to **F5**) or select a button with the mouse.

Off	Does not output the arbitrary waveform, regardless of the state of Generator Control (p. 131). (Output indicator: Off)
On	Outputs the set arbitrary waveform when Generator Control (p. 131) is [RUN] . (Output indicator: Red)
Test	Generates the set test output. (Output indicator: Red)

After selecting [Test]

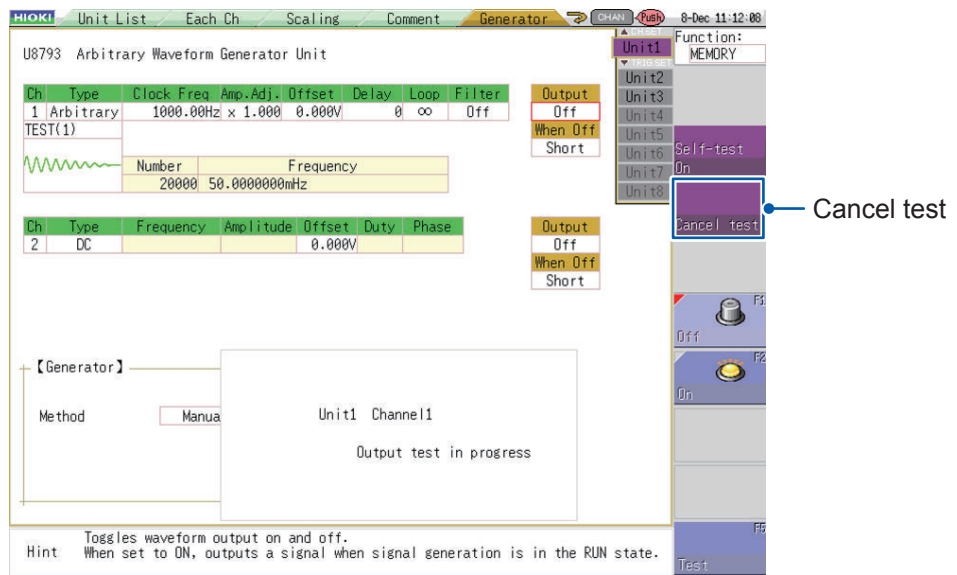

Pressing **TRIG.SET** (**TRIG.SET**) will stop test output.

This test mode does not provide functionality for judging test results with the module. You are responsible for determining whether the set arbitrary waveform is being properly output during the output test.

7.10 Setting the Sync Use to On or Off (MR6000 and MR8740T)



1 Tap the **[Use]** button to set it to **[On]** or **[Off]**.

On	Outputs waveforms when the [Output] button under [Signal generation] (p. 133) is set to [On] . (Output indicator: Red)
Off	Does not output a waveform regardless of the state of the [Output] button under [Signal generation] (p. 133). (Output indicator: Off)

7.11 Setting Behavior When Output is Off

For MR8847A, MR8827, MR8740, and MR8741

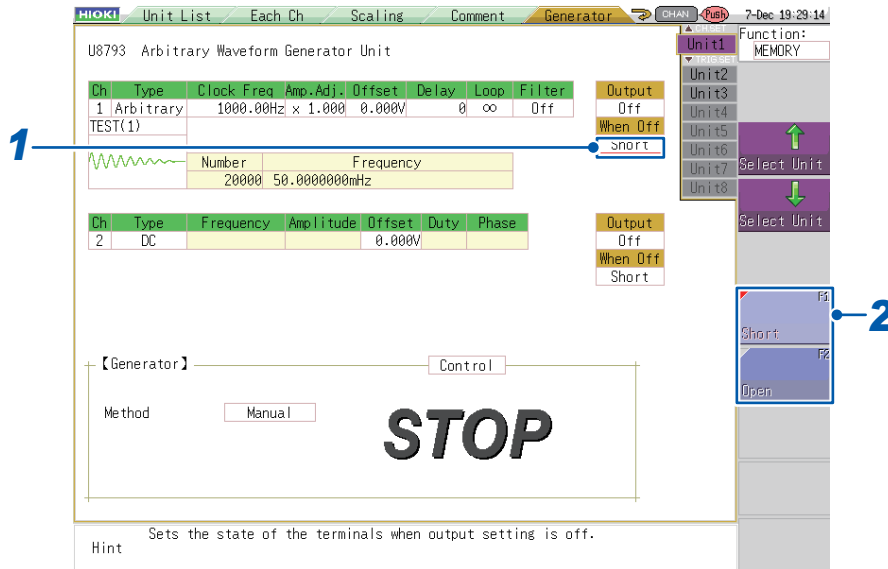

- 1** Select the **[When Off]** setting.
- 2** Press a function key (**F1 to F5**) or select a button with the mouse.

Short	<p>When the output (p.98) is off, places the output terminal in a shorted state by separating it from the module's internal circuitry and introducing resistance.</p>
Open	<p>When the output (p.98) is off, places the output terminal in an open state by separating it from the module's internal circuitry.</p>

For MR6000 and MR8740T



1 Tap [SHORT] or [OPEN] under [When OFF].

SHORT	<p>Disconnects the output terminal from the internal circuit and shorts the terminal using a resistance when the generator control (p.133) is off.</p>
OPEN	<p>Disconnects the output terminal from the internal circuit and opens the terminal when the generator control (p.133) is off.</p>

7.12 Saving the Arbitrary Waveform (MR6000 and MR8740T)

- 1 Press the **SAVE** key of the instrument.
The **[Manual save]** dialog box will be displayed.
Make sure that the instrument will save files according to the set contents with the quick saving settings (see section 4.2 in MR6000 Instruction Manual).

The screenshot shows the 'Manual save' dialog box with the following fields and callouts:

- 1** Points to the 'Execute' button at the bottom.
- 2** Points to the 'Media' dropdown menu, which is currently set to 'SSD/HDD'.
- 3** Points to the 'File name' input field, which contains 'DATA'.
- 4** Points to the 'Type' dropdown menu, which is currently set to 'Arbitrary'.
- 5** Points to the 'Channel' dropdown menu, which is currently set to 'CH1-1'.
- 6** Points to the 'Data name' input field, which contains 'Harmo49D'.

- 2 Tap the **[Media]** box, and then from the list, choose a storage device you wish to use.
- 3 tap the **[File name]** box to enter a file name to be saved.
- 4 Tap the **[Type]** box, and then from the list, select **[Arbitrary]**.
- 5 Tap the **[Channel]** box, and then from the list, choose a channel number of the U8793 that contains the registered waveform you wish to save.
Measured waveforms can also be saved as arbitrary waveforms. In that case, select the channel number of the applicable measured waveform from the list.
- 6 Tap the **[Data name]** box and enter or select the name as follows:
Arbitrary waveform: Select the arbitrary waveform you wish to save.
Measured waveform: Enter the arbitrary waveform's data name (p.79).
- 7 Tap **[Execute]**.
The arbitrary waveform file with the extension .WFG will be saved in the `HIOKI_MR6000\GEN` folder.

7.13 Editing the Arbitrary Waveform (MR6000)

Requires that the SF8000 be installed on the MR6000.

- 1 Install the SF8000 Waveform Maker (if not already installed).**
 - (1) Copy the [setup] folder in [SF8000\ENGLISH] on the CD-R disc that came with the MR6000 to a USB drive.
 - (2) Open explorer from the Function menu.
 - (3) Execute [setup] in the [setup] folder that you copied to the USB drive.
 - (4) Follow the procedure described in “13.2 Installing the SF8000 Application Installing the SF8000 Application” (p. 149) (starting with Step 3) to install the software.

 > [Channel] > [U8793]

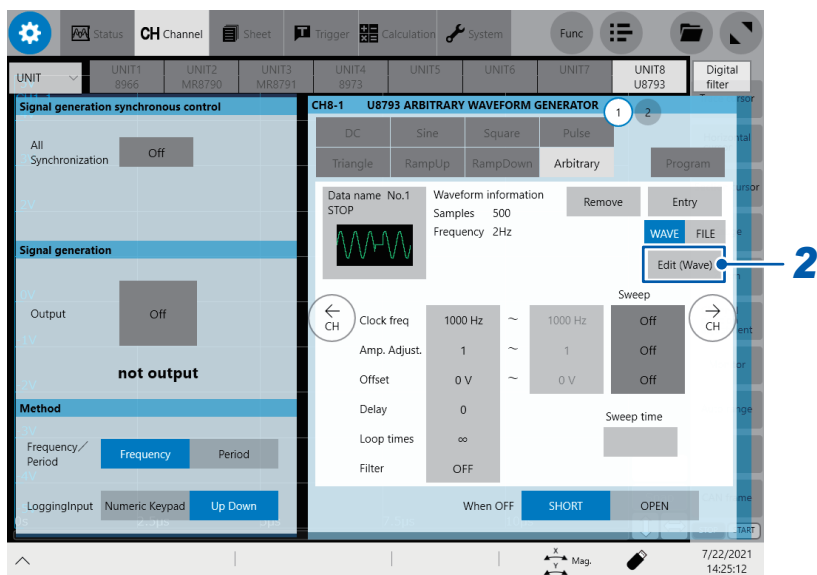

- 2 Tap [Edit (Wave)].**
Launch the SF8000.

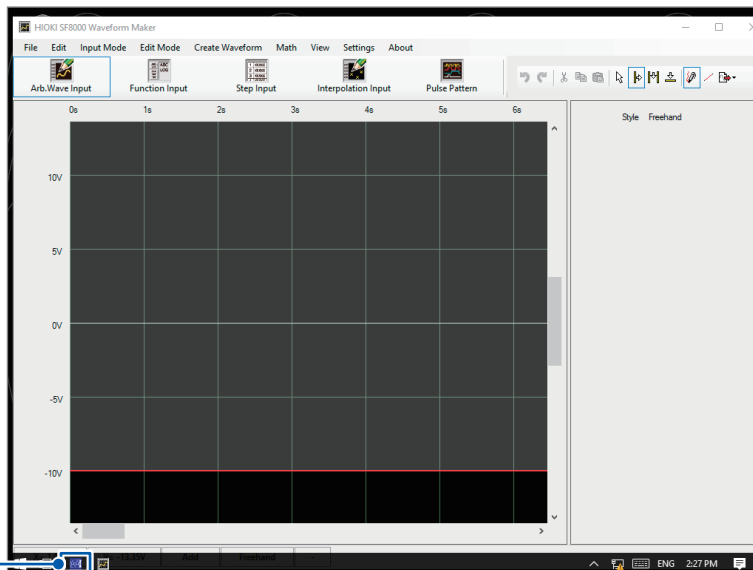

- 3 Tap the blue icon at the bottom left of the screen.**
Return to the MR6000 screen.

8

Program Settings (U8793)

This section describes the settings that are available when an U8793 Arbitrary Waveform Generator Unit is selected on the Generator screen (signal generation settings screen) (p. 15) and the waveform type is set to **[Program]**.

The program function can be used to output waveforms by combining up to 128 steps. A waveform, arbitrary waveform, or sweep waveform can be specified for each step.

8.1 Switching to the Program Settings Screen

For MR8847A, MR8827, MR8740, and MR8741

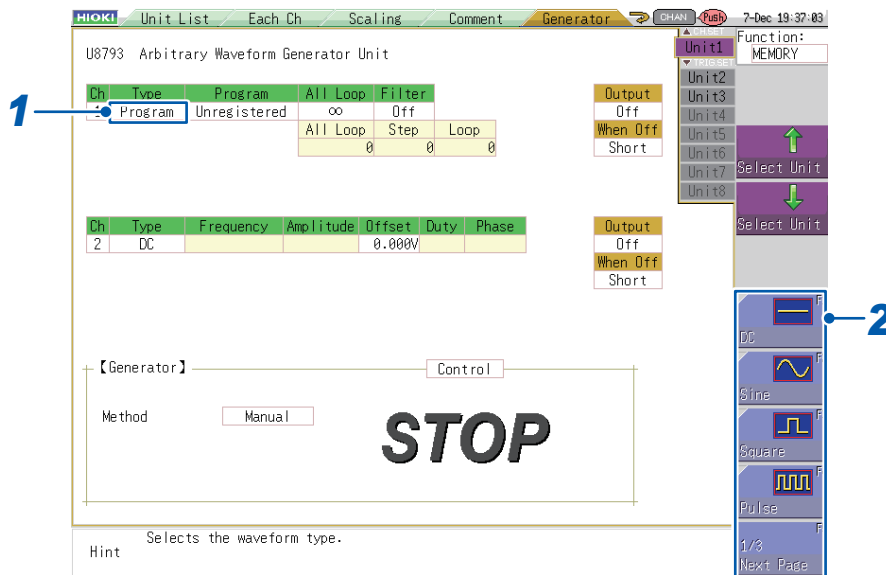

1 Select the **[Type]** setting.

2 Press a function key (**F1** to **F5**) or select **[Program]** (on page 3/3) with the mouse.

For MR6000 and MR8740T

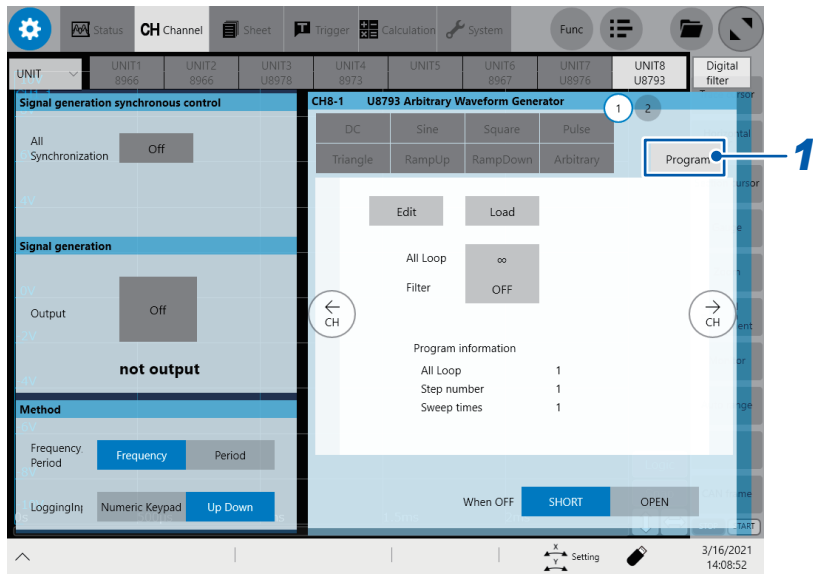

1 Tap [Program] under the waveform types.

8.2 Editing the Program

Opening the Edit screen

For MR8847A, MR8827, MR8740, and MR8741

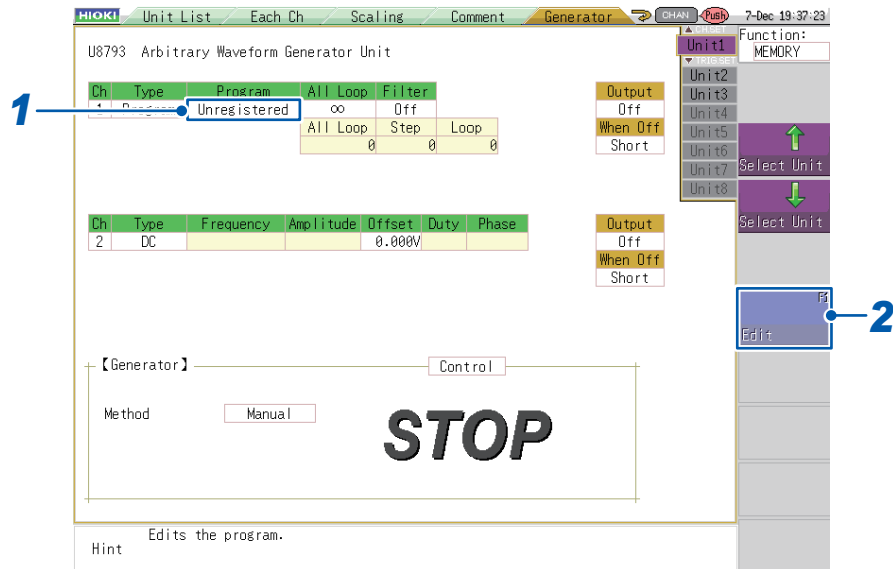

- 1** Select the **[Program]** setting.
- 2** Press the function key (**F1**) or select **[Edit]** with the mouse.
A setting screen will be displayed for each step.

For MR6000 and MR8740T

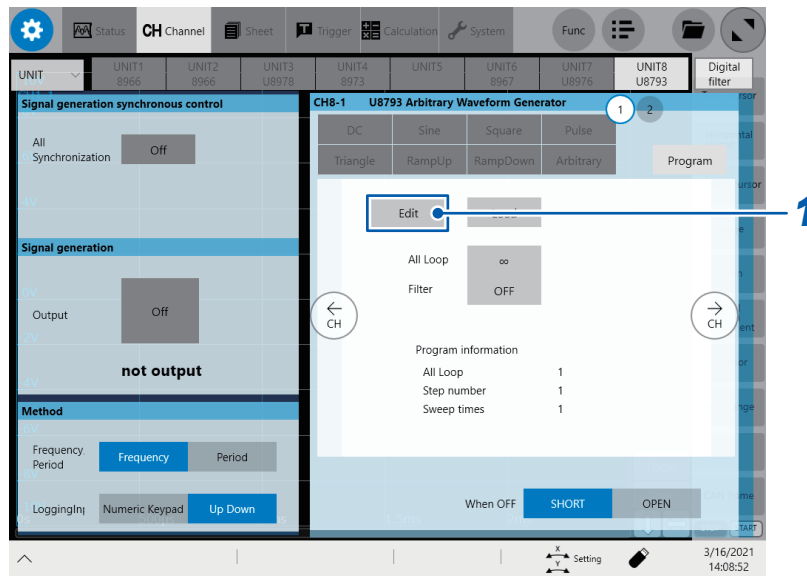

- 1 Tap [Edit].
The step entry screen will be displayed. You can configure up to 128 steps.

How to handle each step

You can edit and display programs with on the step entry screen.

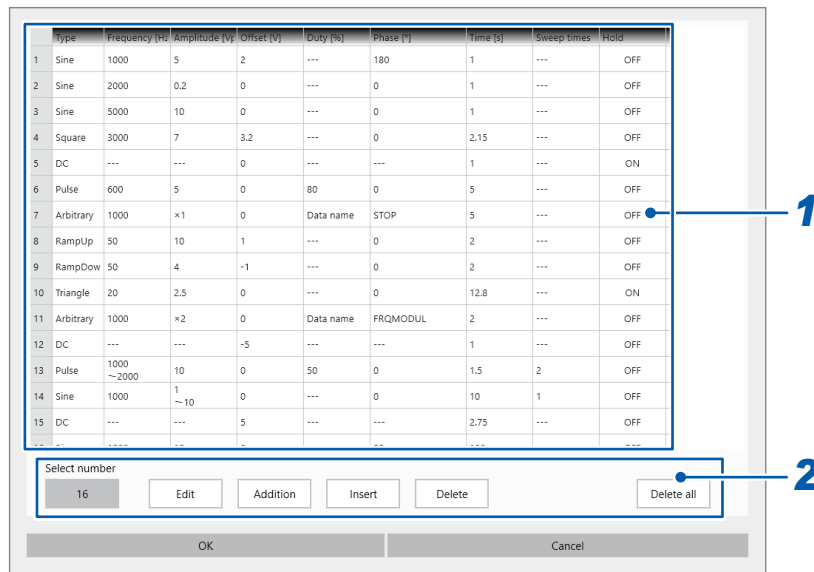

1 After confirming the settings on the step list, tap a step you wish to handle.

2 Handle the step

Select number	Displays the number you chose. Tap this button to change the step number.
Edit	Allows you to edit the step you chose.
Addition	Adds a step after the last step.
Insert	Inserts a step before the chosen step.
Delete	Deletes the step you chose.
Delete all	Deletes all the steps.

Configuring each step

For MR8847A, MR8827, MR8740, and MR8741

A program can consist of up to 128 steps.

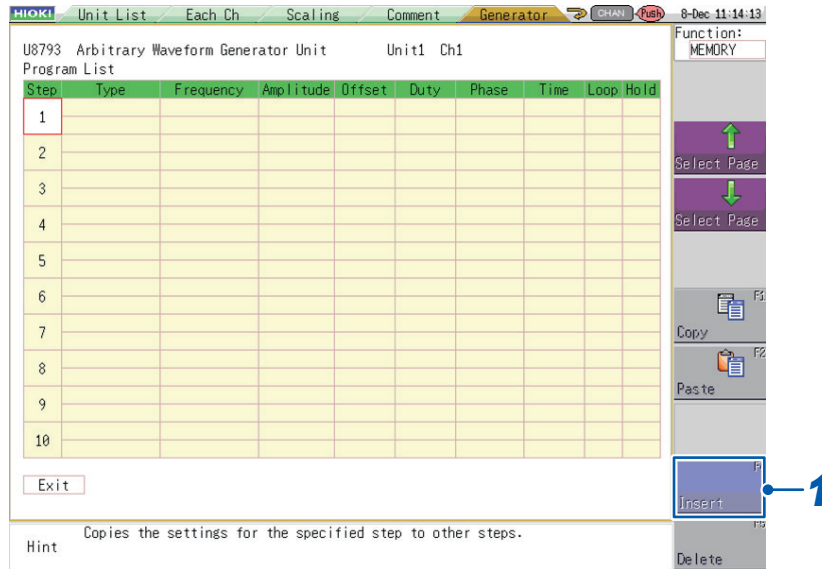

- 1 Press the function key (F4) or select [Insert] with the mouse. Step 1 will become able to be edited.

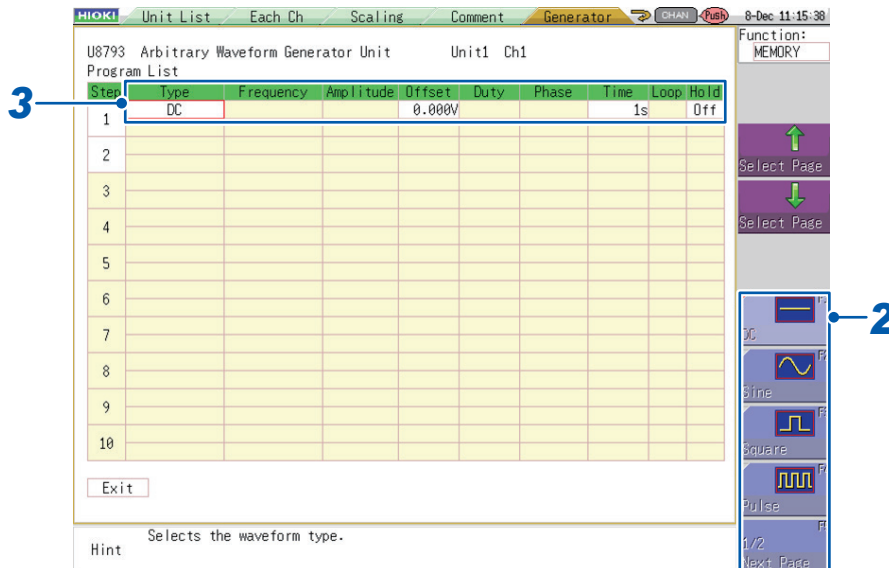

- 2** Press a function key (**F1** to **F5**) or select a waveform type with the mouse.
- 3** Set the parameters for the waveform you selected.

Type	Selects the waveform type. (p.24)
Frequency	Sets the frequency. (p.26)
Amplitude	Sets the amplitude. (p.28)
Offset	Sets the offset. (p.30)
Duty	Sets the duty cycle. (This setting is available only when a pulse waveform is selected.) (p.32)
Phase	Sets the phase at the start of output. (This setting is available only when a waveform other than a DC or arbitrary waveform is selected.) (p.34)
Time	Sets the time at which to output each step's waveform. When using the sweep setting, sets the sweep time.
Loop	Sets the number of times to repeat the sweep waveform. The valid setting range is 1 to 1000. (This setting is available only when using the sweep setting.)
Hold	<p>[Off]: After the time specified in the [Time] column has elapsed, goes on the next step.</p> <p>[On]: After the time specified in the [Time] column has elapsed, continues outputting the signal until the IN signal of the U8793's external control terminal is at a high level. The program will move on to the next step when the IN signal becomes at a low level.</p>

- 4** Move the cursor to the Step 2 position and press the function key (**F4**) or select **[Insert]** with the mouse.

Repeat this process for each step in order.

To edit Step 11 and subsequent steps, press  (**TRIG.SET**) to display the editing screen for those steps.

- To delete a step, move the cursor to the step number you wish to delete and press the function key (**F5**) or select **[Delete]** with the mouse.
- You can use copy and paste to copy the settings of one step to another step. (p.16)
- The start and end values for the sweep setting are displayed on the upper and lower rows. The sweep time controls how long the sweep operation lasts.

When using the sweep setting for a waveform

STEP	Type	Frequency	Amplitude	Offset	Duty	Phase	Time	Loop	Hold
1	SINE	1000.00Hz	10.000Vpp	0.000V		0.0°	1s		
2		500.00Hz	5.000Vpp	1.000V					

Sets the start value.

Sets the end value.

Sets the sweep time.

When using the sweep setting for a user waveform

STEP	Type	Frequency	Amplitude	Offset	Duty	Phase	Time	Loop	Hold
1	USER	200000.00Hz	x 1.000	0.000V	Number		10.000000ms-200.000000ms		
2		100000.00Hz	x 1.500	1.000V	200%				

Sets the start value.

Sets the end value.

Sets the sweep time.

The period for the output waveform's start value and end value is automatically displayed.

For MR6000 and MR8740T

Tapping the **[Edit]** button on the step entry screen to display the **[Setting program step]** dialog box. The setting parameters varies according to the chosen waveform type.

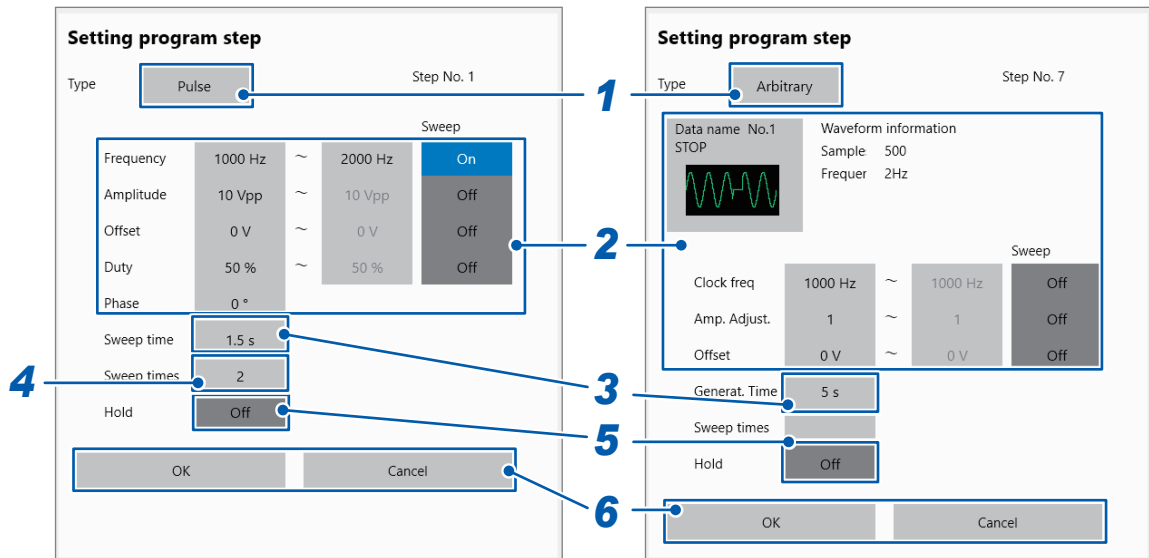

- 1** Tap the **[Type]** button, and then from the list, choose a type you wish to use.
- 2** According to the chosen waveform type, configure each parameters. The setting parameters varies according to the chosen waveform type. For details about each parameter, see “4 Waveform Settings (U8793 and MR8790)” (p. 19) and “7 Arbitrary Waveform Settings (U8793)” (p.71).
- 3** Tap the **[Generat. Time]** box to enter the generating duration (with the sweep, tap the **[Sweep time]** button to enter the sweeping time).
- 4** Tap the **[Sweep times]** box to enter the iteration count for the loop in (only with the sweep).
The generating duration is calculated by multiply the sweeping time and the iteration count for the loop together.
- 5** Tap the **[Hold]** button to set it to **[On]** or **[Off]**.

Off	After the time specified in the [Time] column has elapsed, goes on the next step.
On	After the time specified in the [Time] column has elapsed, continues outputting the signal until the IN signal of the U8793’s external control terminal is at a high level. The program will move on to the next step when the IN signal becomes at a low level.

- 6** Tap **[OK]**.
Your entry will be confirmed. If you do not wish to change it, tap **[Cancel]**.

Hold setting operation

- While the hold function is in effect, high-level output will be generated from the external control terminal's OUT pin (p. 14, p. 145)
- When the hold parameter for a step is set to **[On]**, the waveform set by the that step will be output until the hold is canceled.
- When a step for which the hold parameter is set to **[On]** contains a sweep waveform, the waveform defined by the end value for each sweep parameter will be output after repeating the sweep waveform the set number of loops, and that output will continue until the hold state is canceled.

Sweep waveform setting

Example

The waveform defined by the sweep end values will be output while the hold function is in effect.

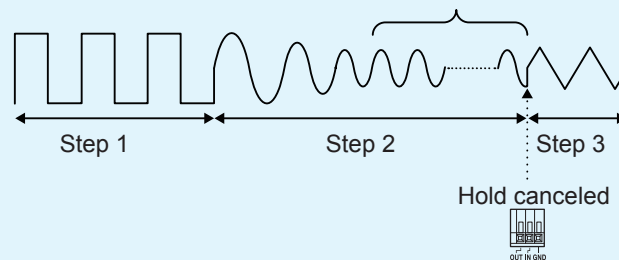

A low-level signal is input to the IN external control terminal.

- To cancel the hold state, input a low-level signal to the module's IN external control terminal. It takes about 100 μs to cancel the hold from the time a low-level signal is inputted. (p. 14, p. 144)

Switching steps

- It takes approximately 20 μs to switch to the next step once the previous step ends. The output voltage during that interval will be the voltage at the time the previous step completed.

Ending program editing



- 1** Select the **[Exit]** setting.
- 2** Press a function key (**F1** to **F5**) or select a button with the mouse.

Save	Saves the edited program and exits.
Close	Exits without saving the edited program.

8.3 Setting the Overall Number of Loops

This section describes how to set the number of times to execute the edited program.

For MR8847A, MR8827, MR8740, and MR8741

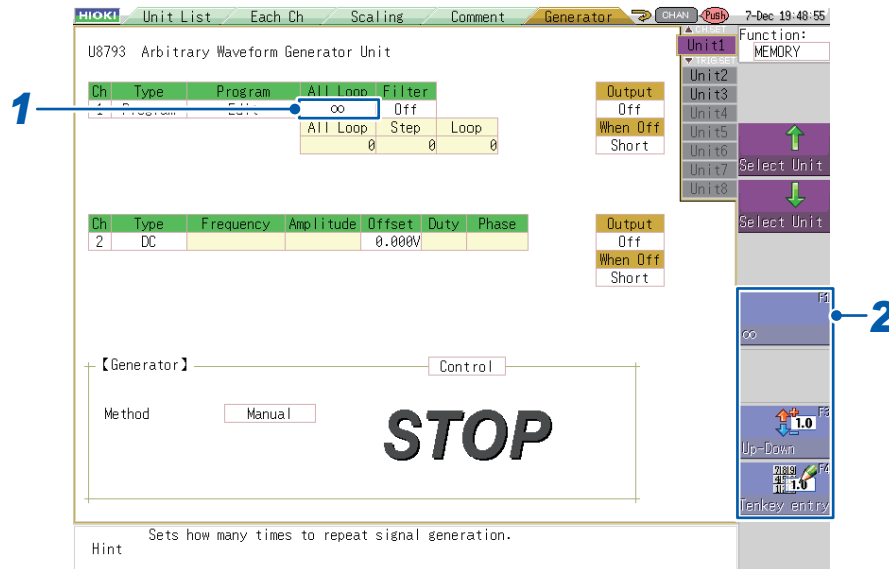

1 Select the **[All Loop]** setting.

2 Press a function key (**F1** to **F5**) or select a button with the mouse.

∞	Continues to repeat the program waveform until output is stopped.
Up-Down	p.20
Tenkey entry	p.21

Valid overall number of loops setting range: 1 to 50,000

When the overall number of loops has been set, approximately 20 μ s will elapse from the time program execution completes until the instrument transitions to the next program execution. The output voltage during that interval will be 0 V.

For MR6000 and MR8740T

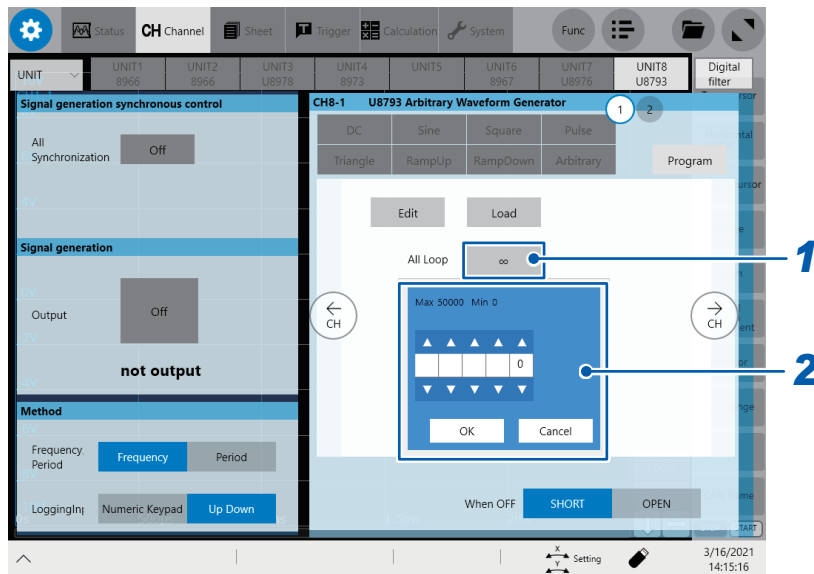

- 1** Tap the **[All Loop]** setting.
- 2** Enter the iteration count for the loop using the **Up Arrow** and **Down Arrow** keys or the **numeric keypad**.
 Entering zero will set it to infinity (∞).
 When infinity (∞) is set, the instrument continues outputting the signal repeatedly until you stop the output.

Valid range of the iteration count for the whole loop: 1 to 50,000

When you have set the iteration count for the whole loop, it will take about 20 μ s between the completion of the program and the start of the next program. During this duration, the instrument will output zero volt.

8.4 Setting the Filter

For MR8847A, MR8827, MR8740, and MR8741

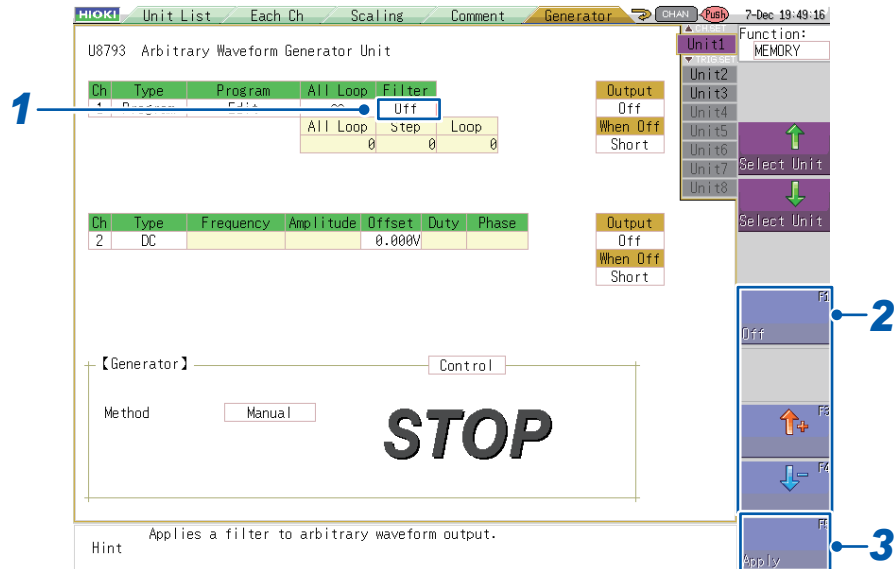

- 1** Select the **[Filter]** setting.
- 2** Press a function key (**F1** to **F5**) or select **[Off]** with the mouse.

OFF (default value), **50 Hz**,
100 Hz, **200 Hz**, **500 Hz**,
1 kHz, **2 kHz**, **5 kHz**,
10 kHz, **20 kHz**, **50 kHz**,
100 kHz, **200 kHz**, **500 kHz**,
1 MHz
- 3** Press the function key (**F5**) or select **[Apply]** with the mouse.
 The set cutoff frequency will be enabled.

- The module provides a two-stage low-pass filter.
- The filter is enabled only for arbitrary waveforms to which program steps have been set.
- The tighter the set filter (i.e., the lower the cutoff frequency), the smaller the amplitude of the waveform that is actually output will be compared to the arbitrary waveform data's amplitude value.
- The filter setting is not available when the generator control (p. 131) is set to **[RUN]** or **[PAUSE]**.
- When changing the filter setting, press **[Apply]**. The filter setting will not take effect unless you do so.

For MR6000 and MR8740T

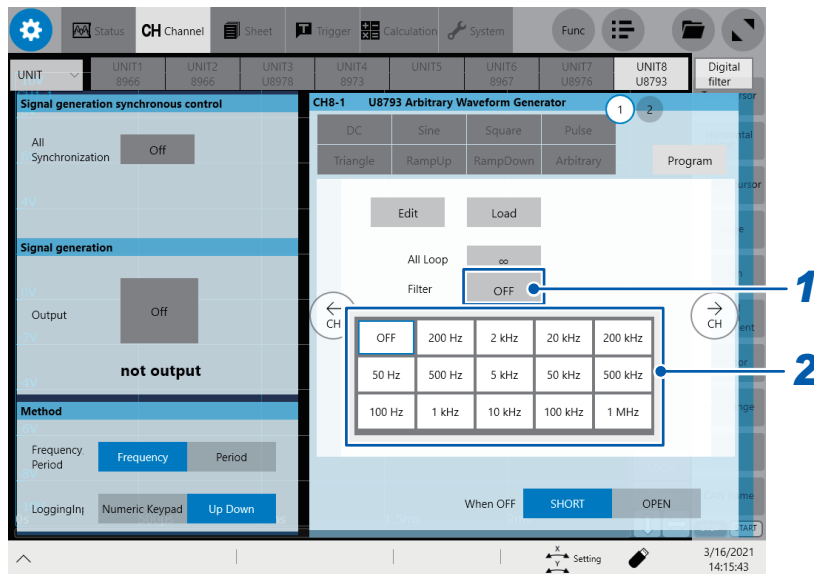

- 1** Tap the **[Filter]** setting.
The selection dialog box will be displayed.
- 2** Choose a the filter (cut-off frequency) you wish to use.

- The instrument is equipped with a second-order low-pass filter.
- The filter is available for only the arbitrary waveform configured in the program's steps.
- The steeper filter (the lower the cut-off frequency) you set, the smaller amplitude of the waveform will be output compared with that of the arbitrary waveform data.
- If the signal output control (p. 133) is set to **[On]** or **[Off]**, you cannot configure the filter setting.

8.5 Saving/Loading the Edited Program

For MR8847A, MR8827, MR8740, and MR8741

This section describes how to save the edited program as a file and to load the saved program file.

Saving the program

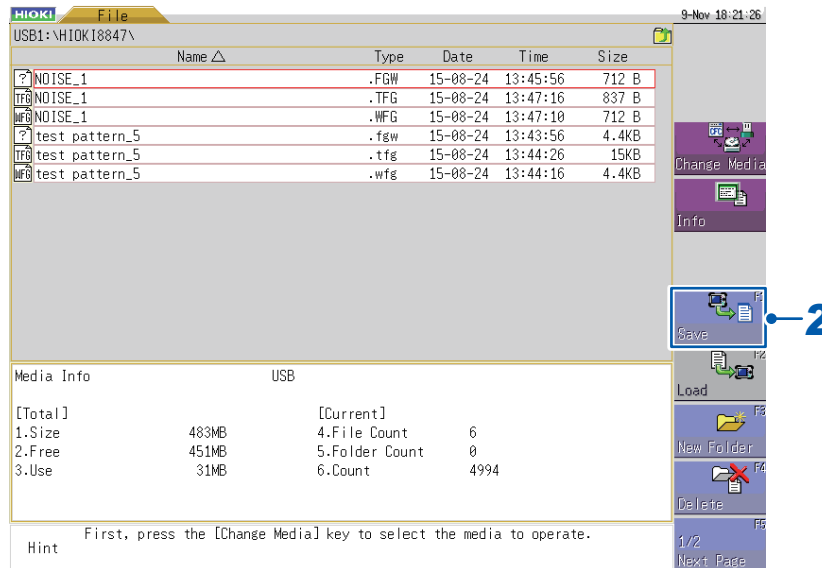

1 Press **FILE** (**FILE**).

2 Press the function key (**F1**) or select **[Save]** (page 1/2) with the mouse.

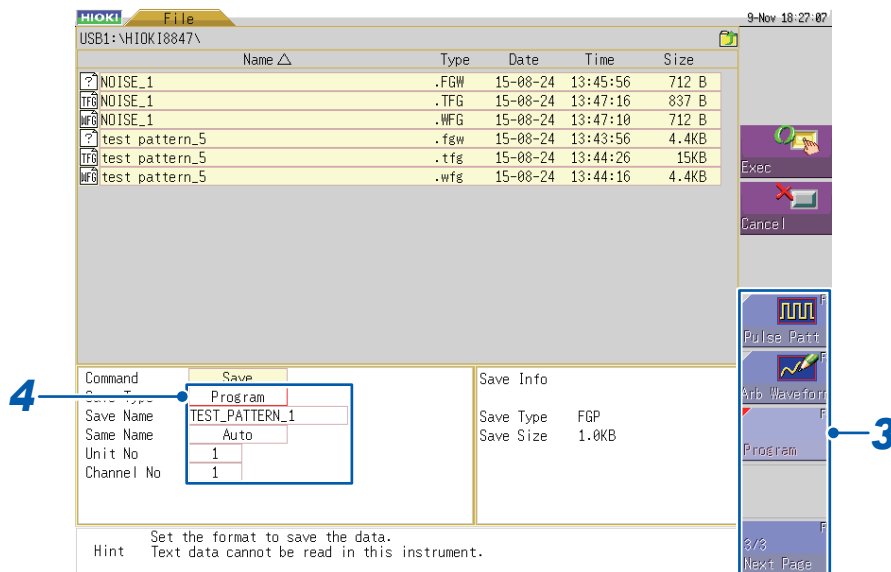

3 Press a function key (**F1** to **F5**) or select **[Program]** (page 3/3) with the mouse.

4 Set the information to save with a function key (F1 to F5) or the mouse.

Save Name	Allows you to enter the program name.
Same Name	Sets the processing to perform if a file with the same name exists in the save folder.
Unit No.	Sets the U8793 unit number to which the program being saved has been registered.
Channel No.	Sets the U8793 channel number to which the program being saved has been registered.

5 Press **CH.SET** (**CH.SET**).

The program will be saved as a file with the extension “.fgp.”

Loading the program

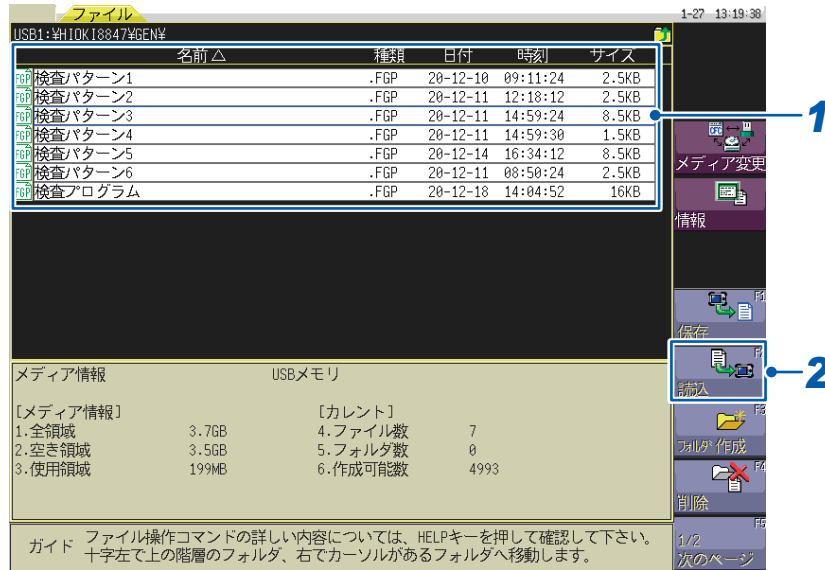

1 Choose a files to load.

2 Use the **F1** function key or the mouse to select **[Load]** on page 1/2.



3 Enter the module number and channel number you wish to load respectively in the **[Unit No.]** box and **[Channel No.]** box.

4 Press the **CH.SET** (**CH.SET**) button.
Otherwise, use the mouse to select **[Execute]**.

For MR6000 and MR8740T

This section describes how to save the edited program as a file and loading the saved program file.

Saving the program

- 1** Press the **SAVE** key of the instrument.
The **[Manual save]** dialog box will be displayed.
Make sure that the instrument will save files according to the set contents with the quick saving settings (see section 4.2 in MR6000 Instruction Manual).

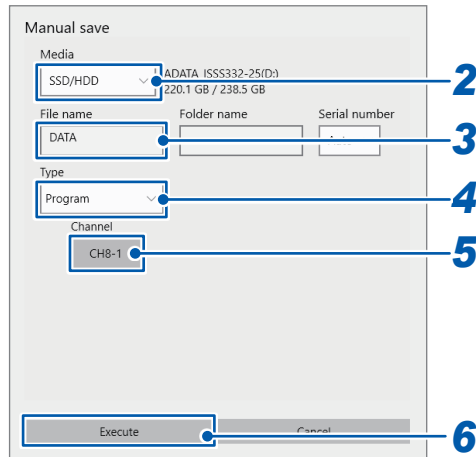

- 2** Tap the **[Media]** box, and then from the list, choose a storage device you wish to use.
- 3** Tap the **[File name]** box to enter a filename to be saved.
- 4** Tap the **[Type]** box, and then from the list, select **[Program]**.
- 5** Tap the **[Channel]** box, and then from the list, choose a channel number of the U8793 that contains the program you wish to save.
- 6** Tap **[Execute]**.
The arbitrary waveform file with the extension .FGP will be saved in the *HIOKI_MR6000\GEN* folder.

This section describes how to save the edited program as a file and loading the saved program file.

Loading the program

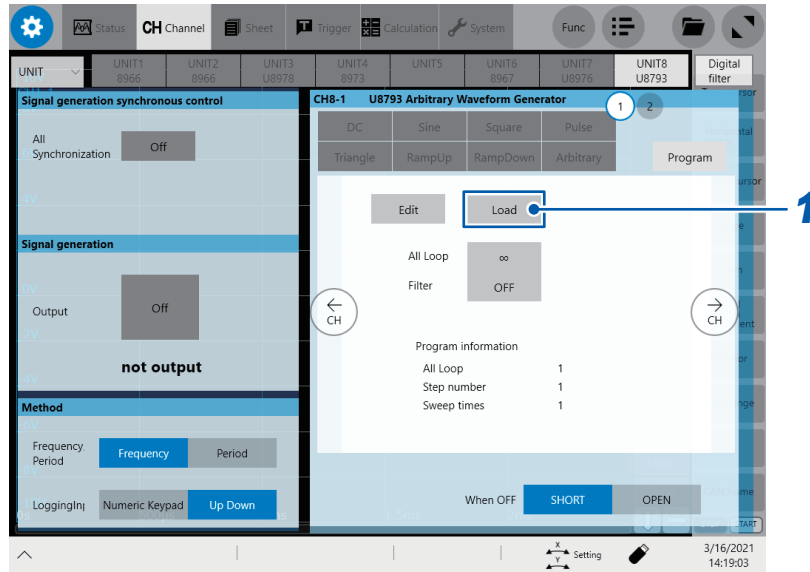

- 1 Tap [Load].
The file screen will be displayed.

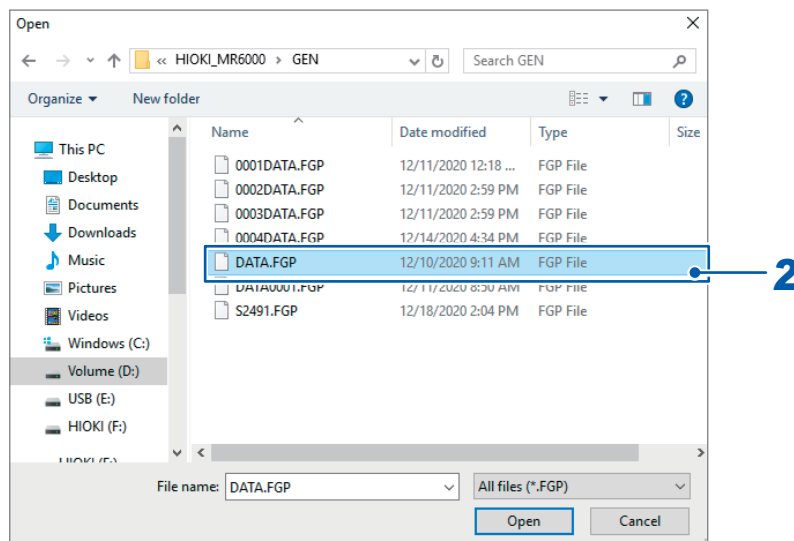

- 2 Choose a file you wish to load.

8.6 Checking Program Progress

For MR8847A, MR8827, MR8740, and MR8741

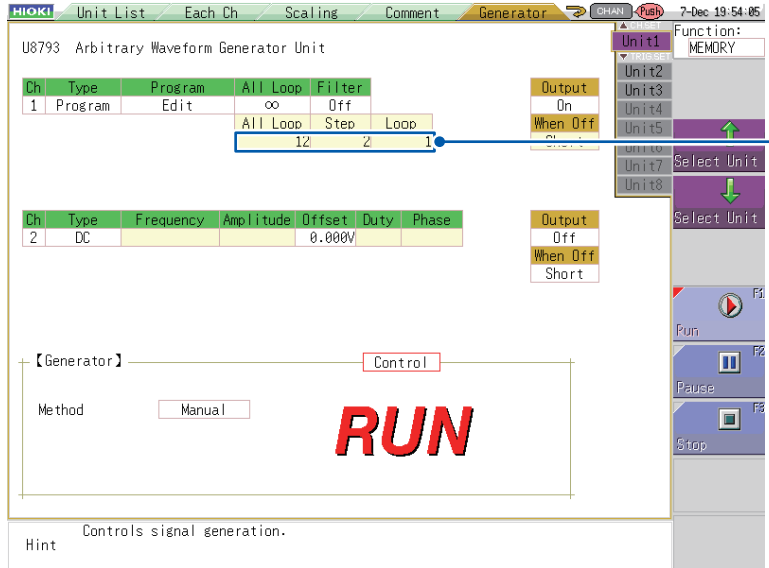

Number of loops and steps completed and total number of loops

You can check the number loops and steps completed and the total number of loops.

When the total number of loops is set to ∞, the total number of loops display will be fixed to [∞] if more than 50,000 loops have been completed.

For MR6000 and MR8740T

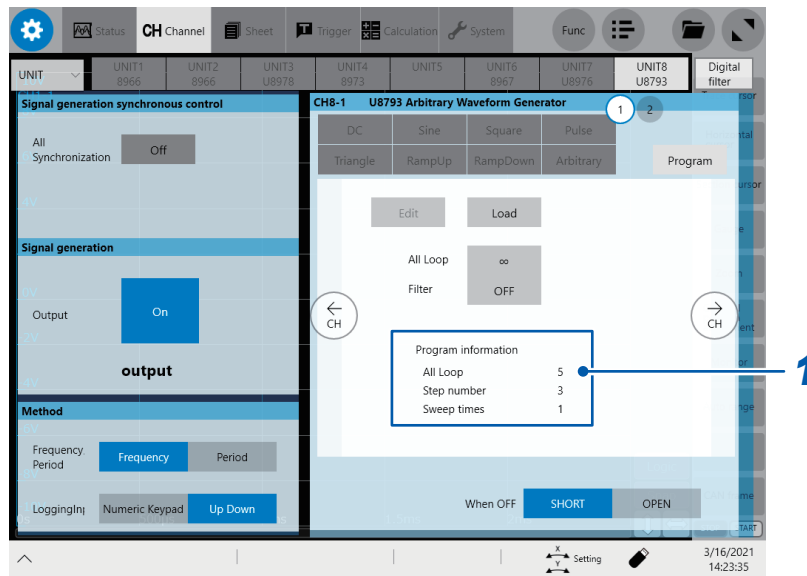

- 1 Confirm the progress in the [Program information] field.**
You can confirm the iteration count for the whole loop, step count, and sweeping count of the still-in-progress process.

When you have set the iteration count for the whole loop to infinity, the instrument will show [∞] as the iteration count for the whole loop of the still-in-progress process repeating more than 50,000 times.

9

Outputting Signals





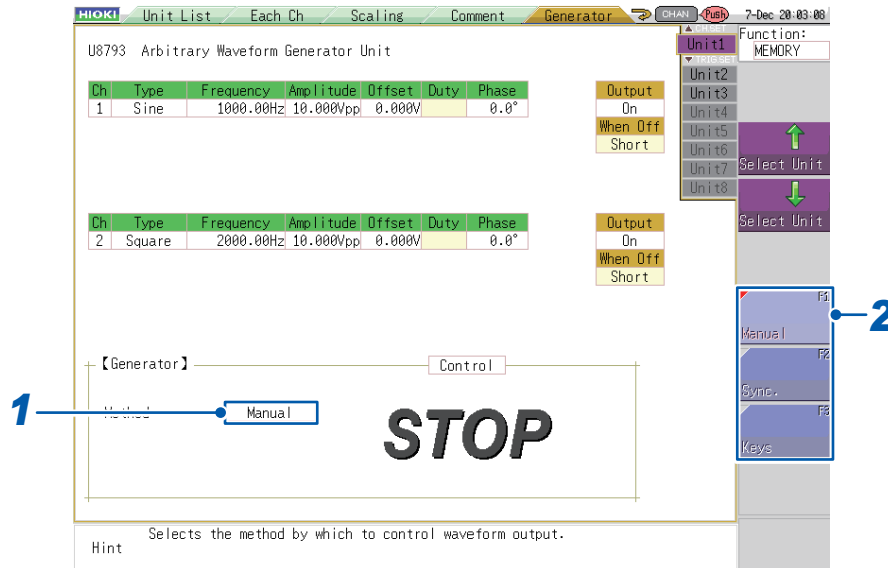

9.1 Setting the Control Method

For MR8847A, MR8827, MR8740, and MR8741



- 1 Select the [Method] setting.

2 Press a function key (F1 to F5) or select a button with the mouse.

Manual	Restricts control of signal output to this Generator screen (signal generation settings screen).
Sync.	<p>Augments manual control with signal output in synchronization with the start and end of measurement.</p> <p> (START): Starts output when measurement starts.</p> <p> (STOP): Stops output when measurement stops.</p>
Keys	<p>Augments manual control by allowing signal output to be manipulated using the Memory HiCorder's keys.</p> <p> (START): Starts output.</p> <p> (STOP): Stops output.</p> <p> : Pauses output.</p> <p>Since this screen is dedicated to use by the output function, the  (START) and  (STOP) keys cannot be used to start or stop measurement.</p>

When the control method is [Sync.], output will start approximately 3 ms before the start of measurement.

For MR6000 and MR8740T

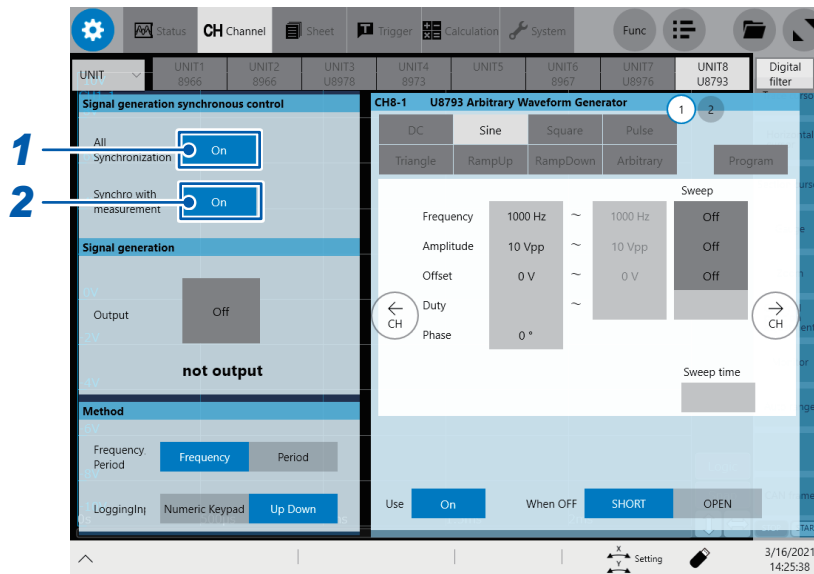

- 1** Tap the **[All Synchronization]** button to set it to **[On]** or **[Off]**.

On	Controls the signal generation of all modules' all channels simultaneously. However, this setting will be applied to the channels with the Sync Use set to [On] .
Off	Controls the signal generation of the channels only set on this screen.

- 2** Tap the **[Synchro with measurement]** button to set it to **[On]** or **[Off]**.

On	Synchronizes signal outputting with the start/stop of measurements. The signals outputs and stops respectively in sync with the start and stop of measurements.
Off	Does not synchronize signal outputting with the start/stop of measurements. You can manually control signal outputting.

9.2 Setting Output When Measurement Completes

For MR8847A, MR8827, MR8740, and MR8741

This setting is available after selecting **[Sync.]**.

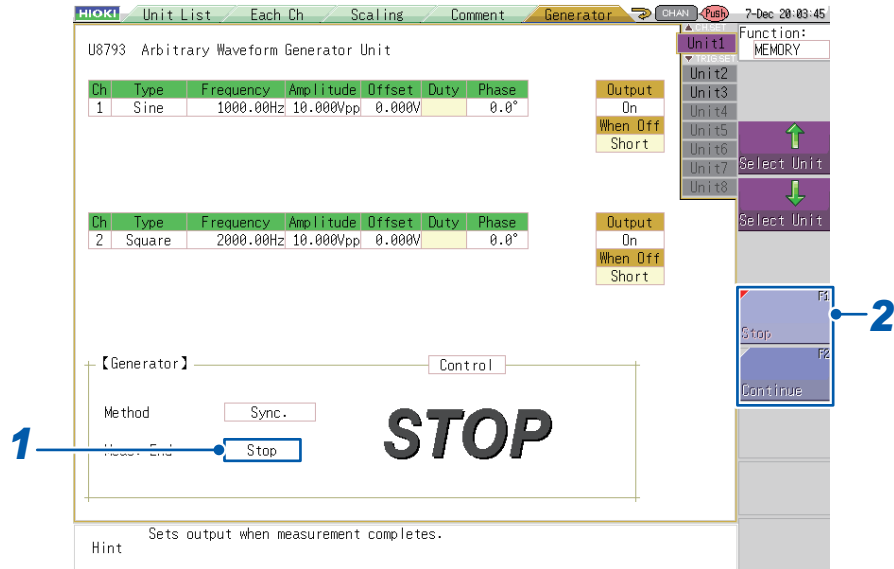

- 1** Select the **[Meas. End]** setting.
- 2** Press a function key (**F1** to **F5**) or select a button with the mouse.

Stop	Stops output when measurement completes.
Continue	Continues output even when measurement completes.

9.3 Controlling Signal Output

For MR8847A, MR8827, MR8740, and MR8741

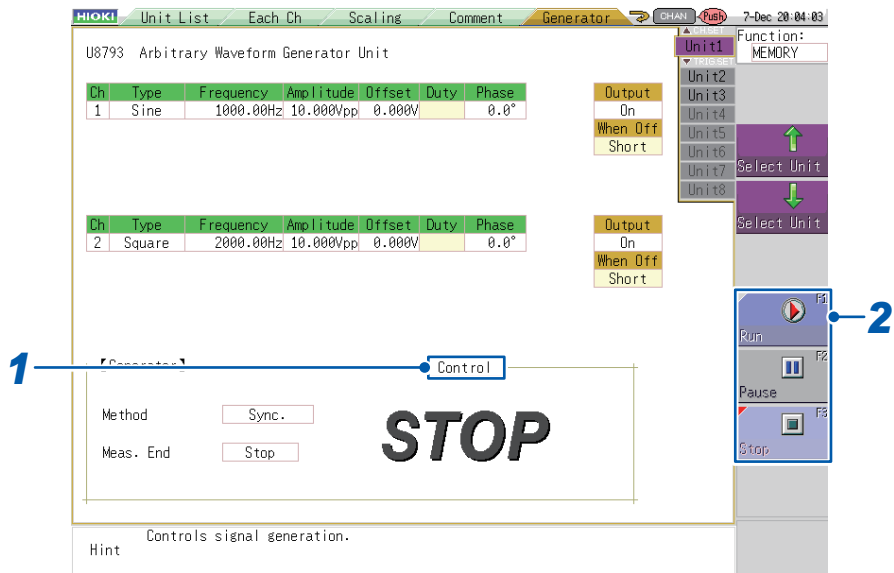

- 1 Select the **[Control]** setting.
- 2 Press a function key (F1 to F5) or select a button with the mouse.

Run	Starts output. (Output indicator: Red)
Pause	Pauses output. While output is paused, the output at the time [PAUSE] was pressed will be output. (Output indicator: Red)
Stop	Stops output. (Output indicator: Off)

The current output status is displayed underneath the **[Control]** setting.

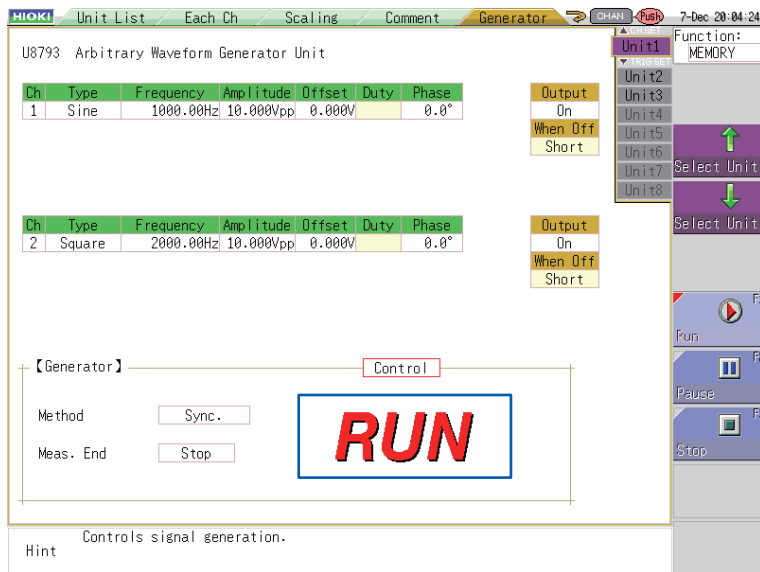

- Pressing **[RUN]** or **[STOP]** may cause the output waveform to exhibit undershoot or overshoot.
- When control is set to **[RUN]** or **[PAUSE]**:
 - U8793: The type of waveform being output cannot be changed. The parameters for the selected waveform type can be changed. (However, the parameters cannot be changed if any parameter has been set to “sweep.”)
 - MR8790: The type of waveform being output as well as associated parameter settings can be changed.
 - MR8791: The output mode cannot be changed. Associated parameter settings can be changed.
- When **[PAUSE]** is pressed, the module will continue to output the voltage at the time **[PAUSE]** was pressed. Subsequently, pressing **[RUN]** will cause output to resume from the phase at the time that **[PAUSE]** was pressed.

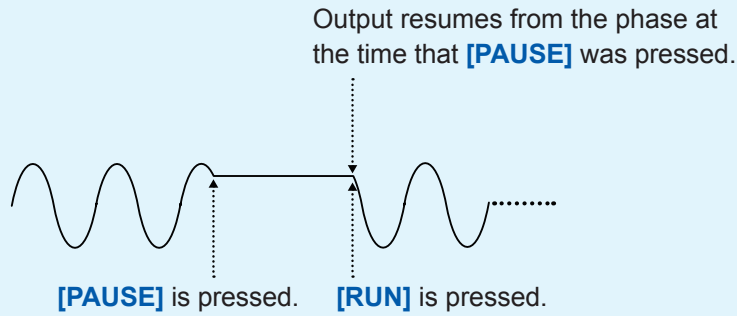

- While in the **[PAUSE]** state, high-level output will be generated from the external control terminal's OUT pin (p. 14, p. 145).
- When output (p.34, p.49, p.98) is set to off while in the **[PAUSE]** state:
 - U8793: Output will be 0 V. When output is turned on again, output will remain 0 V.
 - M8790: Output will be 0 V. When output is turned on again, output will return to the voltage in effect while in the **[PAUSE]** state.
 - MR8791: When operating in pulse mode, output will be low-level. When output is turned on again, output will remain low-level.
- When in pattern mode, output will be at the same level as the first pattern. When output is turned on again, output will remain at the same level as the first pattern.
- When control is set to **[RUN]** or **[PAUSE]**, output can be turned on and off (p.39, p.49, p.61, p.98), but there may be a disturbance in the waveform when output is turned on or off due to the output relay's response.

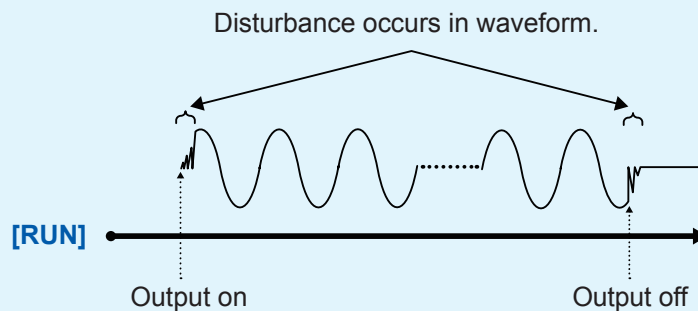

- After turning output on, no disturbance will occur in the waveform when setting control to **[RUN]** or **[STOP]**.

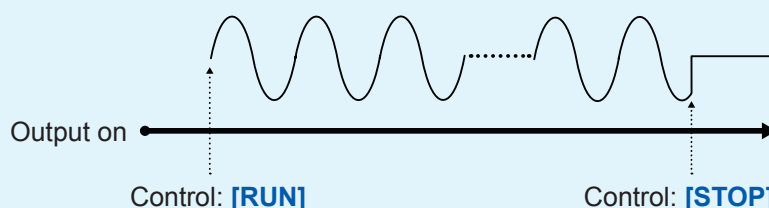

For MR6000 and MR8740T

When all channels sync is set to Off

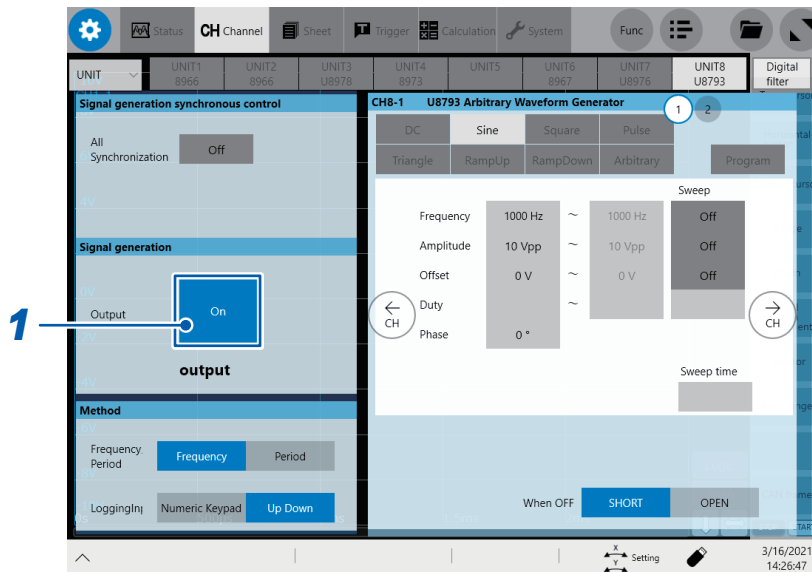

1 Tap the [Output] button to set it to [On] or [Off].

On	Starts the output across the channels set on this screen.
Off	Stops the output across the channels set on this screen.

When all channels sync is set to On



1 Tap the [Output] button to set it to [On] or [Off].

On	Starts the output across all channels simultaneously.
Off	Stops the output across all channels simultaneously.

2 Tap the **[Use]** button to set it to **[On]** or **[Off]**.

On	Uses the channel as the output target. If all channels sync is set to [On] , outputs the waveforms in sync with the [On] setting toggled by pressing the [Output] button.
Off	Does not use the channel as the output target. If all channels sync is set to [On] , does not output the waveforms even with the [On] setting toggled by pressing the [Output] button.

- Toggling between the output settings **[On]** and **[Off]** may cause overshoots and undershoots in the output waveform.
When the output is set to **[On]**:
U8793: The type of waveform being output cannot be changed. The parameters for the selected waveform type can be changed. (However, the parameters cannot be changed if any parameter has been set to “sweep.”)
MR8790: The type of waveform being output as well as associated parameter settings can be changed.
MR8791: The output mode cannot be changed. Associated parameter settings can be changed.
- If the Sync Use is toggled between **[On]** or **[Off]** while the output is being set to **[On]** with all channels sync set to **[On]**, the response of the output relay may cause the waveform disturbance.

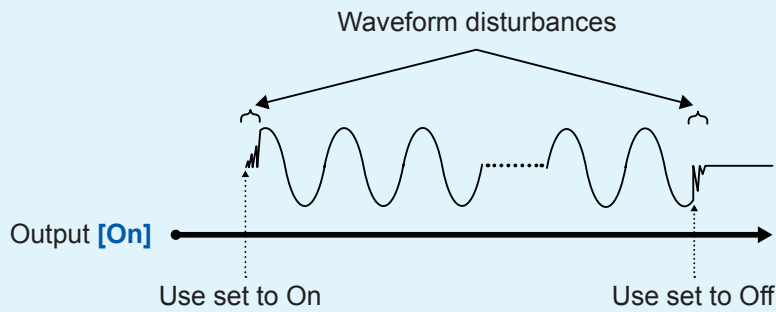

- If you toggle between the output settings **[On]** and **[Off]** after setting the Sync Use to **[On]**, the waveform will hardly be disturbed.

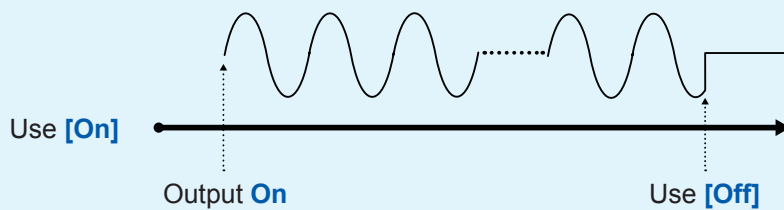

10

Configuring Settings on the Waveform Screen (MR8847A, MR8827, MR8740, and MR8741)

10.1 Setting Output Waveform Parameters

Parameters (frequency, amplitude, and offset) for the output waveform that was configured on the Generator screen (signal generation setting screen) (p. 15) can be changed on the Waveform screen. The ability to configure and change these settings while outputting and measuring the resulting waveform provides a convenient way to measure a waveform while varying its parameters.

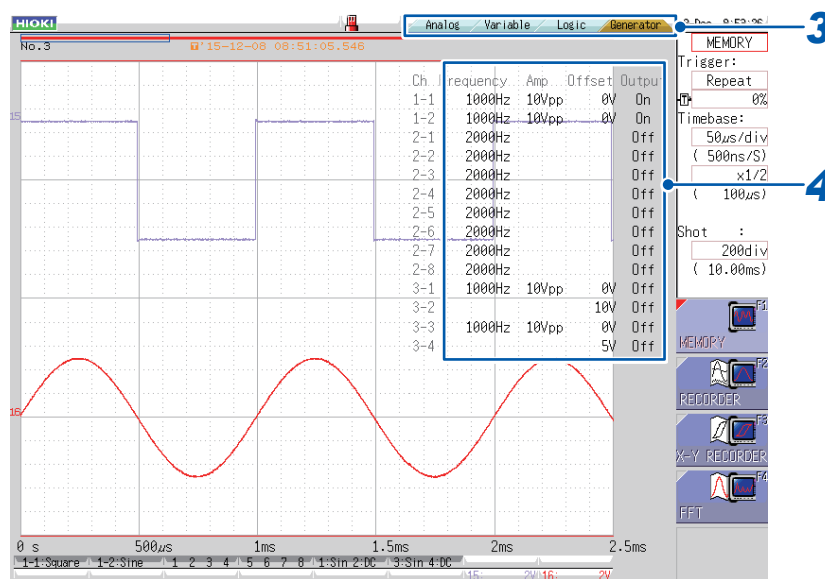

- 1 Display the Waveform screen (if viewing another screen, press **DISP** (**DISP**) to display the Waveform screen).
- 2 Press **CH.SET** (**CH.SET**) (to display the tabs).
- 3 Press **CH.SET** (**CH.SET**) or select the **[Generator]** tab with the mouse.
- 4 Set the following parameters as desired.

Frequency	Sets the frequency. (p.26)
Amp	Sets the amplitude. (p.28)
Offset	Sets the offset. (p.30)
Output	Turns output on or off. (p.39)

To display the waveform and output parameter settings in separate windows

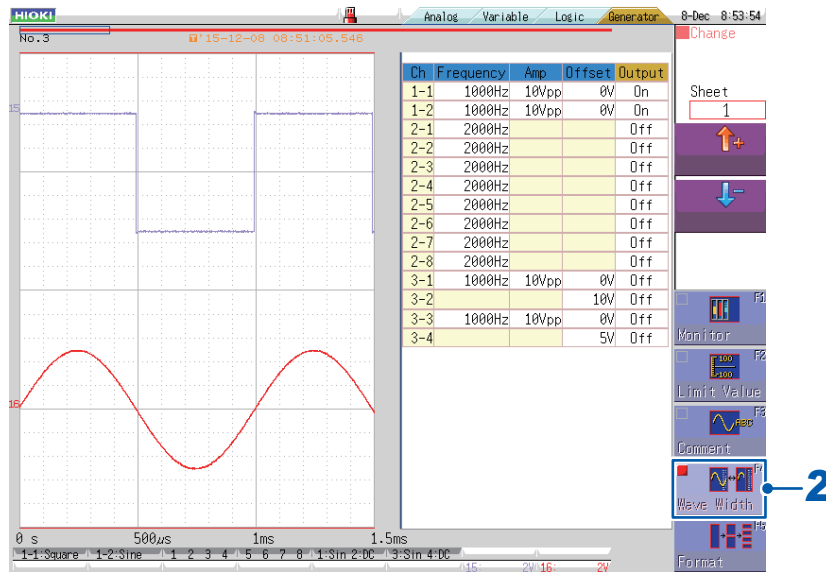

1 Press **(DISP)** (to show the display menu on the right side of the screen).

2 Press the function key **(F4)** or select **[Wave Width]** with the mouse.

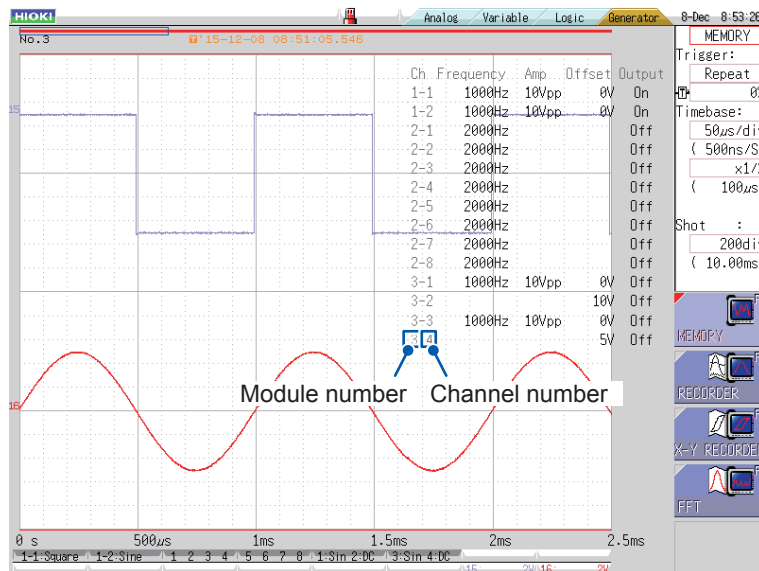

3 Press **(DISP)** twice (so that you can move the cursor to the output parameter settings).

- In addition to turning output on or off, you can set the frequency, amplitude, and offset (or output DC voltage when the waveform type is DC). When the waveform type is arbitrary waveform, you can set the clock frequency, amplitude adjustment, and offset.
- Only the integer portion of the frequency, amplitude, and offset settings is shown. Even if a setting has a decimal portion, it will be rounded to the nearest whole number for display purposes. (Although each setting is shown as an integer, its decimal portion remains valid.)
- Even if output is set to on, the waveform will not be output unless generator control (p. 131) (p.75) is set to **[RUN]**. Set Generator Control to **[RUN]** in advance on the Generator screen.
- Depending on the waveform type, the output parameter settings will be shown as follows:

U8793

Ch	Frequency	Amp	Offset	Output
1-1			15V	0n
1-2	1000Hz	10Vpp	0V	0n

When set to DC

Ch	Frequency	Amp	Offset	Output
1-1			15V	0n
1-2	1000Hz	10Vpp	0V	0n

When set to wave

Ch	Frequency	Amp	Offset	Output
1-1	1000Hz	x1.000	0V	0n
1-2	Program			0n

When set to arb. wave

Ch	Frequency	Amp	Offset	Output
1-1	Sweep			0n
1-2			15V	0n

When set to sweep

Clock frequency (p.85)

Amplitude adjustment (p.88)

MR8790

Ch	Frequency	Amp	Offset	Output
1-1			10V	0n
1-2	1000Hz	10Vpp	0V	0n
1-3			5V	0n
1-4	10000Hz	10Vpp	0V	0n

When set to DC

When set to Sine Wave

When set to DC

When set to sine wave

MR8791

Output mode: Pulse

Ch	Frequency	Amp	Offset	Output
1-1	10000Hz			0n
1-2	10000Hz			0n
1-3	10000Hz			0n
1-4	10000Hz			0n
1-5	10000Hz			0n
1-6	10000Hz			0n
1-7	10000Hz			0n
1-8	10000Hz			0n

Output mode: Pattern

Ch	Frequency	Amp	Offset	Output
1	10000Hz			0n

Clock frequency (p.59)

10.2 Waveform Type and Output Status Display

The output waveform type and output status are shown on the bottom of the Waveform screen.

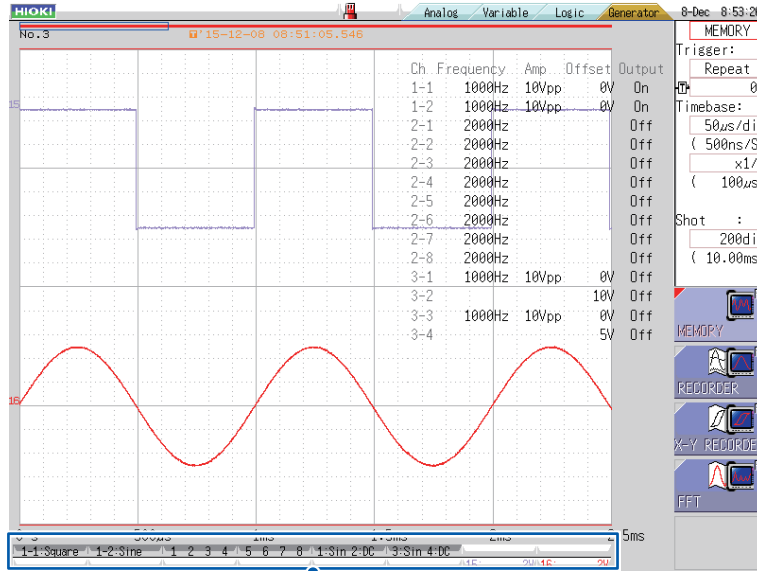

Waveform type and output status display

Module display positions

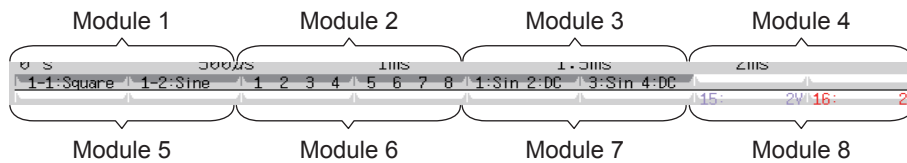

Status display

Output inactive	Output active
1-1: Square 1-2: Sine	1-1: Square 1-2: Sine (Red background)

Waveform type display

U8793 (2 channels/module)	<table border="0"> <tr> <td>1-1: DC DC</td> <td>1-2: Sine Sine</td> <td>1-1: Square Square</td> <td>1-2: Pulse Pulse</td> </tr> <tr> <td>1-1: Tri Triangle</td> <td>1-2: Ramp-up Ramp-up</td> <td>1-1: Ramp-dn Ramp-down</td> <td>1-2: TEST(1) Arbitrary (Filename display Uppercase: 3 letters Lowercase: 7 letters)</td> </tr> <tr> <td colspan="2">1-1: Program 1-2: DC Program</td> <td colspan="2"></td> </tr> </table>	1-1: DC DC	1-2: Sine Sine	1-1: Square Square	1-2: Pulse Pulse	1-1: Tri Triangle	1-2: Ramp-up Ramp-up	1-1: Ramp-dn Ramp-down	1-2: TEST(1) Arbitrary (Filename display Uppercase: 3 letters Lowercase: 7 letters)	1-1: Program 1-2: DC Program			
1-1: DC DC	1-2: Sine Sine	1-1: Square Square	1-2: Pulse Pulse										
1-1: Tri Triangle	1-2: Ramp-up Ramp-up	1-1: Ramp-dn Ramp-down	1-2: TEST(1) Arbitrary (Filename display Uppercase: 3 letters Lowercase: 7 letters)										
1-1: Program 1-2: DC Program													
MR8790 (4 channels/module)	<table border="0"> <tr> <td>1: Sin Sine</td> <td>2: DC DC</td> <td>3: Sin</td> <td>4: DC</td> </tr> </table>	1: Sin Sine	2: DC DC	3: Sin	4: DC								
1: Sin Sine	2: DC DC	3: Sin	4: DC										
MR8791 (8 channels/module)	1 2 3 4 5 6 7 8												

11

Self-test Function (MR8847A, MR8827, MR8740, and MR8741)

11.1 Monitoring Output Values with Test Output

11

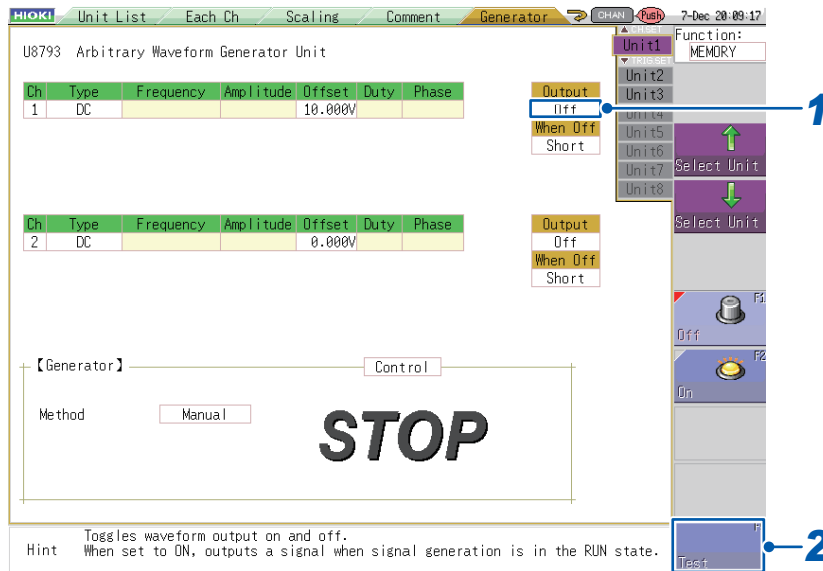

- 1 Select the [Output] setting.
- 2 Press a function key (F5) or select [Test] with the mouse.

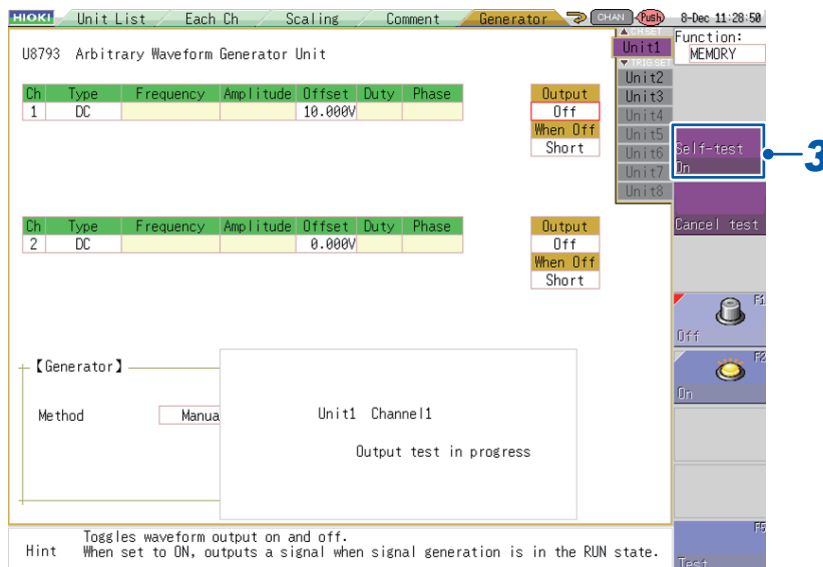

- 3 Press **CH.SET** (**CH.SET**) (to display monitor values).

U8793

U8793 Arbitrary Waveform Generator Unit

Ch	Type	Frequency	Amplitude	Offset	Duty	Phase
1	DC		10.000V			
2	DC		0.000V			

Output test in progress
Voltage: 10.01 V

Method: Manua

Unit1 Channel1

Hint: Toggles waveform output on and off. When set to ON, outputs a signal when signal generation is in the RUN state.

The output voltage monitor value will be displayed.

MR8790

MR8790 Wave Generator Unit

Ch	Type	Frequency	Amplitude	Offset	Output	When Off
1	DC		0.000V	0.000V	Off	Short
2	DC		10.000V	0.000V	Off	Short
3	DC		0.000V	0.000V	Off	Short
4	DC		0.000V	0.000V	Off	Short

Output test in progress
Voltage: 10.01 V
Current: 2.56mA

Method: Manua

Unit3 Channel2

Hint: Toggles waveform output on and off. When set to ON, outputs a signal when signal generation is in the RUN state.

The output voltage and output current monitor values will be displayed.

MR8791

Output mode: Pulse

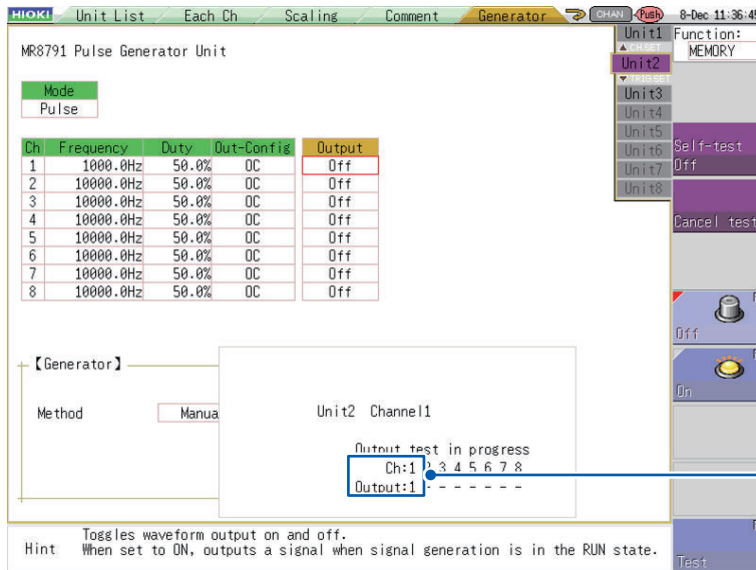

The pulse monitor value will be displayed (1: High level; 0: Low level).

Output mode: Pattern

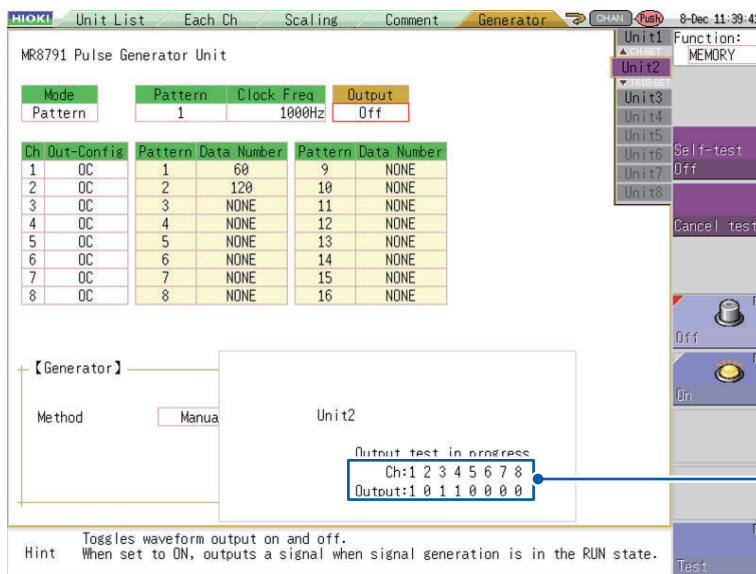

Monitor values for all channels will be displayed (1: High level; 0: Low level).

To toggle the display of monitor values, press **CH.SET** (**CH.SET**) again.

Press **TRIG.SET** (**TRIG.SET**) to end test output.

- Monitor values using test output cannot be displayed when Generator Control is set to **[RUN]** or **[PAUSE]**.
- A waveform will be output from the output terminal during test output.
- Pressing **CH.SET** (**CH.SET**) will toggle the display of monitor values on and off.

External Control Terminal (U8793)

DANGER

To avoid electrical hazards and damage to the module, do not apply voltage exceeding the rated maximum to the input terminals.



	I/O terminal	Maximum input voltage
U8793	IN	-0.5 V to 7 V DC
	OUT	30 V DC/50 mA

WARNING

To avoid electric shock or damage to the equipment, always observe the following precautions when connecting to external terminals or connectors:



- Always turn off the power to the module and to any devices to be connected before making connections.
- Be careful to avoid exceeding the ratings of external terminals and connectors.
- Ensure that devices and systems to be connected to the external control terminals / EXT I/O terminals/ signal input/output terminals are properly isolated.

CAUTION



Use a common ground for both the external control terminal and the connected equipment. Using different ground circuits will result in a potential difference between the external control terminal's ground and the connected equipment's ground. If the cable or cord is connected while such a potential difference exists, it may result in equipment malfunction or failure.

12.1 External Input

Inputting a low-level signal from an external device cancels hold operation if the program function is being used and transitions to the next step.

Signal input method

- 1** **Wire the IN and GND pins to the external signal sources.**
See “Connecting Wires to the External Control Terminals (U8793)” (p. 14).
- 2** **Short the IN and GND pins, or input a high-level (3.5 V to 5.0 V) and low-level (0 V to 0.8 V) pulse wave or rectangular wave to the pins.**
The hold will be canceled at the input waveform’s low level, and the program will transition to the next step.

Input voltage range	High level: 3.5 V to 5.0 V; low level: 0 V to 0.8 V
Pulse width	Low level: 100 μ s or greater
Maximum input voltage	-0.5 V to 7 V

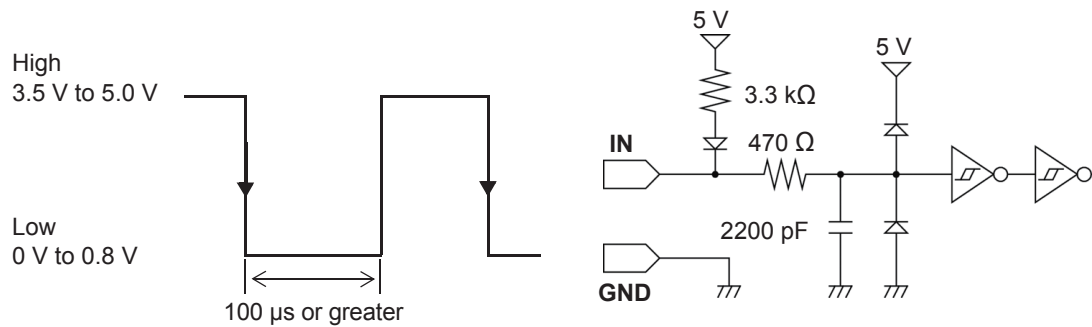

12.2 External Output

This section describes how to output a low-level signal during waveform output.

Signal output method

- 1 Wire the OUT and GND pins to the device being controlled.**
See “Connecting Wires to the External Control Terminals (U8793)” (p. 14).
The module will output a low-level signal during waveform output.

Output format	Open-drain output (with 5 V voltage output), low active
Output voltage levels	High level: 4.0 V to 5.0 V Low level: 0 V to 0.5 V
Maximum switching capacity	5 V DC to 30 V, 50 mA

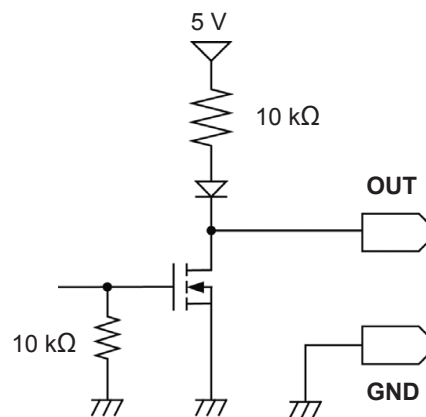

- When the output waveform is a program waveform (p.59), a low-level signal will be output from the OUT pin approximately 2.5 ms before the start of waveform output. When the output waveform is not a program waveform, a low-level signal will be output from the OUT pin approximately 0.6 ms before the start of waveform output.
- When the program function step is being held or when the control state is **[PAUSE]**, a high-level signal will be output from the OUT pin.

13.1 Overview of the SF8000 Waveform Maker

Operating environment

Operating system	Personal computer (PC) capable of running Windows 7 (32-bit/64-bit) or Windows 8.1 (32-bit, 64-bit) Windows 10 (32-bit, 64-bit) (with English and Japanese language support) (Microsoft .NET Framework Ver. 4 or later must be installed.)
CPU	Pentium (1 GHz) or better
RAM	2 GB or more
Monitor resolution	1024 × 768 or higher
Interfaces	Ethernet port (in order to send and receive created data)

Functional specifications

Arbitrary waveforms	Waveform input	Support for waveform input, function input, step input, interpolation input
	Waveform input	Input from a file 8847, MR8847, MR8847A, MR8827, MR8740, MR8741 formats PW3198 format CSV format (format used by Memory HiCorders and this application)
		Input by specifying a basic waveform Sine wave, rectangular wave, triangular wave, ramp wave, SIN (x)/x wave, EXP wave, noise, DC (with variable duration, amplitude, offset, cycle count, and phase)
		Input using a drawing tool Free-form curve or straight line
	Function input	14 types of functions ABS (absolute value), SIN (sine), COS (cosine), DIFF (differential), INTG (integration), CINT (conversion to integer), EXP (exponent), LOG (natural logarithm), NRND (random number), SQUR (square root), RMPD (ramp-down), RAMPU (ramp-up), TRI (triangular wave), INV (inverse)
		7 control words AREA, END, FOR, NEXT, PERIOD, PI, STEP, T, TO, V
	Step input	Input by setting a waveform for each step (max. 100 steps)
		Selection of basic waveforms Sine wave, rectangular wave, triangular wave, ramp wave, SIN(x)/x wave, EXP wave, noise, DC
	Interpolation Input	Maximum number of dots that can be entered: 200
		Dot interpolation method: Curve, straight
Editing of inputted waveforms	Cut, copy, paste, and clear functions	
Calculations using inputted waveforms	Addition, subtraction, multiplication, normalization, size modification, absolute value, inversion, mirror	
Modification of waveform display	Zoom in, zoom out, scroll, TIME/DIV display, V/DIV display, point display (time axis, voltage axis), percent display (voltage axis)	

Arbitrary waveforms	Modification of waveform display	Zoom in, zoom out, scroll, TIME/DIV display, V/DIV display, point display (time axis, voltage axis), percent display (voltage axis)
	Loadable file formats	SF8000 format (FGW) 7990, 7075 format (WFG) 8847, MR8847, MR8847A, MR8827, MR8740, MR8741 format (MEM,CSV) PW3198 format (EVT)
	Save file format	SF8000 format (FGW) 7990, 7075 format (WFG)
Pulse patterns	Input	Input using dedicated editor Select range, copy, paste, delete, and other editing functions are supported in the editor.
	Loadable file formats	SF8000 format (PLS) CSV format
	Save file format	SF8000 format (PLS)
Data transfer	Interface	LAN
	Arbitrary waveforms	Arbitrary waveform data can be transferred to the selected save block (numbered 1 through 8) in the recorder's memory.
	Pulse patterns	Data can be transferred to the selected pattern (numbered 1 through 16) in the recorder's memory.

13.2 Installing the SF8000 Application

This section describes how to install the SF8000 application. The following procedure uses a Windows 8.1 installation as an example but messages and steps may vary depending on the operating system and settings in use.

IMPORTANT

Exit any anti-virus or similar software before installing the application. Anti-virus software may prevent the application from being properly installed.

- 1 Start up Windows®.**
Exit any other software that is running.
- 2 Place the included CD-R disc in the CD-ROM drive.**
Display the SF8000 software installation window and click the [Install] icon at the top right of the screen. Click the [RUN] button on the confirmation dialog box to launch the installer.
- 3 Click the [Next>] button.**

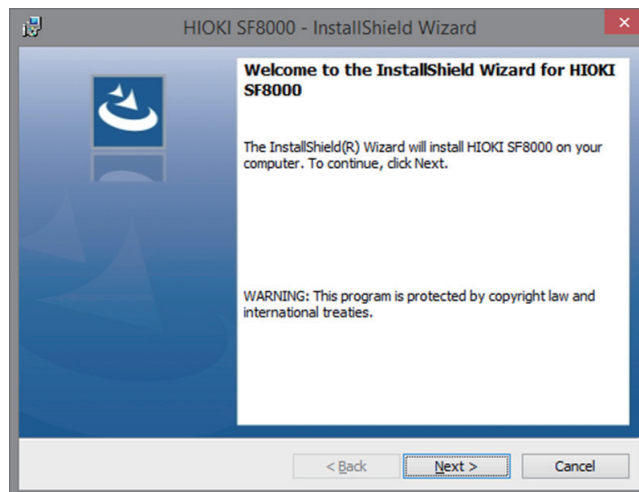

- 4 Click the [Next>] button once you have accepted the software license.**



- 5** To change the installation location, click **[Change]**, and specify the location. Click **[Next>]**.

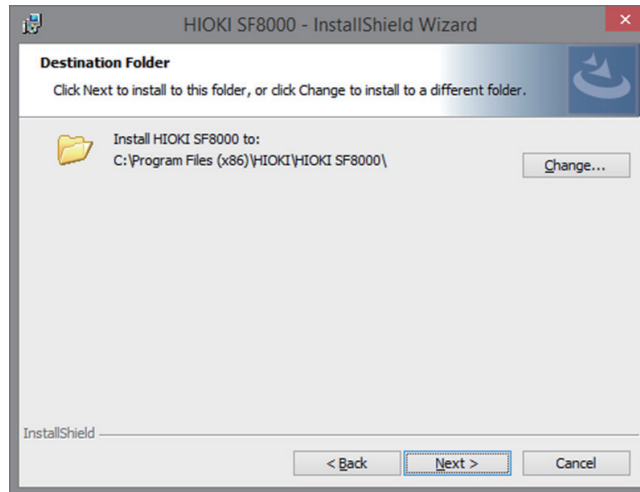

- 6** If the user account control is displayed, click **[Install]**. The installation will begin.

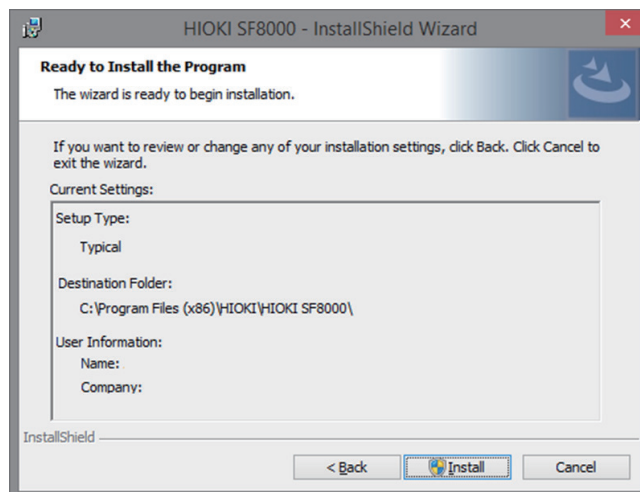

- 7** Click the **[Finish]** button. The installation is complete.

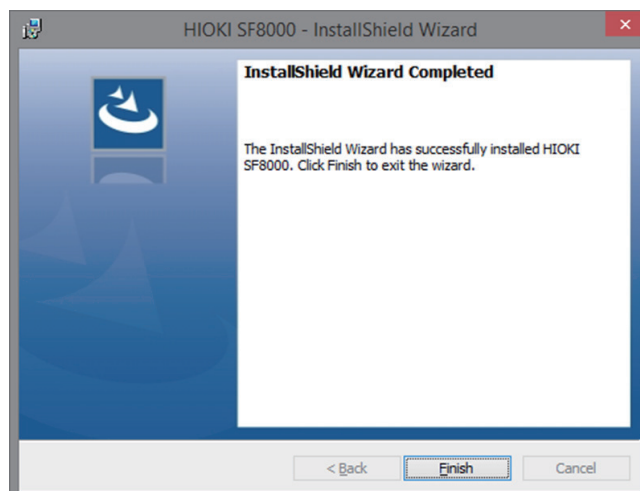

13.3 Launching and Exiting the SF8000 Application

Launching the application

Example: Windows 8.1

- 1 Click **[Start]** on the charm bar.

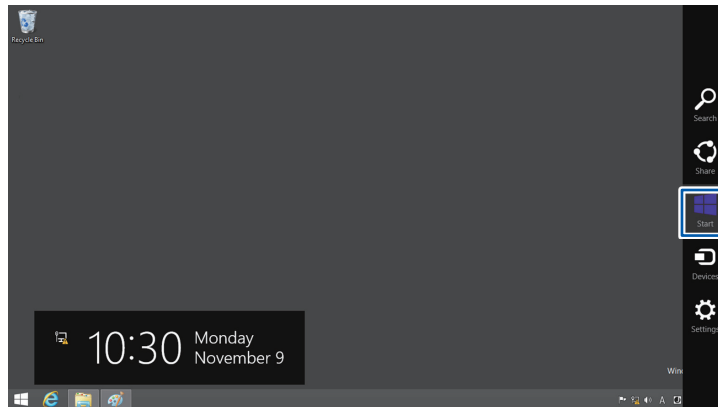

- 2 Click **[SF8000]** on the Start menu.

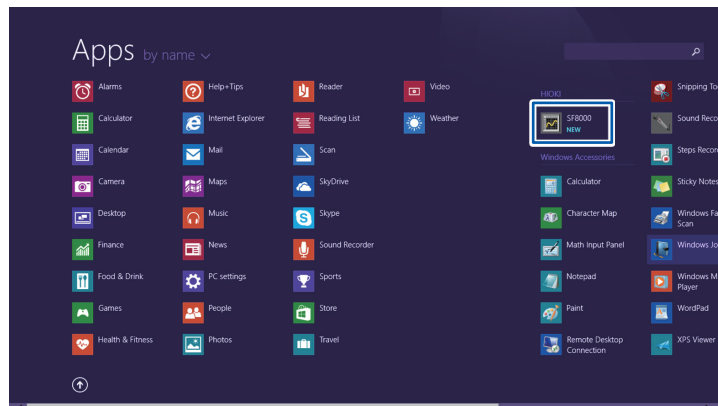

Exiting the application

Example: Windows 8.1

On the **[File]** tab of the main window, click **[Exit]** or click the close button **[x]** at the top right of the main window.

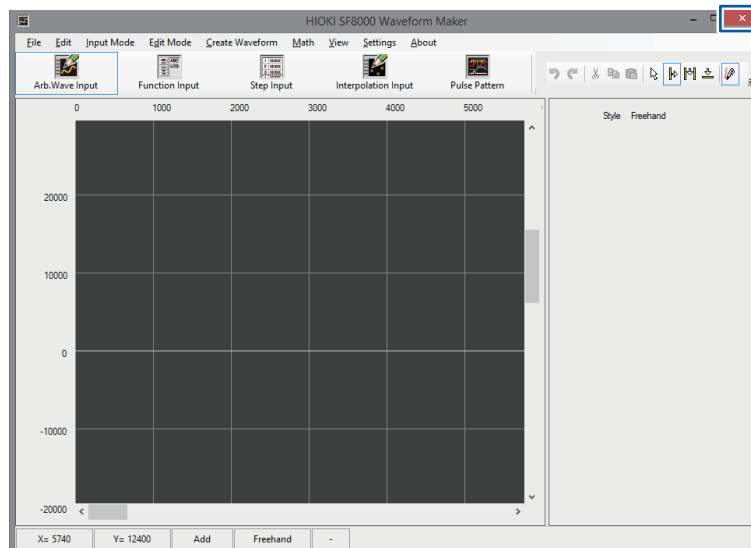
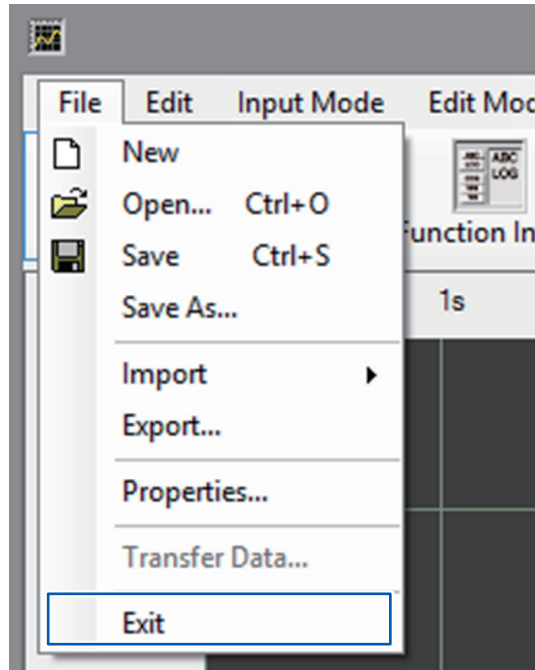

13.4 Uninstalling the SF8000 Application

1 Double-click on [Uninstall a program] on the Control Panel.

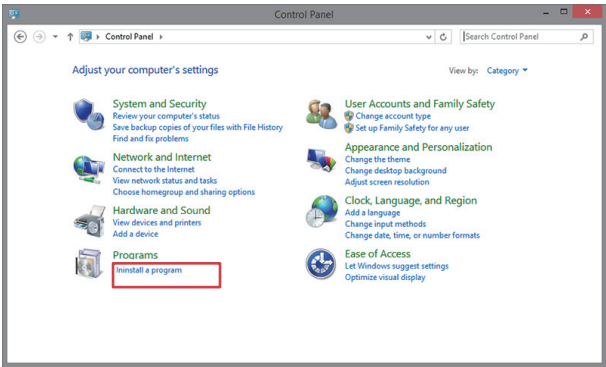

2 Select [HIOKI SF8000] from the list of currently installed programs and delete it.

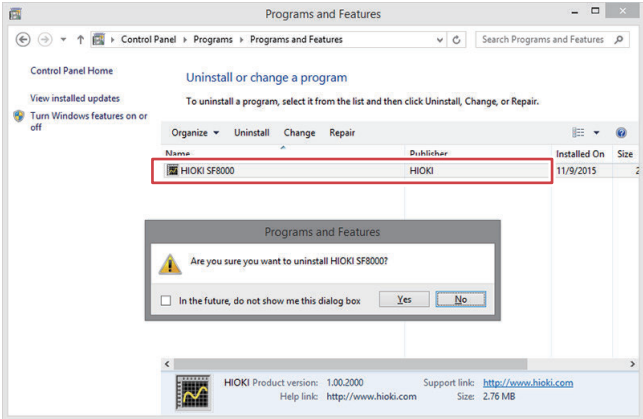

3 The installer will be automatically launched to uninstall the program.

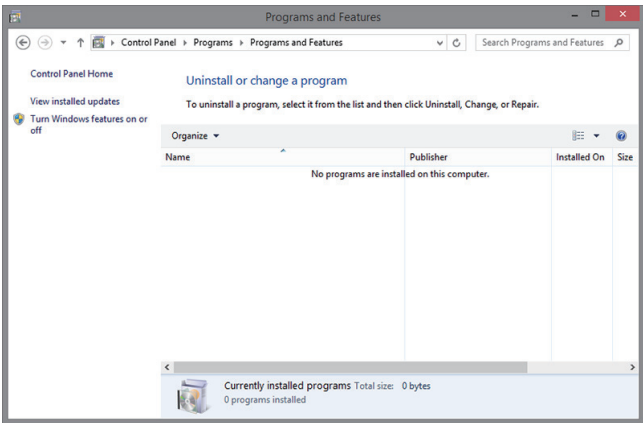

13.5 SF8000 Screen

The SF8000 provides a total of four modes, three for creating waveforms to be output from the U8793 (arbitrary waveform input mode, function input mode, and step input mode) and one for creating pulse patterns to be output from the MR8791. Each mode has its own screen. Each screen includes a waveform input mode selection button, menu bar, toolbar, and status bar, allowing the user to accomplish such tasks as selecting the application mode, creating waveforms, and saving and transferring data.

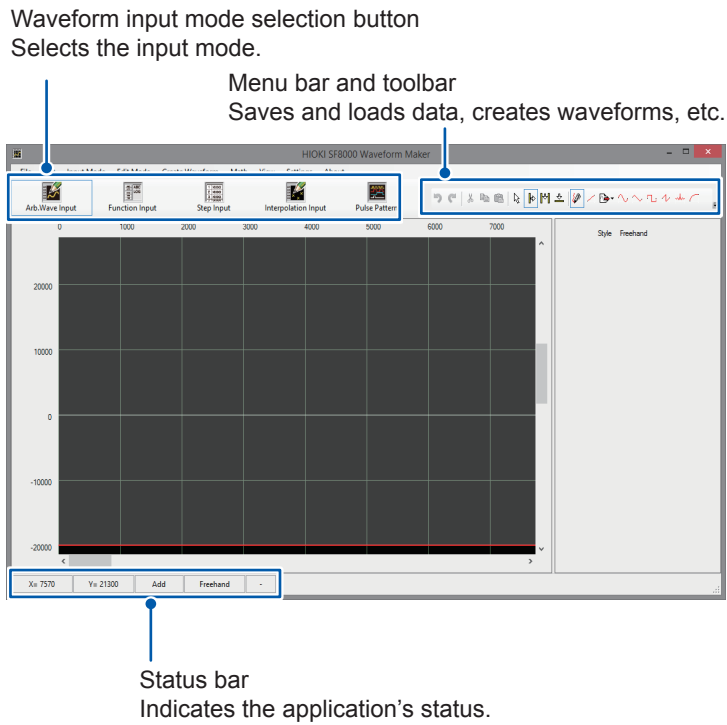

Setting the display format

Set the format used in the waveform display area under [View] on the menu bar.

X-axis▶	–
Time/Div	Displays as the output time.
Point	Displays as the number of samples.
Y-axis▶	–
V/Div	Displays as the voltage axis.
Point	Displays as the number of samples.
%	Displays as a percentage of the maximum value.
Grid▶	–
ON	Displays grid lines.
OFF	Hides grid lines.
Expand X-axis	Enlarges the waveform's X-axis display.
Shrink X-axis	Shrinks the waveform's X-axis display.
Expand Y-axis	Enlarges the waveform's Y-axis display.
Shrink Y-axis	Shrinks the waveform's Y-axis display.
Properties▶	–
Show	Displays property information for the waveform being edited.
Hide	Hides property information for the waveform being edited.
	–

Setting the time axis range

Select **[Settings]** > **[Range]** from the menu bar to change the time axis scale used in the waveform display area. The time axis range is determined by the combination of the value selected as the range and the modules, with 1 div. equivalent to 100 points.

Input mode screens

Arbitrary waveform input mode

In this mode, arbitrary waveforms are created using drawing tools.

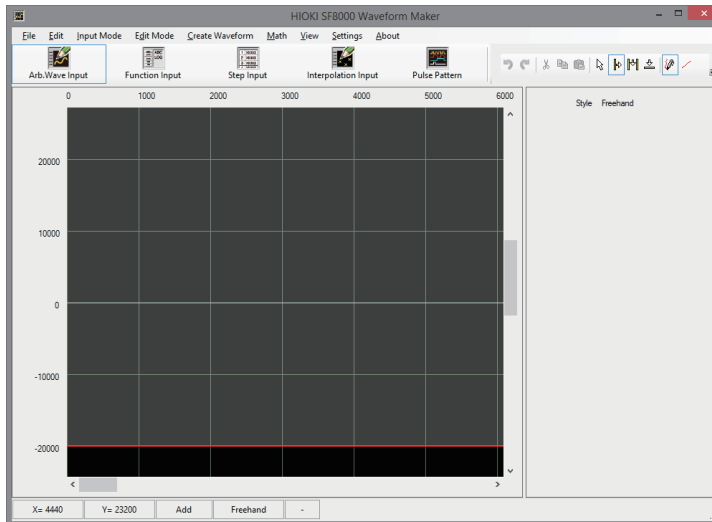

Function input mode

In this mode, arbitrary waveforms are created by entering functions.

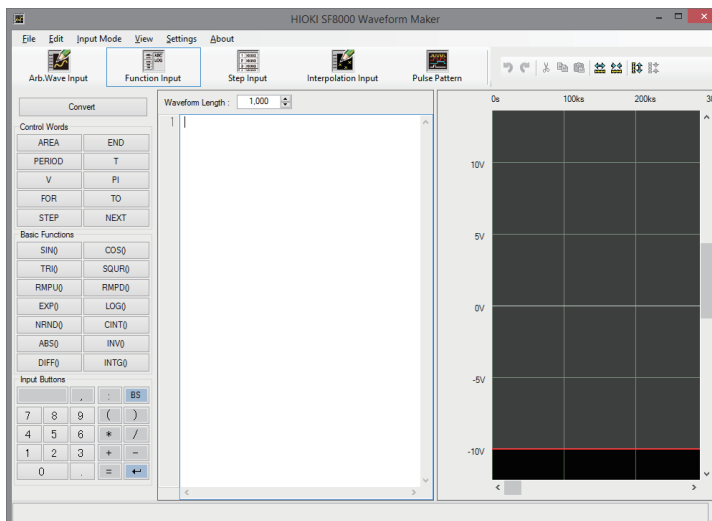

Step input mode

In this mode, arbitrary waveforms are created by entering waveform settings for each step (on one line at a time).

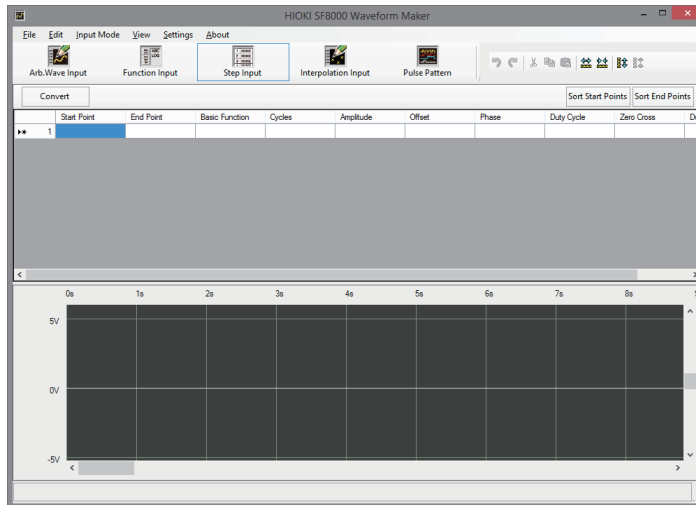

Interpolation Inputmode

This mode is used to create a user-defined waveform by interpolating between entered dots.

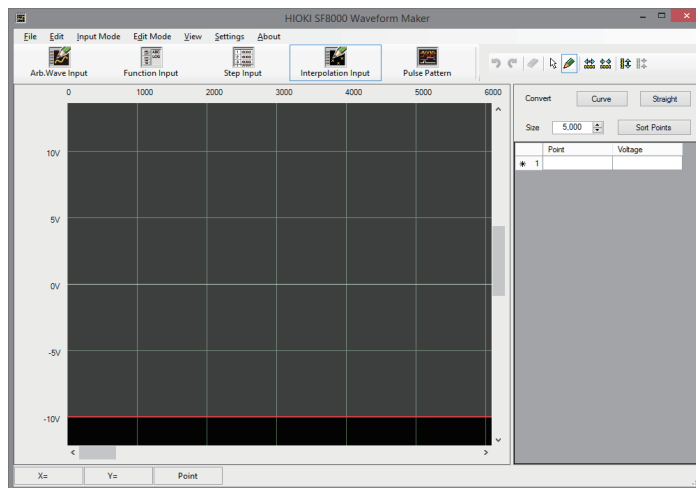

Pulse pattern mode

In this mode, pulse patterns that are output from the MR8791 are created.

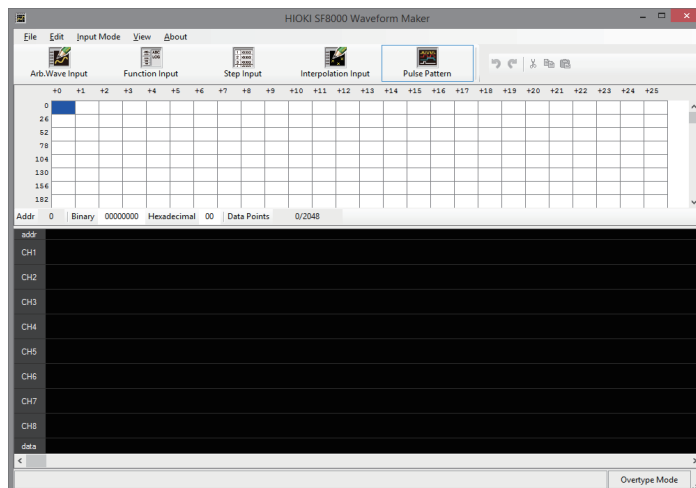

13.6 Arbitrary Waveform Input Mode

Click the **Waveform Input** button or select **[Input Mode] > [Arb.Wave Input]** from the menu bar to enable arbitrary waveform input mode.

Basic instructions

Entering waveforms with the mouse

In general, waveforms are created by dragging with the mouse. The position at which the left mouse button is pressed becomes the start point, and the position at which the button is released becomes the end point. The waveform's phase can be reversed by changing the direction in which the mouse is dragged.

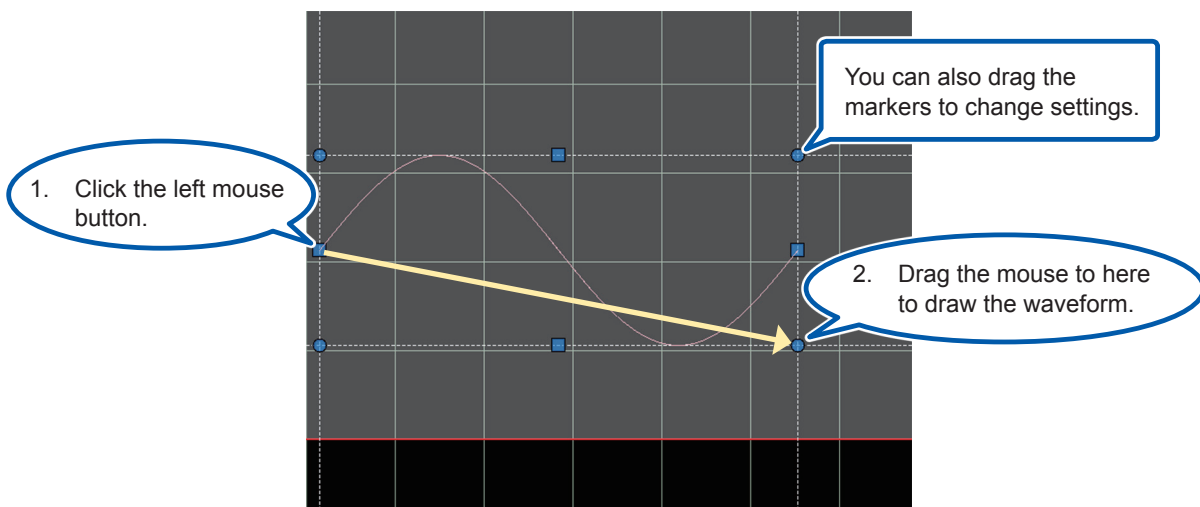

Even after you release the mouse button, you can change settings such as the points and scale by dragging the ● and ■ markers. At this time, clicking an area other than the markers will cause the markers to disappear, finalizing waveform input. Clicking the left mouse button once while the markers are displayed will cause the input to be finalized, and the markers will disappear.

Changing settings by entering properties

Settings also can be changed after waveform input has been finalized in the property entry area on the right side of the screen.

Waveform input range

The horizontal red lines at the top of the screen indicate the upper and lower limits of the range within which waveforms can be input. Data that exceeds this range will be clipped at the upper and lower limits.

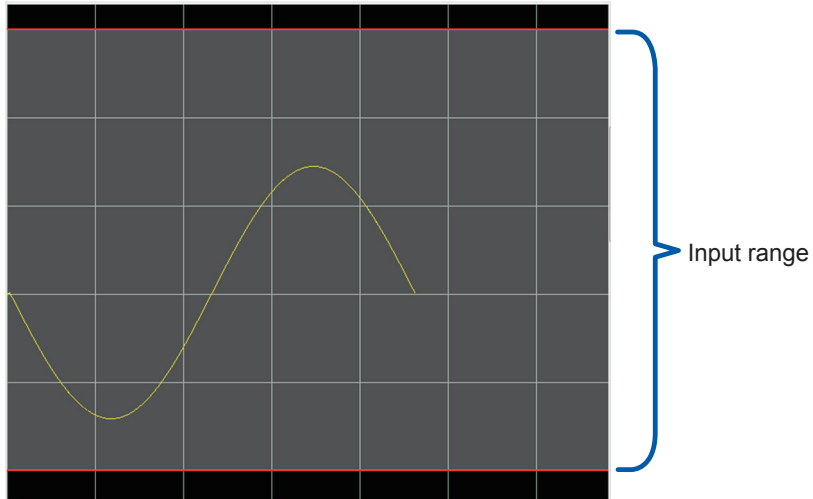

Editing mode

Select the waveform input method.

Select

Selects the position or range of the input waveform. The selection range varies with mouse operation.

- Left single click: Selects the position.
- Drag using left button: Selects a range.
- Left double click: Selects one waveform period.

Add

Adds the waveform to the end of the input waveform. If space is left between the end position of the already created waveform, the software will interpolate with a straight line.



Insert

Inserts a waveform between two segments of the previously input waveform.



Overwrite

Overwrites a previously input waveform with a new waveform.







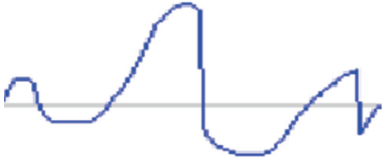

Waveform creation

Select the type of waveform to input. If the waveform is stored in a file, load one of the waveform data file types listed below.

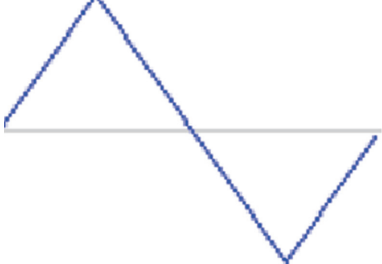
File...	
Power Meter Data...	PW3198 format
Memory HiCorder Data...	MR8740/MR8741/MR8827/MR8847 format
SF8000 Data...	7990/7075 format

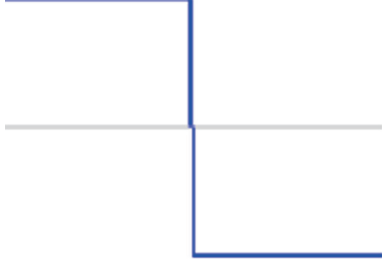
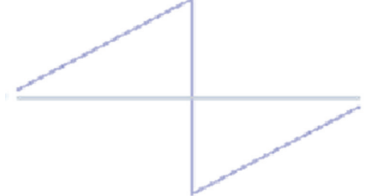
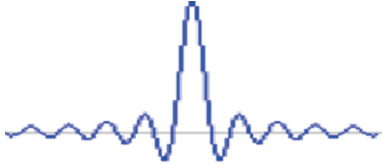
The following waveform types are available. Property values should be set based on the type of waveform selected.

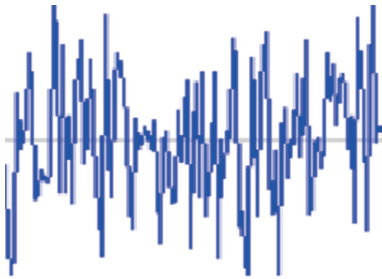
Waveform type	Example of drawn waveform	Properties to set
Freehand		None (Curve is drawn based on mouse movements.)
Straight Line		Start point, number of points
Sine Wave		Start point, number of points, amplitude, offset, period, phase
Triangle Wave		Start point, number of points, amplitude, offset, period, phase

Waveform type	Example of drawn waveform	Properties to set
Pulse Wave		Start point, number of points, amplitude, offset, period, phase, duty cycle
Ramp Wave		Start point, number of points, amplitude, offset, period, phase
Sin (X)/X		Start point, number of points, amplitude, offset, period, phase, zero-cross
Exp		Start point, number of points, amplitude, offset, period, phase, attenuation rate
Noise		Start point, number of points, amplitude, offset
DC		Start point, number of points, offset

Properties

Set the properties described below according to the type of waveform you selected.

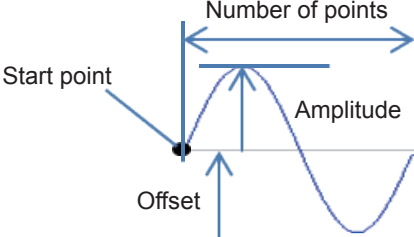
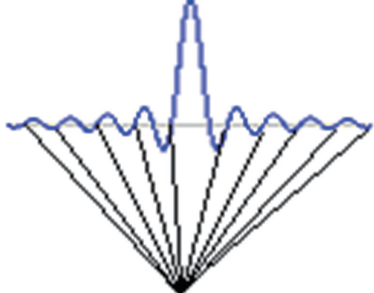
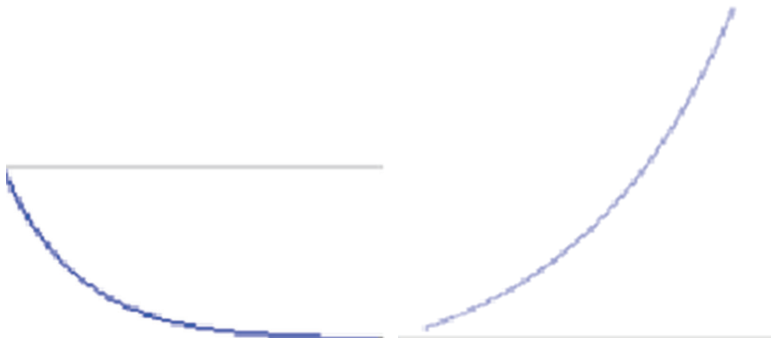
Property	Description
Start Point Number of Points Amplitude Offset Period	 <p>The diagram shows a sine wave starting from a point labeled 'Start point'. A vertical arrow from this point to the horizontal center line is labeled 'Offset'. A vertical arrow from the center line to the peak of the wave is labeled 'Amplitude'. A horizontal double-headed arrow above the wave indicates the 'Number of points' over one full cycle.</p>
Phase	Number of waveforms
Zero-cross	 <p>The diagram shows several sine waves of different amplitudes and phases, all originating from a single point on a horizontal line representing the Y=0 axis. The text below the diagram reads 'Number of intersections with Y = 0 line'.</p>
Attenuation rate	 <p>The diagram shows a curve that is flat (at zero) for negative values and increases exponentially for positive values. The text below the diagram reads 'When value < 0' and 'When 0 < value'.</p>

Calculations using previously input waveforms

Calculations can be performed using previously input waveforms. First, set the editing mode to “Select” and then select the calculation range.

Add	Adds a basic waveform or constant to a previously input waveform. The basic waveform or constant can be set in the properties area.
Subtract	Subtracts a basic waveform or constant from a previously input waveform. The basic waveform or constant can be set in the properties area.
Multiply	Multiplies a previously input waveform by a basic waveform or constant. The basic waveform or constant can be set in the properties area.
Normalize	Adjusts a waveform's peak value to the range's maximum value.
Resize	Changes a waveform's size.
Absolute Value	Calculates a waveform's absolute value.
Invert	Inverts a waveform's polarity.
Mirror	Flips data around the time axis.

13.7 Function Input Mode

This section describes how to generate waveform data by creating a function formula and then performing waveform conversion. Click the Function Input button or select **[Input Mode] > [Function Input]** from the menu bar.

Basic instructions

After first setting the waveform size, create a function expression by combining control words and basic functions. Pressing the **[Convert]** button will display the waveform on the Waveform Display Preview screen.

Example of program creation

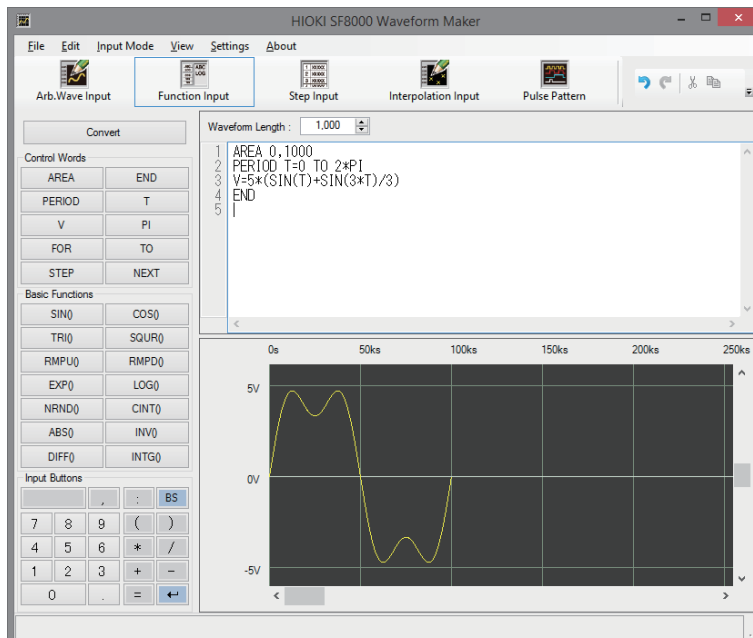

Line	Program code	Meaning
1	AREA 0,1000	Sets the editing range to a value that is less than or equal to the waveform size. Since the waveform size is 1000, this line declares the editing range to be from 0 to 1000.
2	PERIOD T=0 TO 2*PI	Sets the time constant T for a function with a time variable. Without this line, the range of T would be 0 to 2PI.
3	V=5*(SIN(T)+SIN(3*T))/3	Stores the data obtained from the formula on the right side of the equation in V.
4	END	Declares the end of the program. Once this command appears, subsequent commands will not be used in waveform conversion.

Expressions and operations

“Expression” is a general term for standard formulas that join constants and variables with operators (special symbols used in calculations) or simply indicate a value, variable, or function. “Operation” refers to the execution of the operations included in an expression that consists of operators or functions. Calculations include arithmetic operations and functions. Arithmetic operations consist of the following operators and are performed in a predefined order:

Arithmetic operator	Description of calculation performed	Example
\wedge	Exponent (power)	X^Y
$-$	Sign	$-X$
$*$, $/$	Multiplication, division	$X*Y$, X/Y
$+$, $-$	Addition, subtraction	$X+Y$, $X-Y$

“Function” refers to an operation performed on a specified value (function argument) to obtain a result. (Not all functions require an argument.) Functions are expressed by words that are determined by the specific function performed, much like normal instructions (AREA, PERIOD, etc.). The words used to denote instructions are known as control words and are treated, along with functions, as special words.

Operations are subject to precedence. Operations are performed in the following order of precedence:

1. Expressions enclosed in parentheses
2. Functions
3. \wedge (exponents)
4. $+$, $-$ (sign)
5. $*$, $/$ (multiplication, division)
6. $+$, $-$ (addition, subtraction)

Parentheses are used to change the order of operation precedence. Operators enclosed in parentheses are executed before other operations. Expressions enclosed in parentheses are evaluated in accordance with the order of precedence.

Control words

The following words are used to denote instructions.

AREA	
Function	Specifies the editing range.
Format	AREA <start point>, <end point>
Example	AREA 0,500
Explanation	This control word specifies the editing range for the instruction that follows it. The <start point> must be greater than or equal to 0 and less than the <end point>. The <end point> must be greater than the <start point> and less than or equal to the waveform size. If this instruction is omitted, a <start point> of 0 and an <end point> equal to the waveform size will be used. Instructions occurring between the AREA instruction and the next AREA instruction or END instruction will be valid from the <start point> to (<end point> - 1). However, the presence of a PERIOD instruction in that interval will cause data to be repeatedly generated in the specified variation domain. In this case, waveform data will be generated from the <start point> to (<end point> - 1) by the V instruction.

END	
Function	Declares the end of the program.
Format	END
Example	END
Explanation	This control word signals the end of program operations. Any instructions following this instruction will be ignored. The final END instruction in the program may be omitted.

FOR... TO... STEP to NEXT	
Function	Repeatedly executes the series of instructions included between "FOR" and "NEXT."
Format	FOR <variable name> = <Initial value> TO <end value> [STEP <increment>] ~ NEXT
Example	FOR J=0 TO 100 STEP 2 ↓ ~ NEXT
Explanation	<p>The instructions contained inside the FOR... NEXT loop will be repeatedly executed according to the conditions specified in the FOR instruction. Set the <initial value> to the variable's initial value. Set the <end value> to the variable's final value. Set the <increment> to the increment you wish to use between the start value and end value.</p> <p>The example above sets J to 0 before executing the instructions following the FOR instruction. When program execution reaches the NEXT instruction, the J value is increased by the increment of 2 so that it then equals 2, and the instructions following the FOR instruction are again executed. This process is repeated until J equals 100. If [STEP <increment>] were omitted, an <increment> of 1 would be used.</p> <p>If the <start value> or <increment> is greater than the <end value>, the instructions following the FOR instruction will only be executed with the <start value>.</p> <p>Caution FOR... NEXT loops cannot include AREA instructions, PERIOD instructions, other FOR... NEXT loops, or V instructions containing DIFF or INTG instructions.</p>

PERIOD	
Function	Specifies the variation domain of the period variable T.
Format	PERIOD T=<default value> TO <end value>
Example	PERIOD T=0 TO PI
Explanation	This instruction is used to specify the variation domain of the variable T, which is a reserved word. The variable T varies from the <default value> to the <end value> within the area specified with the AREA instruction. In the absence of a PERIOD instruction, or immediately after an AREA instruction, the <default value> is 0, and the <end value> is 2π . When there is a PERIOD instruction, the instructions included before the next AREA instruction, END instruction, or the last line of the program are repeated based on the AREA instruction that is valid at that time.

PI	
Function	Serves as a constant that expresses the ratio of the circumference of a circle to its diameter (π).
Format	PI
Example	$A=2\pi$
Explanation	This instruction is used to denote the ratio of the circumference of a circle to its diameter. Its value is approximately 3.141593.

T	
Function	Used as the period variable.
Format	T
Example	AREA0,10 PERIODT=0 to 2π $V=10\sin(T)$
Explanation	T is a variable. A PERIOD instruction must be used to change the value of T. In the above example, the SIN (sine) is calculated with $T = 0$ when the area is 0 to generate waveform data. Next, a series of substitutions are performed until the data has been generated, setting the value of T to $\pi/5$ when the area is 1, to $2\pi/5$ when the area is 2, and to $9\pi/5$ when the area is 9.

V	
Function	Serves as a variable for storing actual data.
Format	V
Example	$V=10$
Explanation	Although V is a variable, it differs from other variables in that it consists of an array containing the same number of elements as the length of the set waveform size, with each element in the array storing the actual waveform data. Each element in the array is set to 0 by default and stores a value as an expression. When the stored data is retrieved, it is necessary to perform calculations to evaluate the expression.

Functions

Functions perform a predetermined calculation on a specified value (the function argument).

ABS	
Function	Calculates the absolute value.
Format	ABS (<expression>)
Example	B=ABS(-2)
Explanation	The function calculates the absolute value of the <expression>.

CINT	
Function	Converts a decimal to an integer.
Format	CINT (<expression>)
Example	A=CINT(2.5)
Explanation	The function converts <expression> to an integer by rounding off the decimal portion.

COS	
Function	Calculates the cosine.
Format	COS (<expression>)
Example	X=COS(PI/4)
Explanation	This function calculates the cosine of <expression>, which is specified in radians as a value from -2,147,483,648 to 2,147,483,647.

DIFF	
Function	Calculates the differential.
Format	DIFF (V)
Example	V=10*DIFF(V)
Explanation	This function differentiates all data in the area containing the instruction and stores the result as new data. It can only be in a V instruction (instruction starting with "V=") outside a FOR loop, and only the four basic arithmetic functions can be performed simultaneously. In addition, PERIOD instructions, FOR... NEXT instructions, and V instructions other than differentials and integrals cannot be performed from the line containing this instruction to the next AREA instruction or END instruction. A 5-degree Lagrange interpolation formula is used to calculate differentials. Data values greater than 10 V generated with this function are converted to 10 V, while data values less than -10 V generated with this function are converted to -10 V.

EXP	
Function	Calculates the value of the exponent function with e (natural logarithm base).
Format	EXP (<expression>)
Example	E=EXP(1)
Explanation	This function obtains the result of raising <expression> to the e-th power, where <expression> is specified as a value from -708 to 709.

INTG	
Function	Calculates the integral.
Format	INTG (V)
Example	V=INTG(V)/2
Explanation	This function integrates all data in the area containing the instruction and stores the result as new data. It can only be used in a V instruction (i.e., an instruction starting with "V=") outside a FOR loop, and only the four basic arithmetic functions can be performed simultaneously. In addition, PERIOD instructions, FOR instructions, NEXT instructions, and V instructions other than differentials and integrals cannot be performed from the line containing this instruction to the next AREA instruction or END instruction. A trapezoidal formula is used to calculate integrals. Data values greater than 10 V generated with this function are converted to 10 V, while data values less than -10 V generated with this function are converted to -10 V.

INV	
Function	Calculates the result of reversing the sign.
Format	INV (<expression>)
Example	A=INV(B)
Explanation	This function calculates the result of reversing the sign of <expression>.

LOG	
Function	Calculates the natural logarithm value.
Format	LOG (<expression>)
Example	L=LOG(35/9)
Explanation	This function calculates the natural logarithm (logarithm with a base of e) of <expression>, which must be specified as a positive value.

NRND	
Functions	Calculates a random number.
Format	NRND (<expression>)
Example	R=RND(2)
Explanation	This function calculates a pseudo-random number that indicates a standard normal distribution (with an average of 0 and a variance of 1) that is greater than or equal to -1 and less than +1. The <expression> can be specified as an integer that is greater than or equal to 0 and less than or equal to 32767. This value can be used to change sequence of the random numbers obtained from the function.

RMPD	
Function	Calculates the value of a ramp-down wave (saw-tooth wave).
Format	RMPD (<expression>)
Example	X=RMPD(PI/8)
Explanation	This function calculates the value of a ramp-down wave (saw-tooth wave) for <expression>, which is specified in radians as a value from -214,748 to -214,747.

RMPU	
Function	Calculates the value of a ramp-up wave (saw-tooth wave).
Format	RMPU (<expression>)
Example	X=RMPU(PI/4)
Explanation	This function calculates the value of a ramp-up wave (saw-tooth wave) for <expression>, which is specified in radians as a value from -214,748 to 214,747.

SIN	
Function	Calculates the sine value.
Format	SIN (<expression>)
Example	X=SIN(PI/8)
Explanation	This function calculates the sine of <expression>, which is specified in radians as a value from -2,147,483,648 to 2,147,483,647.

SQUR	
Function	Calculates the value of a rectangular wave (square wave).
Format	SQUR (<expression>)
Example	X=SQUR(PI/8)
Explanation	This function calculates the value of a rectangular wave (square wave) function for <expression>, which is specified in radians as a value from -214,748 to 214,747.

TRI	
Function	Calculates the value of a triangular wave.
Format	TRI (<expression>)
Example	X=TRI(PI/8)
Explanation	This function calculates the value of a triangular wave function for <expression>, which is specified in radians as a value from -214,748 to 214,747.

Usable characters

The following characters can be used:

Uppercase and lowercase alphabetical characters	A through Z and a through z	Uppercase and lowercase alphabetical letters are treated as being identical.
Numerals	0 through 9	Numerals are used to indicate a single value or character.
Period	.	The period is used as a single numeric character to indicate the decimal point.
Comma	,	The comma is used as a delimiter for AREA instruction parameters. [Example] AREA200,350↓
Arithmetic operators	*, /, +, -	Arithmetic operators are used as normal operations or to indicate the sign of a value.
Caret	^	The caret is used when raising a value to a power.
Colon	:	The colon is used as a delimiter in multiple statements (when including multiple instructions on a single line). [Example] AREA 100,200:PERIODT=0 TO 2*PI↓
Apostrophe	'	The apostrophe is used to mark the start of a comment in a program. Text from this symbol to the next return (↓) character is not recognized as program instructions. In other words, comments have no effect on the function program.
Underscore	_	The underscore is used as an alphabetical character. It can also be used as the start of an alphabetical word.
Equal sign	=	The equal sign is used as the assignment operator for V instructions and variable instructions.
Return	↓	The return character is used to indicate a line feed in the program.
Space		The space is used as a delimiter between words. It can also be used in expressions.

Constants

Constants have fixed values and can be included directly in programs. They consist of numerals (0 through 9) and a decimal point (.). They are expressed as real, decimal numbers and must be no more than 12 numerals in length. (Neither hexadecimal nor exponential notation may be used.)

Variables

Variables serve as containers for storing data (values and constants) in programs. A total of 128 can be used. Variables are given an alphabetical name and have the value 0 until they are used to store a value. Variable names consist of eight or fewer characters and may include alphanumerical characters (A through Z, a through z, and 0 through 9) as well as the underscore (_) and period (.) characters. However, they must begin with a letter or underscore character. Although reserved words may not be used as variable names, variable names may contain such words. No distinction is made between uppercase and lowercase letters.

13.8 Step Input Mode

In step input mode, waveform data is created by setting and combining step waveforms. Click the step input button or select **[Input Mode] > [Step Input]** from the menu bar.

Basic instructions

Enter the start and end point for each step as well as the waveform type and settings. Once you have entered one step, the waveform will be drawn in the waveform preview area of the screen. Up to 100 steps can be entered.

Example of waveform creation

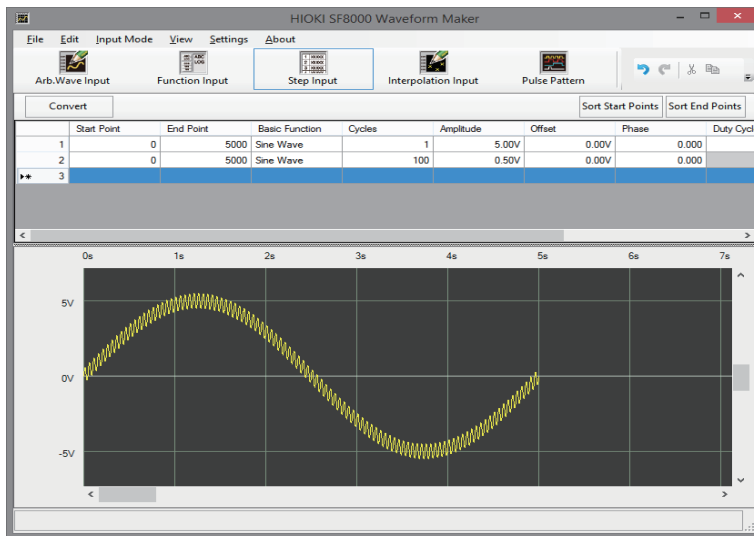

Start point	End point	Basic function	Period	Amplitude	Offset	Phase
0	5000	Sine wave	1	5 V	0 V	0
0	5000	Sine wave	100	0.5 V	0 V	0

Start and end point settings

Specify the waveform's start point and end point as a number of points. The data will include position data for the start point and end point. The valid input range is 0 to 249999.

Waveform type and settings

The table below lists the settings associated with each waveform type. The waveform types and properties are the same as for arbitrary waveform creation mode.

	Sine wave	Pulse wave	Triangle wave	Ramp wave	SIN (X)/X wave	EXP wave	Noise	DC
Cycles	✓	✓	✓	✓	✓	✓	–	–
Coefficient	✓	✓	✓	✓	✓	✓	✓	–
Offset	✓	✓	✓	✓	✓	✓	✓	✓
Phase	✓	✓	✓	✓	✓	✓	–	–
Duty Cycle		✓	–	–	–	–	–	–
Zero-cross	–	–	–	–	✓	–	–	–
Attenuation ratio	–	–	–	–	–	✓	–	–

Editing steps

You can select steps as desired and delete, copy, and paste them. Steps are selected by clicking on the numeral shown to the left of each step. These operations are accessible from **[File]** - **[Edit]** on the toolbar.

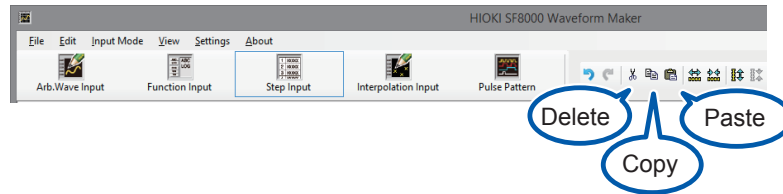

Reordering the display

Pressing the Sort Start Points button reorders the list of steps in ascending order by start point value. Pressing the button again toggles between ascending and descending order.

Pressing the Sort End Points button reorders the list of steps in ascending order by end point value. Pressing the button again toggles between ascending and descending order.

	Sort Start Points	Sort End Points
Duty Cycle	Zero Cross	Dump Fact
50.000	10	-5.000
50.000	10	-5.000

13.9 Interpolation Input Mode

Waveform data is created by interpolating between multiple entered dots. Click the [Interpolation Input] button or select [Input Mode] > [Interpolation Input] from the menu bar.

Basic instructions

Setting the waveform size

Set the waveform size (100 to 250,000).

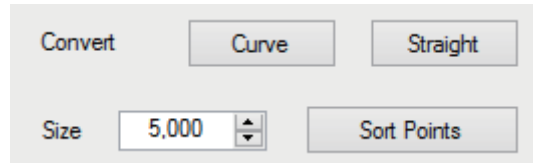

Dot input with the mouse

Clicking the waveform creation area with the left mouse button causes a dot to be entered at that point. Enter only the necessary number of dots.

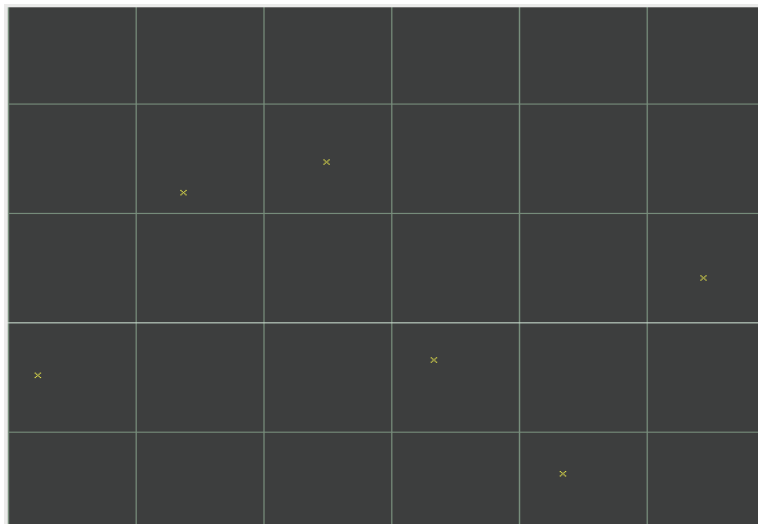

Selecting the conversion method

Click the [Convert] button on the screen to select whether to use curves or straight lines to interpolate between dots.

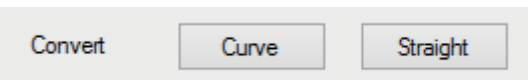

Performing interpolation

Interpolation will be performed using the selected method.

Interpolation with curves

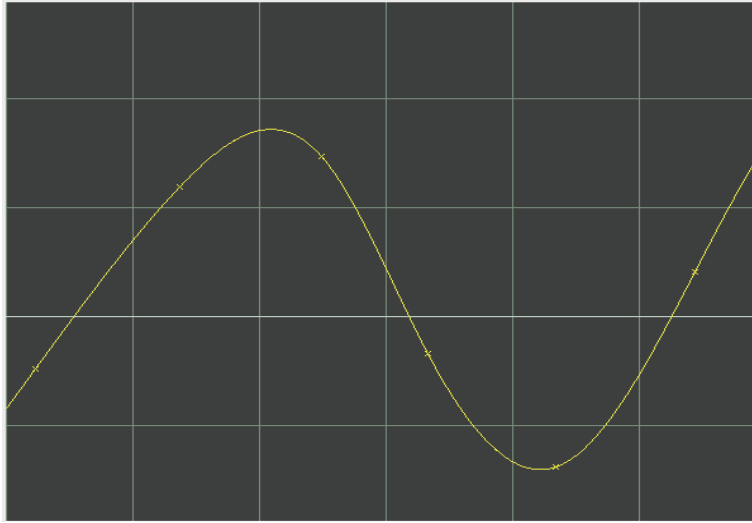

Interpolation with straight lines

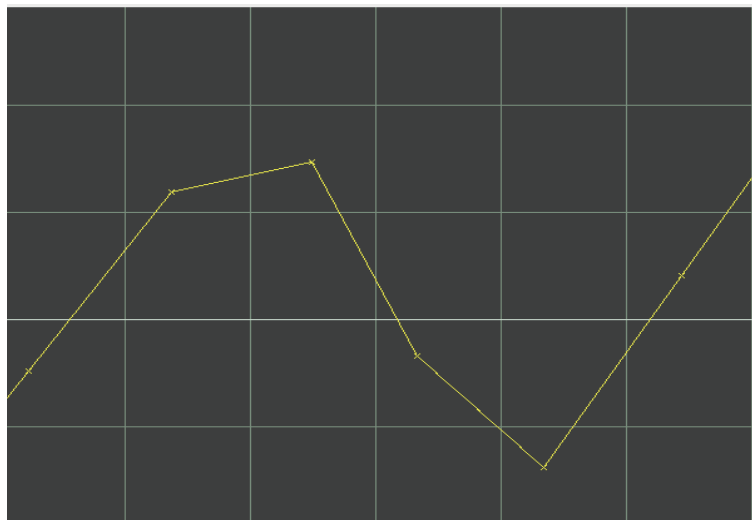

Editing mode

Select the operation to perform when the mouse button is clicked.
Select **[Edit Mode]** on the menu bar or select the operation on the toolbar.

Select

Select the range over which to interpolate between dots.



Left-button click: Selects the start position. A vertical broken line will be displayed at the clicked position.
Left-button drag: Selects the range. A vertical broken line will be displayed at the released position, which will serve as the endpoint of the range.

The dots enclosed within the range defined by the two vertical broken lines will be interpolated.
(Dots in excess of the waveform size will be treated as outside the scope of interpolation.)

Clicking the left button while the two vertical broken lines are displayed will cancel the selected range.

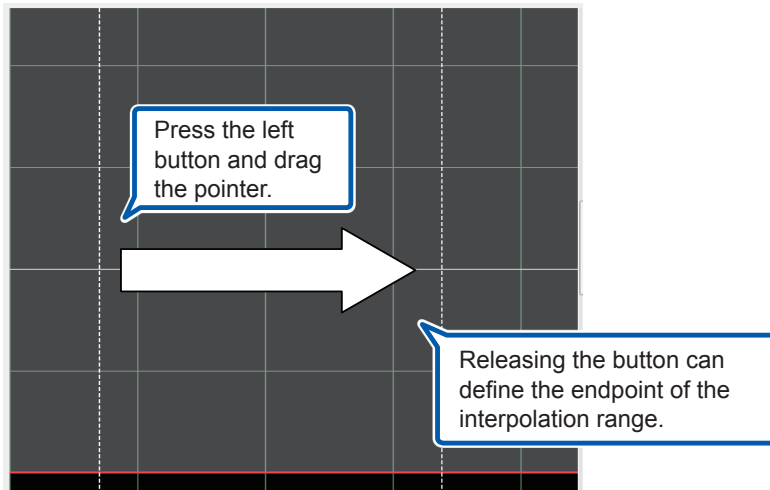

Dot input (default)



A dot will be entered at the position at which you click the left button. Up to 200 dots can be entered. In dot input mode, the selected range will be canceled, and dots within the waveform size will be subject to interpolation.

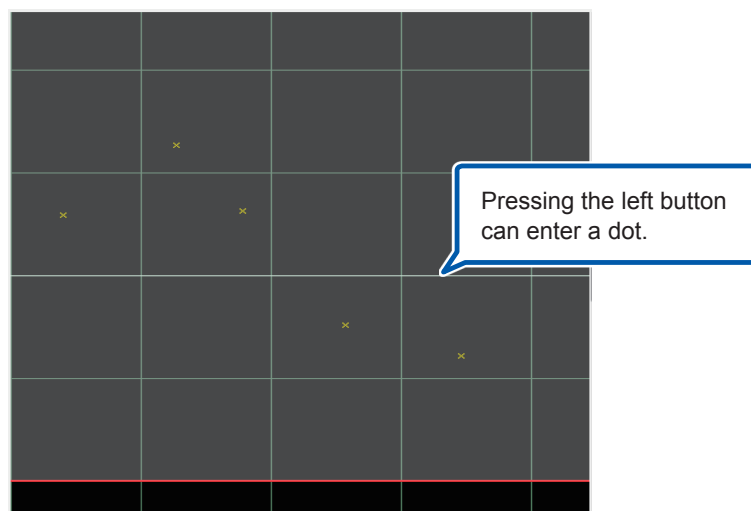

Dot data list

Data for the entered dots will be shown in the dot data list on the right side of the screen. The time-axis position (number of points) and voltage value for each dot will be shown in the list.

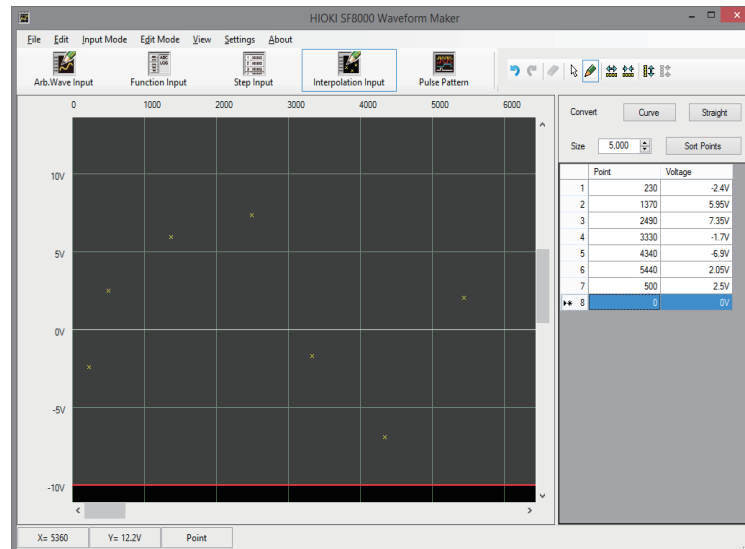

You can change dot data values and add and delete dots in the list.

Changing the list

Click the value you wish to change with the mouse and enter the desired value using the keyboard. Finally, press the RETURN key to change the value.

Adding the list

Enter a value on the bottommost row in the list to add it as a data for a new dot.

Deleting the list

Click the row you wish to delete with the mouse and either select **[Edit] – [Clear]** on the menu bar or click the “Clear” button on the toolbar.

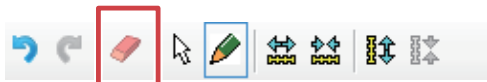

Sorting the list

Click the **[Sort Points]** button above and to the right of the list to sort the dot data into ascending order based on point value.

Interpolation method

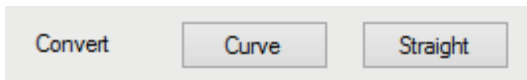

Click the **[Curve]** or **[Straight]** conversion button at the top of the screen to interpolate between the dots.

Interpolation is performed as follows according to the type of interpolation and the number of target dots.

the type of interpolation	Number of target dots			
	0	1	2	3 or more
curves	None	DC (DC waveform at the dot position)	straight lines	Tertiary spline interpolation
straight lines	None	DC (DC waveform at the dot position)	straight lines	straight lines

When an interpolation range has been selected, only the dots within that range are subject to interpolation.

However, if the start of the selected range does not intersect the line, straight-line interpolation will be performed with the endpoint of the line lying before the start position.

In addition, if there is no line data at the start position of the selected range, straight-line interpolation is performed with the coordinate (0,0).

Example: If there is no line data before the selected range

Before execution

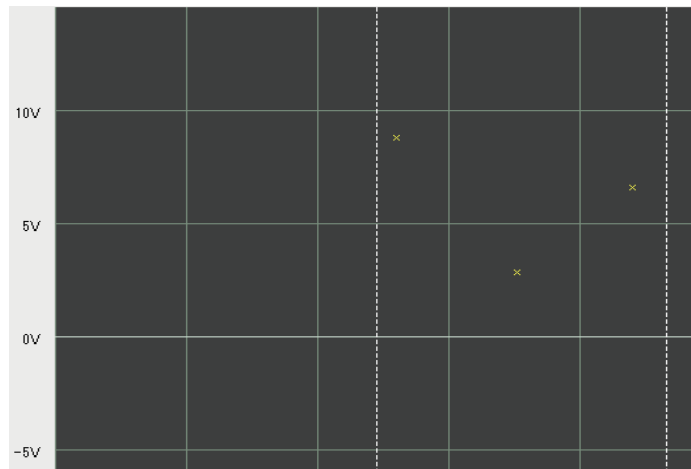

After execution

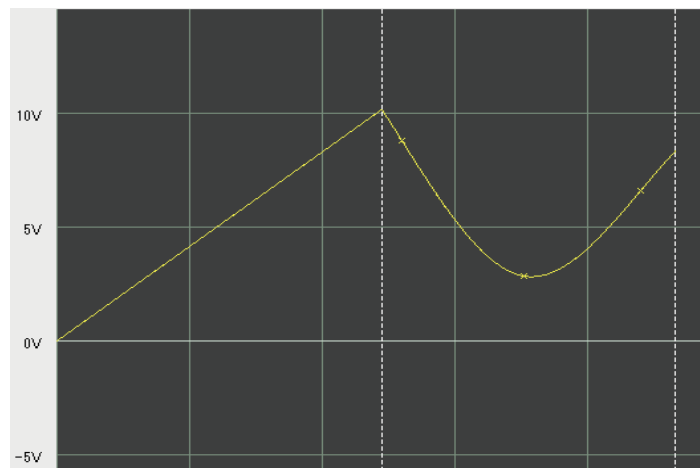

13.10 Pulse Pattern Mode

Pulse pattern mode is used to create pulse patterns for use with the MR8791. Pulse pattern data consists of 8 bits, each of which is allocated to one MR8791 channel (the device has a total of eight channels). (The LSB corresponds to Ch. 1, while the MSB corresponds to Ch. 8.) The value 0 indicates the off state, while the value 1 indicates the on state.

Basic instructions

Up to 2048 samples can be configured. The top left corner of the data input area corresponds to the first data position and with the cell to its right to the second position, with the position increasing as you move to the right. Once the right side of the grid is reached, the data continues from the left side of the next line.

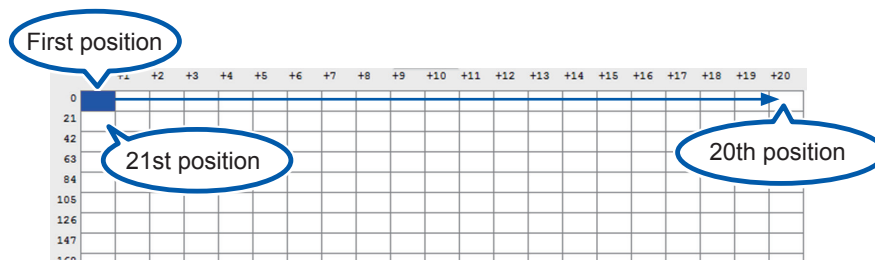

When you select the position at which you wish to enter data, the cell's background color will turn blue. Enter a hexadecimal value with the keyboard and press the return key to accept the entered value and display the waveform.

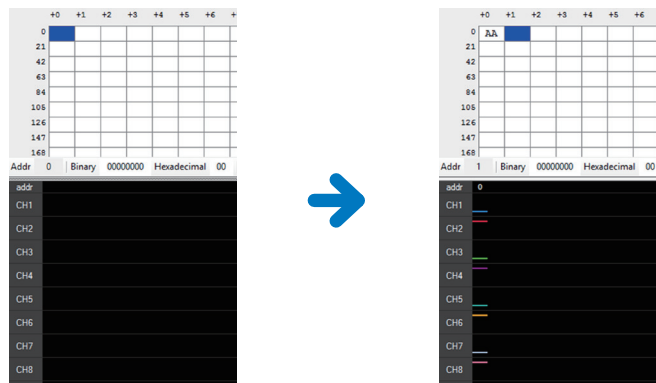

In addition to entering values directly at the desired positions, you may also enter values into the input text box underneath the grid, in which case you can also enter binary values.

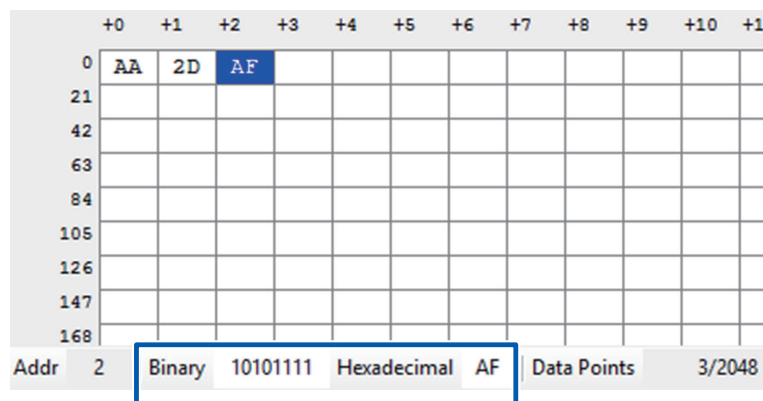

Pulse Pattern Mode

You can also select a range of data to copy and paste into other cells.

Drag the mouse to select the desired range and click the copy button.

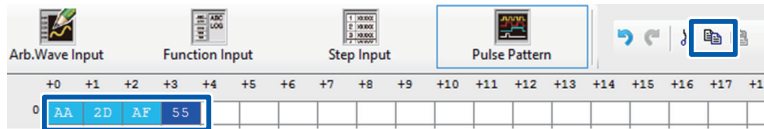

Select the position at which you wish to paste the data and click the paste button.

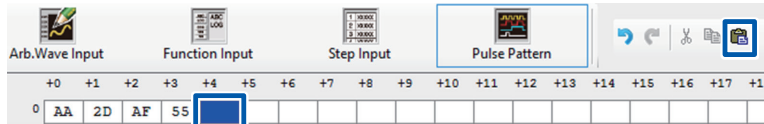

The copied data will be pasted.

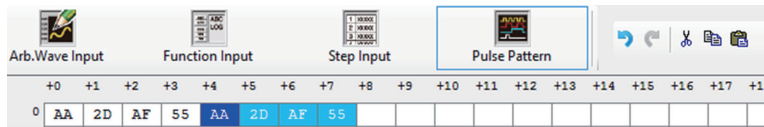

Example of waveform creation

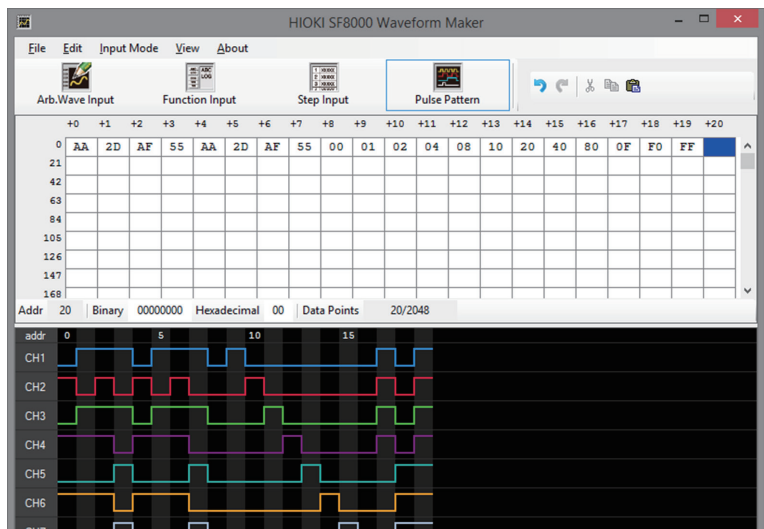

13.11 Transferring Data

This section describes how to transfer data to a LAN-connected Memory HiCorder.

- 1 On the **[File]** tab of the main screen's **[File]** tab, click **[Export]**.

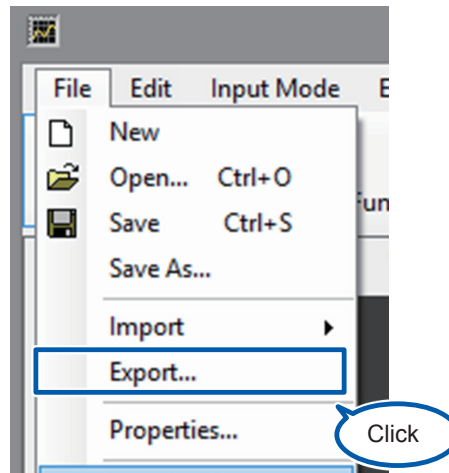

- 2 Enter the destination Memory HiCorder's IP address and LAN port number respectively in the **[IP Address]** and **[Port]** boxes.

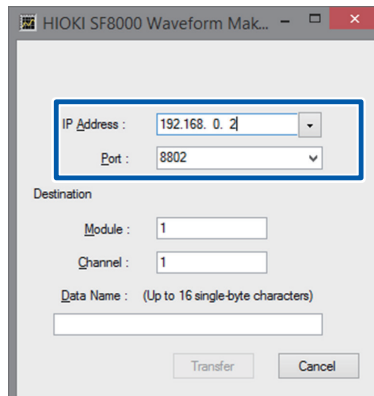

- 3** (For [Arb.Wave Input], [Function Input], and [Step Input] mode)
Enter the module number in the [Module] box, the channel number in the [Channel] box, and the data name in the [Data Name] box and then click [Transfer].

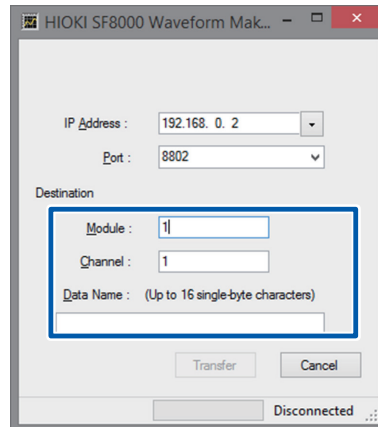

- For [Pulse Pattern] input mode:
Select the module number in the [Module] box and the pattern number in the [Pattern] box and then click [Transfer].

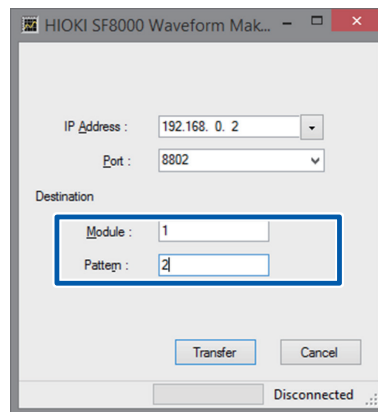

13.12 Saving and Loading Data

This section describes how to save created data and settings as files and how to load data and settings from files. You can save data and settings for all input modes together, or you can save waveform data alone for an individual input mode.

Saving and loading all data

Click “File-Save As...” from the main screen’s menu bar. When the Save File dialog box is displayed, specify the destination and filename and save the data.

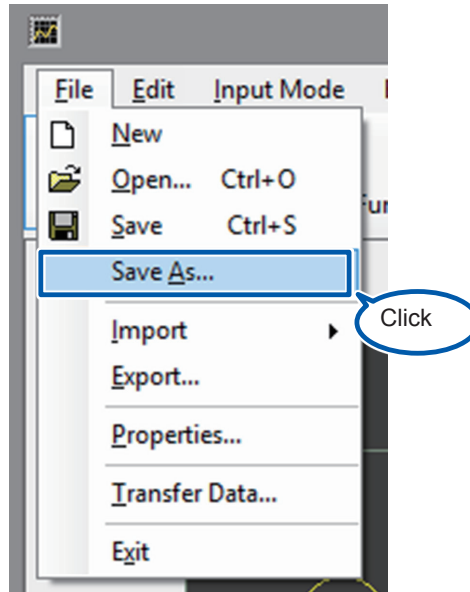

The saved file, which will have the extension “.fgw,” can only be loaded by the SF8000 application. To load a file, click the **[File]** tab > **[Open]**.

To load created data into a recorder, use the export function.

Saving and loading data for an individual input mode (import, export)

To save or load waveforms for individual input modes, use the import and export function. Import is used to load data, while export is used to save data. Both are accessible from the File menu.

Depending on the input mode, you can load data saved by a recorder or power meter. To load created data into a recorder, use the export function.

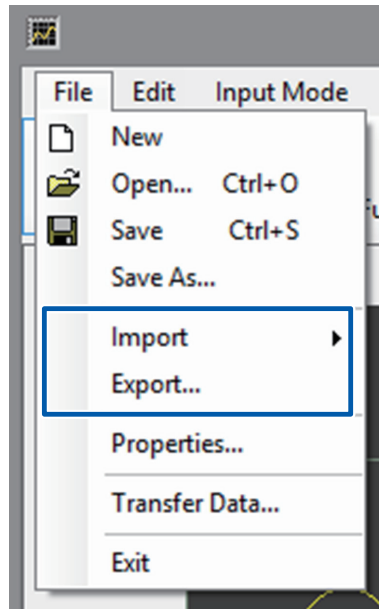

The following table lists the file types that are supported by each input mode:

Input mode	Ext.	Description	Format	SF8000		Recorder	
				Export (Save)	Import (Load)	Save	Load
Arb. Wave Input	WFG	Arbitrary waveform data	Binary	✓	✓	✓	✓
	TFG		Text	✓	✓	-	✓
	MEM	8847, MR8847, MR8827, MR8740, MR8741 waveform file*	Binary	-	✓	✓	✓
	CSV		Text	-	✓	✓	-
	EVT		PW3198 event file	Binary	-	✓	-
Function Input	WFG	Arbitrary waveform data	Binary	✓	✓	✓	✓
	TFG		Text	✓	-	-	✓
	PGM	Function formula data	Text	✓	✓	-	-
	PRG	Function formula data (Legacy format)	Text	-	✓	-	-
Step Input	WFG	Arbitrary waveform data	Binary	✓	✓	✓	✓
	TFG		Text	✓	-	-	✓
	STP	Step settings data	Text	✓	✓	-	-
Interpolation	WFG	Arbitrary waveforms data	Binary	✓	✓	✓	✓
	TFG		Text	✓	-	-	✓
	STP	Dot data	Text	✓	✓	-	-
Pulse Pattern	PLS	Pulse pattern data	Binary	✓	✓	✓	✓
	CSV		Text	✓	✓	-	-

*Waveform data measured at a sampling speed of greater than 500 ns/S cannot be imported.

14 Specifications

14.1 U8793 Arbitrary Waveform Generator Unit

General specifications

Operating environment	As per Memory HiCorder in which U8793 is installed
Operating temperature and humidity	As per Memory HiCorder in which U8793 is installed
Storage temperature and humidity	-20°C to 50°C (-4.0°F to 122°F), 80% RH or less (no condensation)
Standards	Safety: EN61010 EMC: EN61326 Class A
Dielectric strength	350 V AC (sensed current: 1 mA) (between individual output channels and enclosure/external I/O terminals as well as between individual output channels)
Dimensions	Approx. 106W × 19.8H × 196.5D mm (4.17" W × 0.78"H × 7.74"D) (excluding protrusions)
Mass	Approx. 250 g (8.8 oz.)
Product warranty period	3 years
Options*	L9795-01 Connection Cable (terminal type: SMB terminal/mini-alligator clip) L9795-02 Connection Cable (terminal type: SMB terminal/BNC terminal)

*: The options listed below are available for the device. To order an option, please contact your authorized Hioki distributor or reseller. Options are subject to change. Please check Hioki's website for the latest information.

Output specifications

Basic specifications (common for both FG function and arbitrary waveform generation function)

Conditions of guaranteed accuracy	Guaranteed accuracy period: 1 year Temperature and humidity for guaranteed accuracy: 23°C ±5°C (73°F ±9°F), 80% RH or less Warm-up time: At least 30 min. Power supply frequency range for Memory HiCorder in which U8793 is installed: 50 Hz/60 Hz ±2 Hz
Number of output channels	2 channels
Output terminals	SMB terminals
Output type	Unbalanced output (floating)
Maximum rated voltage to earth	30 V AC rms or 60 V DC (between individual output channels and enclosure/external I/O terminals as well as between individual output channels) Anticipated transient overvoltage: 330 V
Maximum output voltage	-10 V to 15 V
Amplitude setting range	0 V p-p to 20 V p-p (setting resolution: 1 mV)

DC offset setting range	-10 V to 15 V (setting resolution: 1 mV)
Output impedance	1 Ω or less
Maximum output current	± 10 mA (per channel)
Allowable load resistance	1.5 k Ω or greater
Output format	Waveform output/open/short

FG function specifications

Output waveform	Sine wave, rectangular wave, pulse wave (variable duty cycle), triangular wave, ramp wave, DC
Output frequency range	0 Hz to 100 kHz (setting resolution: 10 mHz)
Output frequency accuracy	$\pm 0.015\%$ of setting
DC output accuracy	$\pm 0.05\%$ of setting ± 10 mV
DC output temperature characteristics	($\pm 0.005\%$ of setting ± 1 mV)/ $^{\circ}\text{C}$
Amplitude accuracy	$\pm 0.5\%$ of setting ± 10 mV p-p (not lower than 10 mHz but not higher 10 kHz) $\pm 0.8\%$ of setting ± 10 mV p-p (higher than 10 kHz but not higher than 50 kHz) $\pm 1.0\%$ of setting ± 10 mV p-p (higher than 50 kHz but not higher than 100 kHz)
Amplitude temperature characteristics	($\pm 0.05\%$ of setting ± 1 mV p-p)/ $^{\circ}\text{C}$
DC offset accuracy	$\pm 0.5\%$ of setting ± 10 mV
DC offset temperature characteristics	($\pm 0.05\%$ of setting ± 1 mV)/ $^{\circ}\text{C}$
Phase difference setting range	-360° to 360° (setting resolution: 0.1°)
Jitter	Within 50 ns p-p (rectangular waves, pulse waves, triangular waves, ramp waves)
Pulse wave duty cycle setting range	0.1% to 99.9% (setting resolution: 0.1%) Valid with a pulse width of 500 ns or greater
Pulse wave duty cycle accuracy	$\pm 0.1\%$ of period (not lower than 10 mHz but not higher than 5 kHz) $\pm 0.5\%$ of period (higher than 5 kHz but not higher than 20 kHz) $\pm 1.0\%$ of period (higher than 20 kHz but not higher than 100 kHz)

Arbitrary waveform generation function specifications

Output waveform	Waveforms measured with the 8847, MR8847, MR8847A, MR8827, MR8740, MR8740T, MR8741, MR6000 Memory HiCorder (Logic waveforms are not supported.) Waveforms measured with the PW3198 Power Quality Analyzer (via the SF8000) Waveforms saved by the 7075 Waveform Generator (via the SF8000) Waveforms created in CSV format (via the SF8000) Waveforms created with the SF8000 Waveform Maker
Voltage axis resolution	16 bits
Waveform memory capacity	256 kW/channel × 8 blocks (up to 250,000 samples per channel × 8 waveforms)
Low-pass filter	2nd-order LPF, 50 Hz to 1 MHz (14 steps in 1-2-5 progression)
D/A refresh rate	Max. 2 MHz (setting resolution: 10 mHz)
Clock frequency accuracy	±150 ppm
Clock frequency jitter	Within 50 ns p-p
Delay	-250,000 to 250,000 (settable in increments of 1 sample)
Loop count	1 to 50,000 or infinity

Sweep function specifications

Sweep waveform	Non-DC waveforms, arbitrary waveforms	
Sweep form	Linear	
Sweep targets	Waveforms:	Frequency, amplitude, offset, duty cycle (pulse waves only) (Simultaneous sweeping of frequency, amplitude, and offset)
	Arbitrary waveforms:	Clock frequency, amplitude, offset (Simultaneous sweeping of clock frequency, amplitude, and offset)
Sweep time setting range	10 μs to 1000 s (setting resolution: 10 μs)	

Program functional specifications

Sequence length	Output by connecting up to 128 steps
Step control	Ability to set a waveform, sweep waveform, or arbitrary waveform for each step Ability to set the number of loops (for sweep waveforms) or output time (for waveforms and arbitrary waveforms) for each step
Hold setting	On/off setting for each step
Output time setting range	10 μs to 1000 s (for waveforms and arbitrary waveforms)
Step loop count * setting range	1 to 1,000 (for sweep waveforms)
Overall loop count setting range	1 to 50,000 or ∞
Monitor function	Display of step number being executed, step loop count *, and overall loop count

*: Sweep count for the MR6000 and MR8740T

Other specifications

Channel synchronization	Ability to set the phase between channels on the same module (unit) and between modules (units)
Self-test function	Ability to monitor output voltage value Monitor resolution: 10 mV Monitor accuracy: $\pm 3.0\%$ f.s. (f.s. = 15 V)
Output start/stop	Available by operating the Memory HiCorder or inputting a signal to the Memory HiCorder's external control terminal
External input	Cancel hold and transition to next step on low-level signal input from an external source while using the program function. Control voltage level: 3.5 V to 5.0 V (high level), 0 V to 0.8 V (low level) Response pulse width: 100 μ s or greater (low level)
External output	Output during waveform output Output format: Open-drain output (with 5 V voltage output, active low) Output voltage level: 4.0 V to 5.0 V (high level), 0 V to 0.5 V (low level) Maximum switching capacity: 5 V to 30 V DC, 50 mA
External I/O terminals	Push-button type terminal block
Waveform output indicator	Red LED on during waveform output and off when output is off

14.2 MR8790 Waveform Generator Unit

Accuracy figures assume installation in a Memory HiCorder and operation after a 30-minute warm-up period at 23°C ±5°C (73°F ±9°F) and 80% RH (no condensation).

General specifications

Product warranty period	3 years
Guaranteed accuracy period	1 year
Number of output channels	4 channels (all channels isolated from each other and from the enclosure and outputs)
Self-test function	Included (with voltage and current monitor)
Voltage and current monitor function (switchable)	Resolution: 5 µA (current monitor) 10 mV (voltage monitor) Monitor accuracy: ±3.0% f.s. (f.s. = 10 V [voltage monitor] or 5 mA [current monitor])
Maximum output current	±5 mA
Allowable load resistance	2 kΩ or greater
Output terminals	SMB terminals
Output configuration	Waveform output/open/short circuit
Output relay switching time	5 ms or less
Output protection	Output current limited to 40 mA (when output is shorted)
Maximum rated voltage to earth	30 V AC rms or 60 V DC (between individual output channels and enclosure as well as between individual output channels) Anticipated transient overvoltage: 330 V
Dielectric strength	350 V AC (sensed current: 1 mA) (between individual output channels and enclosure as well as between individual output channels)
Operating temperature and humidity	As per Memory HiCorder into which the MR8790 is installed
Operating environment	As per Memory HiCorder into which the MR8790 is installed
Storage temperature and humidity	Temperature: -20°C to 50°C (-4.0°F to 122°F) Humidity: 90% RH or less (no condensation)
Dimensions	Approx. 106W × 19.8H × 196.5D mm (4.17"W × 0.78"H × 7.74"D) (excluding protrusions)
Mass	Approx. 230 g (8.1 oz.)
Standards	Safety: EN61010 EMC: EN61326 Class A
Effect of radiated radio-frequency electromagnetic field	±3% f.s. (max.) at 3 V/m (f.s. = 10 V)

Effect of conducted radio-frequency electromagnetic field	±1% f.s. (max.) at 3 V (f.s. = 10 V)
Options	L9795-01 Connection Cable (terminal type: SMB terminal/mini-alligator clip) L9795-02 Connection Cable (terminal type: SMB terminal/BNC terminal)

Voltage output specifications

Maximum output voltage	±10 V
Resolution	16 bits
Output frequencies	Output frequencies: DC, 0 Hz to 20 kHz (sine wave) Setting resolution: 1 Hz Frequency accuracy: ±0.01% of setting
Amplitude	Setting range: 0 V p-p to 20 V p-p Setting resolution: 1 mV Amplitude accuracy: ±0.25% of setting ±2 mV p-p (not lower than 1 Hz but not higher than 10 kHz) ±0.6% of setting ±2 mV p-p (higher than 10 kHz but not higher than 20 kHz)
DC offset	Setting range: -10 V to 10 V Peak value including amplitude and DC offset is limited to ±10 V. Setting resolution: 1 mV Offset accuracy: ±3 mV
DC output	Output accuracy: ±0.6 mV

14.3 MR8791 Pulse Generator Unit

General specifications

Temperature and humidity for guaranteed accuracy	23°C ±5°C (73°F ±9°F), 80% RH or less (no condensation) (when installed in Memory HiCorder)
Guaranteed accuracy period	1 year
Product warranty period	3 years
Operating temperature and humidity	As per Memory HiCorder in which MR8791 is installed
Operating environment	As per Memory HiCorder in which MR8791 is installed
Storage temperature and humidity	-20°C to 50°C (-4.0°F to 122°F), 90% RH or less (no condensation)
Maximum rated voltage to earth	30 V AC RMS or 60 V DC (between output channels and enclosure) Anticipated transient overvoltage: 330 V
Dielectric strength	350 V AC (sensed current: 1 mA) (between output channels and enclosure) (between output modules)
Dimensions	Approx. 106W × 19.8H × 196.5D mm (4.17"W × 0.78"H × 7.74"D) (excluding protrusions)
Mass	Approx. 230 g (8.1 oz.)
Number of output channels	8 (output channels and enclosure isolated; output modules isolated) (channels not isolated from each other [common GND]) (channels not isolated from output connector frame [common GND])
Output mode 1	Pattern output/pulse output (switched for all 8 channels at once)
Output mode 2	Logic output/open-collector output (set separately for each of 8 channels)
Logic output:	Output voltage level: 0 V to 5 V (high level 3.8 V or greater, low level 0.8 V or less) Rated current: ±5 mA
Open-collector output:	Collector/emitter absolute maximum rated voltage: 50 V Overcurrent protection: 100 mA
Output mode 3	Output/open (=self-test) (switched for all 8 channels at once)
Open-collector output definition (rising time [10% to 90%])	5 μs (max.) (load capacity of 1000 pF, pull-up resistance of 1 kΩ)
Self-test function	Detected voltages: High level 3.4 V or greater, low level 1.6 V or less
Relay switching time	5 ms or less (logic/open collector switching, output/open [self-test] switching)
Standards	Safety: EN61010 EMC: EN61326 Class A

Pulse output specifications

Output frequency	Setting range: 0 Hz to 20 kHz (set separately for each of 8 channels) Setting resolution: 0.1 Hz Frequency accuracy: As per time axis accuracy of Memory HiCorder in which MR8791 is installed
Duty cycle	Setting range: 0.1% to 99.9%, 0, 100% (DC) Setting resolution: 0.1% Duty cycle accuracy: As per time axis accuracy of Memory HiCorder in which MR8791 is installed
Minimum pulse width	1 μ s

Pattern output specifications

Clock frequency	Range: 0 Hz to 120 kHz (common to all 8 channels) Setting resolution: 10 Hz Frequency accuracy: As per time axis accuracy of Memory HiCorder in which MR8791 is installed
Memory (patterns)	2,048 words (16,384 bits = 2,048 words \times 8 bits/word)

Output connector specifications

10250-52A2PL: Sumitomo 3M (SCSI-2 connector) (Centronics half 50-pin female)

Pin	Signal	Pin	Signal
1	I_GND	26	I_GND
2	CH1	27	I_GND
3	CH2	28	I_GND
4	CH3	29	I_GND
5	CH4	30	I_GND
6	I_GND	31	I_GND
7	CH5	32	I_GND
8	CH6	33	I_GND
9	CH7	34	I_GND
10	CH8	35	I_GND
11	I_GND	36	I_GND
12	NC	37	I_GND
13	NC	38	I_GND
14	NC	39	I_GND
15	NC	40	I_GND
16	I_GND	41	I_GND
17	NC	42	I_GND
18	NC	43	I_GND
19	NC	44	I_GND
20	NC	45	I_GND
21	I_GND	46	I_GND
22	TEST2 (DIN03)	47	I_GND
23	TEST3 (DIN02)	48	I_GND
24	NC	49	I_GND
25	NC	50	I_GND
Frame	F_GND		

CH1 to CH8:	Pulse output
I_GND:	Isolation GND (isolation GND)
F_GND:	Non-isolation GND (instrument GND)
NC:	No connection
TESTn:	Test pin (connection prohibited)

Recommended connection cable: KB-SHH2: Sanwa Supply (SCSI-2 connector) (Centronics half 50-pin male)

15 Maintenance and Service

15.1 Cleaning the Module

CAUTION



Clean the module regularly to keep dust from obstructing its air vents. If the vents become blocked, reduced cooling inside the module may cause equipment damage or other issues..

Important

- To clean the module, moisten a soft cloth with water or neutral detergent and lightly wipe it clean.
- Never use detergents or cleansers that contain benzene, alcohol, acetone, ether, ketones, paint thinner, or gasoline. Doing so may cause discoloration or deformation of shape of the module.

15.2 Troubleshooting

CAUTION



Do not attempt to modify, disassemble, or repair the module yourself. Doing so may result in burns, electric shock, or other bodily injury.

If you believe your device may be malfunctioning, review the information in “Before having your device repaired” and contact your authorized Hioki distributor or reseller.

Before having your device repaired

Check the following if your device is behaving in an unexpected manner.

Symptom	What to check	Solution	Refer to
The device will not output a waveform.	<ul style="list-style-type: none"> • Is output set to [ON]? • Is Generator Control set to [RUN]? 	The device will not output a waveform if output is set to [OFF] , even if Generator Control is set to [RUN] . Set Generator Control to [RUN] and output to [ON] .	p. 36 p. 98 p. 131
The output waveform's voltage values are odd.	<ul style="list-style-type: none"> • Is the connection cable properly connected to the output terminal? • Is an offset being added? (Waveforms) • Is the amplitude adjustment setting incorrect, or is an offset not being added? (Arbitrary waveforms) • Has the filter been properly configured? (Arbitrary waveform) 	<ul style="list-style-type: none"> • Verify that the cable is properly connected to the output terminal. • Set the offset to 0 V. • Set amplitude adjustment to 1× and the offset to 0 V. • Set the filter to off or set the filter's cutoff frequency to an appropriate value. 	p. 12 p. 13 p. 30 p. 88 p. 90 p. 96
You are unable to register arbitrary waveform data.	Does the file have an extension that can be registered?	Files that can be registered have an extension of either “.wfg” or “.tfg.” (Pulse pattern files have an extension of “.pls.”)	p. 81
The output frequency of a arbitrary waveform registered from a measured waveform does not match the output frequency of the measured waveform.	Do the sampling frequency used during measurement and the clock frequency used when outputting the arbitrary waveform match?	Use the sampling frequency at measurement as the clock frequency.	p. 85
You are unable to import files with the SF8000 application.	<ul style="list-style-type: none"> • Is the file compatible with the current input mode? • Is the file a waveform file that was measured at a sampling rate faster than 500 ns/S? 	<ul style="list-style-type: none"> • Import a file that is compatible with the current input mode. • Use a waveform file that was measured at a sampling rate of 500 ns/S or less. 	p. 184
You don't know what is causing the issue.	Perform a system reset on the Memory HiCorder. All settings will revert to their factory defaults.		

15.3 Error Messages

U8793 Arbitrary Waveform Generator Unit

Display no.	Message	Solution
111	No space to register arbitrary waveform data.	A maximum of eight arbitrary waveforms can be registered. Delete one or more arbitrary waveforms and then register the new waveform. (p. 73)

This section lists only those messages that pertain to the U8793. For other messages and associated solutions, see the Memory HiCorder's instruction manual.

SF8000 Waveform Maker

Message	Solution
The application is already running.	The SF8000 application is already running. Only one instance of the SF8000 application can run at a time.
Insufficient privileges to access the file <file>.	Check the file's access settings.
The number of steps exceeds tolerances.	The maximum number of steps that can be configured (100) was exceeded. Add new steps after deleting steps that are no longer necessary.
The number of pulse pattern data exceeds tolerances.	The maximum number of pulse pattern settings (2048) was exceeded. Add new pulse pattern settings after deleting data that is no longer necessary.
Unable to create the file <file>.	Check the amount of available space on the destination media as well as the file access settings.
Unable to load the file <file>.	Check whether the file is corrupt, or whether the file format is supported by the SF8000 application.
Unable to load the folder <folder>.	The necessary file could not be found in the EVT folder. Verify that all files are present.
Communications will be interrupted. Proceed?	You attempted to close the data transfer screen while communications were still in progress. Closing the screen will interrupt communications.
The work state has been updated. Save?	The changes have not been applied to the file. To apply them, save the file.
Unable to connect to Memory HiCorder.	Verify that the cable is connected firmly and that the LAN settings have been configured properly.
Unable to communicate with Memory HiCorder or unable to register additional data.	If the Memory HiCorder is performing measurement, end measurement or wait for measurement to complete. If the maximum number of samples that can be registered has been reached, delete unnecessary data before registering new data.

Index

A

Amplitude.....	28
Arbitrary waveform	71
Clock frequency	85
Delay	92
Filter	96, 118
Iteration count for the loop	94
Output	98
Waveform type	71

C

Channel	16
Copying and pasting	16
Clock frequency	
Pattern mode.....	59
Connecting cables	12

D

Duty cycle	32, 45
------------------	--------

E

External control terminal.....	8, 14, 143
External input.....	144
External output	145

F

Frequency.....	26
----------------	----

I

Installation	5
Installing the module.....	11

M

Mode.....	41
Model MR8790	191
General specifications.....	191
Voltage output specifications.....	192
Model MR8791	193
General specifications.....	193
Output connector.....	194
Pattern output specifications	194
Pulse output specifications.....	194
Model SF8000	147
Installing	149
Launching/exiting	151
Overview	147
Uninstalling.....	153

Model U8793

General specifications.....	187
Other specifications.....	190
Output specifications.....	187
Program functional specifications	189
Sweep function specifications	189

O

Offset	30
Output.....	36
Pattern mode.....	61
Output connector	8
Output indicators	8
Output terminals	13

P

Pattern mode	51
Output type.....	51
Pattern to use.....	53
Phase	34
Program.....	105
Overall number of loops	116
Program settings screen	105
Saving edited program	120
Program progress	
Program	125
Pulse.....	41
Pulse mode.....	43
Duty cycle.....	45
Frequency	43
Output	49
Output configuration.....	47

R

Removing the module.....	11
--------------------------	----

S

Self-test function.....	139
Setting output when measurement completes	
Signal	130
Signal.....	127
Control method.....	38, 127
Signal output status.....	131
Signal generation settings screen	15
Specifications	187
Sweep.....	63
End value	67
Start value	65
Sweep time	69

T

Tenkey (numeric input) 21
Troubleshooting 198, 199

U

Up-down (arrow key input) 20
Use 38

W

Waveform 19
Waveform type 24

HIOKI
www.hioki.com/



**All regional
contact
information**

HEADQUARTERS

81 Koizumi
Ueda, Nagano 386-1192 Japan

HIOKI EUROPE GmbH

Helfmann-Park 2
65760 Eschborn, Germany
hioki@hioki.eu

2111 EN

Edited and published by HIOKI E.E. CORPORATION

Printed in Japan

- CE declarations of conformity can be downloaded from our website.
- Contents subject to change without notice.
- This document contains copyrighted content.
- It is prohibited to copy, reproduce, or modify the content of this document without permission.
- Company names, product names, etc. mentioned in this document are trademarks or registered trademarks of their respective companies.