

3561

HIOKI

3561-01

Instruction Manual

BATTERY HiTESTER



! Be sure to read this manual before using the instrument. ▶ p.2

✓ When using the instrument for the first time

Names and Functions of Parts ▶ p.11

Measurement ▶ p.23

📖 Troubleshooting

Maintenance and Service ▶ p.169

Error Display ▶ p.170

EN

Sept. 2020 Revised edition 10
3561A981-10 20-09H



Contents

Introduction.....	1
Verifying Package Contents	1
Safety Information	2
Operating Precautions.....	4
Chapter 1	
Overview	9
1.1 Product Overview	9
1.2 Features	10
1.3 Names and Functions of Parts	11
1.4 Menu Display Sequence (SHIFT → ENTER).....	15
1.5 Measurement Flowchart.....	16
Chapter 2	
Measurement Preparations	17
2.1 Preparation Flowchart	17
2.2 Connecting the Power Cord	18
2.3 Connecting the Optional Test Leads	19
2.4 Turning the Power On and Off	21
2.5 Selecting the Line Frequency.....	22
Chapter 3	
Measurement	23
3.1 Pre-Operation Inspection	23
3.2 Basic Measurement Example	24
3.3 Selecting Measurement Mode	27
3.4 Setting Measurement Range	28
3.4.1 Manual Range Setting	28
3.4.2 Auto-Ranging	29
3.5 Setting Sampling Rate	30
3.6 Zero-Adjust Function	30
3.6.1 Wiring Method for Zero-Adjustment	30
3.6.2 Executing Zero-Adjustment	31
3.7 Displaying Measurement Results.....	33
3.7.1 Measurement Fault Detection	34
3.7.2 Overflow Display	34

Chapter 4 Applied Measurement 35

4.1	Comparator Function.....	36
4.1.1	Comparator Setting Example 1 (Upper and Lower Threshold Judgment)	37
4.1.2	Comparator Setting Example 2 (Reference Value and Tolerance Judgment).....	41
4.1.3	Comparator Judgment Beeper Setting	45
4.1.4	Comparator Execution Mode Setting	46
4.1.5	Comparator Threshold Method Selection	47
4.1.6	Upper and Lower Thresholds Setting (by Reference Value and Tolerance).....	48
4.1.7	Enabling and Disabling the Comparator Function	50
4.1.8	Comparator Judgment Results	51
4.1.9	Switching Between Measurement Value and Comparator Setting Displays	52
4.2	Trigger Function	53
4.2.1	Trigger Source Settings	53
4.2.2	Trigger Delay Settings	54
4.3	Averaging Function.....	55
4.4	Statistical Calculation Functions.....	56
4.5	Memory Function.....	60
4.6	Key-Lock Function.....	62
4.7	Panel Save Function	63
4.8	Panel Load Function.....	64
4.9	Self-Calibration.....	65
4.10	Measurement Value Output Function.....	66
4.11	Key Beeper Setting.....	67
4.12	Reset Function	68

Chapter 5 External Control 71

5.1	Overview.....	71
5.2	Signal Descriptions.....	72
5.2.1	Pinout	72
5.2.2	Input Signals	73
5.2.3	Output Signals	74
5.2.4	ERR Output	75
5.2.5	Instrument Settings	76
5.3	Timing Chart.....	77
5.4	Internal Circuitry	79

Chapter 6		
Printing	<hr/>	81
6.1	Connecting the Printer	81
6.1.1	Connecting the PRINTER to the Instrument	82
6.2	Selecting the Interface	83
6.3	Printing	84
Chapter 7		
RS-232C/GP-IB Interfaces	<hr/>	87
7.1	Overview and Features	87
7.2	Specifications	88
7.2.1	RS-232C Specifications	88
7.2.2	GP-IB Specifications (Model 3561-01 only)	88
7.3	Selecting the Connections and Protocol	89
7.3.1	Attaching the Connector	89
7.3.2	Selecting the Interface	91
7.4	Communication Methods	92
7.4.1	Message Format	92
7.4.2	Output Queue and Input Buffer	97
7.4.3	Status Byte Register	98
7.4.4	Event Registers	100
7.4.5	Initialization Items	103
7.4.6	Local Function	103
7.5	Message List	104
7.5.1	Standard Commands	104
7.5.2	Device-Specific Commands	105
7.6	Message Reference	110
7.6.1	Standard Commands	111
7.6.2	Device-Specific Commands	115
7.6.3	Measurement Value Formats	142
7.6.4	Command Compatibility with the Model 3560 AC mΩ HiTESTER	143
7.7	Basic Data Importing Methods	147
7.8	Sample Programs	148
7.8.1	To be prepared in Visual Basic [®] 5.0/6.0	148
7.8.2	To be prepared in Visual Basic [®] 2005	158
7.8.3	Creation Procedure(Visual Basic [®] 2005)	158
7.8.4	Sample Programs(Visual Basic [®] 2005)	160

Chapter 8	
Specifications	163
8.1 Basic Specifications.....	163
8.2 Accuracy.....	167
8.3 General Specifications.....	168
Chapter 9	
Maintenance and Service	169
9.1 Troubleshooting.....	169
9.2 Cleaning.....	170
9.3 Error Display.....	170
Appendix	171
Appendix 1 Precautions for Making Custom Test Leads ..	171
Appendix 2 AC Four-terminal Method.....	173
Appendix 3 Synchronous Detection System.....	174
Appendix 4 Configuration and Extension of the Test Leads.....	175
Appendix 5 Effect of Eddy Currents.....	176
Appendix 6 Zero Adjustment.....	177
Appendix 7 Calibration Procedure.....	181
Appendix 8 Test Lead Options.....	182
Appendix 9 Rack Mounting.....	183
Appendix 10 Dimensional Diagram.....	185
Index	i

Introduction

Thank you for purchasing the HIOKI "Model 3561, 3561-01 BATTERY HiTESTER." To obtain maximum performance from the instrument, please read this manual first, and keep it handy for future reference.

Trademarks

Microsoft, Windows, and Visual Basic are either registered trademarks or trademarks of Microsoft Corporation in the United States and other countries.

Verifying Package Contents

When you receive the instrument, inspect it carefully to ensure that no damage occurred during shipping. In particular, check the accessories, panel switches, and connectors. If damage is evident, or if it fails to operate according to the specifications, contact your dealer or Hioki representative. Use the original packing materials when transporting the instrument, if possible.

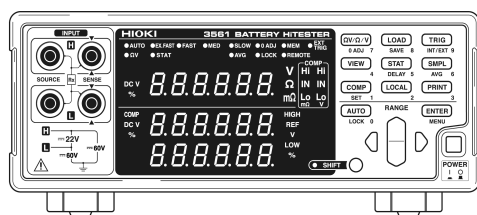

- Model 3561/ Model 3561-01 (GP-IB version)
BATTERY HiTESTER (1)

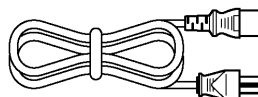

- Power cord (1)

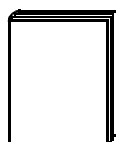

- Instruction manual (this manual/ 1)

Options

The options listed below are available for the instrument. To order an option, please contact your authorized Hioki distributor or reseller. Options are subject to change. Please check Hioki's website for the latest information.

- Model L2107 CLIP TYPE LEAD
- Model 9452 CLIP TYPE LEAD
- Model 9453 FOUR TERMINAL LEAD
- Model 9455 PIN TYPE LEAD (for ultra precision)
- Model 9467 LARGE CLIP TYPE LEAD
- Model 9770 PIN TYPE LEAD
- Model 9771 PIN TYPE LEAD
- Model 9637 RS-232C CABLE (9-pin to 9-pin/cross cable)
- Model 9638 RS-232C CABLE (9-pin to 25-pin/cross cable)
- Model 9151-02 GP-IB CONNECTOR CABLE (2 m)

Safety Information



This instrument is designed to comply with IEC 61010 Safety Standards, and has been thoroughly tested for safety prior to shipment. However, mishandling during use could result in injury or death, as well as damage to the instrument. Using the instrument in a way not described in this manual may negate the provided safety features. Be certain that you understand the instructions and precautions in the manual before use. We disclaim any responsibility for accidents or injuries not resulting directly from instrument defects.

This manual contains information and warnings essential for safe operation of the instrument and for maintaining it in safe operating condition. Before using it, be sure to carefully read the following safety precautions.

	In the manual, the symbol indicates particularly important information that the user should read before using the instrument.
	The symbol printed on the instrument indicates that the user should refer to a corresponding topic in the manual (marked with the symbol) before using the relevant function.
	Indicates a grounding terminal.
	Indicates DC (Direct Current).
	Indicates AC (Alternating Current).
	Indicates the ON side of the power switch.
	Indicates the OFF side of the power switch.

The following symbols in this manual indicate the relative importance of cautions and warnings.

	Indicates that incorrect operation presents an extreme hazard that could result in serious injury or death to the user.
	Indicates that incorrect operation presents a significant hazard that could result in serious injury or death to the user.
	Indicates that incorrect operation presents a possibility of injury to the user or damage to the instrument.
	Indicates advisory items related to performance or correct operation of the instrument.

Other Symbols

	Indicates a prohibited action.
p.	Indicates the location of reference information.
	Indicates quick references for operation and remedies for troubleshooting.
*	Indicates that descriptive information is provided below.

Measurement categories

To ensure safe operation of measurement instruments, IEC 61010 establishes safety standards for various electrical environments, categorized as CAT II to CAT IV, and called measurement categories.

CAT II	Primary electrical circuits in equipment connected to an AC electrical outlet by a power cord (portable tools, household appliances, etc.) CAT II covers directly measuring electrical outlet receptacles.
CAT III	Primary electrical circuits of heavy equipment (fixed installations) connected directly to the distribution panel, and feeders from the distribution panel to outlets.
CAT IV	The circuit from the service drop to the service entrance, and to the power meter and primary overcurrent protection device (distribution panel).

Using a measurement instrument in an environment designated with a higher-numbered category than that for which the instrument is rated could result in a severe accident, and must be carefully avoided.

Use of a measurement instrument that is not CAT-rated in CAT II to CAT IV measurement applications could result in a severe accident, and must be carefully avoided.

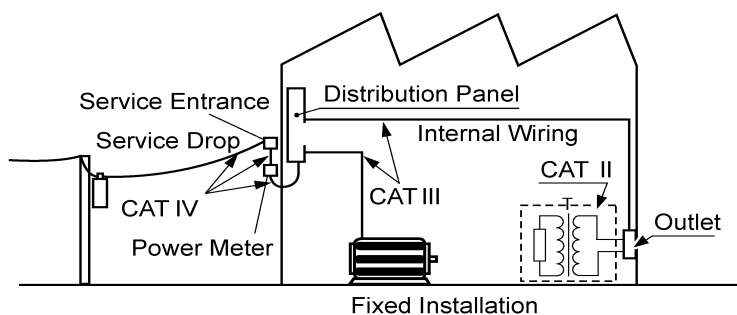

Accuracy

We define measurement tolerances in terms of f.s. (full scale), rdg. (reading) and dgt. (digit) values, with the following meanings:

- f.s. (maximum display value or scale length)
The maximum displayable value or scale length. This is usually the name of the currently selected range.
- rdg. (reading or displayed value)
The value currently being measured and indicated on the measuring instrument.
- dgt. (resolution)
The smallest displayable unit on a digital measuring instrument, i.e., the input value that causes the digital display to show a "1" as the least-significant digit.

Operating Precautions



Follow these precautions to ensure safe operation and to obtain the full benefits of the various functions.

Use of the instrument should conform not only to its specifications, but also to the specifications of all accessories, options, and other equipment in use.

Instrument Installation and Operating Environment





Operating temperature and humidity:

0 to 40°C (32 ± 104°F), 80%RH or less (non-condensating)

Temperature and humidity range for guaranteed accuracy:

23 ± 5°C (73 ± 9°F), 80% RH or less (non-condensating)

Avoid the following locations that could cause an accident or damage to the instrument.

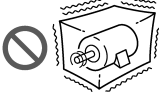
	Exposed to direct sunlight Exposed to high temperature		In the presence of corrosive or explosive gases
	Exposed to liquids Exposed to high humidity or condensation		Exposed to strong electromagnetic fields Near electromagnetic radiators
	Exposed to high levels of particulate dust		Subject to vibration

NOTE

Avoid using near electrically noisy devices, as the noise may impinge upon the test object and cause unreliable measurements.

Installation

Do not install the instrument with any side except the bottom facing down.

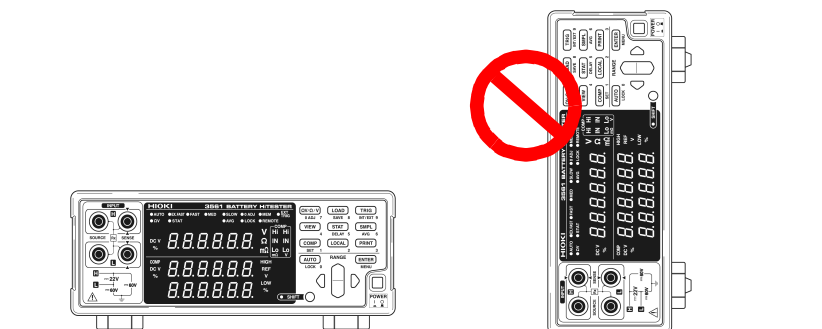

Preliminary Checks

Before using the instrument the first time, verify that it operates normally to ensure that no damage occurred during storage or shipping. If you find any damage, contact your dealer or Hioki representative.

WARNING

Before using the instrument, make sure that the insulation on the power cord and test leads is undamaged and that no bare conductors are improperly exposed. Using the instrument in such conditions could cause an electric shock, so contact your dealer or Hioki representative for replacements.

NOTE

This instrument may cause interference if used in residential areas. Such use must be avoided unless the user takes special measures to reduce electromagnetic emissions to prevent interference to the reception of radio and television broadcasts.

Measurement Precautions

DANGER

- To avoid electrical shock, be careful to avoid shorting live lines with the test leads.
- The maximum rated voltage between input terminals and ground is ± 60 V DC. Attempting to measure voltages exceeding 60 V with respect to ground could damage the instrument and result in personal injury.

WARNING

- To avoid injury or damage to the instrument, do not attempt to measure AC voltage and AC current, or DC voltage exceeding ± 22 V.
- To prevent an electric shock, do not exceed the lower of the ratings shown on the instrument and test leads.

NOTE

- Use only the specified test leads and cables. Using a non-specified cable may result in incorrect measurements due to poor connection or other reasons.
- To ensure certified measurement accuracy, allow at least 30 minutes warm-up. After warm-up, be sure to execute self-calibration. See Section 4.9 Self-Calibration (P. 65).
- The input circuitry includes a protective fuse. Measurement is not possible when the fuse is blown.
- This instrument internally stores (backs up) all settings (except memory function and measurement values), such as measurement range, comparator settings and etc., but only when no operation is performed for a certain time. Therefore, to preserve settings, do not turn the power off for a short time (about five seconds) after changing a setting. However, measurement settings made through the RS-232C or GP-IB interface and measurement settings loaded by LOAD signals of the EXT I/O connector are not memorized.

Before Connecting and Powering On

! WARNING

- Before turning the instrument on, make sure the supply voltage matches that indicated on the its power connector. Connection to an improper supply voltage may damage the instrument and present an electrical hazard.
- To avoid electrical accidents and to maintain the safety specifications of this instrument, connect the power cord provided only to a 3-contact (two-conductor + ground) outlet.

NOTE

To suppress noise, the instrument needs to be set to match the frequency of the power source. Before operating, set the instrument to the frequency of your commercial power. If the supply frequency is not set properly, measurements will be unstable.

See Section 2.5 Selecting the Line Frequency (P. 22).

Make sure the power is turned off before connecting or disconnecting the power cord.

Handling the Instrument

! WARNING

- Never modify the instrument. Only Hioki service engineers should disassemble or repair the instrument. Failure to observe these precautions may result in fire, electric shock, or injury.
- The GP-IB connector location is covered by a blank panel on the Model 3561. To avoid electric shock, do not remove the blank panel.

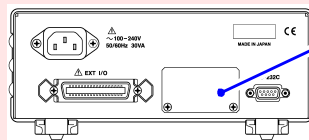

Blank Panel

* This model is the 3561 BATTERY HiTESTER.

! CAUTION

- To avoid damage to the instrument, protect it from physical shock when transporting and handling. Be especially careful to avoid physical shock from dropping.
- Do not apply heavy downward pressure with the stand extended. The stand could be damaged.

NOTE

This instrument may cause interference if used in residential areas. Such use must be avoided unless the user takes special measures to reduce electromagnetic emissions to prevent interference to the reception of radio and television broadcasts.

Handling the Test Leads and Cables



- To avoid breaking the test leads and cables, do not bend or pull them.
- Avoid stepping on or pinching cables, which could damage the cable insulation.
- To avoid equipment failure, do not disconnect the communications cable while communications are in progress.
- Use a common ground for both the instrument and the computer. Using different ground circuits will result in a potential difference between the instrument's ground and the computer's ground. If the communications cable is connected while such a potential difference exists, it may result in equipment malfunction or failure.
- Before connecting or disconnecting any the communications cable, always turn off the instrument and the computer. Failure to do so could result in equipment malfunction or damage.
- After connecting the communications cable, tighten the screws on the connector securely. Failure to secure the connector could result in equipment malfunction or damage.



Overview

Chapter 1

1

Overview

1.1 Product Overview

The Model 3561 and 3561-01 BATTERY HiTESTERS measure battery internal resistance using a four-terminal, 1-kHz AC method, while simultaneously measuring DC voltage (electromotive force [emf]). The high-precision, fast measurement performance and extensive interface capabilities make these models ideal for incorporating into battery testing production lines.

1.2 Features

- ◆ **Simultaneously Measures Battery Internal Resistance and Voltage**

The four-terminal AC method measures resistance and DC voltage simultaneously, so battery internal resistance and emf are measured and judged at once.
- ◆ **High-Precision Measurements**

The instrument provides high-resolution resistance (0.01 m Ω) and voltage measurements (0.1 mV). High precision ($\pm 0.01\%$ rdg.) ensures accurate voltage measurements.
- ◆ **High-Speed Measurements**

Simultaneous resistance and voltage measurements can be performed as fast as once every 10 ms.
- ◆ **Comparator Functions**

Resistance and voltage measurement values are judged in three categories (Hi, IN and Lo), with results clearly displayed. A comparator judgment beeper also provides distinct sounds to indicate pass/fail judgments and to facilitate correct recognition of judgment results.
- ◆ **Statistical Calculation Functions**

Maximum, minimum and average measurement values, standard deviation, process capability indices and other values can be automatically calculated for applications such as production management. Calculation results can also be applied as comparator setting values.
- ◆ **Measurement Value Memory Function**

The instrument includes a Memory function and storage capacity for up to 400 pairs of measurement values. When making many sequential measurements at high speed and sending the measured values to a PC after each measurement, the time to switch test objects can become unsatisfactorily long. The Memory function can avoid the slow-down by sending stored measurements in batches during idle times.
- ◆ **EXT I/O Interface**

EXT I/O and RS-232C interfaces are equipped as standard, supporting transfer rates up to 38,400 bps. Model 3561-01 also supports GP-IB.
- ◆ **Printing Measurement Values and Statistical Results**

Connect the printer to print measurement values and statistical calculation results.

1.3 Names and Functions of Parts

Front Panel

1

Overview

Input Terminals (INPUT)

Connect the optional test leads.

Connections:

See Section 2.3 Connecting the Optional Test Leads (p.19).

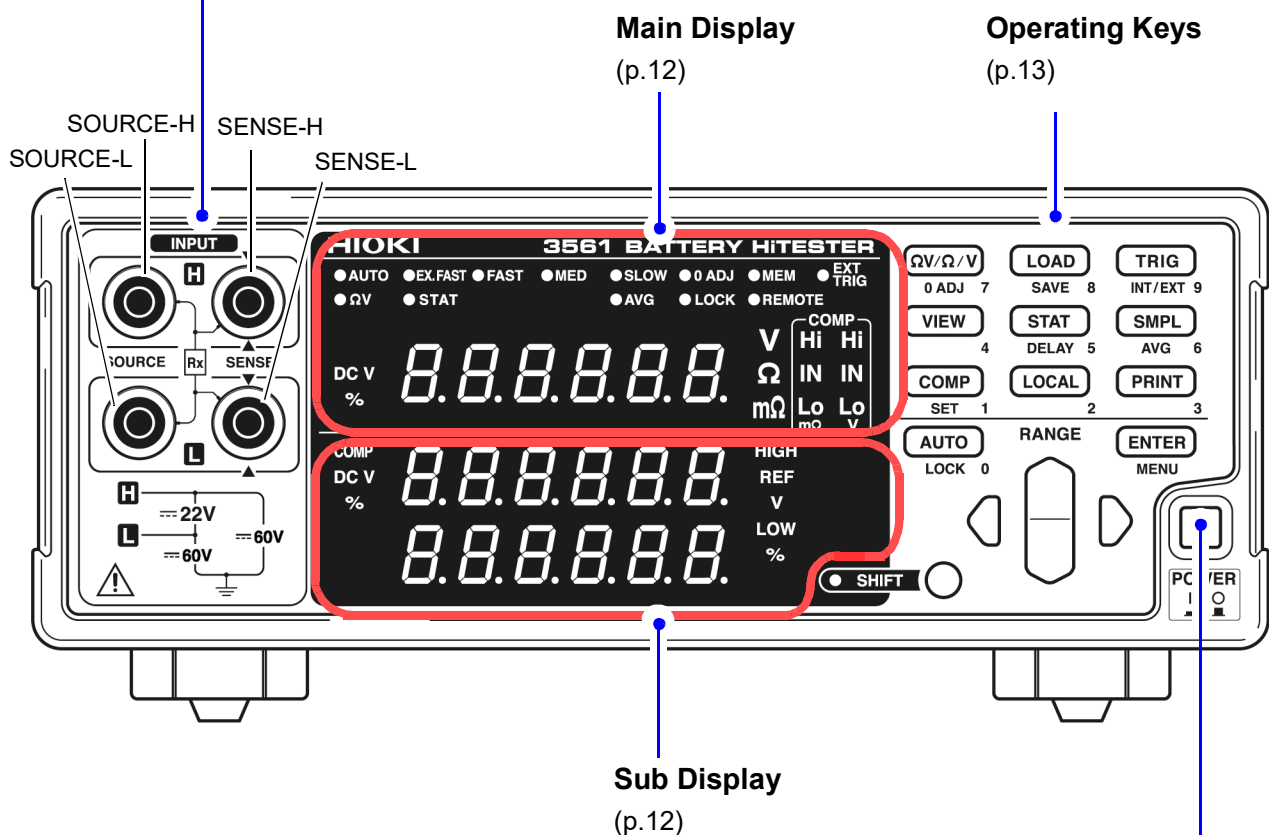

POWER Switch

Turns the instrument on and off.

- : Power OFF
- | : Power ON

See Section 2.4 Turning the Power On and Off (p.21).

Main Display

The current measurement mode is indicated while measuring, and the setting item is displayed while making settings.

(Upper row)	(Lower row)
AUTO Lit when measuring with Auto-Ranging.	ΩV Lit when the Ω V (Resistance and Voltage measurement) mode is selected.
EX.FAST, FAST, MED, SLOW The selected Sampling Rate is lit.	STAT Lit when the Statistical Calculation function is enabled.
0 ADJ Lit when measuring in a range for which Zero-Adjustment has been performed.	AVG Lit when measuring with the Averaging setting enabled.
MEM Lit when the Memory function is enabled.	LOCK Lit when the keys are locked.
EXT TRIG Lit when the External Trigger function is enabled.	REMOTE Lit during communications.

Lit when measuring voltage

Indicates percentage units during relative value comparator operation

Shows measured value or setting item.

Units of displayed measurement

V Unit of voltage

Ω Unit of resistance (lit when the 3 Ω range is selected)

m Ω Unit of resistance (lit when the 300 m Ω range is selected)

Shows Comparator Decision Result.

Hi Indicates that the measured value is above the upper threshold.

IN Indicates that the measured value is between the upper and lower thresholds.

Lo Indicates that the measured value is below the lower threshold.

Sub Display

Upper and lower thresholds and other settings are displayed (when set).

While measuring, indicates the Comparator function is enabled.

Indicates Voltage measurement mode

Indicates percentage units during relative value comparator operation

HIGH, LOW Indicates that absolute value comparator operation is enabled (while measuring), and also when setting.

REF, % Indicates that relative value comparator operation is enabled (while measuring), and also when setting.

V Indicates voltage measurement units.

Operating Keys

To use a function marked on a key, just press the key.

To use a function printed under a key (blue letter), press the **SHIFT** key first (and confirm the SHIFT lamp is lit), and then the key.

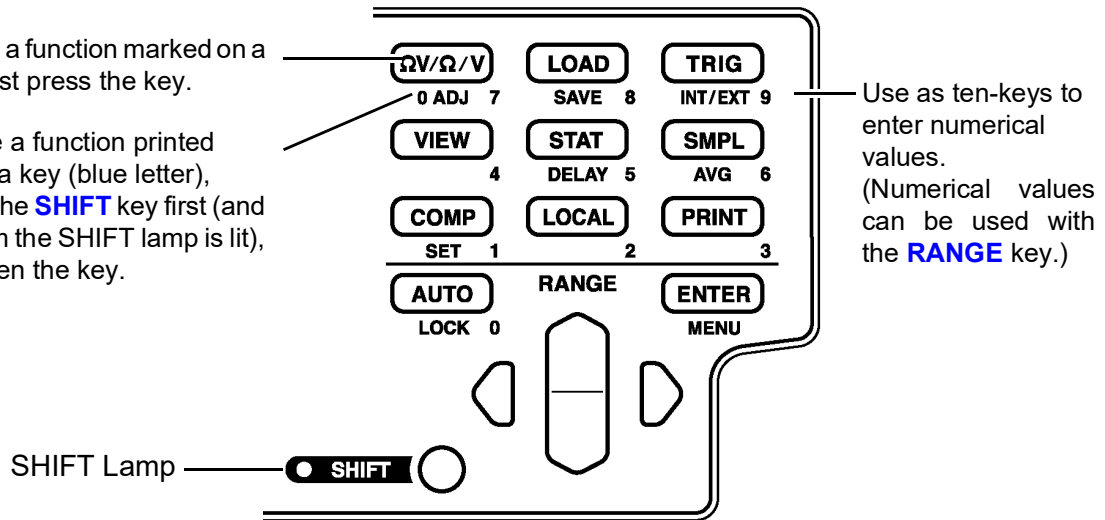

[]: Enabled after pressing the **SHIFT** key (SHIFT lamp lit).

Operating Key	Description	Operating Key	Description
ΩV/Ω/V	Selects Measurement mode. (Resistance and voltage measurement, Resistance measurement or Voltage measurement)	PRINT	Sends measurement values and statistical calculation results to the printer.
[0 ADJ]	Executes Zero-Adjustment.	AUTO	Switches between Auto and Manual range selection.
LOAD	Loads a saved measurement configuration (Panel settings).	[LOCK]	Switches the Key-Lock function on and off.
[SAVE]	Saves the current measurement configuration (Panel settings).	ENTER	Applies settings.
TRIG	Executes a Manual Trigger event.	[MENU]	Selects various operating functions and settings.
[INT/EXT]	Selects internal/external triggering.	RANGE	Up/Down: Changes setting value or numerical value, and range selection. Left/Right: Moves the setting item or digit.
VIEW	Switches the view mode of the ΩV mode.	SHIFT	<ul style="list-style-type: none"> Enables the functions of the operating keys marked in blue. The lamp is lit when the SHIFT state is active. Cancels settings in various setting displays. (Returns to the Measurement display without applying settings.) However, this does not apply to Menu display. However, from a menu item display, changed settings are not canceled, but accepted as the display returns to measurement display (except after Zero-Adjustment clear or resetting).
STAT	Displays and sets Statistical Calculation results.		
[DELAY]	Sets the Trigger Delay.		
SMPL	Selects the Sampling Rate.		
[AVG]	Activates Averaging function settings.		
COMP	Switches the Comparator function on and off.		
[SET]	Activates Comparator function setting.		
LOCAL	Cancels remote control (RMT) and re-enables key operations.		

Rear Panel

Power Inlet

Connect the supplied power cord here.
See Section 2.2 Connecting the Power Cord (p.18).

RS-232C Connector

Connection for the printer or RS-232C interface.
See Section 7.3.1 Attaching the Connector (p.89).

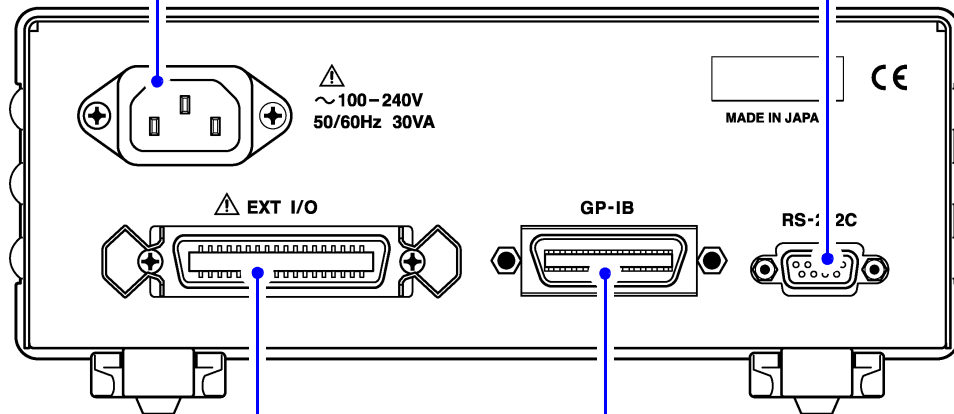

EXT I/O Connector

Connect here to use the EXT I/O interface.

GP-IB Connector (Model 3561-01 only)

Connect here to use the GP-IB interface.
7.3.1 Attaching the Connector (p.89).

* The illustration shows the Model 3561-01 BATTERY HiTESTER (GP-IB version).

! WARNING

The GP-IB connector location is covered by a blank panel on the Model 3561. To avoid electric shock, do not remove the blank panel.

Side View

Stand

Can be opened to tilt the front panel upwards.

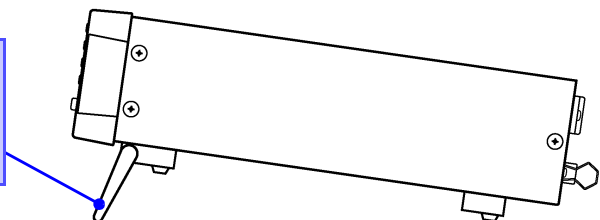

! CAUTION

Do not apply heavy downward pressure with the stand extended. The stand could be damaged.

1.4 Menu Display Sequence (SHIFT → ENTER)

Various auxiliary settings can be performed from the menu item displays.

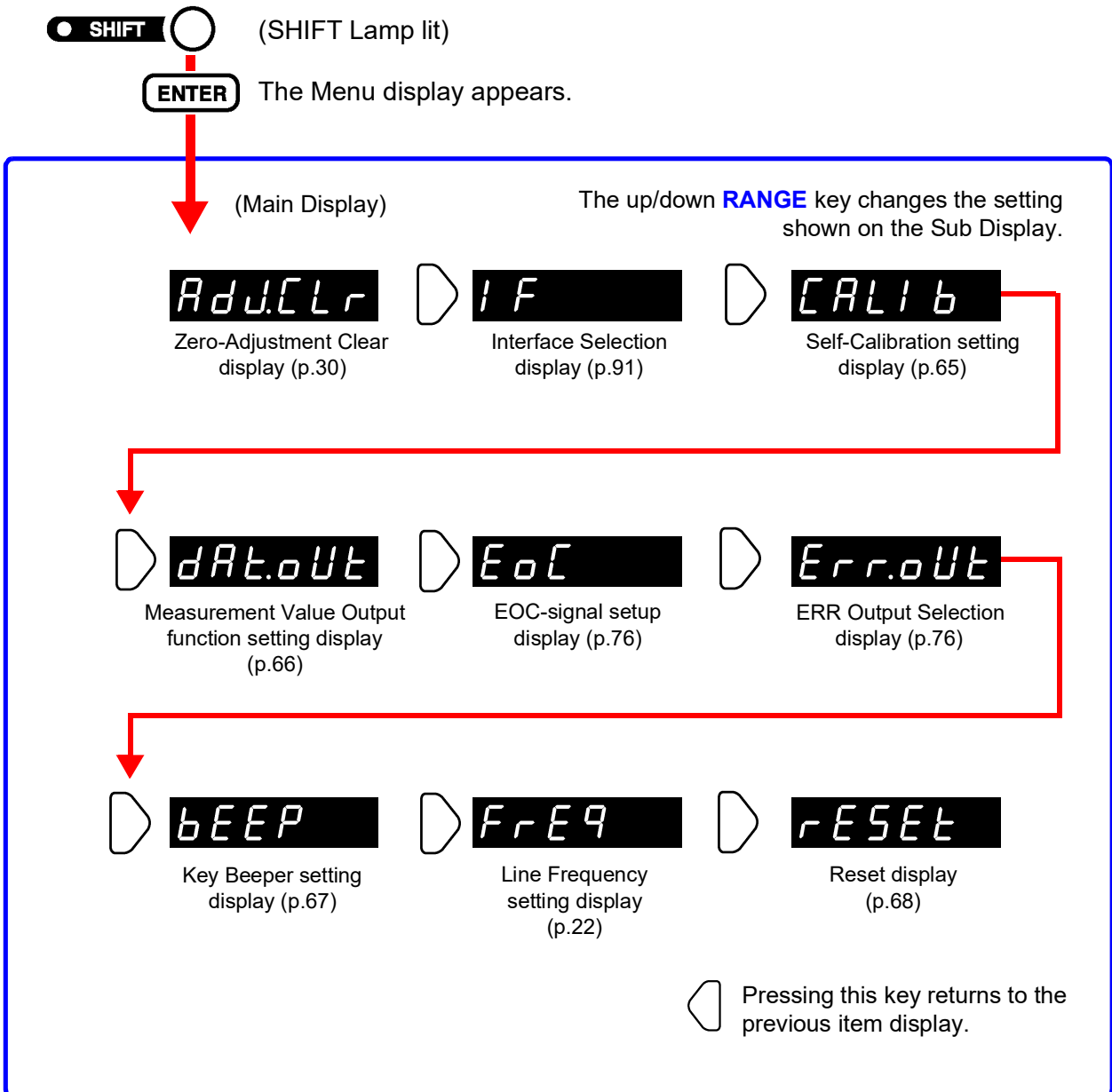

NOTE

Settings on the menu item displays are applied and saved internally when changed.

1.5 Measurement Flowchart

The basic measurement process flow is as follows:

Measurement Preparations

Connecting the power cord (p.18)



Connecting the test leads (p.19)



Turning the power on (p.21)



Selecting the line frequency (p.22)

Instrument's Settings

Selecting measurement mode (p.27)



Selecting measurement range (p.28)



Selecting sampling rate (p.30)

Zero-Adjustment

Short the test leads together (p.31)



Executing zero-adjustment

Measurement Start

Connect the test leads to a test object.



Read the measured value (p.33)

For details about the functions that can be applied to measurement values such as comparator, trigger and averaging functions, refer to Chapter 4 Applied Measurement (p.35).

Measurement Preparations

Chapter 2

2

Measurement Preparations

2.1 Preparation Flowchart

This procedure describes instrument preparations such as making connections and turning power on.

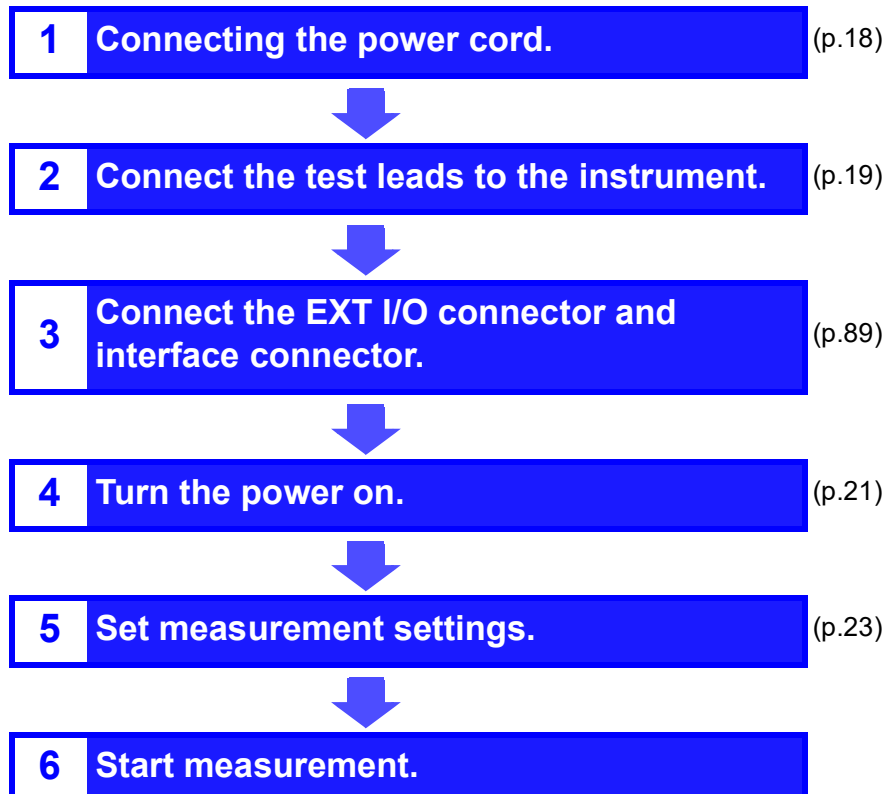
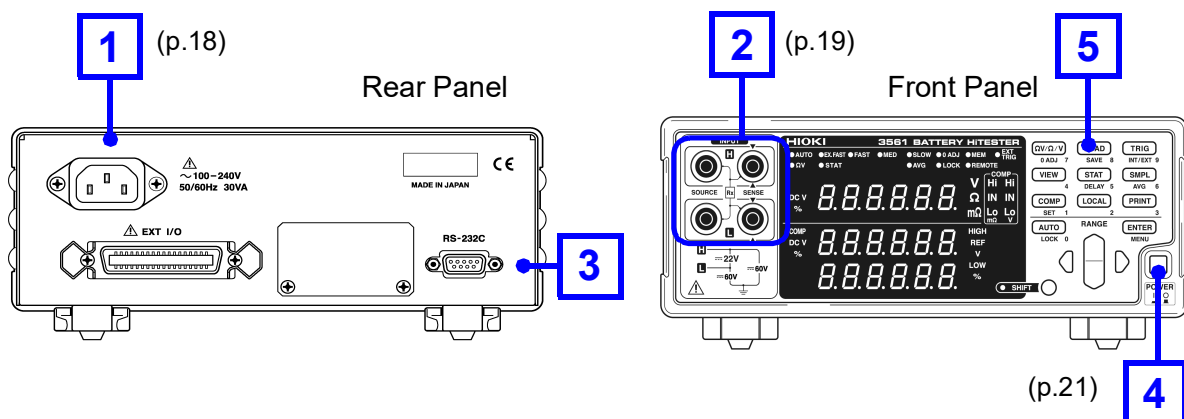

NOTE

Verify that the instrument's line frequency is correctly set when using it for the first time and after initialization following repair or recalibration.

See Section 2.5 Selecting the Line Frequency (p.22).

2.2 Connecting the Power Cord



! WARNING

To avoid electrical accidents and to maintain the safety specifications of this instrument, connect the power cord provided only to a 3-contact (two-conductor + ground) outlet.

! CAUTION

To avoid damaging the power cord, grasp the plug, not the cord, when unplugging it from the power outlet.

NOTE

To suppress noise, the instrument needs to be set to match the line frequency.

Before operating, set the instrument to the frequency of your commercial power. If the supply frequency is not set properly, measurements will be unstable.

See Section 2.5 Selecting the Line Frequency (p.22).

Make sure the power is turned off before connecting or disconnecting the power cord.

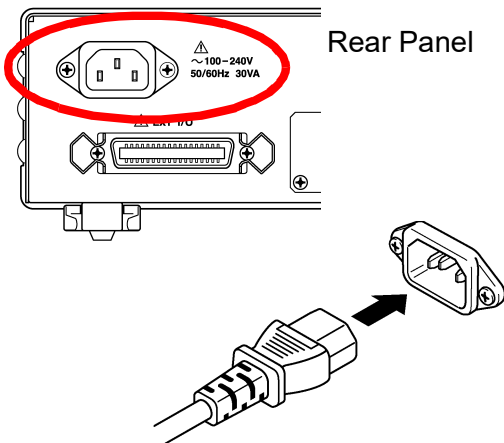

1. Confirm that the instrument's Power switch is OFF.
2. Check that the power supply voltage is correct, and connect the power cord to the power inlet socket on the rear of the instrument.
3. Plug the power cord into the AC outlet.

2.3 Connecting the Optional Test Leads



Test leads are not included as standard accessories with the instrument, so the appropriate options need to be purchased separately or constructed according to the user's application requirements. To construct custom test leads, refer to Appendix 1 Precautions for Making Custom Test Leads (p.171). The resistance measurement terminals on this instrument consist of four separate banana jacks.

See Appendix 1 Precautions for Making Custom Test Leads (p.171).

2

Measurement Preparations

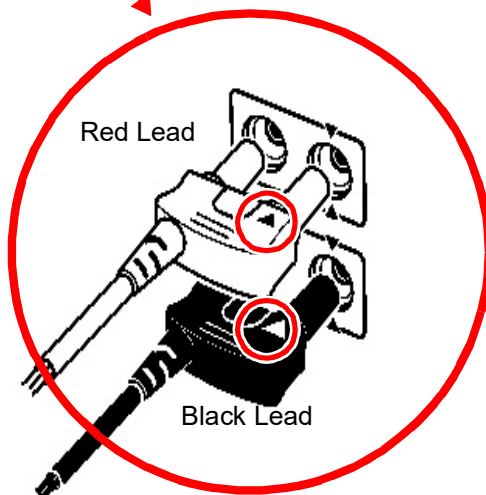
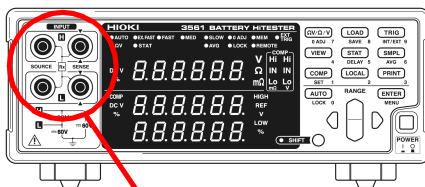

Example: Optional model L2107 CLIP TYPE LEAD

1. Confirm that the instrument's Power switch is OFF.
2. Connect four-terminal test leads such as the L2107 CLIP TYPE LEAD to INPUT A.

Plug the ▲ mark on the red lead into the red ▲ marked jack on the instrument, and plug the ▲ mark on the black lead into the black ▲ marked jack on the instrument.

About Test Leads

(Example: Model L2107 CLIP TYPE LEAD)

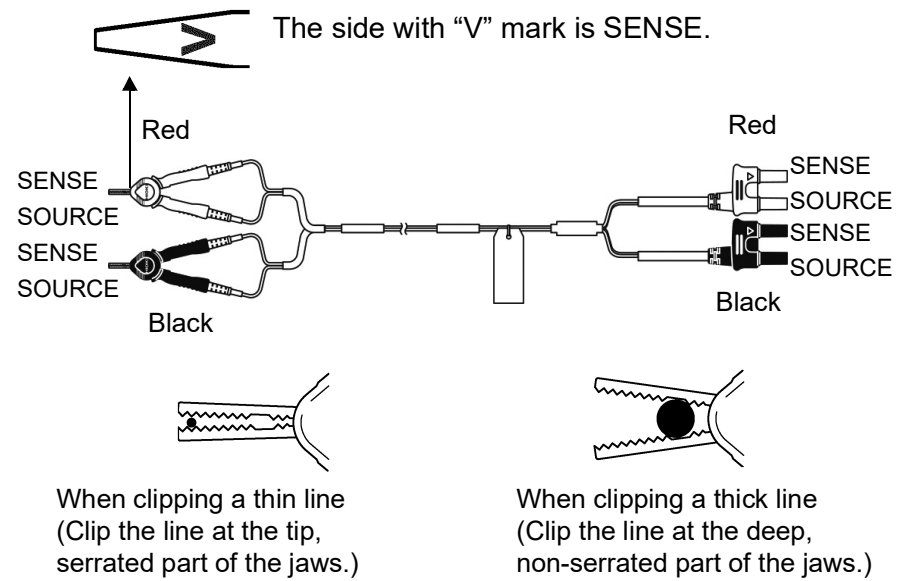

2.4 Turning the Power On and Off

WARNING

Before turning the instrument on, make sure the supply voltage matches that indicated on the its power connector. Connection to an improper supply voltage may damage the instrument and present an electrical hazard.

NOTE

- The measurement setting state is the same as when the power was previously turned off (backup). To preserve changes to settings, wait a short time (about five seconds) after changing a setting before turning power off.
- However, measurement settings made through the RS-232C or GP-IB interface and measurement settings loaded by $\overline{\text{LOAD}}$ signals of the EXT I/O connector are not memorized.
- Before starting to measure, allow 30 minutes for warm-up. After warm-up, be sure to perform a self-calibration. See Section 4.9 Self-Calibration (p.65).

2

Measurement Preparations

Turning the Power On

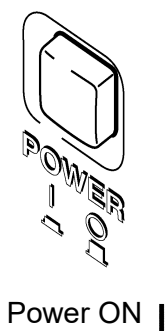

Turn the POWER switch ON.

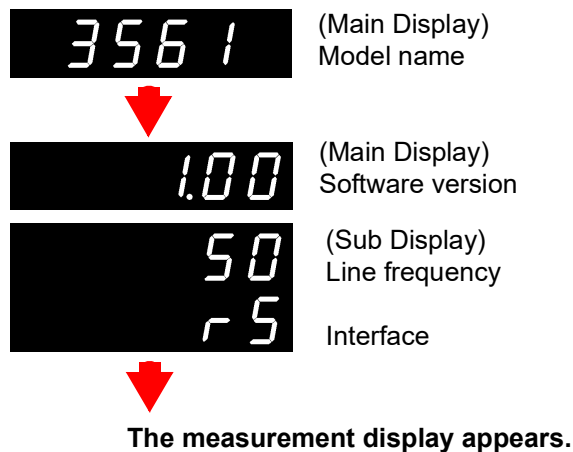

Turning the Power Off

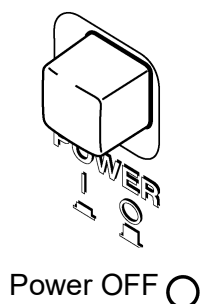

Turn the POWER switch OFF.

2.5 Selecting the Line Frequency

Verify that the instrument's line frequency is correctly set when using it for the first time and after initialization following repair or recalibration.

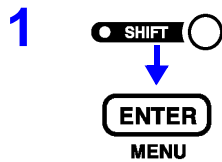

(SHIFT Lamp lit)

The Menu display appears.



Select the Line Frequency setting display.

See Section 1.4 Menu Display Sequence (SHIFT → ENTER) (p.15).

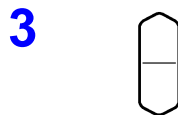
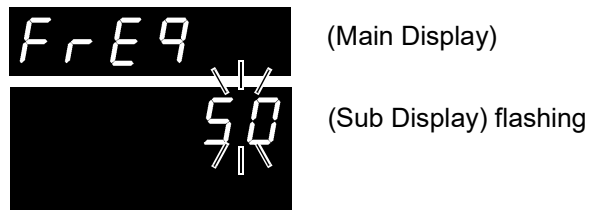

Select the frequency of the AC mains supply being used.

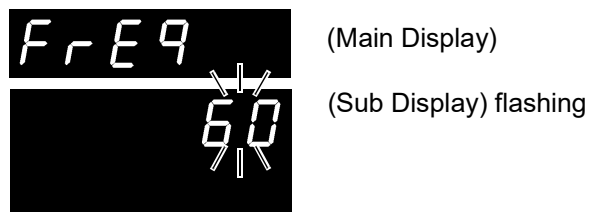

50 50 Hz

60 60 Hz



Applies settings and returns to the Measurement display.

NOTE

To suppress noise, the instrument needs to be set to match the frequency of the power source.

Before operating, set the instrument to the frequency of your commercial power. If the supply frequency is not set properly, measurements will be unstable.

Measurement *Chapter 3*

Before starting measurement, please read **Operating Precautions (p.4)** and **Chapter 2 Measurement Preparations (p.17)**.



- To avoid electrical shock, be careful to avoid shorting live lines with the test leads.
- The maximum rated voltage between input terminals and ground is ± 60 V DC. Attempting to measure voltages exceeding 60 V with respect to ground could damage the instrument and result in personal injury.



To avoid injury or damage to the instrument, do not attempt to measure AC voltage and AC current, or DC voltage exceeding ± 22 V.

3.1 Pre-Operation Inspection

Before using the instrument, perform the following inspection to ensure that it is operating properly.

Check Point	Check Contents
Instrument Chassis (both front and rear panels)	<ul style="list-style-type: none"> • No damage or cracks • No internal circuitry is exposed
Test Leads and Power Cord	<ul style="list-style-type: none"> • Metal parts that should be insulated are not exposed
Good Test Sample	<ul style="list-style-type: none"> • Measures as good and displays the correct measurement value
Bad Test Sample	<ul style="list-style-type: none"> • Measures as bad and displays the correct measurement value

If the inspection reveals a defect, stop using the instrument and contact your dealer or Hioki representative.

3.2 Basic Measurement Example

The following example describes the measurement process.

Example: Measuring resistance and voltage of a 30 mΩ lithium-ion battery

Required items:	Lithium-ion battery (30 mΩ) Test leads: Model 9770 PIN TYPE LEAD are used here.
Measurement conditions:	Measurement mode ΩV (Resistance and Voltage measurement) Range 300 mΩ Sampling range SLOW Zero adjustment Enabled

Preparations

- 1 Connect the power cord.**
See Section 2.2 Connecting the Power Cord (p.18).

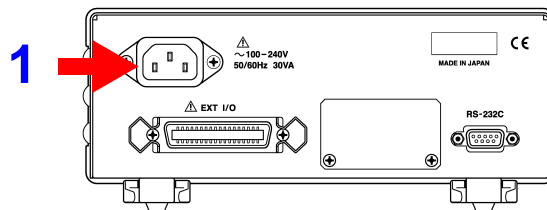

- 2 Connect the test leads.**
See Section 2.3 Connecting the Optional Test Leads (p.19).

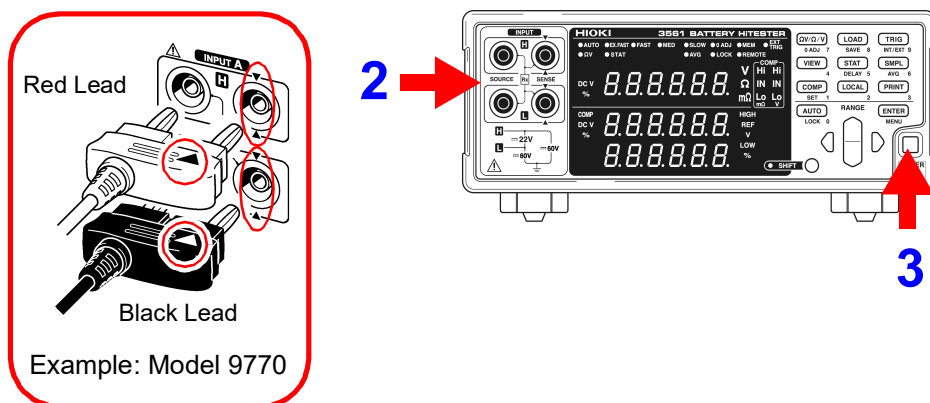

- 3 Turn the power on.**
See Section 2.4 Turning the Power On and Off (p.21).
See Section 2.5 Selecting the Line Frequency (p.22).

Instrument Settings

- 4** Confirm the **SHIFT** lamp is not lit.
If this is lit, press the **SHIFT** key to turn it off.

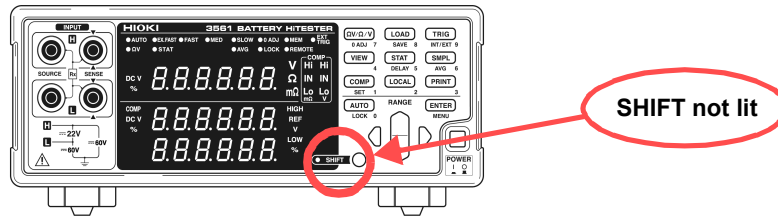

- 5** **Ω V/ Ω /V** Select the Resistance Measurement mode.
(Here, resistance and voltage measurement is selected.)
See Section 3.3 Selecting Measurement Mode (p.27).

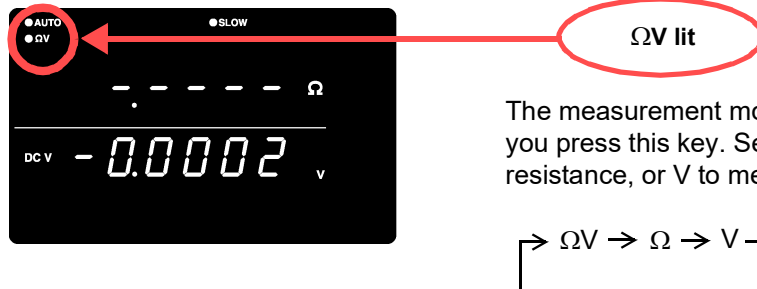

The measurement mode changes each time you press this key. Select Ω to measure only resistance, or V to measure only voltage.

- 6** Set the measurement range. (Here, 300 m Ω range is selected.)
See Section 3.4 Setting Measurement Range (p.28).

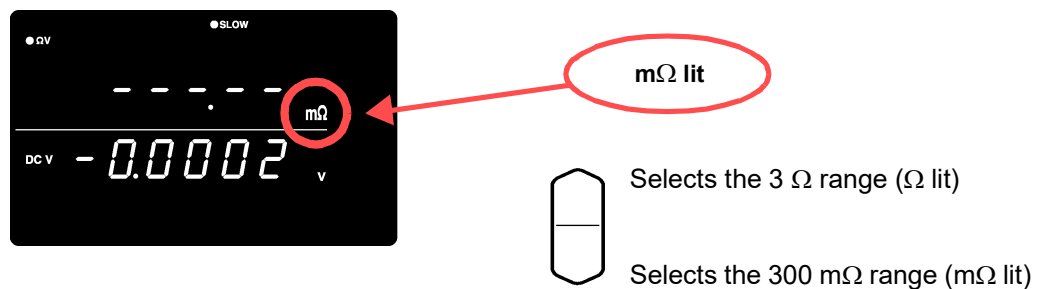

- 7** **SMPL** Set the sampling rate. (Here, SLOW is selected.)
See Section 3.5 Setting Sampling Rate (p.30).

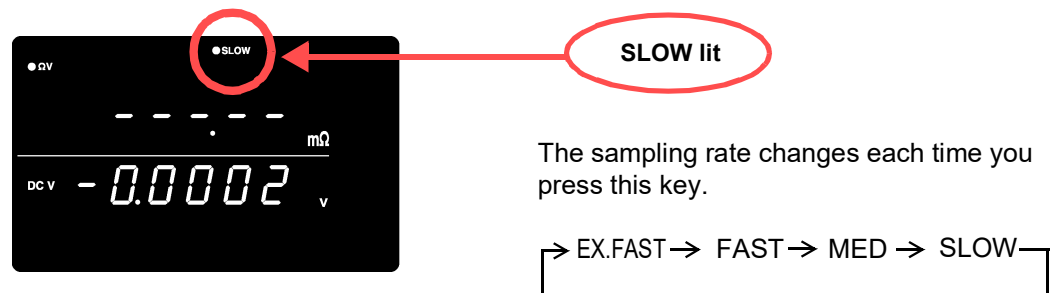

Zero-Adjustment

8

Short the test leads together.

Proper Zero-Adjustment is not possible with incorrect wiring.

See Section 3.6 Zero-Adjust Function (p.30).

Example: Model 9770 PIN TYPE LEAD

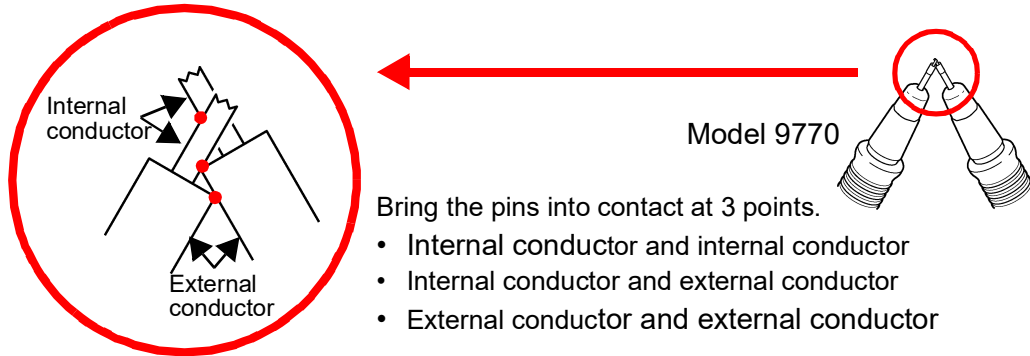

9

SHIFT (SHIFT Lamp lit)

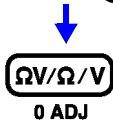

Execute Zero-Adjust.

After zero-adjustment, the display returns to the measurement mode.

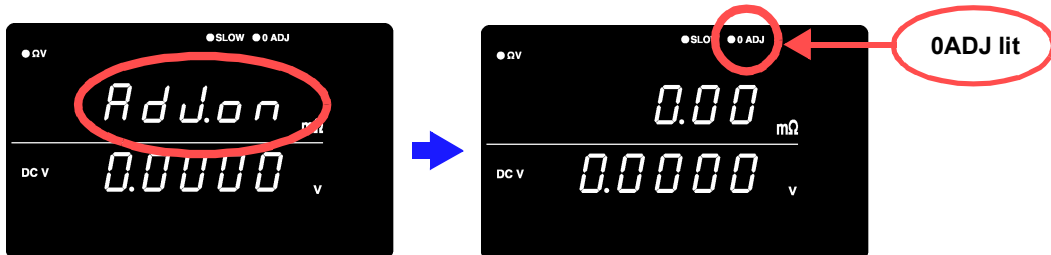

"Err.02" appears if Zero-Adjustment fails. Verify that the test lead tips are properly shorted, and try zero-adjustment again.

Measurement

10

Connect the test leads to a battery.

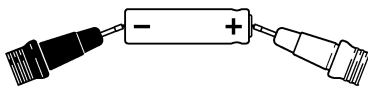

11

Read the measured resistance and voltage.

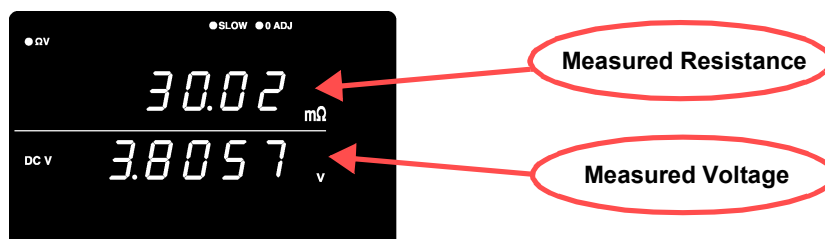

See Section 3.7 Displaying Measurement Results (p.33).

See Section 9.3 Error Display (p.170).

3.3 Selecting Measurement Mode

Select the measurement mode from ΩV (both resistance and voltage measurement), Ω (resistance measurement only) or V (voltage measurement only).

1

Confirm the **SHIFT** lamp is not lit.

If this is lit, press the **SHIFT** key to turn it off.

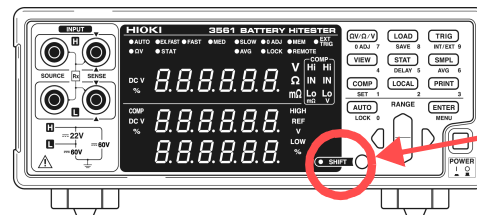

SHIFT not lit

2

 $\Omega V/\Omega/V$

Switches the displayed measurement mode.

Each key-press switches the measurement mode.

ΩV mode

(Resistance and Voltage measurement)

" ΩV " indicates the ΩV mode is selected

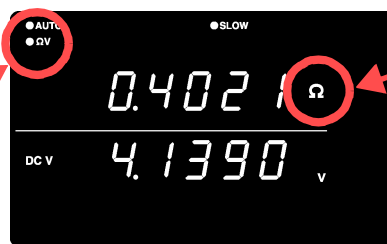

" Ω " indicates the 3 Ω range is selected
 " $m\Omega$ " indicates the 300 $m\Omega$ range is selected

Ω mode
 (Resistance measurement)

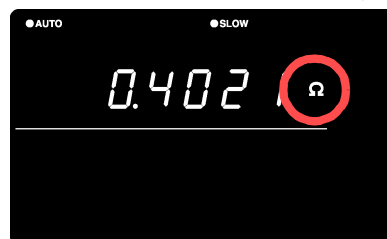

V mode
 (Voltage measurement)

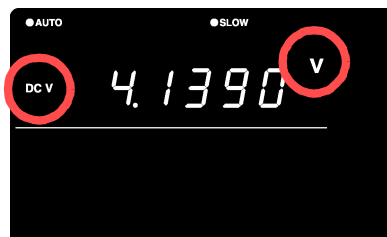
 $\Omega V/\Omega/V$

NOTE

The fastest measurements are provided by selecting the Ω or V mode when measuring resistance or voltage, respectively. See Section Sampling Time (p.164).

3

Measurement

3.4 Setting Measurement Range

Select the resistance measurement range from 3 Ω (" Ω " indicator lit) or 300 m Ω ("m Ω " indicator lit). The auto-ranging function can be enabled to automatically determine the most suitable range. The voltage measurement range is fixed at 20 V.

3.4.1 Manual Range Setting

1

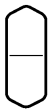

When auto-ranging is enabled, pressing this disables it (AUTO not lit) and enables manual range selection.

2

Select the range to use.

When the 3 Ω range is selected

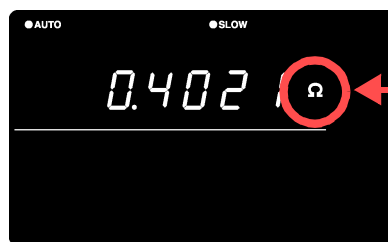

Ω lit

3 Ω range

When the 300 m Ω range is selected



300 m Ω range

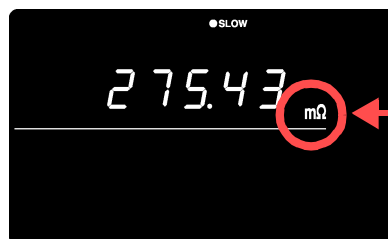

m Ω lit

3.4.2 Auto-Ranging

AUTO

When manual range selection is enabled, pressing this enables **auto-ranging**. The most suitable measurement range is then selected automatically.



Switching from Auto-ranging back to Manual range selection

Press the **AUTO** key again. The range can now be changed manually.

NOTE

- Voltage measurement has only one range. The range cannot be changed.
- Depending on the state of the test object, auto-ranging may be unstable. In this case, select the range manually, or increase the Delay time.
See Section 3.4.1 Manual Range Setting (p.28).
- Auto-ranging is not available when Comparator or Memory functions are enabled (ON).
- Refer to Chapter 8 Specifications (p.163) for details about accuracy.

Range	Displayed Values	Resistance Measurement Mode	
		Measured Current	Open-Terminal Voltage
300 mΩ	-10.00 to 310.00 mΩ	10 mA ± 10%	7 V _{peak} .
3 Ω	-0.1000 to 3.1000 Ω	1 mA ± 10%	7 V _{peak} .
20 V	-19.9999 to 19.9999 V	--	7 V _{peak} .

3.5 Setting Sampling Rate

The sampling rate can be selected from EX.FAST, FAST, MEDIUM and SLOW. Slower sampling rates generally provide greater measurement precision.

SMPL Selects the sampling rate

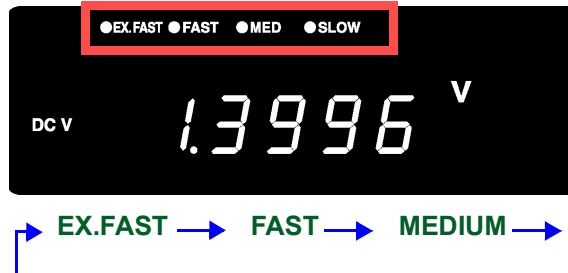

NOTE

- Measurements are especially susceptible to interference from the environment when EX.FAST is selected, so countermeasures such as shielding or twisting of test leads, cables and wiring around the test object may be necessary.
- When SLOW sampling is selected, self-calibration is executed during each measurement. At other sampling rates, self-calibration is executed manually or automatically every 30 minutes. See Section 4.9 Self-Calibration (p.65).
- Refer to the specifications for details of sampling rates. See Section Sampling Time (p.164).

3.6 Zero-Adjust Function

Execute zero adjustment before measuring to nullify any residual offset voltage from the instrument or measurement environment. Measurement accuracy specifications are applicable after zero adjustment. Zero adjustment can also be executed by the 0ADJ terminal of the EXT I/O connector. See Section 5.2 Signal Descriptions (p.72).

3.6.1 Wiring Method for Zero-Adjustment

Before executing zero adjustment, connect the test leads (probes) as follows:

1. Connect SENSE-H to SENSE-L.
2. Connect SOURCE-H to SOURCE-L.
3. Connect the joined SENSE and SOURCE leads together as shown below.

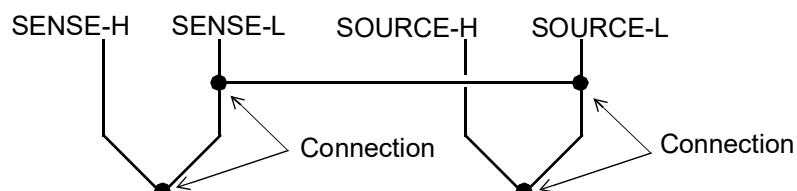

3.6.2 Executing Zero-Adjustment

1

Short the test leads together.

Proper zero adjustment is not possible with incorrect wiring.

Example: Model L2107 CLIP TYPE LEAD

Correct

SENSE

SOURCE

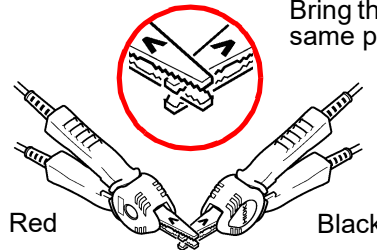

SENSE

SOURCE

Red

Black

Incorrect

SENSE

SOURCE

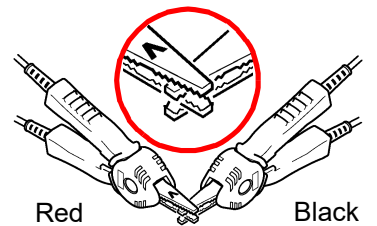

SOURCE

SENSE

Red

Black

Model 9452 (Option)

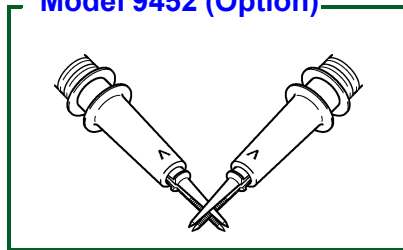

Model 9453 (Option)

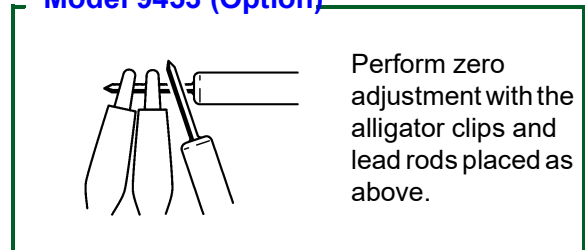

Model 9770 (Option)

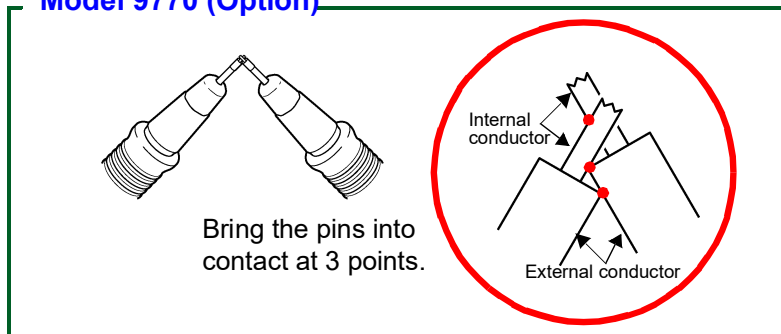

Model 9771 (Option)

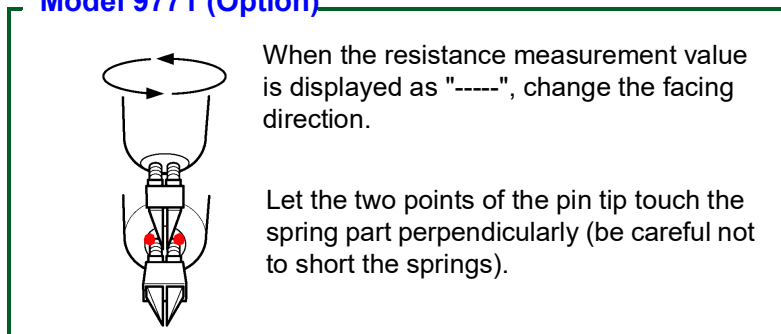

3

Measurement

3.6 Zero-Adjust Function

2  (SHIFT Lamp lit)



Zero-adjust display appears.



After measurement, the measured value of the compensation applied by the zero-adjust function is displayed.

The range of zero adjustment is up to 1,000 dgt.

Clearing Zero-Adjustment

1  (SHIFT Lamp lit)

(SHIFT Lamp lit)

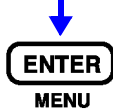

The Menu display appears.



(Main Display)

(Sub Display) flashing

2 

The zero-adjust value is cleared. (**0ADJ** not lit)



(Main Display)



If Err02 is displayed

Indicates that zero adjustment could not be executed, either because the range to be adjusted exceeds $\pm 1,000$ dgt, or a measurement fault condition exists.

The zero adjust function is canceled, so repeat the operation after correcting the cause of the error.

NOTE

- Zero adjustment is limited to $\pm 1,000$ dgt.
- Both resistance (all ranges) and voltage are adjusted together for all modes.
- Zero-adjustment values are retained even when power is turned off.
- The 0ADJ terminal of the EXT I/O connector also executes zero adjustment.
See Section 5.2 Signal Descriptions (p.72).
- Zero adjustment is very difficult with the delicate probe tips of the Model 9455 PIN TYPE LEAD. Refer to 3.6.1 Wiring Method for Zero-Adjustment (p.30) to use other leads when executing zero adjustment.

3.7 Displaying Measurement Results

In the ΩV mode, resistance measurements appear on the upper display, and voltage measurements appear on the lower display.

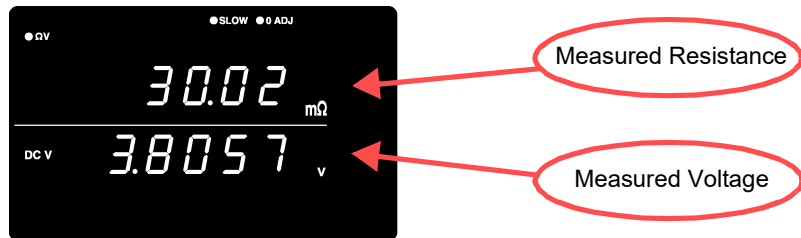

In the Ω mode, resistance measurements appear on the upper display.

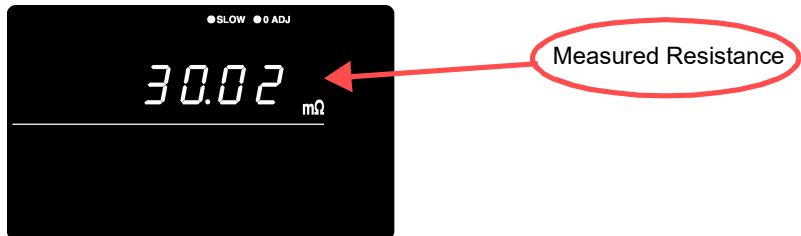

In the V mode, voltage measurements appear on the upper display.

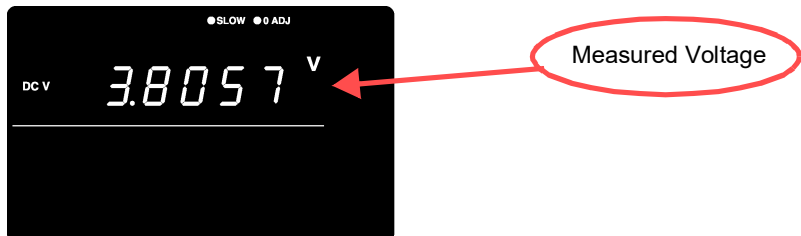

3.7.1 Measurement Fault Detection

If a measurement does not execute properly, a measurement fault “- - - -” is indicated on the display.

In addition, a measurement fault signal (ERR) is output at the EXT I/O connector.

See Section 5.2.4 ERR Output (p.75).

A measurement fault is displayed in the following cases.

- When a test lead is not connected to the test object
- When the resistance of the measured object is over-range
Example: Attempting to measure 30 Ω with the 300 m Ω range selected.
- If any of the following is open, or has a bad connection: SOURCE-H, SOURCE-L, SENSE-H, SENSE-L
- When the resistance between SOURCE-H and SOURCE-L is 50 Ω or more in the 300 m Ω range (or 500 Ω or more in the 3 Ω range)
- When the resistance between SENSE-H and SENSE-L is greater than about 20 Ω . (However, if the capacitance of the test leads is 1 nF or higher, the measurement fault may not be detected.)
- When a bad contact results from damage, excessive wear or impurities on the test leads.
- If the circuit protection fuse is blown
See Section 9.1 Troubleshooting (p.169).

3.7.2 Overflow Display

Overflow is indicated by “OF” or “-OF” on the display, caused by one of the following:

Display	Condition
OF	<ul style="list-style-type: none"> • The measured value exceeds the limit of the current measurement range • When the result of relative value calculation is larger than +99.999%.
-OF	<ul style="list-style-type: none"> • The measured value is below the limit of the current measurement range • When the result of relative value calculation is smaller than -99.999%.

Applied Measurement

Chapter 4

This chapter describes advanced operations employing the Comparator, Statistical Calculation and Memory functions.

Judge measurement values against specified thresholds	Comparator Function	(36 page)
Measure when trigger events occur	Trigger Function	(53 page)
Output averaged measurement values	Averaging Function	(55 page)
Display the results of calculation expressions applied to measurement values	Statistical Calculation Functions	(56 page)
Store measurement values	Memory Function	(60 page)
Lock the keys	Key-Lock Function	(62 page)
Save measurement configurations	Panel Save Function	(63 page)
Load saved measurement configurations	Panel Load Function	(64 page)
Increase measurement precision	Self-Calibration	(65 page)
Output measurement values via the RS-232C interface according to trigger input timing	Measurement Value Output Function	(66 page)
Enable/disable key-press beeps	Key Beeper Setting	(67 page)
Re-initialize the instrument	Reset Function	(68 page)

4.1 Comparator Function

The comparator function compares measured values to preset upper and lower thresholds, judges the measurements according to their relative levels within the preset range, and indicates the results of the comparisons.

Comparator thresholds can be set either by specifying upper and lower thresholds, or by specifying a reference value and tolerance.

Comparator results can be indicated by the Hi, IN and Lo LEDs, beeper sound and signal output at the EXT I/O connector.

See Section Chapter 5 External Control (p.71).

The comparator setting process flow is as follows:

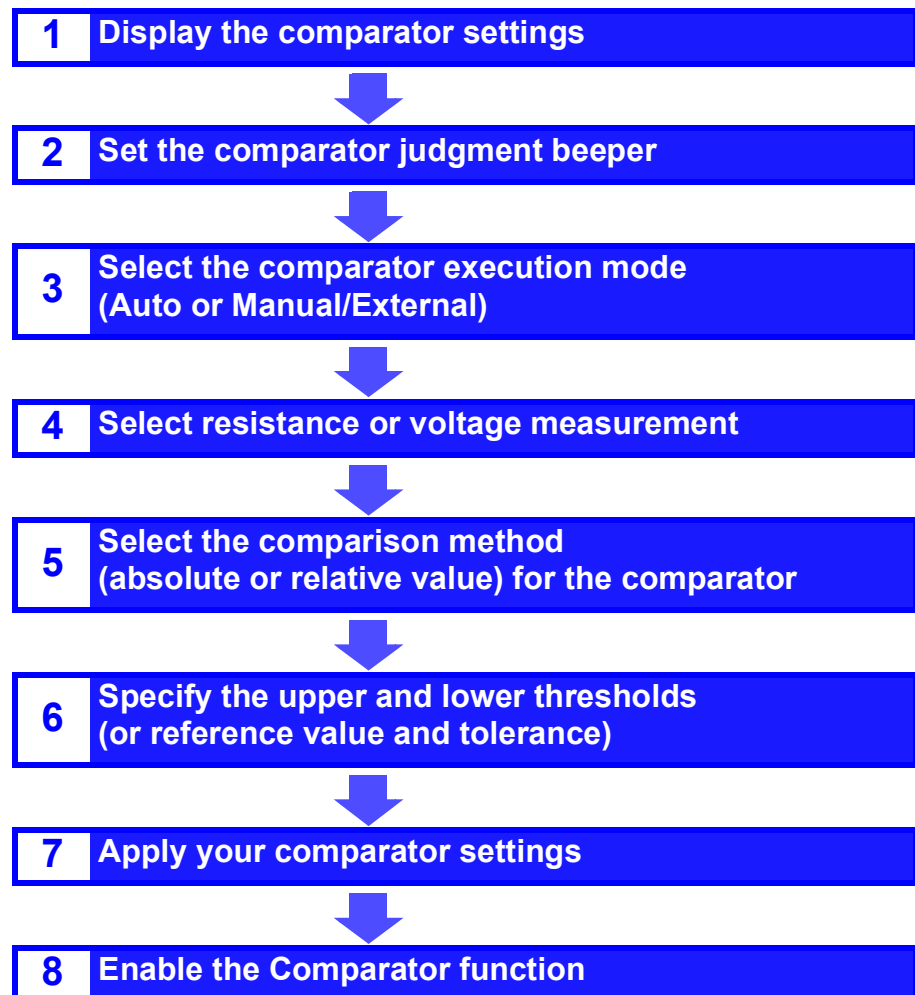

4.1.1 Comparator Setting Example 1 (Upper and Lower Threshold Judgment)

This example describes the comparator setting method.

Example:

Set the upper and lower thresholds for resistance and voltage in the ΩV mode (300 m Ω range), and indicate whether the measurement value exceeds the upper or lower thresholds by sounding the beeper.

Resistance : Upper threshold value 150.00 m Ω , Lower threshold value 100.00 m Ω
Voltage : Upper threshold value 15.2000 V, Lower threshold value 15.0000 V

- 1 **Confirm that the Comparator function is OFF.**
First make sure the Comparator function is disabled. Settings cannot be changed while the Comparator function is enabled. Press the **COMP** key, if necessary, to disable the Comparator function.

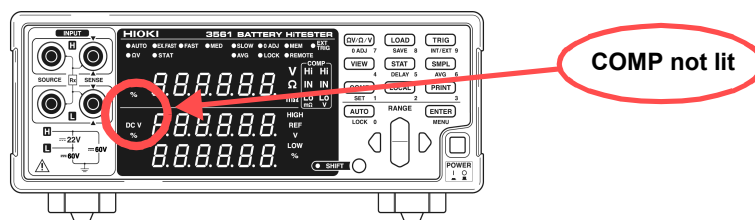

- 2 **$\Omega V/\Omega/V$** Select the ΩV measurement mode.



- 3 Select the measurement range (for this example, the 300 m Ω range).

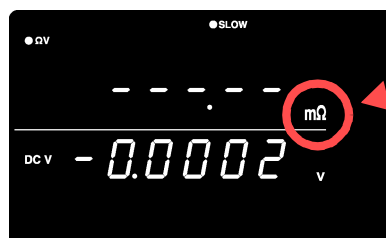

m Ω lit



Selects the 3 Ω range (Ω lit)

Selects the 300 m Ω range (m Ω lit)

- 4 **SHIFT** The Comparator setting display appears.

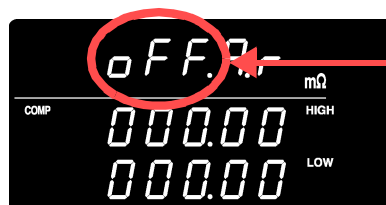
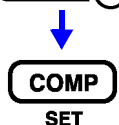

OFF flashing

4.1 Comparator Function

5

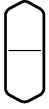

Set the comparator judgment beeper (for this example, select HL).



HL flashing

oFFno beeps sound

Inbeeps continuously (when measurements are IN)

HL.....beeps repeatedly (when measurements are Hi or Lo)

btH1.....beeps continuously while measurements are within the thresholds (IN), and beeps repeatedly when measurements are Hi or Lo.

btH2.....beeps once when measurements move into the threshold range (IN), and beeps repeatedly when measurements go Hi or Lo.

6



Press so that the indicated position blinks, and select the comparator execution mode (for this example, Auto).



A flashing

A..... Auto Comparator (default setting)

E..... Manual Comparator

7



Press so that the indicated position blinks, and select resistance.



r flashing

rResistance

uVoltage

8



Press so that the indicated position blinks, and select the comparison method for the comparator (here, HIGH/LOW).



HIGH & LOW flashing

HIGH, LOW Compare by upper and lower thresholds (default setting)

REF, %..... Compare by reference value and tolerance

9

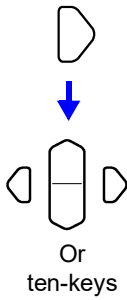

Switch to the upper/lower threshold setting display, and specify the thresholds.



For this example,
Upper Threshold: 150 mΩ

Upper Threshold: 100 mΩ

<p>Using the RANGE keys:</p> <p>Select a digit to change by moving the blinking location, then select the new numerical value.</p> <p> Select a digit</p> <p> Select numerical value</p>	<p>Using the ten-keys:</p> <p>Press the numeric keys corresponding to the digits to be entered.</p> <table border="0"> <tr> <td></td> <td></td> <td></td> </tr> <tr> <td>0 ADJ 7</td> <td>SAVE 8</td> <td>INT/EXT 9</td> </tr> <tr> <td></td> <td></td> <td></td> </tr> <tr> <td>4</td> <td>DELAY 5</td> <td>AVG 6</td> </tr> <tr> <td></td> <td></td> <td></td> </tr> <tr> <td>SET 1</td> <td>2</td> <td>3</td> </tr> <tr> <td></td> <td></td> <td></td> </tr> <tr> <td>LOCK 0</td> <td></td> <td></td> </tr> </table>				0 ADJ 7	SAVE 8	INT/EXT 9				4	DELAY 5	AVG 6				SET 1	2	3				LOCK 0		
0 ADJ 7	SAVE 8	INT/EXT 9																							
4	DELAY 5	AVG 6																							
SET 1	2	3																							
LOCK 0																									

To enter the current measurement as the setting value: **AUTO** key
 To enter the result of statistical calculation as the setting value: **STAT** key
 See Section 4.1.6 Upper and Lower Thresholds Setting (by Reference Value and Tolerance) (p.48).

10



Press so that the indicated position blinks, and select voltage.



u flashing

r Resistance
 u Voltage

11



Press so that the indicated position blinks, and select the comparison method for the comparator (here, HIGH/LOW).



HIGH & LOW flashing

HIGH, LOW Compare by upper and lower thresholds (default setting)
REF, % Compare by reference value and tolerance

4.1 Comparator Function

12

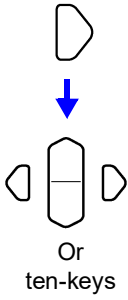

Switch to the upper/lower threshold setting display, and specify the thresholds.



For this example,
Upper Threshold: 15.2 V

Upper Threshold: 15 V

13



Applies setting and returns to the Measurement display. The comparator function is enabled.

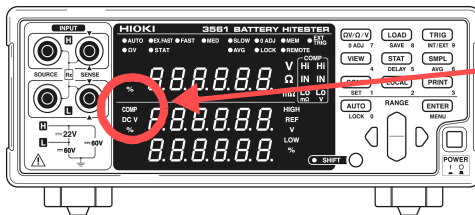

COMP lit

To cancel the settings: **SHIFT** key

14

Connect a test object and judge the measured value.

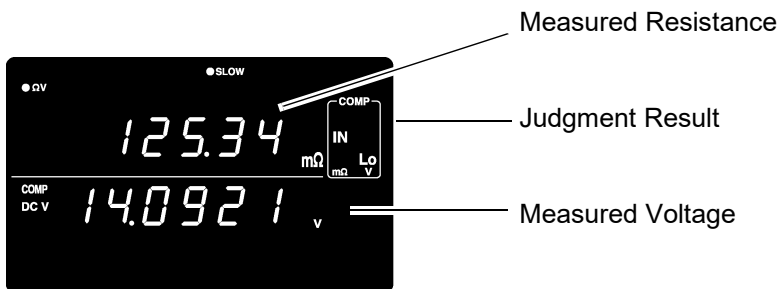

Measured Resistance

Judgment Result

Measured Voltage

In the ΩV mode, you can verify comparator settings by pressing the **VIEW** key. See Section 4.1.9 Switching Between Measurement Value and Comparator Setting Displays (p.52).

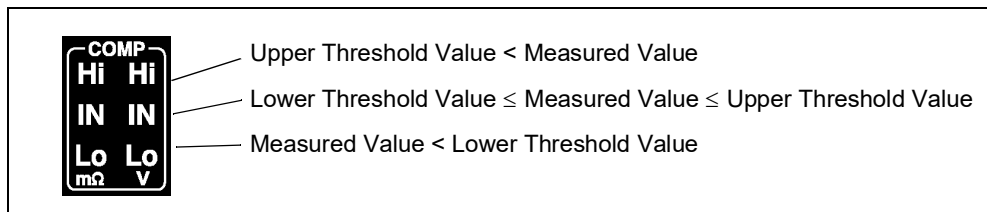

注記

The upper and lower thresholds are saved as the displayed counts (independent of measurement mode and range). Therefore, changing the measurement mode or range results in the same display counts representing different absolute values.

Example:

To specify the lower threshold as 150 mΩ in the 300 mΩ range, enter “15000”. Switching to the 3 Ω range after making this setting changes the lower threshold to 1.5 Ω.

4.1.2 Comparator Setting Example 2 (Reference Value and Tolerance Judgment)

This example describes the comparator setting method.

Example:

Set a reference value and tolerance in the ΩV mode (3 Ω range), and set the beeper to sound while measured values are within tolerance.

Resistance : Reference value 1.5 Ω , Tolerance 5%
 Voltage : Reference value 4.2 V, Tolerance 0.5%

- 1 **Confirm that the Comparator function is OFF.**
 First make sure the Comparator function is disabled. Settings cannot be changed while the Comparator function is enabled. Press the **COMP** key, if necessary, to disable the Comparator function.

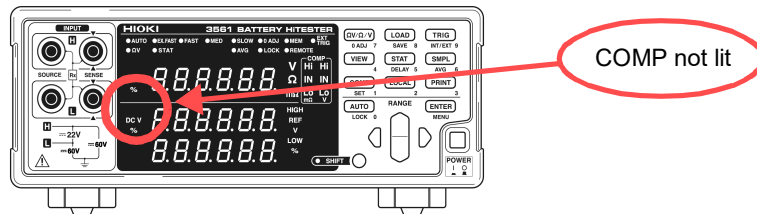

- 2 **$\Omega V/\Omega/V$** Select the ΩV measurement mode.



- 3 Select the measurement range (for this example, the 3 Ω range).

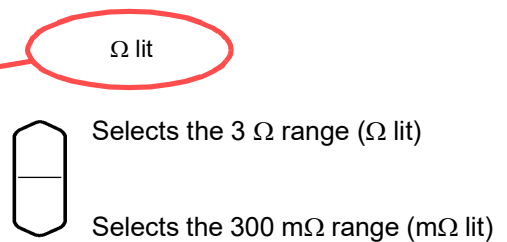

- 4 **SHIFT** The Comparator setting display appears.

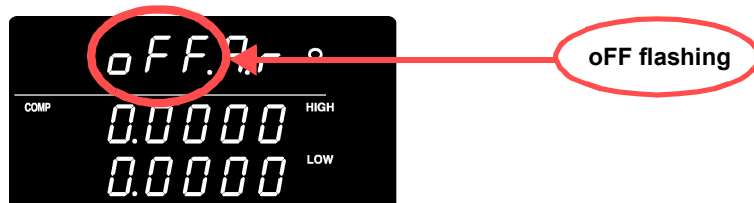
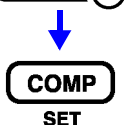

4.1 Comparator Function

5

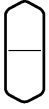

Set the comparator judgment beeper (for this example, select In).

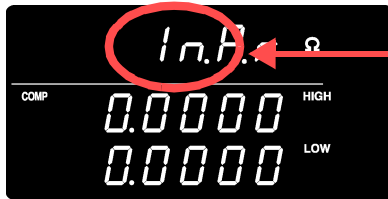

In flashing

oFFno beeps sound

Inbeeps continuously (when measurements are IN)

HLbeeps repeatedly (when measurements are Hi or Lo)

btH1beeps continuously while measurements are within the thresholds (IN), and beeps repeatedly when measurements are Hi or Lo.

btH2beeps once when measurements move into the threshold range (IN), and beeps repeatedly when measurements go Hi or Lo.

6



Press so that the indicated position blinks, and select the comparator execution mode (for this example, Auto).



A flashing

A Auto Comparator (default setting)

E Manual Comparator

7



Press so that the indicated position blinks, and select resistance.

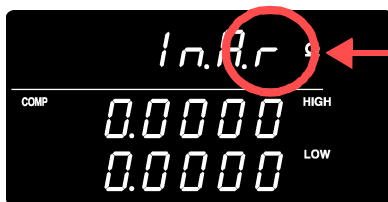

r flashing

rResistance

uVoltage

8



Press so that the indicated position blinks, and select the comparison method for the comparator (here, REF/%).



REF & % flashing

HIGH, LOW Compare by upper and lower thresholds (default setting)

REF, % Compare by reference value and tolerance

9

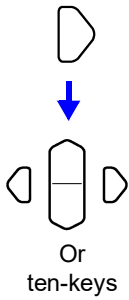

Switch to the Ref/% threshold setting display, and specify the thresholds.



Relative (%) calculation expression

$$\frac{\text{Measured resistance} - \text{Reference value}}{\text{Reference value}} \times 100$$

For this example,
Reference value: 1.5 Ω

Tolerance: 5%

<p>Using the RANGE keys:</p> <p>Select a digit to change by moving the blinking location, then select the new numerical value.</p> <p> Select a digit</p> <p> Select numerical value</p>	<p>Using the ten-keys:</p> <p>Press the numeric keys corresponding to the digits to be entered.</p> <table border="0"> <tr> <td> 0</td> <td> 7</td> <td> 9</td> </tr> <tr> <td> 4</td> <td> 8</td> <td> 9</td> </tr> <tr> <td> 5</td> <td> 6</td> <td> 6</td> </tr> <tr> <td> 5</td> <td> 3</td> <td></td> </tr> <tr> <td> 1</td> <td> 2</td> <td> 3</td> </tr> <tr> <td> 1</td> <td></td> <td></td> </tr> <tr> <td> 0</td> <td></td> <td></td> </tr> <tr> <td> 0</td> <td></td> <td></td> </tr> </table>	0	7	9	4	8	9	5	6	6	5	3		1	2	3	1			0			0		
0	7	9																							
4	8	9																							
5	6	6																							
5	3																								
1	2	3																							
1																									
0																									
0																									

To enter the current measurement as the setting value: **AUTO** key
 To enter the result of statistical calculation as the setting value: **STAT** key
 See Section 4.1.6 Upper and Lower Thresholds Setting (by Reference Value and Tolerance) (p.48).

10



Press so that the indicated position blinks, and select voltage.

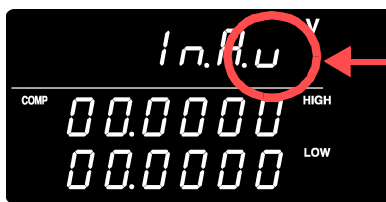

u flashing

r..... Resistance
 u..... Voltage

11



Press so that the indicated position blinks, and select the comparison method for the comparator (here, REF/%).



REF & % flashing

HIGH, LOW..... Compare by upper and lower thresholds (default setting)
REF, % Compare by reference value and tolerance

4.1 Comparator Function

12

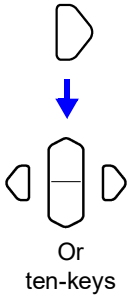

Switch to the Ref/% threshold setting display, and specify the thresholds.



Relative (%) calculation

$$\frac{\text{Measured voltage} - \text{Reference value}}{\text{Reference value}} \times 100$$

For this example,
Reference value: 4.2 V

Tolerance: 0.5%

13



Applies setting and returns to the Measurement display. The comparator function is enabled.

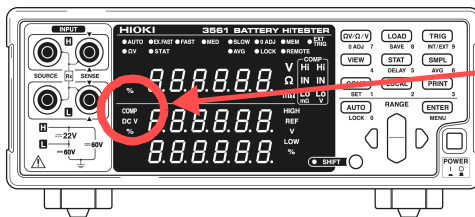

COMP lit

To cancel the settings: SHIFT key

14

Connect a test object and judge the measured value.

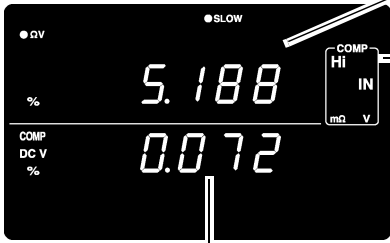

Resistance measurements are displayed as their relative percentage offset from the reference value (%)

Judgment Result

$$\text{Relative percentag} = \frac{\text{Measured resistance} - \text{Reference value}}{\text{Reference value}} \times 100$$



Voltage measurements are displayed as their relative percentage offset from the reference value (%)

In the ΩV mode, you can verify comparator settings by pressing the VIEW key. See Section 4.1.9 Switching Between Measurement Value and Comparator Setting Displays (p.52).

COMP		Upper Threshold Value of setting range < Measured value
Hi	Hi	Lower Threshold Value of setting range ≤ Measured value ≤ Upper Threshold Value of setting range
IN	IN	
Lo	Lo	Measured value < Lower Threshold Value of setting range
mΩ	V	

4.1.3 Comparator Judgment Beeper Setting

Four beeper settings are available to audibly indicate comparator judgment results.

1  (SHIFT Lamp lit)

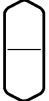
 The Comparator setting display appears.

2  Set the comparator judgment beeper.



oFF no beeps sound

In beeps continuously (when measurements are IN)

HL beeps repeatedly (when measurements are Hi or Lo)

btH1 beeps continuously while measurements are within the thresholds (IN), and beeps repeatedly when measurements are Hi or Lo.

btH2 beeps once when measurements move into the threshold range (IN), and beeps repeatedly when measurements go Hi or Lo.

NOTE

- The beeper does not sound when the comparator judgment beeper setting is disabled (oFF).
- The beeper does not sound when there is no judgment result. See Section 4.1.8 Comparator Judgment Results (p.51).

4.1.4 Comparator Execution Mode Setting

Comparator judgment execution is selected by setting the auto or manual/external comparator mode. Comparator judgment can be enabled and disabled by EXT I/O signals. Refer to 5.2.2 Input Signals (p.73).

1  (SHIFT Lamp lit)



The Comparator setting display appears.

2



Press so that the indicated position blinks, and set the comparator execution mode.



(Main Display)

AAuto comparator (comparator results are always output [default setting])



EManual comparator (comparator results are output only when the MANU EXT I/O input is enabled [ON])

NOTE

The auto setting is appropriate for normal use. Use the manual/external setting when you need to control comparator judgment timing.

4.1.5 Comparator Threshold Method Selection

Two methods are available for setting comparator thresholds.

- 1  (SHIFT Lamp lit)
 The Comparator setting display appears.

- 2  Press so that the indicated position blinks, and set the comparator threshold method.



HIGH, LOW Compare against specified upper and lower thresholds (default setting method)

REF, % Compare against upper and lower thresholds internally calculated from a specified reference value and tolerance

About comparisons based on a reference value and tolerance

When the reference value and tolerance method is selected, thresholds are calculated as follows:

Upper threshold = reference value \times (100 + tolerance [%]) / 100

Lower threshold = reference value \times (100 - tolerance [%]) / 100

Measured values are displayed as a percentage relative to the reference value, calculated as follows:

Relative value = (measured value - reference value) / reference value \times 100 [%]

4.1.6 Upper and Lower Thresholds Setting (by Reference Value and Tolerance)

1 **SHIFT** (SHIFT Lamp lit)

COMP
SET The Comparator setting display appears.

2 Press so that the indicated position blinks, and select resistance or voltage.



rResistance
uVoltage

3 Select the threshold setting display, and enter upper and lower threshold values.

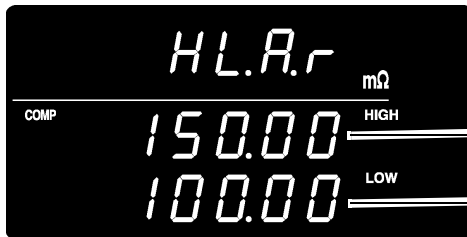
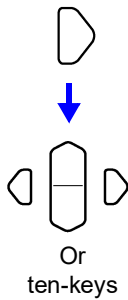

For example,
Upper Threshold: 150 mΩ
Lower Threshold: 100 mΩ

Using the **RANGE** keys:
Select a digit to change by moving the blinking location, then select the new numerical value.



Select a digit

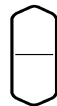

Select numerical value

Using the ten-keys:
Press the numeric keys corresponding to the digits to be entered.

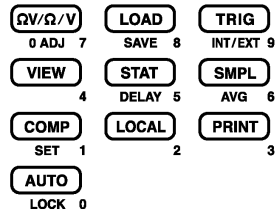

4.1 Comparator Function

To enter the current measurement as the setting value: **AUTO** key

The current measurement value is set as the upper or lower threshold (during upper/lower threshold setting), or as the reference value (during reference value and tolerance setting). If the measured value is faulty or \pm OF, it is ignored (not entered).

To enter a statistical calculation result as the setting value: **STAT** key

The result of statistical calculation is set as follows:

During upper/lower threshold setting	Upper threshold = average value + 3σ Lower threshold = average value - 3σ
During reference value and tolerance setting	Reference value = average value Tolerance = $3\sigma / \text{average value} \times 100\%$

Where " σ " represents population standard deviation (σ_n).

No setting occurs if statistical calculation is disabled and no statistical calculation result exists.

See Section 4.4 Statistical Calculation Functions (p.56).

Setting thresholds from the **AUTO** and **STAT** keys is possible only when the selected (blinking) character is non-numeric.

NOTE

Threshold and reference values can be set from 0 to 99999 (or 999999 for voltage), and tolerance can be set from 0.000 to 99.999%. Negative values are not settable. Entries using statistical calculation results that exceed the valid range are restricted to the range limit.

4.1.7 Enabling and Disabling the Comparator Function

COMP

Enables the comparator

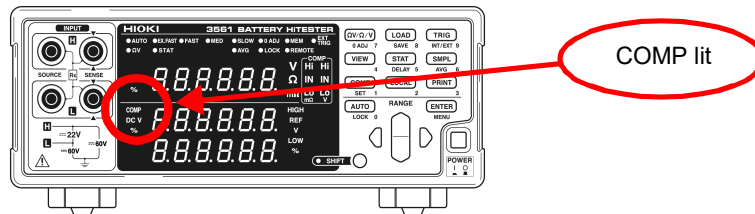

When the comparator is enabled, the following key operations are disabled to avoid inadvertent operations.

- **ΩV/ΩV** key (Measurement mode setting)
- **SHIFT** → **ΩV/ΩV** key (Zero-Adjustment)
- **SHIFT** → **COMP** key (Comparator setting)
- **AUTO** key (Auto-ranging setting)
- **SMPL** key (Sampling rate setting)
- **SHIFT** → **SMPL** key (Averaging setting)
- **SHIFT** → **TRIG** key (Trigger source setting)
- **SHIFT** → **ENTER** key (Menu display)
- **SHIFT** → **STAT** key (Delay setting)
- Range keys

NOTE

When the comparator is enabled, auto-ranging is automatically disabled.

4.1.8 Comparator Judgment Results

Resistance and voltage measurements are judged independently. Both judgment results are indicated on the display.

Judgment Operation The comparator compares measured values with the preset threshold values, and judges whether the measurement is within the thresholds. Resistance and voltage measurements are judged independently. The absolute value of the measurement is compared to the upper and lower thresholds.

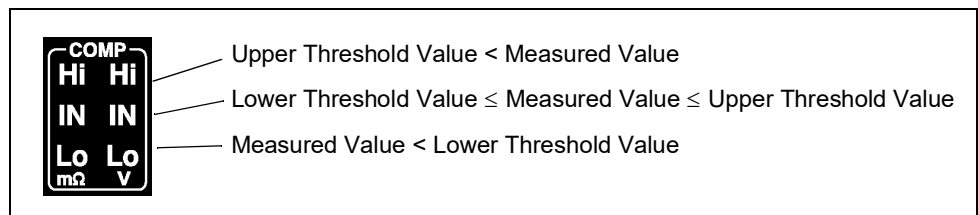

Measurement fault values are judged as follows:

Display	Judgment
.....	No judgment
OF	Hi (exceeds the upper threshold)
-OF	Lo (less than the lower threshold)

AND Judgment Output Judgment results (Hi, IN or Lo for both resistance and voltage) are output to EXT I/O connectors. Also, to facilitate application of judgment results, an AND output terminal indicates when both resistance and voltage are IN (within the threshold range). See Section 5.2.3 Output Signals (p.74).

NOTE

With the relative value comparison method (thresholds defined by a reference value and tolerance), the upper and lower thresholds are calculated internally for comparison with measurements. Therefore, even if a relative display value is equal to a judgment threshold (tolerance limit), it may be judged Hi or Lo.

4.1.9 Switching Between Measurement Value and Comparator Setting Displays

In ΩV mode, both resistance and voltage measurement values are displayed.

Although comparator setting values are not normally displayed when the comparator is enabled, they can be displayed for confirmation by the display switching function.

VIEW

Press this key to switch the display between measurement values and comparator setting values.

Resistance and voltage measurement display

(Shows resistance and voltage measurement values simultaneously)



Resistance measurement and comparator display
(Shows resistance measurement and resistance comparator setting values)

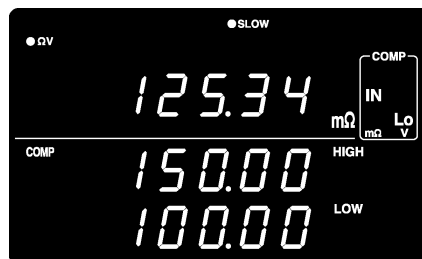

Voltage measurement and comparator display
(Shows voltage measurement and voltage comparator setting values)



VIEW

Measurement display switching is available only with the comparator enabled, and in the ΩV mode.

Use it to confirm comparator setting values.

4.2 Trigger Function

4.2.1 Trigger Source Settings

Two trigger sources are available: internal and external.

Internal Trigger	Trigger signals are automatically generated internally. (free-run)
External Trigger	Trigger signals are provided externally or manually.

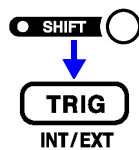

(SHIFT Lamp lit)

Switches the selected trigger source.

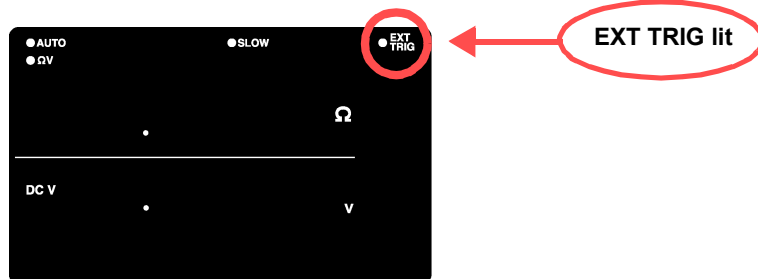

EXT.TRIG lit.....External triggering is selected.

EXT.TRIG not lit.....Internal triggering is selected.

Measurement with External Triggering

An external trigger can be applied in three ways.

- Applying a trigger manually by operating key
Pressing the **TRIG** key causes one measurement.
- Applying a trigger at the EXT I/O connector
Grounding the **TRIG** terminal of the EXT I/O connector on the rear panel causes one measurement.
See Section 5.2.2 Input Signals (p.73).
- Applying a trigger through RS-232C or GP-IB interface
Sending the ***TRG** command via the RS-232C or GP-IB interface causes one measurement.

NOTE

- When Internal triggering is enabled, external input at the EXT I/O **TRIG** terminal and the ***TRG** command are ignored.
- The normal state of operation with the front panel controls is continuous measurement. Setting the trigger source to Internal enables the free-run condition in which triggering occurs continuously. When the trigger source is set to External, a measurement occurs each time an external trigger is applied. Continuous measurement can be disabled via RS-232C or GP-IB interface signals, in which case triggering occurs only when signaled by the external host (PC or PLC).
See Section Triggering System Description (p.136).

4.2.2 Trigger Delay Settings

Specify the delay from the moment a trigger is applied to the start of measurement. By using this function, even when a trigger is applied immediately after connecting a test object, the start of measurement can be delayed to allow sufficient time for the measurement value to stabilize. Trigger delay can be set with 1 ms resolution from 0.000 to 9.999 seconds.

- 1**  (SHIFT Lamp lit)

 The Trigger Delay setting display appears.



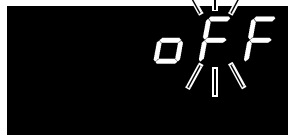

(Main Display)

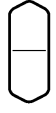

(Sub Display)
The current setting blinks.
- 2** 

Select **ON**.



(Sub Display)
- 3** 

The numerals indicating the trigger delay blink.

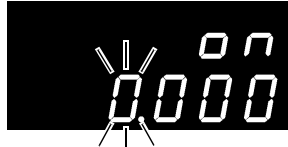

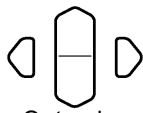

(Sub Display)
- 4** 
Or ten-keys

Set the trigger delay.
- 5** 

Applies setting and returns to the Measurement display.
To cancel the settings: **SHIFT** key

Disabling the Trigger Delay Function

- 1**  (SHIFT Lamp lit)

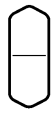
 The Trigger Delay setting display appears.
- 2** 

Select **OFF**.





(Sub Display)
- 3** 

The Trigger Delay is disabled.

4.3 Averaging Function



The Averaging Function averages measurement values for output. This function can minimize instability of displayed values. The number of samples to average can be set from 2 to 16.



- 1**  (SHIFT Lamp lit)

 The Averaging Function setting display appears.

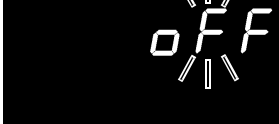

 (Main Display)

 (Sub Display)
The current setting blinks.
- 2**  Select **ON**.

 (Sub Display)
- 3**  The number of samples to average setting blinks.
- 4**  Select the number of samples to average.



Or
ten-keys
- 5**  The Average Measurement display appears. (**AVG** lit)
To cancel the settings: **SHIFT** key

Disabling the Averaging Function

- 1**  (SHIFT Lamp lit)

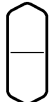
 The Averaging Function setting display appears.

- 2**  Select **OFF**.

 (Sub Display)
- 3**  The Averaging Function is disabled. (**AVG** not lit)

NOTE

When the internal trigger is used for continuous measurement (free-run), the display shows the moving average. Otherwise, the display shows the integrating average.
See Section 4.2 Trigger Function (p.53).

4.4 Statistical Calculation Functions

The mean, maximum, minimum, standard deviation of population, standard deviation of sample and process capability indices are calculated and displayed for up to 30,000 measurement values.

The calculation formulas are as follows:

Mean

$$\bar{x} = \frac{\sum x}{n}$$

Standard deviation of population

$$\sigma = \sqrt{\frac{\sum x^2 - n\bar{x}^2}{n}} \quad (= \sigma_n)$$

Standard deviation of sample

$$s = \sqrt{\frac{\sum x^2 - n\bar{x}^2}{n-1}} \quad (= \sigma_{n-1})$$

Process capability index (dispersion)

$$Cp = \frac{|Hi - Lo|}{6\sigma_{n-1}}$$

Process capability index (bias)

$$CpK = \frac{|Hi - Lo| - |Hi + Lo - 2\bar{x}|}{6\sigma_{n-1}}$$

- In these formulas, n represents the number of valid data samples.
- Hi and Lo are the upper and lower thresholds of the comparator.
- The process capability indices represent the quality achievement capability created by a process, which is the breadth of the dispersion and bias of the process' quality. Generally, depending on the values of Cp and CpK, process capability is evaluated as follows:
 - Cp, CpK > 1.33..... Process capability is ideal
 - 1.33 ≥ Cp, CpK > 1.00..... Process capability is adequate
 - 1.00 ≥ Cp, CpK..... Process capability is inadequate

NOTE

- When only one valid data sample exists, standard deviation of sample and process capability indices are not displayed.
- When σ_{n-1} is 0, Cp and CpK are 99.99.
- The upper limit of Cp and CpK is 99.99. Values of Cp and CpK > 99.99 are displayed as 99.99.
- Negative values of CpK are handled as CpK = 0.
- When comparator, range or auto-ranging settings are changed while statistical data is displayed, the display of Cp and CpK values changes to "- - - -".
- When normal measurement values and relative display values (%) are mixed, correct calculation results cannot be obtained.

Enabling/Disabling the Statistical Calculation Function

- 1**  The Statistical Calculation display appears.

 (Main Display)

 (Sub Display)

- 2**  The function enable/disable display appears.

(press three times)

 (Sub Display)

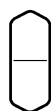

Enable or disable the Calculation Function on the Sub Display.

on..... enables the calculation function (ON).

off disables the calculation function (OFF).

- 3**  Applies setting and returns to the Measurement display.
To cancel the settings: **SHIFT** key

NOTE

- Statistical Calculation function setting (ON, OFF) is not available when the Comparator is enabled.
- If Statistical Calculation is turned off and then back on without first clearing calculation results, it resumes calculating from the point when it was turned off.
- The Statistical Calculation function slows measurements when it is ON.

Clearing Statistical Calculation Results

- 1**  The Statistical Calculation display appears.

 (Main Display)

 (Sub Display)

- 2**  The Clearing screen will appear.

(press once)

 (Sub Display)

- 3**  Clears statistical calculation results.

Automatic Clearing of Statistical Calculation Results after Printing

The instrument can be set to automatically clear statistical calculation results after results are output to the printer.

- 1**  The **Statistical Calculation display** appears.

 (Main Display)

 (Sub Display)

- 2** 
(Press twice) Bring up **Auto Clearing After Printing** in the **Setup** screen.

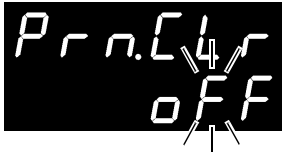
 (Sub Display)

- 3**  Turn **Automatic Clearing After Printing on or off**.

on..... Automatically clears statistical calculation results after they are output to the printer.

off..... Does not clear the results themselves.

- 4**  Applies **setting and returns to the Measurement display**.
To cancel the settings: **SHIFT** key

Importing Data

-  Pressing the **TRIG** key while Statistical Calculation is ON executes one of the following operations:
- External Trigger: Takes one measurement and performs statistical calculation on the result
 - Internal Trigger: Performs statistical calculation on the value displayed immediately after pressing

NOTE

- ***TRG** command executes the same operation.
- Grounding the $\overline{\text{TRIG}}$ terminal of the EXT I/O connector executes the same operation.

Confirming Statistical Calculation Results

- 1**  The **Statistical Calculation display** appears.

- 2**  The indication on the display changes as follows with each key-press.

Example: when the Ω V mode is selected
(not displayed in V mode)

Total data count of resistance measurement

no. 0

Mean of resistance measurement

AVERAGE
2.7019

Valid data
Mean

Maximum of resistance measurement

2.7135
507

Maximum
Data Sample
No.

Minimum of resistance measurement

2.6871
871

Minumum
Data Sample
No.

Standard deviation of population
of resistance measurement

5n
0.01

Standard deviation of sample
of resistance measurement

5n-1
0.01

Process capability indices of resistance
measurement

CP 0.50
C 0.50

Cp
CpK

(not displayed in Ω mode)

Total data count of
voltage measurement

Mean of voltage
measurement

Maximum of voltage
measurement

Minimum of voltage
measurement

Standard deviation of
population of voltage
measurement

Standard deviation of
sample of voltage
measurement

Process capability indices
of voltage measurement

ON/OFF setting

on

Auto Clearing After Printing setup

Prn.Clr
off

Clear setup

Clr

NOTE

- When a valid data count (measurement fault other than \pm OF) is zero, no calculation result is displayed.
- When only one valid data sample exists, standard deviation of sample and process capability indices cannot be displayed.
- When comparator, range or auto-ranging settings are changed while statistical data is displayed, the display of Cp and CpK values changes to "-- --".

Sending Statistical Calculation Results to the Printer

PRINT

With the statistical calculation results displayed, press the **PRINT** key. The statistical calculation results are output to the optional printer. See Section Chapter 6 Printing (p.81).

4.5 Memory Function

The Memory function is only available via communication commands. When the Memory function is enabled, measurement values are stored in the instrument's internal memory according to trigger input sequence (up to 400 values). Stored data can be downloaded later upon command.

When measuring using a scanner to switch multiple test objects, switching time can be quite long if measurement values are downloaded to the PC after each measurement. Test cycle time can be minimized by using this function to store measurement values internally until all channel measurements are finished, at which time the stored values are downloaded together during the next idle period.

- 1 **Select the RS-232C or GP-IB interface.**
See Section 7.3.2 Selecting the Interface (p.91).
- 2 **Send the command to enable the Memory function.**
`:MEMory:STATe ON`
- 3 **The MEM indicator lights.**

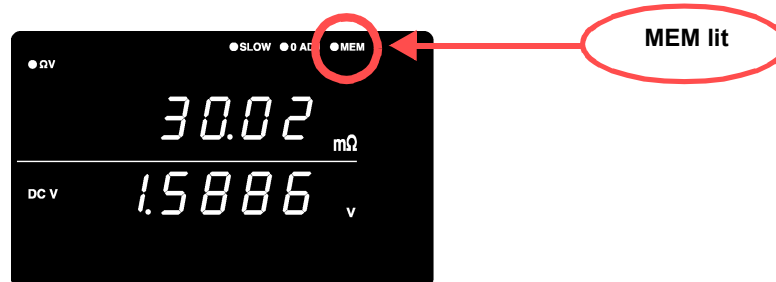

- 4 **Measurement values are stored.**
When a trigger is applied by the **TRIG** key, $\overline{\text{TRIG EXT}}$ I/O input signal or ***TRG** command, the MEM indicator blinks once and the measured value is stored.

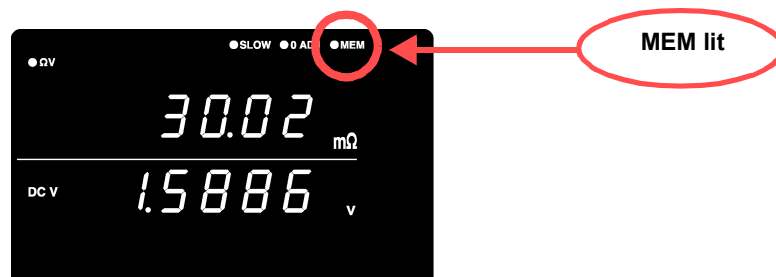

If an external trigger source is selected, one measurement is stored after each trigger event. In the internal triggering case, the first measurement value after triggering is stored. Apply a trigger as many times as is necessary.

5 Send the command to download the data from memory.**:MEMory:DATA?**

The stored measurement values are returned in response.

```

:MEM:DATA?
1, 290.60E-3, 1.3924E+0
2, 290.54E-3, 1.3924E+0
3, 290.50E-3, 1.3923E+0
4, 290.43E-3, 1.3923E+0
5, 290.34E-3, 1.3924E+0
END

```

The "END" character is sent as the last line of the data.

To download stored data one measurement at a time, send this command:

:MEMory:DATA? STEP

The instrument sends one stored data object and enters the wait state.

When the instrument receives an "N" from the PC or other device, the next stored data object is sent.

Repeat until the last data object is downloaded.

When all stored data has been downloaded, the instrument sends an "END" character.

```

:MEM:DATA? STEP
1, 290.60E-3, 1.3924E+0
N, (sent from PC)
2, 290.54E-3, 1.3924E+0
N, (sent from PC)
3, 290.50E-3, 1.3923E+0
N, (sent from PC)
4, 290.43E-3, 1.3923E+0
N, (sent from PC)
5, 290.34E-3, 1.3924E+0
N, (sent from PC)
END

```

6 To clear the instrument's memory, send it the following command.**:MEMory:CLEAr**

Unless the memory is cleared, measurement data continues to be stored upon each trigger event.

NOTE

- The instrument's memory storage capacity is 400 measurements. Be aware that attempting to store more data (by applying a trigger) results in nothing further being stored.
- Refer to Chapter 7 RS-232C/GP-IB Interfaces (p.87), for details about the communication methods and sending and receiving commands.
- When the Memory function is enabled, auto-ranging is not available.
- Memory contents are cleared when performing the following operations:
 - When enabling the Memory function (off to on)
 - When changing the measurement range
 - When changing comparator settings
 - When sending the **:Memory:Clear** command
 - When Reset is executed from the menu display
 - When sending ***RST**
 - When sending **:SYSTEM:RESet**
 - When turning power on

4.6 Key-Lock Function

Executing Key-Lock disables the operating keys on the front of the instrument. This function can be useful for protecting settings.

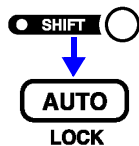

(SHIFT Lamp lit)

Enable the Key-Lock function.

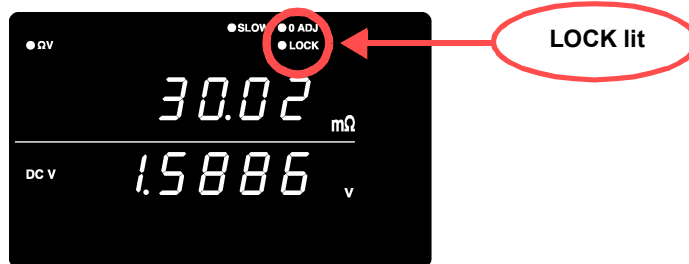

NOTE

- Even if the power supply is interrupted, the Key-Lock function is not canceled.
- The **TRIG** key remains operational.

Disabling Key-Lock

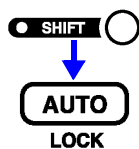

(SHIFT Lamp lit)

Disable the Key-Lock function. (LOCK is not lit)

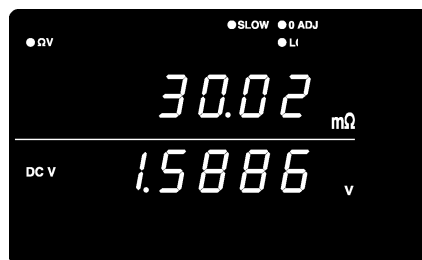

NOTE

When communicating by remote control, the remote control status is canceled.

4.7 Panel Save Function

The current measurement setting state is stored (saved) in non-volatile memory.

Up to 126 sets of measurement states can be saved.

The measurement settings (state) at the time this function is executed are saved.

Saved measurement states can be reloaded using the Panel Load function, described later.

- 1**

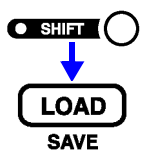

(SHIFT Lamp lit)

The Panel Saving display appears.

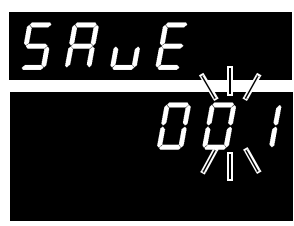

(Main Display)

(Sub Display)
The panel number blinks.
- 2**

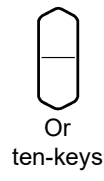

Select the panel number to save.



(Sub Display)
(To save measurement settings as Panel No. 3)

When selecting a saved panel, "USED" is displayed.
- 3**



Saves the measurement setting state and returns to the Measurement display.
To cancel the settings: **SHIFT** key

NOTE

- If you select a Panel number that was previously saved and press the **ENTER** key, the contents are overwritten.
- The Key-Lock state can be saved only by the **:SYSTEM:SAVE** remote command.

Saved Items

- Measurement mode setting
- Range setting
- Auto-ranging setting
- Sampling rate setting
- Comparator settings
- Internal/External trigger setting
- Switching displays setting
- Delay setting
- Zero-Adjust setting
- Averaging setting
- Key-Lock
- Statistical Calculation setting

4.8 Panel Load Function

Loads the measurement settings saved by the Panel Save function from internal non-volatile memory.

1

LOAD

The Panel Loading display appears.

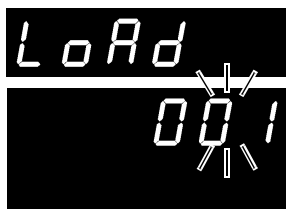

(Main Display)

(Sub Display)

The panel number blinks.

2



Or
ten-keys

Select the panel number to load.



(Sub Display)

(To load measurement settings from Panel No.3)

3

ENTER

Loads the measurement setting state and returns to the Measurement display.

To cancel the settings: **SHIFT** key

NOTE

- If an unsaved Panel No. is selected, a warning beep sounds when you press **ENTER** key.
- When selecting a Panel No. with the up/down **RANGE** keys, only the numbers of previously saved panels appear.
- Loading can also be executed using the TRIG signal and the LOAD0 to LOAD6 pins of the EXT I/O interface.
See Section 5.2.2 Input Signals (p.73).

4.9 Self-Calibration

The self-calibration function adjusts offset voltage and gain drift of the instrument's internal circuitry to improve measurement precision. The instrument's measurement accuracy specifications depend on self-calibration, so it must be executed frequently. In particular, always execute self-calibration after warm-up and when the ambient temperature changes by more than 2°C. However, regardless of this setting, self-calibration is executed during every measurement when SLOW sampling is used.

Self-calibration can be executed by the following two methods:

Auto	Executes self-calibration automatically once every 30 minutes.
Manual	Self-calibration can be executed manually by applying a CAL input signal (grounding the CAL terminal of the EXT I/O connector).

4

Applied Measurement

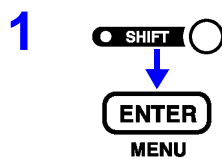

(SHIFT Lamp lit)

The Menu display appears.



The Self-Calibration setting display appears.

See Section 1.4 Menu Display Sequence (SHIFT → ENTER) (p.15).

CALIB

(Main Display)

AUTO

(Sub Display)

The current setting blinks.

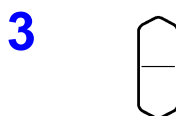

Select Auto or Manual on the Sub Display.

Auto Auto self-calibration

In..... Manual self-calibration



Applies setting and returns to the Measurement display.

NOTE

Self-calibration requires about 55 ms, during which measurement processing is temporarily suspended.

4.10 Measurement Value Output Function

This function causes output of measured values via the RS-232C interface in the same sequence as trigger input.

This function is useful when measuring using internal (free-run) triggering, and for obtaining measured values on a PC when using a footswitch for triggering.

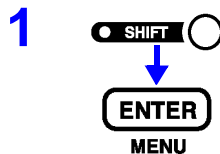

(SHIFT Lamp lit)

The Menu display appears.



The Measurement Value Output function setting display appears.
See Section 1.4 Menu Display Sequence (SHIFT → ENTER) (p.15).



(Main Display)

(Sub Display)

The current setting blinks.

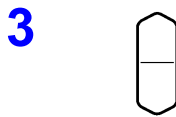

Turn Measurement Value Output Function on or off.

on..... enables the measurement value output function (ON).

off..... disables the measurement value output function (ON).



Applies setting and returns to the Measurement display.



The measured value is output from the RS-232C interface when you press the **TRIG** key or when a signal is applied to the EXT I/O TRIG terminal.

Set the PC to the receiving state beforehand. When a measurement value is received, the PC should perform appropriate processing such as recording or displaying, then re-enable the receiving state.



NOTE

- When external triggering is enabled, a measurement is performed and the value is sent after each trigger event. When internal triggering is enabled, the first value measured after triggering is sent.
- The measurement output function is not applicable to the GP-IB interface or printer.

4.11 Key Beeper Setting

Select whether a beep sounds when an operating key on the front of the instrument is pressed.

- 1**  (SHIFT Lamp lit)

 The Menu display appears.
- 2**  The Key Beeper setting display appears.
See Section 1.4 Menu Display Sequence (SHIFT → ENTER) (p.15).

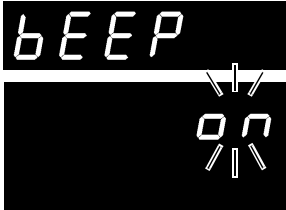

(Main Display)



(Sub Display)
The current setting blinks.
- 3**  Select the key beeper state on the Sub Display.





on..... Key beeper enabled



off Key beeper disabled
- 4**  Applies setting and returns to the Measurement display.

4.12 Reset Function

The reset function can be used to re-initialize current measurement settings (excluding saved panel data) to their factory defaults, or to re-initialize all measurement settings including saved panel data to factory defaults.

- 1**  (SHIFT Lamp lit)
 The Menu display appears.
- 2**  The Reset display appears.
 See Section 1.4 Menu Display Sequence (SHIFT → ENTER) (p.15).

 (Main Display)
 (Sub Display)
 The current setting blinks.
- 3**  **Select the Reset method on the Sub Display.**
SEt Reset (initializes measurement settings other than those stored with Panel Save)
SYS System Reset (initialize all measurement settings)
- 4**  **ENTER** blinks.

 (Sub Display)
 When SYS (system reset) is selected
- 5**  Executes the Reset.
 To cancel the settings: **SHIFT** key

NOTE

System Reset also initializes Panel Save data.

Initial Factory Default Settings

Description	Default
Measurement Mode	Ω V
Resistance Measurement Range	AUTO
Zero-Adjust	OFF
Zero-Adjust Value	0
Delay	OFF
Delay Time	0.000s
Sampling Rate	SLOW
Averaging Function	OFF
Average Times	2
Self-Calibration	AUTO
Continuous Measurement	ON
Trigger Source	Internal trigger
Line Frequency	50 Hz
Key Beeper Setting	ON
Key-Lock Function	OFF
Comparator	OFF
Comparator Threshold Method (resistance and voltage)	Hi, Lo
Comparator Upper Threshold (resistance and voltage)	0
Comparator Lower Threshold (resistance and voltage)	0
Comparator Judgment Beeper	OFF
Comparator Execution Mode	AUTO
Statistical Calculation Functions	OFF
Automatic Clearing of Statistical Calculation Results	OFF
Interface	RS-232C
Baud Rate	9600 bps
GP-IB Address	1
GP-IB Delimiter	LF
Print Interval	0 (The interval print disabled)
Error Output	ASync
Measurement Value Output Function	OFF
EOC Output	HOLD
EOC Pulse Width	1 ms

External Control *Chapter 5*

5.1 Overview



External Control Input Functions

- External trigger input ($\overline{\text{TRIG}}$)
- Select Panel No. to load ($\overline{\text{LOAD0}}$ to $\overline{\text{LOAD6}}$)
- Zero-adjust signal input ($\overline{\text{0ADJ}}$)
- Print Signal input ($\overline{\text{PRINT}}$)
- Self-calibration signal input ($\overline{\text{CAL}}$)
- Manual comparator judgment input ($\overline{\text{MANU}}$)

External Output Terminal Functions

- End-of-Conversion signal output (EOC)
- Reference signal output (INDEX)
- Measurement Fault signal output (ERR)
- Comparator decision signal output (R-Hi, R-IN, R-Lo, V-Hi, V-IN, V-Lo, AND)
- General-purpose outputs (OUT0 to OUT9)

Connector Type

57RE-40360-730B (D29) (manufactured by DDK)

Mating Connector

57-30360 (manufactured by DDK)
RC30-36P (manufactured by HIROSE electric co.,ltd.)
or equivalent

WARNING

To avoid electric shock or damage to the equipment, always observe the following precautions when connecting to EXT I/O connector.

- Always turn off the power to the instrument and to any devices to be connected before making connections.
- Be careful to avoid exceeding the ratings of EXT I/O connector.
- During operation, a wire becoming dislocated and contacting another conductive object can be serious hazard. Make sure that connections are secure the EXT I/O connectors.
- The INT.GND terminals (Page 73) are grounded, so if an external controller has a potential relative to ground, connection could cause a short-circuit accident.

CAUTION

Be aware of the following to avoid damaging the instrument:

- When using relays, always include diodes to absorb back emf.
- Always provide protective grounding for devices the connect to the EXT I/O connectors.

5.2 Signal Descriptions

5.2.1 Pinout

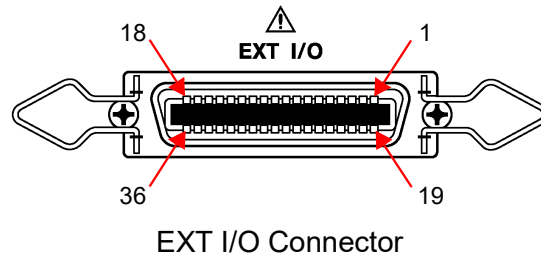

Pin	I/O	Signal name	Pin	I/O	Signal name
1	IN	$\overline{\text{LOAD0}}$	19	IN	$\overline{\text{LOAD1}}$
2	IN	$\overline{\text{LOAD2}}$	20	IN	$\overline{\text{LOAD3}}$
3	IN	$\overline{\text{LOAD4}}$	21	IN	$\overline{\text{LOAD5}}$
4	IN	$\overline{\text{LOAD6}}$	22	IN	$\overline{\text{TRIG}} (\overline{\text{IN0}})$
5	IN	$\overline{\text{CAL}} (\overline{\text{IN1}})$	23	IN	$\overline{\text{0ADJ}} (\overline{\text{IN2}})$
6	IN	$\overline{\text{PRINT}} (\overline{\text{IN3}})$	24	IN	$\overline{\text{MANU}} (\overline{\text{IN4}})$
7	-	INT.GND	25	-	INT.GND
8	-	INT.GND	26	-	INT.GND
9	OUT	R-Hi	27	OUT	R-IN
10	OUT	R-Lo	28	OUT	AND
11	OUT	V-Hi	29	OUT	V-IN
12	OUT	V-Lo	30	OUT	ERR
13	OUT	EOC	31	OUT	INDEX
14	OUT	OUT0	32	OUT	OUT1
15	OUT	OUT2	33	OUT	OUT3
16	OUT	OUT4	34	OUT	OUT5
17	OUT	OUT6	35	OUT	OUT7
18	OUT	OUT8	36	OUT	OUT9

5.2.2 Input Signals

$\overline{\text{LOAD0}}$ to $\overline{\text{LOAD6}}$

Select a Panel No. to load and apply a $\overline{\text{TRIG}}$ signal to load the selected Panel No. and measure. $\overline{\text{LOAD0}}$ is the LSB, and $\overline{\text{LOAD6}}$ is the MSB. When a TRIG signal is applied, if $\overline{\text{LOAD0}}$ through $\overline{\text{LOAD6}}$ are unchanged from the previous trigger event, panel settings are not loaded. In this case, using external triggering, one measurement is taken as usual when the $\overline{\text{TRIG}}$ signal is applied.

Panel No.	$\overline{\text{LOAD6}}$	$\overline{\text{LOAD5}}$	$\overline{\text{LOAD4}}$	$\overline{\text{LOAD3}}$	$\overline{\text{LOAD2}}$	$\overline{\text{LOAD1}}$	$\overline{\text{LOAD0}}$
*	1	1	1	1	1	1	1
1	1	1	1	1	1	1	0
2	1	1	1	1	1	0	1
3	1	1	1	1	1	0	0
4	1	1	1	1	0	1	1
5	1	1	1	1	0	1	0
6	1	1	1	1	0	0	1
7	1	1	1	1	0	0	0
8	1	1	1	0	1	1	1
...							
122	0	0	0	0	1	0	1
123	0	0	0	0	1	0	0
124	0	0	0	0	0	1	1
125	0	0	0	0	0	1	0
126	0	0	0	0	0	0	1
*	0	0	0	0	0	0	0

0: $\overline{\text{LOAD}}$ terminal is shorted to GND 1: $\overline{\text{LOAD}}$ terminal is unconnected, or connected to 5 V

- * When a $\overline{\text{TRIG}}$ signal is applied with $\overline{\text{LOAD0}}$ to $\overline{\text{LOAD6}}$ set to all 1's or all 0's, no Panel Load occurs.
- At least 70 ms is required for the settings to change after executing a Panel Load (the actual time depends on the particular function, range and sampling rate).
- When set to external trigger mode, one measurement is taken upon load completion.
- The Panel Load function cannot be executed from $\overline{\text{LOAD0}}$ to $\overline{\text{LOAD4}}$ when controlling the instrument via RS-232C or GP-IB (Remote State).

$\overline{\text{TRIG}}$

When the external trigger, one measurement is taken each time the $\overline{\text{TRIG}}$ signal transitions from High to Low.

This trigger signal is ignored when internal triggering is enabled.

Trigger functions are also available for statistical calculation, recording to memory and output of measured values (valid also with internal triggering).

$\overline{\text{CAL}}$

When manual self-calibration is selected with EX.FAST, FAST or MEDIUM sampling rate, self-calibration begins when the $\overline{\text{CAL}}$ signal transitions from High to Low.

Self-calibration takes about 55 ms.

When SLOW sampling is selected, the $\overline{\text{CAL}}$ signal is ignored.

See Section 4.9 Self-Calibration p.65).

5.2 Signal Descriptions

$\overline{0ADJ}$	Zero adjustment executes once when the $\overline{0ADJ}$ signal transitions from High to Low.
\overline{PRINT}	The current measurement value prints when the \overline{PRINT} signal transitions from High to Low.
\overline{MANU}	When the MANU comparator mode is selected, comparator judgment is enabled while the \overline{MANU} signal is Low. See Section 4.1.4 Comparator Execution Mode Setting p.46).
$\overline{IN0}$ to $\overline{IN4}$	The \overline{TRIG} , \overline{CAL} , $\overline{0ADJ}$, \overline{PRINT} and \overline{MANU} signals can also serve as general-purpose input terminals, read with the <code>:IO:IN?</code> command. See Section EXT I/O Input p.135).

5.2.3 Output Signals

ERR	Indicates a measurement fault. The Synchronous ERR output setting causes ERR output to be synchronous with EOC output, while with the Asynchronous ERR output setting causes ERR output to follow actual (asynchronous) contact of the probes with the test object. See Section 5.2.4 ERR Output p.75).
INDEX	The INDEX signal is output during the Trigger Wait, Delay, Self-Calibration and Calculation states. This signal is not output while measuring the resistance of test objects. This signal transitions from Off to On to indicate that the test object can be removed.
EOC	This signal indicates the end of a measurement (End-Of-Conversion). This signal indicates when comparator judgment results and ERR output (when SYNC is enabled) are available.
R-Hi, R-IN, R-Lo V-Hi, V-IN, V-Lo	These are the results of comparator decision.
AND	This signal indicates when both resistance and voltage judgment results are IN (Ω V mode). In the Ω and V modes, this signal is the same as R-IN and V-IN outputs, respectively.
OUT0 to OUT9	The output signals are controlled by the <code>:IO:OUT</code> command. See Section EXT I/O Output p.135).
INT.GND	This is the instrument's internal ground.

NOTE

- I/O signals should not be used while measurement settings have been changed.
- The EOC and INDEX signals are initialized (ON) at power on.
- If it is not necessary to change the measurement conditions, set $\overline{LOAD0}$ through $\overline{LOAD6}$ to either Hi or Lo.

5.2.4 ERR Output

The ERR output signal indicates the occurrence of measurement fault conditions (such as open test leads, or a bad contact). There are two ERR output methods.

Synchronized with EOC Output (SYNC)

Measurement faults detected while measuring (not while awaiting trigger or during delay or calculation intervals), are indicated by ERR output synchronous with EOC output (the end-of-measurement signal).

ERR Output On: A measurement fault has prevented correct measurement

ERR Output Off: Correct measurement obtained (OF or -OF: Out-of-range cases are included)

Asynchronous with EOC Output (ASYNC)







Measurement faults (test lead connection conditions) are output in real time. The output is asynchronous with the $\overline{\text{TRIG}}$ signal and EOC output.

ERR Output On: Measurement fault condition (open test leads, or a bad contact)









ERR Output Off: Test lead connections are normal

5.2.5 Instrument Settings

Measurement Fault Output Signal (ERR) Setting

- 1  (SHIFT Lamp lit)
 The Menu display appears.
- 2  **Select the ERR Output Selection display.**
 See Section 1.4 Menu Display Sequence (SHIFT → ENTER) p.15).
 (Main Display)
 (Sub Display)
 The current setting blinks.
- 3  **Select the type of signal to be output on the Sub Display.**
SynC Synchronous output (synchronized with EOC output)
ASynC Asynchronous output (not synchronized with EOC output)
- 4  Applies settings and returns to the Measurement display.

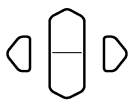
Setting the EOC Signal

- 1  (SHIFT Lamp lit)
 The Menu display appears.
- 2  **Select the EOC-signal setup display.**
 See Section 1.4 Menu Display Sequence (SHIFT → ENTER) p.15).
 (Main Display)
 (Sub Display)
 The current setting blinks.
- 3  **Choose the output method for the EOC signal.**
HoLd Holds the EOC signal after measurement.
 → Go to Step 5.
PULSE Outputs the specified pulse after measurement.
 → Go to the next step.
- 4  (When **PULSE** is selected)
 Or ten-keys
 The number representing the pulse width of the EOC signal will start blinking.
 Set the pulse width in ms.
- 5  Applies settings and returns to the Measurement display.

5.3 Timing Chart

External Trigger Timing Chart

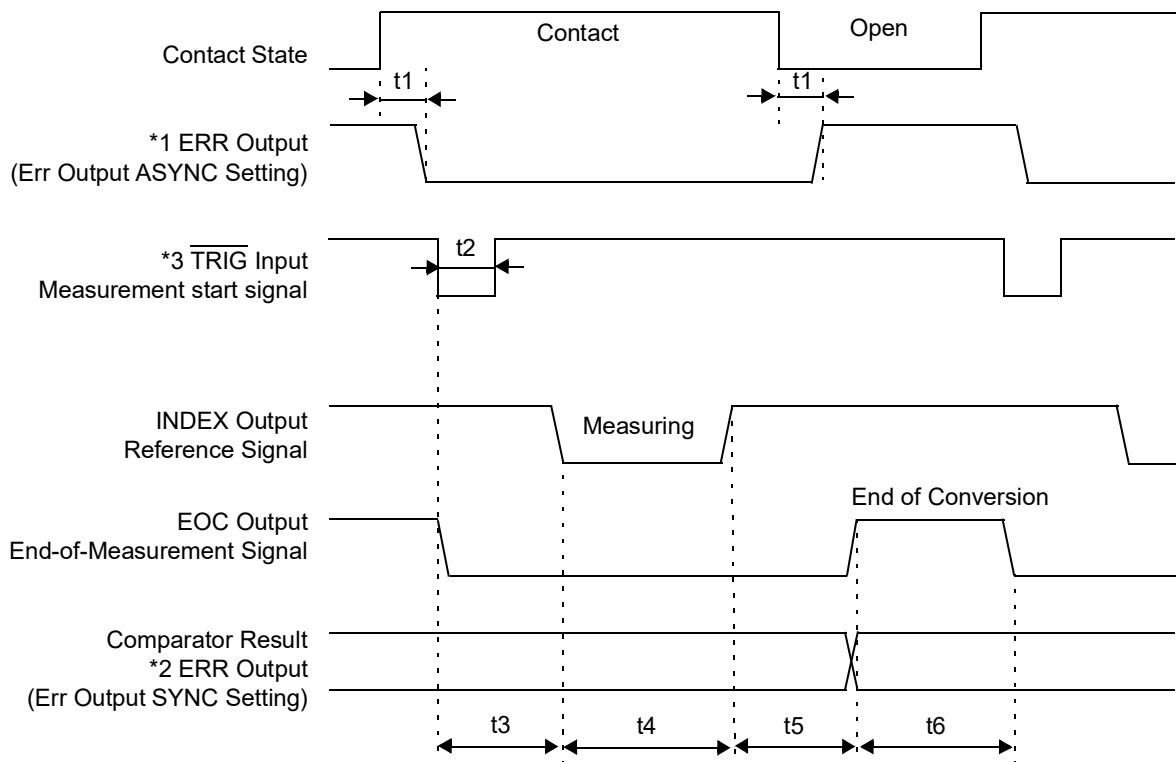

*1: For details, see "5.2.4 ERR Output p.75."

*2: When ERR output is set to the SynChronous mode, measurement fault detection results can be obtained when measurement is finished, as with comparator results.

*3: After connecting to the test object, wait for longer than the response time (approximately 3 ms) before inputting the TRIG signal (It is necessary to wait out the response time for the measurement values to stabilize after connection. Response times depend on the test object).

Internal Trigger Timing Chart

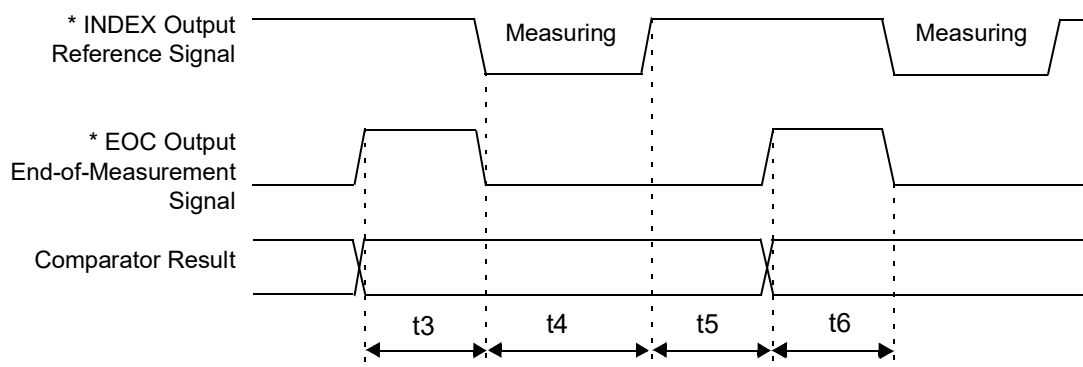

* When the EOC signal is set to PULSE, the signal will remain on only for the specified period upon completion of conversion.

5.3 Timing Chart

Description	Time																																
t1 ERR Output response time*1	1.5 ms																																
t2 Measurement trigger pulse width	0.5 ms min.																																
t3 Delay Time	per setting See Section 4.2.2 Trigger Delay Settings p.54).																																
t4 Measurement time*2	<table border="0"> <tr> <td>ΩV mode</td> <td></td> <td>Ω mode or V mode</td> <td></td> </tr> <tr> <td>EX.FAST</td> <td>6.8 ms</td> <td>EX.FAST</td> <td>3.4 ms</td> </tr> <tr> <td>FAST</td> <td>22.8 ms</td> <td>FAST</td> <td>11.4 ms</td> </tr> <tr> <td>MEDIUM</td> <td>82.8 ms</td> <td>MEDIUM</td> <td>41.4 ms (50 Hz line frequency setting)</td> </tr> <tr> <td></td> <td>68.8 ms</td> <td></td> <td>34.4 ms (60 Hz line frequency setting)</td> </tr> <tr> <td>SLOW</td> <td>257.8 ms</td> <td></td> <td></td> </tr> <tr> <td></td> <td>251.2 ms</td> <td>SLOW</td> <td>156.4 ms (50 Hz line frequency setting)</td> </tr> <tr> <td></td> <td></td> <td></td> <td>149.8 ms (60 Hz line frequency setting)</td> </tr> </table>	Ω V mode		Ω mode or V mode		EX.FAST	6.8 ms	EX.FAST	3.4 ms	FAST	22.8 ms	FAST	11.4 ms	MEDIUM	82.8 ms	MEDIUM	41.4 ms (50 Hz line frequency setting)		68.8 ms		34.4 ms (60 Hz line frequency setting)	SLOW	257.8 ms				251.2 ms	SLOW	156.4 ms (50 Hz line frequency setting)				149.8 ms (60 Hz line frequency setting)
Ω V mode		Ω mode or V mode																															
EX.FAST	6.8 ms	EX.FAST	3.4 ms																														
FAST	22.8 ms	FAST	11.4 ms																														
MEDIUM	82.8 ms	MEDIUM	41.4 ms (50 Hz line frequency setting)																														
	68.8 ms		34.4 ms (60 Hz line frequency setting)																														
SLOW	257.8 ms																																
	251.2 ms	SLOW	156.4 ms (50 Hz line frequency setting)																														
			149.8 ms (60 Hz line frequency setting)																														
t5 Calculation time*3	0.3 ms																																
t6 EOC Output pulse width	<p>When the external trigger is selected</p> <p>HOLD setting : Holds until the next trigger is detected</p> <p>PULSE setting : Remains only for the specified pulse width</p> <p>See Section 5.2.5 Instrument Settings p.76).</p> <p>When the internal trigger is selected</p> <p>HOLD setting : EX.FAST 1 ms, FAST 5 ms, MEDIUM 20 ms, SLOW 50 ms</p> <p>PULSE setting : Remains only for the specified pulse width</p>																																

*1: For details, see "5.2.4 ERR Output p.75)."

*2: About t4 measurement time

When averaging is enabled, the running average is obtained with internal triggering, so measurement time t4 does not change. The measurement time for external triggering is as follows:

With SLOW sampling

Ω V	(t4 - 57.8) X n + 57.8 ms (50 Hz)
	(t4 - 51.2) X n + 51.2 ms (60 Hz)
Ω or V	(t4 - 56.4) X n + 56.4 ms (50 Hz)
	(t4 - 49.8) X n + 49.8 ms (60 Hz)

With other than SLOW sampling

Ω V	(t4 - 2.8) X n + 2.8 ms
Ω or V	(t4 - 1.4) X n + 1.4 ms

(n represents the number of values averaged)

*3: About t5 calculation time

In the following cases, add the indicated times to calculation time t5:

When the Statistical Calculation function is enabled	0.3 ms
When the reference value/tolerance method of comparator decision is selected	0.15 ms

5.4 Internal Circuitry

External Control and External Output Terminal Ratings

	I/O type	Logic	Electrical specification
Output	Open drain		30 V DC, 50 mA max.
Input	C-MOS	Inverse logic	H: 3.8 to 5.0 V, L: 0 to 1.2 V

External Control Terminals

Circuit Diagram

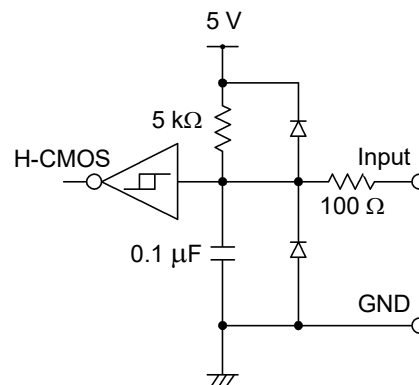

Application Examples

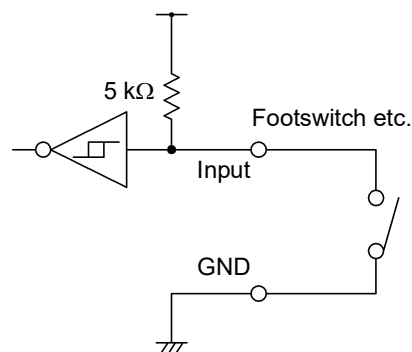

Switch Connection

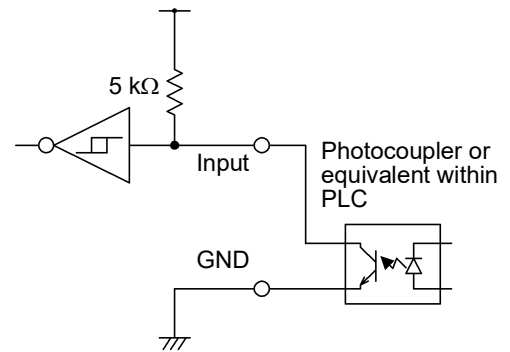

Photocoupler Connection

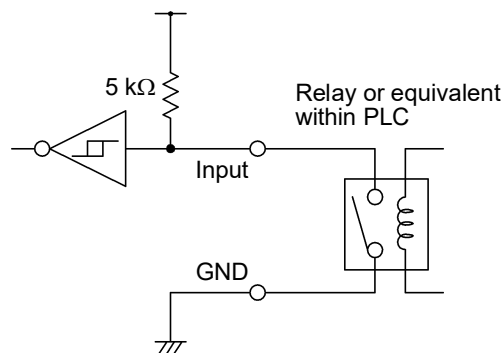

Relay Connection

External Output Terminals

Circuit Diagram

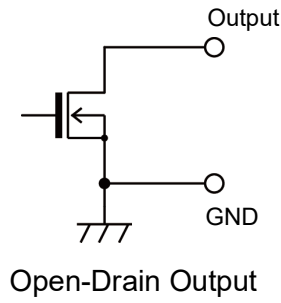

Application Examples

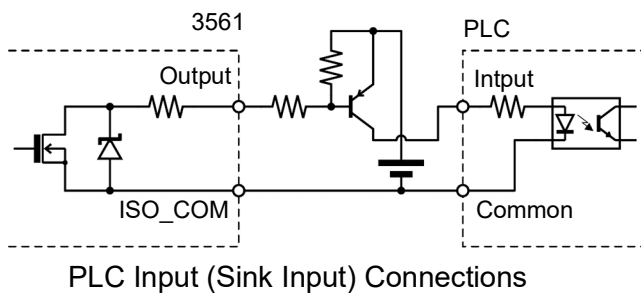
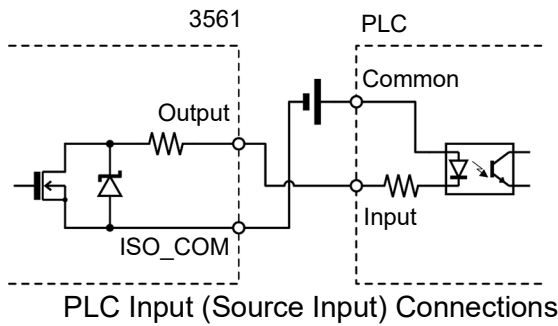
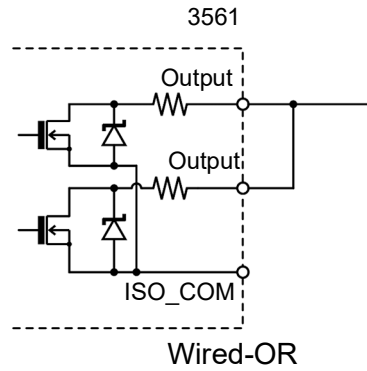
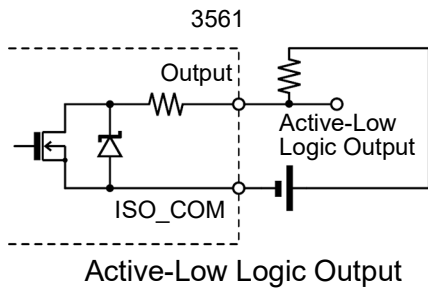
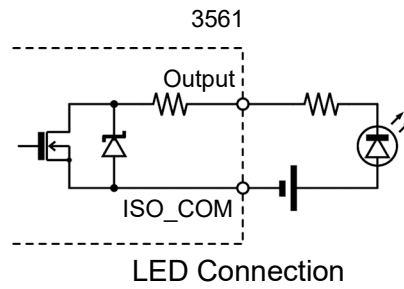
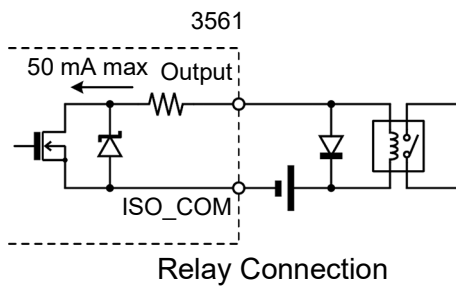

Printing

Chapter 6

6.1 Connecting the Printer

Before connecting the printer



Because electric shock and instrument damage hazards are present, always follow the steps below when connecting the printer.

- Always turn off the instrument and the printer before connecting.
- A serious hazard can occur if a wire becomes dislocated and contacts another conductor during operation. Make certain connections are secure.

NOTE

- As much as possible, avoid printing in hot and humid environments. Otherwise, printer life may be severely shortened.
- Use only compatible recording paper in the printer. Using non-specified paper may not only result in faulty printing, but printing may become impossible.
- If the recording paper is skewed on the roller, paper jams may result.

Recommended printer

The requirements for a printer to be connected to the instrument are as follows.

Confirm compatibility and make the appropriate settings on the printer before connecting it to the instrument.

- Interface RS-232C
- Characters per line At least 45
- Communication speed 9600 bps
- Data bits 8
- Parity none
- Stop bits 1
- Flow control none
- Control codes Capable of directly printing plain text

NOTE

The optional printer model 9670 is no longer available. Their model 9670 printers can still use.

6.1.1 Connecting the PRINTER to the Instrument

Connection Methods

4 Model 3561 (3561-01)

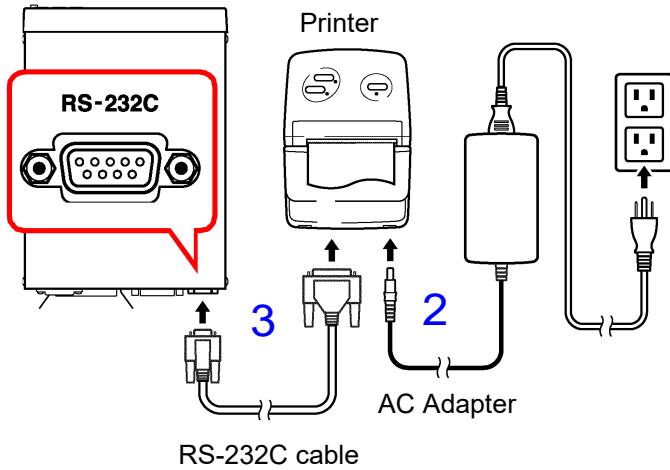

1. Confirm that the instrument and printer are turned off.
2. Connect the AC Adapter to the printer, and insert the power plug into an outlet.
3. Connect the RS-232C cable to the RS-232C connectors on the instrument and printer.
4. Turn the instrument and printer on.

Connector Pinouts

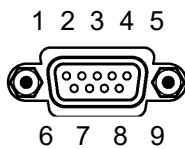

Model 3561(-01) (9-pin) Connector

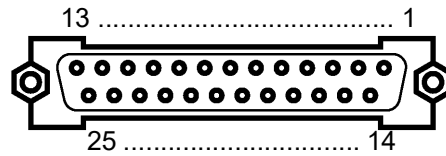

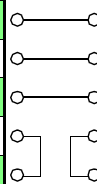

Printer (25-pin) Connector (Example)

Function	Signal Name	Pin
Receive Data	RxD	2
Transmit Data	TxD	3
Signal or Common Ground	GND	5







Pin	Signal Name	Function
2	TxD	Transmit Data
3	RxD	Receive Data
7	GND	Signal or Common Ground
4	RTS	Request to Send
5	CTS	Clear to Send

6.2 Selecting the Interface

- 1**  (SHIFT Lamp lit)
 The Menu display appears.
- 2**  **Select the Interface Selection display.**
 See Section 1.4 Menu Display Sequence (SHIFT → ENTER) (p.15).

 (Main Display)

 (Sub Display)
 The current setting blinks.

 **Select Printer on the Sub Display.**
 rS RS-232C
 GP-Ib ... GP-IB
Prn Printer
- 3**   
 Or
 ten-keys

Set the print interval time.
 0000 Interval printing is OFF. (Printing is carried out once when **PRINT** key is pressed.)
 0001 to 3600 Sets the print interval time in seconds.
- 4**  **Applies setting and returns to the Measurement display.**

6.3 Printing

Printing Measured Values and Decision Results

From the Measurement display, press the **PRINT** key or ground the $\overline{\text{PRINT}}$ pin in the EXT I/O connector to print the measured value and decision result.

NOTE

- When using the external trigger, if you want to print after a triggered measurement finishes, connect the EOC signal of the EXT I/O to the $\overline{\text{PRINT}}$ signal.
- To print all measurements continuously, connect the EOC signal to the $\overline{\text{PRINT}}$ signal and enable the internal trigger.
- When the statistical calculation function is on and the internal trigger is selected, the **TRIG** key or $\overline{\text{TRIG}}$ signal will trigger statistical calculation and printing of the current measurement value.
- Valid counts are 1 to 30000. Above 30000, the count returns to 1.

Interval Printing

This function allows you to automatically print out measurement results at preset intervals. The print interval time must be set from the Interface Selection display.

See Section 6.2 Selecting the Interface (p.83).

The setting range is 1 to 3600 seconds.

When the print interval time is set to "0", interval printing is disabled, and only normal printing is carried out.

Operation when interval printing is selected:

1. Start printing by pressing the **PRINT** key or sending the $\overline{\text{PRINT}}$ signal via EXT I/O.
2. Elapsed time (hours/minutes/seconds) and measurement values are printed automatically at intervals corresponding to the preset interval time.
3. Stop printing by pressing the **PRINT** key or sending the $\overline{\text{PRINT}}$ signal via EXT I/O again.

NOTE

- When the printed elapsed time reaches 100 hours, it resets to 00:00:00 and continues from zero.
(Example)
After 99 hours, 59 minutes and 50 seconds: 99:59:50
After 100 hours, 2 minutes and 30 seconds: 00:02:30
- Selecting a display other than the measurement display causes interval printing to stop.

Printing Statistical Calculation Results

From the Statistical Calculation display, press the **PRINT** key to print statistical calculation results. If no valid data exists, only the data count is printed. When only one valid data sample exists, standard deviation of sample and process capability indices cannot be printed.

Example Printouts

Measurement values (Ω V mode)	Measurement values (Ω mode)	Measurement values (V mode)
1 298.60mOhm, 1.3924 V	15 209.98mOhm	3132 4.2019 V
2 0.2984 Ohm, 1.3924 V	16 0.2103 Ohm	3133 15.2084 V
3 - 3.35mOhm, 0.0000 V		
4 - 0.0054 Ohm, 0.0000 V		
5 299.10mOhm, - 1.3923 V		
6 0.2984 Ohm, - 1.3923 V		
7 3.57mOhm, 13.9071 V		
8 - 16.89mOhm, -13.9088 V		

With the Comparator ON

```

95 105.80mOhm Lo, 0.0000 V IN
96 213.15mOhm Hi
97 213.12mOhm IN
98 213.11mOhm Lo
99 10.0072 V Hi
100 10.0071 V IN
101 10.0070 V Lo
102 O.F. Hi, O.F. Hi
103 - 3.11mOhm Lo, - O.F. Lo
104 ----- --,----- --

```

With the relative value comparison method (reference value and tolerance)

```

84 0.023 % Hi, 0.001 % IN
85 0.014 % IN, 0.000 % IN
86 - 0.019 % Lo, 0.002 % IN

```

With erroneous measurement values

```

10 O.F. , O.F.
11 - O.F. ,- O.F.
12 ----- ,-----
13 Invalid , Invalid
14 O.F. , 12.0097 V
15 - 19.82mOhm,- O.F.

```

Statistical Calculations (Comparator ON)

*** RESISTANCE ***

Number	85	
Valid	85	Max/Min count
Average	13.06mOhm	↓
Max	13.78mOhm (74)
Min	12.10mOhm (3)
Sn	0.38mOhm	
Sn-1	0.38mOhm	
Cp	1.32	
CpK	0.09	
Comp Hi	40	
Comp IN	45	
Comp Lo	0	

Interval print

```

00:00:00 13.74mOhm, 10.0138 V
00:00:01 13.87mOhm, 10.0138 V
00:00:02 13.67mOhm, 10.0139 V
00:00:03 13.47mOhm, 10.0138 V
00:00:04 13.58mOhm, 10.0139 V
00:00:05 13.58mOhm, 10.0139 V
00:00:06 13.68mOhm, 10.0139 V

```

*** VOLTAGE ***

Number	85	
Valid	85	
Average	10.0074 V	
Max	10.0197 V (57)
Min	9.9938 V (31)
Sn	0.0068 V	
Sn-1	0.0068 V	
Cp	0.35	
CpK	0.32	
Comp Hi	10	
Comp IN	59	
Comp Lo	16	

NOTE

Measurement values indicated as "Invalid" cannot be displayed by the instrument.

The number of statistical calculation results indicated as "Valid" equals the count of valid data excluding measurement faults and overflows.

RS-232C/GP-IB Interfaces

Chapter 7

This chapter describes the GP-IB and RS-232C interfaces, using the following symbols to indicate which information pertains to each interface. Sections with neither of these symbols pertain to both interfaces.

GP-IB : GP-IB only

RS-232C : RS-232C only

Before Use

- GP-IB is available only on Model 3561-01.
- Always make use of the connector screws to affix the GP-IB or RS-232C connectors.
- When issuing commands that contain data, make certain that the data is provided in the specified format.

7.1 Overview and Features

All instrument functions other than power on/off switching can be controlled via GP-IB/RS-232C interfaces.

- Resetting is supported.

GP-IB

- IEEE 488.2-1987 Common (essential) Commands are supported.
- Complies with the following standard:
Applicable standard IEEE 488.1-1987^{*1}
- This instrument is designed with reference to the following standard:
Reference standard IEEE 488.2-1987^{*2}
- If the output queue becomes full, a query error is generated and the output queue is cleared. Therefore, clearing the output queue and query error output from the deadlocked condition^{*3} as defined in IEEE 488.2 is not supported.

*1. ANSI/IEEE Standard 488.1-1987, IEEE Standard Digital Interface for Programmable Instrumentation.

*2. ANSI/IEEE Standard 488.2-1987, IEEE Standard Codes, Formats, Protocols, and Common Commands.

*3. The situation in which the input buffer and the output queue become full, so that processing cannot continue.

7.2 Specifications

7.2.1 RS-232C Specifications

RS-232C

Transfer method	Communications : Full duplex Synchronization : Start-stop synchronization
Baud rate	9600 bps/ 19200 bps/ 38400 bps
Data length	8 bit
Parity	none
Stop bit	1 bit
Message terminator (delimiter)	Receiving : CR+LF, CR Transmitting : CR+LF
Flow control	none
Electrical specification	Input voltage levels 5 to 15 V: ON, -15 to -5 V: OFF Output voltage levels 5 to 9 V: ON, -9 to -5 V: OFF
Connector	RS-232C Interface Connector Pinout (Male 9-pin D-sub, with #4-40 attachment screws) The I/O connector is a DTE (Data Terminal Equipment) configuration Recommended cables: <ul style="list-style-type: none"> • Model 9637 RS-232C CABLE (for PC/AT-compatibles) • Model 9638 RS-232C CABLE (for PC98-series) See Section 7.3.1 Attaching the Connector (p.89).

7.2.2 GP-IB Specifications (Model 3561-01 only)

GP-IB is available only on Model 3561-01.

GP-IB

Interface Functions

SH1	All Source Handshake functions are supported.
AH1	All Acceptor Handshake functions are supported.
T6	Basic talker functions are supported. Serial poll function are supported. No talk-only mode. The talker cancel function with MLA (My Listen Address) is supported.
L4	Basic listener functions are supported. No listen-only mode. The listener cancel function with MTA (My Talk Address) is supported.
SR1	All Service Request functions are supported.
RL1	All Remote/Local functions are supported.
PP0	No Parallel Poll function.
DC1	All Device Clear functions are supported.
DT1	All Device Trigger functions are supported.
C0	No Controller functions are supported.

Operating Code: ASCII codes

7.3 Selecting the Connections and Protocol

7.3.1 Attaching the Connector



- Always turn both devices OFF when connecting and disconnecting an interface connector. Otherwise, an electric shock accident may occur.
- After connecting, always tighten the connector screws. The mounting screws must be firmly tightened or the RS-232C connector may not perform to specifications, or may even fail.
- To avoid damage to the instrument, do not short-circuit the connector and do not input voltage to the connector.

RS-232C

RS-232C Connector

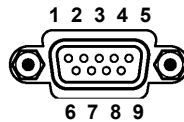

Male 9-pin D-sub
#4-40 attaching screws

Connect the RS-232C cable.

To connect the instrument to a controller (DTE), use a crossover cable compatible with the connectors on both the instrument and the controller.

The I/O connector is a DTE (Data Terminal Equipment) configuration. This instrument uses only pins 2, 3 and 5. The other pins are unconnected.

Pin No.	Signal Name			Signal	Notes
	Common	EIA	JIS		
1	DCD	CF	CD	Unused	No connection
2	RxD	BB	RD	Receive Data	
3	TxD	BA	SD	Transmit Data	
4	DTR	CD	ER	Data Terminal Ready	Internally connected to +5 V
5	GND	AB	SG	Signal Ground	
6	DSR	CC	DR	Unused	No connection
7	RTS	CA	RS	Request to Send	Internally connected to +5 V
8	CTS	CB	CS	Unused	No connection
9	RI	CE	CI	Unused	No connection

RS-232C

**Connecting to a PC/AT-
Compatible (DOS/V)
Machine**

Use a **crossover cable** with **female 9-pin D-sub** connectors.

Crossover Wiring

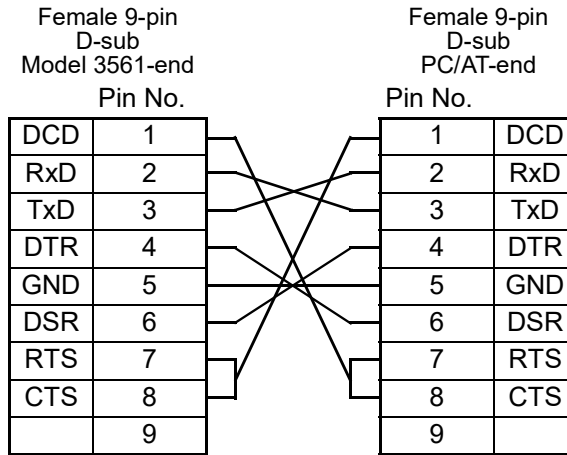

Recommended cable:

HIOKI
Model 9637 RS-232C
CABLE (1.8 m)

**Connecting to an NEC
PC9801 or PC9821
Series Desktop PC
(excluding NX)**

Use a **crossover cable** with a **female 9-pin D-sub** and a **male 25-pin D-sub** connector.

As the figure shows, RTS and CTS pins are shorted together and crossed to DCD in the other connector.

Crossover Wiring

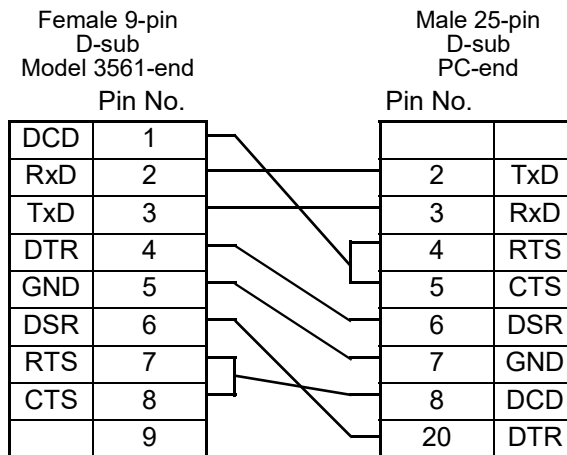

Recommended cable:

HIOKI
Model 9638 RS-232C
CABLE (1.8 m)

Note that the combination of a dual male 25-pin D-sub cable and a 9- to 25-pin adapter cannot be used.

GP-IB

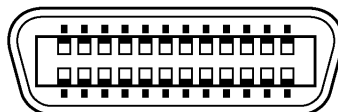

GP-IB Connector





Connecting a GP-IB cable.

Recommended cable:
Model 9151-02 GP-IB CONNECTOR CABLE
(2 m)

7.3.2 Selecting the Interface

- 1**  (SHIFT Lamp lit)
 The Menu display appears.
- 2**  **Select the Interface Selection display.**
 See Section 1.4 Menu Display Sequence (SHIFT → ENTER) (p.15).

 (Main Display)
 (Sub Display)
 The current setting blinks.
- 3**  **Select RS-232C or GP-IB on the Sub Display.**

rS RS-232C
GP-ib GP-IB (Model 3561-01 only)
 Prn Printer



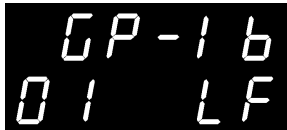

When you select RS-232C, set the communications speed.

 (Sub Display)

When selecting **GP-IB**, also set the Address and Message Terminator.

 (Sub Display)

Message Terminator setting (LF/CRLF)
 Address setting (0 to 30)

 Selects the item to set
  Setting
- 4**  **Applies settings and returns to the Measurement display.**

7.4 Communication Methods

Various messages are supported for controlling the instrument through the interfaces.

Messages can be either program messages, sent from the PC to the instrument, or response messages, sent from the instrument to the PC.

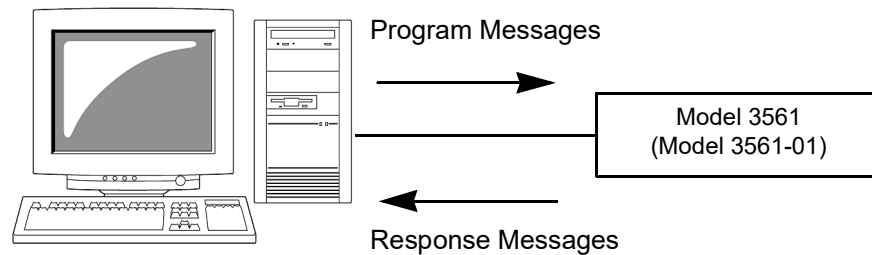

Message types are further categorized as follows:

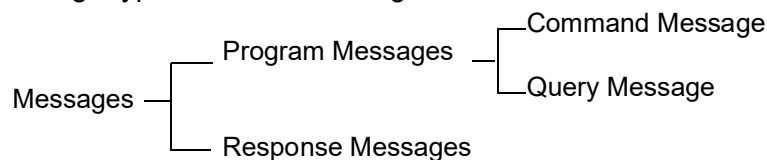

7.4.1 Message Format

Program Messages

Program messages can be either Command Messages or Query Messages.

- **Command Messages**

Instructions to control the instrument, such as to change settings or reset

Example: (instruction to set the measurement range)

:RESISTANCE:RANGE 100E-3



- **Query Messages**

Requests for responses relating to results of operation or measurement, or the state of instrument settings.

Example: (request for the current measurement range)

:RESISTANCE:RANGE?



For details: See Section Headers (p.93), Separators (p.94) and Data Formats (p.95).

Response Messages

When a query message is received, its syntax is checked and a response message is generated.

The **:SYSTEM:HEADer** command determines whether headers are prefixed to response messages.

Header ON **:RESISTANCE:RANGE 300.00E-3**

Header OFF **300.00E-3**

(the current resistance measurement range is 300 mΩ)

At power-on, Header OFF is selected.

If an error occurs when a query message is received, no response message is generated for that query.

No header is applied to commands used only for queries, such as **:FETCH?** and **:CALCulate:LIMit:RESistance:RESult?**.

Command Syntax

Command names are chosen to mnemonically represent their function, and can be abbreviated. The full command name is called the "long form", and the abbreviated name is called the "short form".

The command references in this manual indicate the short form in upper-case letters, extended to the long form in lower case letters, although the commands are not case-sensitive in actual usage.

Response messages generated by the instrument are in long form and

FUNCTION OK (long form)

FUNC OK (short form)

FUNCT Error

FUN Error

in upper case letters.

Headers

Headers must always be prefixed to program messages.

(1) Command Program Headers

There are three types of commands: Simple, Compound and Standard.

- **Headers for Simple Commands**

This header type is a sequence of letters and digits

***ESE 0**

- **Headers for Compound Commands**

These headers consist of multiple simple command type headers separated by colons ":"

:SAMPLE:RATE

- **Headers for Standard Commands**

This header type begins with an asterisk "*", indicating that it is a standard command defined by IEEE 488.2.

***RST**

(2) Query Program Header

These commands are used to interrogate the instrument about the results of operations, measured values and the current states of instrument settings.

As shown by the following examples, a query is formed by appending a question mark "?" after a program header.

:FETCh?

:MEASure:RESistance?

Message Terminators

This instrument recognizes the following message terminators:

GP-IB

- LF
- CR+LF
- EOI
- LF with EOI

RS-232C

- CR
- CR+LF

From the instrument's interface settings, the following can be selected as the terminator for response messages.

GP-IB

- LF with EOI (initial setting)
- LF with CR and EOI

RS-232C

- CR + LF (initial setting)

See Section 7.3.2 Selecting the Interface (p.91).

Separators

(1) Message Unit Separator

Multiple message can be written in one line by separating them with semicolons ";".

```
:SYSTEM:LFREQUENCY 60;*IDN?
```

- When messages are combined in this way and if one command contains an error, all subsequent messages up to the next terminator will be ignored.
- A query error occurs if a query command is combined with an immediately following semicolon and subsequent command.

(2) Header Separator

In a message consisting of both a header and data, the header is separated from the data by a space " ".

```
:SYSTEM:ELOCK ON
```

(3) Data Separator

In a message containing multiple data items, commas are required to separate the data items from one another.

Data Formats

The instrument uses character data and decimal numeric data, depending on the command.

(1) Character Data

Character data always begins with an alphabetic character, and subsequent characters may be either alphabetic or numeric. Character data is not case-sensitive, although response messages from the instrument are only upper case.

As with command syntax, both long and short forms are acceptable.

```
:SYSTEM:ELOCK ON
```

(2) Decimal Numeric Data

Three formats are used for numeric data, identified as NR1, NR2 and NR3. Numeric values may be signed or unsigned. Unsigned numeric values are handled as positive values.

Values exceeding the precision handled by the instrument are rounded to the nearest valid digit.

- NR1 Integer data (e.g.: +12, -23, 34)
- NR2 Fixed-point data(e.g.: +1.23, -23.45, 3.456)
- NR3 Floating-point exponential representation data (e.g.: +1.0E-2, -2.3E+4)

The term "NRf format" includes all three of the above numeric decimal formats.

The instrument accepts NRf format data.

The format of response data is specified for each command, and the data is sent in that format.

```
:ESR0 106
:FETCH? +106.57E-3
```



The instrument does not fully support IEEE 488.2. As much as possible, please use the data formats shown in the Reference section. Also, be careful to avoid constructing single commands that could overflow the input buffer or output queue.

Compound Command Header Omission

When several commands having a common header are combined to form a compound command (e.g., `:CALCulate: LIMit:RESistance:UPPer:` and `:CALCulate: LIMit:RESistance:LOWer`), if they are written together in sequence, the common portion (here, `:CALCulate: LIMit:RESistance`) can be omitted after its initial occurrence.

This common portion is called the "current path" (analogous to the path concept in computer file storage), and until it is cleared, the interpretation of subsequent commands presumes that they share the same common portion.

This usage of the current path is shown in the following example:

Full expression

```
:CALCulate: LIMit:RESistance:UPPer  
30000; :CALCulate: LIMit:LOWer 29000
```

Compacted expression

```
:CALCulate: LIMit:RESistance:UPPer 30000; LOWer 29000
```

↑
This portion becomes the current path, and can be omitted from the messages immediately following.

The current path is cleared when the power is turned on, when reset by key input, by a colon ":" at the start of a command, and when a message terminator is detected.

Standard command messages can be executed regardless of the current path.

They have no effect upon the current path.

A colon ":" is not required at the start of the header of a Simple or Compound command. However, to avoid confusion with abbreviated forms and operating mistakes, we recommend always placing a colon at the start of a header.

7.4.2 Output Queue and Input Buffer

Output Queue

Response messages are stored in the output queue until read by the controller. The output queue is also cleared in the following circumstances:

- Power on
- Device clear
- Query Error

The output queue capacity of the instrument is 64 bytes. If response messages overflow the buffer, a query error is generated and the output queue is cleared.

Also, with GP-IB, if a new message is received while data remains in the output queue, the output queue is cleared and a query error is generated.

Input Buffer

The input buffer capacity of the instrument is 256 bytes.

If 256 bytes are allowed to accumulate in this buffer so that it becomes full, the GP-IB interface bus enters the waiting state until space is cleared in the buffer.

The RS-232C interface will not accept data beyond 256 bytes.

NOTE

Ensure that the no command ever exceeds 256 bytes.

7.4.3 Status Byte Register

This instrument implements the status model defined by IEEE 488.2 with regard to the serial poll function using the service request line. The term "event" refers to any occurrence that generates a service request.

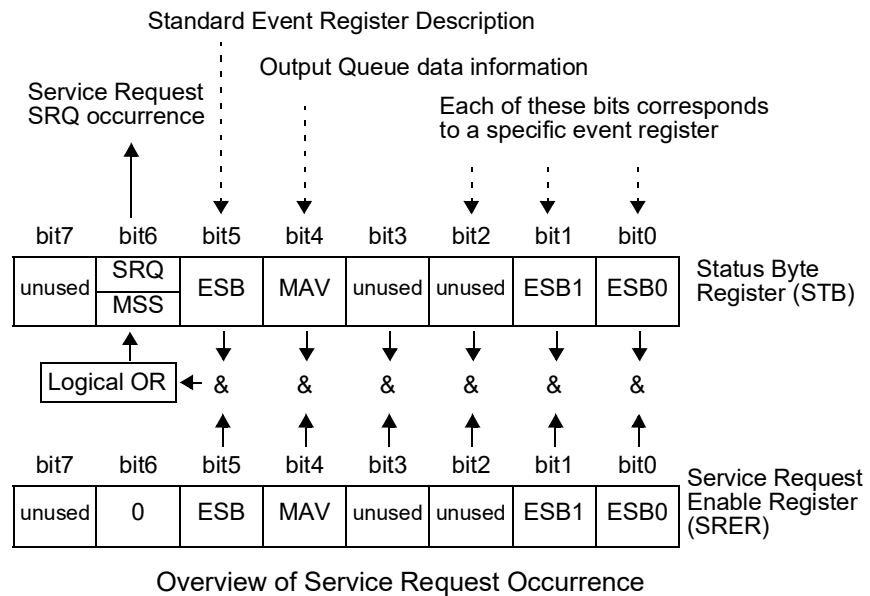

The Status Byte Register contains information about the event registers and the output queue. Required items are selected from this information by masking with the Service Request Enable Register. When any bit selected by the mask is set, bit 6 (MSS; the Master Summary Status) of the Status Byte Register is also set, which generates an SRQ (Service Request) message and dispatches a service request.

Status Byte Register (STB)

During serial polling, the contents of the 8-bit Status Byte Register are sent from the instrument to the controller.

When any Status Byte Register bit enabled by the Service Request Enable Register has switched from 0 to 1, the MSS bit becomes 1. Consequently, the SRQ bit is set to 1, and a service request is dispatched.

The SRQ bit is always synchronous with service requests, and is read and simultaneously cleared during serial polling. Although the MSS bit is only read by an ***STB?** query, it is not cleared until a clear event is initiated by the ***CLS** command.

Bit 7	unused
Bit 6 SRQ MSS	Set to 1 when a service request is dispatched. This is the logical sum of the other bits of the Status Byte Register.
Bit 5 ESB	Standard Event Status (logical OR) bit This is logical sum of the Standard Event Status Register.
Bit 4 MAV	Message available Indicates that a message is present in the output queue.
Bit 3	unused
Bit 2	unused
Bit 1 ESB1	Event Status (logical OR) bit 1 This is the logical sum of Event Status Register 1.
Bit 0 ESB0	Event Status (logical OR) bit 0 This is the logical sum of Event Status Register 0.

Service Request Enable Register (SRER)

This register masks the Status Byte Register. Setting a bit of this register to 1 enables the corresponding bit of the Status Byte Register to be used.

7.4.4 Event Registers

Standard Event Status Register (SESR)

The Standard Event Status Register is an 8-bit register.

If any bit in the Standard Event Status Register is set to 1 (after masking by the Standard Event Status Enable Register), bit 5 (ESB) of the Status Byte Register is set to 1.

The Standard Event Status Register is cleared in the following situations:

- When a ***CLS** command is executed
- When an event register query (***ESR?**) is executed
- When the instrument is powered on

Bit 7	PON	Power-On Flag Set to 1 when the power is turned on, or upon recovery from an outage.
Bit 6		User Request unused
Bit 5	CME	Command Error (The command to the message terminator is ignored.) This bit is set to 1 when a received command contains a syntactic or semantic error: <ul style="list-style-type: none"> • Program header error • Incorrect number of data parameters • Invalid parameter format • Received a command not supported by the instrument
Bit 4	EXE	Execution Error This bit is set to 1 when a received command cannot be executed for some reason. <ul style="list-style-type: none"> • The specified data value is outside of the set range • The specified setting data cannot be set • Execution is prevented by some other operation being performed
Bit 3	DDE	Device-Dependent Error This bit is set to 1 when a command cannot be executed due to some reason other than a command error, a query error or an execution error. <ul style="list-style-type: none"> • Execution is impossible due to an internal instrument fault
Bit 2	QYE	Query Error (the output queue is cleared) This bit is set to 1 when a query error is detected by the output queue control. <ul style="list-style-type: none"> • When an attempt has been made to read an empty output queue (GP-IB only) • When the data overflows the output queue • When data in the output queue has been lost
Bit 1		unused
Bit 0	OPC	Operation Complete (GP-IB only) This bit is set to 1 in response to an *OPC command. <ul style="list-style-type: none"> • It indicates the completion of operations of all messages up to the *OPC command

Standard Event Status Enable Register (SESER)

Setting any bit of the Standard Event Status Enable Register to 1 enables access to the corresponding bit of the Standard Event Status Register.

Standard Event Status Register (SESR) and Standard Event Status Enable Register (SESER)

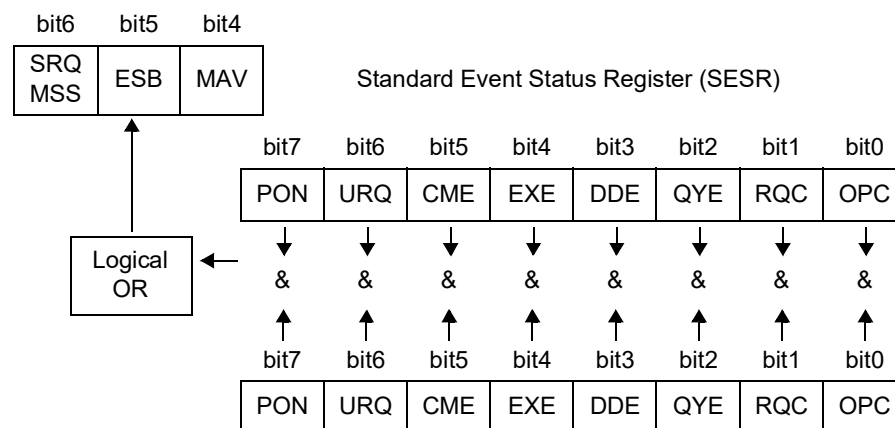

Standard Event Status Enable Register (SESER)

Device-Specific Event Status Registers (ESR0 and ESR1)

This instrument provides two event status registers for controlling events.

Each event register is an 8-bit register.

When any bit in one of these event status registers enabled by its corresponding event status enable register is set to 1, the following happens:

- For Event Status Register 0, bit 0 (ESB0) of the Status Byte Register is set to 1.
- For Event Status Register 1, bit 1 (ESB1) of the Status Byte Register is set to 1.

Event Status Registers 0 and 1 are cleared in the following situations:

- When a ***CLS** command is executed
- When an Event Status Register query (**:ESR0?** or **:ESR1?**) is executed
- When the instrument is powered on

	Event Status Register 0 (ESR0)		Event Status Register 1 (ESR1)	
Bit 7	--	Unused	--	unused
Bit 6	--	Unused	AND	AND
Bit 5	ERR	Measurement Faults	V-Hi	Voltage High Comparator Result
Bit 4	--	Unused	V-IN	Voltage IN Comparator Result
Bit 3	--	Unused	V-Lo	Voltage Low Comparator Result
Bit 2	--	Unused	R-Hi	Resistance High Comparator Result
Bit 1	INDEX	End of Measurement	R-IN	Resistance IN Comparator Result
Bit 0	EOC	End of Conversion	R-Lo	Resistance Low Comparator Result

Event Status Registers 0 (ESR0) and 1 (ESR1), and Event Status Enable Registers 0 (ESER0) and 1 (ESER1)

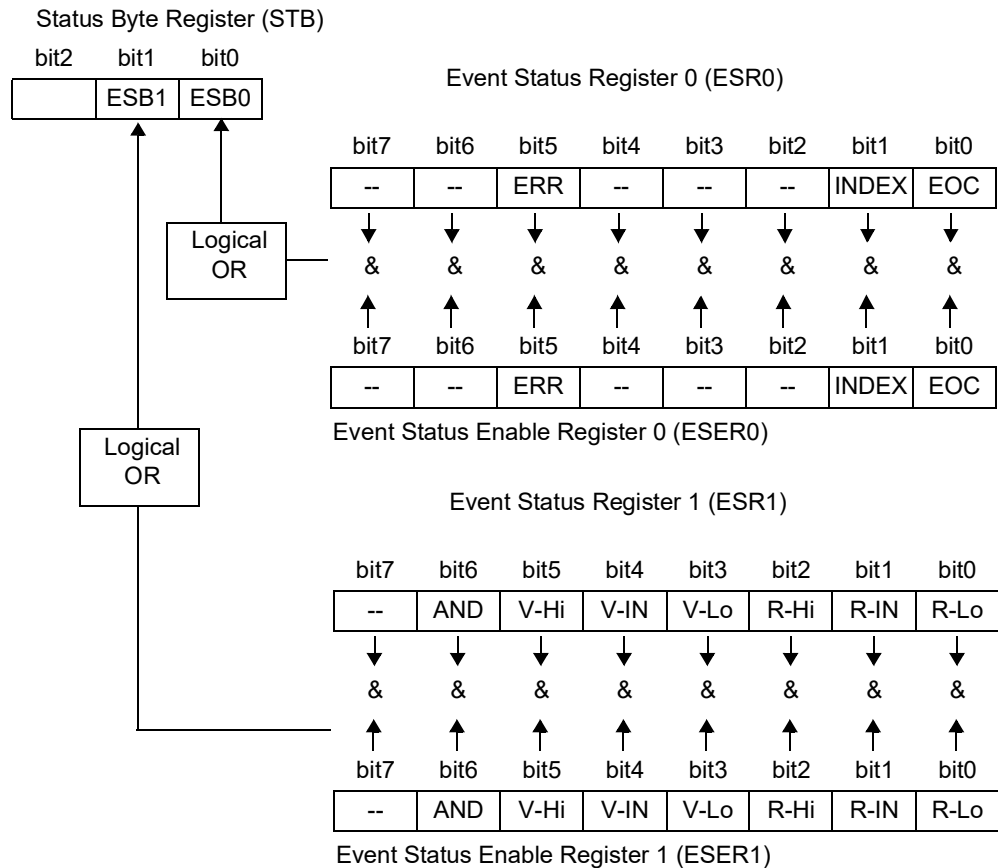

Register Reading and Writing

Register	Read	Write
Status Byte Register	*STB?	–
Service Request Enable Register	*SRE?	*SRE
Standard Event Status Register	*ESR?	–
Standard Event Status Enable Register	*ESE?	*ESE
Event Status Register 0	:ESR0?	–
Event Status Enable Register 0	:ESE0?	:ESE0
Event Status Register 1	:ESR1?	–
Event Status Enable Register 1	:ESE1?	:ESE1

GP-IB Commands

The following commands can be used for performing interface functions.

Command	Description
GTL	Go To Local Cancels the Remote state and enters the Local state.
LLO	Local Lock Out Disables all keys, including the LOCAL key.
DCL	Device CLear Clears the input buffer and the output queue.
SDC	Selected Device Clear Clears the input buffer and the output queue.
GET	Group Execute Trigger When an external trigger occurs, processes one sample.

7.4.5 Initialization Items

✓ = initialized, – = not initialized

Item	Initialization Method	At Power-on	*RST Command	Device Clear	*CLS Command
Device-specific functions (Range, etc.)		–	✓	–	–
Output Queue		✓	–	✓	–
Input buffer		✓	–	✓	–
Status Byte Register		✓	–	– *1	✓*2
Event registers		✓*3	–	–	✓
Enable register		✓	–	–	–
Current path		✓	–	✓	–
Headers on/off		✓	✓	–	–

*1: Only the MAV bit (bit 4) is cleared.

*2: All bits except the MAV bit are cleared.

*3: Except the PON bit (bit 7).

7.4.6 Local Function

During communications, **REMOTE** is lit to indicate the remote control state.

To cancel the Remote state

LOCAL REMOTE off

NOTE

- Remote control can be canceled by pressing the **SHIFT** key and then the **AUTO** key.
- If the Local Lock Out (Page 102) GP-IB command has been issued, the Remote state cannot be canceled.

7.5 Message List

Commands specific to RS-232C or GP-IB are identified by **RS-232C** or **GP-IB**, respectively.

NOTE

- Any spelling mistake in a message results in a command error.
- < > = contents of the data portion.
[Numeric data values are indicated by format as (NR1), (NR2) and (NR3), representing integer, fixed-point and floating point decimal data values respectively, or as (NRf), representing any of these formats]
- []: optional

7.5.1 Standard Commands

Command	Data Formats (Response data if a Query)	Description	Error	Ref page
*IDN?	<Manufacturer's name>, <Model name>,0, <Software version>	Queries the device ID	*2	111
*RST		Initializes the device	*1	111
*TST?	0 to 3 (NR1)	Initiates a self-test and queries the result	*2	111
*OPC		Requests an SRQ after execution completion	*1	112
*OPC?	1	Queries execution completion	*2	112
*WAI		Waits for operations to finish	*1	112
*CLS		Clears the Event Registers and the Status Byte Register	*1	112
*ESE	0 to 255 (NR1)	Sets the contents of the Standard Event Status Enable Register	*3	113
*ESE?	0 to 255 (NR1)	Queries the Standard Event Status Enable Register	*2	113
*ESR?	0 to 255 (NR1)	Queries and clear the Standard Event Status Register	*2	113
*SRE	0 to 255 (NR1)	Sets the Service Request Enable Register	*3	114
*SRE?	0 to 255 (NR1)	Queries the contents of the Service Request Enable Register	*2	114
*STB?	0 to 255 (NR1)	Queries the Status Byte Register	*2	114
*TRG		Requests a sampling	*1	114

Error description (an error occurs when executing messages in the following cases):

- *1 Command ErrorWhen data is present after the command
- *2 Query ErrorWhen the response message exceeds 64 bytes
- *3 Execution ErrorWhen invalid character or numeric data is present

7.5.2 Device-Specific Commands

Message ([] = optional)	Data Contents () = response data	Description	Ref page
Event Registers			
:ESE0	0 to 255	Sets Event Status Enable Register 0	115
:ESE0?	0 to 255	Queries Event Status Enable Register 0	115
:ESR0?	0 to 255	Queries Event Status Register 0	115
:ESE1	0 to 255	Sets Event Status Enable Register 1	115
:ESE1?	0 to 255	Queries Event Status Enable Register 1	115
:ESR1?	0 to 255	Queries Event Status Register 1	115
Measurement Mode			
:FUNction	RV/ RESistance/ VOLTage	Sets measurement mode	116
:FUNction?	RV/ RESistance/ VOLTage	Queries measurement mode	116
Measurement Range			
:RESistance:RANGe	0 to 3.1	Sets resistance measurement range	116
:RESistance:RANGe?	300.00E-3/ 3.0000E+0	Queries resistance measurement range	116
:VOLTage:RANGe	-20 to 20	Sets voltage measurement range	116
:VOLTage:RANGe?	20.0000E+0	Queries voltage measurement range	116
Auto Range			
:AUTorange	1/ 0/ ON/ OFF	Sets the auto range	117
:AUTorange?	ON/ OFF	Queries the auto range setting	117
Zero-Adjust			
:ADJust:CLEAr		Cancels zero-adjustment	117
:ADJust?	0/ 1	Executes zero-adjustment and queries the result	117
Sampling Rate			
:SAMPle:RATE	EXFast/ FAST/ MEDium/ SLOW	Sets the sampling rate	117
:SAMPle:RATE?	EXFast/ FAST/ MEDium/ SLOW	Queries the sampling rate setting	117
Averaging Function			
:CALCulate:AVERage:STATe	1/ 0/ ON/ OFF	Sets averaging function execution	118
:CALCulate:AVERage:STATe?	ON/ OFF	Queries the averaging function execution setting	118
:CALCulate:AVERage	2 to 16	Sets the no. of samples to average	118
:CALCulate:AVERage?	2 to 16	Queries the no. of samples to average setting	118
Comparator			
:CALCulate:LIMit:STATe	1/ 0/ ON/ OFF	Sets comparator execution	118
:CALCulate:LIMit:STATe?	ON/OFF	Queries the comparator execution setting	118

Message ([] = optional)	Data Contents () = response data	Description	Ref page
Comparator			
:CALCulate:LIMit:BEEPer	OFF/ HL/ IN/ BOTH1 / BOTH2	Sets the comparator judgment beeper setting	119
:CALCulate:LIMit:BEEPer?	OFF/ HL/ IN/ BOTH1 / BOTH2	Queries the comparator judgment beeper setting	119
:CALCulate:LIMit:RESistance:MODE	HL/ REF	Sets the resistance comparator execution mode setting	119
:CALCulate:LIMit:RESistance:MODE?	HL/ REF	Queries the resistance comparator execution mode setting	119
:CALCulate:LIMit:VOLTage:MODE	HL/ REF	Sets the voltage comparator execution mode setting	119
:CALCulate:LIMit:VOLTage:MODE?	HL/ REF	Queries the voltage comparator execution mode setting	119
:CALCulate:LIMit:RESistance:UPPer	<Upper threshold>	Sets the resistance comparator upper threshold setting	120
:CALCulate:LIMit:RESistance:UPPer?	<Upper threshold>	Queries the resistance comparator upper threshold setting	120
:CALCulate:LIMit:VOLTage:UPPer	<Upper threshold>	Sets the voltage comparator upper threshold setting	120
:CALCulate:LIMit:VOLTage:UPPer?	<Upper threshold>	Queries the voltage comparator upper threshold setting	120
:CALCulate:LIMit:RESistance:LOWer	<Lower threshold>	Sets the resistance comparator lower threshold setting	121
:CALCulate:LIMit:RESistance:LOWer?	<Lower threshold>	Queries the resistance comparator lower threshold setting	121
:CALCulate:LIMit:VOLTage:LOWer	<Lower threshold>	Sets the voltage comparator lower threshold setting	121
:CALCulate:LIMit:VOLTage:LOWer?	<Lower threshold>	Queries the voltage comparator lower threshold setting	121
:CALCulate:LIMit:RESistance:REFerence	<Reference value>	Sets the resistance comparator reference value	122
:CALCulate:LIMit:RESistance:REFerence?	<Reference value>	Queries the resistance comparator reference value	122
:CALCulate:LIMit:VOLTage:REFerence	<Reference value>	Sets the voltage comparator reference value	122
:CALCulate:LIMit:VOLTage:REFerence?	<Reference value>	Queries the voltage comparator reference value	122
:CALCulate:LIMit:RESistance:PERCent	<Tolerance (%)>	Sets the resistance comparator decision tolerance setting	123
:CALCulate:LIMit:RESistance:PERCent?	<Tolerance (%)>	Queries the resistance comparator decision tolerance setting	123
:CALCulate:LIMit:VOLTage:PERCent	<Tolerance (%)>	Sets the voltage comparator decision Tolerance setting	123
:CALCulate:LIMit:VOLTage:PERCent?	<Tolerance (%)>	Queries the voltage comparator decision tolerance setting	123
:CALCulate:LIMit:RESistance:RESult?	HI/ IN/ LO/ OFF/ ERR	Queries resistance comparator judgment results	124
:CALCulate:LIMit:VOLTage:RESult?	HI/ IN/ LO/ OFF/ ERR	Queries voltage comparator judgment results	124
Statistical Functions			
:CALCulate:STATistics:STATe	1/ 0/ ON/ OFF	Sets statistical calculation function execution	124
:CALCulate:STATistics:STATe?	ON/ OFF	Queries the statistical calculation function execution setting	124
:CALCulate:STATistics:CLEAr		Clears statistical calculation results	124
:CALCulate:STATistics:RESistance:NUMBer?	<Total data count>, <Valid data count>	Queries the resistance data count	125

Message ([] = optional)	Data Contents () = response data	Description	Ref page
:CALCulate:STATistics:VOLTage:NUMBer?	<Total data count>, <Valid data count>	Queries the voltage data count	125
:CALCulate:STATistics:RESistance:MEAN?	<Mean>	Queries the resistance mean value	125
:CALCulate:STATistics:VOLTage:MEAN?	<Mean>	Queries the voltage mean value	125
:CALCulate:STATistics:RESistance:MAXimum?	<Maximum value>, <Data No. of Maximum value>	Queries the resistance maximum value	126
:CALCulate:STATistics:VOLTage:MAXimum?	<Maximum value>, <Data No. of Maximum value>	Queries the voltage maximum value	126
:CALCulate:STATistics:RESistance:MINimum?	<Minimum value>, <Data No. of Maximum value>	Queries the resistance minimum value	126
:CALCulate:STATistics:VOLTage:MINimum?	<Minimum value>, <Data No. of Maximum value>	Queries the voltage minimum value	126
:CALCulate:STATistics:RESistance:LIMit?	<Hi count>, <IN count>, <Lo count>, <Measurement fault count >	Queries comparator results of resistance measurement	127
:CALCulate:STATistics:VOLTage:LIMit?	<Hi count>, <IN count>, <Lo count>, <Measurement fault count >	Queries comparator results of voltage measurement	127
:CALCulate:STATistics:RESistance:DEVIation?	< σ_n >, < σ_{n-1} >	Queries standard deviation of resistance measurement	127
:CALCulate:STATistics:VOLTage:DEVIation?	< σ_n >, < σ_{n-1} >	Queries standard deviation of voltage measurement	127
:CALCulate:STATistics:RESistance:CP?	<Cp>, <CpK>	Queries process capability indices of resistance measurement	128
:CALCulate:STATistics:VOLTage:CP?	<Cp>, <CpK>	Queries process capability indices of voltage measurement	128

Memory Function

:MEMory:STATe	1/ 0/ ON/ OFF	Sets the memory function state	128
:MEMory:STATe?	ON/ OFF	Queries the memory function state	128
:MEMory:CLEAR		Clears instrument memory	128
:MEMory:COUNt?	0 to 400	Queries the memory data count	129
:MEMory:DATA?	[STEP]	Queries the memory data	129

Self-Calibration

:SYSTem:CALibration		Executes self-calibration	130
:SYSTem:CALibration:AUTO	1/ 0/ ON/ OFF	Sets automatic self-calibration	130
:SYSTem:CALibration:AUTO?	ON/ OFF	Queries the automatic self-calibration setting	130

Trigger Input Measured Value Output

:SYSTem:DATAout	1/ 0/ ON/ OFF	Sets measurement value output upon triggering	130
:SYSTem:DATAout?	ON/ OFF	Queries measurement value output upon triggering	130

Key Beeper

:SYSTem:BEEPer:STATe	1/ 0/ ON/ OFF	Sets the key beeper	131
:SYSTem:BEEPer:STATe?	ON/ OFF	Queries the key beeper setting	131

Message ([] = optional)	Data Contents () = response data	Description	Ref page
Line Frequency			
:SYSTem:LFRequency	50/ 60	Selects the AC line frequency	131
:SYSTem:LFRequency?	50/ 60	Queries the AC line frequency selection	131
Key-Lock			
:SYSTem:KLOCK	1/ 0/ ON/ OFF	Sets the key-lock	131
:SYSTem:KLOCK?	ON/ OFF	Queries the key-lock setting	131
EXT I/O Output			
:SYSTem:ELOCK	1/ 0/ ON/ OFF	Sets the external input terminal lock	132
:SYSTem:ELOCK?	ON/ OFF	Queries the external input terminal lock on/off setting	132
Local			
:SYSTem:LOCal		Sets local control	132
Saving and Loading Measurement Setting States			
:SYSTem:SAVE	<Table No.>	Saves the measurement setting state	132
:SYSTem:LOAD	<Table No.>	Loads a measurement setting state	132
:SYSTem:BACKup		Backups current measurement configuration	132
Header Present			
:SYSTem:HEADer	1/ 0/ ON/ OFF	Sets header present	133
:SYSTem:HEADer?	ON/ OFF	Queries the header present setting	133
ERR Output			
:SYSTem:ERRor	SYNChronous/ ASYNchronous	Sets error output timing	133
:SYSTem:ERRor?	SYNChronous/ ASYNchronous	Queries the error output timing setting	133
EOC Output			
:SYSTem:EOC:MODE	<HOLD/PULSE>	Selects the EOC output mode	134
:SYSTem:EOC:MODE?	(<HOLD/PULSE>)	Queries the EOC output mode setting	134
:SYSTem:EOC:PULSE	<HOLD/PULSE>	Selects the EOC pulse width	134
:SYSTem:EOC:PULSE?	(0.001 to 0.100)	Queries the EOC pulse width setting	134
Terminator			
:SYSTem:TERMinator	0/ 1	Sets the terminator	133
:SYSTem:TERMinator?	0/ 1	Queries the terminator	133
System Reset			
:SYSTem:RESet		Executes a system reset, including saved measurement setting state data	134

Message ([] = optional)	Data Contents () = response data	Description	Ref page
EXT I/O			
:IO:OUT	0 to 1023	EXT I/O output	135
:IO:IN?	0 to 31	EXT I/O input	135
Trigger			
:INITiate:CONTinuous	1/ 0/ ON/ OFF	Sets continuous measurement	138
:INITiate:CONTinuous?	ON/ OFF	Queries the continuous measurement setting	138
:INITiate[:IMMediate]		Trigger wait setting	138
Trigger Source Setting			
:TRIGger:SOURce	IMMediate/ EXTernal	Sets the trigger source	139
:TRIGger:SOURce?	IMMediate/ EXTernal	Queries the trigger source setting	139
:TRIGger:DELay:STATe	1/ 0/ ON/ OFF	Sets the trigger delay	139
:TRIGger:DELay:STATe?	ON/ OFF	Queries the trigger delay setting	139
:TRIGger:DELay	<Delay time>	Sets trigger delay time	140
:TRIGger:DELay?	0 to 9.999	Queries the trigger delay time	140
Reading Measured Values			
:FETCh?	<Resistance measured value>, <Voltage measured value> ΩV mode <Resistance measured value> Ω mode <Voltage measured value> V mode	Reads the most recent measurement	140
:READ?	<Resistance measured value>, <Voltage measured value> ΩV mode <Resistance measured value> Ω mode <Voltage measured value> V mode	Executes a measurement and read the measured values	141

7.6 Message Reference

< >: Indicates the contents (character or numeric parameters) of the data portion of a message.
Character parameters are returned as all capital letters.

Numeric Parameters:

- NRfNumber format may be any of NR1, NR2 and NR3
- NR1Integer data(e.g.: +12, -23, 34)
- NR2Fixed-point data(e.g.: +1.23, -23.45, 3.456)
- NR3Floating-point exponential representation data (e.g.: +1.0E-2, -2.3E+4)

Shows the command description. →

Shows the message syntax. →

Explains the command data or response message.

Describes the message. →

Shows an example of an actual command application.
(Normally described with HEADER ON, (except the HEADER command itself).)

Read/Write the Standard Event Status Enable Register (SESER)

Syntax Command ***ESE <0 to 255 (NR1)>**
Query ***ESE?**
Response **<0 to 255 (NR1)>**

Description Command The SESER mask is set to the numerical value 0 to 255.
The initial value (at power-on) is 0.
Query The contents of the SESER, as set by the ***ESE** command, are returned as an NR1 value (0 to 255).

128	64	32	16	8	4	2	1
bit 7	bit 6	bit 5	bit 4	bit 3	bit 2	bit 1	bit 0
PON	URQ	CME	EXE	DDE	QYE	RQC	OPC

Example Command ***ESE 36**
(Sets bits 5 and 2 of SESER)

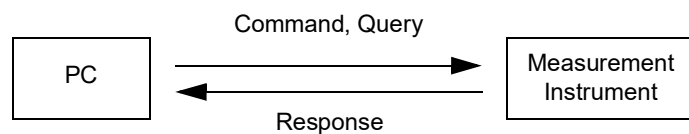

7.6.1 Standard Commands

Messages specific to the RS-232C or GP-IB interface are identified by their corresponding symbols.

System Data Command

Queries device ID.

Syntax	Query	*IDN?
	Response	<Manufacturer's name>,<Model name>,0,<Software version>
Description	Query	Queries the device manufacturer's name, model name and software version.
Example	Query	*IDN?
	Response	HIOKI, 3561, 0, V1.00 The Device ID is HIOKI 3561, 0, software version 1.00.
Note	<ul style="list-style-type: none"> • The response message has no header. • The model name of the Model 3561-01 is "3561-01". 	

Internal Operation Command

Initialize Device

Syntax	Command	*RST
Description	Command	Resets instrument settings (other than saved data) to factory defaults. Operation returns to the initial display after initialization.
Note	<ul style="list-style-type: none"> • The communications state is not initialized. • To initialize saved data as well, send the :SYSTEM:RESet command. 	

Execute Self-Test and Query the Result

Syntax	Query	*TST?
	Response	<0 to 3> 0.....No Errors 1.....RAM Error 2.....EEPROM Error 3.....RAM and EEPROM Errors
Description	Query	Perform instrument self-test and return the result as numerical value 0 to 3.
Example	Query	*TST?
	Response	1 A RAM Error occurred.

Synchronization Commands

Set the OPC bit of SESR When Finished All Pending Operations

Syntax	Command	*OPC
Description	Command	Sets OPC bit 0 of the Standard Event Status Register (SESR) when all prior commands have finished processing.
Example	Command	A ; B ; *OPC ; C The OPC bit of the SESR is set after commands A and B have finished processing.

Respond "1" When Finished All Pending Operations



Syntax	Query	*OPC?
	Response	1
Description	Query	Responds "1" when all prior commands have finished processing.

Wait for Pending Commands to Finish

Syntax	Command	*WAI
Description	Command	The instrument waits until all prior commands finish before executing any subsequent commands.
Note		The *WAI command is supported because it is defined in IEEE 488.2-1987, but because all Model 3561(3561-01) device-specific commands are sequential types, this command has no actual affect.

Status and Event Control Commands

Clear the Status Byte and Related Queues (Except the Output Queue)

Syntax	Command	*CLS
Description	Command	Clears the event registers corresponding to each bit of the Status Byte Register. Also clears the Status Byte Register.
Note		The output queue is unaffected.
		The output queue, the various enable registers and MAV bit 4 of the Status Byte Register are unaffected.

Set and Query the Standard Event Status Enable Register (SESER)

Syntax	Command	*ESE <0 to 255>
	Query	*ESE?
	Response	<0 to 255 (NR1)>
Description	Command	The SESER mask is set to the numerical value 0 to 255. The initial value (at power-on) is 0.
	Query	The contents of the SESER, as set by the *ESE command, are returned as an NR1 value (0 to 255).

128	64	32	16	8	4	2	1
bit 7	bit 6	bit 5	bit 4	bit 3	bit 2	bit 1	bit 0
PON	URQ	CME	EXE	DDE	QYE	RQC	OPC

Example	Command	*ESE 36 Sets bits 5 and 2 of SESER.
	Query	*ESE?
	Response	36 SESER has been set to bit 5 and bit 2.

Query and Clear the Standard Event Status Register (SESR)

Syntax	Query	*ESR?
	Response	<0 to 255 (NR1)>
Description	Query	Returns the contents of the SESR as an NR1 value from 0 to 255, then clears register contents. The response message has no header.

RS-232C

128	64	32	16	8	4	2	1
bit 7	bit 6	bit 5	bit 4	bit 3	bit 2	bit 1	bit 0
PON	unused	CME	EXE	DDE	QYE	unused	unused

GP-IB

128	64	32	16	8	4	2	1
bit 7	bit 6	bit 5	bit 4	bit 3	bit 2	bit 1	bit 0
PON	URQ	CME	EXE	DDE	QYE	RQC	OPC

Example	Query	*ESR?
	Response	32 Bit 5 of the SESR was set to 1.

Set and Query the Service Request Enable Register (SRER)

Syntax	Command	* SRE <0 to 255>
	Query	* SRE?
	Response	<0 to 255 (NR1)>
Description	Command	The SRER mask is set to the numerical value 0 to 255. Although NRf numerical values are accepted, values to the right of the decimal are rounded to the nearest integer. Bit 6 and unused bits 2, 3 and 7 are ignored. The data is initialized to zero at power-on.
	Query	The contents of the SRER, as set by the * SRE command, are returned as an NR1 value (0 to 255). Bit 6 and unused bits 2, 3 and 7 always return as zero.

128 bit 7	64 bit 6	32 bit 5	16 bit 4	8 bit 3	4 bit 2	2 bit 1	1 bit 0
unused	0	ESB	MAV	unused	unused	ESE1	ESE0

Example	Command	* SRE 33 Set SRER bits 0 and 5 to 1.
	Query	* SRE?
	Response	33 SRER bits 0 and 5 have been set to 1.

Query the Status Byte and MSS Bit

Syntax	Query	* STB?
	Response	<0 to 255 (NR1)>
Description	Query	The contents of the STB are returned as an NR1 value (0 to 255). The response message has no header.

128 bit 7	64 bit 6	32 bit 5	16 bit 4	8 bit 3	4 bit 2	2 bit 1	1 bit 0
unused	MSS	ESB	MAV	unused	unused	ESE1	ESE0

Example	Query	* STB?
	Response	16 STB bit 4 has been set to 1.

Request a Sample

Syntax	Command	* TRG
Description	Command	Performs one measurement when external triggering is enabled. When Statistical Calculation is ON, imports calculation data.

7.6.2 Device-Specific Commands

Set and Query Device-Specific Event Status Enable Registers ESER0

Syntax	Command	: ESE0 <0 to 255>
	Query	: ESE0?
	Response	<0 to 255 (NR1)>
Description	Command	Sets the mask pattern in Event Status Enable Register 0 (ESER0) for the Event Status Register.
	Query	Queries the mask pattern in Event Status Enable Register 0 (ESER0) for the Event Status Register.

128 bit 7	64 bit 6	32 bit 5	16 bit 4	8 bit 3	4 bit 2	2 bit 1	1 bit 0
unused	unused	ERR	unused	unused	unused	INDEX	EOC

Note Data initializes to zero at power-on.

Set and Query Device-Specific Event Status Enable Registers ESER1

Syntax	Command	: ESE1 <0 to 255>
	Query	: ESE1?
	Response	<0 to 255 (NR1)>
Description	Command	Sets the mask pattern in Event Status Enable Register 1 (ESER1) for the Event Status Register.

128 bit 7	64 bit 6	32 bit 5	16 bit 4	8 bit 3	4 bit 2	2 bit 1	1 bit 0
unused	AND	V-Hi	V-IN	V-Lo	R-Hi	R-IN	R-Lo

Note Data initializes to zero at power-on.

Read Device-Specific Event Status Registers ESR0 and ESR1

Syntax	Query	: ESR0? : ESR1?
	Response	<0 to 255 (NR1)>

Note Executing **:ESR0?** clears the contents of ESR0.
Executing **:ESR1?** clears the contents of ESR1.

Select and Query the Measurement Mode Setting

Syntax	Command	:FUNCTION <RV/ RESistance/ VOLTage>
	Query	:FUNCTION?
	Response	<RV/ RESISTANCE/ VOLTAGE> RV..... Ω V mode (Resistance and voltage measurement) RESISTANCE Ω mode (Resistance measurement) VOLTAGEV mode (Voltage measurement)
Example	Command	:FUNC RV Selects the Ω V mode.
	Query	:FUNC?
	Response	RV Ω V mode has been selected.

Set and Query the Resistance Measurement Range

Syntax	Command	:RESistance:RANGE < 0 to 3.1>
	Query	:RESistance:RANGE?
	Response	<300.00E-3/ 3.0000E+0 (NR3)>
Example	Command	:RES:RANG 120E-3 Selects the most suitable resistance measurement range for measuring 120 m Ω .
	Query	:RES:RANG?
	Response	300.00E-3 The current resistance measurement range is 300 m Ω .
Note	Changing the resistance measurement range clears stored measurement data (memory function).	

Set and Query the Voltage Measurement Range

Syntax	Command	:VOLTage:RANGE <-20 to 20>
	Query	:VOLTage:RANGE?
	Response	<20.0000E+0 (NR3)>
Example	Command	:VOLT:RANG 15 Selects the voltage measurement range for measuring 15 V.
	Query	:VOLT:RANG?
	Response	20.0000E+0 The voltage measurement range is fixed at 20 V (single range).

Set and Query the Auto-Ranging Setting

Syntax Command :**AUTorange** <1, 0, ON or OFF>

Query :**AUTorange?**

Response <ON or OFF>

Example Command :**AUT ON**

- Note**
- Attempting to enable auto-ranging when the Comparator or Memory function is enabled results in a execution error.
 - Because there is only one voltage range (20 V), auto-ranging does not apply to voltage measurement.

Cancel Zero-Adjustment

Syntax Command :**ADJust:CLEAr**

Description Command Clears zero adjustment.

Execute Zero Adjustment and Query the Result

Syntax Query :**ADJust?**

Response <0/ 1 (NR1)>

0.....Zero adjustment succeeded

1.....Zero adjustment failed

The acceptable range of zero adjustment for both resistance and voltage is $\pm 1,000$ dgt.

Description Query Queries whether zero adjustment has succeeded or failed.

Example Query :**ADJ?**

Response **0**

Zero adjustment executed successfully.

Select and Query the Sampling Rate setting

Syntax Command :**SAMPlE:RATE** <EXFast/ FAST/ MEDium/ SLOW>

Query :**SAMPlE:RATE?**

Response <EXFAST/ FAST/ MEDIUM/ SLOW>

Example Command :**SAMP:RATE MED**

Query :**SAMP:RATE?**

Response **MEDIUM**

Set and Query the Averaging Function Setting

Syntax	Command	:CALCulate:AVERage:STATe <1, 0, ON or OFF>
	Query	:CALCulate:AVERage:STATe?
	Response	<ON or OFF>
Example	Command	:CALC:AVER:STAT OFF
	Query	:CALC:AVER:STAT?
	Response	OFF

Set and Query the No. of samples to average

Syntax	Command	:CALCulate:AVERage <2 to 16>
	Query	:CALCulate:AVERage?
	Response	<2 to 16 (NR1)>
Example	Command	:CALC:AVER 10
	Query	:CALC:AVER?
	Response	10

Set and Query the Comparator

Syntax	Command	:CALCulate:LIMit:STATe <1, 0, ON or OFF>
	Query	:CALCulate:LIMit:STATe?
	Response	<ON or OFF>
Example	Command	:CALC:LIM:STAT ON
	Query	:CALC:LIM:STAT?
	Response	ON
Note	<ul style="list-style-type: none"> • When the Comparator function is enabled, auto-ranging is disabled. • Switching the Comparator function on/off or changing its settings clears stored measurement data (memory function). 	

Set and Query Comparator Judgments

Syntax	Command	:CALCulate:LIMit:BEEPer <OFF/HL/IN/BOTH1/BOTH2>
	Query	:CALCulate:LIMit:BEEPer?
	Response	<OFF/ HL/ IN/ BOTH1/ BOTH2> OFF.....No beeps sound. HL.....The beeper sounds upon Hi and Lo judgments. IN.....The beeper sounds upon IN judgments. BOTH1.....The beeper sounds continuously upon IN judgments, and repeatedly upon Hi and Lo judgments. BOTH2.....The beeper sounds once (briefly) upon IN judgments, and repeatedly upon Hi and Lo judgments.
Example	Command	:CALC:LIM:BEEP IN
	Query	:CALC:LIM:BEEP?
	Response	IN

Set and Query the Comparator Execution Mode Setting

(Resistance Measurement)

Syntax	Command	:CALCulate:LIMit:RESistance:MODE <HL/ REF>
	Query	:CALCulate:LIMit:RESistance:MODE?
	Response	<HL/ REF> HL.....Decision by preset upper and lower thresholds. REL.....Decision by a reference value and tolerance.
Example	Command	:CALC:LIM:RES:MODE REF
	Query	:CALC:LIM:RES:MODE?
	Response	REF

(Voltage Measurement)

Syntax	Command	:CALCulate:LIMit:VOLTage:MODE <HL/ REF>
	Query	:CALCulate:LIMit:VOLTage:MODE?
	Response	<HL/ REF> HL.....Decision by preset upper and lower thresholds. REL.....Decision by a reference value and tolerance.

Set and Query the Comparator Upper Threshold Setting

(Resistance Measurement)

Syntax	Command	:CALCulate:LIMit:RESistance:UPPer <Upper threshold>
	Query	:CALCulate:LIMit:RESistance:UPPer?
	Response	<Upper threshold> <Upper threshold> = 0 to 99999 (NR1)
Example	Command	:CALC:LIM:RES:UPP 28593 Sets the upper threshold to 285.93 mΩ (with the 300 mΩ range selected) (If the 3 Ω range is selected, the threshold is set to 2.8593 Ω)
	Query	:CALC:LIM:RES:UPP?
	Response	28593
Note	The value is sent as a whole integer (count). To set 120.53 mΩ with the 300 mΩ range, send the following: :CALC:LIM:RES:UPP 12053	

(Voltage Measurement)

Syntax	Command	:CALCulate:LIMit:VOLTage:UPPer <Upper threshold>
	Query	:CALCulate:LIMit:VOLTage:UPPer?
	Response	<Upper threshold> <Upper threshold> = 0 to 999999 (NR1)
Example	Command	:CALC:LIM:VOLT:UPP 39500 Sets the upper threshold to 3.9500 V.
	Query	:CALC:LIM:VOLT:UPP?
	Response	39500
Note	The value is sent as a whole integer (count). To set 15.2005 V, send the following command: :CALC:LIM:VOLT:UPP 152005	

Set and Query the Comparator Lower Threshold Setting

(Resistance Measurement)

Syntax Command `:CALCulate:LIMit:RESistance:LOWer`
<Lower threshold>

Query `:CALCulate:LIMit:RESistance:LOWer?`

Response <Lower threshold>
<Lower threshold> = 0 to 99999 (NR1)

Example Command `:CALC:LIM:RES:LOW 28406`
Sets the lower threshold to 284.06 m Ω (with the 300 m Ω range selected)
(If the 3 Ω range is selected, the threshold is set to 2.8406 Ω)

Query `:CALC:LIM:RES:LOW?`

Response `28406`

Note The value is sent as a whole integer (count). To set 120.53 m Ω with the 300 m Ω range, send the following:
`:CALC:LIM:RES:LOW 12053`

(Voltage Measurement)

Syntax Command `:CALCulate:LIMit:VOLTage:LOWer`
<Lower threshold>

Query `:CALCulate:LIMit:VOLTage:LOWer?`

Response <Lower threshold>
<Lower threshold> = 0 to 999999 (NR1)

Example Command `:CALC:LIM:VOLT:LOW 37500`
Sets the lower threshold to 3.7500 V.

Query `:CALC:LIM:VOLT:LOW?`

Response `37500`

Note The value is sent as a whole integer (count).
To set 15.2005 V, send the following command:
`:CALC:LIM:VOLT:LOW 152005`

Set and Query the Comparator Reference Value

(Resistance Measurement)

Syntax	Command	:CALCulate:LIMit:RESistance:REFerence <Reference value>
	Query	:CALCulate:LIMit:RESistance:REFerence?
	Response	<Reference value> <Reference value> = 0 to 99999 (NR1)
Example	Command	:CALC:LIM:RES:REF 5076 Sets the reference value to 50.76 mΩ (with the 300 mΩ range selected) (If the 3 Ω range is selected, the threshold is set to 0.5076 Ω)
	Query	:CALC:LIM:RES:REF?
	Response	5076
Note	The value is sent as a whole integer (count). To set 120.53 mΩ with the 300 mΩ range, send the following: :CALC:LIM:RES:REF 12053	

(Voltage Measurement)

Syntax	Command	:CALCulate:LIMit:VOLTage:REFerence <Reference value>
	Query	:CALCulate:LIMit:VOLTage:REFerence?
	Response	<Reference value> <Reference value> = 0 to 999999 (NR1)
Example	Command	:CALC:LIM:VOLT:REF 38500 Sets the reference value to 3.8500 V.
	Query	:CALC:LIM:VOLT:REF?
	Response	38500
Note	The value is sent as a whole integer (count). To set 15.2005 V, send the following command: :CALC:LIM:VOLT:REF 152005	

Set and Query the Comparator Decision Tolerance Setting (Comparator Function)

(Resistance Measurement)

Syntax Command :CALCulate:LIMit:RESistance:PERCent
<Tolerance (%)>
Query :CALCulate:LIMit:RESistance:PERCent?
Response <Tolerance (%)>
<Tolerance (%)> = 0 to 99.999 (NR2)

Example Command :CALC:LIM:RES:PERC 0.3
Query :CALC:LIM:RES:PERC?
Response 0.300

(Voltage Measurement)

Syntax Command :CALCulate:LIMit:VOLTage:PERCent
<Tolerance (%)>
Query :CALCulate:LIMit:VOLTage:PERCent?
Response <Tolerance (%)>
<Tolerance (%)> = 0 to 99.999 (NR2)

Example Command :CALC:LIM:VOLT:PERC 1.538
Query :CALC:LIM:VOLT:PERC?
Response 1.538

Query Comparator Judgment Results

(Resistance Measurement)

Syntax	Query	:CALCulate:LIMit:RESistance:RESult?
	Response	<HI/ IN/ LO/ OFF/ ERR>
Example	Query	:CALC:LIM:RES:RES?
	Response	HI

(Voltage Measurement)

Syntax	Query	:CALCulate:LIMit:VOLTage:RESult?
	Response	<HI/ IN/ LO/ OFF/ ERR>

Execute Statistical Functions

Syntax	Command	:CALCulate:STATistics:STATe <1, 0, ON or OFF>
	Query	:CALCulate:STATistics:STATe?
	Response	<ON or OFF>
Example	Command	:CALC:STAT:STAT ON
	Query	:CALC:STAT:STAT?
	Response	ON

NOTE

About the Statistical Calculation function

Data samples can be acquired by the following three methods:

- Press the **TRIG** key
- Apply an EXT I/O TRIG signal
- Send the ***TRG** command

The **:CALCulates:STATistics:STATe** command does not clear calculation results.

When the valid data count is zero, σ_{n-1} returns 0.

Clearing calculation results does not disable the Statistical Calculation function.

The upper limit of Cp and CpK is 99.99. Cp and CpK values greater than 99.99 are returned as 99.99.

The lower limit of Cp and CpK is 0. Cp and CpK values less than 0 are returned as 0.00.

Clear Statistical Calculation Results

Syntax	Command	:CALCulate:STATistics:CLEAr
---------------	---------	------------------------------------

Query the Data Count

(Resistance Measurement)

Syntax Query **:CALCulate:STATistics:RESistance:NUMBER?**

Response <Total data count (NR1)>,<Valid data count (NR1)>
 <Total data count (NR1)> = 0 to 30000 (NR1)
 <Valid data count (NR1)> = 0 to 30000 (NR1)

Example Query **:CALC:STAT:RES:NUMB?**

Response **22,20**

Note Measurement faults and out-of-range "OF" measurements are ignored for statistical calculations.

(Voltage Measurement)

Syntax Query **:CALCulate:STATistics:VOLTage:NUMBER?**

Response <Total data count (NR1)>,<Valid data count (NR1)>

Example Query **:CALC:STAT:VOLT:NUMB?**

Response **22,20**

Note Measurement faults and out-of-range "OF" measurements are ignored for statistical calculations.

Query the Mean value

(Resistance Measurement)

Syntax Query **:CALCulate:STATistics:RESistance:MEAN?**

Response <Mean (NR3)>

Example Query **:CALC:STAT:RES:MEAN?**

Response **295.76E-3**

(Voltage Measurement)

Syntax Query **:CALCulate:STATistics:VOLTage:MEAN?**

Response <Mean (NR3)>

Example Query **:CALC:STAT:VOLT:MEAN?**

Response **1.3923E+0**

Query the Maximum value

(Resistance Measurement)

Syntax Query **:CALCulate:STATistics:RESistance:MAXimum?**
Response <Maximum value (NR3)>,<Data No. of Maximum value (NR1)>

Example Query **:CALC:STAT:RES:MAX?**
Response **297.28E-3,15**

(Voltage Measurement)

Syntax Query **:CALCulate:STATistics:VOLTage:MAXimum?**
Response <Maximum value (NR3)>,<Data No. of Maximum value (NR1)>

Example Query **:CALC:STAT:VOLT:MAX?**
Response **1.3924E+0,1**

Query the Minimum value

(Resistance Measurement)

Syntax Query **:CALCulate:STATistics:RESistance:MINimum?**
Response <Minimum value (NR3)>,<Data No. of Minimum value (NR1)>

Example Query **:CALC:STAT:RES:MIN?**
Response **294.88E-3,8**

(Voltage Measurement)

Syntax Query **:CALCulate:STATistics:VOLTage:MINimum?**
Response <Minimum value (NR3)>,<Data No. of Minimum value (NR1)>

Example Query **:CALC:STAT:VOLT:MIN?**
Response **1.3923E+0,2**

Query Comparator Judgment Results (Statistical Calculation Function)

(Resistance Measurement)

Syntax Query **:CALCulate:STATistics:RESistance:LIMit?**

Response <Hi (NR1) count>,<IN (NR1) count>,<Lo (NR1) count>,
<Measurement fault count (NR1)>

Example Query **:CALC:STAT:RES:LIM?**

Response **6,160,13,2**

(Voltage Measurement)

Syntax Query **:CALCulate:STATistics:VOLTage:LIMit?**

Response <Hi (NR1) count>,<IN (NR1) count>,
<Lo (NR1) count>,<Measurement fault count (NR1)>

Example Query **:CALC:STAT:VOLT:LIM?**

Response **1,19,0,2**

Query Standard Deviation

(Resistance Measurement)

Syntax Query **:CALCulate:STATistics:RESistance:DEVIation?**

Response < σ_n (NR3)>,< σ_{n-1} (NR3)>

Example Query **:CALC:STAT:RES:DEV?**

Response **0.82E-3,0.84E-3**

(Voltage Measurement)

Syntax Query **:CALCulate:STATistics:VOLTage:DEVIation?**

Response < σ_n (NR3)>,< σ_{n-1} (NR3)>

Example Query **:CALC:STAT:VOLT:DEV?**

Response **0.0000E+0,0.0000E+0**

Query the Process Capability Indices

(Resistance Measurement)

Syntax Query **:CALCulate:STATistics:RESistance:CP?**
Response **<Cp (NR2)>,<CpK (NR2)>**

Example Query **:CALC:STAT:RES:CP?**
Response **0.04, 0.04**

(Voltage Measurement)

Syntax Query **:CALCulate:STATistics:VOLTage:CP?**
Response **<Cp (NR2)>,<CpK (NR2)>**

Example Query **:CALC:STAT:VOLT:CP?**
Response **0.91, 0.00**

Set and Query the Memory Function State

Syntax Command **:MEMory:STATe <1/0/ON/OFF>**
Query **:MEMory:STATe?**
Response **<ON/OFF>**

Example Command **:MEM:STAT ON**
Query **:MEM:STAT?**
Response **ON**

Clear Instrument Memory

Syntax Command **:MEMory:CLEAr**

Query the Memory Data Count

Syntax Query **:MEMory:COUNT?**
 Response <Memory data count>
 <Memory data count> = 0 to 400 (NR1)

Example Query **:MEM:COUN?**
 Response **5**

Query (Download) Memory Data

Syntax Query **:MEMory:DATA? [STEP]**
 Response <Memory data No. (NR1)>,<Measured resistance (NR3)>,<Measured voltage (NR3)>
 Memory data values are returned as data objects.
 If [STEP] is omitted, all memory data objects are returned continuously.

Example Query **:MEM:DATA?**

Example Response **1, 290.60E-3, 1.3924E+0**
2, 290.54E-3, 1.3924E+0
3, 290.50E-3, 1.3923E+0
4, 290.43E-3, 1.3923E+0
5, 290.34E-3, 1.3924E+0
END

Query **:MEM:DATA? STEP**

Response **1, 290.60E-3, 1.3924E+0**
N (Sent from PC)
2, 290.54E-3, 1.3924E+0
N (Sent from PC)
3, 290.50E-3, 1.3923E+0
N (Sent from PC)
4, 290.43E-3, 1.3923E+0
N (Sent from PC)
5, 290.34E-3, 1.3924E+0
N (Sent from PC)
END

- Note**
- Stored memory data objects are returned continuously, or one data object at a time. The “END” character is returned as the last data object. When the “STEP” parameter is specified, one data object is returned at a time. Sending “N” to the instrument after receiving the data causes the next data object to be returned. The memory index is an unsigned three-digit integer. Refer to “Measurement Value Formats” for format details of returned measurement values.
 - A terminator is appended to the end of each returned memory data object. When sending “N” from the PC or other device, a terminator is required.
See Section Message Terminators (p.94).
 - Measured values are stored in memory when pressing the **TRIG** key, applying a signal to the TRIG EXT I/O connector or sending the ***TRG** command (while the Memory function is enabled). Up to 400 data objects can be stored. When the memory is full, additional measurement data is not stored.
 - When the Memory function is enabled, auto-ranging is disabled.

Execute Self-Calibration

Syntax Command :**SYSTEM:CALibration**

Self-Calibration State and Setting

Command :**SYSTEM:CALibration:AUTO** <1, 0, ON or OFF>

Query :**SYSTEM:CALibration:AUTO?**

Response <ON or OFF>
 ON... AUTO Self-Calibration selected
 (executes approximately every 30 minutes)
 OFF MANUAL Self-Calibration selected

Example Command :**SYST:CAL:AUTO ON**

Query :**SYST:CAL:AUTO?**

Response **ON**

Note Even when AUTO is selected, Self-Calibration can be manually performed at any time by sending the :**SYSTEM:CALibration** command.

Set and Query Measurement Value Output Upon Triggering

Command :**SYSTEM:DATAout** <1, 0, ON or OFF>

Query :**SYSTEM:DATAout?**

Response <ON or OFF>
 ON... Measured values are output automatically when a trigger occurs.
 OFF Measured values are not output.

Example Command :**SYST:DATA OFF**

Query :**SYST:DATA?**

Response **OFF**

Note

- This function is convenient when you want to obtain measured values by applying EXT I/O trigger input. When this function is enabled and a footswitch is connected to the TRIG terminal of the EXT I/O connector, a measured value is sent to the PC automatically each time the footswitch is pressed, so there is no need to send a command from the PC to obtain measurement values.
- Refer to "Measurement Value Formats" for format details of returned measurement values.
- This function is not available when the GP-IB interface is selected. See Section 4.10 Measurement Value Output Function (p.66).

Set and Query the Key Beeper Setting

Syntax Command : **SYSTem: BEEPer: STATe** <1, 0, ON or OFF>
 Query : **SYSTem: BEEPer: STATe?**
 Response <ON or OFF>

Example Command : **SYST: BEEP: STAT ON**
 Query : **SYST: BEEP: STAT?**
 Response **ON**

Note Only key-press beeps are set on or off. Comparator judgment beeps are unaffected.

Select and Query the Line Frequency Setting

Syntax Command : **SYSTem: LFRequency** <50/ 60>
 Query : **SYSTem: LFRequency?**
 Response <50/ 60>

Example Command : **SYST: LFR 60**
 Query : **SYST: LFR?**
 Response **60**

Set and Query the Key-Lock State

Syntax Command : **SYSTem: KLOCK** <1, 0, ON or OFF>
 Query : **SYSTem: KLOCK?**
 Response <ON or OFF>

Example Command : **SYST: KLOC ON**
 Query : **SYST: KLOC?**
 Response **ON**

Set and Query EXT I/O Lock

Syntax	Command	: SYSTem:ELOCk <1, 0, ON or OFF>
	Query	: SYSTem:ELOCk?
	Response	<ON or OFF> ON.....EXT I/O control is disabled (preventing inadvertent operations from electrical noise). OFF.....EXT I/O control is enabled.
Example	Command	: SYST:ELOC ON
	Query	: SYST:ELOC?
	Response	ON
Note	This function affects only command input.	

Set Local Control

Syntax	Command	: SYSTem:LOCa1
Note	Switches from remote control (REMOTE indicator lit) to local control (by panel keys).	

Save and Load Measurement Values

Syntax	Command	: SYSTem:SAVE <1 to 126> : SYSTem:LOAD <1 to 126>
Note	<ul style="list-style-type: none"> Attempting to load a panel number that has not been saved results in an execution error. Up to 126 measurement configurations can be saved and loaded. Refer to “Panel Save and Load Functions” for details. 	

Backup Current Measurement Configuration

Syntax	Command	: SYSTem:BACKup
Description	Command	The current measurement configuration (settings) is backed up so that when power is turned on the next time, the same configuration is restored.
Note	Saved panel and backup settings are stored in the instrument’s EEPROM. Be aware that the number of times that the EEPROM can be rewritten is limited (to about a million times).	

Set and Query the Header Present Setting

Syntax	Command	: SYSTem:HEADer <1, 0, ON or OFF>
	Query	: SYSTem:HEADer?
	Response	<ON or OFF>
Description	Command	Specifies whether a header is sent with response messages.
Example	Command	: SYST:HEAD ON
	Query	: SYST:HEAD?
	Response	: SYSTEM:HEADER ON
	Command	: SYST:HEAD OFF
	Query	: SYST:HEAD?
	Response	: OFF

Set and Query Error Output Timing

Syntax	Command	: SYSTem:ERRor <SYNChronous/ ASYNchronous>
	Query	: SYSTem:ERRor?
	Response	<SYNCHRONOUS/ ASYNCHRONOUS> SYNCHRONOUS Synchronize with EOC output ASYNCHRONOUS Asynchronous with EOC output
Example	Command	: SYST:ERR ASYN
	Query	: SYST:ERR?
	Response	ASYNCHRONOUS

Set and Query the terminator



Syntax	Command	: SYSTem:TERMinator <0/ 1>
	Query	: SYSTem:TERMinator?
	Response	<0/ 1> 0.....LF+EOI 1.....CR ,LF+EOI
Example	Command	: SYST:TERM 1
	Query	: SYST:TERM?
	Response	0

Note The RS-232C delimiter is fixed as CR + LF.
See Section Message Terminators (p.94).

EOC Signal Output Method Settings (software version 1.15 or later)

The following 2 methods can be selected as the EOC signal output method for external I/O. (The EOC signal is set to ON at end-of-measurement and set to OFF according to the output method that has been set)

- **HOLD** Holds the EOC signal until measurement starts by the next trigger signal.
- **PULSE** Sets EOC=OFF according to the specified pulse width.

Also, the pulse width can be set between 0.001 to 0.100 seconds when PULSE is selected.

EOC Output Mode Setting

Syntax Command **:SYSTem:EOC:MODE <HOLD/PULSe>**

Query **:SYSTem:EOC:MODE?**

Response **<HOLD/PULSE>**

ON..... Holds the EOC signal until measurement starts by the next trigger signal.

OFF Sets EOC=OFF according to the specified pulse width.

Example Command **:SYST:EOC:MODE PULS**

EOC Pulse Width Setting

Syntax Command **:SYSTem:EOC:PULSe <Pulse width>**

Query **:SYSTem:EOC:PULSe?**

Response **<Pulse width> = 0.001 ~ 0.100 (NR2)[second]**

Example Command **:SYST:EOC:PULS 0.005**

System Reset

Syntax Command **:SYSTem:RESet**

Description Command All settings including saved panel settings are returned to factory defaults. Refer to "Reset Function" for details.

Example Command **:SYST:RES**

- Note**
- If you want to preserve saved data, use the ***RST** command instead.
 - The communications settings are not re-initialized.

EXT I/O Output

Syntax Command : **IO:OUT** <0 to 1023>

Description Command Any 10-bit data can be output from the EXT I/O connectors. See Section 5.2.3 Output Signals (p.74).

	bit9	bit8	bit7	bit6	bit5	bit4	bit3	bit2	bit1	bit0
	OUT9	OUT8	OUT7	OUT6	OUT5	OUT4	OUT3	OUT2	OUT1	OUT0
Pin No.	36	18	35	17	34	16	33	15	32	14

EXT I/O Input

Syntax Query : **IO:IN?**

Response 0 to 31(NR1)

Description Query Signals at the EXT I/O ($\overline{IN0}$ to $\overline{IN4}$) input terminals are read at the leading edge. Each bit (edge data) is cleared upon reading by this query. A bit is set when the leading edge (short between each signal terminal and the GND terminal) is detected, and is cleared when read by this query command. See Section 5.2.2 Input Signals (p.73).

	bit4	bit3	bit2	bit1	bit0
	$\overline{IN4}$ (\overline{MANU})	$\overline{IN3}$ (\overline{PRINT})	$\overline{IN2}$ ($\overline{0ADJ}$)	$\overline{IN1}$ (\overline{CAL})	$\overline{IN0}$ (\overline{TRIG})
Pin No.	24	6	23	5	22

Note The **TRIG** key and ***TRG** command are detected in the same way as the TRIG terminal signal.

Triggering System Description

Triggering operates as follows depending on the continuous measurement setting (**: INITIATE : CONTINUOUS**) and the trigger source setting (**: TRIGGER : SOURCE**).

See Section 7.7 Basic Data Importing Methods (p.147).

		Continuous Measurement (: INITIATE : CONTINUOUS)	
		ON	OFF ^{*1}
Trigger Source (: TRIGGER : SOURCE)	IMMEDIATE (EXT.TRIG not lit)	Free-Run state. Measurement continues automatically. See next page (1)	Trigger by : INITIATE (or : READ?) command. See next page (2)
	EXTERNAL (EXT.TRIG lit)	Trigger by TRIG terminal, TRIG key or *TRG command. After measurement, enters the trigger wait state. See next page (3)	Issue : INITIATE (or : READ?) command to wait for trigger. Trigger by $\overline{\text{TRIG}}$ terminal, TRIG key or *TRG command. See next page (4) ^{*2}

*1: **: INITIATE : CONTINUOUS OFF**

Can only be set by Remote command.

If this has been set to OFF when operation is returned to the Local state or power is turned off, the following state occurs when power is turned back on.

: INITIATE : CONTINUOUS ON

See Section 7.4.6 Local Function (p.103).

*2: The ***TRG** command cannot be used for triggering while awaiting a trigger after issuing a **: READ?** command. In this case, use the $\overline{\text{TRIG}}$ terminal or **TRIG** key for triggering.

Measurement Flow

1 : INITIATE:CONTINUOUS ON
: TRIGGER:SOURCE IMMEDIATE

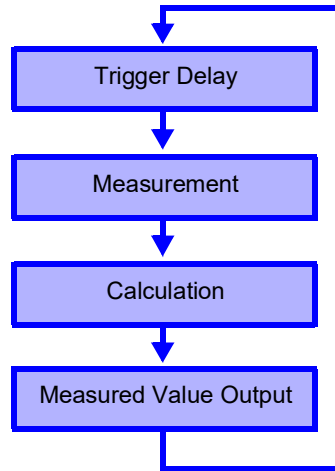

2 : INITIATE:CONTINUOUS OFF
: TRIGGER:SOURCE IMMEDIATE

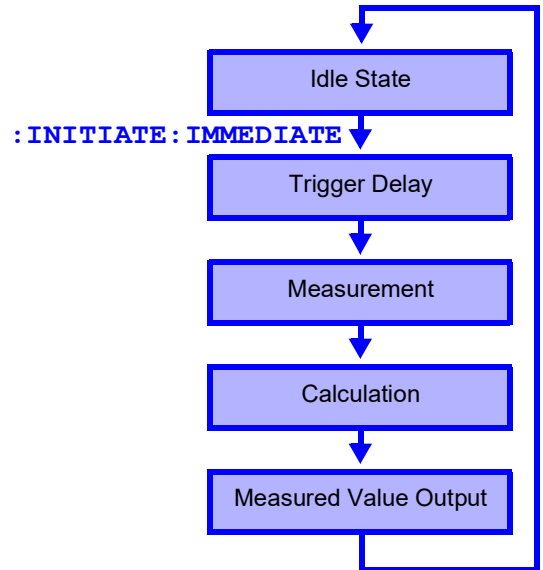

3 : INITIATE:CONTINUOUS ON
: TRIGGER:SOURCE EXTERNAL

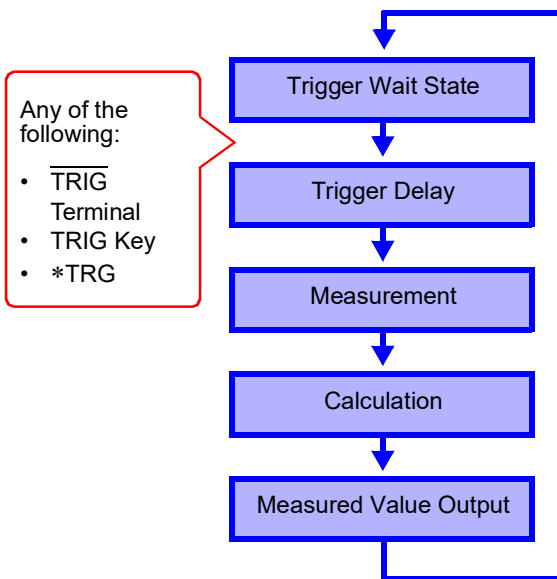

4 : INITIATE:CONTINUOUS OFF
: TRIGGER:SOURCE

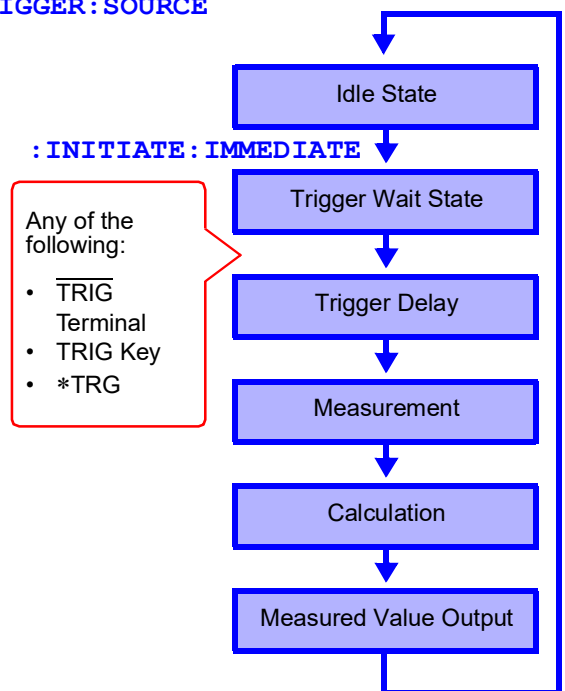

Continuous Measurement Setting

Syntax	Command	:INITiate:CONTinuous <1, 0, ON or OFF>
	Query	:INITiate:CONTinuous?
	Response	<ON or OFF> ON..... Continuous Measurement Enabled OFF..... Continuous Measurement Disabled
Description	Command	Sets continuous measurement.
	Query	Queries the continuous measurement setting.
Example	Command	:INIT:CONT OFF Disables continuous measurement.
	Query	:INIT:CONT?
	Response	ON Enables continuous measurement.
Note	<ul style="list-style-type: none"> • Continuous Measurement Enabled: After measurement, enters the Trigger Wait State. When the trigger source setting is IMMEDIATE, the next trigger occurs immediately (the Free-Run State). • Continuous Measurement Disabled: After measurement, enters the Idle State instead of the Trigger Wait State. • Triggering is ignored in the Idle State. Executing :INITiate[:IMMEDIATE] enables the Trigger Wait State. • Continuous measurement is enabled upon exit from the Remote State. 	

Trigger Wait Setting

Syntax	Command	:INITiate[:IMMEDIATE]
Description	Command	Switches triggering from the Idle State to the Trigger Wait State.
Example	Command	Disable continuous measurement, and read one value for each trigger event
	Send	:TRIG:SOUR IMM... Trigger immediately when entering Trigger Wait State :INIT:CONT OFF... Disables continuous measurement :INIT Enable Trigger Wait Trigger immediately upon :TRIG:SOUR IMM :FETC? Fetch measured value
	Response	2.1641E+0 Measured value is 2.1641 Ω
Error	<ul style="list-style-type: none"> • An execution error occurs when continuous measurement is enabled (:INITiate:CONTINUOUS ON). 	
Note	<ul style="list-style-type: none"> • When the trigger source is IMMEDIATE, triggering occurs immediately before entering the Idle State. • When the trigger source is EXTERNAL, the Trigger Wait State is enabled to wait for an external trigger, and when a trigger occurs, one measurement is taken before entering the Idle State. 	

Set and Query the Trigger Source

Syntax	Command	:TRIGger:SOURCE <IMMediate/ EXTernal>
	Query	:TRIGger:SOURCE?
	Response	<IMMEDIATE/ EXTERNAL> IMMEDIATE...Internal triggering EXTERNAL....External trigger source. Triggering by TRIG key, TRIG terminal or *TRG command.
Description	Command	Selects the trigger source.
	Query	Queries the trigger source selection.
Example	Command	:TRIG:SOUR IMM Sets the trigger source to internal triggering.
	Query	:TRIG:SOUR?
	Response	IMMEDIATE The trigger source is set to internal triggering.

Enable/Disable and Query Trigger Delay

Syntax	Command	:TRIGger:DELAy:STATe <1, 0, ON or OFF>
	Query	:TRIGger:DELAy:STATe?
	Response	<ON or OFF> ON Trigger delay enabled OFF Trigger delay disabled
Example	Command	:TRIG:DEL:STAT ON Enables trigger delay.
	Query	:TRIG:DEL:STAT?
	Response	ON Trigger delay is enabled (ON).

Set and Query Trigger Delay Interval

Syntax	Command	:TRIGger:DElay <0 to 9.999>
	Query	:TRIGger:DElay?
	Response	<0 to 9.999 (NR2)>
Description	Command	Sets the trigger delay interval.
	Query	Queries the trigger delay interval setting.
Example	Command	:TRIG:DEL 0.058 Sets the trigger delay to 0.058 seconds.
	Query	:TRIG:DEL?
	Response	0.058 The trigger delay is set to 0.058 seconds.

Read the Latest Measurement

Syntax	Query	:FETCh?
	Response	<Measured resistance (NR3)>, <Measured voltage (NR3)> (Ω V mode)
		<Measured resistance (NR3)> (Ω mode) <Measured voltage (NR3)> (V mode)
Description	Query	Reads the most recent measurement. No trigger occurs.
Example	Query	:FETC?
	Response	288.02E-3, 1.3921E+0 (Ω V mode) The last measured resistance is 288.02 m Ω , and the last measured voltage is 1.3921 V. See Section 7.6.3 Measurement Value Formats (p.142).

Execute a Measurement and Read the Measured Values

Syntax Query **:READ?**

Response <Measured resistance (NR3)>, <Measured voltage (NR3)>
(Ω V mode)
<Measured resistance (NR3)> (Ω mode)
<Measured voltage (NR3)> (V mode)

Description Query Switches from the Idle State to the Trigger Wait State, then reads the next measured value. With auto-ranging enabled, the most suitable range is selected before measurement.

Trigger Source	Operation
IMMEDIATE	Triggers and reads measured value.
EXTERNAL	After triggering by the TRIG terminal (EXT I/O) or TRIG key, reads the measured value.

Example Query **:READ?**

Response **289.68E-3, 1.3921E+0** (Ω V mode)
Measured resistance is 289.68 m Ω , and voltage is 1.3921 V.

Error This command causes an execution error if issued during the Continuous Measurement state (after **:INITIATE:CONTINUOUS ON**).

Note

- The next command does not execute until measurement is finished.
- When the trigger source is external, the ***TRG** command does not trigger measurement.

See Section 7.6.3 Measurement Value Formats (p.142).

7.6.3 Measurement Value Formats

For the commands that acquire measurement values (:**FETCH?** and :**READ?**), the response formats are as follows.

Measured Resistance

Measurement range	Measured Value	±OF	Measurement Fault
300 mΩ	±□□□□.□□E-3	±1000.00E+6	+1000.00E+7
3 Ω	±□□.□□□□E+0	±10.0000E+8	+10.0000E+9

Measured Voltage

Measurement range	Measured Value	±OF	Measurement Fault
20 V	±□□.□□□□E+0	±10.0000E+8	+10.0000E+9

Relative Value Indication

(same as voltage and resistance)

Measurement range	Measured Value	±OF	Measurement Fault
All ranges	±□□□.□□□□E+0	±100.000E+7	+100.000E+8

For positive measurements, the sign position is blank (20H).

7.6.4 Command Compatibility with the Model 3560 AC m Ω HiTESTER

Model 3561 and 3561-01 BATTERY HiTESTERs accept all of the commands supported by the HIOKI 3560 AC m Ω HiTESTER. However the following differences result from the functional differences.

Comparator Tables

Up to 30 comparator settings can be saved with the Model 3560. The settings of each table can be changed directly by specifying the table number.

With this instrument, up to 126 measurement configurations (including comparator settings) can be saved (Panel Save). Settings for each configuration cannot be set directly. To recall saved configuration settings, specify the table (panel) number and execute Panel Load. A table number does not need to be specified for comparator settings.

Comparator Operations

Model 3560 judges resistance and voltage measurements together as PASS/FAIL.

This instrument judges resistance and voltage independently. Also, when the Comparator function is enabled (ON), auto-ranging is disabled (OFF).

Voltage Limiter

This instrument does not include a voltage limiter function (limiting open-terminal voltage to 20 mV). This instrument's open-terminal voltage is 7 V peak dropping to a few millivolts when the test leads are connected to a test object.

Sense Line Disconnect Detection

The sense line disconnect detection function cannot be switched on/off with this instrument. Detection is always enabled.

Resistance Value Digits with FAST Sampling

When FAST sampling is enabled on Model 3560, the number of resistance measurement digits is decreased from five to four.

With this instrument, measurement values are always five digits (31,000 counts) regardless of sampling rate.

Voltage Measurement

Model 3560 provides 5 and 50 V ranges, with five-digit (50,000 count) measurement values.

This instrument provide one 20 V range with six-digit measurement values (up to 20.0000 V, one digit more than Model 3560).

7.6 Message Reference

Compatibility of each of the Model 3560 commands is described below with details of the functional differences with this instrument.

Message ([] = optional)	Data Contents () = response data	Differences Model 3561 (3561-01)	Model 3560
Standard Commands			
*IDN?	<Manufacturer's name>,<Model name>,0,<Software version>	Model name in response data: 3561 (3561-01)	Model name in response data: 3560
*OPC	_____		
*OPC?	1		
*RST	_____	Initialization contents Measurement mode: Ω V mode (Resistance and voltage measurement) Header: OFF	Initialization contents Measurement mode: Resistance measurement mode Header: ON
*SRE	0 to 255 (NR1)		
*SRE?			
*STB?	0 to 255 (NR1)		
*TRG	_____		
*TST?	0 to 3 (NR1)	Response data bit2: -, bit1: EEPROM, bit0: RAM	Response data bit2: EEPROM, bit1: RAM, bit0: ROM
*WAI			
Device-Specific Commands			
:MODE	R/ RV		
:MODE?			
:RRANge	0 to 3E+0	Resistance range: 0 to 3.1E+0	Resistance range: 0 to 3.1E+3
:RRANge?	300E-3/ 3E+0	(Although not an error, measurements are valid only within the provided 300 m Ω and 3 Ω ranges)	
:VRANge	-50 to 50	Voltage range: -20 to 20	Voltage range: -50 to 50
:VRANge?	20E+0	(Although not an error, measurements are valid only) Response: 20E+0	Response: 5E+0/ 50E+0
:AUTorange	1/ 0/ ON/ OFF	Setting is not possible when the comparator is enabled (when the comparator is set to ON, auto-ranging is turned OFF).	Setting is possible even when the comparator is enabled (ON).
:AUTorange?	ON/ OFF		
:ADJust?	0/ 1	Performs a measurement to generate the zero-adjustment value Zero-adjustment range: 1000 counts	Applies the currently displayed value as the zero-adjustment value Zero-adjustment range: 2400 counts
:SAMPlE	FAST/ MEDium/ SLOW		
:SAMPlE?			
:COMParator	0 to 30	Range of panel numbers: Turns Off when the panel number is 0, and turns On when the panel number is 1 to 30 Response: Returns 0 when the comparator is disabled (OFF), and 1 when enabled (ON)	Range of Comparator Numbers: 0 to 30 Response: Returns the response number
:COMParator?			
:CSET:MODE	R/ RV		
:CSET:MODE?			
:CSET:NUMBer	1 to 126	(function not available)	Specifies the comparator table number to set
:CSET:NUMBer?			

7.6 Message Reference

Message ([] = optional)	Data Contents () = response data	Differences Model 3561 (3561-01)	Model 3560
:CSET:RPARAmeter :CSET:RPARAmeter?	<Upper threshold/ Lower threshold>	Setting range: 0 to 3.1000E+0 (only valid within 300 mΩ and 3 Ω ranges)	Setting range: 0 to 3.1000E+3
:CSET:RRANge :CSET:RRANge?	0 to 3E+0 300E-3/ 3E+0	Resistance range: 0 to 3.1E+0 (Although not an error, measurements are valid only within the provided 300 mΩ and 3 Ω ranges)	Resistance range: 0 to 3.1E+3
:CSET:VPARAmeter :CSET:VPARAmeter?	<Upper threshold/ Lower threshold>	Setting range: 0 to 50.0000 (20 V range) * Negative setting values are invalid.	Setting range: -5.0000 to 5.0000 (5 V range) -50.000 to 50.000 (50 V range)
:CSET:VRANge :CSET:VRANge?	-50 to 50 20E+0	Voltage range: -20 to 20 (Although not an error, measurements are valid only Response: 20E+0)	Voltage range: -50 to 50 Response: 5E+0/ 50E+0
:CTMode :CTMode?	AUTo/ MANual		
:MEASure:BATTery?	<Measured resistance, Measured voltage, Judgment result> FAIL/ PASS/ OFF/ NG	Resistance measurement values consist of five digits with FAST sampling * Numerical values do not include a decimal point.	Resistance measurement values consist of four digits with FAST sampling * Numerical values do not include a decimal point.
:MEASure:RESistance?	<Measured resistance, Judgment result> FAIL/ PASS/ OFF/ NG (ΩV) HI/ IN/ LO/ OFF/ NG (Ω)	Resistance measurement values consist of five digits with FAST sampling * Numerical values do not include a decimal point.	Resistance measurement values consist of four digits with FAST sampling * Numerical values do not include a decimal point.
:MEASure:VOLTage?	<Measured voltage, Judgment result> FAIL/ PASS/ OFF/ NG	Response: Mark: one character + six numerals (20.0000 V range) * Numerical values do not include a decimal point.	Response: * Numerical values do not include a decimal point.
:FREQuency :FREQuency?	50/60		
:LOCK:KEY :LOCK:KEY?	ON/OFF		
:HEADer :HEADer?	ON/OFF		
:LOCK:EXTerMal :LOCK:EXTerMal?	ON/OFF		
:CSET:BEEPer :CSET:BEEPer?	OFF/ PASS/ FAIL (ΩV) OFF/ IN/ HL (Ω)		
:HOLD :HOLD?	ON/ OFF		
:LIMit :LIMit?	ON/ OFF	(function not available)	Open terminal voltage is limited to 20 mV
:SENSecheck :SENSecheck?	ON/ OFF	(function not available)	Sense line disconnect detection is provided
:ZERoclear			

Measurement Value Formats (commands compatible with Model 3560)

For the commands that acquire measurement values (`:MEASure:BATTery?`, `:MEASure:RESistance?` and `:MEASure:VOLTage?`), the response formats are as follows.

Measured Resistance

Measurement Range	Measured Value
300 m Ω	□□□.□□E-3
3 Ω	□.□□□□E+0
± OF	1.0000E+8
Measurement Fault	1.0000E+9

Measured Voltage

Measurement Range	Measured Value
20 V	±□□.□□□□E+0
± OF	±1.0000E+8
Measurement Fault	1.0000E+9

- The positive sign for measured voltage values is returned as a space character.
- The number of displayed digits is unaffected by sampling rate.

Reference: Model 3560 Measurement Value Formats

Measured Resistance

Measurement Range	FAST	MEDIUM/ SLOW
30 m Ω	□□□.□E-3	□□□.□□E-3
300 m Ω	□□□.□E-3	□□□.□□E-3
3 Ω	□.□□□□E+0	□.□□□□E+0
30 Ω	□□.□□E+0	□□.□□□□E+0
300 Ω	□□□.□E+0	□□□.□□E+0
3 k Ω	□.□□□□E+3	□.□□□□E+3
± OF	1.0000E+8	1.0000E+8
Measurement Fault	1.0000E+9	1.0000E+9

Measured Voltage

Measurement Range	All sampling rates
5 V	±□.□□□□E+0
50 V	±□□.□□□□E+0
± OF	±1.0000E+8
Measurement Fault	1.0000E+9

7.7 Basic Data Importing Methods

Flexible data importing is available depending on the application.

Free-Run Data Importing

Initial Setup : **INITiate:CONTinuous ON** (enable continuous measurement)
 : **TRIGger:SOURce IMM** (internal triggering)

Importing : **FETCh?**
 Imports the most recent measurement

Importing by Host Triggering

Initial Setup : **INITiate:CONTinuous OFF** (disable continuous measurement)
 : **TRIGger:SOURce IMM** (internal triggering)

Importing : **READ?**
 A trigger occurs, and a measurement is taken and the result is transferred.

Importing Data by TRIG Key or $\overline{\text{TRIG}}$ Terminal

Initial Setup : **INITiate:CONTinuous OFF** (disable continuous measurement)
 : **TRIGger:SOURce EXT** (external triggering)

Importing : **READ?**
 When triggered by the **TRIG** key or TRIG terminal, a measurement is taken and the result is transferred.

7.8 Sample Programs

7.8.1 To be prepared in Visual Basic[®] 5.0/6.0

These sample programs are written in Microsoft Visual Basic[®] 5.0 and 6.0.

- The following are used for communication:
For RS-232C communication: MScComm from Visual Basic[®] Professional
For GP-IB communication: National Instruments GP-IB Board, Driver and Module for Visual Basic[®]
- During communications, the terminator setting is supposed to be as follows:
RS-232C: CR+LF
GP-IB: LF

RS-232C Communications

(Using Microsoft Visual Basic[®] Professional MScComm)

(1) Simple Resistance Measurement

Imports measured values 10 times, and saves measurements in a text file.

```

Private Sub MeasureSubRS()
Dim recvstr As String           'Receiving char string
Dim i As Integer

MScComm1.Settings = "9600,n,8,1"   'Comm port setting
MScComm1.PortOpen = True          'Open a port
Open App.Path & "data.csv" For Output As #1 'Open a text file for saving

MScComm1.Output = ":TRIG:SOUR IMM" & vbCrLf   'Select internal triggering
MScComm1.Output = ":INIT:CONT ON" & vbCrLf   'Continuous measurement ON
For i = 1 To 10
  MScComm1.Output = ":FETCH?" & vbCrLf       'Send ":FETCH?" to import the most recent
                                              'measurement
  recvstr = ""                                'From here on, continue receiving until an LF code
                                              'occurs

  While Right(recvstr, 1) <> Chr(10)
    recvstr = recvstr + MScComm1.Input
    DoEvents
  Wend
  recvstr = Left(recvstr, Len(recvstr) - 2)   'Delete the terminator (CR+LF)
  Print #1, Str(i) & ", " & recvstr          'Write to the file
Next

Close #1
MScComm1.PortOpen = False
End Sub

```

(2) Measure Resistance by PC Key

Measures and imports by key input on the PC, and saves measurements in a text file.

```

Private Sub MeasureReadSubRS()
Dim recvstr As String                                'Receiving char string
Dim i As Integer

MSComm1.Settings = "9600,n,8,1"                    'Comm port setting
MSComm1.PortOpen = True                            'Open a port
Open App.Path & "\data.csv" For Output As #1       'Open a text file for saving

MSComm1.Output = ":TRIG:SOUR IMM" & vbCrLf         'Select internal triggering
MSComm1.Output = ":INIT:CONT OFF" & vbCrLf        'Continuous measurement OFF
For i = 1 To 10
  'Wait for PC key input
  'Create a key input check routine to set InputKey() = True when a key is pressed
  Do While 1
    If InputKey() = True Then Exit Do
    DoEvents
  Loop

  'After confirming key input, measure once, and read the measured value
  MSComm1.Output = ":READ?" & vbCrLf              'Send ":READ?" to measure and import the
                                                    measurement
  recvstr = ""                                     'From here on, continue receiving until an LF code
                                                    occurs

  While Right(recvstr, 1) <> Chr(10)
    recvstr = recvstr + MSComm1.Input
    DoEvents
  Wend
  recvstr = Left(recvstr, Len(recvstr) - 2)        'Delete the terminator (CR+LF)
  Print #1, Str(i) & ", " & recvstr                'Write to the file
Next

Close #1
MSComm1.PortOpen = False
End Sub

```

(3) External Trigger Measurement 1

Measure and import according to external triggering of the instrument (**TRIG** key or EXT I/O TRIG terminal input), or by PC key input, and save measurements in a text file.

```

Private Sub MeasureTrigSubRS()
Dim rcvstr As String           'Receiving char string
Dim i As Integer

MSComm1.Settings = "9600,n,8,1" 'Comm port setting
MSComm1.PortOpen = True       'Open a port
Open App.Path & "\data.csv" For Output As #1 'Open a text file for saving

MSComm1.Output = ":TRIG:SOUR EXT" & vbCrLf 'Select external triggering
MSComm1.Output = ":INIT:CONT OFF" & vbCrLf 'Continuous measurement OFF
For i = 1 To 10
  MSComm1.Output = ":READ?" & vbCrLf 'Send ":READ?" to measure and import the
                                      measurement

  rcvstr = "" 'From here on, continue receiving until an LF code
              occurs

  While Right(rcvstr, 1) <> Chr(10)
    rcvstr = rcvstr + MSComm1.Input
    DoEvents

    'To execute trigger measurement when a PC key is pressed,
    'Create a key input check routine to set InputKey() = True when a key is pressed
    If InputKey() = True Then
      MSComm1.Output = "*TRG" & vbCrLf 'When key input occurs, send "*TRG" to trigger
                                      measurement

    End If
  Wend
  rcvstr = Left(rcvstr, Len(rcvstr) - 2) 'Delete the terminator (CR+LF)
  Print #1, Str(i) & ", " & rcvstr 'Write to the file
Next

Close #1
MSComm1.PortOpen = False
End Sub

```

(4) External Trigger Measurement 2

Measure and import according to external triggering of the instrument (**TRIG** key or EXT I/O TRIG terminal input), and save measurements in a text file.

(The instrument imports the most recent measurement by trigger input timing with the continuous measurement state)

```

Private Sub MeasureTrig2SubRS()
Dim recvstr As String           'Receiving char string
Dim i As Integer

MSComm1.Settings = "9600,n,8,1"   'Comm port setting
MSComm1.PortOpen = True         'Open a port
Open App.Path & "data.csv" For Output As #1 'Open a text file for saving

MSComm1.Output = ":TRIG:SOUR IMM" & vbCrLf 'Select internal triggering
MSComm1.Output = ":INIT:CONT ON" & vbCrLf 'Continuous measurement ON

'Clear confirmation of External I/O TRIG input
MSComm1.Output = ":IO:IN?" & vbCrLf
recvstr = ""
While Right(recvstr, 1) <> Chr(10)
    recvstr = recvstr + MSComm1.Input
    DoEvents
Wend

For i = 1 To 10
    'Wait for External I/O TRIG input
    Do While 1
        MSComm1.Output = ":IO:IN?" & vbCrLf
        recvstr = ""
        While Right(recvstr, 1) <> Chr(10)
            recvstr = recvstr + MSComm1.Input
            DoEvents
        Wend
        If Left(recvstr, 1) = "1" Then Exit Do
        DoEvents
    Loop

    MSComm1.Output = ":FETCH?" & vbCrLf 'Send ":FETCH?" to import the most recent
                                        'measurement

    recvstr = "" 'From here on, continue receiving until an LF code
                'occurs

    While Right(recvstr, 1) <> Chr(10)
        recvstr = recvstr + MSComm1.Input
        DoEvents
    Wend
    recvstr = Left(recvstr, Len(recvstr) - 2) 'Delete the terminator (CR+LF)
    Print #1, Str(i) & ", " & recvstr 'Write to the file
Next

Close #1
MSComm1.PortOpen = False
End Sub

```

(5) Set Measurement State

Sets up the measurement setting state.

```

'Function: ΩV
'Range: 300 mΩ
'Sampling: SLOW
'Triggering: Internal
'Comparator: ON, Beeper HL,
    Resistance High/Low mode, Upper threshold 20000 (200.00 mΩ), Lower threshold 10000 (100.00 mΩ)
    Voltage REF/%, Reference value 150000 (15.0000 V), toTolerance 0.1%

Private Sub SettingsSubRS()
MSComm1.Settings = "9600,n,8,1"           'Comm port setting
MSComm1.PortOpen = True                 'Open a port

MSComm1.Output = ":FUNC RV" & vbCrLf   'Select ΩV mode
MSComm1.Output = ":RES:RANG 300E-3" & vbCrLf 'Select 300 mΩ range
MSComm1.Output = ":SAMP:RATE SLOW" & vbCrLf 'Select SLOW sampling
MSComm1.Output = ":TRIG:SOUR IMM" & vbCrLf 'Select internal triggering
MSComm1.Output = ":INIT:CONT ON" & vbCrLf 'Continuous measurement ON
MSComm1.Output = ":CALC:LIM:BEEP HL" & vbCrLf 'From here on, comparator settings
MSComm1.Output = ":CALC:LIM:RES:MODE HL" & vbCrLf
MSComm1.Output = ":CALC:LIM:RES:UPP 20000" & vbCrLf
MSComm1.Output = ":CALC:LIM:RES:LOW 10000" & vbCrLf
MSComm1.Output = ":CALC:LIM:VOLT:MODE REF" & vbCrLf
MSComm1.Output = ":CALC:LIM:VOLT:REF 150000" & vbCrLf
MSComm1.Output = ":CALC:LIM:VOLT:PERC 0.1" & vbCrLf
MSComm1.Output = ":CALC:LIM:STAT ON" & vbCrLf 'Comparator ON

MSComm1.PortOpen = False
End Sub

```

GP-IB Communications

(Using National Instruments GP-IB Board)

(1) Simple Resistance Measurement

Imports measured values 10 times, and saves measurements in a text file.

```

Private Sub MeasureSub()
Dim buffer As String * 40           'Receiving buffer
Dim recvstr As String              'Receiving char string
Dim pad As Integer                 'Controller access
Dim gpibad As Integer              'Device Address
Dim timeout As Integer             'Timeout period
Dim ud As Integer                  'State (unused)
Dim i As Integer

pad = 0                             'Board Address 0
gpibad = 1                          '3561 (3561-01) Address 1
timeout = T10s                       'Timeout about 10s

Call ibfind("gpib0", 0)              'Initialize GP-IB
Call ibdev(pad, gpibad, 0, timeout, 1, 0, ud)
Call SendIFC(pad)
Open App.Path & "data.csv" For Output As #1 'Open a text file for saving

Call Send(pad, gpibad, ":TRIG:SOUR IMM", NLEnd) 'Select internal triggering
Call Send(pad, gpibad, ":INIT:CONT ON", NLEnd) 'Continuous measurement ON
For i = 1 To 10
    Call Send(pad, gpibad, ":FETCH?", NLEnd) 'Send ":FETCH?" to import the most recent
                                                measurement
    Call Receive(pad, gpibad, buffer, STOPend) 'Receive
    recvstr = Left(buffer, InStr(1, buffer, Chr(10)) - 1)
    Print #1, Str(i) & ", " & recvstr
Next

Close #1
Call ibonl(pad, 0)
End Sub

```

(2) Measure Resistance by PC Key

Measures and imports by key input on the PC, and saves measurements in a text file.

```

Private Sub MeasureReadSub()
Dim buffer As String * 40           'Receiving butter
Dim recvstr As String              'Receiving char string
Dim pad As Integer                 'Controller access
Dim gpibad As Integer              'Device Address
Dim timeout As Integer             'Timeout period
Dim ud As Integer                  'State (unused)
Dim i As Integer

pad = 0                             'Board Address 0
gpibad = 1                          '3561 (3561-01) Address 1
timeout = T10s                       'Timeout about 10s

Call ibfind("gpib0", 0)              'Initialize GP-IB
Call ibdev(pad, gpibad, 0, timeout, 1, 0, ud)
Call SendIFC(pad)
Open App.Path & "data.csv" For Output As #1 'Open a text file for saving

Call Send(pad, gpibad, ":TRIG:SOUR IMM", NLEnd) 'Select internal triggering
CCall Send(pad, gpibad, ":INIT:CONT OFF", NLEnd) 'Continuous measurement OFF
For i = 1 To 10
  'Wait for PC key input
  'Create a key input check routine to set InputKey() = True when a key is pressed
  Do While 1
    If InputKey() = True Then Exit Do
    DoEvents
  Loop

  'After confirming key input, measure once, and read the measured value
  Call Send(pad, gpibad, ":READ?", NLEnd) 'Send ":READ?" to measure and import the
                                          measurement
  Call Receive(pad, gpibad, buffer, STOPend) 'Receive
  recvstr = Left(buffer, InStr(1, buffer, Chr(10)) - 1)
  Print #1, Str(i) & ", " & recvstr 'Write to the file
Next

Close #1
Call ibonl(pad, 0)
End Sub

```

(3) External Trigger Measurement 1

Measure and import according to external triggering of the instrument (**TRIG** key or EXT I/O TRIG terminal input), and save measurements in a text file.

```

Private Sub MeasureTrigSub()
Dim buffer As String * 40           'Receiving butter
Dim recvstr As String             'Receiving char string
Dim pad As Integer                'Controller access
Dim gpibad As Integer             'Device Address
Dim timeout As Integer            'Timeout period
Dim ud As Integer                 'State (unused)
im i As Integer

pad = 0                            'Board Address 0
gpibad = 1                         '3561 (3561-01) Address 1
timeout = T100s                     'Timeout 100s (because of external trigger wait state)

Call ibfind("gpib0", 0)             'Initialize GP-IB
Call ibdev(pad, gpibad, 0, timeout, 1, 0, ud)
Call SendIFC(pad)
Open App.Path & "\data.csv" For Output As #1 'Open a text file for saving

Call Send(pad, gpibad, ":TRIG:SOUR EXT", NLen) 'Select external triggering
Call Send(pad, gpibad, ":INIT:CONT OFF", NLen) 'Continuous measurement OFF
For i = 1 To 10
  Call Send(pad, gpibad, ":READ?", NLen) 'Send ":READ?" to measure and import the measurement
  Call Receive(pad, gpibad, buffer, STOPend) 'Receive
  recvstr = Left(buffer, InStr(1, buffer, Chr(10)) - 1)
  Print #1, Str(i) & ", " & recvstr 'Write to the file
Next

Close #1
Call ibonl(pad, 0)
End Sub

```

(4) External Trigger Measurement 2

Measure and import according to external triggering of the instrument (**TRIG** key or EXT I/O TRIG terminal input), and save measurements in a text file.

(The instrument imports the most recent measurement by trigger input timing with the continuous measurement state)

```

Private Sub MeasureTrig2Sub()
Dim buffer As String * 40           'Receiving butter
Dim rcvstr As String               'Receiving char string
Dim pad As Integer                 'Controller access
Dim gpibad As Integer              'Device Address
Dim timeout As Integer             'Timeout period
Dim ud As Integer                  'State (unused)
Dim i As Integer

pad = 0                             'Board Address 0
gpibad = 1                          '3561 (3561-01) Address 1
timeout = T100s                      'Timeout 100s (because of external trigger wait state)

Call ibfind("gpib0", 0)              ' Initialize GP-IB
Call ibdev(pad, gpibad, 0, timeout, 1, 0, ud)
Call SendIFC(pad)
Open App.Path & "data.csv" For Output As #1 'Open a text file for saving

Call Send(pad, gpibad, ":TRIG:SOUR IMM", NLEnd) 'Select internal triggering
Call Send(pad, gpibad, ":INIT:CONT ON", NLEnd) 'Continuous measurement ON

'Clear confirmation of External I/O TRIG input
Call Send(pad, gpibad, ":IO:IN?", NLEnd)
Call Receive(pad, gpibad, buffer, STOPend)
rcvstr = Left(buffer, InStr(1, buffer, Chr(10)) - 1)
For i = 1 To 10
  'Wait for External I/O TRIG input
  Do While 1
    Call Send(pad, gpibad, ":IO:IN?", NLEnd)
    Call Receive(pad, gpibad, buffer, STOPend)
    If Left(buffer, 1) = "1" Then Exit Do
    DoEvents
  Loop

  Call Send(pad, gpibad, ":FETCH?", NLEnd) 'Send ":FETCH?" to import the most recent
                                          'measurement
  Call Receive(pad, gpibad, buffer, STOPend) 'Receive
  rcvstr = Left(buffer, InStr(1, buffer, Chr(10)) - 1)
  Print #1, Str(i) & ", " & rcvstr        'Write to the file
Next

Close #1
Call ibonl(pad, 0)
End Sub

```

(5) Set Measurement State

Sets up the measurement setting state.

```

'Function: ΩV
'Range: 300 mΩ
'Sampling: SLOW
'Triggering: Internal
'Comparator: ON, Beeper HL,
Resistance High/Low mode, Upper threshold 20000 (200.00 mΩ), Lower threshold 10000 (100.00 mΩ)
Voltage REF%, Reference value 150000 (15.0000 V), toTolerance 0.1%

Private Sub SettingsSub()
Dim pad As Integer           'Controller access
Dim gpibad As Integer       'Device Address
Dim timeout As Integer      'Timeout period
Dim ud As Integer           'State (unused)

pad = 0                       'Board Address 0
gpibad = 1                   '3561 (3561-01) Address 1
timeout = T10s               'Timeout about 10s

Call ibfind("gpib0", 0)      'Initialize GP-IB
Call ibdev(pad, gpibad, 0, timeout, 1, 0, ud)
Call SendIFC(pad)

Call Send(pad, gpibad, ":FUNC RV", NLEnd)      'Select ΩV mode
Call Send(pad, gpibad, ":RES:RANG 300E-3", NLEnd) 'Select 300 mΩ range
Call Send(pad, gpibad, ":SAMP:RATE SLOW", NLEnd) 'Select SLOW sampling
Call Send(pad, gpibad, ":TRIG:SOUR IMM", NLEnd)  'Select internal triggering
Call Send(pad, gpibad, ":INIT:CONT OFF", NLEnd)  'Continuous measurement OFF
Call Send(pad, gpibad, ":CALC:LIM:BEEP HL", NLEnd) 'From here on, comparator settings
Call Send(pad, gpibad, ":CALC:LIM:RES:MODE HL", NLEnd)
Call Send(pad, gpibad, ":CALC:LIM:RES:UPP 20000", NLEnd)
Call Send(pad, gpibad, ":CALC:LIM:RES:LOW 10000", NLEnd)
Call Send(pad, gpibad, ":CALC:LIM:VOLT:MODE REF", NLEnd)
Call Send(pad, gpibad, ":CALC:LIM:VOLT:REF 150000", NLEnd)
Call Send(pad, gpibad, ":CALC:LIM:VOLT:PERC 0.1", NLEnd)
Call Send(pad, gpibad, ":CALC:LIM:STAT ON", NLEnd) 'Comparator ON

Call ibonl(pad, 0)
End Sub

```

7.8.2 To be prepared in Visual Basic® 2005

This section describes an example of how to use the Windows development language Visual Basic® 2005 Express Edition to operate the 3561 unit from a PC via RS-232C, incorporate measurement values, and save measurement values to a file.

7.8.3 Creation Procedure(Visual Basic® 2005)

This section describes the procedure for using Visual Basic® 2005 to create programs.

NOTE

Depending on the environment of the PC and Visual Basic® 2005, the procedure may differ slightly from the one described here. For a detailed explanation on how to use Visual Basic® 2005, refer to the instruction manual or Help of Visual Basic® 2005.

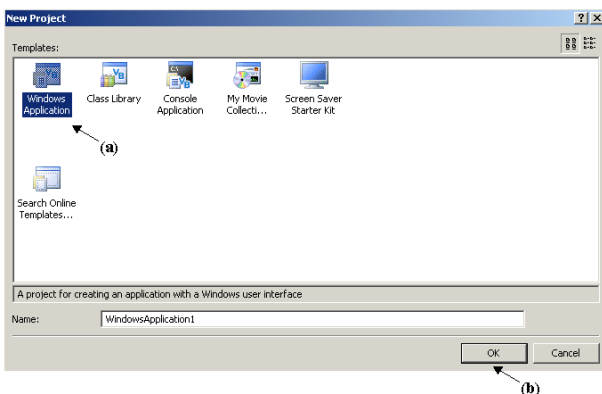

1. Startup Visual Basic® 2005, select [**Windows Application**] from [**File**] - [**New Project**] (a), and click the "OK" button (b).

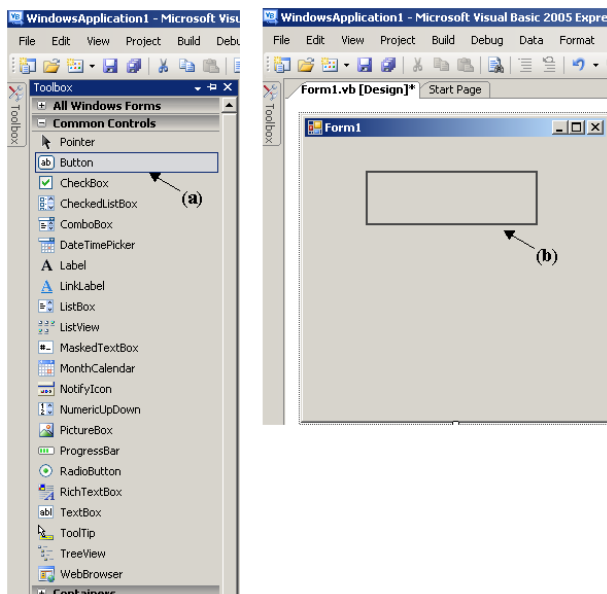

2. Click on the common control [**Button**] icon (a), and then drag the mouse over the form layout window (b) to insert the button.

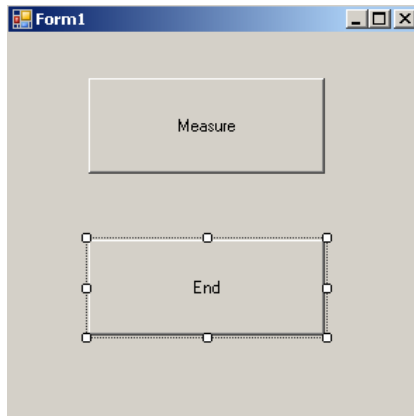

3. Use the method in step 2 to create another button, and edit the text in the property window of each button to appear as in the diagram.

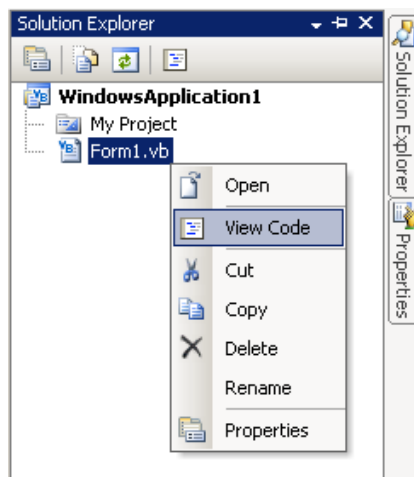

4. Right-click above [**Form1**] in the solution explorer, and select [**View Code**].

Follow the procedure below so that the Visual Basic®2005 window becomes as shown in the diagram below.

Write a program referring to [7.8.4 Sample Programs\(Visual Basic® 2005\) \(p.160\)](#), and execute the created program.

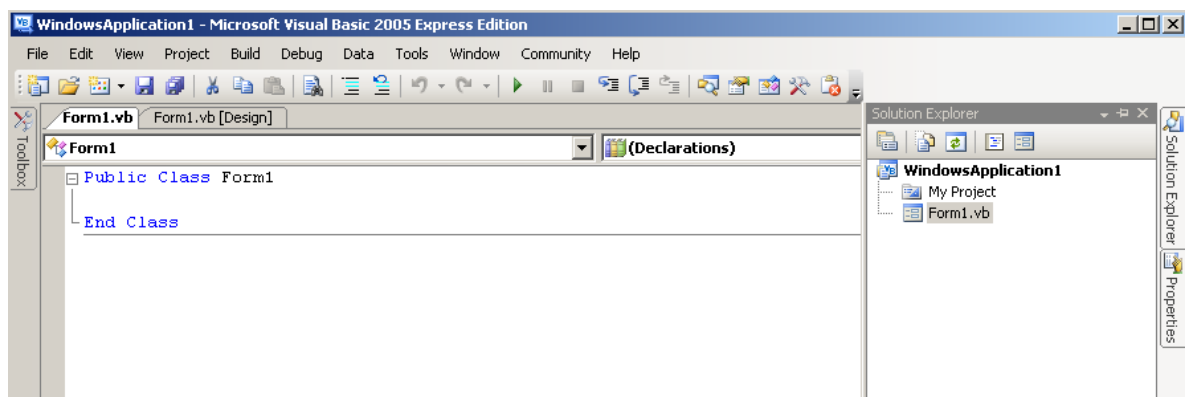

7.8.4 Sample Programs(Visual Basic® 2005)

Shown below is a sample program which uses Visual Basic® 2005 to enact RS-232C communication, set the 3561 measurement conditions, read measurement results and then save them to file. The sample program will be written in the following manner.

[7.8.3 Creation Procedure\(Visual Basic® 2005\) \(p.158\)](#) description

..... Write using sample program

Button created to begin measurement Button1

Button created to close application Button2

When the [Begin Measurement] is pressed, the 3561 takes 10 measurements and writes the measurement values to a [data.csv] file.

When the [Quit] button is pressed the program closes.

The following program is written entirely in [Form1] code.

```
Imports System
Imports System.IO
Imports System.IO.Ports

Public Class Form1
'Perform process when Button1 is pressed
Private Sub Button1_Click(ByVal sender As System.Object, ByVal e As System.EventArgs) Handles Button1.Click
Dim recvstr As String
Dim i As Integer

Try
Button1.Enabled = False           'Disable buttons during communication ..... (a)
Button2.Enabled = False
Dim sp As New SerialPort("COM1", 9600, Parity.None, 8, StopBits.One) 'Communication port setting .... (b)
sp.NewLine = vbCrLf              'Terminator setting .....(c)
sp.ReadTimeout = 2000            '2 second time out ..... (d)
sp.Open()                        'Open port
SendSetting(sp)                  '3561 settings
FileOpen(1, "data.csv", OpenMode.Output) 'Create text file to be saved ..... (e)
For i = 1 To 10
sp.WriteLine("*FETCH?")         'Begin measurement and read measurement
                                'results command ..... (f)

recvstr = sp.ReadLine()         'Read measurement results
WriteLine(1, recvstr)           'Write to file
Next i
FileClose(1)                    'Close file
sp.Close()                       'Close port
Button1.Enabled = True
Button2.Enabled = True
Catch ex As Exception
MessageBox.Show(ex.Message, "Error", MessageBoxButtons.OK, MessageBoxIcon.Error)
End Try

End Sub
'Set measurement conditions
Private Sub SendSetting(ByVal sp As SerialPort)
Try
sp.WriteLine(":TRIG:SOUR IMM")    'Select internal triggering
sp.WriteLine(":INIT:CONT ON")    'Continuous measurement ON
Catch ex As Exception
MessageBox.Show(ex.Message, "Error", MessageBoxButtons.OK, MessageBoxIcon.Error)
End Try
End Sub
'Close program when Button2 is pressed
Private Sub Button2_Click(ByVal sender As System.Object, ByVal e As System.EventArgs) Handles Button2.Click
Me.Dispose()
End Sub
End Class
```

- (a) This makes it so that during communication the [Begin Measurement] and [Close] buttons cannot be pressed.
- (b) Matches the 3561 communication conditions and the computer usage conditions.
 - The port to be used on the computer: 1
 - Transmission speed: 9600 bps
 - Parity: none
 - Data length: 8 bit
 - Stop bit: 1bit
- (c) Sets CR + LF as the terminator indicating the end of the sending and receiving character string.
- (d) Sets the reading operation time to 2 seconds.
- (e) Opens the "data.csv" file. However, if a file with this name already exists, the previous "data.csv" will be deleted and a new file created.
- (f) Sends the command to the 3561 to perform one measurement and return that measurement result to the computer.

Specifications *Chapter 8*

8.1 Basic Specifications

Measurement Items

Measurement items	Resistance and voltage	
Resistance measurement method	AC four-terminal method	
Measurement current frequency	1 kHz	
Resistance measurement range	0.01 m Ω to 3.1 Ω	
Voltage measurement range	± 0.1 mV DC to ± 19.9999 V DC	
Measurement modes	<ul style="list-style-type: none"> • ΩV mode (Resistance and voltage measurement) • Ω mode (Resistance measurement) • V mode (Voltage measurement) 	
Maximum input voltage	± 22 V DC	
Maximum rated voltage to earth	± 60 V DC	
Input impedance	Approx. 1 M Ω	

Measurement Ranges

Resistance measurement	300 m Ω / 3 Ω
Voltage measurement	20 V

Measurement Value Display

Maximum displayed count	Resistance measurement : "31000" Voltage measurement : "199999"
Overflow display	Resistance measurement: OF indicates a measurement exceeds 31000 (display counts) -OF indicates a measurement is below -1000 Voltage measurement: OF indicates a measurement exceeds 199999 (display counts) -OF indicates a measurement is below -199999
Measurement fault detection	"-----"

Sampling Time

Sampling rate	EX.FAST/ FAST/ MEDIUM/ SLOW (four steps)																							
Sampling time	<table border="1"> <thead> <tr> <th>Sampling</th> <th>EX.FAST</th> <th>FAST</th> <th>MEDIUM</th> <th>SLOW</th> </tr> </thead> <tbody> <tr> <td>ΩV (50 Hz) (60 Hz)</td> <td>7 ms</td> <td>23 ms</td> <td>83 ms 69 ms</td> <td>258 ms 252 ms</td> </tr> <tr> <td>Ω (50 Hz) (60 Hz)</td> <td>4 ms</td> <td>12 ms</td> <td>42 ms 35 ms</td> <td>157 ms 150 ms</td> </tr> <tr> <td>V (50Hz) (60Hz)</td> <td>4 ms</td> <td>12 ms</td> <td>42 ms 35 ms</td> <td>157 ms 150 ms</td> </tr> </tbody> </table>				Sampling	EX.FAST	FAST	MEDIUM	SLOW	ΩV (50 Hz) (60 Hz)	7 ms	23 ms	83 ms 69 ms	258 ms 252 ms	Ω (50 Hz) (60 Hz)	4 ms	12 ms	42 ms 35 ms	157 ms 150 ms	V (50Hz) (60Hz)	4 ms	12 ms	42 ms 35 ms	157 ms 150 ms
Sampling	EX.FAST	FAST	MEDIUM	SLOW																				
ΩV (50 Hz) (60 Hz)	7 ms	23 ms	83 ms 69 ms	258 ms 252 ms																				
Ω (50 Hz) (60 Hz)	4 ms	12 ms	42 ms 35 ms	157 ms 150 ms																				
V (50Hz) (60Hz)	4 ms	12 ms	42 ms 35 ms	157 ms 150 ms																				
	* Tolerance for SLOW sampling is ± 5 ms, and ± 1 ms for other sampling rates																							
	* Values within parentheses are line frequency settings																							

Response Time

Response time	<p>Response time is specified as the interval from the moment of connecting (open-circuit) test leads to a test object until the signal becomes stable within the measurement accuracy of the internal measurement circuitry.</p> <p>Resistance measurement : Approx. 3 ms Voltage measurement : Approx. 3 ms</p> <p>* Response times are nominal values. Actual values depend on the impedance characteristics of the object being measured.</p>
Total measurement time	Overall time required for measurement: Response time + sampling time

Zero-Adjustment

Zero-adjustment function	<ul style="list-style-type: none"> Zero-adjustment setting ON/ OFF (Common to both resistance and voltage) Zero-adjustment clear Turns zero-adjustment off and clears all zero-adjustment offset data
Zero-adjustment range	Resistance measurement : -1000 to 1000 count Voltage measurement : -1000 to 1000 count

Self-Calibration

Calibration mode	AUTO/ MANUAL
AUTO	Executes automatically once every 30 minutes
MANUAL	Executes manually by EXT I/O signal or remote command

* When SLOW sampling is selected, self-calibration is performed upon each measurement. In this state, the calibration mode setting is ignored.

Trigger

Trigger source	Internal/ External
----------------	--------------------

Delay

Delay function	ON/ OFF
Delay time	0 to 9.999 sec

Averaging

Averaging function	ON/ OFF
No. of samples to average	2 to 16
Averaging	Moving average with internal triggering, and simple average with external triggering

Comparator

Comparator function	ON/ OFF (Common to both resistance and voltage)						
Comparator setting	<ul style="list-style-type: none"> • Comparator threshold method Upper and lower threshold/ Reference value and tolerance Upper and lower threshold: 0 to 99999 (Resistance) / 0 to 999999 (Voltage) • Reference value and tolerance: 0 to 99999 (Resistance) / 0 to 999999 (Voltage) %: 0.000% to 99.999% • Comparator judgment beeper OFF/ HL/ IN/ BOTH1/ BOTH2 • Comparator execution mode AUTO/ MANUAL <p>* Measurement value data and statistical 3σ (population standard deviation X 3) can be set automatically.</p>						
Decision	<p>Judgment result: Hi/ IN/ Lo (resistance and voltage judged independently)</p> <p>AND judgment: Calculates the logical AND of resistance and voltage judgment results</p> <p>Measurement fault value judgments:</p> <table style="margin-left: 20px; border: none;"> <tr> <td>OF</td> <td>Hi judgment</td> </tr> <tr> <td>-OF</td> <td>Lo judgment</td> </tr> <tr> <td></td> <td>Measurement faultNot judged (no judgment result)</td> </tr> </table>	OF	Hi judgment	-OF	Lo judgment		Measurement faultNot judged (no judgment result)
OF	Hi judgment						
-OF	Lo judgment						
	Measurement faultNot judged (no judgment result)						

Statistical Calculation

Statistical calculation	ON/ OFF/ clear Auto-clear after printing statistical data
Calculations	Total data counts, Valid data counts, Maximum, Minimum, Mean, Standard deviation, Population standard deviation and Process capability indices (Cp and CpK)
Calculations trigger	Statistical calculation of measured values initiated by EXT I/O signals, key or remote command

Measurement Memory and Batch Download Functions

Measurement memory	ON/ OFF/ clear
Memory trigger	Up to 400 measurement values can be stored in internal memory by EXT I/O signals, key or remote command. Stored measurement values can be batch downloaded by remote command.
Measurement value output function	Outputs measured values via the RS-232C interface upon triggering

Key-Lock

Key-lock	ON/ OFF Key operations are disabled when ON.
----------	---

Panel Save

Panel save function	Measurement configurations can be saved and reloaded by specifying a Panel number
No. of panel to save	126
Saved settings	Measurement mode, Resistance measurement range, Auto-ranging setting, Zero-adjust on/off setting and value, Sampling rate, Switching display setting, Trigger source, Delay setting, Averaging setting, Comparator setting, Statistical calculation setting and Key-lock setting

Reset

Reset	Reset/ System reset * System Reset also initializes Panel Save data
-------	--

Display Device

Display device	LED
----------------	-----

External Interfaces

EXT I/O	Input : CMOS level Output : Open drain, 30 V DC, 50 mA max. Input signals : Measurement start trigger, print, zero-adjustment, calibration, manual comparator and panel load (7 bit) Output signals : End-of-measurement, End measurement, Comparator result (resistance Hi/ IN/ Lo, voltage Hi/ IN/ L, AND), measurement fault and General-Purpose output (10 bit) * EXT I/O control (input) can be disabled by a remote command
RS-232C	Communications settings: Data length (8 bit), stop bit (1 bit), parity (none) Baud rate : 9600 bps/ 19200 bps/ 38400 bps Flow control : none
Printer	Output to printer via RS-232C (multi-use) Communications settings: Data length (8 bit), stop bit (1 bit), parity (none) Baud rate : 9600 bps
GP-IB (Model 3561-01 only)	Applicable GP-IB Standards: IEEE488.2 Address : 0 to 30 Delimiter : LF/ CR+LF

8.2 Accuracy

Guaranteed Accuracy Conditions

Temperature and humidity range for guaranteed accuracy	23 ± 5°C (73 ± 9°F), 80% RH or less (non-condensating)
Zero-adjustment	After zero adjustment
Warm-up time	At least 30 minutes
Self calibration	Except when using SLOW sampling, self-calibration should be executed after warm-up. Ambient temperature after self-calibration should be maintained within ± 2°C.

Resistance Measurement

Range	300 mΩ	3 Ω
Maximum displayed values	310.00 mΩ	3.1000 Ω
Resolution	0.01 mΩ	0.1 mΩ
Measured current	10 mA ± 10%	1 mA ± 10%
Measured current frequency	1 kHz ± 0.2 Hz	
Accuracy ^{*1}	± 0.5%rdg. ± 5dgt.	
Temperature coefficient	(± 0.05%rdg. ± 0.5dgt.)°C	
Open-terminal voltage	7 V peak	

Voltage Measurement

Range	20 V
Maximum displayed values	± 19.9999 V
Resolution	0.1 mV
Accuracy ^{*2}	± 0.01%rdg. ± 3dgt.
Temperature coefficient	(± 0.001%rdg. ± 0.3dgt.)°C

*1: Add ± 3 dgt for EX.FAST, or ± 2 dgt for FAST and MEDIUM sampling rates.

*2: Add ± 3 dgt for EX.FAST, or ± 2 dgt for FAST and MEDIUM sampling rates.

8.3 General Specifications

Operating temperature and humidity	0 to 40°C (32 ± 104°F), 80%RH or less (non-condensating)	
Storage temperature and humidity	-10 to 50°C (14 ± 122°F), 80%RH or less (non-condensating)	
Temperature and humidity range for guaranteed accuracy	23 ± 5°C (73 ± 9°F), 80%RH or less (non-condensating)	
Guaranteed accuracy period	1 year	
Operating environment	Indoors, Up to 2000 m (6562 ft) ASL	
Rated supply voltage	AC100 V to AC240 V (Auto selecting) (Voltage fluctuations of ±10% from the rated supply voltage are taken into account.)	
Rated supply frequency	50 Hz/ 60 Hz	
Power consumption	30 VA	
Dielectric strength	1.62 kV AC for 1minute, Cutoff current 10 mA, between all power terminals and protective ground	
Dimensions	Approx. 215W× 80H × 295D mm (8.46"W × 3.15"H × 11.61"D) (sans protrusions)	
Mass	Approx. 2.4 kg (84.7 oz.)	
Accessories	Instruction Manual..... 1 Power Cord 1	
Options	Model L2107	CLIP TYPE LEAD
	Model 9452	CLIP TYPE LEAD
	Model 9453	FOUR TERMINAL LEAD
	Model 9455	PIN TYPE LEAD (for ultra precision)
	Model 9467	LARGE CLIP TYPE LEAD
	Model 9770	PIN TYPE LEAD
	Model 9771	PIN TYPE LEAD
	Model 9637	RS-232C CABLE (9-pin to 9-pin, crossover)
	Model 9638	RS-232C CABLE (9-pin to 25-pin, crossover)
	Model 9151-02	GP-IB CONNECTOR CABLE (2 m)
Applicable Standards	Safety	EN61010
	EMC	EN61326 ClassA
Effect of radiated radio-frequency electromagnetic field	Resistance measurement	: ± 10%rdg. ± 3,000 dgt. at 10 V/m
	Voltage measurement	: ± 0.01%rdg. ± 50 dgt. at 10 V/m
Effect of conducted radio-frequency electromagnetic field	Resistance measurement	: ± 0.5%rdg. ± 100 dgt. at 3 V
Product warranty period	3 years	

Maintenance and Service

Chapter 9

9.1 Troubleshooting

- If damage is suspected, check the "Troubleshooting" section before contacting your dealer or Hioki representative.
- The fuse is housed in the power unit of the instrument. If the power does not turn on, the fuse may be blown. If this occurs, a replacement or repair cannot be performed by customers. Please contact your dealer or Hioki representative.
- Pack the instrument so that it will not sustain damage during shipping, and include a description of existing damage. We cannot accept responsibility for damage incurred during shipping.



Calibration and repair of this instrument should be performed only under the supervision of qualified technicians knowledgeable about the dangers involved.

NOTE

If no measurement value is displayed even when the probes are shorted together, an internal fuse may have blown. If the fuse blows, do not attempt to replace the fuse or repair the instrument: contact your dealer or Hioki representative.

Before returning for repair.

Symptom	Check Items	Countermeasure
The display does not appear when you turn the power on.	Is the power cord disconnected?	Reconnect the power cord.
Keys do not operate.	Is the unit in the key-locked state?	Disable the key-lock state. See Section 4.6 Key-Lock Function (p.62).
	Is the instrument being remotely controlled externally using GP-IB?	Set GP-IB to local.
	Is the instrument being remotely controlled externally using RS-232C?	Set RS-232C to local.
An error is displayed.		See Section 9.3 Error Display (p.170).
Operation is abnormal.		External electrical noise may occasionally cause malfunctions. If operation seems abnormal, try executing a Reset. See Section 4.12 Reset Function (p.68).

9.2 Cleaning

To clean the instrument, wipe it gently with a soft cloth moistened with water or mild detergent. Never use solvents such as benzene, alcohol, acetone, ether, ketones, thinners or gasoline, as they can deform and discolor the case.

9.3 Error Display

	Display	Description
Err02	Zero-Adjust Range Error	The value before zero-adjustment exceeded 1,000 dgt.
Err10	Execution Error	The data portion of a remote command is invalid.
Err11	Command Error	The command portion of a remote command is invalid.
Err90	ROM Error	An internal program error occurred. Repair is required.
Err91	RAM Error	An internal RAM error occurred. Repair is required.
Err92	EEPROM (Adjustment Data) Error	Adjustment data is corrupted. Repair is required.
Err95	A/D Communications Error	The A/D converter is damaged. Repair is required.
	<p>This indicates a measurement fault. It appears in cases of a disconnected test lead, poor probe contact or when the test object's measured value is far above the measurement range.</p> <p>The measurement fault signal is output from the ERR terminal of the EXT I/O connector. The following causes should be considered:</p> <ul style="list-style-type: none"> • A test lead may not be connected to the test object • Test object resistance may be too large for the measurement range Example: Measuring 30 Ω with the 300 mΩ range • Any of the SOURCE-H, SOURCE-L, SENSE-H or SENSE-L leads may be disconnected or poorly connected • When resistance between SOURCE-H and SOURCE-L is 50 Ω or more in the 300 mΩ range (500 Ω or more in the 3 Ω range) • Resistance between SENSE-H and SENSE-L is about 20 Ω or more (however, if test lead capacitance is more than 1 nF, measurement faults may not be detected) • The contact failure circuit protection fuse may have blown due to test lead damage, excessive wear, or impurities. 	

Appendix

Appendix 1 Precautions for Making Custom Test Leads

Bear the following in mind when making custom test leads.

- Be sure to twist together the SOURCE-H and L leads, and the SENSE-H and L leads. Also, connect the shields of all leads to the SOURCE-L lead.

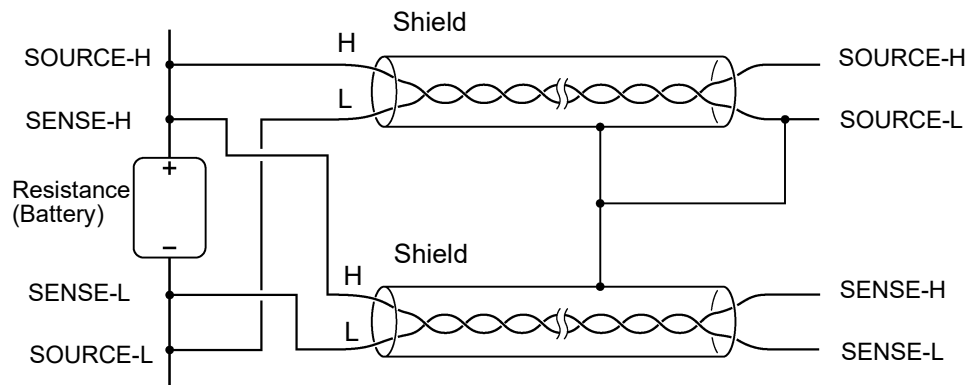

- The four-terminal design requires that all four terminals be used for measurement. Attempting to measure with two terminals (the two lines in the middle) may result in unstable or inconsistent measurements due to the effects of test lead contact resistance.

Wrong Connection

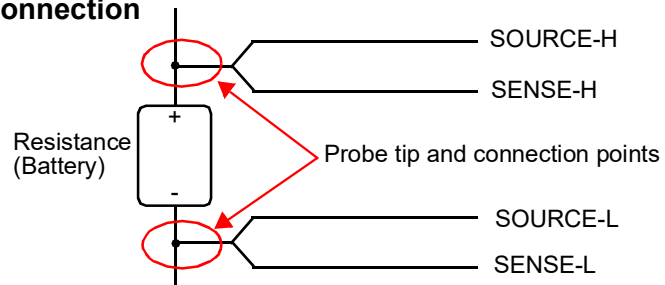

Appendix 1 Precautions for Making Custom Test Leads

- When connecting to a test object, connect SOURCE-H and SOURCE-L toward the outside, and SENSE-H and SENSE-L toward the inside.

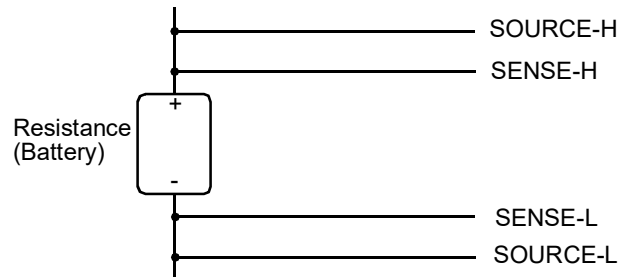

- Do not allow the test leads near metal surfaces. In particular, the lead portions that are not twisted together must be kept away from conductors to avoid unstable measurements resulting from the effects of induced current. See Appendix 5 Effect of Eddy Currents (p.176).

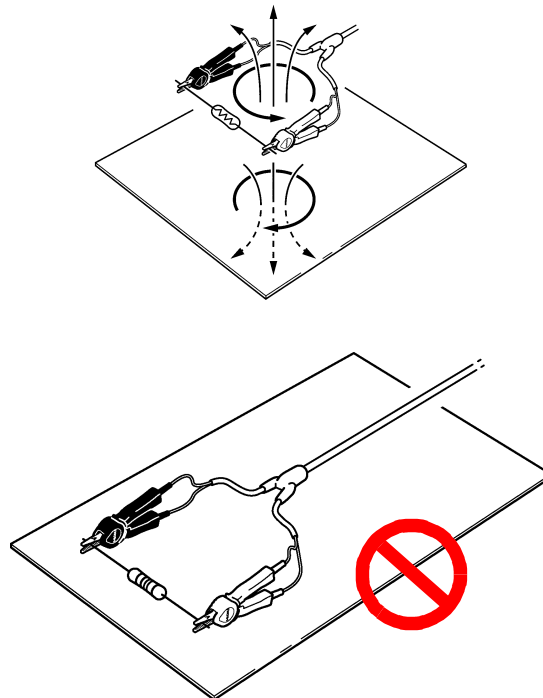

- Leads should be as short as possible (and in no case more than 5 m). Long leads are more susceptible to noise ingress and unstable measurements. The total lead resistance in both directions plus test lead contact resistance must not exceed 20 Ω .

NOTE

When using the probe tips of optional separate test leads, be careful to avoid touching the shield conductors of the SOURCE-H, SENSE-H and SENSE-L lines to their center conductors.

Appendix 2 AC Four-terminal Method

The instrument uses the AC four-terminal method, so that resistance measurement can be carried out with the resistance of the leads and the contact resistance between the leads and the object to be measured canceled out. The following figure shows the principle of the AC four-terminal measurement method.

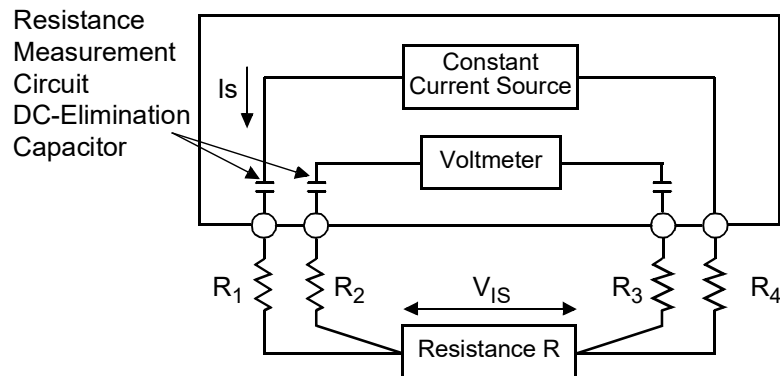

Values R_1 to R_4 are the resistances of the test leads plus contact resistances.

An AC current (I_s) is supplied from the SOURCE terminals of the instrument across the tested battery. The voltage drop across the internal impedance of the battery (V_{IS}) is measured by the SENSE terminals. At this point, since the SENSE terminals are connected to an internal voltmeter with a high impedance, almost no current flows through the resistances R_2 and R_3 which represent the lead resistances and contact resistances. As a result, there is almost no voltage drop across the resistances R_2 and R_3 . Thus the voltage drop due to the lead resistances and contact resistances is very small, and these can be canceled out. In the instrument, a synchronized wave detection system is used, whereby the internal impedance is separated into resistance and reactance, and the resistive component only displayed.

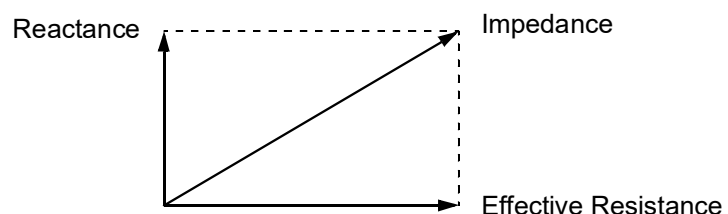

If the lead resistance, the contact resistance between measured object and lead, or the contact resistance between the lead and the instrument instrument increases, the instrument can no longer supply normal current to the measured object, resulting in an abnormal measurement status indicated by "- - - -" within the measured resistance field. For more information on abnormal measurements, see Section 3.7.1 Measurement Fault Detection (p.34)."

Appendix 3 Synchronous Detection System

The figure below shows an equivalent circuit for a battery. If the measured object exhibits other electrical characteristics in addition to resistance, as shown in this figure, we can use the synchronous detection system to obtain the effective resistance of the object. This synchronous detection system is also used to separate faint signals from noise.

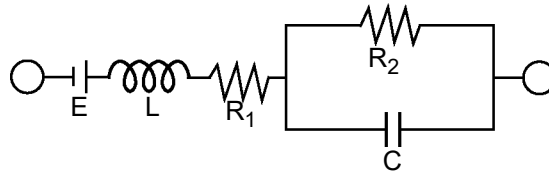

The synchronous detection system picks up the reference signal and those signals having the same phase components. The figure below gives a simplified schematic diagram of the synchronous detection system. The system consists of a multiplying circuit that multiplies two signals and a low-pass filter (LPF) that picks up only DC components from the output.

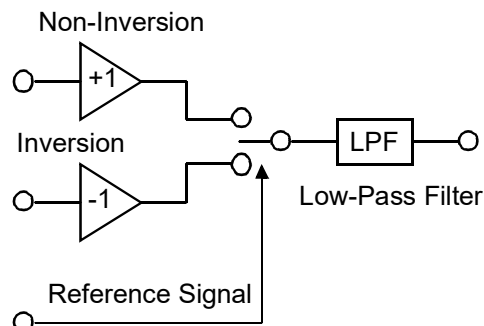

Given "v1," a reference signal voltage for the AC current generated in the instrument, and "v2," the signal voltage for use in synchronous detection, these parameters may be expressed by the equation given below. θ of v2 shows the phase difference against v1 and is generated by the reactance.

$$v_1 = A \sin \omega t$$

$$v_2 = B \sin (\omega t + \theta)$$

When synchronous detection is applied to both v1 and v2, they are expressed as follows:

$$v_1 \times v_2 = \frac{1}{2}AB \cos \theta - \frac{1}{2}AB \cos (2\omega t + \theta)$$

The first term indicates effective resistance. The second term is attenuated by the LPF. The instrument displays the first term.

Appendix 4 Configuration and Extension of the Test Leads

The test lead extension is normally performed by Hioki. If you want extension performed, contact your dealer or Hioki representative.

Observe the following points when extending test leads:

- Use the thickest lead available. Extend the lead only by the necessary amount.
- Maintain the AC four-terminal configuration while extending the lead. Changing the four-terminal configuration to a two-terminal configuration can result in measurement data being affected by lead resistance and/or contact resistance, resulting in inaccurate measurement.
- Make the branch section as short as possible. Try to extend the thick lead instead.
- Make sure the lead is insulated.
- While measuring, avoid as much as possible pulling or repositioning the test leads after executing zero adjustment.
- Extending test leads may result in excessive voltage drop. The total resistance of the test leads and contacts must remain below 20 Ω .
- To prevent eddy currents from affecting measurement, keep test leads away from metallic parts.
- After extending the test leads, confirm proper measurement operation and accuracy.

Reducing Induced Voltage

Since the instrument measures a minute resistance with AC power, it is affected by induced voltage. Induced voltage refers to voltage that allows the current generated in the instrument to build an inductive coupling in a lead and affect signal lines. Since the phase of the induced voltage is shifted from that of the AC current (reference signal) by 90 degrees, it can be eliminated with the synchronous detection circuit if the voltage is low. But for high levels, the induced voltage distorts the signals, causing incorrect synchronous detection. The instrument monitors induced voltage internally and generates an abnormal measurement signal if the level rises above a certain level. Reducing the length of the lead will lower induced voltage. Reducing the length of the branched section is particularly effective.

Appendix 5 Effect of Eddy Currents

The AC current generated in the instrument induces eddy currents in the surrounding metallic plates, which generate induced voltage in the test lead. Since the phase of this induced voltage is shifted from that of the AC current (reference signal) by 180 degrees, it cannot be eliminated by the synchronous detection circuit, resulting in measurement errors. The influence of eddy currents is a phenomenon unique to ohmmeters that measure resistance with AC power. To protect the test lead from such effects, keep metallic parts, including metallic plates, at a suitable distance from the test lead (branched section).

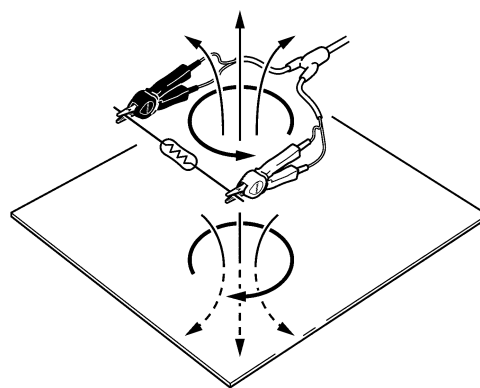

Appendix 6 Zero Adjustment

Zero adjustment is a function which adjusts the zero point by deducting the residual value obtained during $0\ \Omega$ measurement. For this reason, zero adjustment must be performed when connection is made to $0\ \Omega$. However, connecting a sample with no resistance is difficult and therefore is not practical.

In this respect, when performing the actual zero adjustment, create a pseudo connection to $0\ \Omega$ and then adjust the zero point.

To create $0\ \Omega$ connection state

If an ideal $0\ \Omega$ connection is made, the voltage between SENSE-H and SENSE-L becomes $0\ \text{V}$ according to the Ohm's Law of $E = I \times R$. In other words, if you set the voltage between SENSE-H and SENSE-L to $0\ \text{V}$, this gives you the same state of $0\ \Omega$ connection.

To perform zero adjustment using the instrument

The instrument uses a measurement fault detection function to monitor the state of connection between the four measurement terminals. For this reason, when performing zero adjustment, you need to make connections between the terminals appropriately in advance (Figure 1).

First, short between SENSE-H and SENSE-L to set the voltage between SENSE-H and SENSE-L to $0\ \text{V}$. If lead resistances R_{SEH} and R_{SEL} of the cable are less than few Ω , there will be no problem. Because the SENSE terminal is a voltage measurement terminal, almost no current I_0 flows. Therefore, in the $E = I_0 \times (R_{SEH} + R_{SEL})$ formula, $I_0 \approx 0$ is achieved; if lead resistances R_{SEH} and R_{SEL} are less than few Ω , voltage between SENSE-H and SENSE-L will become almost zero.

Next, make connection between SOURCE-H and SOURCE-L. This is to avoid display of error when no measurement current flows through. Lead resistances R_{SOH} and R_{SOL} of the cable must be less than the resistance for flowing measurement current.

Furthermore, if you also monitor the connection between SENSE and SOURCE, you need to make connection between SENSE and SOURCE. If lead resistance R_{Short} of the cable has only few Ω , there will be no problem.

If you wire in the way described above, measurement current I flowing out from SOURCE-H will go to SOURCE-L but not to the lead of SENSE-H or SENSE-L. This enables the voltage between SENSE-H and SENSE-L to be kept accurately at $0\ \text{V}$, and appropriate zero adjustment becomes possible.

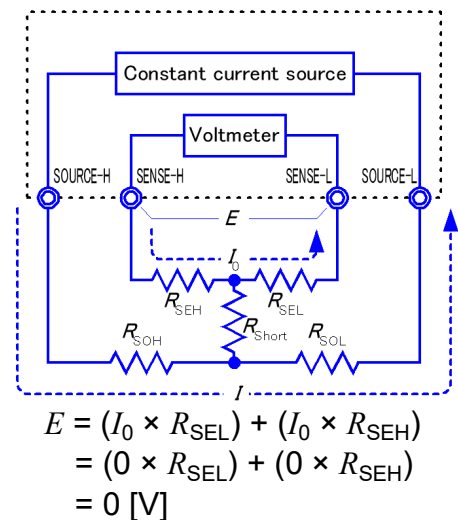

Figure 1 Pseudo connection to $0\ \Omega$

To perform zero adjustment appropriately

Table 1 shows the correct and wrong connections. The resistances in the figure indicate lead resistances; there will be no problem if they are less than few Ω respectively.

In (a), if you connect SENSE-H and SENSE-L as well as SOURCE-H and SOURCE-L respectively, and use one path to make connection between SENSE and SOURCE, no potential difference occurs between SENSE-H and SENSE-L, and 0 V is input. This enables zero adjustment to be carried out correctly.

In (b), on the other hand, if you connect SENSE-H and SOURCE-H as well as SENSE-L and SOURCE-L respectively, and use one path to make connection between Hi and Lo, $I \times R_{\text{Short}}$ voltage occurs between SENSE-H and SENSE-L. For this reason, the pseudo 0 Ω connection state cannot be achieved and zero adjustment cannot be carried out correctly.

Table 1: Connection methods

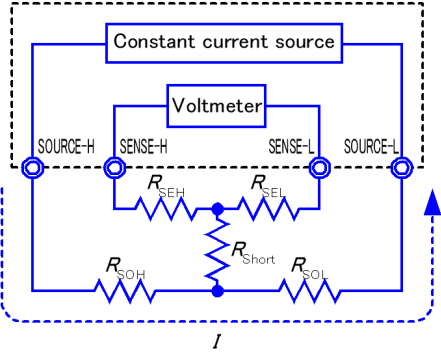
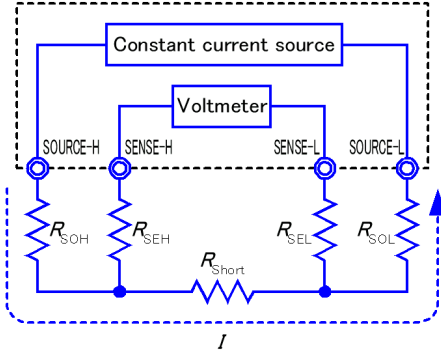
<p>Connection methods</p>	 <p>(a) Use one point each between SENSE and SOURCE for connection</p>	 <p>(b) Use one point each between Hi and Lo for connection</p>
<p>Resistance between SENSE-H and SENSE-L</p>	$R_{\text{SEH}} + R_{\text{SEL}}$	$R_{\text{SEH}} + R_{\text{Short}} + R_{\text{SEL}}$
<p>Measurement current I's flow path</p>	$R_{\text{SOH}} \rightarrow R_{\text{SOL}}$	$R_{\text{SOH}} \rightarrow R_{\text{Short}} \rightarrow R_{\text{SOL}}$
<p>Voltage occurring between SENSE-H and SENSE-L</p>	0	$I \times R_{\text{Short}}$
<p>As connection method for zero adjustment</p>	Correct	Wrong

To perform zero adjustment using a probe

When you actually perform zero adjustment using a probe, you may unexpectedly make the connection shown in Table 1 (b). Therefore, when performing zero adjustment, you need to pay sufficient attention to the connection state of each terminal.

Here, L2107 CLIP TYPE LEAD as mentioned in 3.6.2 Executing Zero-Adjustment (p.31) is used as an example for the connection explanation. Table 2 shows the connection state of the tip of the lead and equivalent circuit in the respective correct and wrong connections. Table 1 (a) indicates the correct connection method, resulting in 0 V between SENSE-H and SENSE-L. However, Table 1 (b) is the wrong connection method, so that 0 V is not obtained between SENSE-H and SENSE-L.

Table 2: Clip type lead connection methods used during zero adjustment

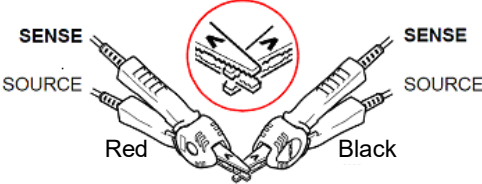
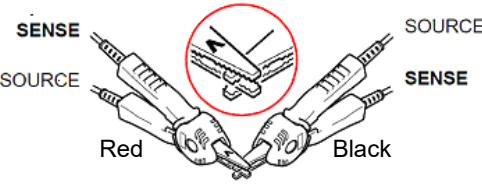
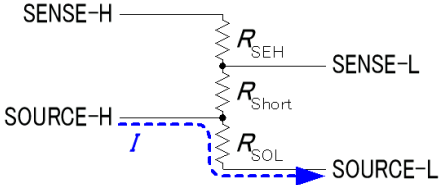
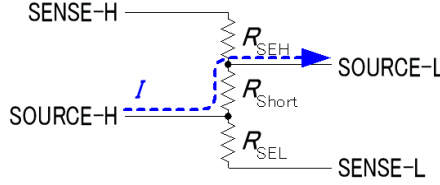
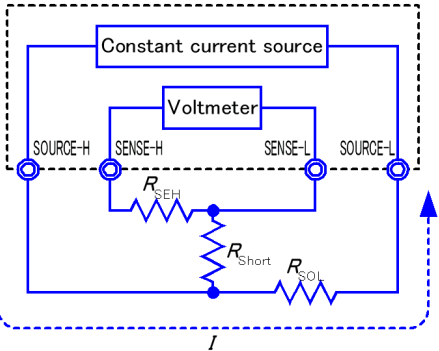
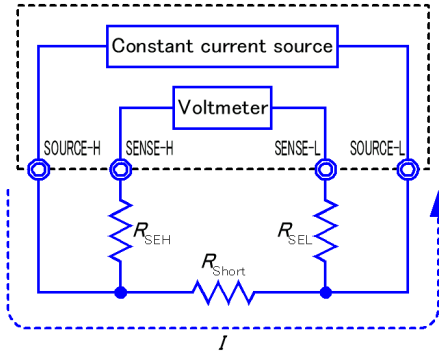
Connection method	Correct	Wrong
Tip of lead		
Equivalent circuit		
Deformed equivalent circuit		
As connection method for zero adjustment	Correct	Wrong

If zero adjustment is difficult when using self-made probe to measure

When you perform zero adjustment using a self-made probe to do measurement, connect the tip of the self-made probe as shown in Table 1 (a). However, if such connection is difficult, you can try the following methods.

If DC resistance meter is used

The main purpose of performing zero adjustment is to remove offset of the measurement instrument. For this reason, the value to be deducted as a result of zero adjustment almost does not depend on the probe. Therefore, after using the standard probe to make the connection shown in Table 1 (a) and performing zero adjustment, you can replace it with a self-made probe to measure with offset removed from the measurement instrument.

If AC resistance meter is used

In addition to removing offset of the measurement instrument, another main purpose of performing zero adjustment is to remove influence of the probe shape. For this reason, when performing zero adjustment, try as much as possible to set the form of the self-made probe close to the measurement state. Then, you need to make the connection as shown in Table 1 (a) and perform zero adjustment.

However, if a HIOKI product is used, even in AC resistance measurement, if the required resolution exceeds $100 \mu\Omega$, the same zero adjustment method used in DC resistance meter may be sufficient.

Appendix 7 Calibration Procedure

For the calibration environment, see Section Chapter 8 Specifications (p.163)."

Calibration of the Ohmmeter

- Use the 9453 FOUR TERMINAL LEAD as the connection lead.
- Use standard resistors with excellent temperature characteristics that resist deterioration over time.
- To prevent influence by the lead, use four-terminal resistors.
- Use a resistor that will reflect the correct resistance at 1 kHz. With wire-wound resistors, the inductance element is so large that the pure resistance (DC resistance) does not equal the effective resistance (real part of impedance, displayed on the instrument).
- For connection of a standard resistor to the instrument, see the figure below.

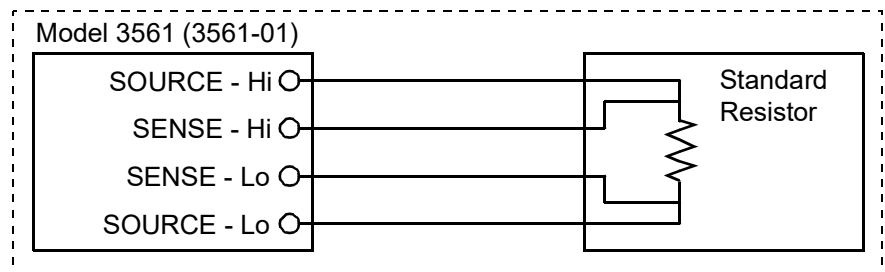

Calibration of the Voltmeter

- Use the 9453 FOUR TERMINAL LEAD as the connection lead.
- Use a generator that can output a DC voltage of 20 V.
- For connection of a generator to the instrument, see the figure below.
- Do not apply an alternating current from the instrument to the generator, as the generator may malfunction.
- Use a low-impedance voltage source.

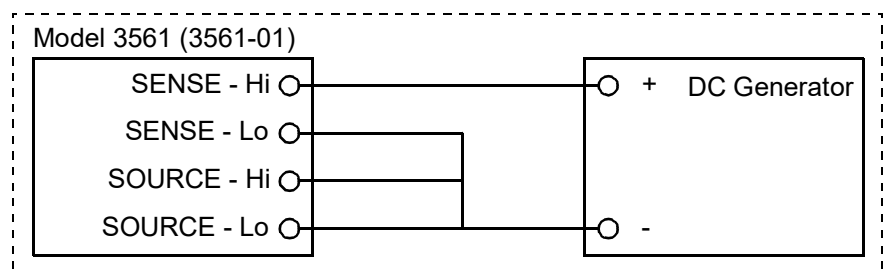

Appendix 8 Test Lead Options

Model L2107 CLIP TYPE LEAD

These leads have clip tips. Four-terminal measurements are provided just by clipping on to the test object.

Maximum clip diameter: 8 mm

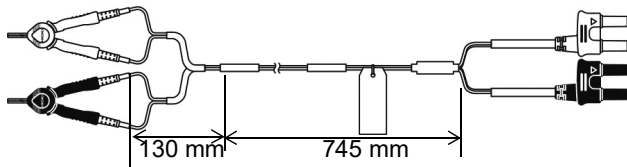

Model 9452 CLIP TYPE LEAD

The probes have pincer-type tips.

Allows reliable four-terminal measurements even on test objects with small contacts such as relay terminals and connectors.

Bifurcation-to-probe length: approx. 200 mm

Plug-to-bifurcation length: approx. 800 mm

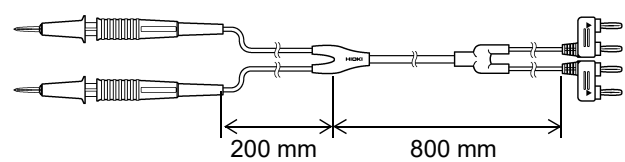

Model 9453 FOUR TERMINAL LEAD

The SOURCE leads of this four-terminal lead set have covered alligator clips, and the SENSE leads have standard test probes. Use for measuring printed circuit board pattern resistance, and where SOURCE and SENSE leads need to be connected separately.

Bifurcation-to-probe length: approx. 300 mm

Plug-to-bifurcation length: approx. 800 mm

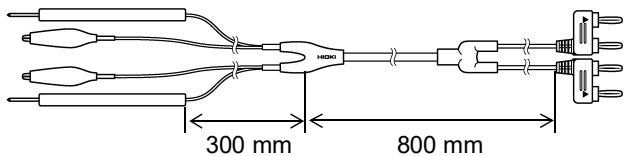

Model 9455 PIN TYPE LEAD

The probe tips have a four-terminal structure designed for checking for floating IC leads on printed circuit boards. Correct measurements are obtained even with very small test objects.

Bifurcation-to-probe length: approx. 250 mm

Plug-to-bifurcation length: approx. 400 mm

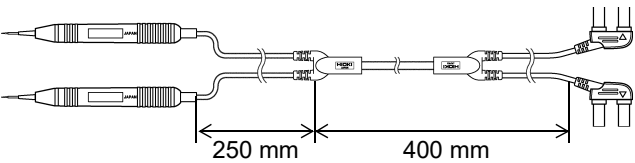

Model 9467 LARGE CLIP TYPE LEAD

These leads are designed to attach to test object with large diameter contacts. Four-terminal measurements can be made just by clipping.

Bifurcation-to-probe length: approx. 250 mm

Plug-to-bifurcation length: approx. 850 mm

Maximum clip diameter: approx. 29 mm

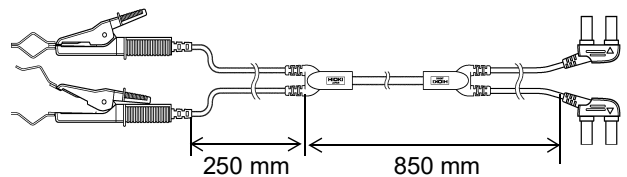

Model 9770 PIN TYPE LEAD

Even on flat contact points that cannot be clipped to, or on test objects with small contacts such as relay terminals or connectors, four-terminal measurements are available by just pressing.

Bifurcation-to-probe length: approx. 250 mm

Plug-to-bifurcation length: approx. 400 mm

Pin base: ϕ 1.8 mm

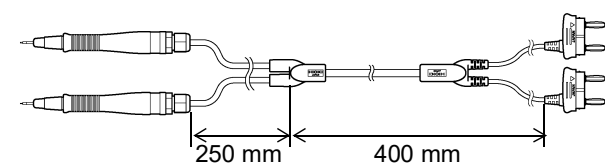

Model 9771 PIN TYPE LEAD

The tips have a four-terminal design developed for floating-foot testing of ICs mounted on boards. Resistance can be correctly measured even with small test objects.

Bifurcation-to-probe length: approx. 250 mm

Plug-to-bifurcation length: approx. 400 mm

Between pin bases: 0.2 mm

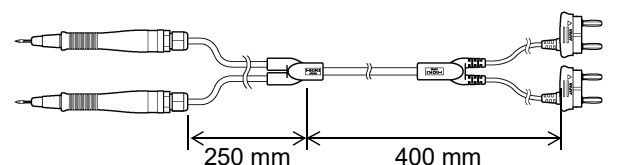

Appendix 9 Rack Mounting

By removing the screws on the sides, this instrument can be installed in a rack mounting plate.



Observe the following precautions regarding the mounting screws to avoid instrument damage and electric shock accidents.

- When installing the Rack Mounting Plate, the screws must not intrude more than 6 mm into either side of the instrument.
- When removing the Rack Mounting Plate to return the instrument to stand-alone use, replace the same screws that were installed originally. (Feet: M3 x 6 mm, Sides: M4 x 6 mm)

Rack Mounting Plate Template Diagram and Installation Procedure

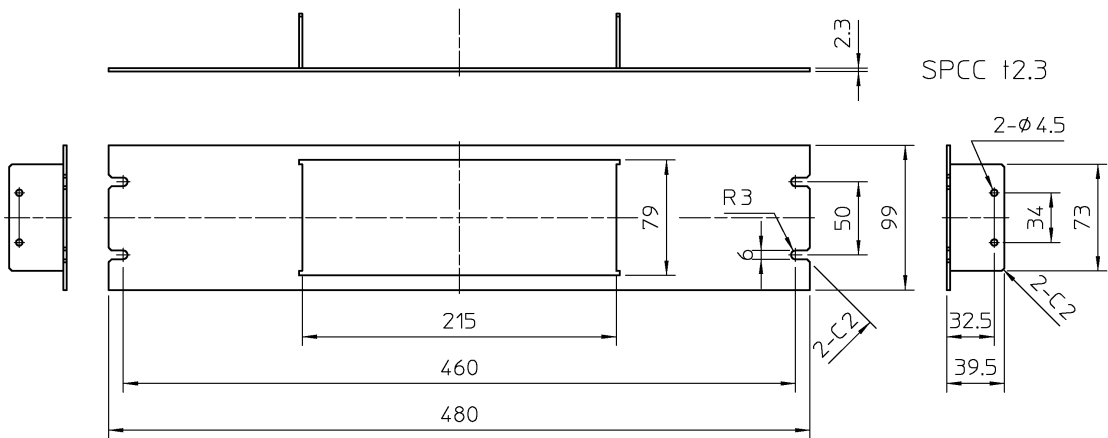

Rack Mounting Plate (JIS)

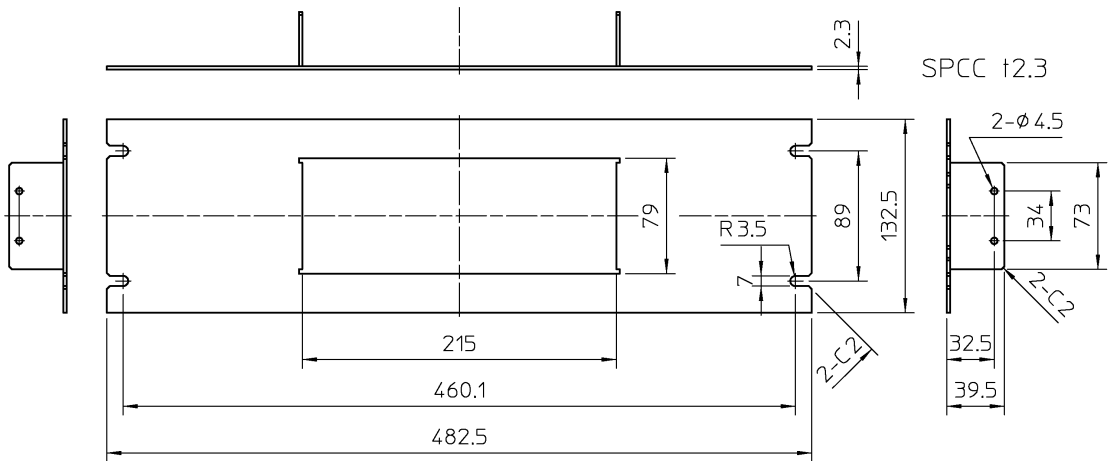

Rack Mounting Plate (EIA)

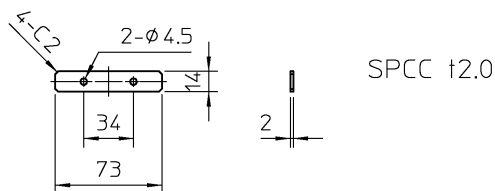

Spacer (Two Required)

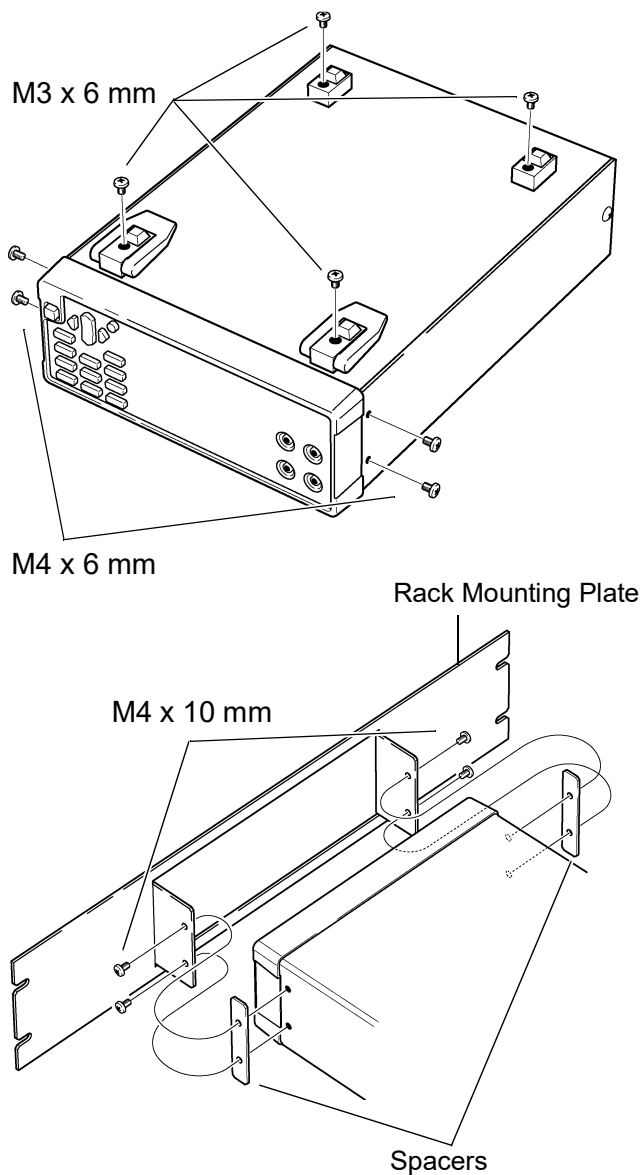

1. Remove the feed from the bottom of the instrument, and the screws from the sides (four near the front).

2. Installing the spacers on both sides of the instrument, affix the Rack Mounting Plate with the M4 x 10 mm screws.

When installing into the rack, reinforce the installation with a commercially available support stand.

Appendix 10 Dimensional Diagram

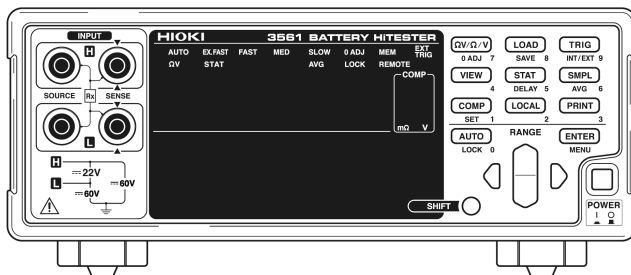
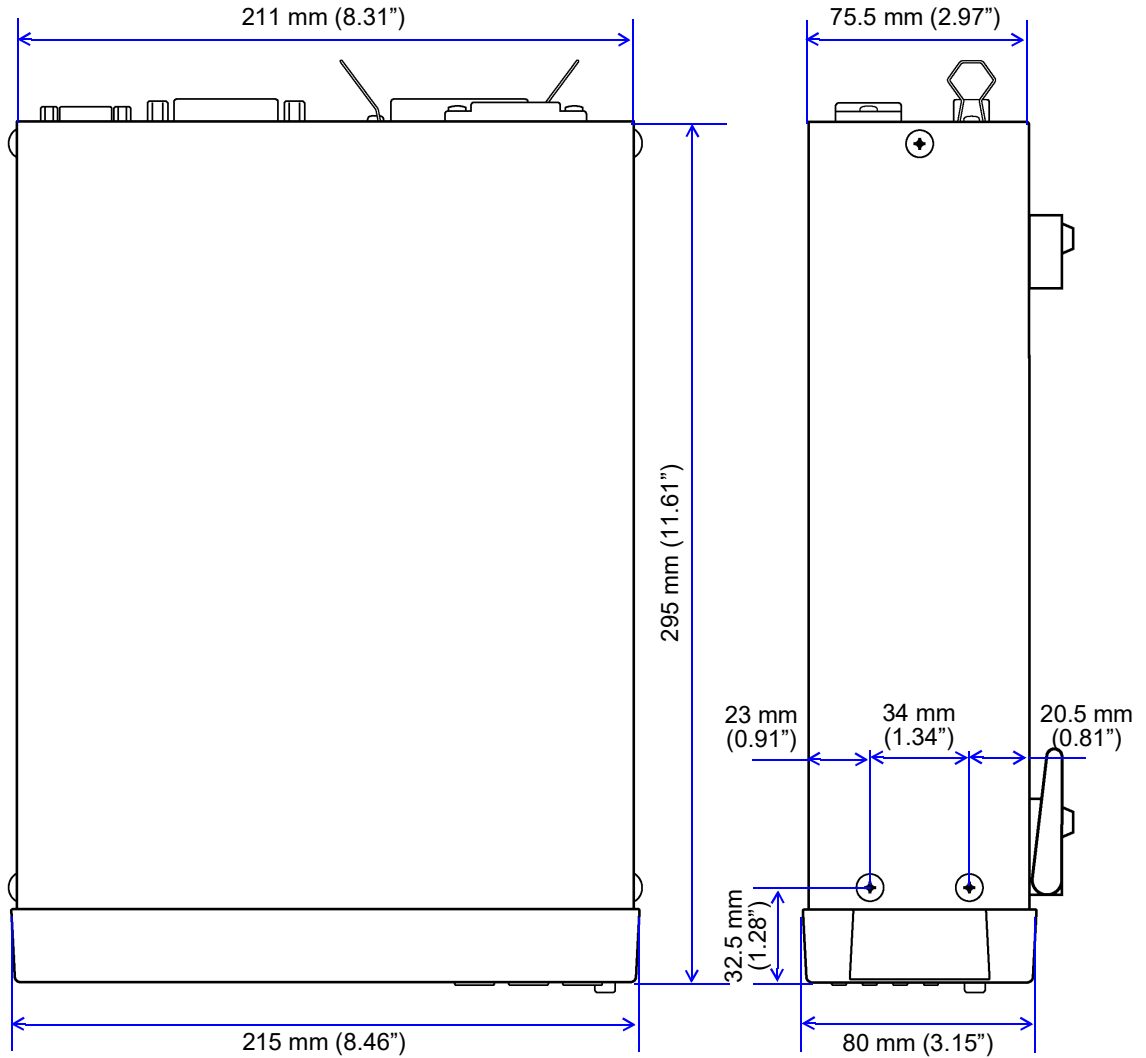



Index

Numerics

0ADJ	74
3560	143

A

AC four-terminal method	173
Accuracy	167
After warm-up	65
AND	51, 74
Auto-Ranging	13, 29
Averaging	13, 55

B

Before connecting and powering on	6
---	---

C

CAL	65, 73
Calibration	181
Character data	95
Cleaning	170
Clearing statistical calculation results	57
Command	92
Command compatibility	143
Comparator	13, 50
Comparator execution mode	46
Comparator function	36
Comparator judgment beeper	45
Comparator judgment results	51
Compare	36
Connector	71, 72, 89
Continuous measurement	136
CR	94
CR+LF	94
Crossover cable	90
Custom test lead	171

D

Damage	169
Data Format	95
Decimal numeric data	95
Device-Specific command	105
dgt.	3
Displayed value	29

E

EOC	74, 76, 78
EOI	94
ERR	74
Error	170
EXT I/O	14, 72
External control	71
External control terminal	79
External output terminal	80
External trigger	53, 77

F

Factory defaults	68
Footswitch	66
Format	142
Fuse	169

G

GP-IB	14, 87
Ground	6, 18, 71
Guaranteed accuracy condition	167

H

Header	93
--------------	----

I

IN	74
INDEX	74
Initialize	68
Input buffer	97
Input impedance	163
Input terminal	11
Inspection	23
Interface	83, 91
Internal circuitry	79
Internal trigger	53, 77
Interval printing	83, 84

J

Judge	36
Judgment results	74

- K**
-
- Key beeper 67
 - Key-Lock 13, 62
- L**
-
- LED connection 80
 - LF 94
 - Line frequency 18, 22
 - LOAD 64, 73
 - Local 102, 103, 132
 - LOCAL key 102
- M**
-
- Main display 11, 12
 - MANU 74
 - Manual range 13
 - Maximum input voltage 163
 - Maximum rated voltage to earth 163
 - Mean 56
 - Measured current 29, 167
 - Measurement Fault 142
 - Measurement fault 34, 51, 74, 75, 76, 146, 163
 - Measurement mode 13, 27
 - measurement precision 65
 - Measurement range 28
 - Measurement setting state 63
 - Measurement settings 64
 - Measurement time 78
 - Measurement value output 66
 - Memory function 60, 128
 - Menu display 15
- N**
-
- Noise 4, 6, 132, 169, 172
 - NR1 95
 - NR2 95
 - NR3 95
- O**
-
- OF 34, 163
 - Operating key 11, 13, 67
 - Option 1, 182
 - OUT 74
 - Output queue 97
 - Overflow 34, 163
- P**
-
- Panel load function 64
 - Panel save function 63
 - Period of guaranteed accuracy 168
 - Photocoupler connection 79
 - Power cord 18, 23
 - Power inlet 14
 - POWER switch 11
 - PRINT 74
 - Printer 13, 81
 - Printing statistical calculation results 84
 - Process capability index 56
- Q**
-
- Query 92
- R**
-
- Rack mounting 183
 - Range 13
 - rdg. 3
 - Reference value and tolerance 47, 48
 - Relative value 47
 - Relay connection 79, 80
 - Remote 13, 62, 102, 103, 132
 - Repair 169
 - Reset 169
 - Reset function 68
 - Resistance and voltage measurement 27
 - Resistance measurement 27
 - Response time 164
 - RS-232C 14, 87
- S**
-
- Sample program 148
 - Sample Programs 160
 - Sampling 65
 - Sampling rate 13, 30
 - Sampling time 164
 - Self calibration 65, 167
 - SENSE-H 11, 171
 - SENSE-L 11, 171
 - Separator 94
 - sn 49, 56
 - sn-1 56
 - SOURCE-H 11, 171
 - SOURCE-L 11, 171
 - Stand 14
 - Standard command 104, 111
 - Standard deviation of population 56
 - Statistical calculation 13
 - Statistical calculation function 56
 - Sub display 11, 12
 - Supply frequency 168
 - Supply voltage 6, 21, 168
 - Switch connection 79
 - Switching 52
 - Switching between measurement value and comparator setting displays 52

T

Temperature coefficient	167
Terminator	94
Test lead	19, 23, 30, 182
Threshold method	47
Timing chart	77
TRIG	53, 58, 60, 66, 73
Trigger	13, 53, 136
Trigger delay	13, 54
Trigger source	136

U

Upper and lower thresholds	47, 48
----------------------------------	--------

V

Voltage measurement	27
---------------------------	----

W

Warm-up time	167
--------------------	-----

Z

Zero-Adjustment	13, 30, 32, 177
-----------------------	-----------------



Warranty Certificate

HIOKI

Model	Serial number	Warranty period Three (3) years from date of purchase (___ / ___)
-------	---------------	--

Customer name: _____

Customer address: _____

Important

- Please retain this warranty certificate. Duplicates cannot be reissued.
- Complete the certificate with the model number, serial number, and date of purchase, along with your name and address. The personal information you provide on this form will only be used to provide repair service and information about Hioki products and services.

This document certifies that the product has been inspected and verified to conform to Hioki's standards. Please contact the place of purchase in the event of a malfunction and provide this document, in which case Hioki will repair or replace the product subject to the warranty terms described below.

Warranty terms

1. The product is guaranteed to operate properly during the warranty period (three [3] years from the date of purchase). If the date of purchase is unknown, the warranty period is defined as three (3) years from the date (month and year) of manufacture (as indicated by the first four digits of the serial number in YYMM format).
2. If the product came with an AC adapter, the adapter is warranted for one (1) year from the date of purchase.
3. The accuracy of measured values and other data generated by the product is guaranteed as described in the product specifications.
4. In the event that the product or AC adapter malfunctions during its respective warranty period due to a defect of workmanship or materials, Hioki will repair or replace the product or AC adapter free of charge.
5. The following malfunctions and issues are not covered by the warranty and as such are not subject to free repair or replacement:
 - 1. Malfunctions or damage of consumables, parts with a defined service life, etc.
 - 2. Malfunctions or damage of connectors, cables, etc.
 - 3. Malfunctions or damage caused by shipment, dropping, relocation, etc., after purchase of the product
 - 4. Malfunctions or damage caused by inappropriate handling that violates information found in the instruction manual or on precautionary labeling on the product itself
 - 5. Malfunctions or damage caused by a failure to perform maintenance or inspections as required by law or recommended in the instruction manual
 - 6. Malfunctions or damage caused by fire, storms or flooding, earthquakes, lightning, power anomalies (involving voltage, frequency, etc.), war or unrest, contamination with radiation, or other acts of God
 - 7. Damage that is limited to the product's appearance (cosmetic blemishes, deformation of enclosure shape, fading of color, etc.)
 - 8. Other malfunctions or damage for which Hioki is not responsible
6. The warranty will be considered invalidated in the following circumstances, in which case Hioki will be unable to perform service such as repair or calibration:
 - 1. If the product has been repaired or modified by a company, entity, or individual other than Hioki
 - 2. If the product has been embedded in another piece of equipment for use in a special application (aerospace, nuclear power, medical use, vehicle control, etc.) without Hioki's having received prior notice
7. If you experience a loss caused by use of the product and Hioki determines that it is responsible for the underlying issue, Hioki will provide compensation in an amount not to exceed the purchase price, with the following exceptions:
 - 1. Secondary damage arising from damage to a measured device or component that was caused by use of the product
 - 2. Damage arising from measurement results provided by the product
 - 3. Damage to a device other than the product that was sustained when connecting the device to the product (including via network connections)
8. Hioki reserves the right to decline to perform repair, calibration, or other service for products for which a certain amount of time has passed since their manufacture, products whose parts have been discontinued, and products that cannot be repaired due to unforeseen circumstances.

HIOKI E.E. CORPORATION

<http://www.hioki.com>

18-07 EN-3

HIOKI

<http://www.hioki.com>



**All regional
contact
information**

HEADQUARTERS

81 Koizumi
Ueda, Nagano 386-1192 Japan

HIOKI EUROPE GmbH

Rudolf-Diesel-Strasse 5
65760 Eschborn, Germany
hioki@hioki.eu

1906 EN

Edited and published by HIOKI E.E. CORPORATION

Printed in Japan

- CE declarations of conformity can be downloaded from our website.
- Contents subject to change without notice.
- This document contains copyrighted content.
- It is prohibited to copy, reproduce, or modify the content of this document without permission.
- Company names, product names, etc. mentioned in this document are trademarks or registered trademarks of their respective companies.