

# ST4030 ST4030A

# HIOKI

Instruction Manual

# IMPULSE WINDING TESTER



The latest edition of the instruction manual



**Read carefully before use.  
Keep for future reference.**

Usage Notes ▶ p.5  
Parts Names and Functions ▶ p.8  
Implementing Tests ▶ p.77

Maintenance and Service ▶ p.207  
Error Display ▶ p.214  
Communication Command  
Instruction Manual ▶ CD

## EN

June 2024 Revised edition 3  
ST4030A961-03



# Measurement Flowchart

The basic measuring flow is as described below.

## Preparation

See “2 Preparation for Measurements” (p.13)

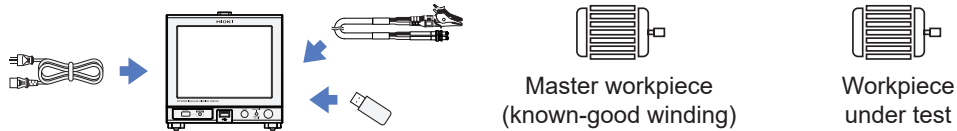

## Setting Test Conditions and Judgment Conditions

- 1 Select [SETTING] in test conditions settings mode. (p.18)

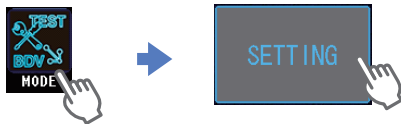

- 2 Select the settings table that will acquire the master waveform. (p.29)

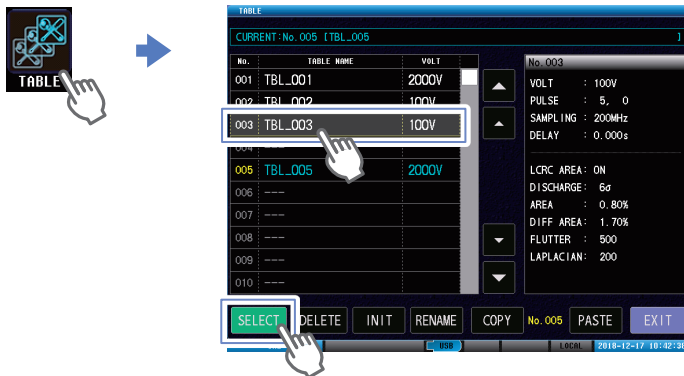

- 3 Set the output items such as applied voltage, applied number of pulses, sampling frequency, etc. (p.41)

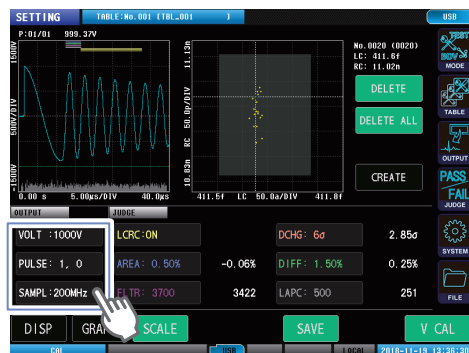

- 4 Connect the master workpiece to the test lead.



- 5 Calibrate the voltage and acquire the master waveform. (p.49)



- 6 Set the judgment criteria. (p.53)



## Implementing tests

- 1 Select [TEST] in test mode. (p.18)

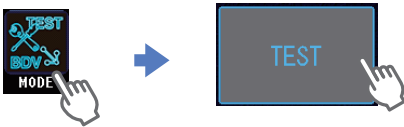

- 2 Select the settings table that acquired the master waveform to be used in the test (p.29)

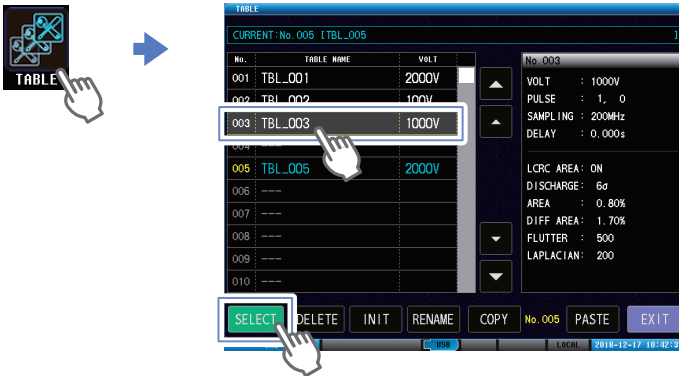

- 3 Connect the workpiece under test to the test lead.



- 4 Start the test and check the test results. (p.84)

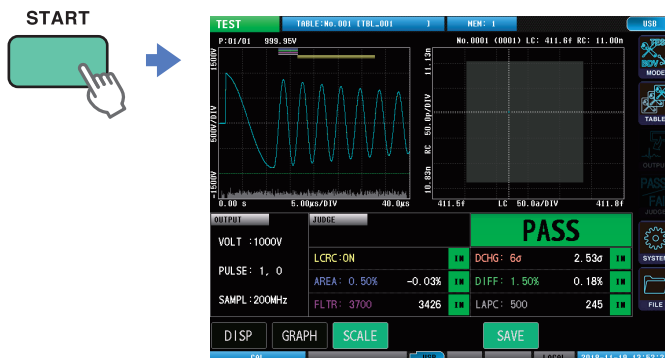

## Save the test results

- 1 Make the settings for saving the data. (p.169)
- 2 Save the test results. (p.176)

# Contents

Introduction.....	1	3.4 Table Deletion .....	31
Notations.....	2	3.5 Changing the Table Name .....	32
Confirming Package Contents.....	3	3.6 Table Copying .....	33
Options (Sold separately).....	4		
Usage Notes.....	5		
<b>1 Overview</b> .....	<b>7</b>	<b>4 Setting the Test Conditions</b> .....	<b>35</b>
1.1 Overview.....	7	4.1 Overview.....	35
1.2 Features.....	7	Operations flowchart in test conditions settings mode.....	35
1.3 Parts Names and Functions .....	8	Screen configuration.....	36
1.4 Screen Operations .....	10	4.2 Applied Voltage.....	41
Measuring mode settings.....	10	4.3 Number of Applied Pulses.....	42
Moving windows.....	11	4.4 Sampling Frequency/Number of Sampling Data .....	44
Touch keyboard inputs.....	11	Automatic settings for range of waveform acquisition .....	46
Screen configuration.....	12	4.5 Trigger Delay.....	47
		4.6 Voltage Calibration .....	49
<b>2 Preparation for Measurements</b> .....	<b>13</b>	<b>5 Setting Judgment Conditions</b> .....	<b>51</b>
2.1 Connecting the Test Lead (on the ST4030).....	14	5.1 Overview.....	51
2.2 Connecting the Power Cord.....	15	Judgment types.....	51
2.3 Power Supply ON/OFF.....	16	Settings operations procedure .....	52
Main power supply ON .....	16	5.2 LC and RC Values Area	
Main power supply OFF.....	16	Judgments <b>[LCRC AREA]</b> .....	53
Sleep mode.....	17	Enabling the LC and RC values judgments function .....	55
Startup mode .....	17	Importing LC and RC master values .....	56
2.4 Select Measuring Mode.....	18	Auto creation of the PASS judgment area ..	58
2.5 Inspecting before Measurement and Verifying Operations .....	19	Manually creating the PASS judgment area...	60
Inspection .....	19	5.3 Waveform Judgments .....	62
Checking the voltage generated .....	20	Surface area comparison judgments <b>[AREA]</b> .....	62
Checking the impulse response waveforms...	21	Differential surface area comparison judgments <b>[DIFF AREA]</b> .....	64
		Flutter detection judgments <b>[FLUTTER]</b> .....	66
		Secondary differential detection judgments <b>[LAPLACIAN]</b> .....	69
		Waveform judgment area and judgment threshold value automatic settings functions .....	71
		5.4 Discharge Judgments (When Incorporating Model ST9000)....	72
		Discharge judgment methods <b>[DISCHARGE]</b> .....	73
3.1 Overview.....	25		
Overview of test conditions switching functions .....	25		
Items that can be saved.....	26		
Operations flowchart in test conditions settings mode and test mode .....	27		
Screen configuration.....	28		
3.2 Current Table Selection .....	29		
3.3 Table Initialization .....	30		

1

2

3

4

5

Threshold value of the test waveform discharge amount over the master waveform discharge amount.....	74
Deviation threshold value of the test waveform discharge amount.....	75
Setting the discharge amount judgment area .....	76
<b>6 Implementing Tests</b>	<b>77</b>
6.1 Overview .....	77
Operations flowchart in test mode .....	77
Screen configuration.....	78
6.2 Checking Test Start and Test Results...	84
<b>7 Break down voltage test (BDV)</b>	<b>85</b>
7.1 Overview .....	85
Operations flowchart in break down voltage test mode .....	85
Screen configuration.....	86
7.2 Checking Test Start and Test Results...	89
7.3 Setting the Test Conditions .....	90
Applied voltage settings.....	90
Number of applied pulses settings .....	91
Setting the sampling frequency and number of sampling data .....	93
Setting the waveform acquisition area automatically .....	94
7.4 Setting Dielectric Break down Judgment Conditions .....	95
LC and RC values judgments .....	95
Discharge judgment .....	96
Waveform surface area comparison judgment .....	97
Peak voltage value fluctuations.....	98
Vibration frequency fluctuations .....	99
<b>8 Other Functions</b>	<b>101</b>
8.1 Interlock Function .....	101
Unlocking the interlocks.....	103
8.2 Key Lock Function.....	104
Unlocking the key locks .....	105
8.3 Double Action Function.....	106
8.4 Memory Function.....	107
Memory function settings (ON/OFF).....	108
Saving memory data.....	109
Deleting memory data .....	110
8.5 Displays .....	111
8.6 Graph Display Settings.....	112
Overlay settings .....	112
Waveform color settings .....	113
LC and RC graph scale settings.....	115
Implementing the LC and RC graph auto scale .....	116
8.7 Judgment Beep.....	117
8.8 Key Beep .....	118
8.9 Test Time (EOM) Display.....	119
8.10 Communications Commands Long Format Settings .....	120
8.11 Initializing the Instrument (System Reset).....	121
8.12 Terminal Open Error Setting .....	122
8.13 Voltage Error Setting.....	123
<b>9 System Settings</b>	<b>125</b>
9.1 Instrument System Information .....	125
9.2 Self-test Function.....	126
Touch panel test.....	126
Touch panel correction .....	127
Screen display test .....	128
ROM/RAM test.....	129
EXT. I/O test.....	131
9.3 Date and Time Settings .....	132
<b>10 External Control (EXT. I/O)</b>	<b>133</b>
10.1 External Control Measurement Flow .....	134
10.2 Sinking Current (NPN) / Sourcing Current (PNP).....	135
10.3 Connection (Instrument and Control Devices) .....	136
Instrument connector and compatible connectors .....	136
Signal functions .....	138
Internal circuit configuration .....	139
Electrical specifications.....	140
Connection examples .....	140
10.4 Timing Chart.....	142
Explanation of timing chart times .....	142
Measurement timing example .....	143
Flow of starting measurements from an external device, and reading the judgment results .....	144

## 11 Communications Interface

11.1 Overview.....	146
Screen display.....	146
11.2 Specifications.....	147
RS-232C.....	147
GP-IB.....	148
USB.....	148
LAN.....	148
Total.....	148
11.3 Mounting and Removing an Interface.....	149
11.4 Interface Settings.....	151
11.5 Connecting and Setting RS-232C (Model Z3001).....	152
11.6 Connecting and Setting GP-IB (Model Z3000).....	154
11.7 Connecting and Setting USB.....	155
11.8 Setting and Connecting LAN.....	157
Connection method.....	157
Setting procedure.....	159
11.9 Remote Mode.....	162
11.10 Communications Monitor.....	163

## 12 USB Host

12.1 Overview.....	165
12.2 Removing the USB Memory.....	166
12.3 File Window.....	168
12.4 Settings for Saving the Data.....	169
Setting auto save.....	169
Setting manual save.....	170
Text save items settings.....	171
Setting the text save format.....	172
Setting the image save format.....	173
Setting the name of the saved file and its folder.....	174
12.5 Saving Test Results.....	176
Saving manually.....	176
Checking the test results that have been saved.....	178
12.6 Saving and Importing Test Conditions.....	180
Saving test conditions.....	180
Importing test conditions.....	182
12.7 Editing Files and Folders.....	184
Formatting USB memory.....	184

Deleting files and folders.....	186
Creating folders.....	187
Changing the folder name and file name..	188
Information display.....	189

## 13 Specifications

13.1 General Specifications.....	191
13.2 Input Specifications/Output Specifications/Measurement Specifications.....	192
Basic specifications.....	192
Accuracy specifications.....	192
13.3 Functional Specifications.....	193
Test conditions settings.....	193
Set judgment conditions.....	193
Test conditions switching functions.....	195
Break down voltage test (BDV) mode.....	196
Safety protection function.....	197
Other functions.....	198
13.4 Interface Specifications.....	200
External control terminal (EXT.I/O) specifications.....	200
Communications interface specifications..	202
USB host specifications.....	203
Test time (Reference value).....	204
13.5 L2250 Clip Type Lead (Option).....	205
General specifications.....	205
Basic specifications.....	205
13.6 L2252 Unprocessed Lead Cable (Option).....	205
General specifications.....	205
Basic specifications.....	205

## 14 Maintenance and Service

14.1 Troubleshooting.....	208
Before sending the instrument for repair ..	208
FAQ regarding external control (EXT. I/O) ..	212
14.2 Initializing the Instrument (Full Reset).....	213
14.3 Error Display.....	214
14.4 Discarding the Instrument (Removing the Lithium Battery).....	220

11

12

13

14

15

6

7

8

9

10

Index

**15 Appendix** 221

15.1 Block Diagram.....221

15.2 Circuit Configuration .....222

    Circuit operations during tests..... 222

    Effects of cable parasitic components ..... 223

15.3 Rack Mount .....224

    Metal fitting dimensions ..... 225

    Installation method ..... 227

15.4 Dimensions Diagram.....229

15.5 Repeat Accuracy (Reference Value) ..230

    Reproducibility of the voltage generated .. 230

    Oscillation waveform reproducibility ..... 231

15.6 Max. Applicable Voltage  
(Reference Value) According to  
the Workpiece Inductance and  
Capacitance .....232

15.7 Voltage Switching Time  
(Reference Value) .....234

15.8 Waveform Differences (Typical  
Values) Between Instruments .....235

15.9 Affects on Measurements  
According to the Length of the  
Test Lead .....237

15.10 Precautions when Processing Test  
Leads.....238

15.11 Ver. 1.01 Compatibility Function.....240

**Index** 241

**Warranty Certificate**

# Introduction

Thank you for choosing the Hioki ST4030, ST4030A Impulse Winding Tester. Preserve this manual carefully and keep it handy to make full use of this instrument for a long time. Read the separate document “Operating Precautions” carefully before using the instrument.

## Product registration

Register your product in order to receive important product information.  
<https://www.hioki.com/global/support/myhioki/registration/>



## Target audience

This manual has been written for use by individuals who use the product in question or who teach others to do so.

It is assumed that the reader possesses basic electrical knowledge (equivalent to that of someone who graduated from the electrical program at a technical high school).

## Trademarks





- Windows is trademark of the Microsoft group of companies.
- Any other products and company names are generally either trade names, registered trademarks or trademarks of respective companies.





# Notations

## Safety symbols

In this document, the risk seriousness and the hazard levels are classified as follows.

 <b>WARNING</b>	Indicates a potentially hazardous situation that may result in death or serious injury to the operator.
 <b>CAUTION</b>	Indicates a potentially hazardous situation that may result in minor injury to the operator or damage to the instrument or malfunction.
<b>IMPORTANT</b>	Indicates information related to the operation of the instrument or maintenance tasks with which the operators must be fully familiar.
	Indicates prohibited actions.
	Indicates an action that must be performed.

## Symbols affixed to the instrument

	Indicates cautions and hazards. Refer to the “Usage Notes” (p. 5) and warning messages presented at the beginning of each instruction for use of the Instruction Manual, and included “Operating Precautions”.
	Indicates that dangerous voltage may be present at this terminal.

## Other Descriptions

(p. )	Indicates the location of reference information.
<b>START</b> (Boldface)	Indicates the names and keys on the windows in boldface.
[ ]	Names of menus, dialog boxes, buttons in a dialog box, and other UI elements on the screen are enclosed in brackets [ ].
S/s	The instrument describes the number per second of digitized analog input signals in units of samples per second (S/s). Example: “20 MS/s” (20 megasamples per second) means digitization of $20 \times 10^6$ times per second.

## Accuracy descriptions

We define measurement tolerances in terms of setting values with the following meanings.

Setting	Indicates the value set as the output voltage, current, or other quantity.
---------	--

# Confirming Package Contents

When you receive the instrument, inspect it carefully to ensure that no damage occurred during shipping. In particular, check the accessories, panel switches, and connectors. If damage is evident, or if it fails to operate according to the specifications, contact your authorized Hioki distributor or reseller.

Store the packaging materials even after unpacking, because you will need them when you transport the instrument.

Confirm that these contents are provided.

- Model ST4030 or ST4030A Impulse Winding Tester

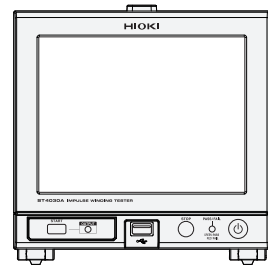

- Power cord

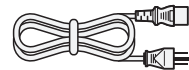

- Instruction Manual (this document)



- Operating Precautions (0990A903)



- Application disc (CD)
  - Communication Command Instruction Manual
  - Communication Command Reference
  - Default settings table
  - USB driver

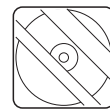

The latest version can be downloaded from our website.

## Options (Sold separately)

The following options are available for the instrument. To purchase an option, please contact your authorized Hioki distributor or reseller. Options are subject to change. Please check Hioki's website for the latest information.

- Model ST9000 Discharge Detection Upgrade  
(Optional when shipped from factory)

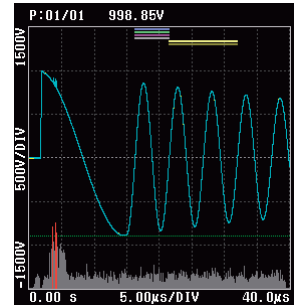

- Model L2250 Clip Type Lead  
(Maximum rated voltage: 3300 V AC peak)



- Model L2252 Unprocessed Lead Cable  
(Maximum rated voltage: 4200 V AC peak)



- Model Z3000 GP-IB Interface

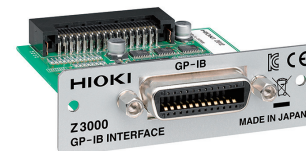

- Model 9151-02 GP-IB Connector Cable (2 m)



- Model Z3001 RS-232C Interface



- Model 9637 RS-232C Cable (9pin-9pin/1.8 m)



## Usage Notes

Read the separate document “Operating Precautions” carefully before using the instrument. Follow these precautions to ensure safe operation and to obtain the full benefits of the various functions.

### Installation

#### ⚠ CAUTION



- Ventilation holes for heat radiation are provided on the rear of the instrument. Leave sufficient space around the ventilation holes and install the instrument with the holes unobstructed.

Installation of the instrument with the ventilation holes obstructed may cause a malfunction of the instrument or a fire.



- Do not place the instrument on an unstable surface or inclined place. Dropping or knocking down the instrument could cause bodily injury or damage to the instrument.

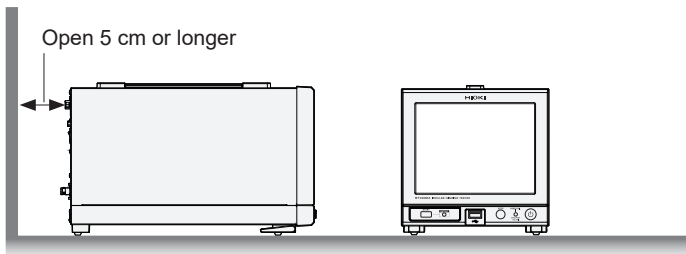

This instrument may cause interference if used in residential areas. Such use must be avoided unless the user takes special measures to reduce electromagnetic emissions to prevent interference to the reception of radio and television broadcasts.

### Application disc

- Exercise care to keep the recorded side of discs free of dirt and scratches. When writing text on a disc's label, use a pen or marker with a soft tip.
- Keep discs inside a protective case and do not expose them to direct sunlight, high temperature, or high humidity.
- Hioki is not liable for any issues your computer system experiences in the course of using this disc.

### Test lead

#### ⚠ CAUTION



- Do not make small bends or repeatedly bend the cable.  
As a benchmark, bending to 6x or less the cable diameter will damage the cable core and cover, causing deterioration.
- Do not hold the cable when removing the clip from the workpiece.



- Hold the clip in your hand, and open and close gently.  
Repeatedly opening and closing so that the clip springs risks damaging and causing deterioration to the opening and closing mechanism.



## 1.1 Overview

Windings (workpieces) found in motors, coils, and other components are covered with insulation, but the insulation resistance may fall and short circuits occur between proximate layers for some reason. The condition is called a “layer short circuit”.

The ST4030, ST4030A Impedance Winding Tester not only compares and judges waveform conformance through comparisons with existing response waveforms, but also detects layer short circuits using judgment methods that employ the rendering of response waveforms as numerical values (LC and RC values). Further, incorporating the ST9000 Discharge Detection Upgrade (optional) into the instrument enables highly precise detection of partial discharges that occur in the stages in advance of a layer short circuit.



## 1.2 Features

### ● High-speed and high-resolution sampling

Sampling using 200 MHz, 12 bit resolution enables the detection of minute changes in the response waveform that hitherto could not be seen. In this way, it is possible to detect layer short circuits with a high level of accuracy compared to before.

### ● Numerical rendering of impulse response waveforms (LC and RC values)

The equivalence circuits for the impulse test are viewed as LCR linear equivalent circuits, and the response waveforms are rendered numerically into LC and RC values. Rendering the response waveforms into numerical values enables the response waveforms to be judged quantitatively. Further, the data can be managed more easily than the waveform data.

### ● Impulse can be tested with the rotor mounted

With the rotor and motor stator mounted, the stray capacitance between the rotor and the stator changes depending on the rotor angle.

Changes in the stray capacitance also change the impulse response waveform, so judgments are difficult using existing waveform comparison methods.

Numerical judgment values using LC and RC values can create PASS judgment area from the LC and RC values distribution, and so by creating PASS judgment area using a healthy phase, it is possible to test the impulse with the rotor mounted.

### ● High-precision Discharge Detection Upgrade

Extracting the high-frequency discharge components of the response waveform enables highly precise detection of partial discharges, which have hitherto been difficult to detect using flutter operations and Laplacian operations.

### ● High waveform reproducibility

The applied voltage variation is small, so it is possible to detect defective products accurately.

Further, the instrument differences when the same workpiece is tested are small, so it is possible to use the master workpiece data as is even if the instrument is replaced.

Reference: “15.5 Repeat Accuracy (Reference Value)” (p. 230)

### ● Easy-to-use interfaces and an abundance of interfaces

The screen uses 8.4-inch color TFT crystals with touch panel for easy viewing and intuitive operability. Compatible with various usage scenarios using external control (EXT. I/O), USB memory, USB devices, and LAN. Further, RS-232C or GP-IB can be added as options.

# 1.3 Parts Names and Functions

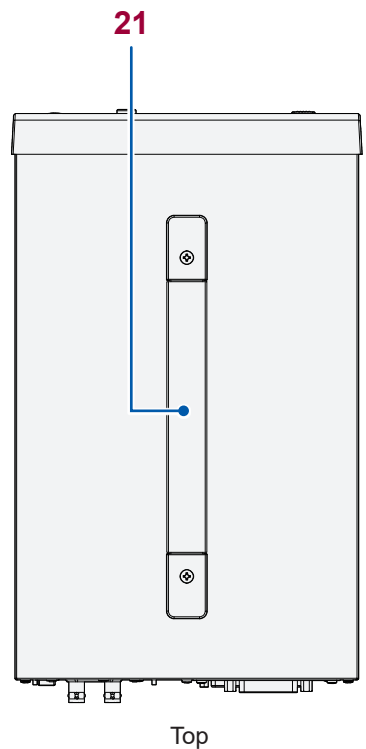
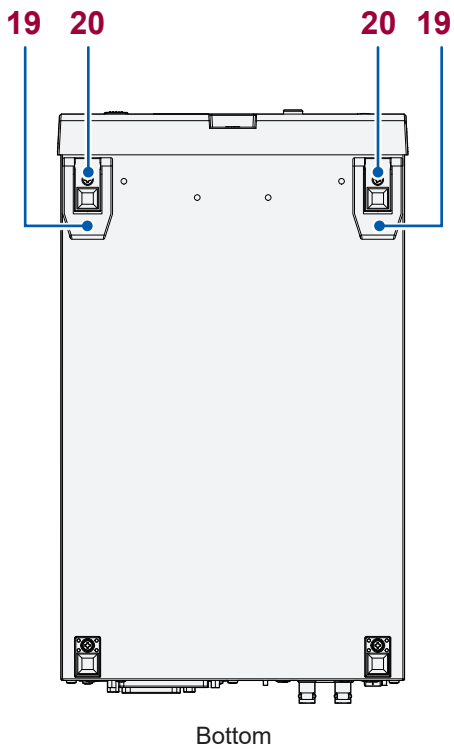
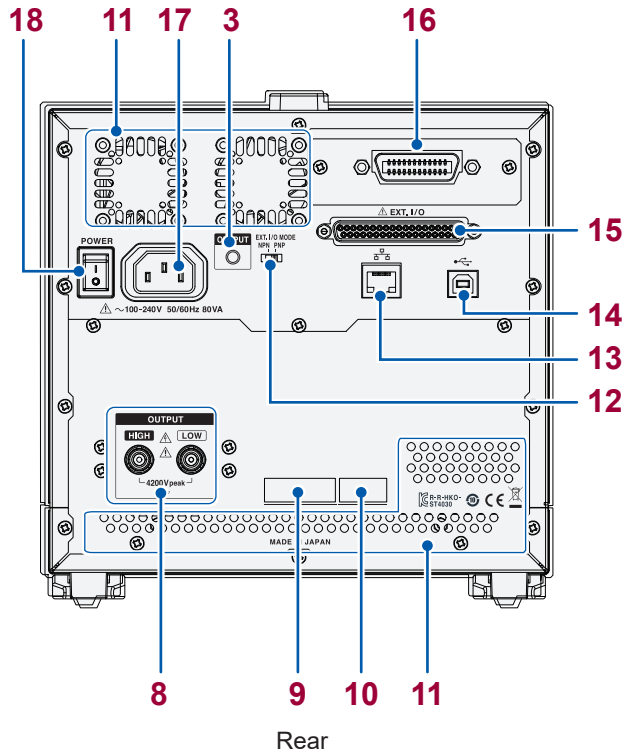
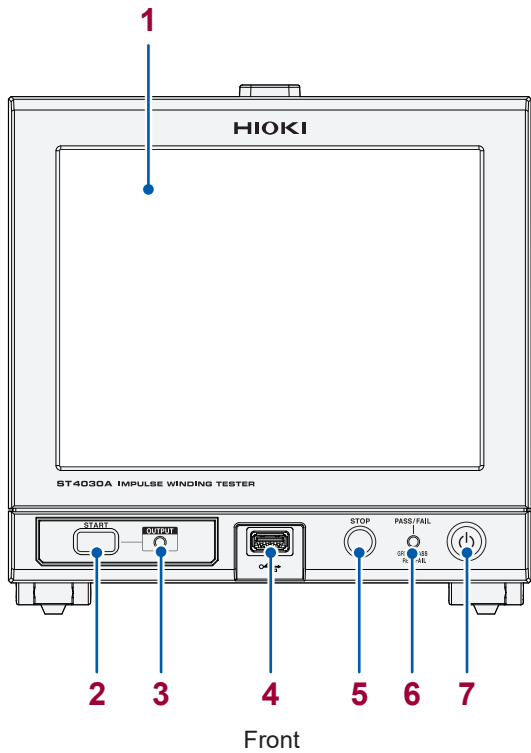

No.	Name	Function	Reference	
1	Display	8.4-inch color TFT liquid crystal display. Comes with a resistant film touch panel.	p. 10	
2	START button	Starts measurements.	p. 77	
3	OUTPUT lamp	Shows the voltage application status.	p. 84	
				Red: Voltage is being applied OFF: Standby
4	USB connector	Connects a USB memory.	p. 165	
5	STOP button	Stops the voltage application and suspends testing. Also used during double actions.	p. 84, p. 106	
6	PASS/FAIL lamp	Shows the total judgment result.	p. 84	
				Green: Total judgment result PASS Red: Total judgment result FAIL
				OFF: No judgments
7	Startup button	Switches the instrument ON and OFF.	p. 16	
				OFF: Main power supply OFF Red: Sleep mode
				Green: ON mode
8	Voltage output terminal	Connects a test lead (optional).	p. 14	
9	Serial number	The serial number consists of nine digits. The first two digits indicate the year of manufacture, while the second two digits indicate the month of manufacture. Do not remove this sticker because the number is important.	p. 125	
10	MAC address	MAC address of the instrument.	p. 125	
11	Vent holes	For ventilation, and to prevent the interior of the instrument from overheating. Install so that the vent holes are not blocked.	–	
12	EXT.I/O NPN/PNP switch	Switches the programmable type of the external control terminal. Left: NPN (current sink) Right: PNP (current source)	p. 133	
13	LAN connector *1	Connects a LAN cable.	p. 157	
14	USB connector *1	Connects a USB cable.	p. 155	
15	External control terminal (EXT.I/O)	Enters signals from the programmable controller and I/O boards to control the instrument.	p. 133	
16	Communications interface*1 mount	Mount a Z3000 GP-IB Interface (optional) or Z3001 RS-232C Interface (optional).	p. 152, p. 154	
17	Power inlet	Connects the provided power cord.	p. 15	
18	Main power supply switch	Turns ON and OFF the main power supply to the instrument.	p. 16	
19	Stand	Tilts the instrument to enable the screen to be viewed easily. Make sure to fully open both the left and right stands before installation.	–	
20	Support legs	When mounting the instrument to a rack*2, remove the support legs.	–	
21	Handle	Used to carry the instrument.	–	

\*1: For how to use RS-232C, GP-IB, USB, and LAN, see the “Communications Commands Instruction Manual” on the application disk.

\*2: The instrument can be mounted to a rack. See “15.3 Rack Mount” (p. 224).



## 1.4 Screen Operations

The instrument uses a touch panel for all settings and changes to the measuring conditions. Gently touch the onscreen keys to select the items and values set for those keys.

### ⚠ CAUTION



Do not press the touch panel forcefully or jab it with the point of a hard object. Doing so may cause a malfunction.

This document describes below the procedures up to displaying the various settings screens. Example: When displaying the [SETTING] screen

(Measurement screen) [MODE] > [SETTING]

### Measuring mode settings

Example: Selecting the test conditions settings mode



- 1** Tap [MODE] to display the measuring mode selection window.
- 2** Select the measuring mode.  
Here, tap [SETTING].
- 3** Tap [EXIT] to return to the measurement screen.

## Moving windows

Press and hold the window title bar while dragging the window to move the window to a new position.

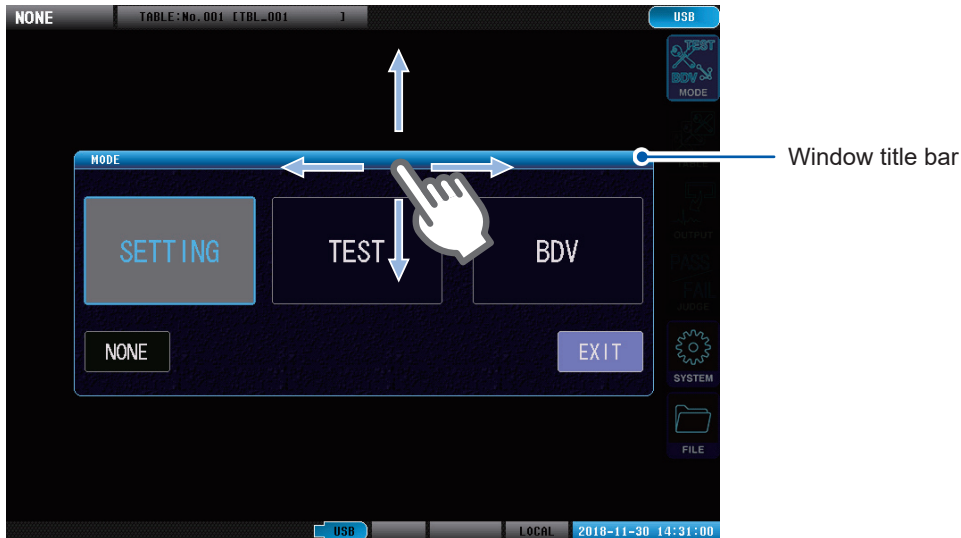

## Touch keyboard inputs

Enter text and then tap **[SET]** to confirm. To cancel, tap **[CANCEL]**.

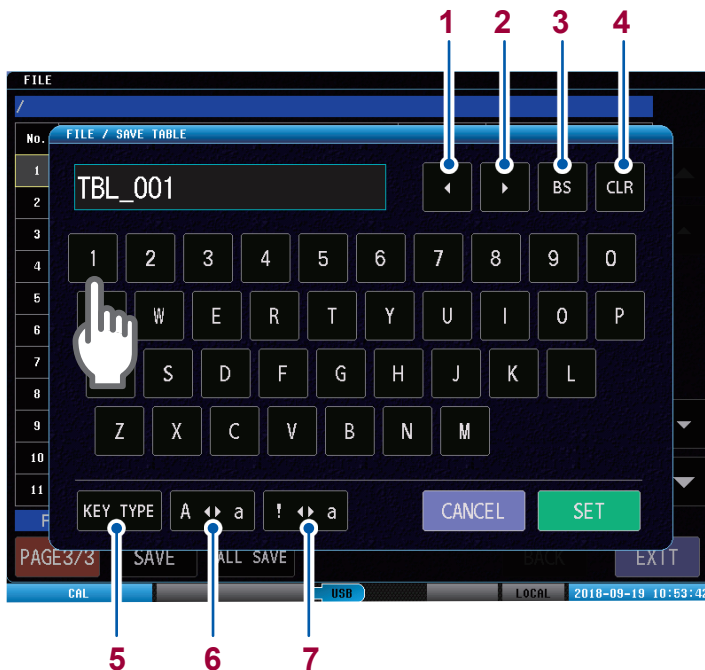

1	◀	Moves the cursor to the left.
2	▶	Moves the cursor to the right.
3	BS	Deletes 1 character.
4	CLR	Deletes all.

5	KEY TYPE	Switches the keyboard type.
6	A ◀▶ a	Switches between upper and lower case.
7	! ◀▶ A	Switches between symbols/numbers, and the alphabet.

## Screen configuration

The instrument settings windows are configured using the following stages.

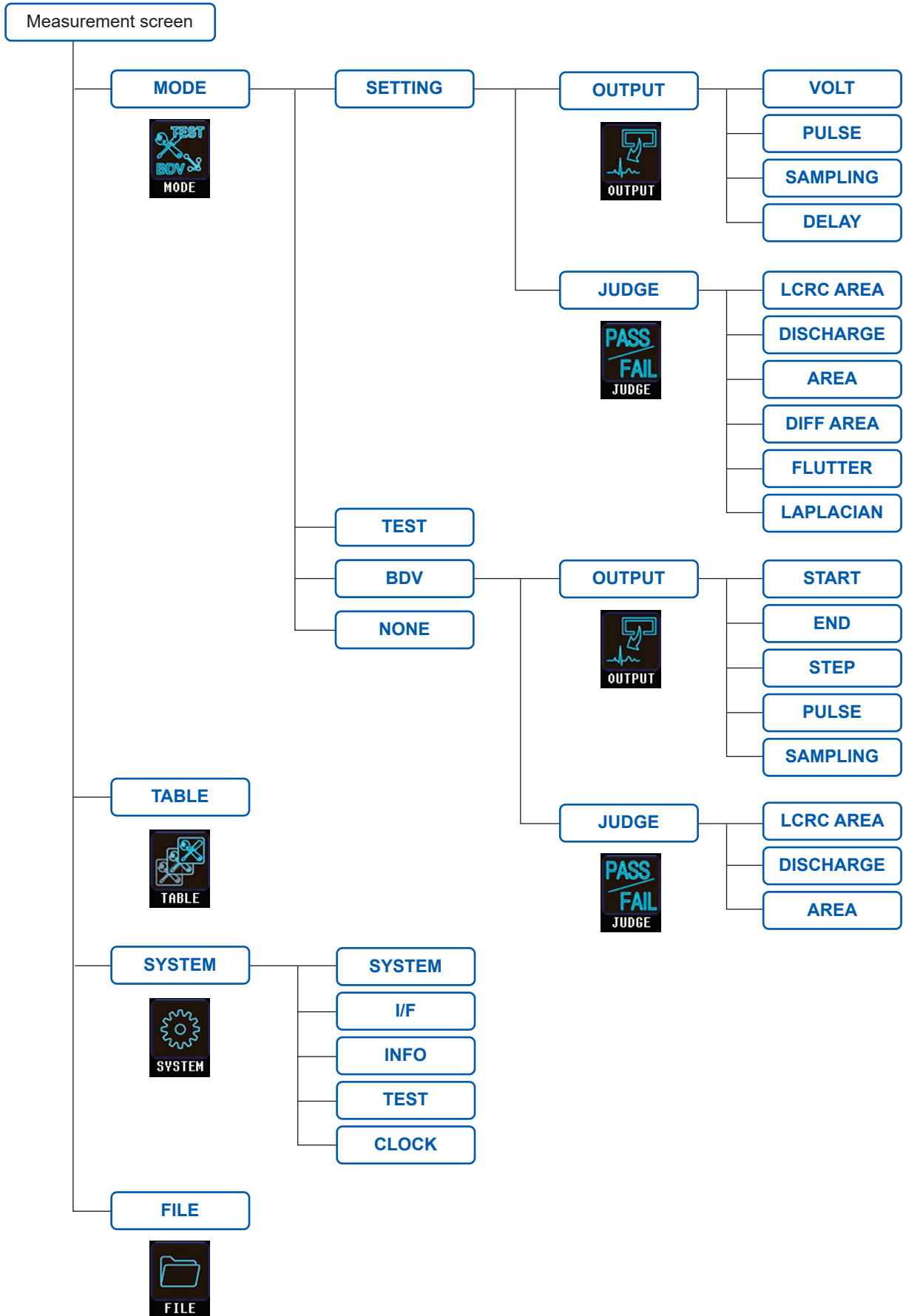

# 2

# Preparation for Measurements

Make sure to read through both “Usage Notes” (p. 5) in this manual and the separate “Operating Precautions” before starting the preparations that precede measuring.  
For rack mounts, see “15.3 Rack Mount” (p. 224).

<b>Installing the device.</b>	p. 5
↓	
<b>Connecting the test lead.</b>	p. 14
↓	
<b>Connecting and setting the external interface (as necessary).</b>	
EXT. I/O	p. 136
RS-232C	p. 152
GP-IB	p. 154
USB	p. 155
LAN	p. 157
USB memory	p. 169
↓	
<b>Connecting the power cord.</b>	p. 15
↓	
<b>Turning on the instrument power supply.</b>	p. 16
↓	
<b>Setting the date and time (as necessary).</b>	p. 132
↓	
<b>Setting the measuring mode.</b>	p. 18
↓	
<b>Inspecting before measurement and verifying operations.</b>	p. 19

# 2

## 2.1 Connecting the Test Lead (on the ST4030)

Connect the test lead to the voltage output terminal on the instrument.

### ⚠ CAUTION



- To prevent damage to the coaxial connectors or joint, make sure to unlock first, and grasp the coaxial connector and pull it out.
- Model L2250 Clip Type Lead's maximum rated voltage is 3300 V AC peak. To test higher voltages, use the L2252 Unprocessed Lead Cable.
- Model L2252 requires customer modification. To prevent electric shock and equipment damage when modifying the lead, see "15.10 Precautions when Processing Test Leads" (p. 238).

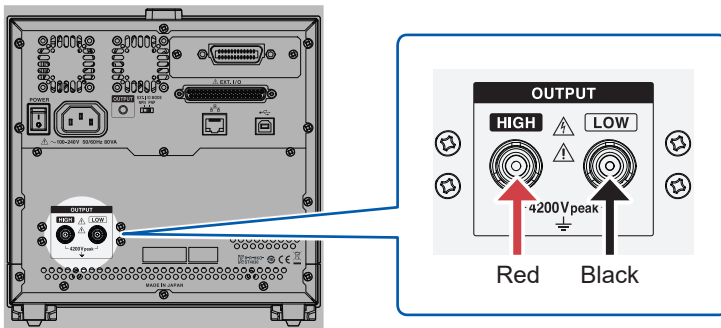

Rear

- 1** Align the groove on the test lead's coaxial cable to the lock pin on the voltage output terminal on the ST4030 side and insert.

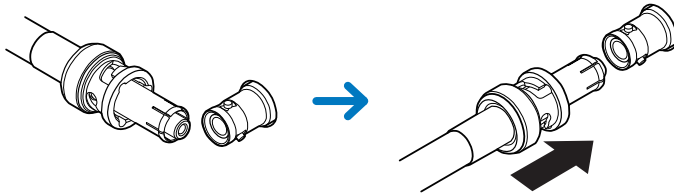

- 2** Rotate the coaxial connector on the test lead to the right to lock it.

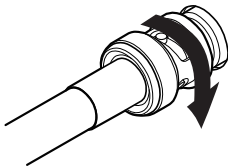

When removing, rotate the coaxial connector on the connection cable to the left and then pull out.

## 2.2 Connecting the Power Cord

To supply power to the instrument, connect the power cord to the power supply inlet on the rear of the instrument.

### WARNING



Before turning on the power supply, check that the power supply voltage described on the power supply connector on the instrument and the power supply voltage to be used match each other. Using outside the range of the designated power supply voltage may cause damage and electrical malfunction to the instrument.

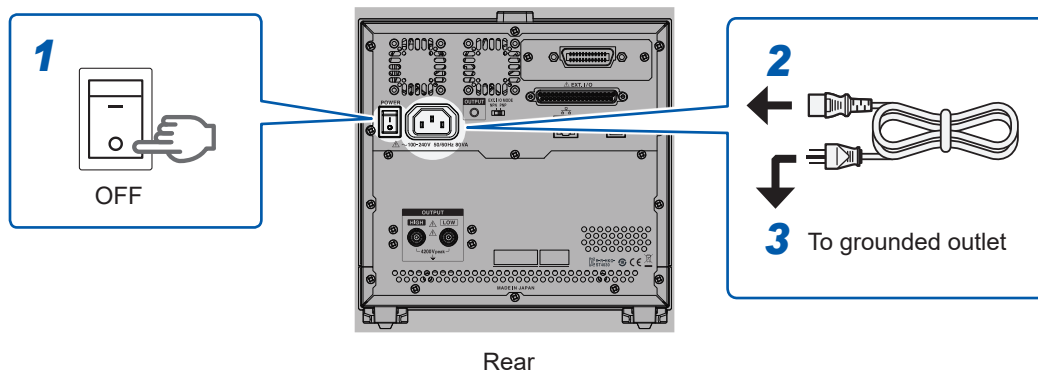

- 1** Turn OFF the main power supply switch on the rear of the instrument.
- 2** Connect the power cord to the power inlet.
- 3** Connect the plug of the power cord to the grounded outlet.

#### IMPORTANT

If the power supply is cut off while the main power supply is ON (by a breaker tripping, etc.), the instrument will start automatically when the power is supplied again.

## 2.3 Power Supply ON/OFF

Turn ON the main power supply on the rear of the instrument beforehand to enable turning ON and OFF the power supply using the startup button on the front. This is convenient if incorporating the instrument into an automated machine or assembly line.

If the main power supply is turned OFF while the instrument is in sleep mode and then turned ON again, the instrument will start in sleep mode.

- Using the startup button in sleep mode will hold the instrument settings even if the main power supply switch is turned OFF (backup).
- If the instrument was not used for a long time, it is necessary to charge the internal backup battery. Turning ON the instrument's main power supply will charge the internal battery. Charge for a minimum of 3 hours, although 24 hours is recommended.

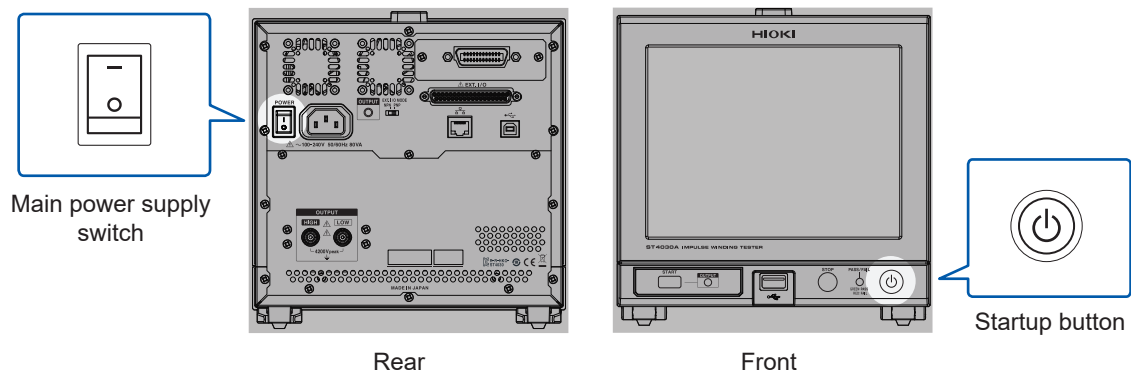

### Main power supply ON

Turn ON the main power supply switch.

The startup button lamp will turn on.

Startup mode



Sleep mode

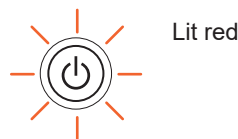

### Main power supply OFF

Turn OFF the main power supply switch.

The startup button lamp will turn off.

#### IMPORTANT

- If the main power supply switch is turned OFF or there is a power failure during startup, the instrument settings may be lost.
- If the instrument's settings have not been saved, "WARNING 101" will be displayed on start-up. If you encounter the warning, perform either of the following steps:
  - Reset the instrument's settings and then reconfigure them.
  - Reset the instrument's settings and then load a previously saved settings file from a USB drive.

## Sleep mode

This is the mode in which the device power supply is OFF.  
Only the circuit that turns on the startup button lamp is operating.

**With the main power supply switch turned ON, press and hold the startup button for approx. 2 sec.**

The startup button lamp will turn red and the instrument will enter sleep mode.



### IMPORTANT

After writing to the settings internal memory is finished, the device will enter sleep mode. While writing is underway, the date and time display will have a red background.

## Startup mode

**Press the startup button when the instrument is in sleep mode.**

The startup button lamp will turn green and the instrument will enter startup mode.



### IMPORTANT

To measure using the accuracy in the specifications, leave the instrument to warm up for 60 minutes or longer after turning ON the main power supply and canceling sleep mode.



## 2.4 Select Measuring Mode

Tap **[MODE]** in the measurement screen to display the measuring mode selection window. Choose from 4 types of measuring mode.

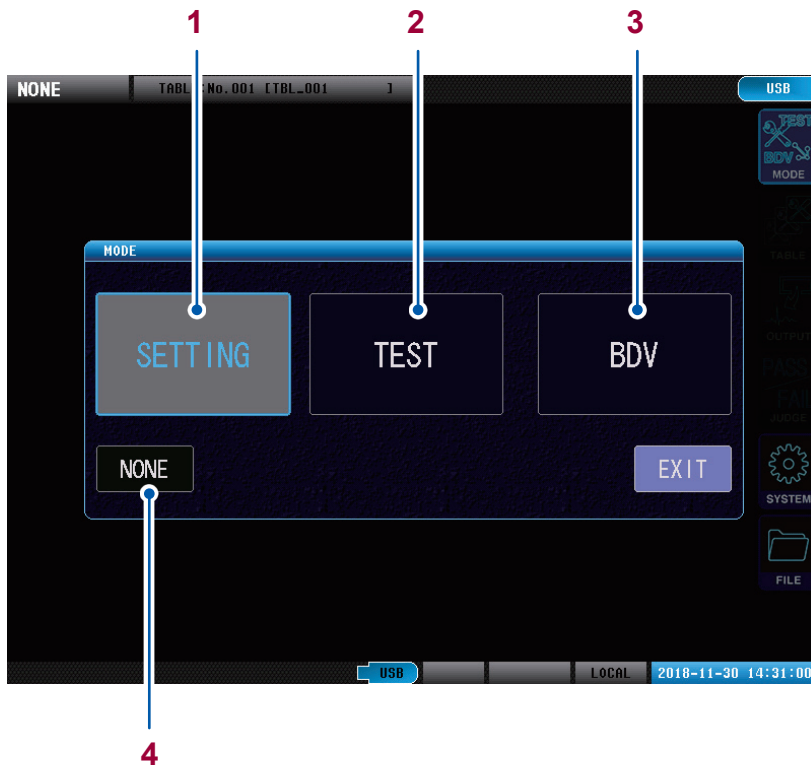

1	<b>[SETTING]</b>	Test conditions settings mode Sets the test conditions, sets the judgment conditions, and acquire the master waveforms.
2	<b>[TEST]</b>	Test mode Calls the test conditions that have been set using test conditions settings mode, and to test objects.
3	<b>[BDV]</b>	Break down voltage test (BDV) mode Tests the impedance while gradually increasing the voltage applied to the workpiece to determine the break down voltage.
4	<b>[NONE]</b>	Voltage application disabled mode It is not possible to output from the instrument for safety reasons.

- The instrument starts up in voltage application disabled mode by default.
- When the instrument is put into sleep mode with the keys locked, it will start up in the same measurement mode that was active before entering sleep mode.
- You can configure the startup mode of the instrument. For more information, see the section titled “Setting and Inquiring about Fixing the Startup Mode” in the Communication Command Instruction Manual. The setting for fixing the startup mode takes precedence over the case where the instrument enters sleep mode with the keys locked.

## 2.5 Inspecting before Measurement and Verifying Operations

### Inspection

Before using the instrument for the first time, verify that it operates normally to ensure that no damage occurred during storage or shipping. If you find any damage, contact your authorized Hioki distributor or reseller.

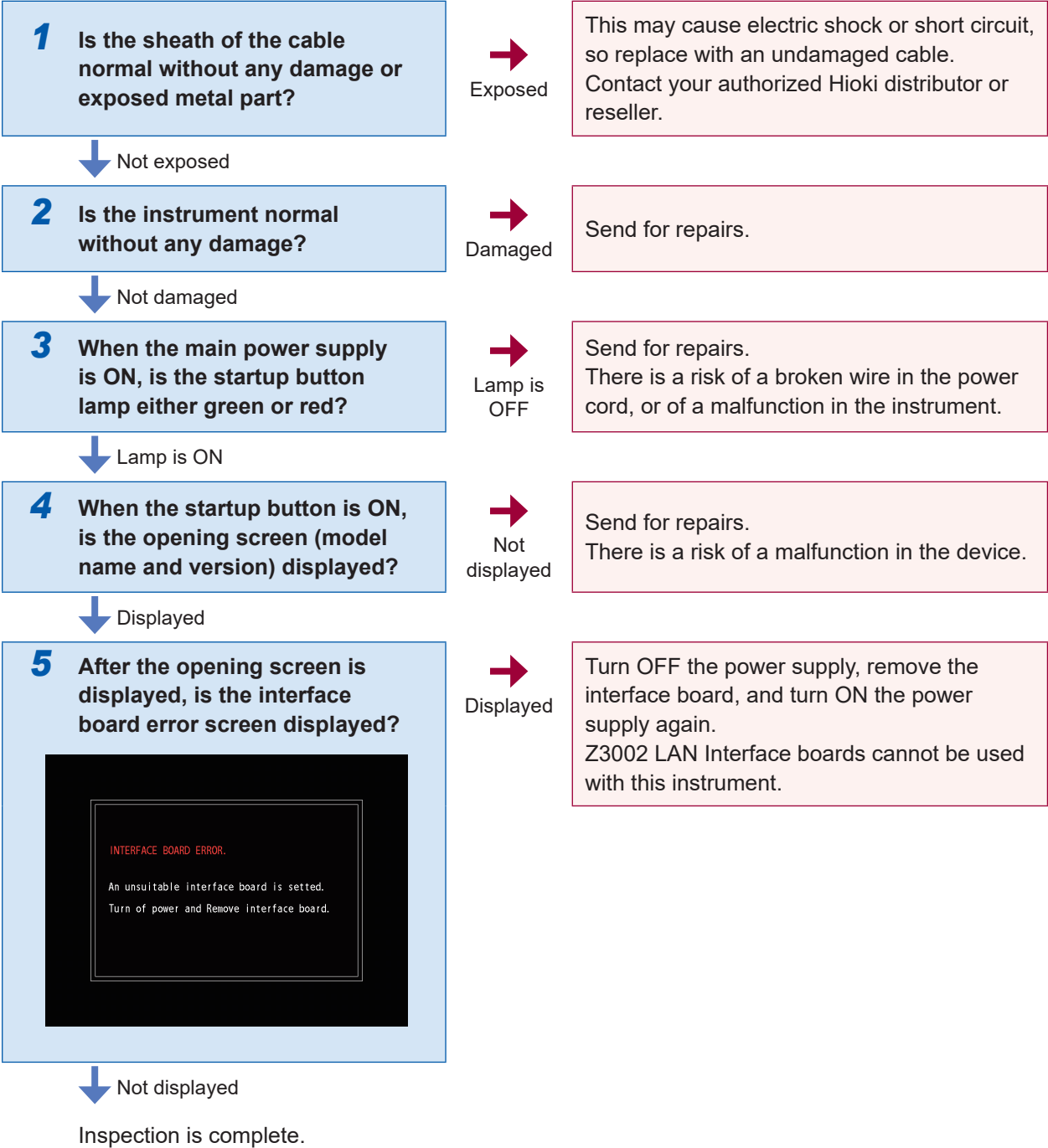

## Checking the voltage generated

Check that operations are at an environmental temperature of  $23^{\circ}\text{C}\pm 5^{\circ}\text{C}$ , and that the humidity is 80% RH or less.

- 1** Select an empty table to which nothing has been saved in the test conditions settings mode.
- 2** Set the applied voltage to 100 V, the sampling frequency to 200 MHz, the number of sampling data to 1001, and the number of pulses to be applied to 1.
- 3** Implement the tests with nothing connected to the voltage output terminal.  
(Illustration below is ST4030A)

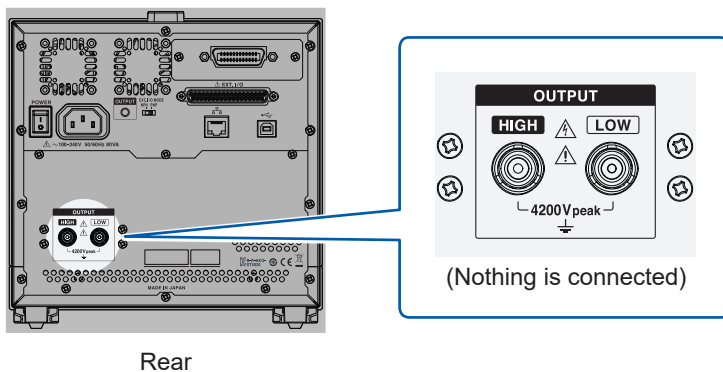

- 4** Check that the peak voltage (value displayed on the instrument) is  $100\text{ V}\pm 2\%$ .
- 5** Change the voltage setting.  
ST4030: 3300 V  
ST4030A: 4200 V
- 6** Press the **START** button with nothing connected to the voltage output terminal.
- 7** Check that the peak voltage (value displayed on the instrument) is below.  
ST4030:  $3300\text{ V}\pm 2\%$   
ST4030A:  $4200\text{ V}\pm 2\%$

### IMPORTANT

Contact your authorized Hioki distributor or reseller if the peak voltage differs from the set voltage by 2% or greater.

## Checking the impulse response waveforms

Implement impulse testing on the inspection master workpiece to check that there are no abnormalities in the instrument or equipment. Set the test conditions according to the workpiece.

### Tools to be prepared

Master workpiece (a workpiece close to the mass production master workpiece, or a coil of approx. 1 mH created using reinforced insulation wire)

Calibrate the voltage of the master workpiece beforehand and record the master waveform.

- 1 Connect the master workpiece to the test lead.
- 2 Select the table to which the master waveform was saved in test mode.
- 3 Implement the test.

### If the waveform shape (peak voltage, zero-cross point, etc.) changes greatly

- (1) Being affected by residual magnetization from the workpiece core.

Apply a degaussing impulse to the workpiece until the waveform stops changing.



You can see how waveforms diverge by turning on waveform superposition and repeating the test multiple times.

Reference: "Overlay settings" (p. 112)

**(2) Waveform reproducibility is poor.**

Periods of magnetic saturation reduces the workpiece inductance, so the vibration frequency of the response waveform increases (i.e., inclination is more sudden).

The waveform may experience major variation when multiple impulse tests are performed on the same workpiece because of the magnetic characteristics of the core.

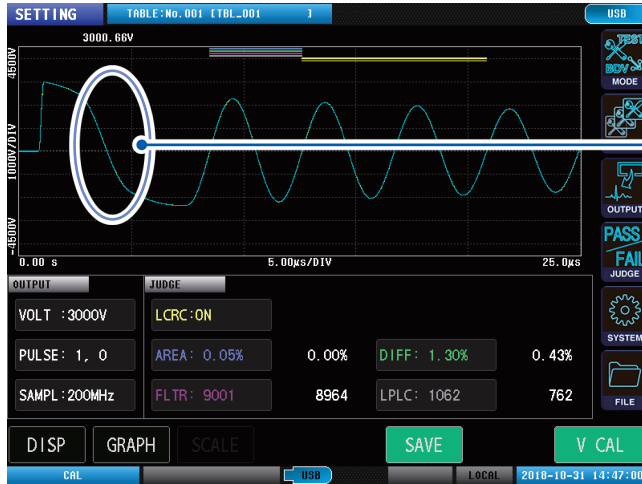

If the core is magnetically saturated, the waveform will tilt rapidly.

**(3) Being affected by the magnetic anisotropy of the workpiece core.**

The characteristics of the magnetic materials may depend on its orientation. Implement the tests using the same layout as during the voltage calibration.

**(4) The master workpiece has been changed.**

Recalibrate the voltages.

Even if the coil and motor have the same model number, if they have different magnetic core characteristics (varied by lot), there is a risk that the waveform will change due to differences in the stray capacitance of the workpiece.

**(5) The equipment cable or device connected in parallel to the instrument has changed.**

The cable capacitance and the parasitic capacitance of the equipment connected in parallel affects the vibration frequency. Recalibrate the voltages.

Example: Waveform difference due to cable length when implementing impulse tests on coils with the same inductance values (1 mH).



If 1.5 m

If 3.0 m

## If ringing occurs that did not occur during voltage calibration

### (1) Master workpiece is grounded.

When the master workpiece is grounded, ringing may occur due to parasitic components of the power cord or test lead.

Do not ground the master workpiece.

### (2) The test lead has been extended.

The longer the test lead the more the parasitic capacitance and parasitic inductance increase, making it easy for ringing to occur.

If the user is processing the test lead themselves, make the lead as short as possible.

If replacing the test lead, recalibrate the voltages.

Ringing



### (3) Master workpiece insulation is worn.

Prepare a new master workpiece, and implement voltage calibration.

### (4) Test lead insulation is worn.

Prepare a new test lead, and implement voltage calibration.

#### IMPORTANT

If none of these apply, there is a risk that the instrument is damaged. Contact your authorized Hioki distributor or reseller.



# Switching Test Conditions (Table Functions)

## 3.1 Overview

- The test conditions, judgment conditions, and master waveform are saved to the instrument's internal memory as settings tables.  
A maximum of 255 settings tables (No. 001 to No. 255) can be created.
- Select a table that creates the master waveform in test conditions settings mode to acquire the master waveform.
- Select the table to which the master waveform to be used in the test was saved in test mode, and implement the test.
- Even if the instrument's power supply is turned OFF, the settings table details will be retained.

### Overview of test conditions switching functions

You can save multiple test conditions, judgment conditions, and master waveforms as settings tables and switch between them as desired.

<b>Number of settings saved</b>	▶ 255
<b>Retained settings</b>	▶ Test conditions, judgment conditions, and master waveforms
<b>Switching between settings tables</b>	▶ Switch using screen operations, communications, and signal inputs to external control terminal (EXT. I/O).
<b>Settings table settings initialization</b>	▶ Restores the settings such as the master waveforms in the settings tables to their default settings.
<b>Settings table name settings</b>	▶ Add a user-selected name to each settings table (127 characters max.) Default value: TBL_XX (XX is the table number)

#### IMPORTANT

Select the table to be used, and change the test conditions and acquire the waveform. Changing the test conditions and acquiring the waveform will overwrite the previous settings.



## Items that can be saved

The following items can be saved to settings tables.

### Test conditions settings

<b>VOLT</b>	Applied voltage
<b>PULSE</b>	No. of applied pulses, No. of degaussing pulses, min. interval between pulse outputs
<b>SAMPLING</b>	Sampling frequency, No. of sampling data
<b>DELAY</b>	Trigger delay

### Judgment conditions settings

<b>LCRC AREA</b>	LC and RC values judgments
<b>DISCHARGE*1</b>	Discharge judgment*1
<b>AREA</b>	Waveform surface area comparison judgment
<b>DIFF-AREA</b>	Waveform difference surface area comparison judgments
<b>FLUTTER</b>	Waveform flutter detection judgments
<b>LAPLACIAN</b>	Waveform secondary differential detection judgments

\*1: When incorporating Model ST9000

### Master waveform

Master waveform data
----------------------

## Operations flowchart in test conditions settings mode and test mode

In test conditions settings mode and test mode, select the table to be used before you move on to the next operation, by using the operations procedure as shown in the diagram.

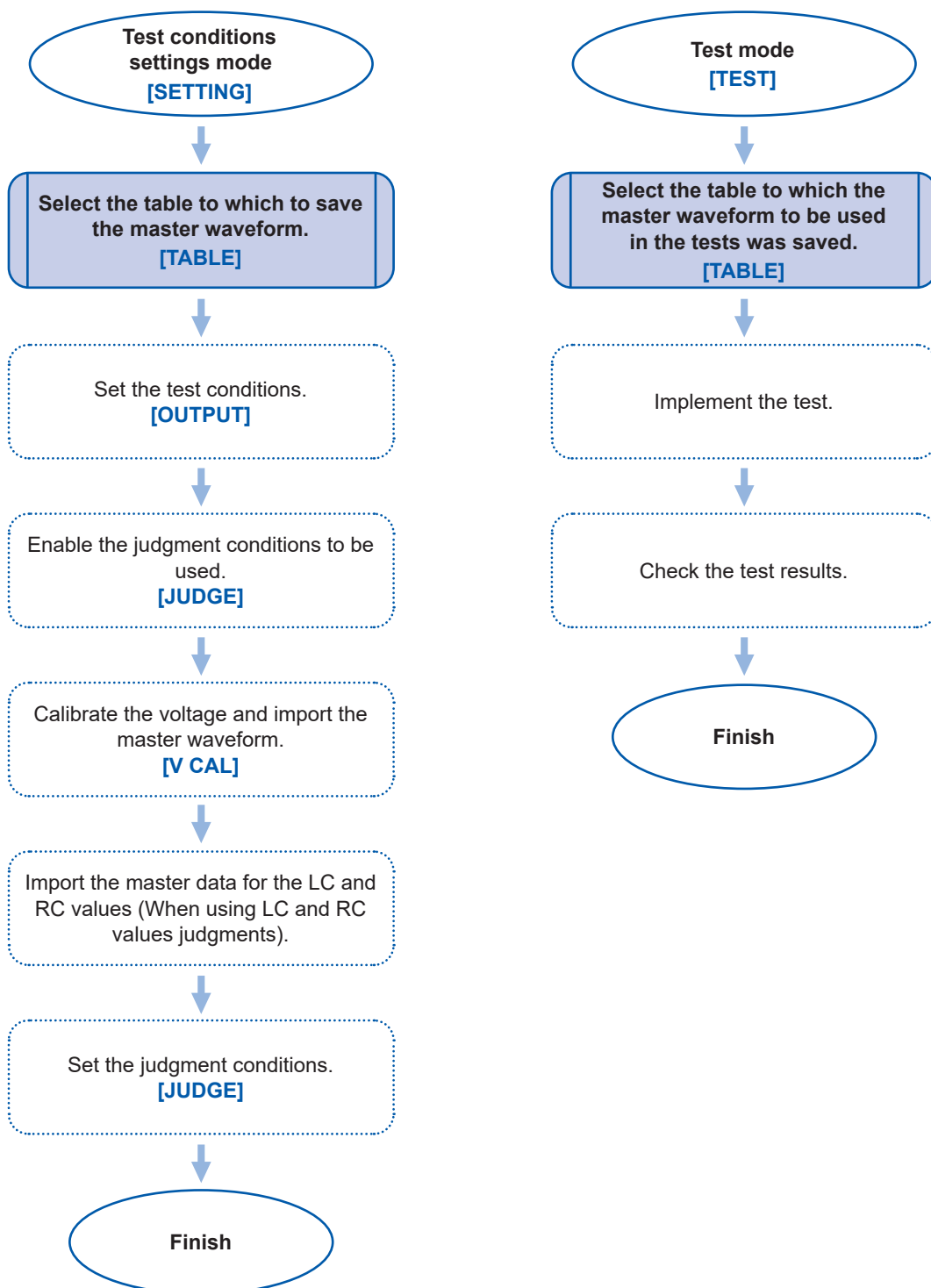

## Screen configuration

(Measurement screen) [MODE] > [SETTING] or [TEST] > [TABLE]

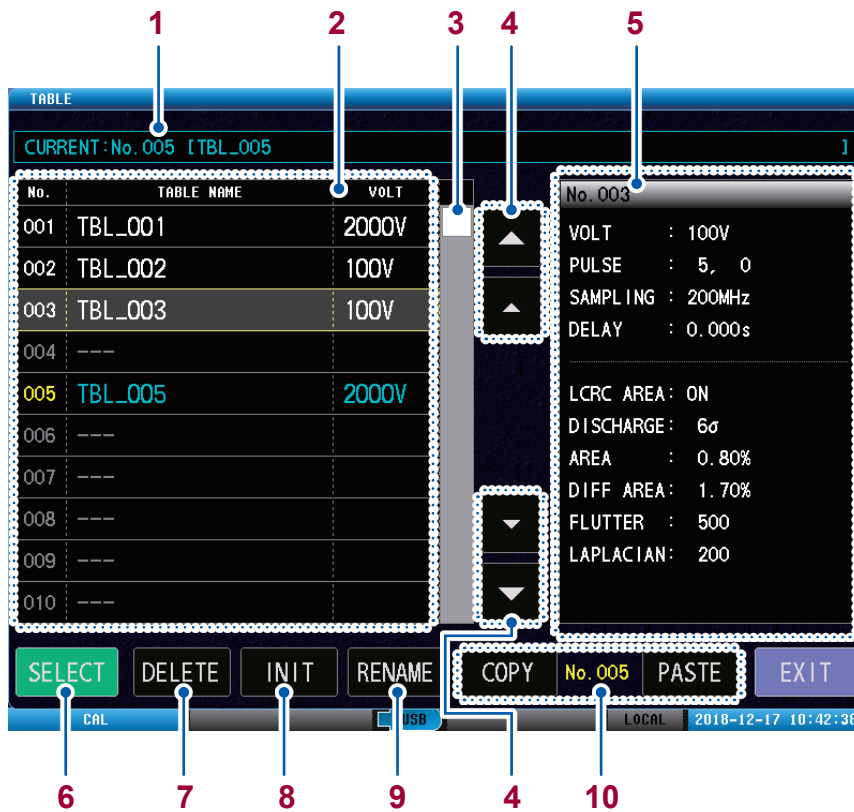

<b>1</b>	<b>Current table number</b> <b>Table name</b>	Number and name of the (current) table that is presently set.
<b>2</b>	<b>Tables list</b>	List of the tables that have been saved. The table in which the characters are light blue is the present table.
<b>3</b>	<b>Scroll bar</b>	Drag to scroll the table.
<b>4</b>	<b>UP/DOWN buttons</b>	Moves up or down the table that is displayed.
<b>5</b>	<b>Table setting description</b>	Settings descriptions for the table selected onscreen.
<b>6</b>	<b>[SELECT]</b>	Sets the selected table as the current table. Reference: "3.2 Current Table Selection" (p. 29)
<b>7</b>	<b>[DELETE]</b>	Deletes the selected table. Reference: "3.4 Table Deletion" (p. 31)
<b>8</b>	<b>[INIT]</b>	Initializes the selected table. Reference: "3.3 Table Initialization" (p. 30)
<b>9</b>	<b>[RENAME]</b>	Changes the name of the selected table. Reference: "3.5 Changing the Table Name" (p. 32)
<b>10</b>	<b>[COPY] [No.xxx] [PASTE]</b>	Copies the table that has been created and pastes it to a table chosen by the user. The table selected for copying is displayed as [No. xxx] (with the characters in yellow). Reference: "3.6 Table Copying" (p. 33)

## 3.2 Current Table Selection

Sets the table used as the test conditions as the current table (i.e., the table to be used from now on).

(Measurement screen) **[MODE]** > **[SETTING]** or **[TEST]** > **[TABLE]**

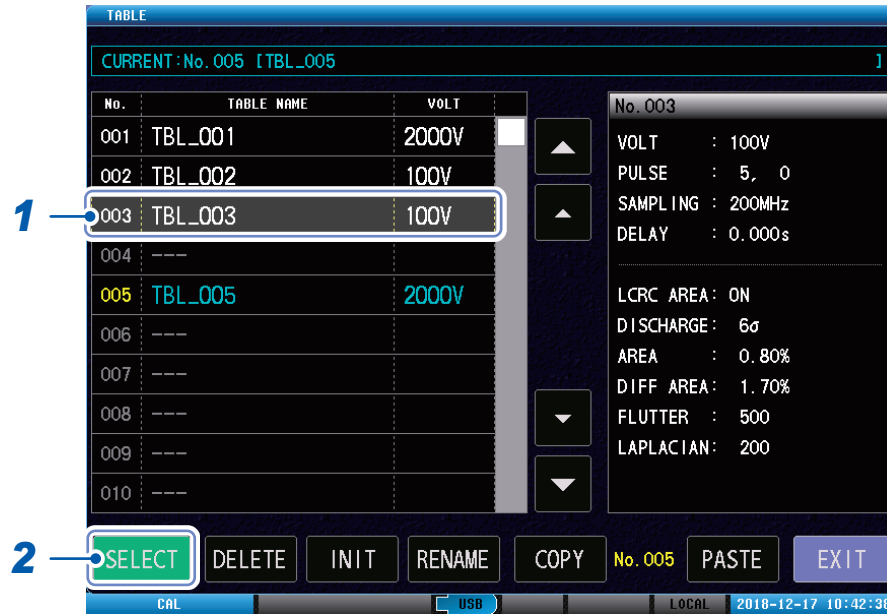

### 1 Tap the table that is to be set as the current table.

The table selected will be surrounded by a yellow frame.

### 2 Tap **[SELECT]**.

The characters in the table selected as the current table will turn light blue.

Test conditions settings mode: Saves the settings and the master waveform to the selected current table.

Test mode: Implements tests using the master waveform in the selected current table.

## 3.3 Table Initialization

Restores the settings details of the selected table to their default values. Also deletes the master waveform.

Reference: "Default settings table" on the application disc

(Measurement screen) [MODE] > [SETTING] > [TABLE]

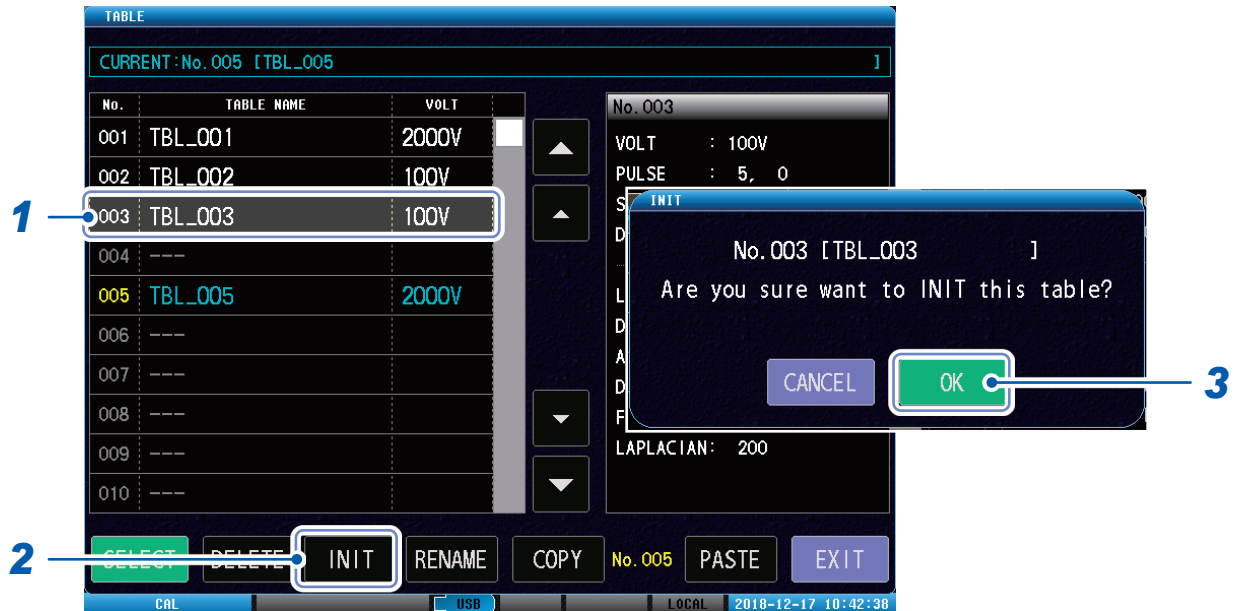

- 1** Tap the table.
- 2** Tap [INIT].  
The confirmation window will be displayed.
- 3** Tap [OK].

## 3.4 Table Deletion

Deletes the settings details from unnecessary tables. After deletion, the [TABLE NAME] is displayed as [---].

(Measurement screen) [MODE] > [SETTING] > [TABLE]

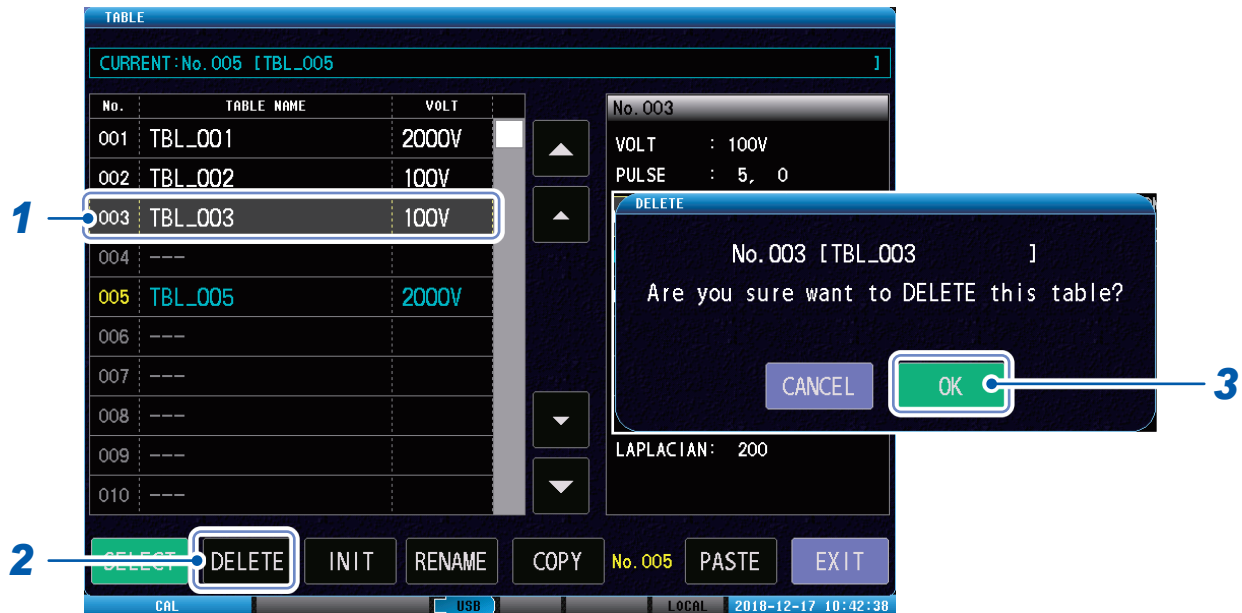

- 1 Tap the table to be deleted.
- 2 Tap [DELETE].  
The confirmation window will be displayed.
- 3 Tap [OK].

3

Switching Test Conditions (Table Functions)

## 3.5 Changing the Table Name

Changes the name of the table saved to the instrument.

(Measurement screen) **[MODE]** > **[SETTING]** > **[TABLE]**

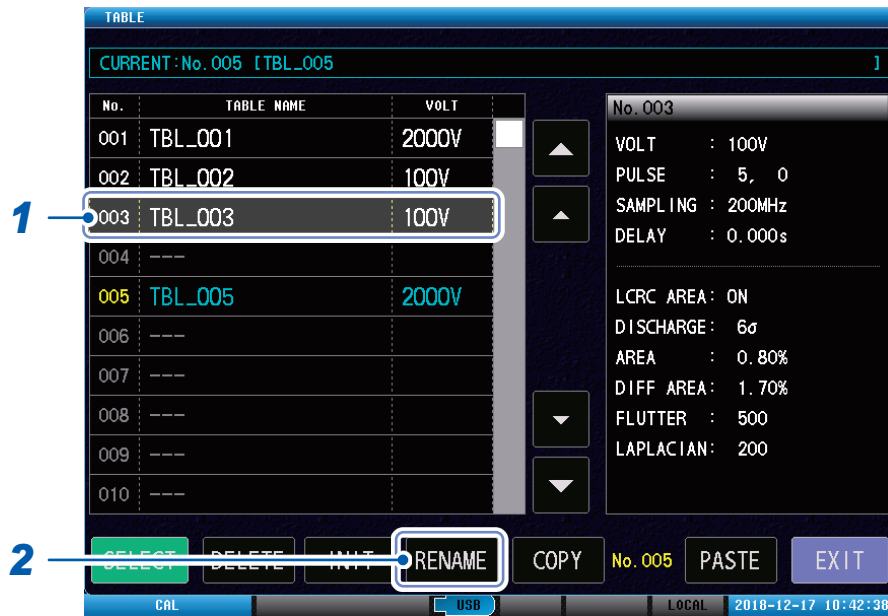

**1** Tap the table whose name you want to change.

**2** Tap **[RENAME]**.

**3** Enter the new name of the table.

Reference: "Touch keyboard inputs" (p. 11)

## 3.6 Table Copying

You can copy the table that has been created and paste it to your chosen table.

(Measurement screen) [MODE] > [SETTING] > [TABLE]

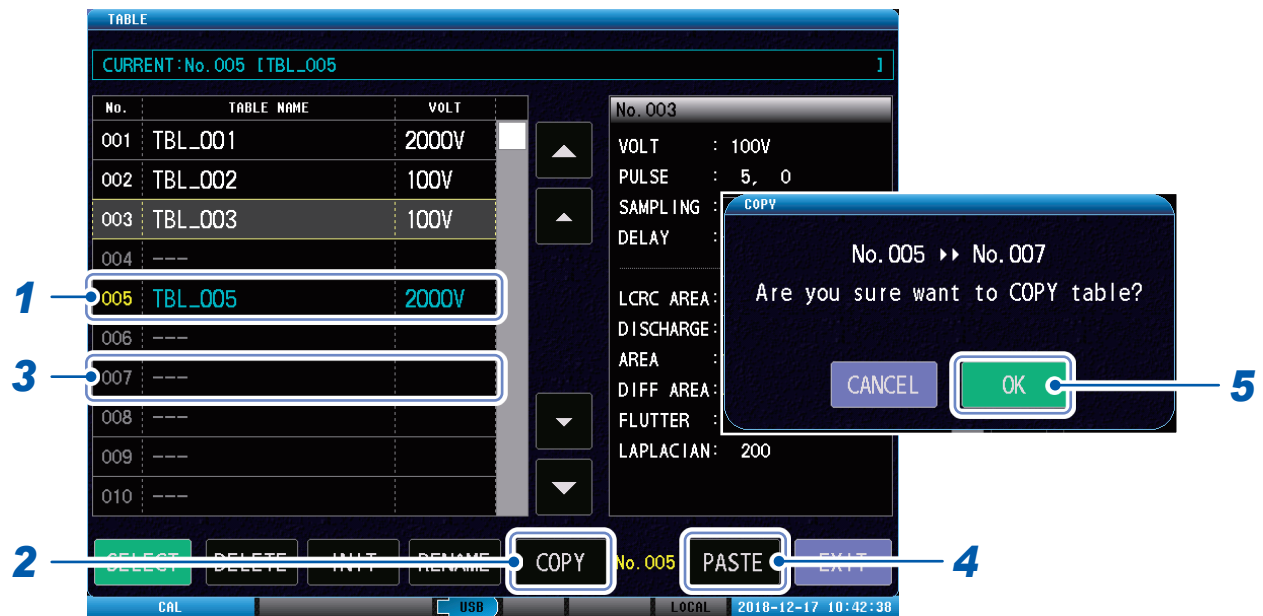

- 1** Tap the table to be copied.
- 2** Tap [COPY].
- 3** Tap the table to be pasted.
- 4** Tap [PASTE].  
The confirmation window will be displayed.
- 5** Tap [OK].

### IMPORTANT

If there is already data in the target table, the source data will be overwritten.





# 4

# Setting the Test Conditions

## 4.1 Overview

Use the master workpiece to set the test conditions in order to judge whether or not the workpiece to be tested is defective.

In test conditions settings mode, set the output conditions and the judgment conditions such as the pulse to be applied, etc., and acquire the master waveform. You can save up to 255 test conditions settings in a table.

### Operations flowchart in test conditions settings mode

In test conditions settings mode, set the output conditions and judgment conditions, and acquire the master waveform using the operations procedure as shown in the diagram.

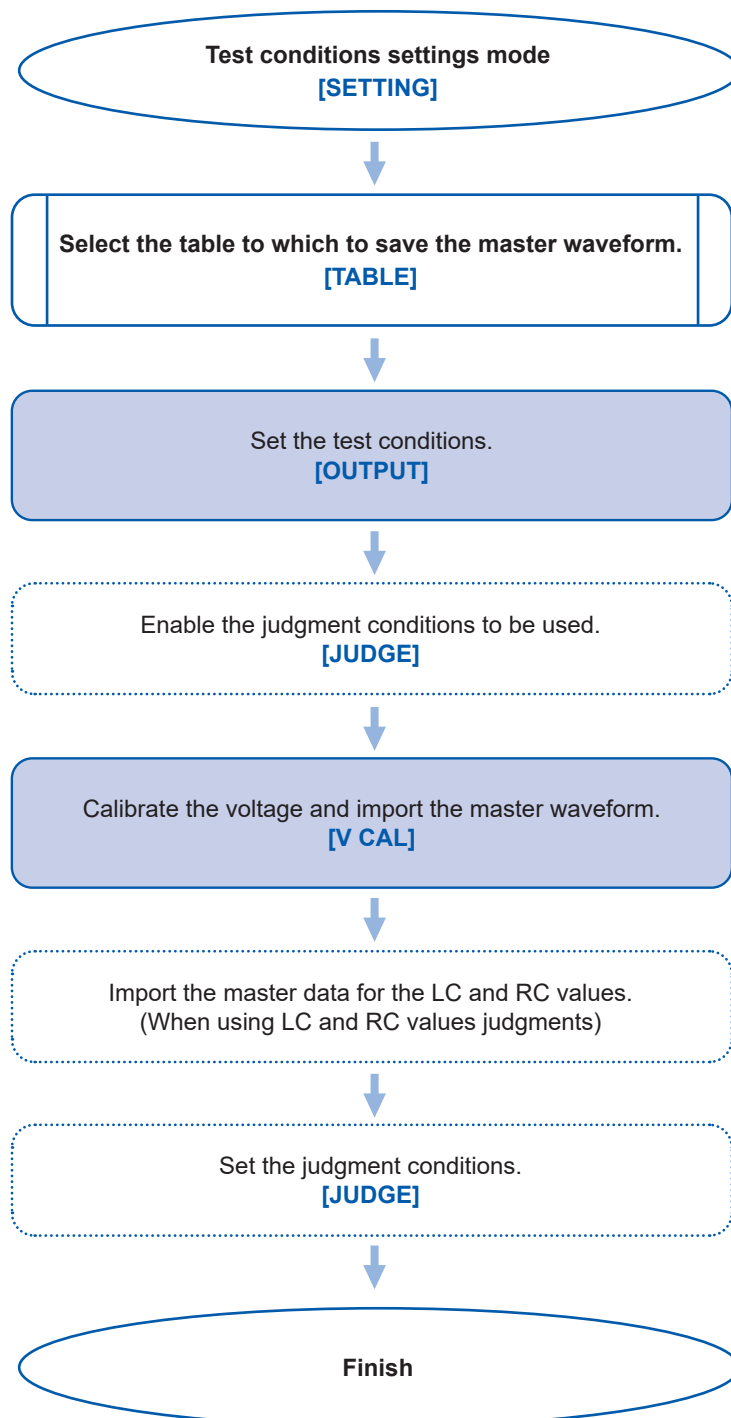

## Screen configuration

### Measurement screen

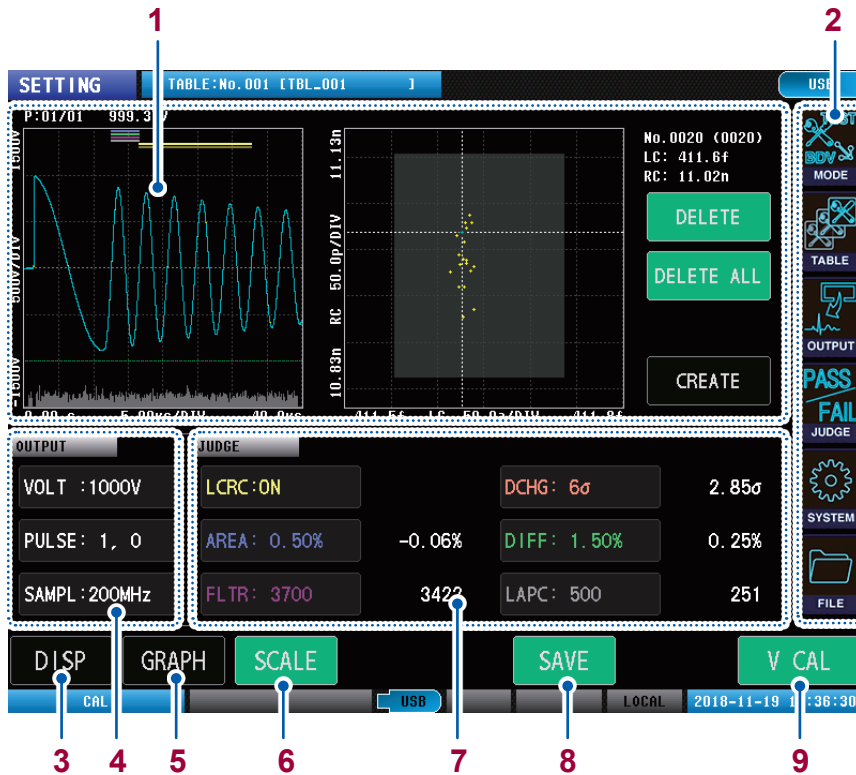

<b>1</b>	Graph display	Displays the waveform graph and the LC and RC graph. Reference: "Graph display (display graph switching)" (p. 37)
<b>2</b>	Menu icons	<b>[MODE]</b> : See "2.4 Select Measuring Mode" (p. 18) <b>[TABLE]</b> : See "3.2 Current Table Selection" (p. 29) <b>[OUTPUT]</b> : See "4 Setting the Test Conditions" (p. 35) <b>[JUDGE]</b> : See "5 Setting Judgment Conditions" (p. 51) <b>[SYSTEM]</b> : See "9 System Settings" (p. 125) <b>[FILE]</b> : See "12 USB Host" (p. 165)
<b>3</b>	<b>[DISP]</b>	Switches the graph displayed onscreen. <b>[WAVE]</b> : Waveform graph <b>[LCRC]</b> : LC and RC graph <b>[WAVE&amp;LCRC]</b> : Waveform graph + LC and RC graph
<b>4</b>	Test conditions settings display	Displays the setting for the applied voltage, number of pulses, and sampling frequency.
<b>5</b>	<b>[GRAPH]</b>	Sets the graph display. Reference: "8.6 Graph Display Settings" (p. 112)
<b>6</b>	<b>[SCALE]</b>	Auto-scales the LC and RC graph. Reference: "LC and RC graph scale settings" (p. 115)
<b>7</b>	Judgment conditions settings display	Displays the judgment conditions settings.
<b>8</b>	<b>[SAVE]</b>	Saves the test results to USB memory. Reference: "12 USB Host" (p. 165)
<b>9</b>	<b>[V CAL]</b>	Calibrates the voltages. Reference: "4.6 Voltage Calibration" (p. 49)

#### IMPORTANT

Tap items such as the output conditions settings and the judgment conditions settings to display each settings window directly.

## Graph display (display graph switching)

### Waveform graph display

Displays the waveform graph only.

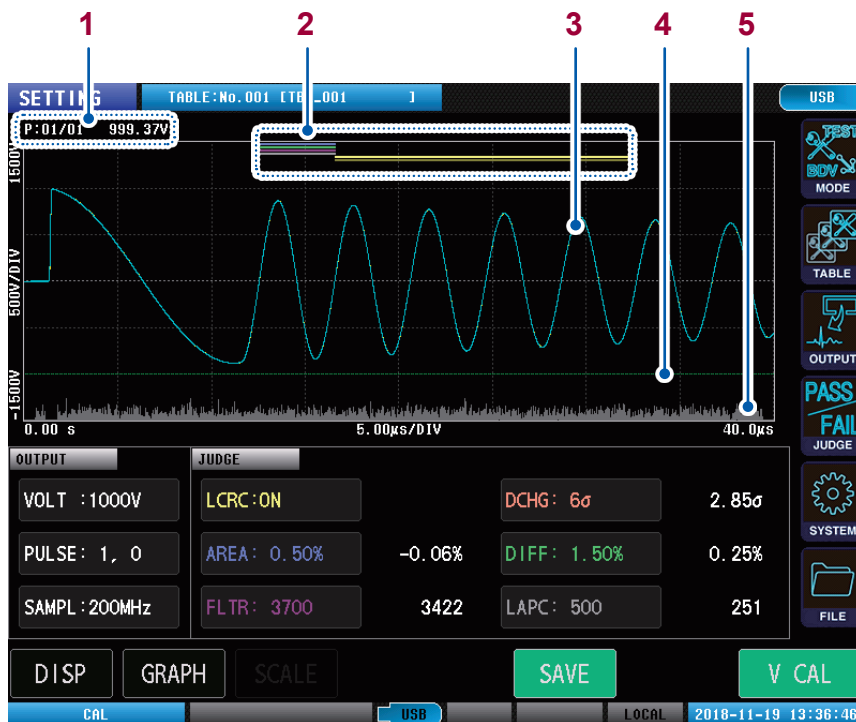

1	Number of applied pulses and peak voltage display	<p>[P:XX/XX]: Number of pulses that have been applied/Total number of pulses</p> <p>[xxxV]: Max. peak voltage value of the response waveform</p>
2	Waveform judgment area and LC and RC values operation range bar	<p>Blue: AREA judgment area</p> <p>Green: DIFF judgment area</p> <p>Purple FLUTTER judgment area</p> <p>Gray: LAPLACIAN judgment area</p> <p>Yellow (×2): LC and RC value operation areas</p>
3	Response waveform	<p>Yellow: Master waveform</p> <p>Blue: Test waveform</p> <p>Note: You can change the color of the waveform.</p> <p>Reference: “8.6 Graph Display Settings” (p. 112)</p>
4	Discharge judgment threshold value bar	Displays the discharge judgment threshold value.
5	Discharge waveform	<p>Green dotted line: Discharge judgment threshold value</p> <p>Gray: Discharge amount graph (Parts where the discharge amount exceeds the threshold value are displayed in red)</p> <p>Note: Displayed only if the Discharge Detection Upgrade is ON.</p> <p>Reference: “5.4 Discharge Judgments (When Incorporating Model ST9000)” (p. 72)</p>

### LC and RC graph display

Displays only the LC and RC graph.

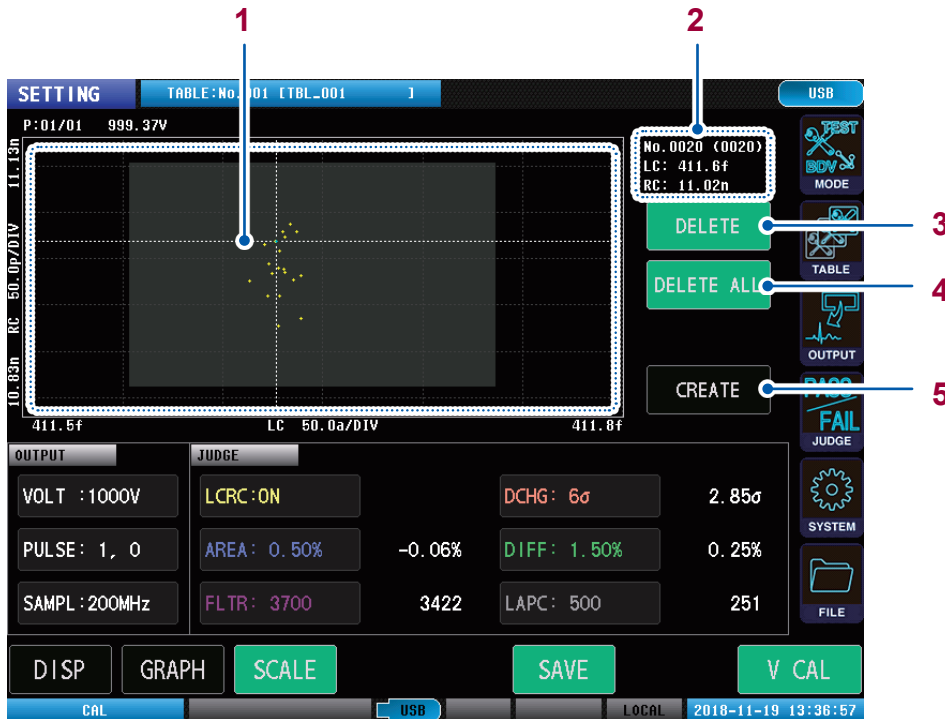

1	LC and RC graph	Blue (dots): Latest LC and RC values Yellow (dots): Imported LC and RC values master data Gray (solid): LC and RC values PASS judgment area Note: Dotted colors operate in tandem with the waveform colors. Also, you can change the color of the waveform. Reference: "8.6 Graph Display Settings" (p. 112)
2	LC and RC cursor values	<b>[No.XXX, (XXX)]</b> : Master data number of the cursor values (Total number of master data that have been imported) <b>[LC/RC: xxx]</b> : LC and RC values selected using the cursor
3	<b>[DELETE]</b>	Deletes the master data for the LC and RC values shown by the cursor. Reference: "Importing LC and RC master values" (p. 56)
4	<b>[DELETE ALL]</b>	Deletes the master data for all LC and RC values. Reference: "Importing LC and RC master values" (p. 56)
5	<b>[CREATE]</b>	Creates the PASS judgment area automatically. Reference: "Auto creation of the PASS judgment area" (p. 58)

**IMPORTANT**

Tap the LC and RC values on the graph to move the cursor and check each LC and RC value.

### Display the waveform graph and the LC and RC graph

Displays the waveform graph and the LC and RC graph simultaneously.

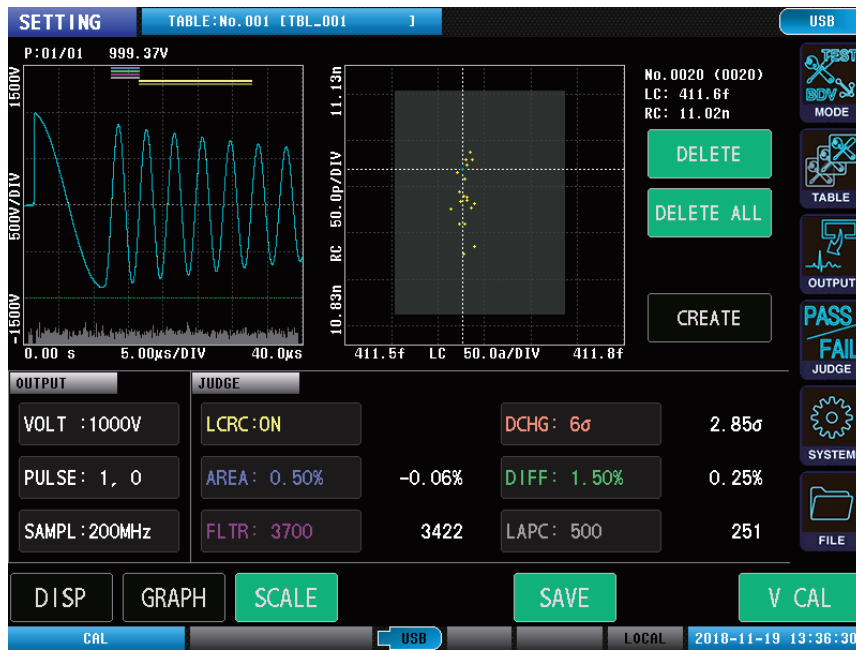

# 4

Setting the Test Conditions

### Instrument status display and error display

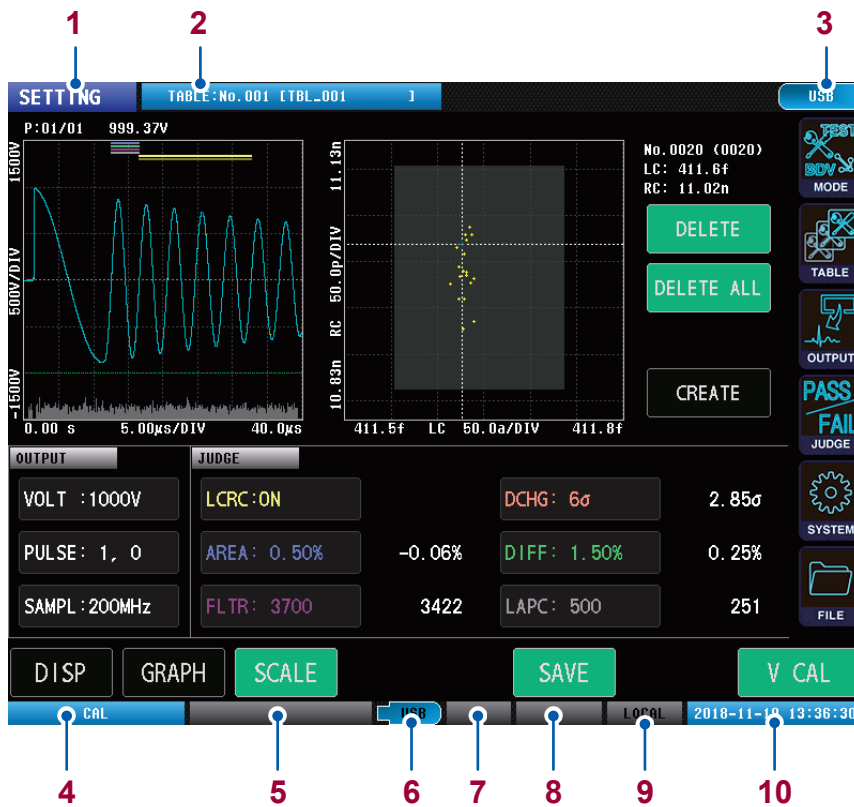

1	Current measurement mode display	NONE	Voltage application disabled mode
		SETTING	Test conditions settings mode
		TEST	Test mode
		BDV	BDV mode
2	Current table display	Displays the number and table name of the table presently being used.	
3	Communications interface settings display	Displays the settings for the communications interface presently being used.	
4	Voltage calibration status display	UNCAL	Voltage calibration not implemented (Master waveform not acquired)
		CAL	Voltage calibration implemented (Master waveform acquired)
5	Test status display	Displays the test status. Reference: "14.3 Error Display" (p. 214)	
6	USB memory status display	USB (Gray)	USB memory not connected
		USB (Blue)	USB memory connecting
		USB (Red)	Accessing USB
7	Double action status display	(No display)	Double action function OFF
		READY (Green)	START button enabled
		READY (Gray)	START button disabled
8	Interlock status display	(No display)	Interlock function OFF
		INTERLOCK (Red)	Interlock engaged
		INTERLOCK (Gray)	Interlock canceled
9	Communications status display	REMOTE	Remote status
		LOCAL	Local status
10	Date and time display	Displays the date and time that has been set in the instrument. Note: The background is displayed in red while writing to the settings internal memory.	

## 4.2 Applied Voltage

Sets the peak voltage value of the pulse applied to the workpiece. Inputs can be set either by using the up and down keys, or be entered using the numeric keypad.

(Measurement screen) **[MODE]** > **[SETTING]** > **[OUTPUT]** > **[VOLT]**

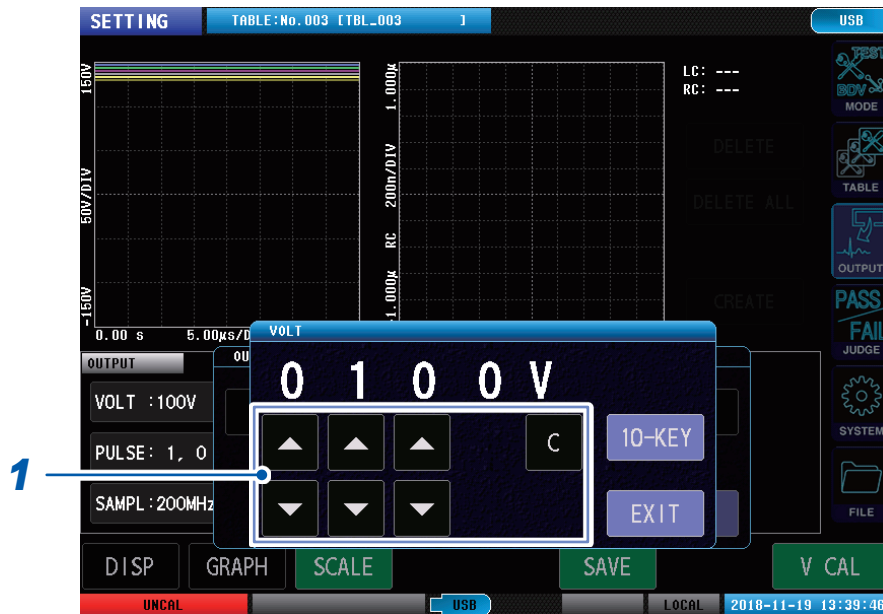

### 1 Set the applied voltage value.

Settings range: ST4030: 100 V to 3300 V (resolution: 10 V)  
ST4030A: 100 V to 4200 V (resolution:10 V)

▲	Increases by 1.
▼	Decreases by 1.
C	Sets to the default values.
10-KEY	Displays the numeric keypad.



## 4.3 Number of Applied Pulses

Sets the number of test pulses to be used in the tests and the number of degaussing pulse applications to eliminate magnetic fields from the workpiece. Both the test pulses and degaussing pulses continue to be applied until their set number is reached.

### PULSE NUM

(Number of test pulses applied)

Sets the number of test pulses to be applied.

When multiple test pulses are applied, each test pulse is judged individually.

### DEGAUSS NUM

(Number of degaussing pulses applied)

Sets the number of degaussing pulses to be applied.

A degaussing pulse is a pulse that is applied before the test pulses to remove any residual magnetization from the workpiece. Degaussing pulse waveforms are not sampled or judged.

### PULSE PERIOD

(Pulse application interval)

Sets the pulse application interval if multiple degaussing pulses and test pulses are to be applied.

When multiple pulses are applied, the pulse application interval operates at or above the set time.

### Overview of application pulse settings

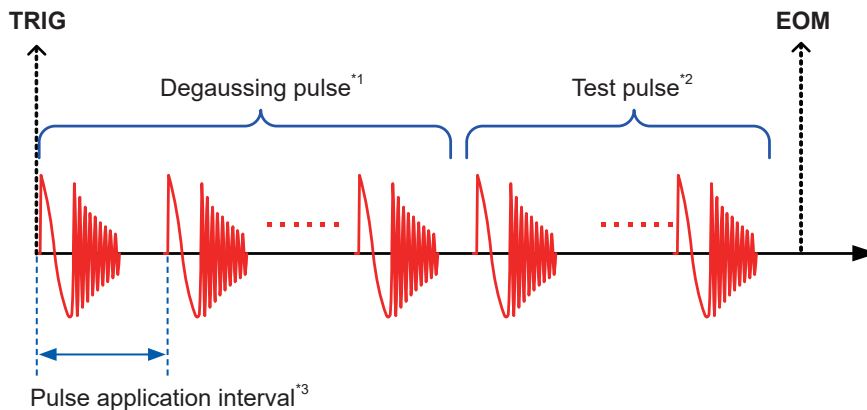

\*1: Sampling and judgment not implemented

\*2: Each pulse is sampled and judged

\*3: If the single pulse test time setting is shorter than the application interval time setting, the set time will wait before applying the next pulse. If the single pulse test time is longer than the set time, the next pulse is applied after the previous pulse test has finished.

(Measurement screen) [MODE] > [SETTING] > [OUTPUT] > [PULSE]



**1 Set the number of test pulses.**

Setting range: 1 to 32

▲	Increases by 1.
▼	Decreases by 1.
C	Sets to the default values.

**2 Set the number of degaussing pulses.**

Setting range: 0 to 10

▲	Increases by 1.
▼	Decreases by 1.
C	Sets to the default values.

**3 Set the pulse application interval.**

Setting range: 0.050 s to 1.000 s (resolution 0.001 s)

▲	Increases by 1.
▼	Decreases by 1.
C	Sets to the default values.
10-KEY	Displays the numeric keypad.

## 4.4 Sampling Frequency/Number of Sampling Data

Sets the voltage sampling frequency and the number of sampling data to be imported to the instrument.

<p><b>SAMPLING</b> (Sampling frequency)</p>	<p>▶ Sets the voltage sampling frequency. <u>If a sufficiently long response waveform cannot be imported because the response waveform vibration period is long, you can extend the length of the waveform being imported by extending the sampling frequency.</u></p>
<p><b>RECORD LENGTH</b> (No. of sampling data)</p>	<p>▶ Sets the number of sampling data to be imported to the instrument. Sets the length of the waveform to be imported, and sets the sampling frequency. Adjust the number of sampling data so that a suitable waveform length can be imported for judgment.</p>
<p><b>AUTO SET</b> (Automatic settings function for range of waveform acquisition)</p>	<p>▶ This function automatically adjusts and sets the sampling frequency and number of sampling data during voltage calibration so that the waveform acquisition range is optimal.</p>

### Sampling waveform lengths

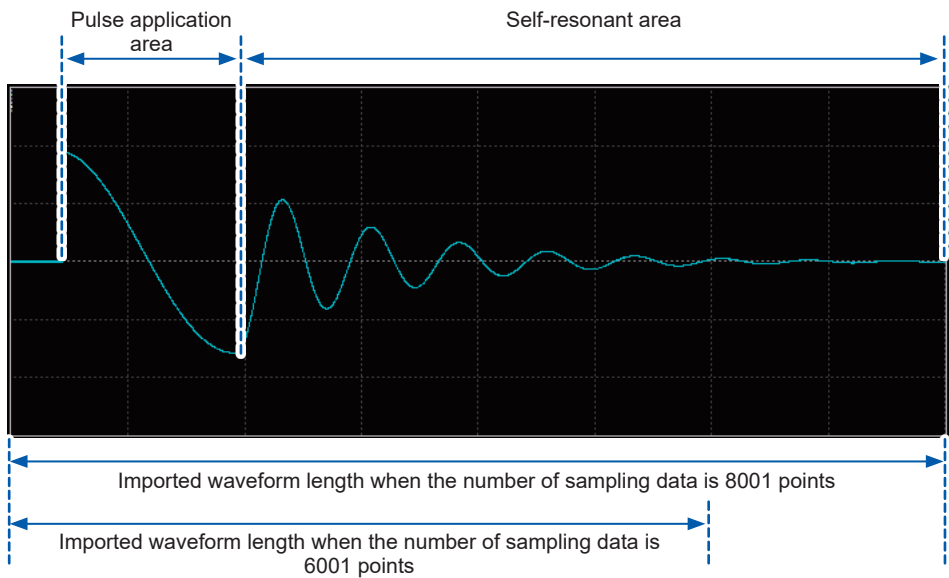

**Important: Recommended import length of the sampling waveform**  
Adjust the sampling wavelength so that the vibration waveform of the self-resonant area imports for 4 or more periods to enable sufficient waveform data to be used by the LC and RC values operations and the waveform judgment function. Slow the sampling frequency to lengthen the waveform to be imported.

(Measurement screen) [MODE] > [SETTING] > [OUTPUT] > [SAMPLING]



**1 Set the sampling frequency.**

Setting range: 10 MHz, 20 MHz, 50 MHz, 100 MHz, 200 MHz

◀	Slows the sampling frequency.
▶	Accelerates the sampling frequency.

**2 Set the number of sampling data.**

Setting range: 1001 points to 8001 points (resolution: 1000 points)

◀	Decreases by 1000.
▶	Increases by 1000.

## Automatic settings for range of waveform acquisition

You can automatically adjust and set the sampling frequency and number of sampling data during voltage calibration so that the waveform acquisition range is optimal.

(Measurement screen) **[MODE]** > **[SETTING]** > **[OUTPUT]** > **[SAMPLING]**



**1** Tap **[AUTO SET]**.

## 4.5 Trigger Delay

Sets the delay time (trigger delay) from the start of measuring to the application of the first pulse. If using this function, you can start measuring after the workpiece connection status has stabilized even if trigger timing and probing timing are the same when combined in the equipment.

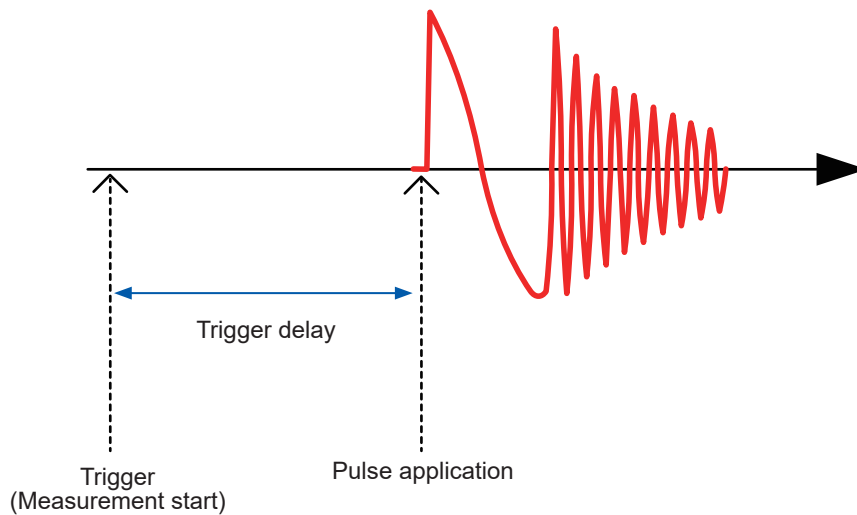
**IMPORTANT**

The **OUTPUT** lamp is synced to the EOM signals and so turns on even if the trigger is delayed.

(Measurement screen) [MODE] > [SETTING] > [OUTPUT] > [DELAY]



**1 Set the trigger delay.**

Setting range: 0.000 s to 9.999 s (resolution: 0.001 s)

▲	Increases by 1.
▼	Decreases by 1.
C	Sets to the default values.
10-KEY	Displays the numeric keypad.

## 4.6 Voltage Calibration

Calibrates the voltages after the test conditions settings are finished. Voltage calibration adjusts the output voltage so that the set voltage is applied to the workpiece, and then imports the master waveform using the output voltage after making the adjustments.

### Items implemented using voltage calibration

<b>Output voltage calibration</b>	▶ Gradually raise and adjust the output voltage so that the max. peak voltage of the response waveform is the same as the set voltage value.
<b>Automatically sets the sampling frequency and number of sampling data</b>	▶ Implemented when the auto setting for the waveform acquisition range is ON.
<b>LC and RC values operation range settings</b>	
<b>Importing basic data for discharge judgments</b>	▶ Implemented when the ST9000 Discharge Detection Upgrade is enabled.
<b>Auto settings for the judgment range and judgment standards for each waveform judgment</b>	▶ Implemented when the auto settings for waveform judgment areas and judgment threshold values are ON.
<b>Importing master waveform</b>	

### Calibrating output voltages

The max. peak voltage of the response waveform is repeatedly compared to the pulse application, max. peak voltage, and set voltage values while gradually increasing the set voltage value and the output voltage.

Max. peak voltage

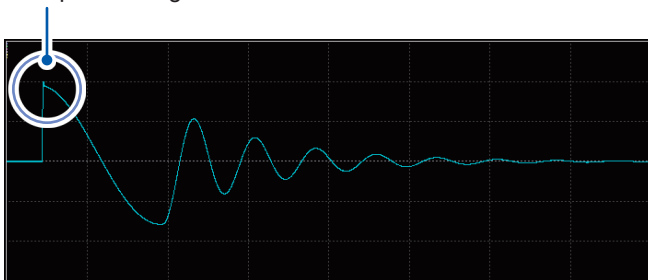

Even if the response waveform max. peak voltage is outside the primary peak, adjust so that the max. peak voltage value is the same as the set voltage value.



(Measurement screen) [MODE] > [SETTING] > [OUTPUT]



**1** Tap [V CAL].

The settings window will open.

**2** Select the calibration type.

<b>TYPE1</b>	If the instrument determines that the entire workpiece response waveform can be measured using more appropriate settings by adjusting the sampling frequency and sampling data count, either "INFORMATION 1021" or "INFORMATION 1022" will be displayed. If the set voltage is not applied, "WARNING 104" will be displayed.
<b>TYPE2</b>	The above information will not be displayed.

**3** Tap [YES].

Voltage calibration starts.

When importing the master waveform has finished after the voltage calibration has finished, the icon at the bottom left of the screen will change from [UNCAL] (red) to [CAL] (blue).

Reference: See "14.3 Error Display" (p. 214).

# 5 Setting Judgment Conditions

## 5.1 Overview

Applies a set impulse voltage using voltage calibration to the workpiece to be tested, and compares the response waveform, LC and RC values, and discharge composition amount to the master workpiece data to judge whether or not the workpiece being tested conforms to quality.

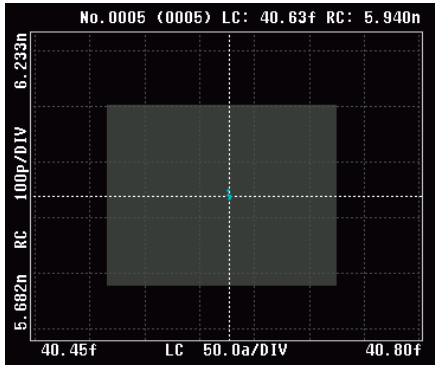

LC and RC values judgments

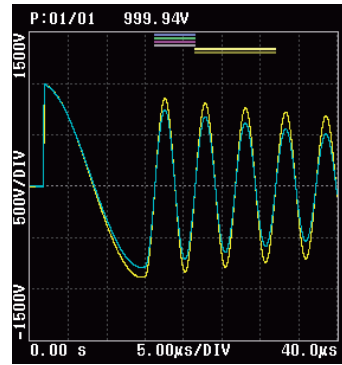

Waveform judgments

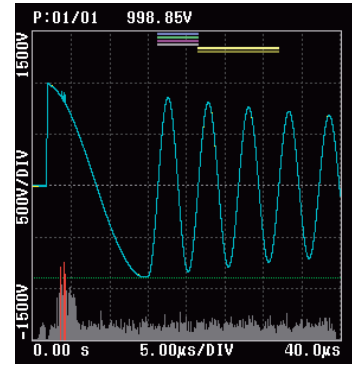

Discharge judgments

### Judgment types

The following three types of judgment are available.

LC and RC values judgments	▶ "LC and RC Values Area Judgments [ <b>LCRC AREA</b> ]" (p. 53)
Waveform judgments	▶ "Surface area comparison judgments [ <b>AREA</b> ]" (p. 62) "Differential surface area comparison judgments [ <b>DIFF AREA</b> ]" (p. 64) "Flutter detection judgments [ <b>FLUTTER</b> ]" (p. 66) "Secondary differential detection judgments [ <b>LAPLACIAN</b> ]" (p. 69)
Discharge judgments (When incorporating ST9000)	▶ "Discharge judgment methods [ <b>DISCHARGE</b> ]" (p. 73)

## Settings operations procedure

Imports the master workpiece waveform as the master waveform, and sets the threshold values for each judgment function from the master waveform.

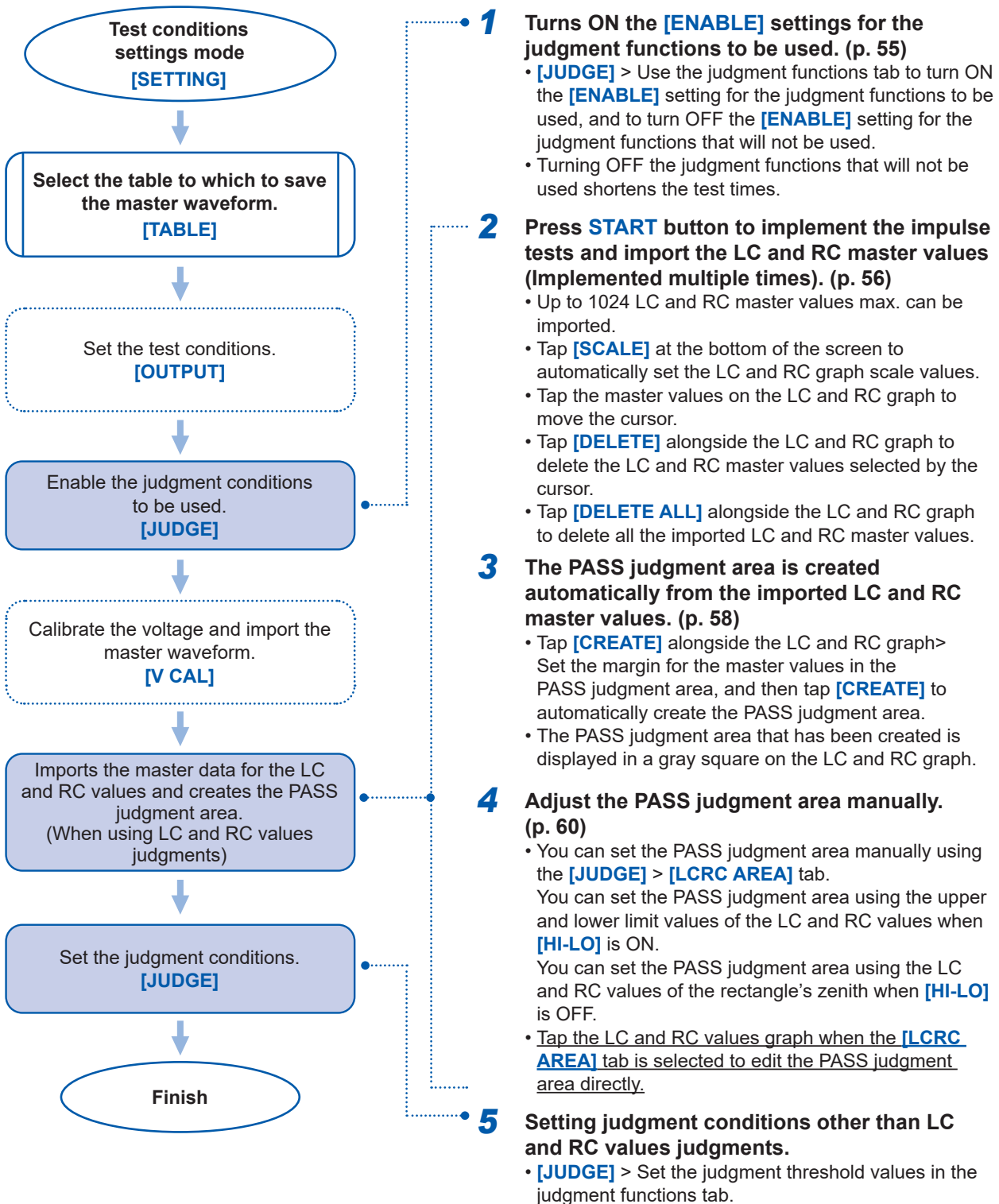

## 5.2 LC and RC Values Area Judgments [LCRC AREA]

### What are LC and RC values?

The equivalence circuit for the impulse tests is viewed as a LCR linear equivalence circuit as shown in the diagram below, and is the value that was quantified as the 2 parameters of “L\*C” value and “R\*C” value using the equivalence circuit and impulse response waveform data.

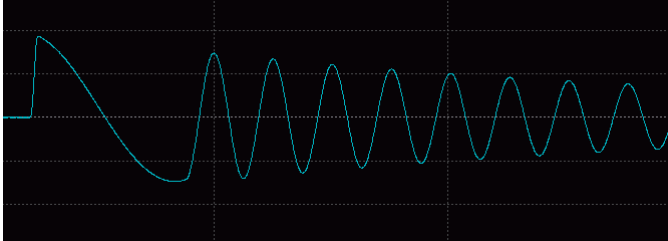

Impulse response waveforms

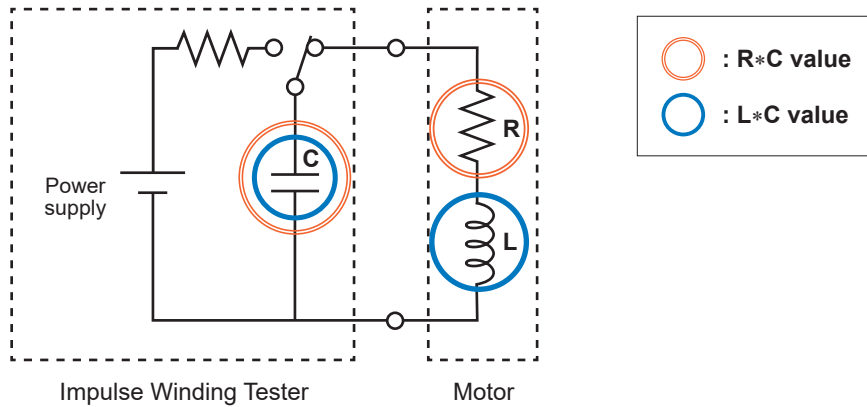

#### IMPORTANT

The LC and RC values are values approximated from the impulse response waveform. Accurate equivalence circuit parameter values may be different.

## LC and RC values judgments

### Test conditions settings mode

The PASS judgment area is created based on multiple LC and RC values imported from the master workpiece after voltage calibration has been implemented.

LC and RC graph (Test conditions settings mode)

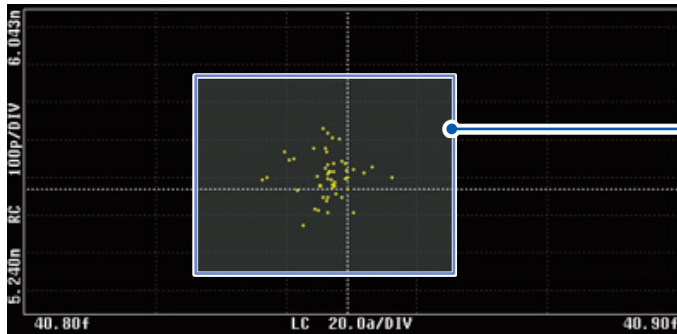

Yellow dots: Imported LC and RC master values  
Gray: The PASS judgment area that has been created

### Test mode

Judged by whether the LC and RC values of the workpiece being tested are inside the PASS judgment area that has been created.

LC and RC graph (Test mode)

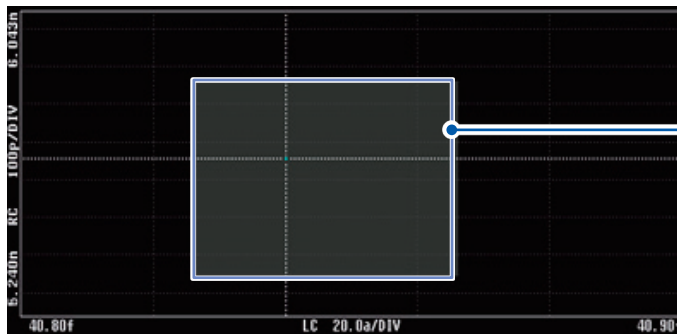

Blue dots: LC and RC values of workpiece under test  
Gray: PASS judgment area

#### IMPORTANT

- The LC and RC values judgments function calculates the internal coefficients such as the waveform operation area of the LC and RC values during voltage calibration. Consequently, make sure to enable the LC and RC values judgments function before implementing voltage calibration.
- The PASS judgment area created during voltage calibration is set based on the LC and RC values variation for the conforming workpiece during voltage calibration. If the settings include LC and RC values variation for the workpiece under test, it is necessary to import the LC and RC master values and create a PASS judgment area, or to adjust the judgment area manually.
- If the measured waveforms lacks the second and subsequent cycles, the LC and RC values will be calculated using the area that includes the point at which the voltage was applied. In this case, the LC and RC values will not correspond to the values calculated based on a conventional LCR resonance circuit, but they can still be used to generate a judgment.

## Enabling the LC and RC values judgments function

(Measurement screen) [MODE] > [SETTING] > [JUDGE] > [LCRC AREA]



**1** Tap [ENABLE], and turn [ON] the LC and RC values area operation functions.

**2** Tap [JUDGE], and turn [ON] the LC and RC values judgments functions.

### IMPORTANT

If implementing LC and RC values operations only with no judgment, turn ON [ENABLE] and turn OFF [JUDGE].

## Importing LC and RC master values

---

Implement voltage calibration and import the master waveform before importing multiple LC and RC values as the master values.

Test while implementing voltage calibration to save the LC and RC values acquired for each test as master values to the instrument.

- Up to 1024 LC and RC master values max. can be imported.
- LC and RC master values are deleted when the power supply is turned OFF.

## Checking and editing imported LC and RC master values

You can check imported LC and RC master values using the cursor. The cursor moves whenever a LC or RC value is tapped.

- Tap **[SCALE]** at the bottom of the screen to automatically set the LC and RC graph scale values.
- Tap **[DELETE]** alongside the LC and RC graph to delete the LC and RC master values presently selected by the cursor.
- Tap **[DELETE ALL]** alongside the LC and RC graph to delete all the imported LC and RC master values.



1	LC and RC cursor values	[No.XXX]: Master data number of the cursor value. [XXX]: Total number of master data that have been imported.
2	[DELETE]	Deletes the master data for the LC and RC values shown by the cursor. Reference: "Importing LC and RC master values" (p. 56)
3	[DELETE ALL]	Deletes the master data for all LC and RC values. Reference: "Importing LC and RC master values" (p. 56)
4	[CREATE]	Creates the PASS judgment area automatically. Reference: "Auto creation of the PASS judgment area" (p. 58)
5	[SCALE]	Auto-scales the LC and RC graph. Reference: "LC and RC graph scale settings" (p. 115)

**IMPORTANT**

Tap the LC and RC values on the graph to move the cursor and check each LC and RC value.



## Auto creation of the PASS judgment area

The PASS judgment area is created automatically from the imported LC and RC master values.

(Measurement screen) [MODE] > [SETTING]



- 1 Tap [CREATE] (on the measurements screen).
- 2 Tap [AREA TYPE] to set the shape of the area when the PASS judgment area is created automatically.

<b>HI-LO</b>	Creates a rectangular PASS judgment area from the maximum and minimum LC and RC master values. Used when the master workpiece's LC and RC values are distributed in close proximity.
<b>FIT</b>	Creates a banded PASS judgment area that covers the LC and RC master values. Used if the LC and RC values distribution is banded by the rotor position (angle) with a motor that has been combined with a rotor.

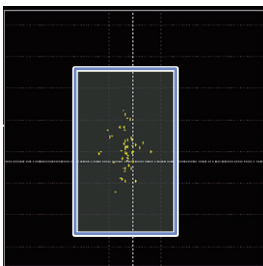

Rectangular PASS judgment area  
[HI-LO]

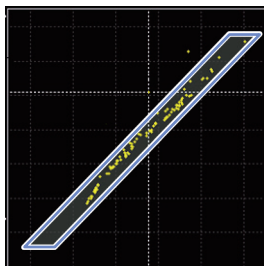

Banded PASS judgment area  
[FIT]

- 3 Set the margin when creating the PASS judgment area automatically.

[AREA TYPE] [HI-LO]: Adds the result of multiplying the LC and RC average values by the margin rate to the upper and lower limit values.

[FIT]: Adds the result of multiplying the length of the long and short sides of the banded area by the margin rate to the outside of the long and short sides, respectively. Since a value of 100% will cause the original lengths to be added on both sides, the long and short sides will be 3 times their original length.

**4 Tap [CREATE].**

The PASS judgment area is created automatically. The PASS judgment area that has been created is displayed in a gray square on the LC and RC graph.

**IMPORTANT**

- When the margin is 0%, the distribution of the imported LC and RC master values remain unchanged, and a PASS judgment area is created for the distribution to act as the PASS judgment area threshold values.
- If the margin rate increases, a PASS judgment area is created so that the PASS judgment area threshold values are greater than the distribution of the imported LC and RC master values.

## Manually creating the PASS judgment area

You can set the PASS judgment area manually. You can manually micro-adjust the PASS judgment area after auto creation.

(Measurement screen) **[MODE]** > **[SETTING]** > **[JUDGE]** > **[LCRC AREA]**



### 1 Tap **[HI-LO]** to set the shape of the PASS judgment area.

<input type="checkbox"/> <b>[HI-LO]</b> (ON)	<b>[LO][HI]</b> Sets the PASS judgment area threshold values using the upper and lower limit values of the LC and RC values.
<input type="checkbox"/> <b>[HI-LO]</b> (OFF)	<b>[POINT1] [POINT2] [POINT3] [POINT4]</b> Sets the PASS judgment area threshold values using the LC and RC values of the rectangle's zenith.

#### IMPORTANT

Adjusts the PASS judgment area directly by tapping the PASS judgment area in the LC and RC graph when **[LCRC AREA]** tab is displayed.

**[HI-LO]** (ON):

Adjusts the size of the rectangle by tapping and dragging the borders of the area rectangle.

**[HI-LO]** (OFF):

Adjusts the zenith positions by tapping and dragging the zeniths of the area trapezoids.

### 2 Tap any of the following: **[HI]** **[LO]** or **[LC]** **[RC]**.

Set the PASS judgment area threshold values using either the upper and lower limit values of the LC and RC values, or the LC and RC values at the rectangle's zenith.

**3 Use the numeric keypad to enter the threshold values.**

Settings range:  $\pm(0.000 \text{ f to } 1.000)$  (effective number of digits: 4)

<b>C</b>	Clear the entered value.
<b>-</b>	Enter a minus sign.
<b>X10<sup>3</sup></b>	Multiplies the entered value by $\times 1000$ .
<b>/10<sup>3</sup></b>	Multiplies the entered value by $\times 1/1000$ .

**[HI-LO] is ON (Threshold value set using upper and lower limit values)**

The screenshot shows the 'LCRC AREA JUDGE' interface. At the top, a graph displays a data point with a vertical error bar. The horizontal axis is labeled 'LC' and the vertical axis is labeled 'RC'. The graph shows a central value 'LC' with 'LO' (Lower Limit) and 'HI' (Upper Limit) markers. The 'HI-LO' button is highlighted in green, indicating it is active. The bottom panel shows the following settings:

LCRC AREA	DISCHARGE	AREA	DIFF AREA	FLUTTER	LAPLACIAN
ENABLE	ON	LC	RC		HI-LO
JUDGE	ON	LO: 8.949p	HI: 8.958p	HI: 49.56n	SCALE
MARGIN	LC 5.00% RC 5.00%	LO: 8.949p	HI: 8.958p	LO: 49.37n	EXIT

**[HI-LO] is OFF (Threshold value set using LC and RC values zeniths)**

The screenshot shows the 'LCRC AREA JUDGE' interface. At the top, a graph displays a data point with a vertical error bar. The horizontal axis is labeled 'LC' and the vertical axis is labeled 'RC'. The graph shows four points: POINT 1 (top-left), POINT 2 (top-right), POINT 3 (bottom-right), and POINT 4 (bottom-left). The 'HI-LO' button is greyed out, indicating it is inactive. The bottom panel shows the following settings:

LCRC AREA	DISCHARGE	AREA	DIFF AREA	FLUTTER	LAPLACIAN	
ENABLE	ON	POINT1	POINT2		HI-LO	
JUDGE	ON	LC: 8.950p	RC: 49.54n	LC: 8.959p	RC: 49.54n	SCALE
MARGIN	LC 5.00% RC 5.00%	POINT4	POINT3	LC: 8.950p	RC: 49.39n	EXIT
		LC: 8.950p	RC: 49.39n	LC: 8.959p	RC: 49.39n	

## 5.3 Waveform Judgments

### Surface area comparison judgments [AREA]

Compares the master waveform surface area and the test waveform surface area in the area specified by the user and judges whether the workpiece being tested conforms by the extent of the difference.

The surface area of the waveform in the judgment area (solid yellow color) is calculated as shown in the “Waveform surface area calculation example” below.

The judgment standard is set using percentage value, and if the surface area difference is within that range, the workpiece being tested is judged to conform.

#### Waveform surface area calculation example

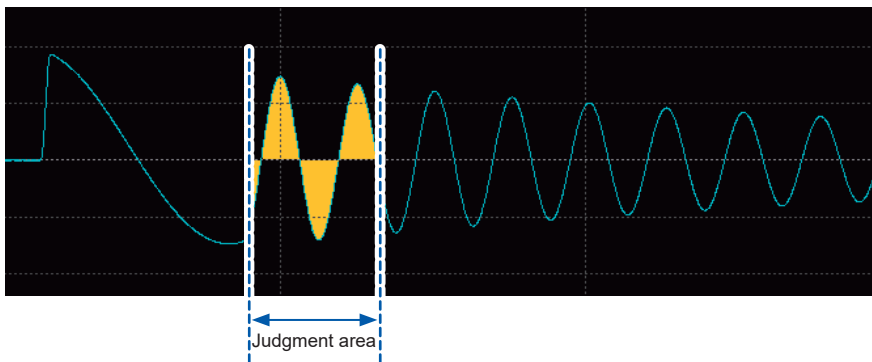

#### Surface area comparison value operation

$$AREA (\%) = \left( \frac{\text{Test waveform surface area value}}{\text{Master waveform surface area value}} - 1 \right) * 100$$

### Enabling the surface area comparison judgment function

(Measurement screen) [MODE] > [SETTING] > [JUDGE] > [AREA]

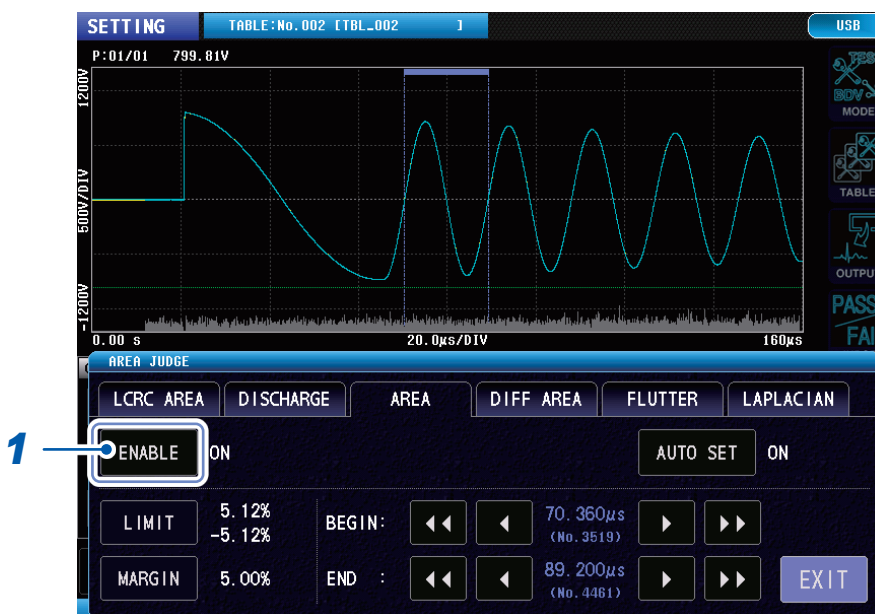

- 1 Tap [ENABLE], and turn [ON] the surface area comparison judgment function.

## Setting the surface area comparison judgment threshold value

(Measurement screen) [MODE] > [SETTING] > [JUDGE] > [AREA]

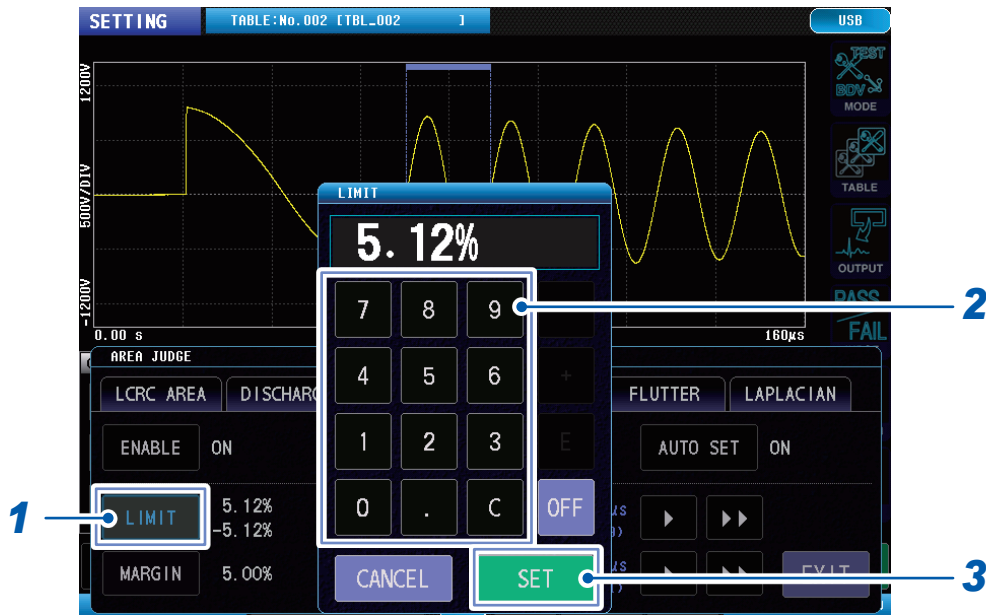

- 1 Tap [LIMIT].
- 2 Use the numeric keypad to enter the surface area comparison threshold value.  
Settings range: 0.00% to 99.99% (resolution: 0.01%)

OFF	Surface area comparison value operations are implemented, but judgments are not.
-----	--

- 3 Tap [SET] to confirm.

## Setting the surface area comparison judgment area

(Measurement screen) [MODE] > [SETTING] > [JUDGE] > [AREA]

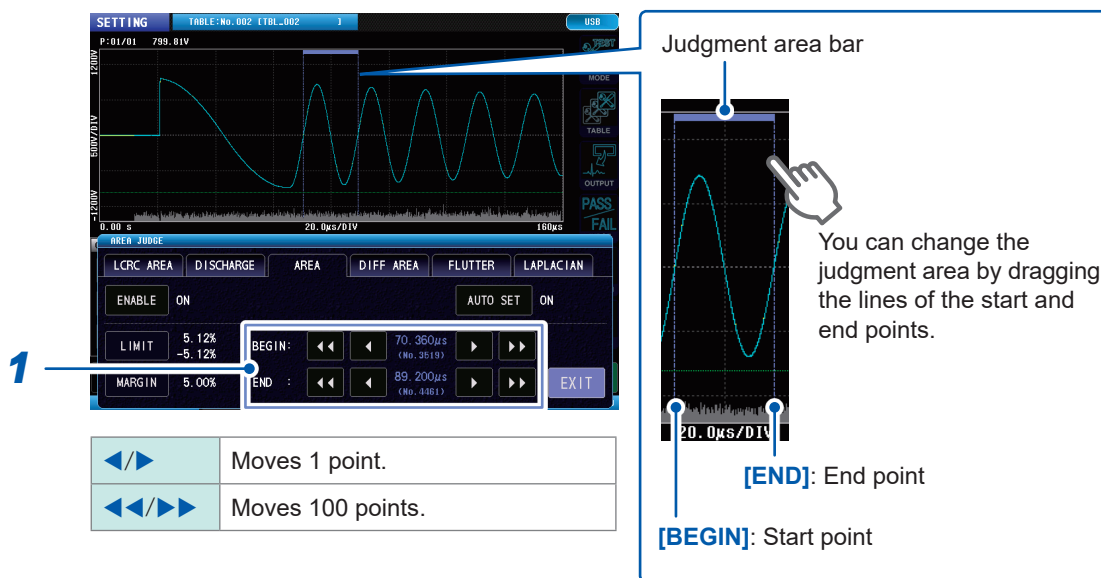

- 1 Set the start and end points for the judgment area.

## Differential surface area comparison judgments [DIFF AREA]

Calculates the surface area surrounded by the master waveform and test waveform in the user-designated area to judge whether the test workpiece within that area conforms.

The surface area surrounded by the master and test waveforms in the judgment area (surface area in a solid orange color) is calculated as shown in the “Differential surface area calculation example” below.

The judgment standards are set using percentages, and the test workpiece is judged to conform if the percentage of the test waveform surface area over the master waveform surface area is in that range.

### Differential surface area calculation example

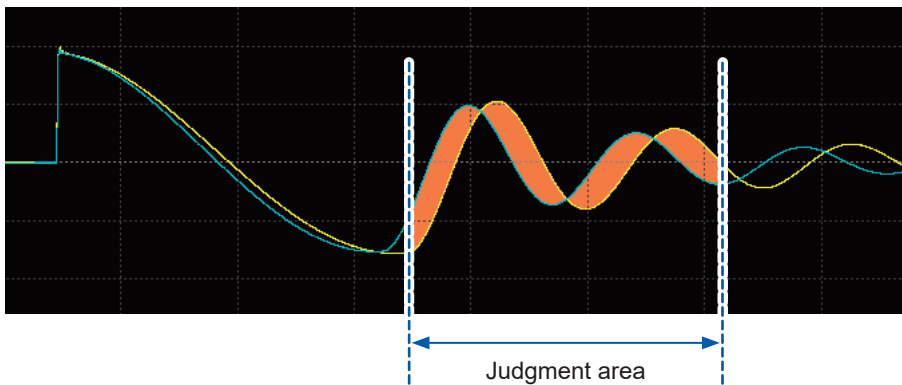

### Differential surface area comparison value operation formula

$$Diff (\%) = \left[ \frac{(\text{Test waveform surface area value} - \text{Master waveform surface area value})}{\text{Master waveform surface area value}} \right] * 100$$

### Enabling the differential surface area comparison judgment function

(Measurement screen) [MODE] > [SETTING] > [JUDGE] > [DIFF AREA]

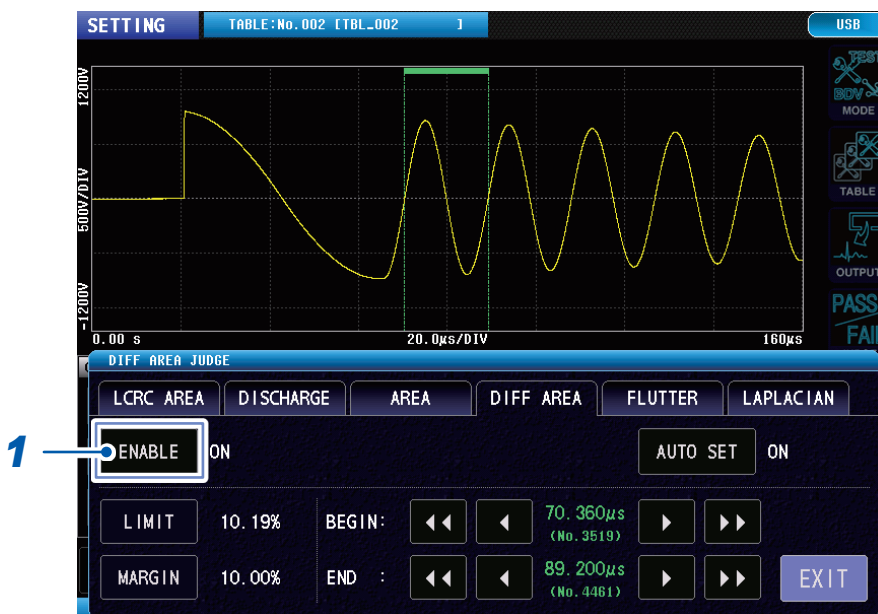

- 1 Tap [ENABLE], and turn [ON] the differential surface area comparison judgment function.

## Setting the differential surface area comparison judgment threshold value

(Measurement screen) [MODE] > [SETTING] > [JUDGE] > [DIFF AREA]

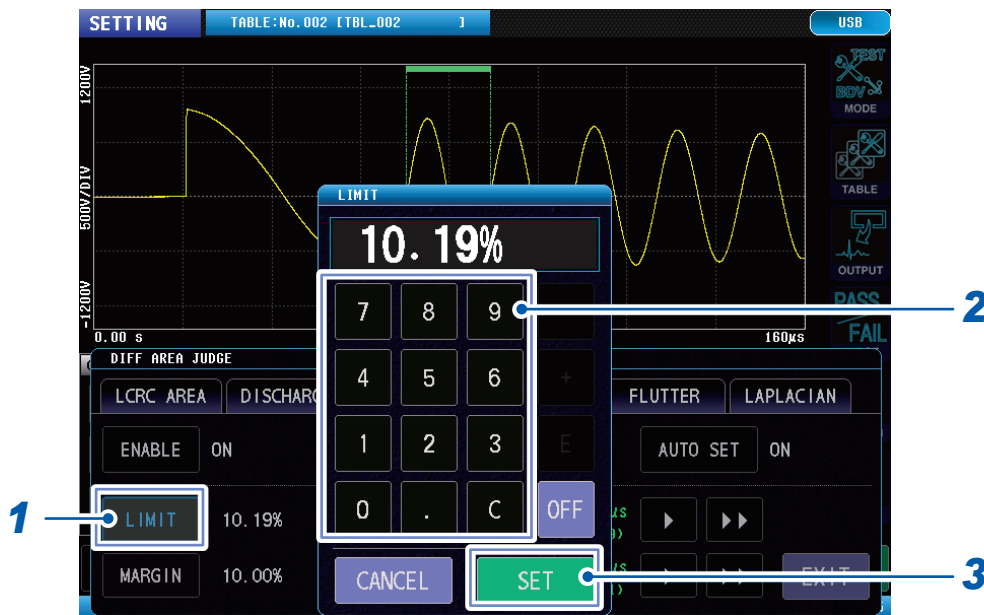

- 1 Tap [LIMIT].
- 2 Use the numeric keypad to enter the threshold values.  
Settings range: 0.00% to 99.99% (resolution: 0.01%)

**OFF** Differential surface area comparison value operations are implemented, but judgments are not.

- 3 Tap [SET] to confirm.

## Setting the differential surface area comparison judgment area

(Measurement screen) [MODE] > [SETTING] > [JUDGE] > [DIFF AREA]

Judgment area bar

You can change the judgment area by dragging the lines of the start and end points.

[END]: End point

[BEGIN]: Start point

	Moves 1 point.
	Moves 100 points.

- 1 Set the start and end points for the judgment area.



## Flutter detection judgments [FLUTTER]

The amount of the high-frequency component expressed by the test waveform in the user-designated area is detected, and the size of the amount used to judge the discharge. The response waveform is primarily differentiated and the surface area of the differentiated waveform calculated as the amount of the high-frequency component.

### Example of the test waveform discharge component

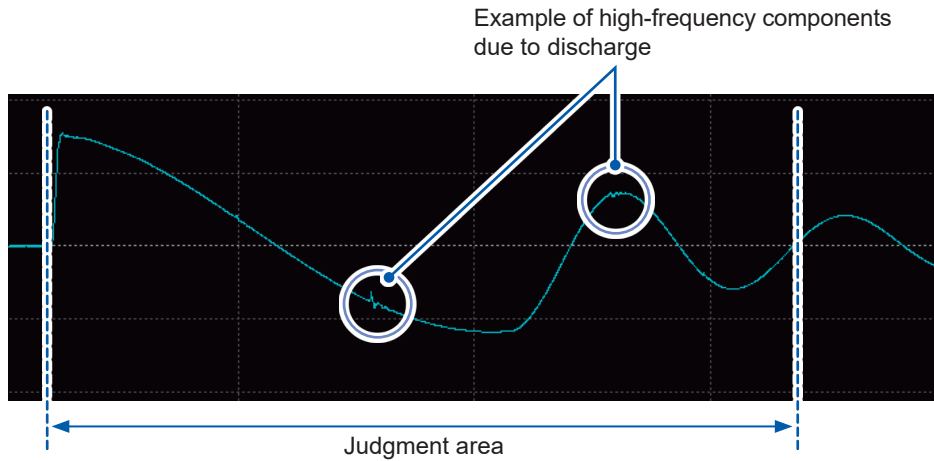

### Flutter value operation

$$Flutter = \sum_{n=1}^{\text{Number of data}} |d_n - d_{n-1}|$$

## Enabling waveform flutter detection judgment functions

(Measurement screen) [MODE] > [SETTING] > [JUDGE] > [FLUTTER]

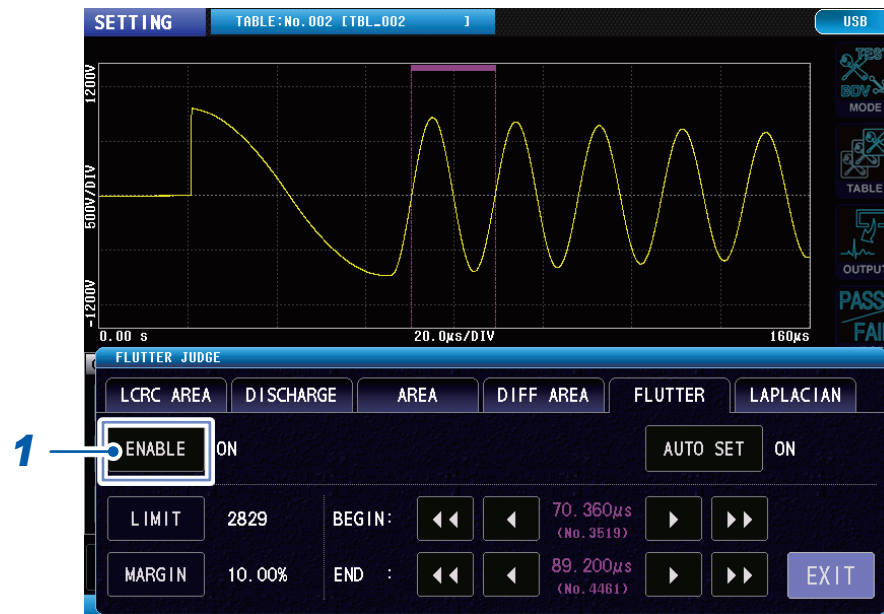

- 1 Tap [ENABLE], and turn [ON] the flutter detection judgment functions.

## Setting the flutter detection judgment threshold values

(Measurement screen) [MODE] > [SETTING] > [JUDGE] > [FLUTTER]

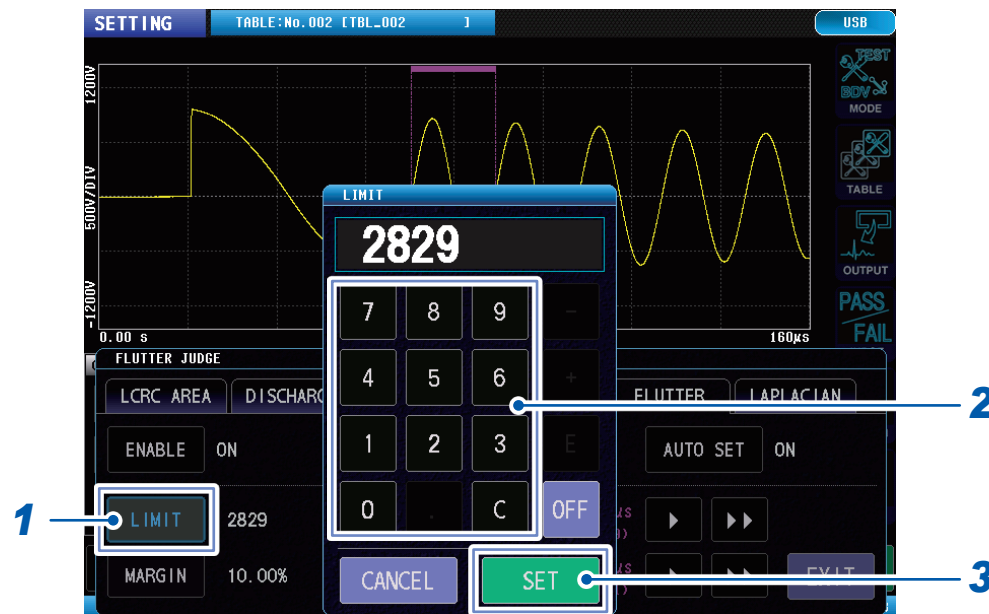

- 1 Tap [LIMIT].
- 2 Enter the flutter detection judgment threshold values.

Setting range: 0 to 999,999 (resolution: 1)

OFF	Flutter value operations are implemented, but judgments are not.
-----	--

- 3 Tap [SET] to confirm.

## Setting the flutter detection judgment area

(Measurement screen) [MODE] > [SETTING] > [JUDGE] > [FLUTTER]

The image shows the 'FLUTTER JUDGE' menu with the following settings:

- LCRC AREA
- DISCHARGE
- AREA
- DIFF AREA
- FLUTTER
- ENABLE ON
- LIMIT 2829
- MARGIN 10.00%
- BEGIN: 70.380µs (No. 3619)
- END: 89.200µs (No. 4881)
- AUTO SET
- EXIT

A zoomed-in view of the 'Judgment area bar' shows a waveform with a purple bar above it. A hand icon indicates that the start and end points of the bar can be adjusted. The scale is 20.0µs/DIV. The [BEGIN] point is at the start of the bar, and the [END] point is at the end of the bar.

You can change the judgment area by dragging the lines of the start and end points.

[END]: End point  
[BEGIN]: Start point

	Moves 1 point.
	Moves 100 points.

- 1 Set the start and end points for the judgment area.

## Secondary differential detection judgments [LAPLACIAN]

The amount of the high-frequency component expressed by the test waveform in the user-designated area is detected, and the size of the amount used to judge the discharge. The response waveform is secondarily differentiated and the surface area of the differentiated waveform calculated as the amount of the high-frequency component.

### Laplacian operations

$$\text{Laplacian} = \sum_{n=1}^{\text{Number of data}-1} |-d_{n-1}+2d_n-d_{n+1}|$$

### Enabling secondary differential detection judgment functions

(Measurement screen) [MODE] > [SETTING] > [JUDGE] > [LAPLACIAN]

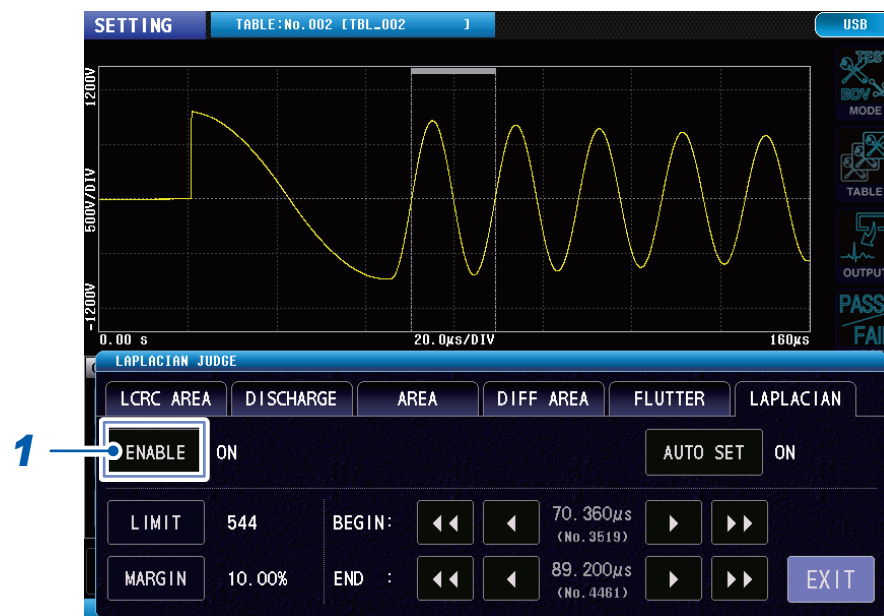

- 1 Tap [ENABLE], and turn [ON] the secondary differential detection judgments.

### Setting the secondary differential detection judgment threshold values

(Measurement screen) [MODE] > [SETTING] > [JUDGE] > [LAPLACIAN]

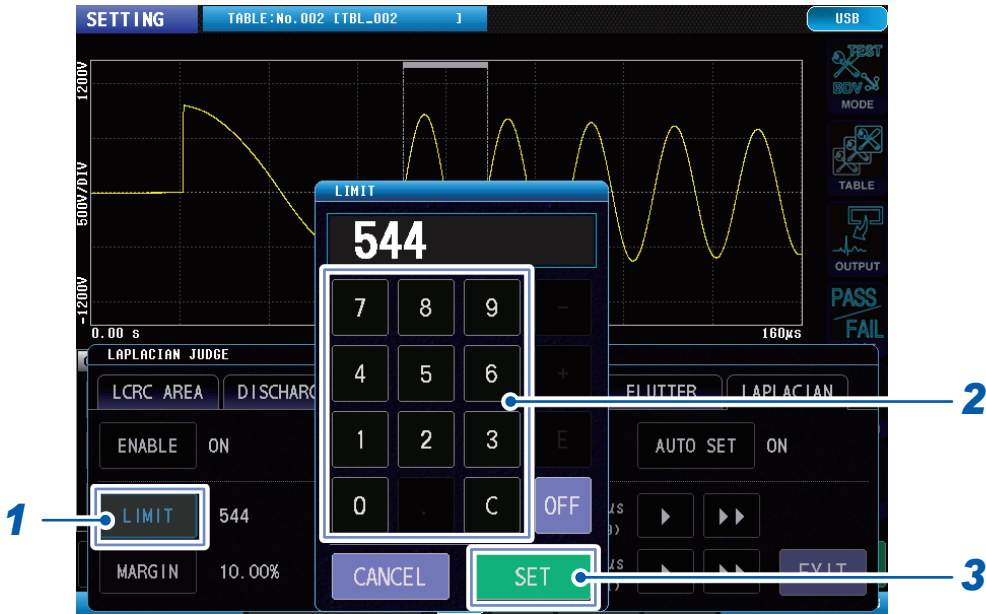

- 1 Tap [LIMIT].
- 2 Enter the secondary differential detection judgment threshold values.  
Setting range: 0 to 999,999 (resolution: 1)

OFF	Laplacian value operations are implemented, but judgments are not.
-----	--

- 3 Tap [SET] to confirm.

### Setting the secondary differential detection judgment areas

(Measurement screen) [MODE] > [SETTING] > [JUDGE] > [LAPLACIAN]

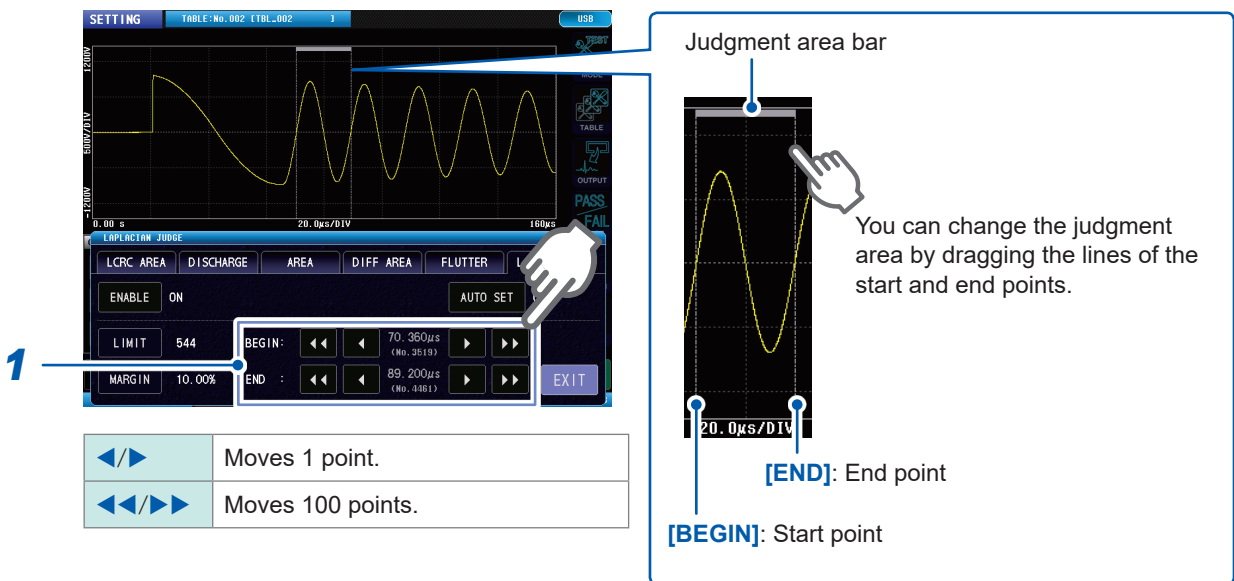

	Moves 1 point.
	Moves 100 points.

- 1 Set the start and end points for the judgment area.

## Waveform judgment area and judgment threshold value automatic settings functions

Waveform judgment areas and judgment threshold values are set automatically by the instrument based on the waveform and variability at the set voltage during voltage calibration so as to optimize judgment settings for waveform judgment functions.

This function can be set individually using the next judgment function. The judgment threshold values and judgment areas for the enabled judgment functions are set automatically during voltage calibration.

- Surface area comparison judgments **[AREA]**
- Differential surface area comparison judgments **[DIFF AREA]**
- Flutter detection judgments **[FLUTTER]**
- Secondary differential detection judgments **[LAPLACIAN]**

Each judgment function sets threshold values by adding the result of multiplying the average measured value by the margin rate to the variability exhibited by each measured value during voltage calibration.

### Enabling waveform judgment area automatic settings functions

(Measurement screen)

**[MODE]** > **[SETTING]** > **[JUDGE]** > **[AREA]**, **[DIFF AREA]**, **[FLUTTER]**, **[LAPLACIAN]**

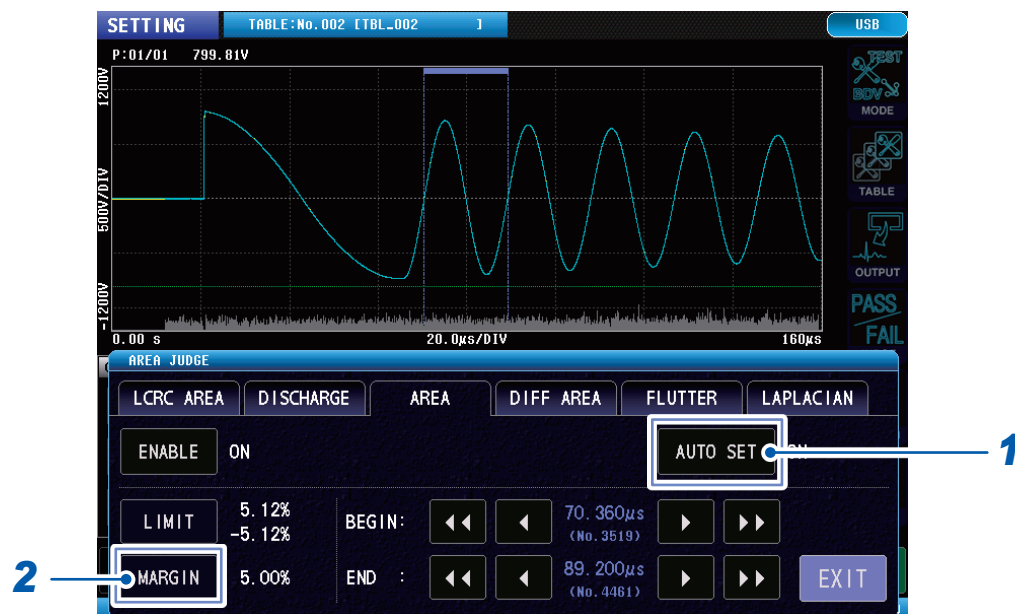

**1** Tap **[AUTO SET]**, and turn **[ON]** the auto settings function.

**2** Tap **[MARGIN]** and set the margin rate to add to the judgment threshold.  
 Setting range: LC, RC, FLUTTER, LAPLACIAN: 0.00% to 999.99% (resolution: 0.01%)  
 AREA, DIFF AREA: 0.00% to 99.99% (resolution: 0.01%)

## 5.4 Discharge Judgments (When Incorporating Model ST9000)

Noise manifesting at a fixed level in the overall waveform among the high-frequency components manifesting in the test waveform is eliminated, and only the amount of the partial discharge components manifesting locally are sampled and judged.

Discharge judgments are enabled only when the Model ST9000 Discharge Detection Upgrade (optional when shipped from factory) has been incorporated.

### IMPORTANT

Discharge detection upgrade eliminates simple noise such as flutter and Laplacian operations that are difficult to separate using primary and secondary differential operations using filtering. This way, you can detect the partial discharge components with high precision.

### Discharge judgment algorithm (when judgments are AUTO)

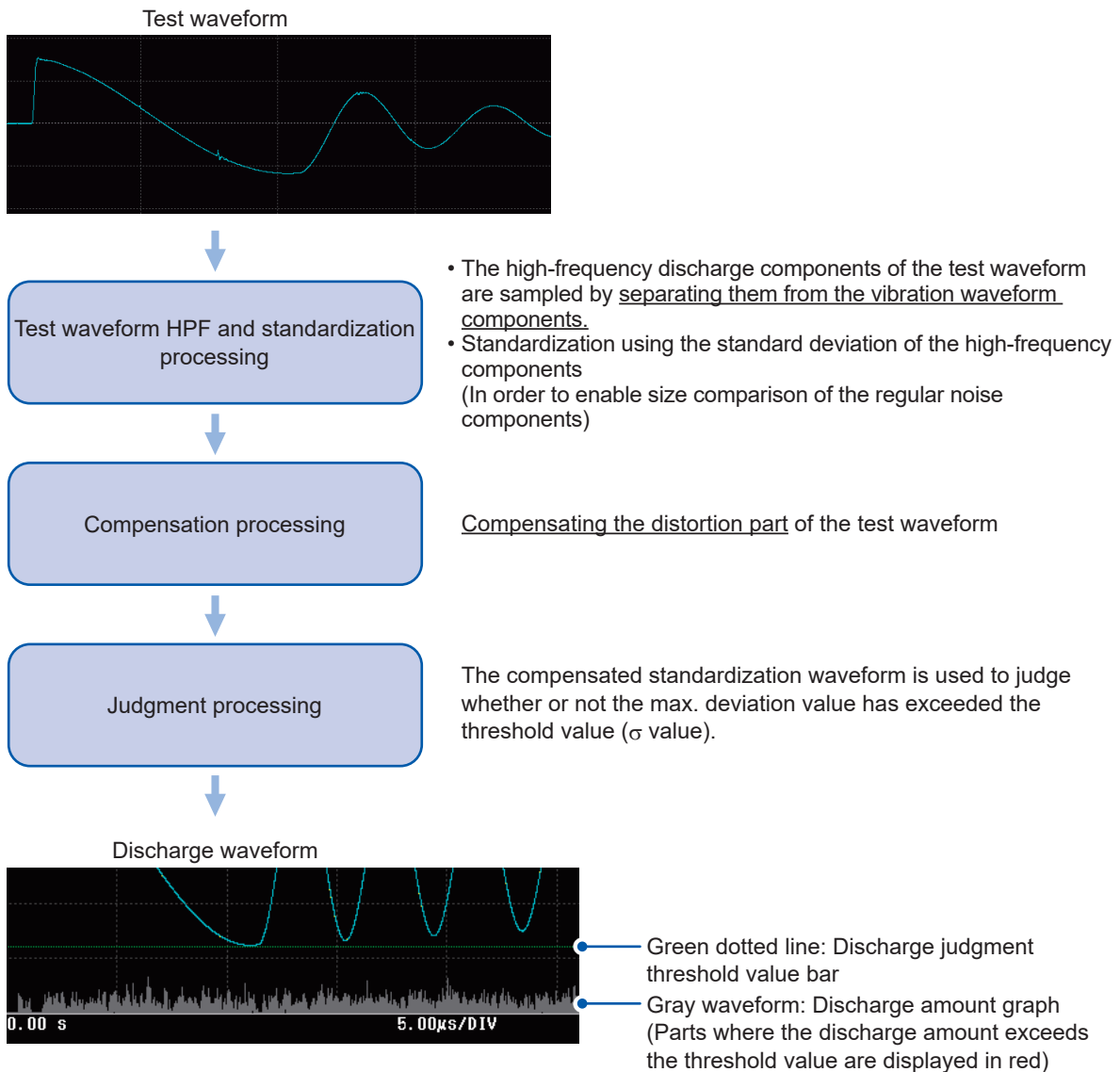

### IMPORTANT

The Discharge Detection Upgrade calculates the internal coefficient, etc., used for judgments during voltage calibration. Consequently, make sure to set the discharge judgment method before implementing voltage calibration.

If voltage calibration is not implemented, the discharge amount is not calculated even if the judgment setting is other than OFF.

## Discharge judgment methods [DISCHARGE]

(Measurement screen) [MODE] > [SETTING] > [JUDGE] > [DISCHARGE]



- 1 Tap [ENABLE], and turn [ON] the discharge judgment methods.

<b>OFF</b>	Disables the Discharge Detection Upgrade.
<b>FIXED</b>	Compares the amount of the discharge component of the master waveform and the amount of the discharge component of the test waveform.
<b>AUTO</b>	Calculates variations in the high-frequency component that appears in test waveforms as the standard deviation ( $\sigma$ ). Discharges will be detected based on whether the deviation exceeds a fixed amount due to a sudden increase in the high-frequency component due to discharge.

### IMPORTANT

If the discharge judgment method is AUTO, suitable filtering is automatically selected according to the response waveform of the conforming workpiece by implementing voltage calibration. The discharge judgment method AUTO has a higher discharge judgment performance than FIXED, so normally make sure to select the AUTO setting. If using a special workpiece that emits a greatly different response waveform than normal, it may be difficult to render judgments when the discharge judgment method is AUTO. In such cases, set the discharge judgment method to FIXED.



## Threshold value of the test waveform discharge amount over the master waveform discharge amount

When the judgment method is **[FIXED]**

(Measurement screen) **[MODE]** > **[SETTING]** > **[JUDGE]** > **[DISCHARGE]**

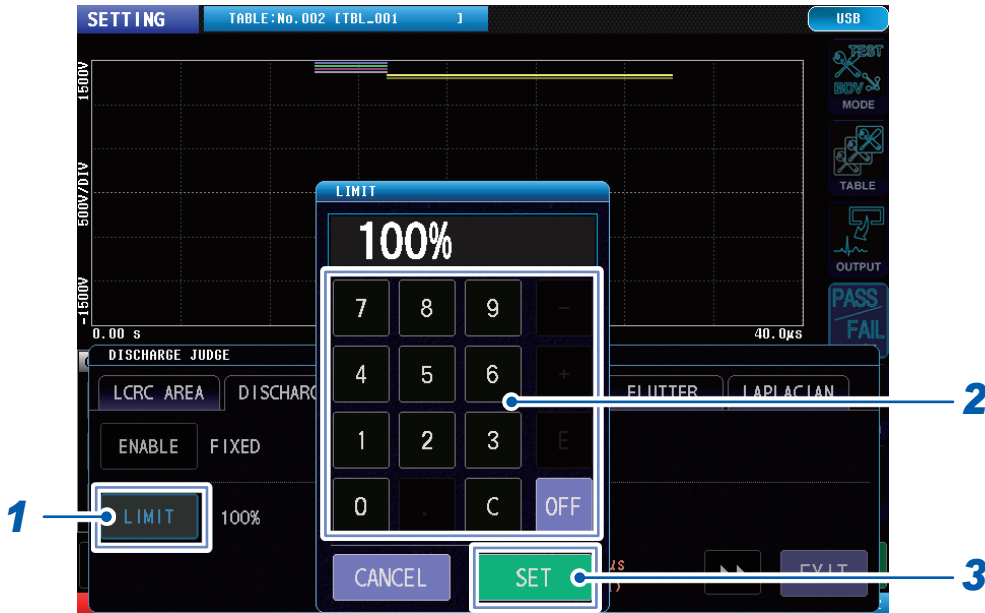

**1** Tap **[LIMIT]**.

**2** Enter the threshold value of the test waveform discharge amount over the master waveform discharge amount.

Settings range: 0% to 999% (resolution: 1)

**OFF** Discharge amount operations are implemented, but judgments are not.

**3** Tap **[SET]** to confirm.

### IMPORTANT

- When the threshold value is 100%, the discharge amount has the same threshold value as the master waveform discharge value.
- When the threshold value is 200%, the discharge amount has double the threshold value of the master waveform discharge value.

## Deviation threshold value of the test waveform discharge amount

When the judgment method is [AUTO]

(Measurement screen) [MODE] > [SETTING] > [JUDGE] > [DISCHARGE]



- 1 Tap [LIMIT].
- 2 Enter the deviation threshold value of the test waveform discharge amount.  
Setting range:  $3\sigma$  to  $100\sigma$  (resolution: 1)

▲	Increases by 1.
▼	Decreases by 1.
C	Sets to the default values.
OFF	Discharge amount operations are implemented, but judgments are not.

### IMPORTANT

- Individual points' high-frequency components are standardized using the standard deviation of the entire waveform's high-frequency component and converted to deviations. This process makes it unnecessary to set thresholds for most workpieces.
- In the absence of any discharges, the deviation for the points will fall within a fixed area.
- In the event of a discharge, the magnitude of the high-frequency component will increase during the discharge, causing the deviation for that point to increase.
- The instrument automatically corrects internally for a certain amount of variation in workpiece L values and applied voltages.
- If a different type of workpiece is measured, or if the waveform changes for another reason, for example due to a short-circuit in the workpiece, the instrument may detect a discharge even though no discharge has occurred.

## Setting the discharge amount judgment area

Sets the extend of the the response waveform for the discharge judgment to target.  
Shorten the judgment area to reduce the operations time.

(Measurement screen) [MODE] > [SETTING] > [JUDGE] > [DISCHARGE]

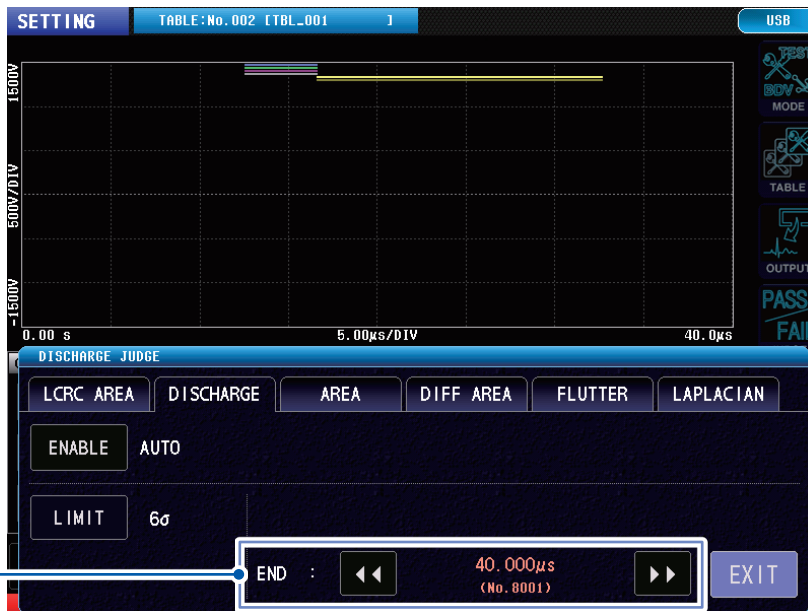

### 1 Set the end point for the judgment area.

Setting range: 1001 points to 8001 points (resolution: 1000 points)

◀◀	Decreases by 1000.
▶▶	Increases by 1000.

#### IMPORTANT

Set the settings range so that the vibration waveform of the self-resonant area includes at least 4 periods. If the settings range is too narrow, the discharge judgment will always be FAIL.

## 6.1 Overview

Calls the master waveform that has been set using test conditions settings mode, and tests the workpiece to be tested.

The text results are output to the screen, communications, and external control terminal (EXT. I/O).

### Operations flowchart in test mode

In test mode, select the master waveform and implement the test, by using the operations procedure as shown in the diagram.

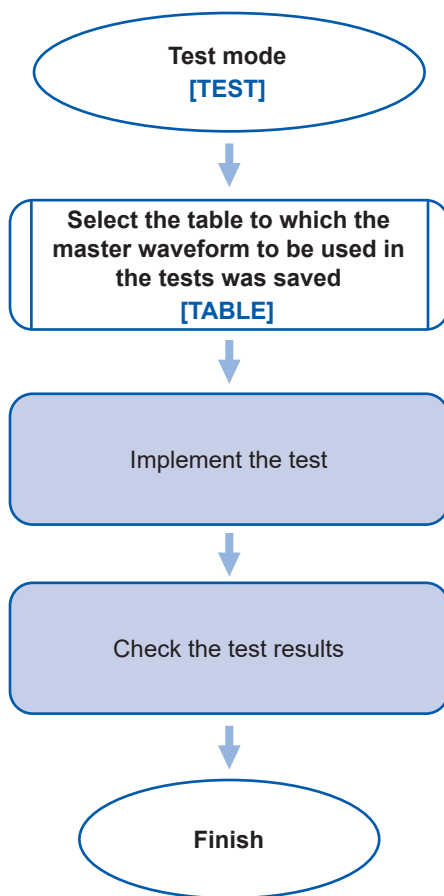

## Screen configuration

### Measurement screen

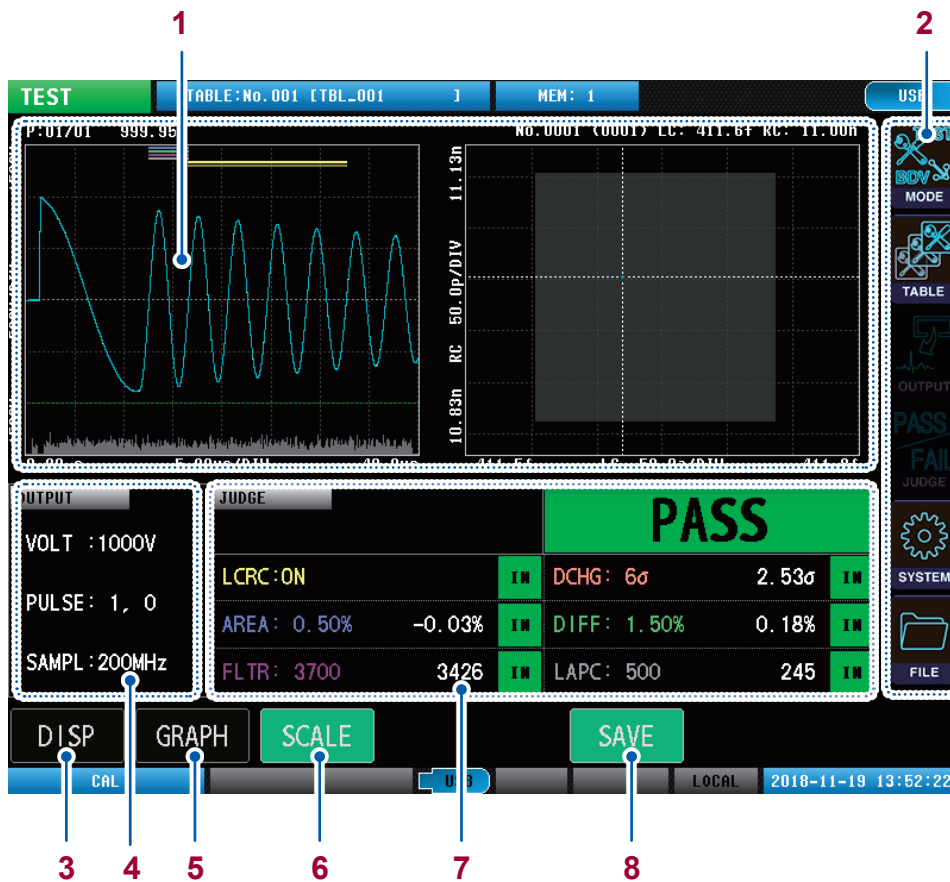

<b>1</b>	Graph display	Displays the waveform graph and the LC and RC graph. Reference: "Graph display (display graph switching)" (p. 79)
<b>2</b>	Menu icons	<b>[MODE]</b> : "2.4 Select Measuring Mode" (p. 18) <b>[TABLE]</b> : "3.2 Current Table Selection" (p. 29) <b>[SYSTEM]</b> : "9 System Settings" (p. 125) <b>[FILE]</b> : "12 USB Host" (p. 165)
<b>3</b>	<b>[DISP]</b>	Switches the graph displayed onscreen. <b>[WAVE]</b> : Waveform graph <b>[LCRC]</b> : LC and RC graph <b>[WAVE&amp;LCRC]</b> : Waveform graph + LC and RC graph <b>[RESULT]</b> : Advanced judgment results display
<b>4</b>	Test conditions settings display	Displays the settings for the applied voltage, number of pulses, and sampling frequency.
<b>5</b>	<b>[GRAPH]</b>	Sets the graph display. Reference: "8.6 Graph Display Settings" (p. 112)
<b>6</b>	<b>[SCALE]</b>	Auto-scales the LC and RC graph. Reference: "LC and RC graph scale settings" (p. 115)
<b>7</b>	Judgment results display	Displays the judgment threshold value settings and the judgment results.
<b>8</b>	<b>[SAVE]</b>	Saves the test results to USB memory. Reference: "12 USB Host" (p. 165)

## Graph display (display graph switching)

### Waveform graph display

Displays the waveform graph only.

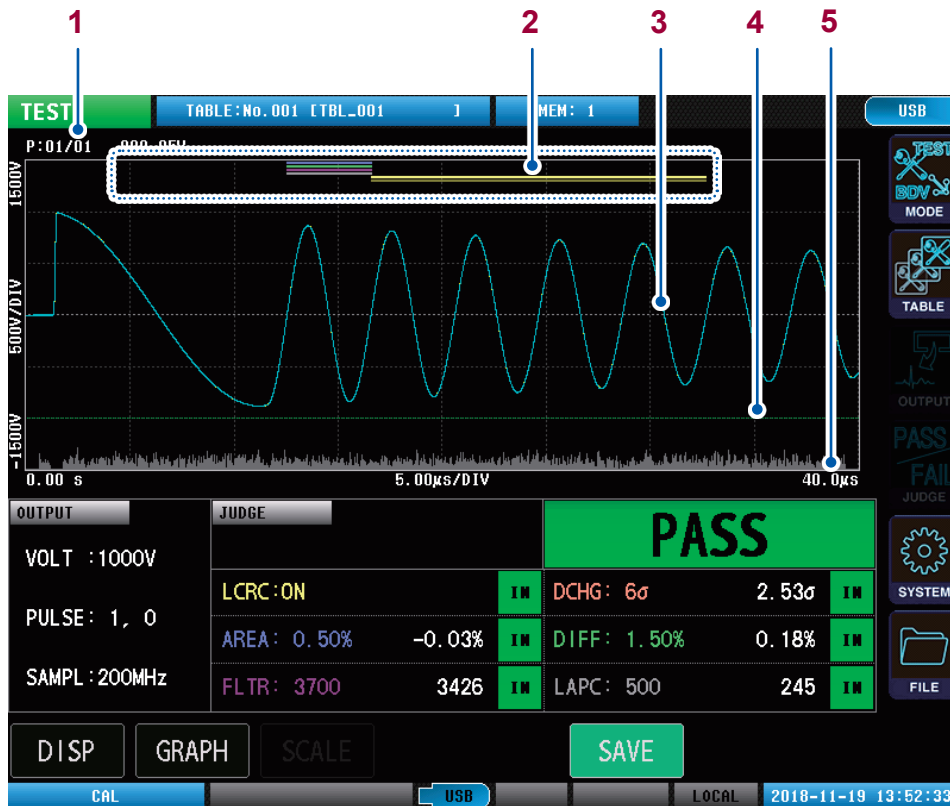

1	Number of applied pulses and peak voltage display	[P:XX/XX]: Number of pulses that have been applied/Total number of pulses [xxxV]: Max. peak voltage value of the response waveform
2	Waveform judgment area and LC and RC values operation range bar	Blue: AREA judgment area Green: DIFF judgment area Purple FLUTTER judgment area Gray: LAPLACIAN judgment area Yellow (x2): LC and RC value operation areas
3	Response waveform	Yellow: Master waveform Blue: Test waveform (Failures are displayed in red)
4	Discharge judgment threshold value bar	Displays the discharge judgment threshold value.
5	Discharge amount graph	Discharge amount graph (Parts where the discharge amount exceeds the threshold value are displayed in red) Note: Displayed only if the Discharge Detection Upgrade is enabled. Reference: "5.4 Discharge Judgments (When Incorporating Model ST9000)" (p. 72)

### LC and RC graph display

Displays only the LC and RC graph.

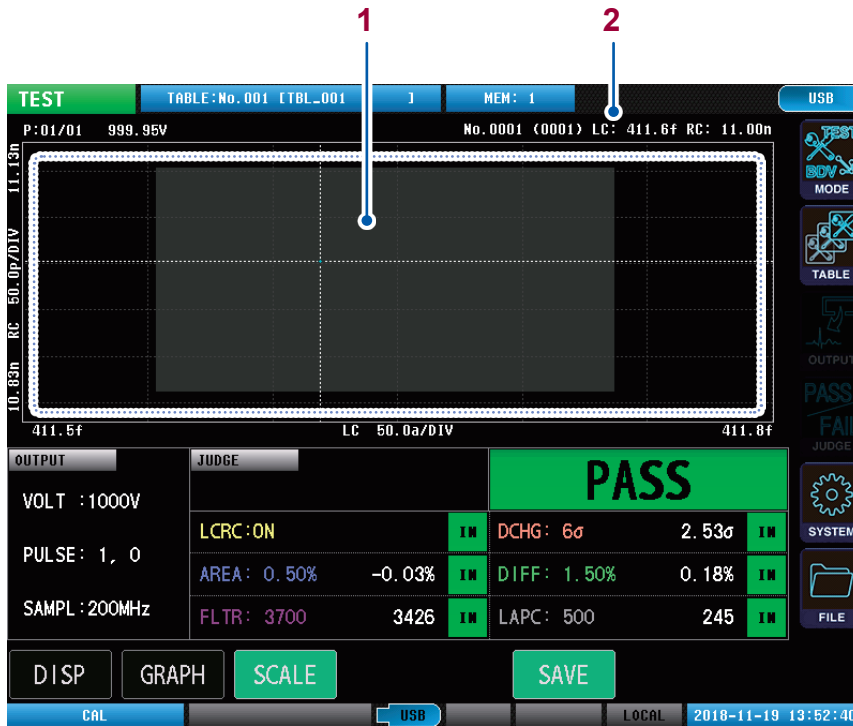

<b>1</b>	LC and RC graph	Blue dots: Test LC and RC values (Failures displayed in red) Gray (solid): LC and RC values PASS judgment area
<b>2</b>	LC and RC cursor values	<b>[No.XXX, (XXX)]</b> : Cursor value test number, (total number of LC and RC values) <b>[LC]/[RC]</b> : LC and RC values presently selected by the cursor

**IMPORTANT**  
Tap the LC and RC values on the graph while multiple pulses are applied, to move the cursor and check each LC and RC value.

### Display waveform graph and the LC and RC graph

Displays the waveform graph and the LC and RC graph simultaneously.

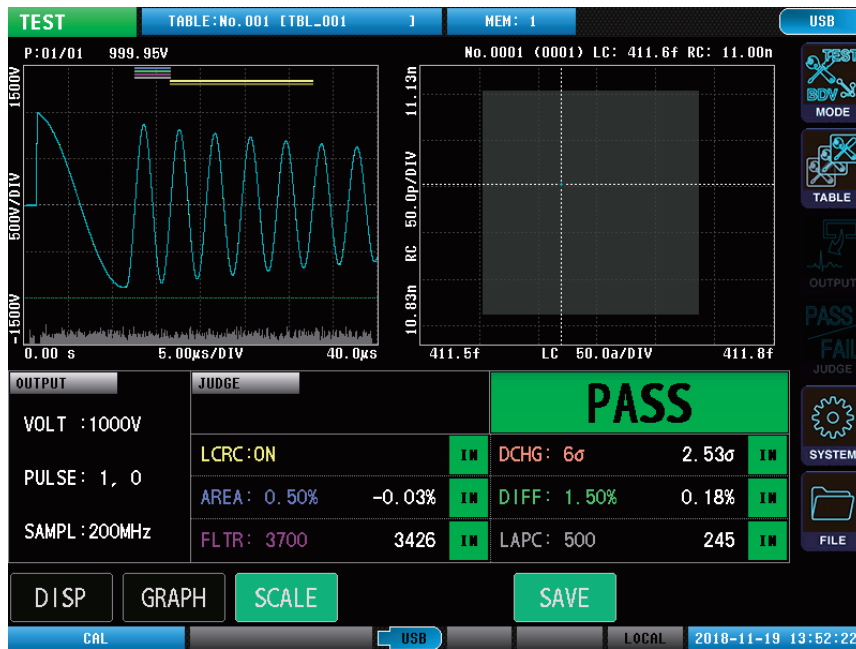



### Expanded judgment results

Expands and displays the judgment results.

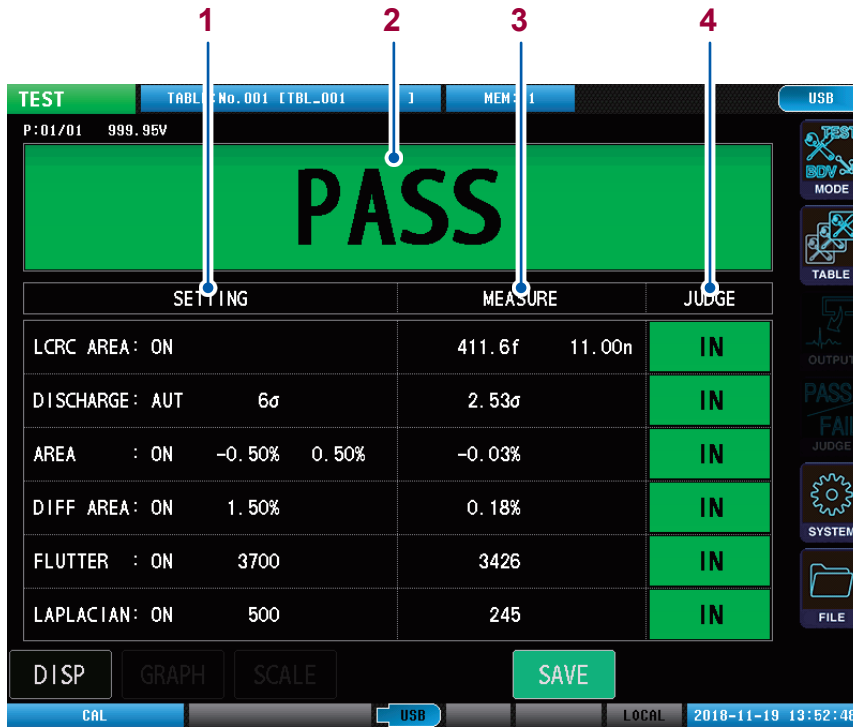

Tap the LC and RC values judgments area to check the LC and RC values for each pulse.

<b>1</b>	Judgment settings	Displays the set values of the judgment functions.
<b>2</b>	Total judgment results	Displays the total judgment results.
<b>3</b>	Judgment values	Displays the judgment operation values of the judgment functions.
<b>4</b>	Judgment results	Displays the judgment results of the judgment functions.

## Instrument status display and error display

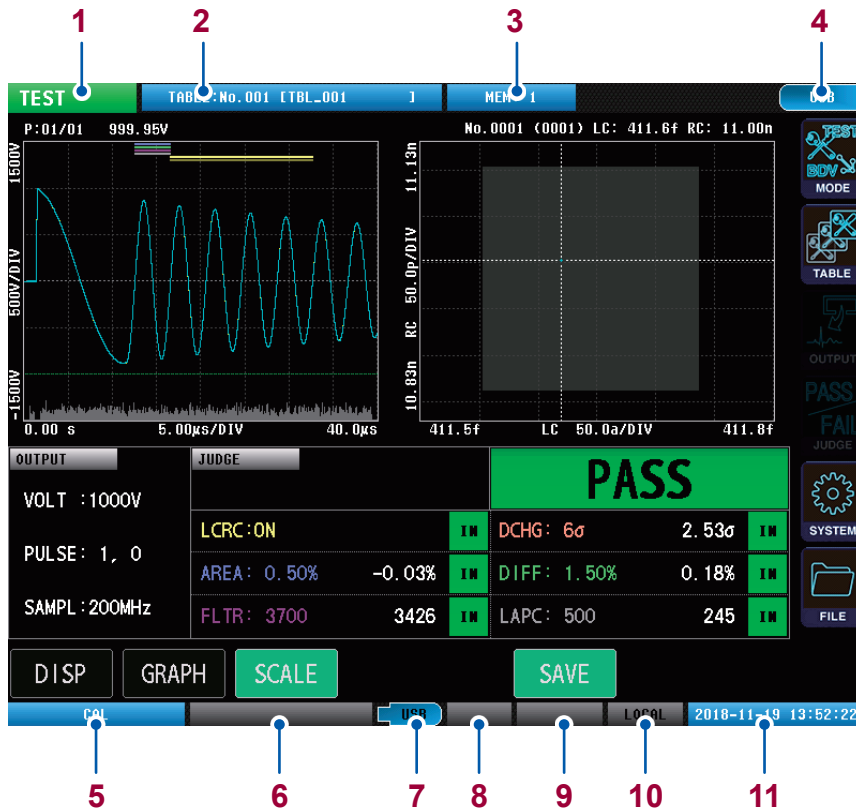

<b>1</b>	Present measurement mode display	<b>NONE</b>	Voltage application disabled mode
		<b>SETTING</b>	Test conditions settings mode
		<b>TEST</b>	Test mode
		<b>BDV</b>	BDV mode
<b>2</b>	Current table display	Displays the number and table name of the table presently being used.	
<b>3</b>	Information saved to internal memory	<b>MEM: 7</b>	Number of data saved to internal memory
<b>4</b>	Communications interface settings display	Displays the settings for the communications interface presently being used.	
<b>5</b>	Voltage calibration status display	<b>UNCAL</b>	Voltage calibration not implemented (Master waveform not acquired)
		<b>CAL</b>	Voltage calibration implemented (Master waveform acquired)
<b>6</b>	Test status display	Displays the test status. Reference: "14.3 Error Display" (p. 214)	
<b>7</b>	USB memory status display	<b>USB</b> (Gray)	USB memory not connected
		<b>USB</b> (Blue)	USB memory connecting
		<b>USB</b> (Red)	Accessing USB
<b>8</b>	Double action status display	(No display)	Double action function OFF
		<b>READY</b> (Green)	<b>START</b> button enabled
		<b>READY</b> (Gray)	<b>START</b> button disabled
<b>9</b>	Interlock status display	(No display)	Interlock function OFF
		<b>INTERLOCK</b> (Red)	Interlock engaged
		<b>INTERLOCK</b> (Gray)	Interlock canceled
<b>10</b>	Communications status display	<b>REMOTE</b>	Remote status
		<b>LOCAL</b>	Local status
<b>11</b>	Date and time display	Displays the date and time that has been set in the instrument. Note: The background is displayed in red while writing to the settings internal memory.	

## 6.2 Checking Test Start and Test Results

Press the instrument **START** button to implement the test. (You can start the test from either communications or external control terminal as well.)

When a test finishes, the test results are output to the screen and external control terminal (EXT.I/O). Test results can also be acquired using communications.

See “6.1 Overview” (p. 77) for the display details of the test results onscreen.

### ⚠ CAUTION



If the **OUTPUT** lamp is red, do not touch the test lead clip or workpiece. There is no adverse impact on the human body but electric shock will occur.

#### PASS judgment example

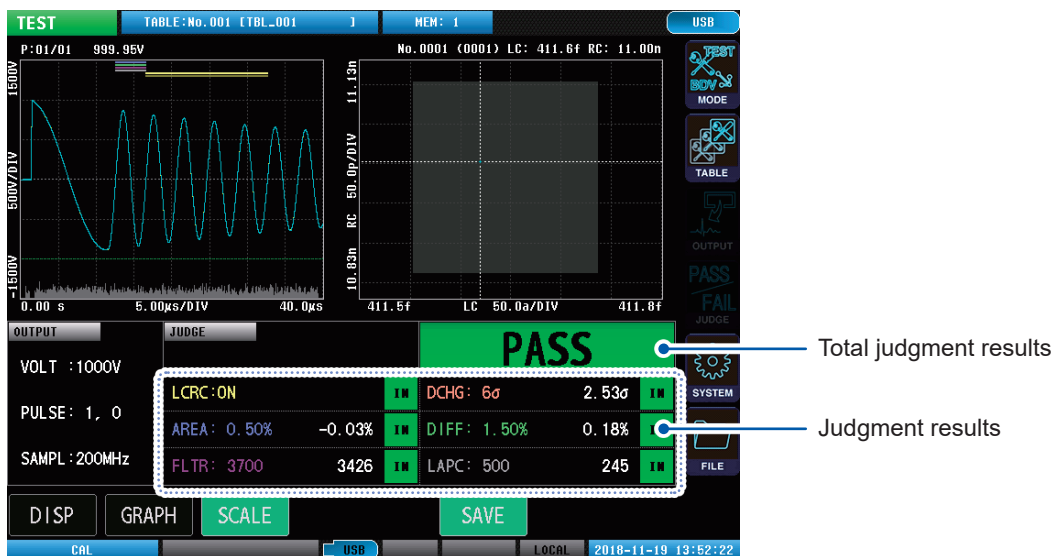

#### FAIL judgment example

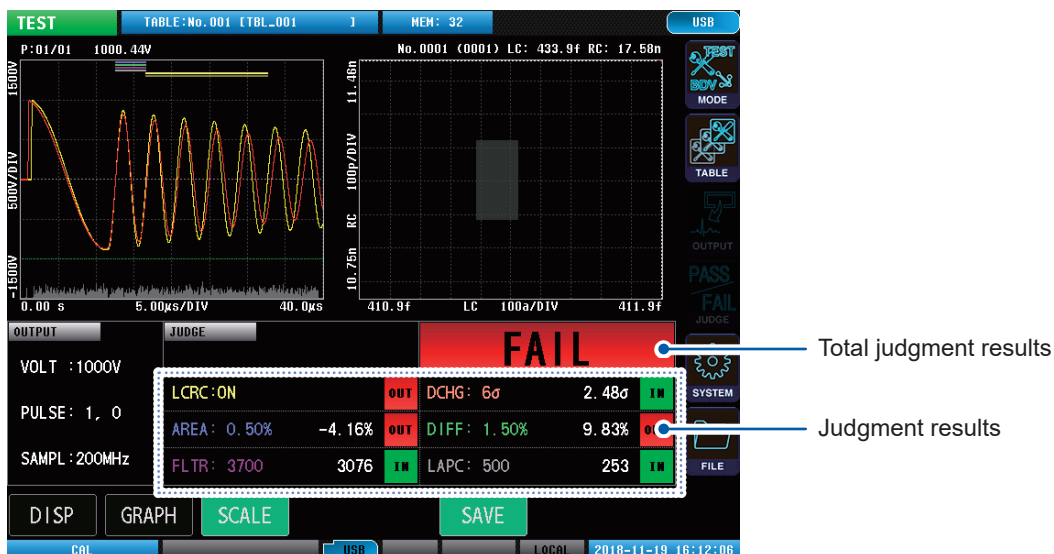

#### IMPORTANT

To cancel a test that is underway, press the **STOP** button.

# 7

# Break down voltage test (BDV)

## 7.1 Overview

Implement the test while gradually increasing the voltage applied to the test object, and evaluate the voltage at which the insulation starts to break down from the waveform LC and RC values, discharge amount, and waveform surface area, etc.

### Operations flowchart in break down voltage test mode

Break down voltage test mode evaluates the break down voltage, by using the operations procedure as shown in the diagram.

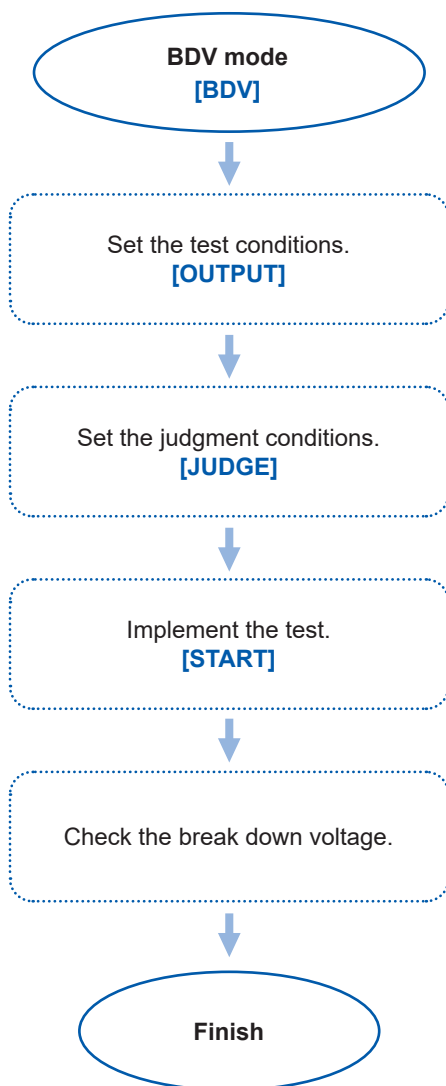

## Screen configuration

### Measurement screen

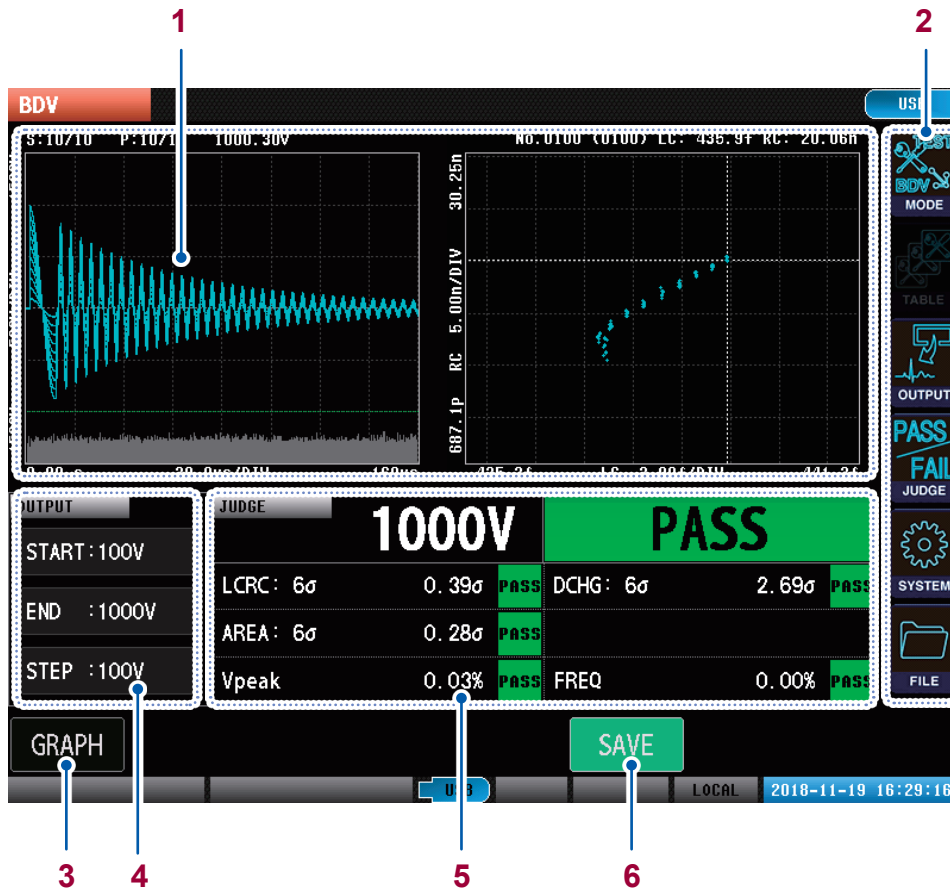

1	Graph display	Displays the waveform graph and the LC and RC graph. Reference: “Graph display (display graph switching)” (p. 37)
2	Menu icons	<p>[MODE]: “2.4 Select Measuring Mode” (p. 18)</p> <p>[OUTPUT]: “7.3 Setting the Test Conditions” (p. 90)</p> <p>[JUDGE]: “7.4 Setting Dielectric Break down Judgment Conditions” (p. 95)</p> <p>[SYSTEM]: “9 System Settings” (p. 125)</p> <p>[FILE]: “12 USB Host” (p. 165)</p>
3	[GRAPH]	Sets the graph display. Reference: “8.6 Graph Display Settings” (p. 112)
4	Test conditions settings display	Displays the settings for application start voltage, max. voltage, and voltage rise width.
5	Judgment results display	Displays the test results and the individual judgment results. Reference: “7.2 Checking Test Start and Test Results” (p. 89)
6	[SAVE]	Saves the test results to USB memory. Reference: “12 USB Host” (p. 165)

## Graph display

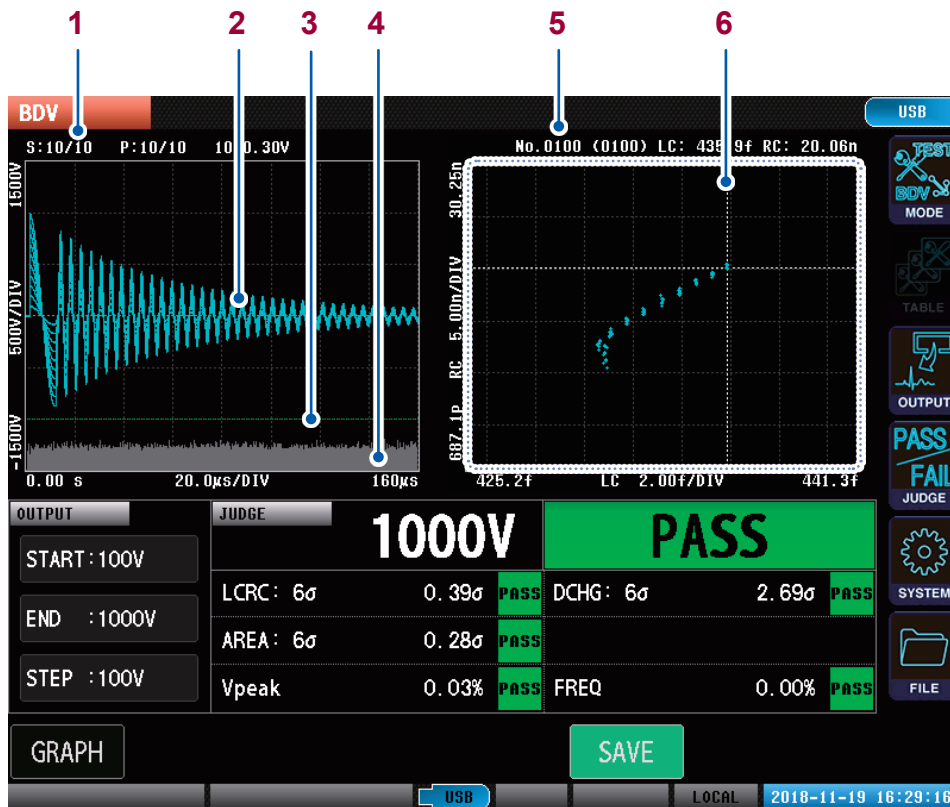

1	Number of steps, number of applied pulses, and peak voltage value display	[S:XXX, (XXX)]: Present number of steps/total number of steps [P:XXX]: Present number of pulse applications/total number of pulses [xxxV]: Response waveform peak voltage
2	Response waveform	Blue: PASS waveform Red: FAIL waveform
3	Discharge judgment threshold value bar	Discharge judgment threshold value
4	Discharge amount graph	Discharge amount graph (Parts where the discharge amount exceeds the threshold value are displayed in red)
5	LC and RC cursor values	[No. XXX, (XXX)]: Cursor value test number, (total number of LC and RC values) [LC]/[RC]: LC and RC values presently selected by the cursor
6	LC and RC graph	Blue dots: Test LC and RC values

### IMPORTANT

Tap the LC and RC values on the graph to move the cursor and check each LC and RC value.

### Instrument status display and error display

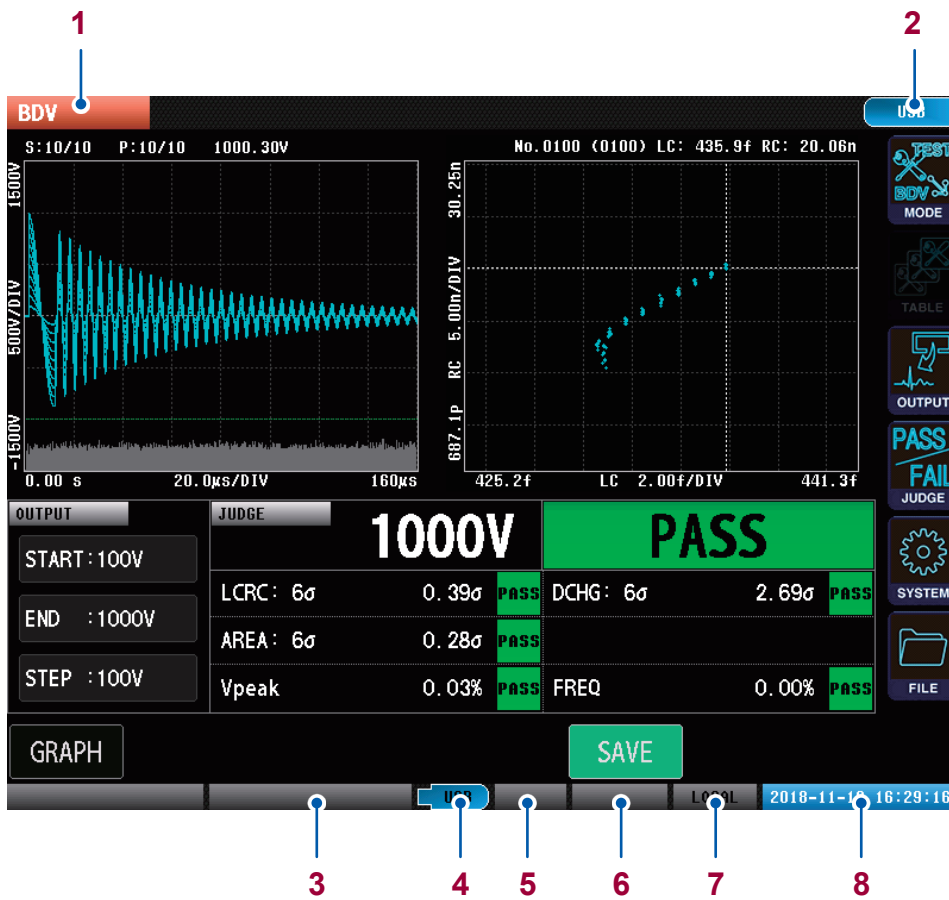

1	Present measurement mode display	NONE	Voltage application disabled mode
		SETTING	Test conditions settings mode
		TEST	Test mode
		BDV	BDV mode
2	Communications interface settings display	Displays the settings for the communications interface presently being used.	
3	Test status display	Displays the test status. Reference: “14.3 Error Display” (p. 214)	
4	USB memory status display	USB (Gray)	USB memory not connected
		USB (Blue)	USB memory connecting
		USB (Red)	Accessing USB
5	Double action status display	(No display)	Double action function OFF
		READY (Green)	START button enabled
		READY (Gray)	START button disabled
6	Interlock status display	(No display)	Interlock function OFF
		INTERLOCK (Red)	Interlock engaged
		INTERLOCK (Gray)	Interlock canceled
7	Communications status display	REMOTE	Remote status
		LOCAL	Local status
8	Date and time display	Displays the date and time that has been set in the instrument. Note: The background is displayed in red while writing to the settings internal memory.	

## 7.2 Checking Test Start and Test Results

Press the instrument **START** button to implement the test. (You can start the test from either communications or external control terminal as well.)

When a test finishes, the test results are output to the screen, communications, and external control terminal (EXT. I/O).

**IMPORTANT**  
 If any of the judgment results are FAIL, it views that dielectric breakdown as having started and the test ends at that point in time.  
 If the judgment results are all PASS, implement testing until max. voltage is reached.

### PASS judgment example

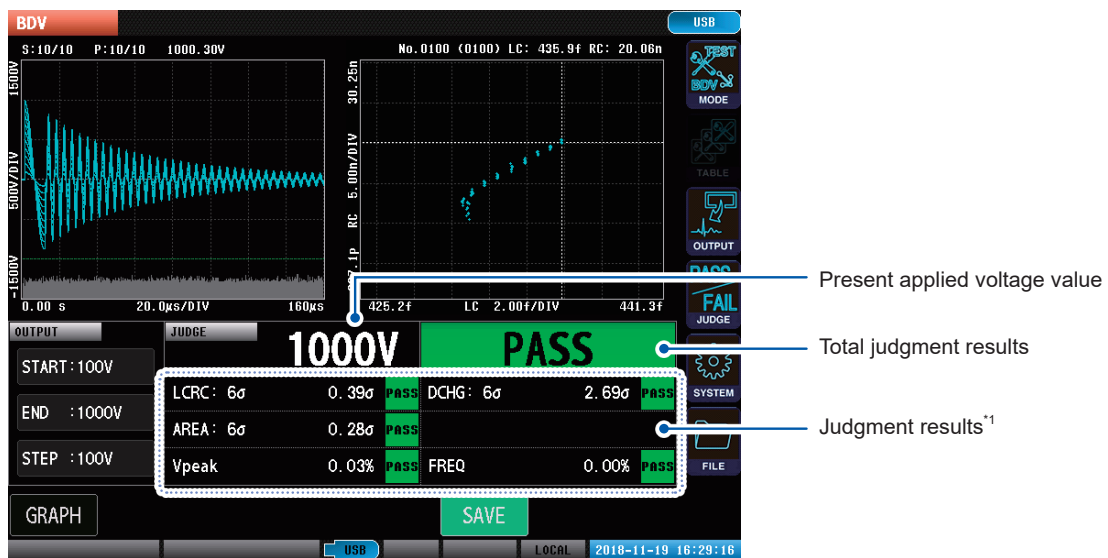

### FAIL judgment example (discharge FAIL at 2000 V)

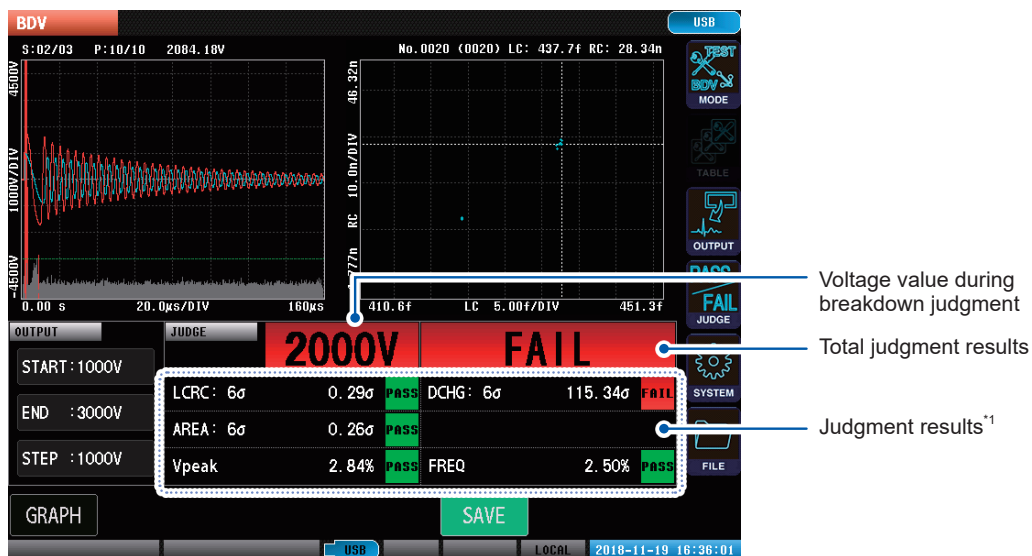

\*1: LCRC: XXσ Max. deviation of LC and RC values  
 DCHG: XXσ Max. deviation of discharge amount  
 AREA: XXσ Max. deviation of waveform surface area value  
 Vpeak XX% Max. misalignment width from standard of the peak voltage value  
 FREQ XX% Max. misalignment value from standard of the vibration frequency

Note: The values displayed are the judgment values and results of the present voltage values



## 7.3 Setting the Test Conditions

Sets the application voltage, number of pulses applied per voltage, and the sampling frequency.

### Applied voltage settings

Sets the start voltage, max. voltage, and voltage rise width.

Evaluate the voltage at which isolation break down starts by implementing impulse tests while increasing the voltage for each voltage rise width from the application start voltage that has been set to the max. application voltage.

<p><b>START</b> (Application start voltage)</p>	<p>▶ Sets the application start voltage. Starts application from the set voltage. Settings range: ST4030: 100 V to 3300 V (resolution: 10 V) ST4030A: 100 V to 4200 V (resolution: 10 V)</p>
<p><b>END</b> (Max. applied voltage)</p>	<p>▶ Sets the max. applied voltage. Implement tests while increasing the voltage to the set voltage. Settings range: ST4030: 100 V to 3300 V (resolution: 10 V) ST4030A: 100 V to 4200 V (resolution: 10 V) Note: If isolation break down is identified before the max. voltage is reached, the test ends at that time.</p>
<p><b>STEP</b> (Voltage rise width)</p>	<p>▶ Sets the voltage rise width. Settings range: ST4030: 10 V to 3200 V (resolution: 10 V) ST4030A: 10 V to 4100 V (resolution: 10 V)</p>

(Measurement screen) **[MODE]** > **[BDV]** > **[OUTPUT]**

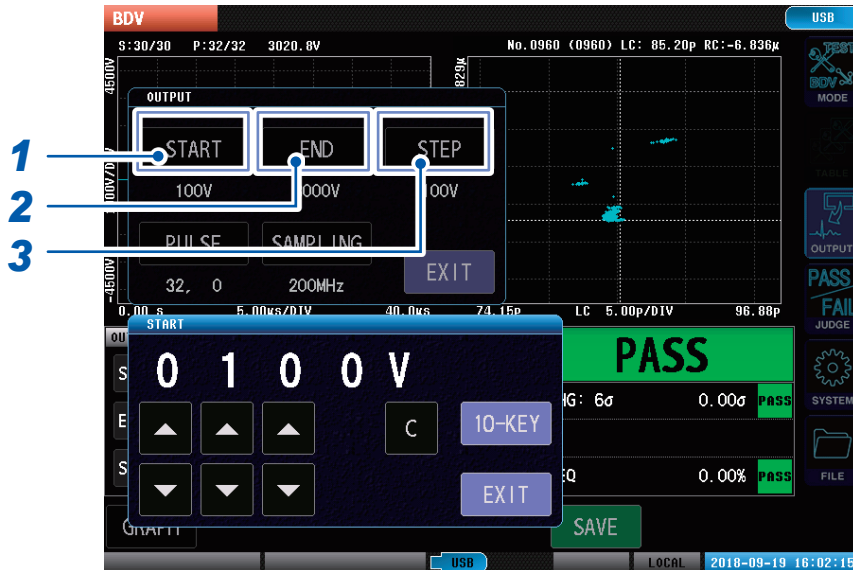

- 1** Tap **[START]**, and set the start voltage.  
Settings range: ST4030: 100 V to 3300 V (resolution: 10 V)  
ST4030A: 100 V to 4200 V (resolution: 10 V)
- 2** Tap **[END]**, and set the max. voltage.  
Settings range: ST4030: 100 V to 3300 V (resolution: 10 V)  
ST4030A: 100 V to 4200 V (resolution: 10 V)
- 3** Tap **[STEP]**, and set the voltage rise width.  
Settings range: ST4030: 10 V to 3200 V (resolution: 10 V)  
ST4030A: 10 V to 4100 V (resolution: 10 V)

## Number of applied pulses settings

Sets the number of test pulses to be used in the tests and the number of degaussing pulse applications to eliminate magnetic fields from the workpiece.

Reference: “4.3 Number of Applied Pulses” (p. 42)

<p><b>PULSE NUM</b> (Number of test pulses applied)</p>	<p>▶ Sets the number of test pulses to be applied. <u>The test pulses are applied continuously for the number of times that have been set respectively in each voltage step.</u></p>
<p><b>DEGAUSS</b> (Number of degaussing pulses applied)</p>	<p>▶ Sets the number of degaussing pulses to be applied. <u>Degaussing pulses are applied continuously for the number of times set at the start of BDV testing. (Degaussing pulse waveforms are not sampled or judged.)</u></p>
<p><b>PERIOD</b> (Pulse application interval)</p>	<p>▶ Sets the pulse application interval if multiple degaussing pulses and test pulses are to be applied. When multiple pulses are applied, the pulse application interval operates at or above the set time.</p>

There can be up to 32 test voltage steps max. If the voltage rise width setting is small, the test will end when 32 steps have been completed even if the max. application voltage has not been reached.

(Measurement screen) [MODE] > [BDV] > [OUTPUT]

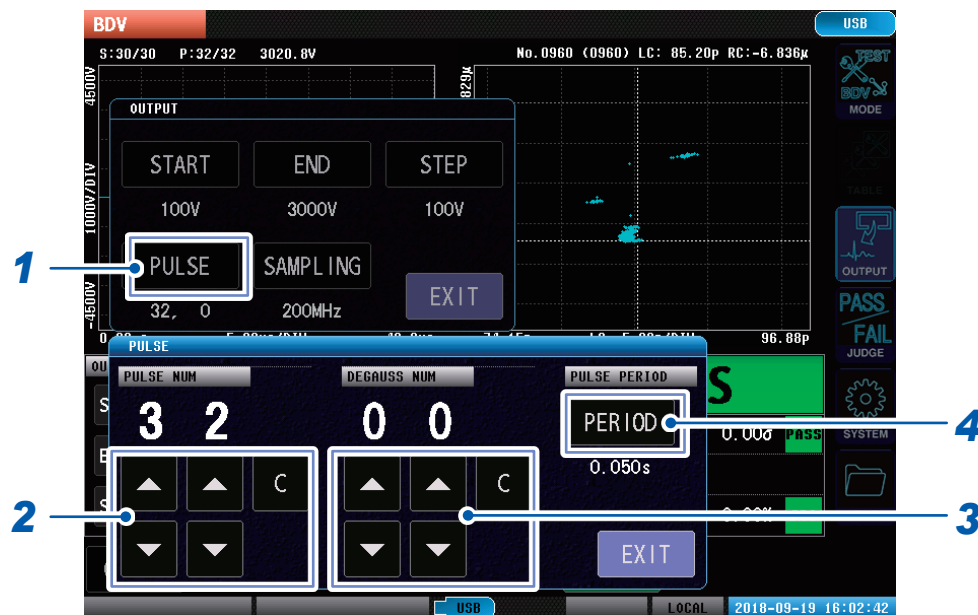

- 1 Tap [PULSE].
- 2 Set the number of test pulses to be applied.  
Setting range: 3 to 32

▲	Increases by 1.
▼	Decreases by 1.
C	Sets to the default values.

- 3 Set the number of degaussing pulses to be applied.  
Setting range: 0 to 10
- 4 Tap [Period], and set the pulse application interval.  
Setting range: 0.050 s to 1.000 s (resolution: 0.001 s)

**IMPORTANT**

Since statistical values are used in the calculation of discharge judgments, reducing the number of pulse applications will increase the magnitude of errors and may result in erroneous judgments. If you encounter this issue, either increase the LCRC and AREA judgment thresholds or set judgment to "OFF."

## Setting the sampling frequency and number of sampling data

Sets the voltage sampling frequency and the number of sampling data to be imported to the instrument.

<p><b>SAMPLING</b> (Sampling frequency)</p>	<p>▶ Sets the voltage sampling frequency. If a sufficiently long response waveform cannot be imported because the response waveform vibration period is long, you can extend the waveform to be imported by extending the sampling frequency.</p>
<p><b>RECORD LENGTH</b> (Number of sampling data)</p>	<p>▶ Sets the number of sampling data to be imported to the instrument. If there are vibration waveform parts that are unnecessary for judgment at the end of the waveform after the sampling frequency has been adjusted and the waveform length decided, you can adjust so as to exclude the unnecessary waveform parts by reducing the number of sampling data.</p>
<p><b>AUTO SET</b> (Automatic settings function for range of waveform acquisition)</p>	<p>▶ This function automatically adjusts and sets the sampling frequency and number of sampling data during voltage calibration so that the waveform acquisition range is optimal.</p>

Reference: “4.4 Sampling Frequency/Number of Sampling Data” (p. 44)

(Measurement screen) **[MODE]** > **[BDV]** > **[OUTPUT]**



**1** Tap **[SAMPLING]**.

**2** Set the sampling frequency.

Setting range: 10 MHz, 20 MHz, 50 MHz, 100 MHz, 200 MHz

◀	Increases by 1.
▶	Decreases by 1.

**3** Set the number of sampling data.

Setting range: 1001 points to 8001 points (resolution: 1000 points)

## Setting the waveform acquisition area automatically

The instrument can automatically adjust the sampling frequency and sampling data count during voltage calibration in order to optimize the waveform acquisition area.

(Measurement screen) **[MODE]** > **[BDV]** > **[OUTPUT]** > **[SAMPLING]**

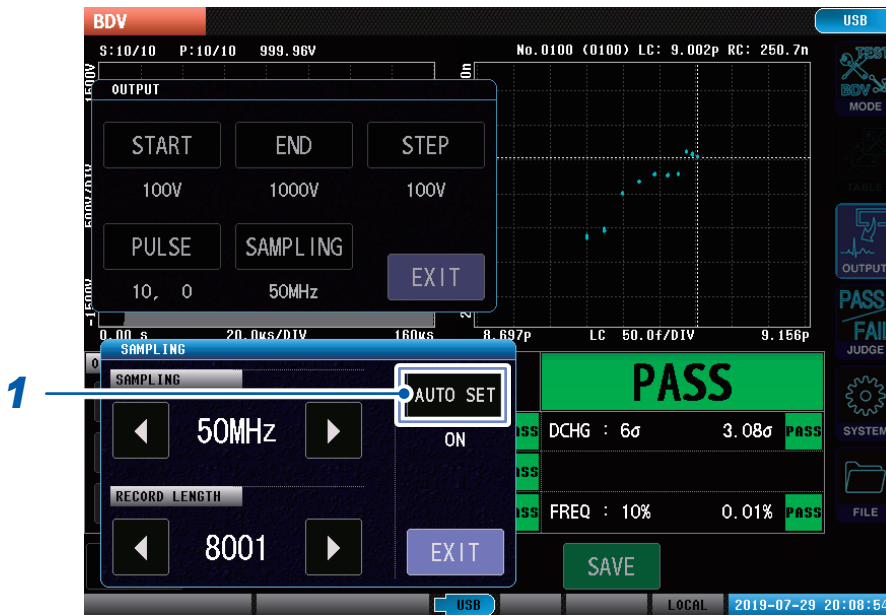

**1** Tap **[AUTO SET]**.

### IMPORTANT

The ST4030 will reduce the sampling frequency when testing insulators and measurement targets with extremely high inductance values due to the absence of zero-cross events in waveforms. If you encounter this issue, set **[AUTO SET]** to **[OFF]** and adjust the values manually.

## 7.4 Setting Dielectric Break down Judgment Conditions

Sets the conditions for judging dielectric break down from variations in the LC and RC values between multiple pulses, discharge amount, waveform surface area values, peak voltage values, and vibration frequency for each applied voltage.

### LC and RC values judgments

Judges breakdown from the variations in the LC and RC values between multiple pulses for each applied voltage.

If the variations in the LC and RC values between multiple pulses are greater than the set deviation threshold value, dielectric break down is judged to have occurred.

(Measurement screen) **[MODE]** > **[BDV]** > **[JUDGE]**



- 1 Tap **[LCRC AREA]**.
- 2 Set the deviation threshold value.

▲	Increases by 1.
▼	Decreases by 1.
C	Sets to the default values.
OFF	LC and RC values judgments are unexecuted.

## Discharge judgment

Judges breakdown from the variations in the discharge amount between multiple pulses for each applied voltage.

If the variations in the discharge amount between multiple pulses are greater than the set deviation threshold value, dielectric breakdown is judged to have occurred.

(Measurement screen) **[MODE]** > **[BDV]** > **[JUDGE]**



**1** Tap **[DISCHARGE]**.

**2** Set the deviation threshold value.

▲	Increases by 1.
▼	Decreases by 1.
C	Sets to the default values.
OFF	Discharge judgment is unexecuted.

## Waveform surface area comparison judgment

Judges breakdown from the variations in the surface area values between multiple pulses for each applied voltage.

If the variations in the surface area values between multiple pulses are greater than the set deviation threshold value, dielectric breakdown is judged to have occurred.

(Measurement screen) [MODE] > [BDV] > [JUDGE]



**1** Tap [AREA].

**2** Set the deviation threshold value.

▲	Increases by 1.
▼	Decreases by 1.
C	Sets to the default values.
OFF	Waveform surface area comparison judgment is unexecuted.



## Peak voltage value fluctuations

Discharges are detected based on variations in the first peak voltages among multiple pulses of each applied voltage.

If the amount of variability in the first peak voltages for multiple pulses exceeds the set threshold, the instrument will conclude that discharges are occurring.

(Measurement screen) **[MODE]** > **[BDV]** > **[JUDGE]**

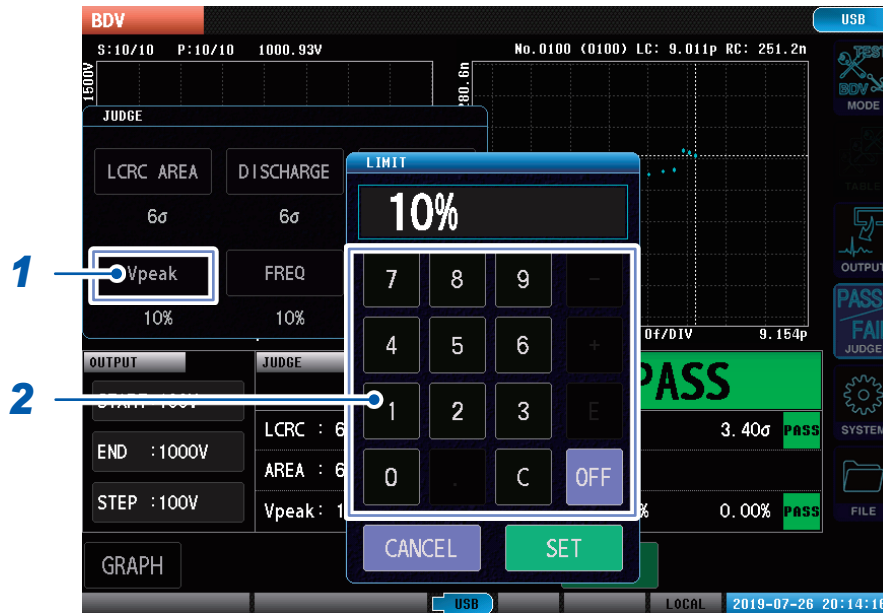

- 1** Tap **[Vpeak]**.  
The numeric keypad window will open.
- 2** Set the deviation threshold value.  
Setting range: 0% to 999%
- 3** Tap **[SET]** to confirm.

## Vibration frequency fluctuations

Discharges are detected based on variations in the vibration frequency among multiple pulses of each applied voltage.

If the amount of variability in the vibration frequency for multiple pulses exceeds the set threshold, the instrument will conclude that discharges are occurring.

(Measurement screen) **[MODE]** > **[BDV]** > **[JUDGE]**

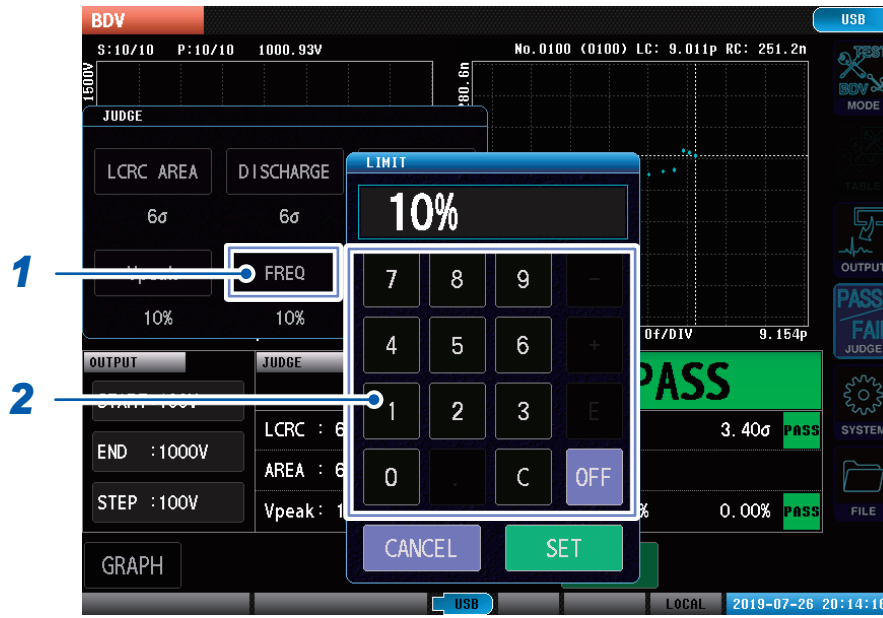

- 1** Tap **[FREQ]**.  
The numeric keypad window will open.
- 2** Set the deviation threshold value.  
Setting range: 0% to 999%
- 3** Tap **[SET]** to confirm.



## 8.1 Interlock Function

The interlock function cuts off instrument outputs by operating in tandem with external devices, etc. All instrument key operations are disabled.

If the interlock functions are enabled while the external control terminal (EXT. I/O) No. 3 pin (INTERLOCK) is OFF, the interlock function operates and the instrument outputs will be disabled.

Reference: “10 External Control (EXT. I/O)” (p. 133)

You can also set the pass code (PIN). If a pass code has been set, it is necessary to enter the code when unlocking the interlocks. Make sure not to forget your pass code.

### IMPORTANT

- Interlock functions are not disabled even if the power supply is turned OFF.
- When setting the interlock functions, set and check the pass code beforehand.

(Measurement screen) [SYSTEM] > [SYSTEM] > [INTERLOCK]



- 1 Tap [PASSCODE].  
The numeric keypad window will open.
- 2 Enter the pass code to unlock the interlocks.  
Setting range: 0 to 4 digits
- 3 Tap [SET].
- 4 Tap [INTERLOCK].

OFF	The interlock function is enabled.
ON	The interlock function is disabled.

### Operations when the interlock is enabled

If the external control terminal (EXT. I/O) INTERLOCK pin is OFF while the interlock function is enabled, the interlock is engaged, and **[INTERLOCK]** is displayed at the bottom right of the screen. The interlocks disable all screen operations, including test operations that use the **START** button. Further, starting tests using communications and external control is also disabled.

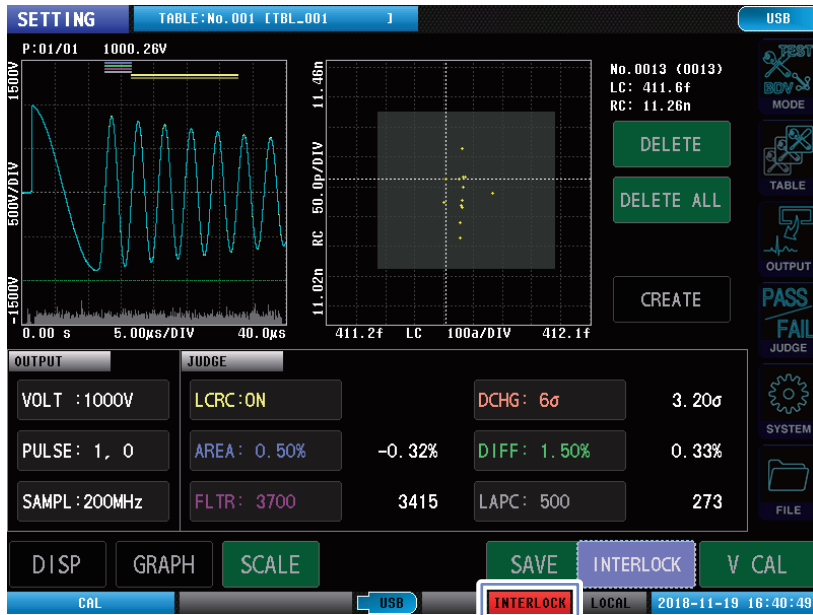

## Unlocking the interlocks

Enter the pass code that has been set, to cancel the interlocks. Make sure not to forget your pass code. If you forget the pass code, full reset to return the system to its factory settings. The default pass code setting is “0000”.

Reference: “14.2 Initializing the Instrument (Full Reset)” (p. 213)

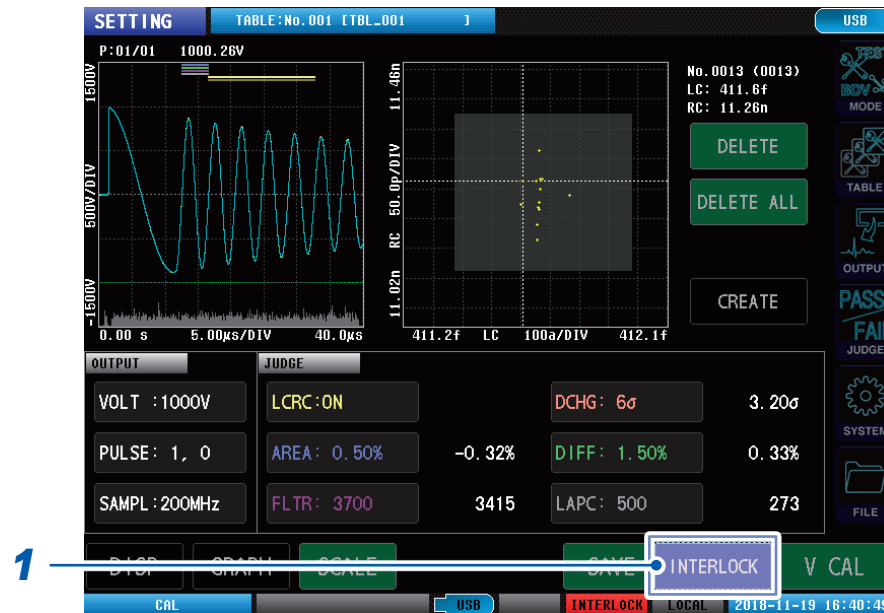

- 1 Tap [INTERLOCK].
- 2 (Setting pass code) Enter the pass code and then tap [SET].  
(Not setting pass code) Tap [SET] without entering anything.

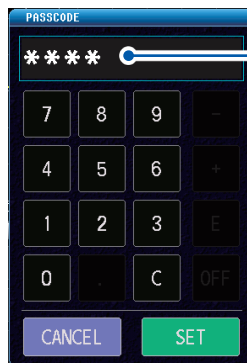

The pass code that has been entered is displayed as [\*\*\*\*].

## 8.2 Key Lock Function

The key lock function disables the instrument touch panel operations. You can also set the pass code (PIN). If a pass code has been set, it is necessary to enter the code when unlocking the key locks. Make sure not to forget your pass code.

### IMPORTANT

- The **START** button is enabled even when the key lock is on. Further, some operations are possible, such as changing the graph onscreen.
- Key lock functions are not disabled even if the power supply is turned OFF.
- When setting the key lock functions, set and check the pass code beforehand.

(Measurement screen) **[SYSTEM]** > **[SYSTEM]** > **[KEYLOCK]**

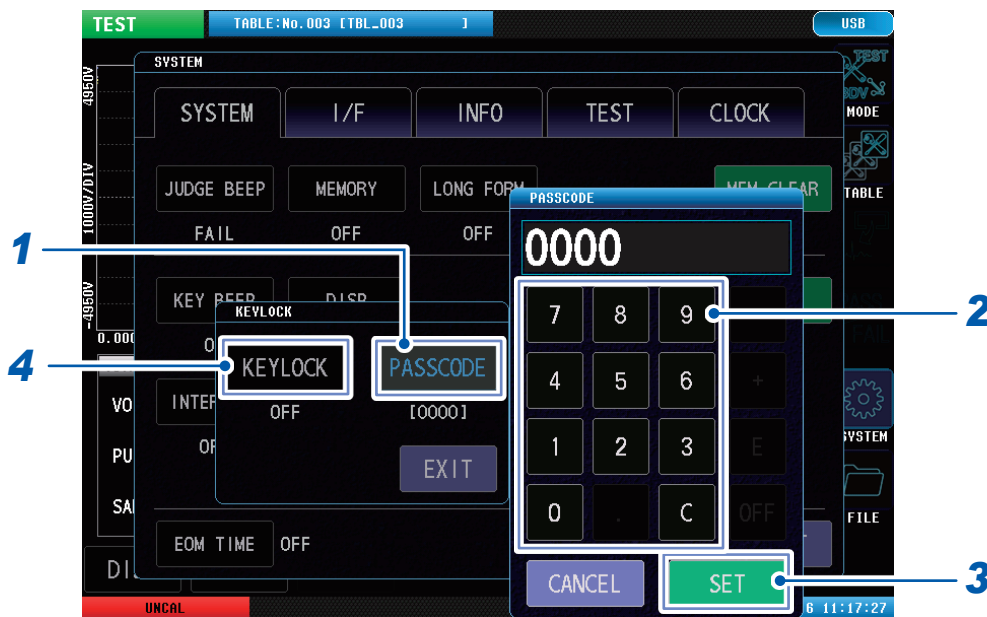

- 1 Tap [PASSCODE].**  
The numeric keypad window will open.
- 2 Enter the pass code to unlock the key locks.**  
Setting range: 0 to 4 digits
- 3 Tap [SET] to confirm.**
- 4 Tap [KEYLOCK].**

<b>OFF</b>	The key lock function is enabled.
<b>ON</b>	The key lock function is disabled.

## Unlocking the key locks

Enter the pass code that has been set to cancel the key locks. Make sure not to forget your pass code. If you forget the pass code, full reset to return the system to its factory settings. The default pass code setting is "0000".

Reference: "14.2 Initializing the Instrument (Full Reset)" (p. 213)

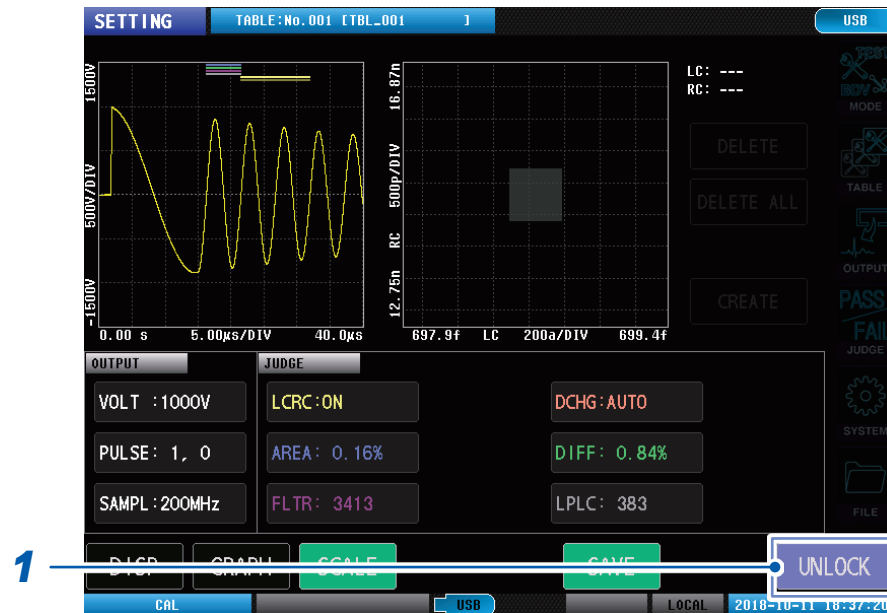

**1** Tap [UNLOCK].

**2** (Setting pass code) Enter the pass code and then tap [SET].  
 (Not setting pass code) Tap [SET] without entering anything.

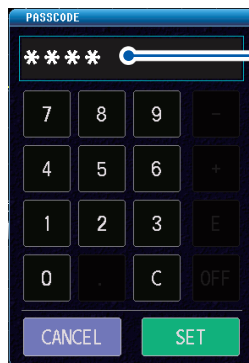

The pass code that has been entered is displayed as [\*].



## 8.3 Double Action Function

The double action function prevents misoperations during test startup. When the double action function is enabled, merely pressing the **START** button does not start the test. Press the **STOP** button and then press the **START** button within approx. 1 sec. to start the test.

(Measurement screen) **[SYSTEM]** > **[SYSTEM]**



**1** Tap **[DBL ACTN]**.

<b>OFF</b>	The double action function is enabled.
<b>ON</b>	The double action function is disabled.

**IMPORTANT**  
 When sending trigger signals using communications and external control (EXT. I/O), testing will start even if the double action function is enabled and the **STOP** button is not pressed.

## 8.4 Memory Function

Saves the test results to the memory in the instrument. (1000 tests max.)  
You can save the test results that have been stored to USB memory.  
Further, you can acquire the saved data using communications commands.

The items saved by the memory function are described below.

- Measurement status
- Total judgment results
- Judgment functions judgment values and judgment results

### IMPORTANT

- The test results are saved to internal memory in test mode only. The test results are not saved in test conditions settings mode or BDV mode.
- If the memory function is enabled, the number of items presently stored in memory is displayed on the measuring screen.
- Internal memory is automatically deleted if memory data is saved to USB memory or data is acquired using communications commands.
- Acquire the measurement results saved inside the instrument either by saving them to USB memory or by acquiring them using communications commands. For the memory data output format, see the memory data acquisition commands in the “Communications Commands Instruction Manual” on the application disk.
- If the instrument memory is full, subsequent measured values will not be saved. If restarting saving, either read from the instrument internal memory, or delete memory data.

## Memory function settings (ON/OFF)

Sets whether to enable or disable the memory functions. If enabled, the test results are automatically saved to the memory in the instrument when the test finishes.

(Measurement screen) **[SYSTEM]** > **[SYSTEM]**

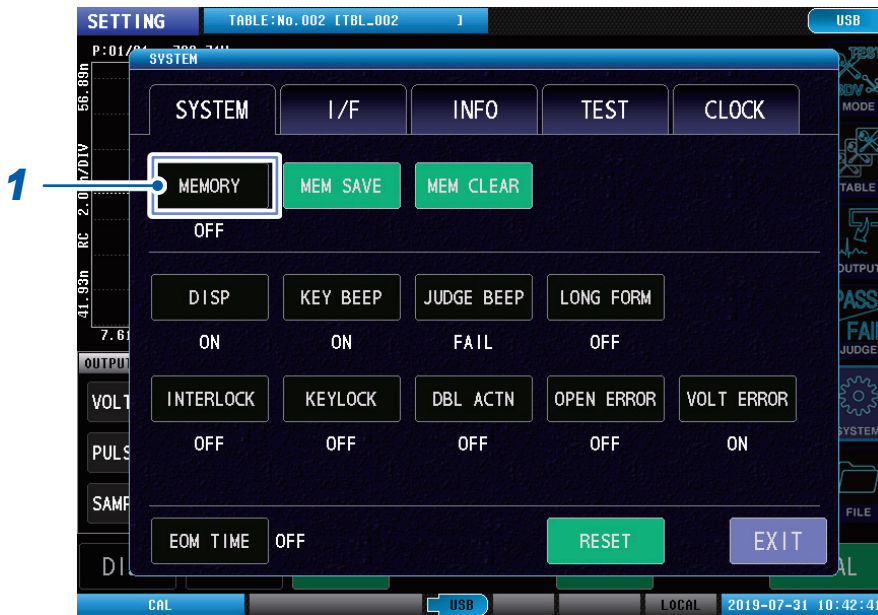

**1** Tap **[MEMORY]**, and set the memory function to ON or OFF.

<b>OFF</b>	Memory function is disabled.
<b>ON</b>	Memory function is enabled.

## Saving memory data

The data saved to internal memory is saved to USB memory.

(Measurement screen) **[SYSTEM]** > **[SYSTEM]**



- 1** Tap **[MEM SAVE]**.  
A confirmation message is displayed.
- 2** Tap **[OK]**.

<b>CANCEL</b>	Cancels the saving.
<b>OK</b>	Implements save.

## Deleting memory data

The data saved to internal memory is deleted.

(Measurement screen) **[SYSTEM]** > **[SYSTEM]**



- 1 Tap **[MEM CLEAR]**.  
A confirmation message is displayed.

- 2 Tap **[OK]**.

<b>CANCEL</b>	Cancels the deletion.
<b>OK</b>	Implements deletion.

## 8.5 Displays

Sets the items to be displayed.

(Measurement screen) **[SYSTEM]** > **[SYSTEM]** > **[DISP]**



### 1 Tap **[DISP]**, and set the display lamps on settings.

<b>OFF</b>	The display will turn off 10 sec. after the touch panel was last touched. After the display turns off, touching the touch panel again will turn on the display again.
<b>ON</b>	The display is always on.
<b>THIN</b>	The display is always on, but the screen update rate is reduced from normal to prioritize communications processing. <u>As communications commands processing is prioritized, screen update frequency is reduced.</u>

### 2 Set the backlight brightness.

Setting range: 0 to 250

▲	Brightens the backlight.
▼	Dims the backlight.

When this setting is turned **[ON]**, the next pulse is applied after the measurement data has finished being displayed onscreen following the present pulse application. All measurement data is displayed.

When this setting is turned **[OFF]** or is **[THIN]**, the next pulse is applied without waiting for the measurement data to finish being displayed onscreen following the present pulse application. It is possible not all the data will be displayed, but the test time will be greatly reduced.

During break down voltage tests (BDV), all measurement data is displayed onscreen even if the setting is **[THIN]**.

## 8.6 Graph Display Settings

You can set the display methods for the graphs displayed on the measurement screen.

### Overlay settings

Sets the overlay of the waveform and LC and RC graphs.

When overlay is enabled, you can check visually any variations per waveform and LC and RC values test.

Overlay can be set from the test conditions settings mode and test mode.

(Measurement screen) **[GRAPH]** (Bottom left of screen)

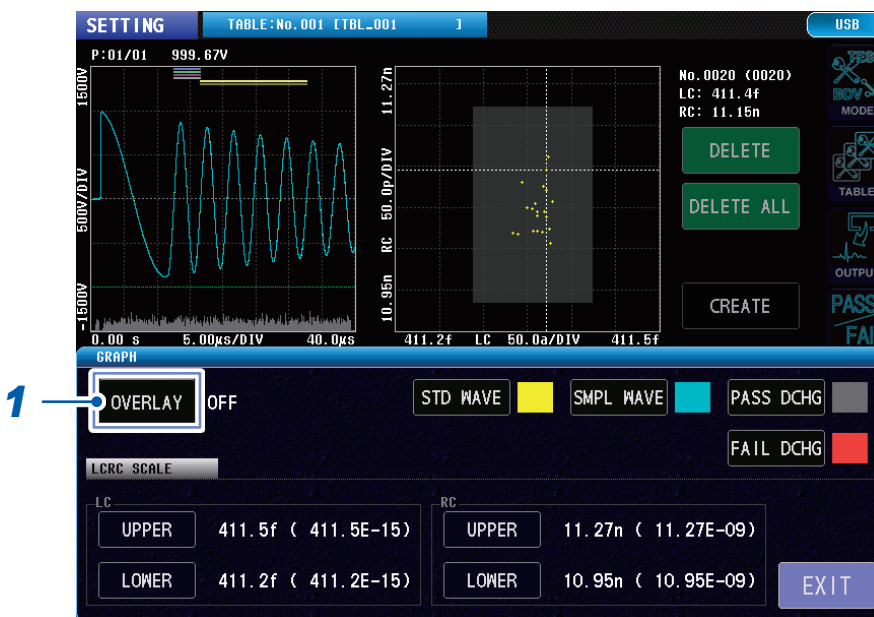

**1** Tap **[OVERLAY]**, and turn ON or OFF the overlay.

<b>OFF</b>	Deletes the graph drawn during the previous test and draws only the graph for the latest test results.
<b>ON</b>	Does not delete the graph drawn during the previous test and overlays the graph for the latest test results.

#### IMPORTANT

Overlaid graphs are deleted when operations such as changing the settings and auto-scaling are implemented.

## Waveform color settings

Sets the colors of the waveform and LC and RC graphs.

Colors can be set using the test conditions settings mode, test mode, and BDV mode respectively.

### Test conditions settings mode

(Measurement screen) **[GRAPH]** (Bottom left of screen)

Example: Test conditions settings mode screen



#### 1 Tap the item buttons.

The settings window will open.

#### 2 Select the color you want to set.

Select **[OFF]** to not draw the waveform.

#### IMPORTANT

Changing the waveform color will delete any graphs that have been overlaid hitherto. Change the waveform color before implementing measurements.



Test conditions settings mode

<b>STD WAVE</b>	Sets the master waveform color and LC and RC values master data color.
<b>SMPL WAVE</b>	Sets the test waveform color and the test LC and RC values color.
<b>PASS DCHG</b>	Sets the waveform color for the part that does not exceed the threshold values on the discharge amount graph.
<b>FAIL DCHG</b>	Sets the waveform color for the part that exceeds the threshold values on the discharge amount graph.

Test mode

<b>STD WAVE</b>	Sets the master waveform color.
<b>PASS WAVE</b>	Sets the test waveform color and the test LC and RC values color when the overall judgment is PASS.
<b>FAIL WAVE</b>	Sets the test waveform color and the test LC and RC values color when the overall judgment is FAIL.
<b>PASS DCHG</b>	Sets the waveform color for the part that does not exceed the threshold values on the discharge amount graph.
<b>FAIL DCHG</b>	Sets the waveform color for the part that exceeds the threshold values on the discharge amount graph.

BDV mode

<b>PASS WAVE</b>	Sets the test waveform color and the test LC and RC values color when the BDV judgment is PASS.
<b>FAIL WAVE</b>	Sets the test waveform color and the test LC and RC values color when the BDV judgment is FAIL.
<b>PASS DCHG</b>	Sets the waveform color for the part that does not exceed the threshold values on the discharge amount graph.
<b>FAIL DCHG</b>	Sets the waveform color for the part that exceeds the threshold values on the discharge amount graph.

## LC and RC graph scale settings

Sets the scale value of the LC and RC graph X axis (LC value) and Y axis (RC value).  
Overlay can be set from the test conditions settings mode and test mode.

(Measurement screen) **[GRAPH]** (Bottom left of screen)

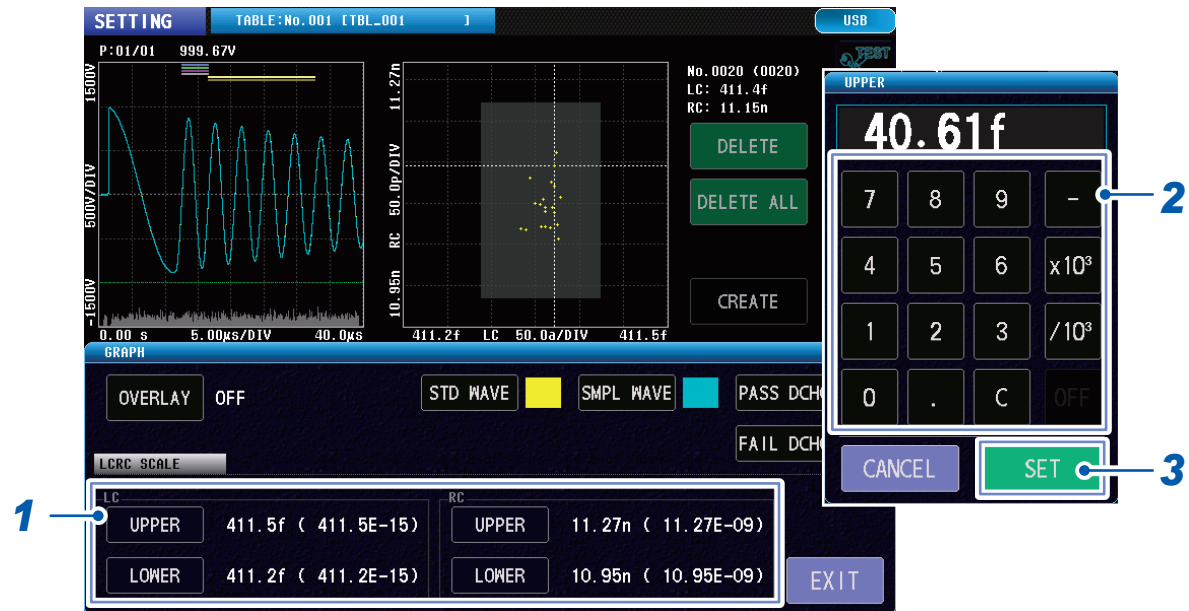

### 1 Tap **[UPPER]** and **[LOWER]** for both LC and RC.

LC

<b>UPPER</b>	Sets the upper limit for the X axis (LC value) graph display.
<b>LOWER</b>	Sets the lower limit for the X axis (LC value) graph display.

RC

<b>UPPER</b>	Sets the upper limit for the Y axis (RC value) graph display.
<b>LOWER</b>	Sets the lower limit for the Y axis (RC value) graph display.

The numeric keypad window will open.

### 2 Enter the upper and lower limit values.

Settings range:  $\pm(0.000 \text{ f to } 1.000)$  (effective number of digits: 4)

### 3 Tap **[SET]** to confirm.

## Implementing the LC and RC graph auto scale

Implements auto scaling so that the upper and lower limits of the LC and RC graph display X axis (LC values) and Y axis (RC axis) are within a suitable display range. Overlay can be implemented from the test conditions settings mode and test mode.

(Measurement screen) **[SCALE]** (Bottom left of screen)



**1** Tap **[SCALE]** to auto-scale the LC and RC graph.

In test condition settings mode, upper and lower limits as well as LC and RC values are automatically scaled each time you tap **[SCALE]**.

## 8.7 Judgment Beep

Sets a beep that varies according to the judgment results.

(Measurement screen) **[SYSTEM]** > **[SYSTEM]** > **[JUDGE BEEP]**

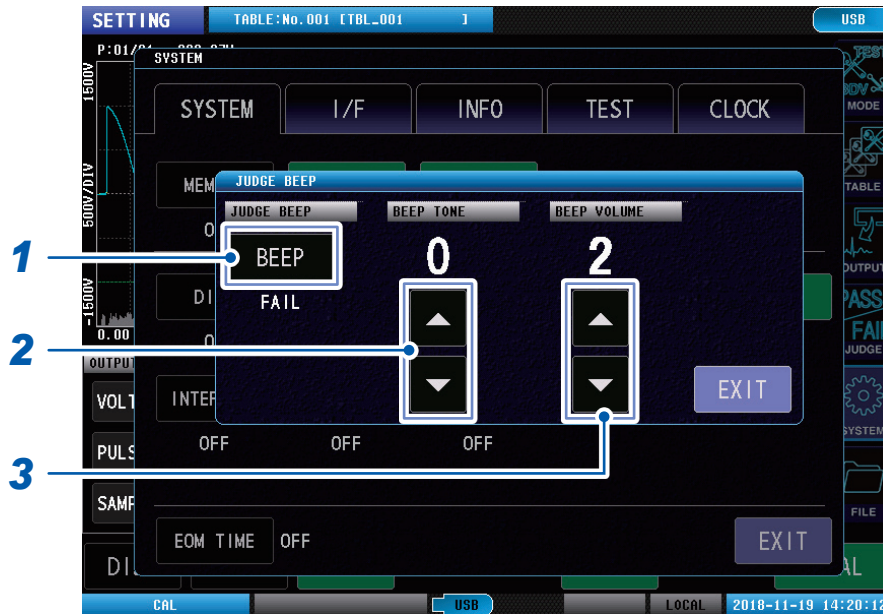

- 1 Tap **[BEEP]**, and set the conditions for when to sound the judgment beep.

<b>OFF</b>	Beep does not sound regardless of the judgment results.
<b>PASS</b>	Sounds the beep when the overall judgment result is PASS.
<b>FAIL</b>	Sounds the beep when the overall judgment result is FAIL.

- 2 Set the scale of the judgment beep sound.

Setting range: 0 to 14  
The greater the value the higher the pitch.

- 3 Adjust the judgment beep volume.

Setting range: 1 to 3  
The greater the value the louder the volume.

## 8.8 Key Beep

You can set the keys to beep.

(Measurement screen) **[SYSTEM]** > **[SYSTEM]** > **[KEY BEEP]**

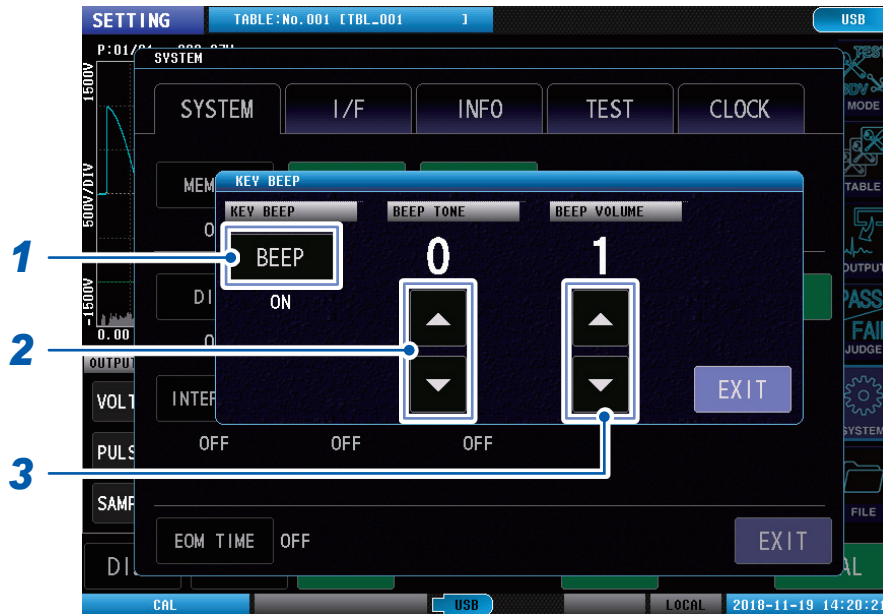

- 1 Tap **[BEEP]**, and set whether or not to sound the key beep.

<b>OFF</b>	Key beep does not sound.
<b>ON</b>	Key beep sounds.

- 2 Set the scale of the key beep sound.

Setting range: 0 to 14

The greater the value the higher the pitch.

- 3 Adjust the key beep volume.

Setting range: 1 to 3

The greater the value the louder the volume.

# 8.9 Test Time (EOM) Display

Displays the test time (EOM) for 1 test.

Test time= (INDEX + software processing time + judgment times) × Number of pulse applications

(Measurement screen) [SYSTEM] > [SYSTEM]



**1** Tap [EOM TIME], and set whether to display or hide the test times (EOM).

<b>OFF</b>	Test times are not displayed.
<b>ON</b>	Test times are displayed.

**2** Implement the test.

After the test finishes, the test time is displayed in the top right of the screen.

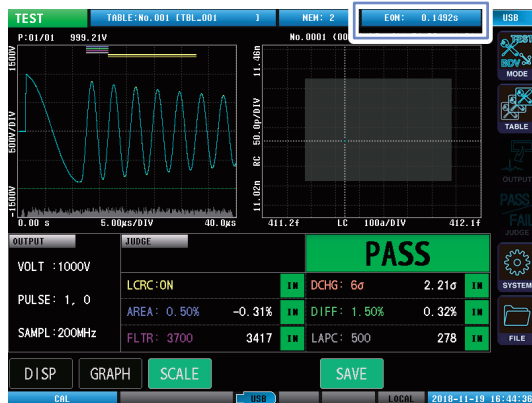

**IMPORTANT**

The test times displayed onscreen are rough estimate times calculated by the internal software, and there is a risk that they will differ considerably from the external control terminal (EXT. I/O) EOM signal outputs. Additionally, if the automatic save setting is enabled, the displayed time will not include the time required for save processing. For accurate EOM times, check using external control terminal EOM signal outputs.

# 8.10 Communications Commands Long Format Settings

Sets the long format during data transfer using communications commands. When the long format is enabled, you can increase the number of effective digits in the voltage values that are acquired using communications commands.

(Measurement screen) **[SYSTEM]** > **[SYSTEM]**

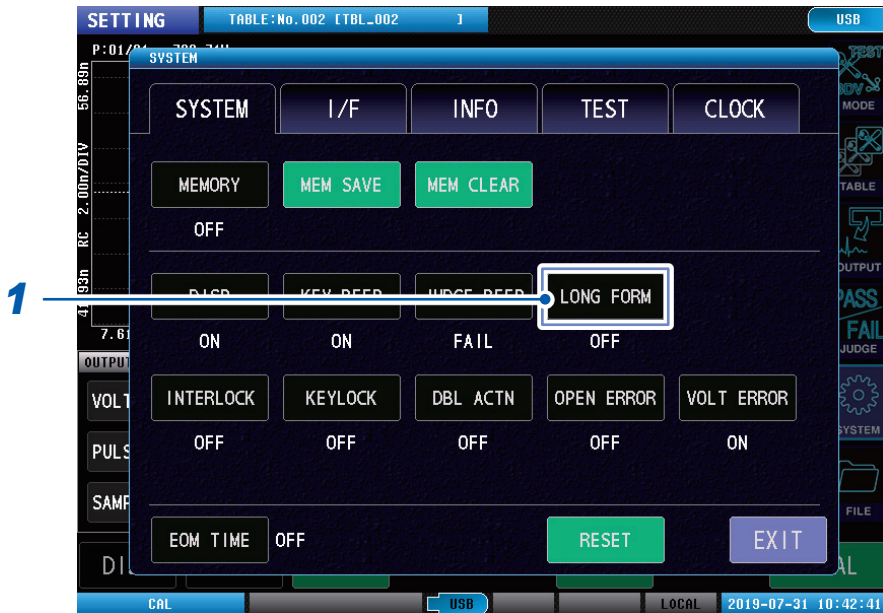

**1** Tap **[LONG FORM]**, and set whether to enable or disable the long format.

<b>OFF</b>	Long format is disabled.
<b>ON</b>	Long format is enabled.

## 8.11 Initializing the Instrument (System Reset)

Initializes all the instrument settings.

For the initialization items and default set values, see the “Default settings table” on the application disc.

If the system reset screen cannot be displayed, implement a full reset.

Reference: “14.2 Initializing the Instrument (Full Reset)” (p. 213)

### IMPORTANT

- Implementing a system reset will restore the instrument to its factory settings.
- Remove the test leads from the workpiece and implement a full reset.

(Measurement screen) **[SYSTEM]** > **[SYSTEM]**

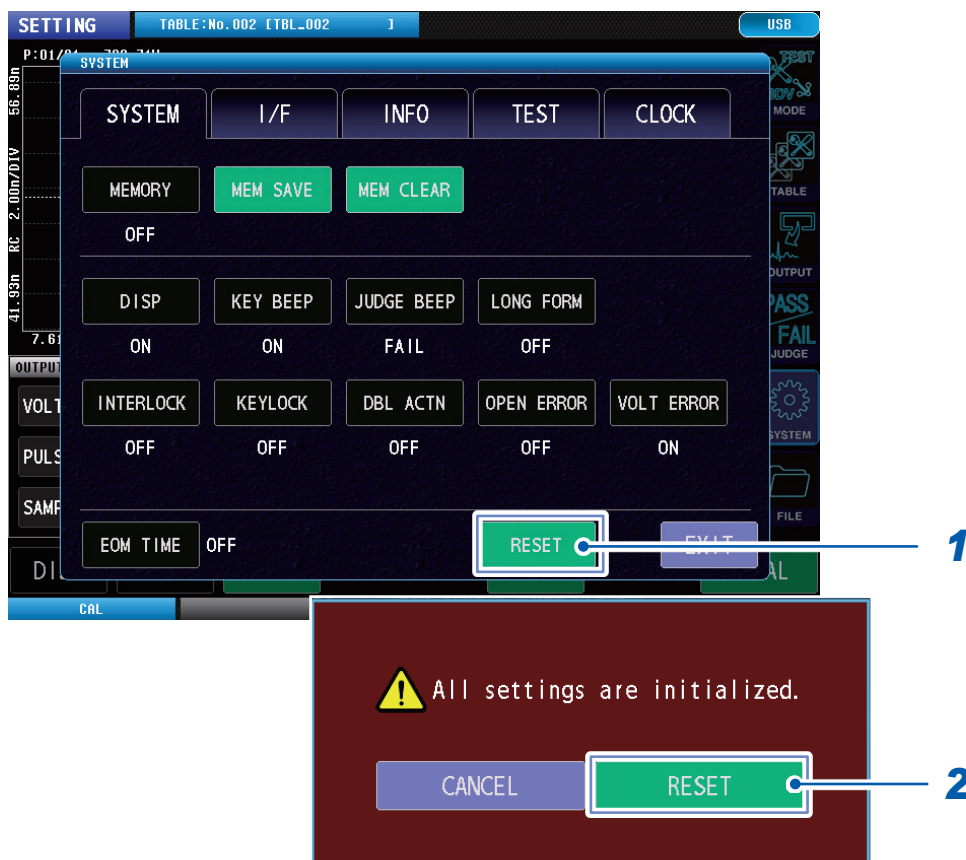

### 1 Tap **[RESET]**.

The confirmation window will be displayed.

### 2 Tap **[RESET]**.

Instrument initialization will start.

When initialization is complete, the window will close and the voltage application disabled mode screen will be displayed.



## 8.12 Terminal Open Error Setting

This section describes how to enable and disable the display of terminal open errors. When the setting is enabled, the instrument will conclude that the terminals are open and display an open error if the voltage value fails to fall after the response waveform's maximum value is acquired.

(Measurement screen) **[SYSTEM]** > **[SYSTEM]**



**1** Tap **[OPEN ERROR]** and set whether to enable or disable display of open errors.

<b>OFF</b>	<p>Disables open errors.</p> <ul style="list-style-type: none"> <li>• No open error will result if the measurement terminals are not connected, if an insulator is measured, if the recording length is short, etc.</li> <li>• The instrument will check for discharge of any residual charge caused by the capacitance of the object under test before applying each pulse when measuring an insulator. Consequently, measurement time may increase.</li> <li>• Since the instrument will not perform a contact check based on detection of open errors, it will be necessary to exercise caution as measurement will proceed even if the measurement terminals have not been connected.</li> </ul>
<b>ON</b>	<p>Enables open errors.</p> <ul style="list-style-type: none"> <li>• The instrument will conclude that an open error has occurred if the waveform's voltage value fails to fall to 25% or less of the maximum voltage after recording the waveform's maximum positive voltage.</li> </ul>

## 8.13 Voltage Error Setting

This section describes how to enable and disable the display of voltage errors.

When voltage errors are enabled, the instrument will display a voltage error if the test voltage fails to reach the set voltage.

(Measurement screen) **[SYSTEM]** > **[SYSTEM]**



- 1 Tap **[VOLT ERROR]** and set whether to enable or disable display of voltage errors.

<b>OFF</b>	Disables voltage errors.
<b>ON</b>	Enables voltage errors.



# 9 System Settings

## 9.1 Instrument System Information

You can check the instrument system information.

(Measurement screen) **[SYSTEM]** > **[INFO]**



<b>Serial No.</b>	Serial number
<b>Software Version</b>	Software version
<b>FPGA Main</b>	Main FPGA version
<b>FPGA Receive</b>	Sub FPGA version
<b>MAC Address</b>	MAC address of the instrument
<b>USB ID</b>	USB ID
<b>Interface Board</b>	Name of the optional interface board that is in use. [--]: Interface board not used
<b>EXT. I/O MODE</b>	This is the external control terminal (EXT. I/O) output mode. NPN: Current sink output mode PNP: Current source output mode
<b>Option</b>	This is whether or not the ST9000 Discharge Detection Upgrade (optional) is present.

## 9.2 Self-test Function

You can self-test for errors in the instrument.

### Touch panel test

You can check that the touch panel is operating normally.

(Measurement screen) [SYSTEM] > [TEST]

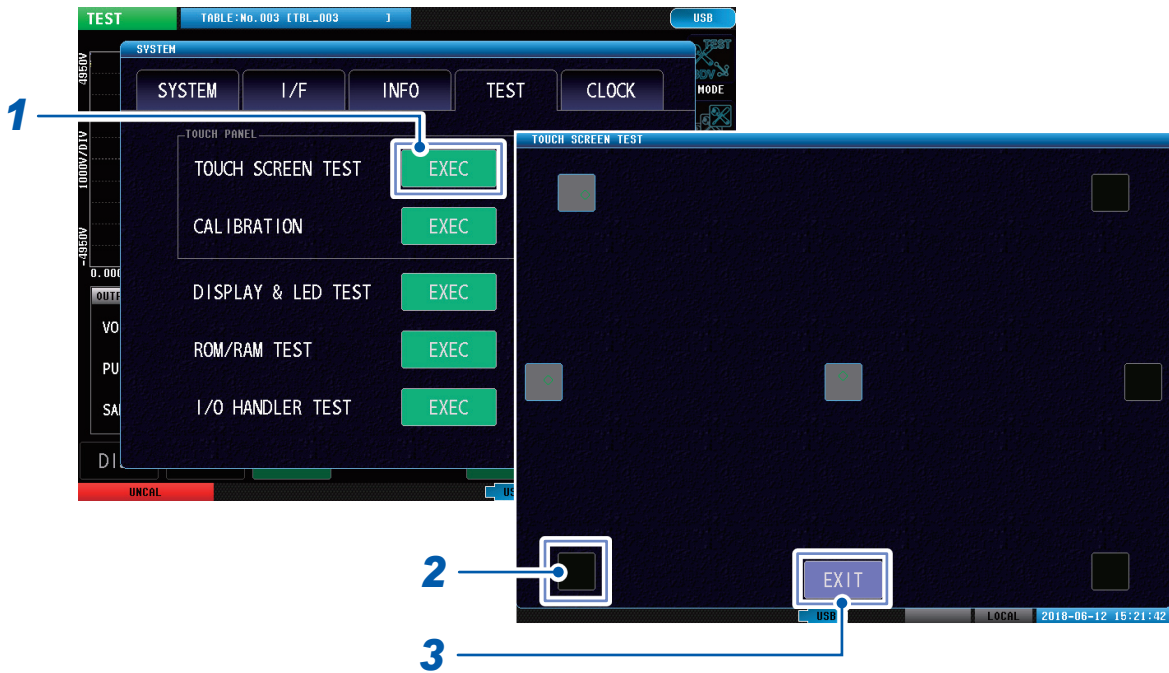

- 1 Tap [EXEC].
- 2 Tap each black square in turn.

■ (Black)	Testing is not implemented.
■ (Gray)	You can tap squares that are normally black.
✗ (Red)	Tapping other than black squares. If you cannot tap a black square even after trying several times, implement touch panel compensation. Reference: "Touch panel correction" (p. 127)

**IMPORTANT**  
If the black square still cannot be tapped even after panel correction, there is a risk of malfunction. Contact your authorized Hioki distributor or reseller.

- 3 When the test is finished, tap [EXIT].

## Touch panel correction

You can correct the touch panel position.

(Measurement screen) **[SYSTEM]** > **[TEST]**

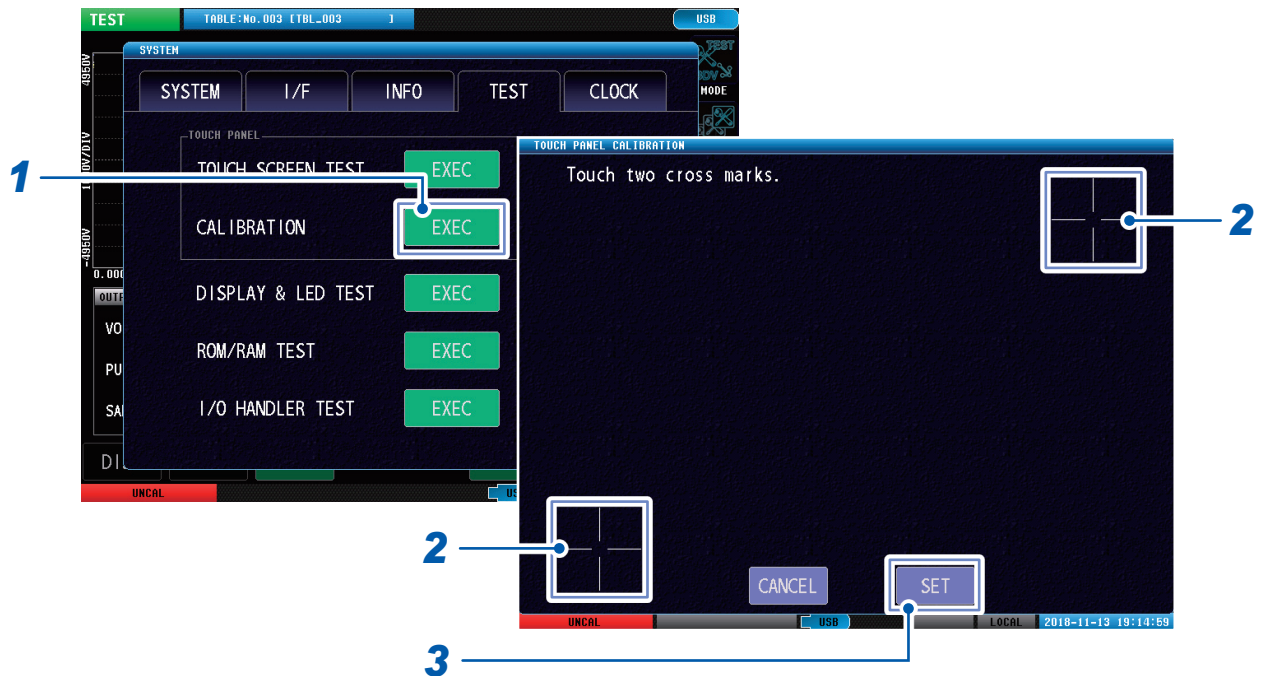

- 1** Tap **[EXEC]**.
- 2** Press and hold on the center of the two **[+]** in order until **■** (green) is displayed.
- 3** Tap **[SET]**.  
**[SET]** is displayed together with the two **[+]** when **■** (green) is displayed.

### IMPORTANT

If **[SET]** is not displayed, repairs are necessary. Contact your authorized Hioki distributor or reseller.

## Screen display test

Checks the screen display status and LED ON/OFF status.

(Measurement screen) **[SYSTEM]** > **[TEST]**

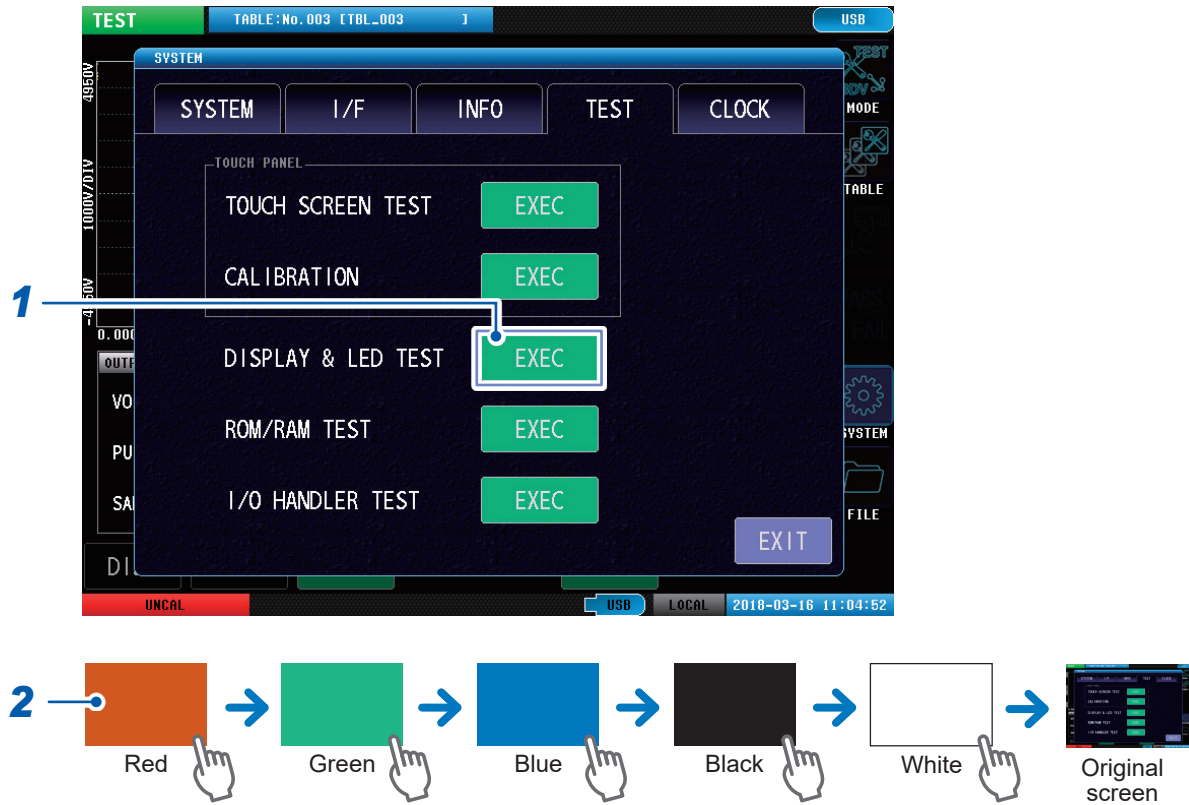

**1** Tap **[EXEC]**.

**2** Tap the screen **5** times.

The screen color will toggle in order.

The **[OUTPUT]** and **[PASS/FAIL]** lamps at the bottom of the instrument will also turn on and off according to the screen color.

### IMPORTANT

If the full screen is not the same color, repairs are necessary. Contact your authorized Hioki distributor or reseller.

## ROM/RAM test

Checks the instrument internal memory (ROM and RAM).

(Measurement screen) **[SYSTEM]** > **[TEST]**



**1** Tap **[EXEC]**.

**2** Tap **[EXEC]**.

The test will start automatically (approx. 90 sec.).

When the test has finished, the test results will be displayed to the right of **[FAST]**.

<b>PASS</b>	All ROM/RAM memories are normal.
<b>NG</b>	One or more of the ROM/RAM memories is abnormal.

### IMPORTANT

- All instrument operations are disabled during ROM/RAM tests.
- If the judgment results display is **[NG]**, repairs are necessary. Contact your authorized Hioki distributor or reseller.



## Full test

Checks the details of all memory statuses.

This check takes approx. 9 minutes. Normally, a full test is not necessary.

(Measurement screen) **[SYSTEM]** > **[TEST]**



**1** Tap **[EXEC]**.

**2** Tap **[FULL TEST]**.

The checks window will open.

**3** Tap **[YES]**.

Restarts the instrument and starts the full test.

**4** When the test has finished, displays the **[ROM/RAM TEST]** screen.

The test results will be displayed to the right of **[FULL]**.

<b>PASS</b>	All ROM/RAM memories are normal.
<b>NG</b>	One or more of the ROM/RAM memories is abnormal.

### IMPORTANT

If the judgment results display is **[NG]**, repairs are necessary. Contact your authorized Hioki distributor or reseller.

## EXT. I/O test

Checks whether the output signals from the external control terminal (EXT.I/O) are normal, and whether the input signals can be read normally.

(Measurement screen) **[SYSTEM]** > **[TEST]**



- 1** Tap **[EXEC]**.
- 2** Implement output signal tests and input signal tests.

<b>I/O OUT</b>	Implements output signal tests. Outputs signals from the I/O output pins with the name of the selected buttons (ON).
<b>I/O IN</b>	The signal wire names for signals that are being input (ON) from among the input signals will be lit green. Signal wires from which signals are not being input will be grayed out (unavailable).

## 9.3 Date and Time Settings

Sets the instrument date and time. You can record and manage data using the set date and time.

(Measurement screen) **[SYSTEM]** > **[CLOCK]**



### 1 Set the date and time.

Settings range: 00 o'clock 00mins. 00s January 1, 2000 to 23 o'clock 59mins. 59s December 31, 2099

### 2 Tap **[SET]**.

# 10

## External Control (EXT. I/O)

### ⚠ WARNING

To prevent an electric shock or damage to the equipment, always observe the following precautions when connecting the cables to external control terminal connectors.



- Always turn OFF the instrument and any devices that are connected before making connections.
- Be careful to avoid exceeding the ratings of the external control terminal connectors.
- During operation, a wire becoming dislocated and contacting another conductive object can be a serious hazard. Use screws to secure the external control terminal connectors.
- Ensure that devices and systems that are connected to the external control terminal connectors are properly isolated from one another.

### ⚠ CAUTION



To keep connected devices from malfunctioning, use a shielded cable of no more than 3 m in length to connect external devices to the instrument.

Using the external control terminals on the rear of the instrument enable the following.

- Output measurements finished signals (EOM signals) and judgment results signals (PASS/FAIL), etc., from the instrument to external device.
- Input START signals, etc., from an external device to the instrument to control the instrument.

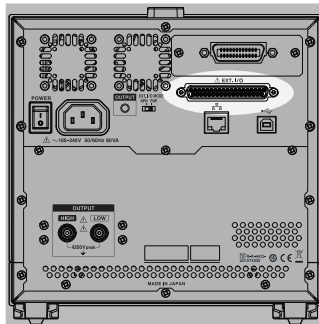

Rear

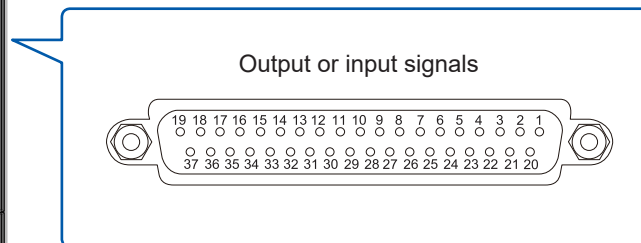

Output or input signals

All signals are isolated from the measuring circuit and the ground (earth). (Common I/O terminals are shared)

The instrument input circuit can be switched so that it can support sinking current output (NPN) or sourcing current output (PNP).

Reference: “10.2 Sinking Current (NPN) / Sourcing Current (PNP)” (p. 135)

Check the input rating and internal circuit configuration, and then understand the safety precautions. After that, connect the control system and use it in a correct manner.

Reference: “Internal circuit configuration” (p. 139)

# 10.1 External Control Measurement Flow

The external control measurement flow is as described below.

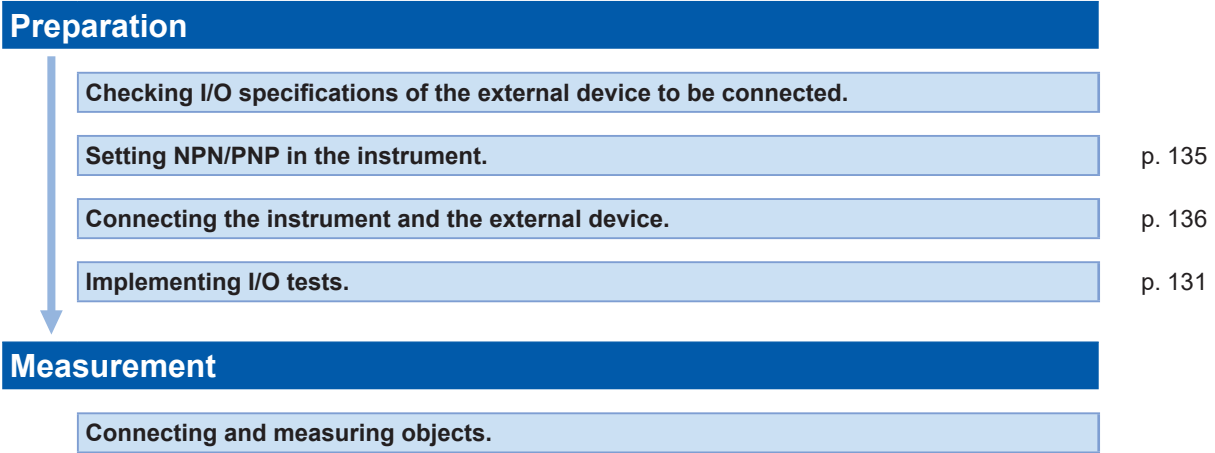

## 10.2 Sinking Current (NPN) / Sourcing Current (PNP)

You can use NPN/PNP switching to change the type of corresponding programmable controller. NPN is sinking current and PNP is sourcing current. It is set to NPN at the time of shipment from the factory.

### ⚠ CAUTION



To avoid damaging the instruments, observe the following.

- Make sure the instrument power supply is OFF when operating the NPN/PNP switches.
- Align the NPN/PNP switch settings to the settings of the externally-connected devices.

Use the NPN/PNP switch on the rear of the instrument.

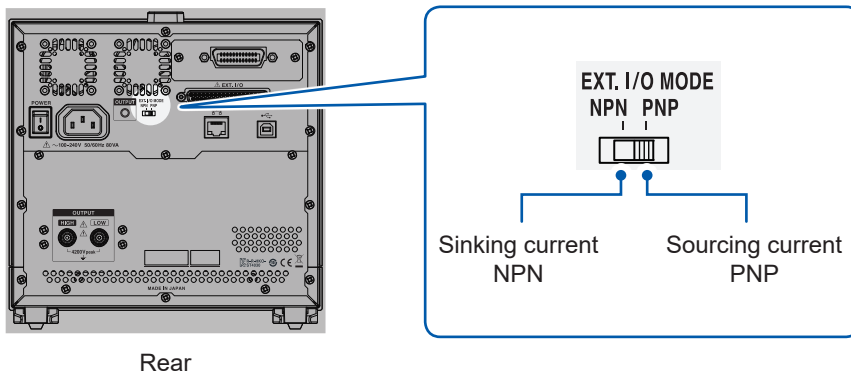

Rear

Reference: “Internal circuit configuration” (p. 139)

	EXT./I/O mode switch settings	
	NPN	PNP
<b>Input circuit</b>	Compatible with sinking outputs programmable controllers	Compatible with sourcing outputs programmable controllers
<b>Output circuit</b>	Non-polar	Non-polar
<b>ISO_5V power supply outputs</b>	+5 V output	-5 V output

# 10.3 Connection (Instrument and Control Devices)

## Instrument connector and compatible connectors

Connectors used (instrument unit side)

- D-SUB 37 pin, female #4-40 inch screw

Compatible connectors

- DC-37P-ULR (solder type)
- DCSP-JB37PR (crimp type) Japan Aviation Electronics Industry, Ltd.

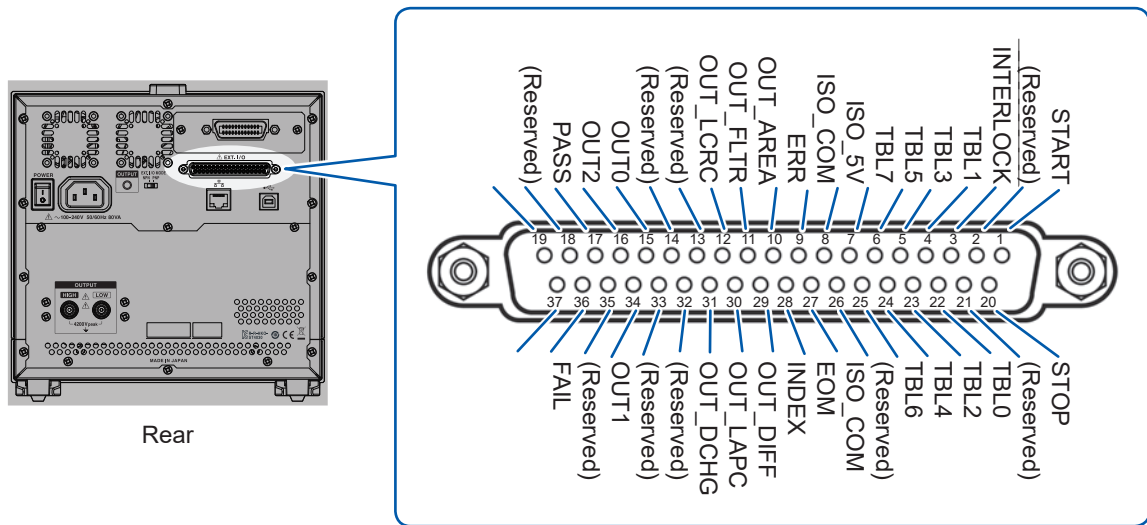

Pin	I/O	Signal name	Logic	Function
1	IN	START	Edge	Start of measurement
2	IN	(Reserved)	–	–
3	IN	INTERLOCK	Level	Interlock unlocked
4	IN	TBL1	Level	Table number selection
5	IN	TBL3	Level	Table number selection
6	IN	TBL5	Level	Table number selection
7	IN	TBL7	Level	Table number selection
8	–	ISO_5V	–	Isolated power supply outputs +5 V (with NPN)/ –5 V (with PNP)
9	–	ISO_COM	–	Isolated power supply common
10	OUT	ERR	–	Error
11	OUT	OUT_AREA	–	AREA judgment OUT
12	OUT	OUT_FLTR	–	FLUTTER judgment OUT, FREQ judgment OUT (with BDV)
13	OUT	OUT_LCRC	–	LC and RC values judgments OUT
14	OUT	(Reserved)	–	–
15	OUT	(Reserved)	–	–
16	OUT	OUT0	–	General outputs

Pin	I/O	Signal name	Logic	Function
17	OUT	OUT2	–	General outputs
18	OUT	PASS	–	Total judgment PASS
19	OUT	(Reserved)	–	–
20	IN	STOP	Edge	Measurement stopped
21	IN	(Reserved)	–	–
22	IN	TBL0	Level	Table number selection
23	IN	TBL2	Level	Table number selection
24	IN	TBL4	Level	Table number selection
25	IN	TBL6	Level	Table number selection
26	IN	(Reserved)	–	–
27	–	ISO_COM	–	Isolated power supply common
28	OUT	EOM	–	Measurements finished (including judgments and operations)
29	OUT	INDEX	–	Analog measurements finished (probe can be left open)
30	OUT	OUT_DIFF	–	DIFF judgment OUT / Vpeak judgment OUT (with BDV)
31	OUT	OUT_LAPC	–	LAPLACIAN judgment OUT
32	OUT	OUT_DCHG	–	DISCHARGE judgment OUT
33	OUT	(Reserved)	–	–
34	OUT	(Reserved)	–	–
35	OUT	OUT1	–	General outputs
36	OUT	(Reserved)	–	–
37	OUT	FAIL	–	Total judgment FAIL

The connector frame is connected to the panel on the rear of the instrument (metal) as well as the protective ground terminal of the power supply inlet.  
If loading tables using commands and touch panel operation, set all the table number selection pins to OFF.

When checking external controls I/O, see “EXT. I/O test” (p. 131).



## Signal functions

### (1) Isolated power supply output

Pin	Signal name	NPN/PNP switch settings	
		NPN	PNP
8	ISO_5 V	Isolated power supply +5 V	Isolated power supply -5 V
9, 27	ISO_COM	Isolated power supply common	Isolated power supply common

### (2) Input signal

Signal name	Description	Reference
START	Starts testing using the START signal ON edge.	
STOP	Stops testing if the STOP signal ON edge is detected during a test.	
INTERLOCK	When the instrument interlock settings are ON, the interlocks are unlocked while the INTERLOCK signals being ON.	"8.1 Interlock Function" (p. 101)
TBL0 to 7	Select the table No. to which the test conditions to be switched are saved. The instrument reads the table number when the START signal is input and switches the table before implementing the test. For details, see the table below.	"3 Switching Test Conditions (Table Functions)" (p. 25)

Pin No.	TBL7	TBL6	TBL5	TBL4	TBL3	TBL2	TBL1	TBL0
–	OFF	OFF	OFF	OFF	OFF	OFF	OFF	OFF
Table 1	OFF	OFF	OFF	OFF	OFF	OFF	OFF	ON
Table 2	OFF	OFF	OFF	OFF	OFF	OFF	ON	OFF
Table 3	OFF	OFF	OFF	OFF	OFF	OFF	ON	ON
...								
Table 255	ON	ON	ON	ON	ON	ON	ON	ON

### (3) Output signal

Signal name	Description	Reference
INDEX	Shows that analog measurements (pulse applications, sampling) have finished. When this signal turns ON, the probe can be opened.	"10.4 Timing Chart" (p. 142)
EOM	Output when a test finishes. The judgment results and ERR signals are updated when EOM signals are output.	"10.4 Timing Chart" (p. 142)
ERR	Output during measurement errors such as open errors and hardware errors, etc.	"14.1 Troubleshooting" (p. 208)
PASS,FAIL	Total judgment results are output.	"5 Setting Judgment Conditions" (p. 51)
OUT_XXX	Outputs when the judgment functions are judged as OUT.	"5 Setting Judgment Conditions" (p. 51)
OUT0 to 2	Usable as general output terminals. Output signals can be controlled using :IO:OUTPut commands.	Application disc "Communication Command Instruction Manual"

## Internal circuit configuration

Use ISO\_COM for the common terminal for both the input and output signals.

If a large current flows through common wiring, branch the output signals common wiring and the input signals common wiring close to the ISO\_COM terminal.

### NPN setting

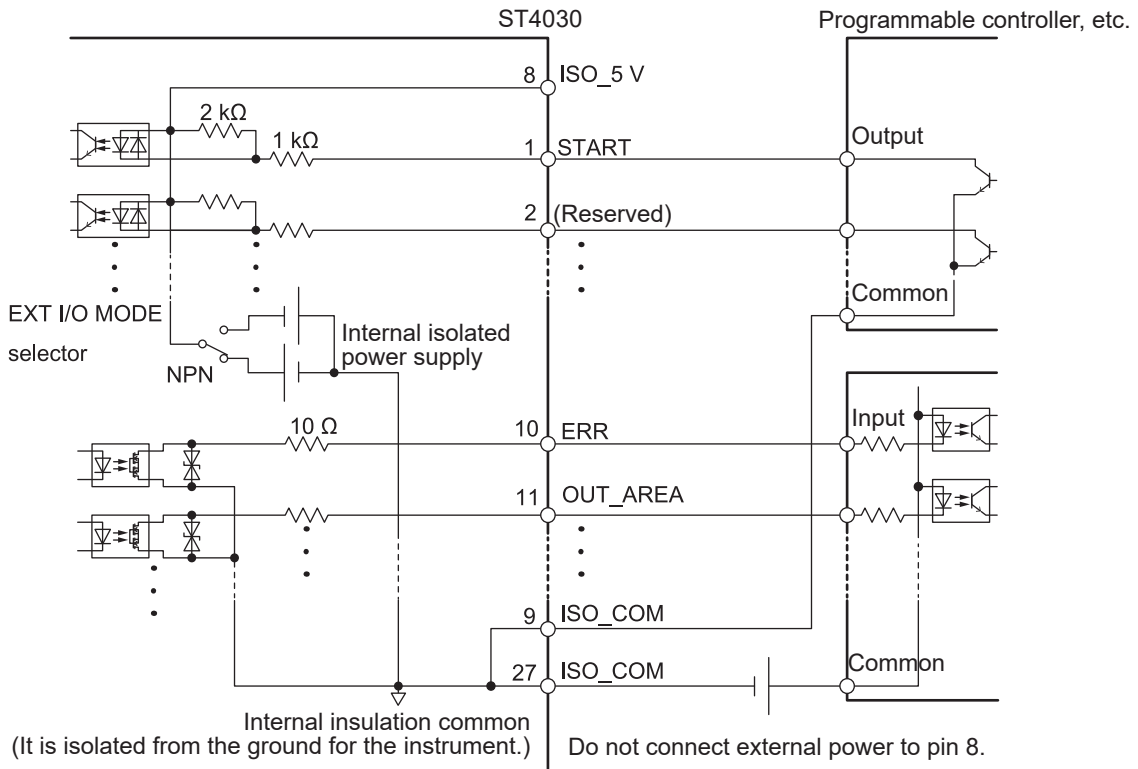

### PNP setting

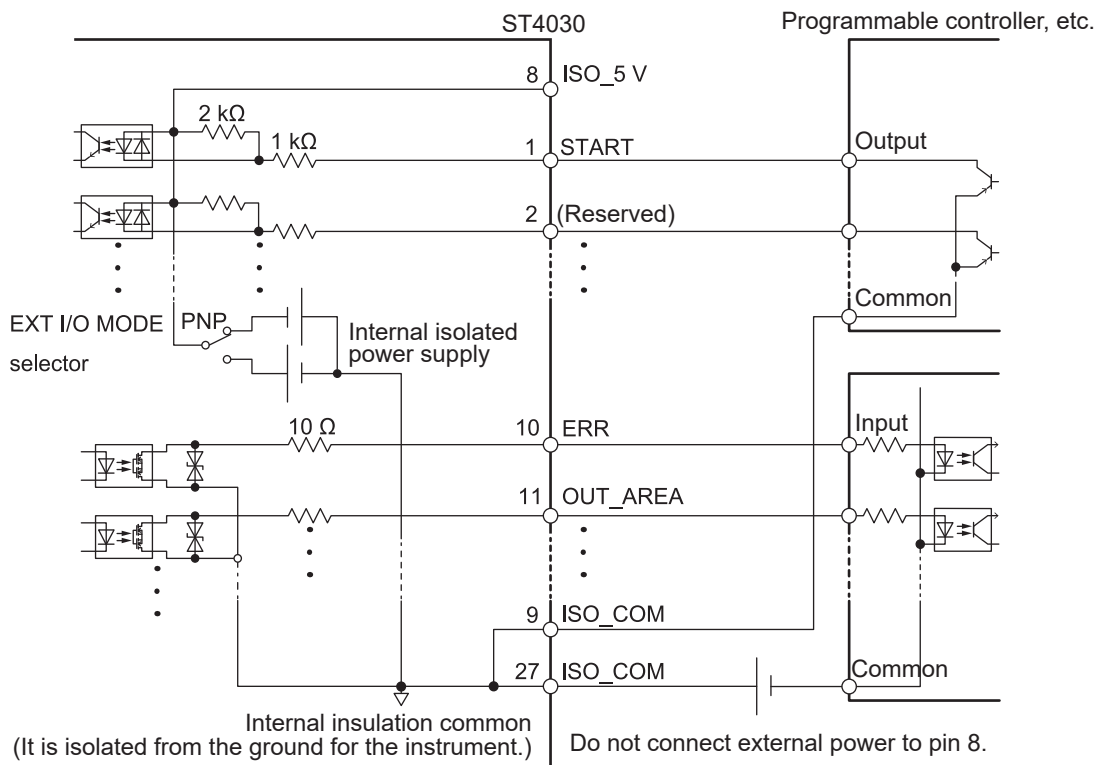

## Electrical specifications

<b>Input signal</b>	Input format	Photocoupler isolated non-voltage contact input (compatible with sinking/sourcing current outputs)
	Input ON	Residual voltage 1 V max. (input ON current 4 mA (reference value))
	Input OFF	OPEN (interrupting current 100 $\mu$ A or less)
<b>Output signal</b>	Output format	Photocoupler isolated open drain output (non-polar)
	Maximum load voltage	30 V DC
	Maximum output current	50 mA/ch
	Residual voltage	1 V or less (load current 50 mA) / 0.5 V or less (load current 10 mA)
<b>Internal isolated power supply</b>	Output voltage	Sinking output compatible: +5.0 V $\pm$ 0.8 V, sourcing output compatible: -5.0 V $\pm$ 0.8 V
	Maximum output current	100 mA
	External power supply input	None
	Insulation	Floating from the protective grounded potential and the measurement circuit
	Insulation rating	Voltage between the module and ground: 50 V DC, 30 V rms AC, 42.4 V peak AC or less

## Connection examples

### Input circuit

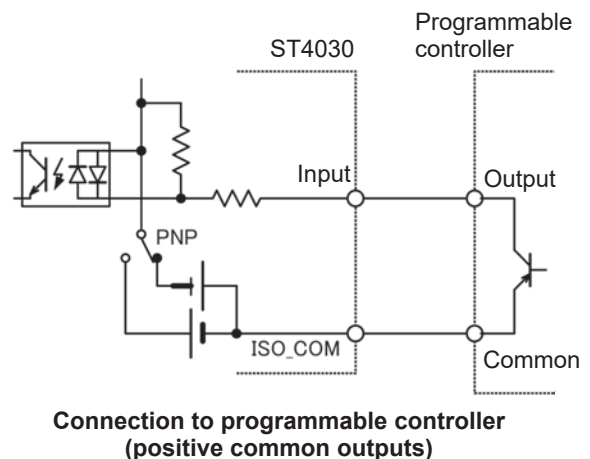
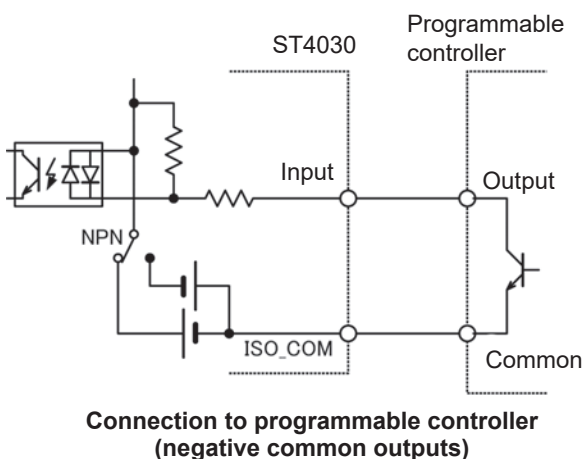
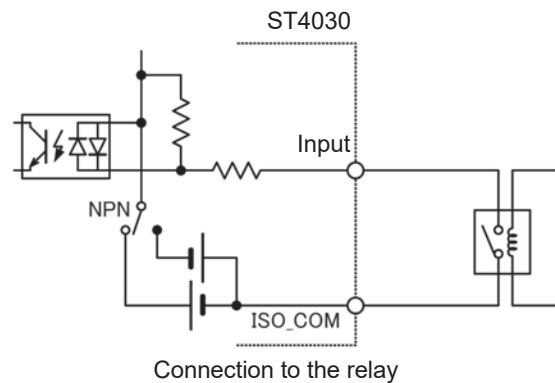
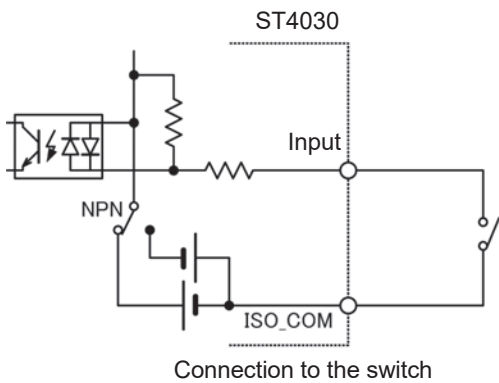

## Output circuit

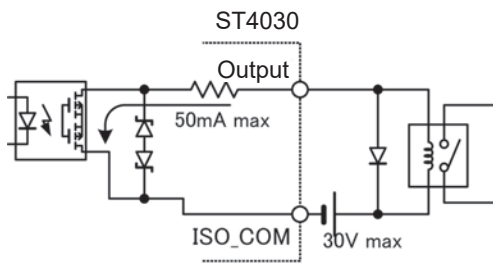

Connection to the relay

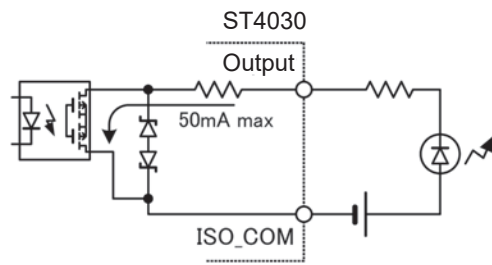

Connection to the LED

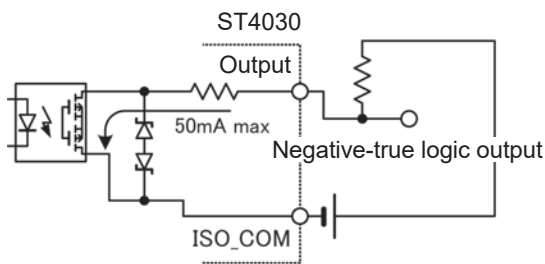

Negative-true logic output

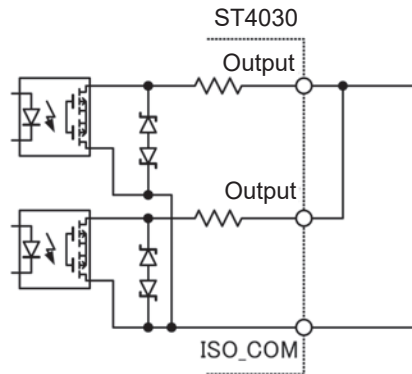

Wired-OR

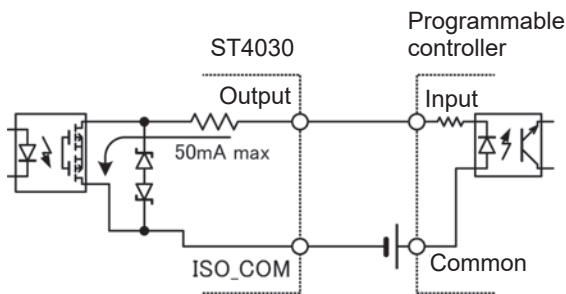

Connection to programmable controller (positive common inputs)

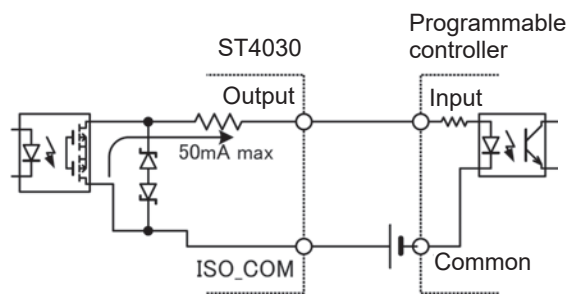

Connection to programmable controller (negative common inputs)

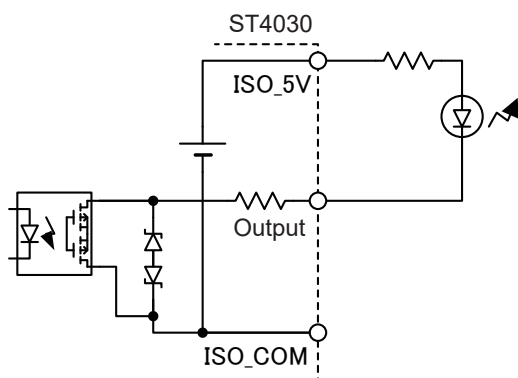

Connection to LED (using ISO\_5V, NPN setting)

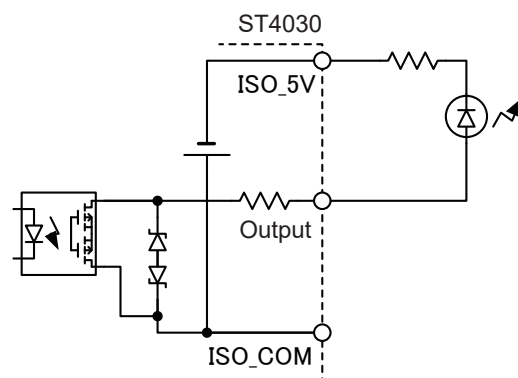

Connection to LED (using ISO\_5V, PNP setting)

## 10.4 Timing Chart

The level of each signal shows the contact ON/OFF status. In the sourcing current (PNP) setting, these are the same as the voltage level of the external control terminal. HI and LO are reversed for the voltage level in the sinking current (NPN) setting.

### Explanation of timing chart times

Item	Description	Time
t1	START signal ON time	1 ms or longer Reference: "Test time (Reference value)" (p. 204)
t2	Trigger detection time	1 ms (Typical value)
t3	Table switching time	10 ms (Typical value) Note: If the table test voltage after switching is lower than the test voltage before switching, an internal discharge time is added. Reference: "15.7 Voltage Switching Time (Reference Value)" (p. 234)
t4	Trigger delay time	0.000 s to 9.999 s
t5	Analog measuring time	50 ms (typical value when set voltage 3000 V, sampling frequency 200 MHz, and 1 pulse application) Reference: "13.4 Interface Specifications" (p. 200)
t6	Operation and judgment time	15 ms (typical value when AREA, DIFF, FLUTTER, and LAPLACIAN judgment functions are enabled) Note: During multiple pulse applications, this comprises the judgment operations time for the final pulse. Reference: "Test time (Reference value)" (p. 204)

## Measurement timing example

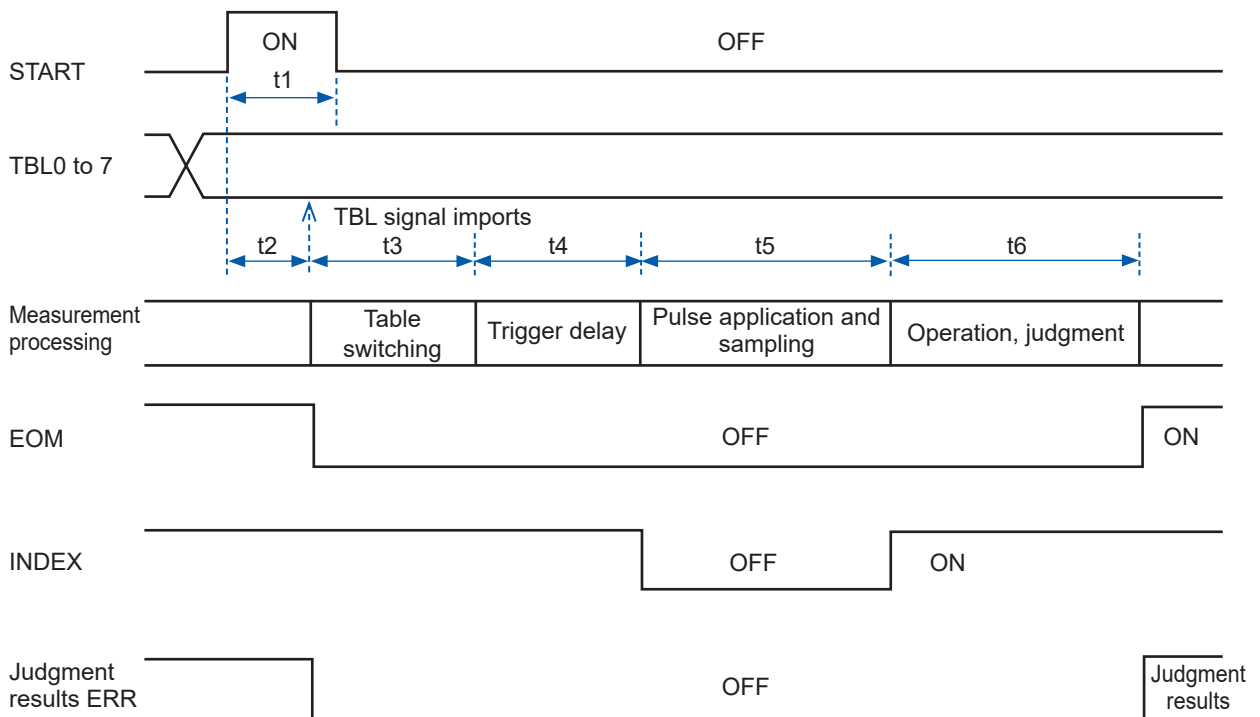

**IMPORTANT**

- The instrument outputs judgment results signals before immediately outputting EOM signals. If responses from the input circuit of the external device that is connected are slow, it may take considerable time to import judgment results after an EOM signal ON is detected.  
Reference: “Flow of starting measurements from an external device, and reading the judgment results” (p. 144)
- Periods when EOM is OFF (during measurements) and START signals are ignored.

## Flow of starting measurements from an external device, and reading the judgment results

Describes the flow from the start of measurements to obtaining the judgment results when a trigger is input from an external device.

The instrument outputs judgment results signals before immediately outputting EOM signals.

If responses from the input circuit of the external device that is connected are slow, it may take considerable time to import judgment results after an EOM signal ON is detected.

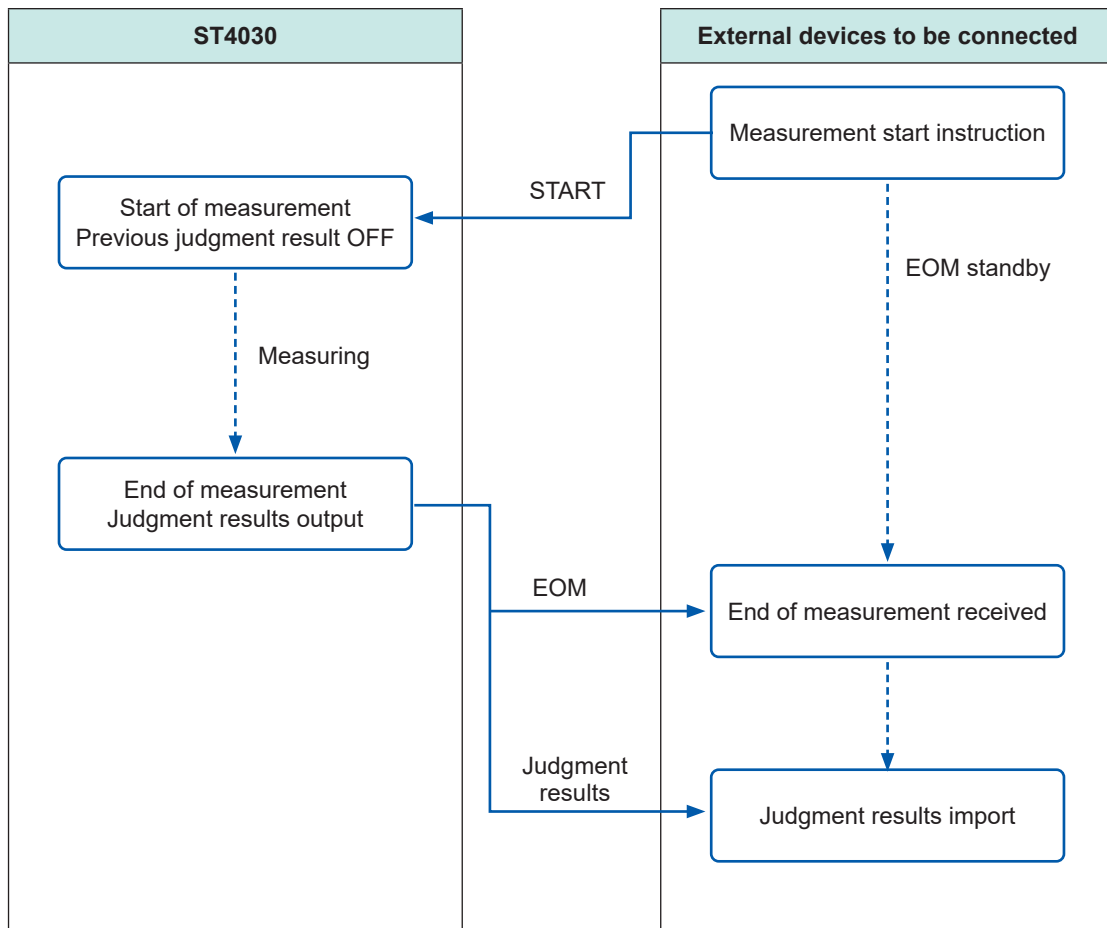

**⚠ WARNING**

- **Make sure to turn OFF the power supply to the devices when connecting or disconnecting interface connectors. Doing so may cause an electric shock accident.**
- **To prevent instrument damage or an electric shock, use only the screws that are originally installed to secure the interface. If you have lost a screw or find that a screw is damaged, please contact your authorized Hioki distributor or reseller.**

**⚠ CAUTION**

- To avoid device failure, do not disconnect the communications cables while communications are in progress.
- Use a common ground for both the instrument and the computer. Using different ground circuits will result in a potential difference between the instrument's ground and the computer's ground. If the cable is connected while such a potential difference exists, it may result in instrument malfunction or failure.
- Before connecting or disconnecting any communications cable, always turn OFF the instrument and the computer. Failure to do so could result in equipment malfunction or damage.
- After connecting the communications cables, tighten the screws on the connector securely. Failure to secure the connector could result in equipment malfunction or damage.
- Hold the metal plate when inserting or removing the optional interface. Touching the PCB directly risks damaging the interface due to static electricity. Using an anti-static wrist band during insertion and removal is recommended.



# 11.1 Overview

You can control the instrument using communications commands from a PC via RS-232C, GP-IB, USB, and LAN.

There are 4 types of interface, as described below. It is necessary to set the instrument communications conditions to communicate.

- RS-232C communications (p. 152)** ▶ You can implement command control using RS-232C serial communications when the Z3001 RS-232C interface is connected.
- GP-IB communications (p. 154)** ▶ You can use IEEE-488-2 1987 common commands (required) when the Z3000 GP-IB interface is connected. The instrument communications commands are designed with reference to IEEE-488.2 1987.
- USB communications (p. 155)** ▶ You can implement command control using USB that is compatible with the communications class.
- LAN communications (p. 157)** ▶ You can implement command control using TCP/IP protocols.

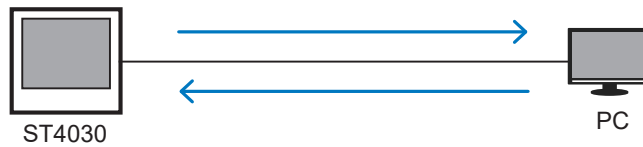

## Screen display

The icons at the top right of the screen show the selected interface.

The screenshot shows the instrument's main screen with various data points and graphs. A callout box highlights the interface selection icons at the top right:

- RS232C** If RS-232C is selected.
- GP-IB** If GP-IB is selected.
- USB** If USB is selected.
- LAN** If LAN is selected.

## 11.2 Specifications

### RS-232C

<b>Transmission method</b>	Communications method: Full duplex Sync method: Asynchronous transmission system	
<b>Transmission speed</b>	9600 bps, 19200 bps, 38400 bps, 57600 bps	
<b>Data length</b>	8 bits	
<b>Parity</b>	None	
<b>Stop bit</b>	1 bit	
<b>Message terminators (delimiters)</b>	CR+LF, CR	
<b>Flow control</b>	Software (XON/XOFF control) See "Handshaking (Buffer Flow Control)" below.	
<b>Electrical specifications</b>	Input voltage level	5 V to 15 V: ON, -15 V to -5 V: OFF
	Output voltage level	5 V to 9 V: ON, -9 V to -5 V: OFF

### Handshaking (Buffer Flow Control)

#### Control during reception

##### XON/XOFF control

- If the data in the reception buffer exceeds 75% of the buffer, XOFF (13H) is sent to notify the controller that there is little space remaining in the buffer.
- If data processing in the buffer is proceeding and the data amount is less than 25%, XON (11H) is sent to notify the controller that there is sufficient space in the buffer.

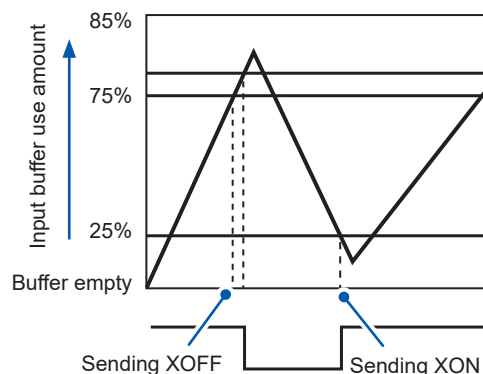

#### Control during transmission

##### XON/XOFF control

- When XOFF is received, data transmission stops. When XON is received, data transmission starts.

#### IMPORTANT

In a noisy environment, there is a risk of data mismatch during RS-232C communications. If using RS-232C communications in a location with a poor noise environment, acquire the data multiple times to check its conformance.

## GP-IB

<b>SH1</b>	There is a full range of source handshake functions.
<b>AH1</b>	There is a full range of acceptor handshake functions.
<b>T6</b>	There are basic talker functions. There are serial poll functions. There is no talk only mode. There is a talker unlock function using MLA (My Listen Address).
<b>L4</b>	There are basic listener functions. There is no listen only mode. There is a listener unlock function using MTA (My Talk Address).
<b>SR1</b>	There is a full range of service request functions.
<b>RL1</b>	There is a full range of remote local functions.
<b>PP0</b>	There is no parallel polling function.
<b>DC1</b>	There is a full range of device clear functions.
<b>DT1</b>	There is a full range of device trigger functions.
<b>C0</b>	There are no controller functions.

Code used: ASCII code

## USB

<b>Connector</b>	Series B receptacle
<b>Electrical specifications</b>	USB2.0 (Full Speed/High Speed)
<b>Number of ports</b>	1
<b>Class</b>	Communications class
<b>Compatible OS</b>	Windows 7, Windows 8, Windows 10

## LAN

<b>Connector</b>	RJ-45 connector ×1
<b>Electrical specifications</b>	Conforms to IEEE802.3
<b>Transmission method</b>	10BASE-T/ 100BASE-TX/ 1000BASE-T automatic recognition
<b>Protocol</b>	TCP/IP
<b>Function</b>	Command control
<b>Max. cable length</b>	30 m max.

## Total

<b>Command system</b>	Unique HIOKI SCPI
-----------------------	-------------------

## 11.3 Mounting and Removing an Interface

You can check onscreen information for interfaces mounted to the instrument.  
 Reference: “9.1 Instrument System Information” (p. 125): “11.4 Interface Settings” (p. 151)

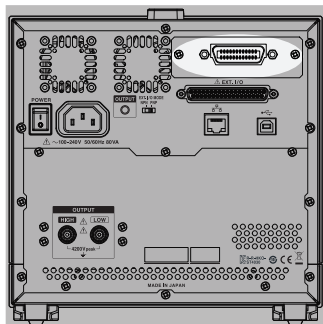

Rear

Communicating using Z3000:GP-IB (p. 154)  
 Communicating using Z3001:RS-232C (p. 152)

### Installation method

**Required items** Phillips screwdriver (No. 2)

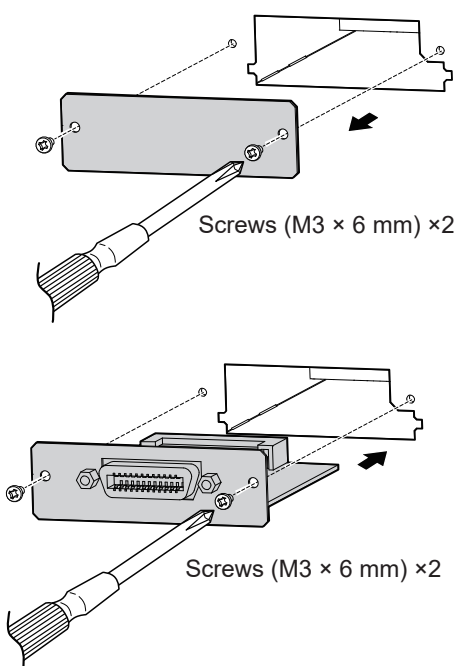

- 1** Remove all cables connected to the instrument.
- 2** Use a Phillips screwdriver to loosen the screws ×2 securing the blank panel.
- 3** Remove the blank panel.
- 4** Pay attention to the interface orientation, and insert firmly all the way to the back.
- 5** Firmly tighten the screws ×2 using the Phillips screwdriver to secure the interface.

## Removal method

Remove the power cord from the outlet, and remove the interface using the reverse order to the mounting procedure.

## When not using the interface after its removal

Mount the blank panel. The specifications cannot be satisfied if measuring without mounting the blank panel. To purchase an additional blank panel, contact your authorized Hioki distributor or reseller.

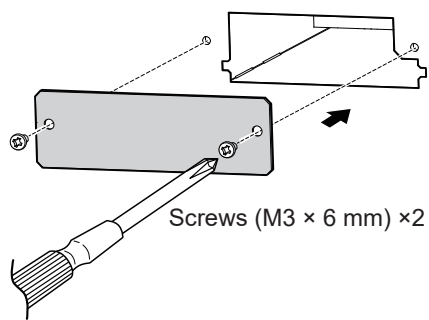

- 1** Mount the blank panel.
- 2** Firmly tighten the screws ×2 using the Phillips screwdriver to secure the blank panel.

## 11.4 Interface Settings

You can control the instrument from a PC via RS-232C, GP-IB, USB, or LAN.

GP-IB settings are possible only when the optional Z3000 GP-IB interface is mounted, and RS-232C settings are possible only when the optional Z3001 RS-232C interface is mounted.

(Measurement screen) **[SYSTEM]** > **[I/F]**

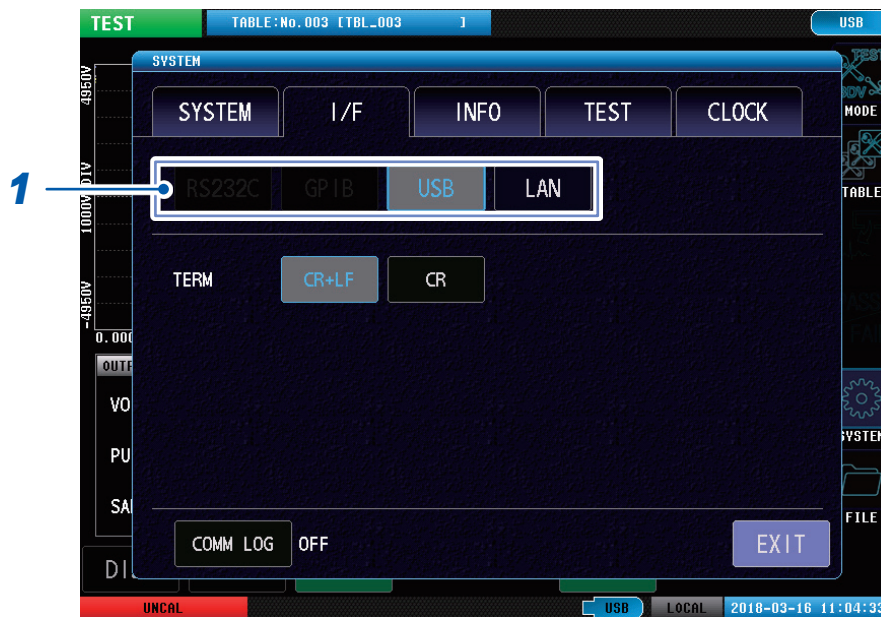

**1** Select the interface to be used.

<b>RS-232C</b>	RS-232C interface (only when Z3001 is mounted)
<b>GP-IB</b>	GP-IB interface (only when Z3000 is mounted)
<b>USB</b>	USB Interface
<b>LAN</b>	LAN Interface

When GP-IB and RS-232C are not mounted, only **[USB]** and **[LAN]** are displayed.

# 11.5 Connecting and Setting RS-232C (Model Z3001)

## Connection method

Connect a RS-232C cable to the RS-232C connector of the instrument.  
 Model 9637 RS-232C cable (9pin-9pin/1.8 m) is recommended.  
 D-sub9 Pin male, terminal block screw #4-40

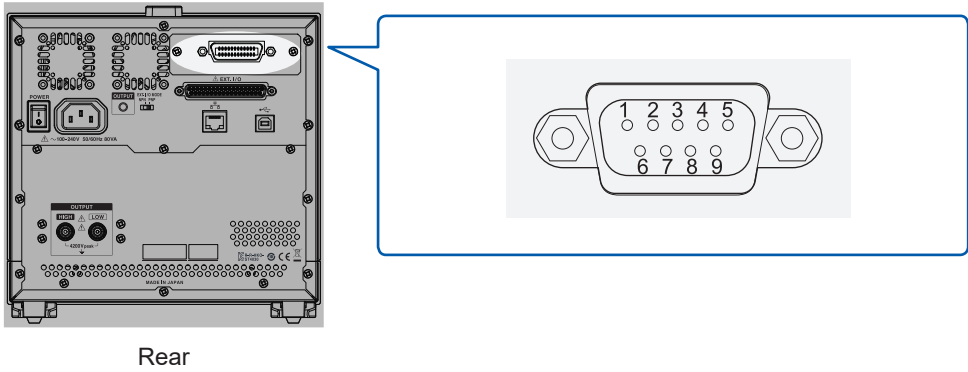

When connecting a controller (DTE), prepare a instrument connector and a cross cable with the controller connector specifications.  
 The I/O connector has terminal (DTE) specifications.

Connector (Dsub) pin No.	Mutual connection circuit name	CCITT circuit No.	EIA code	JIS code	Customary code
1	Unused	–	–	–	–
2	Receive Data	104	BB	RD	RxD
3	Transmit Data	103	BA	SD	TxD
4	Data Terminal Ready	108/2	CD	ER	DTR
5	Signal Ground	102	AB	SG	GND
6	Unused	–	–	–	–
7	Unused	–	–	–	–
8	Unused	–	–	–	–
9	Unused	–	–	–	–

### Example: Connecting DOS/VPC

Specifications: D-sub 9 Pin female-female connector, reverse wiring

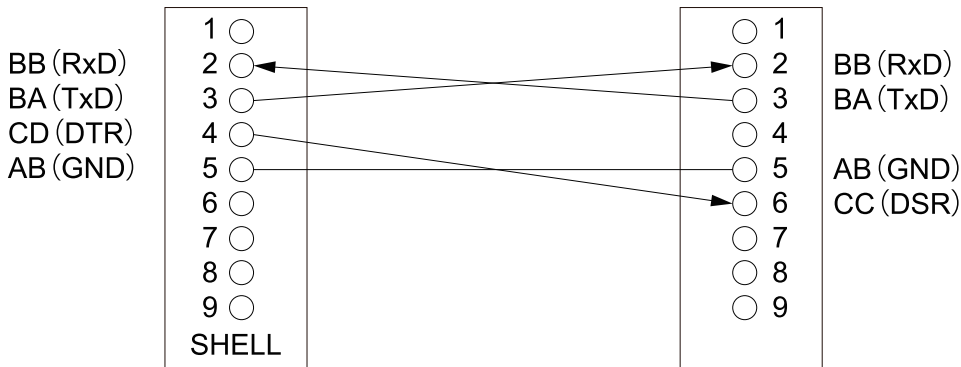

## Setting procedure

Set RS-232C communications settings using the system screen. Settable only when the Z3001 RS-232C interface is mounted to the instrument.

(Measurement screen) **[SYSTEM]** > **[I/F]**



**1** Tap **[RS-232C]**.

**2** Select the baud rate.

<b>9600</b>	9600 bps
<b>19200</b>	19200 bps
<b>38400</b>	38400 bps
<b>57600</b>	57600 bps

**3** Select handshake.

<b>OFF</b>	No flow control
<b>XON/OFF</b>	Software control (XON/XOFF)

**4** Select the terminator.

<b>CR+LF</b>	CR+LF
<b>CR</b>	CR



# 11.6 Connecting and Setting GP-IB (Model Z3000)

## Connection method

Connect a GP-IB cable to the GP-IB connector of the instrument.  
 Model 9151-02 GP-IB connector cable (2 m) is recommended.

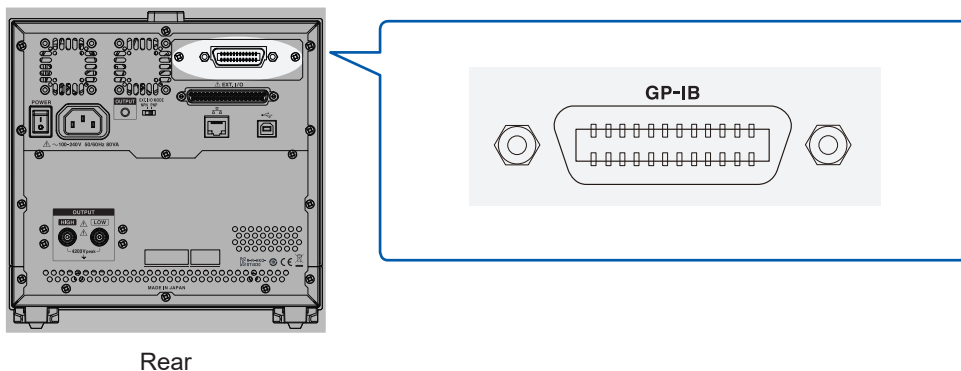

## Setting procedure

Set GP-IB communications settings using the system screen. Settable only when a Z3000 GP-IB interface is mounted to the instrument.

(Measurement screen) **[SYSTEM]** > **[I/F]**



- 1** Tap **[GP-IB]**.
- 2** Set GP-IB addresses.  
Setting range: 00 to 30
- 3** Select the terminator.

<b>LF</b>	LF concomitant with EOI
<b>CR+LF</b>	CR+LF concomitant with EOI

## 11.7 Connecting and Setting USB



When the instrument is connected to a PC for the first time, the dedicated USB driver is required. Before connecting the instrument and PC, install the USB driver.

The USB drivers are on the enclosed application disc, or you can download them from the Hioki website (<http://www.hioki.com>).

Further, the OS that are compatible with the USB drivers are Windows 7 (32/64bit), Windows 8 (32/64bit), and Windows 10 (32/64bit).

In addition, do not switch the PC to sleep mode during a connection.

### ⚠ CAUTION

- 
  - To avoid device failure, do not disconnect the USB cables while communications are in progress.
  - While USB communications between the instrument and PC are underway, do not connect another USB device to the PC, or disconnect from the PC. Doing so risks stopping the communications between the instrument and the PC.
- 
  - Use a common ground for both the instrument and the computer. Using different ground circuits will result in a potential difference between the instrument's ground and the computer's ground. If the USB cable is connected while such a potential difference exists, it may result in instrument malfunction or failure.

### Connection method

Connect one end of a (commercially available) USB cable to the USB connector on the instrument. Connect the other end of the USB cable to the USB interface on the PC.

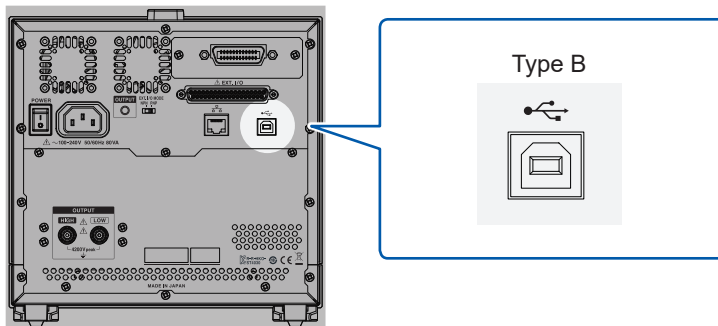

Rear

## Setting procedure

(Test screen) [SYSTEM] > [I/F]



**1** Tap [USB].

**2** Set the terminator.

CR+LF	CR+LF
CR	CR

## 11.8 Setting and Connecting LAN

### Connection method

When connecting the instrument and PC using a LAN cable, you can control and monitor the instrument from the PC. Use a LAN cable to connect the instrument to the 1000BASE-T connector on the PC.

#### CAUTION



If installing a LAN cable outdoors, make sure to include a LAN surge protector. There is a risk to the instrument due to it being easily affected by induced lightning.

There are 2 connection methods, as described below.

#### (1) Connect the instrument to an existing network to use

When connecting the instrument and hub using a LAN cable, you can control and monitor the instrument from the PC.

##### Connecting a single instrument to multiple PCs

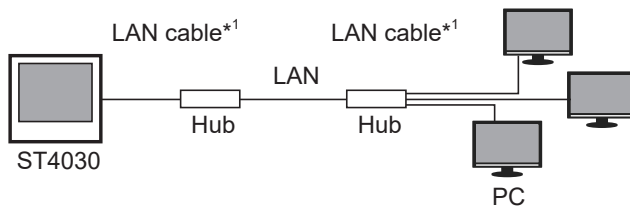

##### Connecting multiple instruments to a single PC

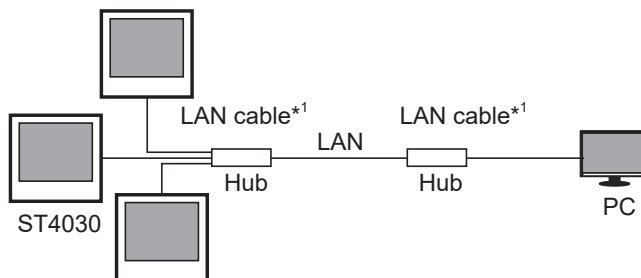

\*1: Use either of the following.

- 1000BASE-T-compatible straight cable (30 m max., commercially available)
- 9642 LAN cable (optional)

## (2) Connect the instrument and PC for 1-to-1 use

When connecting the instrument and PC using a LAN cable, you can control and monitor the instrument from the PC.

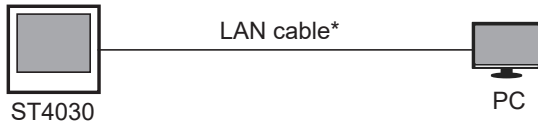

\*Use either of the following.

- 1000BASE-T-compatible cross cable (30 m max.)
- 1000BASE-T-compatible straight cable and cross conversion connector (30 m max.)
- 9642 LAN cable (optional, with cross conversion connector enclosed)

**If connecting using a 9642 LAN cable and cross conversion connector enclosed with the 9642**

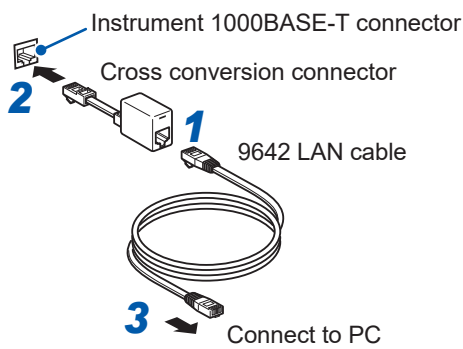

- 1** Connect a 9642 LAN cable to an enclosed cross conversion connector.
- 2** Connect a cross conversion connector to the 1000BASE-T connector on the instrument.
- 3** Connect a 9642 LAN cable to the 1000BASE-T connector on the PC.

## Setting procedure

---

You can implement command control using TCP/IP protocols.  
Set the instrument according to the network environment in use beforehand.

### IMPORTANT

- Make sure to make the LAN settings before connecting to the network.
- If the settings were changed without disconnecting, there is a risk that the IP address will duplicate the address of another instrument on the LAN, so that illegal address information may be sent to the LAN.
- The instrument is not compatible with network systems that automatically acquire IP addresses using DHCP.

## Explanation of setting items

### IP address

An address to identify individual devices that are connected on the network.

Set individual addresses so there is no overlap with other devices.

The instrument uses IP version 4, and IP addresses are displayed as 4 digit decimal numbers separated using "." as in "192.168.0.1".

### Subnet mask

This setting separates the IP address into the network address part showing the network and the host address part showing the device. Displays on the instrument use 4 digit decimal numbers separated using "." as in "255.255.255.0".

### Default gateway

If the PC and instrument that are in communication are on different networks, specify the IP address of the device that will act as the gateway.

If not using a gateway, such as with 1-to-1 connections, set the instrument to "0.0.0.0".

## Network environment configuration example

### Example 1: Connecting the instrument to the existing network

If connecting the instrument to an existing network, it is necessary to check the network settings beforehand.

It is necessary to allocate IP addresses so that they do not overlap with other network devices. Check the following items with the network administrator, and keep a memo.

IP address	_____	_____	_____	_____
Subnet mask	_____	_____	_____	_____
Default gateway	_____	_____	_____	_____

### Example 2: Connecting 1 PC and multiple instruments using a hub

If configuring a local network with no external connections, using a private IP address as shown in the example is recommended.

Private IP address example:

IP address ..... PC: 192.168.0.100

Instrument: 192.168.0.1, 192.168.0.2, 192.168.0.3... (Use an IP address that is different from other network devices)

Subnet mask: ..... 255.255.255.0

Default gateway: .... OFF (0.0.0.0)

### Example 3: Connecting a instrument and PC 1-to-1 using a 9642 LAN cable

If connecting the PC and instrument 1-to-1 using the conversion connector enclosed with the 9642 LAN cable, you can set the IP address as desired, but using a private IP address is recommended.

IP address ..... PC: 192.168.0.100

Instrument: 192.168.0.1 (Set a different IP address from the PC)

Subnet mask: ..... 255.255.255.0

Default gateway: .... OFF (0.0.0.0)

(Measurement screen) [SYSTEM] > [I/F]



- 1** Tap [LAN].
- 2** Set the IP addresses.
- 3** Set the port numbers.  
Setting range: 1024 to 65535
- 4** Set the subnet mask.
- 5** Set the gateway.  
If it is not necessary to set a default gateway, for example if setting the instrument and PC 1-to-1 using a cross cable, the gateway may remain OFF.
- 6** Select the terminator.

<b>CR+LF</b>	CR+LF
<b>CR</b>	CR

The subnet masks that can be set using the instrument are the following 30 patterns.

128.000.000.000	255.128.000.000	255.255.128.000	255.255.255.128
192.000.000.000	255.192.000.000	255.255.192.000	255.255.255.192
224.000.000.000	255.224.000.000	255.255.224.000	255.255.255.224
240.000.000.000	255.240.000.000	255.255.240.000	255.255.255.240
248.000.000.000	255.248.000.000	255.255.248.000	255.255.255.248
252.000.000.000	255.252.000.000	255.255.252.000	255.255.255.252
254.000.000.000	255.254.000.000	255.255.254.000	
255.000.000.000	255.255.000.000	255.255.255.000*1	

\*1: Default setting



# 11.9 Remote Mode

If starting communications after connecting an interface to the instrument, the instrument will enter remote mode (remote operations mode). In remote mode, operations by tapping the screen are disabled.

## Remote mode ON



## Remote mode OFF

To return to local mode (normal communications), tap **[LOCAL]**.



# 11.10 Communications Monitor

You can display the communications commands and query responses onscreen by using the communications monitoring functions.

(Measurement screen) **[SYSTEM]** > **[I/F]**

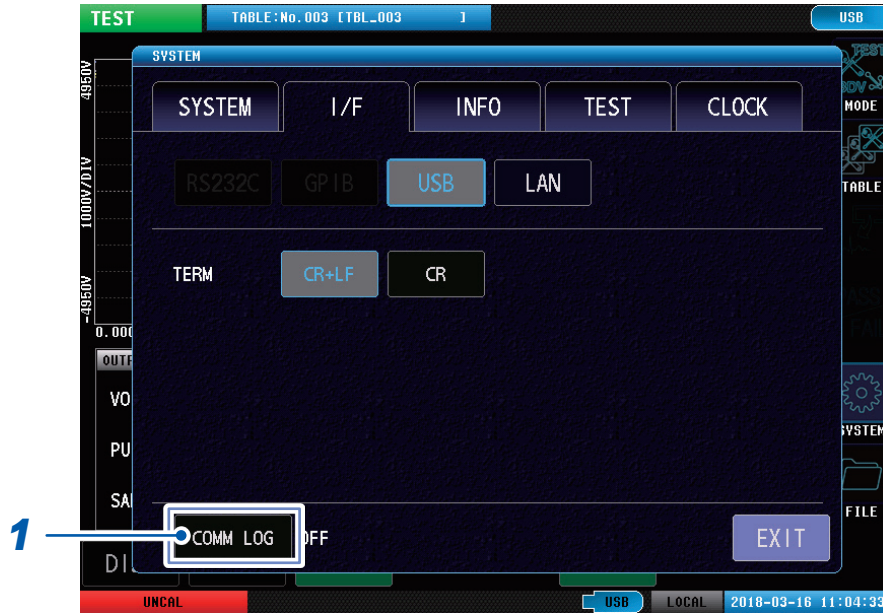

1 Tap **[COMM LOG]**.

OFF	Communications monitor is not displayed.
ON	Communications monitor is displayed.

Communications monitor is displayed onscreen. The max. number of lines that can be displayed is 30.



## Commands and messages displayed by the communications monitor, and their meaning

The displayed commands are color-coded as described below.

<b>Light blue display</b>	Incoming commands
<b>Green display</b>	Outgoing commands
<b>Red display</b>	Error messages

Error messages are displayed as described below.

<b>QUERY ERROR</b>	Query error
<b>DEVICE-SPECIFIC ERROR</b>	Instrument-dependent error
<b>EXECUTION ERROR</b>	Execution error
<b>COMMAND ERROR</b>	Command error

### IMPORTANT

- If the communications monitor function is turned ON, the communications monitor time is displayed onscreen in addition to the communications sending and receiving time. Due to this, the communications time will be lengthened. This lengthening will be particularly conspicuous if the number of response data characters is great.
- If sending commands continuously, the error display position may be misaligned.

# 12 USB Host

## 12.1 Overview

You can save the measured value and instrument settings to USB memory. Further, you can also import the settings that have been saved to USB memory to the instrument.

<b>How to save data</b>	<p>You can save data from the instrument to USB memory.</p> <ul style="list-style-type: none"><li>• Test results (CSV file format)</li><li>• Measurement screen (BMP file format)</li><li>• Memory data (See “8.4 Memory Function” (p. 107))</li><li>• Instrument settings (user-defined table settings, all settings)</li></ul>
<b>Importing data</b>	<p>You can import data from USB memory to the instrument.</p> <ul style="list-style-type: none"><li>• Instrument settings (user-defined table settings, all settings)</li></ul>
<b>File operations</b>	<p>You can implement operations on USB memory.</p> <ul style="list-style-type: none"><li>• Formatting (initializing) USB memory</li><li>• Deleting files and folders</li><li>• Creating folders</li><li>• Changing the names of files and folders</li></ul>

12

USB Host

### CAUTION



- Make sure not to insert USB memory with the incorrect orientation. There is a risk of damaging either USB memory or the instrument.
- To avoid corrupting the data in USB memory, do not turn OFF the instrument power supply while USB memory is being accessed. Further, make sure not to remove the USB memory from the instrument. When accessing USB memory, the USB icon changes from blue to red.
- Do not move the instrument while USB memory is connected. There is a risk of damaging the USB memory.



- There is a risk of static electricity causing USB memory malfunction or instrument misoperation, so handle with care.

### IMPORTANT

- USB memory has a service life. If using for a long period of time or frequently, data memory and import may become disabled. In such cases, buy a new memory.
- Data saved to USB memory cannot be indemnified not matter what the details or cause of any malfunction or damage. Make sure to back up all important data on USB memory.

## 12.2 Removing the USB Memory

### Inserting the USB memory

Insert the USB memory into the USB memory connector on the front.

- Do not insert anything other than a mass storage class-compatible USB memory.
- Not all commercially-available USB memories are compatible.
- If the USB memory is not detected, try another USB memory.

### Removing the USB memory

Check that the USB memory is not being accessed (saving, importing, etc.) by the instrument before removing. Instrument removal operations are not required.

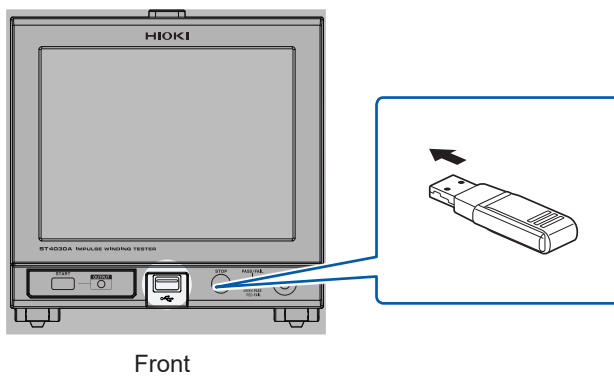



### Icon display when using the USB

When a USB memory is detected normally, the USB memory icon is displayed at the bottom of the measurements screen.

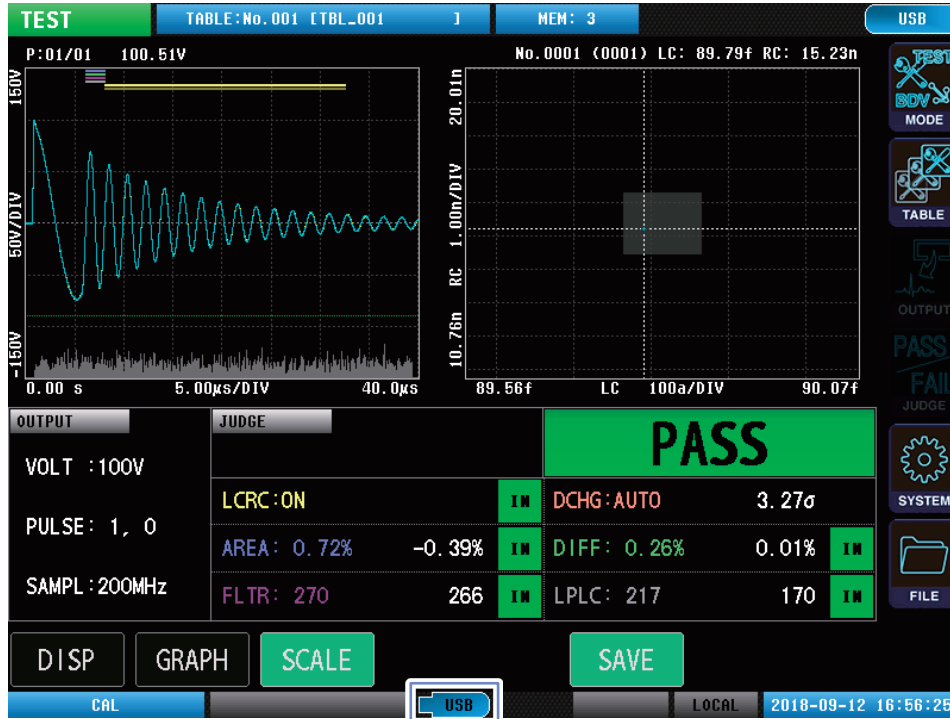
When USB memory is being accessed, the icon color turns red.



 (Blue)	If the instrument detects a USB memory
 (Red)	If accessing USB memory

### File types that the instrument can handle

The instrument cannot display double-byte characters (Japanese, etc.) Double-byte characters are replaced by “??”

The max. number of files that the instrument screen can display is 1000.

Contents	Type	Extension
–	Folder	–
Test results	CSV files	.CSV
Measurement screen	BMP files	.BMP
Instrument settings	User-defined table settings	.TBL
	All settings	.ALL

# 12.3 File Window

When using USB, the following will be displayed.

Further, you can set the format of the file to be saved to USB, the save destination, the text save format, and so on.

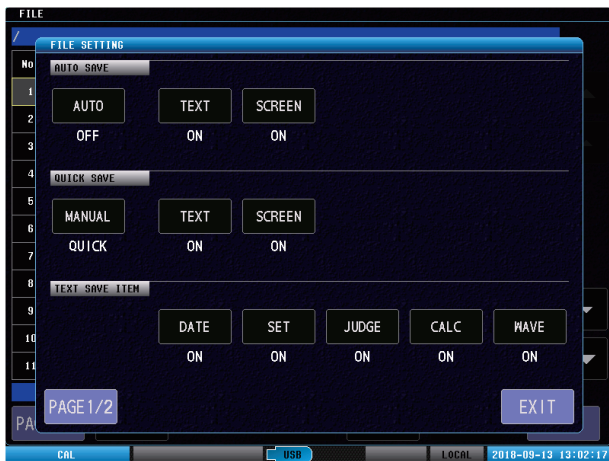
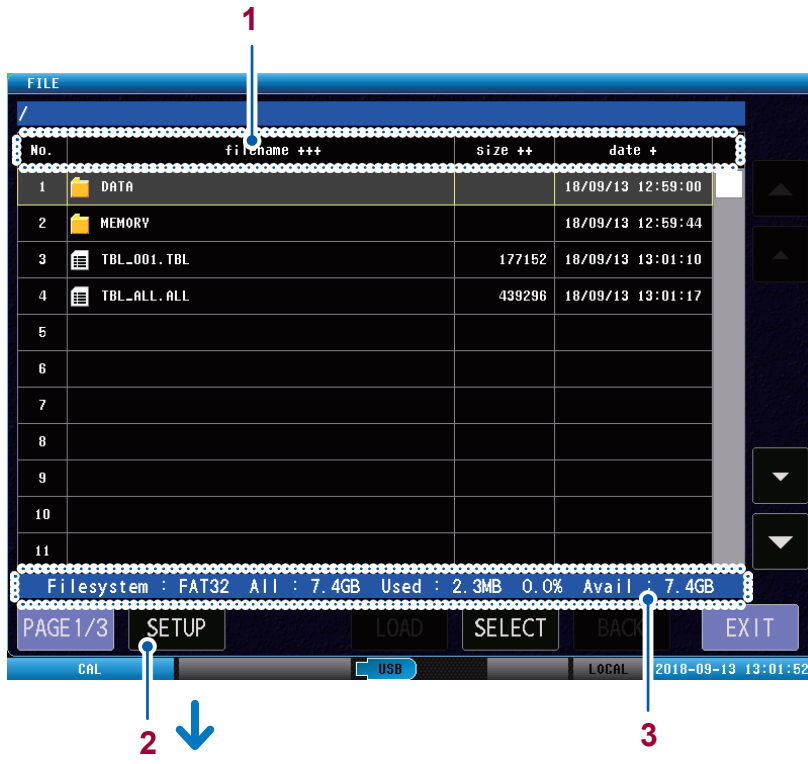

<p><b>1</b></p>	<p><b>Header portion</b></p>	<p><b>[filename +++]</b>: File name  <b>[size ++]</b>: File size  <b>[date +]</b>: File save date and time                  You can sort the files.                  The number of <b>[+]</b> and <b>[-]</b> is the priority order of the sort.                  If <b>[EXT]</b> is appended, the file name sort prioritizes the extension.</p>
<p><b>2</b></p>	<p><b>[SETUP]</b></p>	<p>You can set the file save details.</p>
<p><b>3</b></p>	<p><b>USB memory information</b></p>	<p>You can check the use rate of the USB memory and the file system types.  <b>[Filesystem]</b>: File system type  <b>[All]</b>: Total capacity  <b>[Used]</b>: Amount used  <b>[Avail]</b>: Available space</p>

## 12.4 Settings for Saving the Data

Set beforehand to save the measurement results to USB memory.

Both auto and manual save are available.

You can select the test results (CSV file format) and measurement screen (BMP file format) to be saved.

### Setting auto save

Set to save the measurement results automatically after measuring finishes.

(Measurement screen) [FILE] > [SETUP]

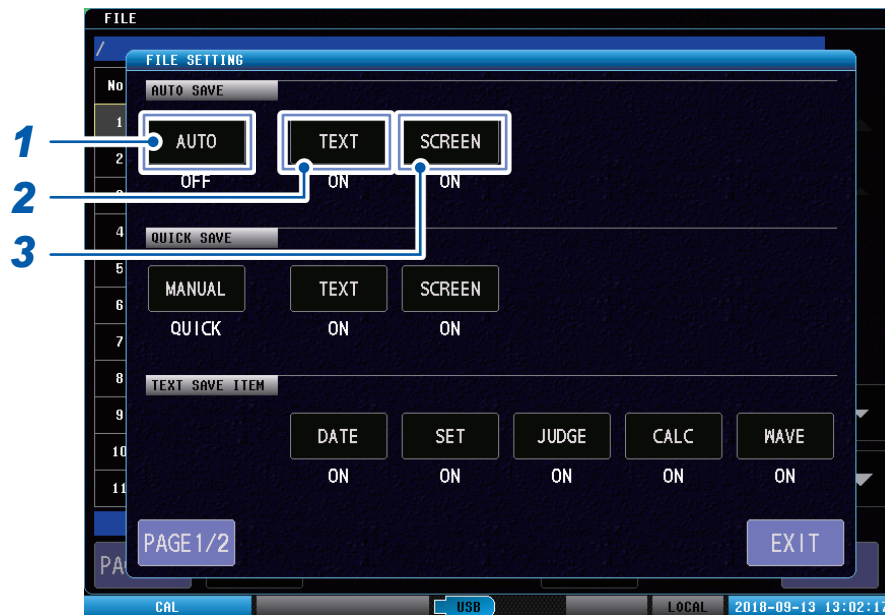

- 1 Tap [AUTO], and set whether or not to save the data automatically after measuring finishes.

OFF	Data is not automatically saved after measurements finish. To save the data requires manual operation.
ON	Data is automatically saved after measurements finish.

- 2 Tap [TEXT], and set whether or not to save text (CSV file format) of the test results during automatic saving.

OFF	Not saved.
ON	Saved.

- 3 Tap [SCREEN], and set whether or not to save the an image of the measurements screen (BMP file format) during automatic saving.

OFF	Not saved.
ON	Saved.



## Setting manual save

Tap **[SAVE]**, and set to save the measurement results.

(Measurement screen) **[FILE]** > **[SETUP]**

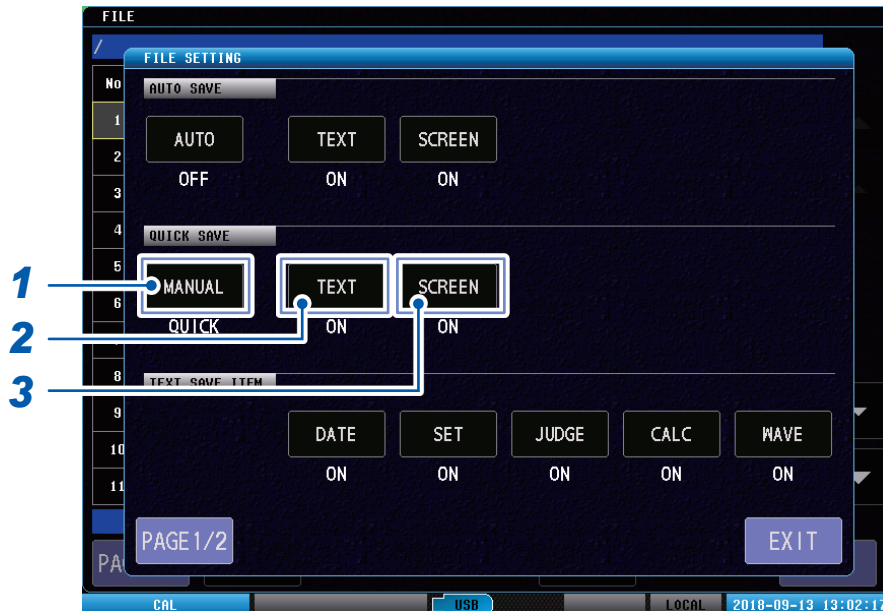

### 1 Set the operations when **[SAVE]** is tapped.

<b>SELECT</b>	The save details selection window will be displayed.
<b>QUICK</b>	Saves the saved items that have been set immediately.

### 2 Tap **[TEXT]**, and set whether or not to save text (CSV file format) of the test results during manual saving.

<b>OFF</b>	Not saved.
<b>ON</b>	Saved.

### 3 Tap **[SCREEN]**, and set whether or not to save the an image of the measurements screen (BMP file format) during manual saving.

<b>OFF</b>	Not saved.
<b>ON</b>	Saved.

## Text save items settings

Sets the save items when saving text of the test results (CSV file format).

(Measurement screen) **[FILE]** > **[SETUP]**

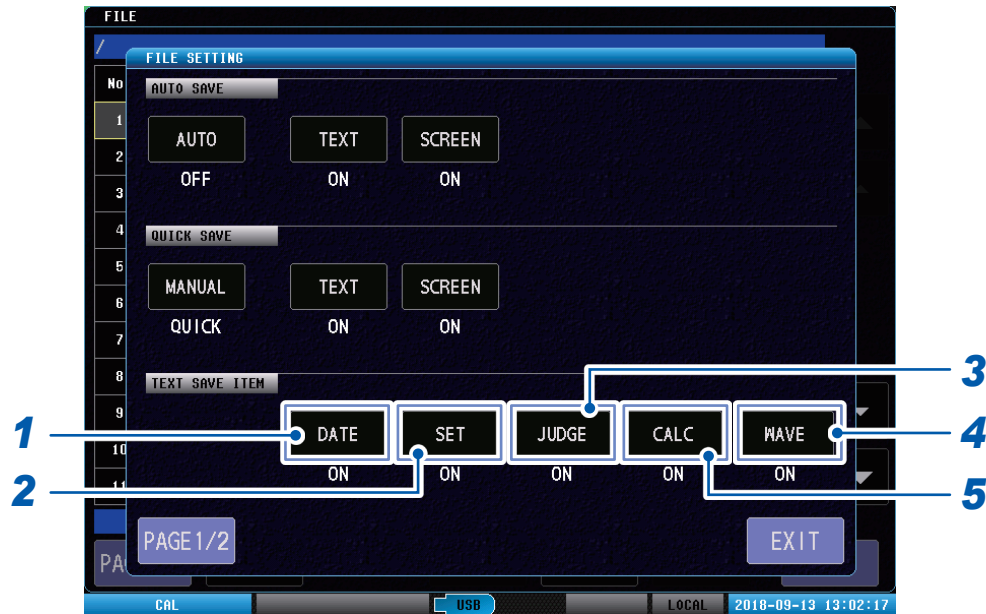

- 1 Tap **[DATE]**, and set whether or not to save the date and time.
- 2 Tap **[SET]**, and set whether or not to save the measuring conditions.
- 3 Tap **[JUDGE]**, and set whether or not to save the judgment values and judgment results.
- 4 Tap **[CALC]**, and set whether or not to save the peak values and zero-cross values.
- 5 Tap **[WAVE]**, and set whether or not to save the measurement waveforms.

## Setting the text save format

Sets the delimiters and quote marks when saving text of the test results (CSV file format).

(Measurement screen) **[FILE]** > **[SETUP]** > **[PAGE]**



**1** Tap **[QUOTE]**, and set the item quotation type.

OFF	None
"	Double quotes
'	Single quotes

**2** Tap **[ITEM DELIM]**, and set the item delimiter type.

,	Comma
TAB	Tab
;	Semicolon
.	Period
SPACE	Space

**3** Tap **[DECIM CHAR]**, and set the decimal point type.

.	Period
,	Comma

**4** Tap **[DATE FORM]**, and set the date format.

<b>YYYYMMDD</b>	Year, month, day
<b>MMDDYYYY</b>	Month, day, year
<b>DDMMYYYY</b>	Day, month, year
<b>YYMMDD</b>	Year, month, day
<b>MMDDYY</b>	Month, day, year
<b>DDMMYY</b>	Day, month, year

**5** Tap **[DATE DELIM]**, and set the date delimiter type.

<b>/</b>	Slash
<b>-</b>	Hyphen
<b>.</b>	Period

**Setting the image save format**

Set when saving the measurement screen image (BMP file format).

(Measurement screen) **[FILE]** > **[SETUP]** > **[PAGE]**

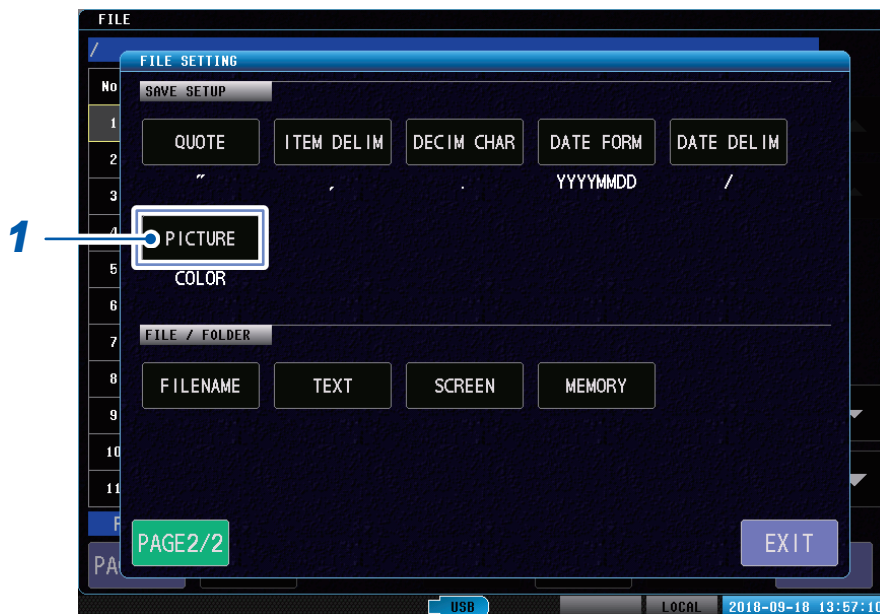
**1** Tap **[PICTURE]**, and set the image to color.

<b>COLOR</b>	Saved using full-color BMP format.
<b>MONO</b>	Saves in grayscale BMP format.

## Setting the name of the saved file and its folder

Specifies the name of the saved file.

### IMPORTANT

File names are shared between text saved data, image saved data, and memory data.  
If a file with the same name already exists, "00001" to "65534" will be appended in order after the file name.

(Measurement screen) **[FILE]** > **[SETUP]** > **[PAGE]**

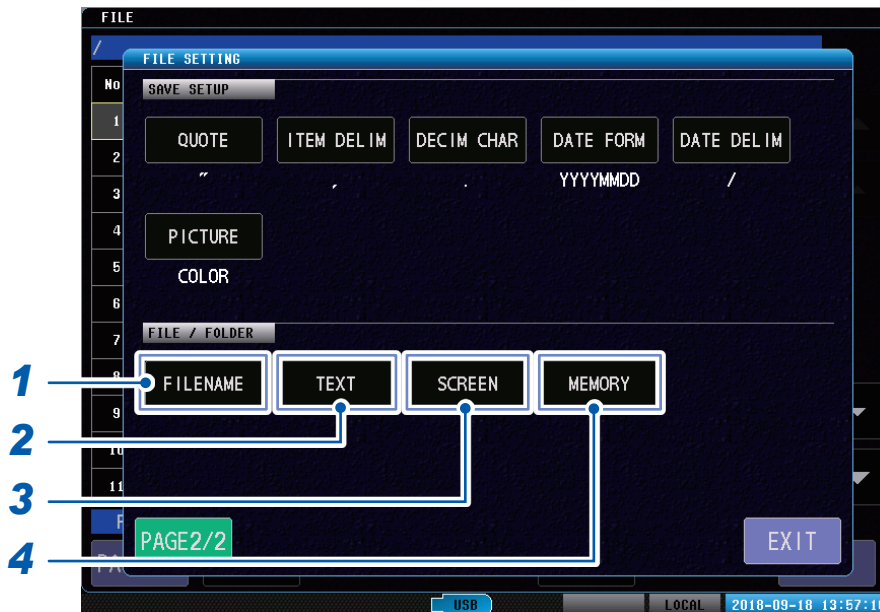

- 1 Tap [FILENAME], and set the name of the saved file.**  
Settings range: 31 characters max.  
If nothing is specified, the date and time will be entered at in the file name header.  
Example: 20190101\_125959.CSV
- 2 Tap [TEXT], and set the save destination folder for the test results text.**  
Settings range: 31 characters max.  
If nothing is specified, the file will be saved to the **[DATA]** folder.
- 3 Tap [SCREEN], and set the name of the save destination folder for images of the measurements screen.**  
Settings range: 31 characters max.  
If nothing is specified, the file will be saved to the **[DATA]** folder.
- 4 Tap [MEMORY], and set the name of the save destination folder for the memory data.**  
Settings range: 31 characters max.  
If nothing is specified, the file will be saved to the **[MEMORY]** folder.

## Operating the file name input screen (Same as the folder name input screen)

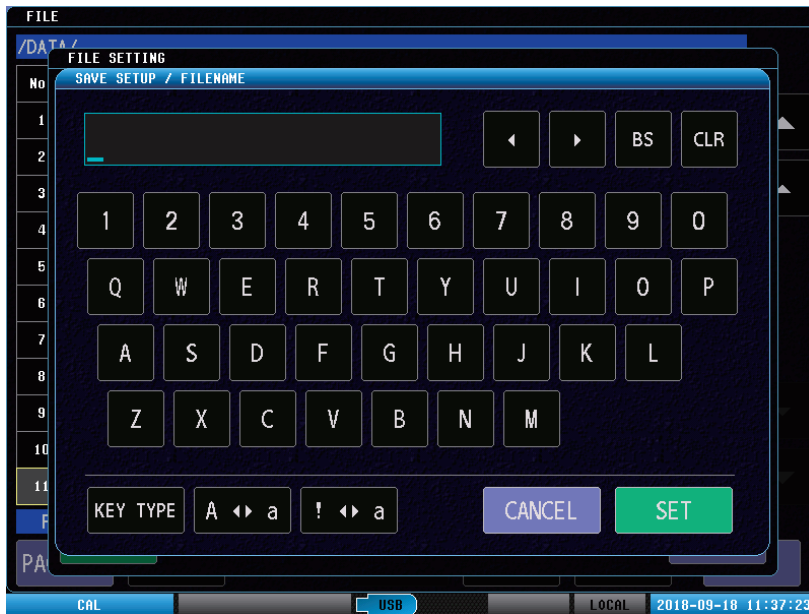

◀▶	Moves the cursor.
<b>BS</b>	Deletes 1 character from the file name that has been entered.
<b>CLR</b>	Deletes all characters from the file name that has been entered.
<b>KEY TYPE</b>	Switches the keyboard type.
<b>A ▶▶ a</b>	Switches between upper and lower case.
<b>! ▶▶ A</b>	Switches between symbols, numbers, and the alphabet.
<b>CANCEL</b>	Cancels the file name that has been entered.
<b>SET</b>	Confirms the file name that has been entered.

# 12.5 Saving Test Results

- Manual saving** ▶ Tap **[SAVE]** to implement the save.  
 QUICK: Tap **[SAVE]** to save immediately according to the settings details.  
 SELECT: Tap **[SAVE]** to display the selection window.
- Automatic saving** ▶ If automatic saving has been turned ON using **[FILE] > [SETUP]**, saving is implemented automatically after measuring has finished.
- Save memory data** ▶ Reference: "8.4 Memory Function" (p. 107)

## Saving manually

If saving manually, you can select from 2 options: QUICK and SELECT.

(Measurement screen) **[MODE]** > **[TEST]**

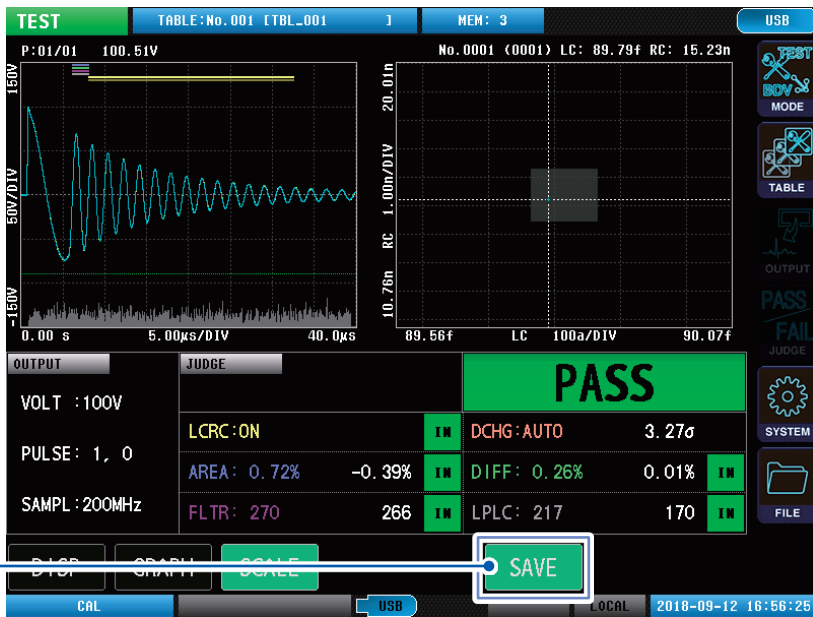

**1** Tap **[SAVE]**.

<b>QUICK</b>	Tap <b>[SAVE]</b> to save immediately according to the settings details.
<b>SELECT</b>	Tap <b>[SAVE]</b> to display the selection window.

**[SAVE]** is displayed only when a USB memory has been inserted into the instrument.

Only when **[SELECT]** is selected

**2** Select the details to be saved and implement the save operation.

<b>TEXT</b>	Saves the text data.
<b>SCREEN</b>	Saves the image.

**3** Tap **[SAVE]**.

Implements manual save.

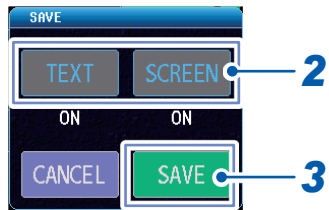



## Checking the test results that have been saved

### Saves using TEST mode

"HIOKI E.E. CORPORATION","ST4030","Ver. ","1.00" "Serial No. ","123456789"	Header
"DATE","2019/02/26" "TIME","08:30:00"	Save date and time (DATE setting is ON)
"TABLE No. ","1","TBL_001" "VOLTAGE","100","V" "PULSE NUM","1","0" "S/s","2E+08","Hz" "RECORD LENGTH","8001","pt" "DELAY","0.000","s"	Measurement conditions (SET setting is ON)
"LCRC","ON" "LCRC POINT1","8.974E-14","1.617E-08" "LCRC POINT2","8.984E-14","1.617E-08" "LCRC POINT3","8.984E-14","1.449E-08" "LCRC POINT4","8.974E-14","1.449E-08" "DISCHARGE","AUTO" "DISCHARGE LIMIT","6","sigma" "AREA","ON" "AREA LIMIT","0.73","%" "AREA SCOPE","1217","1599" "DIFF","ON" "DIFF LIMIT","0.71","%" "DIFF SCOPE","1217","1599" "FLUTTER","ON" "FLUTTER LIMIT","272" "FLUTTER SCOPE","1217","1599" "LAPLACIAN","ON" "LAPLACIAN LIMIT","215" "LAPLACIAN SCOPE","1217","1599"	Judgment conditions (SET setting is ON)
"STATUS","0" "TOTAL JUDGE","PASS" "LCRC JUDGE","IN" "LCRC VALUE","8.977E-14","1.527E-08" "DISCHARGE JUDGE","IN" "DISCHARGE VALUE","3.18","sigma" "AREA JUDGE","IN" "AREA VALUE","0.04","%" "DIFF JUDGE","IN" "DIFF VALUE","0.00","%" "FLUTTER JUDGE","IN" "FLUTTER VALUE","264" "LAPLACIAN JUDGE","IN" "LAPLACIAN VALUE","168"	Judgment values and judgment results (JUDGE setting is ON)
"No. ","PULSE1[V]" "PEAK 1","1.00110E+02" "PEAK 2","-7.41100E+01" "PEAK 3","6.96000E+01" "PEAK 4","-6.27800E+01"	Peak value (CALC setting is ON)
"No. ","PULSE1[pt]" "ZEROCROSS 1","604" "ZEROCROSS 2","1216" "ZEROCROSS 3","1408" "ZEROCROSS 4","1598"	Zero-cross value (CALC setting is ON)
"No. ","STANDARD WAVE[V]","PULSE1 WAVE[V]","PULSE1 DISCHARGE" "1","1.20000E-01","2.50000E-01","0.00" "2","1.90000E-01","2.70000E-01","0.00" "3","8.00000E-02","2.70000E-01","0.00" "4","-1.00000E-02","2.60000E-01","0.00"	Measurement waveform (WAVE setting is ON)

## Saves using BDV mode

"HIOKI E.E. CORPORATION", "ST4030", "Ver. ", "1.00" "Serial No.", "123456789"	Header
"DATE", "2019/02/26" "TIME", "08:30:00"	Save date and time (DATE setting is ON)
"START", "100", "V" "END", "200", "V" "STEP", "100", "V" "PULSE NUM", "10", "0" "S/s", "2E+08", "Hz" "RECORD LENGTH", "8001", "pt"	Measurement conditions (SET setting is ON)
"LCRC", "ON" "LCRC LIMIT", "6", "sigma" "DISCHARGE", "ON" "DISCHARGE LIMIT", "6", "sigma" "AREA", "ON" "AREA LIMIT", "6", "sigma" "PEAK", "ON" "PEAK LIMIT", "10", "%" "FREQUENCY", "ON" "FREQUENCY LIMIT", "10", "%"	Judgment conditions (SET setting is ON)
"STATUS", "0" "TOTAL JUDGE", "PASS" "LAST VOLTAGE", "200", "V" "LCRC JUDGE", "PASS" "LCRC VALUE", "2.37", "sigma" "DISCHARGE JUDGE", "PASS" "DISCHARGE VALUE", "3.04", "sigma" "AREA JUDGE", "PASS" "AREA VALUE", "2.35", "sigma" "PEAK JUDGE", "PASS" "PEAK VALUE", "0.15", "%" "FREQUENCY JUDGE", "PASS" "FREQUENCY VALUE", "15.00", "%"	Judgment values and judgment results (JUDGE setting is ON)
"No.", "VOLTAGE1 WAVE[V]", "VOLTAGE1 DISCHARGE", "VOLTAGE2 WAVE[V]", "VOLTAGE2 DISCHARGE" "1", "2.40000E-01", "0.00", "1.00000E-01", "0.00" "2", "3.90000E-01", "0.00", "-3.40000E-01", "0.00" "3", "2.60000E-01", "0.00", "-5.80000E-01", "0.00" "4", "-7.00000E-02", "0.00", "-2.70000E-01", "0.00"	Measurement waveform (WAVE setting is ON)

## Memory data

"0", "PASS", " 0.68", "IN ", " 0.04", "IN ", " 256", "IN ", " 168", "IN ", " 8.929E-14", " 1.526E-08", "IN ", " 3.53", "IN " "0", "FAIL", " 0.75", "IN ", " 0.34", "OUT ", " 262", "IN ", " 172", "IN ", " 8.931E-14", " 1.523E-08", "IN ", " 2.94", "IN " "0", "PASS", " 0.52", "IN ", " 0.01", "IN ", " 256", "IN ", " 154", "IN ", " 8.930E-14", " 1.528E-08", "IN ", " 3.23", "IN " "0", "FAIL", " 0.71", "IN ", " 0.20", "OUT ", " 256", "IN ", " 172", "IN ", " 8.932E-14", " 1.533E-08", "IN ", " 2.84", "IN " "0", "PASS", " 0.52", "IN ", " 0.10", "IN ", " 254", "IN ", " 176", "IN ", " 8.931E-14", " 1.560E-08", "IN ", " 3.07", "IN " "0", "PASS", " 0.62", "IN ", " 0.01", "IN ", " 256", "IN ", " 159", "IN ", " 8.931E-14", " 1.522E-08", "IN ", " 3.60", "IN " "0", "PASS", " 0.52", "IN ", " 0.01", "IN ", " 254", "IN ", " 155", "IN ", " 8.932E-14", " 1.509E-08", "IN ", " 3.21", "IN " "0", "PASS", " 0.65", "IN ", " 0.05", "IN ", " 258", "IN ", " 160", "IN ", " 8.930E-14", " 1.552E-08", "IN ", " 3.01", "IN " "0", "PASS", " 0.56", "IN ", " 0.03", "IN ", " 256", "IN ", " 170", "IN ", " 8.930E-14", " 1.547E-08", "IN ", " 3.03", "IN " "0", "PASS", " 0.50", "IN ", " 0.12", "IN ", " 258", "IN ", " 170", "IN ", " 8.931E-14", " 1.512E-08", "IN ", " 3.39", "IN "	Memory data per test
--	----------------------

**IMPORTANT**

Output format is the same as the output format for the communications command :**MEMory**:**FETCh**?  
See: Application disc "Communication Command Instruction Manual"

## 12.6 Saving and Importing Test Conditions

Saves the instrument settings information to USB memory as a settings file.  
Imports the settings file that has been saved to USB memory and restores the settings.

### Saving test conditions

There are 2 types of test conditions that can be saved.

- **[SAVE]** to save user-defined table settings  
Saves only 1 user-defined table.
- **[SAVE ALL]** to save all settings  
Batch-saves all settings tables such as interface and beep sound, etc.

### Saving user-defined table settings

(Measurement screen) **[FILE]** > **[PAGE]** > **[PAGE3/3]**



- 1** Tap **[SAVE]**.
- 2** Select the table to be saved.
- 3** Tap **[SELECT]**.  
The keyboard will be displayed.
- 4** Enter the file name.  
Reference: "Touch keyboard inputs" (p. 11)

## Saving all table settings

(Measurement screen) [FILE] > [PAGE] > [PAGE3/3]

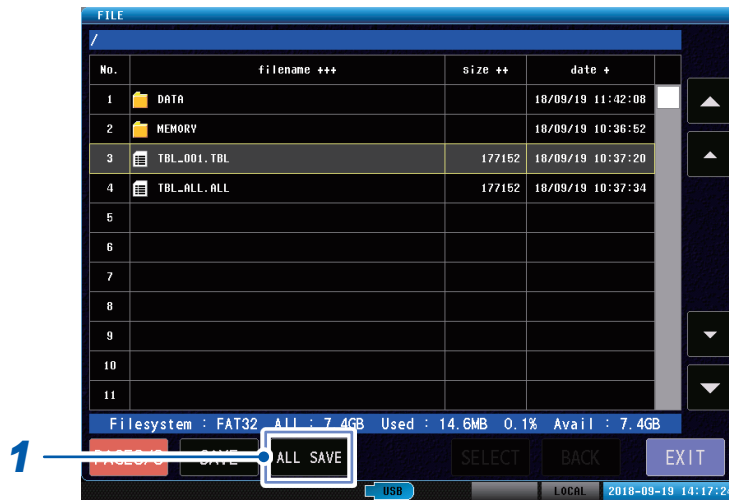

**1** Tap [ALL SAVE].

**2** Enter the file name.

Reference: "Touch keyboard inputs" (p. 11)

## Importing test conditions

You can import the following 2 types of settings file.

- User-defined table settings
- All settings

### IMPORTANT

When loading a settings file saved by the ST4030A with the ST4030, only settings with voltages that can be output by the ST4030 will be loaded.

### Importing user-defined table settings

(Measurement screen) **[FILE]** > **[PAGE]** > **[PAGE1/3]**

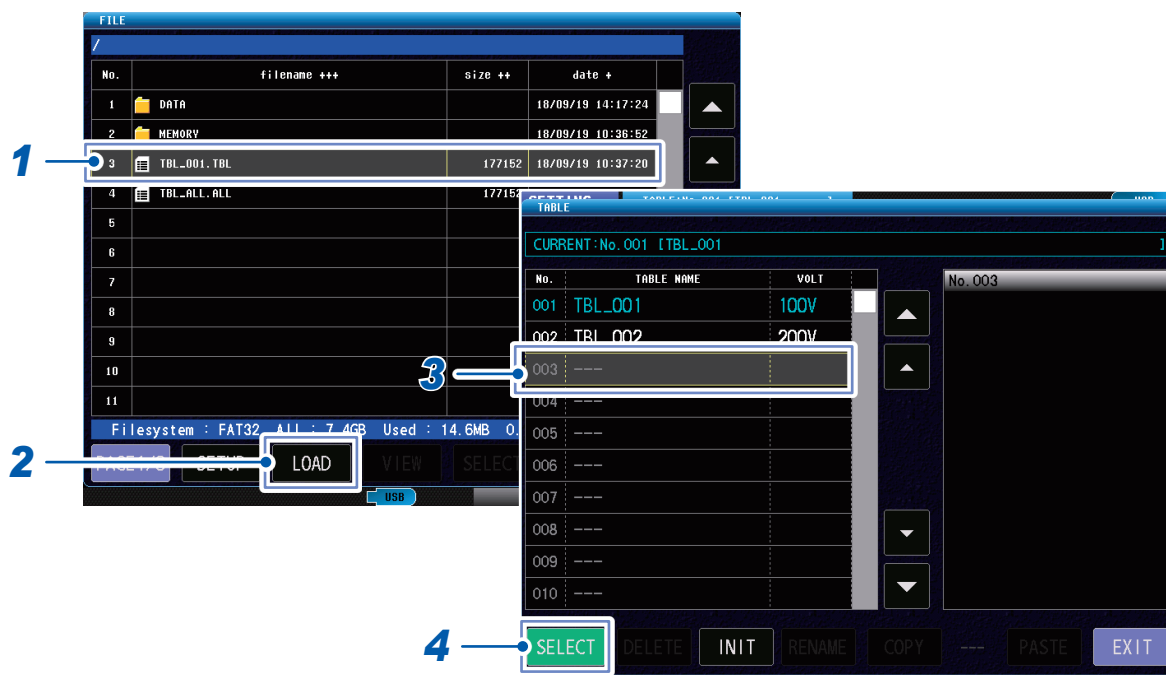

- 1** Select files with the “TBL” extension.
- 2** Tap **[LOAD]**.
- 3** Select the tables you want to write.
- 4** Tap **[SELECT]**.

## Importing all settings

(Measurement screen) **[FILE]** > **[PAGE]** > **[PAGE1/3]**

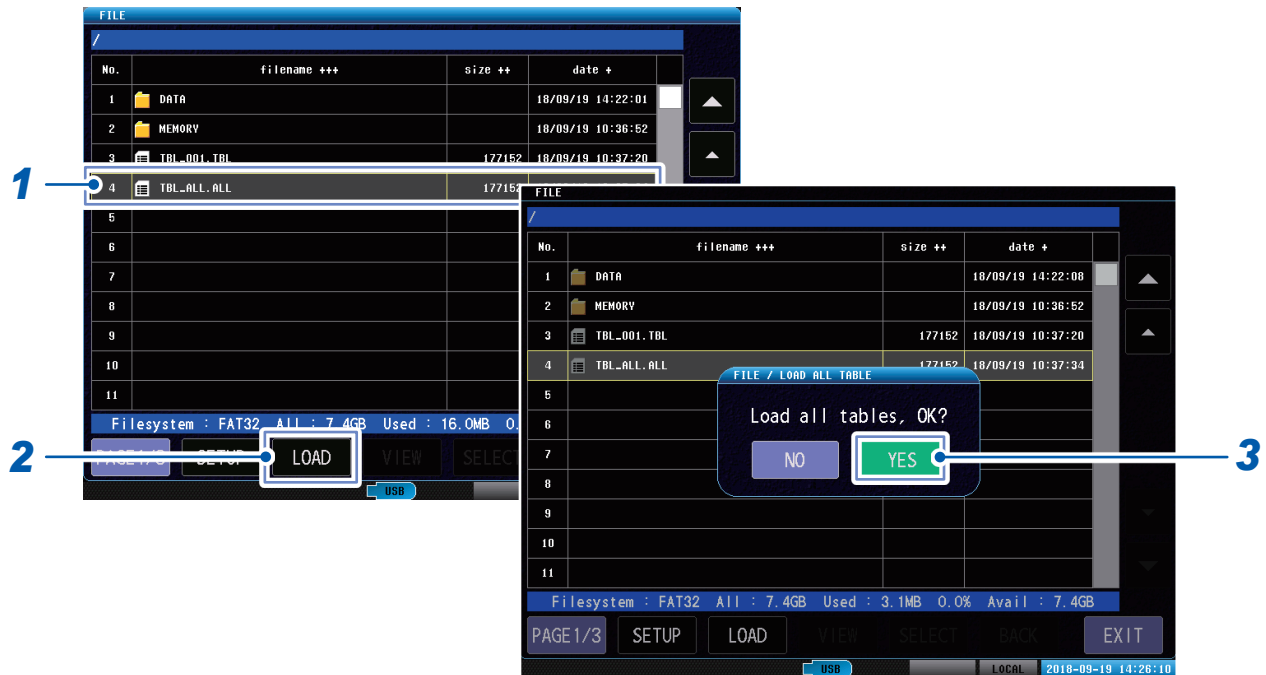

- 1** Select files with the “ALL” extension.
- 2** Tap **[LOAD]**.  
The implementation confirmation window will be displayed.
- 3** Tap **[YES]**.

## 12.7 Editing Files and Folders

You can edit the files and folders that have been saved to USB memory.

- Formatting USB memory
- Deleting files and folders
- Creating folders
- Changing the names of files and folders
- Information display (measurement results and measurement screen)

### Formatting USB memory

---

Format (initialize) the USB memory to be used.

Insert the USB memory to be formatted into the USB memory connector (on the front) and start formatting.

The instrument formats using either FAT32 or FAT16.

#### **IMPORTANT**

- When formatting, all data saved to USB memory will be deleted and cannot be restored. Check the content carefully before implementing.
- It is recommended that you make sure to back up all important data saved to USB memory.

(Measurement screen) [FILE] > [PAGE2/3]

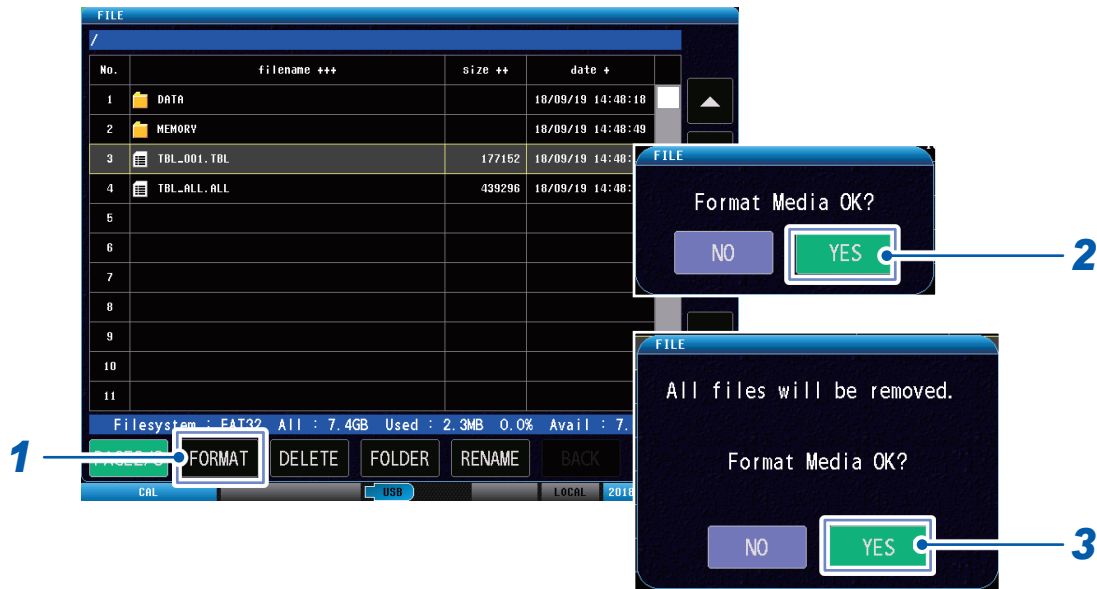

- 1** Tap [FORMAT].  
The confirmation window will be displayed.
- 2** Tap [YES].  
The confirmation window will be displayed again.
- 3** Tap [YES].



## Deleting files and folders

Deletes the files or folders that have been saved to USB memory.

### IMPORTANT

Deleted files and folders cannot be restored. Check thoroughly before deleting.

(Measurement screen) **[FILE]** > **[PAGE]** > **[PAGE2/3]**



(When deleting files)

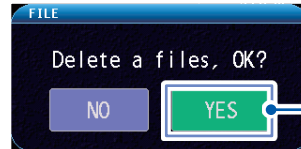

(When deleting folders)

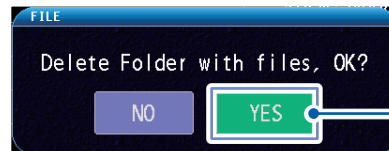

**1** Select the file or folder to be deleted.

**2** Tap **[DELETE]**.  
The confirmation window will be displayed.

**3** Tap **[YES]**.

## Creating folders

Create a folder in USB memory.  
You can set up to 31 characters max.

(Measurement screen) **[FILE]** > **[PAGE 2/3]**

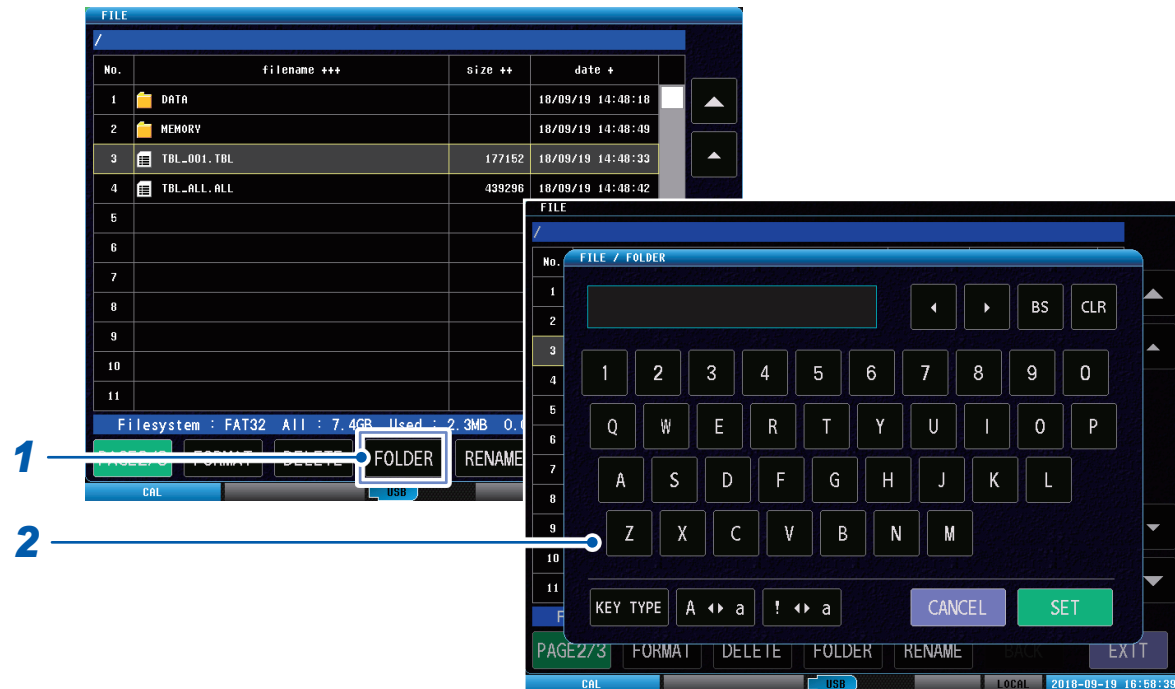

- 1** Tap **[FOLDER]**.  
The keyboard will be displayed.
- 2** Set the folder name.  
Reference: “Touch keyboard inputs” (p. 11)

## Changing the folder name and file name

Changes the name of the files or folders that have been saved to USB memory.

(Measurement screen) **[FILE]** > **[PAGE...]**

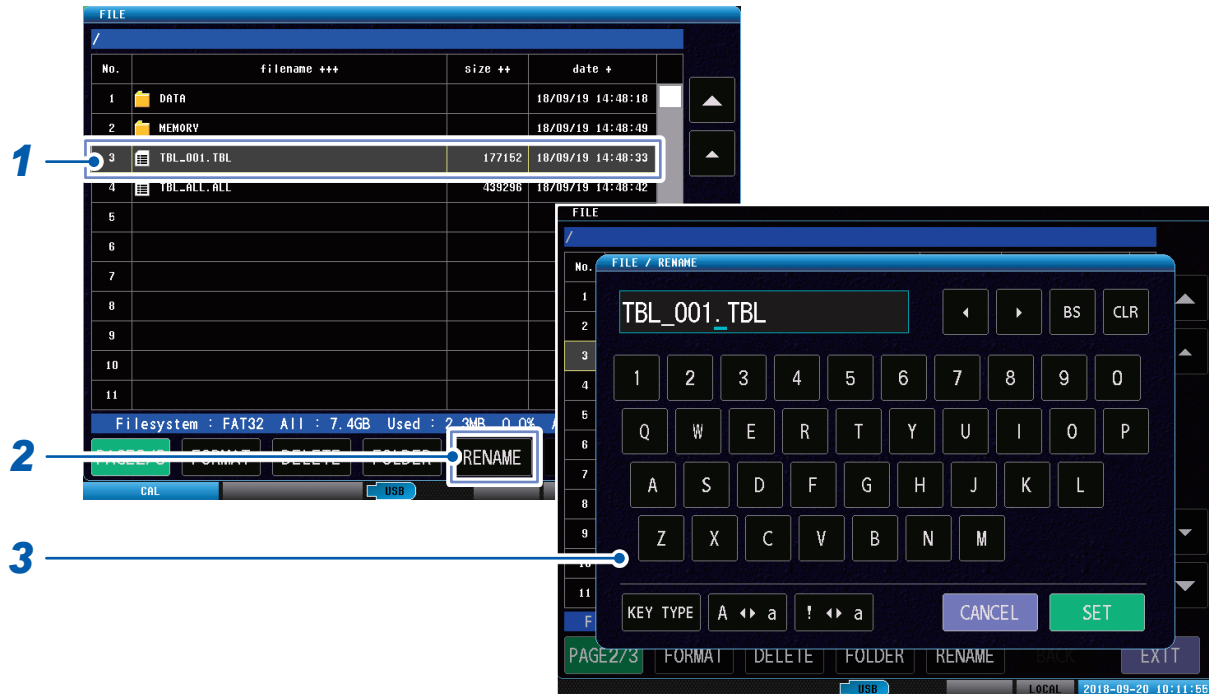

- 1** Tap a file or folder.
- 2** Tap **[RENAME]**.  
The keyboard will be displayed.
- 3** Change the name of a file or folder.  
Reference: "Touch keyboard inputs" (p. 11)

## Information display

You can use the screen to check the test results files (CSV) and measurements screen files (BMP) that have been saved to USB memory.

(Measurement screen) [FILE]

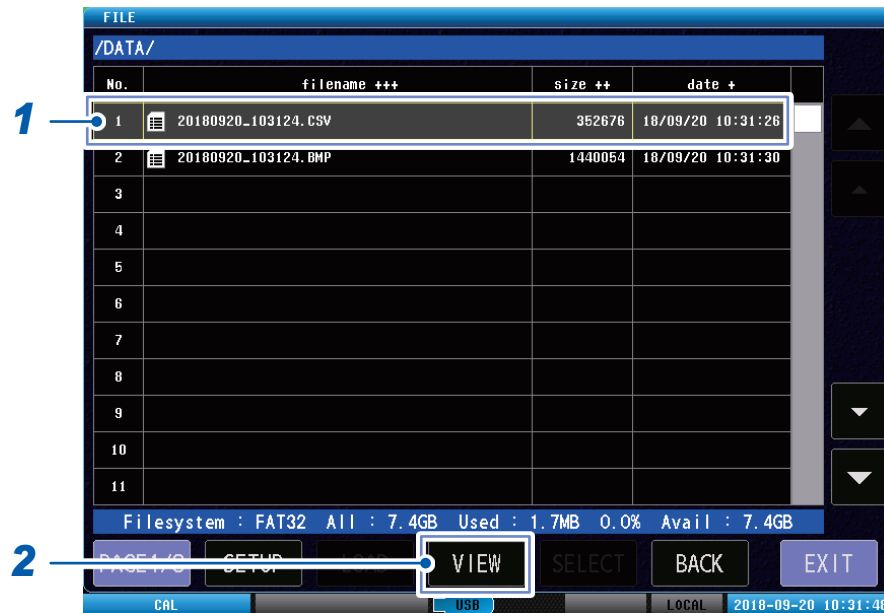

1 Tap the desired file.

2 Tap [VIEW].

Example 1: Measurements screen file (BMP)



Example 2: Test results file (CSV)

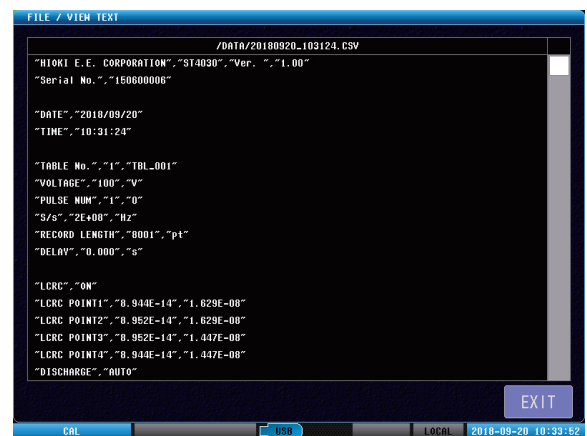



# 13 Specifications

## 13.1 General Specifications

<b>Operating environment</b>	Indoor, Pollution Degree 2, altitude up to 2000 m (6562 ft.)
<b>Operating temperature and humidity</b>	Temperature: 0°C to 40°C (32°F to 104°F) Humidity: 80% RH or less (no condensation)
<b>Storage temperature and humidity</b>	Temperature: -10°C to 50°C (14°F to 122°F) Humidity: 80% RH or less (no condensation)
<b>Standards</b>	Safety EN 61010 EMC EN 61326 Class A
<b>Power supply</b>	Commercial power supply Rated supply voltage: 100 V to 240 V AC (Voltage fluctuations of ±10% from the rated supply voltage are taken into account.) Rated supply frequency: 50 Hz/60 Hz Anticipated transient overvoltage: 2500 V Maximum rated power: 80 VA
<b>Clock backup</b>	Approx. 1 year when not used (reference value)
<b>Interface</b>	EXT.I/O (Standard equipment) USB host (memory) (Standard equipment) USB device (COM) (Standard equipment) LAN (Standard equipment) RS-232C (Z3001) (Option) GP-IB (Z3000) (Option)
<b>Dimensions</b>	Approx. 215W × 200H × 378D mm (8.46"W × 7.87"H × 14.88"D) (excluding the projection)
<b>Mass</b>	Approx. 6.7 kg (236.3 oz.)
<b>Product warranty period</b>	1 year
<b>Accessories</b>	Reference: p. 3
<b>Option</b>	Reference: p. 4

## 13.2 Input Specifications/Output Specifications/ Measurement Specifications

### Basic specifications

<b>Measuring mode</b>	Voltage application disabled mode	Mode disables outputs for safety reasons
	Test conditions settings mode	Mode acquires test condition settings, judgment condition settings, and master waveforms
	Test mode	Used to call the test conditions that have been set using test conditions settings mode, and to test objects
	Break down voltage test (BDV) mode	Used to check a test object for a dielectric breakdown through the impulse test during which the voltages of impulses repeatedly applied to the object increase gradually.
<b>Set voltage range</b>	ST4030: 100 V to 3300 V (Maximum applied energy: approx. 55 mJ) ST4030A: 100 V to 4200 V (Maximum applied energy: approx. 88 mJ)	
<b>Set voltage resolution</b>	10 V	
<b>Testable inductance range</b>	10 $\mu$ H to 100 mH	
<b>Sampling resolution</b>	12 bits	
<b>Sampling frequency</b>	10 MHz/20 MHz/50 MHz/100 MHz/200 MHz	
<b>Number of sampling data</b>	1001 to 8001 points (1000 points step)	
<b>Measurement and operation items</b>	Response waveform LC and RC values Peak voltage value (Peaks from primary to tenth) Zero-cross point value (Zero-cross points from primary to tenth) Discharge component amount (When incorporating Model ST9000)	
<b>Number of applied pulses</b>	Number of measurement pulses: 1 to 32 Number of degaussing pulses: 0 to 10	
<b>Measuring method</b>	2-wire measurement	
<b>Test time</b>	Approx. 60 ms (Reference value for 3000 V, 1 pulse, judgments OFF)	
<b>Number of channels</b>	1	
<b>Display</b>	Display: 8.4-inch SVGA color TFT screen (800 $\times$ 600 dots) Touch panel: Analog resistance film type	

### Accuracy specifications

<b>Conditions of guaranteed accuracy</b>	Guaranteed accuracy period	1 year
	Temperature and humidity for guaranteed accuracy	23°C $\pm$ 5°C, 80% RH or less
	Warm-up time	1 hour or longer
	Power supply frequency	50 Hz/60 Hz $\pm$ 2 Hz
<b>Voltage detection accuracy</b>	DC	$\pm$ 5% of setting
	AC	100 kHz : $\pm$ 1 dB (1000 V peak or more is reference value)
<b>Effect of conducted radio-frequency electromagnetic field</b>	Measurement value $\pm$ 26 V peak max. at test level 10 V (e.m.f.)	

## 13.3 Functional Specifications

For the initialization, see the “Default settings table” on the application disc. The set values are saved even after the power supply is turned off.

### Test conditions settings

<b>Applied voltage</b>	Sets the values of the impulse voltage applied to the workpiece Settings range: ST4030: 100 V to 3300 V (resolution: 10 V) ST4030A: 100 V to 4200 V (resolution: 10 V)	
<b>Number of applied pulses</b>	Sets the number of application pulses and the number of degaussing pulses	Continuously applies the number set for each in the order degaussing pulse and then application pulse Number of pulses: 1 to 32 Number of degaussing pulses: 0 to 10
	Sets the minimum pulse application interval	Sets the minimum time of the pulse application interval when the settings for the number of application pulses and degaussing pulses is 2 or more Setting range: 0.050 s to 1.000 s (resolution: 0.001 s)
<b>Sampling frequency</b>	Sets the voltage sampling frequency Setting range: 10 MHz, 20 MHz, 50 MHz, 100 MHz, 200 MHz	
<b>Number of sampling data</b>	Sets the number of sampling data so that the required waveform length is imported Settings range: 1001 to 8001 points (1000 points step)	
<b>Trigger delay</b>	Sets the delay time from the test start signal to the start of the voltage application Setting range: 0.000 s to 9.999 s (resolution: 0.001 s)	
<b>Voltage calibration</b>	Adjusts the output voltage so that the max. detection waveform value becomes the set voltage, and imports the master waveform using the output voltage after adjustment	

### Set judgment conditions

<b>Judgment procedure</b>	Apply the same impulse voltage to both the master workpiece and the workpiece to be tested, and compare the respective response waveforms, LC and RC values, and discharge component amount to judge pass or fail.	
	LC and RC value judgments	LC and RC values judgments (LCRC AREA)
	Waveform judgments	Waveform surface area comparison judgments (AREA) Waveform difference surface area comparison judgments (DIFF-AREA) Waveform flutter detection judgments (FLUTTER) Waveform secondary differential detection judgments (LAPLACIAN)
	Discharge judgments (When incorporating Model ST9000)	Discharge judgments (DISCHARGE)



## (1) LC and RC value judgments

<b>LC and RC values judgments</b> <b>[LCRC AREA]</b>	<p>Compares the LC and RC values distribution of the master workpiece and the LC and RC values of the workpiece to be tested.                      LC and RC values: The quantification of the response waveform as 2 parameters of the LC and RC values</p> <ol style="list-style-type: none"> <li>1. Sets the waveform area used in LC and RC values operations.                              Automatically set from the master waveform during voltage calibration.                              Settable using communications commands if you want to set your own operations area.                              Settings range: Within sampling data range</li> <li>2. Imports standard LC and RC values to create the PASS judgment area after implementing voltage calibration.</li> <li>3. Sets the PASS judgment area using the imported standard LC and RC values.                              Automatic creation: Automatically creates the PASS judgment area using the imported standard LC and RC values.                              Manual creation: Manually sets the PASS judgment area                              Sets the peaks of the PASS judgment area (square) using the LC and RC values.                              Settings range: ±(0.000 f to 1.000) (valid to 4 digits)</li> </ol>
---	--

## (2) Waveform judgments

<b>Waveform surface area comparison judgment</b> <b>[AREA]</b>	Compares and judges the master waveform surface area and the test waveform surface area in the area specified by the user.	
	Judgment values	Sets the surface area ratio threshold value Settings range: OFF / 0.00 to 99.99% (0.01% steps)
	Judgment area	Sets the judgment area using points Settings area: Within sampling data range
<b>Waveform difference surface area comparison judgments</b> <b>[DIFF-AREA]</b>	Calculates and judges the ratios of the master waveform and test waveform differences over the surface area of the master waveform	
	Judgment values	Sets the difference threshold value Settings range: OFF / 0.00 to 99.99% (0.01% steps)
	Judgment area	Sets the judgment area using points Settings area: Within sampling data range
<b>Waveform flutter detection judgments</b> <b>[FLUTTER]</b>	<p>The amount of the high-frequency component expressed by the test waveform in the user-designated area is detected, and judge the discharge by its size. Primarily differentiates the test waveform, and calculates the surface area of the differentiated waveform as the discharge component amount.</p> <p style="text-align: center;">Number of data</p> $Flutter = \sum_{n=1}  d_n - d_{n-1} $	
	Judgment values	Sets the high-frequency component amount Settings range: OFF / 0 to 999,999 (1 step)
	Judgment area	Sets the judgment area using points Settings area: Within sampling data range

<b>Waveform secondary differential detection judgments</b> <b>[LAPLACIAN]</b>	The amount of the high-frequency component expressed by the test waveform in the user-designated area is detected, and judge the discharge by its size. Secondly differentiates the test waveform, and calculates the surface area of the differentiated waveform as the discharge component amount.  Number of data -1 $Laplacian = \sum_{n=1}  -d_{n-1}+2d_n-d_{n+1} $	
	Judgment values	Sets the noise amount Settings range: OFF / 0 to 999,999 (1 step)
	Judgment area	Sets the judgment area using points Settings area: Within sampling data range

### (3) Discharge judgments (When incorporating Model ST9000)

<b>Discharge judgments</b> <b>[DISCHARGE]</b>	Separates and samples the high-frequency components expressed locally by the discharges as the high-frequency components from stationary noise Detects and judges discharge components using higher detection performance than flutter and LaPlacian judgments	
	Sets the judgment methods	Settings range: OFF, FIXED, AUTO FIXED: Compares and judges the amount of the discharge component of the master waveform and the amount of the discharge component of the test waveform. AUTO: Calculates the variation of the high-frequency components expressed by the test waveform as the standard deviation ( $\sigma$ ), and judges from the discharge whether or not the variation exceeds the fixed amount.
	Sets the threshold value over the master waveform discharge amount when FIXED	Settings range: OFF / 0 to 999% (1% step)
	Sets the deviation ( $\sigma$ ) threshold value during AUTO	Settings range: OFF / 3 to 100 (1 step)

### Test conditions switching functions

<b>Test conditions switching functions</b>	You can save multiple test conditions and master waveforms as settings tables and switch between them as desired.	
	Number of tables	255
	Hold items	Test conditions, judgment conditions, and master waveforms
	Switching between tables	Screen, communications, and external controls (EXT. I/O)
	Table initialization	Initializes the data in the settings tables
	Table settings	Adds a user-selected name to each settings table Number of inputtable characters: 127 characters max.

## Break down voltage test (BDV) mode

<b>Test overview</b>	Tests the impulse while gradually increasing the voltage applied to the workpiece to examine the discharge judgments. Waveform surface area judgments, discharge judgments, LC and RC values area judgments, peak voltage value fluctuations, and vibration frequency fluctuations are used in discharge judgments.	
<b>Applied voltage settings</b>	Sets the values of the start voltage, max. voltage, and voltage rise width	
	Start voltage	Settings range: ST4030: 100 V to 3300 V (resolution: 10 V) ST4030A: 100 V to 4200 V (resolution: 10 V)
	Max. voltage	Settings range: ST4030: 100 V to 3300 V (resolution: 10 V) ST4030A: 100 V to 4200 V (resolution: 10 V)
	Voltage rise width	Settings range: ST4030: 10 V to 3200 V (resolution: 10 V) ST4030A: 10 V to 4100 V (resolution: 10 V)
	Maximum number of steps	32 steps
<b>Number of applied pulses</b>	Sets the number of application pulses and the number of degaussing pulses.	Degaussing pulse: Applied using the set number of continuous pulses during BDV test startup Application pulse: Applied using the set number of continuous pulses for each step Number of pulses: 3 to 32 Number of degaussing pulses: 0 to 10
	Sets the pulse application interval	Sets the minimum time of the pulse application interval when the settings for the number of application pulses and degaussing pulses is 2 or more. Setting range: 0.050 s to 1.000 s (resolution: 0.001 s)
<b>Sampling frequency</b>	Sets the voltage sampling frequency Setting range: 10 MHz, 20 MHz, 50 MHz, 100 MHz, 200 MHz	
<b>Number of sampling data</b>	Sets the number of sampling data so that the required waveform length is imported. Settings range: 1001 to 8001 points (1000 points step)	

## Set judgment conditions

<b>Waveform surface area comparison judgment</b> [AREA]	Discharge judgments from the variation in the waveform surface area with the same voltage.	
	Judgment values	Sets the deviation ( $\sigma$ ) threshold value of the waveform surface area
	Settings range	OFF / 3 to 100
<b>Discharge judgments</b> [DISCHARGE]	Discharge judgments from the variation in the discharge amount with the same voltage.	
	Judgment values	Sets the deviation ( $\sigma$ ) threshold value of the discharge amount
	Settings range	OFF / 3 to 100
<b>LC and RC value judgments</b> [LCRC]	Discharge judgments from the variation in the LC and RC values with the same voltage.	
	Judgment values	Sets the deviation ( $\sigma$ ) threshold value of the LC and RC values
	Settings range	OFF / 3 to 100
<b>Peak voltage value fluctuations</b> [Vpeak]	Discharge judgments from the variation in the peak voltage value with the same voltage.	
	Judgment values	Sets the amount of variation in the first peak value for each pulse relative to the center value for the first peak values of all measurement pulses.
	Settings range	OFF / 0% to 999%
<b>Vibration frequency fluctuations</b> [FREQ]	Discharge judgments from the variation in the vibration frequency with the same voltage.	
	Judgment values	Sets the amount of variation in the vibration frequency for each pulse relative to the center value for the vibration frequency of all measurement pulses.
	Settings range	OFF / 0% to 999%

## Safety protection function

<b>Key lock function</b>	Disables all settings changes and protects the settings details. Enter the user-set pass code to unlock the settings.	
	Function settings	OFF/ON
	Pass code	1 to 4-digit number
<b>Interlock function</b>	Enables test voltage output tests using external input signals. Disables the interlocks by turning ON the external control terminal (EXT. I/O) INTERLOCK pin when the setting is ON. This interlock status disables testing for both key communications and external control terminal (EXT. I/O). Enter the user-set pass code to unlock the settings.	
	Function settings	OFF / ON
	Pass code	1 to 4-digit number
<b>Double action function</b>	After the <b>STOP</b> button is pressed, the <b>START</b> button is enabled for only 1 sec.	
	Function settings	OFF / ON

## Other functions

<b>Automatic settings function for scope of waveform acquisition</b>	This function automatically sets the sampling frequency and number of sampling data during voltage calibration so that the waveform acquisition range is optimal.	
	Function settings	OFF / ON
<b>Waveform judgment range, Automatic settings function for threshold value</b>	This function automatically sets the waveform judgment ranges and threshold values from the waveform variations during voltage calibration so that the waveform judgment settings are optimal. Settable individually for each waveform judgment function	
	Function settings	OFF / ON
<b>Memory function</b>	Saves the test results and judgment results to the instrument.	
	Function settings	OFF / ON
	Number saved	1000
	Save items	Measurement status, overall judgment results, judgment values for each judgment functions, and judgment results
	Read method	USB device, LAN, RS-232C, GP-IB, USB host
<b>Display settings</b>	Sets the items to be displayed	
	Sets whether to show or hide the display	Setting range: OFF / ON / THIN OFF: The display will turn off 10 sec. after the touch panel was last touched. After the display turns off, touching the touch panel again will turn on the display again ON: The display is always on THIN: The display is always on, but the screen update rate is reduced from normal to prioritize communications processing
	Sets the backlight brightness	Setting range: 0 to 250
<b>Waveform overlay setting</b>	Sets the test waveform overlay	
	Function settings	OFF / ON
<b>Waveform color setting</b>	Sets the master waveform, test waveform, and discharge waveform color respectively	
	Settings range	OFF / 1 to 24
<b>Judgment beep setting</b>	Sets the items concerning the judgment beeps	
	Judgment beep	Settings range: OFF / PASS / FAIL OFF: Beep does not sound regardless of the judgment results PASS: Sounds the beep when the overall judgment result is PASS FAIL: Sounds the beep when the overall judgment result is FAIL
	Scale	Setting range: 0 to 14
	Volume	Setting range: 1 to 3
<b>Key beep setting</b>	Sets the items concerning the key beeps when the touch panel is touched	
	Key beep	Settings range: OFF / ON
	Scale	Setting range: 0 to 14
	Volume	Setting range: 1 to 3
<b>Date and time settings</b>	Sets the date and time	
	Settings range	YY-MM-DD HH:MM:SS

<b>Self-check function</b>	Touch panel test	Checks whether there is an error in the touch panel
	Touch panel correction	Corrects the touch panel position
	Screen display test	Checks the screen display status and LED ON/OFF status
	ROM/RAM test	Checks whether there are any errors in the main unit internal memory (ROM and RAM)
	EXT.I/O test	Displays the input signal status of the external control terminal (EXT. I/O), and outputs the user-set output signals.

## 13.4 Interface Specifications

For the initialization, see the “Default settings table” on the application disc. The set values are saved even after the power supply is turned off.

### External control terminal (EXT.I/O) specifications

<b>Connector used</b>	D-SUB 37 pin and socket connection (female) Fixing stud #4-40 inch screw		
<b>NPN/PNP (Sinking current/sourcing current) switching function</b>	Switch settings using the switch on the rear of the main unit.		
		NPN/PNP switch settings	
		NPN	PNP
	Input circuit	Sinking output compatible	Sourcing output compatible
	Output circuit	Non-polar	Non-polar
ISO_5V Power supply output	5 V output	-5 V output	
<b>Input specifications (Electrical specifications)</b>	Input format	Photocoupler isolated non-voltage contact input (Sinking/sourcing current outputs)	
	Input ON	Residual voltage 1 V or less (Input ON current 4 mA/channel reference value)	
	Input OFF	OPEN (interrupting current 100 $\mu$ A/channel or less)	
<b>Output specifications (Electrical specifications)</b>	Output format	Photocoupler isolated open drain output (non-polar)	
	Maximum load voltage	30 V DC	
	Maximum output current	50 mA/CH	
	Residual voltage	1 V or less (load current 50 mA) / 0.5 V or less (load current 10 mA)	
<b>Power supply specifications (Service power supply output)</b>	Output voltage	Compatible sinking output: +5.0 V $\pm$ 0.8 V Compatible sourcing output: -5.0 V $\pm$ 0.8 V	
	Maximum output current	100 mA	
	External power supply input	None	
	Insulation	Floating from the protective grounded potential and the measurement circuit	
	Insulation rating	Voltage between the module and ground: 50 V DC, 30 Vrms AC, 42.4 V AC peak max.	

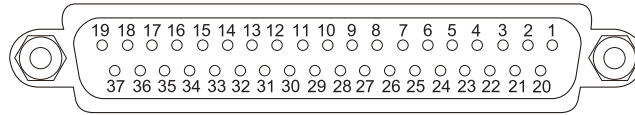

External control terminal (on instrument) pin layout diagram

Pin	I/O	Signal name	Logic	Function
1	IN	START	Edge	Start of measurement
2	IN	(Reserved)	–	–
3	IN	INTERLOCK	Level	Unlocking the interlocks condition
4	IN	TBL1	Level	Table number selection
5	IN	TBL3	Level	Table number selection
6	IN	TBL5	Level	Table number selection
7	IN	TBL7	Level	Table number selection
8	–	ISO_5V	–	Isolated power supply output +5 V (with NPN) / –5 V (with PNP)
9	–	ISO_COM	–	Isolated power supply common
10	OUT	ERR	–	Error
11	OUT	OUT_AREA	–	AREA judgment OUT
12	OUT	OUT_FLTR	–	FLUTTER judgment OUT
13	OUT	OUT_LCRC	–	LC and RC value judgments OUT
14	OUT	(Reserved)	–	–
15	OUT	(Reserved)	–	–
16	OUT	OUT0	–	General outputs terminal (Output signals controlled using :IO:OUTPut commands)
17	OUT	OUT2	–	General outputs terminal (Output signals controlled using :IO:OUTPut commands)
18	OUT	PASS	–	Total judgment PASS
19	OUT	(Reserved)	–	–
20	IN	STOP	Edge	Measurement stopped
21	IN	(Reserved)	–	–
22	IN	TBL0	Level	Table number selection
23	IN	TBL2	Level	Table number selection
24	IN	TBL4	Level	Table number selection
25	IN	TBL6	Level	Table number selection
26	IN	(Reserved)	–	–
27	–	ISO_COM	–	Isolated power supply common
28	OUT	EOM	–	Measurements finished (including judgments and operations)
29	OUT	INDEX	–	Analog measurements finished (probe can be left open)
30	OUT	OUT_DIFF	–	DIFF judgment OUT
31	OUT	OUT_LAPC	–	LAPLACIAN judgment OUT
32	OUT	OUT_DCHG	–	DISCHARGE judgment OUT
33	OUT	(Reserved)	–	–
34	OUT	(Reserved)	–	–
35	OUT	OUT1	–	General outputs terminal (Output signals controlled using :IO:OUTPut commands)
36	OUT	(Reserved)	–	–
37	OUT	FAIL	–	Total judgment FAIL



## Communications interface specifications

### (1) USB device (Standard equipment)

<b>Communication</b>	Remote control and measured value outputs
<b>Connector</b>	Series B receptacle
<b>Electrical specifications</b>	USB2.0 (High Speed)
<b>Class (mode)</b>	CDC class (USB COM)
<b>Terminator</b>	CR+LF/CR

### (2) LAN (Standard equipment)

<b>Communication</b>	Remote control and measured value outputs
<b>Connector</b>	RJ-45 connector
<b>Transmission method</b>	10BASE-T / 100BASE-TX / 1000BASE-T automatic recognition Full duplex communication
<b>Protocol</b>	TCP/IP
<b>Terminator</b>	CR+LF/CR
<b>Other settings</b>	IP address, subnet mask, default gateway Communication command port: 1 to 65535
<b>Cable length</b>	Up to 30 m max.

### (3) GP-IB (Optional)

<b>Communication</b>	Remote control and measured value outputs
<b>Standard</b>	IEEE488.2
<b>Device address</b>	0 to 30
<b>Delimiter</b>	LF / CR+LF

### (4) RS-232C (Optional)

<b>Communication</b>	Remote control and measured value outputs
<b>Connector</b>	D-sub 9-pin, male, fixing stud screw #4-40
<b>Transmission method</b>	Start-stop synchronized system, full duplex
<b>Transmission speed</b>	9600 bps / 19,200 bps / 38,400 bps / 57,600 bps
<b>Data bit length</b>	8 bits
<b>Stop bit</b>	1
<b>Parity bit</b>	None
<b>Delimiter</b>	CR+LF/CR
<b>Handshake</b>	OFF/X flow
<b>Protocol</b>	Non-procedure

<b>Command system</b>	Unique HIOKI SCPI
<b>Communications monitor function</b>	Displays the send and receive status of commands and queries Settings range: OFF / ON

## USB host specifications

### (1) Electrical specifications

<b>Connector</b>	USB type A connector
<b>Electrical specifications</b>	USB2.0 (High Speed)
<b>Power supply</b>	500 mA max.
<b>Number of ports</b>	1
<b>Compatible USB memory</b>	USB Mass Storage Class compatible

### (2) USB host operations

<b>Save the test results</b>	Function	Saves the test results presently displayed onscreen
	Save items	Test condition settings, judgment condition settings, judgment results, waveform data
	Data format	CSV file format
	File name	Automatically generated from the date and time
<b>Save screen copy</b>	Function	Saves the screen that is presently displayed
	Data format	BMP file format (color or monochrome)
	File name	Automatically generated from the date and time
<b>Save and import instrument settings</b>	Function	Sets the settings information such as test conditions and master waveform, etc., saves the settings as a file, imports the saved settings file, and restores the settings
	Save items	All settings items, user-set table settings items
	File name	Specified by the user when saving

## Test time (Reference value)

<b>Measuring time (EOM)</b>	$EOM = (\text{INDEX} + \text{software processing time} + \text{judgment times}) \times \text{Number of pulse applications}$ Note: There is no software processing time or judgment times in degaussing pulses. During multiple pulse applications, control makes sure that the pulse application intervals are not less than the minimum pulse interval setting.														
<b>Analog measuring time (INDEX)</b>	Time until charging, application, and sampling completion (Typical values) <table border="1" data-bbox="544 501 1393 589"> <thead> <tr> <th>Set voltage</th> <th>100 V</th> <th>1000 V</th> <th>2000 V</th> <th>3000 V</th> </tr> </thead> <tbody> <tr> <td>INDEX time</td> <td>30 ms</td> <td>30 ms</td> <td>40 ms</td> <td>50 ms</td> </tr> </tbody> </table> S/s: 200 MHz	Set voltage	100 V	1000 V	2000 V	3000 V	INDEX time	30 ms	30 ms	40 ms	50 ms				
Set voltage	100 V	1000 V	2000 V	3000 V											
INDEX time	30 ms	30 ms	40 ms	50 ms											
<b>Software processing time</b>	Software processing time for data transfer, etc. (Typical values) <table border="1" data-bbox="544 692 756 779"> <thead> <tr> <th>Processing time</th> </tr> </thead> <tbody> <tr> <td>10 ms</td> </tr> </tbody> </table> S/s: 200 MHz, DISP: THIN	Processing time	10 ms												
Processing time															
10 ms															
<b>Judgment times</b>	Processing time when judgment functions are enabled (Typical values) <table border="1" data-bbox="544 882 1074 1202"> <thead> <tr> <th>Judgment</th> <th>Processing time</th> </tr> </thead> <tbody> <tr> <td>AREA *1</td> <td>1 ms</td> </tr> <tr> <td>DIFF *1</td> <td>1 ms</td> </tr> <tr> <td>FLUTTER *1</td> <td>1 ms</td> </tr> <tr> <td>LAPLACIAN *1</td> <td>1 ms</td> </tr> <tr> <td>LC and RC *2</td> <td>100 ms</td> </tr> <tr> <td>DISCHARGE *3</td> <td>75 ms</td> </tr> </tbody> </table> *1: Judgment area 1500 pt *2: Operations area 5000 pt *3: Judgment area 8001 pt when S/s is 200 MHz	Judgment	Processing time	AREA *1	1 ms	DIFF *1	1 ms	FLUTTER *1	1 ms	LAPLACIAN *1	1 ms	LC and RC *2	100 ms	DISCHARGE *3	75 ms
Judgment	Processing time														
AREA *1	1 ms														
DIFF *1	1 ms														
FLUTTER *1	1 ms														
LAPLACIAN *1	1 ms														
LC and RC *2	100 ms														
DISCHARGE *3	75 ms														

## 13.5 L2250 Clip Type Lead (Option)

### General specifications

<b>Operating environment</b>	Indoor, pollution level 2, altitude up to 2000 m (6562 ft.)
<b>Operating temperature and humidity</b>	Temperature: 0°C to 40°C (32°F to 104°F) Humidity: 80% RH or less (no condensation)
<b>Storage temperature and humidity</b>	Temperature: -10°C to 50°C (14°F to 122°F) Humidity: 80% RH or less (no condensation)
<b>Standards</b>	EN61010
<b>Dimensions</b>	Total length      Approx. 1500 mm (including connectors and clips)
<b>Mass</b>	Approx. 260 g (9.2 oz.)

### Basic specifications

<b>Maximum rated voltage</b>	3300 V AC peak
<b>Maximum rated voltage between input terminals and ground</b>	3300 V AC peak
<b>Max. number of clip opening and closing times (Reference value)</b>	Approx. 500 thousand (when opening and closing approx. 1/2 of the max. fully-open distance)

## 13.6 L2252 Unprocessed Lead Cable (Option)

### General specifications

<b>Operating environment</b>	Indoor, pollution level 2, altitude up to 2000 m (6562 ft.)
<b>Operating temperature and humidity</b>	Temperature: 0°C to 40°C (32°F to 104°F) Humidity: 80% RH or less (no condensation)
<b>Storage temperature and humidity</b>	Temperature: -10°C to 50°C (14°F to 122°F) Humidity: 80% RH or less (no condensation)
<b>Dimensions</b>	Total length      Approx. 2000 mm (including connectors)
<b>Mass</b>	Approx. 290 g (10.2 oz.)

### Basic specifications

<b>Maximum rated voltage</b>	4200 V AC peak
<b>Maximum rated voltage between input terminals and ground</b>	4200 V AC peak



# 14 Maintenance and Service

## Precautions during shipment

When transporting the instrument be sure to observe the following precautions:

- To avoid damaging the instrument, remove any recording media, accessories, and options from the instrument. Use the original packing materials instrument was shipped in, and be sure to pack it in a double carton. Damage that occurs during transportation is not covered by the warranty.
- When sending the instrument for repair, be sure to include a memo that describes the problem in detail.

## Cleaning

### CAUTION



Clean the instrument periodically to prevent the vent holes from becoming clogged. When the vent holes are clogged, the cooling effect inside the instrument drops, which can cause a failure.

To clean the instrument, use a soft cloth moistened with water or mild detergent, and wipe the surface gently.

### IMPORTANT

Never use detergents that contain benzene, alcohol, acetone, ether, ketone, thinners, or gasoline. Doing so may cause malformation or discoloring.

## Replaceable parts and operating lifetimes

The characteristics of some of the parts used in the product may deteriorate with extended use.

To ensure the product can be used over the long term, it is recommended to replace these parts on a periodic basis.

When replacing parts, please contact your authorized Hioki distributor or reseller.

The service life of parts varies with the operating environment and frequency of use. Parts are not guaranteed to operate throughout the recommended replacement cycle.

Part name	Recommended replacement period	Remarks and conditions
Electrolytic capacitor	Approx. 10 years	The board on which this part is installed needs to be replaced.
LCD backlight (Brightness reduced by half)	Approx. 8 years	When used for 24 hours per day

# 14.1 Troubleshooting

If damage is suspected, check the “Before sending the instrument for repair” section before contacting your authorized Hioki distributor or reseller.

If the cause is unknown, implement a system reset. All settings will return to the default factory settings.

Reference: “14.2 Initializing the Instrument (Full Reset)” (p. 213)

## Before sending the instrument for repair

### General

Symptom	Check item or cause	Corrective action and reference page
Screen does not display anything even if the power supply switch is turned ON.	<ul style="list-style-type: none"> <li>Is the power cord disconnected?</li> <li>Is the power cord connected correctly?</li> </ul>	Check that the power cord is connected correctly. Reference: “2.2 Connecting the Power Cord” (p. 15)
Keys are disabled.	Is the key lock on?	Unlock the key lock. Reference: “8.2 Key Lock Function” (p. 104)
	Are you using a communications interface in remote mode?	Set to local mode. Reference: “11.9 Remote Mode” (p. 162)
When I pressed a key onscreen, a different key was operated.	Has the panel been corrected?	Implement panel correction. Reference: “Touch panel correction” (p. 127)
No operation. Don't fully understand the operations method.	Have you checked the Instruction Manual?	Check the relevant parts of the Instruction Manual.
	Are you using an automatic system?	Consult the administrator or supervisor for the instrument or automatic system that includes the instrument.
Nothing is displayed on screen.	<ul style="list-style-type: none"> <li>Is the LCD set to turn off automatically after a set time has elapsed.</li> <li>Is the instrument in standby mode?</li> </ul>	<ul style="list-style-type: none"> <li>Touch the panel to turn on again the display. Reference: “8.5 Displays” (p. 111)</li> <li>Unlock standby mode. Reference: “2.3 Power Supply ON/OFF” (p. 16)</li> </ul>

## Measurement issues

Symptom	Check item or cause	Corrective action and reference page
Detection wave varies or abnormal	Is an error displayed?	Check the relevant items in the error display, and remove the cause before measuring. Reference: "14.3 Error Display" (p. 214)
		If <b>[UNCAL]</b> is displayed, implement voltage calibration. Reference: "4.6 Voltage Calibration" (p. 49)
	Is the instrument being used in a noisy environment?	If the instrument is being used in a noisy environment, consult the following countermeasures. <ul style="list-style-type: none"> <li>• Implement guarding processing.</li> <li>• Implement noise countermeasures.</li> <li>• Remove the workpiece, measuring cable, and instrument from the source of the noise (motor, inverter, electromagnetic switches, power lines, spark-producing devices, etc.), or implement measuring in a different room.</li> <li>• Take the power supply from a firmly-grounded outlet.</li> <li>• Take the power supply from a different line from the device causing the noise.</li> </ul>
	Is the test lead connected correctly?	<ul style="list-style-type: none"> <li>• Check the wiring, and rewire correctly if necessary.</li> <li>• Use the designated cable.</li> </ul>
	Has the measuring cable been extended	Wire the measuring cable as short as possible.
	Is probing unstable?	Unless probing is consistent, the effects of contact resistance will distort the detection waveform. Make sure the probing status is always consistent before implementing the tests.
	Are the trigger and measurement timings misaligned?	<ul style="list-style-type: none"> <li>• Stabilize the probing status of the workpiece before triggering.</li> <li>• Set a suitable trigger delay time. Reference: "4.5 Trigger Delay" (p. 47)</li> </ul>
Detection waveform is different when measuring a existing workpiece.	Do the test conditions for the existing workpiece and for the instrument match?	Make sure that the test conditions match.
	Is <b>[UNCAL]</b> displayed?	Calibrate the voltages. Reference: "4.6 Voltage Calibration" (p. 49)
	Is the wait time (stabilization time) from connecting the workpiece to measuring insufficient?	<ul style="list-style-type: none"> <li>• Stabilize the probing status of the workpiece before triggering.</li> <li>• Set a suitable trigger delay time. Reference: "4.5 Trigger Delay" (p. 47)</li> </ul>



Symptom	Check item or cause	Corrective action and reference page
Error occurs during testing	Have you checked the details of the error icon displayed onscreen?	Check the details of the error icon displayed onscreen. Reference: "14.3 Error Display" (p. 214)
	Is probing unstable?	An open error such as unstable probing may occur. Stabilize the probing status. Reference: "14.3 Error Display" (p. 214)
	Is <b>[UNCAL]</b> displayed?	Calibrate the voltages. Reference: "4.6 Voltage Calibration" (p. 49)
Error occurs during voltage calibration	Have you checked the details of the error window displayed onscreen?	Check the details of the error window displayed onscreen. Reference: "14.3 Error Display" (p. 214)
	Is the applied voltage too high?	If the applied voltage is too high, the workpiece discharge will cause an error. Lower the applied voltage to a suitable voltage. Reference: "14.3 Error Display" (p. 214)
	Is the sampling frequency too fast?	Unless a sufficient number of waveforms is sampled during the test, an insufficient number of waveforms will occur. Slow the sampling frequency and make sure that a sufficient number of waveforms is sampled. Reference: "14.3 Error Display" (p. 214)
	Is the workpiece inductance value too low?	If the set voltage is too high for the workpiece inductance value, it may not be possible to apply the set voltage to the data. Set a suitable application voltage for the workpiece inductance value. Reference: "15.6 Max. Applicable Voltage (Reference Value) According to the Workpiece Inductance and Capacitance" (p. 232)
LCD is blurred	Are you pressing the LCD too forcefully?	Press the LCD more gently. Although the blur may be considerable, there is no functional problem.

## Communications

Symptom	Check item or cause	Corrective action and reference page
Communications are disabled ([REMOTE] icon is not displayed)	Have communications been established?	Check that the connector connections are correct.
		Check that the interface settings are correct. Reference: "11 Communications Interface" (p. 145)
		(USB) Install the drivers on the control devices. See: Application disc "Communication Command Instruction Manual"
		(RS-232C) Use a cross cable. Reference: "11 Communications Interface" (p. 145)
		(USB, RS-232C) Check the COM port number of the control devices.
		(RS-232C) Align the baud rates of the instrument and the control devices. Reference: "11 Communications Interface" (p. 145)
Communications are disabled ([REMOTE] icon is displayed)	Do the communications settings match?	When commands are not received, check the control software delimiters.
		(GP-IB) Check the settings of the message terminators. (GP-IB) Check that the address settings are correct. Reference: "11 Communications Interface" (p. 145)
A communications error occurred	Has a command error occurred?	Commands are mismatched <ul style="list-style-type: none"> <li>• Check the command spelling. Space is x20H.</li> <li>• Do not add a ? to commands that are not queries.</li> <li>• (RS-232C) Align the baud rates of the instrument and the control devices.</li> </ul> See: Application disc "Communication Command Instruction Manual"
	Has an implementation error occurred?	When command strings are correct, but unable to be implemented, try using a mode, etc., that can implement the commands. See: Application disc "Communication Command Instruction Manual"
	Have you checked the command send and receive details using the communications monitoring function?	Check the command send and receive details using the communications monitoring function.

## External controls (EXT.I/O)

Symptom	Check item or cause	Corrective action and reference page
All operations are disabled	Is the wiring correct?	When wiring is incorrect, check the EXT. I/O again. <ul style="list-style-type: none"> <li>• Connector is disconnected</li> <li>• Are the pin numbers incorrect?</li> <li>• ISO_COM terminal wiring</li> <li>• NPN/PNP settings</li> <li>• Contact (or open collector) control (not voltage control)</li> <li>• Power supply to external devices (Power supply to the instrument is not required) See: "10 External Control (EXT. I/O)" (p. 133)</li> </ul>
Deliberate movements are disabled	Do the I/O pin connections match?	Test and check the I/O pin operations. Reference: "EXT. I/O test" (p. 131)
	Do the I/O signal control timings match?	Check the I/O signal control timings using the timing chart. Reference: "10.4 Timing Chart" (p. 142)
Cannot change the settings table	Is the table to which you want to switch enabled?	Check the status of the table to which you want to switch using the table settings window. Reference: "3 Switching Test Conditions (Table Functions)" (p. 25)

## FAQ regarding external control (EXT. I/O)

Question	Explanation/Method
How best to connect to START signal inputs?	Short (turn on) the START terminals and ISO_COM terminals using switches and open collector outputs.
Which is the input signal common and the output signal common?	It is the ISO_COM terminal.
Is the common terminal shared for both inputs and outputs?	Use ISO_COM terminal for the common terminal for both the input and output signals.
Check that output signals are being output.	Check the voltage waveform using an oscilloscope. At the same time, pull up the EOM signals (several kΩ) to the instrument isolation voltage outputs (ISO_5V) and check the voltage level.
Input (control) is not performing properly, but what checks should I make?	For example, if the START signal does not work effectively, try shorting the TRIG terminal directly to the ISO_COM terminal instead of controlling using the programmable controller. Be very careful of short circuits to the power supply.
Is the judgment results signal also held during measuring? (Or does it sometimes turn OFF?)	The judgment results are deleted when measuring starts.
Can I connect to the programmable controller directly?	You can connect directly if the programmable controller output circuit is compatible with a relay or open collector, or the programmable controller input circuit is compatible with contact inputs. (Before connecting, check that the voltage level and flow current do not exceed the ratings)
Can I use communications such as RS-232C and an external I/O control simultaneously?	Yes, you can. Example: Set the measuring conditions using communications, and measure using EXT. I/O START signals.
How should I connect the external power supply?	The I/O signals for the instrument external control terminal (EXT. I/O) operates using the isolated power supply in the instrument. Consequently, it is not necessary to supply power from the programmable controller. (ISO_5V terminal inputs are prohibited.)

## 14.2 Initializing the Instrument (Full Reset)

Implementing a full reset will return all settings to their factory default state.

Implement a full reset only in the following circumstances.

- If the regular reset screen cannot be displayed due to a instrument error  
Reference: “8.11 Initializing the Instrument (System Reset)” (p. 121)  
Implement self-test after a full reset to check that there are no errors.  
Reference: “9.2 Self-test Function” (p. 126)
- If you have forgotten the interlock or key lock passwords

### IMPORTANT

- Remove the test leads from the workpiece and implement a full reset.
- If operations are still not normal even after a full reset, repairs are required. Contact your authorized Hioki distributor or reseller.

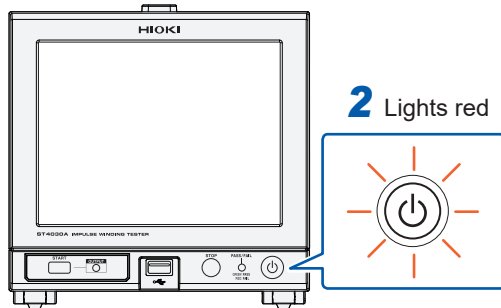

**1** Turn ON the main power supply switch with the power cord connected.

**2** Set the instrument to sleep mode.

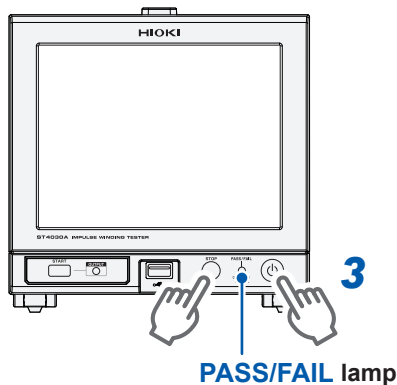

**3** Press and hold the **STOP** button, and press the start button.

**4** Remove your hands when the **PASS/FAIL** lamp turns red.

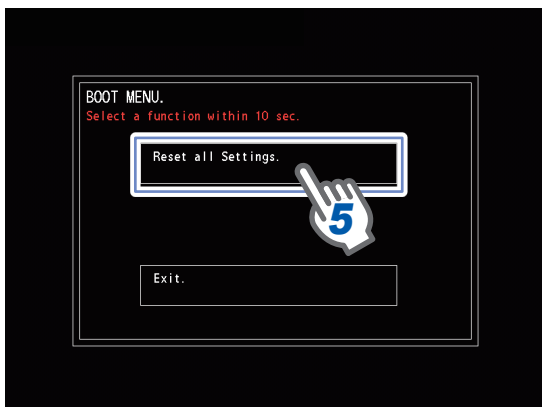

**5** Tap **[Reset all Settings.]** within 10 seconds.

Tap **[Exit]** when not implementing a full reset.

## 14.3 Error Display

If an error is displayed, repairs are required. Contact your authorized Hioki distributor or reseller.

### Error during tests

Error type	EXT./I/O ERR pin	Communications measurement status	Judgment results	Total judgment results	Solution
Normal	OFF	0	Normal judgment	Normal judgment	–
Unmeasured / Measurement stopped	OFF	1	No judgments	No judgments	–
Terminal open error <b>OPEN ERROR</b>	ON	2	OUT	FAIL	There is a risk of being unable to contact the workpiece. Check the probing status.
UNCAL error *2 <b>UNCAL ERROR</b>	ON	4	OUT	FAIL	This happens when “implementing a test with a table that has not yet implemented a voltage calibration” has been selected. Calibrate the voltages in test conditions settings mode.
Over-range error <b>OVER RANGE ERROR</b>	ON	6	OUT	FAIL	A voltage that exceeded the input voltage range was detected. Either the workpiece’s electrical characteristics differ markedly from those of the master workpiece, or the instrument may not be in contact with the workpiece. Check the workpiece and probing state.
Voltage error <b>VOLTAGE ERROR</b>	ON	6	OUT	FAIL	The magnitude of the voltage rise was less than expected, with the result that either the maximum voltage was not reached, or the instrument was unable to apply the set voltage to the workpiece. If the set voltage is too high relative to the workpiece’s inductance value, the instrument may be unable to apply the set voltage. Set an application voltage that is suited to the workpiece’s inductance value.  Refer: “15.6 Max. Applicable Voltage (Reference Value) According to the Workpiece Inductance and Capacitance” (p. 232)
Overcurrent error <b>OVER CURRENT ERROR</b>	ON	7	OUT	FAIL	An excessive output current was detected. This error may occur if the workpiece is shorted.
Invalid table error <b>NOT VALID TABLE</b>	OFF *1	1	No judgments	No judgments	The table’s settings have not been initialized. Choose a table with valid settings.

Error type	EXT./O ERR pin	Communications measurement status	Judgment results	Total judgment results	Solution
Hardware error 	ON	5	OUT	FAIL	The instrument's protective function was triggered. Note the error code and cycle the instrument's power. If the error persists after cycling the instrument's power, switch measurement targets or initialize the instrument's settings. If the error continues to persist, the instrument may be malfunctioning. Please contact your authorized Hioki distributor or reseller.

\*1: If an invalid table is specified using table switching from an external control terminal (EXT./O), measurements will not be performed and the ERR pin will turn ON.

\*2: Generated only in TEST mode.

## Error message during voltage calibration

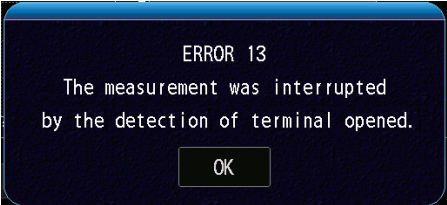
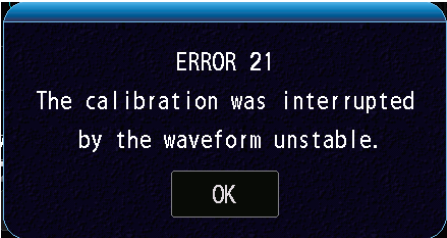
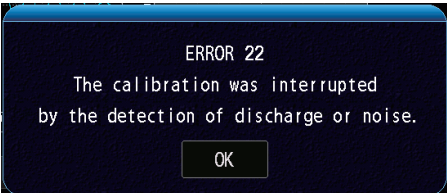

### ERROR

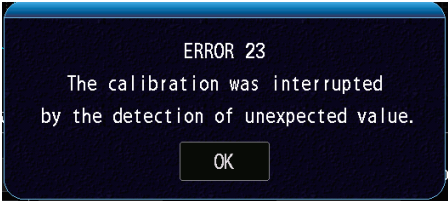
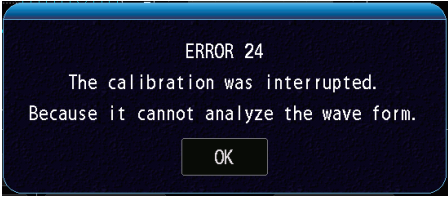
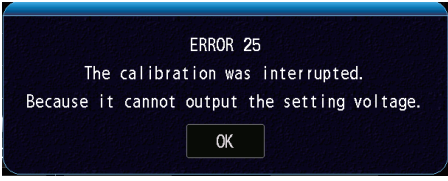
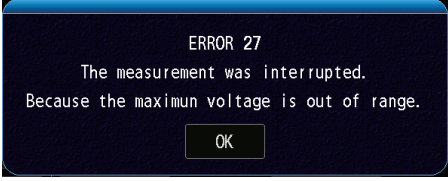
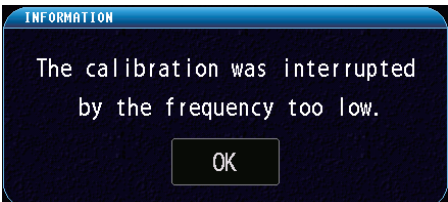
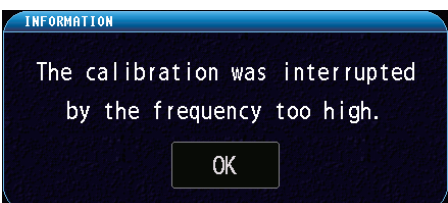
Display *1	EXT./O ERR pin	Communications VCAL status	Solution
ERROR 13 Terminal open 	ON	2	There is a risk of being unable to contact the workpiece. Check the probing status.
ERROR 21 Waveform is unstable 	ON	6	<ul style="list-style-type: none"> <li>• There is a risk of noise influence. Consider noise countermeasures.</li> <li>• There is a risk that the probing status is unstable. Calibrate the voltages while the probing is stable</li> <li>• Check that the workpiece is normal.</li> </ul>
ERROR 22 Discharge components detected 	ON	7	<ul style="list-style-type: none"> <li>• There is a risk of noise influence. Consider noise countermeasures.</li> <li>• There is a risk that the set voltage is too high. Lower the set voltage and check again.</li> </ul>

Display *1	EXT.I/O ERR pin	Communications VCAL status	Solution
<p>ERROR 23 Anomalous value detected</p> 	ON	8	<ul style="list-style-type: none"> <li>Model ST4030 does not support the workpiece.</li> <li>There is a risk that the probing status is unstable.</li> <li>If you encounter this error with a normal, non-defective workpiece, the instrument may be malfunctioning. Please contact your authorized Hioki distributor or reseller.</li> </ul>
<p>ERROR 24 Waveform analysis failure</p> 	ON	9	<ul style="list-style-type: none"> <li>Model ST4030 does not support the workpiece.</li> <li>There is a risk that the probing status is unstable.</li> <li>If you encounter this error with a normal, non-defective workpiece, the instrument may be malfunctioning. Please contact your authorized Hioki distributor or reseller.</li> </ul>
<p>ERROR 25 Voltage set as the application voltage not reached</p> 	ON	3	<p>Cannot apply the set voltage to the workpiece. If the set voltage is too high for the workpiece inductance value, it may not be possible to apply the set voltage. Set a suitable application voltage for the workpiece inductance value. Reference: "15.6 Max. Applicable Voltage (Reference Value) According to the Workpiece Inductance and Capacitance" (p. 232)</p>
<p>ERROR 27 Overrange value detected</p> 	ON	10	<ul style="list-style-type: none"> <li>There is a risk that the probing status is unstable. Perform voltage calibration after establishing stable probing.</li> <li>Check that the workpiece is normal.</li> </ul>
<p>The oscillation frequency of the detection waveform is too long to reach the waveform length</p> 	ON	4	<ul style="list-style-type: none"> <li>The length of the imported waveform is insufficient. Set the sampling frequency and number of sampling data so that at least 4 waves or more are imported. Reference: "4.4 Sampling Frequency/Number of Sampling Data" (p. 44)</li> <li>Under some conditions, this error may occur with Ver. 1.01-compatible tables.</li> </ul>
<p>Excessive waveform length relative to the detected waveform's oscillation period</p> 	ON	5	<ul style="list-style-type: none"> <li>The waveform has shrunk too much due to the excessive length of the captured waveform. Reduce the wave number by setting the sampling frequency and sampling data count. Reference: "4.4 Sampling Frequency/Number of Sampling Data" (p. 44)</li> <li>Under some conditions, this error may occur with Ver. 1.01-compatible tables.</li> </ul>

\*1: If the voltage was calibrated from communications, the window is not displayed.

## WARNING



Display *1	EXT./O ERR pin	Communications VCAL status	Meaning/Solution
WARNING 102 	OFF	102	<ul style="list-style-type: none"> <li>Disturbances were detected in a number of waveforms during voltage calibration.</li> <li>The calibration process may be experiencing the effects of noise. Consider taking steps to prevent noise.</li> <li>Probing may be unstable. Perform voltage calibration after establishing stable probing.</li> <li>Check that the workpiece is normal.</li> <li>This error will result if the instrument determines that this condition existed in 50% or more of the response waveforms used in calibration.</li> </ul>
WARNING 103 	OFF	103	<ul style="list-style-type: none"> <li>Discharges were detected in a number of waveforms during voltage calibration.</li> <li>The calibration process may be experiencing the effects of noise. Consider taking steps to prevent noise.</li> <li>The set voltage may be too high. Lower the set voltage and check instrument operation.</li> <li>This error will result if the instrument determines that this condition existed in 50% or more of the response waveforms used in calibration.</li> </ul>
WARNING 104 	OFF	101	<ul style="list-style-type: none"> <li>The applied voltage failed to reach the set voltage.</li> <li>This warning is displayed when TYPE 1 calibration is performed with the <b>[VOLT ERROR]</b> setting disabled.</li> </ul>

\*1: If the voltage was calibrated from communications, the window is not displayed.

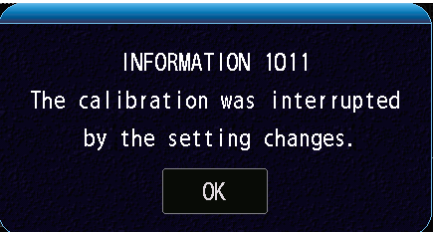
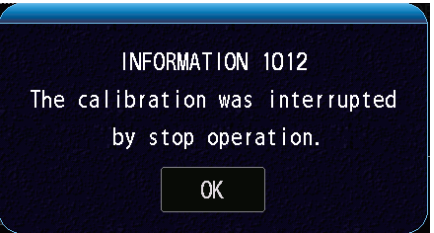
## INFORMATION



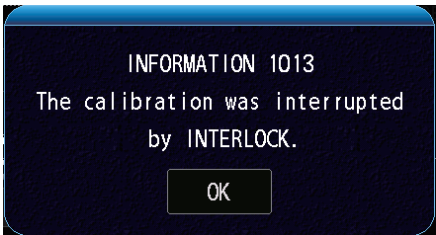
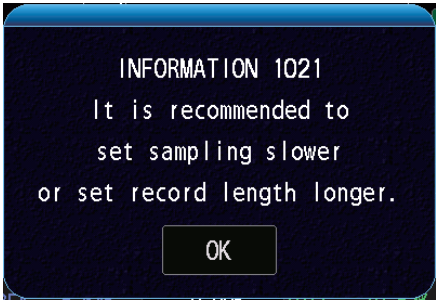

Display *1	EXT./O ERR pin	Communications VCAL status	Meaning
INFORMATION 1011 	ON	1	Indicates that voltage calibration was canceled due to a settings change.
INFORMATION 1012 	ON	1	Indicates that voltage calibration was canceled by the user.





Display *1	EXT.I/O ERR pin	Communications VCAL status	Meaning
<p>INFORMATION 1013</p> 	ON	1	Indicates that voltage calibration was canceled by the instrument's interlock function.
<p>INFORMATION 1021</p> 	OFF	104	The workpiece's entire response waveform can be recorded by either reducing the sampling frequency or increasing the number of data points. For some workpieces, you may encounter this message even if you use the slowest sampling frequency and the maximum number of sampling data points. In such cases, choose the setting that is best suited to the waveform.
<p>INFORMATION 1022</p> 	OFF	105	The workpiece's entire response waveform can be recorded by either increasing the sampling frequency or decreasing the number of data points. This will allow the measurement time to be reduced.

\*1: If the voltage was calibrated from communications, the window is not displayed.

### USB host error

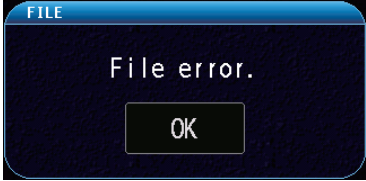
Display	Meaning	Solution
	<ul style="list-style-type: none"> <li>USB memory voltage consumption exceeds 500 mA.</li> </ul>	Use another USB memory.
	<ul style="list-style-type: none"> <li>USB memory format is incompatible with the instrument.</li> </ul>	Use another USB memory.
	<ul style="list-style-type: none"> <li>File is corrupt and so cannot be imported.</li> <li>File is not compatible with the instrument and so cannot be imported.</li> </ul>	Check that the file and USB memory are not damaged.
	<ul style="list-style-type: none"> <li>Insufficient USB memory space.</li> </ul>	Use another USB memory, or increase the available space.

Display	Meaning	Solution
 <p>FILE File error. OK</p>	<ul style="list-style-type: none"> <li>Error occurred during file processing.</li> </ul>	<p>Either use another USB memory, or back up the files on USB memory and then format and use.</p>
 <p>FILE No data. OK</p>	<ul style="list-style-type: none"> <li>Measurement data was saved without measuring.</li> <li>Measuring started while the measurement data was being saved to file, so the measurement data that was being saved was lost.</li> </ul>	<p>Make the measurements again, and then save the measurement data.</p>

### Other errors

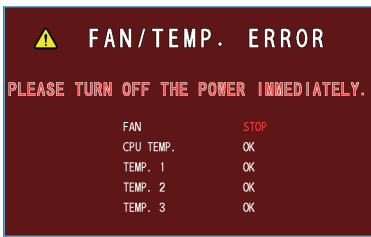
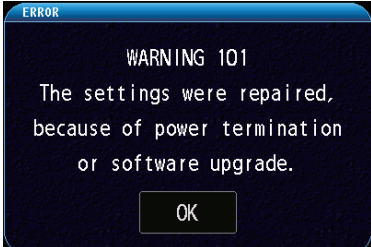
Display	Meaning	Solution
 <p>⚠ FAN/TEMP. ERROR PLEASE TURN OFF THE POWER IMMEDIATELY. FAN STOP CPU TEMP. OK TEMP. 1 OK TEMP. 2 OK TEMP. 3 OK</p>	<ul style="list-style-type: none"> <li>The internal temperature exceeded the operating range, or the cooling fan stopped.</li> </ul>	<p>Turn OFF the power supply immediately, and check the instrument installation environment and cooling fan status. If the situation still does not improve, there is a risk of malfunction. Contact your authorized Hioki distributor or reseller.</p>
 <p>ERROR WARNING 101 The settings were repaired, because of power termination or software upgrade. OK</p>	<p>Displayed in the following cases.</p> <ul style="list-style-type: none"> <li>If the power supply switch was turned OFF while the settings were being saved (including power being lost due to a power failure, etc.)</li> <li>If the settings were initialized due to a version upgrade (When the power supply is turned ON after a version upgrade)</li> </ul>	<ul style="list-style-type: none"> <li>Reconfigure this setting after initializing the instrument's settings.</li> <li>If an error is displayed even after the settings have been redone, there is a risk of malfunction. Contact your authorized Hioki distributor or reseller.</li> </ul>

If you encounter an error that is not listed above, please make a note of the display and contact your authorized Hioki distributor or reseller.

## 14.4 Discarding the Instrument (Removing the Lithium Battery)

When discarding the instrument, remove the lithium battery, and dispose according to local regulations. The instrument has a built-in lithium battery for backup.

**Required items** Phillips screwdriver (No. 2), tweezers, nippers

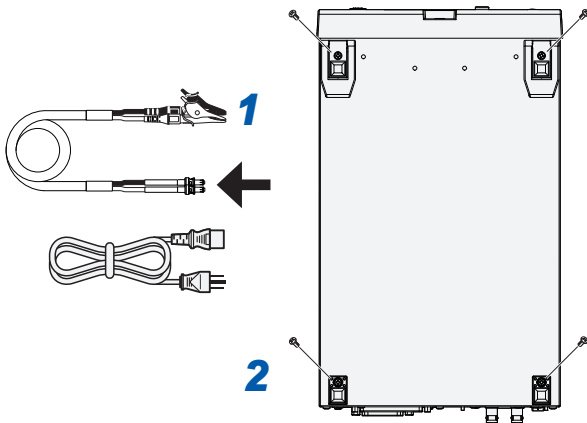

**1** Turn OFF the instrument power supply and remove the cable.

**2** Remove the screws ×4 that secure the support feet on the base.

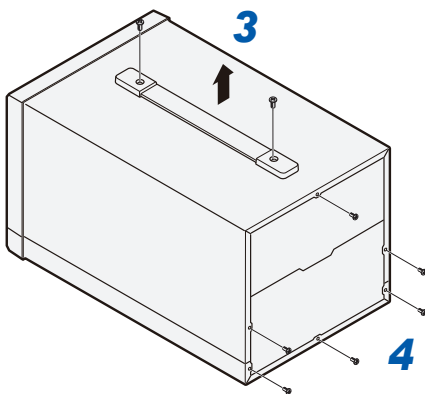

**3** Remove the screws ×2 that secure the handle on the top, and remove the handle.

**4** Remove the screws ×6 from the rear, and remove the top and bottom cases.

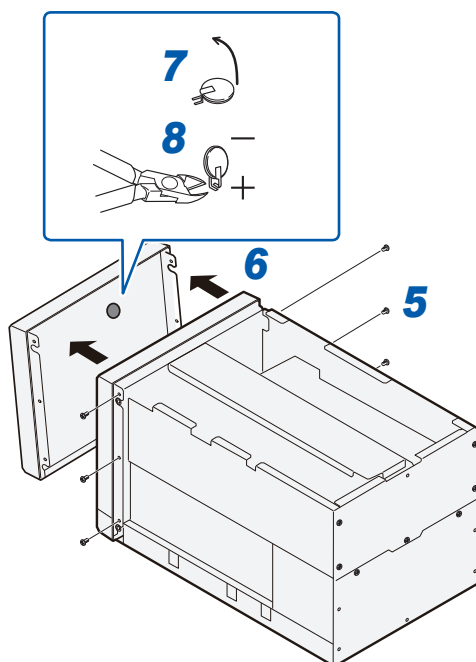

**5** Remove the screws ×6 that secure the front panel.

**6** Remove the front panel.

**7** Sever the + (plus) side of the battery mounted to the plate on the back of the display using the nippers.

**8** Lift up the battery, and use the nippers to sever the - (minus) side under the battery, and remove the battery.

# 15 Appendix

## 15.1 Block Diagram

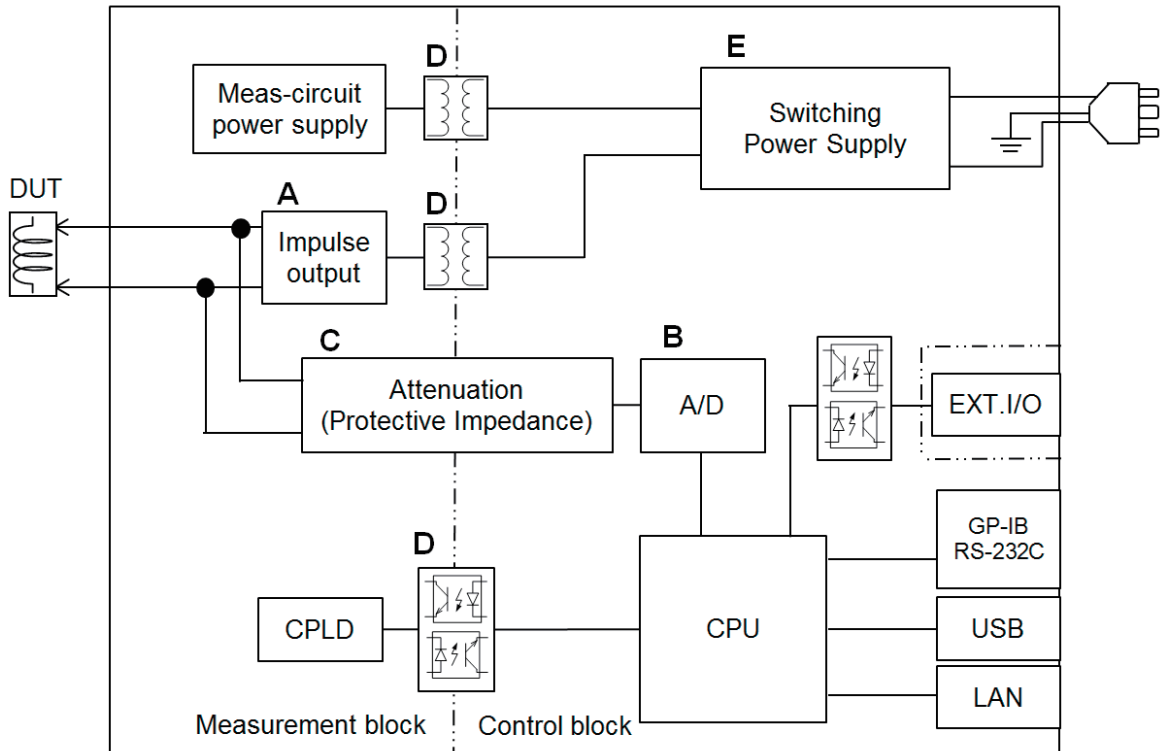

- Outputs impulse signals from 100 V to 3300 V. This is to prevent voltage drop that occurs when the inductance of the workpiece being tested (DUT) is low due to the fast startup of Hioki's proprietary technology (A).
- Built-in 200 MSPS, 12-bit resolution A/D converter (B).
- An attenuator with frequency characteristics flat up to several MHz is built into the detection circuit. You can output minute oscillation waveforms at high speed that are superimposed on the impulse response waveforms from the discharge.
- The attenuator's input impedance is approx. 11 M $\Omega$ . It also fulfills the role of protection impedance (C).
- The connectable parts (interface and case) and the high-voltage circuits are isolated to satisfy IEC61010 safety regulations (C), (D).
- Wide-input switching power supply from 100 V to 240 V is used in the power supply unit to enable stable measurements even in environments where the power supply is unstable (E).

## 15.2 Circuit Configuration

### Circuit operations during tests

A overview of the internal circuit of the instrument is shown below.

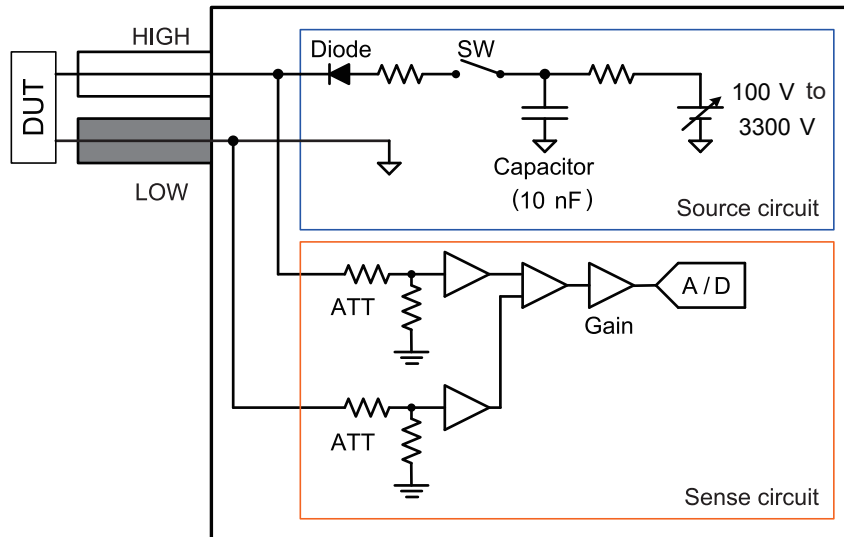

The circuit operations after testing starts are as described below.

- 1** The detection circuit gain is set automatically according to the output voltage.
- 2** The set DC voltage (100 V to 3300 V) is generated by the booster circuit using switching.
- 3** The DC voltage that is generated is fed to a 10 nF capacitor.
- 4** Leave enough time for the capacitor voltage to reach the set voltage, and then turn ON the switch.
- 5** The load stored in the capacitor is applied to the workpiece to be tested via output resistance and a diode.
- 6** When the stored load is exhausted, the internal capacitor and workpiece to be tested are separated by the diode.
- 7** Detects the attenuating oscillation waveform of the workpiece being tested.

When testing is finished, the switch turns OFF.

## Effects of cable parasitic components

The equivalence circuit of the workpiece to be tested and the cable as seen from the output terminal is as described below.

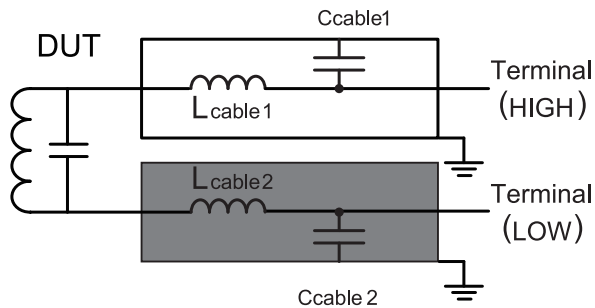

There is parasitic capacity between the core of the coaxial cable and the shield ( $C_{\text{cable1}}$ ,  $C_{\text{cable2}}$ ). Model L2250 capacity is approx. 180 pF each.

Further, there is parasitic inductance in the cable core ( $L_{\text{cable1}}$ ,  $L_{\text{cable2}}$ ). Model L2250 inductance is approx. 2  $\mu\text{H}$  each.

The synthetic circuit of the workpiece to be tested and the measuring cable is as described below.

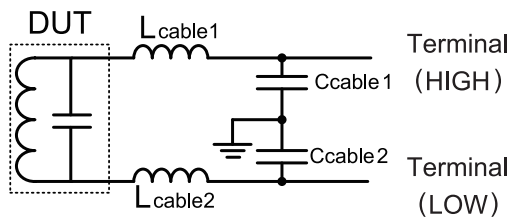

The inductance of the 2 cables enters the workpiece to be tested serially.

The coaxial cable shield is connected to the ground pole via the case.

The synthesis capacity of the 2 cables enters the workpiece to be tested in parallel.

During testing, impulse voltage is applied not only to the workpiece being tested but also to the synthetic components including the cable.

The cable capacity often cannot be ignored compared to the parasitic capacity of the workpiece to be tested, so the oscillation frequency depends greatly on the cable capacity.

For the precautions when processing the cable, see "15.10 Precautions when Processing Test Leads" (p. 238).

## 15.3 Rack Mount

The instrument can be mounted to a rack using metal fittings.  
Carefully store any parts removed from the instrument for when they are reused.

### **WARNING**

Take the following precautions with the screws used to prevent damage to the instrument and electric shock.

- When mounting to a rack, remove the 4 support feet at the base of the instrument, and secure using the screws (M3 × 10 mm) that secure the support feet and the screw holes. (Mounting to a collapsible shelf, etc., and screwing from behind the shelf, etc.)



If the thickness of the collapsible shelf exceeds 4 mm, however, use screws (M3 × thickness +6 mm to 10 mm) of length 6 mm to 10 mm when inserted from the base of the instrument.

Further, if using a JIS rack base and rack mount fittings of the same shape as described in “Metal fitting dimensions” (p. 225), secure using not only the screws that secured the support feet, but also countersunk screws of M3 × 8 mm to 10 mm from the bottom of the metal fittings.

- Use the screws that were used in installation when shipped from the factory to mount to the rack. If you have lost a screw or find that a screw is damaged, please contact your authorized Hioki distributor or reseller.

# Metal fitting dimensions

## JIS

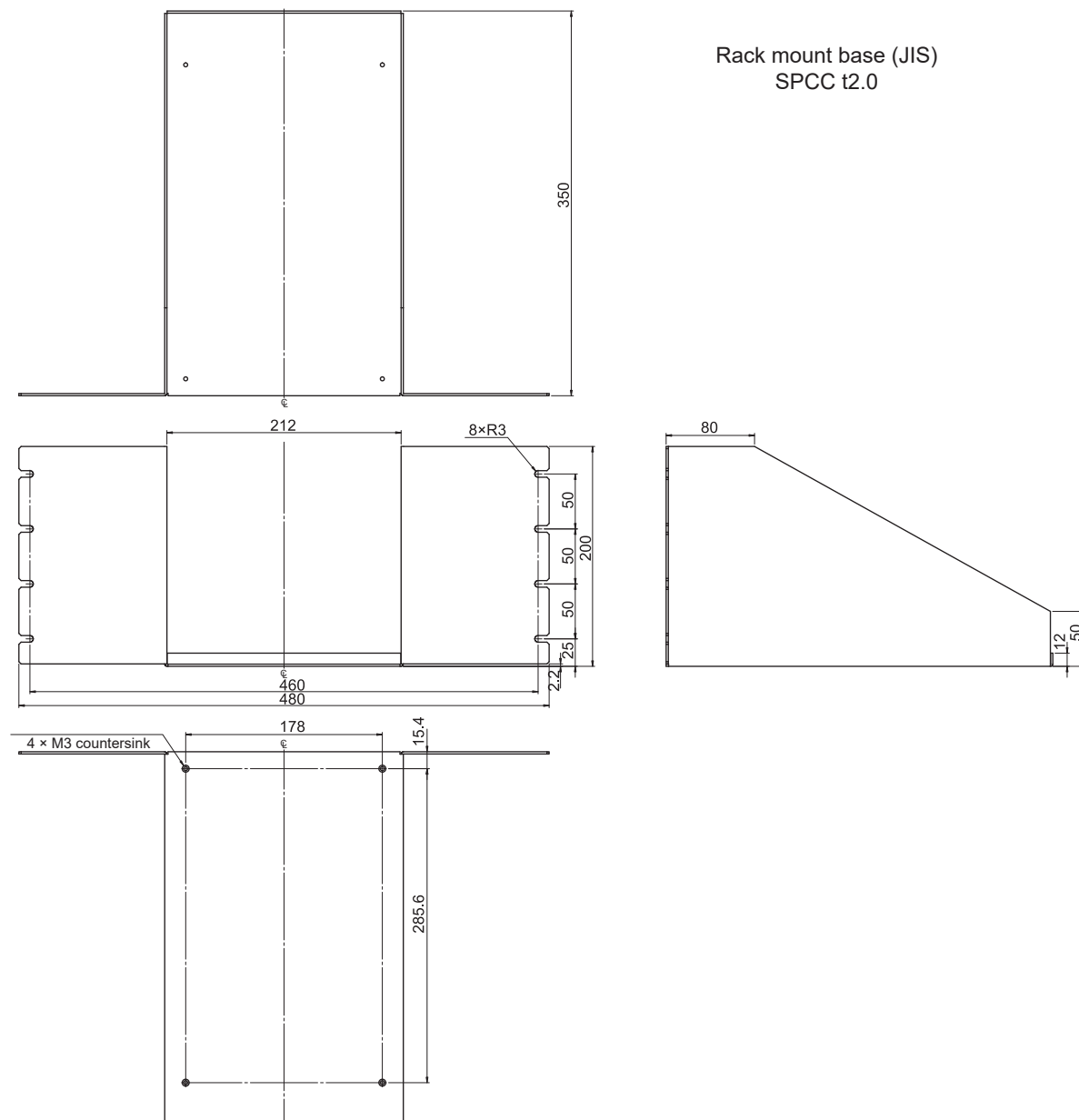

Rack mount base (JIS)  
SPCC t2.0

Unit: mm



EIA

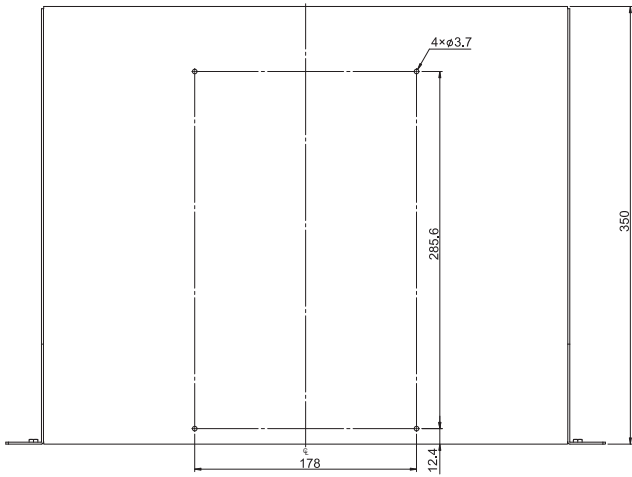

Rack mount base (EIA)  
SPCC t1.6

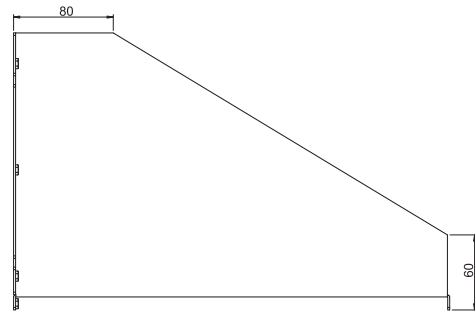
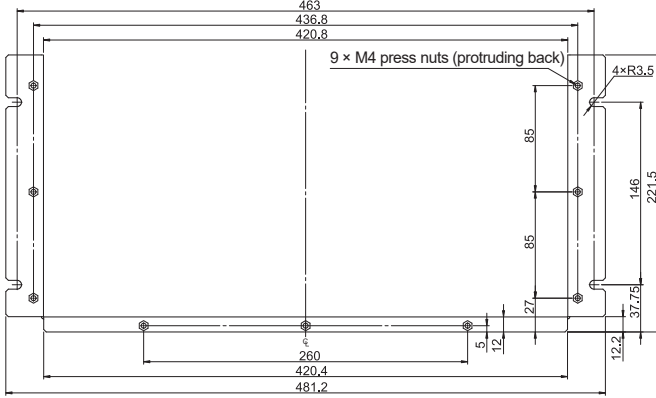

Rack mount panel (EIA)  
SPCC t3.0

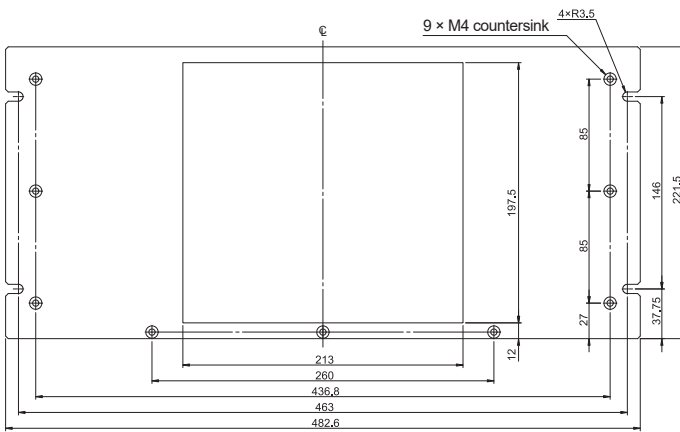

Unit: mm

## Installation method

When mounting the instrument on a rack, use a commercially available base for reinforcement.

### JIS

**Required items** Phillips screwdriver (No. 2), countersunk screws (M3 × 10 mm) ×4

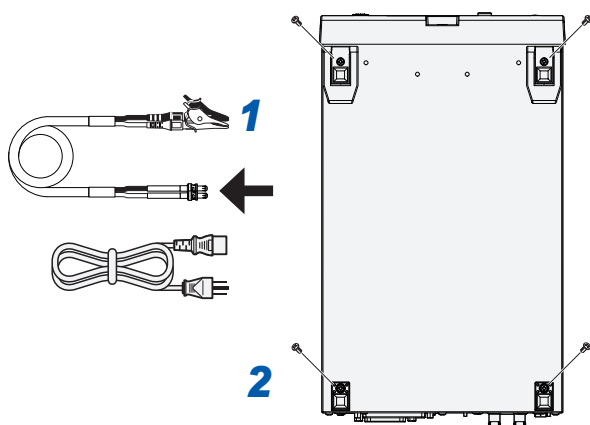

**1** Turn OFF the instrument power supply and remove the cable.

**2** Remove the screws ×4 that secure the support feet on the base.

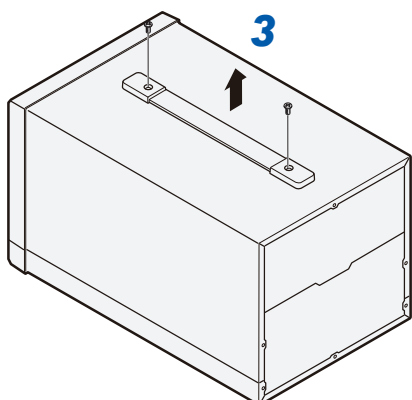

**3** Remove the top screws ×2, and remove the handle.

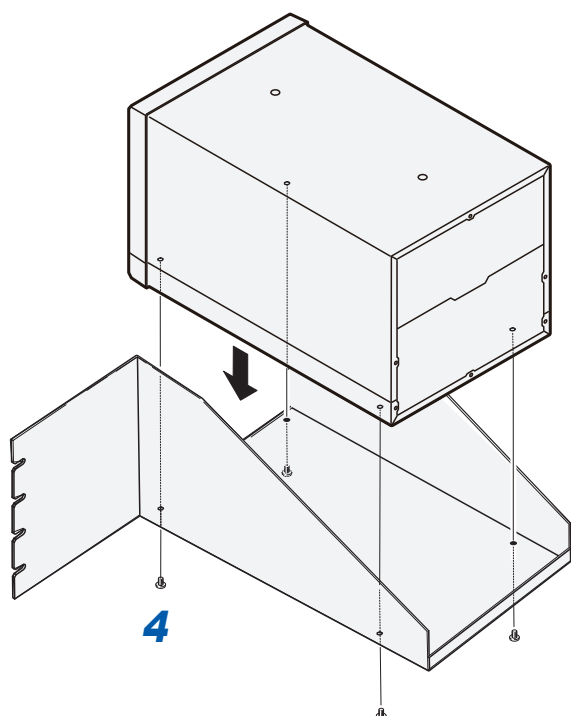

**4** Mount the instrument to the rack metal fittings, and secure from the bottom using countersunk screws (M3 × 10 mm) ×4.

At this time, the screws used to secure the support feet are not used. Carefully store them for when they are reused.

EIA

**Required items** Phillips screwdriver (No. 2)

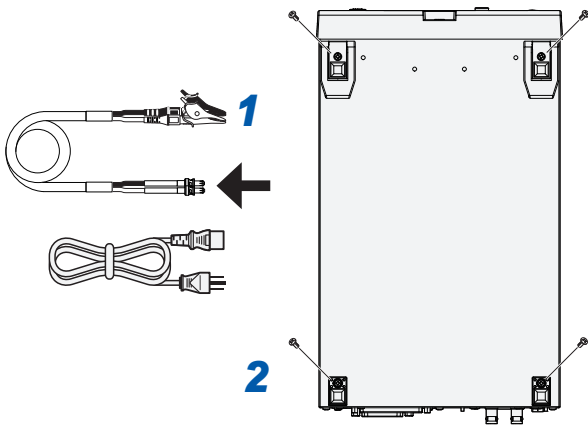

**1** Turn OFF the instrument power supply and remove the cable.

**2** Remove the screws ×4 that secure the support feet on the base.

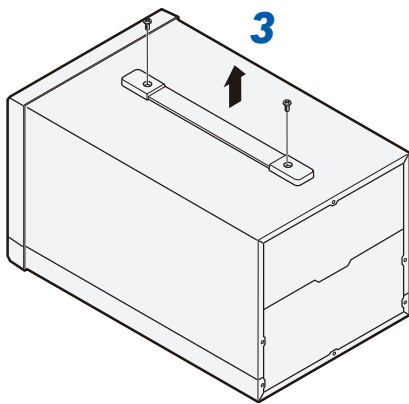

**3** Remove the top screws ×2, and remove the handle.

**4** Slide the instrument from the front of the rack mount fittings until it is all the way in.

**5** Secure using the screws (M3 × 10 mm) ×4 that secure the support feet and the screw holes.  
(Mounting to a collapsible shelf, etc., and screwing from behind the shelf, etc.)

If the thickness of the collapsible shelf exceeds 4 mm, use screws (M3 × thickness + 6 mm to 10 mm) of length 6 mm to 10 mm when inserted from the base of the instrument.

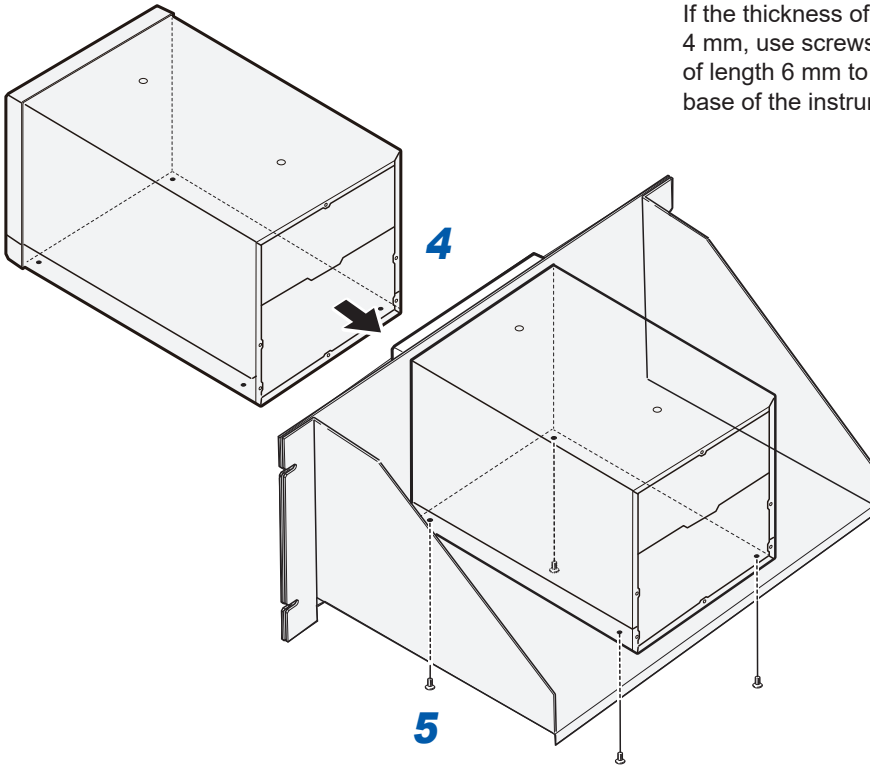

## 15.4 Dimensions Diagram

Unit: mm

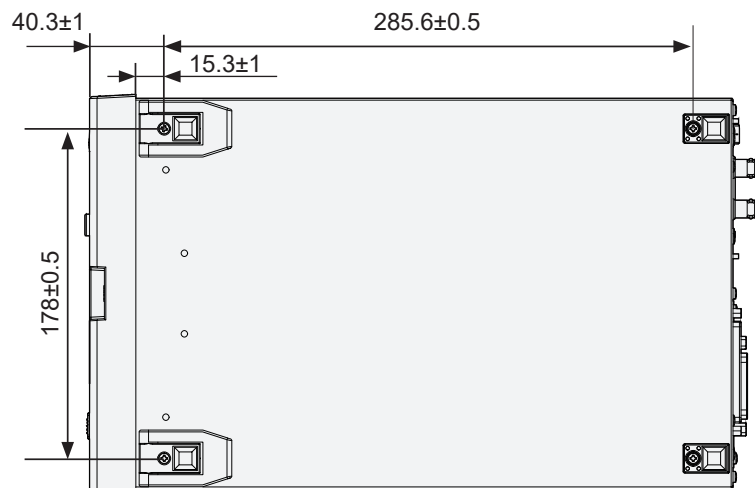
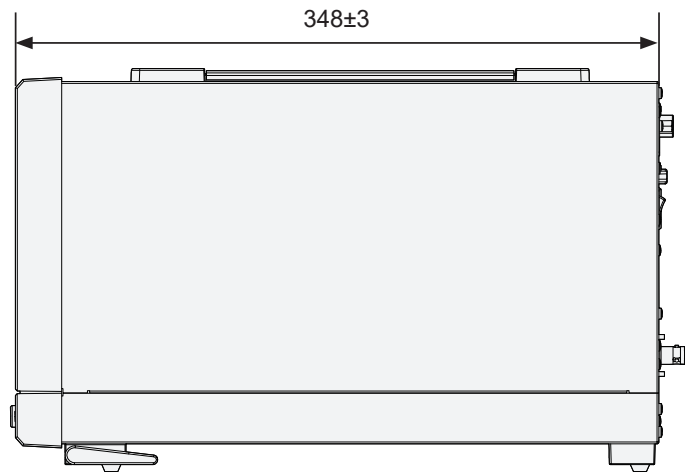
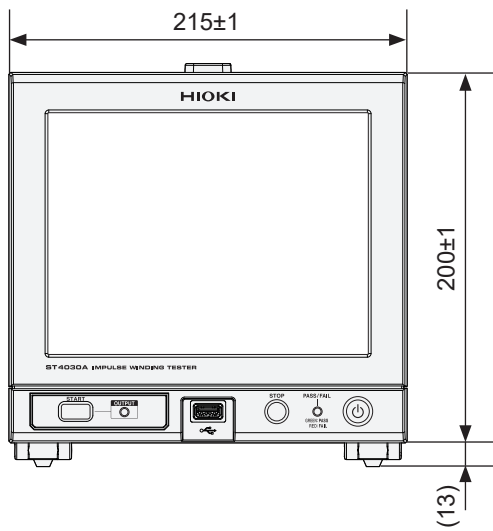

## 15.5 Repeat Accuracy (Reference Value)

### Reproducibility of the voltage generated

The max. value of the waveform obtained by applying the trigger with the terminal open is defined as the generated voltage.

The typical values of the generated voltage variation during 100 repeat outputs is 0.16% max. when the set voltage is 100 V and 0.09% max. when the set voltage is 1000 V.

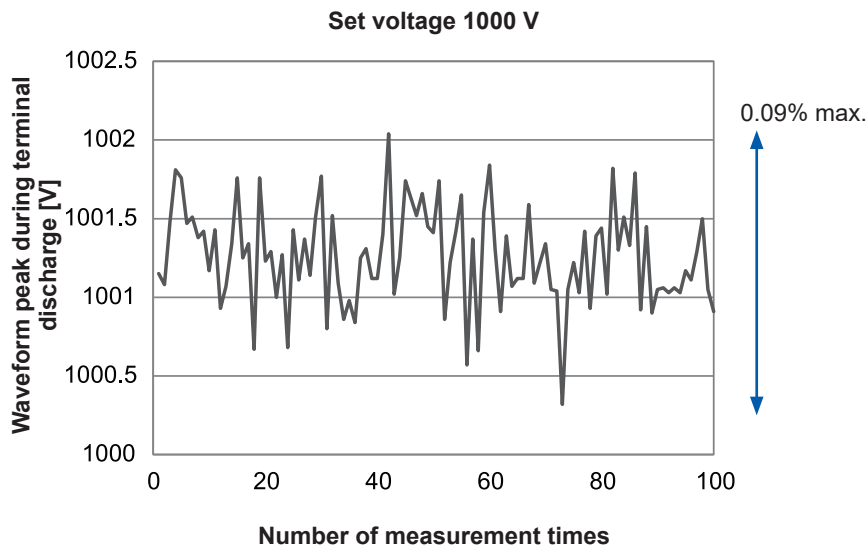
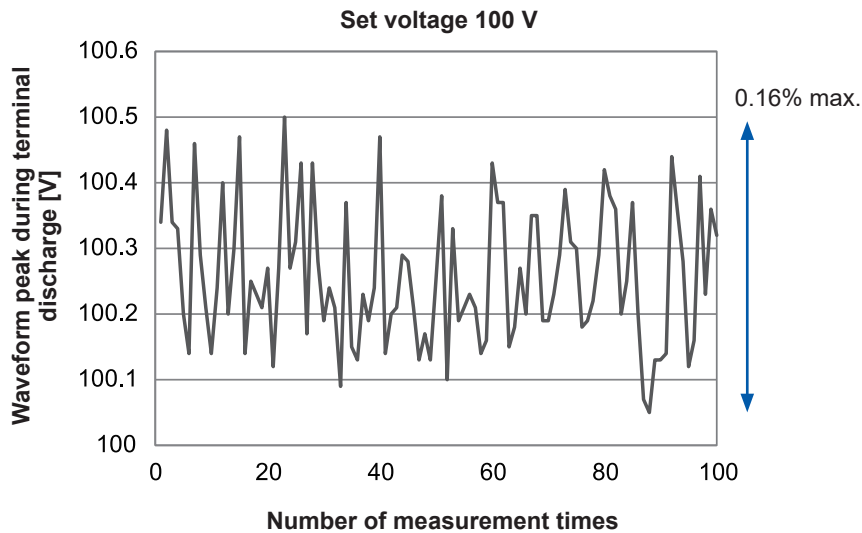

## Oscillation waveform reproducibility

Describes the typical values of waveform variation when implementing impulse tests on the coil. The oscillation waveform when implementing impulse tests on a low-loss 1 mH coil using 1000 V is as described below.

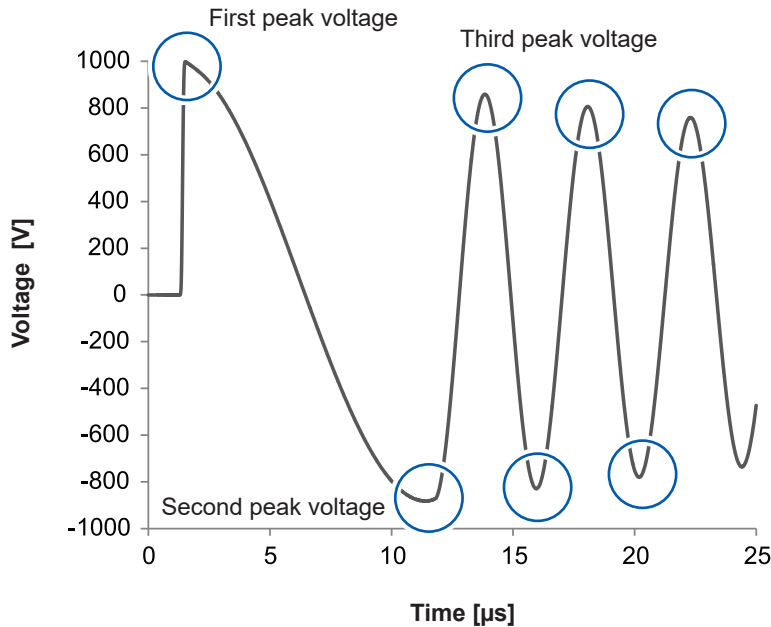

The repeat accuracy of the peak voltages when implementing 100 consecutive tests is as described below.

Nearly all 0.3% max.

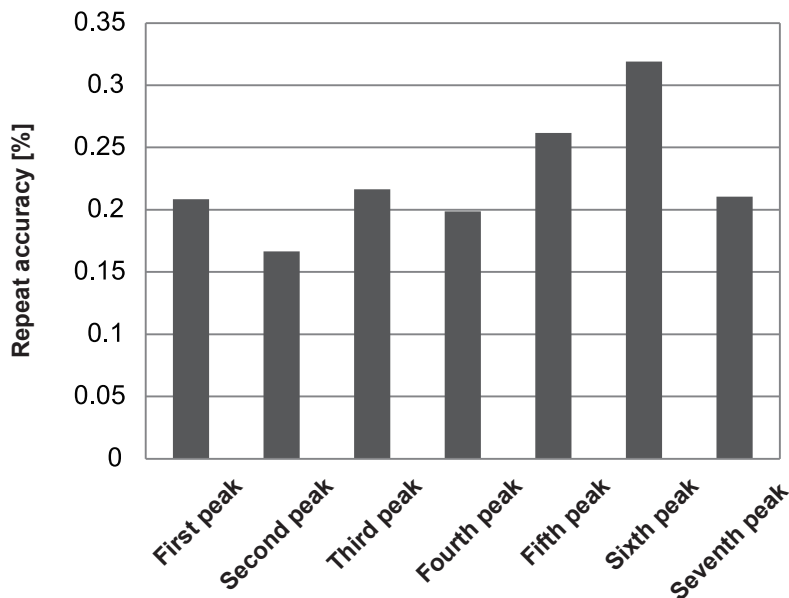

Note: The values shown here are typical values, and repeat accuracy cannot be assured.

Waveform variation depends greatly on the inductance, stray capacitance, linear resistance, and core magnetic characteristics of the workpiece being tested.

For example, the peak voltage will drift a little more each time due to the increasing residual magnetization of the magnetic core.

For good impulse test reproducibility, implement degaussing pulses a sufficient number of times so that there is no more waveform drift.

## 15.6 Max. Applicable Voltage (Reference Value) According to the Workpiece Inductance and Capacitance

The maximum voltage that can be applied to the workpiece being tested decreases as its inductance decreases or its capacitance increases.

If a greater voltage than the max. applicable voltage is set, an error will occur when “4.6 Voltage Calibration” (p. 49) is implemented.

The graph below illustrates the first peak voltage (reference value) during an impulse test implemented on a low-loss coil.

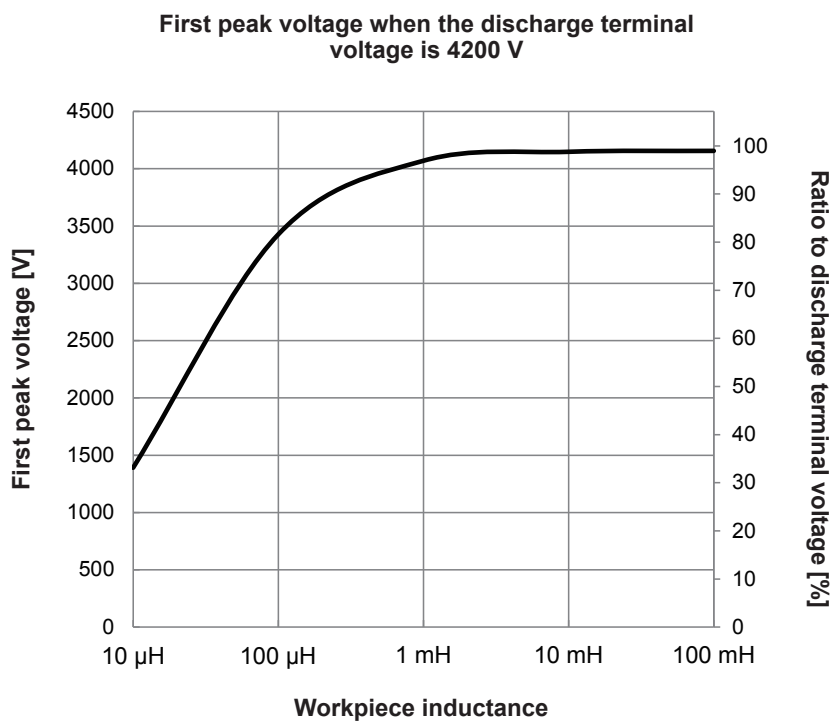

The graph below illustrates the maximum voltage (reference value) during an impulse test implemented on a capacitor.

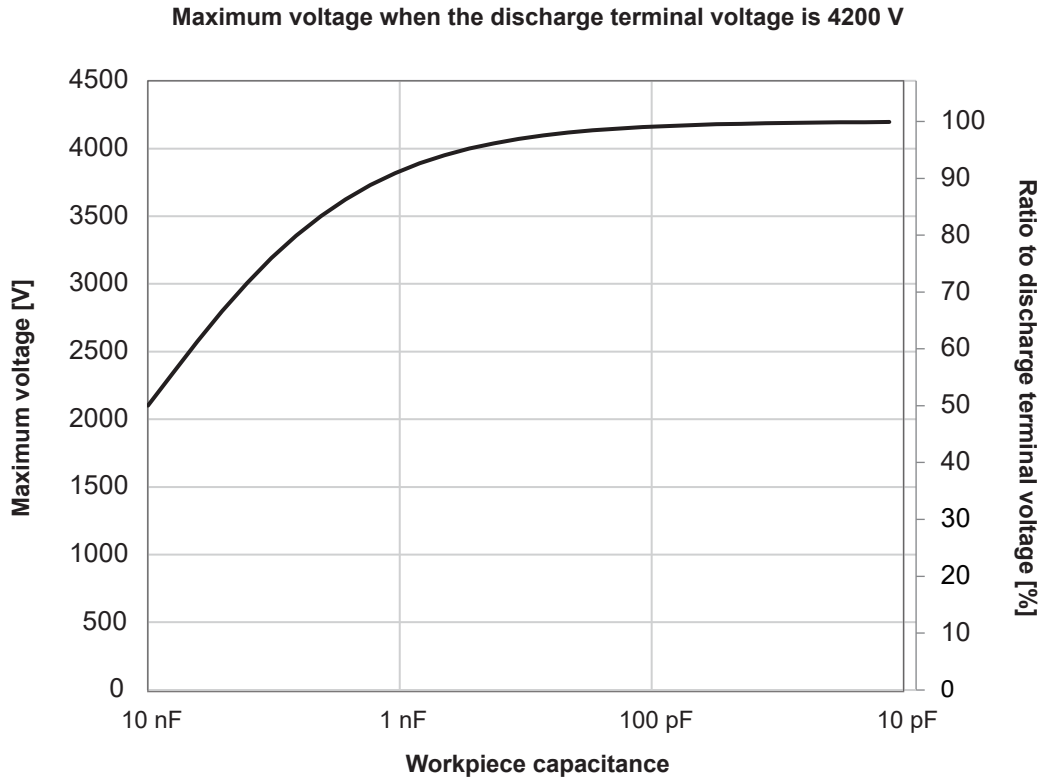

The inductance and capacitance of the workpiece being tested depend on the oscillation period when an impulse voltage is applied. Additionally, the upper limit of the applicable voltage also varies depending on the losses and characteristics of the workpiece being tested. Always confirm in advance whether the voltage used in the test can be applied to the workpiece.



## 15.7 Voltage Switching Time (Reference Value)

If implementing low-voltage impulse tests immediately after high-voltage impulse tests, leave enough time for the voltage inside the tester to fall.

The longest interval is when switching from 3300 V to 100 V, and the 100 V impulse is output approx. 3.8 sec. after the 3300 V impulse is output.

The typical values for the EOM signal (rising and falling edges) intervals when implementing continuous impulse tests with different voltages are as described below.

First voltage	Second voltage	EOM interval [ms]
3300 V	2000 V	410
	1000 V	730
	600 V	1290
	100 V	3840
2000 V	1000 V	480
	600 V	1040
	100 V	3540
1000 V	600 V	480
	100 V	2850
600 V	100 V	2210

First voltage	Second voltage	EOM interval [ms]
100 V	600 V	280
	1000 V	320
	2000 V	320
	3300 V	340
600 V	1000 V	220
	2000 V	260
	3300 V	230
1000 V	2000 V	260
	3300 V	250
2000 V	3300 V	330

Sampling frequency: 200 MHz, number of points: 1001, number of pulses: 1

## 15.8 Waveform Differences (Typical Values) Between Instruments

Even a slight difference in the interior of the impulse winding tester produces a difference in the oscillation waveform even if using the same workpiece and test leads.

Instrument differences for the voltage peak value and cycle (zero-cross value) obtained with 14 Model ST4030 instruments when using the same workpiece and test leads are described as reference values.

### Test conditions

Workpiece	10 $\mu\text{H}$ coil	1 mH coil
Sampling frequency	200 MHz	200 MHz
Sampling data count	1001 points	5001 points
Applied voltage	1000 V	
Voltage calibration	Implemented	
Test lead	L2250	

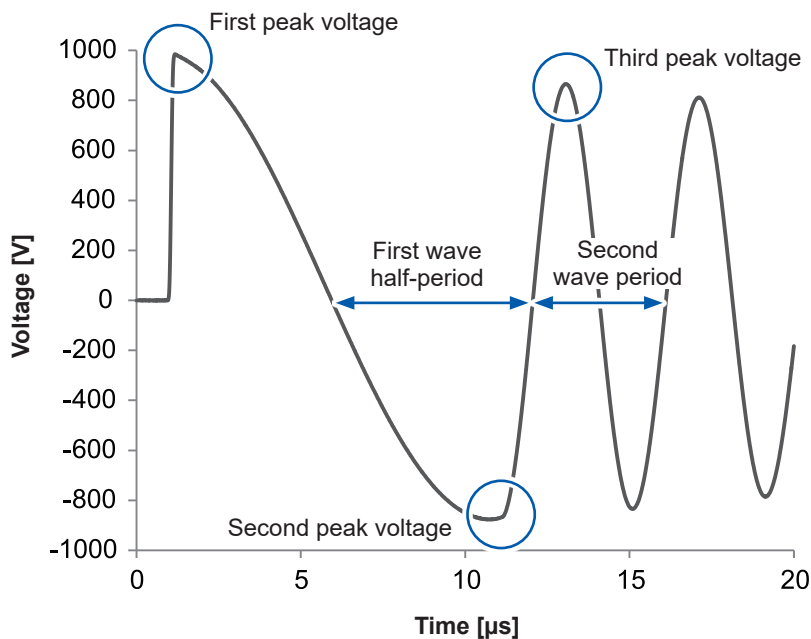

Describes the instrument differences determined using the waveforms obtained using each Model ST4030.

Formula: (Max. value – min. value) / average value [%]

Workpiece	10 $\mu\text{H}$ coil	1 mH coil
First peak voltage	0.90%	0.06%
Second peak voltage	1.80%	0.45%
Third peak voltage	4.46%	0.50%
First wave half-period	0.87%	0.29%
Second wave period	1.09%	0.37%

The instrument difference when measuring 1 mH coils is 1% max. How the instrument differences appear depends on the workpiece. The smaller the inductance, the more likely the instrument differences are affected. A comparison of the response waveforms for the two 10  $\mu$ H coils with the greatest differences are shown in the following graph.

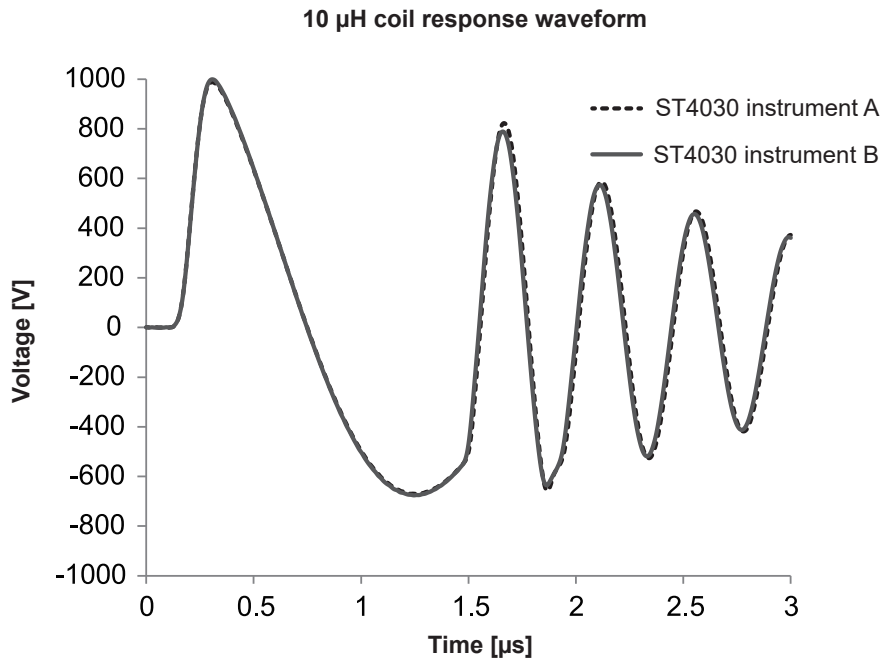

When switching instruments, either set with sufficient space to that the judgment threshold values are not affected by the instrument differences, or recalibrate the voltages and then reset the judgment threshold values.

## 15.9 Affects on Measurements According to the Length of the Test Lead

Even if measuring the same workpiece, the length of the test lead changes the waveform. Following are waveforms with test lead lengths of 1.5 m, 3.0 m, and 5.0 m.

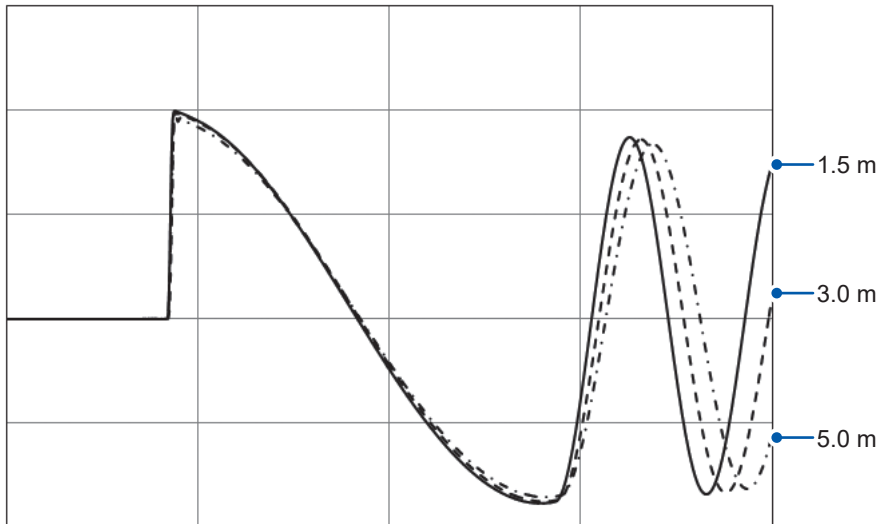

Using a longer test lead increases the cable capacity ( $C$ ). According to  $T=2\pi\sqrt{LC}$ , the longer the lead, the longer the oscillation period.

Because the cable's parasitic inductance and parasitic capacitance increase with the length of the test leads, the rising portion of the waveform is more likely to exhibit ringing. Following are impulse response waveforms for the same workpiece (a coil of xx mH), measured using 1.5 m test leads and 5.0 m test leads. Voltage calibration is performed using the maximum voltage, including ringing. When extending the standard 1.5 m test leads, arrange equipment so that the cables are as short as possible.

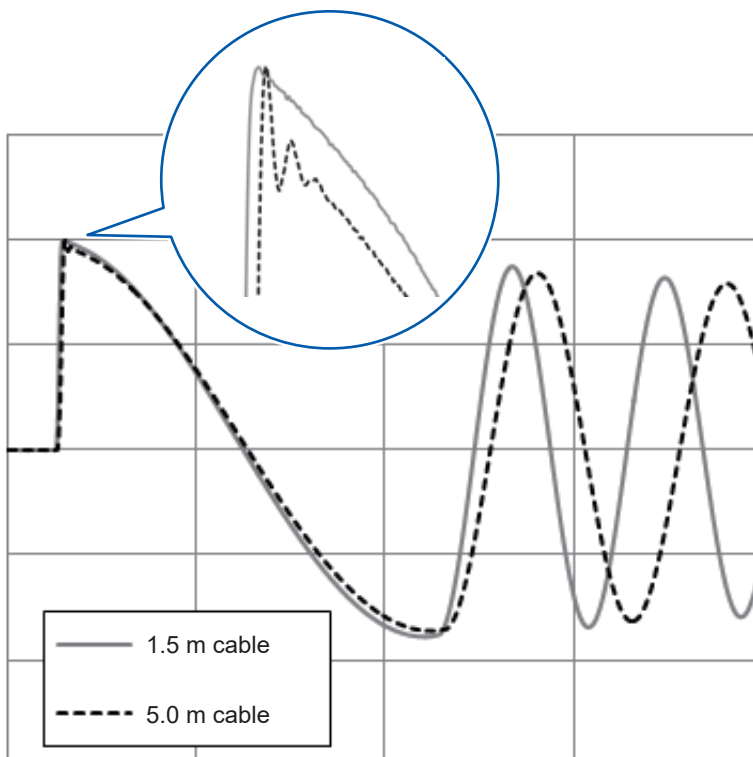

## 15.10 Precautions when Processing Test Leads

### ⚠ WARNING

To prevent electric shock and instrument malfunction, separate the core of the processed lead and the shield (=case pole) by at least 16 mm, and do not connect them.

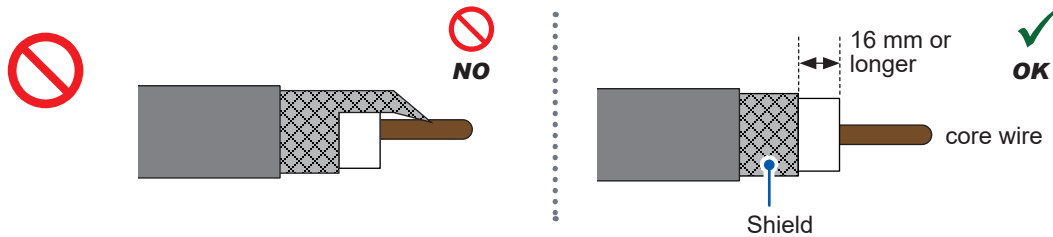

### Precautions when creating a switching device

- To boost test reproducibility, use coaxial measurement cables. When single-wire cables are used, differences in cable routing will result in significant fluctuations in the coupling capacitance between cables. Use coaxial cables whose rated voltage is higher than the test voltage. The instrument uses special-order coaxial connectors that are not available commercially. It is recommended to use Model L2250 Clip Type Leads or Model L2252 Unprocessed Lead Cable to connect probes to the instrument. Model L2250 Clip Type Lead with a cable length of 3.0 m and 5.0 m are available on a special-order basis. Please contact your your authorized Hioki distributor or reseller.
- Test lead shielding, the coaxial connector outer conductor, and the instrument's enclosure are at ground potential. When fabricating cables yourself, connect the coaxial cables' shielding to the ground potential. Failure to do so will make the setup more susceptible to external noise.
- The parasitic inductance of the test leads connected to the HIGH and LOW terminals will fluctuate on the order of several microhenries depending on the shape of the 2 cables.
- For example, the inductance difference when winding a 1.5-m cable (Model L2250) in the 2 ways shown below is approx. 1  $\mu$ H.

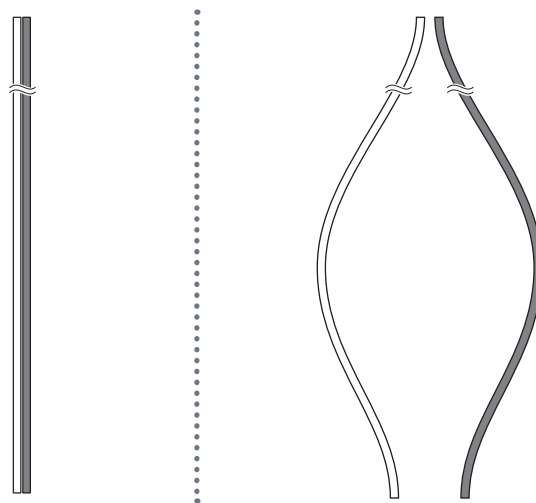

Variations in oscillation frequency and variations in measurement cable inductance will have a particularly significant effect on test results when testing low-inductance workpieces. It is recommended that you bundle the 2 cables as shown below to minimize impedance changes due to shape.

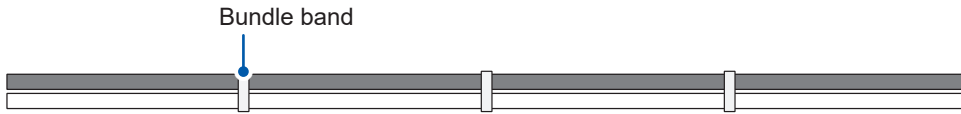

- To reduce the waveform differences between lines when testing the same type of workpiece on multiple lines, etc., as far as possible use cables with the same capacitance values. The cable capacitance value depends on the length and type. Use an inductance measuring instrument to adjust the cable capacitance value between shielding from the core wires.
- The recommended wiring diagram when creating a switching device using relays, etc., is shown below.

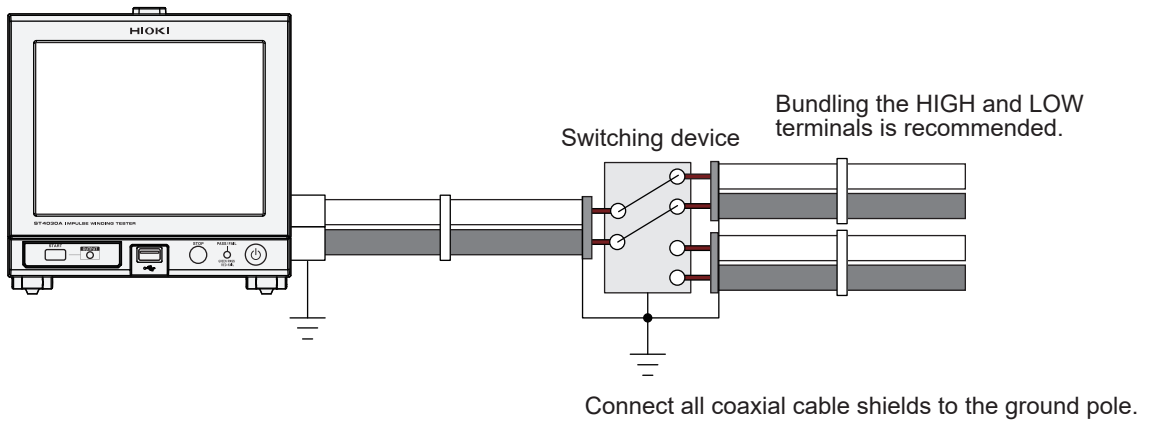

In the case of the diagram below, the cable shields are connected via the case of the switching device to comprise the instrument ground pole. A shorter distance for the core switching unit is recommended.

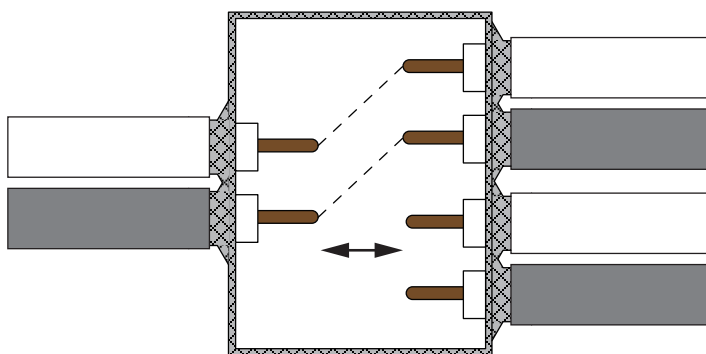

# 15.11 Ver. 1.01 Compatibility Function

- When a SET settings file saved by an ST4030 running firmware Ver. 1.00 or 1.01 is loaded by an ST4030 or ST4030A running firmware Ver. 1.02 or later, the same measurement operation as Ver. 1.01 will be performed for loaded tables only. Subsequent measurements made during voltage calibration or in BDV mode will consist of measurement operation added as new functionality in Ver. 1.02.
- When an ALL settings file saved by an ST4030 running firmware Ver. 1.00 or 1.01 is loaded by an ST4030 or ST4030A running firmware Ver. 1.02 or later, the same measurement operation as Ver. 1.01 will be performed for loaded tables. Subsequent measurements made during voltage calibration or in BDV mode will consist of the same operations used in Ver. 1.01. In this configuration, the **[OPEN ERROR]** and **[VOLT ERROR]** settings will not be shown on the **[SYSTEM]** screen.



- If the instrument's settings are initialized, subsequent operation will consist of measurement operation added as new functionality in Ver. 1.02.
- Tables whose measurement operation is compatible with Ver. 1.01 will be displayed with an asterisk next to their table number in the table list.



- Measurement functionality added as new functionality in Ver. 1.02 and subsequent versions supports a broader range of measurement targets than Ver. 1.01. It is recommended to register new master waveforms in Ver. 1.02 instead of using measurement settings that are compatible with Ver. 1.01.

# Index

## Number

9151-02 GP-IB Connector Cable (2 m) .....	154
9637 RS-232C Cable (9pin-9pin/1.8 m) .....	152
9642 LAN Cable .....	160

## A

Application disc.....	3
Application start voltage .....	90
Applied voltage .....	41
AREA.....	62
AREA TYPE.....	58
AUTO.....	75
Automatic save .....	169
Automatic settings .....	46
Judgment threshold values .....	71
Waveform judgment area .....	71
Auto scale.....	116
AUTO SET.....	44
Auto settings of the waveform acquisition range .....	44

## B

Backlight.....	111
Backup.....	16
Baud rate .....	153
BDV .....	18, 85
Break down.....	85

## C

Cleaning .....	207
CLOCK .....	132
Coaxial connector.....	14
COMMAND ERROR.....	164
COMM LOG.....	163
Communications monitor.....	163
Compatible connectors.....	136
CREATE .....	58
Current table.....	29

## D

DATE DELIM .....	173
DATE FORM.....	173
DBL ACTN .....	106
DECIM CHAR.....	172
Degaussing pulse.....	42
DEGAUSS NUM.....	42
DELAY .....	48
DEVICE-SPECIFIC ERROR .....	164
DIFF AREA.....	64
Differential surface area comparison value operation formula.....	64
DISCHARGE .....	73
Discharge Detection Upgrade .....	72

Discharge judgments.....	72
Discharge judgments flowchart .....	72
DISP .....	36, 78, 111
Disposal.....	220
Double action function.....	106

## E

Effects of magnetic anisotropy .....	22
Electrolytic capacitor.....	207
END .....	90
EOM TIME.....	119
Error display .....	40, 83, 88, 214
Error during tests.....	214
Error during voltage calibration .....	215
Other errors.....	219
USB host error .....	218
Example of test waveform discharge components... ..	66
EXECUTION ERROR.....	164
Expanded judgment results.....	82
External control.....	133
External control terminal	
EXT. I/O test.....	131
External I/O	
Connection example .....	140
EXT I/O.....	133
EXT.I/O test .....	131

## F

FAST.....	129
FILENAME.....	174
FIXED.....	74
FLUTTER .....	66
Flutter value operation.....	66
Folders.....	174
Format .....	184
Frequently Asked Questions (FAQ).....	212
Full reset.....	213
FULL TEST.....	130

## G

Gateway .....	161
Generated voltage.....	20, 230
GP-IB.....	151, 154
GP-IB address .....	154
GRAPH.....	112, 113
Ground.....	23

## H

Handle .....	9
Handshake .....	153
HI-LO.....	58
Hub .....	157



**I**

I/F .....	151
Image save format.....	173
Importing judgment results .....	144
Impulse response waveform.....	21, 53
INFO .....	125
Initialization.....	121
Input circuit .....	140
Input signal .....	138
Input signals test.....	131
Inspection .....	19
Installation .....	5
Instrument difference.....	235
Interface.....	151
INTERLOCK.....	101
Interlock function .....	101
Internal circuit configuration.....	139
I/O IN .....	131
I/O OUT .....	131
IP address .....	161
Isolated power supply outputs.....	138
ITEM DELIM .....	172

**J**

JUDGE BEEP .....	117
Judgment result.....	82
Judgment value .....	82

**K**

KEY BEEP .....	118
Keyboard .....	11
KEYLOCK.....	104
Key lock function .....	104
Key operation sound.....	118

**L**

L2250 Clip Type Lead.....	205
L2252 Unprocessed Lead Cable .....	205
LAN.....	151, 157
LAPLACIAN.....	69
Laplacian operations .....	69
LC and RC graph.....	38, 80
LC and RC master values .....	56
LC and RC values .....	53
LCD backlight .....	207
LCRC AREA .....	53
LOCAL.....	162
Local mode .....	162
LONG FORM.....	120
Long format .....	120

**M**

Magnetic saturation .....	22
Main power supply.....	16
Manual save .....	170
Margin.....	58
Master waveform imports .....	49
Max. applicable voltage.....	232
Max. applied voltage.....	90
Max. peak voltage .....	49
Measuring mode.....	18
MEM CLEAR .....	110
MEMORY .....	174
Memory function .....	107
MEM SAVE.....	109
Moving windows .....	11

**N**

Network .....	157
NONE .....	18
NPN.....	135
NPN/PNP switch .....	135
Number of applied pulses.....	42
Number of sampling data .....	44

**O**

Operations check.....	19
Operations procedure.....	27, 35, 52, 77, 85
Option.....	4
Oscillation period .....	237
Oscillation waveform reproducibility .....	231
Output circuit .....	141
OUTPUT lamp .....	9
Outputs disabled.....	101
Output signal .....	138
Output signals test.....	131
Overlay .....	112
OVERLAY .....	112

**P**

Package contents .....	3
Panel saving	
Savable items.....	26
PASS/FAIL lamp .....	9
PC.....	157
PICTURE.....	173
PNP .....	135
Port number.....	161
Power cord .....	15
Power inlet.....	9
Power supply	
Sleep mode .....	17
Startup mode.....	17
Precautions during shipment.....	207
Pulse application interval.....	42

PULSE NUM.....	42
PULSE PERIOD .....	42

## Q

QUERY ERROR.....	164
QUICK.....	170
QUOTE.....	172

## R

RECORD LENGTH .....	44
Remote mode.....	162
Repeat accuracy.....	231
RESET.....	121
Residual magnetization .....	21
Ringing .....	23, 237
RS-232C.....	151, 152

## S

SAMPLING .....	44
Sampling frequency.....	44
Saved file name.....	174
Scale.....	115
SCALE.....	116
SCREEN.....	174
Screen configuration.....	12
SELECT.....	170
Serial number .....	9
SETTING.....	18
Signals.....	138
Sinking current.....	135
Sleep mode .....	16, 17
Sourcing current .....	135
ST9000 Discharge Detection Upgrade.....	72
Stand .....	9
START .....	90
START button .....	9
Startup button.....	9, 16, 17
Startup mode .....	16, 17
Status display .....	40, 83, 88
STEP .....	90
STOP button.....	9
Subnet mask.....	161
Surface area comparison value operation.....	62
Switching device.....	238
System information.....	125
System reset.....	121

## T

Table	
Changing names.....	32
Copy.....	33
Deletion.....	31
Initialization .....	30

Table functions.....	25
TCP/IP .....	159
Terminator.....	161
TEST .....	18, 126
Test conditions settings mode .....	18
Test lead .....	14
Test mode.....	18
Test pulse .....	42
Test status .....	40, 83, 88
TEXT .....	174
Text save format .....	172
Text save items.....	171
Timing chart.....	142
Total judgment results.....	82
Touch keyboard .....	11
Touch panel .....	127
Trigger delay.....	47
TYPE1 .....	50
TYPE2 .....	50

## U

USB .....	155
USB communications .....	151
USB connector .....	9
USB driver .....	155
USB memory .....	165

## V

Variation.....	230
V CAL .....	50
Vent holes.....	5, 9
VOLT .....	41
Voltage application disabled mode.....	18
Voltage calibration .....	49
Voltage output terminal.....	9, 14
Voltage rise width .....	90

## W

Warming up .....	17
Waveform color .....	113
Waveform difference.....	235
Waveform graph .....	37, 79
Waveform judgment area .....	71

## X

XON/OFF.....	153
--------------	-----

## Z

Z3000 GP-IB Interface.....	154
Z3001 RS-232C Interface.....	153



# Warranty Certificate

# HIOKI

Model	Serial number	Warranty period One (1) year from date of purchase ( ___ / ___ )
-------	---------------	---

Customer name: \_\_\_\_\_

Customer address: \_\_\_\_\_

## Important

- Please retain this warranty certificate. Duplicates cannot be reissued.
- Complete the certificate with the model number, serial number, and date of purchase, along with your name and address. The personal information you provide on this form will only be used to provide repair service and information about Hioki products and services.

This document certifies that the product has been inspected and verified to conform to Hioki's standards.

Please contact the place of purchase in the event of a malfunction and provide this document, in which case Hioki will repair or replace the product subject to the warranty terms described below.

## Warranty terms

1. The product is guaranteed to operate properly during the warranty period (one [1] year from the date of purchase).  
If the date of purchase is unknown, the warranty period is defined as one (1) year from the date (month and year) of manufacture (as indicated by the first four digits of the serial number in YYMM format).
2. If the product came with an AC adapter, the adapter is warrantied for one (1) year from the date of purchase.
3. The accuracy of measured values and other data generated by the product is guaranteed as described in the product specifications.
4. In the event that the product or AC adapter malfunctions during its respective warranty period due to a defect of workmanship or materials, Hioki will repair or replace the product or AC adapter free of charge.
5. The following malfunctions and issues are not covered by the warranty and as such are not subject to free repair or replacement:
  - 1. Malfunctions or damage of consumables, parts with a defined service life, etc.
  - 2. Malfunctions or damage of connectors, cables, etc.
  - 3. Malfunctions or damage caused by shipment, dropping, relocation, etc., after purchase of the product
  - 4. Malfunctions or damage caused by inappropriate handling that violates information found in the instruction manual or on precautionary labeling on the product itself
  - 5. Malfunctions or damage caused by a failure to perform maintenance or inspections as required by law or recommended in the instruction manual
  - 6. Malfunctions or damage caused by fire, storms or flooding, earthquakes, lightning, power anomalies (involving voltage, frequency, etc.), war or unrest, contamination with radiation, or other acts of God
  - 7. Damage that is limited to the product's appearance (cosmetic blemishes, deformation of enclosure shape, fading of color, etc.)
  - 8. Other malfunctions or damage for which Hioki is not responsible
6. The warranty will be considered invalidated in the following circumstances, in which case Hioki will be unable to perform service such as repair or calibration:
  - 1. If the product has been repaired or modified by a company, entity, or individual other than Hioki
  - 2. If the product has been embedded in another piece of equipment for use in a special application (aerospace, nuclear power, medical use, vehicle control, etc.) without Hioki's having received prior notice
7. If you experience a loss caused by use of the product and Hioki determines that it is responsible for the underlying issue, Hioki will provide compensation in an amount not to exceed the purchase price, with the following exceptions:
  - 1. Secondary damage arising from damage to a measured device or component that was caused by use of the product
  - 2. Damage arising from measurement results provided by the product
  - 3. Damage to a device other than the product that was sustained when connecting the device to the product (including via network connections)
8. Hioki reserves the right to decline to perform repair, calibration, or other service for products for which a certain amount of time has passed since their manufacture, products whose parts have been discontinued, and products that cannot be repaired due to unforeseen circumstances.

**HIOKI E.E. CORPORATION**

<http://www.hioki.com>

18-07 EN-1

**HIOKI**  
**www.hioki.com/**



**All regional  
contact  
information**

**HIOKI E.E. CORPORATION**  
81 Koizumi, Ueda, Nagano 386-1192 Japan

2402 EN

Edited and published by HIOKI E.E. CORPORATION

Printed in Japan

- Contents subject to change without notice.
- This document contains copyrighted content.
- It is prohibited to copy, reproduce, or modify the content of this document without permission.
- Company names, product names, etc. mentioned in this document are trademarks or registered trademarks of their respective companies.

**Europe only**

- EU declaration of conformity can be downloaded from our website.
- Contact in Europe: HIOKI EUROPE GmbH  
Helfmann-Park 2, 65760 Eschborn, Germany hioki@hioki.eu