

LR8512
LR8513
LR8514
LR8515

HIOKI

Measurement Guide

WIRELESS PULSE LOGGER
WIRELESS CLAMP LOGGER
WIRELESS HUMIDITY LOGGER
WIRELESS VOLTAGE/TEMP LOGGER



The latest edition of the instruction manual



EN

June 2024 Revised edition 6
LR8512B981-06



600444596

Contents

For customers who are using the LR8410 Wireless Logging Station		1
Instrument Version		2
Introduction.....		3
Trademark		4
Verifying Package Contents		5
■ Options.....		6
Safety Notes.....		8
Usage Notes.....		11
1	Overview	21
1.1	Overview and Features.....	21
1.2	Parts Names and Functions.....	22
2	Preparation for Measurements	23
3	Using the LR8410 as a Unit	27
3.1	Real-time Measurement Using the LR8410.....	27
3.2	Performing Real-time Measurement Using a Windows® PC	28
4	Collecting Measurement Data Using a Windows® PC	29
5	Collecting Measurement Data Using an Android™ Terminal	33

6 Maintenance and Service 37

6.1 Troubleshooting 37

6.2 Error Display 39

For customers who are using the LR8410 Wireless Logging Station

This instrument can be used on the LR8410 firmware version 1.30 or later.
The firmware version for the LR8410 is displayed on the system screen.

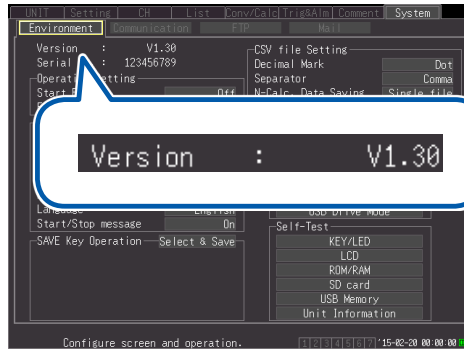

The latest version can be downloaded from our website.
For details on how to upgrade the software, see our website or check with your authorized Hioki distributor or reseller.

Instrument Version

The Wireless Logger Collector can be used on the instrument software **version 1.20** or later.

A version older than 1.20 needs to be updated. The software can be updated in Wireless Logger Collector (Windows® PC version).

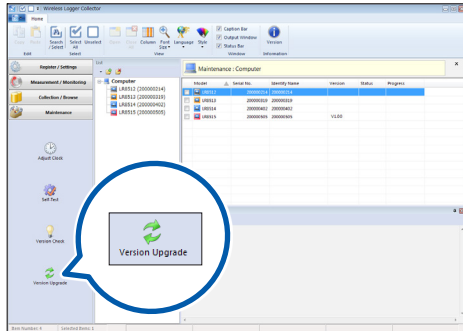

If the software version is older than 1.20, a communication error (protocol error) occurs in any communications attempted between the instrument and Wireless Logger Collector.

Introduction

Thank you for purchasing the HIOKI LR8512 Wireless Pulse Logger, LR8513 Wireless Clamp Logger, LR8514 Wireless Humidity Logger, or LR8515 Wireless Voltage/Temp Logger. To obtain maximum performance from the product, please read this manual first, and keep it handy for future reference.

In this manual, the name of each instrument is indicated as follows.

Product name	Name indicated in the manual
LR8512 Wireless Pulse Logger LR8513 Wireless Clamp Logger LR8514 Wireless Humidity Logger LR8515 Wireless Voltage/Temp Logger	Instrument

There are the following instruction manuals available for this instrument. Please refer to the appropriate manuals for the intended usage.

Model	Manual contents	Printed edition	DVD edition
Measurement Guide (this manual)	For customers who use this instrument for the first time, this manual describes the basic operation procedures.	✓	–
Instruction Manual	Describes details of the functions, operations, and specifications of this instrument.	–	✓
Precautions Concerning Use of Equipment That Emits Radio Waves	Precautions relating to use of equipment that emits radio waves, countries in which the instrument has been certified, etc.	✓	–
Logger Utility* User Manual	Describes how to operate the PC application software.	–	✓

*: To install the PC application software, Logger Utility, see “4.3 Installing the software” in the Instruction Manual. For information about its operating procedure, see the Logger Utility User Manual contained in the accompanying DVD.

Request for product user registration

Please register this product so that you can receive important information regarding the product.

<https://www.hioki.com/global/support/myhioki/registration/>



Trademark

- Excel and Windows are trademarks of the Microsoft group of companies.
- The Bluetooth® word mark and logos are registered trademarks owned by Bluetooth SIG, Inc. and any use of such marks by Hioki E.E. Corporation is under license. Other trademarks and trade names are those of their respective owners.
- Adobe and Adobe Reader are either trademarks or registered trademarks of Adobe Systems Incorporated in the United States and other countries.
- Android and Google Play are trademarks of Google, Inc.

Verifying Package Contents

When you receive the instrument, inspect it carefully to ensure that no damage occurred during shipping. In particular, check the accessories, panel keys, and connectors. If damage is evident, or if it fails to operate according to the specifications, contact your authorized Hioki distributor or reseller.

Check the package contents as follows.

Instrument

- LR8512 × 1

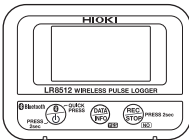

- LR8513 × 1

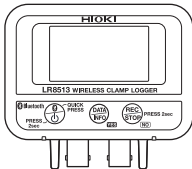

- LR8514 × 1



- LR8515 × 1

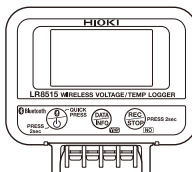

Common accessories

- Logger Application Disc (DVD)*



- Instruction Manual (PDF)
- Logger Utility
- Wireless Logger Collector
- Logger Utility Instruction Manual (PDF)

*: The latest version of the application software can be downloaded from our website.

- Measurement Guide



- Precautions Concerning Use of Equipment That Emits Radio Waves

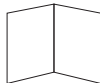

- LR6 Alkaline battery × 2



LR8512 Accessory

- L1010 Connection Cable (length approx. 1.5 m) × 2



Options

The following options are available for the LR8512, LR8513, LR8514, and LR8515. Contact your authorized Hioki distributor or reseller when ordering. Optional equipment is subject to change with no advance notice. Check Hioki's website for the latest information.

Common options

- Z2003 AC Adapter (power cord attached)

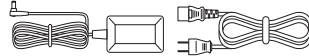

- Z5004 Magnetic Strap
- Z5020 Magnetic Strap



LR8512 Option

- L1010 Connection Cable (length approx. 1.5 m)

LR8513 Option

- 9669 Clamp On Sensor
- 9695-02 Clamp On Sensor
- CT6500 Clamp On Sensor
- 9657-10 Clamp On Leak Sensor
- 9675 Clamp On Leak Sensor
- CT9691-90 Clamp On AC/DC Sensor
- CT9692-90 Clamp On AC/DC Sensor
- CT9693-90 Clamp On AC/DC Sensor
- 9219 Connection Cable (for 9695-02 connection)
- CT7631 AC/DC Current Sensor
- CT7636 AC/DC Current Sensor
- CT7642 AC/DC Current Sensor
- CT7731 AC/DC Auto-Zero Current Sensor
- CT7736 AC/DC Auto-Zero Current Sensor
- CT7742 AC/DC Auto-Zero Current Sensor
- CT9667-01 AC Flexible Current Sensor
- CT9667-02 AC Flexible Current Sensor
- CT9667-03 AC Flexible Current Sensor
- CT7044 AC Flexible Current Sensor
- CT7045 AC Flexible Current Sensor
- CT7046 AC Flexible Current Sensor
- CM7290 Display Unit
 - For the CT7631,CT7636,CT7642,CT7731,CT7736,CT7742,CT7044,CT7045,CT7046
- CM7291 Display Unit
 - For the CT7631,CT7636,CT7642,CT7731,CT7736,CT7742,CT7044,CT7045,CT7046
- L9095 Output Cord (for CM7290/CM7291 connection)

LR8514 Option

- Z2010 Humidity Sensor (Length including the sensor: Approx. 50 mm)
- Z2011 Humidity Sensor (Cable length: Approx. 1.5 m)

Supported instrument

- LR8410 Wireless Logging Station
(Supported for software version 1.30 and later)

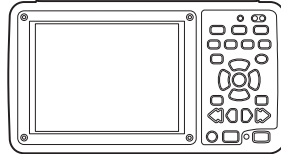

Safety Notes

This instrument is designed to conform to IEC 61010 Safety Standards, and has been thoroughly tested for safety prior to shipment. However, using the instrument in a way not described in this manual may negate the provided safety features. Before using the instrument, be certain to carefully read the following safety notes.

DANGER



Mishandling during use could result in injury or death, as well as damage to the instrument. Be certain that you understand the instructions and precautions in the manual before use.







WARNING





If you do not have knowledge or experience of electrical measurements, use this instrument under supervision of experienced personnel.

Notation



In this manual, the risk seriousness and the hazard levels are classified as follows.

 DANGER	Indicates an imminently hazardous situation that will result in death or serious injury to the operator.
 WARNING	Indicates a potentially hazardous situation that may result in death or serious injury to the operator.
 CAUTION	Indicates a potentially hazardous situation that may result in minor or moderate injury to the operator or damage to the instrument or malfunction.
IMPORTANT	Indicates information related to the operation of the instrument or maintenance tasks with which the operators must be fully familiar.
	Indicates a strong magnetic-field hazard. The effects of the magnetic force can cause abnormal operation of heart pacemakers and/or medical electronics.
	Indicates prohibited actions.
	Indicates an action that must be performed.
*	Additional information is presented below.
Windows	Windows 7, Windows 8, Windows 10, and Windows 11 are referred to as “Windows,” otherwise specified.
Dialog	Windows dialog boxes are referred to as dialogs.
[]	The names and keys on the screen including menus, commands, dialogs, dialog button names, etc. are enclosed in brackets [].

Symbols affixed to the instrument

	Indicates cautions and hazards. When the symbol is printed on the instrument, refer to a corresponding topic in the Instruction Manual.
	Indicates a grounding terminal.
	Indicates DC (Direct Current).

Symbols for various standards

	Indicates the Waste Electrical and Electronic Equipment Directive (WEEE Directive) in EU member states.
	Indicates that the instrument conforms to regulations set out by the EU Directive.
	Indicates that the product incorporates Bluetooth wireless technology.
FCC ID	Indicates the ID number of the wireless module certified by the U.S. Federal Communications Commission (FCC).
IC	Indicates the identification number of a wireless module approved by Industry Canada (IC).

Screen display

The instrument screen displays the alphanumeric characters as follows.

A	B	C	D	E	F	G	H	I	J	K	L	M	N	O	P	Q	R	S	T	U	V	W	X	Y	Z
A	b	c	d	E	F	G	H	I	J	K	L	M	N	O	P	Q	R	S	T	U	V	W	X	Y	Z

1	2	3	4	5	6	7	8	9	0
1	2	3	4	5	6	7	8	9	0

Accuracy

We define measurement tolerances in terms of rdg. (reading) and dgt. (digit) values, with the following meanings:

f.s.	(Maximum display value or scale length/range) The maximum displayable value or scale length. This is usually the name of the currently selected range.
rdg.	(Reading or displayed value) The value currently being measured and indicated on the measuring instrument.
dgt.	(Resolution) The smallest displayable unit on a digital measuring instrument, i.e., the input value that causes the digital display to show a "1" as the least-significant digit.

Measurement categories

To ensure safe operation of measuring instruments, IEC 61010 establishes safety standards for various electrical environments, categorized as CAT II to CAT IV, and called measurement categories.

⚠ DANGER



- **Using a measuring instrument in an environment designated with a higher-numbered category than that for which the instrument is rated could result in a severe accident, and must be carefully avoided.**
- **Using a measuring instrument without categories in an environment designated with the CAT II to CAT IV category could result in a severe accident, and must be carefully avoided.**

- CAT II: When directly measuring the electrical outlet receptacles of the primary electrical circuits in equipment connected to an AC electrical outlet by a power cord (portable tools, household appliances, etc.)
- CAT III: When measuring the primary electrical circuits of heavy equipment (fixed installations) connected directly to the distribution panel, and feeders from the distribution panel to outlets
- CAT IV: When measuring the circuit from the service drop to the service entrance, and to the power meter and primary overcurrent protection device (distribution panel)

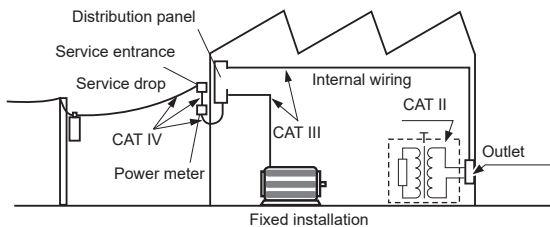

Usage Notes

Follow these precautions to ensure safe operation and to obtain the full benefits of the various functions.

Bluetooth®

This instrument and the LR8410 use radio waves of a band frequency of 2.4 GHz. No radio station license is required to use this product, however, be aware of the following.

WARNING



- **Do not use this instrument in a system that requires high safety and reliability.**
- **Do not use this instrument near any medical equipment, such as a pacemaker, etc.**
- **Do not modify, disassemble, or repair the instrument.**

CAUTION



- If this instrument is used near any equipment that uses the same frequency band, such as wireless LAN equipment, etc., communications may become unstable or other equipment may be affected.
- The line-of-sight distance between the instrument and the LR8410 is 30 m. If there is an obstacle (wall, metal screen, etc.), communications may become unstable or the communications distance may become shorter. In addition, even if multiple instruments are installed in the same environment, each instrument may show a different radio-field strength (antenna-like indication).
- Communications between the instrument and the LR8410 are encrypted by SSP, however, the confidentiality of any information is not guaranteed. We are not responsible for any leakage of measurement data by wireless communications.
- This instrument and the LR8410 generate electric waves. Usage of electric waves requires permission and authorization in each country. Using electric waves in any country or region other than the ones listed in the attached document “Precautions Concerning Use of Equipment That Emits Radio Waves” is against the law and may be subject to punishment.

- When the instrument is positioned on a stand instead of directly on the floor, communications can become more stable.
- The Wireless Logger Collector may not correctly work according to the mobile communication device.

Check before use

Verify that it operates normally to ensure that no damage occurred during storage or shipping. If you find any damage, contact your authorized Hioki distributor or reseller.

Installation

WARNING

Installing the instrument in inappropriate locations may cause a malfunction of the instrument or may give rise to an accident. Avoid the following locations.



- Exposed to direct sunlight or high temperature
- Exposed to corrosive or combustible gases
- Exposed to water, oil, chemicals, or solvents
- Exposed to high humidity or condensation
- Exposed to a strong electromagnetic field or electrostatic charge
- Exposed to high quantities of dust particles
- Near induction heating systems (such as high-frequency induction heating systems and IH cooking equipment)
- Susceptible to vibration

Operating temperature: -20°C to 60°C (-4°C to 140°C)

Humidity: 80% rh or less (non-condensing)

(When using batteries as a power source, refer to the battery's specifications.)

CAUTION



- This instrument is not drip-proof. Water that drips on the connector could cause a malfunction.
- Do not allow any condensation to form. Condensation can form particularly in an environment where the temperature changes drastically.



- Do not allow the instrument to become wet or take measurements with wet hands. Doing so may cause a malfunction.
- Do not position the instrument on an unstable table or inclined surface. When the instrument falls or tips, an injury or malfunction can occur.

Install the LR8515 Wireless Voltage/Temp Logger with attention to the following:

- Take appropriate measures to prevent the ambient temperature near the terminal block from changing. Install the instrument where it is not exposed to direct air from a ventilation fan, air conditioner, etc. A measurement error can occur during thermocouple input.
- When the instrument is moved to a location with a significant temperature change, wait for at least 60 minutes before starting measurement.

Handling of this instrument

CAUTION



Avoid any vibration or impact to prevent damage to the instrument during transportation and handling. Be especially careful regarding the impact by a fall.

This instrument may cause interference if used in residential areas. Such use must be avoided unless the user takes special measures to reduce electromagnetic emissions to prevent interference to the reception of radio and television broadcasts.

Handling of cords and cables

WARNING



Make sure to use the specified power cord when using the instrument. Otherwise, a fire may be caused.

CAUTION



- Avoid stepping on or pinching the cables to prevent damage to the cables. Do not bend or pull the cables.



- To prevent any wires from breaking, pull on the connector end, not the cable, to disconnect the output connector.
- To prevent any wires from breaking, pull on the connector end, not the cord, to disconnect the power cord from the outlet or the instrument.
- The cables become stiff below 0°C. If the cables are bent or pulled in this condition, the cable insulation may be damaged or the wires may be cut.

- When using the instrument, make sure to use the connection cable specified by our company. When any other cable is used, it may not be possible to perform accurate measurement due to a contact failure, etc.
- When a measurement cable that is longer than 3 m is connected, measurement may be affected by factors in the EMC environment, such as exogenous noise.
- Position the measurement cable away from the power line or ground cable.
- When the measurement cable is connected in parallel to other equipment, measurement values may vary. If the measurement cable is to be connected in parallel, make sure to check the operation before use.

Before turning on the power

CAUTION



- When operating the instrument using a UPS (uninterruptible power supply) or DC-AC inverter, do not use any square-wave and pseudo sine-wave UPS or DC-AC inverter. Doing so may damage the instrument.



- Make sure that the power voltage connection is correct. Connection errors could damage the internal circuit.

The instrument and measurement unit will not fail due to a momentary power failure under 40 ms. If the power failure is longer than 40 ms, the power may be shut off temporarily. Install the instrument in consideration of power conditions at the installation location.

Magnet of the optional strap

DANGER



Those with medical electronics such as pacemakers should not use the Z5004/Z5020 Magnetic Strap. Nor should such persons approach the Z5004 or Z5020. It is extremely dangerous. The electronics may not operate properly and the life of the operator may be put at great risk.

WARNING



Swallowing magnets could be life-threatening. Keep any magnets out of reach, especially of small children. If you accidentally swallow magnets, immediately seek medical attention.

CAUTION



- Do not use the Z5004 or Z5020 in locations where it may be exposed to rainwater, dust, or condensation. In those conditions, the magnet may be decomposed or deteriorated. The magnet adhesion may be diminished. In such case, the instrument may not be hung in place and may fall.
- Do not bring the Z5004 or Z5020 near magnetic media such as floppy disks, magnetic cards, pre-paid cards, or magnetized tickets. Doing so may corrupt and may render them unusable. Furthermore, if the Z5004 is brought near precision electronic equipment such as PCs, TV screens, or electronic wrist watches, they may fail.
- Keep magnets away from any impact by a fall. The magnets may chip or crack due to impact.

AC adapter

WARNING



- Make sure to use the optional Z2003 AC Adapter. The rated power voltage for the AC adapter is 100 V to 240 V AC and the rated power frequency is 50 Hz/60 Hz. Do not use the AC adapter at any voltage other than the above to avoid damage to the instrument and electrical accidents.
- Before turning on the power, make sure that the power voltage indicated on the AC adapter matches the power voltage to be used. Using the AC adapter outside the specified power voltage range could cause damage to the instrument or AC adapter or electrical accidents.

CAUTION



- Connect the output plug to the instrument and then connect the plug to an outlet. Connecting the energized output plug to the instrument may damage the instrument.
- When connecting an external power supply, connect the output plug to the instrument and then supply external power.

Handling of batteries

WARNING



- Do not short circuit, disassemble, or incinerate batteries. Do not charge alkaline batteries. Doing so may cause an explosion. Handle and dispose of batteries in accordance with local regulations.
- In order to prevent electric shocks, remove measurement cables and then replace the batteries.
- After battery replacement, reattach and screw down the battery cover before use.
- To prevent damage to the instrument or electric shocks, make sure to use the battery cover screw (screw with a spring) that is attached at the time of shipment. If you lose the screw or spring or find any damage, contact your authorized Hioki distributor or reseller.

CAUTION

Poor performance or damage from battery leakage could result. Observe the cautions listed below.



- Do not mix new and old batteries, or different types of batteries.
- Be careful to observe the battery polarity during installation. Poor performance or damage from battery leakage could result.
- Do not use batteries after their recommended expiry date.
- Do not allow used batteries to remain in the instrument.



- To avoid corrosion from battery leakage and/or damage to the instrument, remove the batteries from the instrument if it is to be kept in storage for an extended period.

IMPORTANT

The displayed remaining battery level may be different from the actual remaining battery level due to the battery characteristics, settings during use, temperature or consumption level. When a battery is used in a low temperature environment or a weak and deteriorated battery is used, the power may shut off regardless of the battery indicator display.

Batteries

The battery indicator display and battery life are based on the use of a new alkaline battery.

Use of nickel-metal hydride batteries

When nickel-metal hydride batteries are used, the battery indicator display does not operate correctly.

The battery life varies depending on the capacity, charging condition, deterioration due to repeated use, etc. Use batteries in consideration of the factors above.

Use of manganese dioxide batteries

Do not use manganese dioxide batteries as the instrument may not be able to measure or communicate.

Wire connection

DANGER



Do not permanently connect the instrument in an environment where there is a possibility of surges exceeding the dielectric withstand voltage. Doing so may damage the instrument and result in personal injury.

WARNING



- Do not allow input that exceeds the maximum rating. Doing so may cause heat to generate, which can cause damage to the instrument, short circuits or electric shocks.
- Do not connect any equipment other than the specified clamp sensor to the LR8513 Wireless Clamp Logger. Doing so may cause electric shocks or damage to the instrument.
- Do not connect any equipment other than the specified temperature and humidity sensor to the LR8514 Wireless Humidity Logger. Doing so may cause electric shocks or damage to the instrument.
- A semiconductor relay is used to isolate between the input terminals and channel of the LR8515 Wireless Voltage/Temp Logger. When any voltage that exceeds the specified rating is applied, the semiconductor relay can fail with a short-circuit. Never input any voltage that exceeds the specified rating. Especially be aware of lightning surges. If there is an error in measurement values, send the instrument for repair.
- Do not connect the measurement cable to the instrument while it is connected to the object to be measured. Doing so may cause electric shocks.
- The analog input terminal maximum input voltage, maximum rated voltage to earth, and maximum rated voltage between the input terminals and channel of each logger is shown in the following table. To avoid electric shocks and damage to the instrument, do not input any voltage over the voltages shown below.

Model	Maximum input voltage	Maximum rated voltage to earth	Maximum rated voltage between input terminals and channel
LR8512	0 to 50 V DC	30 V AC rms or 60 V DC (between each analog input channel and chassis)	Non-isolated (GND common)
LR8515	±50 V DC	30 V AC rms or 60 V DC (between each analog input channel and chassis)	60 V DC

WARNING



- The power supply ground and input terminals (-) are common and not isolated. When using an external power supply, use an isolated external power supply or connect the wires so that there is no potential difference between the ground of the external power supply and the object to be measured to prevent damage to the instrument or electric shocks. In addition, when the instrument measures the external power that drives it, displayed readings may be inaccurate.
- The channels of the LR8515 Wireless Voltage/Temperature Logger are isolated from each other using semiconductor relays. If a voltage exceeding the specifications is applied between channels, the semiconductor relay may fail due to a short circuit. Never apply a voltage exceeding the specifications, and be especially cautious of surges like lightning. If you notice any abnormality in the measured values, please send the instrument for inspection.

Handling of DVD

- Do not allow any dirt or scratches on the disk recording surface. When writing on the label face, use a pen with a soft tip.
- Store the disk in a protective case and do not expose the disk to direct sunlight or high temperatures and humidity.
- We are not responsible for any trouble in the Windows® computer system when this disk is used.

Handling of clamp sensor

CAUTION



- To prevent damage to the BNC connector, make sure to release the lock and then pull on the connector end of the BNC connector.

Precautions during shipment

CAUTION



- To avoid damaging the instrument, remove accessories and options from the instrument.
- Avoid any vibration or impact to prevent damage to the instrument, humidity sensor, and clamp sensor during transportation and handling. Be careful especially with impact by a fall.

Handling of temperature and humidity sensor

CAUTION



- The temperature and humidity sensor is not dustproof or waterproof. Do not use the sensor in locations where it may be exposed to dust or water. It may cause a malfunction of the instrument.
- The temperature and humidity sensor is not drip-proof. Water that drips onto the connector could cause a malfunction.

- Sensor sensitivity and precision will degrade over time, even under normal operating conditions. To maintain the instrument's ability to make measurements that conform to the accuracy specifications, it is recommended to replace the temperature and humidity sensor with a new unit once it has been used for one year after being opened.
- When the sensor is used outside the specified operating (storage) environment, the sensor accuracy may deteriorate even within the 1 year accuracy warranty period and accurate measurement cannot be performed.
- In principle, the surface of the instrument's temperature and humidity sensor may become contaminated if exposed to an environment containing organic gases (ketone, acetone, ethanol, toluene, etc.), increasing the error component of humidity measurement.
- Do not expose the temperature and humidity sensor to any concentrated chemical solvent for an extended period of time while it is used or stored.
- The sensor may become contaminated by organic gases released from some types of vinyl chloride and packaging material.
- When the temperature and humidity sensor is not used, place it with a drying agent in a plastic bag, seal the bag completely, and store it in a cool, dark place.
- Do not allow any condensation to form. Condensation can form particularly in any environment where the temperature changes drastically.
- This instrument does not come with a guarantee against any problem when the sensor is used outside the specified operating (storage) environment.
- Due to a humidity change (from low to high humidity or high to low humidity), up to $\pm 1\%$ RH of change (hysteresis) occurs in the measured humidity value.
- If left in a high humidity environment (80% RH or higher) for an extended period of time, the temperature and humidity sensor may output humidity values higher than the actual. It may take some time for the sensor to return to outputting normal values; however, it will recover quickly if left in a low humidity environment (30% RH or lower) for several days.

1

Overview

1.1 Overview and Features

This is a compact wireless logger that is capable of measurement, display, and recording.

Model	Description
LR8512 Wireless Pulse Logger	<ul style="list-style-type: none">Counts pulses and records an integrated value.Measures the revolution and logic ON/OFF signal.
LR8513 Wireless Clamp Logger	<ul style="list-style-type: none">Measures AC/DC current with the optional (sold separately) clamp sensors installed.Sets the voltage and power factor and measures the power easily.^{*1}
LR8514 Wireless Humidity Logger	<ul style="list-style-type: none">Measures temperature and humidity precisely.
LR8515 Wireless Voltage/Temp Logger	<ul style="list-style-type: none">Measures the voltage of ± 50 mV to ± 50 V and temperature (thermocouple K, T).

Real-time measurement and manual data collection functions

Real-time measurement (used as a unit)

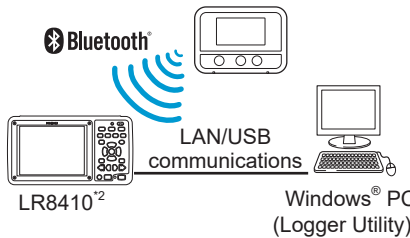

Manual data collection (used as stand-alone)

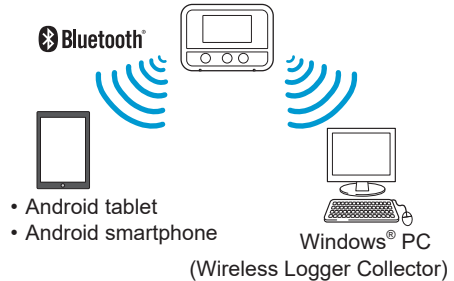

0.1 sec. high-speed sampling

The data update of the LR8513 and LR8514 is every 0.5 sec.

The memory capacity for each channel is 500,000 data

3-way power supply

You can choose a power supply from LR6 alkaline batteries, AC adapter, and external power supply (5 V to 13.5 V).

Average/Maximum recording mode installed

An average/maximum recording mode is installed on the LR8513 Wireless Clamp Logger. An average/maximum of the effective values measured at intervals of 0.5 seconds is recorded for each recording interval.

*1 For a single-phase/2-wire, the power value can be directly read on the instrument using the scaling setting.
For a single-phase/3-wire and three-phase/3-wire, a value can be displayed on the LR8410 with the waveform calculations function of the LR8410.

*2 For the procedure for connecting to the LR8410, refer to the LR8410 instruction manual.

1.2 Parts Names and Functions

Front

Rear

(Common areas of each model are described.)

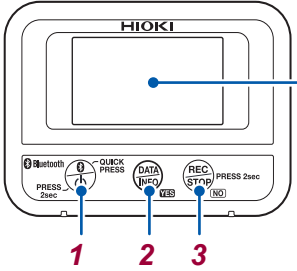

Display

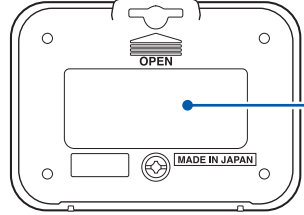

Battery cover

! (p.23)

Operation keys		Press briefly	Hold down (for at least 2 seconds)
1 Power		Bluetooth ON/OFF	Power ON/OFF
2 Display		Display change YES (During operation verification)	—
3 Measurement		NO (During operation verification)	Measurement start/stop

Left side

(Common to all models)

Bottom side

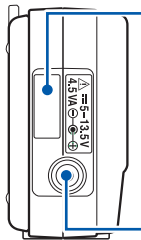

Serial number label

The serial number consists of 9 digits. The first two (from the left) indicate the year of manufacture, and the next two indicate the month of manufacture. It is necessary for production control requirements such as the product warranty. Do not peel off the label.

AC adapter connection terminal

! (p.23)

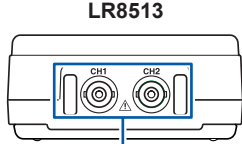

LR8513

Connection terminal

Connect the clamp sensor.

! (p.23)

Right side

LR8512, LR8514

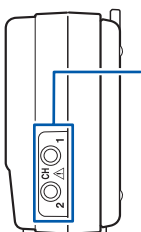

Connection terminal

For LR8512, connect the L1010 Connection Cable.
For LR8514, connect the temperature and humidity sensor.

! (p.23)

Bottom side

LR8515

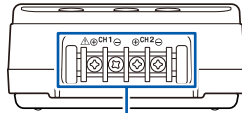

Connection terminal

Connect the input cable or thermocouple.

! (p.23)

2

Preparation for Measurements

1 Choose a power supply (AC adapter or battery).

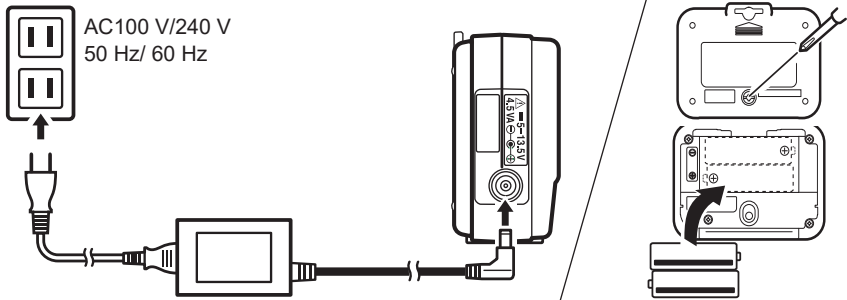

The instrument is automatically powered on.

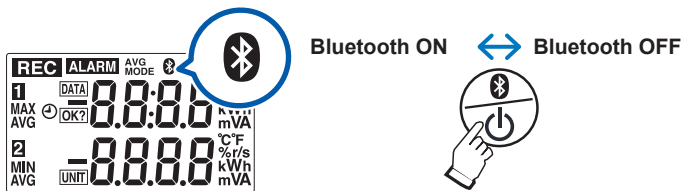

2 Connect measurement cables to the instrument.

LR8512

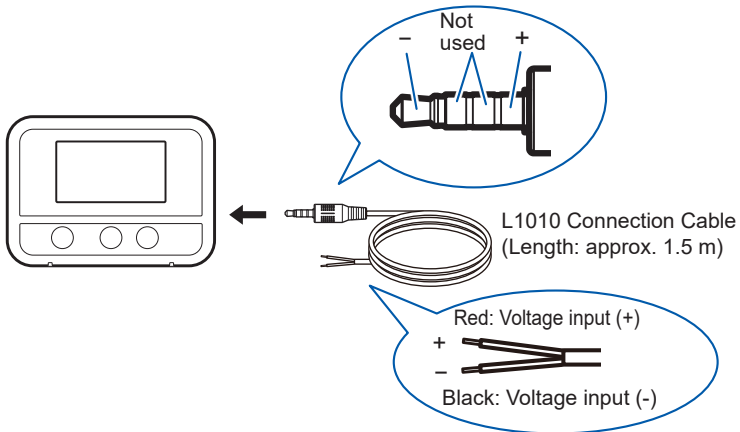

LR8513

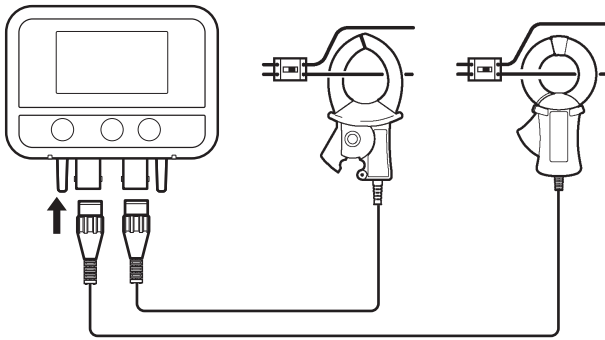

Prepare the combination of Display Unit CM7290 and Output Cord L9095 or that of Display Unit CM7291 and Output Cord L9095 when you use one of the following clamp sensors: Models CT7631, CT7636, CT7642, CT7731, CT7736, CT7742, CT7044, CT7045, and CT7046.

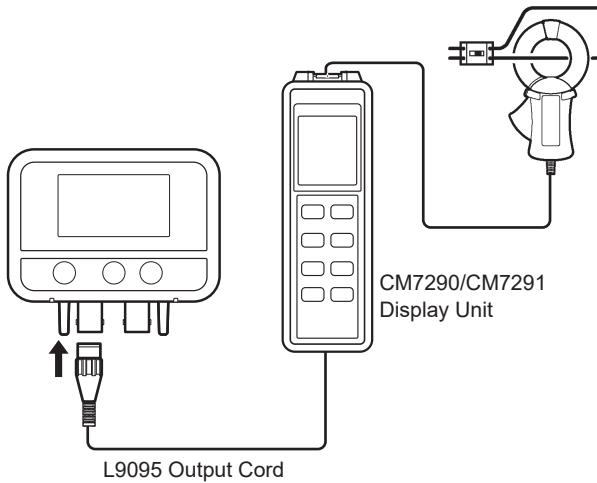

Supported clamp sensor

Model	LR8513 Range	Clamp Sensor Max. input current	Clamp Sensor Max. input voltage
9669	1000 A	1000 A	CAT III AC600 V
9695-02*1	50 A	60 A	CAT III AC300 V
CT6500	500 A	600 A	CAT III AC600 V
9657-10	5 A	30 A*4	CAT III AC300 V
9675	5 A	10 A*4	
CT9691-90	100 A	100 A	CAT III AC/DC 600 V
CT9692-90	200 A	200 A	
CT9693-90	2000 A	2000 A	
CT7631*2	100 A	100 A	CAT IV AC/DC 600 V
CT7636*2	200 A	600 A*4	CAT IV AC/DC 600 V
CT7642*2	2000 A	2000 A	CAT III AC/DC 1000 V
CT7731*2	100 A	100 A	CAT IV AC/DC 600 V
CT7736*2	200 A	600 A*4	CAT IV AC/DC 600 V
CT7742*2	2000 A	2000 A	CAT III AC/DC 1000 V
CT9667-01	5000 A	10000 A*4	CAT IV AC 600 V CAT III AC 1000 V
CT9667-02	5000 A	10000 A*4	
CT9667-03	5000 A	10000 A*4	
CT7044*2	5000 A	1000 A (600 A range) 10000 A (6000 A range)*3*4	
CT7045*2	5000 A	1000 A (600 A range) 10000 A (6000 A range)*3*4	
CT7046*2	5000 A	1000 A (600 A range) 10000 A (6000 A range)*3*4	

*1: The 9219 Connection Cord is required in order to connect a compatible clamp sensor.

*2: The CM7290 or CM7291 Display Unit and L9095 Output Cord are required in order to connect a compatible clamp sensor.

*3: Range changes are controlled from the CM7290/CM7291.

For details, refer to the instruction manual attached to each clamp sensor.

*4: When Model LR8513 is used in combination with these sensors, the instrument cannot measure the maximum values of currents listed above. A maximum measurable current with each of such sensors used is limited to the upper limit of the measurement range you specified with Model LR8513.

LR8514

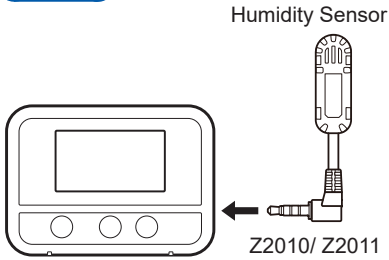

LR8515

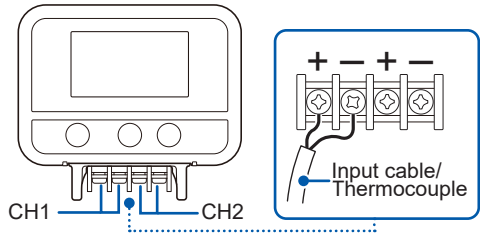

- 3 Set the measurement condition**
Measurement settings can be changed from supported instrument or Windows® PC/Android application.
The settings can't be changed only by this instrument.

3 Using the LR8410 as a Unit

3.1 Real-time Measurement Using the LR8410



- 1 Turn ON the power of the instrument and the LR8410.
- 2 Register the instrument as a unit using the LR8410 Quick Set function (Unit Guide).



- 3 Set the measurement conditions using the Quick Set function (Config Guide) and send the conditions to the instrument.
- 4 Start measurement.
For details, refer to the LR8410 measurement guide.

3.2 Performing Real-time Measurement Using a Windows® PC

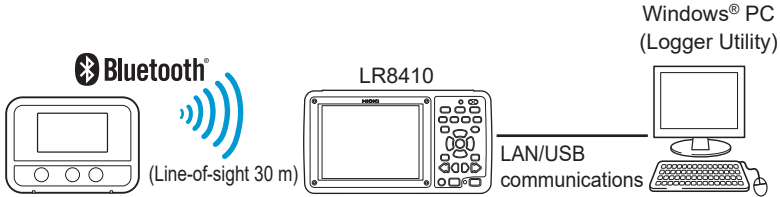

- 1 Register the instrument as a unit in the LR8410. (p.27)
- 2 Install Logger Utility on the Windows® PC.

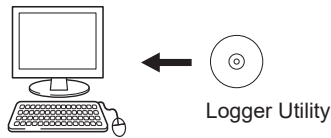

- 3 Start up Logger Utility.
The main screen is displayed when Logger Utility starts up.
The main screen is the basic screen for Logger Utility.

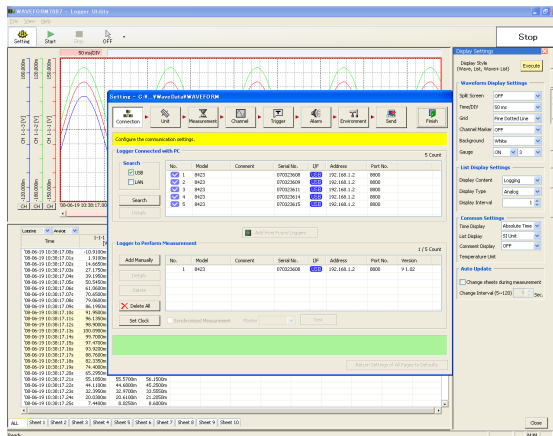

- 4 Set the measurement conditions for the instrument.
- 5 Send the measurement conditions to the instrument.
- 6 Start or stop measurement.

For details, refer to the Logger Utility instruction manual on the provided DVD.

4

Collecting Measurement Data Using a Windows® PC

- 1 Install the instrument referring to “Preparation for Measurements” (p.23).
- 2 Install the software on the Windows® PC.



- 3 Register the instrument in Wireless Logger Collector (up to 100 units).

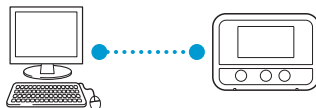
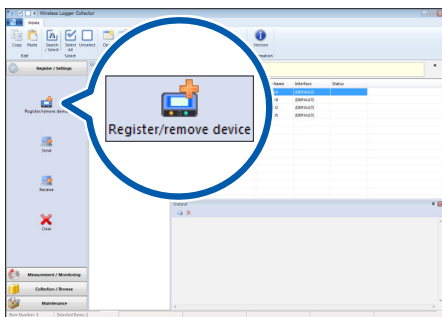

When no wireless logger is found

- When the symbol in the screen is off, press the power key to turn ON the Bluetooth function.
- When the symbol in the screen is off, a wireless connection is not established. Place the instrument closer to the PC or remove any obstacle and then search for the logger again.

- 4 Set the measurement conditions in Wireless Logger Collector.

(4)

5 Send the measurement conditions to the instrument.

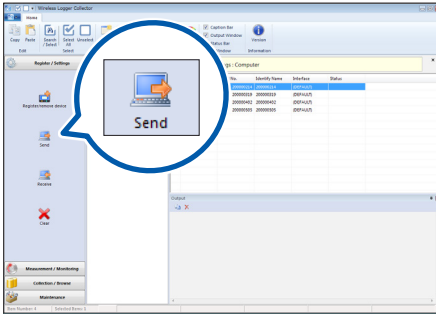

6 Start measurement.

Please be advised that if you start recording, the previously acquired data retained in the internal memory will be deleted.



You can also start measurement by holding down this button.

7 Collect measurement data using Wireless Logger Collector.

Measurement data can be collected during measurement and after measurement stop.

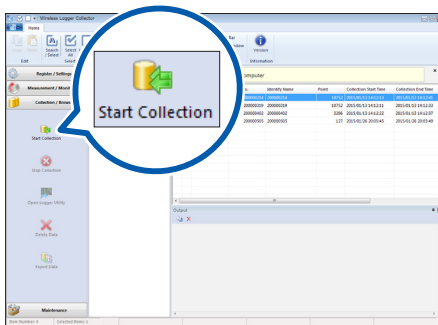

8 Analyze the data on the Windows® PC.

- 1. Display measurement data in the Logger Utility:** The data is displayed in a graph and analyzed.
- 2. Output the collected data in the CSV file format:** The data is displayed in a graph using a spreadsheet program, such as Microsoft® Excel®.

See “Exporting measurement data” in the Instruction Manual.

5

Collecting Measurement Data Using an Android™ Terminal

- 1 Install the instrument referring to “Preparation for Measurements” (p.23).
- 2 Install Wireless Logger Collector on the Android terminal.

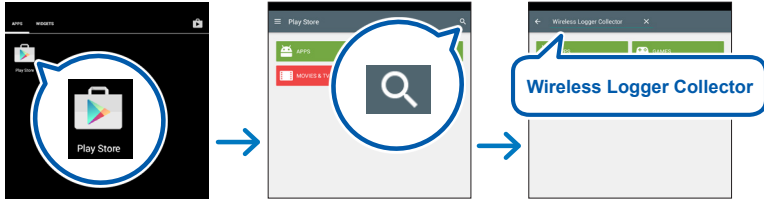

- 3 Register the instrument in Wireless Logger Collector (up to 100 units).

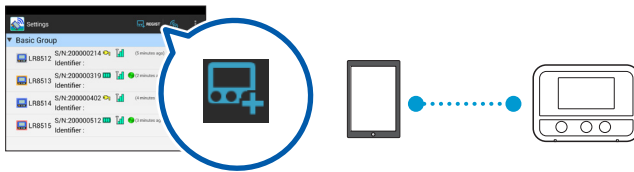

- 4 Set the measurement conditions in Wireless Logger Collector and send the conditions to the instrument.

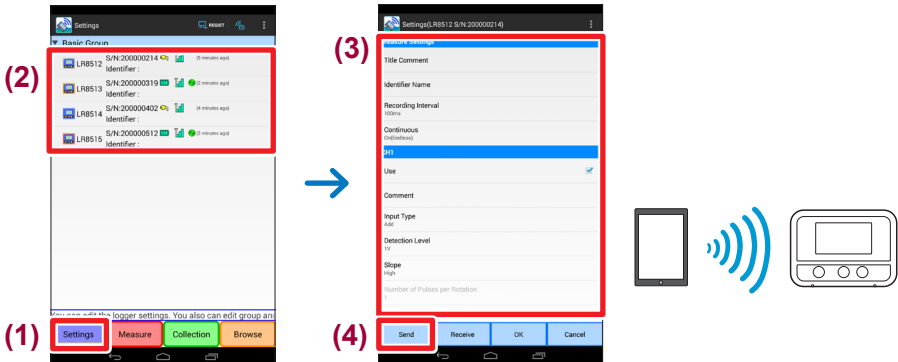

5 Start measurement.

(2)

(1)

(3)

REC STOP

You can also start measurement by holding down this button.

6 Collect measurement data using Wireless Logger Collector.

(2)

(1)

(3)

7 Export the measurement data to a file.

(2)

(3)

(1)

(4)

(5)

Title Comment	Start Time	Measured Data	Update Time
Lab	2015/02/19 05:44:39	1152	2015/02/19 09:54:54
Lab	2015/02/19 05:46:47	452	2015/02/19 09:55:58
Lab	2015/02/19 05:47:44	864	2015/02/19 09:57:30

Select the target for the exported data

Storage1 (/storage/emulated/0/HIOKI/WLC/LR8515_200000512)

Data Management

File Name : 201502190547
Title Comment :
Start Time : 2015/02/19
Measured Data : 864

Delete Data Export Data Show Graph

8 Copy the exported file onto the Windows® PC.

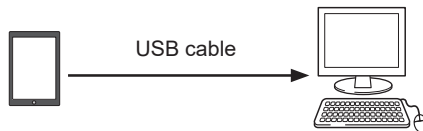

9 Analyze the data on the Windows® PC.

6 Maintenance and Service

6.1 Troubleshooting

When a malfunction of the instrument is suspected, check the battery level and connection cable conditions and then, if necessary, contact your authorized Hioki distributor or reseller.

Before sending the instrument for repair

When the instrument operation does not seem normal, check the following items.

Symptom	Possible cause	Solution and reference
Nothing appears in the display.	<ul style="list-style-type: none"> The power is OFF. The AC adapter is improperly attached. The AC adapter is incorrectly connected. The batteries are exhausted. 	<ul style="list-style-type: none"> Hold down the power key to turn the power ON. Check that the AC adapter is connected correctly. Check to see that the batteries are properly installed. Use new LR6 alkaline batteries. <p>If the problem persists, the instrument needs to be repaired or inspected. Contact your authorized Hioki distributor or reseller.</p>
When the power is turned ON, the date and time are significantly deviated from the correct values.	The backup lithium battery life has expired.	The replacement cycle for the backup lithium battery is 5 years. Contact your authorized Hioki distributor or reseller.
Measured data cannot be found.	Recording has restarted since measurement stop.	Be aware that data is deleted if recording is started accidentally after measurement stops.
<ul style="list-style-type: none"> The wireless logger cannot be found. A connection to the wireless logger cannot be established. 	Are you using the LR8410 to perform real-time measurement?	Data cannot be collected with Wireless Logger Collector during real-time measurement by the LR8410.
	The Bluetooth module power is OFF (⊗ is off or blinking).	Press the power key of the instrument and turn ON the Bluetooth module power.
	The wireless logger cannot be searched for or connected if another terminal (LR8410, PC, or Android terminal) is connected (▬ is lit).	Cut off the communications of the connected terminal and then search for or connect the wireless logger again.
	Communication with all Bluetooth compatible instruments is not guaranteed.	Try other terminals.

Symptom	Possible cause	Solution and reference
<p>Communications with the wireless logger cannot be established. An error occurs.</p>	<p>The settings cannot be sent or received or maintenance cannot be performed while the wireless logger is busy (during measurement or monitoring).</p>	<p>Stop measurement or monitoring and then try again.</p>
	<p>As the security settings are enabled, an authentication error occurs.</p>	<p>Enter the correct password.</p>

6.2 Error Display

When there is an error in the instrument, the error is displayed as follows.

Instrument error display

Error display	Meaning	Solution and reference
Err.1	Adjustment data error An error has occurred in the internal adjustment data.	Repair or inspection is required. Contact your authorized Hioki distributor or reseller.
Err.2	Serial number error An error has occurred in the internal memory.	
Err.3	Microcomputer operation error An error has occurred in the program ROM.	
Err.4	Bluetooth module error An error has occurred in the Bluetooth module.	<ul style="list-style-type: none"> • Disconnect the Z2003 adapter and connect it again. • Remove the batteries and place new LR6 alkaline batteries. • If the problem persists, the instrument needs to be repaired or inspected. Contact your authorized Hioki distributor or reseller.
Err.5	Hardware error An error has occurred in the hardware.	
Err.140	Backup battery error An error has occurred during clock backup.	
O.F. U.F.	The measurement value is outside of the measurement range or display range.	The measurement value cannot be displayed as it is outside of the measurement range or display range. Check the input signal.
BURN	Disconnection detection A thermocouple disconnection or temperature and humidity sensor error has been detected.	<ul style="list-style-type: none"> • Check the thermocouple connection. Check to see that the thermocouple is not disconnected. • Completely insert the temperature and humidity sensor.
BATT LO	Power supply error The power voltage drops to the point where the instrument cannot operate properly.	<ul style="list-style-type: none"> • Remove the Z2003 AC adapter and connect the AC Adapter. • Remove the batteries and place new LR6 alkaline batteries.
----	Not measured A measurement value cannot be displayed as measurement has not been performed.	Start measurement.

Warranty Certificate

HIOKI

Model	Serial number	Warranty period Three (3) years from date of purchase (___ / ___)
-------	---------------	------------------------------------------------------------------------

Customer name: _____

Customer address: _____

Important

- Please retain this warranty certificate. Duplicates cannot be reissued.
- Complete the certificate with the model number, serial number, and date of purchase, along with your name and address. The personal information you provide on this form will only be used to provide repair service and information about Hioki products and services.

This document certifies that the product has been inspected and verified to conform to Hioki's standards.

Please contact the place of purchase in the event of a malfunction and provide this document, in which case Hioki will repair or replace the product subject to the warranty terms described below.

Warranty terms

1. The product is guaranteed to operate properly during the warranty period (three [3] years from the date of purchase).
If the date of purchase is unknown, the warranty period is defined as three (3) years from the date (month and year) of manufacture (as indicated by the first four digits of the serial number in YYYY format).
2. If the product came with an AC adapter, the adapter is warranted for one (1) year from the date of purchase.
3. The accuracy of measured values and other data generated by the product is guaranteed as described in the product specifications.
4. In the event that the product or AC adapter malfunctions during its respective warranty period due to a defect of workmanship or materials, Hioki will repair or replace the product or AC adapter free of charge.
5. The following malfunctions and issues are not covered by the warranty and as such are not subject to free repair or replacement:
 - 1. Malfunctions or damage of consumables, parts with a defined service life, etc.
 - 2. Malfunctions or damage of connectors, cables, etc.
 - 3. Malfunctions or damage caused by shipment, dropping, relocation, etc., after purchase of the product
 - 4. Malfunctions or damage caused by inappropriate handling that violates information found in the instruction manual or on precautionary labeling on the product itself
 - 5. Malfunctions or damage caused by a failure to perform maintenance or inspections as required by law or recommended in the instruction manual
 - 6. Malfunctions or damage caused by fire, storms or flooding, earthquakes, lightning, power anomalies (involving voltage, frequency, etc.), war or unrest, contamination with radiation, or other acts of God
 - 7. Damage that is limited to the product's appearance (cosmetic blemishes, deformation of enclosure shape, fading of color, etc.)
 - 8. Other malfunctions or damage for which Hioki is not responsible
6. The warranty will be considered invalidated in the following circumstances, in which case Hioki will be unable to perform service such as repair or calibration:
 - 1. If the product has been repaired or modified by a company, entity, or individual other than Hioki
 - 2. If the product has been embedded in another piece of equipment for use in a special application (aerospace, nuclear power, medical use, vehicle control, etc.) without Hioki's having received prior notice
7. If you experience a loss caused by use of the product and Hioki determines that it is responsible for the underlying issue, Hioki will provide compensation in an amount not to exceed the purchase price, with the following exceptions:
 - 1. Secondary damage arising from damage to a measured device or component that was caused by use of the product
 - 2. Damage arising from measurement results provided by the product
 - 3. Damage to a device other than the product that was sustained when connecting the device to the product (including via network connections)
8. Hioki reserves the right to decline to perform repair, calibration, or other service for products for which a certain amount of time has passed since their manufacture, products whose parts have been discontinued, and products that cannot be repaired due to unforeseen circumstances.

HIOKI E.E. CORPORATION

<http://www.hioki.com>

18-07 EN-3

HIOKI

www.hioki.com/



**All regional
contact
information**

HIOKI E.E. CORPORATION

81 Koizumi, Ueda, Nagano 386-1192 Japan

2402 EN

Edited and published by HIOKI E.E. CORPORATION

Printed in Japan

- Contents subject to change without notice.
- This document contains copyrighted content.
- It is prohibited to copy, reproduce, or modify the content of this document without permission.
- Company names, product names, etc. mentioned in this document are trademarks or registered trademarks of their respective companies.

Europe only

- EU declaration of conformity can be downloaded from our website.

• Contact in Europe: HIOKI EUROPE GmbH

Helfmann-Park 2, 65760 Eschborn, Germany

hioki@hioki.eu