

HIOKI CT6865, CT6865-05

AC/DC CURRENT SENSOR

Instruction Manual

EN

Sept. 2018 Revised edition 5
Printed in Japan
CT6865A981-05 18-09H



HIOKI
<http://www.hioki.com>



Our regional
contact
information

HEADQUARTERS
81 Koizumi
Ueda, Nagano 386-1192 Japan

HIOKI EUROPE GmbH
Rudolf-Diesel-Strasse 5
65760 Eschborn, Germany
hioki@hioki.eu

Edited and published by HIOKI E.E. CORPORATION Printed in Japan

- CE declarations of conformity can be downloaded from our website.
- Contents subject to change without notice.
- This document contains copyrighted content.
- It is prohibited to copy, reproduce, or modify the content of this document without permission.
- Company names, product names, etc. mentioned in this document are trademarks or registered trademarks of their respective companies.

Warranty

Warranty malfunctions occurring under conditions of normal use in conformity with the Instruction Manual and Product Precautionary Markings will be repaired free of charge. This warranty is valid for a period of three (3) years from the date of purchase. Please contact the distributor from which you purchased the product for further information on warranty provisions.

Introduction

Thank you for purchasing the HIOKI Model CT6865, CT6865-05 AC/DC Current Sensor. To obtain maximum performance from the device, please read this manual first, and keep it handy for future reference.

Usage with Other Hioki Products

The CT6865 is used in connection with a dedicated instrument (Hioki). See "Specifications" for details.

Inspection

When you receive the device, inspect it carefully to ensure that no damage occurred during shipping. In particular, check the accessories and cables. If damage is evident, or if it fails to operate according to the specifications, contact your dealer or Hioki representative.

Overview

The CT6865/CT6865-05 is a feed-through current sensor designed to measure AC/DC currents up to 1000 A with high precision. Featuring good frequency characteristics (amplitude & phase) and good temperature characteristics (sensitivity & offset), the sensor is also suitable for high-precision power measurements.

Safety Information

This manual contains information and warnings essential for safe operation of the device and for maintaining it in safe operating condition. Before using it, be sure to carefully read the following safety precautions.

⚠ DANGER

This device is designed to comply with IEC 61010 Safety Standards, and has been thoroughly tested for safety prior to shipment. However, mishandling during use could result in injury or death, as well as damage to the device. Using the device in a way not described in this manual may negate the provided safety features. Be certain that you understand the instructions and precautions in the manual before use. We disclaim any responsibility for accidents or injuries not resulting directly from device defects.

Safety Symbols

	In the manual, the symbol indicates particularly important information that the user should read before using the device. The symbol printed on the device indicates that the user should refer to a corresponding topic in the manual (marked with the symbol) before using the relevant function.
	Indicates a double-insulated device.

The following symbols in this manual indicate the relative importance of cautions and warnings.

	Indicates that incorrect operation presents an extreme hazard that could result in serious injury or death to the user.
	Indicates that incorrect operation presents a significant hazard that could result in serious injury or death to the user.
	Indicates that incorrect operation presents a possibility of injury to the user or damage to the device.
	Indicates advisory items related to performance or correct operation of the device.

Symbols for Various Standards

	Indicates the Waste Electrical and Electronic Equipment Directive (WEEE Directive) in EU member states.
	This symbol indicates that the product conforms to regulations set out by the EC Directive.

Other Symbol

	Indicates a prohibited action.
--	--------------------------------

Measurement categories

This device complies with CAT III safety requirements. To ensure safe operation of measurement devices, IEC 61010 establishes safety standards for various electrical environments, categorized as CAT II to CAT IV, and called measurement categories.

CAT II: Primary electrical circuits in equipment connected to an AC electrical outlet by a power cord (portable tools, household appliances, etc.)
CAT II covers directly measuring electrical outlet receptacles.

CAT III: Primary electrical circuits of heavy equipment (fixed installations) connected directly to the distribution panel, and feeders from the distribution panel to outlets.

CAT IV: The circuit from the service drop to the service entrance, and to the power meter and primary overcurrent protection device (distribution panel).

Using a measurement device in an environment designated with a higher-numbered category than that for which the device is rated could result in a severe accident, and must be carefully avoided. Use of a measurement instrument that is not CAT-rated in CAT II to CAT IV measurement applications could result in a severe accident, and must be carefully avoided.

Instrument Installation

Operating temperature and humidity: -35 to 85° C, 80%RH or less (non-condensation)

Avoid the following locations that could cause an accident or damage to the instrument.	
Exposed to direct sunlight Exposed to high temperature	In the presence of corrosive or explosive gases
Exposed to water, oil, other chemicals, or solvents Exposed to high humidity or condensation	Exposed to strong electromagnetic fields Near electromagnetic radiators
Exposed to high levels of particulate dust	Near induction heating systems (e.g., high-frequency induction heating systems and IH cooking utensils)
Subject to vibration	

Names of Parts

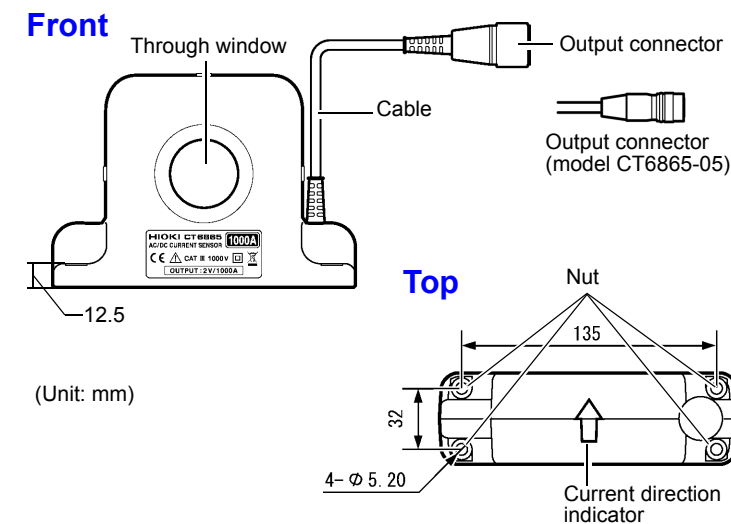

Operating Precautions

Follow these precautions to ensure safe operation and to obtain the full benefits of the various functions.

Preliminary Checks

Before using the device for the first time, verify that it operates normally to ensure that no damage occurred during storage or shipping. If you find any damage, contact your dealer or Hioki representative.

⚠ DANGER

- This device should only be connected to the secondary side of a breaker, so the breaker can prevent an accident if a short circuit occurs. Connections should never be made to the primary side of a breaker, because unrestricted current flow could cause a serious accident if a short circuit occurs.
- The maximum rated voltage between input terminals and ground is 1000 V DC/AC. Attempting to measure voltages exceeding 1000 V with respect to ground could damage the device and result in personal injury.

⚠ WARNING

- Before using the device, make sure that the insulation on the cable is undamaged and that no bare conductors are improperly exposed. Using the device in such conditions could cause an electric shock, so contact your dealer or Hioki representative for repair.
- In order to prevent electric shock and short-circuit accidents, shut off the power to the line to be measured before connecting this device.
- Ensure that the input does not exceed the maximum input voltage or current to avoid device damage, short-circuiting and electric shock resulting from heat building.
- Avoid contact between the cable and the measured line in order to protect the cable from damage. Any contact can cause the device to malfunction and lead to short-circuits or electric shock.
- Do not use the device where it may be exposed to oil, chemicals, or solvents. Contact with these substances may cause cracking in the device, resulting in damage or electric shock.

⚠ CAUTION

- This device is not drip-proof. Water droplets on the connector may result in malfunctions.
- Do not slant the device or place it on top of an uneven surface. Dropping or knocking down the device can cause injury or damage to the device.
- Avoid stepping on or pinching cables, which could damage the cable insulation.
- The cable is hardened under the 0 degree or colder environment. Do not bend or pull it to avoid tearing its shield or cutting cable.
- Keep the cables well away from heat sources, as bare conductors could be exposed if the insulation melts.
- To avoid damage to the device, protect it from physical shock when transporting and handling. Be especially careful to avoid physical shock from dropping.
- When the power to lines to be measured is turned on or off, a current flowing through the lines can exceed considerably the maximum allowable current of the device. This could result in damage to the device. Make sure that there is not any over-current.
- Do not apply any current through the lines to be measured with the device turned off. This could result in damage to the device.

Specifications

Accuracy

f.s.: maximum display value or scale length (Rated current)
 rdg.: reading value (The value currently being measured and indicated on the measuring instrument)

The specs of the CT6865-05 are the same as those of the CT6865 except the output connector and options.

Operating Environment	Indoors, Pollution degree 2, up to 2000 m (6562-ft.) ASL
Operating temperature and humidity	-30°C to 85°C (-22°F to 185°F), 80%RH or less (non-condensation)
Storage temperature and humidity	-30°C to 85°C (-22°F to 185°F), 80%RH or less (non-condensation)
Maximum rated voltage to earth	1000 V AC/ DC (50 Hz/60 Hz), Measurement category III, anticipated transient overvoltage 8000 V
Applicable standards	Safety : EN61010 EMC : EN61326
Product warranty period	3 year
Rated current	1000 A AC/DC
Output voltage	2 V/1000 A
Maximum input current	1200 A AC/DC (1800 A peak continuous, 100 Hz or less, 40°C or less, otherwise within derating range)
Output resistance	50 Ω (±5%)
Temperature and humidity range of guaranteed accuracy	0°C to 40°C (32 to 104°F), 80%RH or less
Guaranteed accuracy period	1 year
Guaranteed accuracy period from adjustment made by Hioki	1 year

Accuracy
 Sine wave input; Conductor at center position; Connected with Model 9555-10; Not including each effect; Measuring instrument that has an input resistance of 1 MΩ or higher
 Amplitude accuracy (Defined at the rated value or less and within the derating curve; The accuracy defined for the frequency range of DC < f < 5 Hz is the design value)
 Phase accuracy (Defined at the rated value or less and within the derating curve; The accuracy defined for the frequency range of DC < f < 10 Hz is the design value)

Frequency	Amplitude	Phase
DC	± 0.05%rdg. ± 0.01%f.s.	-
DC < f < 16 Hz	± 0.10%rdg. ± 0.02%f.s.	± 0.3°
16 Hz ≤ f ≤ 66 Hz	± 0.05%rdg. ± 0.01%f.s.	± 0.2°
66 Hz < f ≤ 100 Hz	± 0.5%rdg. ± 0.02%f.s.	± 0.5°
100 Hz < f ≤ 500 Hz	± 1%rdg. ± 0.02%f.s.	± 2.0°
500 Hz < f ≤ 1 kHz	± 5%rdg. ± 0.05%f.s.	± 3.0°
1 kHz < f ≤ 5 kHz	± 5%rdg. ± 0.05%f.s.	-
5 kHz < f ≤ 10 kHz	± 15%rdg. ± 0.1%f.s.	-
10 kHz < f ≤ 20 kHz	± 30%rdg. ± 0.1%f.s.	-

Noise	5 mVpp or less (100 kHz or less)
Temperature coefficient	-30°C to 0°C and 40°C to 85°C Amplitude sensitivity : ± 0.01%rdg./°C or less Offset voltage : ± 0.01%f.s./°C or less
Effect of conductor position	± 0.05%rdg. or less (at 1000 A input, 50 Hz/60 Hz, using with the wire 20 mm diameter)
Effect of external electromagnetic field	200 mA or less (Scaled value, In a DC or 60 Hz magnetic field of 400 A/m)
Effect of magnetic field	50 mA or less (Scaled value, after 1000 A DC input)
Effect of radiated radio-frequency electromagnetic field	1%f.s. at 10 V/m
Effect of conducted radio-frequency electromagnetic field	0.5%f.s. at 3 V
Measurable conductor diameter	φ36 mm (1.42") or less
Supply voltage	± 11 V to ± 15 V (Tracking)
Power supply capacity	± 300 mA or less (1000 A/55 Hz measurement, with ± 12 V power supply)
Rated power	7 VA or less (1000 A/55 Hz measurement, with ± 12 V power supply)
Dimensions	Approx. 160W × 112H × 50D mm (excluding protrusions, cable) (Approx. 6.30"W × 4.41"H × 1.97"D)
Mass	Approx. 980 g (34.6 oz.)
Cable length	Approx. 3 m

Output connector	CT6865 : Hioki PL23 (male) CT6865-05 : Hioki ME15W (male)		
Accessories	Instruction manual, Mark band 6 (3sets)		
Options	For CT6865	CT9900	Conversion Cable
		CT9903	Extension Cable
		9318	Conversion Cable
	For CT6865-05	9705	Conversion Cable
		CT9901	Conversion Cable
		CT9902	Extension Cable

Combined accuracy and conditions
 Combined accuracy = Accuracy of CT6865(-05) + Accuracy of combined product (Power factor: 1)

Combined product	CT ratio setting	Required option	
		CT6865	CT6865-05
CT9555,CT9556,CT9557 Sensor Unit ¹	-	CT9900	-
PW3390 Power Analyzer	2 ²	CT9900	-
PW6001 Power Analyzer	2 ²	CT9900	-
9602 AC/DC Clamp Input Unit ³	2	-	CT9901
3334-10 AC/DC Power HiTester	50	-	CT9901
8940 F/V Unit ⁴	2	9705 + 9318	CT9901 + 9705 + 9318
8971 Current Unit ⁴	2	9318	CT9901 + 9318
9555-10 Sensor Unit	-	-	CT9901
3390,3390-10 Power Analyzer	2	-	CT9901

¹: Add the sensor unit output accuracy to the combined accuracy when one of the addition functions, that is, RMS output or TOTAL OUTPUT, is used.
²: The CT ratio need not be set for the CT6865-05.
³: Add ±0.1% rdg. to the combined accuracy.
⁴: The sensor recognition methods vary according to the Memory HiCorder settings (refer to the manuals of Memory HiCorder to be connected).

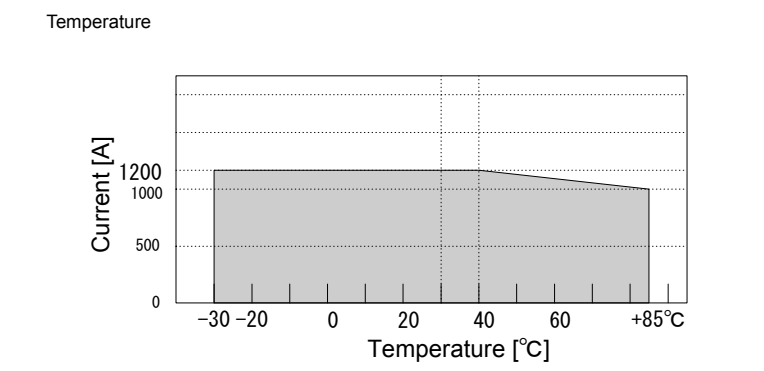
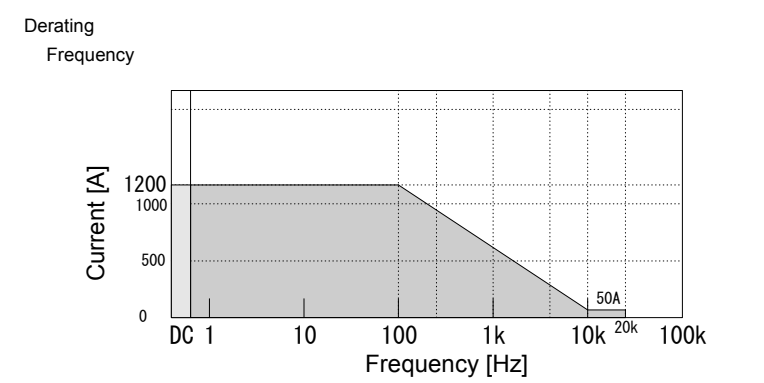

Measurement Procedure

WARNING
 In order to prevent electric shock and short-circuit accidents, shut off the power to the line to be measured before connecting this device.

CAUTION
 To prevent damage to the connected instrument and sensor, never connect or disconnect a sensor while the power is on.
 When the connected instrument's power is turned off, do not apply current to the sensor. Doing so may damage the device.
 When disconnecting the output connector, be sure to release the lock before pulling off the connector. Forcibly pulling the connector without releasing the lock, or pulling on the cable, can damage the connector.

NOTE
 The sensor's signal output circuit is protected by a resistor (output resistor). A digital multimeter used for monitoring should have high input resistance (recommended minimum: 1 MΩ).

Wiring

Make sure the direction of the arrow on the case matches the direction of the current flow, as shown in Figure 1. If they are oriented incorrectly, the output signal from the sensor will be reversed

Figure 1. Wiring example

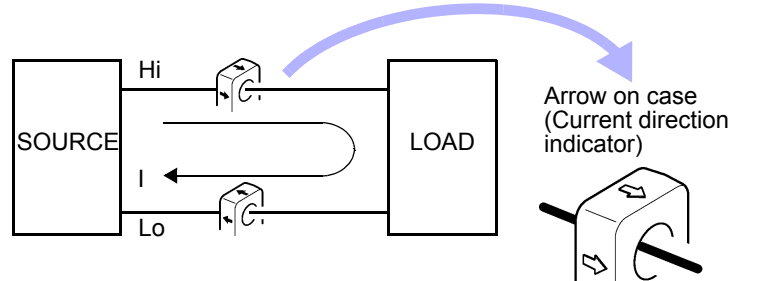

When the CT6865 is used with a wattmeter, follow the wiring instructions provided with the wattmeter.

NOTE
 Make sure to pass only one conductor through. Single-phase (2-wire) or three-phase (3-wire) cables conducted together will not produce any reading.

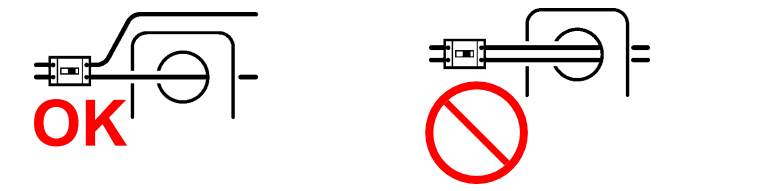

Ground-shielded conductors cannot be accurately measured.

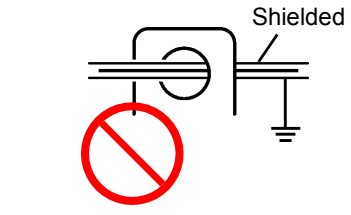

Maintenance and Service

WARNING
 Do not attempt to modify, disassemble or repair the device; as fire, electric shock and injury could result.

To clean the device, wipe it gently with a soft cloth moistened with water or mild detergent. Never use solvents such as benzene, alcohol, acetone, ether, ketones, thinners or gasoline, as they can deform and discolor the case.
 If the device seems to be malfunctioning, contact your dealer or Hioki representative. When returning the device for repair, pack the device so that it will not sustain damage during shipping, and include a description of existing damage. We do not take any responsibility for damage incurred during shipping.

Options

9705 Conversion Cable¹, 9318 Conversion Cable¹, CT9900 Conversion Cable¹, CT9901 Conversion Cable²
 The Conversion Cable makes it possible to connect to and use with products that cannot be directly connected to the device. (Refer to "Connection example").(No figures are added to the accuracy.)

CT9902 Extension Cable²(5 m), CT9903 Extension Cable¹ (5 m)

- Single sensor cable, 5 m extension (max. 10 m extension)
- Up to two of the Extension Cable available (If three or more extension cables are connected to the device, its performance is not guaranteed)
- Add the following values to each of the accuracy per cable:
 Amplitude accuracy : ±0.1% rdg. (DC ≤ f³ ≤ 1 kHz)
 : ±0.5% rdg. (1 kHz < f³)
 Phase accuracy : ±(0.1 × f³ kHz) ° (1 kHz < f³)

¹: For CT6865, ²: For CT6865-05 ³: frequency

Connection Example

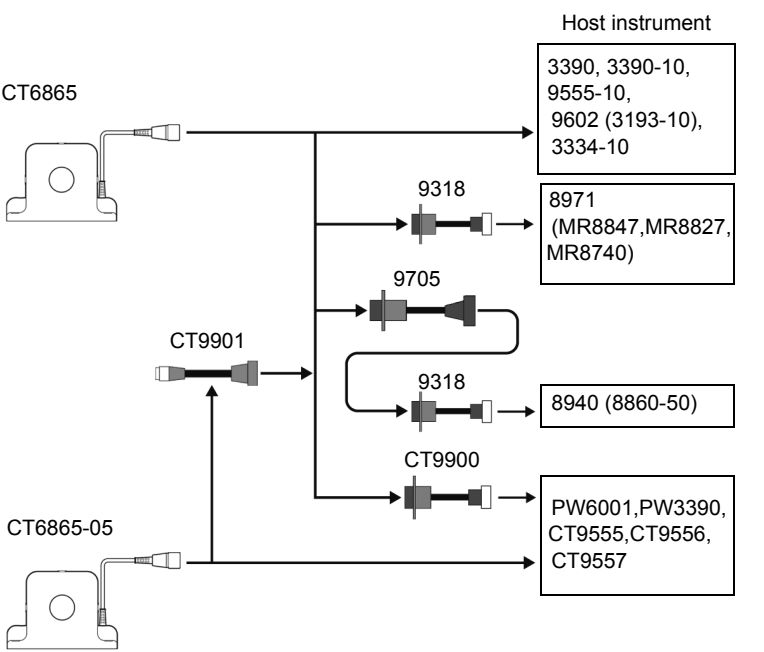

NOTE
 Also refer to the Instruction manual for attached device.