

Power Measurement in the Development of EV Motors and Inverters

By Kazunobu Hayashi, Takumi Ijima, and Hiroki Kobayashi

HIOKI E.E. Corporation

1. Introduction

Amid efforts to realize a sustainable society, development of technologies for reducing greenhouse gas emissions is proceeding apace. One such initiative is the electrification of automobiles.

Two key challenges facing electrification are increasing the efficiency of motor drive systems and decreasing their size. To resolve these issues, it is necessary to accurately measure the input and output power of the inverters in these systems as well as the power of their motors, and to use those measurements to calculate efficiency and loss. Recent widespread adoption of wide-bandgap (WBG) semiconductors manufactured from materials such as SiC and GaN is driving efforts to increase inverter switching frequencies and to develop lower-loss designs [1]-[5]. Evaluating these new technologies requires more precise power measurement over a broader band than in the past [6].

This article introduces expertise, measurement results, and other information related to measurement of power, efficiency, and loss in motor drive systems used in xEVs.

2. Powertrain architecture in xEVs

Fig. 1 provides an example of a power train in a battery electric vehicle (BEV). As shown, the principal components in a BEV powertrain are the battery, inverter, and motor. Motors in BEVs are driven using energy stored in the vehicle's battery. The battery outputs a direct-current (DC) signal that cannot be used directly to drive the motor. Consequently, an inverter is used to convert the battery's output into a 3-phase alternating-current (AC) signal, which is then used to drive the motor.

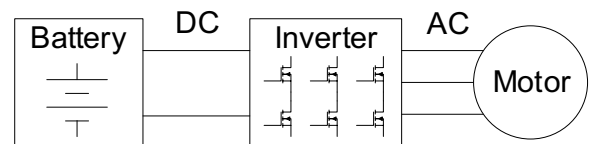

Fig. 1 Powertrain of a BEV

3. Issues in the development of motors and inverters

One key issue in the development of BEVs is the need to increase range by improving energy efficiency [7]. Compared with fossil fuels, batteries have low energy density [8]. Consequently, BEVs must be equipped with a high-capacity battery in order to provide range on par with that of vehicles that are powered by internal combustion engines. Using such batteries drives up vehicle costs, and the associated increase in weight degrades energy efficiency. As a result, manufacturers are under pressure to realize increased range by equipping their vehicles with smaller batteries.

In order to accomplish this goal, engineers need to improve energy efficiency by designing more efficient, lightweight, and compact powertrains. Loss in powertrains can be reduced by boosting efficiency. More lightweight designs make possible vehicles that weigh less overall and that have lower driving loss. Furthermore, use of more compact powertrains increases the degree of freedom with which components can be placed in vehicles while making possible body designs with lower Cd values.

For these reasons, manufacturers need to develop more efficient, lightweight, and compact powertrains. To realize that goal, it is necessary to accurately measure power, efficiency, and loss in the various components that make up the powertrain.

4. Measurement of inverter and motor power, efficiency, and loss

When evaluating a powertrain that includes an inverter and motor, efficiency and loss can be assessed by measuring the inverter's input and output power as well as the motor's power and then calculating the ratio of, and the difference between, input and output power. Fig. 2 provides a block diagram depicting the measurement of efficiency in a typical motor drive system. As an example, Equations (1) and (2) provide equations for the efficiency η and loss P_{loss} shown in Fig. 2. P_{in} represents the inverter's input power, and P_{out} , its output power.

$$\eta = P_{\text{out}}/P_{\text{in}} \quad \cdot \cdot \cdot (1)$$

$$P_{\text{loss}} = P_{\text{in}} - P_{\text{out}} \quad \cdot \cdot \cdot (2)$$

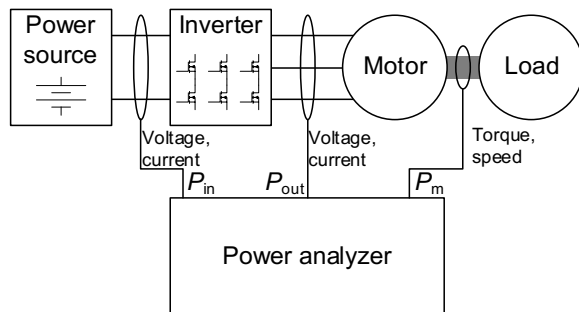

Fig. 2 Measuring the efficiency of a motor drive system

Inverter and motor output fluctuates over time. Consequently, when calculating efficiency and loss based on measurements of multiple locations made with separate instruments, differences in measurement timing and calculation methods make it impossible to obtain accurate values. To avoid this issue, it is necessary to make all measurements simultaneously, either by using one multichannel instrument or multiple instruments that can be controlled in a synchronized manner. Power analyzers are used in such applications. A typical power analyzer can measure power across four to eight channels and provides motor analysis functionality, allowing power and loss to be measured with a high degree of precision.

Taking a more detailed look at the measurement process reveals that the manner in which power calculations are divided into different intervals of time impacts the stability of measured values. Power analyzers determine the intervals across which such calculations are performed by detecting zero-cross

events in the input waveform. Generally speaking, any channel can be set as the signal for which zero-cross events are detected, which is known as the synchronization source. Selecting an optimal synchronization source makes possible stable power measurement, allowing efficiency and loss to be measured with a high degree of precision. For example, when measuring inverter efficiency, calculation intervals can be aligned by setting the same synchronization source for the input and output channels, allowing stable measurement of efficiency and loss. For example Fig. 2 illustrates measurement of power at two locations and motor power at one location. Measurement stability has been increased by setting the inverter output current as the synchronization source for all channels.

Stable zero-cross detection is an important factor in obtaining more stable measured values. When the waveforms being measured are distorted, as is the case with inverter output, it can be particularly difficult to detect stable zero-cross events. To address this issue, most of the latest power analyzers realize stable zero-cross detection by using digital circuitry to accomplish this important task. Digital filters and other sophisticated signal processing techniques facilitate accurate detection of zero-cross events in distorted waveforms. As an example, Fig. 3 provides a block diagram for the zero-cross detection unit in a Hioki power analyzer. Analog signals that have been band-limited by an anti-aliasing filter undergo A/D conversion prior to being used in digital signal processing to detect zero-cross events. This approach makes possible stable zero-cross detection.

In recent years, two-motor setups have been attracting attention as drive systems for xEVs. Such systems integrate a front motor and a rear motor into a single vehicle chassis to realize all-wheel drive. In addition to delivering powerful acceleration, two-motor systems provide high maneuverability and low energy loss by allowing torque to be freely apportioned between the front and rear wheels. In the case of a two-motor vehicle like the one shown in Fig. 4, eight channels of power measurement are needed in order to measure the entire xEV's efficiency and loss. With up to eight channels of power measurement, Hioki's Power Analyzer PW8001 can accommodate sophisticated measurement needs such as this.



Fig. 3 Block diagram of zero-cross detection

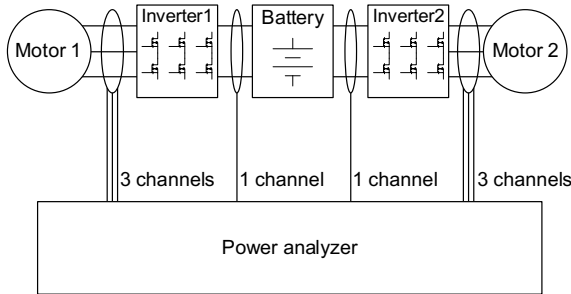

Fig. 4 Measuring the efficiency of a two-motor drive system

High-precision measurement of inverter input power

In order to measure an inverter's efficiency and loss, the inverter's input power and output power are measured. Input power serves as the standard for efficiency and loss measurement. Any errors in the input and output power measured values will significantly affect the efficiency and loss values. Consequently, inverter input power must be measured with a high degree of precision. For example, if an inverter is 99% efficient, a 0.5% error in the input power measured value will introduce a 50% error into the loss measurement results. While general-purpose waveform recorders can be used to obtain voltage and current waveforms for use in calculating power, caution is necessary to ensure that the instrument being used has sufficient accuracy defined for the band being measured.

When measuring a DC signal such as inverter input, any DC offset exhibited by the power analyzer or current sensor can have a significant effect on measured values. To cancel such effects, it is necessary to adjust the power analyzer and current sensor's DC offsets prior to measurement. If the power analyzer being used has a zero adjustment function, that function can be used while inputting zero-level input to the instrument and sensor prior to measurement. This approach allows the instrument's DC offset to be canceled and DC signals to be measured accurately.

High-precision measurement of inverter output power

Inverters generate PWM-modulated output that contains the switching frequency as well as associated harmonic components. Measuring such power signals requires a broader band than is needed to measure DC and grid power. Let us consider the band needed to measure power at switching frequencies and their harmonics. Fig. 5 illustrates an equivalent circuit for a motor being driven by an inverter.

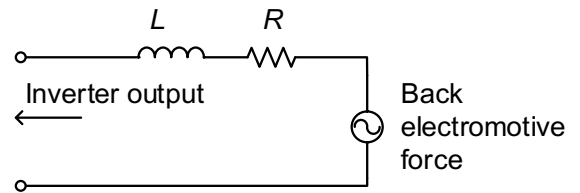

Fig. 5 Equivalent circuit for a motor (1-phase)

The inductance component in the motor's winding resists the flow of high-frequency current. Since the voltage is a PWM waveform, it can be approximated as a rectangular wave. At this time, the current waveform is a triangular wave. When calculating the RMS value of triangular wave in the frequency domain, the RMS value can be measured with an error of 0.1% or less if the instrument can measure up to fifth-order harmonic components. The active power P_f at a given frequency f can be expressed by Equation (3) in terms of the voltage U_f , current I_f , and voltage and current phase difference θ_f .

$$P_f = U_f \cdot I_f \cdot \cos \theta_f \cdot \cdot \cdot (3)$$

Consequently, if either the voltage or current is 0, the active power at that frequency component will be 0. If we consider measurement with a precision of 0.1%, the current for harmonic components at or above the 7th order of the switching frequency can be ignored, as explained above. This means that if we wish to measure power at the switching frequency and its harmonics with an error of 0.1% or less, it is sufficient to be able to accurately measure voltage, current, and phase difference up to the 5th to 7th order of the switching frequency. However, in addition to the resistance R component shown in Fig. 5, loss in an actual motor includes factors such as loss from

magnetic materials and the conductor skin effect of the winding. These losses tend to increase with the frequency. Consequently, more accurately measurement of power at the switching frequency and its harmonics requires a somewhat broader frequency band. The band that is actually necessary depends on factors including the frequency characteristics of each type of loss.

Fig. 6 illustrates voltage and current waveforms from an SiC inverter used to drive a motor, along with associated FFT results. Table 1 provides a detailed description of the circuit that was measured.

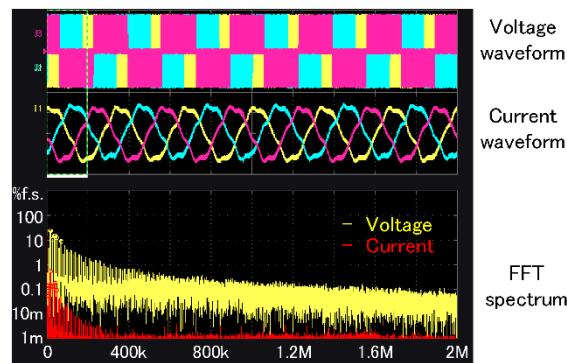

Fig. 6 Waveforms and FFT results for an actual inverter-driven motor (measured with the Power Analyzer PW6001)

Table 1 Specifications of the measured SiC inverter and motor

| Inverter | | Motor | |
|-----------------------------|---------------------|------------|------------|
| Switching elements | Switching frequency | Inductance | Resistance |
| SiC-MOSFET SCH2040KE (ROHM) | 20 kHz | 3.6 mH | 0.9 Ω |

The FFT results indicate the existence of voltage components up to a frequency in excess of 1 MHz. Those components are present because the voltages comprise PWM waveforms. Standard power analyzers do not provide a sufficient measurement band for accurately measuring such voltage waveforms. Turning our attention to current, current components are only present up to about 200 kHz. The waveform resembles a sine wave. This resemblance occurs because the motor’s inductance component resists the flow of high-frequency current, as explained above.

In this way, it is desirable to use a power analyzer with voltage, current, and phase difference characteristics that are favorable in, at a minimum, a frequency band extending to the 5th to 7th order of the switching frequency in order to accurately measure inverter output power.

Measurement of large currents using current sensors

Motor drive systems in xEVs handle large currents on the order of several hundred amps and greater. To measure such large currents, current sensors are used in combination with power analyzers. As explained above, inverter measurement demands high-precision, wideband measurement; the same requirements apply to current sensors. Zero-flux type current sensors (Fig. 7), which combine the flux gate and current transformer (CT) methods, are well suited to high-precision, wideband current measurement. The flux gate method’s detection capabilities start with DC current, and because it does not use semiconductors, the method features low offset voltages along with excellent temperature stability and long-term stability. The zero-flux method forms a negative feedback circuit that includes a magnetic circuit and routes current to a feedback winding so as to cancel the magnetic flux created in the core by the current under measurement. By keeping the operating magnetic flux extremely low, this method has the advantage of being able to minimize the effects of the nonlinearity of the magnetic material. When measuring SiC or GaN inverters, it is particularly important to use current sensors that offer excellent noise resistance along with wideband measurement capability. In recent years, current sensors that harness stronger shielding and creative feedback winding design to address these issues have become available [10]. When choosing hardware, bear in mind that current sensor performance impacts the overall performance of the measurement process [9].

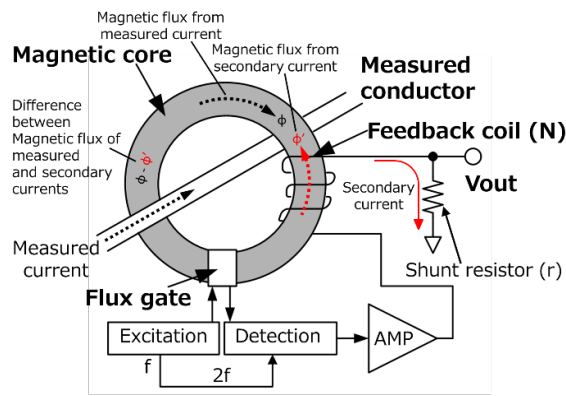

Fig. 7 Zero-flux method (flux-gate type)

Effects of phase error

One issue encountered when using current sensors is the sensors' phase error. Current sensor phase error tends to increase with frequency. Phase error becomes a source of error when measuring high-frequency power. At high frequencies, the impedance of a motor as seen from the inverter is dominated by the inductance component of the motor winding, as illustrated in Fig. 5. For this reason, power at the switching frequency and its harmonics is characterized by a low power factor. In light of Equation (3), the effect of phase error on power measurement error becomes extremely pronounced at low power factors ($\phi \approx 90^\circ$). Consequently, high-precision power measurement is not possible unless the current sensor's phase error is corrected. As an example, Fig. 8 illustrates the phase characteristics of the CT6904, a current sensor manufactured by Hioki (rated for 500 A with a band of 4 MHz)^[10]. If the phase characteristics are not corrected, there will be a large phase error at high frequencies, that is, the switching frequency and its harmonic frequencies. Current sensor phase error also includes a device-specific component that varies from sensor to sensor. As a result, it is necessary to assess the characteristics of individual current sensors and correct for error components properly in order to realize more accurate measurement. That said, it is difficult for users to measure and assess individual current sensors' characteristics. In order to facilitate accurate measurement, it is important for current sensor manufacturers to carry out calibration and then for operators to use the resulting calibration values to correct for errors.

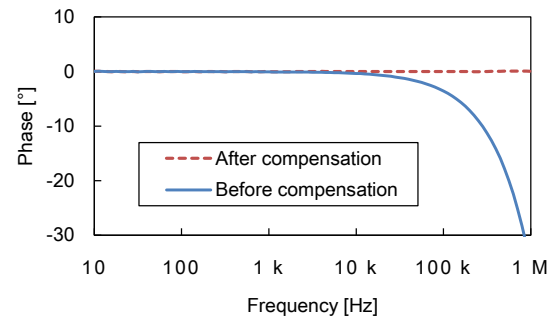

Fig. 8 Phase characteristics of a CT6904A current sensor

In recent years, it has become possible to obtain power analyzers and current sensors that eliminate the need for users to spend time on calibration and correction. Hioki's Power Analyzer PW8001 automatically reads phase error information stored by current sensors and uses it to correct phase error during measurement. Current sensors with this capability have nonvolatile memory that is programmed with the device's phase characteristics as determined during calibration at the time of shipment. These sensors' automatic phase correction functionality makes it possible to measure inverter output power more accurately.

Fig. 9 presents the results of evaluating the dependence of inverter efficiency on inverter output power for the inverter and motor described in Table 1. The evaluation was carried out using the Power Analyzer PW8001 in conjunction with the Input Unit U7005 and the Current Sensor CT6904A. Toggling phase correction on and off introduced a change of about 0.2 points in the inverter's efficiency value. The loss conversion changed by about 8%. These results illustrate the importance of accurately correcting current sensor phase error in order to measure inverter efficiency and loss more precisely.

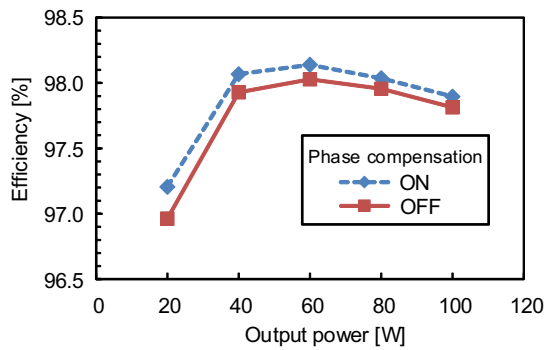

Fig. 9 Efficiency measurement results for an SiC inverter while toggling the phase correction function on and off

Effects of anti-aliasing

Fig. 10 illustrates the relationship between sampling frequency and analog band for a typical power analyzer. Few standard-use power analyzers have input circuitry whose analog band is greater than half the sampling frequency f_s ($f_s/2$, the Nyquist frequency). Under such conditions, the voltage and current components that exist at frequencies higher than $f_s/2$ appear as folding noise in the low-frequency domain. This phenomenon is generally known as aliasing. When measuring a target that includes frequency components across a broad band, for example a PWM waveform, it becomes impossible to distinguish between the folding noise and the original signal. The result is a worsening of measurement error and repeatability in power measurement. When performing harmonic analysis, the inability to distinguish between folding noise and harmonics that are actually present in the signal interferes with accurate analysis, for example by causing detection of false harmonic components.

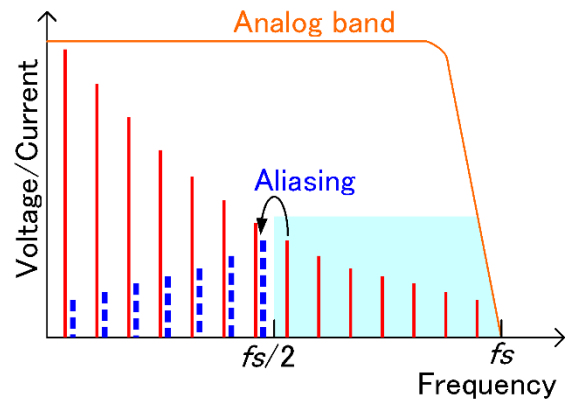

Fig. 10 Relationship between analog band and sampling frequency in a typical power analyzer

As illustrated in Fig. 6, inverters' output voltage includes components in excess of 1 MHz. Typical power analyzers have an analog band of about 200 kHz to 10 MHz and use sampling frequencies of about 100 kHz to 15 MHz. As a result, there are voltage components that exist at frequencies that exceed the Nyquist frequency for these instruments. In such cases, when the relationship between the analog band and sampling frequency resembles that shown in Fig. 10, accurate measurement is impossible. To realize accurate measurement, the analog band must be limited so that it does not exceed the Nyquist frequency. In other words, the band that can actually be used must be no greater than half the sampling frequency. In this way, it is important to use a power analyzer that has been designed in line with sampling theory to achieve accurate measurement and analysis of inverter output power.

Fig. 11 presents the results of measuring the efficiency of the inverter described in Table 1 using Power Analyzer A, which was designed so that its Nyquist frequency is less than the analog band, and the PW8001. The Input Unit U7005 was used with the PW8001. Viewed in light of the U7005's analog band of 5 MHz/-3 dB, the instrument's sampling frequency of 15 MS/s indicates that it has been designed in line with sampling theory. The graph plots changes in the measured efficiency value under conditions of constant-speed, constant-torque operation as a time series. The power analyzer's measured values were updated at an interval of 50 ms. The graph indicates that the measured values from Power Analyzer A exhibit significant variability. This variability occurs

because harmonic components at frequencies in excess of the Nyquist frequency have folded into low-frequency components near DC and manifested themselves as long-term measured value fluctuations. By contrast, the PW8001's anti-aliasing filter has caused signals in excess of the Nyquist frequency to be attenuated, preventing folding noise. As a result, efficiency values exhibit little variability.

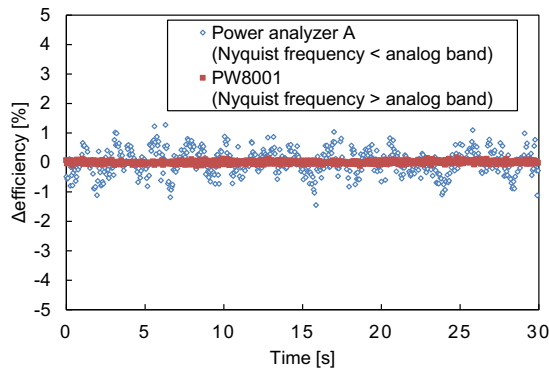

Fig. 11 Fluctuations in the measured efficiency of an SiC inverter

In this way, measured values obtained using a power analyzer that was not designed in line with sampling theory may exhibit greater variability due to folding noise, depending on the measurement target. When measured values exhibit greater variability, inability to detect transient phenomena renders appropriate analysis impossible. This example also highlights the importance of performing such analysis with a power analyzer that is designed in line with sampling theory. As explained above, the stability of power analyzer measured values is also affected by the stability of zero-cross detection. By using a digital filter to remove high-frequency signals superposed on input signals, the PW8001 realizes stable zero-cross detection. It is likely that this characteristic of the instrument contributes to the stability of the measured values obtained in this example evaluation.

High-precision measurement of motor output

In order to measure overall efficiency and loss of a motor alone or a drive system that includes a motor, it is necessary to measure motor power. Equation (4) can be used to calculate motor power. Rotation is measured using a tachometer or pulse encoder, while torque is measured using a torque meter. In order to measure

motor power as defined by Equation (4), it is necessary to accurately measure rotation n and torque T .

$$P_m = T \cdot 2 \cdot \pi \cdot n / 60 \cdot \dots \quad (4)$$

Torque meter error poses an issue when measuring torque. Principal sources of torque meter error are nonlinearity error and friction error. Nonlinearity error occurs when an increase or decrease in torque causes the torque meter's output to vary in a nonlinear manner relative to the straight reference line [11]. Friction error occurs in torque meters with bearings when friction between the motor shaft and the torque meter causes the instrument's output to diverge from the ideal torque [11]. Because friction error depends on rotational speed, it has a particularly pronounced effect on the precision of motor power measurements made at high rotational speeds. As a result, correcting torque meter error is an effective means of facilitating more precise motor power measurement. Fig. 12 and Fig. 13 provide examples in which a torque meter's nonlinearity error and friction error have been corrected using the PW8001. The PW8001 lets users correct these two errors by entering correction values for the torque meter's nonlinearity error and friction error in advance. These corrections make it possible to measure torque more accurately, enabling high-precision motor power measurement.

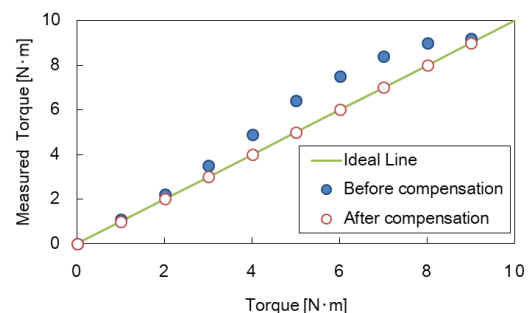

Fig. 12 Compensation of measured torque by the PW8001 (nonlinearity compensation)

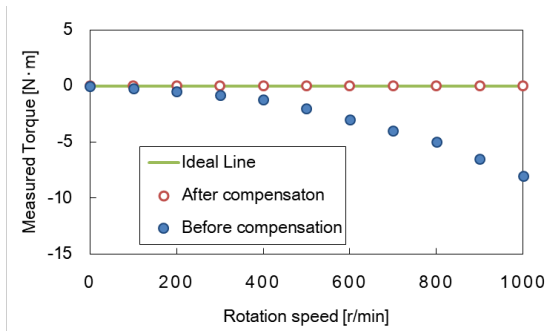

Fig. 13 Compensation of measured torque by the PW8001 (friction compensation)

High-precision measurement of motor efficiency and motor loss

Motor efficiency and loss can be measured in the same manner as for inverters, by calculating the ratio and difference between a motor’s input and output. Equations (5) and (6) define motor efficiency η and motor loss P_{loss} in terms of the power input to the motor P_{in} and the motor power P_{m} .

$$\eta = P_{\text{m}}/P_{\text{in}} \quad \cdot \cdot \cdot \quad (5)$$

$$P_{\text{loss}} = P_{\text{in}} - P_{\text{m}} \quad \cdot \cdot \cdot \quad (6)$$

In order to measure motor output power with a high degree of precision, it is necessary to correct torque meter error as described above. Because doing so requires that torque measured values be corrected after measurement, it is difficult to synchronize motor input power measured values and motor output power measured values in terms of time. In the past, this issue made it difficult to obtain accurate efficiency and loss values for motors.

By contrast, the PW8001 can correct torque meter error by itself. This capability makes it easy to synchronize motor input power measured values and motor output power measured values in terms of time, making it possible to measure motor efficiency and loss in a more accurate and highly stable manner than in the past. It is particularly effective when evaluating motor characteristics that change from moment to moment in situations where operating conditions vary continuously, for example when evaluating energy efficiency using the Worldwide Harmonized Light Vehicles Test Procedure (WLTP).

5. Summary

Two key challenges facing electrification are increasing the efficiency of motor drive systems and decreasing their size. In order to develop smaller, higher-efficiency motor drive systems, it is necessary to accurately measure the input and output power of the inverters and motors that make up such systems in order to ascertain their efficiency and loss.

This article introduced expertise, measurement results, and other information related to measurement of power, efficiency, and loss in motor drive systems used in xEVs. It is the authors' hope that the information it has provided will be useful for power, efficiency, and loss measurement in the development of EV motors and inverters.

References

- [1] M. Okamura and T. Takaoka: “The Evolution of Electric Components in Prius” , IEEJ Journal of Industry Applications, Vol. 11, No. 1, pp.1-6 (2022)
- [2] K. Yoshimoto and T. Hanyu: “NISSAN e-POWER: 100% Electric Drive and Its Powertrain Control”, IEEJ Journal of Industry Applications, Vol. 10, No. 4, pp.411-416 (2021)
- [3] Thal, E., K. Masuda, and E. Wiesner: “New 800A/1200V Full SiC Module”, Bodo’s Power Systems, April, pp.28-31 (2015)
- [4] Fuji Electronic: “Joint Development of Converter-Inverter for The Tokaido Shinkansen Cars Using SiC Power Semiconductor Modules”, retrived from <http://www.fujielectric.com/company/news/2015/20150625120019879.html>
- [5] Mitsubishi Electric : “Mitsubishi Electric’s Railcar Traction Inverter with All-SiC Power Modules Achieves 40% Power Savings”, retrived from <http://www.mitsubishielectric.com/news/2015/0622-a print.html>
- [6] K. Hayashi: ”High-Precision Power Measurement of SiC Inverters”, Bodo’s Power System, September, pp.42-47 (2016)
- [7] E. Ishii and M. Yoshida: “Electric Vehicle Simulator for Evaluating Dynamic Energy

- Performance of Drive Systems with High Accuracy”, Toshiba Review, Vol. 67, No. 7 (2022)
- [8] H. Nisimoto, “ Rechargeable Batteries for Electric Vehicles ”, Tokugikon, Vol. 274 (2014)
- [9] K. Ikeda and H. Masuda, “High-precision, Wideband, Highly Stable Current Sensing Technology ”, HIOKI Technical article (2016)
<https://www.hioki.com/global/download/31445>
- [10] Y. Hajime, “AC/DC Current Sensor CT6904/CT6904-60”, HIOKI Technical Notes (2019)
- [11] NM. Kircanski and AA. Goldenberg: “An experimental study of nonlinear stiffness, hysteresis, and friction effects in robot joints with harmonic drives and torque sensors” , The International Journal of Robotics Research, pp.214-239 (1997)