

⚡ CT6873 / CT6873-01

AC/DC CURRENT SENSOR

Maximum rating 200A, high-stability, high-accuracy, wideband DC to 10 MHz, high-CMRR, high-performance fluxgate technology, pass-through type



Features

- 2 ppm linearity
- 5 ppm offset
- Voltage output
- CT coil structure for broadband and superior frequency characteristics
- Built-in in plated shield for excellent noise resistance (high CMRR)
- Aperture ϕ 24mm for cables and bus-bars
- The Power Analyzer PW8001 or the Data Logger LR8101, LR8102 with the Power Measurement Module M7103 automatically recognizes the current sensor's information (phase shift data, sensor model name, rated current, serial number) when connected.

Applications

- Automotive (e.g. xEV R&D and manufacturing)
- Renewable energy (power conditioner R&D and manufacturing)
- Efficiency measurement of high-efficiency energy converters
- Analysis of industrial inverter motors
- Calibration of shunt resistors
- Measurement of minute superimposed current in battery systems
- Industrial drones
- For feedback control in medical devices (MRI,CT, X-ray)

Specification highlights	Symbol	Unit	Min.	Typ.	Max.
Nominal primary DC current	IPN DC	A	-200		200
Nominal primary AC current	IPN AC	Arms			200
Measurement range	IPM	A	-220		220
Nominal output voltage	V _{out}	V	-2		2
Primary / secondary ratio	Ratio	V/A	0.01	0.01	0.01
Linearity error	ϵ_L	ppm		± 2	
Offset error	ϵ_O	ppm		± 5	
DC amplitude error	ϵ_G	ppm		± 7	
Bandwidth (± 3 dB)	f	MHz		10	
Withstand voltage (1mA, 50/60Hz for 1minute)	U _d	kV			7.4
Power supply voltages	U _c	V	± 11.5		± 15
Operating temperature range	T _A	°C	-40		85
Output cable length	L _{cable}	m		CT6873 : 3m CT6873-01: 10m	

AC/DC CURRENT SENSOR

⚡ **Electrical specifications at T_A = 23°C ±5°C, supply voltage (by using external PSU) = ±12V unless otherwise stated**

Parameter	Symbol	Unit	Min.	Typ.	Max.	Comment
Nominal primary DC current	I _{PN} DC	A	-200		200	Refer to "Figure 1. Frequency derating"
Nominal primary AC current	I _{PN} AC	Arms			200	Refer to "Figure 1. Frequency derating"
Measurement range	I _{PM}	A	-220		220	Refer to "Figure 1. Frequency derating"
Maximum input current	I _{MAX}	A _{peak}	-420		420	Not exceeding derating curve shown in Figure 1 However, it is allowable for up to 20 ms at 40°C or less
Nominal output voltage	V _{out}	V	-2		2	
Primary/secondary ratio	Ratio	V/A	0.01	0.01	0.01	
Bandwidth (-3dB)	f	MHz		10		Refer to "Figure 2. Frequency characteristics"
Output resistance		Ω	40	50	60	
Linearity error	ε _L	ppm		±2		Refer to "Figure 3. Linearity error characteristics"
Offset error	ε _O	ppm		±5		
DC amplitude error	ε _G	ppm		±7		
AC amplitude error 10 Hz - 500 Hz 500 Hz - 3 kHz 3 kHz - 30 kHz 30 kHz - 100 kHz 100 kHz - 400 kHz 400 kHz - 1 MHz	ε _G	%		±0.005 ±0.01 ±0.1 ±0.4 ±1 ±3		
Output noise	noise	μV _{rms}			300	Measurement bandwidth: DC to 1MHz
Effects of temperature Amplitude sensitivity Offset voltage		ppm of reading/°C ppm of full scale/°C	-15 -0.1		15 0.1	Within the range of -40°C to 18°C or 28°C to 85°C
Effects of magnetization		mA			1	Input equivalent, after 200 A DC is inputted
Common mode rejection ratio DC to 1 kHz 1 kHz to 10 kHz 10 kHz to 100 kHz 100 kHz to 1 MHz	CMRR	dB	150 140 120 100			(Effect on output voltage/common-mode voltage) Refer to "Figure 4. CMRR characteristics"
Effects of conductor position DC 50/60 Hz 1 kHz 10 kHz 100 kHz		% of reading	-0.004 -0.005 -0.04 -0.04 -1.2		0.004 0.005 0.04 0.04 1.2	When wire of outer diameter 10 mm is used
Effects of external magnetic field		mA			2 25	Input equivalent, under a magnetic field of 400A/m, DC Input equivalent, under a magnetic field of 400A/m, 60 Hz
Effects of radiated radio-frequency electromagnetic field		% of full scale			0.5	10 V/m
Effects of conducted radio-frequency electromagnetic field		% of full scale			0.1	10 V
Fluxgate excitation frequency	f _{Exc}	kHz		10.4		
Power supply voltages	U _c	V	±11.5		±15	
Positive current consumption	I _{ps}	mA			250	DC + 400 A with ±12V
Negative current consumption	I _{ns}	mA			-250	DC - 400 A with ±12V

⚡ Isolation specifications

Parameter	Unit	Value	Comment
Rated insulation RMS voltage, basic insulation	V	1000	IEC 61010-1 conditions • over voltage cat III • pollution degree 2
Rated insulation RMS voltage, reinforced insulation	V	1000	
RMS voltage for AC isolation test, 50/60 Hz, 1minute	kV	7.4	Between primary and secondary (and shield) Sensed current: 1 mA
Clearance	mm	23.4	Shortest distance through air
Creepage distance	mm	23.4	Shortest path along device body
Comparative tracking index (CTI)	V	< 250	Performance level category (PLC)= 3
Standards			Safety: EN 61010 EMC: EN 61326

AC/DC CURRENT SENSOR

Environmental and mechanical characteristics

Parameter	Symbol	Unit	Min.	Typ.	Max.	Comment
Operating environment (altitude)		m			2000	Indoor use, pollution degree 2
Ambient operating temperature range	T _A	°C	-40		85	
Ambient storage temperature range	T _{Ast}	°C	-40		85	
Relative humidity	RH	%			80	Non-condensing
Protection against mechanical impacts			IK07			Energy level: 2 J, test height defined in EN 61010 Safety requirements: 400 mm
Measurable conductor diameter	D _{meas}	mm			24	
Dimensions	W H D	mm		70 100 53		Refer to "Figure 5. Dimensions"
Output cable length CT6873 CT6873-01	L _{cable}	m		3 10		
Mounting hole diameter	D _{mout}	mm		φ 4.8		M4 screws, recommended tightening torque: 1.2 Nm to 1.5 Nm
Weight CT6873 CT6873-01	m	g		370 690		

Measurement accuracy (total accuracy including uncertainty in calibration system etc.)

Frequency [Hz]	Amplitude		Phase [±°]
	[±% of reading]	[±% of full scale]	
DC	0.03	0.002	-
DC < f < 16	0.1	0.01	0.1
16 ≤ f < 45	0.05	0.01	0.08
45 ≤ f ≤ 66	0.03	0.007	0.05
66 < f ≤ 100	0.04	0.01	0.1
100 < f ≤ 500	0.05	0.01	0.15
500 < f ≤ 3 k	0.1	0.01	0.4
3 k < f ≤ 5 k	0.2	0.02	0.4
5 k < f ≤ 10 k	0.2	0.02	0.5
10 k < f ≤ 1 M	0.018 × f	0.05	0.04 × f + 0.1
Frequency range	10 MHz (±3 dB typical)		-

Electrical specifications at T_A = 23°C ±5°C, supply voltage (by using external PSU) = ±12 V unless otherwise stated

- The variable f in accuracy equations is expressed in kHz.
- Accuracy of amplitude and phase is specified with 110% of full scale input or less and not exceeding derating curve in Figure 1. Accuracy in range of DC < f < 10 Hz are design values.
- Add ±0.01% of reading to amplitude accuracy when input is 100% to 110% of full scale.
- For the CT6873-01, add the following values to accuracy in the range of 1 kHz < f ≤ 1 MHz.
Amplitude accuracy: ±(0.005 × f [kHz])% of reading
Phase accuracy: ±(0.015 × f [kHz])°
- Combined accuracy with HIOKI power analyzer PW8001, PW6001 and PW3390 is specified (DC, 45 Hz ≤ f ≤ 66 Hz).
For details of combined accuracy, refer to the instruction manual (<https://www.hioki.com/download/38401>).

Definition of on accuracy

(total accuracy including uncertainty in calibration system etc.)

Reading (displayed value) error:

Indicates the value displayed by the instrument. Limit values for reading errors are expressed as a percentage of the reading ("%" of reading" or "% rdg").

Range error:

Indicates the instrument's range. Limit values for range errors are expressed as a percentage of the range ("%" of range").

Full scale (rated current) error:

Indicates the rated current. Limit values for full-scale errors are expressed as a percentage of full scale ("%" of full scale" or "% f.s.").

Calibration:

The accuracy of HIOKI products includes all factors that affect the measurement results, such as calibration system errors, ambient temperature, and secular change, as "uncertainty".

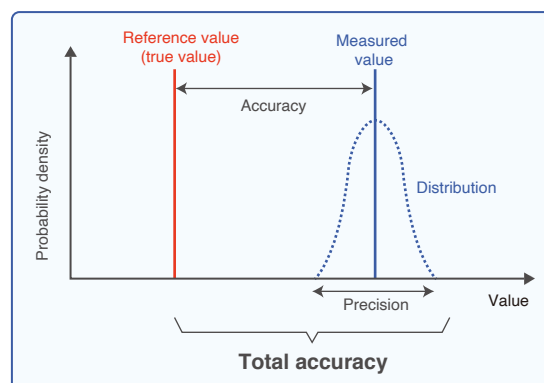





HIOKI is accredited as an official ISO/IEC 17025 calibrator.

⚡ CT6873 / CT6873-01

AC/DC CURRENT SENSOR

⚡ Specific accuracy calculation example

How to measure the current of **DC 100A** of a conductor with a diameter of $\phi 20$ mm or less with high accuracy.
Guaranteed specifications at $T_A = 23^\circ\text{C} \pm 5^\circ\text{C}$

Measuring instrument configuration	CT6873,CT6873-01	CT9555	L9217 + 9704	DM7276
External view				
Range (connection)	200 A (2000 mV)	Front OUTPUT terminal (BNC terminal)	✓	1000 mV
Output voltage	$100\text{A} \times 2000\text{ mV} / 200\text{ A} = 1000\text{ mV}$			-
Error (reading)	0.03%	-	-	0.0011%
Error (full scale)	0.002%	-	-	3 μV
Total error	$1000\text{ mV} \times (0.03 + 0.0011)\% + 2000\text{ mV} \times 0.002\% + (3\ \mu\text{V} \times 10^{-3})\text{ mV} = 0.354\text{ mV}$			
Total error (input equivalent)	$0.354\text{ mV} / 2000\text{ mV} \times 200\text{ A} = 0.0354\text{ A}$			
Error range	$100\text{ A} \pm 0.0354\text{ A} \rightarrow 99.9646\text{ A to } 100.0354\text{ A}$			

⚡ Definition of linearity error

Linearity error ϵ_L :

Indicates that the output (current or voltage) changes linearly in response to the input current.

A regression line is attained by measuring the output voltage in the sequence below in 40 A intervals:

+200 A \rightarrow 0 A \rightarrow -200 A \rightarrow 0 A \rightarrow +200 A

It is defined as the difference between the regression line calculated from the above measurements and the measurement points.

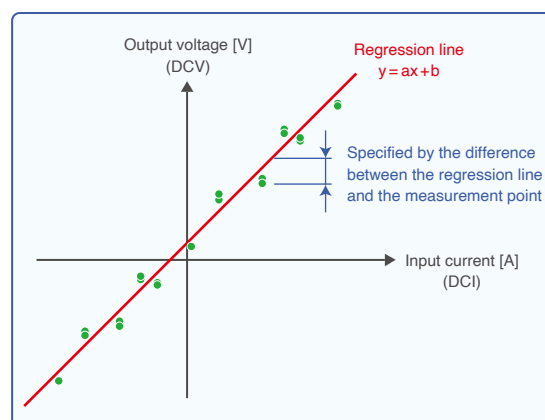

⚡ Definition of offset error

Offset error ϵ_o :

Specified by the ratio of the average value (μ) of the measured values of the offset voltage and the rated current (I_{max}) of each current sensor.

$$\epsilon_o = \mu / I_{max} \text{ [ppm]}$$

⚡ Definition of amplitude error

Amplitude error ϵ_G :

An index showing the degree of flatness of the frequency characteristics of gain.

DC error is defined as (linearity error + offset error).

AC error is defined as deviation from the 55 Hz measurement point.

$$\epsilon_{GDC} = \epsilon_L + \epsilon_o \text{ [ppm]}$$

$$\epsilon_{GAC} = \frac{\text{Gain}(f) - \text{Gain}(55\text{ Hz})}{\text{Gain}(55\text{ Hz})} \times 100 \text{ [%]}$$

AC/DC CURRENT SENSOR

⚡ Figure 1. Frequency derating

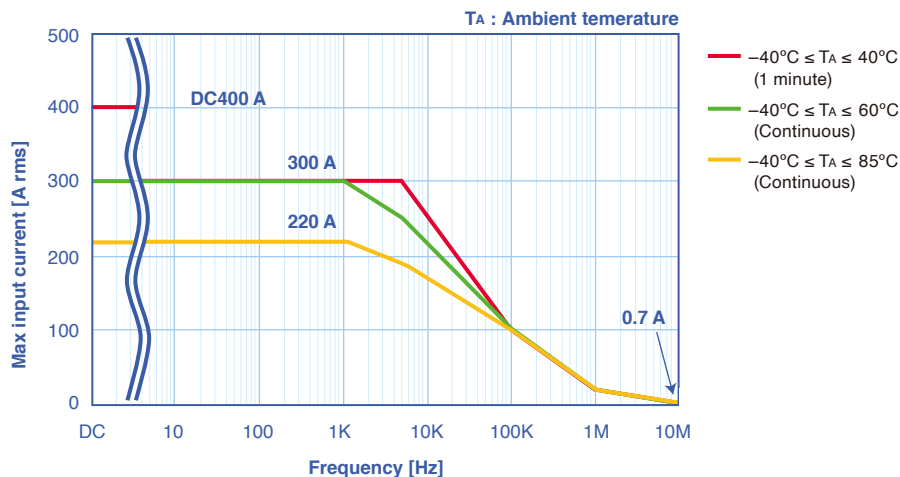

⚡ Figure 2. Frequency characteristics

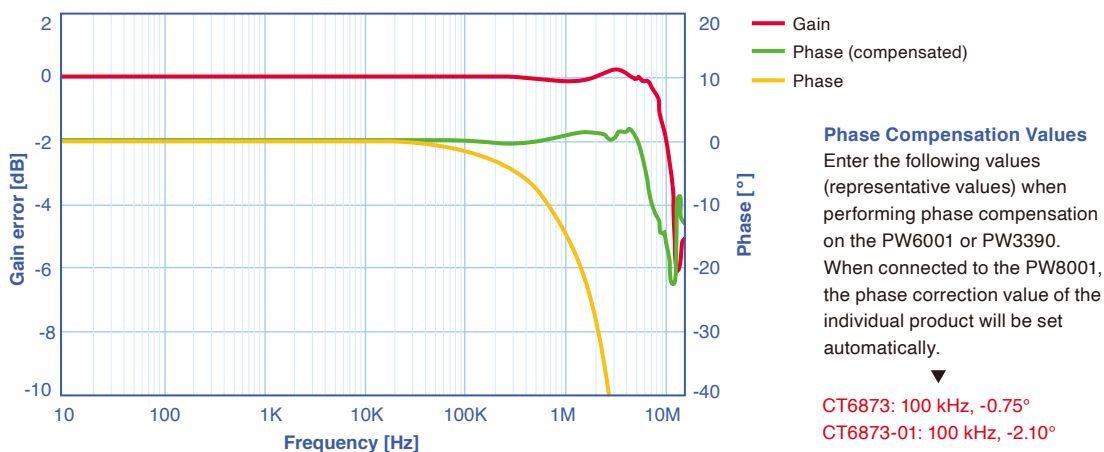

⚡ Figure 3. Linearity error characteristics

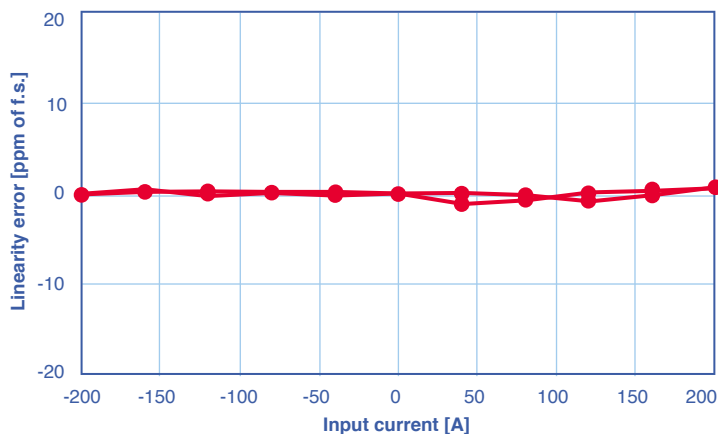

AC/DC CURRENT SENSOR

⚡ Figure 4. CMRR characteristics

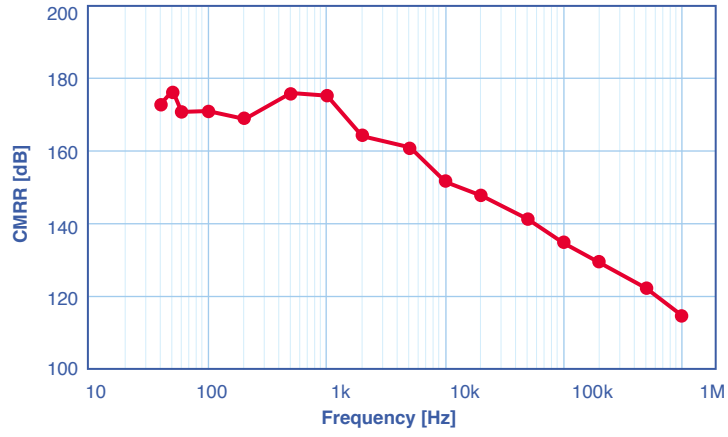

⚡ CT6873 / CT6873-01

AC/DC CURRENT SENSOR

⚡ Figure 5. Dimensions

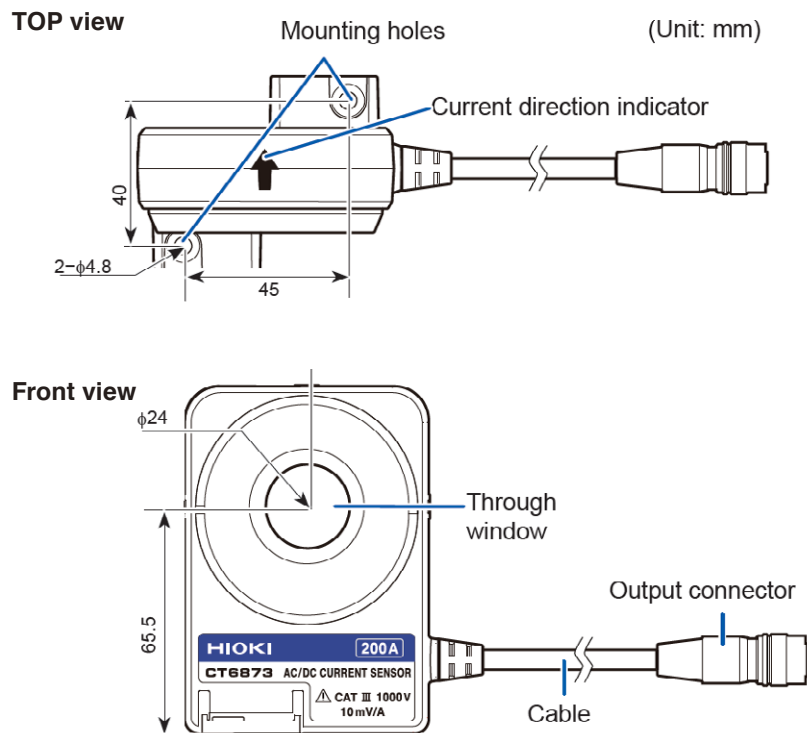

⚡ Figure 6. Pin assignment (when not using the sensor units CT9555, CT9556, or CT9557)

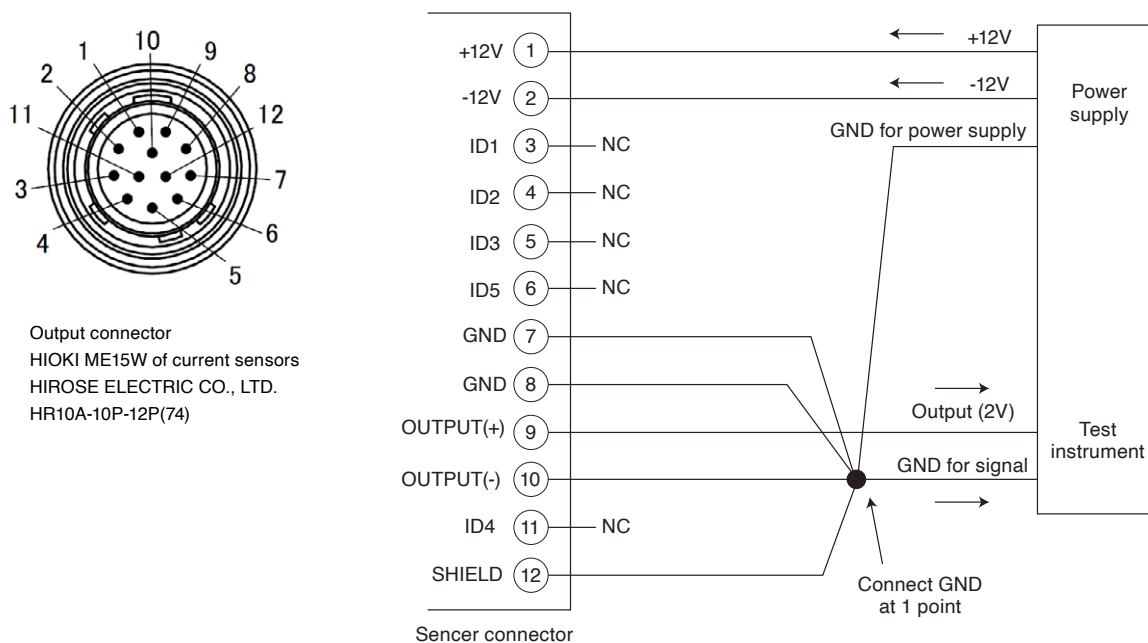

⚡ CT6873 / CT6873-01

AC/DC CURRENT SENSOR

⚡ Figure 7. Options and main combination

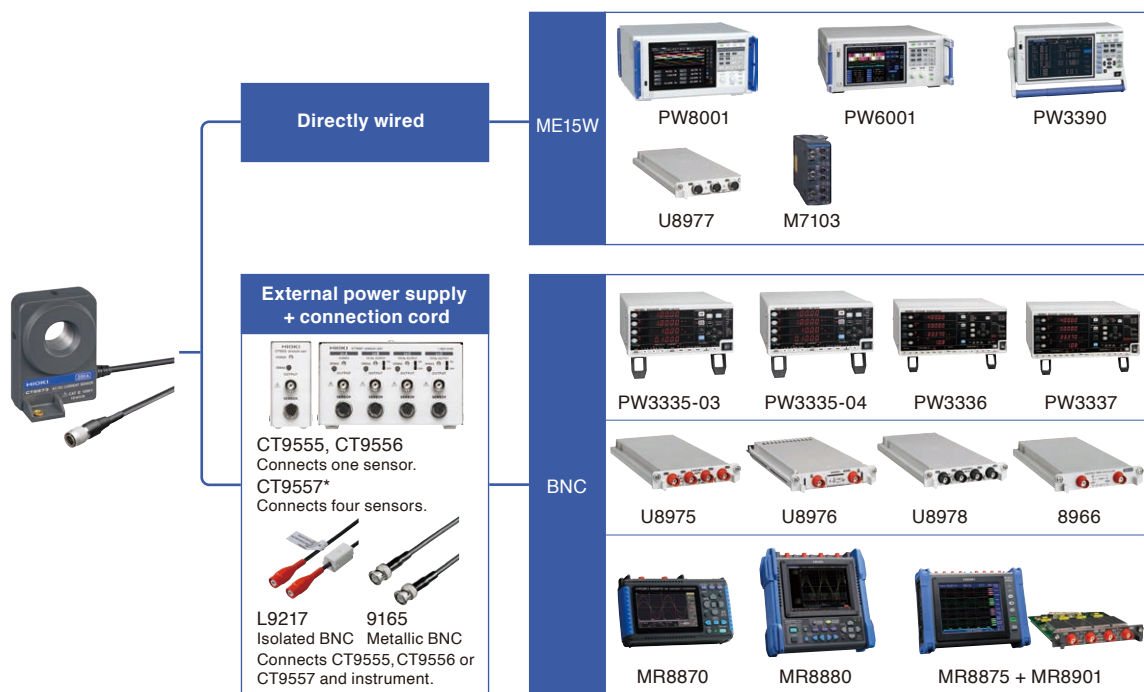

The CT9557 not only functions as a 4-channel power supply, but can also output additive waveform and RMS output from up to four input waveforms.

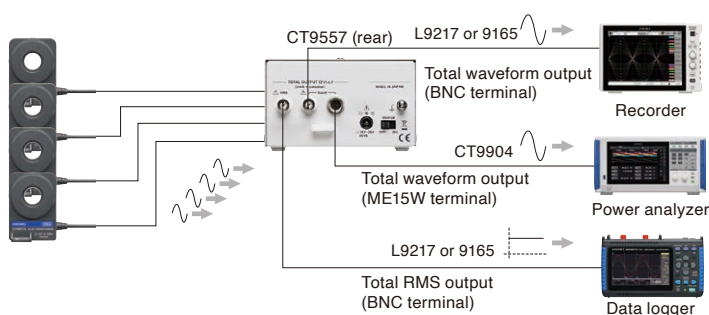

CT9904 CONNECTION CABLE
ME15W (12 pin) terminal - ME15W (12 pin) terminal
The CT9904 is the cable for the CT9557 addition output and POWER ANALYZER PW8001/PW6001/PW3390 connection.



CT9902 EXTENSION CABLE
ME15W (12 pin) terminal - ME15W (12 pin) terminal
The CT9902 can be used to extend a current sensor's cable by 5m. Up two of these cables can be used for a maximum extension of 10 m.
*When using the CT9902, an additional accuracy needs to be added. For details, see the sensor's user manual.

⚡ Links

1. Web site https://www.hioki.com/global/products/current-probes/high-precision/id_470811
2. Accuracy calculation tools
PW8001, PW6001, PW3390, LR8101/LR8102 (M7103): <https://hioki-cierto.com/gl/fm50bha8wk/>
Please download the latest files each time before use.