

PQ3198

Instruction Manual

POWER QUALITY ANALYZER



**Read carefully before use.
Keep for future reference.**



When using the instrument for the first time

Names and Functions of Parts ▶ p.23

Basic Operations ▶ p.27

Measurement Preparations ▶ p.39



Troubleshooting

Maintenance and Service ▶ p.251

Error Indication ▶ p.255

EN



Contents

Introduction	1	3.5 Inserting (Removing) an SD Memory Card	45
Confirming Package Contents	4	3.6 Connecting the Voltage Cords	47
Safety Notes.....	6	3.7 Connecting the Current Sensors	48
Usage Notes.....	7	3.8 Turning the Power On and Off (Setting the Default Language)	50
<hr/>			
Chapter 1 Overview	15		
1.1 Procedure for Investigating Power Supply Quality	15	Chapter 4 Configuring the Instrument before Measurement (SYSTEM - SYSTEM screen) and Wiring	
1.2 Product Overview	19		53
1.3 Features	20	4.1 Warm-up and Zero-adjust Operation	53
1.4 Measurement Flowchart	21	4.2 Setting the Clock	54
■ Start and Stop Recording	22	4.3 Configuring the Connection Mode and Current Sensors	55
		■ Connection diagram	57
		4.4 Setting the Vector Area (Tolerance Level)	61
		4.5 Connecting to the Lines to be Measured (Preparing for Current Measurement)	62
		4.6 Verifying Correct Wiring (Connection Check)	66
		4.7 Quick setup	68
		4.8 Verifying Settings and Starting Recording	71
		4.9 Using the Instrument during a Power Outage	72
		<hr/>	
Chapter 2 Names and Functions of Parts Basic Operations & Screens	23	Chapter 5 Changing Settings (as necessary)	
2.1 Names and Functions of Parts	23		73
2.2 Basic Operations	27	5.1 Changing Measurement Conditions	73
2.3 Display Items and Screen Types	29	5.2 Changing the Recording Settings ..	77
■ Common Display Items	29	<hr/>	
■ Warning Indicators	31		
■ Screen Types	32		
<hr/>			
Chapter 3 Measurement Preparations	39		
3.1 Preparation Flowchart	39		
3.2 Initial Instrument Preparations	40		
■ Affix color clips to the current sensors ..	40		
■ Bundle the voltage cord leads with the spiral tubes	41		
■ Attaching the strap	42		
■ Attaching the Z5020 Magnetic Strap ...	42		
■ Installing the battery pack	43		
3.3 Pre-Operation Inspection	44		
3.4 Connecting the AC Adapter	45		

5.3	Changing the Measurement Period	80
5.4	Changing Hardware Settings	83
5.5	Changing LAN Settings	86
5.6	Changing Event Settings	87
5.7	Initializing the Instrument (System Reset)	94
5.8	Factory Settings	95

Chapter 6 Monitoring Instantaneous Values (VIEW Screen) 97

6.1	Using the VIEW screen	97
6.2	Displaying Instantaneous Waveforms	98
6.3	Displaying Phase Relationships ([VECTOR] Screen)	102
6.4	Displaying Harmonics	105
	■ Displaying harmonics as a bar graph	105
	■ Displaying harmonics as a list	108
6.5	Displaying Measured Values Numerically (DMM Screen)	111

Chapter 7 Monitoring Fluctuations in Measured Values (TIME PLOT Screen) 113

7.1	Using the [TIME PLOT] Screen	115
7.2	Displaying Trends	116
7.3	Displaying detailed trends	123
	■ Displaying a detailed trend graph for each TIME PLOT interval 1	23
7.4	Displaying Harmonic Trends	129
7.5	Displaying Flicker Values in Graph and List Form	133
	■ IEC flicker meters and DV10 flicker meters	133
	■ Displaying an IEC flicker fluctuation graph	133
	■ Displaying an IEC flicker list	136

- Displaying a DV10 flicker fluctuation graph 137
- Displaying a DV10 flicker list 140

Chapter 8 Checking Events (EVENT screen) 141

8.1	Using the EVENT screen	142
8.2	Displaying the Event List	143
8.3	Analyzing the Measurement Line Status When Events Occur	147
8.4	Analyzing Transient Waveforms	149
8.5	Viewing High-order Harmonic Waveforms	152
8.6	Checking Fluctuation Data	155

Chapter 9 Data Saving and File Operations (SYSTEM-MEMORY screen) 159

9.1	[MEMORY] Screen	159
9.2	Formatting SD Memory Cards	162
9.3	Save Operation and File Structure	163
9.4	Saving, Display and Deleting Measurement Data	165
9.5	Saving, Displaying, and Deleting Screen Copies	168
9.6	Saving and Deleting Settings Files (Settings Data)	169
9.7	Loading Settings Files (Settings Data)	170
9.8	File and Folder Names	170
	■ Changing file and folder names	170

Chapter 10 Analyzing Data Using the Application 171

10.1	Using PQ ONE	171
10.2	Using GENNECT One	173

10.3 Installation	174
■ Installation procedure	174

Chapter 11 Connecting External Devices 177

11.1 Using the External Control Terminal	177
■ Connecting to the External Control Terminal	178
■ Using the event input terminal (EVENT IN)	179
■ Using the event input terminal (EVENT OUT)	180

Chapter 12 Operation with a Computer 181

12.1 Downloading Measurement Data Using the USB Interface	182
12.2 Control and Measurement via Ethernet ("LAN") Interface	183
■ LAN Settings and Network Environment Configuration	184
■ Instrument Connection	186
12.3 Remote Control of the Instrument by Internet Browser	188
■ Connecting to the Instrument	188
■ Operating Procedure	189
12.4 Downloading Recorded Data to Computer	191

Chapter 13 Specifications 195

13.1 General Specifications	195
13.2 Input Specifications/Output Specifications/Measurement Specifications	196
13.3 Screen Specifications	218
13.4 Event Specifications	229
13.5 GPS Time Synchronization Function	230
13.6 Interface Specification	231
13.7 Other Functions	233

13.8 Calculation Formula	234
13.9 Range Breakdown and Combination Accuracy	247

Chapter 14 Maintenance and Service 251

14.1 Cleaning	251
14.2 Trouble Shooting	252
14.3 Error Indication	255
14.4 Disposing of the Instrument	258

Appendix A1

Appendix 1 Fundamental Measurement Items	A1
Appendix 2 Explanation of Power Supply Quality Parameters and Events	A2
Appendix 3 Event Detection Methods	A5
Appendix 4 Recording TIME PLOT Data and Event Waveforms	A12
Appendix 5 Detailed Explanation of IEC Flicker and DV10 Flicker....	A16
Appendix 6 Making Effective Use of Channel 4	A19
Appendix 7 3-phase 3-wire Measurement	A22
Appendix 8 Method for Calculating Active Power Accuracy	A24
Appendix 9 Terminology.....	A25

Index

Index1

Introduction

Thank you for purchasing the Hioki PQ3198 Power Quality Analyzer. To obtain maximum performance from the instrument over the long term, be sure to read this manual carefully and keep it handy for future reference.

Be sure to also read the separate document “Operating Precautions” before use.

AC current sensors (optional; see p.5) are required in order to input current to the instrument. (AC current sensors are called "current sensors" throughout this manual.) For more information, see the instruction manual for the current sensors being used.

The latest edition of the instruction manual

The contents of this manual are subject to change, for example as a result of product improvements or changes to specifications.

The latest edition can be downloaded from Hioki's website.

<https://www.hioki.com/global/support/download/>



Product registration

Register this product in order to receive important product information.

<https://www.hioki.com/global/support/myhioki/registration/>



Following manuals are provided along with these models. Refer to the relevant manual based on the usage.

Type	Contents	Print	CD
Operating Precautions	Information on the instrument for safe operations	✓	—
Instruction Manual (This document)	Information about instrument functionality, detailed measurement methods, specifications, etc.	✓	—
Measurement Guide	This instrument's basic measurement methods	✓	—
Application software Instruction Manual	How to use the PQ ONE/GENNECT One application	—	✓

Target audience

This manual has been written for use by individuals who use the product in question or who teach others to do so. It is assumed that the reader possesses basic electrical knowledge (equivalent to that of someone who graduated from the electrical program at a technical high school).







Trademarks

- Microsoft Edge and Windows are either registered trademarks or trademarks of Microsoft Corporation in the United States and other countries.
- Sun, Sun Microsystems, Java, and any logos containing Sun or Java are trademarks or registered trademarks of Oracle Corporation in the United States and other countries.
- SD, SDHC Logos are trademarks of SD-3C LLC.
- Adobe and Adobe Reader are either trademarks or registered trademarks of Adobe in the United States and other countries.





Notation

Safety notations



In this document, the risk seriousness and the hazard levels are classified as follows.

 DANGER	Indicates an imminently hazardous situation that will result in death or serious injury to the operator.
 WARNING	Indicates a potentially hazardous situation that may result in death or serious injury to the operator.
 CAUTION	Indicates a potentially hazardous situation that may result in minor or moderate injury to the operator or damage to the instrument or malfunction.
NOTE	Advisory items related to performance or correct operation of the instrument.
IMPORTANT	Indicates information related to the operation of the instrument or maintenance tasks with which the operators must be fully familiar.
	Indicates a high voltage hazard. If a particular safety check is not performed or the instrument is mishandled, this may give rise to a hazardous situation; the operator may receive an electric shock, may get burnt or may even be fatally injured.
	Indicates a strong magnetic-field hazard. The effects of the magnetic force can cause abnormal operation of heart pacemakers and/or medical electronics.
	Indicates the prohibited action.

Symbols on the instrument

	Indicates cautions and hazards. Refer to the "Usage Notes" section of the instruction manual and the included "Operating Precautions" for more information.
	Indicates a grounding terminal.
	Indicates the ON side of the power switch.
	Indicates the OFF side of the power switch.
	Indicates AC (Alternating Current).

Symbols for various standards

	Indicates the Waste Electrical and Electronic Equipment Directive (WEEE Directive) in EU member states.
 Ni-MH	This is a recycle mark established under the Resource Recycling Promotion Law (only for Japan).
	Indicates that the product conforms to regulations set out by the EU Directive.

Others

(p.)	Indicates the location of reference information.
	Indicates quick references for operation and remedies for troubleshooting.
*	Additional information is presented below.
[]	Screen labels such as menu items, setting items, dialog titles and buttons are indicated by square brackets [].
CURSOR (Bold character)	Bold characters within the text indicate operating key labels.
Windows	Unless otherwise specified, "Windows" represents Windows XP, Windows Vista, or Windows 7, Windows 8, Windows 10.

Accuracy









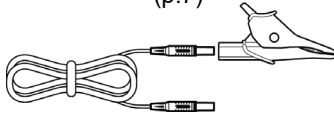

We define measurement tolerances in terms of f.s. (full scale), rdg. (reading) and dgt. (digit) values, with the following meanings:

f.s. (maximum display value or scale length):	The maximum displayable value or scale length. This is usually the name of the currently selected range.
rdg. (reading or displayed value):	The value currently being measured and indicated on the measuring instrument.
dgt. (resolution):	The smallest displayable unit on a digital measuring instrument, i.e., the input value that causes the digital display to show a "1" as the least-significant digit.

Confirming Package Contents

When you receive the instrument, inspect it carefully to ensure that no damage occurred during shipping. In particular, check the accessories, panel switches, and connectors. If damage is evident, or if it fails to operate according to the specifications, contact your authorized Hioki distributor or reseller.

<input type="checkbox"/> PQ3198 Power Quality Analyzer 1	
--	--

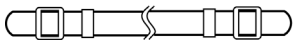
Accessories	
<input type="checkbox"/> L1000 Voltage Cord 1 set 3 m banana plug leads : 8 (red, yellow, blue, gray : 1 each, black: 4) Alligator clips : 8 (red, yellow, blue, gray : 1 each, black: 4) Spiral Tubes (Cord bundling): 20	(p.7) 
<input type="checkbox"/> Z1002 AC Adapter (includes power cord) 1	
<input type="checkbox"/> Z1003 Battery Pack 1 (Ni-MH, 7.2 V/4500 mAh)	
<input type="checkbox"/> USB Cable 1	
<input type="checkbox"/> Z4001 SD Memory Card 2 GB 1	
<input type="checkbox"/> Instruction Manual (This document) 1	
<input type="checkbox"/> Measurement Guide 1	
<input type="checkbox"/> Operating Precautions (0990A903) 1	
<input type="checkbox"/> CD (PC application software) 1 See: "Chapter 10 Analyzing Data Using the Application" (p.171) The latest version can be downloaded from our website.	
<input type="checkbox"/> Colored clips (red, yellow, blue, white) 2 each color coding for current sensors (Affix to current sensor as necessary)	
<input type="checkbox"/> Strap 1	

Options

The following options are available for the instrument. Contact your authorized Hioki distributor or reseller when ordering.

The options are subject to change. Visit our website for updated information.

Voltage measurement

- L9243 Grabber Clip
(CAT II, 1000 V, 1 A)
- 9804-01 Magnetic Adapter
(CAT IV, 1000 V, 2 A)
- 9804-02 Magnetic Adapter
(CAT IV, 1000 V, 2 A)
- L1000 Voltage Cord
- L1021-01 Patch Cord (red)
(CAT III, 1000 V, 10 A / CAT IV, 600 V, 10 A)
- L1021-02 Patch Cord (black)
(CAT III, 1000 V, 10 A / CAT IV, 600 V, 10 A)

Current sensors (current measurement)

- CT7126 AC Current Sensor
(60 A, ϕ 15 mm, can be extended to 10 m)
- CT7131 AC Current Sensor
(100 A, ϕ 15 mm, can be extended to 10 m)
- CT7136 AC Current Sensor
(600 A, ϕ 46 mm, can be extended to 10 m)
- CT7044 AC Flexible Current Sensor
(6000 A, ϕ 100 mm, can be extended to 10 m)
- CT7045 AC Flexible Current Sensor
(6000 A, ϕ 180 mm, can be extended to 10 m)
- CT7046 AC Flexible Current Sensor
(6000 A, ϕ 254 mm, can be extended to 10 m)
- CT7731 AC/DC Auto-Zero Current Sensor
(100 A, ϕ 33 mm, can be extended to 2 m)
- CT7736 AC/DC Auto-Zero Current Sensor
(600 A, ϕ 33 mm, can be extended to 2 m)
- CT7742 AC/DC Auto-Zero Current Sensor
(2000 A, ϕ 55 mm, can be extended to 2 m)
- CT7116 AC Leakage Current Sensor
(6 A, ϕ 40 mm, can be extended to 10 m)
- L9910 Conversion Cable (BNC-PL14)
- L0220-01 Extension Cable (Cable length: 2 m)
- L0220-02 Extension Cable (Cable length: 5 m)
- L0220-03 Extension Cable (Cable length: 10 m)

Power supply

- Z1002 AC Adapter
- Z1003 Battery Pack

Carrying cases

- C1001 Carrying Case (Soft type)
- C1002 Carrying Case (Hard type)
- C1009 Carrying Case (Bag type)

Wiring adapter

- PW9000 Wiring Adapter
(For use with 3-phase
3-wire (3P3W3M) voltages)
- PW9001 Wiring Adapter
(For use with 3-phase 4-wire
voltages)

Recording media

- Z4001 SD Memory Card (2 GB)
- Z4003 SD Memory Card (8 GB)

Other

- PW9005 GPS Box
(Build-to-order)
- 9642 LAN Cable
- Z5004 Magnetic Strap
- Z5020 Magnetic Strap

Safety Notes

This instrument is designed to conform to IEC 61010 Safety Standards and has been thoroughly tested for safety prior to shipment. However, using the instrument in a way not described in this manual may negate the provided safety features.

Before using the instrument, be certain to carefully read the following safety notes:



Mishandling the instrument could result in bodily injury or even death, as well as damage to the instrument. Familiarize yourself with the instructions and precautions in this manual before using the instrument.

Protective gear



This instrument is measured on a live line. To prevent an electric shock, use appropriate protective insulation and adhere to applicable laws and regulations.

Measurement categories

To ensure safe operation of measuring instruments, IEC 61010 establishes safety standards for various electrical environments, categorized as CAT II to CAT IV, and called measurement categories.



- Using a measuring instrument in an environment designated with a higher-numbered category than that for which the instrument is rated could result in a severe accident, and must be carefully avoided.
- Never use a measuring instrument that lacks category labeling in a CAT II to CAT IV measurement environment. Doing so could result in a serious accident.

This instrument conforms to the safety requirements for CAT IV 600 V measuring instruments.

CAT II:	When directly measuring the electrical outlet receptacles of the primary electrical circuits in equipment connected to an AC electrical outlet with a power cord (portable tools, household appliances, etc.).
CAT III:	When measuring the primary electrical circuits of heavy equipment (fixed installations) connected directly to the distribution panel, and feeders from the distribution panel to outlets.
CAT IV:	When measuring the circuit from the service drop to the service entrance, and to the power meter and primary overcurrent protection device (distribution panel).

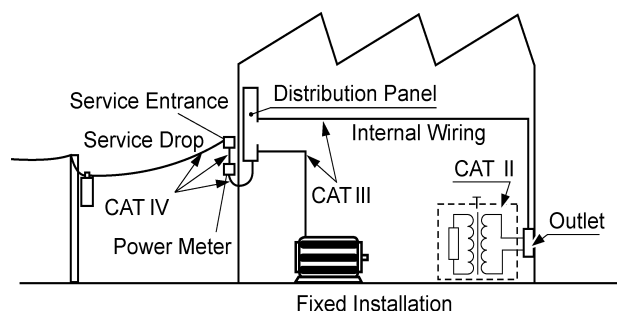

Usage Notes

Follow these precautions to ensure safe operation and to obtain the full benefits of the various functions.

Ensure that your use of the instrument falls within the specifications not only of the instrument itself, but also of any accessories, options and other equipment being used.

Before Use



DANGER

If the voltage cord or the instrument is damaged, there is a risk of an electric shock. Perform the following inspection before using the instrument:

- Check that the insulation of the voltage cord are neither ripped nor torn and that no metal parts are exposed. Using the instrument under such conditions could result in an electric shock. Replace the voltage cord with those specified by our company.
- Before using the instrument, check it and verify that it operates properly to make sure that it suffered no damage during storage or transportation. If you find any damage or failure, contact your authorized Hioki distributor or reseller.

Instrument Installation



WARNING

Installing the instrument in inappropriate locations may cause a malfunction of instrument or may give rise to an accident. Avoid the following locations:

- Exposed to direct sunlight or high temperature
- Exposed to corrosive or combustible gases
- Exposed to a strong electromagnetic field or electrostatic charge
- Near induction heating systems (such as high-frequency induction heating systems and IH cooking equipment)
- Susceptible to vibration
- Exposed to water, oil, chemicals, or solvents
- Exposed to high humidity or condensation
- Exposed to high quantities of dust particles



CAUTION

Do not place the instrument on an unstable table or inclined place. Dropping or knocking down the instrument can cause injury or damage to the instrument.

Installing

- The instrument should be operated only with the bottom or rear side downwards.
- Vents (on the left and right side of the instrument) must not be obstructed.

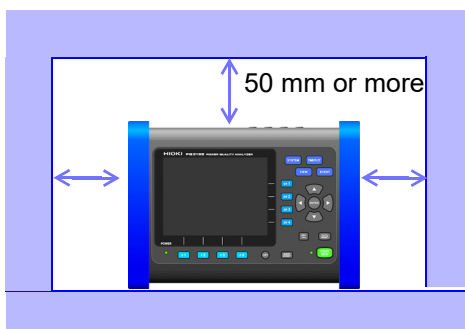

Shipping precautions

Store the packaging in which the instrument was delivered, as you will need it when transporting the instrument.

Handling the Instrument

DANGER

To avoid electric shock, do not open the instrument's case. The internal components of the instrument carry high voltages and may become very hot during operation.

CAUTION

- If the instrument exhibits abnormal operation or display during use, review the information in "14.2 Trouble Shooting" (p.252) and "14.3 Error Indication" (p.255) before contacting your authorized Hioki distributor or reseller.
- To avoid damage to the instrument, protect it from physical shock when transporting and handling. Be especially careful to avoid physical shock from dropping.
- The protection rating for the enclosure of this device (based on EN60529) is *IP30.

*IP30:

This indicates the degree of protection provided by the enclosure of the device against use in hazardous locations, entry of solid foreign objects, and the ingress of water.

3: Protected against access to hazardous parts with tools more than 2.5 mm in diameter. The equipment inside the enclosure is protected against entry by solid foreign objects larger than 2.5 mm in diameter.

0: Not protected against use in hazardous locations. The enclosure does not protected against entry by solid foreign objects.

NOTE

This instrument may cause interference if used in residential areas. Such use must be avoided unless the user takes special measures to reduce electromagnetic emissions to prevent interference to the reception of radio and television broadcasts.

Handling the cords and current sensors

DANGER

If the insulation on a cord melts, the metal conductor may be exposed. Do not use any cord whose metal conductor is exposed. Doing so could result in an electric shock, burn, or other hazards.

WARNING

To prevent an electric shock, do not exceed the every rating shown on either the instrument or the options for voltage measurement, whichever is worse.

CAUTION

- The cable is hardened in freezing temperatures. Do not bend or pull it to avoid tearing its shield or cutting cable.
- To prevent damage to the instrument and current sensor, never connect or disconnect a sensor while the instrument's power is on.
- To avoid damaging the power cord, grasp the plug, not the cord, when unplugging it from the power outlet.
- To avoid breaking the cables, do not bend or pull them.
- For safety reasons, when taking measurements, only use the L1000 Voltage Cord.
- Avoid stepping on or pinching cables, which could damage the cable insulation.
- To prevent damage to the BNC connector, be sure to release the locking mechanism, grip the head of the connector (not the cord), and pull it out.
- To avoid damaging the cables, unplug it by grasping the connector, not the cable.
- When disconnecting the current sensor from the instrument, be sure to grip the part of the connector with the arrows and pull it straight out. Gripping the connector elsewhere or pulling with excessive force may damage the connector.
- Avoid dropping or jarring the clamps, which could damage the jaw, adversely affecting measurement.
- Do not place any foreign object between the jaws or insert any foreign object into the gap of the sensor head. Doing so may worsen the performance of the sensor or the opening-closing operation of the sensor head.
- Keep the clamp closed when not in use, to avoid accumulating dust or dirt on the facing core surfaces, which could interfere with clamp performance.

IMPORTANT

Use only the Hioki specified voltage cords and input cables. Using a non-specified cable may result in incorrect measurements due to poor connection or other reasons.

Before Connecting Measurement Cables

WARNING

- To avoid electric shock, turn off the power to all devices before plugging or unplugging any cables or peripherals.
- Be sure to connect the voltage input and current input terminals correctly. An incorrect connection could damage or short circuit this instrument.
- In order to prevent electric shock or device damage, observe the following precautions when making connections to the external control terminals and other interface connectors.
 - Turn off the instrument and any equipment being connected before connecting the measurement cables.
 - Exercise care not to exceed the ratings of external control terminal and interface connector signals.
 - Make connections securely to avoid the risk of connections coming loose during instrument operation and bringing wires into contact with other electrically conductive parts.
 - Ensure that devices and systems to be connected to the external control terminals are properly isolated.

CAUTION

- To avoid electric shock and short-circuit accidents, use only the supplied voltage cords to connect the instrument input terminals to the circuit to be tested.
- To avoid equipment failure, do not disconnect the communications cable while communications are in progress.
- Use a common ground for both the instrument and the computer. Using different ground circuits will result in a potential difference between the instrument's ground and the computer's ground. If the communications cable is connected while such a potential difference exists, it may result in equipment malfunction or failure.
- Before connecting or disconnecting any communications cable, always turn off the instrument and the computer. Failure to do so could result in equipment malfunction or damage.
- After connecting the communications cable, tighten the screws on the connector securely. Failure to secure the connector could result in equipment malfunction or damage.

About the AC adapter

WARNING

- To prevent an electric shock and to maintain the safety specifications of this instrument, connect the power cord provided only to an outlet.
- Turn the instrument off before connecting the AC adapter to the instrument and to AC power.
- Use only the supplied Hioki Model Z1002 AC Adapter. AC adapter input voltage range is 100 V AC to 240 V AC (with $\pm 10\%$ stability) at 50 Hz/60 Hz. To avoid electrical hazards and damage to the instrument, do not apply voltage outside of this range.

About the battery pack

WARNING

- For battery operation, use only the Hioki Model Z1003 Battery Pack. We do not take any responsibility for accidents or damage related to the use of any other batteries.
- To avoid electric shock, turn off the power switch and disconnect the power cord, voltage cord, and current sensor from the object under measurement before replacing the battery pack.
- To prevent the instrument damage or electric shock, use only the screws for securing the battery cover in place that are originally installed.
If you have lost any screws or find that any screws are damaged, please contact your authorized Hioki distributor or reseller for a replacement.

CAUTION

To avoid problems with battery operation, remove the batteries from the instrument if it is to be stored several week or more.

NOTE

The battery pack is subject to self-discharge. Be sure to charge the battery pack before initial use. If the battery capacity remains very low after correct recharging, the useful battery life is at an end.

Others

CAUTION

Avoid using an uninterruptible power supply (UPS) or DC/AC inverter with rectangular wave or pseudo-sine-wave output to power the instrument. Doing so may damage the instrument.

Before Connecting to the Lines to be Measured

DANGER

- To avoid short circuits and potentially life-threatening hazards, never attach the current sensor to a circuit that operates at more than the maximum rated voltage to earth. Also, do not perform measurement around a bare conductor. (See your current sensor's instruction manual for its maximum ratings.)
- Do not use the instrument to measure circuits that exceed its ratings or specifications. Damage to the instrument or overheating can cause bodily injury. To avoid electrical hazards and damage to the instrument, do not apply voltage exceeding the rated maximum to the input terminals.
- Do not short-circuit two wires to be measured by bringing the voltage cord clip or current sensor into contact with them. Arcs or such grave accidents are likely to occur.
- To prevent a short-circuit or electric shock, do not touch the metal part of the connecting voltage cord tip.
- To prevent electrical shock and personnel injury, do not touch any input terminals on the VT (PT), CT or the instrument when they are in operation.

WARNING

Connect measurement lines to Model L1000 Voltage Cord securely. If a terminal is loose, the contact resistance will increase, resulting in overheating, equipment burnout, or a fire.

CAUTION

When the instrument's power is turned off, do not apply voltage to the instrument. Doing so may damage the instrument.

While Measuring

WARNING

If an abnormality such as smoke, strange sound or offensive smell occurs, stop measuring immediately, disconnect from the measurement lines, turn off the instrument, unplug the power cord from the outlet, and undo any changes to the wiring. Contact your authorized Hioki distributor or reseller as soon as possible. Continuing to use the instrument may result in fire or electric shock.

Disc precautions

NOTE

- Exercise care to keep the recorded side of discs free of dirt and scratches. When writing text on a disc's label, use a pen or marker with a soft tip.
- Keep discs inside a protective case and do not expose to direct sunlight, high temperature, or high humidity.
- Hioki is not liable for any issues your computer system experiences in the course of using this disc.

Using the Magnetic Adapter and Magnetic Strap

DANGER



Persons wearing electronic medical devices such as a pacemaker should not use magnetic adapter and magnetic strap. Such persons should avoid even proximity to the magnetic adapter and magnetic strap, as it may be dangerous. Medical device operation could be compromised, presenting a hazard to human life.

WARNING



Ingesting a magnetic adapter and magnetic strap can cause life-threatening complications. Exercise particular care to keep magnetic adapter and magnetic strap out of the reach of small children. If someone accidentally swallows it, seek immediate medical treatment.

CAUTION

- Do not subject the magnetic adapter and magnetic strap to mechanical shock, for example, due to dropping it. Shock can cause it to be chipped or cracked.
- Do not use the magnetic adapter and magnetic strap in locations where it may be exposed to rainwater, dust, or condensation. In those conditions, the magnetic adapter and magnetic strap may be decomposed or deteriorated. The magnet adhesion may be diminished. In such case, the instrument may not be hung in place and may fall.
- Do not bring the magnetic adapter and magnetic strap near magnetic storage device such as floppy disks, magnetic cards, pre-paid cards, or magnetized tickets. Doing so may corrupt and may render them unusable. Furthermore, if the magnetic adapter and magnetic strap is brought near precision electronic equipment such as computers, TV screens, or electronic wrist watches, they may fail.

Overview

Chapter 1

1

Chapter 1 Overview

1.1 Procedure for Investigating Power Supply Quality

By measuring power supply quality parameters, you can assess the power supply's quality and identify the causes of various power supply malfunctions. The PQ3198's ability to measure all power supply quality parameters simultaneously makes this process a quick and simple one.

This chapter describes the power supply quality investigation process.

Step 1: Identifying a clear objective

1

To assess power supply quality (power quality)

(There is no known problem with the power supply, and you simply wish to assess its quality.)

- Periodic power supply quality statistical investigations
- Testing after the installation of electric or electronic equipment
- Load investigation
- Preventive maintenance



Go to Step 3.

2

To find the cause of a power supply malfunction

(You have discovered a power supply malfunction such as an equipment failure or malfunction and wish to address it quickly.)



Go to Step 2.

Step 2: Identifying the malfunctioning component (measurement location)

Check the following:

1**Where is the issue occurring?**

- Principal electrical system
(Large copier, uninterruptible power supply, elevator, air compressor, air conditioning compressor, battery charger, cooling system, air handler, time-controlled lighting, variable-speed drive, etc.)
- Electric distribution system
(Conduit [electrical conduit] damage or corrosion, transformer heating or noise, oil leak, circuit breaker operation or overheating)

2**When does the issue occur?**

- Does it occur continuously, regularly, or intermittently?
- Does it occur at a specific time of day or on a specific day?

3**What type of investigation (measurement) should be performed to find the cause?**

(It is recommended to measure voltage, current, and possibly power continuously. By analyzing voltage and current trends when the issue occurs, it will be easier to pinpoint the cause of the problem. Additionally, simultaneously measuring multiple locations is an effective way to quickly identify the cause.)

- Electrical substation internal lines (power companies only)
- High or low voltage at a service line entrance
- Distribution boards and switchboards
- Outlets and other points of power supply for electric and electronic equipment

4**What is the expected cause?**

- Voltage abnormalities (RMS value fluctuations, waveform distortion, transient voltages, high-order harmonics [noise at frequencies of several kHz and above])
 - Current abnormalities (leak current, inrush current)
-

Step 3: Checking investigation (measurement) locations (collecting site data)

Collect information (site data) from as many locations as possible to prepare for the investigation. Check the following:

1. Connection (1P2W/1P3W/3P3W2M/3P3W3M/3P4W/3P4W2.5E)
2. Nominal input voltage (100 V to 600 V)
3. Frequency (50 Hz/60 Hz)
4. Need for neutral wire measurement and DC voltage measurement
5. Current capacity (necessary in order to select current sensor to use for measurement)
6. Other items related to the facility as a whole (check for presence of other systems with malfunctioning power supplies, principal electrical system operating cycle, additions or changes to facility equipment, facility distribution circuitry)

Step 4: Making measurements with the power supply quality analyzer

Measurements are performed using the following procedure:

1. Perform quick setup and adjust the relevant settings.
 - Connect the measurement line and select the quick setup according to your objective. (When using the instrument to identify a power supply malfunction whose cause is unknown, it is recommended to select the voltage abnormality detection pattern.)
 - Verify that the proper connection has been selected on the **[SYSTEM]** screen and that the settings have been configured appropriately (nominal input voltage, frequency, range, interval time, etc.). Verify that events are not being generated too frequently.
 - If, based on the information obtained in Steps 2 and 3 above, you find that some necessary settings have not been configured by the quick setup process, reconfigure them on the **[SYSTEM]** screen.
 - Check instantaneous values (voltage level, voltage waveform, current waveform, voltage waveform distortion [THD]) on the **[VIEW]** screen.
2. Start recording.
 - Press the **START/STOP** button to start recording. (Thresholds will have already been set during the quick setup process.)
 - Check the event detection state on the **[EVENT]** screen. If necessary, cancel recording and change the settings or thresholds. (If too many events are occurring, you can increase the thresholds based on measurement results.)
 - Continue recording for the necessary period, check the state of the power supply malfunction based on the detected events, and take corrective action as appropriate. (The PQ3198 can be used not only for the investigation phase, but also to verify the effectiveness of corrective action taken.)

Advice for identifying the cause of abnormalities

■ Record voltage and current trends at the power circuit inlet.

If current consumption in a building is high while the voltage is low, the cause likely lies inside the building. If the voltage and current are both low, the cause is likely to lie outside the building. It's extremely important to select the right measurement locations and to measure current.

■ Check power trends.

Overloaded equipment can cause problems. By understanding power trends, you can more easily identify problematic equipment and locations.

■ Check when the problem occurs.

Equipment that is operating or turning off or on when abnormalities (events) are recorded may be problematic. By understanding the precise times at which abnormalities (events) start and stop, you can more easily identify problematic equipment and locations.

■ Check for heat and unusual sounds.

Motors, transformers, and wiring may produce heat or unusual sounds due to causes such as overloading or harmonics.

1.2 Product Overview

The PQ3198 Power Quality Analyzer is an analytical instrument for monitoring and recording power supply anomalies, allowing their causes to be quickly investigated. The instrument can also be used to assess power supply problems (voltage drops, flicker, harmonics, etc.).

- Record abnormal waveforms
 - Record voltage fluctuations
 - Observe power supply waveforms
 - Measure harmonics
 - Measure flicker
 - Measure power
- One instrument does it all!

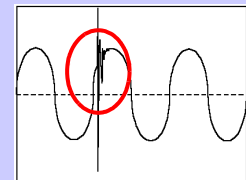

Transient voltages

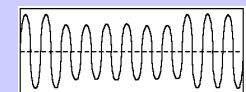

Voltage dips

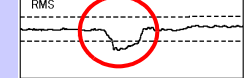

Voltage swells

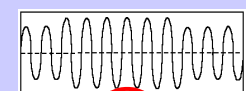

Interruptions

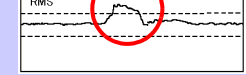

Harmonic

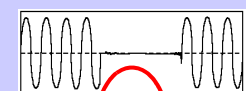

Flicker



How does the PQ3198 record abnormal waveforms?

The instrument automatically judges and records a range of problems.

Transient voltages

Transient voltages are caused by lightning strikes, circuit-breaker and relay contact obstructions and tripping, and other phenomena. They are often characterized by precipitous voltage variations and a high peak voltage.

Voltage dips (falling voltage)

Short-lived voltage drops are caused by the occurrence of a inrush current with a large load, such as when a motor starts.

Voltage swells (rising voltage)

In a voltage swell, the voltage rises momentarily due to a lightning strike or the switching of a high-load power line.

Interruptions

In an interruption, the supply of power stops momentarily or for a short or long period of time due to factors such as a circuit breaker tripping as a result of a power company accident or power supply short-circuit.

Harmonic and high-order harmonic elements

Harmonics are caused by distortions in the voltage and current caused by the semiconductor control devices that are frequently used in equipment power supplies.

Flicker (ΔV_{10} , IEC)

Flicker is caused by blast furnace, arc welding, and thyristor control loads. The resulting voltage fluctuations cause flicker in light bulbs and similar phenomena.

1.3 Features

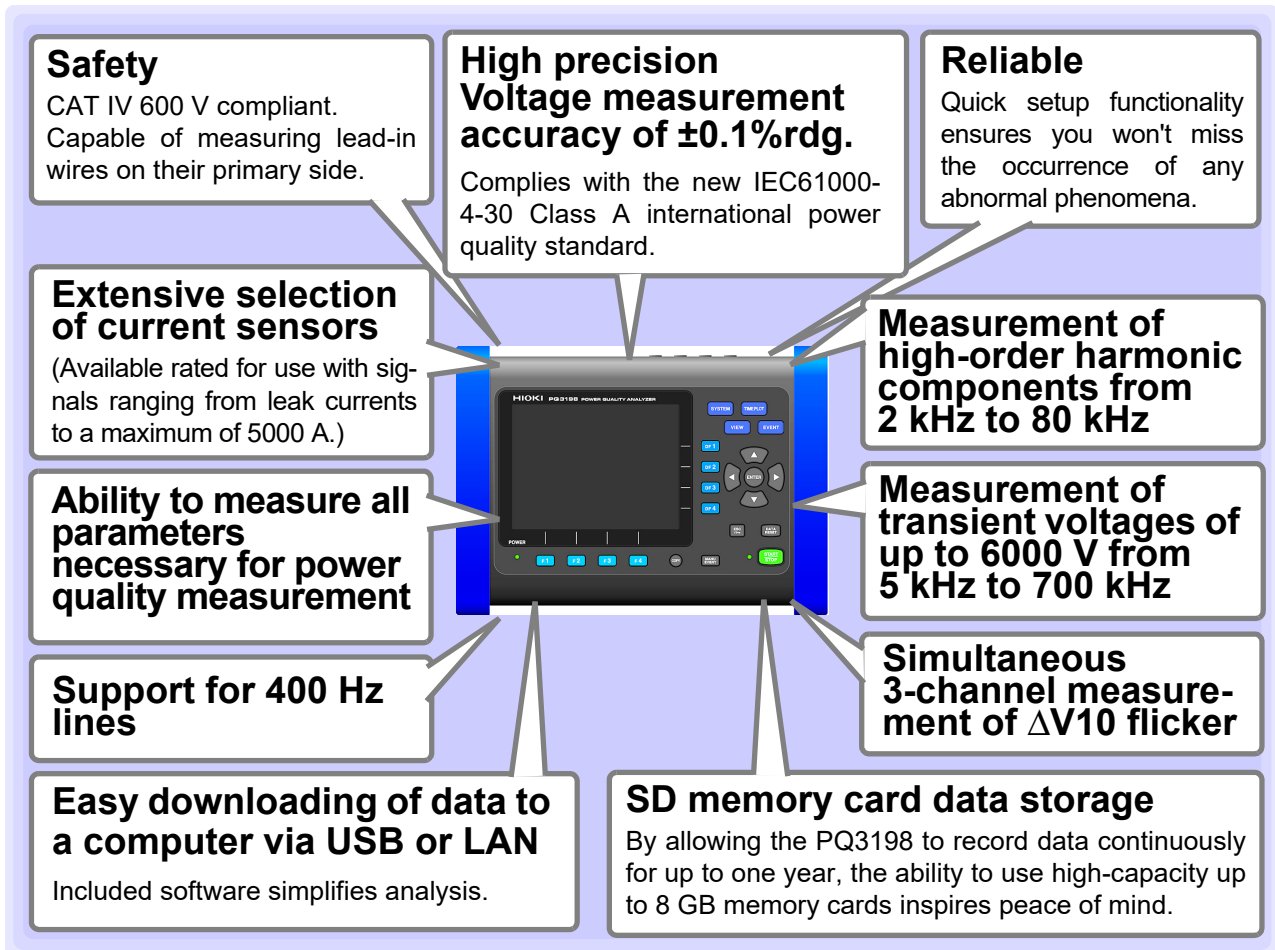

- ◆ Capable of accommodating 1-phase 2-wire, 1-phase 3-wire, 3-phase 3-wire, and 3-phase 4-wire power supplies.
- ◆ Features isolated channels for equipment analysis, neutral line ground fault measurement, and measurement of power supply lines from separate systems.
- ◆ Lets you select line voltage or phase voltage. Includes Δ -Y conversion and Y- Δ conversion functionality.
- ◆ Features a TFT color LCD that is easily visible in both bright and dark settings.
- ◆ Capable of true simultaneous measurement with gap-less continuous operation, assuring your ability to reliably capture target phenomena.
- ◆ Capable of accurately assessing the time at which phenomena occur. A GPS option allows time correction.
- ◆ Can be operated with peace of mind during an extended power outage thanks to a generous battery drive time of 180 minutes.
- ◆ Supports simple inverter measurement.*
Fundamental frequency: 40 Hz to 70 Hz; carrier frequency 20 kHz or less

*: It is recommended to use the PW6001 or PW3390 for high-precision measurement. Although this instrument may yield different voltage readings than the PW6001 and PW3390 due to differences in measurement band, it should yield approximately the same current and power values as the PW6001 and PW3390 since current waveforms approach the fundamental wave. It can also be used to measure the efficiency of DC/3-phase inverters.

1.4 Measurement Flowchart

Be sure to read "Usage Notes" (p.7) before measuring.

Measurement is performed using the following process:



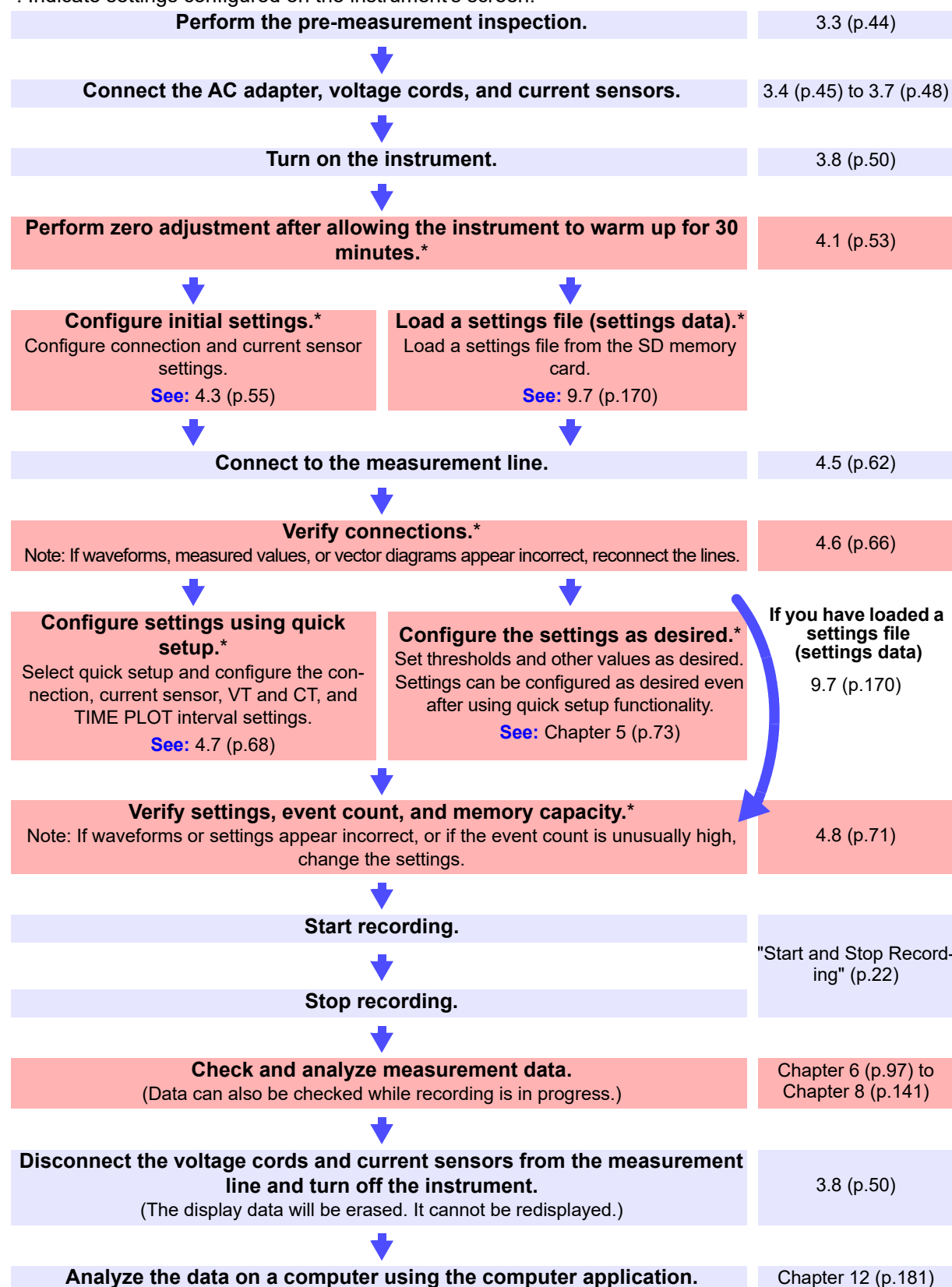

*: Indicate settings configured on the instrument's screen.

See:



Start and Stop Recording

You can start and stop recording either manually or using real-time control. In either case, repeat recording can be used.

	Manual	Real-time control
Start	Press  .	Press  to start recording at the set time and date.
	↓	↓
Stop	Press  to stop recording.	Stops automatically at the specified stop time. Press the  to force stop.
Notes		See: "Time Start" (p.80)
Repeated recording	Recording is performed at the specified interval (once a week or once a day), and files containing measurement data are created at the specified interval. Repeated recording can be used to record for up to 55 weeks (approx. 1 year). See: "Repeat Record" (p.81)	

To start a new recording session after recording has ended, press the **DATA RESET** key, set the instrument to **[Setting]** mode, and then press the **START/STOP** key. (Note that pressing the **DATA RESET** key will erase the displayed measurement data.)

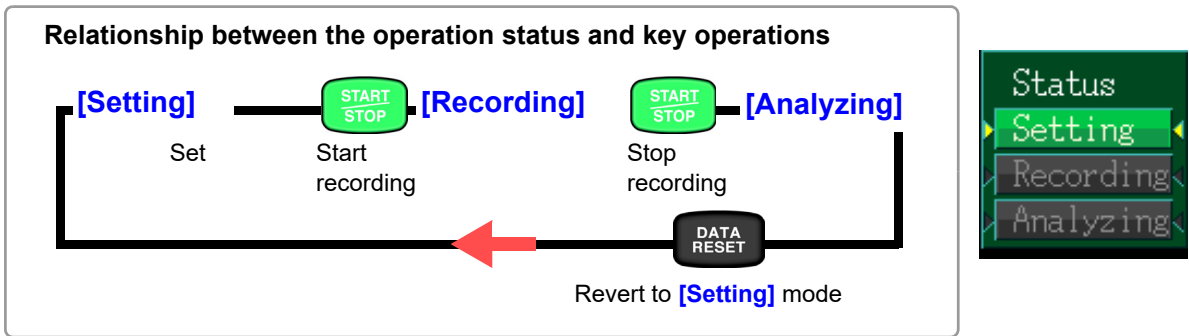

! CAUTION

Do not remove the SD memory card while recording or analyzing data. Doing so may cause data on the card to be corrupted.

Names and Functions of Parts Basic Operations & Screens

Chapter 2

2

Chapter 2 Names and Functions of Parts Basic Operations & Screens

2.1 Names and Functions of Parts

Front

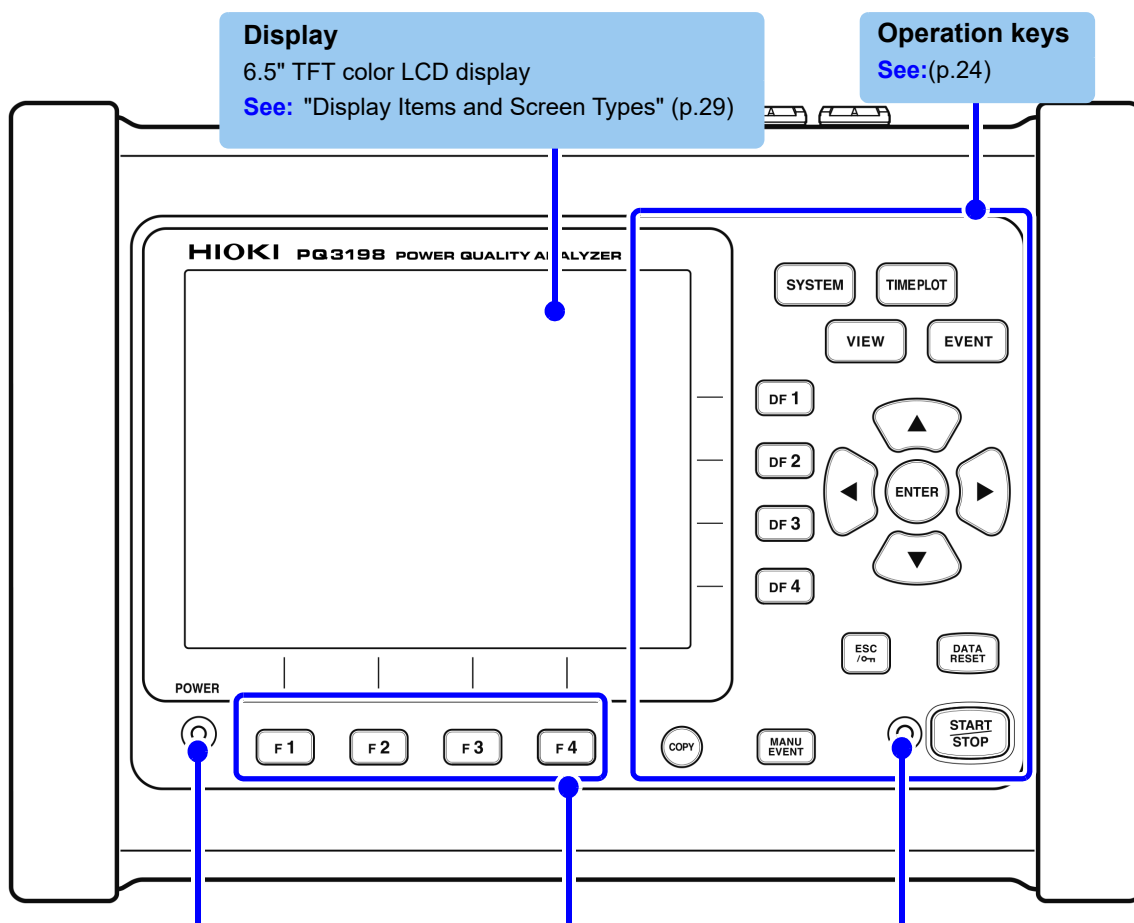
**Display**

6.5" TFT color LCD display

See: "Display Items and Screen Types" (p.29)**Operation keys****See:** (p.24)**POWER LED**

Lights up when the **POWER** switch is turned on and power is supplied to the instrument.

Normal operation: Solid green

When using battery pack: Solid red

See: "3.8 Turning the Power On and Off (Setting the Default Language)" (p.50)

F key (Function key)

Select and change display contents and settings.

See: "2.2 Basic Operations" (p.27)

START/STOP LED

When in the recording standby state:

Flashing green

When recording:

Solid green

Operation keys

Menu keys (Screen selection)

Press a key to select a screen.

SYSTEM	Displays the [SYSTEM] screen (which provides a list of system settings, event settings, recording condition settings, and memory [file] options [settings data, screen copy, measurement data]). (p.32)
VIEW	Displays the [VIEW] screen (which displays waveform and measured values). (p.34)
TIMEPLOT	Displays the [TIME PLOT] screen (which displays time series graphs). (p.36)
EVENT	Displays the [EVENT] screen (which displays an event list). (p.37)

DF keys (display function keys)

Selects which screen to display from the selected **[SYSTEM]**, **[VIEW]**, **[TIME PLOT]**, or **[EVENT]** screen.

ESC key

Cancels any selections or changes made and reverts to the previous settings.

Pressing and holding this key for at least 3 seconds activates the key lock function. (To cancel the key lock, press and hold for at least 3 seconds again.) (p.28)

Cursor keys

Select a setting on the screen. The cursor keys are also used to scroll through graphs or waveforms.

ENTER key

Finalizes the selected or changed item.

DATA RESET key

Deletes all measurement data being presently displayed from the instrument's internal memory. (Data stored on the SD memory card will not be deleted.) To start a new recording session, press this key to reset the data.

COPY key

Outputs data from the currently displayed screen to the SD memory card.

MANU EVENT key

Generates an event, initiating recording of measured values and event waveforms.

START/STOP key

Starts and stops recording. To resume recording, press the **DATA RESET** key to reset the data followed by the **START/STOP** key.

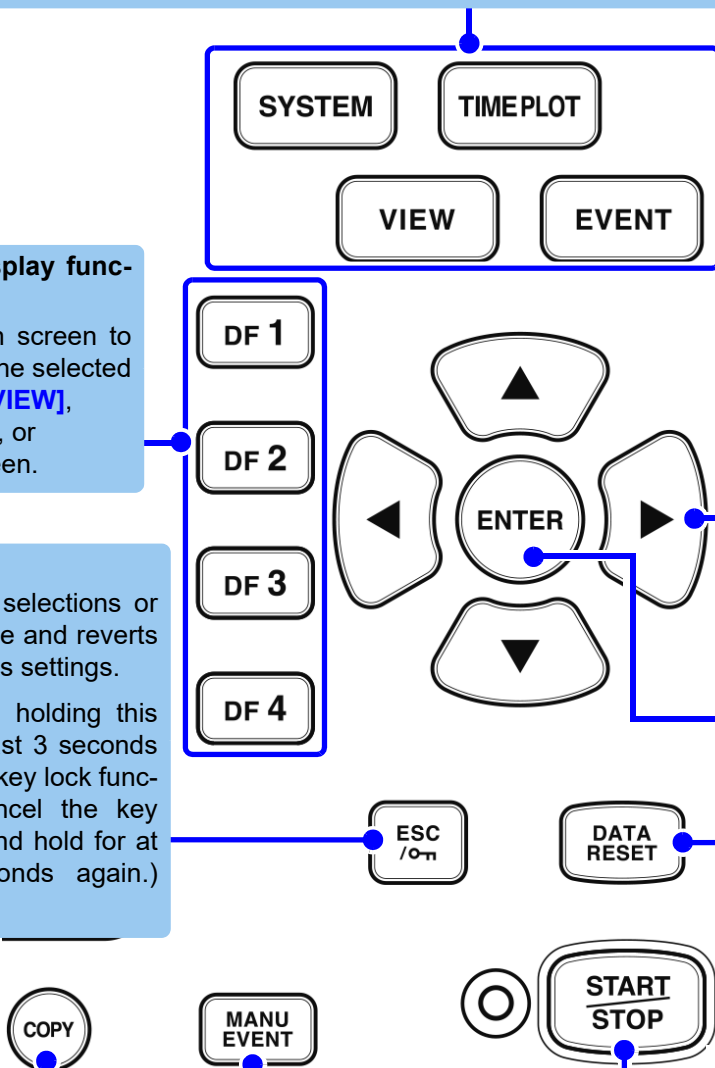

Upper side

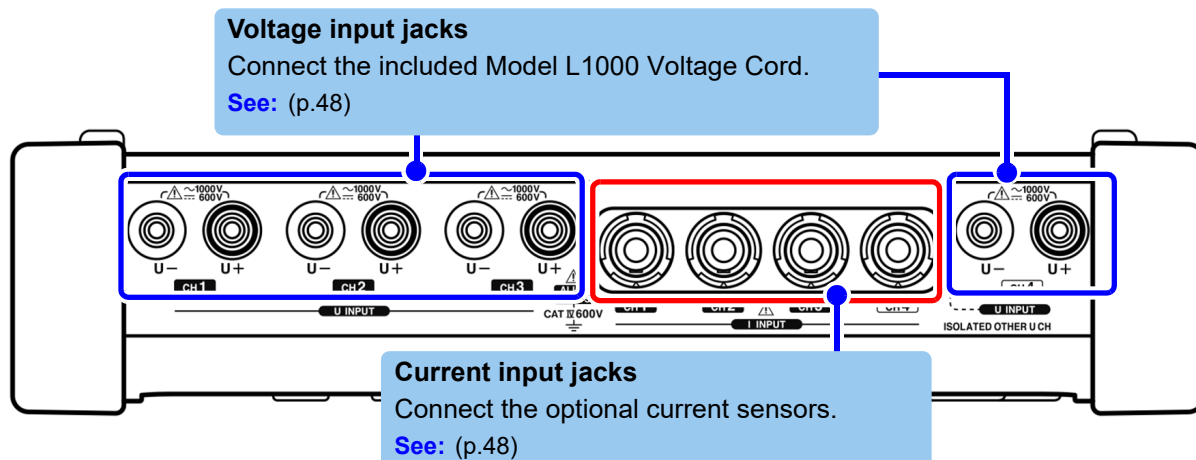

Right side

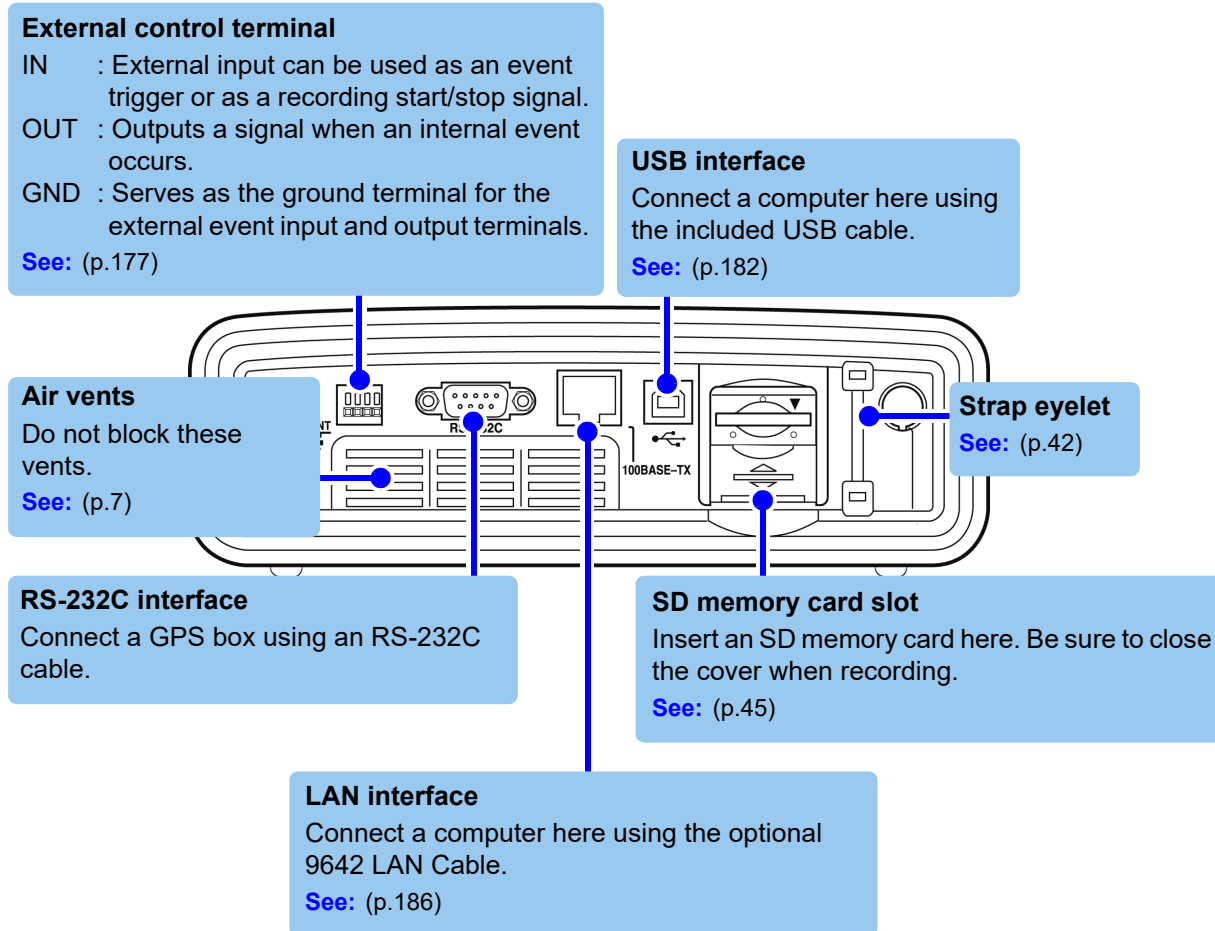

Left side

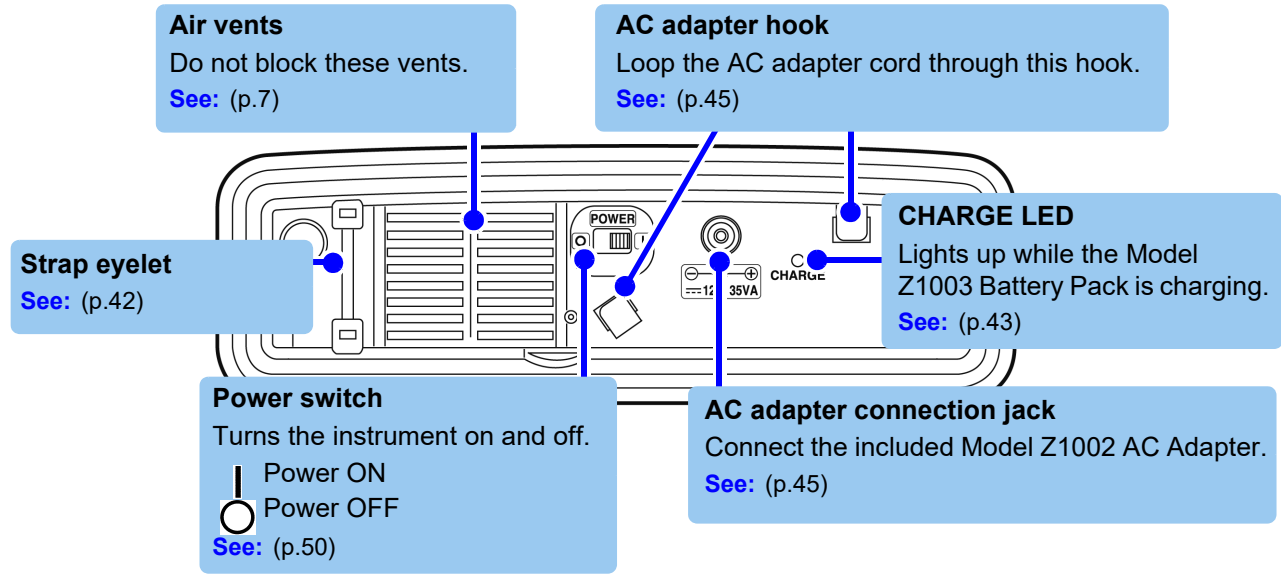

Back

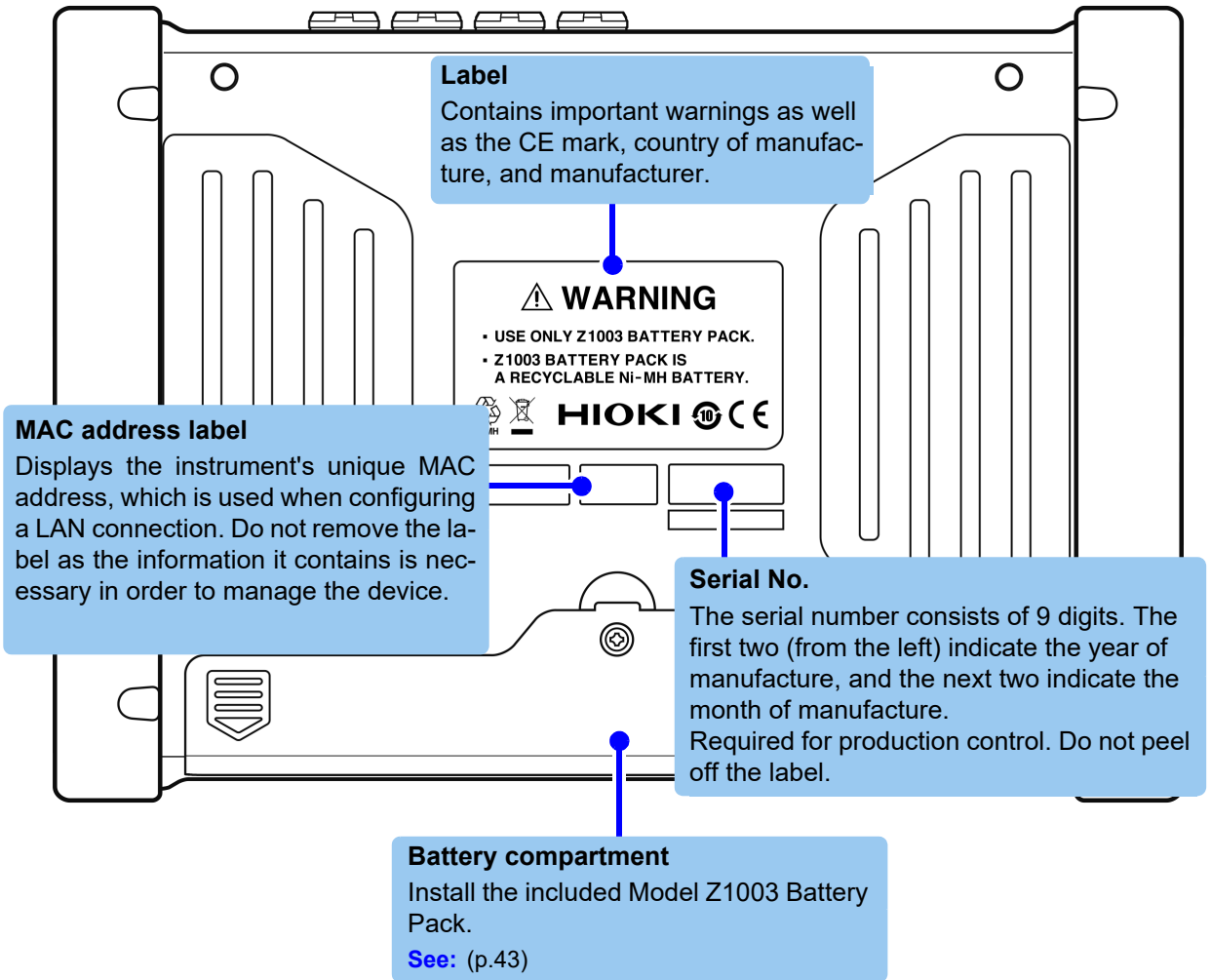

2.2 Basic Operations

1 To select a display screen

Press **SYSTEM**, **VIEW**, **TIME PLOT**, or **EVENT** to display the corresponding screen.

See: "2.3 Display Items and Screen Types" (p.29)

2 Select the screen to display.

Press one of the **DF** keys to select and change display contents and settings. The displayed function labels depend on the currently displayed screen.



3 To select and change display contents and settings

Press one of the **F** keys to select and change display contents and settings. The displayed function labels depend on the currently displayed screen.

Freeze the waveform or value display.

On the **[VIEW]** screen, you can freeze the waveform or value display by pressing the **F4 [HOLD]** key.

5 Start/stop recording.

Press the **START/STOP** key to start/stop recording.

See: "Start and Stop Recording" (p.22)

6 Revert to [Setting] mode after stopping recording.

Press the **DATA RESET** key to reset the measurement data. The instrument will return to **[Setting]** mode from **[Analyzing]** mode.

4 Select and finalize the desired settings.

- Move the cursor to the desired setting
- Display a pull-down menu
- Select the desired setting
- Accept setting
- Cancel the setting

To change a value

- Move the cursor to the desired setting
- Select the value so that it can be changed
- Select a digit
- Select a value
- Accept setting
- Cancel

7 Engage the key lock.

Press and hold the **ESC** key for at least 3 seconds. To cancel the key lock, press and hold the key for at least 3 seconds.

To engage the passcode-protected lock

Press and hold the ESC key for at least 3 seconds, and then enter your passcode in four digits or less. Similarly, to disengage the passcode-protected lock, press and hold the ESC key for 3 seconds, and then enter the passcode you entered when engaging the passcode-protected lock. If you engaged the key lock with entering a passcode, entering the same passcode is required to disengage the lock. If you engaged the key lock without setting a passcode, you can disengage the lock without entering a passcode.

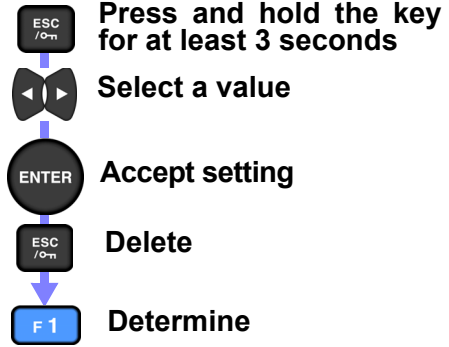

8 Save screen data.

Press the **COPY** key. Data will be saved to the SD card.

See: "9.5 Saving, Displaying, and Deleting Screen Copies" (p.168)

9 Generate an event manually.

Press the **MANU EVENT** key. Measured values and event waveforms at that time will be recorded.

See: "Manual Events" (p.11)

2.3 Display Items and Screen Types

Common Display Items

These items are displayed on every screen.

Screen Types

The tab for the currently displayed screen is shown brighter than the rest.

2, 3

The screenshot shows the instrument's main display screen with several callouts and annotations:

- 1**: Callout pointing to the SD card status indicator (a small SD card icon) in the top right corner.
- 2**: Callout pointing to the 'Status' menu item in the right-hand navigation pane.
- 3**: Callout pointing to the 'U_{in} 230V' and 'f_{nom} 50Hz' display items at the top of the screen.
- 4**: Callout pointing to the 'Zero Adjust' button in the bottom left corner.
- 5**: Callout pointing to the date and time display '2018/11/29 18:18:53' in the bottom right corner.
- 6**: Callout pointing to the 'EVENT 0' display item at the top of the screen.
- Help comment**: A text box explaining that the help comment displays an explanation for the item highlighted by the cursor. It also includes instructions: 'Use up-down cursor to select. Hit ENTER to confirm and ESC to cancel.'
- Current CH1 to CH4 connection state, voltage range, current range settings**: A callout pointing to the wiring diagram area.
- Nominal input voltage and measurement frequency (nominal frequency) settings**: A callout pointing to the 'U_{in} 230V' and 'f_{nom} 50Hz' display items.

1 SD memory card operation and usage status display

	Lights up when no SD card is inserted.
	Lights up when an SD memory card is inserted.
	Lights up when the SD memory card is being accessed.

TIME PLOT data capacity

Once the memory is full, no additional data can be recorded.









2 Operating State Indicators





	Indicates Data Hold is active.
	Lights to indicate Key Lock is active (keys are locked), after holding the ESC key for three seconds.
	Lights up when settings can be configured.
	The [Setting] indicator shows [Waiting] from the time that the START/STOP key is pressed until recording actually starts. During repeated recording, [Waiting] is also displayed when recording is stopped.
	Lights up when data is being recorded.
	Lights up when the instrument is in [Analyzing] mode after recording stops.

2.3 Display Items and Screen Types

3 Interface status display

	Lights up during normal operation.
	Lights up when the instrument is both connected to an HTTP server and downloading data.
	Lights up when the instrument is downloading data.
	Lights up when the instrument is connected to an HTTP server.
 (Blue)	Lights up when GPS positioning is active while connected to the PW9005 GPS Box.
 (Red)	Lights up when the RS connected device is set to GPS but the PW9005 GPS Box is not yet connected.
 (Yellow)	Lights up when the PW9005 GPS Box is connected but GPS positioning is not yet active.

4 Power supply status display



 (White)	Lights up when the instrument is being powered by the AC adapter. The POWER LED will turn green.
 (Orange)	Lights up when the instrument is being powered by the AC adapter and the battery is charging. The POWER LED will turn green.
 (White)	Lights up when the instrument is being powered by the battery. The POWER LED will turn red.
 (Red)	Lights up when the instrument is being powered by the battery and the remaining battery life is limited. Connect the AC adapter and charge the instrument. The POWER LED will turn red.
No display	No display indicates that the instrument is off or charging. The CHARGE LED will light up.

5 Real-time clock display

Displays the present year, month, day, hour, minute, and second.

See: Setting the Clock: (p.84)

6 Event generation status display





 (Orange)	An event has been detected.
 (White)	No event has been detected.

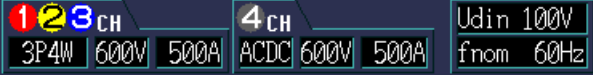

* : When the Max. Recordable events is set to 9999

Warning Indicators

The instrument may display the following warnings:

Display	Cause	Solution and page number for more information
	Normal screen display	-
<p>(Current range indicator turns red.)</p> 	Range or crest factor exceeded (current).	Switch to an appropriate current sensor. See: "Options" (p.5) Change the settings to an appropriate range. See: "5.1 Changing Measurement Conditions" (p.73)
<p>(Voltage indicator turns red.) ([Udin] indicator turns red.)</p> 	<ol style="list-style-type: none"> 1. Range or crest factor exceeded (voltage). 2. The measured value and nominal input voltage ([Udin])* differ. 	For (1), the measured value has exceeded the voltage value that the instrument is capable of measuring. Use VT (PT) to make the measurement. If only (2) applies, change the nominal input voltage to an appropriate value. See: "5.1 Changing Measurement Conditions" (p.73)
<p>([fnom] indicator turns red.)</p> 	The measurement frequency (nominal frequency [fnom]) and measured value differ.	Change the measurement frequency to an appropriate value. See: "5.1 Changing Measurement Conditions" (p.73)
<p>(The voltage range indicator and current range indicator are grayed out.)</p> 	VT (PT) and CT have been set.	-

*: The nominal input voltage (Udin), which is calculated from the nominal supply voltage using the transformer ratio, indicates the voltage that is actually input to the instrument.

Screen Types

SYSTEM

Configure settings (SYSTEM screen)

The [SYSTEM] screen is used to configure various instrument settings. Press the **SYSTEM** key to display the [SYSTEM] screen. The screen can be changed with the **DF** keys.

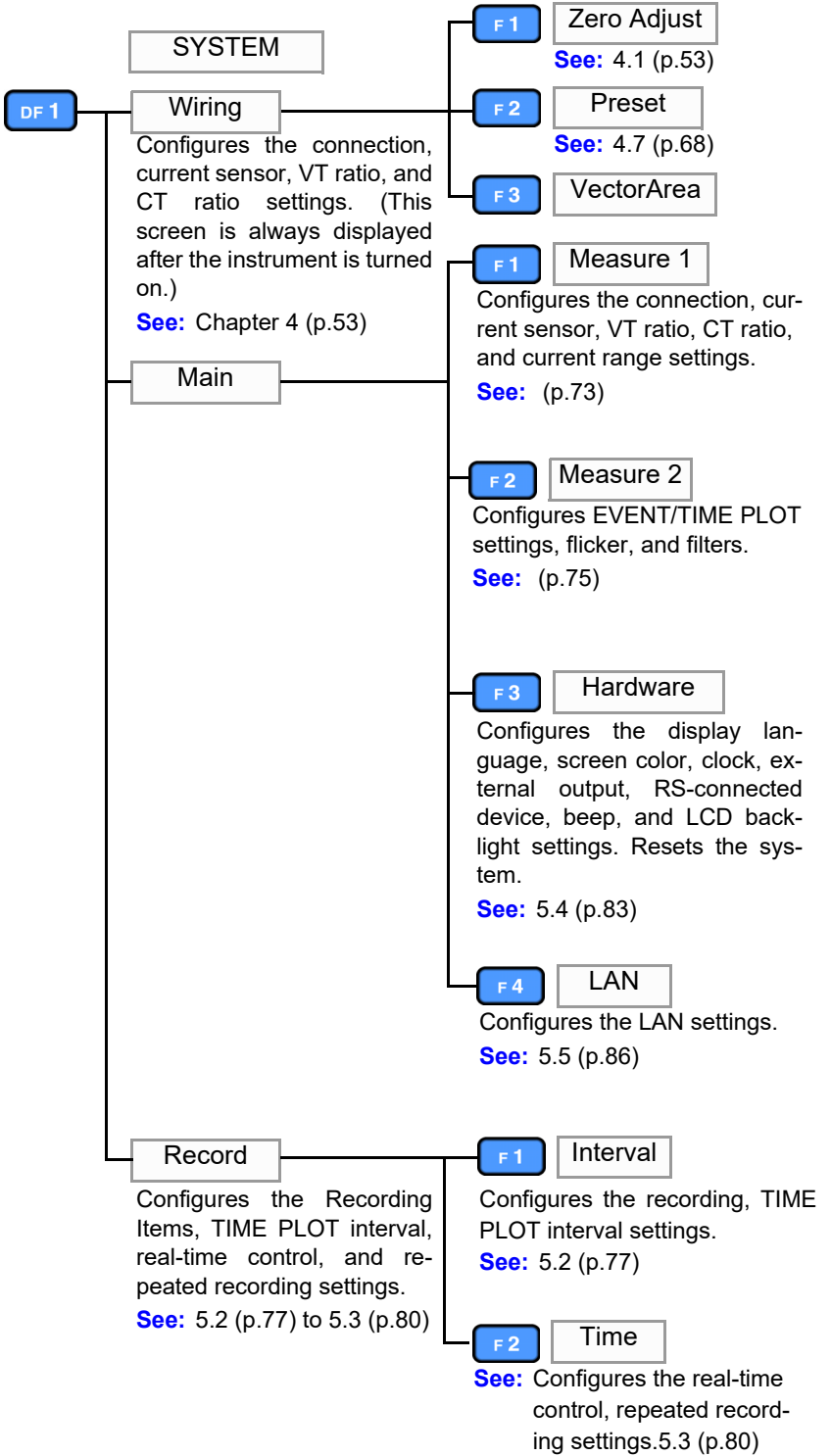



- Event1
[See: 5.6 \(p.87\)](#)
- Voltage1

Configures the frequency, swell, dip, interruption, transient threshold, and hysteresis settings.

Voltage2
Configures the RMS voltage, waveform peak, DC fluctuation, harmonic distortion factor, high-order harmonic component, and unbalance factor threshold settings.

Wave
Configures the threshold settings for generating events with the voltage waveform.

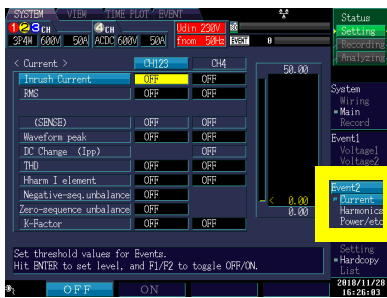

- Event2
[See: 5.6 \(p.87\)](#)
- Current

Configures the inrush current, RMS current, waveform peak, DC fluctuation, harmonic distortion factor, high-order harmonic component, unbalance factor, and K factor threshold settings.

Harmonics
Configures the threshold settings for 0- to 50-order harmonics (voltage, current, power, phase).

Power/etc
Configures the active power, reactive power, apparent power, power factor threshold, timer event, external event, and continuous event settings.



- Memory
[See: Chapter 9 \(p.159\)](#)
- Setting
Displays a list of settings data.
 - F1 Load
 - F2 Save
 - F3 Delete
- Hardcopy
Displays a list of screenshot data.
 - F1 View
 - F3 Delete
- List
Displays a list of the files stored on the SD memory card.
 - F1 Load*
 - F3 Delete
 - F4 Format

*The List's F1 (Load) will appear when the cursor is in the stored data folder. (*****).

VIEW Monitor instantaneous values (VIEW screen)

The **[VIEW]** screen is used to view voltage and current instantaneous waveforms, phase relationships, values, and harmonics.

Press the **VIEW** key to display the **[VIEW]** screen. The screen can be changed with the **DF** keys.

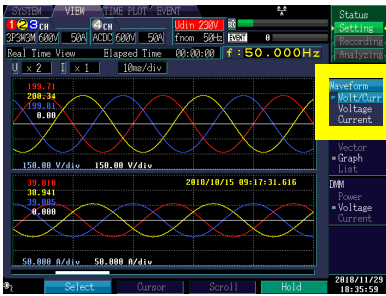

DF 1

Waveform

See: 6.2 (p.98)

Volt/Curr

Displays voltage waveforms for channels 1 to 4 on one screen and current waveforms for channels 1 to 4 on another screen (for a total of two screens).

Voltage

Displays separate voltage waveforms for channels 1 to 4.

Current

Displays separate current waveforms for channels 1 to 4.



DF 2

Harmonics

Vector

Displays the phase relationship between voltage and current for channels 1 to 3 as a vector diagram. The RMS value and phase instantaneous value is also shown for each order.

See: 6.3 (p.102)

Graph

Displays the sum voltage, current, and 0- to 50-order power measured values for channels 1 to 4 as a graph.

See: 6.4 (p.105)

List

Displays the sum voltage, current, power measured values (orders 0 to 50) for channels 1 to 4 as a graph.

See: 6.4 (p.105)

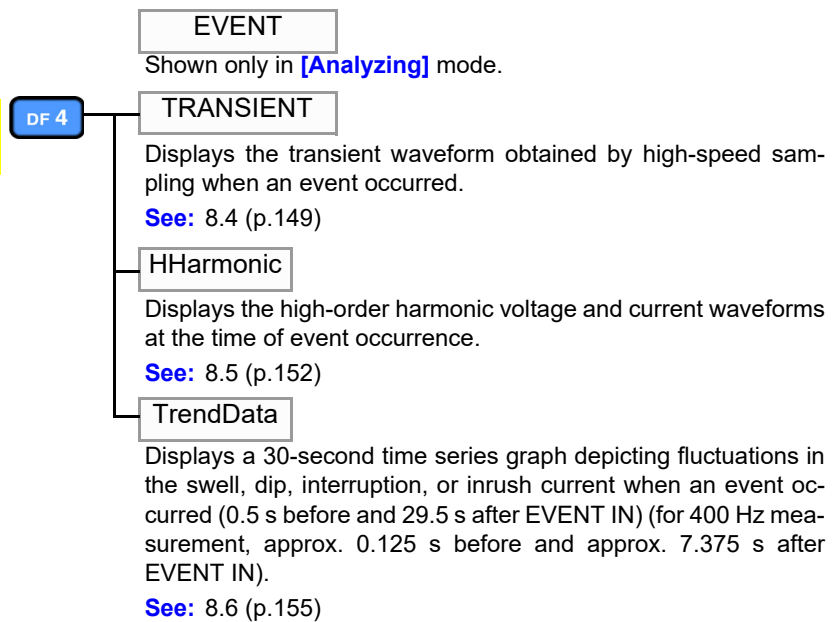
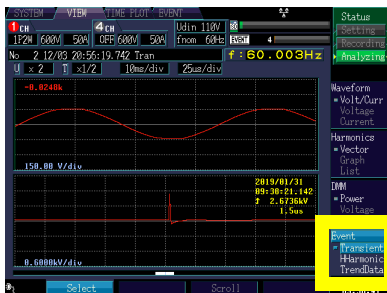
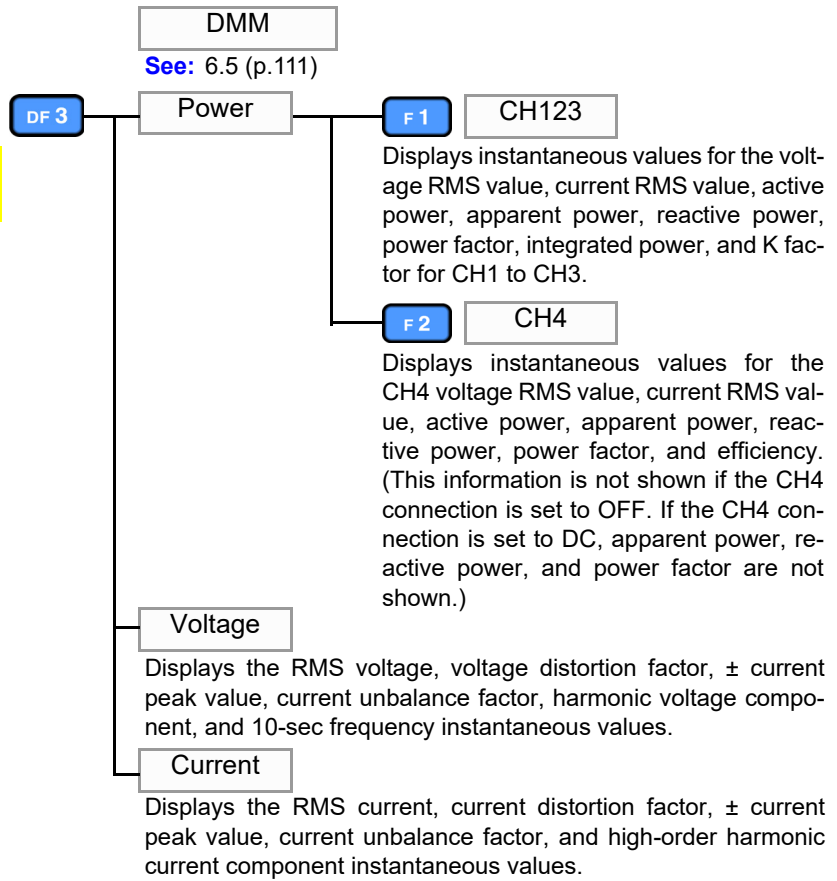

2.3 Display Items and Screen Types

TIMEPLOT

Monitor changes in measured values (TIME PLOT screen)

The [TIME PLOT] screen is used to view RMS, voltage, and harmonic fluctuations as time series graphs. Flicker values can also be shown as a graph or list.

Press the TIMEPLOT key to display the [TIME PLOT] screen. The screen can be changed with the DF keys.



DF 1

Trend

See: 7.2 (p.116)

1-Screen

Displays the RMS value measured using data collected over approximately 200 ms, the average value of peak or other values during the TIME PLOT interval, or the maximum, minimum, and average values as a time series, showing one per screen.

2-Screen

Displays the RMS value measured using data collected over approximately 200 ms, the average value of peak or other values during the TIME PLOT interval, or the maximum, minimum, and average values as a time series, showing two per screen.

Energy

Displays the active energy (WP+/WP-) or reactive energy (WQLAG/WQLEAD) as selected.



DF 2

DetailTrend

See: 7.3 (p.123)

DtlTrend

Displays the maximum and minimum values during the TIME PLOT interval for RMS voltage refreshed each half-cycle, inrush current, Pinst, frequency cycle, or other characteristics measured in half-cycle or one-cycle units.

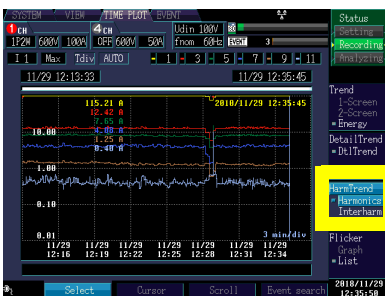

DF 3

HarmTrend

See: 7.4 (p.129)

Harmonics

Can display 6 orders of harmonics. Displays the average value or maximum, minimum, and average value during the TIME PLOT interval as a time series. (You can select voltage, current, power, or phase to be displayed.)

Interharm*

Can display 6 orders of inter-harmonics. Displays the average value or the maximum, minimum, and average values during the TIME PLOT interval as a time series. (You can select voltage or current to be displayed.)

*: Inter-harmonics are displayed when [Recording Items] is set to [All data].



DF 4

Flicker

See: 7.5 (p.133)

Graph

Displays $\Delta 10V$ (instantaneous values) or Pst and Plt values as a time series. You can select either $\Delta 10V$ flicker or IEC flicker to be displayed.

List

Displays $\Delta 10V$ (instantaneous values) or Pst and Plt values as a list. You can select either $\Delta 10V$ flicker or IEC flicker to be displayed.

EVENT

Monitor event occurrence (EVENT screen)

The [EVENT] screen is used to view a list of events that have occurred. In addition to checking whether a given event has occurred and the number of times it has occurred, if any, you can view high-order harmonic measured values.

Press the EVENT key to display the [EVENT] screen.



DF 1

Event

See: Chapter 8 (p.141)

List

Displays a list of events in the order of their occurrence. Detailed information and the waveform at the time of the event occurrence are also shown for the event selected on the list. You can also analyze instantaneous values, waveforms, and other information at the time of the event's occurrence on the [VIEW] screen.

Measurement Preparations

Chapter 3

3.1 Preparation Flowchart

Follow the procedure described below to prepare for measurement. "After-purchase" items need only be performed once.

- 1** Perform the pre-measurement inspection. (p.44)

After-purchase item (1) (voluntary)

Affix color clips to the current sensors. (p.40)

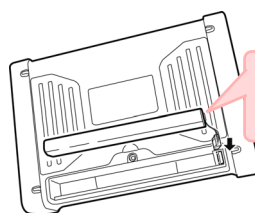
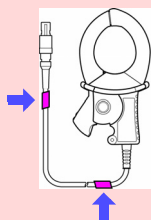

After-purchase item (4)(voluntary)
Install the battery pack. (p.43)

Back side

- 4** Connect the voltage cords (p.47) and current sensors. (p.47)

- 8** Connect to the measurement line. (p.62)

After-purchase item (3) (voluntary)



Secure the voltage cords together with a spiral wrapper. (p.41)

After-purchase item (2) (voluntary)

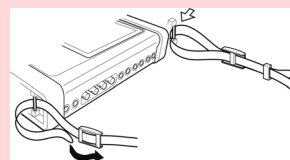

Attach the strap. (p.42)

- 3** Insert an SD memory card. (p.45)

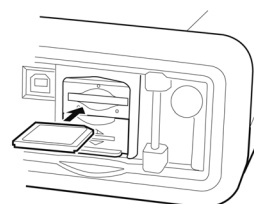

Be sure to close the cover after inserting the card.

- 2** Connect the AC adapter. (p.45)

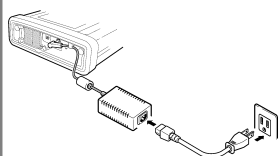

- 5** Turn on the instrument. (p.50)

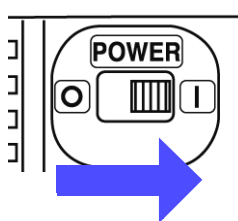

- 6** Perform zero adjustment. (p.53)
To ensure you are able to obtain precise measurements, it is recommended to allow the instrument to warm up for at least 30 minutes before performing zero adjustment or making measurements.

- 7** Set the clock. (p.84)

- 9** Set the connection mode. (p.55)

- 10** Verify that the connections have been made properly. (p.66)

- 11** Perform quick setup. (p.68)

3.2 Initial Instrument Preparations

Perform the following before starting measurement the first time.

Affix color clips to the current sensors

At both the ends of the current sensor cable, connect the clip of the same color as the channel which is to be connected to the current sensor, to avoid wiring mistakes.

Example: In the case of using 2 current sensors

Required items

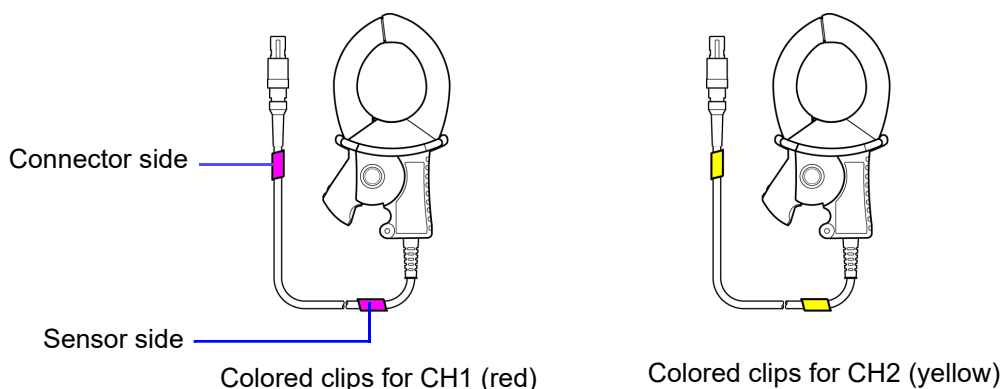
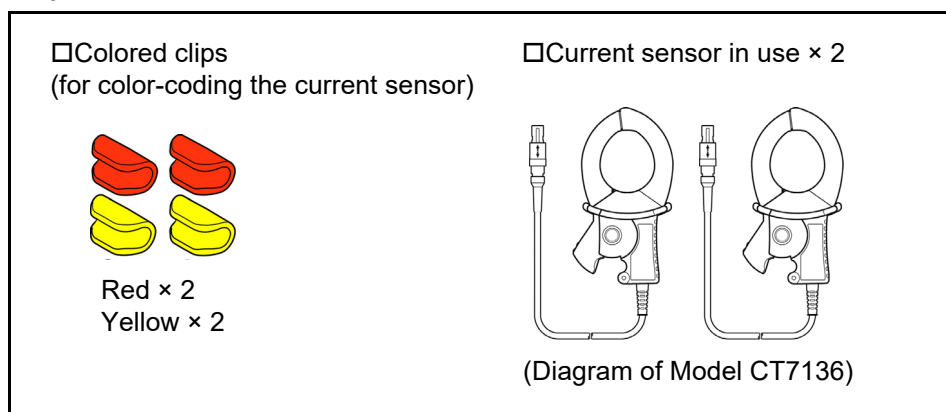

Measuring object	Number of current sensors in use (Colors of the CH and colored clips)
Single-phase 2-wire (1P2W)	1 (CH1 red)
Single-phase 3-wire (1P3W)	2 (CH1 red, CH2 yellow)
3-phase 3-wire (3P3W2M)	
3-phase 3-wire (3P3W3M)	3 (CH1 red, CH2 yellow, CH3 blue)
3-phase 4-wire (3P4W)	

Bundle the voltage cord leads with the spiral tubes

The instrument ships with 20 spiral wrappers. Use the wrappers to bundle pairs of cords (colored and black) together as needed.

Preparation items

L1000 Voltage Cord

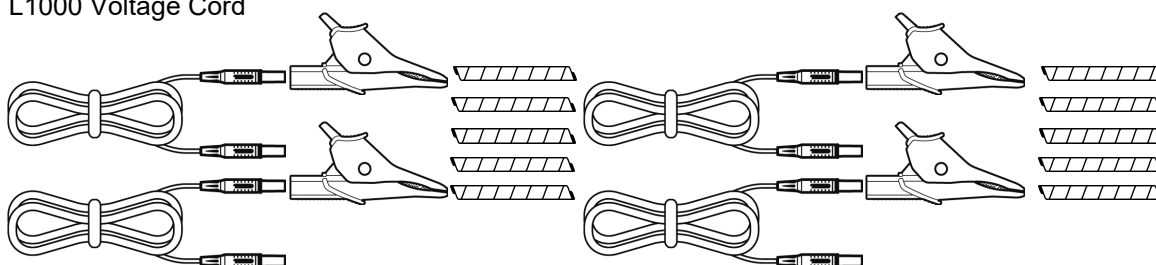

Alligator Clips (eight, one each red, yellow, blue, gray, and four black)

Banana Plug Leads (eight, one each red, yellow, blue, gray, and four black)

Spiral Tubes (twenty, for cable bundling)

Procedure



1. Line up two cords (colored and black).

Start bundling from one end of the leads.

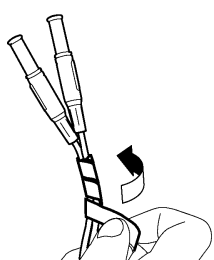

2. Wind the spiral tube around the leads.

Wrap the two leads together with the spiral tube. The five spiral tubes should be applied with suitable spacing.

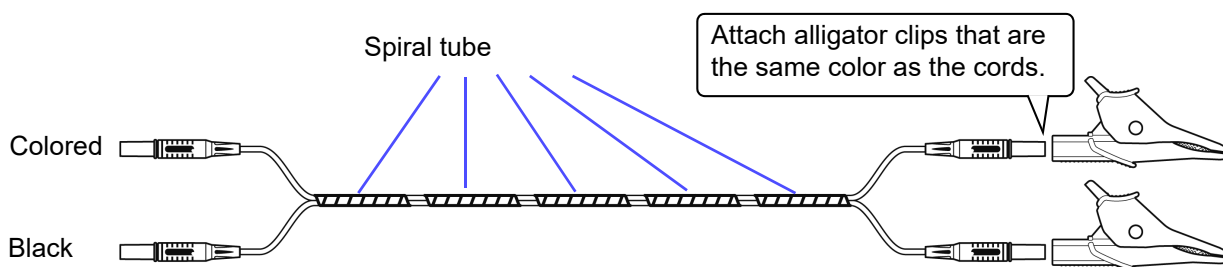

Attaching the strap

Use the strap when carrying the instrument or suspending it from a hook during use.



Attach both ends of the strap securely to the instrument. If insecurely attached, the instrument may fall and be damaged when carrying.

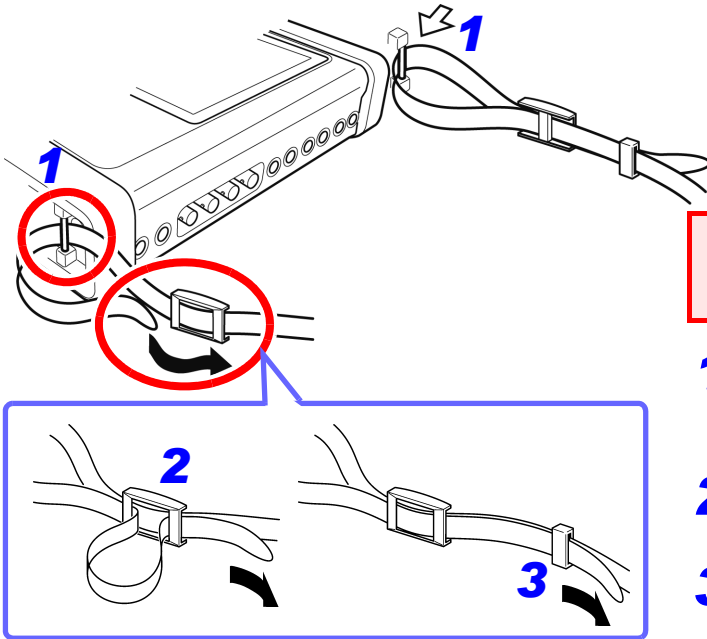

Tighten securely to keep straps from loosening or twisting.

1. Feed each end of the strap through the corresponding eyelet on the instrument.
2. Feed each end of the strap through its buckle.
3. Feed each end of the strap through its loop.

Attaching the Z5020 Magnetic Strap

Be sure to read "Using the Magnetic Adapter and Magnetic Strap" (p.13).

You can attach the instrument to a wall or panel (steel). Put the two pieces of Model Z5020 Magnetic Strap (optional) through each of the strap loops of the instrument and attach the magnets to the wall or panel.

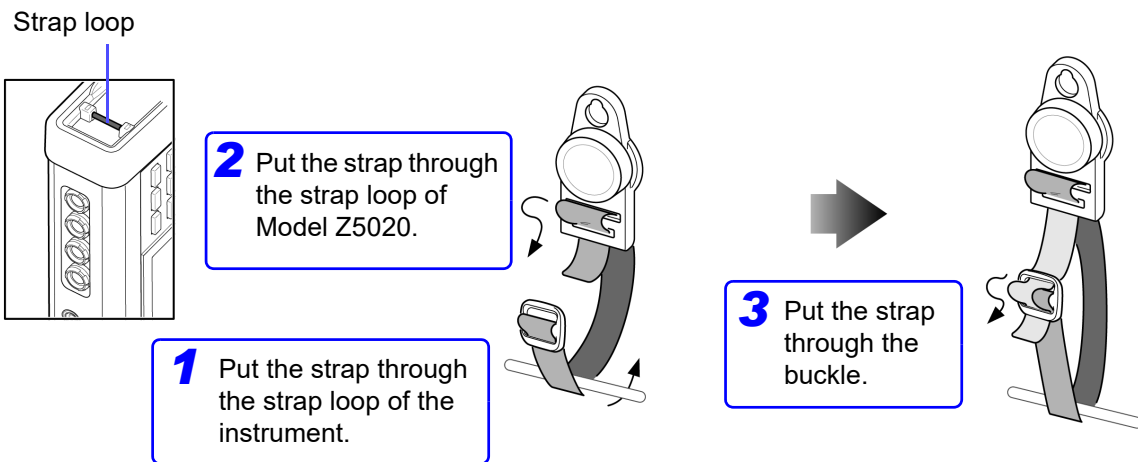

The magnetic force varies depending on thickness and unevenness of steel panels. Check for lack of the magnetic force so as not to let the instrument slip down.

Installing the battery pack

Be sure to read the "About the battery pack" (p.11) before connecting power.

The battery pack is used to power the instrument during power outages and as a backup power supply. When fully charged, it can provide backup power for approximately 180 minutes in the event of a power outage. The battery pack is designed to charge during normal use of the instrument. The CHARGE LED will turn red while the battery pack is charging.

Note that if a power outage occurs while the battery pack is not being used, displayed measurement data will be erased. (Data that has been recorded on the SD memory card is retained.)

Tools needed to install the battery pack: 1 Phillips head screwdriver

1. Turn off the instrument.

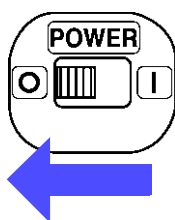

2. Disconnect the AC ADAPTER Z1002.

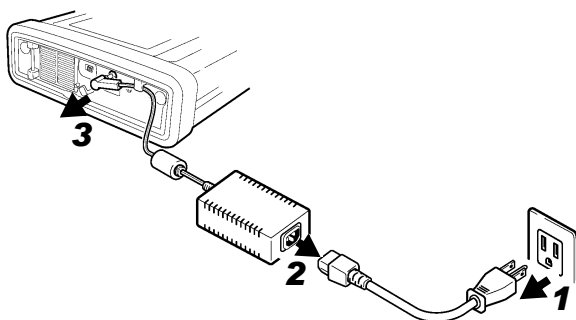

3. Turn the instrument upside down and remove the screws that hold the battery pack cover in place. Remove the cover.

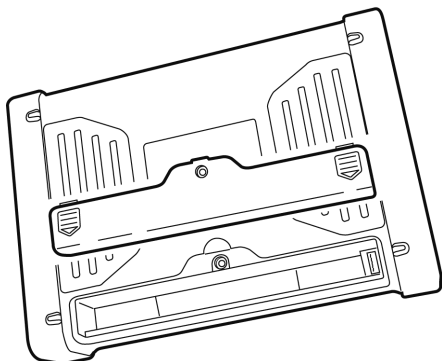

4. Connect the battery pack's plug to the connector (orient the connector so that the two protruding pieces are on the left).

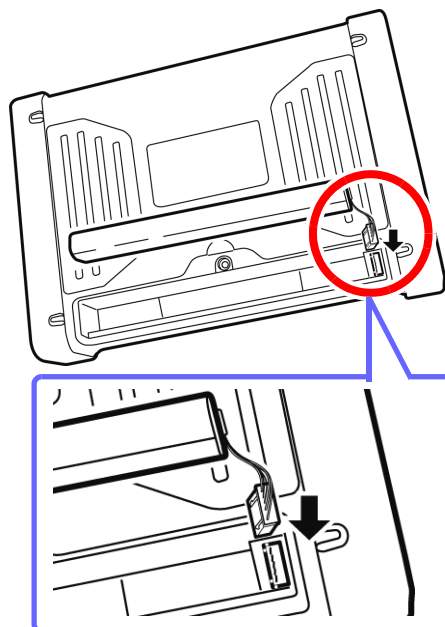

5. Insert the battery pack as indicated by the labeling on the battery pack.

Exercise care not to pinch the battery pack wires between the battery pack and the instrument.

6. Reattach the battery pack cover to the instrument and tighten the screws securely.

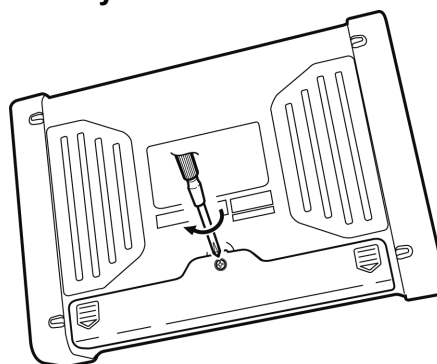

3.3 Pre-Operation Inspection

Before using the instrument the first time, verify that it operates normally to ensure that the no damage occurred during storage or shipping. If you find any damage, contact your dealer or Hioki representative.

1 Inspect the voltage cords

Is the insulation of the voltage cord to be used damaged, or is bare metal exposed?

Metal exposed



Do not use if damage is present, as you could receive an electric shock. Contact your authorized Hioki distributor or reseller if you find any damage.

No metal exposed

2 Inspect the current sensors

Is the clamp cracked or damaged?

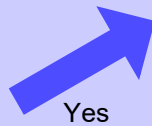

Yes

No

3 Inspect the instrument

Is damage to the instrument evident?

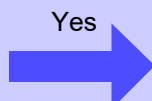

Yes

Contact your authorized Hioki distributor or reseller if you find any damage.

No

4 Inspection after turning on instrument

1. Does the self-test (model and version) display appear?
(The version number may be changed to the latest version number.)

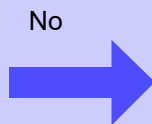

No

The power cord may be damaged, or the instrument may have internal damage. Please contact your authorized Hioki distributor or reseller.



Yes

2. Is the [Wiring] page of the settings screen being displayed?

An error is displayed



The instrument may be damaged internally. Please contact authorized Hioki distributor or reseller.



Yes



Inspection complete

3.4 Connecting the AC Adapter

Be sure to read the "Handling the cords and current sensors" (p.9) and "About the AC adapter" (p.11) before connecting power.

Connect the AC adapter to the power inlet on the instrument, and plug it into an outlet.

Connection Procedure

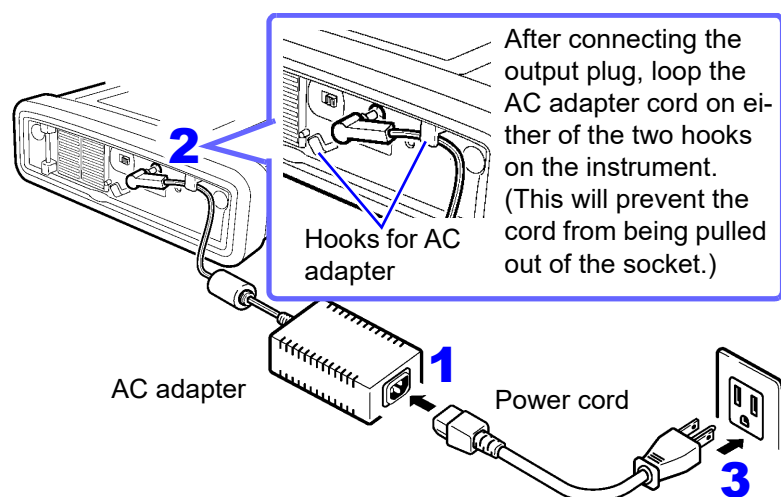

1. Check that the instrument's power switch is turned off. Connect the power cord to the inlet on the AC adapter.
2. Connect the AC adapter's output plug to the instrument.
3. Plug the power cord's input plug into an outlet.

Turn off the instrument before unplugging the AC adapter.

3.5 Inserting (Removing) an SD Memory Card

IMPORTANT

- Use only HIOKI-approved SD memory cards (model Z4001, etc). Proper operation is not guaranteed if other cards are used.
 - Format new SD memory cards before use.
 - Format SD memory cards with the instrument. Formatting an SD card with a computer may cause the card's write speed to decrease, with the result that the instrument may not be able to save data fast enough.
- See: "9.2 Formatting SD Memory Cards" (p.162)
- No compensation is available for loss of data stored on the SD memory card, regardless of the content or cause of damage or loss. Be sure to back up any important data stored on an SD memory card.

CAUTION

- Exercise care when using such products because static electricity could damage the SD card or cause a malfunction of the instrument.
- With some SD card, the instrument may not start up if it is turned on while the SD card is inserted. In such a case, turn on the instrument first, and then insert the SD card.
- Inserting a SD card upside down, backward or in the wrong direction may damage the SD card and/or the instrument.
- Do not turn off the instrument while the SD memory card is being accessed. Never remove the SD memory card from the instrument. Doing so may cause data on the card to be corrupted.
- Do not remove the SD memory card while recording or analyzing data. Doing so may cause data on the card to be corrupted.

3.5 Inserting (Removing) an SD Memory Card

NOTE

- The operating lifetime of the SD memory card is limited by its flash memory. After long-term or frequent usage, data reading and writing capabilities will be degraded. In that case, replace the card with a new one.
- The SD memory card operation indicator (p.29) will turn red while the card is being accessed.

Insert and remove SD memory cards as follows:

1 Turn off the instrument.(p.50)

2 Open the cover.

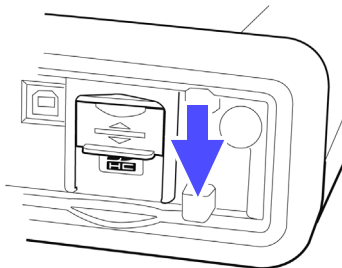

3 Disengage the lock.



4 Insert the SD memory card inside.

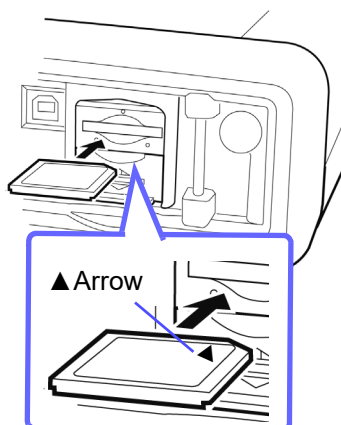

Insert the card horizontally. Inserting the SD memory card at an angle may cause the writeprotect lock to engage, preventing data from being written to the card.

5 Close the cover.

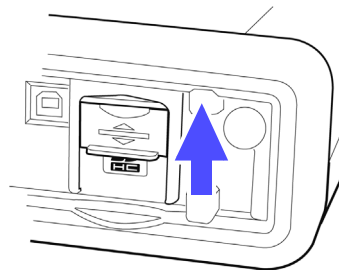

Be sure to close the SD memory card slot cover.

How to remove:

Open the cover, push in the SD memory card and then pull it out.

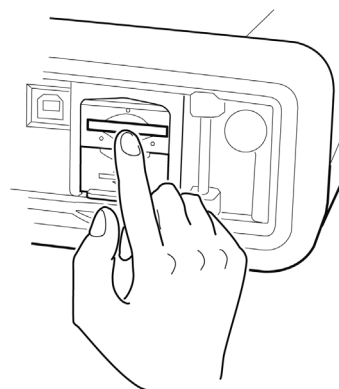

When storing the data to the SD memory card, configure the recording settings.

See: "5.2 Changing the Recording Settings" (p.77)

3.6 Connecting the Voltage Cords

Be sure to read the "Usage Notes" (p.7) before connecting voltage cords.



WARNING

To prevent an electric shock accident, confirm that the white or red portion (insulation layer) inside the cable is not exposed. If a color inside the cable is exposed, do not use the cable.

Plug the voltage cord leads into the voltage input jacks on the instrument (the number of connections depends on the lines to be measured and selected wiring mode).

Connection Procedure

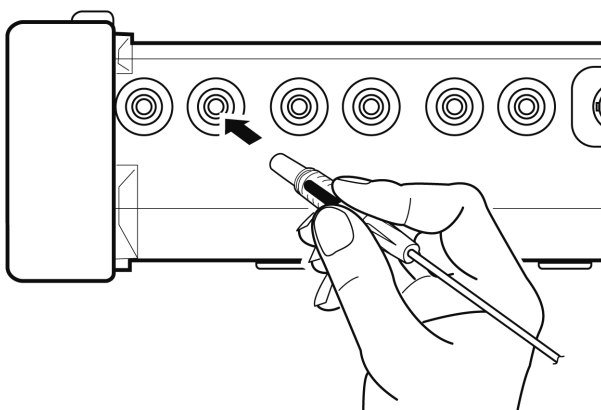

Plug the voltage cables into the appropriate channels' voltage measurement jacks.

Insert the plugs into the jacks as far as they will go.

3.7 Connecting the Current Sensors

Be sure to read the "Usage Notes" (p.7) before connecting current sensors.

Plug the current sensor cables into the current input jacks on the instrument (the number of connections depends on the lines to be measured and selected wiring mode). See the instruction manual supplied with the current sensor for specification details and usage procedures.



To prevent an electrical shock and bodily injury, do not touch any input terminals on the VT (PT), CT or the instrument when they are in operation.



- When using an external VT (PT), avoid short-circuiting the secondary winding. If voltage is applied to the primary when the secondary is shorted, high current flow in the secondary could burn it out and cause a fire.
- When using an external CT, avoid open-circuiting the secondary winding. If current flows through the primary when the secondary is open, high voltage across the secondary could present a dangerous hazard.

NOTE

- Phase difference in an external VT (PT) or CT can cause power measurement errors. For optimum power measurement accuracy, use a VT (PT) or CT that exhibits minimal phase difference at the operating frequency.
- To ensure safety when using a VT (PT) or CT, one side of the secondary should be grounded.

Connection Procedure: Optional current sensors

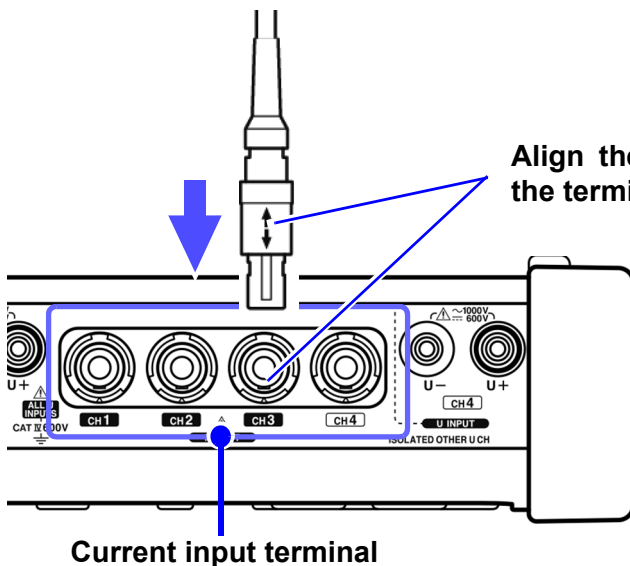

Align the arrow with the concave part of the terminal to insert the connector.

When disconnecting the current sensor, be sure to grip the part of the connector indicated by the arrows and pull it straight out.

Connection Procedure: Current sensors other than the optional

Example: Model 9661 Clamp on Sensor

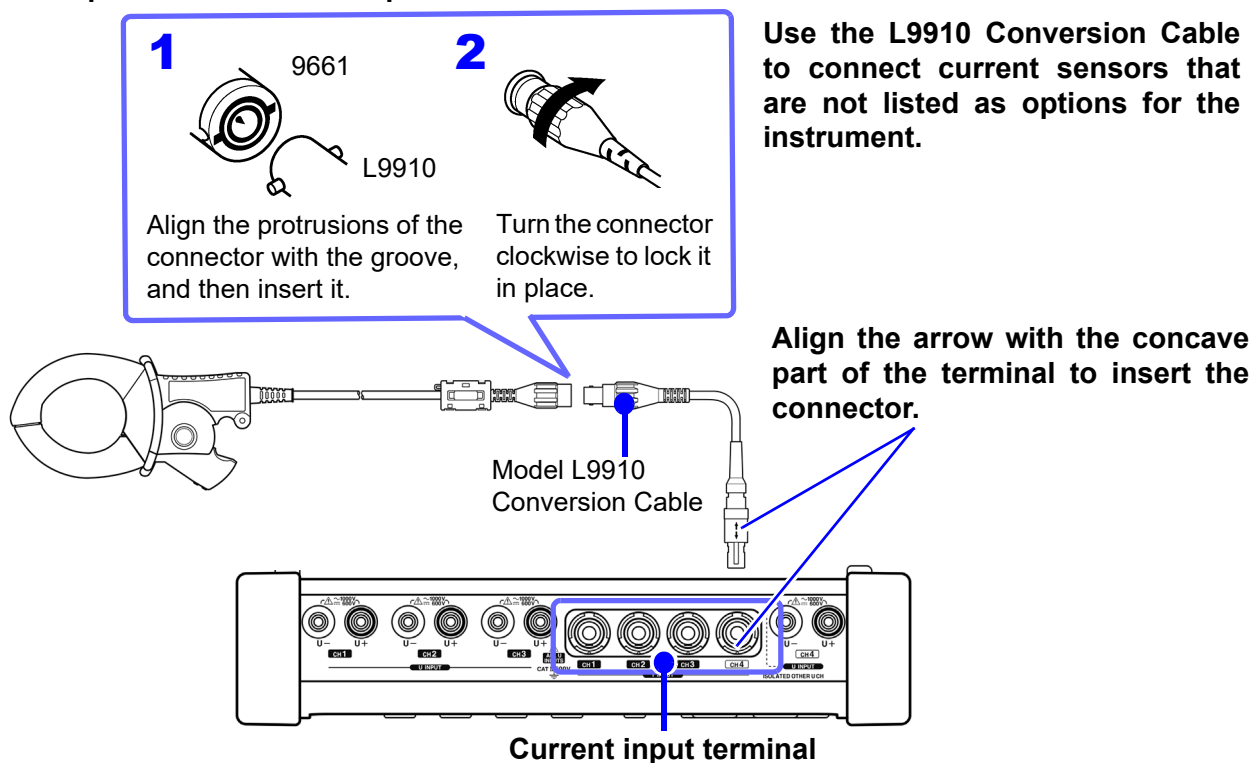

To measure voltage and current beyond the range of the instrument or current sensor
Use an external VT (PT) or CT. By specifying the VT or CT winding ratio on the instrument, the input level at the primary side can be read directly.

See: "4.7 Quick setup" (p.68)

3.8 Turning the Power On and Off (Setting the Default Language)

Be sure to read the "Usage Notes" (p.7) before turning the instrument on.

Turn on the instrument after connecting the AC adapter, voltage cords, and current sensors.

Turning the power on

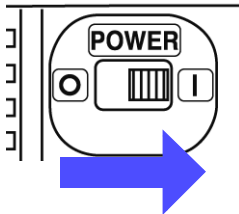

Turn the **POWER** switch on (|).

The instrument performs a 10-second power-on self test.

See: 3.3 (p.44)

After the self-test is complete, the **[SYSTEM]-[Wiring]** screen will be displayed.

NOTE

If the self-test fails, operation stops at the self-test screen. If the fault recurs after turning the power off and on, the instrument may be damaged. Perform the following procedure:

1. Cancel measurement and disconnect the voltage cords and current sensors from the measurement line before turning off the instrument's **POWER** switch.
2. Disconnect the power cord, voltage cords, and current sensors from the instrument.
3. Contact your authorized Hioki distributor or reseller.

For best precision, allow at least 30 minutes warm-up before executing zero adjustment and measuring.

Turning the power off

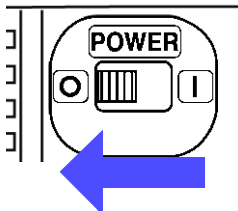

Turn the **POWER** switch off (○).

After use, always turn **OFF** the power.

CAUTION

Do not turn the instrument off with the voltage cords and current sensors connected to the measurement line. Doing so may damage the instrument.

Setting the Default Language

The language setting screen will be displayed when the instrument is turned on for the first time after purchase. Set the desired display language.

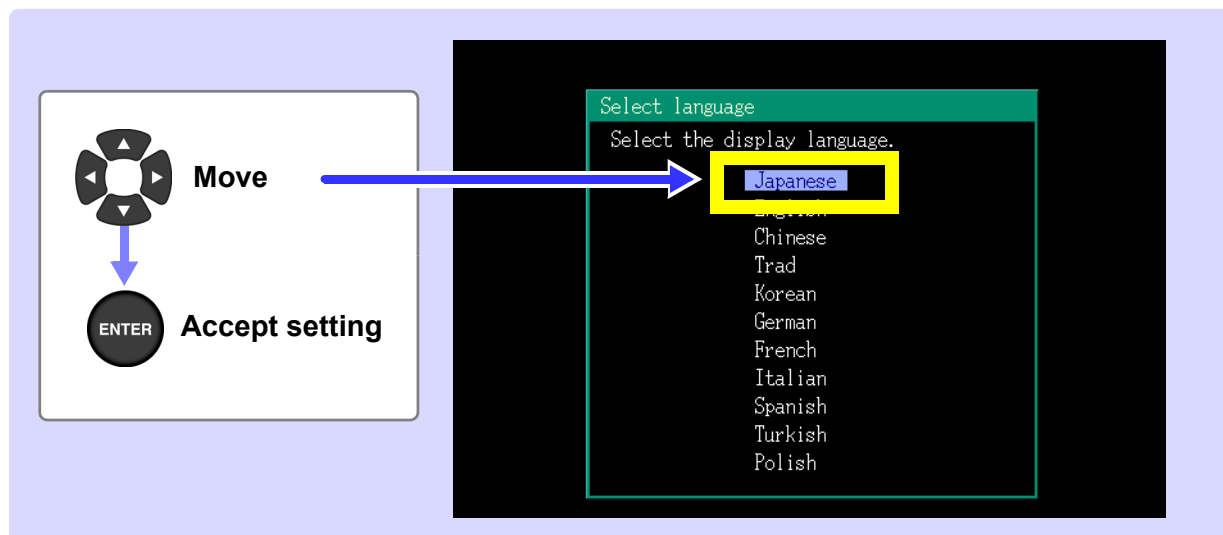

Japanese	Japanese
English	English
Chinese	Simplified Chinese
Trad	Traditional Chinese
Korean	Korean
German	German
French	French
Italian	Italian
Spanish	Spanish
Turkish	Turkish
Polish	Polish

- This default language setting is retained even if the system is reset (p.94).
- The language is not retained when the instrument is reset to its factory settings with a boot key reset (p.94).

Configuring the Instrument before Measurement (SYSTEM - SYSTEM screen) and Wiring

Chapter 4

4.1 Warm-up and Zero-adjust Operation

Warm-up

It is necessary to allow the PQ3198 to warm up to ensure its ability to make precise measurements. Allow the instrument to warm up for at least 30 minutes after turning it on. (p.50)

Zero Adjustment

This function adjusts the DC components superimposing on voltage and current to zero. In order to ensure the device's ability to make precise measurements, it is recommended to perform zero adjustment after allowing the instrument to warm up for at least 30 minutes. Perform zero-adjustment on both voltage and current measurement channels.

The screenshot shows the instrument's SYSTEM screen with the following details:

- SYSTEM screen:** The top menu bar shows 'SYSTEM', 'VIEW', 'TIME PLOT', and 'EVENT'. The 'SYSTEM' menu is highlighted.
- Wiring:** A wiring diagram is displayed in the center, showing three phases (R, S, T) and their connections to the instrument.
- Measurement Data:** A table at the bottom shows data for four channels:

Phase name	1 CH	2 CH	3 CH	4 CH
V	199.70 V	0.33 V	199.80 V	0.00 V
A	39.008 A	.941 A	39.006 A	0.00 A
W	4.498k W	.498k W	4.505k W	0.00k W
- Zero Adjust:** A 'Zero Adjust' menu option is highlighted at the bottom of the screen.
- Flowchart:** On the left, a flowchart shows the sequence of operations: SYSTEM screen, DF 1 [Wiring], F 1 [Zero Adjust], ENTER Execute, and ESC/0 Cancel.

NOTE

- Perform zero adjustment only after plugging the current sensor into the instrument.
- Perform zero adjustment before attaching to the lines to be measured (proper adjustment requires the absence of any input voltage or current).
- In order to ensure the instrument's ability to make precise measurements, zero adjustment should be performed at an ambient temperature level that falls within the range defined by the device specifications.
- The operating keys are disabled during zero adjustment.

4.2 Setting the Clock

This section describes how to set the PQ3198's clock.
It is recommended to check the clock before starting recording.

The diagram illustrates the process of setting the clock on the PQ3198 device. It consists of two main parts: a control panel legend on the left and a screenshot of the device's menu system on the right.

Control Panel Legend:

- SYSTEM** button: [SYSTEM] screen
- DF 1** button: [Main]
- F 3** button: [Hardware]
- Move** (directional arrows): Move
- ENTER** button: Select value to change
- Set value** (up/down arrows): Set value
- ENTER** button: Accept setting
- ESC / On** button: Cancel

Device Screenshot:

The screenshot shows the [SYSTEM] screen with the following settings:

- Display color: Color 1
- Beep sound: ON
- LCD Backlight: ON
- Clock: 2018Y 11 M 29 D 18 : 8 : 35
- External output: Short pulse
- External control(CIN): Event
- RS-232C connection: OFF

Annotations in the screenshot include:

- A yellow box around the **SYSTEM** menu item at the top left.
- A yellow box around the **System** menu item in the right-hand sidebar.
- A yellow box around the **Clock** setting in the main menu.
- A yellow box around the **Hardware** menu item at the bottom right.
- Blue arrows indicate the navigation path: from SYSTEM to Main, then to Hardware, then to the Clock setting, and finally to the Hardware menu.

4.3 Configuring the Connection Mode and Current Sensors

This section describes how to configure the connection mode and current sensors appropriately for the measurement line being analyzed.

Eight wiring modes are available.

To select the wiring mode



SYSTEM [SYSTEM] screen →

DF 1 [Wiring]

Move

ENTER Display the pull-down menu

Select [Wiring]

[CH123], [CH4]

ENTER Display the pull-down menu

Select the connection mode

ENTER Accept setting

ESC / On Cancel

Accepting the settings will cause a connection diagram for the selected connection mode to be displayed. Accepting the selection displays the wiring diagram of the selected wiring mode. (p.57)

Phase name	R	S	T
1 CH	199.71 V	200.33 V	199.80 V
2 CH	39.009 A	38.942 A	39.006 A
3 CH	4.498kW	4.498kW	4.505kW
4 CH	0.000 V	0.000 V	0.000 V

Configuring the current sensors

[SYSTEM] screen

[Wiring]

Move

Display the pull-down menu

Select [Current sensor]

[CH123], [CH4] *

Display the pull-down menu

Select the current sensor

Accept setting

Cancel

1 CH	2 CH	3 CH	4 CH
199.71 V	200.36 V	199.84 V	0.0 V
39.014 A	38.943 A	39.003 A	0.0 A
4.499k W	4.499k W	4.505k W	0.0k W

*: Pressing the **F4 [Sensor]** key will automatically configure the current sensor. However, current sensors that have been connected using the L9910 Conversion Cable will not be automatically configured. These sensors will need to be manually configured.

NOTE

To measure multiphase power, use the same type of current sensor on each phase line. For example, to measure 3-phase 4-wire power, use the same model current sensors on channels 1 to 3.

Connection diagram

(1) Single-circuit measurement

1P2W

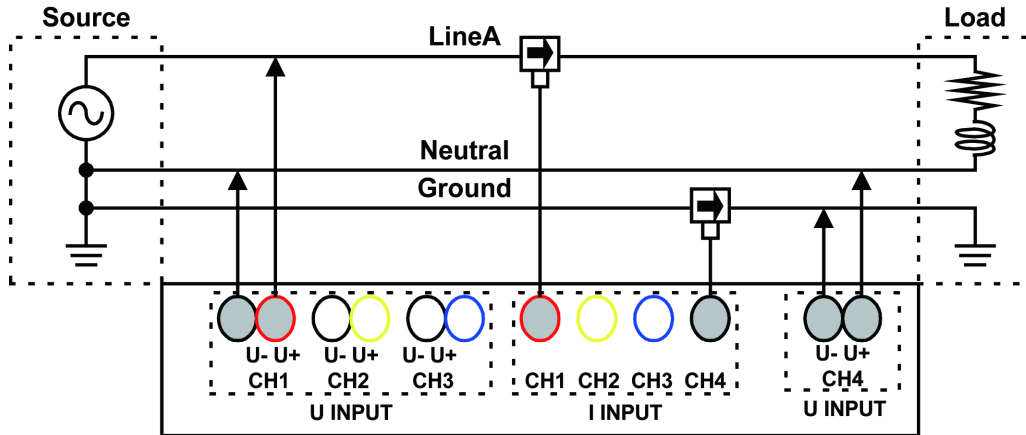

The vector diagram shows the measurement line in its ideal state.

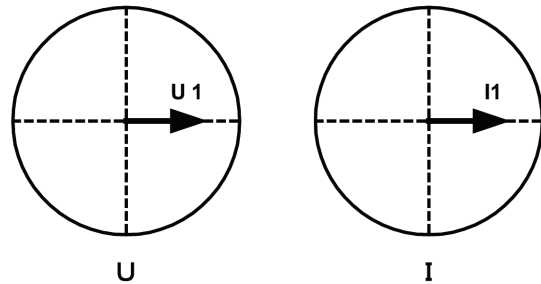

1P3W

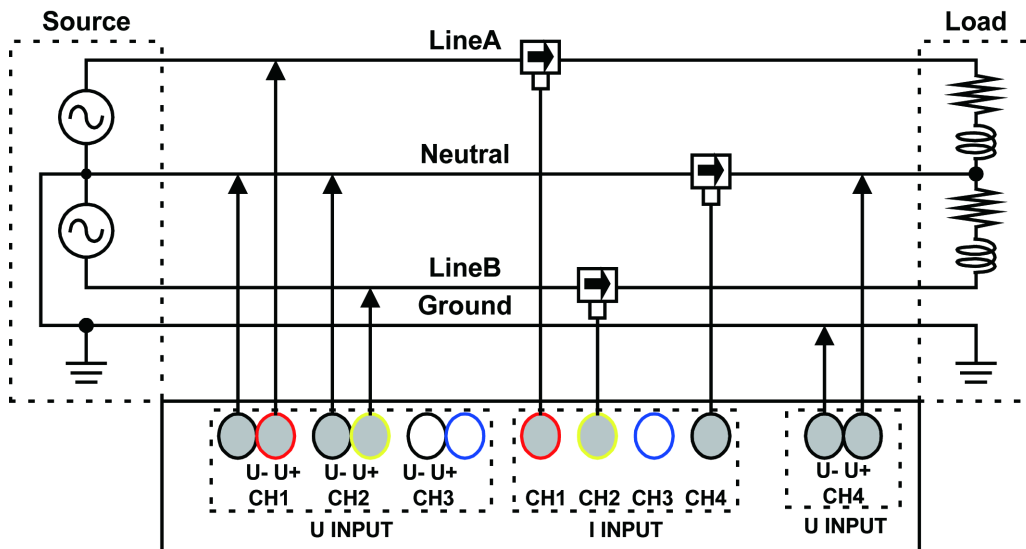

The vector diagram shows the measurement line in its ideal (balanced) state.

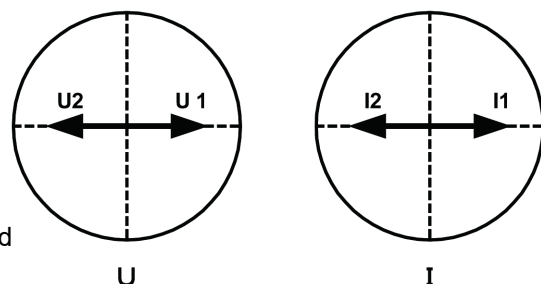

The L1021-01, L1021-02 Patch Cord can be used to consolidate two cords being connected to the same phase into a single cord.

4.3 Configuring the Connection Mode and Current Sensors

3P3W2M

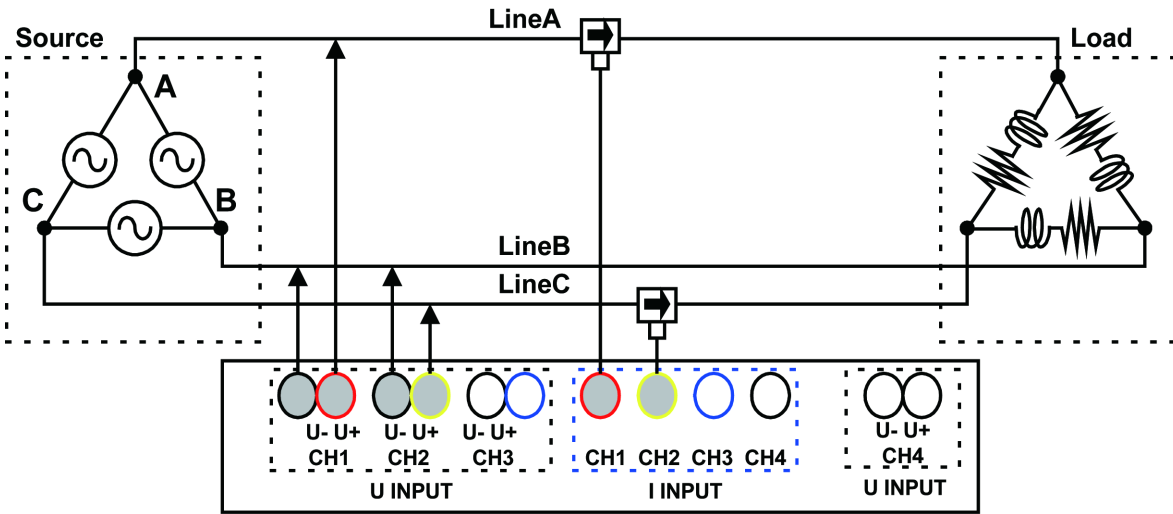

The vector diagram shows the measurement line in its ideal (balanced) state.

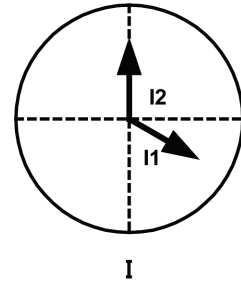
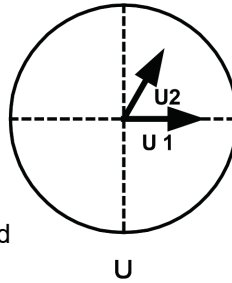

The L1021-01, L1021-02 Patch Cord can be used to consolidate two cords being connected to the same phase into a single cord.

3P3W3M

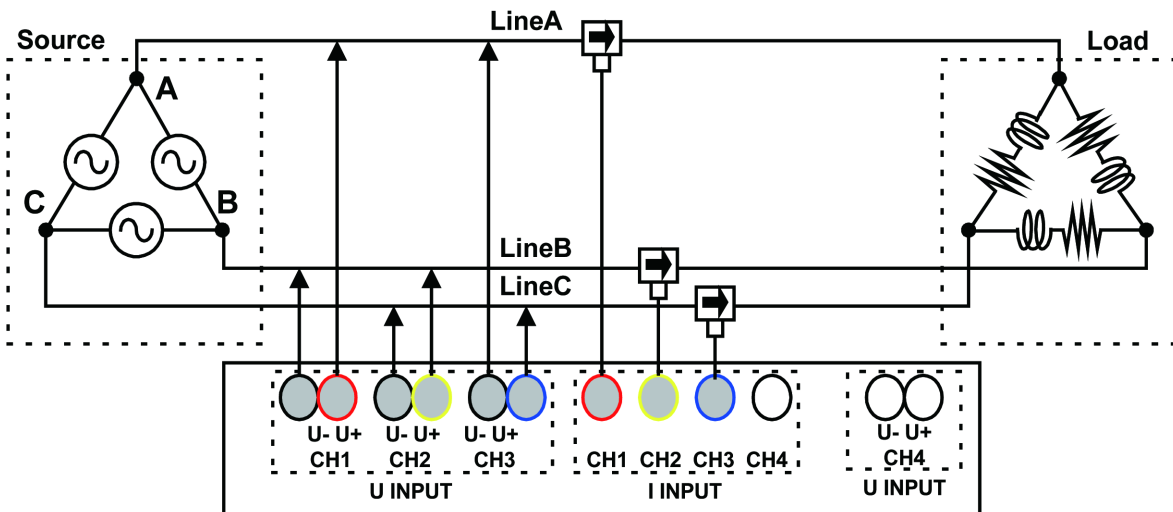

The vector diagram shows the measurement line in its ideal (balanced) state.

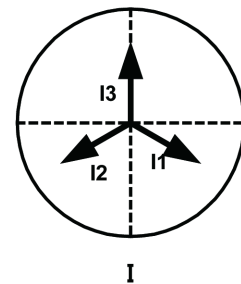
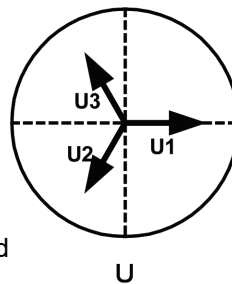

The L1021-01, L1021-02 Patch Cord can be used to consolidate two cords being connected to the same phase into a single cord.

3P4W (CH4:ACDC)

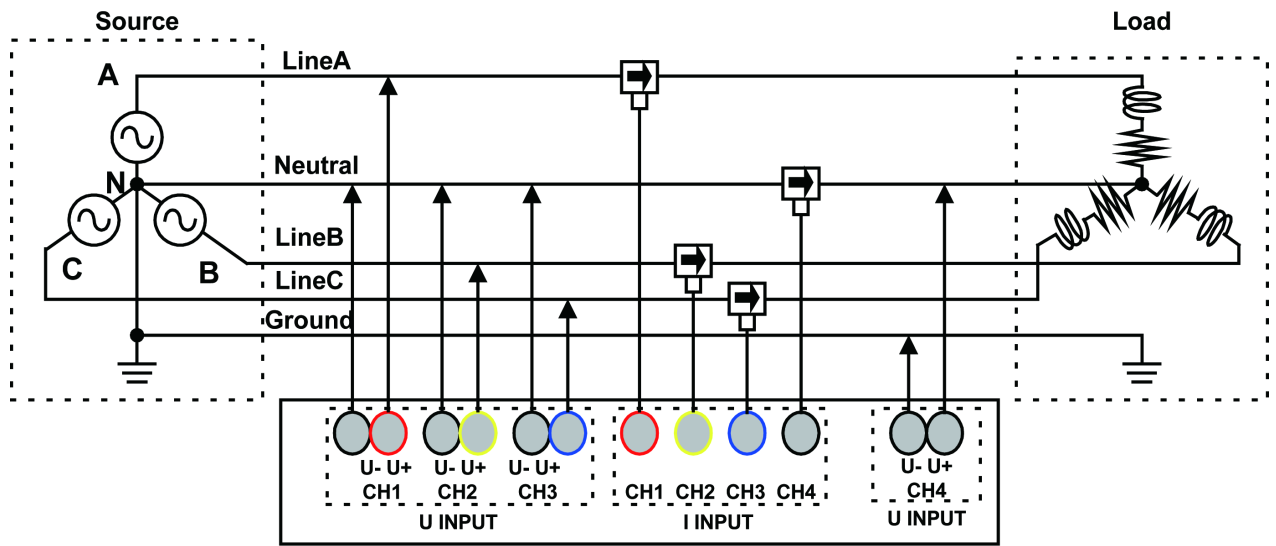

The vector diagram shows the measurement line in its ideal (balanced) state.

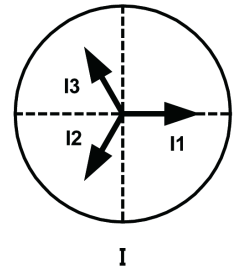
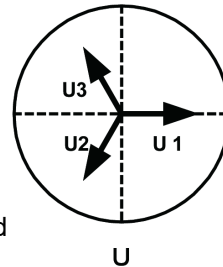

The L1021-01, L1021-02 Patch Cord can be used to consolidate two cords being connected to the same phase into a single cord.

3P4W2.5E (CH4:ACDC)

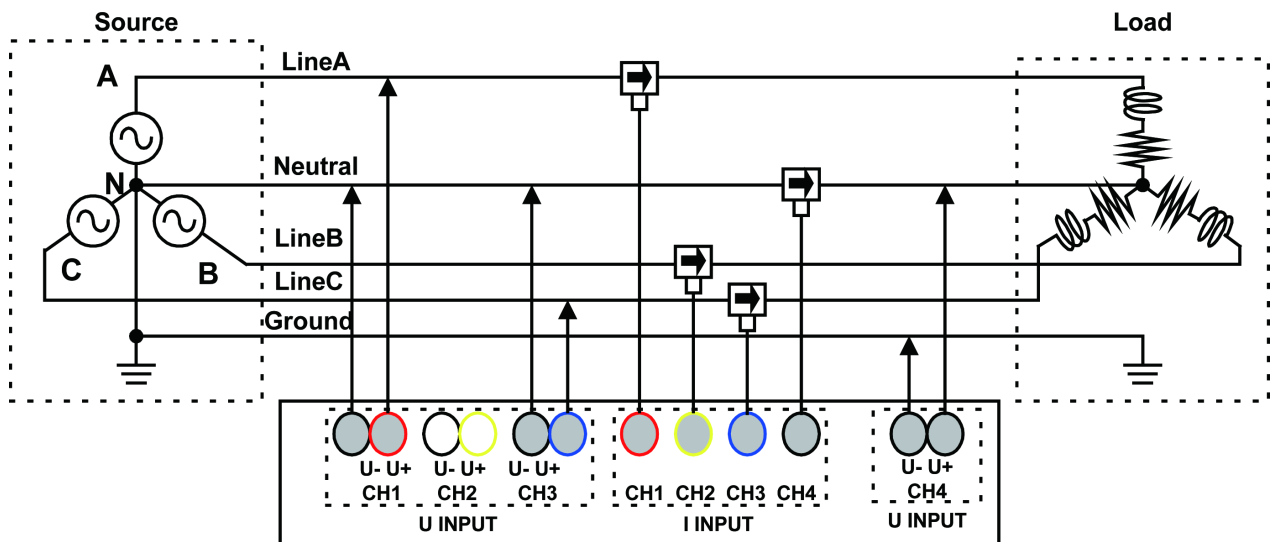

The vector diagram shows the measurement line in its ideal (balanced) state.

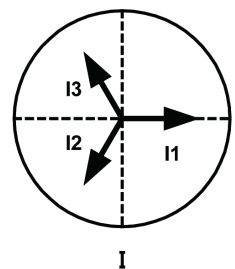
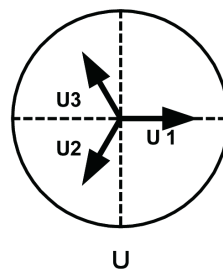

The L1021-01, L1021-02 Patch Cord can be used to consolidate two cords being connected to the same phase into a single cord.

4.3 Configuring the Connection Mode and Current Sensors

(2) Measuring multiple systems

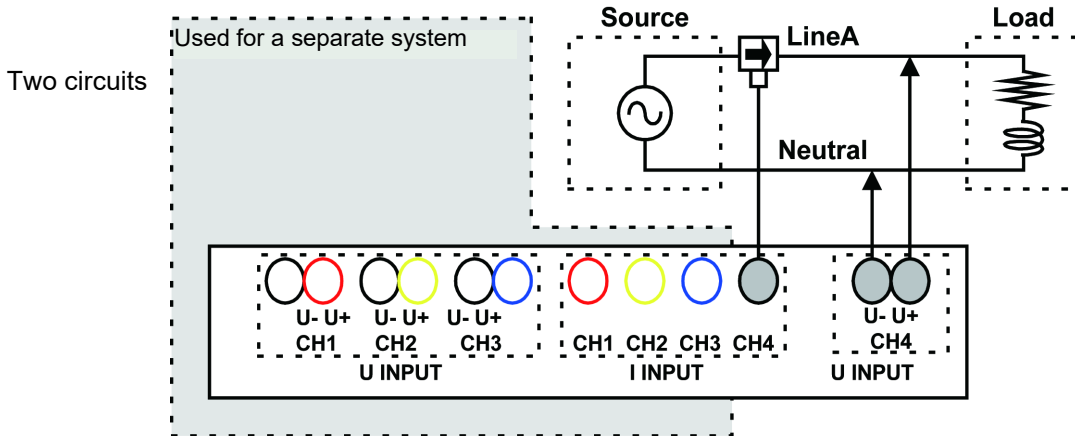

(3) Measuring a system and a DC power supply

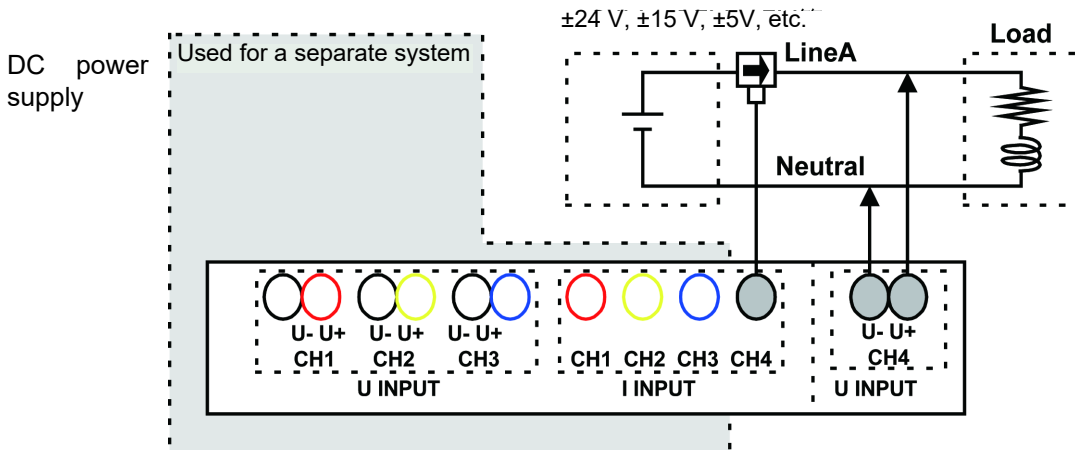

4.4 Setting the Vector Area (Tolerance Level)

This section describes how to determine rough guidelines for verifying that the connection, range, and nominal input voltage (U_{din})* are correct. Changing settings causes corresponding changes in the area and position of the fan-shaped areas on the vector diagram. The instrument can normally be used with the default settings, but those settings can be changed if you wish to change the vector display area (tolerance level).

*: The nominal input voltage (U_{din}), which is calculated from the nominal supply voltage using the transformer ratio, indicates the voltage that is actually input to the instrument.

Key sequence for configuring settings

Phase area

Sets the tolerance level for the phase value of each phase.

Setting Contents:(* : Default setting)

±1 to ±30* (°)



Amplitude area

Sets the tolerance level for the RMS value of each phase. The setting takes the form of (±1% to ±30%) of the nominal voltage for voltage and CH1 for current.

Setting Contents:(* : Default setting)

±1 to ±30 (%) (±20*)

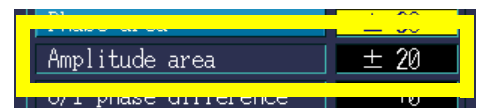

U/I phase difference

Sets the tolerance level for the current phase difference relative to the voltage.

Setting Contents:(* : Default setting)

-60 to +60 (°) (0*)

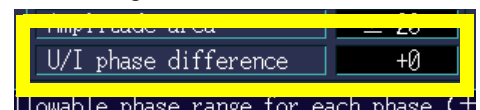

4.5 Connecting to the Lines to be Measured (Preparing for Current Measurement)

Be sure to read the "Before Connecting to the Lines to be Measured" (p.12) before attaching to the lines.

Connect the voltage cords and current sensors to the measurement line as shown in the connection diagram on the screen. (To ensure accurate measurement, consult the connection diagram* while making the connections.)

*: The diagram appears when the wiring mode is selected. (p.55)



To avoid electric shock and short-circuit accidents, do not attach any unnecessary cables.



To avoid risk of electric shock, turn off the supply of electricity to the measurement circuit before making connections.

NOTE

The phases are named R, S, and T on the wiring diagram display. Substitute with equivalent names such as L1,L2, and L3 or U,V, and W, as appropriate.

Changing the phase names

SYSTEM [SYSTEM] screen

DF 1 [Wiring]

[Phase name]

ENTER Display the pull-down menu

ENTER Select the connection mode

ENTER Accept setting

ESC / On Cancel

Accepting the settings will cause the selected phase names to be shown on the connection diagram. (p.57)

4.5 Connecting to the Lines to be Measured (Preparing for Current Measurement)

Attach voltage cords to measurement lines

Example: Secondary side of breaker

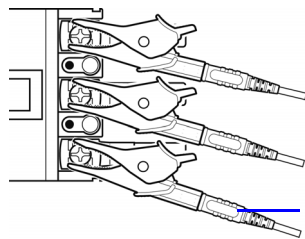

Securely clip the leads to metal parts such as terminal screw terminals or bus bars.

Model L1000 Voltage Cord

Example: When using Model 9804-01 or 9804-02 Magnetic Adapter (standard screw: M6 pan head screw)

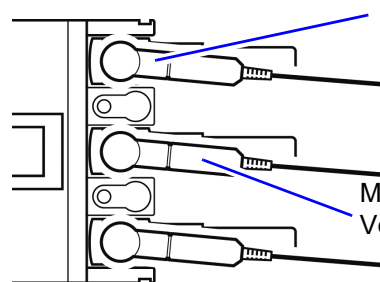

Model 9804-01, 9804-02 Magnetic Adapter

Model L1000 Voltage Cord

Secondary side of breaker

Attach the Model 9804-01 or 9804-02 Magnetic Adapter (option) to the Model L1000 Voltage Cord.

Connect the magnetic part of the 9804-01 or 9804-02 tip to the screws on the secondary side of the breaker.

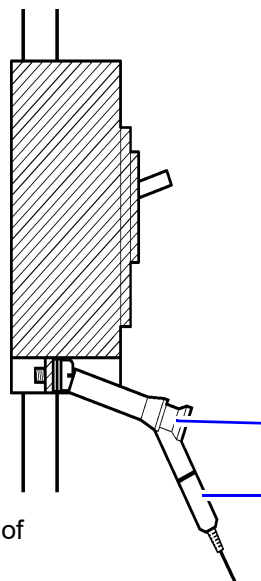

The weight of the voltage cords may prevent you from making a perpendicular connection to the Model 9804-01 or 9804-02 Magnetic Adapter. In this case, connect each cords so that it is hanging off the adapter in a manner that balances its weight.

Check the voltage values to verify that the connections have been made securely.

Model 9804-01, 9804-02 Magnetic Adapter

Model L1000 Voltage Cord

Secondary side of breaker

Applying current sensors to lines to be measured

Example: CT7136

Always clamp the instrument around only one conductor. Clamping the instrument around two or more of conductors in a bundle prevents the instrument from measuring any current regardless of whether the measurement target is a single-phase or three-phase circuit.

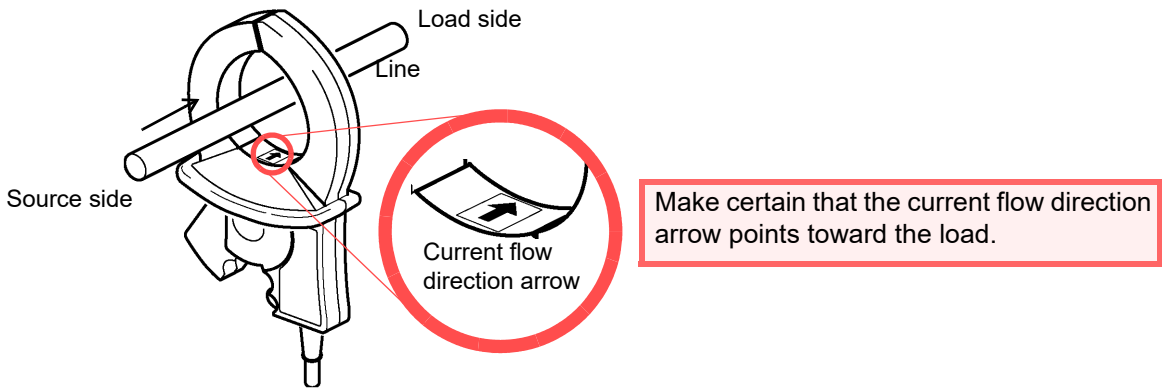
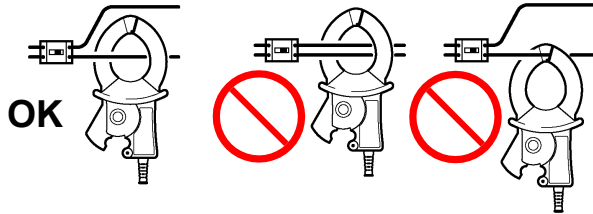

4.5 Connecting to the Lines to be Measured (Preparing for Current Measurement)

■ Leakage current measurement

Grounding wire measurement	Clamp 1 wire only. (Diagram A)
Batch measurement	Clamp the electrical circuits together. (Diagram B) Clamp 2 wires together in the single phase 2-wire system circuit, and 4 wires in the 3-phase 4-wire system circuit.

Example:
Single phase 3-wire system circuit

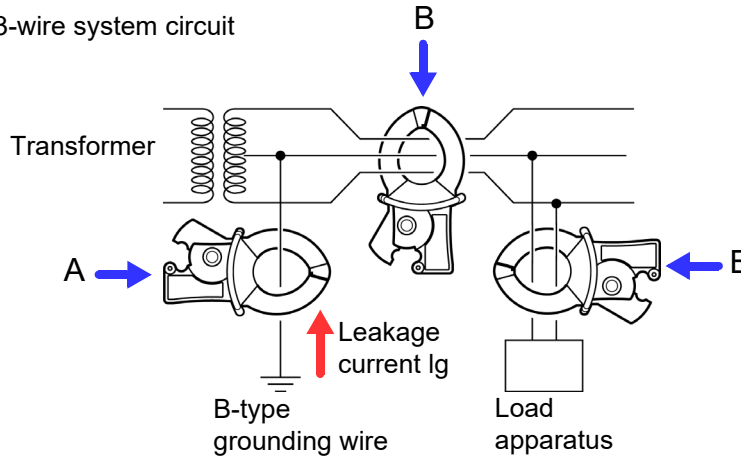

Example:
3-phase 3-wire system circuit

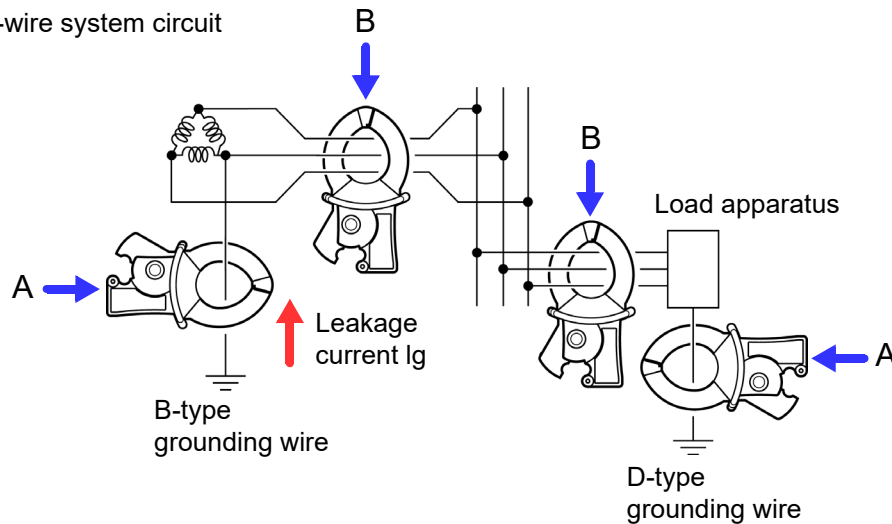

Attaching Cords on a Wall

Be sure to read "Using the Magnetic Adapter and Magnetic Strap" (p.13)

Using Model Z5004 Magnetic Strap allows you to attach voltage cords and cords of current sensors to a wall or panel (steel).

In particular, Model Z5004 can prevent the own weight of the voltage cords from detaching those alligator clips or magnet adapters.

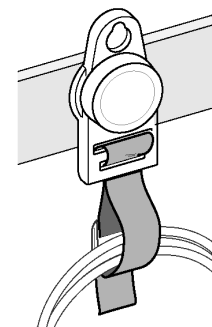

How to attach the strap

"Attaching the Z5020 Magnetic Strap" (p.42)

4.6 Verifying Correct Wiring (Connection Check)

Correct attachment to the lines is necessary for accurate measurements. Check the measured values and vectors on the [SYSTEM]-[Wiring] screen to verify that the connections have been made properly. Refer to the measured values and vector displays to verify that the measurement cables are correctly attached.

For 1P2W systems

Verify that an appropriate measurement value is displayed.

Measured voltage value
Measured current value
Measured active power value



For systems other than 1P2W

- Verify that an appropriate measurement value is displayed.
- Verify that the vectors are displayed with the appropriate range.

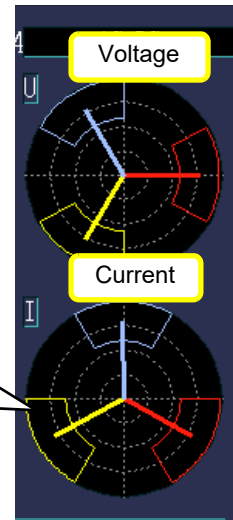

Vector line range
Colors match the corresponding lines in the wiring diagram.

In this case	Check
<p>A measured value is too high or too low compared to the set [Udin].</p>	<ul style="list-style-type: none"> • Are the cables securely plugged into the voltage measurement jacks on the instrument? (p.47) • Are the voltage measurement cable clips properly attached to the lines? (p.63) • Has the appropriate Urms type (phase voltage/line voltage) been selected? (p.75)
<p>If the measured current value is not correct.</p>	<ul style="list-style-type: none"> • Are the current sensors securely plugged into the current measurement jacks on the instrument? (p.48) • Are the current sensors properly attached to the lines? (p.64) • Are the current sensors appropriate for the line current to be measured? • Have the sensor's range settings been configured appropriately?
<p>If the measured active power value is negative.</p>	<ul style="list-style-type: none"> • Are the current sensors properly attached to the lines? (p.63) • Is the arrow marker on the current sensors pointing toward the load? (p.64) • During 3P3W2M measurement, the active power of each channel can become negative in some cases, for example, if a circuit under measurement has a power factor of 0.5 or less.
<p>If vectors are too short, or unequal.</p>	<p>Voltage vectors:</p> <ul style="list-style-type: none"> • Are the cables securely plugged into voltage measurement jacks on the instrument? (p.47) • Are the voltage measurement cable clips properly attached to the lines? (p.63) <p>Current vectors:</p> <ul style="list-style-type: none"> • Are the current sensors securely plugged into the current measurement jacks on the instrument? (p.48) • Are the current sensors properly attached to the lines? (p.64) • Are the current sensors appropriate for the line current to be measured? • Is the sensor range set correctly?

4.6 Verifying Correct Wiring (Connection Check)

In this case	Check
If vector direction (phase) or color is incorrect.	<p>Voltage vectors:</p> <ul style="list-style-type: none">• Check that the voltage measurement clips are attached to the lines according to the wiring diagram. <p>Current vectors:</p> <ul style="list-style-type: none">• Check that the current sensors are attached to the lines according to the wiring diagram.

4.7 Quick setup



What settings are affected by quick setup?

For accurate measurements, settings such as range must be properly configured. When you use quick setup, the following settings are automatically configured using HIOKI-recommended values according to the selected connection settings: current range, nominal input voltage, measurement frequency, event thresholds, etc. (p.223)

NOTE

If measurement line power is off, turn it on before performing quick setup.

Key operation during configuration

The screen shown to the right will be displayed.

[SYSTEM] screen

[Wiring]

[Preset]

[Easy settings course]

Display the pull-down menu

Select a pattern

Accept setting

Check settings and select to change

Display the pull-down menu

Select setting or value

Accept setting

[Next]

	CH123	CH4
Type of measurement lines	3P3W3M	AC+DC
Current sensor used	CT7136 600A	CT7136 600A
External VT Ratio	1	1
External CT Ratio	1	1
TIME PLOT Interval	1 minute	SD 35.0 Days

NOTE

Check settings and change as necessary before you start recording. Execute quick setup when using the instrument the first time, and when changing to a different line configuration.

Type of measurement lines

Set before proceeding to the next step.

Setting Contents:

CH1,2,3: 1P2W/1P3W/3P3W2M/3P3W3M/3P4W/3P4W2.5E
CH4: ACDC/DC/OFF

Current sensor used

Set before proceeding to the next step.

Current sensor			Current range
Optional	Other than the optional		
AC flexible current sensor	CT7044	CT9667-01*	5000 A, 500 A, 50 A
	CT7045	CT9667-02*	
	CT7046	CT9667-03*	
AC leakage current sensor	CT7116	9657-10 9675	5 A, 500 mA
AC current sensor	CT7126	9694, 9695-02	50 A, 5 A
	CT7131	9660, 9695-03	100 A, 50 A
	CT7136	9661	500 A, 50 A
AC/DC auto-zero current sensor	CT7731	-	100 A, 50 A
	CT7736	-	500 A, 50 A
	CT7742	-	5000 A, 500 A
Clamp on sensor	9669	9669	1000 A, 100 A

*: Set the range switch of the sensor to **500 A** when the **current range** of this instrument is set to **500 A** or **50 A**.

When connecting current sensors other than the optional sensors, the L9910 Conversion Cable is required.

External VT Ratio, External CT Ratio

Set when attaching an external VT or CT. Set to 1 if not attaching an external VT or CT.

Setting Contents:

0.01 to 9999.99

TIME PLOT Interval

Sets the TIME PLOT interval.

Setting Contents:(* : Default setting)

1/ 3/ 15/ 30 second(s), 1*/ 5 /10/ 15/ 30 minute(s), 1/2 hour(s), 150/180cycle

If the event icon () is orange after performing quick setup (indicating that the event is being detected continuously), it is recommended to check and reconfigure the event's threshold.

See:"5.6Changing Event Settings" (p.87)

NOTE

The 150 (50 Hz) and 180 (60 Hz) cycle settings provide the TIME PLOT intervals required for IEC61000-4-30-compliant measurement. When using a measurement frequency of 400 Hz, selecting 150/180 cycle will result in a 1200 cycle interval.

Key operation during configuration (continued)

Check the [Declared input voltage] and [Frequency].
Select if you need to change the settings.

These values will be set automatically. Change the values if they are incorrect.

Display the pull-down menu

Select setting or value

Accept setting

[Go]

A message informing you that the simple configuration process is starting will be displayed. Select [Yes] to continue with the process.

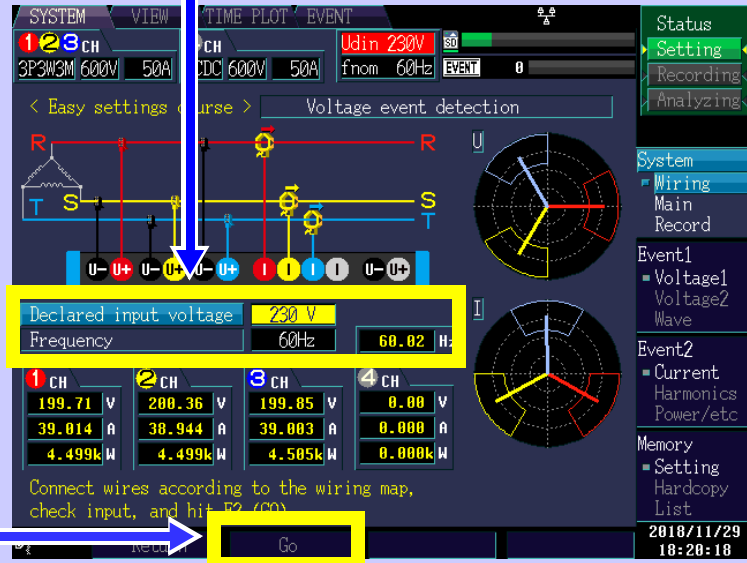

Easy settings course

Five measurement patterns are provided. Select the pattern that best suits your application. Quick setup automatically sets appropriate values for the connections and current types used in measurement, settings other than VT/CT ratios, TIME PLOT interval times, and thresholds used for event detection. Each of these settings can be changed later as desired.

Setting Contents:(* : Default setting)

Voltage event detection*	Monitors voltage factors (dips, swells, interruptions, etc.) and frequency to detect events. It is recommended to select this pattern when you are troubleshooting power supply problems such as hardware malfunctions.
Standard Power Quality	Monitors voltage factors (dips, swells, interruptions, etc.), frequency, current, voltage and current harmonics, and other characteristics to detect events. This pattern is primarily used to monitor systems, so it is recommended to select this pattern when you wish to evaluate power supply quality (power quality). The TIME PLOT interval will be set to 10 minutes.
Inrush Current	Measures inrush current. The TIME PLOT interval will be set to 1 minute, and the inrush current threshold will be set to 200% of the RMS current (reference value) set during quick setup.
Record measured value	Records measured values over an extended period of time using a TIME PLOT interval of 10 minutes. All event detection functionality other than manual events is turned off.
EN50160	Performs EN50160-compliant measurement. Standard-compliant evaluation and analysis can be performed by analyzing data using the application software PQ ONE, which is supplied with the instrument. Do not change the event threshold, or other settings once they have been configured. Doing so will prevent measurement in compliance with EN51060.

Easy settings course details (settings)

For more information about the easy settings course, see "(7) Easy settings" (p.223).

4.8 Verifying Settings and Starting Recording

Once you have determined that the settings are appropriate, start recording by pressing the **START/STOP** key. Verify that the event icon (**EVENT**) is not orange (indicating that the event is occurring frequently) and that measured values and waveforms on the **[VIEW]** screen are normal.

■ If the event icon is appearing frequently

Verify which event is occurring with the event list on the **[EVENT]** screen and change the problematic event threshold on the **[SYSTEM]** screen.

■ If measured values or waveforms are abnormal

Change the measurement condition settings on the **[SYSTEM]** screen and verify measured values again.

Repeat these steps until there are no other problems.

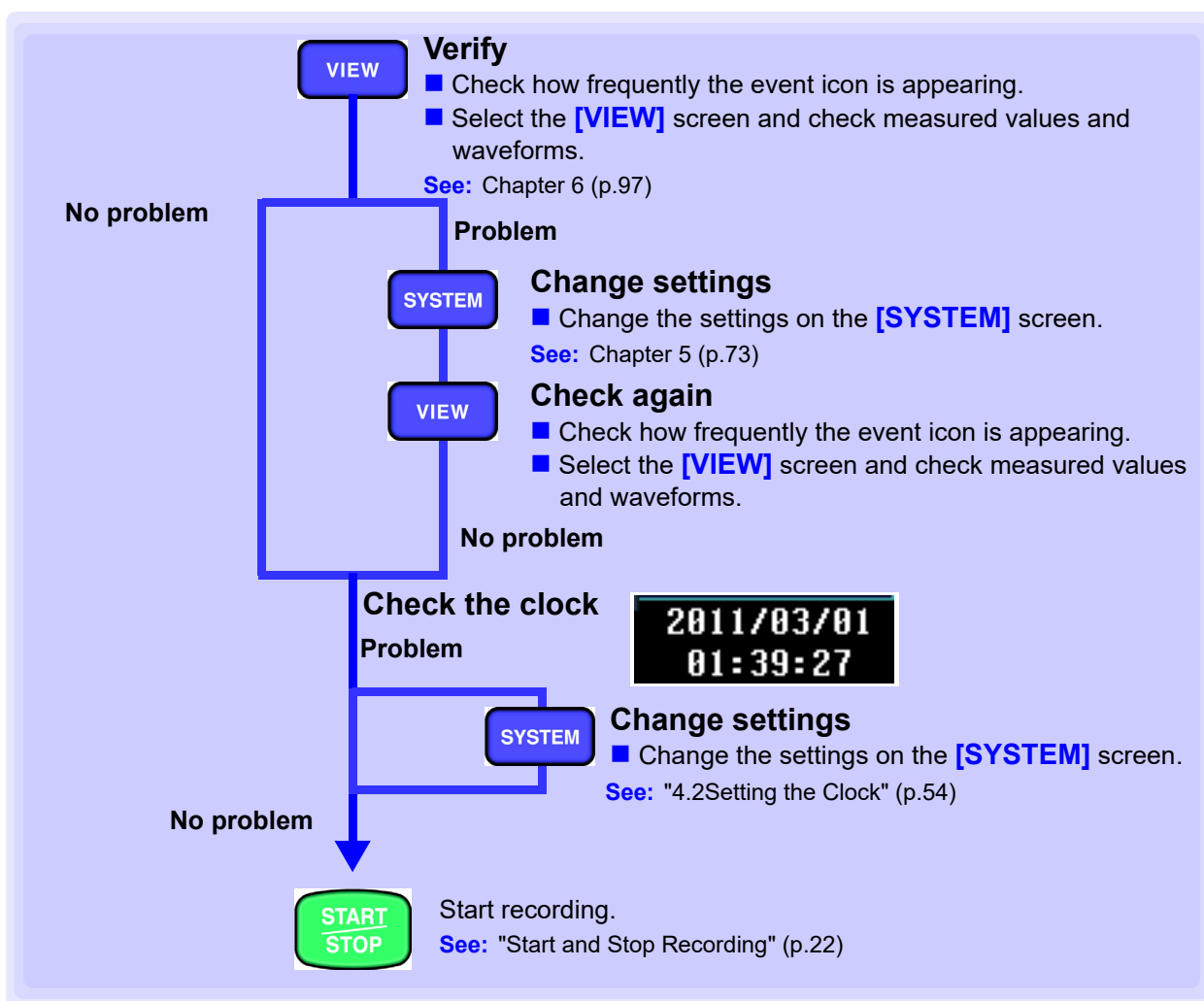

4.9 Using the Instrument during a Power Outage

If the supply of power to the instrument is interrupted (for example, during a power outage), it will operate using battery power (a fully charged battery provides enough power to operate for about 180 minutes). However, the instrument will turn off about 180 minutes after the outage occurs. Once the power is back on, the instrument will turn back on and resume recording. Integral values and other data will be reset, and the integration process will resume.

Changing Settings (as necessary) Chapter 5

5.1 Changing Measurement Conditions

Measure 1

Key operation during configuration

The diagram illustrates the sequence of operations for configuring Measure 1. It starts with the [SYSTEM] screen, followed by pressing DF 1 to reach the [Main] screen, and F 1 to reach the [Measure 1] screen. From there, directional keys are used to select a setting, the ENTER key is used to display a pull-down menu, directional keys are used to select a specific setting, the ENTER key is used to accept the setting, and the ESC/Cm key is used to cancel the operation.

5

Chapter 5 Changing Settings (as necessary)

Wiring

Selects the measurement line.

Setting Contents:(* : Default setting)

CH1,2,3: 1P2W/1P3W/3P3W2M/3P3W3M/3P4W*/3P4W2.5E

CH4: AC+DC*/DC/OFF



Declared input voltage

Selects the nominal input voltage (Udin) for the measurement line.

Setting Contents:(* : Default setting)

100/101/110/120/200/202/208/220/230*/240/277/347/380/400/415/480/600/VARIABLE (set from 50 V to 780 V in 1 V increments)

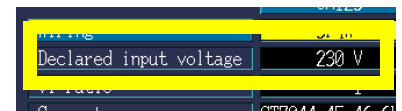

5.1 Changing Measurement Conditions

VT ratio

Sets the external VT (PT) being used.

Setting Contents:(* : Default setting)

1*/60/100/200/300/600/700/1000/2000/2500/5000/
VARIABLE (0.01 to 9999.99)



Current sensor, Current range

Selects the type of current sensor being used and current range. You can also set an output rate and use a sensor that has not been registered.

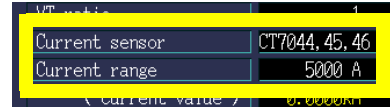

Current sensor			Current range
Optional	Other than the optional		
AC flexible current sensor	CT7044 CT7045 CT7046	CT9667-01* CT9667-02* CT9667-03*	5000 A, 500 A, 50 A
AC leakage current sensor	CT7116	9657-10 9675	5 A, 500 mA
AC current sensor	CT7126	9694 9695-02	50 A, 5 A
	CT7131	9660, 9695-03	100 A, 50 A
	CT7136	9661	500 A, 50 A
AC/DC auto-zero current sensor	CT7731	-	100 A, 50 A
	CT7736	-	500 A, 50A
	CT7742	-	5000 A, 500 A
Clamp on sensor	-	9669	1000 A, 100 A

*: Set the range switch of the sensor to **500 A** when the **current range** of this instrument is set to **500 A** or **50 A**.

When connecting current sensors other than the optional sensors, the L9910 Conversion Cable is required.

CT ratio

Set if using an external CT.

Setting Contents:(* : Default setting)

1*/40/60/80/120/160/200/240/300/400/600/800/1200/
VARIABLE (0.01 to 9999.99)



Frequency

Selects the nominal frequency (fnom) for the measurement line.

Setting Contents:(* : Default setting)

50 Hz*/60 Hz/400 Hz



Measure 2

Key operation during configuration

SYSTEM [SYSTEM] screen

DF 1 [Main]

F 2 [Measure 2]

Select a setting

ENTER Display the pull-down menu

Select a setting

ENTER Accept setting

ESC/On Cancel

Urms Type

Selects the voltage calculation method to use during 3-phase measurement.

Setting Contents:(* : Default setting)

Line-N*/Line-Line



PF Type

Selects the power factor calculation method. You can select either PF (calculate using RMS values) or DPF (calculate using fundamental wave only). The displacement power factor (DPF) is generally used for power systems, while power factor (PF) is used when evaluating device efficiency.

Setting Contents:(* : Default setting)

PF*/DPF



THD Type

Selects the total harmonic distortion (THD) calculation method. You can select either THD-F (distortion component/fundamental wave) or THD-R (distortion component/RMS value).

Setting Contents:(* : Default setting)

THD-F*/ THD-R



Harm Calc

Selects the harmonic calculation method.

Setting Contents:(* : Default setting)

U, I, P: All Levels*/U, I, P: All % of FND/U, P: %, I: Level

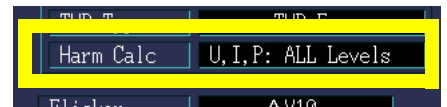

5.1 Changing Measurement Conditions

Flicker

Selects the flicker measurement type.

Setting Contents:(Default setting: $\Delta V10$ when the language is set to Japanese; otherwise, **Pst, Plt**)

Pst, Plt / $\Delta V10$



Filter

Sets the lamp system when **Pst, Plt** are selected for flicker measurement. This setting is not available when $\Delta V10$ is selected for the flicker setting.

Setting Contents:(* : Default setting)

230V* / 120V



Frequency 1

Frequency 1 means the frequency used for measurement of Mains signaling voltage 1 (Msv1, Msv%1).

Setting Contents: (Default setting: 1060.00 Hz)

Measurement frequency of 50 Hz: 55.00 to 2495.00,2500.00 Hz

Measurement frequency of 60 Hz: 65.00 to 2995.00,3000.00 Hz

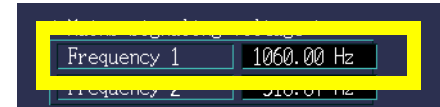

Frequency 2

Frequency 2 means the frequency used for measurement of Mains signaling voltage 2 (Msv2, Msv%2).

Setting Contents: (Default setting: 316.67 Hz)

Measurement frequency of 50 Hz: 55.00 to 2495.00,2500.00 Hz

Measurement frequency of 60 Hz: 65.00 to 2995.00,3000.00 Hz

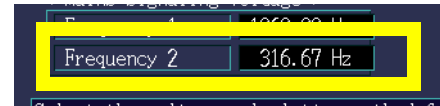

*: Msv1 and Msv2 mean levels, whereas Msv%1 and Msv%2 mean content rates.

The instrument with the measurement frequency set to 400 Hz cannot measure any Mains signaling voltage.

5.2 Changing the Recording Settings

Key operation during configuration

SYSTEM [SYSTEM] screen

DF 1 [Record]

F 1 [Interval]

Select a setting

ENTER Display the pull-down menu

Select a setting

ENTER Accept setting

ESC / On Cancel

Recording Items	Power and Harmonic
TIME PLOT Interval	1 minute
Screen copy interval	OFF

< TIME PLOT >	
(TIME PLOT)	1143 MB
SD Card available capacity	7585 MB
Saveable measurement time	35.0 Days

Select the items to save in TIME PLOT measurement.
Select one from All data, Power and Harmonic, or Power.

Interval Time

2018/12/03 18:43:34

Estimated data (TIME PLOT)

Depending on the settings, Displays an estimate of the amount of data that will be saved. The estimated data volume is calculated based on the recording item, TIME PLOT interval, real-time control, and repeated recording settings. The estimated data volume does not include screen copy data or event data.

If the data volume exceeds the amount of space remaining on the SD card, the value will be shown in red. Either free up space on the card by deleting unneeded data or replace the card with one with more space.

SD Card available capacity

Displays the amount of space remaining on the SD memory card. If the SD memory card experiences an error, "SD Error" will be shown.

Saveable measurement time

Displays an estimate of how many days of data can be saved based on the estimated data volume and the SD card remaining capacity. The actual number of days of data that can be saved may be less than the indicated amount depending on the number of screen copies made and events generated.

Recording Items

Sets the type of measurement data.

See: "Key operation during configuration" (p.77)



Setting Contents:(* : Default setting)

All data*	Records all the calculation values.
Power and Harmonic	Records all calculation values except inter-harmonics.
Power	Records all calculation values except harmonics and inter-harmonics.

Note: If 400 Hz is selected, [All data]* can not be selected.

Recording items	Power	Power and Harmonic	All data	Recording items	Power	Power and Harmonic	All data
RMS voltage refreshed each half-cycle	●	●	●	Instantaneous flicker value	●	●	●
RMS current refreshed each half-cycle	●	●	●	Integral power	●	●	●
Frequency 200 ms	●	●	●	Harmonic voltage	—	●	●
Frequency wave	●	●	●	Harmonic current	—	●	●
10-sec frequency	●	●	●	Harmonic power	—	●	●
Voltage RMS	●	●	●	Phase difference of harmonic voltage and harmonic current	—	●	●
Current RMS	●	●	●	High-order harmonic voltage phase angle	—	●	●
Voltage waveform peak	●	●	●	High-order harmonic current phase angle	—	●	●
Current waveform peak	●	●	●	Inter-harmonic voltage	—	—	●
Active power	●	●	●	Inter-harmonic current	—	—	●
Apparent Power	●	●	●	THD Voltage Percentage	●	●	●
Reactive Power	●	●	●	THD current percentage	●	●	●
Power factor/displacement power factor	●	●	●	High-order harmonic voltage component	●	●	●
Efficiency	●	●	●	Mains signaling voltage	●	●	●
Voltage unbalance factor	●	●	●	High-order harmonic current component	●	●	●
Current unbalance factor	●	●	●	K factor	●	●	●
				Flicker (ΔV10/ Pst, Plt)	●	●	●

NOTE

Detailed trend graphs are always displayed with maximum and minimum values.

TIME PLOT Interval

Sets the TIME PLOT interval (recording interval).

See: "Key operation during configuration" (p.77)

Setting Contents:(* : Default setting)

**1/ 3/ 15/ 30 second(s), 1*/ 5 /10/ 15/ 30 minute(s) ,
1/2 hour(s), 150/180/1200 cycle**

Recording Interval	Default and Unit
TIME PLOT Interval	1 minute
Screen copy Interval	OFF

The time series graph recording time varies with the recorded parameters and TIME PLOT interval setting.

See: "Recording Items" (p.78)

NOTE

The 150 cycle (50 Hz) and 180 cycle (60 Hz) settings provide the TIME PLOT intervals required for IEC 61000-4-30-compliant measurement. You can select 150 cycles (measurement frequency of 50 Hz), 180 cycles (60 Hz), or 1200 cycles (400 Hz).



When the memory is full

The PQ3198 stops recording data to the SD memory card.

Recording times (reference value) for a Z4001 SD Memory Card 2 GB (Repeat Record: 1 week, Repeat Number: 55 times)

TIME PLOT interval	Recording parameter setting		
	All data (Saves all data)	Power and Harmonic (Saves RMS values and harmonics)	Power (Saves RMS values only)
1 second	16.7 hours	23.4 hours	13.2 days
3 seconds	2.1 days	2.9 days	39.7 days
15 seconds	10.4 days	14.6 days	198.4 days
30 seconds	20.9 days	29.3 days	55 weeks
1 minute	41.7 days	58.6 days	55 weeks
5 minutes	208.6 days	292.8 days	55 weeks
10 minutes	55 weeks	55 weeks	55 weeks
15 minutes	55 weeks	55 weeks	55 weeks
30 minutes	55 weeks	55 weeks	55 weeks
1 hour	55 weeks	55 weeks	55 weeks
2 hours	55 weeks	55 weeks	55 weeks
150/180 /1200 cycle (Approx. 3 sec)	2.1 days	2.9 days	39.7 days

- Figures indicate the amount of recording time after the SD memory card has been initialized.
- Recording times do not account for event data and screen copy data. Recording times may be shortened when event data and screen copy data are stored on the card.
- Recording times are not dependent on connections.
- When repeated recording is set to [OFF], the maximum recording time is 35 days.
- When repeated recording is set to [1 Day], the maximum recording time is 366 days.
- When repeated recording is set to [1 Week], the maximum recording time is 55 weeks.
- Harmonics order data is not saved for [Power], but it is saved in THD.



Measuring for an extended period of time.

If repeated recording is enabled and the recording count set, the instrument can make measurements for up to 55 weeks.

See: Long-term measurements over 1 month or longer: Enable repeated recording (see "Repeat Record" (p.81)).

Screen copy interval

Outputs the display image to the SD memory card at the set screen copy interval.

See: "Key operation during configuration" (p.77)

Setting Contents:(* : Default setting)

OFF*/5/ 10/ 30 minute(s)/ 1/ 2 hour(s)

TIME PLOT Interval	1 minute
Screen copy interval	OFF

5.3 Changing the Measurement Period

Key operation during configuration

Legend:

- [SYSTEM] screen
- [Record]
- [Time]
- Select a setting
- Display a pull-down menu to select a setting
- Select a value to change
- Select the setting/change the value
- Accept setting
- Cancel

Screen Content:

SYSTEM VIEW TIME PLOT EVENT

Udin 230V

Time Start Exactly

Repeat Record OFF

Start date and time -- Y -- M -- D -- : --

End date and time -- Y -- M -- D -- : --

Repeat Record <1 day>

Start time -- : -- Repeat Number

End time -- : --

< TIME PLOT >

Estimated data (TIME PLOT) 84 MB

SD Card available capacity 6299 MB

Saveable measurement time 35.0 Days

Set the START/STOP times to automatically record.
No actual time control when using Exactly or Manual time.

Interval Time

2018/11/29 18:10:19

Time Start

This section describes how to set the method used to start and stop recording.



Setting Contents:(* : Default setting)

Manual	Starts and stops recording when the START/STOP key is pressed.
Time	Starts/stops recording at the set time and date. If the start time and date has already passed when the START/STOP key is pressed, an [Exactly] start will result, and the start time and date will automatically be changed to the present time. If the stop time and date has also passed, the stop time and date will be repeated and automatically changed to the longest recording setting interval.
Exactly*	Starts recording at the next [TIME PLOT Interval] after the START/STOP key is pressed. If the START/STOP key is pressed at the time "10:41:22" with the time plot interval set to 10 min, the instrument will enter in the standby state. The recording will start at "10:50:00." If the set recording interval is of 30 s or less, recording will start from the next zero second. Stop operation is the same as with the [Manual] setting.

Repeat Record

Repeated recording operations can be conducted up to 55 weeks at one-day measuring intervals, and up to 366 days at one-week measuring intervals.

The measured data file of repeated recording is saved as a separate binary file for each one-day or one-week period on the SD memory card.

Setting Contents:(* : Default setting)

OFF*	No repeated recording
1 Day	Repeated recording at one-day intervals
1 Week	Repeated recording at one-week intervals

If **[Repeat Record]** is set to **[1 Day]**, set the **[Start Time]**, **[End Time]**, and **[Repeat Number]**.

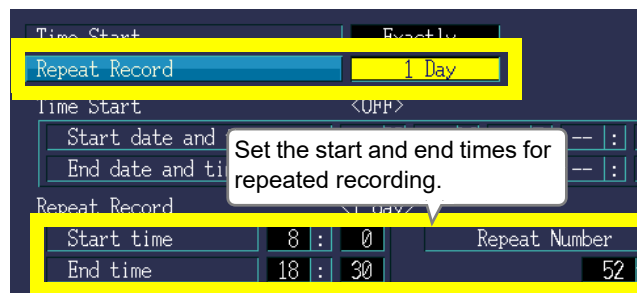

NOTE If **[Time Start]** is set to **[Time]**, you will not be able to set a **[Repeat Number]**.

If **[Repeat Record]** is set to **[1 Week]**, set the **[Repeat Number]**.

Repeat Number

Can be set to a value from 1 to 366.

If **[Repeat Record]** is set to **[1 Week]**, you will be able to set a value of up to 55.)



During repeated recording, the present iteration and total number of set iterations is displayed, and the green arrow flashes.



NOTE When repeated recording is set to **[1 Week]**, the stop time and date is set automatically.

Relationship between real-time control and repeated recording (count) settings

	Real-time control	Repeated measurement	Real-time control and date setting	Repeated measurement time setting	Repeat number
Set-ting	ON	OFF	Start time and date and stop time and date	—	—
	ON	1 Week	Start time and date	—	Any value from 1 to 55
	ON	1 Day	Start date and stop date	Start time and stop time	—
	OFF	OFF	—	—	—
	OFF	1 Week	—	—	Any value from 1 to 55
	OFF	1 Day	—	Start time and stop time	Any value from 1 to 366

5.3 Changing the Measurement Period

Relationship between the repeat setting and the maximum repeat count

■ When the repeat setting is [OFF]

Recording starts when the **START/STOP** key is pressed.

Recording stops when the **START/STOP** key is pressed, or at the stop time and date set for real-time control.

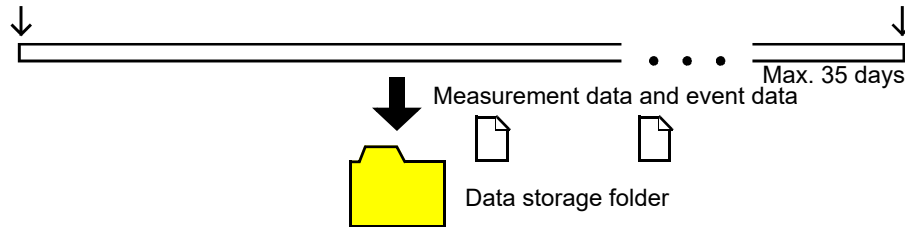

■ When the repeat setting is [1 Day]

The **START/STOP** key is pressed. No gap between the start time and stop time settings, e.g., if the start time and stop time settings are both set to 0:00 (or any same time).

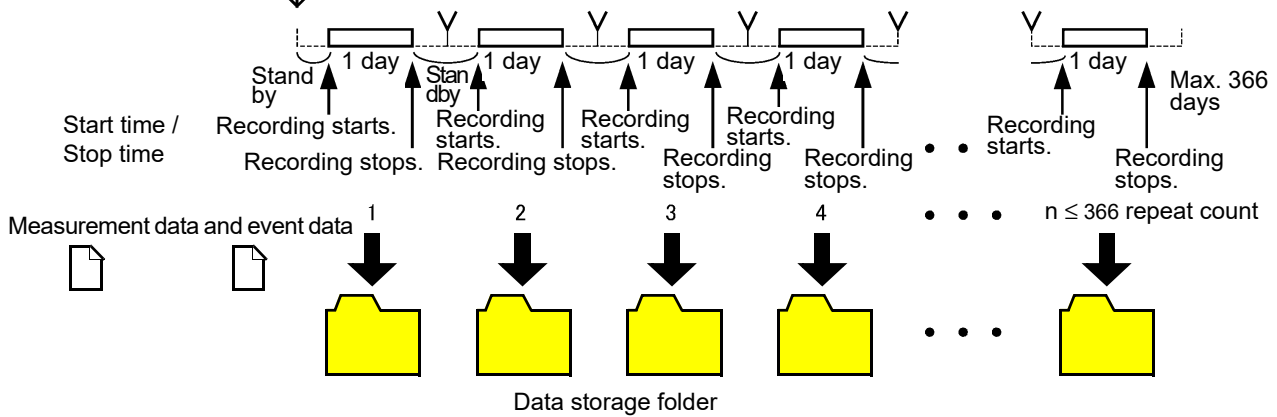

■ When the repeat setting is [1 Week]

Recording starts when the **START/STOP** key is pressed.

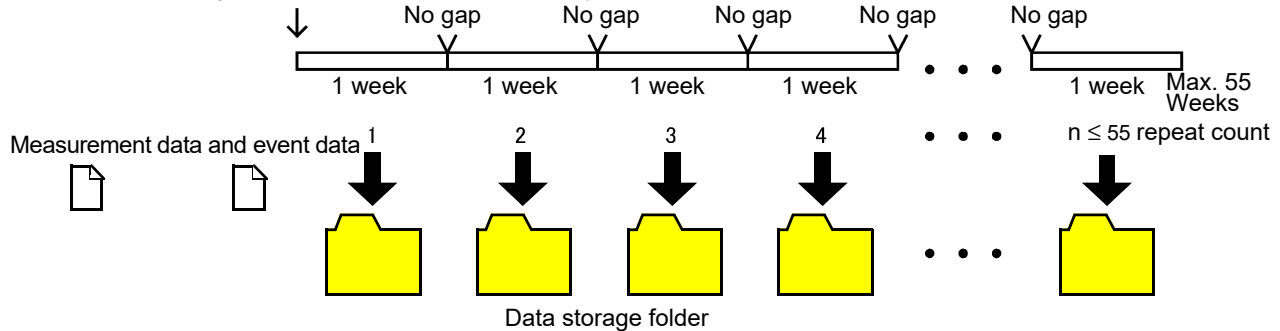

NOTE

- For more information about the data storage folder hierarchy, see "File structure (overall)" (p.164).
- In the event of a power outage (interruption of power to the instrument), the folder will be segmented.
- Once the data storage files exceed about 100 MB, data will be segmented, regardless of the repeat count.

5.4 Changing Hardware Settings

Key operation during configuration

Legend:

- SYSTEM** [SYSTEM] screen
- DF 1** [Main]
- F 3** [Hardware]
- Select a setting** (Left arrow)
- ENTER** Display a pull-down menu to select a setting/ Select a value to change
- Select the setting/ change the value** (Right arrow)
- ENTER** Accept setting
- ESC / On** Cancel

Navigation Path: SYSTEM → Main → Hardware → External output → Short pulse

Language

Sets the display language.

Setting Contents:

Japanese	Japanese
English	English
Chinese	Simplified Chinese
Trad	Traditional Chinese
Korean	Korean
German	German
French	French
Italian	Italian
Spanish	Spanish
Turkish	Turkish
Polish	Polish

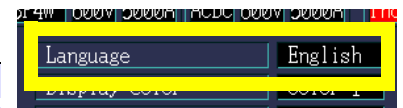

5.4 Changing Hardware Settings

Display Color

Select the grid (graticule) type for the waveform screen. Sets the screen color.

Setting Contents:(* : Default setting)

Color 1*	Blue-gray
Color 2	Blue
Color 3	Black
Color 4	Gray
Color 5	White (Convenient when printing screenshots)

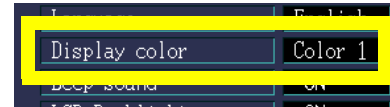

Beep sound

Sets whether to beep when a key is pressed.

Setting Contents:(* : Default setting)

ON*	Beeps are enabled.
OFF	Beeps are disabled.

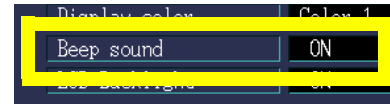

LCD Backlight

The LCD backlight can be set to turn off after a set period of time. Pressing a key will cause the screen to be displayed again.

Setting Contents:(* : Default setting)

AUTO	Automatically turns the backlight off once 2 minutes have elapsed since the last key press.
ON*	Leaves the screen backlight on at all times.

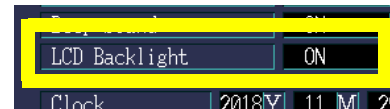

Clock

Sets the time and date, which are used to record and manage data.

Be sure to set the time and date before starting recording (seconds cannot be set).

Valid setting range: 00:00 on January 1, 2010 to 23:59 on December 31, 2079.



External output

Set when using the external control terminal to connect the PQ3198 to an external device.

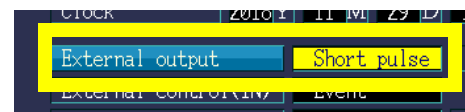

Setting Contents:(* : Default setting)

OFF	Disables external output.
Short pulse*	A short pulse (approx. 10 ms) is output on recording start, stop, and during event IN. A long pulse (approx. 2.5 s) is output only during event IN.
Long pulse	Set this function to be combined with the 2300 Remote Measurement System or a sequencer. Low period is retained for approx. 2.5 s during event IN. If another event IN occurs during the Low period, the Low period for is retained for another approx. 2.5 s.
ΔV10 alarm	This setting can be selected only when the [Flicker] setting is [ΔV10]. Output will be set to low when the set ΔV10 threshold is exceeded. If selecting this setting, set the ΔV10 threshold. (0.00 V to 9.99 V)

External control (IN)

Selects whether to use external control (IN) as an event trigger or START/STOP signal.

Setting Contents:(* : Default setting)

Event*	Use as an event trigger.
START/STOP	Use to start and stop recording.

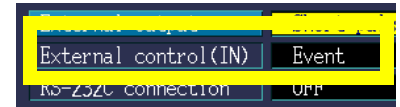
**RS-232C connection**

Set when connecting the PQ3198 to Model PW9005 GPS Box with an RS-232C cable.

Setting Contents:(* : Default setting)

OFF*	Disables the RS connection.
GPS	Outputs data to a Model PW9005 GPS Box. If selecting this setting, select the time zone. (-13:00 to +13:00) See: Model PW9005 Instruction manual

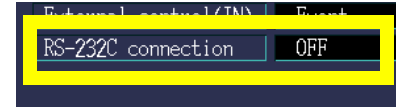

5.5 Changing LAN Settings

Key operation during configuration

SYSTEM [SYSTEM] screen

DF 1 [Main]

F 4 [LAN]*

Select a setting

Display a pull-down menu to select a setting/ Select a value to change

Select the setting/ change the value

Accept setting

Cancel

*: Select a setting other than [Current sensor] when using [Measure 1]. If [Current sensor] is selected, [LAN] will be displayed for F4.

LAN

Set when connecting the PQ3198 to a computer with a LAN cable.

See: "Configure the Instruments LAN Settings" (p.184)

Setting Contents:

IP Address	Sets the IP address. (3 characters.3 characters.3 characters.3 characters (**.***.***.***))
Subnet Mask	Sets the subnet mask. (3 characters.3 characters.3 characters.3 characters (**.***.***.***))
Default Gateway	Sets the default gateway. (3 characters.3 characters.3 characters.3 characters (**.***.***.***))

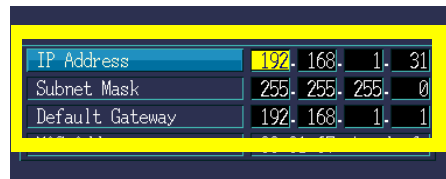

FTP server settings

Set when using the FTP server function to download files.

Setting Contents:

Authentication	Enable when trying to restrict connection to the FTP server.
User name	Configure a user name used when connecting an FTP client to the instrument.
Password	Configure a password used when connecting an FTP client to the instrument.

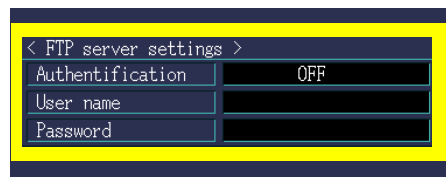

5.6 Changing Event Settings



What is an event?

See: "Appendix 2 Explanation of Power Supply Quality Parameters and Events"

List of event settings

Event parameter	Order selection	Additional functionality	Channel selection	Threshold (Note 9)	Note
Transient overvoltage			(1,2,3) (4) (OFF)	0 V peak to 6000 V peak Specify as absolute value.	1,4
Swell		Slide	(1,2,3) (-) (OFF)	0% to 200%	1,5,10
Dip		Slide	(1,2,3) (-) (OFF)	0% to 100%	1,5,10
Interruption			(1,2,3) (-) (OFF)	0% to 100%	1,5
Inrush current			(1,2,3) (4) (OFF)	0 A to (varies with range) A	1,4,5
Frequency 200 ms			(U1) (-) (OFF)	0.1 Hz to about 9.9 Hz	5
Frequency cycle			(U1) (-) (OFF)	0.1 Hz to about 9.9 Hz	5
Voltage waveform peak			(1,2,3) (4) (OFF)	0 V peak to 1200 V peak	1,4,7
RMS voltage		Phase/line sense	(1,2,3) (4) (OFF)	0 V to 780 V Specify upper and lower limits.	1,3,4,5
DC voltage change (CH4 only)			(-,,-) (4) (OFF)	0 V to 1200 V	1,5
Current waveform peak			(1,2,3) (4) (OFF)	0 A to (varies with range) A×4	1,4,7
RMS current		Sense	(1,2,3) (4) (OFF)	0 A to (varies with range) A	1,4,5
DC current change (CH4 only)			(-,,-) (4) (OFF)	0 A to (varies with range) A×4	1,5
Active power			(1,2,3)(sum) (OFF)	0 to varies with range Specify as absolute value.	1,4,5,8
Apparent power			(1,2,3)(sum) (OFF)	0 to varies with range	1,4,5,8
Reactive power			(1,2,3)(sum) (OFF)	0 to varies with range Specify as absolute value.	1,4,5,8
Power factor/displacement power factor		PF/DPF	(1,2,3)(sum) (OFF)	0 to 1 Specify as absolute value.	3,4,5
Negative-phase voltage unbalance factor			(-,,-) (sum)(OFF)	0% to 100%	5
Zero-phase voltage unbalance factor			(-,,-) (sum)(OFF)	0% to 100%	5
Negative-phase current unbalance factor			(-,,-) (sum)(OFF)	0% to 100%	5
Zero-phase current unbalance factor			(-,,-) (sum)(OFF)	0% to 100%	5
Harmonic voltage	Orders 0 to 50	Level (RMS)/content percentage	(1,2,3) (4) (OFF)	0 V to 780V/0% to 100% Specify the 0th order level as an absolute value.	1,2,3,4,5,6
Harmonic current	Orders 0 to 50	Level (RMS)/content percentage	(1,2,3) (4) (OFF)	$1.3 \times (0 \text{ to } [\text{varies with range}]) \text{ A}$ /0% to 100% Specify the 0th order level as an absolute value.	1,2,3,4,5,6
Harmonic power	Orders 0 to 50	Level/content percentage	(1,2,3)(sum) (OFF)	$1.3 \times (0 \text{ to } [\text{varies with range}]) \text{ W}$ Specify as absolute value. /0% to 100%	1,2,3,4,5,6,8

List of event settings

Event parameter	Order selection	Additional functionality	Channel selection	Threshold (Note 9)	Note
Harmonic voltage-current phase difference	Orders 1 to 50		(1,2,3)(sum) (OFF)	0° to 180° Specify as absolute value.	2,4,5,6
Total harmonic voltage distortion factor		-F/-R	(1,2,3) (4) (OFF)	0% to 100%	3,4,5
Total harmonic current distortion factor		-F/-R	(1,2,3) (4) (OFF)	0% to 500%	3,4,5
K factor			(1,2,3) (4) (OFF)	0 to 500	4,5
High-order harmonic voltage component			(1,2,3) (4) (OFF)	0 V to 600 V	1,4
High-order harmonic current component			(1,2,3) (4) (OFF)	0 V to (varies with range) A	1,4
Voltage waveform comparison			(1,2,3) (-) (OFF)	0% to 100%	1
Mains signaling voltage		Signal frequency timeout	(1,2,3) (-) (OFF)	0% to 15%	11
Time event			(-, -, -) (-) (OFF)	OFF, 1, 5, 10, 30, 60, 120 minute(s).	
Continuous event			(-, -, -) (-) (OFF)	OFF, 1, 2, 3, 4, 5 times	
External event			(External) (OFF)	None	
Manual event				None	
Start				None	
Stop				None	

Note 1: The threshold range is expanded by the VT ratio and CT ratio settings (for harmonics, level value only).

Note 2: Settings can be made for individual orders as specified in the “Order selection” column.

Note 3: Phase voltage/line voltage, level/content percentage/voltage content percentage or current power level, THD-F/THD-R, power factor/displacement power factor selections are made in the system settings.

Note 4: Thresholds can be set separately for individual channels as grouped together (other than “OFF”) in the “Channel selection” column. (However, channels 1, 2, and 3 must share the same setting.)

Note 5: Hysteresis applies. However, the frequency is fixed at 0.1 Hz.

Note 6: During 400 Hz measurement, harmonic voltage, harmonic current, harmonic power, and harmonic voltage-current phase difference can be measured up to the 10th order.

Note 7: Only when CH4 is set to DC, use an absolute value of DC values in an approx. 200 ms aggregation to specify the threshold.

Note 8: The sum value threshold is 2 times for 1P3W, 3P3W2M, and 3P3W3M, and 3 times for all others.

Note 9: The setting precision for thresholds is ± 1 dgt.

Note 10: Sets the threshold values as percentages of nominal voltage (Uref)*.

Note 11: The signal frequency range

60 Hz to 2.5 kHz (for a measurement frequency of 50 Hz)

70 Hz to 3.0 kHz (for a measurement frequency of 60 Hz)

Choose between two timeout settings: 30 seconds and 120 seconds.

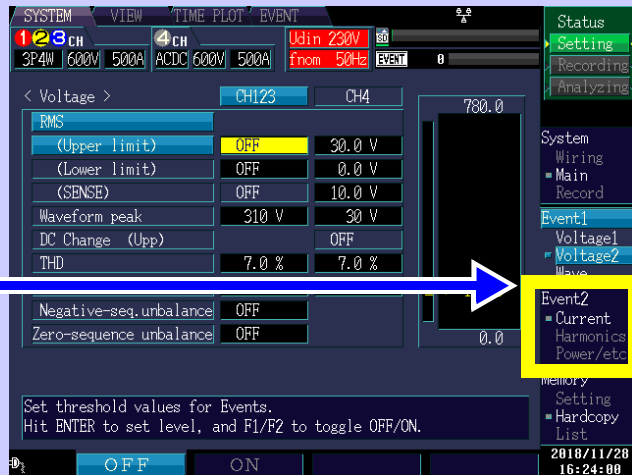
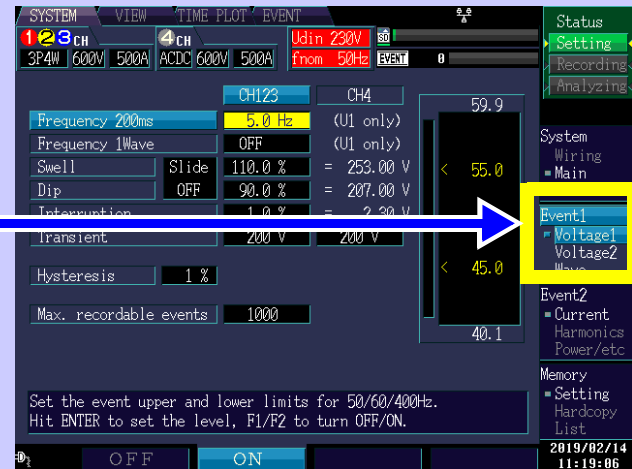
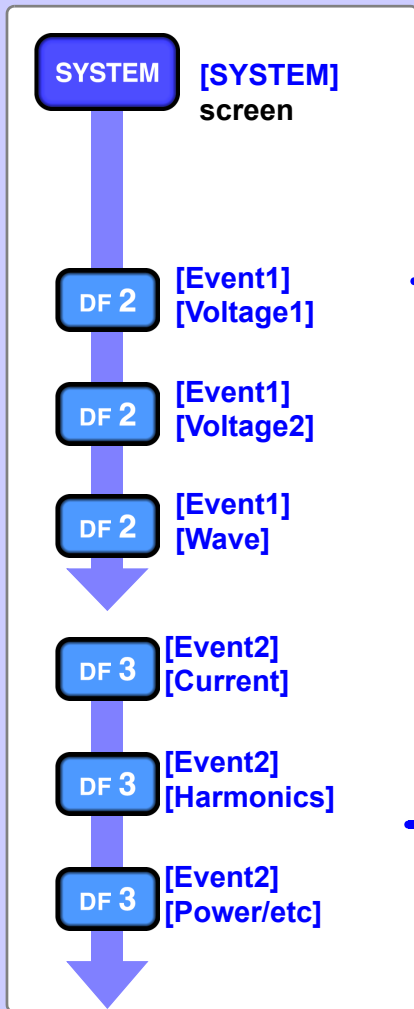

- To turn voltage/current/power events on or off, or to adjust associated thresholds (p.90).
- To turn harmonic events on or off, or to adjust associated thresholds (p.91).
- To generate an event using an external input signal (p.92).
- To generate an event manually (p.92).
- To periodically generate an event (p.93).

Turning events on and off and adjusting thresholds (applies to voltage, current, and power)

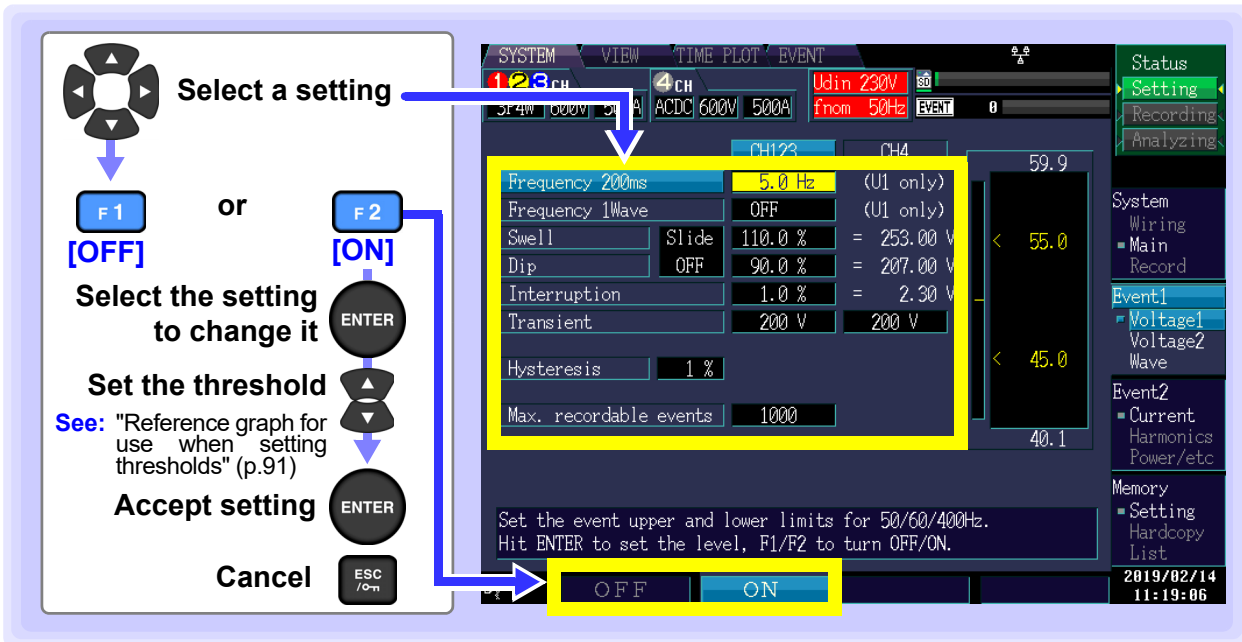

Setting Contents:(* : Default setting)

OFF*	Disables the event function for the selected setting.
ON	Sets the threshold at which to enable the event function for the selected setting.

NOTE

- Sets the voltage swell, voltage dip, and voltage interruption threshold values as percentages of nominal voltage (Uref)*. The converted voltage is displayed to the right of the percentage setting.
 - *: The nominal voltage (Uref) is obtained by multiplying the nominal input voltage (Udin) by the VT ratio. When the VT ratio is 1, the nominal voltage (Uref) is equal to the nominal input voltage (Udin).
- Setting the voltage swell and voltage dip [Slide] settings to [ON] causes the threshold to be expressed as a percentage of the slide reference voltage.
- If the threshold value falls outside the valid setting range, "-----" will be displayed. Pressing the **ENTER** key resets the value to the threshold upper limit.

Hysteresis Hysteresis, which applies at the set percentage to the threshold for voltage, current, power, and similar events or at the fixed value of 0.1 Hz to the threshold for frequency and similar events, prevents the detection of an excessive number of events. Normally it is recommended to use a setting of 1% to 2%.

Slide (slide reference voltage) When the voltage value fluctuates gradually, allows dip and swell to be judged using the fluctuating voltage values as a reference.
See: "Appendix 6 Terminology""Slide reference voltage" (p.A28)

SENSE (Sense) When the RMS voltage or RMS current continues to fluctuate in excess of the threshold, generates an event when the value obtained by adding the set sense value and the measured value is exceeded. You can track events to identify the status when the RMS voltage or RMS current exceeds the threshold.
See: "Appendix 6 Terminology""Sense" (p.A28)

Max. recordable events Sets the number of events that can be recorded during one measurement. When the repeat setting is enabled, the number of events is obtained by multiplying this setting by the repeat count. Setting [Max. recordable events] to [9999] disables waveform comparison events. If an event occurs for 5 min. or more at a frequency of 3 times

per second or greater while **[Max. recordable events]** is set to **[9999]**, the resulting event data may be incomplete.

Reference graph for use when setting thresholds

You can adjust thresholds while viewing the present measured value and measurement waveform state.

For events other than voltage waveform comparison
(Example: Frequency 200 ms)

Threshold upper limit: 59.9

Current measured value: 55.0

Currently threshold: 55.0

Current threshold: 55.0

Threshold lower limit: 40.1

Voltage waveform comparison

The **[U_Wave]** screen can be displayed with the **DF2** key. A voltage waveform comparison event is generated when the measurement waveform exceeds the waveform envelope level. The waveform envelope level is set as a percentage of the nominal input voltage. When using a 3-phase connection, the waveform envelope level applies to the voltages of all 3 phases.

Red: Current measurement waveform

Top of waveform envelope level

Bottom of waveform envelope level

Set thresholds are stored internally regardless of the event's ON/OFF setting. Even if a threshold is set, no events will be generated unless the event is set to ON.

Turning events ON and OFF and adjusting thresholds (harmonics)

Events can be configured by pressing the **DF3** key to display the **[Harmonics]** screen. Settings can be turned ON or OFF for each harmonic order.

Select the harmonic order to set

F1 [OFF] or F2 [ON]

Select the setting to change it

ENTER

Set the threshold

↑ ↓

Accept setting

ENTER

Cancel

ESC / On

Bar for harmonic order being set (green)

Threshold (red)

CH1 value

Setting Contents:(* : Default setting)

OFF*	Disables the event function for the selected setting.
ON	Sets the threshold at which to enable the event function for the selected setting.

Set thresholds are stored internally regardless of the event's ON/OFF setting.

Even if a threshold is set, no events will be generated unless the event is set to ON.

When the measurement frequency (fnom) is 400 Hz, measurement is limited to the 10th order.

Generating events using an external input signal (external event settings)

Events can be configured by pressing the **DF3** key to display the **[Power/etc]** screen. External events are detected using external control terminal (EVENT IN) shorts or pulse signal falling edge input. The voltage and current waveforms and measured values when the external event occurs can be recorded. This functionality is enabled by setting external events to ON.

See: "11.1 Using the External Control Terminal" (p.177)

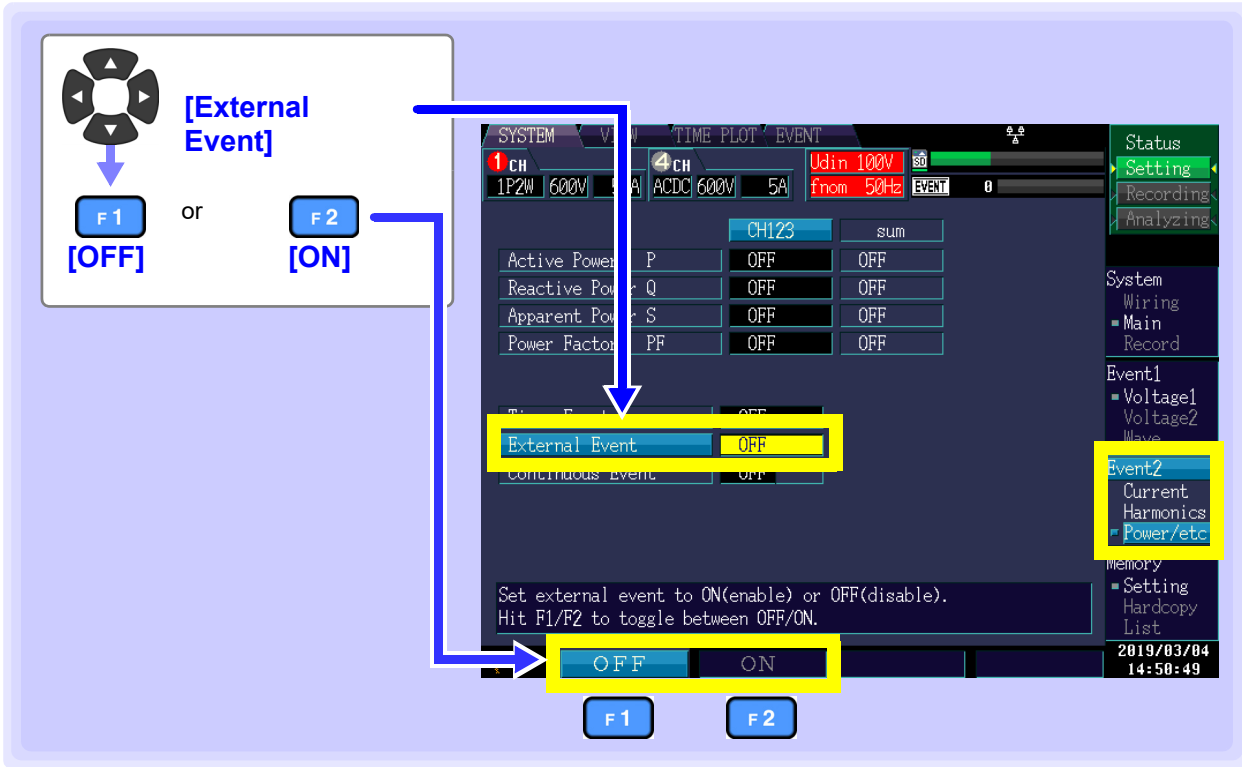

Generating events manually (manual event settings)

Events are detected when the **MANU EVENT** (manual event) key is pressed. The voltage and current waveforms and measured values when the external event occurs can be recorded. Manual events are always enabled.

See: More about how to record event waveforms: "Appendix 4 Recording TIME PLOT Data and Event Waveforms" (p.A12)

Generating events periodically (timer event settings)

Events can be configured by pressing the **DF3** key to display the **[Power/etc]** screen. Events are generated at the set interval and recorded as external events.

The screenshot shows the 'EVENT' menu with the following options:

Timer Event	1 minute
External Event	OFF
Continuous Event	OFF

The 'Timer Event' option is highlighted in yellow. A navigation guide on the left indicates the following steps:

- Use the directional keys to select the setting to change it.
- Use the directional keys to set the interval at which to generate the timer event.
- Press **ENTER** to accept the setting.
- Press **ESC / ON** to cancel.

The background screen shows various power measurement parameters for CH123, including Active Power P, Reactive Power Q, Apparent Power S, and Power Factor PF, all currently set to OFF. The 'Event2' menu is also visible on the right, with 'Power/etc' selected.

Once recording is started, timer events will be recorded at a fixed interval (the set time) from the start time.

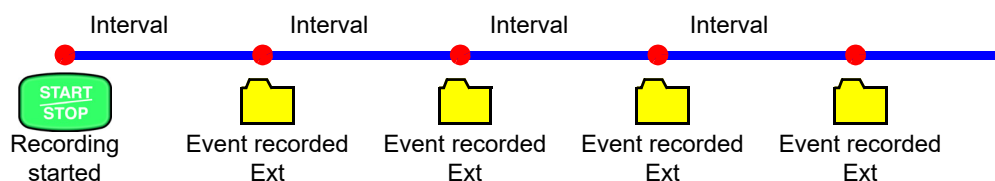

Generating Events Continuously (Continuous Event Function)

A function to continuously generate the number of set events (1 time to 5 times) automatically each time an event is generated.

Event apart from the first event will be recorded as "continuous event".

Due to this, instantaneous waveforms of up to one second can be recorded after an event has been generated.

However, in an event generated during a continuous event generation, continuous event will not be generated.

Continuous event generation will stop as soon as the measurement is finished.

Used to observe the instance when the event is generated and the changes in the instantaneous waveforms after that. In the case of this instrument, waveforms of up to one second are recorded.

5.7 Initializing the Instrument (System Reset)

If the instrument seems to be malfunctioning, consult "Before having the instrument repaired" (p.254).

If the cause of the problem remains unclear, try a system reset.

Key operation during configuration

The diagram illustrates the navigation sequence for performing a system reset:

- SYSTEM** [SYSTEM] screen
- DF 1** [Main]
- F 3** [Hardware]
- [System Reset]**
- ENTER** Accept setting
- ESC / On** Cancel

The background image shows the instrument's screen with the following settings visible:

- SYSTEM** menu selected
- Language**: English
- Display color**: Color 1
- Beep sound**: ON
- LCD Backlight**: ON
- Clock**: 2018Y 11 M 29 D 18 : 8 : 35
- External output**: Short pulse
- External control (IN)**: Event
- RS-232C connection**: OFF
- System Reset** option highlighted
- Hardware** menu highlighted

NOTE Performing a system reset causes all settings other than the display language, time, phase names, IP address, subnet mask, and RS connected device to be reverted to their default values. Additionally, displayed measurement data and screen data will be deleted.
See: "5.8 Factory Settings" (p.95)

Reverting the instrument to its factory settings (boot key reset)

You can revert all settings, including language and communications settings, to their default values by turning on the instrument while holding down the **ENTER** and **ESC** keys.

5.8 Factory Settings

All settings' default values are as follows:

Measurement settings

Setting	Default value	Setting	Default value
Wiring	CH123: 3P4W CH4: AC+DC	Current sensor	CH123: CT7136 CH4: CT7136
Phase Name	RST	I Range	CH123: 500 A CH4: 500 A
VT ratio	CH123: 1 CH4: 1	CT ratio	CH123: 1 CH4: 1
Declared input voltage	230 V	THD Type	THD-F
Frequency	50 Hz	Harm Calc	U,I,P: All Levels
Urms Type	Phase-N	Flicker	Varies with set display language.
PF Type	PF	Mains signaling voltage frequency	Frequency 1: 1060.00 Hz Frequency 2: 316.67 Hz

Measurement period and recording settings

Setting	Default value	Setting	Default value
Time Start	Exactly	TIME PLOT interval	1 min
Repeat Record	OFF	Screen copy interval	OFF
Recording Items	All data		

Hardware settings

Setting	Default value	Setting	Default value
Language	Set language	LCD Backlight	ON
Display color	Color 1	External output	Short pulse
Beep sound	ON	External control (IN)	Event
		RS-232C connection	OFF

Vector area settings

Setting	Default value	Setting	Default value
Phase area	±30	U/I phase difference	0
Amplitude area	±20		

Monitoring Instantaneous Values (VIEW Screen) Chapter 6

6.1 Using the VIEW screen

The VIEW screen is composed of a number of screens corresponding to the DF1 to DF4 (DF: display function) keys. When you press a DF key, the screen corresponding to that key appears. Each time you press the same DF key, the display changes.

VIEW

VIEW screen selector

About screen configuration (p.32)

Switching screen display

DF 1

Waveform

See: "6.2 Displaying Instantaneous Waveforms" (p.98)

DF 2

Harmonics

See: "6.3 Displaying Phase Relationships ([VECTOR] Screen)" (p.102),
"6.4 Displaying Harmonics" (p.105)

DF 3

DMM

See: "6.5 Displaying Measured Values Numerically (DMM Screen)" (p.111)

The screen shown varies with the instrument's internal operating state.

Internal operating state	Display	Display update
[Setting]	Contents of the display update during setting.	Approximately 1 second
[Waiting]		
[Recording]	Contents of the latest display update during measurement.	
[Analyzing]	Contents of the display update during analysis, or contents at the moment an event selected in [EVENT] screen occurs.	



Normal screen display:

Displays the current measurement screen.

Note: [Waiting]

From the time the START/STOP key is pressed until measurement actually starts, settings are shown as [Waiting]. Settings are also shown as [Waiting] when measurement has been stopped due to use of repeated recording.

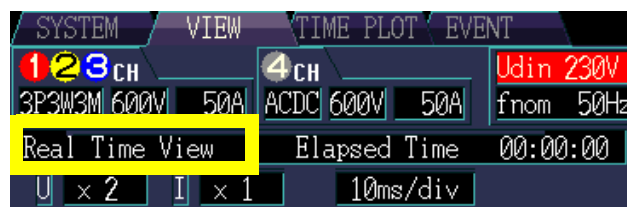

Screen display after an event is selected:

This screen is shown when an event is selected on the [EVENT] screen in [Analyzing] mode. As shown in the screenshot to the right, the event number, time and date, and type are displayed.

See: "8.3 Analyzing the Measurement Line Status When Events Occur" (p.147)

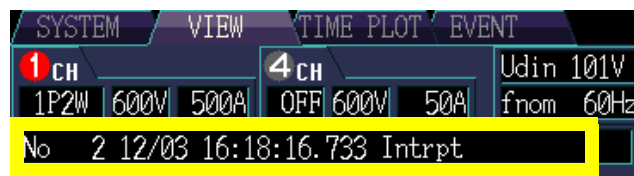

6.2 Displaying Instantaneous Waveforms

This section describes how to display the voltage and current instantaneous waveforms.

VIEW [VIEW] screen

Superimposes and displays 4 channels of the voltage waveform.

DF 1 [Waveform] [Volt/Curr]

Superimposes and displays 4 channels of the current waveform.

DF 1 [Waveform] [Voltage]

DF 1 [Waveform] [Current]

Example: Waveform showing four 3P4W (3-phase, 4-wire) channels

Waveform colors
 Red: CH1, Yellow: CH2
 Blue: CH3, White: CH4

Select with the **F** key.

- To reduce or enlarge the waveform (p.99)
- To view the value and time over the cursor (p.100)
- To scroll through the waveform (p.101)
- To hold the display (p.101)

NOTE The instantaneous waveform displays the waveform sampled at 20 kHz. (Measured values are calculated using waveforms sampled at a different frequency for each parameter.)

Reduce or enlarge the waveform (changing the X- and Y-axis scale)

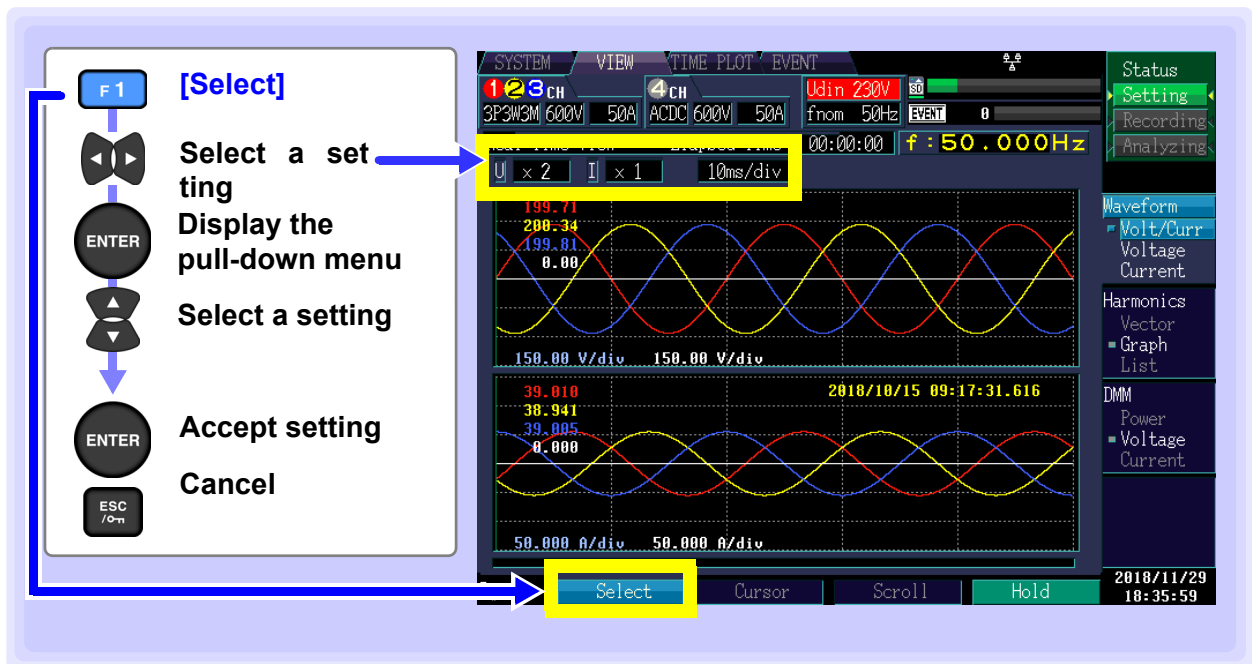

Y-axis scale (U: Voltage, I: Current)

To reduce the graph, decrease the scale.
To enlarge the graph, increase the scale.

Setting Contents:(* : Default setting)

x1/3, x1/2, x1*, x2, x5, x10, x20, x50

The scale can also be changed without using the pull-down menu by pressing the up and down cursor keys.



X-axis scale

To reduce the graph, decrease the scale.
To enlarge the graph, increase the scale.

Setting Contents:(* : Default setting)

5ms/div*, 10ms/div, 20ms/div, 40ms/div

The scale can also be changed without using the pull-down menu by pressing the up and down cursor keys.

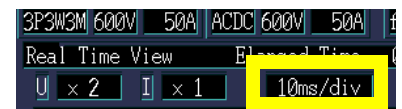

Viewing the value and time over the cursor (cursor measurement)

The cursor on the scroll bar shows where the cursor is located relative to all measurement data. Cursor values when cursor measurement is not being performed are shown as RMS values.

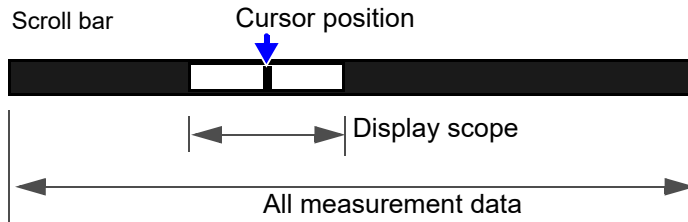

[Volt/Curr] display

F2 [Cursor]

Move the vertical cursor left and right to read the display value.

Cursor color
 Red: CH1
 Yellow: CH2
 Blue: CH3
 White: CH4

You can read waveform instantaneous values and time with the cursor. Normally, the cursor is located at the beginning of the waveform.

[Voltage] or [Current] display

F2 [Cursor]

Move the vertical cursor left and right to read the display value.

Cursor color
 Red: CH1
 Yellow: CH2
 Blue: CH3
 White: CH4

You can read waveform instantaneous values with the cursor. Normally, the cursor is located at the beginning of the waveform.

Scrolling through the waveform

You can review all measurement data by scrolling horizontally.

F3 [Scroll]



Scroll the waveform

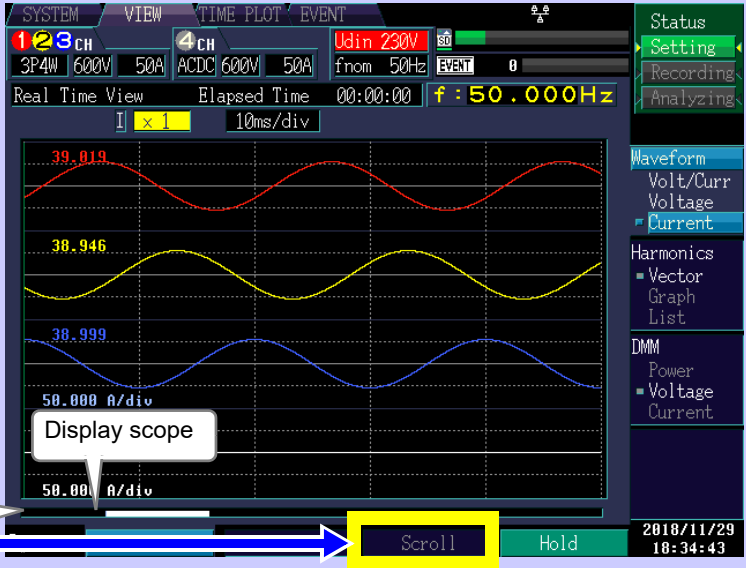

Display scope

Scroll bar

The display scope on the scroll bar (shown in white) illustrates which range of all waveform data is being shown on the screen.

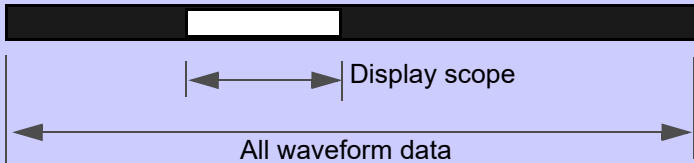

Scroll bar

Display scope

All waveform data

NOTE If you select an event and display a waveform, you can scroll horizontally to analyze 14 waveforms at 50 Hz, 16 waveforms at 60 Hz, or 112 waveforms at 400 Hz.

Holding the display

F4 [Hold]

(Measured values and waveforms will be held.)



6.3 Displaying Phase Relationships ([VECTOR] Screen)

Example: 3P4W (3-phase, 4-wire)

VIEW [VIEW] screen

↓

DF 2 [Harmonics] [Vector]

Select with the **F** key.

- To change the axis display (p.103)
- To change the RMS value/phase angle value display (p.103)
- To change the phase angle display method (p.103)
- RMS/phase angle/content percentage display (p.103)
- To change the harmonic number of orders (p.104)
- To hold the display (p.110)

Changing the axis display, RMS value/phase angle display, and phase angle value display

- Select a setting
- Display the pull-down menu
- Select a setting
- Accept setting
- Cancel

6.3 Displaying Phase Relationships ([VECTOR] Screen)

Axis display

You can select whether to use a linear display (LINEAR) or logarithmic display (LOG) for the vector axis. If you select the logarithmic display method, the vector is easy to see even at low levels.

Setting Contents:(* : Default setting)

LINEAR*	Linear display
LOG	Log Logarithmic display



NOTE

When the 400 Hz measurement frequency is selected, harmonic analysis is performed up to the 10th order, and inter-harmonic analysis is not available.

RMS/phase angle/content percentage display

Selects which value to display (RMS value display, phase angle display, or content percentage display). If **[Phase]** is selected, you can also set the phase angle value display method.

Setting Contents:(* : Default setting)

Level*	RMS
Phase	Phase angle
Content	Content percentage



Phase angle value display method

You can select the type of phase angle display. (This setting can be configured only when **[Phase]** is selected.)

Setting this parameter to **[lag360]** allows the display to be rotated clockwise 0° to 360°.

If **[lag360]** is selected, you can also set the phase angle reference source.

Setting Contents:(* : Default setting)

±180*	lead 0 to 180°, lag 0 to -180°
lag360	lag 0 to 360°



Phase angle reference source

You can select the reference source (0°) to display the phase angle value.

U1*	Uses U1 as the reference source.
I1	Uses I1 as the reference source.
U2	Uses U2 as the reference source.
I2	Uses I2 as the reference source.
U3	Uses U3 as the reference source.
I3	Uses I3 as the reference source.



Changing the harmonic number of orders

You can select what value to display.

When you change the number of orders, the values change along with the vector.

In this case, the voltage and current unbalance factors remain the same as the values calculated using the fundamental wave (1st order).

[Harmonic Order]

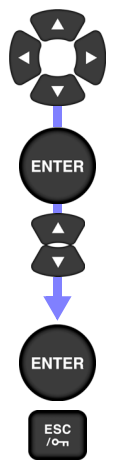

Display the pull-down menu

Change the number of order
(Up to the 50th order can be set)

Accept setting

Cancel

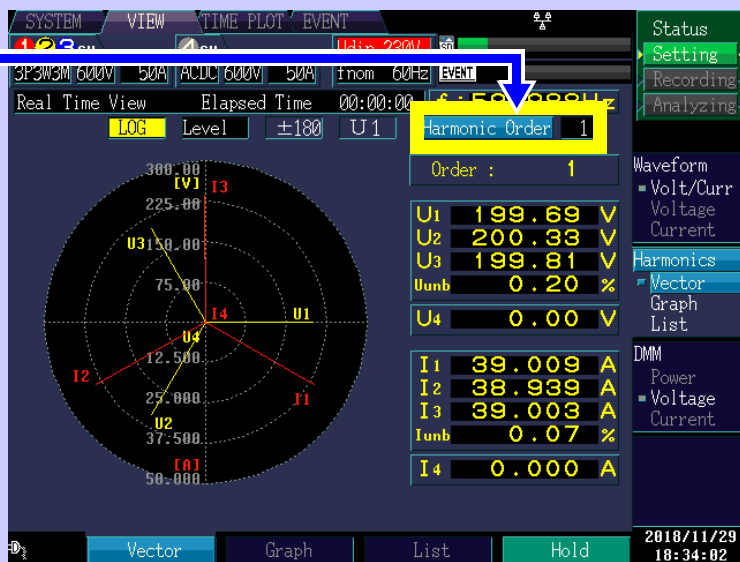

Order	U	I	Uunb	Iunb
U1	199.69 V	39.009 A	0.20 %	0.07 %
U2	200.33 V	38.939 A		
U3	199.81 V	39.003 A		
U4	0.00 V	0.000 A		

The harmonic number of orders can also be changed without using the pull-down menu by pressing the up and down cursor keys.

6.4 Displaying Harmonics

Displaying harmonics as a bar graph

Example: 3P4W (3-phase, 4-wire)

VIEW [VIEW] screen

DF 2 [Harmonics] [Graph]

Harmonic voltage

Harmonic current

Harmonic power

Data for the channel selected here is displayed.

High-order harmonic

High-order harmonic

harml 0.15 V

harml 0.007 A

150.86 V THD-F

9.986 THD-F

1.506kW

Vector Graph List Hold

Select with the **F** key.

- To change the display channel (p.106).
- To change the axis display (p.106).
- To change the RMS value/phase angle display (p.106).
- To display inter-harmonics (p.107).
- To change the display order (p.107).
- To hold the display (p.110).

Changing the display channel, axis display, RMS/phase angle display, and inter-harmonics

Select a setting

Display the pull-down menu

Select a setting

Accept setting

Cancel

Displayed channel

Setting Contents:(* : Default setting)

CH1* / CH2 / CH3 / CH4 / sum



NOTE

When the 400 Hz measurement frequency is selected, harmonic analysis is performed up to the 10th order, and inter-harmonic analysis is not available.

Axis display

If you select the logarithmic display method, the vector is easy to see even at low levels.

Setting Contents:(* : Default setting)

LINEAR*	Linear display
LOG	Log Logarithmic display



RMS/phase angle/content percentage display

Select the harmonic bar graph display (RMS value display, phase angle display, or content percentage). The harmonic power phase angle indicates the harmonic voltage-current phase difference.

Setting Contents:(* : Default setting)

Level*	RMS
Phase	Phase angle
Content	Content percentage



In the level display, the high-order harmonic component bar graph and measured value (harmH) are displayed next to the U and I bar graphs.

Inter-harmonics

Setting Contents:(* : Default setting)

iharmOFF*, **iharmON**

The setting can also be changed without using the pull-down menu by pressing the up and down cursor keys.

When the inter-harmonics display is enabled (iharmON), the screen changes as shown to the right.

Turquoise: inter-harmonics components

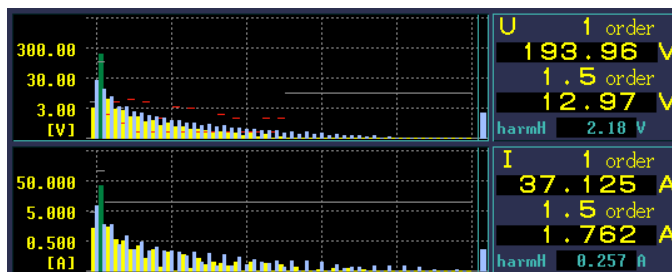

Changing the Displayed Order

The selected order number becomes green on the bar graph.

If you change the order number, the values change along with the bar graph.

Set the order number to THD to display THD values. (When you set the inter-harmonics setting, previously described, to iharmOFF, THD values will always be displayed. If you want to watch THD values with the iharmON selected, set the order number to THD.)

You can also change the displayed order without displaying the pull-down menu by using the up and down cursor keys.

[Harmonic Order]

Display the pull-down menu

Change the number of order
(Selectable settings: THD, 0th order through 50th order)

Accept setting

Cancel

Displaying harmonics as a list

The 1st to 50th harmonic orders and 0.5 to 49.5 inter-harmonic orders are displayed in a list for the selected item.

VIEW [VIEW] screen

↓

DF 2 [Harmonics] [List]

Example: 3P3W3M Wiring

? To change the displayed channels (p.106)
 To change the displayed items (p.106)
 To change the RMS value/phase angle display (p.106)
 To display inter-harmonics (p.107)

NOTE When the 400 Hz measurement frequency is selected, harmonic analysis is performed up to the 10th order, and inter-harmonic analysis is not available.

Changing the display channels, items, RMS value, phase angle, inter-harmonics

◀ ▶ Select a setting

ENTER Display the pull-down menu

▲ ▼ Select a setting

ENTER Accept setting

ESC / On Cancel

Displayed channel

Setting Contents:(* : Default setting)

CH1*/ CH2/ CH3/ CH4/ sum



Displayed item

Setting Contents:(* : Default setting)

U*	Voltage
I	Current
P	Active power



RMS/phase angle/content percentage display

Select the harmonics list display (RMS value display, phase angle display, or content percentage). The harmonic power phase angle indicates the harmonic voltage-current phase difference.

Setting Contents:(* : Default setting)

Level*	RMS
Phase	Phase angle
Content	Content percentage



Inter-harmonics

When active power (P) is selected as the display item, inter-harmonics are not displayed.

Setting Contents:(* : Default setting)

iharmOFF*, iharmON



The setting can also be changed without using the pull-down menu by pressing the up and down cursor keys.

When the inter-harmonics display is enabled (iharmON), the screen changes as shown to the right.

The left side of the example shows harmonics and the right inter-harmonics.

The inter-harmonics order is obtained by adding 0.5 to the harmonics order for the same row.

Example:

The order of inter-harmonics on the right of the 20th harmonic is 20.5.

Order	Value 1	Value 2	Order	Value 1	Value 2	Order	Value 1	Value 2
0:	- 2.62	24.41	17:	0.42	0.58	34:	0.20	0.30
1:	159.36	20.39	18:	0.38	0.57	35:	0.18	0.29
2:	4.99	6.18	19:	0.35	0.53	36:	0.19	0.28
3:	2.88	3.41	20:	0.35	0.50	37:	0.18	0.27
4:	2.02	2.57	21:	0.31	0.49	38:	0.17	0.27
5:	1.36	2.04	22:	0.31	0.45	39:	0.18	0.26
6:	1.24	1.64	23:	0.30	0.44	40:	0.16	0.25
7:	1.02	1.45	24:	0.27	0.42	41:	0.16	0.24
8:	0.83	1.25	25:	0.27	0.40	42:	0.16	0.24
9:	0.81	1.10	26:	0.26	0.39	43:	0.15	0.23
10:	0.68	1.02	27:	0.24	0.37	44:	0.16	0.22
11:	0.61	0.90	28:	0.25	0.36	45:	0.15	0.22
12:	0.60	0.83	29:	0.23	0.35	46:	0.14	0.22
13:	0.50	0.78	30:	0.22	0.33	47:	0.15	0.21
14:	0.50	0.71	31:	0.23	0.33	48:	0.14	0.21
15:	0.47	0.67	32:	0.20	0.32	49:	0.13	0.20
16:	0.41	0.63	33:	0.20	0.30	50:	0.14	----

Holding the display

F4

[Hold]

(Measured values and waveforms will be held.)



2020/04/13
10:16:57

6.5 Displaying Measured Values Numerically (DMM Screen)

Example: 4-channel DMM display for 3P3W3M connection + channel 4

VIEW screen → **DF 3 [DMM] [Power]** → **F1 [CH123]** → **F2 [CH4]** → **DF 3 [DMM] [Voltage]** → **DF 3 [DMM] [Current]**

Power Screen Data:

U _{rms}	1 199.71 V	2 200.34 V	3 199.82 V
I _{rms}	1 39.012 A	2 38.942 A	3 39.004 A
P	1 4.499kW	2 4.499kW	3 4.505kW
Q	1 -0.004kvar	2 -0.005kvar	3 -0.009kvar
WP+	0.0578kWh	0.0000kWh	0.0000kWh
WP-	0.0000kWh	0.0000kWh	0.0001kWh
WQLEAD	-0.0001kvarh		
S	1 4.499kVA	2 4.499kVA	3 4.505kVA
PF	1 -1.0000	2 -1.0000	3 -1.0000
KF	1 1.00	2 1.00	3 1.00
sum	13.502kW	13.502kVA	

Voltage Screen Data:

U _{rms}	1 199.71 V	2 200.38 V	3 199.87 V	4 0.00 V
U _{pk+}	1 0.2830kV	2 0.2838kV	3 0.2832kV	4 0.0002kV
U _{pk-}	1 -0.2827kV	2 -0.2836kV	3 -0.2833kV	4 -0.0002kV
U _{rmsAVG}	199.99 V			
U _{unb0}	0.00 %			
U _{unb}	0.20 %			
U _{harmH1}	0.13 V			
U _{harmH2}	0.14 V			
U _{harmH3}	0.14 V			
U _{harmH4}	0.05 V			

Current Screen Data:

I _{rms}	1 39.009 A	2 38.949 A	3 39.002 A	4 0.000 A
I _{pk+}	1 55.25 A	2 55.17 A	3 55.26 A	4 0.05 A
I _{pk-}	1 -55.21 A	2 -55.13 A	3 -55.21 A	4 -0.04 A
I _{rmsAVG}	38.987 A			
I _{unb0}	0.06 %			
I _{unb}	0.05 %			
I _{harmH1}	0.024 A			
I _{harmH2}	0.027 A			
I _{harmH3}	0.028 A			
I _{harmH4}	0.011 A			

Navigation and Callouts:

- VIEW screen**: Initial display.
- DF 3 [DMM] [Power]**: Selects Power measurement.
- F1 [CH123]** → **F2 [CH4]**: Selects channels.
- DF 3 [DMM] [Voltage]**: Selects Voltage measurement.
- DF 3 [DMM] [Current]**: Selects Current measurement.

Callouts for Power Screen: RMS voltage, Active Power, Reactive Power, Active energy, Reactive energy, RMS current, Apparent power, Power factor (displacement power factor), K factor.

Callouts for Voltage Screen: RMS voltage, Voltage waveform peak (positive peak value), Voltage average value, Voltage unbalance factor, 10-sec frequency *, Total voltage distortion, Voltage waveform peak (negative peak value), Harmonic voltage.

Callouts for Current Screen: RMS current, Current waveform peak (positive peak value), Current average value, Current unbalance factor, Total current distortion, Current waveform peak (negative peak value), Harmonic current.

Legend: Select with the F key. To hold the display (p.112)

See: For more information about the voltage calculation method (Urms type), power factor calculation method (PF type), and THD calculation method (THD type) settings: "5.1 Changing Measurement Conditions" (p.73)

*: The instrument displays measured values in red in the following occasions:

- When a swell, dip, or interruption has occurred
- When the instrument has failed to synchronize

When the interruption event is set to off, the instrument evaluates measured values on the basis of a threshold value of 200% for swell, or 10% for dip and interruption.

Holding the display

F4

[Hold]

(Measured values will be held.)



Monitoring Fluctuations in Measured Values (TIME PLOT Screen)

Chapter 7

The **[TIME PLOT]** screen allows you to view measured value fluctuations as a time series graph.

Trend and harmonic trend time series graphs:

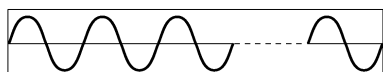

50 Hz: 10 waveforms, 60 Hz: 12 waveforms, 400 Hz: 80 waveforms

↓
RMS value calculation
Harmonic calculation

RMS voltage, RMS current, and other measured values calculated every 200 ms are displayed as a time series graph. The maximum, minimum, and average values during the TIME PLOT interval are recorded.

Example:

If the TIME PLOT interval is set to 1 s, five values will be calculated in 1 s. Of those, the maximum, minimum, and average values will be recorded.

Detailed trend time series graph:

During 50 Hz/60 Hz measurement

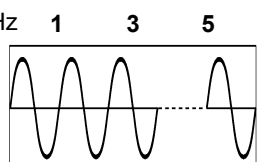

↓ ↓ ↓ ↓ ↓
1 2 3 4 5
RMS voltage calculation

During 400 Hz measurement

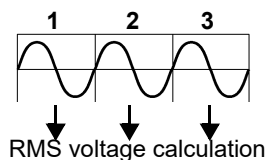

↓ ↓ ↓
RMS voltage calculation

The RMS voltage refreshed each half-cycle, frequency cycle, and other measured values calculated for each waveform are displayed as a time series graph. The maximum and minimum values during the TIME PLOT interval are recorded. As shown in the figure, RMS voltage refreshed each half-cycle is shifted a half-wave and calculated every wave.

Example:

If the TIME PLOT interval is set to 1 s, there are 100 RMS values and 50 frequency values calculated every 1 s (for a 50 Hz signal). Of those, the maximum and minimum values are recorded.

See: Trend graph recording methods: "Recording TIME PLOT Data and Event Waveforms" (pA.12)

Display of trend data, detailed trend data, and harmonic trend data on the instrument is subject to certain constraints. Updating of the displayed time series graph will stop when the times listed in the following table are exceeded. Data will continue to be recorded to the SD memory card (see recording times (p.79)) even if updating of the displayed time series graph stops.

[TIME PLOT] screen maximum display times

TIME PLOT Interval	Recording Items setting		
	All data (Saves all data)	Power and Harmonic (Saves RMS values and harmonics)	Power (Saves RMS values only)
1 second	7 min. 52 sec.	15 min. 44 sec.	2 hours 37 min. 20 sec.
3 seconds	23 min. 36 sec.	47 min. 12 sec.	7 hours 52 min.
15 seconds	1 hour 58 min.	3 hours 56 min.	1 day 15 hours 20 min.
30 seconds	3 hours 56 min.	7 hours 52 min.	3 days 6 hours 40 min.
1 minute	7 hours 58 min.	15 hours 44 min.	6 days 13 hours 20 min.
5 minutes	1 day 15 hours 20 min.	3 days 6 hours 40 min.	32 days 18 hours 40 min.
10 minutes	3 days 6 hours 40 min.	6 days 13 hours 20 min.	35 days
15 minutes	4 days 22 hours	9 days 20 hours	35 days
30 minutes	9 days 20 hours	19 days 16 hours	35 days
1 hour	19 days 16 hours	35 days	35 days
2 hours	35 days	35 days	35 days
150/180 cycle (Approx. 3 sec)	23 min. 36 sec.	47 min. 12 sec.	7 hours 52 min.

7.1 Using the [TIME PLOT] Screen

The TIME PLOT screen is composed of a number of screens that correspond to the DF1 to DF4 (DF: display function) keys.

When you press a DF key, the screen corresponding to that key appears. When there are multiple screens, the screen display will change every time the same DF key is pressed.

TIMEPLOT

TIME PLOT screen selector

About screen configuration (p.32)

Switching screen display

- DF 1

Trend
See: "7.2 Displaying Trends" (p.116)
- DF 2

DetailTrend
See: "7.3 Displaying detailed trends" (p.123)
- DF 3

HarmTrend
See: "7.4 Displaying Harmonic Trends" (p.129)
- DF 4

Flicker
See: "7.5 Displaying Flicker Values in Graph and List Form" (p.133)

The screen shown varies with the instrument's internal operating state.

When recording starts, the time series graph is displayed on the TIME PLOT screen. The Y-axis and X-axis are automatically scaled so that all the time series graphs are displayed on the screen. When recording is stopped, updating of the time series graph display stops.

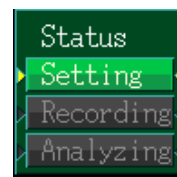

Internal operation status	Display	Display update
[Setting]	No time series graph display data.	-----
[Waiting]		
[Recording]	The time series graph display is updated.	Every set TIMEPOT interval
[Analyzing]	Updating of the time series graph display stops.	-----

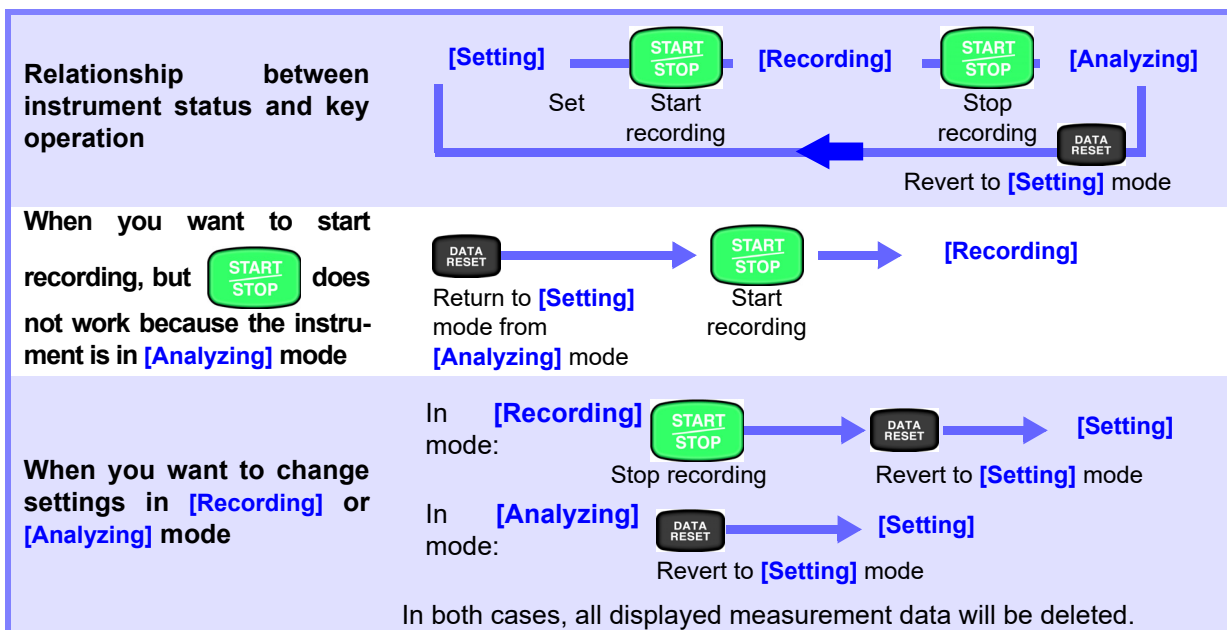

7.2 Displaying Trends

This section describes how to generate a time series display of values calculated internally every 200 ms each TIME PLOT interval. When using one or two screens, the maximum, minimum, and average values during the TIME PLOT interval are shown.

TIMEPLOT [TIME PLOT] screen

↓

DF 1 [Trend] [1-Screen]

↓

DF 1 [Trend] [2-Screen]

↓

DF 1 [Trend] [Energy]

Example: 3P4W (3-phase, 4-wire)

Final time in displayed data

Initial time in displayed data (One interval time prior to that displayed for cursor measurement)

When displaying [2-Screen], you can select two characteristics to display.

Select with the **F** key.

- To change the displayed characteristic, channel, waveform, or measured value (when displaying [1-Screen] or [2-Screen] screen) (p.117)
- To change the displayed characteristic (when displaying [Energy] screen) (p.119)
- To enlarge or reduce the graph (p.120)
- To view the value and time over the cursor (p.121)
- To scroll through display data (p.121)
- To search for an event (p.122)

Changing the displayed items, channels, waveforms, or measured value ([1-Screen] and [2-Screen] screen)

[Select] (F1)

Select (Arrow)

Display the pull-down menu (ENTER)

Select a setting (Arrow)

Accept setting (ENTER)

Cancel (ESC / O-m)

Flag
Indicates that a dip, swell, or interruption occurred during the displayed TIME PLOT interval based on IEC61000-4-30 flag conversion. A flag indicates that integrated values may be unreliable.
See: "Flags" (p.122)

Displayed items and channels

Allows you to select the displayed item and channel. Which channels are available depends on the selected displayed item.



Setting Contents:(* : Default setting)

Displayed item	Displayed channel	Displayed item	Displayed channel
Freq*	Freq* f10s	lunb	unb* unb0
Urms	CH1* CH2 CH3 CH4 AVG	lharmH	CH1* CH2 CH3 CH4
Upk+	CH1* CH2 CH3 CH4	lthd	CH1* CH2 CH3 CH4
Upk-	CH1* CH2 CH3 CH4	P	CH1* CH2 CH3 CH4 sum
Udc	CH4*	S	CH1* CH2 CH3 CH4 sum
Uunb	unb* unb0	Q	CH1* CH2 CH3 CH4 sum
UharmH	CH1* CH2 CH3 CH4	PF	CH1* CH2 CH3 CH4 sum
Uthd	CH1* CH2 CH3 CH4	KF	CH1* CH2 CH3 CH4
Irms	CH1* CH2 CH3 CH4 AVG	Msv1	CH1* CH2 CH3
Ipk+	CH1* CH2 CH3 CH4	Msv2	CH1* CH2 CH3
Eff	Eff1* Eff2 Eff	Msv%1	CH1* CH2 CH3
Ipk-	CH1* CH2 CH3 CH4	Msv%2	CH1* CH2 CH3
Idc	CH4*		

- For Freq, Uunb, lunb, and Eff you can select a detailed measurement item, rather than a channel.
- AVG indicates the average value for channels 1 through 3 (varies with connection).
- Sum indicates the sum for channels 1 through 3 (varies with connection).
- CH4 for S, Q, and PF can only be selected when CH4 is set to AC+DC. These values cannot be selected when CH4 is set to OFF for Eff.

7.2 Displaying Trends

- Msv1, Msv%1, Msv2, or Msv%2 cannot be chosen if the measurement frequency is set at 400 Hz.

NOTE The channels available for selection vary with the connection mode setting.

Notation meaning

Symbol	Measurement Items	Symbol	Measurement Items	Symbol	Measurement Items
Freq*	Frequency 200ms	IrmsAVG	Average RMS current (when avg is selected)	lharmH	High-order harmonic current component
f10s	Frequency 10 sec (Freq10s)	Idc	Current DC	Uthd-F Uthd-R	Total harmonic voltage distortion factor
Upk+ Upk-	Voltage waveform peak+ Voltage waveform peak-	P	Active power	lthd-F lthd-R	Total harmonic current distortion factor
lpk+ lpk-	Current waveform peak+ Current waveform peak-	S	Apparent power	KF	K factor
Urms	RMS voltage (phase/line)	Q	Reactive power	Msv1	Level of Mains signaling voltage 1
UrmsAVG	Average RMS voltage (when avg is selected)	PF	Power factor	Msv%1	Content rate of Mains signaling voltage 1
Udc	Voltage DC	Uunb0 Uunb	Voltage zero-phase unbalance factor current Negative-phase unbalance factor	Msv2	Level of Mains signaling voltage 2
Eff	Efficiency	lunb0 lunb	Current zero-phase unbalance factor current Negative-phase unbalance factor	Msv%2	Content rate of Mains signaling voltage 2
Irms	RMS current	UharmH	High-order harmonic voltage component		

Displayed waveform and measured value

Setting Contents:(* : Default setting)

MAX	Displays the maximum value during the TIME PLOT interval.
MIN	Displays the minimum value during the TIME PLOT interval.
AVG	Displays the average value during the TIME PLOT interval.
ALL*	Displays the maximum, minimum, and average values during the TIME PLOT interval.

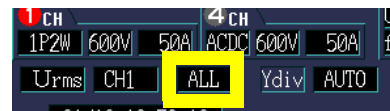

Changing the displayed items ([ENERGY] screen)

The screenshot shows the [ENERGY] screen with a time plot. The plot displays energy consumption in kWh over time. The WP+ line (yellow) shows an increase from 0.000kWh to 0.2600kWh. The WP- line (red) shows a decrease from 0.000kWh to -0.1591kWh. The graph is titled '2010/12/03 18:19:52'. The screen also shows system parameters like Udin 200V, fnom 50Hz, and various settings like Ydiv AUTO and Tdiv AUTO. A legend on the right side of the screen lists various trend items: Status, Setting, Recording, Analyzing, Trend (1-Screen, 2-Screen, Energy), DetailTrend (DtITrend), HarmTrend (Harmonics), and Flicker (Graph, List). A blue box highlights the 'Select' button at the bottom of the screen.

Displayed items

Setting Contents:(* : Default setting)

WP*	Active integration amount for WP+ consumption, WP- regeneration
WQ	Reactive power WQLAG lag, WQLEAD lead

Enlarging or reducing the graph (changing the X- and Y-axis scale)

[Select]

- Select a setting
- Display the pull-down menu
- Select a setting
- Accept setting
- Cancel

0.2000kV MAX: 100.98 V 2011/01/10 18:54:08
 AVG: 82.78 V
 MIN: 9.16 V
 0.1000kV
 0.0000kV 0.2000kV/div 1min/div
 01/10 01/10 01/10 01/10 01/10 01/10
 18:53 18:54 18:55 18:56 18:57 18:58 18:59
 Select Cursor Scroll Event search 2018/11/29 19:08:36

Y-axis scale (Ydiv)

To reduce the graph, decrease the scale.
 To enlarge the graph, increase the scale.

Setting Contents:(* : Default setting)

AUTO*, **x1**, **x2**, **x5**, **x10**, **x25**, **x50**

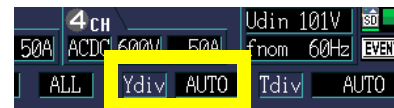

X-axis scale (Tdiv)

Selects the X-axis scale.

Setting Contents:

AUTO*, From **1min/div**

When recording, use AUTO.



Viewing the value and time over the cursor (Cursor measurements)

You can read the value above the cursor and the time on the time series graph

F2 [Cursor]

 **Move the vertical cursor left and right to read the display value.**

When using one or two screens:
MAX (maximum value),
AVG (average value),
MIN (minimum value)

When using the [Energy] screen:
WP+ (consumption), WP- (regeneration),
LAG (lag), LEAD (lead)

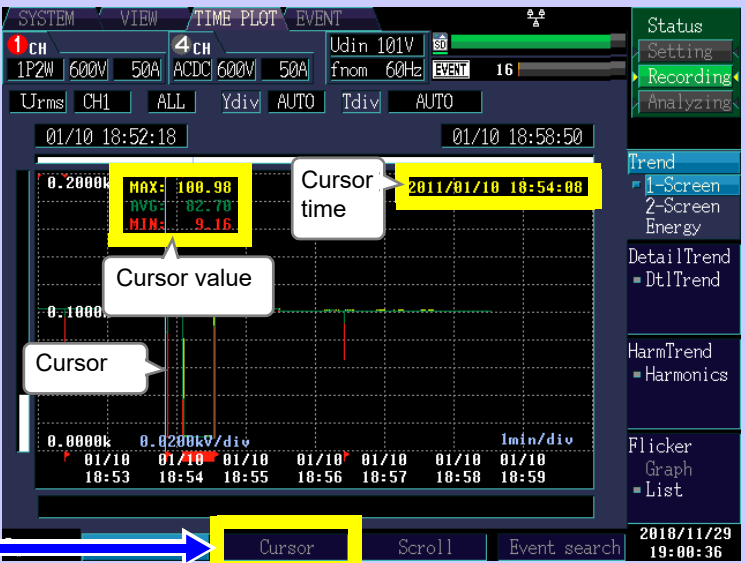

The screenshot shows a time series graph with a vertical cursor. The cursor is positioned at a specific point on the waveform. Callouts indicate the cursor value (MAX: 100.98, AVG: 82.70, MIN: 9.16) and the cursor time (2011/01/10 18:54:08). The cursor is highlighted with a yellow box.

Scrolling through display data

During recording, the X- and Y-axis are automatically scaled so that the full time series graph fits on the screen. Once recording has stopped and the X- and Y-axis scale has been changed so that the waveforms do not fit on the screen, you can scroll through the time series graph by moving left, right, up, and down.

F3 [Scroll]

 **Scroll through the graph**

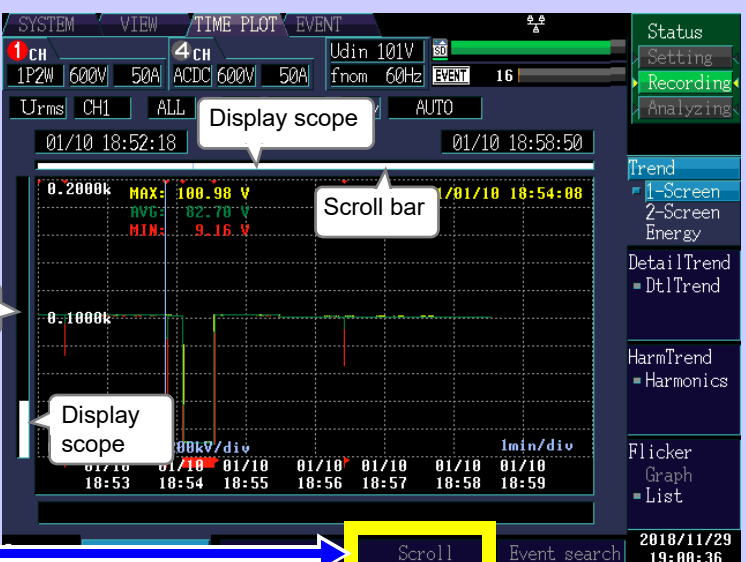

The screenshot shows a time series graph with a scroll bar. The scroll bar is positioned at a specific point on the waveform. Callouts indicate the display scope and the scroll bar. The scroll bar is highlighted with a yellow box.

- The display scope on the scroll bar (shown in white) illustrates which range of all measurement data is being shown on the screen.
- The cursor on the scroll bar shows where the cursor is located relative to all measurement data.

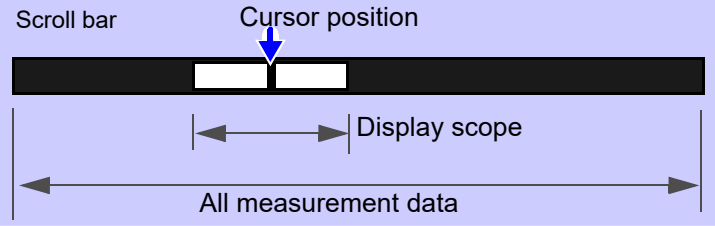

The diagram shows a horizontal scroll bar. A white box represents the 'Display scope' and a blue arrow represents the 'Cursor position'. Below the scroll bar, a double-headed arrow indicates the 'All measurement data' range.

Searching for events

You can search for the time the event occurred (event marker).
 When recording starts and stops, start and stop events are generated. This corresponds to the event selected on the event list.

F4 [Event search]

Skips sideways through the event markers.

ENTER Analyzing events using waveforms

Event mark ▼ (Red): Indicates a normal event.

Event number	Time	Date	Type	Channel
5	01/10 18:54:07.758	01/10	Dip	CH1 IN

Event search

NOTE

Flags

The measurement algorithm may generate unreliable values during dips, swells, and interruptions. The possible unreliability of these measured values (set-values) is indicated by flags that are displayed with TIME PLOT data when dips, swells, or interruptions occur. Even when dip, swell, and interruption events have been turned off, flags are shown with measurement data when a dip or interruption (when the voltage falls 10% relative to the nominal voltage) or swell (when the voltage rises 200%) is judged to have occurred.

Flag icon:

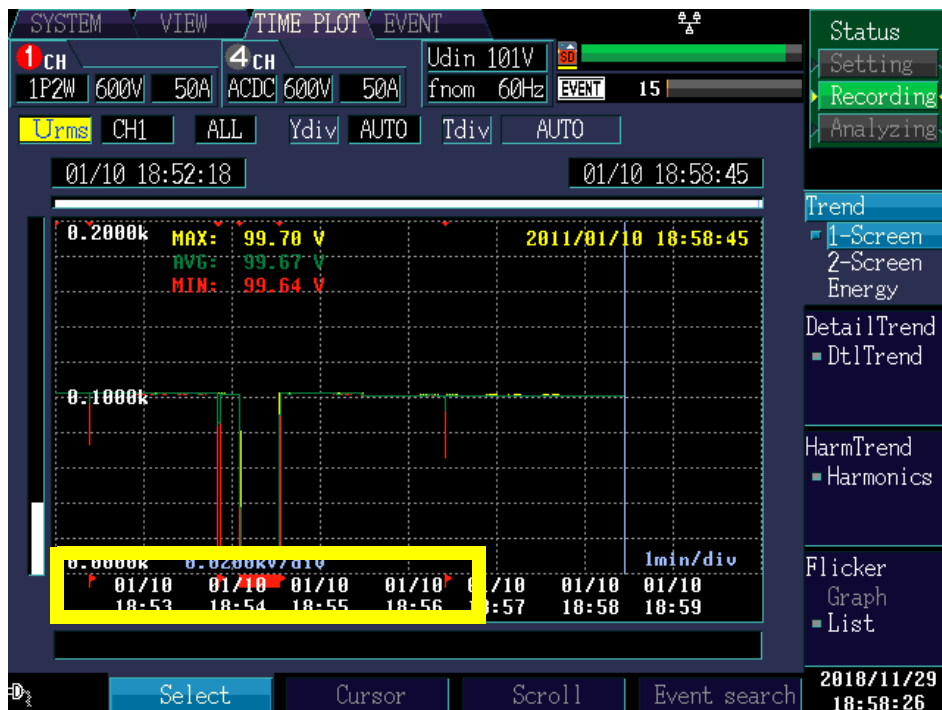

7.3 Displaying detailed trends

Displaying a detailed trend graph for each TIME PLOT interval

This section describes how to display a time series graph for each TIME PLOT interval for Urms1/2, Irms1/2, Inrush (inrush current), Pinst, or one frequency cycle.

TIMEPLOT [TIME PLOT] screen

↓

DF 2 [DetailTrend]

Example: 3P4W (3-phase, 4-wire)

Waveform/measured value colors when displaying CH1/2/3 data

- Red : CH1
- Yellow : CH2
- Blue : CH3

Select with the **F** key.

- To change displayed items and displayed channel (p.124)
- To enlarge or reduce the graph (p.125)
- To read the value above the cursor (p.126)
- To scroll through display data (p.127)
- To search for an event (p.128)

NOTE

Unlike trend data, which consists of one graph each for the maximum, minimum, and average values, detailed trend data is displayed as a single graph with vertically connected bands between the maximum and minimum values.

Changing the displayed items and displayed channel

Displayed items

Setting Contents:(* : Default setting)

Urms1/2*	RMS voltage refreshed each half-cycle
Irms1/2	RMS current refreshed each half-cycle (inrush current)
Freq_wav	One frequency cycle
Pinst	Instantaneous flicker value
Inrush	Inrush current

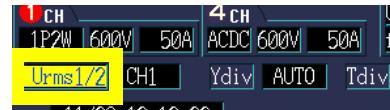

NOTE

Pinst is only displayed when **[Flicker]** is set to **[Pst, Pit]**.

Displayed channel

Setting Contents:(* : Default setting)

CH1*/ CH2/ CH3/ CH4

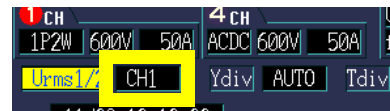

Enlarging or reducing the graph (changing the X- and Y-axis scale)



Y-axis scale (Ydiv)

When you want to reduce the graph, make the scale smaller.
When you want to enlarge the graph, make the scale larger.

Setting Contents:(* : Default setting)

AUTO*, **x1**, **x2**, **x5**, **x10**, **x25**, **x50**

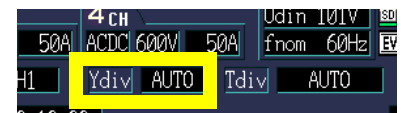

X-axis scale (Tdiv)

When you want to reduce the graph, make the scale smaller.
When you want to enlarge the graph, make the scale larger.

Setting Contents:(* : Default setting)

AUTO*, From **1min/div** (varies with TIME PLOT interval)

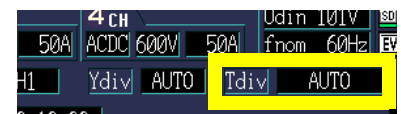

NOTE

AUTO scaling is used during recording. This cannot be changed.

Reading the value above the cursor (Cursor measurements)

You can read the value above the cursor and the time on the time series graph.

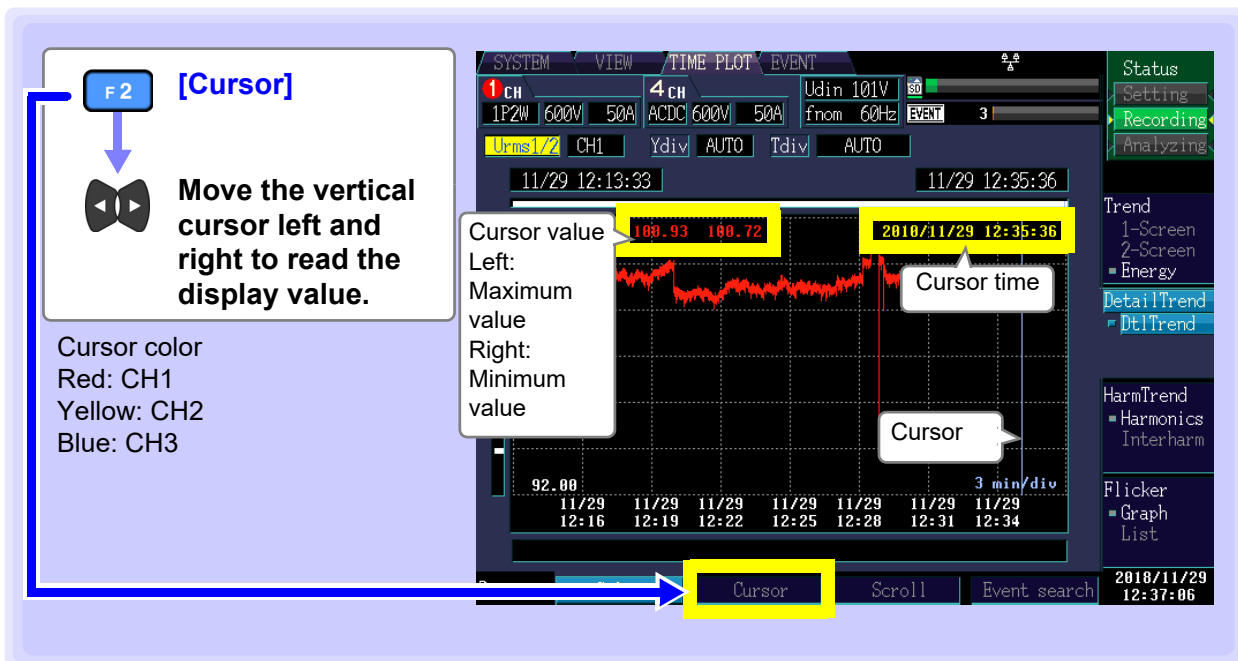

NOTE

- When the TIME PLOT interval is set to 150 or 180 cycles, the time is shown in ms units.
- The time displayed during cursor measurement is based on the CH1 voltage (U1). The event time shown on the event list and the time displayed during cursor measurement may not agree.

Scrolling through display data

During recording, the X- and Y-axis are automatically scaled so that the full time series graph fits on the screen. Once recording has stopped and the X- and Y-axis scale has been changed so that the waveforms do not fit on the screen, you can scroll through the time series graph by moving left, right, up, and down.

F3 [Scroll]



Scroll through the graph

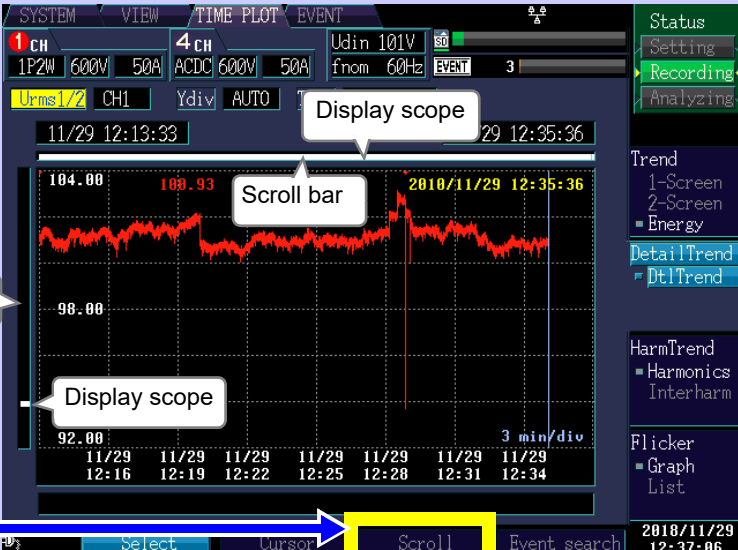

- The display scope on the scroll bar (shown in white) illustrates which range of all measurement data is being shown on the screen.
- The cursor on the scroll bar shows where the cursor is located relative to all measurement data.

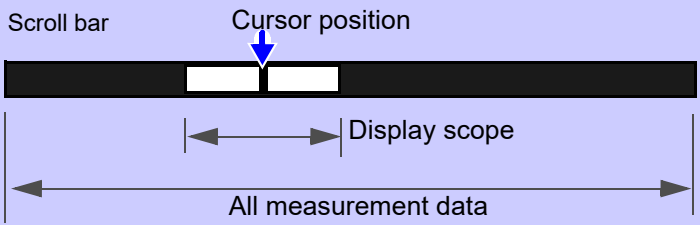

Searching for events

You can search for the time (event mark) at which an event occurred. When recording starts and stops, start and stop events are generated. This corresponds to the event selected on the event list.

F4 [Event search]

ENTER Analyzing events using waveforms

Event mark ▼ (Red):
Indicates a normal event.

Event number, time and date, type, channel

Event search

SYSTEM VIEW TIME PLOT EVENT

1 CH 4 CH Udim 200V 50A from 50Hz EVENT 1

1P2W 600V 50A OFF 600V 50A

Urms1/2 Ydiv AUTO Tdiv AUTO

12/03 18:26:30 12/03 18:27:02

212.00 207.85 207.84 V 2010/12/03 18:26:30

206.00

200.00 1 min/div

12/03 18:27	12/03 18:28	12/03 18:29	12/03 18:30	12/03 18:31	12/03 18:32	12/03 18:33
1	12/03 18:26:29.022	Start				

Status
Setting
Recording
Analyzing

Trend
1-Screen
2-Screen
Energy
DetailTrend
DtTrend

HarmTrend
Harmonics
Interharm

Flicker
Graph
List

2018/12/03 18:27:19

7.4 Displaying Harmonic Trends

This section describes how to select six orders and display their harmonic time series graphs. The maximum, minimum, or average value during the TIME PLOT interval can be displayed.

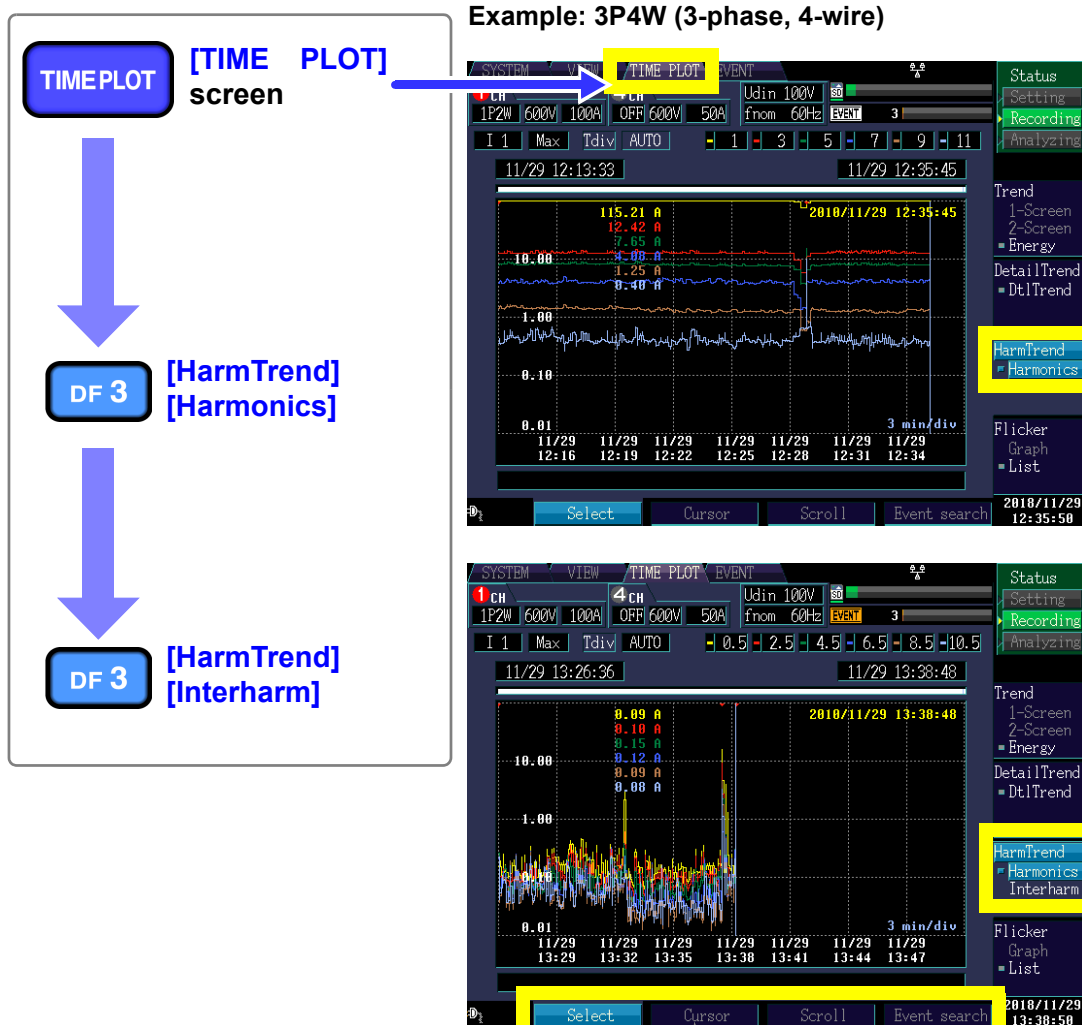

Select with the **F** key.

To change displayed items/waveform/measurement value (p.130)

To enlarge or reduce the graph (p.130)

To change display number of order (p.130)

To read the value above the cursor (p.131)

To scroll waveform data (p.132)

To search for an event (p.132)

NOTE

- When **[Power]** is selected under the **[Recording Items]** settings (see **SYSTEM-DF1 [Record]-F1[Interval]** (p.78)), harmonic trends (the harmonic trend graph and inter-harmonic trend graphs) will not be displayed. Additionally, inter-harmonic trend data will not be displayed if **[P&Harm]** is selected.
- During 400 Hz measurement, harmonic analysis is performed up to the 10th order, and inter-harmonic analysis is not available.

Changing displayed items, displayed waveforms, and displayed measured values; enlarging and reducing graphs (changing the X-axis scale); and changing the displayed order

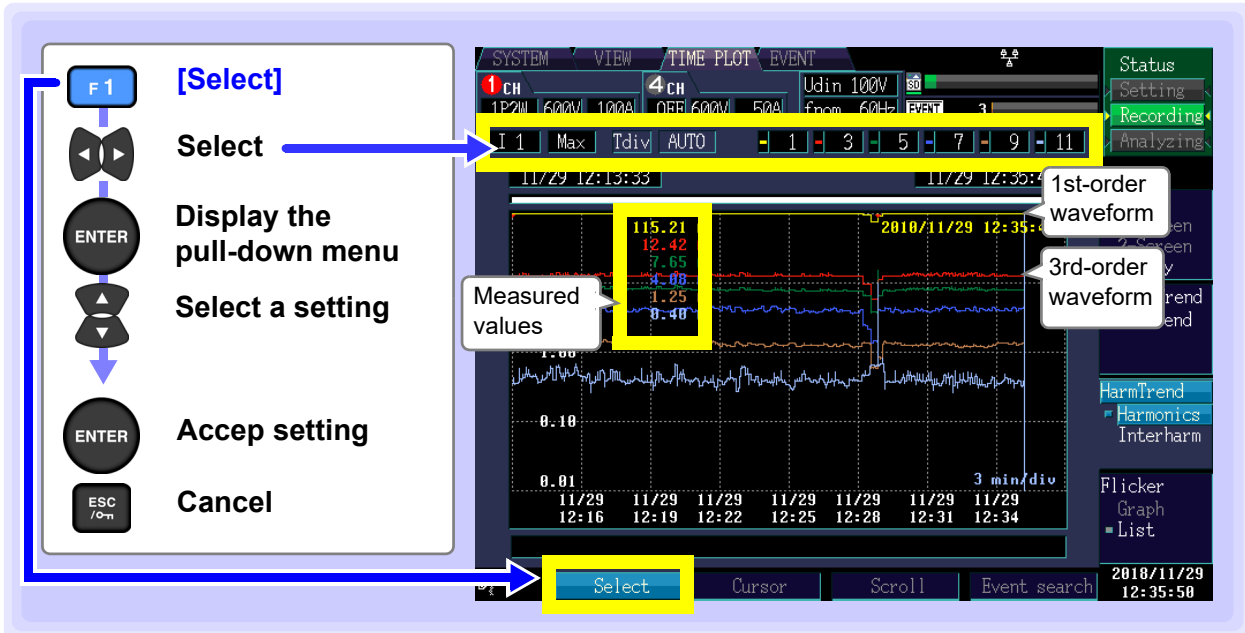

Displayed items

Setting Contents:(* : Default setting)

U1*/U2/U3/U4	Voltage (CH1/2/3/4)
I1/I2/I3/I4	Current (CH1/2/3/4)
P1/P2/P3	Active power (CH1/2/3)
Psum	Total active power
θ1/θ2/θ3	Phase difference (P phase) (CH1/2/3)
θsum	Total phase difference (P phase)



The available displayed characteristics options vary with the connection method.

NOTE Only U1/U2/U3/U4/I1/I2/I3/I4 can be selected for the inter-harmonic time series graph.

Displayed waveforms, displayed measured values

Setting Contents:(* : Default setting)

MAX*	Displays the maximum value during the TIME PLOT interval.
MIN	Displays the minimum value during the TIME PLOT interval.
AVG	Displays the average value during the TIME PLOT interval.



X-axis scale (Tdiv)

Selects the X-axis scale.

Setting Contents:

AUTO*, From **1min/div** (varies with TIME PLOT interval)

AUTO scaling is used during recording. This cannot be



NOTE

The Y-axis scale cannot be changed. The Y-axis maximum value will be the same as the range's full-scale value.

Displayed Order

Six orders can be selected and displayed at the same time. The measured value and waveform are displayed using the color of the order at the left.

Setting Contents:(* : Default setting)

(1,3,5,7,9,11)*, 0 to 50 (**[Harmonic]** screen)

(1.5,3.5,5.5,7.5,9.5,11.5)*, 0.5 to 49.5 (**[Interharm]** screen)



Reading the value above the cursor (Cursor measurements)

This section describes how to read the value and time above the time series graph cursor.

F2 [Cursor]

Move the vertical cursor left and right to read the display value.

The cursor value is shown in the same color as the selected order.

Scrolling through waveforms

During recording, the X-axis is automatically scaled so that the full time series graph fits on the screen. Once recording has stopped and the X-axis scale has been changed so that the waveforms do not fit on the screen, you can scroll through the time series graph by moving left and right.

F3 [Scroll]



Scroll through the graph

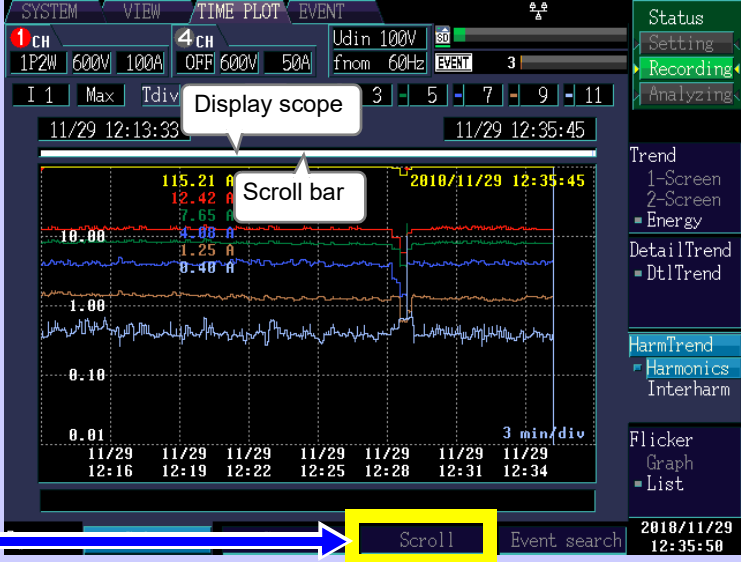

The screenshot shows a multi-channel waveform plot. A white band on the scroll bar indicates the display scope. A cursor is positioned on the scroll bar. The 'Scroll' button is highlighted in yellow.

- The white band on the scroll bar indicates the range of measured values that can be displayed. When this band does not include the cursor position, the cursor and cursor value are not displayed.
- The cursor on the scroll bar shows where the cursor is located relative to all measurement data.

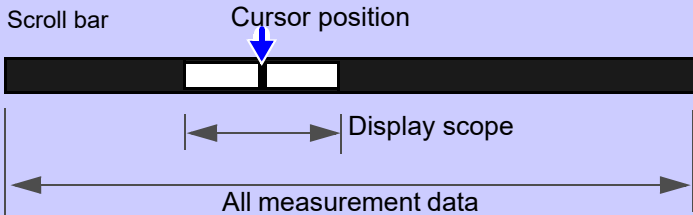

The diagram illustrates the scroll bar's function. It shows a long horizontal bar representing 'All measurement data'. A smaller white bar within it represents the 'Display scope'. A vertical line indicates the 'Cursor position' on the scroll bar.

Searching for events

You can search for the time the event occurred (event marker). The start time and stop time event markers are always displayed. Synchronization is achieved with an event selected from the event list.

F4 [Event search]



Skips sideways through the event markers.



Analyzing events using waveforms



The screenshot shows the same waveform plot as before, but with a red downward-pointing triangle (▼) marking an event. The 'Event search' button is highlighted in yellow. A callout box explains that a red triangle indicates a normal event.

Event number, time and date, type, channel

1 11/29 12:13:33.017 Start

7.5 Displaying Flicker Values in Graph and List Form

NOTE

- Flicker measurement cannot be performed during 400 Hz measurement.
- The graph is not displayed unless **[Flicker]** is set to **[Pst, Plt]** in **[SYSTEM]-DF1 [Main]-F2 [Measure2]**.

IEC flicker meters and ΔV_{10} flicker meters

Flicker meters are used to measure the sensation of visual instability that occurs due to changes in light source brightness and wavelength. There are two types of flicker meters: IEC flicker meters (UIE flicker meters), which comply with IEC standards, and ΔV_{10} flicker meters, which are used domestically in Japan. Both types of flicker meter observe fluctuations in voltage and display values used to objectively judge flicker.

Displaying an IEC flicker fluctuation graph

This section describes how to display an IEC flicker fluctuation graph.

TIMEPLOT [TIME PLOT] screen

↓

DF 4 [Flicker] [Graph]

Select with the **F** key.

- To change the displayed channels (p.134)
- To enlarge or reduce the graph (p.134)
- To read the value above the cursor (p.135)
- To scroll waveform data (p.135)

NOTE

- The graph is updated every 10 minutes, regardless of the **[TIME PLOT Interval]** set in **[SYSTEM]-DF1 [Record]-F1 [Interval]**(p.79).
- Urms1/2, Irms1/2, Inrush, Freq_wav, and Pinst are recorded continuously.
- Due to the influence of the high pass filter used, measured values are unstable when starting Pst, Plt measurement immediately after settings have been configured, and the initial measured value may be excessively high. It is recommended to wait about 2 minutes after making settings on the **[SYSTEM]** screen before starting measurement.

Changing the displayed channel and enlarging and reducing graphs (changing the X- and Y-axis scale)



Displayed channel

Setting Contents:(* : Default setting)

CH1*, CH2, CH3

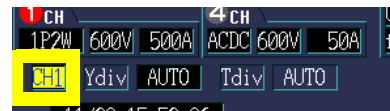

Y-axis scale (Ydiv)

When you want to reduce the graph, make the scale smaller.
When you want to enlarge the graph, make the scale larger.

Setting Contents:(* : Default setting)

AUTO*, x1, x2, x5, x10, x25, x50

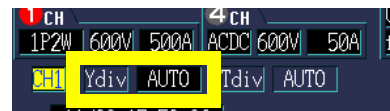

X-axis scale (Tdiv)

Selects the X-axis scale.

Setting Contents:

AUTO*, From 1min/div

AUTO scaling is used during recording. This cannot be changed.

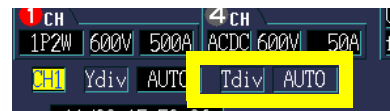

Reading the value above the cursor (Cursor measurements)

This section describes how to read the Pst and Plt measured values every 10 minutes.

F 2 [Cursor]



Move the vertical cursor left and right to read the display value.

Cursor value
Top: Pst measured value
Bottom: Plt measured value

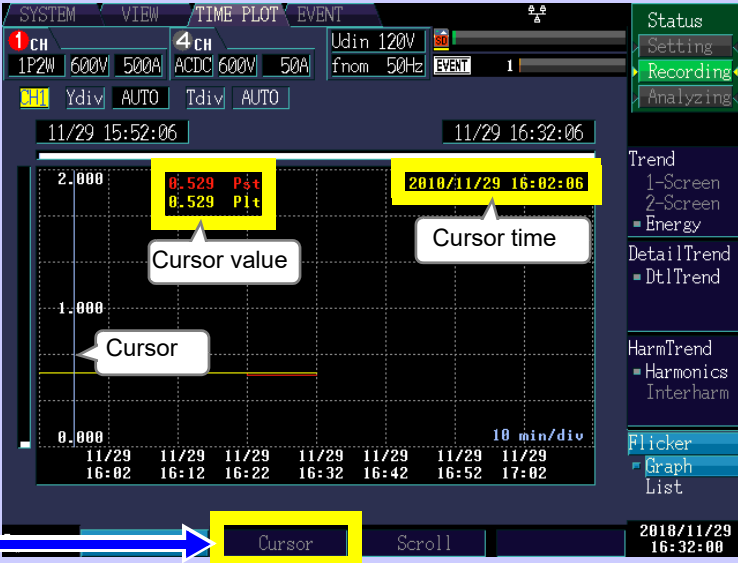

Cursor Scroll

Scrolling through waveforms

During recording, the X- and Y-axis are automatically scaled so that the full time series graph fits on the screen. Once recording has stopped and the X- and Y-axis scale has been changed so that the waveforms do not fit on the screen, you can scroll through the time series graph by moving left, right, up, and down.

F 3 [Scroll]



Scroll through the graph

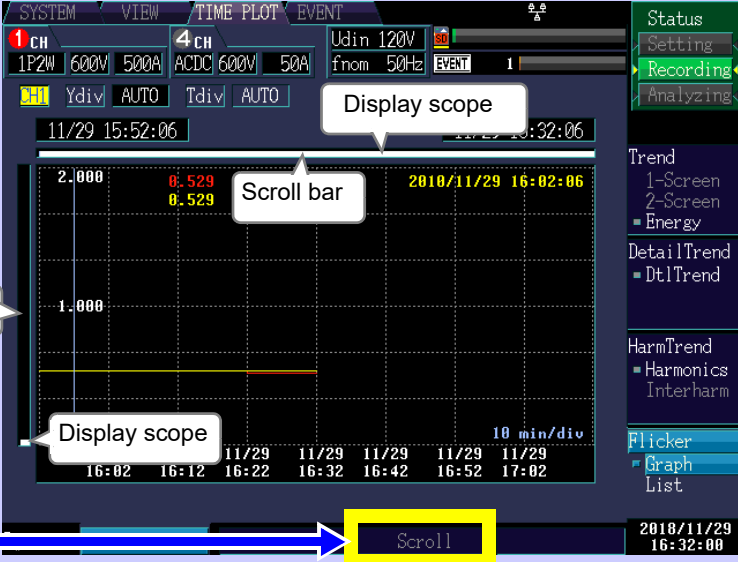

Scroll

Scroll bar Cursor position

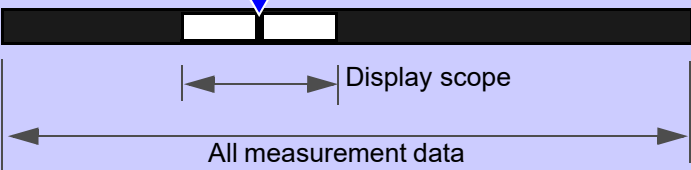

All measurement data

- The display scope on the scroll bar (shown in white) illustrates which range of all measurement data is being shown on the screen.
- The cursor on the scroll bar shows where the cursor is located relative to all measurement data.

Displaying an IEC flicker list

This section describes how to display Pst and Plt statistics along with the time and date every 10 minutes.

TIME PLOT [TIME PLOT] screen

DF 4 [Flicker] [List]

No.	Date	Time	Pst	Plt
1	11/29	16:02:06	0.529	0.529
2	11/29	16:12:06	0.529	0.529
3	11/29	16:22:06	0.529	0.529
4	11/29	16:32:06	0.513	0.525

Press the **F** key to select a channel.

- Pst: Short interval flicker value
- Plt: Long interval flicker value

NOTE

- Statistics consist of a list of the following IEC flicker statistics (Pst and Plt) along with the time and date, which is updated every 10 minutes.
- This information will not be displayed unless **[Flicker]** has been set to **[Pst, Plt]** in **[SYSTEM]-DF1 [Main]-F2 [Measure2]**.
- EN50160, "Voltage Characteristics in Public Distribution Systems," gives "Plt ≤ 1 for 95% of a week" as a limit value.
- For IEC 61000 Plt values, use only the values shown with even numbered 2-hour intervals, and discard the other Plt values. The other Plt values are provided for information only, and are not IEC 61000 Plt values.

Flags

The measurement algorithm may generate unreliable values during dips, swells, and interruptions. The possible unreliability of these measured values (set-values) is indicated by flags that are displayed with TIME PLOT data when dips, swells, or interruptions occur. Even when dip, swell, and interruption events have been turned off, flags are shown with measurement data when a dip or interruption (when the voltage falls 10% relative to the nominal voltage) or swell (when the voltage rises 200%) is judged to have occurred.

Flag icon:

Displaying a ΔV_{10} flicker fluctuation graph

This section describes how to display a ΔV_{10} flicker fluctuation graph.

TIME PLOT [TIME PLOT] screen

DF 4 [Flicker] [Graph]

Select with the **F** key.

- To enlarge or reduce the graph (p.138)
- To read the value above the cursor (p.139)
- To scroll waveform data (p.139)

NOTE

- The graph is updated once a minute, regardless of the TIME PLOT interval set in [SYSTEM]-DF1 [Record]-F1 [Interval].
- The graph is not displayed unless [Flicker] is set to [ΔV_{10}] in [SYSTEM]-DF1 [Main]-F2 [Measure2].
- ΔV_{10} flicker can be measured simultaneously for the voltage channels U1, U2, and U3 (depends on connection).

ΔV_{10} flicker reference voltage

In ΔV_{10} flicker measurement, the reference voltage is automatically set internally using AGC (automatic gain control).

Once the fluctuating voltage value has stabilized, the reference voltage is automatically changed to that value. Consequently, there is no need to switch supply voltage settings as with conventional ΔV_{10} flicker meters.

Example:

Fluctuating voltage: Stabilizes at 96 V rms The reference voltage is automatically changed to 96 V rms.

Fluctuating voltage: Stabilizes at 102 V rms The reference voltage is automatically changed to 102 V rms.

Due to the influence of the high pass filter used in ΔV_{10} flicker measurement, measured values are unstable when starting ΔV_{10} measurement immediately after settings have been configured, and the first and second ΔV_{10} measured values may be excessively high. It is recommended to wait about 5 minutes after making settings on the [SYSTEM] screen before starting measurement.

Enlarging or reducing the graph (changing the X- and Y-axis scale)



Y-axis scale (Ydiv)

When you want to reduce the graph, make the scale smaller.
When you want to enlarge the graph, make the scale larger.

Setting Contents:(* : Default setting)

AUTO*, **x1**, **x2**, **x5**, **x10**, **x25**, **x50**

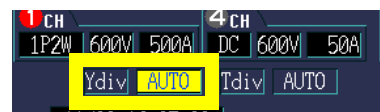

X-axis scale (Tdiv)

Selects the X-axis scale.

Setting Contents:

AUTO*, From **10min/div**

AUTO scaling is used during recording. This cannot be changed.

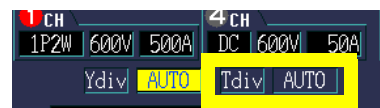

Reading the value above the cursor (Cursor measurements)

This section describes how to read the ΔV_{10} flicker measured value once a minute.

F2 [Cursor]



Move the vertical cursor left and right to read the display value.

Cursor value
Left: Measured value
Right: ΔV_{10}

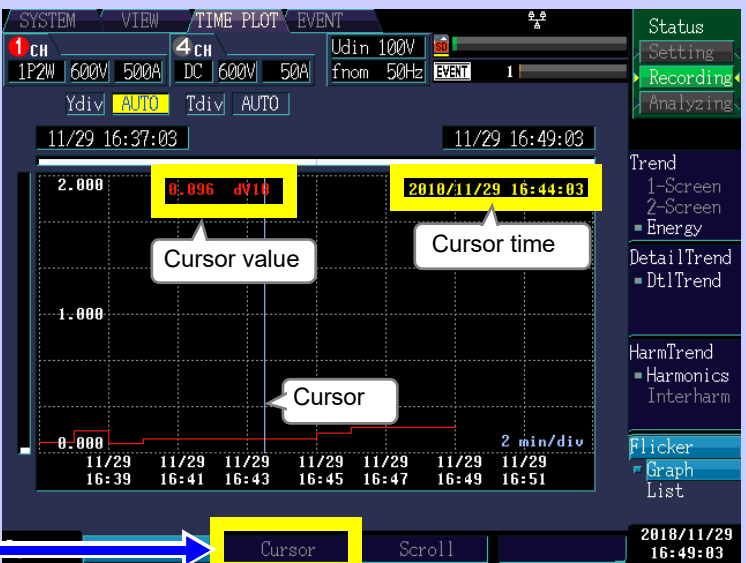

Scrolling through waveforms

During recording, the X- and Y-axis are automatically scaled so that the full time series graph fits on the screen. Once recording has stopped and the X- and Y-axis scale has been changed so that the waveforms do not fit on the screen, you can scroll through the time series graph by moving left, right, up, and down.

F3 [Scroll]



Scroll through the graph

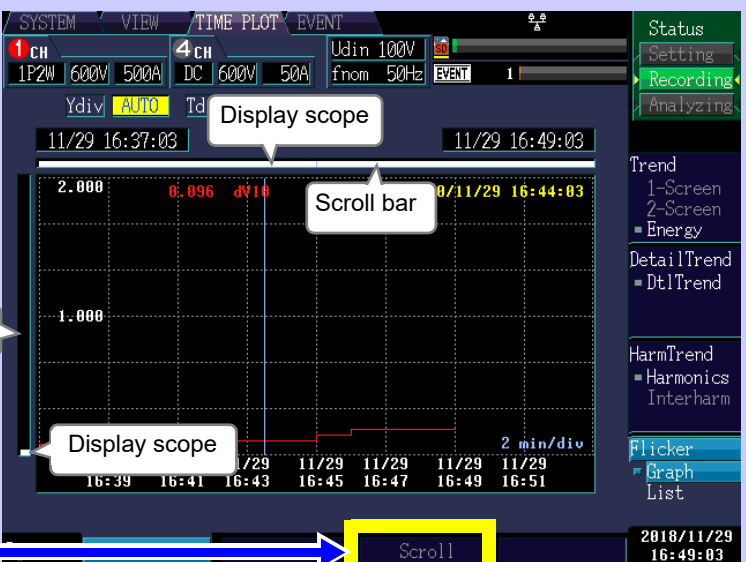

- The display scope on the scroll bar (shown in white) illustrates which range of all measurement data is being shown on the screen.
- The cursor on the scroll bar shows where the cursor is located relative to all measurement data.

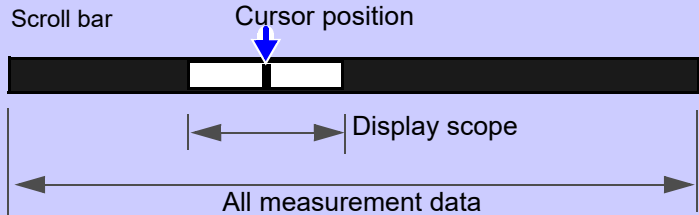

Scroll bar Cursor position

← Display scope →

← All measurement data →

Displaying a ΔV_{10} flicker list

This section describes how to display the following ΔV_{10} flicker statistics along with the time and date once an hour:

- ΔV_{10} flicker 1-hour maximum value
- ΔV_{10} flicker 1-hour fourth-largest value
- ΔV_{10} flicker 1-hour average value

ΔV_{10} flicker statistics for the measurement period are displayed. Each ΔV_{10} value is updated once a minute.

- ΔV_{10} flicker overall maximum value

The diagram illustrates the navigation from the TIME PLOT screen to the DF 4 Flicker List screen. On the left, a box labeled 'TIMEPLOT [TIME PLOT] screen' has a downward arrow pointing to a box labeled 'DF 4 [Flicker] [List]'. On the right, a screenshot of the device's interface shows the 'TIME PLOT' screen. A yellow box highlights the 'TIME PLOT' label at the top, and a blue arrow points from this box to the 'DF 4' box on the left. Another yellow box highlights the 'Flicker List' option in the bottom right corner of the interface. The main display area shows a table of flicker statistics:

No.	Date	Time	Max. [V]	4th Max. [V]	Avg. [V]
1	12/28	14:01:44	1.179	0.015	0.452
2	12/28	15:01:44	3.300	0.002	0.829
3	12/28	16:01:44	0.006	0.002	0.003
4	12/28	17:01:44	0.002	0.002	0.002

Below the table, the 'Total Maximum' is displayed as 3.300 V. The interface also shows various status indicators and settings on the right side, including 'Status', 'Setting', 'Recording', 'Analyzing', 'Trend', 'DetailTrend', 'HarmTrend', and 'Flicker Graph List'.

NOTE

- Statistics are updated once an hour, and the ΔV_{10} flicker overall maximum value is updated once a minute.
- The list is not displayed unless [Flicker] is set to [ΔV_{10}] in [SYSTEM]-DF1 [Main]-F2 [Measure2].

Checking Events (EVENT screen) Chapter 8

Data is analyzed on the **[EVENT]** screen. For more information about events, see "Appendix 2 Explanation of Power Supply Quality Parameters and Events" (p.A2).

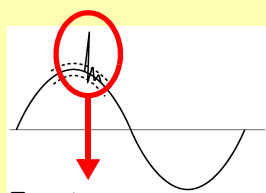

Event occurrence

Each time an event occurs, an event is added to the event list screen.

■ Display the event list. (p.143)

You can check events that have occurred on the event list screen.

■ Analyze events. (p.147 to p.155)

You can display the screen at the time the selected event occurred.

Events displayed by the PQ3198

- Start recording events
- Stop recording events
- Calculation events (events for which one or more thresholds can be set)
- Event waveforms (transient waveforms, high-order harmonic data, fluctuation data)

NOTE

- When making measurements using events, be sure to set the event setting on the **[SYSTEM]** screen to ON.



See: "5.6 Changing Event Settings" (p.87)

- The maximum number of events that can be displayed is 9999. (Event data should be analyzed using the application software PQ ONE, which is supplied with the instrument.)

8.1 Using the EVENT screen

Pressing the **DF1** key on the **[EVENT]** screen displays the event list screen.



The screen shown varies with the instrument's internal operating state.

Screen operation is limited depending on the instrument's internal operating state.

Internal operating state	Display update
[Setting]	None
[Recording]	After each event
[Analyzing]	Stop

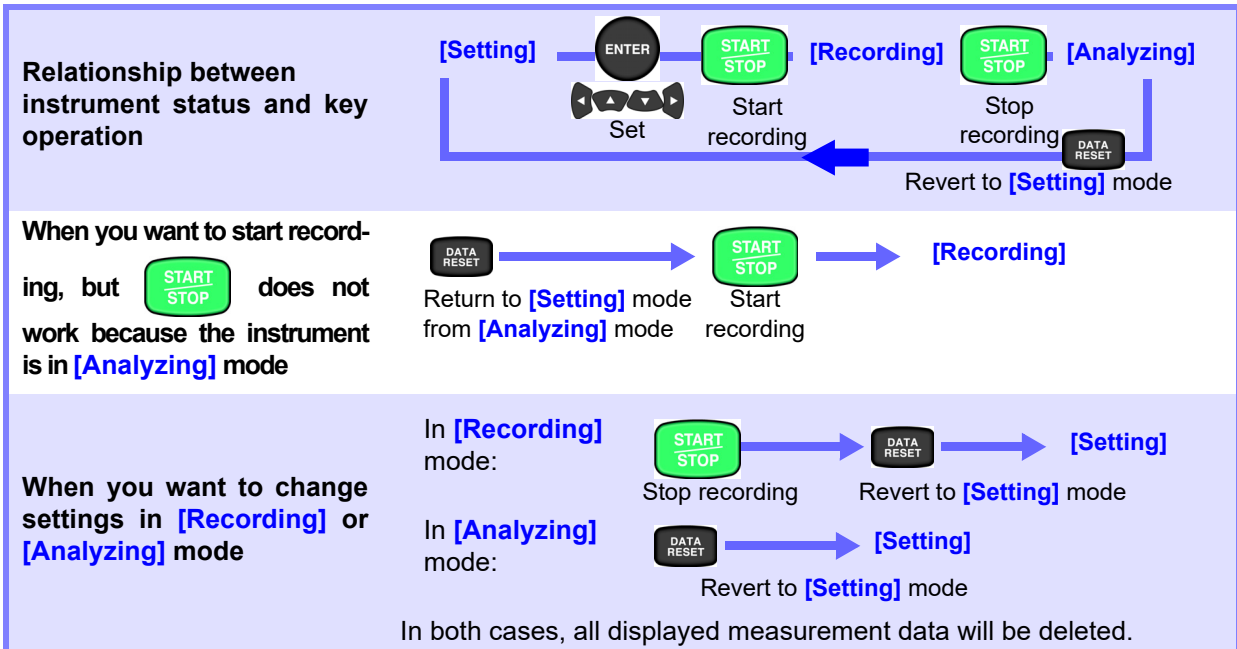
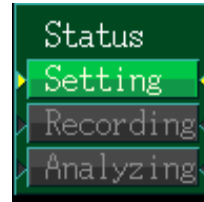

8.2 Displaying the Event List

Displays events in a list.

EVENT

[Event] screen

↓

DF 1

**[Event]
[List]**

Scroll the event list up and down

See: "Event items, list notation, and saved items" (p.145)

To analyze the state when the event occurred (p.147)
(Available only in **[Analyzing]** mode.)

To analyze the transient waveform (p.149)

To view high-order harmonic measured values (p.152)

To check fluctuation data (p.155)

- Information that is recorded as the event includes the start, stop, the PQ3198 message, and event parameters set in the **[SYSTEM]** screen.
- Up to 9999 events can be displayed, numbered from 1 to 9999.
- When events with multiple differing parameters occur during the same approximately 200 ms period, they are displayed together as a single event. A list of the multiple parameters is shown to the right.





Operation when there are too many events

When the event count reaches 9999, the instrument will continue to save time plot data but stops saving event data.

Displaying event details

Select an event to display detailed event information and multiple event parameters.

 **Move the yellow cursor to select an event**

 **Select the event type in the detail display**

The voltage waveform when the event occurred is shown.



Event	Time	Event	CH IN/OUT
4	11/17 20:24:23.774	Dip	CH2 IN
5	11/17 20:24:23.974	Urms Low	CH1 SENSE
6	11/17 20:25:56.178	Dip	CH2 OUT
7	11/17 20:25:56.375	Urms Low	CH1 SENSE
8	11/17 20:28:20.976	Dip	CH2 IN
9	11/17 20:28:21.179	Urms Low	CH1 SENSE
10	11/17 20:28:28.979	Dip	CH1 OUT
11	11/17 20:28:29.176	Urms Low	CH1 SENSE

 You can move the yellow cursor up and down 100 rows at a time with the **F1** and **F2** keys.

 You can move the cursor to the most recent event with the **F4** key.

Event items, list notation, and saved items

Event items	Event list notation	IN/OUT/ SENSE	Synchronized save items			
			Measurement items	Event waveform	High-speed waveform	Fluctuation data
Transient overvoltage	Tran	IN/OUT	All instantaneous values Frequency, voltage, current, power, power factor, unbalance factor, harmonic voltage, harmonic current, harmonic power, harmonic voltage distortion factor, harmonic current distortion factor, K factor, high-order harmonic voltage component and current component. (Event category)	✓	Transient over-voltage waveform	
Swell	Swell	IN/OUT		✓		✓
Dip	Dip	IN/OUT		✓		✓
Interruption	Intrpt	IN/OUT		✓		✓
Inrush current	Inrush	IN/OUT		✓		✓
Frequency 200 ms	Freq	IN/OUT		✓		
Frequency cycle	Freq_wav	IN/OUT		✓		
Voltage waveform peak	Upk	IN/OUT		✓		
RMS voltage	Urms	IN/OUT/SENSE		✓		
Voltage DC change (CH4 only)	Upp	IN/OUT		✓		
Current waveform peak	Ipk	IN/OUT		✓		
RMS current	Irms	IN/OUT/SENSE		✓		
Current DC change (CH4 only)	Ipp	IN/OUT		✓		
Active power	P	IN/OUT		✓		
Apparent power	S	IN/OUT		✓		
Reactive power	Q	IN/OUT		✓		
Power factor/ displacement factor	PF	IN/OUT		✓		
Voltage negative-phase unbalance factor	Uunb	IN/OUT		✓		
Voltage zero-phase unbalance factor	Uunb0	IN/OUT		✓		
Current negative-phase unbalance factor	Iunb	IN/OUT		✓		
Current zero-phase unbalance factor	Iunb0	IN/OUT		✓		
Harmonic voltage	Uharm	IN/OUT		✓		
Harmonic current	Iharm	IN/OUT		✓		
Harmonic power	Pharm	IN/OUT		✓		
Phase difference of harmonic voltage and harmonic current	Pphase	IN/OUT		✓		
Total harmonic voltage distortion factor	Uthd	IN/OUT		✓		
Total harmonic current distortion factor	Ithd	IN/OUT		✓		
K factor	KF	IN/OUT		✓		
High-order harmonic voltage component	UharmH	IN/OUT		✓	High-order harmonic waveform	
High-order harmonic current component	IharmH	IN/OUT		✓	High-order harmonic waveform	
Voltage waveform comparison	Wave			✓		
Mains signaling voltage	Msv	IN/OUT		✓		
Timer event	Timer			✓		
Continuous event	Cont		✓			
External event	Ext		✓			
Manual event	Manu		✓			
Start	Start		✓			
Stop	Stop		✓			
GPS <small>Note 1</small>	GPS_IN		✓			
	GPS_OUT		✓			
	GPS_Err		✓			

8.2 Displaying the Event List

Note1

- GPS error (GPS error): GPS IN
 - GPS error cleared (GPS positioning): GPS OUT
 - GPS time correction failure (GPS time error): GPS Err
- IN/OUT rules are irrelevant.

NOTE

Fluctuation data is only displayed for IN events. If a series of swell, dip, interrupt, or inrush current IN events occur, fluctuation data may be unavailable.

Event list order

The first event to occur (the start event) is assigned No. 1, and subsequent events are assigned numbers in order as they occur.

Event list display

Event list

The event list is displayed in the order events occur.

Displayed item	Contents	Example
No.	Order of event occurrence	1
Date	Event occurrence (date)	2019/1/1
Time	Event occurrence (time)	10:05:32.016
EVENT	Event item	Uharm
CH	Event channel (CH1, CH2, CH3, CH4, sum)	CH2
IN/OUT	IN : Event occurrence OUT : Event end SENSE : Sense event occurrence	IN

When two event IN items occur simultaneously, voltage factor events are given precedence in the display. Similarly, when two event OUT items occur simultaneously, voltage factor events are given precedence in the display.

Event details list

Some detailed information cannot be displayed in the event list alone, and multiple events may occur simultaneously. In that case, representative events are shown in the event list, and other events are shown with the event description on the details list.

Displayed item	Contents	Example
Event	Event item (variable) Harmonic and inter-harmonic orders are also shown for harmonic events.	Uharm (2)
CH	Event channel (CH1, CH2, CH3, CH4, sum) and IN (event occurrence), OUT (event end), and SENSE (sense event occurrence) For frequency events, the list indicates either up (when the reading was greater than the threshold) or down (when the reading was less than the threshold).	CH4 OUT
Date	Indicates the date on which the event was detected.	2019/1/1
Time	Indicates the time at which the event was detected.	10:05:32.016
Threshold	Set event threshold (sense value, measured value)	62.053 V
Level	Measured value when event was detected For transient overvoltage values, the transient width is also shown in 500 ns units.	1012.0 V
Duration	Indicates the period after which the reading returned after the threshold was exceeded, or the period from IN to OUT.	0:57:12.032 10.5 μ s
Worst	Level	Worst measured value during event period For transient overvoltage values, the maximum transient overvoltage value width during the event period is also shown.
	Date	Indicates the date on which the worst value was detected.
	Time	Indicates the time at which the worst value was detected.
	CH	Channel on which the worst value was detected
Times	Number of transient overvoltages detected from the transient overvoltage event IN to the transient overvoltage event OUT (up to 99999)	5Times

8.3 Analyzing the Measurement Line Status When Events Occur

You can display the waveform and measured values that obtained when an event occurred on the [VIEW] screen by selecting the event you wish to analyze on the event list screen.

EVENT [Event] screen

DF 1 [Event] [List]

Select a event

ENTER Accept setting
The display will switch to the [VIEW] screen, and the waveform at the time of the event will be displayed.

ESC / 0 Return to event list

The event number, event time, and event type will be displayed.

Event waveform screen

You can analyze the waveform when the event occurred.

No.	DATE	TIME	EVENT	CH	IN/OUT
1	11/17	20:23:57.173	Start		
2	11/17	20:24:23.774	Dip	CH2	IN
3	11/17	20:24:23.974	Urms Low	CH1	SENSE
4	11/17	20:25:55.975	Dip	CH2	IN
5	11/17	20:25:56.178	Dip	CH2	OUT
6	11/17	20:25:56.375	Urms Low	CH1	SENSE
7	11/17	20:28:20.976	Dip	CH2	IN
8	11/17	20:28:21.179	Urms Low	CH1	SENSE
9	11/17	20:28:28.979	Dip	CH1	OUT
10	11/17	20:28:29.176	Urms Low	CH1	SENSE

No. 2 03/11 08:54:00.124 UaharmH

60.00 V/div

0.0020k

250.00 A/div

2019/03/11 08:54:00.124

8.3 Analyzing the Measurement Line Status When Events Occur

NOTE

You can change to the event generation screens (**DF1 [Wave]**, **DF2 [Harmonics]**, **DF3 [DMM]**, and **DF4 [Event]**) by pressing a **DF** key from the event waveform screen.

Screen transitions and measurement data when events occur

Event jump function

Moving the cursor to the event you wish to view on the event list and pressing the **ENTER** key displays the measurement data for that time. The screen displayed initially varies with the event that occurred. Subsequently, you can press a **DF** key to display the desired screen and check measurement data.

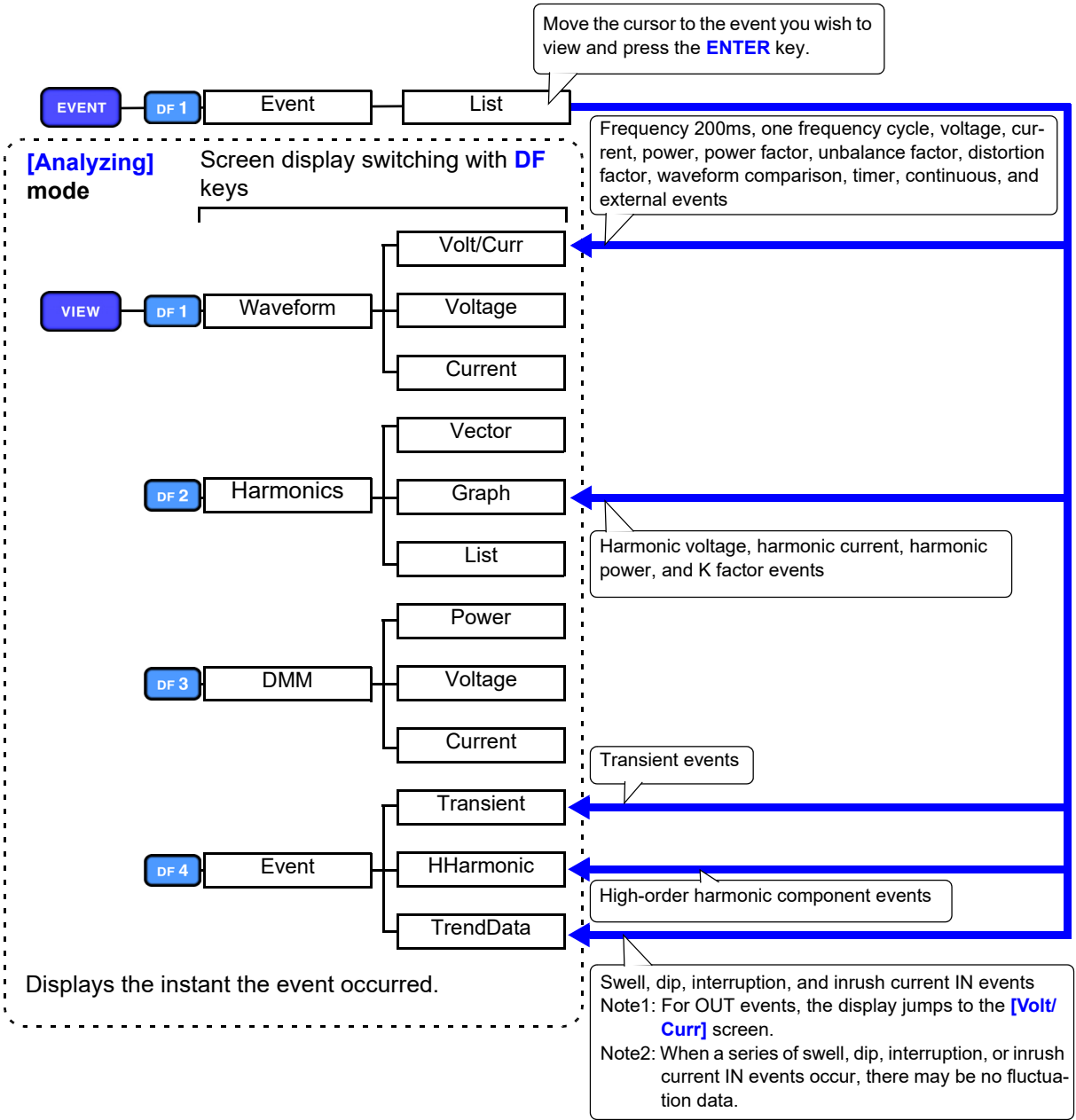

How can event waveforms be recorded?

See: "Appendix 4 Recording TIME PLOT Data and Event Waveforms" (p.A12)

8.4 Analyzing Transient Waveforms

Displaying transients

[Event] screen

[Event] [List]

Select an event for which "Tran" is shown on the event list or event details list

Accept setting
The display will switch to the **[VIEW]** screen, and the waveform at the time of the event will be displayed.

[Transient]

Return to event list

Voltage/Transient waveforms display

Voltage Waveform

Transient waveform

Year, month, day; time; Rising transient voltage value ; and duration of transient

Select with the **F** key.

To enlarge or reduce the transient waveform (p.150)

To scroll transient waveform data (p.151)

- The transient waveform consisting the fundamental component 50 Hz/60 Hz from a waveform sampled at 2 MHz.
- The transient value measured from the waveform obtained by eliminating the fundamental component 50 Hz/60 Hz from having a sampled waveform pass through a highpass filter ($f_c = 5 \text{ kHz}$).
- Since voltage waveform display data reduced to 20 kS/s, the effect from a transient waveform may not be reflected to the voltage waveforms.

Enlarging and reducing the transient waveform

[Select]

F1

Select a setting

Display the pull-down menu

Select a setting

Accept setting

Cancel

U x 2 T x1/2 10ms/div 25us/div

150.00 V/div

2019/01/31 09:38:21.142

2.6736kV

1.5us

0.6000kV/div

Select

Y-axis range

To reduce the waveform, increase the voltage value per division.
To enlarge the waveform, reduce the voltage value per division.

Setting Contents:(* : Default setting)

Voltage waveform range (U)

x1/3, x1/2, x1*, x2, x5, x10, x20, x50

Transient waveform range (T)

x1/2*, x1, x2, x5, x10, x20



X-axis range (Tdiv)

(left: voltage waveform range; right: transient waveform range)

Selects the X-axis scale.

Setting Contents:(* : Default setting)

Voltage waveform range:

5ms/div*, 10ms/div, 20ms/div, 40ms/div

Transient waveform range:

25μs/div*, 50μs/div, 100μs/div, 200μs/div, 400μs/div

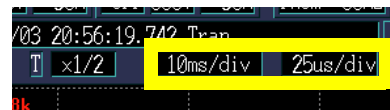

Scrolling the transient waveform

You can check all waveform data by scrolling the waveform horizontally.

F3 [Scroll]

Scroll the waveform

ESC /cm

Return to event list

Display scope

Scroll

Scroll bar

Scroll bar

The display scope on the scroll bar (shown in white) illustrates which range of all measurement data is being shown on the screen.

Display scope

All measurement data

8.5 Viewing High-order Harmonic Waveforms

RMS values for noise components at 2 kHz and higher are known as the high-order harmonic component. When a high-order harmonic component event is detected, the high-order harmonic waveform is recorded. The high-order harmonic waveform is a 40 ms instantaneous waveform sampled at 200 kHz.

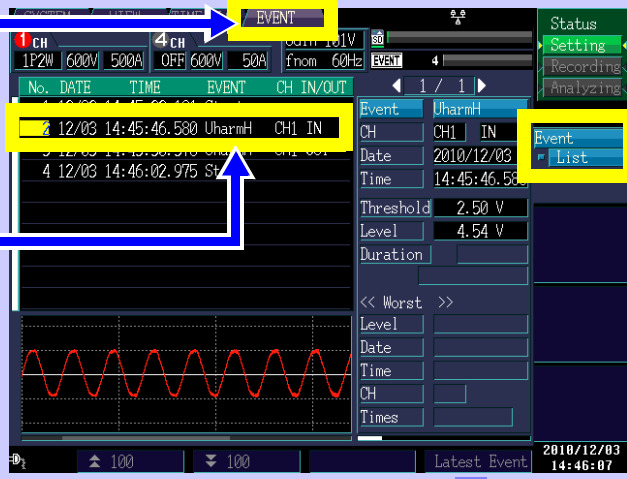
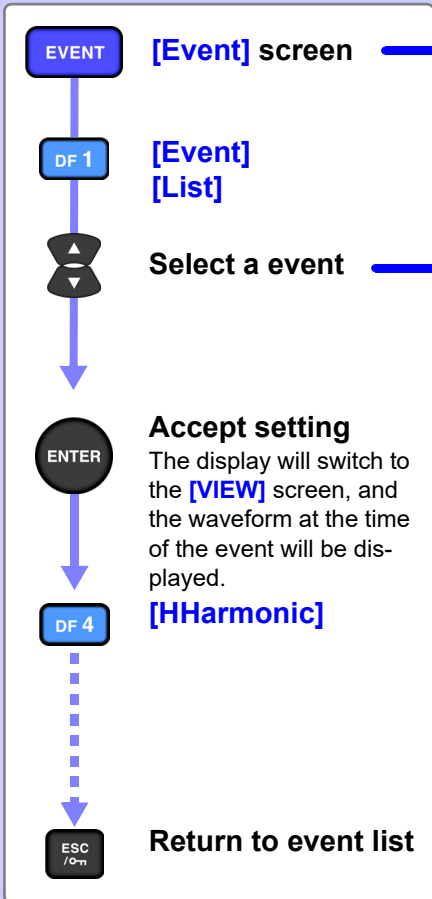

High-order harmonic waveforms display

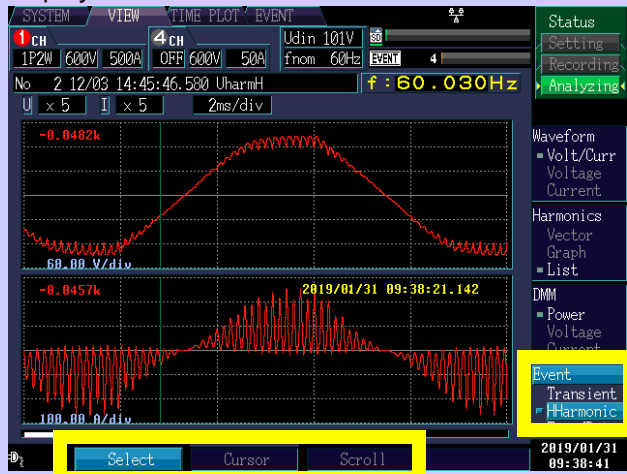

Select with the **F** key.
 To enlarge or reduce the graph (p.153)
 To read the value above the cursor (p.154)
 To scroll waveform data (p.154)

Enlarging or reducing the graph (changing the X- and Y-axis scale)

[Select]

F1

Select a setting

ENTER

Display the pull-down menu

Select a setting

ENTER

Accept setting

ESC / 0

Cancel

SYSTEM VIEW TIME PLOT EVENT

1 CH 4 CH U_{in} 101V

1P2W 600V 500A OFF 600V 50A f_{nom} 60Hz EVENT 4

U × 5 I × 5 2ms/div

-0.0482k

60.00 V/div

-0.0457k

2019/01/31 09:38:21.142

100.00 A/div

Select Cursor Scroll

Status

Setting

Recording

Analyzing

Waveform

Volt/Curr

Voltage

Current

Harmonics

Vector

Graph

List

DMM

Power

Voltage

Current

Event

Transient

Harmonic

TrendData

2019/01/31 09:38:41

Y-axis scale (U: Voltage, I: Current)

When you want to reduce the graph, make the scale smaller.
When you want to enlarge the graph, make the scale larger.

Setting Contents:(* : Default setting)

[x1/3](#), [x1/2](#), [x1*](#), [x2](#), [x5](#), [x10](#), [x20](#), [x50](#)



X-axis scale

Selects the X-axis scale.

Setting Contents:(* : Default setting)

[0.5ms/div*](#), [1ms/div](#), [2ms/div](#), [5ms/div](#), [10ms/div](#)

The scale can also be changed without using the pull-down menu by pressing the up and down cursor keys.

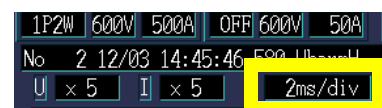

Viewing the value and time at the cursor position (Cursor measurements)

You can read the value and time at the cursor position on waveform graphs.

F2 [Cursor]



Move the vertical cursor left and right to read the display value.

Cursor color
 Red: CH1
 Yellow: CH2
 Blue: CH3
 Gray: CH4

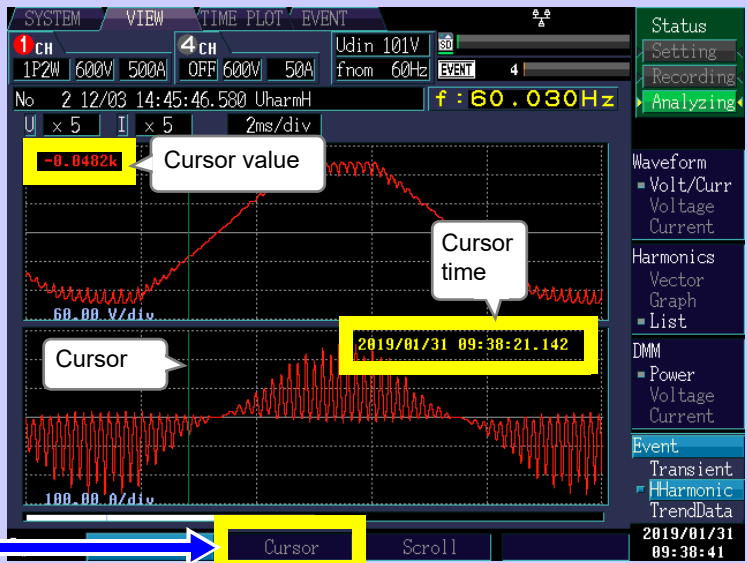

Scrolling the waveform

During recording, the X-axis is automatically scaled so that the full waveform graph fits on the screen. Once recording has stopped and the X-axis scale has been changed so that the waveforms do not fit on the screen, you can scroll through the waveform graph by moving left, right, up, and down.

F3 [Scroll]



Scroll through the graph

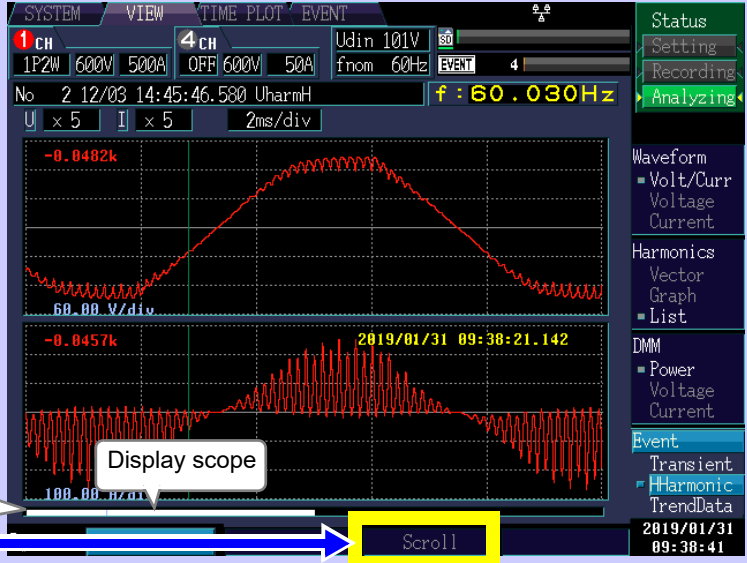

- The display scope on the scroll bar (shown in white) illustrates which range of all measurement data is being shown on the screen.
- The cursor on the scroll bar indicates where the cursor is located relative to all waveform data.

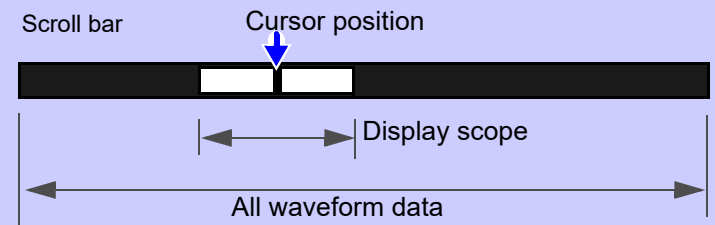

Scroll bar Cursor position

Display scope

All waveform data

8.6 Checking Fluctuation Data

Fluctuation data for swell, dip, interruption, and inrush current events when an event occurs is displayed for 30 s (from 0.5 s before to 29.5 s after the event IN) as a time series graph (during 400 Hz measurement, from 0.125 s before to 7.375 s after the event IN).

EVENT [Event] screen

DF 1 [Event] [List]

Select a event

ENTER Accept setting
The display will switch to the [VIEW] screen, and an event will occur.

DF 4 [TrendData]

ESC / ON Return to event list

Fluctuation data display

The U1, U2, and U3 time series graphs are displayed. The pre-trigger and total recording periods are fixed at 0.5 and 30 s, respectively.

Red: CH1

Yellow: CH2

Blue: CH3

Gray: CH4

The maximum and minimum values during the TIME PLOT interval are shown as the MAX and MIN values.



Select with the **F** key.

To change the displayed channels (p.156)

To enlarge or reduce the graph (p.156)

To read the value above the cursor (p.157)

To scroll waveform data (p.158)

8.6 Checking Fluctuation Data

NOTE

- Data can be recorded regardless of the recording item settings (p.78) and the TIME PLOT interval settings (p.79) (**[SYSTEM]-DF1 [Recording]-F1 [Interval]**).
- When an event occurs while 30 s of fluctuation data is being recorded, fluctuation data is only recorded for the first event.
- Ultimately, data can be analyzed in detail and reports generated using the application software PQ ONE, which is supplied with the instrument.

Changing the displayed channel and enlarging or reducing the graph (changing the X-axis scale)

Displayed channel

Setting Contents:(* : Default setting)

CH1* / CH2 / CH3 / CH4 (varies with connection)

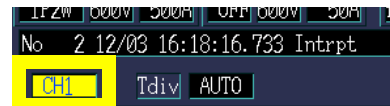

X-axis scale (Tdiv)

When you want to reduce the graph, make the scale smaller.
When you want to enlarge the graph, make the scale larger.

Setting Contents:(* : Default setting)

AUTO*, x5, x2, x1, x1/2, x1/5, x1/10

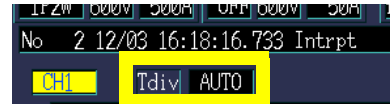

Viewing the value and time at the cursor position (Cursor measurements)

You can read the value and time at the cursor position on time series graphs.

F 2 [Cursor]

Move the vertical cursor left and right to read the display value.

Cursor color
 Red: CH1
 Yellow: CH2
 Blue: CH3
 Gray: CH4

SYSTEM VIEW TIME PLOT EVENT

1 CH 4 CH Udim 101V 50

1P2W 600V 500A OFF 600V 50A from 60Hz EVENT 4

No 2 12/03 16:18:16.733 Intrpt

CHI Tdi AUTO

120.00 60.00 0.00

50.00 25.00 0.00

5.00 10.00 15.00 20.00 25.00 30.00 35.00 sec

Cursor value Cursor

U1 106.32 V

I1 0.45 A

2019/01/31 09:38:21.142

Cursor time

Cursor Scroll

Status
 Setting
 Recording
 Analyzing

Waveform
 Volt/Curr
 Voltage
 Current

Harmonics
 Vector
 Graph
 List

DMM
 Power
 Voltage
 Current

Event
 Transient
 Harmonic
 TrendData

2019/01/31
 09:38:41

NOTE

The time displayed during cursor measurement is based on the CH1 voltage (U1). Event occurrence times displayed in the event list and times shown during cursor measurement may not agree.

Scrolling the waveform

During recording, the X-axis and Y-axis are automatically scaled so that the full time series graph fits on the screen. Once recording has stopped and the X-axis or Y-axis scale has been changed so that the waveforms do not fit on the screen, you can scroll through the time series graph by moving left, right, up, and down.

F 3 [Scroll]



Scroll through the graph

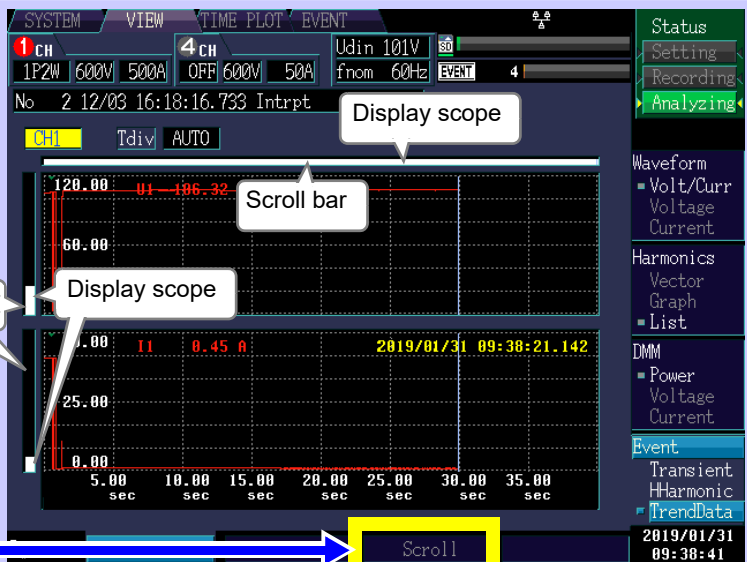

- The display scope on the scroll bar (shown in white) illustrates which range of all measurement data is being shown on the screen.
- The cursor on the scroll bar shows where the cursor is located relative to all measurement data.

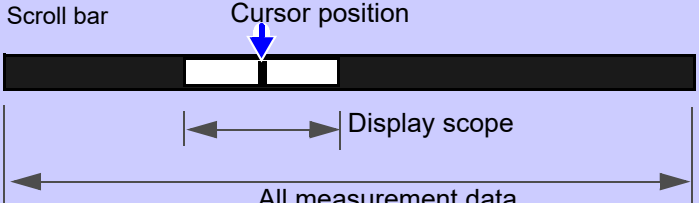

Data Saving and File Operations (SYSTEM-MEMORY screen)

Chapter 9

The PQ3198 saves settings data, measurement data, waveform data, event data, and screen copy data to an optional SD memory card. (Of this data, only setting conditions can be loaded by the instrument.)

See: "3.5 Inserting (Removing) an SD Memory Card" (p.45)

9.1 [MEMORY] Screen

This section describes the [MEMORY] screen.

The screenshot shows the [MEMORY] screen with the following elements:

- Header:** CVCTEM, WTRM, TIME, PLOT, EVENT, Status
- Folder Path:** /PQ3198
- Used Memory:** 4 MB / 7592 MB
- File List:**

No.	File Name	Size	Date
1	HARDCOPY	<Folder>	2009/01/23 23:15
2	SETTING	<Folder>	2018/11/22 18:19
3	18112800	<Folder>	2018/11/28 16:18
- Summary:** total: 3 files
- Instructions:** Use the ↑ ↓ keys to select file. Use the ← → to switch folders. (View up to 204 files.)
- Buttons:** Delete, Format
- Right Panel:**
 - Recording: Analyzing
 - System: Wiring, Main, Record
 - Event1: Voltage1, Voltage2, Wave
 - Event2: Current, Harmonics, Power/etc
 - Memory: Setting, Hardcopy, List
 - Date/Time: 2018/11/28 16:18:33

Callouts provide additional information:

- Displays the present display position. This screen indicates that the contents of the PQ3198 folder on the SD memory card are being displayed.
- Displays how much of the SD memory card has been used.
- Displays a list of files saved on the SD memory card.
- Allows you to scroll around the screen with the up and down cursor keys and displays the present display position as a white bar.

NOTE

An error message will be displayed if the SD memory card experiences an error. SD utilization is not shown.

About File Types

The following file data types may be stored.

Name	Type	Description
00000001.SET	SET	Settings file
00000001.BMP	BMP	Screen copy data file
EV000001.EVT	EVT	Event data file
TR000001.TRN	TRN	Transient waveform file
HH000001.HHC	HHC	High-order harmonic waveform file
000001.WDU	WDU	Fluctuation data file
AT000000.BMP	BMP	Screen data file saved once each screen copy interval
PQ3198.SET	SET	Settings data file at start of time series measurement
TP0000.ITV	ITV	Time series measurement normal binary file
FL0000.FLC	FLC	Time series measurement flicker data
HARDCOPY	<Folder>	Folder for saving screen copy data files
SETTING	<Folder>	Folder for saving settings
YYMMDDNN	<Folder>	Folder for saving data (name varies with date and number of folder)(p.164))
EVENT	<Folder>	Folder for saving events
AUTOCOPY	<Folder>	Folder for automatically saving screen data (folder for saving AT*****.BMP files)

- Files are numbered consecutively inside each folder.
- In the name of the folder used to store data, YY indicates the last two digits of the Western year; MM, the month; DD, the day; and NN, a sequential number for that day.

Moving inside folders, moving to the root folder, and list displays

■ Moving inside a folder

- You can display the contents of a folder by moving the cursor to the folder with the up and down cursor keys and then pressing the right cursor key.
- While the root folder [/] is being displayed, you can move to the [PQ3198] folder with the right cursor key, regardless of the cursor position.
- To go back one folder when the [HARDCOPY] or [AUTOCOPY] folder is being displayed, press the **ESC** key. For other folders, press the left cursor key.
- You cannot move to folders unrelated to the instrument.

■ List displays

The contents of [HARDCOPY] and [AUTOCOPY] folders are displayed as a list of BMP file thumbnails, and their contents are displayed in list form. Other folder contents are displayed as a list of filenames.

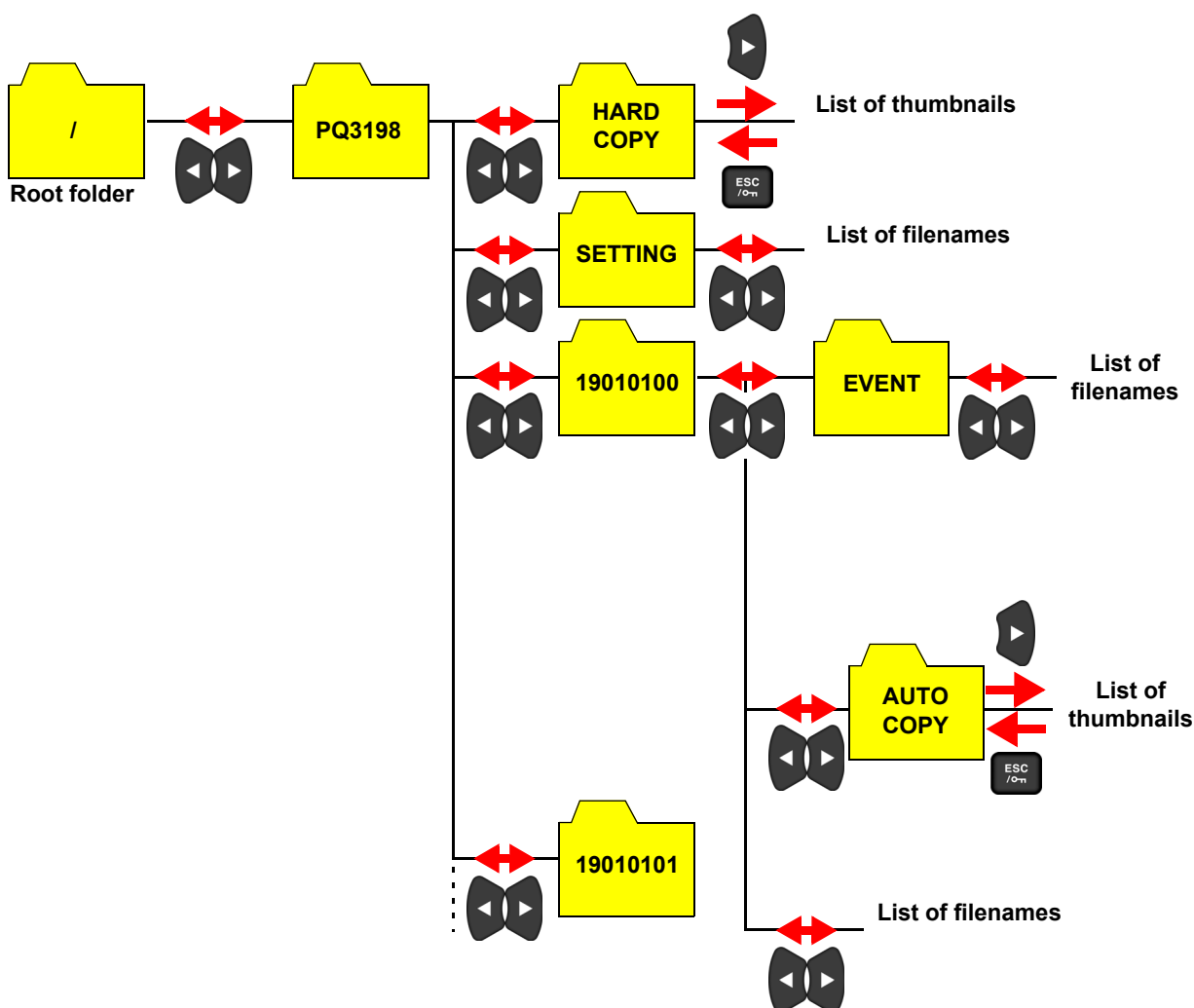

9.2 Formatting SD Memory Cards

You will need to use this functionality if the SD memory card being used has not been formatted (initialized). Start the formatting process after inserting the SD memory card you wish to format into the instrument (p.45).

Once formatting is complete, the [PQ3198] folder will be automatically created in the root directory (the uppermost level in the directory structure on the SD memory card).



NOTE

- Formatting erases any data stored on the SD memory card so that it cannot be recovered. Execute only after confirming that no important files will be lost. We recommend keeping a backup of any precious data stored on a SD memory card.
- Use the instrument to format cards. Cards formatted on a computer may not use the proper SD format, resulting in decreased memory card performance.
- The instrument can only store data on memory cards that use the SD format.
- Use only HIOKI-approved SD memory cards (model Z4001, etc). Proper operation is not guaranteed if other cards are used.

9.3 Save Operation and File Structure

Save operation

Saving measurement data (p.165)

Saving method

Data is automatically saved according to the time control settings.

- When the file size exceeds 100 MB, the instrument will create a new file and continue saving data to it.
- The instrument will stop saving data once the SD memory card is full.
- Up to 204 files can be displayed on the [\[List\]](#) screen.
- Up to 100 measurement data files can be created on a single date.

SD memory card root

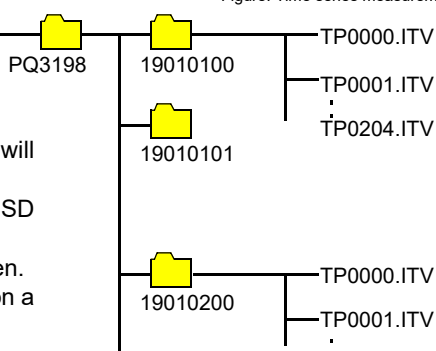

Saving screen copies (p.168)

Saving method

Press the **COPY** key while the screen you wish to save is being displayed.

- Up to 102 files can be displayed on the [\[Hardcopy\]](#) screen.

SD memory card root

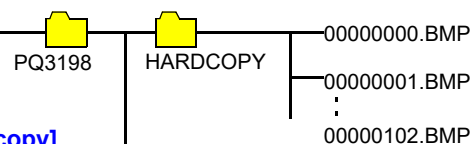

Saving settings data (p.169)

Saving method

Move to the folder in which you wish to save the data on the SD memory card screen and press the **F2** key.

- Up to 102 files can be displayed on the [\[Setting\]](#) screen.

SD memory card root

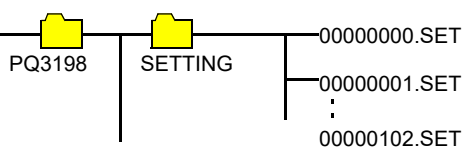

File structure (overall)

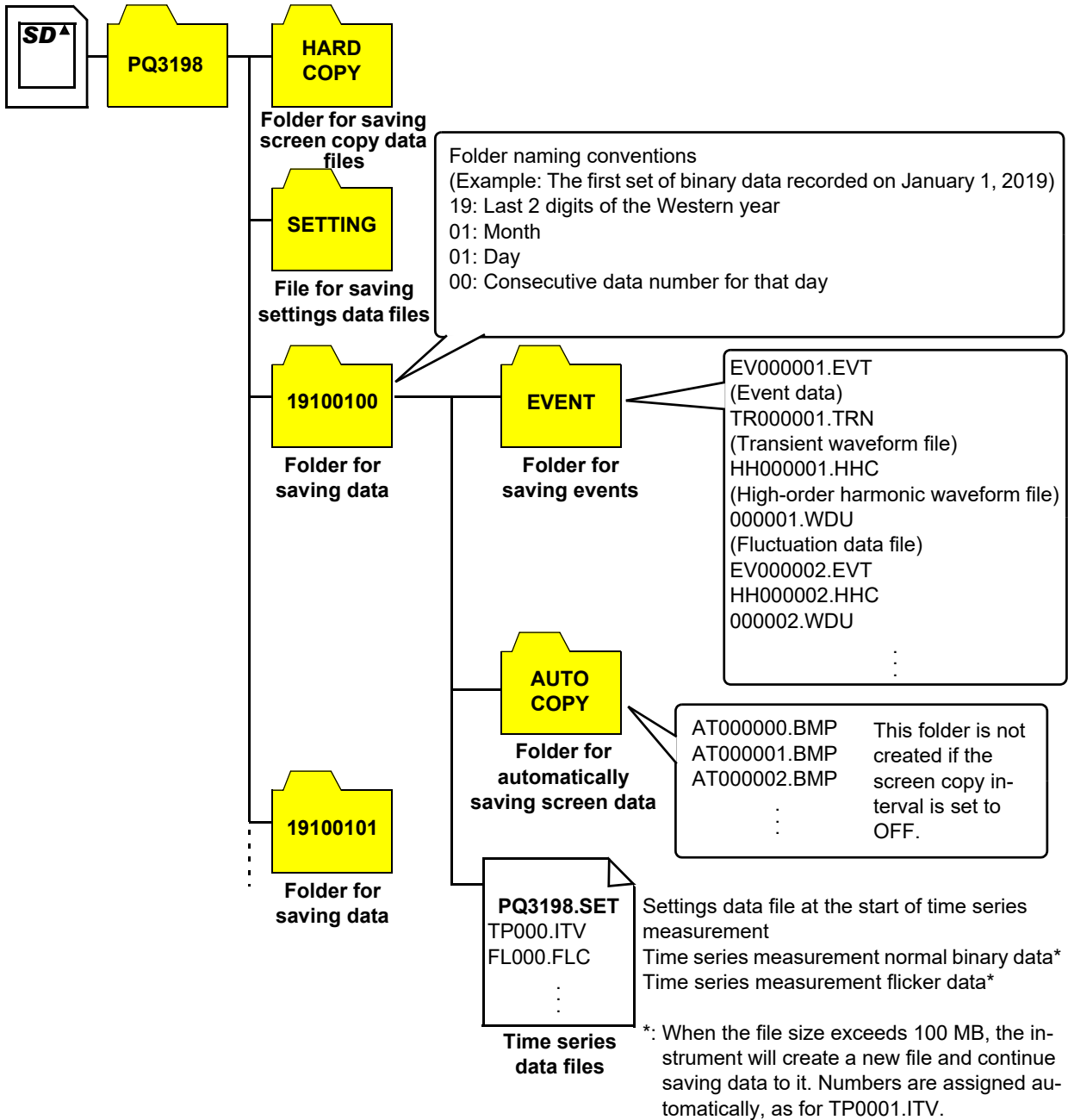

9.4 Saving, Display and Deleting Measurement Data

Saving data

Characteristics selected with the **[Recording Items]** setting are all automatically saved to the SD memory card in the binary format. Up to 100 measurement data files can be created on a single date.

NOTE

If an SD memory card is not inserted into the instrument, measurement data will not be saved.

Save procedure

- 1.** Set the recorded items and TIME PLOT interval.
(See "Recording Items" (p.78), "TIME PLOT Interval" (p.79))
- 2.** Set the recording start time and end time (as necessary).
(See "Time Start" (p.80))
- 3.** Press the  key to start recording.

(To cancel recording, press the  key again.)

(A folder will be automatically created, and the data will be stored there. See 9.3 (p.163).)

Save destination:	SD memory card
File names:	<p>Filenames are automatically created based on the start time and date and given an extension of "ITV" (time series measurement normal binary data) or "FLC" (time series measurement flicker data). Numbering starts at 0000 and goes to 9999. Example: TP0000.ITV (the first set of time series measurement normal binary data saved in the folder)</p>



Remaining storage time

The remaining storage time on the SD memory card being used is displayed when setting the recorded items and TIME PLOT interval. The time is calculated and displayed based on the SD memory card's storage capacity, the number of items being recorded, and the TIMEPOT interval time. This calculation does not take event data into account, so the recording time may vary significantly with the number of events.

Recording times for (reference value) a Z4001 SD Memory Card 2 GB (Repeat Record: 1 Week, Repeat Number: 55 times)

TIME PLOT interval	Recording parameter setting		
	All data (Saves all data)	Power and Harmonic (Saves RMS values and harmonics)	Power (Saves RMS values only)
1 second	16.6 hours	23.2 hours	11.9 days
3 seconds	2.1 days	2.9 days	35.8 days
15 seconds	10.4 days	14.5 days	25.5 weeks
30 seconds	20.7 days	29 days	51 weeks
1 minute	41.5 days	8.3 weeks	55 weeks
5 minutes	29.6 weeks	41.5 weeks	55 weeks
10 minutes	55 weeks	55 weeks	55 weeks
15 minutes	55 weeks	55 weeks	55 weeks
30 minutes	55 weeks	55 weeks	55 weeks
1 hour	55 weeks	55 weeks	55 weeks
2 hours	55 weeks	55 weeks	55 weeks
150/180 /1200wave (Approx. 3 sec)	2.1 days	2.9 days	35.8 days

- Recording times do not account for event data and screen copy data. Recording times may be shortened when event data and screen copy data are stored on the card.
- Recording times are not dependent on connections.
- When repeated recording is set to **[OFF]**, the maximum recording time is 35 days.
- When repeated recording is set to **[1 Day]**, the maximum recording time is 366 days.
- When repeated recording is set to **[1 Week]**, the maximum recording time is 55 weeks.
- Harmonics order data is not saved for **[Power]**, but it is saved in THD.

Delete

The screenshot shows a device's file management screen. At the top, there are tabs for 'SYSTEM', 'VIEW', 'TIME PLOT', and 'EVENT'. Below these, there are various status indicators like '3P4W 600V 500A ACDC 600V 500A', 'Udin 230V', and 'fnom 50Hz'. A file list is displayed with columns for 'No.', 'File Name', 'Size', and 'Date'. The file list contains three entries: 1. HARDCOPY <Folder> (2009/01/23 23:15), 2. SETTING <Folder> (2018/11/22 18:19), and 3. 18112800 <Folder> (2018/11/28 16:18). A 'Delete' button is visible at the bottom of the screen. On the right side, there is a vertical menu with options like 'Memory', 'Setting', 'Hardcopy', and 'List'. A legend on the left side of the image provides the following instructions:

- SYSTEM** [SYSTEM] screen
- DF 4** [List]
- Select the number (No.) you wish to delete
- F 3** [Delete] A deletion confirmation dialog box will be displayed.
- ENTER** Execute
- ESC / On** Cancel

Display Measurement Data (Load)

When you move the cursor, on the [SYSTEM]-[Memory]-[List] screen, to a data storage folder you wish to display, the **F1 [Load]** key will appear.

When you press the **F1 [Load]** key, [Analyze] will be activated, displaying the event list, trend data, detailed trend data in the specified folder.

Event, trend data and detailed trend data can be checked.

Refer to "Chapter 8 Checking Events (EVENT screen)" (p.141) for the Event Confirmation Method.

Return to [Settings] with the **DATARESET** key.

CAUTION

- The maximum displayed times of the trend data, detailed trend data, and harmonic trend data in the [TIME PLOT] screen of the Hioki PQ3198 is subject to certain constraints. To confirm all measured trend data, use the application software PQ ONE, which is supplied with the instrument.
- Data measured in different versions will not load even if the instrument is the same.
- The **F1 [Load]** key will appear when the cursor is in the stored data folder. (*****).

[TIME PLOT] screen maximum display times

TIME PLOT Interval	Recording Items setting		
	All data (Saves all data)	Power and Harmonic (Saves RMS values and harmonics)	Power (Saves RMS values only)
1 second	7 min. 52 sec.	15 min. 44 sec.	2 hours 37 min. 20 sec.
3 seconds	23 min. 36 sec.	47 min. 12 sec.	7 hours 52 min.
15 seconds	1 hour 58 min.	3 hours 56 min.	1 day 15 hours 20 min.
30 seconds	3 hours 56 min.	7 hours 52 min.	3 days 6 hours 40 min.
1 minute	7 hours 58 min.	15 hours 44 min.	6 days 13 hours 20 min.
5 minutes	1 day 15 hours 20 min.	3 days 6 hours 40 min.	32 days 18 hours 40 min.
10 minutes	3 days 6 hours 40 min.	6 days 13 hours 20 min.	35 days
15 minutes	4 days 22 hours	9 days 20 hours	35 days
30 minutes	9 days 20 hours	19 days 16 hours	35 days
1 hour	19 days 16 hours	35 days	35 days
2 hours	35 days	35 days	35 days
150/180 wave (Approx. 3 sec)	23 min. 36 sec.	47 min. 12 sec.	7 hours 52 min.

9.5 Saving, Displaying, and Deleting Screen Copies

You can save the currently displayed screen as a BMP (256-color) file. The file extension is “.bmp.”

Save

You can save (output) the screen at a given instant to the set SD memory card by pressing the  key while the screen you wish to save is displayed.

RS Connection:	SD memory card
File names:	Auto generated, extension of “.bmp” 00000000.bmp (consecutive numbering in the folder ranges from 00000000 to 99999999) Example: 00000001.bmp

NOTE Up to 102 files can be displayed on the **[Hardcopy]** screen.

Displaying and deleting files

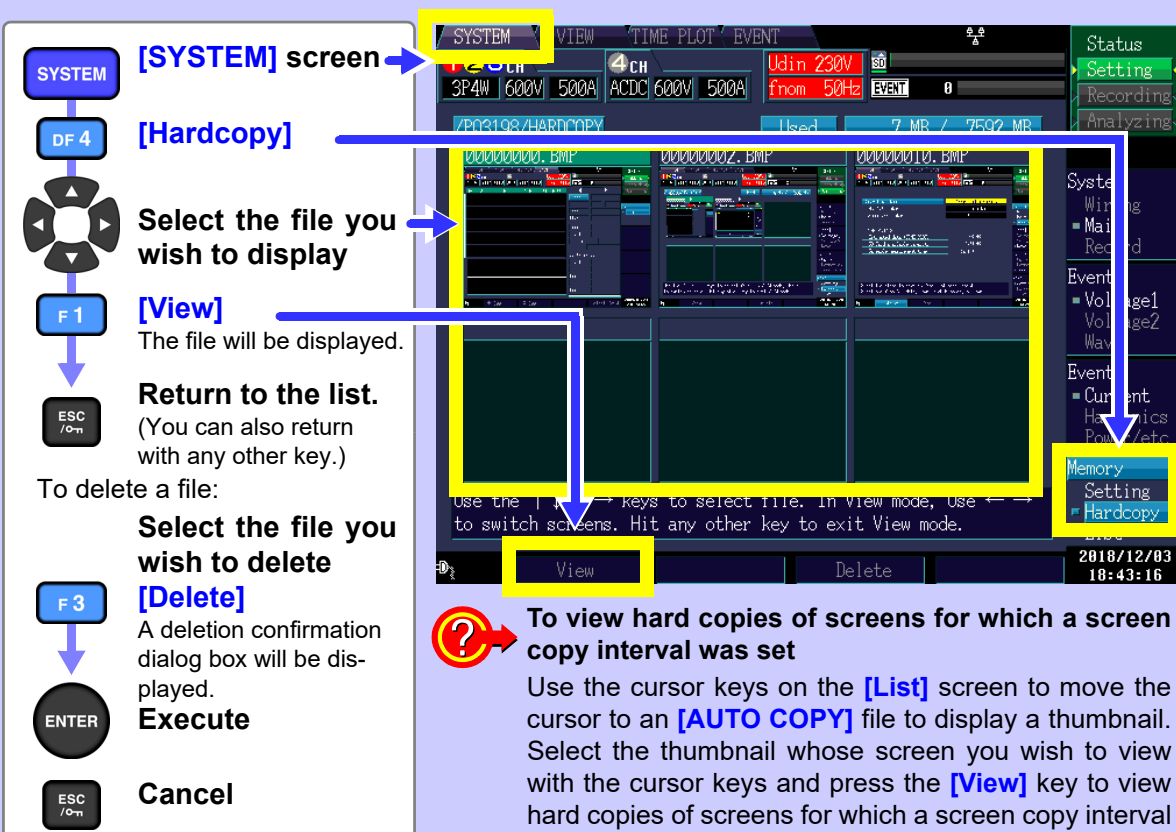

[SYSTEM] screen → **[Hardcopy]** → **[List]** → **[View]** → **[Delete]**

[SYSTEM] screen

DF 4 **[Hardcopy]**

Select the file you wish to display

F1 **[View]**
The file will be displayed.

ESC / On **Return to the list.**
(You can also return with any other key.)

To delete a file:
Select the file you wish to delete

F3 **[Delete]**
A deletion confirmation dialog box will be displayed.

ENTER **Execute**

ESC / On **Cancel**

[View] **[Delete]**

To view hard copies of screens for which a screen copy interval was set
Use the cursor keys on the **[List]** screen to move the cursor to an **[AUTO COPY]** file to display a thumbnail. Select the thumbnail whose screen you wish to view with the cursor keys and press the **[View]** key to view hard copies of screens for which a screen copy interval was set.

9.6 Saving and Deleting Settings Files (Settings Data)

This section describes how to save the instrument's present settings.

SYSTEM [SYSTEM] screen

DF 4 [Setting]

F 2 [Save]
The file will be saved.

To delete a file

F 3 [Delete]
Select the number (No.) you wish to delete

ENTER Execute
A deletion confirmation dialog box will be displayed.

ESC /Cn Cancel

No.	File Name	Size	Date
1	00000000.SET	4128	2018/11/29 18:07

total: 1 files
Use the ↑ ↓ keys to select file.
102 files can be saved.

Buttons: Load, Save, Delete

NOTE

- All filenames are assigned automatically and cannot be changed by the user (for example, 00000000.SET).
- See: "9.3 Save Operation and File Structure" (p.163)
- Up to 102 files can be displayed on the [Setting] screen.

9.7 Loading Settings Files (Settings Data)

This section describes how to select and load saved settings.

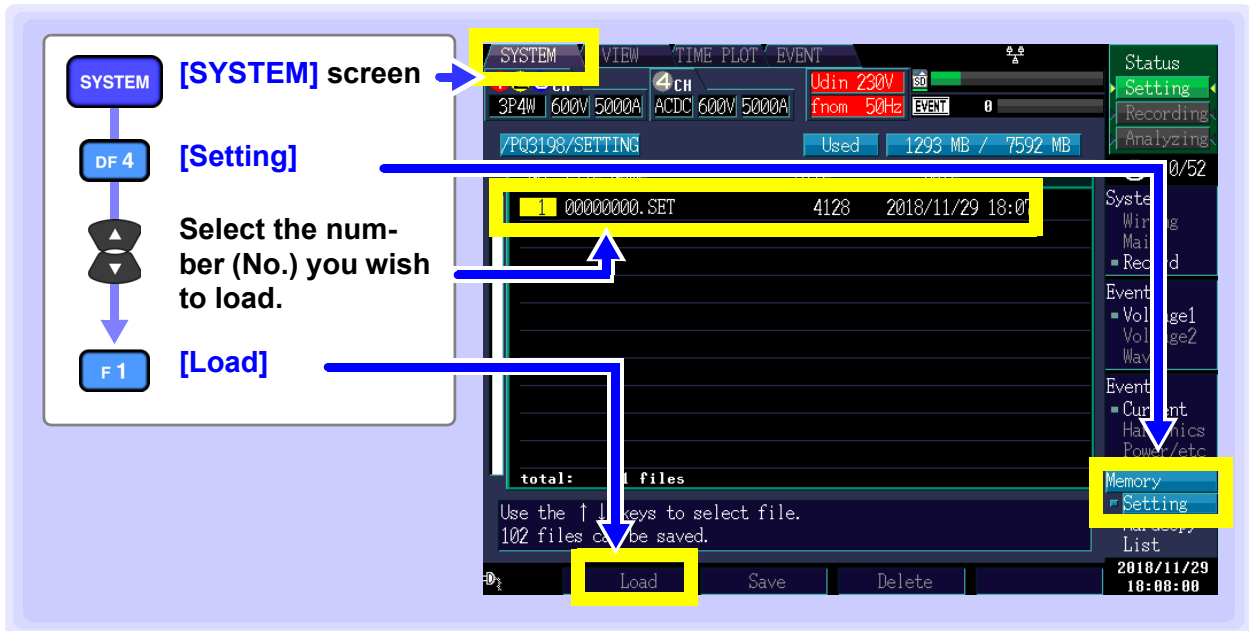

9.8 File and Folder Names

NOTE

The instrument does not allow users to create folders. All folders are created automatically. Additionally, file and folder names cannot be changed.

Changing file and folder names

The names of files and folders downloaded to your computer can be changed. Names can be up to 8 characters long. Settings files should be placed in the **[SETTING]** folder, and screen copy files should be placed in the **[HARDCOPY]** folder. Filenames containing characters other than letters and numbers may not be properly displayed by the instrument.

Analyzing Data Using the Application

Chapter 10

10.1 Using PQ ONE

The PQ ONE application (which ships with the instrument) provides functionality for analyzing data from the instrument (saved in binary format) on a computer.

Key features

- ◆ Displays and analyzes measurement data
Event statistics function allows analyzing measured data in detail.
Checking event status daily or hourly allows detecting events with higher frequency at specific a time or on a specific day of the week.
- ◆ Easily creates the required graphs
Adjusting the display period of the trend graph when the output is good, and integrating the trend data for 3 phases to a single graph is possible.
- ◆ Generates measurement data reports
Contents displayed on the screen can be output without any modifications. No complicated report settings are required, and the required reports can be created.
- ◆ Displays measurement data in EN50160 mode
- ◆ Converts measurement data to CSV format
Any range of measurement data can be converted to CSV format.
The converted files can be used in spreadsheet programs.
- ◆ Judges anomalies based on the ITIC (CBEMA) curve* (Ver.5.00.0 or later)
*: The ITIC Curve is commonly used in the U.S. and is a standard for evaluating voltage anomalies by specifying a range of acceptable tolerance. A "User-Defined Curve" can be optionally defined for voltage anomaly evaluation.
- ◆ Displays lists of file information including settings and the number of events
Dragging a folder containing measurement data displays lists of all data and event occurrences included in the folder.

Refer to the Application software Instruction Manual (CD) for details.

Operating environment

Supported operating systems	Windows 7 (32-bit/64-bit), Windows 8.1 (32-bit/64-bit), Windows 10 (32-bit/64-bit), Windows 11
Software environment	Microsoft .NET Framework 4.5.2 or later
Display resolution	1024 × 768 dots or more
CD-ROM drive	Used for installation

How to use Instruction Manual

The Instruction Manual is provided in PDF format.

The Adobe® Reader® must be installed on your computer to view the Instruction Manual. (Adobe Reader can be downloaded from the Adobe website.)

10.2 Using GENNECT One

The application GENNECT One, which can connect the instrument and your computer on a LAN, has various functions, including real-time measurement observation and measurement file acquisition.

Key features

- ◆ **Logging (LAN)**
Can acquire measured values from instruments in a LAN periodically (at logging intervals) and plot them on a single graph in real-time.
- ◆ **Dashboard (LAN)**
Can acquire measured values from instruments in a LAN periodically (at monitor intervals) and display them graphically. You can customize where measured values are displayed, background images, and other settings.
- ◆ **Automatic file transfer (LAN)**
Centralized management of measurement files saved by LAN-connected instruments by automatically transferring them to a computer.

For details, visit the GENNECT website.

Operating environment

Supported operating systems	Windows 7 (32-bit/64-bit), Windows 8.1 (32-bit/64-bit), Windows 10 (32-bit/64-bit), Windows 11
Software environment	Microsoft .NET Framework 4.6.2 or later
CPU	Clock speed: 2 GHz or greater
RAM	4 GB or more
Display resolution	1366 × 768 dots or more
Hard drive	1 GB or more available space
CD-ROM drive	Used for installation

For detailed methods for using, see "GENNECT One User's Manual (PDF)," which can be displayed by choosing Help in GENNECT One's information menu.

10.3 Installation

Contents on included CD

File name / folder name	File description
Readme_Jpn.pdf	Descriptions about the contents on included CD (Japanese)
Readme_Eng.pdf	Descriptions about the contents on included CD (English)
setup.exe	Application software installer
PQ ONE	PQ ONE folder
setup.exe	PQ ONE installer
SampleData	Sample data folder
Manual	Instruction manuals (in PDF format) folder (Japanese and English)
GENNECT One	GENNECT One folder
setup.exe	GENNECT One installer
Readme_Jpn.pdf	Description about GENNECT One (Japanese)
Readme_Eng.pdf	Description about GENNECT One (English)
BT3554	BT3554-50 driver folder

The latest version can be downloaded from Hioki's website.

Installation procedure

Screen sample: Windows 10

- 1. Start the computer.**
Administrator authority may be required for the installation.
- 2. Set the included CD to the CD-ROM drive.**
- 3. Enter "explorer" in the search box on the taskbar, and then click [Open] under [File Explorer].**
- 4. Click [This PC], and then, double-click [CD-ROM Drive].**

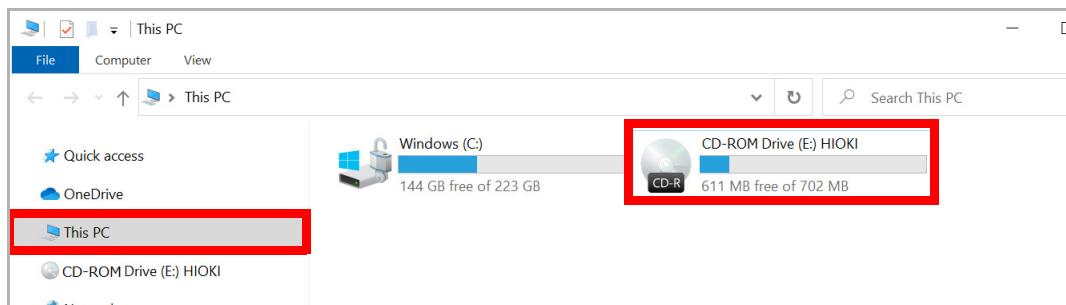

5. Double-click [setup.exe].

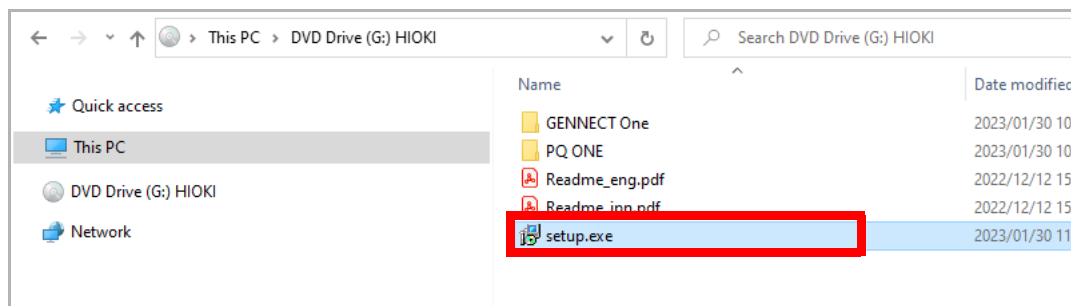

6. Select the application software you wish to install on the [Select Components] screen and click [Next].

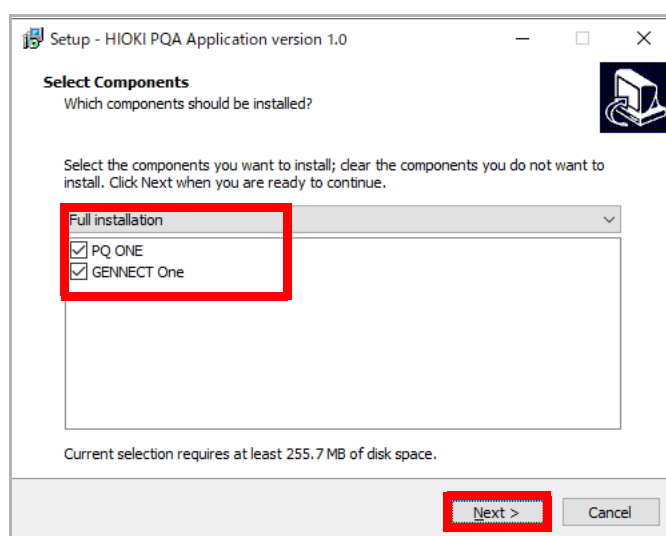

The installer you selected will start.

When PQ ONE is selected

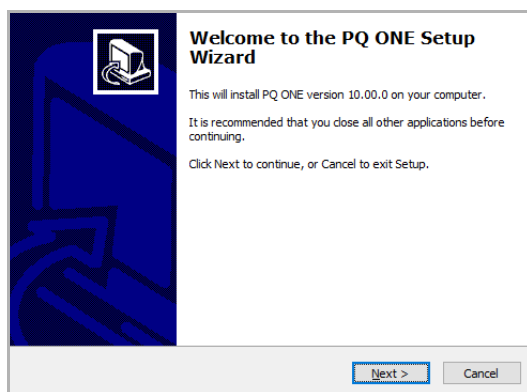

When GENNECT One is selected

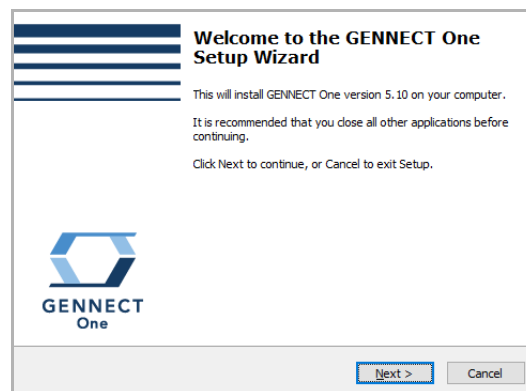

7. Install the application software by following the instructions on the screen.

Connecting External Devices

Chapter 11

11.1 Using the External Control Terminal

You can enter events and output event occurrence times with the external control terminals.

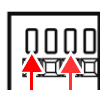
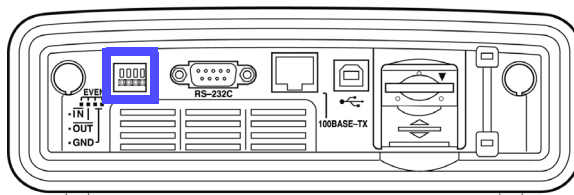

Anomaly search device

Event input terminal ($\overline{\text{EVENT IN}}$)

Used to start and stop recording and analyze anomalies based on the operational timing of an external device.

When you connect the search signal of an anomaly search device such as an overcurrent relay to the event input terminal, you can analyze anomalies using this device according to anomaly operations.

See: "Using the event input terminal (EVENT IN)" (p.179)

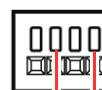

Trigger input terminal

Hioki Memory HiCorder

Event output terminal ($\overline{\text{EVENT OUT}}$)

This informs an external device when anomalies occur within the PQ3198.

When you connect the event output terminal to a trigger input terminal on a waveform recording device such as the Hioki Memory HiCorder, you can record waveforms on the Memory HiCorder when events occur.

See: "Using the event output terminal (EVENT OUT)" (p.180)



CAUTION

To avoid damaging this device, do not input voltages outside the ranges -0.5 V to +6.0 V ($\overline{\text{EVENT IN}}$) or -0.5 V to +6.0 V ($\overline{\text{EVENT OUT}}$) to the external control terminals.

Connecting to the External Control Terminal

Be sure to read "Before Connecting Measurement Cables" (p.10) before attempting to connect the instrument to a computer.



WARNING

To prevent electrical accidents, use the recommended wire type to connect to the current input terminals, or otherwise ensure that the wire used has sufficient current handling capacity and insulation.

Items to connect (required items):



Electric wires that conform with: single line: $\phi 0.65$ mm (AWG22)
twisted wire: 0.32 mm² (AWG22)
diameter of search wire: $\phi 0.12$ mm or more

Supported electric wires single line: $\phi 0.32$ mm to $\phi 0.65$ mm (AWG28 to AWG22)
twisted wire: 0.08 mm² to 0.32 mm² (AWG28 to AWG22)
diameter of search wire: $\phi 0.12$ mm or more

Standard direction wire length : 9 mm to 10 mm

Tools that conform to button operations : flat head screwdriver (diameter: 3 mm, width of blade-tip: 2.6 mm)

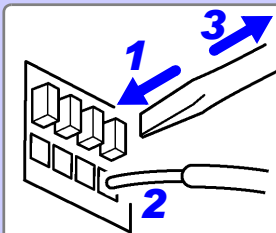

1 Press down on the terminal button using a tool, such as a flat head screwdriver.

2 While the button is depressed, insert the wire into the electric wire connection hole.

3 Release the button.

The electric wire is locked in place.

Longer wires may cause malfunction due to external noise. Wind the wires around a ferrite clamp as shown in the figure before connection (position the ferrite clamp as near the terminal block as possible).

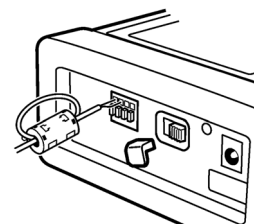

Using the event input terminal (EVENT IN)

By inputting an external signal to the event input terminal, you can detect external events or start and stop recording based on the timing of input.

If using the terminal to trigger external events, you can record the voltage and current waveforms as well as measured values when external events occur, just as for other events.

Using this device, you can analyze power anomalies that occur in other electrical equipment.

CAUTION

To avoid damaging this device, do not input voltages outside the range -0.5 V to +6.0 V to the external control terminals.

NOTE

- To use the external control terminal to start or stop recording based on an external signal, set the external control (IN) setting to START/STOP.
- To use the external control terminal to provide external event functionality, make the following two settings:
 - Set the external event to ON.
[See:](#) "Generating events using an external input signal (external event settings)" (p.92)
 - Set external control (IN) to Event.
[See:](#) "External control (IN)" (p.85)

Signal input methods

Short-circuit the terminal or input a pulse signal.

Use the event input terminal (EVENT IN) and the ground terminal (GND).

You can control the event input terminal by short-circuiting the terminal (active LOW) or dropping the pulse signal (1.0 V).

Input voltage range	HIGH level : 3.0 V to 5.0 V LOW level : 0 V to 0.8 V
Maximum input voltage	-0.5V to +6.0 V

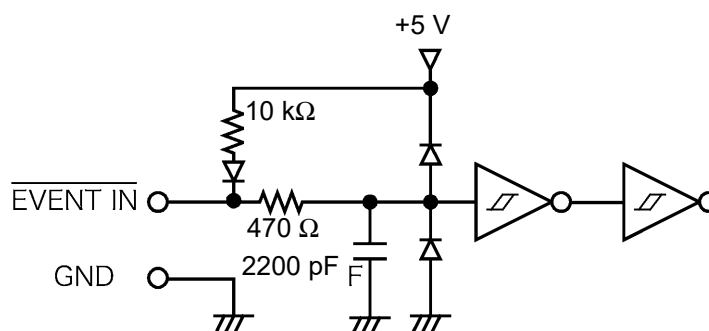
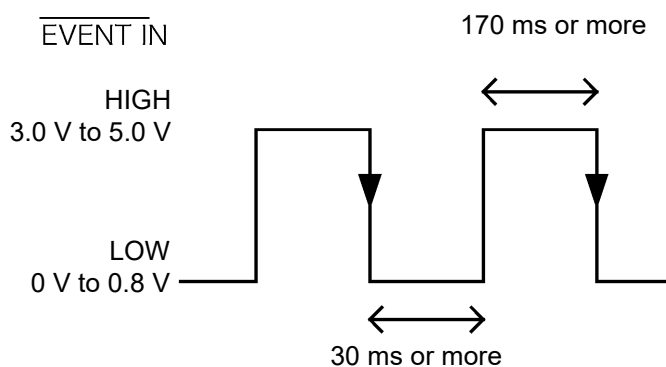

Using the event input terminal (EVENT OUT)

This indicates events occurring externally that were synchronized with events occurring internally for this device.

Usage method 1. Connect a warning device.

This is a good way to output warnings when events such as interruptions occur.

Usage method 2. Connect to the trigger input terminal of a Memory HiCorder.

This allows you to record waveforms on the Memory HiCorder when events occur on the PQ3198. You can record between 14 and 16 waveforms on the PQ3198 when events occur. When you want to record waveforms for a longer period of time, use the PQ3198 in parallel with a Memory HiCorder.

CAUTION

To avoid damaging this device, do not input voltages outside the -0.5 V to +6.0 V range to the external control terminal.

NOTE

Configure the external output.

See: "External output" (p.84)

Signal output method

If an event occurs in the PQ3198, a pulse signal is output. Use the event output terminal ($\overline{\text{EVENT OUT}}$) and the ground terminal (GND).

Output signal	Open collector output (includes voltage output) Active LOW
Output voltage range	HIGH level: 4.5 V to 5.0 V LOW level: 0 V to 0.5 V
Pulse width	LOW level: Short pulse setting : longer than 10 ms Long pulse setting: Approx. 2.5 s
Maximum input voltage	-0.5 V to +6.0 V

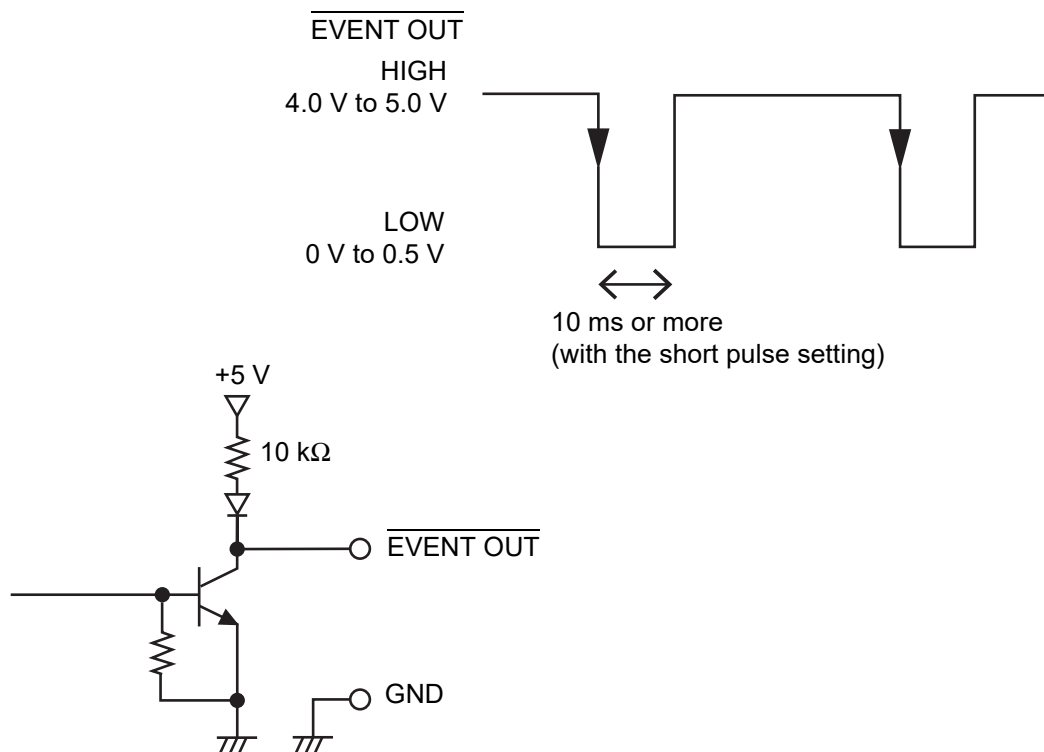

Operation with a Computer

Chapter 12

The instrument includes standard USB and Ethernet interfaces to connect a computer for remote control.

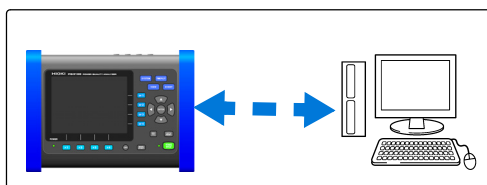

USB Connection Capabilities

The SD memory card will be detected as a removable disk, and you will be able to copy data to a computer.

Ethernet ("LAN") Connection Capabilities

- Control the instrument remotely by internet browser. (p.188)
- You can download measurement data from the instrument to a computer (using the FTP server function). (p.191)
- You can use GENNECT One (PC application software) to log instrument data, control the instrument remotely, and download data. (p.173)

12.1 Downloading Measurement Data Using the USB Interface

Since the instrument includes a standard USB interface, measurement data can be transferred to a USB-connected computer (using the instrument's mass storage function).

Connect the instrument to the computer with a USB cable. No instrument settings are necessary to establish the USB connection.

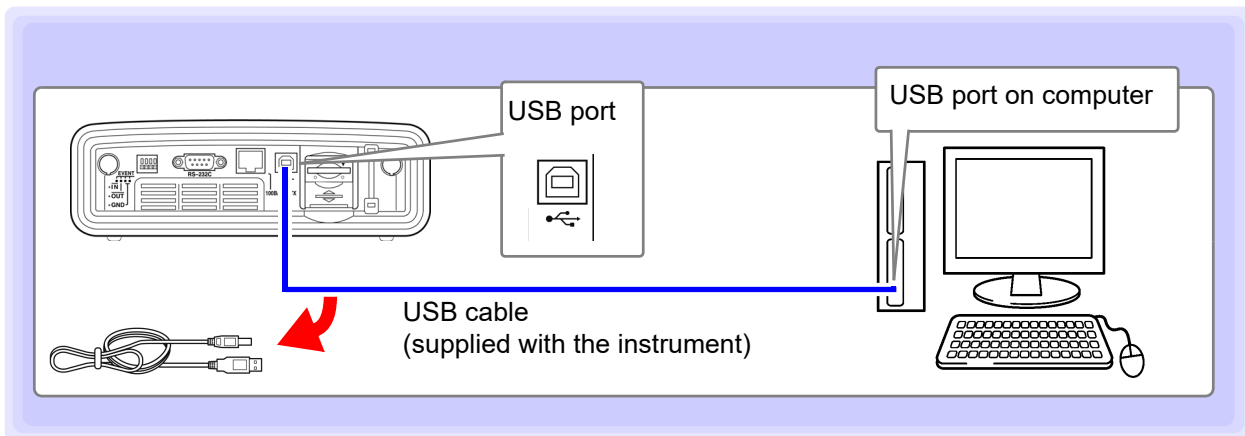

A message such as the following is displayed on the instrument when it is connected to a computer:

```

Accessing USB storage.
To stop, hit ESC.

Stop: ESC
  
```

CAUTION

- To avoid faults, do not disconnect or reconnect the USB cable during instrument operation.
- Connect the instrument and the computer to a common earth ground. Using different grounds could result in potential difference between the instrument and the computer. Potential difference on the USB cable can result in malfunctions and faults.

NOTE

If both the instrument and computer are turned off the power while connected by the USB cable, turn on the power of the computer first. It is not able to communicate if the instrument is turned on the power first.

After Connecting

Use the following procedure when disconnecting a USB cable connected to the instrument from the computer:

1. Press the **ESC** key to terminate the USB connection. Alternately, you can use the computer's "Safely Remove Hardware" icon to end the connection.
2. Disconnect the USB cable from the computer.

The transferred data can be analyzed using the attached PQ ONE application software. Files other than screen copies cannot be opened directly.

12.2 Control and Measurement via Ethernet ("LAN") Interface

Measured data can be transferred to a computer remotely using an Internet browser or the FTP server function.

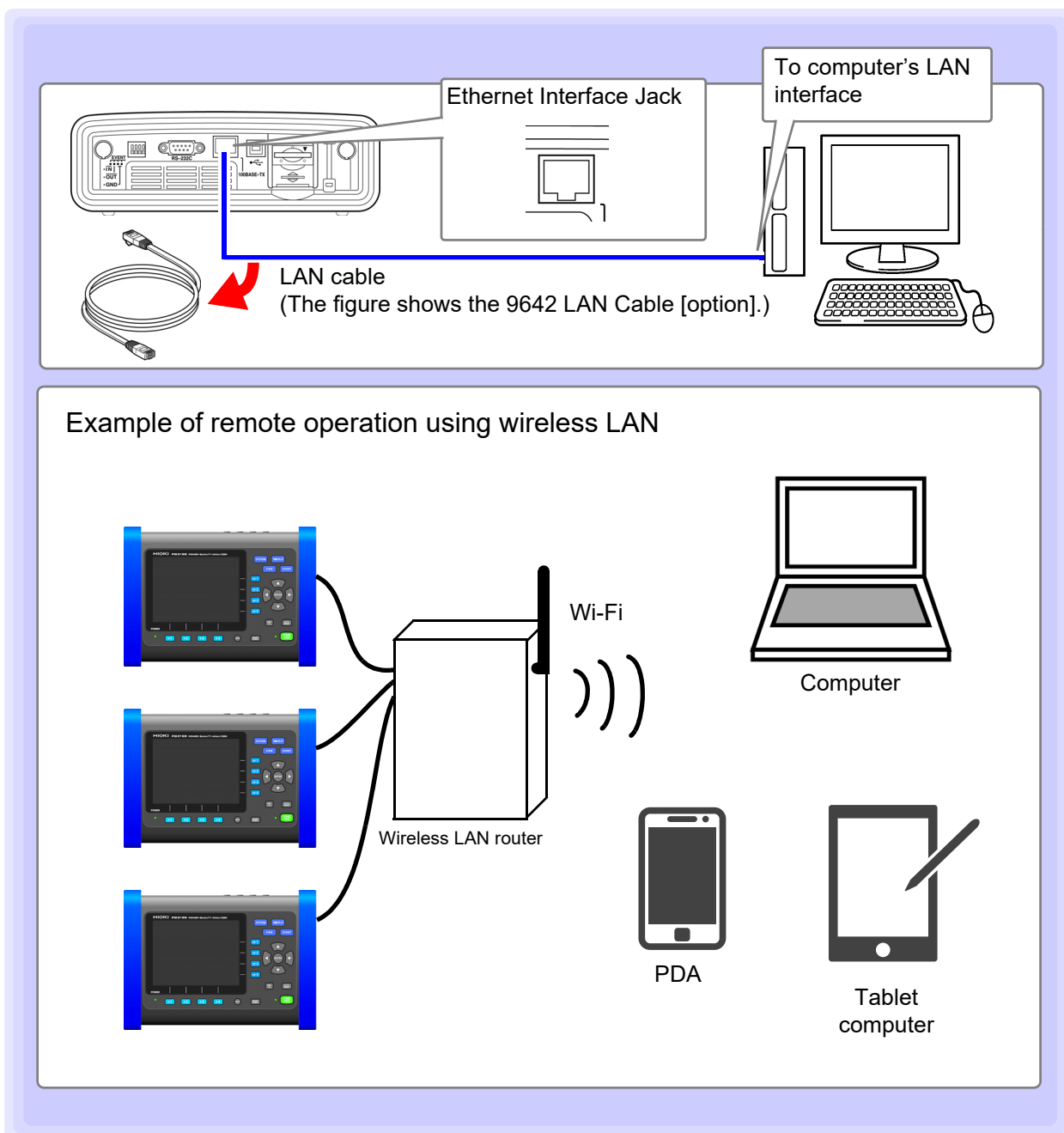

Configure the instruments LAN settings for the network environment, and connect the instrument to a computer with the Ethernet cable.

When using a wireless LAN router

The instrument does not support network environments where an IP address is automatically acquired using DHCP. Configure the router to assign a fixed IP address to the PQ3198. For more information about router settings, see the instruction manual for your wireless LAN router.

NOTE For details on how to use the included application software, see the accompanying instruction manual (CD).

LAN Settings and Network Environment Configuration

Configure the Instruments LAN Settings

NOTE

- Make these settings before connecting to a network. Changing settings while connected can duplicate IP addresses of other network devices, and incorrect address information may otherwise be presented to the network.
- The instrument does not support DHCP (automatic IP address assignment) on a network.

The screenshot shows the instrument's LAN settings menu. The settings are as follows:

IP Address	192.168.0.31
Subnet Mask	255.255.255.0
Default Gateway	192.168.0.1
MAC Address	00:01:67:abcd:ef

Below the settings is the FTP server settings section:

Authentication	OFF
User name	
Password	

At the bottom of the screen, there is a message: "Set the IP address of the PQ3198 to use LAN. Ask your Network Administrator for further assistance." The LAN menu item is highlighted in yellow.

Navigation Instructions:

- [SYSTEM] screen
- DF 1 [Main]
- F 4 [LAN]
- Select a setting
- ENTER Select value to change
- Select field
- Increase or decrease value
- ENTER Accept the setting
- ESC / Cancel

Reboot the instrument when changing the network settings.

Setting Items

- IP Address** Identifies each device connected on a network. Each network device must be set to a unique address. The instrument supports IP version 4, with IP addresses indicated as four decimal octets, e.g., "192.168.0.1".
- Subnet Mask** This setting is used to distinguish the address of the network from the addresses of individual network devices. The normal value for this setting is the four decimal octets "255.255.255.0".
- Default Gateway** When the computer and instrument are on different but overlapping networks (subnets), this IP address specifies the device to serve as the gateway between the networks. If the computer and instrument are connected one-to-one, no gateway is used, and the instrument's default setting "0.0.0.0" can be kept as is.

Network Environment Configuration

Example 1. Connecting the instrument to an existing network

To connect to an existing network, the network system administrator (IT department) has to assign settings beforehand.

Some network device settings must not be duplicated.

Obtain the administrator's assignments for the following items, and write them down.

IP Address _____ Subnet Mask _____ Default Gateway _____
--

Example 2. Connecting multiple instruments to a single computer using a hub

When building a local network with no outside connection, the following private IP addresses are recommended.

Configure the network using addresses 192.168.1.0 to 192.168.1.24

IP Address : Computer : 192.168.1.1
 : PQ3198 : assign to each instrument in order 192.168.1.2, 192.168.1.3,
 192.168.1.4, ...

Subnet Mask : 255.255.255.0

Default Gateway: Computer : _____
 : PQ3198 : 0.0.0.0

Example 3. Connecting one instrument to a single computer using the 9642 LAN Cable

The 9642 LAN Cable can be used with its supplied connection adapter to connect one instrument to one computer, in which case the IP address is freely settable. Use the recommended private IP addresses.

IP Address : Computer : 192.168.1.1
 : PQ3198 : 192.168.1.2 (Set to a different IP address than the computer.)

Subnet Mask : 255.255.255.0

Default Gateway: Computer : _____
 : PQ3198 : 0.0.0.0

Instrument Connection

Connect the instrument to the computer using an Ethernet LAN cable.

⚠ CAUTION

When connecting the instrument to your LAN using a LAN cable of more than 30 m or with a cable laid outdoors, take appropriate countermeasures that include installing a surge protector for LANs. Such signal wiring is susceptible to induced lightning, which can cause damage to the instrument.

Required items:

When connecting the instrument to an existing network

(prepare any of the following):

- A 100BASE-TX-compatible straight cable (commercially available). For 10BASE communication, a 10BASE-T-compliant cable may also be used.
- Hioki Model 9642 LAN Cable (option)

When connecting one instrument to a single computer

(prepare any of the following):

- 100BASE-TX-compliant cross-over cable
- 100BASE-TX-compliant straight-through cable with cross-over adapter
- Hioki Model 9642 LAN Cable (option)

Instrument Ethernet ("LAN") interface

The Ethernet interface jack is on the right side.

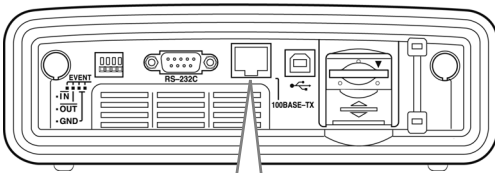

Ethernet Interface Jack

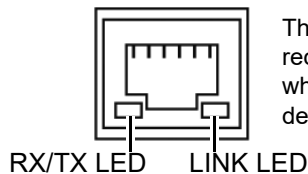

The RX/TX LED blinks when sending and receiving data, and the LINK LED lights when linked to the destination network device.

Connecting the Instrument to a Computer with an Ethernet ("LAN") Cable

Connect by the following procedure.

When connecting the instrument to an existing network (connect the instrument to a hub)

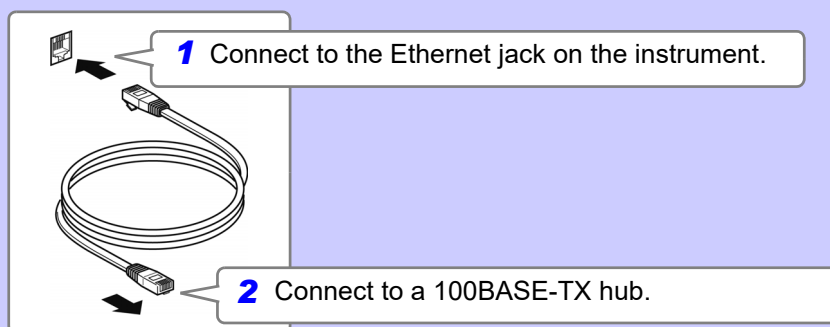

When connecting the instrument to a single computer (connect the instrument to the computer)

Use the Hioki 9642 LAN Cable and cross-over adapter (9642 accessory)

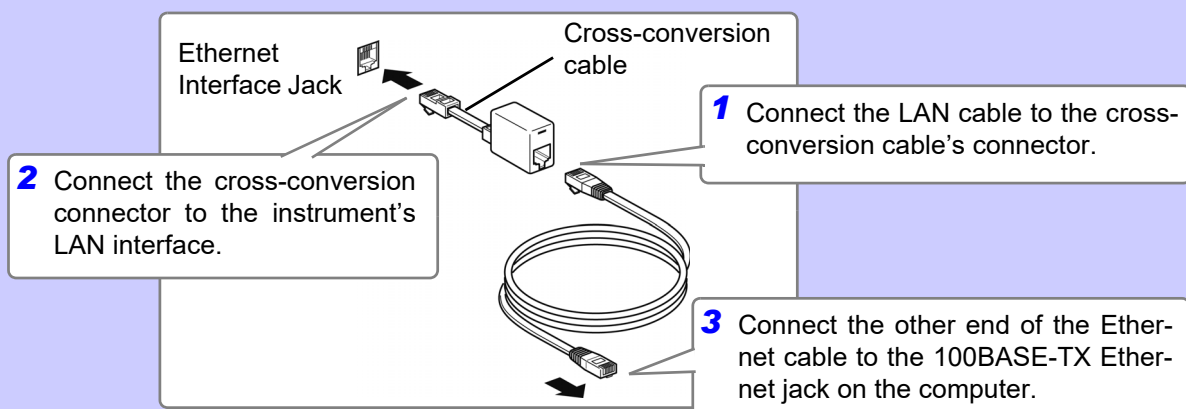

The icon display varies with the state of the LAN connection as follows:

	HTTP server and data download connection
	Data download connection
	HTTP server connection



12.3 Remote Control of the Instrument by Internet Browser

The instrument includes a standard HTTP server function that supports remote control by an internet browser on a computer.

The instrument's display screen and control panel keys are emulated in the browser. Operating procedures are the same as on the instrument.

NOTE

- It is recommended to use Microsoft Edge.
- Set the browser security level to "Medium" or "Medium-high," or enable Active Scripting settings.
- Unintended operations may occur if remote control is attempted from multiple computers simultaneously. Use one computer at a time for remote control.
- Remote control can be performed even if the instrument's key lock is active.

Connecting to the Instrument

Enter "http://" followed by the IP address assigned to the instrument in the browser's address bar. For example, if the instrument's IP address is 192.168.1.33, enter as follows.

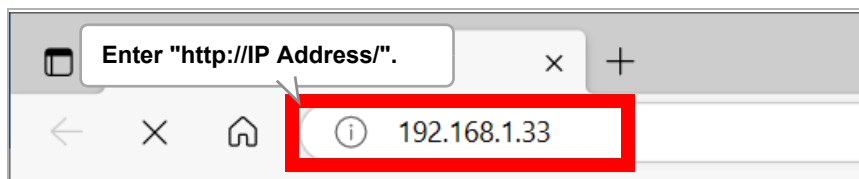

A main page such as the following will be displayed when the browser has successfully connected to the instrument:

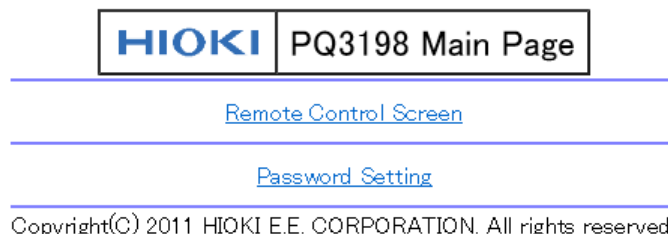

If no HTTP screen is displayed



1. Perform this procedure.
 - (1) Enter "internet options" in the search box on the taskbar, and then click **[Open]** under **[Internet Options]**.
 - (2) On the **[Advanced]** tab, under HTTP 1.1 settings, enable **[Use HTTP1.1]** and disable **[Use HTTP1.1 through proxy connections]**.
 - (3) On the **[Connections]** tab, click **[LAN Settings]**, and disable **[Use a proxy server]**.
2. LAN communications may not be possible.
 - (1) Check the network settings on the instrument and the IP address of the computer.
See:"LAN Settings and Network Environment Configuration" (p.184)
 - (2) Check that the LINK LED in the Ethernet internet jack is lit, and that  (the LAN indicator) is displayed on the instrument's screen.
See:"Instrument Connection" (p.186)

Operating Procedure

Click the [\[Remote Control Screen\]](#) link to jump to the Remote Control page.

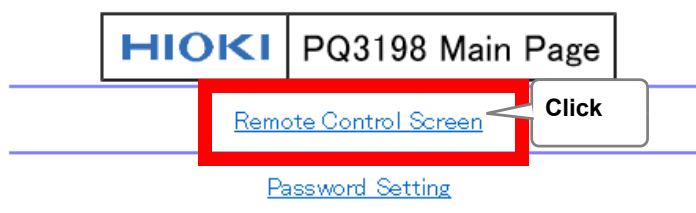

If a password has been set, the following page will be displayed:

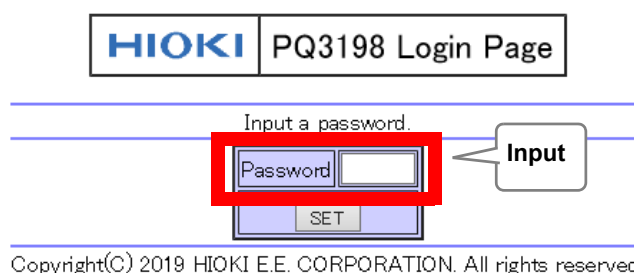

Enter the password and click the [\[SET\]](#) button to display the control panel in the browser window. (If no password has been set or the password has been set to "0000" [four zeroes], this screen will not be displayed. The default password setting is "0000.")

Setting a password

You can restrict remote operation by setting a password.

1. Click [\[Password Setting\]](#) on the main page. (The following page will be displayed.)

2. Enter the [\[Old Password\]](#), [\[New Password\]](#), and [\[Confirm New Password\]](#) fields and click the [\[SET\]](#) button. (Enter up to four English letters. If setting a password for the first time, enter "0000" (four zeroes) as the [\[Old Password\]](#). If changing a previously set password, enter the previously set password.)

The new password will become effective immediately.



If you forget your password

Triggering a boot key reset* on the instrument will cause the password to be reset to its default value of "0000." The password cannot be initialized by means of remote operation.

*: The boot key reset will cause the instrument's settings to be reverted to their default values. You can revert all settings, including language and communications settings, to their default values by turning on the instrument while holding down the [ENTER](#) or [ESC](#) key.

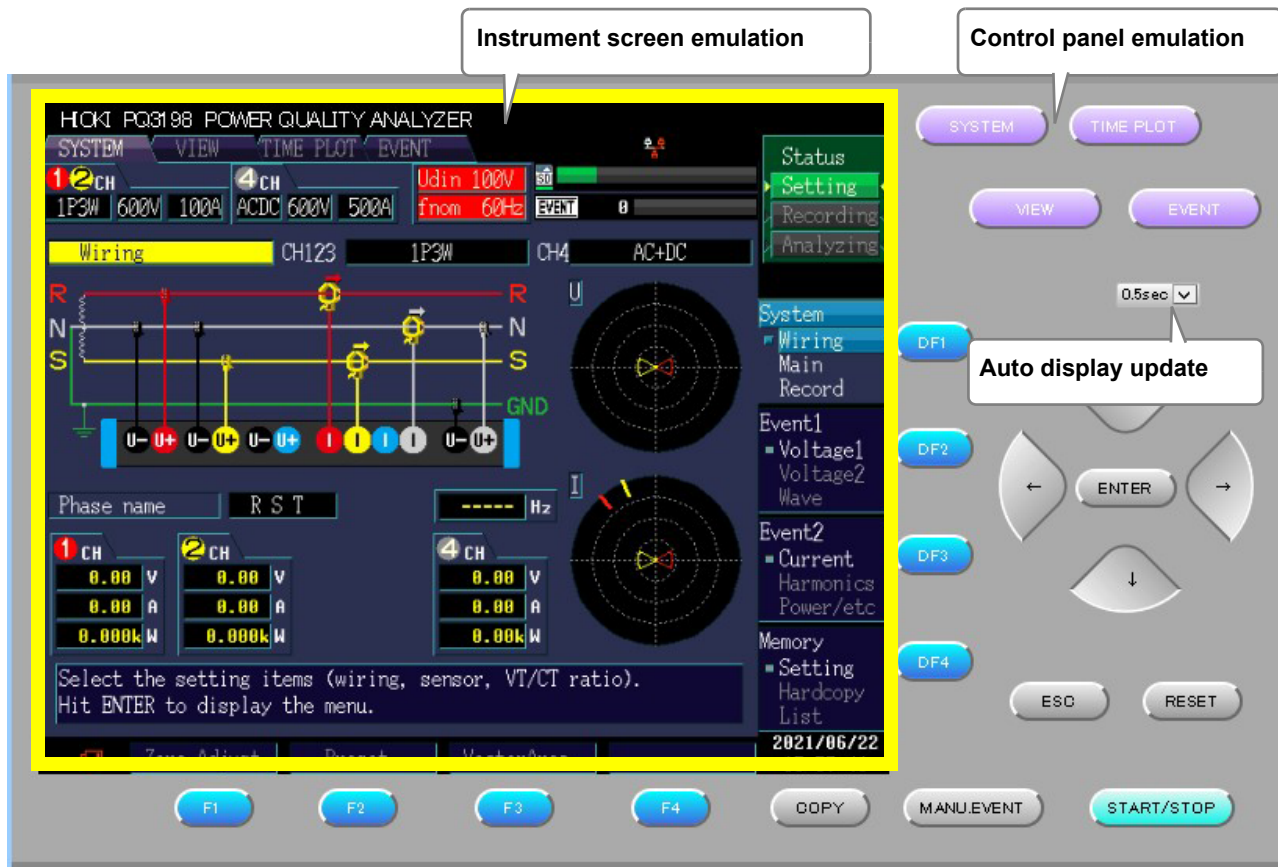

Click on the control panel keys to perform the same operations as the instrument keys.
To enable automatic browser screen updating, set the update time in the auto update menu.

Auto display update The instrument screen emulation updates at the specified interval.

Setting Contents:(* : Default setting)

OFF, 0.5*/ 1/ 2/ 5/ 10 sec



If the instrument does not accept key input

Is the browser's security level set to "High", or has JavaScript been disabled?
Change the browser's security setting to Medium or Medium-high.

NOTE

The displayed information may vary with the browser being used.

12.4 Downloading Recorded Data to Computer

Because the instrument is running an FTP (File Transfer Protocol)* server, using the FTP client function of the computer allows files from the SD memory card to be downloaded to the computer.

*: A protocol to transfer files within the network.

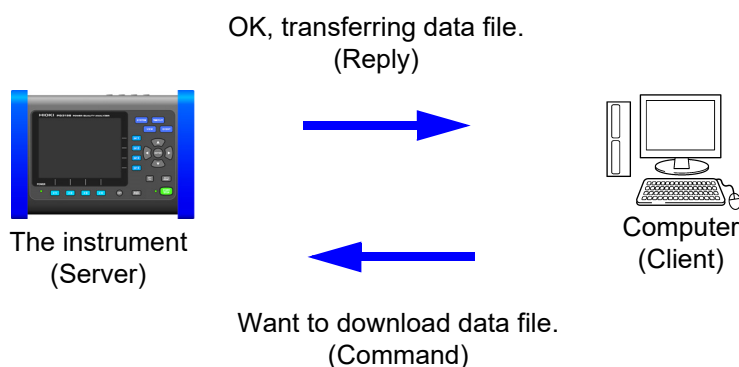

Configuring FTP server settings

To download file with the FTP server function, basic LAN communication needs to be configured in advance (p.184).

To restrict the connection, use the following procedure for configuration.

SYSTEM [SYSTEM] screen

DF 1 [Main]

F 4 [LAN]

Select a setting

When the field is selected, a drop-down menu will be displayed. When entering alphanumeric characters, the setting will change.

ENTER Select a setting/ Enter alphanumeric characters.

ENTER Accept the setting

ESC / On Cancel

Reboot the instrument when changing the network settings.

12.4 Downloading Recorded Data to Computer

FTP server settings

Setting Contents:

Authentication	Enable when trying to restrict connection to the FTP server. (Enable the Authentication and set a User name and Password.)
User name	Configure a user name used when connecting an FTP client to the instrument. (Up to 20 one-byte characters, example: HIOKI)
Password	Configure a password used when connecting an FTP client to the instrument. The password does not appear on the screen (displayed as *****). (Up to 20 one-byte characters, example: PQ3198)

Download

1. Run an FTP client software.

This section explains an example of using a free software WinSCP. Explorer can be used when the FTP authorization is not used.

2. Enter the following and click [Login].

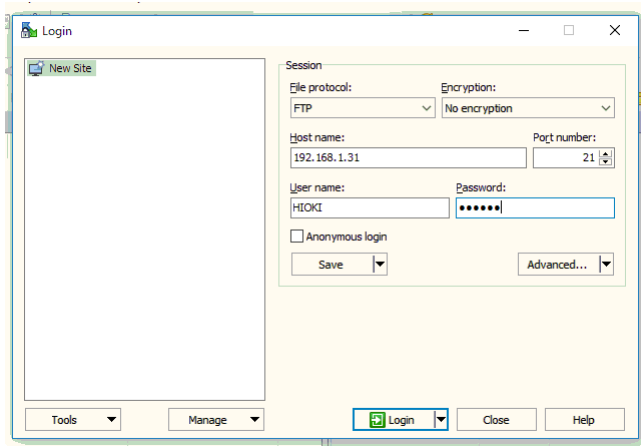

Host name IP address of the instrument (p.184)

User name When FTP authentication is enabled, enter the setting of the instrument.

Password

3. Click [PQ3198].

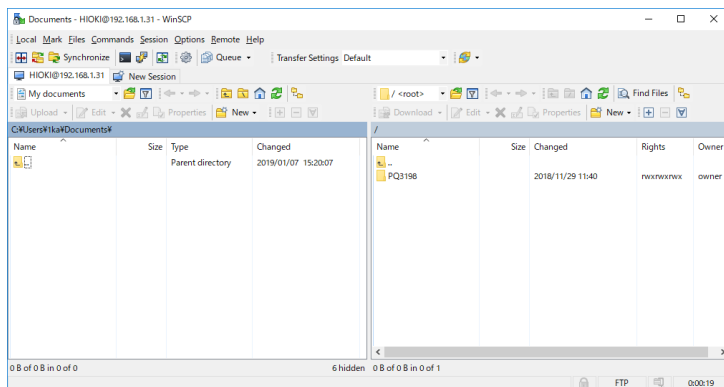

4. Copy to any folder by selecting a folder or file.

- To copy measured data, copy the "Folder for saving data".
See: "9.3 Save Operation and File Structure" (p.163)
- Do not move any folder or file. It is recommended to delete the folder and file after the data is copied and checked.
- Unintended operations may occur if operation is attempted from multiple computers simultaneously. Use one computer at a time when operating.
- The instrument may lose connection if no operation is done for 3 minutes or more after making connections. In such case, start over from procedure 1.
- FTP may not connect when trying to reconnect after being disconnected. In such case, try reconnecting after waiting for about one minute.
- The file being recorded cannot be downloaded during recording. When wanting to download a file while continuing to record, have Recording start configured to **[Repeat Record]** (p.81). Since recording will repeatedly start and stop after each day when repeat is set to 1 day, the folder used to store data will be segmented, and you will be able to download measurement data up to the previous day.
- When changing the SD memory card, stop the measurement.
- Avoid accessing any files at the same time as when downloading from within the instrument or externally using such tools as telnet and GENNECT One. Doing so may cause unintended results.
- Date/time of file update between the Internet browser and the instrument may not be identical.
- Previous data excluding the latest one may end up getting downloaded to the computer (as data left from the previous access gets saved as temporary Internet files in web browsers).

When wanting to perform remote control:

See: "Remote Control of the Instrument by Internet Browser" (p.188)

To analyze data or convert to text data :

Use the included PQ ONE application.

For more information, see the PQ ONE instruction manual.

Specifications Chapter 13

13.1 General Specifications

Operating environment	Indoor use, pollution degree 2, altitude up to 3000 m (9843 ft.) At an altitude of above 2000 m (6562 ft.), the measurement categories are lowered to 600 V CAT III.
Operating temperature and humidity	0°C to 30°C (32°F to 86°F) 95% RH or less (no condensation) When charging battery: 10°C to 30°C (50°F to 86°F) 30°C to 50°C (86°F to 122°F) 80% RH or less (no condensation) When charging battery: 30°C to 35°C (86°F to 95°F)
Storage temperature and humidity	-20°C to 30°C (-4°F to 86°F) 95% RH or less (no condensation) 30°C to 50°C (86°F to 122°F) 80% RH or less (no condensation) (If the instrument will not be used for an extended period of time, remove the battery pack and store in a cool location [from -20°C to 30°C (-4°F to 86°F)].)
Dust and water resistance	IP30 (EN60529)
Standards	Safety EN61010 EMC EN61326 Class A
Power supply quality measurement method	IEC 61000-4-30 Ed3:2015 Class A, IEEE 1159
Power supply	Z1002 AC Adapter Rated supply voltage : 100 V AC to 240 V AC (Voltage fluctuations of $\pm 10\%$ from the rated supply voltage are taken into account.) Rated power supply frequency : 50 Hz/60 Hz Anticipated transient overvoltage: 2500 V Maximum rated power : 80 VA (When charging, including the AC adapter) 35 VA (When charging, main unit only) Z1003 Battery Pack Rated supply voltage : 7.2 V DC Maximum rated power : 8 VA
Recharge function	Charges the battery regardless of whether the instrument is on or off. Charging time 5 hours 30 minutes at a maximum (at 23°C, as a referential)
Continuous operating time	When Z1003 Battery Pack is used (at 23°C, as a referential) Approx. 3 hours (fully charged, continuous operation, LCD backlight AUTO OFF)
Backup battery	Approx. 10 years (at 23°C, as a referential) For backup clock and setting conditions (Lithium battery)
Maximum recording interval	Repeat recording function, 1 week: 55 weeks Repeat recording function, 1 day: 366 days Repeat recording function, off: 35 days
Maximum recording events	9999 events (Switchable between 1000 events and 9999 events)
Clock function	Auto-calendar, leap-year correcting 24-hour clock
Real-time clock accuracy	± 0.3 s per day (instrument on, 23°C \pm 5°C [73°F \pm 9°F]) ± 1 s per day (instrument on, within operating temperature and humidity range) ± 3 s per day (instrument off) (at 23°C, as a referential)
Display refresh rate	Approx. 0.5 s
Display	6.5-inch TFT color LCD (640 × 480 dots)
Interface	SD memory card, USB, LAN, RS-232C, External I/O
Dimensions	Approx. 300W × 211H × 68D mm (11.81"W × 8.31"H × 2.68"D)
Body	Strap can be attached.
Mass	Approx. 2.5 kg (88.2 oz.) (with Z1003 Battery Pack installed)
Product warranty period	3 years
Accessories	See: "Accessories" (p.4)
Options	See: "Options" (p.5)

13.2 Input Specifications/Output Specifications/Measurement Specifications

-1. Basic specifications

Number of channels	Voltage: 4 channels Current: 4 channels
Input terminal form	Voltage: Plug-in terminals (Safety terminals) Current: Dedicated connectors (Hioki PL14)
Current sensor power supply	For AC/DC auto-zero current sensors and AC flexible current sensors +5 V \pm 0.25 V, -5 V \pm 0.25 V; supplied current: 30 mA max./ch.
Measurement line type	Single-phase 2-wire: 1P2W Single-phase 3-wire: 1P3W 3-phase 3-wire 2-watt meter measurement: 3P3W2M 3-phase 3-wire 3-watt meter measurement: 3P3W3M 3-phase 4-wire: 3P4W 3-phase 4-wire 2.5 element: 3P4W2.5E In addition to one of the above, input CH4. (must be synchronized to reference channel during AC/DC measurement)
Input methods	Voltage input section: Isolated and differential inputs (Between U1,U2 and U3: channels not isolated, Between U1,U2 and U3 to U4: channels isolated) Current input section: Isolated input through a current sensor
Input resistance	Voltage input section: 4 M Ω \pm 2% Current input section: 100 k Ω \pm 10%
Maximum input voltage	Voltage input section: 1000 V AC, \pm 600 V DC, 6000 V peak Current input section: 1.7 V AC/DC, 2.4 V peak
Maximum rated voltage to earth	Voltage input section: 600 V AC (Measurement categories IV), anticipated transient overvoltage 8000 V Current input section: Depends upon the current sensor being used
Measurement method	Digital simultaneous sampling of voltage and current, zero-cross synchronized calculation method
Sampling frequency	Voltage and current, active power, etc. : 200 kHz Transient voltage measurement : 2 MHz
A/D converter resolution	RMS voltage and current: 16bit Transient voltage measurement: 12bit
Display range	Voltage: 0.48 V to 780 V Current: 0.5% to 130% of range Power: 0.0% to 130% of range Measurement items other than the above: 0% to 130% of range
Zero display range	Voltage: Less than 0.48 V; when the voltage RMS value is 0, the power value is set to 0. Current: Less than 0.5% f.s.; when the voltage RMS value is 0, the power value is set to 0.
Effective measurement range	Voltage: 10 V AC to 780 V AC, 1 V DC to 600 V DC Current: 1% to 120% of range Power: 0.15% to 130% of range (with both voltage and current within effective measuring range) See separate specifications for harmonic measurement
Effective peak range	Voltage measurement: \pm 1200 V Transient voltage measurement: \pm 6.0000 kV Current measurement: \pm 400% of range

-2. Measurement items

(1) Items detected at 2 MHz sampling without a gap

Measurement items	Notation	1P2W	1P3W	3P3W2M	3P3W3M	3P4W	3P4W2.5E	MAX/MIN/AVG
Transient overvoltage	Tran	1,4	1,2,4	1,2,4	1,2,3,4	1,2,3,4	1,3,4	

(2) Items measured without gaps for each waveform

Measurement items	Notation	1P2W	1P3W	3P3W2M	3P3W3M	3P4W	3P4W2.5E	MAX/MIN/AVG
Frequency cycle	Freq_wav	U1	U1	U1	U1	U1	U1	**

(3) Items measured without gaps with 1 overlapping waveform every half-cycle
(When measuring at 400 Hz, items measured in a wave without gaps)

Measurement items	Notation	1P2W	1P3W	3P3W2M	3P3W3M	3P4W	3P4W2.5E	MAX/MIN/AVG
RMS voltage refreshed each half-cycle	Urms1/2	1,4	1,2,4	1,2,3,4 *1	1,2,3,4	1,2,3,4	1,2,3,4	**
RMS current refreshed each half-cycle	Irms1/2	1,4	1,2,4	1,2,3,4 *1	1,2,3,4	1,2,3,4	1,2,3,4	**
Swell	Swell	1	1,2	1,2	1,2,3	1,2,3	1,2,3	
Dip	Dip	1	1,2	1,2	1,2,3	1,2,3	1,2,3	
Interruption	Intrpt	1	1,2	1,2	1,2,3	1,2,3	1,2,3	
Instantaneous flicker	Pinst	1	1,2	1,2	1,2,3	1,2,3	1,2,3	**

(4) Items measured without gaps every half-cycle

Measurement items	Notation	1P2W	1P3W	3P3W2M	3P3W3M	3P4W	3P4W2.5E	MAX/MIN/AVG
Inrush current	Inrush	1,4	1,2,4	1,2,3,4 *1	1,2,3,4	1,2,3,4	1,2,3,4	**

(5) Items measured without gaps and aggregated every approx. 200 ms
(about once every 10 cycles at 50 Hz, every 12 cycles at 60 Hz, or every 80 cycles at 400 Hz)

Measurement items	Notation	1P2W	1P3W	3P3W2M	3P3W3M	3P4W	3P4W2.5E	MAX/MIN/AVG
Frequency 200 ms	Freq	U1	U1	U1	U1	U1	U1	*
10-sec frequency	Freq10s	U1	U1	U1	U1	U1	U1	*
Voltage Waveform Peak	Upk+, Upk-	1,4	1,2,4	1,2,4	1,2,3,4	1,2,3,4	1,2,3,4	*
Current Waveform Peak	lpk+, lpk-	1,4	1,2,4	1,2,4	1,2,3,4	1,2,3,4	1,2,3,4	*
RMS voltage (phase/line)	Urms	1,4	1,2,4,AVG	1,2,3,4,AVG *1	1,2,3,4,AVG	1,2,3,4,AVG	1,2,3,4,AVG	*
Voltage DC	Udc	4	4	4	4	4	4	*
RMS current	Irms	1,4	1,2,4,AVG	1,2,3,4,AVG *1	1,2,3,4,AVG	1,2,3,4,AVG	1,2,3,4,AVG	*
Current DC	Idc	4	4	4	4	4	4	*
Active power	P	1,4	1,2,4,sum	1,2,4,sum	1,2,3,4,sum	1,2,3,4,sum	1,2,3,4,sum	*
Efficiency	Eff1, Eff2	1,4	sum,4	sum,4	sum,4	sum,4	sum,4	*
Active energy	WP+, WP-	1	sum	sum	sum	sum	sum	
Apparent power	S	1,4	1,2,4,sum	1,2,4,sum	1,2,4,sum	1,2,4,sum	1,2,4,sum	*
Reactive power	Q	1,4	1,2,4,sum	1,2,4,sum	1,2,3,4,sum	1,2,3,4,sum	1,2,3,4,sum	*
Reactive energy (lag) (lead)	WQLAG, WQLEAD	1	sum	sum	sum	sum	sum	

13.2 Input Specifications/Output Specifications/Measurement Specifications

(5) Items measured without gaps and aggregated every approx. 200 ms
(about once every 10 cycles at 50 Hz, every 12 cycles at 60 Hz, or every 80 cycles at 400 Hz)

Measurement items	Notation	1P2W	1P3W	3P3W2M	3P3W3M	3P4W	3P4W2.5E	MAX/MIN /AVG
Power factor/displacement power factor*2	PF/DPF	1,4	1,2,4,sum	1,2,4,sum	1,2,3,4, sum	1,2,3,4, sum	1,2,3,4, sum	*
Zero-phase voltage unbalance factor Voltage negative-phase unbalance factor	Uunb0, Uunb	-	-	sum	sum	sum	sum	*
Zero-phase current unbalance factor Current negative-phase unbalance factor	Iunb0, Iunb	-	-	sum	sum	sum	sum	*
High-order harmonic voltage component	UharmH	1,4	1,2,4	1,2,4	1,2,3,4	1,2,3,4	1,2,3,4	*
High-order harmonic current component	IharmH	1,4	1,2,4	1,2,4	1,2,3,4	1,2,3,4	1,2,3,4	*
Harmonic voltage (orders 0 to 50th)	Uharm	1,4	1,2,4	1,2,4	1,2,3,4	1,2,3,4	1,2,3,4	*
Harmonic current (orders 0 to 50th)	Iharm	1,4	1,2,4	1,2,4	1,2,3,4	1,2,3,4	1,2,3,4	*
Harmonic power (orders 0 to 50th)	Pharm	1	1,2,sum	sum	sum	1,2,3,sum	1,2,3,sum	*
Inter-harmonic voltage (orders 0.5 to 49.5th)	Uiharm	1,4	1,2,4	1,2,4	1,2,3,4	1,2,3,4	1,2,3,4	*
Inter-harmonic current (orders 0.5 to 49.5th)	Iiharm	1,4	1,2,4	1,2,4	1,2,3,4	1,2,3,4	1,2,3,4	*
Harmonic voltage phase angle (orders 1 to 50th)	Uphase	1,4	1,2,4	1,2,4	1,2,3,4	1,2,3,4	1,2,3,4	
Harmonic current phase angle (orders 1 to 50th)	Iphase	1,4	1,2,4	1,2,4	1,2,3,4	1,2,3,4	1,2,3,4	
Harmonic voltage-current phase difference (orders 1 to 50th)	Pphase	1	1,2,sum	sum	sum	1,2,3,sum	1,2,3,sum	*
Total harmonic voltage distortion factor*2	Uthd-F/Uthd-R	1,4	1,2,4	1,2,4	1,2,3,4	1,2,3,4	1,2,3,4	*
Total harmonic current distortion factor*2	Ithd-F/Ithd-R	1,4	1,2,4	1,2,4	1,2,3,4	1,2,3,4	1,2,3,4	*
K factor	KF	1,4	1,2,4	1,2,4	1,2,3,4	1,2,3,4	1,2,3,4	*
Voltage waveform comparison	Wave	1	1,2	1,2	1,2,3	1,2,3	1,2,3	
Mains signaling voltage	Msv1, Msv%1, Msv2, Msv%2	1	1,2	1,2	1,2,3	1,2,3	1,2,3	*

Note 1: All CH4 displayed turn ON when CH4 is set to AC+DC.

Note 2: When CH4 is set to DC, the instrument does not display apparent power, reactive power, and power factor of CH4.

Note 3: When CH4 is turned OFF, all CH4 display values and waveforms are also turned OFF.

Note 4: Meaning of "*" in the "MAX/MIN/AVG" column

Indicates that maximum, minimum, and average values (all) can be displayed during the MAX/MIN/AVG TIME PLOT interval.

Note 5: Meaning of "****" in the "MAX/MIN/AVG" column

Indicates that maximum and minimum values (all) can be displayed, regardless of the MAX/MIN/AVG TIME PLOT interval.

*1: CH3 is calculated but not displayed. It can be output only as binary data.

*2: Select either.

(6) Flicker measurement items:

Measurement items	Notation	1P2W	1P3W	3P3W2M	3P3W3M	3P4W	3P4W2.5E	MAX/MIN /AVG
ΔV_{10} (every minute, 1-hour average value, 1-hour maximum value, 1-hour fourth-largest value, overall maximum value [during measurement period])	dV10, dV10 AVG, dV10max, dV10max4, dV10 total max	1	1,2	1,2	1,2,3	1,2,3	1,2,3	
Short interval voltage flicker Pst Long interval voltage flicker Plt	Pst Plt	1	1,2	1,2	1,2,3	1,2,3	1,2,3	

-3. Accuracy specifications

Conditions of guaranteed accuracy	Guaranteed accuracy period: 1 year Temperature and humidity for guaranteed accuracy: 23°C±5°C (73°F±9°F), 80% RH or less Warm-up time: at least 30 minutes Power factor=1, common-mode voltage 0 V, specified after zero-adjustment For AC measurement, add the following conditions: With reference channel (U1) input that is greater than or equal to 10 V rms Frequency Range : When the measurement frequency is set to 50 Hz: 40 Hz to 58 Hz : When the measurement frequency is set to 60 Hz: 51 Hz to 70 Hz : When the measurement frequency is set to 400 Hz: 360 Hz to 440 Hz
Temperature coefficient	Specified with the instrument operated within the operating temperature and humidity range Voltage, current, power: 0.03% f.s./°C (add 0.05% f.s./°C for DC measurement)
Effect of common mode voltage	Within ±0.2% f.s. (600 V rms AC, 50 Hz/60 Hz, between voltage input terminal and the instrument case) Within ±2% f.s. (600 V rms AC, 400 Hz, between voltage input terminal and the instrument case)
Effect of external magnetic field	In a magnetic field of 400 A rms AC/m, 50 Hz/60 Hz Voltage: Within ±3 V Current: Within ±1.5% f.s.

-4. Measurement items and events

There are no accuracy specifications where measurement accuracy is not noted or for 3P3W2M CH3 measured values.

(1) Transient overvoltage (Tran)

Measurement method	Detected from waveform obtained by eliminating the fundamental component (50 Hz/60 Hz/400 Hz) from the sampled waveform. Detection occurs once for each fundamental voltage waveform.	
Displayed item	Transient voltage value	: Waveform peak value during 4 ms period after elimination of fundamental component
	Transient width	: Period during which threshold is exceeded (2 ms max.)
	Max. transient voltage value	: Max. peak value of waveform obtained by eliminating the fundamental component during the period from transient IN to transient OUT (leaving channel information)
	Transient period	: Period from transient IN to transient OUT
	Transient count during period	: Number of transients occurring during period from transient IN to transient OUT (transients occurring across all channels or simultaneously on multiple channels count as 1)
Measurement range	±6.0000 kV pk	
Measurement band	5 kHz (-3 dB) to 700 kHz (-3 dB), specified at 20 V rms	
Minimum detection width	0.5 μs	
Measurement accuracy	±5.0% rdg.±1.0% f.s. (specified at 1000 V rms/30 kHz and 700 V rms/100 kHz)	
Event threshold	6,000.0 V Specify the absolute value of a threshold for the peak value (crest value) of the waveform from which the fundamental component has been eliminated	
Event IN	First transient overvoltage detected in an approx. 200 ms aggregation interval. The event occurrence time indicates the time when the threshold was exceeded. The peak voltage value and transient width are shown.	

13.2 Input Specifications/Output Specifications/Measurement Specifications

(1) Transient overvoltage (Tran)

Event OUT	Start of approx. 200 ms aggregation in which no transient overvoltage was detected for any channel in the transient event IN state. The transient period (difference between the IN and OUT times) is indicated.
Multiple-phase system treatment	Begins when a transient is detected for any one of the U1 to U4 channels and ends when no transient is detected for any of the channels.
Saved waveforms	Event waveforms, Transient waveforms Waveforms are saved for 2 ms before and after the position at which the transient overvoltage waveform was detected for the first transient IN and 2 ms before and after the point at which the transient maximum voltage waveform was detected between the IN and OUT points.

(2) Frequency cycle (Freq_wav)

Measurement method	Reciprocal method Calculated as the reciprocal of the accumulated whole-cycle time during one U1 (reference channel) cycle. Frequency is given per waveform. When set to a measurement frequency of 400 Hz, calculated as the reciprocal of the accumulated whole-cycle time during 8 cycles. Average frequency is given for 8 waveforms.
Displayed item	Worst frequency cycle value between EVENT IN and EVENT OUT (max. deviation).
Measurement range	When the measurement frequency is set to 50 Hz/60 Hz :70.000 Hz When the measurement frequency is set to 400 Hz : 440.00 Hz
Measurement accuracy	When the measurement frequency is set to 50 Hz/60 Hz: ± 0.200 Hz or less (for input from 10% f.s. to 110% f.s.) When the measurement frequency is set to 400 Hz: ± 2.00 Hz or less (for input from 10% f.s. to 110% f.s.)
Event threshold	Specified as deviation of 0.1 Hz to 9.9 Hz in 0.1 Hz increments.
Event IN	The time when the waveform exceeded the positive threshold or fallen below the negative threshold for the first time
Event OUT	The time when the waveform returned to the range between the negative threshold plus 0.1 Hz and the positive threshold minus 0.1 Hz Note: Equivalent to 0.1 Hz frequency hysteresis.
Multiple-phase system treatment	None
Saved waveforms	Event waveforms

(3) RMS voltage refreshed each half-cycle (Urms1/2)

Measurement method	True RMS type, compliant with IEC61000-4-30 When the measurement frequency is set to 50 Hz/60 Hz, RMS voltage values are calculated using sample data for 1 waveform derived by overlapping the voltage waveform every half-cycle. When the measurement frequency is set to 400 Hz, the RMS voltage value is calculated for each voltage waveform. The line voltage is used for 3-phase 3-wire (3P3W3M) connections, while the phase voltage is used for 3-phase 4-wire connections.
Displayed item	RMS voltage refreshed each half-cycle
Measurement range	600.00 V
Measurement accuracy	When the measurement frequency is set to 50 Hz/60 Hz: With 10 V to 660 V input: Specified as 0.2% of nominal voltage with a nominal input voltage (U_{din}) of at least 100 V. With input outside the range of 10 V to 660 V or a nominal input voltage (U_{din}) of less than 100 V: $\pm 0.2\%$ rdg. $\pm 0.08\%$ f.s. When the measurement frequency is set to 400 Hz: $\pm 0.4\%$ rdg. $\pm 0.50\%$ f.s.
Event threshold	See the Dip, Swell, and Interruption sections.
Event IN	See the Dip, Swell, and Interruption sections.
Event OUT	See the Dip, Swell, and Interruption sections.

(3) RMS voltage refreshed each half-cycle (Urms1/2)

Multiple-phase system treatment	None
Saved waveforms	None
Constraints	With a 400 Hz measurement frequency, measured values recorded on the event voltage fluctuation graph consist of RMS voltage values for each waveform.

(4) RMS current refreshed each half-cycle (Irms 1/2)

Measurement method	RMS current values are calculated from sample data of 1 overlapping current waveform every half-cycle (in sync with voltage acquired across the same channel)
Displayed item	RMS current refreshed each half-cycle
Measurement range	Varies with current sensor used (see input specifications).
Measurement accuracy	$\pm 0.2\%$ rdg. $\pm 0.1\%$ f.s. + current sensor accuracy

(5) Inrush current (Inrush)

Measurement method	When the measurement frequency is set to 50 Hz or 60 Hz, the current RMS value is calculated from data sampled from a current waveform at intervals of half cycle (in synchronization with voltage waveform acquired across the same channel) and the inrush current is detected. When the measurement frequency is set to 400 Hz, the current RMS value is calculated for each current waveform, and the inrush current is detected if the greatest of four current RMS values (400 Hz single-waveform calculated values) in a 10 ms interval exceeds the threshold.
Displayed item	The maximum current of current RMS values acquired through the measurement described above.
Measurement range	Varies with current sensor used (see input specifications).
Measurement accuracy	When the measurement frequency is set to 50 Hz or 60 Hz : $\pm 0.3\%$ rdg. $\pm 0.5\%$ f.s. + current sensor accuracy When the measurement frequency is set to 400 Hz : $\pm 0.4\%$ rdg. $\pm 1.0\%$ f.s. + current sensor accuracy
Event threshold	Varies with set range.
Event IN	Start time of each channel's half-cycle voltage waveform with an inrush current that exceeded the threshold value.
Event OUT	Start time of the half-cycle voltage waveform with an inrush current that dropped to less than the threshold value minus the hysteresis width.
Multiple-phase system treatment	None
Saved waveforms	Event waveforms
Fluctuation data	Saves the data of RMS voltage refreshed each half-cycle and inrush RMS current acquired in the period equivalent to that between 0.5 s before and 29.5 s after the event IN. With the 400 Hz setting, saves the data of RMS voltage refreshed each half-cycle and inrush RMS current acquired in the period equivalent to that between 0.125 s before and 7.375 s after the event IN.

(6) Swell (Swell)

Measurement method	Compliant with IEC61000-4-30 During 50 Hz/60 Hz measurement, a swell is detected when the RMS voltage refreshed each half-cycle exceeds the threshold in the positive direction. During 400 Hz measurement, a swell is detected when the maximum of 4 RMS voltage values occurring within 10 ms (values calculated for one 400 Hz waveform) exceeds the threshold.
Displayed item	Swell height: Worst value for RMS voltage refreshed each half-cycle [V] Swell duration: Period from the time a U1 to U3 swell is detected until the reading falls below the value calculated by subtracting the hysteresis from the threshold
Measurement range	600.00 V

13.2 Input Specifications/Output Specifications/Measurement Specifications

(6) Swell (Swell)

Measurement accuracy	Same as for RMS voltage refreshed each half-cycle Period: Within half a cycle of the start accuracy time, within half a cycle of the end accuracy time (not specified for 400 Hz measurement)
Event threshold	Percentage of the nominal voltage or percentage of the slide reference voltage (user-selectable)
Event IN	Start of the waveform for which the RMS voltage refreshed each half-cycle exceeded the threshold in the positive direction
Event OUT	Start of the waveform for which the RMS voltage refreshed each half-cycle fallen below the value calculated by subtracting the hysteresis from the threshold
Multiple-phase system treatment	Starts when any of the U1 to U3 channels experiences a swell and ends when the swell has ended for all channels.
Saved waveforms	Event waveforms
Fluctuation data	Saves the data of RMS voltage refreshed each half-cycle and RMS current refreshed each half-cycle obtained in the period between 0.5 sec prior to the event IN and 29.5 sec after the event IN. When set to 400 Hz, saves the data of RMS voltage refreshed each half-cycle and RMS current refreshed each half-cycle obtained in the period between 0.125 sec prior to the event IN and 7.375 sec after the event IN.

(7) Dip (Dip)

Measurement method	Compliant with IEC61000-4-30 During 50 Hz/60 Hz measurement, a dip is detected when the RMS voltage refreshed each half-cycle falls below the threshold. During 400 Hz measurement, a dip is detected when the minimum of 4 RMS voltage values occurring within 10 ms (values calculated for one 400 Hz waveform) falls below the threshold.
Displayed item	Dip depth : Worst value for RMS voltage refreshed each half-cycle [V] Dip duration: Period from the time a U1 to U3 dip is detected until the reading exceeds the value obtained by subtracting the hysteresis from the threshold in the positive direction
Measurement range	600.00 V
Measurement accuracy	Same as for RMS voltage refreshed each half-cycle Period: Within half a cycle of the start accuracy time, within half a cycle of the end accuracy time (not specified for 400 Hz measurement)
Event threshold	Percentage of the nominal voltage or percentage of the slide reference voltage (user-selectable)
Event IN	Start of the waveform for which the RMS voltage refreshed each half-cycle fallen below the threshold
Event OUT	Start of the waveform for which the RMS voltage refreshed each half-cycle fallen below the value calculated by adding the hysteresis to the threshold.
Multiple-phase system treatment	Starts when any of the U1 to U3 channels experiences a dip and ends when the dip has ended for all channels.
Saved waveforms	Event waveforms
Fluctuation data	RMS data refreshed each cycle is saved from 0.5 s before to 29.5 s after the EVENT IN. When set to 400 Hz, RMS data refreshed each cycle is saved from 0.125 s before to 7.375 s after.

(8) Interruption (Intrpt)

Measurement method	Compliant with IEC61000-4-30 During 50 Hz/60 Hz measurement, an interruption is detected when the RMS voltage refreshed each half-cycle falls below the threshold. During 400 Hz measurement, an interruption is detected when the minimum of 4 RMS voltage values occurring within 10 ms (values calculated for one 400 Hz waveform) exceeds the threshold in the negative direction.
Displayed item	Interruption depth : Worst value for RMS voltage refreshed each half-cycle [V] Interruption duration : Period from the time a U1 to U3 interruption is detected until the reading exceeds the value obtained by adding the hysteresis to the threshold
Measurement range	600.00 V

(8) Interruption (Intrpt)

Measurement accuracy	Same as for RMS voltage refreshed each half-cycle Period: Within half a cycle of the start accuracy time, within half a cycle of the end accuracy time (not specified for 400 Hz measurement)
Event threshold	Percentage of the nominal voltage
Event IN	Start of the waveform for which the RMS voltage refreshed every cycle exceeded the threshold in the negative direction
Event OUT	Start of the waveform for which the RMS voltage refreshed each half-cycle exceeded the value calculated by adding the hysteresis to the threshold
Multiple-phase system treatment	Starts when all of the U1 to U3 channels experience an interruption and ends when the interruption ends for any of the channels.
Saved waveforms	Event waveforms
Fluctuation data	RMS data refreshed each cycle is saved from 0.5 s before to 29.5 s after the EVENT IN. When set to 400 Hz, RMS data refreshed each cycle is saved from 0.125 s before to 7.375 s after.

(9) Instantaneous flicker value (Pinst)

Measurement method	As per IEC61000-4-15 User-selectable from 230 V lamp/120 V lamp (when Pst and Plt are selected for flicker measurement)
Displayed item	Instantaneous flicker value
Measurement range, resolution	99.999, 0.001
Measurement accuracy	-
Event threshold	N/A

(10) Frequency 200 ms (Freq)

Measurement method	Reciprocal method Calculated as the reciprocal of the accumulated whole-cycle time during approx. 200 ms period of 10, 12, or 80 U1 (reference channel) cycles.
Displayed item	Frequency 200 ms
Measurement range	When the measurement frequency is set to 50 Hz/60 Hz: 70.000 Hz When the measurement frequency is set to 400 Hz : 440.00 Hz
Measurement accuracy	When the measurement frequency is set to 50 Hz/60 Hz: ± 0.020 Hz or less When the measurement frequency is set to 400 Hz : ± 0.20 Hz or less (with input voltage of 4% f.s. to 110% f.s.)
Event threshold	Specified as deviation from 0.1 Hz to 9.9 Hz in 0.1 Hz increments
Event IN	Start of approx. 200 ms aggregation in which \pm threshold was exceeded
Event OUT	Start of approx. 200 ms aggregation in which reading returned to \pm (threshold - 0.1 Hz) Note: Equivalent to 0.1 Hz frequency hysteresis.
Multiple-phase system treatment	None
Saved waveforms	Event waveforms

(11) 10-sec frequency (Freq10s)

Measurement method	Reciprocal method Calculated as the reciprocal of the accumulated whole-cycle time during the specified 10 s period for U1 (reference channel) as per IEC61000-4-30.
Displayed item	10-sec frequency

13.2 Input Specifications/Output Specifications/Measurement Specifications

(11) 10-sec frequency (Freq10s)

Measurement range	When the measurement frequency is set to 50 Hz/60 Hz: 70.000 Hz When the measurement frequency is set to 400 Hz : 440.00 Hz
Measurement accuracy	When a signal with a frequency of less than 45.000 Hz is inputted with the measurement frequency setting of 50 Hz: 0.01 Hz or less When a signal with a frequency of 45.000 Hz or more is inputted with the measurement frequency setting of 50 Hz: With the measurement frequency setting of 50 Hz: 0.003 Hz or less With the measurement frequency setting of 400 Hz: 0.10 Hz or less (with input voltage of 10 V to 1660 V)
Event threshold	N/A

(12) Voltage waveform peak (Upk)

Measurement method	Measured every 10 cycles (50 Hz) or 12 cycles (60 Hz); maximum and minimum points sampled during approx. 200 ms aggregation. During 400 Hz measurement, measured every 80 cycles; maximum and minimum points sampled during approx. 200 ms aggregation.
Displayed item	Positive peak value and negative peak value
Measurement range	± 1200.0 V peak
Measurement accuracy	With input of 10% to 150% of the nominal voltage: 5% of the nominal voltage Other than the above: 2% f.s.
Event threshold	0 to 1200 V (value before setting VT ratio), in 1 V increments, absolute value comparison
Event IN	Start of approx. 200 ms aggregation in which \pm threshold was exceeded
Event OUT	Start of first approx. 200 ms aggregation after IN state in which \pm threshold was not exceeded
Multiple-phase system treatment	Separate by channel
Saved waveforms	Event waveforms

(13) Current waveform peak (Ipk)

Measurement method	Measured every 10 cycles (50 Hz) or 12 cycles (60 Hz); maximum and minimum points sampled during approx. 200 ms aggregation. During 400 Hz measurement, measured every 80 cycles; maximum and minimum points sampled during approx. 200 ms aggregation.
Displayed item	Positive peak value and negative peak value
Measurement range	400% of the current range
Measurement accuracy	With input greater than or equal to 50% f.s.: 5% rdg. + current sensor accuracy Other than above: 2% f.s. + current sensor accuracy
Event threshold	0 to 4 times rated current of current sensor being used represented in ampere (value before setting CT), absolute value comparison
Event IN	Start of approx. 200 ms aggregation in which \pm threshold was exceeded
Event OUT	Start of first approx. 200 ms aggregation after IN state in which \pm threshold was not exceeded
Multiple-phase system treatment	Separate by channel
Saved waveforms	Event waveforms

(14) RMS voltage (Urms)

Measurement method	AC+DC True RMS type IEC61000-4-30 compliant: 10 cycles (50 Hz) or 12 cycles (60 Hz) (approx. 200 ms) During 400 Hz measurement, calculated from 80 cycles (approx. 200 ms) When set to 3P3W3M/3P4W/3P4W2.5E, the phase voltage/line voltage setting is applied to the RMS voltage Urms. Includes Zero-display range.
Displayed item	RMS voltage for each channel and AVG (average) RMS voltage for multiple channels (for more information, see "13.8 Calculation Formula" (p.234))
Measurement range	600.00 V
Measurement accuracy	When the measurement frequency is set to 50 Hz/60 Hz With input of 10 V to 660 V: $\pm 0.1\%$ of the nominal voltage; defined for a nominal input voltage (U _{din}) of 100 V or greater. With input outside the range of 10 V to 660 V or a nominal input voltage (U _{din}) of less than 100 V: $\pm 0.2\%$ rdg. $\pm 0.08\%$ f.s. When the measurement frequency is set to 400 Hz $\pm 0.2\%$ rdg. $\pm 0.16\%$ f.s.
Event threshold	The upper and lower limits can be separately set within the range of 0 to 780 V (lower limit < upper limit) (value before setting VT ratio) When set to 3P3W3M/3P4W/3P4W2.5E, the phase voltage/line voltage setting is applied.
Sense	Set from 0 V to 600 V.
Event IN	Start of the approx. 200 ms aggregation during which the reading exceeded the upper limit or fallen below the lower limit
Event OUT	Start of the approx. 200 ms aggregation during which the reading was less than upper limit minus hysteresis after being greater than the upper limit or was greater than lower limit plus hysteresis after being less than the lower limit
Multiple-phase system treatment	Separate by channel
Saved waveforms	Event waveforms

(15) Voltage DC value (Udc)

Measurement method	Average value during approx. 200 ms aggregation synchronized with the reference channel (CH4 only) Includes Zero-display range.
Displayed item	Voltage DC value
Measurement range	600.00 V
Measurement accuracy	$\pm 0.3\%$ rdg. $\pm 0.08\%$ f.s.
Event threshold	0 V to 1200 V The difference between the positive and negative waveform peak values in the 200 ms aggregation is compared to the threshold to generate DC fluctuation events.
Event IN	Start of the 200 ms aggregation in which the threshold was exceeded
Event OUT	Start of the first 200 ms aggregation after the IN state in which the threshold was not exceed
Multiple-phase system treatment	None
Saved waveforms	Event waveforms

13.2 Input Specifications/Output Specifications/Measurement Specifications

(16) RMS current (Irms)

Measurement method	AC+DC True RMS type IEC61000-4-30 compliant: 10 cycles (50 Hz) or 12 cycles (60 Hz) (approx. 200 ms) 80 cycles (400 Hz) (approx. 200 ms) Includes Zero-display range.
Displayed item	RMS current for each channel and AVG (average) RMS current for multiple channels (for more information, see "13.8 Calculation Formula" (p.234))
Measurement range	See input specifications.
Measurement accuracy	When the measurement frequency is set to 50 Hz/60 Hz: $\pm 0.1\%$ rdg. $\pm 0.1\%$ f.s. + current sensor accuracy When the measurement frequency is set to 400 Hz: $\pm 0.2\%$ rdg. $\pm 0.6\%$ f.s. + current sensor accuracy
Event threshold	0 to current range
Sense	Set to 0 to range rating
Event IN	Start of approx. 200 ms aggregation in which threshold was exceeded
Event OUT	Start of approx. 200 ms aggregation in which reading was less than (threshold - hysteresis)
Multiple-phase system treatment	Separate by channel
Saved waveforms	Event waveforms

(17) Current DC value (Idc)

Measurement method	Average value during approx. 200 ms aggregation synchronized to reference channel (CH4 only) Includes Zero-display range.
Displayed item	Current DC value
Measurement range	Varies with current sensor used.
Measurement accuracy	$\pm 0.5\%$ rdg. $\pm 0.5\%$ f.s. + current sensor specifications accuracy Not specified when using AC dedicated current sensor.
Event threshold	0 to ($\pm 400\%$ of the current range) The difference between the positive and negative waveform peak values in the 200 ms aggregation is compared to the threshold to generate DC fluctuation events.
Event IN	Start of the 200 ms aggregation in which the threshold was exceeded
Event OUT	Start of the first 200 ms aggregation after the IN state in which the threshold was not exceeded
Multiple-phase system treatment	None
Saved waveforms	Event waveforms

(18) Active power (P)

Measurement method	Measured every 10 cycles (50 Hz) or 12 cycles (60 Hz) (approx. 200 ms). During 400 Hz measurement, measured every 80 cycles using the 8-cycle waveform (approx. 200 ms).
Displayed item	Active power for each channel and sum value for multiple channels (for more information, see "13.8 Calculation Formula" (p.234)) Sink (consumption) : Unsigned Source (regeneration) : Negative
Measurement range	Combination of voltage × current range (see "13.9 Range Breakdown and Combination Accuracy" (p.247))
Measurement accuracy	DC: $\pm 0.5\%$ rdg. $\pm 0.5\%$ f.s. + current sensor accuracy (defined for CH4 only) AC: When the measurement frequency is set to 50 Hz/60 Hz: $\pm 0.2\%$ rdg. $\pm 0.1\%$ f.s. + current sensor accuracy (The sum value is the total value for channels being used.) When the measurement frequency is set to 400 Hz: $\pm 0.4\%$ rdg. $\pm 0.6\%$ f.s. + current sensor accuracy (The sum value is the total value for channels being used.)
Effects of power factor	1.0% rdg. or less (with power factor of 0.5) Phase difference between internal circuit voltage and current: $\pm 0.2865^\circ$
Event threshold	Comparison of power range absolute values
Event IN	Start of approx. 200 ms aggregation in which the absolute value was greater than the threshold
Event OUT	Start of approx. 200 ms aggregation in which the reading was less than (threshold - hysteresis) following the EVENT IN state
Multiple-phase system treatment	Separate by channel
Saved waveforms	Event waveforms

(19) Efficiency (Eff)

Measurement method	Calculated based on the ratio of channels' respective active power values (For more information, see "13.8 Calculation Formula" (p.234))
Displayed item	Eff1, Eff2
Measurement range	0.00 to 200.00[%]
Measurement accuracy	± 1 dgt. for calculations derived from the various measurement values.
Event threshold	N/A

13.2 Input Specifications/Output Specifications/Measurement Specifications

(20) Active energy and reactive energy (WP+, WP-/WQLAG, WQLEAD)

Measurement method	Measured every 10 cycles (50 Hz) or 12 cycles (60 Hz) (approx. 200 ms). During 400 Hz measurement, measured every 80 cycles using the 8-cycle waveform (approx. 200 ms). Integrated separately by consumption and regeneration from active power. Integrated separately by lag and lead from reactive power. Recorded at the specified TIME PLOT interval. Data is updated every 10 cycles (50 Hz), 12 cycles (60 Hz), or 80 cycles (400 Hz) (approx. 200 ms). Integration starts at the same time as recording and continues to previous TIME PLOT update at termination of recording.
Displayed item	Active energy: WP+ (consumption), WP- (regeneration) Sum of multiple channels (for more information, see "13.8 Calculation Formula" (p.234)) Reactive energy: WQLAG (lag), WQLEAD (lead) Sum of multiple channels (for more information, see "13.8 Calculation Formula" (p.234)) Elapsed time
Measurement range	Combination of voltage × current range (See "13.9 Range Breakdown and Combination Accuracy" (p.247)) Value display: 6 digits
Measurement accuracy	Active energy : Active power measurement accuracy ±10 dgt. Reactive energy : Reactive power measurement accuracy ±10 dgt. Cumulative time accuracy : ±10 ppm ±1 s (23°C [73°F])
Event threshold	N/A

(21) Apparent power (S)

Measurement method	Calculated from RMS voltage U and RMS current I. No polarity
Displayed item	Apparent power of each channel and its sum for multiple channels (For details, see "13.8 Calculation Formula" (p.234))
Measurement range	Depends on the voltage × current range combination (See "13.9 Range Breakdown and Combination Accuracy" (p.247))
Measurement accuracy	±1 dgt. for calculations derived from the various measurement values (sum is ±3 dgt.)
Event threshold	Power range
Event IN	Start of approx. 200 ms aggregation in which the absolute value was greater than the threshold
Event OUT	Start of approx. 200 ms aggregation in which the reading was less than (threshold - hysteresis) following the EVENT IN state
Multiple-phase system treatment	Separate by channel
Saved waveforms	Event waveforms

(22) Reactive power (Q)

Measurement method	Calculated using apparent power S and active power P. Lag phase (LAG: current lags voltage): Unsigned Lead phase (LEAD: current leads voltage): Negative
Displayed item	Reactive power of each channel and its sum for multiple channels. (For details, see "13.8 Calculation Formula" (p.234).)
Measurement range	Depends on the voltage × current range combination (See "13.9 Range Breakdown and Combination Accuracy" (p.247))
Measurement accuracy	±1 dgt. for calculations derived from the various measurement values (sum is ±3 dgt.)
Event threshold	Power range (specified as absolute value)
Event IN	Start of approx. 200 ms aggregation in which the absolute value was greater than the threshold
Event OUT	Start of approx. 200 ms aggregation in which the reading was less than (threshold - hysteresis) following the EVENT IN state
Multiple-phase system treatment	Separate by channel
Saved waveforms	Event waveforms

(23) Power factor and displacement power factor (PF, DPF)

Measurement method	Power factor : Calculated from RMS voltage U, RMS current I, and active power P. Displacement power factor : Calculated from the phase difference between the fundamental voltage wave and the fundamental current wave. Lag phase (LAG: current lags voltage) : Unsigned Lead phase (LEAD: current leads voltage) : Negative
Displayed item	Power factor and displacement power factor of each channel and its sum value for multiple channels. (For details, see "13.8 Calculation Formula" (p.234).)
Measurement range	-1.0000 (lead) to 0.0000 to 1.0000 (lag)
Displacement power factor measurement accuracy	For voltage of 100 V or greater and current input greater than or equal to 10% of the range: When displacement power factor = 1: ±0.05% rdg. When $0.8 \leq \text{displacement power factor} < 1$: ±1.50% rdg. When $0 < \text{displacement power factor} < 0.8$: $\pm(1 - \cos(\varphi + 0.2865)/\cos(\varphi)) \times 100\%$ rdg. + 50 dgt. (reference value) φ : Display value for 1st order harmonic voltage/current phase difference In all cases, add current sensor's phase accuracy.
Event threshold	0.000 to 1.000 (specified as absolute value)
Event IN	Start of approx. 200 ms aggregation in which the absolute value was less than the threshold
Event OUT	Start of the approx. 200 ms aggregation in which the reading was greater than (absolute value + hysteresis) following the EVENT IN state
Multiple-phase system treatment	Separate by channel
Saved waveforms	Event waveforms

13.2 Input Specifications/Output Specifications/Measurement Specifications

(24) Voltage unbalance factor (negative-phase unbalance factor, zero-phase unbalance factor) (Uunb, Uunb0)

Measurement method	Calculated using various components of the 3-phase fundamental voltage wave (line-to-line voltage) for 3-phase 3-wire (3P3W2M, 3P3W3M) and 3-phase 4-wire connections. (For details, see "13.8 Calculation Formula" (p.234)) The string "-----" will appear when the RMS voltage values of all three phases are zero.
Displayed item	Negative-phase unbalance factor (Uunb), zero-phase unbalance factor (Uunb0)
Measurement range	Component is V and unbalance factor is 0.00% to 100.00%.
Measurement accuracy	When the measurement frequency is set to 50 Hz/60 Hz, $\pm 0.15\%$ (0.0% to 5.0% range specified for IEC61000-4-30 performance testing)
Event threshold	0.0% to 100.0%
Event IN	Start of approx. 200 ms aggregation in which reading was greater than the threshold
Event OUT	Start of approx. 200 ms aggregation in which the reading was less than (threshold - hysteresis)
Multiple-phase system treatment	None
Saved waveforms	Event waveforms

(25) Current unbalance factor (negative-phase unbalance factor, zero-phase unbalance factor) (Iunb, Iunb0)

Measurement method	For 3-phase 3-wire (3P2W2M and 3P3W3M) and 3-phase 4-wire, calculated using 3-phase fundamental current component (For details, see "13.8 Calculation Formula" (p.234).) The string "-----" will appear when the RMS current values of all three phases are zero.
Displayed item	Negative-phase unbalance factor (Iunb), zero-phase unbalance factor (Iunb0)
Measurement range	Component is A and unbalance factor is 0.00% to 100.00%.
Measurement accuracy	-
Event threshold	0.0% to 100.0%
Event IN	Start of approx. 200 ms aggregation in which reading was greater than the threshold
Event OUT	Start of approx. 200 ms aggregation in which the reading was less than (threshold - hysteresis)
Multiple-phase system treatment	None
Saved waveforms	Event waveforms

(26) High-order harmonic voltage component and high-order harmonic current component (UharmH, IharmH)

Measurement method	The waveform obtained by eliminating the fundamental component is calculated using the true RMS method during 10 cycles (50 Hz), 12 cycles (60 Hz), or 80 cycles (400 Hz) (approx. 200 ms) of the fundamental wave.
Displayed item	High-order harmonic voltage component value: RMS voltage value for the waveform consisting of components having frequencies of 2 kHz to 80 kHz High-order harmonic current component value: RMS current value for the waveform consisting of components having frequencies of 2 kHz to 80 kHz High-order harmonic voltage component maximum value: Maximum RMS value for the voltage waveform consisting of components having frequencies of 2 kHz to 80 kHz obtained during the period from EVENT IN to EVENT OUT (leaving channel information) High-order harmonic current component maximum value: Maximum RMS value for the current waveform consisting of components having frequencies of 2 kHz to 80 kHz obtained during the period from EVENT IN to EVENT OUT (leaving channel information) High-order harmonic voltage component period: Period from high-order harmonic voltage component EVENT IN to EVENT OUT High-order harmonic current component period: Period from high-order harmonic current component EVENT IN to EVENT OUT
Measurement range	High-order harmonic voltage component: 600.00 V High-order harmonic current component: Varies with the current sensor used (see input specifications).
Measurement band	2 kHz (-3 dB) to 80 kHz (-3 dB)
Measurement accuracy	High-order harmonic voltage component: $\pm 10\% \text{ rdg.} \pm 0.1\% \text{ f.s.}$ (specified for 10 V sine wave at 5 kHz, 10 kHz, and 20 kHz) High-order harmonic current component: $\pm 10\% \text{ rdg.} \pm 0.2\% \text{ f.s.} + \text{current sensor accuracy}$ (specified as 1% f.s. sine wave at 5 kHz, 10 kHz, and 20 kHz)
Event threshold	High-order harmonic voltage component: 0 V or greater, 600.00 V or less High-order harmonic current component: 0 A or greater, current range or less
Event IN	Start of approx. 200 ms aggregation in which reading was greater than the threshold
Event OUT	Start of approx. 200 ms aggregation in which high-order harmonics were not detected during the first approx. 200 ms aggregation following the IN state
Multiple-phase system treatment	Separate by channel
Saved waveforms	Event waveforms High-order harmonic waveform 40 ms from the end of the first approx. 200 ms aggregation interval in which the reading was greater than the threshold (8000 data points)

13.2 Input Specifications/Output Specifications/Measurement Specifications

(27) Harmonic voltage and harmonic current (including fundamental component) (U_{harm}/I_{harm})

Measurement method	Compliant with IEC61000-4-7:2009 Indicated harmonic voltage and harmonic current values incorporate inter-harmonics components adjacent to the next whole-number harmonic component after harmonic analysis. (For details see "13.8 Calculation Formula" (p.234).) Measurement accuracy is specified for input that is 10% to 200% of IEC61000-2-4 Class 3.
Analysis window width	10 cycles (50 Hz), 12 cycles (60 Hz), or 80 cycles (400 Hz)
Number of window points	Rectangular, 4096 points
Displayed item	From the 0th to 50 th order (with a fundamental wave of 40 Hz to 70 Hz) From the 0th to 10 th order (with a fundamental wave of 360 Hz to 440 Hz) Select either RMS or content percentage (When using content percentage, Zero-display range causes all orders to be given as 0% when the RMS value is 0.)
Measurement range	Harmonic voltage: 600.00 V Harmonic current: Varies with the current sensor used (see input specifications).
Measurement accuracy	See measurement accuracy with a fundamental wave of 50 Hz/60 Hz and measurement accuracy with a fundamental wave of 400 Hz.
Event threshold	Level Harmonic voltage: 0.00 to 780.00 V (order 0: specified as absolute value) Harmonic current: From 0 to (1.3 × current range) (see input specifications) (order 0: specified as absolute value). Content percentage 0.00% to 100.00%
Event IN	Start of approx. 200 ms aggregation in which readings were greater than the threshold for each order
Event OUT	Start of approx. 200 ms aggregation in which readings were less than (threshold - hysteresis) for each order
Multiple-phase system treatment	Separate by channel
Saved waveforms	Event waveforms
Constraints	When using an AC-only current sensor, the 0th order is not specified for current and power.

(28) Harmonic power (including fundamental component) (P_{harm})

Measurement method	Compliant with IEC61000-4-7:2009 Indicates harmonic power values consisting of harmonic power for each channel and the sum of multiple channels. (For details see "13.8 Calculation Formula" (p.234).)
Analysis window width	10 cycles (50 Hz), 12 cycles (60 Hz), or 80 cycles (400 Hz)
Number of window points	Rectangular, 4096 points
Displayed item	From the 0th to 50 th order (with a fundamental wave of 40 Hz to 70 Hz) From the 0th to 10 th order (with a fundamental wave of 360 Hz to 440 Hz) Select either RMS or content percentage (When using content percentage, Zero-display range causes all orders to be given as 0% when the RMS value is 0.)
Measurement range	See power ranges.
Measurement accuracy	See measurement accuracy with a fundamental wave of 50 Hz/60 Hz and measurement accuracy with a fundamental wave of 400 Hz.
Event threshold	Harmonic power: From 0 to (1.3 × current range) (specified as absolute value)
Event IN	Start of approx. 200 ms aggregation in which the reading is greater than the threshold (when the threshold is positive) or less than the threshold (when the threshold is negative)
Event OUT	Start of the approx. 200 ms aggregation in which the reading is less than (threshold - hysteresis) (when the threshold is positive) or greater than (threshold + hysteresis) (when the threshold is negative) in the EVENT IN state
Multiple-phase system treatment	Separate by channel
Saved waveforms	Event waveforms
Constraints	When using an AC-only current sensor, the 0th order is not specified for current and power.

13.2 Input Specifications/Output Specifications/Measurement Specifications

Measurement accuracy with a fundamental wave of 50 Hz/60 Hz

	Harmonic input	Measurement accuracy	Notes
Voltage	1% or greater of nominal voltage	The 0th order: $\pm 0.3\%$ rdg. $\pm 0.08\%$ f.s. 1 st or higher : $\pm 5.00\%$ rdg.	Defined for a nominal voltage of 100 V or greater.
	<1% of nominal voltage	The 0th order: $\pm 0.3\%$ rdg. $\pm 0.08\%$ f.s. 1 st or higher : $\pm 0.05\%$ of nominal voltage	Defined for a nominal voltage of 100 V or greater.
Current		The 0th order : $\pm 0.5\%$ rdg. $\pm 0.5\%$ f.s. 1 st to 20 th : $\pm 0.5\%$ rdg. $\pm 0.2\%$ f.s. 21 st to 50 th : $\pm 1.0\%$ rdg. $\pm 0.3\%$ f.s.	Add current sensor accuracy.
Power		The 0th order : $\pm 0.5\%$ rdg. $\pm 0.5\%$ f.s. 1 st to 20 th : $\pm 0.5\%$ rdg. $\pm 0.2\%$ f.s. 21 st to 30 th : $\pm 1.0\%$ rdg. $\pm 0.3\%$ f.s. 31 st to 40 th : $\pm 2.0\%$ rdg. $\pm 0.3\%$ f.s. 41 st to 50 th : $\pm 3.0\%$ rdg. $\pm 0.3\%$ f.s.	Add current sensor accuracy.

Measurement accuracy with a fundamental wave of 400 Hz

	Harmonic input	Measurement accuracy	Notes
Voltage		The 0th order : $\pm 0.5\%$ rdg. $\pm 0.08\%$ f.s. 1 st to 2 nd : $\pm 0.5\%$ rdg. $\pm 0.20\%$ f.s. 3 rd to 6 th : $\pm 1.0\%$ rdg. $\pm 0.30\%$ f.s. 7 th to 10 th : $\pm 5.0\%$ rdg. $\pm 0.30\%$ f.s.	
Current		The 0th order: $\pm 0.5\%$ rdg. $\pm 0.5\%$ f.s. 1 st to 2 nd : $\pm 0.5\%$ rdg. $\pm 0.2\%$ f.s. 3 rd to 6 th : $\pm 1.0\%$ rdg. $\pm 0.3\%$ f.s. 7 th to 10 th : $\pm 5.0\%$ rdg. $\pm 0.3\%$ f.s.	Add current sensor accuracy.
Power		The 0th order: $\pm 0.5\%$ rdg. $\pm 0.5\%$ f.s. 1 st to 2 nd : $\pm 0.5\%$ rdg. $\pm 0.2\%$ f.s. 3 rd to 6 th : $\pm 1.0\%$ rdg. $\pm 0.3\%$ f.s. 7 th to 10 th : $\pm 7.0\%$ rdg. $\pm 0.3\%$ f.s.	Add current sensor accuracy.

(29) Inter-harmonic voltage and inter-harmonic current (Uiharm, liharm)

Measurement method	Compliant with IEC61000-4-7:2009 After harmonic analysis, harmonic voltage and harmonic current are displayed by adding as inter-harmonic contents with the harmonic contents according to harmonic order Measurement accuracy is defined for input that is 10% to 200% of IEC61000-2-4 Class 3.
Analysis window width	10 cycles (50 Hz) or 12 cycles (60 Hz)
Number of window points	Rectangular, 4096 points
Displayed item	From the 0.5th to 49.5th order (with a fundamental wave of 40 Hz to 70 Hz) Select either RMS or content percentage (When using content percentage, Zero-display range causes all orders to be given as 0% when the RMS value is 0.)
Measurement range	Inter-harmonic voltage: U1 to U4, 600.00 V Inter-harmonic current: I1 to I4, Varies with used current sensor (see input specifications).
Measurement accuracy	Inter-harmonic voltage (Defined for a nominal voltage of at least 100 V.) 1% or greater of harmonic input nominal voltage: $\pm 5.00\%$ rdg. <1% of harmonic input nominal voltage: $\pm 0.05\%$ of nominal voltage Inter-harmonic current: Unspecified
Event threshold	N/A
Constraints	Not displayed for 400 Hz measurement.

13.2 Input Specifications/Output Specifications/Measurement Specifications

(30) Harmonic voltage phase angle and Harmonic current phase angle (including fundamental component) (Uphase/Iphase)

Measurement method	Compliant with IEC61000-4-7:2009
Analysis window width	10 cycles (50 Hz), 12 cycles (60 Hz), or 80 cycles (400 Hz)
Number of window points	Rectangular, 4096 points
Displayed item	The harmonic phase angle components for whole orders are displayed. (Reference channel's fundamental wave phase angle is 0°.)
Measurement range	0.00 to $\pm 180.00^\circ$
Measurement accuracy	-
Event threshold	N/A

(31) Harmonic voltage-current phase angle (including fundamental component) (Pphase)

Measurement method	Compliant with IEC61000-4-7:2009
Analysis window width	10 cycles (50 Hz), 12 cycles (60 Hz), or 80 cycles (400 Hz)
Number of window points	Rectangular, 4096 points
Displayed item	Indicates the difference between the harmonic voltage phase angle and the harmonic current phase angle. Harmonic voltage-current phase difference for each channel and sum (total) value for multiple channels (For details, see "13.8 Calculation Formula" (p.234).)
Measurement range	0.00° to $\pm 180.00^\circ$
Measurement accuracy	At 50 Hz/60 Hz: 1st order : $\pm 1^\circ$ 2nd, 3rd order : $\pm 2^\circ$ 4th order to 50th order: $\pm(0.05^\circ \times k + 2^\circ)$ (k: harmonic orders) At 400 Hz: 1st order to 10th order: $\pm(0.16^\circ \times k + 2^\circ)$ (k: harmonic orders) However, current sensor accuracy is added. Harmonic voltage of every order is specified as 1% of the declared voltage, and current level is specified as 1% f.s. or more.
Event threshold	Specified from 0° to 180° in 1° resolution (specified as absolute value).
Event IN	Start of approx. 200 ms aggregation in which the absolute value is greater than the threshold.
Event OUT	Start of the approx. 200 ms aggregation in which the absolute value is less than (threshold - hysteresis) in the EVENT IN state.
Multiple-phase system treatment	Separate by channel
Saved waveforms	Event waveforms

(32) Total harmonic voltage and Total harmonic current distortion factor (U_{thd}, I_{thd})

Measurement method	IEC61000-4-7:2009 compliant. Max. order: 50th The string "-----" will appear for the voltage distortion factor when the RMS voltage is zero; for the current distortion factor when the RMS current is zero.
Analysis window width	10 cycles (50 Hz), 12 cycles (60 Hz), or 80 cycles (400 Hz)
Number of window points	Rectangular, 4096 points
Displayed item	THD-F (total harmonic distortion factor for the fundamental wave) THD-R (total harmonic distortion factor for the total harmonic including the fundamental wave)
Measurement range	0.00% to 100.00% (Voltage), 0.00% to 500.00% (Current)
Measurement accuracy	0.5% Defined for the following input with a nominal input voltage of 100 V to 440 V: Voltage, 1st order: 100% of the nominal input voltage; 5th and 7th orders: 1% of the nominal input voltage Current, 1st order: 100% of current range; 5th and 7th orders: 1% of current range
Event threshold	0.00% to 100.00%
Event IN	Start of approx. 200 ms aggregation in which the absolute value was greater than the threshold
Event OUT	Start of approx. 200 ms aggregation in which the reading was less than (threshold - hysteresis) following the EVENT IN state
Multiple-phase system treatment	Separate by channel
Saved waveforms	Event waveforms

(33) K Factor (multiplication factor) (KF)

Measurement method	Calculated using the harmonic RMS current of the 2nd to 50th orders. (For details, see "13.8 Calculation Formula" (p.234).)
Analysis window width	10 cycles (50 Hz), 12 cycles (60 Hz), or 80 cycles (400 Hz)
Number of window points	Rectangular, 4096 points
Displayed item	K factor
Measurement range	0.00 to 500.00
Measurement accuracy	-
Event threshold	0 to 500.0
Event IN	Start of approx. 200 ms aggregation in which the absolute value was greater than the threshold
Event OUT	Start of approx. 200 ms aggregation in which the reading was less than (threshold - hysteresis) following the EVENT IN state
Multiple-phase system treatment	Separate by channel
Saved waveforms	Event waveforms

13.2 Input Specifications/Output Specifications/Measurement Specifications

(34) Voltage waveform comparison (Wave)

Measurement method	A judgment area is automatically generated from the previous 200 ms aggregation waveform, and events are generated based on a comparison with the judgment waveform. Waveform judgments are performed once for each 200 ms aggregation.
Comparison window width	10 cycles (50 Hz), 12 cycles (60 Hz), or 80 cycles (400 Hz)
Number of window points	4096 points synchronized with harmonic calculations
Displayed item	Event detection only
Event threshold	0.0% to 100.0% of nominal voltage RMS value
Event IN	First time at which waveform diverges from judgment area
Event OUT	None
Multiple-phase system treatment	Separate by channel
Saved waveforms	Event waveforms

(35) ΔV_{10} Flicker (ΔV_{10})

Measurement method	"13.8 Calculation Formula" (p.234), "Perceived flicker curve p.A18" Calculated values are subject to 100 V conversion following gap-less measurement once each minute.
Standard voltage	Automatic (with AGC)
Displayed item	ΔV_{10} measured at one minute intervals, average value for one hour, maximum value for one hour, fourth largest value for one hour, total (within the measurement interval) maximum value
Measurement range	0.000 V to 99.999 V
Measurement accuracy	$\pm 2\%$ rdg. ± 0.01 V (with a fundamental wave of 100 V rms [50 Hz/60 Hz], a fluctuation voltage of 1 V rms [99.5 V rms to 100.5 V rms], and a fluctuation frequency of 10 Hz)
Threshold	0.00 V to 9.99 V Alarm output is generated when the reading for each minute is compared to the threshold and found to be greater
Event threshold	N/A

(36) IEC Flicker (Pst, Plt)

Measurement method	IEC61000-4-15:2010 compliant, Calculated as described in "13.8 Calculation Formula" (p.234). Pst is calculated after 10 minutes of continuous measurement and Plt after 2 hours of continuous measurement.
Displayed item	Short interval flicker Pst, long interval flicker Plt
Measurement range	0.0001 to 10000 PU broken into 1024 segments with a logarithm
Flicker filter	Select 230 V lamp, 120 V lamp.
Measurement accuracy	Pst $\pm 5\%$ rdg. (Specified within range 0.1000 to 20.000 using IEC61000-4-15 Class F1 performance test.)
Event threshold	N/A

(37) Mains signaling voltage Msv, Msv%

Measurement method	Compliant with IEC61000-4-30 Levels (Msv) or content rates compared to the nominal voltage (Msv%) are calculated based on the mid-harmonic bin of 10/12-cycle RMS values of up to two set signal frequencies or four mid-harmonic bins that most closely approximate those frequencies to display.
Displayed item	Msv1, Msv%1, Msv2, Msv%2, the worst value between event IN and event OUT
Measurement range	600.00 V
Measurement accuracy	Within the range of 3% to 15% of nominal voltage: $\pm 5\%$ rdg. Within the range of 1% to 3% of nominal voltage: $\pm 0.15\%$ of nominal voltage
Event threshold	Percentage of the nominal voltage
Event IN	Start time of approx. 200 ms aggregation in which the Msv value exceeds the threshold value
Event OUT	Depends on the set timeout.
Multiple-phase system treatment	Starts when any one of the channels from U1 to U3 exceeds the threshold value.
Saved waveforms	Available
Constraints	Not displayed for 400 Hz measurement.

-5. RMS frequency characteristics

Frequency	Voltage	Current	Power
40 Hz to 70 Hz	Specified as RMS value	Specified as RMS value	Specified as RMS value
70 Hz to 360 Hz	$\pm 1\%$ rdg. $\pm 0.2\%$ f.s.	$\pm 1\%$ rdg. $\pm 0.5\%$ f.s.	$\pm 1\%$ rdg. $\pm 0.5\%$ f.s.
360 Hz to 440 Hz	Specified as RMS value	Specified as RMS value	Specified as RMS value
440 Hz to 5 kHz	$\pm 5\%$ rdg. $\pm 0.2\%$ f.s.	$\pm 5\%$ rdg. $\pm 0.5\%$ f.s.	$\pm 5\%$ rdg. $\pm 1\%$ f.s.
5 kHz to 20 kHz	$\pm 5\%$ rdg. $\pm 0.2\%$ f.s.	$\pm 5\%$ rdg. $\pm 0.5\%$ f.s.	$\pm 5\%$ rdg. $\pm 1\%$ f.s.
20 kHz to 50 kHz	$\pm 20\%$ rdg. $\pm 0.4\%$ f.s.	$\pm 20\%$ rdg. $\pm 0.5\%$ f.s.	
80 kHz	-3 dB	-3 dB	

Specified for RMS voltage U_{rms} and RMS current I_{rms} . Current and power values incorporate current sensor accuracy.

-6. Flag concept

IEC61000-4-30 Flagging concept

If an unreliable values are produce during a dip, swell, or interruption, approx. 200-ms aggregation will be "flagged."

An interval data including the flagged 200-ms aggregation will also be flagged.

Flagged data are referenced to decide the frequency for an interruption, and are recorded in status information of the TIME PLOT data. If events of a dip, swell, or interruption are set to off, the values are also flagged.

13.3 Screen Specifications

Operating modes

Four modes: **[Setting]**, **[Recording]**, **[Waiting]**, and **[Analyzing]**

A group of screens including **[SYSTEM]**, **[VIEW]**, **[TIME PLOT]**, and **[EVENT]** displays groups exists for each mode.

[Setting] **(Setting)**

Instrument has been turned on, and there is no data stored internally.

[SYSTEM]	Settings can be changed, and measured values are updated approximately once every 0.5 s.
[VIEW]	Screen updated approximately once every 0.5 s
[TIME PLOT]	None
[EVENT]	None
START LED	Off

[Waiting] **(Waiting)**

Effective from the time the **START/STOP** button is pressed until the recording start time.

[SYSTEM]	Settings cannot be changed, and measured values are updated approximately once every 0.5 s.
[VIEW]	Screen updated approximately once every 0.5 s
[TIME PLOT]	Standby display with time series graph
[EVENT]	Standby display
START LED	Flashing

[Recording] **(Recording)**

Recording has started, and measurement data is being saved on the SD memory card.

[SYSTEM]	Settings cannot be changed, and measured values are updated approximately once every 0.5 s.
[VIEW]	Screen updated approximately once every 0.5 s
[TIME PLOT]	Screen updated every TIME PLOT interval
[EVENT]	Screen updated every time an event occurs
START LED	On

[Analyzing] **(Analyzing)**

Recording has stopped, and the instrument's internal measurement data can be analyzed.

[SYSTEM]	Settings cannot be changed, and measured values are updated approximately once every 0.5 s.
[VIEW]	Analysis of event specified on the [TIME PLOT] or [EVENT] screen
[TIME PLOT]	Time series graph display
[EVENT]	Event display
START LED	Off

-1. [SYSTEM] screen

(1) System settings

Setting	Choices	
	CH123	CH4
Wiring	1P2W/1P3W/3P3W2M/3P3W3M/3P4W/3P4W2.5E	AC/DC/OFF
Current sensor and current range	CT7116 (6 A)/9657-10, 9675: 5 A/500 mA CT7131 (100 A)/9660, 9695-03: 100 A/50 A CT7136 (600 A)/9661: 500 A/50 A CT7044, CT7045, CT7046 (600 A)/CT9667 (500 A): 500 A/50 A CT7044, CT7045, CT7046 (6 kA)/CT9667 (5 kA): 5000 A/500 A 9669 : 1000 A/100 A CT7126 (60 A)/9694, 9695-02 : 50 A/5 A CT7731 (100 A): 100 A/50 A CT7736 (600 A): 500 A/50 A CT7742 (2 kA): 5000 A/500 A	
Current sensor automatic detection	Connected sensors that support the HIOKI PL14 connector are automatically detected when selected on the settings screen.	
Phase names	R S T/A B C/L1 L2 L3/U V W	—
Zero-adjustment	Zero-adjustment is performed.	
Vector area	Vector area phase range : $\pm 1^\circ$ to $\pm 30^\circ$ Vector area amplitude range : $\pm 1\%$ to $\pm 30\%$ Vector area U/I phase difference: -60° to $+60^\circ$	—
VT ratios	1/60/100/200/300/600/700/1000/2000/2500/5000/User-selectable (0.01 to 9999.99)	
CT ratios	1/40/60/80/120/160/200/240/300/400/600/800/1200/User-selectable (0.01 to 9999.99)	
Nominal input voltage	100/101/110/120/127/200/202/208/220/230/240/277/347/380/400/415/480/600/User-selectable (50 V to 780 V, in 1 V increments)	—
Measurement frequency	50 Hz/60 Hz/400 Hz	—
Urms type*	Phase voltage/line voltage	—
PF type*	PF/DPF	—
THD type*	THD-F/THD-R	—
Harmonics*	U, I, P: All Levels/U, I, P: All content percentage/U, P: Content percentage, I: Level	—
Flicker	Pst, Plt/ ΔV_{10}	—
Filters (luminosity curve filters)	230 V lamp/120 V lamp (When Pst or Plt is selected during flicker measurement)	—

*: Detailed description of Urms type, PF type, THD type, and harmonics

Details	Selection	Urms type	PF type	THD type	Harmonics
Measured value (DMM screen)		Selection is applied to RMS voltage (Urms) only and does not affect RMS voltage refreshed each half-cycle or transient measured values.	Selection is applied.	Selection is applied.	Selection is applied.
Measured value display switching (DMM screen display only)		Phase voltage/line voltage switched on DMM screen.	-	-	Level/content percentage switched on DMM screen.
TIME PLOT and events		Selection on main settings screen is applied to RMS voltage (Urms) but does not affect RMS voltage refreshed each half-cycle or transient events.	Selection on main settings screen is applied.	Selection on main settings screen is applied.	Selection on main settings screen is applied.
Binary data storage (displayed on computer application)		Phase voltage and line voltage	Power factor and displacement power factor	THD-F and THD-R	Level and content percentage
Other		Valid with 3P3W3M, 3P4W, and 3P4W2.5E connections. Does not apply to waveform.	DPF values for channels (excluding sum values) for 3P3W2M and 3P3W3M connections are undefined.		

13.3 Screen Specifications

(2) Hardware settings

Display language	Japanese/English/Chinese Simple (Simplified)/Chinese Trad (Traditional)/Korean/German/French/Italian/Spanish/Turkish/Polish				
Beep sound	ON/OFF				
Screen color	COLOR1/COLOR2/COLOR3/COLOR4/COLOR5				
Clock setting	Western calendar year, month, day, hours, and minutes				
LCD backlight	AUTO OFF (2 min) /ON (Continuous) Backlight automatically turns off 2 min. after last key operation. Once the backlight has turned off, it will automatically turn back on with operation of any key (including when the key lock is engaged).				
System reset	System reset reverts the instrument to factory defaults (except for display language, time, phase names, RS host, IP address, subnet mask, default gateway and FTP server settings).				
Instrument information	Software version and serial number display				
External event output parameters	OFF/short pulse/long pulse/ ΔV10 alarm (when ΔV10 has been selected during flicker measurement)				
External control (IN)	Event, START/STOP				
ΔV10 alarm threshold	0.00 V to 9.99 V				
External interface settings	<table border="1"> <tr> <td>RS-232C</td> <td>RS host: OFF/GPS GPS: Time zone, expressed as the divergence from coordinated universal time (UTC): -13:00 to +13:00, user-selectable</td> </tr> <tr> <td>LAN</td> <td>IP Address : 3 characters.3 characters.3 characters.3 characters (**.***.***.***) Subnet Mask : 3 characters.3 characters.3 characters.3 characters (**.***.***.***) Default Gateway: 3 characters.3 characters.3 characters.3 characters (**.***.***.***) FTP authentication: ON/OFF User name : Up to 20 one-byte characters (Available only with the authentication set to on) Password : Up to 20 one-byte characters (Available only with the authentication set to on)</td> </tr> </table>	RS-232C	RS host: OFF/GPS GPS: Time zone, expressed as the divergence from coordinated universal time (UTC): -13:00 to +13:00, user-selectable	LAN	IP Address : 3 characters.3 characters.3 characters.3 characters (**.***.***.***) Subnet Mask : 3 characters.3 characters.3 characters.3 characters (**.***.***.***) Default Gateway: 3 characters.3 characters.3 characters.3 characters (**.***.***.***) FTP authentication: ON/OFF User name : Up to 20 one-byte characters (Available only with the authentication set to on) Password : Up to 20 one-byte characters (Available only with the authentication set to on)
RS-232C	RS host: OFF/GPS GPS: Time zone, expressed as the divergence from coordinated universal time (UTC): -13:00 to +13:00, user-selectable				
LAN	IP Address : 3 characters.3 characters.3 characters.3 characters (**.***.***.***) Subnet Mask : 3 characters.3 characters.3 characters.3 characters (**.***.***.***) Default Gateway: 3 characters.3 characters.3 characters.3 characters (**.***.***.***) FTP authentication: ON/OFF User name : Up to 20 one-byte characters (Available only with the authentication set to on) Password : Up to 20 one-byte characters (Available only with the authentication set to on)				

(3) Recording Settings

Time Start	Manual/Time/Exactly Start time and date: Western year/Month/Day Hours:Minutes Stop time and date: Western year/Month/Day Hours:Minutes (The stop time cannot be set when repeat recording is set to 1 week. If repeat recording is set to 1 day, the hours and minutes can be set based on the start and stop times.)
Repeat setting	OFF/1 Week/1 Day OFF: Repeat recording not performed. 1 Week: Repeat recording is performed one week at a time. Set the repeat count. 1 Day: Repeat recording is performed one day at a time. Specify the start and stop times for one day.
Repetition time	With a repeat setting of one day, specify the start and stop times for one day. Start time: Hours and minutes, in 1-minute increments (using 24-hour time) Stop time: Hours and minutes, in 1-minute increments (using 24-hour time)
Repeat number	When repeated recording is set to 1 week: 1 to 55 count When repeated recording is set to 1 day: 1 to 366 count (When actual time control is enabled, set based on the stop time and date.)

(4) Time-series data settings

Recording parameter setting	Power (Small) / Power and Harmonic (Normal) / All data (Full) Records MAX, MIN, and AVG values. Note: Only MAX and MIN values are recorded for voltage 1/2 RMS values, current 1/2 RMS values, frequency 1 wave, and instantaneous flicker values. During 400 Hz measurement, the "all" (Full) setting is not available.
-----------------------------	--

Power (Small) / Power and Harmonic (Normal) / All data (Full) details

Recorded item	Power	Power and Harmonic	All data	Recorded item	Power	Power and Harmonic	All data
RMS voltage refreshed each half-cycle	Yes	Yes	Yes	Harmonic voltage		Yes	Yes
RMS current refreshed each half-cycle	Yes	Yes	Yes	Harmonic current		Yes	Yes
Frequency 200 ms	Yes	Yes	Yes	Harmonic power		Yes	Yes
Frequency cycle	Yes	Yes	Yes	Harmonic voltage and current phase difference		Yes	Yes
10-sec frequency	Yes	Yes	Yes	Harmonic voltage phase angle		Yes	Yes
RMS voltage	Yes	Yes	Yes	Harmonic current phase angle		Yes	Yes
RMS current	Yes	Yes	Yes				
Voltage waveform peak	Yes	Yes	Yes	Inter-harmonic voltage			Yes
Current waveform peak	Yes	Yes	Yes	Inter-harmonic current			Yes
Active power	Yes	Yes	Yes	Total harmonic voltage distortion factor	Yes	Yes	Yes
Efficiency	Yes	Yes	Yes	Total harmonic current distortion factor	Yes	Yes	Yes
Apparent power	Yes	Yes	Yes	Mains signaling voltage	Yes	Yes	Yes
Reactive power	Yes	Yes	Yes				
Power factor/displacement power factor	Yes	Yes	Yes	High-order harmonic voltage component	Yes	Yes	Yes
Voltage unbalance factor	Yes	Yes	Yes	High-order harmonic current component	Yes	Yes	Yes
Current unbalance factor	Yes	Yes	Yes	K factor	Yes	Yes	Yes
Instantaneous flicker value	Yes	Yes	Yes				
Integral power	Yes	Yes	Yes	Flicker ($\Delta V10/ Pst, Plt$)	Yes	Yes	Yes

TIME PLOT interval 1 second/3 seconds/15 seconds/30 seconds/1 minute/5 minutes/10 minutes/15 minutes/30 minutes/1 hour/2 hours/150 cycle (only at 50 Hz)/180 cycle (only at 60 Hz) /1200 cycle (only at 400 Hz)

Automatic saving Saves data to the SD memory card for each TIME PLOT interval.

Screen copy interval OFF/5 minutes/10 minutes/30 minutes/1 hour/2 hours
Outputs the display image to the SD memory card on a regular basis.

13.3 Screen Specifications

(5) Event Settings

Event hysteresis	0% to 10% (Applies to all parameters except frequency.) Fixed to 0.1 Hz for frequency; percentage of threshold value for other parameters.
Maximum recordable events	1000/9999 Sets the maximum number of recordable events per measurement when repeat recording is off. When the repeat recording function is on, the number of events is obtained by multiplying this setting by the repeat count. A setting of 9999 disables voltage waveform comparison events.
Slide reference voltage	OFF/ON (Applies to swells and dips.) When turned on, the slide reference voltage is used instead of the nominal voltage.
Timer event count	OFF/1 minute/5 minutes/10 minutes/30 minutes/1 hour/2 hours Events are generated at the chosen interval.
Continuous event count	OFF/1/2/3/4/5 times Applies to all events being recorded. When time target events occur, they are automatically treated as sequential events if the event in question occurs the set number of times. However, events occurring during sequential events cannot trigger sequential events. In addition, generation of sequential events stops when recording stops.
External event	OFF,ON
Event setting details	See: "5.6 Changing Event Settings" (p.87)

(6) [MEMORY] Screen

Target interface	SD memory card
Function	Mass storage, saving (of settings data), loading (of settings data, measurement data, event data, screen data, and version upgrade files), deletion of folders and files, and formatting

(7) Easy settings

Setting	Pattern	Abnormal voltage detection	Basic power supply quality measurement	Inrush current measurement	Measured value recording	EN50160
Connection		Set in advance				
Current sensor		Set in advance				
CT, PT ratios		Set in advance				
Measurement frequency		Automatic detection of 50 Hz/60 Hz/400 Hz; if unable to detect, user (manual) setting				
Nominal input voltage		Automatic detection; if unable to detect, user (manual) setting				
Flicker		Pst, Plt	Pst, Plt	Pst, Plt	Pst, Plt	Pst, Plt
Measurement RMS voltage selection		Default	Default	Default	Default	Default
Measurement harmonics selection		RMS value	RMS value	RMS value	RMS value	Content percentage
Total harmonic distortion factor selection		THD_F	THD_F	THD_F	THD_F	THD_F
Power factor selection		PF	PF	PF	PF	PF
Repeat setting and iterations		OFF (max. 35 days)	OFF (max. 35 days)	OFF (max. 35 days)	OFF (max. 35 days)	OFF (max. 35 days)
Recorded items setting		Power and Harmonic	All data	Power and Harmonic	All data	All data
TIME PLOT interval		1 minute	10 minutes	1 minute	10 minutes	10 minutes
Current range		Automatic detection	Automatic detection	Max. range	Automatic detection	Automatic detection
Event hysteresis		1%	1%	1%	1%	2%
Transient overvoltage		70% of nominal voltage	70% of nominal voltage	OFF	OFF	100% of nominal voltage
Voltage swell		110% of nominal voltage	110% of nominal voltage	OFF	OFF	110% of nominal voltage
Voltage dip		90% of nominal voltage	90% of nominal voltage	OFF	OFF	90% of nominal voltage
Interruption		10% of nominal voltage	10% of nominal voltage	OFF	OFF	1% of nominal voltage
Frequency 200 ms		±5 Hz of nominal frequency	±0.5 Hz of nominal frequency	OFF	OFF	±0.5 Hz of nominal frequency
Frequency cycle		OFF	OFF	OFF	OFF	OFF
Voltage waveform peak (±)		150% of reference value	150% of reference value	OFF	OFF	170% of nominal voltage
Voltage DC fluctuation (±) (when DC is selected)		±10% based on DC measured value	±10% based on DC measured value	OFF	OFF	OFF
Current waveform peak (±)		OFF	200% of reference value	300% of reference value	OFF	OFF
Current DC fluctuation (±) (when DC is selected)		±10% based on DC measured value	±10% based on DC measured value	OFF	OFF	OFF
RMS voltage		10% of reference value SENSE width: ±10 V	10% of reference value SENSE width: ±10 V	OFF	OFF	OFF
RMS current		OFF SENSE width: OFF	50% of reference value SENSE width: OFF	OFF SENSE width: OFF	OFF SENSE width: OFF	OFF SENSE width: OFF
Inrush current (I _{rms} 1/2)		OFF	OFF	200% of reference value	OFF	OFF
Active power		OFF	OFF	OFF	OFF	OFF
Apparent power		OFF	OFF	OFF	OFF	OFF
Reactive power		OFF	OFF	OFF	OFF	OFF
Power factor/displacement power factor		OFF	OFF	OFF	OFF	OFF
Voltage unbalance factor (zero-phase, negative-phase)		OFF, 3%	OFF, 3%	OFF, OFF	OFF, OFF	OFF, 2%

13.3 Screen Specifications

(7) Easy settings

Setting \ Pattern	Abnormal voltage detection	Basic power supply quality measurement	Inrush current measurement	Measured value recording	EN50160
Current unbalance factor (zero-phase, negative-phase)	OFF, OFF	OFF, OFF	OFF, OFF	OFF, OFF	OFF, OFF
Harmonic voltage fundamental wave order 0 Harmonic orders 3, 5, 7, 9 11	OFF OFF OFF	OFF 5% of nominal voltage 10% of nominal voltage	OFF OFF OFF	OFF OFF OFF	As per EN50160 harmonic voltage limit value; see table below.
Harmonic current fundamental wave order 0 Harmonic orders 3, 5, 7, 9, 11	OFF OFF OFF	OFF 5% of range OFF	OFF OFF OFF	OFF OFF OFF	OFF OFF OFF
Harmonic power fundamental wave order 0 Harmonic orders 3, 5, 7, 9 11	OFF OFF OFF	OFF OFF OFF	OFF OFF OFF	OFF OFF OFF	OFF OFF OFF
Harmonic voltage and current phase difference	OFF	OFF	OFF	OFF	OFF
Total harmonic voltage distortion factor	5%	7%	OFF	OFF	OFF
Total harmonic current distortion factor	OFF	OFF	OFF	OFF	OFF
K factor	OFF	OFF	OFF	OFF	OFF
High-order harmonic voltage component	OFF	OFF	OFF	OFF	OFF
High-order harmonic current component	OFF	OFF	OFF	OFF	OFF
Voltage waveform comparison	±15%	±10%	OFF	OFF	OFF
Mains signaling voltage	OFF	OFF	OFF	OFF	OFF

- For current (RMS value, inrush current, and peak current), when the reference value (measured value) is 10% or less of the range, 10% of the range is used as the threshold value, and when the reference value (measured value) exceeds 100% of the range, 100% of the range is used as the threshold value.
- When the RMS voltage is less than 3% f.s. of the range, 5% of the range is used as the upper limit, and 0% of the range is used as the lower limit. When the voltage peak value is less than or equal to 3% f.s. of the range, 5% of the range is used as the threshold value.
- For total harmonic voltage and current distortion as well as harmonic voltage, functionality is disabled when the measured value (voltage RMS value or current RMS value) is less than or equal to 3% f.s. of the range.
- If VT or CT is changed after simple configuration (including when changed outside of the simple configuration process), the threshold and sense values will not change. (Either repeat simple configuration or reconfigure the event threshold values after setting VT and CT.)
- As a rule, settings not included in the table are set to OFF (other than manual events).

EN50160 harmonic voltage limits

Odd harmonics				Even harmonics	
Not multiples of 3		Multiples of 3			
Order h	Relative voltage (Un)	Order h	Relative voltage (Un)	Order h	Relative voltage (Un)
5	6.0%	3	5.0%	2	2.0%
7	5.0%	9	1.5%	4	1.0%
11	3.5%	15	0.5%	6...24	0.5%
13	3.0%	21	0.5%		
17	2.0%				
19	1.5%				
23	1.5%				
25	1.5%				

Un = nominal voltage (Uref)

-2. [VIEW] screen**(1) Waveform display**

Displayed screens	1. Voltage/Current : 2-segment split display (voltage waveform (U1 to U4), current waveform (I1 to I4)) 2. Voltage 4 channels: 4-segment split display (voltage waveform (U1 to U4)) 3. Current 4 channels: 4-segment split display (current waveform (I1 to I4))
Display axis selection	Vertical axis: Choose from $\times 1/3$, $\times 1/2$, $\times 1$, $\times 2$, $\times 5$, $\times 10$, $\times 20$, and $\times 50$. Time axis: 5 ms/div., 10 ms/div., 20 ms/div., or 40 ms/div.
Cursor measurement	CH1, CH2, CH3, and CH4 waveform cursor values and cursor times
Scroll function	Vertical axis scrolling, horizontal axis scrolling

(2) Harmonic display

Displayed screens	Vector/harmonic graph/harmonic list	
Vectors	1. Level: Vector display + harmonic RMS value display 2. Content percentage: Vector display + Harmonic content percentage display 3. Phase angle: Vector display + Harmonics phase angle display	
	Display format	Display of harmonic voltage RMS value and harmonic current RMS value vectors Display of harmonic voltage and current content percentage vectors (including fundamental wave)
	Display parameter	By order: Harmonic voltage RMS value, content percentage, phase angle, and harmonic current RMS value or phase angle Fundamental wave: Frequency, voltage unbalance factor, current unbalance factor
	Vertical axis display format	Choose from LINEAR or LOG.
	Selection of phase angle display	Choose from $\pm 180^\circ$ and $+360^\circ$ lag. (When $+360^\circ$ lag has been selected, the user can choose the reference source [U1 to U3, I1 to I3]. The selected reference source will be used as the reference [0°] for each order. When $\pm 180^\circ$ has been selected, the U1 fundamental wave is used as the reference source.)
	Order selection	Order cursor values (during 400 Hz measurement, 0th to 10th orders)
Harmonic graph	Display format	3-segment display Area 1: harmonic voltage RMS value, content percentage, phase angle, inter-harmonic voltage Area 2: harmonic current RMS value, content percentage, phase angle, inter-harmonic current Area 3: harmonic power, content percentage, harmonic voltage/current phase difference Display of inter-harmonics is not available during 400 Hz measurement. The voltage and current RMS value display incorporates high-order harmonic components.
	Display selection	Channel : Choose from CH1, CH2, CH3, CH4, and sum. Vertical axis display format : Choose from LINEAR and LOG. Display parameter 1 : Inter-harmonics ON/OFF (Display of inter-harmonics is not available during 400 Hz measurement.) Display parameter 2 : Choose from LEVEL (RMS value), % of Fnd (content percentage), and PHASE (phase angle).
	Order selection	Select THD or an order number for the order cursor values (For the 400 Hz measurement, orders of 0th to 10th are available.)
Harmonic list	Display format	List display of one of following: harmonic voltage, harmonic current, harmonic power, harmonic voltage phase angle, harmonic current phase angle, harmonic voltage/current phase difference, inter-harmonic voltage, and inter-harmonic current.
	Display selection	Channel : Choose from CH1, CH2, CH3, CH4, and sum. Vertical axis display format : Choose from LINEAR and LOG. Display parameter 1 : Inter-harmonics ON/OFF (Display of inter-harmonics is not available during 400 Hz measurement.) Display parameter 2 : Choose from LEVEL (RMS value), % of Fnd (content percentage), and PHASE (phase angle).

13.3 Screen Specifications

(3) DMM display

Display screens and parameters	<ol style="list-style-type: none"> 1. Power : RMS voltage, RMS current, Active power, Reactive power, Apparent power, Power factor/displacement power factor, Frequency 200 ms, Active energy, Reactive energy, K factor, Efficiency 2. Voltage : 10-sec frequency, RMS voltage, Voltage total harmonic distortion, Current waveform peak value (positive, negative), Frequency 200 ms, High-order harmonic component, Zero-sequence negative-sequence unbalance ratio 3. Current : RMS current, Current total harmonic distortion, Current waveform peak value (positive, negative), Frequency 200 ms, High-order harmonic component, Zero-sequence negative-sequence unbalance ratio
--------------------------------	---

-3. [TIME PLOT] screen

(1) Trend graph display

Displayed screens	1-screen display/2-screen display/Integrated power display				
Display update rate during measurement	Every TIME PLOT interval				
Displayed content					
	Displayed screens	Displayed item	Channel selection	Display parameters and description	Remarks
	1-screen display	Freq/Freq10s/Upk+/Upk-/Ipk+/Ipk-/Urms/UrmsAVG/Udc/Urms/UrmsAVG/Idc/P/S/Q/PF/DPF/Uunb0/Uunb/	✓	Time-series graph showing the MAX, MIN, and AVG values for 1 parameter	Display parameters are limited based on the recording parameter setting.
	2-screen display	lunb0/lunb/UharmH/lharmH/Uthd-F/Uthd-R/lthd-F/lthd-R/KF/Eff1/Eff2/Msv1/Msv%1/Msv2/Msv%2	✓	Time-series graph showing the MAX, MIN, and AVG values for 2 parameters	
	Integrated power display	WP+/WP-/WQLAG/WQLEAD	—	Time-series graph showing 1 parameter	
Additional display	Event occurrence point display function (not available on the [Integrated Power] screen)				
Event jump function	Allows details for specified event to be analyzed on [VIEW] screen.				
Time-series graph cursors	Yes				

(2) Detailed trend graph display (interval)

Displayed screens	Time series graph of maximum and minimum values for fluctuation data
Display update rate during measurement	Every TIME PLOT interval
Displayed content	Select and display any 1 of Urms1/2, Irms1/2, Pinst, Frequency cycle, and Inrush cycle.
Additional display	Event threshold value display function, Event occurrence point display function
Event jump function	Allows details for specified event to be analyzed on [VIEW] screen.
Time-series graph cursors	Yes

(3) Harmonic trend graph display

Displayed screens	1-screen display
Display update rate during measurement	Every TIME PLOT interval
Displayed content	Time series graph of maximum, minimum, and average values for up to 6 items
Additional display	Event occurrence point display function
Event jump function	Allows details for specified event to be analyzed on [VIEW] screen.
Time-series graph cursors	Yes

(4) Inter-harmonics trend graph display

Displayed screens	1-screen display
Display update rate during measurement	Every TIME PLOT interval
Displayed content	Time series graph of maximum, minimum, and average values for up to 6 items
Additional display	Event occurrence point display function
Event jump function	Allows details for specified event to be analyzed on [VIEW] screen.
Time-series graph cursors	Yes

(5) ΔV_{10} flicker graph display (when flicker is set to ΔV_{10})

Displayed content	Time series graph of ΔV_{10} (instantaneous value) (simultaneous display for all measurement channels)
Time-series graph cursors	Yes
Constraints	No display for 400 Hz measurement

(6) ΔV_{10} flicker list display (when flicker is set to ΔV_{10})

Display refresh rate	Every 1 min (ΔV_{10} overall maximum value), every 1 hour (others)
Displayed content	ΔV_{10} 1-hour average value, ΔV_{10} 1-hour maximum value, ΔV_{10} 1-hour fourth-largest value, ΔV_{10} overall maximum value
Display selection	CH1 to CH3 (varies with connection)
Constraints	No display for 400 Hz measurement

(7) IEC flicker graph display (when flicker is set to IEC **[Pst, Plt]**)

Displayed content	Time series graph of Pst and Plt values
Time-series graph cursors	Yes
Constraints	No display for 400 Hz measurement

(8) IEC flicker list display (when flicker is set to IEC **[Pst, Plt]**)

Display refresh rate	Each time Pst is updated
Displayed content	Pst and Plt values
Constraints	No display for 400 Hz measurement

13.3 Screen Specifications

-4. [EVENT] screen

Event list display

Display format	<ul style="list-style-type: none"> • Event list display • Event details display (detailed information for event selected on event list) • Waveform display (waveform for event selected on event list; either voltage or current screen as set with [VIEW] screen's [VOLT/CURR] display setting)
Event list display order	Order of occurrence
Event jump function	Allows details for specified event to be analyzed on [VIEW] screen.

-5. Event monitor screen

Displayed content	Event data chosen on the [TIME PLOT] or [EVENT] screen
Content	Waveform / Harmonics / DMM / Transient Waveforms / High-order Harmonic Waveforms / Fluctuation data

(1) Transient overvoltage waveform display

Display selection	All voltage channels
Display period	2 ms before and 2 ms after trigger point

(2) High-order harmonics waveform display

Display format	High-order harmonic voltage component and current component waveforms
Display selection	Channel: Select from CH1, CH2, CH3, and CH4
Display period	40 ms starting after the first approx. 200 ms aggregation interval in which event occurred (8000 data points)
Cursor measurement	Yes

(3) Fluctuation data display (detailed trend graph at event occurrence)

Displayed screens	Time series graph of fluctuation data at event occurrence
Display update rate during measurement	Each time a displayed event occurs (display is overwritten)
Displayed content	Any one of Urms1/2, Irms1/2 or Inrush
Cursor measurement	Yes

13.4 Event Specifications

-1. Event content

See: "Event items, list notation, and saved items" (p.145)

-2. Event detection

Event detection method	<ul style="list-style-type: none"> • The detection method relative to measured values for each event target is listed in the measurement specifications. • External events are detected by detecting signal input to the external event (EVENT IN) terminal. • Manual events are detected when the MANU EVENT key is pressed. • Enabled measurement item events are detected using OR logic. • Events cannot be detected using maximum, minimum, or average values. • The threshold setting error is ± 1 dgt. relative to the setting.
------------------------	--

-3. Event-synchronized save functionality

Event waveform	Approx. 200 ms aggregation (10 cycle/12 cycle) + instantaneous waveforms for 2 cycles before and after (20 kS/s) (for 400 Hz measurement, 80 cycles + 16 cycles before and after)
Transient waveform	Instantaneous waveform for 2 ms before and after the transient overvoltage waveform detection position (2 MS/s)
High-order harmonic waveform	Instantaneous waveform for 40 ms following the first approx. 200 ms aggregation period in which the reading is greater than the threshold (200 kS/s) 8000 data points
Fluctuation data	Display of RMS fluctuation data every half cycle equivalent to from 0.5 s before the event to 29.5 s after event (for 400 Hz, measurement, from 0.125 s before to 7.375 s after) as a detailed trend graph

-4. Sense function

A SENSE START event occurs and sense starts when the upper or lower value is exceeded while sense is on. While the sense function is operating, measured values are continuously compared to the range defined by (the measured value when the event last occurred + the sense threshold) and (the measured value when the event last occurred - the sense threshold). If the value falls outside this range, a sense event is generated, and the sense range is updated. When the upper limit or lower limit exceeded event ends, a SENSE END event is generated, and sense function operation terminates.

If SENSE and SENSE END overlap, SENSE END will have priority. (SENSE START and SENSE END are not shown on the display.)

13.5 GPS Time Synchronization Function

The PW9005 GPS Box can be connected to the instrument to synchronize the instrument's time with the GPS satellite time (coordinated universal time).

GPS settings and status display function

GPS box connection setting	RS connected device: GPS	
GPS reception status display	Positioning status	: Err (no positioning data), 2D (2D independent positioning), 3D (3D independent positioning), D2D (differential 2D positioning), D3D (differential 3D positioning)
	No. of positioning satellites	: 0 to 12 (no. of satellites that can be used in position calculation)
	DOP value	: 0 to 9999 (GPS positioning status reliability) (smaller values other than 0 indicate higher reliability)
GPS mark	A GPS mark is displayed among other icons along the top of the screen to indicate the GPS positioning status.	
	Blue GPS mark	: Time correction has been performed.
	Yellow GPS mark	: The device is unable to acquire GPS satellites or unable to calculate its position. The yellow mark is also shown when time correction is canceled during recording.
	Red GPS mark	: The PQ3198 has not detected the GPS box.

Time correction function

Corrected time and correction accuracy	Set to amount of variation from universal coordinated time (UTC). The instrument's clock is corrected within ± 2 ms of the GPS time accuracy.
Initial position	1. The GPS mark is yellow after connecting the model PW9005 GPS Box to the instrument. 2. The GPS mark turns blue after the unit has acquired GPS satellites and positioning status and finished correcting the instrument time.
Time correction processing	<ul style="list-style-type: none"> • Time correction is performed once every 1 s (during recording, once every 30 s). • If the time variation is 16 ms or less during recording, time correction is performed every second with ms-order precision. If the time variation is greater than 16 ms, a "GPS Err event" occurs, and time correction is not performed.
GPS event function	When recording is started in the time-corrected state (while the GPS mark is blue), a GPS event is generated when any of the following occur during recording: <ul style="list-style-type: none"> • GPS error (GPS error): GPS IN • GPS error cleared (GPS positioning): GPS OUT • GPS time correction failure (GPS time error): GPS Err

13.6 Interface Specification

USB	Connector	Series B receptacle
	Method Connection destination	USB 2.0 (full-speed, high-speed), mass storage class Computer: Windows 7 (32-bit/64-bit) / Windows 8 (32-bit/64-bit) / Windows 10 (32-bit/64-bit)
	Connection	Recognition of the SD memory card as a removable disk when connected to a computer. The instrument cannot be connected during recording (including standby operation).
LAN	Connector	RJ-45
	Electrical specifications	IEEE 802.3-compliant Ethernet
	Transmission method	100BASE-TX
	Protocol	TCP/IP
	Functions	<ul style="list-style-type: none"> · HTTP server function · Remote operation application function · Measurement start and stop control functions · System configuration function · Event list function (capable of displaying event waveforms, event vectors, and event harmonic bar graphs) · Acquisition of measurement files using GENNECT (FTP client function)
RS-232C	Connector	D-sub 9 pin
	Method	RS-232C "EIA RS-232D", "CCITT V.24", "JIS XS101" compliant
	Connection destination	GPS box (cannot be connected to computer)
	Functions	Measurement and control using GPS-synchronized time
SD memory card	Slot	SD standard compliant
	Compatible card	SD memory card/ SDHC memory card
	Functions	<ul style="list-style-type: none"> · Saving of binary data (measured data / event data) (up to 9999 files) Up to 100 files of measurement data can be saved on the same date. · Loading of binary data (measurement data/event data) · Saving of settings files (up to 102 files) · Loading of settings files (up to 102 files) · Saving of screen copies (up to 99,999,999 files) · Loading of screen copies (up to 102 files) · Deleting of files · Formatting of SD memory cards
	Media full processing	Saving of data to SD memory card is stopped (time series data is stored on a first-in, first-out basis.)

13.6 Interface Specification

External control

Connector 4-pin screwless terminal block

External event input

External event input item setting	Operation	Pulse width
ON	Events occur at TTL low or short between the [GND] and [EVENT IN] terminals.	Low level for 30 ms or more
START/STOP	Recording starts and stops at TTL low or short between the [GND] and [EVENT IN] terminals. When a START (or STOP) event is detected, the instrument accepts no STOP (or START) events for one second. Using the external control to start recording data causes the instrument to reset data forcibly.	Low level for 50 ms or more

Rated voltage -0.5 V to +6.0 V

External event output

External event output item setting	Operation	Pulse width
Short pulse output	TTL low output at event generation between [GND] terminal and [EVENT OUT] terminal	Low level for 10 ms or more
Long pulse output	TTL low output at event generation between [GND] terminal and [EVENT OUT] terminal No external event output at START event and STOP event.	Low level for 2.5 s
$\Delta V10$ alarm	TTL low output at $\Delta V10$ alarm generation between [GND] terminal and [EVENT OUT] terminal	Low level while alarm occurring; reverts to high at data reset

Rated voltage -0.5 V to +6.0 V

Pin assignment

Pin	Signal name	I/O	Function	Operation
1	EVENT IN	IN	Event-in	Level
2	EVENT OUT	OUT	Event-out	Level
3	GND	—	Ground	—
4	GND	—	Ground	—

13.7 Other Functions

-1. Warning functions

Wiring check	Checks connections and current sensor reverse connections as well as phase order on the connection diagram screen.
Out of range	When the input exceeds 130% of the range, [- - - -] is displayed.
Out of crest factor	When the waveform peak exceeds 2 times the voltage range or 4 times the current range, "crest factor exceeded" is displayed.
Event check	Displays event icons when events occur.
Power supply status display, Charge status display, Battery strength display	See: "Power supply status display" (p.30)

-2. Settings confirmation function

Function description	Press the ESC key during recording (including while in standby mode) to check the present settings.
----------------------	--

-3. Screen copy

Function description	Pressing the COPY key causes the instrument to store the screenshot displayed at the time onto the SD memory card.
Data form	Compressed BMP format
File names	Auto generated, extension of ".bmp"

-4. Special key operation

Key lock function	Disables all key operation except for POWER switch and key lock cancelation. Press and hold ESC key from at least 3 s to turn the function on and off. If a passcode (in four digits or less) was entered at the time of the key lock activation, entering the same passcode is required to disengage the key lock.
Display hold	Retains displayed values excluding the time

-5. Action in the event of an anomaly

Action in the event of a power outage	With Model Z1003 Battery Pack sufficiently charged, the instrument starts to be powered by Model Z1003, allowing continuous recording. With Model Z1003 Battery Pack drained, the instrument stops recording. The settings used at the time are backed up; however, integrated values are discarded. When power is then recovered, the instrument starts recording and accumulating data anew in the previous settings.
---------------------------------------	---

-6. Setup functionality

Function description	Sets the language when the instrument is turned on for the first time.
Boot key reset	Reverts all settings, including the language setting, to the factory defaults. Turn on the instrument while holding down the ENTER and ESC keys.

13.8 Calculation Formula

-1. RMS voltage refreshed each half-cycle (Urms1/2), Dip (Dip), Swell (Swell), interruption (Intrpt), RMS current refreshed each half-cycle (Irms1/2), Inrush current (Inrush)

Connection setting Items	Single-phase 2-wire 1P2W	Single-phase 3-wire 1P3W	Three-phase 3-wire 3P3W2M	Three-phase 3-wire 3P3W3M	Three-phase 4-wire 3P4W
Urms1/2 Dip Swell Intrpt	U_1 U_4 $U_c = \sqrt{\frac{1}{M} \sum_{s=0}^{M-1} (U_{cs})^2}$	U_1 U_2 U_4	Line-to-line voltage $U_{12} = \sqrt{\frac{1}{M} \sum_{s=0}^{M-1} (U_{1s})^2}$ $U_{32} = \sqrt{\frac{1}{M} \sum_{s=0}^{M-1} (U_{2s})^2}$ U_{31} is calculated from the RMS value for ($U_{3s} = U_{2s} - U_{1s}$). U_4	Line-to-line voltage $U_{12} = \sqrt{\frac{1}{M} \sum_{s=0}^{M-1} (U_{1s})^2}$ $U_{23} = \sqrt{\frac{1}{M} \sum_{s=0}^{M-1} (U_{2s})^2}$ $U_{31} = \sqrt{\frac{1}{M} \sum_{s=0}^{M-1} (U_{3s})^2}$ U_4	Phase voltage U_1 U_2 U_3 U_4 With 3P4W2.5E connections $U_2 (U_{2s} = -U_{1s} - U_{3s})$ (Assumes $U_{1s} + U_{2s} + U_{3s} = 0$.)
<ul style="list-style-type: none"> • For 50 Hz/60 Hz measurement, calculated with 1 overlapping waveform each half-cycle. • For 400 Hz measurement, calculated with 1 waveform (M = number of samples in one 400 Hz period). 					
Irms1/2 Inrush	I_1 I_4 $I_c = \sqrt{\frac{1}{M} \sum_{s=0}^{M-1} (I_{cs})^2}$	I_1 I_2 I_4	Line-to-line voltage $I_1 = \sqrt{\frac{1}{M} \sum_{s=0}^{M-1} (I_{1s})^2}$ $I_2 = \sqrt{\frac{1}{M} \sum_{s=0}^{M-1} (I_{2s})^2}$ I_3 is calculated from the RMS value for ($I_{3s} = -I_{1s} - I_{2s}$). I_4	Line-to-line voltage $I_1 = \sqrt{\frac{1}{M} \sum_{s=0}^{M-1} (I_{1s})^2}$ $I_2 = \sqrt{\frac{1}{M} \sum_{s=0}^{M-1} (I_{2s})^2}$ $I_3 = \sqrt{\frac{1}{M} \sum_{s=0}^{M-1} (I_{3s})^2}$ I_4	I_1 I_2 I_3 I_4
<ul style="list-style-type: none"> • For 50 Hz/60 Hz measurement, Irms1/2 is calculated with 1 overlapping waveform each half-cycle, and Inrush is calculated every half-cycle. • For 400 Hz measurement, calculated with 1 waveform. 					

c: measured channel, M: number of samples per period, s: number of sampling points

-2. Voltage Waveform Peak (Upk), Current Waveform Peak (Ipk)

Phase System Items	Single Phase 2-wire 1P2W	Single Phase 3-wire 1P3W	3-Phase, 3-Wire, 2-Measurement 3P3W2M	3-Phase, 3-Wire, 3-Measurement 3P3W3M	3-Phase, 4-Wire 3P4W
Upk+ Upk-	U_{p1} U_{p4}	U_{p1} U_{p2} U_{p4}	U_{p12} U_{p23} U_{p4}	U_{p12} U_{p23} U_{p31} U_{p4}	U_{p1} U_{p2} U_{p3} U_{p4}
<ul style="list-style-type: none"> • The maximum positive and negative values are calculated for all points with 10 waveforms (50 Hz measurement) or 12 waveforms (60 Hz measurement). For 400 Hz measurement, the calculation is performed with 80 waveforms. • The CH4 voltage peak value can be calculated regardless of the connection type. 					
Ipk+ Ipk-	I_{p1} I_{p4}	I_{p1} I_{p2} I_{p4}	I_{p1} I_{p2} I_{p4}	I_{p1} I_{p2} I_{p3} I_{p4}	I_{p1} I_{p2} I_{p3} I_{p4}
<ul style="list-style-type: none"> • The maximum positive and negative values are calculated for all points with 10 waveforms (50 Hz) or 12 waveforms (60 Hz). During 400 Hz measurement, the calculation is performed with 80 waveforms. • The voltage waveform peak for CH4 can be calculated regardless of the connection method. 					

c: measured channel, M: number of samples per period, s: number of sampling points

-3. RMS Voltage (Urms), RMS Current (Irms)

Phase System Items	Single Phase 2-wire 1P2W	Single Phase 3-wire 1P3W	3-Phase, 3-Wire, 2-Measurement 3P3W2M	3-Phase, 3-Wire, 3-Measurement 3P3W3M	3-Phase, 4-Wire 3P4W
Urms	U_1 U_4 $U_{c=}$ $\sqrt{\frac{1}{M} \sum_{s=0}^{M-1} (U_{cs})^2}$	U_1 U_2 U_4	Line-to-line voltage $U_{12} = \sqrt{\frac{1}{M} \sum_{s=0}^{M-1} (U1s)^2}$ $U_{32} = \sqrt{\frac{1}{M} \sum_{s=0}^{M-1} (U2s)^2}$ U_{31} is calculated from the RMS value for ($U3s=U2s-U1s$).	Line-to-line voltage $U_{12} = \sqrt{\frac{1}{M} \sum_{s=0}^{M-1} (U1s)^2}$ $U_{23} = \sqrt{\frac{1}{M} \sum_{s=0}^{M-1} (U2s)^2}$ $U_{31} = \sqrt{\frac{1}{M} \sum_{s=0}^{M-1} (U3s)^2}$	Phase voltage U_1 U_2 U_3
			U_4	U_4	U_4
			Phase voltage	Phase voltage $U_{1j} = \sqrt{\frac{1}{M} \sum_{s=0}^{M-1} \left(\frac{U1s - U3s}{3}\right)^2}$ $U_{2j} = \sqrt{\frac{1}{M} \sum_{s=0}^{M-1} \left(\frac{U2s - U1s}{3}\right)^2}$ $U_{3j} = \sqrt{\frac{1}{M} \sum_{s=0}^{M-1} \left(\frac{U3s - U2s}{3}\right)^2}$	Line-to-line voltage $U_{12} = \sqrt{\frac{1}{M} \sum_{s=0}^{M-1} (U1s - U2s)^2}$ $U_{23} = \sqrt{\frac{1}{M} \sum_{s=0}^{M-1} (U2s - U3s)^2}$ $U_{31} = \sqrt{\frac{1}{M} \sum_{s=0}^{M-1} (U3s - U1s)^2}$
			U_4	U_4	U_4
		$U_{ave} = \frac{1}{2}(U_1 + U_2)$	Line-to-line voltage $U_{ave} = \frac{1}{2}(U_{12} + U_{32})$	Line-to-line voltage $U_{ave} = \frac{1}{3}(U_{12} + U_{23} + U_{31})$	Phase voltage $U_{ave} = \frac{1}{3}(U_1 + U_2 + U_3)$
			Phase voltage	Phase voltage $U_{ave} = \frac{1}{3}(U_1 + U_2 + U_3)$	Line-to-line voltage $U_{ave} = \frac{1}{3}(U_{12} + U_{23} + U_{31})$
<ul style="list-style-type: none"> • Calculated with 10 waveforms (50 Hz measurement) or 12 waveforms (60 Hz measurement). For 400 Hz measurement, the calculation is performed with 80 waveforms. • For 3-phase 3-wire connections, the phase voltage is calculated so that the neutral point is at the center. The CH4 RMS voltage can be calculated regardless of the connection type. 					
Irms	I_1 I_4 $I_{c=}$ $\sqrt{\frac{1}{M} \sum_{s=0}^{M-1} (I_{cs})^2}$	I_1 I_2 I_4	I_1 I_2 I_3 is calculated from the RMS value for ($I3s=-I1s-I2s$). I_4	I_1 I_2 I_3 I_4	I_1 I_2 I_3 I_4
			$I_{ave} = \frac{1}{2}(I_1 + I_2)$	$I_{ave} = \frac{1}{2}(I_1 + I_2)$	$I_{ave} = \frac{1}{3}(I_1 + I_2 + I_3)$
<ul style="list-style-type: none"> • Calculated with 10 waveforms (50 Hz measurement) or 12 waveforms (60 Hz measurement). For 400 Hz measurement, the calculation is performed with 80 waveforms. • The CH4 RMS current can be calculated regardless of the connection type. 					

c: measured channel, M: number of samples per period, s: number of sampling points

-4. Active Power (P), Apparent Power (S), Reactive Power (Q), Efficiency (Eff)

Phase System Items	Single Phase 2-wire 1P2W	Single Phase 3-wire 1P3W	3-Phase, 3-Wire, 2-Measurement 3P3W2M	3-Phase, 3-Wire, 3-Measurement 3P3W3M	3-Phase, 4-Wire 3P4W
P	P_1 P_4 $P_c = \frac{1}{M} \sum_{S=0}^{M-1} (U_{cs} \times I_{cs})$	P_1 P_2 P_4	P_1 P_2 P_4	P_1 P_2 P_3 P_4	P_1 P_2 P_3 P_4
		$P_{sum} = P_1 + P_2$	$P_{sum} = P_1 + P_2$	$P_{sum} = P_1 + P_2 + P_3$	$P_{sum} = P_1 + P_2 + P_3$
<ul style="list-style-type: none"> • Calculated with 10 waveforms (50 Hz measurement) or 12 waveforms (60 Hz measurement). For 400 Hz measurement, the calculation is performed with 80 waveforms. • For 3P3W3M and 3P4W systems, phase voltage is used for waveform voltage U_{cs}. (3P3W3M: $U_{1s} = (U_{1s} - U_{3s})/3$, $U_{2s} = (U_{2s} - U_{1s})/3$, $U_{3s} = (U_{3s} - U_{2s})/3$) • The polarity sign for active power indicates power flow direction: positive (+P) for forward power (consumption), and negative (-P) for reverse power (regeneration), and indicates net current flow for power. 					
S	S_1 S_4 $S_c = U_c \times I_c$	S_1 S_2 S_4	S_1 S_2 S_4	S_1 S_2 S_3 S_4	S_1 S_2 S_3 S_4
		$S_{sum} = S_1 + S_2$	$S_{sum} = \frac{\sqrt{3}}{2} (S_1 + S_2)$	$S_{sum} = S_1 + S_2 + S_3$	$S_{sum} = S_1 + S_2 + S_3$
For 3P3W3M and 3P4W systems, phase voltage is used for waveform voltage U_c .					
Q	Q_1 Q_4 $Q_c = \text{sic} \sqrt{S_c^2 - P_c^2}$	Q_1 Q_2 Q_4	Q_1 Q_2 Q_4	Q_1 Q_2 Q_3 Q_4	Q_1 Q_2 Q_3 Q_4
		$Q_{sum} = Q_1 + Q_2$	$Q_{sum} = Q_1 + Q_2$	$Q_{sum} = Q_1 + Q_2 + Q_3$	$Q_{sum} = Q_1 + Q_2 + Q_3$
<ul style="list-style-type: none"> • The polarity sign (sic) for reactive power (Q) is indicated by [none] for lag or [-] for lead. • The reverse of the fundamental wave reactive power (using $k = 1$ (1st order)) after calculating the harmonic reactive power for each measurement channel (c) is used as the polarity sign sic. (See the harmonic reactive power formula.) 					
Eff	$Eff1 = 100 \times P4 / P1 $ $Eff2 = 100 \times P1 / P4 $	$Eff1 = 100 \times P4 / P_{sum} $ $Eff2 = 100 \times P_{sum} / P4 $			
	<ul style="list-style-type: none"> • When the power is over-range, efficiency results will also be over-range. • When the power value used as the denominator is 0, the efficiency results will be over-range. 				

c: measured channel, M: number of samples per period, s: number of sampling points

-5. Power factor (PF), Displacement power factor (DPF)

Phase System Items	Single Phase 2-wire 1P2W	Single Phase 3-wire 1P3W	3-Phase, 3-Wire, 2-Measurement 3P3W2M	3-Phase, 3-Wire, 3-Measurement 3P3W3M	3-Phase, 4-Wire 3P4W
PF	PF_1 PF_4 $PFc = \text{sic} \left \frac{P_c}{S_c} \right $	PF_1 PF_2 PF_4	PF_1 PF_2 PF_4	PF_1 PF_2 PF_3 PF_4	PF_1 PF_2 PF_3 PF_4
		$PF_{sum} = \text{sisum} \left \frac{P_{sum}}{S_{sum}} \right $	$PF_{sum} = \text{sisum} \left \frac{P_{sum}}{S_{sum}} \right $	$PF_{sum} = \text{sisum} \left \frac{P_{sum}}{S_{sum}} \right $	$PF_{sum} = \text{sisum} \left \frac{P_{sum}}{S_{sum}} \right $
<ul style="list-style-type: none"> The polarity symbol si for power factors indicates a LEAD or LAG in polarity; no symbol indicates a LAG, while the "-" symbol indicates a LEAD. Calculate the harmonic reactive power using the polarity symbol sic and attach the opposit symbol for the fundamental wave reactive power (using $k = 1$ (1st order) for each measured channel (c)). Calculate the harmonic reactive power using the polarity symbol sisum and attach the opposite symbol of the sum of the fundamental wave reactive power (using $k = 1$ (1st order)). (See the harmonic reactive power formula.) 					
DPF	DPF_1 $DPFc = \text{sic} \cos \theta_{c1} $	DPF_1 DPF_2	DPF_1 DPF_2	DPF_1 DPF_2 DPF_3	DPF_1 DPF_2 DPF_3
		$DPF_{sum} = \text{sisum} \left \frac{P_{sum1}}{S_{sum1}} \right $	$DPF_{sum} = \text{sisum} \left \frac{P_{sum1}}{S_{sum1}} \right $	$DPF_{sum} = \text{sisum} \left \frac{P_{sum1}}{S_{sum1}} \right $	$DPF_{sum} = \text{sisum} \left \frac{P_{sum1}}{S_{sum1}} \right $
<ul style="list-style-type: none"> The polarity symbol si of power factors indicates a LEAD or LAG in polarity; no symbol indicates a LAG, while the "-" symbol indicates a LEAD. Calculate the harmonic reactive power using the polarity symbol sic and attach the opposit symbol for the fundamental wave reactive power (using $k = 1$ (1st order) for each measured channel (c)). Calculate the harmonic reactive power using the polarity symbol sisum and attach the opposite symbol for the sum of the fundamental wave reactive power (using $k = 1$ (1st order)). (See the harmonic reactive power formula.) θ_{c1} indicates the voltage-current phase difference for the fundamental wave. (See the voltage-current phase difference formula.) P_{sum1} indicates the total of fundamental wave power and the formula becomes $k = 1$ for the sum of harmonic power. (See the harmonic power formula.) S_{sum1} indicates the total of fundamental wave apparent power and can be calculated using the fundamental wave RMS voltage and fundamental wave RMS current. (For information on the formulae for harmonic voltage, harmonic current, and the sum of apparent power, see each of their calculation formulae.) 					

c: measured channel, k: order for analysis

-6. Voltage unbalance factor, Current unbalance factor

Phase System Items	Single Phase 2-wire 1P2W	Single Phase 3-wire 1P3W	3-Phase, 3-Wire, 2-Measurement 3P3W2M	3-Phase, 3-Wire, 3-Measurement 3P3W3M	3-Phase, 4-Wire 3P4W
Voltage unbalance factor Uunb0 [%]	/	/	$U_{unb0} = \frac{U_{zero}}{U_{pos}} \times 100$		
Voltage unbalance factor Uunb [%]	/	/	$U_{unb} = \frac{U_{neg}}{U_{pos}} \times 100$		
Current unbalance factor Iunb0 [%]	/	/	$I_{unb0} = \frac{I_{zero}}{I_{pos}} \times 100$		
Current unbalance factor Iunb [%]	/	/	$I_{unb} = \frac{I_{neg}}{I_{pos}} \times 100$		

Voltage zero-phase component Uzero [V]

$$U_{zero} = \frac{1}{3}$$

$$\sqrt{(U1 \cdot \cos(\alpha) + U2 \cdot \cos(\beta + seq2) + U3 \cdot \cos(\gamma + seq3))^2 + (U1 \cdot \sin(\alpha) + U2 \cdot \sin(\beta + seq2) + U3 \cdot \sin(\gamma + seq3))^2}$$

The fundamental RMS voltage (phase voltage) from harmonic calculations is used for U1, U2, and U3.

For 3-phase 3-wire connections, the value is detected as a line voltage and then converted to a phase voltage.

At the zero-phase, seq2=0°, seq3=0°

α=U1 phase angle, β=U2 phase angle, γ=U3 phase angle

Voltage positive-phase component Upos [V]

$$U_{pos} = \frac{1}{3}$$

$$\sqrt{(U1 \cdot \cos(\alpha) + U2 \cdot \cos(\beta + seq2) + U3 \cdot \cos(\gamma + seq3))^2 + (U1 \cdot \sin(\alpha) + U2 \cdot \sin(\beta + seq2) + U3 \cdot \sin(\gamma + seq3))^2}$$

The fundamental RMS voltage (phase voltage) from harmonic calculations is used for U1, U2, and U3.

For 3-phase 3-wire connections, the value is detected as a line voltage and then converted to a phase voltage.

At the positive-phase, seq2=120°, seq3=240°

α=U1 phase angle, β=U2 phase angle, γ=U3 phase angle

Voltage negative-phase component Uneg [V]

$$U_{neg} = \frac{1}{3}$$

$$\sqrt{(U1 \cdot \cos(\alpha) + U2 \cdot \cos(\beta + seq2) + U3 \cdot \cos(\gamma + seq3))^2 + (U1 \cdot \sin(\alpha) + U2 \cdot \sin(\beta + seq2) + U3 \cdot \sin(\gamma + seq3))^2}$$

The fundamental RMS voltage (phase voltage) from harmonic calculations is used for U1, U2, and U3.

For 3-phase 3-wire connections, the value is detected as a line voltage and then converted to a phase voltage.

At the negative-phase, seq2=240°, seq3=120°

α=U1 phase angle, β=U2 phase angle, γ=U3 phase angle

Current zero-phase component I_{zero} [A]I_{zero}

$$= \frac{1}{3} \sqrt{(I_1 \cdot \cos(\alpha) + I_2 \cdot \cos(\beta + \text{seq}2) + I_3 \cdot \cos(\gamma + \text{seq}3))^2 + (I_1 \cdot \sin(\alpha) + I_2 \cdot \sin(\beta + \text{seq}2) + I_3 \cdot \sin(\gamma + \text{seq}3))^2}$$

The fundamental RMS current (phase current) from harmonic calculations is used for I₁, I₂, and I₃.

At the zero-phase, seq₂=0°, seq₃=0°

α=l₁ phase angle, β=l₂ phase angle, γ=l₃ phase angle

Current positive-phase component I_{pos} [A]I_{pos}

$$= \frac{1}{3} \sqrt{(I_1 \cdot \cos(\alpha) + I_2 \cdot \cos(\beta + \text{seq}2) + I_3 \cdot \cos(\gamma + \text{seq}3))^2 + (I_1 \cdot \sin(\alpha) + I_2 \cdot \sin(\beta + \text{seq}2) + I_3 \cdot \sin(\gamma + \text{seq}3))^2}$$

The fundamental RMS current (phase current) from harmonic calculations is used for I₁, I₂, and I₃.

At the positive-phase, seq₂=120°, seq₃=240°

α=l₁ phase angle, β=l₂ phase angle, γ=l₃ phase angle

Current negative-phase component I_{neg} [A]I_{neg}

$$= \frac{1}{3} \sqrt{(I_1 \cdot \cos(\alpha) + I_2 \cdot \cos(\beta + \text{seq}2) + I_3 \cdot \cos(\gamma + \text{seq}3))^2 + (I_1 \cdot \sin(\alpha) + I_2 \cdot \sin(\beta + \text{seq}2) + I_3 \cdot \sin(\gamma + \text{seq}3))^2}$$

The fundamental RMS current (phase current) from harmonic calculations is used for I₁, I₂, and I₃.

At the negative-phase, seq₂=240°, seq₃=120°

α=l₁ phase angle, β=l₂ phase angle, γ=l₃ phase angle

-7. Harmonic Voltage (U_{harm}), Harmonic Current (I_{harm}), Inter-harmonic voltage (U_{iharm}), Inter-harmonic current (I_{iharm})

Phase System Items	Single Phase 2-wire 1P2W	Single Phase 3-wire 1P3W	3-Phase, 3-Wire, 2-Measure- ment 3P3W2M	3-Phase, 3-Wire, 3-Measure- ment 3P3W3M	3-Phase, 4-Wire 3P4W
U _{harm} [Vrms]=U _{ck} (including adjacent inter-harmonic components)	U_{1k} U_{4k} $U'_{ck} = \sqrt{\{(U_{ckr})^2 + (U_{cki})^2\}}$ $U_{ck} = \sqrt{\sum_{n=-1}^1 U'^2_{c((10k+n)/10)}}$	U_{1k} U_{2k} U_{4k}	U_{12k} U_{32k} U_{4k}	U_{12k} U_{23k} U_{31k} U_{4k}	U_{1k} U_{2k} U_{3k} U_{4k}
<ul style="list-style-type: none"> For 3-phase 3-wire connections, indicates the result of harmonic calculations using the line voltage. For 3-phase 4-wire connections, indicates the result of harmonic calculations using the phase voltage. The harmonic voltage content percentage is calculated by dividing the harmonic voltage component for the specified order by the fundamental voltage component and multiplying by 100. When k = 0, the U_{c0} component is treated as DC for order 0. For 60 Hz measurement, the value 10 in the formula is replaced with 12. For 400 Hz measurement, the value 10 in the formula is replaced with 80. 					
I _{harm} [Arms]=I _{ck} (including adjacent inter-harmonic components)	I_{1k} I_{4k} $I'_{ck} = \sqrt{\{(I_{ckr})^2 + (I_{cki})^2\}}$ $I_{ck} = \sqrt{\sum_{n=-1}^1 I'^2_{c((10k+n)/10)}}$	I_{1k} I_{2k} I_{4k}	I_{1k} I_{2k} I_{4k}	I_{1k} I_{2k} I_{3k} I_{4k}	I_{1k} I_{2k} I_{3k} I_{4k}
<ul style="list-style-type: none"> The harmonic current content percentage is calculated by dividing the harmonic current component for the specified order by the fundamental current component and multiplying by 100. When k = 0, the I_{c0} component is treated as DC for order 0. When using 60 Hz, the number "10" in the expression above is "12." When using 400 Hz, the number "10" in the expression above is "80." 					
U _{iharm} [Vrms]=U _{ck}	U_{1k} U_{4k} $U'_{ck} = \sqrt{\{(U_{ckr})^2 + (U_{cki})^2\}}$ $U_{ck} = \sqrt{\sum_{n=-3}^3 U'^2_{c((10k+n)/10)}}$	U_{1k} U_{2k} U_{4k}	U_{12k} U_{32k} U_{4k}	U_{12k} U_{23k} U_{31k} U_{4k}	U_{1k} U_{2k} U_{3k} U_{4k}
<ul style="list-style-type: none"> The values 3 and -3 in the formula apply to 50 Hz measurement and are replaced with 4 and -4 for 60 Hz measurement. In the formula, k = 0.5, 1.5, 2.5, 3.5,... For 3-phase 3-wire connections, indicates the result of harmonic calculations using the line voltage. For 3-phase 4-wire connections, indicates the result of harmonic calculations using the phase voltage. The inter-harmonic voltage content percentage is calculated by dividing the inter-harmonic voltage component for the specified order by the fundamental voltage component and multiplying by 100. For 60 Hz measurement, the value 10 in the formula is replaced with 12. 					

-7. Harmonic Voltage (U_{harm}), Harmonic Current (I_{harm}), Inter-harmonic voltage (U_{iharm}), Inter-harmonic current (I_{iharm})

Phase System Items	Single Phase 2-wire 1P2W	Single Phase 3-wire 1P3W	3-Phase, 3-Wire, 2-Measure- ment 3P3W2M	3-Phase, 3-Wire, 3-Measure- ment 3P3W3M	3-Phase, 4-Wire 3P4W
I _{iharm} [Arms]=I _{ck}	I_{1k} I_{4k} $I'_{ck} = \sqrt{\{(I_{ckr})^2 + (I_{cki})^2\}}$ $I_{ck} = \sqrt{\sum_{n=-3}^3 I'^2_{cn}((10k+n)/10)}$	I_{1k} I_{2k} I_{4k}	I_{1k} I_{2k} I_{4k}	I_{1k} I_{2k} I_{3k} I_{4k}	I_{1k} I_{2k} I_{3k} I_{4k}
<ul style="list-style-type: none"> • The values 3 and -3 in the formula apply to 50 Hz measurement and are replaced with 4 and -4 for 60 Hz measurement. In the formula, k = 0.5, 1.5, 2.5, 3.5, ... • For 60 Hz measurement, the value 10 in the formula is replaced with 12. • The inter-harmonic current content percentage is calculated by dividing the inter-harmonic current component for the specified order by the fundamental current component and multiplying by 100. 					

c: Measurement channel, k: Order of analysis, r: resistance after FFT, i: reactance after FFT
 However, for 60 Hz measurement, the value 10 in the formula is replaced with 12.

-8. Harmonic Power (Pharm), Harmonic Reactive Power (Qharm), K Factor (KF)

Phase System Items	Single Phase 2- wire 1P2W	Single Phase 3-wire 1P3W	3-Phase, 3-Wire, 2-Mea- surement 3P3W2M	3-Phase, 3-Wire, 3-Measurement 3P3W3M	3-Phase, 4-Wire 3P4W
Pharm[W]=Pck	P_{1k} $P_{ck} = +U_{ckr} \times I_{ckr}$ $+U_{cki} \times I_{cki}$	P_{1k} P_{2k}	P_{1k} P_{2k}	$P_{1k} =$ $\frac{1}{3}(U_{1kr} - U_{3kr}) \times I_{1kr} + \frac{1}{3}(U_{1ki} - U_{3ki}) \times I_{1ki}$ $P_{2k} =$ $\frac{1}{3}(U_{2kr} - U_{1kr}) \times I_{2kr} + \frac{1}{3}(U_{2ki} - U_{1ki}) \times I_{2ki}$ $P_{3k} =$ $\frac{1}{3}(U_{3kr} - U_{2kr}) \times I_{3kr} + \frac{1}{3}(U_{3ki} - U_{2ki}) \times I_{3ki}$	P_{1k} P_{2k} P_{3k}
		$P_{sumk} =$ $P_{1k} + P_{2k}$	$P_{sumk} =$ $P_{1k} + P_{2k}$	$P_{sumk} =$ $P_{1k} + P_{2k} + P_{3k}$	$P_{sumk} =$ $P_{1k} + P_{2k} + P_{3k}$
<ul style="list-style-type: none"> The harmonic power content percentage is calculated by dividing the harmonic power component for the specified order by the absolute value of the fundamental power component and multiplying by 100. For 3P3W2M and 3P3W3M connections, CH1 to CH3 values are used only for internal calculations. 					
Only for use with in- ternal calculation Qharm[var]=Qck	Q_{1k} $Q_{ck} =$ $U_{ckr} \times I_{cki} - U_{cki} \times I_{ckr}$	Q_{1k} Q_{2k}	Q_{1k} Q_{2k}	$Q_{1k} =$ $\frac{1}{3}(U_{1kr} - U_{3kr}) \times I_{1ki} - \frac{1}{3}(U_{1ki} - U_{3ki}) \times I_{1kr}$ $Q_{2k} =$ $\frac{1}{3}(U_{2kr} - U_{1kr}) \times I_{2ki} - \frac{1}{3}(U_{2ki} - U_{1ki}) \times I_{2kr}$ $Q_{3k} =$ $\frac{1}{3}(U_{3kr} - U_{2kr}) \times I_{3ki} - \frac{1}{3}(U_{3ki} - U_{2ki}) \times I_{3kr}$	Q_{1k} Q_{2k} Q_{3k}
		$Q_{sumk} =$ $Q_{1k} + Q_{2k}$	$Q_{sumk} =$ $Q_{1k} + Q_{2k}$	$Q_{sumk} =$ $Q_{1k} + Q_{2k} + Q_{3k}$	$Q_{sumk} =$ $Q_{1k} + Q_{2k} + Q_{3k}$
KF []	KF_1 KF_4 $KFc =$ $\frac{\sum_{k=1}^{50} \left(k^2 \times I_{ck}^2 \right)}{\sum_{k=1}^{50} I_{ck}^2}$	KF_1 KF_2 KF_4	KF_1 KF_2 KF_4	KF_1 KF_2 KF_3 KF_4	KF_1 KF_2 KF_3 KF_4
	<ul style="list-style-type: none"> The K factor is also called the multiplication factor, and indicates the power loss using the harmonic RMS current for the electrical transformer. 				

c: Measurement channel, k: Order of analysis, r: resistance after FFT, i: reactance after FFT

-9. Total Harmonic Voltage Distortion Factor (Uthd-F, Uthd-R) and Total Harmonic Current Distortion Factor (Ithd-F, Ithd-R)

Phase System Items	Single Phase 2-wire 1P2W	Single Phase 3-wire 1P3W	3-Phase, 3-Wire, 2-Measurement 3P3W2M	3-Phase, 3-Wire, 3-Measurement 3P3W3M	3-Phase, 4-Wire 3P4W
Uthd-F[%]	$THDUF1$ $THDUF4$ $THDUFc = \frac{\sqrt{\sum_{k=2}^K (U_{ck})^2}}{U_{c1}} \times 100$	$THDUF1$ $THDUF2$ $THDUF4$	$THDUF12$ $THDUF32$ $THDUF4$	$THDUF12$ $THDUF23$ $THDUF31$ $THDUF4$	$THDUF1$ $THDUF2$ $THDUF3$ $THDUF4$
<ul style="list-style-type: none"> • For 3-phase 3-wire connections, indicated values represent harmonic calculation results obtained using line voltage. • The value K in the equation indicates the total number of analyzed orders. 					
Ithd-F[%]	$THDIF1$ $THDIF4$ $THDIFc = \frac{\sqrt{\sum_{k=2}^K (I_{ck})^2}}{I_{c1}} \times 100$	$THDIF1$ $THDIF2$ $THDIF4$	$THDIF1$ $THDIF2$ $THDIF4$	$THDIF1$ $THDIF2$ $THDIF3$ $THDIF4$	$THDIF1$ $THDIF2$ $THDIF3$ $THDIF4$
<ul style="list-style-type: none"> • The value K in the equation indicates the total number of analyzed orders. 					
Uthd-R[%]	$THDUR1$ $THDUR4$ $THDURc = \frac{\sqrt{\sum_{k=2}^K (U_{ck})^2}}{\sqrt{\sum_{k=1}^K (U_{ck})^2}} \times 100$	$THDUR1$ $THDUR2$ $THDUR4$	$THDUR12$ $THDUR32$ $THDUR4$	$THDUR12$ $THDUR23$ $THDUR31$ $THDUR4$	$THDUR1$ $THDUR2$ $THDUR3$ $THDUR4$
<ul style="list-style-type: none"> • For 3-phase 3-wire connections, indicated values represent harmonic calculation results obtained using line voltage. • The value K in the equation indicates the total number of analyzed orders. 					
Ithd-R[%]	$THDIR1$ $THDIR4$ $THDIRc = \frac{\sqrt{\sum_{k=2}^K (I_{ck})^2}}{\sqrt{\sum_{k=1}^K (I_{ck})^2}} \times 100$	$THDIR1$ $THDIR2$ $THDIR4$	$THDIR1$ $THDIR2$ $THDIR4$	$THDIR1$ $THDIR2$ $THDIR3$ $THDIR4$	$THDIR1$ $THDIR2$ $THDIR3$ $THDIR4$
<ul style="list-style-type: none"> • The value K in the equation indicates the total number of analyzed orders. 					

13.8 Calculation Formula

-10. Harmonic Voltage Phase Angle (Uphase), Harmonic Current Phase Angle (Iphase), Phase Difference of Harmonic Voltage and Harmonic Current (Pphase)

Phase System Items	Single Phase 2-wire 1P2W	Single Phase 3-wire 1P3W	3-Phase, 3-Wire, 2-Measurement 3P3W2M	3-Phase, 3-Wire, 3-Measurement 3P3W3M	3-Phase, 4-Wire 3P4W
Uphase[deg]=θUk	θ_{U1k} θ_{U4k} $\theta_{Uck}=\tan^{-1}\left\{\frac{Uckr}{-Ucki}\right\}$	θ_{U1k} θ_{U2k} θ_{U4k}	θ_{U12k} θ_{U32k} θ_{U4k}	θ_{U12k} θ_{U23k} θ_{U31k} θ_{U4k}	θ_{U1k} θ_{U2k} θ_{U3k} θ_{U4k}
Iphase[deg]=θIk	θ_{I1k} θ_{I4k} $\theta_{Ick}=\tan^{-1}\left\{\frac{Ickr}{-Icki}\right\}$	θ_{I1k} θ_{I2k} θ_{I4k}	θ_{I1k} θ_{I2k} θ_{I4k}	θ_{I1k} θ_{I2k} θ_{I3k} θ_{I4k}	θ_{I1k} θ_{I2k} θ_{I3k} θ_{I4k}
Pphase[deg]=θk	θ_{Ik} $\theta_{ck}=\theta_{ckr}-\theta_{cUk}$	θ_{I1k} θ_{2k}	θ_{I1k} θ_{I2k}	θ_{I1k} θ_{I2k}	θ_{I1k} θ_{2k} θ_{3k}
		$\theta_{sum}=\tan^{-1}\left\{\frac{Qsumk}{Psumk}\right\}$	$\theta_{sum}=\tan^{-1}\left\{\frac{Qsumk}{Psumk}\right\}$	$\theta_{sum}=\tan^{-1}\left\{\frac{Qsumk}{Psumk}\right\}$	$\theta_{sum}=\tan^{-1}\left\{\frac{Qsumk}{Psumk}\right\}$
<ul style="list-style-type: none"> • For 3-phase 3-wire connections, indicated values represent harmonic calculation results obtained using line voltage. • The harmonic voltage phase angle is displayed after correction using the reference channel's fundamental wave to 0°. • When Uckr=Ucki=0, θuk=0° • The harmonic voltage used in calculations is calculated using only whole-number orders. 					
<ul style="list-style-type: none"> • The harmonic voltage phase angle is displayed after correction using the reference channel's fundamental wave to 0°. • When Ickr=Icki=0, θIk=0° • The harmonic voltage used in calculations is calculated using only whole-number orders. 					
<ul style="list-style-type: none"> • When Psumk=Qsumk=0, θk=0° • Psumk indicates the total harmonic power (see the equations for harmonic power). • Qsumk indicates total harmonic reactive power (see the equations for harmonic reactive power). 					

c: measurement channel; k: order of analysis; r: resistance after FFT; i: reactance after FFT

-11. Voltage Flicker (dV10), Short Interval Voltage Flicker (Pst), and Long Interval Voltage Flicker (Plt)

Phase System Items	Single Phase 2-wire 1P2W	Single Phase 3-wire 1P3W	3-Phase, 3-Wire, 2-Measurement 3P3W2M	3-Phase, 3-Wire, 3-Measurement 3P3W3M	3-Phase, 4-Wire 3P4W
dV10=ΔV10	$\Delta V10_{(1)}$ $\Delta V10_{(c)}=\frac{100}{U_f^2}\sqrt{\sum(a_n \times \Delta U_n)^2}$	$\Delta V10_{(1)}$ $\Delta V10_{(2)}$	$\Delta V10_{(12)}$ $\Delta V10_{(32)}$	$\Delta V10_{(12)}$ $\Delta V10_{(23)}$ $\Delta V10_{(31)}$	$\Delta V10_{(1)}$ $\Delta V10_{(2)}$ $\Delta V10_{(3)}$
Pst	Pst_1 $Pst_c=\sqrt{K_1 P_{0.1} + K_2 P_{1s} + K_3 P_{3s} + K_4 P_{10s} + K_5 P_{50s}}$	Pst_1 Pst_2	Pst_1 Pst_2	Pst_1 Pst_2 Pst_3	Pst_1 Pst_2 Pst_3
Plt	Plt_1 $Plt_c=\sqrt[3]{\frac{\sum_{n=1}^N (Pst_n)^3}{N}}$	Plt_1 Plt_2	Plt_1 Plt_2	Plt_1 Plt_2 Plt_3	Plt_1 Plt_2 Plt_3
<ul style="list-style-type: none"> • Uf represents the reference voltage for voltage flicker and indicates the 1-minute average of RMS voltage values. • an represents the flicker luminosity coefficient corresponding to the fluctuation frequency fn [Hz] calculated from the flicker luminosity curve. • ΔUn represents the voltage fluctuation in fn. • Indicates values for K1=0.0314, K2=0.0525, K3=0.0657, K4=0.28, and K5=0.08. • Calculations are performed using a 1,024-class cumulative probability function (CPF). • Results are calculated from cumulative probability (Pi) values using linear interpolation, smoothed using the following methods, and used to calculate the cumulative probability (Pis): P1s=(P0.7+P1+P1.5)/3, P3s=(P2.2+P3+P4)/3, P10s=(P6+P8+P10+P13+P17)/5, P50s=(P30+P50+P80)/3 • N indicates the number of measurements (N=12). (When N<12, the number of measurements is used as N.) 					

c: measurement channel

-12. Active energy (WP), reactive energy (WQ)

Phase System Items	Single Phase 2-wire 1P2W	Single Phase 3-wire 1P3W	3-Phase, 3-Wire, 2-Measure- ment 3P3W2M	3-Phase, 3-Wire, 3-Measure- ment 3P3W3M	3-Phase, 4-Wire 3P4W
WP+	$WPI+=k \sum_1^h (P1(+))$	$WPsum+=k \sum_1^h (Psum(+))$			
	<ul style="list-style-type: none"> • h: measurement period; k: coefficient for converting to 1 hour • (+): Value is only used when positive (consumption). 				
WP-	$WPI-=k \sum_1^h (P1(-))$	$WPsum-=k \sum_1^h (Psum(-))$			
	<ul style="list-style-type: none"> • h: measurement period, k: coefficient converted to 1 hour • (-): Value is only used when negative (regeneration). 				
WQLAG	$WQLag=k \sum_1^n (Q1(+))$	$WQLAG=k \sum_1^h (Qsum(+))$			
	<ul style="list-style-type: none"> • h: measurement period, k: coefficient converted to 1 hour • (+): Value is only used when positive (lag). 				
WQLEAD	$WQLEAD=k \sum_1^h (Q1(-))$	$WQLEAD=k \sum_1^h (Qsum(-))$			
	<ul style="list-style-type: none"> • h: measurement period, k: coefficient converted to 1 hour • (-): Value is only used when negative (lead). 				

-13. Average calculation

Average calculation methods

	CH1 to CH4	sum/AVG	Comment
Freq	Signed average	-	Same as Freq10s.
Upk	Signed average	-	
lpk	Signed average	-	
Urms	RMS	Average results for all channels are averaged.	
lrms	RMS	Average results for all channels are averaged.	
Udc	Signed average	-	
ldc	Signed average	-	
P	Signed average	Average results for all channels are totaled.	
S	Signed average	Average results for all channels are totaled.	
Q	Signed average	Average results for all channels are totaled.	
Eff	Simple average	-	
PF/DPF	See *1 below.	Sum value is calculated using the formula described in *1 below.	This calculation is used for both PF and DPF.
Uunb	RMS	-	Same applies to Uunb0.
lunb	RMS	-	Same applies to lunb0.
Uharm	RMS (See *3 below.)	-	Same applies to Uiharm.
lharm	RMS (See *3 below.)	-	Same applies to liharm.
Pharm	Signed average	Average results for all channels are totaled.	The content percentage is calculated from the sum value calculated from the level.
Uphase	See *2 below.	See *2 below.	
lphase	See *2 below.	See *2 below.	

13.8 Calculation Formula

Average calculation methods

	CH1 to CH4	sum/AVG	Comment
Pphase	See *2 below.	See *2 below.	
Uthd	Calculated from RMS value of RMS values.	-	This calculation is used for both THD-F and THD-R.
Ithd	Calculated from RMS value of RMS values.	-	This calculation is used for both THD-F and THD-R.
KF	Signed average	-	
UharmH	RMS	-	
IharmH	RMS	-	
Msv	RMS	-	
Msv%	RMS	-	

Signed average: Signs of values are included in average calculation.
 "(AVG)" following a parameter indicates the average result.

*1: PF/DPF average calculation

Addition processing : If the power factor value is negative, it is multiplied by (-). If the power factor value is positive, it is multiplied by (-), and the value 2 is added. The resulting value is integrated.

Averaging processing : The result of addition processing described above is divided by the number of added data points. If the result is less than 1, it is multiplied by (-). If it is greater than or equal to 1, it is multiplied by (-), and the value 2 is added.

*2: Phase average calculation

Uphase average calculation

$$\tan^{-1} \left\{ \frac{U_{ckr}}{-U_{cki}} \right\} \quad U_{ckr} \text{ and } U_{cki} \text{ represent the signed averages for each channel.}$$

Iphase average calculation

$$\tan^{-1} \left\{ \frac{I_{ckr}}{-I_{cki}} \right\} \quad I_{ckr} \text{ and } I_{cki} \text{ represent the signed averages for each channel.}$$

Pphase average calculation

(Channel averaging processing) : $\tan^{-1} \left\{ \frac{Q_{harm_k}}{P_{harm_k}} \right\}$ Q_{harm_k} and P_{harm_k} represent the signed averages for each channel.

(Sum averaging processing) : $\tan^{-1} \left\{ \frac{Q_{sumk}}{P_{sumk}} \right\}$ Q_{sumk} and P_{sumk} represent the signed averages for each channel.

*3: For content percentage and order 0, signed average.

13.9 Range Breakdown and Combination Accuracy

Applies to active power (unit: W), apparent power (unit: VA), and reactive power (unit: var).

-1. When using the CT7131 AC Current Sensor

Power range breakdown (SUM)

Wiring	Current range	
	50.000 A	100.00 A
1P2W	30.000 k	60.000 k
1P3W 3P3W2M 3P3W3M	60.000 k	120.00 k
3P4W 3P4W2.5E	90.00 k	180.00 k

Each channel has the same ranges as 1P2W.

Combination accuracy

Current range	Current RMS value*	Active power*
100.00 A	0.4% rdg.+0.12% f.s.	0.5% rdg.+0.12% f.s.
50.000 A	0.4% rdg.+0.14% f.s.	0.5% rdg.+0.14% f.s.

*: When the measurement frequency (f) satisfies the following condition: $45 \leq f \leq 66$ (Hz)

-2. When using the CT7136 AC Current Sensor

Power range breakdown (SUM)

Wiring	Current range	
	50.000 A	500.00 A
1P2W	30.000 k	300.00 k
1P3W 3P3W2M 3P3W3M	60.000 k	600.00 k
3P4W 3P4W2.5E	90.00 k	0.9000 M

Each channel has the same ranges as 1P2W.

Combination accuracy

Current range	Current RMS value*	Active power*
500.00 A	0.4% rdg.+0.112% f.s.	0.5% rdg.+0.112% f.s.
50.000 A	0.4% rdg.+0.22% f.s.	0.5% rdg.+0.22% f.s.

*: When the measurement frequency (f) satisfies the following condition: $45 \leq f \leq 66$ (Hz)

13.9 Range Breakdown and Combination Accuracy

-3. When using the CT7126 AC Current Sensor

Power range breakdown (SUM)

Wiring	Current range	
	5.0000 A	50.000 A
1P2W	3.0000 k	30.000 k
1P3W 3P3W2M 3P3W3M	6.0000 k	60.000 k
3P4W 3P4W2.5E	9.000 k	90.00 k

Each channel has the same ranges as 1P2W.

Combination accuracy

Current range	Current RMS value*	Active power*
50.000 A	0.4% rdg.+0.112% f.s.	0.5% rdg.+0.112% f.s.
5.0000 A	0.4% rdg.+0.22% f.s.	0.5% rdg.+0.22% f.s.

*: When the measurement frequency (f) satisfies the following condition: $45 \leq f \leq 66$ (Hz)

-4. When using the CT7731 AC/DC Auto-Zero Current Sensor

Power range breakdown (SUM)

Wiring	Current range	
	50.000 A	100.00 A
1P2W	30.000 k	60.000 k
1P3W 3P3W2M 3P3W3M	60.000 k	120.00 k
3P4W 3P4W2.5E	90.00 k	180.00 k

Each channel has the same ranges as 1P2W.

Combination accuracy

Current range	Current DC value	Current RMS value*	Active power*
100.00 A	1.5% rdg.+1.0% f.s.	1.1% rdg.+0.6% f.s.	1.2% rdg.+0.6% f.s.
50.000 A	1.5% rdg.+1.5% f.s.	1.1% rdg.+1.1% f.s.	1.2% rdg.+1.1% f.s.

*: When the measurement frequency (f) satisfies the following condition: $45 \leq f \leq 66$ (Hz)

-5. When using the CT7736 AC/DC Auto-Zero Current Sensor

Power range breakdown (SUM)

Wiring	Current range	
	50.000 A	500.00 A
1P2W	30.000 k	300.00 k
1P3W 3P3W2M 3P3W3M	60.000 k	600.00 k
3P4W 3P4W2.5E	90.00 k	0.9000 M

Each channel has the same ranges as 1P2W.

Combination accuracy

Current range	Current DC value	Current RMS value*	Active power*
500.00 A	2.5% rdg.+1.1% f.s.	2.1% rdg.+0.70% f.s.	2.2% rdg.+0.70% f.s.
50.000 A	2.5% rdg.+6.5% f.s.	2.1% rdg.+6.10% f.s.	2.2% rdg.+6.10% f.s.

*: When the measurement frequency (f) satisfies the following condition: $45 \leq f \leq 66$ (Hz)

-6. When using the CT7742 AC/DC Auto-Zero Current Sensor

Power range breakdown (SUM)

Wiring	Current range	
	500.00 A	5.0000 kA
1P2W	300.00 k	3.0000 M
1P3W 3P3W2M 3P3W3M	600.00 k	6.0000 M
3P4W 3P4W2.5E	0.9000 M	9.000 M

Each channel has the same ranges as 1P2W.

Combination accuracy

Current range	Input	Current DC value	Current RMS value*	Active power*
5.0000 kA	$I > 1800 \text{ A}$	2.0% rdg.+0.7% f.s.	2.1% rdg.+0.3% f.s.	2.2% rdg.+0.3% f.s.
	$I \leq 1800 \text{ A}$		1.6% rdg.+0.3% f.s.	1.7% rdg.+0.3% f.s.
500.00 A	—	2.0% rdg.+2.5% f.s.	1.6% rdg.+2.1% f.s.	1.7% rdg.+2.1% f.s.

*: When the measurement frequency (f) satisfies the following condition: $45 \leq f \leq 66$ (Hz)**-7. When using the CT7044, CT7045, CT7046 AC Flexible Current Sensor**

Power range breakdown (SUM)

Wiring	Current range		
	Figures in parentheses indicate the sensor range.		
	50.000 A (600 A)	500.00 A (600 A)	5.0000 kA (6000 A)
1P2W	30.000 k	300.00 k	3.0000 M
1P3W 3P3W2M 3P3W3M	60.000 k	600.00 k	6.0000 M
3P4W 3P4W2.5E	90.00 k	0.9000 M	9.000 M

Each channel has the same ranges as 1P2W.

Combination accuracy

Current range	Current RMS value*	Active power*
5000.0 A	1.6% rdg.+0.4% f.s.	1.7% rdg.+0.4% f.s.
500.00 A		
50.000 A	1.6% rdg.+3.1% f.s.	1.7% rdg.+3.1% f.s.

*: When the measurement frequency (f) satisfies the following condition: $45 \leq f \leq 66$ (Hz)

13.9 Range Breakdown and Combination Accuracy

-8. When using the CT7116 AC Leakage Current Sensor

Power range breakdown (SUM)

Wiring	Current range	
	500.00 mA	5.0000 A
1P2W	300.00	5.0000 k
1P3W 3P3W2M 3P3W3M	600.00	10.000 k
3P4W 3P4W2.5E	0.9000 k	15.000 k

Each channel has the same ranges as 1P2W.

Combination accuracy

Current range	Current RMS value*	Active power*
5.0000 A	1.1% rdg.+0.16% f.s.	1.2% rdg.+0.16% f.s.
500.00 mA	1.1% rdg.+0.7% f.s.	1.2% rdg.+0.7% f.s.

*: When the measurement frequency (f) satisfies the following condition: $45 \leq f \leq 66$ (Hz)

Maintenance and Service

Chapter 14

14

Chapter 14 Maintenance and Service

14.1 Cleaning

Instrument

- To clean the instrument, wipe it gently with a soft cloth moistened with water or mild detergent.
- Wipe the LCD gently with a soft, dry cloth.
- Clean the vents periodically to avoid blockage.

IMPORTANT

Never use solvents such as benzene, alcohol, acetone, ether, ketones, thinners or gasoline, as they can deform and discolor the case.

Current Sensor

NOTE

Measurements are degraded by dirt on the facing core surfaces of the current sensor, so keep the surfaces clean by gently wiping them with a soft, dry cloth.

14.2 Trouble Shooting

Before having the instrument repaired or inspected, check the information described in "Before having the instrument repaired" (p.254) and "14.3 Error Indication" (p.255).

Inspection and Repair

The calibration period varies depending on the status of the instrument and installation environment. We recommend that the calibration period be determined in accordance with the state of the instrument and installation environment. Please contact your Hioki distributor to have your instrument periodically calibrated.



WARNING

Do not attempt to modify, disassemble or repair the instrument; as fire, electric shock and injury could result.

- If damage is suspected, check the "Before having the instrument repaired" (p.254) section before contacting your authorized Hioki distributor or reseller.

However, in the following circumstances, you should stop using the instrument, unplug the power cord, and contact your authorized Hioki distributor or reseller:

- When you are able to confirm that the instrument is damaged
- When you are unable to make measurements
- When the instrument has been stored for an extended period of time in a hot, humid, or otherwise undesirable environment
- When the instrument has been subjected to the stress of being transported under harsh conditions
- When the instrument has gotten wet or soiled with oil or dust (ingress of water, oil, or dust into the enclosure may cause electrical insulation to deteriorate, increasing the hazard of electric shock or fire)

Backing up the data

The instrument may be initialized (returned to the factory default settings) when it is repaired or calibrated.

Before you ask for repair or calibration, it is recommended to back up (save or record) the measurement conditions and measured data.

When transporting the instrument

When transporting the instrument, use the original packing materials in which it was shipped, and pack in a double carton. Pack the instrument so that it will not sustain damage during shipping, and include a description of existing damage. We do not take any responsibility for damage incurred during shipping.

Replaceable Parts and Operating Lifetimes

The characteristics of some of the parts used in the product may deteriorate with extended use. To ensure the product can be used over the long term, it is recommended to replace these parts on a periodic basis. When replacing parts, please contact your authorized Hioki distributor or reseller. The service life of parts varies with the operating environment and frequency of use. Parts are not guaranteed to operate throughout the recommended replacement cycle.

Part	Life	Remarks
Electrolytic Capacitors	Approx. 10 years	The service life of electrolytic capacitors varies with the operating environment. Requires periodic replacement.
Lithium battery	Approx. 10 years	The instrument contains a built-in backup lithium battery, which offers a service life of about ten years. If the date and time deviate substantially when the instrument is switched on, it is the time to replace that battery. Contact your authorized Hioki distributor or reseller.
LCD backlight (50% drop-off in brightness)	Approx. 50,000 hours	Requires periodic replacement.
Model Z1003 Battery Pack	Approx. 1 year or approx. 500 charge/recharge cycles	Requires periodic replacement.
Model Z4001 SD Memory Card 2 GB	Data storage of approx. 10 years or approx. 2 million rewrites	The SD card service life varies with the manner in which it is are used. Requires periodic replacement.

Before having the instrument repaired

Verify below before returning the instrument for repair.

Symptom	Check item or cause	Remedy and reference
The display does not appear when you turn the power on.	Has the power cord been disconnected? Is it connected properly?	Verify that the power cord is connected properly. See: "3.4 Connecting the AC Adapter" (p.45)
Keys do not work.	Has the key lock been activated?	Press and hold the ESC key for at least 3 seconds to cancel the key lock. If you set a passcode, enter the same passcode to disengage the key lock. See: "7 Engage the key lock." (p.28)
Voltage or current measured values are not being displayed.	Are the voltage cords or current sensors connected improperly?	Verify connections. See: "3.6 Connecting the Voltage Cords" (p.47) to "4.6 Verifying Correct Wiring (Connection Check)" (p.66)
	Are the input channels and display channels incorrect?	-
The instrument cannot measure the frequency. Measured values do not stabilize.	Is the input frequency within the guaranteed accuracy range? For a measurement frequency of 50 Hz, 40 Hz to 58 Hz. For a measurement frequency of 60 Hz, 51 Hz to 70 Hz. For a measurement frequency of 400 Hz, 360 Hz to 440 Hz. Measurement cannot be performed if the input frequency is outside the guaranteed accuracy fundamental wave range.	-
	Is the input frequency lower than the setting? Is a signal being input to U1? Stable measurement may not be possible if input of at least 2% f.s. is not being supplied to U1 (the reference channel).	-
The instrument displays [- - - - -].	Has the instrument's range been exceeded? When input exceeds 130% of the range, the instrument will display [- - - - -]. See: "Warning functions" (p.233)	If you encounter this display while the range is not being exceeded, the instrument needs to be repaired. Contact your authorized Hioki distributor or reseller.

When no apparent cause can be established

Perform a system reset.

This will return all settings to their factory defaults.

See: "5.7 Initializing the Instrument (System Reset)" (p.94)

14.3 Error Indication

Any instrument errors are displayed on the screen. If you experience an error, check the appropriate corrective action. To clear the error display, press any key.

Error display	Cause	Corrective action/more information
FPGA initializing error	FPGA initializing error.	The instrument needs to be repaired. Contact your authorized Hioki distributor or reseller.
DRAM1, 2 error	DRAM error.	
SRAM error	SRAM error.	
Invalid FLASH.	FLASH error.	
Invalid ADJUST.	Adjustment value error.	
Invalid Backup values.	One or more erroneous backed-up system variables have created a conflict.	
*** SD card error *** Error while attempting to access the SD Card.	Attempted to access a corrupt file or corrupt SD memory card. The SD memory card was removed while it was being accessed.	Back up the SD memory card's contents on a computer and then format the card with the instrument. Remove the SD memory card and then insert it again. See: "9.2 Formatting SD Memory Cards" (p.162), "3.5 Inserting (Removing) an SD Memory Card" (p.45)
*** SD card error *** Save failed.	Attempted to write data to a write-protected file. The SD memory card was removed while data was being saved, or a similar issue occurred.	Using a computer, check whether the file attributes are set to read-only. If the attributes are set to read-only, clear that setting. Check whether the SD memory card is inserted into the instrument. See: "3.5 Inserting (Removing) an SD Memory Card" (p.45)
*** SD card error *** Load failed.	The file being loaded does not exist on the SD memory card. The file being loaded is corrupt.	Update the instrument's file list. You can update the file list by accessing another screen, for example by pressing the DF1 key, and then pressing the DF4 key again. If the file is corrupt, it is recommended to back up the file on a computer (if possible) and then format the SD memory card. See: "9.2 Formatting SD Memory Cards" (p.162)
*** SD card error *** Formatting failed.	An SD memory card error occurred, or the SD memory card was removed during formatting.	Reinsert the SD memory card or replace the SD memory card. See: "3.5 Inserting (Removing) an SD Memory Card" (p.45)
*** SD card error *** SD Card locked.	The SD memory card is locked.	Unlock the SD memory card.
*** SD card error *** SD Card full.	Unable to save file due to insufficient space on the SD memory card.	Delete files to make space or replace the SD memory card. (Insufficient memory capacity will abort storing data into the SD card.) See: "3.5 Inserting (Removing) an SD Memory Card" (p.45)
*** SD card error *** SD Card not found.	No memory card is inserted.	Insert an SD memory card. See: "3.5 Inserting (Removing) an SD Memory Card" (p.45)
*** SD card error *** SD Card not compatible.	An unsupported card such as an SDXC memory card has been inserted into the instrument.	Use a compatible SD memory card.
*** SD card error *** No readable files found.	Unable to load files in the [PQ3198] folder as it has been deleted.	The [PQ3198] folder is created when the SD memory card is formatted. It is also automatically created when recording is started. See: "9.2 Formatting SD Memory Cards" (p.162)

Error display	Cause	Corrective action/more information
*** SD card error *** File or folder could not be deleted.	The cause is one of the following: <ul style="list-style-type: none"> • The SD memory card is write-protected. • The file or folder is write-protected. 	If the SD memory card is locked, unlock it. If the file or folder is set to read-only, change its attributes on a computer and then delete it.
*** SD card error *** Maximum files reached. Additional files cannot be created.	The maximum number of files that can be created during a single recording period was exceeded. The number of settings files exceeded 102. The number of measurement folders created on a single day exceeded 100.	Change the event detection items and detection levels to reduce the number of events that occur. Delete unnecessary settings files. Delete unnecessary measurement folders. See: "5.6 Changing Event Settings" (p.87), "9.6 Saving and Deleting Settings Files (Settings Data)" (p.169), "9.4 Saving, Display and Deleting Measurement Data" (p.165)
*** SD card error *** SD Card is not formatted for this device.	The SD memory card has not been formatted using the SD format.	Format the card with the instrument. See: "9.2 Formatting SD Memory Cards" (p.162)
*** Setting error*** Folder cannot be moved.	Attempted to move to a folder other than the [PQ3198] folder.	When viewing folders other than the [PQ3198] folder, use the mass storage function or access the card directly using a computer. See: "12.1 Downloading Measurement Data Using the USB Interface" (p.182)
*** Operation error*** This folder cannot be deleted.	Attempted to delete the [PQ3198] , [SETTING] , or [HARDCOPY] folder.	These folders are required for the instrument to operate. To delete them, use a computer.
*** SD card error *** SD-CARD ERROR.	An SD memory card error other than those listed above occurred.	Contact Hioki with information about the instrument's operational status at the time of the error.
*** Operation error*** Outside of settings range.	Attempted to set a voltage outside the valid range when using a user-defined nominal input voltage.	Use a nominal input voltage of 50 V to 780 V.
*** Operation error*** Cannot modify settings while recording is in progress.	Attempted to change a setting that cannot be changed while recording is in progress.	If you need to change the settings, stop recording operation with the START/STOP key and then reset the measurement data with the DATA RESET key.
*** Operation error*** Cannot modify settings while analyzing is in progress.	Attempted to change a setting that cannot be changed while analyzing data.	If you need to change the settings, reset the measurement data with the DATA RESET key.
*** Operation error *** Cannot modify settings while waiting is in progress.	Attempted to change a setting that cannot be changed while in the standby state.	If you need to change the settings, stop recording operation with the START/STOP key. If the instrument is in the standby state during repeated recording (after recording has paused and before recording starts again), reset the measurement data with the DATA RESET key after stopping recording operation with the START/STOP key.
*** Operation error *** Operation not available while recording is in progress.	A key such as the DATA RESET key that cannot be used during recording was pressed.	If you need to change the settings, stop recording operation with the START/STOP key and then reset the measurement data with the DATA RESET key.
*** Operation error *** Operation not available while analyzing is in progress.	A key such as the START/STOP key that cannot be used during analysis was pressed.	If you need to change the settings, reset the measurement data with the DATA RESET key.

Error display	Cause	Corrective action/more information
*** Operation error *** Operation not available while waiting is in progress.	A key such as the DATA RESET key that cannot be used while in the standby state was pressed.	In the standby state before recording has begun, stop recording with the START/STOP key. If the instrument is in the standby state during repeated recording (after recording has paused and before recording starts again), reset the measurement data with the DATA RESET key after stopping recording operation with the START/STOP key.
*** Operation error *** Recovering from a power interruption. Please wait.	A key such as the START/STOP key that cannot be used while performing power outage recovery processing immediately after the instrument was turned on was pressed.	Wait a while and then press the key again.
*** Operation error *** Settings cannot be modified under present 4ch wiring.	Attempted to change a setting whose value is constrained by the CH4 setting conditions, for example by changing a DC fluctuation event while CH4 is set to ACDC.	Change the connection (CH4) as necessary.
*** Operation error *** Settings cannot be made under present wiring.	Attempted to change a setting whose value is constrained by the connection, for example by changing the Urms type (phase/line voltage) while CH123 is set to 1P2W.	Change the connection (CH123) as necessary.
*** Operation error *** Cannot be configured when the RMS level is set to OFF.	Attempted to set a sense event while the RMS event is in the OFF state.	Set the sense event after setting the RMS event threshold.
*** Operation error*** This operation is unavailable when using Preset. ESC to exit.	A key other than F1 to F4 , the cursor arrows, ENTER , or the ESC key was pressed on the quick setup screen.	Exit the quick setup display with the ESC key.
*** Setting error*** Preset configuration could not be completed.	Unable to perform quick setup.	Check connections, verify that appropriate input is being provided, and repeat the quick setup process.
*** Zero adjustment *** Zero adjustment failed.	Zero adjustment did not terminate normally.	Perform zero adjustment again with the instrument in the no-input state. If the instrument is located close to a noise source, place it further away and repeat zero adjustment.
Maximum number of recordable events exceeded.	More than 9999 events occurred during the recording period. Consequently, recorded results could not be saved.	Change the event threshold setting so that the number of events does not exceed 9999 during the recording period.
*** Operation error *** START/STOP set to external input (IN).	External events cannot be turned on because [External control (IN)] is set to START/STOP.	Set [External control (IN)] to [Event] .

Contact your authorized Hioki distributor or reseller if a repair should become necessary.

NOTE

Turning on the instrument while the measurement target line is live may damage the instrument, causing an error to be displayed when it is turned on. Always turn on the instrument first and only activate power to the measurement line after verifying that the instrument is not displaying any errors.

14.4 Disposing of the Instrument

The PQ3198 uses lithium batteries as a power source for saving measurement conditions. When disposing of this instrument, remove the lithium battery and dispose of battery and instrument in accordance with local regulations.

Dispose the other options appropriately.

⚠ WARNING

- To avoid electric shock, turn off the **POWER** switch and disconnect the power cord, voltage cord, and current sensor before removing the lithium battery.
- To avoid the possibility of explosion, do not short circuit, disassemble or incinerate battery pack. Handle and dispose of batteries in accordance with local regulations.
- Keep batteries away from children to prevent accidental swallowing.

Lithium Battery Removal

You will need: 1 Phillips head screwdriver (No. 2) and 1 pair of tweezers

1. Turn off the instrument's power switch.
2. Disconnect all cords, including current sensors, voltage cords, and the AC adapter.
3. Remove the 11 screws shown in the following diagram with the Phillips head screwdriver and remove the battery pack cover and side covers.
4. Remove the rear cover and remove the screw attaching the metal plate.

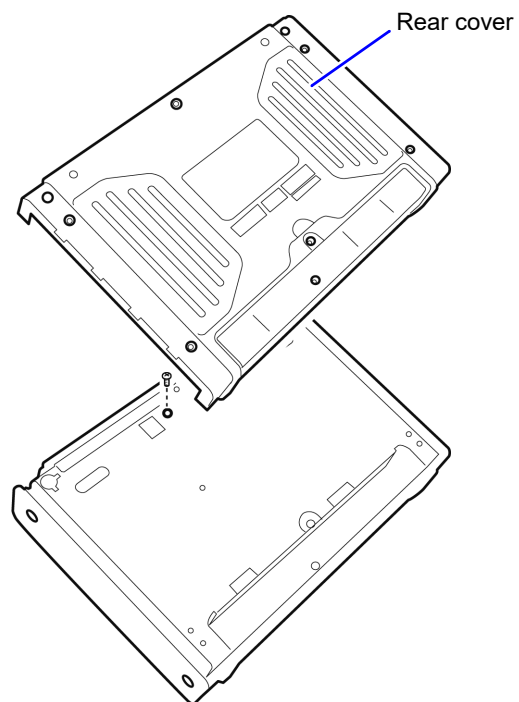
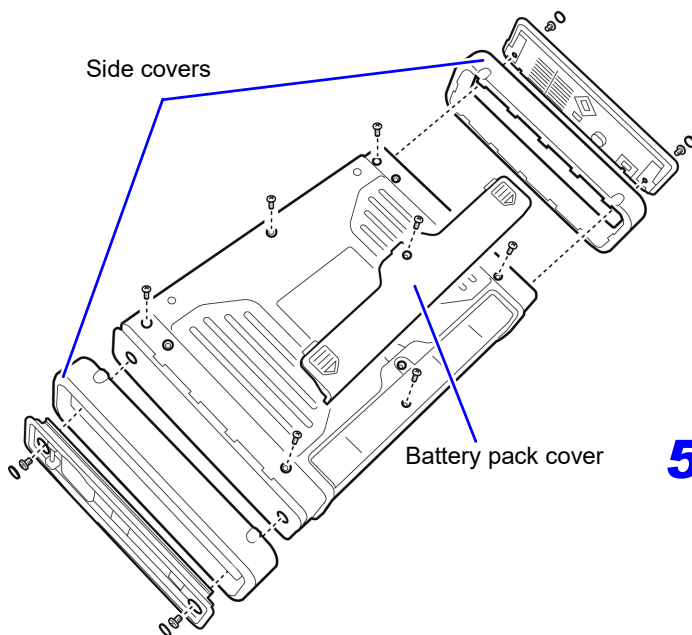

5. Remove the 2 screws on the front cover.

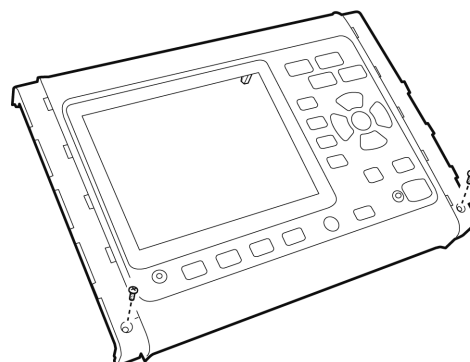

- 6.** Remove the 17 screws shown in the following diagram and remove the upper chassis.

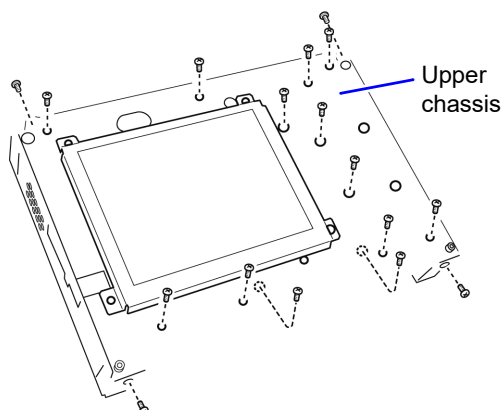

- 7.** Insert the tweezers between the battery holder and the battery and lift up the battery to remove it.

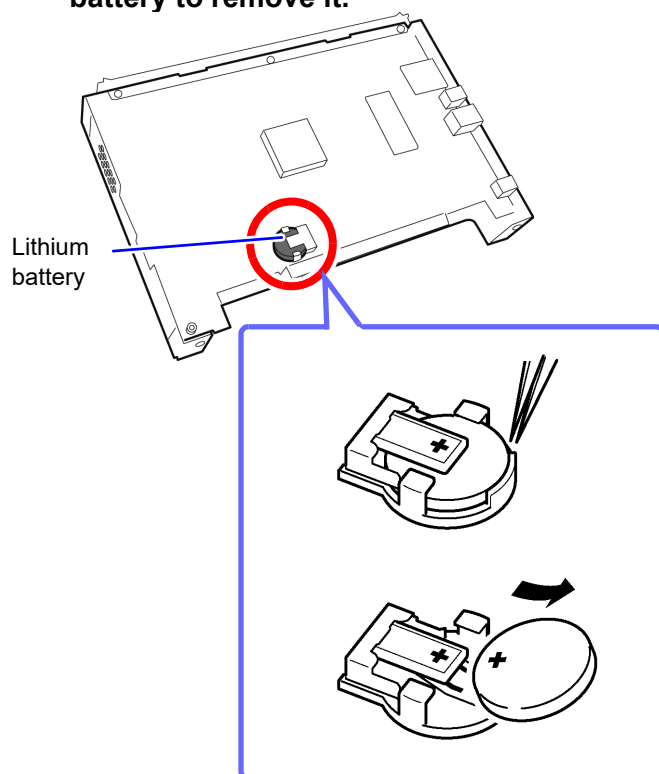

CALIFORNIA, USA ONLY

Perchlorate Material - special handling may apply.
See www.dtsc.ca.gov/hazardouswaste/perchlorate

Appendix

Appendix 1 Fundamental Measurement Items

Item	Display	Item	Display
Transient voltage	Tran	Power factor	PF
Frequency (1 wave)	Freq_wav	Displacement power factor	DPF
RMS voltage refreshed each half-cycle	Urms1/2	Harmonic voltage (0th to 50th order harmonics)	U_{harm}
RMS current refreshed each half-cycle	Irms1/2	Harmonic current (0th to 50th order harmonics)	I_{harm}
Inrush current	Inrush	Harmonic power (0th to 50th order harmonics)	Pharm
Swell	Swell	Harmonic voltage phase angle (1st to 50th order harmonics)	U_{phase}
Dip	Dip	Harmonic current phase angle (1st to 50th order harmonics)	I_{phase}
Interruption	Intrpt	Harmonic voltage-current phase difference (1st to 50th order harmonics)	P_{phase}
Instantaneous flicker value	Pinst	Total harmonic distortion (THD-F/THD-R) (voltage)	U_{thd} (U_{thd-F} or U_{thd-R})
Frequency (10 s)	Freq10	Total current harmonic distortion (current) (THD-F/ THD-R)	I_{thd} (I_{thd-F} or I_{thd-R})
Interharmonic voltage	Uiharm	Voltage negative-phase unbalance factor	U_{unb}
Interharmonic current	Iiharm	Voltage zero-phase unbalance factor	U_{unb0}
Frequency (200 ms)	Freq	Current negative-phase unbalance factor	I_{unb}
Voltage waveform peak+	Upk+	Current zero-phase unbalance factor	I_{unb0}
Voltage waveform peak-	Upk-	K factor	KF
Current waveform peak+	Ipk+	Short-term voltage flicker	Pst
Current waveform peak-	Ipk-	Long-term voltage flicker	Plt
RMS voltage (phase/line)	Urms	ΔV_{10} (Every 1 min.)	dV10
Voltage DC	Udc	ΔV_{10} (Average hourly value)	dV10 AVG
RMS current	Irms	ΔV_{10} (Maximum hourly value)	dV10 MAX
Current DC	Idc	ΔV_{10} (4th. maximum hourly value)	dV10 MAX4
Active power	P	ΔV_{10} (Overall maximum value)	dV10 total MAX
Apparent power	S	High-order harmonic voltage component	U_{harmH}
Reactive power	Q	High-order harmonic current component	I_{harmH}
Active energy (Consumption)	WP+	Voltage waveform comparison	Wave
Active energy (Regeneration)	WP-	Efficiency	Eff1, Eff2
Reactive energy (Lag)	WQLAG	Harmonic power (0th to 50th order harmonics)	Pharm
Reactive energy (Lead)	WQLEAD		

Appendix 2 Explanation of Power Supply Quality Parameters and Events

Power supply quality parameters are necessary in order to investigate and analyze the phenomenon of power supply problems^{*1}. By measuring these parameters, it is possible to assess power supply quality. In order to allow the PQ3198 to detect abnormal values and abnormal waveforms, you set thresholds^{*2}. When these thresholds are exceeded, events are generated.

*1: Meaning issues caused by a reduction in power supply quality, resulting in the following substation issues and electronically controlled device malfunctions: lighting flicker, frequent burning out of incandescent light bulbs, malfunctioning office equipment, occasional abnormal machine operation, overheating of reactor-equipped capacitor equipment, and occasional malfunctioning of overload, negative-phase, and open-phase relays.

*2: Thresholds are set based on an estimation of abnormal values, so events do not necessarily indicate a problem.

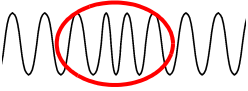
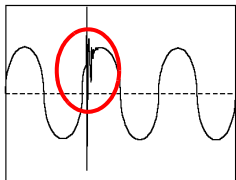
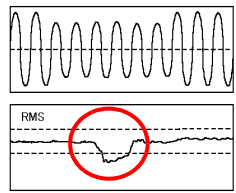
Principal parameters indicating power quality	Waveform	Phenomenon	Primary issues	PQ3198 events and measurements
Frequency fluctuations		Occurs due to line separation caused by changes in the supply/demand balance of active power, the shut-down of a high-capacity generator, or circuit issues.	Changes in the speed of synchronized motors may cause product defects.	Events are detected using frequency 200 ms (Freq) and frequency cycle (Freq_wav). Measurement items include IEC61000-4-30 10-second average frequency and 10-second frequency (Freq10s).
Transient overvoltage (impulse)		Occurs due to phenomena such as lightning, breaker point damage, or closure on the circuit breaker or relay. Often occurs when there is a radical change in voltage or when the peak voltage is high.	Close to the source of the break, the device's power is damaged because of exceptionally high voltages and this may cause the device to reset.	Events involving transients of 5 kHz or more are detected using transient overvoltage. They can also be detected as voltage waveform distortions using voltage waveform peak and voltage waveform comparison functionality.
Voltage dip (SAG)		Most dips are caused by natural phenomena such as lighting. When an equipment fault is detected and taken offline due to the occurrence of a power system ground fault or short-circuit, a large inrush current caused by a motor startup or other load can occur, causing a temporary voltage dip.	Dips in the supply voltage can cause equipment to stop operating or be reset, discharge lamps to turn off, electric motors to increase or decrease in speed or stop, or synchronized motors and generators to lose synchronization.	Events are detected using dips.

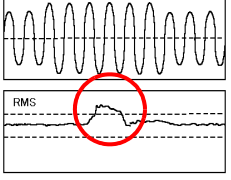
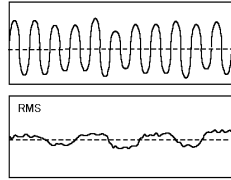
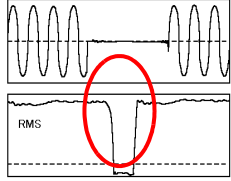
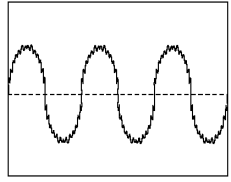
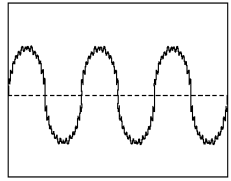
Principal parameters indicating power quality	Waveform	Phenomenon	Primary issues	PQ3198 events and measurements
Voltage swell (SURGE)		<p>Swells occur when the voltage rises momentarily, for example when a power line turns on or off due to lightning or a heavy load, when a high-capacity capacitor bank is switched, when a one-line ground occurs, or when a high-capacity load is cut off. This phenomenon also includes voltage surges due to grid-tied dispersed power supplies (solar power, etc.).</p>	<p>A surge in voltage may cause the device's power to be damaged or the device to reset.</p>	<p>Events are detected using swells.</p>
Flicker		<p>Flicker consists of voltage fluctuations resulting from causes such as blast furnace, arc welding, and thyristor control loads. Manifestations include light bulb flicker.</p>	<p>Because this phenomenon reoccurs regularly, it may cause the light to flicker or the device to malfunction. Large flicker values indicate that most people would find the flickering of lighting unpleasant.</p>	<p>Events are measured using ΔV_{10} flicker and IEC flicker Pst and Plt.</p>
Interruption (momentary power outage)		<p>Interruptions consist of momentary, short-term, or extended power supply outages as a result of factors such as circuit breakers being tripped due primarily to power company issues (interruption of power due to lightning strikes, etc.) or power supply short-circuits.</p>	<p>Recently, due to the spread of UPS (uninterruptible power sources), most of these problems can be fixed using a computer, but this may cause the device to stop operating due to an interruption or to reset.</p>	<p>Events are detected using interruptions.</p>
Harmonic		<p>Harmonics are caused by distortions of the voltage and current waveforms when a device's power supply uses semiconductor control devices.</p>	<p>Large harmonic components can lead to major malfunctions, including overheating of motors and transformers and burnout of reactors connected to phase advance capacitors.</p>	<p>Events are detected using harmonic voltage, harmonic current, and harmonic power. They can also be detected as voltage waveform distortions using voltage waveform comparison functionality.</p>
Inter-harmonics		<p>Inter-harmonics are caused when the voltage or current waveform is distorted due to static frequency conversion equipment, cycloconverters, Scherbius machines, induction motors, welders, or arc furnaces. The term refers to frequency components that are not a whole multiple of the fundamental wave.</p>	<p>Displacement of the voltage waveform zero-cross may damage equipment, cause it to malfunction, or degrade its performance.</p>	<p>Inter-harmonics are measured using inter-harmonic voltage and inter-harmonic current. Events are not supported, but it may be possible to detect events as voltage waveform distortions using voltage waveform comparison functionality.</p>

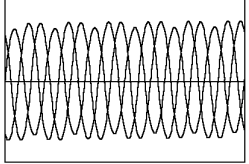
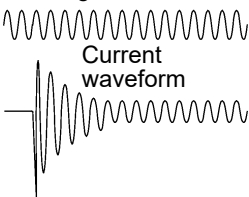
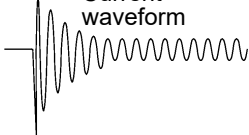
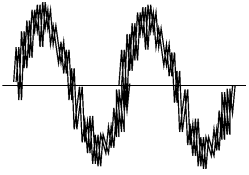
Principal parameters indicating power quality	Waveform	Phenomenon	Primary issues	PQ3198 events and measurements
Unbalance		<p>Unbalance is caused by increases or decreases in the load connected to each phase of a power line, or by distortions in voltage and current waveforms, voltage dips, or negative-phase voltage caused by the operation of unbalanced equipment or devices.</p>	<p>Voltage unbalance, negative-phase voltage, and harmonics can cause issues including variations in motor speed and noise, reduced torque, tripping of 3E breakers, overloading and heating of transformers, and increased loss in capacitor smoothing rectifiers.</p>	<p>Events are detected using voltage unbalance factor and current unbalance factor.</p>
Inrush current	<p>Voltage waveform  Current waveform </p>	<p>Inrush current is a large current that flows momentarily, for example when electric equipment is turned on.</p>	<p>Inrush current can cause power switch contact and relay fusing, fuse blowouts, circuit breaker disconnections, issues with rectifying circuits, and supply voltage instability, causing equipment sharing the same power supply to stop operating or be reset.</p>	<p>Events are detected using inrush current.</p>
High-order harmonic component		<p>The high-order harmonic component consists of noise components of several kHz or more caused by voltage and current waveform distortions when equipment power supplies use semiconductor devices. It includes various frequency components.</p>	<p>The high-order harmonic component can damage equipment power supplies, cause equipment operation to be reset, or result in abnormal sound from TVs and radios.</p>	<p>Events are detected using high-order harmonic voltage component RMS values and high-order harmonic current component RMS values.</p>

Appendix 3 Event Detection Methods

Transient overvoltage

Measurement method:

- Detected when the waveform obtained by eliminating the fundamental component (50/60/400 Hz) from a waveform sampled at 2 MHz exceeds a threshold specified as an absolute value.
- Detection occurs once for each fundamental voltage waveform, and voltages of up to $\pm 6,000$ V can be measured.

Recorded data:

- Transient voltage value : Peak value of waveform during 4 ms period after elimination of fundamental component
- Transient width : Period during which threshold is exceeded (2 ms max.)
- Max. transient voltage value: : Max. peak value of waveform obtained by eliminating the fundamental component during the period from transient IN to transient OUT (leaving channel information)
- Transient period : Period from transient IN to transient OUT
- Transient count during period : Number of transients occurring during period from transient IN to transient OUT (transients occurring across all channels or simultaneously on multiple channels count as 1)
- Transient waveforms : Event waveform and transient waveform
(Waveforms are saved for 2 ms before and after the position at which the transient overvoltage waveform was detected for the first transient IN and 2 ms before and after the point at which the transient maximum voltage waveform was detected between the IN and OUT points.)

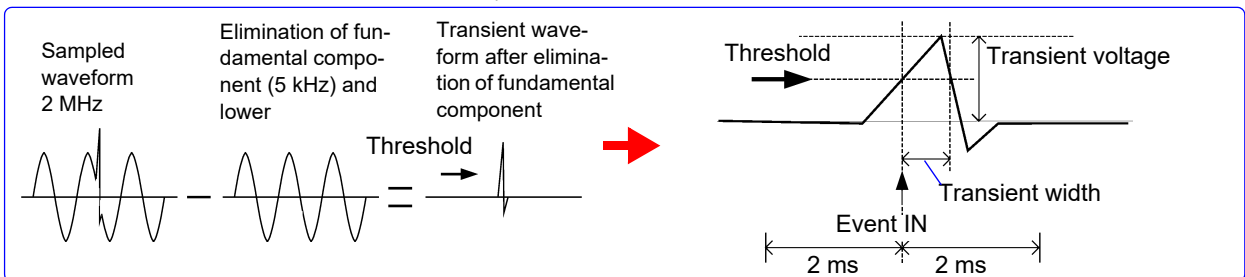

Event IN and OUT

- Event IN : The event occurrence time when the first transient overvoltage is detected during an aggregation period of approx. 200 ms. indicates the peak voltage value and transient width detected when the threshold was exceeded.
- Event OUT : Indicates the first transient period (difference between the IN time and OUT time) for the approx. 200 ms aggregation period during which no transient overvoltage was detected for any channel within the first approx. 200 ms aggregation period following the transient event IN state.

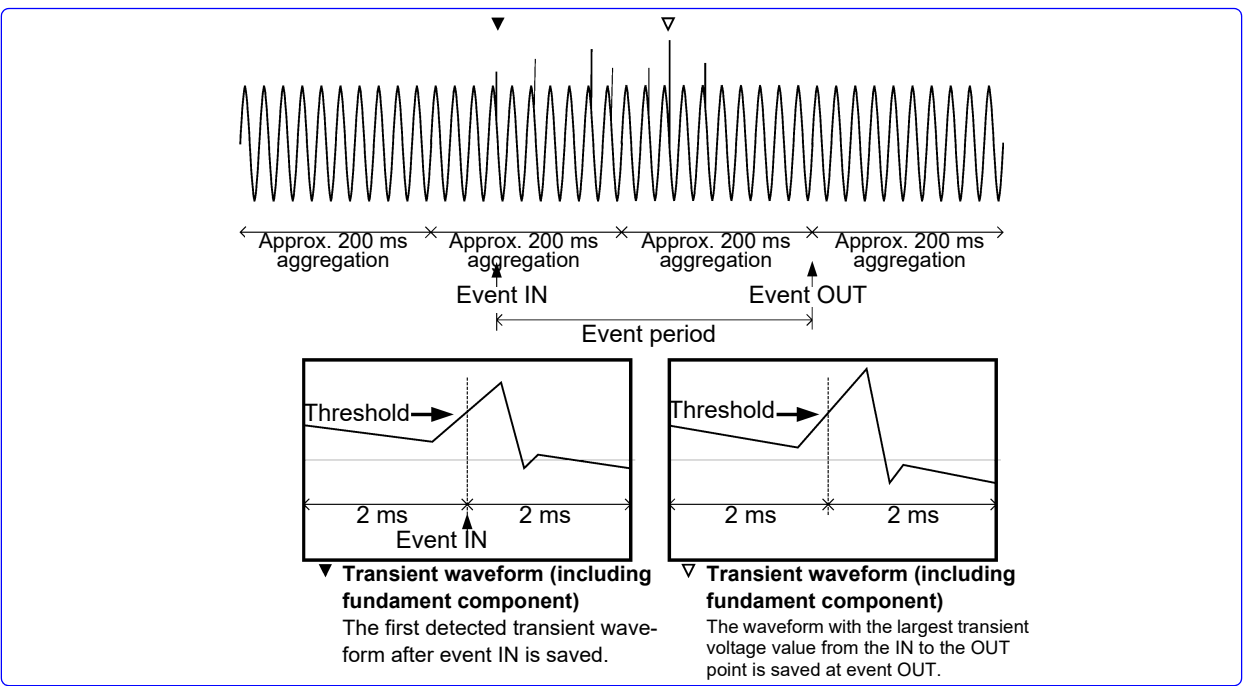

Voltage Swells, Voltage Dips, and Interruptions

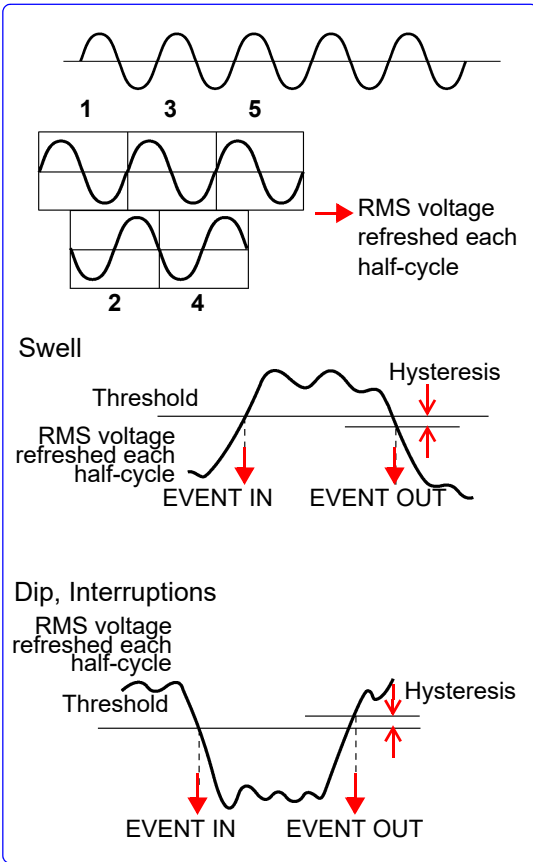

Measurement method:

- When the measurement frequency is set to 50/60 Hz, events are detected using the RMS voltage refreshed each half-cycle based on sample data for 1 waveform derived by overlapping the voltage waveform every half-cycle.
- When the measurement frequency is set to 400 Hz, events are detected using the RMS voltage refreshed each half-cycle based on sample data for each waveform.
- Events are detected using line voltage for 3-phase 3-wire connections and phase voltage for 3-phase 4-wire connections.
- Swells are detected when the RMS voltage refreshed each half-cycle exceeds the threshold in the positive direction, while dips and interruptions are detected when the RMS voltage refreshed each half-cycle exceeds the threshold in the negative direction (hysteresis applies in all cases).

Event IN and OUT:

- Event IN : Start of the waveform during which the RMS voltage refreshed each half-cycle exceeds the threshold in the positive direction
- Event OUT : Start of the waveform during which the RMS voltage refreshed each half-cycle exceeds the value obtained by subtracting the hysteresis from the threshold in the negative direction

Frequency 200 ms

Measurement method:

Frequency is calculated as the reciprocal of the accumulated whole-cycle time during 10, 12, or 80 U1 (reference channel) cycles. This value is detected when the absolute value is exceeded.

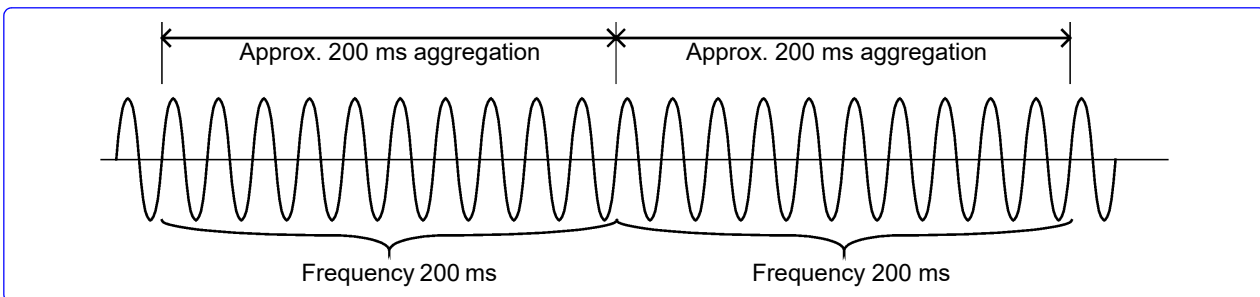

Event IN and OUT:

- Event IN : Start of the approx. 200 ms aggregation in which the reading is greater than \pm threshold
- Event OUT : Start of the approx. 200 ms aggregation in which the reading returns to \pm (threshold - 0.1 Hz)
- Note: Equivalent to 0.1 Hz frequency hysteresis.

Frequency cycle

Measurement method:

- Frequency for every U1 (reference channel) waveform, calculated using the reciprocal method.
- When the measurement frequency is set to 400 Hz, the frequency cycle is calculated as the reciprocal of the accumulated whole-cycle time during 8 cycles.
- The frequency cycle is calculated as the average frequency for 8 waveforms.

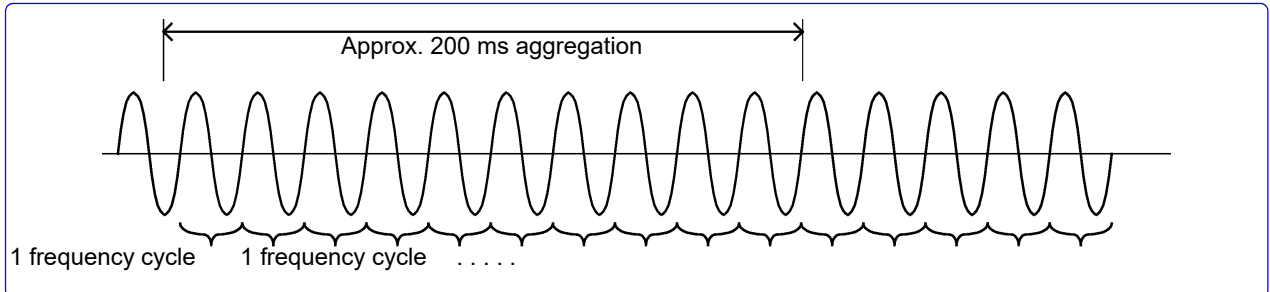

Event IN and OUT:

Event IN : Start time of waveform exceeding \pm threshold

Event OUT : Start time of waveform returning to \pm (threshold - 0.1 Hz)

Note Equivalent to 0.1 Hz frequency hysteresis.

Voltage Waveform Peak, Current Waveform Peak, RMS Voltage, RMS Current, Active Power, Reactive Power, Apparent Power, Power Factor, and Displacement Power Factor

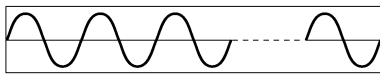

50 Hz: 10 waveforms; 60 Hz: 12 waveforms;
400 Hz: 80 waveforms ↓

RMS value calculation

RMS voltage (upper limit)

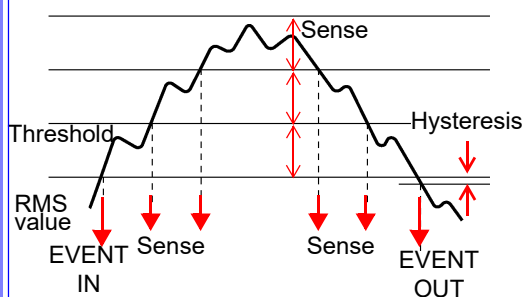

Measurement method:

- Events are detected when the value in question calculated from the approx. 200 ms aggregation of 10 cycles (50 Hz), 12 cycles (60 Hz), or 80 cycles (400 Hz) is greater than or less than the threshold.
- RMS values are calculated from an approx. 200 ms aggregation of 10 cycles (50 Hz), 12 cycles (60 Hz), or 80 cycles (400 Hz) as per IEC61000-4-30.

Event IN and OUT:

Event IN : Start of the approx. 200 ms aggregation in which the reading is greater than the upper limit or less than the lower limit

Event OUT : Start of the first approx. 200 ms aggregation in which the reading is less than (the upper limit - hysteresis) after being greater than the upper limit, or in which the reading is greater than (the lower limit + hysteresis) after being less than the lower limit

Sense : Sense events are detected when the reading is greater than or less than the sense upper limit between the event IN and event OUT.
(When event OUT conditions are fulfilled, the event OUT takes precedence.)

Voltage DC Value, Current DC Value (CH4 only)

Measurement method:

Values are detected when the average value for the approx. 200 ms aggregation synchronized to the reference channel U1 exceeds a threshold specified as an absolute value.

Event IN and OUT:

- Event IN : Start of the approx. 200 ms aggregation in which the reading is greater than the upper limit or less than the lower limit
- Event OUT : Start of the first approx. 200 ms aggregation in which the reading is less than (the upper limit - hysteresis) after being greater than the upper limit, or in which the reading is greater than (the lower limit + hysteresis) after being less than the lower limit

Voltage DC Change and Current DC Change (CH4 only)

Measurement method:

DC fluctuation events are detected when the difference between the positive and negative waveform peak values in an approx. 200 ms aggregation exceeds the set threshold.

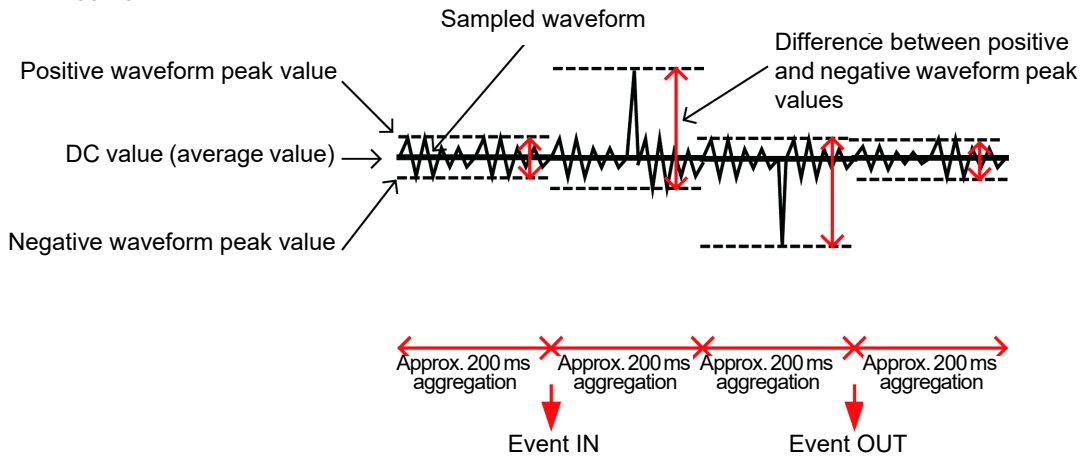

Measured values in the event list are displayed as the voltage or current value for the difference between the positive and negative waveform peak values. (These measured values are not recorded.)

Voltage Unbalance Factor, Current Unbalance Factor, Harmonic Voltage, Harmonic Current, Harmonic Power, Harmonic Voltage-Current Phase Difference, Total Harmonic Voltage Distortion Factor, Total Harmonic Current Distortion Factor, and K Factor

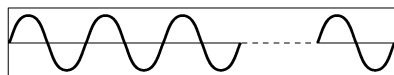

50 Hz: 10 cycles, 60 Hz: 12 cycles, 400 Hz: 80 cycles

Harmonic calculation using rectangular window

3rd-order harmonic voltage

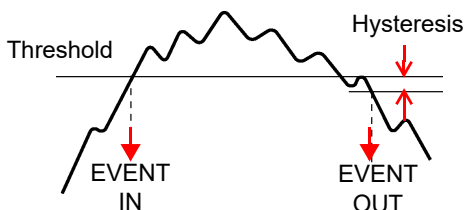

Measurement method:

Measured values are calculated for a rectangular window of 4,096 points in an approx. 200 ms aggregation of 10 cycles (50 Hz), 12 cycles (60 Hz), or 80 cycles (400 Hz), and events are detected when the calculated values are greater than or less than the corresponding threshold.

Event IN and OUT:

- Event IN : Start of the approx. 200 ms aggregation in which the reading is greater than the threshold
- Event OUT : Start of the approx. 200 ms aggregation in which the reading is less than (the threshold - hysteresis)

Voltage Waveform Comparison

Measurement method:

- A judgment area is automatically generated from the previous 200 ms aggregation waveform, and events are generated based on a comparison with the judgment waveform.
- Waveform comparison is performed at once for the entire 200 ms aggregation. Thresholds are applied as a percentage of the nominal input voltage RMS value.

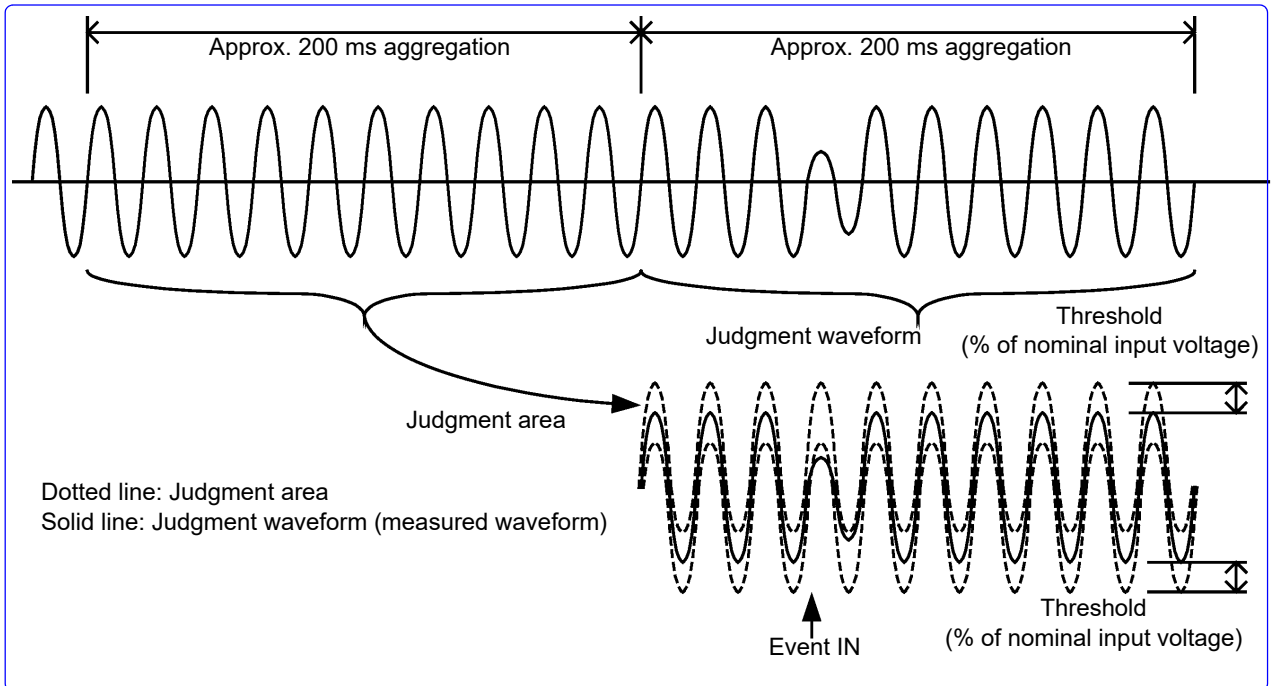

Event IN and OUT:

Event IN : First time at which waveform diverges from judgment area

Event OUT : None

Inrush current

Measurement method:

- Events will be detected when the current RMS Inrush exceeds the threshold value.
- For 400 Hz measurement, events are detected when the maximum of 4 RMS current values existing within the same 10 ms period (calculated values for one 400 Hz waveform) is greater than the threshold in the positive direction.

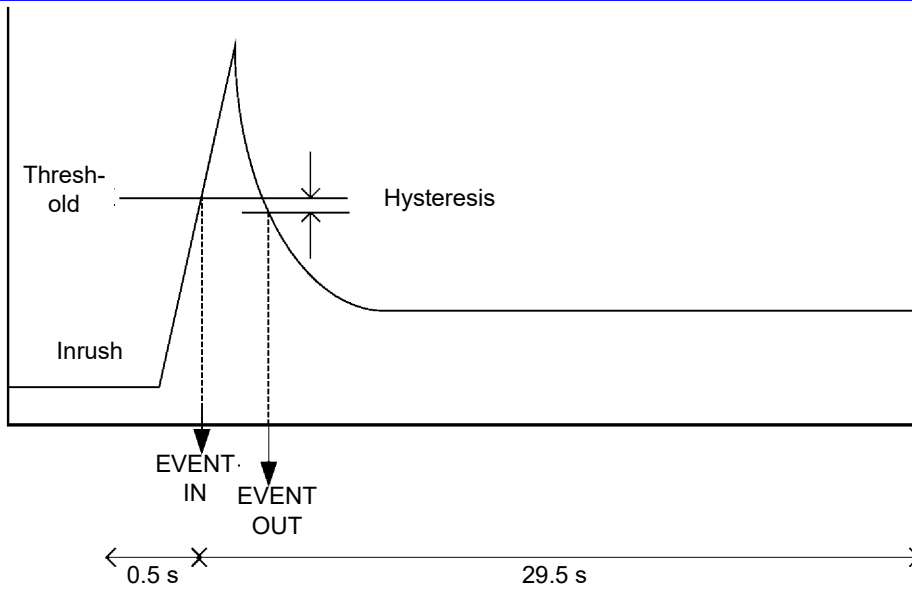

The current RMS Inrush within the period between 0.5 s before and 29.5 s after the event, as fluctuating data, is saved.

Event IN and OUT:

Event IN : Time of start of channel half-cycle voltage waveform in which the RMS current refreshed each half-cycle was greater than the threshold.

Event OUT : Time at the start of the voltage half-cycle waveform in which the RMS current refreshed each half-cycle exceeded (threshold - hysteresis) in the negative direction

Voltage waveform



Current waveform

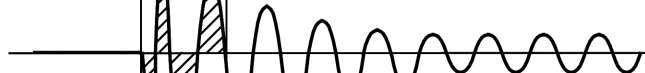

Event IN

Event OUT

High-order Harmonic Voltage Component and High-order Harmonic Current Component

Measurement method:

- The waveform consists of components having frequencies of 2 kHz to 80 kHz is calculated using the true RMS method during 10 cycles (50 Hz), 12 cycles (60 Hz), or 80 cycles (400 Hz) of the fundamental wave. Events are detected when this RMS value is greater than the threshold.
- When an event is detected, the high-order harmonic waveform is recorded in addition to the event waveform for 40 ms (8000 points of data) from the end of the first approx. 200 ms aggregation interval in which the reading was greater than the threshold.

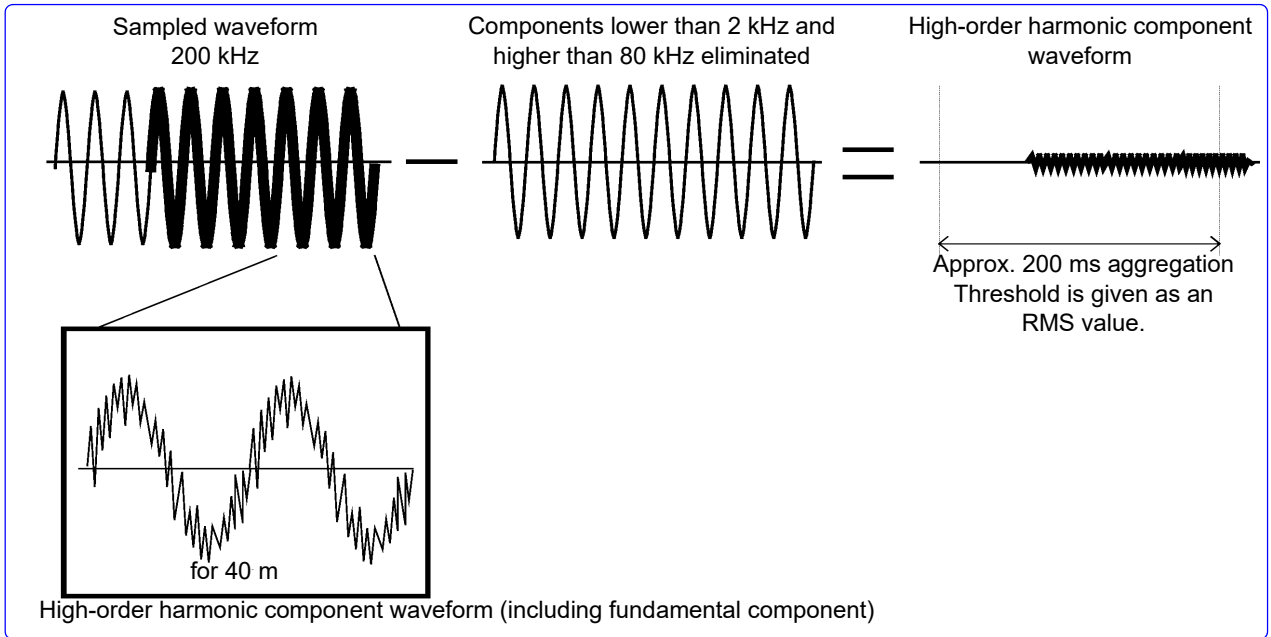

Event IN and OUT:

- Event IN : Start of the approx. 200 ms aggregation in which the reading is greater than the threshold
- Event OUT : Start of the approx. 20 ms aggregation in which no high-order harmonics were detected during the first approx. 200 ms aggregation following the IN state

Timer Events

Events are generated at the set interval. Once recording has started, timer events are recorded at a fixed interval (the set time) starting with the start time.

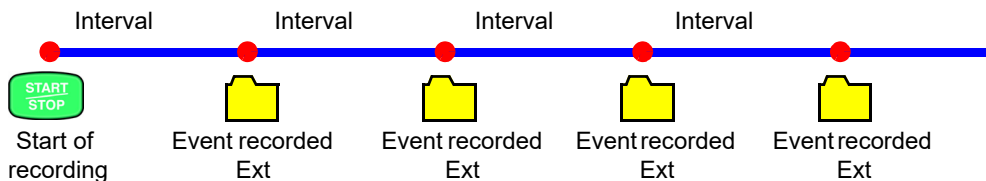

External Events

External events are detected using external control terminal (EVENT IN) shorts or pulse signal falling edge input. The voltage and current waveforms and measured values when the external event occurs can be recorded.

See: "11.1 Using the External Control Terminal" (p.177)

Manual Events

Manual events are detected when the MANU EVENT (manual event) key is pressed. The voltage and current waveforms and measured values when the external event occurs can be recorded.

See: For more information about how to record event waveforms: "Appendix 4 Recording TIME PLOT Data and Event Waveforms" (p.A12)

Appendix 4 Recording TIME PLOT Data and Event Waveforms

TIME PLOT screen (trends and harmonic trends)

■ When recording RMS values:

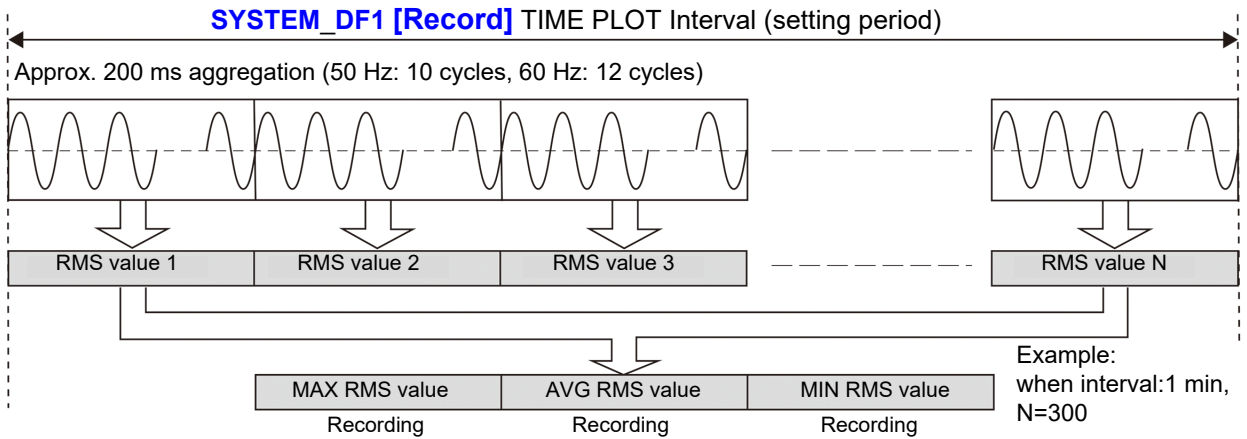

■ When recording peak values:

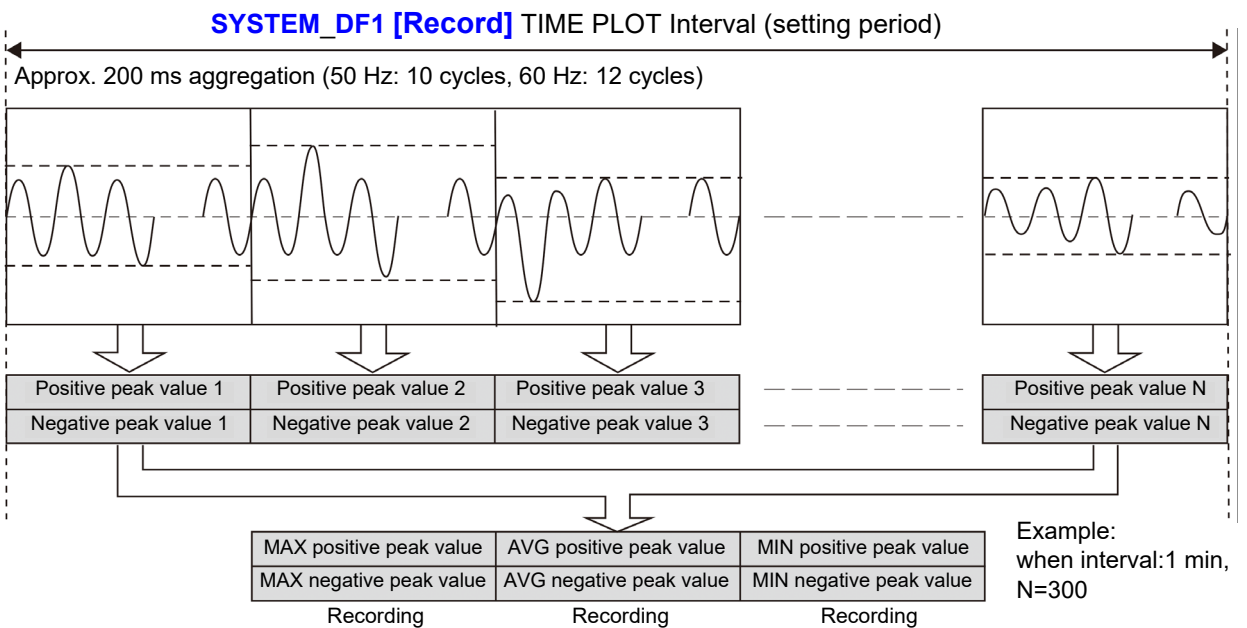

TIME PLOT screen (detailed trends)

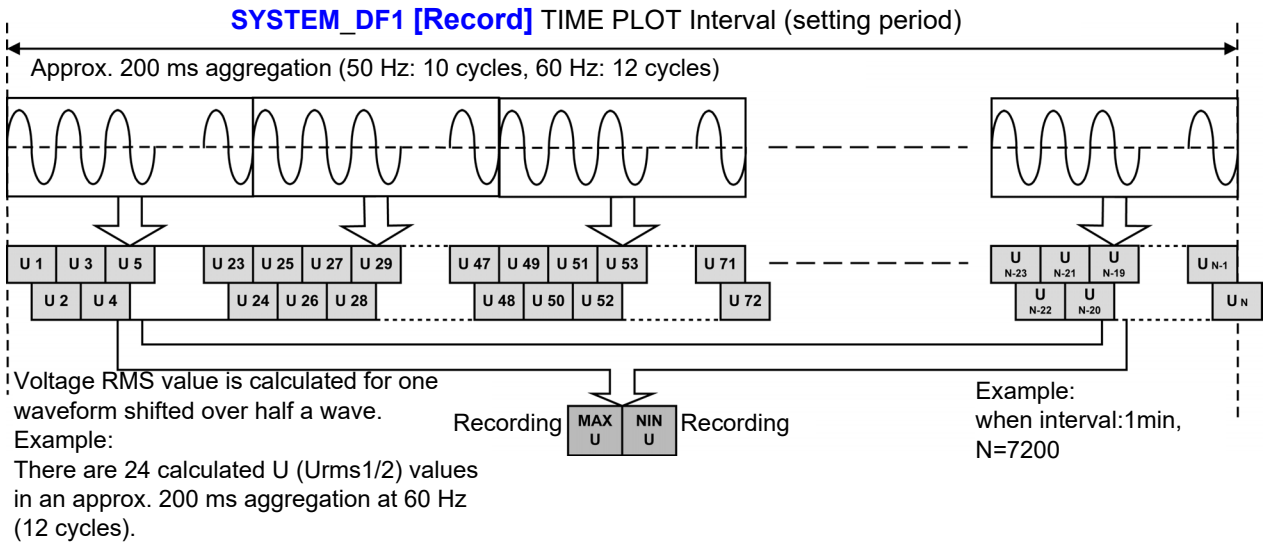

Event Waveform Recording Method Generating events using approx. 200 ms aggregation measured values

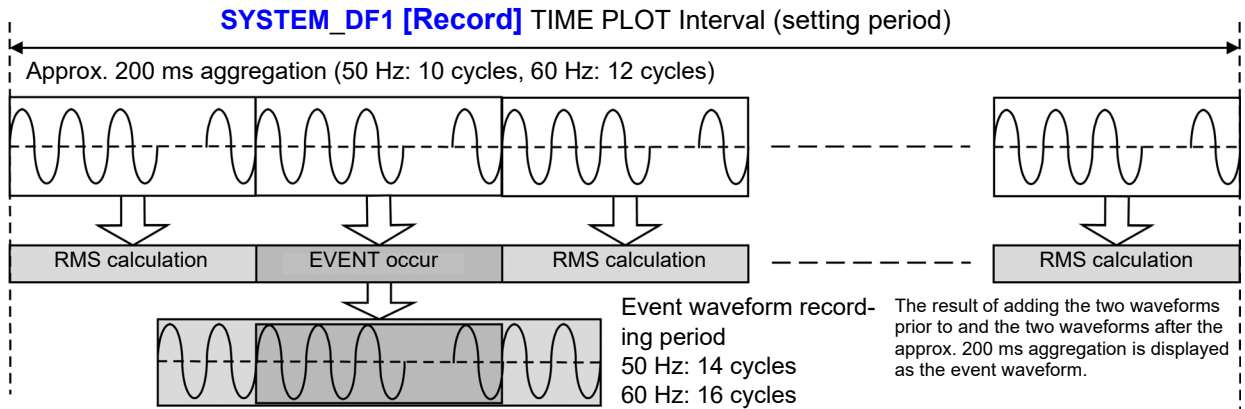

Generating events using one- or half-wave measured values

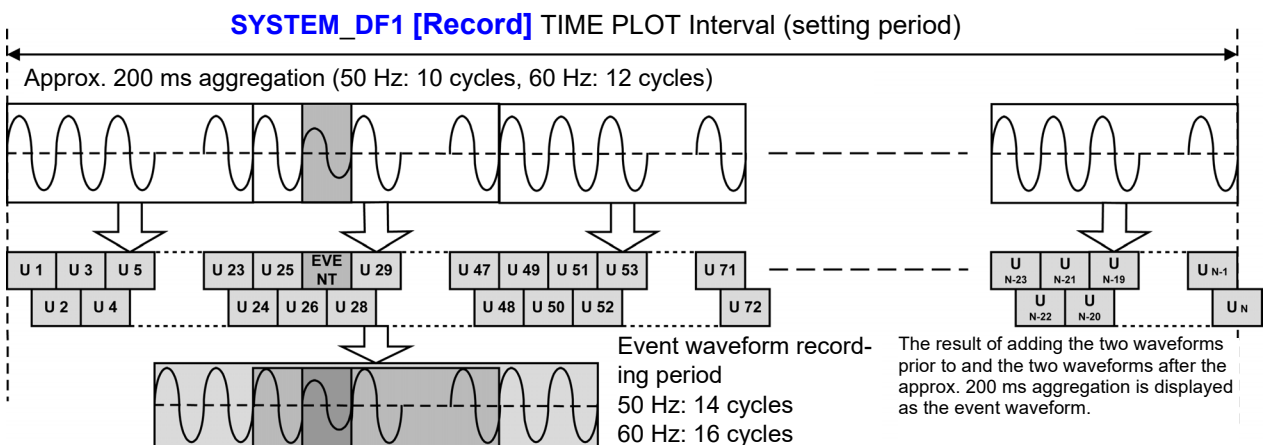

TIME PLOT time synchronization and overlap

Instruments defined under IEC61000-4-30 Class A must generate measurement results within the stipulated accuracy range when measuring the same signal, even if different instruments are used to make the measurement.

A series of 150/180 cycle time intervals is resynchronized every 10 minutes as shown in the figure to align measurement times and measured values. Consequently, the approx. 200 ms aggregations (10 or 12 cycles) are also resynchronized every 10 minutes.

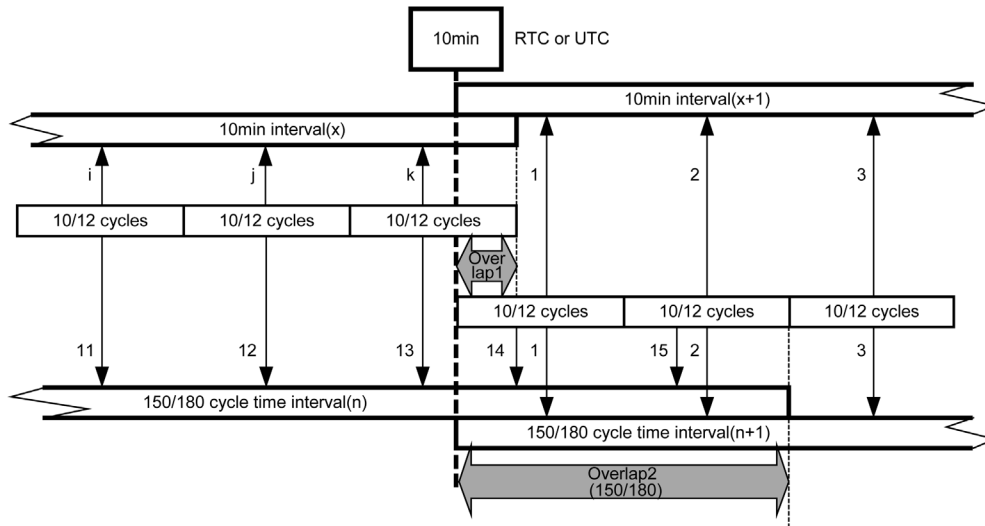

Figure. Synchronization Required by IEC61000-4-30 Class A

A new 150/180 cycle time interval starts every 10 minutes (for example, $x+1$), while measurement of the existing 150/180 cycle time interval (for example, x) continues until it is complete. In this way, there is an overlap between the two 150/180 cycle time intervals and between approx. 200 ms aggregations (10 or 12 cycles). The PQ3198 synchronizes the start of the set TIME PLOT interval every 10 minutes. For this reason, approx. 200 ms aggregations (10 or 12 cycles) are also resynchronized every 10 minutes.

A new TIME PLOT interval starts every 10 minutes, while measurement of the existing TIME PLOT interval continues until it is complete. In this way, there is an overlap between the two TIME PLOT intervals.

To perform standard-compliant measurement, the TIME PLOT interval must be set to 50 Hz/150 cycles or 60 Hz/180 cycles.

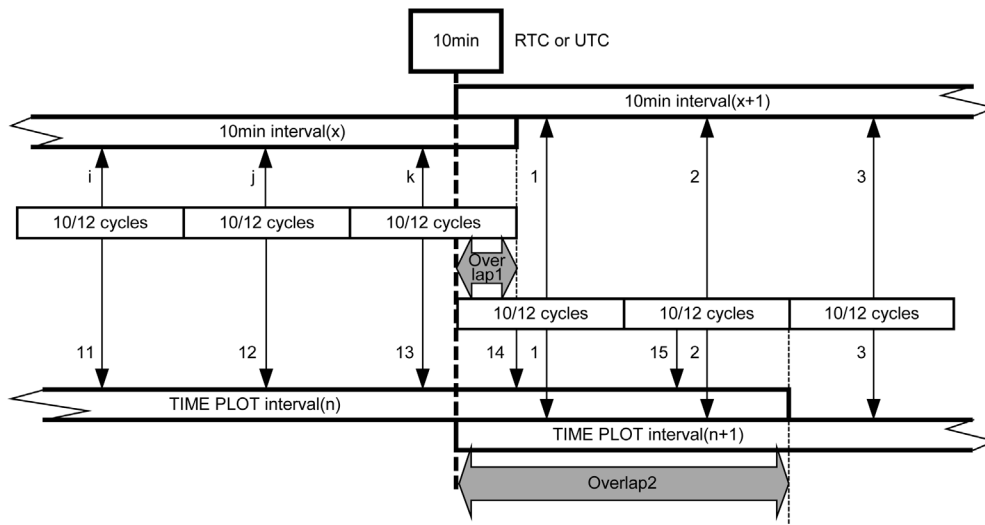

Figure. PQ3198 Synchronization

Note: 10/12 cycles = 200 ms aggregation

Method for verifying aggregation values required by IEC61000-4-30

	3-second aggregated values (=150/180cycle data)	10-minute aggregated values	2-hour aggregated values
Magnitude of the Supply Voltage	Applies to average value of channel Urms values on the [TIME PLOT] - [TREND] screen.	Applies to average value of channel Urms values on the [TIME PLOT] - [TREND] screen.	Applies to average value of channel Urms values on the [TIME PLOT] - [TREND] screen.
Voltage harmonics	Applies to average values on the [TIME PLOT] - [Harm-Trend] screen.	Applies to average values on the [TIME PLOT] - [Harm-Trend] screen.	Applies to average values on the [TIME PLOT] - [Harm-Trend] screen.
Voltage inter-harmonics	Applies to average values for each channel's orders on the [TIME PLOT] - [Harm Trend] - [INTERHARM] screen.	Applies to average values for each channel's orders on the [TIME PLOT] - [Harm Trend] - [INTERHARM] screen.	Applies to average values for each channel's orders on the [TIME PLOT] - [Harm Trend] - [INTERHARM] screen.
Supply Voltage unbalance	Applies to average value of unb0 and unb for Uunb on the [TIME PLOT] - [TREND] screen.	Applies to average value of unb0 and unb for Uunb on the [TIME PLOT] - [TREND] screen.	Applies to average value of unb0 and unb for Uunb on the [TIME PLOT] - [TREND] screen.
Measurement conditions	<ul style="list-style-type: none"> The TIME PLOT interval is set to 150/180 cycles. During analysis, cursor measurement is performed after setting Tdiv to the minimum value. The order being checked for harmonics and inter-harmonics is selected and displayed. Recorded items for inter-harmonics are set to [All data]. Set the real-time control to [Exactly]. 	<ul style="list-style-type: none"> The TIME PLOT interval is set to 10 minutes. During analysis, cursor measurement is performed after setting Tdiv to the minimum value. The order being checked for harmonics and inter-harmonics is selected and displayed. Recorded items for inter-harmonics are set to [All data]. Set the real-time control to [Exactly]. 	<ul style="list-style-type: none"> The TIME PLOT interval is set to 2 hours. During analysis, cursor measurement is performed after setting Tdiv to the minimum value. The order being checked for harmonics and inter-harmonics is selected and displayed. Recorded items for inter-harmonics are set to [All data]. Set the real-time control to [Exactly].

IEC flicker

For IEC 61000-4-30 Plt values, use only the values shown with even numbered 2-hour intervals, and discard the other Plt values. The other Plt values are provided for information only, and are not IEC 61000-4-30 Plt values.

10-second frequency measurement

The parameter that is labeled "f10s" in TIMEPLOT is not an IEC 61000-4-30 measurement. User can find frequency data for 10-second frequency measurement that is compliant with IEC 61000-4-30 here (View>DMM>Voltage Freq10s)

Time clock accuracy

IEC61000-4-30 Class A requires that regardless of the overall time interval, time clock accuracy must be within ± 20 ms for 50 Hz and within ± 16.7 ms for 60 Hz. When accurate time synchronization using an external signal is not possible, a tolerance of less than ± 1 second over 24 hours is permitted, but regardless of the overall time interval, accuracy must be within ± 20 ms for 50 Hz and ± 16.7 ms for 60 Hz.

By synchronizing the PQ3198 with the PW9005 GPS Box, the instrument time can be synchronized to UTC at a high degree of accuracy. In the event that accurate time synchronization using an external signal, such as that provided by the GPS unit, is not possible, the instrument incorporates a clock capable of operating at a real-time accuracy of within ± 1 second per day (within the specified operating temperature and humidity range).

Appendix 5 Detailed Explanation of IEC Flicker and ΔV_{10} Flicker



To measure the IEC Flicker or ΔV_{10} Flicker

Flicker calculation and IEC flicker filter settings are configured on the **SYSTEM-DF1 [Main]-F2 [Measure 2]** screen.

See: "5.1 Changing Measurement Conditions" (p.73)

IEC Flicker Meter

The IEC flicker function is based on international standard IEC61000- 4-15, "Flickermeter - Functional and design specifications".

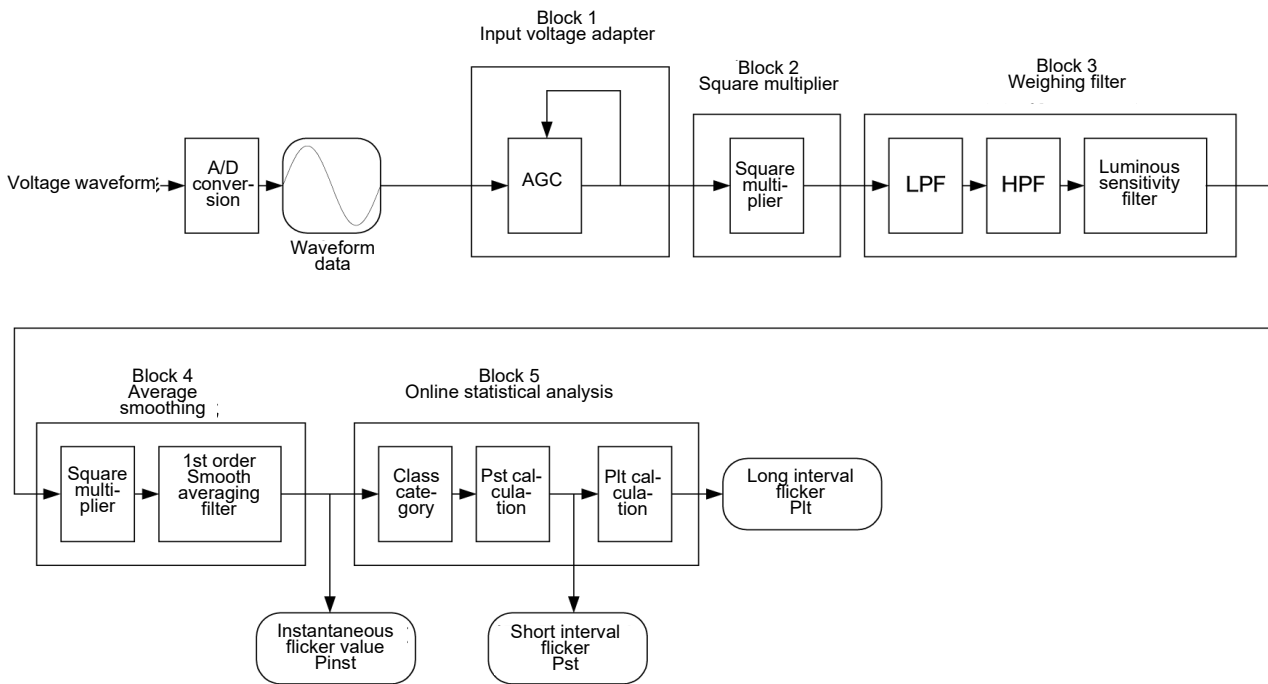

Weighting Filter You can select a weighted filter for either a 230 V lamp system or a 120 V lamp system.

Statistical Processing Statistics on flicker are compiled by applying the cumulative probability function (CPF) to 1024 logarithmic divisions of instantaneous flicker values P_{inst} in the range from 0.0001 to 10000 P.U. to obtain cumulative probabilities P0.1, P1s, P3s, P10s, and P50s.

Short Interval Flicker Value Pst This indicates degree of perceptibility (severity) of flicker measured over a 10-minute period.

Calculation:

$$P_{st} = \sqrt{0.0314P_{0.1} + 0.0525P_{1s} + 0.0657P_{3s} + 0.28P_{10s} + 0.08P_{50s}}$$

$$P_{50s} = (P_{30} + P_{50} + P_{80})/3$$

$$P_{10s} = (P_6 + P_8 + P_{10} + P_{13} + P_{17})/5$$

$$P_{3s} = (P_{2.2} + P_3 + P_4)/3$$

$$P_{1s} = (P_{0.7} + P_1 + P_{1.5})/3$$

P0.1 is not smoothed

Long Interval Flicker Value Plt Indicates the degree of perceptibility (severity) of flicker determined from successive Pst measurements over a 2-hour period. To calculate a moving average of Pst, the displayed value is updated every 10 minutes.

Calculation:

$$P_{lt} = \sqrt[3]{\frac{\sum (P_{sti})^3}{N}}$$

ΔV10 Flicker Meter

ΔV10 flicker The ΔV10 flicker function can calculate ΔV10 flicker values by making a calculation using the arithmetic expression that employs the perceived flicker curve, which is based on the digital Fourier transformation, and then converting the obtained value into the 100-volt-equivalent value.

Calculation:

$$\Delta V_{10} = \frac{100}{U_f^2} \sqrt{\sum_{n=1}^{\infty} (a_n \cdot \Delta U_n)^2}$$

ΔUn : RMS value [V] for voltage fluctuations in frequency fn.

an : Luminosity coefficient for fn where 10 Hz is 1.0.

(0.05 Hz to 30 Hz)

Evaluation period: for 1 minute

ΔV10 flicker function diagram

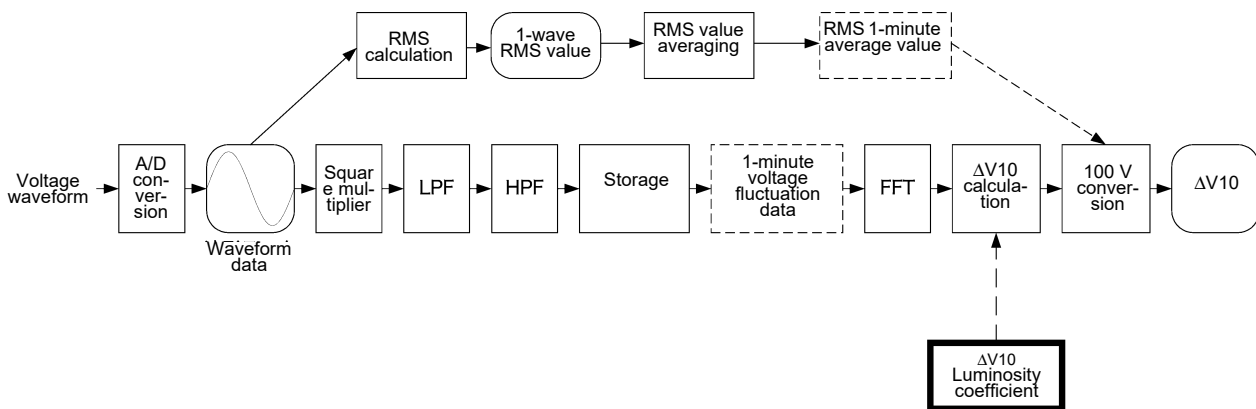

ΔV10 Perceived flicker coefficient

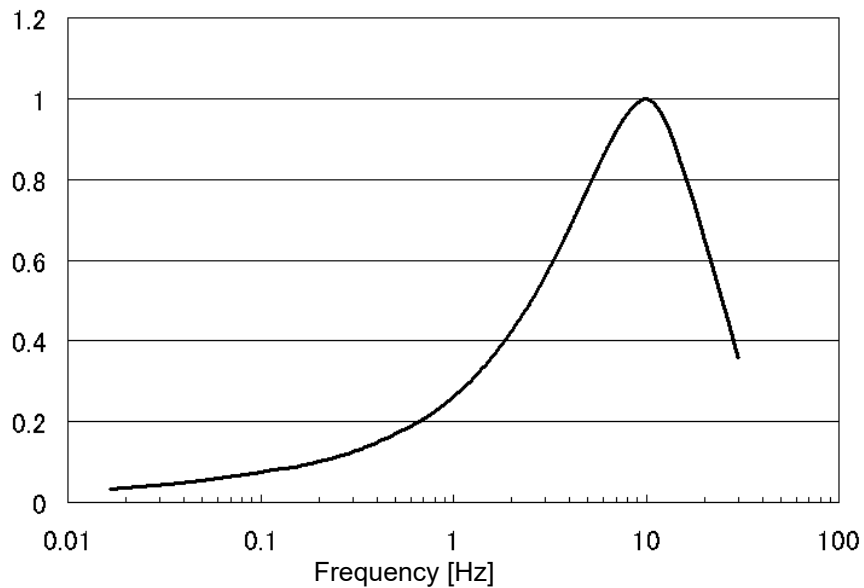

Appendix 6 Making Effective Use of Channel 4

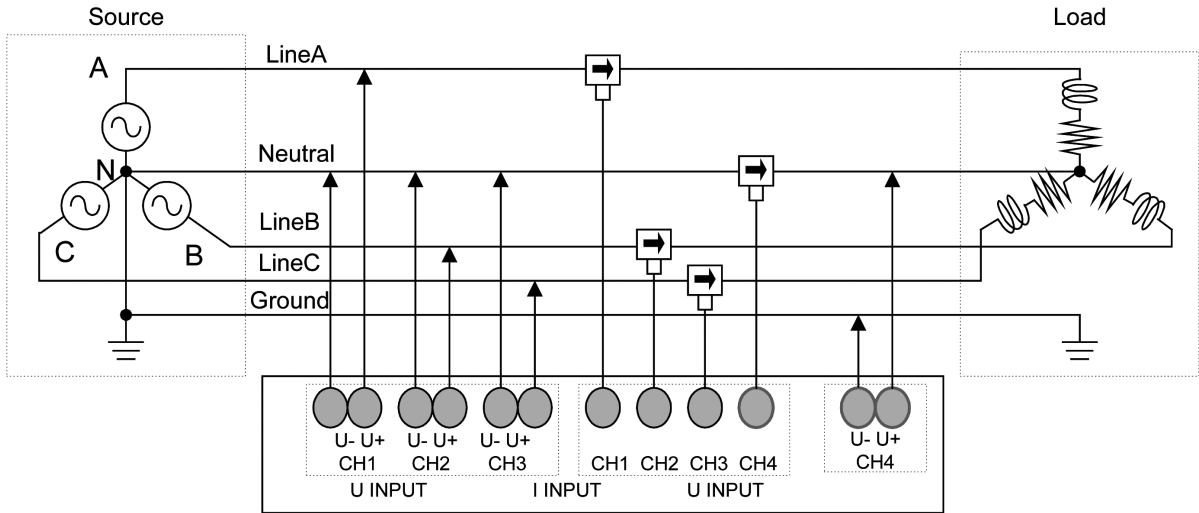

While channel 4 is often used to measure the neutral line of 3-phase 4-wire connections, there are a variety of other uses since it is isolated from the instrument's other channels.

DC power supply measurement

This is an extremely broad range of applications that extends from monitoring DC power supply systems to monitoring hardware internal power supplies. Since events can be detected using DC measured values, it is possible to monitor the AC power supply on channels 1 through 3 when DC power supply disturbances occur.

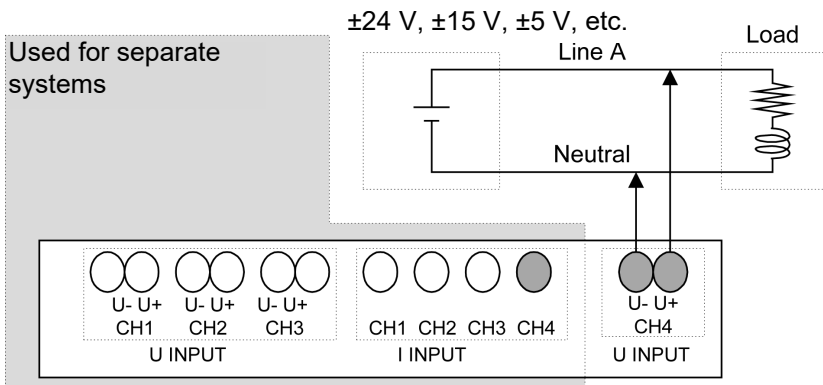

Example of DC power supply measurement

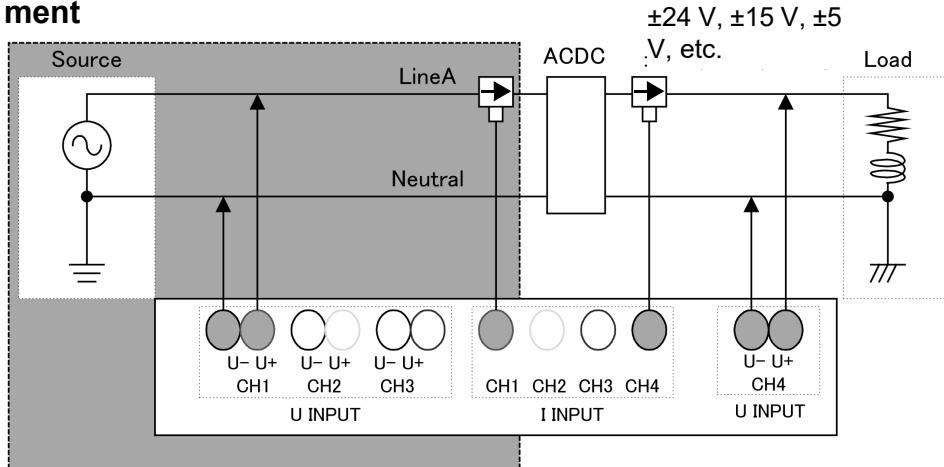

Two-system, two-circuit measurement

Although it is necessary to measure a system synchronized to the reference channel in order to obtain accurate measurements, channel 4 can be used to measure a different system than channels 1 through 3.

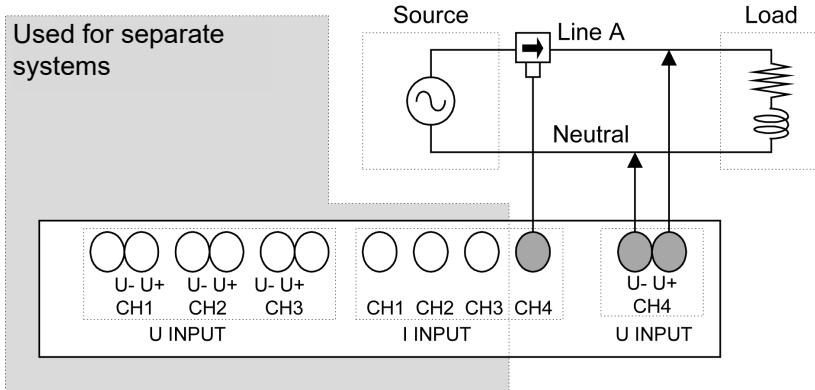

Example of 2-system measurement

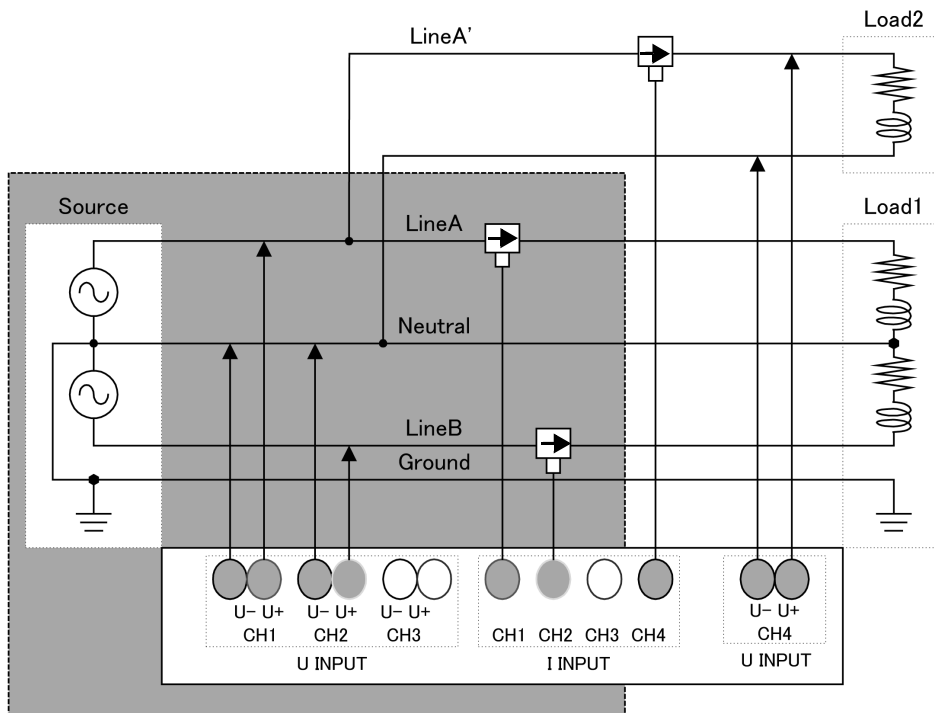
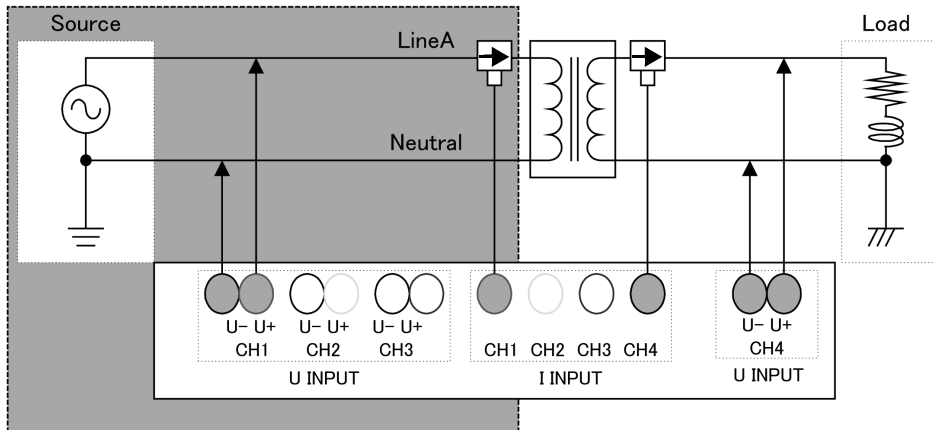

Example of 2-system measurement 2

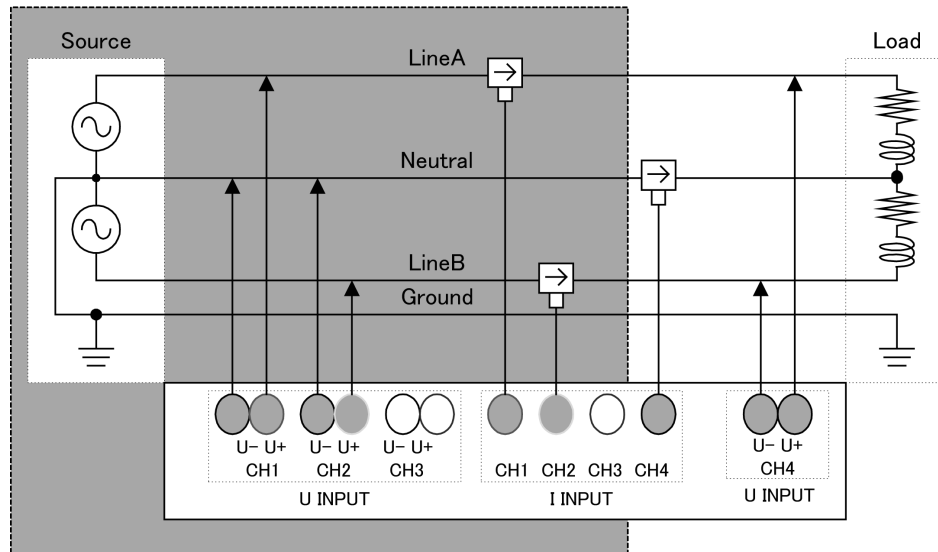

EV quick-charge measurement example

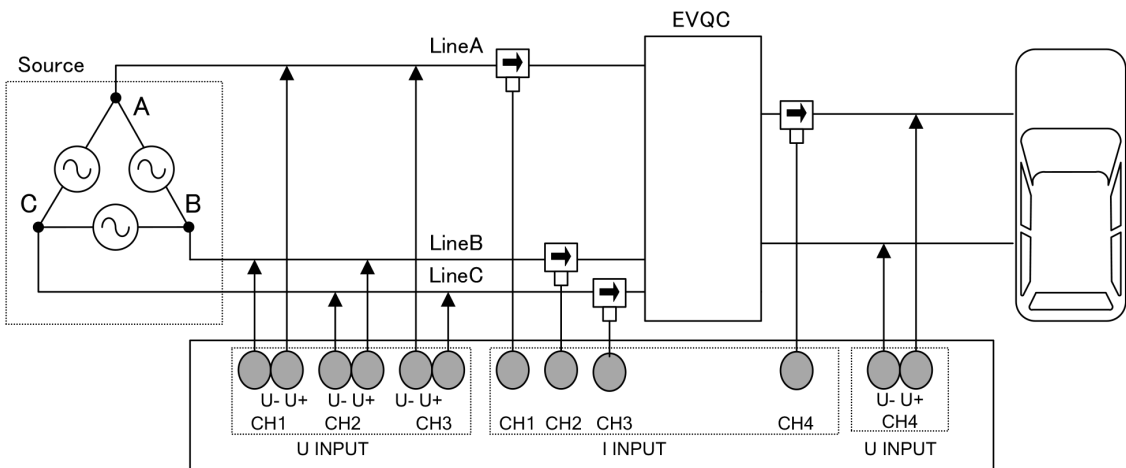

Solar power system measurement example

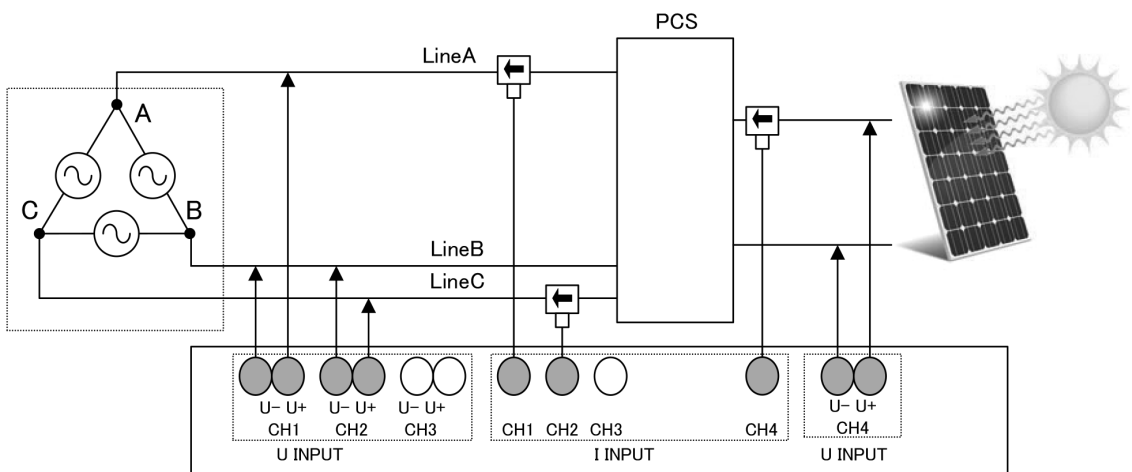

Appendix 7 3-phase 3-wire Measurement

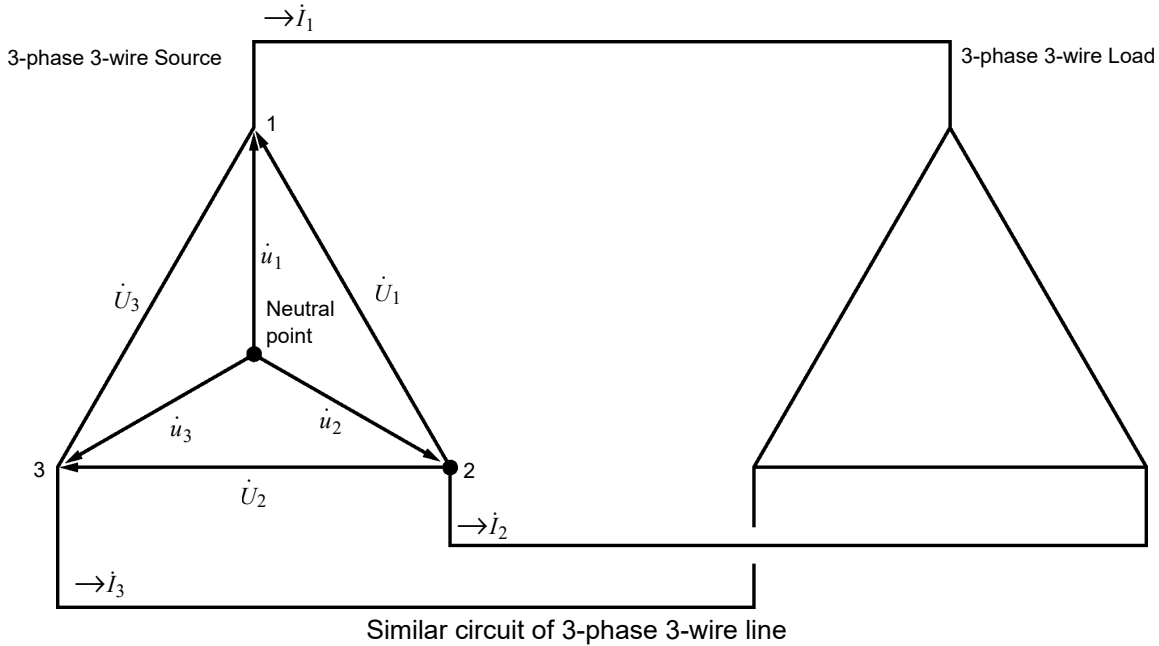

$\dot{U}_1, \dot{U}_2, \dot{U}_3$: The vectors of line-to-line voltage

$\dot{u}_1, \dot{u}_2, \dot{u}_3$: The vectors of phase to neutral voltage

$\dot{I}_1, \dot{I}_2, \dot{I}_3$: The vectors of line (phase) current

3-phase/3-wire/3-wattmeter measurement (3P3W3M)

In 3-wattmeter measurement, 3 line voltages $\dot{U}_1, \dot{U}_2, \dot{U}_3$ and 3 line (phase) currents $\dot{I}_1, \dot{I}_2, \dot{I}_3$ are measured. Because the actual phase voltage cannot be measured for a 3-phase/3-wire line due to the lack of a neutral point, the phase voltage is calculated based on the line voltages.

$$\dot{u}_1 = \frac{(\dot{U}_1 - \dot{U}_3)}{3}$$

$$\dot{u}_2 = \frac{(\dot{U}_2 - \dot{U}_1)}{3}$$

$$\dot{u}_3 = \frac{(\dot{U}_3 - \dot{U}_2)}{3}$$

The 3-phase active power P is calculated as the sum of all the phase active power values.

$$P = \dot{u}_1 \dot{I}_1 + \dot{u}_2 \dot{I}_2 + \dot{u}_3 \dot{I}_3 \quad \dots(1)$$

3-phase/3-wire/2-wattmeter measurement (3P3W2M)

In 2-wattmeter measurement, two line-to-line voltages \dot{U}_1, \dot{U}_2 and two line (phase) currents \dot{I}_1, \dot{I}_3 are measured.

The 3-phase active power P can be derived from two voltage and current values, as shown below:

$$P = \dot{U}_1 \dot{I}_1 + \dot{U}_2 \dot{I}_3 \quad (\text{from } \dot{U}_1 = \dot{u}_1 - \dot{u}_2, \dot{U}_2 = \dot{u}_3 - \dot{u}_2)$$

$$= (\dot{u}_1 - \dot{u}_2) \dot{I}_1 + (\dot{u}_3 - \dot{u}_2) \dot{I}_3$$

$$= \dot{u}_1 \dot{I}_1 + \dot{u}_2 (-\dot{I}_1 - \dot{I}_3) + \dot{u}_3 \dot{I}_3 \quad (\text{from } \dot{I}_1 + \dot{I}_2 + \dot{I}_3 = 0 \text{ as the precondition of a closed circuit})$$

$$P = \dot{u}_1 \dot{I}_1 + \dot{u}_2 \dot{I}_2 + \dot{u}_3 \dot{I}_3 \quad \dots(2)$$

Since equations (1) and (2) agree, it is possible to prove that 2-wattmeter measurement can be used to measure the power of a 3-phase, 3-wire line. The circuit allowing 3-phase power measurements with this method is a only closed circuit without leakage current. Since there are no special conditions other than the above, it is possible to calculate 3-phase power regardless of the balanced or unbalanced state of the electric circuit.

Additionally, since the sum of the voltage and current vectors always equals 0 under these conditions, the instrument internally calculates the third voltage \dot{U}_3 and current \dot{I}_2 values as follows:

$$\dot{U}_3 = \dot{U}_2 - \dot{U}_1$$

$$\dot{I}_2 = -\dot{I}_1 - \dot{I}_3$$

However, because the three phases are calculated from two power values in 2-wattmeter measurement, it is not possible to check the power balance between respective phases. If you wish to check the power balance for individual phases, use 3-wattmeter (3P3W3M) measurement.

Item		3P3W2M		Relative merits	3P3W3M	
Voltage	U1	\dot{U}_1		=	$\dot{U}_1, \dot{u}_1 = \frac{(\dot{U}_1 - \dot{U}_3)}{3}$	
	U2	\dot{U}_2			$\dot{U}_2, \dot{u}_2 = \frac{(\dot{U}_2 - \dot{U}_1)}{3}$	
	U3	$\dot{U}_3 = \dot{U}_2 - \dot{U}_1$			$\dot{U}_3, \dot{u}_3 = \frac{(\dot{U}_3 - \dot{U}_2)}{3}$	
Current	I1	\dot{I}_1		=	\dot{I}_1	
	I2	\dot{I}_3			\dot{I}_2	
	I3	$\dot{I}_2 = -\dot{I}_1 - \dot{I}_3$			\dot{I}_3	
Active power	P1	$\dot{U}_1 \dot{I}_1$	Since the three phases are calculated from 2-wattmeter, it is not possible to check the active power balance for individual phases.	<	$\dot{u}_1 \dot{I}_1$	It is possible to check the active power balance for individual phases.
	P2	$\dot{U}_2 \dot{I}_3$			$\dot{u}_2 \dot{I}_2$	
	P3	-			$\dot{u}_3 \dot{I}_3$	
	P	$\dot{U}_1 \dot{I}_1 + \dot{U}_2 \dot{I}_3 = \dot{u}_1 \dot{I}_1 + \dot{u}_2 \dot{I}_2 + \dot{u}_3 \dot{I}_3$ See equation (2).		=	$\dot{u}_1 \dot{I}_1 + \dot{u}_2 \dot{I}_2 + \dot{u}_3 \dot{I}_3$	
Apparent power	S1	$\dot{U}_1 \dot{I}_1$	Since calculations are based on the line-to-line voltage and phase (line) current, apparent power values are not generated for individual phases.	<	$\dot{u}_1 \dot{I}_1$	Since calculations are based on the phase voltage and phase (line) current, it is possible to check the apparent power for individual phases.
	S2	$\dot{U}_2 \dot{I}_3$			$\dot{u}_2 \dot{I}_2$	
	S3	$\dot{U}_3 \dot{I}_2$			$\dot{u}_3 \dot{I}_3$	
	S	$\frac{\sqrt{3}}{3} (\dot{U}_1 \dot{I}_1 + \dot{U}_2 \dot{I}_3 + \dot{U}_3 \dot{I}_2)$		=	$\frac{\sqrt{3}}{3} (\dot{U}_1 \dot{I}_1 + \dot{U}_2 \dot{I}_2 + \dot{U}_3 \dot{I}_3)$	

In 3P3W2M measurement, the instrument inputs the 3-phase line's T-phase current as each current's I2 parameter. For display purposes, a current value of Phase T in the 3-phase line is displayed as the current I2; and a calculated value of Phase S in the 3-phase line, as the current I3.

Appendix 8 Method for Calculating Active Power Accuracy

The accuracy of active power calculations can be calculated as follows, taking into account the phase accuracy:

Example measurement conditions

Wiring: 3-phase/4-wire (3P4W)
 Current sensor: Model CT7136
 Current range: 50 A (power range: 90 kW)
 "13.9 Range Breakdown and Combination Accuracy" (p.247)
 Measured values: Active power of 30 kW, power factor lag 0.8

Accuracy

Active power accuracy for current sensor combination (Model CT7136 sensor, 50 A range):
 $\pm 0.5\%$ rdg. $\pm 0.22\%$ f.s.

Internal circuit voltage of the instrument - current phase difference: $\pm 0.2865^\circ$

(Effect of power factor: 1.0% rdg. or less)

Phase accuracy of the CT7136: $\pm 0.5^\circ$

"13.2 Input Specifications/Output Specifications/Measurement Specifications" (p.196)

"13.9 Range Breakdown and Combination Accuracy" (p.247)

Phase accuracy shown in "Specifications" of the CT7136 Instruction Manual

Power factor accuracy based on phase accuracy

Phase accuracy (in combination with current sensor) = Instrument internal circuit phase accuracy ($\pm 0.2865^\circ$) + CT7136 phase accuracy ($\pm 0.5^\circ$) = $\pm 0.7865^\circ$

Phase difference $\theta = \cos^{-1}(\text{power factor}) = \cos^{-1}0.8 = 36.87^\circ$

Power factor error range based on phase accuracy = $\cos(36.87^\circ \pm 0.7865^\circ) = 0.7916$ to 0.8082

Power factor accuracy based on phase accuracy (minimum) = $\frac{0.7916 - 0.8}{0.8} \times 100\% = -1.05\%$

Power factor accuracy based on phase accuracy (maximum) = $\frac{0.8082 - 0.8}{0.8} \times 100\% = +1.025\%$

Power factor accuracy based on phase accuracy: **$\pm 1.05\%$ rdg.**

The value, whichever is worse, is specified to be the phase accuracy.

Power factor accuracy based on phase accuracy

Active power accuracy = current sensor combined accuracy + power factor accuracy based on phase accuracy

= $\pm 0.5\%$ rdg. $\pm 0.22\%$ f.s. $\pm 1.05\%$ rdg.

= $\pm 1.55\%$ rdg. $\pm 0.22\%$ f.s.

Accuracy relative to measured values = active power 30 kW $\times \pm 1.55\%$ rdg. + 90 kW range $\times 0.22\%$ f.s.

= ± 0.663 kW

= ± 0.663 kW/30 kW = $\pm 2.21\%$ rdg.

Appendix 9 Terminology

EN50160	A European power supply quality standard that defines limit values for supply voltage and other characteristics. The PQ ONE application software can be used with data from the PQ3198 to perform standard-compliant evaluation and analysis.								
IEC61000-4-7	An international standard governing measurement of harmonic current and harmonic voltage in power supply systems as well as harmonic current emitted by equipment. The standard specifies the performance of a standard instrument.								
IEC61000-4-15	A standard that defines testing techniques for voltage fluctuation and flicker measurement as well as associated measuring instrument requirements.								
IEC61000-4-30	<p>A standard governing testing involving power quality measurement in AC power supply systems and associated measurement technologies. Target parameters are restricted to phenomena that are propagated in power systems, specifically frequency, supply voltage amplitude (RMS), flicker, supply voltage dips, swells, (momentary) interruptions, transient overvoltages, supply voltage unbalance, harmonics, inter-harmonics, supply voltage carrier signals, and high-speed voltage variations.</p> <p>The standard defines measurement methods for these parameters as well as the necessary instrument performance. It does not define specific thresholds.</p> <p>Measurement classes</p> <p>The standard defines three classes (A, S, and B) for various instrument measuring methods and measurement performance levels:</p> <table border="1" data-bbox="513 969 1433 1274"> <thead> <tr> <th>Class</th> <th>Applications</th> </tr> </thead> <tbody> <tr> <td>Class A</td> <td>Used in applications where accurate measurement is required, for example verification of standard compliance and dispute settlement. In order to ensure accurate measurement, the standard includes detailed stipulations concerning instrument time clock accuracy, RMS value calculation methods, and TIME PLOT data grouping.</td> </tr> <tr> <td>Class S</td> <td>Used in surveys and power supply quality evaluation.</td> </tr> <tr> <td>Class B</td> <td>Used in applications where a high level of accuracy is not required, for example troubleshooting.</td> </tr> </tbody> </table>	Class	Applications	Class A	Used in applications where accurate measurement is required, for example verification of standard compliance and dispute settlement. In order to ensure accurate measurement, the standard includes detailed stipulations concerning instrument time clock accuracy, RMS value calculation methods, and TIME PLOT data grouping.	Class S	Used in surveys and power supply quality evaluation.	Class B	Used in applications where a high level of accuracy is not required, for example troubleshooting.
Class	Applications								
Class A	Used in applications where accurate measurement is required, for example verification of standard compliance and dispute settlement. In order to ensure accurate measurement, the standard includes detailed stipulations concerning instrument time clock accuracy, RMS value calculation methods, and TIME PLOT data grouping.								
Class S	Used in surveys and power supply quality evaluation.								
Class B	Used in applications where a high level of accuracy is not required, for example troubleshooting.								
ITIC curve	A graph created by the Information Technology Industry Council plotting voltage disturbance data for detected events using the event duration and worst value (as a percentage of the nominal input voltage). The graph format makes it easy to quickly identify which event data distribution should be analyzed. The PQ ONE application software can be used to create ITIC curves using PQ3198 data.								
K factor	<p>Shows the power loss caused by the harmonic current in transformers. Also referred to as the "multiplication factor." The K factor (KF) is formulated as shown below:</p> $KF = \frac{\sum_{k=1}^{50} (k^2 \times I_k^2)}{\sum_{k=1}^{50} I_k^2}$ <p>k: Order of harmonics Ik: Ratio of the harmonic current to the fundamental wave current [%]</p> <p>Higher-order harmonic currents have a greater influence on the K factor than lower-order harmonic currents.</p> <p>Purpose of measurement</p> <p>To measure the K factor in a transformer when subjected to maximum load. If the measured K factor is larger than the multiplication factor of the transformer used, the transformer must be replaced with one with a larger K factor, or the load on the transformer must be reduced. The replacement transformer should have a K factor one rank higher than the measured K factor for the transformer being replaced.</p>								

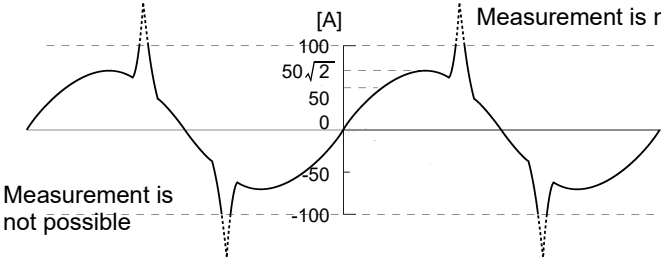
<p>LAN</p>	<p>LAN is the abbreviation of Local Area Network. The LAN was developed as a network for transferring data through a PC within a local area, such as an office, factory, or school. This device comes equipped with the LAN adapter Ethernet 10/100Base-T. Use a twisted-pair cable to connect this device to the hub (central computer) of your LAN. The maximum length of the cable connecting the terminal and the hub is 100 m. Communications using TCP/IP as the LAN interface protocol are supported.</p>
<p>Mains signaling</p>	<p>The control signal, one of the measurement parameters required by IEC 61000-4-30, is applied to the mains to control various industrial equipment remotely. The signal is referred to as "ripple control signal" in several applications.</p>
<p>RS-232C</p>	<p>The RS-232C is a serial interface established by the EIA (Electronics Industries Association), and conforms to the specifications for DTE (data terminal equipment) and DCE (data circuit terminating equipment) interface conditions. Using the signal line part of the RS-232C specifications with this unit allows you to use GPS box.</p>
<p>SD memory card</p>	<p>A type of flash memory card.</p>
<p>TIME PLOT interval</p>	<p>The recording interval. This setting applies to TIME PLOT and SD memory card recording.</p>
<p>USB-F (USB function)</p>	<p>An interface for sending data to a host controller (typically a computer) connected with a USB cable. For this reason, communication between functions is not possible.</p>
<p>Event</p>	<p>Power supply quality parameters are necessary in order to investigate and analyze power supply issues. These parameters include disturbances such as transients, dips, swells, interruptions, flicker, and frequency fluctuations. As a rule, the term "event" refers to the state detected based on thresholds for which abnormal values and abnormal waveforms for these parameters have been set. Events also include timer and repeat event settings, which are unrelated to power supply quality parameters.</p>
<p>Inter-harmonics</p>	<p>All frequencies that are not a whole-number multiple of the fundamental frequency. Inter-harmonics include intermediate frequencies and inter-order harmonics, and the term refers to RMS values for the spectral components of electrical signals with frequencies between two contiguous harmonic frequencies.</p> <p>(Inter-harmonics of the order 3.5 assume a drive of 90 Hz or similar rather than a frequency synchronized to the fundamental wave of an inverter or other device. However, inter-harmonics do not generally occur in high-voltage circuits under present-day conditions. Most inter-harmonics are currently thought to be caused by the circuit load.)</p>
<p>External event function</p>	<p>Functionality for generating events by detecting a signal input to the instrument's external event input terminal and recording measured values and event waveforms at the time of detection. In this way, events are generated based on an alarm signal from a device other than the PQ3198. By inputting an operating signal from an external device, an operation start or stop trigger can be applied in order to record waveforms with the PQ3198.</p>
<p>Coordinated universal time (UTC)</p>	<p>The official time used worldwide. Although UTC is almost identical to Greenwich Mean Time (GMT), which is based on astronomical observations, UTC is determined by measuring 1 SI second using an atomic clock. Regular adjustments ensure that GMT and UTC differ by no more than 1 second.</p>
<p>Out of crest factor</p>	<p>The crest factor expresses the size of the dynamic range of input on the measurement device and can be defined with the following expression.</p> <p>Crest factor = crest value (peak value)/RMS value</p> <p>For example, when measuring a distorted wave with a small RMS and a large peak on a measurement device with a small crest factor, because the peak of the distorted wave exceeds the detection range of the input circuit, an RMS or harmonic measurement error occurs.</p>  <p style="text-align: center;">A measurement device with a small crest factor (When the crest factor is 2 for a 50 A range)</p> <p>When you increase the measurement range, the peak does not exceed the input circuit's detection range, but because the resolution of the RMS decreases, measurement errors may occur.</p> <p style="text-align: right;">(Continues on next page)</p>

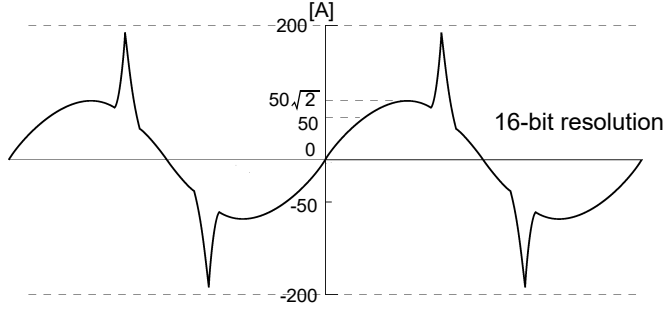
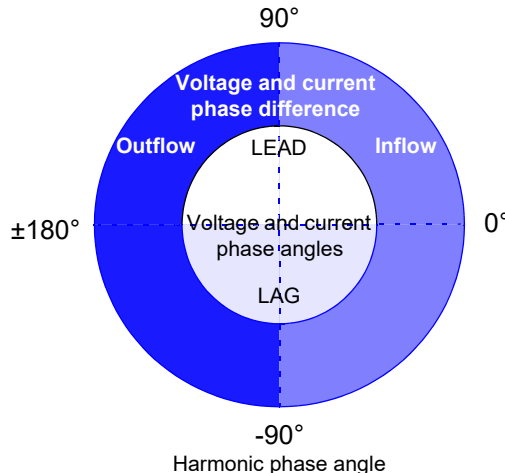
<p>Out of crest factor</p>	 <p style="text-align: center;">Crest factors of the PQ3198 (The crest factor of the current input area is 4.)</p> <p>However, when a measurement that exceeds the peak is input, it appears outside the crest factor and you are informed of data that contains measurement errors.</p>
<p>High-order harmonic component</p>	<p>The noise component at and above several kHz. For the PQ3198, the term refers to RMS values for the noise component at 2 kHz and above. By measuring the high-order harmonic component, it is possible to monitor harmonic noise at the 50th and higher order emitted by switching power supplies, inverters, LED lighting, and other devices. Recently, increases in the switching frequencies used by switching power supplies and inverters have resulted in the problematic introduction of noise in excess of 10 kHz into power supply lines.</p>
<p>Nominal supply voltage (Uc)</p>	<p>Typically, the system's rated voltage U_n. When a voltage that differs from the rated voltage is applied to the contact in accordance with an agreement between the electricity provider and the customer, that voltage is used as the nominal supply voltage U_c. The nominal supply voltage is defined by IEC61000-4-30.</p>
<p>Nominal voltage (Uref)</p>	<p>The same voltage as the nominal supply voltage (U_c) defined by IEC61000-4-30 or the rated voltage (U_n). Nominal voltage (U_{ref}) = nominal input voltage (U_{din}) × VT ratio</p>
<p>Nominal input voltage (Udin)</p>	<p>The value calculated from the nominal supply voltage using the transformer ratio. The nominal input voltage is defined by IEC61000-4-30.</p>
<p>Harmonics</p>	<p>A phenomenon caused by distortions in the voltage and current waveforms that affect many devices with power supplies using semiconductor control devices. In the analysis of non-sine waves, the term refers to one RMS value among the components with harmonic frequencies.</p>
<p>Harmonics phase angle and Phase difference</p>	<p>The harmonic voltage phase angle and harmonic current phase angle are expressed in terms of the synchronized source's fundamental component phase.</p> <p>The difference between each order's harmonic component phase and the fundamental component phase is expressed as an angle ($^{\circ}$), and its sign indicates either a lagging phase (negative) or leading phase (positive). The sign is the reverse of the power factor sign. The harmonic voltage-current phase angle expresses the difference between each order's harmonic voltage component phase angle and harmonic current component phase angle for each channel as an angle ($^{\circ}$).</p> <p>When using the sum display, the sum of each order's harmonic power factor (calculated from the sums of harmonic power and harmonic reactive power) is converted to an angle ($^{\circ}$). When the harmonic voltage-current phase angle is between -90° and $+90^{\circ}$ (harmonics active power is positive), that order's harmonics are flowing toward the load (influx). When the harmonic voltage-current phase angle is between $+90^{\circ}$ and $+180^{\circ}$ or between -90° and -180° (harmonics active power is negative), that order's harmonics are flowing from the load (outflow).</p>  <p style="text-align: center;">Harmonic phase angle</p>

<p>Harmonic content percentage</p>	<p>The ratio of the K-order size to the size of the fundamental wave, expressed as a percentage using the following equation: $K\text{-order wave} / \text{fundamental wave} \times 100 [\%]$</p> <p>By observing this value, it is possible to ascertain the harmonic component content for individual orders. This metric provides a useful way to track the harmonic content percentage when monitoring a specific order.</p>
<p>RMS value</p>	<p>The root mean square of instantaneous values for a quantity obtained over a particular time interval or bandwidth.</p>
<p>Frequency cycle (Freq wav or fwav)</p>	<p>The frequency of a single waveform. By measuring the frequency cycle, it is possible to monitor frequency fluctuations on an interconnected system at a high degree of detail.</p>
<p>10-sec frequency (Freq10s or f10s)</p>	<p>The frequency measured value as calculated according to IEC61000-4-30, consisting of a 10-second average of the frequency. It is recommended to measure this characteristic for at least one week.</p>
<p>Interruption</p>	<p>A phenomenon in which the supply of power stops momentarily or for a short or long period of time due to factors such as a circuit breaker tripping as a result of a power company accident or power supply short-circuit.</p>
<p>Swell</p>	<p>A phenomenon in which the voltage rises momentarily due to a lightning strike or the switching of a high-load power line.</p>
<p>Slide reference voltage</p>	<p>The voltage used as the reference for judging voltage dip and swell thresholds. The slide reference voltage is calculated from a 1st-order filter with a time constant of 1 minute relative to RMS values. Although the fixed nominal input voltage value is usually used as the reference voltage, dips and swells can be detected when the voltage value is fluctuating gradually by using the fluctuating voltage value as the reference.</p>
<p>Zero, positive, and negative phases</p>	<p>The positive phase can be considered normal 3-phase power consumption, while the negative phase functions to operate a 3-phase motor backwards. The positive phase causes the motor to operate in the forward direction, while the negative phase act as a break and causes heat to be generated, exerting a negative impact on the motor. Like the negative phase, the zero phase is unnecessary. With a 3-phase 4-wire connection, the zero phase causes current to flow and heat to be generated. Normally, an increase in the negative phase causes an increase of the same magnitude in the zero phase.</p>
<p>Sense</p>	<p>Measured values are continuously compared with the range defined by (the measured value the last time the event occurred + the sense threshold) and (the measured value the last time the event occurred - the sense threshold). When the value falls outside this range, a sense event occurs, and the sense range is updated.</p>

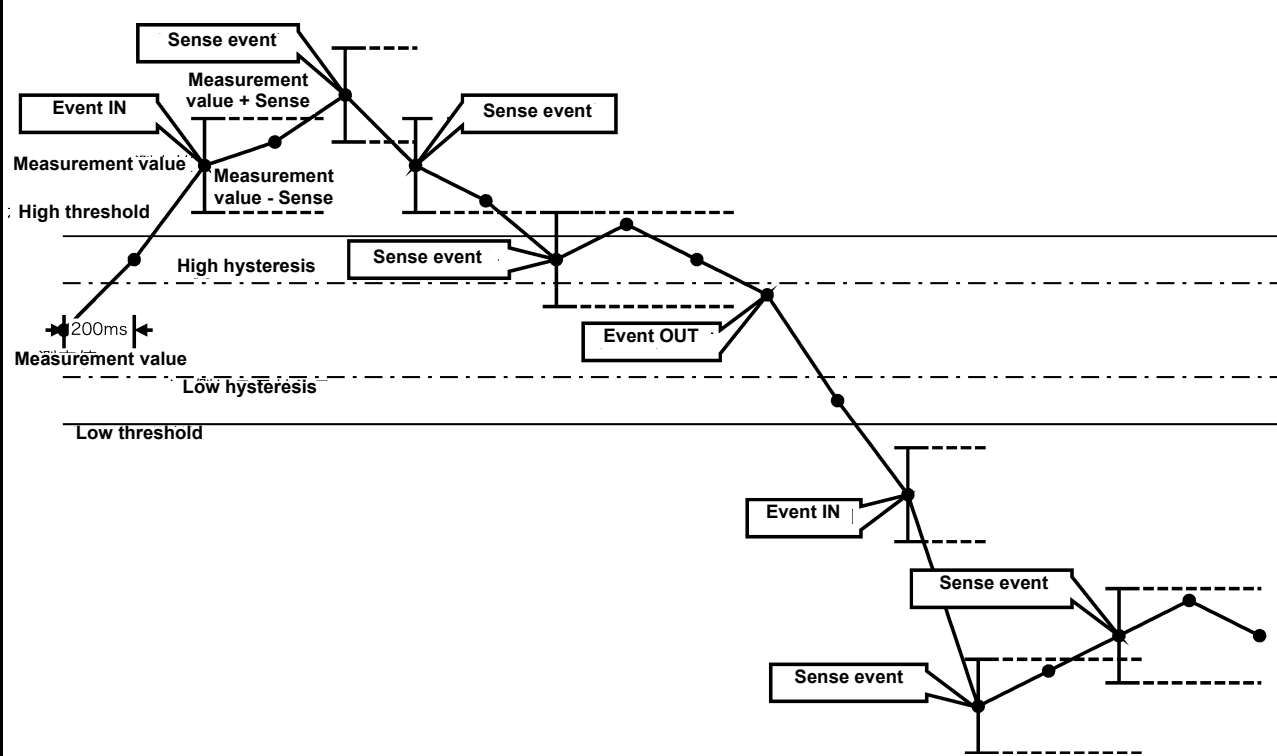

<p>Total harmonic distortion factor</p>	<p>THD-F: The ratio of the size of the total harmonic component to the size of the fundamental wave, expressed as a percentage using the following equation: $\frac{\sqrt{\sum (\text{from 2nd order})^2}}{\text{fundamental wave}} \times 100 [\%] \text{ (for the PQ3198, calculated to the 50th order)}$ This value can be monitored to assess waveform distortion for each item, providing a yardstick that indicates the extent to which the total harmonic component is distorting the fundamental waveform. As a general rule, the total distortion factor for a high-voltage system should be 5% or less; it may be higher at the terminal point of the system.</p> <p>THD-R: The ratio of the size of the total harmonic component to the size of RMS values, expressed as a percentage using the following equation: $\frac{\sqrt{\sum (\text{from 2nd order})^2}}{\text{RMS value}} \times 100 [\%] \text{ (for the PQ3198, calculated to the 50th order)}$ THD-F is typically used.</p>
<p>Measurement frequency (fnom)</p>	<p>The nominal frequency of the system being measured. Select from 50 Hz/60 Hz/400 Hz. (The measurement frequency is automatically set during the quick setup process.)</p>
<p>Timer event function</p>	<p>Functionality for generating events at a set time interval and recording the measured value and event waveform at that time. This function allows you to capture instantaneous waveforms and other data regularly, even if no abnormalities have occurred. Use this functionality when you wish to record a waveform at a fixed time interval.</p>
<p>Multiple-phase system treatment</p>	<p>Method for defining the start and end of events such as dips, swells, and interruptions in multiple-phase systems, for example systems with 3 phases</p> <p>Dip: A dip begins when the voltage of at least one channel is less than or equal to the threshold and ends when voltage readings for all measurement channels exceed (threshold + hysteresis voltage).</p> <p>Swell: A swell begins when the voltage of at least one channel exceeds the threshold and ends when voltage readings for all measurement channels are less than or equal to (threshold + hysteresis voltage).</p> <p>Interruption: An interruption begins when voltage readings for all channels are less than or equal to the threshold and ends when the voltage of a user-specified channel is greater than or equal to (threshold + hysteresis).</p>
<p>Dip</p>	<p>A short-lived voltage drop caused by the occurrence of a inrush current with a large load, such as when a motor starts. When recording voltage and current trends at the power service inlet, you can determine whether you should look for the cause of the dip inside or outside the building. If the voltage drops while the building's current consumption rises, the cause likely lies inside the building. If the voltage and current are both low, the cause is likely to lie outside the building.</p>
<p>Text data</p>	<p>A file containing only data expressed using characters and character codes.</p>
<p>RMS voltage refreshed each half-cycle</p>	<p>The RMS value of one voltage waveform overlapped every half-cycle.</p>
<p>RMS current refreshed each half-cycle</p>	<p>The RMS value of the current waveform every half-cycle.</p>
<p>Inrush current</p>	<p>A large current that flows temporarily, for example when an electric device is turned on. A inrush current can be equal to or greater than 10 times the current that flows when the device is in the normal operating state. Inrush current measurement can be a useful diagnostic when setting circuit breaker capacity.</p>
<p>Transient overvoltage</p>	<p>An event caused by lightning strikes, circuit-breaker and relay contact obstructions and tripping, and other phenomena. Transient overvoltages are often characterized by precipitous voltage variations and a high peak voltage.</p>
<p>Binary data</p>	<p>All data other than text (character) data. Used when analyzing data with the included PQ ONE application.</p>
<p>Apparent power</p>	<p>The (vector) power obtained by combining active power and reactive power. As its name suggests, apparent power expresses the "visible" power and comprises the product of the voltage and current RMS values.</p>

<p>Unbalance factor</p>	<p>Balanced (symmetrical) 3-phase voltage (current) Three-phase AC voltage (current) with equal voltage and current magnitude for each phase and 120° phase separation.</p> <p>Unbalanced (asymmetrical) 3-phase voltage (current) Three-phase AC voltage (current) with equal voltage and current magnitude for each phase and 120° phase separation.</p> <p>Though all of the following descriptions refer to voltage, they apply to current as well.</p> <p>Degree of unbalance in three-phase alternating voltage Normally described as the voltage unbalance factor, which is the ratio of negative-phase voltage to positive-phase voltage</p> <p>Voltage unbalance factor = $\frac{\text{Negative-phase voltage}}{\text{Positive-phase voltage}} \times 100$ [%]</p> <p>Zero-phase/positive-phase/negative-phase voltage The concept of a zero-phase-sequence/positive-phase-sequence/negative-phase-sequence component in a three-phase alternating circuit applies the method of symmetrical coordinates (a method in which a circuit is treated so as to be divided into symmetrical components of a zero phase, positive phase, and negative phase).</p> <ul style="list-style-type: none"> • Zero-phase-sequence component: Voltage that is equal in each phase. Described as V_0. (Subscript 0: Zero-phase-sequence component) • Positive-phase-sequence component: Symmetrical three-phase voltage in which the value for each phase is equal, and each of the phases is delayed by 120 degrees in the phase sequence a->b->c. Described as V_1. (Subscript 1: Positive-phase-sequence component) • Negative-phase-sequence component: Symmetrical three-phase voltage in which the value for each phase is equal, and each of the phases is delayed by 120 degrees in the phase sequence a->c->b. Described as V_2. (Subscript 2: Negative-phase-sequence component) <p>If V_a, V_b, and V_c are given as the three-phase alternating voltage, the zero-phase voltage, positive-phase voltage, and negative voltage are formulated as shown below.</p> <p>Zero-phase voltage $\dot{V}_0 = \frac{\dot{V}_a + \dot{V}_b + \dot{V}_c}{3}$</p> <p>Positive-phase voltage $\dot{V}_1 = \frac{\dot{V}_a + a\dot{V}_b + a^2\dot{V}_c}{3}$</p> <p>Negative-phase voltage $\dot{V}_2 = \frac{\dot{V}_a + a^2\dot{V}_b + a\dot{V}_c}{3}$</p> <p>$a$ is referred to as the “vector operator.” It is a vector with a magnitude of 1 and a phase angle of 120 degrees. Therefore, the phase angle is advanced by 120 degrees if multiplied by a, and by 240 degrees if multiplied by a^2. If the three-phase alternating voltage is balanced, the zero-phase voltage and negative-phase voltage are 0, and only positive phase voltage, which is equal to the effective value of the three-phase alternating voltage, is described.</p> <p>Unbalance factor of three-phase current Used in applications such as the verification of power supplied to electrical equipment powered by a 3-phase induction motor. The current unbalance factor is several times larger than the voltage unbalance factor. The less a three-phase induction motor slips, the greater the difference between these two factors. Voltage unbalance causes such phenomena as current unbalance, an increase in temperature, an increase in input, a decline in efficiency, and an increase in vibration and noise. Unb must not exceed 2%, and Inub must be 10% or less. In a 3P4W system with an unbalanced load, the Unb0 and Inub0 components indicate the current that flows to the N (neutral) line.</p>
<p>Flag</p>	<p>A marker used to distinguish unreliable measured values occurring due to disturbances such as dips, swells, and interruptions. Flags are recorded as part of the TIME PLOT data status information. The concept is defined by the IEC61000-4-30 standard.</p>
<p>Flicker</p>	<p>A disturbance caused by a voltage drop resulting when equipment with a large load starts up or when a large current flows under a temporary high-load state. For lighting loads, flicker primarily manifests itself as blinking. Electric-discharge lamps such as fluorescent and mercury-vapor lights are particularly prone to the effects of flicker.</p> <p>When temporary dimming of lights due to voltage drops occurs frequently, it produces a flickering effect (caused by repeated dimming) that produces an extremely unpleasant visual sensation.</p> <p>Measurement methods can be broadly divided into IEC flicker and $\Delta V10$ flicker. In Japan, the $\Delta V10$ method is most frequently used.</p>

Manual event function	Functionality for generating events when the MANU EVENT key is pressed and recording the measured value and event waveform at that time. In this way, events can be generated as a snapshot of the system being measured. Use this functionality when you wish to record a waveform but cannot find another event that defines the desired phenomenon or when you wish to record data manually to avoid the generation of too many events.
Reactive power	Power that does not perform actual work, resulting in power consumption as it travels between the load and the power supply. Reactive power is calculated by multiplying the active power by the sine of the phase difference ($\sin \theta$). It arises from inductive loads (deriving from inductance) and capacitive loads (deriving from capacitance), with reactive power derived from inductive loads known as lag reactive power and reactive power derived from capacitive loads known as lead reactive power.
Reactive power demand	The average reactive power used during a set period of time (usually 30 minutes).
Active power	Power that is consumed doing work.
Active power demand	The average active power used during a set period of time (usually 30 minutes).
Power factor (PF/DPF)	<p>Power factor is the ratio of effective power to apparent power. The larger the absolute value of the power factor, the greater the proportion of effective power, which provides the power that is consumed, and the greater the efficiency. The maximum absolute value is 1. Conversely, the smaller the absolute value of the power factor, the greater the proportion of reactive power, which is not consumed, and the lower the efficiency. The minimum absolute value is 0.</p> <p>For this device, the sign of the power factor indicates whether the current phase is lagging or leading the voltage. A positive value (no sign) indicates that the current phase is lagging the voltage. Inductive loads (such as motors) are characterized by lagging phase. A negative value indicates that the current phase is leading the voltage. Capacitive loads (such as capacitors) are characterized by leading phase.</p> <p>The power factor (PF) is calculated using rms values that include harmonic components. Larger harmonic current components cause the power factor to deteriorate. By contrast, since the displacement power factor (DPF) calculates the ratio of effective power to apparent power from the fundamental voltage and fundamental current, no voltage or current harmonic component is included. This is the same measurement method used by reactive power meters installed at commercial-scale utility customers' facilities.</p> <p>Displacement power factor, or DPF, is typically used by the electric power system, although power factor, or PF, is sometimes used to measure equipment in order to evaluate efficiency.</p> <p>When a lagging phase caused by a large inductive load such as a motor results in a low displacement power factor, there are corrective measures that can be taken to improve the power factor, for example by adding a phase advance capacitor to the power system. Displacement power factor (DPF) measurements can be taken under such circumstances to verify the improvement made by the phase advance capacitor.</p>
Continuous event function	Functionality for automatically generating the set number of events in succession every time a target event occurs. Events after the initial event are recorded as continuous events. This functionality allows an instantaneous waveform of up to 1 s in duration to be recorded after the event occurs. However, continuous events are not generated when an event occurs while continuous events are occurring. Additionally, continuous event generation stops when measurement is stopped. Use this function when you wish to observe a waveform at the instant an event occurs as well as subsequent changes in the instantaneous waveform. For the PQ3198, a waveform of up to 1 s in duration will be recorded.



Index

Numbers

10-sec frequency A28

A

Application 171

B

Battery pack 43

Beep sound 84

Before connecting measurement cables 10

Boot key reset 94

C

Clock 54, 84

Colored clips 40

Connection check 66

Connection diagram 57

Connection mode 55

Continuous event 93, A31

Converting binary data to text data 193

Crest factor A26

CT 49

CT ratio 74

Current range 74

Current sensor

 Applying current 64

 Colored clips 40

 Connecting to the instrument 48

 Settings 55, 74

D

Declared input voltage 73

Default Gateway 184

DELETE 166

Dip A29

Display color 84

DPF A31

E

EN50160 70, A25

Ethernet (LAN) connection 181, 187

Event A26

Event icon 69

EVENT indicator 30

Event list 143

Event list notation 145

Event waveform 229

External event A26

External output 84

F

Factory settings 95

File types 160

Filter 76

Flag A30

Flag concept 217

Flicker 76, A3, A30

Fluctuation data 229

FORMAT 162

Frequency 74

Frequency cycle A28

Frequency fluctuations A2

G

GENNECT One 173

H

Harm Calc

 Settings 75

Harmonic A3

Harmonic content percentage A28

Harmonics phase angle A27

High-order harmonic component 105, A4, A27

High-order harmonic waveform 229

HOLD indicator 29

HTTP server 188

I

IEC61000-4-30 A25

Initializing 94

Inrush Current 70

Inrush current A4, A29

Inspection 252

Inter-harmonics A3, A26

Interruption A3, A28

IP address 185

ITIC curve A25

Index 2

Index

K

K factor	A25
Key lock	24

L

LAN	86
LAN cable	186, 187
LAN interface	183
Language	83
LCD Backlight	84
List of event settings	87
Lithium battery	258
Load	170

M

MANU EVENT key	92
Manual event	A31
Manual event settings	92
Measurement categories	6

N

Negative phase	A28
Noise	152
Nominal input voltage	A27
Number or order	104

O

Operating state	29
Operation when there are too many events	143
Options	5

P

PF	A31
PF Type	75
Phase difference	A27
Phase names	62
Positive phase	A28
Power factor	A31
PQ ONE	171
PT	49

Q

Quick setup	68
-------------------	----

R

Real-time clock	195
Record measured value	70
Recording Items	78
Recording times	79, 165

Remaining storage time	165
Remote control	183, 188
Repair	252
Repeat Record	81
Replaceable parts and operating lifetimes	253
Reverting the instrument to its factory settings ..	94

S

SAVE	169
Save operation	163
Screen copy interval	79
SD memory card	29, 46
Format	162
Self-test	44
Sense	A28
Slide reference voltage	A28
Spiral tube	41
Standard Power Quality	70
Strap	42
Subnet mask	185
Swell	A28
System reset	94

T

THD Type	75
TIME PLOT Interval	79
Time Start	80
Timer event function	A29
Timer event settings	93
Total harmonic distortion factor	A29
Transient overvoltage	A2
Transient waveform	229
Transporting	252
Trend time series graphs	113

U

Unbalance	A4
Unbalance factor	A30
Urms Type	75
USB connection	181
USB interface	182

V

Vector	66
VIEW	168
Voltage cord	
Attaching	63
Voltage dip	A2
Voltage event detection	70
Voltage swell	A3
Voltage Waveform Comparison	A9
VT ratio	74

VT(PT)49

W

Warm-up50, 53

When the memory is full79

Wiring73

Z

Zero adjustment53

Zero phase A28

Warranty Certificate

HIOKI

Model	Serial number	Warranty period Three (3) years from date of purchase (___ / ___)
-------	---------------	--

Customer name: _____

Customer address: _____

Important

- Please retain this warranty certificate. Duplicates cannot be reissued.
- Complete the certificate with the model number, serial number, and date of purchase, along with your name and address. The personal information you provide on this form will only be used to provide repair service and information about Hioki products and services.

This document certifies that the product has been inspected and verified to conform to Hioki's standards.

Please contact the place of purchase in the event of a malfunction and provide this document, in which case Hioki will repair or replace the product subject to the warranty terms described below.

Warranty terms

1. The product is guaranteed to operate properly during the warranty period (three [3] years from the date of purchase).
If the date of purchase is unknown, the warranty period is defined as three (3) years from the date (month and year) of manufacture (as indicated by the first four digits of the serial number in YYYY format).
2. If the product came with an AC adapter, the adapter is warrantied for one (1) year from the date of purchase.
3. The accuracy of measured values and other data generated by the product is guaranteed as described in the product specifications.
4. In the event that the product or AC adapter malfunctions during its respective warranty period due to a defect of workmanship or materials, Hioki will repair or replace the product or AC adapter free of charge.
5. The following malfunctions and issues are not covered by the warranty and as such are not subject to free repair or replacement:
 - 1. Malfunctions or damage of consumables, parts with a defined service life, etc.
 - 2. Malfunctions or damage of connectors, cables, etc.
 - 3. Malfunctions or damage caused by shipment, dropping, relocation, etc., after purchase of the product
 - 4. Malfunctions or damage caused by inappropriate handling that violates information found in the instruction manual or on precautionary labeling on the product itself
 - 5. Malfunctions or damage caused by a failure to perform maintenance or inspections as required by law or recommended in the instruction manual
 - 6. Malfunctions or damage caused by fire, storms or flooding, earthquakes, lightning, power anomalies (involving voltage, frequency, etc.), war or unrest, contamination with radiation, or other acts of God
 - 7. Damage that is limited to the product's appearance (cosmetic blemishes, deformation of enclosure shape, fading of color, etc.)
 - 8. Other malfunctions or damage for which Hioki is not responsible
6. The warranty will be considered invalidated in the following circumstances, in which case Hioki will be unable to perform service such as repair or calibration:
 - 1. If the product has been repaired or modified by a company, entity, or individual other than Hioki
 - 2. If the product has been embedded in another piece of equipment for use in a special application (aerospace, nuclear power, medical use, vehicle control, etc.) without Hioki's having received prior notice
7. If you experience a loss caused by use of the product and Hioki determines that it is responsible for the underlying issue, Hioki will provide compensation in an amount not to exceed the purchase price, with the following exceptions:
 - 1. Secondary damage arising from damage to a measured device or component that was caused by use of the product
 - 2. Damage arising from measurement results provided by the product
 - 3. Damage to a device other than the product that was sustained when connecting the device to the product (including via network connections)
8. Hioki reserves the right to decline to perform repair, calibration, or other service for products for which a certain amount of time has passed since their manufacture, products whose parts have been discontinued, and products that cannot be repaired due to unforeseen circumstances.

HIOKI E.E. CORPORATION

<http://www.hioki.com>

18-07 EN-3

HIOKI
www.hioki.com/



**All regional
contact
information**

HEADQUARTERS
81 Koizumi
Ueda, Nagano 386-1192 Japan

HIOKI EUROPE GmbH
Helfmann-Park 2
65760 Eschborn, Germany
hioki@hioki.eu

2111 EN

Edited and published by HIOKI E.E. CORPORATION

Printed in Japan

- CE declarations of conformity can be downloaded from our website.
- Contents subject to change without notice.
- This document contains copyrighted content.
- It is prohibited to copy, reproduce, or modify the content of this document without permission.
- Company names, product names, etc. mentioned in this document are trademarks or registered trademarks of their respective companies.