

PQ3100

Instruction Manual

POWER QUALITY ANALYZER



Video PQ3100 ▶

Scan this code to watch the instructional video(s).
Carrier charges may apply.



! Be sure to read this manual before using the instrument. ▶ p.4

✓ When using the instrument for the first time

Names and Functions of Parts ▶ p.21

Preparing for Measurement ▶ p.35

📖 Troubleshooting

Maintenance and Service ▶ p.225

Error Indication ▶ p.227

EN



Contents

Introduction.....	1
Verifying Package Contents	2
Safety Information	4
Operating Precautions	7

1 Overview 15

1.1 Procedure for Investigating Power Quality	15
■ Step 1: Clarifying the purpose	15
■ Step 2: Identifying the malfunctioning component (measurement location).....	15
■ Step 3: Checking investigation (measurement) locations (collecting site data)	16
■ Step 4: Making measurements with the power quality analyzer (measurement procedure).....	16
■ Advice for identifying the cause of abnormalities	18
1.2 Product Overview.....	19
1.3 Features	20
1.4 Names and Functions of Parts	21
1.5 Screen Configuration.....	24
■ Displaying and switching screens	24
■ MONITOR screen	25
■ TREND screen.....	26
■ EVENT screen	27
■ WIRING screen.....	27
■ SET UP screen	28
■ FILE screen	29
■ QUICK SET screen.....	29
1.6 Basic Key Operations	30
■ Changing the required items.....	30
■ Entering characters.....	31
1.7 Screen Display	32
1.8 Error Screen Display.....	34

2 Preparing for Measurement 35

2.1 Preparation Flowchart	35
2.2 Initial Measurement Preparations.	36
■ Color coding of current sensor (for channel identification).....	36
■ Bundling the voltage cords and current sensors (If required).....	37
■ Installing the battery pack.....	38
■ Attaching the strap (if required)	39
■ Attaching the Z5020 Magnetic Strap (if required)	39
■ Setting the language, clock, and measurement frequency	40

2.3 Pre-measurement Inspection.....	41
2.4 Inserting the SD Memory Card.....	42
2.5 Power Supply	43
2.6 Turning On/Off the Instrument.....	44
2.7 Warm-up.....	44

3 Quick Set 45

3.1 Configurable Items.....	45
3.2 Adding Settings.....	46

4 Wiring (WIRING Screen) 47

4.1 Wiring Procedure	47
4.2 Wiring Method and Declared Input Voltage Settings.....	48
■ Wiring diagram.....	50
4.3 Connecting Voltage Cords to Instrument.....	51
4.4 Connecting Current Sensors and Configuring Current Sensor Settings	52
■ Connecting the optional current sensor	52
■ Connecting current sensors other than the optional sensors.....	53
4.5 Zero Adjustment.....	54
4.6 Connecting Voltage Cords to Objects	55
4.7 Attaching Current Sensors to Objects	56
■ Load current measurement.....	56
■ Leakage current measurement.....	57
4.8 Attaching Cords on a Wall (if required)	57
4.9 Configuring Current Range Setting	58
4.10 Checking Wiring.....	59

5 Setting Change (SET UP Screen) 63

5.1 Measurement Settings.....	64
■ SET UP, Measurement Settings 1 screen	64
■ SET UP, Measurement Settings 2 screen	66
5.2 Recording Settings	69
5.3 Event Settings	72
■ SET UP, Event Settings 1 screen	72
■ SET UP, Event Settings 2 screen	74
5.4 System Settings	75
■ System reset (Default).....	76
■ Factory reset (Default).....	77
■ Factory settings	78

6 Verifying the Waveform, Measured Values (MONITOR Screen) 81

- Fixing the waveform display and measured values 81
- 6.1 Verifying the Voltage Waveform and Current Waveform..... 82**
 - Screen display 82
 - Changing the zoom factor for the vertical axis and horizontal axis (X and Y axis) of the waveform..... 83
 - Verifying the measured value and time at the cursor position (cursor measurement) 83
 - Scrolling the waveform 83
- 6.2 Verifying the Electric Power (List of Numerical Values) 84**
- 6.3 Verifying the Electric Energy 85**
- 6.4 Verifying the Voltage Details 86**
- 6.5 Verifying the Current Details 87**
- 6.6 Verifying the Vector..... 88**
- 6.7 Verifying the Harmonics Graph and Harmonics Numerical Values 89**
- 6.8 Zoom of the Measured Value 92**

7 Recording (Save) (SET UP Screen) 93

- 7.1 Start and Stop of the Recording ... 93**
- 7.2 Using the Instrument During an Interruption 96**

8 Verifying the Trends (Fluctuations) in Measured Values (TREND Screen) 97

- Verifying the measured value and time at the cursor position (cursor measurement) 98
- Scrolling the graph..... 98
- Event search..... 99
- 8.1 Verifying the Basic Trend 100**
- 8.2 Verifying the Detail Trend 102**
- 8.3 Verifying the Harmonic Trend 103**
- 8.4 Verifying the Flicker 104**
 - IEC flicker meter and ΔV_{10} flicker meter.. 104
 - Verifying graphs and lists of IEC flicker (Pst, Plt)..... 104
 - Verifying ΔV_{10} flicker graphs and lists..... 106

- 8.5 Verifying the Electric Energy 108**
- 8.6 Verifying the Demand 109**

9 Checking Events (EVENT Screen) 111

- 9.1 Checking Event List.....113**
 - Checking event details..... 114
- 9.2 Checking Event Status115**
 - Switching event monitor screen..... 116
 - Checking trend data on event..... 117
 - Checking transient waveforms during an event..... 118
- 9.3 Checking Event Statistics Data ...119**
- 9.4 Checking the Event IN/OUT Status of the Worst Value 120**

10 File Saving and Operations (FILE Screen) 121

- 10.1 Viewing and Using FILE Mode Screen 122**
- 10.2 Folder and File Structure..... 124**
 - SD memory card..... 124
 - Internal memory..... 126
- 10.3 Screen Hard Copy 127**
 - Checking images 127
- 10.4 Saving Setting Files 128**
- 10.5 Loading Setting Files..... 129**
- 10.6 Loading Measured Data..... 130**
- 10.7 Copy from the Internal Memory to SD Memory Card..... 131**
- 10.8 Deleting Folders and Files 131**
- 10.9 Formatting SD Memory Card (Deleting All Files)..... 132**
- 10.10 Removing SD Memory Card during Recording 133**

11 Analysis (with Computer) 135

- 11.1 Copying Files..... 135**
 - Use of SD Memory Cards..... 136
 - Use of USB Cable..... 137
- 11.2 Use of Application Software PQ One (Included) 139**
 - What can be done with the application software 139
 - Installation..... 140

12 Communications (USB/LAN/RS-232C) 143

- 12.1 Preparing for LAN Communications 144
 - Settings (SET UP Screen) 144
 - Example of establishing a network environment 145
 - Connection 147
- 12.2 Remote Control of the Instrument through the Internet Browser (LAN Communications Only) 149
 - Preparations 149
 - Remote operation 150
 - Restrict the access (password settings) ... 151
- 12.3 Downloading Recorded Data to Computer 152
 - Setup (SET UP screen) 152
 - Download 154
- 12.4 Automatically Sending Data Being Recorded to the Computer 155
 - Setting FTP Server of the Computer 156
 - Configuring the instrument (SET UP screen) 162
 - Connection test 163
 - Start of Automatic Transmission 164
- 12.5 E-mail Transmission 165
 - Setup (SET UP screen) 165
 - Transmission test 168
 - Start of e-mail transmission 169
- 12.6 RS-232C Communication Preparations 170
 - Settings (SET UP screen) 170
 - Connection 170
- 12.7 LR8410 Link Compatible Logger Communication Preparations 171
 - Bluetooth® serial conversion adapter setup and connections 171
 - Configuring the instrument (SET UP screen and MONITOR screen) 172

13 External I/O 173

- 13.1 Event Input 174
- 13.2 External Output 175
- 13.3 External Output Settings (SET UP Screen) 176
- 13.4 Connection 177

14 Specifications 179

- 14.1 General Specifications 179

- 14.2 Input Specifications/ Output Specifications/ Measurement Specifications 181
- 14.3 Flagging Concept 199
- 14.4 QUICK SET Specifications 199
- 14.5 Event Specifications 202
- 14.6 Interface Specifications 203
- 14.7 Calculation Formula 205
- 14.8 Range Configuration and Combination Accuracy 220

15 Maintenance and Service 225

- Calibrations 225
- 15.1 Troubleshooting 225
 - Before having the instrument repaired 225
 - Replaceable parts and operating lifetimes 226
- 15.2 Cleaning 227
- 15.3 Error Indication 227
- 15.4 Disposing the Instrument 232

Appendix Appx.1

- Appx. 1 Fundamental Measurement Items Appx.1
- Appx. 2 Event Item Appx.3
- Appx. 3 Explanation of Power Quality Parameters and Events Appx.4
- Appx. 4 Event Detection Methods Appx.8
- Appx. 5 Recording Trends and Event Waveforms Appx.16
 - Trend screen recording method Appx.16
 - Recording event waveforms Appx.17
 - Method for verifying aggregation values required by IEC61000-4-30 Appx.18
- Appx. 6 Detailed Explanation of IEC Flicker and ΔV_{10} Flicker Appx.19
 - ΔV_{10} flicker meter Appx.21
- Appx. 7 3-phase 3-wire Measurement Appx.22
- Appx. 8 Method for Calculating Active Power Accuracy . Appx.24
- Appx. 9 Terminology Appx.25

Index Ind.1

11

12

13

14

15

6

7

8

9

10

Appx.

Ind.

Introduction

Thank you for purchasing the Hioki PQ3100 Power Quality Analyzer. To obtain maximum performance from the instrument, please read this manual, Operating Precautions, and Measurement Guide, and keep it handy for future reference.

This instrument comes with the following documentation. Please refer to these resources as necessary in light of your specific application.

Before using the instrument, please read “Operating Precautions” (provided separately).

Model	Manual contents	Printed edition	CD edition
Operating Precautions	Information to ensure safe use of the instrument	✓	–
Instruction Manual (this manual)	Detailed information about the instrument and specifications	✓	–
Measurement Guide	The instrument's basic measurement procedure with Quick Set	✓	–
Application software Instruction Manual	How to use the PQ ONE application	–	✓







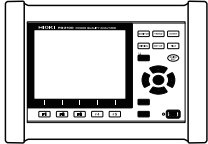
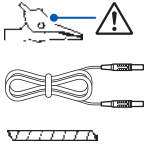

Trademarks

- Microsoft and Windows, Microsoft Excel, and Internet Explorer are either registered trademarks or trademarks of Microsoft Corporation in the United States and other countries.
- SD and SDHC logos are trademarks of SD-3C, LLC.
- The Bluetooth® word mark and logos are registered trademarks owned by Bluetooth SIG, Inc. and any use of such marks by Hioki E.E. Corporation is under license. Other trademarks and trade names are those of their respective owners.
- **Parani** is a trademark of SENA Technologies Co., Ltd.
- FILEZILLA is a registered trademark or trademark of Tim Kosse INDIVIDUAL FED REP GERMANY.
- Any other products and company names are generally either trade names, registered trademarks or trademarks of respective companies.

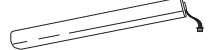
Verifying Package Contents

When you receive the instrument, inspect it carefully to ensure that no damage occurred during shipping. In particular, check the accessories, keys, switch, and connectors. If damage is evident, or if it fails to operate according to the specifications, contact your authorized Hioki distributor or reseller.

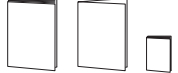
Check that the package contents are correct.

<input type="checkbox"/> PQ3100 Power Quality Analyzer	× 1	
Accessories		
<input type="checkbox"/> L1000-05 Voltage Cord Maximum rated voltage: 1000 V, maximum rated current: 10 A Alligator clips (black, red, yellow, blue, gray) 3 m banana plug leads (black, red, yellow, blue, gray) Spiral Tubes (Cord bundling) See “Bundling the voltage cords and current sensors (If required)” (p. 37), “Connecting Voltage Cords to Instrument” (p. 51), and “Connecting Voltage Cords to Objects” (p. 55).	×1 each ×1 each ×5	
<input type="checkbox"/> Z1002 AC Adapter (with power cord)	×1	
<input type="checkbox"/> Z1003 Battery Pack	×1	
<input type="checkbox"/> USB cable	×1	
<input type="checkbox"/> Colored clip in red, yellow, blue and white (color coding for current sensors)	×2 each	
<input type="checkbox"/> Spiral tubes in black (cord bundling for current sensors)	×5	
<input type="checkbox"/> Strap See “Attaching the strap (if required)” (p. 39).	×1	
<input type="checkbox"/> Instruction Manual*	×1	
<input type="checkbox"/> Measurement Guide*	×1	
<input type="checkbox"/> Operating Precautions (0990A903)	×1	
<input type="checkbox"/> CD (computer application software) See “11.2 Use of Application Software PQ One (Included)” (p. 139). The latest version can be downloaded from our website.	×1	

*: Please visit our website for other languages.

Precautions when transporting the instrument

Handle the instrument carefully so that it is not damaged due to a vibration or shock.

Options

The options listed below are available for the instrument. To order an option, please contact your authorized Hioki distributor or reseller.

Options are subject to change. Please check Hioki's website for the latest information.

For current measurement

- CT7126 AC Current Sensor (60 A, ϕ 15 mm)
- CT7131 AC Current Sensor (100 A, ϕ 15 mm)
- CT7136 AC Current Sensor (600 A, ϕ 46 mm)
- CT7044 AC Flexible Current Sensor (6000 A, ϕ 100 mm)
- CT7045 AC Flexible Current Sensor (6000 A, ϕ 180 mm)
- CT7046 AC Flexible Current Sensor (6000 A, ϕ 254 mm)
- CT7731 AC/DC Auto-Zero Current Sensor (100 A, ϕ 33 mm)
- CT7736 AC/DC Auto-Zero Current Sensor (600 A, ϕ 33 mm)
- CT7742 AC/DC Auto-Zero Current Sensor (2000 A, ϕ 55 mm)
- CT7116 AC Leakage Current Sensor (6 A, ϕ 40 mm)
- L9910 Conversion Cable (BNC-PL14)

For voltage measurement

- L1000-05 Voltage Cord (accessory)
Measurement category: CAT III, maximum rated voltage: 1000 V, maximum rated current: 10 A
Measurement category: CAT IV, maximum rated voltage: 600 V, maximum rated current: 10 A
- 9804-01 Magnetic Adapter (Red: 1, for changing the voltage cord tips)
Measurement category: CAT IV, maximum rated voltage: 1000 V, maximum rated current: 2 A
- 9804-02 Magnetic Adapter (Black: 1, for changing the voltage cord tips)
Measurement category: CAT IV, maximum rated voltage: 1000 V, maximum rated current: 2 A
- L9243 Grabber Clip (Red/Black: 1 each, for changing the voltage cord tips)
Measurement category: CAT II, maximum rated voltage: 1000 V, maximum rated current: 1 A

Power supply

- Z1002 AC Adapter (accessory)
- Z1003 Battery Pack (accessory)

Media for recording

- Z4001 SD Memory Card 2GB
- Z4003 SD Memory Card 8GB

Communication

- 9637 RS-232C Cable (9 pin-9 pin/1.8 m, cross cable)
- 9642 LAN Cable

Carrying Case

- C1009 Carrying Case (Bag)
- C1001 Carrying Case (Soft)
- C1002 Carrying Case (Hard)

Attaching strap

- Z5004 Magnetic Strap
- Z5020 Magnetic Strap

Safety Information

This instrument is designed to conform to IEC 61010 Safety Standards, and has been thoroughly tested for safety prior to shipment. However, using the instrument in a way not described in this manual may negate the provided safety features.

Before using the instrument, be certain to carefully read the following safety notes.

DANGER



Mishandling during use could result in injury or death, as well as damage to the instrument. Be certain that you understand the instructions and precautions in the manual before use.



WARNING







With regard to the electricity supply, there are risks of electric shock, heat generation, fire, and arc discharge due to short circuits. Individuals using an electrical measuring instrument for the first time should be supervised by a technician who has experience in electrical measurement.







Notation

In this document, the risk seriousness and the hazard levels are classified as follows.



 DANGER	Indicates an imminently hazardous situation that will result in death or serious injury to the operator.
 WARNING	Indicates a potentially hazardous situation that may result in death or serious injury to the operator.
 CAUTION	Indicates a potentially hazardous situation that may result in minor or moderate injury to the operator or damage to the instrument or malfunction.
IMPORTANT	Indicates information related to the operation of the instrument or maintenance tasks with which the operators must be fully familiar.

	Indicates a high voltage hazard. If a particular safety check is not performed or the instrument is mishandled, this may give rise to a hazardous situation; the operator may receive an electric shock, may get burnt or may even be fatally injured.
	Indicates a strong magnetic-field hazard. The effects of the magnetic force can cause abnormal operation of heart pacemakers and/or medical electronics.
	Indicates a prohibited action.
	Indicates the action which must be performed.
MONITOR (Bold character)	Names on the screen are displayed in bold characters .
[]	Operation keys are displayed in brackets ([]).
*	Additional information is presented below.

Symbols on the instrument

	Indicates cautions and hazards. When the symbol is printed on the instrument, refer to a corresponding topic in the Instruction Manual.
	Indicates DC (Direct Current).
	Indicates the ON side of the power switch.
	Indicates the OFF side of the power switch.
	Indicates a grounding terminal.
	Indicates an instrument that has been protected throughout by double insulation or reinforced insulation. (L9243 Grabber Clip)

Symbols for various standards

	Indicates the Waste Electrical and Electronic Equipment Directive (WEEE Directive) in EU member states.
	Indicates that the product conforms to regulations set out by the EU Directive.
 Ni-MH	This is a recycle mark established under the Resource Recycling Promotion Law (only for Japan).

Accuracy

We define measurement tolerances in terms of f.s. (full scale), rdg. (reading) and dgt. (digit) values, with the following meanings:

f.s.	(maximum display value, range) The maximum value that can be displayed. This is usually the name of the currently selected range.
rdg.	(reading or displayed value) The value currently being measured and indicated on the measuring instrument.
dgt.	(resolution) The smallest displayable unit on a digital measuring instrument, i.e., the input value that causes the digital display to show a "1" as the least-significant digit.

Protective gear

WARNING



This instrument measures live lines. To prevent electric shock, use appropriate protective insulation and adhere to applicable laws and regulations.

Measurement categories

To ensure safe operation of measuring instruments, IEC 61010 establishes safety standards for various electrical environments, categorized as CAT II to CAT IV, and called measurement categories.

DANGER



- Using a measuring instrument in an environment designated with a higher-numbered category than that for which the instrument is rated could result in a severe accident, and must be carefully avoided.
- Never use a measuring instrument that lacks category labeling in a CAT II to CAT IV measurement environment. Doing so could result in a serious accident.

The instrument conforms to the safety requirements for CAT III 1000 V, CAT IV 600 V measuring instruments.

CAT II: When directly measuring the electrical outlet receptacles of the primary electrical circuits in equipment connected to an AC electrical outlet by a power cord (portable tools, household appliances, etc.).

CAT III: When measuring the primary electrical circuits of heavy equipment (fixed installations) connected directly to the distribution panel, and feeders from the distribution panel to outlets.

CAT IV: When measuring the circuit from the service drop to the service entrance, and to the power meter and primary overcurrent protection device (distribution panel).

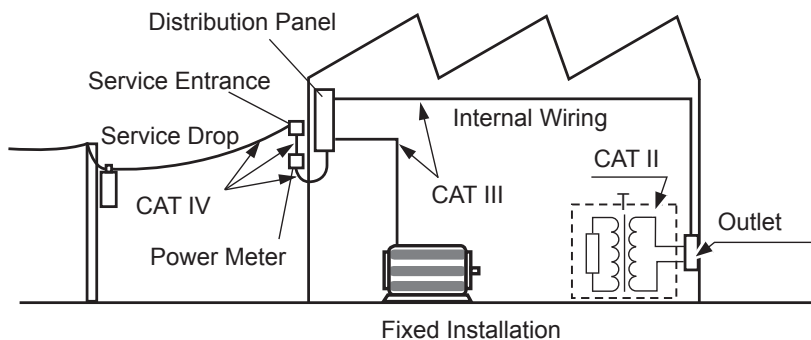

Operating Precautions

Follow these precautions to ensure safe operation and to obtain the full benefits of the various functions.

Preliminary Checks

Before using the instrument, verify that it operates normally to ensure that no damage occurred during storage or shipping. If you find any damage, contact your authorized Hioki distributor or reseller.

DANGER



To prevent an electric shock, confirm that the white portion (insulation layer) inside the cable is not exposed. If a color inside the cable is exposed, do not use the cable.

Installation Environment

WARNING

Installing the instrument in inappropriate locations may cause a malfunction of instrument or may give rise to an accident. Avoid the following locations:



- Exposed to direct sunlight or high temperature
- Exposed to corrosive or combustible gases
- Exposed to a strong electromagnetic field or electrostatic charge
- Near induction heating systems (such as high-frequency induction heating systems and IH cooking equipment)
- Susceptible to vibration
- Exposed to water, oil, chemicals, or solvents
- Exposed to high humidity or condensation
- Exposed to high quantities of dust particles

CAUTION



Do not place the instrument on an unstable table or an inclined place. Dropping or knocking down the instrument can cause injury or damage to the instrument.

Handling the Instrument

CAUTION



To avoid damage to the instrument, protect it from physical shock when transporting and handling. Be especially careful to avoid physical shock from dropping.

This instrument may cause interference if used in residential areas. Such use must be avoided unless the use takes special measures to reduce electromagnetic emissions to prevent interference to the reception of radio and television broadcasts.

Handling Cords and Cables

DANGER



If the insulation on a cord or cable melts, the metal conductor may be exposed. Do not use any cord or cable whose metal conductor is exposed. Doing so could result in electric shock, or other hazard.

WARNING



To prevent an electric shock, do not exceed the every rating shown on either the instrument or the options for voltage measurement, whichever is worse.

CAUTION



The cord and cable are hardened under the 0 degree or colder environment. Do not bend or pull them to avoid tearing their shield or cutting them.

Using Voltage Cords

DANGER



To prevent an electric shock, confirm that the white portion (insulation layer) inside the cable is not exposed. If a color inside the cable is exposed, do not use the cable.

WARNING



- Use only the specified voltage cords. Using a non-specified cord may result in electric shock or short circuits.
- Avoid contact between the cord and the measured line in order to protect the cord from damage. Any contact can cause the instrument to malfunction and lead to short-circuits or electric shock.

Using Battery Pack

WARNING



- To avoid the possibility of explosion, do not short circuit, disassemble or incinerate battery pack. Battery may explode if mistreated. Handle and dispose of batteries in accordance with local regulations.



- Be sure to observe the following precautions. Incorrect handling may result in liquid leaks, heat generation, ignition, bursting and other hazards.
 - The battery pack contains lye, which may cause blindness if it comes into contact with the eyes. Should battery liquid get into your eyes, avoid rubbing them. Flush them with water and seek immediate medical attention.
 - When storing the instrument, make sure no objects that could short-circuit the connectors are placed near them.
- For battery operation, use only the HIOKI Model Z1003 Battery Pack. We do not take any responsibility for accidents or damage related to the use of any other batteries.
- To avoid electric shock, turn off the power switch, disconnect all the power and voltage cords and current sensor from the device to be measured, and replace the battery pack.
- To prevent the instrument damage or electric shock, use only the screws (M6×12 mm) for securing the battery cover in place that are originally installed. If you have lost any screws or find that any screws are damaged, please contact your Hioki distributor for a replacement.

CAUTION



- Observe the following to avoid damage to the instrument.
 - Use the battery pack in an ambient temperature range of 0°C to 50°C and charge it in an ambient temperature range of 10°C to 35°C.
 - If the battery pack fails to finish charging within the stipulated time, disconnect the AC adapter to stop charging and contact your dealer or Hioki representative.
 - Consult your dealer or nearest service station should liquid leaks, strange odor, heat, discoloration, deformation and other abnormal conditions occur during use, charging or storage. Should these conditions occur during use or charging, turn off and disconnect the instrument immediately.
 - Do not expose the instrument to water and do not use it in excessively humid locations or locations exposed to rain.
 - Do not expose the instrument to strong impact and do not throw it around.
 - Heed the following instructions to avoid battery pack performance drop or leakage.

- The battery pack is a consumable. If you are able to use the instrument for only a limited period of time despite the battery pack being properly charged, the battery pack's service life is at an end, and it should be replaced.
- When a battery pack that has not been used for a long time is used, charging may end before the battery pack is fully charged. In such a case, repeat charging and discharging a number of time before use. (A battery pack may also be in such a state immediately after purchase.)
- The life of the battery pack (when capacity is 60% or more of initial capacity) is approximately 500 charge-discharge cycles. (The life differs depending on the conditions of use.)
- To prevent battery pack deterioration when the battery will not be used for 1 month or longer, remove it and store it in a dry location with an ambient temperature range of between -20°C to 30°C.
- When a battery pack is used, the instrument turns off automatically when the capacity drops. Leaving the instrument in this state for a long time may lead to over discharge so be sure to turn off the power switch on the instrument.
- The charging efficiency of the battery pack deteriorates at high and low temperatures.
- The battery pack is subject to self-discharge. Be sure to charge the battery pack before initial use. If the battery capacity remains very low after correct recharging, the useful battery life is at an end.

Attaching the Strap

CAUTION



Attach the strap securely at 2 locations of the instrument. If insecurely attached, the instrument may fall and be damaged when carrying.

Using SD Memory Cards

CAUTION



• Do not remove a card while data is being written to it. Doing so may damage the card. See “10.10 Removing SD Memory Card during Recording” (p. 133).



• Exercise care when using such products because static electricity could damage the SD card or cause malfunction of the instrument.

IMPORTANT

- Format the card with the instrument. Using a computer to format the card may reduce the card's performance. See “10.9 Formatting SD Memory Card (Deleting All Files)” (p. 132).
- No compensation is available for loss of data stored on the SD memory card, regardless of the content or cause of damage or loss. Be sure to back up any important data stored on an SD memory card.
- Observe the following to avoid corruption or loss of stored data:
 - Do not touch the electrical contacts on the card or inside the insertion slot with your skin or metallic objects.
 - While writing or reading data, avoid vibration or shock, and do not turn the power off or remove the card from the instrument.
 - Before formatting (initializing) a card, confirm that it contains no important information (files).
 - Do not bend or drop the card, or otherwise subject it to intense shock.
- The operating lifetime of the SD memory card is limited by its flash memory. After long-term or frequent usage, data reading and writing capabilities will be degraded. In that case, replace the card with a new one.
- If you are unable to write data to an SD memory card, manipulate folders and files, or format the card, check the position of the write-protect lock and disengage it if necessary. The connector of the SD memory card is used to judge whether the card is write-protected. If the write-protected lock is in an intermediate position, the determination of whether the card is write-protected will depend on the connector. For example, even if the instrument determines that the card is not write-protected and allows data to be written to it, a computer may determine that it is write-protected, preventing data from being written to it.

Using AC Adapter

WARNING

- Use only the supplied Model Z1002 AC ADAPTER. AC adapter rated input voltage range is 100 to 240 V AC at 50 Hz/60 Hz. To avoid electrical hazards and damage to the instrument, do not apply voltage outside of this range.
- Turn the instrument off before connecting the AC adapter to the instrument and to AC power.
- To avoid electrical accidents and to maintain the safety specifications of this instrument, connect the power cord provided only to an outlet.

CAUTION

- Avoid using an uninterruptible power supply (UPS) or DC/AC inverter with rectangular wave or pseudo-sine-wave output to power the instrument. Doing so may damage the instrument.

Turning On the Instrument

WARNING

- Before turning the instrument on, make sure the supply voltage matches that indicated on its power connector. Connection to an improper supply voltage may damage the instrument and present an electrical hazard.

CAUTION

- Do not connect the supply voltage improperly. Doing so may damage the instrument's internal circuitry.
- If the power does not turn on, the AC adapter or the instrument may be malfunctioning or the power cord may be disconnected. Contact your authorized Hioki distributor or reseller.
- If an error during the self-test, the instrument is damaged. Contact your authorized Hioki distributor or reseller.

Using Magnetic Adapter and Magnetic Strap

DANGER

- Persons wearing electronic medical devices such as a pacemaker should not use the Magnet Adapter and Magnetic Strap. Such persons should avoid even proximity to the Magnet Adapter and Magnetic Strap, as it may be dangerous. Medical device operation could be compromised, presenting a hazard to human life.

CAUTION

- Do not bring the Magnet Adapter and Magnetic Strap near magnetic media such as floppy disks, magnetic cards, pre-paid cards, or magnetized tickets. Doing so may corrupt and may render them unusable. Furthermore, if the Magnet Adapter and Magnetic Strap is brought near precision electronic equipment such as computers, TV screens, or electronic wrist watches, they may fail.

Wiring

DANGER

- Do not short-circuit two wires to be measured by bringing the metal part of the voltage cord clips or current sensor tips into contact with them. Doing so could result in a severe accident such as arcing.
 - To prevent electrical shock and personal injury, do not touch any input terminals on the VT (PT), CT or the instrument when they are in operation.
 - Do not use the instrument with circuits that exceed its ratings or specifications. Doing so may damage the instrument or cause it to become hot, resulting in bodily injury.
 - To avoid electric shock, be careful to avoid shorting live lines with the voltage cords.
-
- We recommend measurements at the secondary side of the distribution panel. Measurements at the primary side cause unrestricted current flow. The instrument and equipment could be damaged if a short circuit occurs.
 - To avoid short circuit or electric shock, do not touch the metal parts of the voltage cords or current sensor tips.

CAUTION

- To avoid damaging the instrument, do not short the voltage cord input terminals or current sensor input terminals or input any voltage to them.
- To ensure safe operation, use only the voltage cord and current sensor specified by Hioki.

Displayed values can frequently fluctuate due to induction potential even when no voltage is applied. This, however, is not a malfunction.

Using USB Connector (USB Cable)

CAUTION

- To avoid equipment failure, do not disconnect the USB cable while communications are in progress.
 - Use a common ground for both the instrument and the computer. Using different ground circuits will result in a potential difference between the instrument's ground and the computer's ground. If the USB cable is connected while such a potential difference exists, it may result in equipment malfunction or failure.
-
- If the instrument and computer are both off and connected with the USB cable, turn on the computer and then the instrument. Powering up the devices in a different order may prevent the instrument and computer from communicating.
 - Copying large data files from the SD memory card to a computer via the instrument's USB interface can be time-consuming. When you need to copy a large data file to a computer, it is recommended to use an SD memory card reader.

Connecting the Instrument to an External Device

CAUTION



- When any device that does not accept the power supplied through Pin 9 is connected to the RC-232C interface of the instrument, do not set the **RS-232C connection** destination to **Bluetooth**. Doing so will damage the connected device.



- Use a common ground for both the instrument and the computer. Using different ground circuits will result in a potential difference between the instrument's ground and the computer's ground. If the communications cable is connected while such a potential difference exists, it may result in equipment malfunction or failure.
- Before connecting or disconnecting any communications cable, always turn off the instrument and the computer. Failure to do so could result in equipment malfunction or damage.
- After connecting the RS-232C cable, tighten the screws on the connector securely. Failure to secure the connector could result in equipment malfunction or damage.
- When connecting the instrument to your LAN using a LAN cable of more than 30 m or with the cable laid outdoors, take appropriate countermeasures that include installing a surge protector for LANs. Such signal wiring is susceptible to induced lighting, which can cause damage to the instrument.

Using External I/O Terminals

WARNING

To avoid electric shock or damage to the equipment, always observe the following precautions when connecting to external terminals or connectors.



- **Always turn off the power to the instrument and to any devices to be connected before making connections.**
- **Be careful to avoid exceeding the ratings of external terminals and connectors.**
- **During operation, a wire becoming dislocated and contacting another conductive object can be serious hazard. Use screws to secure the external connectors.**

CD precautions

- Exercise care to keep the recorded side of discs free of dirt and scratches. When writing text on a disc's label, use a pen or marker with a soft tip.
- Keep discs inside a protective case and do not expose to direct sunlight, high temperature, or high humidity.
- Hioki is not liable for any issues your computer system experiences in the course of using this disc.

1 Overview

1.1 Procedure for Investigating Power Quality

By measuring power quality parameters, you can assess the power quality and identify the causes of various power supply malfunctions. The ability of the instrument to measure all power quality parameters simultaneously makes this process a quick and simple one. The following is the description of the investigation process for the power quality.

1

Overview

Step 1: Clarifying the purpose

To find the cause for the power supply malfunction



A power supply malfunction such as an equipment failure or malfunction has occurred and you wish to address it quickly.

Go to Step 2 (p. 15).

To assess power supply quality (power quality)



There is no known problem with the power supply, and you just want to assess the power quality.

- Periodic power quality statistical investigation
- Testing after the installation of electric or electronic equipment
- Load investigation
- Preventive maintenance

Go to Step 3 (p. 16).

Step 2: Identifying the malfunctioning component (measurement location)

Check the following:

(1) Where is the issue occurring?

- Principal electrical system
Large copier, uninterruptible power supply, elevator, air compressor, air conditioning compressor, battery charger, cooling system, air handler, time-controlled lighting, variable-speed drive, etc.
- Electric distribution system
Conduit [electrical conduit] damage or corrosion, transformer heating or noise, oil leak, circuit breaker operation or overheating

(2) When does the issue occur?

- Does it occur continuously, regularly, or intermittently?
- Does it occur at a specific time of the day or on a specific day of the week?

(3) What type of investigation (measurement) should be performed to find the cause?

- Measure the voltage, current (power) continuously to analyze voltage and current trends when the issue occurs.
- Concurrent measurements at more than one location
Examples:
 - Dedicated systems lines in the electrical substation (can be measured only by the power companies)
 - High-voltage and low-voltage lines of the service entrance
 - Distribution panels and switchboards
 - Power feeder and outlets of power supply for electric and electronic equipment

(4) What is the expected cause?

- Abnormal voltage
RMS value trends, waveform distortion, transient voltage
- Abnormal current
Leakage current, inrush current

Step 3: Checking investigation (measurement) locations (collecting site data)

Collect information (site data) from as many locations as possible to prepare for the investigation. Check the following:

(1) Wiring

1P2W (DC) / 1P3W /
3P3W2M / 3P3W3M / 3P4W /
3P4W2.5E

(2) Declared input voltage

50 V to 800 V

(3) Frequency

50 Hz/60 Hz

(4) Is the voltage between the neutral line and ground, and neutral line current required to be measured?

If the measurements are required, CH4 of the wiring settings should be set to ON. See p. 48, and p. 64.

(5) Current capacity

Current capacity is required to select current sensors used for the measurements.

(6) Other items related to the whole facility

- Other systems causing power supply malfunctions
- Principal electrical system operating cycle
- Any additions or changes to facility equipment
- Check of the power distribution system in the facilities

Step 4: Making measurements with the power quality analyzer (measurement procedure)

Measurements are performed using the following procedure:

Preparations



Attach accessories and optional equipment required for the measurements to the Power Quality Analyzer.
See "2 Preparing for Measurement" (p. 35).

Measurement settings/Connections/Wiring*



Configure the conditions required for the measurements and connect voltage cord and current sensors to the instrument.
Connect the wires to the measuring object and check if there is any mistake.
See "Installation Environment" (p. 7) and "4 Wiring (WIRING Screen)" (p. 47).

Recording settings/Event settings*



Configure the conditions and events required for recording.
If the EVENT indicator on the screen (p. 32) frequently changes to red, too many events have occurred.
When the number of events reaches 9999 during recording/measurement, subsequent events will not be recorded (trend recording continues). Adjust the event settings as required.
See "5 Setting Change (SET UP Screen)" (p. 63).

Measured value check



Press the **[MONITOR]** key, and use the **MONITOR** screen to check if there is any problem with the values measured.
See “6 Verifying the Waveform, Measured Values (MONITOR Screen)” (p. 81).

Recording start*



Press the **[START/STOP]** key to start recording.
See “7 Recording (Save) (SET UP Screen)” (p. 93).

Analysis/Actions

Continue recording for the period necessary for the analysis, check the state of the power supply malfunction based on the detected events.

Check while recording	▶	“8 Verifying the Trends (Fluctuations) in Measured Values (TREND Screen)” (p. 97), and “9 Checking Events (EVENT Screen)” (p. 111).
Check after recording is stopped	▶	“11 Analysis (with Computer)” (p. 135)

Next, take the preventive measures for the power supply malfunction.
(The instrument is effective not only for the power supply investigation but also to check after taking the measures for the power supply malfunction.)

***: Use “Quick Set” for easy and secure setting, and recording start!**

The Quick Set allows easy and secure procedure for setting and recording start by following the navigation of the instrument.
The event settings also allows typical setting by only selecting the menu.
(Menu: Voltage events, Inrush current, Trend record only, EN50160)
See “3 Quick Set” (p. 45), supplied Measurement Guide.

Advice for identifying the cause of abnormalities

■ Record voltage and current trends at the power circuit inlet.

If the voltage drops while the building's current consumption rises, the likely cause for power abnormality lies inside the building. If the voltage and current are both low, the cause is likely to lie outside the building.

It's extremely important to select the right measurement locations and measure current for troubleshooting.

■ Check power trends.

Overloaded equipment can cause problems. By understanding power trends, you can more easily identify problematic equipment and locations.

See "8 Verifying the Trends (Fluctuations) in Measured Values (TREND Screen)" (p. 97).

■ Check when the problem occurs.

Equipment that is operating or turning on or off when events (abnormalities) are recorded may be the cause of malfunction. By understanding the precise times at which events start and stop, you can more easily identify problematic equipment and locations.

See "9 Checking Events (EVENT Screen)" (p. 111).

■ Check for heat and unusual sounds.

Motors, transformers, and wiring may produce heat or unusual sounds due to causes such as overloading or harmonics.

1.2 Product Overview

The PQ3100 Power Quality Analyzer is a measuring instrument used to manage power quality and identify abnormalities of the power line to analyze the cause of the trouble.

1

Overview

All parameters can be recorded simultaneously.

Trends and power abnormalities (events) of all parameters can be recorded simultaneously.

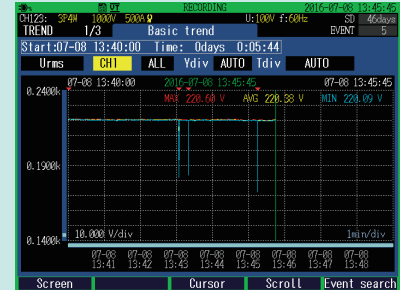

The instrument guides the procedures.

The Quick Set function allows proper and easy item settings and connections required for measurements by following the steps.

See “3 Quick Set” (p. 45), Measurement Guide (provided separately).

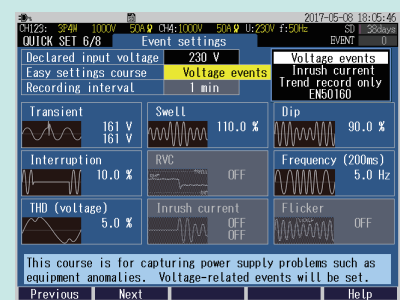

Data can be easily analyzed and reported.

The data loaded to a computer can be easily analyzed and reported with the supplied software.

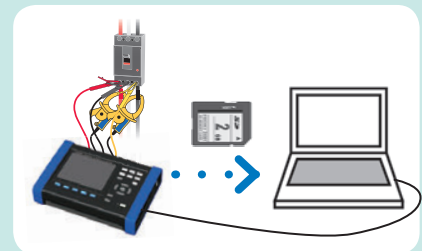

See “11 Analysis (with Computer)” (p. 135) and “12 Communications (USB/LAN/RS-232C)” (p. 143).

1.3 Features

Long-term event waveform recording	Waveforms for up to 11.2 s when event occurs (1 s before event, 0.2 s on event, 10 s after event) can be saved for power abnormality analysis.
DC (Direct Current) measurements	DC voltages can be measured. AC/DC Auto Zero Sensor allows DC current measurements.
Easy and secure	The Quick Set allows easy operations by following the steps for secure measurements. Continuous calculation without a gap also allows simultaneous measurements of all the parameters required for the power quality measurements to securely identify the phenomenon.
Wiring check	Checks the wiring state. If the instrument has been connected improperly, tips for correct connections will be displayed by the help function.
Easy analysis and reporting of data	The supplied software PQ One allows easy analysis and reporting of the data.
Safety	Compatible with CAT III 1000 V and CAT IV 600 V
High accuracy	Voltage measurement accuracy of $\pm 0.2\%$ rdg. Complies with the IEC61000-4-30 Class S international power quality standard
4 voltage channels 4 current channels	Measurements for voltage between neutral line and ground, and neutral line current are available for 3-phase 4-wire wiring.
Transient measurements	Transient measurements for 5 kHz to 40 kHz, up to 2200 V
3-channel simultaneous ΔV_{10} flicker measurement	3-channel simultaneous ΔV_{10} flicker measurement is available.
Simultaneous measurement of line voltage and phase voltage for 3-phase	For 3-phase 3-wire 3-watt meter measurement (3P3W3M) and 3-phase 4-wire measurement (3P4W), both line voltage and phase voltage are measured and output. Line voltage or phase voltage, whichever is selected, is displayed.
Extensive lineup of current sensors	You can choose the best current sensors for your measurement application ranging from leakage currents to a maximum rating of 6,000 A. The instrument can feed the power to both Flexible Current Sensor and AC/DC Auto-Zero Sensor enabling you to make long-term measurements without worrying about the power supply.
Ability to operate for about 8 hours on battery power	Even when AC power is not available, the supplied battery pack can be used for about 8 hours of measurement.
Broad operating temperature range	Operating temperature range is from -20°C to 50°C . However, the operating temperature range is from 0°C to 50°C when Battery Pack is used.
Saving to SD memory cards	Data can be continuously recorded to an optional 2 GB or an 8 GB memory card for up to one year.
TFT color LCD	The instrument uses an LCD that is easy to see in both dim and bright conditions.
Communications functionality	The instrument includes standard USB and Ethernet interfaces to connect a computer for the following operations. <ul style="list-style-type: none"> • To configure the instrument using a computer. • To download data from the instrument to the computer. • To operate the instrument remotely. See "12 Communications (USB/LAN/RS-232C)" (p. 143).

1.4 Names and Functions of Parts

Front

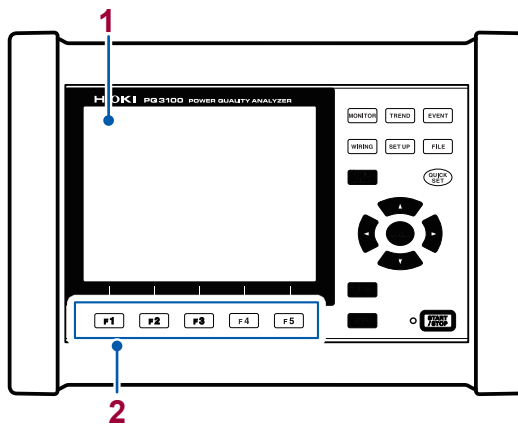

Operation keys

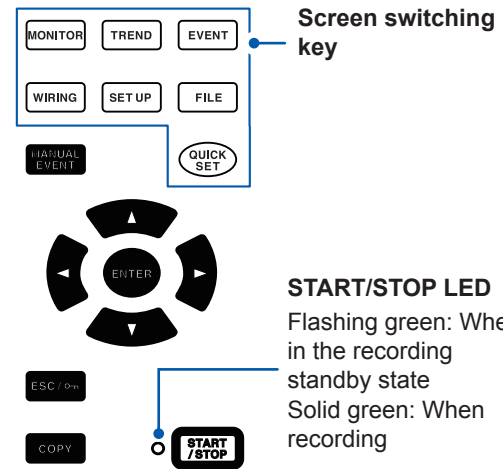

1

Overview

No.	Name and description	Reference
1	Display 6.5" TFT color LCD	p. 24
2	Function key ([F1] to [F5] key) Select and change display contents and settings.	—

Keys	Description	Reference
MONITOR	Displays and changes the MONITOR screen (waveform and measured values).	p. 81
TREND	Displays and changes the TREND screen (time series trend graphs).	p. 97
EVENT	Displays and changes the EVENT screen (event status).	p. 111
WIRING	Displays and changes the WIRING screen (wiring settings, wiring check).	p. 47
SET UP	Displays and changes the SET UP screen (settings).	p. 63
FILE	Displays and changes the FILE screen (SD memory card/internal memory).	p. 121
QUICK SET	Displays and changes the QUICK SET screen. Pressing this key during recording allows checking the current main settings.	p. 45 Measurement Guide
MANUAL EVENT	An event occurs at the timing when this key is pressed during recording. The voltage and current waveforms and measured values when an event occurs are recorded.	—
ENTER	Moves the cursor on the screen. Scrolls through graphs or waveforms. ENTER: Selects items on the screen and accepts changes.	—
ESC / ON	Cancels any selections or changes made and reverts to the previous settings. Switches to the previous screen. Pressing and holding this key for at least 3 s activates the key lock function. (Same operation for unlock)	—
COPY	Outputs the image of the currently displayed screen to the SD memory card.	p. 127
START / STOP	Starts and stops recording.	p. 93

Upper

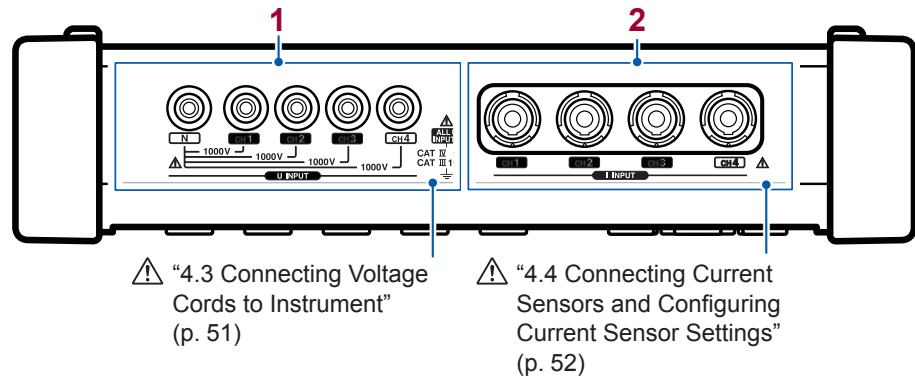

No.	Name	Description	Reference
1	Voltage input terminal	Connects supplied L1000-05 voltage cord to one of the jacks.	p. 51
2	Current input terminal	Connects optional current sensors.	p. 52

Left

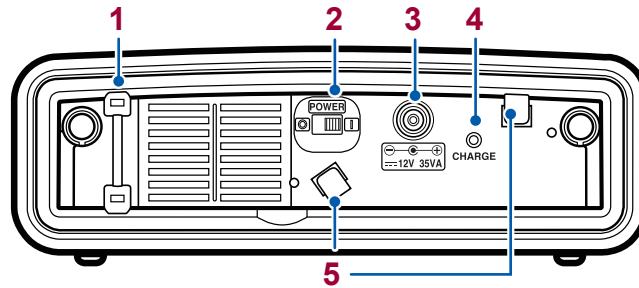

No.	Name	Description	Reference
1	Strap eyelet	Attaches the strap.	p. 39
2	POWER Switch	Turns the instrument on and off.	p. 44
3	AC adapter connection jack	Connects the AC adapter.	p. 43
4	CHARGE LED	Lights up when the Z1003 Battery Pack is charging.	p. 38
5	Hook for AC adapter	Loops the AC adapter cord through these hooks.	p. 43

Right

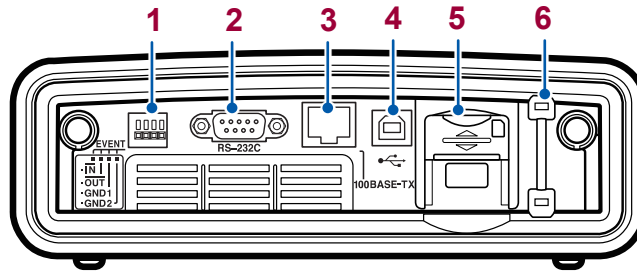

No.	Name	Description	Reference
1	External I/O terminals	Uses commercially available wires to connect with external devices.	p. 173
2	RS-232C interface	Connects to a computer with an RS-232C cable. Connects to a logger supporting LR8410 Link with a Bluetooth® serial conversion adapter.	p. 170 p. 171
3	LAN interface	Connects to a computer using the LAN cable.	p. 144
4	USB port	Connects to a computer using the supplied USB cable.	p. 137
5	SD memory card slot	Inserts an SD memory card. Be sure to close the cover when recording.	p. 42
6	Strap eyelet	Attaches the strap.	p. 39

Back

⚠ "Installing the battery pack" (p. 38)

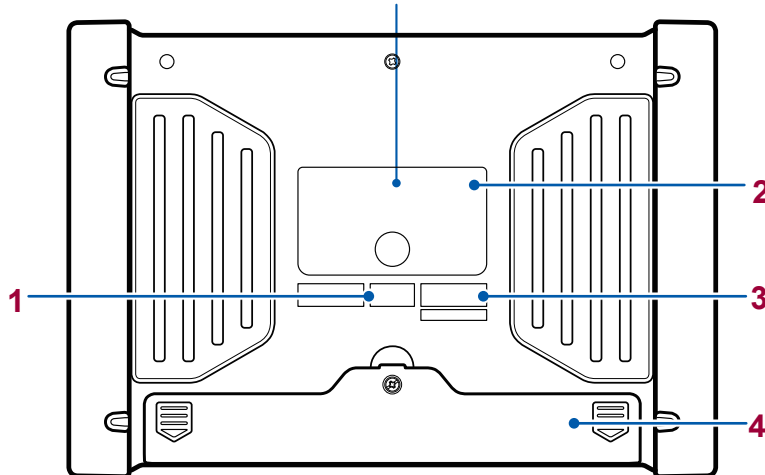

No.	Name	Description	Reference
1	MAC address label	Displays the instrument's unique MAC address. This address is used when configuring a LAN connection. Do not remove the label as the information is necessary for managing the device.	p. 144
2	Label	Indicates the warning, CE mark, KC mark, WEEE Directive mark, and manufacturer.	—
3	Serial No.	The 9-digit serial number indicates the year (first two digits) and the month of manufacture (next two digits). Do not remove this sticker as the number is important.	—
4	Battery compartment	Installs the supplied Z1003 Battery Pack within the compartment.	p. 38

1.5 Screen Configuration

Displaying and switching screens

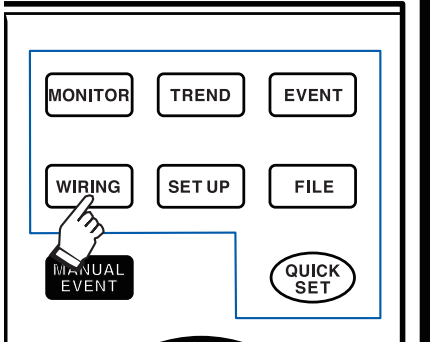
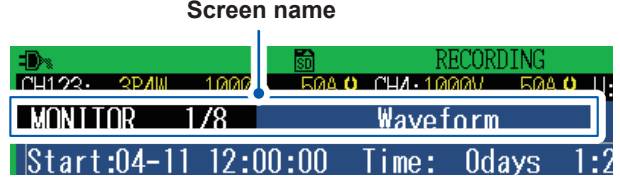
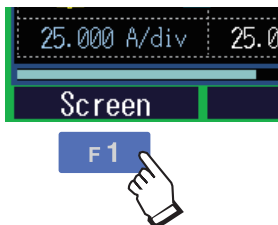
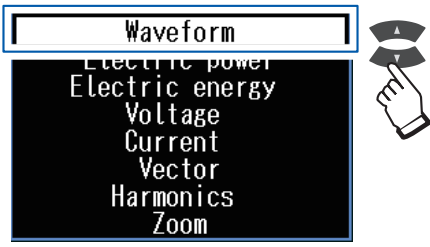
Use operation keys (screen switching key)	Use [F1] (SCREEN) key to switch screens
 <p>The screens consist of seven screens each of which corresponds to the operation keys. The screen corresponding to the key pressed is displayed. The screen can be switched by pressing the key repeatedly.</p> <p>Screen name</p> 	<p>Screen example: MONITOR screen</p> <p>1</p>  <p>2</p> 

MONITOR screen

A screen that is used to monitor instantaneous values. This screen is used to view voltage and current instantaneous waveforms, and the measured values.

Display/switch screen: **[MONITOR]** key

See “6 Verifying the Waveform, Measured Values (MONITOR Screen)” (p. 81).

Waveform screen

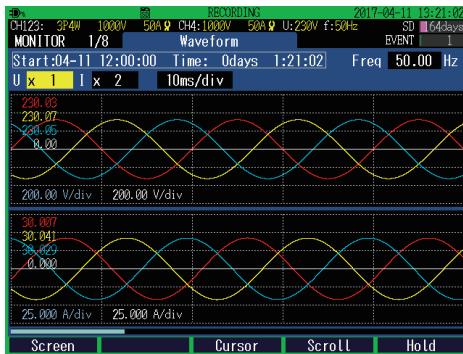

Voltage and current waveforms of CH1 to CH4 are displayed.

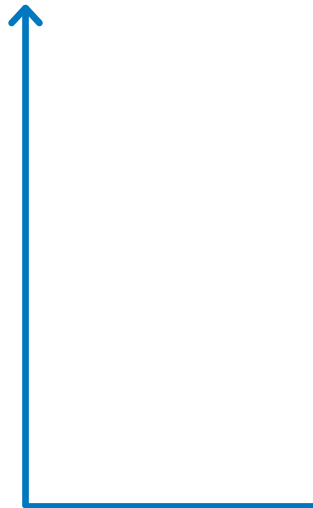

Electric power screen

→ RMS voltage, RMS current, frequency, power, power factor, active energy (consumption) and elapsed time are displayed.



Electric energy screen

Electric energy, energy cost, start time, stop time, elapsed time, power and power factor are displayed.



Voltage screen

Measured values related to voltage are displayed.



Current screen

Measured values related to current are displayed.



Vector screen

Phase relationship between voltage and current is displayed in a vector diagram.



Harmonics screen

Harmonic current, harmonic voltage, and harmonic power from 0 to 50th order are displayed.



Zoom screen

Enlarged view of 6 user-selected parameters are available.

TREND screen

A screen used to check the trend (fluctuations) of the measured values.

Display/switch screen: **[TREND]** key

See “8 Verifying the Trends (Fluctuations) in Measured Values (TREND Screen)” (p. 97).

Basic trend screen



This screen is used to check fluctuation width of maximum, minimum and average values between recording intervals.

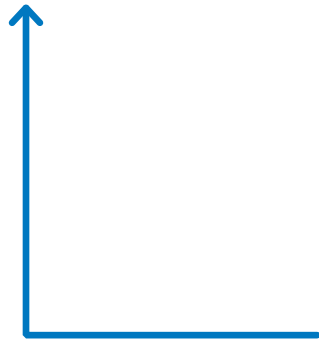

Detail trend screen

This screen is used to check fluctuation width of maximum and minimum values between recording intervals for the following parameters.

- RMS voltage refreshed each half-cycle
- RMS current refreshed each half-cycle
- Inrush current
- Frequency (1 wave)

Harmonics trend screen

This screen is used to check trends of harmonics and interharmonics.

Flicker : graph screen

This screen is used to check trends of IEC flicker or ΔV_{10} flicker.

Electric energy screen

This screen is used to check electric energy trends for each recording interval.

Demand screen

This screen is used to check demand trends.

EVENT screen

A screen used to check the event status.

Display/switch screen: **[EVENT]** key
See “9 Checking Events (EVENT Screen)” (p. 111).

Event list screen

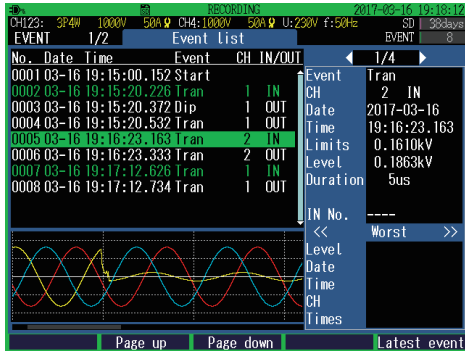

Events can be checked on the list.
The events are sorted in the order of occurrence.

EVENT MONITOR screen: See p. 116.

Event statistics screen

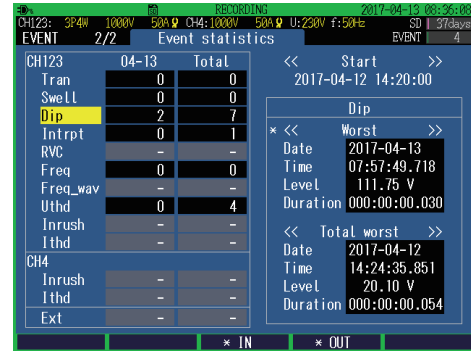

This screen is used to check the statistical results for each event type.

WIRING screen

A screen used to check the wiring settings.

Display/switch screen: **[WIRING]** key
See “4 Wiring (WIRING Screen)” (p. 47).

Wiring settings screen

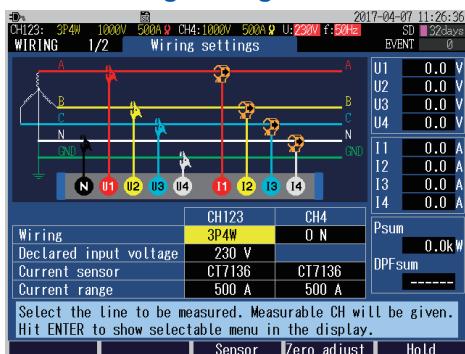

This screen is used to configure the wiring.
Make wiring by checking the wiring diagram.

Wiring check screen

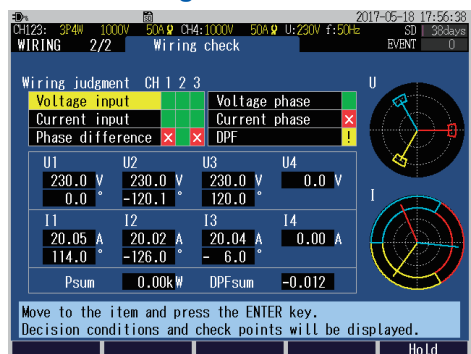

This screen is used to check whether the instrument has been connected properly.

SET UP screen

A screen used to configure settings.

Display/switch screen: **[SET UP]** key

See “5 Setting Change (SET UP Screen)” (p. 63).

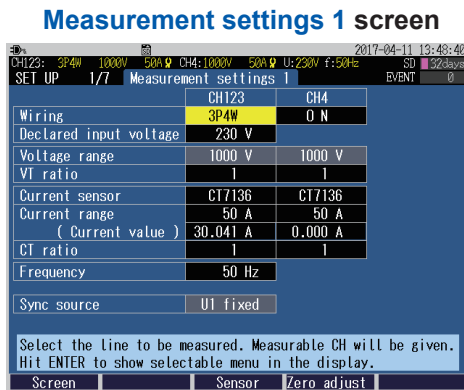

This screen is used to configure the wiring.

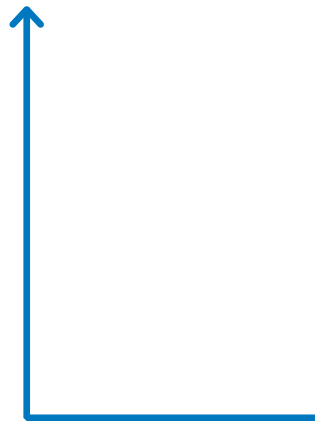

Measurement settings 2 screen
 This screen is used to configure settings for calculation method, energy cost, and flicker.



Recording settings screen
 This screen is used to configure the settings for recording.



Event settings 1 screen
 This screen is used to configure the event threshold value and hysteresis for voltage and current.



Event settings 2 screen
 This screen is used to configure the timer event, external event, and event waveform recording time.



System settings screen
 This screen is used to configure the clock, beep sound, language, display color, and phase name.



Interface settings screen
 This screen is used to configure the settings for LAN, RS-232C, and external output.

FILE screen

A screen used for file operations.

This screen allows listing and operations for files of the SD memory card and internal memory.

Display/switch screen: **[FILE]** key

See “10 File Saving and Operations (FILE Screen)” (p. 121).

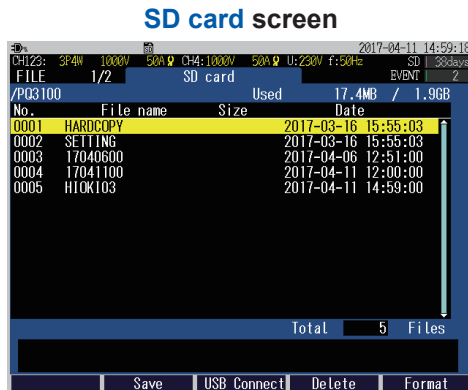

This screen shows lists of folders and files in the SD memory card.

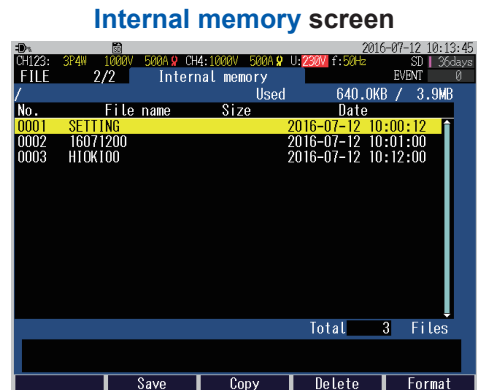

This screen shows lists of folders and files in the internal memory.

QUICK SET screen

Minimum conditions required for recording can be set by following the Quick Set instructions.

Quick Set start: **[QUICK SET]** key

See “3 Quick Set” (p. 45) and refer to Measurement Guide (provided separately).

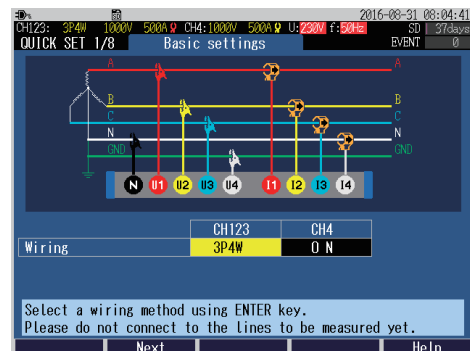
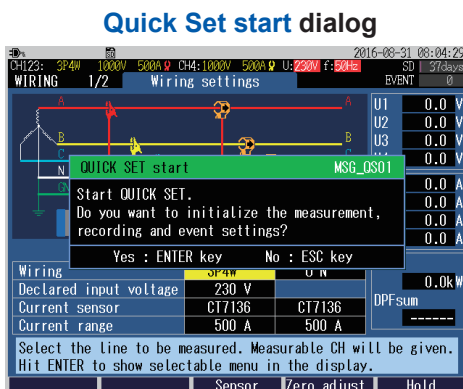

1.6 Basic Key Operations

See “Displaying and switching screens” (p. 24).

Changing the required items

1  Move the cursor to the item.

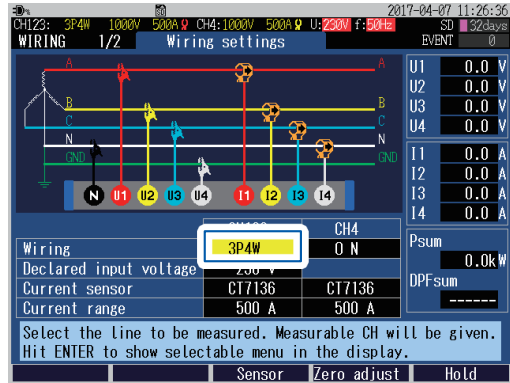

2  The drop down list will be displayed.

3  Select an item.

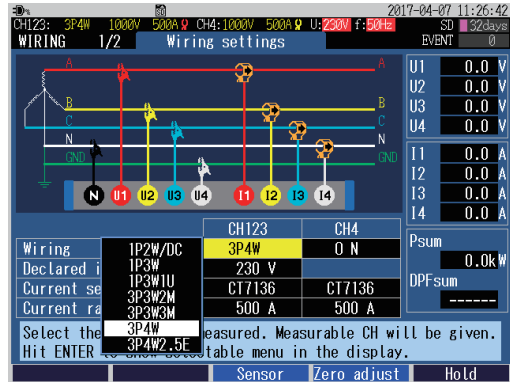

4  Accept the setting.

On the **MONITOR** screen and the **TREND** screen, the items can be changed by pressing the keys  without the drop-down list box displayed.

Entering characters

1  Move the cursor to the item.

2  A dialog box will be displayed.

3  Character selection

3  Input

 Delete a character

4  **OK**
The setting will be accepted.

 **Cancel**
The entry will be canceled.

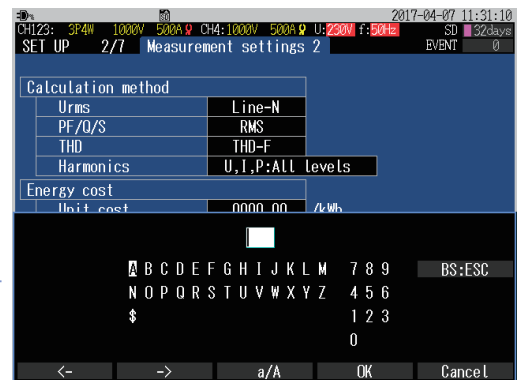
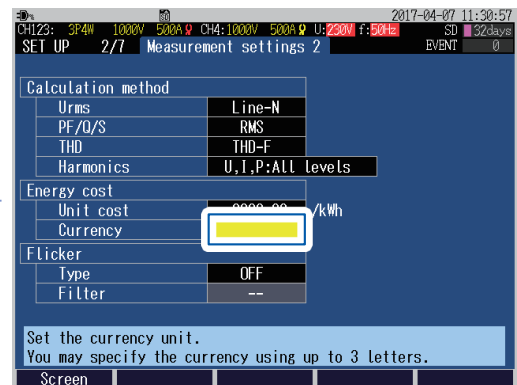

1.7 Screen Display

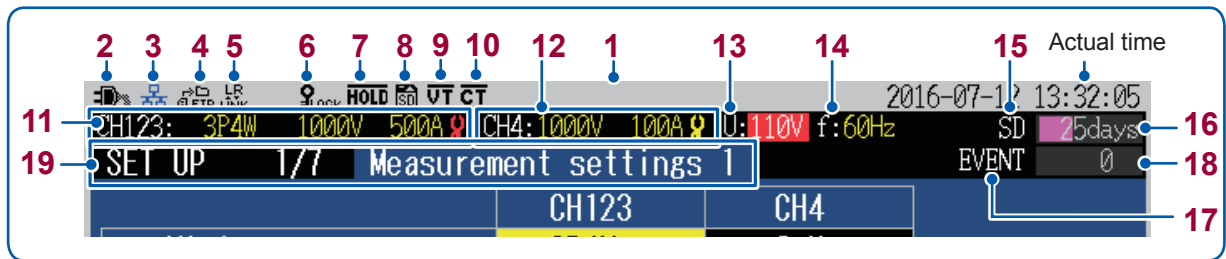





















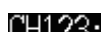







	CH123	CH4
Wiring	3P4W	0 N
Declared input voltage	110 V	
Voltage range	1000 V	1000 V
VT ratio	60	1
Current sensor	CT7136	CT7731
Current range (Current value)	500 A	100 A
CT ratio	40	1
Frequency	60 Hz	
Sync source	U1 fixed	

Select the line to be measured. Measurable CH will be given.
Hit ENTER to show selectable menu in the display.









20 — Screen Sensor Zero adjust

No.	Display	Description
1	<p>Operation status</p>	<p>Gray (no character): (START/STOP LED: Off)</p> <ul style="list-style-type: none"> Recording is stopped. The setting can be changed.
		<p>Yellow (WAITING): (START/STOP LED: Blinking)</p> <ul style="list-style-type: none"> Recording is in standby. This screen is shown from the time the [START/STOP] key is pressed until the recording actually starts. During repeated recording, this screen is also displayed when recording is stopped. The setting cannot be changed.
		<p>Green (RECORDING): (START/STOP LED: On)</p> <ul style="list-style-type: none"> Recording is in progress. The setting cannot be changed.

No.	Display	Description	Reference
2		The instrument is operating with the AC adapter.	p. 43
		The instrument is running on the battery.	p. 38
	 (Blinking)	The instrument is running on the battery, which is almost out of charge. Connect the AC adapter and charge the battery.	p. 38
3	 (Black)	The LAN is connected.	p. 144
	 (Blue)	The HTTP server is connected.	p. 150
4		FTP data is being transmitted.	p. 152
5		The LR8410 Link is connected.	p. 171
6		The key lock is engaged.	p. 21
7		Holding the screen display.	p. 58 p. 81
8	 (Black)	The SD memory card is inserted and identified.	p. 42
	 (Red)	The SD memory card is locked. Unlock it.	
9		The VT ratio has been set.	p. 64
10		The CT ratio has been set.	
11		Wiring, voltage range, and current range for CH1 to CH3.  (Red): No current sensors are connected. Otherwise, the sensors are erroneously configured. (p. 52)  (Yellow): The current sensors are correctly configured.	p. 48 p. 64
12		Voltage range and current range for CH4. When CH4 is OFF, no icon is displayed.  (Red): The current sensor is erroneously configured. (p. 52)  (Yellow): The current sensor is correctly configured.	
13		Declared input voltage.	
14		Measuring frequency (nominal frequency).	
15	 (Black background)	The SD memory card has been inserted in the instrument.	p. 42
	 (Green background)	The SD memory card is being accessed.	–
	 (Black background)	As no SD memory card is inserted to the instrument, measured data will be saved in the instrument's internal memory. The shortest recording interval of the internal memory is 2 s. If the interval is set to 1 s or less, measured data cannot be saved in the internal memory.	–
	 (Green background)	The internal memory is being accessed.	–
16		Indicates how much recording time or days remains on the SD memory card or in the instrument's internal memory. If the event data is recorded as well, the actual recording time will become shorter than the displayed recording time. The utilization status is indicated with a level meter.	–

No.	Display	Description	Reference
17	 (Black background)	No event has been detected.	—
	 (Red background)	Event IN (detection) state.	—
18		Number of events recorded. Up to 9999 events. The event detection status is indicated with a level meter.	—
19	Screen name	This is the screen name. Select with the key. [[Present screen number) / (number of screens)] is displayed within the screen.	p. 24
20	F key text	Texts of function keys assigned for each screen.	—

1.8 Error Screen Display

Display	Description
	If a voltage peak over, i.e., that the peak of the voltage exceeds 2200 V or falls below -2200V, occurs, the background of the voltage range turns red.
	If a voltage overrange, i.e., that the voltage exceeds 1300 V, occurs, the background of the voltage range turns yellow.
	If a current peak over, i.e., that the peak of the current exceeds 400% of the present range or falls below -400% of it, occurs, the background of the current range turns red.
	If a current overrange, i.e., that the current exceeds 130% of the present range, occurs, the background of the current range turns yellow.
	When a voltage value exceeds a certain ratio based on the declared input voltage, the background color turns any of the following colors: 110% < Yellow 90% ≤ (Regular background color) ≤ 110% 80% ≤ Yellow < 90% Red < 80%
	When the measured value is different from the declared frequency, the background of the declared frequency turns red. The background turns red even when measuring a DC voltage.
	Measured value became overrange (the measurement is out of measuring range). The voltage that the instrument is capable of measuring is being exceeded. Immediately disconnect the instrument. If the current is overrange, increase the current range.
	Measurement is not possible. Shown instead of the measured value. If there is no input, the power factor cannot be measured.

2

Preparing for Measurement

Before starting measurement, connect accessories and options to this instrument. Before performing measurement, be sure to read “Operating Precautions” (p. 7) and to inspect the instrument, accessories, and options to ensure that there is no damage.

2.1 Preparation Flowchart

Follow the procedure for preparation described below. (The items preceded by † need to be performed only during the first use.)

† Initial Measurement Preparations

- Color coding of current sensor (for channel identification) (p. 36)
- Bundling the voltage cords and current sensors (if required) (p. 37)
- Installing the battery pack. (p. 38)
- Attaching the strap (if required) (p. 39)
- Attaching the Z5020 Magnetic Strap (if required) (p. 39)
- Setting the language, clock, and measurement frequency (p. 40)

Pre-Measurement Inspection (p. 41)

Inserting the SD Memory Card (p. 42)

Power Supply (p. 43)

Turning On the Instrument (p. 44)

Warm-up (p. 44)

- At least 30 min.

2

2.2 Initial Measurement Preparations

Color coding of current sensor (for channel identification)

Be sure to read “Handling Cords and Cables” (p. 8).

At both the ends of the current sensor cable, connect the clip of the same color as the channel which is to be connected to the current sensor, to avoid wiring mistakes.

Example: In the case of using 2 current sensors

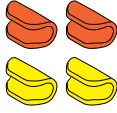
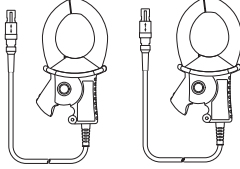
Required items	
<input type="checkbox"/> Colored clips (for color-coding the current sensor)	<input type="checkbox"/> Current sensor in use × 2
 Red × 2 Yellow × 2	 (Diagram of Model CT7136)

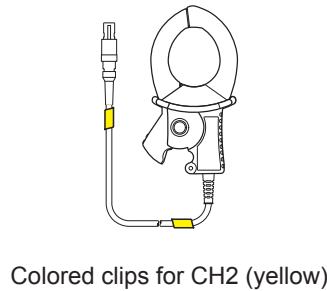
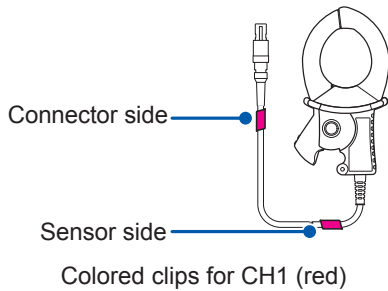

Measuring object	Number of current sensors in use (Colors of the CH and colored clips)
Single-phase 2-wire (1P2W/DC)	1 (CH1 red)
Single-phase 3-wire (1P3W)	2 (CH1 red, CH2 yellow)
3-phase 3-wire (3P3W2M)	
3-phase 3-wire (3P3W3M)	3 (CH1 red, CH2 yellow, CH3 blue)
3-phase 4-wire (3P4W)	

Bundling the voltage cords and current sensors (If required)

Be sure to read “Handling Cords and Cables” (p. 8), “Using Voltage Cords” (p. 8).

If required, group the cables together by using the spiral tubes (black).

Example: In the case of using 3 voltage cords and 2 current sensors

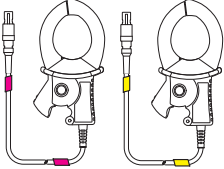
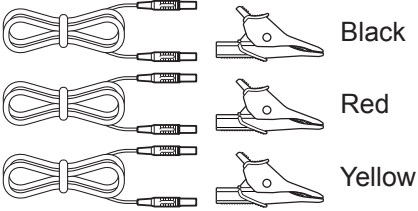
Required items	
<input type="checkbox"/> Spiral tubes (for grouping the cables together)  Black (thick) ×10	<input type="checkbox"/> Current sensor in use ×2  (The model illustrated above is Model CT7136)
<input type="checkbox"/> Model L1000-05 Voltage Cord ×3 	

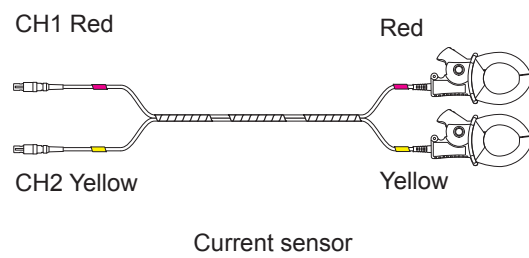
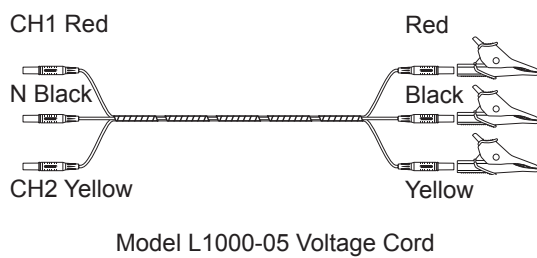

Installing the battery pack

Be sure to read “Using Battery Pack” (p. 9).

The battery pack is subject to self-discharge. Be sure to charge the battery pack before initial use (See Step 7).

If the battery can only be used for a considerably short time even after correct charging, replace it with a new battery pack.

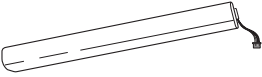
Required items	
<input type="checkbox"/> Phillips screwdriver (No. 2)	<input type="checkbox"/> Model Z1003 battery pack
	

1 Turn off the instrument. (p. 44)

2 Remove all cords.

3 Turn the instrument over, remove the screws on the primary battery compartment and remove the cover.

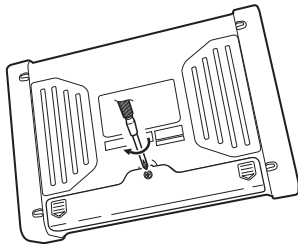

4 Connect the plug of the Model Z1003 battery pack to the connector of the instrument. (Turn the 2 projection surfaces of the plug to the left and connect.)

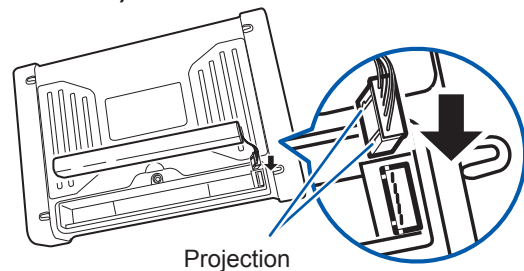

5 Insert the battery pack in the direction that is indicated by the labeling on the battery pack.

Be careful not to pinch the wires of the battery pack.

6 Put the cover and tighten the screws.

7 Connect the AC adapter (p. 43) to the instrument and charge the battery pack.

The battery pack will be charged regardless of whether the power is ON or OFF.

(Left side surface of the instrument)

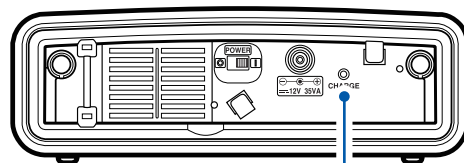

CHARGE LED

Solid red	During charging
Off	Fully charged or when the battery is not attached

- The battery pack is used as a backup power supply for the instrument during interruption. When fully charged, it can provide backup power for approximately 8 hours in the event of an interruption.
- Note that if an interruption occurs while the battery pack is not being used, the displayed time series data will be cleared. (Data that has been recorded on the SD memory card and instrument's internal memory will be retained.)
- For more information about the operating temperature and humidity and the storage temperature and humidity, see “14.1 General Specifications” (p. 179).

Attaching the strap (if required)

Be sure to read “Attaching the Strap” (p. 10).

If required, attach the strap when carrying the instrument or hanging it on a hook at the installed location.

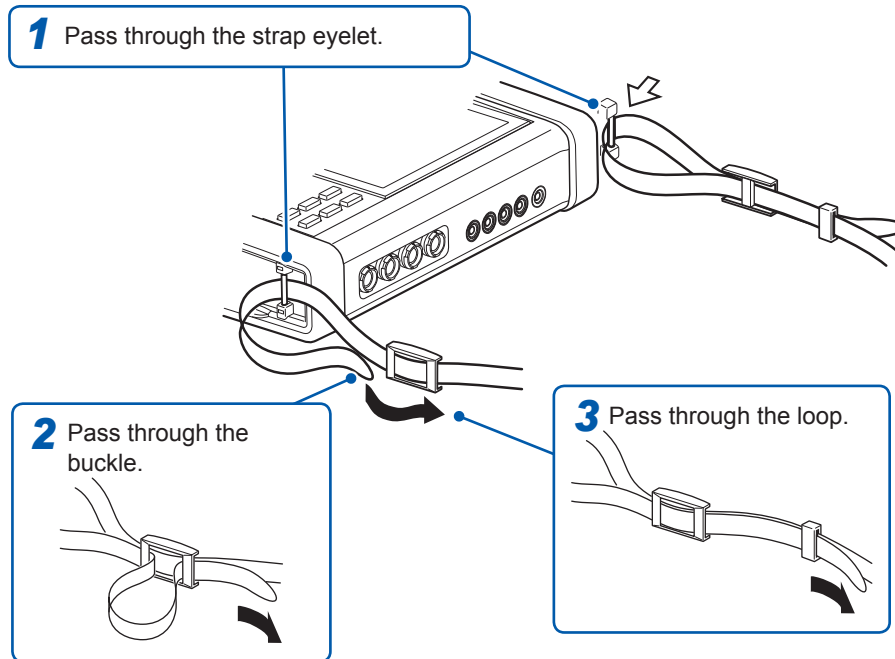

Tighten the straps securely to avoid loosening or twisting.

Attaching the Z5020 Magnetic Strap (if required)

Be sure to read “Using Magnetic Adapter and Magnetic Strap” (p. 11)

You can attach the instrument to a wall or panel (steel). Put the two pieces of Model Z5020 Magnetic Strap (optional) through each of the strap loops of the instrument and attach the magnets to the wall or panel.

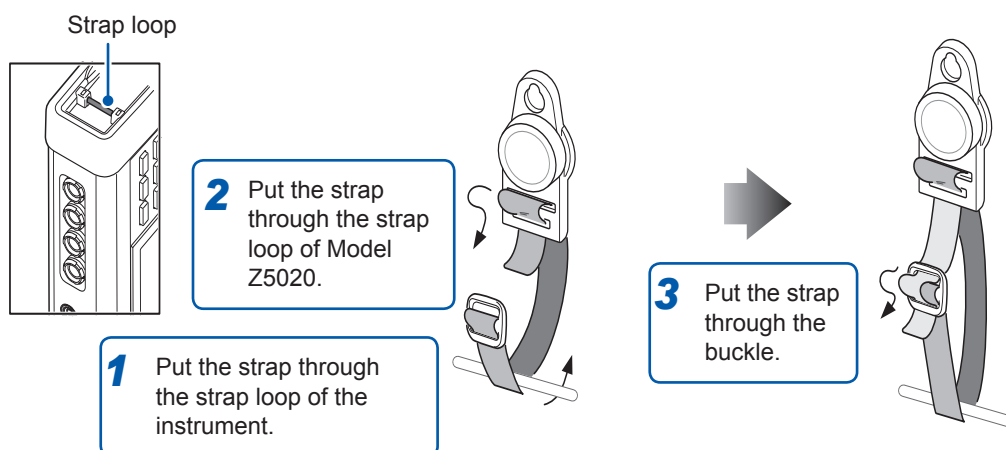

The magnetic force varies depending on thickness and unevenness of steel panels. Check for lack of the magnetic force so as not to let the instrument slip down.

Setting the language, clock, and measurement frequency

When you turn on the instrument for the first time after purchase, the language setting screen, clock setting screen, and frequency setting screen will be displayed. Configure these settings. Similarly, these settings must be configured if a factory reset (p. 77) is performed to reset the instrument to its default settings.

1 Turn on the instrument. (p. 44)

2 Select the display language.

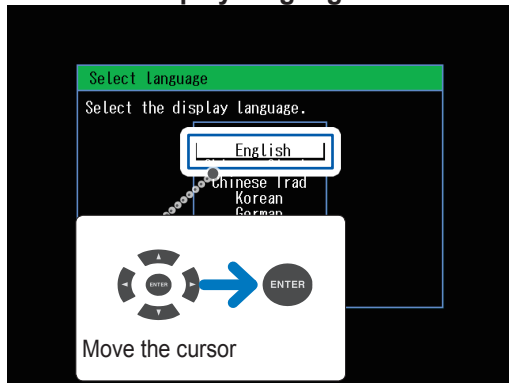

Japanese
English
Chinese Simple
Chinese Trad
Korean
German
French
Italian
Spanish
Turkish
Polish

3 Set the date and time.

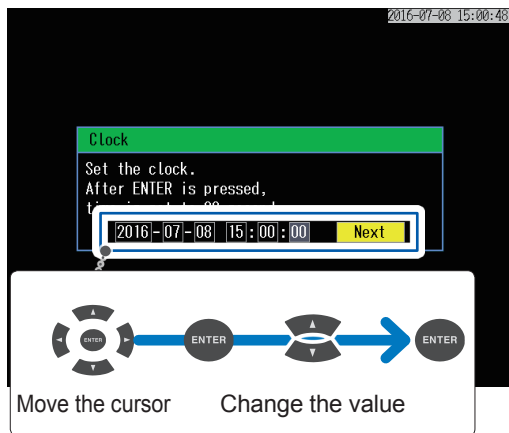

The seconds cannot be set. If you press the **[Enter]** key after changing value, the seconds will be set to 00.

4 Select the frequency for the measuring object using the function keys.

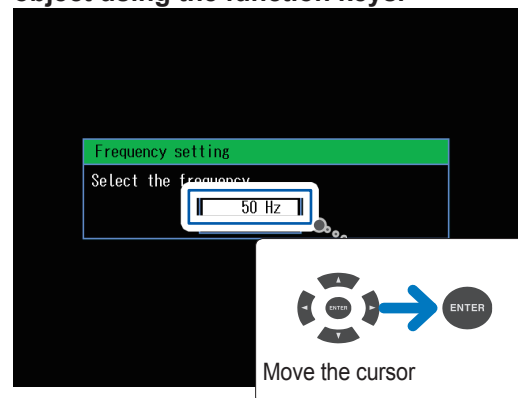

Either **50 Hz** or **60 Hz** can be set for measuring frequency to measure a DC voltage. The **WIRING, wiring setting** screen will be displayed.

Once you have set the display language, time, and measurement frequency, this settings screen will not be shown again when the instrument is turned on.

You can change these settings on the setting screen.

See Display language, time “System Settings” (p. 75), and measurement frequency “SET UP, Measurement Settings 1 screen” (p. 64).

2.3 Pre-measurement Inspection

Before using the instrument, verify that it operates normally to ensure that no damage occurred during storage or shipping. If you find any damage, contact your authorized Hioki distributor or reseller.

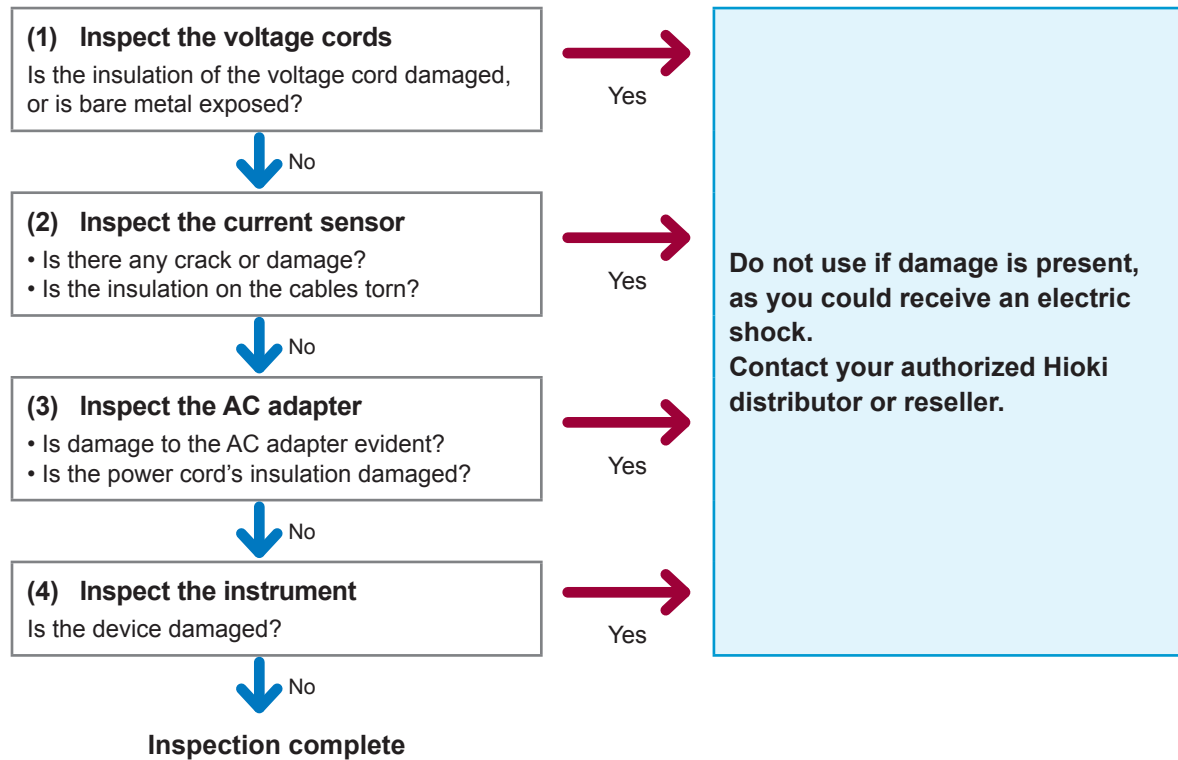

2.4 Inserting the SD Memory Card

Be sure to read “Using SD Memory Cards” (p. 10).

1 Turn off the instrument. (p. 44)

2 Open the cover.

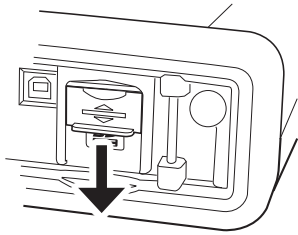

3 Disengage the lock.

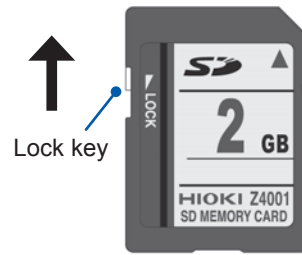

4 Insert the SD memory card inside.

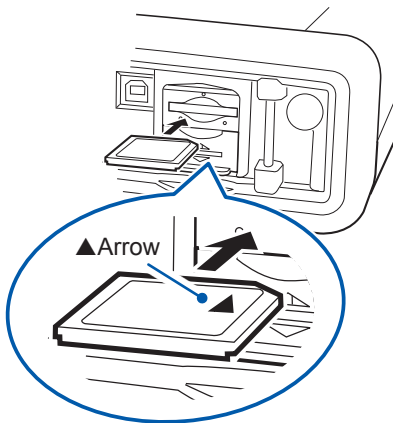

Insert the card horizontally. Inserting the SD memory card at an angle may cause the write-protect lock to engage, preventing data from being written to the card.

5 Close the cover.

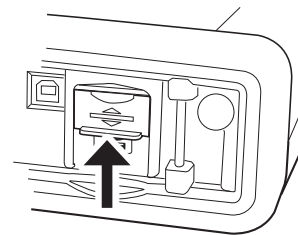

How to remove:

Open the cover, push in the SD memory card and then pull it out.

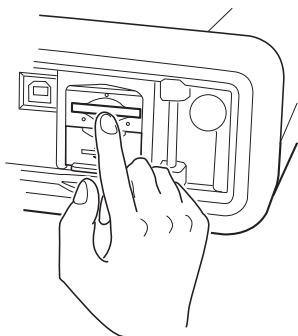

When storing the data to the SD memory card, configure the recording settings. See “5.2 Recording Settings” (p. 69).

2.5 Power Supply

Be sure to read “Using AC Adapter” (p. 11).

Required items

- Model Z1002 AC adapter



(AC adapter + power cord)

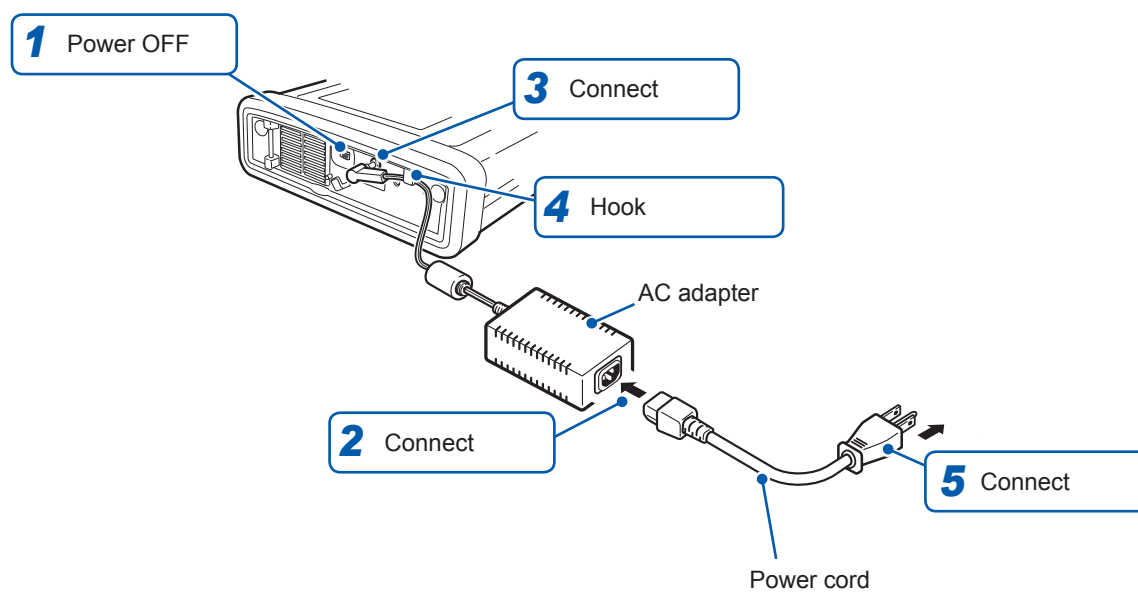

2.6 Turning On/Off the Instrument

Be sure to read “Turning On the Instrument” (p. 11).

Turn on the instrument. After the measurement is complete, always turn off the power.

How to turn on the instrument

Slide the knob of the POWER switch toward ON (|).

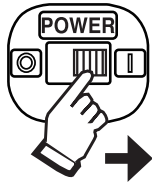

When the instrument is turned on, the Self-test screen will be displayed.

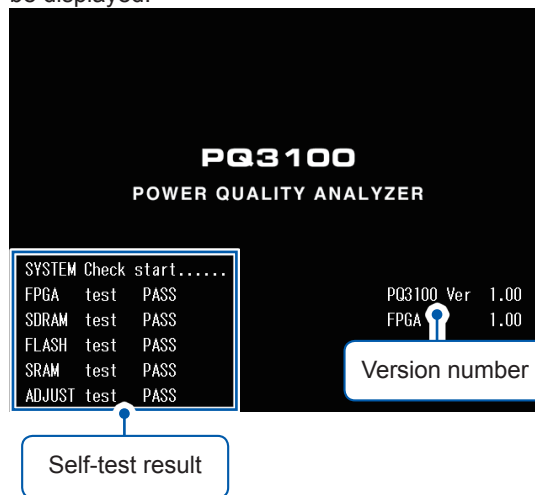

After the self-test is complete, the screen that appears before turning off the instrument will be displayed. (When the instrument is turned on for the first time, the **WIRING, wiring settings** screen will be displayed.)

How to turn off the instrument

Slide the knob of the POWER switch toward OFF (○).

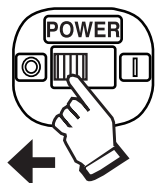

2.7 Warm-up

Warm up the instrument before performing the measurement to ensure accurate measurements. After turning on the instrument, allow it warm-up for at least 30 min.

3 Quick Set

The Quick Set function allows easy settings for minimum recording/measurement requirements by following the guidance.

The setting proceeds in the following order: “1. Basic Settings,” “2. Device Connections,” “3. Voltage Wiring,” “4. Current Wiring,” “5. Wiring Check,” “6. Event Settings,” “7. Recording Settings,” and “8. Recording Start.”

See the supplied Measurement Guide for details.

3.1 Configurable Items

The items listed below can be configured with the Quick Set.

To configure other items not listed here*, see “3.2 Adding Settings” (p. 46).

*Example:

- Set the VT and CT ratios.
- Change the event settings.

Setting	Details
Wiring	Configure the wiring.
Current sensor	Configure the current sensor.
Declared input voltage	Configure the declared input voltage.
Current range	Configure the current range.
Easy settings course	After this course is selected, event settings and recording interval will be automatically configured.
Recording interval	Configure the recording interval.
Recording start method	Configure the recording start method.
Recording stop method	Configure the recording stop method.
Folder/File name	Configure the folder/ file name.
Clock	Configure the clock.

3.2 Adding Settings

Using the following procedure, normal settings can be applied in combination with the Quick Set to perform recording as desired:

- 1** Press the **[QUICK SET]** key to start the Quick Set.
- 2** Follow the Quick Set to proceed with the operations up to the **QUICK SET, Recording start** screen.

- 3** Exit the Quick Set without starting a recording.

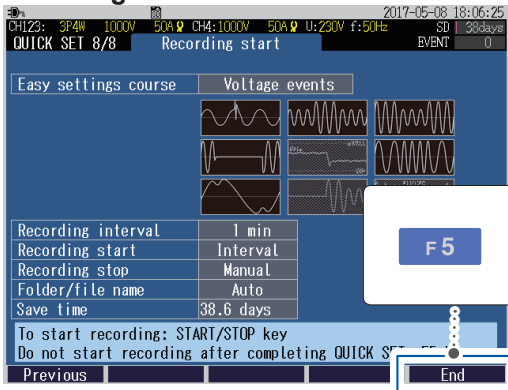

The Quick Set will be completed. All the setting that have been configured with the Quick Set will not be deleted.

- 4** Press the **[SET UP]** key to add settings.

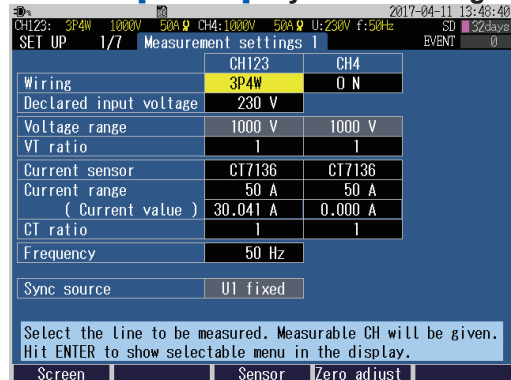

Example: Configure the VT ratio or CT ratio, change the event settings.

See "5 Setting Change (SET UP Screen)" (p. 63).

- 5** Press the **[WIRING]** key to display the **WIRING, Wiring check** screen.

- 6** Reconfirm the wiring and measured values.

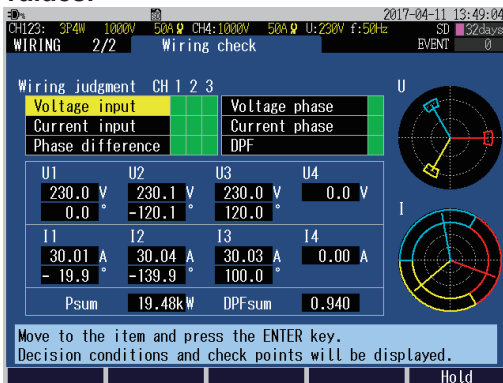

See "4.10 Checking Wiring" (p. 59).

- 7** Press the **[MONITOR]** key as required to check the measured values on the **MONITOR** screen.

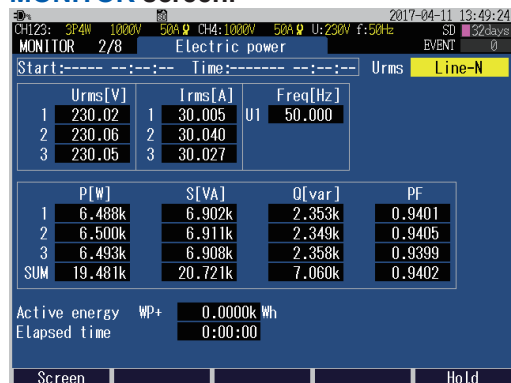

See "6 Verifying the Waveform, Measured Values (MONITOR Screen)" (p. 81).

- 8** Press the **[START/STOP]** key.

The recording will start.

4.1 Wiring Procedure

Connect the voltage codes and the current sensors to the instrument according to the following procedure.

This chapter explains the procedure for wiring without using the Quick Set.

Setting the wiring method and the declared input voltage



"4.2 Wiring Method and Declared Input Voltage Settings" (p. 48)

Connecting the cords and the sensors and performing the zero adjustment



"4.3 Connecting Voltage Cords to Instrument" (p. 51)

"4.4 Connecting Current Sensors and Configuring Current Sensor Settings" (p. 52)

"4.5 Zero Adjustment" (p. 54)

Connecting the voltage cords to the measuring object



"4.6 Connecting Voltage Cords to Objects" (p. 55)

Attaching the current sensor to the measuring object



"4.7 Attaching Current Sensors to Objects" (p. 56)

Attaching Cords on a Wall (if required)



"4.8 Attaching Cords on a Wall (if required)" (p. 57)

Checking the wiring

"4.10 Checking Wiring" (p. 59)

4.2 Wiring Method and Declared Input Voltage Settings

Press the **[WIRING]** key to display the **WIRING, wiring settings** screen. Sets the wiring method and declared input voltage.

The wiring diagram (p. 50) of the specified wiring mode is displayed.

The screenshot displays the 'WIRING, wiring settings' screen. At the top, it shows 'WIRING 1/2' and 'Wiring settings'. Below this is a wiring diagram with four channels (U1, U2, U3, U4) and four current sensors (I1, I2, I3, I4). A table at the bottom shows settings for CH123 and CH4. Callouts point to various values: Voltage value (RMS value) for U1-U4, Current value (RMS value) for I1-I4, Active power (Psum), and Displacement Power Factor (DPFsum).

	CH123	CH4
Wiring	3P4W	0 N
Declared input voltage	230 V	
Current sensor	CT7136	CT7136
Current range	500 A	500 A

U1: 0.0 V, U2: 0.0 V, U3: 0.0 V, U4: 0.0 V
 I1: 0.0 A, I2: 0.0 A, I3: 0.0 A, I4: 0.0 A
 Psum: 0.0k
 DPFsum: -----

Select the line to be measured. Measurable CH will be given. Hit ENTER to show selectable menu in the display.

Sensor Zero adjust Hold

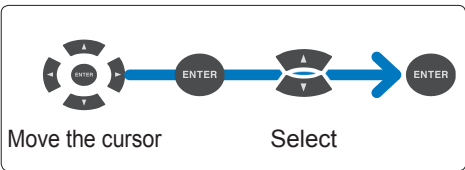

*: DPF (Displacement Power Factor) is displayed as the power factor irrespective of **PF/Q/S** calculation method settings of the **SET UP, measurement settings 2** screen in the **WIRING, wiring** setting screen. See "SET UP, Measurement Settings 2 screen" (p. 66), and "Terminology" (p. Appx.25).

1 Enables you to select the wiring method for CH1 to CH3, and select ON/OFF of the input to CH4.

CH123	1P2W/DC	Single-phase 2-wire line/ DC (direct current) line
	1P3W	Single-phase 3-wire line
	1P3W1U	Single-phase 3-wire line (1-voltage measurement) Although voltages should be usually input to 2 channels for the single-phase 3-wire line, a voltage is input to only CH1 in a simplistic way. Additionally, the power of 1P3W is calculated, assuming that the voltage U2 is equal to U1.
	3P3W2M	3-phase 3-wire line (2-watt meter method) Two line voltages and two line currents are measured to perform the 3P3W2M measurement. U3 is calculated from U1 and U2; I3, from I1 and I2. Although the active power of the 3-phase line as a whole is equal to the one measured by the 3P3W3M measurement, the balance of the each phase cannot be checked. To check the balances, select the 3P3W3M . See "Appx. 7 3-phase 3-wire Measurement" (p. Appx.22).
	3P3W3M	3-phase 3-wire line (3-watt meter method) Three phase voltage from the virtual neutral point and three line currents are measured to obtain results for the 3-phase 3-wire line.
	3P4W	3-phase 4-wire line
	3P4W2.5E	3-phase 4-wire line (2-voltage measurement) Only the voltage U1 and U3 are measured to obtain results for the 3-phase 4-wire line. U2 is calculated from U1 and U3.
CH4	ON	Enables the input to CH4. Voltage: To measure a voltage between the neutral line and the grounding wire To obtain the voltage values, the potential differences between the terminal N and each of the channels, CH1 through CH4. The voltage terminal N is shared by CH1 through CH3 and CH4. Inputting a voltage to CH1 through CH3 enables the U4 field to display the value even though no voltage is input to CH4. Current: To measure a neutral line current of 3P4W or 1P3W To measure a leakage current
	OFF	Disables the input to CH4.

2 Enables you to set the declared input voltage for the measurement line. It will be referenced for the event settings (swell, dip, interruption).
See "SET UP, Event Settings 1 screen" (p. 72).

Variable (50 V to 800 V in 1 V increments), 100, 101, 110, 115, 120, 127, 200, 202, 208, 220, 230, 240, 277, 347, 380, 400, 415, 440, 480, 600

The settings can also be configured in the **SET UP, measurement settings** screen or in the Quick Set screen. See "SET UP, Measurement Settings 1 screen" (p. 64), and refer to Measurement Guide.

Wiring diagram

The vector diagram in the following screen example shows the measurement line in its ideal (balanced, power factor 1) state.
The wiring diagram shows the CH4 with ON state.

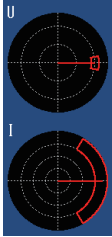
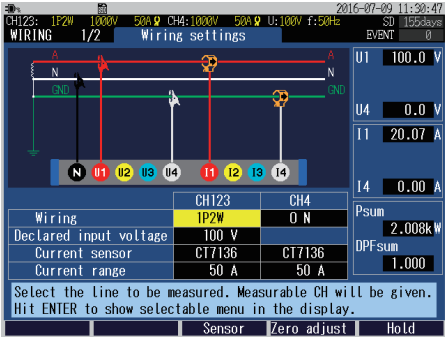
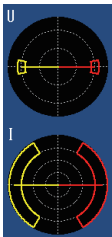
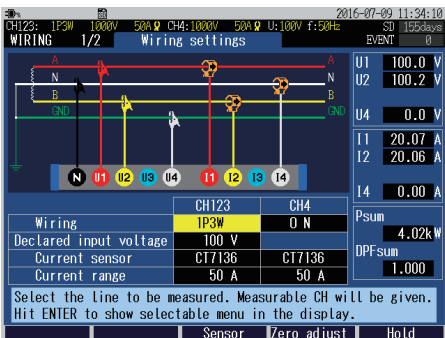
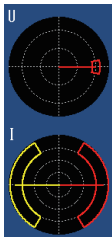
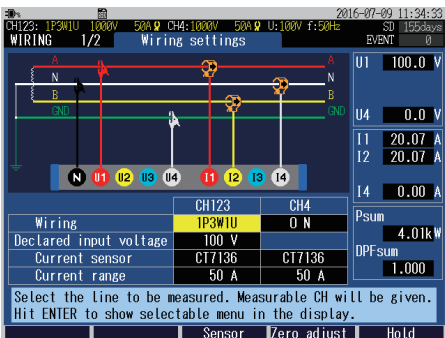
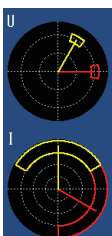
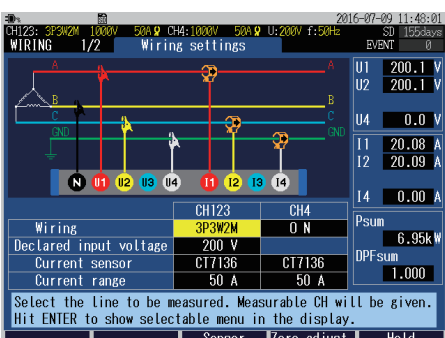
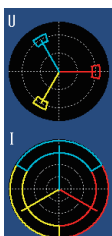
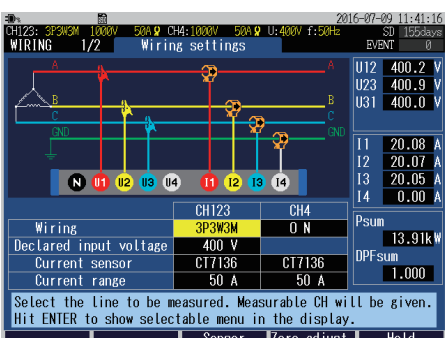
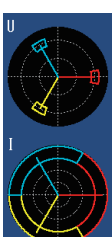
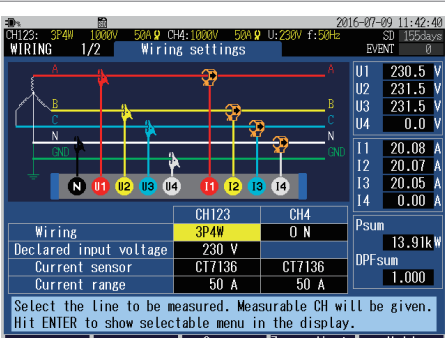
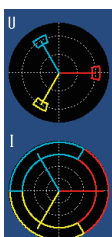
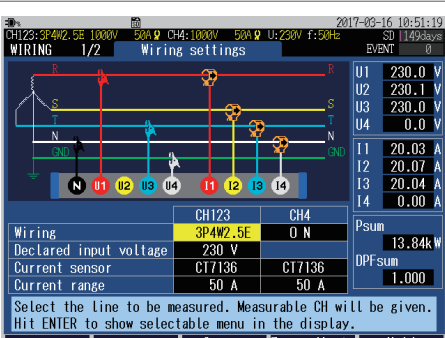
Wiring selection vector diagram	Screens	Wiring selection vector diagram	Screens																								
<p>1P2W/DC</p> 	 <table border="1"> <thead> <tr> <th>Wiring</th> <th>CH123</th> <th>CH4</th> </tr> </thead> <tbody> <tr> <td>Declared input voltage</td> <td>100 V</td> <td>0 N</td> </tr> <tr> <td>Current sensor</td> <td>CT7136</td> <td>CT7136</td> </tr> <tr> <td>Current range</td> <td>50 A</td> <td>50 A</td> </tr> </tbody> </table>	Wiring	CH123	CH4	Declared input voltage	100 V	0 N	Current sensor	CT7136	CT7136	Current range	50 A	50 A	-	-												
Wiring	CH123	CH4																									
Declared input voltage	100 V	0 N																									
Current sensor	CT7136	CT7136																									
Current range	50 A	50 A																									
<p>1P3W</p> 	 <table border="1"> <thead> <tr> <th>Wiring</th> <th>CH123</th> <th>CH4</th> </tr> </thead> <tbody> <tr> <td>Declared input voltage</td> <td>100 V</td> <td>0 N</td> </tr> <tr> <td>Current sensor</td> <td>CT7136</td> <td>CT7136</td> </tr> <tr> <td>Current range</td> <td>50 A</td> <td>50 A</td> </tr> </tbody> </table>	Wiring	CH123	CH4	Declared input voltage	100 V	0 N	Current sensor	CT7136	CT7136	Current range	50 A	50 A	<p>1P3W1U</p> 	 <table border="1"> <thead> <tr> <th>Wiring</th> <th>CH123</th> <th>CH4</th> </tr> </thead> <tbody> <tr> <td>Declared input voltage</td> <td>100 V</td> <td>0 N</td> </tr> <tr> <td>Current sensor</td> <td>CT7136</td> <td>CT7136</td> </tr> <tr> <td>Current range</td> <td>50 A</td> <td>50 A</td> </tr> </tbody> </table>	Wiring	CH123	CH4	Declared input voltage	100 V	0 N	Current sensor	CT7136	CT7136	Current range	50 A	50 A
Wiring	CH123	CH4																									
Declared input voltage	100 V	0 N																									
Current sensor	CT7136	CT7136																									
Current range	50 A	50 A																									
Wiring	CH123	CH4																									
Declared input voltage	100 V	0 N																									
Current sensor	CT7136	CT7136																									
Current range	50 A	50 A																									
<p>3P3W2M</p> 	 <table border="1"> <thead> <tr> <th>Wiring</th> <th>CH123</th> <th>CH4</th> </tr> </thead> <tbody> <tr> <td>Declared input voltage</td> <td>200 V</td> <td>0 N</td> </tr> <tr> <td>Current sensor</td> <td>CT7136</td> <td>CT7136</td> </tr> <tr> <td>Current range</td> <td>50 A</td> <td>50 A</td> </tr> </tbody> </table>	Wiring	CH123	CH4	Declared input voltage	200 V	0 N	Current sensor	CT7136	CT7136	Current range	50 A	50 A	<p>3P3W3M*</p> 	 <table border="1"> <thead> <tr> <th>Wiring</th> <th>CH123</th> <th>CH4</th> </tr> </thead> <tbody> <tr> <td>Declared input voltage</td> <td>400 V</td> <td>0 N</td> </tr> <tr> <td>Current sensor</td> <td>CT7136</td> <td>CT7136</td> </tr> <tr> <td>Current range</td> <td>50 A</td> <td>50 A</td> </tr> </tbody> </table>	Wiring	CH123	CH4	Declared input voltage	400 V	0 N	Current sensor	CT7136	CT7136	Current range	50 A	50 A
Wiring	CH123	CH4																									
Declared input voltage	200 V	0 N																									
Current sensor	CT7136	CT7136																									
Current range	50 A	50 A																									
Wiring	CH123	CH4																									
Declared input voltage	400 V	0 N																									
Current sensor	CT7136	CT7136																									
Current range	50 A	50 A																									
<p>3P4W</p> 	 <table border="1"> <thead> <tr> <th>Wiring</th> <th>CH123</th> <th>CH4</th> </tr> </thead> <tbody> <tr> <td>Declared input voltage</td> <td>230 V</td> <td>0 N</td> </tr> <tr> <td>Current sensor</td> <td>CT7136</td> <td>CT7136</td> </tr> <tr> <td>Current range</td> <td>50 A</td> <td>50 A</td> </tr> </tbody> </table>	Wiring	CH123	CH4	Declared input voltage	230 V	0 N	Current sensor	CT7136	CT7136	Current range	50 A	50 A	<p>3P4W2.5E</p> 	 <table border="1"> <thead> <tr> <th>Wiring</th> <th>CH123</th> <th>CH4</th> </tr> </thead> <tbody> <tr> <td>Declared input voltage</td> <td>230 V</td> <td>0 N</td> </tr> <tr> <td>Current sensor</td> <td>CT7136</td> <td>CT7136</td> </tr> <tr> <td>Current range</td> <td>50 A</td> <td>50 A</td> </tr> </tbody> </table>	Wiring	CH123	CH4	Declared input voltage	230 V	0 N	Current sensor	CT7136	CT7136	Current range	50 A	50 A
Wiring	CH123	CH4																									
Declared input voltage	230 V	0 N																									
Current sensor	CT7136	CT7136																									
Current range	50 A	50 A																									
Wiring	CH123	CH4																									
Declared input voltage	230 V	0 N																									
Current sensor	CT7136	CT7136																									
Current range	50 A	50 A																									



*: If 3P3W3M is selected, do not apply a voltage to CH4 even with CH4 set to ON.

4.3 Connecting Voltage Cords to Instrument

Be sure to read “Handling Cords and Cables” (p. 8), “Using Voltage Cords” (p. 8).

Connect a Model L1000-05 voltage cord to the voltage input terminal of this instrument.
Secure the cords together with a spiral tube if necessary.

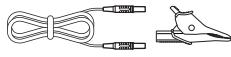
See “Bundling the voltage cords and current sensors (If required)” (p. 37).

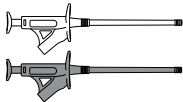
Required items		
<input type="checkbox"/> Model L1000-05 Voltage Cord  (Necessary number of cords)	<input type="checkbox"/> Model 9804-01 Magnetic Adapter (Optional) 	Red, compatible with the M6 pan head screw
	<input type="checkbox"/> Model 9804-02 Magnetic Adapter (Optional) 	Black, compatible with the M6 pan head screw
	<input type="checkbox"/> Model L9243 Grabber Clip (Optional) 	Red and black, 1 each

1 Insert alligator clip, magnetic adapter, or grabber clips into the socket at the tip of the cord.

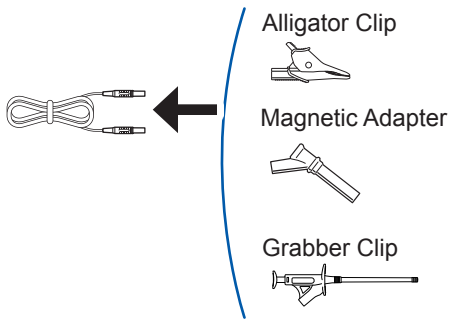

2 Press the **[WIRING]** key to display the **WIRING, wiring settings** screen.

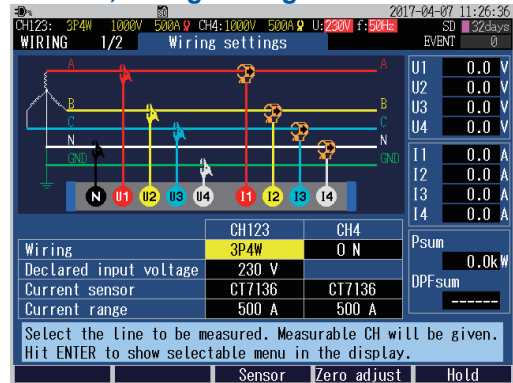

3 Insert the voltage cord while checking the channel on the screen.

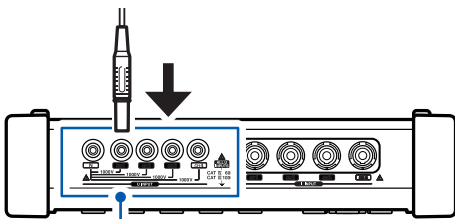

Voltage input terminal
Insert the cord into the terminal as far as it will go.

4.4 Connecting Current Sensors and Configuring Current Sensor Settings

Be sure to read “Handling Cords and Cables” (p. 8).

Connect the optional current sensor to the current input terminal of this instrument.

- To make it easier to identify channels, color-code the cords with colored clips. See “Color coding of current sensor (for channel identification)” (p. 36).
- Secure the cords together with a spiral tube if necessary. See “Bundling the voltage cords and current sensors (If required)” (p. 37).
- Refer to the instruction manual supplied with the current sensor for specification details and usage procedures.

When measuring power lines that use multiple channels

Use a current sensor of the same model.

Example: Use current sensors of the same model from CH1 to CH3 for the 3-phase 4-wire system.

Connecting the optional current sensor

- 1 Press the **[WIRING]** key to display the **WIRING, wiring settings** screen.

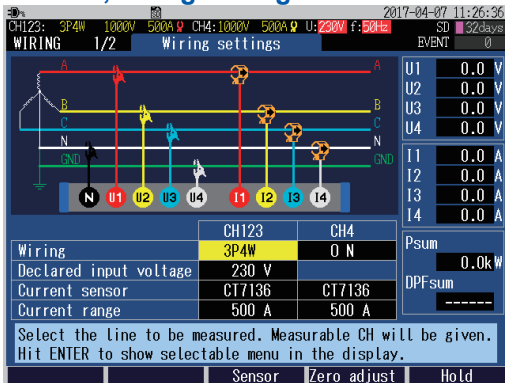

- 2 Insert the connector of the current sensor while checking the channel on the screen.

Align the arrow with the concave part of the terminal to insert the connector.

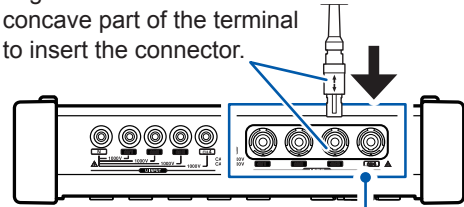

Current input terminal

When disconnecting the current sensor, be sure to grip the part of the connector indicated by the arrows and pull it straight out.

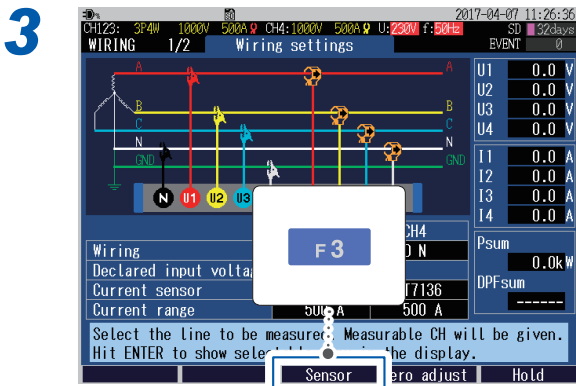

The current sensor and the maximum current range are set automatically.

Connecting current sensors other than the optional sensors

1 Press the **[WIRING]** key to display the **WIRING, wiring settings** screen.

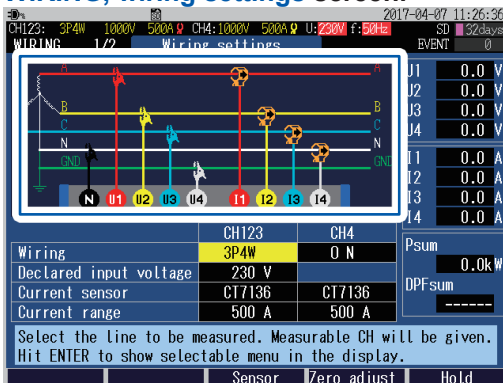

2 Insert the connector of the current sensor while checking the channel on the screen.

Example: Model 9661 Clamp on Sensor

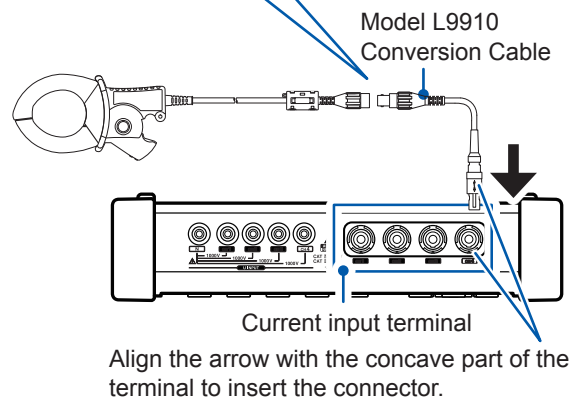
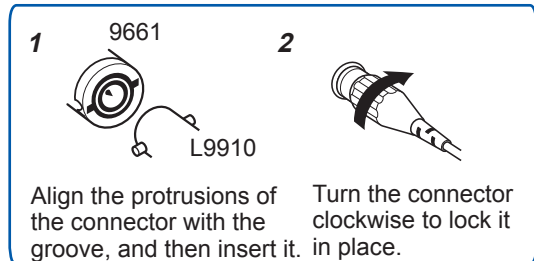

3 See the table given on the right side, and select the corresponding optional current sensor.

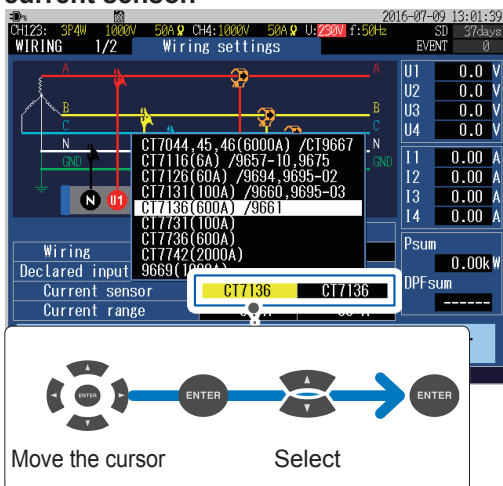

Example: Select **CT7136** for Model 9661 Clamp on Sensor

Current sensor		
Other than the optional*		Optional
CT9667-01*	CT7044	AC Flexible Current Sensor
CT9667-02*	CT7045	
CT9667-03*	CT7046	
9657-10 9675	CT7116	AC Leakage Current Sensor
9694 9695-02	CT7126	
9660 9695-03	CT7131	AC Current Sensor
9661	CT7136	
9669	9669	Clamp on Sensor

*: Set the range switch of the sensor to 500 A when the **current range** of this instrument is set to **500 A** or **50 A**.

4

Wiring (WIRING Screen)

4.5 Zero Adjustment

This function adjusts the DC components superimposing on voltage and current to zero. In order to obtain precise measurements, it is recommended to perform the zero adjustment in advance of the measurements after allowing the instrument to warm-up for more than 30 min.

1 Press the **[WIRING]** key to display the **WIRING, wiring settings** screen.

2 Execute zero adjustment.

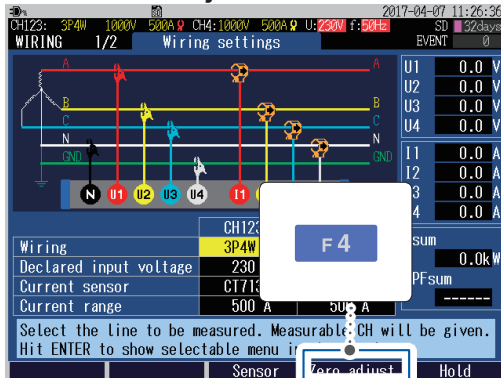

3

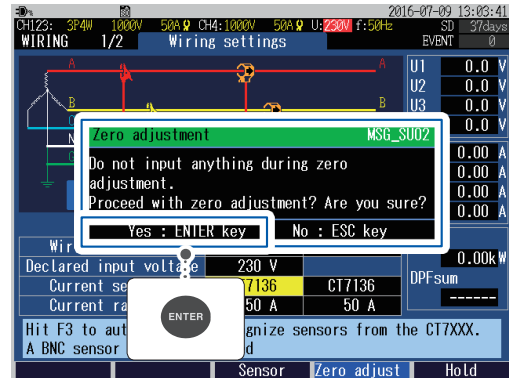

The DC components superimposing on voltage and current are adjusted to zero. It will take approximately 20 s.

- Perform zero adjustment only after connecting the current sensor to the instrument.
- Perform zero adjustment before wiring to the measurement line. (The zero adjustment must be performed when there is no input of voltage and current.)
- In order to obtain precise measurements, zero adjustment should be performed at an ambient temperature level, that falls within the range defined by the device specifications.
- The key operations are disabled during zero adjustment.

4.6 Connecting Voltage Cords to Objects

Be sure to read "Wiring" (p. 12).

Connect the voltage cords to the measuring objects while checking the **WIRING, wiring settings** screen.

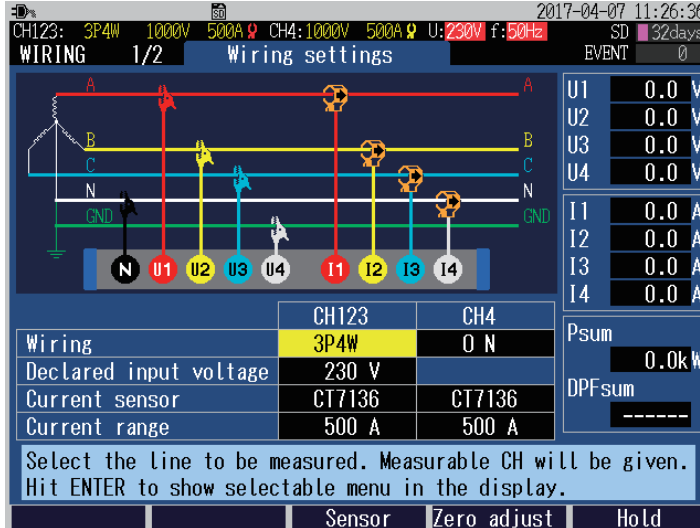

Use alligator clips or Model L9243 Grabber Clip.
Securely clip the cords to metal parts such as bus bars and screws on the secondary side of the breaker.

Method to open and close Model L9243

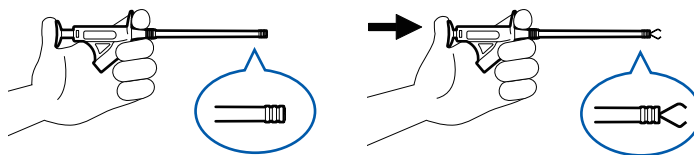

Secondary side of breaker

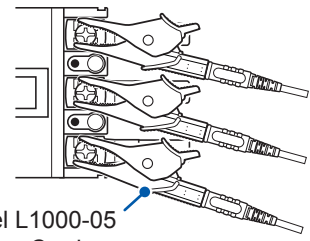

Model L1000-05 Voltage Cord

Example: Alligator clip

Using Model 9804-01 (9804-02) Magnetic Adapter
Connect the magnetic adapter to the screws on the secondary side of the breaker.

Secondary side of breaker

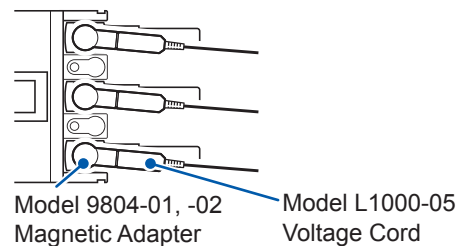

Model 9804-01, -02 Magnetic Adapter

Model L1000-05 Voltage Cord

The weight of the voltage cords may prevent you from making a perpendicular connection between the magnetic adapter and the head of the screw.

In this case, connect each cord such that it hangs off the adapter in a manner that balances its weight. Check the voltage values to verify that the connections have been made securely.

* Optional, standard screws: M6 small pan head screws

Secondary side of breaker

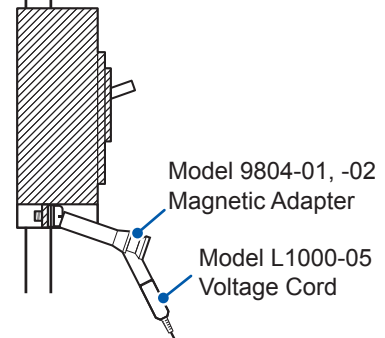

Model 9804-01, -02 Magnetic Adapter

Model L1000-05 Voltage Cord

4.7 Attaching Current Sensors to Objects

Be sure to read “Wiring” (p. 12).

Connect the current sensors to the measuring objects while checking the **WIRING, wiring settings** screen.

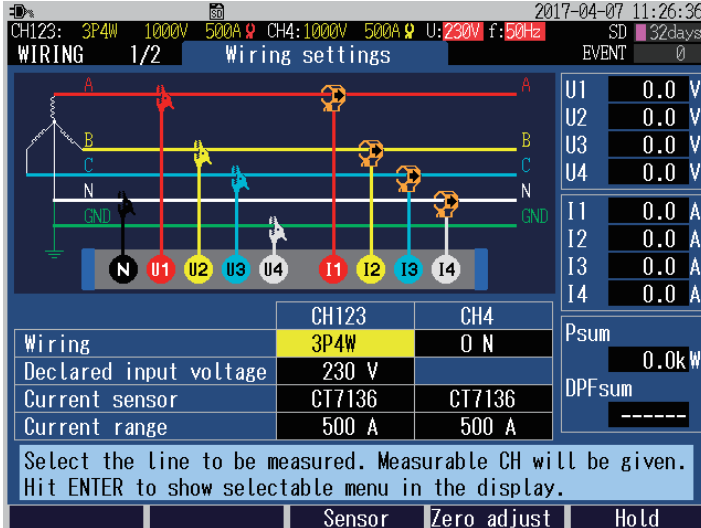

Load current measurement

Make sure that the current flow direction arrow points toward the load side, then clamp the conductor.

Example:

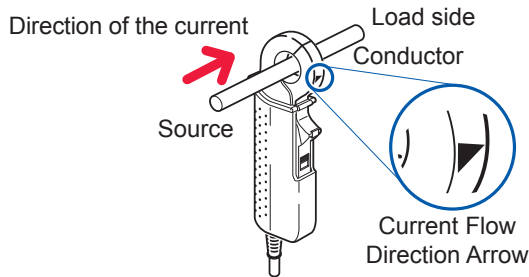

Model CT7126/CT7131 AC current sensor

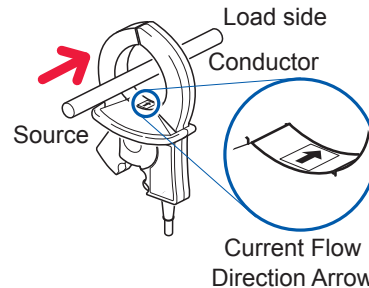

Model CT7136 AC current sensor

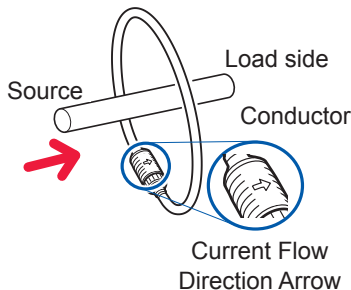

CT7044/ CT7045/ CT7046 AC flexible current sensor

IMPORTANT

Attach the clamp around only one line of the conductor.
Single-phase (2-wire) or three-phase (3-wire, 4-wire) cables clamped together will not produce any reading.



Leakage current measurement

Grounding wire measurement	Clamp 1 line only. (Diagram A)
Batch measurement	Clamp the electrical circuits together. (Diagram B) Clamp 2 wires together in the single phase 2-wire system circuit, and 4 wires in the 3-phase 4-wire system circuit.

Example:

Single phase 3-wire system circuit

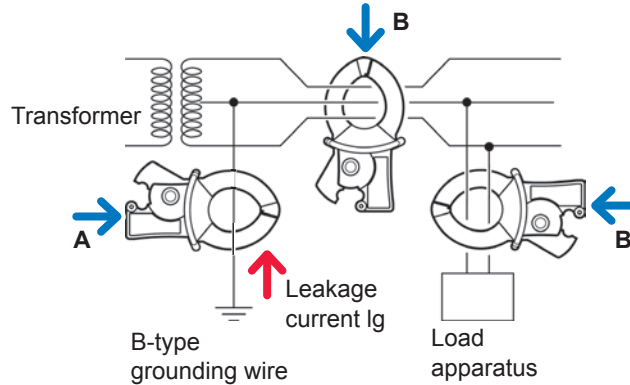

3-phase 3-wire system circuit

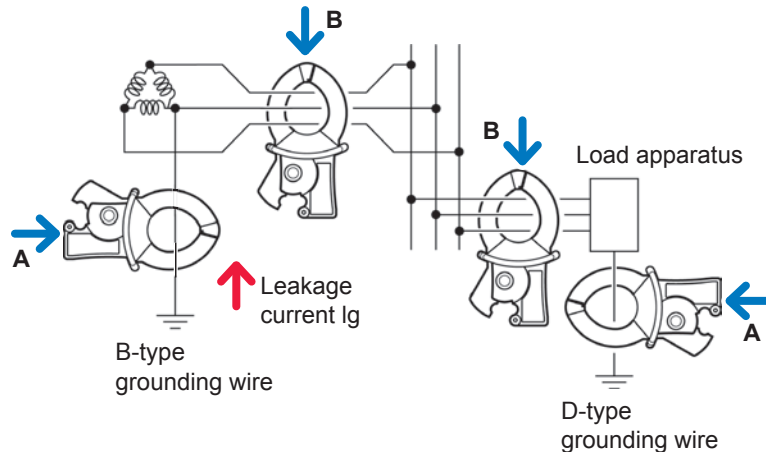

4.8 Attaching Cords on a Wall (if required)

Be sure to read “Using Magnetic Adapter and Magnetic Strap” (p. 11)

Using Model Z5004 Magnetic Strap allows you to attach voltage cords and cords of current sensors to a wall or panel (steel).

In particular, Model Z5004 can prevent the own weight of the voltage cords from detaching those alligator clips or magnet adapters.

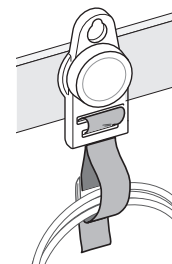

How to attach the strap

“Attaching the Z5020 Magnetic Strap (if required)” (p. 39)

4.9 Configuring Current Range Setting

Check the current value in the **WIRING, wiring settings** screen and select an appropriate current range.

1 Press the **[WIRING]** key to display the **WIRING, wiring settings** screen.

2 Check the current value (RMS value) and select the current range.

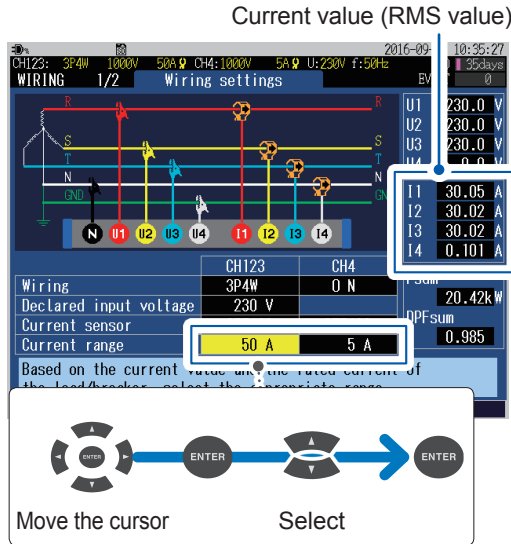

Current sensor			Current range
Optional	Other than the optional		
AC flexible current sensor	CT7044 CT7045 CT7046	CT9667-01* CT9667-02* CT9667-03*	5000A, 500A, 50A
AC leakage current sensor	CT7116	9657-10 9675	5A, 500mA, 50mA
AC current sensor	CT7126	9694 9695-02	50A, 5A, 500mA
	CT7131	9660 9695-03	100A, 50A, 5A
	CT7136	9661	500A, 50A, 5A
AC/DC auto-zero current sensor	CT7731	-	100A, 10A
	CT7736	-	500A, 50A
	CT7742	-	2000A, 1000A, 500A
Clamp on sensor	9669	9669	1000A, 100A

*: Set the range switch of the sensor to 500 A when the **current range** of this instrument is set to **500 A** or **50 A**.

Selecting an appropriate current range

Set the current range based on the anticipated maximum load current that will generate during the measurement. (Refer to the operating status, load rating, breaker rating, and other data to make this determination.)

If the range is too low, then an over-range current will be generated during measurement, and accurate measurement will not be possible.

And if the range is too high, then errors will increase and accurate measurement will not be possible.

4.10 Checking Wiring

Press the **[WIRING]** key to display the **WIRING, wiring check** screen.
 This screen is used to check whether the instrument has been connected properly.

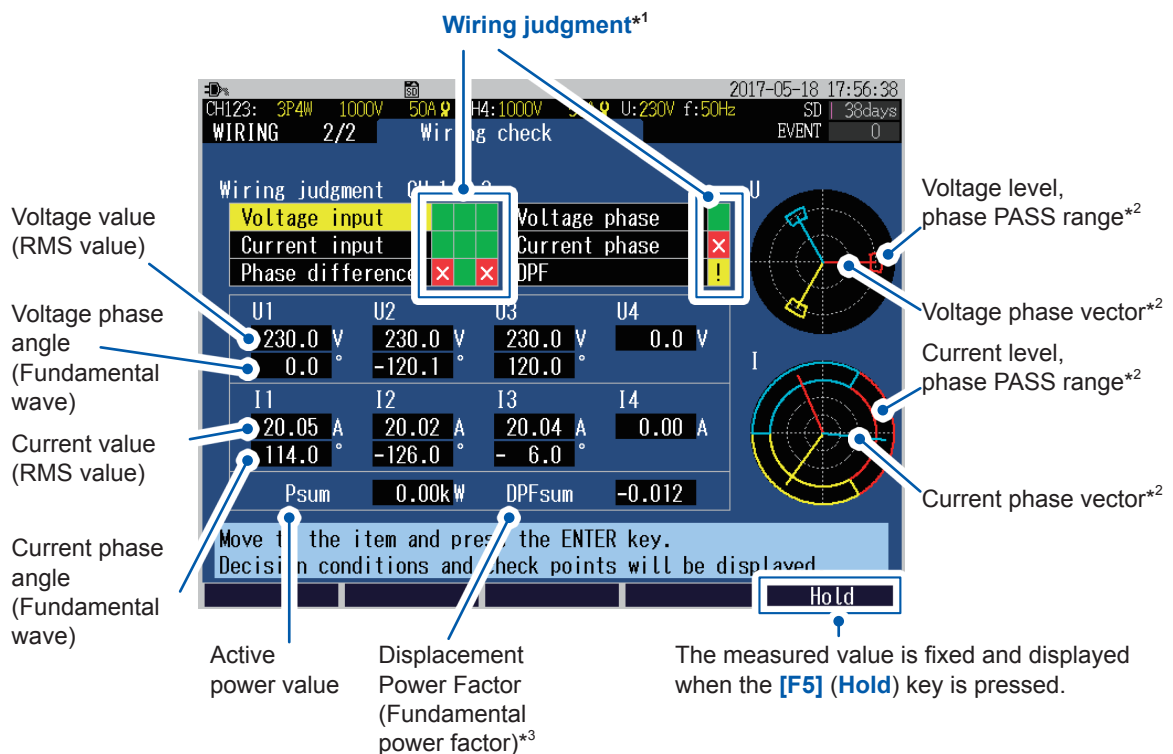

Wiring state check cannot be used for direct current (DC) measurements. Check with the polarity of the active power P. The active power value will not be negative while power is being consumed.

*1: The wiring judgment results are displayed.

Green	PASS (Normal)
Red (x)	FAIL (Abnormal)
Yellow (!)	CHECK (Confirmation required)

*2: The wiring is normal if the phase vector is within the 'PASS' range. (If outside the PASS range, see "Voltage phase" (p. 61), "Current phase" (p. 61))

*3: DPF (Displacement Power Factor) is displayed as the power factor irrespective of the **PF/Q/S** calculation method settings of the **SET UP, measurement settings 2** screen in the **WIRING, wiring check** screen. See "SET UP, Measurement Settings 2 screen" (p. 66) and "Power factor (PF/DPF)" (p. Appx.29).

If the wiring judgment result is red (FAIL) or yellow (CHECK)

1 Select an item to be checked.

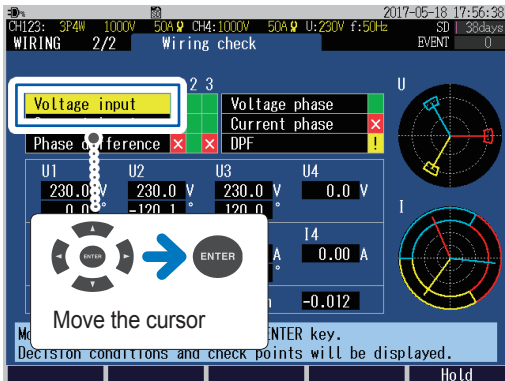

A dialog box with helpful information for fixing the wiring will be displayed.

2 Review its contents.

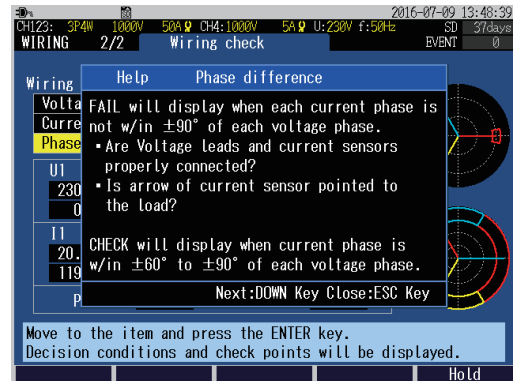

(Press the [ESC] key to close the dialog box)

3 Press the [WIRING] key to display the WIRING, wiring settings screen.

4 Verify that the actual wiring connections are the same as the ones shown on the screen.

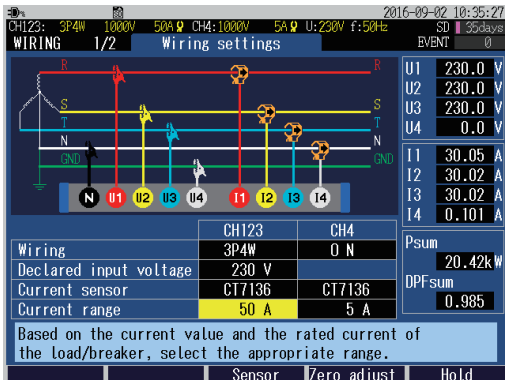

Correct the wiring if the connections are incorrect.

5 Once again, press [WIRING] key and confirm the wiring judgment result on WIRING, wiring check confirmation screen.

Recording can be started even if the wiring judgment result remains red (FAIL) or yellow (CHECK).

Wiring judgment items	Judgment conditions	Confirmation steps
Voltage input	To determine the voltage value based on the declared input voltage. 110% < CHECK 90% ≤ PASS ≤ 110% 80% ≤ CHECK < 90% FAIL < 80%	<ul style="list-style-type: none"> • Has the declared input voltage been set correctly? • Are the voltage cords completely inserted into the voltage input terminals? • Are the tip clip and cord of the voltage cord completely inserted? • Is the tip clip of the voltage cord connected to the metal parts of the measurement line?
	See “4.2 Wiring Method and Declared Input Voltage Settings” (p. 48). See “4.3 Connecting Voltage Cords to Instrument” (p. 51). See “4.6 Connecting Voltage Cords to Objects” (p. 55).	
Current input	FAIL will be displayed when input is less than 1% of the current range. CHECK will be displayed when input is less than 10% of the current range.	Wiring cannot be checked when no current is flowing. Operate the equipment and keep the current flowing in order to check the wiring. If the wiring cannot be checked even if the equipment is operating, as exact diagnosis cannot be done, visually check for proper wiring before measuring. <ul style="list-style-type: none"> • Are the current sensors properly inserted into the current sensor input terminals? • Are the current sensors correctly wired? • Is the set current range too large for the input level?
	See “4.4 Connecting Current Sensors and Configuring Current Sensor Settings” (p. 52). See “4.7 Attaching Current Sensors to Objects” (p. 56).	
Voltage phase	FAIL will be displayed when the voltage phase exceeds the range (exceeds the reference value ±10°).	<ul style="list-style-type: none"> • Are the wiring settings correct? • Are the voltage cords correctly wired? • The phases may have been incorrectly laid out during wiring. Switch the voltage cords and adjust the connections of the current sensors so that PASS is displayed. To recheck the phases, use a phase detector to confirm that the phases are in the correct sequence.
	See “4.2 Wiring Method and Declared Input Voltage Settings” (p. 48). See “4.6 Connecting Voltage Cords to Objects” (p. 55).	
Current phase	FAIL will be displayed when the current phase sequence is incorrect.	<ul style="list-style-type: none"> • Are the current sensors connected in the right places? (On both the wiring side, and the input terminal of this instrument) • Does the arrow of the current sensor point to the load side?
	See “4.2 Wiring Method and Declared Input Voltage Settings” (p. 48). See “4.4 Connecting Current Sensors and Configuring Current Sensor Settings” (p. 52). See “4.7 Attaching Current Sensors to Objects” (p. 56).	

Wiring judgment items	Judgment conditions	Confirmation steps
Voltage and current phase difference	FAIL will be displayed when each current phase is not within 90° with respect to the voltage of each phase.	<ul style="list-style-type: none"> • Are the voltage cords and current sensors connected in the right places? (On both the wiring side, and the input terminal of this instrument) • Does the arrow of the current sensor point to the load side?
	CHECK appears if current phase is within ±60° to ±90° of each voltage phase.	<ul style="list-style-type: none"> • Are the voltage cords and current sensors connected in the right places? (On both the wiring side, and the input terminal of this instrument) • Does the arrow of the current sensor point to the load side? • In light loads, power factor may be low and phase difference may be large. Check the wiring and if no problems are observed, proceed with the measurement. • When phase advances too much due to the phase advance capacitor in light loads, power factor may be low and phase difference may be large. Check the wiring and if no problems are observed, proceed with the measurement.
	See “4.3 Connecting Voltage Cords to Instrument” (p. 51) to “4.7 Attaching Current Sensors to Objects” (p. 56).	
Displacement power factor (DPF)	CHECK will be displayed if the displacement power factor is less than 0.5 but more than -0.5.	<ul style="list-style-type: none"> • Are the current sensors connected in the right places? (On both the wiring side, and the input terminal of this instrument) • Does the arrow of the current sensor point to the load side? • When the load is light, the power factor may be low. Check the wiring and if no problems are observed, proceed with the measurement. • When the phase advances too much due to the use of a phase advance capacitor during a light load, the power factor may be low. Check the wiring and if no problems are observed, proceed with the measurement.
See “4.4 Connecting Current Sensors and Configuring Current Sensor Settings” (p. 52). See “4.7 Attaching Current Sensors to Objects” (p. 56).		

5 Setting Change (SET UP Screen)

All settings can be changed on the **SET UP** screen.

Press the **[SET UP]** key to display the **SET UP** screen.

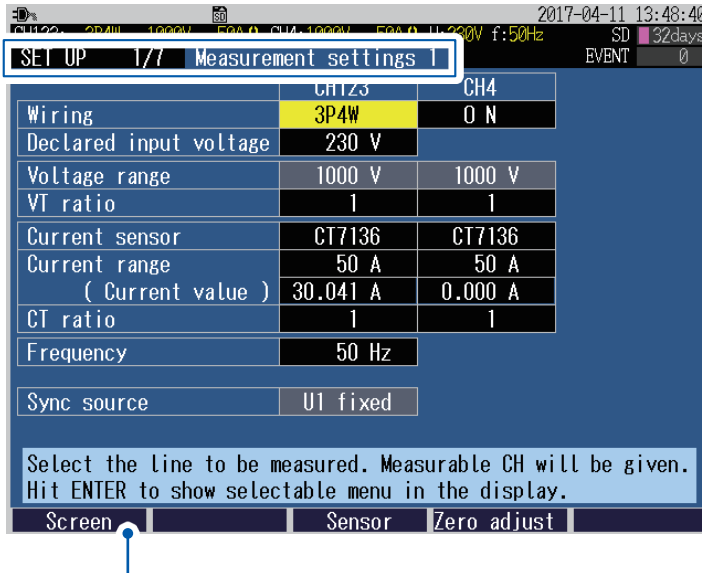

In addition to the **[SET UP]** key, you can switch to the **SET UP** screen from here also.

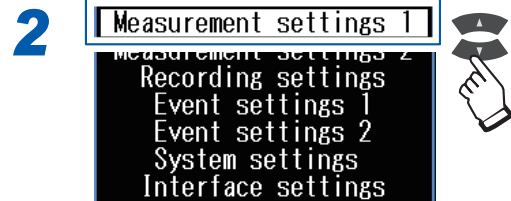

For the **SET UP, Interface Settings** screen, see “12 Communications (USB/LAN/RS-232C)” (p. 143) and “13 External I/O” (p. 173).

5.1 Measurement Settings

SET UP, Measurement Settings 1 screen

Press the [SET UP] key to display the SET UP, measurement settings 1 screen.

The screenshot shows the 'SET UP, Measurement settings 1' screen with the following settings:

	CH123	CH4
1 Wiring	3P4W	0 N
2 Declared input voltage	230 V	
3 Voltage range	1000 V	1000 V
4 VT ratio	1	1
5 Current sensor	CT7136	CT7136
6 Current range	50 A	50 A
7 (Current value)	30.041 A	0.000 A
8 CT ratio	1	1
9 Frequency	50 Hz	
Sync source	U1 fixed	

Navigation callout: Move the cursor (using arrow keys) and Select (using the ENTER key).

See "4.5 Zero Adjustment" (p. 54).

The wiring method, declared input voltage, current sensor and current range can be set on the "WIRING, Wiring Settings Screen" or on the "Quick Settings Screen." See "4.2 Wiring Method and Declared Input Voltage Settings" (p. 48), and Measurement Guide.

- 1 Enables you to select the wiring method of CH1 to CH3, and select ON/OFF input for CH4.

CH123	1P2W/DC	Single-phase 2-wire line/ DC (direct current) line
	1P3W	Single-phase 3-wire line
	1P3W1U	Single-phase 3-wire line (1-voltage measurement)
	3P3W2M	3-phase 3-wire line (2-watt meter method)
	3P3W3M	3-phase 3-wire line (3-watt meter method)
	3P4W	3-phase 4-wire line
	3P4W2.5E	3-phase 4-wire line (2-voltage measurement)
CH4	ON	Enables the input to CH4. Voltage: To measure the voltage of a grounded wire. Current: To measure the N wire current of 3P4W or 1P3W. To measure the leakage current.
	OFF	Disables the input to CH4.

- 2 Enables you to set the declared input voltage for the measurement line. It will be referenced for the event settings (swell, dip, interruption). See "SET UP, Event Settings 1 screen" (p. 72).

Variable (50 V to 800 V in 1 V increments), 100, 101, 110, 115, 120, 127, 200, 202, 208, 220, 230, 240, 277, 347, 380, 400, 415, 440, 480, 600

- 3 The voltage range is fixed to 1000 V.

- 4** Enables you to set if an external VT is being used.

Variable (0.01 to 9999.99), 1, 60, 100, 200, 300, 600, 700, 1000, 2000, 2500, 5000

While taking measurements on the secondary side of a voltage transformer (VT), if you set the VT ratio, you can display the voltage value by converting it to primary-side voltage values.

Example: If the voltage on primary side of a VT is 6.6 kV and the voltage on secondary side is 110 V then the VT ratio = 60 (6600 V / 110 V)

As the voltage range of 1000 V is fixed, it would be multiplied by the VT ratio of 60 to obtain a voltage range of 60 kV.

5 When connecting the optional current sensor

If you press the **[F3] (sensor)** key, the current sensor and the maximum current range will be set automatically.

Check the current value (RMS value) and select an appropriate current range.

When connecting current sensors other than the optional sensors

The sensor and the range will not be set automatically. See the following table and select the compatible optional current sensor.

Check the current value (RMS value) and select an appropriate current range.

Current sensor		Current range
Optional	Other than the optional	
AC flexible current sensor	CT7044 CT7045 CT7046	CT9667-01* CT9667-02* CT9667-03* 5000A, 500A, 50A
AC leakage current sensor	CT7116	9657-10 9675 5A, 500mA, 50mA
AC current sensor	CT7126	9694 9695-02 50A, 5A, 500mA
	CT7131	9660 9695-03 100A, 50A, 5A
	CT7136	9661 500A, 50A, 5A
AC/DC auto-zero current sensor	CT7731	- 100A, 10A
	CT7736	- 500A, 50A
	CT7742	- 2000A, 1000A, 500A
Clamp on sensor	9669	9669 1000A, 100A

*: Set the range switch of the sensor to 500 A when the **current range** of this instrument is set to **500 A** or **50 A**.

When measuring power lines that use multiple channels

Combine the multiple types of the current sensor.

Example: Use current sensors of the same type from CH1 to CH3 for the 3-phase 4-wire system.

Selecting an appropriate current range

Set the current range based on the anticipated maximum load current that will generate during the measurement. (Refer to the operating status, load rating, breaker rating, and other data to make this determination.)

If the range is too low, then an over-range current will be generated during measurement, and accurate measurement will not be possible.

And if the range is too high, then errors will increase and accurate measurement will not be possible.

- 6** The present current value will be displayed.

- 7** Enables you to set if using an external CT.

Variable (0.01 to 9999.99), 1, 40, 60, 80, 120, 160, 200, 240, 300, 400, 600, 800, 1200

While taking measurements on the secondary side of a current transformer (CT), if you set the CT ratio, you can display the current value by converting it to primary-side current values.

Example: If the current on primary side is 200 A and the current on secondary side is 5 A then the CT ratio = 40 (200 A / 5 A)

If the current range of 5 A is selected (with the current sensor), it would be multiplied by the CT ratio of 40 to obtain a current range of 200 A.

- 8** Enables you to select the nominal frequency for the measurement line. It will be referenced for the event settings (frequency).
See "5.3 Event Settings" (p. 72).

50 Hz, 60 Hz

- After performing a factory reset (default) (p. 77) to reset the instrument to the default settings, when you turn on the power, first set the frequency that matches with the measuring object. See "Setting the language, clock, and measurement frequency" (p. 40).
- The **Frequency setting** dialog box will be displayed if the instrument detects voltage input and determines that the frequency differs from the set frequency. Press the **[ENTER]** key to change the frequency settings.

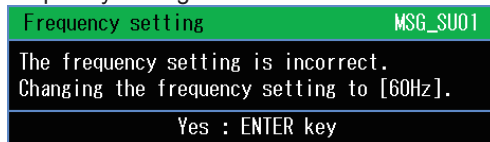

- Measurement of DC does not care that either 50 Hz or 60 Hz is configured.

- 9** Enables you to sync source referenced for the measurement is fixed to U1.

SET UP, Measurement Settings 2 screen

Press the **[SET UP]** key to display the **SET UP, measurement settings 2** screen.

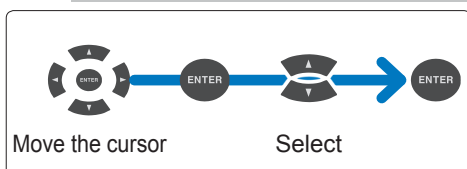
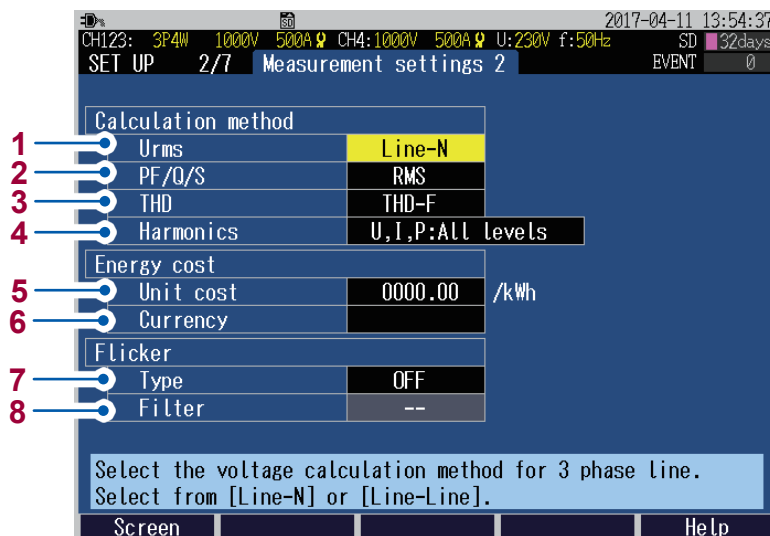

- 1** Enables you to select whether to display the RMS voltage of **TREND** screen in the form of line voltage or in phase voltage.

Line-N (Phase voltage), **Line-Line** (Line voltage)

For 1P2W, 1P3W	Line-N
For 3P3W2M	Line-Line
For 3P3W3M, 3P4W, 3P4W2.5E	Can be switched between Line-N and Line-Line . Both the phase voltage and line voltage are stored as a output data.

- 2** Enables you to select the method for calculating power factor (PF/DPF), reactive power (Q), and apparent power (S) on the display screen. Both the RMS calculation and fundamental calculation values are stored as a output data. See "14.7 Calculation Formula" (p. 205).

RMS value	Uses RMS voltage and RMS current to calculate.
Fundamental	Uses voltage and current fundamentals to calculate. This is the same measurement method used for measuring reactive energy established at commercial-scale utility customers' facilities.

RMS calculation is generally used in applications such as checking transformer capacity. Fundamental calculation is used when measuring power factor and reactive power, which are related to the energy cost.

- 3** Enables you to select the calculation method for calculating the total harmonic distortion (THD) on the display screen and event settings. Both the THD-F calculation value and THD-R calculation value are taken as output data.

THD-F	Calculates by dividing harmonic components (total of 2nd to 50th orders) with fundamental wave.
THD-R	Calculates by dividing harmonic components (total of 2nd to 50th orders) with RMS value (1st to 50th order).

- 4** Enables you to select the **TREND**, **Harmonics trend** screens to be displayed either by level or content percentage (%). Output data is saved for both level and content percentage of FND.

U,I,P: All Levels, U,I,P: All content percentages, U,P: content percentage, I: Level

- 5** When the unit cost (/kWh) is set, the energy cost is displayed by multiplying the active energy (consumed) WP+ with the energy cost per unit. See "Unit cost input method" (p. 68).

0.00000 /kWh to 99999.9 /kWh

- 6** Enables you to set the currency. Set to any 3 alphanumeric characters (example: set **USD** for the US dollar)

- 7** Enables you to select the flicker measurement type.

OFF	No flicker measurement (display)
Pst,Plt	The IEC61000-4-15:2010 standard are applied.
ΔV10	A ΔV10 flicker meter used in Japan is applied.

- 8** Enables you to select a weighting filter when **Pst, Plt** is selected for the type of flicker measurement.

230V lamp	230 V lamp system filter
120V lamp	120 V lamp system filter

Unit cost input method

1 Select the unit cost.

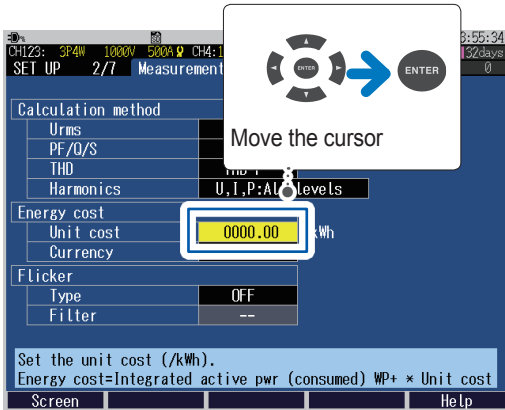

2 Change the value.

When moving the decimal point

: Move the cursor to the position of decimal point.

: Change the location of the decimal point.

When changing the value

: Move the cursor to the digit that you wish to change.

: Change the value.

3 Accept the settings.

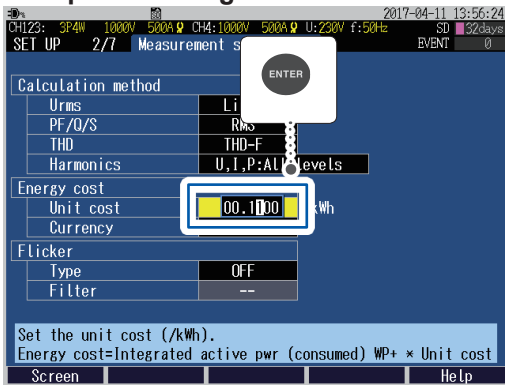

5.2 Recording Settings

Press the **[SET UP]** key to display the **SET UP, recording settings** screen.

Perform the settings regarding recording (storage).

The maximum recording period is up to 1 year and then the recording stops automatically.

The screenshot shows the 'Recording settings' screen with the following settings:

- 1 Save to...: SD card
- 2 Recording interval: 1 min
- 3 Recording items: Yes harmonic
- 4 Screen save: OFF
- 5 Clock: 2016-09-02 10:43:00
- 6 Recording start: Repeat 2016-09-03
- 7 Recording stop: Repeat 2016-11-13
- 8 Recording period: 00:00-24:00
- 9 Folder/file name: Auto
- 10 Save time: 35.1 days

Legend:

- Move the cursor: (Circular arrow icon)
- Select: (ENTER key icon)

- The storage destination of measurement data is fixed to the **SD card**. If no SD memory card is inserted or if there is no free space in the SD memory card, data will be stored in the instrument's internal memory (capacity of approx. 4 MB).
 - No data such as event data but only the setting data and the trend record data are stored in the internal memory. See "File Saving and Operations (FILE Screen)" (p. 121).

- Enables you to select the recording interval. It will also reflect in the intervals in the trend graph.

150 cycle (only in the case of 50 Hz), **180 cycle** (only in the case of 60 Hz), **200 ms**, **600 ms**, **1 sec**, **2 sec**, **5 sec**, **10 sec**, **15 sec**, **30 sec**, **1 min**, **2 min**, **5 min**, **10 min**, **15 min**, **30 min**, **1 hour**, **2 hour**

- The **150 cycle** (50 Hz) and **180 cycle** (60 Hz) settings provide the recording intervals required for IEC61000-4-30-compliant measurement.
- The shortest recording interval of the internal memory is 2 s. If the recording interval of 1 sec or below is set, then the data cannot be stored in the internal memory.

Setting a recording interval of less than one second disables the following functions:

- Saving data of harmonics (Data of THD and K factor can be saved)
- Recording events
- The action activated by pressing the COPY key during recording

- Enables you to select the parameters that you wish to record. It will also reflect in the parameters that are displayed on the **TREND** screen.

Yes harmonic	All the parameters are recorded.
No harmonic	Records the parameters other than the harmonic or interharmonic parameters. Records the total harmonic distortion (THD).

The display possible time of the **TREND** screen changes according to the setting of **Recording interval** and **Recording items**.

- 4** Enables you to select **ON**, for saving the display screen in the BMP format data (screen copy). Screen copies cannot be saved in the instrument's internal memory. If the **Recording interval** is set to below **5 min**, then they are saved every 5 min.

ON/OFF

- 5** Enables you to set the date and time.
(The seconds cannot be set. If you press the **[Enter]** key after changing time, the seconds will be set to 00.)

- 6** Enables you to set the method used to start recording.

Manual	Recording starts immediately after the [START/STOP] key is pressed.
Specified time	After the [START/STOP] key is pressed, recording starts at the set time. (If the set time has already passed when the key is pressed, " Interval " starting method will be used.) YYYY-MM-DD hh:mm
Interval time	Recording starts at an even time division based on the Recording interval . If the [START/STOP] key is pressed at the time "10:41:22" with the time interval set to 10 min, the instrument will enter in the standby state. The recording will start at "10:50:00." If the set recording interval is of 30 s or less, recording will start from the next zero second.
Repeat	Segments the file every day and repeats the recording. Sets the Recording period . If a folder is labeled arbitrarily, data recorded for up to 99 days can be stored. After the [START/STOP] key is pressed, recording starts in the Recording period of the set start date. (If the set time has already passed when the key is pressed, " Interval " starting method is used.) The Recording intervals of 1 sec and above are valid. YYYY-MM-DD

See "7.1 Start and Stop of the Recording" (p. 93).

- 7** Enables you to set the method used to stop the recording.

Manual	Press the [START/STOP] key to stop the recording.
Specified time	Recording stops at the set time. (If the set time has already passed when recording starts, recording will be stopped using the " Manual " method.) YYYY-MM-DD hh:mm
Timer	Stops the recording automatically if the set timer time has elapsed. hh:mm:ss
Repeat	Displayed when Recording start setting is configured to Repeat . Recording is stopped if the Recording period of the stop date has passed. The stop method cannot be changed for repeat recording. YYYY-MM-DD

See "7.1 Start and Stop of the Recording" (p. 93).

- 8** Displayed when **Recording start** setting is configured to **Repeat**.
Set the recording period.

hh:mm to **hh:mm**

- 9** Enables you to set the folder name and file name used to save the data. See “10.2 Folder and File Structure” (p. 124)

Variable	Sets variable folder name in the dialog. (maximum 5 half-width characters) If recording and measurement are performed again without changing the [Folder/file name] , sequentially numbered (00 to 99) folders will be automatically created, and the data will be saved there. If Recording start setting is configured to Repeat, data recorded for up to 100 days can be stored because folders are created at daily intervals. Example: “ABCDE00,” “ABCDE01,” and then, “ABCDE02”
Automatic	The folder will be named automatically as “YYMMDDXX.” YYMMDD is the year, month, and date while XX is the serial number (00 to 99).

- 10** Calculates the save time from the recording settings and displays it. Since the maximum recording time is 1 year, the maximum data storage time is also 1 year. Calculates the save time when there is no event (not occurred). If the event occurs, the save time shortens.

- If the save time of the SD memory card or internal memory is shorter than the specified duration, recording will be started, but only the capacity during save time will be recorded.
- The maximum recording and measurement period is 1 year. Recording will stop after 1 year.
- If the SD memory card is full, the instrument saves data into the internal memory. If both the SD card and the internal memory are full, the instrument stops saving data. The stored data is not overwritten.

Recording times (when using the Z4001 SD Memory Card 2GB)

Recording interval	No harmonic	Yes harmonic	Event recording
200 ms	25 hours	No	No
1 sec	5 days	7 hours	Yes
2 sec	10 days	14 hours	Yes
10 sec	53 days	2 days	Yes
1 min	321 days	17 days	Yes
10 min	1 year	178 days	Yes
30 min	1 year	1 year	Yes
...

5.3 Event Settings

An event will occur using the set threshold value on this screen as the basis. For more information about events, see “Appx. 3 Explanation of Power Quality Parameters and Events” (p. Appx.4), “Appx. 4 Event Detection Methods” (p. Appx.8).

SET UP, Event Settings 1 screen

Press the [SET UP] key to display the **SET UP, event settings 1** screen.

The screenshot shows the 'SET UP, Event settings 1' screen with the following settings:

Voltage		CH123	CH4
1	Transient	161 V	161 V
2	Swell	110.0 %	= 253.00 V
3	Dip	90.0 %	= 207.00 V
4	Interruption	10.0 %	= 23.00 V
5	RVC	OFF	= OFF
6	Frequency (200ms)	5.0 Hz	
7	Frequency (1wave)	OFF	
8	THD	5.0 %	
Current		CH123	CH4
9	Inrush current	OFF	OFF
10	THD	OFF	OFF
11	Hysteresis	1 %	

Reference graph for setting threshold values: MAX: ± 2200 V, MIN: ± 4 V, current value: 161 V.

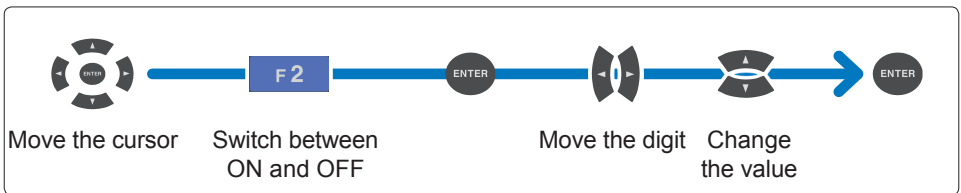

- 1*1 Enables you to set the threshold value of the voltage transient.
OFF, 4 V to 2200 V

- 2*1,2 Enables you to set the threshold value of the voltage swell.
OFF, 0.0% to 200.0%

- 3*1,2 Enables you to set the threshold value of the voltage dip.
OFF, 0.0% to 100.0%

- 4*1,2 Enables you to set the threshold value of the interruption.
OFF, 0.0% to 100.0%

- 5*1,2 Enables you to set a threshold for RVC (Rapid voltage change).
When the RVC event is enabled, swell and dip are also enabled.
OFF, 1.0% to 8.0%

*1: The actual event threshold value is obtained by multiplying with the VT ratio.
*2: The threshold value is set in terms of % of the declared voltage Uref (declared input voltage Udin × VT ratio).

6 Enables you to set the threshold value of the frequency (200 ms). (Only U1)
OFF, 0.1Hz to 9.9Hz

7 Enables you to set the threshold value of the frequency (1 wave). (Only U1)
OFF, 0.1Hz to 9.9Hz

8 Enables you to set the threshold value of the voltage total harmonic distortion.
OFF, 0.0% to 100.0%
 The value depends on the **THD** settings of the **calculation method** of the **SET UP, Measurement settings 2** screen (**THD-F/THD-R**).

9 Enables you to set the threshold value of the inrush current.

5000 A range	OFF, 0 A to 5000 A
2000 A range	OFF, 0 A to 2000A
1000 A range	OFF, 0 A to 1000A
500 A range	OFF, 0 A to 500A
100 A range	OFF, 0 A to 100A
50 A range	OFF, 0 A to 50A
10 A range	OFF, 0 A to 10A
5 A range	OFF, 0 A to 5A
500 mA range	OFF, 0 A to 500mA
50 mA range	OFF, 0 A to 50mA

The actual event threshold value is obtained by multiplying with the CT ratio.

10 Enables you to set the threshold value of the current total harmonic distortion.
OFF, 0.0% to 500.0%
 The value depends on the **THD** settings of the **Calculation method** of the **SET UP, Measurement settings 2** screen (**THD-F/THD-R**).

11 Enables you to set hysteresis for the event threshold value to prevent from frequent event occurrence. Hysteresis can be set to all items excluding frequency and RVC. The frequency is fixed to 0.1 Hz and RVC is fixed to 50%. Set a hysteresis value for swell, dip, or interruption in terms of a percentage of the declared voltage; set that for others in terms of a percentage of each threshold value.
0% to 10%

Reference graph for setting threshold values

You can adjust threshold values while viewing the present measured values.

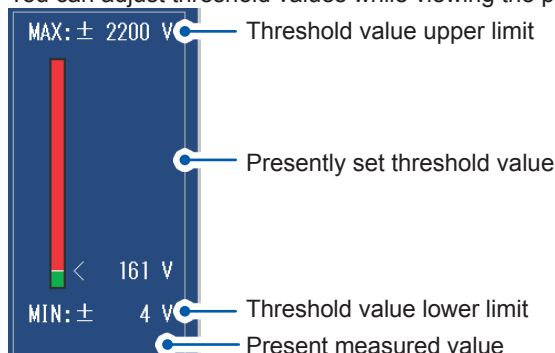

SET UP, Event Settings 2 screen

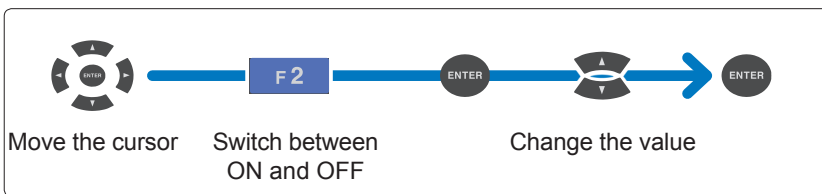
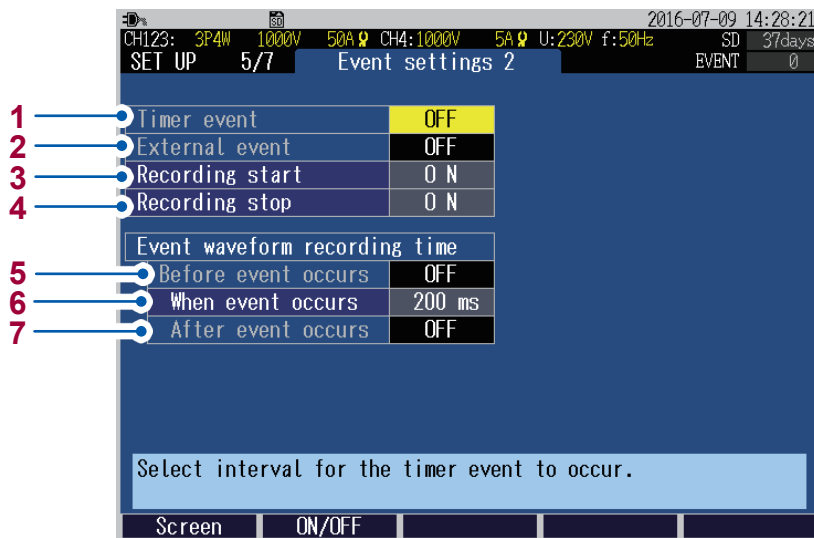

- 1** Enables you to select the timer event.
The timer events are recorded at the set intervals.

OFF, 1min, 2min, 5min, 10min, 15min, 30min, 1hour, 2hour

- 2** Select **ON** for using an external event.
External events occur at the time of short-circuiting the event input terminal (EVENT IN) or of the pulse signal falling and they are recorded.

OFF, ON

- 3** The recording start event occurs when the recording starts.

- 4** The recording stop event occurs when the recording stops.

- 5*1** Enables you to select the event waveform recording time (before-event) before the event occurs.

OFF, 200ms, 1sec

- 6** The event waveform recording time when the event occurs is fixed to 200 ms.

- 7*1** Enables you to select the event waveform recording time (after-event) after the event occurs.
Only the event which initially occurred is recorded.
If another event occurs during the after-event, the after-event of this another event cannot be stored.

OFF, 200ms, 400ms, 1sec, 5sec, 10sec

*1: Only the event IN is recorded (See “14.5 Event Specifications” (p. 202)). The event OUT, timer, external, manual, recording start, and recording stop events are not recorded in the event waveform recording of before-event and after-event. Only the event waveform of 200 ms, when the event occurs, will be saved. The event waveform is divided at intervals of 200 ms. When the after event is set to 1 sec, five pieces, which is obtained by dividing 1 sec by 200 ms, of the event waveform are saved. If the before event or the after even set to exceeding 200 ms, only the waveform recorded during 200 ms can be observed with the instrument. To observe the entire length of the waveform, use the application software PQ One, which is supplied with the instrument.

5.4 System Settings

Press the **[SET UP]** key to display the **SET UP, System settings** screen.

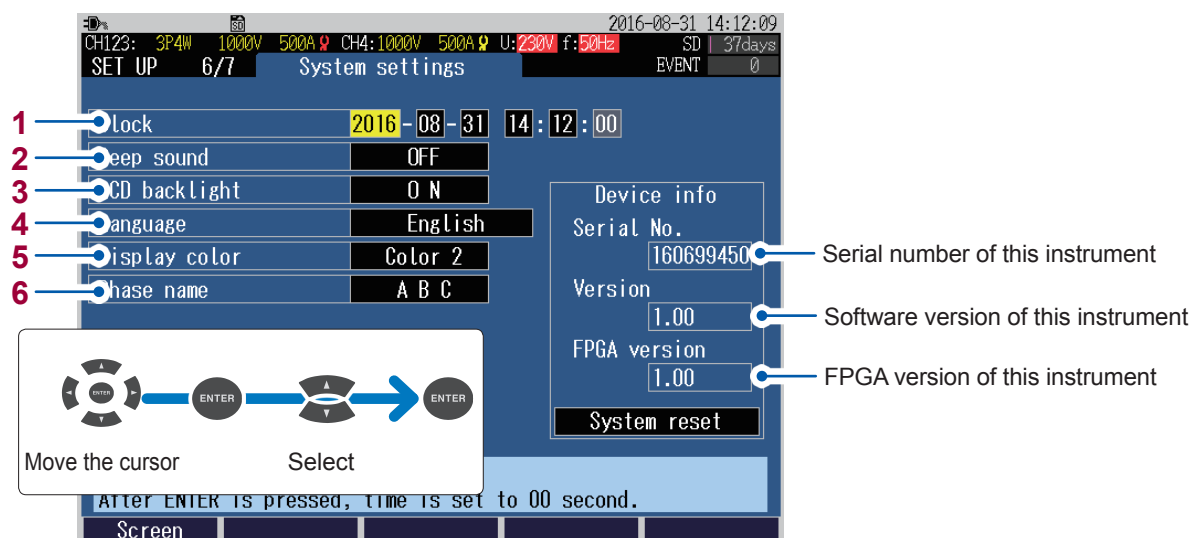

- 1** Enables you to set the date and time.
(The seconds cannot be set. If you press the **[Enter]** key after changing the value, the seconds will be set to 00.)

- 2** Select **ON** to enable a beep sound when pressing a key.

ON, OFF

- 3** Enables you to select whether or not to auto-off the backlight of the display.

Auto OFF	The backlight automatically turns off after 2 min have elapsed since the last key operation.
ON	The backlight is on at all times.

- 4** Enables you to select the display language.

Japanese		German	
English		French	
Chinese Simple	(Simplified)	Italian	
Chinese Trad	(Traditional)	Spanish	
Korean		Turkish	
		Polish	

- 5** Enables you to select the display color.

Color 1, color 2, color 3

- 6** Enables you to select the phase names for the measuring objects displayed on the wiring diagram.

RST, ABC, L1L2L3, UVW

System reset (Default)

Move the cursor to the **system reset** and press **[ENTER]** key to reset the system settings of this instrument. (Factory settings: p. 78)

Perform if the instrument is operating in an odd or unexpected manner with no clear cause.

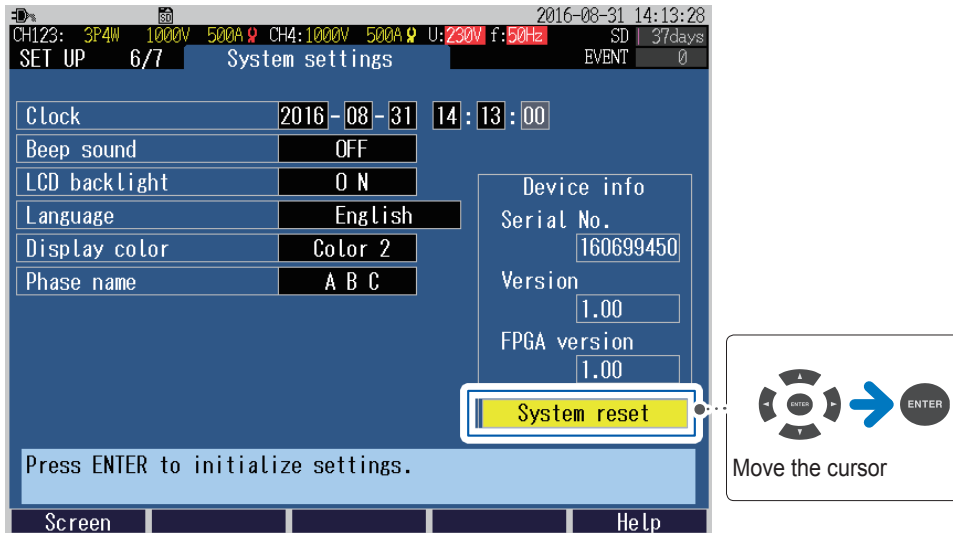

All settings other than the measurement frequency, clock, language, and communication settings (LAN and RS-232C) are initialized to their factory settings. The internal memory will not be cleared.

Factory reset (Default)

If you perform the factory reset, all settings, including frequency, language, and communications settings will revert to their factory settings (p. 78). The internal memory will be cleared.

1 Turn off the instrument. (p. 44)

2 Turn on the instrument while holding down the [ENTER] and [ESC] keys, and continue holding them down until the beep sounds after the self-test is complete.

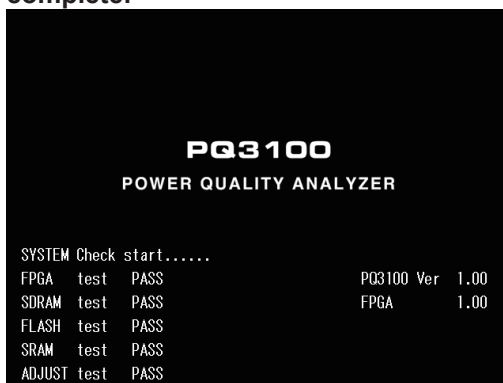

The factory reset will complete, and the language setting screen will be displayed.

Set the language, clock, and measurement frequency (p. 40).

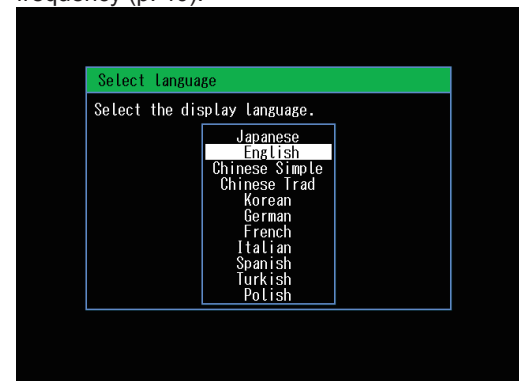

5

Setting Change (SET UP Screen)

Factory settings

All the default settings are as follows:

- *1: Checked parameters (✓) are the parameters that are not initialized in quick set.
 *2: Checked parameters (✓) are the parameters that are not initialized during the system reset.
 These are initialized in the factory reset only.

Screens	items	Default values	*1	*2	
Measurement settings 1	Wiring	Display Language: Japanese	CH123: 3P3W2M CH4: OFF		
		Display language: Other than above	CH123: 3P4W CH4: ON		
	Declared input voltage	Display Language: Japanese	200V		
		Display language: Other than above	230V		
	VT ratio	CH123: 1 CH4: 1			
	Current sensor	CH123: CT7136 CH4: CT7136			
	Current range	CH123: 500 A CH4: 500 A			
	CT ratio	CH123: 1 CH4 :1			
	Measurement frequency	Select 50 Hz or 60 Hz after the factory reset.	✓	✓	
Measurement settings 2	Urms	Other than 3P3W: Phase voltage 3P3W: Line voltage			
	PF/Q/S	RMS value			
	THD	THD-F			
	Harmonics	U, I, P: All levels			
	Energy unit cost	0000.00/kWh			
	Energy cost currency	_____			
	Flicker	OFF			
	Filter	—			
Recording settings	Recording interval	1min			
	Recording items	Yes harmonic			
	Screen save	OFF			
	Recording start method	Interval time			
	Recording stop method	Manual			
	Folder/ File name	Automatic			

Screens	items	Default values	*1	*2
Event settings 1	Transient	CH123: OFF CH4: OFF		
	Swell	OFF		
	Dip	OFF		
	Interruption	OFF		
	RVC	OFF		
	Frequency (200 ms)	OFF		
	Frequency (1 wave)	OFF		
	Voltage total harmonic distortion	OFF		
	Inrush current	CH123: OFF CH4: OFF		
	Current total harmonic distortion	CH123: OFF CH4: OFF		
Hysteresis	1%			
Event settings 2	Timer event	OFF		
	External event	OFF		
	Event waveform recording time Before event occurs	OFF		
	Event waveform recording time After event occurs	OFF		
System settings	Clock	Set at the time of shipment	✓	✓
	Beep sound	ON	✓	
	LCD backlight	Auto OFF	✓	
	Display language	Language selection after factory reset	✓	✓
	Display color	Color 1	✓	
	Phase name	Display Language: Japanese RST Display language: Other than above ABC	✓	✓
Interface settings	DHCP	OFF	✓	✓
	IP address	192.168.1.31	✓	✓
	Subnet mask	255.255.255.0	✓	✓
	Default gateway	192.168.1.1	✓	✓
	DNS	OFF	✓	✓
	DNS IP address	0.0.0.0	✓	✓
	RS-232C connection	PC	✓	✓
	RS-232C baud rate	19,200bps	✓	✓
	External output	Short pulse	✓	✓

Screens	items	Default values	*1	*2
FTP server settings	Authentication	OFF	✓	✓
	User name	(Blank)	✓	✓
	Password	(Blank)	✓	✓
Auto FTP send	Auto send	OFF	✓	✓
	FTP Server name	(Blank)	✓	✓
	IP address	0.0.0.0	✓	✓
	User name	(Blank)	✓	✓
	Password	(Blank)	✓	✓
	Save directory	PQ3100	✓	✓
	PASV mode	OFF	✓	✓
Mail settings 1	Email at event	OFF	✓	✓
	Email at time	OFF	✓	✓
	Time setting	00:00	✓	✓
	To address	(Blank)	✓	✓
	Mail server name	(Blank)	✓	✓
	IP address	0.0.0.0	✓	✓
	Port number	25	✓	✓
	From address	(Blank)	✓	✓
	From	(Blank)	✓	✓
	Subject	PQ3100	✓	✓
Mail settings 2	Mail authentication	OFF	✓	✓
	Server name	(Blank)	✓	✓
	IP address	0.0.0.0	✓	✓
	Port number	110	✓	✓
	Account name	(Blank)	✓	✓
	Password	(Blank)	✓	✓

6

Verifying the Waveform, Measured Values (MONITOR Screen)

You can view the measured waveforms and measured values on the **MONITOR** screen.

Press the **[MONITOR]** key to display the **MONITOR** screen.

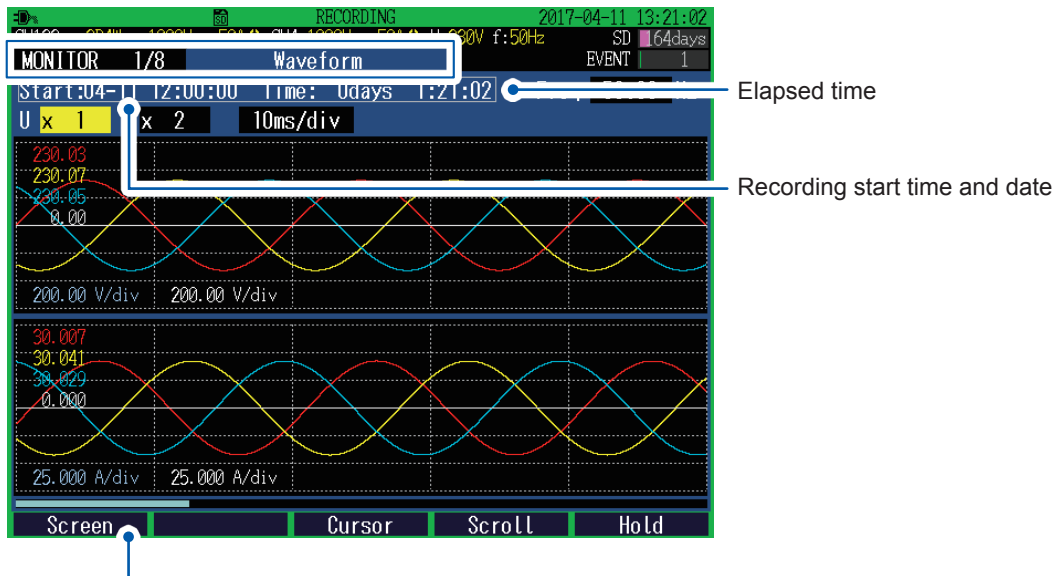

In addition to the **[MONITOR]** key, you can also switch to the **MONITOR** screen by using the **[F1]** (**Screen**) key.

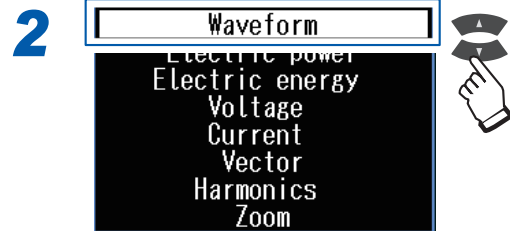
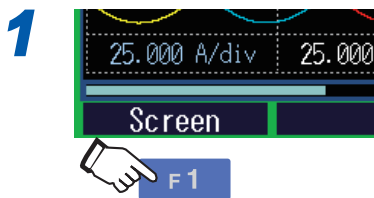

Fixing the waveform display and measured values

Press the **[F5]** (**Hold**) key to fix the waveform display and measured values.

Press the **[F5]** key again to cancel the fixed waveform display and measured values.

- If a setting is changed while measured values and waveform display are being held, the hold will be canceled.
- The time display is not fixed.

6.1 Verifying the Voltage Waveform and Current Waveform

Press the **[MONITOR]** key to display the **MONITOR, Waveform** screen.

The voltage waveforms and current waveforms of up to 4 channels are overlapped and displayed. The color of waveform is same as the phase color.

Screen display

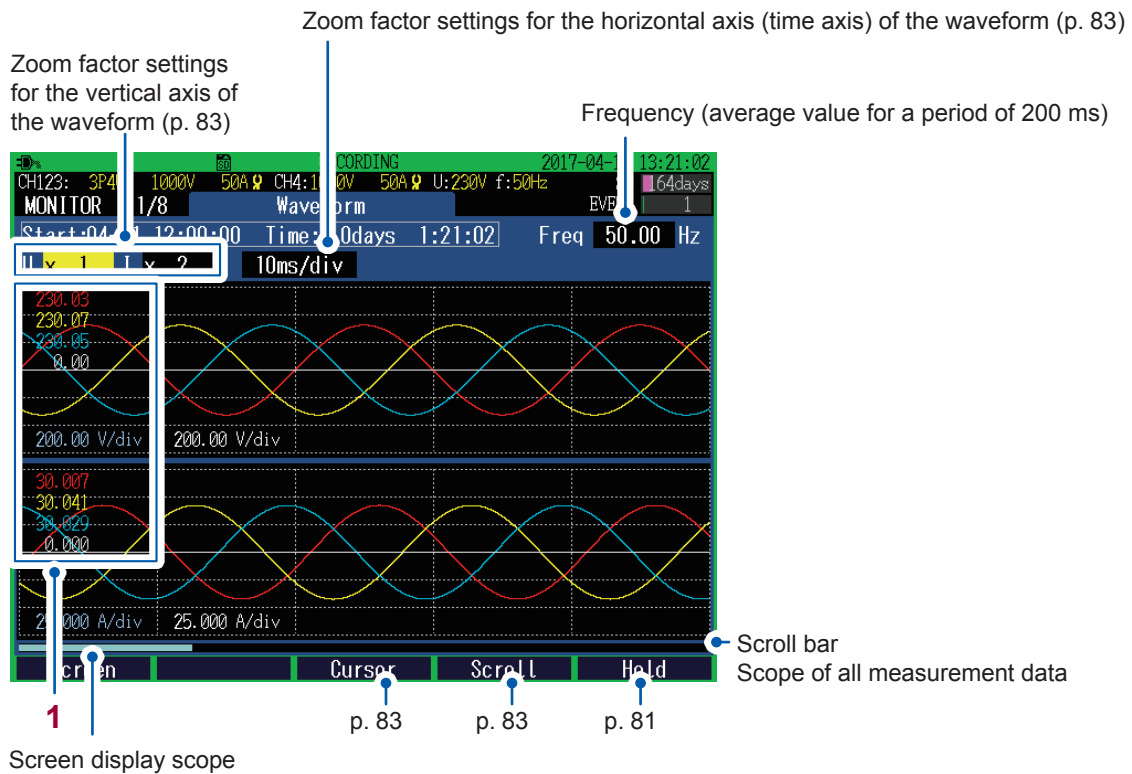

- 1 When the cursor is OFF: measured values of each channel (RMS value)
At the time of the cursor measurement: cursor measured values of the waveforms of each channel
(Above diagram shows the screen that is displayed when the cursor is OFF)

See "Verifying the measured value and time at the cursor position (cursor measurement)" (p. 83).

Changing the zoom factor for the vertical axis and horizontal axis (X and Y axis) of the waveform



- 1 Enables you to set the zoom factor for the vertical axis (Y axis) of the waveform (U: voltage, I: current).

x1/4, x1/2, x1, x2, x5, x10, x20, x50

- 2 Enables you to set the zoom factor for the horizontal axis (time axis) of the waveform.

10ms/div, 20ms/div, 40ms/div

Verifying the measured value and time at the cursor position (cursor measurement)

If you press the **[F3] (Cursor)** key, the measured value and time at the cursor position will also display along with the cursor.

Move the position of the cursor by using the **◀▶** keys.

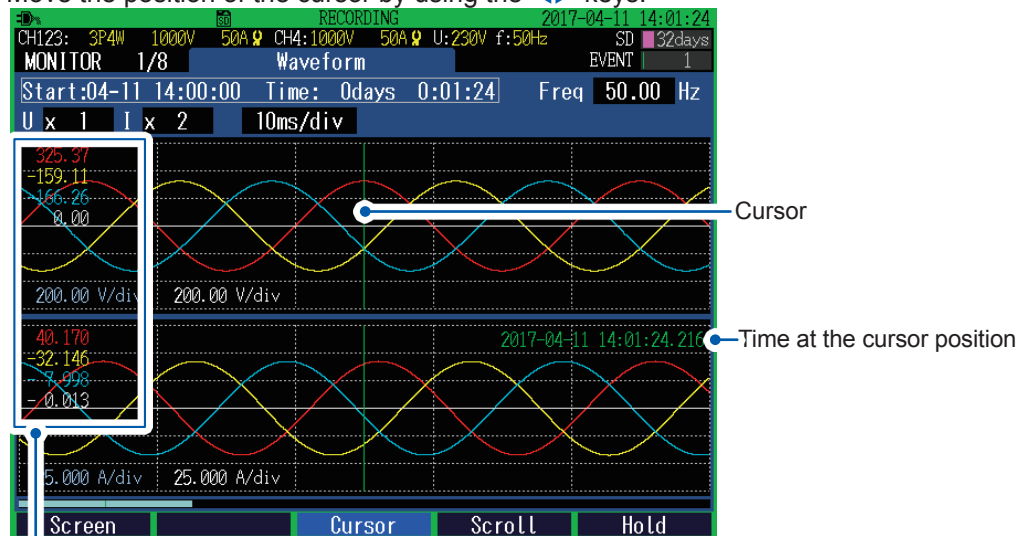

Measured value at the cursor position

Scrolling the waveform

If the waveform is protruding from the screen, press the **[F4] (Scroll)** key to be able to scroll the waveform.

Enables you to scroll the waveform in the vertical and horizontal directions by using the **▲▼◀▶** keys.

6.2 Verifying the Electric Power (List of Numerical Values)

Press the **[MONITOR]** key to display the **MONITOR, Electric power** screen.

1 When the wiring method is 3P3W3M, 3P4W, or 3P4W2.5E, the display method of the RMS voltage can be switched (between phase voltage and line voltage).

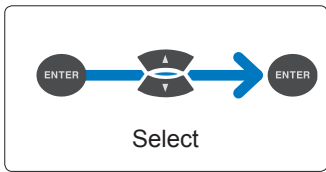

Line-N (Phase voltage), **Line-Line** (Line voltage)

For 1P2W, 1P3W	Fixed to Line-N
For 3P3W2M	Fixed to Line-Line
For 3P3W3M, 3P4W, 3P4W2.5E	Can be switched between the Line-n and Line-Line . Both the phase voltage and line voltage are stored as a output data.

6.3 Verifying the Electric Energy

Press the **[MONITOR]** key to display the **MONITOR, Electric energy** screen.

The screenshot displays the 'MONITOR, Electric energy' screen with the following data:

Item	Value	Unit
Active energy WP+	1.7490k	Wh
Active energy WP-	0.0000k	Wh
Active power P	19.481k	W
Apparent energy WS	1.8603k	VAh
Apparent power S	20.721k	VA
Reactive energy WQ_LAG	0.6339k	varh
Reactive energy WQ_LEAD	0.0000k	varh
Reactive power Q	7.060k	var
Energy cost Ecost	-----	
Power factor PF	0.9402	
Recording start	2017-04-11 14:00:00	
Recording stop	2018-04-12 14:00:00 (Schedule)	
Elapsed time	0:05:23	

Annotations on the right side of the screen:

- Active power
- Apparent power
- Reactive power
- PF: Power factor
- DPF: Displacement power factor (Not displayed for 3-phase 3-wire line) See Calculation method (p. 66).

At the bottom of the screen, there are buttons for 'Screen' and 'Hold'.

1 Active energy (**WP+**: consumption, **WP-**: regeneration)

2 Reactive energy (**WQ_LAG**: lag, **WQ_LEAD**: lead)

3 Energy cost
Value obtained by multiplying the "active energy consumption: **WP+**" by the **Unit cost***

*: See "SET UP, Measurement Settings 2 screen" (p. 66)

6.4 Verifying the Voltage Details

Press the **[MONITOR]** key to display the **MONITOR, Voltage** screen.

The screenshot shows the MONITOR Voltage screen with the following data:

Urms [V]	Upk+ [V]	Upk- [V]	Uthd-F[%]	Ucf
1 230.02	1 0.3260k	-0.3256k	0.06	1.4173
2 230.06	2 0.3263k	-0.3259k	0.05	1.4182
3 230.05	3 0.3261k	-0.3258k	0.05	1.4177
AVG 230.04				
4 0.00	4 0.0000k	0.0000k	-----	-----

Udc [V]	Freq [Hz]	Freq10s [Hz]	Uunb [%]	Uunb0 [%]
1 0.06	50.000	49.999	0.03	0.04
2 0.03				
3 0.02				
4 0.00				

Callouts and their descriptions:

- Average value of the channels**: Points to the AVG row in the Urms table.
- Voltage waveform peak (+)**: Points to the Upk+ column.
- Voltage waveform peak (-)**: Points to the Upk- column.
- RMS voltage**: Points to the Urms column.
- Voltage total harmonic distortion (calculation method THD-F / THD-R) See Calculation method (p. 66).**: Points to the Uthd-F column.
- Voltage crest factor ([absolute value of voltage waveform peak]/[RMS voltage])**: Points to the Ucf column.
- Frequency for 10 sec (average value for a period of 10 s) Displayed in red if one of the following occurs: swell, dip, interruption, or out of synchronization.**: Points to the Freq10s column.
- Voltage zero-phase unbalance factor (not displayed for 3-phase 3-wire line) See "Unbalance factor" (p. Appx.30).**: Points to the Uunb0 column.
- Voltage negative-phase unbalance factor See "Unbalance factor" (p. Appx.30).**: Points to the Uunb column.
- Frequency for 200 ms (average value for a period of 200 ms)**: Points to the Freq column.
- Voltage DC value**: Points to the Udc column.

- When the wiring method is 3P3W3M, 3P4W, or 3P4W2.5E, the display method of the RMS voltage can be switched (between phase voltage and line voltage).

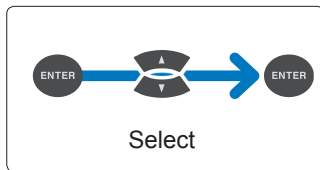

Line-N (Phase voltage), **Line-Line** (Line voltage)

For 1P2W, 1P3W	Fixed to Line-N
For 3P3W2M	Fixed to Line-Line
For 3P3W3M, 3P4W, 3P4W2.5E	Can be switched between the Line-Ne and Line-Line . Both the phase voltage and line voltage are stored as a output data.

6.5 Verifying the Current Details

Press the [MONITOR] key to display the MONITOR, Current screen.

Current total harmonic distortion (calculation method THD-F / THD-R)
See Calculation method (p. 66).

Current waveform peak (-)

Current waveform peak (+)

Current crest factor
([absolute value of current waveform peak]/[RMS current])

RMS current

Average value of the channels

K factor
See "Appx. 9 Terminology" (p. Appx.25).

Current DC value

Current negative-phase unbalance factor
See "Unbalance factor" (p. Appx.30).

Current zero-phase unbalance factor
(Not displayed for 3-phase 3-wire)
See "Unbalance factor" (p. Appx.30).

	Irms [A]	Ipk+ [A]	Ipk- [A]	Ithd-F[%]	Icf
1	30.005	42.59	- 42.43	0.05	1.4193
2	30.041	42.54	- 42.64	0.05	1.4193
3	30.028	42.50	- 42.59	0.05	1.4182
AVG	30.025				
4	0.000	0.00	0.00	-----	-----

	Idc [A]	KF	Iunb [%]	Iunb0[%]
1	0.068	1.00	0.06	0.01
2	- 0.032	1.00		
3	- 0.038	1.00		
4	0.000	0.00		

6

6.6 Verifying the Vector

Press the **[MONITOR]** key to display the **MONITOR, Vector** screen.

The voltage and current phase relationships for each harmonic order of the CH1 to CH4 are displayed in the vector diagram.

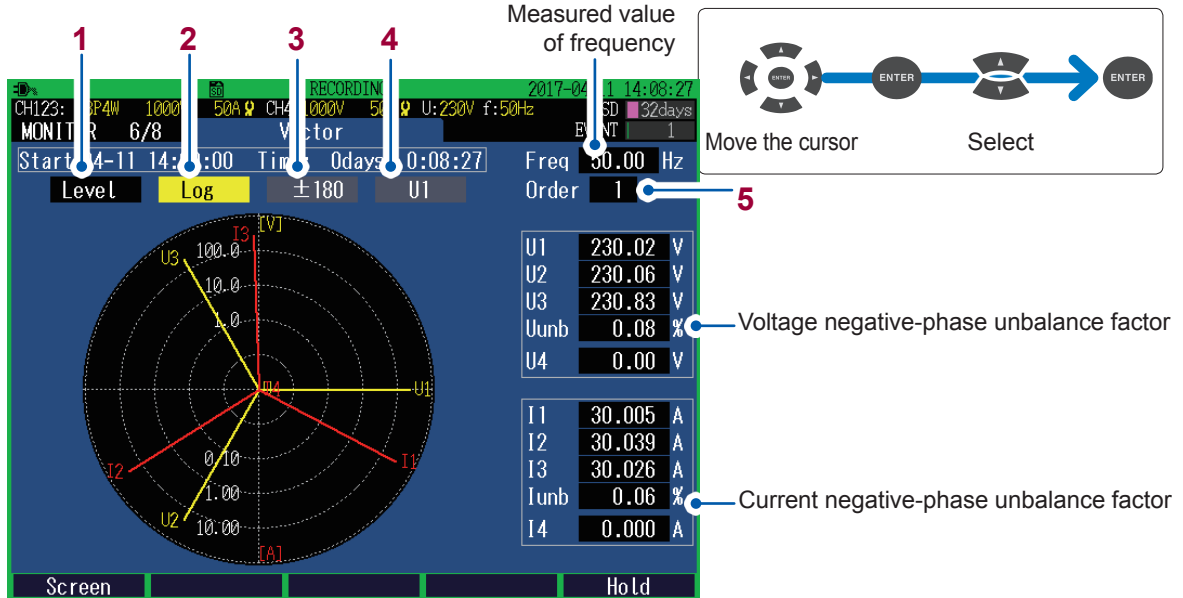

- 1** Enables you to set the numerical values to be displayed.

Level	RMS voltage and RMS current
% of FND	Takes the fundamental wave component as 100% and shows a harmonic of each order in terms of proportion to the fundamental wave component.
Phase	The phase angle of each harmonic order when the phase of fundamental wave components of the reference source is expressed in terms of 0°.

- 2** Enables you to set the display method of the axes.

Linear	Linear display
Log	Logarithmic display (low levels also become easily visible.)

- 3** Enables you to set at the time of **Phase** display. Set the display method of numbers of phase angle.

±180	Lead 0 to 180°, lag 0 to -180°
Lag360	Lag 0 to 360°

- 4** Enables you to set when **Lag360** is set. Select the reference (0°)source.

U1, I1, U2, I2, U3, I3

- 5** Enables you to set the number of harmonic orders to be displayed. The values of the frequency, voltage negative-phase unbalance factor (**Uunb**), and current negative-phase unbalance factor (**Iunb**) remain the same as calculated by using the fundamental wave (1st order).

0 to 50

6.7 Verifying the Harmonics Graph and Harmonics Numerical Values

Press the **[MONITOR]** key to display the **MONITOR, Harmonics: graph** screen or **MONITOR, Harmonics: list** screen. You can switch between the harmonics graph and harmonics numerical values by using the **[F2]** key.

MONITOR, Harmonics: graph screen

Measured value of frequency

2017-04-1 09:42:38
1147days

U: 20V f:60Hz

Start: 07 00:00 Time: 0days 9:43:38 Freq: 59.98 Hz

CH1 Level Log iharm ON Order 5

U
5 4.56 V
5.5 0.03 V
THD-F 2.89 %

I
5 5.045 A
5.5 0.026 A
THD-F 54.61 %

P
5 - 0.005k W

Screen List Limits Hold

1 2 3 4 5

Move the cursor Select

*: See calculation method (p. 66).

If 0th order (direct current component) of voltage and current is negative, the bar will turn green.

1 Enables you to set the display channel.

CH1 to CH4	The voltage (U), current (I), and electric power (P) of the selected channels are displayed.
ALL	The bar graphs of all the channels (all phases) are displayed. The orders are displayed up to 30th order.
SUM	Only the active power (P) is displayed.

2 Enables you to set the parameters to be displayed.

Level	RMS voltage, RMS current, and electric power
% of FND	Takes the fundamental wave component as 100% and shows a harmonic of each order in terms of proportion to the fundamental wave component.
Phase	Voltage, current: The phase angle of each harmonic order when the phases of the fundamental wave components of U1 are expressed in terms of 0° Active power: The power factor of each harmonic order is expressed in terms of angle A bar graph is displayed in yellow when the level is greater than 0.01% of the range, and in gray when the level is 0.01% or less of the range.

3 Enables you to set at the time of **Level** display and **% of FND** display. Enables you to set the display method of the axes.

Linear	Linear display
Log	Logarithmic display (low levels also become easily visible.)

4 Enables you to set the display of the interharmonics.

ON, OFF

- 5 Set the number of harmonic order to be displayed.
The Cursor moves to the selected order.

0 to 50

Setting limits for harmonic content percentage of a voltage (MONITOR, Harmonics:limits screen)

Set limits for 2nd to 25th order. When the limit indication is enabled, a limit is displayed on the MONITOR, Harmonics:graph screen (p. 89).

The initial value is specified by the standard EN50160. The limit can be changed to any value.

02:	2.00 %	08:	0.50 %	14:	0.50 %	20:	0.50 %
03:	5.00 %	09:	1.50 %	15:	0.50 %	21:	0.50 %
04:	1.00 %	10:	0.50 %	16:	0.50 %	22:	0.50 %
05:	6.00 %	11:	3.50 %	17:	2.00 %	23:	1.50 %
06:	0.50 %	12:	0.50 %	18:	0.50 %	24:	0.50 %
07:	5.00 %	13:	3.00 %	19:	1.50 %	25:	1.50 %

This function is used to hold the MAX value of each order.
Set whether to display in the harmonics graph screen.

Return Default Maximum Hold

*: See calculation method (p. 66).

- 1 Enables you to set whether limits are displayed on the MONITOR, Harmonics:graph screen (voltage content percentage).
When enabled, limits from 2nd to 25th order are displayed in a red bar graph.

ON, OFF

- 2 Enables you to set whether maximum values are displayed on the MONITOR, Harmonics:graph screen (voltage content percentage).
When enabled, maximum values from 0th to 50th order are displayed in a gray bar graph.
The maximum values are continuously updated from the start to end of the recording.

ON, OFF

- 3 Set limits for 2nd to 25th order.

0.00% to 100.00%

- 4 Enables you to return to the MONITOR, Harmonics:graph screen.

- 5 Enables you to recover the initial value (standard EN50160).

- 6 Enables you to switch the maximum value (10% or 100%) for the vertical axis of the graph.

MONITOR, Harmonics: list screen

Measured value of frequency

2017-04-09 09:48:48
147days

RECORDING
23: 3P 3M 1000V 50A 7/8 U 00V f:60Hz EVB 1

MONITOR Harmonics: list

Start: 07:00:00 Time: 0days 9:47 Freq: 59.98 Hz

Order	Level	iharm	ON	Uthd-F	%			
00:	0.08	0.06	17:	1.19	0.03	34:	0.01	0.01
01:	199.90	0.08	18:	0.01	0.02	35:	0.45	0.02
02:	0.09	0.03	19:	0.90	0.02	36:	0.01	0.01
03:	0.53	0.03	20:	0.02	0.01	37:	0.35	0.01
04:	0.02	0.03	21:	0.02	0.01	38:	0.01	0.01
05:	3.75	0.03	22:	0.02	0.01	39:	0.11	0.01
06:	0.06	0.04	23:	0.88	0.01	40:	0.01	0.01
07:	1.77	0.04	24:	0.01	0.01	41:	0.25	0.01
08:	0.06	0.02	25:	0.73	0.02	42:	0.01	0.01
09:	0.29	0.02	26:	0.02	0.01	43:	0.21	0.01
10:	0.04	0.02	27:	0.08	0.01	44:	0.01	0.01
11:	1.23	0.02	28:	0.02	0.01	45:	0.08	0.01
12:	0.03	0.03	29:	0.65	0.02	46:	0.01	0.01
13:	0.87	0.01	30:	0.01	0.02	47:	0.21	0.02
14:	0.02	0.02	31:	0.54	0.01	48:	0.01	0.01
15:	0.24	0.02	32:	0.02	0.01	49:	0.24	0.01
16:	0.02	0.01	33:	0.12	0.01	50:	0.01	0.01

Screen

Interharmonics

Total harmonic distortion

Example: 41.5th order

Move the cursor

Select

*: See calculation method (p. 66).

- 1** Enables you to set the display parameters.

U	Voltage
I	Current
P	Active power

- 2** Enables you to set the display channel.

CH1 to CH4	The voltage (U), current (I), and active power (P) of the selected channels are displayed.
SUM	Only the active power (P) is displayed.

- 3** Enables you to set the parameters to be displayed.

Level	RMS voltage, RMS current, and active power
% of FND	Takes the fundamental wave component as 100% and shows a harmonic of each order in terms of proportion to the fundamental wave component.
Phase	Voltage, current: The phase angle of each harmonic order when the phases of the fundamental wave components of U1 are expressed in terms of 0° Active power: The power factor of each harmonic order is expressed in terms of angle

- 4** Enables you to set the display of the interharmonics.

ON, OFF

6.8 Zoom of the Measured Value

Press the **[MONITOR]** key to display the **MONITOR, Zoom** screen. Six desired items are zoomed in and displayed.

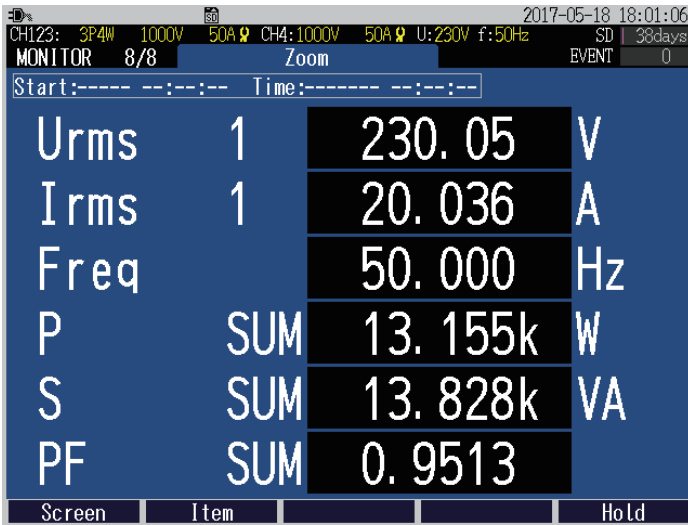

Changing the display item

1

Enable setting change.

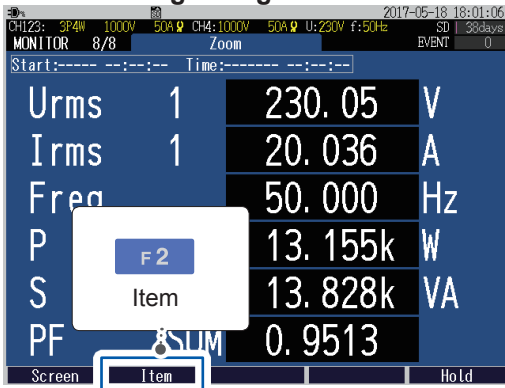

2

Select items to be displayed.

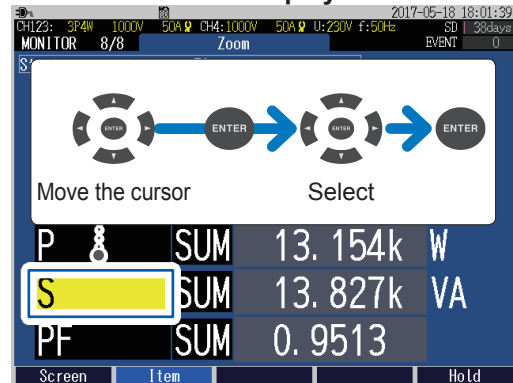

See "8.1 Verifying the Basic Trend"(p. 100),
"8.5 Verifying the Electric Energy"(p. 108)

3

Disable setting change.

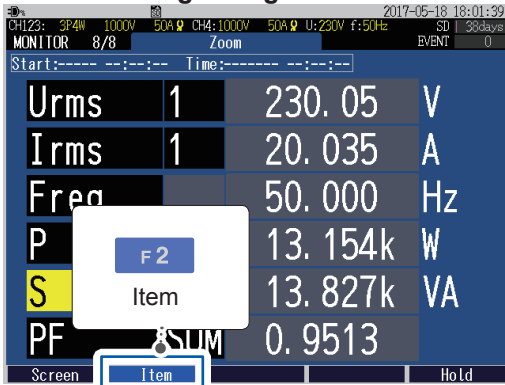

Only the total harmonic distortion (THD) harmonic parameter can be selected. All the other items can't be selected.

7

Recording (Save) (SET UP Screen)

7.1 Start and Stop of the Recording

Press the **[START/STOP]** key to start or stop the recording by the method which is described on the **SET UP, Recording settings** screen (p. 69).

The measurement data is stored to SD memory card. (If no SD memory card is inserted, data will be saved in the instrument's internal memory.)

See "File Saving and Operations (FILE Screen)" (p. 121).

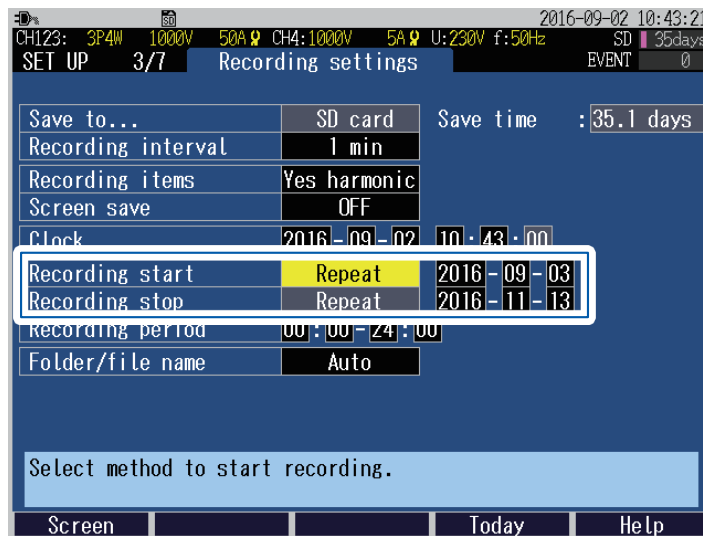

Start and stop the recording manually

Recording start: **Manual**, Recording stop: **Manual**

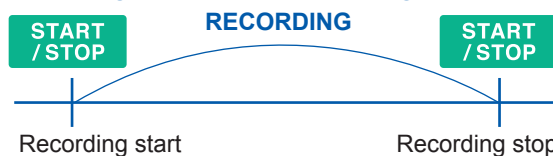

Start and stop recording at the determined time

Recording start: **Time**, Recording stop: **Time**

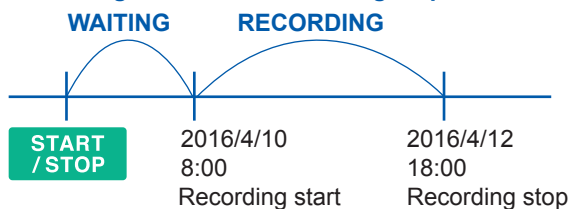

If the set time has already passed when the **[START/STOP]** key is pressed, the recording will be started at an appropriate time punctuation (**Interval**).

Start recording at an appropriate time punctuation

Recording start: Interval

Example: **Recording interval** is set to **10 min**

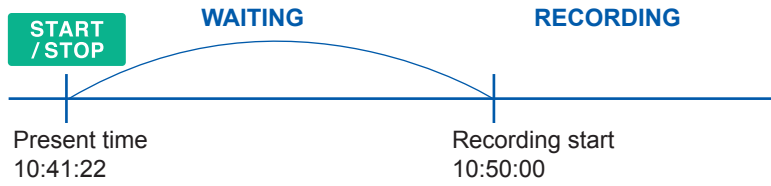

If the recording interval is 30 sec or below, the recording will start at “10:42:00.”

Repeat recording

Recording start: Repeat, **Recording stop:** Repeat, **Recording period:** variable period

Example 1: If the **Recording period** is **00:00 to 24:00** and **Recording interval** is **10 min**.

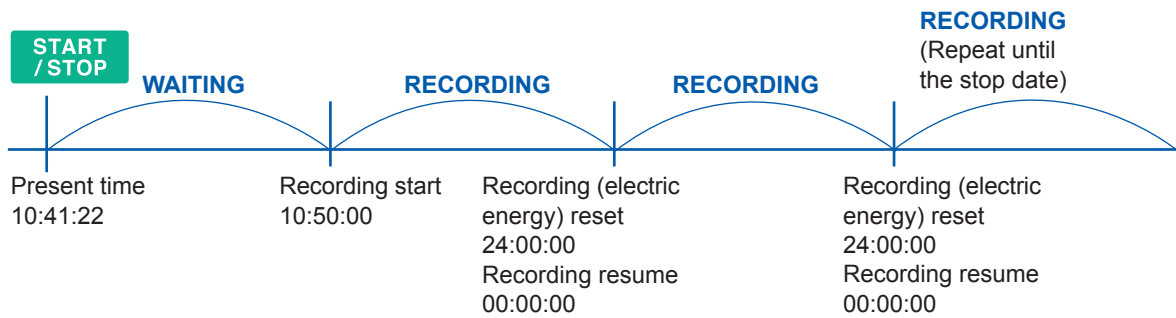

Example 2: If the **Recording period** is **08:00 to 18:00**

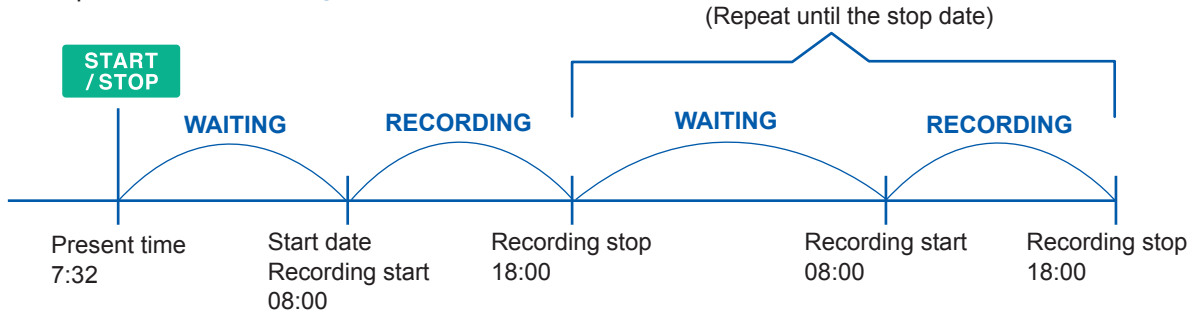

If the set time has already passed when the **[START/STOP]** key is pressed, the recording will start at an appropriate time punctuation (**Interval**).

Status of the recording operation

It can be determined from the background color of the screen and lighting state of the START/STOP LED.

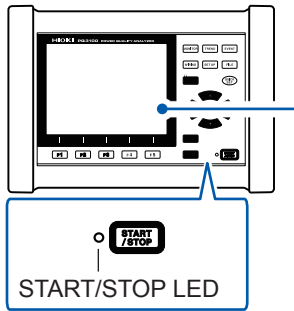

Screen background	Operation status
	<p>Gray (no character): (START/STOP LED: Off)</p> <ul style="list-style-type: none"> Recording is stopped. These settings can be changed.
	<p>Yellow (WAITING): (START/STOP LED: Blinking)</p> <ul style="list-style-type: none"> Recording is in standby. This screen is shown from the time the [START/STOP] key is pressed until the recording actually starts. During repeated recording, this screen is also displayed when recording is stopped. These settings can not be changed.
	<p>Green (RECORDING): (START/STOP LED: On)</p> <ul style="list-style-type: none"> Recording is in progress. These settings can not be changed.

7.2 Using the Instrument During an Interruption

If the supply of power to the instrument is cut off while recording is in progress, measurement operation will stop during the interruption. The setting conditions will be backed up. When the power supply is restored, the recording will reset once and it will be resumed as a new recording.

If the Model Z1003 Battery pack has been installed, the instrument will automatically switch to battery power in the event of an interruption and continue recording.

IMPORTANT

If the supply of power to the instrument is cut off while accessing the SD memory card, files on the card may be corrupted. Since the SD memory card is accessed frequently when recording with a short recording interval time, file corruption is more likely to occur if an interruption occurs during such use.

It is recommended to avoid such influences of interruptions by using the Model Z1003 Battery pack supplied as an accessory.

8

Verifying the Trends (Fluctuations) in Measured Values (TREND Screen)

You can view the measured value fluctuations as a time series graph on the **TREND** screen.

Press the **[TREND]** key to display the **TREND** screen.



In addition to the **[TREND]** key, you can also switch to the **TREND screen** by using the **[F1]** (screen select) key.



The fluctuation data that can be displayed on this instrument is limited. If the times listed in the following tables exceed, the old time series data is rewritten to the new time series data.

Recording items	Yes harmonic	Recording interval × 530
	No harmonic	Recording interval × 10000

Verifying the measured value and time at the cursor position (cursor measurement)

If you press the **[F3] (Cursor)** key, the measured value and time at the position of cursor will also be displayed along with the cursor.

You can move the position of the cursor by using the **◀▶** keys.



- When the recording interval is set to **150 cycle** or **180 cycle**, the time is displayed, followed by a small number on the order of milliseconds.
- The time displayed at the time of cursor measurement is based on the CH1 voltage (U1). The time displayed on the event list and the time displayed at the time of cursor measurement may not match.

Scrolling the graph

If the graph continues out of the borders of the screen, press the **[F4] (scroll)** key to be able to scroll the graph. **▲▼◀▶** Use this key to scroll the graph in every direction.

(If the zoom factor for horizontal axis [time axis] is set to Auto, the horizontal and vertical axes are automatically scaled so that the time series graph is entirely displayed on the screen.)



Event search

1



2

Select an event mark to be checked.

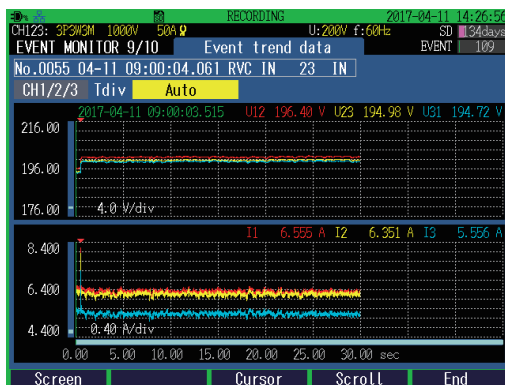
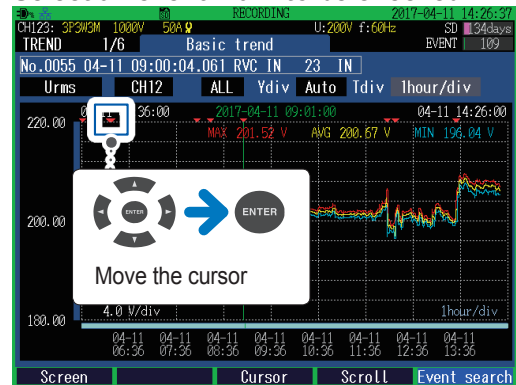

For switching the screen display of the **EVENT MONITOR** screen

Press the **[MONITOR]** key.

For closing the **EVENT MONITOR** screen

Press the **[F5] (End)** key.

The screen switches to the **EVENT MONITOR** screen (p. 116).

The waveform* or graph* at the time of event occurrence is displayed.

*: The screen which displays initially varies according to the event items.

- The recording start event generates when the recording starts and recording stop event generates when the recording stops.

8.1 Verifying the Basic Trend

Press the **[TREND]** key to display the **TREND, Basic trend** screen.

This screen is used to check fluctuation width of maximum, minimum and average values between recording intervals.

(The maximum, minimum, and average values are calculated every 200 ms.)

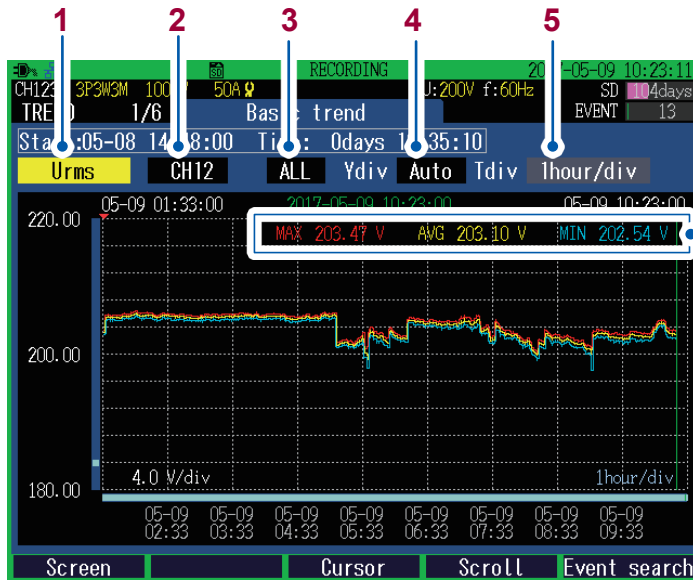

MAX: Maximum value
AVG: Average value
MIN: Minimum value

The latest measured values are displayed when the cursor is disabled, while the measured values at the position of cursor are displayed during the cursor measurement.

(The figure on the left illustrates the screen that is displayed when the cursor is disabled.)

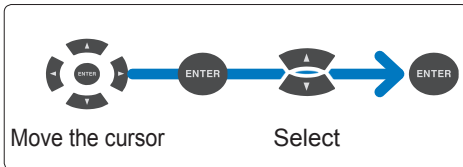

- 1** Enables you to set the display parameters.

Freq	Frequency (200 ms)
Freq10s	Frequency (10 sec)
Urms	RMS voltage (200 ms)
Upk+	Voltage waveform peak (+)
Upk-	Voltage waveform peak (-)
Udc	Voltage DC value
Ucf	Voltage crest factor
Uthd	Voltage total harmonic distortion (calculation method THD-F / THD-R)
Uunb	Voltage negative-phase unbalance factor
Uunb0	Voltage zero-phase unbalance factor
Irms	RMS current (200 ms)
Ipk+	Current waveform peak (+)
Ipk-	Current waveform peak (-)
Idc	Current DC value
Icf	Current crest factor
Ithd	Current total harmonic distortion (calculation method THD-F / THD-R)
Iunb	Current negative-phase unbalance factor
Iunb0	Current zero-phase unbalance factor
P	Active power
S	Apparent power
Q	Reactive power
PF/DPF	Power factor/displacement power factor
KF	K factor

- 2** Enables you to set the display channel.
The channel which can be set differs according to the display items and wiring settings.

- 3** Set the type of graph to be displayed.
The type that can be set differs according to the display items.

MAX	The maximum value during the recording interval is displayed.
AVG	The average value during the recording interval is displayed.
MIN	The minimum value during the recording interval is displayed.
ALL	The maximum, average, and minimum values during the recording interval are displayed.

- 4** Set the zoom factor for the vertical axis of the graph.

Auto, x1, x2, x5, x10, x25, x50

- 5** Set the zoom factor for the horizontal axis (time axis) of the graph.

The horizontal axis (time axis) which can be set, differs according to the recording intervals.

8.2 Verifying the Detail Trend

Press the **[TREND]** key to display the **TREND, Detail Trend** screen.

You can check the fluctuation range of the maximum value and minimum value during the recording intervals.

(The fluctuation range of the maximum and minimum value is calculated per wave or per half wave.)

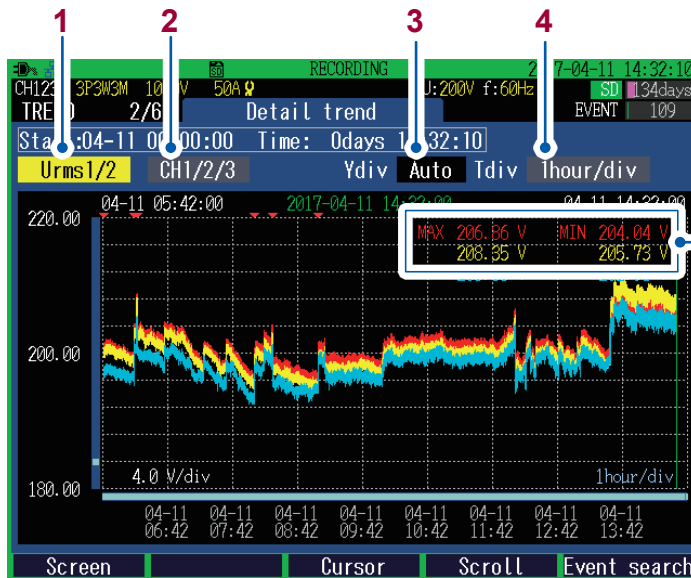

MAX: Maximum value
MIN: Minimum value

The latest measured values are displayed when the cursor is disabled, while the measured values at the position of cursor are displayed during the cursor measurement (The figure on the left illustrates the screen that is displayed when the cursor is disabled).

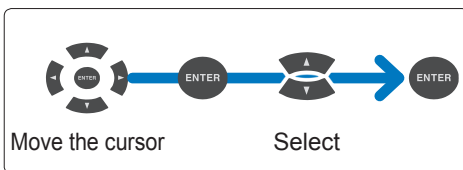

1 Enables you to set the display parameters.

Urms1/2	RMS voltage refreshed each half-cycle	Calculation over a 1-cycle time, refreshed each half-cycle See "RMS voltage refreshed each half-cycle" (p. Appx.11).
Irms1/2	RMS current refreshed each half-cycle	Calculation over a 1-cycle time, refreshed each half-cycle
Inrush	Inrush current	Calculation over each half-cycle time See "Inrush current" (p. Appx.14).
Freq_wav	Frequency (1 wave)	Calculation over each 1-cycle time See "Frequency (1 wave)" (p. Appx.13).
Pinst	Instantaneous flicker	Displayed when the flicker type is selected to Pst,Plt . See "IEC flicker meter" (p. Appx.19)

2 Enables you to set the display channel.
The channel which can be set differs according to the display items and wiring settings.

3 Set the zoom factor for the vertical axis of the graph.

Auto, x1, x2, x5, x10, x25, x50

4 Set the zoom factor for the horizontal axis (time axis) of the graph.
The horizontal axis (time axis) which can be set, differs according to the recording intervals.

8.3 Verifying the Harmonic Trend

Press the **[TREND]** key to display the **TREND, Harmonic trend** screen.

This screen is used to check fluctuation width of maximum, minimum and average values between recording intervals of selected harmonics order.

(The maximum, minimum, and average values are calculated every 200 ms.)

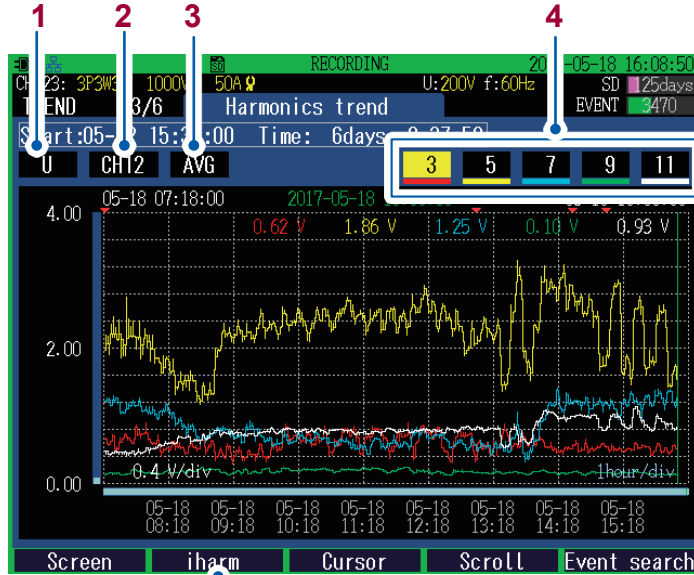

Allows switching between harmonics and interharmonics.

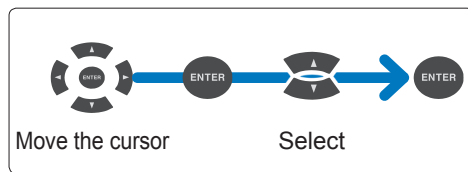

- 1 Enables you to set the display parameters.

U	Voltage
I	Current
P	Active power*
θP	Voltage and current phase difference*

*: Not displayed when interharmonics is selected.

- 2 Set a display channel.
The channel which can be set differs according to the display items and wiring settings.

- 3 Set the type of graph to be displayed.

MAX	The maximum value during the recording interval is displayed.
AVG	The average value during the recording interval is displayed.
MIN	The minimum value during the recording interval is displayed.

- 4 Enables you to set the number of harmonic orders to be displayed.

User-specified	Set any orders from 0th (DC component) to 50th order.
OFF	Not displayed.

8.4 Verifying the Flicker

The display depends on the **Type of Flicker** set on the **SET UP, Measurement settings 2** screen (p. 66).

OFF	No flicker measurement (display)
Pst,Plt	The IEC61000-4-15:2010 standards are applied.
ΔV10	A ΔV10 flicker meter used in Japan is applied.

IEC flicker meter and ΔV10 flicker meter

Flicker meters are used to measure unstable visual feeling caused by fluctuation of brightness and wavelength of light source. There are two types of flicker meter: IEC flicker meter (UIE flicker meter) based on the IEC standards and ΔV10 flicker meter used in Japan. These meters indicate values used to objectively determine flicker by observing the voltage fluctuation.

See “Appx. 6 Detailed Explanation of IEC Flicker and ΔV10 Flicker” (p. Appx.19)

Verifying graphs and lists of IEC flicker (Pst, Plt)

Press the **[TREND]** key to display the **TREND, Flicker:graph** screen or **TREND, Flicker:list** screen. Graph and value can be switched for display with the **[F2]** key.

- Graph or value is displayed when the **Type of Flicker** is set to **Pst,Plt** on the **SET UP, Measurement Settings 2** screen.
- The graph is updated every 10 min. regardless of how the recording interval is configured.
- **Urms1/2** (RMS voltage refreshed each half-cycle), **Irms1/2** (RMS current refreshed each half-cycle), **Freq_wav** (frequency (1 wave)), and **Pinst** (instantaneous flicker value) are always being recorded.
- The first and second measured values immediately after flicker type setting may be larger than the actual values due to the effect of High-pass filter used in the instrument. It is recommended to start recording approx. 5 min. after the flicker type setting.

TREND,Flicker:graph screen

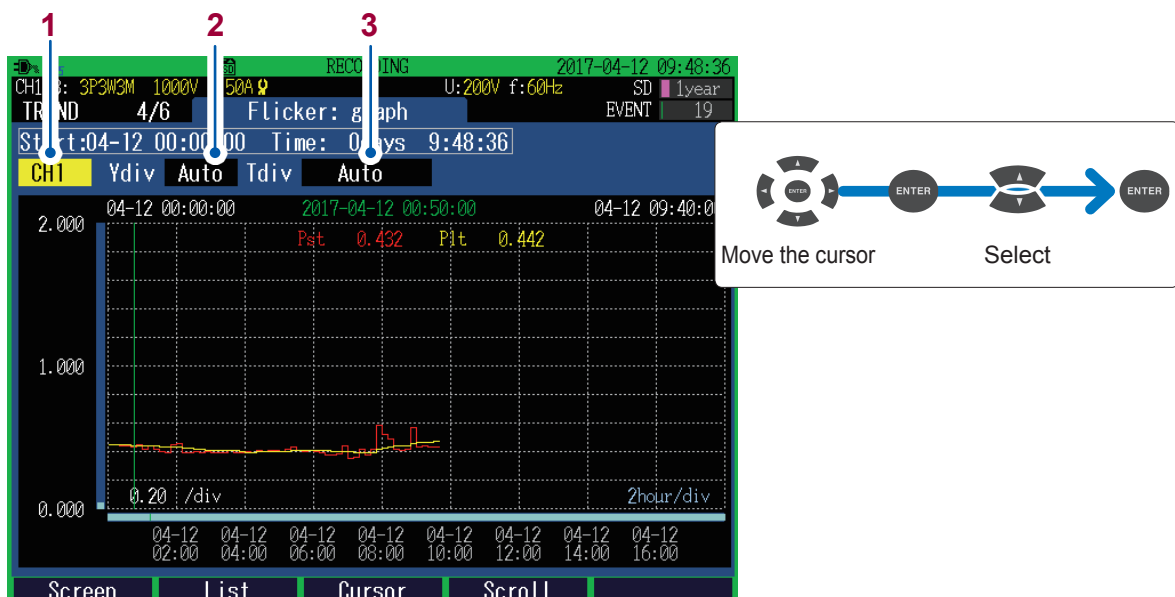

- 1 Set a display channel.
The channel which can be set differs according to the wiring settings.

- 2 Set the zoom factor for the vertical axis of the graph.

Auto, **x1**, **x2**, **x5**, **x10**, **x25**, **x50**

- 3 Set the zoom factor for the horizontal axis (time axis) of the graph.

Auto, **10min/div**, **30min/div**, **1hour/div**, **2hour/div**, **6hour/div**, **12hour/div**, **1day/div**

TREND, Flicker:List screen

CH1	No.	Date	Time	Pst	Plt
	47	04-12	07:50:00	0.418	0.393
	48	04-12	08:00:00	0.582	0.415
	49	04-12	08:10:00	0.522	0.428
	50	04-12	08:20:00	0.485	0.436
	51	04-12	08:30:00	0.417	0.438
	52	04-12	08:40:00	0.412	0.441
	53	04-12	08:50:00	0.416	0.443
	54	04-12	09:00:00	0.565	0.456
	55	04-12	09:10:00	0.435	0.461
	56	04-12	09:20:00	0.440	0.466
	57	04-12	09:30:00	0.434	0.467
	58	04-12	09:40:00	0.431	0.470
	59	04-12	09:50:00	0.429	0.471

Screen | Graph | **Channel** | | |

1

- 1 Set a display channel.
The channel which can be set differs according to the wiring settings.

- The EN50160 “Voltage characteristics of electricity supplied by public distribution systems” gives a limit as “Plt≤1 for 95% of period within a week”.
- Verify the Plt supporting the standard every 2 hours after 2 hours or more has lapsed from the start of measurement.

Verifying ΔV_{10} flicker graphs and lists

Press the **[TREND]** key to display the **TREND, Flicker: graph** screen or **TREND, Flicker: list** screen. Graph and value can be switched for display with the **[F2]** key.

- Graph or value is displayed when the **Type** of **Flicker** is set to **ΔV_{10}** on the **SET UP, Measurement Settings 2** screen.
- The graph is updated every 1 min. regardless of how the recording interval is configured.
- Three voltage U1, U2, and U3 channels are measured at the same time for ΔV_{10} flicker. (Depending on the wiring)
- The first and second measured values immediately after flicker type setting may be larger than the actual values due to the effect of high-pass filter used in the instrument. It is recommended to start recording approx. 5 min. after the flicker type setting.

Reference voltage for ΔV_{10} flicker

- During ΔV_{10} flicker measurements, the reference voltage is automatically set with AGC (Automatic Gain Control).
- When fluctuating voltage is stable, the reference voltage is automatically changed to the stable voltage. Thus, whereas ΔV_{10} flicker meters require taps to be changed, such is not required for the instrument.

Example: Fluctuating voltage: Stable at 96 V rms → Reference voltage: Automatically changed to 96 V rms.

TREND, Flicker: graph screen

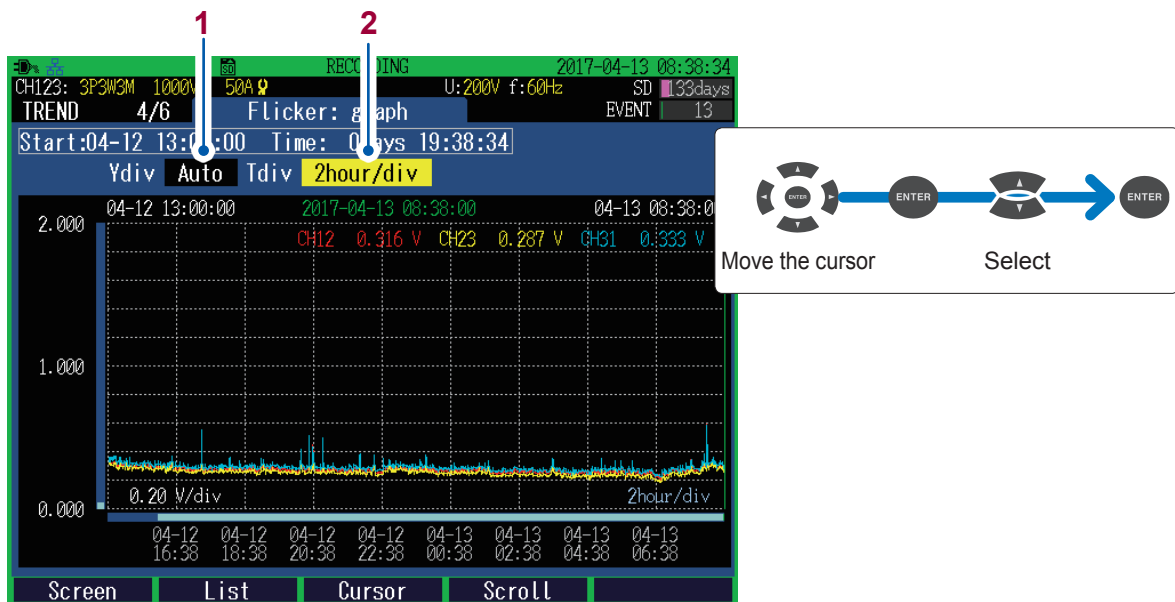

- 1 Set the zoom factor for the vertical axis of the graph.

Auto, x1, x2, x5, x10, x25, x50

- 2 Set the zoom factor for the horizontal axis (time axis) of the graph.

Auto, 1min/div, 2min/div, 5min/div, 10min/div, 30min/div, 1hour/div, 2hour/div, 6hour/div, 12hour/div, 1day/div

TREND, Flicker:list screen



- 1 Set a display channel.
The channel which can be set differs according to the wiring settings.
- 2 Δ V10 flicker statistics for every 1 hour is listed with the date and time.
- 3 The maximum Δ V10 flicker during the measurement period is displayed. One Δ V10 value is updated for every 1 min.

The Δ V10 flicker limits used in Japan are 0.32 V for the average value (average hourly value), and 0.45 V for the maximum value (maximum hourly value, 4th maximum hourly value, or total maximum value).

8.5 Verifying the Electric Energy

Press the **[TREND]** key to display the **TREND, Electric energy** screen.
 This screen is used to check electric energy trends for each recording interval.

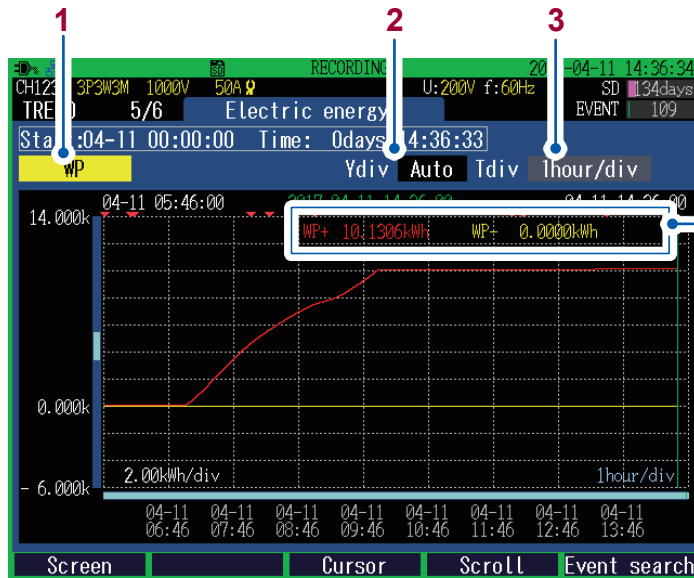

When the cursor is disabled, the latest measured value is displayed; when the cursor is being measured, measuring time and measured value of the cursor position are displayed.

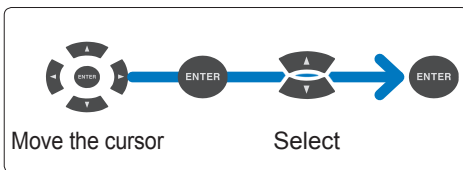

- 1 Enables you to set the display parameters.

WP	Active electric energy (WP+ : consumption, WP- : regeneration)
WQ	Reactive electric energy (LAG , LEAD)
WS	Apparent electric energy
Ecost	Energy Cost

- 2 Set the zoom factor for the vertical axis of the graph.

Auto, ×1, ×2, ×5, ×10, ×25, ×50

- 3 Set the zoom factor for the horizontal axis (time axis) of the graph.
 The horizontal axis (time axis) which can be set, differs according to the recording intervals.

8.6 Verifying the Demand

Press the [TREND] key to display the **TREND, Demand** screen.
 This screen is used to check demand trends for each recording interval.
 And the screen allows up to 108 data points to be checked at a time.

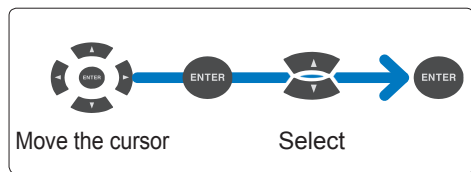
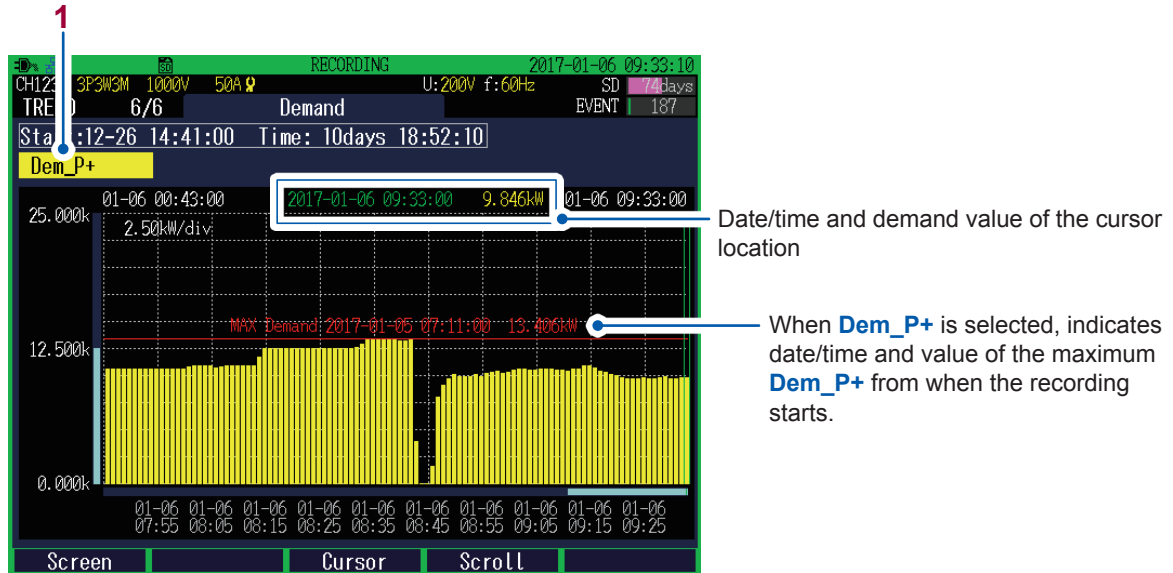

1 Enables you to set the display parameters.

Dem_P+	Active power demand value (Consumption)
Dem_P-	Active power demand value (Regeneration)
Dem_Q_LAG	Reactive power demand value (Lag)
Dem_Q_LEAD	Reactive power demand value (Lead)
Dem_S	Apparent power demand value
Dem_PF	Power factor demand value

Checking Events (EVENT Screen)

On the **EVENT** screen, you can check the list of events occurred and event statistics process. The **EVENT MONITOR** screen can be used to check the status at the time of event occurrence.

For more information on events, see “Appx. 3 Explanation of Power Quality Parameters and Events” (p. Appx.4).

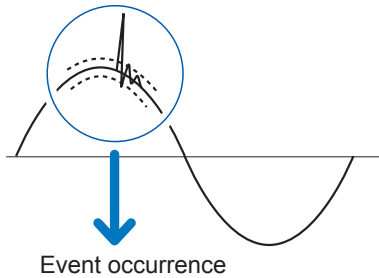

Each time an event occurs, the event is added to the **Event list** screen.

- When making measurements using events, ensure that event settings has been enabled by using the **Event Setting** screen in **SET UP** mode.
- Up to 9999 events can be displayed. Depending on the repeated recording setting, events for up to 9999 × days (up to one year) can be recorded.

Save items (event waveform, event trend data) change depending on the event items.

- Event waveform** ▶ Approx. 200 ms waveform data
(Data sampled at 200 kS/s reduced to 12.5 kS/s)
- Transient waveform** ▶ Approx. 3 ms waveform data
(Data sampled at 200 kS/s)
- Event trend data** ▶ RMS (one or half wave) data, 0.5 s before an event and 29.5 s after an event

Event parameter	Screen display	IN/OUT	Measurement Items	Saved data	
				Event waveform	Event trend data
Transient voltage	Tran	IN/OUT	All instantaneous values • Frequency • Voltage • Current • Power • Power factor • Unbalance factor • Harmonic voltage • Harmonic current • Harmonic power • Voltage total harmonic distortion • Current total harmonic distortion	✓*1	—
Swell	Swell	IN/OUT		✓	✓*2 • RMS voltage refreshed each half-cycle (One wave calculation per half wave)
Dip	Dip	IN/OUT		✓	
RVC	RVC	IN/OUT/ DISCARD *3		✓	• RMS current refreshed each half-cycle (One wave calculation per half wave)
Interruption	Intrpt	IN/OUT		✓	
Frequency (200 ms)	Freq	IN/OUT		✓	—
Frequency (1 wave)	Freq_wav	IN/OUT		✓	—
Voltage total harmonic distortion	Uthd	IN/OUT		✓	—
Inrush current	Inrush	IN/OUT		✓	✓*2 • RMS voltage refreshed each half-cycle (One wave calculation per half wave) • RMS inrush current (Half wave calculation)
Current total harmonic distortion	lthd	IN/OUT		✓	—
Timer event	Timer	—	✓	—	
External event	Ext	—	✓	—	
Manual event	Manu	—	✓	—	
Pre-event recording	Before	—	✓	—	
Post-event recording	After	—	✓	—	
Recording start	Start	—	✓	—	
Recording stop	Stop	—	✓	—	

✓: Saved, -: Not saved

*1: Transient waveforms are also saved.

*2: Saved only for event IN. If a number of event IN occur continuously, no event trend data may be present.

*3: If swell event or dip event occurs after RVC event IN or before RVC event OUT, the RVC event is discarded and becomes swell event or dip event.

9.1 Checking Event List

Press the [EVENT] key to display **EVENT**, **Event list** screen.

Events can be checked on the list. The events are sorted in the order of occurrence.

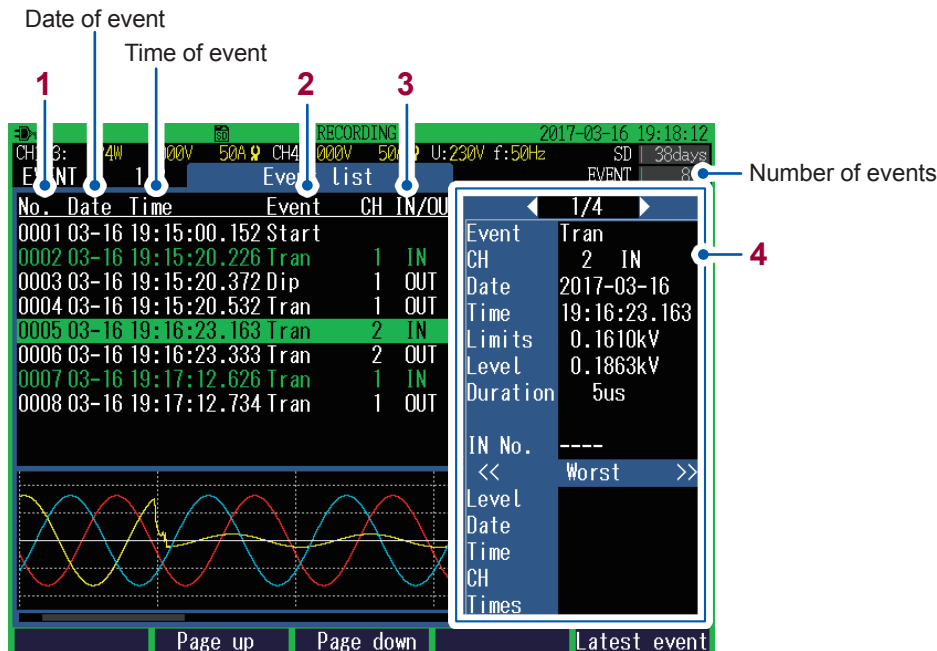

- 1** Event No.
- Number of listed events is all events from No. 1 through No. 9999.
 - The first event to occur (the starting recording event) is assigned No. 1, and subsequent events are assigned numbers in order as they occur.

- 2** Event item
See “Appx. 2 Event Item” (p. Appx.3).

- 3** **IN** Event occurrence
- OUT** Event end

- 4** Event list details (Details of the selected event numbers are displayed)

Event Event item

Event CH **CH** Event channel (**CH1/CH2/CH3/CH4**)

IN Event occurrence

OUT Event end

DISCARD Displayed when the RVC event was discarded upon occurrence of swell event or dip event after RVC event IN.

UP For frequency events, the list indicates up (when the reading is greater than the threshold value).

DOWN For frequency events, the list indicates down (when the reading is less than the threshold value).

Date Date of event

4	Time	Time of event
	Threshold	Threshold value with event (measured value)
	Measured value	Measured value when an event was detected If a transient voltage event occurred, the transient width is also displayed.
	Duration	Indicates the period after which the reading returned after the threshold value was exceeded, or the period from IN to OUT.
	IN No.	Event No. of IN for Event OUT
	Worst*	Level Worst measured value during event period
		Date Indicates the date on which the worst value was detected.
		Time Indicates the time at which the worst value was detected.
		CH Channel on which the worst value was detected (CH1/CH2/CH3/CH4)
		Times Number of transient voltage detected from the transient voltage event IN to the transient voltage event OUT (up to 999999 Times)

*: Indicates the worst measured value during event period. For example in the case of voltage drop due to DIP, the lowest voltage is the worst value.

- An SD card is required to be inserted to display the Event list details.
- Event data with characters colored in green include event trend data. (p. 117)
- When events with multiple differing parameters occur during the same approximately 200 ms period, they are displayed together as a single event. A list of the multiple parameters is displayed in the "Event list details" at the right.
- When two event IN items occur simultaneously, they will be displayed according to the priority. Two event OUT items occurring simultaneously are treated in the same manner.

Checking event details

1 Select an event No.

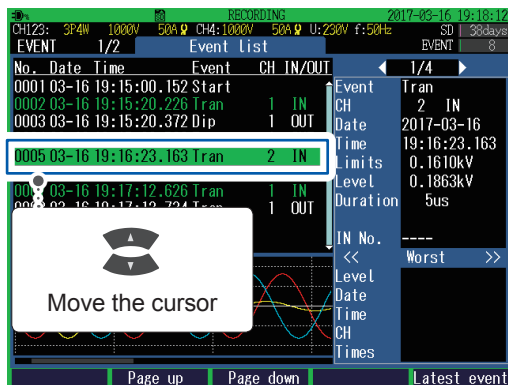

[F2] (Page up) key, [F3] (Page down) key:
Cursor position can be changed for each page.
[F5] (Latest Event) key:
You can move the cursor to the latest event.

2 When more than one event has occurred simultaneously, change the event item to check the event list details.

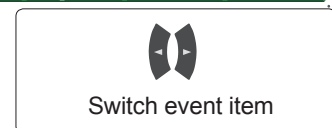
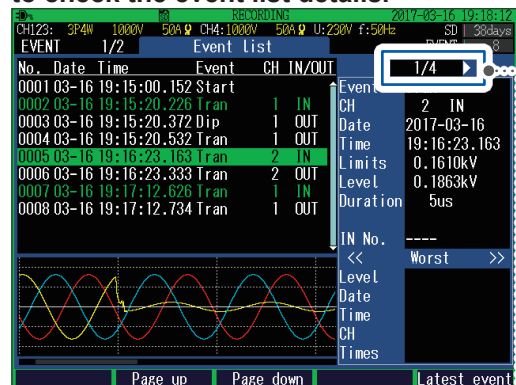

An SD card is required to be inserted to refresh the displayed details

9.2 Checking Event Status

Use the following procedure to display the **EVENT MONITOR** screen. Waveforms and measured values of the event can be checked.

1 Press the **[EVENT]** key to display **EVENT, Event list** screen.

2 Select an event No. to be analyzed.

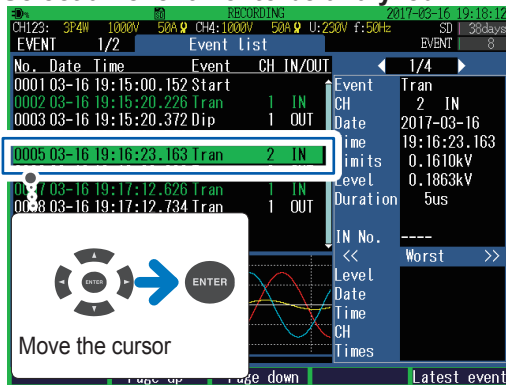

The display will switch to the **EVENT MONITOR** screen to show waveforms and a graph when the event occurred.

The screen displayed initially depends on the event items.

3 Use the **[MONITOR]** key to switch the screen.

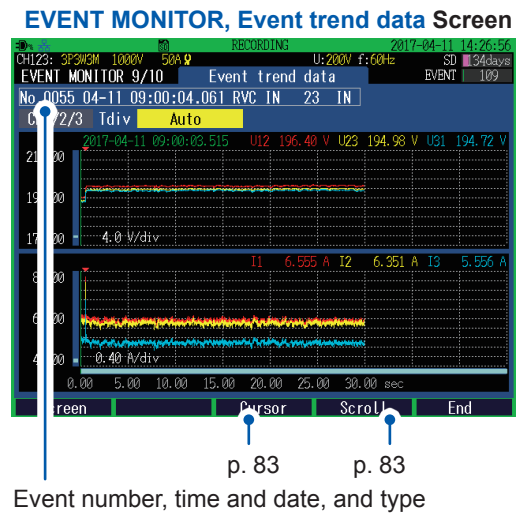

To exit the EVENT MONITOR screen:

Press the **[F5] (End)** key.

The value less than 1 ms of the time shown in the event list is discarded. The value less than 1 ms used for cursor time (waveforms) is rounded off, possibly leading to the difference of 1 ms between the event list time and cursor time.

Switching event monitor screen

When event monitor is displayed, [EVENT] and [MONITOR] keys are lit.

Display/switch screen: [MONITOR] key

Event trend data screen (p. 117)

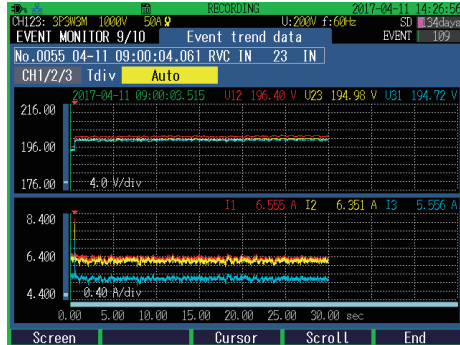

Event trend data is shown in a time series graph.

(Displayed only for swell, dip, interruption, RVC, or inrush current event IN.)



Zoom screen (p. 92)*

Enlarged view of 6 user-selected items are available.

Transient waveform screen (p. 118)

Transient waveforms are displayed. (Displayed only when a transient voltage event has occurred.)



Waveform screen (p. 82)*

Voltage and current waveforms of CH1 through CH4 are displayed.



Electric power screen (p. 84)*

RMS voltage, RMS current, frequency, power, power factor, active energy (consumption) and elapsed time are displayed.



Electric energy screen (p. 85)*

Electric energy, energy cost, start time, stop time, elapsed time, power and power factor are displayed.



Voltage screen (p. 86)*

Measured values related to voltage are displayed.



Current screen (p. 87)*

Measured values related to current are displayed.



Vector screen (p. 88)*

Phase relationship between voltage and current is displayed in a vector diagram.



Harmonics screen (p. 89)*

Harmonic voltage, harmonic current, and harmonic power from 0 to 50th order are displayed.

*: Data for every 200 ms on an event is displayed.

Checking trend data on event

Event trend data of swell, dip, interruption, RVC, and inrush current event for 30 s (0.5 s before event IN, 29.5 s after Event IN) is displayed in a time series graph.

How to display the **EVENT MONITOR** screen: p. 115

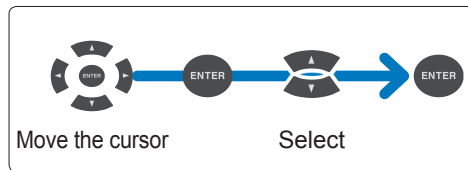
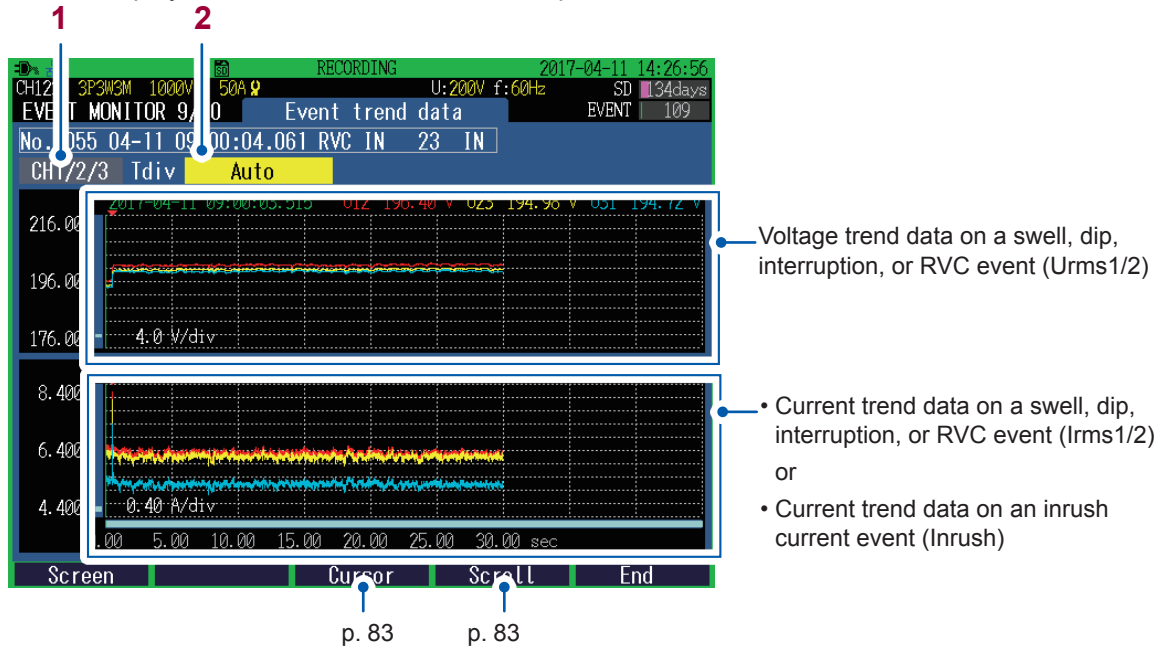

- Enables you to set the display channel.
CH1/2/3 (depending on the wiring settings), **CH4** (when the wiring settings are enabled)
- Set a horizontal axis zoom factor for the graph.
Auto, 0.10sec/div, 0.25sec/div, 0.50sec/div, 1.00sec/div, 2.50sec/div, 5.00sec/div

- Event trend data is displayed only for swell, dip, interruption, RVC, or inrush current event IN.
- Even if another event occurred during event trend data recording (30 s), the event trend data for the event will not be saved.

Checking transient waveforms during an event

Waveform (for 3 ms) at the time of a transient voltage (**Tran**) event occurrence is displayed.

How to display the EVENT MONITOR screen: p. 115

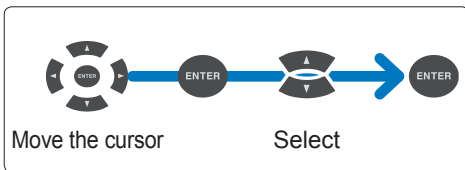
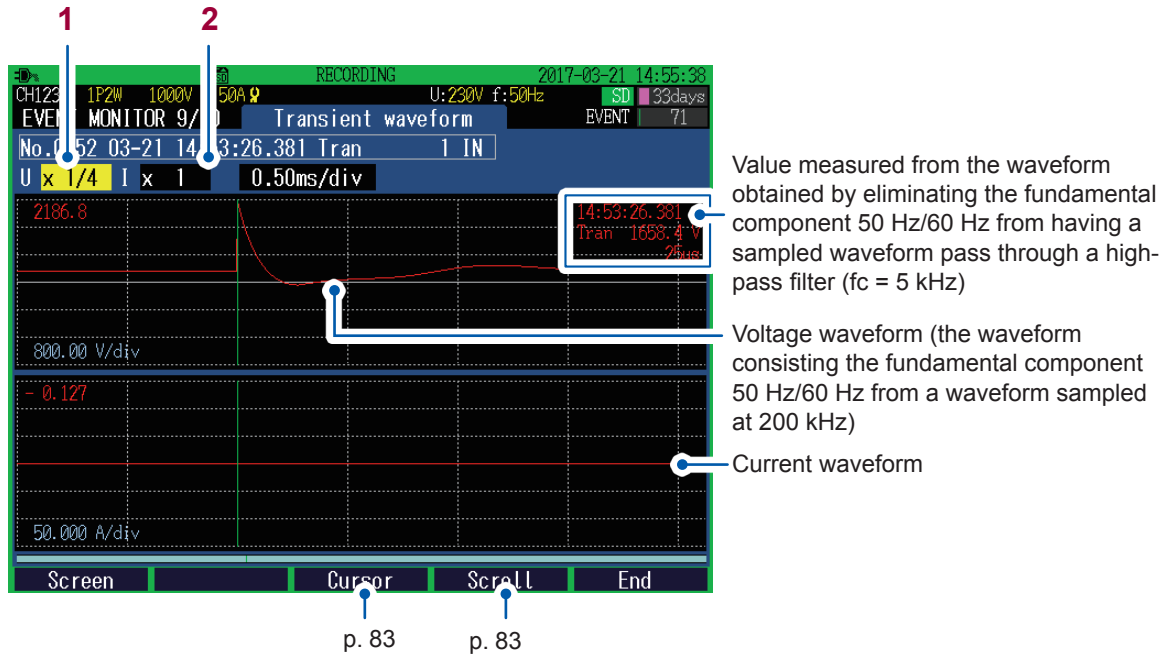

- 1 Set the zoom factor for the vertical axis of the waveform (U: voltage, I: current).

$\times 1/4$, $\times 1/2$, $\times 1$, $\times 2$, $\times 5$, $\times 10$, $\times 20$, $\times 50$

- 2 Set the zoom factor for the horizontal axis (time axis) of the waveform.

0.10ms/div, 0.25ms/div, 0.50ms/div

- Transient waveforms are only displayed for transient voltage events.
- The transient waveform displays data sampled at 200 kS/s. Since event waveforms display data reduced to 12.5 kS/s, the effect from a transient waveform may not be reflected to the event waveforms.

9.3 Checking Event Statistics Data

Press the [EVENT] key to display the **EVENT**, **Event statistics** screen. This screen is used to check the number of occurrences per event item.

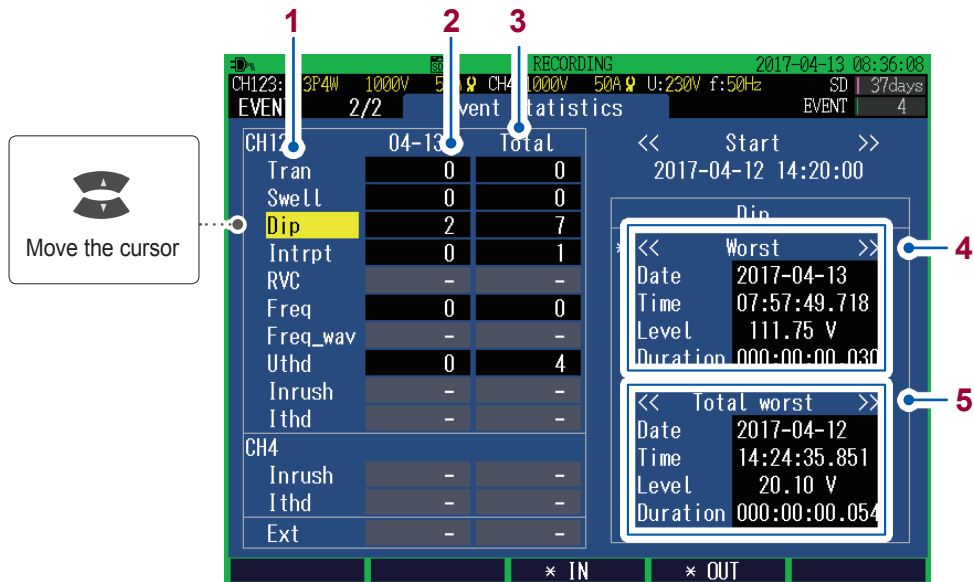

- 1** Event item
See "Appx. 2 Event Item" (p. Appx.3)

- 2** Number of events occurred per event item

- 3** Total number of events occurred from the start of repeat recording
(Only when **Recording start** setting is configured to **Repeat** (p. 70).)

- 4** Worst value for the event parameter at the cursor position

- 5** Worst value of the day from the start of repeated recording to present for the event parameter at the cursor position
(Only when **Recording start** is configured to **Repeat** (p. 70).)

CH4 transients are included in the statistics for CH123.

9.4 Checking the Event IN/OUT Status of the Worst Value

Use the following procedure to check the event IN or event OUT status of the worst value for the event item selected on the **Event**, **Event statistics** screen.

1 Press the **[EVENT]** key to display the **EVENT**, **Event statistics** screen.

2 Select an event parameter and press the **[F3] (*IN)** key or **[F4] (*OUT)** key.

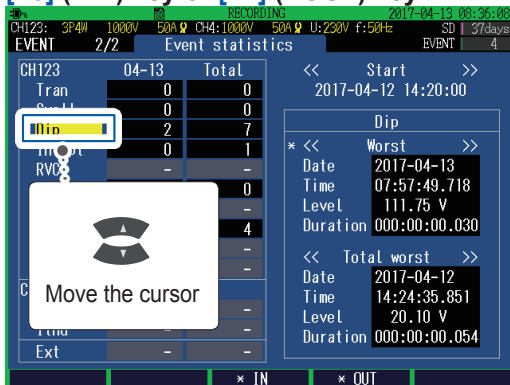

EVENT, **Event list** screen

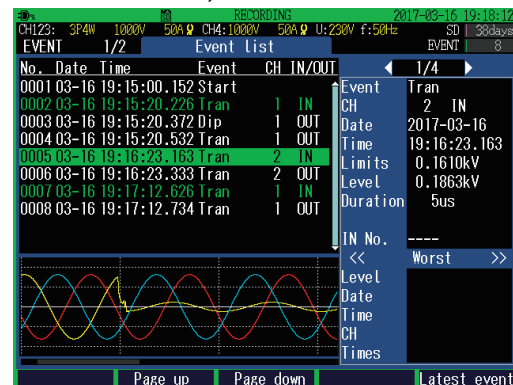

The screen switches to the **EVENT**, **Event list** screen (See. p. 115).

- During repeated recording, the status of event IN/OUT for that day's worst value can be checked. The status of event IN/OUT for that day's worst value from the start of repeated recording cannot be checked.
- The instrument will not switch to the **Event List** screen if there is no corresponding event data on the SD memory card, as described below:
 - The instrument was unable to save data because the SD memory card was full.
 - The SD memory card was changed.

File Saving and Operations (FILE Screen)

The instrument can save the following data on an SD memory card or in its internal memory.

File contents	Extension	Format	SD memory card	Internal memory
Screen copy data	BMP	Binary	✓	–
Setting data	SET	Binary	✓	✓
Trend record data	ITV	Binary	✓	✓
Flicker record data	FLC	Binary	✓	–
Event list	EVL	Binary	✓	–
Event data	EVT	Binary	✓	–
Event trend data	WDU	Binary	✓	–
Event statistics data*	CNT	Binary	✓	–

✓: Saved, –: Not saved

*: Saved when recording stops.

10.1 Viewing and Using FILE Mode Screen

Press the **[FILE]** key to display the **FILE** screen.

FILE, SD card screen



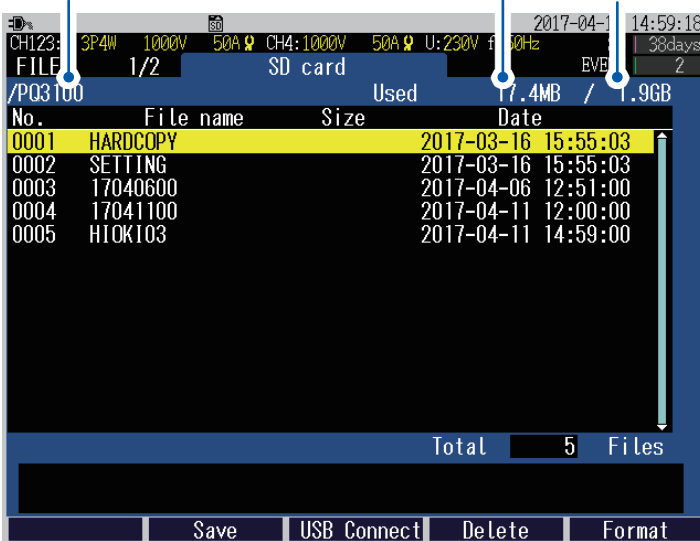





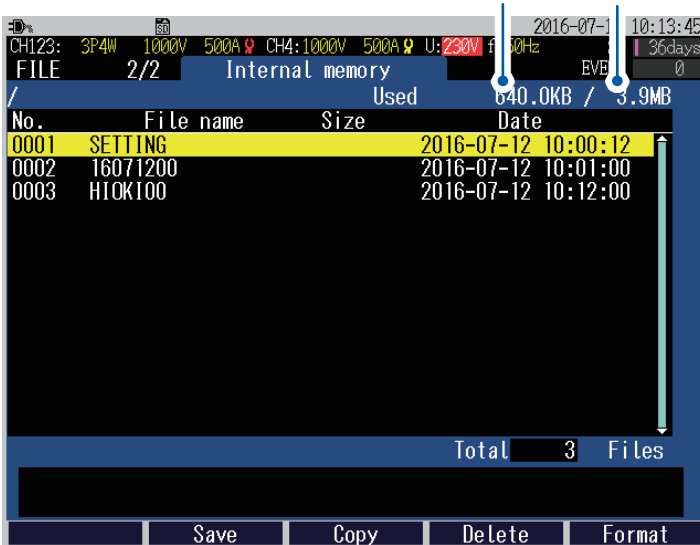

Folder hierarchy Occupied memory size SD memory card size



FILE, Internal memory screen

Occupied memory size Internal memory size



Keys	Description
	Navigates within the folder hierarchy.
	Selects folders and files.
	Navigates to lower hierarchy when a folder is selected.
 (Load)	Loads setting data (p. 129). Loads measured data (p. 130).
 (Remove SD)	Enables the state which allows the removal of the SD memory card during recording (p. 133).
 (Save)	Saves setting data (p. 128).
 (USB Connect)	FILE, SD card screen The USB cable is used to connect the instrument with a computer (mass storage connection) and copy data from an SD memory card to the computer (p. 137).
 (Copy)	FILE, Internal memory screen Copies data selected from the internal memory to the SD memory card (p. 131).
 (Delete)	Deletes selected folders/files (p. 131).
 (Format)	Formats the SD memory card or the internal memory (p. 132).

10.2 Folder and File Structure

SD memory card

The **PQ3100** base folder is required for the instrument to save data on the SD memory card. If the **PQ3100** base folder does not exist on the SD memory card, it will be created automatically when a file is created.

SD memory card
root

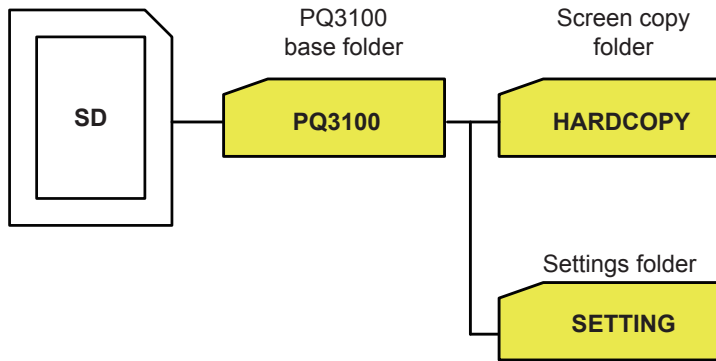

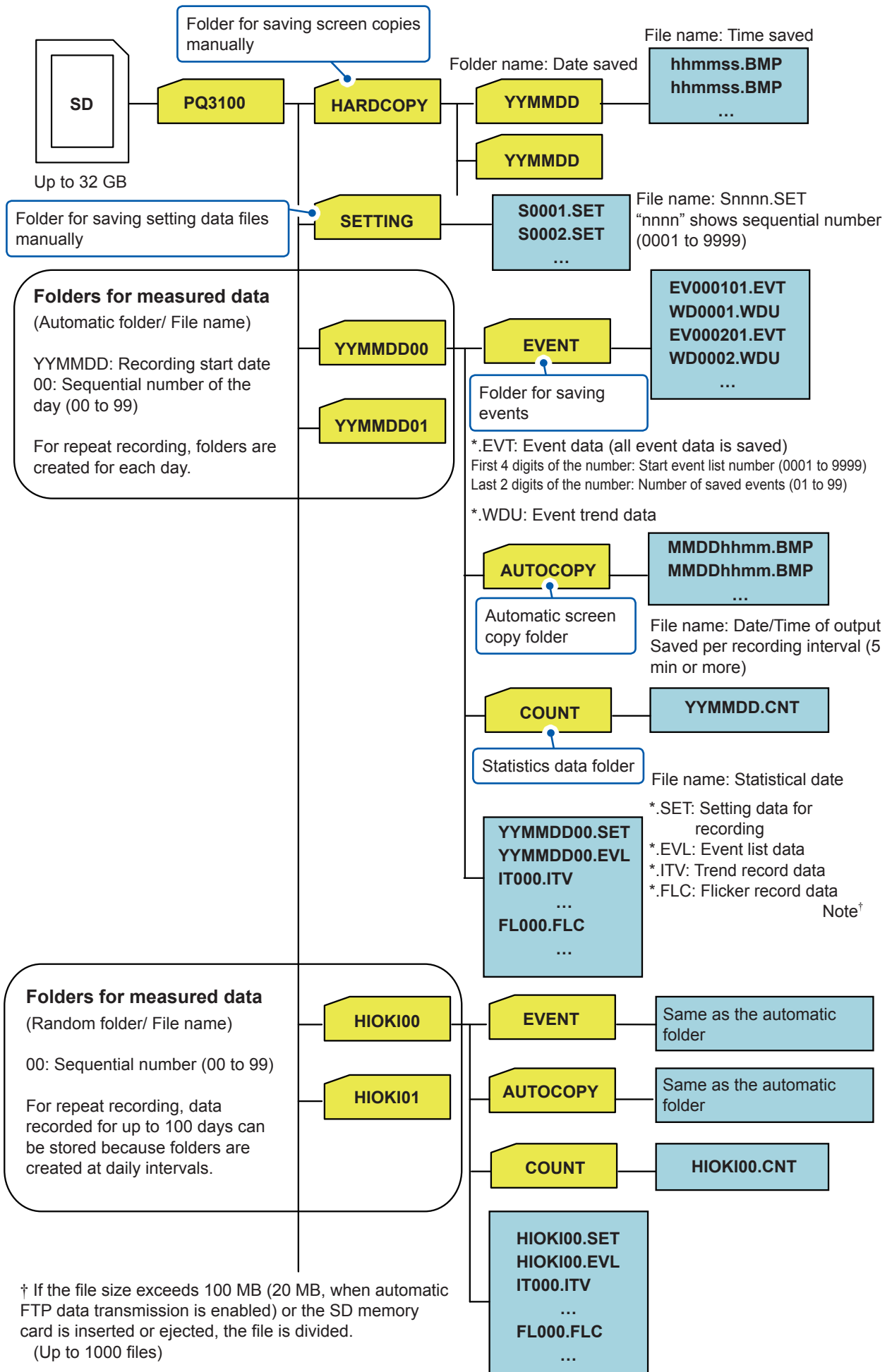

† If the file size exceeds 100 MB (20 MB, when automatic FTP data transmission is enabled) or the SD memory card is inserted or ejected, the file is divided.
(Up to 1000 files)

Internal memory

If no SD memory card is inserted or if there is no free space in the SD memory card, data will be stored in the instrument's internal memory. Only the setting data and the trend record data are stored in the internal memory.

Event data and screen hard copies can be stored in only an SD memory card. After the recording is terminated, if an SD memory card is inserted before the instrument is turned on or a new recording starts, the data stored in the internal memory will be moved to the SD memory card.

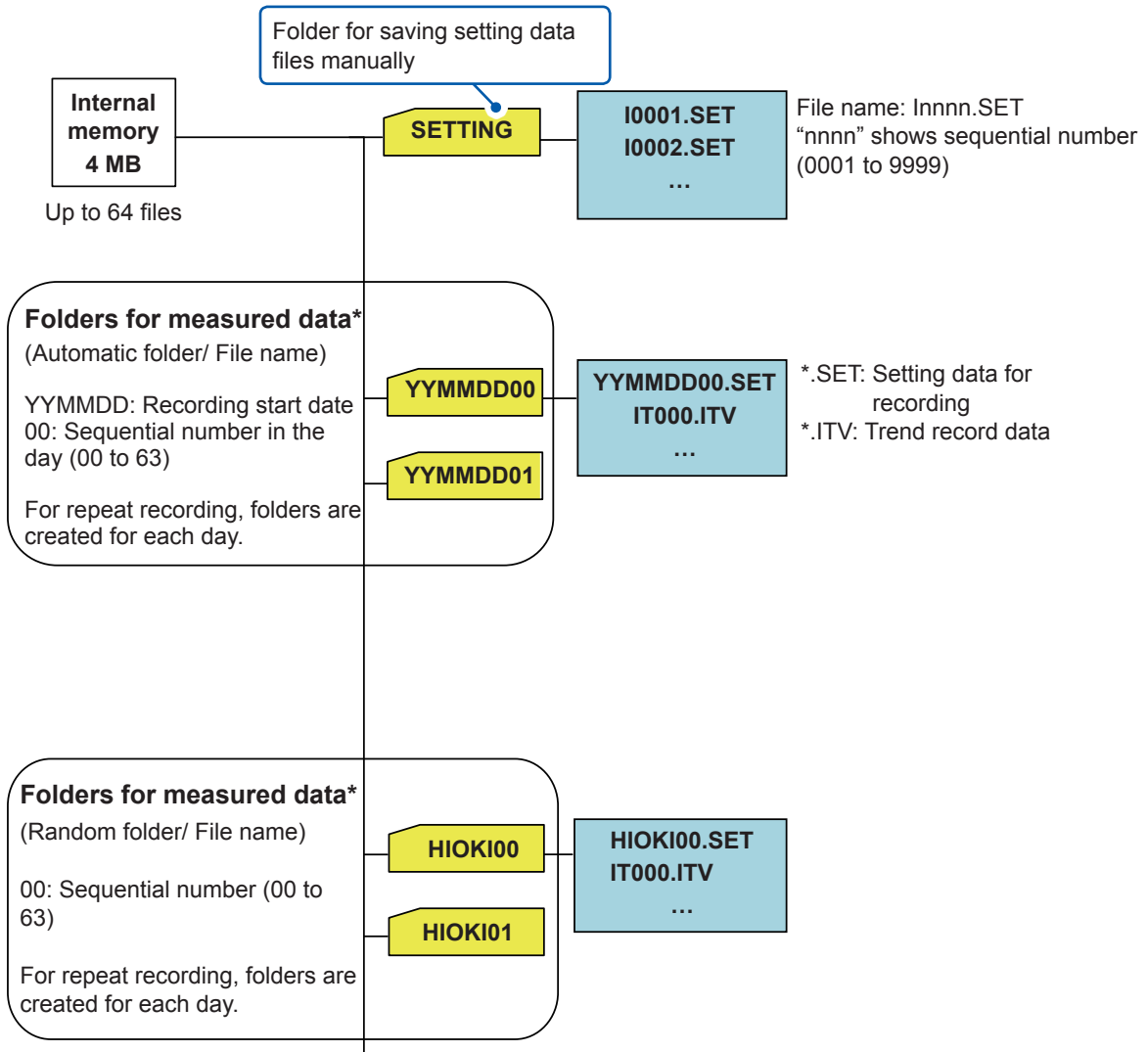

*: When 64 files are created, no further recording is available.

10.3 Screen Hard Copy

The screen currently being displayed can be saved in BMP format on the SD memory card.

- 1** Verify that an SD memory card has been inserted into the instrument ( appears on the screen).
- 2** Display the screen you wish to save.
- 3** Press the **[COPY]** key. Screen copy data is saved in the **/PQ3100/HARDCOPY** folder of the SD memory card.

If no SD memory card has been inserted, screen copy data cannot be saved.

Checking images

Screen copy data will be saved to the SD memory card.

- 1** Verify that an SD memory card has been inserted into the instrument ( appears on the screen).
- 2** Press the **[FILE]** key to display the **FILE, SD card** screen.

- 3** Move to one of the following.

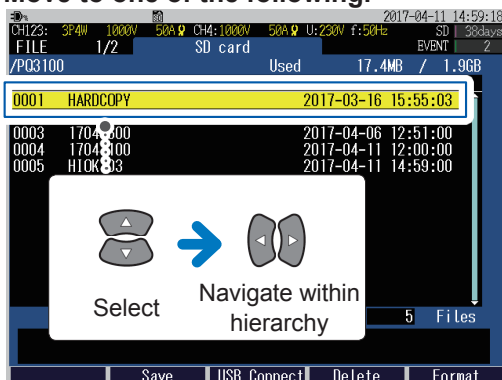

- **HARDCOPY** folder
- **AUTOCOPY** folder under the measurement data folder

- 4** Select screen copy data (.BMP).

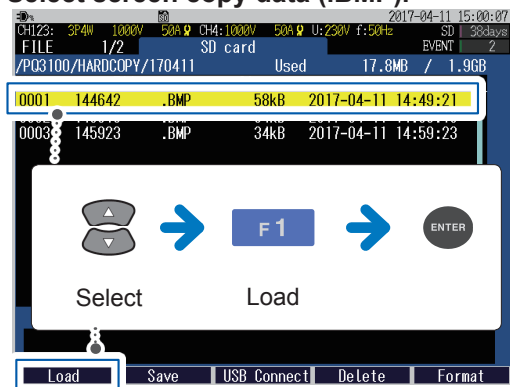

The image is displayed.
Pressing the **[ESC]** key will close the image.

10.4 Saving Setting Files

Present setting state can be saved.

Either SD memory card or internal memory can be used to save the setting files.

- 1 Verify that an SD memory card has been inserted before saving data to it. (SD icon appears on the screen)

- 2 Press the **[FILE]** key to display the **FILE, SD card** screen or **FILE, Internal memory** screen.

- 3 Save the setting file.

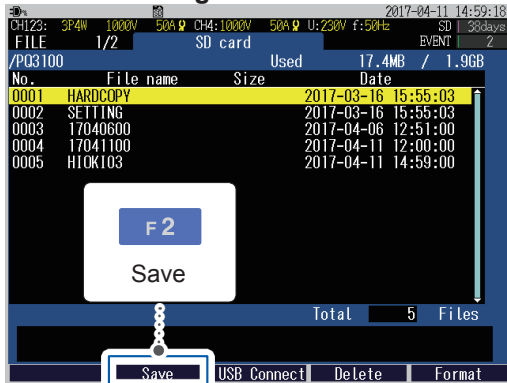

Sample screen: **FILE, SD card** screen

The setting file will be saved.

Save to folder

On the **FILE, SD card** screen:
/PQ3100/SETTING

On the **FILE, Internal memory** screen:
/SETTING

10.5 Loading Setting Files

Loading a setting file allows you to restore the instrument to the state when the settings were saved.

Settings related to LAN cannot be loaded.

- 1 Verify that an SD memory card has been inserted before loading data from it. (SD appears on the screen)
- 2 Press the [FILE] key to display the FILE, SD card screen or FILE, Internal memory screen.

- 3 Navigate to a folder.

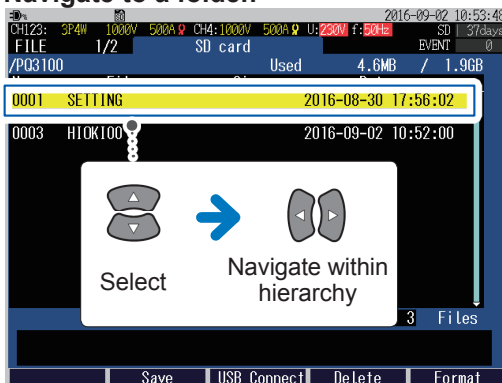

SD memory card:
/PQ3100/SETTING

Internal memory:
/SETTING

The measured data save folder also has the setting file used during the measurement.

- 4 Select a settings file (.SET) to load.

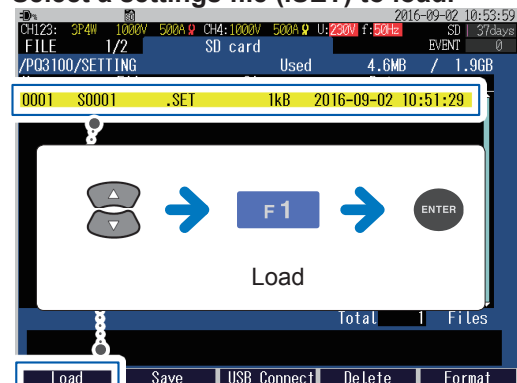

The setting file will be loaded to the instrument.

10.6 Loading Measured Data

The measured data in the SD memory card and internal memory can be loaded to the instrument to check the measured values.

- 1 Verify that an SD memory card has been inserted before loading data from it. (SD appears on the screen)

- 2 Press the **[FILE]** key to display the **FILE, SD card** screen or **FILE, Internal memory** screen.

- 3 Select a folder to load.

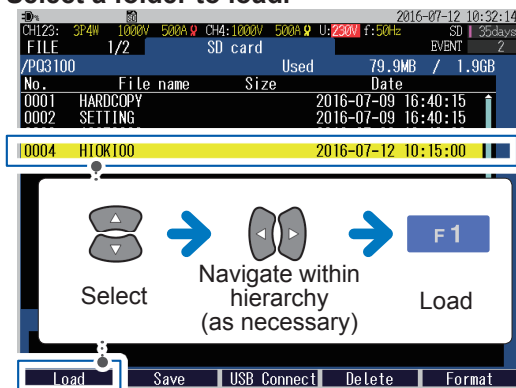

When a folder to load is selected, the **F1 (Load)** key is displayed.

Press the **F1 (Load)** key to load the measured data to the instrument.

After the loading is complete, the **EVENT, Event list** screen is displayed.

The data that has been loaded will be retained until a new recording is started or the power is turned off.

Folder for the measured data

SD memory card:

/PQ3100/YMMDDXX or
/PQ3100/HIOKI (desired folder name)**XX**

Internal memory:

/YMMDDXX or
/HIOKI (desired folder name)**XX**

Screen sample:

/PQ3100/HIOKI00 folder on the **FILE, SD card** screen

10.7 Copy from the Internal Memory to SD Memory Card

This section describes how to copy folders and files of the internal memory to the SD memory card.

- 1 Verify that an SD memory card has been inserted into the instrument ( appears on the screen).
- 2 Press the [FILE] key to display the **FILE, Internal memory** screen.

- 3 Select the folder or file to copy.

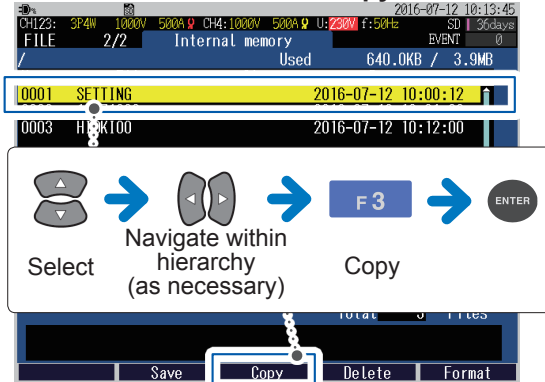

The folders or the files will be copied to the SD memory card.

10.8 Deleting Folders and Files

This section describes how to delete folders and files stored on the SD memory card or in the instrument's internal memory.

- 1 Verify that an SD memory card has been inserted before deleting folders or files from it. ( appears on the screen)
- 2 Press the [FILE] key to display the **FILE, SD card** screen or **FILE, Internal memory** screen.

- 3 Select the folder or file to delete.

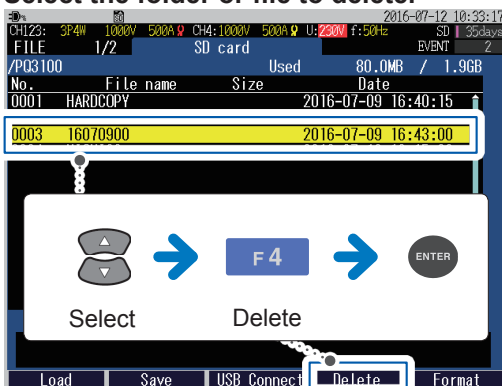

The folders or the files will be deleted.

Sample screen: **FILE, SD card** screen

10.9 Formatting SD Memory Card (Deleting All Files)

An SD memory card and the internal memory can be formatted.

- 1** Verify that an SD memory card has been inserted before formatting it.
(The icon  appears on the screen)
- 2** Press the **[FILE]** key to display the **FILE, SD card** screen or **FILE, Internal memory** screen.

3 Start formatting the SD memory card.

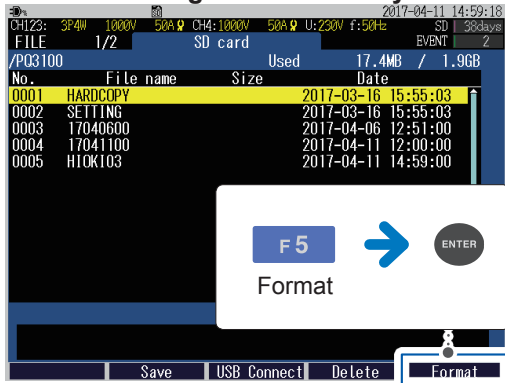

The SD memory card / the internal memory is formatted and the PQ3100 master folder is in it (p. 124).

Sample screen: **FILE, SD card** screen

- Be sure to use the instrument to format SD memory cards. The instrument can only save data to SD memory cards that have been initialized with the dedicated SD format (The format of Hioki's optional SD memory cards is dedicated SD format).
- Using a computer to format the card may reduce the card's performance.

10.10 Removing SD Memory Card during Recording

Removing an SD memory card while recording data to the card may damage the data. To remove the SD memory card safely during recording, saving data to the SD memory card can be stopped.

Only when the recording interval is set to 2 s or more, the SD memory card can be removed.

1 Press the **[FILE]** key to display the **FILE, SD card** screen.

2 Execute card removal.

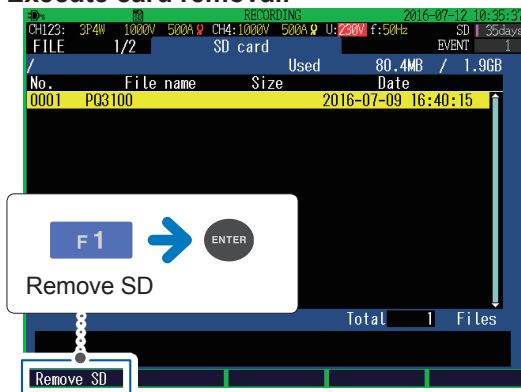

The SD memory card can be removed.

Procedure after removal

- After all data in the SD memory card is copied to a computer or a similar device, insert the SD memory card into the instrument.
If the SD memory card is returned to its original state by deleting the stored data or another SD memory card is inserted, a measurement data folder is newly created. A measurement data folder that differs from the previously created folder will cause the application software PQ One, which is supplied with the instrument, not to recognize both of the measurement data to be the same.
To analyze the data stored in the SD memory card that was previously ejected and the one stored in the card that is subsequently inserted, considering both of the data as equal, insert the SD memory card with the original data left in it.
- Check that the SD memory card is recognized.
(The icon  appears on the screen)

Trend record data will be divided and a new file will be created.

Saving operation when an SD memory card is removed during a recording

Only trend record data (p. 121) will be backed up in the internal memory with the recording interval time that has been set. When an SD memory card is inserted into the instrument while recording is stopped, backup data will be automatically moved to the SD memory card (the data will be divided and saved as a new file).

- Files that are backed up to the internal memory are not transferred by the FTP client function.

This section describes how to load data recorded with the instrument onto a computer and analyze the data using the supplied application software, PQ One. Refer to Application Software Instruction Manual (CD).

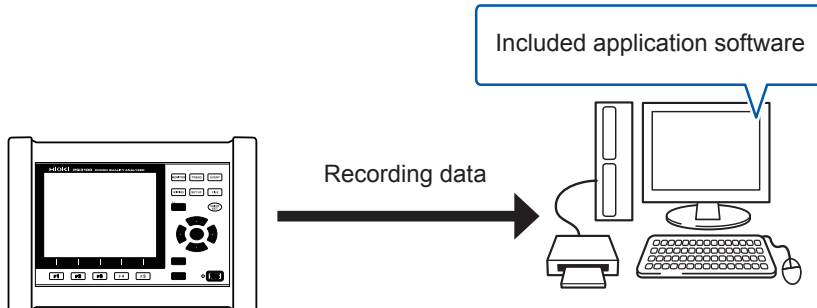

File contents	Extension	Format	Supported software	
			Application software	Other than application software
Screen copy data	BMP	Binary	—	Graphics software
Setting data	SET	Binary	✓	—
Trend record data	ITV	Binary	✓	
Flicker record data	FLC	Binary	✓	
Event list	EVL	Binary	✓	
Event data	EVT	Binary	✓	
Event trend data	WDU	Binary	✓	

✓: Supported, —: Not supported

The data measured by the instrument is written in binary format and cannot be directly read using spreadsheet software such as Microsoft Excel®. When the measured data is read using the appropriate application software and output in CSV format, the data can be read using spreadsheet software.

11.1 Copying Files

The following methods are available to copy data saved to a computer.

Method	SD memory card	Internal memory	Reference
Use an SD memory card reader	✓	—	p. 136
The SD memory card is recognized as a removable disk by connecting the instrument to a computer with a USB cable	✓	—	p. 137
Copy the data from the internal memory to the SD memory card and copy the data from the SD memory card	—	✓	p. 131

✓: Supported, —: Not supported

Use of SD Memory Cards

Be sure to read “Using SD Memory Cards” (p. 10) before use.

Screen sample: Windows 10

1 Verify that recording has stopped.

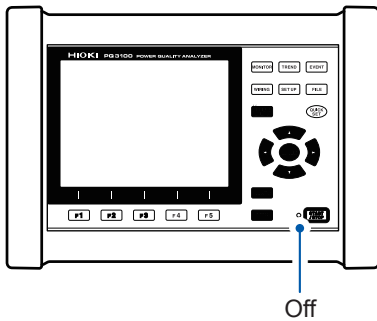

2 Eject the SD memory card from the instrument.

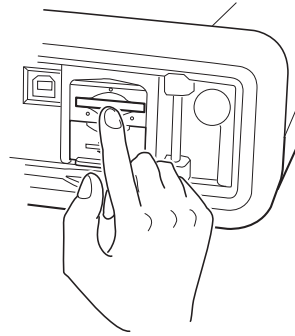

3 Insert the SD memory card into the SD memory card slot on the computer.

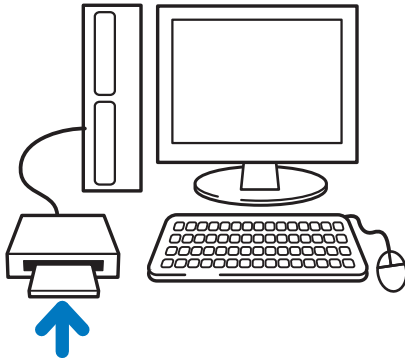

4 Click the Start button, and then, click **File Explorer** to start Explorer.

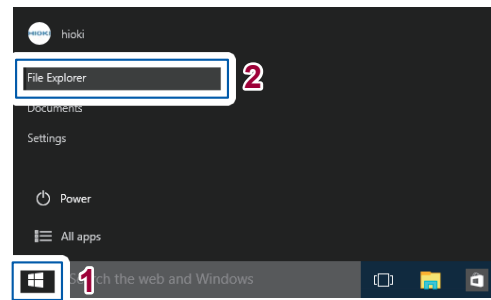

5 Click **This PC**, and then, double-click **PQ3100SD**.

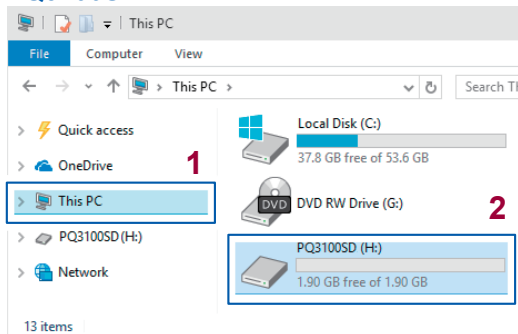

6 Copy the necessary folders to the any folder on the computer.

If the SD memory card was not formatted with the instrument, then **Removable Disk** will be displayed.

Use of USB Cable

Be sure to read “Using USB Connector (USB Cable)” (p. 12) before use.

The USB cable included is used to connect the instrument with a computer and copy data from the SD memory card to the computer.

1 Turn on the computer.

2 Turn on the instrument. (p. 44)

3 Connect the instrument and computer with the USB cable.

4 Press the [FILE] key to display the FILE, SD card screen.

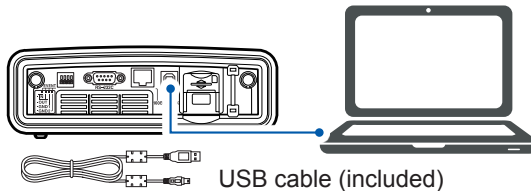

5 Change the mode to USB Connect (mass storage connection).

6 Copy the necessary folders to the any folder on the computer.

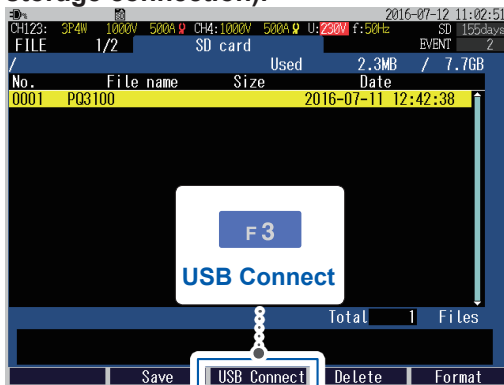

After the mode is changed to USB Connect, the following message appears on the instrument screen.

USB connected
To cancel
Cancel: ESC key

- Data on the instrument’s SD memory card cannot be accessed (to delete files, change filenames, etc.) from the computer.
- The USB connection is not possible if the SD memory card is not inserted.

The effects of electromagnetic interference such as noise from an external source may cause communications errors when using a USB connection. If you encounter such errors, wind the USB cable around a commercially available ferrite clamp as shown in the figure below before connecting the instrument with the computer.

The effectiveness of the clamp can be increased as follows:

- Attach the clamp as close as possible to the connector of the computer.
- Make more than one turn cable around the clamp (5 turns are more effective).

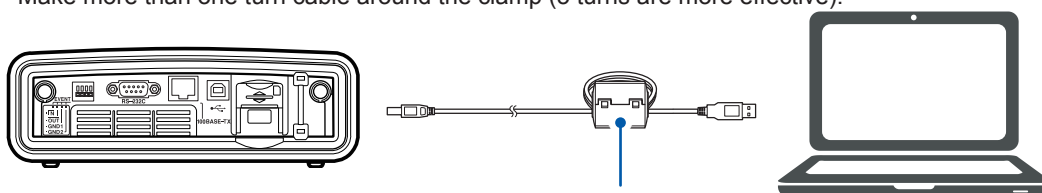

Ferrite clamp (commercially available)

The ferrite clamp (segmented core) shown in the figure is the product of NEC Tokin. (Model: ESD-SR-250)

Disconnecting the USB cable from the computer

To disconnect a USB cable connected to the instrument from a computer which is ON:

- 1** Press the **[ESC]** key to terminate the **USB connection**.
Alternately, eject the disk by using the **[Safely Remove Hardware and Eject Media]** icon on the computer.
- 2** Disconnect the USB cable from the computer.

11.2 Use of Application Software PQ One (Included)

What can be done with the application software

The application software PQ One (included) is used for analyzing the data from the instrument (binary-format) on a computer.

Displays and analyzes measurement data

Event statistics function allows analyzing measured data in detail. Checking event status daily or hourly allows detecting events with higher frequency at specific a time or on a specific day of the week.

Easily creates the required graphs

Adjusting the display period of the trend graph when the output is good, and integrating the trend data for 3 phases to a single graph is possible.

Generates measurement data reports

Contents displayed on the screen can be output without any modifications. No complicated report settings are required, and the required reports can be created.

Displays measurement data in EN50160 mode (available after the firmware update)

Converts measurement data to CSV format (available after the firmware version 2.00.0)

Any range of measurement data can be converted to CSV format. The converted files can be used in spreadsheet programs.

Judges anomalies based on the ITIC (CBEMA) curve* (available after the firmware update)

*: The ITIC Curve is commonly used in America, and is a standard for evaluating voltage anomalies by specifying a range of acceptable tolerance. A "User-Defined Curve" can be optionally defined for voltage anomaly evaluation.

Displays lists of file information including settings and the number of events

Dragging a folder containing measurement data displays lists of all data and event occurrences included in the folder.

Refer to the Application Software Instruction Manual (CD) for details.

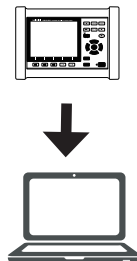

Installation

Contents of included CD

Language	File description	
English	PQONE_Manual_Eng.pdf	Instruction Manual (English)
	Setup.exe	PQ One Installer (English)
	Setup_Eng.msi	
Japanese	PQONE_Manual_Jpn.pdf	Instruction Manual (Japanese)
	Setup.exe	PQ One Installer (Japanese)
	Setup_Jpn.msi	

The latest version can be downloaded from our website.

How to use Instruction Manual

The Instruction Manual is provided in PDF format.

The Adobe Reader must be installed on your computer to view the Instruction Manual. (Adobe Reader can be downloaded from the Adobe website.)

To request a paper copy of the user manual, contact an authorized Hioki distributor or reseller. You can purchase the manuals.

Operating environment

Operating System (OS)	Windows 7, Windows 8.1, Windows 10
Display	Resolution 1280 × 768 dots or more
CD-ROM drive	Used for installation

Installation procedure

Screen sample: Windows 10

- 1 Start the computer.**
Administrator authority may be required for the installation.

- 2 Set the included CD to the CD-ROM drive.**

- 3 Click the Start button, and then, click File Explorer to start Explorer**

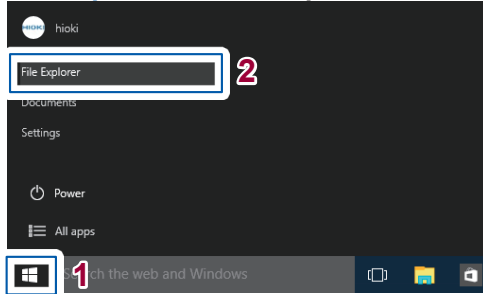

- 4 Click This PC, and then, double-click DVD RW Drive.**

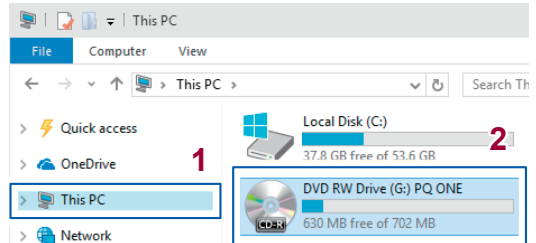

- 5 Double-click the English folder.**

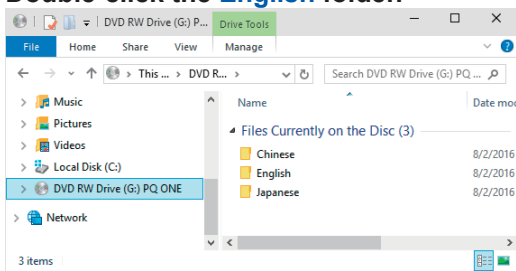

- 6 Double-click setup.exe (SET UP file).**

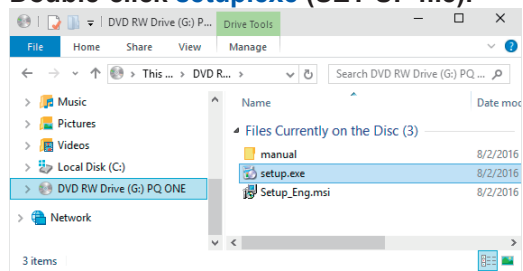

(The extension may not be displayed.)
After the installer starts, follow the instruction to proceed with the installation.

This instrument includes the USB, LAN, and RS-232C as standard interfaces.

Capabilities	USB	LAN	RS-232C	Reference
Recognizing the SD memory card as a removable disk and copying the data to computer.	✓	—	—	p. 137
Remote control of the instrument through an internet browser (HTTP server function)	—	✓	—	p. 149
Downloading the data measured by the instrument to the computer. (FTP server function)	—	✓	—	p. 152
Automatically sending data being measured with the instrument to the computer. (FTP client function)	—	✓	—	p. 155
Sending event data to the computer or mobile phone via e-mail at the time of event occurrence or at a specified time. (E-mail transmission function)	—	✓	—	p. 165
Configuration of the settings, acquiring the measurement data, and downloading the data from the computer voluntarily, can be done by using communication command.	—	✓	✓	Contact your authorized Hioki distributor or reseller for more information about communications commands and related topics.
Connecting an LR8410 Link compatible logger (LR8410 or LR8416 [available only in Japan]) using Bluetooth® and sending the instrument's measured values to the logger.	—	—	✓	p. 171
Controlling the instrument remotely and sending the data automatically to the computer by using GENNECT One.	—	✓	—	https://gennect.net/en/one/index

✓: Supported, —: Not supported

12.1 Preparing for LAN Communications

- To use LAN communications, you must perform the following tasks:
- Configure LAN settings in the instrument. (See the following “Settings”)
 - Build a network environment. (p. 145)
 - Connect the instrument and a computer with a LAN cable. (p. 147)

Settings (SET UP Screen)

IMPORTANT

- Be sure to perform these settings before connecting to a network. Changing settings while connected to the network can cause the overlapping of the IP addresses with other devices on the LAN, and incorrect address information may be presented to the LAN.
- After configuring the LAN settings, be sure to turn the instrument off and then turn it back on. If this is not performed, the changed LAN setting will not be enabled and communication will not be possible.

- 1** Press the [SET UP] key to display the SET UP, Interface settings screen.
- 2** Set the items of LAN.
- 3** Turn on the instrument once again.
- 4** Refer to the following table to set LAN communication parameters.

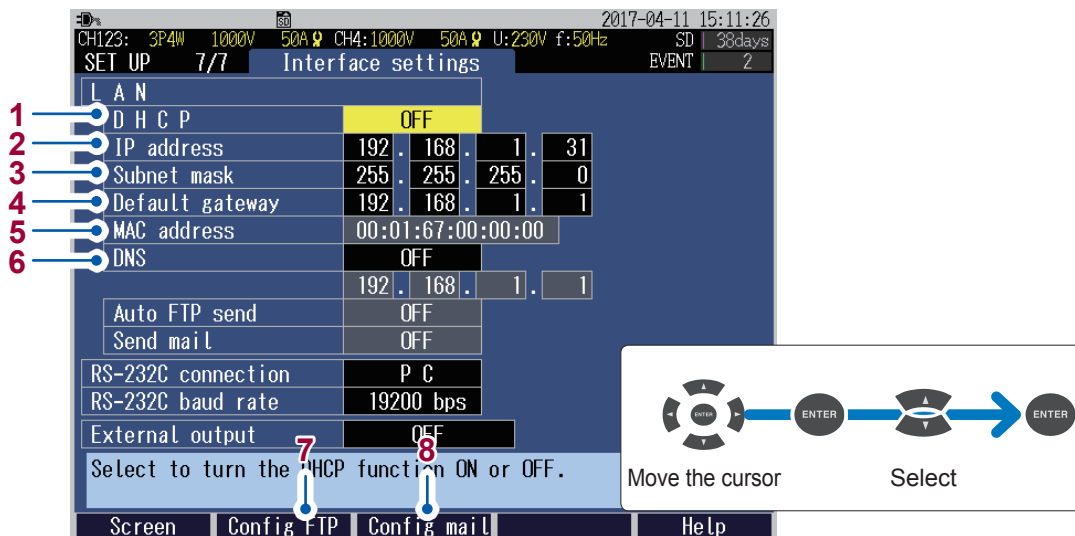

Settings	For using after connecting the instrument to an existing network		Connect one instrument to a single computer
	Connecting to a network by automatically acquiring IP addresses	Connecting to a network with a preset IP address	
1 DHCP	ON	OFF	OFF
2 IP address of the instrument	Automatic setting	Manual setting	Manual setting
3 Subnet mask	Automatic setting	Manual setting	Manual setting
4 Default gateway	Automatic setting	Manual setting	Manual setting
6 DNS (OFF/ON)	Automatic setting	ON	OFF
	Automatic setting	Manual setting	–

- 1 DHCP (Dynamic Host Configuration Protocol) is a method by which an instrument configures communication by automatically acquiring IP addresses. Enabling the **DHCP** while a DHCP server is running on the same network would automatically configure IP address, subnet mask, default gateway, and DNS. When these parameters have been successfully acquired, IP address and other parameters will be dimmed. If IP address and other parameters are not dimmed despite enabling the DHCP, it would indicate that the acquisition has failed. Check the connection.

OFF, ON

- 2 This address is for identifying each device connected to a network. Each network device must be set to a unique address. This instrument is IP version 4, so the IP address is indicated by the four decimals separated by three periods, for example, "192.168.0.1."
- 3 This setting is used to distinguish the IP address of the network from the addresses of individual network devices. Normally, it is indicated by the value containing four decimals separated by three periods, for example, "255.255.255.0."
- 4 When the computer and instrument are on different networks, specify the IP address of the device which serves as a gateway. If the computer and instrument are connected one-to-one, and no gateway is used, set "0.0.0.0" on this instrument.
- 5 A MAC address is assigned as a device-specific address, so it cannot be changed.
- 6 DNS stands for "Domain Name System". Due to an IP address being a series of numbers, memorizing them can be difficult. To that end, enabling **DNS** to specify devices with names instead of IP addresses would relieve the need to memorize them.

ON	This allows specifying a communication party with a name instead of an IP address. When a server operating on the network is requesting domain names instead of IP addresses, configure the IP address of the server to allow IP addresses to be searched from domain names.
OFF	Specify a communication party with an IP address. See "12.3 Downloading Recorded Data to Computer" (p. 152)

- 7 When FTP function is used, press the **[F2] (Config FTP)** key to configure the details. See "12.3 Downloading Recorded Data to Computer" (p. 152) "12.4 Automatically Sending Data Being Recorded to the Computer" (p. 155)
- 8 When trying to send an e-mail, press the **[F3] (Config mail)** key to configure the details. See "12.5 E-mail Transmission" (p. 165)

Example of establishing a network environment

(1) Connecting the instrument to an existing network

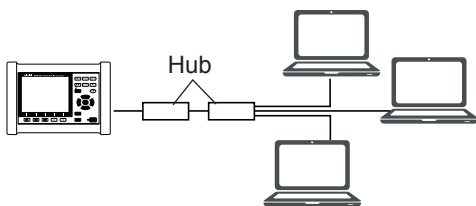

To connect to an existing network, the network system administrator (IT department) has to assign the settings beforehand. The settings must not overlap with another device. Obtain assignments from the administrator (IT department) for the following items, and write them down.

IP address	____.____.____.____
Subnet mask	____.____.____.____
Default gateway	____.____.____.____

(2) Connecting multiple instruments to a single computer using a hub

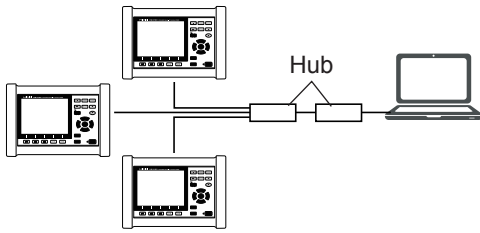

When building a local network with no outside connection, it is recommended to use the following private IP addresses.

Example: When building the network using network addresses 192.168.1.0/24 (192.168.0.1 to 192.168.1.255)	
IP address	Computer: <u>192.168.1.1</u> Instrument (first): <u>192.168.1.2</u> Instrument (second): <u>192.168.1.3</u> Instrument (third): <u>192.168.1.4</u> In this way, assign the addresses in order.
Subnet mask	<u>255.255.255.0</u>
Default gateway	Computer : <u> . . . </u> Instrument : <u>0.0.0.0</u>

(3) Connecting one instrument to a single computer using the Model 9642 LAN cable.



When connecting one instrument to a single computer using the conversion connector supplied with the Model 9642 LAN cable, variable IP address can be set but it is recommended to use private IP addresses.

Example: When building the network using network addresses 192.168.1.0/24 (192.168.0.1 to 192.168.1.255)	
IP address	Computer : <u>192.168.1.1</u> Instrument : <u>192.168.1.2</u> (Set to a different IP address than the computer.)
Subnet mask	<u>255.255.255.0</u>
Default gateway	Computer : <u> . . . </u> Instrument : <u>0.0.0.0</u>

Connection

Be sure to read “Connecting the Instrument to an External Device” (p. 13).

- (1) When connecting the instrument to an existing network, or when connecting the multiple instruments to a single computer using a hub

Required items	
<input type="checkbox"/> Model 9642 LAN cable (option)	or <input type="checkbox"/> A 100BASE-TX-compatible straight cable (up to 100 m, commercially available).
	

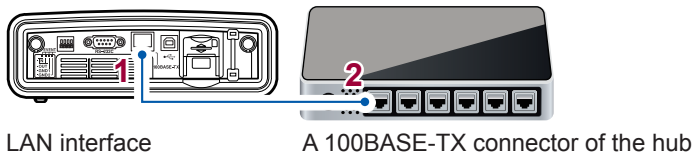

- (2) When connecting one instrument to a single computer

Required items	
<input type="checkbox"/> Model 9642 LAN cable (option)	or <input type="checkbox"/> A 100BASE-TX-compatible cross cable or straight cable (up to 100 m, commercially available)
	

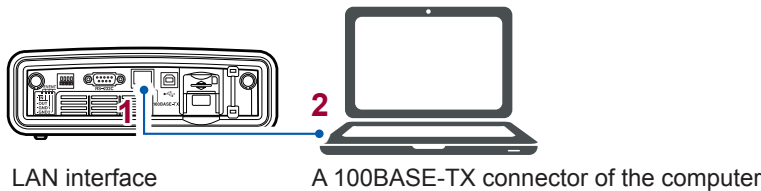

Since this instrument is equipped with the function to automatically differentiate between the straight and cross cable, a straight cable may also be used for communication. If you are unable to establish communications with the computer due to a problem such as compatibility, try a cross conversion cable (Model 9642 accessory).

Verifying the Transmission and Reception

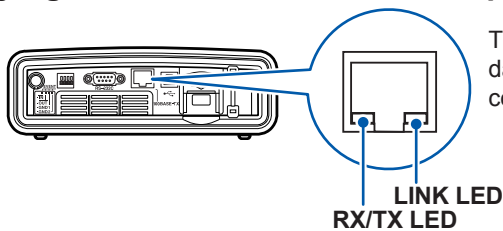

The RX/TX LED blinks during the transmission or reception of data. The LINK LED lights up, when the communication with the connected device is possible.

Example of Remote Control Using Wireless LAN

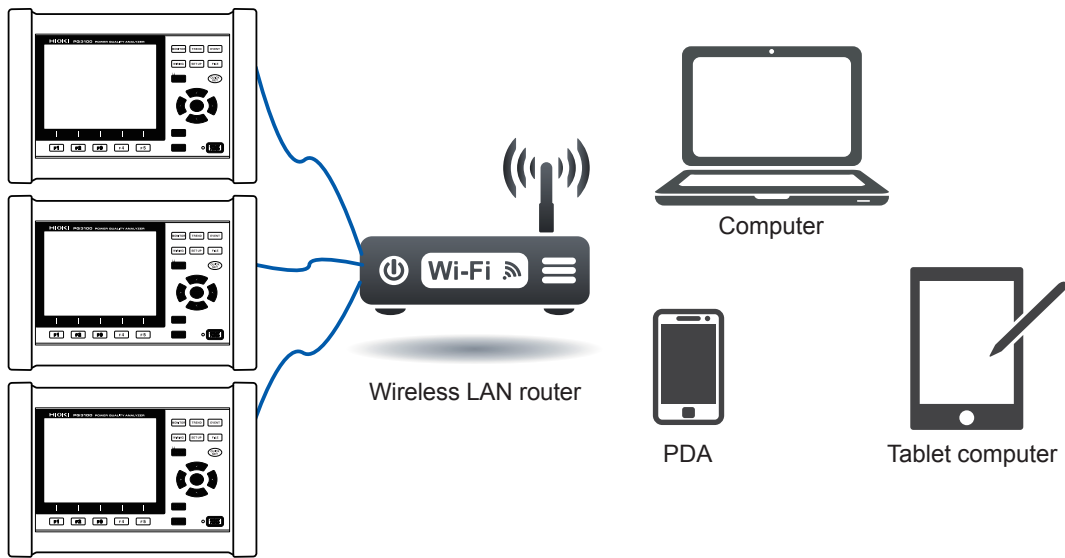

12.2 Remote Control of the Instrument through the Internet Browser (LAN Communications Only)

This instrument includes a standard HTTP server function that supports the remote control through the Internet browser on a computer. The instrument's display screen and control panel are emulated in the browser. Operating procedures are the same as on the instrument.

The preparations for LAN communication are necessary. (p. 144)

12

Communications (USB/LAN/RS-232C)

Preparations

1 Launch the Internet browser.

2 In the address bar, enter "http://" followed by the IP address configured in the instrument.

For example, if the instrument's IP address is 192.168.1.31, enter as follows.

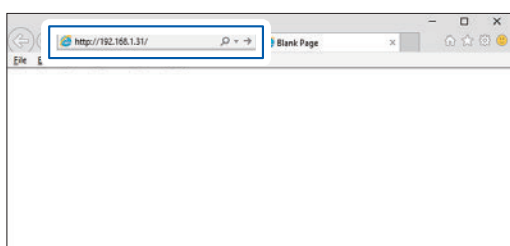

When the browser has successfully connected to the instrument, a main page such as the following will be displayed.

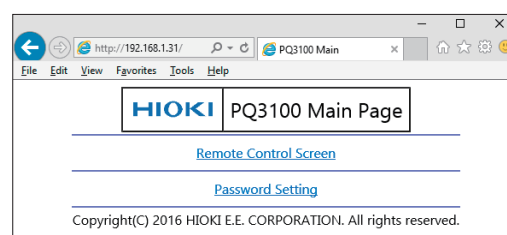

- It is recommended to use Microsoft Internet Explorer® version 9 or later.
- Unintended operations may occur if remote control is attempted from multiple computers simultaneously. Use one computer at a time for remote control.
- Set the browser security level to "Medium" or "Medium-high." Or enable the active scripting settings.
- Remote control can be performed even if the instrument's key lock is active.

If no HTTP screen is displayed

(1) Verify the settings of the Internet browser.

- 1 On the Internet Explorer settings, click **Tools-Internet Options.**
- 2 On the **Advanced** tab, enable the **“Use HTTP1.1”** and disable the **“Use HTTP1.1 through proxy connections.”**
- 3 Under **LAN settings** on the **Connections** tab, disable the **Proxy server** settings.

(2) Verify the LAN settings.

- 1 Check the instrument’s LAN settings and the computer’s IP address.
See “Settings (SET UP Screen)” (p. 144).
- 2 Verify that the **LINK LED** on the LAN interface is on and that the **WEB** mark is being shown on the instrument’s screen.
See “Connection” (p. 147), “1.7 Screen Display” (p. 32).
- 3 Under **LAN settings** on the **Connections** tab, disable the **Proxy server** settings.

IMPORTANT

After configuring the LAN settings, be sure to turn the instrument off and on. If this is not performed, the changed LAN setting will not be enabled and communication will not be possible.

Remote operation

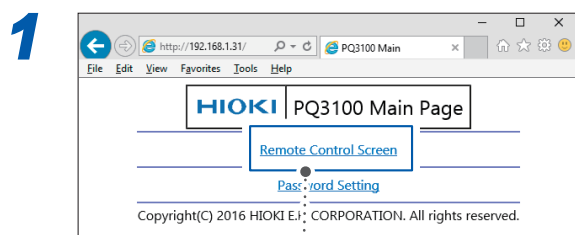

Click

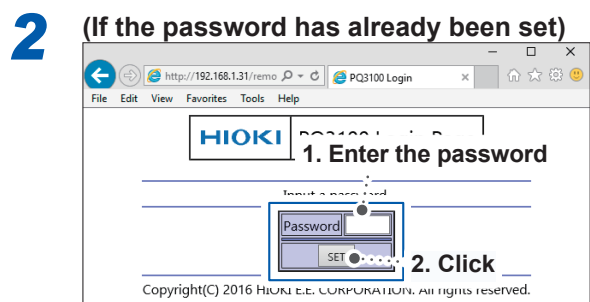

If no password has been set or the password has been set to “0000” (four zeros), this screen will not be displayed. The default password is “0000.”

The same screen and control panel being displayed on the instrument will be displayed on the browser.

Restrict the access (password settings)

1

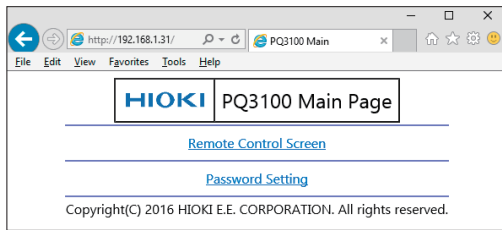

2

(In the case of setting a password)

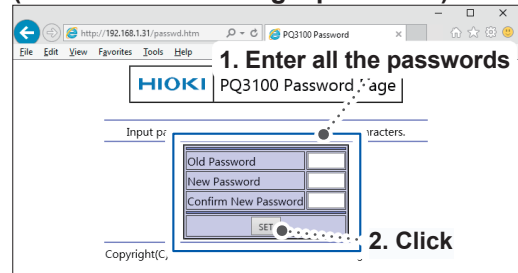

Enter up to four alphanumeric characters. When setting a password for the first time, enter "0000" (four zeros) in the **Old Password** box. When changing the password for the second or subsequent times, enter the previously set password.

If you forget your password

Perform "Factory reset (Default)" (p. 77) on the instrument to reset the password to its default figures of "0000." The password cannot be initialized by remote control.

12

Communications (USB/LAN/RS-232C)

12.3 Downloading Recorded Data to Computer

Because the instrument is running an FTP (File Transfer Protocol)* server, using the FTP client function of the computer allows files from the SD memory card or internal memory to be downloaded to the computer.

*: A protocol to transfer files within the network.

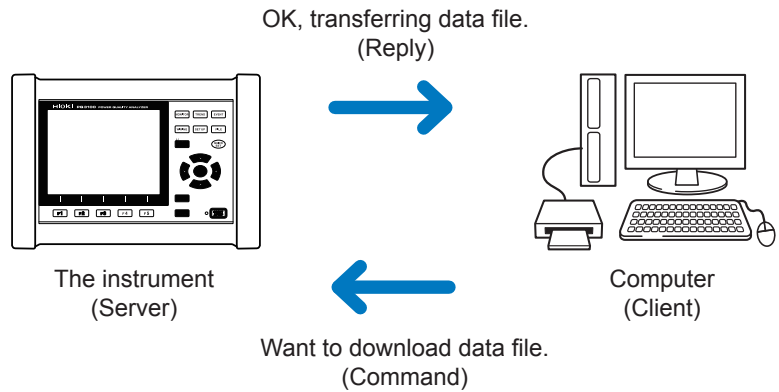

Setup (SET UP screen)

To download file with the FTP server function, basic LAN communication needs to be configured in advance (p. 144).

To restrict the connection, use the following procedure for configuration.

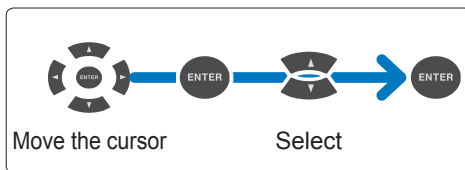

1 Press the [SET UP] key to display the **SET UP, Interface settings** screen.

2 Display the **Interface : FTP** screen.

The screenshot shows the 'Interface settings' screen. A pop-up window displays 'F2' and 'Config FTP'. The background screen shows various network settings like LAN, DHCP, IP address, Subnet mask, etc. The 'Config FTP' option is highlighted with a blue box.

3 Enable the authorization setting for the **FTP server**.
 Enable the **Authentication** and set a **User name** and **Password**.

The FTP server of this instrument is set to anonymous authentication, thereby allowing all devices on the network to access to the instrument when **Authentication** is set to disable.

To complete the settings:
 Press the **[F1] (Return)** key.

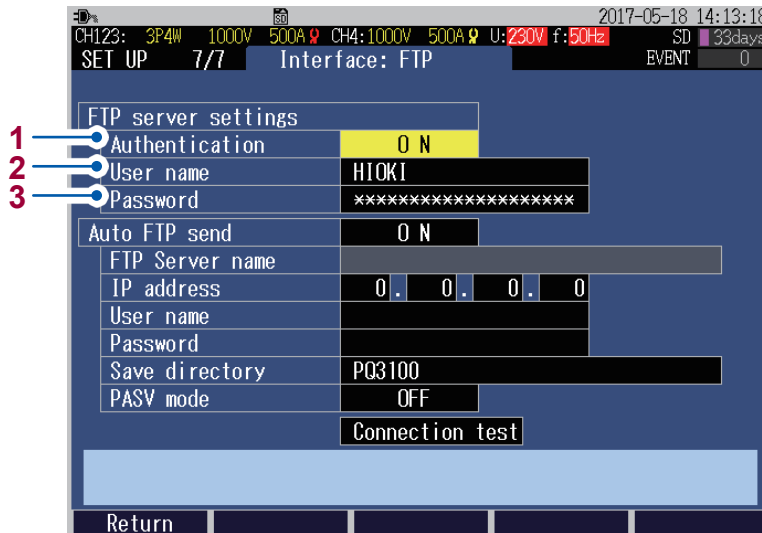

-
- 1** Enable when trying to restrict connection to the FTP server.

ON, OFF

-
- 2** Configure a user name used when connecting an FTP client to the instrument.
(Up to 20 one-byte characters, example: HIOKI)

-
- 3** Configure a password used when connecting an FTP client to the instrument.
The password does not appear on the screen (displayed as *****).
(Up to 20 one-byte characters, example: PQ3100)
-

Download

1 Run an FTP client software.

This section explains an example of using a free software WinSCP. Explorer can be used when the FTP authorization is not used.

2 Enter the following and click Login.

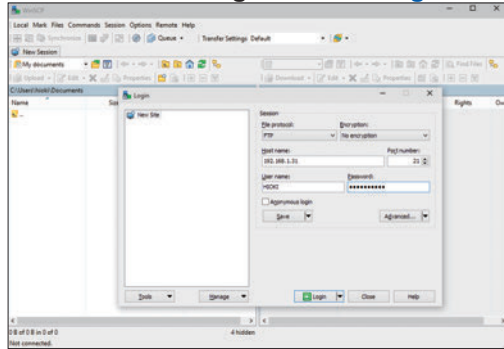

Host name	IP address of the instrument (p. 144)
User name	When FTP authentication is enabled (p. 152), enter the setting of the instrument.
Password	

3 Click SD or MEM.

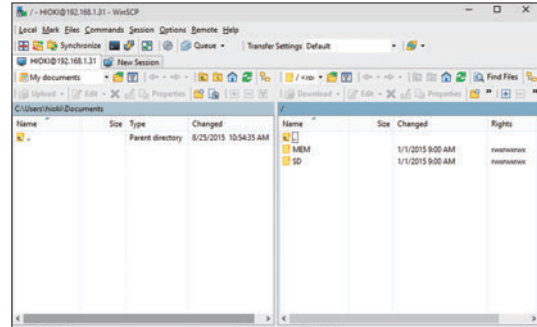

MEM	Internal memory
SD	SD memory card

4 Copy to any folder by selecting a folder or file.

- To copy measured data, copy the "Folders for measured data". See "10.2 Folder and File Structure" (p. 124)
- Do not move any folder or file. It is recommended to delete the folder and file after the data is copied and checked.

- Unintended operations may occur if operation is attempted from multiple computers simultaneously. Use one computer at a time when operating.
- The instrument may lose connection if no operation is done for 3 minutes or more after making connections. In such case, start over from procedure 1.
- FTP may not connect when trying to reconnect after being disconnected. In such case, try reconnecting after waiting for about one minute.
- The file being recorded cannot be downloaded during recording. When wanting to download file while continuing to record, have **Recording start** configured to **Repeat** (p. 69)
This setting repeats the start and stop of the recording every day, allowing the measured data up to the previous day to be downloaded through segmentation of measured data folders.
- Disconnect when changing the SD memory card.
- Avoid accessing any files at the same time as when downloading from within the instrument or externally using such tools as telnet and GENNECT Cross. Doing so may cause unintended results.
- Date/time of file update between the Internet browser and the instrument may not be identical.
- Previous data excluding the latest one may end up getting downloaded to the computer (as data left from the previous access gets saved as temporary Internet files in web browsers).

When wanting to perform remote control:

See "12.2 Remote Control of the Instrument through the Internet Browser (LAN Communications Only)" (p. 149)

12.4 Automatically Sending Data Being Recorded to the Computer

This instrument includes FTP client function that allows measured data during recording (such as event data and trend record data) to be sent automatically to the FTP server of the computer located within the network or remotely.

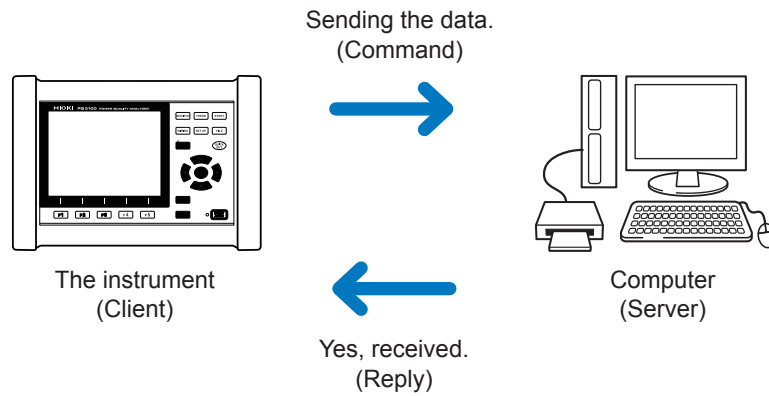

- To automatically send data using an FTP client, you must specify the IP address of the computer on which the FTP server is operating.
- You can use such FTP server software as Windows FTP server (IIS) and FILEZILLA Server (free software).

Setting FTP Server of the Computer

Necessary configuration may change depending on environment. If no connection is achieved, refer to the FTP server help or consult your network administrator. This section explains the case in which the OS used is Windows 10.

(1) FTP installation

1 Click **Control Panel** and then **Programs**.

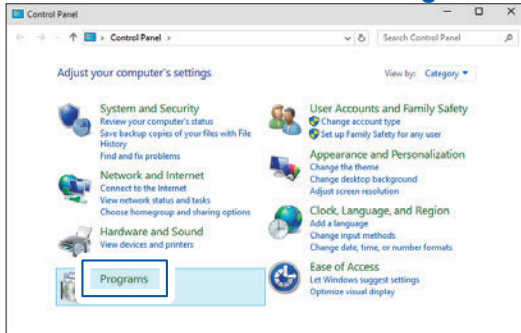

2 Click **Turn Windows features on or off**.

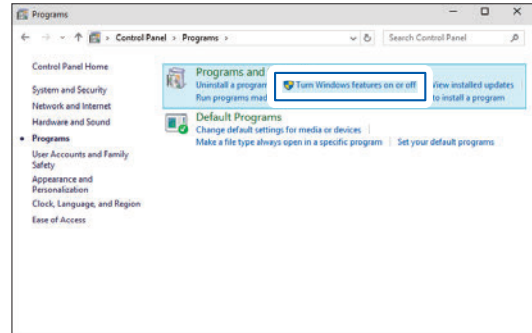

3 Check **FTP Service** and **IIS Management Console** and then click **OK**.

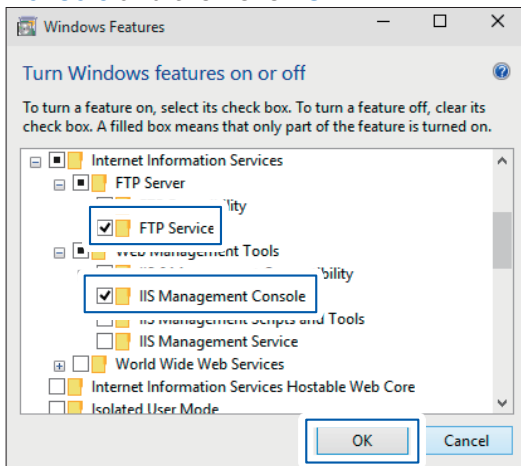

The FTP will be installed to the computer. After the installation, **inetpub** folder will be created under the root of the drive C.

(2) FTP configuration

1 Click **Control Panel** and then **System and Security**.

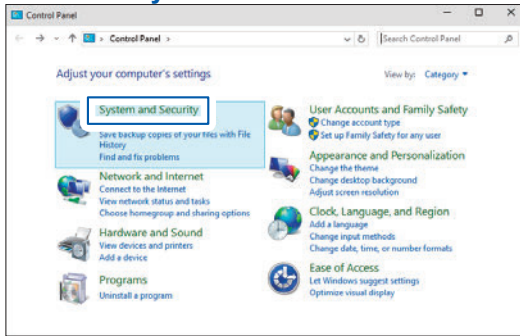

2 Click **Administrative Tools**.

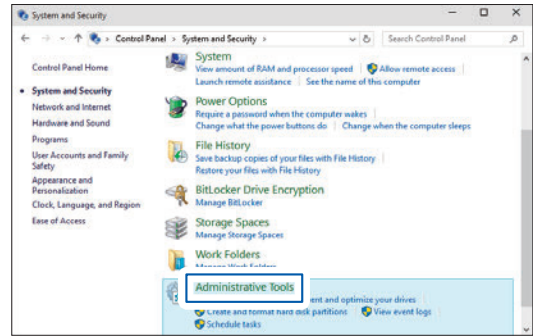

3 Click **Internet Information Service (IIS) Manager**.

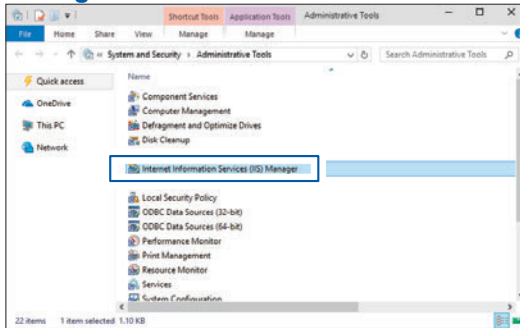

4 Click **Add FTP Site**.

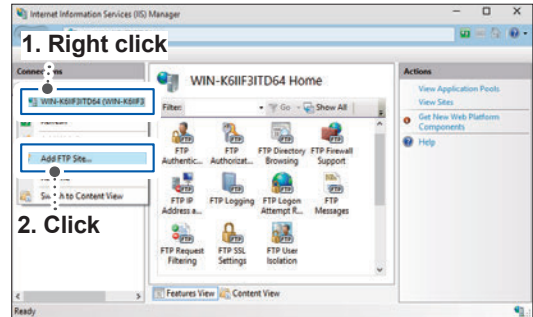

Communication may be blocked depending on the configuration of the software protecting the computer (e.g. firewall).

5 Enter the site information and then click **Next**.

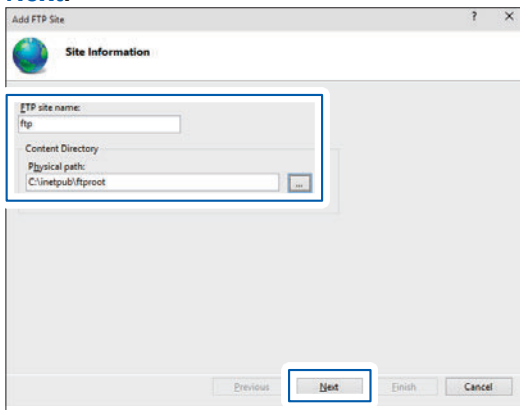

FTP site name	ftp (example)
Content Directory	Specify a directory to which data will be saved from the FTP client.

6 Set as follows and then click **Next**.

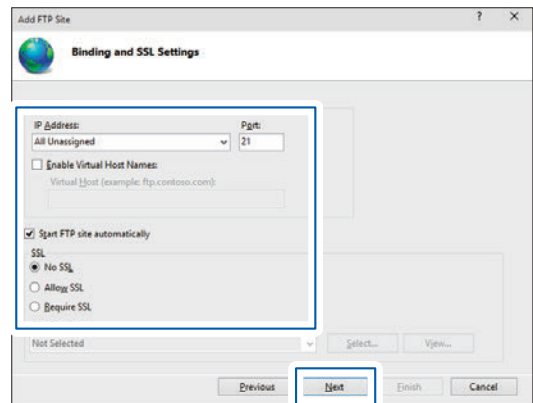

IP Address	All unassigned
Port	21
Start FTP site automatically	Check
SSL	No SSL

7 Set as follows and then click **Finish**.

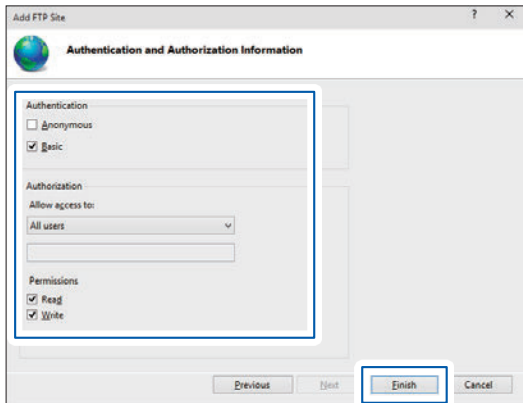

Authentication	Basic
Authorization	All users
Permissions	Check Read and Write .

(3) Enable the FTP traffic with a firewall.

1 Click **Control Panel** and then **System and Security**.

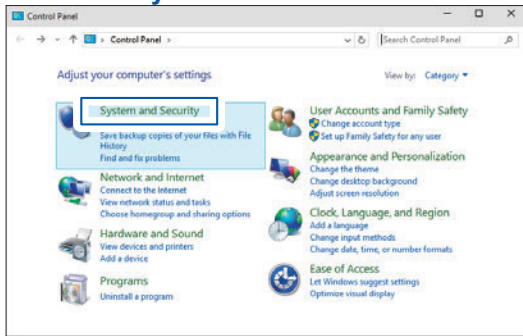

2 Click **Windows Firewall**.

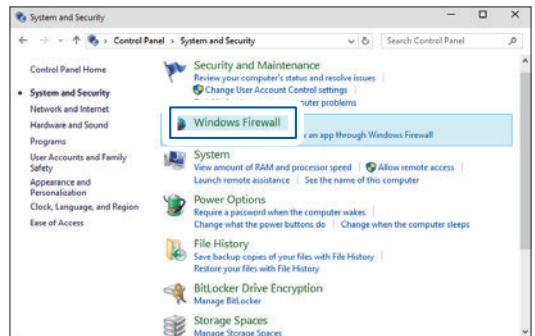

3 Click **Advanced Settings**.

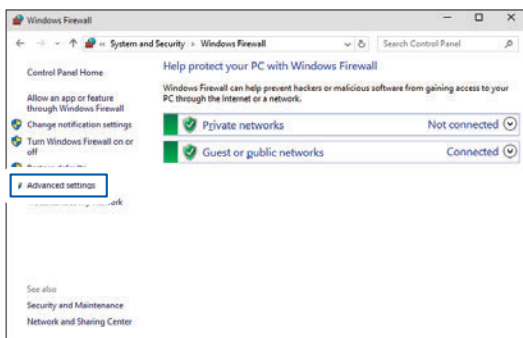

4 Click **Inbound Rules** and then right click **FTP Server (FTP Traffic-In)** to **Properties**.

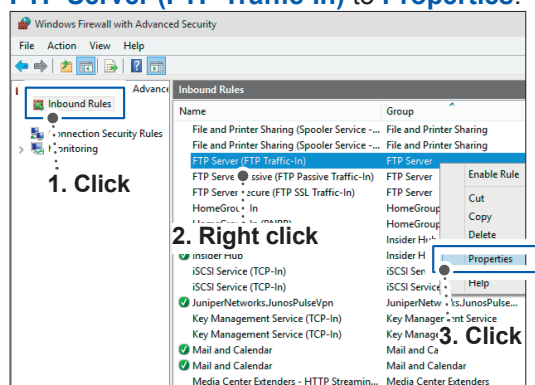

Communication may be blocked depending on the configuration of the software protecting the computer (e.g. firewall).

5 Check **Enabled for FTP Server (FTP Traffic-In)** and then click **OK**.

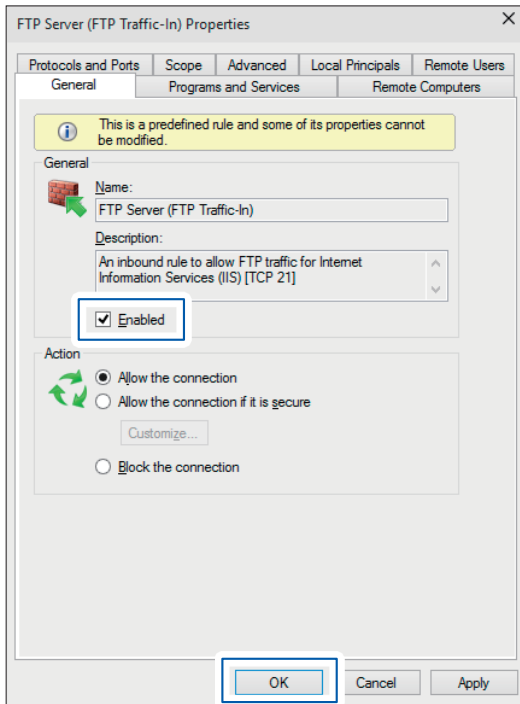

6 Check that **FTP Server (FTP Traffic-In)** is enabled (checked) and then close the dialog.

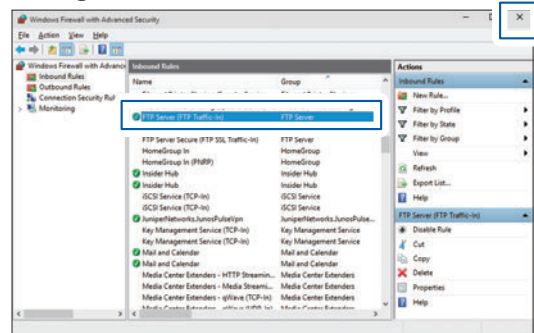

12

Communications (USB/LAN/RS-232C)

(4) Configuration for user access

1 Click **Control Panel** and then **System and Security**.

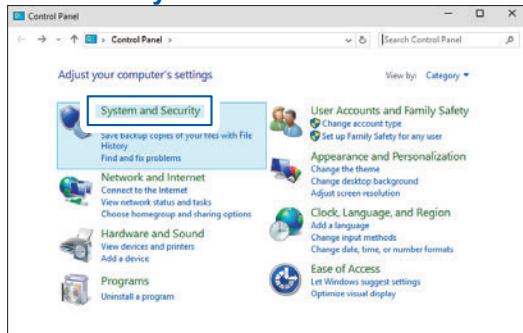

2 Click **Administrative Tools**.

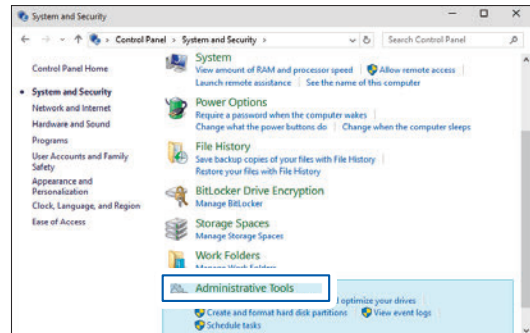

3 Click **Computer Management**.

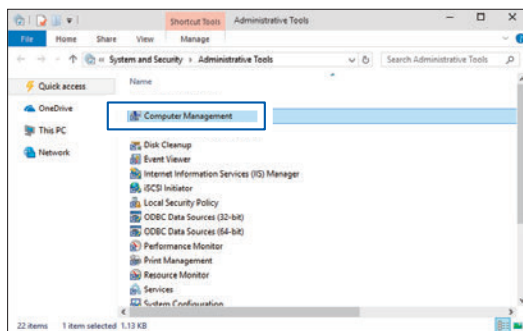

4 **System Tools - Local Users and Group Users - Right click Users and then click New User.**

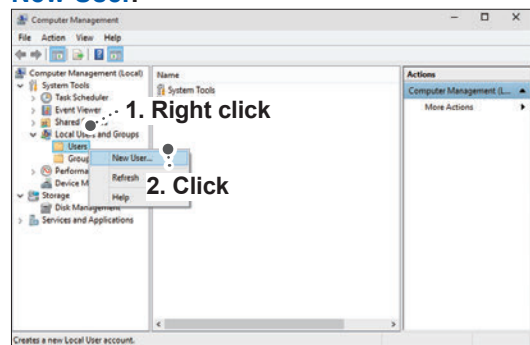

5 Set as follows and then click **Create**.

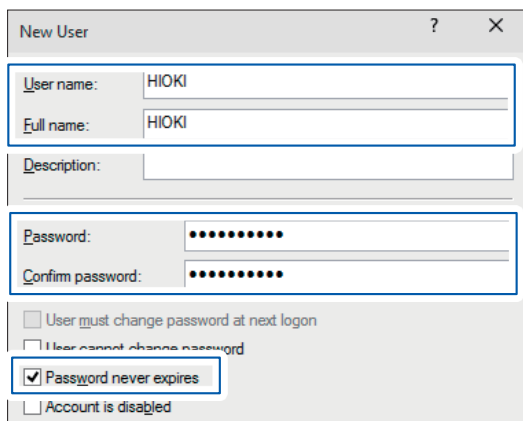

User name	HIOKI
Full name	HIOKI
Password	Enter your password
Confirm password	Re-enter your password
Password never expires	Check

6 Check that HIOKI has been registered as a user and then close the dialog.

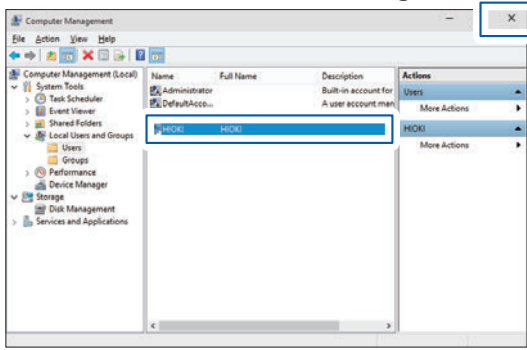

(5) Access permission configuration for FTP folders

1 Open "C:\inetpub" and then click Properties for ftproot.

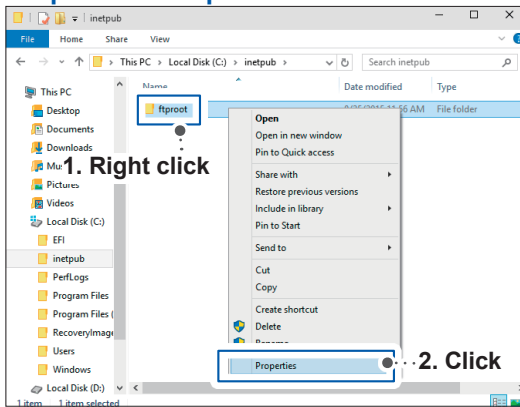

2 On the Security tab, click Users and then click Edit.

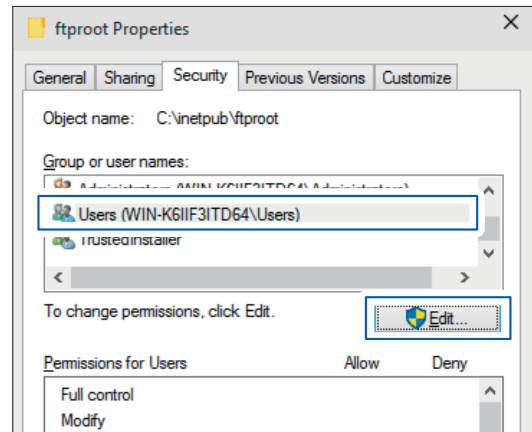

3 Check the box for Full control and then click OK.

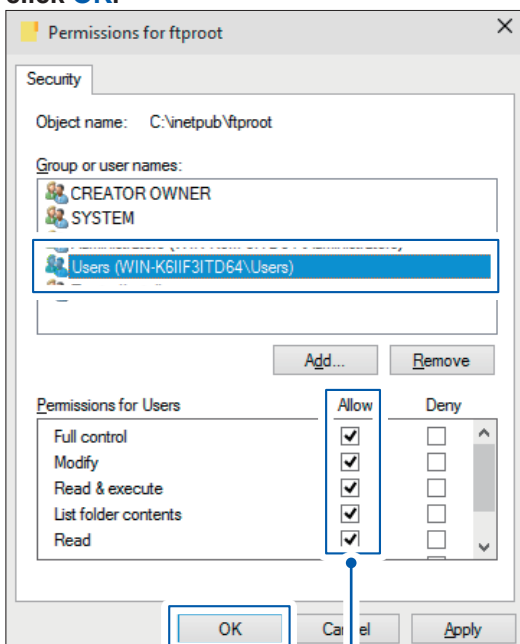

All of the other allow check boxes will automatically become checked.

This completes the FTP configuration for Windows 10.

The FTP is now available for use with the user name and password created.

Configuring the instrument (**SET UP** screen)

The preparations for LAN communication are necessary (p. 144).

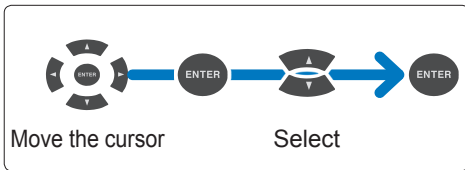

1 Press the **[SET UP]** key to display the **SET UP, Interface settings** screen.

2 Display the **Interface : FTP** screen.

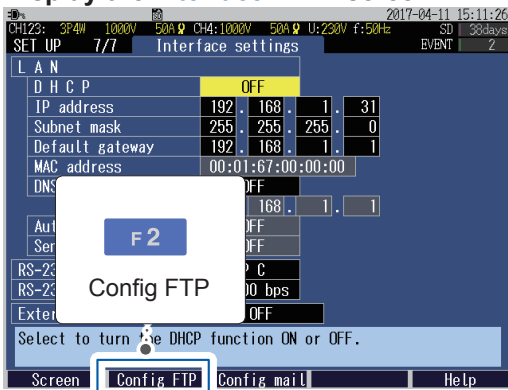

3 Configure automatic FTP data transmission.

Enable **Auto FTP send** to perform advanced settings.

To complete the settings:
Press the **[F1]** (Return).

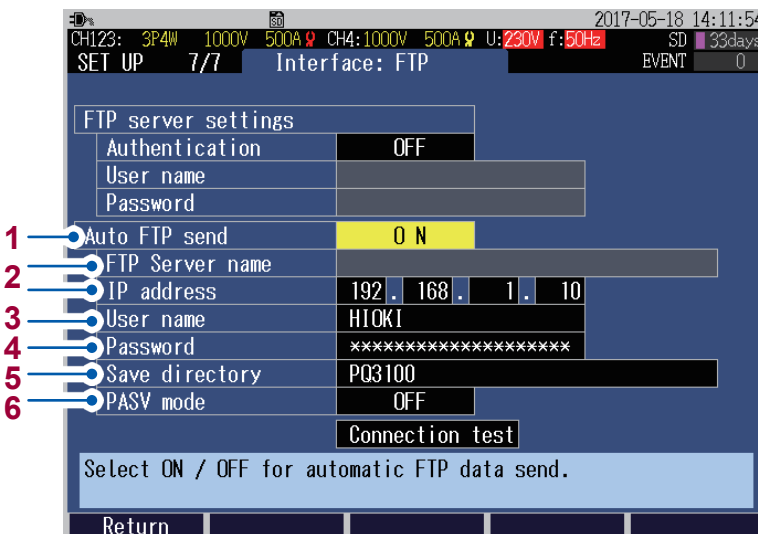

1 Select **ON** to allow automatic FTP data transmission.

ON, OFF

2 Enter a server name or an IP address of the FTP that sends data. Whether to set the FTP server name or the IP address depends on the DHCP and DNS setting (p. 144).

FTP Server name: Up to 32 one-byte characters

IP address: _._._._ ("_" must be between 0 and 255), (e.g. 192.168.1.10)

3 Set a user name needed to log in to the FTP server. Use the user name of the instrument registered to the FTP server of the computer (p. 160). (Up to 20 one-byte characters, example: HIOKI)

- 4 Set a password needed to log in to the FTP server.
Use the password of the instrument registered to the FTP server of the computer (p. 160).
The password does not appear on the screen (displayed as *****).
(Up to 20 one-byte characters, example: PQA)
- 5 Set a directory on the FTP server for saving measured data.
(Up to 32 one-byte characters, example: PQ3100)
- 6 Select **ON** to use passive mode for communication.
ON, OFF

Connection test

Be sure to conduct a connection test after making connections to confirm that there is no problem.

- 1 Press the **[SET UP]** key to display the **SET UP, Interface settings** screen.

- 2 Display the **Interface : FTP** screen.

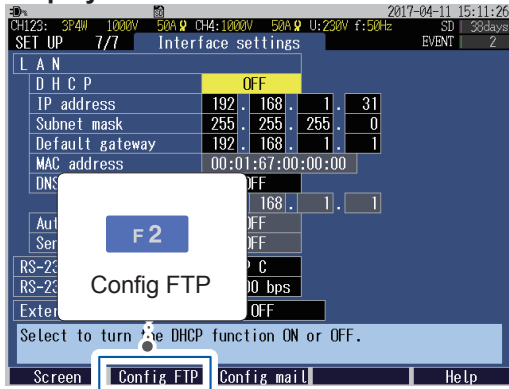

- 3 Conduct a connection test.

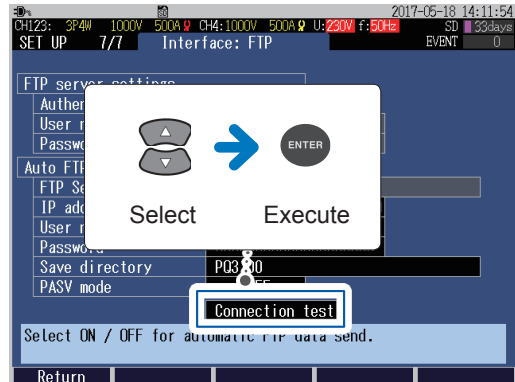

FTP Error ERR_FT02
Cannot connect to the FTP server.

Upon error, check “Setting FTP Server of the Computer” (p. 156) and “Configuring the instrument (SET UP screen)” (p. 162).

Start of Automatic Transmission

Automatic transmission starts when the recording starts.
See "7.1 Start and Stop of the Recording" (p. 93)

Measured data (event data, trend record data) will be sent from the instrument to the FTP server at the following timing.

Data sent	Timing of automatic transmission
Event data	At the time of event occurrence
Trend record data	<ul style="list-style-type: none"> • When the recording stops • When the file size reaches 20 MB (the file will automatically be divided)
Others	When the recording stops

Recording cannot be started during automatic FTP transmission ( p. 33) after the recording is stopped (an error is displayed). Be sure to start recording after the transmission is completed. Removing the SD memory card or turning off the instrument while automatic FTP transmission is in process will cause the file transfer to be aborted.

Duration of data transmission

Duration of transmission is calculated with the following formula:
Duration of transmission (sec.) = File size (KB)/Transmission speed (KB/s) + Preparation time for transmission (sec.)

Approximate size of a file is as follows:

- Event data (event waveform recording time: 200 ms): Approx. 208 KB/event
- Trend record data (1 interval), Without harmonics: Approx. 1.8 KB, With harmonics: Approx. 36 KB

Approximate transmission speed should be 300 KB/s and approximate preparation time for transmission should be 3 seconds.

Example: When the total size of a file is 20 MB (= 20000 KB)

Duration of transmission
= 20000 KB/300 (KB/s) + 3 (sec.)
= 67 + 3 (sec.)
= 70 (sec.)

Duration of data transmission may vary depending on the condition of communication lines and the state of the instrument. Duration of transmission may be longer than the above when there is no sufficient capability of the instrument such as in the case where communication line state is not good or event frequently occurs.

When wanting to perform remote control:

See "12.2 Remote Control of the Instrument through the Internet Browser (LAN Communications Only)" (p. 149)

12.5 E-mail Transmission

E-mails can be sent within the network, to computers located remotely or to mobile phones through the SMTP mail server at the time of event occurrence during recording or at a specified time every day.

Setup (SET UP screen)

The preparations for LAN communication are necessary.(p. 144)

The example explains the case where an e-mail is sent from “pqa@xyz.xx.xx” of the instrument to “abc@xyz.xx.xx” of a mobile phone (or a computer) through the SMTP mail server (192.168.1.100).

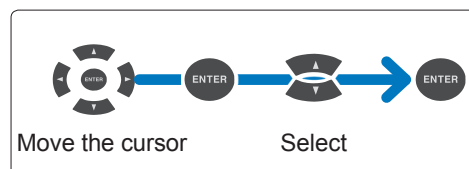
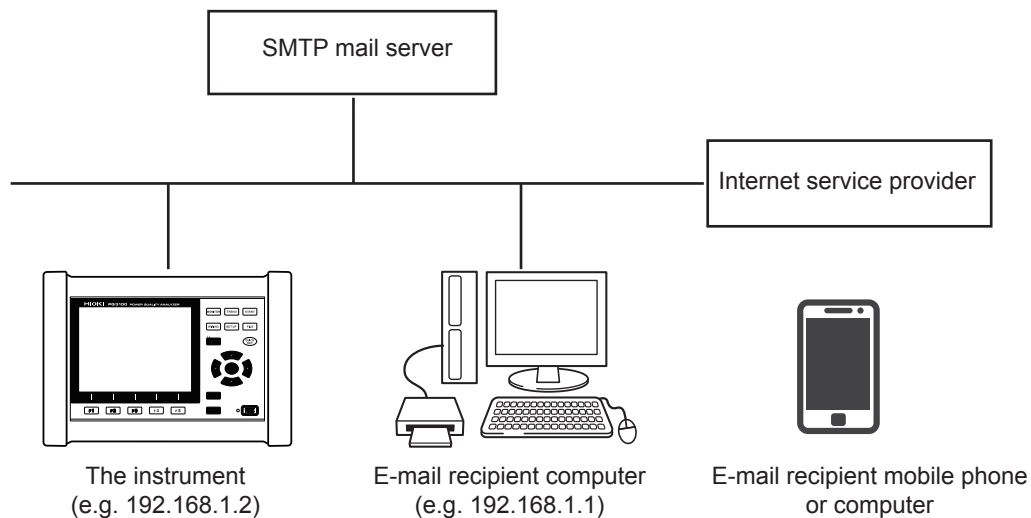

1 Press the [SET UP] key to display the **SET UP, Interface settings** screen.

2 Display the **Interface: Email 1** screen for configuration.

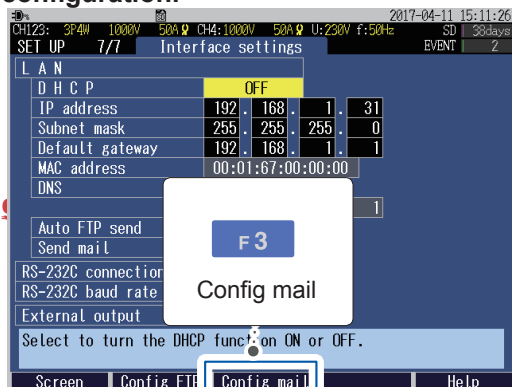

Interface: Email 1 screen

1	Email at event	ON
2	Email at time	ON
3	Time setting	00:00
4	To address	abc@xyz.xx.xx
5	Mail server name	
6	IP address	192.168.1.100
7	Port number	25
8	From address	pqa@xyz.xx.xx
	From	HIOKI
	Subject	PQ3100

Send test

Send email when an event occurs.
Send the contents of the event that occurred.

Return Email 2 Help

- 1 Select **ON** to allow an e-mail to be sent at the time of event occurrence. An e-mail is immediately sent out at the time of event occurrence related to recording start/stop. For other events, one e-mail will be sent out 5 minutes after the occurrence of an event, summarizing all events that took place from the time of occurrence to the time of the email being sent. If an e-mail is over a specified size (14 KB) due to frequent events, part of the content may not be sent.

ON, OFF

- 2 Select **ON** to allow an e-mail containing statistics event data of the previous day at a specified time every day to be sent out. Enable (**ON**) specified time mail to specify a time at which an e-mail is sent out.

ON, OFF

- 3 Enter a destination e-mail address. (Up to 50 one-byte characters), Example: abc@xyz.xx.xx

- 4 Enter a mail server (SMTP server) name or an IP address. Whether to set the server name or the IP address depends on the DHCP and DNS setting (p. 144). Server name or IP address for the SMTP and POP3 should be the one specified by the network system administrator or Internet provider.

Mail server name: up to 32 one-byte characters

IP address: _._._._ ("_" must be between 0 and 255), Example: 192.168.1.100

- 5 Enter a port number for the mail server if it is other than the standard number (25).

1 to **65535**

- 6 Enter a sender's e-mail address. (Up to 32 one-byte characters), Example: pqa@xyz.xx.xx

- 7 Enter a sender's name. (Up to 50 one-byte characters), (e.g. HIOKI)

- 8 Enter the subject of the e-mail. (Up to 20 one-byte characters)

3 (Setting e-mail authorization)

Display the **Interface: Email 2** screen for configuration.

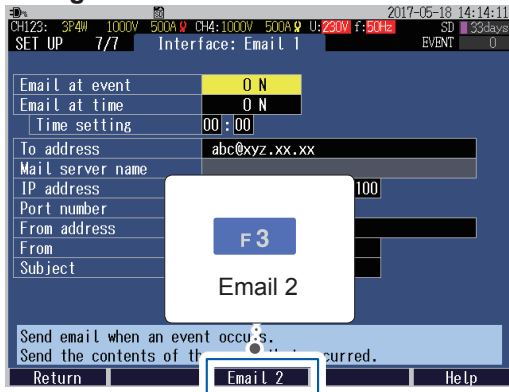

To complete the settings:
Press the **[F1] Return** key.

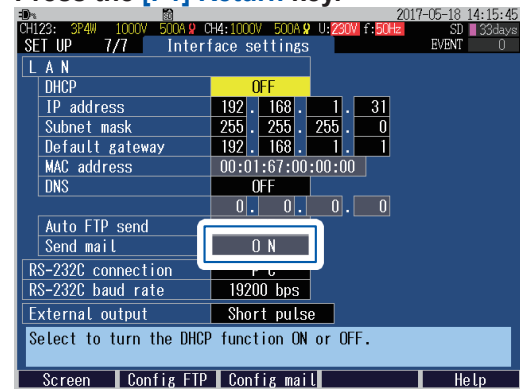

When either the Event mail or the Specified time mail is enabled, then **ON** will be displayed.

Interface: Email 2 screen

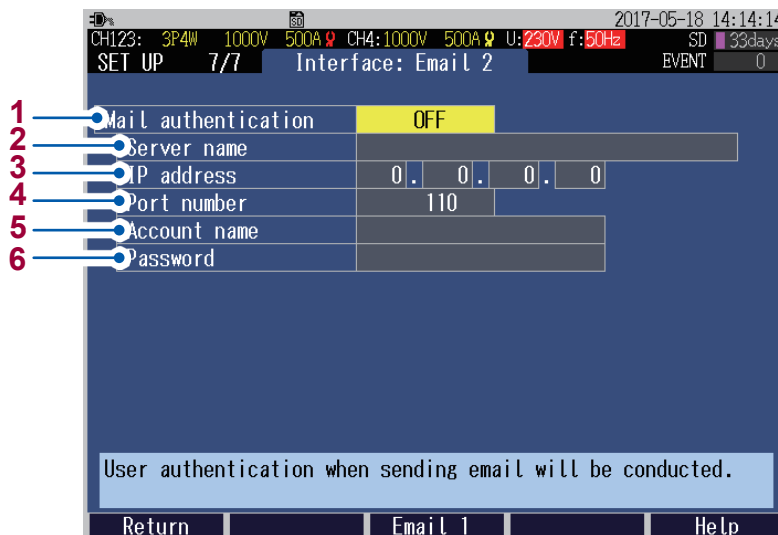

- 1 Set the e-mail authorization if required. The instrument supports POP authorization (POP before SMTP) and SMTP authorization.

OFF	No e-mail authorization
POP	POP before SMTP is used. Set the following parameters: <ul style="list-style-type: none"> • Server name or IP address • Port number • Account name • Password
SMTP	SMTP authorization is used. (Supports PLAIN, LOGIN, CRAM-MD5) Set an account name and a password.

- As IMAP/SSL/STARTTLS are not supported, mails will not be sent to some mail servers such as that of Gmail.
- There are some SMTP server incapable of sending e-mails depending on the server setting.

- 2 (POP authorization only) Set a server name or an IP address for the POP3 server. Whether to set the server name or the IP address depends on the DHCP and DNS setting (p. 144).

Server name: Up to 32 one-byte characters

IP address: _._._._ (“_”: must be between 0 and 255)

- 3 (POP authorization only) Set a port number for the POP3 server.

1 to 65535

- 4 Set a user account name for e-mail authorization.
(Up to 20 one-byte characters)
- 5 Set a password for e-mail authorization.
The password does not appear on the screen (displayed as *****).
(Up to 20 one-byte characters)

Transmission test

Be sure to conduct a transmission test after making connections to check that there is no problem.

- 1 Press the [SET UP] key to display the SET UP, Interface settings screen.

- 2 Display the Interface: Email 1 screen.

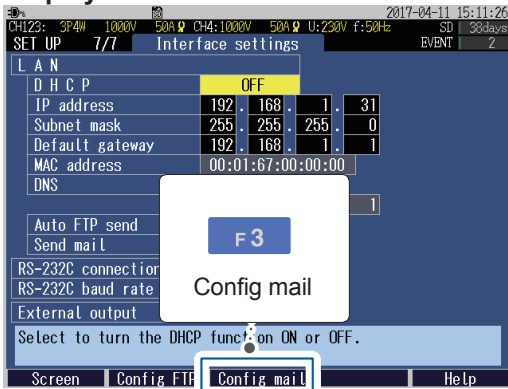

- 3 Execute a transmission test.

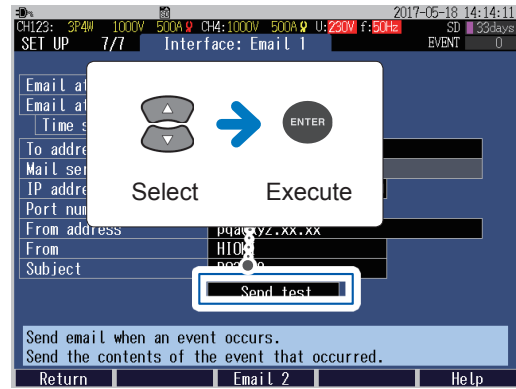

A test e-mail will be sent.

If a test e-mail does not reach the destination specified, check the setting.

The transmission test results will be saved to the log file in the PQ3100 basic folder (MAIL_LOG.TXT).

Time required for e-mail transmission

It takes approximately 1 second to send an e-mail.

Start of e-mail transmission

Once recording is started, an e-mail will automatically be sent in line with the e-mail transmission setting.

See “7.1 Start and Stop of the Recording” (p. 93)

E-mail set up	Timing and content of transmission
When event mail is on	Recording start/stop event: e-mail sent out immediately upon event occurrence Other events: one e-mail sent out 5 minutes after the occurrence of an event, summarizing all events that took place during that interval
When Specified time mail is on	An e-mail containing statistics event data of the previous day at a specified time will be sent out.

The transmission test results will be saved to the log file in the measurement data folder (MAIL_LOG.TXT).

Example of an event mail

```
PQ3100(SN.000000000 Ver.1.10)
SD REST:4.0GB
=====Event Occured!!=====

2016-11-29 16:14:30.0
EVENT No.0002
Dip CH 1 IN Level: 70.33 V
Intrpt CH 1 IN Level: 3.04 V
Freq_wav Low IN Level: 38.462 Hz

2016-11-29 16:14:30.2
EVENT No.0003
Freq_wav Up IN Level: 67.705 Hz
Freq_wav Low OUT Level: 67.705 Hz Worst: 38.462 Hz Duration: 000:00:00.026
Freq_wav Up OUT Level: 59.970 Hz Worst: 67.705 Hz Duration: 000:00:00.030
Uthd CH 1 IN Level: 7.98 %

2016-11-29 16:14:42.0
EVENT No.0004
Dip CH 1 OUT Level: 96.60 V Worst: 2.97 V Duration: 000:00:11.969
Intrpt CH 1 OUT Level: 16.78 V Worst: 2.97 V Duration: 000:00:11.937
Freq_wav Up IN Level: over Hz
Freq_wav Up OUT Level: 60.057 Hz Worst: over Hz Duration: 000:00:00.025

2016-11-29 16:14:42.2
EVENT No.0005
Uthd CH 1 OUT Level: 3.84 % Worst: 21.10 % Duration: 000:00:12.028
```

When wanting to perform remote control:

See “12.2 Remote Control of the Instrument through the Internet Browser (LAN Communications Only)” (p. 149)

12.6 RS-232C Communication Preparations

To use RS-232C communications, you must perform the following tasks.

- Configure the settings of RS-232C on the instrument.
- Connect the instrument and a computer with a RS-232C cable (p. 204).

Settings (SET UP screen)

Be sure to read “Connecting the Instrument to an External Device” (p. 13).

- 1 Press the [SET UP] key to display the SET UP, Interface settings screen.
- 2 Configure RS-232C connection to PC.

- 3 Select RS-232C baud rate.

19200 bps, 38400 bps

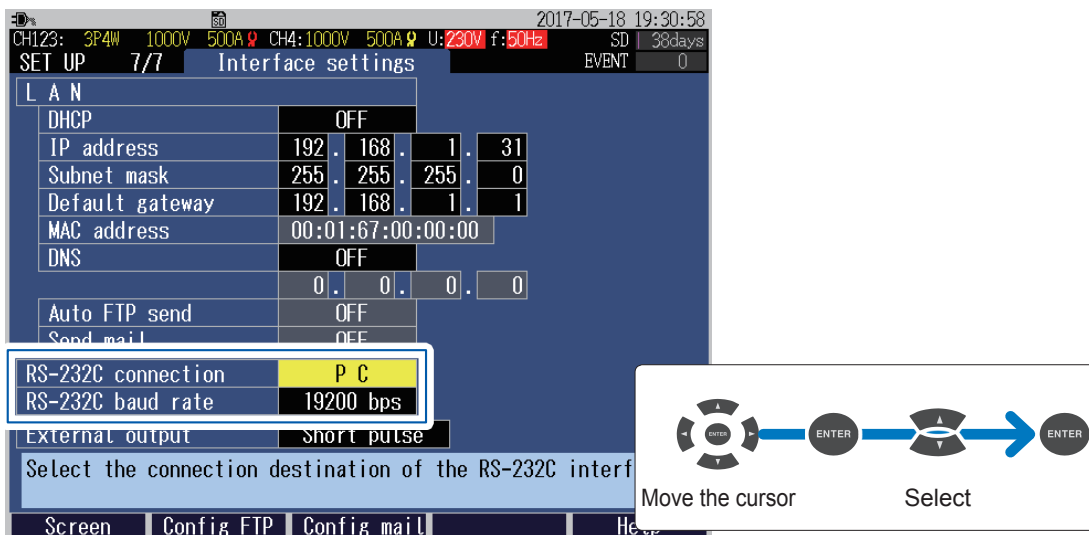

2017-05-18 19:30:58
CH123: 3P4W 1000V 500A CH4:1000V 500A U:230V f:50Hz SD 38days
SET UP 7/7 Interface settings EVENT 0

LAN	
DHCP	OFF
IP address	192 . 168 . 1 . 31
Subnet mask	255 . 255 . 255 . 0
Default gateway	192 . 168 . 1 . 1
MAC address	00:01:67:00:00:00
DNS	OFF
	0 . 0 . 0 . 0
Auto FTP send	OFF
Send mail	OFF
RS-232C connection	PC
RS-232C baud rate	19200 bps
External output	Short pulse

Select the connection destination of the RS-232C interf

Screen Config FTP Config mail Help

Move the cursor Select

Connection

- 1 Connect the instrument and computer with the Model 9637 RS-232C Cable (cross cable).
- 2 Turn on the computer.

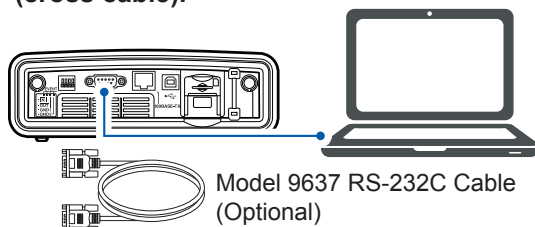

- 3 Turn on the instrument. (p. 44)

12.7 LR8410 Link Compatible Logger Communication Preparations

When the instrument is connected to Hioki LR8410 Link compatible logger (LR8410, LR8416 [available only in Japan]) with Bluetooth[®], measured values (6 parameters selected on the Zoom-in screen) of the instrument can be sent to the logger.

The LR8410 Link compatible logger allows observing and recording multi-channel measured voltage, temperature, and humidity, and measured values of the instrument at the same time. This connection requires the following Bluetooth[®] serial conversion adapter.

Bluetooth[®] serial conversion adapter Parani-SD1000 (by SENA Technologies Co., Ltd.)
Bluetooth[®] class: Class 1

Precautions

- Before using, please read the Instruction Manual supplied with the Parani-SD1000.
- Measured values of the instrument sent to the logger are displayed at the resolution of the logger, resulting in a slight difference between the value displayed in the logger and in the instrument. To record a measured value closer to the one on the instrument, select a suitable input range.

Bluetooth[®] serial conversion adapter setup and connections

Please read “Connecting the Instrument to an External Device” (p. 13).

1 Check that the instrument power has been turned off.

Be sure to turn off the power to avoid any damage to the instrument.

2 Configure the communication speed for the adapter.

Set the DIP switch to the **RS-232C baud rate** of the PQ3100 (19200 bps or 38400 bps).

3 Connect the adapter to the RS-232C interface of the instrument.

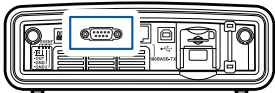

4 Turn on the instrument power (p. 44).

Configuring the instrument (SET UP screen and MONITOR screen)

1 Press the **[SET UP]** key to display the **SET UP, Interface settings** screen.

2 Set the **RS-232C Connection** to **Bluetooth**.

The instrument supplies 5-volt power toward the Bluetooth® serial conversion adapter through Pin 9 of the RS-232C interface connector, driving the adapter.

3 Set the **RS-232C baud rate** to match the one set for the adapter.

19200 bps, 38400 bps

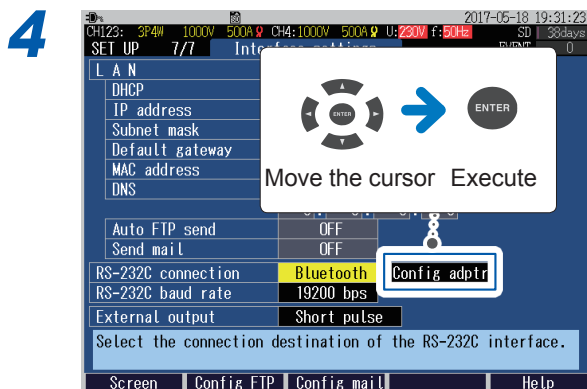
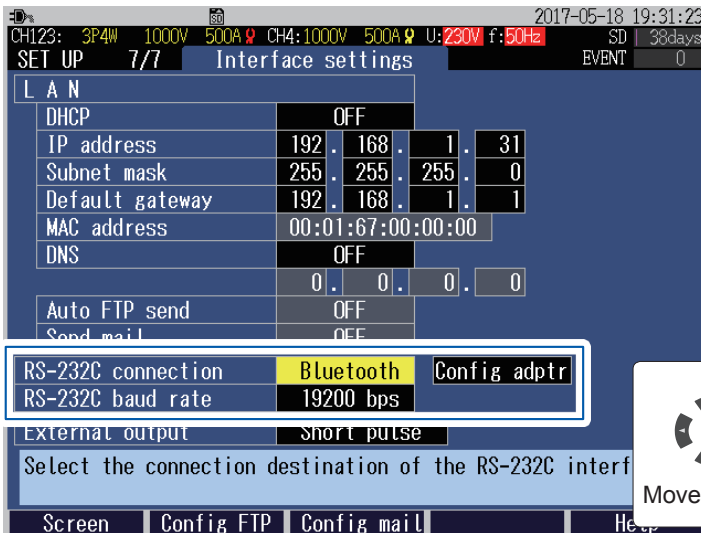

A dialog to confirm the execution of initial setting for the adapter appears.

5 Press the **[ENTER]** key.

The adapter will be configured as follows:

Device name	PQ3100#nnnnnnnnn:HIOKI (n: Serial No. of the instrument in 9 digits)
Operation mode	Mode3 (Standby for the connections from all the Bluetooth® devices)
Pin code	0000
Response	Not used
Escape sequence character	Prohibited

6 Press the **[MONITOR]** key to display the **MONITOR, Zoom** screen for parameter selection.

See "6.8 Zoom of the Measured Value" (p. 92)

Six parameters data selected on the **MONITOR, Zoom** screen now can be sent wirelessly to the logger.

For detailed settings for Hioki LR8410 Link compatible logger (LR8410, LR8416 [available only in Japan]), refer to the Instruction Manual of the logger.

Important

When measured values of the instrument are automatically saved to the LR8410 Link compatible logger, any change to the display item of zoom screen and the current range of the instrument during automatic saving leads to the measured values being saved improperly. Do not change the setting after automatic saving is started.

13 External I/O

External I/O terminals are used to allow event signal input from an external device and to output a signal to external device when an event occurs.

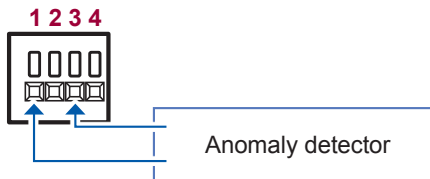
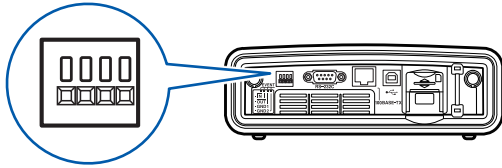

External devices are connected to **1** “Event input terminal (EVENT IN)” and **3** “Ground terminal for event input (non-isolated) (GND1).”

When you connect the detection signal of an anomaly detector such as an over-current relay to the event input terminal, an event will occur when there is an anomaly operation.

See “13.1 Event Input” (p. 174).

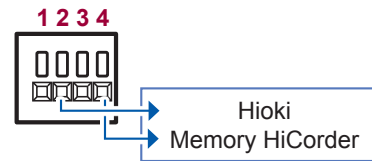

External devices are connected to **2** “External output terminal (EXTERNAL OUT)” and **4** “Ground terminal for external output (non-isolated) (GND2).”

The anomalies occurring in the instrument will be informed to the external device. When you connect the external output terminal to a trigger input terminal on a waveform recording device such as the Hioki Memory HiCorder, you can record waveforms on the Memory HiCorder when an abnormality occurs.

See “13.2 External Output” (p. 175).

To use the external I/O terminals, you must perform the following tasks:

To use event input

- Check how to use event input terminal
- Set the external event to ON (p. 74)
- Use cables to connect the instrument with the external device (p. 177)

To use external output

- Check how to use the external output terminal
- Set the external output (p. 176)
- Use cables to connect the instrument with the external device (p. 177)

13.1 Event Input

Event input function is used to enable recording of the voltage and current waveforms and measured values of an external event.

This function is useful to analyze power anomalies that may occur when other electronic/electrical devices are started.

By inputting a signal to the event input terminal (EVENT IN) externally, you can make the instrument determine that an external event has occurred when that event was input.

Setting

External event (p. 74) must be set to **ON**.

Signal input methods

External devices are connected to **1** “Event input terminal” (EVENT IN)” and **3** “Ground terminal for event input (non-isolated) (GND1).”

Short the terminals **1** and **3** or input a pulse signal to the terminal **1**.

Event input is recognized when the terminal is shorted (active LOW) or the pulse signal is fell.

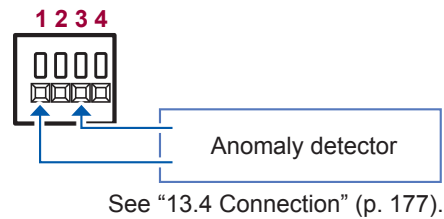

Specifications

Input voltage range	High level: 2 V to 45 V Low level: 0 V to 0.5 V
Maximum input voltage between terminals	45 V
Maximum rated voltage to earth	Non-isolated (GND is shared by the instrument)

Timing chart

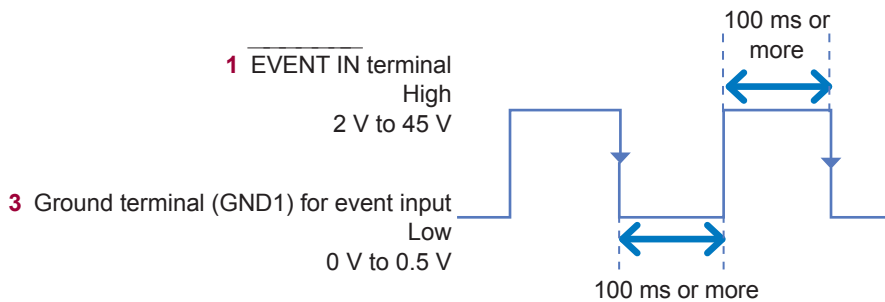

- **3** “Ground terminal for event input (GND1)” is shared by GND of the instrument and is not isolated. Isolate as required for input (**4** “Ground terminal for external output (GND2)” is isolated).
- Use a single route for the wires connected to the event input terminal as any other cables bound together with them may cause malfunction due to external noise.
- Longer wires may cause malfunction due to external noise. Wind the wires around a ferrite clamp as shown in the figure before connection (position the ferrite clamp as near the terminal block as possible).

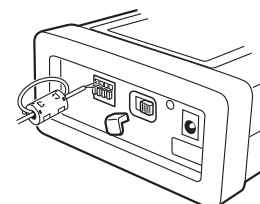

13.2 External Output

Outputs a signal to the external device synchronized with an event in the instrument showing that there is an event.

Application

(1) Connect a warning device.

This is a good way to output warnings when events such as an interruption occurs.

(2) Connect to the trigger input terminal of a Memory HiCorder.

The instrument allows recording waveforms of an event for 200 ms to 11.2 s (1 s before event, 200 ms during the event, and 10 s after event) (see **Before event occurs, After event occurs** (p. 74)). Use a Memory HiCorder with the instrument to record waveforms for a longer period.

Setting

See “13.3 External Output Settings (SET UP Screen)” (p. 176).

Signal output method

2 “External output terminal” (EXTERNAL OUT) and **4** “Ground terminal for external output (non-isolated) (GND2)” are connected to an external device.

2 and **4** are isolated from the internal circuit of the instrument. Connect terminal **2** to an external power supply through a pull-up resistor as shown in the following circuit diagram.

If an event occurs in the instrument, a pulse signal is output.

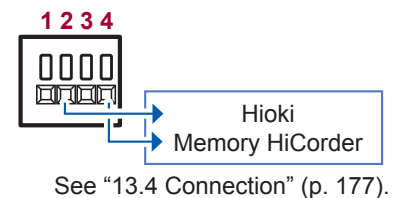

Circuit Diagram

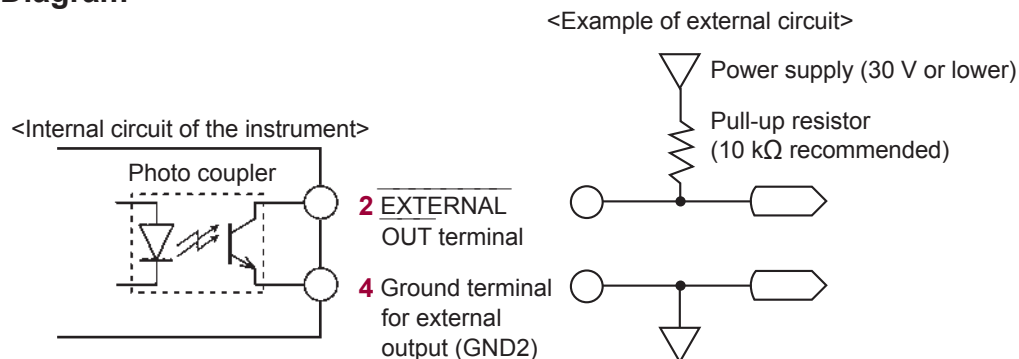

Specifications

Output signal	Open collector output Isolated with a photo coupler Active Low	Maximum input current	5 mA
Maximum input voltage	30 V	Output format	Short pulse setting: Approx. 10 ms pulse output Long pulse setting: Approx. 2.5 s pulse output ΔV_{10} alarm setting: Low level during alarm

Timing chart

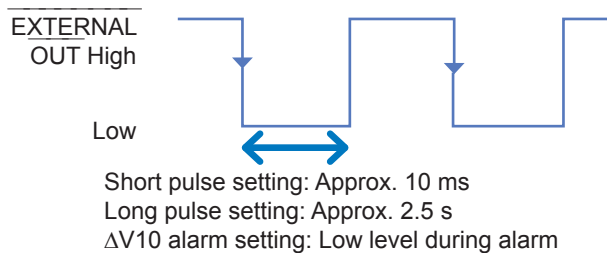

13.3 External Output Settings (SET UP Screen)

Set when using the external I/O terminal to connect the instrument to an external device.

1 Press the [SET UP] key to display the **SET UP, Interface settings** screen.

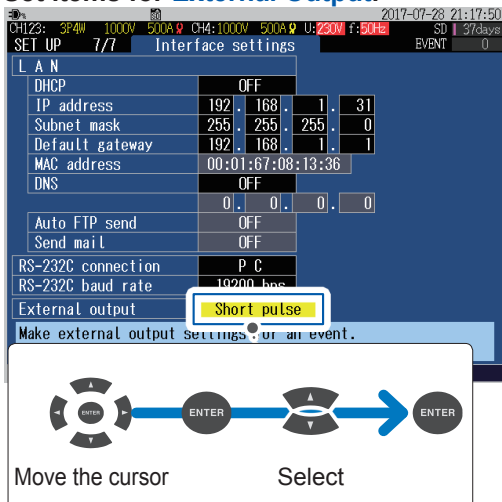

2 Set items for **External Output**.



OFF	External output is disabled.
Short pulse	A short pulse (approx. 10 ms) is output on recording start and stop, or during event IN.
Long pulse	A long pulse (approx. 2.5 s) is output only during event IN. Set this function to be combined with the 2300 Remote Measurement System or a sequencer. Low period is retained for approx. 2.5 s during event IN. If another event IN occurs during the Low period, the Low period for is retained for another approx. 2.5 s.
ΔV10 alarm	This setting can be selected only when the flicker setting is ΔV10 (p. 66). If the ΔV10 alarm is set, also set the threshold value (0.00 V to 9.99 V). Output will be set to low when the set threshold value is exceeded.

13.4 Connection

Be sure to read “Using External I/O Terminals” (p. 13) before start.

Required items	
<input type="checkbox"/> Wires	
<input type="checkbox"/> Slotted screwdriver	
<ul style="list-style-type: none"> • Shaft diameter $\phi 3$ mm • Blade width: 2.6 mm 	

Recommended wire

Single wire:	$\phi 0.65$ mm (AWG22)
Stranded wire:	0.32 mm ² (AWG22)
Strand diameter:	$\phi 0.12$ mm or more
Acceptable limits	
Single wire:	$\phi 0.32$ mm to $\phi 0.65$ mm (AWG28 to AWG22)
Stranded wire:	0.08 mm ² to 0.32 mm ² (AWG28 to AWG22)
Strand diameter:	$\phi 0.12$ mm or more
Standard insulation stripping length:	9 mm to 10 mm

1 Use cables to connect the instrument with the external device.

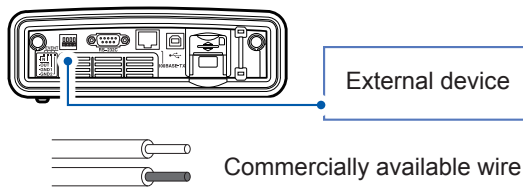

Wire connection procedure

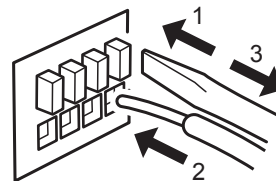

1. Press the terminal button down using a tool, such as a slotted screwdriver.
2. While the button is pressed, insert the wire into the electric wire connection hole.
3. Press the button.

The electric wire is locked in place.

2 Turn on the external device.

3 Turn on the instrument. (p. 44)

14 Specifications

14.1 General Specifications

Operating environment	Indoor use, pollution degree 2, altitude up to 3000 m (9843 ft.) At an altitude of above 2000 m (6562 ft.), the measurement categories are lowered to 1000 V CAT II, 600 V CAT III.
Operating temperature and humidity	Temperature: -20°C to 50°C (-4°F to 122°F) When communicating via LAN or USB: 0°C to 50°C (32°F to 122°F) When using the external control terminal: 0°C to 50°C (32°F to 122°F) When running on battery: 0°C to 50°C (32°F to 122°F) When charging battery: 10°C to 35°C (50°F to 95°F) Humidity: 80% RH or less (no condensation)
Storage temperature and humidity	-30°C to 60°C (-22°F to 140°F), 80% RH or less (no condensation) When the instrument is not in use for an extended period, remove the battery pack from the body and store in an environment of -20°C to 30°C (-4°F to 86°F).
Dust-proofness, Water-proofness	IP30 (EN 60529)
Applicable standards	Safety EN 61010 EMC EN 61326 Class A
Compliance standards	Harmonics IEC 61000-4-7:2009, IEC 61000-2-4 Class 3 Power quality IEC 61000-4-30:2015 Class S, EN 50160, IEEE 1159 Flicker IEC 61000-4-15:2010
Power supply	<ul style="list-style-type: none">• Z1002 AC Adapter Rated supply voltage: 100 V to 240 V AC (Voltage fluctuations of ±10% for the rated supply voltage are taken into account.) Rated supply frequency: 50 Hz/60 Hz Anticipated transient overvoltage: 2500 V Maximum rated power: 80 VA (including AC adapter), 35 VA (main unit only)• Z1003 Battery Pack (Ni-MH 4500 mAh) Rated supply voltage: 7.2 V DC
Recharge function	Charges the battery regardless of whether the instrument is on or off. Charging time 5 hours 30 min at a maximum (at 23°C, as a referential)
Continuous operating time	When Z1003 Battery Pack is used (at 23°C, as a referential) Approx. 8 hours (fully charged, continuous operation, with LCD backlight turned off automatically and sensors not involving AC/DC sensors used)
Backup battery	Approx. 10 years (at 23°C, as a referential) For backup clock and setting conditions (Lithium battery)
Memory capacity	4 MB
Maximum recording period	1 year (366 days)
Maximum recording events	9999 events
Clock function	Auto-calendar, leap-year correcting, 24-hour clock
Real-time clock accuracy	±0.5 s per day (when main unit is on, within operating temperature and humidity range)
Display refresh rate	Approx. 0.5 s
Display	6.5-inch TFT color LCD (640 × 480 dots)
Interface	SD memory card, USB, LAN, RS-232C, external I/O
Dimensions	Approx. 300W × 211H × 68D mm (11.81"W × 8.31"H × 2.68"D) (excluding protrusions)
Body	Strap can be attached.

General Specifications

Mass	Approx. 2.5 kg (88.2 oz.) (with Z1003 Battery Pack installed)
Product warranty period	3 years
Accessories	See “Accessories” (p. 2).
Options	See “Options” (p. 3).

14.2 Input Specifications/Output Specifications/Measurement Specifications

1. Basic specifications

Number of channels	Voltage: 4 channels Current: 4 channels
Input Terminal Specifications	Voltage: Plug-in terminal (Safety terminal) Current: Special connector (Hioki PL14)
Current sensor power supply	For AC/DC Auto-Zero Current Sensor, AC Flexible Current Sensor +5 V \pm 0.25 V, -5 V \pm 0.25 V, supply current up to 30 mA per channel
Wiring	Single-phase 2-wire/DC: 1P2W/DC Single-phase 3-wire: 1P3W Single-phase 3-wire 1-voltage measurement: 1P3W1U 3-phase 3-wire 2-watt meter measurement: 3P3W2M 3-phase 3-wire 3-watt meter measurement: 3P3W3M 3-phase 4-wire: 3P4W 3-phase 4-wire 2.5 element: 3P4W2.5E In addition to one of the above, input CH4.
Input method	Voltage: Isolated input (U1, U2, U3, U4 and N terminal have a common differential input, and U1, U2, U3, U4 and N terminal are internally non-isolated) Current: Isolated input through a current sensor
Input resistance	Voltage input section: 5 M Ω \pm 20% Current input section: 200 k Ω \pm 20%
Maximum input voltage	Voltage input section: 1000 V AC/DC, 2200 V peak Current input section: 1.7 V AC/DC, 2.4 V peak
Maximum rated voltage to earth	Voltage input section: 1000 V AC (Measurement category III), 600 V AC (Measurement category IV), and anticipated transient overvoltage 8000 V Current input section: Depends upon the current sensor being used
Measurement method	Digital sampling, zero-cross synchronized calculation method
Sampling frequency	200 kHz
A/D converter resolution	16 bits
Display range	Voltage: 2 V to 1300 V Current: 0.4% to 130% of range Power: 0.0% to 130% of range Measurement items other than the above: 0% to 130% of range
Zero display range	RMS voltage: Lower than 2 V If the RMS voltage is 0 V, the voltage DC value, harmonic voltage (all orders), power value, harmonic active power (all orders), and reactive power (all orders) are made to be zero. RMS current: Less than 0.4% f.s. If the RMS current is 0 A, the current DC value, harmonic current (all orders), power value, harmonic active power (all orders), and reactive power (all orders) are made to be zero.
Effective measurement range	<ul style="list-style-type: none"> • Voltage AC: 10 V to 1000 V The peak voltage is \pm2200 V. DC: 5 V to 1000 V • Current 5% to 120% of range The peak current is \pm400% of range. • Power 5% to 120% of range (with both voltage and current within effective measuring range) See separate specifications for harmonic measurement
Event judgment	Use internal data (floating point) instead of displayed value for event judgment.

2. Measurement items

(1) Item detected at a sampling frequency of 200 kHz with no gaps

	Notation	1P2W	1P3W	1P3W1U	3P3W2M	3P3W3M	3P4W	3P4W2.5E
Transient voltage	Tran	1,4	1,2,4	1,4	1,2,4	1,2,3	1,2,3,4	1,3,4

(2) Items measured each 1 cycle with no gaps

	Notation	1P2W	1P3W	1P3W1U	3P3W2M	3P3W3M	3P4W	3P4W2.5E
Frequency (1 wave)	Freq_wav	U1						

(3) Item measured over 1 cycle with no gaps, commencing at a fundamental zero crossing, and refreshed each half-cycle

	Notation	1P2W	1P3W	1P3W1U	3P3W2M	3P3W3M	3P4W	3P4W2.5E
RMS voltage refreshed each half-cycle	Urms1/2	1,4	1,2,4	1,4	1,2,3,4	12,23,31	1,2,3,4	
Swell	Swell	1	1,2	1	1,2,3	12,23,31	1,2,3	
Dip	Dip	1	1,2	1	1,2,3	12,23,31	1,2,3	
Interruption	Intrpt	1	1,2	1	1,2,3	12,23,31	1,2,3	
RVC	RVC	1	1,2	1	1,2,3	12,23,31	1,2,3	
Instantaneous flicker value	Pinst	1	1,2	1	1,2,3	12,23,31	1,2,3	
RMS current refreshed each half-cycle	Irms1/2	1,4	1,2,4		1,2,3,4			

(4) Items measured over half-cycle with no gaps

	Notation	1P2W	1P3W	1P3W1U	3P3W2M	3P3W3M	3P4W	3P4W2.5E
Inrush current	Inrush	1, 4	1, 2, 4		1, 2, 3, 4			

(5) Items measured over the approximately 200-ms (10/12-cycle for 50 Hz / 60 Hz, respectively) aggregation with no gaps

	Notation	1P2W	1P3W	1P3W1U	3P3W2M	3P3W3M	3P4W	3P4W2.5E
Frequency (200 ms)	Freq	U1						
Frequency (10 sec)	Freq10s	U1						
Voltage waveform peak	Upk+,Upk-	1,4	1,2,4	1,4	1,2,3,4	12,23,31	1,2,3,4	
Current waveform peak	lpk+,lpk-	1,4	1,2,4		1,2,3,4			
RMS voltage (phase)	Urms	1,4	1,2, AVG,4	1,4	-	1,2,3, AVG	1,2,3, AVG,4	
RMS voltage (line)		-	-	-	1,2,3, AVG,4	12,23,31, AVG	12,23,31, AVG,4	
Voltage DC	Udc	1,4	1,2,4	1,4	1,2,3,4	12,23,31	1,2,3,4	
Voltage CF	Ucf	1,4	1,2,4	1,4	1,2,3,4	12,23,31	1,2,3,4	

	Notation	1P2W	1P3W	1P3W1U	3P3W2M	3P3W3M	3P4W	3P4W2.5E
RMS current	Irms	1,4	1,2,AVG,4		1,2,3,AVG,4			
Current DC	Idc	1,4	1,2,4		1,2,3,4			
Current CF	Icf	1,4	1,2,4		1,2,3,4			
Active power	P	1	1,2,SUM			1,2,3,SUM		
Active energy	WP+,WP-	1	SUM					
Energy cost	Ecost	1	SUM					
Reactive power	Q	1	1,2,SUM			1,2,3,SUM		
Reactive energy	WQ_LAG, WQ_LEAD	1	SUM					
Apparent power	S	1	1,2,SUM		1,2,3,SUM			
Apparent energy	WS	1	SUM					
Power factor / displacement power factor	PF/DPF	1	1,2,SUM			1,2,3,SUM		
Active power demand quantity	Dem_WP+, Dem_WP-	1	SUM					
Reactive power demand quantity	Dem_WQ_LAG, Dem_WQ_LEAD	1	SUM					
Apparent power demand quantity	Dem_WS	1	SUM					
Active power demand value	Dem_P+, Dem_P-	1	SUM					
Reactive power demand value	Dem_Q_LAG, Dem_Q_LEAD	1	SUM					
Apparent power demand value	Dem_S	1	SUM					
Power factor demand value	Dem_PF	1	SUM					
Voltage negative-phase unbalance factor	Uunb		-		SUM			
Voltage zero-phase unbalance factor	Uunb0		-				SUM	
Current negative-phase unbalance factor	Iunb		-		SUM			
Current zero-phase unbalance factor	Iunb0		-				SUM	
Harmonic voltage	Uharm	1,4	1,2,4	1,4	1,2,3,4	12,23,31	1,2,3,4	
Harmonic current	Iharm	1,4	1,2,4		1,2,3,4			
Harmonic power	Pharm	1	1,2,SUM		SUM	1,2,3,SUM		
Interharmonics voltage	Uiharm	1,4	1,2,4	1,4	1,2,3,4	12,23,31	1,2,3,4	
Interharmonics current	Iiharm	1,4	1,2,4		1,2,3,4			

	Notation	1P2W	1P3W	1P3W1U	3P3W2M	3P3W3M	3P4W	3P4W2.5E
Harmonics voltage phase angle	Uphase	1,4	1,2,4	1,4	1,2,3,4	12,23,31	1,2,3,4	
Harmonics current phase angle	Iphase	1,4	1,2,4		1,2,3,4			
Harmonic voltage-current phase difference	Pphase	1,4	1,2,SUM		SUM	1,2,3,SUM		
Voltage total harmonic distortion rate	Uthd-F/Uthd-R	1,4	1,2,4	1,4	1,2,3,4	12,23,31	1,2,3,4	
Current total harmonic distortion rate	Ithd-F/Ithd-R	1,4	1,2,4		1,2,3,4			
K factor	KF	1,4	1,2,4		1,2,3,4			

(6) Flicker measurement parameter

	Notation	1P2W	1P3W	1P3W1U	3P3W2M	3P3W3M	3P4W	3P4W2.5E
Short-term voltage flicker	Pst	1	1,2	1	1,2,3	12,23,31	1,2,3	
Long-term voltage flicker	Plt	1	1,2	1				
ΔV10 (Every 1 min., average hourly value, maximum hourly value, 4th maximum hourly value, overall (during the measurement) maximum value)	dV10, dV10 AVG, dV10 MAX, dV10 MAX4, dV10 total MAX	1	1,2	1				

3. Accuracy specifications

Conditions of guaranteed accuracy	Guaranteed accuracy period: 1 year Guaranteed accuracy period from adjustment made by Hioki: 1 year Temperature and humidity for guaranteed accuracy: 23°C±5°C (73°F±5°F), 80% RH or less Warm-up time: at least 30 min Power supply frequency range: 50 Hz/60 Hz ± 2 Hz Power factor=1, common-mode voltage 0 V, specified after zero-adjustment For AC measurement, add the following conditions: Input of 10 V rms or more in the standard channel (U1) Frequency Range: When the measurement frequency is set to 50 Hz: 40 Hz to 58 Hz When the measurement frequency is set to 60 Hz: 51 Hz to 70 Hz
Temperature coefficient	0.1% f.s./°C
Effect of common mode voltage	Within ±0.2% f.s. (1000 V rms AC, 50 Hz/60 Hz, between voltage input and the instrument case)
Effect of external magnetic	Within 1.5% f.s. (in a magnetic field of 400 A rms/m AC, 50 Hz/60 Hz)

4. Transient voltage measurement specifications Tran

Measurement method	Detected using the sampled waveform from which the fundamental wave component (50 Hz/60 Hz) (detected once for every waveform of fundamental voltage)
Displayed items	<p>Transient voltage value: Peak value of a waveform from which the fundamental component is eliminated obtained over a 3-ms time</p> <p>Transient width: Period during which threshold value is exceeded (up to 2 ms)</p> <p>Maximum transient voltage value: The maximum of peak values of a waveform from which the fundamental component is eliminated obtained during the period from transient IN to transient OUT (leaving channel information)</p> <p>Transient period: Period from transient IN to transient OUT</p> <p>Transient count within the period: Number of transients occurring during period from transient IN to transient OUT (The number of transients includes ones occurring across every channel; however, transients occurring simultaneously on multiple channels are counted as one) (RMS transient: For testing purposes)</p>
Measurement range	± 2.200 kV peak
Measurement band	5 kHz (–3 dB) to 40 kHz (–3 dB), specified at 20 V rms
Minimum detection width	5 µs
Measurement accuracy	±5.0% rdg. ±1.0% f.s. (specified at 1000 V rms, 15 kHz)
Event threshold	2200.0 V Set as an absolute value relative to the peak value (crest value) of the waveform from which the fundamental component is eliminated.
Event IN	In the state that the transient voltage is detected for the first time during the 200-ms aggregation period Event occurrence time represents the time when a peak value exceeds the threshold value. The detected peak voltage and transient width are displayed.
Event OUT	The lead of the 200-ms aggregation period in which no transient voltages were detected on any one of the channels, following the transient event IN state. The transient period (difference between the IN time and OUT time) is indicated.
Multiple-phase system treatment	Begins when a transient voltage is detected for any one of the U1 to U4 channels and ends when no transient voltage is detected for every channels.
Saved waveforms	<p>Event waveforms</p> <p>Transient waveforms</p> <p>Event IN: Saves a waveform 1 ms before and 2 ms after the position at which the maximum transient voltage is detected within one waveform including event IN.</p> <p>Event OUT: Saves a waveform 1 ms before and 2 ms after the position at which the maximum transient voltage is detected between event IN and event OUT.</p>

5. Frequency cycle measurement specifications Freq_wav

Measurement method	Reciprocal method Frequency calculated from the reciprocal of the accumulated time over a 1-cycle time on U1 (reference channel)
Displayed items	Frequency obtained over a 1-cycle time, maximum deviation between event IN and event OUT
Measurement range	70.000 Hz
Measurement accuracy	±0.200 Hz or less (at an input of between 50 V and 1100 V)
Event threshold	Specified in deviation, 0.1 Hz to 9.9 Hz, 0.1 Hz increments

Event IN	Start time when the waveform exceeds the positive threshold value or falls below the negative threshold value
Event OUT	Start time when the waveform falls below the value calculated by subtracting 0.1 Hz from the positive threshold value in the negative direction or exceeds the one calculated by adding 0.1 Hz to the negative threshold value in the positive direction. Frequency hysteresis corresponds to 0.1 Hz.
Multiple-phase system treatment	None
Saved waveforms	Event waveforms

6. RMS voltage refreshed each half-cycle measurement specifications **Urms1/2**

Measurement method	RMS voltage calculated using data obtained over a 1-cycle time refreshed each half-cycle Line voltage is used for 3-phase 3-wire (3P3W3M) wiring, while phase voltage is used for 3-phase 4-wire wiring.
Displayed items	RMS voltage refreshed each half-cycle
Measurement range	1000.0 V
Measurement accuracy	During 10 V to 660 V input: $\pm 0.3\%$ of declared voltage (at a declared input voltage of 100 V or more, but at an input of 10% to 150% for the declared input voltage) Other than above: $\pm 0.2\%$ rdg. $\pm 0.1\%$ f.s.

7. RMS current refreshed each half-cycle measurement specifications **Irms1/2**

Measurement method	RMS current calculated using data obtained over a 1-cycle time refreshed each half-cycle (synchronized with voltage of same channel).
Displayed items	RMS current refreshed each half-cycle
Measurement range	Depends on the current sensor in use
Measurement accuracy	$\pm 0.2\%$ rdg. $\pm 0.1\%$ f.s. + (current sensor accuracy) (Note: While using 2000 A range of Model CT7742, f.s. tolerance should be 2.5 times the value)

8. Swell measurement specifications**Swell**

Measurement method	Detected when the RMS voltage refreshed each half-cycle rises above the threshold value.
Displayed items	Swell height: Maximum value for RMS voltage refreshed each half-cycle [V] Swell duration: Period from the time a U1 to U3 swell is detected until the reading falls below the value obtained by subtracting the hysteresis from the threshold value.
Measurement range	1000.0 V
Measurement accuracy	Same as for RMS voltage refreshed each half-cycle Duration: Within a half-cycle time from the starting time and another half-cycle until the end time
Event threshold	Percentage with respect to declared input voltage
Event IN	Start of a waveform with the RMS voltage refreshed each half-cycle greater than the threshold value
Event OUT	Start of a waveform with the RMS voltage refreshed each half-cycle being (threshold value - hysteresis) or less
Multiple-phase system treatment	Begins when a swell is detected in any one of the channels among U1 to U3, and ends when no swell is detected in every channels.
Saved waveforms	Event waveforms
Trend Data	Saved the data of RMS voltage refreshed each half-cycle and RMS current refreshed each half-cycle obtained in the period between 0.5 sec prior to the event IN and 29.5 sec after the event IN.

9. Dip measurement specifications**Dip**

Measurement method	Detected when the RMS voltage refreshed each half-cycle falls below the threshold value.
Displayed items	Dip depth: Minimum value of the RMS voltage refreshed each half-cycle [V] Dip duration: Period from the time a U1 to U3 dip is detected until the reading exceeds the value obtained by adding the hysteresis to the threshold value.
Measurement range	1000.0 V
Measurement accuracy	Same as for RMS voltage refreshed each half-cycle Duration: Within a half-cycle time from the starting time and another half-cycle until the end time
Event threshold	Percentage with respect to declared input voltage
Event IN	Start of a waveform with the RMS voltage refreshed each half-cycle falling below the threshold value
Event OUT	Start of a waveform with the RMS voltage refreshed each half-cycle is (threshold value + hysteresis) or greater
Multiple-phase system treatment	Begins when a dip is detected in any one of the channels among U1 to U3, and ends when no dip is detected in any of the channels.
Saved waveforms	Event waveforms
Trend Data	Saved the data of RMS voltage refreshed each half-cycle and RMS current refreshed each half-cycle obtained in the period between 0.5 sec prior to the event IN and 29.5 sec after the event IN.

10. Interruption measurement specifications **Intrpt**

Measurement method	Detected when the RMS voltage refreshed each half-cycle falls below the threshold value.
Displayed items	Interruption depth: Worst value for RMS voltage refreshed each half-cycle [V] Interruption duration: Period from the time a U1 to U3 interruption is detected until the reading exceeds the value obtained by adding the hysteresis to the threshold value.
Measurement range	1000.0 V
Measurement accuracy	Same as for RMS voltage refreshed each half-cycle Duration: Within a half-cycle time from the starting time and another half-cycle until the end time
Event threshold	Percentage with respect to declared input voltage
Event IN	Start of a waveform with the RMS voltage refreshed each half-cycle falling below the threshold value
Event OUT	Starting time of a half-cycle voltage waveform to which an inrush current belongs when it falls below the value calculated by subtracting the hysteresis from the threshold value
Multiple-phase system treatment	Begins when an interruption is detected in any one of the channels among U1 to U3, and ends when no interruption is detected in any of the channels.
Saved waveforms	Event waveforms
Trend Data	Saved the data of RMS voltage refreshed each half-cycle and RMS current refreshed each half-cycle obtained in the period between 0.5 sec prior to the event IN and 29.5 sec after the event IN.

11. Rapid voltage change measurement Specifications **RVC**

Measurement method	Detected when the RMS voltage refreshed each half-cycle exceeded the threshold value. However, detected as a dip when the value falls below the threshold value of a dip, and detected as a swell when the value exceeds the threshold value of a swell.
Displayed items	ΔU_{ss} : Absolute difference [V] between 1-second average value of the RMS voltage refreshed each half-cycle immediately before the event and the first 1-second average value of the RMS voltage refreshed each half-cycle after the event. ΔU_{max} : Absolute difference [V] between all the RMS voltage refreshed each half-cycle between the events and 1-second average value of the RMS voltage refreshed each half-cycle immediately before the event. Both values are the maximum value across the channels for multiple phase system. The ΔU_{ss} is indicated for the minimum value in the event list.
Measurement range	1000.0 V
Measurement accuracy	Same with the RMS voltage refreshed each half-cycle Duration: Within a half-cycle time from the accurate starting time and another half-cycle until the accurate end time
Event threshold value	Percentage of nominal voltage
Event IN	Start of a waveform outside of 1-second average value of the RMS voltage refreshed each half-cycle \pm the threshold value
Event DISCARD	RVC event is discarded if a dip or swell event is occurred after event IN.
Event OUT	Start of a waveform entering the 1-second average value of the RMS voltage refreshed each half-cycle \pm the threshold value (including hysteresis) and remaining for 1 s. The event period becomes a period 1 second shorter than the period between IN and OUT.
Multiple-phase system treatment	Started when any of the channels from U1 to U3 became RVC and ended when all the channels ended the RVC.

Saved waveforms	Event waveforms
Trend Data	Saved the data of RMS voltage refreshed each half-cycle and RMS current refreshed each half-cycle obtained in the period between 0.5 sec prior to the event IN and 29.5 sec after the event IN.

12. Instantaneous flicker measurement specifications **Pinst**

Measurement method	Uses IEC61000-4-15 230 V lamp/120 V lamp (Pst and Plt is selected for flicker measurement)
Displayed items	Instantaneous flicker value
Measurement range	99.999
Resolution	0.001
Measurement band	See RMS frequency characteristics.
Measurement accuracy	Accuracy not defined

13. Inrush current measurement specifications **Inrush**

Measurement method	Detected by observing the RMS current calculated using data obtained over a 1-cycle time refreshed each half-cycle. (synchronized with voltage of same channel)
Displayed items	Maximum current of the RMS current measured above
Measurement range	Depends on the current sensor in use See "14.8 Range Configuration and Combination Accuracy" (p. 220).
Measurement accuracy	$\pm 0.3\%$ rdg. $\pm 0.3\%$ f.s. + (current sensor accuracy) (Note: While using 2000 A range of Model CT7742, f.s. tolerance should be 2.5 times the value)
Event threshold	From 0 to the value of the current range
Event IN	Starting time of a half-cycle voltage waveform of each channel in which an inrush current exceeded the threshold value
Event OUT	Start of half-cycle voltage waveform with its inrush current being (threshold value - hysteresis) or less
Multiple-phase system treatment	None
Saved waveforms	Event waveforms
Trend Data	Saved the data of RMS voltage refreshed each half-cycle and RMS inrush current obtained in the period between 0.5 sec prior to the event IN and 29.5 sec after the event IN

14. Frequency 10 s measurement specifications Freq10s

Measurement method	Reciprocal method Frequency calculated from the reciprocal of the accumulated time for 10 s on U1 (reference channel)
Displayed items	Frequency
Measurement range	70.000 Hz
Measurement accuracy	± 0.010 Hz or less

15. Frequency 200 ms measurement specifications Freq

Measurement method	Reciprocal method Value calculated from the reciprocal of the accumulated time for 20 ms on U1
Displayed items	Frequency
Measurement range	70.000 Hz
Measurement accuracy	± 0.020 Hz or less
Event threshold	Specified in deviation, 0.1 Hz to 9.9 Hz, 0.1 Hz increments
Event IN	Starting time of an approximately 200-ms aggregation period to which a value belongs when it exceeds the positive threshold value or falls below the negative threshold value
Event OUT	Start time of waveform returned to \pm (threshold value - 0.1 Hz) Equivalent to a frequency hysteresis of 0.1 Hz
Multiple-phase system treatment	None
Saved waveforms	Event waveforms

16. Voltage waveform peak measurement specifications Upk

Measurement method	Maximum point and minimum point of the sampled data during the 200-ms aggregation period
Displayed items	Positive waveform peak value Negative waveform peak value
Measurement range	± 2200.0 V pk
Measurement accuracy	With a voltage of between 10% to 150% of the declared voltage input: 5% of declared input voltage value With a voltage other than above input: 2% f.s.

17. Current waveform peak measurement specifications Ipk

Measurement method	Maximum point and minimum point of the sampled data during the 200-ms aggregation period
Displayed items	Positive waveform peak value Negative waveform peak value
Measurement range	Ranges added the crest factor to each of the current ranges
Measurement accuracy	With a current of 50% f.s. or more input: 5% rdg. + (current sensor accuracy) With a current of less than 50% f.s. input: 2% f.s.+ (current sensor accuracy)

18. RMS voltage measurement specifications**Urms**

Measurement method	Measured during the 200-ms aggregation period in accordance with IEC61000-4-30 When set to 3P3W3M, 3P4W or 3P4W2.5E, the phase voltage and line voltage setting is applied to the RMS voltage, Urms
Displayed items	RMS voltage on each channel AVG (average) RMS voltage on multiple channels (For details, see Calculation Formula.)
Display selection	Phase voltage/line voltage (When 3P3W3M/3P4W/3P4W2.5E are set, both will be stored)
Measurement range	1000.0 V
Measurement accuracy	With a voltage of between 10 V and 660 V input: $\pm 0.2\%$ of the declared voltage input (at a declared input voltage of 100 V to 440 V but with a voltage of between 10% and 150% of the declared input voltage input) With a voltage other than above input: $\pm 0.1\%$ rdg. $\pm 0.1\%$ f.s.

19. Voltage DC value measurement specifications**Udc**

Measurement method	Average value of the values obtained during the 200-ms aggregation period
Displayed items	Voltage DC value
Measurement range	1000.0 V
Measurement accuracy	$\pm 0.3\%$ rdg. $\pm 0.1\%$ f.s.

20. Voltage CF value measurement specifications**Ucf**

Measurement method	Calculated according to the RMS voltage and the peak value of the voltage waveform
Displayed items	Voltage CF Value
Measurement range	224.00
Measurement accuracy	Accuracy not defined

21. RMS current measurement specifications**Irms**

Measurement method	True RMS method Measured during the 200-ms aggregation period based on IEC61000-4-30.
Displayed items	RMS current on each channel AVG (average) RMS current on multiple channels (For details, see Calculation Formula.)
Measurement range	Depends on the current sensor in use
Measurement accuracy	$\pm 0.1\%$ rdg. $\pm 0.1\%$ f.s. + (current sensor accuracy) (Note: While using 2000 A range of Model CT7742, f.s. tolerance should be 2.5 times the value)

22. Current DC value measurement specifications**Idc**

Measurement method	Average value of the values obtained during the 200-ms aggregation period
Displayed items	Current DC value
Measurement range	Depends on the current sensor in use
Measurement accuracy	$\pm 0.5\%$ rdg. $\pm 0.5\%$ f.s. + (current sensor accuracy) (Note: While using 2000 A range of Model CT7742, f.s. tolerance should be 2.5 times the value)

23. Current CF value measurement specifications Icf

Measurement method	Calculated from the RMS current and the peak value of the current waveform.
Displayed items	Current CF Value
Measurement range	408.00
Measurement accuracy	Accuracy not defined

24. Active power measurement specifications P

Measurement method	Measured every 200 ms.
Displayed items	Active power on each channel Sum of values on multiple channels (For details, see Calculation Formula.) Inflow (consumption): Unsigned Outflow (regeneration): Negative
Measurement range	Depends on the combination of voltage and current ranges (see "14.8 Range Configuration and Combination Accuracy" (p. 220))
Measurement accuracy	DC: $\pm 0.5\%$ rdg. $\pm 0.5\%$ f.s. + (current sensor accuracy) AC: $\pm 0.2\%$ rdg. $\pm 0.1\%$ f.s. + (current sensor accuracy) (Note: While using 2000 A range of Model CT7742, f.s. tolerance should be 2.5 times the value)
Power Factor Influence	1.0% rdg. or less (40 Hz to 70 Hz at power factor = 0.5) Phase difference between voltage and current of the internal circuit: $\pm 0.2865^\circ$

25. Apparent power measurement specifications S

Measurement method	RMS value calculation: Calculated from RMS voltage value, Urms and RMS current, Irms. Fundamental wave calculation: Calculated from fundamental wave active power and reactive power
Displayed items	Apparent power on each channel Sum of values on multiple channels (For details, see Calculation Formula.)
Display selection	RMS calculation / fundamental wave calculation (Both of them are stored.)
Measurement range	Depends on the voltage \times current range combination (see "14.8 Range Configuration and Combination Accuracy" (p. 220))
Measurement accuracy	± 1 dgt. for calculations derived from the various measured values. (sum is ± 3 dgt.)

26. Reactive power measurement specifications Q

Measurement method	RMS value calculation: Calculated from apparent power S and active power P Fundamental wave calculation: Calculated from fundamental wave voltage and current. Lag phase (LAG: current lags the voltage): Unsigned Lead phase (LEAD: current leads the voltage): Negative
Displayed items	Reactive power on each channel Sum of values on multiple channels (For details, see Calculation Formula.)
Display selection	RMS calculation / fundamental wave calculation (Both of them are stored.)
Measurement range	Depends on the voltage × current range combination (see “14.8 Range Configuration and Combination Accuracy” (p. 220))
Measurement accuracy	During RMS calculation: ±1 dgt. for calculations derived from the various measured values. (sum is ±3 dgt.) During fundamental wave calculation: ±0.3% rdg.±0.1% f.s. + Current sensor specifications (reactive factor=1) in fundamental wave frequency of 45 Hz to 66 Hz (Note: While using 2000 A range of Model CT7742, f.s. tolerance should be 2.5 times the value)
Influence of Reactive Factors (During fundamental wave calculation)	1.0% rdg. or less (40 Hz to 70 Hz at a reactive factor of 0.5) Phase difference between voltage and current of the internal circuit: ± 0.2865°

27. Active energy, reactive energy, apparent energy measurement specifications WP+, WP-; WQ_LAG, WQ_LEAD; WS

Measurement method	Integrated from active power separately by consumption and regeneration Integrated from reactive power separately by lag and lead Integration from apparent power Electric energy is measured from the start of recording
Displayed items	<ul style="list-style-type: none"> • Active energy WP+ (consumption), WP- (regeneration) Sum of values on multiple channels (For details, see Calculation Formula.) • Reactive energy WQ_LAG (lag), WQ_LEAD (lead) Sum of values on multiple channels (For details, see Calculation Formula.) • Apparent energy: WS Sum of values on multiple channels (For details, see Calculation Formula.) • Elapsed time
Measurement range	Depends on the combination of voltage range, current range, and elapsed time. (see “14.8 Range Configuration and Combination Accuracy” (p. 220))
Measurement accuracy	Active energy: Active power measurement accuracy ±10 dgt. Reactive energy: Reactive power measurement accuracy ±10 dgt. Apparent energy: Apparent power measurement accuracy ±10 dgt. Cumulative time accuracy: ±10 ppm±1 s (23°C [73°F])

28. Energy cost measurement specifications Ecost

Measurement method	Calculated by multiplying active energy (consumption) WP+ by the unit energy cost (per kilowatt-hour).
Displayed items	Energy cost
Measurement accuracy	±1 dgt. relative to calculations from measured values

29. Power factor and displacement power factor measurement specifications **PF, DPF**

Measurement method	Power Factor: Calculated from apparent power S and active power P Displacement Power Factor: Calculated according to fundamental wave active power and reactive power Lag phase (LAG: current lags more than the voltage): Positive Lead phase (LEAD: current leads more than the voltage): Negative
Displayed items	Power factor/Displacement power factor on each channel Sum of values on multiple channels (For details, see Calculation Formula.)
Display selection	RMS calculation / fundamental wave calculation (Both of them are stored.)
Displacement power factor measurement accuracy	Inputs with its measurement accuracy voltage is 100 V or greater and its current is 10% or greater than the range: When displacement power factor = 1: $\pm 0.05\%$ rdg. When $0.8 \leq \text{Displacement power factor} < 1$: $\pm 1.50\%$ rdg. When $0 < \text{Displacement power factor} < 0.8$: $\pm (1 - \cos(\phi + 0.2865)/\cos(\phi)) \times 100\%$ rdg. + 50 dgt. (reference) ϕ : 1st order indication for phase difference between harmonics voltage and current Phase accuracy of the current sensor is added to any of ϕ .

30. Active power demand quantity (value), reactive power demand quantity (value), apparent power demand quantity (value) measurement specifications

Dem_WP+ (Dem_P+), Dem_WP-(Dem_P-), Dem_WQ_LAG (Dem_Q_LAG), Dem_WQ_LEAD (Dem_Q_LEAD), Dem_WS (Dem_S)

Measurement method	Active power demand quantity (value): Integrated from active power separately by consumption and regeneration Reactive power demand quantity (value): Integrated from reactive power separately by lag and lead Apparent power demand quantity (value): Integration from apparent power Demand quantity: energy measured by the set interval time (not displayed if there is only the record) Demand value: average value of power measured by the set interval time
Measurement range	Depends on the voltage range \times current range \times interval time combination (see "14.8 Range Configuration and Combination Accuracy" (p. 220))
Demand quantity measurement accuracy	Active energy: Active power measurement accuracy ± 10 dgt. Reactive energy: Reactive power measurement accuracy ± 10 dgt. Apparent energy: Apparent power measurement accuracy ± 10 dgt. Cumulative time accuracy: ± 10 ppm ± 1 s (23°C)
Demand value measurement accuracy	Accuracy of each measured value ± 1 dgt.

31. Power factor demand value measurement specifications **Dem_PF**

Measurement method	Calculated using the active power demand value (consumption) Dem_P+ and the reactive power demand value (lag) Dem_Q_LAG
Measurement accuracy	± 1 dgt. for calculations derived from the various measured values.

32. Harmonic voltage and harmonic current measurement specifications U_{harm}, I_{harm}

Measurement method	Uses IEC61000-4-7 Following the harmonic analysis, indicated added the harmonics components that are adjacent to the integer order interharmonic components. (For details, see Calculation Formula.)
Analysis window width	10 cycles/12 cycles
Window point count	Rectangular 2048 points
Displayed items	From 0th to 50th order Options for RMS and content percentage For content percentage, when the RMS is 0, all orders should be set to 0%.
Measurement range	<ul style="list-style-type: none"> • Harmonic voltage RMS value: 1000.0 V Content percentage: 100% • Harmonic current RMS value: Depends on the current sensor in use Content percentage: 500%
Measurement accuracy	<ul style="list-style-type: none"> • Voltage Defined by the declared input voltage of 100 V to 440V 0th order: Same as Voltage DC value 1st order: Same as RMS voltage 2nd order or higher: $\pm 10.0\%$ rdg. when the value is more than 1% of the declared input voltage, and the value should be $\pm 0.05\%$ of the declared input voltage when the value is less than 1% of the declared input voltage. • Current 0th order: same as Current DC value 1st to 20th order: $\pm 0.5\%$ rdg. $\pm 0.2\%$ f.s. + (current sensor accuracy) 21st to 30th order: $\pm 1.0\%$ rdg. $\pm 0.3\%$ f.s. + (current sensor accuracy) 31st to 40th order: $\pm 2.0\%$ rdg. $\pm 0.3\%$ f.s. + (current sensor accuracy) 41st to 50th order: $\pm 3.0\%$ rdg. $\pm 0.3\%$ f.s. + (current sensor accuracy) (Note: While using 2000 A range of Model CT7742, f.s. tolerance should be 2.5 times the value)

33. Harmonic power measurement specifications Pharm

Measurement method	Uses IEC61000-4-7 Indicates harmonic power for each channel and the sum for multiple channels (For details, see Calculation Formula.)
Analysis window width	10 cycles/12 cycles
Window point count	Rectangular 2,048 points
Displayed items	From 0th to 50th order Options for RMS and content percentage For content percentage, when the RMS is 0, all orders should be set to 0%.
Measurement range	Depends on the voltage \times current range combination (see Power range configuration table)
Measurement accuracy	<ul style="list-style-type: none"> 0th order : $\pm 0.5\%$ rdg. $\pm 0.5\%$ f.s. + (current sensor accuracy) 1st to 20th order: $\pm 0.5\%$ rdg. $\pm 0.2\%$ f.s. + (current sensor accuracy) 21st to 30th order: $\pm 1.0\%$ rdg. $\pm 0.3\%$ f.s. + (current sensor accuracy) 31st to 40th order: $\pm 2.0\%$ rdg. $\pm 0.3\%$ f.s. + (current sensor accuracy) 41st to 50th order: $\pm 3.0\%$ rdg. $\pm 0.3\%$ f.s. + (current sensor accuracy) (Note: While using 2000 A range of Model CT7742, f.s. tolerance should be 2.5 times the value)

34. Interharmonic voltage and interharmonic current measurement specifications Uiharm, liharm

Measurement method	Uses IEC61000-4-7 Following the harmonic analysis, indicated added the harmonics components between the integer orders harmonics components.
Analysis window width	10 cycles/12 cycles
Window point count	Rectangular 2,048 points
Displayed items	From order 0.5 to 49.5 Options for RMS and content percentage For content percentage, when the RMS is 0, all orders should be set to 0%.
Measurement range	Interharmonic voltage: 1000.0 V Interharmonic current: Depends on the current sensor in use
Measurement accuracy	Interharmonic voltage: Harmonic input has been specified with the declared input voltage, 100 V to 440 V, input. With a harmonic input of 1% or more of the declared input voltage input: $\pm 10.0\%$ rdg. With a harmonic input of less than 1% of the declared input voltage: $\pm 0.05\%$ of the declared input voltage Interharmonic current: Accuracy not defined

35. Harmonic voltage phase angle and harmonic current phase angle measurement specifications Uphase, lphase

Measurement method	Applies IEC61000-4-7
Analysis window width	10 cycles/12 cycles
Window point count	Rectangular 2,048 points
Displayed items	Indicates the harmonic phase angle component of the integer-numbered order (including the fundamental wave component) (Where the reference channel's fundamental wave phase angle is treated as 0°)
Measurement range	0.00° to $\pm 180.00^\circ$
Measurement accuracy	Accuracy not defined

36. Harmonic voltage and current phase difference measurement specifications Pphase

Measurement method	Uses IEC61000-4-7
Analysis window width	10 cycles/12 cycles
Window point count	Rectangular 2,048 points
Displayed items	Indicates the difference between the harmonic voltage phase angle and the harmonic current phase angle (including fundamental wave component). Phase difference between the harmonic voltage and the harmonic current on each channel Sum of values on multiple channels (For details, see Calculation Formula.)
Measurement range	0.00° to $\pm 180.00^\circ$
Measurement accuracy	1st order: $\pm 1^\circ$ 2nd, 3rd order: $\pm 2^\circ$ 4th order to 50th order: $\pm (0.05^\circ \times k + 2^\circ)$ (k: Harmonic Orders) However, current sensor accuracy is added. Harmonic Voltage of every order is specified as 1% of the declared voltage, and current level is specified as 1% f.s. or more.

37. Voltage THD and current THD measurement specifications **Uthd, Ithd**

Measurement method	Uses IEC61000-4-7
Analysis window width	10 cycles/12 cycles
Window point count	Rectangular 2,048 points
Displayed items	THD-F (total harmonic distortion factor for the fundamental wave) THD-R (total harmonic distortion factor for the total harmonics including the fundamental wave)
Display selection	THD-F/THD-R (storage is implemented for both)
Measurement range	Voltage: 0.00% to 100.00% Current: 0.00% to 500.00%
Measurement accuracy	0.5% Defined for the following input for a nominal input voltage of 100 V to 440 V: Voltage 1st order: 100% of the nominal input voltage; 5th order or 7th order: 1% of the nominal input voltage Current 1st order: 100% of the current range; 5th or 7th order: 1% of the current range
Event threshold	Voltage: 0.0% to 100.0% Current: 0.0% to 500.0%
Event IN	Start of 200-ms aggregation at which the value exceeds the threshold value.
Event OUT	Start of 200-ms aggregation at which the value becomes (threshold value - hysteresis) or less.
Multiple-phase system treatment	Separate by channel
Saved waveforms	Event waveforms

38. Voltage unbalance factor (negative-phase unbalance factor, zero-phase unbalance factor) measurement specifications **Uunb, Uunb0**

Measurement method	Calculated using the fundamental voltage component of each 3-phase in the 3-phase 3-wire (3P3W2M, 3P3W3M) and 3-phase 4-wire wiring (For details, see Calculation Formula.).
Displayed items	Negative-phase unbalance factor (Uunb) Zero-phase unbalance factor (Uunb0)
Measurement range	Component: V Unbalance factor: 0.00% to 100.00%

39. Current unbalance factor (negative-phase unbalance factor, zero-phase unbalance factor) measurement specifications **Iunb, Iunb0**

Measurement method	Calculated using the fundamental current component of each 3-phase in the 3-phase 3-wire (3P3W2M, 3P3W3M) and 3-phase 4-wire wiring (For details, see Calculation Formula.).
Displayed items	Negative-phase unbalance factor (Iunb) Zero-phase unbalance factor (Iunb0)
Measurement range	Component: A Unbalance factor: 0.00% to 100.00%.

40. K Factor (multiplication factor) measurement specifications KF

Measurement method	Calculated using the harmonic RMS current value of 2nd order to 50th order. (For details, see Calculation Formula.)		
Analysis window width	10 cycles/12 cycles		
Window point count	Rectangular	2,048 points	
Displayed items	K factor KF		
Measurement range	0.00 to 500.00		

41. IEC flicker measurement specifications Pst, Plt

Measurement method	Uses IEC61000-4-15 (See "14.7 Calculation Formula" (p. 175)) Pst and Plt are calculated for every 10 min.		
Displayed items	Short-term flicker: Pst, Long-term flicker: Plt		
Measurement range and resolution	0.000 to 99.999		
Flicker filter	230 V lamp/120 V lamp		
Measurement accuracy	Pst $\pm 5\%$ rdg. (Specified by the performance test from the IEC61000-4-15 Class F3) Pst (value k) range: 0.1 to 20 (7 CPM or higher, 1620 CPM or less) 0.1 to 5 (less than 7 CPM, over 1620 CPM) (CPM means the number of changes for 1 min)		

42. ΔV_{10} flicker measurement specifications dV10

Measurement method	See "14.7 Calculation Formula" (p. 205) (Calculated values are converted to 100 V.) Calculated per minute		
Reference voltage	Automatic (using AGC)		
Displayed items	Value every 1 min., 1 hr. average value, 1 hr. maximum value, 4th largest value in 1 hr., and overall (within measurement period) maximum value for ΔV_{10}		
Measurement range and resolution	0.000 V to 99.999 V		
Measurement accuracy	$\pm 2\%$ rdg. ± 0.01 V (with a 100 V rms sine wave [50 Hz/60 Hz], a fluctuating voltage of 1 V rms [99.5 V rms to 100.5 V rms] , and a fluctuation frequency of 10 Hz)		
Threshold	0.00 V to 9.99 V Alarm output is generated if the threshold value is exceeded after comparing the value to every 1 min. value.		

43. RMS frequency characteristics

Frequency	Voltage	Current	Power
40 Hz to 70 Hz	Specified as RMS value	Specified as RMS value	Specified as RMS value
70 Hz to 1 kHz	$\pm 3\%$ rdg. $\pm 0.2\%$ f.s.	$\pm 3\%$ rdg. $\pm 0.2\%$ f.s.	$\pm 3\%$ rdg. $\pm 0.2\%$ f.s.
1 kHz to 10 kHz	$\pm 10\%$ rdg. $\pm 0.2\%$ f.s.	$\pm 10\%$ rdg. $\pm 0.2\%$ f.s.	$\pm 10\%$ rdg. $\pm 0.2\%$ f.s.
40 kHz	-3 dB	-3 dB	-

(Note: While using 2000 A range of Model CT7742, f.s. tolerance of the current and power should be 2.5 times the value)

14.3 Flagging Concept

IEC61000-4-30 Flagging concept

If an unreliable values are produce during a dip, swell, or interruption, the 200-ms aggregation will be “flagged.” An interval data including the flagged 200-ms aggregation will also be flagged.

Flagged data are referenced to decide the frequency for an interruption, and are recorded in status information of the TREND data. If events of a dip, swell, or interruption are set to off, the values are also flagged.

Using the included PQ ONE application software to load data and output it in the CSV format will cause a flag to be output to the status information.

14.4 QUICK SET Specifications

QUICK SET screen

Start confirmation	Confirmation of whether to launch the settings after initialization of the concerned measurement settings and recording settings
Basic settings	CH123: 1P2W/DC, 1P3W, 1P3W1U, 3P3W2M, 3P3W3M, 3P4W, 3P4W2.5E CH4: OFF/ON
Connected devices	Diagrams for connecting voltage codes and current sensors as well as inserting SD memory card Automatic sensor recognition (Manual setting when a legacy model sensor is connected) Implementation of zero adjustment
Voltage wiring	Make voltage wiring Sets the declared input voltage and confirm the level, phase and frequency.
Current wiring	Make current wiring Sets the range.
Wiring check	Check the wiring
Event settings	Select “Easy Settings Course”
Recording settings	Recording interval: 1/2/5/10/15/30 sec, 1/2/5/10/15/30 min, 1/2 hour, 150 cycles (only at 50 Hz) / 180 cycles (only at 60 Hz) Display the available save time Recording start: Interval time (*) / manual / specified time / repeat (Recording period is 00:00 to 24:00) Recording stop: Manual (*)/specified time/timer Folder/file name: Auto (*)/variable
Settings confirmation Recording start	After confirming the settings, start the measurement (otherwise, complete the settings without starting)

*: Default Settings

Easy settings course

Setting items		Course	Voltage events	Inrush current	Trend record only	EN50160
Wiring		Set in advance				
Current sensor		Set in advance				
Current range		Set in advance	Switches to an upper range when the reference value is 1/5th or more of the rated range		Set in advance	
Measurement frequency		Set in advance				
Declared input voltage		Set in advance				
Selection of calculation method	Urms type	Default				
	THD type	THD_F				
	PF/Q/S calculation selection	RMS value calculation				
	Harmonics	All levels			All percentages	
Recorded item settings		Yes harmonic				
Recording interval		1 min			10 min	
Event hysteresis		1%			2%	
Transient voltage		70% of the declared input voltage	Off		100% of the declared input voltage	
Voltage Swell		110% of the declared input voltage	Off		110% of the declared input voltage	
Voltage Dip		90% of the declared input voltage	Off		90% of the declared input voltage	
Interruption		10% of the declared input voltage	Off		5% of the declared input voltage	
RVC		Off			3% of the declared input voltage	
Frequency (200 ms)		Nominal input frequency ± 5 Hz	Off		Nominal input frequency ± 0.5 Hz	
Frequency (1 wave)		Off	Off			
Inrush current		Off	200% of the reference value	Off		
Voltage total harmonic distortion		5%	Off		8%	
Current total harmonic distortion		Off	Off			
Flicker		Off			Pst, Plt	

- Range settings for inrush current should not be changed without considering the reference value when the prior set range is at its maximum. A value of 10% of the range is used as threshold value when the reference value (measured value at the effective time of the easy setting) is 10% or less of the range.
If the reference value of 200% exceeds the rated range, the rated range value is set as the threshold value.
- Voltage THD is set as off if the RMS voltage value is 3% f.s. or less of the range.

- After easy setting, (not only for easy setting) if the VT, CT are changed after setting the threshold value, the threshold value does not change. (Event threshold value is set again after setting the VT, CT)
- Fundamentally, the settings that are not included in the table are taken as default values.
- The flicker filter is set to the 230 V lamp when the nominal input voltage is greater than 127 V and the 120 V lamp when the nominal input voltage is less than or equal to 127 V.

14.5 Event Specifications

Event detection method It can be detected in the recording interval of 1 sec or more.
 The detection method relative to measured values for each event target is listed in the measurement specifications.
 External events: Event is detected by detecting the signal towards the EVENT IN terminal.
 Manual events: Events are detected by pressing the **[MANUAL EVENT]** key.
 Enabled measurement item events are detected using OR logic.
 Events cannot be detected using maximum (MAX), minimum (MIN), and average (AVG) values.

Event-synchronized save functionality Event waveform: Approx. 200-ms aggregation (12.5 kS/s)
 Transient waveform: instantaneous waveform 1 ms prior to and 2 ms after the position at which the transient voltage waveform is detected (200 kS/s)
 Event trend data: RMS trend data for each half-cycle equivalent to 0.5 sec prior to an event and 29.5 sec after an event

Event contents

✓: Yes, —: No

Event parameter	Event list notation	IN/OUT support	Measurement Items	Event waveforms	Transient waveform	Event trend data
Transient voltage	Tran	IN/OUT	All instantaneous values	✓	✓	—
Swell	Swell	IN/OUT		✓	—	✓
Dip	Dip	IN/OUT	Frequency, voltage, current, electric power, power factor, unbalance factor, harmonic voltage, harmonic current, harmonic power, voltage THD, current THD (event category)	✓	—	✓
Interruption	Intrpt	IN/OUT		✓	—	✓
RVC	RVC	IN/OUT/DISCARD		✓	—	✓
Inrush current	Inrush	IN/OUT		✓	—	✓
Frequency (200 ms)	Freq	IN/OUT		✓	—	—
Frequency (1 wave)	Freq_wav	IN/OUT		✓	—	—
Voltage total harmonic distortion	Uthd	IN/OUT		✓	—	—
Inrush current	Inrush	IN/OUT		✓	—	✓
Current total harmonic distortion	Ithd	IN/OUT		✓	—	—
Timer event	Timer	—		✓	—	—
External event	Ext	—	✓	—	—	
Manual event	Manu	—	✓	—	—	
Pre-event recording	Before	—	✓	—	—	
Post-event recording	After	—	✓	—	—	
Recording start	Start	—	✓	—	—	
Recording stop	Stop	—	✓	—	—	

14.6 Interface Specifications

1. SD memory card

Slot	SD standard compliant × 1
Compatible card	SD memory card/ SDHC memory card (Use only Hioki-approved card)
Format	SD memory card format
Functions	Save and read the following content: <ul style="list-style-type: none"> • Binary data (measurement data) • Settings file • Screen copy Deleting of files Format

2. LAN interface

Connector	RJ-45 × 1
Electrical specifications	IEEE802.3 compliant
Transmission method	100BASE-TX
Protocol	TCP/IP
Functions	HTTP server function (Compatible software: Internet Explorer® Ver. 9 or later) Remote control application function Recording Start and End control function Configuration Function Event list function (capable of displaying event waveforms, event vectors, and event harmonic bar graphs) Settings according to the communication commands, acquisition of measurement data, and data download Automatic data transmission with FTP client function Automatic data acquisition with FTP server Acquisition of file during saving not available Acquisition of the data from the internal memory not available when recording interval is less than 1 min. E-mail transmission
Maximum cable length	100 m

3. USB interface

Connector	Series B receptacle × 1
Method	USB 2.0 (full-speed, high-speed), mass storage, class
Connection destination	Computer: Windows 7 (32-bit/64-bit) or Windows 10 (32-bit/64-bit)
Functions	When connected to the computer, the computer recognizes the SD memory card to be a removable disk, and downloads the data from the SD memory card. Note: The instrument cannot be connected while recording (including standby).

4. RS-232C interface

Connector	D-sub 9-pin × 1
Method	Compliance with RS-232C “EIA RS-232D,” “CCITT V.24,” and “JIS X 5101.”
Transmission mode	Full-duplex, start-stop synchronization method
Communication speed	19200 bps / 38400 bps
Data length	8 bits
Parity check	None
Stop bit	1
Connection destination	Computer: Windows 7 (32-bit/64-bit) or Windows 10 (32-bit/64-bit) Bluetooth®
Functions	Measurement and acquisition of measurement data by sending communication commands LR8410 Link compatible

5. External control interface

Connector	4-pin screwless terminal block × 1
Details	External event input: input terminal [IN] × 1, ground terminal [GND1] × 1 External output: output terminal [OUT] × 1, ground terminal [GND2] × 1
Event Input	Recognizes as an event input by the fall in the pulse signal or the short-circuiting (active LOW) of the GND1 terminal and the IN terminal each other. Non-insulated (GND1 is common with this instrument ground) Maximum rated power between terminals: 45 V DC Voltage input (High: 2 V to 45 V, Low: 0 V to 0.5 V) High duration: 100 ms or more, Low duration: 100 ms or more
Output	Open Collector 30 V, max 5 mA (isolation using photo-couplers) Output between the GND2 terminal and OUT terminal depending on the external output settings. Short pulse: TTL low output at event generation, pulse width approx. 10 ms Long pulse: TTL low output at event generation, pulse width approx. 2.5 s ΔV10 alarm: TTL low output at ΔV10 alarm, reverts to high at recording stop or when waiting to start recording

14.7 Calculation Formula

1. RMS voltage refreshed each half-cycle (Urms1/2), Dip, Swell, Interruption (Intrpt), RMS current refreshed each half-cycle (Irms1/2), Inrush current (Inrush)

Wiring Item	Single phase 2-wire 1P2W	Single phase 3-wire 1P3W	3-phase 3-wire 3P3W2M	3-phase 3-wire 3P3W3M	3-phase 4-wire 3P4W
Urms1/2 Dip Swell Intrpt [Vrms]= U_c	U_1 U_4 $U_c = \sqrt{\frac{1}{M} \sum_{s=0}^{M-1} (U_{cs})^2}$	U_1 U_2 U_4 During 1P3W1U Without U_2	U_1 U_2 $U_3 (U_{3S} = U_{2S} - U_{1S})$ U_4	Line voltage $U_{12} = \frac{1}{M} \sum_{s=0}^{M-1} (U_{1s} - U_{2s})^2$ $U_{23} = \frac{1}{M} \sum_{s=0}^{M-1} (U_{2s} - U_{3s})^2$ $U_{31} = \frac{1}{M} \sum_{s=0}^{M-1} (U_{3s} - U_{1s})^2$	U_1 U_2 U_3 U_4 During 3P4W2.5E $U_2 (U_{2S} = -U_{1S} - U_{3S})$
<ul style="list-style-type: none"> For 3P3W2M wiring, it is assumed that $U_{1S} - U_{2S} + U_{3S} = 0$ For 3P3W3M wiring, phase voltage U is measured from the virtual neutral point, and line voltage is determined by calculation. For 3P4W2.5E wiring, it is assumed that $U_{1S} + U_{2S} + U_{3S} = 0$ Dip, Swell and Intrpt excludes U_4 and U_3 of 3P3W2M 					
Irms1/2 Inrush [Arms]= I_c	I_1 I_4 $I_c = \sqrt{\frac{1}{M} \sum_{s=0}^{M-1} (I_{cs})^2}$	I_1 I_2 I_4	I_1 I_2 $I_3 (I_{3S} = -I_{1S} - I_{2S})$ I_4	I_1 I_2 I_3 I_4	
<ul style="list-style-type: none"> For 3P3W2M wiring, it is assumed that $I_{1S} + I_{2S} + I_{3S} = 0$. 					

c : Measurement channel, M : Number of samples per period, s : Number of sample points

2. Voltage waveform peak (Upk), Voltage crest factor (Ucf), Current waveform peak (Ipk), Current crest factor (Icf)

Wiring Item	Single phase 2-wire 1P2W	Single phase 3-wire 1P3W	3-phase 3-wire 3P3W2M	3-phase 3-wire 3P3W3M	3-phase 4-wire 3P4W
Upk+ Upk- [V]=Up _c	Up ₁ Up ₄	Up ₁ Up ₂ Up ₄ During 1P3W1U Without Up ₂	Up ₁ Up ₂ Up ₃ Up ₄	Up ₁₂ Up ₂₃ Up ₃₁	Up ₁ Up ₂ Up ₃ Up ₄ During 3P4W2.5E U _{2S} = -U _{1S} - U _{3S}
	<ul style="list-style-type: none"> • For 3P3W2M wiring, it is assumed that $U_{1S} - U_{2S} + U_{3S} = 0$ • For 3P3W3M wiring, phase voltage U is measured from the virtual neutral point, and line voltage is determined by calculation. • For 3P4W2.5E wiring, it is assumed that $U_{1S} + U_{2S} + U_{3S} = 0$ 				
Ucf []	Ucf ₁ Ucf ₄ Ucf _c = $\left \frac{Up_c}{U_c} \right $	Ucf ₁ Ucf ₂ Ucf ₄ During 1P3W1U Without Ucf ₂	Ucf ₁ Ucf ₂ Ucf ₃ Ucf ₄	Ucf ₁₂ Ucf ₂₃ Ucf ₃₁	Ucf ₁ Ucf ₂ Ucf ₃ Ucf ₄ During 3P4W2.5E U _{2S} = -U _{1S} - U _{3S}
	<ul style="list-style-type: none"> • The larger absolute value among +, - is used for Up_c. • For 3P3W2M wiring, it is assumed that $U_{1S} - U_{2S} + U_{3S} = 0$ • For 3P3W3M wiring, phase voltage U is measured from the virtual neutral point, and line voltage is determined by calculation. • For 3P4W2.5E wiring, it is assumed that $U_{1S} + U_{2S} + U_{3S} = 0$ 				
Ipk+ Ipk- [A]=Ip _c	Ip ₁ Ip ₄	Ip ₁ Ip ₂ Ip ₄	Ip ₁ Ip ₂ Ip ₃ Ip ₄		
	<ul style="list-style-type: none"> • With 3P3W2M wiring, it is assumed that $I_{1S} + I_{2S} + I_{3S} = 0$. 				
Icf []	Icf ₁ Icf ₄ Icf _c = $\left \frac{Ip_c}{I_c} \right $	Icf ₁ Icf ₂ Icf ₄	Icf ₁ Icf ₂ Icf ₃ Icf ₄		
	<ul style="list-style-type: none"> • The larger absolute value among +, - is used for Ip_c. 				

c: Measurement channel

3. RMS voltage (Urms), RMS current (Irms)

Wiring Item	Single phase 2-wire 1P2W	Single phase 3-wire 1P3W	3-phase 3-wire 3P3W2M	3-phase 3-wire 3P3W3M	3-phase 4-wire 3P4W
Urms [Vrms]= U_c	U_1 U_4 $U_c = \sqrt{\frac{1}{M} \sum_{s=0}^{M-1} (U_{cs})^2}$	U_1 U_2 U_4	U_1 U_2 $U_3 (U_{3S}=U_{2S}-U_{1S})$ U_4	Line voltage $U_{12} = \frac{1}{M} \sum_{s=0}^{M-1} (U_{1s} - U_{2s})^2$ $U_{23} = \frac{1}{M} \sum_{s=0}^{M-1} (U_{2s} - U_{3s})^2$ $U_{31} = \frac{1}{M} \sum_{s=0}^{M-1} (U_{3s} - U_{1s})^2$	Phase voltage U_1 U_2 U_3 U_4
		During 1P3W1U Without U_2		During 3P4W2.5E $U_2 (U_{2S}=-U_{1S}-U_{3S})$	Phase voltage U_1 U_2 U_3
		$U_{avg} = \frac{1}{2}(U_1 + U_2)$ During 1P3W1U Without U_{avg}	$U_{avg} = \frac{1}{3}(U_1 + U_2 + U_3)$	Line voltage $U_{avg} = \frac{1}{3}(U_{12} + U_{23} + U_{31})$	Phase voltage $U_{avg} = \frac{1}{3}(U_1 + U_2 + U_3)$
				Phase voltage $U_{avg} = \frac{1}{3}(U_1 + U_2 + U_3)$	Line voltage $U_{avg} = \frac{1}{3}(U_{12} + U_{23} + U_{31})$
<ul style="list-style-type: none"> • For 3P3W2M wiring, it is assumed that $U_{1S}-U_{2S}+U_{3S}=0$ • For 3P3W3M wiring, phase voltage U is measured from the virtual neutral point, and line voltage is determined by calculation. • For 3P4W2.5E wiring, it is assumed that $U_{1S}+U_{2S}+U_{3S}=0$ 					
Irms [Arms]= I_c	I_1 I_4 $I_c = \sqrt{\frac{1}{M} \sum_{s=0}^{M-1} (I_{cs})^2}$	I_1 I_2 I_4	I_1 I_2 $I_3 (I_{3S}=-I_{1S}-I_{2S})$ I_4	I_1 I_2 I_3 I_4	
		$I_{avg} = \frac{1}{2}(I_1 + I_2)$			$I_{avg} = \frac{1}{3}(I_1 + I_2 + I_3)$
<ul style="list-style-type: none"> • For 3P3W2M wiring, it is assumed that $I_{1S}+I_{2S}+I_{3S}=0$. 					

c: Measurement channel, M: Number of samples per period, s: Number of sample points

4. Active power (P)

Wiring	Single phase 2-wire 1P2W	Single phase 3-wire 1P3W	3-phase 3-wire 3P3W2M	3-phase 3-wire 3P3W3M	3-phase 4-wire 3P4W
P [W]	P_1 $P_c = \frac{1}{M} \sum_{s=0}^{M-1} (U_{cs} \times I_{cs})$	P_1 P_2 During 1P3W1U $U_2 = -U_1$	P_1 P_2	P_1 P_2 P_3	P_1 P_2 P_3 During 3P4W2.5E $U_{2s} = -U_{1s} - U_{3s}$
		$P_{sum} = P_1 + P_2$		$P_{sum} = P_1 + P_2 + P_3$	
<ul style="list-style-type: none"> The polarity symbols of active power P, indicate the current flow direction of the power during consumption (+P), and during regeneration (-P). For 3P4W2.5E wiring, it is assumed that $U_{1s} + U_{2s} + U_{3s} = 0$ 					

c: measurement channel, M: number of samples per period, s: number of sample points

5. Voltage DC value (Udc), Current DC value (Idc)

Wiring	Single phase 2-wire 1P2W	Single phase 3-wire 1P3W	3-phase 3-wire 3P3W2M	3-phase 3-wire 3P3W3M	3-phase 4-wire 3P4W
Udc [V]	Udc_1 Udc_4 $Udc_c = \frac{1}{M} \sum_{s=0}^{M-1} U_{cs}$	Udc_1 Udc_2 Udc_4 During 1P3W1U Without Udc_2	Udc_1 Udc_2 $Udc_3 (U_{3s} = U_{2s} - U_{1s})$ Udc_4	$Udc_{12} = \frac{1}{M} \sum_{s=0}^{M-1} (U_{1s} - U_{2s})^2$ $Udc_{23} = \frac{1}{M} \sum_{s=0}^{M-1} (U_{2s} - U_{3s})^2$ $Udc_{31} = \frac{1}{M} \sum_{s=0}^{M-1} (U_{3s} - U_{1s})^2$	Udc_1 Udc_2 Udc_3 Udc_4 During 3P4W2.5E $U_{2s} = -U_{1s} - U_{3s}$
<ul style="list-style-type: none"> For 3P3W2M wiring, it is assumed that $U_{1s} - U_{2s} + U_{3s} = 0$ For 3P3W3M wiring, phase voltage U is measured from the virtual neutral point, and line voltage is determined by calculation. For 3P4W2.5E wiring, it is assumed that $U_{1s} + U_{2s} + U_{3s} = 0$ 					
Idc [A]	Idc_1 Idc_4 $Idc_c = \frac{1}{M} \sum_{s=0}^{M-1} I_{cs}$	Idc_1 Idc_2 Idc_4	Idc_1 Idc_2 $Idc_3 (I_{3s} = -I_{1s} - I_{2s})$ Idc_4	Idc_1 Idc_2 Idc_3 Idc_4	
<ul style="list-style-type: none"> For 3P3W2M wiring, it is assumed that $I_{1s} + I_{2s} + I_{3s} = 0$ 					

c: Measurement channel, M: Number of samples per period, s: Number of sample points

6. Apparent power (S)

Wiring Item	Single phase 2-wire 1P2W	Single phase 3-wire 1P3W	3-phase 3-wire 3P3W2M	3-phase 3-wire 3P3W3M	3-phase 4-wire 3P4W
S [VA]	PF/Q/S calculation selection: RMS value calculation • S_1, S_2 and S_3 of 3P3W3M uses phase voltage, while S_{sum} uses line voltage.				
	S_1 $S_c = U_c \times I_c$	S_1 S_2	S_1 S_2 S_3		
		During 1P3W1U $U_2 = U_1$			
	$S_{sum} = S_1 + S_2$		$S_{sum} =$ $\frac{\sqrt{3}}{3} (S_1 + S_2 + S_3)$	$S_{sum} =$ $\frac{\sqrt{3}}{3} (U_{12} \times I_1 + U_{23} \times I_2 + U_{31} \times I_3)$	$S_{sum} = S_1 + S_2 + S_3$
PF/Q/S calculation selection: fundamental wave calculation • This apparent power S is defined as the fundamental wave apparent power. • (1): Harmonic calculation fundamental wave (1st order)					
S_1 $S_c =$ $\sqrt{P_{c(1)}^2 + Q_{c(1)}^2}$	S_1 S_2			S_1 S_2 S_3	
	$S_{sum} = \sqrt{P_{sum(1)}^2 + Q_{sum(1)}^2}$				

c: Measurement channel

7. Reactive power (Q)

Wiring Item	Single phase 2-wire 1P2W	Single phase 3-wire 1P3W	3-phase 3-wire 3P3W2M	3-phase 3-wire 3P3W3M	3-phase 4-wire 3P4W
Q [var]	PF/Q/S calculation selection: RMS value calculation • When $S < P $ due to the effects of measurement errors or unbalance, $S = P $ and $Q = 0$. • S_i : indicates lag and lead. The sign of reactive power Q (fundamental wave reactive power) is used. Sign +: lag Sign -: lead				
	Q_1 $Q_c = Si\sqrt{S_c^2 - P_c^2}$	Q_1 Q_2			Q_1 Q_2 Q_3
		$Q_{sum} = Si\sqrt{S_{sum}^2 - P_{sum}^2}$			
	PF/Q/S calculation selection: Fundamental wave calculation • This reactive power Q is defined as the fundamental wave reactive power. • (1): Harmonic calculation fundamental wave (1st order) • r : resistance after FFT, i : reactance after FFT • Sign +: lag Sign -: lead				
Q_1 $Q_c = -U_{c(1)r} \times I_{c(1)i} + U_{c(1)i} \times I_{c(1)r}$	Q_1 Q_2	During 1P3W1U $U_2 = -U_1$	Q_1 Q_2	Q_1 Q_2 Q_3	
	$Q_{sum} = Q_1 + Q_2$		$Q_{sum} = Q_1 + Q_2 + Q_3$		

c: Measurement channel

8. Power factor (PF), Displacement power factor (DPF)

Wiring Item	Single phase 2-wire 1P2W	Single phase 3-wire 1P3W	3-phase 3-wire 3P3W2M	3-phase 3-wire 3P3W3M	3-phase 4-wire 3P4W
PF [] PF/Q/S Calculation Selection: RMS value calculation	PF_1 $PF_c = si \left \frac{P_c}{S_c} \right $	PF_1 PF_2 $PF_{sum} = si \left \frac{P_{sum}}{S_{sum}} \right $		PF_1 PF_2 PF_3	
	<ul style="list-style-type: none"> • Si: indicates lag and lead. The sign of reactive power Q (fundamental wave reactive power) is used. Sign +: lag Sign -: lead • When $S < P$ due to the effects of measurement errors or unbalance, $S = P$ and $PF = 1$. • When $S = 0$, PF is taken as invalid data. 				
DPF [] PF/Q/S Calculation Selection: Fundamen- tal wave calculation	DPF_1 $DPF_c = si \left \frac{P_{c(1)}}{S_{c(1)}} \right $	DPF_1 DPF_2 $DPF_{sum} = si \left \frac{P_{sum(1)}}{S_{sum(1)}} \right $		DPF_1 DPF_2 DPF_3	
	<ul style="list-style-type: none"> • Si: indicates lag and lead. The sign of reactive power Q (fundamental wave reactive power) is used. Sign +: lag Sign -: lead • (1): indicates the harmonic calculation fundamental wave (1st order) • When $S_{c(1)} = 0$, DPF is taken as invalid data. 				

c: Measurement channel

9. Active energy (WP+/WP-), Reactive energy (WQ_LAG/WQ_LEAD), Apparent energy (WS), Energy cost (Ecost)

Wiring Item	Single phase 2-wire 1P2W	Single phase 3-wire 1P3W	3-phase 3-wire 3P3W2M	3-phase 3-wire 3P3W3M	3-phase 4-wire 3P4W
WP+ [Wh] (consumption)	$WP+ = k \sum_1^h P_{sum}(+)$				
	• $P(+)$: Only the consumption component of active power (positive component) is used.				
WP- [Wh] (Regeneration)	$WP- = k \sum_1^h P_{sum}(-)$				
	• $P(-)$: Only the regeneration component of active power (negative component) is used.				
WQ_LAG [varh] (Lag)	$WQ_LAG = k \sum_1^h Q_{sum}(LAG)$				
	• $Q(LAG)$: Only the lag component of reactive power is used.				
WQ_LEAD [varh] (Lead)	$WQ_LEAD = k \sum_1^h Q_{sum}(LEAD)$				
	• $Q(LEAD)$: Only the lead component of reactive power is used.				
WS [VAh]	$WS = k \sum_1^h S_{sum}$				
Ecost [Variable]	$Ecost = WP+ \times rate$				
	• $rate$: Electrical unit cost (variable setting from 0.00000 to 99999.9/kWh)				

k: Calculation unit time [h], h: Measurement duration

10. Active power demand quantity (Dem_WP+/Dem_WP-), reactive power demand quantity (Dem_WQ_LAG/Dem_WQ_LEAD), apparent power demand quantity (Dem_WS)

Item \ Wiring	Single phase 2-wire 1P2W	Single phase 3-wire 1P3W	3-phase 3-wire 3P3W2M	3-phase 3-wire 3P3W3M	3-phase 4-wire 3P4W
Dem_WP+[Wh] (Consumption)	$Dem_WP+= k \sum_1^h P_{sum}(+)$ • P(+): Only the consumption component of active power (positive component) is used.				
Dem_WP-[Wh] (Regeneration)	$Dem_WP-= k \sum_1^h P_{sum}(-)$ • P(-): Only the regeneration component of active power (negative component) is used.				
Dem_WQ_LAG[varh] (Lag)	$Dem_WQ_LAG= k \sum_1^h Q_{sum}(LAG)$ • Q(LAG): Only the lag component of reactive power is used.				
Dem_WQ_LEAD[varh] (Lead)	$Dem_WQ_LEAD= k \sum_1^h Q_{sum}(LEAD)$ • Q(LEAD): Only the lead component of reactive power is used.				
Dem_WS[VAh]	$Dem_WS= k \sum_1^h S_{sum}$				

Does not display only with the data output. *k*: Calculation unit time [h], *h*: Interval

11. Active power demand value (Dem_P+/Dem_P-), reactive power demand value (Dem_Q_LAG/Dem_Q_LEAD), apparent power demand value (Dem_S), power factor demand value (Dem_PF)

Item \ Wiring	Single phase 2-wire 1P2W	Single phase 3-wire 1P3W	3-phase 3-wire 3P3W2M	3-phase 3-wire 3P3W3M	3-phase 4-wire 3P4W
Dem_P+[W] (Consumption)	$Dem_P+= \frac{1}{h} \sum_1^h P_{sum}(+)$ • P(+): Only the consumption component of active power (positive component) is used.				
Dem_P-[W] (Regeneration)	$Dem_P-= \frac{1}{h} \sum_1^h P_{sum}(-)$ • P(-): Only the regeneration component of active power (negative component) is used.				
Dem_Q_LAG[var] (Lag)	$Dem_Q_LAG= \frac{1}{h} \sum_1^h Q_{sum}(LAG)$ • Q(LAG): Only the lag component of reactive power is used.				
Dem_Q_LEAD[var] (Lead)	$Dem_Q_LEAD= \frac{1}{h} \sum_1^h Q_{sum}(LEAD)$ • Q(LEAD): Only the lead component of reactive power is used.				
Dem_S[VA]	$Dem_S= \frac{1}{h} \sum_1^h S_{sum}$				
Dem_PF[]	$Dem_PF= \frac{Dem_P+}{\sqrt{(Dem_P+)^2 + (Dem_Q_LAG)^2}}$				

h: Interval

12. Voltage negative-phase unbalance factor (U_{unb}), Voltage zero-phase unbalance factor (U_{unb0}), Current negative-phase unbalance factor (I_{unb}), Current zero-phase unbalance factor (I_{unb0})

Wiring Item	Single phase 2-wire 1P2W	Single phase 3-wire 1P3W	3-phase 3-wire 3P3W2M	3-phase 3-wire 3P3W3M	3-phase 4-wire 3P4W
U _{unb} [%]			$U_{unb} = \frac{U_{neg}}{U_{pos}} \times 100$		
U _{unb0} [%]					$U_{unb0} = \frac{U_{zero}}{U_{pos}} \times 100$
I _{unb} [%]			$I_{unb} = \frac{I_{neg}}{I_{pos}} \times 100$		
I _{unb0} [%]					$I_{unb0} = \frac{I_{zero}}{I_{pos}} \times 100$

	3-phase 3-wire 3P3W2M	3-phase 3-wire 3P3W3M	3-phase 4-wire 3P4W
U _{zero} U _{pos} U _{neg}	$\frac{1}{3} \sqrt{(U_1 \cdot \cos(\alpha) + U_2 \cdot \cos(\beta + seq2) + U_3 \cdot \cos(\gamma + seq3))^2 + (U_1 \cdot \sin(\alpha) + U_2 \cdot \sin(\beta + seq2) + U_3 \cdot \sin(\gamma + seq3))^2}$ <ul style="list-style-type: none"> The fundamental RMS voltage (phase voltage) from the results of harmonic calculations is used. α: Phase angle of U_1, β: Phase angle of U_2, γ: Phase angle of U_3 Use 3P3W2M after vector calculations in phase voltage as it is detected by line voltage. 		
I _{zero} I _{pos} I _{neg}	$\frac{1}{3} \sqrt{(I_1 \cdot \cos(\alpha) + I_2 \cdot \cos(\beta + seq2) + I_3 \cdot \cos(\gamma + seq3))^2 + (I_1 \cdot \sin(\alpha) + I_2 \cdot \sin(\beta + seq2) + I_3 \cdot \sin(\gamma + seq3))^2}$ <ul style="list-style-type: none"> The fundamental RMS current (phase voltage) from the results of harmonic calculations is used. α: Phase angle of I_1, β: Phase angle of I_2, γ: Phase angle of I_3 For 3P3W2M, the calculations are performed with I_2 and I_3 replaced with each other. 		

	Seq2	Seq3
U _{zero} , I _{zero}	0°	0°
U _{pos} , I _{pos}	120°	240°
U _{neg} , I _{neg}	240°	120°

13. Harmonic voltage (U_{harm}), Harmonic current (I_{harm}), Interharmonic voltage (U_{iharm}), Interharmonic current (I_{iharm})

Wiring Item	Single phase 2-wire 1P2W	Single phase 3-wire 1P3W	3-phase 3-wire 3P3W2M	3-phase 3-wire 3P3W3M	3-phase 4-wire 3P4W
U _{harm} [Vrms]=U _{ck} (including adjacent interharmonic components)	U _{1k} U _{4k} $U'_{ck} = \sqrt{(U_{ckr})^2 + (U_{cki})^2}$ $U_{ck} = \sqrt{\sum_{n=1}^k \left(U'_{c \left(\frac{10k+n}{10} \right)} \right)^2}$	U _{1k} U _{2k} U _{4k} During 1P3W1U Without U _{2k}	U _{1k} U _{2k} U _{3k} U _{4k}	U _{12k} U _{23k} U _{31k}	U _{1k} U _{2k} U _{3k} U _{4k}
	<ul style="list-style-type: none"> • For 60 Hz measurement, the value 10 in the formula is replaced with 12. • Harmonic voltage content percentage (%): $U_{ck}/U_{c1} \times 100$ (%) • U_{c0} component is treated as DC for 0th order when k = 0. 				
I _{harm} [Arms]=I _{ck} (including adjacent interharmonic components)	I _{1k} I _{4k} $I'_{ck} = \sqrt{(I_{ckr})^2 + (I_{cki})^2}$ $I_{ck} = \sqrt{\sum_{n=1}^k \left(I'_{c \left(\frac{10k+n}{10} \right)} \right)^2}$	I _{1k} I _{2k} I _{4k}	I _{1k} I _{2k} I _{3k} I _{4k}	I _{1k} I _{2k} I _{3k} I _{4k}	
	<ul style="list-style-type: none"> • For 60 Hz measurement, the value 10 in the formula is replaced with 12. • Harmonic voltage and current content percentage (%): $I_{ck}/I_{c1} \times 100$ (%) • For 3P3W2M wiring, it is assumed that $I_{1s} + I_{2s} + I_{3s} = 0$. • I_{c0} component is treated as DC for 0th order when k = 0. 				
U _{iharm} [Vrms]=U _{ck}	U _{1k} U _{4k} $U'_{ck} = \sqrt{(U_{ckr})^2 + (U_{cki})^2}$ $U_{ck} = \sqrt{\sum_{n=3}^k \left(U'_{c \left(\frac{10k+n}{10} \right)} \right)^2}$	U _{1k} U _{2k} U _{4k} During 1P3W1U Without U _{2k}	U _{1k} U _{2k} U _{3k} U _{4k}	U _{12k} U _{23k} U _{31k}	U _{1k} U _{2k} U _{3k} U _{4k}
	<ul style="list-style-type: none"> • For 60 Hz measurement, the value 10 in the formula is replaced with 12; 3, with -3; and 4, with -4. • Intermediate harmonic voltage content percentage (%): $U_{ck}/U_{c1} \times 100$ (%) • For 3P3W2M wiring, it is assumed that $U_{1s} - U_{2s} + U_{3s} = 0$ 				
I _{iharm} [Arms]=I _{ck}	I _{1k} I _{4k} $I'_{ck} = \sqrt{(I_{ckr})^2 + (I_{cki})^2}$ $I_{ck} = \sqrt{\sum_{n=3}^k \left(I'_{c \left(\frac{10k+n}{10} \right)} \right)^2}$	I _{1k} I _{2k} I _{4k}	I _{1k} I _{2k} I _{3k} I _{4k}	I _{1k} I _{2k} I _{3k} I _{4k}	
	<ul style="list-style-type: none"> • For 60 Hz measurement, the value 10 in the formula is replaced with 12; 3, with -3; and 4, with -4. • Intermediate harmonic current content percentage (%): $I_{ck}/I_{c1} \times 100$ (%) • For 3P3W2M wiring, it is assumed that $I_{1s} + I_{2s} + I_{3s} = 0$. 				

c: Measurement channel

14. Harmonic power (Pharm), Harmonic reactive power (Qharm), K factor (KF)

Wiring Item	Single phase 2-wire 1P2W	Single phase 3-wire 1P3W	3-phase 3-wire 3P3W2M	3-phase 3-wire 3P3W3M	3-phase 4-wire 3P4W
Pharm [W]= P_{ck}	P_{1k} $P_k = U_{chr} \times I_{chr} + U_{cki} \times I_{cki}$	P_{1k} P_{2k}	(P_{1k}) (P_{2k})	P_{1k} P_{2k} P_{3k}	
		During 1P3W1U $U_2 = -U_1$			
		$P_{sumk} = P_{1k} + P_{2k}$		$P_{sumk} = P_{1k} + P_{2k} + P_{3k}$	
<ul style="list-style-type: none"> • Harmonic voltage content percentage (%): $P_{ck} / P_{C1} \times 100$ (%) • The P_{1k}, P_{2k} values of the 3P3W2M wiring are used in internal calculations, but are not displayed. 					
Qharm [W]= Q_{ck}	(Q_{1k}) $Q_k = U_{chr} \times I_{cki} - U_{cki} \times I_{chr}$	(Q_{1k}) (Q_{2k})	(Q_{1k}) (Q_{2k})	(Q_{1k}) (Q_{2k}) (Q_{3k})	
		During 1P3W1U $U_2 = -U_1$			
		$(Q_{sumk}) = Q_{1k} + Q_{2k}$		$(Q_{sumk}) = Q_{1k} + Q_{2k} + Q_{3k}$	
<ul style="list-style-type: none"> • Harmonic reactive power Q_{ck} is used in internal calculations, but is not displayed. 					
KF []	KF_1 KF_4 $KF_c = \frac{\sum_{k=1}^{50} (k^2 \times I_{ck}^2)}{\sum_{k=1}^{50} I_{ck}^2}$	KF_1 KF_2 KF_4	KF_1 KF_2 KF_3 KF_4		
<ul style="list-style-type: none"> • K factor, also referred to as multiplication factor, indicates the power loss caused due to the harmonic current RMS value in the transformer. 					

c : Measurement channel, k : Order of analysis, r : Resistance after FFT, i : Reactance after FFT

15. Harmonic voltage phase angle (Uphase), Harmonic current phase angle (Iphase), Harmonic voltage-current phase difference (Pphase)

Item \ Wiring	Single phase 2-wire 1P2W	Single phase 3-wire 1P3W	3-phase 3-wire 3P3W2M	3-phase 3-wire 3P3W3M	3-phase 4-wire 3P4W
Uphase [deg]= θU_k	θU_{1k} θU_{4k} $\theta U_{ck} = \tan^{-1}\left(\frac{U_{ckr}}{-U_{cki}}\right)$	θU_{1k} θU_{2k} θU_{4k} During 1PU3W1U Without θU_{2k}	θU_{1k} θU_{2k} θU_{3k} θU_{4k}	θU_{12k} θU_{23k} θU_{31k}	θU_{1k} θU_{2k} θU_{3k} θU_{4k}
	• When $U_{ckr}=U_{cki}=0$, $\theta U_{ck}=0^\circ$				
Iphase [deg]= θI_k	θI_{1k} θI_{4k} $\theta I_{ck} = \tan^{-1}\left(\frac{I_{ckr}}{-I_{cki}}\right)$	θI_{1k} θI_{2k} θI_{4k}	θI_{1k} θI_{2k} θI_{3k} θI_{4k}		
	• When $I_{ckr} = I_{cki} = 0$, $\theta I_{ck} = 0^\circ$				
Pphase[deg]= θP_k	θP_{1k} $\theta P_{ck} = \tan^{-1}\left(\frac{Q_{ck}}{P_{ck}}\right)$	θP_{1k} θP_{2k}		θP_{1k} θP_{2k} θP_{3k}	
		θP_{sumk}			
• When $P_{ck} = Q_{ck} = 0$, $\theta P_{ck} = 0^\circ$.					

c: Measurement channel, *k*: Order of analysis, *r*: Resistance after FFT, *i*: Reactance after FFT

16. Voltage THD (U_{thd-F}/U_{thd-R}), Current THD (I_{thd-F}/I_{thd-R})

Wiring Item	Single phase 2-wire 1P2W	Single phase 3-wire 1P3W	3-phase 3-wire 3P3W2M	3-phase 3-wire 3P3W3M	3-phase 4-wire 3P4W
U _{thd-F} [%]=THD-F_ U _c	$\begin{matrix} THD-F_{U_1} \\ THD-F_{U_4} \\ THD-F_{U_c} = \sqrt{\frac{\sum_{k=2}^K U_{ck}^2}{U_{c(1)}^2}} \times 100 \end{matrix}$	$\begin{matrix} THD-F_{U_1} \\ THD-F_{U_2} \\ THD-F_{U_4} \end{matrix}$ <p>During 1P3W1U Without THD-F_ U₂</p>	$\begin{matrix} THD-F_{U_1} \\ THD-F_{U_2} \\ THD-F_{U_3} \\ THD-F_{U_4} \end{matrix}$	$\begin{matrix} THD-F_{U_{12}} \\ THD-F_{U_{23}} \\ THD-F_{U_{31}} \end{matrix}$	$\begin{matrix} THD-F_{U_1} \\ THD-F_{U_2} \\ THD-F_{U_3} \\ THD-F_{U_4} \end{matrix}$
I _{thd-F} [%]=THD-F_ I _c	$\begin{matrix} THD-F_{I_1} \\ THD-F_{I_4} \\ THD-F_{I_c} = \sqrt{\frac{\sum_{k=2}^K I_{ck}^2}{I_{c(1)}^2}} \times 100 \end{matrix}$	$\begin{matrix} THD-F_{I_1} \\ THD-F_{I_2} \\ THD-F_{I_4} \end{matrix}$ <p>During 1P3W1U Without THD-F_ I₂</p>	$\begin{matrix} THD-F_{I_1} \\ THD-F_{I_2} \\ THD-F_{I_3} \\ THD-F_{I_4} \end{matrix}$		
• The numerator of the mathematical formula is recorded but is not displayed (MAX, MIN, AVG)					
U _{thd-R} [%]=THD-R_ U _c	$\begin{matrix} THD-R_{U_1} \\ THD-R_{U_4} \\ THD-R_{U_c} = \sqrt{\frac{\sum_{k=2}^K U_{ck}^2}{\sum_{k=1}^K U_{ck}^2}} \times 100 \end{matrix}$	$\begin{matrix} THD-R_{U_1} \\ THD-R_{U_2} \\ THD-R_{U_4} \end{matrix}$ <p>During 1P3W1U Without THD-R_ U₂</p>	$\begin{matrix} THD-R_{U_1} \\ THD-R_{U_2} \\ THD-R_{U_3} \\ THD-R_{U_4} \end{matrix}$	$\begin{matrix} THD-R_{U_{12}} \\ THD-R_{U_{23}} \\ THD-R_{U_{31}} \end{matrix}$	$\begin{matrix} THD-R_{U_1} \\ THD-R_{U_2} \\ THD-R_{U_3} \\ THD-R_{U_4} \end{matrix}$
I _{thd-R} [%]=THD-R_ I _c	$\begin{matrix} THD-R_{I_1} \\ THD-R_{I_4} \\ THD-R_{I_c} = \sqrt{\frac{\sum_{k=2}^K I_{ck}^2}{\sum_{k=1}^K I_{ck}^2}} \times 100 \end{matrix}$	$\begin{matrix} THD-R_{I_1} \\ THD-R_{I_2} \\ THD-R_{I_4} \end{matrix}$	$\begin{matrix} THD-R_{I_1} \\ THD-R_{I_2} \\ THD-R_{I_3} \\ THD-R_{I_4} \end{matrix}$		
• The numerator of the mathematical formula is recorded but is not displayed (MAX, MIN, AVG)					

c: Measurement channel, K: Total number of analyzed orders, k: Analysis order, (1): Harmonic calculation fundamental wave (1st order)

17. Short-term flicker (Pst), long-term flicker (Plt), ΔV10 flicker (dV10)

Wiring Item	Single phase 2-wire 1P2W	Single phase 3-wire 1P3W	3-phase 3-wire 3P3W2M	3-phase 3-wire 3P3W3M	3-phase 4-wire 3P4W
Pst	Pst_1 $Pst_c = \frac{1}{\sqrt{K_1 P_{0.1} + K_2 P_{1s} + K_3 P_{3s} + K_4 P_{10s} + K_5 P_{50s}}}$	Pst_1 Pst_2 During 1PU3W1U Without Pst_2	Pst_1 Pst_2	Pst_{12} Pst_{23} Pst_{31}	Pst_1 Pst_2 Pst_3
	Values for $K_1=0.0314$, $K_2=0.0525$, $K_3=0.065$, and $K_5=0.08$. • Classification of cumulative probability function (CPF) uses 1024 classes. • Cumulative probabilities (P_i) are obtained from the linear interpolation method, and smoothed cumulative probability is calculated with the following method: • $P_{1s} = (P_{0.7} + P_1 + P_{1.5})/3$ • $P_{3s} = (P_{2.2} + P_3 + P_4)/3$ • $P_{10s} = (P_6 + P_8 + P_{10} + P_{13} + P_{17})/5$ • $P_{50s} = (P_{30} + P_{50} + P_{80})/3$				
Plt	Plt_1 $Plt_c = \sqrt{\frac{\sum_{i=1}^N (Pst_i)^2}{N}}$	Plt_1 Plt_2 During 1PU3W1U Without Plt_2	Plt_1 Plt_2	Plt_{12} Plt_{23} Plt_{31}	Plt_1 Plt_2 Plt_3
	• N is the number of measurements (N = 12 times). (When N<12, use the number of measurement N.)				
dV10=ΔV10	$\Delta V10_{(1)}$ $\Delta V10_{(e)} = \frac{100}{U_f^2} \sqrt{\sum (a_n \times \Delta U_n)^2}$	$\Delta V10_{(1)}$ $\Delta V10_{(2)}$ During 1PU3W1U Without $\Delta V10_{(2)}$	$\Delta V10_{(1)}$ $\Delta V10_{(2)}$	$\Delta V10_{(12)}$ $\Delta V10_{(23)}$ $\Delta V10_{(31)}$	$\Delta V10_{(1)}$ $\Delta V10_{(2)}$ $\Delta V10_{(3)}$
	• U_f is a reference voltage for ΔV10 flicker, and the average RMS voltage for 1 min. • “ a_n ” is luminosity coefficient corresponding to fluctuation frequency f_n [Hz] obtained from the perceived flicker curve. • ΔU_n is voltage fluctuation for the f_n .				

18. Averaging method

	CH 1 to 4	sum/AVG	Comment
Freq	Signed average		Freq10s is similar as well
Upk (+/-)	Signed average		
lpk (+/-)	Signed average		
Ucf	Calculated from the average of Upk (absolute values of the positive one or the negative one, whichever is larger) and the average of Urms.		
lcf	Calculated from the average of lpk (absolute values of the positive one or the negative one, whichever is larger) and the average of lrms.		
Urms	Root mean square (RMS)	Average results for all channels are averaged.	
lrms	Root mean square (RMS)	Average results for all channels are averaged.	
Udc	Signed average		
ldc	Signed average		
P	Signed average	Average results for all channels are added.	
S	Signed average	Average results for all channels are added.	
Q	Signed average	Average results for all channels are added.	
PF	Calculated from Pavg and Savg.		
DPF	Calculated from P ₍₁₎ avg and S ₍₁₎ avg.		
Uunb	Calculated from mean square of U _{neg} and U _{pos}		
Uunb0	Calculated from mean square of U _{zero} and U _{pos}		
lunb	Calculated from mean square of I _{neg} and I _{pos}		
lunb0	Calculated from mean square of I _{zero} and I _{pos}		
Uharm (Level)/ Uiharm (Level)	Root mean square (RMS)		0th order is signed average.
lharm (Level)/ liharm (Level)	Root mean square (RMS)		0th order is signed average.
Pharm (Level)	Signed average	Average results for all channels are added.	
Uharm (Content percentage)/ Uiharm (Content percentage)	{(N-th order harmonic average value) / (Fundamental average value)} × 100%		
lharm (Content percentage)/ liharm (Content percentage)	{(N-th order harmonic average value) / (Fundamental average value)} × 100%		

	CH 1 to 4	sum/AVG	Comment
Pharm (Content percentage)	{{(N-th order harmonic average value) / (Fundamental average value)} × 100%		
Uphase	Vector average		
Iphase	Vector average		
Pphase	Vector average		
Uthd-F/Uthd-R	Calculated from mean squared RMS values		
Ithd-F/Ithd-R	Calculated from mean squared RMS values		
KF	Calculated from mean squared RMS values		

Signed averaging: Signs of values are included in average calculation.

AVG calculation of Uphase

$$\tan^{-1}\left(\frac{U_{ckr}}{-U_{cki}}\right)$$

Here, U_{ckr} and U_{cki} use the signed average values for each channel.

AVG calculation of Iphase

$$\tan^{-1}\left(\frac{I_{ckr}}{-I_{cki}}\right)$$

Here, I_{ckr} and I_{cki} use the signed average values for each channel.

AVG calculation of Pphase

$$\text{(Averaging process for each channel)} \quad \tan^{-1}\left\{\frac{Q_{harm_k}}{P_{harm_k}}\right\}$$

Here, Q_{harm_k} and P_{harm_k} use the signed average values for each channel.

$$\text{(Averaging process of the sum)} \quad \tan^{-1}\left\{\frac{Q_{sumk}}{P_{sumk}}\right\}$$

Here, Q_{sumk} and P_{sumk} use the sum calculation of the signed average results for each channel.

14.8 Range Configuration and Combination Accuracy

1. While using the Model CT7131 AC Current Sensor

Power range configuration

Wiring	Current range		
	5.0000 A	50.000 A	100.00 A
1P2W/DC	5.0000 kW	50.000 kW	100.00 kW
1P3W 1P3W1U 3P3W2M 3P3W3M	10.000 kW	100.00 kW	200.00 kW
3P4W 3P4W2.5E	15.000 kW	150.00 kW	300.00 kW

Display format varies according to the declared voltage settings.

Combination Accuracy

Current range	RMS current value $45 \leq f \leq 66$ (Hz)	Active power $45 \leq f \leq 66$ (Hz)
100.00 A	0.4% rdg.+0.12% f.s.	0.5% rdg.+0.12% f.s.
50.00 A	0.4% rdg.+0.14% f.s.	0.5% rdg.+0.14% f.s.
5.000 A	0.4% rdg.+0.50% f.s.	0.5% rdg.+0.50% f.s.

2. While using the Model CT7136 AC Current Sensor

Power range configuration

Wiring	Current range		
	5.0000 A	50.000 A	500.00 A
1P2W/DC	5.0000 kW	50.000 kW	500.00 kW
1P3W 1P3W1U 3P3W2M 3P3W3M	10.000 kW	100.00 kW	1.0000 MW
3P4W 3P4W2.5E	15.000 kW	150.00 kW	1.5000 MW

Display format varies according to the declared voltage settings.

Combination Accuracy

Current range	RMS current value $45 \leq f \leq 66$ (Hz)	Active power $45 \leq f \leq 66$ (Hz)
500.00 A	0.4% rdg.+0.112% f.s.	0.5% rdg.+0.112% f.s.
50.00 A	0.4% rdg.+0.22% f.s.	0.5% rdg.+0.22% f.s.
5.000 A	0.4% rdg.+1.3% f.s.	0.5% rdg.+1.3% f.s.

3. While using the Model CT7126 AC Current Sensor

Power range configuration

Wiring	Current range		
	500.00 mA	5.0000 A	50.000 A
1P2W/DC	500.00 W	5.0000 kW	50.000 kW
1P3W 1P3W1U 3P3W2M 3P3W3M	1.0000 kW	10.000 kW	100.00 kW
3P4W 3P4W2.5E	1.5000 kW	15.000 kW	150.00 kW

Display format varies according to the declared voltage settings.

Combination Accuracy

Current range	RMS current value $45 \leq f \leq 66$ (Hz)	Active power $45 \leq f \leq 66$ (Hz)
50.000 A	0.4% rdg.+0.112% f.s.	0.5% rdg.+0.112% f.s.
5.0000 A	0.4% rdg.+0.22% f.s.	0.5% rdg.+0.22% f.s.
500.0 mA	0.4% rdg.+1.3% f.s.	0.5% rdg.+1.3% f.s.

4. While using Model CT7731 AC/DC Auto-Zero Current Sensor

Power range configuration

Wiring	Current range	
	10.000 A	100.00 A
1P2W/DC	10.000 kW	100.00 kW
1P3W 1P3W1U 3P3W2M 3P3W3M	20.000 kW	200.00 kW
3P4W 3P4W2.5E	30.000 kW	300.00 kW

Display format varies according to the declared voltage settings.

Combination Accuracy

Current range	Current DC value	RMS current value $45 \leq f \leq 66$ (Hz)	Active power $45 \leq f \leq 66$ (Hz)
100.00 A	1.5% rdg.+1.0% f.s.	1.1% rdg.+0.6% f.s.	1.2% rdg.+0.6% f.s.
10.000 A	1.5% rdg.+5.5% f.s.	1.1% rdg.+5.1% f.s.	1.2% rdg.+5.1% f.s.

5. While using Model CT7736 AC/DC Auto-Zero Current Sensor

Power range configuration

Wiring	Current range	
	50.000 A	500.00 A
1P2W/DC	50.000 kW	500.00 kW
1P3W 1P3W1U 3P3W2M 3P3W3M	100.00 kW	1.0000 MW
3P4W 3P4W2.5E	150.00 kW	1.5000 MW

Display format varies according to the declared voltage settings.

Combination Accuracy

Current range	Current DC value	RMS current value 45 ≤ f ≤ 66 (Hz)	Active power 45 ≤ f ≤ 66 (Hz)
500.00 A	2.5% rdg.+1.1% f.s.	2.1% rdg.+0.70% f.s.	2.2% rdg.+0.70% f.s.
50.000 A	2.5% rdg.+6.5% f.s.	2.1% rdg.+6.10% f.s.	2.2% rdg.+6.10% f.s.

6. While using Model CT7742 AC/DC Auto-Zero Current Sensor

Power range configuration

Wiring	Current range		
	500.00 A	1000.0 A	2000.0 A
1P2W/DC	500.00 kW	1.0000 MW	2.0000 MW
1P3W 1P3W1U 3P3W2M 3P3W3M	1.0000 MW	2.0000 MW	4.0000 MW
3P4W 3P4W2.5E	1.5000 MW	3.0000 MW	6.0000 MW

Display format varies according to the declared voltage settings.

Combination Accuracy

Current range	Input	Current DC value	RMS current value 45 ≤ f ≤ 66 (Hz)	Active power 45 ≤ f ≤ 66 (Hz)
2000.0 A	I > 1800 A	2.0% rdg.+1.75% f.s.	2.1% rdg.+0.75% f.s.	2.2% rdg.+0.75% f.s.
	I ≤ 1800 A		1.6% rdg.+0.75% f.s.	1.7% rdg.+0.75% f.s.
1000.0 A	-	2.0% rdg.+1.5% f.s.	1.6% rdg.+1.1% f.s.	1.7% rdg.+1.1% f.s.
500.00 A	-	2.0% rdg.+2.5% f.s.	1.6% rdg.+2.1% f.s.	1.7% rdg.+2.1% f.s.

7. While using the Model CT7044, CT7045, CT7046 AC Flexible Current Sensor

Power range configuration

Wiring	Current range		
	50.000 A (600A)	500.00 A (600A)	5000.0 A (6000A)
1P2W/DC	50.000 kW	500.00 kW	5.0000 MW
1P3W 1P3W1U 3P3W2M 3P3W3M	100.00 kW	1.0000 MW	10.000 MW
3P4W 3P4W2.5E	150.00 kW	1.5000 MW	15.000 MW

Display format varies according to the declared voltage settings.

Combination Accuracy

Current range	RMS current value $45 \leq f \leq 66$ (Hz)	Active power $45 \leq f \leq 66$ (Hz)
5000.0 A	1.6% rdg.+0.4% f.s.	1.7% rdg.+0.4% f.s.
500.00 A		
50.000 A	1.6% rdg.+3.1% f.s.	1.7% rdg.+3.1% f.s.

8. While using the Model CT7116 AC Leakage Current Sensor

Power range configuration

Wiring	Current range		
	50.000 mA	500.00 mA	5.0000 A
1P2W/DC	50.000 W	500.00 W	5.0000 kW
1P3W 1P3W1U 3P3W2M 3P3W3M	100.00 W	1.0000 kW	10.000 kW
3P4W 3P4W2.5E	150.00 W	1.5000 kW	15.000 kW

Display format varies according to the declared voltage settings.

Combination Accuracy

Current range	RMS current value $45 \leq f \leq 66$ (Hz)	Active power $45 \leq f \leq 66$ (Hz)
5.0000 A	1.1% rdg.+0.16% f.s.	1.2% rdg.+0.16% f.s.
500.00 mA	1.1% rdg.+0.7% f.s.	1.2% rdg.+0.7% f.s.
50.000 mA	1.1% rdg.+6.1% f.s.	1.2% rdg.+6.1% f.s.

15 Maintenance and Service

! WARNING



Customers are not allowed to modify, disassemble, or repair the instrument. Doing so may cause fire, electric shock, or injury.

Calibrations

The calibration frequency varies depending on the status of the instrument or installation environment. We recommend that the calibration period be determined in accordance with the status of the instrument or installation environment. Please contact your Hioki distributor to have your instrument periodically calibrated.

15.1 Troubleshooting

If damage is suspected, check the “Troubleshooting” section before contacting your authorized Hioki distributor or reseller.

Before having the instrument repaired

Symptom	Check Item, or Cause	Remedy and Reference
Unable to write data to the SD memory card. Unable to manipulate folders and files, or format the card.	The write-protected lock of the SD memory card is in an intermediate position.	Check the position of the write-protect lock and disengage it. The connector of the SD memory card is used to judge whether the card is write-protected. If the write-protected lock is in an intermediate position, the determination of whether the card is write-protected will depend on the connector. For example, even if the instrument determines that the card is not write-protected and allows data to be written to it, a computer may determine that it is write-protected, preventing data from being written to it. “2.4 Inserting the SD Memory Card” (p. 42)
The display does not appear when you turn the power on.	If powering the instrument with the AC adapter <ul style="list-style-type: none"> • Are the power cord and AC adapter connected properly? 	Verify that the power cord and AC adapter are connected properly. “2.5 Power Supply” (p. 43)
	If powering the instrument with the battery <ul style="list-style-type: none"> • Has the Z1003 Battery Pack been properly installed? • Has the Battery Pack been charged properly? 	Verify that the battery pack has been charged and installed. “Installing the battery pack” (p. 38)
Keys do not work.	• Has the key lock been activated? 	Press and hold the ESC key for at least 3 s to cancel the key lock.

Symptom	Check Item, or Cause	Remedy and Reference
Voltage or current measured values are not displayed.	<ul style="list-style-type: none"> • Are the voltage cord and current sensors connected properly? • Are the input channels and displayed channels correct? • Has an appropriate current range been selected? 	Verify the connections and wiring. See “4.3 Connecting Voltage Cords to Instrument” (p. 51) through “4.10 Checking Wiring” (p. 59).
Measured values do not stabilize.	<ul style="list-style-type: none"> • Is the frequency of the measuring line 50 Hz/60 Hz? The instrument is not supporting 400 Hz frequency lines. 	The instrument can only be used with 50/60 Hz lines. 400 Hz frequency cannot be measured.
	<ul style="list-style-type: none"> • Is there any voltage input applied? 	The instrument may not be able to perform stable measurement without voltage input to U1 (Sync source).
Unable to charge the Z1003 Battery Pack (the Charge LED does not light up).	<ul style="list-style-type: none"> • Verify that the ambient temperature is within the range of 10°C to 35°C. 	The instrument’s battery can be charged within the ambient temperature range of 10°C to 35°C.
	<ul style="list-style-type: none"> • Has the instrument been stored for an extended period of time with the battery pack installed? 	The battery pack may be degraded. Please purchase a new battery pack. Contact your authorized Hioki distributor or reseller. If you do not want to use the instrument for one month or longer, remove the battery pack and store at –20°C to 30°C.

If the cause of the issue remains unclear, execute a system or factory reset. Doing so will initialize settings to their factory defaults.

See “System reset (Default)” (p. 76) and “Factory reset (Default)” (p. 77).

Replaceable parts and operating lifetimes

The characteristics of some of the parts used in the product may deteriorate with extended use. To ensure the product can be used over the long term, it is recommended to replace these parts on a periodic basis.

When replacing parts, please contact your authorized Hioki distributor or reseller.

The service life of parts varies with the operating environment and frequency of use. Parts are not guaranteed to operate throughout the recommended replacement cycle.

Part	Life	Notes
Lithium battery	Approx. 10 years	The instrument contains a built-in backup lithium battery. The backup battery offers a service life of about 10 years. If the date and time deviate substantially when the instrument is switched on, it is the time to replace that battery. Contact your authorized Hioki distributor or reseller.
Electrolytic Capacitors	Approx. 10 years	The service life of electrolytic capacitors varies with the operating environment. Requires periodic replacement.
LCD backlight (with 50% brightness)	Approx. 50,000 hr	Requires periodic replacement.

Part	Life	Notes
Model Z1003 Battery Pack	Approx. 1 year or approx. 500 recharge/discharge cycles whichever comes first	Requires periodic replacement.

15.2 Cleaning

- To clean the instrument, wipe it gently with a soft cloth moistened with water or mild detergent.
- Wipe the LCD gently with a soft, dry cloth.

15.3 Error Indication

<System Error>			
Code	Error indication	Cause	Corrective action/more information
SY01	The internal programming of the PQ3100 is corrupted and the instrument must be repaired.	The internal programming of the instrument is corrupt.	The instrument must be repaired. Contact your authorized Hioki distributor or reseller.
SY02	The SDRAM of the PQ3100 is corrupted and the instrument must be repaired.	The memory of the instrument is corrupt.	
SY03	The adjustment values of the PQ3100 are corrupted and the instrument must be repaired.	The adjustment values of the instrument are corrupt.	
SY04	The display memory of the PQ3100 is corrupted and the instrument must be repaired.	The display memory of the instrument is corrupt.	
SY05	BACKUP ERROR. The PQ3100 must be returned to default factory condition. Initialize? YES: ENTER key	Backed-up system variables are incorrect or contradictory.	

<File Error>			
Code	Error indication	Cause	Corrective action/more information
FL01	Save failed.	The instrument was unable to save the file due to a problem with the SD memory card.	Format the SD memory card (p. 132).
		The instrument was unable to save the file due to a problem with its internal memory.	Format the internal memory (p. 132).
FL02	Load failed.	The instrument was unable to load settings data due to a problem with the settings file.	Save the settings file once again (p. 128) and load it (p. 129).
FL03	File or folder could not be deleted.	The SD memory card is in the locked (write-protected) state, or the file or folder attribute is set to "read-only."	If the SD memory card is locked, unlock it (p. 42). If the file or folder attribute is set to "read-only," change the attribute using a computer.
FL04	A file of the same name exists.	The instrument was unable to copy data from its internal memory to the SD memory card because data with the same filename already existed on the SD memory card.	Delete the data with the same filename from the SD memory card (p. 131) or change the filename using a computer.
FL05	Formatting failed.	An SD memory card error occurred, or the card was ejected, during formatting it.	Reinsert the SD memory card and format it again (p. 132). If the card cannot be formatted, the card may be damaged and should be replaced with a new one.
		An internal memory error occurred.	The instrument must be repaired. Contact your authorized Hioki distributor or reseller.
FL06	Maximum files reached. Additional files cannot be created.	The maximum number of files or folders that can be created was exceeded.	Execute any of the following. <ul style="list-style-type: none"> • Replace the SD memory card with a new one. • Copy the data on the SD memory card to a computer (p. 135), delete unnecessary data on the card with the instrument (p. 131), or format the card (p. 132).
FL07	Setting file and data file do not match.	Replacement of the SD memory card resulted in the measured data having saved in a folder containing a different setting file. This measured data cannot be loaded to the instrument.	This measured data cannot be loaded to the instrument. If the SD memory card is extracted during recording, it is recommended inserting the card extracted once again or insert a different card that has been formatted with the instrument (p. 133).

<SD Card Error>			
Code	Error indication	Cause	Corrective action/more information
SD01	SD card not found. Insert an SD card.	Data cannot be saved to the SD memory card because no SD memory card has been inserted into the instrument. Otherwise, data cannot be loaded from the SD memory card.	Insert an SD memory card (p. 42).
SD02	Error while attempting to access the SD card.	You attempted to access a corrupt file or a corrupt SD memory card. Or, the SD memory card was removed while it was being accessed.	Copy the data on the SD memory card to a computer (p. 135) and format the SD memory card with the instrument (p. 132).
SD03	Unlock the SD card.	The SD memory card is in the locked (write-protected) state.	Unlock the SD memory card (p. 42).
SD04	SD card is full. Delete files or reformat.	Data cannot be saved to the SD memory card because the card is full.	Execute any of the following. <ul style="list-style-type: none"> • Replace the SD memory card with a new one. • Copy the data on the SD memory card to a computer (p. 135), delete unnecessary data on the card with the instrument (p. 131), or format the card (p. 132).
SD05	SD card is not formatted properly. Format card? YES: ENTER key No: ESC key	SD memory card is not formatted properly.	Format the SD memory card (p. 132).
SD06	SD card not compatible.	An unsupported card such as an SDXC memory card has been inserted into the instrument.	Use the instrument's optional SD memory card (p. 3).
SD07	This is a read-only file.	The SD memory card is in the locked (write-protected) state, or the file or folder attribute is set to "read-only."	If the SD memory card is locked, unlock it (p. 42). If the file or folder attribute is set to "read-only," change the attribute using a computer.

<Internal Memory Error>			
Code	Error indication	Cause	Corrective action/more information
ME01	Internal memory is full. Delete files or reformat.	The instrument's internal memory is full.	Perform this procedure. 1. If recording is in progress, stop recording. 2. Copy the data on the internal memory to the SD memory card (p. 131). 3. Delete all the files on the internal memory (p. 131) or format the internal memory (p. 132).
ME02	Cannot be used because internal memory is damaged. Proceed with reformatting? YES: ENTER key No: ESC key	The instrument's internal memory is corrupt.	Format the internal memory (p. 132).

FTP error			
Code	Error indication	Cause	Corrective action/more information
FT01	The login name or password is incorrect.	Connection to the FTP server failed due to entering a wrong user name or password for login.	Check the setting for automatic data transmission for the FTP (p. 162). Check the connection for the LAN communication (p. 147).
FT02	Cannot connect to the FTP server.	Connection to the FTP server failed due to the problem with the setting or connection for the FTP server.	Check the FTP server setting (p. 156). Check the setting for automatic data transmission for the FTP (p. 162). Check the connection for the LAN communication (p. 147).
FT03	Cannot save the file in the save destination.	The file cannot be saved because either the FTP server setting has a problem or the attribute of the destination directory (folder) is "Read Only".	Check the FTP server setting (p. 156). When the attribute of the destination directory (folder) is "Read Only", use your computer to change the attribute.

E-mail error			
Code	Error indication	Cause	Corrective action/more information
ML01	Cannot connect to mail server.	Connection to the mail server failed due to the problem with the e-mail setting or connection.	Check the e-mail setting or connection. See "12.5 E-mail Transmission" (p. 165).
ML02	Cannot connect to POP server.	Connection to the POP server failed due to the problem with the e-mail setting or connection.	
ML03	Could not send email.	E-mail transmission failed due to the problem with the e-mail setting or connection.	

<Operation Error>			
Code	Error indication	Cause	Corrective action/more information
OP01	This folder cannot be deleted.	You attempted to delete the [PQ3100] base folder.	The [PQ3100] base folder cannot be deleted. If you wish to delete it, you must do so on a computer.

<Error>			
Code	Error indication	Cause	Corrective action/more information
ER01	Invalid setting value.	You attempted to configure the setting with a value that is outside the valid setting range.	Configure the setting with a value that falls within the valid setting range. See "5 Setting Change (SET UP Screen)" (p. 63)
ER02	Maximum number of recordable events exceeded.	The number of events exceeds the upper limit, 9999. No further events can be recorded.	Stop the recording and change the event threshold value in order that 10000 events do not occur. See "5.3 Event Settings" (p. 72)
ER03	Battery level is insufficient. Please charge or use the AC adapter.	Unable to upgrade the version due to low battery level.	Charge the battery or use an AC adapter to upgrade the version.
ER04	The setting could not be initialized.	Initialization for the adapter failed.	Check the setting and connection to the Bluetooth® serial conversion adapter (p. 171).

15.4 Disposing the Instrument

When disposing of this instrument, remove the lithium battery and dispose of battery and instrument in accordance with local regulations.

WARNING



To avoid electric shock, turn off the power switch, disconnect all the cords and cables from the device to be measured, and remove the lithium battery.

CALIFORNIA, USA ONLY

Perchlorate Material - special handling may apply.
See www.dtsc.ca.gov/hazardouswaste/perchlorate

Required items

- Phillips screwdriver (No. 2)



- 1** Turn off the instrument. (p. 44)
- 2** Remove all the cords connected to the instrument.
- 3** Remove the 10 screws shown in the following diagram with the Phillips head screwdriver and remove the battery pack cover and side covers.
- 4** If the Z1003 Battery Pack has been installed, remove the battery and the screw at the battery pack holder.

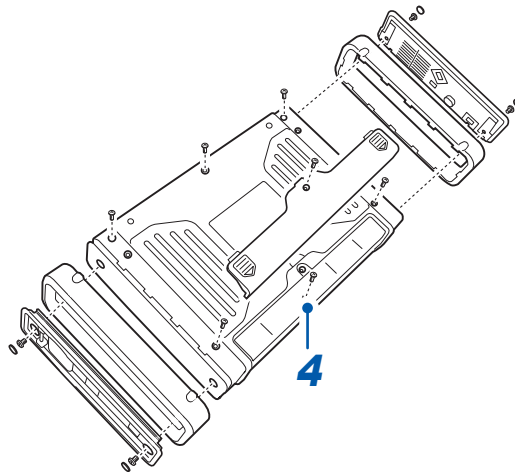

5 Remove the rear cover and remove one screw of the metal plate.

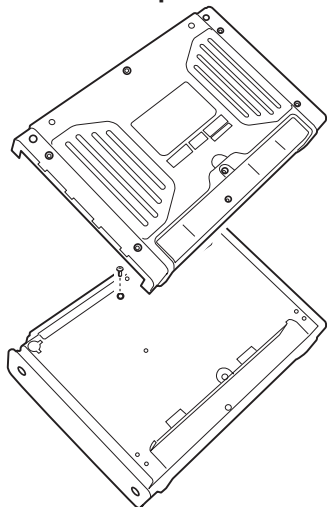

6 Remove the 2 screws on the front cover and then remove the front cover and rubber key.

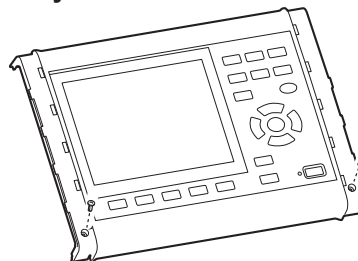

7 Remove the 17 screws shown in the following diagram and then remove the key printed circuit board and upper chassis.

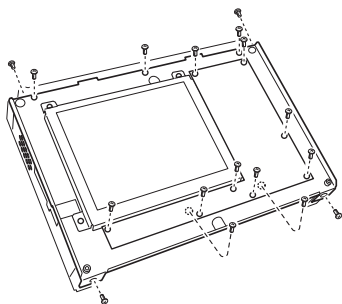

8 Insert the tweezers between the battery holder and the battery and lift the battery up to remove it.

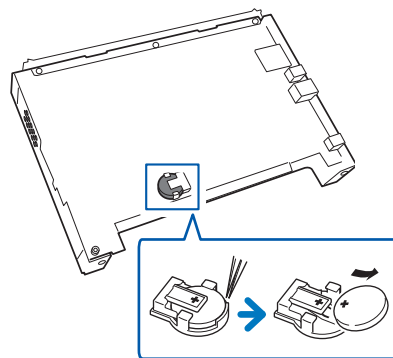

Appendix

Appx. 1 Fundamental Measurement Items

Item	Display	Item	Display
Transient voltage	Tran	Power factor	PF
Frequency (1 wave)	Freq_wav	Displacement power factor	DPF
RMS voltage refreshed each half-cycle	Urms1/2	Active power demand quantity (Consumption)	Dem_WP+
RMS current refreshed each half-cycle	Irms1/2	Active power demand quantity (Regeneration)	Dem_WP-
Swell	Swell	Active power demand value (Consumption)	Dem_P+
Dip	Dip	Active power demand value (Regeneration)	Dem_P-
Interruption	Intrpt	Reactive power demand quantity (Lag)	Dem_WQ_LAG
Inrush current	Inrush	Reactive power demand quantity (Lead)	Dem_WQ_LEAD
RVC (Rapid voltage change)	RVC	Reactive power demand value (Lag)	Dem_Q_LAG
Instantaneous flicker value	Pinst	Reactive power demand value (Lead)	Dem_Q_LEAD
Frequency (10 s)	Freq10s, F10s	Apparent power demand quantity	Dem_WS
Interharmonic voltage	Uiharm	Apparent power demand value	Dem_S
Interharmonic current	Iiharm	Power factor demand value	Dem_PF
Frequency (200 ms)	Freq	Harmonic voltage (0th to 50th order harmonics)	Uharm
Voltage waveform peak+	Upk+	Harmonic current (0th to 50th order harmonics)	Iharm
Voltage waveform peak-	Upk-	Harmonic power (0th to 50th order harmonics)	Pharm
Current waveform peak+	Ipk+	Harmonic voltage phase angle (1st to 50th order harmonics)	Uphase
Current waveform peak-	Ipk-	Harmonic current phase angle (1st to 50th order harmonics)	Iphase
RMS voltage (phase/line)	Urms	Harmonic voltage-current phase difference (1st to 50th order harmonics)	Pphase
Voltage DC	Udc	Total harmonic distortion (THD-F/THD-R) (voltage)	Uthd (Uthd-F or Uthd-R)
Voltage CF	Ucf	Total current harmonic distortion (current) (THD-F/THD-R)	Ithd (Ithd-F or Ithd-R)
RMS current	Irms	Voltage negative-phase unbalance factor	Uunb

Item	Display	Item	Display
Current DC	Idc	Voltage zero-phase unbalance factor	Uunb0
Current CF	Icf	Current negative-phase unbalance factor	Iunb
Active power	P	Current zero-phase unbalance factor	Iunb0
Apparent power	S	K factor	KF
Reactive power	Q	Short-term voltage flicker	Pst
Active energy (Consumption)	WP+	Long-term voltage flicker	Plt
Active energy (Regeneration)	WP-	$\Delta V10$ (Every 1 min.)	dV10
Reactive energy (Lag)	WQ_LAG	$\Delta V10$ (Average hourly value)	dV10 AVG
Reactive energy (Lead)	WQ_LEAD	$\Delta V10$ (Maximum hourly value)	dV10 MAX
Apparent energy	WS	$\Delta V10$ (4th. maximum hourly value)	dV10 MAX4
Energy cost	Ecost	$\Delta V10$ (Overall maximum value)	dV10 total MAX

Appx. 2 Event Item

Category	Sub-category	Display
Transient voltage	-	Tran
Swell	-	Swell
Dip	-	Dip
Interruption	-	Intrpt
RVC (Rapid voltage change)	-	RVC
Inrush current	-	Inrush
Frequency (200 ms)	Upper frequency limit exceeded	Freq Up
	Lower frequency limit exceeded	Freq Low
Frequency (1 wave)	Upper frequency limit exceeded, lower frequency limit exceeded	Freq_wav
Voltage total harmonic distortion	-	Uthd
Current total harmonic distortion	-	Ithd
External event	External input event	Ext
	Manual key event	Manu
	Starting recording event	Start
	Stopping recording event	Stop
	Timer event	Timer
Recording before/after event	Recording before the event	Before
	Recording after the event	After

Appx. 3 Explanation of Power Quality Parameters and Events

Power quality parameters are necessary to investigate and analyze power supply issues*¹. By measuring these parameters, it is possible to assess power quality. To allow instrument to detect abnormal values and abnormal waveforms, you set the threshold values. When these threshold values are exceeded, events are generated. (Threshold values are set based on an estimation of abnormal values, so events do not necessarily indicate an error.)

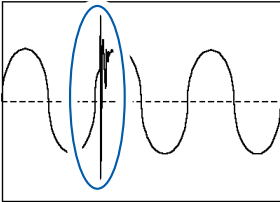
Transient voltage (Impulse)		
Waveform and event		An event caused by lightning strikes, circuit-breaker and relay contact obstruction and tripping, etc. Often occurs when there is a steep change in voltage or when the peak voltage is high.
Primary fault	Close to the source of the break, the power supply of the device is damaged because of the exceptionally high voltage and this may cause the device to reset.	
Event to be detected	Transient (A transient of 5 kHz or higher occurred* ²)	

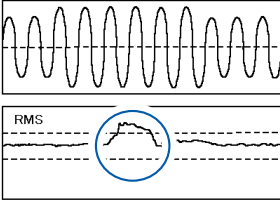
Voltage swell (Surge)		
Waveform and event		Mainly occurs under following circumstances and the voltage rises momentarily. <ul style="list-style-type: none"> • Lightning • Open/close of power line with heavy load • When switching capacitor bank with large capacity • One-line ground fault • Disconnection from high capacity load • Voltage surges due to grid-tied dispersed power supplies (solar power, etc.) during reverse power supply
Primary fault	A surge in voltage may cause the power supply of the device to be damaged or the device to reset.	
Event to be detected	Swell	

*1: Issues caused by a reduction in the power quality. These issues cause failures of substation equipment and electronically controlled devices. (Lighting flicker, frequent burning out of incandescent light bulbs, malfunctioning office equipment, occasional malfunctioning of machine operations, overheating of reactor-equipped capacitor equipment, and occasional malfunctioning of overload, negative-phase, and open-phase relays.)

*2: Measurement band for the transient voltage of the instrument is 40 kHz (200 kHz sampling). Use Model PW3198 Power Quality Analyzer to capture higher-speed transient voltage. Measurement band of Model PW3198 is 700 kHz (sampling: 2 MHz).

Voltage dip (Sag)		
Waveform and event		<p>Most dips are caused by natural phenomena such as lighting. Short-term voltage drops occur under the following conditions:</p> <ul style="list-style-type: none"> • An equipment fault is detected and the power supply is switched off, due to the occurrence of a power system ground fault or short-circuit • When there is a inrush current with a large load, such as when a motor starts.
Primary fault	<p>Power supply voltage dips may cause the following events:</p> <ul style="list-style-type: none"> • Equipment stops operating or is reset • Lamps turn off • Speed fluctuation or stopping of motors • Synchronized motors and generators lose synchronization 	
Event to be detected	Dip	

Interruption		
Waveform and event		<p>Interruptions are caused by momentary, short/long-term power supply outages, mainly under the following circumstances:</p> <ul style="list-style-type: none"> • Fault at the power company (interruption of power due to lightning strikes, etc.) • Circuit breaker tripping due to power supply short-circuits
Primary fault	Interruptions may cause the device to stop operating or to reset.	
Event to be detected	Interruption	

RVC (Rapid voltage change)		
Waveform and event		<p>Rapid voltage change not exceeding the threshold values of the voltage swell and voltage dip.</p>
Primary fault	The standards may have specified the number of RVC events per day.	
Event to be detected	RVC	

Frequency fluctuations		
Waveform and event		<p>Occurs due to line separation caused by changes in the supply/demand balance of active power, the shutdown of a high-capacity generator, or circuit issues.</p>
Primary fault	Changes in the speed of synchronized motors may cause product defects.	
Event to be detected	Frequency: 200 ms (Freq), frequency 1 wave (Freq_wav)	
Measurement Items	IEC61000-4-30 Average frequency of frequencies obtained for 10-s periods (Freq10s)	

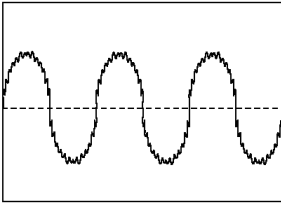
Harmonics		
Waveform and event		Harmonics are caused by distortions of the voltage and current waveforms when a device's power supply uses semiconductor control devices.
Primary fault	Larger harmonic components may cause any of the following major failures: <ul style="list-style-type: none"> • Abnormal heat or increased noise of motors and transformers • Fire of reactor connected to phase advance capacitor 	
Event that may be detected	Total harmonic distortion (THD) (voltage)	
Measurement Items	Harmonic voltage, harmonic current, harmonic power	

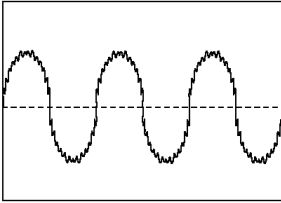
Interharmonics		
Waveform and event		Frequency components that are not a whole multiple of the fundamental wave caused by distortions of the voltage and current waveforms due to any of the following: <ul style="list-style-type: none"> • Static frequency conversion equipment • Cycloconverters • Scherbius machines • Induction motors • Welder machines • Arc furnaces
Primary fault	Displacement of the voltage waveform zero-cross may damage equipment, cause it to malfunction, or degrade its performance.	
Event that may be detected	Total harmonic distortion (THD) (voltage)	
Measurement Items	Interharmonic voltage, interharmonic current	

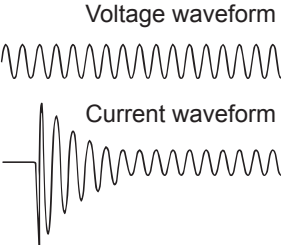
Inrush current		
Waveform and event	<p>Voltage waveform</p>  <p>Current waveform</p>	Inrush current is a large current that flows momentarily, for example, when the electric equipment is turned on.
Primary fault	Inrush current may cause the following events: <ul style="list-style-type: none"> • Fusing of power switch contact or relay • Fuse blowouts • Circuit breaker disconnections • Failure of rectifying circuits • Supply voltage instability • Equipment sharing the same power supply stops operating or resets due to supply voltage instability 	
Event to be detected	Inrush current	

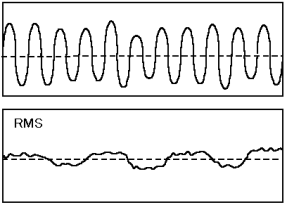
Flicker		
Waveform and event		<p>Voltage fluctuation caused by blast furnace, arc welding, and thyristor control loads. This causes flicker in light bulbs etc.</p>
Primary fault	<p>Because this phenomenon reoccurs regularly, it may cause the light to flicker or the device to malfunction. Large flicker values indicate that most people would find the flickering of lighting unpleasant.</p>	
Measurement Items	IEC flicker Pst, Plt, ΔV_{10} flicker	

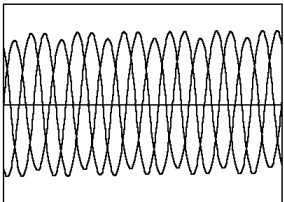
Unbalance		
Waveform and event		<p>Unbalance is caused by increase or decrease in the load connected to each phase of a power line, or by distortions in voltage and current waveforms, voltage drops, or negative-phase voltage caused by the operation of unbalanced equipment or devices.</p>
Primary fault	<p>Voltage unbalance, negative-phase voltage, and harmonics generation may cause the following events:</p> <ul style="list-style-type: none"> • Variations in motor rotation and noise • Reduced torque • Tripping of 3E breakers • Overloading and heating of transformers • Increased loss in rectifiers with smoothing capacitor 	
Measurement Items	Voltage unbalance factor, current unbalance factor	

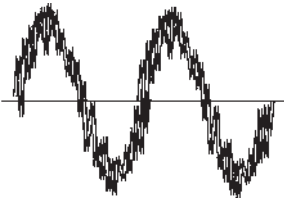
High-order harmonic component		
Notes	This cannot be measured with the instrument. Use Model PW3198 Power Quality Analyzer for such measurements.	
Waveform and event		<p>The high-order harmonic component consists of noise components of several kHz or more caused by voltage and current waveform distortions when equipment power supply uses semiconductor devices. It includes various frequency components.</p>
Primary fault	<p>The high-order harmonic component can damage the equipment power supply, cause the equipment operation to be reset, or result in abnormal sound from TV and radio.</p>	
Event that is detected by the instrument	High-order harmonic voltage component RMS values, high-order harmonic current component RMS values	

Appx. 4 Event Detection Methods

Transient voltage

Measurement method

Transient voltage event is detected when the waveform obtained by eliminating the fundamental component (50 Hz/60 Hz) from a waveform sampled at 200 kHz exceeds a threshold value specified as an absolute value.

Detection occurs once for each the fundamental voltage waveform, and voltages of up to $\pm 2,200$ V can be measured.

Recorded data

Transient voltage value	Waveform peak value during 3 ms period after elimination of fundamental component
Transient width	Period during which threshold value is exceeded (2 ms max.)
Max. transient voltage value	Max. peak value of waveform obtained by eliminating the fundamental component during the period from transient IN to transient OUT (leaving channel information)
Transient period	Period from transient IN to transient OUT
Transient count during period	Number of transients occurring during period from transient IN to transient OUT (Transients occurring across all channels or simultaneously on multiple channels are counted as 1)
Transient waveform	Event IN: Saves a waveform 1 ms before and 2 ms after the position at which the maximum transient voltage is detected within one waveform including Event IN. Event OUT: Saves a waveform 1 ms before and 2 ms after the position at which the maximum transient voltage is detected between Event IN and Event OUT.

Transient waveform

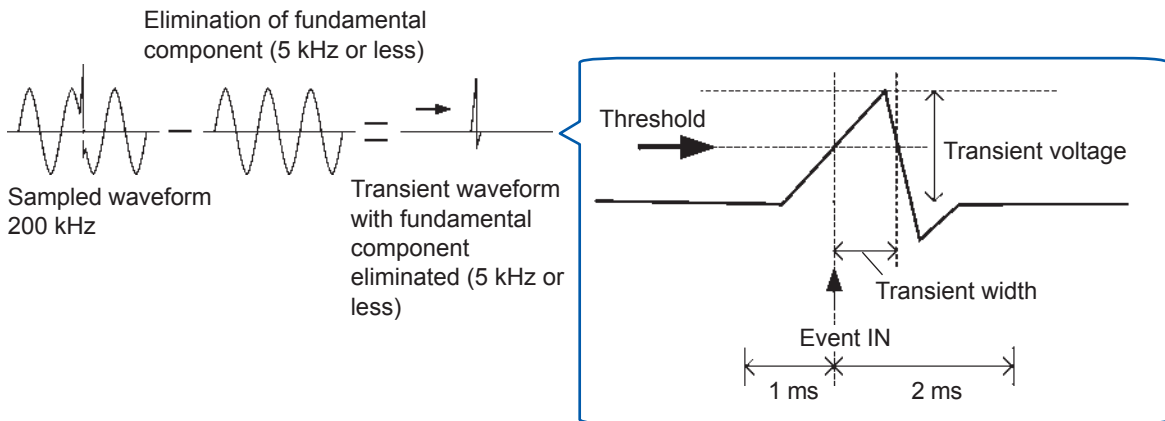

Event IN and OUT

Event IN	Time when the first transient voltage is detected (the waveform exceeded the threshold value) in an approx. 200 ms aggregation interval.
Event OUT	Start time of approx. 200 ms aggregation in which no transient voltage was detected for any channel within the first approx. 200 ms aggregation period following the transient event IN state.

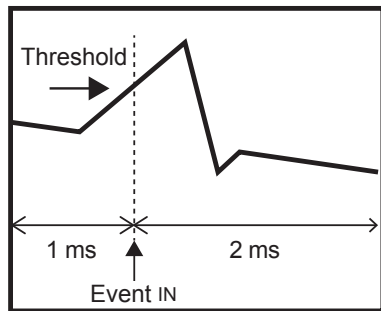
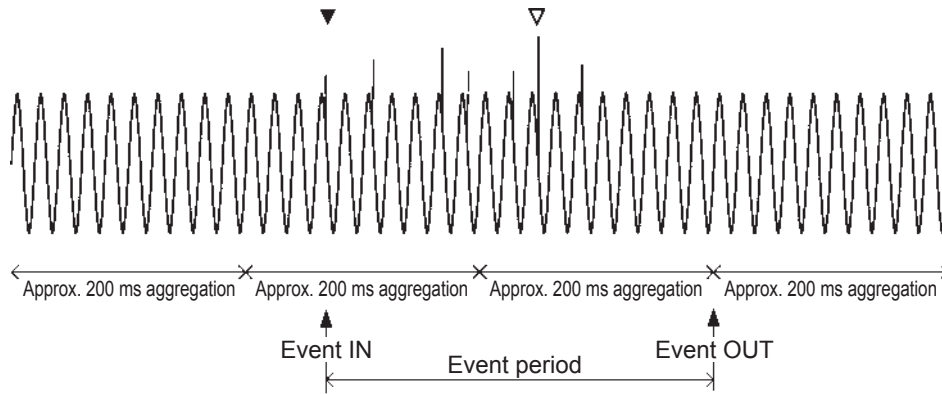

Transient waveform (including fundamental component)
Saves a waveform in which the maximum transient voltage is detected within one waveform including Event IN.

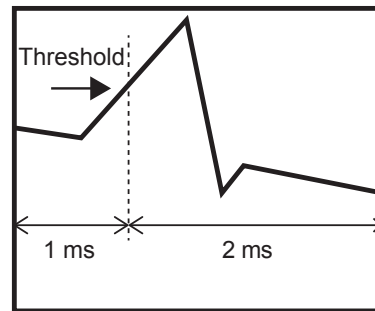

Transient waveform (including fundamental component)
Saves a waveform in which the maximum transient voltage is detected between Event IN and Event OUT.

Voltage swells, Voltage dips, Interruptions

Measurement method

- Voltage swell, voltage dip, and interruption events are detected using the RMS voltage refreshed each half-cycle that is calculated from the voltage waveform obtained over a 1-cycle time, refreshed each half-cycle.
- Events are detected using line voltage for 3-phase 3-wire wiring and phase voltage for 3-phase 4-wire wiring.
- Voltage swells are detected when RMS voltage refreshed each half-cycle exceeds the threshold value.
- Voltage dips and interruptions are detected when RMS voltage refreshed each half-cycle falls below the threshold value.

Event IN and OUT

Event IN	Voltage swells: Time when RMS voltage refreshed each half-cycle exceeds the threshold value. Voltage dip/Interruption: Time when RMS voltage refreshed each half-cycle falls below than the threshold value.
Event OUT	Voltage swells: Time at which RMS voltage refreshed each half-cycle that exceeded the threshold value once falls to or below the value (threshold value – hysteresis). Voltage dip/Interruption: Time at which RMS voltage refreshed each half-cycle that fell below the threshold value once exceeds the value (threshold value + hysteresis).

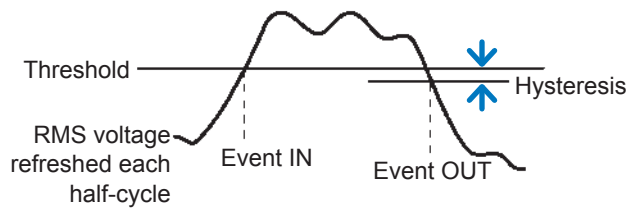

Voltage swell

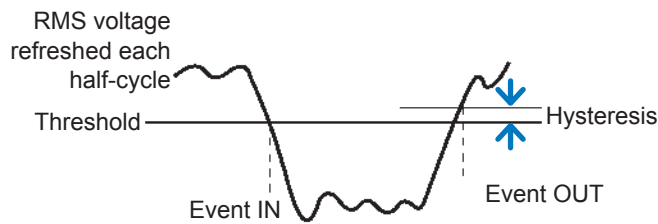

Voltage dip, interruption

RMS voltage refreshed each half-cycle

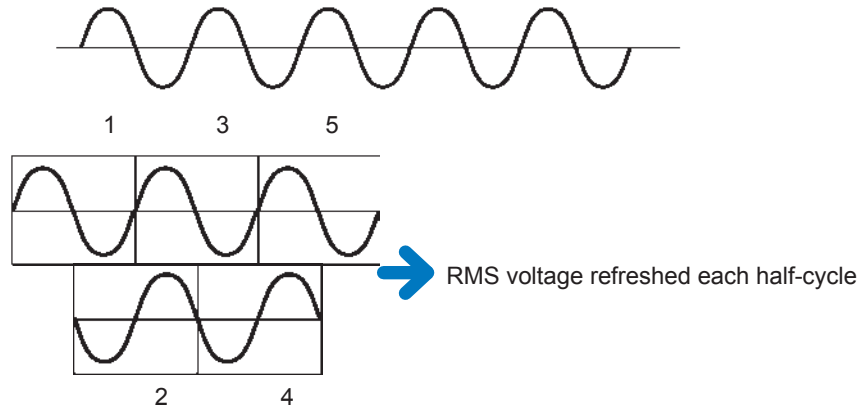

RVC (Rapid voltage change)

Measurement method

- A phenomenon in which a voltage rapidly changes within a range not exceeding the threshold values of the voltage swell and voltage dip is detected.
- The RMS voltage refreshed each half-cycle is calculated from the voltage waveform obtained over a 1-cycle time, refreshed each half-cycle, and the value calculated is compared and detected with the average value for 1 second (100 average values at 50 Hz / 120 average values at 60 Hz).
- Line voltage is used to detect an event for 3-phase 3-wire wiring, and phase voltage is used to detect an event for 3-phase 4-wire wiring.

Event IN and OUT

Event IN	Time when the RMS voltage refreshed each half-cycle exceeds (the average value for 1 second prior to including the value) \pm the threshold value.
Event OUT	Time when the RMS voltage refreshed each half-cycle entered the value in which the hysteresis was subtracted from (the average value for 1 second prior to including the value) \pm the threshold value. However, for it to be OUT, one second needs to elapse without deviating after entering the threshold values.
Event DISCARD	When exceeded the threshold value of the voltage swell and the voltage dip before event OUT, the RVC event is discarded and becomes the swell event or dip event.

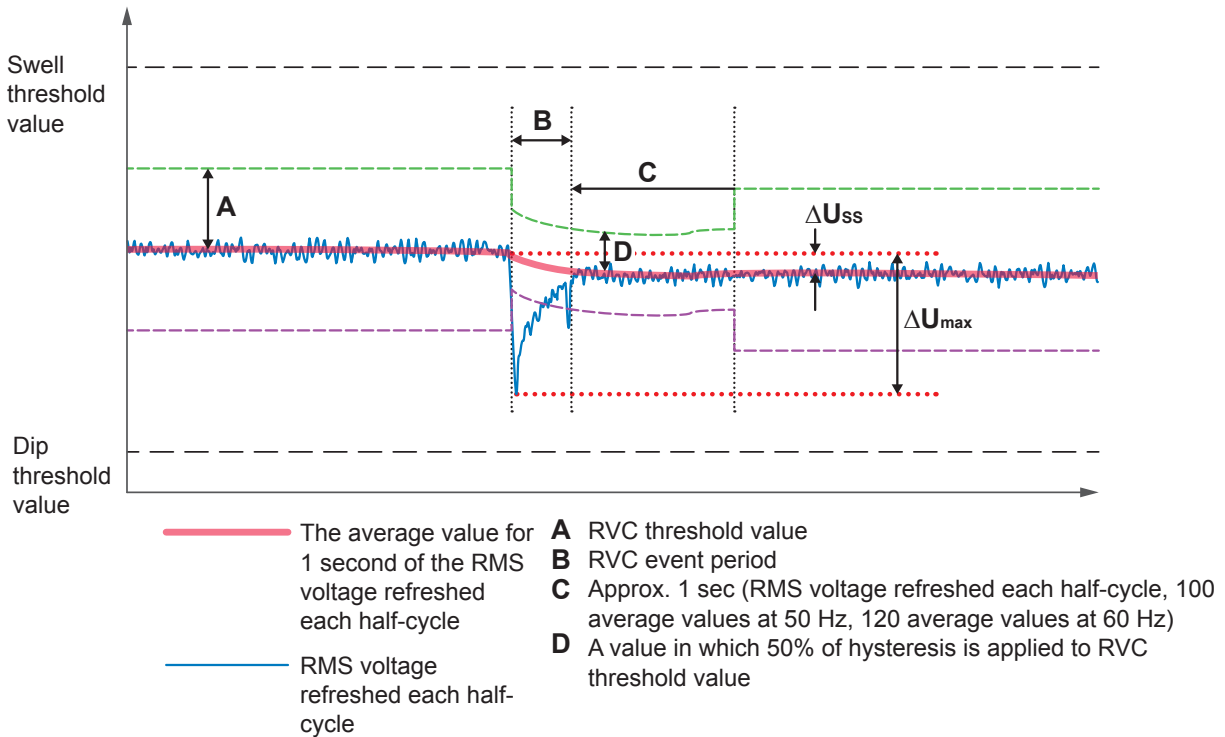

ΔU_{max} : Maximum absolute difference between the value for $U_{rms(1/2)}$ and the average value for 1 second of the $U_{rms(1/2)}$

ΔU_{ss} : Maximum absolute difference between the average value for 1 second of $U_{rms(1/2)}$ immediately before RVC event and the average value for 1 second of $U_{rms(1/2)}$ immediately after RVC event

Frequency (200 ms)

Measurement method (Reciprocal method)

Values of Frequency (200 ms) are calculated from the reciprocal of the accumulated time over the approximately 200-ms (10/12-cycle for 50 Hz / 60 Hz, respectively) aggregation period on U1 (reference channel). This value is detected when this value exceeds the positive threshold value or falls below the negative threshold value.

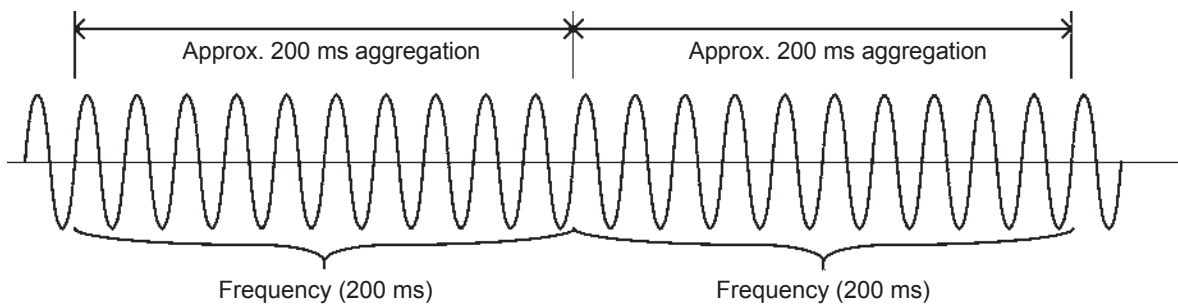

Event IN and OUT

Event IN	Starting time of an approximately 200-ms aggregation period to which the frequency value belongs when it exceeds the positive threshold value or falls below the negative threshold value
Event OUT	Starting time of the approximately 200-ms aggregation period to which a frequency value belongs when it falls below the value calculated by subtracting 0.1 Hz from the positive threshold value or exceeds the value calculated by adding 0.1 Hz to the negative threshold value (Equivalent to a frequency hysteresis of 0.1 Hz)

Frequency (1 wave)

Measurement method (Reciprocal method)

Frequency for every U1 (reference channel) waveform.

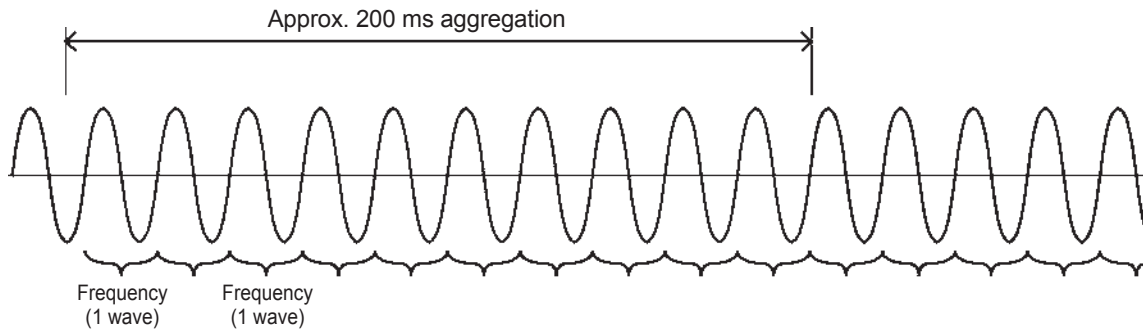

Event IN and OUT

Event IN	Time when a frequency exceeds the positive threshold value or falls below the negative threshold value
Event OUT	Time when a frequency falls below the value calculated by subtracting 0.1 Hz from the positive threshold value or exceeds the value calculated by adding 0.1 Hz to the negative threshold value (Equivalent to a frequency hysteresis of 0.1 Hz)

Voltage total harmonic distortion, Current total harmonic distortion

Measurement method

Measured values are calculated for a rectangular window of 2048 points over the approximately 200-ms (10/12-cycle for 50 Hz / 60 Hz, respectively) aggregation. Events are detected when the calculated values are greater than the corresponding threshold value.

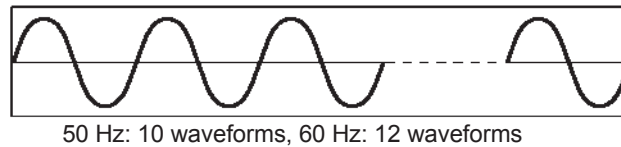

Harmonic calculation using rectangular window

Event IN and OUT

Event IN	Starting time of an approximately 200-ms aggregation period to which a value belongs when it exceeds the threshold value
Event OUT	Starting time of an approximately 200 ms aggregation period during which the signal falls beneath the value (threshold value – hysteresis).

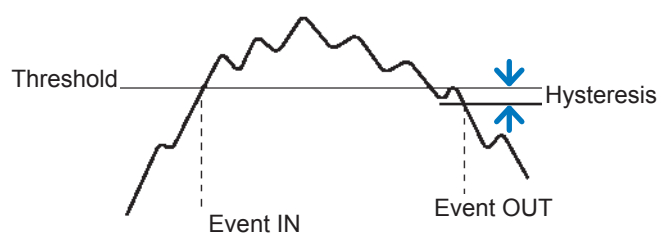

Harmonic distortion

Inrush current

Measurement method

Inrush current events are detected when the RMS current (inrush current) calculated for every half cycle exceeds the threshold value.

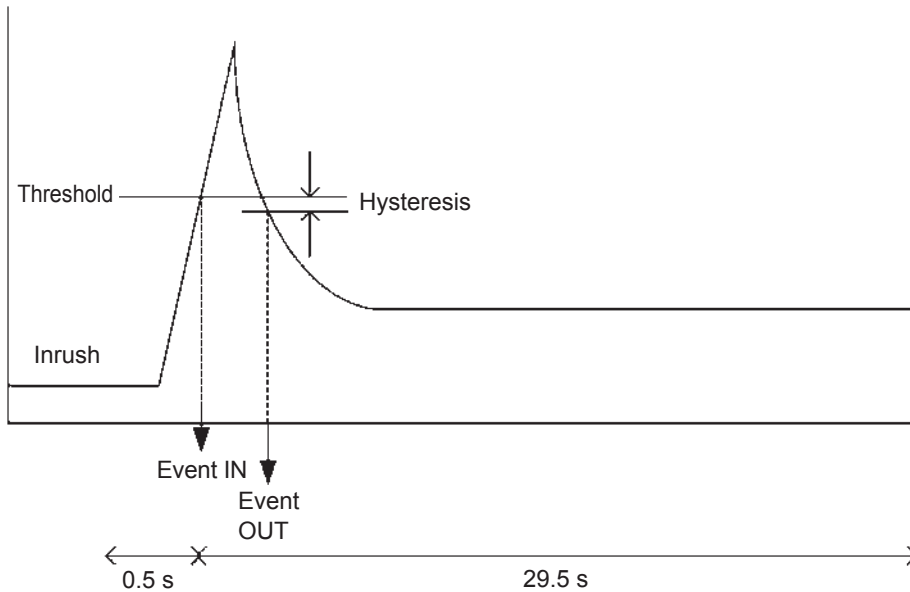

Inrush current, Inrush is saved from 0.5 s before the event to 29.5 s after the event as event trend data.

Event IN and OUT

Event IN	Starting time of a half-cycle voltage waveform to which an inrush current (Inrush) belongs on each channel when it exceeds the threshold value
Event OUT	Starting time of a half-cycle voltage waveform whose inrush current falls beneath the value (threshold value – hysteresis)

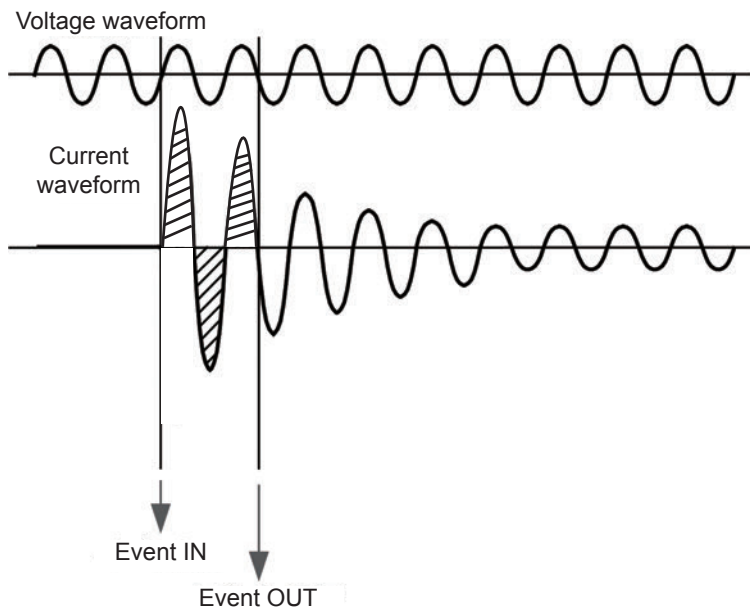

Timer event

- Events are generated at the set interval.
- Once recording is started, timer events will be recorded at a fixed interval (the set time) from the start time.

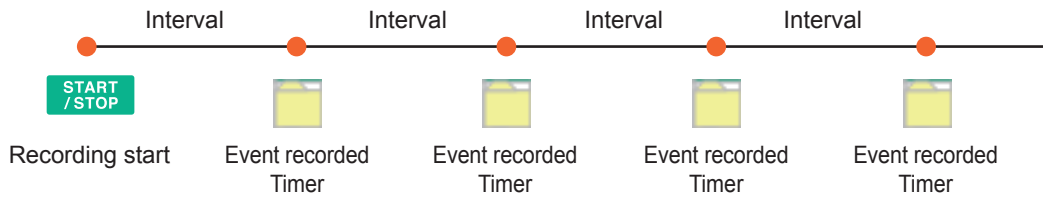

External event

External events are detected when any of the following occurs due to the input signal for the EXT I/O terminals.

- When a falling of the pulse signal input to Pin 1 (EVENT IN) is detected
- When Pin 1 (EVENT IN) and Pin 3 (GND1) are short-circuited each other

The voltage and current waveforms and measured values are recorded, when the external event occurs.

See "13 External I/O" (p. 173).

Manual event

Pressing the **[MANUAL EVENT]** key generates an event.

The voltage and current waveforms as well as measured values are recorded, when the manual event occurs.

Appx. 5 Recording Trends and Event Waveforms

Trend screen recording method

Basic trend and harmonics trend

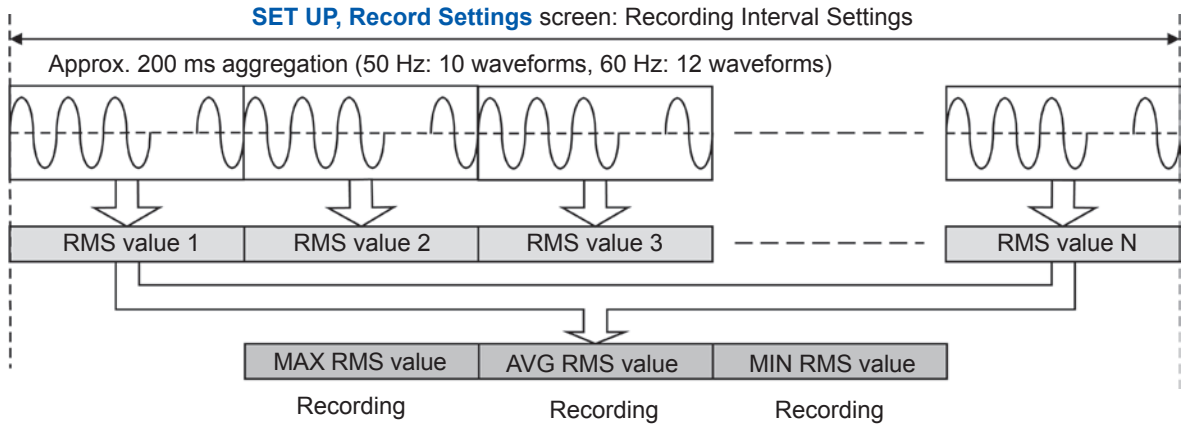

Example: When interval: 1 min, N = 300

Detailed trend

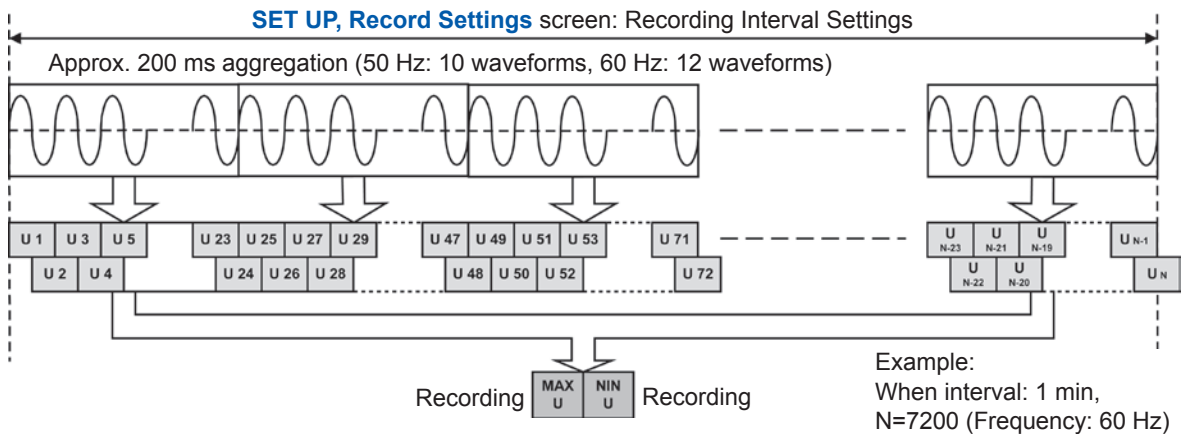

RMS voltage refreshed each half-cycle ($U_{rms1/2}$) is calculated for one waveform shifted over half a wave. Example: There are 24 RMS voltage refreshed each half-cycle in approx. 200 ms aggregation at 60 Hz (12 cycles).

Recording event waveforms

Waveforms observed in the approximately 200-ms aggregation period are recorded as event waveforms.

Event waveform recording period

50 Hz: Waveform observed for a 10-cycle period

60 Hz: Waveform observed for a 12-cycle period

When an event occurs on a measured value obtained over an approximately 200-ms aggregation period

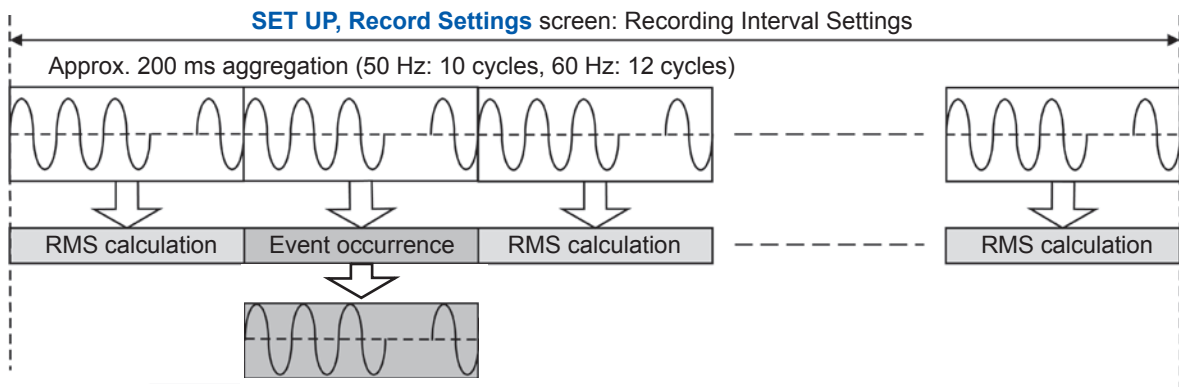

When an event is occurred on a measured value obtained a 1-cycle or half-cycle

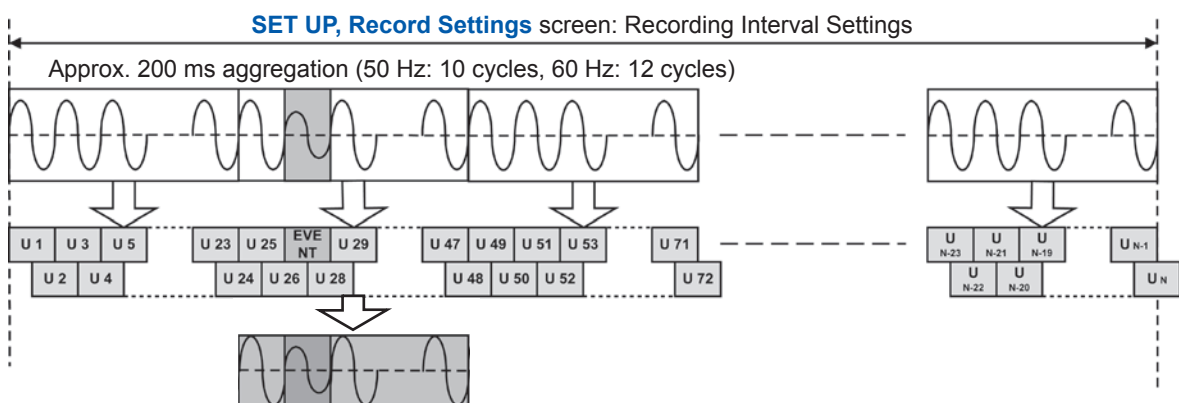

- On the **SET UP, Event settings 2** screen, **Event waveform recording time: “Before event occurs”** setting allows an immediately previous waveform with a length of a set time to be stored in addition to an event waveform with a length of a 200-ms aggregation period observed at an event. (p. 74).
Event waveform recording time: “Before event occurs”: OFF, 200 ms, 1 s
- On the **SET UP, Event settings 2** screen, **Event waveform recording time: “After event occurs”** setting allows an immediately previous waveform with a length of a set time to be stored in addition to an event waveform with a length of a 200-ms aggregation period observed at an event. (p. 74).
Event waveform recording time: “After event occurs”: OFF, 200 ms, 400 ms, 1 s, 5 s, 10 s

Method for verifying aggregation values required by IEC61000-4-30

	3-s aggregated values (= 150/180-cycle data)	10-min aggregated values	2-h aggregated values
Magnitude of the supply voltage	Applies to the average value of Urms values obtained on each channel over the recording interval.		
Voltage harmonics	Measurement condition: Recording items ^{*1} is set to Yes harmonic .		
Voltage interharmonics	Applies to the average value of the values obtained over the recording interval.		
Supply voltage unbalance	Applies to the average value of unb values and unb0 values of Uunb obtained over the recording interval.		
Measurement conditions	• Recording interval ^{*1} is set to 150/180 cycle .	• Recording interval ^{*1} is set to 10 min .	• Recording interval ^{*1} is set to 2 hour .
	• TREND screen check requires that Tdiv (horizontal axis) be set to the minimum value to make cursor measurements. ^{*2}		

*1: See "5.2 Recording Settings" (p. 69).

*2: See "8.1 Verifying the Basic Trend" (p. 100).

IEC flicker

When measuring IEC flicker based on the standard, set the **Recording interval** to **2 hour** and use only a Plt value with even-numbered but 2 hours after the recording starts (e.g., 2 hours, 4 hours and more).

Appx. 6 Detailed Explanation of IEC Flicker and ΔV_{10} Flicker

To measure the IEC Flicker or ΔV_{10} Flicker

On the **SET UP, Measurement setting 2** screen, configure the flicker.
See "SET UP, Measurement Settings 2 screen" (p. 66).

IEC flicker meter

The IEC flicker function is based on the international standard IEC61000-4-15, "Flickermeter - Functional and design specifications."

IEC flicker meter function diagram

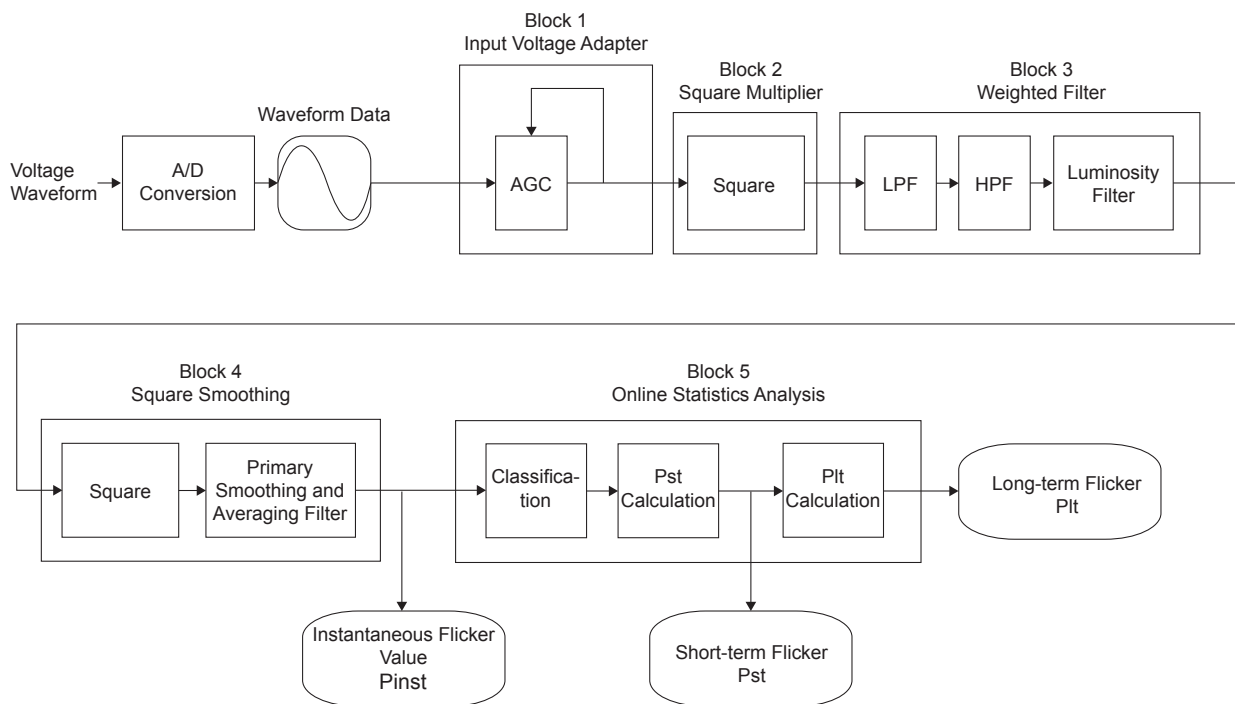

Weighting filter

You can select a weighted filter for either a 230 V lamp system or a 120 V lamp system.

Statistical processing

Statistics on flicker are compiled by applying the cumulative probability function (CPF) to 1,024 divisions of instantaneous flicker values P_{inst} in the range from 0.0001 p.u.* to 10000 p.u. on the logarithmic axis to obtain cumulative probabilities $P_{0.1}$, P_{1s} , P_{3s} , P_{10s} , and P_{50s} .

*: The unit [p.u.] stands for perceptibility unit. Various filters are designed in order that the maximum value of P_{inst} corresponds to 1 [p.u.] when a voltage fluctuation that human beings recognize as a flicker is input to them.

Short interval flicker (P_{st})

This indicates degree of perceptibility (severity) of flicker measured over a 10-min period.

Short interval flicker value is defined with the following expression.

$$P_{st} = \sqrt{0.0314P_{0.1} + 0.0525P_{1s} + 0.0657P_{3s} + 0.28P_{10s} + 0.08P_{50s}}$$

$$P_{50s} = (P_{30} + P_{50} + P_{80})/3$$

$$P_{10s} = (P_6 + P_8 + P_{10} + P_{13} + P_{17})/5$$

$$P_{3s} = (P_{2.2} + P_3 + P_4)/3$$

$$P_{1s} = (P_{0.7} + P_1 + P_{1.5})/3$$

$P_{0.1}$ is not smoothed

Long interval flicker (P_{lt})

Indicates the degree of perceptibility (severity) of flicker determined from successive P_{st} measurements over a 2-hour period.

The displayed value is updated every 10 min because P_{st} is calculated with the moving average.

Long interval flicker value is defined with the following expression.

$$P_{lt} = \sqrt[3]{\frac{\sum (P_{sti})^3}{N}}$$

ΔV10 flicker meter

ΔV10 flicker

The ΔV10 flicker function is calculated using the “perceived flicker curve” calculation method, which is based on the digital Fourier transformation.

The ΔV10 flicker is defined with the following expression.

$$\Delta V_{10} = \sqrt{\sum_{n=1}^{\infty} (a_n \cdot \Delta V_n)^2}$$

ΔV_n: RMS value [V] for voltage fluctuations in frequency f_n.

a_n: Luminosity coefficient for f_n where 10 Hz is 1.0. (0.05 Hz to 30 Hz)

Evaluation period: for 1 min

ΔV10 flicker function diagram

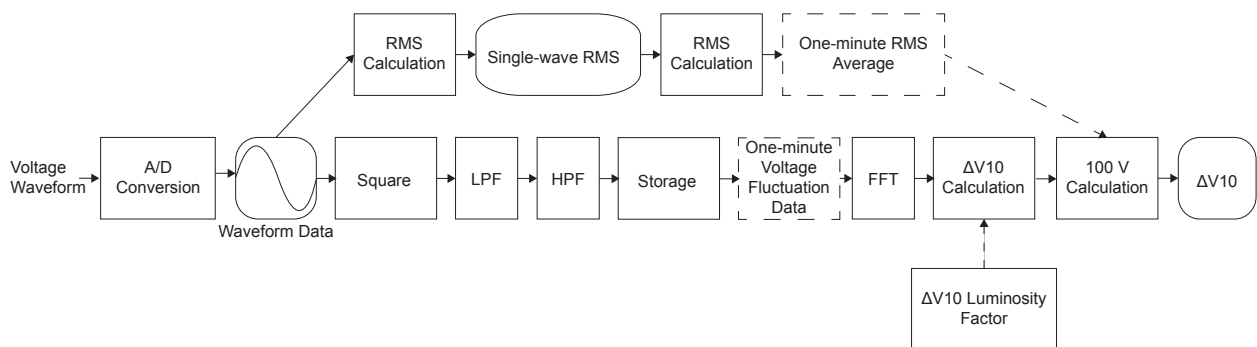

ΔV10 Perceived flicker coefficient

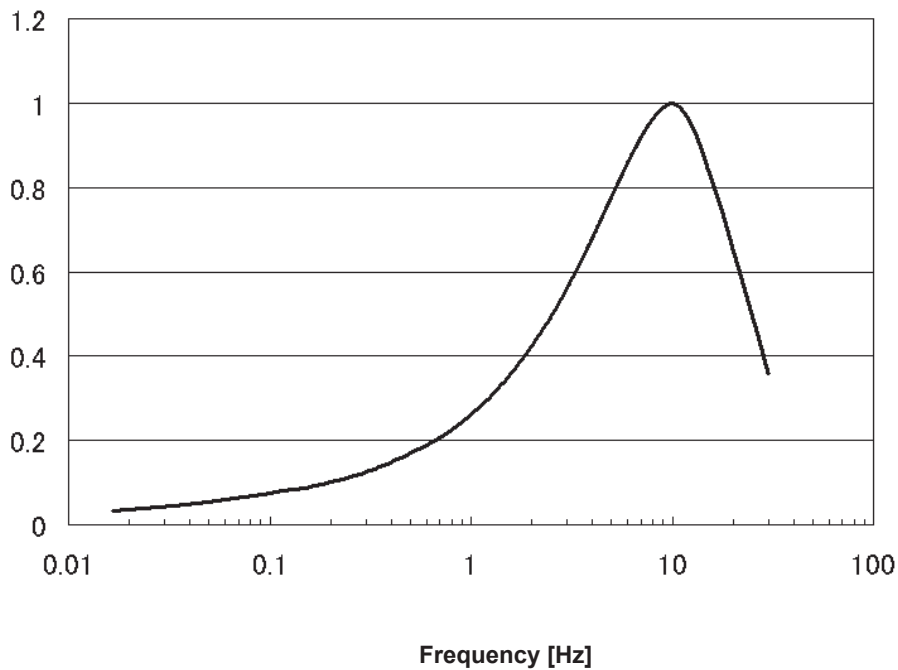

Appx. 7 3-phase 3-wire Measurement

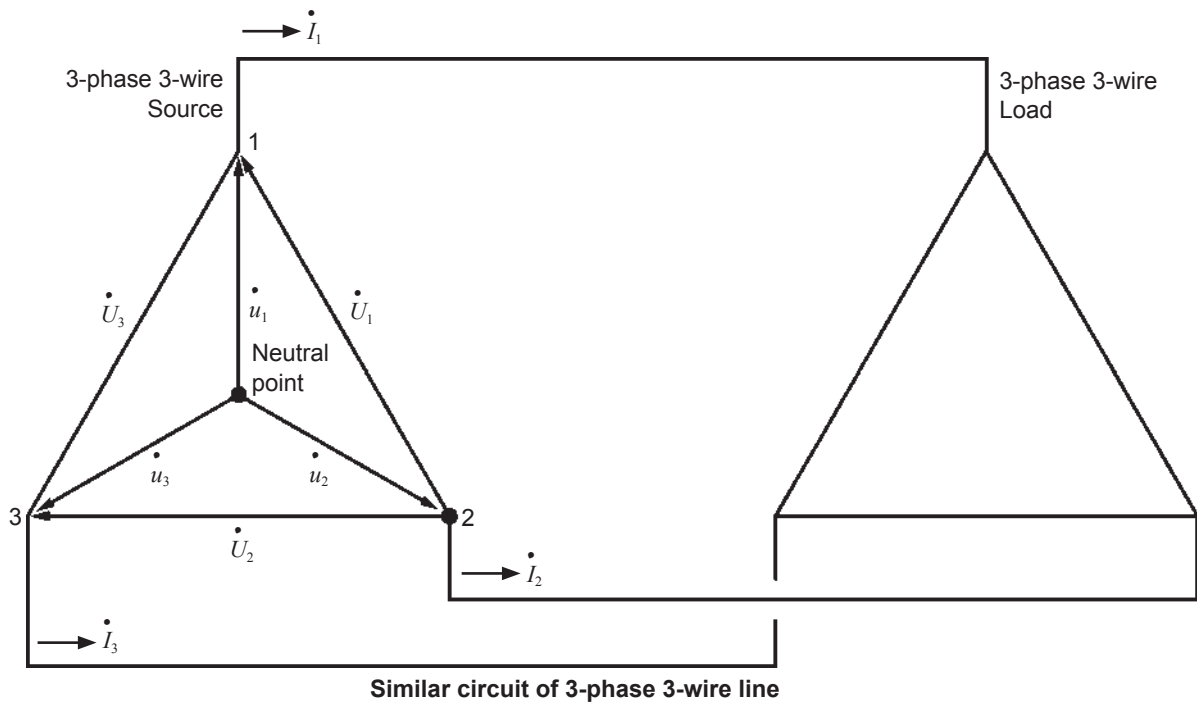

$\dot{U}_1, \dot{U}_2, \dot{U}_3$: The vectors of line-to-line voltage
 $\dot{u}_1, \dot{u}_2, \dot{u}_3$: The vectors of phase to neutral voltage
 $\dot{I}_1, \dot{I}_2, \dot{I}_3$: The vectors of line (phase) current

3-phase/3-wire/3-wattmeter measurement (3P3W3M)

In 3-wattmeter measurement, 3 phase voltages $\dot{u}_1, \dot{u}_2, \dot{u}_3$ and three line (phase) currents $\dot{I}_1, \dot{I}_2, \dot{I}_3$ are measured.

Measuring actual phase voltages are not possible because of the lack of a neutral point in the 3-phase, 3-wire line, therefore, phase voltages are measured from a virtual neutral point.

The 3-phase active power P is calculated as the sum of all the phase active power values.

$$P = u_1 I_1 + u_2 I_2 + u_3 I_3 \dots (1)$$

3-phase/3-wire/2-wattmeter measurement (3P3W2M)

In 2-wattmeter measurement, two line-to-line voltages \dot{U}_1, \dot{U}_2 and two line (phase) currents \dot{I}_1, \dot{I}_3 are measured.

The 3-phase active power P can be derived from two voltage and current values, as shown below:

$$\begin{aligned}
 P &= \dot{U}_1 \dot{I}_1 + \dot{U}_2 \dot{I}_3 \text{ (from } \dot{U}_1 = \dot{u}_1 - \dot{u}_2, \dot{U}_2 = \dot{u}_3 - \dot{u}_2) \\
 &= (\dot{u}_1 - \dot{u}_2) \dot{I}_1 + (\dot{u}_3 - \dot{u}_2) \dot{I}_3 \\
 &= \dot{u}_1 \dot{I}_1 + \dot{u}_2 (-\dot{I}_1 - \dot{I}_3) + \dot{u}_3 \dot{I}_3 \text{ (from } \dot{I}_1 + \dot{I}_2 + \dot{I}_3 = 0 \text{ as the precondition of a closed circuit)} \\
 &= \dot{u}_1 \dot{I}_1 + \dot{u}_2 \dot{I}_2 + \dot{u}_3 \dot{I}_3 \dots (2)
 \end{aligned}$$

Since equations (1) and (2) agree, it is possible to prove that 2-wattmeter measurement can be used to measure the power of a 3-phase, 3-wire line. The circuit allowing 3-phase power measurements with this method is a only closed circuit without leakage current. Since there are no special conditions other than the above, it is possible to calculate 3-phase power regardless of the balanced or unbalanced state of the electric circuit.

Additionally, since the sum of the voltage and current vectors always equals 0 under these conditions, the instrument internally calculates the third voltage \dot{U}_3 and current \dot{I}_2 values as follows:

$$\begin{aligned}
 \dot{U}_3 &= \dot{U}_1 - \dot{U}_2 \\
 \dot{I}_2 &= -\dot{I}_1 - \dot{I}_3
 \end{aligned}$$

Since the values calculated internally \dot{U}_3 and \dot{I}_2 are also applied to the 3-phase total reactive power Q , apparent power S , and power factor PF values, these values can also be calculated accurately in the event of an unbalanced state. [When **PF/Q/S** setting (p. 66) is **RMS**]

However, because the three phases are calculated from two power values in 2-wattmeter measurement, it is not possible to check the power balance between respective phases. If you wish to check the power balance for individual phases, use 3-wattmeter (3P3W3M) measurement.

Item		3P3W2M	Relative merits	3P3W3M	
Voltage	U1	\dot{U}_1	=	$\dot{U}_1 = \dot{u}_1 - \dot{u}_2$	
	U2	\dot{U}_2		$\dot{U}_2 = \dot{u}_2 - \dot{u}_3$	
	U3	$\dot{U}_3 = \dot{U}_2 - \dot{U}_1$		$\dot{U}_3 = \dot{u}_3 - \dot{u}_1$	
Current	I1	\dot{I}_1	=	\dot{I}_1	
	I2	\dot{I}_3		\dot{I}_2	
	I3	$\dot{I}_2 = -\dot{I}_1 - \dot{I}_3$		\dot{I}_3	
Active power	P1	$\dot{U}_1 \dot{I}_1$	<	$\dot{u}_1 \dot{I}_1$	It is possible to check the active power balance for individual phases.
	P2	$\dot{U}_2 \dot{I}_3$		$\dot{u}_2 \dot{I}_2$	
	P3	-		$\dot{u}_3 \dot{I}_3$	
	P	$\dot{U}_1 \dot{I}_1 + \dot{U}_2 \dot{I}_3 = \dot{u}_1 \dot{I}_1 + \dot{u}_2 \dot{I}_2 + \dot{u}_3 \dot{I}_3$ See equation (2).	=	$\dot{u}_1 \dot{I}_1 + \dot{u}_2 \dot{I}_2 + \dot{u}_3 \dot{I}_3$	
Apparent power (When PF/Q/S setting is RMS)	S1	$U_1 I_1$	<	$u_1 I_1$	Since calculations are based on the phase voltage and phase (line) current, it is possible to check the apparent power for individual phases.
	S2	$U_2 I_3$		$u_2 I_2$	
	S3	$U_3 I_2$		$u_3 I_3$	
	S	$\frac{\sqrt{3}}{3}(U_1 I_1 + U_2 I_3 + U_3 I_2)$	=	$\frac{\sqrt{3}}{3}(U_1 I_1 + U_2 I_2 + U_3 I_3)$	

In 3P3W2M measurement, the instrument inputs the 3-phase line's T-phase current as each current's I2 parameter. For display purposes, a current value of Phase T in the 3-phase line is displayed as the current I2; and a calculated value of Phase S in the 3-phase line, as the current I3.

Appx. 8 Method for Calculating Active Power Accuracy

The accuracy of active power calculations can be calculated as follows, taking into account the phase accuracy:

Example measurement conditions

Wiring: 3-phase/4-wire (3P4W)

Current sensor: Model CT7136

Current range: 50 A (power range: 150 kW)

“14.8 Range Configuration and Combination Accuracy” (p. 220)

Measured values: Active power of 30 kW, power factor lag 0.8

Accuracy

Active power accuracy for current sensor combination (Model CT7136 sensor, 50 A range): **±0.5% rdg. ±0.22% f.s.**

Internal circuit voltage of the instrument - current phase difference: ±0.2865° (Effect of power factor: 1.0% rdg. or less)

Phase accuracy of the CT7136: ±0.5°

“14.2 Input Specifications/Output Specifications/Measurement Specifications” (p. 181)

“14.8 Range Configuration and Combination Accuracy” (p. 220)

Phase accuracy shown in “Specifications” of the CT7136 Instruction Manual

Power factor accuracy based on phase accuracy

Phase accuracy (in combination with current sensor) = Instrument internal circuit phase accuracy (±0.2865°) + CT7136 phase accuracy (±0.5°) = ±0.7865°

Phase difference $\theta = \cos^{-1}(\text{power factor}) = \cos^{-1}0.8 = 36.87^\circ$

Power factor error range based on phase accuracy = $\cos(36.87^\circ \pm 0.7865^\circ) = 0.7916$ to 0.8082

Power factor accuracy based on phase accuracy (minimum) = $\frac{0.7916 - 0.8}{0.8} \times 100\% = -1.05\%$
use the worst value as the power factor accuracy.

Power factor accuracy based on phase accuracy (maximum) = $\frac{0.8082 - 0.8}{0.8} \times 100\% = +1.025\%$

The value, whichever is worse, is specified to be the phase accuracy.

Power factor accuracy based on phase accuracy: **±1.05% rdg.**

Active power accuracy

Active power accuracy = current sensor combined accuracy + power factor accuracy based on phase accuracy

= ±0.5% rdg. ±0.22% f.s. ±1.05% rdg.

= ±1.55% rdg. ±0.22% f.s.

Accuracy relative to measured values = active power 30 kW × ±1.55% rdg. + 150 kW range × 0.22% f.s.

= ±0.795 kW

= ±0.795 kW/30 kW = ±2.65% rdg.

Appx. 9 Terminology

Active power	Power that is consumed doing work.
Active power demand	The average active power used during a set period of time (usually 30 min).
Apparent power	The (vector) power obtained by combining active power and reactive power. As its name suggests, apparent power expresses the “visible” power and comprises the product of the RMS voltage and RMS current.
Binary data	All data other than text (character) data. Since the measured data of the instrument is written in binary format, the data cannot be directly opened in commercially available spreadsheet software. Use the supplied software to load the data from the instrument to your computer for analysis.
Declared input voltage (U_{din})	The value calculated from the nominal supply voltage using the transformer ratio. The declared input voltage is defined by IEC61000-4-30.
Declared voltage (U_{ref})	The same voltage as the nominal supply voltage (U _c) or the rated voltage (U _n) defined by IEC61000-4-30 . Declared voltage (U _{ref}) = declared input voltage (U _{din}) × VT ratio
Dip	A short-lived voltage drop caused by the occurrence of a inrush current with a large load, such as when a motor starts. When recording voltage and current trends at the power service inlet, you can determine whether you should look for the cause of the dip inside or outside the building. If the voltage drops while the building’s current consumption rises, the likely cause lies inside the building. If the voltage and current are both low, the cause is likely to lie outside the building.
EN50160	A European power quality standard that defines limit values for supply voltage and other characteristics. Obtaining statistics from the instrument data with the supplied application software PQ One allows standard-compliant evaluation and analysis (available after the firmware update).
Event	Power quality parameters are necessary in order to investigate and analyze power supply issues. These parameters include disturbances such as transients, dips, swells, interruptions, and frequency fluctuations. As a rule, the term “event” refers to the state detected based on threshold values for which abnormal values and abnormal waveforms for these parameters have been set. Events also include the timer and manual event settings that are unrelated to power quality parameters.
External event function	Functionality for generating events by detecting a signal input to the instrument’s external event input terminal and recording measured values and event waveforms at the time of detection. In this way, events are generated based on an alarm signal from a device other than the instrument. By inputting an operating signal from an external device, an operation start or stop trigger can be applied in order to record waveforms with the instrument.
Flag	A marker used to distinguish unreliable measured values occurring due to disturbances such as swells, dips, and interruptions. Flags are recorded as part of the trend record data status information. The concept is defined by the IEC61000-4-30 standard.
Flicker	A disturbance caused by a voltage drop resulting when equipment with a large load starts up or when a large current flows under a temporary high-load state. For lighting loads, flicker primarily manifests itself as blinking. Electric-discharge lamps such as fluorescent and mercury-vapor lights are particularly prone to the effects of flicker. When temporary dimming of lights due to voltage drop occurs frequently, a flickering effect that causing an extremely unpleasant visual sensation is produced. Measurement methods can be broadly divided into IEC flicker and ΔV10 flicker. In Japan, the ΔV10 method is most frequently used.
Frequency (1 wave) (Freq wav)	The frequency of a single waveform. By measuring the frequency (1 wave), it is possible to monitor frequency fluctuations on an interconnected system at a high degree of detail.

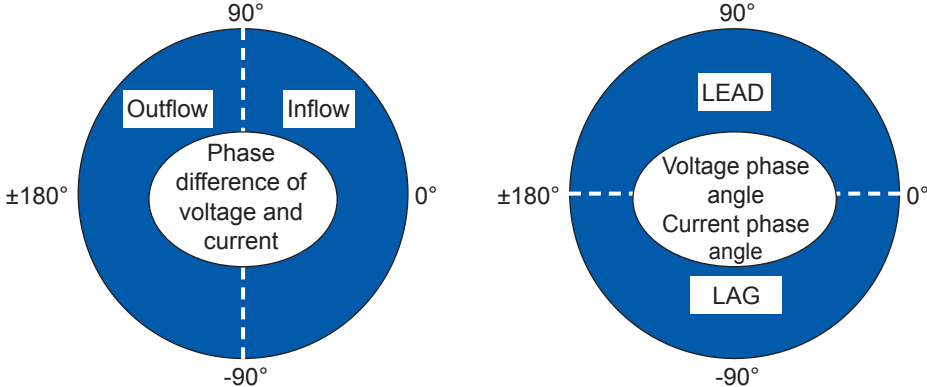
<p>Frequency 10 s (Freq10s)</p>	<p>The frequency measured value as calculated according to IEC61000-4-30. This value is an average of the frequencies measured for 10 s. It is recommended to measure this characteristic for at least one week.</p>
<p>Harmonics</p>	<p>A phenomenon caused by distortions in the voltage and current waveforms that affect many devices with power supplies using semiconductor control devices. In the analysis of non-sine waves, the term refers to one RMS value among the components with harmonic frequencies</p>
<p>Harmonic content percentage</p>	<p>The ratio of the K-th order size to the size of the fundamental wave, expressed as a percentage using the following equation: $(K\text{-th order wave}) / (\text{fundamental wave}) \times 100 [\%]$ By observing this value, it is possible to ascertain the harmonic component content for individual orders. This metric provides a useful way to track the harmonic content percentage when monitoring a specific order.</p>
<p>Harmonics phase angle and phase difference</p>	<p>The harmonic voltage phase angle and harmonic current phase angle are expressed in terms of the synchronized source's fundamental component phase. The difference between each order's harmonic component phase and the fundamental component phase is expressed as an angle ($^{\circ}$), and its sign indicates either a lagging phase (LAG) "-" (negative) or leading phase (LEAD) "+" (positive). Angle signs of the above are the opposite of those for power factor. The harmonic voltage-current phase angle expresses the difference between each order's harmonic voltage component phase angle and harmonic current component phase angle for each channel as an angle ($^{\circ}$). When using the sum display, the sum of each order's harmonic power factor (calculated from the sums of harmonic power and harmonic reactive power) is converted to an angle ($^{\circ}$). When the harmonic voltage-current phase angle is between -90° and $+90^{\circ}$ (harmonics active power is positive), that order's harmonics are flowing toward the load (influx). When the harmonic voltage-current phase angle is between $+90^{\circ}$ and $+180^{\circ}$ or between -90° and -180° (harmonics active power is negative), that order's harmonics are flowing from the load (outflow).</p> 
<p>IEC61000-4-7</p>	<p>An international standard governing measurement of harmonic current and harmonic voltage in power supply systems as well as harmonic current emitted by equipment. The standard specifies the performance of a standard instrument.</p>
<p>IEC61000-4-15</p>	<p>A standard that defines testing techniques for voltage fluctuation and flicker measurement as well as associated measuring instrument requirements.</p>

IEC61000-4-30	<p>A standard governing testing involving power quality measurement in AC power supply systems and associated measurement technologies. Target parameters are restricted to phenomena that are propagated in power systems. The target parameters consist of frequency, supply voltage amplitude (RMS), flicker, supply voltage dips, swells, (momentary) interruptions, transient voltage, supply voltage unbalance, harmonics, interharmonics, supply voltage carrier signals, and high-speed voltage variations. The standard defines measurement methods for these parameters as well as the necessary instrument performance. It does not define specific threshold values.</p> <p>Measurement classes:</p> <p>The standard defines three classes (A, S, and B) for various instrument measuring methods and measurement performance levels:</p> <table border="1" data-bbox="467 521 1428 848"> <thead> <tr> <th data-bbox="467 521 619 562">Class</th> <th data-bbox="619 521 1428 562">Applications</th> </tr> </thead> <tbody> <tr> <td data-bbox="467 562 619 725">Class A</td> <td data-bbox="619 562 1428 725">Used in applications where accurate measurement is required, for example verification of standard compliance and dispute settlement. In order to ensure accurate measurement, the standard includes detailed stipulations concerning instrument time clock accuracy, RMS value calculation methods, and trend data grouping.</td> </tr> <tr> <td data-bbox="467 725 619 772">Class S</td> <td data-bbox="619 725 1428 772">Used in surveys and power quality evaluation.</td> </tr> <tr> <td data-bbox="467 772 619 848">Class B</td> <td data-bbox="619 772 1428 848">Used in applications where a high level of accuracy is not required, for example troubleshooting.</td> </tr> </tbody> </table>	Class	Applications	Class A	Used in applications where accurate measurement is required, for example verification of standard compliance and dispute settlement. In order to ensure accurate measurement, the standard includes detailed stipulations concerning instrument time clock accuracy, RMS value calculation methods, and trend data grouping.	Class S	Used in surveys and power quality evaluation.	Class B	Used in applications where a high level of accuracy is not required, for example troubleshooting.
Class	Applications								
Class A	Used in applications where accurate measurement is required, for example verification of standard compliance and dispute settlement. In order to ensure accurate measurement, the standard includes detailed stipulations concerning instrument time clock accuracy, RMS value calculation methods, and trend data grouping.								
Class S	Used in surveys and power quality evaluation.								
Class B	Used in applications where a high level of accuracy is not required, for example troubleshooting.								
Inrush current	<p>A large current that flows temporarily, for example when an electric device is turned on. An inrush current can be equal to or greater than 10 times the current that flows when the device is in the normal operating state.</p> <p>Inrush current measurement can be a useful diagnostic when setting circuit breaker capacity.</p> <p>The inrush current measurements by the instrument use the RMS value refreshed each half-cycle.</p>								
Interharmonics	<p>All frequencies that are not a whole-number multiple of the fundamental frequency. The interharmonics include inter-order harmonics. The term refers to RMS values for the spectral components of electrical signals with frequencies between two contiguous harmonic frequencies.</p> <p>(Interharmonics of the order 3.5 assume a drive of 90 Hz or similar rather than a frequency synchronized to the fundamental wave of an inverter or other device. However, interharmonics do not generally occur in high-voltage circuits under present-day conditions. Most interharmonics are currently thought to be caused by the circuit load.)</p>								
Interruption	<p>A phenomenon in which the supply of power stops momentarily or for a short or long period of time due to factors such as a circuit breaker tripping as a result of a power company accident or power supply short-circuit.</p>								
ITIC curve	<p>This curve was created by the Information Technology Industry Council.</p> <p>Voltage disturbance data for detected events is plotted on a graph using the event duration and worst value (as a percentage of the declared input voltage). The graph format makes it easy to clearly identify which event data distribution should be analyzed.</p> <p>The supplied software PQ One can be used to create ITIC curves using the data of the instrument (available after the firmware update)</p>								

K factor	<p>Shows the power loss caused by the harmonic current in transformers. Also referred to as the “multiplication factor.”</p> <p>The K factor (KF) is formulated as shown below:</p> $KF = \frac{\sum_{k=1}^{50} (k^2 \times I_k^2)}{\sum_{k=1}^{50} I_k^2}$ <p>where <i>k</i>: Order of harmonics <i>I_k</i>: Harmonic current value [A] Higher-order harmonic currents have a greater influence on the K factor than lower-order harmonic currents.</p> <p>Purpose of measurement: To measure the K factor in a transformer when subjected to maximum load. If the measured K factor is larger than the multiplication factor of the transformer used, the transformer must be replaced with one with a larger K factor, or the load on the transformer must be reduced. The replacement transformer should have a K factor one rank higher than the measured K factor for the transformer being replaced</p>
LAN	<p>LAN is the abbreviation of Local Area Network. The LAN was developed as a network for transferring data through a computer within a local area, such as an office, factory, or school.</p> <p>The instrument is equipped with the LAN adapter Ethernet 100BASE-TX. Use a twisted-pair cable and connect with a star connection to the device generally called the hub (central computer) of your LAN. The maximum length of the cable that can be used for connecting the terminal and the hub is 100 m. Communications using TCP/IP as the Ethernet interface protocol are supported.</p>
Manual event function	<p>Functionality for generating events when the [MANUAL EVENT] key is pressed and recording the measured value and event waveform at that time.</p> <p>In this way, events can be generated as a snapshot of the system being measured. Use this functionality when you wish to record a waveform but cannot find an event that defines the desired phenomenon or when you wish to record data manually to avoid the generation of too many events.</p>
Measurement frequency (fnom)	<p>The nominal frequency of the system being measured. Select 50 Hz or 60 Hz.</p>
Multiple-phase system treatment	<p>Method for defining the start and end of events such as dips, swells, and interruptions in multiple-phase systems, for example systems with 3 phases</p> <p>Swell: A swell begins when the voltage on at least one channel exceeds the threshold and ends when the voltage readings on all measurement channels falls below or is equal to the value calculated by subtracting the hysteresis from the threshold value.</p> <p>Dip: A dip begins when the voltage on at least one channel falls below the threshold and ends when voltage readings on all measurement channels exceeds or is equal to the value calculated by adding the hysteresis to the threshold value.</p> <p>Interruption: An interruption begins when voltage readings on all channels falls below the threshold and ends when the voltage on a user-specified channel exceeds or is equal to the value calculated by adding the hysteresis to the threshold value.</p>
Nominal supply voltage (Uc)	<p>Typically, the system’s rated voltage Un. When a voltage that differs from the rated voltage is applied to the contact in accordance with an agreement between the electricity provider and the customer, that voltage is used as the nominal supply voltage Uc. The nominal input voltage is defined by IEC61000-4-30.</p>

Power factor demand value	<p>The power factor calculated using the active power demand value (consumption) and the reactive power demand value (lag) for the set interval time (usually 30 min).</p> $PFdem = \frac{Pdem +}{\sqrt{(Pdem+)^2 + (Qdem - LAG)^2}}$
Power factor (PF/DPF)	<p>Power factor is the ratio of active power to apparent power. The larger the absolute value of the power factor, the greater the proportion of active power to the apparent power, and greater the efficiency. The maximum absolute value is 1. Conversely, the smaller the absolute value of the power factor, the greater the reactive power with the apparent power, and lower the efficiency. The minimum absolute value is 0. For this device, the sign of the power factor indicates whether the current phase is lagging or leading the voltage.</p> <p>A positive value (no sign) indicates that the current phase is lagging the voltage. Inductive loads (such as motors) are characterized by a lagging phase.</p> <p>A negative value indicates that the current phase is leading the voltage. Capacitive loads (such as capacitors) are characterized by a leading phase. These signs are the opposite of those for the harmonics phase angle and phase difference.</p> <p>The power factor (PF) is calculated using RMS values that include harmonic components. Larger harmonic current components cause the power factor to deteriorate.</p> <p>By contrast, since the displacement power factor (DPF) calculates the ratio of active power to apparent power from the fundamental voltage and fundamental current, no voltage or current harmonic component is included.</p> <p>This is the same measurement method used by reactive power meters installed at commercial-scale utility customers' facilities.</p> <p>Displacement power factor, or DPF, is typically used by the electric power system, although power factor, or PF, is sometimes used to measure equipment in order to evaluate efficiency.</p> <p>When a lagging phase caused by a large inductive load such as a motor results in a low displacement power factor, there are corrective measures that can be taken to improve the power factor, for example by adding a phase advance capacitor to the power system. Displacement power factor (DPF) measurements can be taken under such circumstances to verify the improvement made by the phase advance capacitor.</p>
Reactive power	<p>Power that does not perform actual work, resulting in no power consumption as it travels between the load and the power supply.</p> <p>Reactive power is calculated by multiplying the active power with the sine of the phase difference ($\sin\theta$). It arises from inductive loads (deriving from inductance) and capacitive loads (deriving from capacitance), with reactive power derived from inductive loads known as lag reactive power and reactive power derived from capacitive loads known as lead reactive power.</p>
Reactive power demand	The average reactive power used during a set period of time (usually 30 min).
RMS current refreshed each half-cycle (Irms1/2)	<p>The RMS current is calculated using a value measured over a 1-cycle time refreshed each half-cycle.</p> <p>Model PW3198 Power Quality Analyzer uses the RMS for every half-cycle.</p>
RMS value	The root mean square of instantaneous values for a quantity obtained over a particular time interval or bandwidth.
RMS voltage refreshed each half-cycle (Urms1/2)	The RMS voltage is calculated using a value measured over a 1-cycle time refreshed each half-cycle.
RS-232C	The RS-232C is a serial interface established by the EIA (Electronics Industries Association). RS-232C also conforms with the specifications of DTE (data terminal equipment) and DCE (data circuit terminating equipment) interface conditions.
RVC (Rapid Voltage Change)	Refers to a phenomenon in which a voltage rapidly changes within a range not exceeding the threshold values of the voltage swell and voltage dip.
SD memory card	A type of flash memory card.
Swell	A phenomenon in which the voltage rises momentarily due to a lightning strike or the switching of a high-load power line.
Text data	A file containing only data expressed using characters and character codes.

<p>Timer event function</p>	<p>Functionality for generating events at a set time interval and recording the measured value and event waveform at that time. This function allows you to capture instantaneous waveforms and other data regularly, even if no abnormalities have occurred. Use this functionality when you wish to record a waveform at a fixed time interval.</p>						
<p>Total harmonic distortion factor</p>	<p>THD-F: The ratio of the size of the total harmonic component to the size of the fundamental wave, expressed as a percentage using the following equation: $\frac{\sqrt{\sum (2\text{nd order and above})^2}}{\text{Fundamental wave}} \times 100[\%] \quad (\text{for the instrument, calculated to the 50th order})$ This value can be monitored to assess waveform distortion for each item, providing a yardstick that indicates the extent to which the total harmonic component is distorting the fundamental waveform. As a general rule, the total distortion factor for a high-voltage system should be 5% or less; it may be higher at the terminal point of the system.</p> <p>THD-R: The ratio of the size of the total harmonic component to the size of the RMS, expressed as a percentage using the following equation: $\frac{\sqrt{\sum (2\text{nd order and above})^2}}{\text{RMS}} \times 100[\%] \quad (\text{for the instrument, calculated to the 50th order})$ THD-F is typically used.</p>						
<p>Transient voltage</p>	<p>An event caused by lightning strikes, circuit-breaker and relay contact obstructions and tripping, and other phenomena. Transient voltage are often characterized by steep voltage changes and a high peak voltage.</p>						
<p>Unbalance factor</p>	<p>Unbalanced (symmetrical) 3-phase voltage (current): 3-phase AC voltage (current) with equal voltage and current magnitude for each phase and 120° phase separation.</p> <p>Unbalanced (asymmetrical) 3-phase voltage (current): 3-phase AC voltage (current) with unequal voltage magnitude for each phase or without 120° phase separation.</p> <p>Degree of unbalance in 3-phase alternating voltage Normally described as the voltage unbalance factor, which is the ratio of negative-phase voltage or zero-phase voltage to positive-phase voltage</p> <p>Voltage negative-phase unbalance factor = $\frac{\text{Negative-phase voltage}}{\text{Positive-phase voltage}} \times 100[\%]$</p> <p>Voltage zero-phase unbalance factor = $\frac{\text{Zero-phase voltage}}{\text{Positive-phase voltage}} \times 100[\%]$</p> <p>Zero-phase/positive-phase/negative-phase voltage: The concept of a zero-phase-sequence/positive-phase-sequence/negative-phase-sequence component in a three-phase alternating circuit applies the method of symmetrical coordinates (a method in which a circuit is treated so as to be divided into symmetrical components of a zero phase, positive phase, and negative phase).</p> <table border="1" data-bbox="432 1682 1390 2056"> <tr> <td data-bbox="432 1682 627 1787"> <p>Zero-phase-sequence component</p> </td> <td data-bbox="627 1682 1390 1787"> <p>Voltage that is equal in each phase. Described as $[V_0]$ (Subscript 0: Zero-phase-sequence component).</p> </td> </tr> <tr> <td data-bbox="432 1787 627 1921"> <p>Positive-phase-sequence component</p> </td> <td data-bbox="627 1787 1390 1921"> <p>Symmetrical three-phase voltage in which the value for each phase is equal, and each of the phase is delayed by 120 degrees in the following phase sequence: a, b, and c. Described as $[V_1]$ (Subscript 1: Positive-phase-sequence component).</p> </td> </tr> <tr> <td data-bbox="432 1921 627 2056"> <p>Negative-phase-sequence component</p> </td> <td data-bbox="627 1921 1390 2056"> <p>Symmetrical three-phase voltage in which the value for each phase is equal, and each of the phases is delayed by 120 degrees in the following phase sequence: a, b, and c. Described as $[V_2]$ (Subscript 2: Negative-phase-sequence component).</p> </td> </tr> </table>	<p>Zero-phase-sequence component</p>	<p>Voltage that is equal in each phase. Described as $[V_0]$ (Subscript 0: Zero-phase-sequence component).</p>	<p>Positive-phase-sequence component</p>	<p>Symmetrical three-phase voltage in which the value for each phase is equal, and each of the phase is delayed by 120 degrees in the following phase sequence: a, b, and c. Described as $[V_1]$ (Subscript 1: Positive-phase-sequence component).</p>	<p>Negative-phase-sequence component</p>	<p>Symmetrical three-phase voltage in which the value for each phase is equal, and each of the phases is delayed by 120 degrees in the following phase sequence: a, b, and c. Described as $[V_2]$ (Subscript 2: Negative-phase-sequence component).</p>
<p>Zero-phase-sequence component</p>	<p>Voltage that is equal in each phase. Described as $[V_0]$ (Subscript 0: Zero-phase-sequence component).</p>						
<p>Positive-phase-sequence component</p>	<p>Symmetrical three-phase voltage in which the value for each phase is equal, and each of the phase is delayed by 120 degrees in the following phase sequence: a, b, and c. Described as $[V_1]$ (Subscript 1: Positive-phase-sequence component).</p>						
<p>Negative-phase-sequence component</p>	<p>Symmetrical three-phase voltage in which the value for each phase is equal, and each of the phases is delayed by 120 degrees in the following phase sequence: a, b, and c. Described as $[V_2]$ (Subscript 2: Negative-phase-sequence component).</p>						

If V_a , V_b , and V_c are applied as the three-phase alternating voltage, the zero-phase voltage, positive-phase voltage, and negative-phase voltage are formulated as shown below.

$$\text{Zero-phase Voltage } \dot{V}_0 = \frac{\dot{V}_a + \dot{V}_b + \dot{V}_c}{3}$$

$$\text{Positive-phase Voltage } \dot{V}_1 = \frac{\dot{V}_a + a\dot{V}_b + a^2\dot{V}_c}{3}$$

$$\text{Negative-phase Voltage } \dot{V}_2 = \frac{\dot{V}_a + a^2\dot{V}_b + a\dot{V}_c}{3}$$

a is referred to as the “vector operator.” It is a vector with a magnitude of 1 and a phase angle of 120 degrees. Therefore, the phase angle is advanced by 120 degrees if multiplied by a , and by 240 degrees if multiplied by a^2 .

If the three-phase alternating voltage is balanced, the zero-phase voltage and negative-phase voltage are 0, and positive phase voltage is equal to the RMS value of the three-phase alternating voltage.

Unbalance factor of three-phase current:

Used in applications such as the verification of power supplied to electrical equipment powered by a 3-phase induction motor.

The current unbalance factor is several times larger than the voltage unbalance factor.

The less a three-phase induction motor slips, the greater the difference between these two factors.

Voltage unbalance causes phenomena such as current unbalance, an increase in temperature, an increase in input, a decline in efficiency, and an increase in vibration and noise.

The requirements may require that U_{unb} does not exceed 2%, and I_{unb} is 10% or less. In a 3P4W system with an unbalanced load, the U_{unb0} and I_{unb0} components indicate the current that flows to the N (neutral) line.

Zero, positive, and negative phases

The positive phase can be considered normal 3-phase power consumption. The negative phase functions to operate a 3-phase motor backwards. The positive phase causes the motor to operate in the forward direction, while the negative phase acts as a brake. This negative phase causes heat to be generated. This heat has a negative impact on the motor. Like the negative phase, the zero phase is not necessary. With a 3-phase 4-wire wiring, the zero phase causes current to flow and heat to be generated. Normally, an increase in the negative phase causes an increase of the same magnitude in the zero phase.

Index

Symbols

Δ V10 Flicker 67, 104, 176, Appx.19, Appx.21

A

AC adapter 43
Alligator clips 51, 55

B

Backlight 75
Basic trend 100, Appx.16
Battery 38
Beep sound 75
Bluetooth 171

C

Calculation method 67
Clock 40, 70, 75
Crest factor 86, 87
CT 66
Currency 67
Current 87
Current phase 59
Current range 58, 65
Current sensor 52, 56, 65

D

Declared input voltage 49, 64
Default gateway 145
Demand 109
Detailed trend Appx.16
Detail Trend screen 102
DHCP 145
Dip Appx.10, Appx.25
Display color 75
DNS 145

E

Electric energy 85, 108
Electric power 84
E-mail 165
Energy cost 67, 85
Event input 174
Event list 113
Event statistics 119
Event trend data 112, 117
Event waveform recording time 74
Event waveforms 112, Appx.16
External event 74, Appx.15
External output 176

F

Factory reset 77
Flag Appx.25
Flicker 104, Appx.19
Folder/file name 71
Formatting 132
Frequency 40, 66
Frequency (1 wave) Appx.13
Frequency (200 ms) Appx.12
Frequency fluctuations Appx.5
FTP 143, 152, 155
Fundamental wave 67

G

Grabber clip 51, 55

H

Hard copy 127
Harmonics 103, Appx.6
Harmonics trend Appx.16
High-order harmonic component Appx.7
Hold 81
HTTP server 149

I

IEC61000-4-30 Appx.18, Appx.27
IEC flicker 104, Appx.19
Impulse Appx.4
Inrush current Appx.14
Installation environment 7
Interharmonics Appx.6
Internal memory 69
Internet browser 149
Interruption 96, Appx.10
Interval 70, 94
IP address 145
ITIC curve 139, Appx.27

K

Key lock 21, 33, 225
K factor 87, Appx.28

L

LAN 144
Language 40, 75
Leakage current 57
Line voltage 84
Load 129, 130
LR8410 Link 171

M

MAC address.....	145
Mail.....	165
Manual event.....	Appx.15
Measurement procedure.....	16
MONITOR screen.....	81

N

Negative phase.....	Appx.31
---------------------	---------

O

Options.....	3
Overrange.....	34

P

Phase difference.....	62
Phase name.....	75
Phase voltage.....	67, 84
Pit.....	67, 104, Appx.19
POP.....	167
Positive phase.....	Appx.31
Pst.....	67, 104, Appx.19

R

Recording interval.....	69
Recording items.....	69
Recording period.....	70
Recording start.....	70, 93
Recording stop.....	70, 93
Repeat.....	70, 94
RMS value.....	67
RMS voltage.....	67
RS-232C.....	170
RVC.....	Appx.11

S

Sag.....	Appx.5
Save time.....	71
Screen copy.....	70
SD memory card.....	42, 69
Settings files.....	128, 129
SMTP.....	167
Strap.....	39
Subnet mask.....	145
Surge.....	Appx.4
Swell.....	Appx.10, Appx.29
System reset.....	76

T

THD.....	67
Timer.....	70
Timer event.....	74, Appx.15
Total harmonic distortion.....	Appx.13, Appx.30
Transient voltage.....	Appx.8
Transient waveform.....	112, 118, Appx.8
Trend.....	97, Appx.16

U

Unbalance.....	Appx.7
Unbalance factor.....	Appx.30

V

Vector.....	88
Voltage.....	86
Voltage cord.....	51, 55
Voltage dip.....	Appx.10
Voltage phase.....	59
Voltage range.....	64
Voltage swell.....	Appx.10
VT.....	65

W

Warm-up.....	44
Waveform.....	82
Wiring.....	49, 64
Wiring check.....	59
Wiring diagram.....	50
Wiring method.....	49

Z

Zero adjustment.....	54
Zero phase.....	Appx.31
Zoom.....	92

Warranty Certificate

HIOKI

Model	Serial number	Warranty period Three (3) years from date of purchase (___ / ___)
-------	---------------	--

Customer name: _____

Customer address: _____

Important

- Please retain this warranty certificate. Duplicates cannot be reissued.
- Complete the certificate with the model number, serial number, and date of purchase, along with your name and address. The personal information you provide on this form will only be used to provide repair service and information about Hioki products and services.

This document certifies that the product has been inspected and verified to conform to Hioki's standards. Please contact the place of purchase in the event of a malfunction and provide this document, in which case Hioki will repair or replace the product subject to the warranty terms described below.

Warranty terms

1. The product is guaranteed to operate properly during the warranty period (three [3] years from the date of purchase).
If the date of purchase is unknown, the warranty period is defined as three (3) years from the date (month and year) of manufacture (as indicated by the first four digits of the serial number in YYYY format).
2. If the product came with an AC adapter, the adapter is warranted for one (1) year from the date of purchase.
3. The accuracy of measured values and other data generated by the product is guaranteed as described in the product specifications.
4. In the event that the product or AC adapter malfunctions during its respective warranty period due to a defect of workmanship or materials, Hioki will repair or replace the product or AC adapter free of charge.
5. The following malfunctions and issues are not covered by the warranty and as such are not subject to free repair or replacement:
 - 1. Malfunctions or damage of consumables, parts with a defined service life, etc.
 - 2. Malfunctions or damage of connectors, cables, etc.
 - 3. Malfunctions or damage caused by shipment, dropping, relocation, etc., after purchase of the product
 - 4. Malfunctions or damage caused by inappropriate handling that violates information found in the instruction manual or on precautionary labeling on the product itself
 - 5. Malfunctions or damage caused by a failure to perform maintenance or inspections as required by law or recommended in the instruction manual
 - 6. Malfunctions or damage caused by fire, storms or flooding, earthquakes, lightning, power anomalies (involving voltage, frequency, etc.), war or unrest, contamination with radiation, or other acts of God
 - 7. Damage that is limited to the product's appearance (cosmetic blemishes, deformation of enclosure shape, fading of color, etc.)
 - 8. Other malfunctions or damage for which Hioki is not responsible
6. The warranty will be considered invalidated in the following circumstances, in which case Hioki will be unable to perform service such as repair or calibration:
 - 1. If the product has been repaired or modified by a company, entity, or individual other than Hioki
 - 2. If the product has been embedded in another piece of equipment for use in a special application (aerospace, nuclear power, medical use, vehicle control, etc.) without Hioki's having received prior notice
7. If you experience a loss caused by use of the product and Hioki determines that it is responsible for the underlying issue, Hioki will provide compensation in an amount not to exceed the purchase price, with the following exceptions:
 - 1. Secondary damage arising from damage to a measured device or component that was caused by use of the product
 - 2. Damage arising from measurement results provided by the product
 - 3. Damage to a device other than the product that was sustained when connecting the device to the product (including via network connections)
8. Hioki reserves the right to decline to perform repair, calibration, or other service for products for which a certain amount of time has passed since their manufacture, products whose parts have been discontinued, and products that cannot be repaired due to unforeseen circumstances.

HIOKI E.E. CORPORATION

<http://www.hioki.com>

18-07 EN-3

HIOKI

<http://www.hioki.com>



**All regional
contact
information**

HEADQUARTERS

81 Koizumi
Ueda, Nagano 386-1192 Japan

HIOKI EUROPE GmbH

Rudolf-Diesel-Strasse 5
65760 Eschborn, Germany
hioki@hioki.eu

1906 EN

Edited and published by HIOKI E.E. CORPORATION

Printed in Japan

- CE declarations of conformity can be downloaded from our website.
- Contents subject to change without notice.
- This document contains copyrighted content.
- It is prohibited to copy, reproduce, or modify the content of this document without permission.
- Company names, product names, etc. mentioned in this document are trademarks or registered trademarks of their respective companies.