

# LR8410-20

Instruction Manual

# WIRELESS LOGGING STATION



Video

Scan this code to watch the instructional video(s).  
Carrier charges may apply.



**Read carefully before use.**  
**Keep for future reference.**

✓ **When using the instrument for the first time**

- Safety Information ▶ p.5
- Names and Functions of Parts, Screen Configurations ▶ p.28
- Basic Operation ▶ p.37

📖 **Troubleshooting**

- Troubleshooting ▶ p.305

**EN**



# Contents

Introduction .....	1
Confirming Package Contents .....	3
Safety Information .....	5
Operating Precautions .....	8

## Chapter 1

### Overview 23

1.1 Product Overview and Features .....	23
1.2 Measurement Flow .....	24
1.3 Names and Functions of Parts, Screen Configurations .....	28
■ Wireless Logging Station .....	28
■ UNIT .....	31
■ Measurement Units .....	32
■ Wireless logger .....	33
■ Types of wireless logger .....	33
■ LR8512 Wireless Pulse Logger .....	33
■ LR8513 Wireless Clamp Logger .....	33
■ LR8514 Wireless Humidity Logger .....	34
■ LR8515 Wireless Voltage/Temp Logger .....	34
■ LR8520 Wireless Fungal Logger .....	34
1.4 Basic Operation .....	37
■ Screen Operations (changing settings, scrolling waveforms, and displaying values) .....	37
■ Starting and Stopping Measurement .....	38
■ Disabling Key Operations (Key-Lock Function) .....	40
■ Performing Zero Adjustment .....	40
■ Saving Data .....	41
■ Confirming Inputs (Monitor) .....	42

## Chapter 2

### Measurement Preparations 43

2.1 Using the Battery Pack (Option) .....	43
■ Install the Battery Pack .....	43
■ Charge the Battery Pack .....	44
2.2 Connecting the AC Adapter .....	46

<b>2.3</b>	<b>Connecting the External Power Supply .....</b>	<b>48</b>
<b>2.4</b>	<b>Making Connections .....</b>	<b>49</b>
	■ Pre-Connection Inspection .....	49
	■ Voltage and Thermocouple Temperature Measurement .	50
	■ Temperature Measurement with a Resistance Temperature Detector (RTD) .....	52
	■ Humidity Measurement .....	53
	■ Resistance Measurement .....	54
	■ Connecting Alarm Outputs .....	55
	■ External Control (using TRIG OUT and EXT TRIG) .....	56
<b>2.5</b>	<b>Turning the Power On and Off .....</b>	<b>57</b>
<b>2.6</b>	<b>Register measurement units and wireless logger with the instrument .....</b>	<b>58</b>
	■ Registering Measurement Units and Wireless Logger ....	59
	■ Deleting Registered Units .....	61
<b>2.7</b>	<b>Inserting a SD Memory Card or USB Flash Drive (when saving data) .....</b>	<b>63</b>
	■ SD Card Insertion & Removal .....	64
	■ USB flash drive Insertion & Removal .....	64
	■ Formatting a SD memory card/USB flash drive .....	65
<b>2.8</b>	<b>Compensating for Input Circuit Offset (Zero Adjustment) .....</b>	<b>66</b>

## **Chapter 3**

### **Settings** **69**

---

<b>3.1</b>	<b>Setting Flow Overview .....</b>	<b>69</b>
<b>3.2</b>	<b>Configuring Measurement Settings .....</b>	<b>70</b>
	■ Time Setting by Key Operations .....	70
<b>3.3</b>	<b>Input Channel Settings .....</b>	<b>74</b>
	■ Key Setting Procedure .....	75
	■ Voltage Measurement Settings .....	77
	■ Temperature Measurement Settings (using thermocouples) .....	78
	■ Temperature Measurement Settings (for RTDs) .....	80
	■ Temperature Measurement Settings (When LR8514 or LR8520 is used) .....	81
	■ Humidity Measurement Settings (When LR8511 is used)	82
	■ Humidity Measurement Settings (When LR8514 or LR8520 is used) .....	82

---

■ Resistance Measurement Settings .....	83
■ Integration (Count) Measurement Settings .....	84
■ Revolution Measurement Settings .....	86
■ Logic Measurement Settings .....	88
■ Current Measurement Settings .....	89
■ Fungal Index and Fungal Growth Projection Settings .....	91
<b>3.4 Alarm Settings .....</b>	<b>92</b>
<b>3.5 Data Saving Settings .....</b>	<b>92</b>
<b>3.6 Waveform Display Settings (as needed) .....</b>	<b>93</b>
■ Key Setting Procedure .....	93
■ Selecting Waveform Display Color .....	93
■ Specifying Vertical Display Range by Magnification and Zero Position (vertical axis expansion/compression) .....	94
■ Specifying the Vertical Display Range b y Upper and Lower Limits (expansion/compression) .....	95
■ Setting the Display Time Base (horizontal axis magnification) .....	96
<b>3.7 Scaling Settings (as needed) .....</b>	<b>97</b>
<b>3.8 Entering Titles and Comments (as needed) .....</b>	<b>100</b>
<b>3.9 Suppressing Noise (Enable Digital Filtering) .....</b>	<b>102</b>
<b>3.10 Viewing and Editing with the All-Channel Settings List .....</b>	<b>103</b>
■ Batch Copying Channel Settings .....	104
■ Batch Setting Waveform Display/Hide and Waveform Color Settings for All Channels .....	106
■ Initializing Settings (to factory defaults) .....	107
■ Aligning Zero Positions on the Grid .....	108
■ Setting CH1 of UNIT1 Value as a Scaling Value (Inter-Channel Compensation function) .....	109

## Chapter 4

### Observing Measurements and Data \_\_\_\_\_ 113

<b>4.1 Confirming Measured Values, and Starting Measurement .....</b>	<b>113</b>
■ If the power goes out during measurement .....	113
■ If communications fail temporarily .....	113
■ Handling of waveform display and data when data cannot be acquired .....	114
■ Synchronization and acquired data discrepancies .....	114

<b>4.2 Observing Waveforms .....</b>	<b>115</b>
■ Displaying Waveforms (Display Descriptions) .....	115
■ Displaying Gauges .....	116
■ Viewing Input Signals as Numerical Values .....	117
■ Scrolling Waveforms .....	118
■ Verifying Waveform Display Position .....	118
■ Magnifying and Compressing Horizontally .....	119
■ Viewing Any Waveform Location (Jump Function) .....	119
■ Specifying a Waveform Time Span .....	120
■ Displaying Cursor Values .....	121
<b>4.3 Marking Waveforms and Searching Marks (Search Function) .....</b>	<b>123</b>
■ Inserting Event Marks While Viewing Waveforms .....	123
■ Inserting Event Marks Using External Input Signals .....	124
■ Alarm Event Marks .....	125
■ How are event marks handled in text (CSV) conversion? .....	126
■ Searching Event Marks .....	127

## Chapter 5

### Specifying Criteria for Measurements \_\_\_\_ 129

■ About Triggering .....	129
<b>5.1 Triggering Measurement Start and Stop .....</b>	<b>131</b>
■ Types of Trigger Criteria .....	131
■ Enable the Trigger Function .....	132
■ Key Setting Procedure .....	132
■ Setting Trigger Criteria .....	133
■ Selecting Triggering Criteria (Trigger Source) .....	137
■ Using External Triggering .....	138
■ When You Want to Measure Data before Triggering (Pre-trigger) .....	139
■ Applying Trigger at Fixed Time Interval (Interval Trigger) .....	140
<b>5.2 Trigger Setting Examples .....</b>	<b>141</b>
<b>5.3 Confirming All Trigger and Alarm Criteria Settings .....</b>	<b>142</b>
<b>5.4 Starting &amp; Stopping Measurement on a Specified Day .....</b>	<b>143</b>
<b>5.5 Starting &amp; Stopping Measurement Periodically .</b>	<b>145</b>
<b>5.6 Canceling a Schedule .....</b>	<b>147</b>
<b>5.7 About Schedule Function Operation .....</b>	<b>149</b>

<b>5.8</b>	<b>Setting Examples .....</b>	<b>152</b>
<b>5.9</b>	<b>Alarm Output .....</b>	<b>153</b>
	■ Checking Alarm Criteria .....	154
	■ Alarm Settings .....	157

## **Chapter 6**

### **Saving & Loading Data \_\_\_\_\_ 161**

<b>6.1</b>	<b>About Saving and Loading Data .....</b>	<b>161</b>
	■ What happens to data in a power outage? .....	163
	■ Preparation for power outages during long-term measurements .....	163
<b>6.2</b>	<b>Saving Data .....</b>	<b>164</b>
	■ Automatic Saving (Waveform Data and Numerical Calculation Results) ....	165
	■ Replacing Removable Storage During Real-Time Saving	168
	■ Saving Manually (Waveform Data, Settings, Screen Images, Numerical Calculation Results) .....	169
	■ To Save a Setting Configuration .....	172
<b>6.3</b>	<b>Loading Data on the instrument .....</b>	<b>173</b>
	■ Loading a Setting Configuration .....	173
	■ Reverting to previous settings .....	175
	■ Loading Waveform Data and Screen Images .....	176
<b>6.4</b>	<b>Data Management .....</b>	<b>178</b>
	■ Switching removable storage .....	178
	■ Viewing Folder Contents and the Parent Folder .....	178
	■ Deleting Data .....	179
	■ Renaming Files and Folders .....	180
	■ Copying Data .....	181
	■ Sorting Files .....	182
<b>6.5</b>	<b>Transferring Data to a PC (USB Drive Mode) .....</b>	<b>183</b>
	■ Select the USB Drive Mode .....	183
	■ Connecting the USB Cable .....	184

## **Chapter 7**

### **Numerical Calculations/Waveform Calculations \_\_\_\_\_ 185**

<b>7.1</b>	<b>Calculate Average, Maximum, Minimum, and Etc. ....</b>	<b>185</b>
	■ Key Setting Procedure .....	188

■ Real-Time Calculation While Measuring (Auto Calculation) .....	188
■ Calculation after Measuring (Manual Calculation) .....	190
■ Apply Calculations to a Specific Time Span (Manual Calculation Only) .....	191
<b>7.2 Numerical Value Calculation Expressions .....</b>	<b>192</b>
<b>7.3 Waveform Calculations .....</b>	<b>193</b>
■ Key Setting Procedure .....	193
■ Calculating Power (When Using the LR8513) .....	195

## Chapter 8

### System Environment Settings \_\_\_\_\_ 197

■ Key Setting Procedure .....	198
<b>8.1 Operation Settings .....</b>	<b>198</b>
■ Using the Auto-Resume Function (Resume After Power Restoration) .....	198
■ File Protection Level Setting .....	199
<b>8.2 Screen Key Operation Settings .....</b>	<b>199</b>
■ Enabling and Disabling the Backlight Saver .....	199
■ Adjust Backlight Brightness .....	200
■ Selecting Black or White Screen Background .....	200
■ Enabling or Disabling the Beeper .....	200
■ Selecting the Horizontal (Time) Axis Display .....	201
■ Selecting the Display Language .....	201
■ Display of Start/Stop Confirmation Messages .....	201
<b>8.3 CSV File Saving Settings .....</b>	<b>202</b>
■ CSV File Data Decimal and Separator Characters .....	202
■ Select the sort order for numerical calculation results ...	202
■ Setting How to Handle Date Data Stored in CSV Files ..	203
<b>8.4 External Trigger Input Settings .....</b>	<b>203</b>
■ Selecting the External Trigger Function .....	203
■ Set Alarm Event Marking .....	203
<b>8.5 Making System Settings .....</b>	<b>204</b>
■ Setting the Date and Time .....	204
■ Initializing the instrument (System Reset) .....	205
■ Self-Test .....	206

## Chapter 9

### External Control \_\_\_\_\_ 207

9.1	External Trigger Input .....	207
9.2	External Signal Output (Trigger Output) .....	208
9.3	Alarm Signal Output (Alarm Output) .....	209
9.4	Synchronous Measurements with Multiple instruments .....	211

## Chapter 10

### Connection to a PC(Communication)\_\_\_\_\_ 213

■	Communication Features .....	213
10.1	<b>USB Settings and Connections .....</b>	<b>214</b>
■	1. Configuring the instrument .....	214
■	2. Installing the USB Driver .....	215
■	3. Connecting the instrument to a PC .....	218
■	Features Available After USB Setting and Connection ..	220
■	4. Installing the Logger Utility Program .....	221
■	Uninstalling the Logger Utility .....	224
10.2	<b>LAN Settings and Connections (Before connecting to the network) .....</b>	<b>226</b>
■	Things to Check Before Making Settings .....	226
■	1. PC Network Setup .....	228
■	2. Instrument Settings .....	229
■	3. Connecting the instrument to a PC .....	233
■	Features Available After LAN Setting and Connection ..	234
■	When LAN Communication Fails .....	235
10.3	<b>Using the Logger Utility .....</b>	<b>236</b>
■	Starting and Ending Logger Utility .....	237
10.4	<b>Remote Measurement with the HTTP Server Function .....</b>	<b>238</b>
■	Displaying the Main Page .....	238
■	Remote Operating .....	240
■	Start/Stop Measurement .....	241
■	Viewing Current Measurement Values .....	241
■	Acquiring Data from Internal Memory .....	242
■	Setting Comments .....	243
10.5	<b>Transferring Data to a PC with the FTP Server Function .....</b>	<b>244</b>
■	Restricting FTP Server Connections (FTP Authentication) .....	247



- 10.6 Auto Sending Data using the FTP Client Function ..... 248
  - Setting Up an FTP Server on a PC ..... 249
  - Instrument Auto-Send Settings ..... 261
  - Testing File Transfer ..... 263
  - Checking LAN Communication Status ..... 264
- 10.7 Sending E-Mail ..... 265
  - Instrument E-Mail Settings ..... 266
  - Testing E-Mailing ..... 269
  - Checking Mail Communication Status ..... 270
  - E-Mail Sending Authentication ..... 271
- 10.8 About Communications Commands ..... 272
  - Configuring Communications Command Operation ..... 272

**Chapter 11**  
**Using Other Hioki Products (LR8410 Link) 273**

- 11.1 Register Link Product on Instrument ..... 273
- 11.2 Configure Settings ..... 274
- 11.3 Carry Out Measurement ..... 276
- 11.4 Measurement data ..... 276
  - Measurement value errors ..... 276
  - Measurement values ..... 276

**Chapter 12**  
**Specifications ..... 277**

- 12.1 LR8410-20 Wireless Logging Station Specifications ..... 277
- 12.2 LR8510 Wireless Voltage/Temp Unit Specifications ..... 288
- 12.3 LR8511 Wireless Universal Unit Specifications . 294
- 12.4 Z2000 Specifications ..... 301

**Chapter 13**  
**Maintenance and Service ..... 303**

- 13.1 Inspection, Repair, and Cleaning ..... 303
- 13.2 Troubleshooting ..... 305
- 13.3 Disposing of the instrument ..... 307

---

- Removing the Lithium Battery ..... 307

## **Appendix \_\_\_\_\_ A1**

**Appendix 1 Scan Timing ..... A1**

**Appendix 2 Error Messages and Remedial Actions ..... A3**

**Appendix 3 File Naming ..... A9**

**Appendix 4 Text File Internal Format..... A10**

**Appendix 5 Binary File Size Calculation..... A11**

**Appendix 6 List of Default Settings ..... A12**

**Appendix 7 Maximum Recordable Time ..... A14**

**Appendix 8 Concerning Noise Countermeasures ..... A15**

**Appendix 9 Frequently Asked Questions..... A21**

- Questions about measurement units  
(Wireless Voltage/Temp Unit and Wireless Universal Unit) A21

- Questions about the Wireless Logging Station ..... A23

**Appendix 10 Introduction to Measurement Applications A29**

- Connecting a 4 to 20 mA Output Device and Recording  
Average Values Every Minute ..... A29

**Appendix 11 Input Circuit Diagram ..... A32**

**Appendix 12 Instrument/Unit Communications Interruptions  
and Reestablishment ..... A33**

## **Index \_\_\_\_\_ Index 1**

**X**

***Contents***

---



---

---

## Introduction

Thank you for purchasing the HIOKI Model LR8410-20 Wireless Logging Station. To obtain maximum performance from the instrument and measurement units, please read this manual first, and keep it handy for future reference.

This document uses the following device names:

	<p>The latest edition of the instruction manual The contents of this manual are subject to change, for example as a result of product improvements or changes to specifications. The latest edition can be downloaded from Hioki's website. <a href="https://www.hioki.com/global/support/download">https://www.hioki.com/global/support/download</a></p>
	<p>Product registration Register your product in order to receive important product information. <a href="https://www.hioki.com/global/support/myhioki/registration/">https://www.hioki.com/global/support/myhioki/registration/</a></p>

Product	Name in this document
LR8410-20 Wireless Logging Station	The instrument
LR8510 Wireless Voltage/Temp Unit	Measurement unit
LR8511 Wireless Universal Unit	
LR8512 Wireless Pulse Logger	Wireless logger
LR8513 Wireless Clamp Logger	
LR8514 Wireless Humidity Logger	
LR8515 Wireless Voltage/Temp Logger	
LR8520 Wireless Fungal Logger	

The following documents are provided with this instrument. Refer to them as appropriate for your application.

Document	Description
<b>1</b> Measurement Guide	<b>Read first.</b> Offers an introduction to the instrument's basic measuring method for first time users.
<b>2</b> Instruction Manual (This document)	Contains explanation and instructions regarding the instrument's operating method and functions.

In this document, the terms "master" and "slave" used in the earlier editions have been replaced with "primary" and "secondary," respectively.

### **Trademarks**

- Internet Explorer<sup>®</sup> and Windows are trademarks of the Microsoft group of companies.
  - The Bluetooth<sup>®</sup> word mark and logos are registered trademarks owned by Bluetooth SIG, Inc. and any use of such marks by Hioki E.E. Corporation is under license. Other trademarks and trade names are those of their respective owners.
  - SD, SDHC Logos are trademarks of SD-3C LLC.
  - Sun, Sun Microsystems, Java, and any logos containing Sun or Java are trademarks or registered trademarks of Oracle Corporation in the United States and other countries.
-

## Confirming Package Contents

When you receive the instrument, inspect it carefully to ensure that no damage occurred during shipping. In particular, check the accessories, panel switches, and connectors. If damage is evident, or if it fails to operate according to the specifications, contact your authorized Hioki distributor or reseller.

### Confirm that these contents are provided.

- LR8410-20 Wireless Logging Station ..... 1
- Instruction manual ..... 1

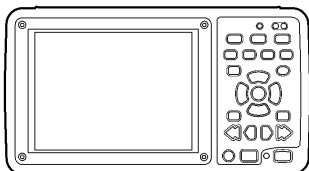

- Measurement guide..... 1



- Z1008 AC Adapter..... 1

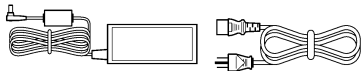

(p. 46)

- Precautions Concerning Use of  
Equipment That Emits Radio Waves.. 1



- Logger Utility(Data acquisition appli-  
cation program CD)..... 1



The latest version can be down-  
loaded from our web site.

- USB Cable ..... 1



(p. 184)

- Z4001 SD Memory Card (2 GB) ..... 1



**Options**

The following options are available for the instrument. Contact your authorized Hioki distributor or reseller when ordering.

The options are subject to change. Visit our website for updated information.

- |  |  |
|--|--|
| <input type="checkbox"/> LR8510 Wireless Voltage/Temp Unit   | <input type="checkbox"/> Z1007 Battery Pack (Li-ion) |
| <input type="checkbox"/> LR8511 Wireless Universal Unit      | <input type="checkbox"/> Z1008 AC Adapter            |
| <input type="checkbox"/> LR8512 Wireless Pulse Logger        | <input type="checkbox"/> C1007 Carrying Case         |
| <input type="checkbox"/> LR8513 Wireless Clamp Logger        | <input type="checkbox"/> Z1009 Fixed Stand           |
| <input type="checkbox"/> LR8514 Wireless Humidity Logger     | <input type="checkbox"/> 9642 LAN Cable              |
| <input type="checkbox"/> LR8515 Wireless Voltage/Temp Logger | <input type="checkbox"/> Z4001 SD Memory Card (2 GB) |
| <input type="checkbox"/> LR8520 Wireless Fungal Logger       | <input type="checkbox"/> Z4003 SD Memory Card (8 GB) |
| <input type="checkbox"/> P9000-01 Differential Probe         |  |
| <input type="checkbox"/> P9000-02 Differential Probe         |  |

**Storing the instrument and measurement units in the C1007 Carrying Case**

Store the instrument and measurement units in the C1007 Carrying Case as shown below.

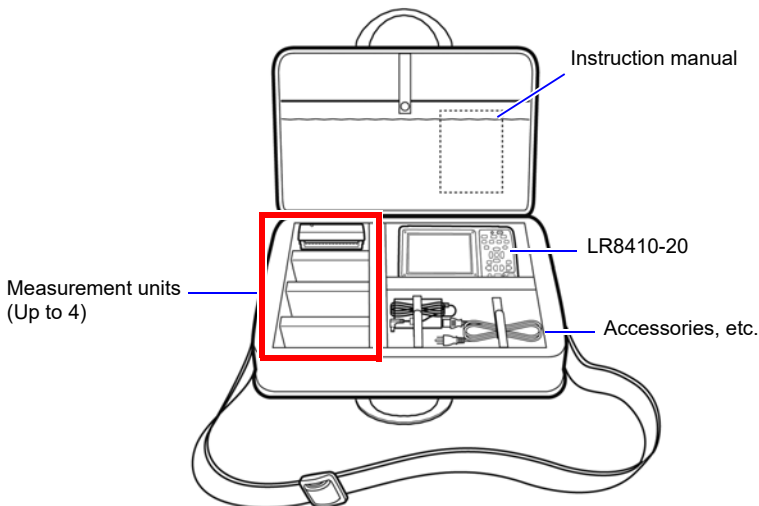

## Safety Information

This instrument and measurement units are designed to comply with IEC 61010 Safety Standards, and has been thoroughly tested for safety prior to shipment. However, mishandling during use could result in injury or death, as well as damage to the instrument and measurement units. Using the instrument and measurement units in a way not described in this manual may negate the provided safety features.

Be certain that you understand the instructions and precautions in the manual before use. We disclaim any responsibility for accidents or injuries not resulting directly from instrument and measurement units defects.

### NOTE

Please carefully review all safety information about the wireless logger in the Measurement Guide.

### DANGER

**Mishandling during use could result in injury or death, as well as damage to the instrument. Be certain that you understand the instructions and precautions in the manual before use.**



### WARNING

**With regard to the electricity supply, there are risks of electric shock, heat generation, fire, and arc discharge due to short circuits. If persons unfamiliar with electricity measuring instruments are to use the instrument, another person familiar with such instruments must supervise operations.**

## Safety Symbols



In the manual, the  symbol indicates particularly important information that the user should read before using the instrument.

The  symbol printed on the instrument indicates that the user should refer to a corresponding topic in the manual (marked with the  symbol) before using the relevant function.



Indicates a high voltage hazard.

If a particular safety check is not performed or the instrument is mishandled, this may give rise to a hazardous situation; the operator may receive an electric shock, may get burnt or may even be fatally injured.



Indicates a double-insulated device.



Indicates a grounding terminal.



Indicates DC (Direct Current).

The following symbols in this manual indicate the relative importance of cautions and warnings.



### DANGER

Indicates that incorrect operation presents an extreme hazard that could result in serious injury or death to the user.



### WARNING

Indicates that incorrect operation presents a significant hazard that could result in serious injury or death to the user.



### CAUTION



Indicates that incorrect operation presents a possibility of injury to the user or damage to the instrument and measurement units.

### NOTE

Indicates advisory items related to performance or correct operation of the instrument and measurement units.



**Symbols for Various Standards**

	Indicates that the product conforms to regulations set out by the EU Directive.
FCC ID	Indicates the ID number of the wireless module certified by the U.S. Federal Communications Commission (FCC).
IC	Indicates the number of the wireless module certified by Industry Canada.
 Li-ion	This is a recycle mark established under the Resource Recycling Promotion Law (only for Japan).
	Indicates the Waste Electrical and Electronic Equipment Directive (WEEE Directive) in EU member states.

**Other Symbols**

	Indicates the prohibited action.
(p. )	Indicates the location of reference information.
*	Indicates that descriptive information is provided below.
[ ]	The names of setting objects and buttons on the screen are indicated by square brackets [ ].
<b>SET</b> (Bold characters)	Bold characters within the text indicate operating key labels.
<ul style="list-style-type: none"> <li>• Unless otherwise specified, "Windows" represents Windows XP, Windows Vista, Windows 7, Windows 8, and Windows 10.</li> <li>• Dialog box represents a Windows dialog box.</li> <li>• Click: Press and quickly release the left button of the mouse.</li> <li>• Double click: Quickly click the left button of the mouse twice.</li> </ul>	

**Accuracy**

We define measurement tolerances in terms of f.s. (full scale), rdg. (reading) and dgt. (digit) values, with the following meanings:

f.s. (maximum display value or scale length)	The maximum displayable value or scale length. This is usually the name of the currently selected range. Example: For the 1 V range, f.s. = 1 V
rdg. (reading or displayed value)	The value currently being measured and indicated on the measuring instrument.
dgt. (resolution)	The smallest displayable unit on a digital measuring instrument, i.e., the input value that causes the digital display to show a "1" as the least-significant digit.

## Measurement categories

To ensure safe operation of measurement instruments, IEC 61010 establishes safety standards for various electrical environments, categorized as CAT II to CAT IV, and called measurement categories.

**⚠ DANGER**



- Using a measuring HiLogger in an environment designated with a higher-numbered category than that for which the HiLogger is rated could result in a severe accident, and must be carefully avoided.
- Never use a measuring HiLogger that lacks category labeling in a CAT II to CAT IV measurement environment. Doing so could result in a serious accident.

Hioki LR8510 Wireless Voltage/Temp Unit and LR8511 Wireless Universal Unit complies with CAT II (300 VAC, DC) safety requirements.

CAT II:	When directly measuring the electrical outlet receptacles of the primary electrical circuits in equipment connected to an AC electrical outlet by a power cord (portable tools, household appliances, etc.).
CAT III:	When measuring the primary electrical circuits of heavy equipment (fixed installations) connected directly to the distribution panel, and feeders from the distribution panel to outlets.
CAT IV:	When measuring the circuit from the service drop to the service entrance, and to the power meter and primary overcurrent protection device (distribution panel).

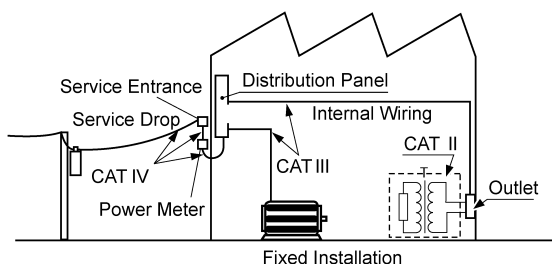

## Operating Precautions



Follow these precautions to ensure safe operation and to obtain the full benefits of the various functions.

**NOTE** Please carefully review all safety information about the wireless logger in the Measurement Guide.

### Bluetooth®

The Wireless Voltage/Temp Unit, Wireless Universal Unit, and Wireless Logging Station use the 2.4 GHz frequency band. No radio station license is required in order to use the product, but the following precautions should be observed:

#### **WARNING**

- Do not use with systems required to exhibit a high level of safety or reliability.
- Do not use in proximity to pacemakers or other medical devices.
- Do not attempt to modify or disassemble.

#### **CAUTION**

- When used in proximity to other devices that use the same frequency band, for example wireless networking devices, transmission and reception of data may become unstable, or the product may be affected by the other devices.
- The line-of-sight communications range between the Wireless Logging Station and the Wireless Voltage/Temp Unit and Wireless Universal Unit is 30 m. Obstructions (such as walls or metal shielding) may cause communications to become unreliable and/or reduce the communications range. In addition, radio wave intensities, which are indicated with the antenna-like indicators, vary depending on units even while these units are operating in the same environment.
- Although communications between the Wireless Voltage/Temp Unit and Wireless Universal Unit and the Wireless Logging Station are encrypted using SSP, this does not guarantee the integrity or secrecy of transmitted data. Hioki is not liable for the electronic interception or unauthorized disclosure by other means of measured values sent via wireless communications.
- The Wireless Voltage/Temp Unit, Wireless Universal Unit, and Wireless Logging Station emit radio waves. Use of radio waves is subject to licensing requirements that are specific to the country of use, and use of these products in areas other than the countries listed in the provided "Precautions Concerning Use of Equipment That Emits Radio Waves" may constitute a violation of applicable law, resulting in fines or other penalties.

**NOTE** To facilitate stable transmission and reception of data, the product should be positioned away from the floor, for example on a stand, rather than close to the floor.

---

## Before Use

- Before using the instrument the first time, verify that it operates normally to ensure that no damage occurred during storage or shipping. If you find any damage, contact your authorized Hioki distributor or reseller.
- Before using the instrument, make sure that the insulation on the cables is undamaged and that no bare conductors are improperly exposed. Using the instrument in such conditions could cause an electric shock, so contact your authorized Hioki distributor or reseller for replacements.

## Installation

LR8410-20 Wireless Logging Station

Operating temperature and humidity:

Temperature: -10°C to 50°C, Humidity: 30 to 80%RH (non-condensating)

(Charging temperature range: 5°C to 35°C)

LR8510 Wireless Voltage/Temp Unit, LR8511 Wireless Universal Unit

Operating temperature and humidity:

Temperature: -20°C to 60°C

Humidity: -20°C to 40°C, 80%RH or less (non-condensating)

40°C to 45°C, 60%RH or less (non-condensating)

45°C to 50°C, 50%RH or less (non-condensating)

50°C to 60°C, 30%RH or less (non-condensating)

(Charging temperature range: 5°C to 35°C)

Temperature and humidity range for guaranteed accuracy:

Temperature: 23±5°C, Humidity 80%RH or less (non-condensating)

### NOTE

- Avoid temperature changes around the terminal block. Especially avoid directed airflow such as from an electric fan or air conditioner vent. Thermocouple inputs are prone to measurement errors.
- When the instrument is moved to a location with significantly different ambient temperature, allow at least 60 minutes for thermal equalization before measuring.

### Avoid the following locations that could cause an accident or damage to the instrument and measurement units.



Exposed to direct sunlight  
Exposed to high temperature



In the presence of corrosive or explosive gases



Exposed to water, oil, other chemicals, or solvents  
Exposed to high humidity or condensation



Exposed to strong electromagnetic fields  
Near electromagnetic radiators



Exposed to high levels of particulate dust



Subject to vibration



Near induction heating systems  
(e.g., high-frequency induction heating systems and IH cooking utensils)

**Handling the Instrument**

To avoid electric shock, do not remove the instrument's case. The internal components of the instrument carry high voltages and may become very hot during operation.



Touching any of the high-voltage points inside the instrument is very dangerous.

**Do not attempt to modify, disassemble or repair the instrument; as fire, electric shock and injury could result.**



To avoid damage to the instrument, protect it from physical shock when transporting and handling. Be especially careful to avoid physical shock from dropping.

**NOTE**

This instrument and measurement units may cause interference if used in residential areas. Such use must be avoided unless the user takes special measures to reduce electromagnetic emissions to prevent interference to the reception of radio and television broadcasts.

**Handling the Cords and Cables**

- Avoid stepping on or pinching cables, which could damage the cable insulation.
- To avoid breaking the cables, do not bend or pull them.
- To avoid damaging the power cord, grasp the plug, not the cord, when unplugging it from the power outlet.

**Before Turning Power On**

**Before turning the instrument on, make sure the supply voltage matches that indicated on the AC adapter. Connection to an improper supply voltage may damage the instrument or AC adapter and present an electrical hazard.**



When the power is turned off, do not apply voltage or current to the measurement units. Doing so may damage the measurement units.

**NOTE**

- After use, always turn OFF the power.
  - Brief power interruptions of 40 ms or less will not cause this instrument and measurement units to malfunction. However, Longer interruptions may cause the instrument to shut itself off, so consider local power conditions before installing, as appropriate.
  - To ensure that recording is not interrupted by power outages, you can use the Z1008 AC Adapter and Z1007 Battery Pack together.
-

## Using the Battery Pack

If handled or used improperly, the battery pack may leak, become excessively hot, catch on fire, crack, or suffer other damage. Please observe the following precautions.

### DANGER

- **Use the Z1007 Battery Pack with the instrument and measurement units. Use of other battery packs may damage the device or cause an accident. Hioki is not liable for such damage.**

**See:** "2.1 Using the Battery Pack (Option)" (p. 43)

- **Do not attempt to disassemble or modify the battery pack. The battery pack incorporates safety mechanisms and protective devices to prevent dangerous operation. If these are damaged, the battery pack may leak, become excessively hot, generate smoke, crack, or catch on fire.**
- **Do not connect the battery pack's positive and negative terminals with wire or other metallic objects. Do not carry or store the battery pack together with metal necklaces, hairpins, or other metal objects. Doing so may short the battery pack, causing an excessively large current to flow; the battery to leak, become excessively hot, generate smoke, crack, or catch on fire; or the wire, necklace, hairpin, or other metal object to become excessively hot.**
- **Do not submerge the battery pack in water or heat it. Doing so may melt the insulation, damage the gas release valve or other safety devices, cause the electrolyte to ignite, or cause the battery to leak, become excessively hot, generate smoke, crack, or catch on fire.**
- **Do not use or leave the battery pack near a flame or heater or in any other hot location (80°C or hotter). If the resin separator becomes damaged by heat, the battery may experience an internal short, causing it to leak, become excessively hot, generate smoke, crack, or catch on fire.**
- **Do not place the battery pack in, or expose it to, water, seawater, or any other liquid. Damage to safety devices in the battery pack may allow the battery to charge at an abnormal current or voltage, causing an abnormal chemical reaction inside the battery pack and causing it to leak, become excessively hot, generate smoke, crack, or catch on fire.**
- **Do not pierce the battery pack with wire, strike it with a hammer, or step on it. Doing so may damage or deform the battery pack so that internal components are shorted, causing it to leak, become excessively hot, generate smoke, crack, or catch on fire.**



- Do not subject the battery pack to strong mechanical shock or throw it. Doing so may cause it to leak, become excessively hot, generate smoke, crack, or catch on fire. Damage to safety devices in the battery pack may allow the battery to charge at an abnormal current or voltage, causing an abnormal chemical reaction inside the battery pack and causing it to leak, become excessively hot, generate smoke, crack, or catch on fire.
  - Do not use battery packs that have suffered external damage or become deformed in shape due to having been dropped or for other reasons. Doing so may cause the battery pack to leak, become excessively hot, generate smoke, crack, or catch on fire.
  - Do not solder directly to the battery pack. The resulting heat may melt the insulation, damage the gas release valve or other safety devices, cause the electrolyte to ignite, or cause the battery to leak, become excessively hot, generate smoke, crack, or catch on fire.
  - Using this battery pack in devices other than those designated by Hioki may degrade its performance or service life, and some devices may trigger an abnormal current flow or damage the battery pack, causing it to leak, become excessively hot, generate smoke, crack, or catch on fire.
  - If you get fluid that has leaked from the battery pack in your eyes, avoid rubbing them and immediately flush with a large volume of tap water or other clean water. Seek immediate medical attention. Failure to do so may cause permanent vision damage.
-

**⚠ WARNING**

- If the battery pack fails to charge fully even though the normal charge time has elapsed, unplug the AC adapter from the instrument or measurement unit to stop charging. Failure to do so may cause the battery pack to leak, become excessively hot, generate smoke, crack, or catch on fire.
- Do not place the battery pack on top of an electromagnetic range or inside a microwave oven or pressure cooker. Doing so may heat the battery pack rapidly or break its airtight seal, causing it to leak, become excessively hot, generate smoke, crack, or catch on fire.
- If the battery pack starts to leak or emit an unusual odor, move it away from fire immediately. Failure to do so may ignite the leaked electrolyte and cause the battery pack to generate smoke, crack, or catch on fire.
- If you notice the battery pack emitting an unusual odor, changing color, becoming deformed in shape, or otherwise exhibiting a different appearance than usual while it is being used, charged, or stored, immediately halt use and contact your authorized Hioki distributor or reseller. Continued use may cause the battery pack to leak, become excessively hot, generate smoke, crack, or catch on fire.

**⚠ CAUTION**

- Do not use or leave the battery pack in a hot location, for example in a place that is exposed to strong, direct sunlight or inside a closed vehicle on a hot summer day. Doing so may cause it to leak, become excessively hot, or generate smoke. It may also degrade the battery pack's performance or service life.
- If the battery leaks onto your skin or clothing, immediately rinse with a large volume of tap water or other clean water. Failure to do so may result in a skin rash.
- If you notice rust, an unusual odor, excessive heat, or any other abnormal state upon using the battery for the first time after purchase, stop use and contact your HIOKI distributor.



**NOTE**

- Check the battery pack's positive and negative terminals and connect them properly to the instrument or measurement unit.
- Always charge the battery before using it for the first time after purchase or after it has been stored for an extended period of time.
- Keep the ambient temperature between 5°C and 35°C while charging the battery pack. When charging at low temperatures near 5°C, the battery pack will hold less charge than when charged at 23°C. The lower the temperature, the shorter the time the battery pack will power the device.
- The battery pack's service life (defined as the ability to retain 70% or more of its initial capacity) is approximately 300 charge/discharge cycles. (Service life varies with the method of storage and operating environment.)
- When storing for an extended period of time, remove the battery pack from the instrument or measurement unit and store in a cool place (about 20°C). Charge the battery pack for approximately 30 minutes once every year in an instrument or measurement unit.
- The battery pack is a consumable. Degraded operating times following proper charging indicate that the battery pack has reached the end of its service life. Replace it with a new battery pack.

**When transporting the Z1007 Battery Pack on an aircraft**

- The Z1007 Battery Pack uses a rechargeable lithium-ion battery.
  - Transport of lithium-ion batteries on aircraft is subject to restrictions based on UN recommendations.
  - Before air-transporting the instrument equipped with the Z1007 Battery Pack for any reason, such as repair and calibration, please consult with a shipping company or an airline.
-

**Using the AC Adapter** **WARNING**

- Use only the supplied Model Z1008 AC Adapter. AC adapter input voltage range is 100 to 240 VAC (with  $\pm 10\%$  stability) at 50/60 Hz. To avoid electrical hazards and damage to the instrument and measurement units, do not apply voltage outside of this range.
- When connecting the AC adapter to the instrument, a measurement unit, or a power outlet, always turn off the instrument and measurement unit first.
- To avoid electrical accidents and to maintain the safety specifications of this instrument and measurement units, connect the supplied power cord only to a 3-contact (two-conductor + ground) outlet.

**NOTE**

Turn off the power before disconnecting the AC adapter.

**Handling of temperature and humidity sensor****⚠ CAUTION**

Model Z2000 Humidity Sensor and Model Z2010/Z2011 Humidity Sensor are not dustproof or waterproof. Do not use the sensor in locations where it may be exposed to dust or water. It may cause a malfunction of the instrument.

**NOTE**

- Sensor sensitivity and precision will degrade over time, even under normal operating conditions. To maintain the instrument's ability to make measurements that conform to the accuracy specifications, it is recommended to replace the temperature and humidity sensor with a new unit once it has been used for one year after being opened.
- When the sensor is used outside the specified operating (storage) environment, the sensor accuracy may deteriorate even within the 1 year accuracy warranty period and accurate measurement cannot be performed.
- In principle, the surface of the instrument's temperature and humidity sensor may become contaminated if exposed to an environment containing organic gases (ketone, acetone, ethanol, toluene, etc.), increasing the error component of humidity measurement.
- Do not expose the temperature and humidity sensor to any concentrated chemical solvent for an extended period of time while it is used or stored.
- The sensor may become contaminated by organic gases released from some types of vinyl chloride and packaging material.
- When the temperature and humidity sensor is not used, place it with a drying agent in a plastic bag, seal the bag completely, and store it in a cool, dark place.
- Do not allow any condensation to form. Condensation can form particularly in any environment where the temperature changes drastically.
- This instrument does not come with a guarantee against any problem when the sensor is used outside the specified operating (storage) environment.
- Change in humidity (lower to higher, or higher to lower) affects measured humidity values due to hysteresis. For the Z2000 Humidity Sensor, an arithmetic difference of about 3%RH will arise; for the Z2010/Z2011 Humidity Sensor, an arithmetic difference of  $\pm 1\%$ RH or narrower will arise.

## Connection Precautions

When connecting measurement cables to a Wireless Voltage/Temp Unit or Wireless Universal Unit

 **DANGER**

Do not leave the Unit connected to test objects in environments where a voltage surge might exceed the dielectric withstand voltage. Doing so could result in damage to the measurement units, bodily injury or fatal accident.

 **WARNING**

- To avoid electric shock or a short-circuit accident, disconnect power to the measurement line before turning on the measurement unit.
- To avoid shock and short circuits, turn off all power before connecting measurement cables.
- Do not connect a cable to the measurement units while it is connected to the object to be measured. Otherwise, an electric shock accident may occur.
- To avoid short-circuit accidents, make certain that connections are secure.
- To avoid electric shock and short-circuit accidents, always close the analog input terminal cover and tighten the screws.
- To avoid electric shock, use the recommended wire type to connect to the current input terminals, or otherwise ensure that the wire used has sufficient current handling capacity and insulation.
- Measurement units are not drip-proof and should be installed so that water or other liquids cannot flow down measurement cables and enter the unit enclosure via the terminal block. One way to do so is to orient the unit so that the measurement cables are lower than the unit.

**⚠ WARNING**

- The following table lists the analog input terminals' maximum input voltage, input-to-ground maximum rated voltage, and channel-to-channel maximum rated voltage for each unit. To avoid electric shock accidents and damage to the instrument and measurement units, do not exceed these voltages.
- Channels are insulated by semiconductor relays. When a voltage beyond the specification is applied between the channels, the semiconductor relay may short circuit. Please ensure that a voltage beyond specification, especially a surge such as a lightning, is never applied. When an abnormal measurement value is observed, please contact your authorized Hioki distributor or reseller for inspection.

Input and Output Terminals	Maximum Input Voltage	Maximum rated voltage to earth	Max. Inter-Channel Voltage
Analog Input Terminals (both Voltage/Temp Unit, and Universal Unit)	±100 VDC	300 V AC,DC	300 VDC, However, channels are not isolated when using resistance thermometer sensors and during resistance or humidity measurement.

**NOTE**

- When connecting a measurement cable of 3 m or more in length, the cable may experience external noise or other EMC effects.
- Route measurement leads and cables as far away as possible from power and earth lines.
- Measurement values may be scattered if the leads are routed in parallel with other devices. If they must be parallel, check operation before taking measurements.

## When connecting to the instrument's alarm output terminals or external control terminal



- To avoid electric shock or damage to the instrument, always observe the following precautions when connecting to alarm output terminals and External Control Terminals.
- Always turn off the power to the instrument and to any devices to be connected before making connections.
- Ensure that devices and systems to be connected to the External Control Terminals are properly isolated.
- Be careful to avoid exceeding the ratings of External Control Terminals.

Input and Output Terminals	Maximum Input Voltage	Maximum rated voltage to earth	Max. Inter-Channel Voltage
Alarm Output Terminals	–	Non-Isolated (instrument/GND Common)	Non-Isolated (instrument/GND Common)
External Trigger (EXT.TRIG) Terminal	0 to 10 VDC	Non-Isolated (instrument/GND Common)	–
Trigger Output (TRIG.OUT) Terminal	–	Non-Isolated (instrument/GND Common)	–

- Never apply voltage to the Alarm output terminals and TRIG OUT terminals. The instrument will be damaged.
- The grounds for the Alarm output, EXT TRG and TRIG OUT terminals are common with the instrument grounds (GND), and are not isolated. To avoid damaging the instrument, connect wiring so as to avoid any potential difference between the grounds of the Alarm output, EXT TRIG and TRIG OUT terminals and connected devices (or system).

**Using a SD memory card/USB flash drive****⚠ WARNING**

- **Store SD memory cards and USB flash drives out of reach of children to prevent accidental ingestion.**
- **Do not modify, disassemble, or repair SD memory cards or USB flash drives. Doing so may result in fire, electric shock, or injury.**

**⚠ CAUTION**

- Inserting a SD memory card/USB flash drive upside down, backwards or in the wrong direction may damage the SD memory card, USB flash drive, or instrument.
- Never eject a SD memory card/USB flash drive while measuring or when the instrument is accessing the card. Data on the SD memory card/USB flash drive may be destroyed. (The SD icon/USB flash drive icon at the lower left is red while the card is being accessed.)
- Do not transport the instrument while a USB flash drive is connected. Damage could result.
- As the SD memory card/USB flash drive is sensitive to static electricity, damage to the SD memory card/USB flash drive or wrong operations by the instrument may occur due to static electricity. Please be careful when handling it.
- With some USB flash drives, the instrument may not start up if power is turned on while the USB flash drive is inserted. In such a case, turn power on first, and then insert the USB flash drive. It is recommended to try out operation with a USB flash drive before starting to use it for actual measurements.
- Use USB flash drives within the specified temperature and humidity range.
- Using SD memory cards or USB flash drives while there is moisture on their terminals may result in fire or electric shock.
- Do not apply labels or other adhesives to SD memory cards. Doing so may cause them to become excessively hot or catch on fire.

**NOTE**

- The Flash memory in a SD memory card/USB flash drive has a limited operating life. After long-term usage, data storage and retrieval become difficult. In this case, replace the SD memory card/USB flash drive with a new one.
- We cannot provide compensation for data loss in a SD memory card/USB flash drive, regardless of content or cause of the damage. Data is also cleared from memory if a long time passes after measuring. Always maintain a backup of important data stored on a SD memory card/USB flash drive.
- Format new SD memory cards and USB flash drives before use.
- Format SD memory cards and USB flash drives with the instrument.
- Formatting an SD memory card or USB flash drive on a computer may cause automatic saving of data to take more time or prevent real-time saving from keeping pace with data recording.
- Verify that the SD memory card is not write-protected before inserting it into the instrument.
- Although data can be saved in real time on a USB flash drive, it is recommended to use an SD memory card in order to ensure data integrity. Proper operation is not guaranteed for media other than the included (or an optional) genuine Hioki SD memory card.
- Adhere to the following precautions to prevent internal data from being damaged or lost:
  - Do not touch terminals or contact surfaces directly or with metal.
  - Do not cause the instrument to vibrate, subject it to mechanical shock, or turn it off while writing or reading data.
  - Before initializing an SD memory card or USB flash drive, verify that it does not contain any necessary data (files).
  - Do not bend SD memory cards or USB flash drives, subject them to excessive force or shock, or drop them.

**CD Handling** **CAUTION**

- Exercise care to keep the recorded side of discs free of dirt and scratches. When writing text on a disc's label, use a pen or marker with a soft tip.
- Keep discs inside a protective case and do not expose to direct sunlight, high temperature, or high humidity.
- Hioki is not liable for any issues your computer system experiences in the course of using this disc.





# Overview

# Chapter 1

## 1.1 Product Overview and Features

The LR8410-20 Wireless Logging Station allows the collection and observation of data transmitted wirelessly from measurement unit and wireless logger that have been placed in remote measurement locations.

### Voltage change, temperature, humidity, and resistance observation

You can collect and observe data transmitted wirelessly from measurement units and wireless logger.

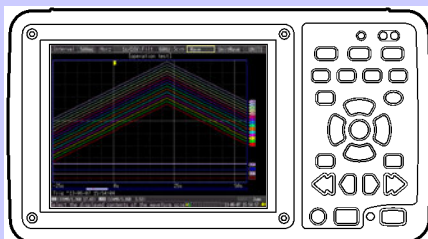
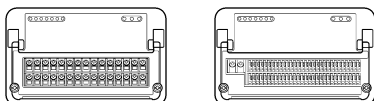

### Record anomalies

Abnormal events can be analyzed by recording with the trigger function (p. 129).

Use the alarm function to output signals when anomalies occur (p. 153).

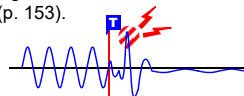

### Measurement data and setting configurations are stored, read and managed as data files

Measurement data can be stored to and read from the included or an optional SD memory card or USB flash drive (p. 161).



### Waveform observation

**Gauge**      **Zoom in/**      **Numerical dis-**      **Event search**  
display (p. 116)      out (p. 119)      play (p. 117)      (p. 123)



123.4V



### Cursor Measurements (p. 121)



Using the A/B cursors, values at cursor locations on waveforms and the time at trigger positions can be displayed.

### Numerical Calculations (p. 185)



Simultaneously performs six numerical calculation types, including maximum and average values.

### Waveform Calculations (p. 193)

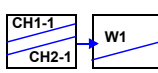

Displays on one channel the sum, difference, product, or quotient of values measured on any two analog channels.

### Observe on a PC

Monitor and analyze measurement data with the supplied application program "Logger Utility" (p. 236).



### Display in converted units

Using the scaling function, input values can be displayed in units of the actual physical quantity being measured, such as current or flow volume (p. 97).

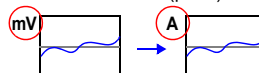

## 1.2 Measurement Flow

### 1. Register measurement units, and wireless loggers with the instrument

Each instrument can connect wirelessly to up to seven measurement units, and wireless loggers.

Once a measurement unit and wireless logger has been registered, device registration information will be saved even if the instrument, measurement units, and wireless loggers are turned off (p. 62), unless the unit's registration information is initialized (p. 205) or the unit is deleted (p. 61).

- (1) Place the measurement unit and wireless logger close to the instrument (in a location where there are no obstructions to wireless communications).

Up to 7 measurement units and wireless loggers

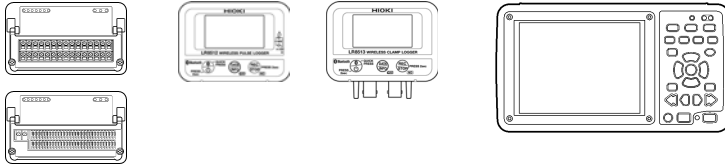

- (2) Connect an AC adapter or fully charged battery pack to the instrument and measurement unit. Connect the AC adapter to the wireless logger or install its batteries.



- (3) Turn on both the instrument and the measurement unit. (The wireless logger will turn on automatically once the AC adapter is connected or batteries are installed.)

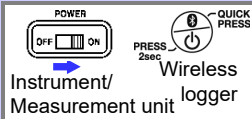

- (4) Register the measurement unit and wireless logger. (p. 58)  
(If there are no registered units when the instrument is powered on, **[QUICK SET]**-**[Unit Guide]** will be displayed initially. For more information about the **[Unit Guide]**, see the Measurement Guide.)

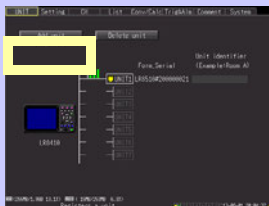

Unit Registration screen



Configuration Navigator screen  
(see the Measurement Guide)

## 2. Prepare for measurement (installation and wiring).

- (1) Insert the SD memory card (included) into the instrument.



- (2) Attach the fixed stand (optional feature) and mounting bracket (included)

**Instrument** : Use the Z1009 Fixed Stand to place the instrument at an angle on a table or desk or mount it on a wall. (For more information about how to attach the Z1009, see the instruction manual that came with the Z1009.)

**Measurement unit** : Use the mounting bracket (included) to mount the measurement unit on the wall.

### Attaching and Mounting the Bracket

- 1** Using the included M3 × 4 mm screws, attach the bracket to the measurement unit. (Use M3 × 4 mm screws. If you use screws longer than 4 mm, they may damage the measurement unit by pushing against it.)
- 2** Mount the bracket on the wall with two M4 screws. (Screws for mounting the bracket on the wall are not included. Use appropriate commercially available screws. It is recommended to use screws that are at least 8 mm in length.)

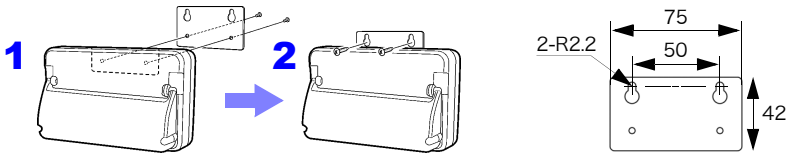

- (3) Install the measurement unit in the measurement location (check the LED display).

Check the unit No. LED.

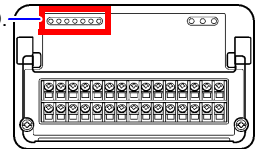

Measurement unit

**Flashing:** The communications state is poor.

Move the measurement unit closer or remove obstructions to communications.

**Off:** No connection has been established.

Move the measurement unit closer or remove obstructions to communications and then check the connection again.

Position the wireless logger in the measurement location (check the screen display).

Check the Bluetooth and antenna icons.

 (Bluetooth icon)

**Displayed** : The unit can communicate with the instrument.

**Not displayed** : The unit cannot communicate with the instrument. Press the power key once quickly to display the Bluetooth icon.

Power key

 (Antenna icon)

Signal strength is indicated using a three-bar display. If possible, position the wireless logger so that all three antenna bars are shown.

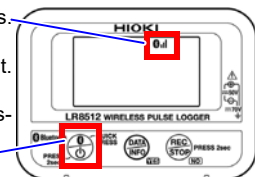

Wireless logger

(3) Connect the measurement cables.(p. 49)

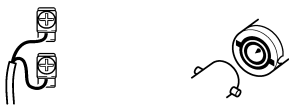

(4) Connect the measurement unit and wireless logger to the measurement target.



### 3. Set the measurement conditions.(p. 70)

#### Configure Recording Settings (p. 70)

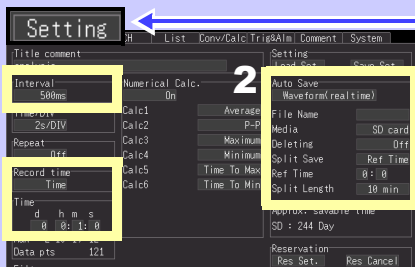
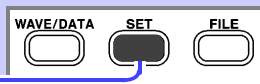

1 Set the data acquisition (recording) interval (**Interval**), and recording length (**Record time**).

2 Enable auto saving of measured data to removable storage (SD memory card or USB flash drive) (p. 165).

**Data stored in internal buffer memory is lost about 30 minutes after power-off. It is recommended to have the instrument automatically save important data to the included SD memory card or an optional SD memory card. (Data can also be automatically saved to a USB memory stick.)**

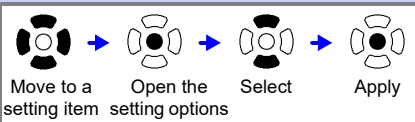

#### Configure Input Channels (p. 74)



Select input channels, and set input types and measurement ranges.

**Make other settings as needed.**

- Waveform Display (p. 93)
- Scaling (p. 97)
- Titles and Comments (p. 100)
- Noise Suppression (p. 102)
- View/Edit All-Channel Settings List (p. 103)

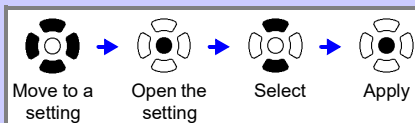

Pre-existing setting configuration data can be loaded from the instrument or removable storage (p. 173).

#### 4. Correct for input unit divergence. (Zero Adjustment)(p. 66)

#### 5. Starting and Stopping Measurement (p. 38)

Press the **START / STOP**

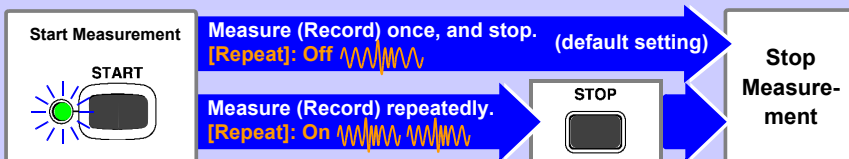

When measuring (recording) using the trigger function (p. 129), measuring occurs only when an input waveform satisfies the specified trigger criteria.

#### 6. Observing Data

View Measurement Data (p. 113)



Waveforms can be zoomed and numerical values confirmed.

Save Data (p. 161)



Measurement data, waveform data, screen images and numerical calculation results can be saved.

Calculate (p. 185)



Numerical measurement data can be applied to calculations.

View on a PC (p. 236)



Observe measurement data with the supplied Logger Utility program.

#### 7. When Finished

Turn the instrument, measurement units, and wireless loggers Off (p. 57)

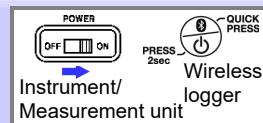

# 1.3 Names and Functions of Parts, Screen Configurations

## Wireless Logging Station

### Front Panel

External Control Terminals (p. 30)

**Display Screen (p. 115)**  
5.7-inch TFT color LCD  
Screen Configurations (p. 36)

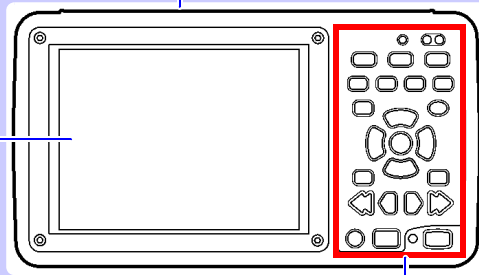

Operating Keys/LED (p. 29)

### Rear Panel

**Battery Compartment (p. 43)**  
The optional Model Z1007 Battery Pack is installed here.

**MAC address**

Shows the MAC address.  
Do not remove this label, as it is required for product support.

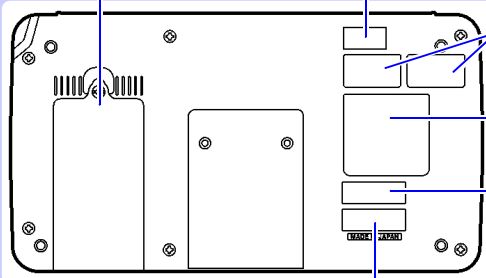

Wireless certification number

Warning

Environmental protection use period(EPUP) label

**Serial number**

Shows the serial number. The serial number consists of 9 digits. The first two (from the left) indicate the year of manufacture, and the next two indicate the month of manufacture. Do not remove this label, as it is required for product support.

## Operating Keys/LED

### Instrument status

#### ■ Warning(Alarm)

Lights up when any of the four alarm channels satisfies the alarm conditions.

#### ■ POWER

Lights when powered on (p. 57).

#### ■ CHARGE

Lights while charging the Z1007 Battery Pack (p. 44).

### Choose a screen

#### ■ WAVE/DATA

Selects among Waveform/Numerical screen displays (p. 36).

#### ■ SET

Displays the Settings screens, and switches among the screen tabs with each press (p. 36).

#### ■ FILE

Displays file information(p. 35).

### Scroll waveforms and read cursor values

#### ■ SCROLL/CURSOR

Select waveform scrolling or A/B cursor movement.

#### ■ Left and Right Cursor keys

Scroll waveforms and move A/B cursors (p. 37).

### Saving operations

Press to save data manually (p. 164).

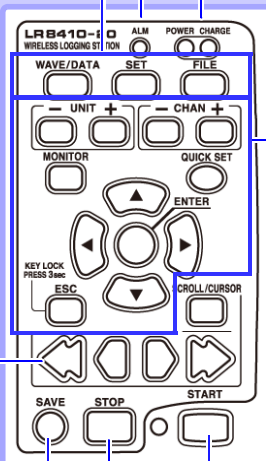

### Setup and display

#### ■ UNIT

Switches input units.

#### ■ CHAN

Select channels.

#### ■ MONITOR

Shows the current input waveform and numerical values (Data is not captured to the instrument's internal buffer memory or external media [SD memory card or USB memory stick].)

#### ■ QUICK SET

Switches to the Configuration Navigator.

#### ■ ESC

Cancels the operation.

#### ■ Cursor keys

Moves the position of the cursor (blinking selection) on the screen.



#### ■ ENTER

Accepts displayed settings.



### Stop measurement

### Start measurement

Start and stop measurement. The LED at the left lights green while measuring (p. 38).

Press while measuring to insert event markers in the measurement data. (p. 123)



**Upper Side**

**LAN cable port**

Use for PC communications via LAN.  
Connect an optional Model 9642 LAN Cable (p. 233).

**SD memory card Slot**

Use to save data to a SD memory card.  
Insert the included or an optional SD memory card. (p. 63).

**USB Cable Port  
(USB 2.0 mini-B receptacle)**

Use for PC communications via USB. Connect the supplied USB cable (p. 218).

**POWER Switch**

Turns the instrument on and off (p. 57)

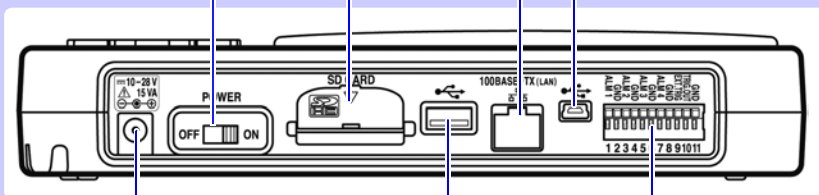

**Power inlet**

Connect the supplied Model Z1008 AC Adapter (p. 46). You can externally supply power here.(p. 48)

**USB Port**

Use to save data to a USB flash drive.  
Insert an USB flash drive (p. 64).

**External control terminals**

ALM1 to ALM4:  
Output alarm signals.(p. 153)  
EXT.TRIG:  
Inputs the external trigger signal. (p. 207)  
TRIG.OUT:  
Outputs the trigger signal.(p. 208)  
GND: Ground terminal

## UNIT

## 1

## Front Panel

**Unit No.**

The LED for the registered unit number will light up. If the communications status is poor, the LED will flash.

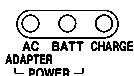
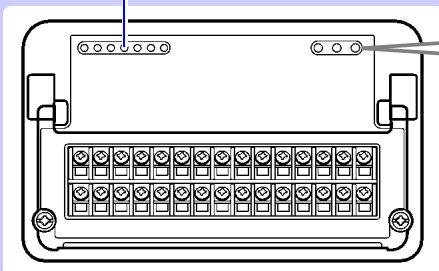
• **AC ADAPTER**

Lights up when power is being supplied from the AC adapter or another external source.

• **BATT**

Lights up when power is being supplied from the Z1007 Battery Pack.

• **CHARGE**

Lights up when the Z1007 Battery Pack is being charged.

## Rear Panel

## Wireless certification number

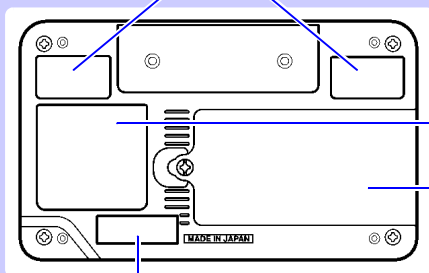
**Warning****Battery Compartment(p. 43)**

The optional Model Z1007 Battery Pack is installed here.

**Environmental protection use period(EPUP) label****POWER Switch**

Turns the instrument on and off (p. 57)

## Right Side

**Serial No.**

Shows the serial number. The serial number consists of 9 digits. The first two (from the left) indicate the year of manufacture, and the next two indicate the month of manufacture.

Do not remove this label, as it is required for product support.

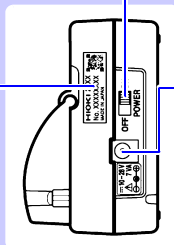
**Power inlet**

Connect the supplied Model Z1008 AC Adapter (p. 46). You can externally supply power here.(p. 48)

## Measurement Units

The instrument is used with the following two types of measurement units. For more information about measurement units, see "12.2 LR8510 Wireless Voltage/Temp Unit Specifications" (p. 288) and "12.3 LR8511 Wireless Universal Unit Specifications" (p. 294).

**NOTE** Up to seven units can be connected wirelessly to one Wireless Logging Station.

### LR8510 Wireless Voltage/Temp Unit

Measures voltage as well as temperature using a thermocouple.(p. 49)

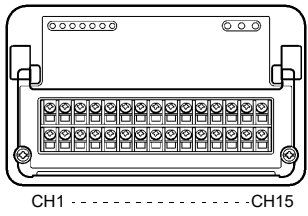

Measurement Parameter

- Voltage
- Temperature (thermocouple)

M3 screw terminal block  
Input channels: 15

### LR8511 Wireless Universal Unit

Measures voltage, temperature using a thermocouple, temperature using a resistance temperature detector, resistance, and humidity using the Z2000 Humidity Sensor.(p. 49)

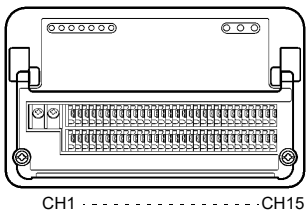

Measurement Parameter

- Voltage
- Temperature  
(thermocouple or resistance temperature detector)
- Resistance
- Humidity (using Hioki Z2000 Humidity Sensor)

Push-button terminal block  
Input channels: 15

## Wireless logger

For more information about part names and functionality, see the wireless logger's User Manual.

## Types of wireless logger

The wireless logger is available in the five types shown below. For more information about wireless logger specifications, see each model's User Manual.

**NOTE** Each wireless logging station can accommodate up to seven wireless connections.

## LR8512 Wireless Pulse Logger

The LR8512 provides pulse measurement, RPM measurement, and logic measurement capability.

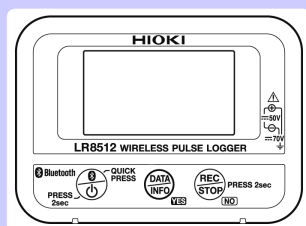

Measurement Parameter

- Pulse
- RPM

Connection terminal

Connection cable: L1010

No. of input channels:2

## LR8513 Wireless Clamp Logger

The LR8513 provides current measurement capability using clamp sensors.

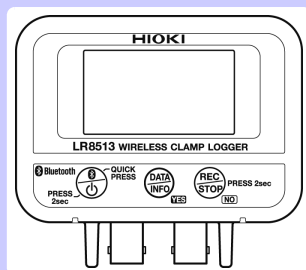

Measurement Parameter

- Current

Connection terminal

Clamp Sensors:

9657-10,9669,9675\*,9695-02,  
CT6500,CT7044,CT7045,CT7046,  
CT7631,CT7636,CT7642,CT7731,  
CT7736,CT7742,CT9667,CT9691-90,  
CT9692-90,CT9693-90

No. of input channels:2

## LR8514 Wireless Humidity Logger

The LR8514 provides temperature and humidity measurement.

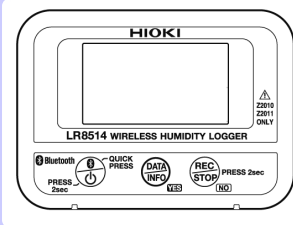

Measurement Parameter

- Temperature
- Humidity

Connection terminal

External temperature/humidity sensor:

Z2010/Z2011 Humidity Sensor

No. of input channels: 2 (2 temperature channels + 2 humidity channels)

## LR8515 Wireless Voltage/Temp Logger

The LR8515 provides voltage measurement and thermocouple-based temperature measurement.

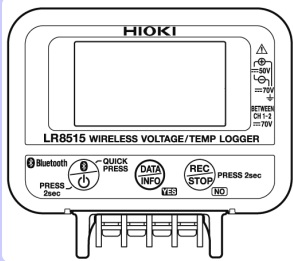

Measurement Parameter

- Voltage
- Temperature(thermocouple)

M3 screw-down terminal block

No. of input channels: 2

## LR8520 Wireless Fungal Logger

In addition to performing temperature and humidity measurement, the LR8520 can record fungal index and fungal growth projection data.

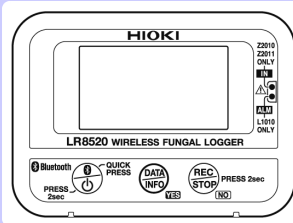

• Fungal index

(Computed from temperature and humidity)

• Fungal growth projection

(Project fungal growth from fungal index)

Connection terminal

External temperature/humidity sensor:

Z2010/Z2011 Humidity Sensor

No. of input channels:1 (1 temperature channels + 1 humidity channels)

Output terminal No. of alarm outputs:1

Connection Cable:L1010

Measurement Parameter

- Temperature
- Humidity

About the Icons (on all screens)

(Bottom of the screen)

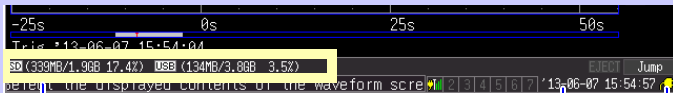

**SD memory card, USB flash drive**

Displayed when a SD memory card/USB flash drive is inserted. The icon appears red when accessing the SD memory card/USB flash drive.

The icon for the media that has been selected as the priority save destination will turn green. If there is no priority save destination media, the icon for the media serving as the save destination will turn yellow.

**Clock**

"Setting the Date and Time" (p. 204)

**Power source indicator**

Indicates the instrument's power source.

-  AC adapter operation

---

-  Battery pack operation (Fully charged battery pack)

---

-  Battery pack operation

---

-  Battery pack operation (low battery)

---

-  Status of communications with the unit (searching)

---

-  Status of communications with the unit (good)

---

-  Status of communications with the unit

---

-  Status of communications with the unit (poor)

File Screen

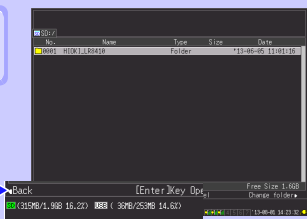

Operational information is displayed along the bottom of the screen.

View and manage files on the SD memory card/USB flash drive (p. 176), (p. 178).

## Settings Screens

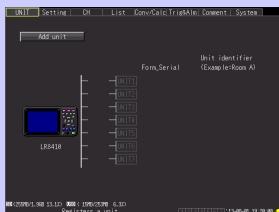

**[UNIT] Screen**

Register measurement units and wireless loggers. You can also edit each unit's ID name.

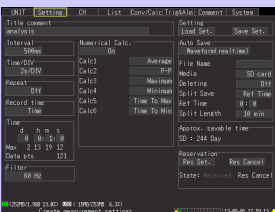

**[Setting] Screen**

Make settings for recording (p. 70). Set numerical calculation, auto-saving and reservation.

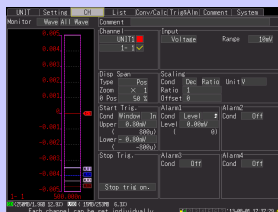

**[CH] Screen**

Make input channel settings while viewing the monitor display (p. 74).



**[List] Screen**

Make settings while viewing all channel settings (p. 103).

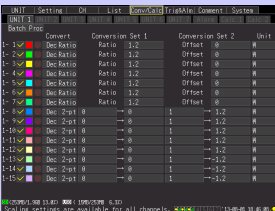

**[Conv/Calc] Screen**

Make these settings to convert measured values to arbitrary units for display (p. 103).



**[Trig & Alm] Screen**

Recording criteria (triggering) and warning sounds can be set for each channel (p. 129).

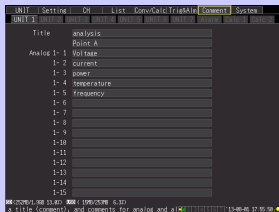

**[Comment] Screen**

Enter channel comments (p. 100).

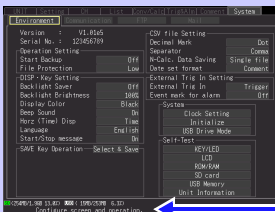

**[System] Screen**

Configure the system environment (p. 197).

Operational information is displayed along the bottom of the screen.

**WAVE/DATA SET FILE**

The screen switches each time you press the key. (8 display types)

Press the left/right keys to select between the Settings screens.

When a tab is selected with the cursor, press the left/right cursor keys to select between the Settings screens.

Selects a measurement input unit and its settings.



# 1.4 Basic Operation

## Screen Operations (changing settings, scrolling waveforms, and displaying values)

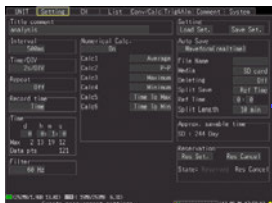

Setting Screen

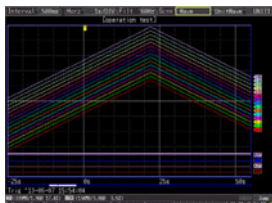

Waveform/Numerical Screen

### Changing screen contents

- Select the item to change.
- Show available setting options.
- Select the desired setting.
- Apply the new setting, or cancel it.

### Scrolling a waveform

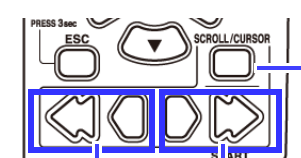

- 1** Hide A/B cursors
- 2** Scroll backward
- Scroll forward

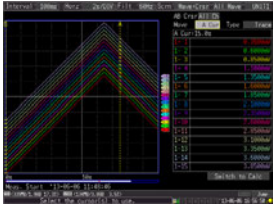

See: "Scrolling Waveforms"(p .118)

### Reading values at cursors

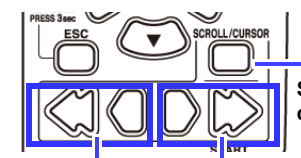

- 1** Show A/B cursors
- 2** Move the A/B cursors.

Values at cursor positions can be read numerically.

AB Crsr	All	Ch	Type	Trace
A	Cur	1	15.0s	
1-1				0.3500mV
1-2				0.6000mV
1-3				0.8500mV

You can select the cursor display type and which cursor(s) to move (p. 121).



## Starting and Stopping Measurement

Start measuring (acquiring measurement data) as follows.

When Auto saving is enabled, data is recorded to the specified removable storage (SD memory card or USB flash drive) as it is being recorded to internal buffer memory.

### Start Measurement

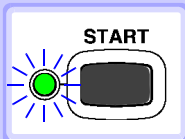

Press **START**.  
(The green LED lights.)

#### Important

If **[Start/Stop message]** is enabled on the System screen, the Start confirmation message appears. Select **[Yes]** to start measurement.

When restarting measurement after stopping, data in the instrument's internal memory is overwritten. Be sure to save important data to removable storage before restarting measurement.

### Finish Measurement



- ◆ When **[Repeat]** (record multiple instances of the specified recording length) is enabled or **[Record time]** set to **[Cont]** (record continuously) :

**Pressing STOP stops measuring.**

- ◆ When **[Repeat]** is disabled (Off) or **[Record time]** set to **[Time]** :

**Measuring stops after the specified recording length.**

(If **[Start/Stop message]** is enabled on the System screen, the Stop confirmation message appears when you press **STOP** during measurement. Pressing **STOP** during recording displays a confirmation message. Select **[Yes]** to stop measuring.)

For details about repeating and continuous recording:

**See:** "Recording time specification(Record time specification)"(p .71),  
"Repeat Recording (Repeat)"(p .71)

### NOTE

To automatically save measurement data, confirm the following before starting:

- Auto saving is properly set (p. 165)
- The removable storage is properly inserted (p. 63)
- There is sufficient free space on the removable storage (p. A14)

## About Measuring Operation

See: About Continuous and Repeating Recording: (p. 70)

○ Press **START**

● Press **STOP**

Record time	Repeat: Off	Repeat: On
Time		
Time (Recording is stopped before one recording length has elapsed)		
Cont		(Repeat Recording: same as Off)

### About Dead time

When repeating recording is enabled ([Repeat] set to [On])

After a recording length has elapsed, some “dead time” is needed for internal processing before recording can resume. No measurement occurs during the dead time. So to avoid information loss, split data into files at a specified interval by enabling continuous recording ([Cont]), and selecting [Split Save] for auto saving.

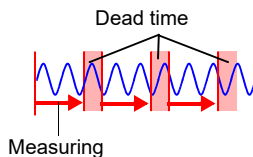

### NOTE

Measurement operation depends on whether the trigger or Reservation function is used (p. 141).

## Disabling Key Operations (Key-Lock Function)

Keys can be disabled to avoid inadvertent operations.

**ESC**



Press and hold the **ESC** key for three seconds to lock the other keys, and repeat to unlock.

## Performing Zero Adjustment

- With the Waveform/Numerical or **[CH]** screen displayed, press the up and down cursor keys simultaneously.

See: "From the [Waveform/Numerical] screen or the [CH] screen"(p .66)



- Select zero-adjustment on the bottom right of the Waveform/Numerical screen - **[Gauge+Wave]** screen.

See: "From the [Gauge+Wave] screen"(p .67)

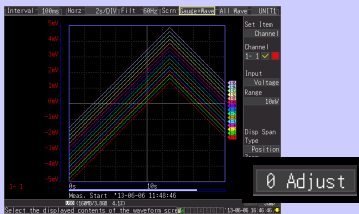

- Select zero-adjustment on the Setting screen - **[List]** screen.

See: "From the [List] screen"(p .68)

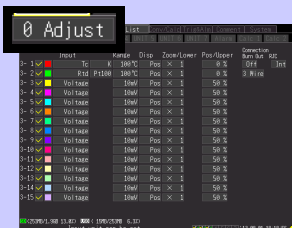

## Saving Data

Measurement data, settings, screen images and numerical calculation results can be saved.

For details of the saving methods, see "Chapter 6 Saving & Loading Data" (p. 161).

(Default settings)

Saving Method: **[Select & Save]** (Press **SAVE** to select and save data.)

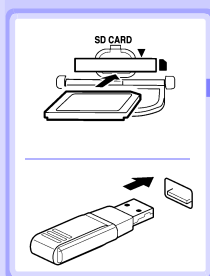

Insert a SD memory card  
(or USB flash drive).

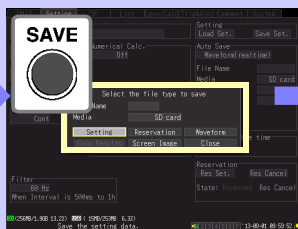

Press **SAVE**.  
(A dialog appears.)

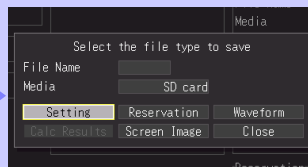

Select the save destination  
and item to save, and press  
**ENTER**.

Select **[Yes]** in the confirma-  
tion dialog, and press  
**ENTER** again.

(Data is saved on the selected  
removable storage.)

## Confirming Inputs (Monitor)

You can confirm the status of inputs and display ranges with the current settings (data is not acquired to internal buffer memory).

This function is convenient for checking measured values before activating real-time saving(Auto saving).

### MONITOR



#### Press MONITOR.

You can switch the monitor display format by pressing the monitor key again.

#### Wave

Select to display the waveforms for all channels, or for those on a selected input unit or channel.

#### Unit

Select the input unit for the value display.

Move the cursor to **[UNIT1]**, press **ENTER**, and switch with the up/down cursor or **UNIT**.

Each channel's display is switched with the **CHAN** keys.

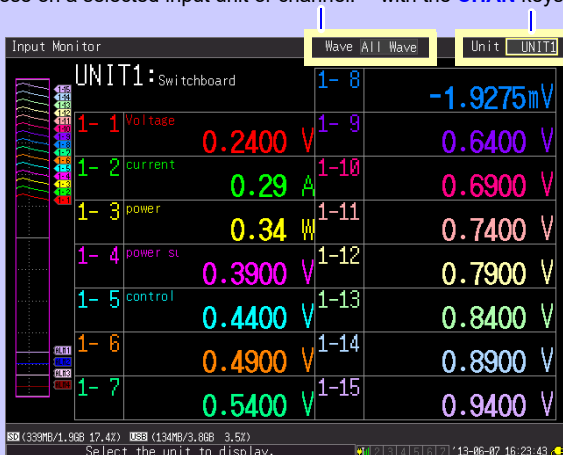

### NOTE

- The monitor function is not available while measuring.
- To display instantaneous values while the instrument is measuring, first press **WAVE/DATA** to switch to the **[Wave+Value]** display, then start measurement.
- Depending on the scaling setting, channels requiring more than 14 characters to display the measured value and unit symbols may be displayed in smaller characters.

# Measurement Preparations

## Chapter 2

2

Chapter 2 Measurement Preparations

### 2.1 Using the Battery Pack (Option)



When not connecting the AC adapter to supply commercial power to the instrument or measurement unit, either device can operate on the optional Z1007 Battery Pack alone. When using commercial power, the battery pack can be used as a backup power supply in case of a power outage.

Charge the battery pack fully before using it the first time.

Be sure to read "Using the Battery Pack" (p .11) before installing.

#### Install the Battery Pack

Required items: phillips screwdriver (No.2), Hioki Z1007 Battery Pack

##### Instrument

- 1** Turn off the instrument.  
(Disconnect the AC adapter and cables, if connected.)
- 2** On the back of the instrument, loosen the screws affixing the battery compartment cover, and remove it.

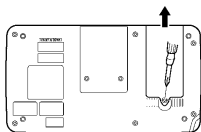

- 3** Insert the Z1007 Battery Pack vertically and slide into place toward the pins.

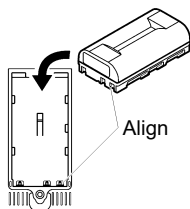

Orient the battery pack so that the flat surface is facing down (toward the instrument).

- 4** Tighten the screws in the compartment cover.

##### Measurement units

- 1** Turn off the measurement unit.  
(Disconnect the AC adapter and cables, if connected.)
- 2** On the back of the measurement unit, loosen the screws affixing the battery compartment cover, and remove it.

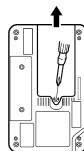

- 3** Insert the Z1007 Battery Pack vertically and slide into place toward the pins.

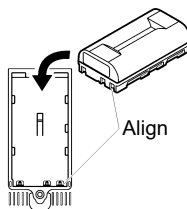

Orient the battery pack so that the flat surface is facing down (toward the instrument).

- 4** Tighten the screws in the compartment cover.

## Charge the Battery Pack

An attached battery pack can be charged whenever the instrument or measurement unit is connected to commercial power using the Z1008 AC Adapter, regardless of whether the instrument or unit is turned on. (p. 46)

### Instrument

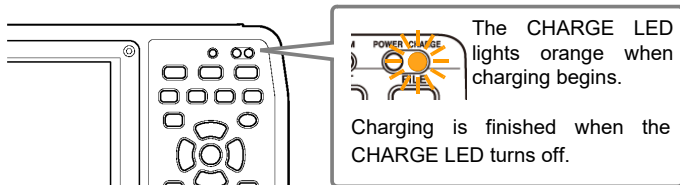

### Measurement unit

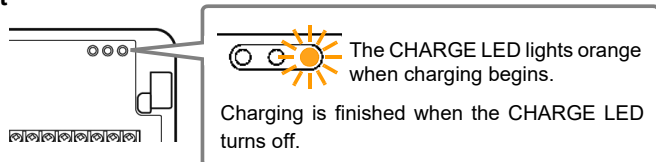

## Battery pack continuous operating times

### Instrument:

The continuous operating time when powered by the battery pack alone is approximately three hours (after being fully charged, with 25% backlight brightness, reference value at 23°C).

**See:** "Adjust Backlight Brightness" (p. 200)

### Measurement units:

Longer continuous operating times can be achieved on battery pack power if a longer recording interval is used. The continuous operating time when powered by the battery pack alone is approximately 24 hours (after being fully charged, recording interval of 100 ms, reference value at 23°C) or approximately 120 hours (after being fully charged, recording interval of 1 min, reference value at 23°C).

### NOTE

- Displaying the monitor screen or channel configuration screen will use the same amount of battery power as measurement (even if measurement has not been started), because those screens cause the instrument to communicate with measurement units.
- Operating times will shorten as the temperature falls.

### When to charge

**Instrument:**

When powering the instrument from the battery pack without the Model Z1008 AC Adapter, the low battery indicator (  ) is displayed when the battery is almost out of power, indicating that the battery pack requires charging.

The battery will be completely out of power approximately 10 minutes after the instrument's battery icon changes to (  ) (after being fully charged, with 2 measurement units connected, while saving waveform data to the SD memory card [in real time], with 70% backlight brightness, with the backlight saver off, reference value at 23°C).

**Measurement units:**

When powering the instrument from the battery pack without the Model Z1008 AC Adapter, the battery LED (BATT) will change from being lit up to flashing when the battery is almost out of power.

The battery will be completely out of power approximately 1 hour (with a recording interval of 100 ms) or 10 hours (with a recording interval of 1 min) after the unit's battery LED starts flashing (after starting measurement with the battery fully charged, reference values at 23°C).

**Approximate charging time(Instrument and measurement units):**

Charge time: Approx. 7 hours (when charging a battery pack with little power left)

**NOTE**

- For reasons involving the battery pack's characteristics, the displayed remaining battery life will differ from the actual amount of remaining battery power depending on the settings in use, operating temperature, and number of battery charge cycles.
- When charged at low temperatures near 5°C, the battery pack will not charge as fully as when it is charged at 23°C.



## 2.2 Connecting the AC Adapter



Connect the included Z1008 AC Adapter and power cord to the instrument and measurement units and plug the cord into a wall outlet. When used with the battery pack installed, the battery serves as an operating backup supply in case of power failure, and the AC adapter otherwise has priority.

Before connecting, be sure to read "Using the AC Adapter" (p .15) and "Handling the Cords and Cables" (p .10).

### CAUTION

- Connect the output plug to the instrument or measurement units before plugging the power cord into an outlet. Connecting an energized output plug to the instrument could damage the instrument.
- When connecting an external power supply, connect the output plug to the instrument or measurement units before activating the external power supply.

Rated supply voltage is 100 to 240 VAC,  
and rated supply frequency is 50 or 60 Hz.

(Instrument)

- 4** Plug the power cord into the mains outlet.

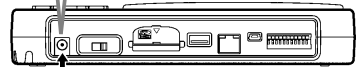
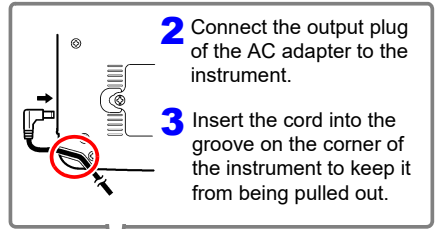
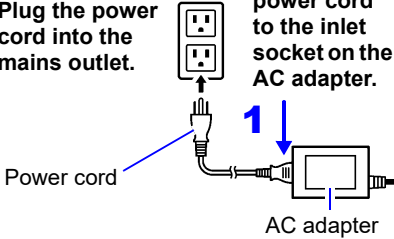

(Measurement unit)

- 4** Plug the power cord into the mains outlet.

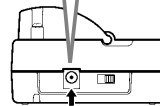
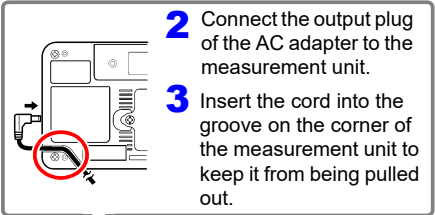
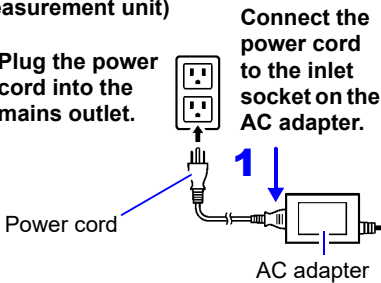

**NOTE** For more information about how to connect the AC adapter to the wireless logger or install its batteries, see the wireless logger's User Manual.

## 2.3 Connecting the External Power Supply

The instrument and wireless modules are capable of externally-DC-powered operation.

Hioki offers the DC power cord, which connects the instrument and an external power supply with each other. Contact your authorized Hioki distributor or reseller.

### CAUTION

- Supply power having only the rated supply voltage to the instrument or the wireless modules.  
Rated supply voltage: 10 V to 28 V DC
- Turn off the instrument and the wireless modules before plugging the DC power cords.
- Insert the output plugs into the instrument and wireless modules before supplying power.
- Observe the correct polarity when connecting the wires of the DC power cord. Failure to do so could cause damage to the product.

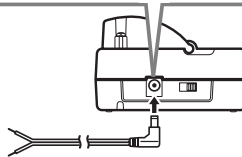
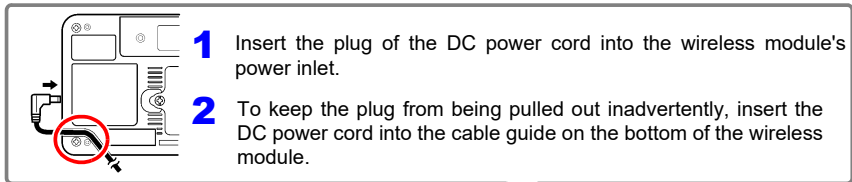
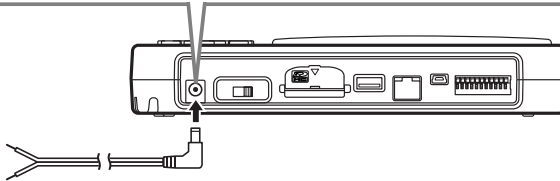
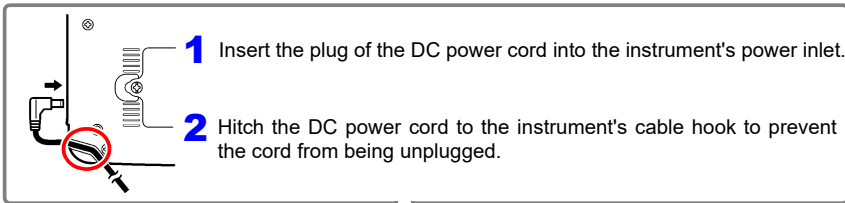

**NOTE** Using a DC power cord of 3 m or longer can subject the wireless module to harmful electromagnetic environments such as external noises.

## 2.4 Making Connections



### Pre-Connection Inspection

Before using the instrument and measurement units the first time, verify that it operates normally to ensure that no damage occurred during storage or shipping. If you find any damage, contact your authorized Hioki distributor or reseller.

#### 1 Peripheral Equipment Inspection

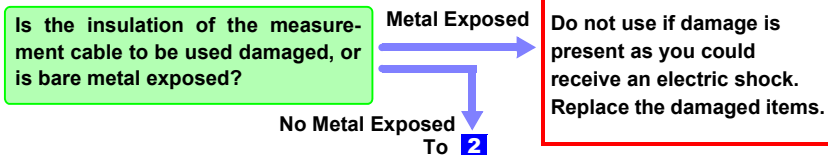

Turn power off before making connections.

#### 2 Instrument Inspection

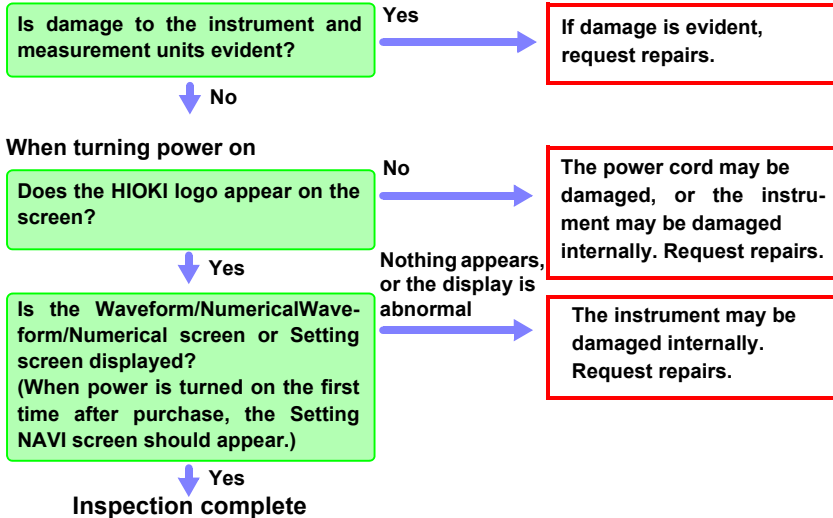

Before connecting, be sure to read "Before Use" (p .9), "Handling the Cords and Cables" (p .10), and "Connection Precautions" (p .17).

For more information about how to connect the wireless logger and clamp sensor connection cables, see the wireless logger's User Manual.

## 2.4 Making Connections

### NOTE

If connecting crimped terminals to the analog input terminals, use insulated terminals for M3 screws with the size shown below.

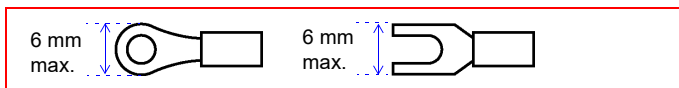

## Voltage and Thermocouple Temperature Measurement

### <Connecting to the terminals of the Wireless Voltage/Temp Unit>

Required items: phillips screwdriver (No.2), measurement leads (for voltage measurement), or thermocouple (for temperature measurement)

- 1** Loosen the screws in the terminal block cover, and lift the cover.

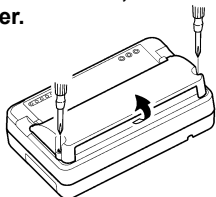

- 2** Loosen the terminal block screws, insert the bare ends of the leads, and tighten the screws.

Tighten the terminal block screws to 0.8 N·m or less (recommended: 0.4 N·m).

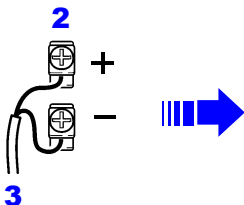

- 3** Connect to the measurement object.

The insulation colors of wires, which are to be connected to the plus and minus terminals, differ depending on countries or manufactures. Check with the manufacturer on the colors and connect them according to instructions.

- 4** Replace the terminal block cover, and tighten the screws.

Tighten the terminal block cover screws to 0.6 N·m or less.

**When measuring instrumentation control equipment  
(Applying 4 - 20 mA input current)**

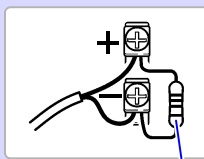

**For details on instrumentation control equipment measurements, see (p. 77).**

**Connect a 250 Ω shunt resistor as shown.**

### NOTE

K, E thermocouples experience a physical phenomenon known as short range ordering, which can prevent accurate measurement within the range of 250°C to 600°C.

Please choose a sensor after checking with the manufacturer of the thermocouple you intend to use.

**<Connecting to the terminals of the Wireless Universal Unit>**

Required items: phillips screwdriver (No.2), flat-blade screwdriver (tip width 2.6 mm), measurement leads (for voltage measurement), or thermocouple (for temperature measurement)

Recommended wire diameter:

Single strand diameter:  $\phi 0.4$  mm -  $\phi 1.2$  mm (AWG26-16)

Multi-strand:  $0.2$  mm<sup>2</sup> -  $0.75$  mm<sup>2</sup> (AWG24-20)

Standard insulation stripping length: 8 mm

- 1** With a Phillips screwdriver, loosen the screws in the terminal block cover, and lift the cover.

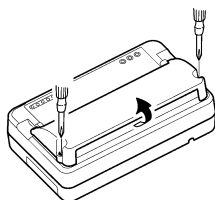

- 2** Push in the button on the connector with a flat-blade screwdriver.

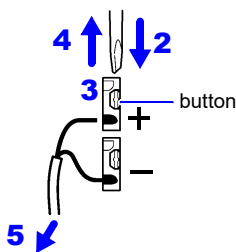

The insulation colors of wires, which are to be connected to the plus and minus terminals, differ depending on countries or manufactures. Check with the manufacturer on the colors and connect them according to instructions.

- 3** With the button held in, insert the cable into the cable connection hole.

- 4** Release the button.  
The cable is locked.

- 5** Connect to the measurement object.

- 6** Replace the terminal block cover, and tighten the screws.

Tighten the terminal block cover screws to 0.6 N·m or less.

## Temperature Measurement with a Resistance Temperature Detector (RTD)

### <Connecting to the terminals of the Wireless Universal Unit>

Required items: phillips screwdriver (No.2), flat-blade screwdriver (tip width 2.6 mm), RTD

Recommended wire diameter:

Single strand diameter:  $\phi 0.4 \text{ mm} - \phi 1.2 \text{ mm}$  (AWG26-16)

Multi-strand:  $0.2 \text{ mm}^2 - 0.75 \text{ mm}^2$  (AWG24-20)

Standard insulation stripping length: 8 mm

- 1** With a Phillips screwdriver, loosen the screws in the terminal block cover, and lift the cover.

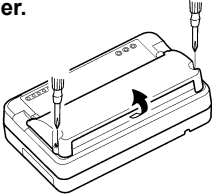

- 2** Push in the button on the connector with a flat-blade screwdriver.

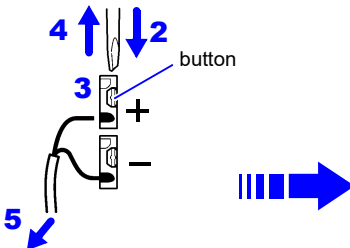

The insulation colors of wires, which are to be connected to the plus and minus terminals, differ depending on countries or manufactures. Check with the manufacturer on the colors and connect them according to instructions.

- 3** With the button held in, insert the cable into the cable connection hole.
- 4** Release the button.  
The cable is locked.
- 5** Connect to the measurement object.

- 6** Replace the terminal block cover, and tighten the screws.

Tighten the terminal block cover screws to 0.6 N.m or less.

#### 3-wire configuration

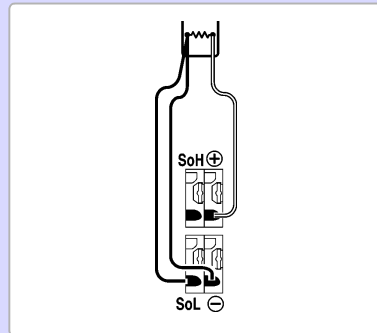

#### 4-wire configuration

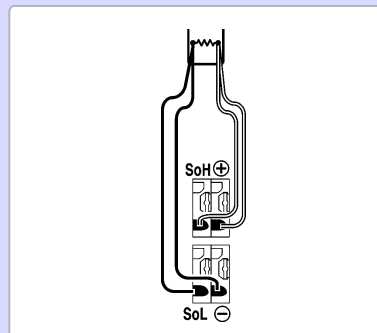

## Humidity Measurement

### <Connecting to the terminals of the Wireless Universal Unit>

Required items: phillips screwdriver (No.2), flat-blade screwdriver (tip width 2.6 mm), Hioki Z2000 Humidity Sensor

- 1** With a Phillips screwdriver, loosen the screws in the terminal block cover of the Wireless Universal Unit, and lift the cover.

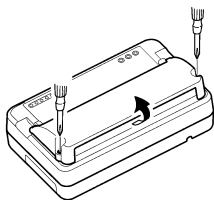

- 2** Loosen the screws on the humidity sensor power supply terminals (POWER OUTPUT), insert the tips of the cables as shown in the figure, and retighten the screws.

Tighten the terminal block screws to 0.8 N·m or less (recommended: 0.4 N·m).

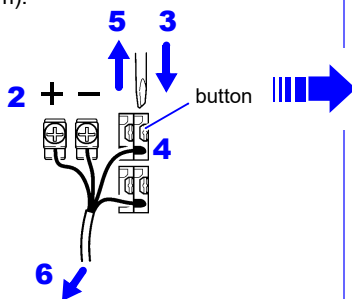

- 3** Push in the button on the Wireless Universal Unit's connector with a flat-blade screwdriver.

- 4** With the button held in, insert the cable into the cable connection hole.

- 5** Release the button.  
The cable is locked.



Connect the wires as follows.

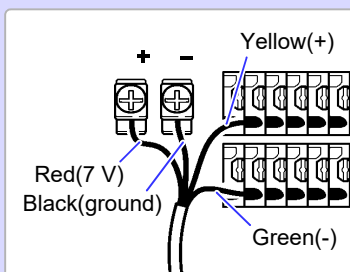

- 6** Connect to the measurement object.

- 7** Replace the terminal block cover on the Wireless Universal Unit, and tighten the screws.

Tighten the terminal block cover screws to 0.6 N·m or less.

### NOTE

The instrument can supply power to up to 60 pieces of Model Z2000 Humidity Sensor at once. If the required number of sensors cannot be connected to the power-supply terminals for humidity sensors, use external terminal blocks to connect the sensors.



## Resistance Measurement

## &lt;Connecting to the terminals of the Wireless Universal Unit&gt;

Required items: phillips screwdriver (No.2), flat-blade screwdriver (tip width 2.6 mm), measurement leads

Recommended wire diameter:

Single strand diameter:  $\phi 0.4$  mm -  $\phi 1.2$  mm (AWG26-16)

Multi-strand:  $0.2$  mm<sup>2</sup> -  $0.75$  mm<sup>2</sup> (AWG24-20)

Standard insulation stripping length: 8 mm

- 1** With a Phillips screwdriver, loosen the screws in the terminal block cover, and lift the cover.

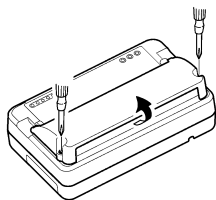

- 2** Push in the button on the connector with a flat-blade screwdriver.

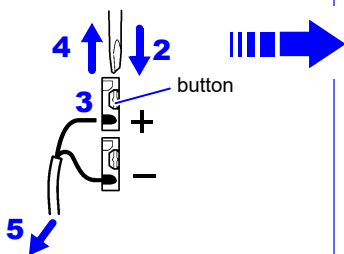

- 3** With the button held in, insert the cable into the cable connection hole.
- 4** Release the button.  
The cable is locked.

- 5** Connect to the measurement object.

- 6** Replace the terminal block cover, and tighten the screws.

Tighten the terminal block cover screws to 0.6 N·m or less.

**4-wire configuration**  
(2- and 3-wire configurations are not supported)

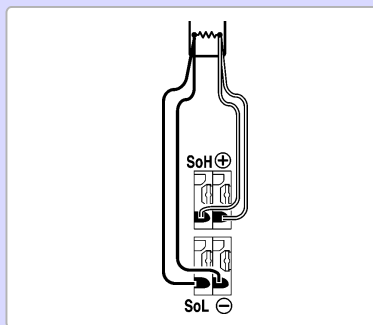

## Connecting Alarm Outputs

### < Connecting to the external control terminals >

See: "9.3 Alarm Signal Output (Alarm Output)" (p. 209)

Required items: flat-blade screwdriver (tip width 2.6 mm) (to connect wires to the push-button type terminal block on the top of the instrument), measurement leads

Recommended wire diameter:

Single strand diameter:  $\phi 0.32$  mm -  $\phi 0.65$  mm (AWG28-AWG22)

Multi-strand:  $0.08$  mm<sup>2</sup> -  $0.32$  mm<sup>2</sup> (AWG28-AWG22)

Strand diameter: 0.12 mm or greater

Standard insulation stripping length: 9 mm - 10mm

- 1 Push in the button on the connector with a flat-blade screwdriver.

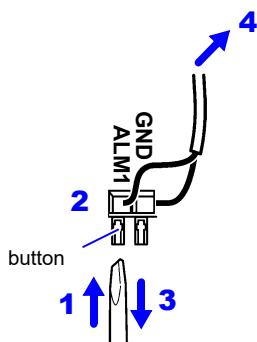

- 2 With the button held in, insert the cable into the cable connection hole.
- 3 Release the button. The cable is locked.
- 4 Connect to an external relay or control device.

Connect the '+' wire to the ALM1 (or ALM2 to ALM4) terminal.  
Connect the '-' wire to a GND terminal.

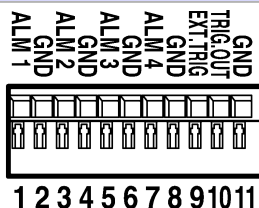

Five GND terminals are provided. Connections can be made to any GND terminal.

## External Control (using TRIG OUT and EXT TRIG)

### < Connecting to the external control terminals >

See: "9.1 External Trigger Input" (p. 207)

See: "9.2 External Signal Output (Trigger Output)" (p. 208)

Required items: flat-blade screwdriver (tip width 2.6 mm) (to connect wires to the push-button type terminal block on the top of the instrument), measurement leads

Recommended wire diameter:

Single strand diameter:  $\phi 0.32$  mm -  $\phi 0.65$  mm (AWG28-AWG22)

Multi-strand:  $0.08$  mm<sup>2</sup> -  $0.32$  mm<sup>2</sup> (AWG28-AWG22)

Strand diameter: 0.12 mm or greater

Standard insulation stripping length: 9 mm - 10mm

- 1 Push in the button on the connector with a flat-blade screwdriver.

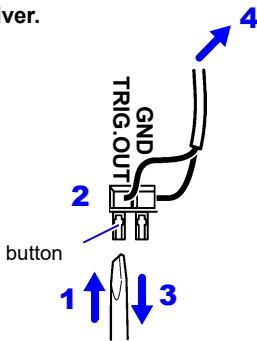

- 2 With the button held in, insert the cable into the cable connection hole.
- 3 Release the button.  
The cable is locked.
- 4 Connect to the trigger signal's input and output terminals.

Connect the '+' wire to the TRIG.OUT (or EXT.TRIG) terminal, and the '-' wire to a GND terminal.

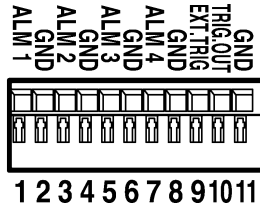

- Connect the TRIG.OUT terminal a trigger input on another device, and connect the EXT.TRIG (input) terminal to the trigger output another device (as needed).
- Five GND terminals are provided. Connections can be made to any GND terminal.

## 2.5 Turning the Power On and Off

Be sure to read "Before Turning Power On" (p. 10) before turning power on.

### Turning Power On (Wireless Logging Station)

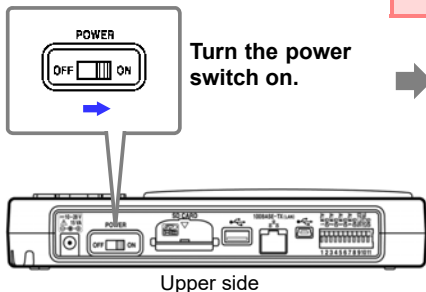

Verify that the instrument and peripheral devices are correctly connected.

Initial screen

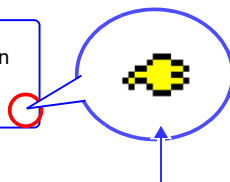

The power supply icon appears near the bottom right corner of the screen (p. 35).

If the "☐" indicator is not displayed, the instrument is not being powered from the AC line. In this state, the battery charge will be depleted if measuring for a long time, and measurement may be interrupted. Verify that the AC adapter is securely connected to an AC power source and to the instrument.

Perform zero adjustment as needed (p. 66).

### Turning Power On (measurement unit)

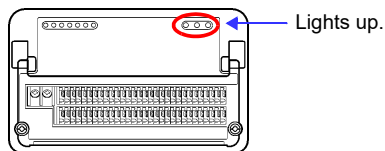
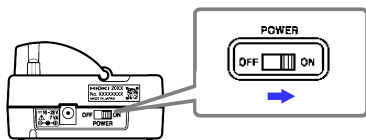

### Turning Power Off

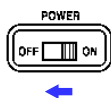

Turn the power switch off.

The installed battery pack is charged whenever the AC adapter is plugged into a power outlet, even when the instrument is off.

## 2.6 Register measurement units and wireless logger with the instrument

### NOTE

- Settings can also be accessed from [\[QUICK SET\]](#) - [\[Unit Guide\]](#).
  - If there are no registered measurement units when the instrument starts up, the screen will default to [\[QUICK SET\]](#) - [\[Unit Guide\]](#).
  - If there is one or more measurement units when the instrument starts up, the [\[Unit Guide\]](#) screen will be displayed, and registered units will be connected automatically. (p. 62)
-

## Registering Measurement Units and Wireless Logger

**1** Select the [UNIT] screen.

UNIT

**2** Select [Add unit].

Add unit

A search dialog box will be displayed.

Performing search...  
Please wait.

**3** The [Add unit] screen will be displayed.

Select the unit you wish to temporarily register (up to seven may be selected).

Apply

(Ten found units can be displayed at once. When 11 or more units are found, the page buttons can be used.)

The name of the unit you wish to temporarily register will move to the right side of the screen.

Selecting [ENTER] causes the temporarily registered unit to be registered.

(Pressing the **ESC** key cancels the temporary registration and returns you to the [UNIT] screen.)

The registration dialog box will be displayed.

**4** The unit will be added.

**5** Enter the unit's identifier (as necessary). (p. 100)

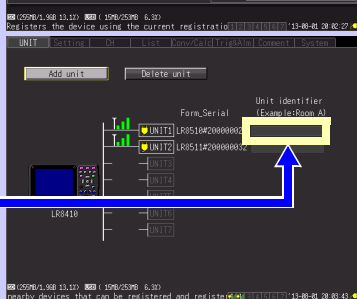
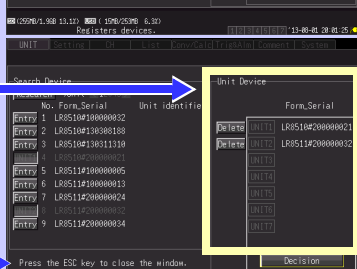
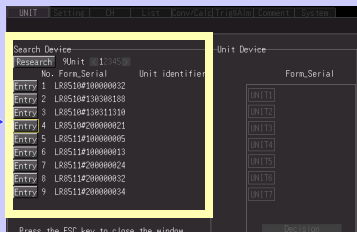

## 2.6 Register measurement units and wireless logger with the instrument

### To cancel the temporary registration



Select **[Delete]**.



Apply

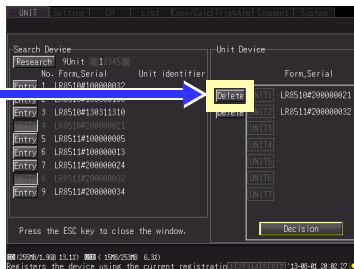

#### NOTE

To search for measurement units again, select **[Research]**. When you do so, temporary registrations will be canceled, reverting the instrument to its state before the **[Add unit]** screen was opened.

### If the instrument is unable to communicate with the registered units

If the instrument is still unable to communicate with the units after some time has elapsed,



Select **[!]**.



Apply

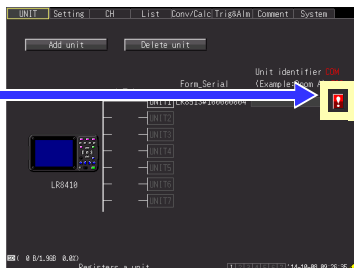







Switch to **[Dealing with communications issues]** on the **[Quick Setup]** screen. Follow the instructions to check the settings.

**See:** "Unable to establish communications between the Wireless Logging Station and a Unit." (p .305)

## Deleting Registered Units

There are two ways to delete registered units.

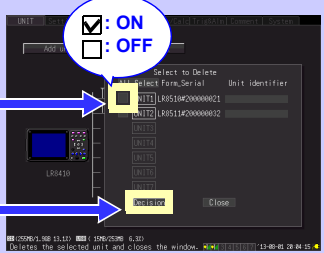
Deleting a registered unit from the [Delete unit] screen

- 1  Select the [UNIT] screen. 
- 2  Select [Delete unit].
- 3 The [Delete unit] screen will be displayed.
  -  Select the checkbox(es) [] for the unit(s) you wish to delete. (Selecting [All Select] will select all units.) 
  -  Select [Decision].
- 4 A deletion dialog box will be displayed, and the selected unit(s) will be deleted.



## 2.6 Register measurement units and wireless logger with the instrument

### Deleting a registered unit from the [Add unit] screen

1 Select the [UNIT] screen.

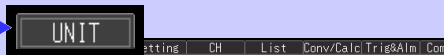

2 Select [Add unit].



A search dialog box will be displayed.

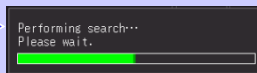

3 The [Add unit] screen will be displayed.

Select [Delete].

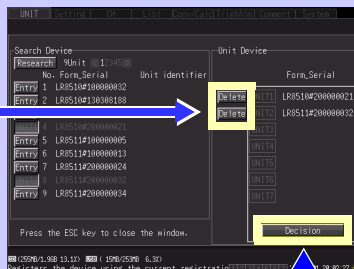

Apply

Select [Decision].  
(Selecting the **ESC**, cancels the deletion and returns you to the [UNIT] screen.)

4 A deletion dialog box will be displayed, and the selected unit(s) will be deleted.

### If there are registered units when the instrument starts up

The instrument will connect to registered units one at a time. The connection process may take anywhere from several seconds to several dozens of seconds.

#### NOTE

If the [Add unit] or [Delete unit] screen is displayed, connection processing will not be performed.

## 2.7 Inserting a SD Memory Card or USB Flash Drive (when saving data)

To save and reload the instrument measurement data, use the included or an optional SD memory card (as described below) or an after-market USB flash drive.

Be sure to read "Using a SD memory card/USB flash drive" (p .20) before using removable storage media.

### Important

Performance specifications cannot be guaranteed when using storage media other than the included or an optional SD memory card.

See "6.4 Data Management" (p. 178) for details about managing data storage in the media.

**SD Card Insertion & Removal****Inserting a SD memory card**

- 1** Open the SD memory card slot cover.
- 2** Face the SD memory card with the arrow mark on top (▲), and insert it in the direction of the arrow all the way in the slot.
- 3** Close the SD memory card slot cover.

Be sure to close the cover on the SD memory card slot.

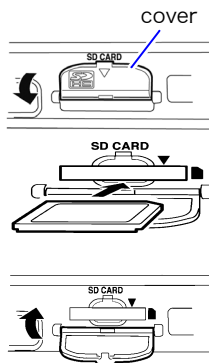
**Removing a SD memory card**

Be sure to verify that the instrument is not accessing the card (to save or load data, etc.).

- 1** Open the SD memory card slot cover.
- 2** Push the SD memory card in and then once it is protruding slightly from the slot, grip it and pull it out.

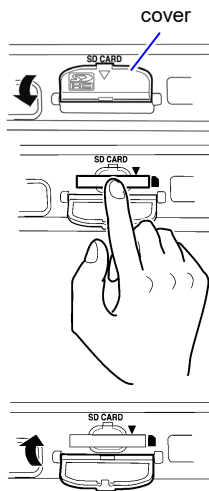

- 3** Close the SD memory card slot cover.

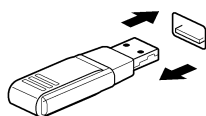
**USB flash drive Insertion & Removal****Inserting a USB flash drive**

Align the USB flash drive connector with the USB port, and insert it all the way in.

**Removing a USB flash drive**

**Pull the USB flash drive out.**





Be sure to verify that the instrument is not accessing the card (to save or load data, etc.).

**See:** To replace removable storage during real-time saving: (p. 168)

## Formatting a SD memory card/USB flash drive

The SD memory card or USB flash drive can be formatted by a PC or by the instrument. Format a new SD memory card or USB flash drive before use.

This procedure describes how to format a SD memory card or USB flash drive in the instrument.

- 1**  **Select the File Screen.**
- 2**  **Press the ENTER key to open the control panel.**
- 3**  **Select [Format].**
- 4**  **Select [Yes].**
- 5**  **Select [Yes].**

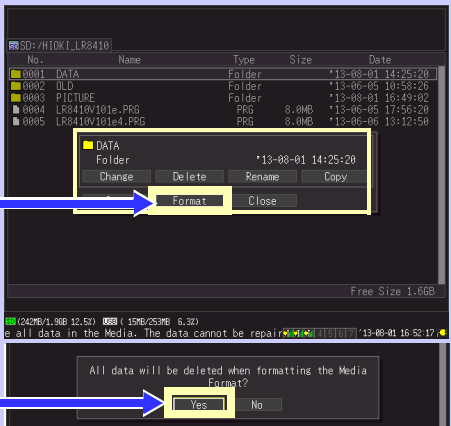

The screenshot shows a file manager interface with a table of files and folders. A context menu is open over the 'DATA' folder, showing options: Change, Delete, Rename, Copy, Format, and Close. The 'Format' option is highlighted with a yellow box. Below the table, a confirmation dialog box is displayed with the text: 'All data will be deleted when formatting the Media. Format?' and 'Yes' and 'No' buttons. The 'Yes' button is highlighted with a yellow box.

### NOTE

Formatting irretrievably erases all data on the SD memory card/USB flash drive. Always backup important data from the SD memory card/USB flash drive before formatting.

## 2.8 Compensating for Input Circuit Offset (Zero Adjustment)

This step is only performed when using the LR8510 or LR8511.

Zero adjustment corrects for voltage offset at the input terminals, so that the instrument measurements are relative to zero volts.

Execute zero adjustment whenever input circuit offset is a concern.

Zero adjustment can be performed by means of the following three methods:

- From the [\[Waveform/Numerical\]](#) screen or the [\[CH\]](#) screen(p. 66)
- From the [\[Gauge+Wave\]](#) screen(p. 67)
- From the [\[List\]](#) screen(p. 68)

From the [\[Waveform/Numerical\]](#) screen or the [\[CH\]](#) screen

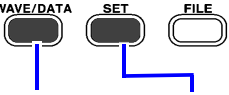
- 

Display the [\[Waveform/Numerical\]](#) screen or [\[CH\]](#) screen
- 

Press and hold these keys simultaneously for one second.  
(simultaneously) The Zero Adjust dialog appears.
- 

Select [\[0 Adjust\]](#).



Apply

Zero adjustment is executed.

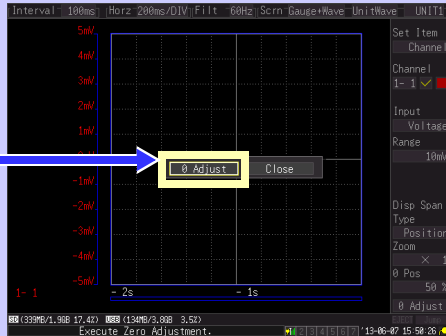

From the Waveform/Numerical screen

## 2.8 Compensating for Input Circuit Offset (Zero Adjustment)

### NOTE

- Any zero-adjust setting is cleared upon system reset (p. 205). (Zero-adjust values are only cleared for units that are connected. The unit's zero-adjust values are not cleared when unit registration information is initialized.)
- Zero adjustment cannot be performed while measuring.
- Change over time can be minimized by allowing the instrument to warm up for about 30 minutes after turning it on before performing zero adjustment.
- Execute zero adjustment without inputting any signals. Zero adjustment may not be complete normally with signals input. There is no need to short-circuit the positive and negative terminals of the measuring instrument.

From the [Gauge+Wave] screen

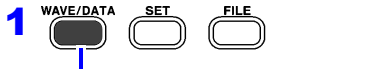
- 

Display the [Gauge+Wave] screen
- 

Select [0 Adjust].
- 

Apply

Zero adjustment is executed.

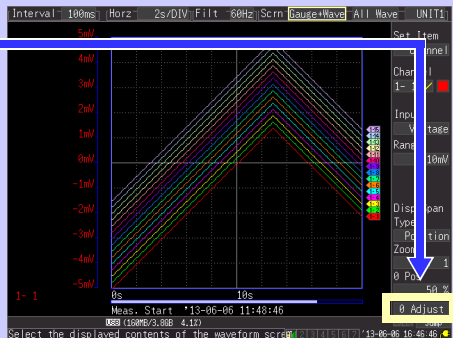

## 2.8 Compensating for Input Circuit Offset (Zero Adjustment)

From the [List] screen

1  WAVE/DATA SET FILE

Display the [List] screen

2  Select [0 Adjust].

3  Apply

Zero adjustment is executed.

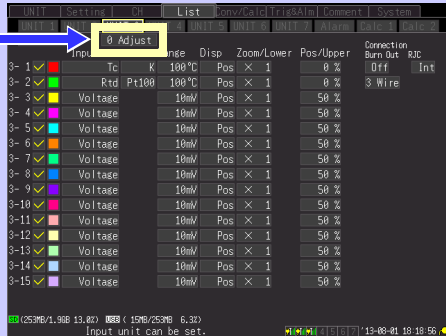

UNIT	Setting	UNIT	List	Conv/Cal	Trig/Alm	Comment	System
UNIT	UNIT	UNIT	UNIT	UNIT	UNIT	UNIT	UNIT
3-1	✓	Inpt	0 Adjust.				
3-2	✓	Tc	K	100 °C	Pos	×	1
3-3	✓	Rtd	Pt100	100 °C	Pos	×	1
3-4	✓	Voltage		10mV	Pos	×	1
3-5	✓	Voltage		10mV	Pos	×	1
3-6	✓	Voltage		10mV	Pos	×	1
3-7	✓	Voltage		10mV	Pos	×	1
3-8	✓	Voltage		10mV	Pos	×	1
3-9	✓	Voltage		10mV	Pos	×	1
3-10	✓	Voltage		10mV	Pos	×	1
3-11	✓	Voltage		10mV	Pos	×	1
3-12	✓	Voltage		10mV	Pos	×	1
3-13	✓	Voltage		10mV	Pos	×	1
3-14	✓	Voltage		10mV	Pos	×	1
3-15	✓	Voltage		10mV	Pos	×	1

Connection: Burn Out 83C  
Off Int

(25370/1.000 13.80) 888 (1510/2530 6.30)  
Input unit can be set.

13-08-01 18:18:58

# Settings

# Chapter 3

## 3.1 Setting Flow Overview

Configure measurement settings before starting to measure.

Select the display method and configure auto saving as needed.

After a measurement setting configuration has been saved (p. 172), you can start measuring immediately after loading the setting configuration data.

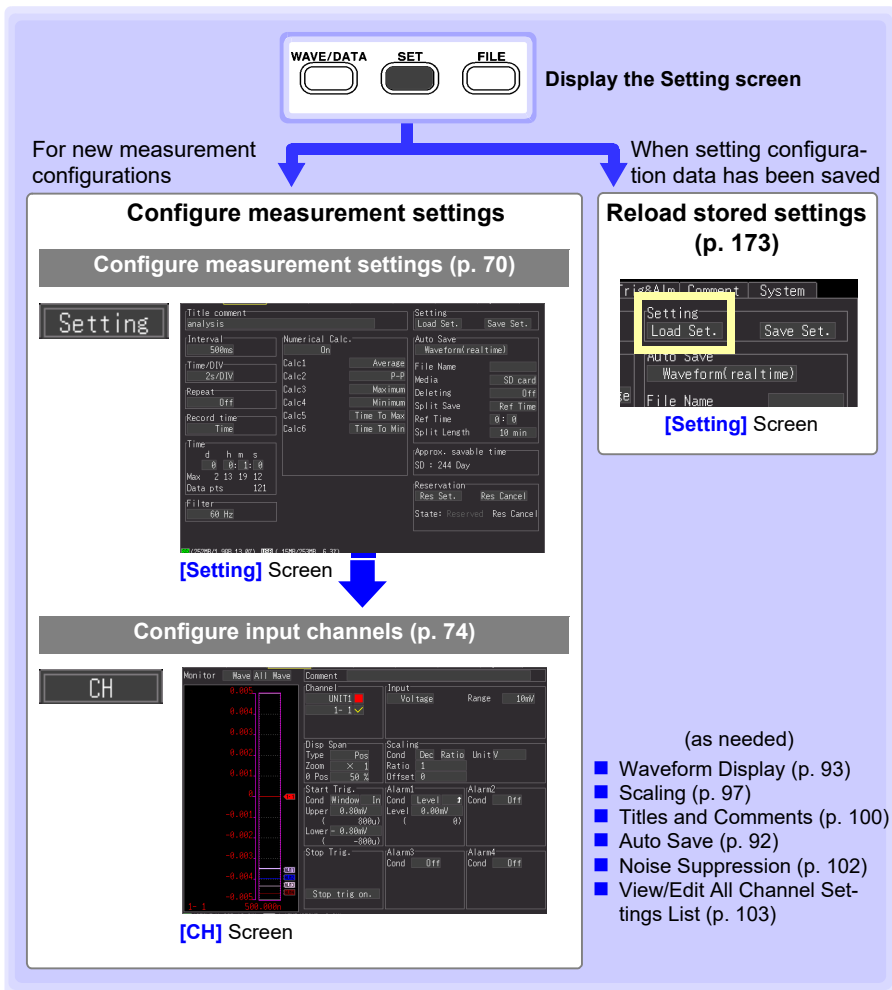



## 3.2 Configuring Measurement Settings

Configure measurement settings on the **[Setting]** screen. The instrument provides continuous recording and timed recording. You can specify whether to perform repeat recording for each.

**NOTE** The Setting screen cannot be displayed while measuring.

Start Measurement    Stop Measurement

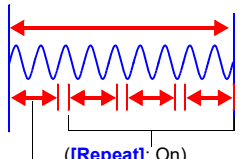

([Repeat]: On)

Measurement is performed for the specified amount of time.

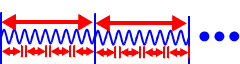

**Continuous Recording ([Cont])** Press **STOP** to stop measuring. Otherwise, measurement continues until the stop-trigger criteria are met.

---





**Timed recording ([Time])** Measurement is performed for the specified amount of time. Measurement stops when the specified recording time has elapsed. Measurement can also be stopped by pressing **STOP** before the end of the recording time, or the stop-trigger criteria are met.

---

**Repeat Recording** When stopped by a stop trigger or elapsed recording time, measurement automatically restarts. Press **STOP** to stop measuring.

Measuring Method	Setting Method
<b>Continuous Recording</b>	Sets the record time to <b>[Cont]</b> .
<b>Timed recording</b>	Sets the record time to <b>[Time]</b> . This allows you to set the amount of time for which to record data.
<b>Repeat Recording</b>	Set <b>[Repeat]</b> to On.

### Time Setting by Key Operations

- 1  Select the **[Setting]** screen.
- 2  Move to a setting item.
-  Open the setting options for the item to be set.
-  Select from the listed options.
-  Apply

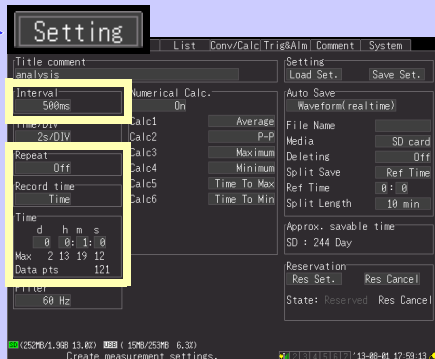

### Recording Interval (Interval)

Select the data acquisition interval.

Setting options:( \* : default setting)

**100 ms\***, **200 ms**, **500 ms**, **1 s**, **2 s**, **5 s**, **10 s**, **20 s**, **30 s**, **1 min**, **2 min**, **5 min**, **10 min**, **20 min**, **30 min**, **1 h**

### Repeat Recording (Repeat)

Select whether to automatically start a new measurement after stopping, or to finish after one measurement.

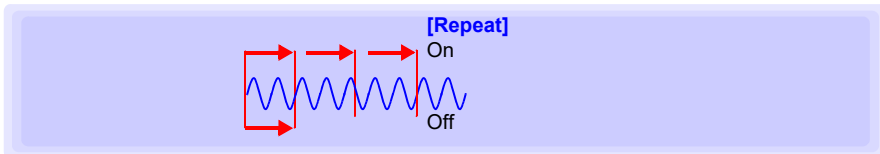

Setting options:( \* : default setting)

<b>Off*</b>	Measuring stop after one recording length (time span).
<b>On</b>	When stopped by a stop trigger or after measurement for the specified amount of time, measurement automatically restarts. Press <b>STOP</b> to stop measuring.

### Recording Time (Record time)

Select whether to measure for a specified time span, or continuously.

Setting options:( \* : default setting)

<b>Time</b>	Use when you wish to specify the recording time for measurement.
<b>Cont*</b>	Use when you wish to conduct measurement until the <b>STOP</b> key is pressed or until the stop trigger criteria are satisfied.

### Recording time specification(Record time specification)

Set when the record time is set to **[Time]**.

Specify the duration of one recording length (time span).

The maximum setting is limited by the recording capacity of internal buffer memory. The actual limit depends on the selected recording interval and number of channels used for measurements, so the maximum settable time is displayed as the **[Max]** value (indicated by the red box).

**[Max]**, **[Data pts]**

If you wish to record to the SD memory card or USB memory stick beyond the maximum recording time for the instrument's internal memory, set the record time to **[Cont]**.

"Maximum Recordable Time" (p.14)

You cannot specify 0 d 0 h 0 min 0 s as the time. If you do so, the time will automatically be set to 0 d 0 h 0 min 1 s.

Setting options:(default setting: 10 seconds)

**d (0 to 499)**, **h (0 to 23)**, **min (0 to 59)**, **s (0 to 59)**

## 3.2 Configuring Measurement Settings

### NOTE

#### About the Recording Interval

- Select the data acquisition interval to suit your measurement objectives.
- Note that shorter recording intervals restrict the maximum recording time.
- You can specify values starting at 100 ms without regard to the number of units.
- When the burnout detection setting is on, you can specify values starting at 200 ms.

**See:** "Chapter 12 Specifications" (p. 277)

- Some waveform peaks may not be displayable with certain interval settings.

For example, when the **[Interval]** is 1 s and the **[Time/DIV]** (time base) is 5 s/DIV.

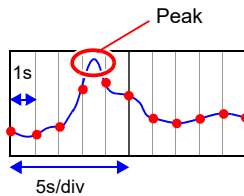

**See:** About Horizontal Axis Settings: (p. 96)

- The recording interval cannot be changed while measuring. Stop measurement before setting.

When the record time is set to **[Time]** and **[Repeat]** is on, it may take time to perform internal processing after measurement for the specified amount of time, before measurement can be resumed (dead time). Measurement cannot be performed during this period of time. If you wish to avoid losing any data or segment files at a particular time, set the record time to **[Cont]** and the **[Split Save]** setting to on for automatic saving.

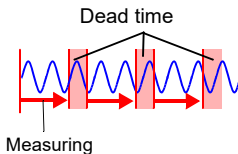

**NOTE****Data update interval**

Data is updated at the unit's minimum recording interval, regardless of the instrument's recording interval setting.

Unit	Minimum recording interval (data refresh interval)
LR8510	100 ms
LR8511	100 ms
LR8512	100 ms
LR8513	500 ms
LR8514	500 ms
LR8515	100 ms
LR8520	500 ms

If the recording interval setting is shorter than the data update interval, there will be some intervals when the data is not updated. Since the measured value shown at such times will be the same as the value for the last data update, the waveform will take on a stepped appearance.

Example: If the recording interval is set to 100 ms while using the LR8510 and LR8513

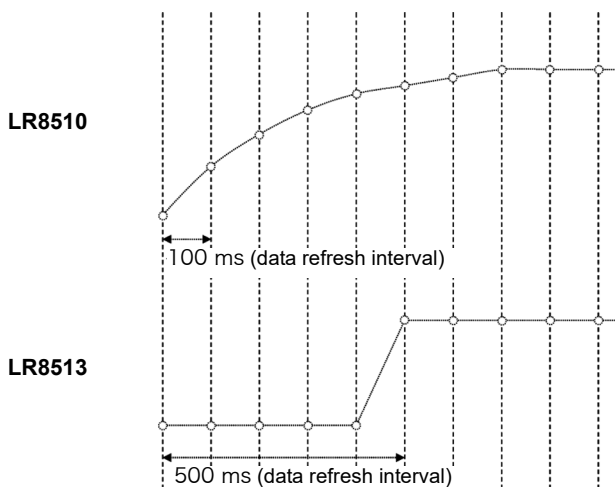

## 3.3 Input Channel Settings

Configure the input channel settings on the **[CH]** screen.

**NOTE** The Setting screen cannot be displayed while measuring.

Input channels are as follows. Each channel can provide the following measurements.

- Wireless Voltage/Temp Unit  
(UNIT1 to UNIT7, each with channels CH1 to CH15)
- Wireless Universal Unit  
(UNIT1 to UNIT7, each with channels CH1 to CH15)
- Wireless Pulse Logger (UNIT1-7, each with channels CH1-2)
- Wireless Clamp Logger (UNIT1-7, each with channels CH1-2)
- Wireless Humidity (UNIT1-7, each with channels CH1-2)
- Wireless Voltage/Temp Logger (UNIT1-7, each with channels CH1-2)
- Wireless Fungal Logger (UNIT1-7, each with channels CH1 onl)

Application	Channels Used	Reference page
Voltage Measurement	Channels on a Wireless Voltage/Temp Unit or Wireless Universal Unit	(p. 77)
Temperature Measurement (using thermocouples)		(p. 78)
Temperature Measurement (using RTDs)		(p. 80)
Humidity Measurement	Channels on a Wireless Universal Unit	(p. 82)
Resistance Measurement		(p. 83)
Integration Measurement		(p. 84)
RPM measurement	Channels on a Wireless Pulse Logger	(p. 86)
Logic Measurement		(p. 88)
Current Measurement	Channels on a Wireless Clamp Logger	(p. 89)
Temperature Measurement	Wireless Humidity Logger	(p. 81)
Humidity Measurement	Wireless Fungal Logger	(p. 82)
Fungal index		(p. 91)
Fungal growth projection	Wireless Fungal Logger	(p. 91)

Other than these, measurements with specific criteria and alarm outputs are available. See "Chapter 5 Specifying Criteria for Measurements" (p. 129) for details.

## Key Setting Procedure

**1** Select the [CH] screen.

**2** Move to a setting item.

**3** Open the setting options for the item to be set.

**4** Select from the listed options.

**5** Apply

**UNIT** selects the input unit and **CHAN** select the channel to be set.

### Unit Switching

(Input channel settings) UNIT1 •••UNIT7 → (alarm output channel settings) ALARM → (numerical calculation channel settings) CALC1 → CALC2 → and return to UNIT1

### Channel Switching

(Input channel settings) 1-1 ••• 1-15 → 2-1 ••• 2-15 → 3-1 ••• 3-15 → 4-1 ••• 4-15 → 5-1 ••• 5-15 → 6-1 ••• 6-15 → 7-1 ••• 7-15 (alarm output channel settings) ALM1 ••• ALM4 → (waveform calculation channel settings) W1 ••• W30 → and return to 1-1

### View input status and the display range while making settings on the [CH] screen.

After setting, press **MONITOR** to confirm input status and display ranges (p. 42).

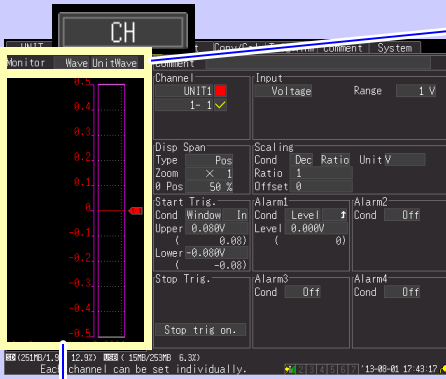

### Level Monitor

Selecting **[Wave]** causes the scale for the currently selected channel to be displayed. The gauge scale is determined by measurement and display range settings.

**Monitoring is not available for disabled (Measurement Off) channels, and those with [X] selected for their color.**

### Monitor display switching

Allows you to switch the information displayed by the level monitor.

(Settings on left)

■ **[Wave]**  
Displays the waveform.

■ **[Value]**  
Displays values for the units set on the right side of the screen.

(Settings on right)

Allows you to select which waveform to display if the setting on the left includes any **[wave]**.

■ **[All Wave]**  
Displays the waveforms for all channels.

■ **[UnitWave]**  
Displays the waveforms for all channels from the units set on the right side of the screen.

■ **[Ch Wave]**  
Displays the waveforms for channels set on the right side of the screen.

### NOTE

Level monitor numerical value refresh rate and waveform horizontal axis span depend on the recording interval and horizontal axis (time base) settings. Therefore, long recording intervals can delay numerical value display refresh by as much as 5 seconds. If you need faster value display refresh, select a shorter recording interval. If the horizontal axis (time span) is too long, one division of the waveform may not be displayed.

## Voltage Measurement Settings

Configure these settings for each voltage measurement channel.

See: "Key Setting Procedure" (p .75)

**1** Select the input unit (**UNIT1 to 7**) and channel (**1-1 to 7-15**), and check the box to enable the channel.

**2** Select **[Voltage]**.

**3** Select the appropriate measurement amplitude range.

Setting options:( \* : default setting)

When LR8510 or LR8511 is used

**10 mV\***, **20 mV**, **100 mV**, **200 mV**, **1 V**, **2 V**, **10 V**, **20 V**,  
**100 V**, **1-5 V**

When LR8515 is used

**50 mV\***, **500 mV**, **5 V**, **50 V**

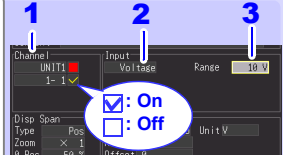

### When a measured value far exceeds the range limit (range label)

"OVER" or "-OVER" is displayed in place of numerical/cursor values, and the following values are applied to calculations and data storage.

Input type	Input range	+OVER value	-OVER value
Voltage	10 mV	0.0163835	-0.016384
	20 mV	0.032767	-0.032768
	50 mV	0.32767	-0.32768
	100 mV	0.163835	-0.16384
	200 mV	0.32767	-0.32768
	500 mV	3.2767	-3.2768
	1 V	1.6384	-1.6384
	2 V	3.2767	-3.2768
	5 V	32.767	-32.768
	10 V	16.3835	-16.384
	20 V	32.767	-32.768
	50 V	327.67	-327.68
	100 V	163.835	-163.84
	1-5 V	16.3835	-16.384

### Instrumentation and Control Device Measurements

- To measure 4-20 mA current, connect a 250  $\Omega$  shunt resistor between + and - analog input terminals (p. 50).
- Select the **[1-5 V]** range to measure 4-20 mA instrumentation control signal outputs.
- The **[1-5 V]** setting automatically selects the **[10 V]** range with an 5-V upper limit and 1-V lower limit. To change the upper and lower limits, select the **[10 V]** range.

### NOTE

Use the scaling function to scale measurements to any arbitrary unit value for display (p. 97).



## Temperature Measurement Settings (using thermocouples)

Follow this procedure to configure thermocouple temperature measurement channels. Make these settings on the [CH] screen.

See: "Key Setting Procedure" (p .75)

**1** Select the input unit (UNIT1 to 7) and channel (1-1 to 7-15), and check the box to enable the channel.

**2** Select [Tc].

**3** Select the temperature measurement range.

Setting options:( \* : default setting)

When LR8510 or LR8511 is used

100°C\*, 500°C, 2000°C

The type-B thermocouple setting is disabled when the 100°C or type-B thermocouple, first set the range to 2000°C.

Setting options:

When LR8515 is used

1000°C

**4** Select the type of thermocouple to be used.

Setting options:( \* : default setting)

When LR8510 or LR8511 is used

K\*, J, E, T, N, R, S, B, W

When LR8515 is used

K\*, T

**5** Enable/disable burn-out detection.

Setting options:( \* : default setting)

**OFF\*** Disable burn-out detection. Normally when the thermocouple is disconnected, the value will fluctuate, etc. and will not be stable.

**ON** Detect burn-out during thermocouple measurement. When a burn-out occurs, "BURNOUT" is displayed as the numerical, cursor, or calculation value, and the following values are applied to calculations and data storage: 327.66, 1638.3, and 3276.6°C for the 100, 500, 1000°Cf.s. and 2000°Cf.s. ranges, respectively. Note that the recording interval setting is limited.

See: "About the Recording Interval" (p .72)

**6** Select the reference junction compensation (RJC) method.

Setting options:( \* : default setting)

**Int\*** Use the instrument's internal compensation. Select this when connecting the thermocouple (or compensating leads) directly to the instrument. Measurement accuracy is the sum of the temperature measurement accuracy and the RJC accuracy.

**Ext** Use an external RJC method instead of the instrument's internal compensation. Use this setting when connecting an external reference junction compensation device (0°C ice water, etc.). The instrument measurement accuracy is equivalent to the temperature measurement accuracy.

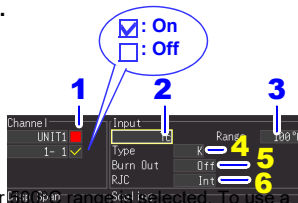

### Temperature Measurement Range

(Depends on thermocouple type)

<b>K</b>	-200°C to 1350°C
<b>J</b>	-200°C to 1200°C
<b>E</b>	-200°C to 1000°C
<b>T</b>	-200°C to 400°C
<b>N</b>	-200°C to 1300°C
<b>R</b>	0°C to 1700°C
<b>S</b>	0°C to 1700°C
<b>B</b>	400°C to 1800°C
<b>W</b>	0°C to 2000°C

- With type B, the display shows 0 to 400°C, but accuracy is not guaranteed.
- The K temperature measurement range for the LR8515 is -200°C to 999.9°C.

### About Burn Out Detection

- When burn out detection is enabled, the instrument detects wiring breaks by outputting a minuscule current every recording interval during thermocouple measurement.?
- Since the detection process uses different timing than measurement, this operation does not affect measured values.
- When using the same recording interval on the LR8510 or LR8511, the cutoff frequency when burn out detection is enabled is higher than when the setting is disabled, reducing noise rejection effectiveness.

**See:** "Cut-off frequency" (p .292)

- When measuring the range's positive full-scale temperature, burn out detection may be triggered if the thermocouple's resistance value exceeds the applicable value listed below. When you need to string a long thermocouple for use with burn out detection enabled, take steps to avoid this phenomenon, for example by using a thick wire diameter.

		Range			
		100 °C f.s.	500 °C f.s.	1000 °C f.s.	2000 °C f.s.
thermo couple	K	310	5400	960	2940
	J	470	4150	—	200
	E	450	5970	—	570
	T	270	5440	5820	5440
	N	270	1470	—	590
	R	50	1040	—	580
	S	50	120	—	1300
	B	—	—	—	350
	W	220	910	—	250

Unit:  $\Omega$

Reference: When measuring temperature close to the positive full-scale value in the K 100 C range while using a thermocouple with a wire diameter of 0.32 mm, a wiring length of about 25 m or more may trigger burn out detection.

### If Thermocouple Measurement Range is Exceeded, or If the Range's Measurement Range Is Greatly Exceeded

- Example: Using a type T thermocouple with range -200 to +400°C. When measurements are outside of the range of the thermocouple, the waveform saturates and clings to the top of the screen as shown at the right.
- If the range's measurement range is greatly exceeded, the value display and cursor value will indicate "OVER" or "-OVER," and calculation values and save data will be replaced with a value from the table below.

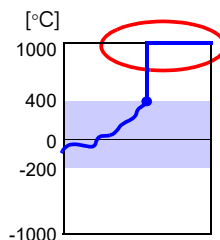

Input type	Input range	+OVER value	-OVER value
thermocouple	100°C	327.67	-327.68
	500°C	1638.4	-1638.4
	1000°C	3276.7	-3276.8
	2000°C	3276.7	-3276.8

- When burn out detection is enabled, measurement results that fall outside the thermocouple's measurement range or the range's measurement range may be treated as a burn out event. (p. 78)

## Temperature Measurement Settings (for RTDs)

Follow this procedure to configure resistance temperature detector (RTD) measurement channels. Make these settings on the [CH] screen.

See: "Key Setting Procedure" (p.75)

**1** Select the input unit (UNIT1 to 7) and channel (1-1 to 7-15), and check the box to enable the channel.

**2** Select [Rtd].

**3** Select the appropriate temperature measurement range.

Setting options:( \* : default setting)

**100°C\***, 500°C, 2000°C

**4** Select the type of RTD to be used.

Setting options:( \* : default setting)

**Pt100\***, JPt100

**5** Select the wiring method.

Setting options:( \* : default setting)

**3 Wire\*** 3-wire RTD connection configuration

**4 Wire** 4-wire RTD connection configuration

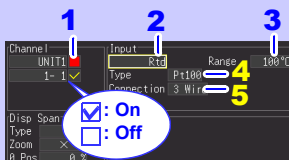

The range setting determines the measurable temperature range

<b>100°C</b>	-100°C to 100°C
<b>500°C</b>	-200°C to 500°C
<b>2000°C</b>	-200°C to 2000°C

Temperature measurement limits are determined by the measurement range selected for each sensor.

Temperature Measurement Ranges

(Temperature measurement range depends on RTD characteristics)

<b>Pt100</b>	-200°C to 800°C
<b>JPt100</b>	-200°C to 500°C

**When the RTD measurement range is exceeded, or when a measured value far exceeds the range limit (range label)**

- Example: Using a type Pt100 RTD with range -200 to +800°C  
When a measured value exceeds the measurement range of the RTD and far exceeds the range limit (range label), the waveform saturates at the top of the screen, as shown at the right.
- When a measured value far exceeds range limit (range label), "OVER" or "-OVER" is displayed in place of numerical/cursor values, and the following values are applied to calculations and data storage.

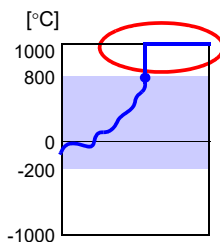

Input type	Input range	+OVER value	-OVER value
RTD	100°C	327.67	-327.68
	500°C	1638.4	-1638.4
	2000°C	3276.7	-3276.8

## Temperature Measurement Settings (When LR8514 or LR8520 is used)

Enable this channel setting for temperature measurement with the LR8514 Wireless Humidity Logger, LR8520 Wireless Fungal Logger. Make these settings on the [CH] screen.

**See:** "Key Setting Procedure" (p .75)

- 1** Select the input unit (UNIT1 to 7) and channel (1-1 to 7-15), and check the box to enable the channel.

The measurement setting applies to the two temperature and humidity inputs for the LR8514 and to the four temperature, humidity, fungal index, and fungal growth projection inputs for the LR8520.

- 2** The input type is fixed to temperature, and the measurement range is fixed to 100°C.  
-100°C to 100°C

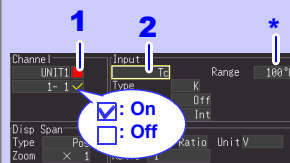

\* The range is fixed at [100% f.s.].

### When a measured value far exceeds the range limit (range label)

"OVER" or "-OVER" is displayed in place of numerical/cursor values, and the following values are applied to calculations and data storage.

Input type	Input range	+OVER value	-OVER value
Temperature	100°C	3276.7	-3276.8

### 3.3 Input Channel Settings

#### Humidity Measurement Settings (When LR8511 is used)

Enable this channel setting for humidity measurement with the optional Z2000 Humidity Sensor. Make these settings on the [CH] screen.

See: "Key Setting Procedure" (p.75)

**1** Select the input unit (UNIT1 to 7) and channel (1 to 7), and check the box to enable the channel.

**2** Select [Humid].

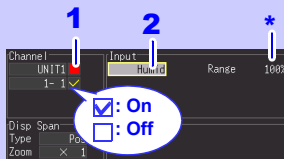

\* The range is fixed at [100% f.s.].

#### When a measured value far exceeds the range limit (range label)

"OVER" or "-OVER" is displayed in place of numerical/cursor values, and the following values are applied to calculations and data storage.

Input type	Input range	+OVER value	-OVER value
Humidity	100%RH	3276.7	-3276.8

#### Humidity Measurement Settings (When LR8514 or LR8520 is used)

Enable this channel setting for humidity measurement with the LR8514 Wireless Humidity Logger, LR8520 Wireless Fungal Logger. Make these settings on the [CH] screen.

See: "Key Setting Procedure" (p.75)

**1** Select the input unit (UNIT1 to 7) and channel (1-1H to 7-2H), and check the box to enable the channel.

The measurement setting applies to the two temperature and humidity inputs for the LR8514 and to the four temperature, humidity, fungal index, and fungal growth projection inputs for the LR8520.

**2** The input type is fixed to temperature, and the measurement range is fixed to 100°C.

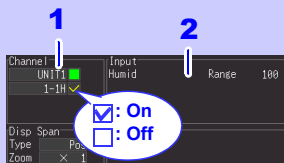

## Resistance Measurement Settings

Make these channel settings for resistance measurement.

Make these settings on the [CH] screen.

See: "Key Setting Procedure" (p .75)

**1** Select the input unit (UNIT1 to 7) and channel (1-1 to 7-15), and check the box to enable the channel.

**2** Select [Resist].

**3** Select the appropriate measurement amplitude range.

Setting options:( \* : default setting)

10 Ω\*, 20 Ω, 100 Ω, 200 Ω

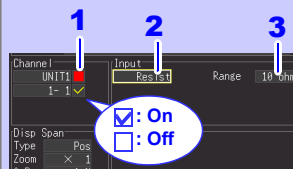

### NOTE

When measuring an inductive load, for example from a wire-wound resistor, the instrument's response may not be fast enough when the inductor value is 50 mH or greater, preventing accurate measurement.

### When a measured value far exceeds the range limit (range label)

"OVER" or "-OVER" is displayed in place of numerical/cursor values, and the following values are applied to calculations and data storage.

Input type	Input range	+OVER value	-OVER value
Resistance	10 Ω	16.3835	-16.384
	20 Ω	32.767	-32.768
	100 Ω	163.835	-163.84
	200 Ω	327.67	-327.68

## Integration (Count) Measurement Settings

Configure these settings for each pulse channel receiving input from a pulse output device such as a watt-hour or flow meter. Make these settings on the [CH] screen.

See: "Key Setting Procedure" (p.75)

**1** Select the input unit (**UNIT1 to 7**) and channel, and check the box to enable the channel.

**2** Select [Count].

**3** Select the integration mode (Count Mo).

Setting options:( \* : default setting)

**Add\*** Counts the number of pulses acquired from the start of measurement.

**Inst** Counts the number of pulses acquired during each recording interval. The pulse count is reset at the beginning of each recording interval.

**4** Select the basis of measurement (Slope).

Setting options:( \* : default setting)

↑\* Counts the number of L - H transitions.

↓ Counts the number of H - L transitions.

**5** Select the High/Low reference (threshold) values.

Setting options:( \* : default setting)

**1V\*** Judge 1.0 V or higher as HIGH, and 0 to 0.5 V as LOW.

**4V** Judge 4.0 V or higher as HIGH, and 0 to 1.5 V as LOW.

**6** Select a filter setting.

Setting options:( \* : default setting)

**Off\*** Filter is disabled.

**On** Filter is enabled. Prevents incorrect counts due to relay contact chatter (noise).

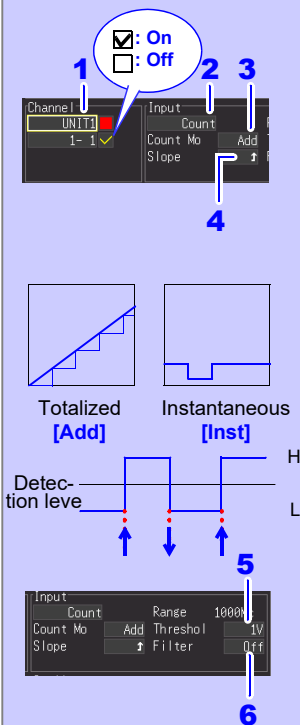

### When a measured value far exceeds the range limit (range label)

"OVER" or "-OVER" is displayed in place of numerical/cursor values, and the following values are applied to calculations and data storage.

Input type	Input range	+OVER value	-OVER value
Integration	1000Mc	2147483647	-

**NOTE**

- Use the scaling function to display integrated pulse counts as the corresponding physical units (such as Wh or VA) of the measurement parameter (p. 97).
- The counter saturates at 1,073,741,823 counts. If you expect to exceed this count, we recommend measuring with the Integration Mode (Count Mo) set to Instantaneous (Inst), and summing later with a spreadsheet program.



## Revolution Measurement Settings

Configure these settings for each pulse channel on which you will be counting pulses corresponding to revolutions, such as output from a rotary encoder or tachometer. The revolution measurement is obtained by counting the number of pulses input per second. Make these settings on the [CH] screen.

See: "Key Setting Procedure" (p.75)

**1** Select the input unit (**UNIT1 to 7**) and channel, and check the box to enable the channel.

**2** Select [Revolve].

**3** Set the number of pulses per rotation output from the sensor.



Increment/decrement by 1



Increment/decrement by 10

Setting options:( \* : default setting)

**1\*** to **1000**

The range is automatically determined by this setting.

**4** Select the basis of measurement (Slope).

Setting options:( \* : default setting)

↑\* Counts the number of revolutions based on L - H transitions.

↓ Counts the number of revolutions based on H - L transitions.

**5** Select the High/Low reference (threshold) values.

Setting options:( \* : default setting)

**1V\*** Judge 1.0 V or higher as HIGH, and 0 to 0.5 V as LOW.

**4V** Judge 4.0 V or higher as HIGH, and 0 to 1.5 V as LOW.

**6** Select a filter setting.

Setting options:( \* : default setting)

**Off\*** Filter is disabled.

**On** Filter is enabled. Prevents incorrect counts due to relay contact chatter (noise).

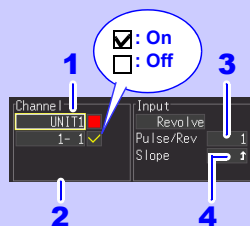

5000 r/s (n=1)

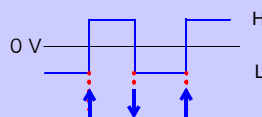

### When a measured value far exceeds the range limit (range label)

"OVER" or "-OVER" is displayed in place of numerical/cursor values, and the following values are applied to calculations and data storage.

Input type	Input range	+OVER value	-OVER value
Revolution	5000r/s	2147483647	-

### Revolution Measurement Theory

Pulse count is measured using the Memory HiLogger's internal 100 ms sampling interval.

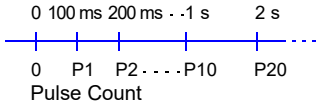

The revolution rate ( $r$ ) per second during time  $t$  [s] is obtained by dividing the number of pulses from  $(t-1)$  to  $t$  [s] by the number of pulses per revolution.

$$r [r/s] = \frac{\text{Pulse count at } t_s \text{ minus pulse count at } (t-1)_s}{\text{Pulses per revolution}}$$

( $r/s$ : Revolutions per second)

#### Example: Pulses per revolution = 4

When the number of pulses counted in one second is  $P_{10} = 1000$  c, and the number of pulses counted in two seconds is  $P_{20} = 2000$  c, then the revolution rate ( $r/s$ ) at  $t=2s$  ( $r_{t=2}$ ) can be obtained.

$$r_{t=2} = \frac{2000 - 1000}{4} = 250 [r/s]$$

#### Exception: When time $t_s$ is less than one second

The pulse count at  $(t-1)_s$  (whole seconds) cannot be measured, so 10 times the pulse count between

$(t-0.1)_s$  and  $t_s$  serves and the pulse count for one second to obtain the revolution rate.

As a result, revolution measurements when  $t$  is less than one second are scattered.

$$r [r/s] = \frac{\text{Pulse count at } t_s \text{ minus pulse count at } (t-0.1)_s}{\text{Pulses per revolution}} \times 100$$

#### NOTE

Use the scaling function to display integrated pulse counts as the corresponding physical units (such as Wh or VA) of the measurement parameter (p. 97).

## Logic Measurement Settings

Make these channel settings for logic measurements.

Make these settings on the [CH] screen.

See: "Key Setting Procedure" (p .75)

**1** Select the input unit (**UNIT1 to 7**) and channel, and check the box to enable the channel.

**2** Select [Logic].

**3** Select the High/Low reference (threshold) values.

Setting options:( \* : default setting)

**1V\*** Judge 1.0 V or higher as HIGH, and 0 to 0.5 V as LOW.

**4V** Judge 4.0 V or higher as HIGH, and 0 to 1.5 V as LOW.

**4** Select a filter setting.

Setting options:( \* : default setting)

**Off\*** Filter is disabled.

**On** Filter is enabled. Prevents incorrect counts due to relay contact chatter (noise).

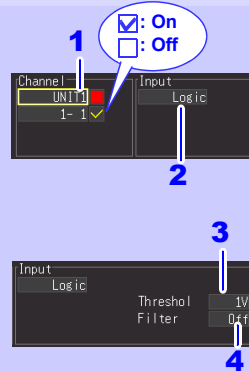

## Current Measurement Settings

Make these channel settings for current measurements.

Make these settings on the [CH] screen.

See: "Key Setting Procedure" (p .75)

**1** Select the input unit (UNIT1 to 7) and channel, and check the box to enable the channel.

**2** Select the clamp sensor being used.

Setting options:( \* : default setting)

9657-10,9669,9675\*,9695-02,CT6500,CT7044,  
CT7045,CT7046,CT7631,CT7636,CT7642,CT7731,  
CT7736,CT7742,CT9667,CT9691-90,CT9692-90,  
CT9693-90

**3** Select the appropriate measurement amplitude range.

Setting options:( \* : default setting)

9657-10	500 mA*,5 A
9669	1000 A*
9675	500 mA*,5 A
9695-02	5 A*,50 A
CT6500	50 A*,500 A
CT7044	50 A*,500 A,5000 A
CT7045	50 A*,500 A,5000 A
CT7046	50 Av,500 A,5000 A
CT7631	10 A*,100 A
CT7636	20 A*,200 A
CT7642	200 A*,2000 A
CT7731	10 A*,100 A
CT7736	20 A*,200 A
CT7742	200 A*,2000 A
CT9667	500 A*,5000 A
CT9691-90	10 A*,100 A
CT9692-90	20 A*,200 A
CT9693-90	200 A*,2000 A

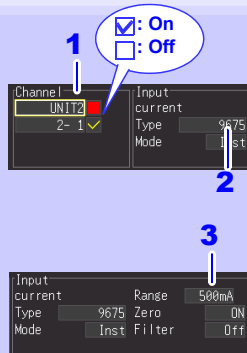

### 3.3 Input Channel Settings

#### 4 Select the zero-suppression setting.

Setting options:( \* : default setting)

<b>On*</b>	Suppresses values of less than 10 counts in each range.
<b>Off</b>	Enables display of values of less than 10 counts. (For zero-adjustment purposes during DC measurement)

#### 5 Select the clamp measurement method.

Setting options:( \* : default setting)

<b>Int*</b>	Records the instantaneous value for each recording interval.
<b>Avg</b>	Takes measurements at an interval of 0.5 sec. and records the average value for each recording interval. (If the recording interval is less than 1 sec., the instrument will record the instantaneous value instead.)
<b>Max</b>	Takes measurements at an interval of 0.5 sec. and records the maximum value for each recording interval. (If the recording interval is less than 1 sec., the instrument will record the instantaneous value instead.)

#### 6 Select a filter setting.

Setting options:( \* : default setting)

<b>Off*</b>	Disables the filter, allowing current measurement including high-frequency components.
<b>On</b>	Allows you to cut unnecessary high-frequency components when performing 50 Hz/60 Hz current measurement.

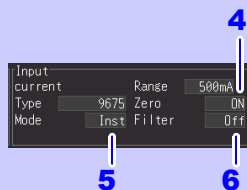

#### NOTE

- The Model LR8513 Wireless Clamp Logger firmware version 1.40 or later is required to be installed to use the following clamp sensors: CT7044, CT7045, CT7046, CT7631, CT7636, CT7642, CT7731, CT7736, CT7742, or CT9667.
- The Model LR8513 Wireless Clamp Logger firmware version 1.30 or later is required to be installed to use the instrument with the clamp measurement method setting set to **[MAX]**

## Fungal Index and Fungal Growth Projection Settings

Make these settings for fungal index and fungal growth projection channels.

Make these settings on the [CH] screen.

See: "Key Setting Procedure" (p .75)

- 1 Select the input unit (UNIT1 to 7) and channel (1-1F to 7-1F, 1-1G to 7-1G), and check the box to enable the channel.

On the LR8520, the measurement setting applies to the four temperature, humidity, fungal index, and fungal growth projection inputs.

- 2 The input types are fixed to fungal index and fungal growth projection, and the measurement ranges are fixed to 200 and 10.

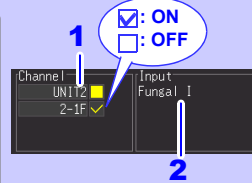

## 3.4 Alarm Settings

When setting alarm conditions for each input signal (channel), you can sound a buzzer or output an alarm signal from the instrument. For more information, see "5.9 Alarm Output" (p. 153). To output an alarm signal, it is necessary to make connections to the external control terminal. For more information, see "9.3 Alarm Signal Output (Alarm Output)" (p. 209).

## 3.5 Data Saving Settings

Before measuring, select whether to automatically save data to SD memory card or USB flash drive while measuring, or to immediately save manually (only when you press **SAVE**). See Auto Saving (p. 165) and Immediate Saving (p. 169) for setting procedures.





## 3.6 Waveform Display Settings (as needed)

Set the waveform display settings as needed.

These settings can be changed on the Numerical/Waveform screen after measurement (p. 116).

**NOTE** The Setting screen cannot be displayed while measuring.

### Key Setting Procedure

- 1  Select the [CH] screen.
- 2  Move to a setting item.
-  Open the setting options for the item to be set.
-  Select from the listed options.
-  Apply

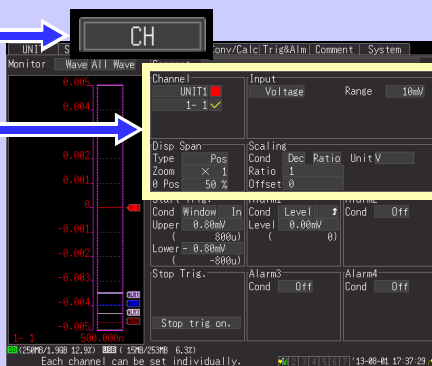

**UNIT** selects the input unit and the **CHAN** selects the channel to be set.

### Selecting Waveform Display Color

Different display colors can be selected for each input channel waveform.

Select from the waveform display color setting options.

Setting options: Off (x), 24-color

You can switch between off and the selected color by pressing the **ESC** key. (This operation is not available while the Configuration Navigator is running.)

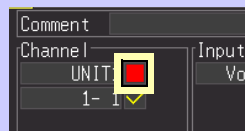



3.6 Waveform Display Settings (as needed)

Specifying Vertical Display Range by Magnification and Zero Position (vertical axis expansion/compression)

The vertical display range and zero position can be specified for each channel. The magnification setting determines the displayed range. Waveforms are expanded or compressed vertically relative to the center of the screen.

The display range of the vertical axis emphasizing 0V display position

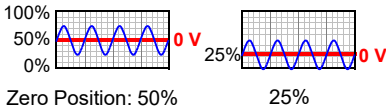

Display range magnification setting (expansion/compression)

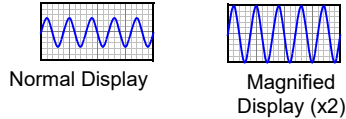

Make these settings on the [CH] screen.

See: "Key Setting Procedure" (p.93)

- 1 Select [Pos].
- 2 Select the magnification.  
Setting options:( \* : default setting)
- 3 Set the desired zero position as a percentage of screen height.

x100, x50, x20, x10, x5, x2, x1\*, x1/2

Setting options:  
-50 to 150% (with x1 magnification)

Zoom	Zero-Position setting range	Zoom	Zero-Position setting range
x1/2	0 to 100%	x10	-950 to 1050%
x1	-50 to 150%	x20	-1950 to 2050%
x2	-150 to 250%	x50	-4950 to 5050%
x5	-450 to 550%	x100	-9950 to 10050%

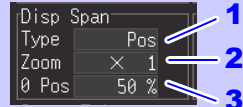

Change 1's digit  
The expansion/compression range depends on the selected magnification.

Default Setting

Input type	Zoom	Zero position	Input type	Zoom	Zero position	Input type	Zoom	Zero position
Voltage	x1	50	Humidity (Humid)	x1	0	Rotation	x1	0
Temperature (Tc)	x1	0	Resistance (Resist)	x1	0	Logic	-	-
Temperature (Rtd)	x1	0	Integration (Count)	-	-	Current (AC Clamp) <sup>*</sup> Current (AC/DCClamp) <sup>*</sup>	x1	0
Temperature	x1	0	Fungal index	x1	0	Fungal growth projection	x1	0

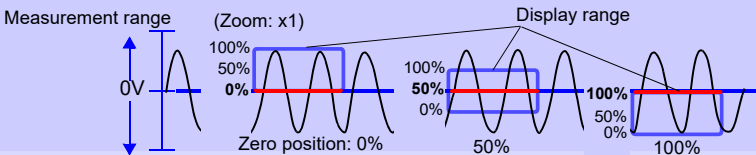

## NOTE

Magnification and zero-position settings are ignored when the display range is defined by upper and lower limits.

### Specifying the Vertical Display Range by Upper and Lower Limits (expansion/compression)

The vertical display range can be defined by upper and lower limits.

Using this method, the voltage range does not need to be selected because the optimum range is selected automatically for the display.

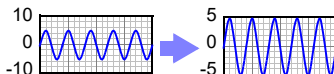

Make these settings on the [CH] screen.

See: "Key Setting Procedure" (p .93)

**1** Select [Up/Lwr].

**2** Specify the [Upper] value for the top of the display.

Move the cursor to the numerical value and press **ENTER** to display the numerical setting dialog.

See: Numerical Value Entry (below)

**3** Specify the [Lower] value for the bottom of the display.

Set in the same way as the upper value.

The display range and scaling settings are interlinked.

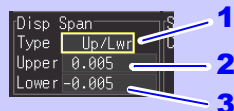

Numerical Setting Dialog

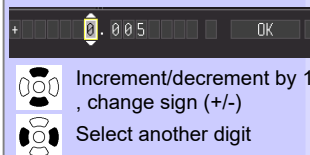

Increment/decrement by 1, change sign (+/-)

Select another digit

#### Default Setting

Input type	Upper/Lower Limits	Input type	Upper/Lower Limits
Voltage	-0.005 to 0.005	Humidity (Humid)	0 to 100
Temperature (Tc)	0 to 100	Resistance (Resist)	0 to 10
Temperature (Rtd)	0 to 100	Integration (Count)	0 to 5000
Rotation	0 to 5000	Logic	-
Current	0 to 1	Temperature	0 to 100
Fungal index	0 to 200	Fungal growth projection	0 to 4

#### ■ Numerical Value Entry

1. Select a digit to change with the left/right cursor keys, and increment/decrement the digit with the up/down keys.

(The rightmost character is for an optional measurement unit symbol. Pressing the up/down keys selects from among E - P - T - G - M - k - (blank) - m - u - n - p - f - a. If no unit symbol is needed, it can be left "blank".)

2. When the desired value is selected, press [OK].

## NOTE

- However, upper and lower limit settings are ignored when magnification and zero position are enabled to define the display range.
- The range is not automatically optimized when the upper and lower limits are set on the Waveform/Numerical screen.



## 3.7 Scaling Settings (as needed)

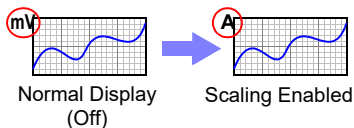

Normal Display  
(Off)

Scaling Enabled

The Setting screen cannot be displayed while measuring.

Use the scaling function to convert input voltage to the physical units of the measurement parameter for display, such to convert voltage input for display as electrical current.

Converted values can be displayed in fixed or floating-point notation.

Make these settings on the [CH] screen.

See: "Key Setting Procedure" (p.93)

### Scaling Voltage, Temperature, Humidity, Resistance, Revolution, and Current Measurements

#### 1 Select the desired numerical notation.

Setting options:( \* : default setting)

<b>Dec</b>	Displays converted values using fixed-point notation.
<b>Exp</b>	Displays converted values using floating-point notation.
<b>Off*</b>	Scaling is disabled.

#### 2 Select the scaling method.

Setting options:( \* : default setting)

<b>Ratio*</b>	Convert by specifying the ratio of physical units per volt of input signal (conversion ratio), offset, and the name of the units.
<b>2-pt</b>	Convert by specifying the input signal voltage at two points, the physical unit values at those points, and the name of the units.

#### 3 Enter the [Unit] name on the comment entry screen. (Up to 7 characters)

See: About Comments (p. 100)

#### 4 Ratio: Enter the conversion ratio and offset.

**2-pt: Enter the values at two points before and after conversion.**

Move the cursor to the numerical value and press **ENTER** to display the numerical setting dialog.

See: "Numerical Value Entry" (p.95)

With [Cond] set to [Dec]



Conversion Ratio Setting

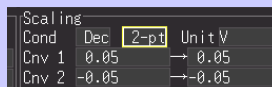

2-Point Setting

With [Cond] set to [Exp]

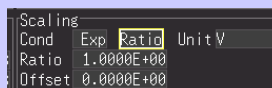

Conversion Ratio Setting

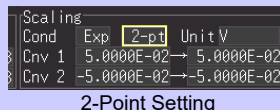

2-Point Setting

A value measured on CH1 of UNIT1 (Analog channel CH1-1) can be set as the scaling value (Inter-Channel Compensation function) (p. 109).

**3.7 Scaling Settings (as needed)**

**Conversion Ratio Setting Method**

**2-Point Setting Method**

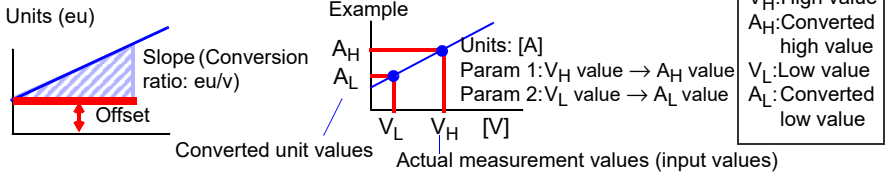

**When using the LR8513 Wireless Clamp Logger to calculate 1-phase/2-wire power**

By using the logger's scaling function, you can convert measured current values into 1-phase/2-wire power values.

By setting the [Conversion factor] under [Scaling] to  $(V \times \lambda)$  (where V indicates the voltage and  $\lambda$  the power factor) and setting the [Unit] to [W], you can display the 1-phase/2-wire power value.

Power value  $W =$  Scaling conversion factor  $\times$  current value  $= V \times \lambda \times$  current value

Example setting: To measure the 1-phase/2-wire power value when the voltage is 100 V and the power factor is 0.8 $\lambda$

- 1** Set the scaling method to [Ratio].
- 2** Set the conversion factor to [80].  
(Since  $100 \times 0.8 = 80$ )
- 3** Set the unit to [W].

When [Condition] is set to [Decimal]

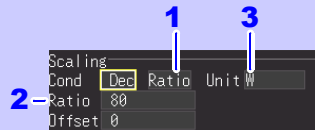

## Integration Measurement Scaling Setting

Integrated pulse values can be converted for display as physical units of the measurement parameter (such as Wh or VA).

Pulse output devices determine the amplitude per pulse in physical units, or the number of pulses per fundamental unit (for example, per kWh, liter or m<sup>3</sup>).

### 1 Select the desired numerical notation.

Setting options: (\* : default setting)

<b>Dec</b>	Displays converted values using fixed-point notation.
<b>Exp</b>	Displays converted values using floating-point notation.
<b>Off*</b>	Scaling is disabled.

### 2 Enter the [Unit] name on the comment entry screen. Enter the [Unit] name on the comment entry screen. (Up to 7 characters)

**See:** About Comments (p. 100)

### 3 Specify the physical units per pulse or the number of pulses per fundamental unit (for example, if 1 c = 1 pulse, select [1 pulse]).

Move the cursor to the numerical value and press **ENTER** to display the numerical setting dialog.

**See:** "Numerical Value Entry" (p. 95)

The settings for physical units per pulse and pulses per fundamental unit are interlinked.

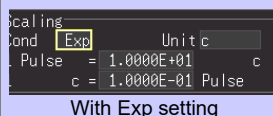
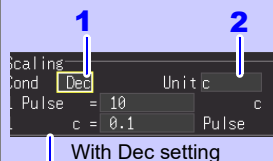

### Scaling Setting Example

**For integration with a 50,000 pulse/kWh watt-hour meter:**

Cond: Dec  
Units: kWh  
1kWh=50000 pulse

**For integration with a 10 liter/pulse flow meter:**

Cond: Dec  
Units: L  
1 pulse=10L

### NOTE

#### Combining scaling and display positioning (upper/lower limits)

To use both scaling and upper/lower display limits, set the scaling first, then upper/lower limit values.

#### Scaling and data save and load operation

When scaling has been set, the raw data (unscaled data) is recorded along with scaling information in a binary format. When a previously saved file is loaded, the scaled data will be displayed. However, you can also check the raw data by disabling scaling.

## 3.8 Entering Titles and Comments (as needed)

You can assign titles to measurement data, comments for input waveforms, and unit IDs (up to 20 double-byte or 40 single-byte characters; up to 8 double-byte or 16 single-byte characters for unit IDs). Titles and comments are shown on Waveform/Numerical screens (comments are displayed only on the [Value+Cmnt] screen). Unit IDs are displayed on the [Wave+Cmnt] and [Value] screens.

Titles can be set on the [Setting] screen and [Comment] screen. Comments can be set on the [CH] screen and [Comment] screen. Unit IDs can be set on the [UNIT] screen.

File names and folder names can be entered in the same manner.

See: "6.2 Saving Data" (p. 164)

See: "6.4 Data Management" (p. 178)

This section describes how to enter comments on the [CH] screen.

**NOTE** The Setting screen cannot be displayed while measuring.

**1** **WAVE/DATA** **SET** **FILE**  
Select the [CH] screen.

**2**  
Select the field to enter the comment.

**Apply**  
The character entry screen appears.

**3**  
Select the characters to enter  
To enter a space, select a blank character.

**Apply**  
Characters appear in the entry field as you select them.

Finished with entry

Navigate the entry field

## Operating Panel

The operating panel depicts the functions of instrument's operating keys.

### List

Displays the pick list of pre-registered measurement-related phrases.

### Hist

Displays a pick list of previously entered phrases.

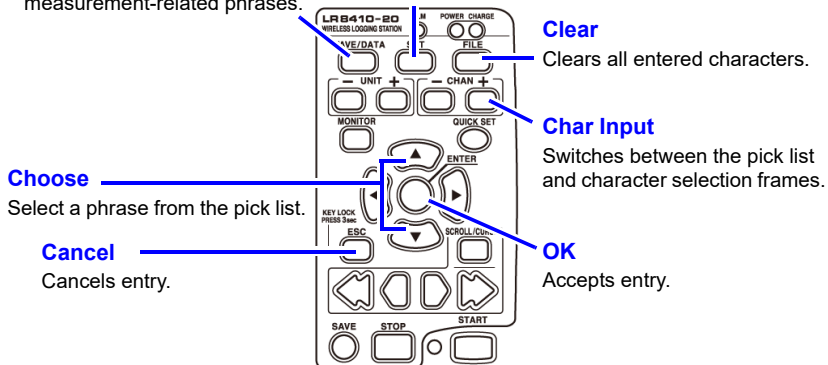

The following characters are converted as follows when saved to a text file.

Entered character	Entered character	Entered character	Entered character	Entered character	Entered character
~	~	~	~	~	~
Converted plain text equivalent	^2	^3	~u	~o	~c ~e



## 3.9 Suppressing Noise (Enable Digital Filtering)

Electrical noise mixed with input signals can be removed by digital filtering.  
(This setting is valid for the LR8510, LR8511 and LR8515.)



LR8510, LR8511

When the recording interval is from 500 ms to 1 h, 50/60 Hz power supply noise can be rejected.

It is recommended to set the filter to either 50 Hz or 60 Hz based on the power frequency in your area. Doing so will increase the difference in measurement times between measurement unit channels. Set the filter to OFF if you wish to minimize the difference in measurement times between channels.

**See:** "Cut-off frequency" (p .299)

LR8515

The filter can reject 50/60 Hz power supply noise when using a recording interval of at least 100 ms. When set to OFF, operation is the same as when set to 60 Hz.

**NOTE** The Setting screen cannot be displayed while measuring.

### Setting Procedure

Make these settings on the **[Setting]** screen.

**See:** "Time Setting by Key Operations" (p .70)

#### **[Filter]**

Setting options:( \* : default setting)

**60Hz\***, 50Hz, Off

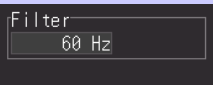

## 3.10 Viewing and Editing with the All-Channel Settings List

All channel settings can be viewed and changed in the list. You can copy batches of settings between channels.



The Setting screen cannot be displayed while measuring.

[List] screen

UNIT	Setting	CH	List	Conv/Calc	Trig&Alm	Comment	System
UNIT 1	UNIT 2	UNIT 3	UNIT 4	UNIT 5	UNIT 6	UNIT 7	Alarm Calc 1 Calc 2
Batch Proc		0 Adjust					
3- 1	✓	Red	Tc	K	100°C	Pos	× 1 0 %
3- 2	✓	Green	Rtd	Pt100	100°C	Pos	× 1 0 %
3- 3	✓	Yellow	Voltage		10mV	Pos	× 1 50 %

[Conv/Calc] screen

UNIT	Setting	CH	List	Conv/Calc	Trig&Alm	Comment	System
UNIT 1	UNIT 2	UNIT 3	UNIT 4	UNIT 5	UNIT 6	UNIT 7	Alarm Calc 1 Calc 2
Batch Proc							
1- 1	✓	Red	Dec Ratio	Ratio	1.2	Offset	0 W
1- 2	✓	Green	Tc	Dec 2-pt	0.05	→ 0.06	-0.05 → -0.06 W

Inputtype (  : Voltage,  : Thermocouple,  : RTD,  : Humidity,  : Resistance,  : Integration,  : Rotation,  : Logic,  : Current,  : Alarm,  : Temperature,  : Fungal index,  : Fungal growth projection )

[Trig & Alm] screen

UNIT	Setting	CH	List	Conv	Trig&Alm	Comment	System
UNIT 1	UNIT 2	UNIT 3	UNIT 4	UNIT 5	UNIT 6	UNIT 7	Alarm Calc 1 Calc 2
Trig		On Timing		Start Alarm On			
Batch Proc		Start Stop		Alarm1 Alarm2 Alarm3 Alarm4		1- 1	
1- 1	✓	Red	Tc	Level	Off	Off	Off
1- 2	✓	Green	Window	Off	Off	Off	Off

Inputtype (  : Voltage,  : Thermocouple,  : RTD,  : Humidity,  : Resistance,  : Integration,  : Rotation,  : Logic,  : Current,  : Alarm,  : Temperature,  : Fungal index,  : Fungal growth projection )

[Comment] screen

UNIT	Setting	CH	List	Conv/Calc	Trig&Alm	Comment	System
UNIT 1	UNIT 2	UNIT 3	UNIT 4	UNIT 5	UNIT 6	UNIT 7	Alarm Calc 1 Calc 2
Title		analysis					
		Point A					
Analog 1- 1		Voltage					

## Batch Copying Channel Settings

The CH1-1, CH2-1, CH3-1, CH4-1, CH5-1, CH6-1, CH7-1, W1, and W16 channel settings can be copied to other channels.

**1** **WAVE/DATA** **SET** **FILE**

Select the screen showing the channel to copy.  
[List], [Conv/Calc], [Trig & Alm]

**2** Select a unit.

**3** Select [Batch Proc].

**Apply**  
The selected items are displayed.

**4** Select the desired action.  
The actions that can be selected depend on the input units (see below).

**Apply**

The screenshot shows the following text on the screen:

```

UNIT 11
Batch Proc
Select command
Initialize all the range settings of all units shown on screen.
Initialize all the settings of this unit shown on screen.
Copy the settings of DR-1 shown on screen to DR-2 till DR-15.
Put all channels at 5% intervals with DR zero position reference.
Put all channels at 10% intervals with DR zero position reference.
Set all analog channels color off.
Set all analog channels color default.
Correct max/min values to the same as CH-1 when input type is same.
  
```

At the bottom of the screen, it says: (6:00/7:38 00.72) Close the operating panel. 15-03-04 11:29:10

#### ■ UNIT1 to UNIT7

##### • [Copy the settings of CHX-1 shown on screen to CHX-2 till CHX-15.]

(X indicates a measurement unit symbol.)

Copies the settings from channel CH1 on the screen to channels CH2 to CH15 in the same input unit.

On a wireless logger, the screen will display the following message: [Copy the settings of CHX-1 shown on screen to CHX-2.]

On the Wireless Humidity Logger's [Settings List] screen, the CHX-1T/CHX-1H settings will be copied to CHX-2T/CHX-2H. On the [Conversion/Calculation] and [Trigger/Warning] screens, the instrument will display the following message and copy the CHX-1T settings to other channels: [Copy the settings of CHX-1T shown on screen to other channels.] This message is not displayed on the Wireless Fungal Logger.

##### • [Copy the settings of CH1-1 shown on screen to all analog CHs.]

Copies the settings on the CH1 screen to CH2 through CH15 and all analog channels of units 2 through 7 for which the measurement setting is on.

Settings cannot be copied to a unit of a different type than UNIT1, with the sole exception that settings for channels whose input type is voltage or thermocouple can be copied between a Wireless Voltage/Temp Logger and a Wireless Universal Unit.

If UNIT1 is a Wireless Pulse Logger, the instrument will display the following message: [Copy the settings of CH1-1 shown on screen to pulse CH.]

On a Wireless Humidity Logger or Wireless Fungal Logger, the CH1-1 settings on the [Settings List] screen will be copied two or four channels at a time. On the [Conversion/Calculation] and [Trigger/Warning] screens, the instrument will display the following message and copy the CH1-1T settings to other channels: [Copy the settings of CH1-1T shown on screen to all analog channels.] On a Wireless Humidity Logger or Wireless Fungal Logger, the CH1-1 settings on the [Settings List] screen will be copied two or four channels at a time. On the [Conversion/Calculation] and [Trigger/Warning] screens, the instrument will display the following message and copy the CH1-1T settings to other channels: [Copy the settings of CH1-1T shown on screen to all analog channels.]

#### ■ calc1

##### • [Copy the settings of W1 shown on screen to W2 till W15.]

Copies the settings from waveform calculation channels W1 and W16 on the screen to channels W2 to W15.

##### • [Copy the settings of W1 shown on screen to all the other waveform calc. CHs.]

Copies the settings from waveform calculation channel W1 on the screen to the enabled (On) channels from W2 to W30.

#### ■ calc2

##### • [Copy the settings of W16 shown on screen to W17 till W30.]

Copies the settings from waveform calculation channel W16 on the screen to channels W17 to W30.

#### NOTE

- The contents of the displayed settings are copied, except for "waveform display color", "input type", and "measurement On/Off settings". However, "input type" and "measurement On/Off settings" can be copied from the [List] screen.
- RTD (Resistance Temperature Detector), resistance and temperature settings (specific to a Wireless Universal Unit) cannot be copied to a Voltage/Temperature Unit.

**Batch Setting Waveform Display/Hide and Waveform Color Settings for All Channels**

The display of all waveforms can be hidden, and all waveform display colors can be set to defaults. This setting is only available on the **[List]** screen.

**1** **Select [Batch Proc].**

**Apply**  
The selected items are displayed.

**2** **Select the desired action.**

**Apply**

The diagram includes two screenshots of the device's menu system. The top screenshot shows the 'Batch Proc' option highlighted in a yellow box. The bottom screenshot shows a list of actions, with 'Set all analog channels color default' highlighted in a yellow box.

## Initializing Settings (to factory defaults)

Certain settings in all input units (or a selected input unit) can be reset to their factory default state.

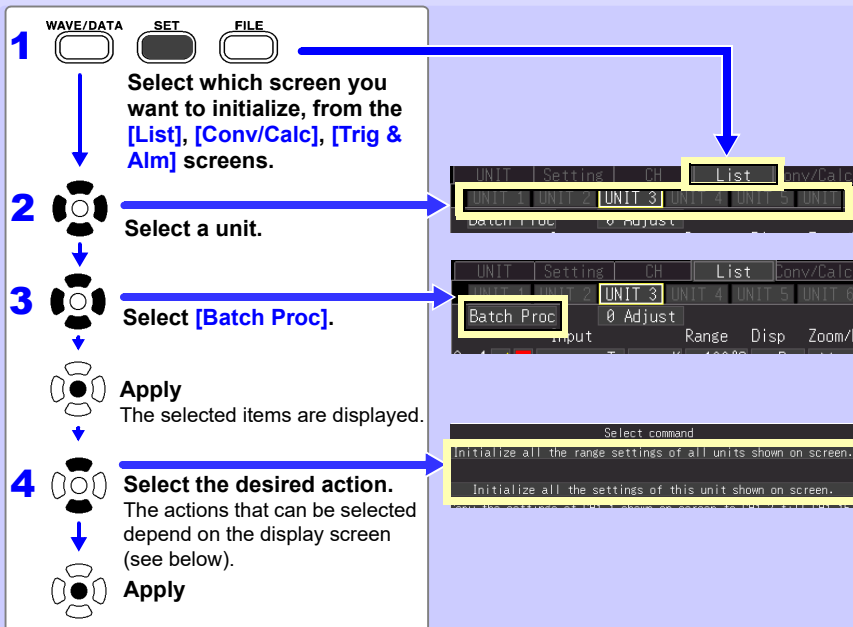

### ■ [List] Screen

- [Initialize all the List settings of all units shown on screen.]

Resets the List screen settings of all input units.

- [Initialize all the settings of this unit shown on screen.]

Resets the List screen settings of the selected input unit.

### ■ [Conv/Calc] Screen

- [Initialize all the scaling settings of all units.]

Resets the scaling settings of all input units.

- [Initialize all the waveform calculation settings of all units.]

Resets the waveform calculation settings of all input units.

- [Initialize all the settings of this unit shown on screen.]

Resets the conversion/calculation settings of the selected input unit.

### ■ [Trig & Alm] Screen

- [Initialize all the trigger/alarm settings of all units on screen.]

Resets the [Trig & Alm] screen settings of all input units.

- [Initialize all the settings of this unit shown on screen.]

Resets the [Trig & Alm] screen settings of the selected input unit.

3.10 Viewing and Editing with the All-Channel Settings List

**Aligning Zero Positions on the Grid**

All channels in every unit (CH1-1 to 15, CH2-1 to 15 ●●● CH7-1 to 15) can be displayed evenly spaced at 5% or 10% intervals on the vertical axis, from top to bottom.

Only those channels set for the same input type and range as the reference channel, and with **[Disp span]** set to **[Pos]** (p. 94), are valid.

**1**  **Select the unit you wish to align.**

**2**  **Select [Batch Proc].**

 **Apply**  
The selected items are displayed.

**3**  **Select the desired action.**

 **Apply**

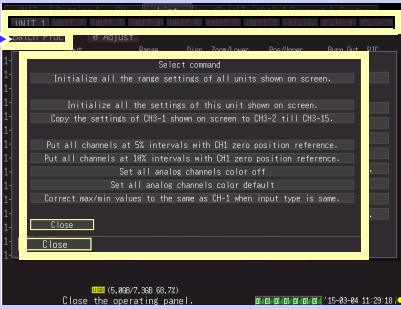

**Alignment Example (with CH1-1 zero-position aligned at 90% and occupying 5% of vertical screen height)**

Channel	Zero-position (%)
CH1-1	90
CH1-2	85
CH1-3	80
CH1-4	75
CH1-5	70
CH1-6	65
CH1-7	60
CH1-8	55
CH1-9	50
CH1-10	45
CH1-11	40
CH1-12	35
CH1-13	30
CH1-14	25
CH1-15	20

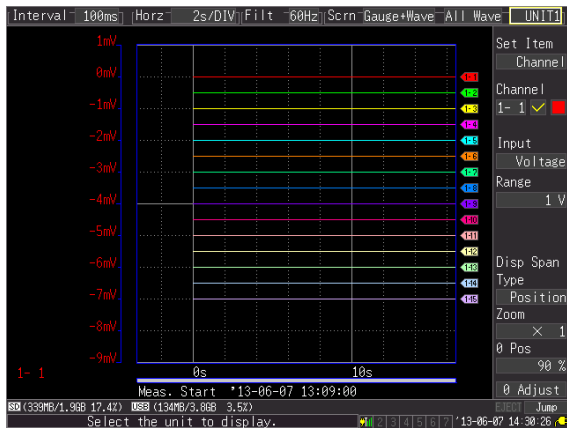

## Setting CH1 of UNIT1 Value as a Scaling Value (Inter-Channel Compensation function)

A value measured on CH1 of UNIT1 (Analog channel CH1-1) can be set as the scaling value. This function is convenient for thermocouple measurements when errors (such as thermocouple deviations) give different values for the same known temperature. It applies only to channels with the units, same input type and range setting as CH1 of UNIT1.

### NOTE

When used between the LR8510 and LR8511, it applies to channels with the same input type and range.



### NOTE

When scaling is automatically set by steps 1 to 6 on next page procedure, the measurement units are initially set to [V].

To set all channels to [°C] make the following settings beforehand.

1. Set the [Convert] setting to [Dec] and [unit] to [°C] on the [Conv/Calc] screen.





2. For [Batch Proc], execute [Correct the value to the same as CH1 when input type is same.] (p. 104).



**3.10 Viewing and Editing with the All-Channel Settings List**

WAVE/DATA
SET
FILE

**1**  Select the [Conv/Calc] screen.

**2** 

Select [Batch Proc].

↓



Apply

The selected items are displayed.

UNIT	Setting	CH	List	Conv/Calc
UNIT 1				
	Convert		Conversion Set 1	
1- 1	✓	Red	Dec Ratio	Ratio 1.2
1- 2	✓	Green	Dec 2-pt	0.05 → 0.06

**3** 

Select the desired action.

↓



Apply

To display waveforms at the same position as CH1, next select the display position as follows. (Applies to the upper/lower limits set for CH1)

WAVE/DATA
SET
FILE

**4**  Select the [List] screen.

**5** 

Select [Batch Proc].

↓



UNIT	Setting	CH	List	Conv/Calc
UNIT 3				
	0 Adjust			
3- 1	✓	Red	input	Tr K 100°C Pos X

**6** 

Select the desired action.

↓



Apply

Display temperature on all channels using °F after scaling conversion

Correct the value to the same as CH-1 when input type is same.

Close

Set all analog channels color default

Correct max/min values to the same as CH-1 when input type is same.

Close

## Display Celsius (°C) temperature values as Fahrenheit (°F)

All measured temperature values can be converted at once from Celsius to Fahrenheit units.

The conversion is simultaneously reflected appropriately on all scaled values.

To revert from Fahrenheit units to Celsius, disable (set to Off) the scaling function (p. 97).

This setting is only available on the [\[Conv/Calc\]](#) screen.

**1**  **Select [Batch Proc].**

 **Apply**  
The selected items are displayed.

**2**  **Select the desired action.**

 **Apply**

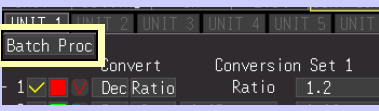
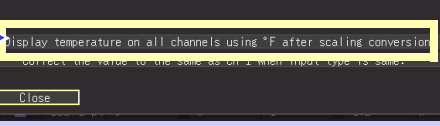

# Observing Measurements and Data

## Chapter 4

### 4.1 Confirming Measured Values, and Starting Measurement

Before starting a formal measurement, press **MONITOR** to check measured values as needed (p. 42).

When you have confirmed that the settings are correct, press **START** to start formal measurement (p. 38).

Pay attention to the following items while measuring.

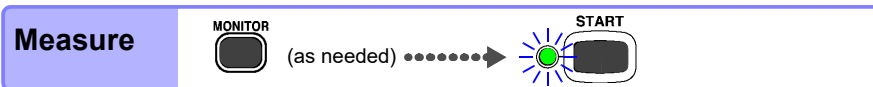

#### If the power goes out during measurement

- If a power outage affects only measurement units or wireless loggers  
Data during the outage will be treated as lost. Measurement can be continued once power is restored.
- If the outage is limited to the instrument  
Set the smart backup setting to on. Recording will start automatically when power is restored. Since measurement data from before the outage will not be stored in the instrument's internal buffer, it is recommended to automatically save data to the included or optional SD memory card. Data will be lost while the power to the instrument is interrupted, even if measurement units and wireless loggers continue to receive power.

#### If communications fail temporarily

Both measurement units and wireless loggers have internal backup memory. When communications are restored, measurement units will retransmit (65,536/n) data points (where n indicates the number of channels) to restore the data on the Wireless Logging Station.

If there are multiple units to which communications are restored, data will be restored in the order in which the units are reconnected. For example, a communications failure can last for about 72 minutes without loss of data when measuring 15 channels of data at a recording interval of 1 sec. with a measurement unit.

**See:** "When Temporarily Unable to Communicate with a Measurement Unit" (p. A34)

## 4.1 Confirming Measured Values, and Starting Measurement

### CAUTION

- Data stored in the instrument's 8 MWord internal buffer memory will be restored.
- Saved data will be restored if automatically saved as waveform (binary) data but not if automatically saved as .CSV (text) data.
- If power to a measurement unit or wireless logger is interrupted during measurement, data collected prior to the outage will be lost.
- If power to the instrument is interrupted during measurement, data from any measurement units or wireless loggers will not be restored.

### Handling of waveform display and data when data cannot be acquired

Waveforms for data that the instrument was unable to acquire from a measurement unit or wireless logger will be shown as "stuck" at the top of the waveform screen. If communications with one or more measurement units are interrupted during measurement, the numbers of those units will be displayed to the bottom right of the scroll bar on the Waveform screen.

Rendering of waveforms will stop when a communications error with a unit occurs and while data is being restored. **[NO DATA]** will be displayed for numerical and cursor value displays, while values will be displayed for input values and the input range as appropriate.

**See:** "Treatment of the Waveform Display When Unable to Acquire Data and Data" (p. 33)

### Synchronization and acquired data discrepancies

The instrument, measurement units, and wireless loggers are synchronized as they communicate during measurement. Consequently, since time will progress at each device's own level of precision in the event that communications with measurement units or wireless loggers are interrupted during measurement, time differences will appear among the three devices. In some cases, there may be discrepancies in the number of data points captured once communications between the instrument and the measurement units and wireless loggers are reestablished following an interruption. In the event of discrepancies in the number of data points or time between the instrument on the one hand and the measurement units and wireless loggers on the other, data will be restored based on the assumption that the instrument's data is correct.

**See:** "Synchronization and acquired data discrepancies" (p. A36)

### CAUTION

Data continuity may be compromised when a discrepancy occurs.

## 4.2 Observing Waveforms

View data during and after measuring on the Waveform/Numerical Screen.

### Displaying Waveforms (Display Descriptions)

Press the **WAVE/DATA** to display the Waveform/Numerical screen. Repeated key presses cycle the screen through nine types (p. 36).

Screen Example: **[Wave]** display (\* : default setting)

Settings can be changed.

(See indicated page for details)

- Recording interval (data acquisition interval) (p. 70)
- Display time base (time per horizontal division) (p. 96)
- Digital filtering (noise suppression) (p. 102)

All Waveforms/Unit Waveforms/CH Waveforms

**[All Wave\*]**

Displays the waveforms for all channels enabled for measurement (On).

**[UnitWave]**

Displays the waveforms of each input unit.

**[CH Wave]**

Displays the waveforms of each channel.

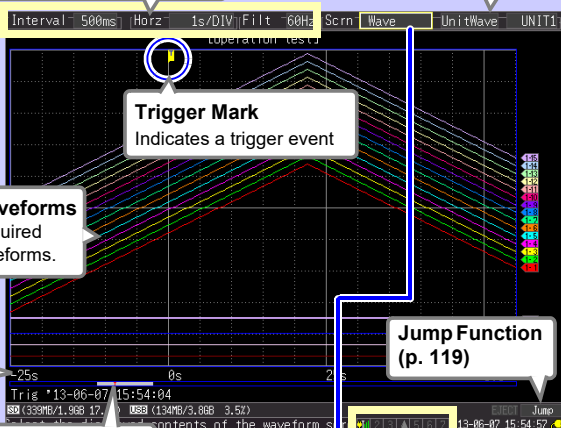

**Trigger Mark**

Indicates a trigger event

**Analog waveforms**

Displays acquired data as waveforms.

**Time Values**

**Scroll Bar**

Shows the range and position of the displayed waveform.

Viewing the Scroll bar (p. 118)

Information such as measurement start time and start trigger times is displayed below the scroll bar.

**Jump Function**  
(p. 119)

Allows you to check the communications status and remaining battery life for units 1 through 7.

**UNIT1\* – W30**

Select the input unit with the waveforms to view when **[UnitWave]** is selected. Press **UNIT** to switch input units. Input units can be switched in jumps as described below. Selects which channel's waveform to display when **[CH Wave]** is selected. Waveforms can also be switched with the **CHAN** key.

The screen display span also be changed here.

**([Gauge+Wave \*])**

- A gauge can be displayed for each channel, and channel settings can be changed (p. 116).
- Measurement data can be displayed as waveforms and numerical values, as numerical values with comments, or as numerical values only (p. 117).
- Numerical values at waveform cursor positions can be viewed (p. 121)
- Numerical calculation results can be displayed (p. 185)

■ Unit 1 (1-1 to 15)→Unit 2 (2-1 to 15)→Unit 3 (3-1 to 15)→Unit 4 (4-1 to 15)→Unit 5 (5-1 to 15)→Unit 6 (6-1 to 15)→Unit 7 (7-1 to 15)→Alarm (ALM1 to ALM4)→Waveform Calculation 1 (W1 to 15)→Waveform Calculation 2 (W16 to 30)→returned to Unit 1 (1-1 to 15) (Unregistered units are skipped.)

Key Setting Procedure

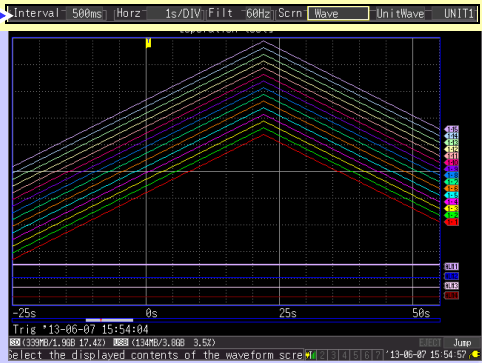
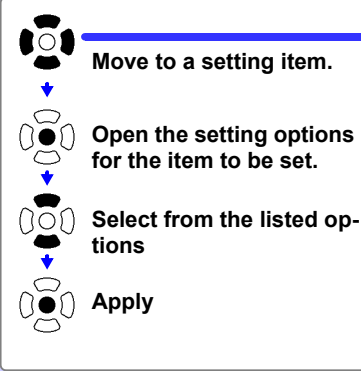

Displaying Gauges

A gauge corresponding to the measurement range of each channel can be displayed at the left side of the screen, for confirming measurement values. The color of the gauge matches the waveform display color of its input channel. Channel settings can also be changed.

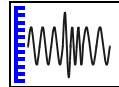

Switches between channel settings and event settings.

- Event Search (p. 123)

Channel marker  
Displays the waveform's channel.

- Display area settings  
Display position (p. 94)  
Upper and lower display limits (p. 95)

WAVE/DATA    SET    FILE

Select [Gauge+Wave].

- Voltage measurement (p. 77)
- Temperature measurement (Thermocouple) (p. 78)
- Temperature measurement (RTD) (p. 80)
- Humidity measurement (p. 81)
- Resistance Measurement (p. 83)
- Temperature Measurement Settings (When LR8514 or LR8520 is used) (p. 81)
- Humidity Measurement Settings (When LR8511 is used) (p. 82)
- Humidity Measurement Settings (When LR8514 or LR8520 is used) (p. 82)
- Resistance Measurement Settings (p. 83)
- Integration (Count) Measurement Settings (p. 84)
- Revolution Measurement Settings (p. 86)
- Current Measurement Settings (p. 89)
- Fungal Index and Fungal Growth Projection Settings (p. 91)

- Select the alarm display type (p. 153)
- Waveform Calculation (p. 193)

About Channel Settings

Press **CHAN** to select channels for gauge display. However, note that when measurement data is displayed, only those channels that are enabled (set to On ) for measurement can be selected. (Measurement cannot be started with measurement disabled for all channels.)

## Viewing Input Signals as Numerical Values

Numerical values can be displayed in three ways: numerical values only, waveforms and numerical values, and numerical values and comments.

Displayed numerical values are those of the current input signals.

**See:** To view cursor position values numerically: "Displaying Cursor Values" (p. 121)

**See:** Data not acquired due to unit power outage or communications issue: (p. A 33)

### To display waveforms and numerical values

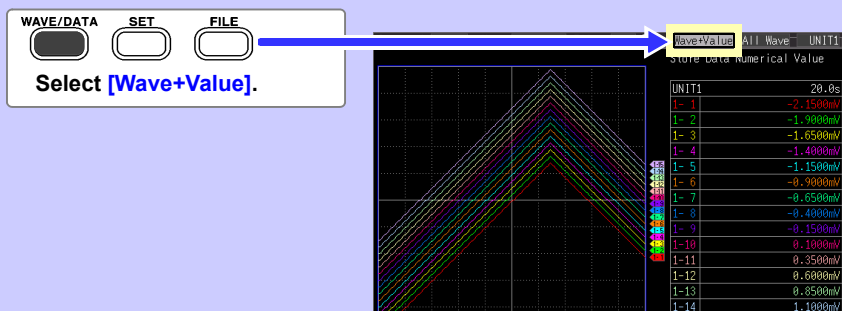

WAVE/DATA SET FILE  
Select [Wave+Value].

UNIT1	Value
1- 1	-2.1500mV
1- 2	-1.9000mV
1- 3	-1.6500mV
1- 4	-1.4000mV
1- 5	-1.1500mV
1- 6	-0.9000mV
1- 7	-0.6500mV
1- 8	-0.4000mV
1- 9	-0.1500mV
1-10	0.1000mV
1-11	0.3500mV
1-12	0.6000mV
1-13	0.8500mV
1-14	1.1000mV

### To display numerical values and comments



WAVE/DATA SET FILE  
Select [Value+Cmnt].

UNIT1	Value	Comment
1- 1	-1.0500mV	Voltage
1- 2	-0.8000mV	current
1- 3	-0.5500mV	power
1- 4	-0.3000mV	power supply
1- 5	-0.0500mV	control
1- 6	0.2000mV	
1- 7	0.4500mV	
1- 8	0.7000mV	
1- 9	0.9500mV	
1-10	1.2000mV	
1-11	1.4500mV	
1-12	1.7000mV	
1-13	1.9500mV	
1-14	2.2000mV	

### To display numerical values only

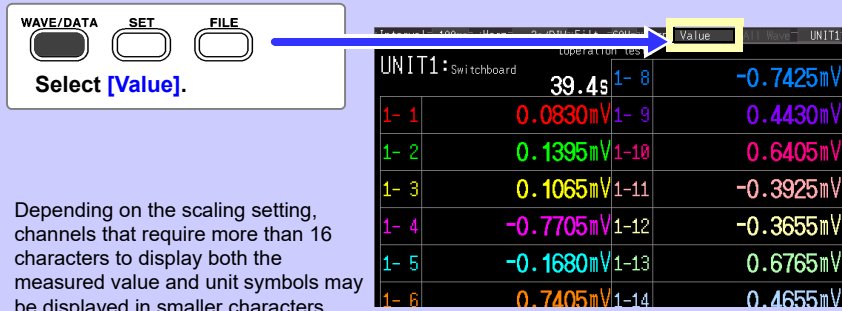

WAVE/DATA SET FILE  
Select [Value].

UNIT1: Switchboard	Value
1- 8	-0.7425mV
1- 1	0.0830mV
1- 9	0.4430mV
1- 2	0.1395mV
1-10	0.6405mV
1- 3	0.1065mV
1-11	-0.3925mV
1- 4	-0.7705mV
1-12	-0.3655mV
1- 5	-0.1680mV
1-13	0.6765mV
1- 6	0.7405mV
1-14	0.4655mV

Depending on the scaling setting, channels that require more than 16 characters to display both the measured value and unit symbols may be displayed in smaller characters.



Scrolling Waveforms

When measuring or displaying an existing waveform, use **SCROLL/CURSOR** to scroll.

When measuring with the record time set to **[Cont]**.

If internal buffer memory becomes full, recording continues by overwriting the oldest acquired data. Because of that, scrolled waveforms viewed while measuring are limited to the part that has not yet been erased.

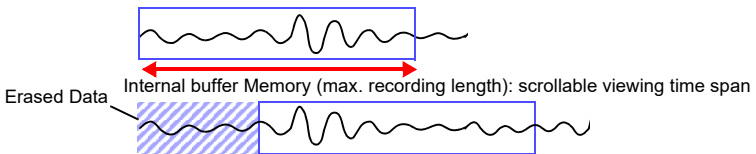

Verifying Waveform Display Position

From the scroll bar you can verify the relative position and size of the displayed portion of a waveform within the overall measured waveform.

The width of the currently displayed time span indicator within the scroll bar depends on the time base (time per horizontal division) setting, even when the recording length is unchanged.

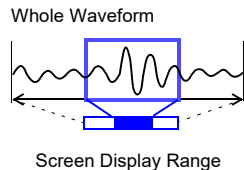

## Magnifying and Compressing Horizontally

Waveforms can be magnified (expanded or compressed) along the time axis by changing the time per horizontal division.

Detailed waveform data is usually best observed with the time axis expanded, while longer-term trends are best observed with it compressed.

Horizontal magnification can be changed while measuring.

However, when measuring with auto saving enabled, the 200 and 500 ms settings are not selectable.

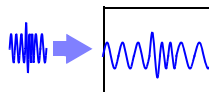

Select from the **[Horz]** setting options.

200 ms, 500 ms, 1 s\*, 2 s, 5 s, 10 s, 20 s, 30 s, 1 min, 2 min, 5 min, 10 min, 20 min, 30 min, 1 h, 2 h, 5 h, 10 h, 12 h, 1 day, [/DIV]

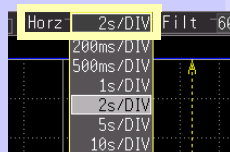

Indicates the center point for horizontal magnification. When the A/B cursors are displayed, the position of cursor A becomes the reference point.

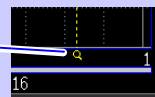

## Viewing Any Waveform Location (Jump Function)

When the recording length of a waveform is long, you can specify the portion to be displayed immediately.

This is available only when measurement is stopped. When a past waveform is displayed during measurement, **[Jump]** changes to **[Trace]** (p. 118)

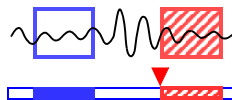

**1** Select **[Jump]**.

**Apply**

The location of the currently displayed portion of the overall waveform is indicated on the scroll bar.

**2** Move the mark to display a different portion of the waveform.

**3** **Apply**

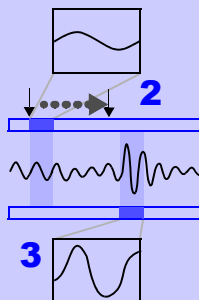
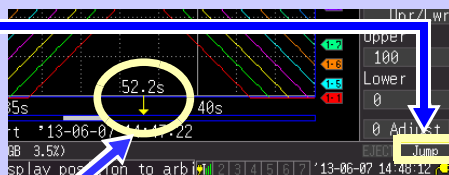



## Specifying a Waveform Time Span

Specify a waveform time span when saving a partial waveform or applying numerical calculations (Trace cursors or Vertical cursors).

**1** Press **SCROLL/CURSOR** to display A/B cursors and their values.

**2**  Select **[Move]**.

 Open the setting options for the item to be set.

 Select which cursor(s) to move.

 Apply

**3** Move the A/B cursors using the left/right cursor keys to specify the time span.

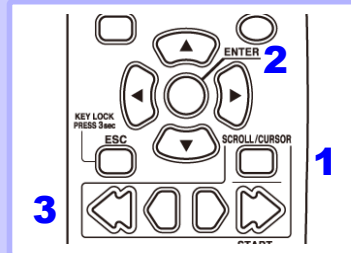
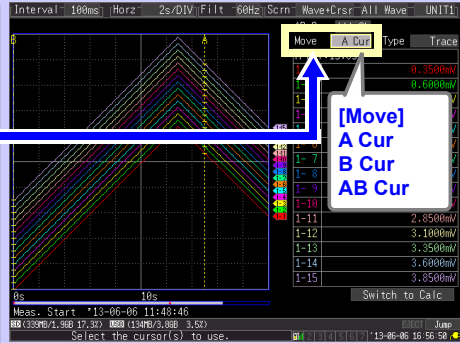

## Displaying Cursor Values

Time difference and potential difference (and when scaling is enabled, scaling values) can be read as numerical values using the A/B cursors.

**See:** Data not acquired due to unit power outage or communications issue:  
(p. A 33)

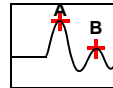

**1** Press **SCROLL/CURSOR** to display A/B cursors and their values.

(To hide the cursor items again, press **SCROLL/CURSOR**.)

**2** Move the A/B cursors using the left/right cursor keys.

Values along the waveforms can be confirmed.

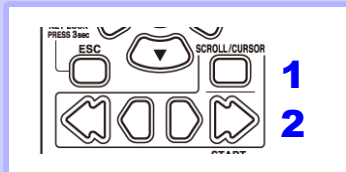
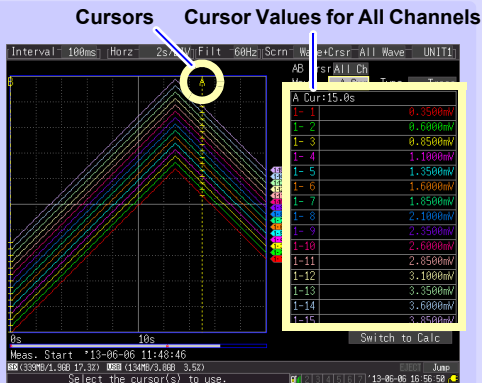

Cursor values can be displayed for all channels, or for only desired channels (p. 122).

4.2 Observing Waveforms

**Selecting which channels have their cursor values displayed**

Select from the **[AB Crsr]** setting options.

- **[All Ch]\***  
Displays all channels. The cursor selected for **[Move]** is displayed. (Selecting **[AB Cur]** displays the difference between A and B cursor values.)
- **[Ch Set]**  
Specify which channels to display with A and B cursors. The cursor values for the specified channels are displayed.  
(\* : default setting)

**Cursor Value for Specified Channels**

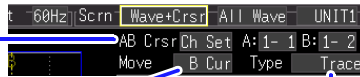
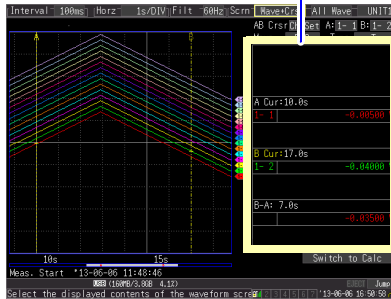

**To select which cursor to move**

Select from the **[Move]** setting options.

- **A Cur\***
- **B Cur**
- **AB Cur**
- (\* : default setting)

**Changing Cursor Type**

Select from the **[Type]** setting options.

- **Trace\***
- **Vert (Vertical)**
- **Horz (Horizontal)**
- (\* : default setting)



Press the outer left and right scrolling keys to scroll in large steps.

**About Cursor Types**

Cursor Type	Example	Cursor Value
<b>Trace Cursors</b>		Displays the time and measurement values at the A/B cursors, or the time and measurement differences between the A/B cursors. Displays the intersections (trace points) of cursors and waveforms. (the intersections of waveform traces of selected channels)
<b>Vertical Cursors</b>		Displays the time and frequency values at the A/B cursors, or the time and frequency differences between the A/B cursors.
<b>Horizontal Cursors</b>		Displays the measurement values at the A and B cursors for the selected channel(s), or the difference between A/B cursor values. A/B cursors can be enabled for any channel.

## 4.3 Marking Waveforms and Searching Marks (Search Function)

You can insert up to 1000 event marks at any point while measuring, to help find them later.

See: "Searching Event Marks" (p. 127)

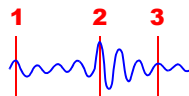

Event marks can be applied by the following methods.

- Press **START** while measuring
- Press the on-screen **[Make Mark]** button.
- Apply a signal to the EXT TRIG terminal
- When a warning occurs

### Inserting Event Marks While Viewing Waveforms

Use this procedure to insert event marks while viewing data on the Waveform/Numerical Value screen during measurement.

Press **START** to apply a mark.

Event marks are numbered in the sequence they are inserted.

Marks can also be applied with the following procedures.

- 1** **WAVE/DATA**    **SET**    **FILE**  
 Select **[Gauge+Wave]**.
- 2**   
 Select **[Channel]**.
- Select **[Event]**.
- Apply
- 3**   
 Move to **[Make Mark]**.
- Press to insert an event mark.  
 Event numbers appear on the waveform displayed when you select **[Make Mark]**.

The event settings are displayed.

- 2** — Event
- 3** — Make Mark

Total 0006

MoveNo. 3

Move

PrevEvent

NewEvent

## Inserting Event Marks Using External Input Signals

Event marks can be inserted by applying external input signals.  
Make this setting before starting measurements.

**1**  Select the [System] screen.

**2**  Select [External Trig In].

 Open the setting options for the item to be set.

 Select [Event].

 Apply

**3** Connect and configure the external signal input (p. 138)

An event mark is inserted when the external trigger input (EXT TRIG external control terminal) switches from High to Low (falling edge) while measuring.

**See:** For input signal specifications:  
"Trigger Input Signals" (p .207)

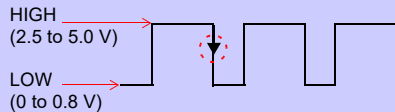
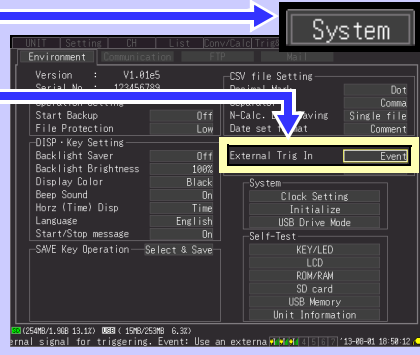

## Alarm Event Marks

Event marks can be inserted by alarm events.  
Make this setting before starting measurements.

The screenshot shows the 'System' settings menu. The 'Event mark for alarm' option is highlighted with a yellow box. The status bar at the bottom indicates 'Signal for triggering. Event Use an external'.

**1** **WAVE/DATA** **SET** **FILE**  
Select the **[System]** screen.

**2**  
Select **[Event mark for alarm]**.  
Open the setting options for the item to be set.

Select **[On/Off]**.

Apply



4.3 Marking Waveforms and Searching Marks (Search Function)

**How are event marks handled in text (CSV) conversion?**

The instrument's text conversion process includes event numbers along with measured values. This is convenient when you need to later extract only marked data.

**<Example>**

File name	WAVE0001.CSV						
Title comment							
Trigger Timr	#####						
Ch	A 1- 1	A 1- 2	A 1- 3	----- Z 1	Z 2		
Mode	Voltage	Voltage	Voltage	Calculation	Calculation		
Range	10mV	10mV	10mV				
Comment							
Scaling	OFF	OFF	OFF				
Ratio	1.00E+00	1.00E+00	1.00E+00				
Offset	0.00000E+00	0.00000E+00	0.00000E+00	00"	0.00000E+00"	0.00000E+00"	0.00000E+
Time	1-1 [V]	1-2[V]	1-3[V]	CALC-1[V]	CALC-2[V]	Event	
0.00E+00	-1.18E-04	-1.23E-04	-1.98E-04	-2.36E-04	-2.36E-04	0	
5.00E-01	-1.19E-04	-1.22E-04	-1.97E-04	-2.37E-04	-2.37E-04	0	
1.00E+00	-1.20E-04	-1.22E-04	-1.97E-04	-2.39E-04	-2.39E-04	1	
1.50E+00	-1.20E-04	-1.21 E-04	-1.97E-04	-2.40E-04	-2.40E-04	0	
2.00E+00	-1.21 E-04	-1.20E-04	-1.96E-04	-2.42E-04	-2.42E-04	0	
2.50E+00	-1.23E-04	-1.18E-04	-1.96E-04	-2.45E-04	-2.45E-04	2	
3.00E+00	-1.23E-04	-1.18E-04	-1.95E-04	-2.46E-04	-2.46E-04	0	
3.50E+00	-1.24E-04	-1.16E-04	-1.94E-04	-2.48E-04	-2.48E-04	3	
4.00E+00	-1.25E-04	-1.16E-04	-1.93E-04	-2.50E-04	-2.50E-04	0	
4.50E+00	-1.27E-04	-1.15E-04	-1.93E-04	-2.53E-04	-2.53E-04	4	
5.00E+00	-1.28E-04	-1.14E-04	-1.90E-04	-2.55E-04	-2.55E-04	0	
5.50E+00	-1.30E-04	-1.12E-04	-1.89E-04	-2.59E-04	-2.59E-04	0	
6.00E+00	-1.31 E-04	-1.12E-04	-1.87E-04	-2.61 E-04	-2.61 E-04	0	

Event No.

**NOTE** The Logger Utility program's text conversion process does not include event mark information.

## Searching Event Marks

Any event mark can be found by searching.

**1** Select the [Gauge+Wave] Screen.

**2** When [Channel] is displayed, switch to [Event].

**3** Apply  
The event setting items are displayed.  
Select [MoveNo.].  
Open the setting options for the item to be set.  
For the [MoveNo.] setting, select the number of the event you want to find.  
Apply

**4** Select [Move].  
Apply  
The waveform with the specified event number is displayed.

You can search by incrementing and decrementing the event number.

<b>PrevEvent</b>	Search for the previous event mark.
<b>NextEvent</b>	Search for the next event mark.



# Specifying Criteria for Measurements Chapter 5

You can set recording to start and stop under specific criteria (start/stop triggers), and to output alarm signals. You can also set specific times to start and stop recording, using the Reservation function.

## About Triggering

Triggering is the process of controlling the start and stop of recording by specific signals or conditions (criteria). When recording is started or stopped by a specific signal, we say the trigger is "applied" or "triggering occurs".

In this manual, **T** indicates a "trigger point", as the time at which a trigger is applied.

Criteria can be specified for the following event trigger types.

Trigger criteria met

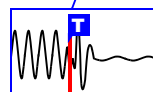

Trigger Type	Description	Setting Screen	Ref.
<b>Start Trigger</b>	Recording starts when the specified Start Trigger criteria are satisfied.	[CH]/ [Trig & Alm]	(p. 131)
<b>Stop Trigger</b>	Recording stops when the specified Stop Trigger criteria are satisfied. When [Repeat] is enabled (set to [On]), recording restarts automatically.	[CH]/ [Trig & Alm]	(p. 131)
<b>Trigger Source</b>	Various trigger criteria can be combined with logical AND/OR operations for each channel.	[Trig & Alm]	(p. 137)
<b>External Trigger</b>	Triggering can be applied by an external signal at the EXT.TRIG input terminal.	[Trig & Alm]	(p. 138)
<b>Pre-trigger</b>	Records data acquired during a specified period prior to each trigger event.	[Trig & Alm]	(p. 139)
<b>Alarm</b>	An alarm signal can be output when any specified criteria are met.	[CH]/ [Trig & Alm]	(p. 153)
<b>Reservation</b>	Records at a specified date and time.	[Setting]	(p. 143)

Set trigger criteria for individual channels on the Channel [CH] screen, and set trigger and alarm settings for all channels on the [Trig & Alm] screen (p. 142).

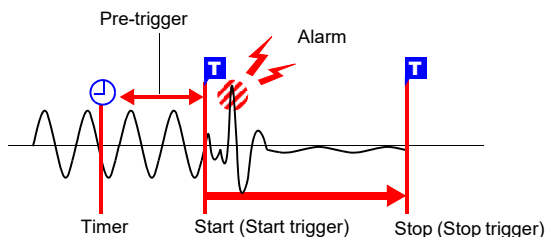

**IMPORTANT**

- Trigger judgment is not performed in the event that there is no data due to an interruption of communications with measurement units and wireless loggers. Judgment processing is performed all at once after communications with measurement units and wireless loggers have been established and data restored, and then the trigger is applied when the trigger conditions are satisfied. Trigger output is generated at the same timing. For stop triggers, data after the stop trigger criterion is satisfied will be reported as “NO DATA.”(p. A 33)
  - When using a pre-trigger, the trigger will not activate for restored data. Additionally, data will not be restored while waiting for a pre-trigger event.
-

## 5.1 Triggering Measurement Start and Stop

There are two ways to set the criteria to start and stop recording according to wave-form slope.

Select whether to trigger at the rising or falling edge of the input signal.

### Types of Trigger Criteria

Type of Analog Trigger	Trigger Example	Description
<b>Level Trigger</b> (p. 133) [Level]		Recording starts (or stops) when the input signal crosses the specified trigger level (voltage).
<b>Window Trigger</b> (p. 135) [In]		Recording starts (or stops) when the input signal enters a range defined by upper and lower thresholds.
[Out]		Recording starts (or stops) when the input signal exits a range defined by upper and lower thresholds.
<b>Pattern Trigger</b> (p. 136) [1]		Measuring starts and stops when the input signal logic switches from Low to High.
[0]		Measuring starts and stops when the input signal logic switches from High to Low.
[X]		Signal is ignored. No triggering occurs.

**Enable the Trigger Function**

Before setting trigger criteria, trigger functions need to be validated.

**Enable the Trigger Function**

1. Select the trigger to use, and press **ENTER**.

Put the cursor on **[Start trig on.]** for a start trigger, or on **[Stop trig on.]** for a stop trigger, and press **ENTER**.

2. Press it again when the confirmation message appears.

**[Cond:Off]** appears, and trigger criteria settings are enabled.

When **[Cond:\*\*]** is displayed, triggering is enabled (On).

To disable triggering, set **[Trig Func:Off]** on the **[Trig & Alm]** screen.

**Set trigger criteria**

Select the trigger criteria to be applied.

See: P.133 to P.137

Triggering can be enabled/disabled (On/Off) and criteria selections can be set on the **[Trig & Alm]** screen.(p. 142)

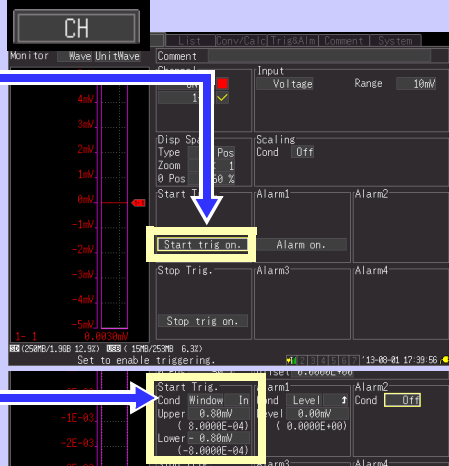

The **[Timing]** setting on the **[Trig & Alm]** screen determines the effect of triggering, as follows:

- Start recording upon trigger: **[Start]**
- Stop recording upon trigger: **[Stop]**
- Alternately start and stop upon trigger: **[Start/Stop]**

Measuring

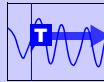

Start

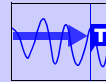



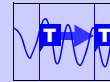

Stop



Start / Stop

**Key Setting Procedure**

1. **WAVE/DATA** **SET** **FILE**  
Select the **[CH]** or **[Trig & Alm]** Screen.
2.  Move to a setting item.  
 Open the setting options for the item to be set.  
 Select from the listed options.  
 Apply

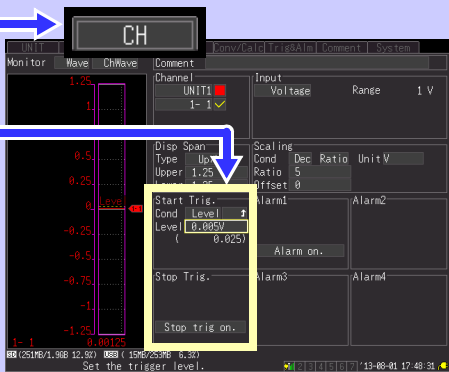

## Setting Trigger Criteria

### Using Level Triggering

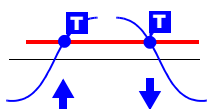

Enter the signal level threshold at which to start or stop measuring, and whether triggering occurs on the upslope or downslope of the input signal.

Recording starts or stops when the signal crosses the specified threshold. Levels can be confirmed on the level monitor or on the

Waveform/Numerical screen. Make trigger settings on the [CH] screen of the displayed channel.

See: "Key Setting Procedure" (p .132)

- 1** Select [Level] as the start/stop trigger type.
- 2** Select the input signal rising (↑) or falling (↓) edge setting option.

Setting options: (\* : default setting)

↑\* Measurement starts (or stops) when the signal crosses the threshold on the upslope (rising edge ↑).

↓ Measurement starts (or stops) when the signal crosses the threshold on the downslope (falling edge ↓).

- 3** Set the input signal level at which to start or stop measuring.

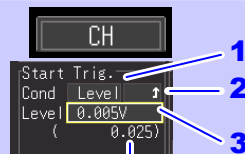

When scaling is enabled, the scaled value is also displayed.

Default setting: 0



## 5.1 Triggering Measurement Start and Stop

### Ranges and Trigger Resolution

Channels	Input type	Range	Resolution
1-1 to 7-15	Voltage	10 mV f.s	0.01 mV
		20 mV f.s	0.02 mV
		50 mV f.s	0.05 mV
		100 mV f.s.	0.1 mV
		200 mV f.s.	0.2 mV
		500 mV f.s.	0.5 mV
		1 V f.s.	0.001 V
		2 V f.s.	0.002 V
		5 V f.s.	0.005 V
		10 V f.s.	0.01 V
		20 V f.s.	0.02 V
		100 V f.s.	0.1 V
		1-5 V f.s.	0.01 V
	Temperature (thermocouple and RTD)	100°Cf.s	0.1°C
		500°Cf.s.	0.5°C
		1000°Cf.s.	1°C
	Humidity	2000°Cf.s.	2°C
100% RH f.s		0.1% RH	
Resistance	10 Ω f.s.	0.01 Ω	
	20 Ω f.s.	0.02 Ω	
	100 Ω f.s.	0.1 Ω	
	200 Ω f.s.	0.2 Ω	
1-1 to 7-15	Integration	-	1c
	Rotation	-	1r/s
	Current	500 mA f.s	0.1 mA
		5 A f.s	1 mA
		50 A f.s	10 mA
		500 A f.s	100 mA
		10 A f.s	10 mA
		100 A f.s	100 mA
		1000 A f.s	1 A
		20 A f.s	10 mA
		200 A f.s	100 mA
2000 A f.s	1 A		
Fungal index	200	1	
Fungal growth projection	10	1	

### Using a Window Trigger

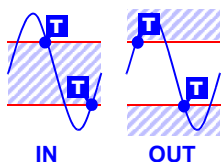

Set the range within which you wish to start or stop measurement using the upper and lower limit values. You can select whether measurement starts or stops when the input signal level enters (In) or exits (Out) of this window.

Upper and lower thresholds can be verified in the monitor or on the Waveform screen. When scaling is enabled, the scaled threshold values are displayed.

Make trigger settings on the [CH] screen of the displayed channel.

See: "Key Setting Procedure" (p. 132)

**1** Select [Window] as the start/stop trigger type.

**2** Select trigger timing (window type).

Setting options: (\* : default setting)

**In\*** Trigger when the input signal level enters the window defined by the upper/lower thresholds.

**Out** Trigger when the input signal level exits the window defined by the upper/lower thresholds.

**3** Enter the upper/lower threshold value.

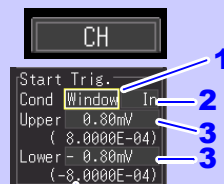

Scaled values are displayed when scaling is enabled.

5.1 Triggering Measurement Start and Stop

Using Pattern Triggering

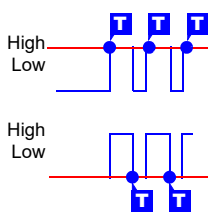

Logic triggering is available when Logic is selected for pulse input channels (p. 88).

Triggering is controlled by the signal state and combination of logic input signal channels.

Select a trigger pattern (1, 0, or X) and AND/OR combining logic so that triggering occurs when the combined criteria are satisfied.

Make trigger settings on the [CH] screen.

See: "Key Setting Procedure" (p. 132)

**1** Select the trigger signal combining Pattern.  
(Select [OR] or [AND] as the start/stop trigger type.)

Setting options: (\* : default setting)

<b>OR*</b>	Triggering occurs when the state of any one of the trigger signals matches the set pattern.
<b>AND</b>	Triggering occurs only when the states of all of the trigger signals match the set pattern.

**2** Select the triggering state (pattern) for each pulse channel.  
(This setting applies to the pulse input channels selected for trigger logic.)

Setting options: (\* : default setting)

<b>X*</b>	Signal is ignored.
<b>0</b>	Triggering can occur when the signal switches from High to Low.
<b>1</b>	Triggering can occur when the signal switches from Low to High.

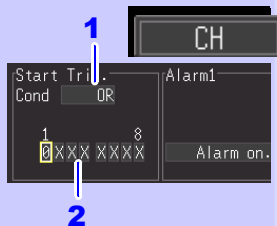

## Selecting Triggering Criteria (Trigger Source)

Enable the trigger function (set to On), select recording start/stop timing, and set trigger criteria. Make these settings on the **[Trig & Alm]** screen.

See: "Key Setting Procedure" (p .132)

**NOTE** If trigger settings have been made on the **[CH]** screen, skip steps 1 and 2. (The settings in steps 1 and 2 are interlinked with those on the **[CH]** screen.)

**1** Select the **[CH]** or **[Trig&Alm]** Screen.

**2** Enable triggering **[On]**.

**3** Select measurement start/stop timing.

Setting options: ( \* : default setting)

**Start\*** Start recording according to Start Trigger criteria.

**Stop** Stop recording according to Stop Trigger criteria.

**Start/Stop** Start and stop recording according to the Start and Stop Trigger criteria, respectively.

(Start and stop triggers can be set for each channel independently.)

**4** Select trigger combining logic.

Setting options: ( \* : default setting)

**OR\*** Triggering occurs when any one of the specified trigger source criteria is met. (includes external trigger signal)

**AND** Triggering occurs only when all of the specified trigger source criteria are met. (includes external trigger signal)

Interval triggers are not included in the above trigger criteria, and start trigger events will occur when criteria set with an interval trigger are satisfied.

See: "Applying Trigger at Fixed Time Interval (Interval Trigger)" (p .140)

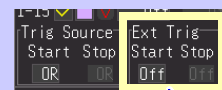

See: "Using External Triggering" (p .138)

### Triggering Criteria

To apply a trigger when the upslope ( $\uparrow$ ) of the waveform crosses zero volts:

Trigger: Level  
Level: 0 V  
Slope:  $\uparrow$

#### When **[AND]** is selected

No triggering occurs initially if trigger criteria are already met when measurement starts. Before triggering can occur, trigger criteria must first become invalid once.

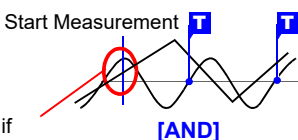

One waveform has crossed above 0 V as the other crosses on the upslope

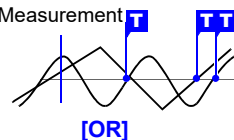

Either waveform crosses 0 V on the upslope

## Using External Triggering

To use an external signal as a trigger source, make the following settings.

**1** Connect the external trigger signal to the instrument's EXT.TRIG external control terminal.  
(See the connection procedure on P.56 )

**2** Press **SET** to open the [System] screen.

**3** Set the [External Trig In] to [Trigger] (default setting).

**4** Press **SET** to open the [Trig & Alm] screen.

**5** Set triggering criteria (p. 137).

**6** Select the slope for the [Ext trig] [Start] and [Stop] settings.

Select whether triggering occurs on the trigger signal's upslope or downslope.

Setting options: (\* : default setting)

Off*	External triggering is disabled.
↑	Triggering occurs on the upslope from Low (0 to 0.8 V) to High (2.5 to 5.0 V).
↓	Triggering occurs on the downslope from High (2.5 to 5.0 V) to Low (0 to 0.8 V), or when the EXT TRIG terminal is connected to a GND terminal.

This setting is forced Off when [External Trig In] is set to [Event] on the [System] screen.

**7** Confirm whether triggering is provided by an external signal or by shorting the EXT.TRIG terminal to GND (only when [Ext trig] is set to [↓]).

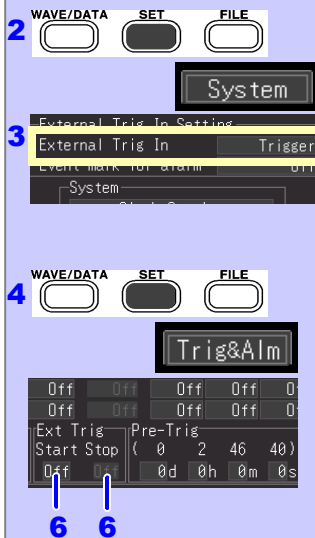

## When You Want to Measure Data before Triggering (Pre-trigger)

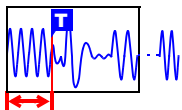

When trigger timing is set to **[Start]** or **[Start/Stop]**, not only the waveform following the trigger can be measured, but a specified span of the waveform before triggering as well.

However, when trigger timing is set to **[Stop]**, pre-trigger settings are disabled.

Make these settings on the **[Trig & Alm]** screen.

See: "Key Setting Procedure" (p. 132)

### [Pre-Trig]

**Set the amount of time to record before each trigger event.**

To also measure the waveform after triggering, the recording time must be set longer than the pre-trigger time.  
(See "Pre-Trigger and Recording Times" below.)

Trig&Alm

```
Pre-Trig
( 0 2 46 40 )
 0d 0h 0m 0s
```

The maximum settable time is displayed.



Increment/decrement by 1

(when the recording interval is longer than 2 seconds, increment/decrement by one recording interval)



Increment/decrement by 10

(when the recording interval is longer than 10 seconds, increment/decrement by one recording interval)

### NOTE

The instrument pre-trigger time can be set up to 99 days. Logger Utility settings of 100 days or more are reduced to 99 days when transferred to the instrument.

### Difference between [Waiting for pre-trigger] and [Waiting for trigger]

When measurement is started, the specified pre-trigger length is recorded. This period is indicated as the **[Waiting for pre-trigger]**.

After the specified pre-trigger length has been recorded, the period indicated as **[Waiting for trigger]** continues until a trigger occurs.

During the **[Waiting for pre-trigger]** interval, trigger criteria are ignored.

### Pre-Trigger and Recording Times

**When the recording time is shorter than pre-trigger time**

Measurement ends with the trigger event

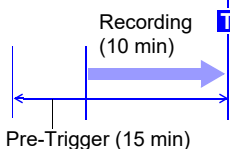

**When the recording time is longer than pre-trigger time**

Measuring before and after triggering

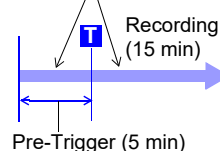

5.1 Triggering Measurement Start and Stop

Applying Trigger at Fixed Time Interval (Interval Trigger)

You can apply a trigger at a fixed time interval. This can be set on the [Trig&Alm] screen.

- 1** Select the [Trig&Alm] Screen.
- 2** Enable triggering [On].
- 3** Select the interval conditions.  
 Setting options: (\* : default setting)  

<b>Off*</b>	Disables the interval trigger.
<b>OR</b>	Applies the interval trigger using OR logic (see figure below).
<b>AND</b>	Applies the interval trigger using AND logic (see figure below).
- 4** Set the time interval for repeat measurement.  
 [Day]/ [Hour]/ [Min]/ [Sec]

**NOTE** When using the Logger Utility to perform measurement, interval triggers are disabled.

Displays the maximum amount of time that can be set.

- Change 1's digit
- Change 10's digit

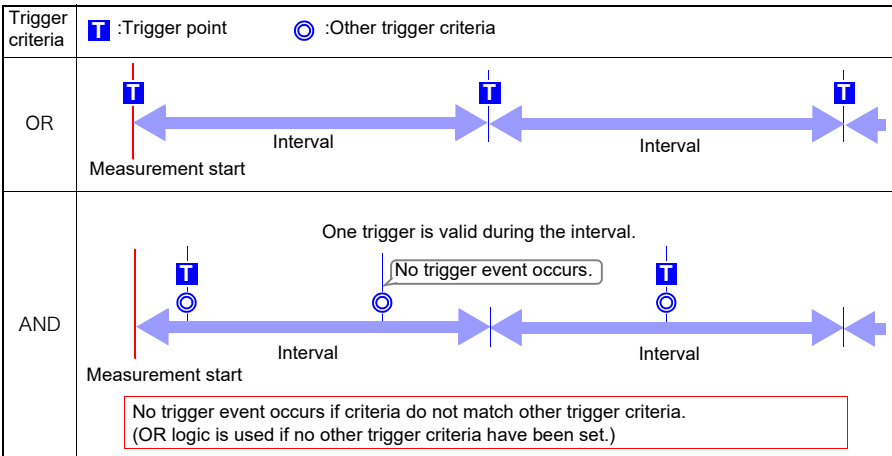

## 5.2 Trigger Setting Examples

Following are examples of typical trigger settings.

Intended Measurement Objective	Ref. No. (next table)
Acquire data from when you press <b>START</b> until you press <b>STOP</b>	No.1
Acquire data for one minute after each time you press <b>START</b>	No.2
Acquire data at one-minute intervals for sixty minutes after you press <b>START</b>	No.3
When the temperature measured on CH1 exceeds 500°C, acquire data until you press <b>STOP</b> .	No.4
Acquire data from when you press <b>START</b> until the temperature measured on CH1 exceeds 500°C.	No.5
Acquire data from when the temperature measured on CH1 exceeds 500°C until it drops below 300°C.	No.6
Acquire data whenever the temperature measured on CH1 exceeds 500°C, until it drops below 300°C.	No.7
Acquire data for only one minute from when the temperature measured on CH1 exceeds 500°C.	No.8
Acquire data for one minute before and after the time when the temperature measured on CH1 exceeds 500°C.	No.9

No.	[Setting] Screen				[Trig & Alm] Screen			[CH] Screen	
	Repeat	Record time	Split Save	Trig Func	Timing	Trig Source	Pre-Trig	Start Trig.	Stop Trig.
1	Off	[Cont]	Off	Off	-	-	-	-	-
2	Off	[Time] 0h: 1min: 0s	Off	Off	-	-	-	-	-
3	Off	[Time] 1h: 0min: 0s	On [Split Length] 1 min	Off	-	-	-	-	-
4	Off	[Cont]	Off	On	[Start]	[Start] OR	-	[Cond]Level↑ [Level] 500°C	-
5	Off	[Cont]	Off	On	[Stop]	[Stop] OR	-	-	[Cond]Level↑ [Level] 500°C
6	Off	[Cont]	Off	On	[Start/ Stop]	[Start] OR [Stop] OR	-	[Cond]Level↑ [Level] 500°C	[Cond]Level↓ [Level] 300°C
7	On	[Cont]	Off	On	[Start/ Stop]	[Start] OR [Stop] OR	-	[Cond]Level↑ [Level] 500°C	[Cond]Level↓ [Level] 300°C
8	Off	[Time] 0h: 1min: 0s	Off	On	[Start]	[Start] OR	-	[Cond]Level↑ [Level] 500°C	-
9	Off	[Time] 0h: 2min: 0s	Off	On	[Start]	[Start] OR	1 m	[Cond]Level↑ [Level] 500°C	-



## 5.3 Confirming All Trigger and Alarm Criteria Settings

You can view and change trigger and alarm criteria settings for all channels on the **[Trig & Alm]** screen.

**Trig Func (p. 137)**  
Select On to enable triggering.

**Alarm**  
Select On to enable alarms.

**Input type**

- V: Voltage
- TC: Temperature (Thermocouple)
- RTD: Temperature (RTD)
- H: Humidity
- R: Resistance
- I: Integration
- Q: Rotation
- L: Logic
- A: Current
- Al: Alarm
- Te: Temperature
- F: Fungal index
- Fg: Fungal growth projection

Channel-specific settings (start, stop and alarm triggers) are displayed to the right of the list for the channel selected (highlighted) by the cursor.

Select **[Batch Proc]** to initialize settings and to copy trigger and alarm settings from channels 1-1, 2-1, 3-1, 4-1, 5-1, 6-1, 7-1 and W1 to W16 to any other channel. Copied settings include level, slope, and threshold values.

**See:** "3.10 Viewing and Editing with the All-Channel Settings List" (p. 103)

1- 1 :Trig and alarm setup.

Close

Start Trig. Cond Level ↑ Level 0.05mV ( 5.0000E-05)	Alarm1 Cond Window In Upper 0.80mV ( 8.0000E-04) Lower - 0.80mV (-8.0000E-04)	Alarm2 Cond Off
Stop Trig. Cond Level ↑ Level 0.00mV ( 0.0000E+00)	Alarm3 Cond Off	Alarm4 Cond Off

Press **ENTER** to display the dialog at the right for the cursor-selected channel. Trigger and alarm criteria for the selected channel can be set.

## 5.4 Starting & Stopping Measurement on a Specified Day

You can specify dates as desired for measurement to start and stop. Before configuring these settings, ensure that the instrument's clock is set to the correct time. Before setting, confirm that the instrument clock is set to the correct time. If not, reset the clock on the [System] screen (p. 204). Instrument settings cannot be changed once these settings are active. Configure instrument settings before scheduling measurement.

WAVE/DATA
SET
FILE

Select the [Setting] screen.

**1. Schedule the measurement.**

- 1** Select [Res Set.]
- 2** Select the checkbox  for the number (No. 1 to No. 10) of the schedule you wish to set.
- 3** Set [Spc.Dt (Specified Date)] in [Type] for the schedule.
 

Setting options: ( * : default setting)	
<b>Off*</b>	Disables the schedule with the selected number.
<b>Spc.Dt</b>	Select when you wish to start and stop measurement by specifying a date and time.
<b>Reg</b>	Select when you wish to start and stop measurement regularly, for example every day or on specific days.
- 4** Set the date and time you want to start and stop measurement.  
Set each of year-month-day, hour, and minute. You can enter the current time by selecting the clock mark and pressing the **ENTER** key.

Setting

**1**

No.	Type	Strt.Day
1	<input checked="" type="checkbox"/> Spc.Dt	2013-08-01
2	<input type="checkbox"/> Off	
3	<input type="checkbox"/> Off	

Strt.Day	Strt.Tm.	Stop Day	Stop Tm.
2013-08-01	19:58	2013-08-01	21:58

(continues on next page)

**5** Select **[Conditn. (Condition)]**.

Setting options: (\* : default setting)

<b>Current*</b>	Performs measurement using the instrument's settings as configured at the time the schedule was entered.
<b>Save No. 1 to Save No. 5</b>	Performs measurement using one of five sets of settings saved in the instrument's internal memory.

**About error display**

Green display: Starts measurement immediately after the schedule starts.

<b>Strt&lt;crnt.</b>	Measurement will start immediately after the schedule is set since the current time is already past the measurement time.
----------------------	---

Red display: Displays a description of the error. The schedule cannot be set for the parameter in question because the schedule criteria have not been properly configured. Change the setting.

<b>Stop&lt;start</b>	The stop time is set to a time that is before the start time.
<b>Stop&lt;crnt.</b>	The stop time is set to a time that is before the current time.
<b>Overlap</b>	The schedule times overlap those of another setting.

```
Conditn.  Error.
Current   Strt<crnt.
```

**6** Select **[Settings Summary]**.

The schedule confirmation screen appears.

**7** Select **[OK]**.Selecting **[Cancel]** returns you to the Scheduling screen.

When the schedule settings are complete, the screen switches from the Measurement Schedule screen to the normal Setting screen.

At that time, the **[Reserved]** indication flashes green on the bottom right of the screen to indicate that the instru-

**NOTE** About operation restrictions while **[Reserved]** is displayed (standby state)  
Keys related to starting, stopping, files, and saving do not work.

**When you want cancel a schedule while **[Reserved]** is displayed**

Press the **ENTER** key to display the schedule cancellation dialog box.  
Select **[OK]** to cancel the schedule.

## 5.5 Starting & Stopping Measurement Periodically

You can perform measurement periodically.

WAVE/DATA    SET    FILE

Select the **[Setting]** screen.

**1. Schedule the measurement.**

- 1** Select **[Res Set.]**.
- 2** Select the checkbox  for the number (No. 1 to No. 10) of the schedule you wish to set.
- 3** Set **[Reg]** in **[Type]** for the schedule.

Setting options:	( * : default setting)
<b>Off*</b>	Disables the schedule with the selected number.
<b>Spc.Dt</b>	Select when you wish to start and stop measurement regularly, for example every day or on specific days.
<b>Reg</b>	Select when you wish to start and stop measurement regularly, for example every day or on specific days.

- 4** Set the periodic measurement conditions.

You can set each of the start day and time. You can enter the current time by selecting the clock mark and pressing the **ENTER** key.

Setting options: ( \* : default setting)

<b>Daily*</b>	Perform measurement from the set start time to the set stop time every day.
<b>Mon. to Fri.</b>	Perform measurement from the set start time to the set stop time every day from Monday to Friday.
<b>Mon. to Sat.</b>	Perform measurement from the set start time to the set stop time every day from Monday to Saturday.
<b>Sun., Mon., Tue., Wed., Thur., Fri., Sat.</b>	Perform measurement from the set start time to the set stop time on the selected days every week.

(continues on next page)

5

Chapter 5 Specifying Criteria for Measurements

**5** Select **[Conditn. (Condition)]**.

Setting options: (\* : default setting)

<b>Current*</b>	Perform measurement using the instrument setting conditions configured at the time of scheduling.
<b>Save No. 1 to Save No. 5</b>	Select any conditions from 5 setting conditions saved to the internal memory of the instrument and perform measurement. (When you select a save number, unit registration information for the specified settings will also be loaded.)

**About error display**

Green display: Starts measurement immediately after the schedule starts.

<b>Strt&lt;crnt.</b>	Measurement will start immediately after the schedule is set since the current time is already past the measurement time.
----------------------	---

Red display: Displays a description of the error. The schedule cannot be set for the parameter in question because the schedule criteria have not been properly configured. Change the setting.

<b>Stop&lt;start</b>	The stop time is set to a time that is before the start time.
<b>Stop&lt;crnt.</b>	The stop time is set to a time that is before the current time.
<b>Overlap</b>	The schedule times overlap those of another setting.

**6** Select **[Settings Summary]**.

The schedule confirmation screen appears.

**7** Select **[OK]**.

When the schedule settings are complete, the screen switches from the Measurement Schedule screen to the normal Setting screen.

At that time, the **[Reserved]** indication flashes green on the bottom right of the screen to indicate that the instrument has entered the schedule standby state.

Measurement starts automatically at the scheduled date and time.

The setting conditions of the enabled schedule cannot be changed.

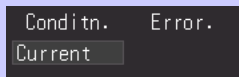
**When you want cancel a schedule while **[Reserved]** is displayed**

Press the **ENTER** key to display the schedule cancellation dialog box. Select **[OK]** to cancel the schedule.

## 5.6 Canceling a Schedule

To cancel a schedule or change the settings of a schedule, **[Reserved]** (schedule standby state) needs to be cancelled first.

WAVE/DATA    SET    FILE    Select the **[Setting]** screen.

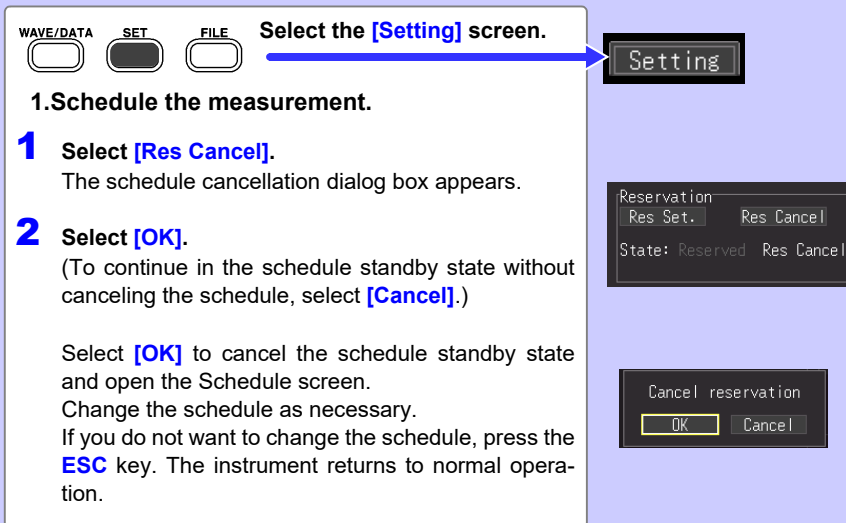

**1. Schedule the measurement.**

**1** Select **[Res Cancel]**.  
The schedule cancellation dialog box appears.

**2** Select **[OK]**.  
(To continue in the schedule standby state without canceling the schedule, select **[Cancel]**.)

Select **[OK]** to cancel the schedule standby state and open the Schedule screen.  
Change the schedule as necessary.  
If you do not want to change the schedule, press the **ESC** key. The instrument returns to normal operation.

Setting

Reservation  
Res Set.    Res Cancel  
State: Reserved    Res Cancel

Cancel reservation  
OK    Cancel

**NOTE About operation restrictions while [Reserved] is displayed (standby state)**

- Keys related to starting, stopping, files, and saving do not work.
- To change a setting, first cancel the schedule. If you change a setting in the standby state, a dialog box to confirm canceling the schedule operation will appear.

**About schedule start and stop operations**

- Normal settings files cannot be saved or loaded as schedule settings. Select schedule settings to save on the Schedule Confirmation screen or when saving selections and load the corresponding file as necessary.
  - If the first schedule start time has passed at the point in time that the schedule is set, the set measurement conditions are accessed and measurement starts immediately.
  - "The reservation will be started soon." is displayed 1 minute before a schedule start time, and then measurement starts at the start time.
  - When repeat recording is set to [Off], the schedule operation finishes when one measurement ends. When repeat recording is set to [On], measurement is performed repeatedly until the stop time.
  - When the state is [Waiting for pre-trigger] or [Waiting for trigger] at the stop time, measurement stops and the state switches to the waiting for next schedule (schedule standby) state. When the state is [Storing], measurement is halted, calculation, and saving is performed using the data up until that point in time, and then the state switches to the next schedule standby state.
  - If the next schedule start time has passed because of the time required for saving, the measurement conditions are accessed and the next measurement starts immediately.
  - When all schedules are complete, the scheduled state is cancelled.
  - If the power is cut off when measurement is scheduled, the scheduled state is resumed when the power recovers and measurement is started if the time when the power recovers is between the schedule start time and schedule stop time, regardless of the Start Backup setting (On/Off).
  - When schedule settings include errors, for example due to overlap with a properly configured schedule, only properly configured schedules will be executed.
  - Lower schedule numbers take precedence when checking for overlapping schedule setting times.
-





5.7 About Schedule Function Operation

The stop time setting is within the recording length

- Enable schedule    ⌚ Start time or stop time    ↔ Recording time
- ➡ Measuring    📌 Trigger criteria match    ▨ Deadtime

Trig-ger	[Repeat: Off]	[Repeat: On]
Off		
Start		
Stop		
Start& Stop		

### ■ About Dead Time

After measurement is performed for the recording time portion, time is needed for internal processing before measurement can be resumed (dead time). Measurement is not performed during this dead time.

When you want to perform measurement without any loss of data, perform measurement with the record time is set to **[Cont]**.

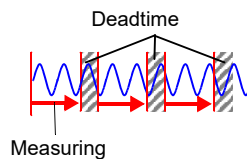

## 5.8 Setting Examples

This section introduces examples of setting measurement schedules.

Intended Measurement Objective	Ref. No. (next table)
Record data to a SD memory card from 9:00 to 17:00 on May 15, 2013.	No.1
Record data periodically to a SD memory card for each 24 hours every day during a 1-month period from 9:00 on May 15, 2013.	No.2
Record data to a SD memory card for a 1-hour period every 6 hours (9:00, 15:00, 21:00 and 3:00) during a 1-month period from 9:00 on May 15, 2013.	No.3
Record data to a SD memory card from 9:00 to 17:00 every day, until the schedule is cancelled.	No.4
Record data to a SD memory card from when a trigger is met between 8:30 to 17:15 on Monday to Friday, until the schedule is cancelled.	No.5
Record data to a SD memory card from 9:00 to 12:00 and 13:00 to 17:30 on Thursday every week, until the schedule is cancelled.	No.6

Measurement Schedule Screen [Reservation]				[Setting] screen					
No	Type	Start Date	Stop Date	Repeat	Record time	Priority save location	Split Save	Trig Func	
		Start time	Stop time		Time				
1	1	Spc.Dt	2013-05-17	2013-05-17	Off	Cont	SD	Off	Off
			9:00	17:00		-----			
2	1	Spc.Dt	2013-05-17	2013-06-17	Off	Cont	SD	Reg RefTime: 00:00 Split Len: 1day	Off
			8:59	9:01		-----			
3	1	Spc.Dt	2013-05-17	2013-06-17	On	Time	SD	Off	OR Interval trigger: 6:00
			9:00	9:01		1h			
4	1	Reg	Daily	-----	Off	Cont	SD	Off	Off
			9:00	17:00		-----			
5	1	Reg	Mon. to Fri.	-----	On	Time	SD	Off	On (Specify trigger criteria)
			8:30	17:15		(Desired settings)			
6	1	Reg	Thur.	-----	Off	Cont	SD	Off	Off
			9:00	12:00		-----			
	2	Reg	Thur.	-----	Off	Cont	SD	Off	Off
13:00	17:30	-----							

## 5.9 Alarm Output

You can enable beep tones and an alarm output signal (for external use) for each input channel by setting its alarm criteria.

External alarm output requires connection to the external control terminals.

See "9.3 Alarm Signal Output (Alarm Output)" (p. 209) for details.

### NOTE

Warning detection is not performed in the event that there is no data due to an interruption of communications with measurement units and wireless loggers (with the exception of a warning indicating that such an interruption of communications has occurred). Detection processing is performed all at once after communications with measurement units and wireless loggers have been established and data restored, and then warnings are issued when the warning conditions are satisfied. Alarm output is generated at the same timing.(p. A 33)

- Output response time  
Recording interval + 3 sec or less  
(with 1 measurement unit or 1 wireless logger connected with good communications)  
Recording interval + 5 sec or less  
(When seven measurement units and wireless loggers are connected with good communications)  
Weak communications may result in longer output update times.

## Checking Alarm Criteria

Alarm Criteria and history can be verified on the Alarm screen.

WAVE/DATA    SET    FILE

Select **[Alarm]**.

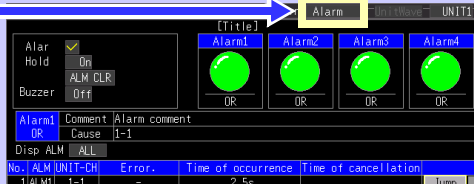

**[Alar]**  
Alarm function on/off  
The following settings are not available when not checked  .

**[Hold]**  
Alarm retention function on/off  
Selecting **[ALM CLR]** causes retained alarms to be cleared.

**[Buzzer]**  
Buzzer on/off

● (Red) Alarm output  
● (Green) No alarm output  
“OR” and “AND” below refer to the alarm source table.

Allows you to select the alarms for which to display a list.  
(All, alarms 1 to 4, communications interruptions)

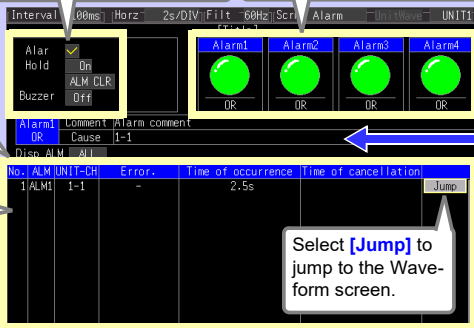

**[No.]:** Alarm memory no.  
**[ALM]:** Alarm no.  
**[UNIT-CH]:** Unit-ch. no.  
**[Error.]:** Error type  
**[Time of occurrence]:** Time of alarm  
The display can be set to time, date, or number of data points. (p. 201)  
**[Time of cancellation]:** Time at which alarm was cleared

Select **[Jump]** to jump to the Waveform screen.

Displays alarm information for the selected jump parameter.

**NOTE**

- The alarm memory can store up to 100 alarms.
- A log of communications interruptions is kept regardless of alarm settings.
- Alarms after trigger events are recorded in the log.

You can verify whether the alarm criteria have been satisfied for a given channel and whether that channel is in the alarm state on the [Wave+Value], [Value+Cmnt], or [Value] screen.

■ Alarm output status (ALM)

- Red: alarm signal output active
- Green: alarm signal output inactive

**1** Select the [Wave+Value], [Value+Cmnt], or [Value] Waveform/Numerical screen.

**2** Select [ALARM] with the UNIT key. Put the cursor here and press ENTER to directly select which input unit to display.

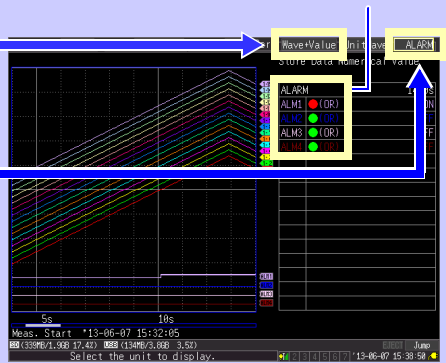

**1** Select the [Wave+Value], [Value+Cmnt], or [Value] Waveform/Numerical screen.

**2** Select [UNIT1],[CALC1], [CALC2] with the UNIT key. Put the cursor here and press ENTER to directly select which input unit to display.

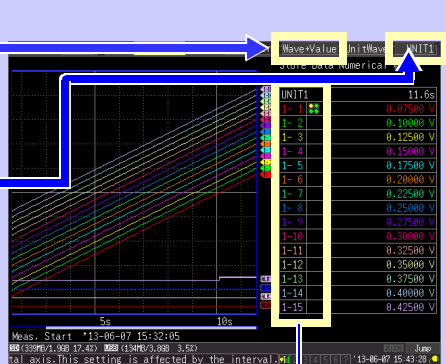

■ Channel alarm status



- Yellow\*: alarm criteria are satisfied
- Green: alarm criteria are not satisfied
- \*: When [Alarm Hold] is enabled (set to [On]), the indicator remains yellow because the criteria remain satisfied (until measurement is finished).

## 5.9 Alarm Output

### ■ Some alarm settings are available on the [Gauge+Wave] screens.

On the [Gauge+Wave] screen, the alarm beeper, alarm hold, and [ALM CLR] (when alarm hold is enabled) can be set. (Alarm hold can only be set when measurement is stopped.)

**1** **WAVE/DATA** **SET** **FILE**



Select the [Gauge+Wave] Waveform/Numerical screen.

**2** Select [ALARM] with the UNIT key. Put the cursor here and press ENTER to directly select which input unit to display.

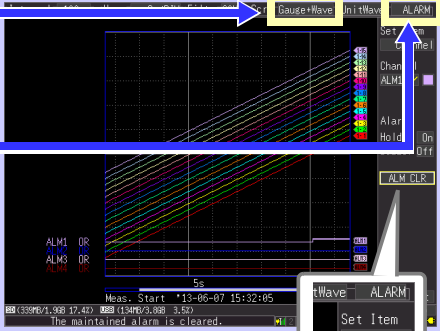

■ **Hold**  
Selects whether to reset or hold (latch) alarm outputs while measuring. (can only be set when measurement is stopped)

■ **Buzzer (beeper)**  
Enables and disables the alarm beeper. (can be set while measuring or not)

■ **ALARM CLR**  
When alarm hold is enabled, put the cursor here and press ENTER to clear the alarm manually.  
An alarm can be cleared only when the alarm criteria are no longer met.

Set Wave ALARM

Set Item

Channel

Channel

ALM1 ✓

Alarm

Hold On

Buzzer Off

ALM CLR

## Alarm Settings

Select alarm input channels on the [CH] screen, and specify alarm criteria on the [Trig & Alm] screen.

See: "Key Setting Procedure" (p.132)

WAVE/DATA  

SET  

FILE  

Select the [CH] Screen.



**1. Configuring Alarm Output**

- 1** Select [ALM].
- 2** Choose an alarm channel (ALM1 to ALM4) for output, and select the checkbox .

To enable ALM1 to ALM4 outputs, on the setting screen for channels 1-1 to 7-15, move the cursor to [Alarm on.], select the checkbox , and press ENTER. ALM1 to ALM4 are enabled and disabled together. ALM1 cannot be enabled by itself.

- 3** Select whether to reset or hold (latch) alarm outputs while measuring.

This setting is also available on the [Gauge+Wave] Waveform/Numerical screen (p. 156).

Setting options: ( \* : default setting)

<b>Off*</b>	Disable the alarm output signal when alarm criteria are no longer met.
<b>On</b>	Hold the alarm output active state until measurement is finished.

- 4** Enable or disable the alarm beeper by the [Buzzer] setting.

This setting is also available on the [Gauge+Wave] Waveform/Numerical screen (p. 156).

Setting options: ( \* : default setting)

<b>Off*</b>	The instrument will not sound an audible beep during alarm signal output.
<b>On</b>	The instrument will sound an audible beep during alarm signal output.

**2. Setting Alarm Criteria for Each Channel**

- 1** Choose the input unit and channel(s) to serve as alarm criteria, and select the checkbox .
- 2** (If alarm criteria settings are disabled) Select [Alarm on.].\*

ALM1 to ALM4 outputs are all enabled .

(continues on next page)



1 2

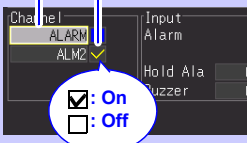
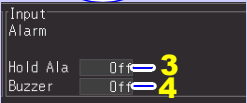

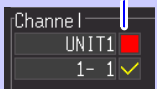

- Alarm hold and beeper can also be set on the Waveform/Numerical screen ([Gauge+Wave] display).
- To stop the alarm beeper while measuring, set the beeper to [Off] in the ALM channel settings on the Waveform/Numerical screen.

1

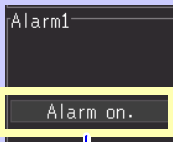

2



\*: Displayed when the box is not checked in step 2 of procedure 1.



### 3 Configure Alarm Criteria.

Setting options: (\* : default setting)

<b>Off*</b>	Disable alarms for this channel.
<b>Level</b>	Trigger an alarm when the input reaches a specified level.
<b>Window</b>	WindowTrigger an alarm when the input transitionsthrough upper and lower limits.

### 4 (If using a [Level] setting)

Setting options: (\* : default setting)

<b>↑*</b>	Sound an alarm when the value is bigger than the level value set.
<b>↓</b>	Sound an alarm when the value is smaller than the level value set.

(When [Window] is selected)

Setting options: (\* : default setting)

<b>In*</b>	Sound an alarm when the value is within the range of the window (upper and lower values) set.
<b>Out</b>	Sound an alarm when the value is outside the range of the window (upper and lower values) set.

When the selected channel is logic input.

### 5 Configure Alarm Criteria.

Setting options: (\* : default setting)

<b>OR*</b>	An alarm is output when any one of the criteria match the set pattern.
<b>AND</b>	An alarm is output only when all of the criteria match the set pattern.

### 6 Set the alarm pattern.

Setting options: (\* : default setting)

<b>X*</b>	Signal is ignored.
<b>0</b>	An alarm is output when the signal switches from High to Low.
<b>1</b>	An alarm is output when the signal switches from Low to High.

**NOTE** If the criteria are satisfied at the start of measurement, alarm output will be generated immediately.

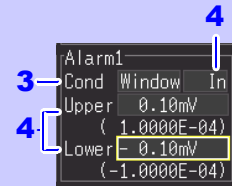
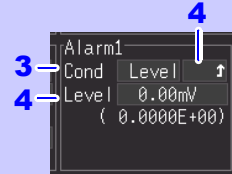

WAVE/DATA



SET



FILE



Select the [Trig &amp; Alm] Screen.



Trig&amp;Alm

### 3. Selecting Combined Alarm Output Criteria

Setting options: ( \* : default setting)



**OR\*** Alarm output occurs when the alarm criteria specified for any alarm-enabled channel are satisfied.

**AND** Alarm output occurs only when the alarm criteria for every alarm-enabled channel are satisfied.

```
Alarm Source
AL1 AL2 AL3 AL4
OR  OR  OR  OR
```

If [Alarm] is set to [Off], change it to ([On]).

- Alarms can be output at thermocouple burnout, communications interruption, and low remaining battery life.

- Select the [Trig & Alm] Screen.   
- Select a [Alarm] .
- Select the criterion for which you wish to output an alarm and set it to on.



- Set [Alarm at burn out.] to [ON].  
Alarm output will be generated when a burnout is detected, regardless of the [AND] and [OR] settings for other alarm criteria settings and alarm source settings.  

Alarm at burn out	Off	Off	Off	Off
-------------------	-----	-----	-----	-----
- Set [Alarm at disconnect.] to [ON].  
A warning is output when the instrument is unable to communicate with a measurement unit or wireless logger, regardless of the [AND] and [OR] settings for other alarm criteria settings and alarm source settings.  

Alarm at disconnect	Off	Off	Off	Off
---------------------	-----	-----	-----	-----
- Set [Alarm at disconnect.] to [DELAY].  
If the data containing 2000 or more samples is not received from the unit with [Alarm at disconnect.] set to [DELAY], the alarm output will be generated.
- Set [Alarm at low battery] to [ON].  
A warning is output when a measurement unit or wireless logger indicates low battery strength, regardless of the [AND] and [OR] settings for other alarm criteria settings and alarm source settings.  

Alarm at low battery	Off	Off	Off	Off
----------------------	-----	-----	-----	-----

# Saving & Loading Data

## Chapter 6

Data measured using the instrument can be saved to an SD memory card or USB flash drive.

**See:** "2.7 Inserting a SD Memory Card or USB Flash Drive (when saving data)" (p. 63)

Data saved (in binary format) to removable storage can be reloaded into the instrument.

### 6.1 About Saving and Loading Data

When saving data, a folder named HIOKI\_LR8410 is created, and files are stored in the folder as follows. WAVE\*\*\*\* and MEAS\*\*\*\* are used as filenames when saving data manually when no save filename has been set. When saving data automatically with no save filename set, the AUTO00001.xxx filename format is used.

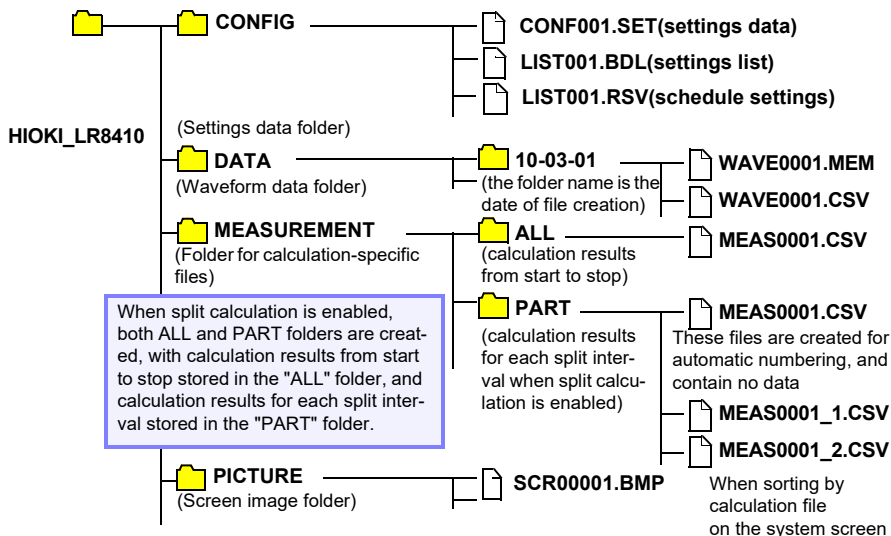

## 6.1 About Saving and Loading Data

√: Available/ -: Not Available

File Type	File Format	Folder Name	File Name*5 (Auto-numbered from 1)	Save		Load	
				Auto	Man- ual	LR 8410	PC
Setting Data	Binary	CONFIG	CONF0001.SET	-	√	√	-
Setting List	Binary	CONFIG	LIST001.BDL	-	√	√	-
Schedule settings	Binary	CONFIG	LIST001.RCV	-	√	√	-
Waveform Data*1	Binary	DATA(date)*4 (e.g.: 08-07-30)	AUTO0001.MEM WAVE0001.MEM	√	√	√	√
	Text *2	DATA(date)*4 (e.g.: 08-07-30)	AUTO0001.CSV WAVE0001.CSV*6	√	√	-	√
Numerical Calculation Results	Text *2	MEASUREMENT	AUTO0001.CSV MEAS0001.CSV*7	√	√	-	√
Captured Screen Image	BMP *3	PICTURE	SCR00001.BMP	-	√	√	√

\*1: Save waveform data in binary format if you intend to view it later in the instrument or on a PC with the supplied Logger Utility program. Waveform data and some measurement-related settings data are saved.

To save a waveform partially, specify a period by using A/B cursors before saving (p. 120).

When scaling has been set, the raw data (unscaled data) is recorded along with scaling information in a binary format. When a previously saved file is loaded, the scaled data will be displayed. However, you can also check the raw data by disabling scaling.

\*2: When opening a CSV file in a spreadsheet program, note that the number of rows that can be loaded at one time is limited (p. A9).

\*3: BMP Format: This is a standard Windows® graphics format. These files can be handled by many graphics programs.

\*4: Date (YY-MM-DD) folders are automatically created inside the DATA folder.

\*5: When saved manually. See "Appendix 3 File Naming" (p. A9) for file naming details.

\*6: The TXT file extension is applied except when **[Separator:Comma]** is selected on the **[System]** screen.

\*7: When creating calculation-specific files, an underbar and a serial number (\_n) is appended to the file name, e.g., MEAS0001\_1.CSV, MEAS0001\_2.CSV, etc.

### NOTE

Depending on file size and SD memory card capacity, each folder can store over 1,000 files. However, the file screen display is limited to a maximum of 1,000 files. Also, as more files are created, more time is needed to start and stop recording. We recommend setting measurement criteria so that the number of saved files stays below 1,000 whenever possible.

## What happens to data in a power outage?

Data in internal buffer memory is retained for about 30 minutes after power-off.

If power is off for more than 30 minutes, the data is lost.

Also, when Auto-Resume (p. 198) is enabled, measurement resumes automatically when power is restored, so previous measurement data is deleted.

To avoid data loss in such cases during long-term measurement, we recommend the following settings to prepare for power outages.

## Preparation for power outages during long-term measurements

- Connect the (optional) battery pack before starting (p. 43)  
Measurement can continue on battery power when mains power is lost.
- Configure Auto Save beforehand (save **[Waveform(realtime)]**, P.165 )  
Data is periodically saved to removable storage. The instrument includes a large-value capacitor to provide power to save the most recent data and close the files when power fails.

### CAUTION

If power is lost within about ten minutes after power-on, files on the removable storage may be corrupted, and the device could be damaged.

If a damaged storage device is used, files may fail to close within the allotted time, and data may be lost.

When **[File Protection:High]** is selected on the **[System]** screen, storage media is not recognized for ten minutes after power-on, during which files may be inaccessible and could become corrupted.

**See:** "File Protection Level Setting" (p.199)

Although **[CSV(realtime)]** saving is possible, data is saved only as text, so waveforms cannot be displayed later by reloading into the instrument or by application programs. Note that the recording interval setting is limited (p. 165).

## 6.2 Saving Data

Basically, three methods are available for saving.

To save automatically while measuring

### Auto Save

Measurement data is simultaneously saved during measurement. Calculation results are saved only after measurement is finished.

Make this setting before starting measurements.

Insert a removable storage (p. 63)

[Setting] Screen

Set the Auto Save (p. 165)

Select what to save.

The following can be saved simultaneously:

- Waveform Data
- Numerical Calculation Results

Measurement

Saving proceeds automatically

To save immediately upon pressing the SAVE

### Quick Save

Before saving, select the items to be saved on the [System] screen. These are saved immediately when you press **SAVE**. This is convenient for saving certain types of data, or when you want to save immediately while monitoring (p. 169).

Insert a removable storage (p. 63)

[System] Screen

Set the function of **SAVE** to [Quick Save] (p. 169)

Select what to save.\*

- Waveform Data
- Screen Image
- Setting Data
- Numerical Calculation Results

Press **SAVE** after measuring.\*  
(Saving is not possible while measuring.)

Save

To save selected contents

### Select & Save

(Default setting)

Press **SAVE** to select and save the selected contents. No settings are needed before saving this way (p. 169).

Insert a removable storage (p. 63)

[System] Screen

Set the function of **SAVE** to [Select & Save] (p. 169)

Press **SAVE** after measuring  
(Saving is not possible while measuring.)

Save Dialog

Select what to save.\*  
Set the save filename.  
(Up to 8 characters)

- Waveform Data
- Screen Image
- Setting Data
- Numerical Calculation Results
- Reservation

Press **ENTER**.

Save

\*: To save a waveform partially, specify a period by using A/B cursors. (Saving a waveform section is not available with Auto Save)(p. 120)

To save a screen image, display the desired screen before saving.

• Current measurement conditions are saved as settings.

**See:** "Loading a Setting Configuration" (p. 173)

• The measurement start and stop dates are saved as schedule settings. (p. 143)

## Automatic Saving (Waveform Data and Numerical Calculation Results)

When auto save is enabled before starting measurement, data can be automatically saved to removable storage during or after measurement.

The following types of measurement data can be auto-saved.

Saved Data	Settings	File Extension	Description
Waveform Data Only	Waveform (realtime)	.MEM	During measurement, waveform data is saved in binary format. Conversion to text (CSV) format can be done later, so we suggest selecting Waveform(realtime) for typical operation.
	CSV (realtime) *2	.CSV*3	During measurement, waveform data is saved in text format. Saved data cannot be reloaded into the instrument or by the Logger Utility. However, this format is ideal for loading into spreadsheets like Excel.
Calculation Results Only *1	Calc (post meas.)	.CSV*3	Calculation results are saved after measurement. When <b>[Repeat]</b> recording is enabled (On), each measurement's calculation results are appended to the file. When <b>[Split Calculation]</b> is enabled (On), calculation results are appended at each save interval.
Both Waveform Data and Calculation Results*1	Waveform +Calc	.MEM, .CSV*3	Waveform data is saved in binary format during measurement, and calculation results are saved at the end of measurement.
	CSV + Calc*2	.CSV*3, .CSV*3	Waveform data is saved in text format during measurement, and calculation results are saved at the end of measurement. Saved data cannot be reloaded into the instrument.

- \*1. Calculation must be enabled before starting measurement (p. 185).
- \*2. When using the **[CSV (realtime)]** and **[CSV+Calc]** settings, the available recording interval settings are subject to limitations based on the total number of analog, alarm, and waveform calculation channels (when alarms are on, fixed at four channels).  
Up to 35 channels: No limitations  
From 36 to 75 channels: The 100 ms setting is not available.  
76 or more channels: The 100 ms and 200 ms settings are not available. Also, when opening a CSV file in a spreadsheet program, the number of rows that can be loaded is limited.
- \*3. The TXT file extension is applied except when **[Separator:Comma]** is selected on the **[System]** screen.

### NOTE

When communications with a measurement unit and/or a wireless logger are reestablished after a temporary interruption while automatically saving waveform (binary) data, data being saved is also restored when missing data is restored. However, when using the split save setting, data in files that have already been split and saved will not be restored. Only data associated with files that are currently being saved (i.e., that have not yet been split) can be restored. When automatically saving data in the CSV (text) format, saved data is not restored. Additionally, data cannot be restored if the data in question cannot be found on the media, for example if the media has been changed.(p. A33)



**Setting Procedure**

- Select the [Setting] Screen.
- Move to a setting item.
- Open the setting options for the item to be set.
- Select from the listed options.
- Apply

**Setting**

analysis	Interval	Numerical Calc.	Auto Save	Waveform(realtime)
Time/DIV	Calc1	Average	File Name	SD card
2s/DIV	Calc2	P-P	Media	SD card
Repeat	Calc3	Maximum	Deleting	Off
Off	Calc4	Minimum	Split Save	Ref Time
Record time	Calc5	Time To Max	Ref Time	0: 0
Time	Calc6	Time To Min	Split Length	10 min

Approx. savable time  
SD : 244 Day

Displays an estimate of the remaining time available on the attached SD memory card/ USB flash drive.

- 1 Select the contents to be saved.**  
Setting options: ( \* : default setting)

**Off\***: **Waveform(realtime), CSV(realtime), Calc (post meas.), Waveform + Calc, CSV + Calc**

If [**Off**] is selected, skip steps 2 to 5.

If [**Calc (post meas.)**] is selected, skip steps 4 and 5.

- 2 Specify the waveform file name (if needed). (Up to 8 characters)**

**See**: How to enter filenames: "3.8 Entering Titles and Comments (as needed)" (p. 100)

If left blank, file names are created automatically.

**See**: "Appendix 3 File Naming" (p. A9)

- 3 Select the removable storage priority (SD memory card or USB flash drive)**

- 4 Select whether to delete while saving.**

Select the desired operation when removable storage becomes full while saving.

Setting options: ( \* : default setting)

**Off\*** Saving ends when the removable storage is nearly full.

**On** When the free capacity of the removable storage reaches a certain minimum size, waveform files are deleted, oldest first. If deletion is not possible, saving stops. Delete while saving does not apply to numerical calculation files.

- 5 Select whether to save data into multiple files ("Split Save").**

Select single (per measurement) or multiple (timed) file creation.

Setting options: ( \* : default setting)

**Off\*** Creates a single file per measurement.

**On** Saves data by splitting the file every time the [**Split Length**] elapses. The time at which to split files is set with [**Split Length**]. (See figure to right.)

**Ref Time** Automatically adjusts the initial file split time so that data is saved by splitting files after a certain time ([**Split Length**] elapses after the [**Ref Time**]). (The initial file alone will be shorter than the [**Split Length**].) (See figure to right.)

- 6 Press START to start measuring.**

After measurement, the data is automatically saved to removable storage (p. 161).

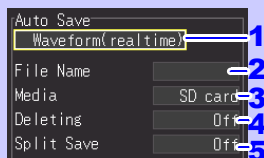

The horizontal axis setting is limited when auto saving waveforms (p. 96).

- With [**Split Save**] set to [**On**]

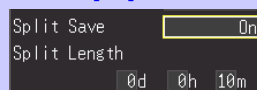

Also set the [**Split Length**].  
Days (0 to 30), Hours (0 to 23),  
Minutes (0 to 59)

- With [**Split Save**] set to [**Ref Time**]  
You cannot set the split time to 0 d 0 h 0 m. If you attempt to do so, it will be set automatically to 0 d 0 h 1 m.

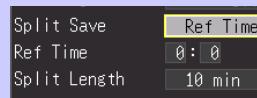

Also set the following items:

**[Ref Time]**: 0:0 to 23:59

**[Split Length]**: 1, 2, 5, 10, 15, 20, 30 minutes, 1, 2, 3, 4, 6, 8, 12 hours, 1 day

The "Waiting for fixed-time synchronization" message will be displayed at the start of measurement until the recording interval has synchronized with the reference time.

Before starting to measure, confirm that Auto Save is configured correctly, and that the removable storage is properly installed.

## Replacing Removable Storage During Real-Time Saving

During real-time saving, removable storage can be replaced without interrupting measurement. This procedure describes replacing a USB flash drive.

**Move the cursor to [EJECT].**

**Execute**

**Move the cursor to [Unmount USB memory].**

**Execute**

**Move the cursor to [Yes].**

**Execute**

**Remove the USB flash drive (p. 64).**

**Insert a formatted removable storage.**

Measurement data acquired while the device was removed is automatically written.

**See:** Formatting: (p. 65)  
Insertion: (p. 63)

When both a SD memory card and USB flash drive are installed and either is removed, the save destination automatically switches to the remaining media.

### NOTE

- If a storage device is not replaced within ten minutes after selecting "Yes" in the "Do you want to remove the USB memory/SD card?" confirmation dialog, data may overflow internal buffer memory and be lost.
- If a storage device is replaced during real-time saving, data is saved to a new file.
- If measurement ends while the removable storage is ejected, even if a removal storage is then inserted, the remaining data is lost. In that case, when connected to a LAN, data can be read from the instrument via the HTTP function. See "10.4 Remote Measurement with the HTTP Server Function" (p. 238).

## Saving Manually (Waveform Data, Settings, Screen Images, Numerical Calculation Results)

Press **SAVE** to save data.

### NOTE

- Internal buffer memory capacity limits saving to the most recent eight million data points. If you need to save more data points, enable real-time auto-saving beforehand.
- Saving can only occur when measurement stops. Saving is not possible while measuring (both waveform data and screen images).

## Setting Procedure

The diagram illustrates the setting procedure through a sequence of five steps, each accompanied by a directional pad icon:

- Select the [System] Screen.** An arrow points from the 'FILE' button on the device to the 'System' screen on the screenshot.
- Move to a setting item.** An arrow points from the 'SET' button to the 'Environment' menu item on the screenshot.
- Open the setting options for the item to be set.** An arrow points from the 'SET' button to the 'Select & Save' option in the 'SAVE Key Operation' list on the screenshot.
- Select from the listed options.** An arrow points from the 'WAVE/DATA' button to the 'Select & Save' option.
- Apply.** An arrow points from the 'WAVE/DATA' button to the 'Apply' step.

First select the saving method.

Choose **[Select & Save]** or **[Quick Save]**.

### SAVE Key Settings

Setting options: ( \* : default setting)

<b>Select &amp; Save*</b>	Pressing <b>SAVE</b> displays a dialog. Select the type of contents to be saved, and save the data.
<b>Quick Save</b>	Pressing <b>SAVE</b> saves data according to the settings on the <b>[System]</b> screen.

See "When [Select & Save] is selected (to save after selecting setting contents)" (p .171) when selecting **[Select & Save]**, and "When you select [Quick Save] (to save data upon pressing SAVE)" (p .170) for **[Quick Save]**.

## When you select [Quick Save] (to save data upon pressing SAVE)

Press **SAVE** to immediately save data according to current settings.

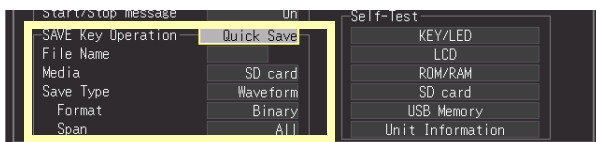

**File Name** Sets the save filename.(Up to 8 characters)

### File Name

**Media** Select the priority save destination when **[Quick Save]** is selected.

Setting options: ( \* : default setting)

**SD card\*** Save to the SD memory card first

**USB Memory** Save to the USB flash drive first

**Save Type** Select the type of data to save.

### Save Type

Setting options: ( \* : default setting)

**Waveform\*** Save waveform data.

**Screen Image** Save screen image.

**Setup File** Save setting configuration data.

**Calc Results** Save numerical calculation results.

Calculation must be configured before saving numerical calculation results (p. 185).

**Format** (When **[Waveform]** is selected) Select the data format.

Setting options: ( \* : default setting)

**Binary\*** Select this format to be able to reload the saved data into the instrument, or so that it can be loaded into the Logger Utility program.

**CSV** Select this format to save the data as a text file. This format is ideal for loading into spreadsheet programs like Excel.

Data saved in CSV format cannot be reloaded into the instrument or Logger Utility program. Fortunately, data saved in binary format can be later converted to text (CSV) format with the instrument or Logger Utility.

**Span** (When **[Waveform]** is selected) Select the time span to be saved.

Setting options: ( \* : default setting)

**All\*** Save all measured waveform data.

**A-B** Save waveform data between A/B cursors.

**Start-A** Save waveform data from the start of measurement to cursor A.

**Start-B** Save waveform data from the start of measurement to cursor B.

**A-End** Save waveform data from cursor A to the end of measurement.

**B-End** Save waveform data from cursor B to the end of measurement.

- Before saving a partial waveform, specify the span to be saved (p. 120).
- When a save span is specified for calculation, the results are saved for the specified span.

### When [Select & Save] is selected (to save after selecting setting contents)

Settings are the same as for Quick Save.

**See:** For details about the type, format, and span, see (p. 170), and for setting procedures, see (p. 172).

#### Waveform Data

**SAVE**



The setting dialog is displayed.

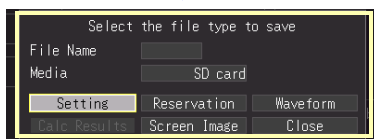

Set the **[File Name]**.

**See:** Filename when no setting has been made (p. 161)

Select **[Media]**.  
(SD card/USB Memory)

Select **[Waveform]**, and press **ENTER**.

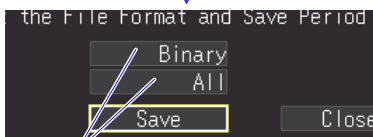

Select, and press **ENTER**.

Select **[Save]**, and press **ENTER**.

Select **[Yes]** in the confirmation dialog, and press **ENTER**.

Before saving a partial waveform, specify the span to be saved (p. 120).

#### Settings, Reservations, Screen Images and Numerical Calculation Results

**SAVE**



The setting dialog is displayed.

Note:

Display the screen to be captured before pressing **SAVE**.

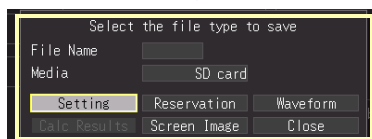

Set the **[File Name]**.

**See:** Filename when no setting has been made (p. 161)

Select **[Media]**.  
(SD card/USB Memory)

Select **[Screen Image]** or **[Calc Results]**, and press **ENTER**.

Select **[Yes]** in the confirmation dialog, and press **ENTER**.

- Numerical calculation must be configured in order to save calculation results (p. 185).
- When a save span is specified for calculation results, the results are saved for the specified span.

## To Save a Setting Configuration

Setting configurations can be saved as data files and later reloaded into the instrument when you need to make more measurements with the same settings.

Up to five setting configurations can be saved to internal memory, and more can be stored on the removal storage device.

**1**  Select the **[Setting]** Screen.

**2**  Select **[Save Set.]**

 **Apply**

The Save dialog appears.

**3**  Select whether to save to instrument memory, SD memory card, or USB flash drive.

 **Apply**

**4** (When **[Memory]** is selected)

Setting conditions saved in the instrument's memory can be saved together in a file on the SD memory card or USB flash drive. Set the save location for the setting list (BDL file) to **[SD]** or **[USB]** and press **ENTER**. A file with the filename [LIST+Automatic\_number(0001).BDL] will be saved in the "Config" folder in the "HIOKI\_LR8410" directory.

 Select **[Save]** for the configuration instance (No.) to save.

Enter a comment as needed (p. 100).

 **Apply**

(When **[SD Card]**, or **[USB memory]** is selected)

Setting configuration files are automatically named CONFnnnn.SET in a folder named [HIOKI\_LR8410]-[CONFIG] (p. 161).

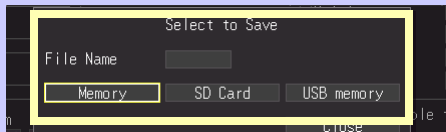
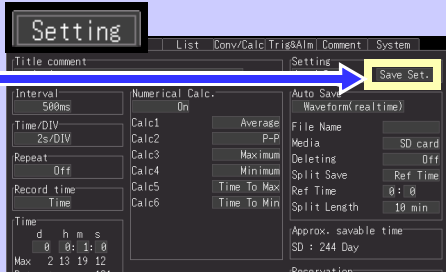

Comments entered on the **[Comment]** screen are displayed here.

If no comments have been entered, the date and time at which the file was saved will be displayed in the format [Year-Month-Date Hour:Min.:Sec.].

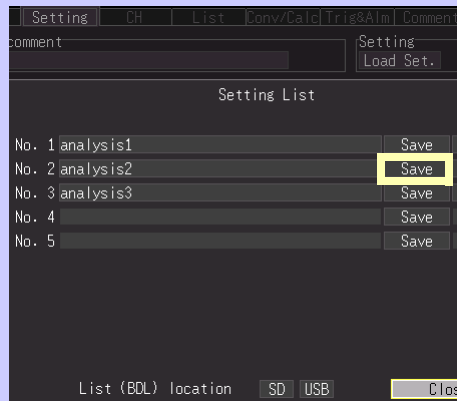







## 6.3 Loading Data on the instrument

Previously stored binary waveform data, captured screen images and saved setting configurations can be reloaded into the instrument (p. 161).

**NOTE** Communications settings (LAN, USB) cannot be loaded while the instrument is sending an e-mail.(p. 265)

### Loading a Setting Configuration

Setting configurations saved in the instrument's memory or on a removable storage can be reloaded.

- 1  Select the **[Setting]** Screen.
- 2  Select **[Load Set.]**.  
 **Apply**  
 The loading dialog appears.
- 3  Select the load destination.  
 **Apply**  
 (If you selected **[Memory]**)  
 Select **[Load]** for the configuration you want to load.  
 (If you selected **[SD Card]**, or **[USB memory]**)  
 Select the configuration file to load.

_SET: (settings data)	Measurement condition settings
_BDL: (settings list)	List of all settings saved in the instrument's memory
_RSV: (schedule settings)	Schedule information consisting of measurement start and stop dates

(continues on next page)

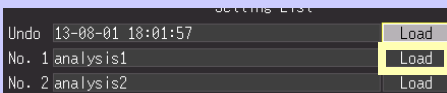
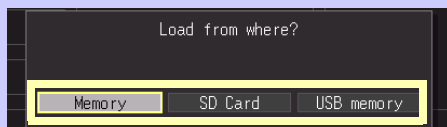
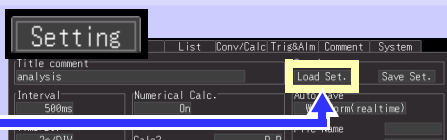

#### When Loading from instrument Memory

The list of configurations stored in instrument memory is displayed.

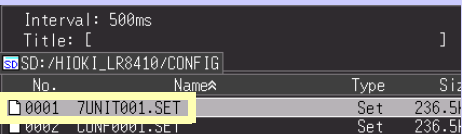

#### When Loading from removable storage

Configuration files stored in the [HIOKI\_LR8410]-[CONFIG] folder on the removable storage are displayed.

**See:** To Save a Setting Configuration: (p. 172)



### 6.3 Loading Data on the instrument

Select the checkboxes to indicate whether to load unit registration information and communications settings and select [Yes]. (Select the unit registration information checkbox to load unit registration information, and select the communications settings (LAN, USB) checkbox to load communications settings.)

**4**  **Apply**

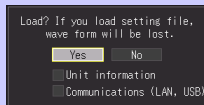

Setting configurations saved to removable storage can be reloaded from the File screen.

#### To load settings data automatically (auto setup)

- Loading settings from the instrument's memory

- 1** Open the [Load Set] screen.  
See: "Loading a Setting Configuration" (p.173)
- 2** Select the load destination.
- 3** Set the [Auto load] setting to the settings number you wish to have load automatically.

Select:( \* : default setting)

<b>Off*</b>	Does not load settings automatically.
<b>No1 to No 5</b>	Selects the file to load automatically.

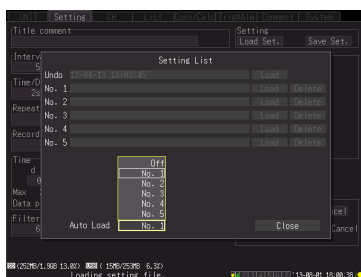

- Loading settings from external media  
Setting configuration data saved as a file named STARTUP.SET in the [HIOKI\_LR8410] - [CONFIG] folder can be automatically reloaded at power-on.  
When setting configurations are stored on both SD memory card and USB flash drive, the SD memory card has priority.  
When [File Protection: High] is selected on the System screen, Auto Setup is not available.

## Reverting to previous settings

When a settings file is loaded, the current settings will be automatically saved to the settings list Undo in the instrument's memory. Settings are overwritten each time a settings file is loaded.

You can revert the instrument to its state before the last settings file was loaded by loading the Undo settings.

**1**  → **Select the [Setting] Screen.**

**2**  **Select [Load Set.].**

**Apply**  
The loading dialog appears.

**3**  **Select the [Memory].**

**Apply**

**4**  **Select [Load] for the Undo settings file.**

**Apply**

**5**  **Select [Load] for the Undo settings file. Select the checkboxes to indicate whether to load unit registration information and communications settings and then select [Yes].**

**Apply**

(Select the unit registration information checkbox to load unit registration information, and select the communications settings (LAN, USB) checkbox to load communications settings.)

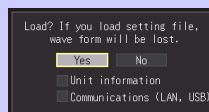
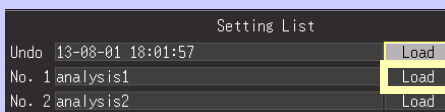
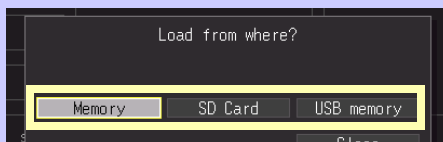

**Loading Waveform Data and Screen Images**

Saved binary waveform data and screen images can be reloaded in the instrument.

**1** **Select the File Screen.**  
The contents of the removable storage are displayed.

**2** **Select a file to load**

— Displays the child folder. (Viewing folder contents)  
 — Displays the parent folder.

After selecting a folder by pressing **ENTER**, select **[Change]** in the displayed control dialog box.

No.	Name	Type	Size	Date
0001	HIOKI_LR8410	Folder		*13-06-05 11:01:16

**Apply**  
The control dialog box appears.

**3** **Select [Load].**

**Apply**

AUTO0002.MEM				
Wave	Size	Date		
Wave	1.8MB	*13-05-24 11:56:04	Load	Delete
			Rename	Copy
			Sort	Format
				Close

### When loading waveforms

When the amount of data in a file to be loaded exceeds the internal buffer memory capacity, you can specify a data point (number) at which to start loading ([ **Top of data num** ] in fig. below). The loadable data size shows the [ **Readable data num** ] (maximum number of data points) that can be loaded. This setting is not needed if the data to be loaded will fit in internal buffer memory. Select [ **OK** ] to load the data.

The screenshot shows the following menu structure with callouts:

- File name:** AUTO0005.MEM (Callout: Waveform data file name)
- Trigger Time:** \*13-05-24 14:48:16 (Callout: Waveform data start trigger time)
- Data num:** 2400 (Callout: Number of data points in the file)
- Saved Ch:**
  - UNIT1: 1 2 3 4 5 6 7 8 9 10 11 12 13 14 15 (Callout: Channels saved in waveform data to be loaded (Analog and Alarm))
  - UNIT2: 1 2 3 4 5 6 7 8 9 10 11 12 13 14 15
  - UNIT3: 1 2 3 4 5 6 7 8 9 10 11 12 13 14 15
  - UNIT4: 1 2 3 4 5 6 7 8 9 10 11 12 13 14 15
  - UNIT5: 1 2 3 4 5 6 7 8 9 10 11 12 13 14 15
  - UNIT6: 1 2 3 4 5 6 7 8 9 10 11 12 13 14 15
  - UNIT7: 1 2 3 4 5 6 7 8 9 10 11 12 13 14 15
  - ALARM: 1 2 3 4
  - CALC1: 1 2 3 4 5 6 7 8 9 10 11 12 13 14 15
- Readable data num:** 49056 (Callout: Maximum number of data points that can be loaded (to internal buffer memory))
- Top of data num:** 1 0 ~ 0 0 (Callout: Settable range of offset to first data point)
- Scope of data read:** \*13-05-24 14:48:16.0 ~ \*13-05-24 14:50:15.9 (Callout: Times of first and last data points to be loaded)
- Load settings?** Unit information Communications (LAN, USB)

Unit registration information and communications settings (LAN, USB) can also be loaded. Select the checkbox for the settings you wish to load. Settings for unselected checkboxes will not be loaded.

## 6.4 Data Management

You can manage data stored on a removable storage in the instrument.

- Format removable storage (p. 65)
- Load a file (when the file is selected) (p. 173)
- Move displayed folders (when the folder is selected) (p. 178)
- Delete data (p. 179)
- Rename files and folders (p. 180)
- Copy data (p. 181)
- Sort files (p. 182)

### Switching removable storage

**1**  **Select the File screen**  
SD memory card contents\* are displayed.

**2**  **Press FILE again.**  
USB flash drive contents are displayed.  
Press FILE to toggle between SD memory card drive and USB flash drive.

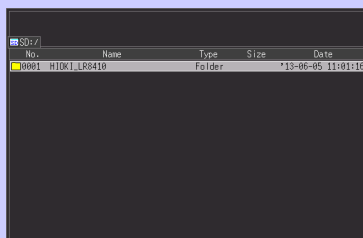

\*: When only a USB flash drive is inserted in the instrument, its contents are displayed. If only one media type has been inserted, the drive cannot be switched.

### Viewing Folder Contents and the Parent Folder

**1**  **Select the File screen**  
SD memory card contents\* are displayed.

**2**  **Select a folder to view.**

**View child folder**  
(view contents of the currently highlighted folder)  
(press **ENTER** and select **[Change]** in the displayed control dialog box)

**Displays the parent folder.**

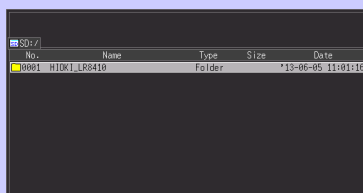





\*: When only a USB flash drive is inserted in the instrument, its contents are displayed.

- Another drive can be selected when the root folder is displayed.
- The path name may have up to 128 characters.

## Deleting Data

Folder and files on the removable storage can be deleted.

- 1  Select the File Screen.
- 2  Select a folder or a file to delete.  
↓  
 Apply
- 3  Select **[Delete]**.  
↓  
 Apply  
A confirmation dialog appears. Select **[Yes]** and press **ENTER** to delete.

 What if the file I want to delete is not displayed?

See: "Switching removable storage" (p.178)

See: "Viewing Folder Contents and the Parent Folder" (p.178)

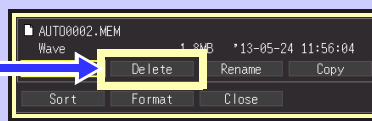





### NOTE

- To protect against inadvertent data loss, the HIOKI\_LR8410 and DATA folders cannot be deleted. If you need to delete one of these folders, rename it first.
- Read-only files can only be deleted with a PC.

## Renaming Files and Folders

Folders and files on a removable storage can be renamed. File names may consist of up to 26 regular characters.

- 1  Select the File Screen.
- 2  Select the file or folder to rename.  
↓  
 Apply
- 3  Select **[Rename]**.  
↓  
 Apply

The character entry dialog appears. Enter the new file name (the same way as when entering a comment) (p. 100).

A confirmation dialog appears. Select **[Yes]** and press the **ENTER** to apply the new name.



### What if the file I want to rename is not displayed?

**See:** "Switching removable storage" (p. 178)

**See:** "Viewing Folder Contents and the Parent Folder" (p. 178)

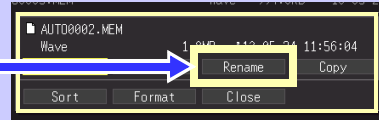

## Copying Data

Files and folders can be copied between a SD memory card and USB flash drive.

**1**  **Select the File Screen.**

**2**  **Select a folder or file to copy.**

 **Apply**

**3**  **Select [Copy].**

 **Apply**

**4**  **Select the copy destination folder.**

 **Apply**

A confirmation dialog is displayed. Select **[Yes]** and press **ENTER** to execute the copy operation.

 **What if the file I want to copy is not displayed?**

**See:** "Switching removable storage" (p.178)

**See:** "Viewing Folder Contents and the Parent Folder" (p.178)

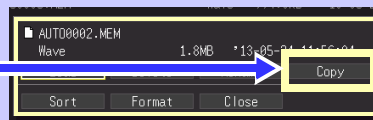











### NOTE

- Folder copying is supported for up to eight hierarchical levels. Folders more than eight levels deep cannot be copied.
- A file cannot be copied if one with the same name already exists at the destination.



## Sorting Files

Files can be sorted in ascending or descending order according to a selected sort key.

- 1     
Select the File Screen.
- 2  **Apply**  
The control dialog box appears.
- 3  **Select [Sort].**  
  
 **Apply**
- 4  **Select the key on which to sort.**  
 **Apply**
- 5  **Execute the sort.**  
Files are redisplayed sorted in ascending or descending order.  
(Press to toggle ascending/descending order)
- 6  **Finish**

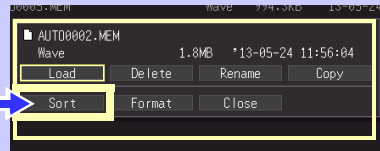
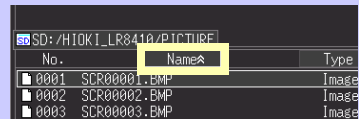
A screenshot of a file list on an SD card. The files are sorted by name in ascending order. The 'Name' column is highlighted with a yellow box.

No.	Name	Type
0001	SCR00001.BMP	Image
0002	SCR00002.BMP	Image
0003	SCR00003.BMP	Image

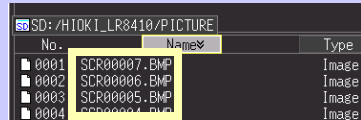

A screenshot of a file list on an SD card. The files are sorted by name in descending order. The 'Name' column is highlighted with a yellow box.

No.	Name	Type
0001	SCR00007.BMP	Image
0002	SCR00006.BMP	Image
0003	SCR00005.BMP	Image
0004	SCR00004.BMP	Image

Reordering also applies to non-displayed files.  
(In the last figure above, all (six) files are displayed in descending order by file name.)

## 6.5 Transferring Data to a PC (USB Drive Mode)

Data saved to a SD memory card can be transferred to a PC using the supplied USB cable. Before connecting the USB cable to the instrument, set the communications interface setting to USB (p. 218), and select “USB Drive Mode” on the instrument.

- NOTE**
- Refer to the Logger Utility Instruction Manual (on the supplied CD) to observe data using the Logger Utility program on a PC (p. 236).
  - USB flash drive data cannot be loaded. Instead, insert the USB flash drive into the computer's USB slot.

### Select the USB Drive Mode

**1**  Select the [System] Screen.

**2**  Select [USB Drive Mode].

**Apply**  
A confirmation dialog is displayed. Select [Yes] and press the **ENTER** key to activate USB drive mode.

**No other instrument operations are available when the USB Drive Mode is enabled. Also, instrument communications with the supplied Logger Utility program are disabled.**

**See:** "To exit USB Drive Mode" (p.184)

**3** Connect the USB cable (p. 184).

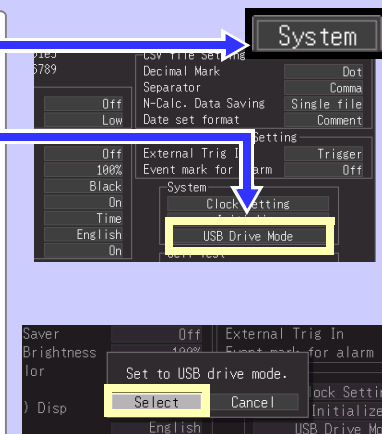

- NOTE**
- If you use a computer to format the memory to a format other than FAT or FAT32 (for example, NTFS) while in USB drive mode, the instrument may not be recognized the next time you change to USB drive mode, or data may be not loaded on the File screen.

## Connecting the USB Cable

Compatible OS: Windows XP, Windows Vista, Windows 7, Windows 8 or Windows 10

### ⚠ CAUTION

- Do not eject the SD memory card or pull out the USB cable during data transfer. Doing so would prevent proper data transfer.
- The instrument and PC should be connected to the same earth ground. If grounded separately, potential difference between the ground points can cause malfunctions or damage when connecting the USB cable.

Before connecting the USB cable to the instrument, select the USB Drive Mode on the [System] screen. Otherwise, the instrument's SD memory card cannot be accessed.



- 1 Orient the USB cable plug properly, and insert it into the receptacle.

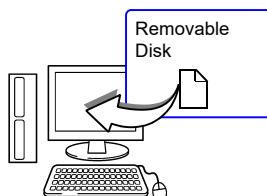

- 2 Connect the other end of the cable to a USB port on the PC.

The PC should recognize the instrument as a removable disk when the cable is connected.

### To exit USB Drive Mode

- 1 Click the Safely Remove Hardware (  ) icon in the Windows<sup>®</sup> notification area.
- 2 Click the appropriate line "Safely remove USB Mass Storage Device? Drive(H:)" where H is the drive letter that Windows<sup>®</sup> assigned to the instrument.
- 3 When "Safe to remove hardware" appears, click [X] or [OK].
- 4 Disconnect the USB cable.
- 5 Press ENTER.

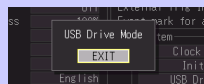
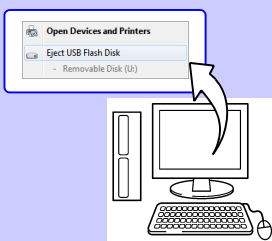

# Numerical Calculations/Waveform Calculations Chapter 7

## 7.1 Calculate Average, Maximum, Minimum, and Etc.

Calculations can be applied to measured data. Six types of calculation are available, six of which can be applied at the same time.

**See:** Refer to "7.2 Numerical Value Calculation Expressions" (p. 192) for details of the calculation methods. You can specify the measurement time span over which calculations are to be applied (p. 191).

### Types of calculations

- Average value                      Average value of waveform data
- Peak value                         Peak-to-peak value of waveform data
- Maximum value                  Maximum value of waveform data
- Minimum value                  Minimum value of waveform data
- Time to maximum value        Time elapsed from the start of measurement to the maximum value
- Time to minimum value        Time elapsed from the start of measurement to the minimum value

Two methods are available for applying calculations, as follows.

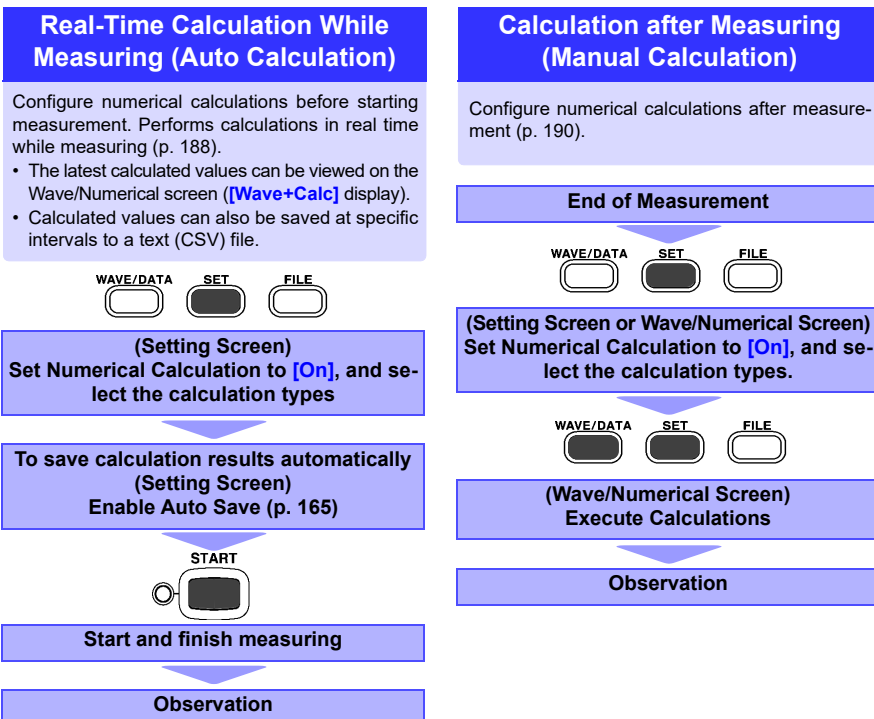

**7.1 Calculate Average, Maximum, Minimum, and Etc.****NOTE**

When input significantly exceeds the range's measurable range (in the positive direction, +OVER; in the negative direction, -OVER), calculated values and saved data are treated as described in the following table in the event of a temporary interruption to communications or burnout detection (during thermocouple measurement):

Input type	Input range	+OVER	-OVER	Burnout detection
Voltage	10 mV	0.0163835	-0.016384	-
	20 mV	0.032767	-0.016384	-
	50 mV	0.32767	-0.32768	-
	100 mV	0.163835	-0.16384	-
	200 mV	0.32767	-0.32768	-
	500 mV	3.2767	-3.2768	-
	1 V	1.6384	-1.6384	-
	2 V	3.2767	-3.2768	-
	5 V	32.767	-32.768	-
	10 V	16.3835	-16.384	-
	20 V	32.767	-32.768	-
	50 V	327.67	-327.68	-
Thermocouple	100 °C	327.67	-327.68	327.66
	500 °C	1638.4	-1638.4	1638.3
	1000 °C	3276.7	-3276.8	3276.6
	2000 °C			
RTD	100 °C	327.67	-327.68	-
	500 °C	1638.4	-1638.4	-
	2000 °C	3276.7	-3276.8	-
Humidity	100%RH	3276.7	-3276.8	3276.6 (LR8514 or LR8520)
Resistance	10 Ω	16.3835	-16.384	-
	20 Ω	32.767	-32.768	-
	100 Ω	163.835	-163.84	-
	200 Ω	327.67	-327.68	-
Integration	1000Mc	2147483647	-	-
Rotation	5000r/s	2147483647	-	-
Logic	-	-	-	-

### 7.1 Calculate Average, Maximum, Minimum, and Etc.

Input type	Input range	+OVER	-OVER	Burnout detection
Current	500 mA	3.2767	-3.2768	-
	5 A	32.767	-32.768	-
	50 A	327.67	-327.68	-
	500 A	3276.7	-3276.8	-
	10 A	327.67	-327.68	-
	100 A	3276.7	-3276.8	-
	1000 A	32767	-32768	-
	20 A	327.67	-327.68	-
	200 A	3276.7	-3276.8	-
	2000 A	32767	-32768	-
Temperature	100°C	3276.7	-3276.8	3276.6
Fungal index	200	-	-	-
Fungal growth projection	100	-	-	-

#### NOTE

- If "NO DATA" is displayed for the data of the object channels for calculation due to a communication interruption or other causes, the data will be not treated as the object for the numerical calculation.
- If the calculation range consists of the data that are displayed as "NO DATA," the instrument will display "---" on the screen and the numerical calculation result to be saved will be zero.

## Key Setting Procedure

**1** Select the [Setting] Screen.

**2** Move to a setting item.

Open the setting options for the item to be set.

Select from the listed options.

Apply

**Setting**

Title comment: analysis

Interval: 500ms

Repeat: Off

Record time: Time

Time: 0 0:0:10

Max: 2 13 19 12

Data pts: 21

Filter: 60 Hz

Numerical Calc.: On

Calc1: Maximum

Calc2: Minimum

Calc3: Average

Calc4: Off

Calc5: Off

Calc6: Off

Split Calc.: On

Length: 0d 0h 10m

Setting: Load Set. Save Set.

Auto Save: Calc(post meas.)

File Name: [ ]

Media: SD card

Reservation: Res. Set. Res. Cancel

State: Reserved Res. Cancel

(2576/1.998 13.02) (883 / 1276/2576: 6.32)

Specifies the split time. Ref Time: Specifies the reference time.

19:46:41 17:57:00

## Real-Time Calculation While Measuring (Auto Calculation)

Calculations are automatically performed in real time while measuring.

**Setting**

CH List Conv/Calc/Trig&Alm Comment System

Title comment: analysis

Interval: 500ms

Time/DIV: 2s/DIV

Repeat: Off

Record time: Time

Numerical Calc.: On

Calc1: Maximum

Calc2: Minimum

Calc3: Average

Calc4: Off

Calc5: Off

Calc6: Off

Setting: Load Set. Save Set.

Auto Save: Calc(post meas.)

File Name: [ ]

Media: SD card

- 1** Select [On].
- 2** Select numerical calculation types.

Setting options: (\* : default setting)

**Average, P-P, Maximum, Minimum, Time to Max, Time to Min, Off\***

To record calculated values at specified intervals (split calculations), perform steps 3 and 4.

(To record calculated values only from measurement start to the present, skip to step 5.)

(continues on next page)

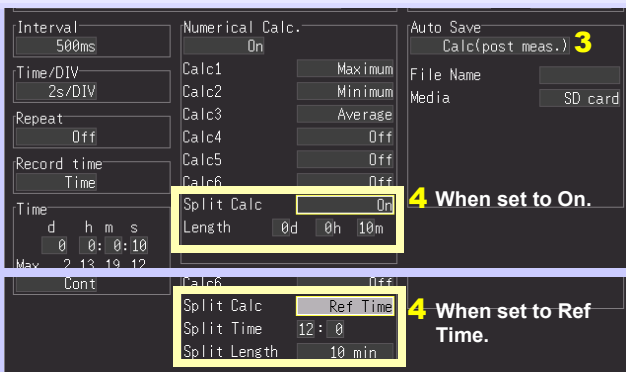

**3** Configure Auto Save.

Select **[Calc(post meas.)]**, **[Waveform + Calc]**, or **[CSV + Calc]**.

When **[Waveform(realtime)]** or **[CSV(realtime)]** is selected, the settings in step 4 are not available.

**4** Select a split-calculation (timing) method.

Setting options: ( \* : default setting)

- Off\*** Save only the last calculation results.
- On** Saves calculated values every time a certain time (**[Length]**) elapses from the start trigger. Set the calculation interval equal to the **[Length]**.
- Ref Time** Automatically adjusts the initial interval length so that calculated values are saved every time a certain time elapses from the start of measurement. (The initial interval alone will be shorter than the **[Split Length]**.) The reference time and time interval for calculations are set with **[Split time]** and **[Split Length]**.

**5** Start measuring.



**6** Select **[Wave+Calc]** display on the Wave/Numerical screen.

Numerical calculation results are displayed.



**Calc1** The results of the selected calculation (no.) are displayed.

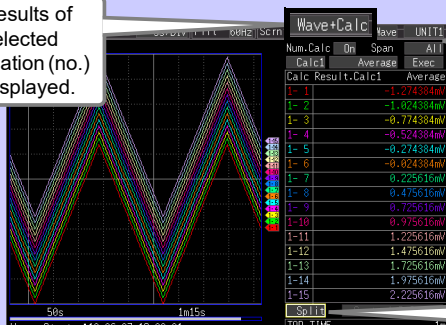



**UNIT1** The results of the selected input unit are displayed. Press **UNIT** to switch the display to another input unit.

**Usual** **Split** Select whether to display calculations from the start of measurement (normal), or the latest calculations after each interval (split value). When split calculation is disabled, the split value is displayed as "- - -".



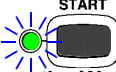

Calculation after Measuring (Manual Calculation)

After measuring, configure and execute calculations.

- 1 Start and finish measuring.  → 
- 2 Select the [Wave+Calc] display on the Wave/Numerical screen.
- 3 Select [On].
- 4 Select any of [Calc1] to [Calc6]. (Default setting: [Calc1])
- 5 Select the calculation type.

Setting options: (\* : default setting)

Average, P-P, Maximum, Minimum, Time to Max, Time to Min, Off\*

- 6 Select [Exec], and execute.  

Numerical calculation results are displayed.

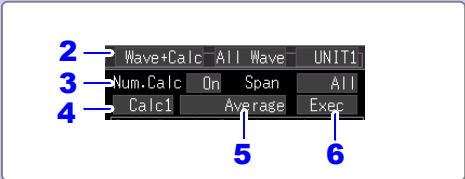

**Calc1** The results of the selected calculation (Calc no.) are displayed.

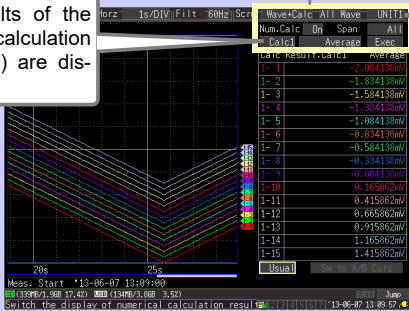

**UNIT1** The results of the selected input unit are displayed. Press **UNIT** to switch the display to another input unit.

Make these settings on the [Setting] screen. After setting, select [Wave+Calc] display on the Wave/Numerical screen, and select [Exec] to execute calculations.

## Apply Calculations to a Specific Time Span (Manual Calculation Only)

After measuring, calculation can be applied to a specified time span. Make any other calculation settings before specifying the calculation time span (P.190 , 1 to 5).

**1** Press **SCROLL/CURSOR** to display A/B cursors.

**2** Press the left/right **SCROLL/CURSOR** keys to move the A/B cursors to specify the time span.

See: Changing the cursor to move (p. 120)

**3**  Select **[Switch to Calc.]**.

 Apply

**4**  Move to a **[Span]** item.

 Open the setting options for the item to be set.

 Select the calculation time span.

See the table at the right for setting choices

 Apply

**5**  Select **[Exec.]**.

 Apply  
The results of calculations are displayed.

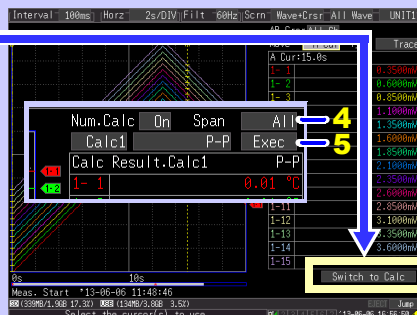
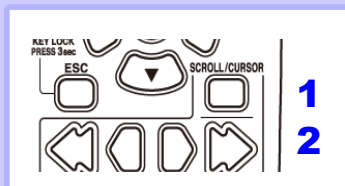

Setting options: ( \* : default setting)

<b>All*</b>	The entire acquired waveform
<b>A-B</b>	The time span between cursors A and B
<b>Start-A</b>	From the start of the acquired waveform to cursor A
<b>Start-B</b>	From the start of the acquired waveform to cursor B
<b>A-End</b>	From cursor A to the end of the acquired waveform
<b>B-End</b>	From cursor B to the end of the acquired waveform

## 7.2 Numerical Value Calculation Expressions

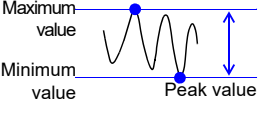
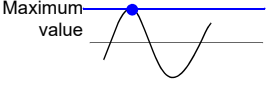
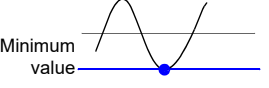
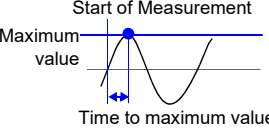
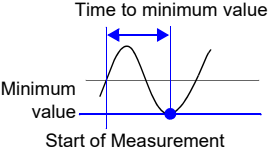
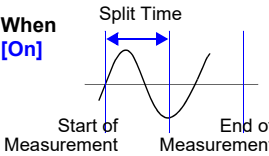
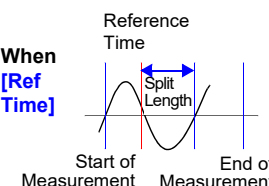
Average	$AVE = \frac{1}{n} \sum_{i=1}^n di$	<p>Obtains the average value of waveform data.</p> <p><i>AVE</i>: Average value  <i>n</i>: Data count  <i>di</i>: Data on channel number <i>i</i></p>
Peak Value (P-P)		<p>Obtains the value of the difference (peak-to-peak value) between maximum and minimum values of waveform data.</p>
Maximum Value		<p>Obtains the maximum value of waveform data.</p>
Minimum Value		<p>Obtains the minimum value of waveform data.</p>
Time to maximum value		<p>Acquires the time (s) elapsed from the start of recording to maximum value. When there are two or more maxima, this value is the first to occur.</p>
Time to minimum value		<p>Acquires the time (s) elapsed from the start of recording to minimum value. When there are two or more minima, this value is the first to occur.</p>
Interval Calculation (Auto Calc only) (p. 189)	<p><b>When [On]</b></p>  <p><b>When [Ref Time]</b></p> 	<p>When <b>[Split Save]</b> is enabled (<b>[On]</b> or <b>[Ref Time]</b>), calculation results are saved at the specified interval.</p> <p>When <b>[On]</b>:  Set the <b>[Split Length]</b>. Calculation results for the specified time span are automatically saved. You cannot set the split time to 0 d 0 h 0 m. If you attempt to do so, it will be set automatically to 0 d 0 h 1 m.</p> <p>When <b>[Ref Time]</b>:  Set the <b>[Split time]</b> and <b>[Split Length]</b>. Calculation results starting from the reference time are automatically saved for the specified time span.</p>

## 7.3 Waveform Calculations

### Coefficient a × [CH A] (×, ÷, +, or -) coefficient b × [CH B] + coefficient c

(CH A and CH B may be any input channels' measurement data, selectable from CH1-1 to 7-15 or waveform calculation result channels W1 to W29 (reused as inputs, as long as the channel number is smaller than number of the final calculation result channel). For example, to obtain results on W3, [CHA] and [CHB] can be set to W1 and W2, respectively.)

The above formula is set up beforehand, calculation result waveforms are displayed on the Waveform screen while measuring, and calculated values can be saved. Up to 30 calculation result waveform channels (W1 to W30) are available at once.

Power calculation settings can also be configured.

#### NOTE

Waveform calculations cannot be performed after measurement.

### Key Setting Procedure

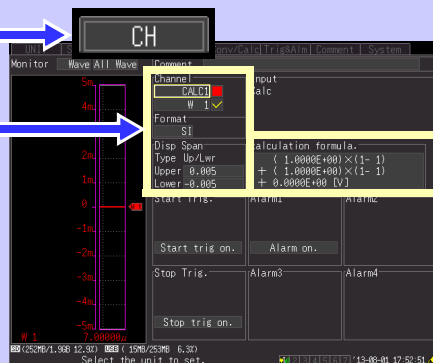
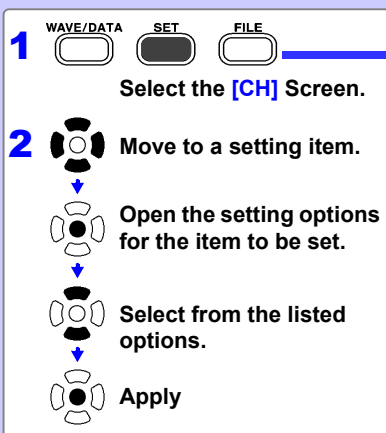

**UNIT** selects the input unit and **CHAN** select the channel to be set.

- 1** Select **[CALC1]** or **[CALC2]** and channel **W1** to **W30**, then select the check box () to enable calculation.
- 2** Set the **[calculation formula]**, and press **ENTER**.  
The coefficient setting dialog is displayed.
- 3** Enter or select coefficient **a**, **CH A**, coefficient **b**, **CH B**, coefficient **c**, and the measurement units, and press **ENTER**.

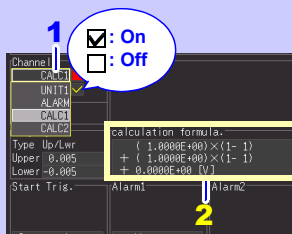

#### Coefficient setting dialog

See: "Numerical Value Entry" (p.95)

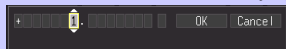

Increment/decrement by 1, change sign (+/-)

Select setting field

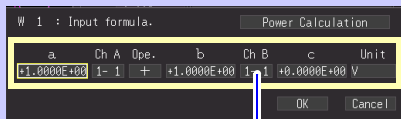

3

The calculation formula can be entered on the **[Conv/Calc]** screen.  
The calculation formula entered for channel **W1** can be copied to other channels (p.103).

- 1** Select the **[Conv/Calc]** Screen.
- 2** Move the cursor to **[Calc 1]** or **[Calc 2]**.
- 3** Select channel **W1** to **W30**.  
The coefficient setting dialog is displayed.
- 4** Enter or select coefficient **a**, **CH A**, coefficient **b**, **CH B**, coefficient **c**, and the measurement units, and press **ENTER**.

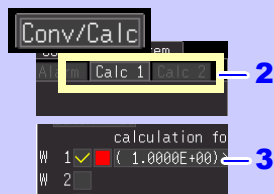

2

3

#### Coefficient setting dialog



Increment/decrement by 1, change sign (+/-)

Select setting field

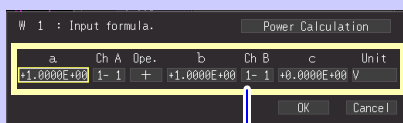

4

## Calculating Power (When Using the LR8513)

You can have the instrument calculate power using the waveform calculation formula by configuring the settings shown in the [Power Calculation] dialog box.

- NOTE**
- This functionality uses a simplified approach to calculating the power, and the calculation results may differ from the actual power value. Use a power meter if you require an accurate power measurement.
  - Data that has been specified as a current value is not checked to verify that it does in fact represent a current value. The calculation will be performed regardless of the type of data specified.

**1** Select **[CALC1]** or **[CALC2]** and channel **W1** to **W30**, then select the check box () to enable calculation.

**2** Set the **[calculation formula]**, and press **ENTER**.

The coefficient setting dialog is displayed.

**3** Select **[Power calculation]** in the dialog box and press the **ENTER** key.

A power calculation settings dialog box will be displayed.

**4** Enter/select the power type, current channel 1, current channel 2, voltage 1, voltage 2, and power factor and press **[ENTER]**.

The waveform calculation settings will be configured automatically based on your settings.

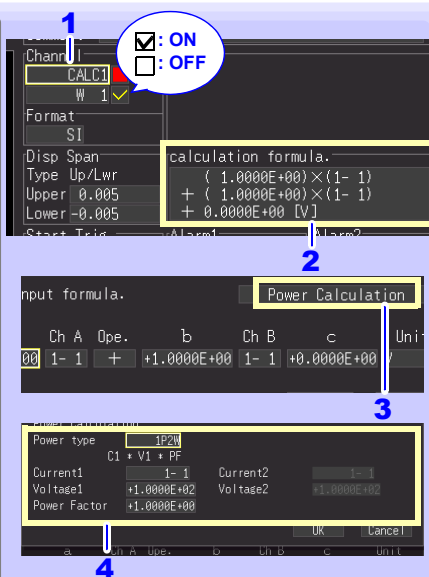

### 7.3 Waveform Calculations

The calculation formula can be entered on the [Conv/Calc] screen.

The calculation formula entered for channel W1 can be copied to other channels (p. 103).

- 1** Select the [Conv/Calc] Screen.
- 2** Move the cursor to [Calc 1] or [Calc 2].
- 3** Select channel W1 to W30.  
The coefficient setting dialog is displayed.
- 4** Select [Power calculation] in the dialog box and press the **ENTER** key.  
A power calculation settings dialog box will be displayed.
- 5** Enter/select the power type, current channel 1, current channel 2, voltage 1, voltage 2, and power factor and press **ENTER**.

The waveform calculation settings will be configured automatically based on your settings.

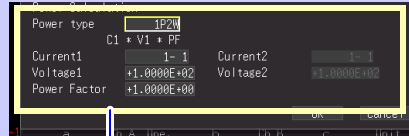
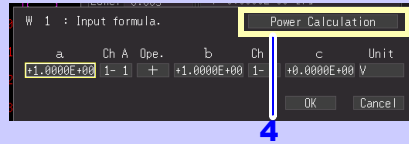
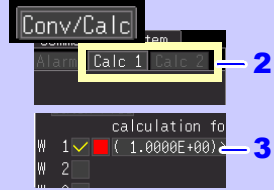

# System Environment Settings

## Chapter 8

Settings affecting the clock, **SAVE** key operation and self testing are made from the [System] screen.

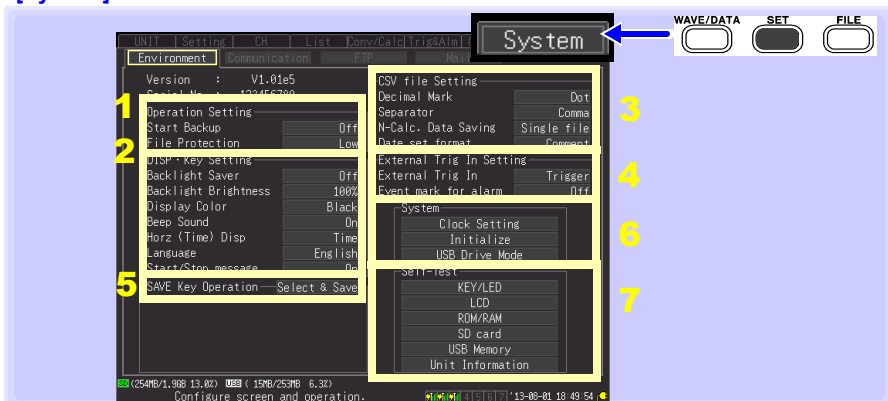

<b>1</b>	<b>Operation Related Settings</b>	<ul style="list-style-type: none"> <li>Specify operating behavior when recovering from power outages (Auto-Resume) (p. 198)</li> <li>Set the file protection level (p. 199)</li> </ul>
<b>2</b>	<b>Screen and Key Related Settings</b>	<ul style="list-style-type: none"> <li>Set backlight power saving (p. 199)</li> <li>Set backlight brightness (p. 200)</li> <li>Select black or white screen background (p. 200)</li> <li>Enable or disable the beeper (p. 200)</li> <li>Set the horizontal axis (time value display) (p. 201)</li> <li>Select display language (p. 201)</li> <li>Set start/stop confirmation message display (p. 201)</li> </ul>
<b>3</b>	<b>CSV File Saving</b>	<ul style="list-style-type: none"> <li>Select CSV file data decimal and separator characters (p. 202)</li> <li>Select the sort order for numerical calculation results (p. 202)</li> <li>Setting How to Handle Date Data Stored in CSV Files (p. 203)</li> </ul>
<b>4</b>	<b>External Trigger Input</b>	<ul style="list-style-type: none"> <li>Select the external trigger function (p. 203)</li> <li>Set alarm event marking (p. 203)</li> </ul>
<b>5</b>	<b>Saving (SAVE key)</b>	<ul style="list-style-type: none"> <li>Select the saving method for <b>SAVE</b> (p. 169)</li> <li>Select the type of data to save* (p. 170)</li> <li>Select save formats* (p. 170)</li> <li>Select the time span to save* (p. 170)</li> </ul> <p>*: Set when [Quick Save] is selected.</p>
<b>6</b>	<b>System-Related Settings</b>	<ul style="list-style-type: none"> <li>Set the clock (p. 204)</li> <li>Reinitialize the instrument(p. 205)</li> <li>Transfer data (p. 183)</li> </ul>
<b>7</b>	<b>Self Testing</b>	<ul style="list-style-type: none"> <li>KEY/LED test (p. 206)</li> <li>LCD test (p. 206)</li> <li>ROM/RAM test (p. 206)</li> <li>SD memory card test (p. 206)</li> <li>USB flash drive test (p. 206)</li> <li>Input unit test (p. 206)</li> </ul>



## Key Setting Procedure

**1** Select the [System] Screen.

**2** Move to a setting item.

Open the setting options for the item to be set.

Select from the listed options.

Apply

## 8.1 Operation Settings

Using the Auto-Resume Function  
(Resume After Power Restoration)

If a power outage or other power loss causes an interruption in recording (while the LED on the left side of **START** is lit), you can automatically resume recording when the power is restored. If you are using triggers, the triggers are restored to the **[Waiting for trigger]** state.

**NOTE** When Auto-Resume is enabled, measurement data that was in internal buffer memory before the outage is lost when measurement resumes. To retain measurement data from before an outage, disable Auto-Resume (set to Off).  
To retain measurement data from before an outage and resume measuring automatically afterwards, enable Auto Save (p. 165).

Start Backup  
(Auto Resume)

Setting options: (\* : default setting)

<b>Off*</b>	Do not use the Auto-Resume Function.
<b>On</b>	Use the Auto-Resume Function.



## File Protection Level Setting

If power is lost within about ten minutes after power-on, files on the removable storage may be corrupted, and the device could be damaged. These risks can be avoided by setting the file protection level to **[High]**.

### File Protection

Setting options:( \* : default setting)

<b>Low*</b>	Although removable storage is recognized and ready for recording immediately upon power-on, if power is lost within about ten minutes after power-on, files on the removable storage may be corrupted, and the device could be damaged.
<b>High</b>	Removable storage is not recognized for ten minutes after power-on (when data could be corrupted or the device damaged).



**NOTE** Auto-Setup is not available when **[High]** is selected (p. 174).

## 8.2 Screen Key Operation Settings

**See:** "Key Setting Procedure" (p .198)

### Enabling and Disabling the Backlight Saver

A backlight saver can be activated after a specified number of minutes during which no operation key is pressed. The backlight saver turns off the backlight of the LCD, prolonging the lifetime of the backlight by turning it off when not needed.

To deactivate the backlight saver, press any key. The operating screen appears again.

### Backlight Saver

Setting options:( \* : default setting)

<b>Off*</b>	Disables the backlight saver function. The operating screen is always displayed.
<b>1 min, 2 min, 5 min, 10 min, 30 min</b>	The backlight saver is activated if the specified time is exceeded.

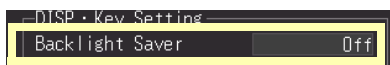

- Be aware that power is still consumed even when the backlight is off, so be sure to turn the instrument power switch off when not in use.
- While the backlight saver is active, the instrument's measuring state is still indicated by the LED.

## Adjust Backlight Brightness

Backlight brightness can be selected from four levels. Lower brightness settings provide longer battery operating time.

**Backlight Brightness** When the [Backlight Brightness] setting is selected, pressing **ENTER** repeated cycles through the four brightness levels.

Setting options:( \* : default setting)

**100%\***, **70%**, **40%**, **25%** (four-step brightness setting)



## Selecting Black or White Screen Background

The screen background can be set to black or white.

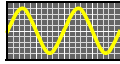

Black Background

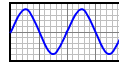

White Background

**Display Color  
(Background  
Color)**

Setting options:( \* : default setting)

**Black\*** Make background black.

**White** Make background white.



## Enabling or Disabling the Beeper

The beeper can be set to sound when an error occurs.

**Beep Sound  
(Beeper)**

Setting options:( \* : default setting)

**On\*** Emit a beep sound on error messages (error and warning displays).

**Off** Do not emit beep sound.



### NOTE

When the alarm beeper is enabled, no beep sounds when a warning or error occurs while measuring.

## Selecting the Horizontal (Time) Axis Display

Select the display method for the horizontal axis at the bottom of the screen. This setting also determines the time display for data saved in CSV format.

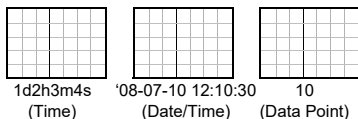

### Horz(Time) Disp (Time Value Display)

Setting options:( \* : default setting)

<b>Time*</b>	Displays the time span from the start of measurement. If triggering is enabled, the displayed time span is from the last trigger event.
<b>Date</b>	Displays the date and time every ten divisions.
<b>Data Pts</b>	Displays the number of data points from the start of measurement. If triggering is enabled, the displayed data points begin from the last trigger event.

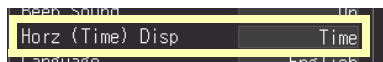

## Selecting the Display Language

Select the display language.

### Language

Setting options:( \* : default setting)

<b>English*</b>	Display in English.
<b>Japanese</b>	Display in Japanese.



## Display of Start/Stop Confirmation Messages

To help avoid operator errors, confirmation messages can be displayed when measurement is manually started or stopped.

### Start/Stop message (Start/Stop Confirmation Messages)

Setting options:( \* : default setting)

<b>Off</b>	Confirmation messages are not displayed. Pressing <b>START</b> and <b>STOP</b> start and stop measurement immediately.
<b>On*</b>	Confirmation messages are displayed. To start or stop measurement, move the cursor to "Yes" and press <b>ENTER</b> .

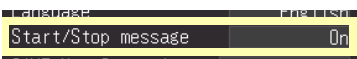

## 8.3 CSV File Saving Settings

See: "Key Setting Procedure" (p.198)

### CSV File Data Decimal and Separator Characters

Select decimal point and separator characters for CSV file data.

#### Decimal Mark (Decimal Point Character)

Setting options:( \* : default setting)

<b>Dot*</b>	Select the period character.
<b>Comma</b>	Select the comma character.



#### Separator (Separator Character)

Setting options:( \* : default setting)

<b>Comma*</b>	Select the comma character.
<b>Space</b>	Select the space character.
<b>Tab</b>	Select the tab character.
<b>Semicolon</b>	Select the semicolon character.



#### NOTE

The comma character cannot be selected for both decimal point and separator at the same time. By default, comma is the separator character, so it is not available as the decimal character. To select comma as the decimal character, first select a different separator character.

### Select the sort order for numerical calculation results

Select whether to save numerical calculation results in a single or multiple CSV files

#### N-Calc. Data Saving (Sort order for numerical calculation results)

Setting options:( \* : default setting)

<b>Single file*</b>	Saves numerical calculation results in a single file.
<b>Split save</b>	Saves numerical calculation results in multiple files.

See: "Appendix 3 File Naming" (p. A9)

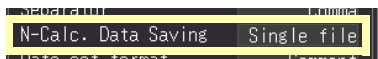

## Setting How to Handle Date Data Stored in CSV Files

This section describes how to configure the handling of date data stored in CSV files.

### Date set format

Setting options:( \* : default setting)

**Comment\*** When opening data as a text file, outputs date data using the following format: ' [apostrophe] year (2 digits) - month (2 digits) - day (2 digits) hours (2 digits) : minutes (2 digits) : seconds (2 digits) . milliseconds (1 digit). This information is treated as a comment in Excel.

**Split msec.** When opening data as a text file, outputs date data using the following format: " [double-quotation mark] year (4 digits) - month (2 digits) - day (2 digits) hours (2 digits) : minutes (2 digits) : seconds (2 digits) " [double-quotation mark]. Time data less than 1 s (unit: ms) is output as separate data. In Excel, sub-second time data is displayed in a separate column. This format is convenient when you wish to combine CSV data acquired from different instruments in Excel.

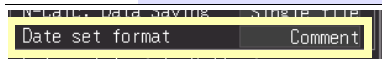

## 8.4 External Trigger Input Settings

See: "Key Setting Procedure" (p.198)

### Selecting the External Trigger Function

Select the function of the EXT.TRIG input terminal.

### External Trig In (External Trigger Input)

Setting options:( \* : default setting)

**Trigger\*** Triggering occurs when a signal is applied to the EXT.TRIG terminal.

**Event** An event mark is inserted into measurement data when a signal is applied to the EXT.TRIG terminal.

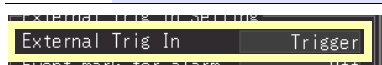

### Set Alarm Event Marking

Selects whether an event mark is inserted when an alarm event occurs.

### Event mark for alarm (Alarm Event Marking)

Setting options:( \* : default setting)

**Off\*** Event marks are not inserted by alarm events.

**On** Event marks are inserted by alarm events.



## 8.5 Making System Settings



### Setting the Date and Time

The instrument is equipped with an auto-calendar, automatic leap year detection, and a 24-hour clock.

If the clock is not set to the correct time, measurement start time (start trigger time) and file date information will be incorrect. If this occurs, reset the clock.

When a wireless logger is connected, the wireless logger will be set to the same time as the instrument.

**1**  **Select the [System] Screen.**

**2**  **Select [Clock Setting].**  
 **Apply**  
 The setting dialog appears.

**3**  **Select an item to change.**  
 (year, month, day, hour, minute or second)

 **Apply**

 **Adjust the setting.**

 **Apply**

**4**  **Select [Set].**

 **Apply**  
 The clock is reset.

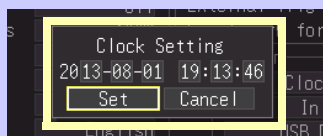
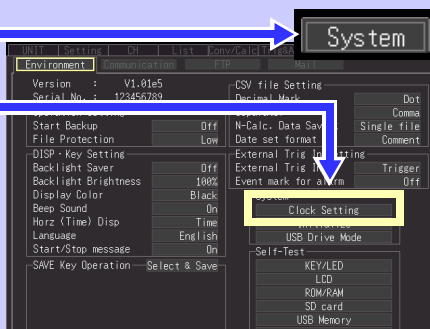

 **Change 1's digit**

 **Change 10's digit**

## Initializing the instrument (System Reset)

This procedure resets all settings to their factory defaults. You can select whether to initialize unit registration information and communications settings (LAN, USB). The system is reset by pressing and holding **STOP** while turning the instrument **POWER** switch on.

**See:** About the factory default settings: "Appendix 6 List of Default Settings" (p. A12)

**1** Select the **[System]** Screen.

**2** Select **[Initialize]**.  
 Apply  
A confirmation dialog appears.

**3** Select the checkbox(es) for the setting(s) you wish to initialize.

Unit information:	Deletes units that have been registered with the instrument.
Communications (LAN, USB):	Resets communications settings.

**4** Select **[Yes]**.  
 Apply  
Initialization proceeds.

The screenshot shows the 'System' screen with the 'Initialize' option highlighted. The 'Initialize?' dialog box is shown with the 'Yes' button selected and the 'Unit information' and 'Communications (LAN, USB)' checkboxes checked.

Setting configuration and language selection saved in the instrument are not reset. Communications settings (LAN, USB) cannot be reset while the instrument is sending an e-mail (p. 265).

### Initializing All Settings (All Reset)

To reset the setting configuration and language selection saved in the instrument, hold **START** and **STOP** while turning the instrument on.

When the power is switched on, the language selection screen will display for you to choose the language you wish to use.

All Reset sets the communications interface to USB.



Self-Test

The following self tests are available. Results are displayed on the screen. If any faults are found, have the instrument repaired. Contact your authorized Hioki distributor or reseller.

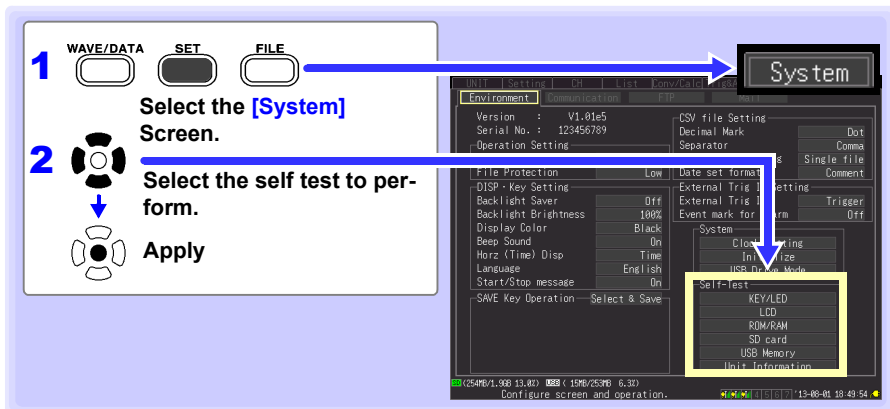

Self-Test	Details
<b>KEY/LED</b>	Tests the keys and LEDs for correct operation. After every key has been pressed, the KEY/LED check finishes. Pressing <b>START</b> also tests whether the LED lights. <b>If you notice a malfunction, press START and STOP simultaneously to abort the test.</b>
<b>LCD</b>	Tests the screen display (character test, gradation test, color test) The screen changes each time you press an operation key. <b>If the display screen seems abnormal, request repairs.</b>
<b>ROM/RAM</b>	ROM/RAM Tests the instrument's internal memory (ROM and RAM) <b>If "NG" appears, request repairs.</b>
<b>SD card</b>	Tests whether the inserted SD memory card can be recognized by the instrument. Use only the included SD memory card or a genuine HIOKI optional SD memory card. Proper operation is not guaranteed with other SD memory cards, and you may not be able to properly save and load data.
<b>USB Memory</b>	Tests whether the inserted USB flash drive is recognized by the instrument. (Proper operation of USB flash drives cannot be guaranteed. It is recommended to use the included SD memory card or a genuine HIOKI optional SD memory card.)
<b>Unit Information</b>	Tests the configuration display for currently connected input units as well as the input units.

# External Control Chapter 9

The external control terminals on the instrument support trigger signal input and output.

Be sure to read p. 55 to p. 56 for external control terminal connection details.

## 9.1 External Trigger Input

Triggering can be controlled by applying a signal from an external trigger source (p. 138).

This allows synchronous operation of multiple instruments by parallel triggering (p. 211).

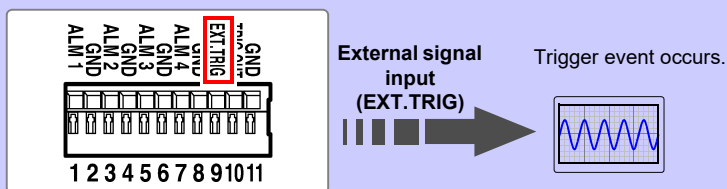

See "Using External Triggering" (p. 138) for setting procedures and trigger signal details.

The external signal input function can be changed to insert event marks.

See: "Inserting Event Marks Using External Input Signals" (p. 124)

### Trigger Input Signals

<b>Voltage range</b>	HIGH level: 2.5 to 5.0 V, LOW level: 0 to 0.8 V
<b>Pulse width</b>	HIGH period: 2.5 ms or greater, LOW period 2.5 ms or greater
<b>Maximum input voltage</b>	DC0 to 10 V

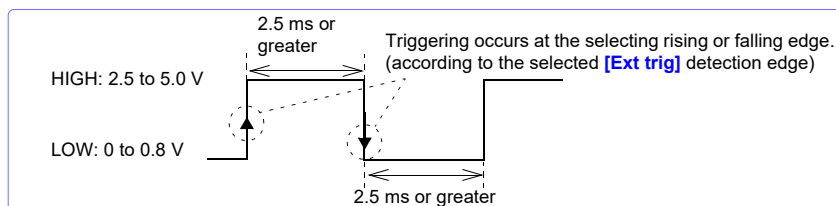

## 9.2 External Signal Output (Trigger Output)

You can output a signal when a trigger event occurs. This allows synchronous operation of multiple instruments by parallel triggering (p. 211).

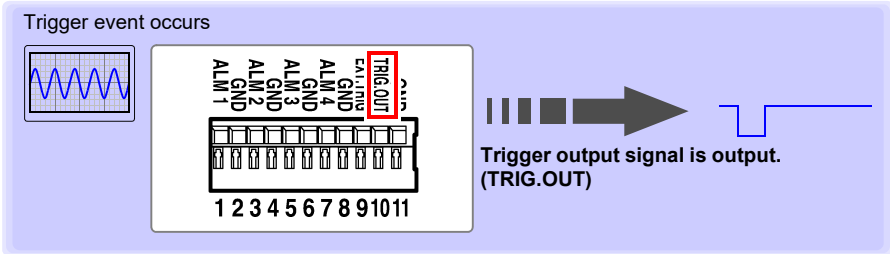

### Trigger Output Signals

<b>Output signal</b>	Open drain output (with 5 V voltage output), active LOW
<b>Output voltage level</b>	HIGH level: 4.0 to 5.0 V, LOW level: 0 to 0.5 V
<b>Pulse width</b>	LOW level: 100 ms or greater
<b>Maximum switching capacity</b>	5 to 30 VDC, 5 mA max

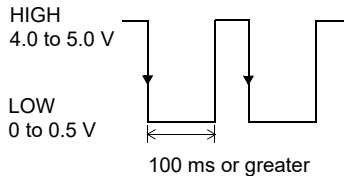
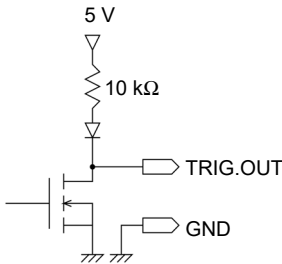

**NOTE** The signal is output even when triggering is not enabled. When triggering is not otherwise used, a trigger signal is output during measurement.

### Signal Output Procedure

**Connect the instrument's TRIG.OUT external control terminal to the external device to be triggered. (See the connection procedure on p. 56 )**

When a trigger event occurs, a pulse wave changing from the HIGH level (4.0 to 5.0 V) to the LOW level (0 to 0.5 V) is output from the TRIG.OUT terminal.

## 9.3 Alarm Signal Output (Alarm Output)

This signal is output when alarm criteria are satisfied.

Specify the desired alarm criteria.

See: "5.9 Alarm Output" (p. 153)

When alarm criteria are satisfied

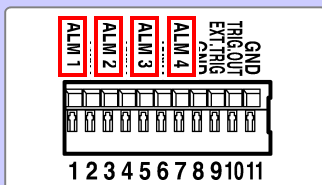
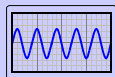

Alarm signal output  
(ALM1 to ALM4)

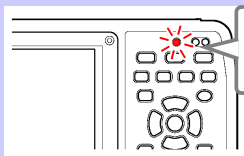
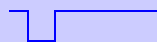

The alarm LED will light up (turn red) when any of the ALM1 to ALM4 alarm criteria are satisfied.

### About the Alarm Output Signal

<b>Output signal</b>	Open drain output (with 5 V voltage output), active LOW
<b>Output voltage level</b>	HIGH level: 4.0 to 5.0 V, LOW level: 0 to 0.5 V
<b>Output response time</b>	Recording interval + 3 sec. or less (When one measurement unit or wireless logger is connected, good communications) Recording interval + 5 sec. or less (When seven measurement units or wireless loggers are connected, good communications)
<b>NOTE</b>	When the communications state is poor, it may take some time for the alarm to be output.
<b>Maximum switch rating</b>	5 to 30 V DC, 200 mA

### 9.3 Alarm Signal Output (Alarm Output)

#### ALARM terminal circuit diagram and example connection

Select the relay with the contact configuration to perform the desired operation.

The example connection illustrates a circuit in which the relay will operate when the alarm output is low.

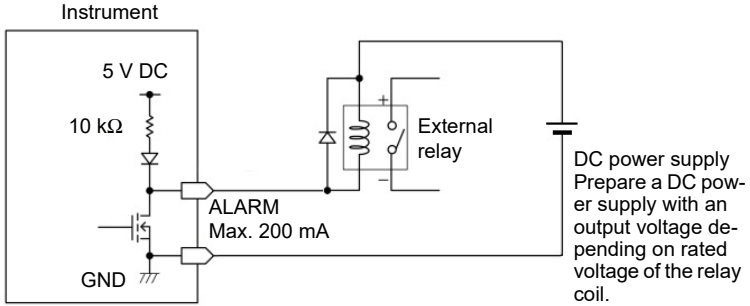

### Signal Output Procedure

**Connect the instrument's ALM external control terminals to the external devices.**

**(See the connection procedure on p. 55 )**

When the alarm criteria are satisfied, a Low level (0 to 0.5 V) signal is output.

## 9.4 Synchronous Measurements with Multiple Instruments

**NOTE** Although this function synchronizes the measurement start time of multiple instruments to the external trigger signal, it does not synchronize actual sampling times. Over long-term measurements, data acquisition times will differ because of sampling block scattering on each instrument.

**Multiple instruments can be synchronized using the external control terminals. Two synchronization methods are available, as follows.**

### Daisy chain (serial) synchronization

Set all to primary instruments.

Setting Procedure

On all instruments, set the **[External Trig In]** to **[Trigger]** (p. 138).

Triggering any instrument triggers all connected instruments. As the number of connected instruments is increased, the trigger time difference between them becomes larger.

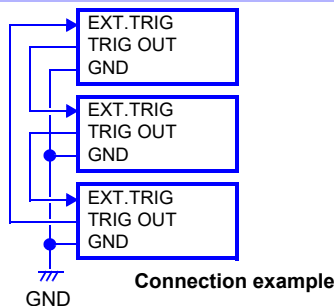

### Parallel synchronization

Set one to a primary instrument and the others to secondary instruments.

Setting Procedure

On the secondary instruments, set the **[External Trig In]** to **[Trigger]** (p. 138)

One serves as the primary instrument (for trigger control), so that when it is triggered, all other instruments start measuring at the same time.

Use this method to minimize the trigger time difference between instruments.

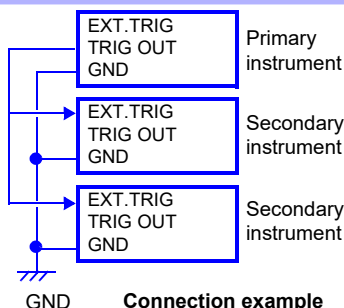



# Connection to a PC (Communication) Chapter 10

Communication is available by connecting a PC to the instrument with an Ethernet or USB cable.

## Communication Features

Item	LAN (100BASE-T)	USB	Ref.
Real-time measurements using the Logger Utility program (on the supplied CD)	○	○	10.3 (p. 236)
Remote operation by HTTP server	○*2	X	10.4 (p. 238)
Manual data acquisition by FTP server	○	X	10.5 (p. 244)
Auto send data to FTP client	○*1	X	10.6 (p. 248)
Automatic e-mail sending (notification)	○*1	X	10.7 (p. 265)
Measuring with a program created with Visual Basic	○*3	○	10.8 (p. 272)

\*1 : Not available while measuring with the Logger Utility.

\*2 : Not available while measuring with the Logger Utility or a program created with Visual Basic or other languages.

\*3 : Data cannot be transferred in real time with recording intervals shorter than one second. Use the Logger Utility for shorter recording intervals. However, data recorded at shorter intervals can still be obtained after measurement has finished. To create a program, see the Communications Command Instruction Manual on the supplied application CD.



When connecting the instrument to your LAN using a LAN cable of more than 30 m or with a cable laid outdoors, take appropriate countermeasures that include installing a surge protector for LANs. Such signal wiring is susceptible to induced lighting, which can cause damage to the instrument.



# 10.1 USB Settings and Connections

Connect the USB cable to a PC to transfer data from the SD memory card (p. 183), and to communicate using the Logger Utility (p. 236), or communications commands (p. 272).

## 1. Configuring the instrument

Select the instrument's USB interface.

**1** Select the [System] Screen.

**2** Select [Communication].  
The Communications Settings appear.

**3** Select [Communication Interface].

Open

Select [USB].

Apply

System

Communication

Communication Interface

USB

USB

LAN

Delimiter CR+LF

Header Off

254MB/1.3GB 13.1% 19MB/253MB 6.30

the communication interface. Select LAN or USB.

13-08-01 19:12:27

## 2. Installing the USB Driver

Install the USB driver as described below before connecting to the instrument via USB cable.

### 1 Install the driver.

Run **[DriverSetup32.msi]** in the CD.

If [Logger Utility] is already installed, run the CD from the following location.

**[c:\Program Files\HIOKI\LoggerUtility\Driver\SetupDriver32.msi]**

If you are using the Windows Vista®/Windows 7/Windows 8/Windows 10 64bit version:

Run **[DriverSetup64.msi]** in the CD.

If Logger Utility is already installed, run the CD from the following location.

**[c:\Program Files\HIOKI\LoggerUtility\Driver\SetupDriver64.msi]**

**NOTE** Depending on the environment, the dialog box may take some time to appear so please wait till it does so.

### 2 Click [Next].

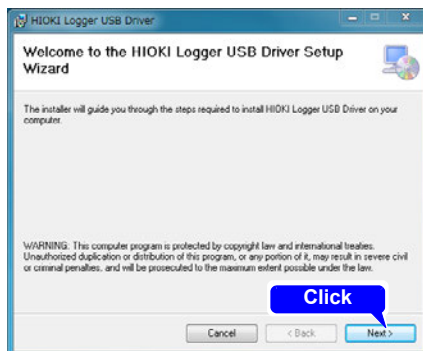

### 3 When you want to change the installation destination

Click **[Browse...]** to change the folder to install into. Normally, there is no need to change.

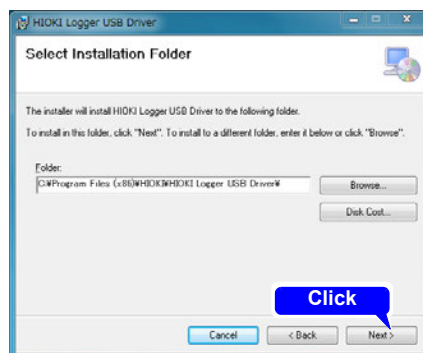

4 Click [Next] to start installing.

Installing

For Windows Vista®/Windows 7/  
Windows 8/Windows 10

When a dialog box requesting your permission to continue the program appears, click [Continue].

For Windows XP

During the installation, a message saying that the software has not passed Windows® Logo testing will appear a few times, click [Continue Anyway] to continue installing.

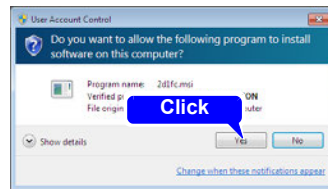
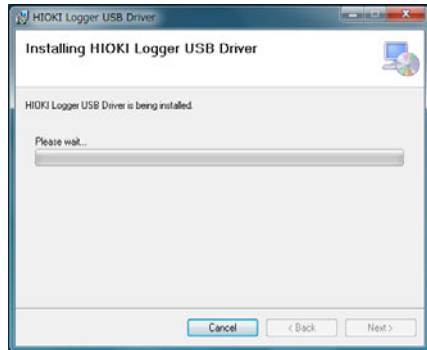
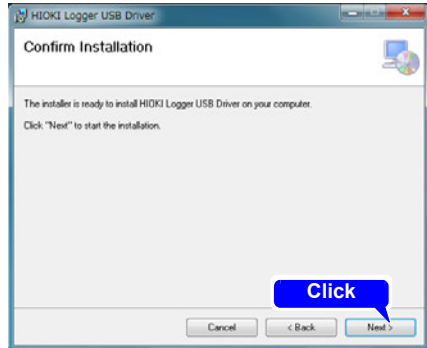

Sometimes another dialog box requesting your permission to install the software may appear. When it does, check **[Always trust software from "HIOKI E.E. CORPORATION"]** and click [Install] to continue.

- 5** When installation is completed and the dialog box appears, click **[Close]** to exit.

This completes the driver installation.

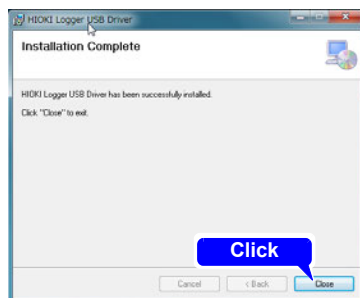
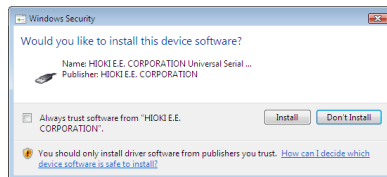

**3. Connecting the instrument to a PC**

Connect the instrument to the PC with a USB cable.

Install the USB driver before communicating with the instrument the first time (p. 215).

**⚠ WARNING**

**To avoid electric shock hazards, turn off all devices before connecting or disconnecting the USB cable.**

**⚠ CAUTION**

- Do not pull out the USB cable during data transfer. Doing so would prevent proper data transfer.
- The instrument and PC should be connected to the same earth ground. If grounded separately, potential difference between the ground points can cause malfunctions or damage when connecting the USB cable.

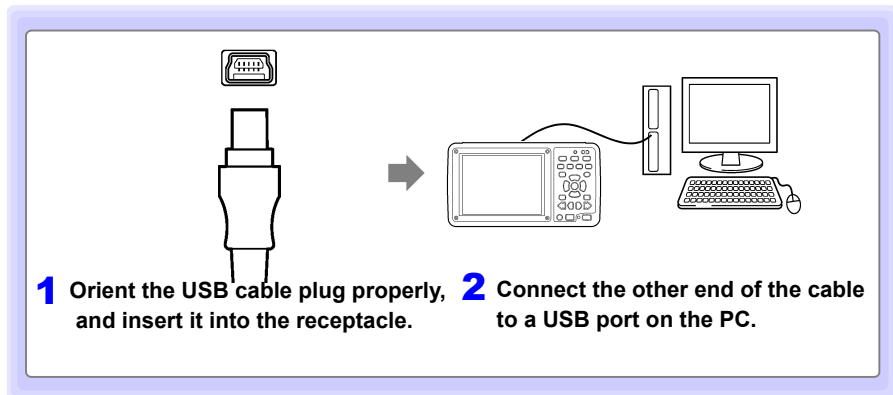

The first time the computer is connected to the instrument, follow the next steps to recognize the instrument.

**For Windows Vista®/Windows 7/Windows 8/Windows 10**

The instrument is automatically recognized, and preparations to use the device are complete.

## For Windows XP

- 1 A [Found New Hardware Wizard] dialog box will appear and the new hardware detection wizard will begin.

Check [No, not this time] and click [Next].



- 2 Check [Install the software automatically (Recommended)] and click [Next].

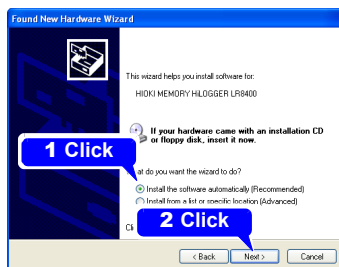

Please wait while the driver is being installed.

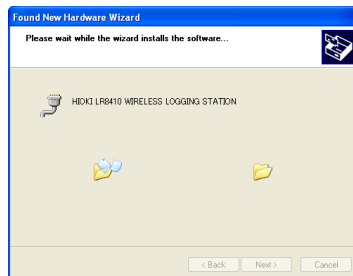

- 3 Click [Continue Anyway].

A message saying that the software has not passed Windows® Logo testing will appear a few times, click [Continue Anyway] to continue installing.



- 4** When installation is completed and the dialog box appears, click **[Close]** to exit.

This completes the driver installation.



## Features Available After USB Setting and Connection

### **Transferring Data from a SD memory card to a PC (p. 183)**

Data saved to a SD memory card can be transferred to a PC.

### **Controlling by Logger Utility(p. 236)**

The supplied Logger Utility program provides PC control over instrument settings and measurement data recording and observing.

### **Controlling by Communications Commands (p. 272)**

See the Communications Command Instruction Manual on the supplied application CD.

## 4. Installing the Logger Utility Program

The Logger Utility program can be installed from the supplied CD, or you can download the latest version from the Hioki web site.

### Operating Environment Confirmation and Preparation

Verify operating environment compatibility before installing.

#### Operating Environment

<b>OS</b>	Windows XP (32-bit) Windows Vista® (32-bit/64-bit) Windows 7 (32-bit/64-bit) Windows 8 (32-bit/64-bit) Windows 10 (32-bit/64-bit)
<b>CPU</b>	1 GHz or faster x 86 or 64-bit processor
<b>Display</b>	1,024 × 768 dots or better, 65,536 color or better
<b>Memory</b>	RAM: 1 GB or more for 32-bit, 2 GB or more for 64-bit
<b>Hard disk space</b>	3 GB or more
<b>Interface</b>	An available Ethernet or USB receptacle

#### Preparation

Insert the supplied CD in the PC's CD-ROM drive, or unzip the downloaded application program file on the PC.



## Installation Procedure

Install the Logger Utility with this procedure. This explanation is for installing the software on Windows 7. The messages displayed may differ slightly depending on other operation system or settings you are using.

### Important

If you are running software such as antivirus software, be sure to end the software before you start the installation. The installation may not be performed properly if antivirus software is running.

## 1 Start up Windows®.

Exit all running applications.

## 2 Insert the included CD into the PC's CD-ROM drive.

The installer run automatically.

## 3 Click the [Next] button, accept the terms of the license agreement, and click the [Next] button.

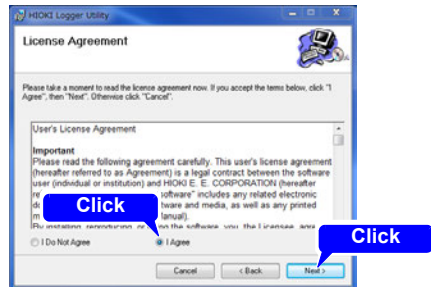

If the installer does not launch Run [Setup.exe] on the CD-R disc.

In Windows Vista®, Windows 7, Windows 8, and Windows 10, Although the dialog which ask for installation permission of application, click [Allow].

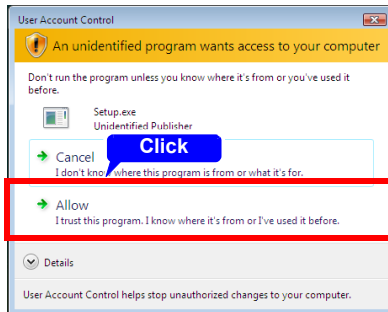

- 4 Select the **[All users]** checkbox and click the **[Next]** button.

To change the install location:  
Click the **[Browse]** button and select the folder into which you wish to install the software. There is normally no need to change the install location.

- 5 Click **[Next]** to start installing.

Installation starts.

To interrupt installation in progress, click **[Cancel]**.

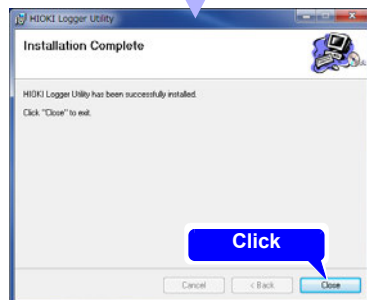
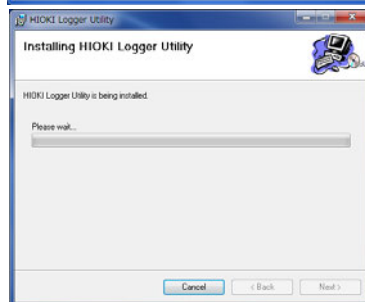
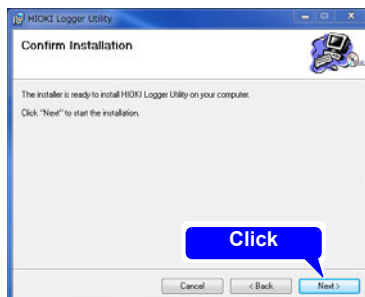
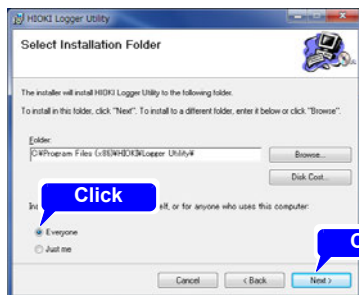

Installation finished

## Uninstalling the Logger Utility

When the Logger Utility is no longer needed, uninstall it with the following procedure.

- 1 Windows Vista®/Windows XP/Windows 7:**  
From the Windows® Start menu, select the **[Control Panel]**.  
**Windows 8:**  
On the desktop, in the Charm Bar, click **[Settings]** - **[Control Panel]**.  
**Windows 10:**  
From the Windows® Start menu, select the **[Windows System]** -**[Control Panel]**

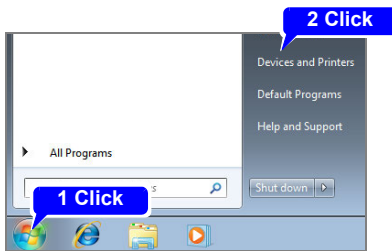

- 2 Double click **[Add or Remove Programs]**.**

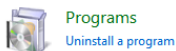

The **[Add or Remove Programs]** screen appears.

- 3** Select **[HIOKI Logger Utility]** on the list of currently installed programs and delete it.  
The installer will be launched automatically.

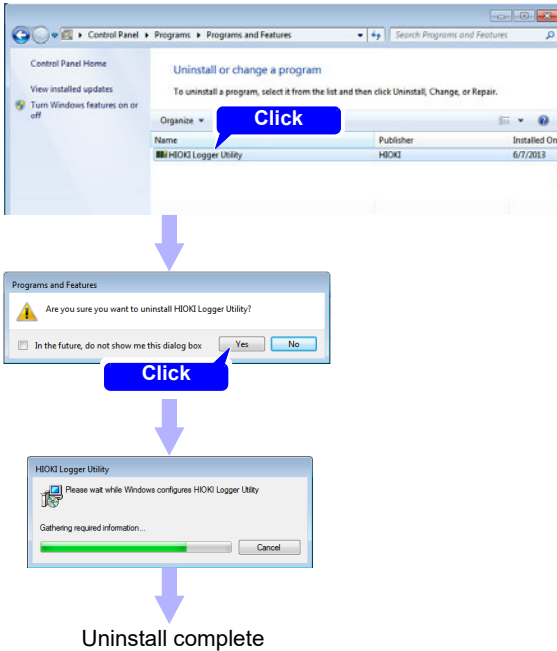

You will be returned to the **[Add and Delete Programs]** dialog box. Settings and other files will be left on the computer and can be deleted manually if no longer needed.

## 10.2 LAN Settings and Connections (Before connecting to the network)

Before operating a computer to use FTP or a web browser, or to communicate with the instrument by using commands, be sure to make LAN setting on the instrument and connect between the instrument and computer with a LAN cable.

**NOTE** Always make LAN settings before connecting to the network. If you change settings while connected to the network, IP addresses may overlap or invalid address data may flow over the network.

### Things to Check Before Making Settings

The required settings are different, depending on whether the instrument is to be connected to an existing network or whether a new network consisting only of the instrument and one PC is to be configured.

#### When Connecting the instrument to an Existing Network

The following items must be assigned in advance by your network administrator. Be sure that there is no conflict with other devices.

<b>Whether to use DHCP</b>	Yes/No
<b>The host name and address of the instrument</b>	Subnet mask: _____ (When DHCP is used, the IP address and subnet mask are not required)
<b>Gateway</b>	Whether to use a gateway: Yes/No IP Address (when used): _____ (When DHCP is used, the gateway address is obtained from the DHCP server, so it does not need to be specified here)
<b>Whether to use DNS</b>	Yes/No
<b>IP address (if used)</b>	_____ (When DHCP is used, the IP address is obtained from the DHCP server, so it does not need to be specified here)
<b>The TCP/IP port number to use</b>	____X (default 880x) (Specify at least the three most significant digits of the four- or five-digit port number. The least significant digit (0 to 9) is reserved for use by the instrument. Specify when the default 8800 to 8809 cannot be used.)

#### When Configuring a New Network with a PC and This instrument

(Using as Local Network Without External Connections)

If there is not administrator for your network, or if you have been entrusted with settings, the following addresses are recommended.

#### (Settings example)

```

IP Address
PC           : 192.168.1.1
First logger : 192.168.1.2
Second logger : 192.168.1.3 and so on, in sequence.
              ↓
Host name    : Any name (However, must be unique)
Subnet mask  : 255.255.255.0
Gateway      : Off
DNS          : Off
DHCP        : Off
Port number  : 880X
  
```

## 10.2 LAN Settings and Connections (Before connecting to the network)

### Setting Items

<b>Use DHCP*</b>	DHCP is a protocol that allows devices to automatically obtain and set their own IP addresses.
<b>*: Dynamic Host Configuration Protocol</b>	If you enable DHCP and there is a DHCP server operating in the same network, the instrument's IP address, subnet mask, and gateway can be obtained and set automatically.
<b>Host Name</b>	This is a name that identifies the instrument on the network. Assign a host name that is different from the names of all other devices. This instrument does not support dynamic DNS, the name that you set is not registered with a DNS server.
<b>IP Address</b>	This is an address that identifies an individual device on a network. Assign an address that is different from the addresses of all other devices. If DHCP is enabled, the address is assigned automatically by the DHCP server.
<b>Subnet Mask</b>	This is a setting used to divide an IP address shown to the network into a network address and a host address. Use the same subnet mask for all devices in the same network. If DHCP is enabled, the subnet mask is assigned automatically by the DHCP server.
<b>Use Gateway IP Address</b>	<ul style="list-style-type: none"> <li>For network connections: When your PC (or the communicating device) is on another network than this instrument, set this to [On] and specify the gateway device. When the PC is on the same network, this is usually set to the same address as the default gateway in the PC communications settings.</li> <li>When connecting the instrument to one computer: Set to [OFF] when connecting the instrument and computer to the same hub. When DHCP is enabled, the gateway IP address will be acquired from the DHCP server.</li> </ul>
<b>DNS(Domain Name System)</b>	<p>When DNS is enabled, you will be able to specify the destination device by name rather than IP address. (IP addresses, which consist of a series of numbers, are difficult to remember. It is easier to specify devices by name than by IP address.)</p> <p>If there is a nameserver operating on the network, it is possible to query that server to search for an IP address based on a name. When DNS is enabled, this information will be acquired from the DHCP server.</p>

### Authorization User Name and Password

These are used when you login to the instrument by FTP, or use a PC browser (with the authorization setting set to on).

When authorization is enabled, login is not possible unless a correct user name and password are entered. This setting is recommended if you wish to restrict the users who can access the instrument.

The "Password" item is displayed as "\*\*\*\*\*".

Valid characters: Alphabetic characters and symbols

If you want to allow anyone to access, or you wish to login as "anonymous" with a FTP client, leave the user name and password fields blank.

## 1. PC Network Setup

The setup procedure is the same when connecting one instrument to the PC as it is when connecting multiple instruments to the PC through a hub.

These instructions presume a network configured as follows.

IP Address	192.168.1.0/24 (network address) (or, enter 192.168.1.1 as a private IP address*)
Subnet Mask	255.255.255.0

\*: Although the IP address can be freely set, a private IP address is normally more secure.

### To display the following dialogs

#### Windows 7/Windows 8/Windows 10





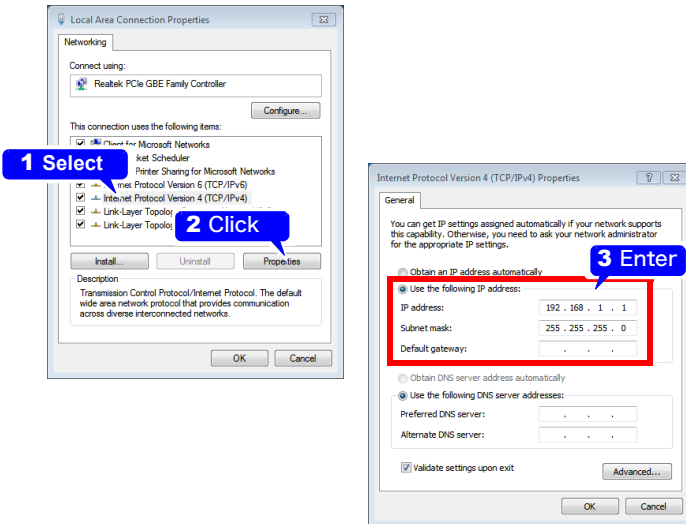

1. Display network connections by selecting **[Control Panel] - [Network and Sharing Center] - [Change adapter settings]**.
2. Right-click on the icon of the adapter you wish to use (it will be named "Local area connection," "Ethernet," etc.) and select "Properties."

#### Windows XP

1. Select **[Control Panels]-[Network and Internet Connections]-[Network Connections]-[Local Area Connection]**.
2. Right click **[Local Area Connection]**, and select Properties.



## 2.Instrument Settings

- 1    Select the [System] Screen.
- 2  Select [Communication].  
The communications settings appear.
- 3  Select [Communication Interface].  
Open  
Select [LAN].  
Apply
- 4  Move to a setting item.  
Open  
Set  
Apply
- 5  Move to [Apply] item.  
Apply



See: "Setting Items"(p. 231)  
"Setting Example"(p. 232)

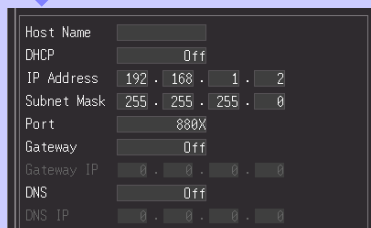

## Numerical Settings



Increment/decrement by 1



Increment/decrement by 10

## Character Settings

See: "3.8 Entering Titles and Comments (as needed)" (p. 100)



**10.2 LAN Settings and Connections (Before connecting to the network)**

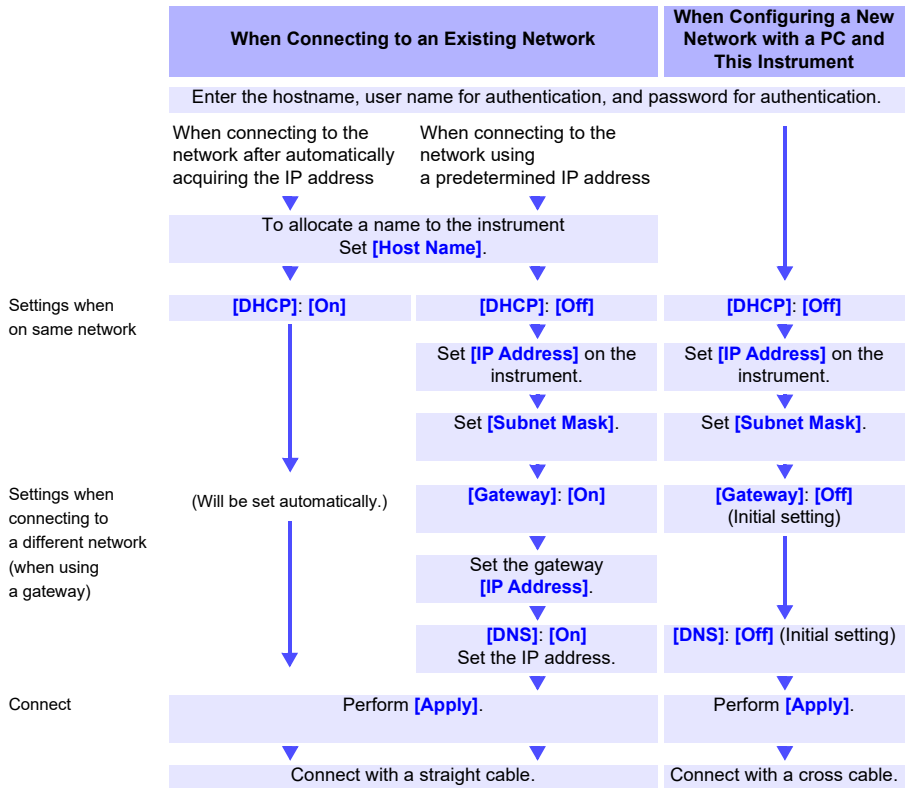

## 10.2 LAN Settings and Connections (Before connecting to the network)

### Setting Items

<b>Host Name</b>	Specify the host name for the instrument. Setting options Up to 12 characters (e.g., LOGGER)				
<b>DHCP</b>	Enable or disable DHCP function. When enabled, the IP address and subnet mask are obtained automatically. Setting options: ( * : default setting)				
	<table border="1" style="width: 100%; border-collapse: collapse;"> <tbody> <tr> <td style="padding: 2px;"><b>Off*</b></td> <td style="padding: 2px;">Disable DHCP.</td> </tr> <tr> <td style="padding: 2px;"><b>On</b></td> <td style="padding: 2px;">Enable DHCP.</td> </tr> </tbody> </table>	<b>Off*</b>	Disable DHCP.	<b>On</b>	Enable DHCP.
<b>Off*</b>	Disable DHCP.				
<b>On</b>	Enable DHCP.				
<b>IP Address</b>	Set the instrument's IP address. Setting options _._._._ (where _ is 0 to 255, e.g., 192.168.1.2)				
<b>Subnet Mask</b>	Set the subnet mask. Setting options _._._._ (where _ is 0 to 255, e.g., 255.255.255.0)				
<b>Port (Port Number)</b>	Set the TCP/IP port number to be used by the instrument. The lowest digit is reserved for use by the instrument. Setting options ____ (where _ is 0 to 9, e.g., 880X)				
<b>Gateway IP</b>	Set this only when <b>[Gateway]</b> is enabled. Set the IP address of the gateway device. Setting options _._._._ (where _ is 0 to 255)				
<b>DNS</b>	Select whether to use DNS. Setting options: ( * : default setting)				
	<table border="1" style="width: 100%; border-collapse: collapse;"> <tbody> <tr> <td style="padding: 2px;"><b>OFF*</b></td> <td style="padding: 2px;">Do not use DNS.</td> </tr> <tr> <td style="padding: 2px;"><b>ON</b></td> <td style="padding: 2px;">Use DNS.</td> </tr> </tbody> </table>	<b>OFF*</b>	Do not use DNS.	<b>ON</b>	Use DNS.
<b>OFF*</b>	Do not use DNS.				
<b>ON</b>	Use DNS.				
<b>DNS IP</b>	Set this only when <b>[DNS]</b> is enabled. Set the DNS server's IP address. Setting options _._._._ (where _ is 0 to 255)				

**Setting Example****Connecting one instrument to one PC**

Host Name	LOGGER
DHCP	Off
IP Address	192.168.1.2
Subnet Mask	255.255.255.0
Port	880X
Gateway	Off
DNS	Off

**When connecting multiple instruments to a PC through a hub**

This example is a local area network with no external connection. We recommend using only private IP addresses. As below, make sure that no host names or IP addresses are duplicated.

## First instrument

Host Name	LOGGER1
IP Address	192.168.1.2

## Second instrument

Host Name	LOGGER2
IP Address	192.168.1.3

## Third instrument

Host Name	LOGGER3
IP Address	192.168.1.4

## Common Settings

DHCP	Off
Subnet Mask	255.255.255.0
Gateway	Off
Port	880X

**NOTE**

LAN communications with a PC require that the instrument is first set correctly.

### 3. Connecting the instrument to a PC

Connect the instrument to the PC with an Ethernet cable.



**Always turn both devices OFF when connecting and disconnecting a LAN cable. Otherwise, an electric shock accident may occur.**

#### Instrument Ethernet Jack

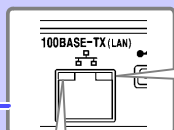

#### Green LED

Lights when linked, and blinks during communication.

#### Yellow LED

Lights when communicating at 10 Mbps, and not lit at 10 Mbps.

#### NOTE

If the green LED does not light when connected to the LAN, the instrument or connected device may be damaged, or the cable may be faulty.

#### Connecting one instrument to one PC

Items to prepare: 9642 LAN Cable, Cross-over adapter (supplied)

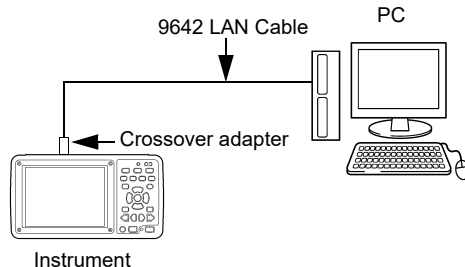
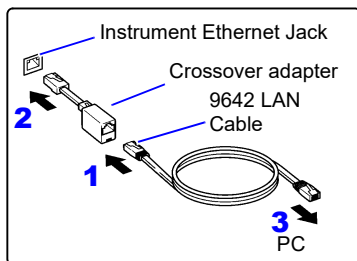

#### Connecting through a Hub

Items to prepare: 9642 LAN Cable (2), Hub

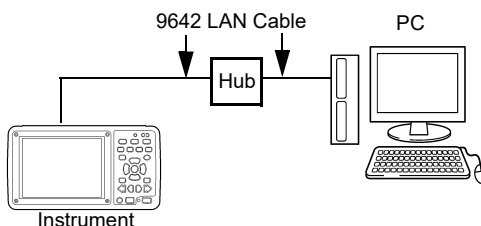
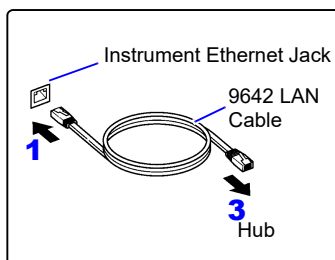

**Features Available After LAN Setting and Connection****Using the Logger Utility (p. 236)**

The supplied Logger Utility program provides PC control over instrument settings and measurement data recording, and data observation.

**Remote Operation (p. 238)**

A standard web browser such as Internet Explorer<sup>®</sup> can be used to make instrument settings and to control remote data acquisition and on-screen monitoring (HTTP server functions).

**Downloading Data to a PC (p. 244)**

The instrument's internal buffer memory data and files on its removable storage can be transferred to a PC running an FTP client.

**Automatically Sending Data to a PC (p. 248)**

Binary files auto saved by the instrument to removable storage can be automatically sent to other network clients, or to a remote FTP server. Use the FTP client function.

**Sending E-Mail (p. 265)**

E-Mail notifications can be automatically sent from the instrument when start or stop triggering occurs, and when an alarm, power outage recovery, internal memory full, or media full event occurs. It can be sent to a network device, remote PC, or mail-capable cell phone via an SMTP mail server.

**Controlling by Communications Commands (p. 272)**

See the Communications Command Instruction Manual on the supplied application CD.

## When LAN Communication Fails

### ■ Confirm cable connections.

When connecting one instrument to one PC, use the supplied cross-over adapter with the 9642 LAN Cable.

In case of poor connection, disconnect and reconnect the cable to clean the contacts. When connecting the cable, the green LED on the instrument's LAN jack should light.

### ■ Confirm the PC's IP address.

Click **[Run...]** on the Windows® Start menu (or select **[All Programs]-[Accessories]-[Comand Prompt]**) and enter "**ipconfig /all**" to confirm the IP address of the network interface, subnet mask, and gateway address.

#### If settings are incorrect:

Refer to "1. PC Network Setup"(p. 228) to reset the IP address.

### ■ Confirm communication between the instrument and PC.

After confirming that the IP addresses of the instrument and PC are correct, use the "**ping**" utility to test data transfer.

1.From the Start menu, select **[All Programs]-[Accessories]-[Comand Prompt]**.

2.(at the blinking cursor)

Enter "**ping XXX.XXX.X.X**"(the IP address of the host device to test).

Alternatively, the host name can be entered if its IP address is assigned by DNS.

For example, if the instrument's IP address is 192.168.1.2, enter "**ping 192.168.1.2**" and press Enter.

The following display text indicates normal operation. The "time" is the communication response time.

#### Pinging 192.168.1.2 with 32 bytes of data:

Reply from 192.168.1.2: bytes=32 time<10ms TTL=32

Reply from 192.168.1.2: bytes=32 time<10ms TTL=32

Reply from 192.168.1.2: bytes=32 time<10ms TTL=32

Reply from 192.168.1.2: bytes=32 time=1ms TTL=32

The following display text indicates communications failure.

Recheck cable connections.

#### Pinging 192.168.1.2 with 32 bytes of data:

Reply from 192.168.1.2: Host is down.

Reply from 192.168.1.2: Host is down.

Reply from 192.168.1.2: Host is down.

Reply from 192.168.1.2: Host is down.

## 10.3 Using the Logger Utility

The supplied Logger Utility program provides PC control over instrument settings and measurement data recording, and data observation.

**NOTE** Even if data is restored to the instrument following a temporary interruption to communications between the instrument and one or more measurement units or wireless loggers, data that has been transferred from the instrument to the Logger Utility will not be changed during measurement. If you wish to access that data, load the restored data that was saved on the instrument after stopping measurement.(p. A33)

**Display on the PC screen waveform files that were saved to removal storage on the instrument.**

(Convert binary data to CSV format for importing to spreadsheet programs on the PC.)

**Search event marks and measurement data using various criteria such as maxima and fluctuation values.**

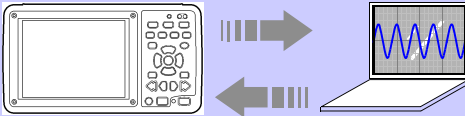

**Configure instrument settings on the PC, and transfer to the instrument.**

**Real-time measurement data can be acquired by one PC via LAN or USB from up to five instrument at once.**

(Monitor waveforms, numerical values and alarm output status in real time while measuring.)

For details such as Logger Utility operating instructions, read the instruction manual (PDF file) provided on the CD.

## Starting and Ending Logger Utility

### Starting Logger Utility(Windows XP/Windows Vista®/Windows 7 )

From the Start Menu of Windows®, click **[All Programs]-[HIOKI]-[Logger Utility] -[Logger Utility]**.

### Starting Logger Utility(Windows 10)

From the Start Menu of Windows®, click **[HIOKI]-[Logger Utility]**.

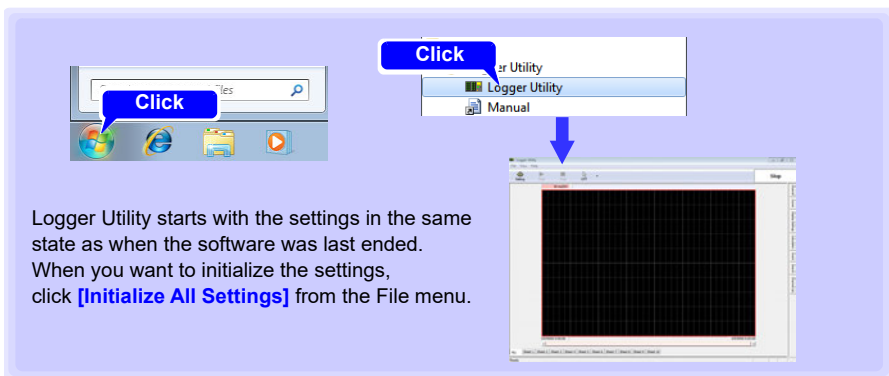

### Ending Logger Utility

Click **[Exit Application]** from the File menu of the main screen. Alternatively, you can click the **[x]** close button at the top right of the main screen.

### Starting Logger Utility(Windows 8)

Click **[Start]** from the charm and click **[Logger Utility]** on the Start menu.





## 10.4 Remote Measurement with the HTTP Server Function

The instrument includes an HTTP server function for remote data acquisition and on-screen monitoring using a web browser such as Internet Explorer®.

- NOTE**
- LAN settings and connections must be made before using the HTTP server function for remote measurements (p. 226).
  - The HTTP server function is not available while measuring using the Logger Utility program.

### Displaying the Main Page

- 1 Start Internet Explorer®.
- 2 Enter the instrument's address (e.g., <http://192.168.1.2>) in the [Address] field.

The main page appears.

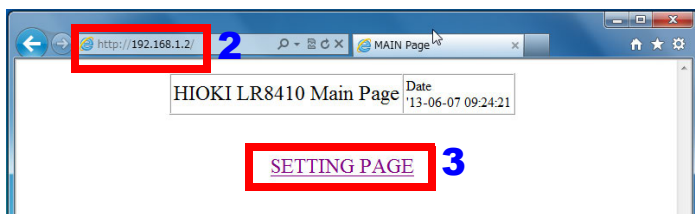

- 3 Select [SETTING PAGE].
- 4 (When the [FTP/HTTP Authentication] instrument setting is enabled) Enter the user name and password, and press the [SET].

To avoid unauthorized access to HTTP functions, we recommend securing connections with a user name and password on the Communications Settings display of the instrument's [System] screen. FTP/HTTP authentication can be disabled when frequent access to the instrument from multiple PCs is necessary.

**See:** "Restricting FTP Server Connections (FTP Authentication)"(p. 247)

**See:** "10.5 Transferring Data to a PC with the FTP Server Function" (p. 244)

- NOTE**
- Microsoft Internet Explorer® Version 5 or later is recommended as the browser. Set the security level to "Medium" or "Medium-high", and invalidate the pop-up block.
  - Remote operation by HTTP is not available while measuring with the Logger Utility or a Visual Basic program.

**If no HTTP screen is displayed**

1. Perform this procedure.
  - (1) Click **[Tools]-[Internet Options]** to display Internet Explorer® settings.
  - (2) On the **[Advanced]** tab, under HTTP 1.1 settings, enable **[Use HTTP1.1]** and disable **[Use HTTP1.1 through proxy connections]**.
  - (3) On the **[Connections]** tab, click **[LAN Settings]**, and disable **[Use a proxy server]**.
2. LAN communications may not be possible. See "When LAN Communication Fails"(p. 235).

**What if the Remote Operating Screen does not appear?**

- Java may not be installed. To operate the instrument from a web browser, depending on the PC's software environment, Java may need to be installed separately. In that case, download and install JRE (Java Runtime Environment) from the Java web page.
- Attempting to operate the instrument by multiple PCs at the same time may result in unintended actions. Remote control operation should be performed from only one PC at a time.
- If the remote operation screen cannot be displayed because it is blocked by your security settings, refer to the instructions on the Java website for adding exception sites and add the instrument's address (for example, <http://192.168.1.2/DISP.HTM>) as an exception site.

**See:**Java website

[https://www.java.com/ja/download/faq/exception\\_sitelist.xml](https://www.java.com/ja/download/faq/exception_sitelist.xml)

## Remote Operating

Click [\[REMOTE CONTROL\]](#) to view the current instrument screen in the web browser.

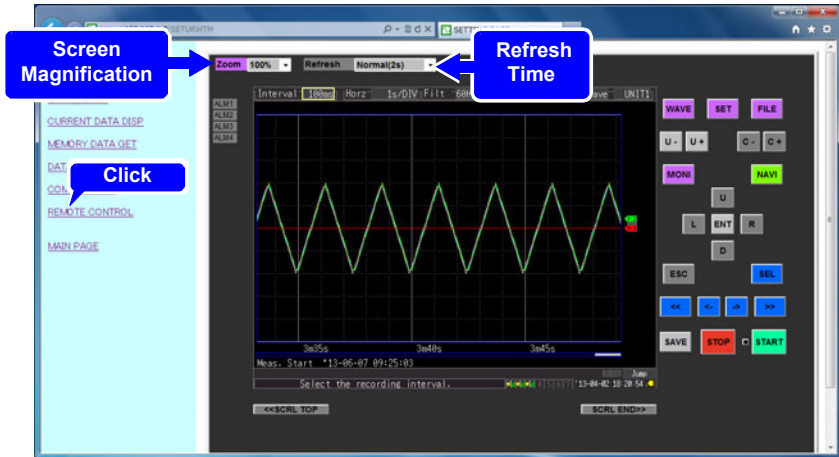

- The displayed panel emulates the instrument's. Click the keys with the mouse to operate.
- Screen refresh time can be selected from Off, or 2, 10, or 60 seconds. Refreshing the screen also refreshes the on/off state of the Start LED.
- The emulated screen can be enlarged or reduced.
- If Java fails to operate properly or operates slowly while using remote operation, it may be helpful to delete Java temporary files.

## Start/Stop Measurement

Click **[START/STOP]** to display this screen.

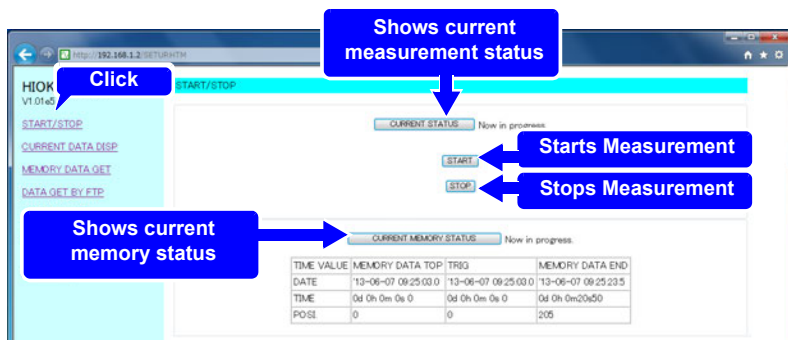

Click the buttons to operate.

## Viewing Current Measurement Values

Click **[CURRENT DATA DISP]** to display current measurements.

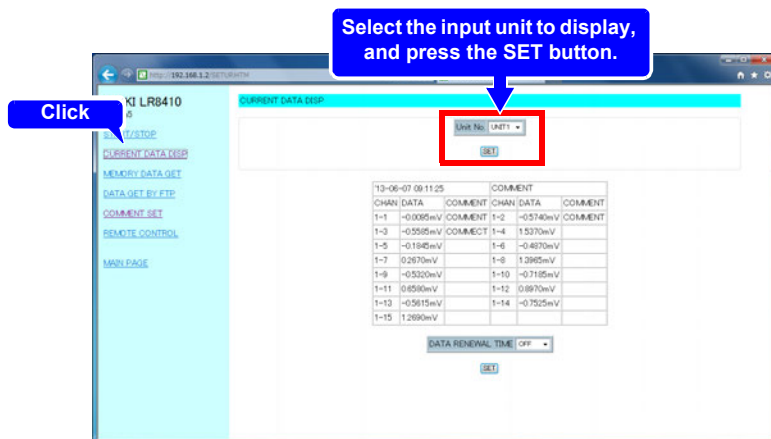

- While measuring, you can monitor numerical data acquired from each channel at every recording interval. Screen refresh time can be selected from Off, or 5, 10, or 60 seconds.
- When measurement is stopped, instantaneous input data from each channel is displayed.
- You can select which input unit to display.
- It may take 2 to 3 s for data to be acquired.

## Acquiring Data from Internal Memory

Click **[MEMORY DATA GET]** to display this screen.

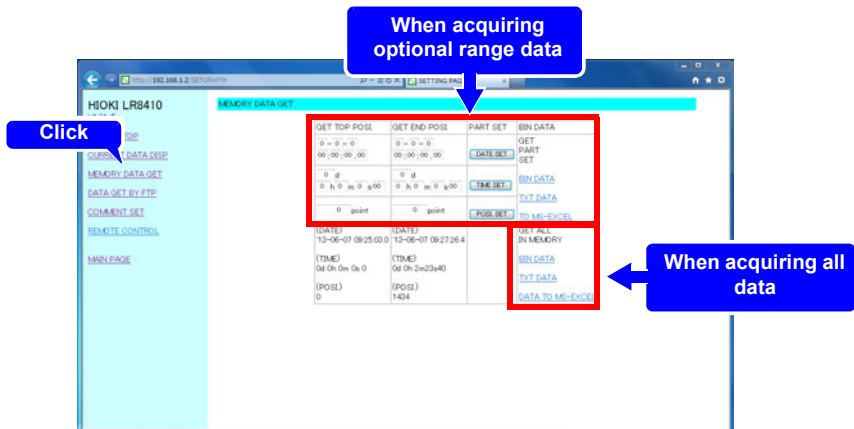

**NOTE** Data acquired into the instrument's internal memory cannot be accessed while measuring. It is possible only after measurement stops.

### When acquiring optional range data

- 1** Specify the time span of data to acquire, and click the **SET** button.
- 2** Under **[GET PART SET]**, click **[BIN DATA]**, **[TXT DATA]**, or **[TO MS-EXCEL]**.

### When acquiring all data

Under **[GET ALL IN MEMORY]**, click **[BIN DATA]**, **[TXT DATA]**, or **[DATA TO MS-EXCEL]**.

Setting options:

<b>BIN DATA</b>	Acquires data in binary format.
<b>TXT DATA</b>	Acquires data in text format.
<b>TO MS-EXCEL,</b> <b>DATA TO</b> <b>MS-EXCEL</b>	Send data to Excel. Useful for creating graphics.

## Setting Comments

Click **[COMMENT SET]** to display this screen.

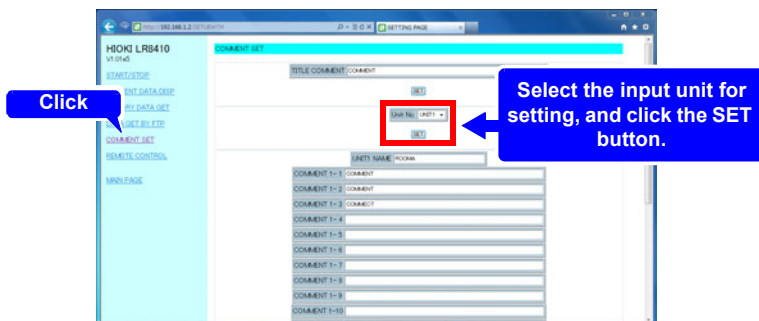

- Comments for each channel can be simply entered from the web browser. Enter a comment, and click the **[SET]** button.
- You can select another input unit for setting.

### NOTE

- Comments cannot be changed while measuring.
- Please input 8-bit ASCII characters, the instrument can not display other characters.

## 10.5 Transferring Data to a PC with the FTP Server Function

FTP (File Transfer Protocol) is used for file transfers within a network. The instrument's FTP server function works with an FTP client running on a PC to transfer instrument data files from internal buffer memory and removable storage to the PC.

- 1 Start Internet Explorer® to display the Settings screen (p. 238).
- 2 Click **[DATA GET BY FTP]**.

This screen is displayed.

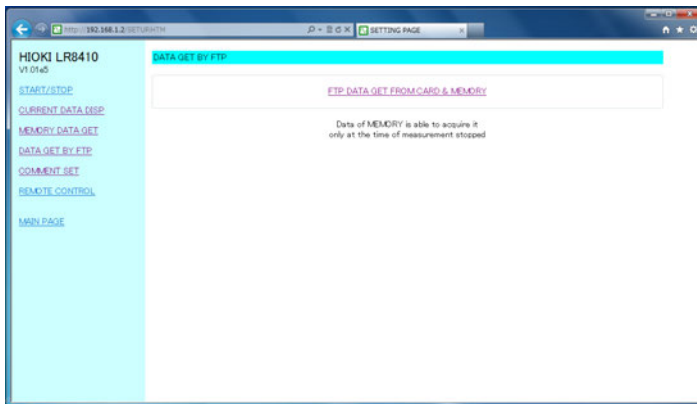

- 3 Click **[FTP DATA GET FROM CARD & MEMORY]**.

The instrument's SD memory card, USB flash drive, and internal buffer memory file folders are listed.

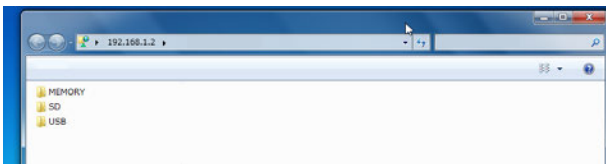

**[SD]** indicates the SD memory card, **[USB]** the flash drive, and **[MEMORY]** indicates internal buffer memory.

## NOTE

- Entering just the instrument's IP address (e.g., <ftp://192.168.1.2>) in a browser such as Internet Explorer® displays the SD card, USB flash drive, and internal buffer memory file folders.
  - Internal buffer memory data cannot be transferred while measuring. It is accessible when measurement stops. Files containing either current or previously saved data (real-time, CSV, and calculation results) are inaccessible while measuring.
  - When **[FTP/HTTP Authentication]** is enabled, enter the required user name and password, and press the **[SET]** button.
- See:** We recommend restricting file access with a user name and password to avoid unauthorized access. "Restricting FTP Server Connections (FTP Authentication)"(p. 247)

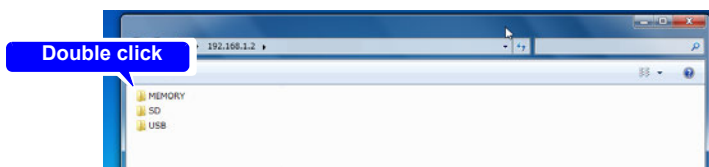
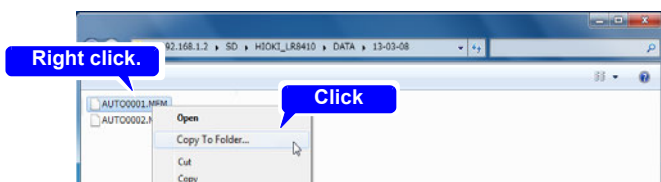
**4** Open a folder.**5** Select a file, and **[Copy To Folder]**.



**NOTE**

- The FTP server of the instrument allows only one connection at a time. More than one PC cannot access the server simultaneously.
  - If no command is sent from a PC for more than one minute after connecting to the FTP server, the FTP may disconnect the PC. Reconnect the FTP.
  - The FTP connection may fail after disconnecting and attempting to reconnect. In this case, disconnect again and wait for one minute before reconnecting.
  - During real-time, auto, or manual saving, and when deleting files, creating or deleting folders, or renaming, formatting, or loading files on the instrument, only file transfers are possible from the FTP client.
  - If an FTP transfer is writing to removable storage when auto saving starts or numerical calculations are saved, FTP operation is suspended during data saving.
  - When measurement ends during an FTP transfer, the transfer may be suspended during data saving.
  - Before inserting or removing a removal storage, terminate the FTP connection.
  - Although the instrument's removable storage can be externally accessed using FTP, avoid other instrument operations such as using telnet at the same time. Otherwise, unintended operations could occur.
  - With Internet Explorer<sup>®</sup>, the refresh date of files may not match those of the main instrument.
  - With Internet Explorer<sup>®</sup>, previously obtained data can be retained in temporary internet files, and may be reloaded in place of the latest data. If the instrument's data has been refreshed, restart Internet Explorer<sup>®</sup> before using FTP. (A free alternative to Internet Explorer<sup>®</sup> is FFFTP.)
  - Depending on your computer's FTP client and browser, canceling while in the process of moving one or more files or folders may cause all selected files or folders to be deleted, regardless of whether the move operation is complete. Exercise caution when moving files and folders. It is recommended to use the copy function to download files and folders instead of the move function, and then to delete the files or folders once they have downloaded.
-

## Restricting FTP Server Connections (FTP Authentication)

[FTP/HTTP Authentication] Setting.

- 1 Set the [Time Difference].**  
If the computer time differs from the instrument's FTP server time, set that difference here.

Setting options:

-12h12h (default setting: 0h)

- 2 Set [FTP/HTTP Authentication.]**  
If limiting FTP/HTTP server connections, set [FTP/HTTP Authentication] to on and set a username and password.

Setting options: ( \* : default setting)

**Off\*** Does not limit FTP/HTTP server connections.

**On** Limits FTP/HTTP server connections.

- 3 If [FTP/HTTP Authentication] is set to on**

**Set the [User Name].**

Set the user name that will be used when connecting to the instrument from an FTP client or HTTP user agent.

Setting options:

String of no more than 12 single-byte characters

**Set the [Password].**

Set the password that will be used when connecting to the instrument from an FTP client or HTTP user agent.

Setting options:

String of no more than 12 single-byte characters

The password will be displayed as [\*\*\*\*\*].

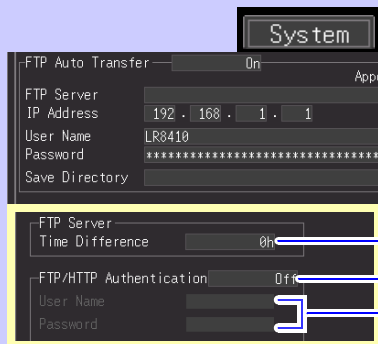
**Setting numbers**

- Increment/  
decrement by 1
- Increment/decrement by 10

**Setting characters**

**See:** "3.8 Entering Titles and Comments (as needed)" (p. 100)

Anonymous authentication allows unrestricted access to the instrument's FTP server by all network devices.

To restrict access to the FTP server, enable FTP/HTTP authentication and set a user name and password.

We recommend restricting file access with a user name and password to avoid unauthorized use.

## 10.6 Auto Sending Data using the FTP Client Function

Files auto saved by the instrument to removable storage can be automatically sent to other network clients, or to a remote FTP server.

### NOTE

- Set Auto Save to Waveform (realtime), CSV (realtime), Waveform+Calc, or CSV+Calc.
- Calculated values are not transferred automatically.
- To save or transfer data periodically, set the Split Save setting to Periodic.
- To continue saving or transferring data even when the SD memory card becomes full, select Overwrite Oldest Save.

**See:** "Automatic Saving (Waveform Data and Numerical Calculation Results)"(p. 165)

- For the FTP client to control auto sending of data, the IP address of the FTP server PC must be specified.
- The Windows® FTP server function can be used. Enter and register the instrument user name and password in the FTP server. For details about the Windows® FTP server, see Internet Information Services (IIS) in Windows® Help.
- Free programs such as FileZilla Server can be used in place of Windows® FTP server.

### General Procedure

- 1 LAN Settings and Connections (p. 226)**
  - 2 Set up the FTP server on the PC (p. 249)**
  - 3 Enable FTP auto sending on the instrument (p. 261 to p. 263 )**
  - 4 Configure auto saving (p. 165).**
  - 5 Start measuring with the instrument**  
When auto saving a file on removable storage, the file is also sent automatically to the FTP server PC.
  - 6 Check communication status (p. 264)**
-

## Setting Up an FTP Server on a PC

**NOTE** Necessary settings depend on the network environment. If a connection cannot be established, refer to the FTP server program's help, or contact the network administrator.

(The FTP server is not provided with Windows XP Home Edition, but you can use another FTP server program such as FileZilla Server.)

### For Windows 7

#### Installing FTP

**1** Select **[Programs]** under **[Control Panel]**.

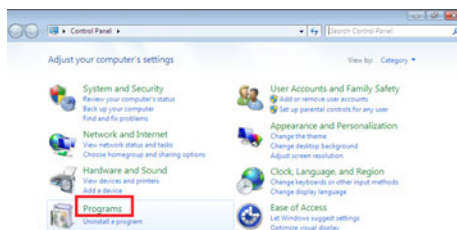

**2** Select **[Turn Windows features on or off]**.

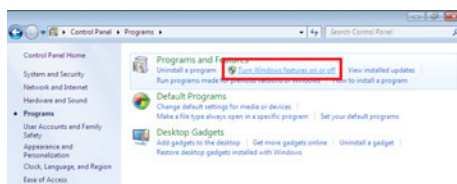

**3** On Windows®, click the **[+]** button to the left of **[Internet Information Services]** to expand the list of functions.

Click the **[+]** button to the left of **[FTP Server]** and check **[FTP Service]**. Click the **[+]** button to the left of **[Web Management Tools]** and check **[IIS Management Console]**. Click **[OK]**.

This completes the installation of the FTP server.

After finishing the installation, **[inet-pub]** folder is created on root of the C drive.

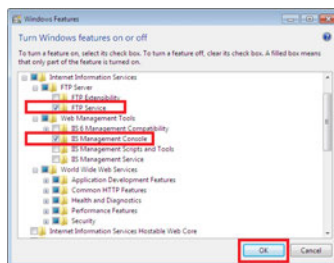

## 10.6 Auto Sending Data using the FTP Client Function

### Configuring FTP settings

- 4 Select the **[System and Security]** control panel.

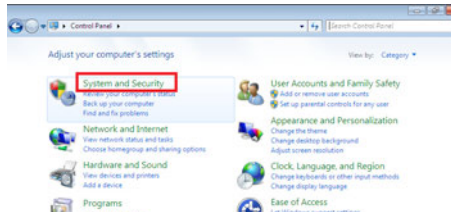

- 5 Select **[Administrative Tools]**.

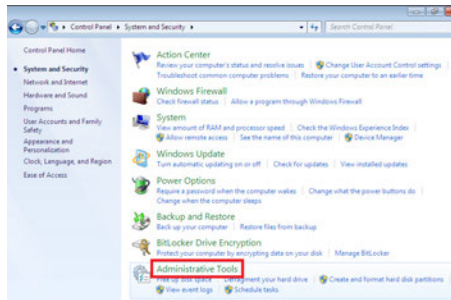

- 6 Select **[Internet Information Services (IIS) Manager]**.

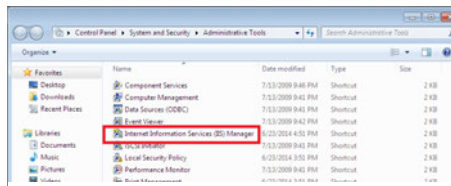

- 7 Right-click on the item listed as a connection in the left box to display the menu and select **[Add FTP Site]**.

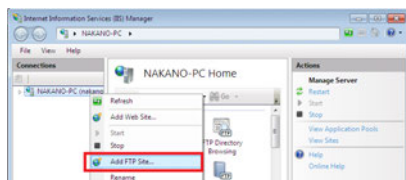

**NOTE** Communications may be blocked depending on the settings for software (for example, a firewall) Used to protect the computer.

## 8 Enter the site information and click the [Next] button.

Use an FTP site name such as [ftp]. Set the directory into which you wish to save data from the FTP client as the content directory.

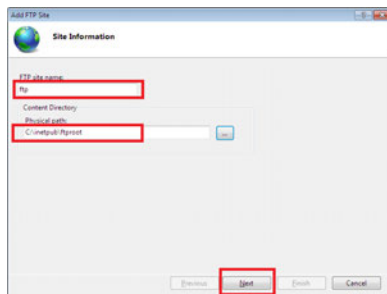

## 9 Configure the bind and SSL settings and click the [Next] button.

Configure the settings as follows:

Binding settings

IP address: All Unassigned

Port: 21

Start FTP site automatically: Check

SSL: No SSL

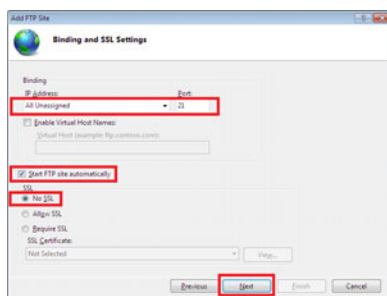

## 10 Enter authentication and approval information and click the [Finish] button.

Configure the settings as follows:

Authentication: Basic

Authorization: All users

Permissions:

Check both Read and Write.

This completes the configuration of the FTP server.

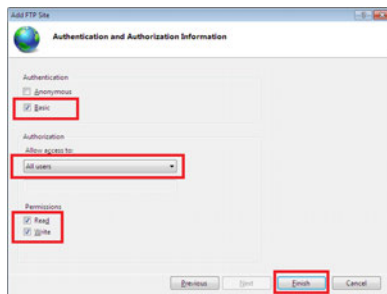

Traffic of FTP is validated by a firewall.

## 11 Select [ System and Security] from [Control Panel].



## 12 Select [Windows Firewall].

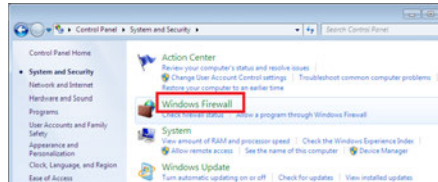

## 13 Select [Advanced settings].



## 14 Select [Properties] of the [FTP Server (FTP Traffic-In)] from [Inbound Rules].

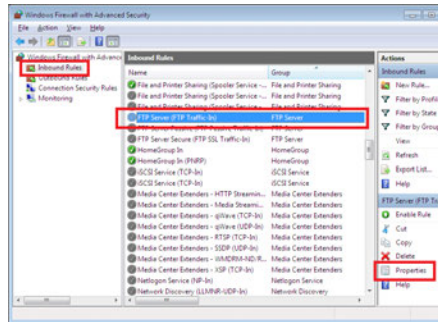

## 15 On the [FTP Server (FTP Traffic-In) Properties], Select [Enable].

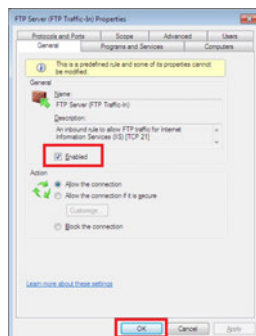

## 10.6 Auto Sending Data using the FTP Client Function

- 16** Confirm that **[FTP Server (FTP Traffic-In)]** is enabled, and close the dialog box.

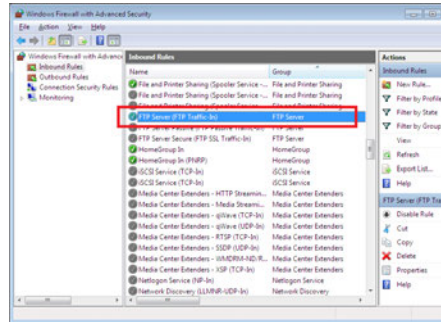

Setting the users that will access the server.

- 17** Select **[Administrative Tools]** from **[Control Panel]**.

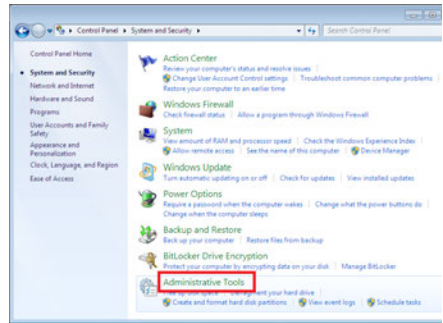

- 18** Select **[Computer Management]**.

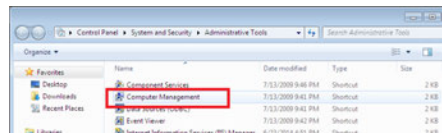

- 19** Right-click on **[Local Users and Groups] - [Users]** to display the menu and select **[New User]**.

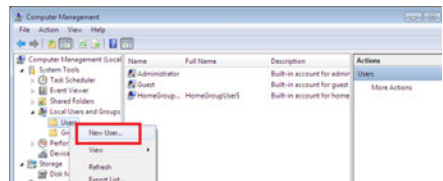



## 10.6 Auto Sending Data using the FTP Client Function

### 20 Set the user and click the [Create] button.

Set the username and password and select the [Password never expires] check box.

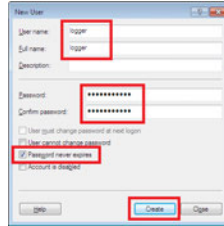

### 21 Confirm that the set-up logger is registered as a user, and close the dialog box.

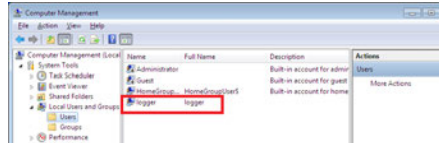

The access permit of the folder for FTP is set up.

### 22 Open C:\inetpub, right-click on [ftproot], and then, select [Properties].

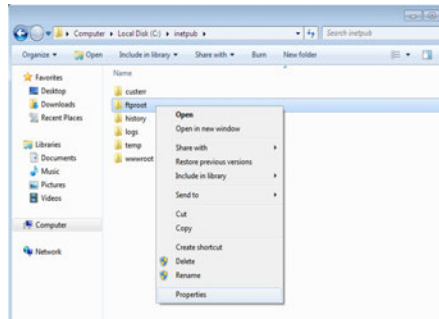

### 23 Select [Edit] of [Users] from [Security].

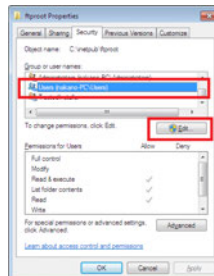

## 24 Select [Full control] from [Permissions for Users].

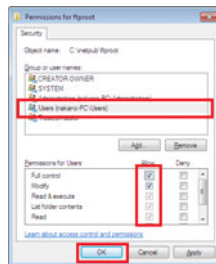

Above, a setup of FTP of Windows 7 is an end.

You can use the FTP server by using the created username and password.

## 10.6 Auto Sending Data using the FTP Client Function

The following example uses Windows XP Professional.

- 1 In the [Control Panel], select [Add or Remove Programs].

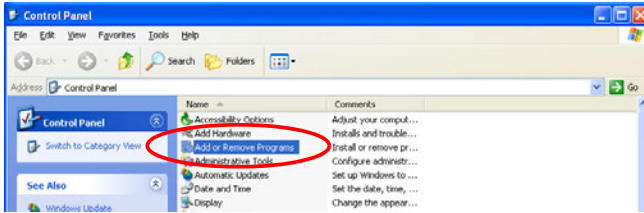

- 2 Select [Add/Remove Windows Components].

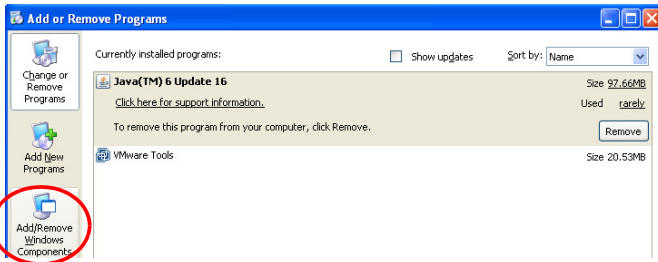

- 3 Select [Internet Information Services (IIS)], and then [Details].

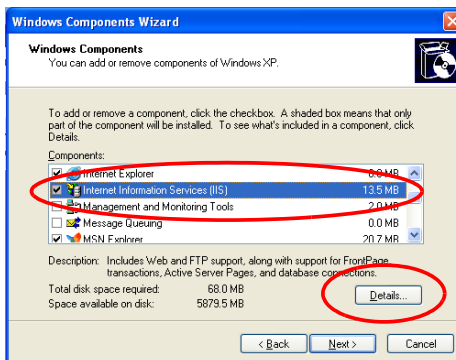

- 4 Select [File Transfer Protocol (FTP) Service], and click [OK].

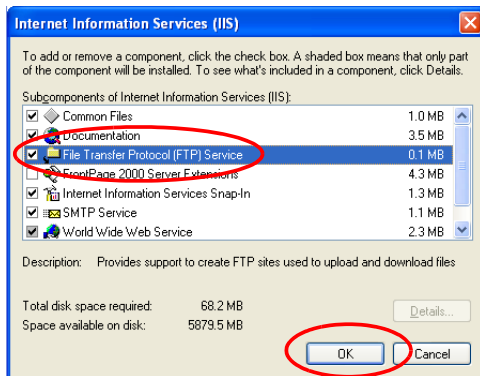

- 5 Click [Next].  
At this point, your Windows XP CD is requested.

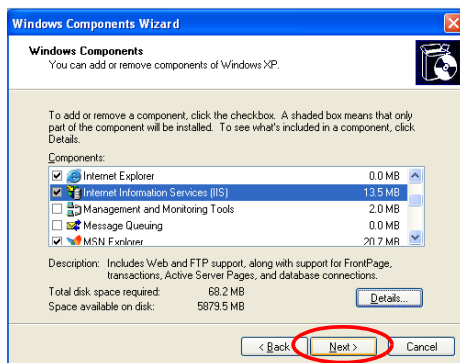

- 6 Click [Finish].



## 10.6 Auto Sending Data using the FTP Client Function

When installation is finished, the **[inetpub]** folder is created.

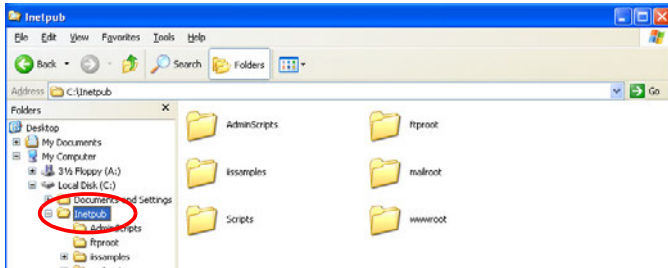

**7** In the **[Control Panel]**, select **[Administrative Tools]**.

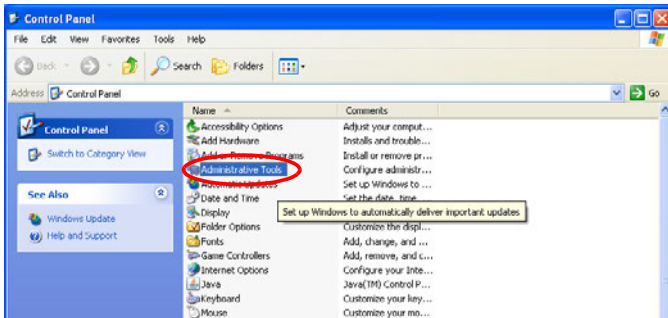

**8** Select **[Internet Information Services]**.

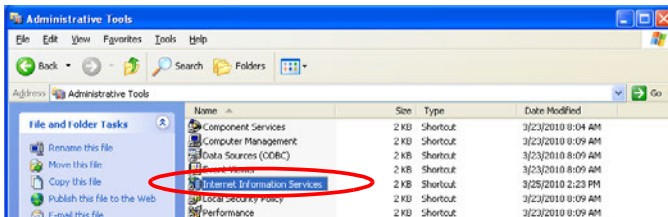

**9** Select **[Default FTP Site]**, and right click to select **[Properties]**.

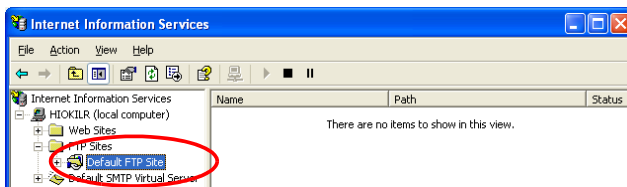

- 10** For the IP Address, select **[(All Unassigned)]**.

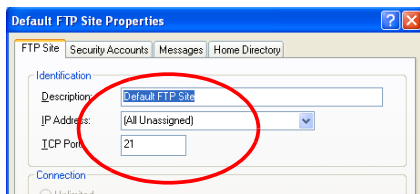

- 11** On the **[Home Directory]** tab, select **[Read]**, **[Write]**, and **[Log visits]**, and click **[OK]**.

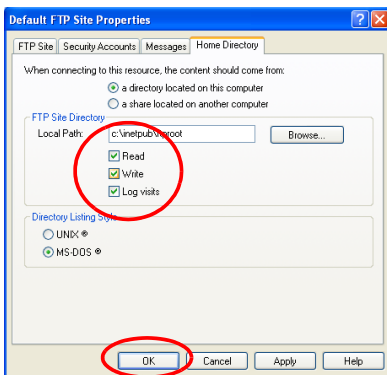

- 12** Back in the **[Administrative Tools]**, select **[Computer Management]**.

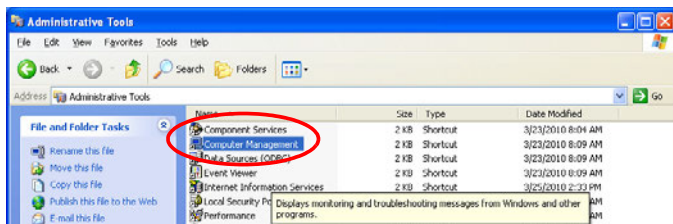

- 13** In **[Local Users and Groups]**, select **[Users]** then right click in the right pane and select **[New User]**.

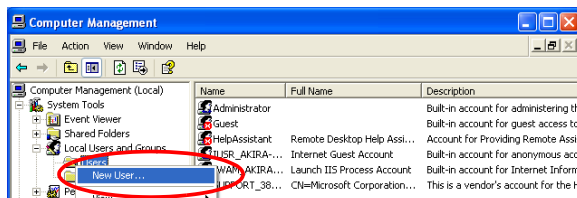

10.6 Auto Sending Data using the FTP Client Function

14 Enter a user name, full name, password and confirmation (e.g., "logger"), and click [Create].

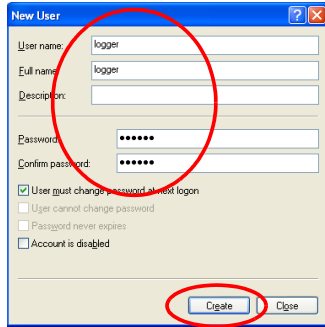

The created [logger] user is registered.

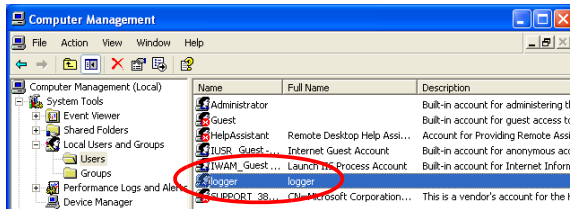

This completes FTP setup on the PC.

**Instrument Auto-Send Settings**

This example illustrates sending data to an FTP server with address 192.168.1.1.

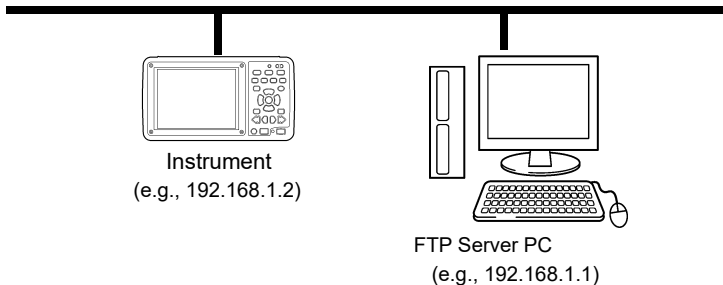

**Key Setting Procedure**

- 1 Select the [System] Screen.
- 2 Select [FTP].  
[FTP] cannot be selected when the [Communication Interface] is set to [USB]. Set the communications interface to [LAN] before selecting [FTP].
- 3 Set [FTP Auto Transfer] to [ON].
- Select from the listed options.(p. 262)
- Apply

The screenshot shows the 'System' screen with the 'FTP' option highlighted in the 'Communication Interface' section. Below it, the 'FTP Auto Transfer' is set to 'On'. The 'FTP Server' settings are visible, including IP Address (192.168.1.1), User Name (L88410), and Password (masked with asterisks). Other options like 'Append identifier to file name', 'Host Name', 'IP Address', 'Date', 'PASV Mode', and 'FTP Transfer test' are also shown.

Increment/decrement by 1

Increment/decrement by 10

**Character Settings**

See: "3.8 Entering Titles and Comments (as needed)" (p.



**Setting Items****FTP Server** Enter the name of the data sending FTP server.

Setting options

Up to 32 characters

**IP Address** Enter the IP address of the data sending FTP server.  
This is the IP address of the PC acting as the FTP server.

Setting options

\_.\_.\_.\_ (where \_ is 0 to 255, e.g., 192.168.1.1)

**User Name** Enter the FTP server logon user name.  
This is the user name of the instrument registered with the FTP server.

Setting options

Up to 32 characters (e.g., LOGGER)

**Password** Enter the FTP server logon password.  
This is the password of the instrument registered with the FTP server.

Setting options

Up to 32 characters (e.g., LOGGER)

The password is displayed as "\*\*\*\*...\*\*\*\*" (32 asterisks (\*)).

**Save Directory** Specify the destination folder for saving data on the FTP server.

Setting options

Up to 32 characters(e.g., abc)

**Append identifier to file name** Select identifiers to be prepended to file names.

Setting options

**Host Name** Include the host name in the names of files sent to the FTP server.**IP Address** Include the IP address in the names of files sent to the FTP server.**Date** Include a timestamp in the names of files sent to the FTP server.**Examples**

Host Name: LOGGER

IP Address: 192.168.1.2

Date: '10-04-01 08:30:05

Auto Save file name: AUTO0001.MEM

When the host name, IP address, and time are set as above, the file name is LOGGER\_192-168-1-2\_100401-083005\_AUTO0001.MEM. Identification is possible when using multiple instruments.

PASV mode: Set to on if you wish to use PASV mode during data transfers.

## Testing File Transfer

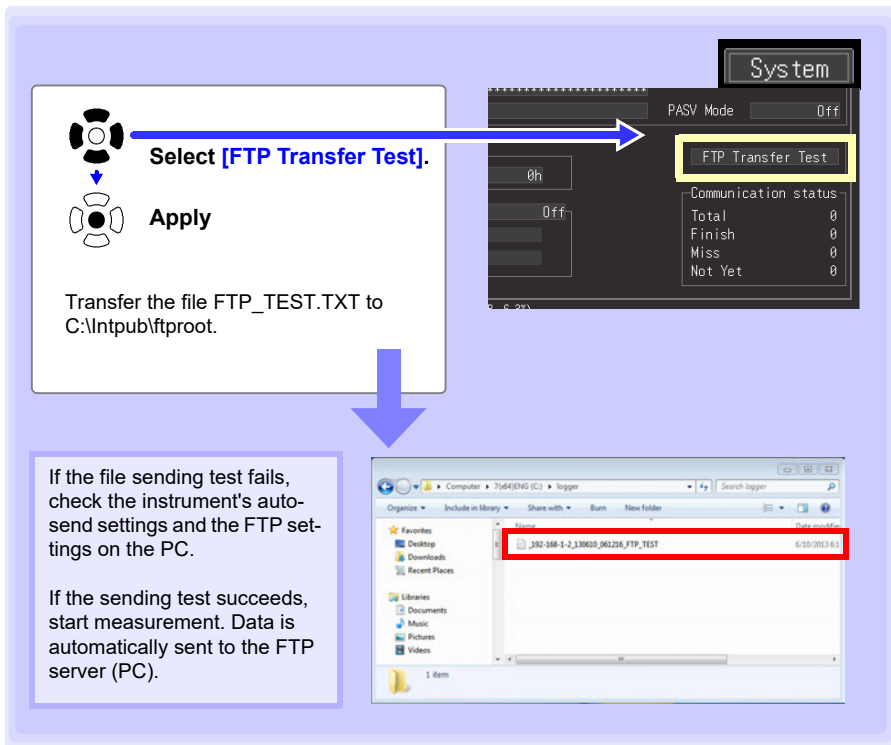
**Data Transfer Timing**

To calculate: transfer time (s) = file size (KB) / transfer speed (KB/s) + transfer preparation time (s).

See "Appendix 5 Binary File Size Calculation"(p. A11) for file size information.

Typical transfer speed is 300KB/s, and typical transfer preparation time is 3 s.

Example: For a 3MB (3,000KB) file,

$$\begin{aligned} \text{Transfer time} &= 3,000\text{KB} / 300 \text{ (KB/s)} + 3 \text{ (s)} \\ &= 10 + 3 \text{ (s)} \\ &= 13 \text{ (s)} \end{aligned}$$

## Checking LAN Communication Status

The LAN communication status can be checked as follows.

The status of all FTP file transfers, the number already sent, the number that failed to send, and the number of unsent files are displayed.

Status values are reset to zero by the following:

- When pressing **START** to start measuring
- When changing LAN-related settings

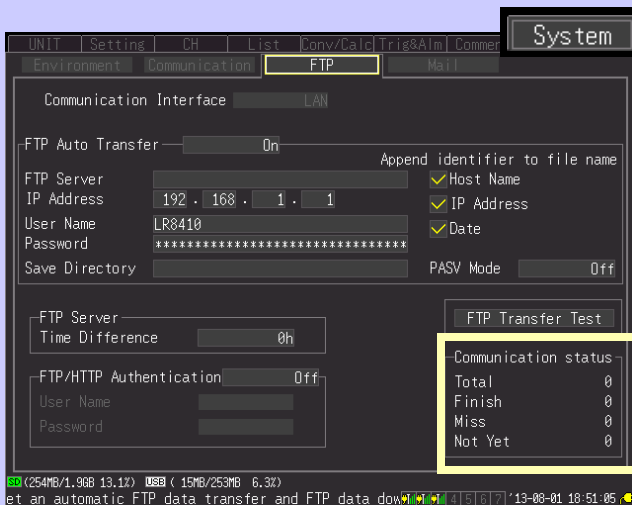

**For example, Total 10, Sent (Finish) 7, Failed (Miss) 1, and Unsent (Not Yet) 2**

Here, ten FTP transfers were initiated, seven of which were sent, one of which failed, and two of which are waiting to be sent.

## 10.7 Sending E-Mail

The instrument can send e-mail to a locally networked or remote computer or e-mail-capable mobile phone via an SMTP mail server either regularly or when a unit communications error, unit low remaining battery life, start trigger, stop trigger, alarm, restoration of power, internal buffer memory full, or media full event occurs during measurement. Up to three recipient e-mail addresses may be registered.

**NOTE** Frequent alarm events can generate excessive e-mails. In this case, enable Alarm Hold to limit notifications to the first alarm event on each channel. (See Alarm Hold Settings on p. 157 .)

### General Procedure

- 1 LAN Settings and Connections (p. 226)**
- 2 Instrument E-Mail Settings (p. 266)**
- 3 Testing E-Mailing (p. 269)**
- 4 Start Measuring with the instrument**  
E-mail is sent by the mail server when a trigger or alarm event occurs.
- 5 Confirming E-Mail Sending Status (p. 270)**

## Instrument E-Mail Settings

This example illustrates sending mail from the instrument logger@xyz.xx.xx to a cell phone (or PC) with address abc@xyz.xx.xx via SMTP mail server 192.168.1.100 when a Start trigger occurs.

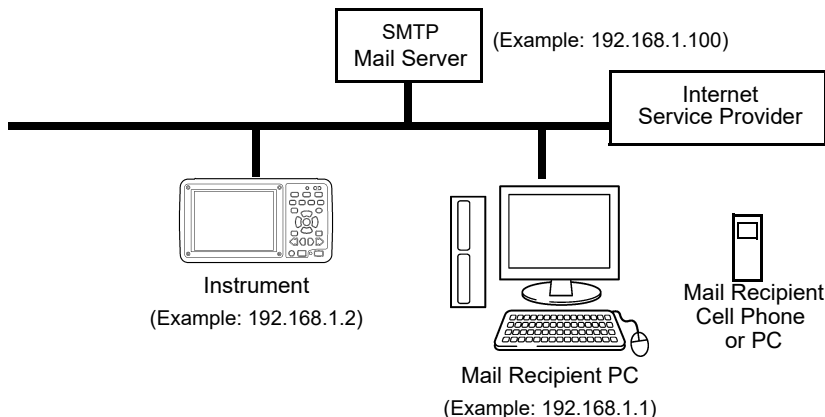

### Key Setting Procedure

- 1 Select the **[System]** Screen.
- 2 Select **[Mail].\***
- 3 Move to a setting item.
  - Open the setting options for the item to be set.
  - Select from the listed options.
  - Apply

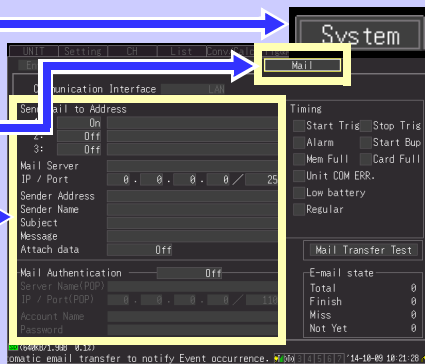

\*: **[Mail]** cannot be selected when the **[Communication Interface]** is set to **[USB]**.  
Set the **[Communication Interface]** to **[LAN]** before selecting **[Mail]**.

### 1 Enable or disable the [Send Mail to Address].

Up to three addresses can be entered.  
Setting options: (\* : default setting)

Off*	Mail is not sent.
On	Mail is sent.

(When [Send Mail to Address] is enabled)

### 2 Enter the [Send Mail to Address].

Enter the recipient's e-mail address for notifications.

Setting options:

Up to 32 characters  
(e.g., abc@xyz.xx.xx)

### 3 Set each item (p. 268).

### 4 Configuring [Timing].

Select the check boxes for the desired mail sending criteria.

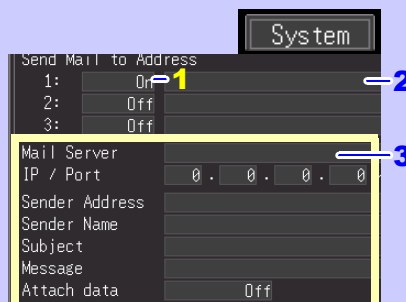

### Numerical Settings



Increment/decrement by 1



Increment/decrement by 10

### Character Settings

See:

"3.8 Entering Titles and Comments (as needed)" (p. 100)

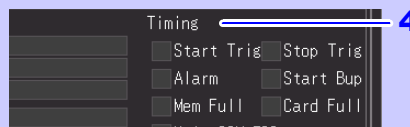

Setting options:

<b>Start Trig</b>	Send mail when a Start trigger event occurs. (for example, to notify a starting trigger)
<b>Stop Trig</b>	Send mail when a Stop trigger event occurs.
<b>Alarm</b>	Send mail when an alarm event occurs.
<b>Start Bup</b>	Send mail upon recovery from a power outage.
<b>Mem Full</b>	Send mail when instrument internal buffer memory is full and old data begins to be overwritten. Mail is sent only once: the first time memory becomes full.
<b>Media Full</b>	Send mail when the SD memory card or USB flash drive becomes full.
<b>Unit com error</b>	Sends an email if communications with a measurement unit or wireless logger are interrupted or if the instrument is otherwise unable to send data.
<b>Low battery</b>	Sends an email in the event a measurement unit or wireless logger's battery strength declines.
<b>Regular</b>	Send mail describing the measurement state on a regular basis. The interval at which to send mail can be set with the [Interval] setting. To send measurement data as well, set data attachment to on. <b>See:</b> Data attachment (p. 268)

## Setting Items

**Mail Server** Sets the mail server name or IP address.  
Enter the server name or IP address as specified by the network system administrator or Internet service provider.

### Mail server settings

<b>Mail server name</b>	Enter the mail server name. Specifies the SMTP mail server. Setting options: Up to 32 characters.
<b>IP Address</b>	Set the IP address of the mail server. Specifies the SMTP mail server. Setting options: _._._._ (where _ is 0 to 255, e.g., 192.168.1.100)
<b>IP / Port</b>	Set the port address of the mail server. Default is port 25. If the mail server is using a port other than the standard port (25), set to that port number. Setting options: 1 to 65535

**Sender Address** Enter the sender's e-mail address.  
Setting options  
\_\_\_\_\_

Up to 32 characters.  
(e.g., logger@xyz.xx.xx)

**Sender Name** Enter the sender's name.  
Setting options  
\_\_\_\_\_

Up to 32 characters. (e.g., logger)

**Subject** Enter the subject for mail notifications.  
Setting options  
\_\_\_\_\_

Up to 32 characters. (e.g., logger\_mail)

**Message** Enter the text for mail notifications.  
Setting options  
\_\_\_\_\_

Up to 32 characters.  
(e.g., E-mail from logger)

**Attach data** Enable/disable attachment of measurement data (Data sends only when Start trigger, Stop trigger, alarm event occurs or when sending a regular mail).

Setting options: ( \* : default setting)

<b>Off*</b>	Do not attach measurement data to e-mail.
<b>On</b>	Attach measurement data to e-mail.

## Testing E-Mailing



**Select [Mail Transfer Test]**



**Apply**

Sends a test e-mail.

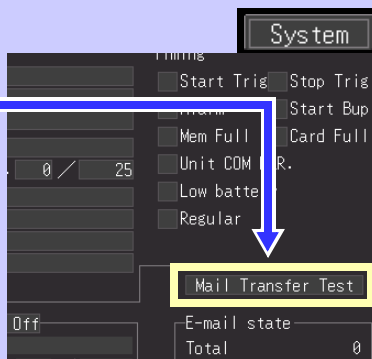

If the e-mailing test fails, check your instrument e-mailing settings.

If the e-mailing test succeeds, you can start measurement.

### E-Mail Sending Timing

Each e-mail should take about one second.



## Checking Mail Communication Status

The mail communication status can be checked as follows.

The status of all mail transfers, the number already sent, the number that failed to send, and the number of unsent files are displayed.

Status values are reset to zero by the following :

- When pressing **START** to start measuring
- When changing LAN-related settings

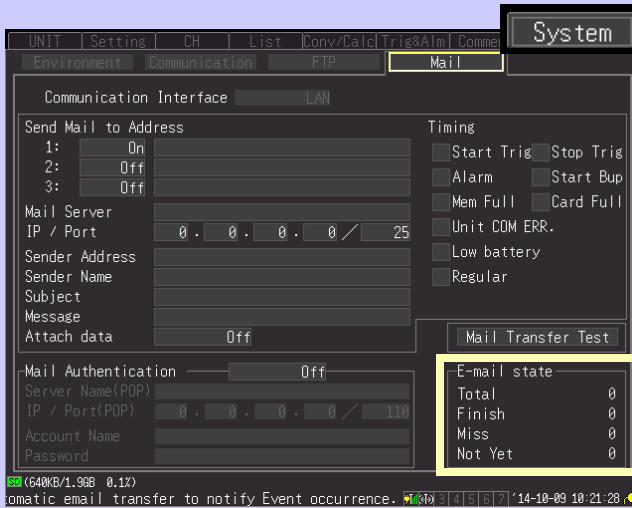

**For example, Total 10, Sent (Finish) 7, Failed (Miss) 1, and Unsent (Not Yet) 2**

Here, ten e-mails were initiated, seven of which were sent, one of which failed, and two of which are waiting to be sent.

### NOTE

- If more than 30 unsent mails accumulate, the oldest is marked as failed, and cannot be sent. Unsent mail is deleted whenever measurement starts.
- The body of the mail will be converted depending on the text type and sent.(p. 101)

## E-Mail Sending Authentication

The instrument supports POP (POP before SMTP) and SMTP authentication in order to send email. Set as needed.

SMTP authentication can be used with Version 1.20 and later of the instrument software.

### 1 Set the [Mail Authentication].

Setting options: ( \* : default setting)

<b>OFF</b>	Disables authentication.
<b>POP authentication</b>	Uses POP before SMTP. Set the server name, IP address and port number, account username, and password.
<b>SMTP authentication</b>	Uses SMTP authentication (PLAIN or LOGIN). Set the account username and password.

### 2 Enter the [Server Name(POP)].

Enter the name of the POP3 server.

Setting options:

Up to 32 characters.

### 3 Set the [IP / Port(POP)].

Set the POP3 server's IP address and port number.

Setting options:

IP Address \_\_\_\_\_.\_\_\_\_ (where \_ is 0 to 255)

Port No. 0 to 65535 (Default setting: 110)

### 4 Enter the [Account Name].

Enter the name of the user account for authentication.

Setting options:

Up to 32 characters.

### 5 Enter a [Password].

Enter the password for authentication.

The password is displayed as "\*\*\*\* ... \*\*\*\*" (32 asterisks (\*)).

Setting options:

Up to 32 characters.

#### Numerical Settings



Increment/decrement by 1



Increment/decrement by 10

#### Character Settings

**See:** "3.8 Entering Titles and Comments (as needed)" (p. 100)

## 10.8 About Communications Commands

Communications commands can be used to control the instrument remotely by connecting it to a PC with a USB or Ethernet cable.

This description applies only to instrument settings, and does not describe the communications commands themselves. For details about the communications commands, see the supplied Logger Utility CD. Communications command descriptions are provided in HTML format.

These can be viewed by the following procedure.

- 1** Insert the supplied CD in the PC's CD-ROM drive.
- 2** Click index.htm in the LR8410 folder.

See "10.1 USB Settings and Connections" (p. 214) for the USB settings and connection procedures.

See "10.2 LAN Settings and Connections (Before connecting to the network)" (p. 226) for the LAN settings and connection procedures.

### Configuring Communications Command Operation

- 1** Select the **[Delimiter]**.  
Set as needed for command communications control.  
Setting options: ( \* : default setting)  
**LF**, **CR+LF\***

- 2** Enable/disable the **[Header]**.  
Enable or disable command response headers.  
Setting options: ( \* : default setting)  
**On** Attach headers.  
**Off\*** Do not attach headers.

See: Key Setting Procedure (p. 214)

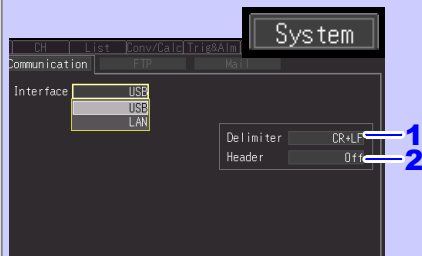

# Using Other Hioki Products (LR8410 Link)

## Chapter 11

Connecting the instrument with a Hioki product that supports LR8410 Link (hereafter referred to as Link product) enables you to obtain measurement data using the instrument. For more details including the wireless setting, refer to each of the Link product s' instruction manuals.

### 11.1 Register Link Product on Instrument

After the wireless setting is configured, the Link product can be registered and deleted by following the same procedure as described in "2.6 Register measurement units and wireless logger with the instrument" (p. 58).

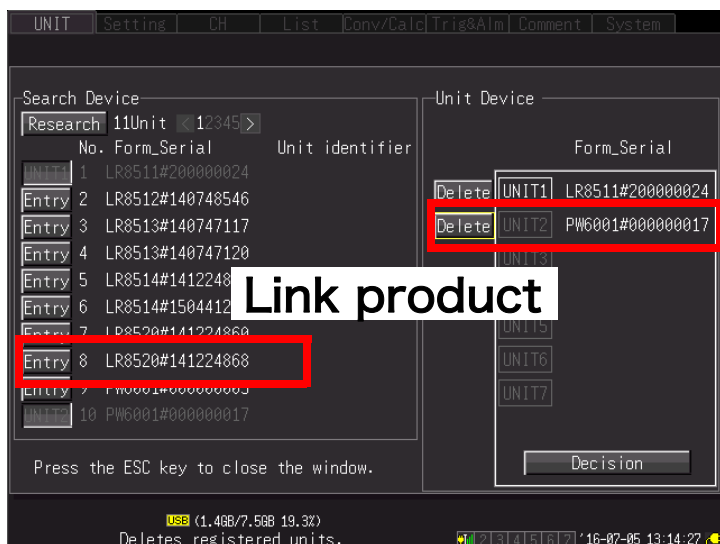

Product supporting LR8410 Link  
Model PW6001 (with the firmware version 2.0 or later installed)

# 11.2 Configure Settings

The instrument will automatically receive the setting information about the connected Link product.

At this time, the scaling setting and the upper and lower limits setting of the waveform display will be automatically configured.

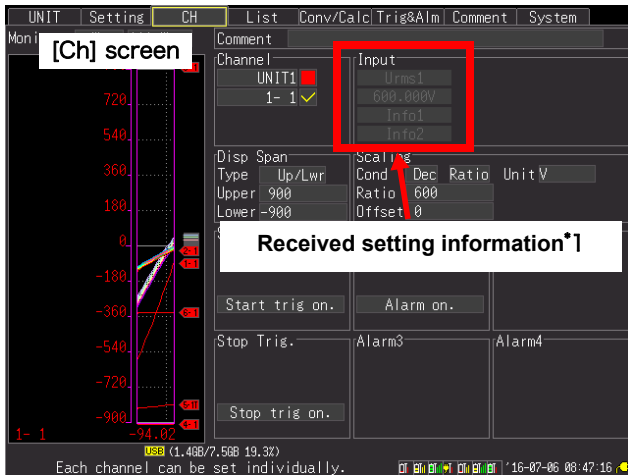
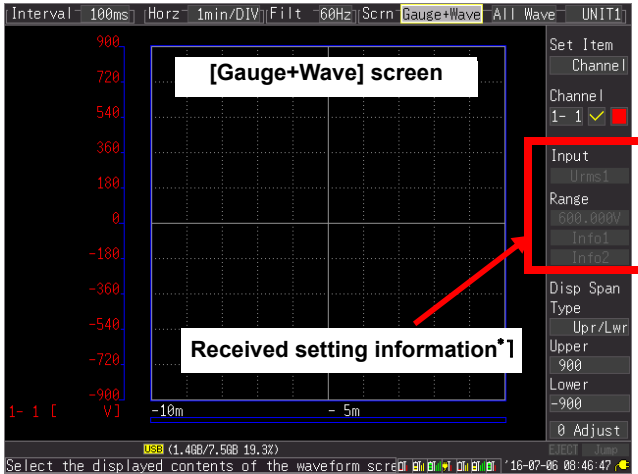

[List] screen

UNIT	Setting	CH	Unit	Disp	Zoom/Lower	Pos/Upper	Comment	System
UNIT 1	UNIT 2	UNIT 3	UNIT 4	Unit	Calc	Calc 2		
Batch Proc	0	Adjust						
	Input	Range		Disp	Zoom/Lower	Pos/Upper		
1- 1	Urms1	600.000V	Up/Lwr	-900	900	Info1		
1- 2	Umn1	600.000V	Up/Lwr	-900	900	Info1		
1- 3	Ufnd1	600.000V	Up/Lwr	-900	900	Info1		
1- 4	Uac1	600.000V	Up/Lwr	-900	900	Info1		
1- 5	Irms1	50.0000A	Up/Lwr	-75	75	Info1		
1- 6	Imn1	50.0000A	Up/Lwr	-75	75	Info1		
1- 7	Ifnd1	50.0000A	Up/Lwr	-75	75	Info1		
1- 8	Iac1	50.0000A	Up/Lwr	-75	75	Info1		

Received setting information\*1

USB (1.468/7.568 19.3%)  
All channel settings are available. 16-07-06 08:47:28

\*1: The Info1 or Info2 will be displayed only if the setting information corresponding to each of them is received. No information will be displayed without any corresponding setting information.

#### NOTE

- The scaling setting and the upper and lower limits setting in the instrument will be reflected when the mode or the range setting information of the Link product is changed. If it is changed manually, the scaling function will be enabled until the mode or range setting information of the Link product is changed.
- If the unit registration information is loaded from the internal memory, the setting information will be considered to be not obtained until it is received after the Link product is connected to the instrument.
- The Link products' settings cannot be configured with the instrument. Configure the settings with each of the Link products, referring to each product's instruction manual.
- The level values of the trigger and the alarm as well as the window upper and lower limits will be the value that is the measurement mode of [Voltage] and the measurement range of [1 V] to which the scaling setting is reflected.

## 11.3 Carry Out Measurement

Configure various settings with the instrument as needed and start a measurement.

**NOTE**

- The setting information of the Link product will not be updated during the measurement. Complete the configuration of necessary settings prior to the measurement.
- If the setting information is made different from the one configured before the measurement, for example, the Link product setting is changed after the measurement, the setting information will not be reflected to the instrument until the measurement data is deleted.
- The measurement starts after the setting information is automatically received.

## 11.4 Measurement data

### Measurement value errors

Some errors between values measured with the instrument and ones measured with a Link product may be observed depending on the difference in the data retention methods.

### Measurement values

A datum at a request from the instrument to a Link product will be saved as a measurement value.

If the request interval is longer than the sampling interval, a step-like waveform is displayed because lack of data is compensated with the most recent data. The data will not be recovered if the communications break.

For more details, refer to each of the Link product's instruction manuals.

---

# Specifications Chapter 12

## 12.1 LR8410-20 Wireless Logging Station Specifications

### (1) General Specifications

#### Basic Specifications

<b>Product warranty period</b>	3 years
<b>Period of guaranteed accuracy</b>	1 year
<b>Controllable devices</b>	LR8510 Wireless Voltage/Temp Unit LR8511 Wireless Universal Unit LR8512 Wireless Pulse Logger LR8513 Wireless Clamp Logger LR8514 Wireless Humidity Logger LR8515 Wireless Voltage/Temp Logger LR8520 Wireless Fungal Logger
<b>Number of controllable devices</b>	7 (max. 105 channels, up to 105 channels; when using the LR8510 or LR8511)
<b>Control and communications (Between instrument and units)</b>	Bluetooth 2.1+EDR Communications range: 30 m, line of sight Security: SSP
<b>Internal buffer memory</b>	8 MWords volatile RAM (SDRAM)
<b>External memory</b>	SD memory card(includes Z4001 2 GB)
<b>Clock functions</b>	Auto calendar, auto leap year judgment, 24-hour timer
<b>Clock accuracy</b>	±3 s/day (@23°C)
<b>Timebase accuracy</b>	±0.2 s/day while measuring (@23°C, 73.4°F)
<b>Backup battery life</b>	At least five years for clock and settings (@23°C, 73.4°F)
<b>Operating environment</b>	Indoors, Pollution degree 2, up to 2000 m (6562-ft.) ASL
<b>Operating temperature and humidity</b>	Temperature:-10°C to 50°C (14°F to 122°F), Humidity:30 to 80%RH or less(non-condensating) (temperature variation range is 5°C to 35°C (41°F to 95°F))
<b>Storage temperature and humidity</b>	Temperature:-20°C to 60°C (-4°F to 140°F), Humidity 80% RH or less (noncondensating)
<b>Dimensions</b>	Approx. 230W × 125H × 36D mm (9.06"W × 4.92"H × 1.42"D) (without projections)
<b>Mass</b>	Approx. 700 g (24.7 oz.)



12.1 LR8410-20 Wireless Logging Station Specifications**Basic Specifications**

<b>Applicable Standards</b>	Safety EN61010 EMC: EN61326 Class A
<b>Vibration endurance</b>	JIS D 1601:1995 5.3(1), Category 1: Vehicle, Condition: Category A equiv.(45 m/s <sup>2</sup> oscillating acceleration on X-axis for 4 h, and on Y- and Z-axes for 2 h)
<b>External control terminals</b>	External trigger input, trigger output, four alarm channel outputs, ground

**External Storage**

<b>SD memory card</b>	
<b>Slot:</b>	SD standard-compliant × 1 (Supports SD memory cards and SDHC memory cards.)
<b>Card capacities:</b>	Z4001 (2 GB), Z4003 (8 GB)
<b>Data formats:</b>	FAT16, FAT32
<b>USB flash drive</b>	
<b>Applicable standard:</b>	USB 2.0 compliant
<b>Connector:</b>	Series A receptacle
<b>Data formats:</b>	FAT16, FAT32

**Communications Functions**

<b>LAN Interface</b>	
<b>LAN</b>	IEEE802.3 Ethernet 100BASE-TX DHCP, DNS
<b>Connector</b>	RJ-45
<b>LAN Function</b>	<ul style="list-style-type: none"> <li>• Data acquisition and measurement criteria setting with the Logger Utility</li> <li>• Setting and measurement by communications commands</li> <li>• Manual file transfer by FTP server (from the instrument memory or removable storage).</li> <li>• Auto sending files by FTP client (periodically transfer files from removable storage during or after measurement)</li> <li>• Remote control by HTTP server (remote control, start/stop measurement, display current values, data acquisition to memory, FTP file transfers, comment entry)</li> <li>• E-Mailing (Sends regular e-mails as well as e-mails when any of the following occurs: unit communications error, unit low battery, start trigger, stop trigger, warning, power restoration, internal memory full, media full.)</li> </ul>
<b>USB Interface</b>	
<b>USB standard</b>	USB2.0 compliant High Speed
<b>Connector</b>	Series-mini B receptacle

## Communications Functions

<b>USB Function</b>	<ul style="list-style-type: none"> <li>• Data acquisition and measurement criteria setting with the Logger Utility</li> <li>• Setting and measurement by communications commands</li> <li>• USB Drive Mode (Data can be sent from an external SD memory card to a computer.)</li> </ul>
---------------------	---

## Display Section

<b>Display type</b>	5.7-in TFT Color LCD (640 x 480 dots)
<b>Display resolution (with Waveform display selected)</b>	Max. 16 divisions (time axis) × 10 divisions (vertical axis) (1 division = 36 dots (time axis) × 36 dots (vertical axis))
<b>Display character</b>	English/Japanese selectable
<b>Backlight life span</b>	Approx. 50,000 hours (@23°C, 73.4°F)
<b>Backlight saver</b>	The backlight turns off when no key is pressed (Off, or 1 to 30 minutes)
<b>Backlight Brightness</b>	Selectable from four levels (100%, 70%, 40%, 25%)

## Power source

<b>AC adapter</b>	Z1008 AC Adapter(DC12 V)
<b>Rated supply voltage</b>	100 V to 240 V AC
<b>Rated supply frequency</b>	50 Hz/60 Hz
<b>Battery</b>	Z1007 Battery Pack (The AC Adapter has priority when connected)
<b>External Power</b>	10 V to 28 V DC
<b>Power consumption</b>	
<b>Typical power consumption</b>	With Z1008 AC Adapter or other 12 V DC external power, without battery pack w/LCD max. brightness: 8 VA (LR8410 only) w/LCD backlight off: 7 VA (LR8410 only)
<b>Maximum rated power</b>	When using the Z1008 AC Adapter: 45 VA (including the AC adapter), 15 VA (LR8410 only) When using an external DC28 V power source: 15 VA (when battery is charged, and w/LCD max. blightness) When using a Z1007 Battery Pack :7 VA (w/LCD max. brightness)
<b>Continuous operating time</b>	When using Model Z1007 Battery Pack, approx. 3 hours (Backlight brightness 25%, @23°C, 73.4°F)
<b>Charging function</b>	The AC adapter or a 10 V to 28 V DC external power supply can be connected while the Z1007 Battery Pack is installed. Charging time: Approx. 7 hours (@23°C, 73.4°F)

## 12.1 LR8410-20 Wireless Logging Station Specifications

### Trigger Function

<b>Trigger method</b>	Digital comparison
<b>Trigger modes</b>	Single or continuous
<b>Trigger timing</b>	Start, stop, start&stop
<b>Trigger source</b>	
<b>Analog, pulse and logic input</b>	Up to 105 channels, depending on how many LR8510 Wireless Voltage/Temp Unit, LR8511 Wireless Universal Unit, LR8512 Wireless Pulse Logger, LR8513 Wireless Clamp Logger, LR8514 Wireless Humidity Logger, LR8515 Wireless Voltage/Temp Logger and LR8520 Wireless Fungal Logger are connected (U1-1 to U7-15).
<b>External trigger</b>	Trigger on external input signal rising or falling edge (selectable).
	Rising : triggers upon transition from 0 V to 0.8 V (LOW) to 2.5 V to 5.0 V (HIGH).
	Falling : triggers upon transition from 2.5 V to 5.0 V (HIGH) to 0 V to 0.8 V (LOW), or when the external trigger terminal is shorted to a GND terminal.
	Trigger input voltage range : 0 V to 10 V DC
	Minimum response time : H period 2.5 ms or greater, L period 2.5 ms or greater
	Trigger input terminals : Push-button type terminal block
<b>Interval trigger</b>	The trigger is activated at a measurement interval set in days, hours, minutes, and seconds.
<b>Trigger criteria</b>	<ul style="list-style-type: none"> <li>• AND or OR of each trigger source</li> <li>• Trigger criteria can be set for each channel.</li> <li>• Free-running when all are Off</li> </ul>
<b>Trigger types</b>	
<b>Level Trigger</b>	Triggering occurs when the signal rises (or falls) through a specified value.
<b>Window Trigger</b>	Triggering occurs when the input signal level enters or exits the amplitude window defined by upper/lower thresholds.
<b>Pattern trigger</b>	Applies the trigger when a pattern defined in terms of 1, 0, and values is matched (where " " indicates either value). *Setting only available when using logic measurement with the LR8512.
<b>Trigger response time</b>	Recording interval + 3 sec. or less (with 1 unit, good communications) Recording interval + 5 sec. or less (When seven units are connected, good communications)
<b>Trigger level resolution</b>	Analog: 0.1% f.s. (f.s. = 10 frames) Pulse: Integration 1c, RPM 1/n (where n equals the pulse count setting per revolution) *Pulse setting only available when using the LR8512.
<b>Pre-trigger</b>	Time span setting (any span). Settable with real-time saving.

## Trigger Function

<b>Trigger output</b>	Open-drain output (5 V voltage output, active low) Output voltage level high: 4.0 V to 5.0 V; low: 0 V to 0.5 V Pulse Width: at least 100 ms Max. switching capacity: 5 V to 30 V DC, 5 mA max Output response time: Recording interval + 3 sec. or less (with 1 unit, good communications) Recording interval + 5 sec. or less (When seven units are connected, good communications)
<b>Trigger output terminal</b>	Push-button type terminal block

## Alarm Output

<b>Alarm Output Channels</b>	Four, non-isolated (Common GND with the instrument)
<b>Output settings</b>	Output occurs when the logical sum (OR) or product (AND) of alarm trigger sources is true.
<b>Alarm source</b>	
<b>Analog, pulse and logic input</b>	Up to 105 channels, depending on how many LR8510 Wireless Voltage/Temp Units and LR8511 Wireless Universal Units are connected (U1-1 to U7-15).
<b>Communication error</b>	When a communications error occurs
<b>Thermocouple burnout</b>	When thermocouple burn-out detection is enabled
<b>Unit battery</b>	When the LR8510 Wireless Voltage/Temp Unit or LR8511 Wireless Universal Unit battery is low When the LR8512 Wireless Pulse Logger or LR8513 Wireless Clamp Logger LR8514 Wireless Humidity Logger or LR8515 Wireless Voltage/Temp Logger or LR8520 Wireless Fungal Logger's battery is depleted
<b>Alarm types</b>	
<b>Level</b>	Outputs an alarm when the level is greater than or less than a preset level value.
<b>Window</b>	The user sets trigger level upper and lower limit values. Outputs an alarm when the value falls inside the set area or outside the set area.
<b>Pattern</b>	Outputs an alarm when a pattern consisting of 1, 0, and × values satisfied (where × indicates either value). *Setting available only when using logic input on the LR8512.
<b>Alarm level resolution</b>	Analog: 0.1%f.s. (f.s. = 10 divisions) Pulse: Integration 1c, RPM 1/n (where n equals the pulse count setting per revolution) *Pulse setting only available when using the LR8512.
<b>Latch setting</b>	Alarm output can be set to be held (latched), or not.
<b>Cancel Hold</b>	Enable Alarm Hold to latch alarm output without stopping measurement.
<b>Beeper</b>	Built-in beeper On/Off

## 12.1 LR8410-20 Wireless Logging Station Specifications

### Alarm Output

<b>Output form</b>	Open drain output (with 5 V pull-up, active low)
<b>Output voltage level</b>	HIGH:4.0 V to 5.0 V, LOW:0 V to 0.5 V
<b>Maximum switch rating</b>	5 V to 30 V DC, 200 mA
<b>Output response time</b>	Recording interval + 3 sec. or less (with 1 unit, good communications) Recording interval + 5 sec. or less (with 7 units, good communications)

## (2) Measurement Functions

### Measurement

<b>Recording interval</b>	100 ms <sup>*1, *2</sup> , 200 ms <sup>*2</sup> , 500 ms, 1 s, 2 s, 5 s, 10 s, 20 s, 30 s, 1 min, 2 min, 5 min, 10 min, 20 min, 30 min, 1 h *1: Setting not available when the thermocouple burnout detection setting is on. *2: For the LR8513 Wireless Clamp Logger, LR8514 Wireless Humidity Logger and LR8520 Wireless Fungal Logger data is updated at a 500 ms interval.
<b>Recording length (time span)</b>	Set continuous recording Off or On. When Off, any time can be set.
<b>Repeating Measurement Recording</b>	Set Off or On. When On, measurement repeats at the set recording interval.
<b>Recording Data Quantity</b>	Analog recording n channels: 8 M/n data values
<b>Waveform storage</b>	The most recent 8 M data values (one analog channel recording time, or 8 M / n values for n channels) are stored in internal buffer memory (where n = number of analog and logic channels + number of pulse (integration, RPM) channels + number of waveform calculation channels × 4 + alarm data, where alarm data is 36 when an alarm is in use or 0 when not in use) Data retained in memory can be observed by backward scrolling.
<b>Measurement data backup</b>	Data is retained for about 30 minutes after power-off (except when powered off while writing to removable storage, or within 10 minutes after power-on)

## Display

<b>Display Screen Selection (Hybrid display configurations)</b>	<ul style="list-style-type: none"> <li>• Simultaneous waveform, gauge and setting display</li> <li>• Waveform display</li> <li>• Simultaneous waveform and numerical value display</li> <li>• Simultaneous numerical value and comment display</li> <li>• Simultaneous waveform and comment display</li> <li>• Numerical value display</li> <li>• Simultaneous waveforms and numerical calculation results display</li> <li>• Waveform and A/B cursor values displayed at the same time</li> <li>• Alarm display</li> </ul>
<b>Waveform colors</b>	24 colors
<b>Waveform compression and magnification</b>	
<b>Time axis</b>	200 ms., 500 ms., 1 s., 2 s., 5 s., 10 s., 20 s., 30 s., 1 min., 2 min., 5 min., 10 min., 20 min., 30 min., 1 h., 2 h., 5 h., 10 h., 12 h., 1day /divisions
<b>Voltage axis</b>	Select by position or upper/lower limits <ul style="list-style-type: none"> <li>• When selecting by position, magnification can be <math>\times 100</math>, <math>\times 50</math>, <math>\times 20</math>, <math>\times 10</math>, <math>\times 5</math>, <math>\times 2</math>, <math>\times 1</math>, <math>\times 1/2</math>, 0 Position : Set between -50 to 150% (at 1X magnification)</li> <li>• When selected by upper/lower limits, specify the limit values.</li> </ul>
<b>Waveform scrolling</b>	Time-axis scrolling is available by left/right arrow keys while measuring and when measurement stops (waveform drawing period).  These keys make large jumps
<b>Jump function</b>	Selects the displayed span of the waveform.
<b>Monitor function</b>	Confirm instantaneous values and waveforms without recording data. (Monitoring is performed while triggering)
<b>Unit battery life remaining display</b>	Displays the remaining battery life for wirelessly connected units as 1 of 3 levels.
<b>Signal strength display</b>	Displays the signal strength for wirelessly connected units as 1 of 3 levels.
<hr/>	
<b>Save</b>	
<b>Save destination</b>	SD memory card or USB flash drive selectable
<b>Auto save</b>	Waveform data and interval calculation results (real-time saving) Numerical calculation results other than interval calculations (after measurement saving)
<b>Real-time saving</b>	<ul style="list-style-type: none"> <li>• Saves waveform data in binary or CSV format to selected removable storage about once per minute (for slower recording intervals, saves every interval).</li> <li>• Real-time saving to removable storage is possible while communicating with the Logger Utility.</li> </ul>

## 12.1 LR8410-20 Wireless Logging Station Specifications

### Save

<b>Split Save</b>	Selectable Off, On or Periodic <ul style="list-style-type: none"> <li>• On: Saves data split into separate files from measurement start, at the set interval.</li> <li>• Periodic: Saves data split into separate files from a set reference time (within 24 hours), at the set interval.</li> </ul>
<b>Deleting</b>	Selectable Off or On <ul style="list-style-type: none"> <li>• On: Deletes the oldest file to save the newest file when removable storage becomes</li> </ul>
<b>Remove external media</b>	During real-time saving, press a button, confirm the displayed message, and remove the storage media. When the removable media is re-inserted, data retained in internal memory is saved continuously to a separate file.
<b>Data protection</b>	If a power outage occurs or the battery runs out during real-time saving, power is cut off after the file is closed (protection becomes possible approximately 10 min. or more after the instrument is turned on).
<b>Manual saving</b>	Press SAVE to save. Select SAVE operation from selection or immediate saving. During immediate saving, the save type, format, range, and filename are set in advance. The filename can be entered when saving.
<b>Save types</b>	Setting criteria, waveform data (binary format), waveform data (CSV format), numerical calculation results, screen captures (compressed bitmap format), reservation settings
<b>Reloading data</b>	Up to 8 M data values can be saved in binary format to a specified location. (one analog channel recording time, or 8 M / n values for n channels) (where n = number of analog and logic channels + number of pulse (integration, RPM) channels + number of waveform calculation channels × 4 + alarm data, where alarm data is 36 when an alarm is in use or 0 when not in use)

### Calculations

<b>Numerical calculations</b>	
<b>No. of calculations</b>	Six calculations are available at the same time
<b>Calculations</b>	Average value, peak value, maximum value, Time to maximum value, minimum value, Time to minimum value
<b>Calculation time span (After measuring)</b>	Applies calculations to all data in internal buffer memory, or to the time-span specified by A/B cursors.
<b>Calculation time span (While measuring)</b>	Applies calculations to all data in internal buffer memory.  Interval calculation: Values are calculated for each specified timeframe, and the latest calculated value is displayed. Select from time periods (segment times) of 1 min., 2 min., 5 min., 10 min., 15 min., 20 min., 30 min., 1 h., 2 h., 3 h., 4 h., 6 h., 8 h., 12 h., and 1 day.

## Calculations

<b>Auto saving calculation results</b>	After measuring, the most recent calculation results are automatically saved in TXT format to removable storage.  Interval calculation: Saves real-time calculation results in TXT format at the specified interval.
<b>Waveform calculations</b>	
<b>Calculation Method</b>	Calculate sum, difference, product, and quotient between channels, with calculated results displayed as channels W1 to W30 (valid during measurement only). Formulas for performing waveform calculations based on the LR8513 Wireless Clamp Logger's current measured values and voltage/power factor settings can be configured (select from 1-phase/2-wire, 1-phase/3-wire, and 3-phase/3-wire) (valid during measurement only).
<b>Auto saving calculation results</b>	Saved in real time with a channel's waveform data.

## Other Functions

<b>Event mark function</b>	
<b>Search function</b>	Displays the waveform before and after a specified event mark.
<b>Event mark insertion</b>	<ol style="list-style-type: none"> <li>1. When pressing <b>START</b> while measuring</li> <li>2. When pressing the on-screen <b>[Make Mark]</b> button.</li> <li>3. When a signal is applied to the external trigger input terminal (External Trigger and Exclusive settings on the System screen)</li> <li>4. When an alarm event occurs (can be enabled/disabled)</li> </ol>
<b>No. of Marks</b>	Up to 1000 per measurement
<b>Cursor measurement functions</b>	
<b>Cursor measurement</b>	Time difference between A/B cursors, measured value difference, cursor measured value, time
<b>Cursor display</b>	Select All or Selected channels
<b>Cursor movement</b>	Select A, B, or Both (simultaneous)
<b>Cursor types</b>	Select trace, vertical, or horizontal
<b>Scaling function</b>	Scaling can be set for each channel Selectable from Ratio or 2-Point setting methods
<b>Fahrenheit display</b>	Scaling can be set to display Fahrenheit (F) when English language is selected.
<b>Inter-Channel compensation function</b>	The value measured on UNIT1, CH1 can be applied as the scaling value (only to other channels with the same input type and range).
<b>Comment entry</b>	Titles and comments can be entered for each channel.
<b>Auto Resume function</b>	Settable On or Off. When On, recording resumes automatically after a power outage. (resumes with the trigger wait state when using triggering)



**12.1 LR8410-20 Wireless Logging Station Specifications**

**Other Functions**

<b>Setting configuration saving function</b>	Up to 5 setting configurations can be stored in instrument memory. Previous settings when loading waveform files or setting files are automatically stored.
<b>Unit registration function</b>	Information about connected units can be stored.
<b>Auto setup function</b>	Settings stored in the instrument's memory or on an SD memory card can be automatically loaded when the instrument is turned on.
<b>Inadvertent START/STOP prevention</b>	Displays a confirmation message when pressing <b>START/STOP</b> keys.
<b>Confirmation message</b>	Select enable/disable (Default: enabled)
<b>Key-Lock function</b>	Disables key operations (Set by pressing and holding the <b>CANCEL</b> key for 3 sec. or more.)
<b>Beeper</b>	On/Off
<b>Reservation function</b>	Set up to 10 sets of measurement start and stop conditions.
<b>Spc.Dt</b>	<ul style="list-style-type: none"> <li>• Set start and stop times (year, month, day, hour, minutes).</li> <li>• Set configuration conditions when performing reserved operation.</li> </ul>
<b>Reg</b>	<ul style="list-style-type: none"> <li>• Set a start date (everyday, or specify Monday through Friday, Monday through Saturday, or Sunday).</li> <li>• Set start and stop times (hours and minutes).</li> <li>• Set configuration conditions when performing reserved operation.</li> </ul>
<b>Configuration Navigator function</b>	Guides users through unit connection settings.

**Others**

<b>Accessories</b>	<ul style="list-style-type: none"> <li>• Instruction Manual (This document) ..... 1</li> <li>• Measurement Guide ..... 1</li> <li>• Precautions Concerning Use of Equipment That Emits Radio Waves ..... 1</li> <li>• Z4001 SD memory card(2 GB)..... 1</li> <li>• Logger Utility (Data acquisition application program)CD-R ..... 1</li> <li>• USB Cable..... 1</li> <li>• Z1008 AC Adapter(with supplied power cord)..... 1</li> </ul>
--------------------	--

**Others****Options  
(sold separately)**

- LR8510 Wireless Voltage/Temp Unit
  - LR8511 Wireless Universal Unit
  - LR8512 Wireless Pulse Logger
  - LR8513 Wireless Clamp Logger
  - LR8514 Wireless Humidity Logger
  - LR8515 Wireless Voltage/Temp Logger
  - LR8520 Wireless Fungal Logger
  - Z1007 Battery Pack(Li-ion)
  - Z1008 AC Adapter(with supplied power cord)
  - C1007 Carrying Case
  - Z1009 Fixed Stand
  - 9642 LAN Cable
  - Z4001 SD memory card(2 GB)
  - Z4003 SD memory card(8 GB)
  - P9000-01 Differential Probe
  - P9000-02 Differential Probe
-

## 12.2 LR8510 Wireless Voltage/Temp Unit Specifications

### Basic Specifications

<b>Product warranty period</b>	3 years
<b>Period of guaranteed accuracy</b>	1 year
<b>Supported model</b>	LR8410-20 Wireless Logging Station
<b>Control and communications (Between instrument and unit)</b>	Bluetooth 2.1+EDR Communications range: 30 m, line of sight Security: SSP
<b>Backup memory</b>	When recording n channels: (65,536/n) data points Data is maintained in the event of a communications error and resent when communications are restored.
<b>Operating environment</b>	Indoors, Pollution degree 2, up to 2000 m (6562-ft.) ASL
<b>Operating temperature and humidity</b>	Temperature: -20°C to 60°C(-4°F to 140°F) Humidity: -20°C to 40°C(-4°F to 104°F)80%RH or less (noncondensating) 40°C to 45°C(104°F to 113°F)60%RH or less (noncondensating) 45°C to 50°C(113°F to 122°F)50%RH or less (noncondensating) 50°C to 60°C(122°F to 140°F)30%RH or less (noncondensating) (temperature variation range is 5 to 35°C (41 to 95°F))
<b>Storage temperature and humidity</b>	Temperature: -20°C to 60°C(-4 to 140°F) Humidity: -20°C to 40°C(-4°F to 104°F)80%RH or less (noncondensating) 40°C to 45°C(104°F to 113°F)60%RH or less (noncondensating) 45°C to 50°C(113°F to 122°F)50%RH or less (noncondensating) 50°C to 60°C(122°F to 140°F)30%RH or less (noncondensating)
<b>Conditions of guaranteed accuracy</b>	Defined after zero-adjustment has been performed. The 50/60 Hz cut-off setting is selected (see the Cut-Off Frequency Table)
<b>Temperature and humidity range for guaranteed accuracy</b>	Temperature: 23±5°C (73±9°F), Humidity 80% RH or less (non-condensating)
<b>Dielectric strength</b>	AC3.0 kV/60 seconds (between each input channel and chassis) AC350 V/60 seconds (between input channels)
<b>Dimensions</b>	Approx.150W×90H×56D mm (5.91"W × 3.54"H × 2.2"D) (including cover)
<b>Mass</b>	Approx. 340 g (12.0 oz.)
<b>Applicable Standards</b>	Safety: EN61010 EMC: EN61326 Class A
<b>Vibration endurance</b>	JIS D 1601:1995 5.3(1), Category 1: Vehicle, Condition: Category A equiv.(45 m/s <sup>2</sup> oscillating acceleration on X-axis for 4 h, and on Y- and Z-axes for 2 h)

## Inputs

<b>No. of Input Channels</b>	15 channels(select voltage or thermocouple for each channel)
<b>Input terminals</b>	M3 screw type terminal block (2 terminals per channel) Terminal block cover mounting
<b>Measurement objects</b>	Voltage Thermocouple (K, J, E, T, N, R, S, B, W)

**Measurement ranges/  
Measurable Range/  
Resolution/  
Measurement accuracy**

Measurement Object	Type	Range	Max. Resolution	Measurable Range	Measurement accuracy
Voltage		10 mV f.s	500 nV	-10 mV to 10 mV	± 10 μV
		20 mV f.s	1 μV	-20 mV to 20 mV	± 20 μV
		100 mV f.s.	5 μV	-100 mV to 100 mV	± 100 μV
		200 mV f.s.	10 μV	-200 mV to 200 mV	± 200 μV
		1 V f.s.	50 μV	-1 V to 1 V	± 1 mV
		2 V f.s.	100 μV	-2 V to 2 V	± 2 mV
		10 V f.s.	500 μV	-10 V to 10 V	± 10 mV
		20 V f.s.	1 mV	-20 V to 20 V	± 20 mV
		100 V f.s.	5 mV	-100 V to 100 V	± 100 mV
		1-5 V f.s.	500 μV	1 V to 5 V	± 10 mV

**12.2 LR8510 Wireless Voltage/Temp Unit Specifications**

**Inputs**

Measurement Object	Type	Range	Max. Resolution	Measurable Range	Measurement accuracy
Thermocouple (not including RJC accuracy) *1: JIS C 1602-1995, IEC584	K*1	100°Cf.s	0.01°C	-100°C to 0°C or less	±0.8°C
				0°C to 100°C	±0.6°C
		500°Cf.s	0.05°C	-200°C to -100°C or less	±1.5°C
				-100°C to 0°C or less	±0.8°C
		2000°Cf.s	0.1°C	0°C to 500°C	±0.6°C
				-200°C to -100°C or less	±1.5°C
	-100°C to 1350°C	±0.8°C			
		J*1	100°Cf.s	0.01°C	-100°C to 0°C or less
	0°C to 100°C				±0.6°C
	500°Cf.s		0.05°C	-200°C to -100°C or less	±1.0°C
				-100°C to 0°C or less	±0.8°C
	2000°Cf.s		0.1°C	0°C to 500°C	±0.6°C
				-200°C to -100°C or less	±1.0°C
	-100°C to 0°C or less	±0.8°C			
	0°C to 1200°C	±0.6°C			
E*1	100°Cf.s	0.01°C	-100°C to 0°C or less	±0.8°C	
			0°C to 100°C	±0.6°C	
	500°Cf.s	0.05°C	-200°C to -100°C or less	±1.0°C	
			-100°C to 0°C or less	±0.8°C	
	2000°Cf.s	0.1°C	0°C to 500°C	±0.6°C	
			-200°C to -100°C or less	±1.0°C	
-100°C to 0°C or less	±0.8°C				
0°C to 1000°C	±0.6°C				

## Inputs

Measurement Object	Type	Range	Max. Resolution	Measurable Range	Measurement accuracy
Thermocouple (not including RJC accuracy) *1: JIS C 1602- 1995, IEC584 *2: ASTM E- 988-96	T*1	100°Cf.s	0.01°C	-100°C to 0°C or less	±0.8°C
				0°C to 100°C	±0.6°C
		500°Cf.s.	0.05°C	-200°C to -100°C or less	±1.5°C
				-100°C to 0°C or less 0°C to 400°C	±0.8°C ±0.6°C
		2000°Cf.s.	0.1°C	-200°C to -100°C or less	±1.5°C
				-100°C to 0°C or less 0°C to 400°C	±0.8°C ±0.6°C
	N*1	100°Cf.s	0.01°C	-100°C to 0°C or less	±1.2°C
				0°C to 100°C	±1.0°C
		500°Cf.s.	0.05°C	-200°C to -100°C or less	±2.2°C
				-100°C to 0°C or less 0°C to 500°C	±1.2°C ±1.0°C
		2000°Cf.s.	0.1°C	-200°C to -100°C or less	±2.2°C
				-100°C to 0°C or less 0°C to 1300°C	±1.2°C ±1.0°C
	R*1	100°Cf.s	0.01°C	0°C to 100°C	±4.5°C
				0°C to 100°C or less	±4.5°C
		500°Cf.s.	0.05°C	100°C to 300°C or less	±3.0°C
				300°C to 500°C	±2.2°C
		2000°Cf.s.	0.1°C	0°C to 100°C or less	±4.5°C
				100°C to 300°C or less 300°C to 1700°C	±3.0°C ±2.2°C
	S*1	100°Cf.s	0.01°C	0°C to 100°C	±4.5°C
				0°C to 100°C or less	±4.5°C
		500°Cf.s.	0.05°C	100°C to 300°C or less	±3.0°C
				300°C to 500°C	±2.2°C
		2000°Cf.s.	0.1°C	0°C to 100°C or less	±4.5°C
				100°C to 300°C or less 300°C to 1700°C	±3.0°C ±2.2°C
B*1	2000°Cf.s.	0.1°C	400°C to 600°C or less	±5.5°C	
			600°C to 1000°C or less	±3.8°C	
			1000°C to 1800°C	±2.5°C	
W*2	100°Cf.s	0.01°C	0°C to 100°C	±1.8°C	
			500°Cf.s.	0.05°C	0°C to 500°C
	2000°Cf.s.	0.1°C	0°C to 2000°C		±1.8°C

**Reference junction compensation accuracy**

±0.5°C  
Add to thermocouple measurement accuracy when internal RJC is enabled.

**Temperature characteristic**

Add (Measurement accuracy x 0.1) /°C to measurement accuracy

**Reference junction compensation**

Internal/External selectable (for thermocouple measurements)

## 12.2 LR8510 Wireless Voltage/Temp Unit Specifications

### Inputs

<b>Thermocouple burnout detection</b>	Enable/disable thermocouple burn-out detection at each recording interval. 5 $\mu\text{A} \pm 20\%$ detection current. No current flow when acquiring measurement data. (The burnout detection setting cannot be used with a recording interval of 100 ms.)
---------------------------------------	--

<b>Digital filter</b>	Off, 50 Hz, 60 Hz (automatically sets the cut-off frequency according to the recording interval)
-----------------------	--

#### Cut-off frequency

Digital filter settings	Burn-out detection setting	Recording interval								
		100 ms	200 ms	500 ms	1 s	2 s	5 s	10 s	20 s	30 s to
60 Hz	OFF	1.8 k	0.7 k	60	60	60	60	60	60	60
	ON	-	1.8 k	0.7 k	60	60	60	60	60	60
50 Hz	OFF	1.8 k	0.7 k	50	50	50	50	50	50	50
	ON	-	1.8 k	0.7 k	50	50	50	50	50	50
OFF	OFF	1.8 k	1.8 k	1.8 k	1.8 k	1.8 k	1.8 k	1.8 k	1.8 k	1.8 k
	ON	-	1.8 k	1.8 k	1.8 k	1.8 k	1.8 k	1.8 k	1.8 k	1.8 k

[Unit:Hz]

<b>Input resistance</b>	1 M $\Omega \pm 5\%$ (voltage and thermocouple measurement)
-------------------------	---

<b>Normal mode rejection ratio</b>	50dB minimum (with 50 Hz input with 5 s recording interval, and 50 Hz digital filter enabled) (with 60 Hz input with 5 s recording interval, and 60 Hz digital filter enabled)
------------------------------------	---

<b>Common mode rejection ratio</b>	with 100 $\Omega$ maximum signal source impedance 100dB minimum (with 50 Hz or 60 Hz input and digital filter disabled) 140dB minimum (for 50-Hz input with 5 s recording interval, 50-Hz digital filter enabled, 10 mV f.s. range setting) (for 60-Hz input with 5 s recording interval, 60-Hz digital filter enabled, 10 mV f.s. range setting)
------------------------------------	---

<b>Maximum input voltage</b>	DC $\pm 100$ V
------------------------------	----------------

<b>Max. inter-channel voltage</b>	DC300 V
-----------------------------------	---------

<b>Maximum rated voltage to earth</b>	300 VAC, DC (between each input channel and chassis) Measurement category II Anticipated transient overvoltage 2,500 V
---------------------------------------	--

## 12.2 LR8510 Wireless Voltage/Temp Unit Specifications

### Power source

<b>Power source</b>	
<b>AC adapter</b>	Z1008 AC Adapter (12 V DC) Rated supply voltage:100 to 240 VAC Rated supply frequency:50 Hz / 60 Hz
<b>Battery</b>	Z1007 Battery Pack (The AC Adapter has priority when connected)
<b>External Power</b>	10 V to 28 V DC

### Power consumption

<b>Typical power consumption</b>	With Z1008 AC Adapter or other 12 V DC external power, without battery pack 1.0 VA (unit only)
<b>Maximum rated power</b>	When using the Z1008 AC Adapter: 23 VA(including the AC adapter), 7 VA(LR8410-20 only) When using an external DC28 V power source: 7 VA(when battery is charged) When using a Z1007 Battery Pack:0.4 VA

### Continuous operating time

<b>Battery</b>	When using Model Z1007 Battery Pack approx. 24 hours (with a recording interval of 100 ms, @23°C, 73.4°F) approx. 120 hours (with a recording interval of 1 min., @23°C, 73.4°F)
----------------	--

<b>Charging function</b>	The AC adapter or a 10 to 28 V DC external power supply can be connected while the Z1007 Battery Pack is installed. Charging time: Approx. 7 hours (@23°C, 73.4°F)
--------------------------	---

### LED indicators

<b>Unit number, status indicator</b>	The UNIT1 through UNIT7 LEDs light up or flash according to the unit number. Lit up: Strong communications state or connected Flashing: Poor communications state or communications lost during measurement
<b>AC adapter/external power supply indicator</b>	Lights up to indicate use of AC adapter or external power supply.
<b>Battery remaining life indicator</b>	LED lights up when the unit is operating on battery power and flashes when the remaining battery life is low while operating on battery power.
<b>Charge indicator</b>	Lights up while the battery pack is charging.

### Others

<b>Accessories</b>	<ul style="list-style-type: none"> <li>• Instruction Manual (This document)</li> <li>• Model Z1008 AC Adapter (with supplied power cord)</li> <li>• Bracket</li> <li>• M3×4 screw(2)</li> </ul>
<b>Options (sold separately)</b>	<ul style="list-style-type: none"> <li>• LR8410-20 Wireless Logging Station</li> <li>• Z1007 Battery Pack(Li-ion)</li> <li>• Z1008 AC Adapter(with supplied power cord)</li> </ul>



## 12.3 LR8511 Wireless Universal Unit Specifications

### Basic Specifications

<b>Product warranty period</b>	3 years
<b>Period of guaranteed accuracy</b>	1 year
<b>Supported device</b>	LR8410-20 Wireless Logging Station
<b>Control and communications (Between instrument and unit)</b>	Bluetooth 2.1+EDR Communications range: 30 m, line of sight Security: SSP
<b>Backup memory</b>	When recording n channels: (65,536/n) data points Data is maintained in the event of a communications error and resent when communications are restored.
<b>Operating environment</b>	Indoors, Pollution degree 2, up to 2000 m (6562-ft.) ASL
<b>Operating temperature and humidity</b>	Temperature: -20°C to 60°C(-4°F to 140°F) Humidity: -20°C to 40°C(-4°F to 104°F)80%RH or less (noncondensating) 40°C to 45°C(104°F to 113°F)60%RH or less (noncondensating) 45°C to 50°C(113°F to 122°F)50%RH or less (noncondensating) 50°C to 60°C(122°F to 140°F)30%RH or less (noncondensating) (temperature variation range is 5 to 35°C (41 to 95°F))
<b>Storage temperature and humidity</b>	Temperature: -20°C to 60°C(-4 to 140°F) Humidity: -20°C to 40°C(-4°F to 104°F)80%RH or less (noncondensating) 40°C to 45°C(104°F to 113°F)60%RH or less (noncondensating) 45°C to 50°C(113°F to 122°F)50%RH or less (noncondensating) 50°C to 60°C(122°F to 140°F)30%RH or less (noncondensating)
<b>Conditions of guaranteed accuracy</b>	Defined after zero-adjustment has been performed. With a cutoff frequency of 50/60 Hz (see cutoff frequency chart)
<b>Temperature and humidity range for guaranteed accuracy</b>	Temperature 23±5°C (73±9°F), Humidity 80% RH or less (non-condensating)
<b>Dielectric strength</b>	3.0 kV AC for 60 seconds (between each input channel and chassis) 350 V AC for 60 seconds (between input channels)
<b>Dimensions</b>	Approx.150W×90H×56D mm (5.91"W × 3.54"H × 2.2"D) (including cover)
<b>Mass</b>	Approx. 320 g (11.3 oz.)
<b>Applicable Standards</b>	Safety: EN61010 EMC: EN61326 Class A
<b>Vibration endurance</b>	JIS D 1601:1995 5.3(1), Category 1: Vehicle, Condition: Category A equiv.(45 m/s <sup>2</sup> oscillating acceleration on X-axis for 4 h, and on Y- and Z-axes for 2 h)

## Inputs

<b>No. of Input Channels</b>	15 channels (select voltage, thermocouple, RTD, humidity, or resistance for each channel)
<b>Input terminals</b>	Push-button terminals (4 terminals per channel) Terminal block cover mounting
<b>Measurement objects</b>	<ul style="list-style-type: none"> <li>• Voltage</li> <li>• Thermocouple (K, J, E, T, N, R, S, B, W)</li> <li>• RTDs (Pt100, JPt100, 3- or 4-wire configuration, 1 mA±5% measurement current)</li> <li>• Resistance (4-wire configuration, 1 mA±5% measurement current)</li> <li>• Humidity (Only with Hioki Z2000 Humidity Sensor)</li> </ul>

**Measurement ranges/  
Measurable Range/  
Resolution/  
Measurement accuracy**

Measurement Object	Type	Range	Max. Resolution	Measurable Range	Measurement accuracy
Voltage		10 mV f.s	500 nV	-10 mV to 10 mV	± 10 μV
		20 mV f.s	1 μV	-20 mV to 20 mV	± 20 μV
		100 mV f.s.	5 μV	-100 mV to 100 mV	± 100 μV
		200 mV f.s.	10 μV	-200 mV to 200 mV	± 200 μV
		1 V f.s.	50 μV	-1 V to 1 V	± 1 mV
		2 V f.s.	100 μV	-2 V to 2 V	± 2 mV
		10 V f.s.	500 μV	-10 V to 10 V	± 10 mV
		20 V f.s.	1 mV	-20 V to 20 V	± 20 mV
		100 V f.s.	5 mV	-100 V to 100 V	± 100 mV
1-5 V f.s.	500 μV	1 V to 5 V	± 10 mV		

12.3 LR8511 Wireless Universal Unit Specifications

Inputs

Measurement Object	Type	Range	Max. Resolution	Measurable Range	Measurement accuracy		
Thermocouple (not including RJC accuracy) *1: JIS C 1602-1995, IEC584	K*1	100°Cf.s	0.01°C	-100°C to 0°C or less 0°C to 100°C	±0.8°C ±0.6°C		
		500°Cf.s.	0.05°C	-200°C to -100°C or less 0°C to 500°C	±1.5°C ±0.6°C		
				-100°C to 0°C or less 0°C to 500°C	±0.8°C ±0.6°C		
		2000°Cf.s.	0.1°C	-200°C to -100°C or less -100°C to 1350°C	±1.5°C ±0.8°C		
				100°Cf.s	0.01°C	-100°C to 0°C or less 0°C to 100°C	±0.8°C ±0.6°C
						500°Cf.s.	0.05°C
	-100°C to 0°C or less 0°C to 500°C	±0.8°C ±0.6°C					
		-200°C to -100°C or less 0°C to 1200°C	±1.0°C ±0.6°C				
	E*1	100°Cf.s	0.01°C	-100°C to 0°C or less 0°C to 100°C	±0.8°C ±0.6°C		
				500°Cf.s.	0.05°C	-200°C to -100°C or less -100°C to 0°C or less 0°C to 500°C	±1.0°C ±0.8°C ±0.6°C
		-200°C to -100°C or less -100°C to 0°C or less 0°C to 500°C	±1.0°C ±0.8°C ±0.6°C				
			-200°C to -100°C or less -100°C to 0°C or less 0°C to 1000°C			±1.0°C ±0.8°C ±0.6°C	

## 12.3 LR8511 Wireless Universal Unit Specifications

## Inputs

Measurement Object	Type	Range	Max. Resolution	Measurable Range	Measurement accuracy
Thermocouple (not including RJC accuracy) *1: JIS C 1602-1995, IEC584 *2: ASTM E-988-96	T* <sup>1</sup>	100°Cf.s	0.01°C	-100°C to 0°C or less	±0.8°C
				0°C to 100°C	±0.6°C
		500°Cf.s	0.05°C	-200°C to -100°C or less	±1.5°C
				-100°C to 0°C or less	±0.8°C
				0°C to 400°C	±0.6°C
				-200°C to -100°C or less	±1.5°C
	2000°Cf.s	0.1°C	-100°C to 0°C or less	±0.8°C	
			0°C to 400°C	±0.6°C	
			-200°C to -100°C or less	±1.5°C	
			-100°C to 0°C or less	±0.8°C	
	N* <sup>1</sup>	100°Cf.s	0.01°C	-100°C to 0°C or less	±1.2°C
				0°C to 100°C	±1.0°C
		500°Cf.s	0.05°C	-200°C to -100°C or less	±2.2°C
				-100°C to 0°C or less	±1.2°C
				0°C to 500°C	±1.0°C
				-200°C to -100°C or less	±2.2°C
	2000°Cf.s	0.1°C	-100°C to 0°C or less	±1.2°C	
			0°C to 1300°C	±1.0°C	
			-200°C to -100°C or less	±2.2°C	
			-100°C to 0°C or less	±1.2°C	
	R* <sup>1</sup>	100°Cf.s	0.01°C	0°C to 100°C	±4.5°C
				0°C to 100°C or less	±4.5°C
		500°Cf.s	0.05°C	100°C to 300°C or less	±3.0°C
				300°C to 500°C	±2.2°C
0°C to 100°C or less				±4.5°C	
100°C to 300°C or less				±3.0°C	
2000°Cf.s	0.1°C	300°C to 1700°C	±2.2°C		
		0°C to 100°C	±4.5°C		
		0°C to 100°C or less	±4.5°C		
		100°C to 300°C or less	±3.0°C		
S* <sup>1</sup>	100°Cf.s	0.01°C	0°C to 100°C	±4.5°C	
			0°C to 100°C or less	±4.5°C	
	500°Cf.s	0.05°C	100°C to 300°C or less	±3.0°C	
			300°C to 500°C	±2.2°C	
			0°C to 100°C or less	±4.5°C	
			100°C to 300°C or less	±3.0°C	
2000°Cf.s	0.1°C	300°C to 1700°C	±2.2°C		
		0°C to 100°C or less	±4.5°C		
		100°C to 300°C or less	±3.0°C		
		300°C to 1700°C	±2.2°C		
B* <sup>1</sup>	2000°Cf.s	0.1°C	400°C to 600°C or less	±5.5°C	
			600°C to 1000°C or less	±3.8°C	
			1000°C to 1800°C	±2.5°C	
W* <sup>2</sup>	100°Cf.s	0.01°C	0°C to 100°C	±1.8°C	
	500°Cf.s	0.05°C	0°C to 500°C	±1.8°C	
	2000°Cf.s	0.1°C	0°C to 2000°C	±1.8°C	

Inputs

Measurement Object	Type	Range	Max. Resolution	Measurable Range	Measurement accuracy	
RTD *3: JIS C 1604-1997, IEC751 *4: JIS C 1604-1989	Pt 100 *3	100°Cf.s. 500°Cf.s. 2000°Cf.s.	0.01°C 0.05°C 0.1°C	-100°C to 100°C -200°C to 500°C -200°C to 800°C	±0.6°C ±0.8°C ±1.0°C	
	JPt 100 *4	100°Cf.s. 500°Cf.s. 2000°Cf.s.	0.01°C 0.05°C 0.1°C	-100°C to 100°C -200°C to 500°C -200°C to 500°C	±0.6°C ±0.8°C ±1.0°C	
	Resistance		10 Ωf.s.	0.5 mΩ	0°C to 10 Ω	± 10 mΩ
			20 Ωf.s.	1 mΩ	0°C to 20 Ω	± 20 mΩ
100 Ωf.s.			5 mΩ	0°C to 100 Ω	± 100 mΩ	
200 Ωf.s.			10 mΩ	0°C to 200 Ω	± 200 mΩ	
Humidity		100%RH f.s.	0.1%RH	5.0% to 95.0%RH	See Humidity Accuracy Table (includes Z2000 Humidity Sensor accuracy)	

Humidity Accuracy Table

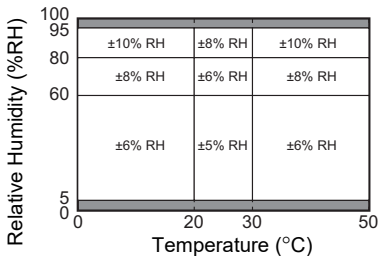

█ : Out of accuracy guarantee range

Each boundary line is included in the better measurement accuracy area.

**Reference junction compensation accuracy**

±0.5°C

Reference junction compensation:

Add to thermocouple measurement accuracy when internal RJC is enabled.

**Temperature characteristic**

Add (Measurement accuracy x 0.1) /°C to measurement accuracy (see Humidity Accuracy Table for humidity)

**Reference junction compensation**

Internal/External selectable (for thermocouple measurements)

**Thermocouple burnout detection**

Enable/disable thermocouple burn-out detection at each recording interval. 5 μA±20% detection current. No current flow when acquiring measurement data.

## Inputs

**Digital filter** Off, 50 Hz, 60 Hz  
(automatically sets the cut-off frequency according to the recording interval)

### Cut-off frequency

Digital filter settings	Burn-out detection setting	Recording interval								
		100 ms	200ms	500ms	1 s	2 s	5 s	10 s	20 s	30 s to
60 Hz	OFF	1.8 k	0.7 k	60	60	60	60	60	60	60
	ON	-	1.8 k	0.7 k	60	60	60	60	60	60
50 Hz	OFF	1.8 k	0.7 k	50	50	50	50	50	50	50
	ON	-	1.8 k	0.7 k	50	50	50	50	50	50
OFF	OFF	1.8 k	1.8 k	1.8 k	1.8 k	1.8 k	1.8 k	1.8 k	1.8 k	1.8 k
	ON	-	1.8 k	1.8 k	1.8 k	1.8 k	1.8 k	1.8 k	1.8 k	1.8 k

[Unit:Hz]

**Input resistance** 1 M $\Omega$ ±5% (voltage and thermocouple measurement)  
2 M $\Omega$ ±5% (RTD and resistance measurement)

**Normal mode rejection ratio** 50dB minimum (with 50 Hz input with 5 s recording interval, and 50 Hz digital filter enabled)  
(with 60 Hz input with 5 s recording interval, and 60 Hz digital filter enabled)

**Common mode rejection ratio** with 100  $\Omega$  maximum signal source impedance  
100dB minimum (with 50 Hz or 60 Hz input and digital filter disabled)  
140dB minimum  
(for 50-Hz input with 5 s recording interval, 50-Hz digital filter enabled, 10 mV f.s. range setting)  
(for 60-Hz input with 5 s recording interval, 60-Hz digital filter enabled, 10 mV f.s. range setting)

**Maximum input voltage** ±100 VDC

**Max. inter-channel voltage** 300 VDC (during voltage and thermocouple measurement) (Channels are not isolated during resistance temperature detector, resistance, or humidity measurement.)

**Maximum rated voltage to earth** 300 VAC, DC (between each input channel and chassis)  
Measurement category II  
Anticipated transient overvoltage 2,500 V

## Power source

### Power source

**AC adapter** Z1008 AC Adapter (12 VDC)  
Rated supply voltage:100 to 240 VAC  
Rated supply frequency:50 Hz / 60 Hz

**Battery** Z1007 Battery Pack (The AC Adapter has priority when connected)

**External Power** 10 V to 28 V DC

### Power consumption

### 12.3 LR8511 Wireless Universal Unit Specifications

#### Power source

<b>Typical power consumption</b>	With Z1008 AC Adapter or other 12 V DC external power, without battery pack 1.0 VA(LR8511 only)
<b>Maximum rated power</b>	When using the Z1008 AC Adapter: 23 VA (including the AC adapter), 7 VA (LR8511 only) When using an external DC28 V power source: 7 VA(when battery is charged) When using a Z1007 Battery Pack 0.6 VA
<b>Continuous operating time</b>	
<b>Battery</b>	When using Model Z1007 Battery Pack approx. approx. 24 hours (with a recording interval of 100 ms, @23°C, 73.4°F) approx. 120 hours(with a recording interval of 1 min., @23°C, 73.4°F)
<b>Charge indicator</b>	The AC adapter or a 10 to 28 V DC external power supply can be connected while the Z1007 Battery Pack is installed. Charging time: Approx. 7 h. (23°C reference value)

#### LED indicators

<b>Unit number, status indicator</b>	The UNIT1 through UNIT7 LEDs light up or flash according to the unit number. Lit up: Strong communications state or connected Flashing: Poor communications state or communications lost during measurement
<b>AC adapter/external power supply indicator</b>	Lights up to indicate use of AC adapter or external power supply.
<b>Battery remaining life indicator</b>	Battery remaining life indicator LED lights up when the unit is operating on battery power and flashes when the remaining battery life is low while operating on battery power.
<b>Charge indicator</b>	Lights up while the battery pack is charging.

#### Others

<b>Accessories</b>	<ul style="list-style-type: none"> <li>• Instruction Manual (This document)</li> <li>• Z1008 AC Adapter(with supplied power cord)</li> <li>• Bracket</li> <li>• M3×4 screw(2)</li> </ul>
<b>Options (sold separately)</b>	<ul style="list-style-type: none"> <li>• LR8410-20 Wireless Logging Station</li> <li>• Z1007 Battery Pack(Li-ion)</li> <li>• Z1008 AC Adapter(with supplied power cord)</li> <li>• Z2000 Humidity Sensor</li> </ul>

## 12.4 Z2000 Specifications

<b>Product warranty period</b>	1 year
<b>Period of guaranteed accuracy</b>	1 year
<b>Accuracy guarantee range</b>	5.0% RH to 95.0% RH
<b>Measurement accuracy</b>	As per the following humidity accuracy table. (Including the measurement accuracy of applicable models)

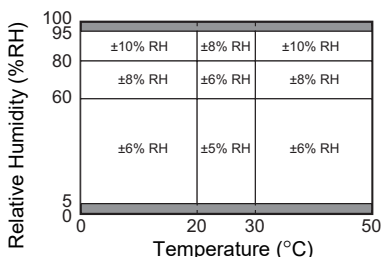

■ : Out of accuracy guarantee range  
 Each boundary line is included in the better measurement accuracy area.

<b>Operating temperature and humidity</b>	0°C to 50°C (32°F to 122°F), 100% RH or less (non-condensing)
<b>Storage temperature and humidity</b>	-20°C to 70°C (-4°F to 158°F), 90% RH or less (non-condensing)
<b>Cord</b>	Approx. 3 m
<b>Dimensions</b>	Approx. 44.0W × 19.5H × 10.1D mm (1.73"W × 0.77"H × 0.40"D) (including connector)
<b>Mass</b>	Approx. 55.0 g (1.9 oz, including 3 m-long cord)





# Maintenance and Service

## Chapter 13

13

Chapter 13 Maintenance and Service

### 13.1 Inspection, Repair, and Cleaning

**WARNING**

Internal circuitry in the instrument and measurement units generates high voltages and is extremely dangerous if touched. Do not attempt to modify, disassemble, or repair these devices. Doing so may result in fire, electric shock, or bodily injury.

#### Replaceable Parts and Operating Lifetimes

Useful life depends on the operating environment and frequency of use.

Operation cannot be guaranteed beyond the following periods.

For replacement parts, contact your authorized Hioki distributor or reseller.

Part	Recommended replacement cycle	Remarks/conditions
Electrolytic Capacitors	Approx. 10 years	The board on which the parts in question are mounted should be replaced.
LCD backlight (Brightness reduced by half)	Approx. 5 years (Approx. 50,000 hours)	Assuming continuous use 24 hours a day
Lithium battery	Approx. 5 years	Replace if the time and date are significantly off when the instrument is turned on. Contact your authorized Hioki distributor or reseller.
Z1007 Battery Pack		Once the battery pack has been fully charged from an empty state and then discharged 300 times, 70% of the initial battery capacity will remain.
Electric double-layer capacitors	Approx. 3 years	If the backup time for measurement data becomes excessively short, it is time to replace the electric double-layer capacitors.

### **13.1 Inspection, Repair, and Cleaning**

#### **Fuse**

The fuse is housed in the power unit of the instrument. If the power does not turn on, the fuse may be blown. If this occurs, a replacement or repair cannot be performed by customers. Please contact your authorized Hioki distributor or reseller.

#### **Calibrations**

##### **Important**

Periodic calibration is necessary in order to ensure that the instrument provides correct measurement results of the specified accuracy.

The calibration frequency varies depending on the status of the instrument or installation environment. We recommend that the calibration frequency is determined in accordance with the status of the instrument or installation environment and that you request that calibration be performed periodically.

During repair and calibration work, your instrument may be initialized, and its software may be updated to the latest version. Back up any necessary data before having the device repaired or calibrated.

#### **Transporting**

- Use the original packing materials when transporting the instrument, if possible.
- Pack the instrument so that it will not sustain damage during shipping, and include a description of existing damage. We do not take any responsibility for damage incurred during shipping.

#### **NOTE**

When transporting the Z1007 Battery Pack on an aircraft

- The Z1007 Battery Pack uses a rechargeable lithium-ion battery.
- Transport of lithium-ion batteries on aircraft is subject to restrictions based on UN recommendations.
- Before air-transporting the instrument equipped with the Z1007 Battery Pack for any reason, such as repair and calibration, please consult with a shipping company or an airline.

#### **Cleaning**



To clean the instrument, wipe it gently with a soft cloth moistened with water or mild detergent. Never use solvents such as benzene, alcohol, acetone, ether, ketones, thinners or gasoline, as they can deform and discolor the case. And, wipe the LCD gently with a soft, dry cloth.

## 13.2 Troubleshooting

If damage is suspected, check the "Before Returning for Repair"(p. 305) section before contacting your authorized Hioki distributor or reseller.

### Before Returning for Repair

If abnormal operation occurs, check the following items.

Symptom	Check Items	
The display does not appear when you turn the power on.	<ul style="list-style-type: none"> <li>Is the power cord disconnected?</li> <li>Are connections made correctly?</li> <li>Is the battery pack installed correctly?</li> </ul>	<p>Verify that the power cord is connected properly (p. 46). Verify that the battery pack is correctly installed (p. 43).</p>
Keys do not work.	<ul style="list-style-type: none"> <li>Is any key being held down?</li> <li>Is the key-lock state active? (A message appears when a key is pressed while key-lock is active.)</li> </ul>	<p>Verify key operation.</p> <p><b>Cancel key-lock:</b> (Hold the  key for three seconds)</p>
Power does not turn on.	<ul style="list-style-type: none"> <li>Check the AC adapter (if 12 V DC is not output, the adapter is faulty).</li> <li>A power protection component may be damaged.</li> </ul>	<p>Contact your authorized Hioki distributor or reseller.</p> <p>Customers should not attempt to perform parts replacement and repair. Contact your authorized Hioki distributor or reseller.</p>
Unable to establish communications between the Wireless Logging Station and a Unit.	<ul style="list-style-type: none"> <li>Is the unit turned on?</li> </ul>	<ul style="list-style-type: none"> <li>Check whether the power LED (either AC ADAPTER or BATT) on the measurement unit is lit up.</li> <li>Verify that the wireless logger's LCD is on.</li> </ul>
	<ul style="list-style-type: none"> <li>An obstruction may be interfering with communications between the Wireless Logging Station and the unit.</li> </ul>	<ul style="list-style-type: none"> <li>Position the measurement unit close to the wireless logging station and verify that one of the measurement unit's UNIT NO. LEDs (1 through 7) is lit up.</li> <li>Verify that the  (Bluetooth icon) on the wireless logger's screen is lit up.</li> </ul>
	<ul style="list-style-type: none"> <li>The instrument may not be recognizing the unit.</li> </ul>	<ul style="list-style-type: none"> <li>Cycle the Wireless Logging Station power and check again.</li> <li>Temporarily delete the unit's registration, re-register it, and check again.</li> </ul>
	<ul style="list-style-type: none"> <li>If the measurement unit is already connected to another Wireless Logging Station, you will not be able to register it.</li> </ul>	<p>Check whether the unit is already registered with another Wireless Logging Station and delete the registration.</p>

### 13.2 Troubleshooting

<p><b>A waveform does not appear when you press <b>START</b>.</b></p>	<ul style="list-style-type: none"> <li>• Is the "Waiting for pre-trigger" message displayed?</li> <li>• Is the "Waiting for trigger" message displayed?</li> <li>• Is the waveform display color selection box selected ( <input checked="" type="checkbox"/> )?</li> </ul>	<p>When pre-triggering is enabled, triggering is ignored until the pre-trigger portion of the waveform has been acquired. Recording starts when a trigger occurs.</p>
<p><b>No changes occur in the displayed waveform.</b></p>	<ul style="list-style-type: none"> <li>• Is the measurement cable connected correctly?</li> <li>• Is the measurement range set properly?</li> </ul>	<p>Verify that the measurement cable or connection cable is connected correctly (p. 49).</p>
<p><b>Data cannot be saved to the removal storage.</b></p>	<ul style="list-style-type: none"> <li>• Is the removal storage inserted properly?</li> <li>• Is the removal storage formatted?</li> <li>• Is the remaining capacity of the removal storage too low?</li> </ul>	<p>"Using a SD memory card/USB flash drive" (p. 63)</p>
<p><b>Z1007 battery pack cannot be charged (Charging LED is not lit).</b></p>	<ul style="list-style-type: none"> <li>• Please confirm that the surrounding temperature is within 5 to 35°C range.</li> </ul>	<p>The temperature range within which the instrument and measurement unit can be used to charge the battery pack is 5°C to 35°C.(p. 11)</p>
	<ul style="list-style-type: none"> <li>• Is the instrument and measurement units stored for a long time in a plugged condition?</li> </ul>	<p>The battery pack may have deteriorated and the battery life may be expiring soon. (p. 303) Please purchase a new battery pack. Please contact your authorized Hioki distributor or reseller. If the instrument is not used for more than a month, please remove the battery pack for storage.(p. 11)</p>
<p><b>The battery back operating time is dramatically lower than before, even immediately after charging completes.</b></p>	<ul style="list-style-type: none"> <li>• Possibility of capacity decrease due to the deterioration of the battery pack.</li> </ul>	<p>The battery pack may have deteriorated and the battery life may be expiring soon. (p. 303) Please purchase a new battery pack. Please contact your authorized Hioki distributor or reseller.</p>

If the cause is unknown

Try performing a system reset (p. 205).  
All settings are returned to their factory defaults(p. A12).

## 13.3 Disposing of the instrument

The instrument contains a lithium battery for memory backup. When disposing of this instrument, remove the lithium battery and dispose of battery and instrument in accordance with local regulations.

### Removing the Lithium Battery



**WARNING**

To avoid electric shock, turn off the power switch and disconnect the power cord and measurement cables before removing the lithium battery.

Required tools: One Phillips screwdriver (No.1), one pair of nippers

- 1** Verify that the power is off, and remove the cables and power cord.
- 2** Turn the instrument over and remove the six screws affixing the lower case.

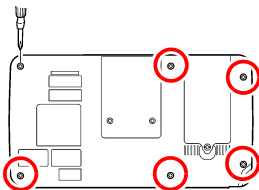

- 3** Lift the lithium-ion battery up off the printed circuit board and cut the leads from the positive and negative poles with the pair of nippers.

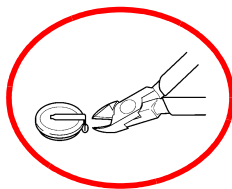
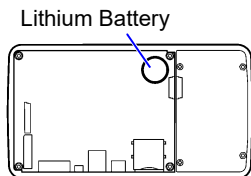

#### CALIFORNIA, USA ONLY

This product contains a CR Coin Lithium Battery which contains Perchlorate Material - special handling may apply.

See <https://dtsc.ca.gov/perchlorate/>



# Appendix

## Appendix 1 Scan Timing

For sampling of the LR8510 Wireless Voltage/Temp Unit and LR8511 Wireless Universal Unit, there is a scan system for each channel.

The following figure illustrates scan timing when measurement is on for all 15 unit channels with a 50/60 Hz digital filter and recording intervals of 100 ms and 5s, respectively.

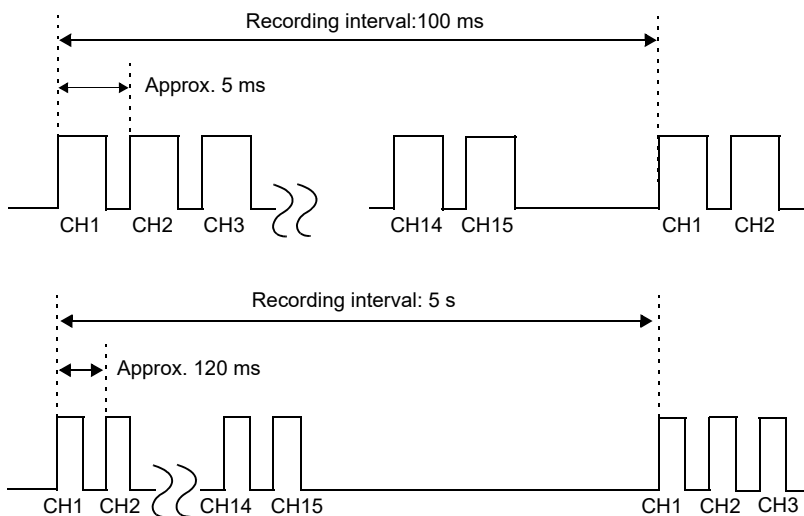

When the digital filter is off, the timing is the same as with a recording interval of 100 ms, regardless of the recording interval setting.

When the digital filter is set to 50 Hz or 60 Hz, the scan width varies with the recording interval. If the recording interval is 5 s, the scan width per channel will be approximately 120 ms. Even with a recording interval that is slower than 5 s, the scan width per channel will be set at approximately 120 ms.

The maximum disparity in sampling among measurement units is 1 sample (recording interval), regardless of the number of units.



## Appendix 1 Scan Timing

The following figure illustrates scan timing when measurement is on for all 15 unit channels with a 50/60 Hz digital filter and a recording interval of 10 s.

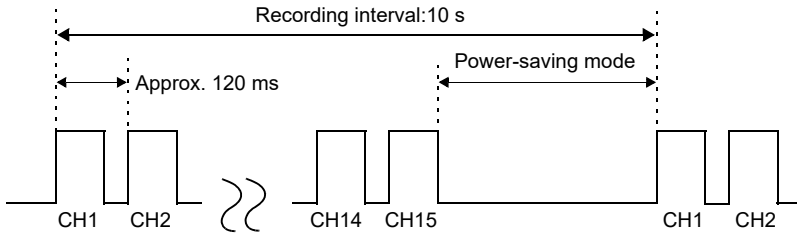

The scan width per channel is similar to the value when using a recording interval of 5 s. For recording intervals of 10 s or greater, the instrument will enter power-saving mode between the completion of one 15-channel scan and the next sample. As the recording interval gets longer, the time for which the instrument is in power-saving mode increases, causing the operating time when using the battery to increase.

The following figure illustrates scan timing when measurement is on for unit channels 1 and 2 (but off for other channels) with a 50/60 Hz digital filter and a recording interval of 10 s.

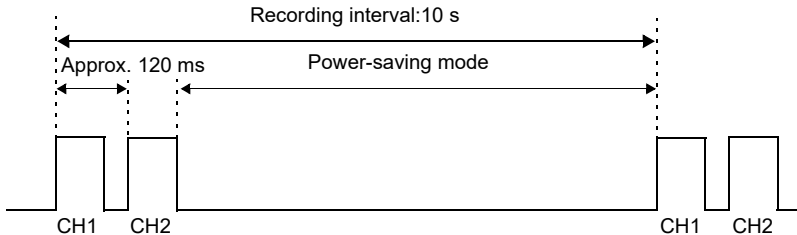

Since the instrument will enter power-saving mode once the scan of channels 1 and 2 completes, it is possible to increase the length of power-saving mode compared to when measurement is on for all 15 channels. The battery can be made to last longer by limiting the number of channels being measured.

## Appendix 2 Error Messages and Remedial Actions

Error messages consist of either "Error" or "Warning" displays.

A screen message appears whenever an error occurs. In either case, take the remedial action indicated.

### Error Messages



To clear an error message, press **ENTER** or **ESC**.

Message	Remedial Action
<b>002</b> A communications error occurred between the instrument and a unit during measurement.	1. Verify that the unit is turned on. 2. Check the communications state with the unit. If poor, move the instrument to a location where good reception is possible.
<b>004</b> The instrument or unit has almost no remaining battery life.	There is a device with a low battery. Connect an AC adapter or external power supply so that the battery can charge, or replace the battery with an adequately charged battery.
<b>005</b> FPGA error.	The FPGA has an abnormality. Update the firmware of the instrument. Try updating the firmware, and if the error persists, submit the instrument for repair.
<b>008</b> FPGA PLL error. Turn off and on the power.	Measurement stopped due to FPGA internal PLL fault. Turn power off and on, check ambient conditions (temperature and noise), and try measuring again.
<b>011</b> The time of the clock was initialized.	Reset the clock. If the problem remains, have the instrument repaired.
<b>012</b> Internal memory error.	Internal buffer memory could not be properly recognized. Contact your authorized Hioki distributor or reseller, as it may be damaged.
<b>013</b> Zero-adjustment failed for one or more units. Check the power supply and communications status for the following units.	Verify that the specified unit is turned on and check its communications state.
<b>700</b> Communications with a unit have been interrupted.	Verify that registered units are turned on and check their communications state.

## Warning Messages

Appears just once when an error occurs. Disappears within a few seconds. Also disappears when any key is pressed.

Message	Remedial Action
<b>101</b> Invalid key.	The pressed key is disabled due to measuring or other operation. Press the key again after the current operation finishes.
<b>103</b> Cannot change while measuring.	Press <b>STOP</b> to stop measuring before changing the setting.
<b>104</b> No measurement data was found for the specified position.	Specify the location at which measurement data exists in the internal buffer memory, or save the measurement data to a storage medium and then load the data from a specified location into the internal buffer memory.
<b>201</b> Exceeding the setting range.	The entered numerical value is out of the valid range. Enter a valid value.
<b>204</b> Measurement range changed.	When <b>[Type]-[Up/Lwr]</b> is selected, the measurement range is automatically changed to match the upper and lower limits.
<b>230</b> Recording time has been changed due to memory limit.	Increasing the number of measurement channels has decreased Internal memory waveform data capacity.
<b>231</b> Pre-Trigger span changed.	Increasing the recording interval or length requires reducing pre-trigger recording time.
<b>232</b> Recording and Pre-Trigger spans changed due to waveform memory limit.	Increasing the recording interval requires reducing recording length and pre-trigger recording time.
<b>234</b> Burn Out (broken-wire) detection changed.	Burn-out detection is not available with the current settings. To enable burn-out detection, select a longer recording interval or reduce the number of channels used. <b>See:</b> "About the Recording Interval" (p .72)
<b>235</b> Burnout detection cannot be turned On for the current recording interval setting. Change the recording interval to a value from 200 ms to 1h.	The setting is not available due to the combination of the number of channels used and the recording interval. To enable burn-out detection, select a longer recording interval, or reduce the number of channels used. <b>See:</b> "About the Recording Interval" (p .72)
<b>236</b> File partition period was changed.	The segment time span has been changed in response to changing the recording interval.
<b>237</b> File partition time was changed.	The segment time span has been changed in response to changing the recording interval.
<b>238</b> Unable to set CSV auto-save with the current record interval.	The recording intervals available for CSV auto saving are limited. Select a longer recording interval. <b>See:</b> "Automatic Saving (Waveform Data and Numerical Calculation Results)" (p .165) *2

## Appendix 2 Error Messages and Remedial Actions

Message	Remedial Action
<b>239</b> CSV auto save has been set. Unable to set the specified record interval.	Select non-CSV auto saving to measure with the specified recording interval.
<b>240</b> The schedule has not been set properly.	Check the schedule settings.
<b>244</b> Auto-save has been changed from CSV to waveform.	The saving method was changed to Waveform (binary) because the selected recording interval is too short for CSV saving. To enable CSV saving, select a longer recording interval or reduce the number of channels used. <b>See:</b> "Automatic Saving (Waveform Data and Numerical Calculation Results)" (p .165) *2
<b>301</b> No waveform data.	No waveform data is preset, so data saving and calculations cannot be performed. Press <b>START</b> to start acquiring measurement data.
<b>302</b> Confirm the A-B cursor position.	The A/B cursor positions are invalid (out of waveform range). Check the cursor positions.
<b>303</b> No numerical calculation data.	Execute numerical calculation (p. 185)
<b>304</b> Invalid event mark.	Try moving to an event mark that is not in memory.
<b>401</b> File processing error.	An unexpected fault occurred while processing a file on the removal storage. Turn the instrument off and back on.
<b>402</b> Cannot load this file.	The format of the file is incompatible with the instrument, or the file is corrupt. Refer to "6.1 About Saving and Loading Data" (p. 161) for loadable file formats.
<b>403</b> Insert a Media.	A SD memory card or USB flash drive is not present. Insert storage media.
<b>405</b> Not enough capacity.	The removal storage has insufficient space to save the file. Delete files to increase free space, or replace the removal storage.
<b>406</b> Process interrupted (not enough battery capacity).	The software cannot be updated with a low battery. Power the instrument with the AC adapter or an external power supply, or charge the battery adequately first.
<b>407</b> Insert SD memory card or USB memory.	A SD memory card or USB flash drive is not present. Insert storage media.
<b>408</b> Preparing to protect files.	Wait approximately 10 minutes for the instrument's built-in high-capacity capacitor to charge.
<b>430</b> Unsaved data present.	The removal storage is not inserted, or does not have enough free space. Insert a removal storage and manually save needed data.
<b>431</b> Insert media to save waveform data.	Insert a removal storage.
<b>432</b> Change media.	Removable storage cannot be accessed. Replace the SD memory card or USB flash drive.

## Appendix 2 Error Messages and Remedial Actions

Message		Remedial Action
434	<b>Media is full or cannot delete oldest wave file.</b>	This may appear while measuring using waveform auto save. A file could not be saved: Not enough space on the removable storage.
435	<b>Media is nearly full.</b>	Not enough space on the removal storage. Replace with a new removal storage.
437	<b>Saving wave data. Wait for a moment.</b>	Some key operations are disabled because of the increased load during real-time saving. Minimize key operations as much as possible during real-time saving.
438	<b>This folder is protected. Rename for deleting.</b>	This message is displayed to prevent accidental deletion of data folders. To delete a folder, first rename it.
441	<b>Insert the recording media. Unsaved data will be lost soon.</b>	Real-time saving was attempted without removable storage, and with less than 50% internal buffer memory available. Insert removable storage.
442	<b>File name is too long to change.</b>	The instrument cannot rename files with names longer than 26 characters. Use a PC to rename the file.
501	<b>File system error (I/O error).</b>	An I/O error occurred while accessing the removal storage. Reformat the removal storage. If the error persists, try a different removal storage. If this error occurs while using a good removal storage, the instrument may be damaged, in which case contact your authorized Hioki distributor or reseller.
502	<b>File system error (Incorrect file handle).</b>	Turn the instrument off and back on. If the fault persists, perform system reset (p. 205).
503	<b>File system error (system configuration).</b>	
504	<b>File system error (not enough memory).</b>	
505	<b>File system error (incompleted information).</b>	The removable storage could not be recognized. Reformat the removable storage on a PC. If the error persists, try a different removable storage. If this error occurs while using a good removable storage, the instrument may be damaged, in which case contact your authorized Hioki distributor or reseller.
506	<b>File system error (incorrect device).</b>	Turn the instrument off and back on. If the fault persists, perform system reset (p. 205).
507	<b>File system error (file protected).</b>	The requested write process (including deletion) could not be performed because the file attribute is read-only. Use a PC to cancel the read-only setting.
508	<b>File system error (failed to recognize the format).</b>	The removable storage could not be recognized. Reformat the removable storage on a PC. If the error persists, try a different removable storage. If this error occurs while using a good removable storage, the instrument may be damaged, in which case contact your authorized Hioki distributor or reseller.

## Appendix 2 Error Messages and Remedial Actions

Message	Remedial Action
<b>509</b> File system error (limit of the number of files).	Turn the instrument off and back on. If the fault persists, perform system reset (p. 205).
<b>510</b> File system error (same name file).	An attempt was made to create a file with the same name as an existing file. Change the name of the file to be created (p. 180).
<b>511</b> File system error (system busy).	Processing could not be performed because files are in use by another executing process. Wait for the current process to finish. If there is no other executing process, turn the instrument off and back on.
<b>512</b> File system error (too long path name).	The specified path name is too long. Re-enter the name of a removable storage folder from the PC.
<b>513</b> File system error (no file).	Turn the instrument off and back on. If the fault persists, perform system reset (p. 205).
<b>514</b> File system error (mode error).	
<b>515</b> File system error (invalid file handle).	
<b>516</b> File system error (file offset error).	
<b>517</b> File system error (not enough capacity).	Insufficient free space is available on the removable storage for the process to execute. Delete files to increase free space, or try another removable storage.
<b>518</b> File system error (invalid file name).	The file name contains an invalid character. Rename the file (p. 180).
<b>519</b> File system error (directory error).	Turn the instrument off and back on. If the fault persists, perform system reset (p. 205).
<b>520</b> File system error (invalid file type).	
<b>521</b> File system error (file rename error).	
<b>522</b> File system error (internal parameter error).	
<b>523</b> File system error (block size error).	
<b>524</b> File system error (semaphore error).	
<b>525</b> File system error (not supported action).	
<b>627</b> An error occurred while communicating with the computer.	Check the instrument and the connection destination.
<b>629</b> DHCP failed.	Check the LAN connections.
<b>632</b> Bad FTP server IP address.	Check the IP addresses for FTP auto sending.
<b>633</b> Can not connect to FTP server.	Check the FTP auto sending settings and connections.
<b>634</b> Can not find FTP server/DNS failed.	Check the FTP auto sending settings, DNS IP address, and connections.
<b>635</b> Bad Mail server IP address.	Check the mail server IP address setting.
<b>636</b> Can not connect to Mail server.	Check the mail server settings and connections.
<b>637</b> Can not find Mail server/DNS failed.	Check the mail server settings, DNS IP address, and connections.
<b>638</b> Bad POP server IP address.	Check the POP server IP address setting.
<b>639</b> Can not connect to POP server.	Check the POP server settings and connections.
<b>640</b> Can not find POP server/DNS failed.	Check the DNS IP address and connection.

## Appendix 2 Error Messages and Remedial Actions

Message	Remedial Action
<b>663</b> Automatic data transfer via FTP is not possible while data is being saved.	Obtain manually the data file, if unable to be transferred, or copy the data to PC from the storage media.
<b>664</b> FTP data transfer failed. File not found.	
<b>701</b> No peripheral devices that can be registered were found. Check whether the unit is turned on and search again.	Verify that the unit you are trying to register is turned on and check its communications state.
<b>702</b> The attempt to register a unit failed. If you are unable to reconnect after waiting a while, repeat the search and try registering the unit again.	Register the target unit again. Alternatively, search again and then register the unit.
<b>703</b> The attempt to delete a unit failed. Try deleting the target unit again. Alternatively, cycle the instrument's power and then try to delete the unit.	Delete the target unit again. Alternatively, cycle the instrument's power and then delete the unit.
<b>704</b> Failed to register the unit. Try registering the unit again.	Verify that the unit you are trying to register is on and verify its communications state. Then register it again.
<b>705</b> Failed to delete all units. Try deleting all units again. Alternatively, cycle the instrument's power and then try deleting all units.	Delete all units again. Alternatively, cycle the instrument's power and then delete all units.
<b>707</b> Registration UNIT has reached the maximum. Delete unneeded units.	Up to seven units can be registered. Delete any unneeded units and then register the target unit.
<b>708</b> Unable to start since there are no registered units. Register a unit.	Start after registering a unit.
<b>720</b> The unit with a version of the firmware that cannot perform any correct measurement in the present setting installed is registered.	Visit our website to download the latest version of the unit's firmware and install it.
<b>721</b> The product supporting LR8410 Link with a new version of the firmware installed is registered.	Visit our website to download the latest version of the instrument's firmware and install it.





## Appendix 4 Text File Internal Format

Text files consist of header and data portions.

The header includes the following information related to measurement data.

- (1) File name and version
- (2) Title comment
- (3) Start trigger time
- (4) Channel number of each line
- (5) Measurement contents
- (6) Range
- (7) Comment
- (8) Scaling setting
- (9) Scaling ratio
- (10) Scaling offset
- (11) Channel number and input unit of each line

```
"File name","AUTO0001.CSV","V 1.00" .....(1)
"Title comment","" .....(2)
"Start trigger time","13-5-17 13:52:32" .....(3)
"CH","A 1- 1","ALM-1","ALM-2","ALM-3","ALM-4","ALM-SOURCE-1","ALM-SOURCE-2","ALM-SOURCE-3","ALM-SOURCE-4","Z 1", .....(4)
"Mode","Voltage","Alarm","Alarm","Alarm","Alarm Source","Alarm Source","Alarm Source","Alarm Source","Alarm Source","Calculation", .....(5)
"Range","1V" .....(6)
"Comment","" .....(7)
"Scaling","OFF","OFF","OFF", .....(8)
"Ratio","1.00000E+00","1.00000E+00","1.00000E+00", .....(9)
"Offset","0.00000E+00","0.00000E+00","0.00000E+00" .....(10)
"Time","1-1[V]","ALM-1","ALM-2","ALM-3","ALM-4","ALM-SOURCE-1","ALM-SOURCE-2","ALM-SOURCE-3","ALM-SOURCE-4","CALC-1[V]","Event", .....(11)
0.000000000E+00,1,0,0,0,0,"",,,"",2.4200000000E-02,0,
1.000000000E-01,1,0,0,0,0,"",,,"",2.3400000000E-02,0,
2.000000000E-01,1,0,0,0,0,"",,,"",2.3000000000E-02,0,
3.000000000E-01,1,0,0,0,0,"",,,"",2.3300000000E-02,0,
4.000000000E-01,1,0,0,0,0,"",,,"",2.3300000000E-02,0,
5.000000000E-01,1,0,0,0,0,"",,,"",1.8100000000E-02,0,
6.000000000E-01,1,0,0,0,0,"",,,"",2.4100000000E-02,0,
7.000000000E-01,1,0,0,0,0,"",,,"",1.8900000000E-02,0,
8.000000000E-01,1,0,0,0,0,"",,,"",1.9200000000E-02,0,
9.000000000E-01,1,0,0,0,0,"",,,"",1.9600000000E-02,0,
1.000000000E+00,1,0,0,0,0,"",,,"",2.0100000000E-02,0,
```

## Appendix 5 Binary File Size Calculation

(Byte units)

**File size** = Header size + Data size

**Header size** = Text header size + Binary header size

**Text header**

**size** =  $512 \times (7 + \text{number of channels for Unit 1 through Unit 7} \times 3 + \text{no. of alarm channels} \times 3 + \text{no. of waveform calculations} \times 3)$

**Binary header**

**size** =  $512 \times (35 + \text{no. of channels of UNIT1 to UNIT7} \times 4 + \text{no. of alarm channels} \times 17 + \text{no. of waveform calculations} \times 3)$

**Data size** = (Number of channels other than wireless pulse loggers for Unit 1 through Unit 7  $\times 2$  + Number of wireless pulse logger (integration or RPM) channels  $\times 4$  + number of units with wireless pulse logger (logic) channels  $\times 1$  + waveform calculations  $\times 8$  + alarm data\*)  $\times$  number of data points

\*Alarm data is equal to 74 when using alarms or 0 when not using alarms.

You can check an estimate of the remaining time available on the attached SD memory card/ USB flash drive on the **[Setting]** screen.

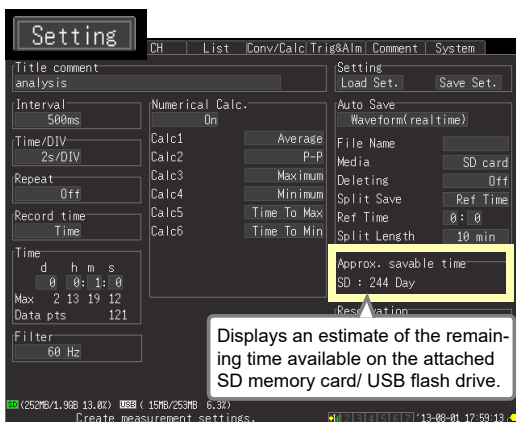

### Appendix 6 List of Default Settings

When shipped from the factory or initialized to factory defaults, the settings are as follows.

Screen	Setting Item	Default Setting
Setting	Interval	100 ms
	Filter	60 Hz
	Time/DIV	1s/DIV
	Repeat	Off
	Recording time	Continuous recording
	Numerical Calc.	Off
	Calc1,2,3,4,5,6	Off
	Timer	Off
	Auto Save	Off
	CH	On/Off
Input		Voltage (LR8510,LR8511,LR8515) Integration (LR8512) Current (LR8513) Temperature, Humidity (LR8514) Temperature, Humidity, Fungal index, Fungal growth projection (LR8520)
Range		10 mV (LR8510,LR8511) 1000 Mc(LR8512) 500 mA(LR8513) 100°C, 100% (LR8514) 50 mV (LR8515) 100°C,100%,200,10 (LR8520)
Senser		9675
Thermocouple		K
Burn Out		Off
RJC		Int
Count Mo		Addition
Slope		↑
threshold		1V
Filter		OFF
Measurement method		Instantaneous
Zero-suppression		ON
Disp Span		Pos
Zoom		×1

Screen	Setting Item	Default Setting	
CH	0 Pos	Voltage: 50%, Other than voltage: 0%	
	Upper	Voltage: 0.005, Tc: 100 Resistance thermome- ter sensor:100 Humidity: 100 Resistance: 10 Integration: 0.005 RPM: 100 Current:0.005 Temperature: 100 Fungal index: 200 Fungal growth projec- tion: 4	
		Lower	Voltage: -0.005 Tc: 0 Resistance thermome- ter sensor:0 Humidity: 0 Resistance: 0 Integration: -0.005 RPM: 0 Current: -0.005 Temperature: 0 Fungal index: 0 Fungal growth projec- tion: 0
	Scaling	Off	
	Start Trig.	Off	
	Stop Trig.	Off	
	Alarm	Off	
	Trig & Alm	Trig Func	Off
		Timing	Start
		Trig Source	
		Start	OR
		Stop	OR
		Ext trig	
		Start	Off
Stop		Off	
Pre-Trig		0d 0h 0m 0s	
Alarm Source		Off	
ALM	OR		

Screen	Setting Item	Default Setting
System	Start Backup	Off
	File Protection	Low
	Backlight saver	OFF
	Backlight Brightness	100%
	Display Color	Black
	Beep Sound	ON
	Time Disp	Time
	External Trig In	Trigger
	Start/Stop message	ON
	Decimal Mark	Dot
	Separator	Comma
	N-Calc. Data Saving	Single file
	Date format	Comment
	Event mark for alarm	OFF
	SAVE Key Operation	Select & Save

### Appendix 7 Maximum Recordable Time

When saving waveform files in binary format to the internal buffer memory, SD memory card, or USB flash drive, the maximum recording time can be calculated using the following formula:

Max. recording time = Storage capacity<sup>\*1</sup> × recording interval (seconds) / (data size from Appendix 5)

\*1. For internal buffer memory,  $16 \times 1024 \times 1024$

The table below lists maximum recording times as reference values when measuring only 30 analog channels with two units (no alarm output or waveform calculations). The waveform file header is not included, so use about 90% of the values in the following table to estimate actual sizes.

The maximum recording time is longer when fewer channels are recorded.

Interval	Storage capacity	
	Instrument's internal memory (16 MB)	Z4001(2 GB)
100 ms	7h 46min	41d 10h 12min
200 ms	15h 32min	82d 20h 24min
500 ms	1d 14h 50min	207d 3h 1min
1 s	3d 5h 40min	(1 year or more)
2 s	6d 11h 20min	(1 year or more)
5 s	16d 4h 21min	(1 year or more)
10s	32d 8h 43min	(1 year or more)

## Appendix 8 Concerning Noise Countermeasures

### Mechanism of Noise Introduction into Thermocouple Temperature Measurements

#### What are the sources of noise?

Within a factory, power is provided by large current flows at 50/60Hz. The main loads are primarily L loads, such as motors and solenoids; in addition, large current pulses are produced by capacitor input-type switching power supplies for device such as inverters and high-frequency induction furnaces. Basic wave component leak current, harmonic wave current, and other types of noise become mixed into the flow from each ground point to ground lines.

#### What are the paths of noise propagation?

- Common mode voltage introduced between the ground points of the device being tested and the measurement unit leaks to the input signal lines
- AC magnetic fields produced by current in power lines couple into loops in the input signal lines
- Coupling due to electrostatic capacitance between input signal lines and power supply lines

#### What is common mode noise?

Noise that is generated between ground and the "+" and "-" input terminals of the instrument.

#### What is normal mode noise?

Inter-line noise that is generated between the "+" and "-" input terminals of the instrument.

#### Example of Connections Where Noise Can Affect Measurements

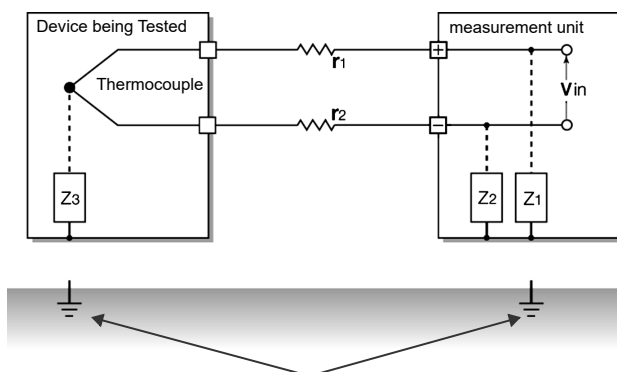

When using a thermocouple to measure temperature, noise can affect measurements unless both the device being tested and the measurement units are grounded. Although there is no problem if the measurement units is running on battery power, the instrument must be connected to ground if an AC adapter is being used.

Equivalent Circuit of Noise Introduction Path

Measurements are directly affected by normal mode voltages from electromagnetically induced noise resulting from electromagnetic coupling into looped measurement unit input lines by AC magnetic fields produced by inverters and commercial power lines, as well as the capacitive coupling that results from interline capacitance.

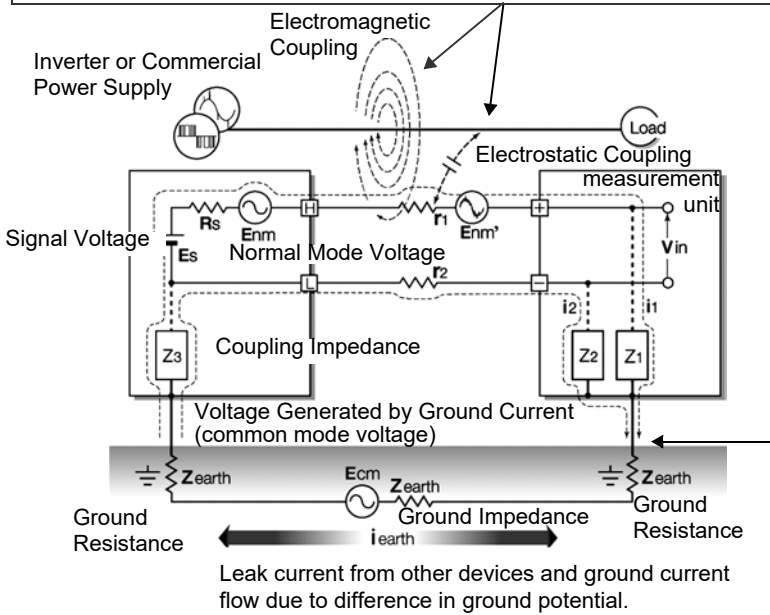

Common mode noise results from the interposition of ground impedance between the ground point of the device being tested and the ground point of the measurement units, and from capacitor coupling between the ground wire and noise source. Common mode noise is converted to normal mode voltage ( $E_{nm}$ ) that is added to the "+" and "-" input terminals of the measurement units as a result of the noise current ( $i_1$ ) and ( $i_2$ ) that flows to the coupling impedance ( $Z_1$ ) and ( $Z_2$ ) between the "+" and "-" input terminals of the instrument and ground. Because common mode noise is generated between the input pins, it has a direct effect on the measurements.

## Noise Countermeasure Example

### 1st. The Importance of Device Grounding

#### Ground the measurement units securely

The measurement units is designed so that the chassis is grounded when the three-prong power cord from the adapter is plugged directly into a grounded, three-prong receptacle.

#### Securely ground the chassis of the device being tested

Securely connect the chassis of the device being tested to a good ground.

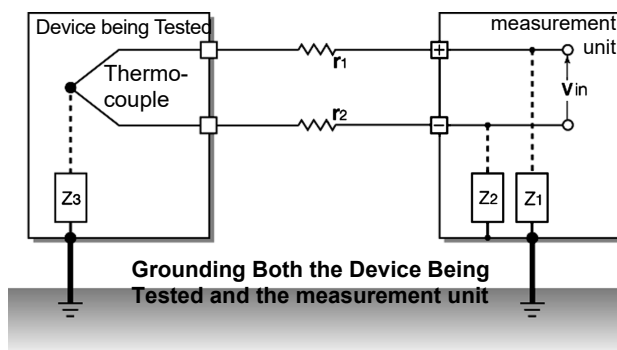

The wireless logger's design does not permit it to be grounded. If the unit is being affected by noise, operate it using battery power.



### Running the measurement units on battery power/ Running a wireless logger on dry cells

When the measurement unit is being powered by batteries Running a wireless logger on dry cells and the AC adapter is not connected, the ground current loop is eliminated, making it possible to reduce the effects of common mode noise.

### Common Mode Noise Countermeasures

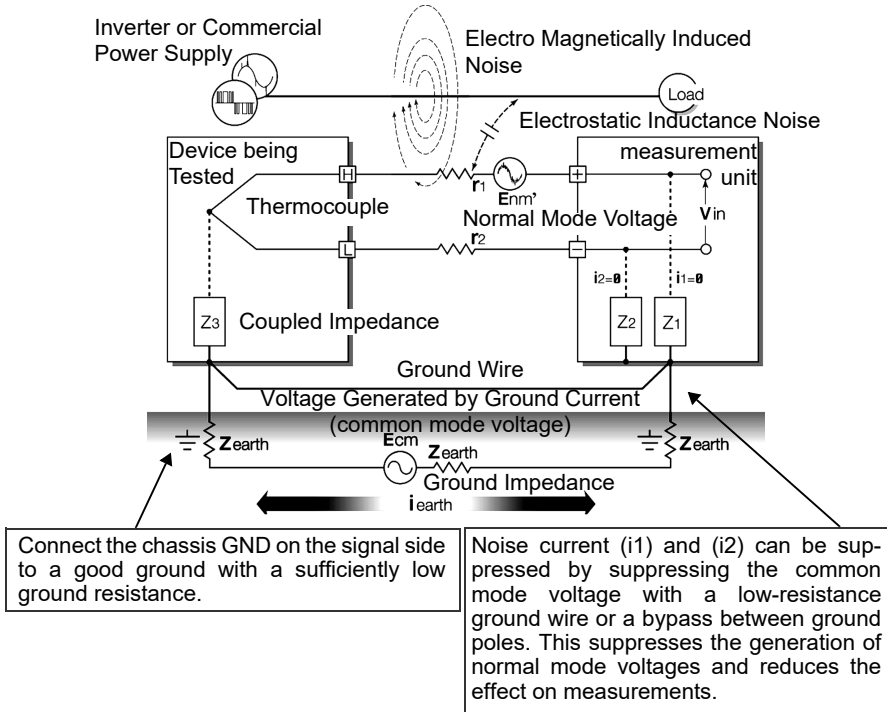

## 2nd. Blocking Noise from External Sources

### Keep signal lines away from noise sources

Keep input signal lines (of the thermocouple) away from wiring that is a noise source (such as power lines, etc.), and make any permanent installation with as much separation as possible; for example, by running wires through a separate duct.

### Use shielded twisted pair wiring

It is effective to use shielded twisted pairs for the input signal lines (of the thermocouple). Twisted pairs are effective for preventing electromagnetic induction, and shielded wires are effective for preventing electrostatic induction.

The shielded wires should be grounded on the signal source side.

Shielded twisted pair wires for the thermocouple can be obtained from thermocouple manufacturers.

### Normal Mode Noise Countermeasures

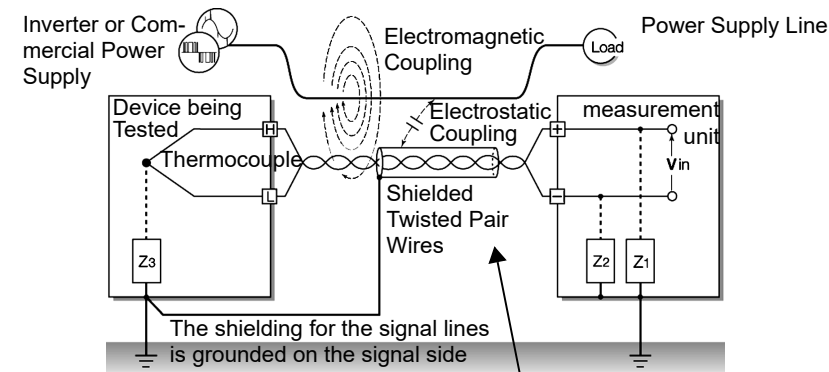

Keep the signal lines (of the thermocouple) away from wiring that is a noise source (such as power lines, etc.). It is also possible to shield the signal lines from electrostatic coupling and to block noise by grounding the shield.

### Insulation from noise sources (temperature measurement by thermocouple)

The analog input channels are insulated from the chassis and each other.

Therefore, the measurement unit allows you to attach the thermocouple directly to a conductor with a potential to measure it, provided that the voltage to ground does not exceed the maximum rating. If noise is likely affect measurement, wrap heat-resistant tape around the thermocouple for insulation, or use an ungrounded thermocouple and electrically insulate the input line.

### Setting the Digital Filter (valid for the LR8510, LR8511 and LR8515)

To remove noise from input signals, the digital filter can be set for the analog channels. Select 50 Hz or 60 Hz to match the local line frequency.

See: "3.9 Suppressing Noise (Enable Digital Filtering)" (p. 102)

### Inserting a Capacitor in the Signal Line

When noise affects the signal source directly or when measuring high-frequency pulses, it is effective to insert a capacitor between the "+" and "-" input terminals so that the noise does not enter the 8430-20. When inserting a capacitor, use one with a rated voltage that is equal to or exceeds the input voltage.

When a capacitor is inserted between the "+" and "-" input terminals, there are no restrictions on the recording interval because the filter is applied before the channel scan operation.

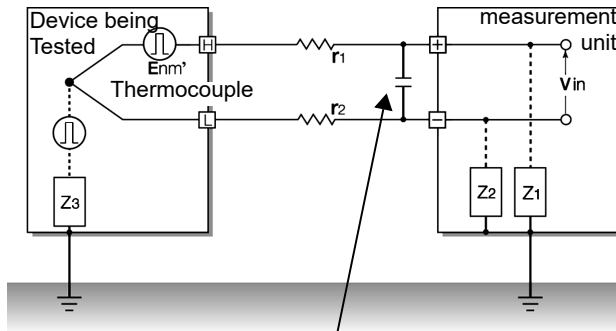

The capacitance of the capacitor should range from several  $\mu\text{F}$  to several thousand  $\mu\text{F}$ . Insert the capacitor between the "+" and "-" input terminals.

## Appendix 9 Frequently Asked Questions

Here are some common questions and answers about the instrument and measurement units.

### Questions about measurement units (Wireless Voltage/Temp Unit and Wireless Universal Unit)

Question	Remedial Action	Reference page
<b>Can measurement units be mounted on a wall?</b>	Measurement units can be mounted on the wall using the included mounting bracket.	"Accessories" (p.300)
<b>How to measure the temperature of an object having applied voltage?</b>	This application is supported. Since the maximum voltage between channels is 300 V DC and the maximum terminal-to-ground voltage is 300 V AC/DC for both the Wireless Voltage/Temp Unit and the Wireless Universal Unit, be sure not to exceed either of these values. If the possibility exists that either value will be exceeded, use an ungrounded thermocouple or other means to keep the units from being exposed to a voltage.	"4.1 Confirming Measured Values, and Starting Measurement" (p. 113): WARNING
<b>Is current measurement available?</b>	Measure by connecting a 250 $\Omega$ resistor between + and - input terminals.	"Connecting a 4 to 20 mA Output Device and Recording Average Values Every Minute"(p. A29)
<b>What is the maximum measuring time using the battery pack?</b>	The maximum measuring time is approximately 24 hours (after being fully charged with a recording interval of 100 ms, reference value at 23°C) or approximately 120 hours (after being fully charged with a recording interval of 1 min., reference value at 23°C). The longer the recording interval, the more time measurement can be performed on battery power.	"2.1 Using the Battery Pack (Option)" (p. 43)
<b>How to minimize thermocouple measurement error when moving the measurement unit between places with much different temperatures?</b>	For thermocouple measurements, terminal temperature is measured by an internal sensor to provide reference junction compensation. When the ambient temperature changes abruptly, or when air blows directly on the terminals, errors occur due to thermal imbalance between the terminals and temperature sensor. When the instrument is moved to a location with significantly different ambient temperature, allow at least 60 minutes for thermal equalization before measuring.	"Installation" (p.9)

**Appendix 9 Frequently Asked Questions**

Question	Remedial Action	Reference page
<p><b>When connecting a thermocouple directly to the instrument, should reference junction compensation be set to external (EXT) or internal (INT)? How is accuracy affected?</b></p>	<p>Select INT when connecting a thermocouple (or compensating leads) directly to the instrument. Overall measurement accuracy is the sum of the accuracies of the thermocouple and the reference junction compensation (RJC).                      Example: when measuring 0 to 100°C with a K 100°C f.s. thermocouple For ±0.6°C thermocouple accuracy and ±0.5°C RJC accuracy, temperature measurement accuracy is ±1.1°C.</p>	<p>"Temperature Measurement Settings (using thermocouples)" (p .78)</p>
<p><b>What happens to data if a power outage occurs during measurement?</b></p>	<p>If only the measurement unit loses power, data during the outage is treated as being lost. Measurement can be continued as before once the power has been restored.</p>	
<p><b>What happens to data if communications are temporarily interrupted?</b></p>	<p>Both the Wireless Voltage/Temp Unit and Wireless Universal Unit have internal buffer memory that can store (65,536/n) data points, where n represents the number of channels being recorded. Data will be resent once communications are restored.</p> <p>For example, if you are measuring 15 channels with a recording interval of 1 s, communications can be interrupted for approximately 71 minutes before any data is lost.</p>	

## Questions about the Wireless Logging Station

### Installation and settings

<b>Can the Wireless Logging Station be placed at an angle on a workbench or mounted on a wall?</b>	Use the Z1009 Fixed Stand (option).	"Attaching and Mounting the Bracket" (p .25)
<b>How long can I perform measurement using the battery pack to power the Wireless Logging Station?</b>	Approximately 3 hours (after being fully charged, with 25% backlight brightness, reference value at 23°C).	"2.1 Using the Battery Pack (Option)" (p. 43)
<b>Will recording resume automatically when power is restored following an outage during measurement?</b>	(When the Wireless Logging Station loses power) Turn on the start backup setting. Recording will start automatically when power is restored following an outage. Since measurement data from before the outage will not be stored in the internal buffer memory, it is recommended to automatically save data on the included (or an optional genuine Hioki) SD memory card. Data will not be saved while the Wireless Logging Station's power is out, even if the measurement units remain on.	"Using the Auto-Resume Function (Resume After Power Restoration)" (p .198)
<b>How to display only CH1 to CH3?</b>	Select only the channels to be used on the Input Channel Settings display. To acquire data without displaying it, select × as the waveform display color.	"Input Channel Settings" (p .74) "Selecting Waveform Display Color" (p .93)
<b>I want to measure motor temperature. How can I display the difference between ambient and measured temperature in real time?</b>	Use the waveform calculation function. Calculates and displays the waveform of the real-time sum, difference, product, or quotient of values measured on two channels.	"7.3 Waveform Calculations" (p. 193)
<b>How can I acquire maximum, minimum, and average values every hour?</b>	"Interval Calculation" calculates and displays the latest results after each interval. TXT format data can be saved to removable storage in real time.	"Select a split-calculation (timing) method." (p .189)
<b>I am measuring humidity with a converter that converts 0 to 100% RH to 1 to 5 V. How can I read humidity directly?</b>	Set the scaling method to <b>[2-pt]</b> , and enter the values. (1:1 conversion → 0, 2:5 conversion → 100, units: %RH)	"3.7 Scaling Settings (as needed)" (p. 97)

**Triggering**

Question	Remedial Action	Reference page
<b>Why does measurement not start when "Waiting for trigger" is displayed?</b>	Triggering is enabled. To start recording immediately with the <b>START</b> key, disable all trigger criteria or the trigger function on the <b>[Trig &amp; Alm]</b> screen.	"5.3 Confirming All Trigger and Alarm Criteria Settings" (p. 142)
<b>How to acquire data before a trigger?</b>	Enable pre-triggering to acquire data before trigger events.	"When You Want to Measure Data before Triggering (Pre-trigger)" (p.139)
<b>How to acquire data only when an external signal is HIGH?</b>	Apply the external signal to the EXT.TRIG terminal, and set as follows: <b>[Ext trig]-[Start]:</b> ↑ (Rising), <b>[Stop]:</b> ↓ (Falling) Data will now be acquired only when the external signal is HIGH.	"Using External Triggering" (p.138)
<b>Can I record data every day from 9:00 am to 5:00 pm for one month starting on April 1, 2013?</b>	Use the following settings: Measurement conditions Continuous recording: OFF 8 hr 0 min 0 s  Repeat recording: On  Schedule Schedule type: Regular Start day: Every day Start time: 09:00 Stop time: 17:00	"3.2 Configuring Measurement Settings" (p. 70)  "5.5 Starting & Stopping Measurement Periodically" (p. 145)
<b>Is it possible to measure on 210 channels using two synchronized instruments?</b>	Measurement start can be synchronized using an external trigger. Sampling cannot be synchronized.	"9.4 Synchronous Measurements with Multiple instruments" (p. 211)

## Measuring

Question	Remedial Action	Reference page
<b>What should I do about zero offset when the input is shorted?</b>	Execute zero adjustment to compensate for offset when the inputs are shorted.	"2.8 Compensating for Input Circuit Offset (Zero Adjustment)" (p. 66)
<b>Even though a signal is only input on CH1, why do similar waveforms appear on unused channels?</b>	An open-circuit input terminal can be affected by signals on other channels. By closing the input terminal circuit, normal measurement is possible. If this is impractical, disable unused measurement channels, or short the + and - terminals together.	
<b>How to display numerical data values?</b>	Press <b>WAVE/DATA</b> repeatedly to cycle through the Waveform (only), Waveform + Numerical Values, and Numerical Values (only) displays. Numerical values can be displayed in a large font on the enlarged numerical display. Numerical values at specific locations can be displayed using A/B cursors.	"Settings Screens" (p.36) "Viewing Input Signals as Numerical Values" (p .117) "Displaying Cursor Values" (p .121)
<b>What is the timing difference between CH1 and CH2?</b>	When the <b>[Filter]</b> is Off, the time difference between data on neighboring channels is about 5 ms, regardless of recording interval. When the <b>[Filter]</b> is enabled (50 or 60 Hz), the time difference increases with longer recording intervals. Sampling discrepancies between measurement units are within 1 sampling cycle (recording interval), regardless of the number of units.	"Appendix 1 Scan Timing" (p. A1)
<b>How can I apply markers while measuring for easy searching later? How can I search for alarm event locations?</b>	Event marks can be applied by the following methods. <ul style="list-style-type: none"> <li>• Press <b>START</b> while measuring</li> <li>• Press the on-screen <b>[Make Mark]</b> button.</li> <li>• Apply a signal to the EXT.TRIG terminal</li> <li>• When a warning occurs</li> </ul>	"4.3 Marking Waveforms and Searching Marks (Search Function)" (p. 123)
<b>Multiple temperature measurement values are scattered, even at the same location. Is it possible to match the value measured on CH1?</b>	The Offset Cancel function is convenient for this. The value measured on UNIT1, CH1 is used as the scaling (offset) value for other channels.	"3.7 Scaling Settings (as needed)" (p. 97)
<b>Is it possible to signal an alarm on ALM1 when the temperature on CH1 exceeds 40°C, and on ALM2 when it exceeds 50°C?</b>	Yes. Four alarm channels are provided. Multiple alarms can be assigned to the same input channel.	"5.9 Alarm Output" (p. 153)



Data Saving

Question	Remedial Action	Reference page
<b>Can after-market SD memory cards be used?</b>	Proper operation is not guaranteed. To ensure peace of mind, use the included (or an optional genuine Hioki) SD memory card.	"2.7 Inserting a SD Memory Card or USB Flash Drive (when saving data)" (p. 63)
<b>Can after-market USB flash drives be used?</b>	Yes, but when saving data in real time, it is recommended to use the included (or an optional genuine Hioki) SD memory card to ensure data integrity. Proper operation is only guaranteed for the included (or optional genuine Hioki) SD memory card. USB cards with security features such as fingerprint authentication cannot be used.	"2.7 Inserting a SD Memory Card or USB Flash Drive (when saving data)" (p. 63)
<b>Can removable media be replaced while measuring?</b>	Yes. Put the cursor on the <b>[EJECT]</b> button at the lower right of the screen, press <b>ENTER</b> , and remove the media following the displayed message.	"Replacing Removable Storage During Real-Time Saving" (p. 168)
<b>How much recording space is available?</b>	It depends on setting conditions (number of channels and recording interval). About 400 days of recording is possible using 15 analog channels at 1 s recording interval to 1 GB media.	"Appendix 7 Maximum Recordable Time" (p. A14)
<b>How can I process acquired data later with a spreadsheet program?</b>	Files saved automatically with the <b>[Waveform (realtime)]</b> setting on the included (or an optional genuine Hioki) SD memory card or USB flash drive can be quickly and easily converted into text (CSV) data with the Logger Utility and then opened with Excel. Note that data saved automatically using the <b>[CSV (realtime)]</b> setting can be opened directly with Excel but not loaded by the instrument.	"Automatic Saving (Waveform Data and Numerical Calculation Results)" (p. 165)
<b>How can I load data from a SD memory card onto the PC when it has no SD memory card slot?</b>	Data can be transferred to a PC using the supplied USB cable and the USB Drive mode. Data can also be transferred to a PC using the FTP function and LAN communications.	"6.5 Transferring Data to a PC (USB Drive Mode)" (p. 183) "10.5 Transferring Data to a PC with the FTP Server Function" (p. 244)
<b>How can I create files every hour, from 0:00 (ideal split time)?</b>	Set auto-saving <b>[Split Save]</b> to Periodic ( <b>[Ref Time]</b> ).	"Automatic Saving (Waveform Data and Numerical Calculation Results)" (p. 165)

Question	Remedial Action	Reference page
<b>What is the file limit when auto saving to removable storage?</b>	Depending on file size and SD memory card capacity, more than 1,000 files can be saved in one folder, although only 1,000 can be displayed on the file screen. As the number of files increases, the time required to start and stop measurement also increases, so we recommend storing no more than 1,000 files, if possible. (When saving, a folder named "HIO-KI_LR8410" is created, and files with different data types are saved in sub-folders within it.)	"6.1 About Saving and Loading Data" (p. 161)
<b>Is data retained in internal memory when I turn the power off after measuring? I did not use auto saving to removable storage.</b>	If waveforms are displayed when power is turned on, the data has been retained. Data in internal memory is retained for about 30 minutes after power-off. However, the internal buffer memory comprises temporary memory. If more than 30 minutes elapses before the instrument is turned back on, the data will be erased. To avoid such data loss, we recommend preparing and making settings for power outages when measuring for a long time.	"What happens to data in a power outage?" (p .163)
<b>Why is only part of the data saved when saving to removable storage after measuring?</b>	When A/B cursors are set to specify a save time span, only data within that span is saved. Also, internal memory capacity limits saving of measurement data to the most recent eight million data points. If you need to save more data points, enable real-time auto saving beforehand.	"Specifying a Waveform Time Span" (p .120) "Automatic Saving (Waveform Data and Numerical Calculation Results)" (p .165)
<b>After starting measurement with real-time auto saving, can I still acquire data if I neglected to insert removable storage media until later?</b>	As long as storage media is inserted before internal buffer memory overflows, data from the start of measurement will be saved to the removable storage. The fastest that the internal buffer memory will be full is about 10 minutes.	"Replacing Removable Storage During Real-Time Saving" (p .168)
<b>Why does "Saving" continue to be displayed and saving not finish when saving internal memory data as text after measurement?</b>	To save all data from a full internal memory to removable media as text after measurement takes about one hour. To abort the saving process, press and hold <b>STOP</b> for some time. We recommend saving binary data, and later converting to text with the Logger Utility (which takes only a few seconds).	Logger Utility Instruction manual "7.1.1 Saving Measurement Data as Text"
<b>How to view data saved in binary format on a PC?</b>	The Logger Utility PC application program is included on the supplied CD. Install it on the PC and use it to open the file.	"10.3 Using the Logger Utility" (p. 236)

**Appendix 9 Frequently Asked Questions**

Question	Remedial Action	Reference page
<b>When opened in Excel, the time displayed is elapsed time from start. How can I display real time?</b>	<p>When saving data in CSV format on the instrument, the displayed time is determined by the <b>[Time Disp]</b> setting on the System screen. Select <b>[Date]</b> to display real time.</p> <p>When converting CSV format with the Logger Utility, set the <b>[Time Axis Format]</b> to <b>[Absolute Time]</b>.</p>	<p>"Selecting the Horizontal (Time) Axis Display" (p .201)</p> <p>Logger Utility Instruction manual "7.1.1 Saving Measurement Data as Text"</p>
<b>What are the files with .MEM and .LUW extensions?</b>	<p>MEM is the file extension for instrument waveform data, and LUW is the file extension for Logger Utility waveform data.</p> <p>LUW files cannot be loaded into the instrument.</p>	<p>"6.1 About Saving and Loading Data" (p. 161) Logger Utility Instruction manual</p>
<b>How are event marks handled when converting data to text (CSV)?</b>	<p>When converting data to text with the instrument:</p> <p>Event numbers are included alongside measurement data. This is convenient when you need to later extract only marked data.</p> <p>When converting data to text with the Logger Utility:</p> <p>Event mark information is not included.</p>	<p>"4.3 Marking Waveforms and Searching Marks (Search Function)" (p. 123)</p>

**Logger Utility**

Question	Remedial Action	Reference page
<b>What kind of program is the Logger Utility?</b>	<p>Running on a PC connected to the instrument by LAN or USB cable, it provides real time data acquisition, display, and calculation; display and analysis of waveform (binary) data acquired by the instrument; conversion of binary data to text (CSV) data; and printing.</p>	<p>Logger Utility Instruction manual</p>
<b>While measuring with the Logger Utility, can measurement data be transferred to a PC connected only when needed, and the PC disconnected at other times?</b>	<p>This is not possible while measuring with the Logger Utility. However, it can be done by transferring data files from removable storage using the FTP function.</p>	<p>"Automatic Saving (Waveform Data and Numerical Calculation Results)" (p .165)</p> <p>"10.5 Transferring Data to a PC with the FTP Server Function" (p. 244)</p>
<b>What is the method for converting data to a text (CSV) file with the Logger Utility?</b>	<ol style="list-style-type: none"> <li>1. In the menu bar, select <b>[File]? [Save File in Text Format]</b>.</li> <li>2. Select a file for CSV conversion in the displayed dialog, and set <b>[CSV (comma separated)]</b> as the file type.</li> <li>3. Make other settings as necessary, and click the <b>[Save]</b> button.</li> </ol>	<p>Logger Utility Instruction manual</p>

## Appendix 10 Introduction to Measurement Applications

### Connecting a 4 to 20 mA Output Device and Recording Average Values Every Minute

This section describes how to measure current fluctuations by connecting an instrumentation device that generates 4 to 20 mA output. We will record average values every minute.

## 1 Prepare the Following Before Measuring

#### Items to prepare

- LR8410-20
- Measurement unit
- AC Adapter (supplied)
- Measurement (input) leads
- 250  $\Omega$  shunt resistor
- SD memory card \*

\*:Included or optional

- 1** Place the instrument and measurement unit close together.
- 2** Connect them to a wall outlet.
- 3** Turn on both the instrument and the measurement unit.
- 4** Register the measurement unit with the instrument.
- 5** Insert the SD memory card (exercising care to orient it properly).
- 6** Install the measurement unit in the measurement location (verify that the UNIT LED for the registered unit is lit up).
- 7** Connect the input cable and the 250  $\Omega$  shunt resistor to CH1 (p. 50).
- 8** Connect the instrumentation device to the output terminal.

## 2 Configure Measurement Settings

Set the recording interval, recording time, automatic save, and numerical calculation settings on the [Setting] screen.

1

2 Select

Apply

Set to 50 or 60 Hz according to the power frequency in the area of use.

The default values can be used for settings other than those enclosed in boxes. Configure them as necessary.

### Example settings

Record measurement data for 1 h at a 5 s interval, saving automatically to the SD memory card along with calculated values every minute.

Recording interval: 5 s; record time: Time, 1 h

Numerical calculation: On; Calc 1: Maximum; Split calc: On; Length: 1 min.

Auto Save: Waveform+calcu; Split Save: Off; Media: SD card

### Measurement tips

Filter: When the recording interval is from 500 ms to 1 h, 50/60 Hz power supply noise can be rejected.

Make input channel settings on the [CH] screen.

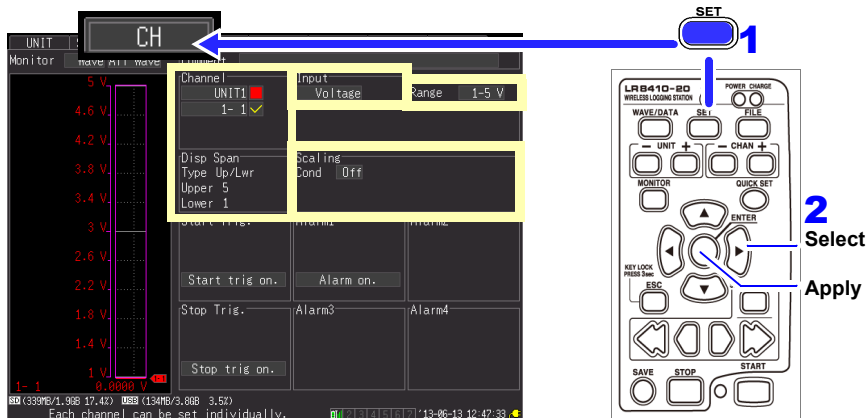

### Example settings

Unit: Unit 1; channel: 1-1; input: voltage;  
range: 1 to 5 V

When set as shown at the left,  
the vertical axes appear like this.



### Measurement Hints

The 1 to 5 V range is obtained by automatically setting the upper and lower limit for the 10 V range display range to 5 V and 1 V, respectively. If you wish to change the upper and lower limit values, use the 10 V range.

## 3 Start and finish measuring

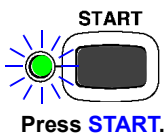

- Data corresponding to the set recording time is recorded along with calculated value data every minute and saved to the SD memory card. Once recording is started, it will stop after 1 h.
- To stop recording early, press **STOP**.

# Appendix 11 Input Circuit Diagram

Diagrams of the LR8510 and LR8511 input circuits are shown below.

## Analog Inputs (Voltage, Thermocouple, Humidity, RTD, and Resistance)

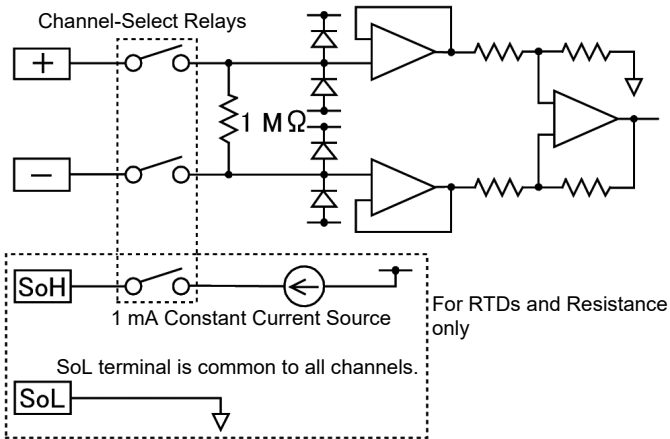

## Appendix 12 Instrument/Unit Communications Interruptions and Reestablishment

### Treatment of the Waveform Display When Unable to Acquire Data and Data

Waveforms corresponding to data that the instrument was unable to acquire from measurement unit or wireless logger are displayed at the top of the Waveform screen, as shown in Figure 1 below (shown in black when the screen color is white, and in white otherwise). If there is one or more units with which communications were interrupted during measurement, the associated unit numbers will be displayed to the right of and below the scroll bars on the Waveform screen, as shown in Figure 2 below.

Waveform rendering is stopped during measurement unit or wireless logger communications errors and while restoring data. “NO DATA” is shown for the value display and as cursor values, and calculated values and saved data are treated as described in Table 1 below.

Input type	Input range	No-data value
Voltage	10 mV	0.0163825
	20 mV	0.032765
	50 mV	0.32675
	100 mV	0.163825
	200 mV	0.32765
	500 mV	3.2765
	1 V	1.63825
	2 V	3.2765
	5 V	32.765
	10 V	16.3825
	20 V	32.765
	50 V	327.65
Thermocouple	100°C	327.65
	500°C	1638.25
	1000°C	3276.5
	2000°C	3276.5
Resistance thermometer sensor	100°C	327.65
	500°C	1638.25
	2000v	3276.5
Humidity	100%RH	3276.5
Resistance	10 Ω	16.3825
	20 Ω	32.765
	100 Ω	163.825
	200 Ω	327.65

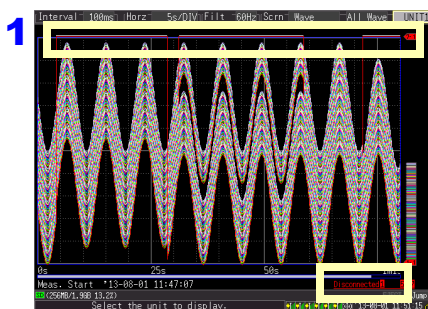

Figure 1

2

Input type	Input range	No-data value
Current	500 mA	3.2765
	5 A	32.765
	50 A	327.65
	500 A	3276.5
	10 A	327.65
	100 A	3276.5
	1000 A	32765
	20 A	327.65
	200 A	3276.5
	2000 A	32765
Temperature	100°C	3276.5
Fungal index	200	3276.5
Fungal growth projection	10	3276.5



**When Temporarily Unable to Communicate with a Measurement Unit**

If wireless communications between the instrument and a wireless unit or wireless logger are interrupted during measurement, measurement data for the period of no communications will be stored internally by the measurement unit or wireless logger.

Once wireless communications are reestablished, the instrument will receive the stored measurement data, restoring it on the instrument. The amount of data that can be restored in this manner is limited to the capacity of the instruments' internal buffer memory, which holds 8 MWords of data. If there are multiple measurement unit being restored, data is progressively restored in the order in which the units are reconnected.

If communications are restored with more than one measurement unit or wireless logger, data will be restored in order from each reconnected measurement unit and wireless logger.

**IMPORTANT**

- If a measurement unit is turned off during measurement, data from before the unit was turned off will be lost.
- If the instrument is turned off during measurement, unit data will not be restored.
- If measurement is started while there are measurement units with which communications have been interrupted, measurement will resume. Measurement will start progressively and be performed in parallel, starting with the units with which communications are established during measurement.
- Frequent communication interruptions can cause delays in the processing of data recovery, resulting in a failure of data acquisition.

The maximum number of data points that can be stored for later restoration is  $(65,565/n)$ , where  $n$  indicates the number of channels.

Table 2 provides a rough guide to the amount of time required for data to be restored. (If the maximum number of data points that can be stored is exceeded, old data will be overwritten on the unit as new data is stored.)

## Appendix 12 Instrument/Unit Communications Interruptions and Reestablishment

		Channels used							
		1	2	3	4	5	6	7	
Recording interval	100 ms	109.2	54.6	36.4	27.3	21.8	18.2	15.6	min
	200 ms	218.5	109.2	72.8	54.6	43.7	36.4	31.2	min
	500 ms	546.1	273.1	182.0	136.5	109.2	91.0	78.0	min
	1 s	18.2	9.1	6.1	4.6	3.6	3.0	2.6	min
	2 s	36.4	18.2	12.1	9.1	7.3	6.1	5.2	hour
	5 s	91.0	45.5	30.3	22.8	18.2	15.2	13.0	hour
	10 s	182.0	91.0	60.7	45.5	36.4	30.3	26.0	hour
	20 s	364.1	182.0	121.4	91.0	72.8	60.7	52.0	hour
	30 s	22.8	11.4	7.6	5.7	4.6	3.8	3.3	hour
	1 min	45.5	22.8	15.2	11.4	9.1	7.6	6.5	day
	2 min	91.0	45.5	30.3	22.8	18.2	15.2	13.0	day
	5 min	227.6	113.8	75.9	56.9	45.5	37.9	32.5	day
	10 min	455.1	227.6	151.7	113.8	91.0	75.9	65.0	day
	20 min	910.2	455.1	303.4	227.6	182.0	151.7	130.0	day
	30 min	1365.3	682.7	455.1	341.3	273.1	227.6	195.0	day
1 hour	2730.7	1365.3	910.2	682.7	546.1	455.1	390.1	day	

		Channels used								
		8	9	10	11	12	13	14	15	
Recording interval	100 ms	13.7	12.1	10.9	9.9	9.1	8.4	7.8	7.3	min
	200 ms	27.3	24.3	21.8	19.9	18.2	16.8	15.6	14.6	min
	500 ms	68.3	60.7	54.6	49.6	45.5	42.0	39.0	36.4	min
	1 s	2.3	2.0	1.8	1.7	1.5	1.4	1.3	1.2	min
	2 s	4.6	4.0	3.6	3.3	3.0	2.8	2.6	2.4	hour
	5 s	11.4	10.1	9.1	8.3	7.6	7.0	6.5	6.1	hour
	10 s	22.8	20.2	18.2	16.5	15.2	14.0	13.0	12.1	hour
	20 s	45.5	40.5	36.4	33.1	30.3	28.0	26.0	24.3	hour
	30 s	2.8	2.5	2.3	2.1	1.9	1.8	1.6	1.5	hour
	1 min	5.7	5.1	4.6	4.1	3.8	3.5	3.3	3.0	day
	2 min	11.4	10.1	9.1	8.3	7.6	7.0	6.5	6.1	day
	5 min	28.4	25.3	22.8	20.7	19.0	17.5	16.3	15.2	day
	10 min	56.9	50.6	45.5	41.4	37.9	35.0	32.5	30.3	day
	20 min	113.8	101.1	91.0	82.7	75.9	70.0	65.0	60.7	day
	30 min	170.7	151.7	136.5	124.1	113.8	105.0	97.5	91.0	day
1 hour	341.3	303.4	273.1	248.2	227.6	210.1	195.0	182.0	day	

**Synchronization and acquired data discrepancies**

The instrument, measurement units, and wireless loggers are synchronized as they communicate during measurement. Consequently, since time will progress at each device's own level of precision in the event that communications with measurement units or wireless loggers are interrupted during measurement, time differences will appear among the three devices. In some cases, there may be discrepancies such as those illustrated below in the number of data points captured once communications between the instrument and the measurement units and wireless loggers are reestablished following an interruption. In the event of discrepancies in the number of data points or time between the instrument on the one hand and the measurement units and wireless loggers on the other, data will be restored based on the assumption that the instrument's data is correct.

**IMPORTANT**

Data continuity may be compromised when a discrepancy occurs.

---

## Appendix 12 Instrument/Unit Communications Interruptions and Reestablishment

- When the data counts for the instrument and measurement units are the same

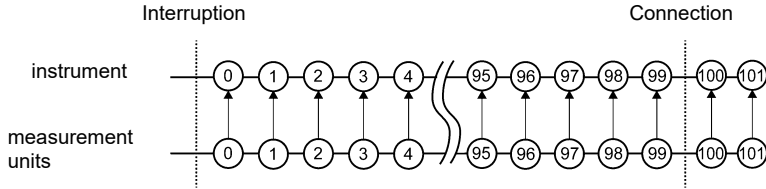

(The instrument will acquire data remaining on the unit after communications are established. Data may become discontinuous at the synchronization point after communications are established.)

- When there is a discrepancy so that the measurement unit data count is less than that of the instrument

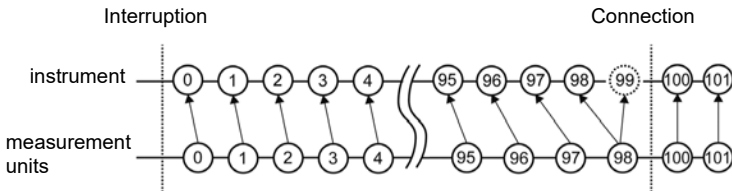

(The instrument will acquire data remaining on the unit after communications are established. Insufficient data is treated as the same data as the one before.)

- When there is a discrepancy so that the measurement unit data count is greater than that of the instrument

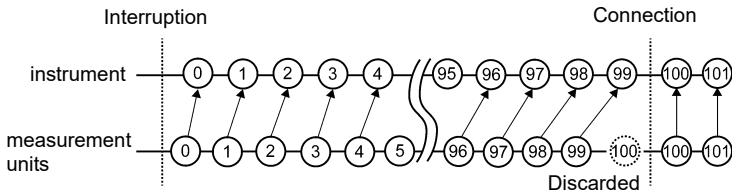

(The instrument will acquire data remaining on the unit after communications are established. Excessive data is discarded.)

**Triggers**

If communications with a unit are interrupted so that there is no data for a channel targeted by a trigger, no trigger judgment will be performed for that channel. Trigger judgment is only performed for channels for which there is data available. Once communications have been reestablished with the unit and data has been restored from the unit, trigger judgment will be performed for restored data all at once, and trigger events will occur as trigger criteria are satisfied. Trigger output will be generated as trigger judgments are made. For stop triggers, data after the stop trigger criteria are satisfied will be reported as "NO DATA."

**NOTE** When using a pre-trigger, the trigger will not activate for restored data. Additionally, data will not be restored while waiting for a pre-trigger event.

## Appendix 12 Instrument/Unit Communications Interruptions and Reestablishment

Example: Stop trigger criteria

When the stop trigger falling slope $\downarrow$  AND and the stop trigger rising slope $\uparrow$  AND are the same

### Unit data

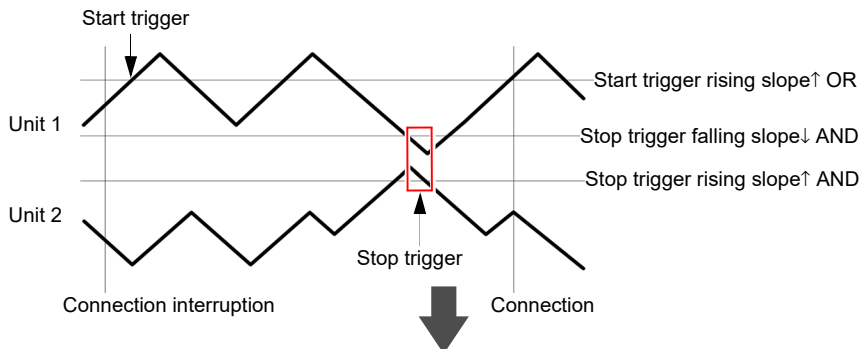

When unit 1 and then unit 2 are connected to the instrument (in that order)

- (1) Recording of data starts at the start trigger position.
- (2) All data from unit 1 is restored.
- (3) Data from unit 2 is restored.
- (4) Since the stop trigger criteria were met while data from unit 2 was being restored, both the data restoration and measurement stop.

### Instrument data

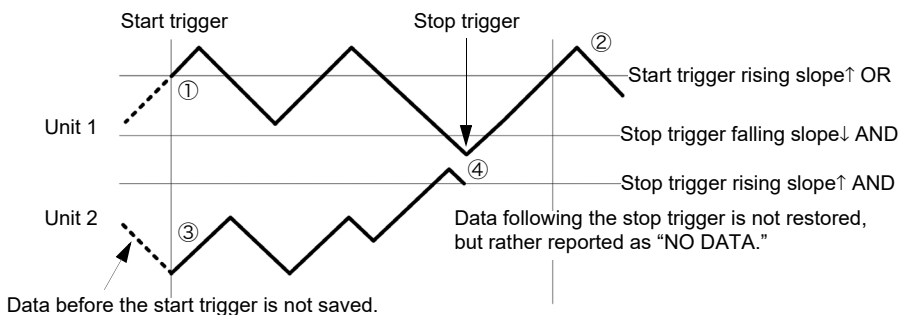

## **Alarms**

Apart from the alarm when communications with a unit are interrupted, no alarm judgment is made when there is no data due to an interruption of communications with a unit. Judgment will be performed all at once when data from the unit is restored after communications are established, and alarms will occur as alarm criteria are satisfied. Alarm output will be generated at the same timing.

## **Saving data to storage media**

When automatically saving waveform (binary) data, data being saved is also restored when data is restored on the instrument. However, when using the split save setting, data in files that have already been split and saved will not be restored. Only data associated with files that are currently being saved (i.e., that have not yet been split) can be restored. When automatically saving data in the CSV (text) format, saved data is not restored. Additionally, data cannot be restored if the data in question cannot be found on the media, for example if the media has been changed.

## **Numerical calculations**

If "NO DATA" is displayed for the data of the object channels for calculation due to a communication interruption or other causes, the data will be not treated as the object for the numerical calculation.

If the calculation range consists of the data that are displayed as "NO DATA," the instrument will display "----" on the screen and the numerical calculation result to be saved will be zero.

## **Logger Utility**

Once data has been transferred from the instrument to the Logger Utility, it cannot be changed during measurement, even if data is restored on the instrument. If you wish to access that data, load the restored data that was saved on the instrument after stopping measurement.

---

# Index

## Number

0 position .....	90
100BASE-T .....	209
4-20 mA .....	45

## A

A/B cursors .....	117
Alarm .....	125, 149
Alarm Event Marking .....	199
Alarm output .....	149, 205
Upon thermocouple burn-out .....	156
ALM .....	50, 151, 205
AND .....	133
Auto calculation .....	184
Auto Resume .....	194
Auto save .....	160
Average value .....	181, 188

## B

Background Color .....	196
Backlight Brightness .....	196
Backlight Saver .....	195
Batch Proc .....	100, 102, 103, 104, 106
Battery pack .....	39
Beep Sound .....	196
Beeper .....	196
Binary .....	158
Burn-out detection .....	74

## C

Calculation formula .....	190, 191
Calculation Results	
Save .....	160
CF card	
Copy .....	177
Delete .....	175
Rename .....	176
Sort .....	178
Charging time .....	41
Cleaning .....	297
Clock Setting .....	200
Communications commands .....	268
Cursor	

Type .....	118
Cursor values .....	117

## D

Daisy chain (serial) synchronization ....	207
Decimal Mark .....	198
Decimal Point Character .....	198
Default Setting .....	A 12, A 13
Default settings .....	A 12
Delete while saving .....	163
DHCP .....	223, 227
Display Color .....	196
Display range .....	90
DNS .....	227
Drive .....	174

## E

E-Mail .....	261
Error messages .....	A 3
Event mark .....	119, 123
Event mark for alarm .....	199
EXT.TRIG .....	51, 199, 203
External control terminals .....	203
External Trig In .....	134, 199
External trigger .....	125
External Trigger Input .....	203

## F

File naming .....	A 9
File Protection .....	195
File screen .....	60, 174
Formatting .....	60
FTP .....	257
FTP client .....	244
FTP server .....	240
FTP/HTTP authentication .....	234, 243

## G

Gateway .....	227
Gateway IP .....	227
Gauges .....	112
GND .....	51



# Index 2

## Index

---

---

### H

---

Horizontal axis (Time Base) .....	92
Horizontal cursors .....	118
Host Name .....	227
Humidity measurement .....	78

### I

---

Initialize .....	201
Initializing .....	103
Inspection .....	44, 297
Installing .....	217
Integration measurement .....	80
Interval Calculation .....	188
IP Address .....	224

### J

---

Jump .....	115
------------	-----

### K

---

Key operation	
Trouble .....	299
KEY/LED .....	202
Key-Lock .....	36

### L

---

LAN .....	222
Communication features .....	209
When LAN communication fails .....	231
Language .....	197
LCD .....	202
Level monitor .....	72
Level trigger .....	127, 129
Load .....	172
Load Set. ....	169, 171
Logger Utility .....	232

### M

---

Maximum value .....	181, 188
Measurement unit .....	1
Measurement values .....	33
Memory .....	168
Minimum value .....	181, 188
Monitor .....	38
Move the cursor(s) .....	118

### N

---

N-Calc. Data Saving .....	198
Network .....	222
Noise .....	98, A 15
Numerical calculations .....	181
Numerical values .....	113

### O

---

Operating keys .....	25
OR .....	133

### P

---

Peak value .....	181, 188
Port Number .....	227
Pre-Trig .....	135

### Q

---

Quick Save .....	165, 166
------------------	----------

### R

---

Real-Time Calculation .....	181
Recording time .....	67
Ref Time .....	163
Remote operating .....	236
Repair .....	297
Repeat recording .....	67
Resistance measurement .....	79
ROM/RAM .....	202
RTD .....	76

### S

---

Save	
Auto save .....	160
Calc Results .....	167
File type .....	158
Quick save .....	160
Save Set .....	168
Screen Image .....	167
Select & Save .....	160
Waveform .....	167
Waveform data .....	167
Scrolling .....	114
SD card .....	58
Select & Save .....	165
Self-Test .....	202
Separator .....	198
Slope .....	80, 82

---

Specified time span for calculation .....	187
Split Length .....	163
Split Save .....	163
Split-calculation .....	185
Start Backup .....	194
Start/Stop Confirmation Messages .....	197
Start/Stop message .....	197
Subnet Mask .....	224, 227
System Reset .....	201
System screen .....	193

**T**

Temperature measurement	
RTD .....	76
Thermocouple .....	74
Text .....	158
Thermocouple .....	74
Time Disp .....	197
Time to maximum value .....	181, 188
Time to minimum value .....	181, 188
Time Value Display .....	197
Trace cursors .....	118
TRIG.OUT .....	51, 204
Trigger combining logic .....	133
Trigger input .....	203
Trigger output .....	204
Triggering .....	125
Triggering criteria .....	133

**U**

Uninstalling .....	220
Unit Information .....	202
USB .....	210
Communication features .....	209
USB cable .....	214
USB Drive Mode .....	179
USB driver .....	211
USB flash drive .....	58
USB flash driver	
Copy .....	177
Delete .....	175
Rename .....	176
Sort .....	178
USB Memory .....	202

**V**

Vertical cursors .....	118
Voltage measurement .....	73

**W**

Waveform calculations .....	181
Waveform display color .....	89
Waveform/Numerical screen .....	111
Window trigger .....	127, 131
Wireless logger .....	1

**Z**

Zero Adjust .....	61, 62, 63
Zoom .....	90

**Index 4**

*Index*

---

---

## Warranty Certificate

# HIOKI

Model	Serial number	Warranty period Three (3) years from date of purchase ( ___ / ___ )
-------	---------------	--

Customer name: \_\_\_\_\_

Customer address: \_\_\_\_\_

### Important

- Please retain this warranty certificate. Duplicates cannot be reissued.
- Complete the certificate with the model number, serial number, and date of purchase, along with your name and address. The personal information you provide on this form will only be used to provide repair service and information about Hioki products and services.

This document certifies that the product has been inspected and verified to conform to Hioki's standards. Please contact the place of purchase in the event of a malfunction and provide this document, in which case Hioki will repair or replace the product subject to the warranty terms described below.

### Warranty terms

1. The product is guaranteed to operate properly during the warranty period (three [3] years from the date of purchase).  
If the date of purchase is unknown, the warranty period is defined as three (3) years from the date (month and year) of manufacture (as indicated by the first four digits of the serial number in YYMM format).
2. If the product came with an AC adapter, the adapter is warranted for one (1) year from the date of purchase.
3. The accuracy of measured values and other data generated by the product is guaranteed as described in the product specifications.
4. In the event that the product or AC adapter malfunctions during its respective warranty period due to a defect of workmanship or materials, Hioki will repair or replace the product or AC adapter free of charge.
5. The following malfunctions and issues are not covered by the warranty and as such are not subject to free repair or replacement:
  - 1. Malfunctions or damage of consumables, parts with a defined service life, etc.
  - 2. Malfunctions or damage of connectors, cables, etc.
  - 3. Malfunctions or damage caused by shipment, dropping, relocation, etc., after purchase of the product
  - 4. Malfunctions or damage caused by inappropriate handling that violates information found in the instruction manual or on precautionary labeling on the product itself
  - 5. Malfunctions or damage caused by a failure to perform maintenance or inspections as required by law or recommended in the instruction manual
  - 6. Malfunctions or damage caused by fire, storms or flooding, earthquakes, lightning, power anomalies (involving voltage, frequency, etc.), war or unrest, contamination with radiation, or other acts of God
  - 7. Damage that is limited to the product's appearance (cosmetic blemishes, deformation of enclosure shape, fading of color, etc.)
  - 8. Other malfunctions or damage for which Hioki is not responsible
6. The warranty will be considered invalidated in the following circumstances, in which case Hioki will be unable to perform service such as repair or calibration:
  - 1. If the product has been repaired or modified by a company, entity, or individual other than Hioki
  - 2. If the product has been embedded in another piece of equipment for use in a special application (aerospace, nuclear power, medical use, vehicle control, etc.) without Hioki's having received prior notice
7. If you experience a loss caused by use of the product and Hioki determines that it is responsible for the underlying issue, Hioki will provide compensation in an amount not to exceed the purchase price, with the following exceptions:
  - 1. Secondary damage arising from damage to a measured device or component that was caused by use of the product
  - 2. Damage arising from measurement results provided by the product
  - 3. Damage to a device other than the product that was sustained when connecting the device to the product (including via network connections)
8. Hioki reserves the right to decline to perform repair, calibration, or other service for products for which a certain amount of time has passed since their manufacture, products whose parts have been discontinued, and products that cannot be repaired due to unforeseen circumstances.

HIOKI E.E. CORPORATION

<http://www.hioki.com>

18-07 EN-3

# HIOKI

[www.hioki.com/](http://www.hioki.com/)



**All regional  
contact  
information**

## **HEADQUARTERS**

81 Koizumi  
Ueda, Nagano 386-1192 Japan

## **HIOKI EUROPE GmbH**

Helfmann-Park 2  
65760 Eschborn, Germany  
[hioki@hioki.eu](mailto:hioki@hioki.eu)

2111 EN

---

Edited and published by HIOKI E.E. CORPORATION

Printed in Japan

- CE declarations of conformity can be downloaded from our website.
- Contents subject to change without notice.
- This document contains copyrighted content.
- It is prohibited to copy, reproduce, or modify the content of this document without permission.
- Company names, product names, etc. mentioned in this document are trademarks or registered trademarks of their respective companies.