

IM3533

HIOKI

IM3533-01

Instruction Manual

LCR METER



Video

Scan this code to watch an instructional video.
Carrier charges may apply.



! Be sure to read this manual before using the instrument

Safety Information ▶ p.3

✓ When using the instrument for the first time

Names and Functions of Parts ▶ p.10

Screen Configuration and Operation ▶ p.12

Measurement Preparations ▶ p.29

📖 Troubleshooting

Troubleshooting ▶ p.357

Error display ▶ p.362

EN

Sept. 2018 Revised edition 6
IM3533A981-06 18-09H



Contents

Introduction.....	1
Verifying Package Contents.....	1
Safety Information.....	3
Operating Precautions.....	5

Chapter 1 Overview 9

1.1 Product Overview Features	9
1.2 Names and Functions of Parts	10
1.3 Screen Configuration and Operation .	12
1.3.1 Initial Screen	12
1.3.2 Measurement Mode Selection Screen	13
1.3.3 Advanced Settings Screen	14
1.3.4 Compensation Settings Screen	24
1.3.5 System Settings Screen	25
1.3.6 Save Settings Screen	27
1.3.7 Parameter Settings Screen	28

Chapter 2 Measurement Preparations 29

2.1 Preparation Flowchart	29
2.2 Pre-Operation Inspection	30
2.3 Connecting the Power Cord	31
2.4 Connecting the Measurement Cables, Probes, or Fixture	32
2.5 Connecting a Temperature Probe	33
2.6 Connecting an Interface	34
2.7 Turning the Power On and Off	35

Chapter 3 Measurement Example 37

3.1 When LCR Mode	37
3.2 When ANALYZER Mode (IM3533-01 only).....	39
3.3 When TRANSFORMER Mode	41

Chapter 4 LCR Function 45

4.1 About LCR function	45
4.1.1 Measurement screen	45
4.1.2 Setting Display Parameters	47
4.1.3 Enlarging Display of Measurement Values	49
4.2 Setting Basic Settings of Measurement Conditions	50
4.2.1 Setting the Measurement frequency ..	50
4.2.2 Setting the Measurement signal level	52
4.2.3 Limiting the Voltage and Current Applied to the Sample (Limit Values)	56
4.2.4 Setting the DC bias	58
4.2.5 Perform Measurements with User-defined Timing (Trigger Measurement).....	60
4.2.6 Setting the Measurement Range	62
■ Setting the method for determining the measurement range (AUTO, HOLD, JUDGE SYNC)	62
■ Low Z High Accuracy Mode	71
■ 4.2.7 Setting the Measurement speed	73
■ 4.2.8 Displaying Average Values (Averaging Set)	74
■ 4.2.9 Setting the Delay Time until Measurement Data is Captured (Trigger Delay).....	76
■ 4.2.10 Applying the Signal to the Sample during Measurement Only (Trigger Synchronous Output Function) ...	77
4.3 Setting DC Resistance Measurement	80
4.3.1 Configuring the Temperature Correction Function.....	81
4.3.2 Setting the DC Measurement Delay Time (DC Delay)	83
4.3.3 Setting the Offset Measurement Delay Time (Adjustment Delay).....	85
4.3.4 Setting the Line Frequency	87
4.3.5 Setting the Measurement Range	88
■ Setting the method for determining the measurement range (HOLD, AUTO, JUDGE SYNC)	88
■ Low Z High Accuracy Mode	96
■ 4.3.6 Setting the Measurement Speed	98

Contents

■ 4.3.7 Displaying Average Values (Average set)	99
4.4 Judging Measurement Results	100
4.4.1 Judging with Upper and Lower Limit Values (Comparator Measurement Mode)	102
■ Setting the Upper or Lower Limit Value as an Absolute Value (ABS) (Absolute Value Mode)	104
■ Setting the Upper or Lower Limit Value as a Percentage (%) Relative to a Reference Value (Percentage Mode)	105
■ Setting Upper and Lower Limit Values as ($\Delta\%$) Values Relative to the Offset from the Reference Value (Deviation Percentage Mode)	107
■ 4.4.2 Classifying Measurement Results (BIN Measurement)	109
■ Setting the Upper or Lower Limit Value as an Absolute Value (ABS) (Absolute Value mode)	111
■ Setting the Upper or Lower Limit Value as a Percentage (%) Relative to a Reference Value (Percentage mode) ..	114
■ Setting Upper and Lower Limit Values as ($\Delta\%$) Values Relative to the Offset from the Reference Value (Deviation Percentage Mode)	117
4.5 Setting Application Settings	120
4.5.1 Setting Measurement Conditions for Individual Measurement Ranges (Range Synchronization Function)	120
4.5.2 Setting the Detection Signal Waveform Averaging Count (Waveform Averaging Function)	128
4.5.3 Detecting OPEN during 2-terminal Measurement (HIGH-Z Reject Function)	130
4.5.4 Checking Contact Defects and the Contact State (Contact Check Function)	132
4.5.5 Setting the Delay Time from the Output of Comparator and BIN Judgment Results until Output of EOM (LOW) and Resetting Judgment Results	134
4.5.6 Enabling Trigger Input for during Measurement and Setting the Valid Edge of Trigger Input	136
4.5.7 Setting the EOM Output Method	137
4.5.8 Saving Measurement Results (Memory function)	138
4.5.9 Setting the Number of Display Digits	140

4.5.10 Setting the LCD to ON/OFF	142
4.5.11 Setting Operation Sounds (Beep Sounds)	143
4.5.12 Disabling Key Operation (Key-lock Function)	144
4.5.13 Initializing (System Reset)	147

Chapter 5 ANALYZER Function (IM3533-01) 149

5.1 About ANALYZER function	149
5.1.1 Measurement screen	149
5.2 Setting Basic Settings of Measurement	150
5.2.1 Setting the measurement parameter	150
5.2.2 Setting the Trigger	151
5.2.3 Setting the Display Timing	152
5.2.4 Setting the Trigger Delay	153
5.2.5 Setting Sweep Points	155
5.2.6 Setting the Measurement Signal Level	158
5.2.7 Setting the Measurement Range	160
■ Setting the method for determining the measurement range (AUTO, HOLD)	160
■ Low Z high accuracy mode	164
■ 5.2.8 Setting the Measurement Speed	166
■ 5.2.9 Displaying as Average Values (Average set)	167
■ 5.2.10 Setting the Point Delay	168
■ 5.2.11 Setting the DC Bias	169
5.3 Application Settings	171
5.3.1 Applying the Signal to the Sample Only during Measurement (Trigger Synchronous Output Function)	171
5.3.2 Setting the Detection Signal Waveform Averaging Count (Waveform Averaging Function)	173
5.3.3 Detecting OPEN during 2-terminal Measurement (HIGH-Z Reject Function)	175
5.3.4 Checking Contact Defects and the Contact State (Contact Check Function)	177
5.3.5 Saving Measurement Results (Memory function)	179
5.3.6 AUTO Range Limit Function	182

5.3.7	Setting the LCD to ON/OFF	184
5.3.8	Setting Operation Sounds (Beep Sounds)	185
5.3.9	Disabling Key Operation (Key-lock Function)	186
5.3.10	Enabling Trigger Input for during Measurement and Setting the Valid Edge of Trigger Input	189
5.3.11	Setting the $\overline{\text{EOM}}$ Output Method	190
5.3.12	Initializing (System Reset)	191

Chapter 6 TRANSFORMER Function 193

6.1	About TRANSFORMER function	193
6.1.1	Measurement screen	193
6.1.2	Measurement Methods	194
6.1.3	Setting the measurement parameter	196
6.1.4	Setting Calculation Parameters	197
6.2	Setting Basic Settings of Measurement Conditions	198
6.3	Judging with Upper and Lower Limit Values (Comparator Measurement Mode)....	199
	■ Setting the Upper or Lower Limit Value as an Absolute Value (ABS) (Absolute Value Mode)	202
	■ Setting the Upper or Lower Limit Value as a Percentage (%) Relative to a Reference Value (Percentage Mode).....	203
	■ Setting Upper and Lower Limit Values as ($\Delta\%$) Values Relative to the Offset from the Reference Value (Deviation Percentage Mode)	205
6.4	Setting Application Settings	207

Chapter 7 CONTINUOUS Measurement Function 209

7.1	About CONTINUOUS Measurement Function	209
7.1.1	Measurement screen	209
7.2	Configuring CONTINUOUS Measurement Basic Settings	210
7.3	Performing CONTINUOUS Measurement.....	211

7.4	Checking CONTINUOUS Measurement Results	212
7.5	Configuring CONTINUOUS Measurement Application Settings ...	213
7.5.1	Setting the Display Timing	213
7.5.2	Setting the LCD to ON/OFF	214

Chapter 8 Error Compensation 215

8.1	Setting Open Circuit Compensation	215
8.1.1	All Compensation	216
8.1.2	Spot Compensation	220
8.2	Short Circuit Compensation	224
8.2.1	All Compensation	226
8.2.2	Spot Compensation	228
8.3	Compensating Values to Match Reference Values (Load Compensation).....	232
8.4	Compensating Measurement Cable Errors (Cable Length Compensation).....	245
8.5	Calculating Values (Scaling)	246

Chapter 9 Saving and Loading Panel Information 249

9.1	Saving Measurement Conditions (Panel Save Function)	251
9.2	Loading Measurement Conditions (Panel Load Function)	256
9.3	Changing a Panel Name	258
9.4	Deleting a Panel	260

Chapter 10 Setting the SYSTEM 263

10.1	Setting the Interface	263
10.2	Checking the Version of the Instrument	264
10.3	Self Checks (Self Diagnosis)	265
10.4	Setting the Date and Time	272

Chapter 11 Using USB Flash Drive 273

11.1	Inserting and Removing USB flash drive.....	274
11.2	About the File Operation Screen	275
11.3	About the File Save Setting Screen	276
11.4	Saving Measurement Data	277
■	Saving Measurement Data	277
■	Saving a Copy of the Screen	287
■	Checking the Contents of Files	290
■	Changing the Save Folder	291
11.5	Saving Instrument Settings	293
■	Saving Instrument Settings	293
■	Saving All Settings of Instrument (ALL SAVE Function).....	295
11.6	Loading Instrument Settings	297
■	Loading instrument settings	297
■	Loading all settings saved on a USB flash drive (ALL LOAD Function).....	300
11.7	File and Folder Operations	302
■	Formatting a USB Flash Drive	302
■	Deleting Files and Folders	304
■	Creating Folders	305
■	Displaying the USB Flash Drive Information	307

Chapter 12 External Control 309

12.1	External Input/Output Connector and Signals	309
■	Connector Type and Signal Pinouts	310
■	Signal function details	316
12.2	Timing Chart	318
12.2.1	LICR Mode	318
12.2.2	ANALYZER Mode (IM3533-01 only)	321
12.2.3	TRANSFORMER Mode	322
12.2.4	CONTINUOUS Measurement Mode	323
12.3	Internal Circuitry	325
■	Electrical Specifications	326
■	Connection Examples	327
12.4	External I/O Settings	328
■	Setting Delay Time from Output of Comparator and BIN Judgment Results until Output of EOM (LOW)	328
■	Setting Reset of Judgment Results	328

■	Enabling Trigger Input for during Measurement	328
■	Setting Valid Edge of Trigger Input	328
12.5	External Control Q&A	329
12.6	Measurement Using a Computer	329

Chapter 13 Printing 331

13.1	Connecting the Printer	331
■	Connecting the Printer to the Instrument	332
13.2	Instrument and Printer Settings	333
■	Make Instrument Settings	333
13.3	Printing	334

Chapter 14 Specifications 337

14.1	General Specifications	337
14.2	Measurement Range and Accuracy	343
14.3	About Measurement Times and Measurement Speed	352

Chapter 15 Maintenance and Service 355

15.1	Inspection, Repair and Cleaning	355
15.2	Troubleshooting	357
15.3	Error display	362
15.4	Discarding the Instrument	364

Appendix A 1

Appendix1	Measurement Parameters and Calculation Formula	A 1
Appendix2	Measurement of High Impedance Components	A 3
Appendix3	Measurement of In-circuit Components	A 4
Appendix4	Countermeasures Against Incorporation of External Noise	A 5
Appendix4.1	Countermeasures Against Incorporation of Noise from the Power Line	A 5

Appendix4.2Countermeasures Against Noise from the measurement Cables .A 6	
Appendix5 Supplying DC Bias.....A 7	
Appendix5.1How to Supply a DC Bias Voltage.....A 7	
Appendix5.2How to Supply a DC Bias CurrentA 9	
Appendix6 The Residual Charge Protection FunctionA 10	
Appendix7 Series Equivalent Circuit Mode and Parallel Equivalent Circuit Mode.....A 11	
Appendix8 Open Circuit Compensation and Short Circuit Compensation....A 12	
Appendix9 Temperature Correction Function (TC).....A 13	
Appendix10Rack MountingA 15	
Appendix11Dimensional DiagramA 17	
Appendix12Initial Settings TableA 18	
Appendix 13Device Compliance StatementA 23	

Index**Index 1**

Introduction

Thank you for purchasing the HIOKI Model IM3533, IM3533-01 LCR Meter. To obtain maximum performance from the instrument, please read this manual first, and keep it handy for future reference.

Trademark

Microsoft and Windows are either registered trademarks or trademarks of Microsoft Corporation in the United States and other countries.

Verifying Package Contents

When you receive the instrument, inspect it carefully to ensure that no damage occurred during shipping. In particular, check the accessories, panel switches, and connectors. If damage is evident, or if it fails to operate according to the specifications, contact your authorized Hioki distributor or reseller.

Confirm that these contents are provided.

IM3533 or IM3533-01 LCR Meter 1



Power Cord (2-line + ground) 1



Instruction Manual (This document) 1



LCR Application Disk 1
(Communications instruction manual [PDF format], explanation of communications commands, USB driver, sample application)



The latest version can be downloaded from our web site.

- NOTE**
- Probes, fixture are not supplied with the instrument as standard equipment. You should order them separately, according to requirements.
 - The instrument ships from the factory configured as described in "Appendix12 Initial Settings Table"(p. A18).

Transporting the instrument

Use the original packing materials when transporting the instrument, if possible.

See "Transporting the instrument" (p. 356)

Verifying Package Contents

Options

For more information, contact the store (distributor) from which you purchased the instrument or your nearest HIOKI sales office.

L2000 4-terminal Probe

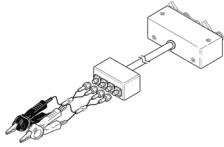

▼ Alligator-clip-type measurement probes. These general-purpose dual-electrode clips fit a wide range of conductor thicknesses.

Measurable range: DC to 8 MHz
 Maximum voltage: ± 42 V_{peak} (AC+DC)
 Maximum current: ± 1 A_{peak} (AC+DC)
 Measurement terminal hole diameter: 0.3 mm to 5 mm

9140-10 4-terminal Probe



Measurable range: DC to 200 kHz
 Maximum voltage: ± 42 V_{peak} (AC+DC)
 Maximum current: ± 1 A_{peak} (AC+DC)
 Measurement terminal hole diameter: 0.3 mm to 5 mm

9500-10 4-terminal Probe

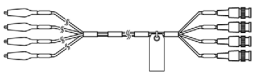

▼ Rubber-sheathed alligator clip type

Measurable range: DC to 200 kHz
 Maximum voltage: DC ± 40 V (42 V_{peak} (Measurement signal + bias voltage))
 Maximum current: 1 A_{peak} (Measurement signal + bias current)
 Measurement terminal hole diameter: 0.3 mm to 2 mm

L2001 Pincher Probe

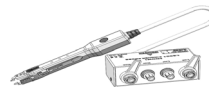

▼ Pincher type

Measurable range: DC to 8 MHz
 Maximum applied voltage: ± 42 V_{peak} (AC+DC)
 Maximum applied current: ± 1 A_{peak} (AC+DC)
 Electrode tip spacing: 0.3 to approx. 6 mm

9261-10 Test Fixture

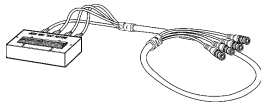

Measurable range: DC to 8 MHz
 Maximum applied voltage: DC ± 40 V
 Measurement terminal hole diameter: 0.3 mm to 1.5 mm

9262 Test Fixture

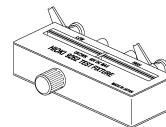

▼ This fixture is for measuring lead components. (less than 10 m Ω residual resistance after zero adjustment)

Measurable range: 42 Hz to 8 MHz
 Maximum applied voltage: DC ± 40 V
 Test sample dimensions: Lead diameter of 0.3 mm to 2 mm
 Lead pitch of 5 mm or more

9263 SMD Test Fixture

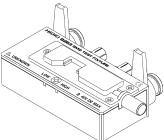

▼ This fixture is for measuring chip components. (less than 10 m Ω residual resistance after zero adjustment)

Measurable range: DC to 8 MHz
 Maximum applied voltage: DC ± 40 V
 Test sample dimensions: Test sample width of 1 to 10 mm

9677 SMD Test Fixture

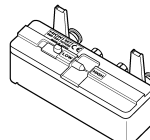

Measurable range: DC to 120 MHz
 Maximum applied voltage: DC ± 40 V
 Test sample width of 3.5 ± 0.5 mm or less

9268-10 DC Bias Voltage Unit

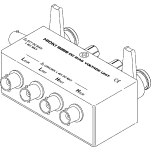

Measurable range: 40 Hz to 8 MHz
 Maximum applied voltage: DC ± 40 V

9269-10 DC Bias Current Unit

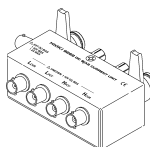

Measurable range: 40 Hz to 2 MHz
 Maximum applied current: DC 2 A

9699 SMD Test Fixture

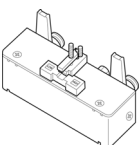

▼ This fixture is for the lower electrode.

Measurable range: DC to 120 MHz
 Maximum applied voltage: DC ± 40 V
 Test sample dimensions: Test sample width of 1 to 4 mm
 Test sample height of 1.5 mm or less

IM9100 SMD Test Fixture

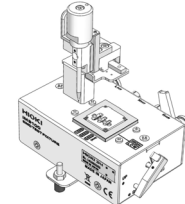

Measurable range: DC to 8 MHz
 Maximum applied voltage: ± 42 V_{peak} (AC+DC)
 Maximum applied current: ± 0.15 A rms (± 0.15 ADC)
 Measurement test sample dimensions: 0.4 \times 0.2 mm, 0.6 \times 0.3 mm, 1.0 \times 0.5 mm

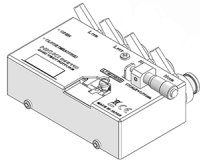
IM9110 SMD Test Fixture

Measurable range: DC to 1 MHz
 Maximum applied voltage: ± 42 V_{peak} (AC+DC)
 Maximum applied current: ± 0.15 A rms (± 0.15 ADC)
 Measurement test sample dimensions: 0.25×0.125×0.125mm

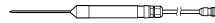
9478 Temperature Probe

Platinum resistance bulb (Pt100), waterproof design (EN60529:1991, IP67)
 Measurable range: -10.0°C to 99.9°C
 Tip diameter: $\phi 2.3$ mm
 Cord length: 1 m

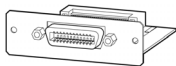
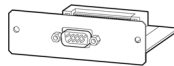
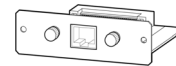
**Z3000
GP-IB Interface****Z3001
RS-232C Interface****Z3002
LAN Interface**

Safety Information

! WARNING This instrument is designed to comply with IEC 61010 Safety Standards, and has been thoroughly tested for safety prior to shipment. However, mishandling during use could result in injury or death, as well as damage to the instrument. However, using the instrument in a way not described in this manual may negate the provided safety features.
 Be certain that you understand the instructions and precautions in the manual before use. We disclaim any responsibility for accidents or injuries not resulting directly from instrument defects.

This manual contains information and warnings essential for safe operation of the instrument and for maintaining it in safe operating condition. Before using it, be sure to carefully read the following safety precautions.



Safety Symbols

	In the manual, the symbol indicates particularly important information that the user should read before using the instrument. The symbol printed on the product indicates that the user should refer to a corresponding topic in the manual (marked with the symbol) before using the relevant function.
	Indicates AC (Alternating Current).
	Indicates the ON side of the power switch.
	Indicates the OFF side of the power switch.

The following symbols in this manual indicate the relative importance of cautions and warnings.

	Indicates that incorrect operation presents a significant hazard that could result in serious injury or death to the user.
	Indicates that incorrect operation presents a significant hazard that could result in serious injury or death to the user.
	Indicates that incorrect operation presents a possibility of injury to the user or damage to the product.
	Advisory items related to performance or correct operation of the product.

Symbols for Various Standards

	WEEE marking: This symbol indicates that the electrical and electronic appliance is put on the EU market after August 13, 2005, and producers of the Member States are required to display it on the appliance under Article 11.2 of Directive 2002/96/EC (WEEE).
	Indicates that the product conforms to regulations set out by the EU Directive.

Notation

Symbols in this manual

	Indicates the prohibited action.
(p.)	Indicates the location of reference information.
*	Indicates that descriptive information is provided below.
[]	Menus, commands, dialogs, buttons in a dialog, and other names on the screen and the keys are indicated in brackets.
CURSOR (Bold character)	Bold characters within the text indicate operating key labels.
Windows	Unless otherwise specified, "Windows" represents Windows 95, 98, Me, Widows NT4.0, Windows 2000, Windows XP, Windows Vista or Windows 7.
Dialogue	Dialogue box represents a Windows dialog box.

Accuracy

We define measurement tolerances in terms of f.s. (full scale), rdg. (reading), dgt. (digit) and setting values, with the following meanings:

f.s. (maximum display value or scale length)	The maximum displayable value or scale length. This is usually the name of the currently selected range.
rdg. (reading or displayed value)	The value currently being measured and indicated on the measuring instrument.
dgt. (resolution)	The smallest displayable unit on a digital measuring instrument, i.e., the input value that causes the digital display to show a "1" as the least-significant digit.
Setting	Indicates the value set as the output voltage, current, or other quantity.

Measurement categories

To ensure safe operation of measurement instruments, IEC 61010 establishes safety standards for various electrical environments, categorized as CAT II to CAT IV, and called measurement categories. These are defined as follows.

CAT II	Primary electrical circuits in equipment connected to an AC electrical outlet by a power cord (portable tools, household appliances, etc.) CAT II covers directly measuring electrical outlet receptacles.
CAT III	Primary electrical circuits of heavy equipment (fixed installations) connected directly to the distribution panel, and feeders from the distribution panel to outlets.
CAT IV	The circuit from the service drop to the service entrance, and to the power meter and primary over-current protection device (distribution panel).

Using a measurement instrument in an environment designated with a higher-numbered category than that for which the instrument is rated could result in a severe accident, and must be carefully avoided.

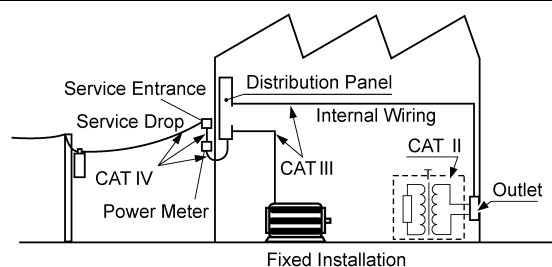

Operating Precautions



Follow these precautions to ensure safe operation and to obtain the full benefits of the various functions.

Preliminary Checks

Before using the instrument for the first time, verify that it operates normally to ensure no damage occurred during storage or shipping. If you find any damage, contact your authorized Hioki distributor or reseller.



Before using the instrument, make sure that the insulation on the voltage cords is undamaged and that no bare conductors are improperly exposed. Using the instrument in such conditions could cause an electric shock, so contact your dealer or Hioki representative for replacements.

Instrument Installation

Operating temperature and humidity:

0 to 40°C (32 to 104°F), 20 to 80% RH or less, Indoors (non-condensating)

Storing temperature and humidity:

-10 to 55°C (14 to 131°F) 20 to 80% RH or less, Indoors (non-condensating)

Temperature and humidity range for guaranteed accuracy, 23±5°C, RH or less

Avoid the following locations that could cause an accident or damage to the instrument.



Exposed to direct sunlight
Exposed to high temperature



In the presence of corrosive or explosive gases



Exposed to water, oil, other chemicals, or solvents
Exposed to high humidity or condensation



Exposed to strong electromagnetic fields
Near electromagnetic radiators



Exposed to high levels of particulate dust



Near induction heating systems
(e.g., high-frequency induction heating systems and IH cooking utensils)



Subject to vibration

To prevent overheating, be sure to leave the specified clearances around the instrument.

- The instrument should be operated only with the bottom or rear side downwards.
- The instrument must not be placed on an unstable table or tilted surface.
- Vents must not be obstructed.

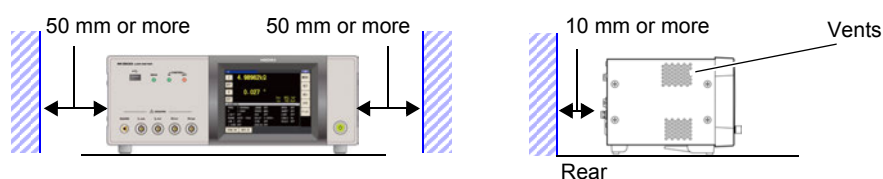

The instrument can be used with the stand (p. 11).
It can also be rack-mounted (p.A15).

Shipping precautions

Hioki disclaims responsibility for any direct or indirect damages that may occur when this instrument has been combined with other devices by a systems integrator prior to sale, or when it is resold.

Handling the Instrument** DANGER**

- To avoid electric shock, do not remove the instrument's case. The internal components of the instrument carry high voltages and may become very hot during operation.
- Do not allow the instrument to get wet, and do not take measurements with wet hands. This may cause an electric shock.

 CAUTION

- If the instrument exhibits abnormal operation or display during use, review the information in "Inspection, Repair and Cleaning" (p. 355) and "Error display" (p. 362) before contacting your dealer or Hioki representative. Note that the instrument may be damaged if the applied voltage or current exceeds the measurement range.
- This instrument is not designed to be entirely water- or dust-proof. Do not use it in an especially dusty environment, nor where it might be splashed with liquid. This may cause damage.
- To avoid damage to the instrument, protect it from physical shock when transporting and handling. Be especially careful to avoid physical shock from dropping.
- Do not apply heavy downward pressure with the stand extended. The stand could be damaged.
- Do not use excessive force on the touch panel, and do not use sharp objects that could damage the touch screen.
- After use, always turn OFF the power.

NOTE

This instrument may cause interference if used in residential areas. Such use must be avoided unless the user takes special measures to reduce electromagnetic emissions to prevent interference to the reception of radio and television broadcasts.

Before Turning Power On** WARNING**

- Before turning the instrument on, make sure the supply voltage matches that indicated on its power connector. Connection to an improper supply voltage may damage the instrument and present an electrical hazard.
- Be careful to avoid connecting the supply voltage improperly. Doing so may damage the instrument's internal circuitry.
- To avoid electrical accidents and to maintain the safety specifications of this instrument, connect the power cord only to a 3-contact (two-conductor + ground) outlet.
- To avoid shock and short circuits, turn off the power to lines to be measured before making connections to terminals to be measured and turning on the instrument.

About Handling of Cords, Fixtures and Temperature probes

CAUTION

- For safety reasons, disconnect the power cord when the instrument is not used. To avoid damaging the power cord, grasp the plug, not the cord, when unplugging it from the power outlet.
- Do not apply a voltage to the measurement terminals. Doing so may damage the instrument.
- When disconnecting the BNC connector, be sure to release the lock before pulling off the connector. Forcibly pulling the connector without releasing the lock, or pulling on the cable, can damage the connector.
- To avoid breaking the cables or probes, do not bend or pull them.
- Avoid stepping on or pinching cables, which could damage the cable insulation.
- Keep the cables well away from heat sources, as bare conductors could be exposed if the insulation melts. Keep in mind that, in some cases, conductors to be measured may be hot.
- The sensor used in the temperature probe is a thin, precision platinum film. Be aware that excessive voltage pulses or static discharges can destroy the film.
- Avoid subjecting the temperature probe tip to physical shock, and avoid sharp bends in the leads. These may damage the probe or break a wire.
- When measuring high temperatures, do not let the handle of the temperature probe or the compensation lead wire exceed the temperature range.
- The temperature probe has a protective nylon cap fitted on the end of the probes. Remove the cap before using the probe.
- Put the protective cap back on the connector when not in use. If the protective cap is not properly inserted, dust or other foreign matter may enter the connector and cause damage.
- The sheath of the temperature probe is filled with magnesium oxide powder. If the probe is broken, the magnesium oxide powder may spill out. Be careful not to subject the sheath to excess stress. Inhaling large quantities of magnesium oxide may be hazardous to your health.

NOTE

- Use only the specified connection cables. Using a non-specified cable may result in incorrect measurements due to poor connection or other reasons.
- Before using a fixture or the like, read the instruction manual supplied with the product to be used.

Before Connecting EXT I/O

WARNING

To avoid electric shock or damage to the equipment, always observe the following precautions when connecting to the EXT I/O connector.

- Always turn off the power to the instrument and to any devices to be connected before making connections.
- Be careful to avoid exceeding the ratings of external terminals (p. 326).
- During operation, a wire becoming dislocated and contacting another conductive object can be serious hazard. Use screws to secure the external connectors.
- Properly insulate any devices and mechanisms to be connected to the EXT I/O connector.
- The ISO_5V pin of the EXT I/O connector is a 5V power output. Do not apply external power to this pin.

Input modules (option)**Before replacing the input module**

- Use a common ground for both the instrument and the computer. Using different ground circuits will result in a potential difference between the instrument's ground and the computer's ground. If the communications cable is connected while such a potential difference exists, it may result in equipment malfunction or failure.
- Before connecting or disconnecting any the communications cable, always turn off the instrument and the computer. Failure to do so could result in equipment malfunction or damage.
- After connecting the communications cable, tighten the screws on the connector securely. Failure to secure the connector could result in equipment malfunction or damage.
- To avoid electric shock accident, before removing or replacing an input module, confirm that the instrument is turned off and that the power cord and connection cables are disconnected.
- Always turn both devices OFF when connecting and disconnecting an interface connector. Otherwise, an electric shock accident may occur.

When not using an input module (option)

To avoid the danger of electric shock, never operate the instrument with an input module removed. To use the instrument after removing an input module, be sure to attach the blank panel.

Handling the LCR Application Disk

- Always hold the disc by the edges, so as not to make fingerprints on the disc or scratch the printing.
- Never touch the recorded side of the disc. Do not place the disc directly on anything hard.
- Do not wet the disc with volatile alcohol or water, as there is a possibility of the label printing disappearing.
- To write on the disc label surface, use a spirit-based felt pen. Do not use a ball-point pen or hard-tipped pen, because there is a danger of scratching the surface and corrupting the data. Do not use adhesive labels.
- Do not expose the disc directly to the sun's rays, or keep it in conditions of high temperature or humidity, as there is a danger of warping, with consequent loss of data.
- To remove dirt, dust, or fingerprints from the disc, wipe with a dry cloth, or use a CD cleaner. Always wipe from the inside to the outside, and do no wipe with circular movements. Never use abrasives or solvent cleaners.
- Hioki shall not be held liable for any problems with a computer system that arises from the use of this LCR Application Disk, or for any problem related to the purchase of a Hioki product.

Overview

Chapter 1

1

Chapter 1 Overview

1.1 Product Overview Features

The HIOKI IM3533 and IM3533-01 LCR METER is an impedance measuring instrument which achieves high speed and high accuracy.

With measurement frequencies of 1 MHz to 200 kHz and measurement signal levels of 5 mV to 5 V, the instrument allows you to configure a broad range of measurement conditions. Additionally, features such as a dedicated transformer and coil measurement screen, DC resistance measurement with temperature correction, and a ANALYZER function (IM3533-01 only) make the IM3533 and IM3533-01 excellent choices for use in a wide range of applications, from transformer and coil production lines to research and development.

Wide range of measurement conditions (p. 50)

Capable of measurement under a wide range of measurement conditions: measurement frequencies from 1 mHz to 200 kHz and measurement signal levels from 5 mV to 5 V.

Capable of high-speed measurement

The IM3533 and IM3533-01 can perform measurements at speeds of up to 2 ms (typical values).

ANALYZER mode (IM3533-01 only) (p. 149)

The IM3533-01's frequency sweep function lets you measure frequency characteristics (list display only).

TRANSFORMER mode (p. 193)

A dedicated screen allows you to measure transformers, coils, and other windings quickly and efficiently.

CONTINUOUS measurement mode (p. 209)

Capable of consecutive measurements using measurement conditions stored in the memory of the instrument. This function enables, for example, making pass/fail judgment with different measurement conditions. (Example: Performing C-D measurement with 120 Hz and Rs measurement with 100 kHz in succession)

Various interfaces supported

Supports the most suitable external I/O (handler interface) for production lines, USB, GP-IB, RS-232C and LAN.
*GP-IB, RS-232C, and LAN interfaces are optional.



Comparator function

LCR mode: (p. 102)
Capable of making HI/IN/LO pass/fail judgments based on the measurement values for two parameters.
TRANSFORMER mode: (p. 193)
Capable of making HI/IN/LO pass/fail judgments for calculation parameters.

BIN function (p. 109)

With LCR mode, easily ranks measurement items into up to 10 classifications based on the measurement values.

Low impedance can be measured with high degree of accuracy

LCR mode includes a setting for measuring low impedance with a high degree of accuracy.

Temperature correction function

The temperature correction function lets you perform even more precise DC resistance measurement.

1.2 Names and Functions of Parts

Front

(Example: IM3533)

Measurement LEDs

Lights during measurement.

Judgment Result Indication LEDs

Indicates the judgment results for comparator and BIN measurement.
LCR mode (p. 102)
TRANSFORMER mode (p. 193)

LCD Display

This is a touch panel display.
Press the keys displayed on the screen to operate the instrument.

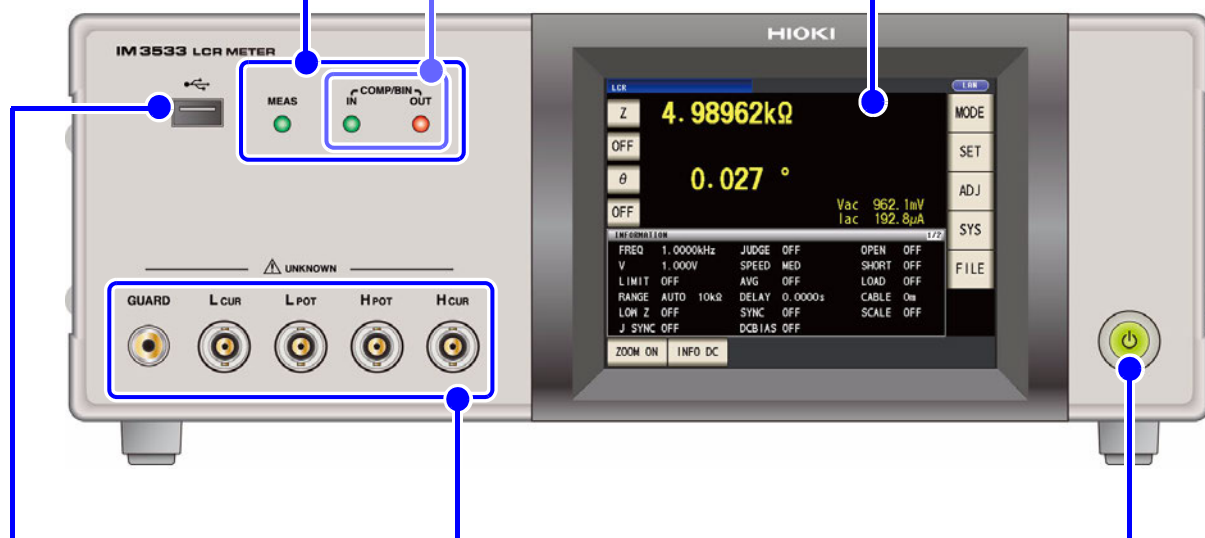

Front USB connector

Connect a USB flash drive storage device. (p. 274)

Measurement Terminals

Connect measurement cables or a fixture. (p. 32)

- H_{CUR} jack: Current source terminal
- H_{POT} jack: Detected voltage high terminal
- L_{POT} jack: Detected voltage low terminal
- L_{CUR} jack: Measurement current detected terminal
- GUARD jack: Shield (measurement ground) terminal

Standby Key

Toggle standby state (p. 35)
(The main power switch is located at the rear.)

Bottom Panel



This instrument can be rack mounted.

See "Appendix10 Rack Mounting"(p. A15)

Parts removed from this instrument should be stored in a safe place to enable future reuse.

Rear

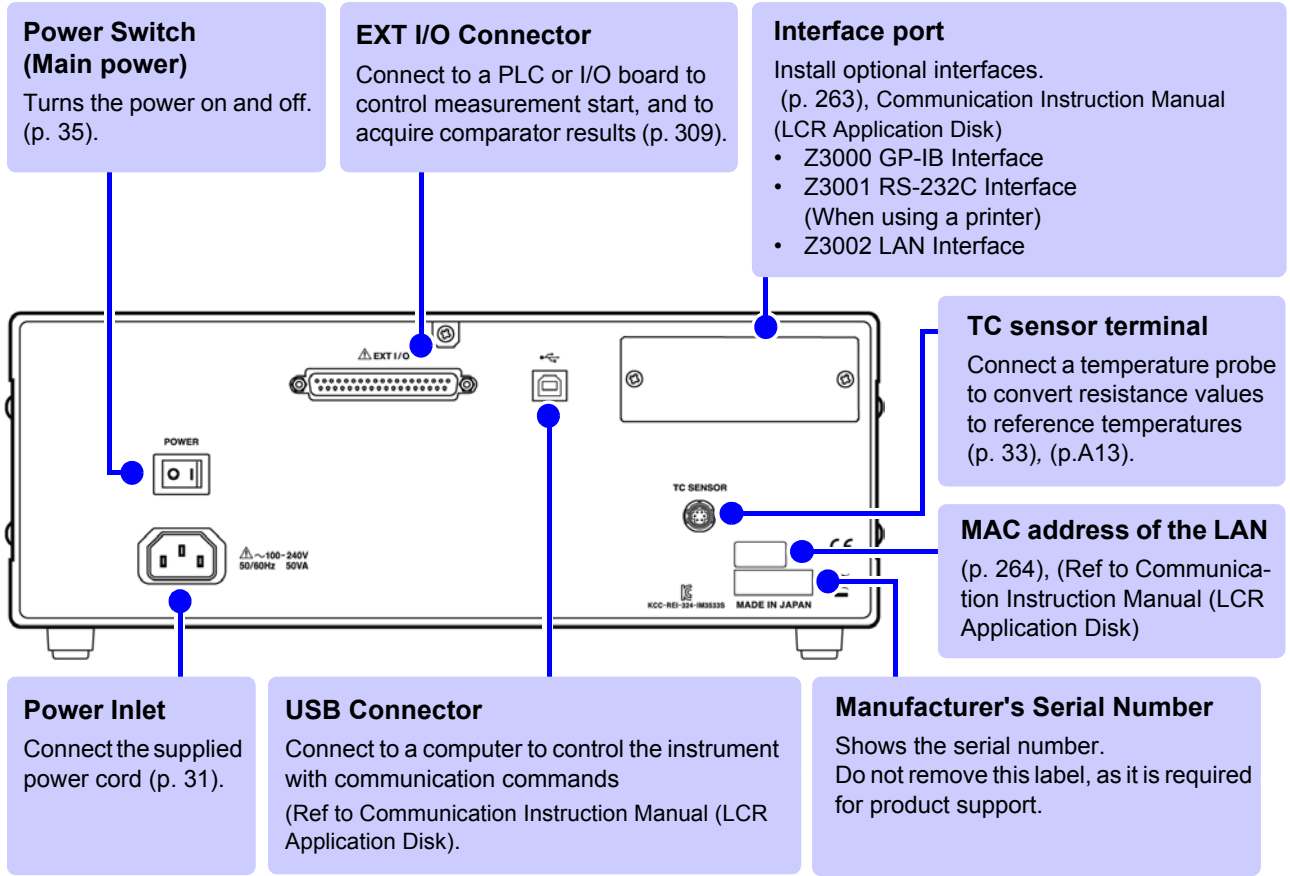

Left side

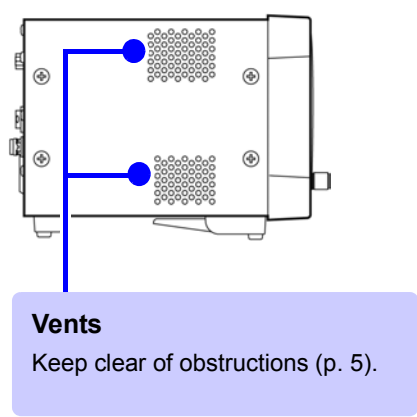

Right side

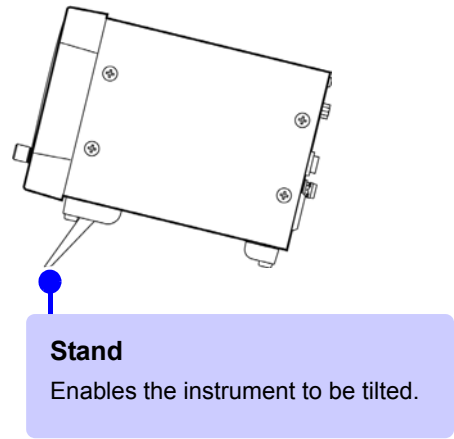

CAUTION Do not apply heavy downward pressure with the stand extended. The stand could be damaged.

1.3 Screen Configuration and Operation

This instrument allows you to use a touch panel to set and change all measurement conditions. Gently touch a key on the screen to select the item or numerical value set for that key. A selected key turns black.

In this manual, to gently touch the screen is referred to as "press".

CAUTION Do not use excessive force on the touch panel, and do not use sharp objects that could damage the touch screen.

1.3.1 Initial Screen

This is the screen that is first displayed when the power is turned on. It allows you to perform measurement while checking the measurement conditions. When the power is turned on again, display is in accordance with the measurement mode used immediately before the power was turned off.

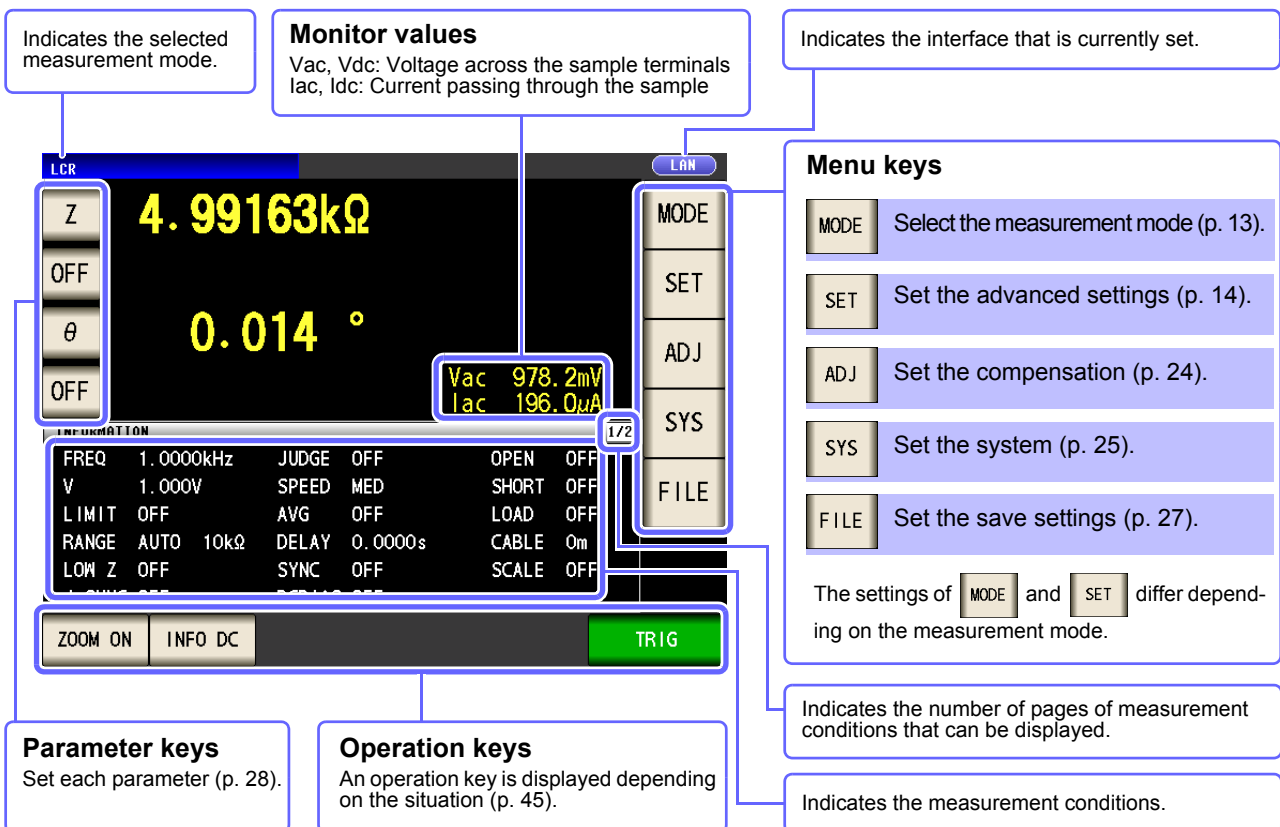

1.3.2 Measurement Mode Selection Screen

Select the measurement mode.

Procedure

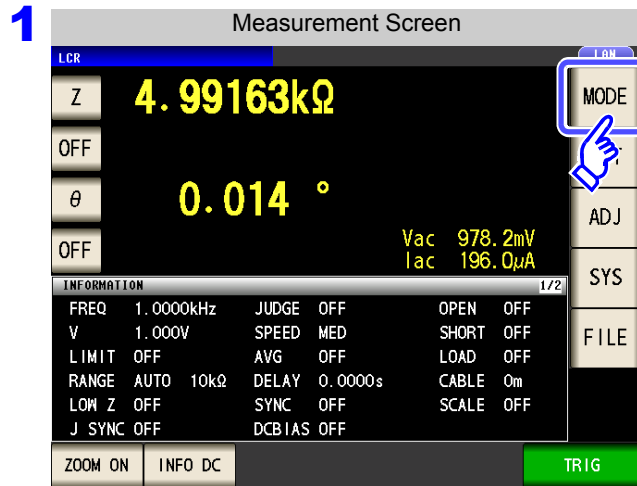

Press MODE .

2 When IM3533

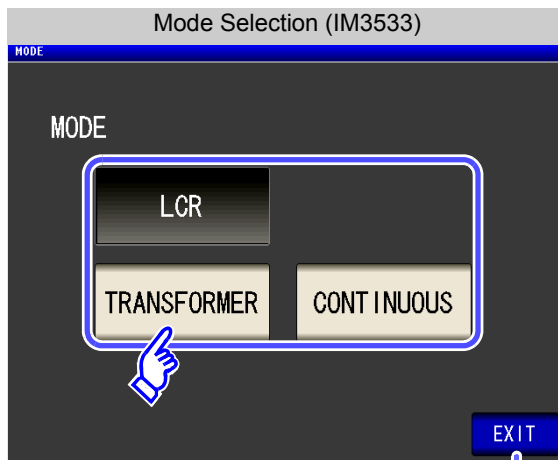

When IM3533-01

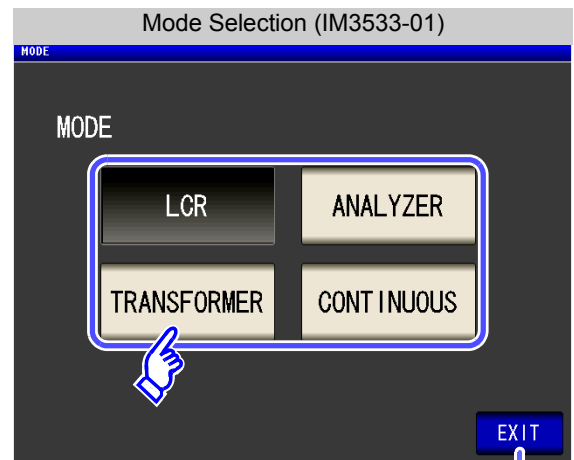

Displays the measurement screen for the selected mode.

Select the measurement mode.

LCR	LCR mode (p. 45)
ANALYZER	ANALYZER mode (IM3533-01 only) (p. 149)
TRANSFORMER	TRANSFORMER mode (p. 193)
CONTINUOUS	CONTINUOUS measurement mode (p. 209)

NOTE After changing the measurement mode, check all settings (including compensation) before performing measurement.

1.3.3 Advanced Settings Screen

This screen is for configuring the measurement conditions you want to change and other advanced settings. Select the measurement mode (p. 13) before configuring the advanced settings.

Procedure

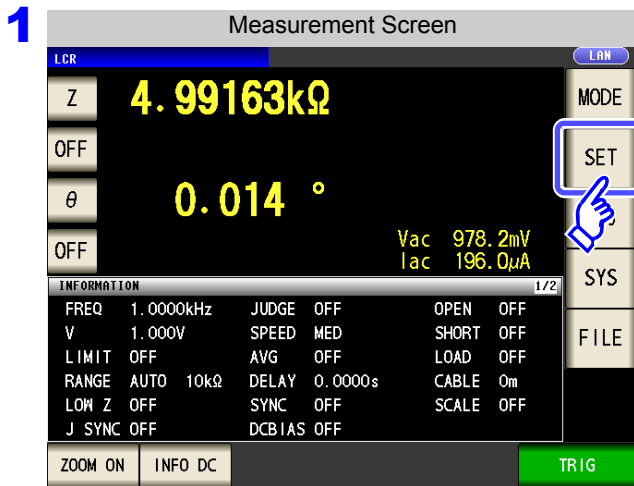

Press **SET**.

2 Configure settings for LCR mode, TRANSFORMER mode, and CONTINUOUS measurement mode. On the IM3533-01, you can also configure ANALYZER mode settings.

LCR Mode

Basic setting



LCR mode measurement screen is displayed.

FREQ Measurement frequency setting (p. 50)

LEVEL Measurement signal level setting (p. 52)

LIMIT Voltage and current limit settings (p. 56)

DC BIAS DC bias setting (p. 58)

TRIG Trigger setting (p. 60)

RANGE Measurement range setting (p. 62)

SPEED Measurement speed setting (p. 73)

AVG Average setting (p. 74)

DELAY Trigger delay setting (p. 76)

SYNC Trigger synchronous output function setting (p. 77)

DC resistance measurement setting



LCR mode measurement screen is displayed.

TEMP ADJ	Temperature correction function setting (p. 81)
DC DELAY	DC delay setting (p. 83)
ADJ DELAY	Adjustment delay setting (p. 85)
LINE FREQ	Line frequency setting (p. 87)
RANGE	Measurement range setting (p. 88)
SPEED	Measurement speed setting (p. 98)
AVG	Average setting (p. 99)

Application settings



LCR mode measurement screen is displayed.

- JUDGE** Measurement result judgment setting (p. 100)
- RNG SYNC** Range synchronization function setting (p. 120)
- WAVE NUM** Waveform averaging function setting (p. 128)
- Hi Z** HIGH-Z reject function setting (p. 130)
- CONTACT** Contact check function setting (p. 132)
- IO JUDGE** I/O output setting of judgment results (p. 134)
- IO TRIG** I/O trigger setting (p. 136)
- IO EOM** $\overline{\text{EOM}}$ Output Method Setting (p. 137)
- MEMORY** Save settings of measurement results (p. 138)
- DIGIT** Number of display digits setting for each parameter (p. 140)
- DISP** LCD setting (p. 142)
- BEEP** Beep sound setting (p. 143)
- KEYLOCK** Key-lock setting (p. 144)
- PANEL** Panel loading and saving (p. 249)
- RESET** System reset (p. 147)

Checking the setting information

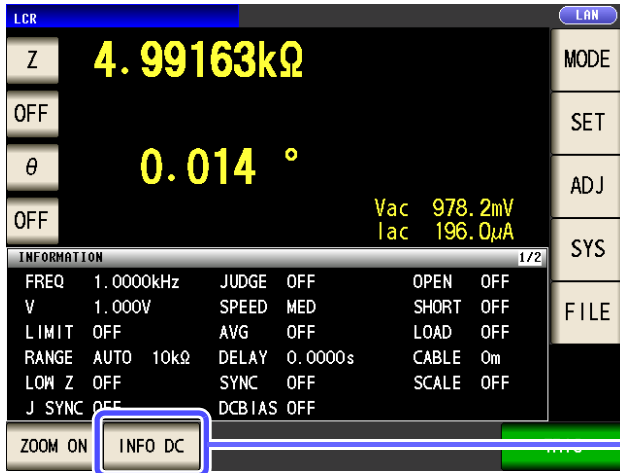

You can check the settings on the measurement screen.

The key display will vary depending on what type of information is being displayed.

INFO AC Displays information regarding the AC signal.

INFO DC Displays information regarding the DC signal.

When using comparator measurement

INFO AC Displays information about comparator measurement judgment standards.

When using BIN measurement

INFO BIN Displays information about BIN measurement judgment standards.

When displaying AC signal (AC) information



When displaying DC signal (DC) information



When displaying information about comparator measurement judgment standards

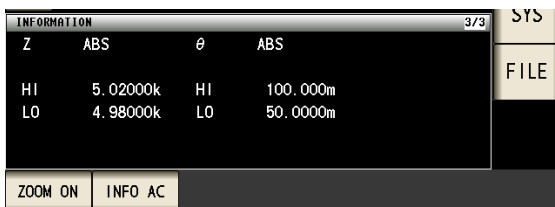

When displaying information about BIN measurement judgment standards

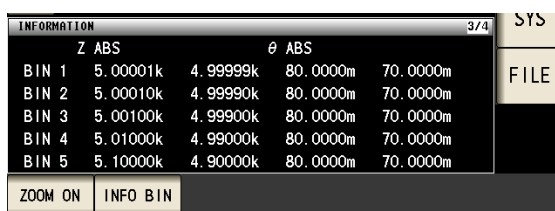

ANALYZER Mode (IM3533-01 only)

Basic setting

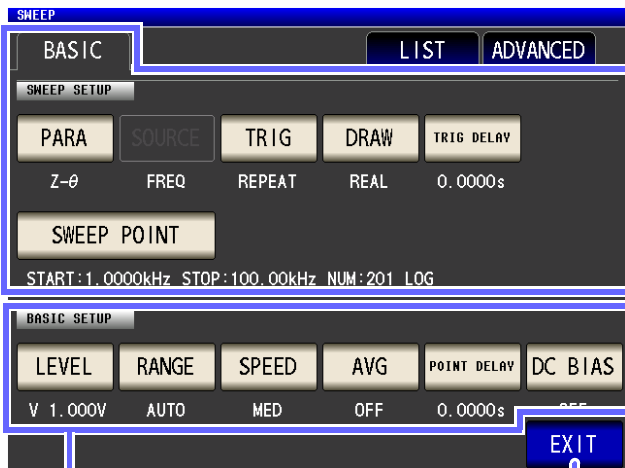

ANALYZER mode measurement screen is displayed.

- PARA** Measurement parameter setting(p. 150)
- TRIG** Trigger setting (p. 151)
- DRAW** Display timing setting(p. 152)
- TRIG DELAY** Trigger delay setting (p. 153)
- SWEET POINT** Sweep point setting (p. 155)

- LEVEL** Measurement signal level setting (p. 158)
- RANGE** Measurement range setting (p. 160)
- SPEED** Measurement speed setting (p. 166)
- AVG** Average setting(p. 167)
- POINT DELAY** Point delay setting (p. 168)
- DC BIAS** DC bias setting (p. 169)

List

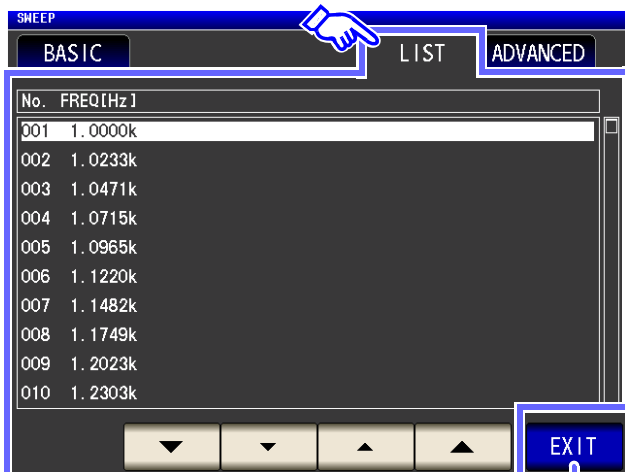

ANALYZER mode measurement screen is displayed.

Application settings

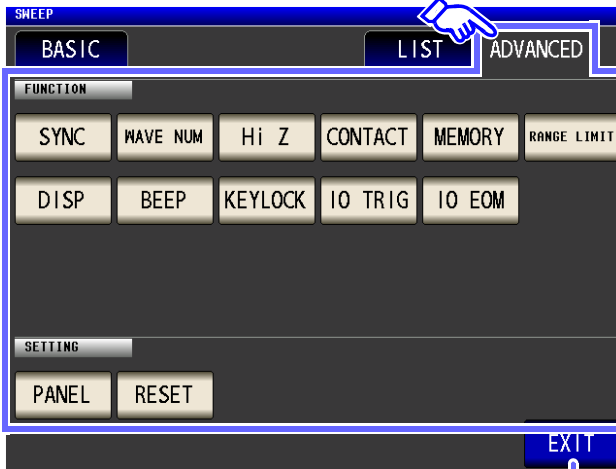

ANALYZER mode measurement screen is displayed.

SYNC	Trigger synchronous output function (p. 171)
WAVE NUM	Waveform averaging function setting (p. 173)
Hi Z	HIGH-Z reject function setting (p. 175)
CONTACT	Contact check function setting (p. 177)
MEMORY	Save settings of measurement results (p. 179)
RANGE LIMIT	AUTO range limit function (p. 182)
DISP	Backlight setting (p. 184)
BEEP	Beep sound setting (p. 185)
KEYLOCK	Key-lock setting (p. 186)
IO TRIG	IO trigger setting (p. 189)
IO EOM	$\overline{\text{EOM}}$ output method setting (p. 190)
PANEL	Panel loading and saving (p. 251)
RESET	System reset (p. 191)

TRANSFORMER Mode

Basic setting



TRANSFORMER mode measurement screen is displayed.

FREQ Measurement frequency setting (p. 50)

LEVEL Measurement signal level setting (p. 52)

LIMIT Voltage and current limit settings (p. 56)

RANGE Measurement range setting (p. 62)

SPEED Measurement speed setting (p. 73)

AVG Average setting (p. 74)

DELAY Trigger delay setting (p. 76)

SYNC Trigger synchronous output function (p. 77)

Application settings



TRANSFORMER mode measurement screen is displayed.

JUDGE	Measurement result judgment setting (p. 199)
RNG SYNC	Range synchronization function setting (p. 120)
WAVE NUM	Waveform averaging function setting (p. 128)
Hi Z	HIGH-Z reject function setting (p. 130)
CONTACT	Contact check function setting (p. 132)
IO JUDGE	I/O output setting of judgment results (p. 134)
IO TRIG	I/O trigger setting (p. 136)
IO EOM	$\overline{\text{EOM}}$ Output Method Setting (p. 137)
MEMORY	Save settings of measurement results (p. 138)
DIGIT	Number of display digits setting for each parameter (p. 140)
DISP	LCD setting (p. 142)
BEEP	Beep sound setting (p. 143)
KEYLOCK	Key-lock setting (p. 144)
PANEL	Panel loading and saving (p. 249)
RESET	System reset (p. 147)

1.3 Screen Configuration and Operation

Checking the setting information

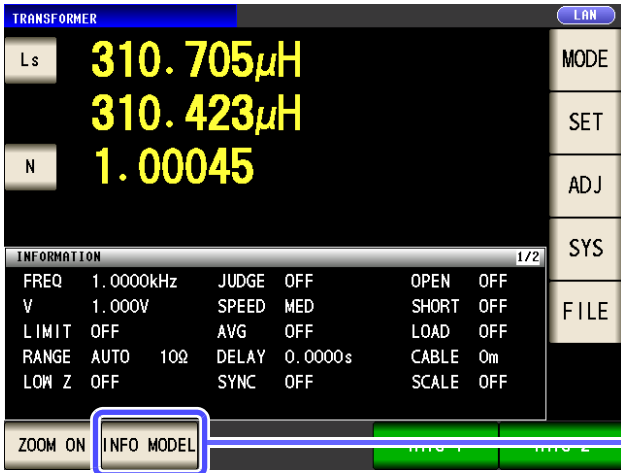

You can check the settings on the measurement screen.

INFO MODEL Displays the transformer model.

INFO AC Displays information regarding the AC signal.

The key display will vary depending on what type of information is being displayed.

When displaying AC signal (AC) information

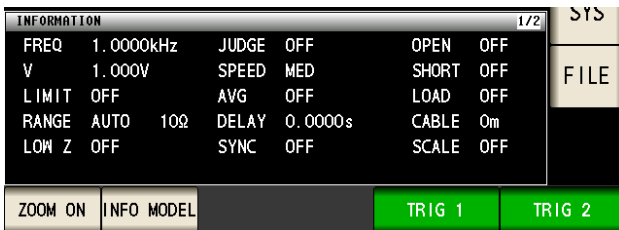

When displaying a transformer model

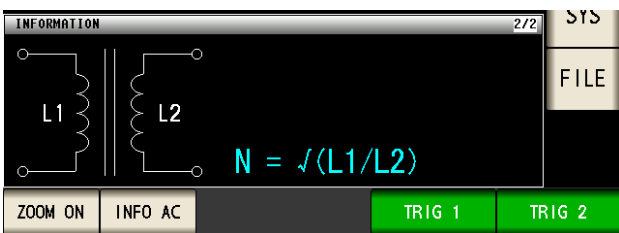

CONTINUOUS Measurement Mode

Basic setting



OFF Removes item from targets for continuous measurement (p. 210)

ON Sets item as target for continuous measurement (p. 210)

ALL OFF Removes all items from targets for continuous measurement (p. 210)

ALL ON Sets all items as targets for continuous measurement (p. 210)

INFO Displays panel information (p. 210)

CONTINUOUS measurement mode measurement screen is displayed.

Application settings

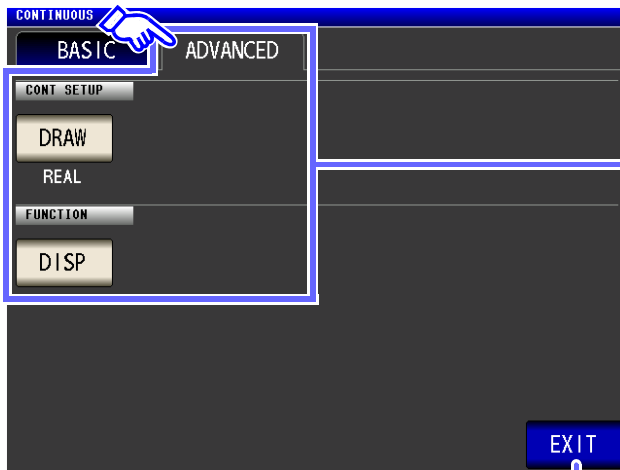

DRAW Display timing setting (p. 213)

DISP LCD setting (p. 214)

CONTINUOUS measurement mode measurement screen is displayed.

1.3.4 Compensation Settings Screen

Procedure

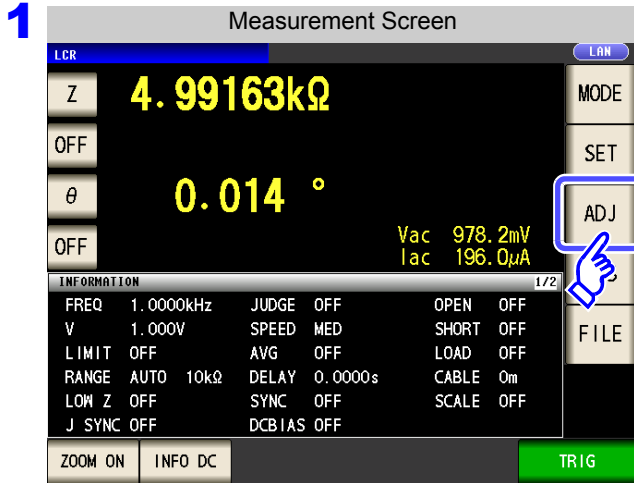

Press **ADJ**.

2 Set the compensation condition.

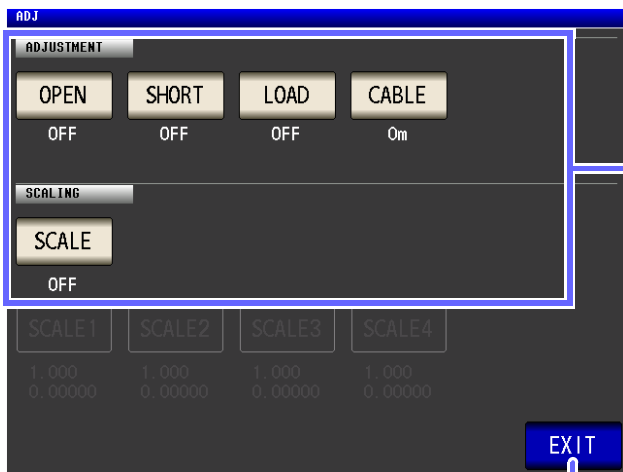

- OPEN** Open circuit compensation setting (p. 215)
- SHORT** Short circuit compensation setting (p. 224)
- LOAD** Load circuit compensation setting (p. 232)
- CABLE** Cable length compensation setting (p. 245)
- SCALE** Scaling setting (p. 246)

Measurement screen is displayed.

1.3.5 System Settings Screen

Procedure

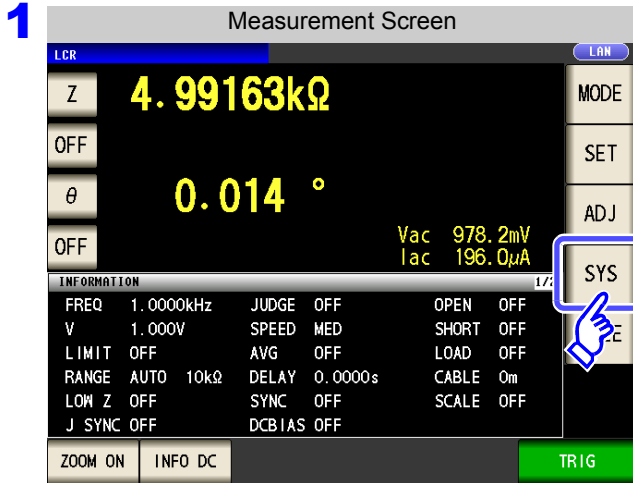

Press **SYS** .

2 To set the details of the system.

Interface type settings

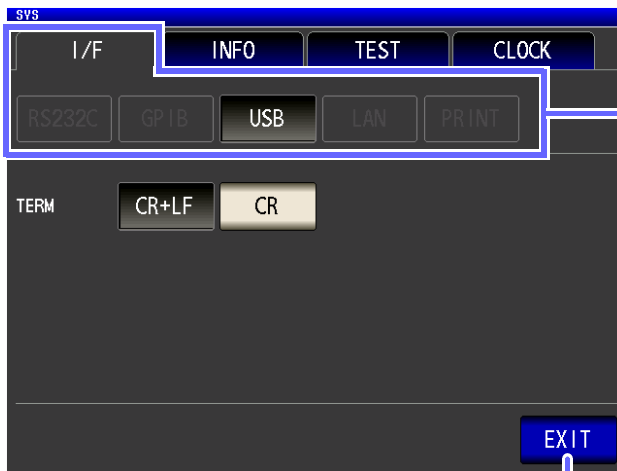

Measurement screen is displayed.

- RS232C** RS-232C Setting
(Ref to Communication Instruction Manual (LCR Application Disk))
(Setting only available when the Z3001 is installed.)
- GPIB** GP-IB Setting
(Ref to Communication Instruction Manual (LCR Application Disk))
(Setting only available when the Z3000 is installed.)
- USB** USB Setting
(Ref to Communication Instruction Manual (LCR Application Disk))
(Standard setting)
- LAN** LAN Setting
(Ref to Communication Instruction Manual (LCR Application Disk))
(Setting only available when the Z3002 is installed.)
- PRINT** Printer Setting (p. 331)
(Setting only available when the Z3001 is installed.)

1.3 Screen Configuration and Operation

Check the version of the instrument (p. 264)

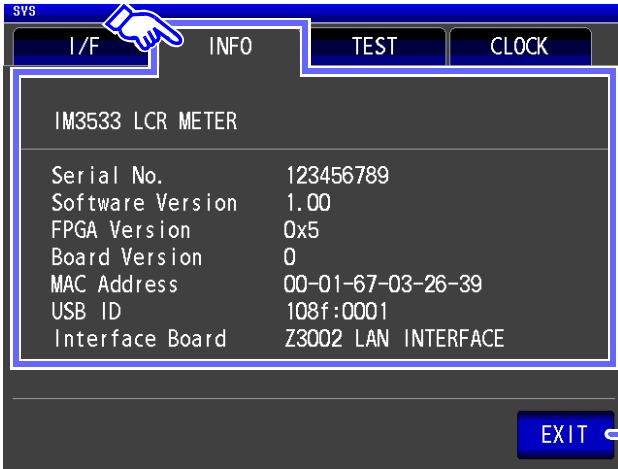

Measurement screen is displayed.

Checking the Display Screen

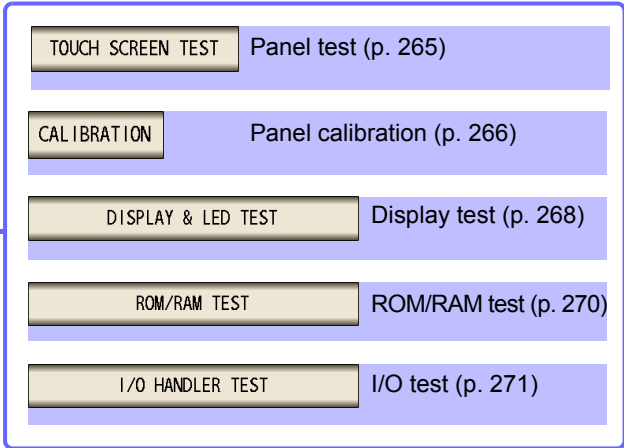
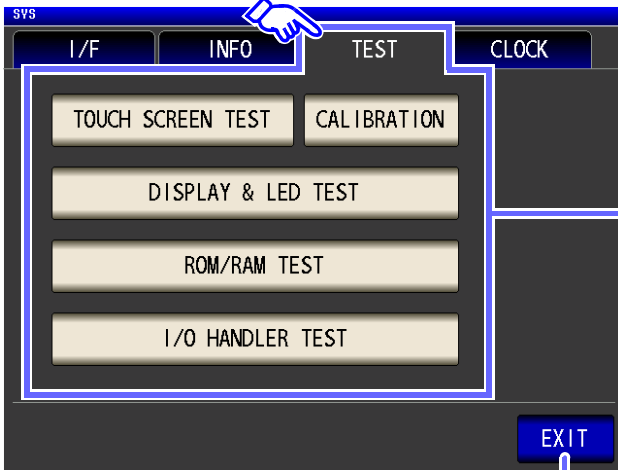

Measurement screen is displayed.

Setting the Date and Time (p. 272)

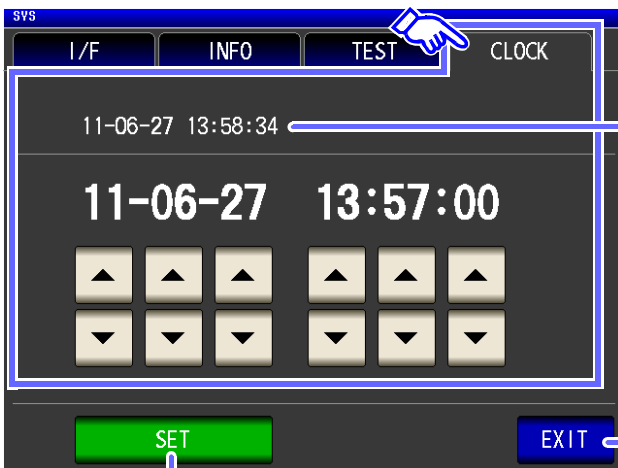

Indicates the current date and time set on the instrument.

Measurement screen is displayed.

Accepts the set time and date.

1.3.6 Save Settings Screen

Procedure

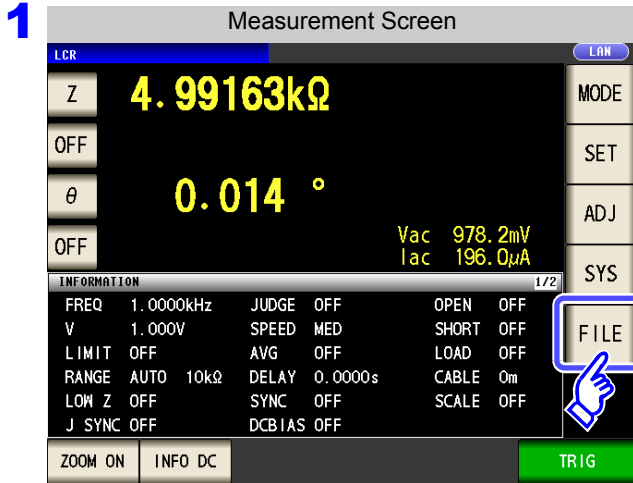

Press **FILE**.

2 Set the save destination and type.

Save the measurement condition

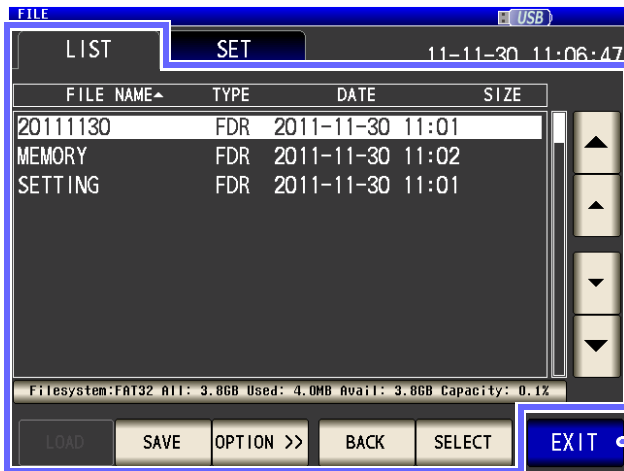

SAVE Saves the setting conditions (p. 293)

OPTION >> Switches operation buttons. (p. 275)

BACK Displays the screen immediately above (p. 275)

SELECT Selects a file (p. 275)

Measurement screen is displayed.

Save method setting

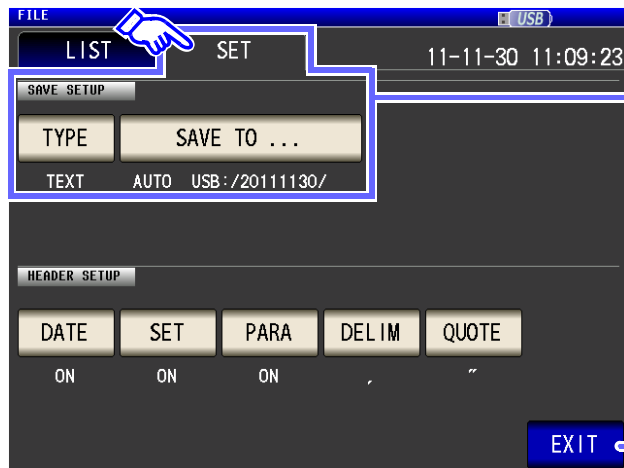

TYPE Save type setting (p. 277)

SAVE TO ... Save destination folder setting (p. 291)

Measurement screen is displayed.

1.3 Screen Configuration and Operation

1.3.7 Parameter Settings Screen

This screen is for selecting the measurement parameters to display.

See "4.1.2 Setting Display Parameters" (p. 47), "Appendix7 Series Equivalent Circuit Mode and Parallel Equivalent Circuit Mode"(p. A11)

Procedure

1 Press the key to set.

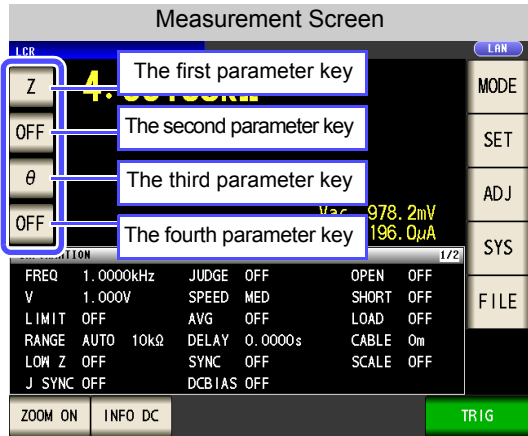

2 Select parameters.

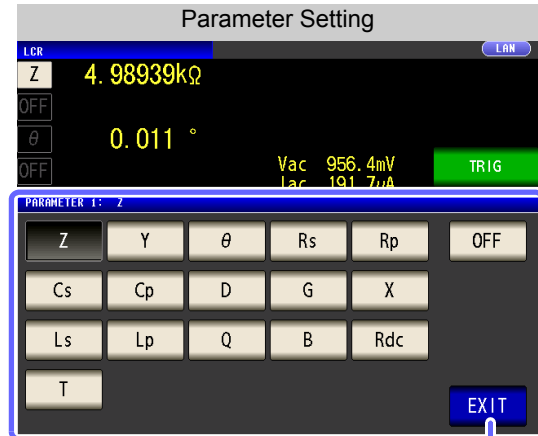

Measurement Screen is displayed.

Z	Impedance (Ω)	X	Reactance (Ω)
Y	Admittance (S)	Ls	Inductance in series equivalent circuit mode (H)
θ	*Impedance phase angle ($^\circ$) *	Lp	Inductance in parallel equivalent circuit mode (H)
Rs	Effective resistance in series equivalent circuit mode ESR = (Ω)	Q	Q factor
Rp	Effective resistance in parallel equivalent circuit mode (Ω)	B	Susceptance (S)
Cs	Static capacitance in series equivalent circuit mode (F)	Rdc	DC Resistance(Ω)
Cp	Static capacitance in parallel equivalent circuit	T	Temperature ($^\circ$ C)
D	Loss coefficient = $\tan\delta$	OFF	Display no measurement parameter in the chosen position.
G	Conductance (S)		

* The phase angle q is shown based on the impedance Z. When performing measurements using admittance Y as the reference, the sign of the impedance Z phase angle will be reversed.

Measurement Preparations

Chapter 2

2

Chapter 2 Measurement Preparations

Be sure to read the "Follow these precautions to ensure safe operation and to obtain the full benefits of the various functions." (p. 5) before installing and connecting this instrument. Refer to "Appendix10 Rack Mounting"(p. A15) for rack mounting.

2.1 Preparation Flowchart

1 Installing the Instrument (p. 5)

2 Connecting the Power Cord (p. 31)

3 Connect measurement cables, optional Hioki probes or test fixture (p. 32)

Check that the instrument's power switch is turned off.

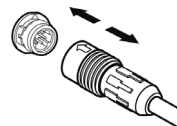
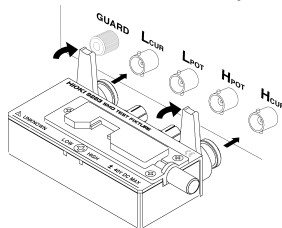

9478 Sheath Type Temperature Probe (Option)

4 Connect the external interface (as needed)

- USB cable
- GP-IB cable (only when the Z3000 is connected)
- Printer (only when the Z3001 is connected) (p. 331)
- RS-232C cable (only when the Z3001 is connected)
- LAN cable (only when the Z3002 is connected)
- EXT I/O (p. 309)

5 Turning Power On (p. 35)

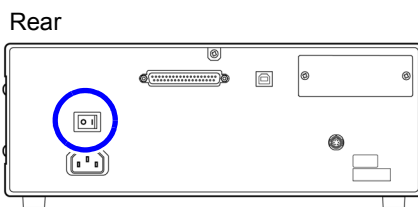

6 Make instrument settings

When measuring DC resistance, be sure to set the line frequency before performing measurement. See "4.3.4 Setting the Line Frequency" (p. 87)

Connect to the test sample

After using the instrument, remove the test sample and turn off the power. (p. 35)

2.2 Pre-Operation Inspection

Please read the "Follow these precautions to ensure safe operation and to obtain the full benefits of the various functions." (p. 5) before use.

Before using the instrument for the first time, verify that it operates normally to ensure that no damage occurred during storage or shipping. If you find any damage, contact your authorized Hioki distributor or reseller.

1 Peripheral Device Inspection

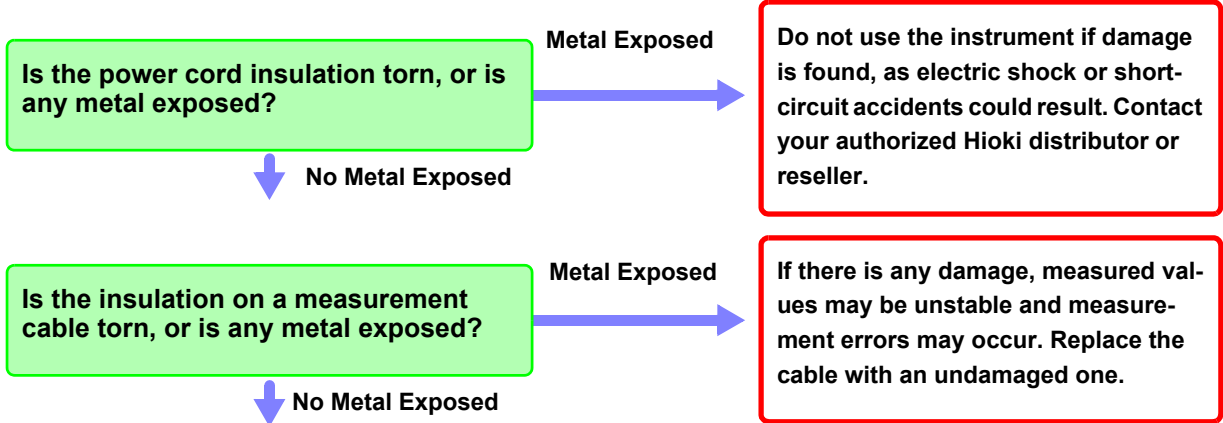

2 Instrument Inspection

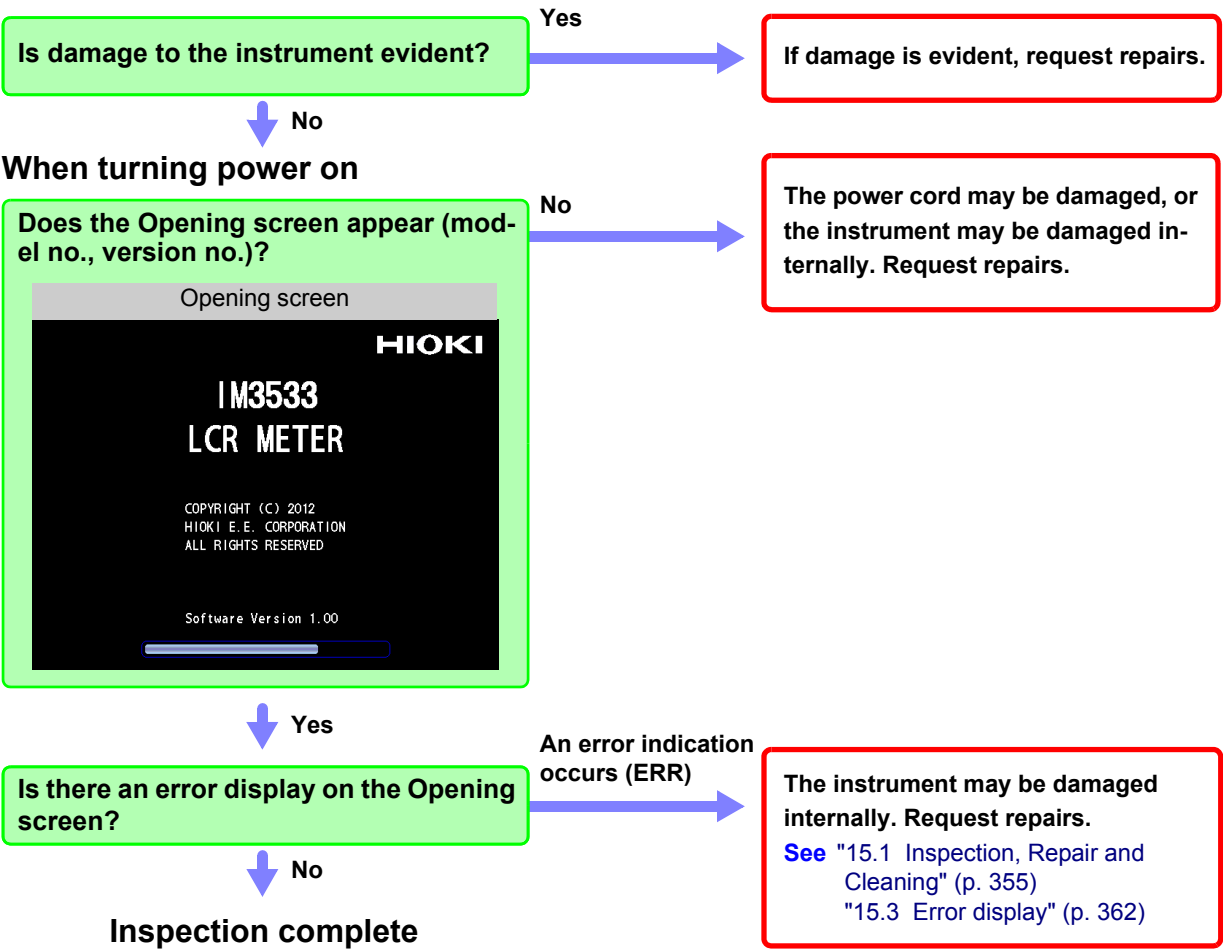

2.3 Connecting the Power Cord



Be sure to read the "Before Turning Power On" (p. 6), "About Handling of Cords, Fixtures and Temperature probes" (p. 7) before connecting power.

Connect the power cord to the power inlet on the instrument, and plug it into an outlet.

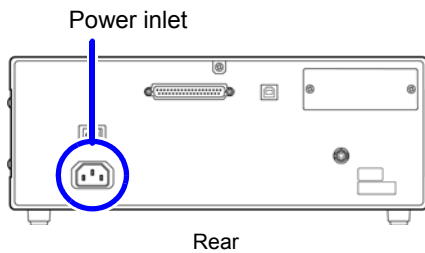

1 Check that the instrument's power switch is turned off.

2 Connect a power cord that matches the line voltage to the power inlet on the instrument. (100 V to 240 VAC)

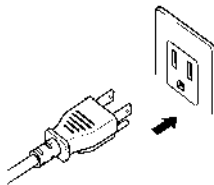

3 Plug the other end of the power cord into an outlet.

Turn off the power before disconnecting the power cord.

2.4 Connecting the Measurement Cables, Probes, or Fixture



Be sure to read the "About Handling of Cords, Fixtures and Temperature probes" (p. 7) before connecting measurement cables, probes or test fixture.

Connect your measurement cables, optional Hioki probes or test fixture to the measurement terminals.

Refer to "Options" (p. 2) for details.
See the instructions provided with the fixture for operating details.

Connecting a measurement cable/fixture

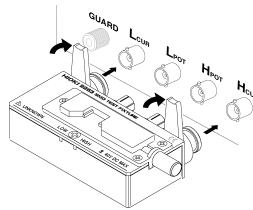

Connect directly to the measurement jacks with the label side up, and affix with the levers on the left and right.

(When using the optional 9140-10 or L2001)
Connect the red plugs to the H_{CUR} and H_{POT} jacks, and the black plugs to the L_{CUR} and L_{POT} jacks.

(When using the optional 9500-10)
BNC plug of H_{CUR}, H_{POT}, L_{CUR} and L_{POT} connected properly to the measurement terminals of each of the instruments.

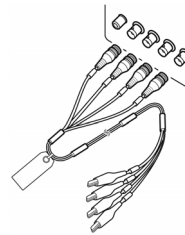
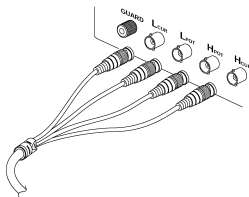

Points to pay attention to when making your own probe

- Use 50 Ω coaxial cable for the measurement cable.
- Ensure that the length of the cable is the same as that set for the instrument.
(IM3533: 1 m, IM3533-01: 1 m/ 2 m/ 4 m)
- The cable length is defined as the length from the tip of the BNC connector to the tip of the probe electrode.
- Make the portion of the core wire that is exposed as short as possible.
- Connect the H_{CUR}, L_{CUR}, H_{POT}, and L_{POT} shield pairs at the measurement object side.
(Ensure that a shield is not connected to a core wire.)

NOTE

- Basically, when you make a probe yourself, it may not be able to satisfy the specifications of this instrument.
See: "Options" (p. 2)
- If all four terminals are disconnected, a meaningless number may be displayed on the unit.

Measurement Terminal Configuration

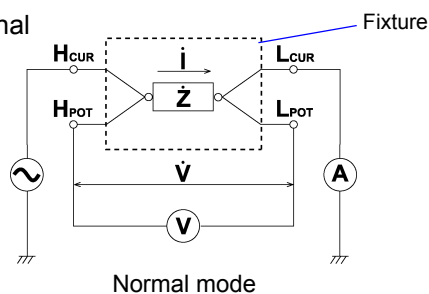

2.5 Connecting a Temperature Probe



Be sure to read the "About Handling of Cords, Fixtures and Temperature probes" (p. 7) before connecting measurement cables, probes or test fixture.

2

Rear

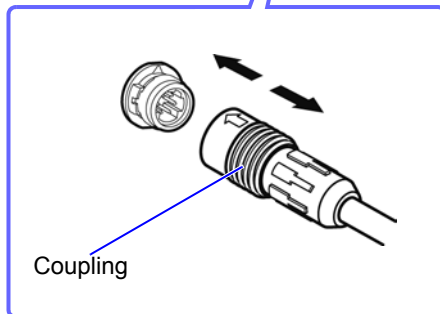
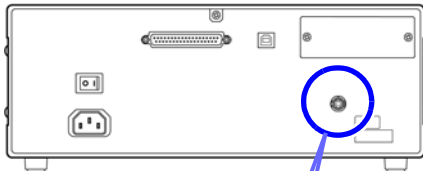

- 1** Check that the instrument's power switch is turned off.
- 2** Holding the connector, orient so that the arrow is on the top and connect to the terminal.
The connector will lock in place with a clicking sound.
- 3** Gently pull on the connector (the part other than the coupling) to verify that it has been connected properly.

When disconnecting the temperature probe:

Grasp the connector's coupling and disconnect the line by pulling straight back.

NOTE

The 9478 Sheath Type Temperature Probe's measurement unit is located at the tip of the metal sheath. When measuring the internal temperature of a target object, insert the metal sheath to a length of at least 40 mm in order to assure accurate measurement, as illustrated below:

OK

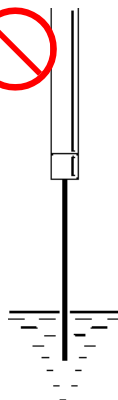
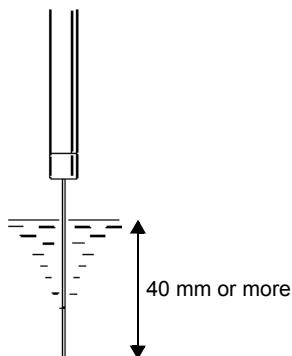

2.6 Connecting an Interface



Be sure to read the "Input modules (option)" (p. 8) before connecting measurement cables, probes or test fixture.

Read this section before installing or replacing an optional interface or removing the interface and using the instrument without it.

Installing an interface

You will need: A Phillips head screwdriver

Rear

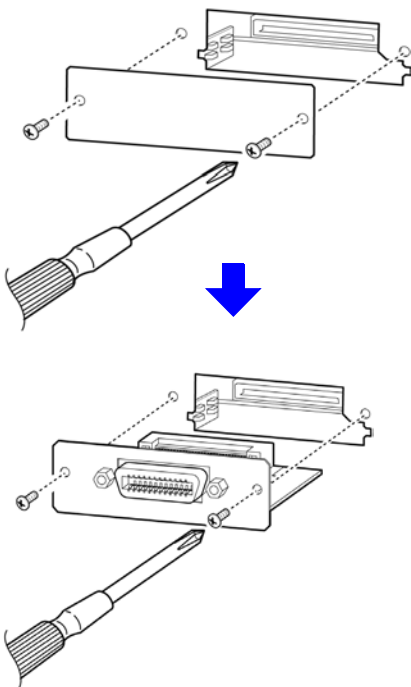

- 1** Unplug the instrument's power cord from the wall outlet. Disconnect connection cords.
- 2** Remove the blank panel.
- 3** Paying attention to the orientation of the interface, inset it firmly into place.
- 4** Secure the interface in place by tightening the two fixing screws with a Phillips head screwdriver.

When removing the interface:

Unplug the power cord from the wall outlet and perform the above procedure in reverse to remove the interface.

When a removed interface will not be used

Rear

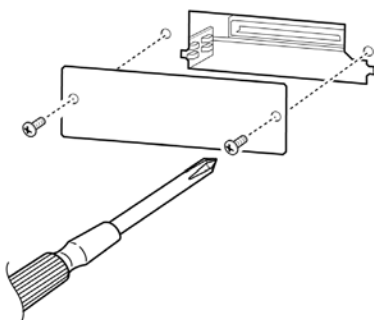

- 1** Unplug the instrument's power cord from the wall outlet. Disconnect connection cords.
- 2** Attach the blank panel and secure it in place by tightening the two fixing screws with a Phillips head screwdriver.

Making measurements without reattaching the blank panel will prevent the instrument from performing to its specifications.

You can check information about the interface installed in the instrument on the screen.

See "10.1 Setting the Interface" (p. 263), "10.2 Checking the Version of the Instrument" (p. 264)

2.7 Turning the Power On and Off



Connect the power cord and voltage and current measurement cables before turning the main power on.

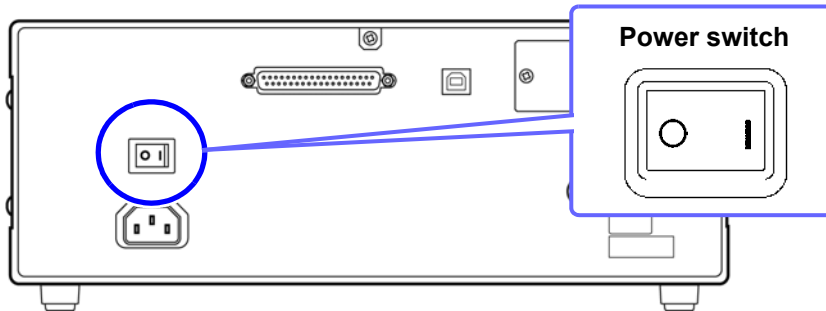

Turning main power on

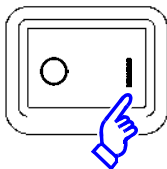

Turn the **POWER switch** on (|).



Lights green

To ensure that measurements fulfill the degree of accuracy described in the specifications, allow at least 60 minutes warm-up before executing zero adjustment.

NOTE If the main power switch is turned off while the instrument is in the standby state, it will start up in the standby state the next time the main power switch is turned on.

Turning main power off

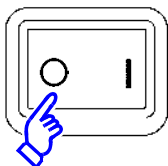

Turn the **POWER switch** off (O).

Instrument settings are retained, even if the POWER switch is turned off (backup function).



OFF

NOTE When the power supply is interrupted by a power failure or the like, the instrument recovers in the measurement mode used before the power failure.

2.7 Turning the Power On and Off

Be on standby

ON the main power in the state, hold down the front Standby Key 2 seconds approximately.



What is the standby state?

The instrument is in the standby state when measurement has been stopped and the instrument is waiting for STANDBY key input to be detected. To allow STANDBY key input to be detected, some internal circuitry is operating with power consumption of approximately 4 W.

To cancel the standby

The instrument is in standby state, press the Standby Key on the front.

To ensure that measurements fulfill the degree of accuracy described in the specifications, allow the instrument to warm up for at least 60 minutes after standby state operation is canceled.



Measurement Example

Chapter 3

This chapter provides example measurement scenarios for LCR mode, ANALYZER mode (IM3533-01 only), and TRANSFORMER mode.

3.1 When LCR Mode

Measuring a Laminated Ceramic Capacitor

Necessary items: 9263 SMD test fixture, Laminated ceramic capacity you want to measure

- 1 Connect the 9263 SMD test fixture to the measurement terminals.

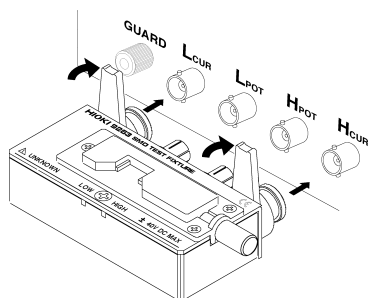

For the connection procedure, refer to the instruction manual supplied with the fixture.

- 2 Set the first parameter to Cs and the third parameter to D. (p. 47)

- 3 Set the measurement conditions.

Touch **SET** on the Measurement screen, select the item you want to set, and set it as follows.

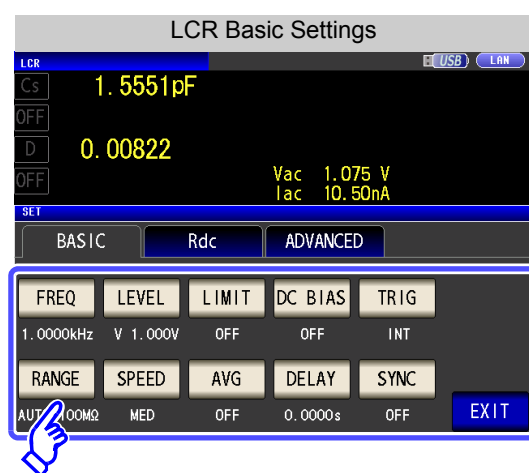

FREQ	Measurement frequency: 1.0000 kHz (p. 50)
LEVEL	Measurement signal mode: Open circuit voltage (V) mode (p. 52) Measurement signal level: 1.000 V (p. 52)
LIMIT	Voltage and current limit: (p. 56)
DC BIAS	DC bias: OFF (p. 58)
TRIG	Trigger: INT(p. 60)
RANGE	Measurement range: AUTO (p. 62)
SPEED	Measurement speed: MED (p. 73)
AVG	Average: OFF (p. 74)
DELAY	Trigger delay: 0.0000 s (p. 76)
SYNC	Trigger synchronous output function setting: OFF (p. 77)

3.1 When LCR Mode

4 Connect the test sample to the 9263 SMD test fixture.

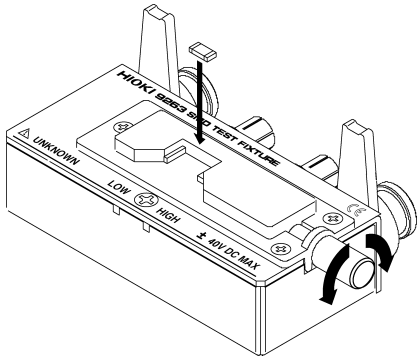

For the connection procedure of the test sample, refer to the instruction manual supplied with the fixture.

5 Check the measurement results.



- When you want to judge the measurement results
[See:](#) "4.4.1 Judging with Upper and Lower Limit Values (Comparator Measurement Mode)" (p. 102)
- When you want to save the measurement results
[See:](#) "4.5.8 Saving Measurement Results (Memory function)" (p. 138)

3.2 When ANALYZER Mode (IM3533-01 only)

In ANALYZER mode, you can sweep through a user-specified range of frequencies.

See "Chapter 5 ANALYZER Function (IM3533-01)" (p. 149)

Measuring Element with Resonance Point

Necessary items: 9262 Test fixture, Element you want to measure

1 Connect the 9262 Test Fixture to the measurement terminals.

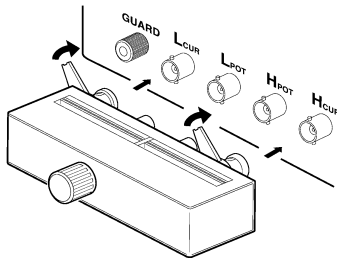

For the connection procedure, refer to the instruction manual supplied with the fixture.

2 Set the measurement conditions.

Touch **SET** on the Measurement screen, select the setting you wish to configure, and configure it as follows.

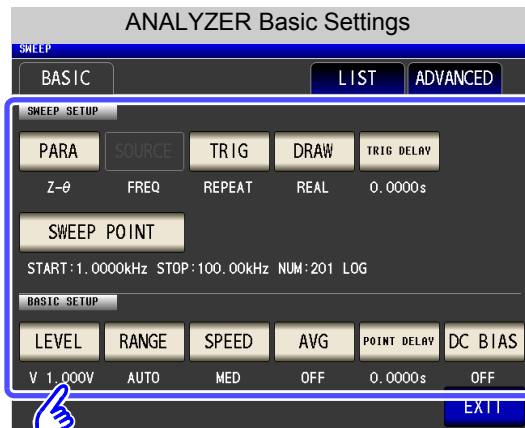

PARAMETER	Parameter: Z-θ (p. 150)
TRIG	Sweep method: REPEAT (p. 151)
DRAW	Draw timing: REAL (p. 152)
TRIG DELAY	Trigger delay: 0.0000 s (p. 153)
SWEEP POINT	Sweep range: 1.0000 kHz to 100.00 kHz (p. 155) No. of sweep points: 201 Setting method: LOG
LEVEL	Measurement signal mode: Open voltage (V) mode (p. 158) Measurement signal level: 1.000 V (p. 158)
RANGE	Range: AUTO (p. 160)
POINT DELAY	POINT DELAY: 0.0000 s (p. 168)

3 Connect the test sample to the 9263 Test Fixture.

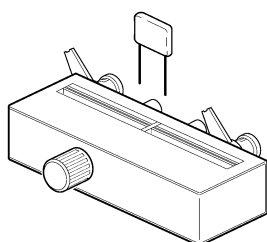

3.2 When ANALYZER Mode (IM3533-01 only)

4 Execute the sweep.

The sweep is repeated since TRIG is set to REPEAT.

FREQ [Hz]	Z [Ω]	θ [°]
77.625k	112.269	-83.203
79.433k	109.380	-82.904
81.283k	106.540	-82.454
83.176k	104.140	-81.838
85.114k	102.398	-81.253
87.096k	101.100	-81.016
89.125k	99.5554	-81.252
91.201k	97.2109	-81.592
93.325k	94.3769	-81.678
95.499k	91.4715	-81.399
97.724k	88.8412	-80.715
100.00k	87.0991	-79.671

- When you want to check the measurement values.
[See: "5.1.1 Measurement screen" \(p. 149\)](#)

3.3 When TRANSFORMER Mode

Measuring a transformer's turn ratio

You will need: Switch cable and transformer to measure

- 1 Wire together the instrument and transformer together as shown below:

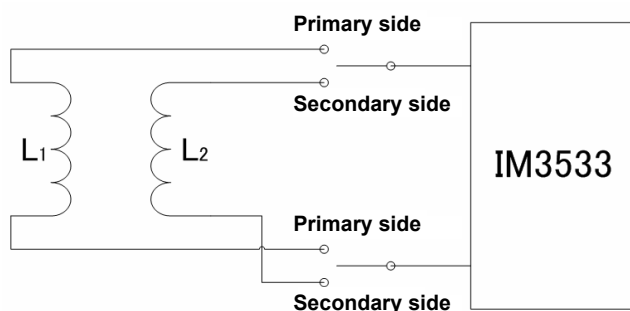

- 2 Set the measurement parameter to Ls and the computation parameter to N (p. 196), (p. 197).



- 3 Set the measurement conditions.

Touch **SET** on the Measurement screen, select the item you want to set, and set it as follows.

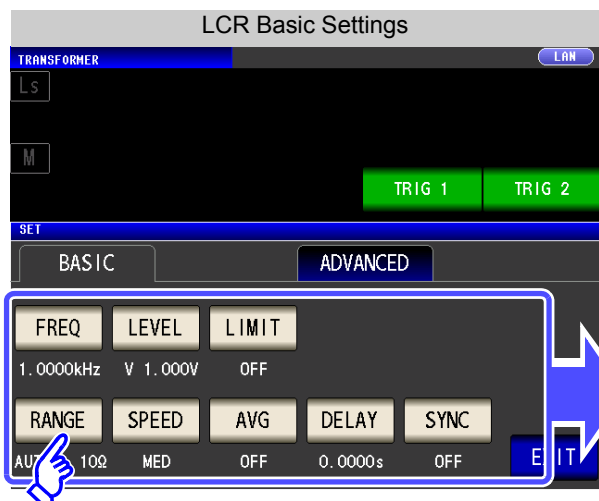

FREQ	Measurement frequency: 1.0000 kHz (p. 50)
LEVEL	Measurement signal mode: Open circuit voltage (V) mode (p. 52) Measurement signal level: 1.000 V (p. 52)
LIMIT	Voltage and current limit: OFF (p. 56)
RANGE	Measurement range: AUTO (p. 62)
SPEED	Measurement speed: MED (p. 73)
AVG	Average: OFF (p. 74)
DELAY	Trigger delay: 0.0000 s (p. 76)
SYNC	Trigger synchronous output function: OFF (p. 77)

3.3 When TRANSFORMER Mode

4 Wire together the primary side.

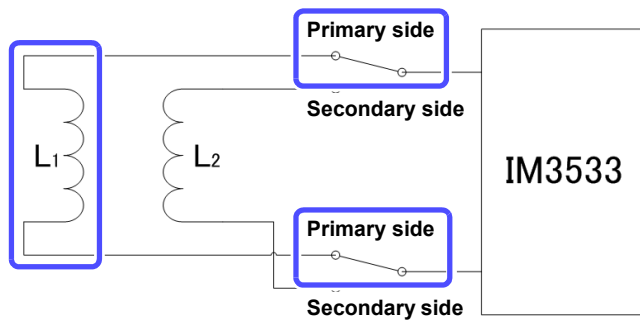

5 Execute the TRIG1 command.

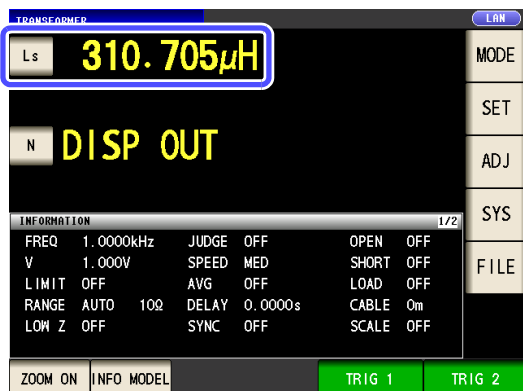

Touch **TRIG 1** and measure the primary side of the transformer.

6 Wire together the secondary side.

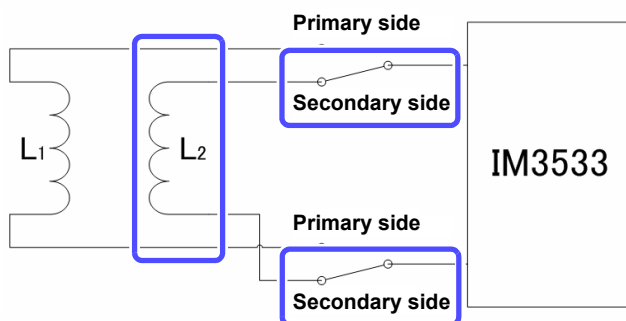

7 Execute the TRIG2 command.



Touch **TRIG 2** and measure the secondary side of the transformer.

8 Check the measurement results.



- When you want to judge the measurement results
See "6.3 Judging with Upper and Lower Limit Values (Comparator Measurement Mode)" (p. 199)
- When you want to save the measurement results
See "4.5.8 Saving Measurement Results (Memory function)" (p. 138)

LCR Function

Chapter 4

4.1 About LCR function

The LCR function allows you to measure the impedance, phase angle, and other items by applying any frequency or level (effective value) signal to the element you want to measure. This function is suitable for evaluating the passive element of a capacitor, coil, or the like.

NOTE

The settings are synchronized between LCR mode, ANALYZER mode, and TRANS mode.

4.1.1 Measurement screen

It allows you to perform measurement while checking the measurement conditions. When the power is turned on again, display is in accordance with the measurement mode used immediately before the power was turned off. For details on the screen configuration (p. 14).

The diagram shows the LCR measurement screen with various callouts explaining the function of different keys and indicators.

Parameter keys
Set each parameter (p. 47).

Indicates the name of the loaded panel (p. 256).

Indicates error messages and other information (p. 362).

Indicates the usage status of internal memory (p. 138).

Indicates that a USB flash drive is connected (p. 273).

Indicates the interface that is currently set (p. 263).

Menu keys

- MODE** Select the measurement mode (p. 13).
- SET** Set the details (p. 50).
- ADJ** Set the compensation (p. 215).
- SYS** Set the system (p. 263).
- FILE** Set the save settings (p. 273).

The settings of **SET** differ depending on the measurement mode.

Vac, Vdc: Voltage between the sample terminals
Iac, Idc: Current passing through the sample

A measurement condition is displayed (p. 17).

Operation keys An operation key is displayed depending on the situation.

- ZOOM ON** Enlarges the screen (p. 49).
- INFO DC** Displays the measurement conditions for DC measurement (p. 17).
- INFO AC** Displays the measurement conditions for AC measurement (p. 17).
- INFO COMP** Displays the comparator settings (p. 17).
- INFO BIN** Displays the BIN settings (p. 17).
- SAVE** Saves the measurement data (p. 277).
- PRINT** Prints the measurement data (p. 331).

The screen displays the following information:

- LCR No. 001 1110191128 Reference Value Memory Full USB PRINT
- Z 4.93874k Ω
- OFF
- θ 0.014 $^{\circ}$
- Rdc 4.99050k Ω
- Vdc 777.4mV
- Idc 155.8 μ A
- Vac 978.3mV
- Iac 198.1 μ A
- Information: FREQ 1.0000kHz JUDGE OFF OPEN OFF, V 1.000V SPEED MED SHORT OFF, LIMIT OFF AVG OFF LOAD OFF, RANGE HOLD 100 Ω DELAY 0.0000s CABLE 0m, LOW Z OFF SYNC OFF SCALE OFF
- ZOOM ON INFO DC SAVE PRINT TRIG

4.1 About LCR function

NOTE

When a measurement value is outside the guaranteed accuracy range, "Reference Value" is displayed in the error display area. When this happens, the cause is likely to be one of the following. Check the guaranteed accuracy range in "14.2 Measurement Range and Accuracy" (p. 343) and change the measurement conditions or you should consider the measured values as values for reference.

- Perhaps the test signal level is too low, increase the test signal level.
- If the current measurement range (during HOLD setting) is not appropriate, set again in the AUTO range, or change the range by manual.

4.1.2 Setting Display Parameters

You can select up to four measurement parameters to display in any location from 16 types.

See "1.3.7 Parameter Settings Screen" (p. 28)

"Appendix2 Measurement of High Impedance Components"(p. A3)

"Appendix7 Series Equivalent Circuit Mode and Parallel Equivalent Circuit Mode"(p. A11)

Procedure

Example: The first parameter key: Capacitance Cs,
The third parameter key: Loss coefficient D

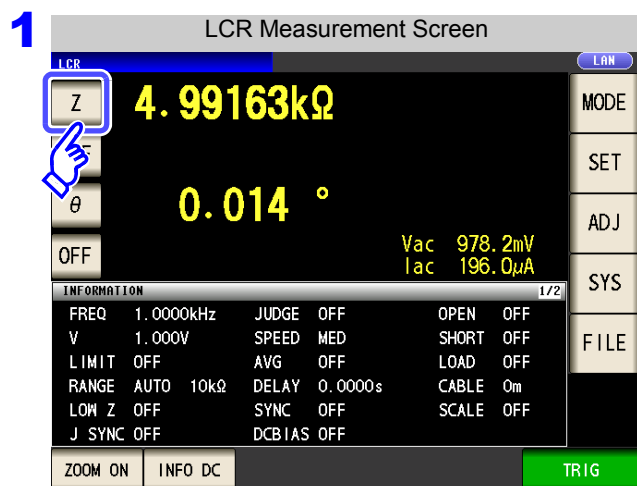

Press the first parameter key.

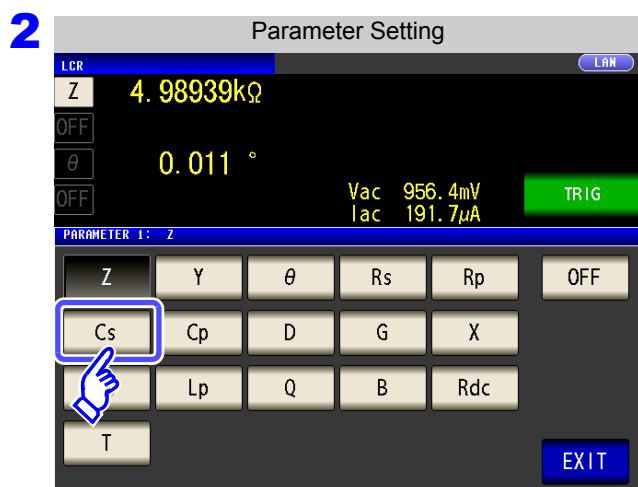

Press **Cs**.

Press **EXIT** to confirm the setting.

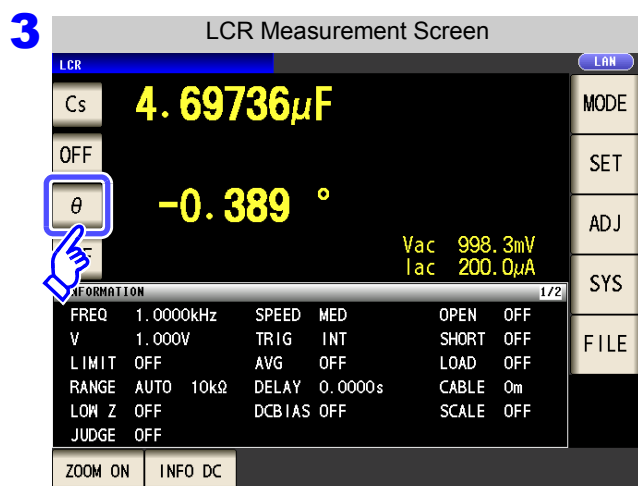

Press the third parameter key.

48

4.1 About LCR function

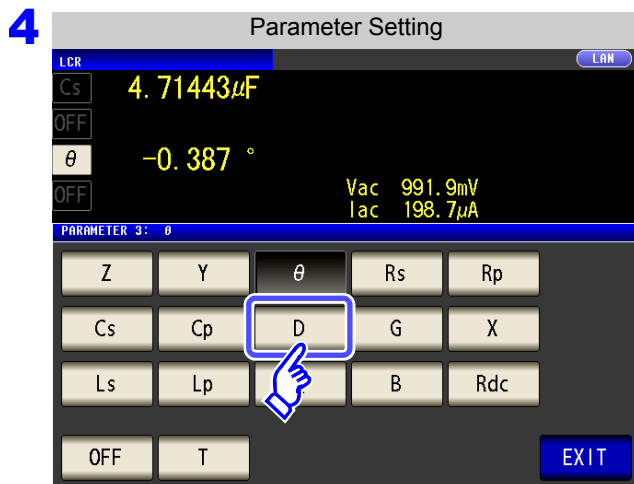

Press **D** .

Press **EXIT** to confirm the setting.

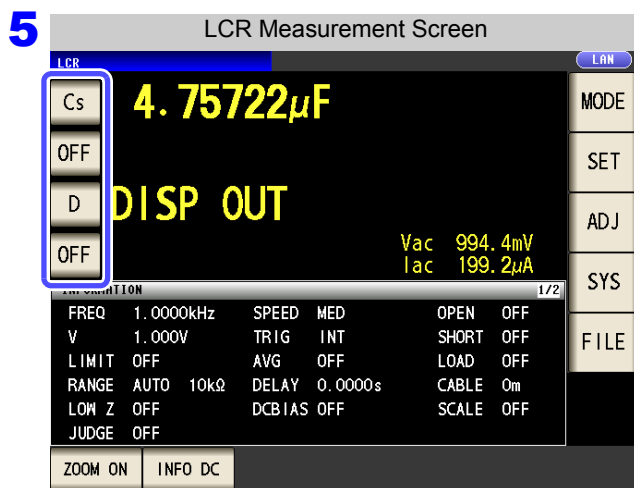

Cs and **D** are set as the parameters.

NOTE If **OFF** is selected in the parameter setting, a measurement value is not displayed.

4.1.3 Enlarging Display of Measurement Values

The measurement values and comparator decision results can be displayed in enlarged form. This function is convenient when the instrument is used under constant measurement conditions.

If the power is turned off when **ZOOM ON** is displayed, **ZOOM ON** will be displayed when the instrument starts the next time you turn the power on.

Procedure

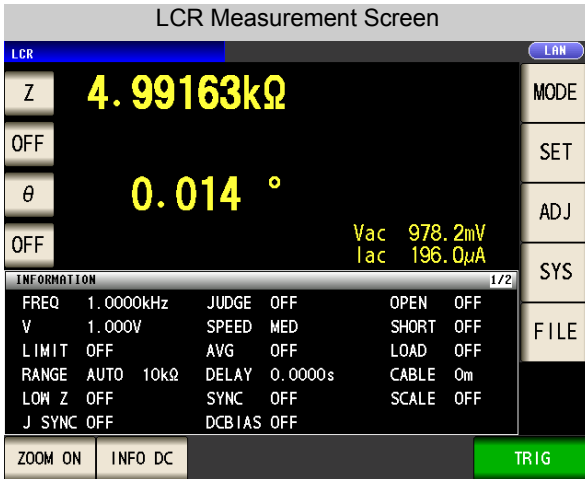

Press **ZOOM ON** in the measurement screen to display the magnification display screen.

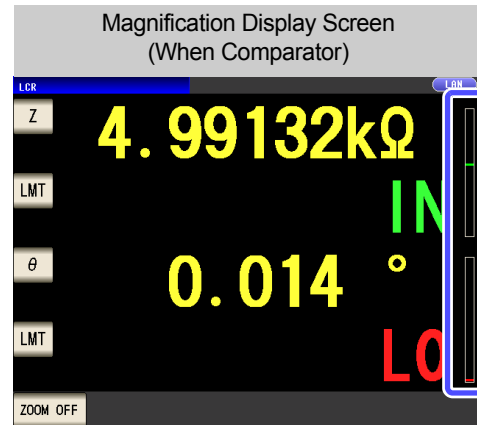
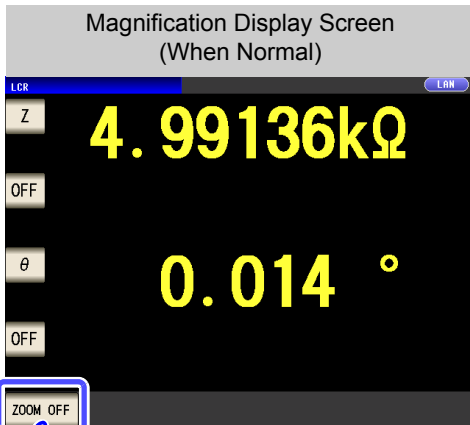

- Indicates the position of the measurement value relative to the comparator thresholds with a bar.
- The bars will not be displayed unless both upper and lower limit values have been set.

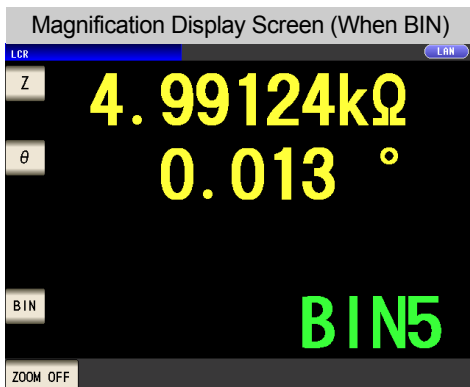

When you want to show normal display:

Press **ZOOM OFF** in the magnification display screen.

4.2 Setting Basic Settings of Measurement Conditions

4.2.1 Setting the Measurement frequency

Set the frequency of the signal to apply to the test sample. For some test samples, the value may vary depending on the measurement frequency.

Procedure Example: Measurement frequency: 1 MHz

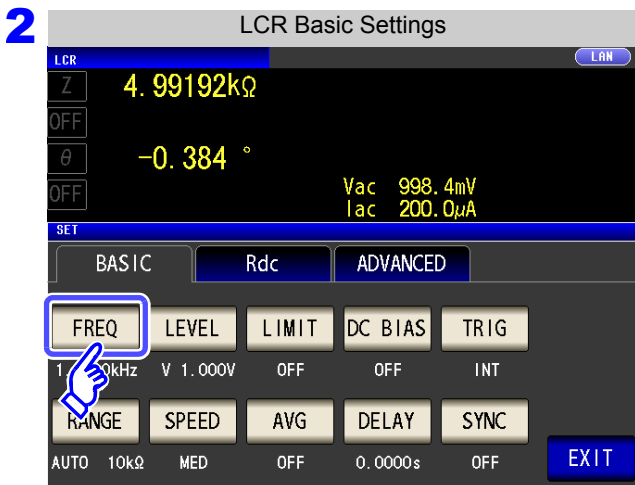
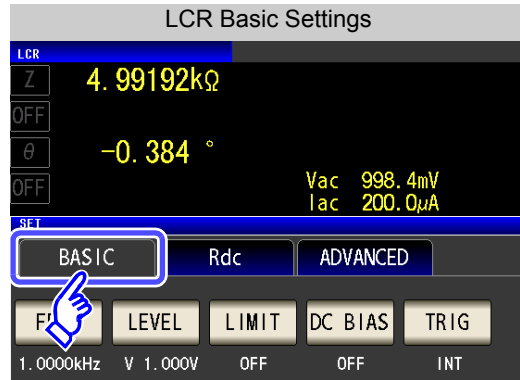
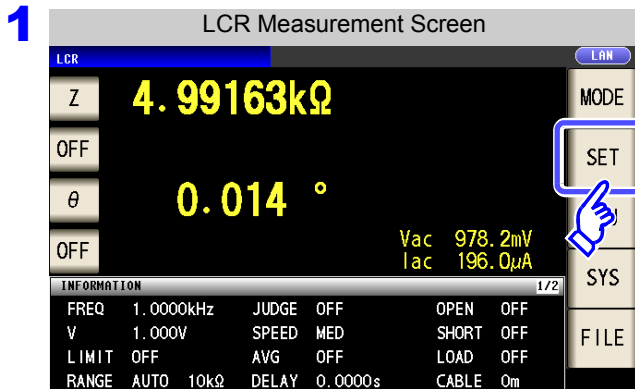

Press **FREQ**.

There are the following two frequency input methods.

Press **10-KEY** or **DIGIT** to change the input method.

Settable range : 1 mHz to 200 kHz

3 Set each digit.

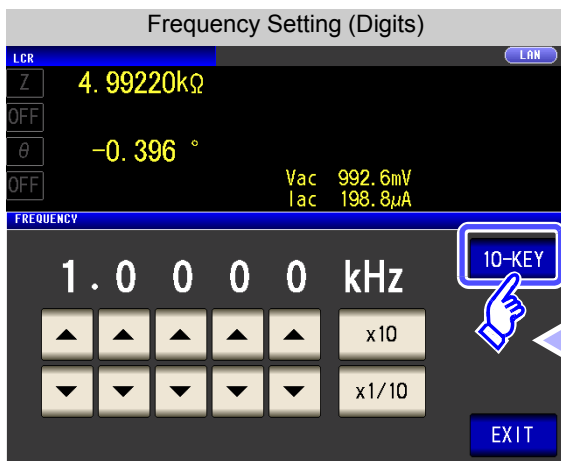

Set the frequency with the numeric keypad.

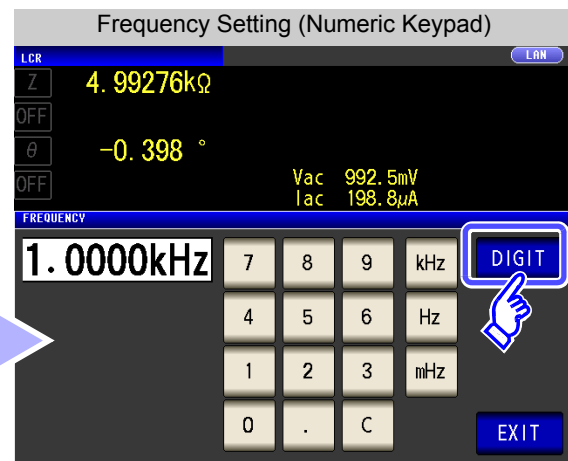

4.2 Setting Basic Settings of Measurement Conditions

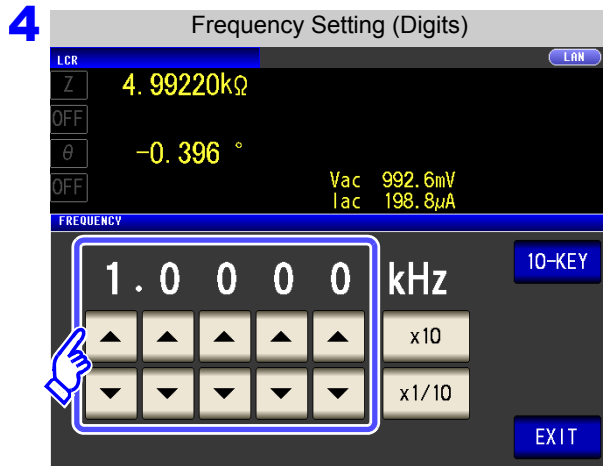

Use **▲** or **▼** to enter each digit of the frequency.

Holding down a digit key changes the value continuously.

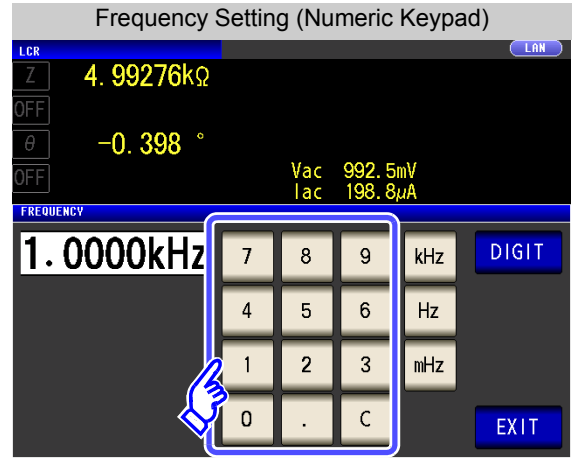

Use the numeric keypad to enter the frequency.

If you make a mistake during input :

Press the **C** to cancel the input so far, and start again.

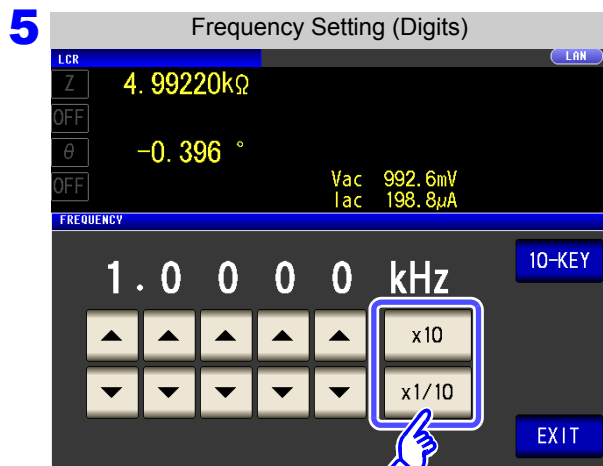

Use **x10** or **x1/10** to select the position of the decimal point and the instrument.

- x10** Sets the measurement frequency to x10.
- x1/10** Sets the measurement frequency to x $\frac{1}{10}$.

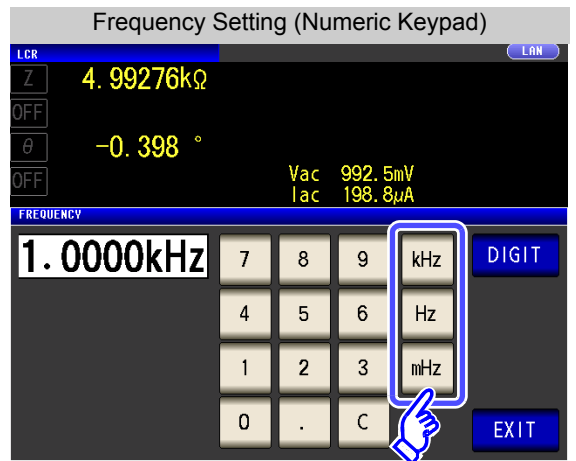

Press a instrument key to confirm the setting.

- Settable range : 1 mHz to 200 kHz
- The frequency is not confirmed until a instrument key is pressed.
- The instrument keys are disabled until a number is entered.
- If you attempt to set a measurement frequency greater than 200 kHz, it will automatically be reduced to 200 kHz.
- If you attempt to set a measurement frequency lower than 1 mHz, it will automatically be increased to 1 mHz.

6 Press **EXIT** to close the setting screen.

4.2 Setting Basic Settings of Measurement Conditions

4.2.2 Setting the Measurement signal level

The value of the test signal level may change according to the sample which is being tested. This instrument is possible to vary the level of the test signal applied to the object under test over a wide range using the following three methods. Selecting constant voltage or constant current mode will result in increased measurement times due to use of software feedback control.

- Open circuit voltage (V) mode** ▶ The value of the open circuit voltage is set.
- Constant voltage (CV) mode** ▶ The value of the voltage between the terminals of the object under test is set.
- Constant current (CC) mode** ▶ The value of the current flowing through the object under test is set.

CAUTION Do not switch between V, CV and CC while the test sample is still connected to the measurement terminals because doing so may damage the test sample.

- NOTE**
- In constant voltage (CV) mode, the generated voltage is controlled using software feedback so that the set constant voltage value is applied. Since the voltage used for the most recent measurement is output as the generated voltage initial value, a voltage in excess of the set constant voltage value may be applied before feedback control is active if the sample's impedance is higher than that of the last measured sample.
 - In constant current (CC) mode, the generated voltage is controlled using software feedback so that the set constant current value is applied. Since the voltage used for the most recent measurement is output as the generated voltage initial value, a current in excess of the set constant current value may be applied before feedback control is active if the sample's impedance is lower than that of the last measured sample.

Procedure

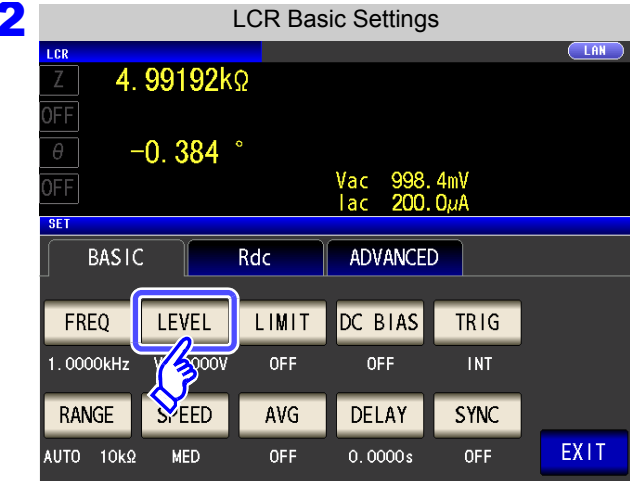
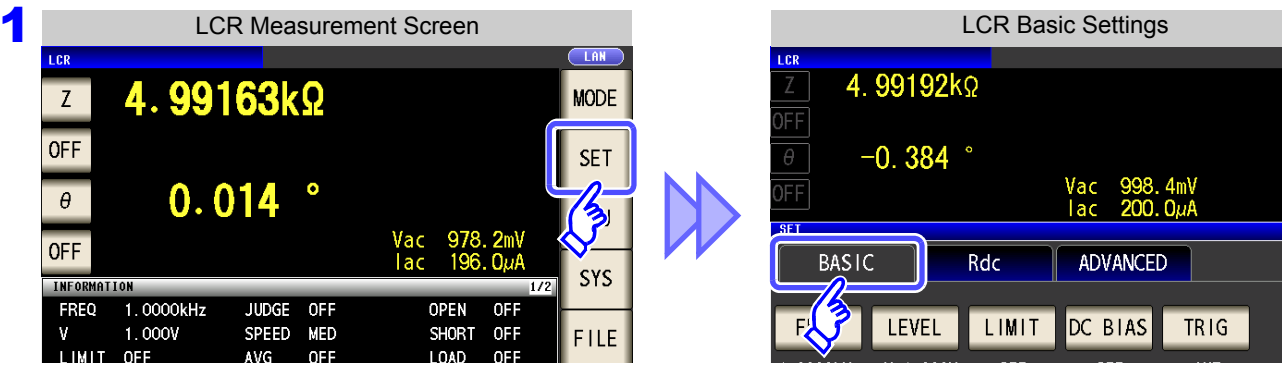

Press **LEVEL**.

4.2 Setting Basic Settings of Measurement Conditions

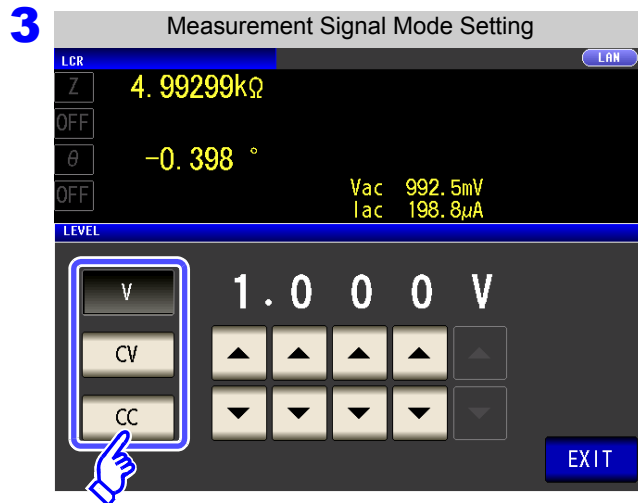

To select the measurement signal mode.

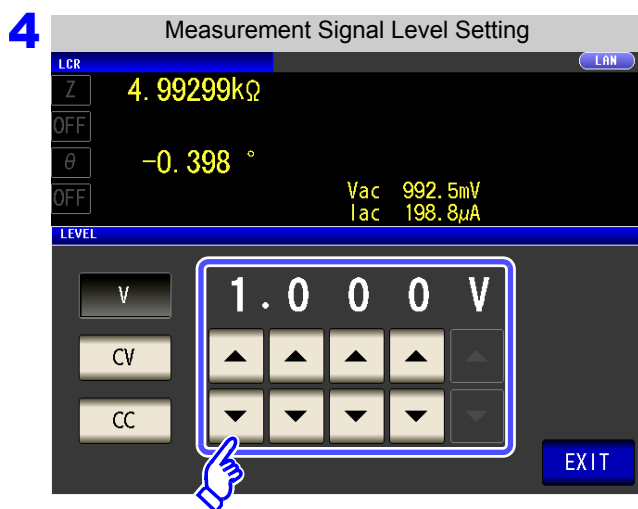
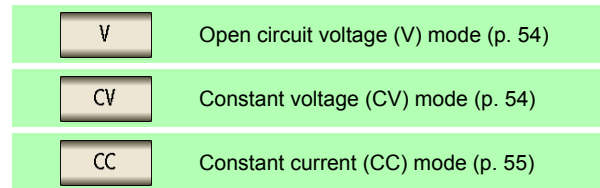

Use or to enter the voltage or current value.

Normal measurement mode

Measurement signal mode	Settable range
V, CV	0.005 V to 5.000 V
CC	0.01 mA to 50.00 mA

Low Z high accuracy mode

Measurement signal mode	Settable range
V, CV	0.005 V to 2.500 V
CC	0.01 mA to 100.00 mA

See "For setting range and accuracy" (p. 54)

The accuracy of testing varies according to the test signal level.

See "14.2 Measurement Range and Accuracy" (p. 343)

5 Press **EXIT** to close the setting screen.

NOTE

When the measurement value is outside the guaranteed accuracy range, the following icon appears at the top of the screen.

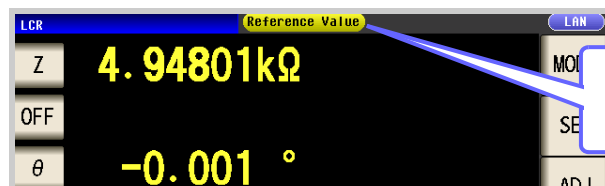

In this case, you should consider the following possible causes, and you should either change the test conditions while checking the accuracy assured ranges "14.2 Measurement Range and Accuracy" (p. 343), or you should consider the measured values as values for reference.

- Perhaps the test signal level is too low, increase the test signal level.
- If the current measurement range (during HOLD setting) is not appropriate, set again in the AUTO range, or change the range by manual.

4.2 Setting Basic Settings of Measurement Conditions

About the test signal mode

Relationship between the measurement signal mode of the instrument and the sample is as follows.

Open circuit voltage (V) mode

This voltage value is the value which is applied across the two terminals of the series combination of the object which is being tested and the output impedance. As for the voltage which is applied across the terminals of the object which is being tested (by itself), if required, you should either check the monitor voltage value, or select constant voltage (CV) and set a voltage value across these terminals.

Constant current (CC) mode

You should select this if you wish to set the current passing through the object to be tested to a constant value.

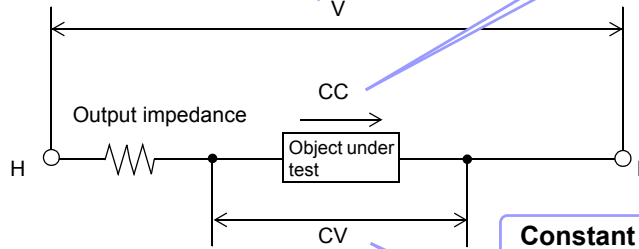

Constant voltage (CV) mode

You should select this if you wish to set the voltage across the terminals of the object to be tested to a constant value.

For setting range and accuracy

Open circuit voltage (V) mode and Constant voltage (CV) mode setting

Measurement mode (p. 72)	Normal mode	Low Z high accuracy mode
Open circuit voltage setting range	0.005 V to 5.000 V	0.005 V to 2.500 V
Open circuit voltage accuracy	±10%rdg. ±10 mV	±10%rdg. ±10 mV
Output impedance	100 Ω ±10 Ω	25 Ω ±5 Ω

NOTE

Depending on the sample, you may not be able to perform constant voltage measurement. In this situation, the following mark will be displayed:

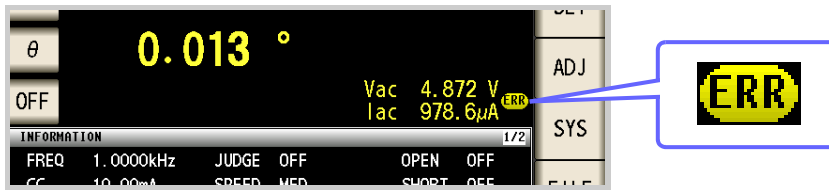

Constant voltage measurement will not be performed.

Change the constant voltage level so that it is less than or equal to the displayed Vac monitor values.

Example: Range in which constant voltage operation is supported when measuring a 1 µF C at 10 kHz

The sample impedance Zm is as follows:

$$Z_m = R_m + jX_m = 0 [\Omega] - j15.9 [\Omega]$$

$$X_m = \frac{-1}{(2\pi fC)}$$

4.2 Setting Basic Settings of Measurement Conditions

NOTE

The impedance Z_m' observed from the generator is as follows:

$$Z_m' = R_o + Z_m = 100 [\Omega] - j15.9 [\Omega] \quad R_o: \text{Output resistance (100 } [\Omega] \text{)}$$

Accordingly, the voltage V_m across both leads of the sample is as follows:

$$V_m = \frac{|Z_m| \times V_o}{|Z_m'|} = \frac{15.9 [\Omega] \times V_o}{101.3 [\Omega]} \quad V_o: \text{generator output}$$

Because the generator output voltage range is 5[mV] to 5[V], the CV operation range per the above expression is $V_m = 0.8[\text{mV}]$ to $0.78[\text{V}]$.

In low Z high accuracy mode, the output resistance R_o becomes 25 $[\Omega]$.

Constant current (CC) mode setting

The constant current operation range differs depending on the test sample to be measured.

Measurement mode (p. 72)	Normal mode	Low Z high accuracy mode
Constant current setting range	0.01 mA to 50.00 mA	0.01 mA to 100.00 mA
Constant current accuracy	$\pm 10\%$ rdg. $\pm 10 \mu\text{A}$	$\pm 10\%$ rdg. $\pm 10 \mu\text{A}$
Output impedance	100 $\Omega \pm 10 \Omega$	25 $\Omega \pm 5 \Omega$

NOTE

Testing some types of sample is not possible using constant current. In this case, the following symbol appears on the display:

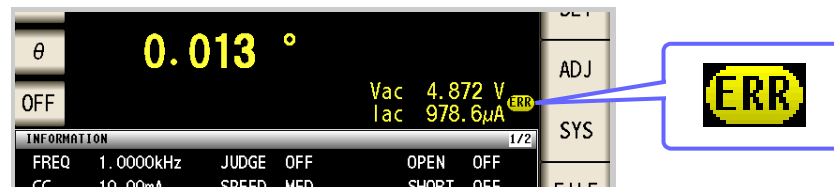

Constant current measurement will not be performed.

Change the constant current level so that it is less than or equal to the displayed Iac monitor values.

Example: When a 1 mH impedance is measured at 1 kHz, the CC operation range can be obtained as follows.

Sample impedance Z_m becomes as follows:

$$Z_m = R_m + jX_m = 0 [\Omega] - j6.28 [\Omega] \quad X_m = 2\pi fL$$

The impedance Z_m' observed from the generator is as follows:

$$Z_m' = R_o + Z_m = 100 [\Omega] - j6.28 [\Omega] \quad R_o: \text{output resistance (100 } [\Omega] \text{)}$$

Accordingly, the current I_m across both leads of the sample is as follows:

$$I_m = \frac{V_o}{|Z_m'|} = \frac{V_o}{100.2 [\Omega]} \quad V_o: \text{generator output}$$

Because the generator output voltage range is 5 [mV] to 5 [V] (see the table of page 54), the CC operation range per the above expression is $I_m = 49.9[\mu\text{A}]$ to $49.9[\text{mA}]$.

In low Z high accuracy mode, the output resistance R_o becomes 25 $[\Omega]$.

4.2 Setting Basic Settings of Measurement Conditions

4.2.3 Limiting the Voltage and Current Applied to the Sample (Limit Values)

Depending on the measurement signal level, in some cases it is possible to damage the sample which is being tested by applying to it a voltage or a current greater than its rated value.

For this reason, set a limit value to restrict the voltage that can be applied to the test sample or current that can flow to the test sample. Enabling the limit function will result in increased measurement times due to use of software feedback control.

When open circuit voltage (V) mode or constant voltage (CV) mode is set:

Set the current limit.

When constant current (CC) mode is set:

Set the voltage limit.

Procedure

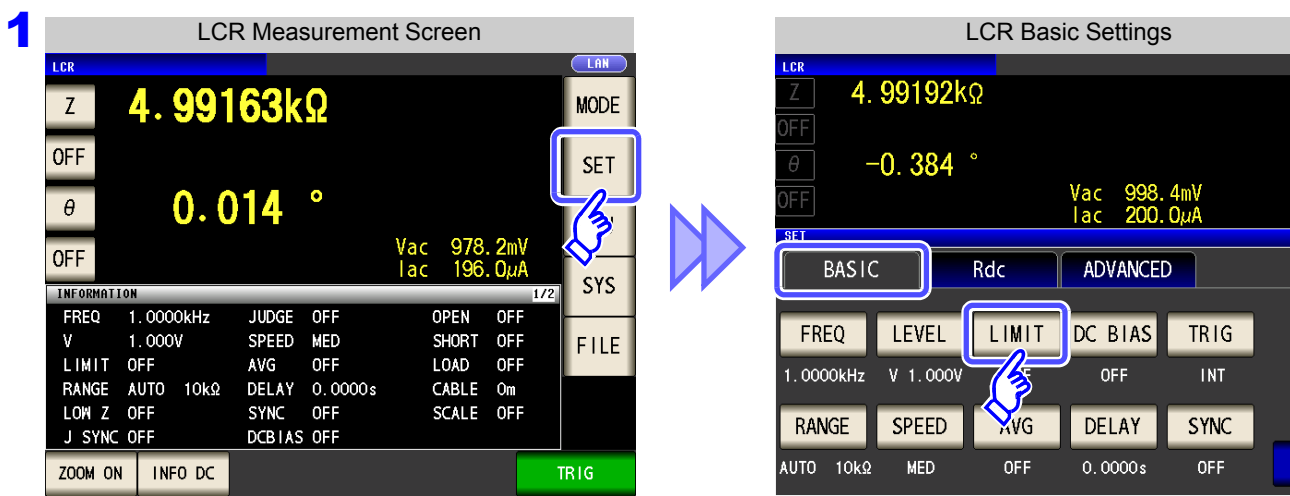

2 When the measurement signal level is a voltage (V, CV)

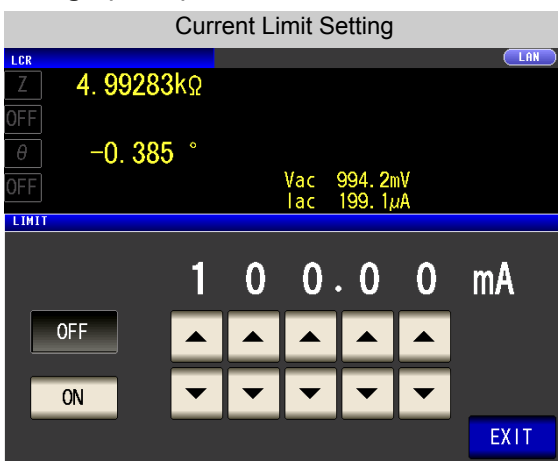

When the measurement signal level is a current (CC)

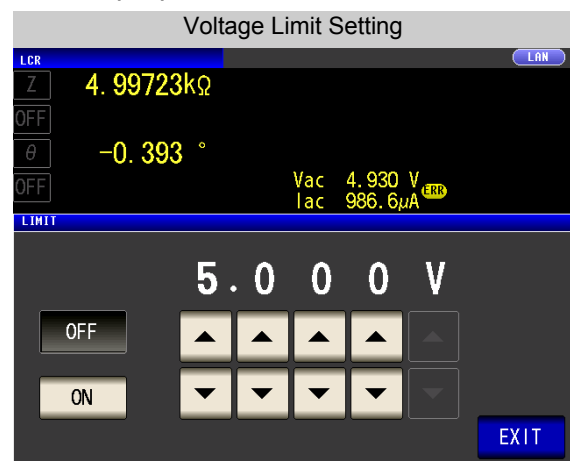

- You can check the measurement signal level on the monitor display.
- The monitor display is different for V, CV, and CC.

NOTE

First set the measurement signal level, and thereafter set the voltage or current limit. The setting for voltage or current limit changes automatically to current or voltage limit, according to the present measurement signal mode setting.

See "4.2.2 Setting the Measurement signal level" (p. 52)

4.2 Setting Basic Settings of Measurement Conditions

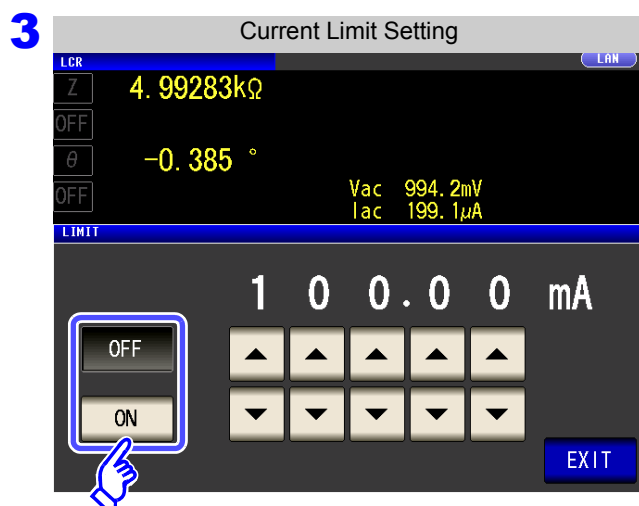

Select ON/OFF for the limit function.

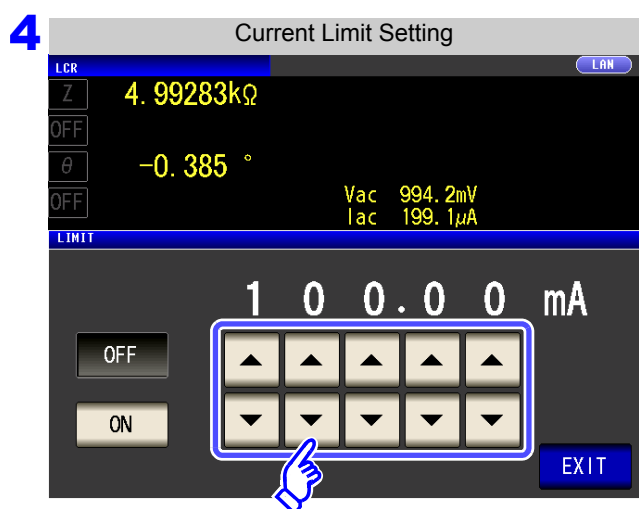
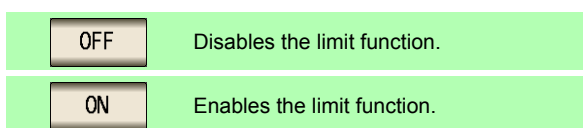

Use or to enter the limit value.

Limit range

Measurement signal mode	Limit set	Setting range
V, CV	Current limit	0.01 mA to 100.00 mA
CC	Voltage limit	0.005 V to 5 V

Current limit accuracy : $\pm 10\%$ rdg. ± 10 mA

Voltage limit accuracy : $\pm 10\%$ rdg. ± 10 mV

When the limit function is on, you may encounter a display such as the following.

Example: When constant voltage (CV) setting

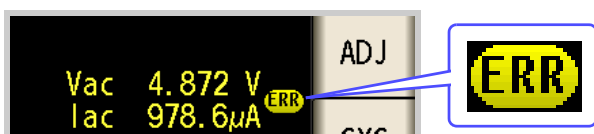

If the voltage or current which is applied to the sample under test exceeds the limit value (the current exceeding the limit value flows through the sample even when the open-circuit voltage is set to minimum value.)

Lower the measurement signal level so that the limit value is not exceeded.

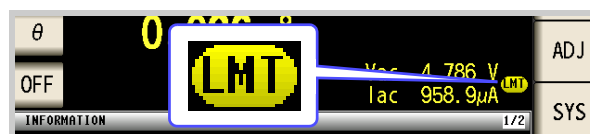

When a voltage or current in excess of the applicable limit value is not applied to the sample so that the measurement signal level setting is not reached, changes to the measurement signal level are canceled.

At this time, the voltage or current which exceeds the limit value is not being applied to the sample under test. You should change the test signal level so that it does not exceed the limit value.

5 Press to close the setting screen.

4.2 Setting Basic Settings of Measurement Conditions

4.2.4 Setting the DC bias

You can superimpose a DC voltage on the measurement signal during capacitor measurement.

Procedure

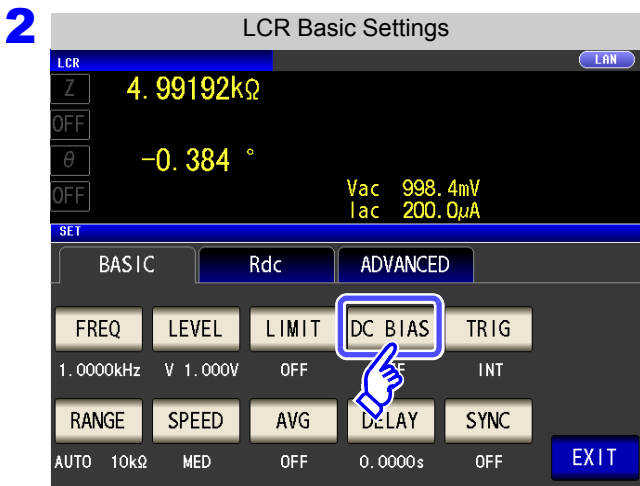
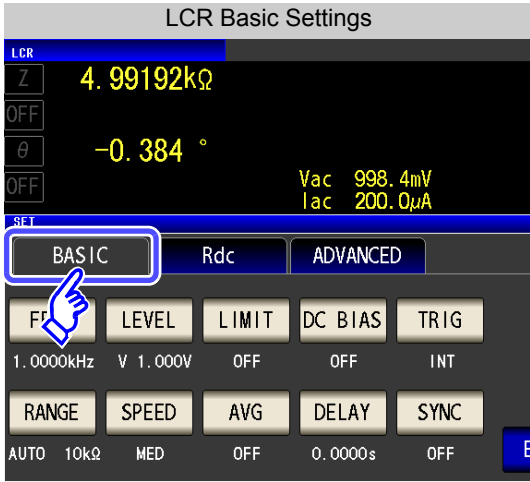
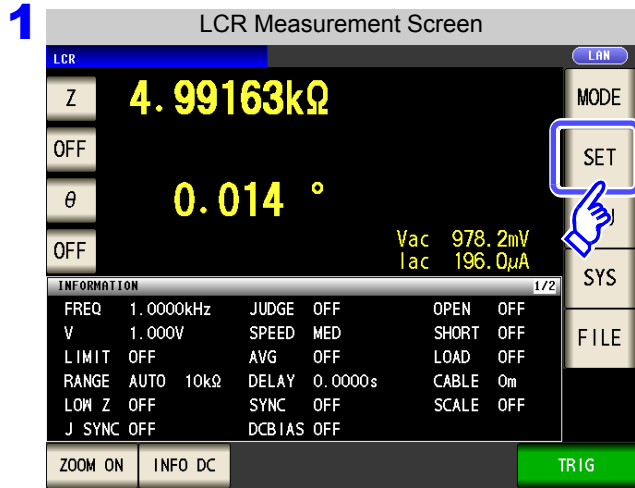

Press **DC BIAS**.

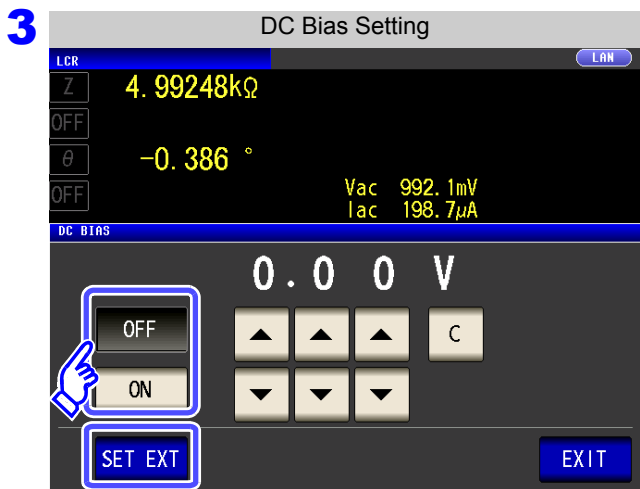

Select ON/OFF for the DC bias.

- Disables DC bias.
- Enables DC bias.

SET EXT Press this button when using an external DC bias unit. The DC bias will be set to ON, and the bias value will be set to 0.00 V.

4.2 Setting Basic Settings of Measurement Conditions

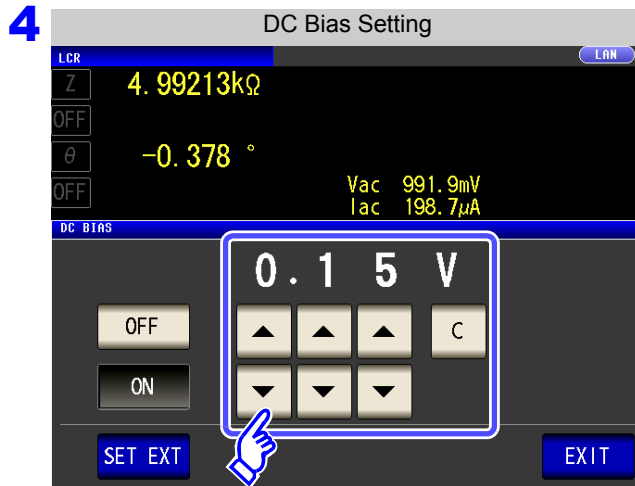

Use or to set the DC level to superimpose.

- Settable range :
-5.00 V to 5.00 V (Normal mode)
-2.50 V to 2.50 V (low Z high accuracy mode)
- If you make a mistake during input:
press to cancel the input and start again.

5 Press to close the setting screen.

NOTE

- The DC bias function is specifically for capacitor measurement. If it is used for resistor, inductor, and other elements with low DC resistance, the following are likely.
 - Normal measurement is not possible
 - AUTO ranging is unable to determine a range.
- The DC bias function cannot be set during DC resistance measurement.
- The DC bias function cannot be configured when the **:MEASure:ITEM** setting has been configured to perform **Rdc** measurement.
- When superimposing a DC voltage that falls outside the valid setting range for the built-in DC bias function, refer to "Appendix5.1 How to Supply a DC Bias Voltage"(p. A7).
- When superimposing a DC voltage on a coil or the like, refer to "Appendix5.2 How to Supply a DC Bias Current"(p. A9).
- If the total value for the measurement signal level ($AC \text{ level setting value} \times \sqrt{2} + DC \text{ bias setting value}$) will become $> 5\sqrt{2}$ [V], the measurement signal cannot be raised any higher. Reduce the AC level or DC bias value, and then configure the setting. In low Z high accuracy mode, the AC level and DC bias value can be set when the total value is in the range of $2.5\sqrt{2}$ [V] or below.

4.2 Setting Basic Settings of Measurement Conditions

4.2.5 Perform Measurements with User-defined Timing (Trigger Measurement)

Triggering is the process of controlling the start and stop of recording by specific signals or conditions (criteria). When recording is started or stopped by a specific signal, we say the trigger is "applied" or "triggering occurs".

With this instrument, you can select the following two types of trigger.

- Internal Trigger** ▶ Trigger signals are automatically generated internally to repeat measurement.
- External trigger** ▶ Measurements are triggered by an external signal. Manual measurement triggering is also available.

Procedure

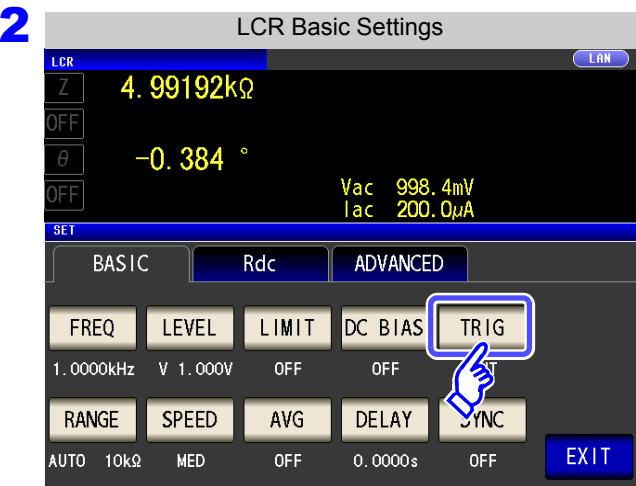
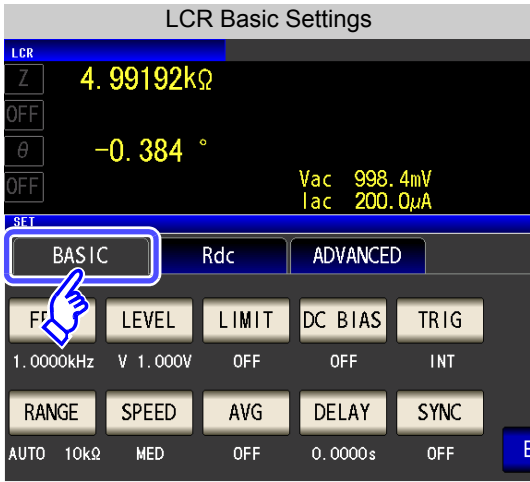
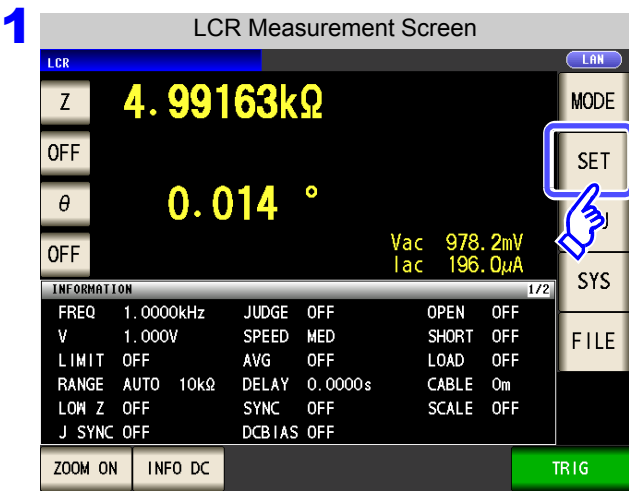

Press **TRIG**.

4.2 Setting Basic Settings of Measurement Conditions

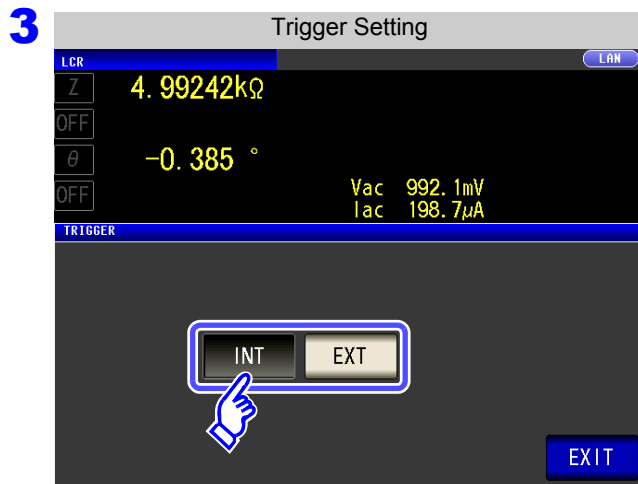

Select the trigger type.

- INT** Internal trigger Automatically repeats measurement.
- EXT** External trigger Input the trigger manually via EXT I/O or from the interface.

When **EXT** is selected

There are the following three types of input method for a trigger.

- Press **TRIG** on the screen to manually input a trigger: Measurement is performed once.
- Input via **EXT I/O**: Measurement is performed once each time a negative logic pulse signal is applied.
See "Connector Type and Signal Pinouts" (p. 310)
- Input from interface: Measurement is performed once when *TRG is transmitted.
See LCR Application Disk - Communication Commands

TRIG is displayed on the screen.

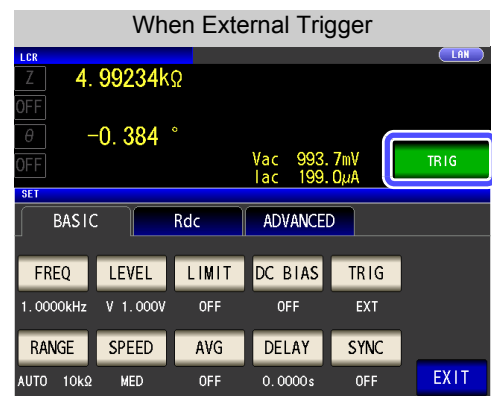
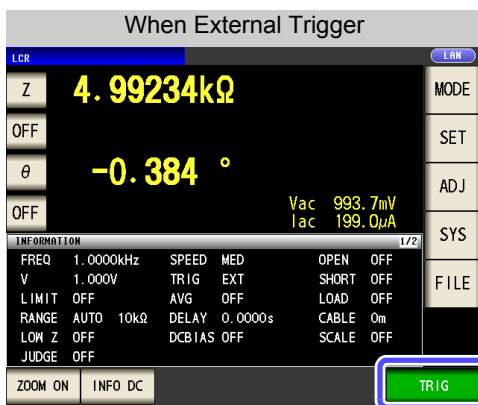

4 Press **EXIT** to close the setting screen.

4.2.6 Setting the Measurement Range

1 Setting the method for determining the measurement range (AUTO, HOLD, JUDGE SYNC)

There are the following three methods for setting the measurement range.

AUTO

The most suitable test range is set automatically.
(This allows the most suitable measurement range to be set when measuring, for example, a test sample whose impedance varies greatly with frequency or a test sample whose nature is unknown.)

HOLD

The measurement range is fixed. The range is set manually.
(When the range is fixed, high-speed measurement is possible.)

JUDGE SYNC

The optimal range is set automatically based on the comparator and BIN measurement judgment standards.
(This allows the optimal range to be fixed relative to the comparator and BIN measurement judgment results when testing a sample whose impedance varies greatly with frequency.)

NOTE

- The ranges are all defined in terms of impedance. Therefore, for a parameter other than impedance, the value is obtained by calculating from the measured values of $|Z|$ and θ .
See "Appendix1 Measurement Parameters and Calculation Formula"(p. A1)
- When the HOLD and AUTO settings are activated when the judgment synchronization setting is on, the judgment synchronization setting is automatically turned off.

Setting AUTO Ranging

Procedure

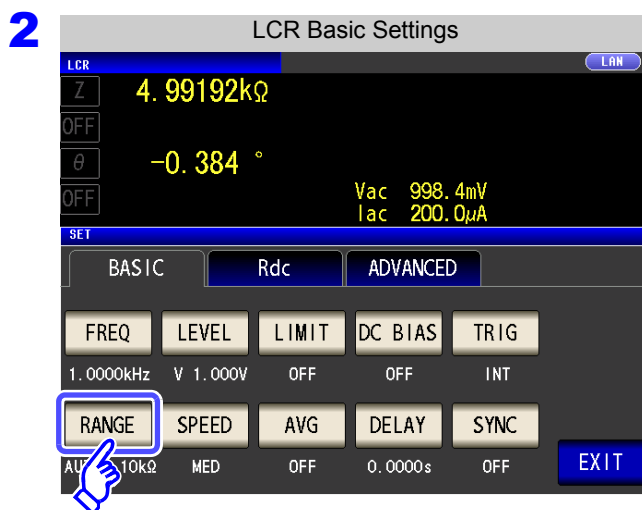
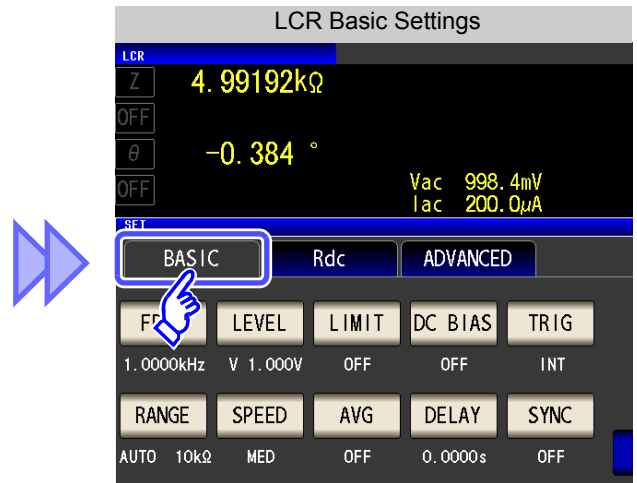
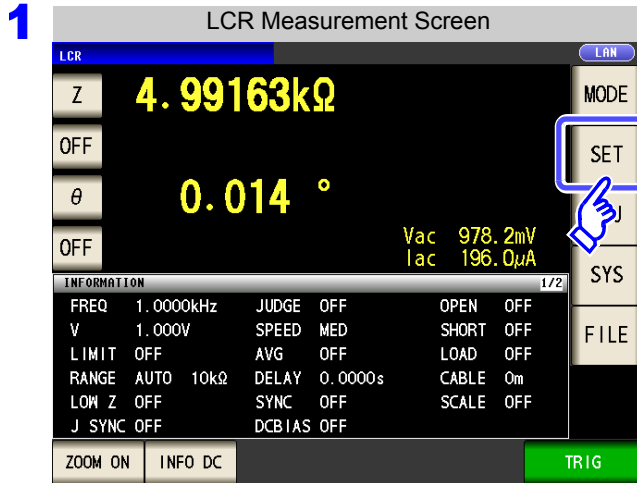

Press **RANGE**.

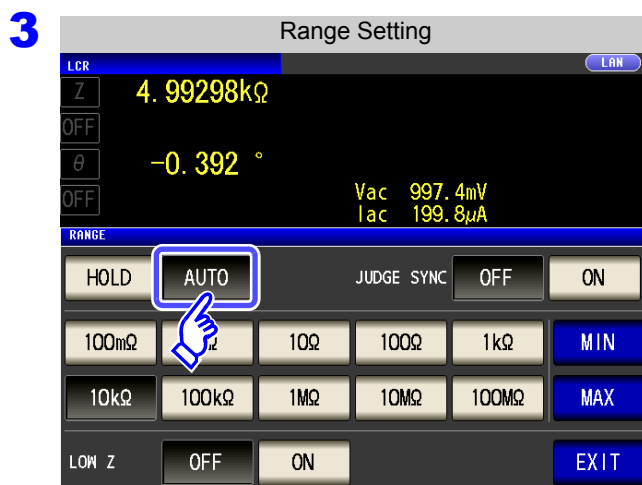

Press **AUTO**.

- The ranges that can be set vary with the frequency. (p. 67)
- When you want to control the AUTO ranging range:
See "AUTO range limit function" (p. 64)
- If the instrument is being used outside the limits of its specification, the suitable range may not be set in auto ranging function. In this case, check the accuracy assured ranges in "14.2 Measurement Range and Accuracy" (p. 343) and then change the test conditions.

4 Press **EXIT** to close the setting screen.

4.2 Setting Basic Settings of Measurement Conditions

AUTO range limit function

The AUTO range limit function allows you to limit the AUTO ranging range.

Procedure

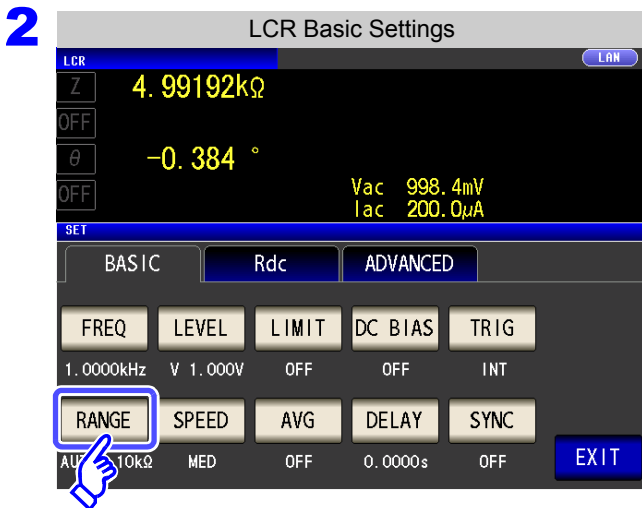
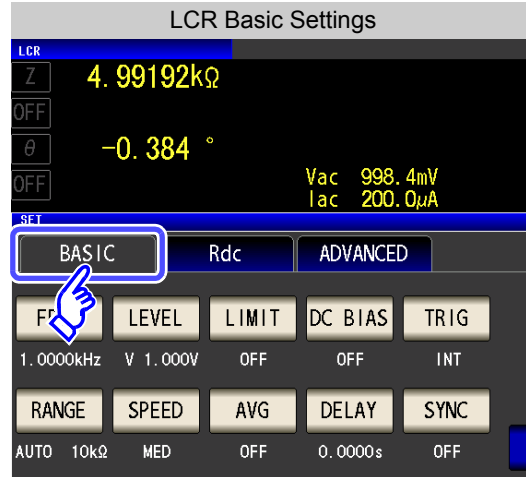
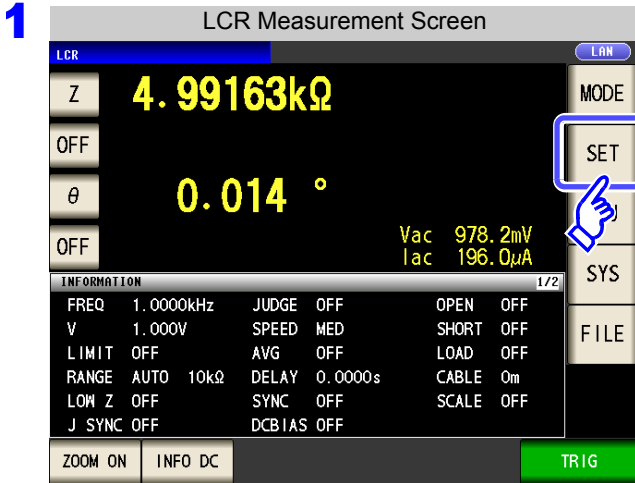

Press **RANGE**.

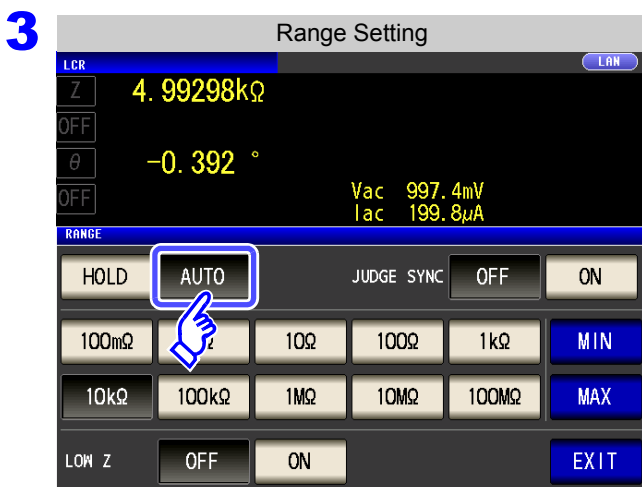

Press **AUTO**.

If the instrument is being used outside the limits of its specification, the suitable range may not be set in auto ranging function. In this case, check the accuracy assured ranges in "14.2 Measurement Range and Accuracy" (p. 343) and then change the test conditions.

4.2 Setting Basic Settings of Measurement Conditions

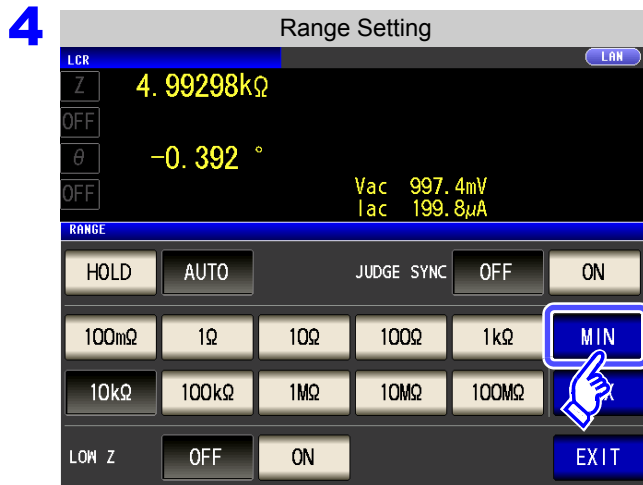

Press **MIN**.

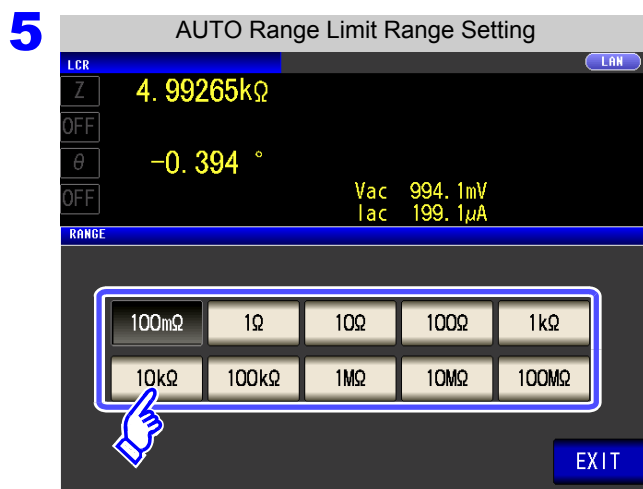

Select the AUTO range lower limit range.

6 Touch **EXIT** to accept the lower limit range.

7 Return to **step 4**, touch **MAX**, and select the AUTO range upper limit range.

8 Press **EXIT** to close the setting screen.

NOTE When canceling the AUTO range limit function, set the lower limit range to 100 mΩ and the upper limit range to 100 MΩ.

Screen displayed when the AUTO range limit function has been enabled

Example: When the upper limit range is set to 1 kΩ and the lower limit range is set to 1 MΩ



Operation is only enabled within the set AUTO ranging range.

4.2 Setting Basic Settings of Measurement Conditions

Setting the Ranging to HOLD

Procedure

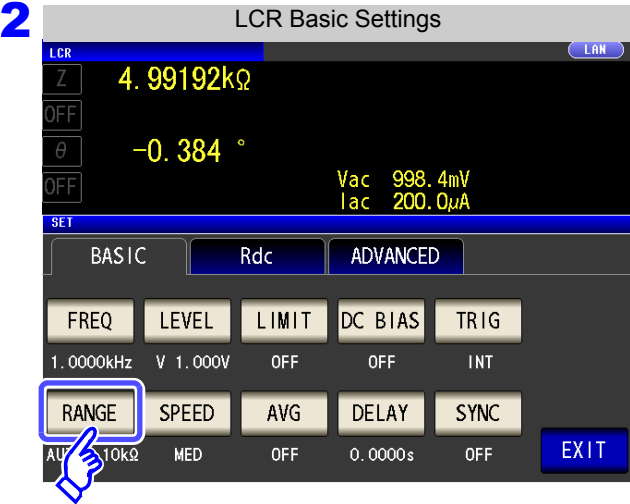
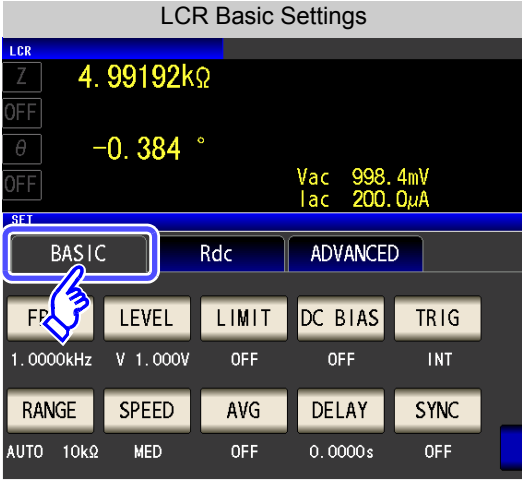
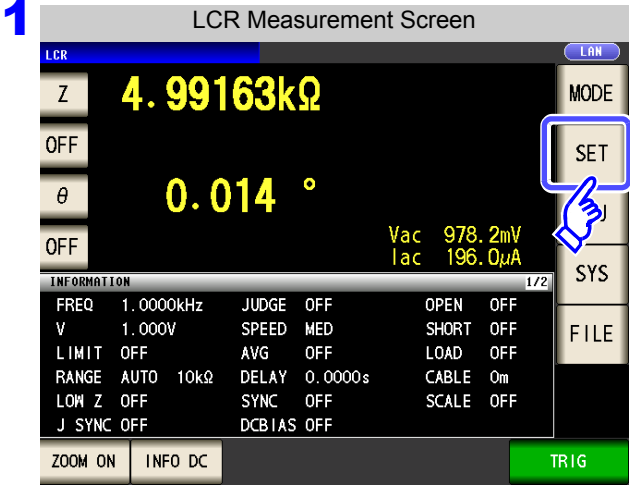

Press **RANGE**.

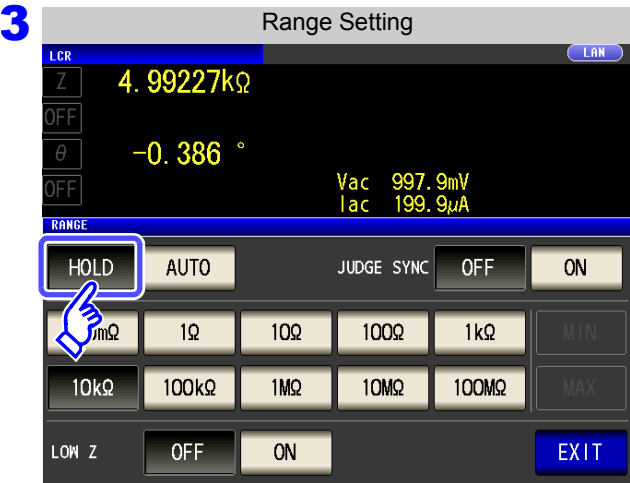

Press **HOLD**.

4.2 Setting Basic Settings of Measurement Conditions

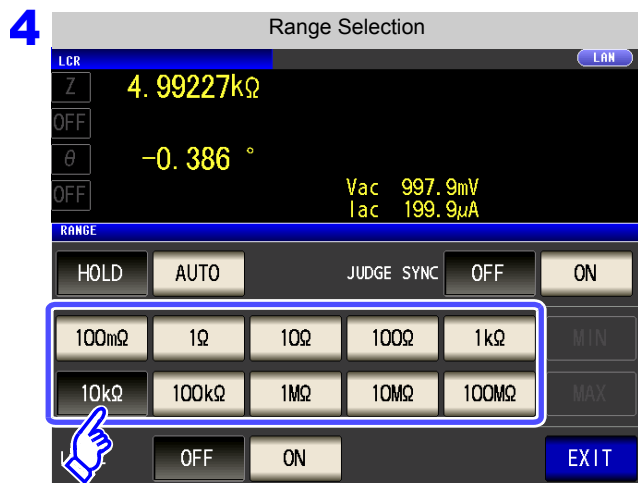

Set the test range according to the combined impedance value of the sample to be tested and the test cables.

To select the measurement range.

The ranges that can be set vary with the frequency.

Frequency	Selectable ranges	Range Settings screen
DC		
0.001 Hz to 10.000 kHz	Entire range	
10.001 kHz to 100.00 kHz	100 mΩ to 10 MΩ	
100.01 kHz to 200.00 kHz	100 mΩ to 1 MΩ	

Test range	Accuracy guaranteed range	AUTO Ranging Range
100 MΩ	8 MΩ to 200 MΩ	8 MΩ or more
10 MΩ	800 kΩ to 100 MΩ	800 kΩ to 10 MΩ
1 MΩ	80 kΩ to 10 MΩ	80 kΩ to 1 MΩ
100 kΩ	8 kΩ to 1 MΩ	8 kΩ to 100kΩ
10 kΩ	800 Ω to 100 kΩ	800 Ω to 10 kΩ
1 kΩ	80 Ω to 10 kΩ	80 Ω to 1 kΩ
100 Ω	8 Ω to 100 Ω	8 Ω to 100 Ω
10 Ω	800 mΩ to 10 Ω	800 mΩ to 10 Ω
1 Ω	80 mΩ to 1Ω	80 mΩ to 1 Ω
100 mΩ	10 mΩ to 100 mΩ	0 Ω to 100 mΩ

NOTE

- The guaranteed accuracy range varies depending on the measurement conditions. **See** Check the accuracy assured ranges in "14.2 Measurement Range and Accuracy" (p. 343)
- Changing the set range when auto ranging is enabled automatically enables the HOLD setting.
- The measurement range is determined according to the test range setting. If the display for the measured value shows "**OVER FLOW**" or "**UNDER FLOW**", that means that measurement cannot be performed using the currently set test range. Either you should set AUTO ranging so as to select the most suitable test range automatically, or you should set a more suitable test range manually. If a measurement result is outside the display range (p. 337), "**DISP OUT**" is displayed.
- The guaranteed accuracy range is for the measurement values before compensation.
- The AUTO ranging range is the range within which the AUTO range is switched. When the AUTO range limit function is enabled, the range will not be switched outside the defined limit range.

5 Press **EXIT** to close the setting screen.

4.2 Setting Basic Settings of Measurement Conditions

NOTE

- In the case of a test sample whose impedance changes according to the frequency, when testing is being performed with HOLD set, it may happen, when the frequency is changed over, that measurement cannot be continued to be performed upon the same test range. You should change the test range if this happens.
- The test range setting is made according to the combination of the impedances of the sample being tested and the test cables. Therefore it can happen that testing is not possible, if the test range is held with HOLD only upon the basis of the impedance of the sample under test. If this happens, you should change the test range, making reference to "8.1 Setting Open Circuit Compensation" (p. 215) and "8.2 Short Circuit Compensation" (p. 224).
- When the measurement value is outside the guaranteed accuracy range, the following icon appears at the top of the screen.

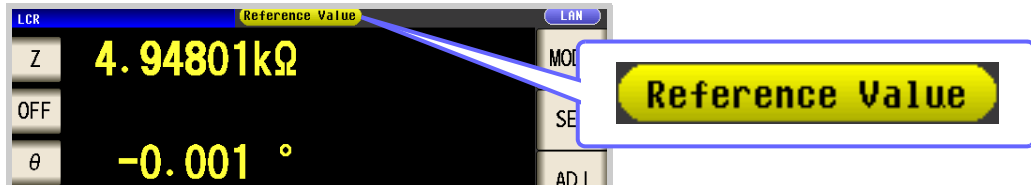

In this case, you should consider the following possible causes, and you should either change the test conditions while checking the accuracy assured ranges "14.2 Measurement Range and Accuracy" (p. 343), or you should consider the measured values as values for reference.

- Perhaps the test signal level is too low, increase the test signal level.
- If the current measurement range (during HOLD setting) is not appropriate, set again in the AUTO range, or change the range by manual.

4.2 Setting Basic Settings of Measurement Conditions

Judgment synchronization setting

When the judgment synchronization setting is enabled and you want to set the optimal range relative to the comparator or BIN measurement judgment standards, it is necessary to re-set the range with **HOLD**. When performing comparator or BIN measurement of a sample whose impedance varies greatly with the frequency, you can fix the measurement range to the optimal range relative to the judgment standards.

- NOTE**
- This setting is only available when the judgment standards have been set for comparator and BIN measurement (p. 100).
 - When judgment standards have been set for comparator and BIN measurement with this setting on, the range will be automatically switched to the optimal range. However, AUTO range operation will be used when no judgment standards have been set.

Procedure

Example: Comparator

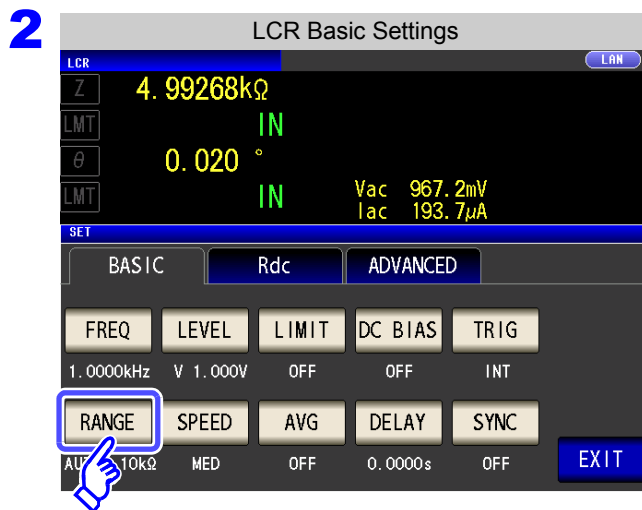
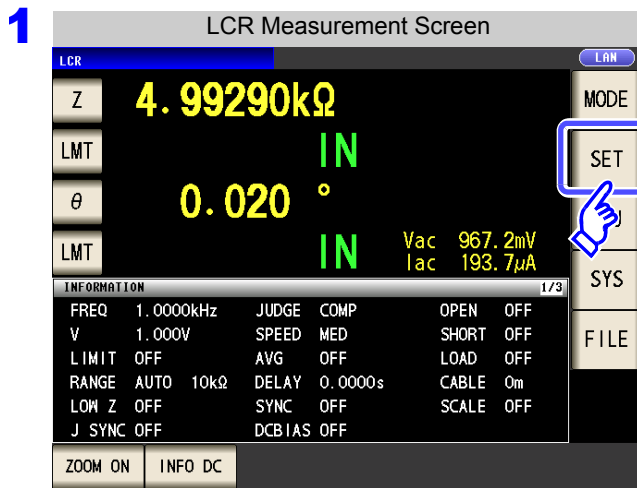

Press **RANGE**.

4.2 Setting Basic Settings of Measurement Conditions



Turn the judgment synchronization setting on or off.

- OFF** Disables the judgment synchronization setting.
- ON** Enables the judgment synchronization setting.

4 Press **EXIT** to close the setting screen.

NOTE

- The ranges that can be set vary with the frequency. (p. 67)
- When only, D, or Q has been set, **AUTO** functionality is used.
- Because the phase angle cannot be calculated for some combinations of parameters, the range is determined from ideal values. For more information, see the table below.
See "Appendix1 Measurement Parameters and Calculation Formula"(p. A1)

Parameter combination conditions for the judgment synchronization setting

		The third parameter															
		AC	OFF	Z	Y	Rs	Rp	X	G	B	Ls	Lp	Cs	Cp	θ	D	Q
The first parameter	OFF	×	●	●	△	△	△	△	△	△	△	△	△	△	×	×	×
	Z	●	●	●	△	△	△	△	△	△	△	△	△	△	●	●	●
	Y	●	●	●	△	△	△	△	△	△	△	△	△	△	●	●	●
	Rs	△	△	△	△	△	△	△	△	△	△	△	△	△	●	●	●
	Rp	△	△	△	△	△	△	△	△	△	△	△	△	△	●	●	●
	X	△	△	△	△	△	△	△	△	△	△	△	△	△	●	●	●
	G	△	△	△	△	△	△	△	△	△	△	△	△	△	●	●	●
	B	△	△	△	△	△	△	△	△	△	△	△	△	△	●	●	●
	Ls	△	△	△	△	△	△	△	△	△	△	△	△	△	●	●	●
	Lp	△	△	△	△	△	△	△	△	△	△	△	△	△	●	●	●
	Cs	△	△	△	△	△	△	△	△	△	△	△	△	△	●	●	●
	Cp	△	△	△	△	△	△	△	△	△	△	△	△	△	●	●	●
	θ	×	●	●	●	●	●	●	●	●	●	●	●	●	×	×	×
	D	×	●	●	●	●	●	●	●	●	●	●	●	●	×	×	×
	Q	×	●	●	●	●	●	●	●	●	●	●	●	●	×	×	×

×	Invalid setting (treated as AUTO range)
△	Set from ideal value since phase angle cannot be calculated.
●	Setting prohibited.

4.2 Setting Basic Settings of Measurement Conditions

2 Low Z High Accuracy Mode

In low Z high accuracy mode, an output resistance of 25 Ω is used so that adequate current can flow to the measurement sample, allowing highly accurate measurement.

Procedure

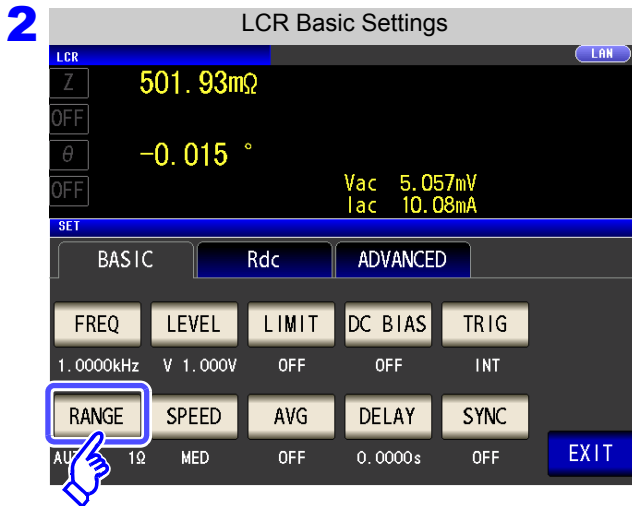
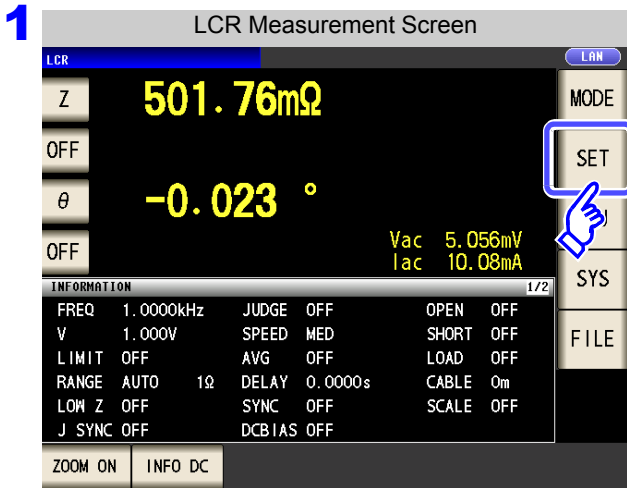

Press **RANGE**.

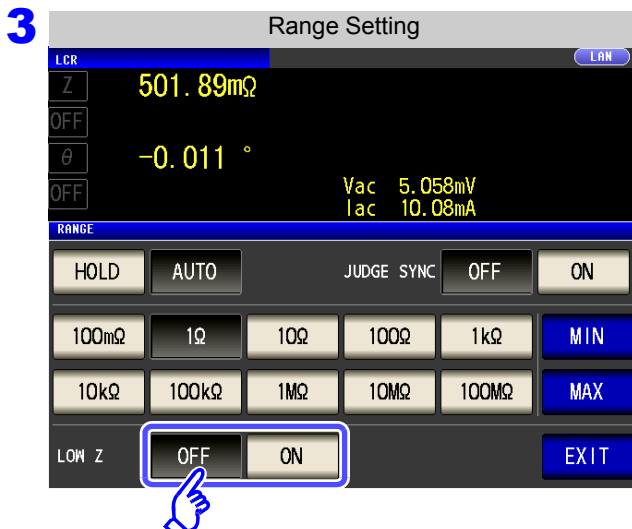

Select ON/OFF for the low Z high accuracy mode.

- OFF Sets the low Z high accuracy mode to OFF.
- ON Sets the low Z high accuracy mode to ON.

4 Press **EXIT** to close the setting screen.

4.2 Setting Basic Settings of Measurement Conditions

NOTE

- Low Z high accuracy mode is only available for the 100 mΩ and 1 Ω ranges. Refer to the following.

No.	Measurement range	to 1 kHz	to 10 kHz	to 100 kHz	to 200 kHz
1	100 MΩ	Normal mode only (setting not possible for low Z high accuracy mode).	None	None	None
2	10 MΩ				
3	1 MΩ				
4	100 kΩ				
5	10 kΩ				
6	1 kΩ				
7	100 Ω				
8	10 Ω				
9	1 Ω				
10	100 mΩ	Low Z high accuracy mode/ normal mode			

- The valid setting range for the measurement signal level varies in low Z high accuracy mode (p. 54).
- Changing the low Z high accuracy mode setting while open compensation, short compensation, or load compensation is enabled causes the compensation values to be disabled.

4.2.7 Setting the Measurement speed

The testing speed can be set. The slower the testing speed is, the more accurate are the results.

Procedure

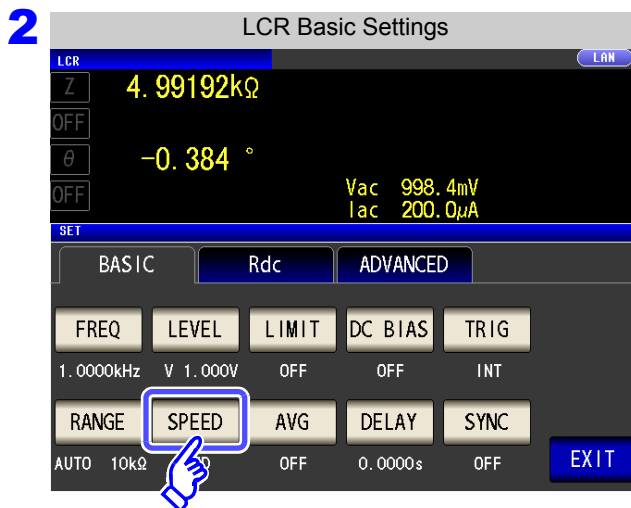
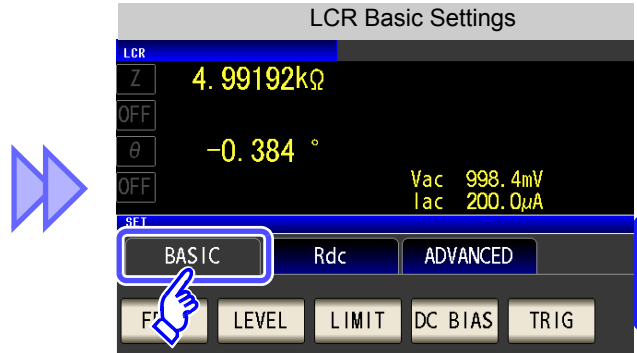
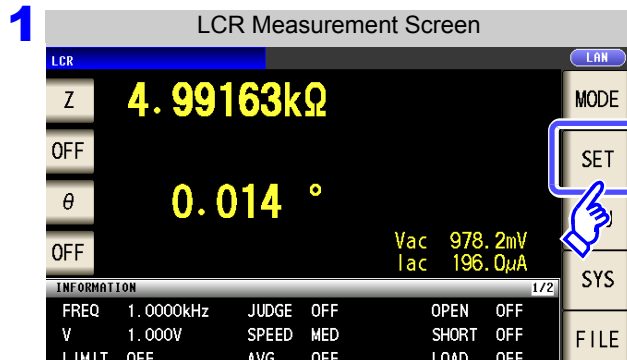

Press **SPEED**.

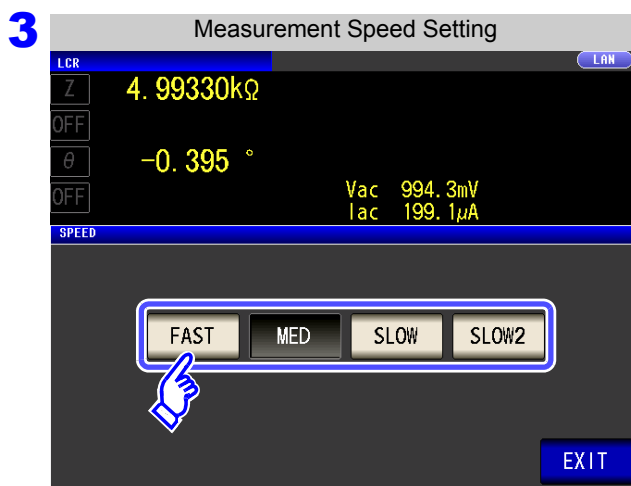

4 Press **EXIT** to close the setting screen.

To select the measurement speed.

FAST	Performs high-speed measurement.
MED	This is the normal measurement speed.
SLOW	Measurement precision improves.
SLOW2	Measurement accuracy is better than SLOW.

Measurement speed varies with the measurement conditions.

See "About Measurement Times and Measurement Speed" (p. 352)

NOTE

The waveform averaging function allows you to set the measurement speed at a higher level of detail. When the waveform averaging function is enabled, speed settings are not available. Disable the waveform averaging function before setting the speed.

See "4.5.2 Setting the Detection Signal Waveform Averaging Count (Waveform Averaging Function)" (p. 128)

4.2 Setting Basic Settings of Measurement Conditions

4.2.8 Displaying Average Values (Averaging Set)

With the averaging function, the measured values can be averaged. Using this function, it is possible to reduce fluctuations in the measured value display.

With internal trigger

A rolling average of the tested values over the set number of times for averaging is always calculated backwards from the present.
(When the sample to be tested is changed over, it takes a little time for a certain stabilization time period until the results is reliable.)

With external trigger

Average over the number of averaging times based on trigger input.

When the number of averaging times is 4, the number of measurements, measurement output points, and measurement value calculation method during output are as follows.

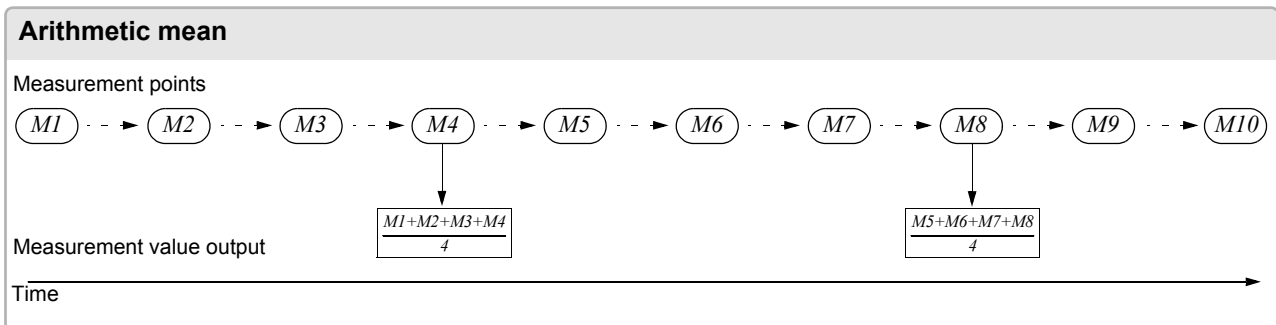
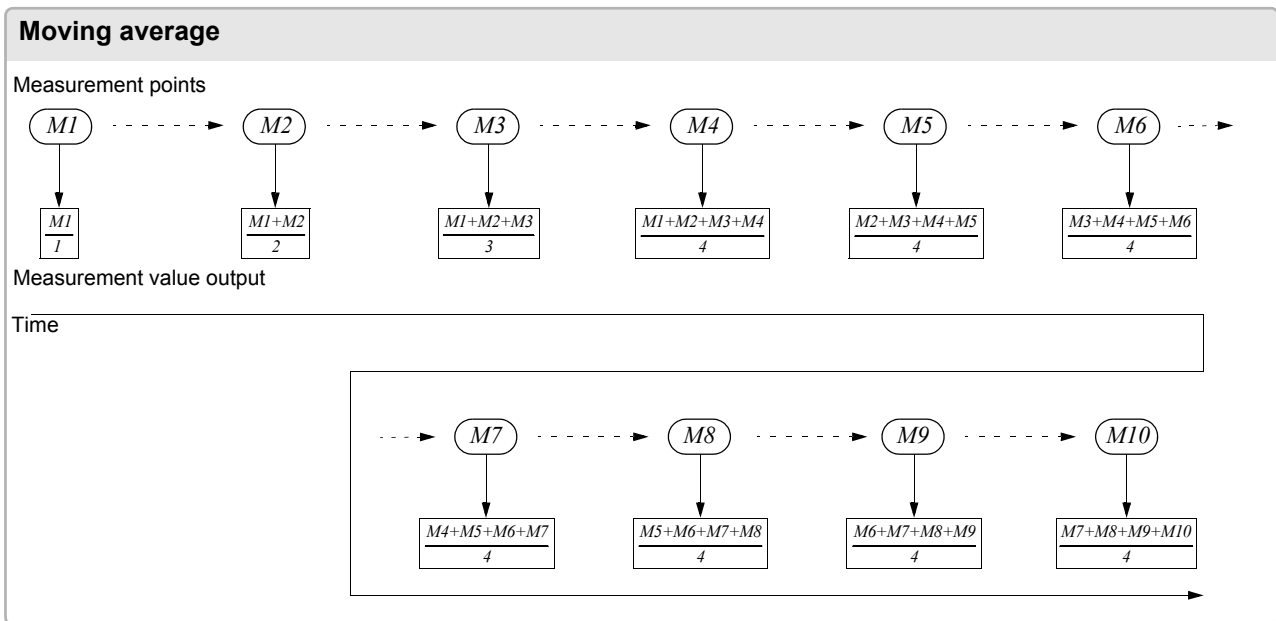

4.2 Setting Basic Settings of Measurement Conditions

Procedure

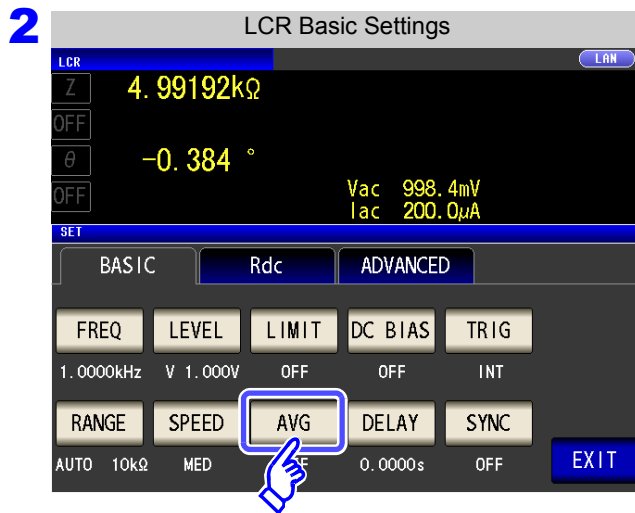
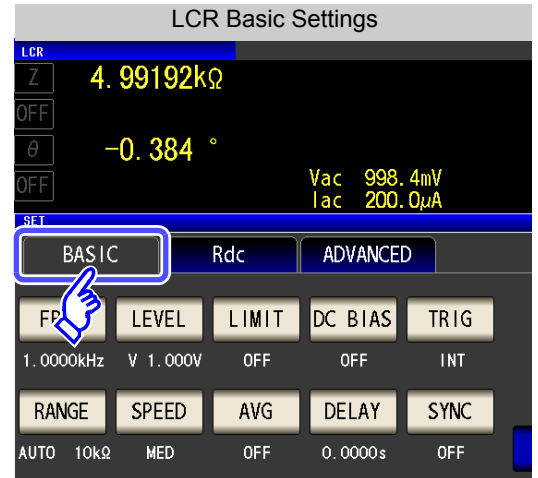
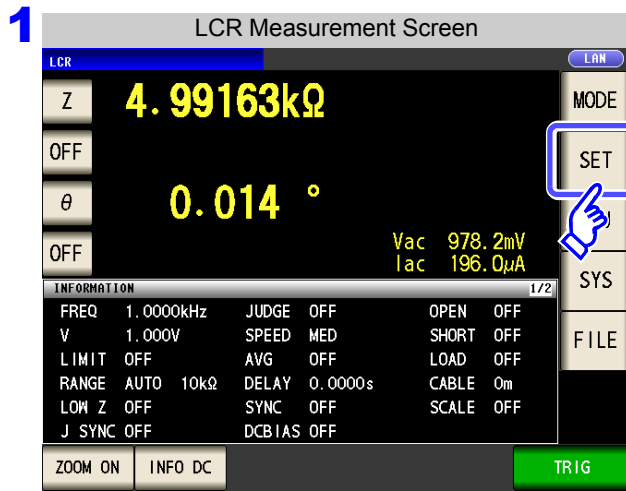

Press .

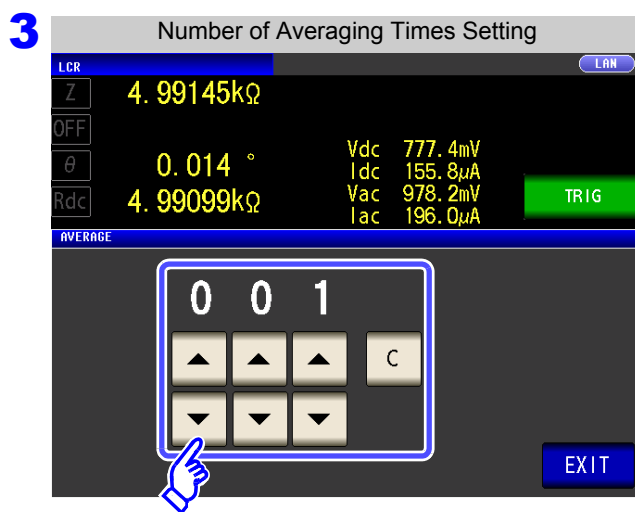

Use or to enter the number of averaging times.

Settable range: 1 to 256 times

When you want to turn off the averaging function: Press .
The number of averaging times is set to 001, and the averaging function is set to OFF.

4 Press to close the setting screen.

4.2 Setting Basic Settings of Measurement Conditions

4.2.9 Setting the Delay Time until Measurement Data is Captured (Trigger Delay)

The delay time period from input of the trigger signal to measurement can be set. With this function it is possible to ensure that testing is started after the connection condition of the object being tested and the test cables has stabilized.

See "Trigger delays and the trigger synchronous output function" (p. 79)

Procedure

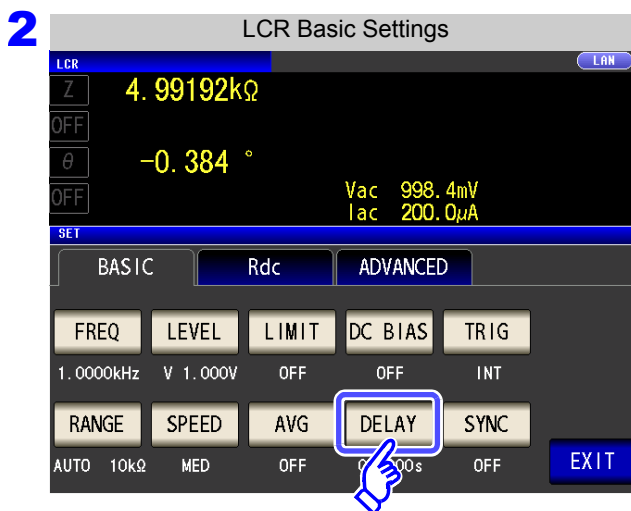
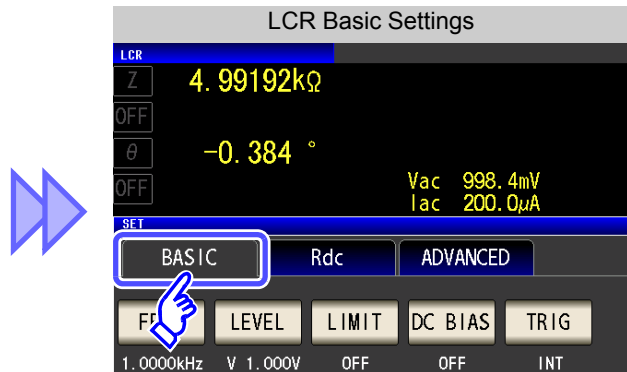
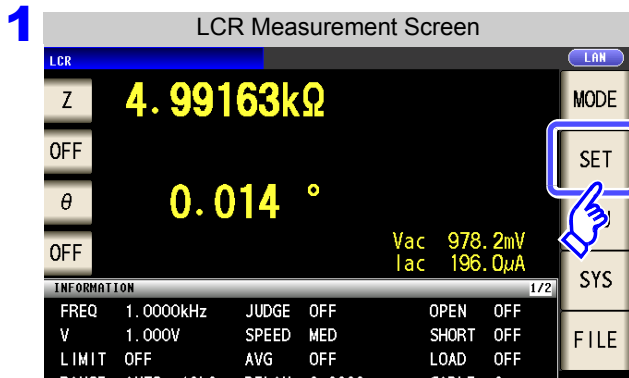

Press **DELAY**.

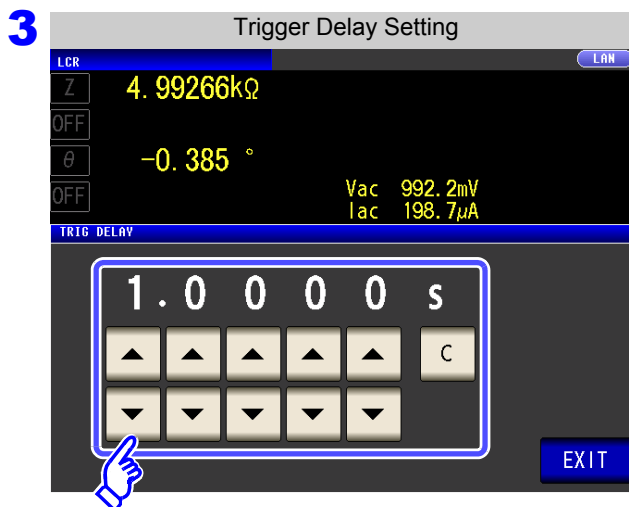

Use **▲** or **▼** to enter the delay time.

Settable range: 0 s to 9.9999 s with resolution of 0.1 ms

When you want to turn off the trigger delay

function: Press **C**.

The set time is set to 0 s.

4 Press **EXIT** to close the setting screen.

NOTE When trigger delay is used, the LED for indicating that measurement is in progress is lit from when the trigger is input until measurement ends.

4.2.10 Applying the Signal to the Sample during Measurement Only (Trigger Synchronous Output Function)

This function generates measurement signal output after trigger input and applies the signal to the sample only during measurement. You can also set a delay time to ensure that data is acquired after the sample stabilizes.

Thus reducing the generation of heat in the sample and decreasing electrode wear.

See "Trigger delays and the trigger synchronous output function" (p. 79)

Procedure

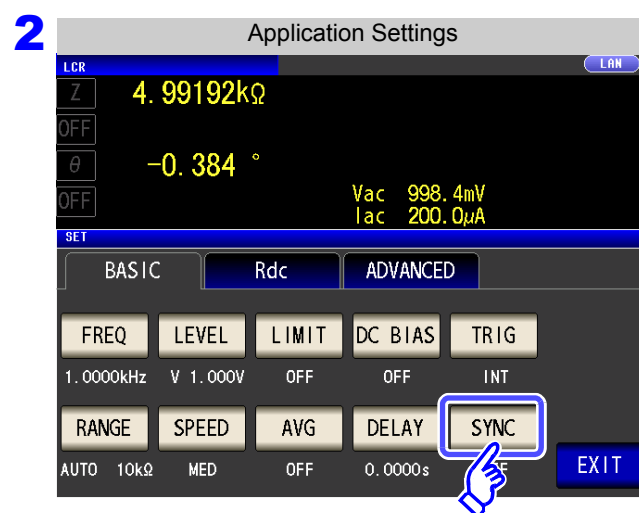
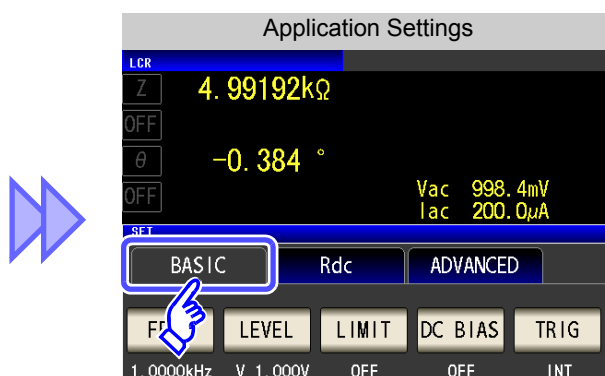
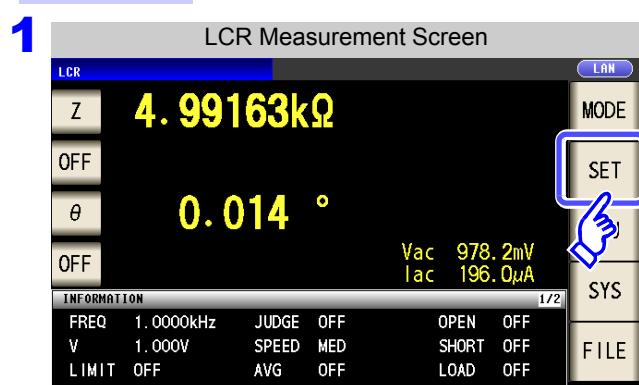

Press **SYNC**.

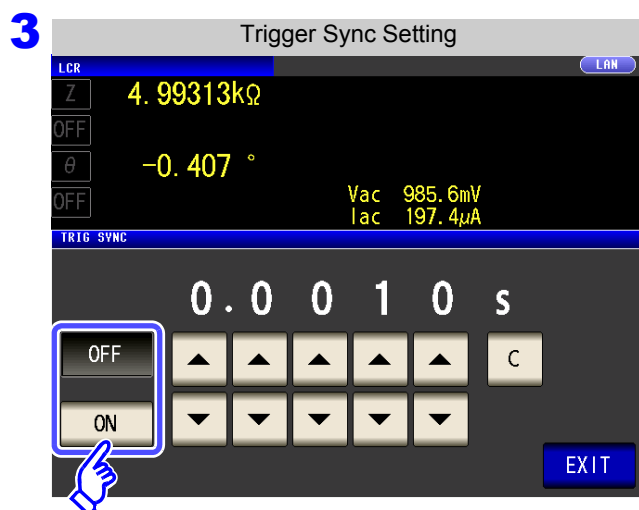

Select ON/OFF for the trigger synchronous output function.

OFF

Disables the trigger synchronous output function.

ON

Enables the trigger synchronous output function.

4.2 Setting Basic Settings of Measurement Conditions

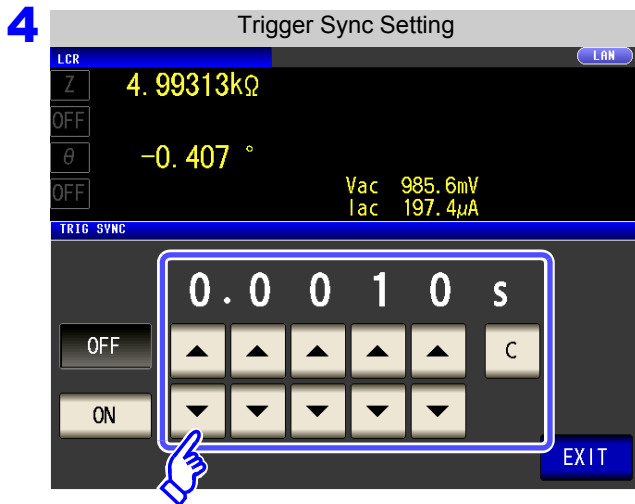

Use or to set the wait time from after the measurement signal is output by applying a trigger to the start of measurement.

Settable range: 0.0010 s to 9.9999 s

When you want to return the time to the initial state: Press .
The set time is set to 0.0010 s.

5 Press to close the setting screen.

NOTE

- When the trigger synchronous output function is set to ON, the measurement time will increase due to the incorporation of a wait time between output of the measurement signal and data acquisition.
[See "14.3 About Measurement Times and Measurement Speed" \(p. 352\)](#)
- When the trigger synchronous output function is set to ON, the set level may be output momentarily if a measurement condition is changed.
- The measurement signal is output when the trigger signal is input and stops after measurement ends.
- When the contact check timing is set to either or for the contact check function, the trigger synchronous output function is automatically turned on. Set the time to wait until the start of measurement.
[See "4.5.4 Checking Contact Defects and the Contact State \(Contact Check Function\)" \(p. 132\)](#)
- In CONTINUOUS measurement mode, the measurement signal stops after measurement of the last panel ends.

Trigger delays and the trigger synchronous output function

The trigger delay function allows you to set a delay time from the time the trigger signal is input until measurement. The trigger synchronous output function outputs the measurement signal only during measurement and allows you to set a delay time that will be allowed to elapse before data is acquired.

The measurement process is as follows:

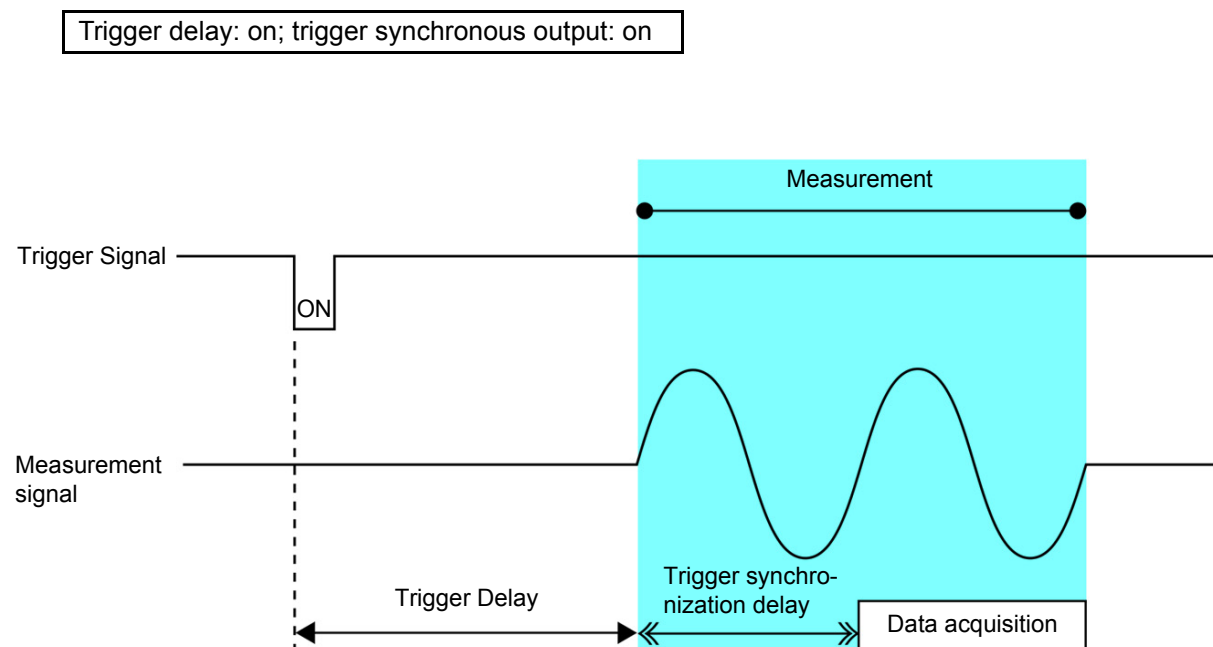
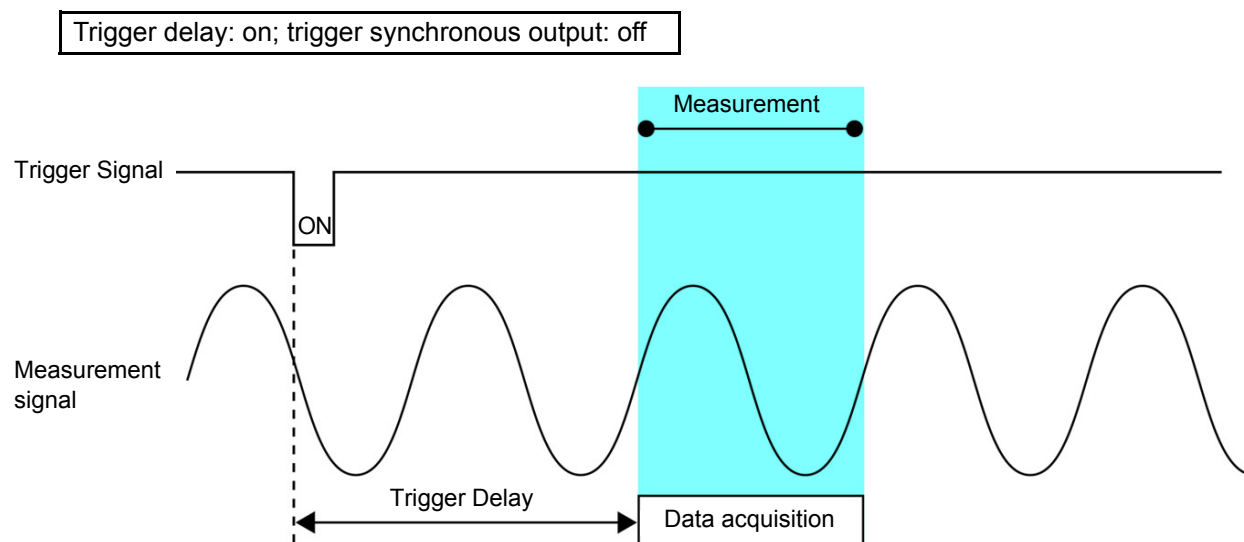

NOTE

When the range synchronization function has been set, the range settings at which the trigger delay and trigger synchronous output function are enabled vary with the parameter settings.

Parameter	Range setting at which function is enabled
AC measurement only	AC measurement range
AC+DC measurement	AC measurement range
DC measurement only	DC measurement range

4.3 Setting DC Resistance Measurement

The DC resistance **Rdc** can be measured by outputting a 2.0 V (fixed) DC signal. The measurement process is as follows:

1. Measure the DC resistance with an applied voltage of 2.0 V.
2. Measure the DC resistance with an applied voltage of 0 V and use the result as the offset value.
3. Using the offset value, reduce the measurement error.
4. Output the **Rdc** measurement value.

NOTE

- It is necessary to set the line frequency for the power supply being used so that the instrument can reject noise. Set this parameter to the frequency of the commercial power supply being used before using the instrument to make measurements. Failure to properly set the line frequency will prevent you from acquiring stable measurement values.
See "4.3.4 Setting the Line Frequency" (p. 87)
- To measure DC resistance, you need to set **Rdc** in the measurement parameters beforehand.
See "1.3.7 Parameter Settings Screen" (p. 28), "4.1.2 Setting Display Parameters" (p. 47)
- When **Rdc** and other parameters are set, the DC resistance is measured after those other parameters have been measured with the AC signal. The measurement conditions can be set individually.
- The DC bias function cannot be enabled when DC resistance measurement is performed.
- When the sample is a capacitor, it may not be possible to perform DC resistance measurement normally.
- The time required until the DC signal level stabilizes differs depending on the test sample to be measured. To ensure measurement is performed accurately, observe the measurement waveform in advance and then set the delay time required until the DC signal level stabilizes.
See "4.3.2 Setting the DC Measurement Delay Time (DC Delay)" (p. 83)
"4.3.3 Setting the Offset Measurement Delay Time (Adjustment Delay)" (p. 85)

Adding Rdc to Measurement Parameters

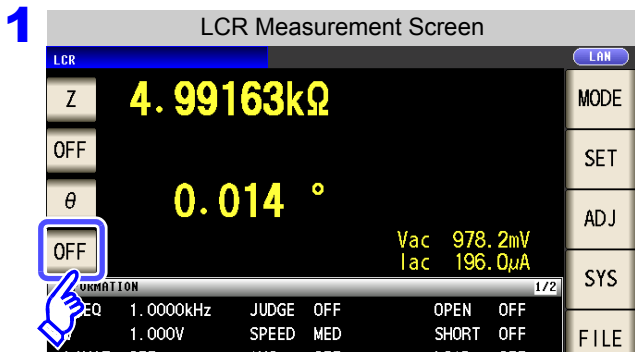

Select the parameter you want to change.

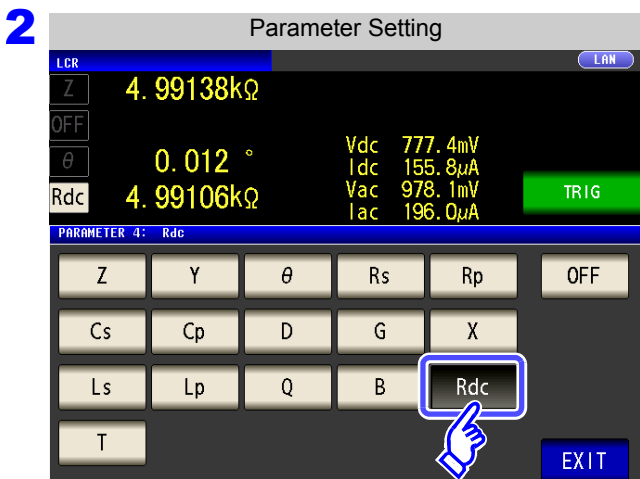

Press **Rdc**.

3 Press **EXIT** to close the setting screen.

4.3.1 Configuring the Temperature Correction Function

The principle of temperature correction (see "Appendix9 Temperature Correction Function (TC)"(p. A13)) can be used to convert resistance values to a reference temperature value and display the results. Be sure to read the following when connecting the 9478 Sheath type temperature probe to the TC SENSOR terminal on the back of the instrument.

See "2.5 Connecting a Temperature Probe" (p. 33)

NOTE When a 9478 Sheath type temperature probe is not connected, this function cannot be enabled. Attempting to do so will cause "TC ERR" to be displayed as the Rdc measurement value. (p. 363)

Procedure

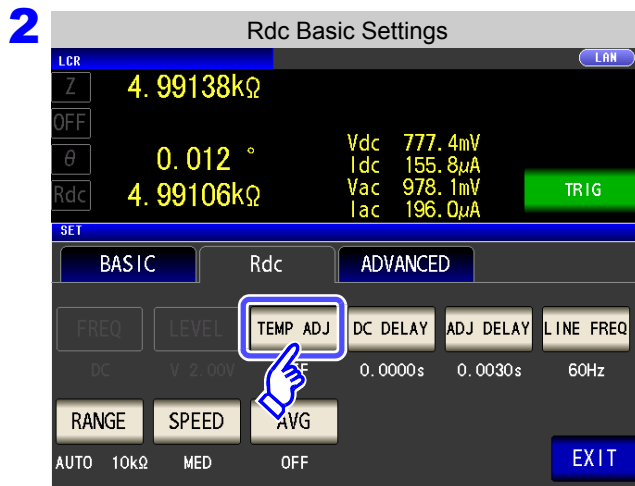
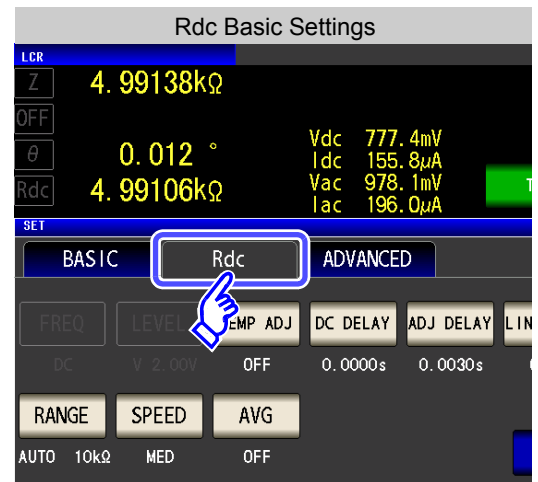
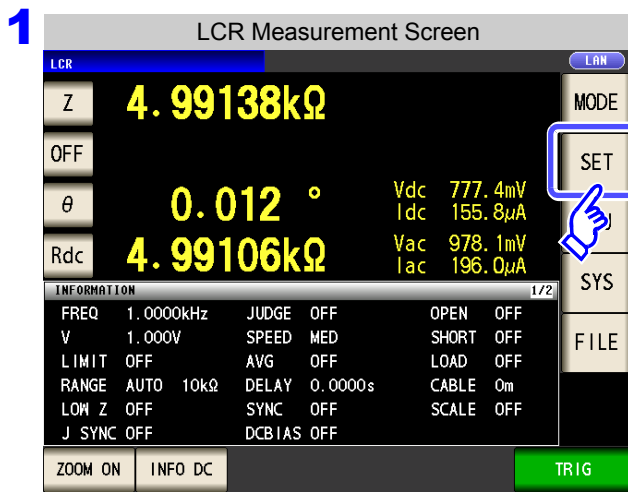

Press **TEMP ADJ**.

4.3 Setting DC Resistance Measurement

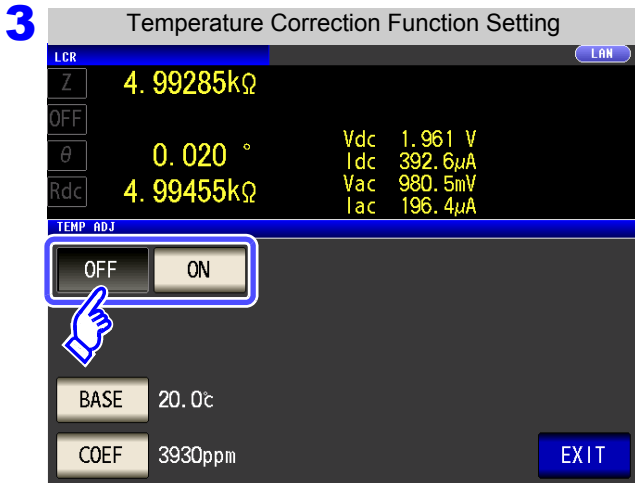

Turn the temperature correction function on or off.

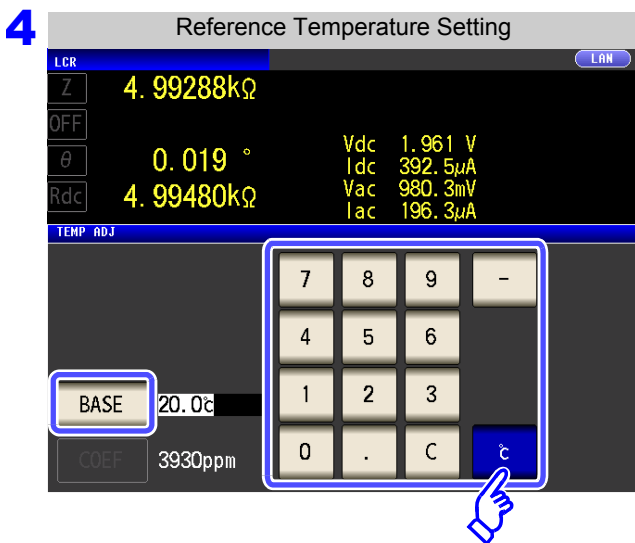
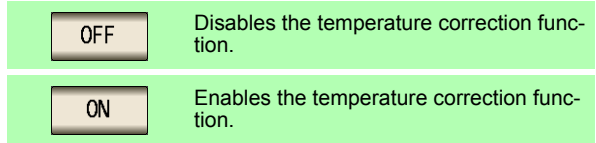

Press **BASE** and use the numeric keypad to set the reference temperature.

Settable range: -10°C to 99.9°C

Press **°C** key to confirm the setting.

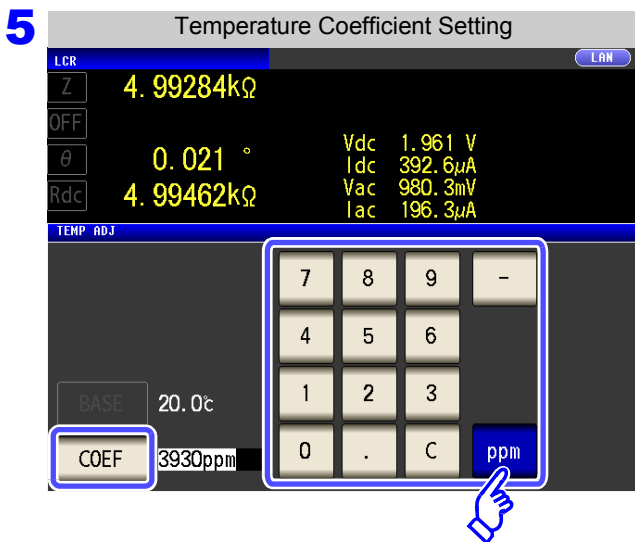

Press **COEF** and use the numeric keypad to set the temperature coefficient.

Settable range: -99999ppm to 99999ppm

Press **ppm** key to confirm the setting.

6 Press **EXIT** to close the setting screen.

4.3.2 Setting the DC Measurement Delay Time (DC Delay)

This section describes how to set the time allowed to elapse before DC resistance measurement starts, for example when switching from measurement using an AC signal to DC resistance measurement. This delay time serves to delay measurement until the DC level stabilizes.

When number of averaging times is 1



When the number of averaging times is 2 or more (The number of times is 2 in this example)

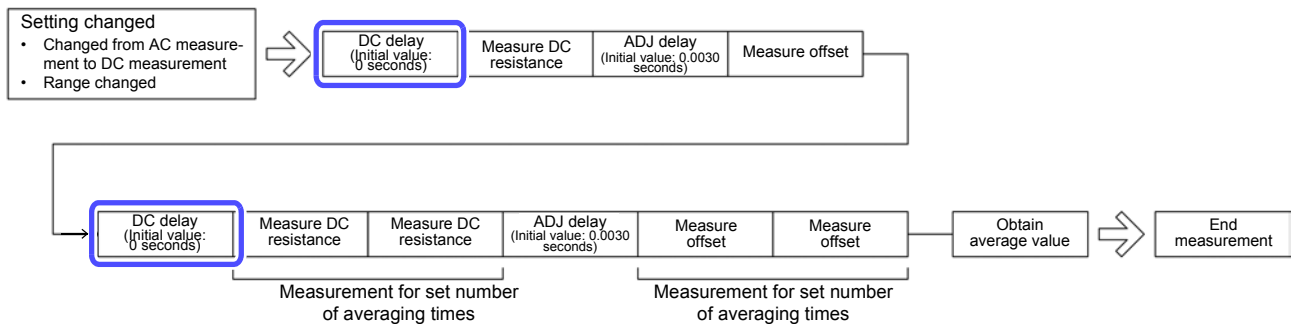

Procedure

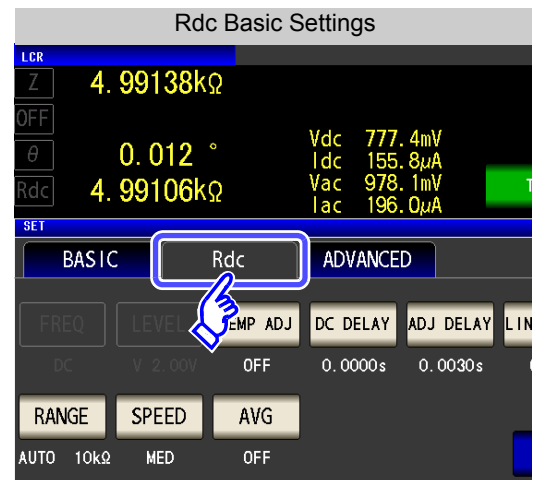
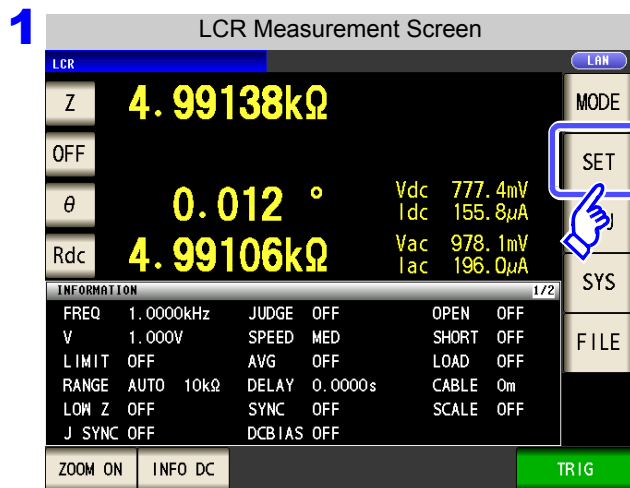

NOTE

The time required until the DC signal level stabilizes differs depending on the test sample to be measured. To ensure measurement is performed accurately, observe the measurement waveform in advance and then set the delay time required until the DC signal level stabilizes.

4.3 Setting DC Resistance Measurement

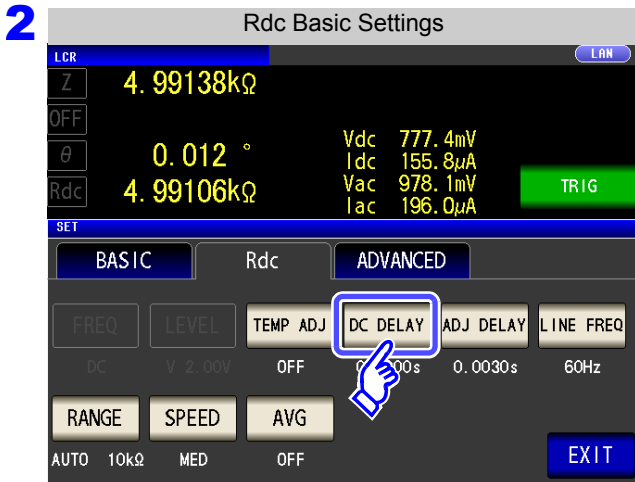

Press .

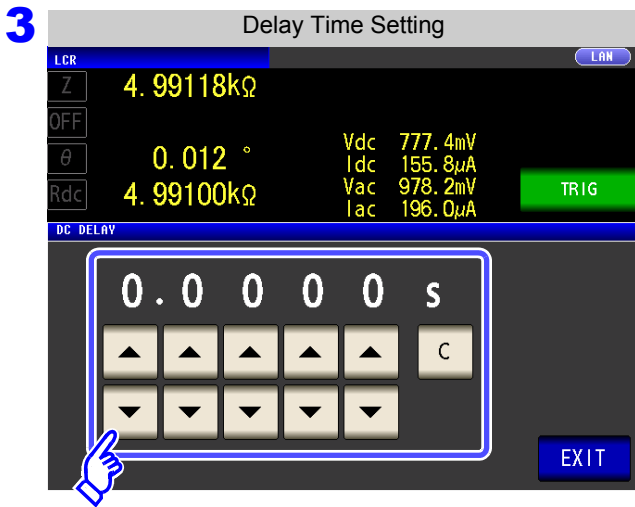

Use or to enter the delay time.

Settable range: 0 s to 9.9999 s

When you want to cancel setting of the delay

time: Press .

The set time is set to 0 s.

4 Press to close the setting screen.

4.3.3 Setting the Offset Measurement Delay Time (Adjustment Delay)

This delay time serves to delay measurement until offset measurement (0 VDC) stabilizes.

When number of averaging times is 1

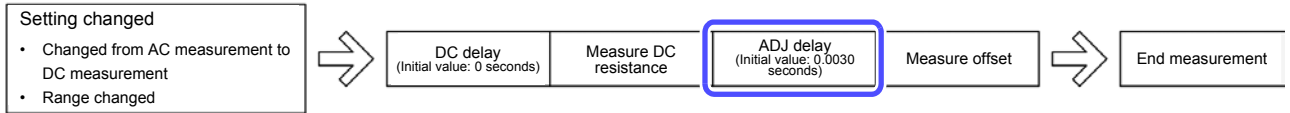

When the number of averaging times is 2 or more
(The number of times is 2 in this example)

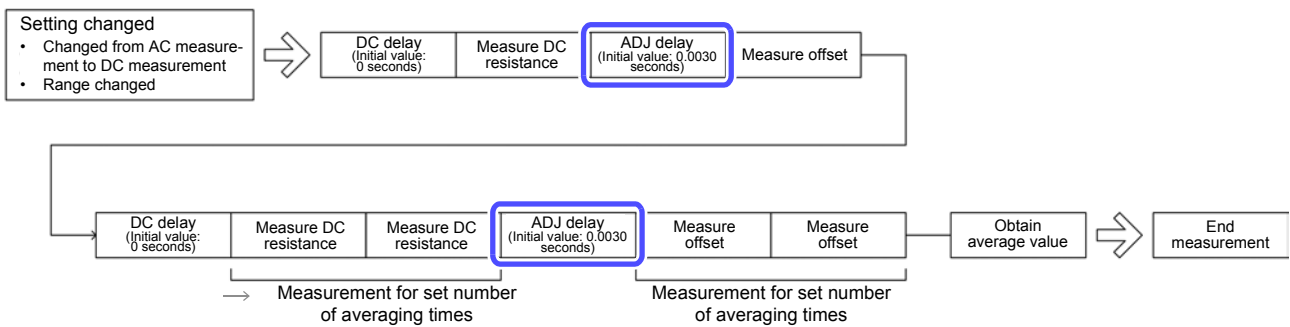

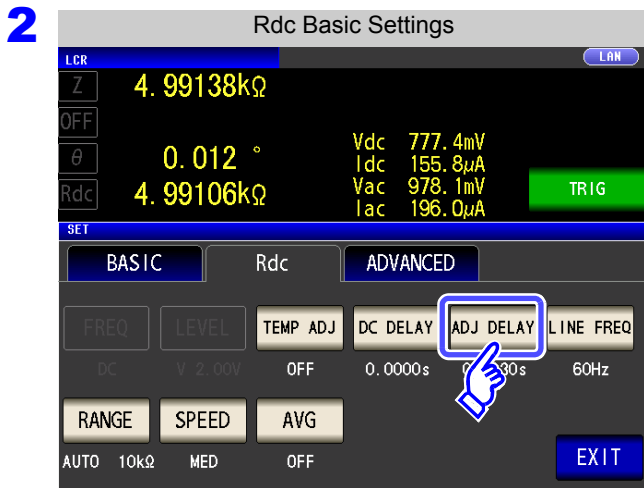
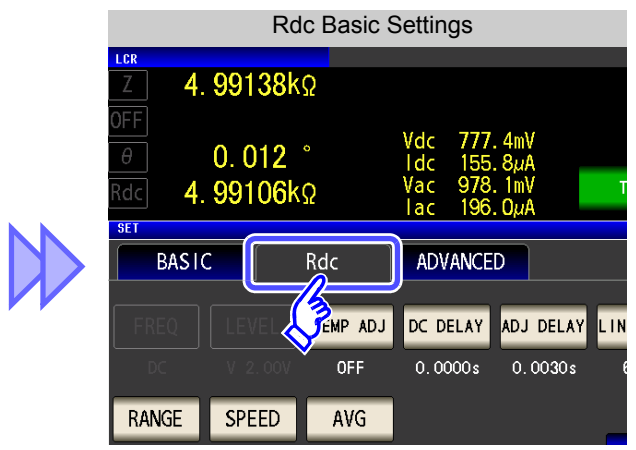
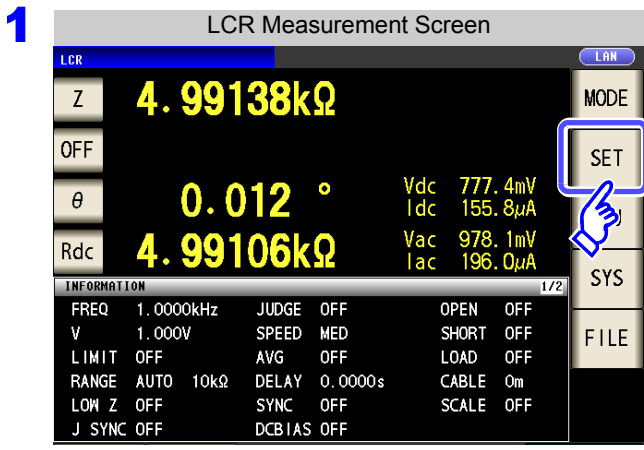

Procedure

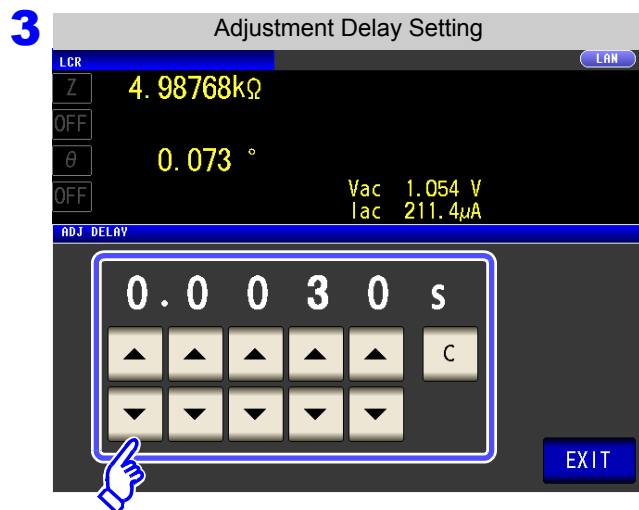

Press ADJ DELAY.

4.3 Setting DC Resistance Measurement



Set the offset measurement time with  and .

Settable range: 0.0030 s to 9.9999 s

When you want to revert the offset measurement delay time to its default value: Press . The set time is set to 0.0030 s.

4 Press  to close the setting screen.

4.3.4 Setting the Line Frequency

When performing DC resistance measurement, be sure to set the line frequency of the power supply being used.

Procedure

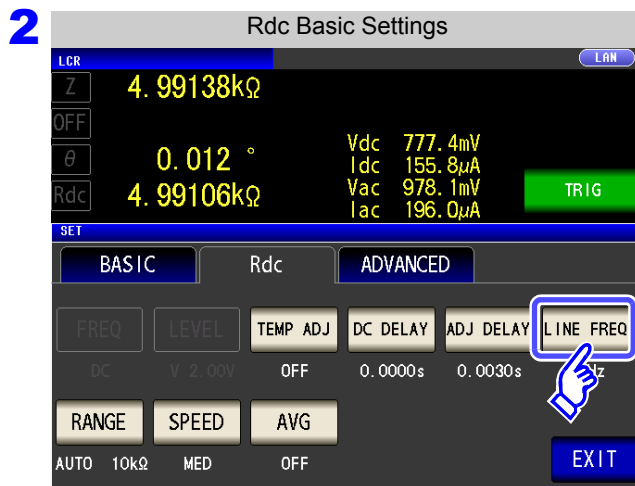
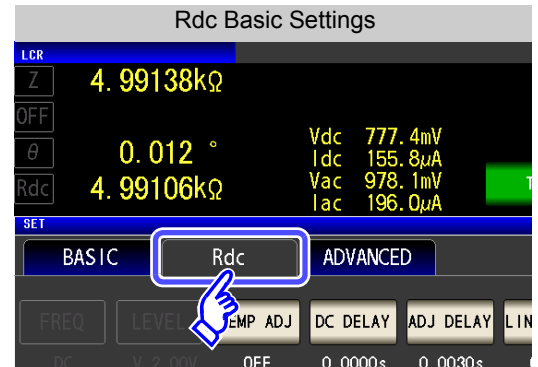
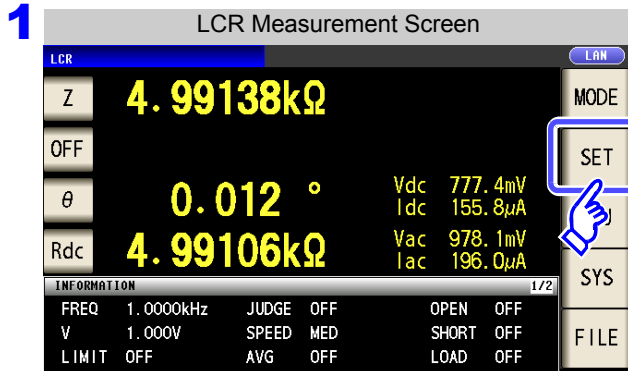

Press **LINE FREQ**.

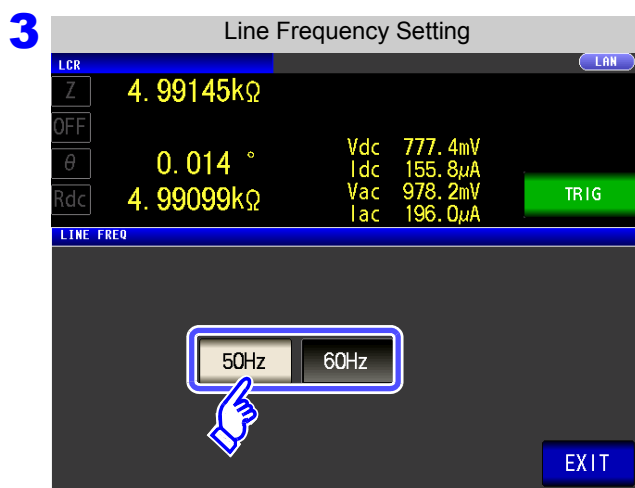

Select the line frequency.

50Hz Sets the line frequency to 50 Hz.

60Hz Sets the line frequency to 60 Hz.

4 Press **EXIT** to close the setting screen.

NOTE It is necessary to set the line frequency for the power supply being used so that the instrument can reject noise. Set this parameter to the frequency of the commercial power supply being used before using the instrument to make measurements. Failure to properly set the line frequency will prevent you from acquiring stable measurement values.

4.3 Setting DC Resistance Measurement

4.3.5 Setting the Measurement Range

1 Setting the method for determining the measurement range (HOLD, AUTO, JUDGE SYNC)

There are the following three methods for setting the measurement range.

- AUTO** → The most suitable test range is set automatically. (This allows the most suitable measurement range to be set when, for example, measuring a test sample whose nature is unknown.)
- HOLD** → The measurement range is fixed. The range is set manually. (When the range is fixed, high-speed measurement is possible.)
- JUDGE SYNC** → The optimal range is set automatically based on the comparator and BIN measurement judgment standards. (This allows the optimal range to be fixed relative to the comparator and BIN measurement judgment results when testing a sample whose impedance varies greatly with frequency.)

NOTE Selecting the HOLD or AUTO setting while the judgment synchronization setting is enabled automatically disables the judgment synchronization setting.

Setting AUTO Ranging

Procedure

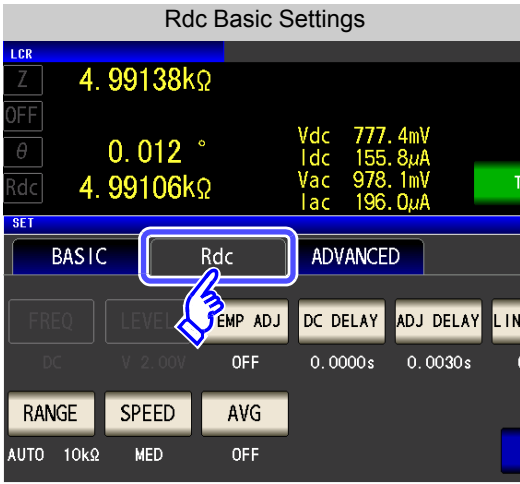
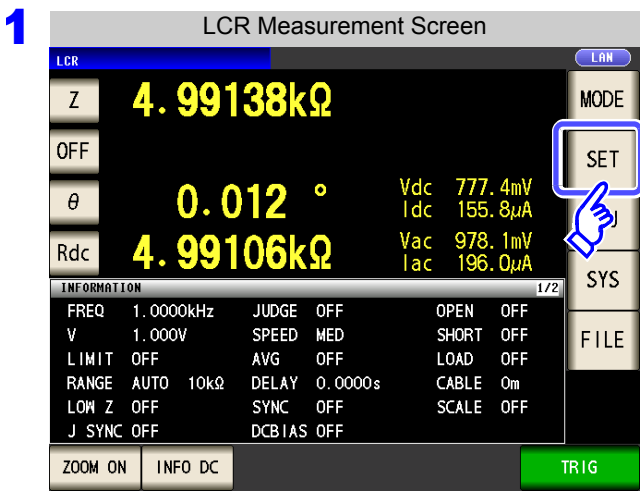

4.3 Setting DC Resistance Measurement

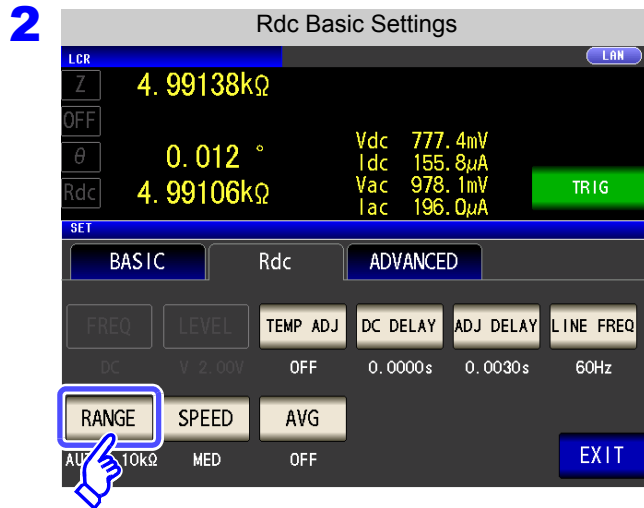

Press **RANGE**.

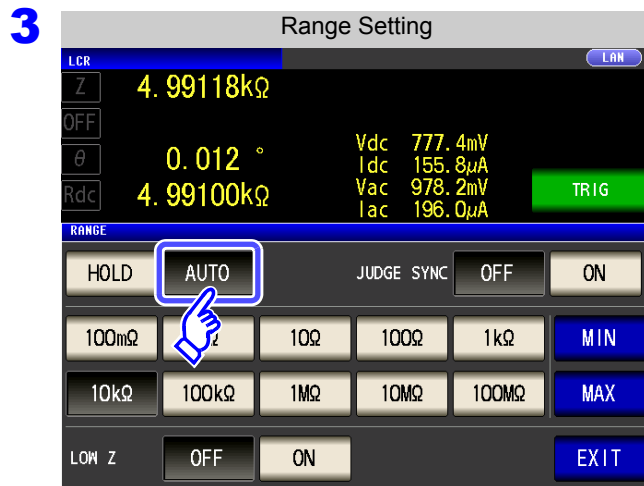

Press **AUTO**.

- When you want to limit the AUTO ranging range:
See "AUTO range limit function" (p. 90)
- If the instrument is being used outside the limits of its specification, the suitable range may not be set in auto ranging function. In this case, check the accuracy assured ranges in "14.2 Measurement Range and Accuracy" (p. 343) and then change the test conditions.

4 Press **EXIT** to close the setting screen.

4.3 Setting DC Resistance Measurement

AUTO range limit function

The following procedure describes how to limit the AUTO ranging range.

Procedure

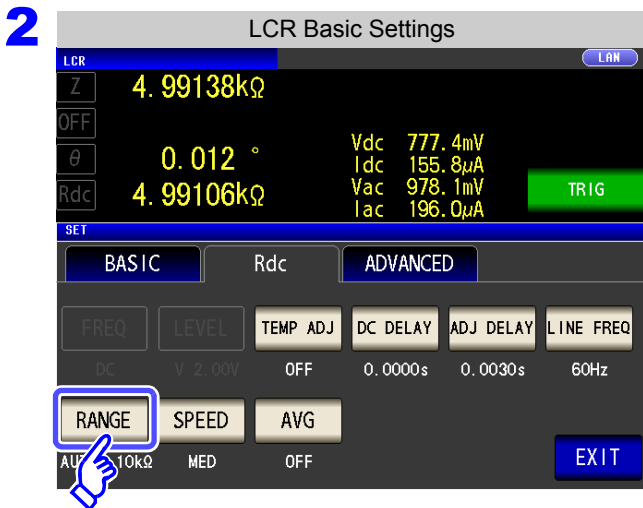
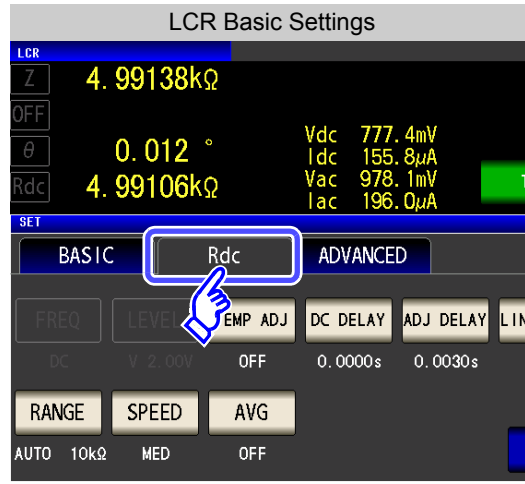
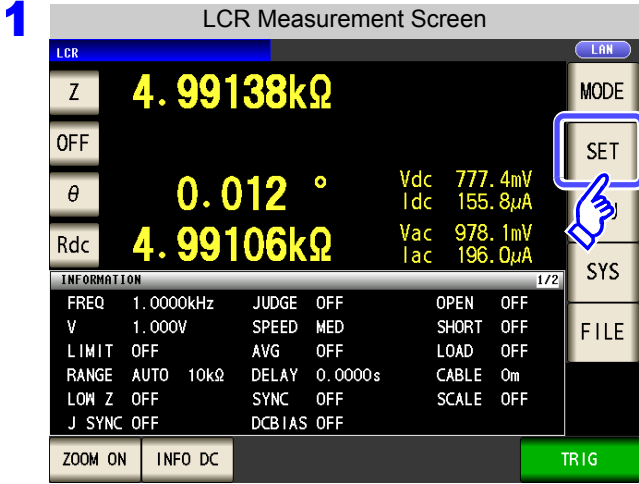

Press **RANGE**.

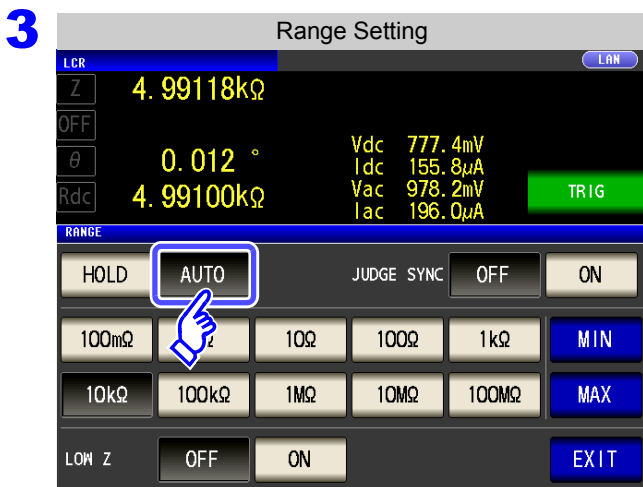

Press **AUTO**.

If the instrument is being used outside the limits of its specification, the suitable range may not be set in auto ranging function. In this case, check the accuracy assured ranges in "14.2 Measurement Range and Accuracy" (p. 343) and then change the test conditions.

4.3 Setting DC Resistance Measurement



Press **MIN**.

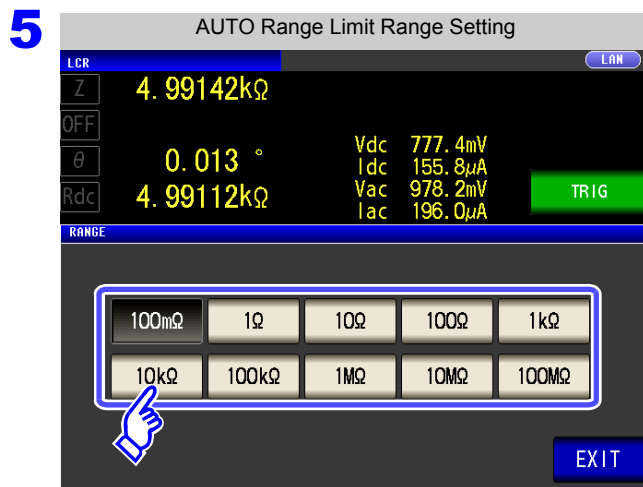

Select the AUTO range lower limit range.

6 Touch **EXIT** to accept the lower limit range.

7 Return to **step 4**, touch **MAX**, and select the AUTO range upper limit range.

8 Press **EXIT** to close the setting screen.

NOTE When canceling the AUTO range limit function, set the lower limit range to 100 mΩ and the upper limit range to 100 MΩ.

Screen displayed when the AUTO range limit function has been enabled

Example: When the upper limit range is set to 1 kΩ and the lower limit range is set to 1 MΩ

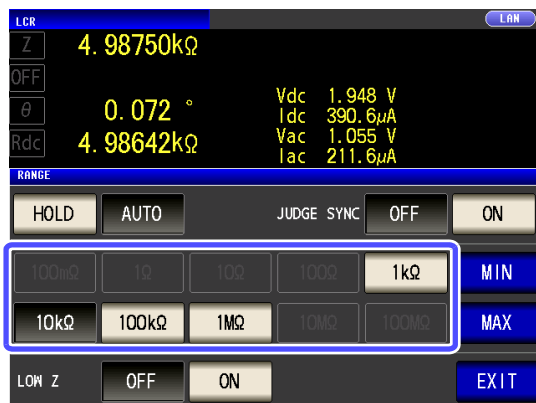

Operation is only enabled within the set AUTO ranging range.

4.3 Setting DC Resistance Measurement

Setting the Ranging to HOLD

Procedure

1 LCR Measurement Screen

LCR Measurement Screen

Z 4.99138kΩ

θ 0.012°

Rdc 4.99106kΩ

Vdc 777.4mV
Idc 155.8μA
Vac 978.1mV
Iac 196.0μA

MODE
SET
SYS
FILE

INFORMATION

FREQ 1.0000kHz	JUDGE OFF	OPEN OFF
V 1.000V	SPEED MED	SHORT OFF
LIMIT OFF	AVG OFF	LOAD OFF
RANGE AUTO 10kΩ	DELAY 0.0000s	CABLE 0m
LOW Z OFF	SYNC OFF	SCALE OFF
J SYNC OFF	DCBIAS OFF	

ZOOM ON INFO DC TRIG



Rdc Basic Settings

Rdc Basic Settings

Z 4.99138kΩ

θ 0.012°

Rdc 4.99106kΩ

Vdc 777.4mV
Idc 155.8μA
Vac 978.1mV
Iac 196.0μA

SET

BASIC Rdc ADVANCED

FREQ LEVEL TEMP ADJ DC DELAY ADJ DELAY LINE

DC V 2.00V OFF 0.0000s 0.0030s

RANGE SPEED AVG

AUTO 10kΩ MED OFF

2 Rdc Basic Settings

Rdc Basic Settings

Z 4.99138kΩ

θ 0.012°

Rdc 4.99106kΩ

Vdc 777.4mV
Idc 155.8μA
Vac 978.1mV
Iac 196.0μA

SET

BASIC Rdc ADVANCED

FREQ LEVEL TEMP ADJ DC DELAY ADJ DELAY LINE FREQ

DC V 2.00V OFF 0.0000s 0.0030s 60Hz

RANGE SPEED AVG

AUTO 10kΩ MED OFF EXIT

Press RANGE .

3 Range Selection

Range Selection

Z 4.99182kΩ

θ 0.015°

Rdc 4.99119kΩ

Vdc 777.4mV
Idc 155.8μA
Vac 978.2mV
Iac 196.0μA

RANGE

HOLD AUTO JUDGE SYNC OFF ON

mΩ 1Ω 10Ω 100Ω 1kΩ MIN

10kΩ 100kΩ 1MΩ 10MΩ 100MΩ MAX

LOW Z OFF ON EXIT

Press HOLD .

4.3 Setting DC Resistance Measurement

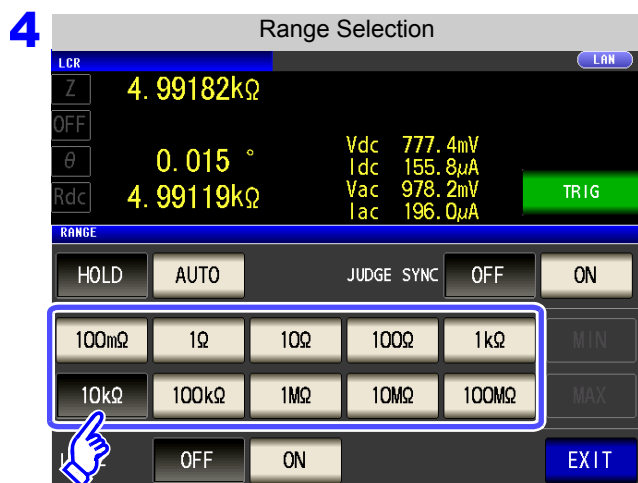

Set the test range according to the combined impedance value of the sample to be tested and the test cables.

To select the measurement range.

Test range	Accuracy guaranteed range	AUTO Ranging Range
100 MΩ	8 MΩ to 200 MΩ	8 MΩ or more
10 MΩ	800kΩ to 100MΩ	800 kΩ to 10 MΩ
1 MΩ	80kΩ to 10MΩ	80 kΩ to 1 MΩ
100 kΩ	8 kΩ to 1MΩ	8 kΩ to 100kΩ
10 kΩ	800 Ω to 100 kΩ	800 Ω to 10 kΩ
1 kΩ	80 Ω to 10 kΩ	80 Ω to 1 kΩ
100 Ω	8 Ω to 100 Ω	8 Ω to 100 Ω
10 Ω	800 mΩ to 10 Ω	800 mΩ to 10 Ω
1 Ω	80 mΩ to 1Ω	80 mΩ to 1 Ω
100 mΩ	10 mΩ to 100 mΩ	0 Ω to 100 mΩ

NOTE

- The guaranteed accuracy range varies depending on the measurement conditions. **See** Check the accuracy assured ranges in "14.2 Measurement Range and Accuracy" (p. 343)
- The measurement range is determined according to the test range setting. If the display for the measured value shows "**OVER FLOW**" or "**UNDER FLOW**", that means that measurement cannot be performed using the currently set test range. Either you should set AUTO ranging so as to select the most suitable test range automatically, or you should set a more suitable test range manually. If a measurement result is outside the display range (p. 337), "**DISP OUT**" is displayed.

5 Press **EXIT** to close the setting screen.

NOTE

- The test range setting is made according to the combination of the impedances of the sample being tested and the test cables. Therefore it can happen that testing is not possible, if the test range is held with HOLD only upon the basis of the impedance of the sample under test. If this happens, you should change the test range, making reference to "8.1 Setting Open Circuit Compensation" (p. 215) and "8.2 Short Circuit Compensation" (p. 224).
- When the measurement value is outside the guaranteed accuracy range, the following icon appears at the top of the screen.

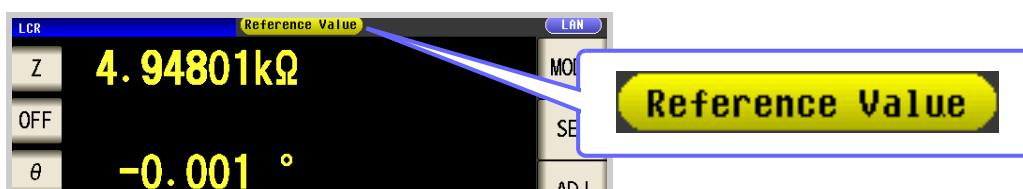

In this case, you should consider the following possible causes, and you should either change the test conditions while checking the accuracy assured ranges "14.2 Measurement Range and Accuracy" (p. 343), or you should consider the measured values as values for reference.

- Perhaps the test signal level is too low, increase the test signal level.
- If the current measurement range (during HOLD setting) is not appropriate, set again in the AUTO range, or change the range by manual.

4.3 Setting DC Resistance Measurement

Judgment synchronization setting

When the judgment synchronization setting is enabled and you want to set the optimal range relative to the comparator or BIN measurement judgment standards, it is necessary to re-set the range with **HOLD** .

NOTE

- This setting is only available when the judgment standards have been set for comparator and BIN measurement.
- When judgment standards have been set for comparator and BIN measurement with this setting on, the range will be automatically switched to the optimal range. However, AUTO range operation will be used when no judgment standards have been set.

Procedure

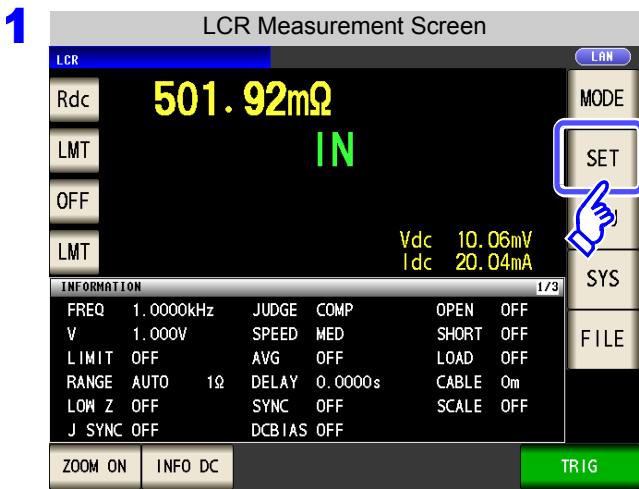

Press **RANGE** .

4.3 Setting DC Resistance Measurement

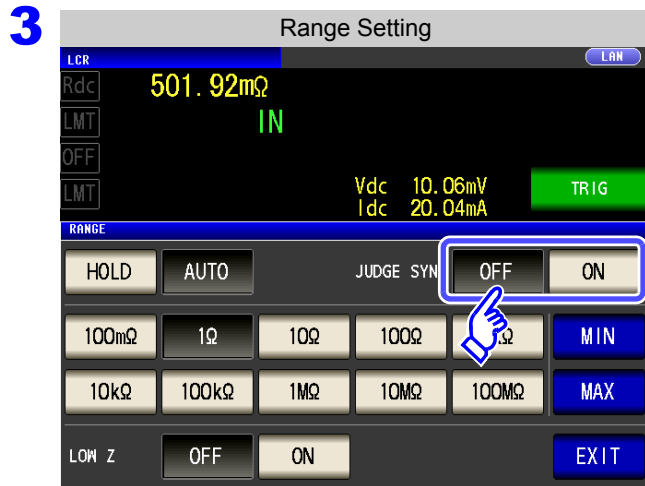

Turn the judgment synchronization setting on or off.

- OFF Disables the judgment synchronization setting.
- ON Enables the judgment synchronization setting.

4 Press **EXIT** to close the setting screen.

Parameter combination conditions while the judgment synchronization setting is enabled

		The third parameter	
		OFF	Rdc
The first parameter	OFF	×	●
	Rdc	●	●

×	Invalid setting (treated as <input type="button" value="AUTO"/> range)
●	Valid setting

4.3 Setting DC Resistance Measurement

2 Low Z High Accuracy Mode

Low Z high accuracy mode allows high-accuracy measurement by setting the output resistance to 25 Ω to ensure adequate current flow to the measurement sample.

Procedure

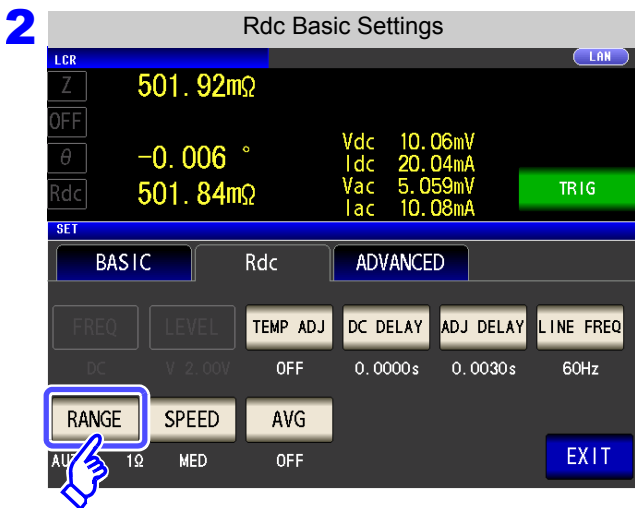
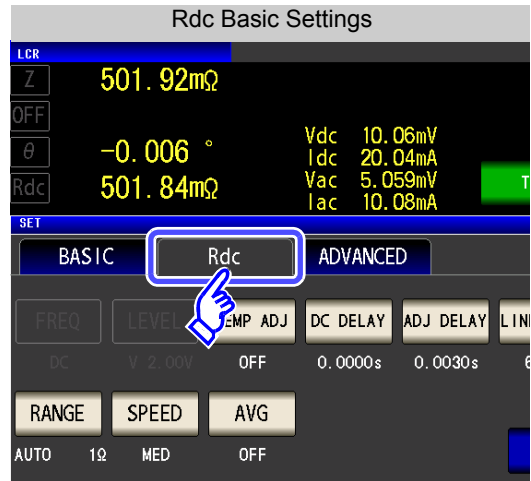
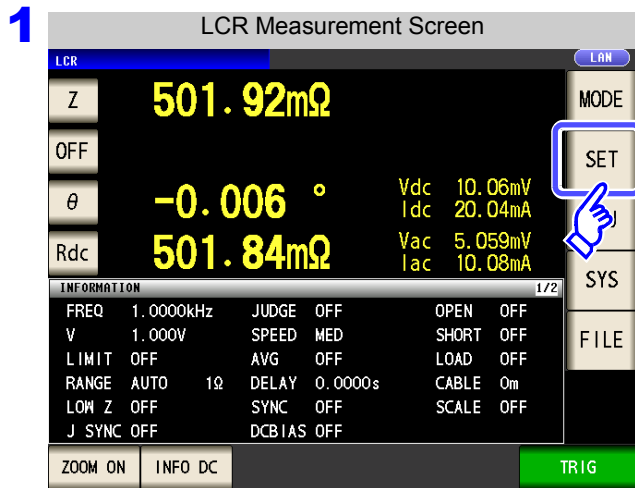

Press **RANGE**.

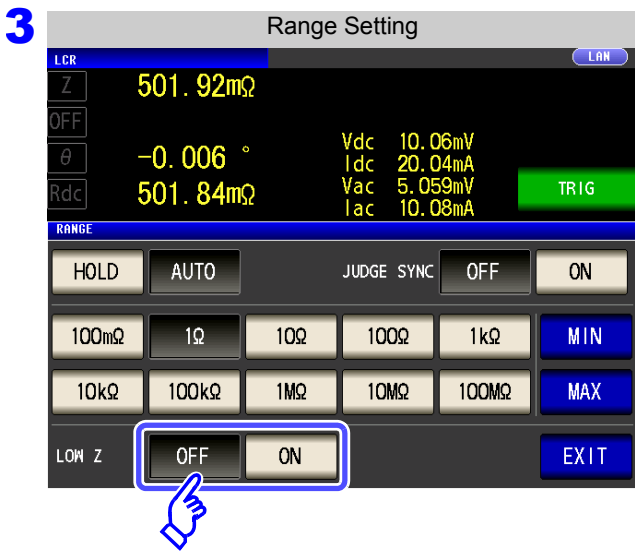

Select ON/OFF for the low Z high accuracy mode.

- Disables low Z high accuracy mode.
- Enables low Z high accuracy mode.

4 Press **EXIT** to close the setting screen.

4.3 Setting DC Resistance Measurement

NOTE

- Low Z high accuracy mode is only available for the 100 mΩ and 1 Ω ranges. Refer to the table below.

No.	Measurement range	
1	100 MΩ	Normal mode only (setting not possible for low Z high accuracy mode).
2	10 MΩ	
3	1 MΩ	
4	100 kΩ	
5	10 kΩ	
6	1 kΩ	
7	100 Ω	
8	10 Ω	
9	1 Ω	
10	100 mΩ	

- Changing the low Z high accuracy mode setting while open compensation, short compensation, or load compensation is enabled causes the compensation values to be disabled.

4.3 Setting DC Resistance Measurement

4.3.6 Setting the Measurement Speed

The testing speed can be set. The slower the testing speed is, the more accurate are the results.

Procedure

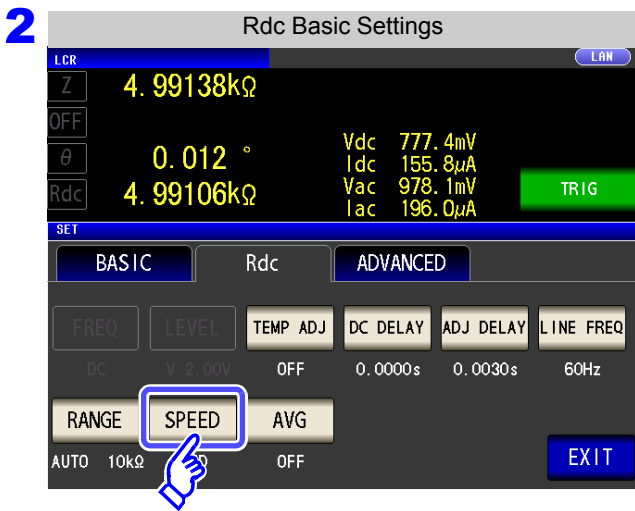
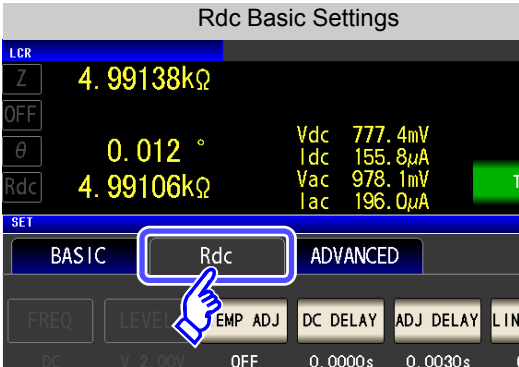
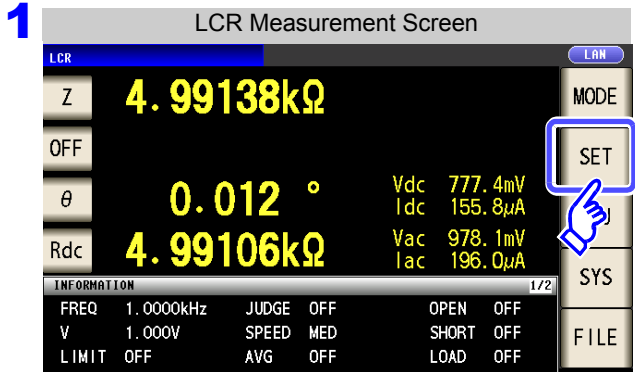

Press **SPEED**.

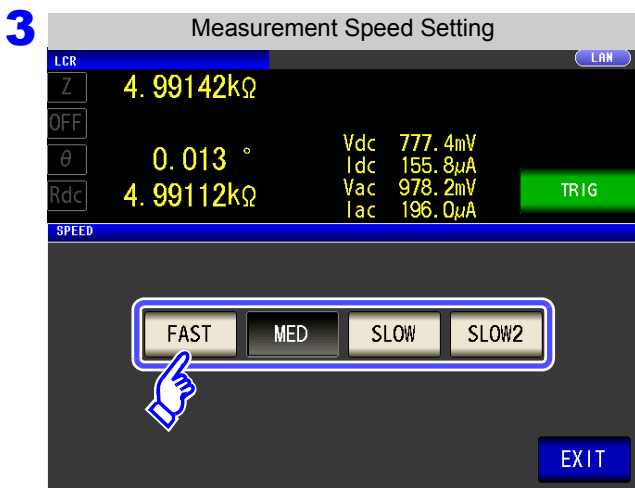

To select the measurement speed.

- FAST** Performs high-speed measurement.
- MED** This is the normal measurement speed.
- SLOW** Measurement precision improves.
- SLOW2** Measurement accuracy is better than SLOW.

Measurement speed varies with the measurement conditions.
 See "About Measurement Times and Measurement Speed" (p. 352)

4 Press **EXIT** to close the setting screen.

NOTE

The waveform averaging function allows you to set the measurement speed at a higher level of detail. When the waveform averaging function is enabled, speed settings are not available. Disable the waveform averaging function before setting the speed.

See "4.5.2 Setting the Detection Signal Waveform Averaging Count (Waveform Averaging Function)" (p. 128)

4.3.7 Displaying Average Values (Average set)

With the averaging function, the measured values can be averaged. Using this function, it is possible to reduce fluctuations in the measured value display.

After the signal level and range are set, measurement is performed for the set number of averaging times and the measurement values are displayed.

NOTE The averaging process during DC resistance measurement performs arithmetic mean processing regardless of the trigger setting.

Procedure

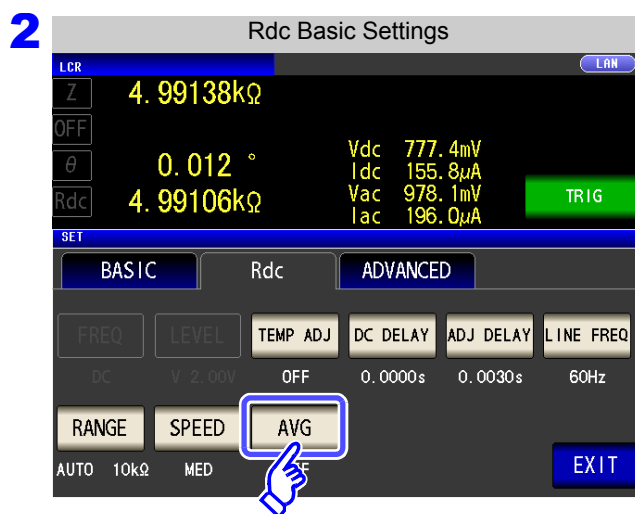
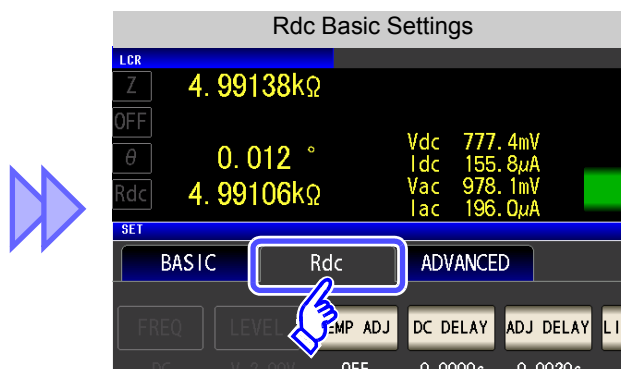
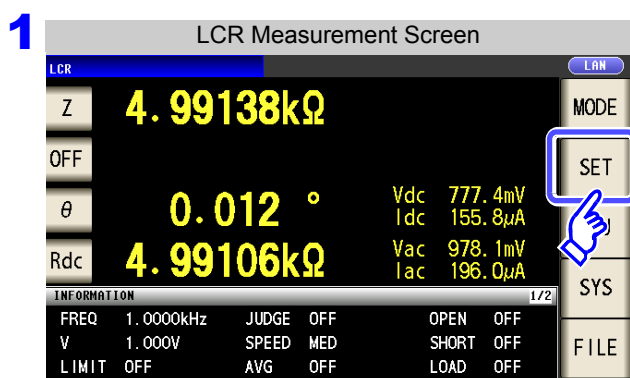

Press **AVG**.

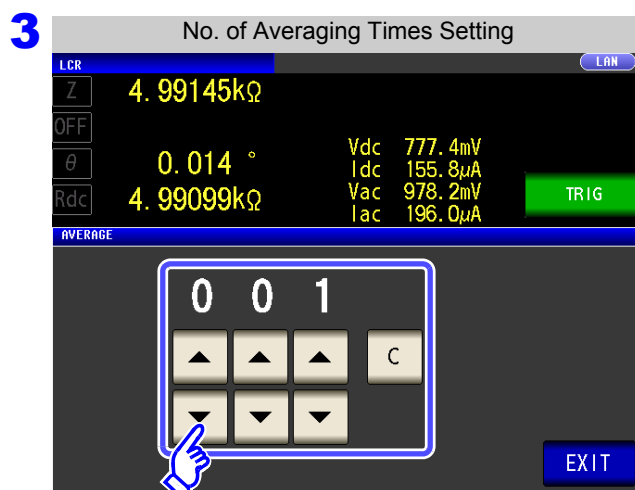

Use **▲** or **▼** to enter the number of averaging times.

Settable range: 1 to 256

When you want to turn off the averaging

function: Press **C**.

The number of averaging times is set to 1.

4 Press **EXIT** to close the setting screen.

4.4 Judging Measurement Results

The measurement results are compared to an arbitrarily set reference and then the judgment results are displayed. This function is useful for quality evaluation and the like.

There is comparator measurement which compares one judgment reference and the measurement values, and BIN measurement which compares multiple judgment reference values (up to 10) and the measurement values.

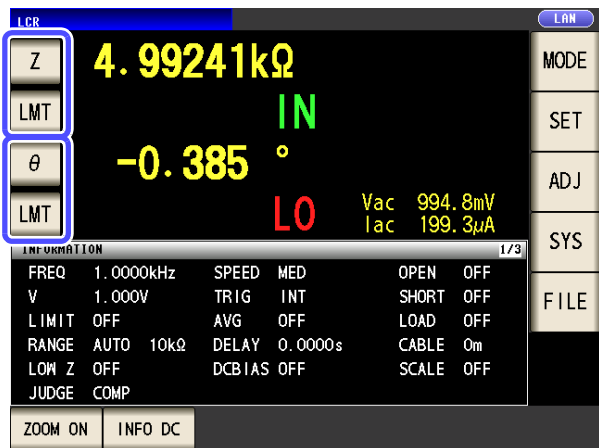

Judgment by comparator measurement and BIN measurement is performed for the first parameter and third parameter.

Judgment Target	Result Display
First parameter	Second parameter area
Third parameter	Fourth parameter area

Therefore, set the measurement values you want to judge for the first parameter and third parameter in advance. See "4.1.2 Setting Display Parameters" (p. 47)

Setting the judgment mode

Use the following procedure to select and set one of the modes.

Procedure

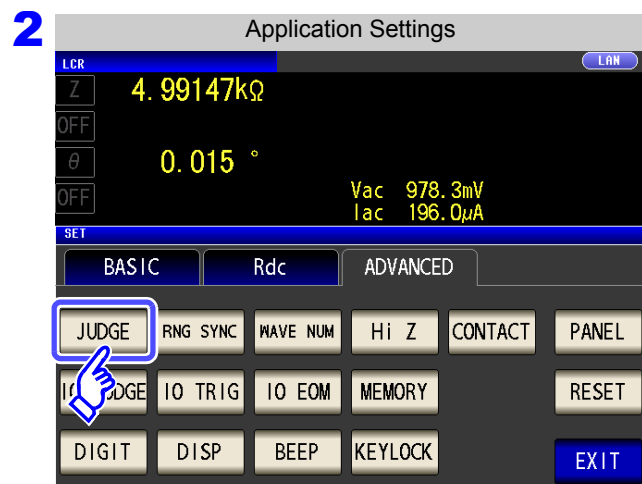
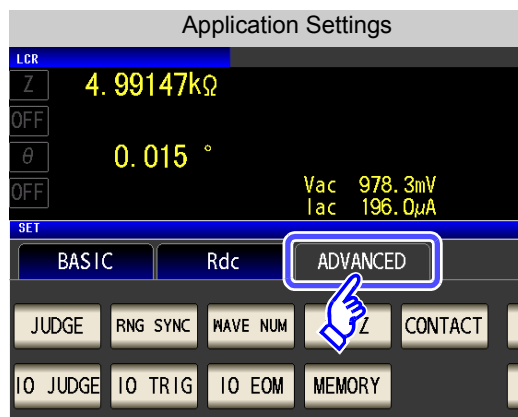
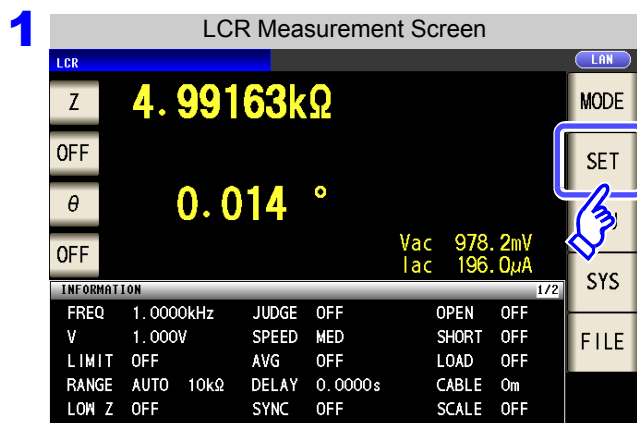

Press **JUDGE**.

4.4 Judging Measurement Results

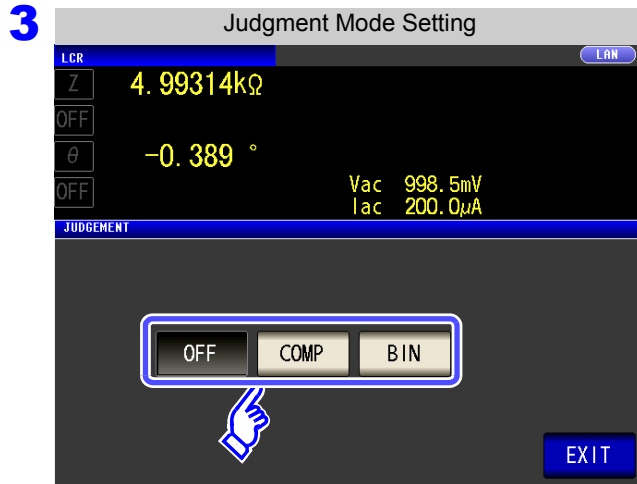

4 Press **EXIT** to close the setting screen.

To select the judgment mode.

OFF

Disables comparator and BIN measurement.

COMP

Enables comparator measurement (p. 102).

BIN

Enables BIN measurement (p. 109).

When comparator measurement and BIN measurement are performed, only the first and third parameters can be set.

The second and fourth parameters become **LMT**.

4.4 Judging Measurement Results

4.4.1 Judging with Upper and Lower Limit Values (Comparator Measurement Mode)

The comparator measurement allows you to do the following.

- Preset a reference value and upper and lower limit values as the judgment reference, and display a judgment result as **HI** (higher than the upper limit value), **IN** (within the range set for the upper and lower limit values), or **LO** (lower than the lower limit value).
- Output the judgment results to an external device (via the EXT I/O connector).
- Select different settings and perform judgment for up to two parameters.
- Be notified of judgment results by buzzer.
- See "4.5.11 Setting Operation Sounds (Beep Sounds)" (p. 143)
- Confirm the judgment result from the judgment result indication LEDs on the front panel of the instrument.
- See "Judgment Result Indication LEDs" (p. 10)

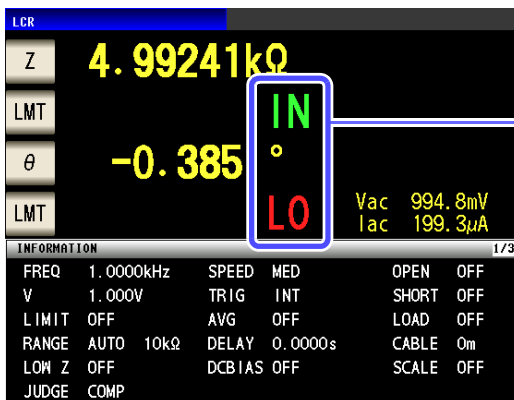
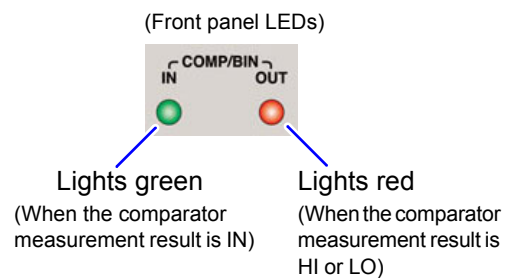

- HI** Measured value is above upper limit
- IN** Upper limit value \geq calculated value \geq lower limit value
- LO** Measured value is below lower limit
- When no reference standards have been set

The comparator decision mode can be set as one of the following:

Absolute value (ABS) setting (p. 104)

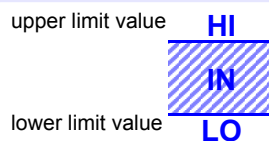

Set absolute values for the upper limit and lower limit values of the measurement parameters. The measurement values displayed are the same as those of the measurement parameters.

Percent (%) Setting (p. 105)

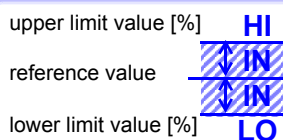

Enter reference values and then set percentages corresponding to the reference values as the upper limit and lower limit^{*1} values. The measurement values displayed are the same as those of the measurement parameters.

Deviation Percent ($\Delta\%$)^{*2} Setting (p. 107)

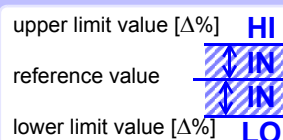

Enter reference values and then set percentages corresponding to the reference values as the upper limit and lower limit^{*1} values. The measurement values are displayed in deviations ($\Delta\%$) from the reference value.

4.4 Judging Measurement Results

*1: The following equation is used to calculate the comparison upper limit value and comparison lower limit value. (In the case of the comparison lower limit value, if a value that is lower than the reference value is set, the minus (-) sign is required for the percentage setting value.)

$$\text{Upper limit comparison value (Lower limit comparison value)} = \text{reference value} + |\text{reference value}| \times \frac{\text{Percentage set value}}{100}$$

*2: The following equation is used to calculate the $\Delta\%$ value.

$$\Delta\% = \frac{\text{measurement value} - \text{reference value}}{|\text{reference value}|} \times 100$$

NOTE

- The comparator judgment is made in the following order.
 - If the measurement value is "OVER FLOW", **HI** is displayed. (However, LO is displayed when the parameters are Y, Cs, Cp, G, and B.)
If the measurement value is "UNDER FLOW", **LO** is displayed. (However, HI is displayed when the parameters are Y, Cs, Cp, G, and B.)
If the measurement value is "SAMPLE ERR," "OVER CUR," "TC ERR," or a contact error, **HI** is displayed.
 - Whether the measurement value is higher than the lower limit value is judged, and **LO** is displayed if the judgment is NG.
 - Whether the measurement value is lower than the upper limit value is judged, and **HI** is displayed if the judgment is NG.
 - If (1), (2), and (3) above do not apply, **IN** is displayed.

No test is performed to ensure that the upper limit value is greater than the lower limit value, so no error message will be displayed if you set the upper limit value and lower limit value the wrong way around.

- If the power is turned off while the comparator measurement screen is displayed, the comparator measurement screen will be displayed when the instrument starts the next time you turn the power on.
- Comparator measurement can be used even if only the upper or lower limit value has been set.

When only an upper limit value has been set

Upper limit value **HI**
IN

When only a lower limit value has been set

Lower limit value **IN**
LO

4.4 Judging Measurement Results

1 Setting the Upper or Lower Limit Value as an Absolute Value (ABS) (Absolute Value Mode)

Procedure

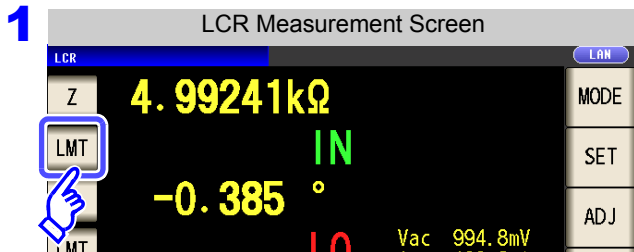

Press **LMT**.

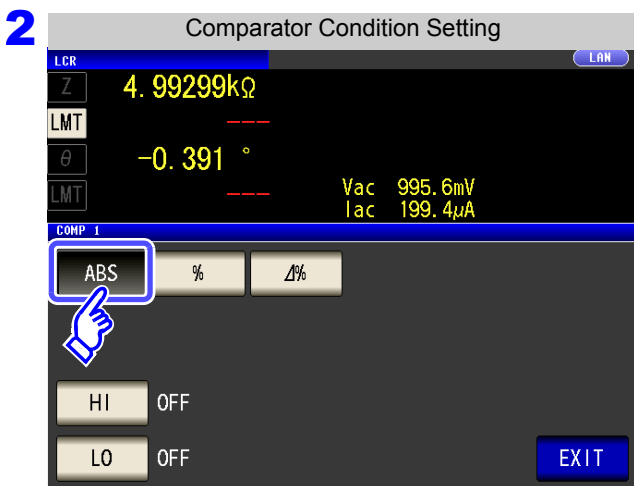

Press **ABS**.

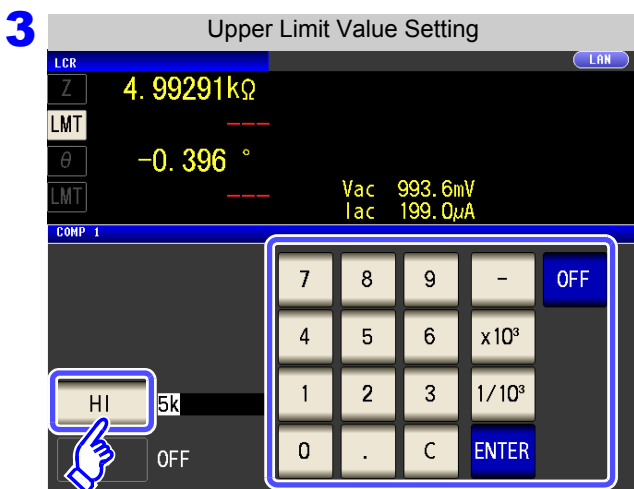

Press **HI** and use the numeric keypad to set the upper limit value.

Settable range: -9.99999 G to 9.99999 G

Changing the unit (a/ f/ p/ n/ μ/ m/ None/ k/ M/ G)

x10³

Step the units up.

1/10³

Step the units down.

When you do not want to set the upper and lower limit values: Press **OFF**.

4 Presses **ENTER** to confirm the upper limit value.

5 Return to **Step 2**, press **LO**, use the numeric keypad to set the lower limit value, and press **ENTER**.

Settable range: -9.99999 G to 9.99999 G

6 Press **EXIT** to close the setting screen.

2 Setting the Upper or Lower Limit Value as a Percentage (%) Relative to a Reference Value (Percentage Mode)

Procedure

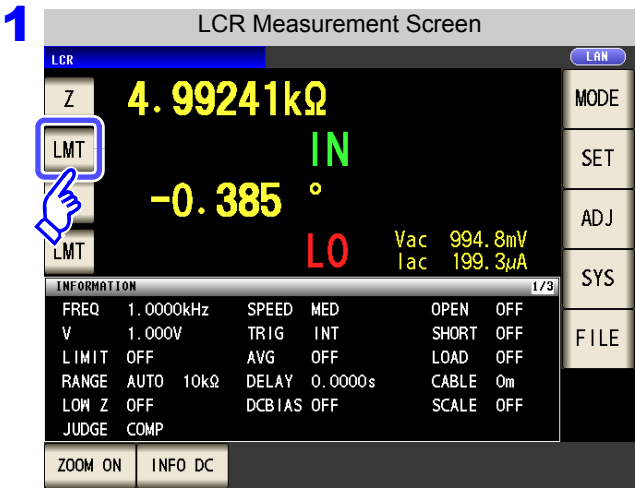

Press **LMT**.

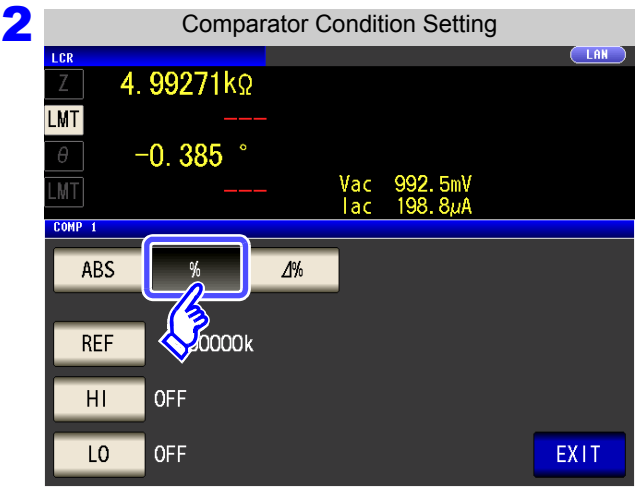

Press **%**.

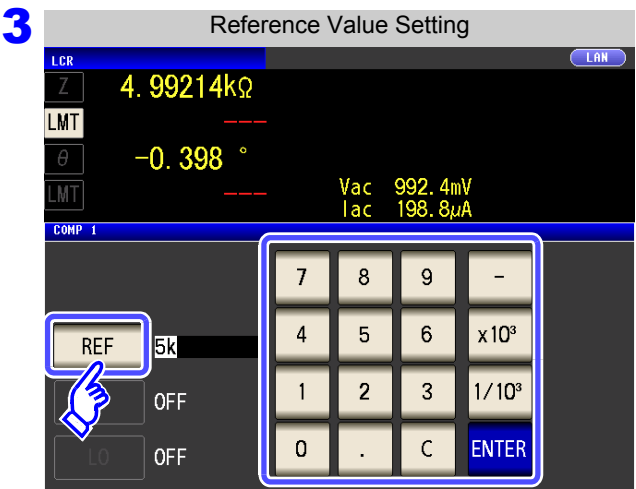

Press **REF** and use the numeric keypad to set the reference value.

Settable range: -9.99999G to 9.99999G

- Changing the unit (a/ f/ p/ n/ μ/ m/ None/ k/ M/ G)
- x10³** Step the units up.
 - 1/10³** Step the units down.

4 Press **ENTER** to confirm the reference value.

4.4 Judging Measurement Results

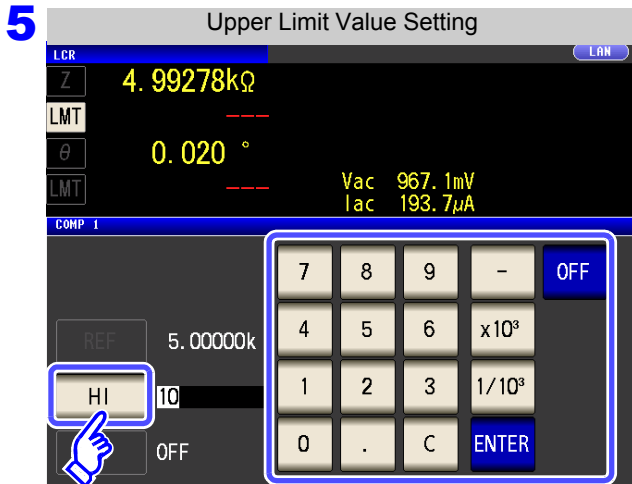

Press **HI** and use the numeric keypad to set the upper limit value.

Set the upper limit value as a percentage relative to the reference value.

When you do not want to set the upper limit: Press **OFF**.

- Settable range: -999.999% to 999.999%
- The actual internal operation consists of calculating the upper-limit value of comparison using the equation given below, and comparing it to the measurement value to enable a decision to be made.

$$\text{Upper limit comparison value} = \text{reference value} + |\text{reference value}| \times \frac{\text{Percentage set value}}{100}$$

6 Press **ENTER** to confirm the upper limit value.

7 Return to **Step 2**, press **LO**, use the numeric keypad to enter the lower limit value, and press **ENTER**.

- Settable range: -999.999% to 999.999%
- The actual internal operation calculates the lower limit comparison value with the following equation, and when a value that is lower than the reference value is set, the minus (-) sign is required for the percentage setting value.

$$\text{Lower limit comparison value} = \text{reference value} + |\text{reference value}| \times \frac{\text{Percentage set value}}{100}$$

8 Press **EXIT** to close the setting screen.

NOTE

The set reference value and upper and lower limit values are common to percentage mode and percentage deviation mode.

3 Setting Upper and Lower Limit Values as ($\Delta\%$) Values Relative to the Offset from the Reference Value (Deviation Percentage Mode)

Procedure

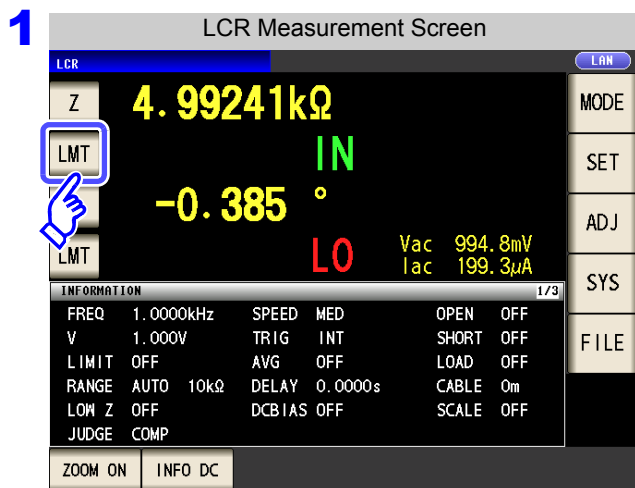

Press **LMT**.

- In the deviation percentage mode, the measurement value is displayed as a deviation ($\Delta\%$) from the reference value.
- The reference value and upper and lower limit values are set in the same manner as in the percentage mode.
 - See "Setting the Upper or Lower Limit Value as a Percentage (%) Relative to a Reference Value (Percentage Mode)" (p. 105)
- The settings of the reference value and the upper and lower limit values are common to both the percentage mode and deviation percentage mode.
- The $\Delta\%$ value is calculated using the following equation:

$$\Delta\% = \frac{\text{measurement value} - \text{reference value}}{|\text{reference value}|} \times 100$$

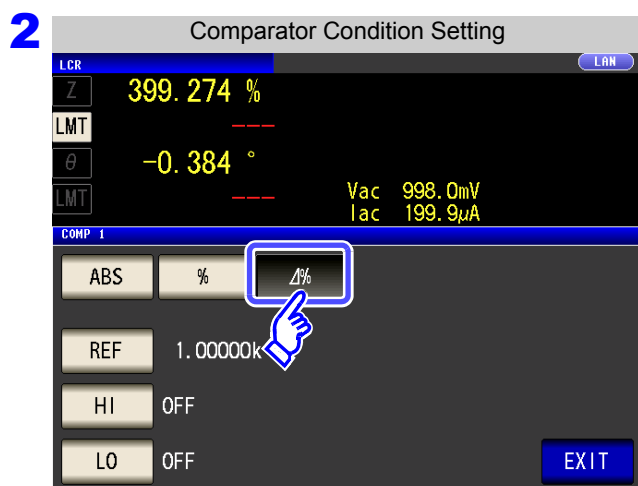

Press **$\Delta\%$** to select deviation percentage mode.

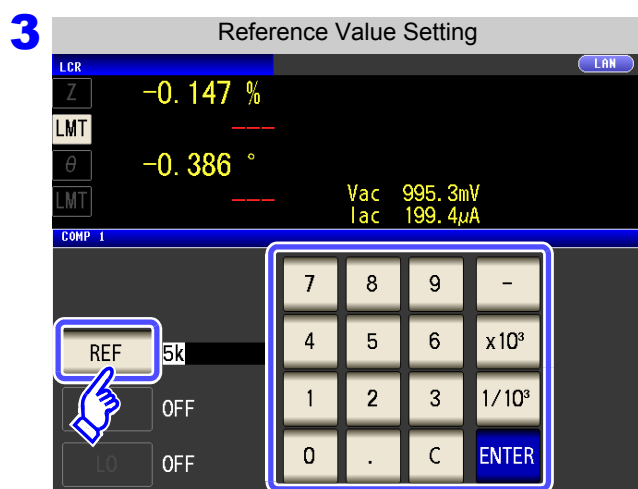

Press **REF** and use the numeric keypad to enter the reference value.

Settable range: -9.99999G to 9.99999G

Changing the unit (a/ f/ p/ n/ μ / m/ None/ k/ M/ G)

$\times 10^3$

Step the units up.

$1/10^3$

Step the units down.

4 Press **ENTER** to confirm the reference value.

4.4 Judging Measurement Results

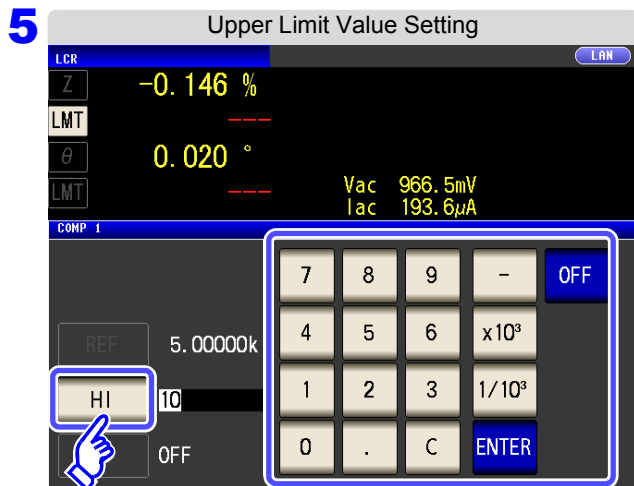

Press **HI** and use the numeric keypad to set the upper limit value.

Settable range: -999.999% to 999.999%

When you do not want to set the upper limit: Press **OFF**.

6 Press **ENTER** to confirm the upper limit value.

7 Return to **Step 2**, press **LO**, and use the numeric keypad to enter the lower limit value.

Settable range: -999.999% to 999.999%

8 Press **EXIT** to close the setting screen.

NOTE

The set reference value and upper and lower limit values are common to percentage mode and percentage deviation mode.

4.4.2 Classifying Measurement Results (BIN Measurement)

Set the upper and lower limit values for two parameters and display up to 10 classifications of judgment results. You can also output the judgment results to an external device.

Select the judgment mode for BIN measurement before setting the judgment conditions (p. 100).

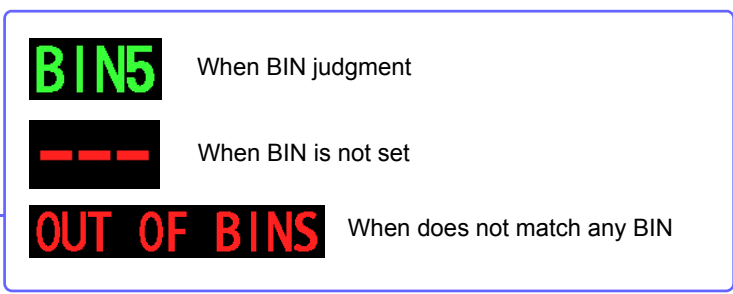
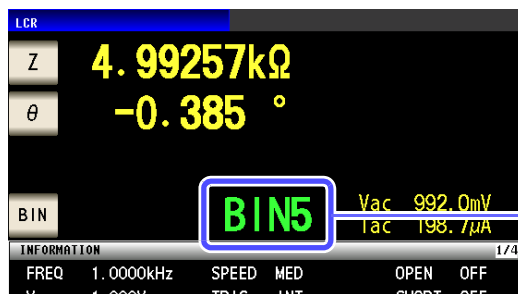
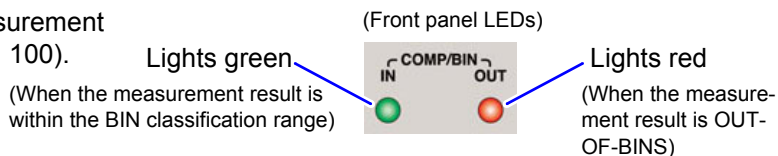

About BIN function

BIN judgment starts with the first parameter for BIN1 and proceeds in order to BIN10, as described below. The instrument will display the first BIN number for which the measurement value is judged to be within the set judgment standard. If none of the BIN judgments is determined to apply, [OUT OF BINS] will be displayed.

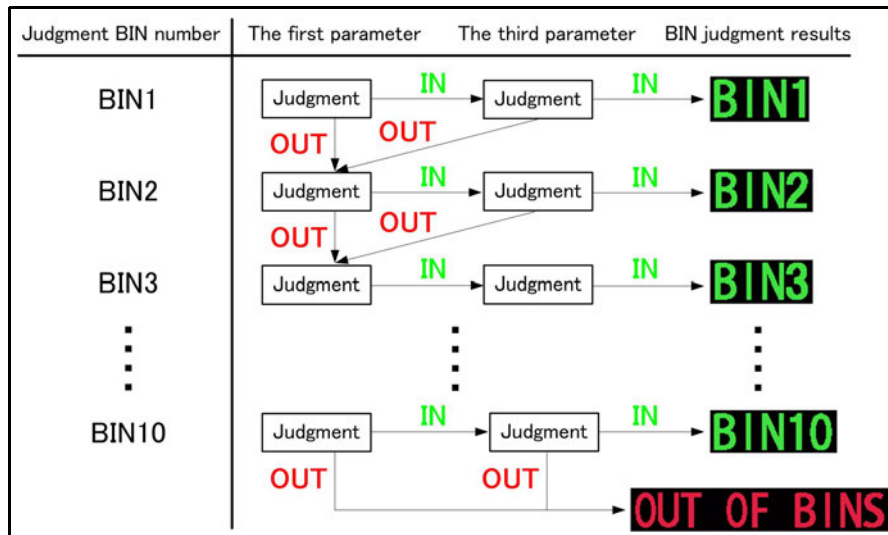

NOTE By setting a series of increasingly lenient judgment standards as shown in the following diagram, you can rank (sort) measurement elements.

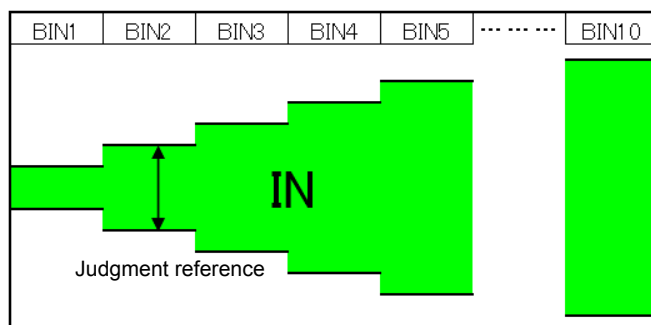

4.4 Judging Measurement Results

The comparator decision mode can be set as one of the following:

Absolute value (ABS) setting (p. 104)



Set absolute values for the upper limit and lower limit values of the measurement parameters.
The measurement values displayed are the same as those of the measurement parameters.

Percent (%) Setting (p. 105)

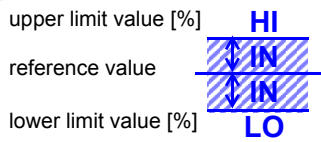

Enter reference values and then set percentages corresponding to the reference values as the upper limit and lower limit^{*1} values.
The measurement values displayed are the same as those of the measurement parameters.

Deviation Percent ($\Delta\%$)^{*2} Setting (p. 107)

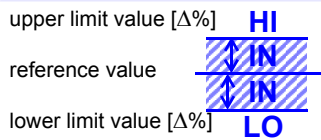

Enter reference values and then set percentages corresponding to the reference values as the upper limit and lower limit^{*1} values.
The measurement values are displayed in deviations ($\Delta\%$) from the reference value.

*1: The following equation is used to calculate the comparison upper limit value and comparison lower limit value.
(In the case of the comparison lower limit value, if a value that is lower than the reference value is set, the minus (-) sign is required for the percentage setting value.)

$$\text{Upper limit comparison value (Lower limit comparison value)} = \text{reference value} + |\text{reference value}| \times \frac{\text{percentage set value}}{100}$$

*2: The following equation is used to calculate the $\Delta\%$ value.

$$\Delta\% = \frac{\text{measurement value} - \text{reference value}}{|\text{reference value}|} \times 100$$

NOTE

- For more information about HI/IN/LO judgment procedures, see Page 103.
- If the power is turned off in BIN measurement mode, the mode will be BIN measurement mode when the instrument starts the next time you turn the power on.
- For a BIN number that does not require a BIN judgment, set the upper and lower limit values to OFF.
- The measurement conditions that are used when normal measurement is performed are inherited as is for the measurement conditions when BIN is performed.
- BIN measurement can be used even if only the upper or lower limit value has been set.

When only an upper limit value has been set



When only a lower limit value has been set



1 Setting the Upper or Lower Limit Value as an Absolute Value (ABS) (Absolute Value mode)

Procedure

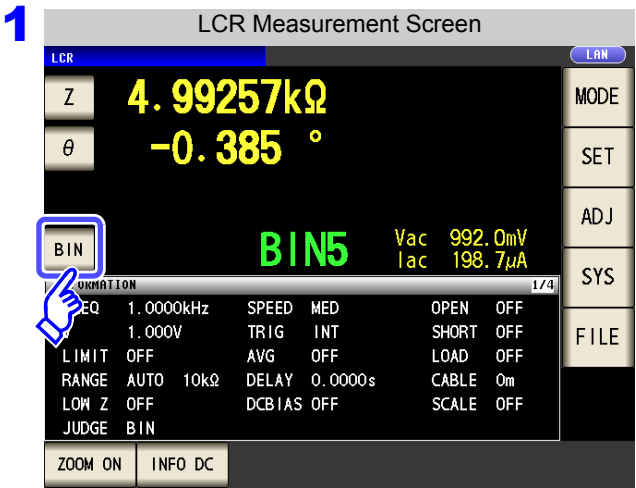

Press **BIN** .

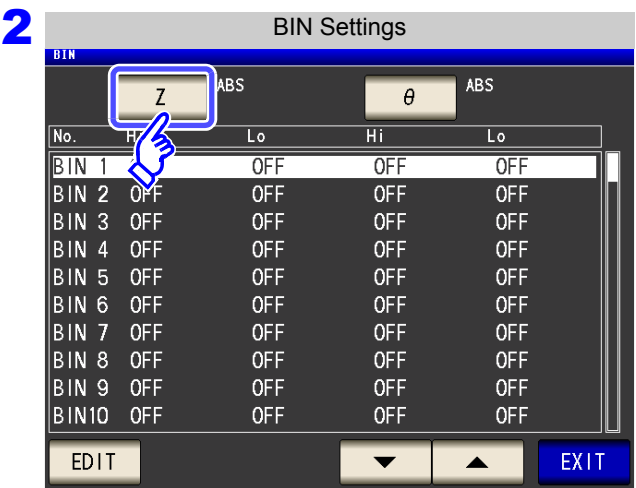

Press **Z** .

The button display differs depending on the measurement parameter.

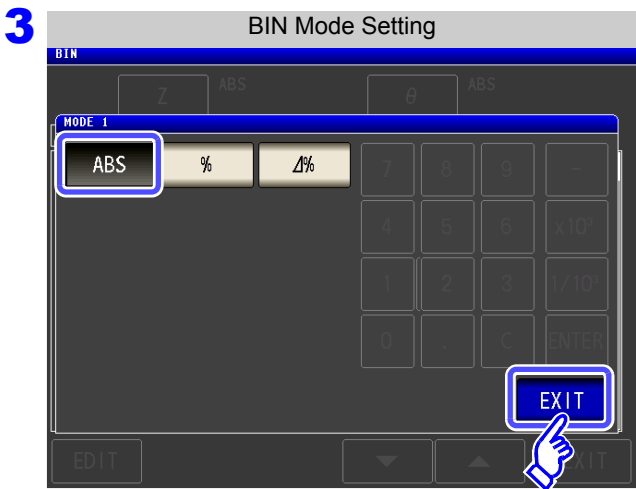

Press **ABS** .

Press **EXIT** to return to the BIN setting screen.

4.4 Judging Measurement Results

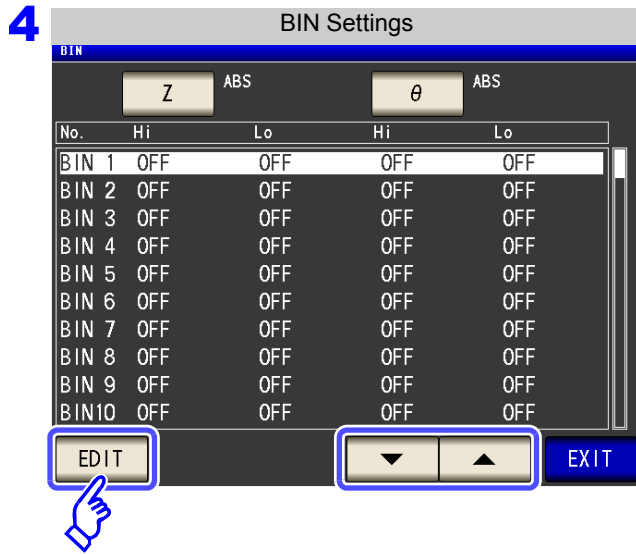

Use or to select the BIN number to set, and press .

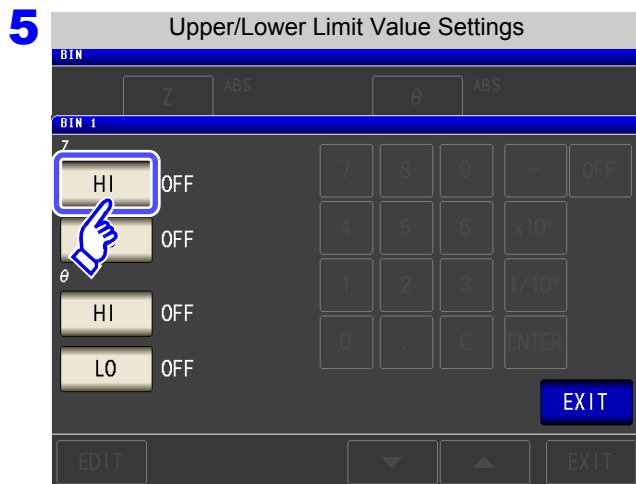

Press .

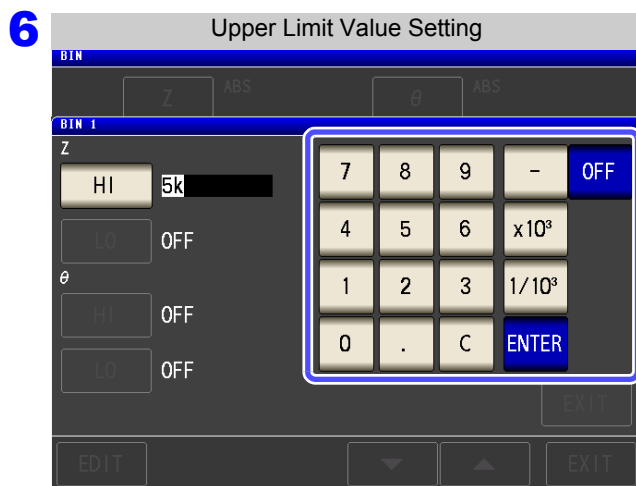

Use the numeric keypad to input the upper limit value of the first parameter.

Settable range: -9.99999G to 9.99999G

Press to confirm the upper limit value.

When you do not want to set the upper and lower limit values: Press .

7 Return to **step 5**, press , and use the numeric keypad to set the lower limit value.

Settable range: -9.99999G to 9.99999G

8 Press to confirm the lower limit value.

- 9 Return to **step 4**, and set the upper and lower limit values of the third parameter in the same way.

- 10 Press **EXIT** to return to the BIN setting screen.

- 11 Press **EXIT** to close the setting screen.

4.4 Judging Measurement Results

2 Setting the Upper or Lower Limit Value as a Percentage (%) Relative to a Reference Value (Percentage mode)

Procedure

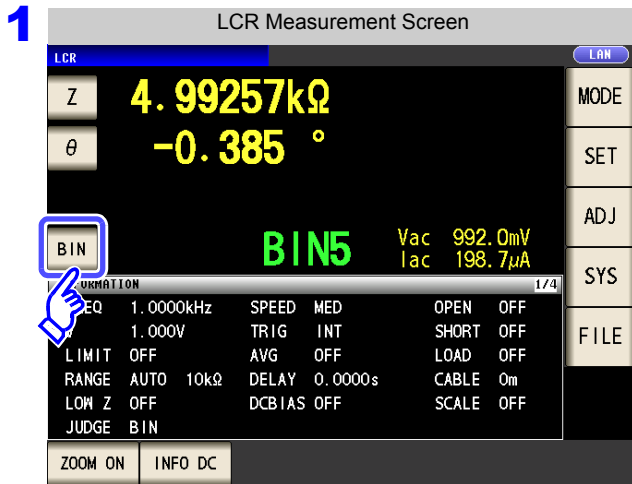

Press **BIN**.

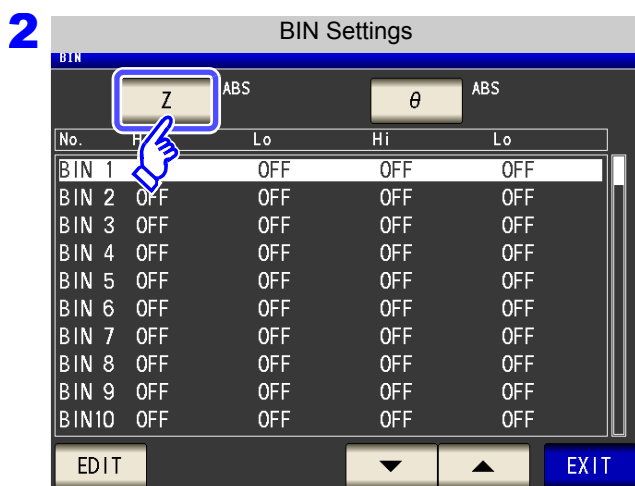

Press **Z**.

The button display differs depending on the measurement parameter.

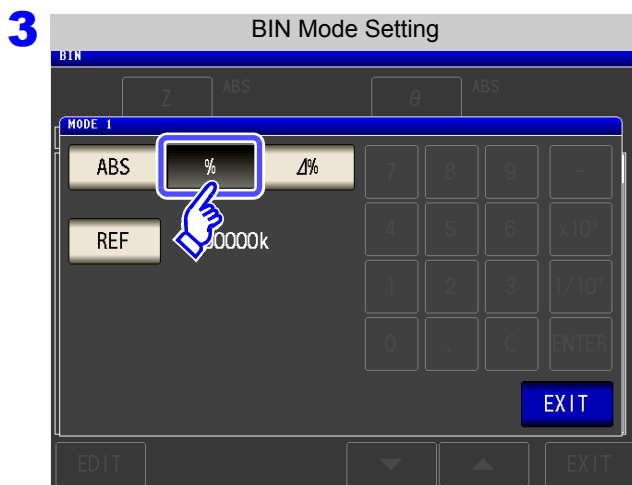

Press **%** to select percentage mode.

4.4 Judging Measurement Results

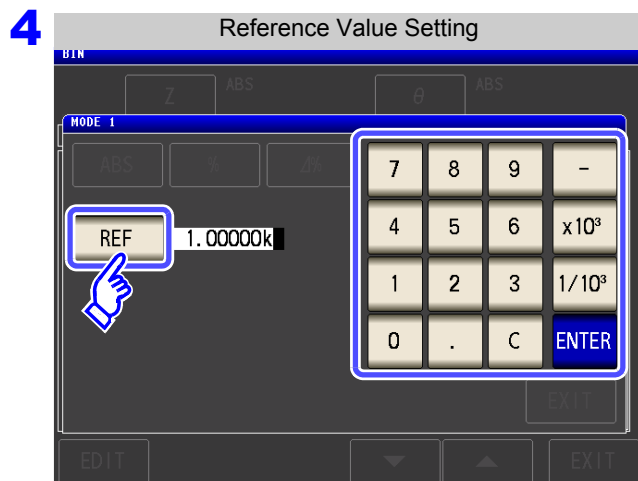

Press **REF** .

Use the numeric keypad to enter the reference value and press **ENTER** .

Settable range: -9.99999G to 9.99999G

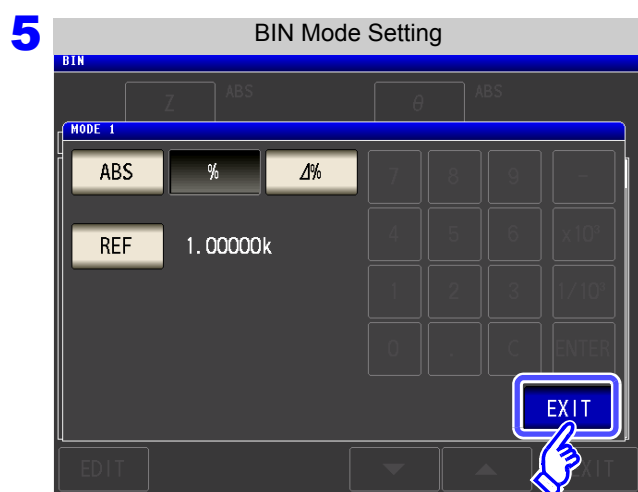

Press **EXIT** to return to the BIN setting screen.

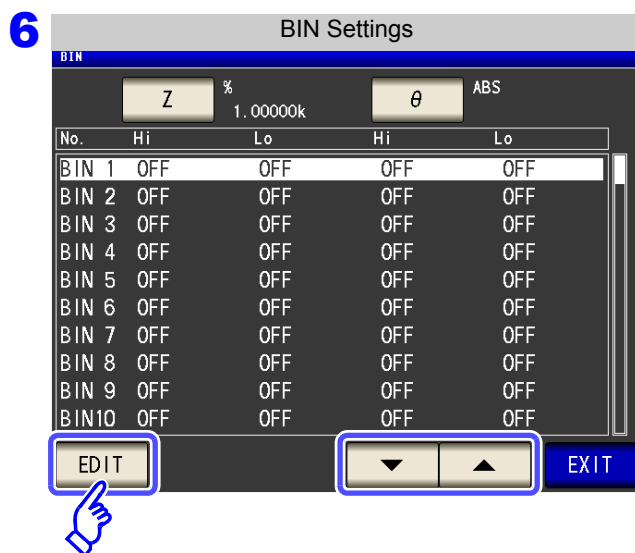

Use **▲** or **▼** to select the BIN number to set, and press **EDIT** .

4.4 Judging Measurement Results

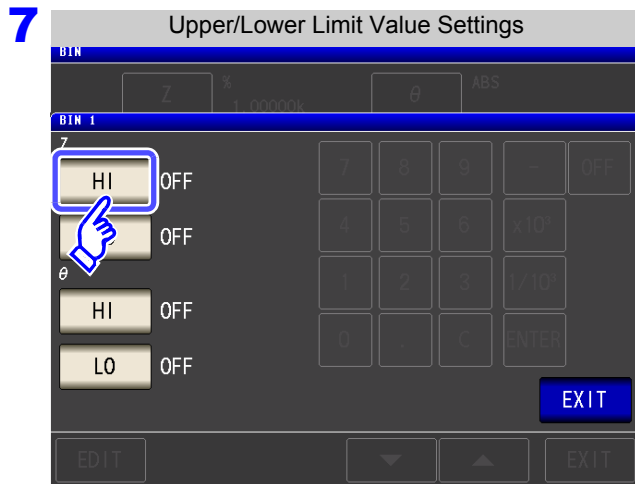

Press .

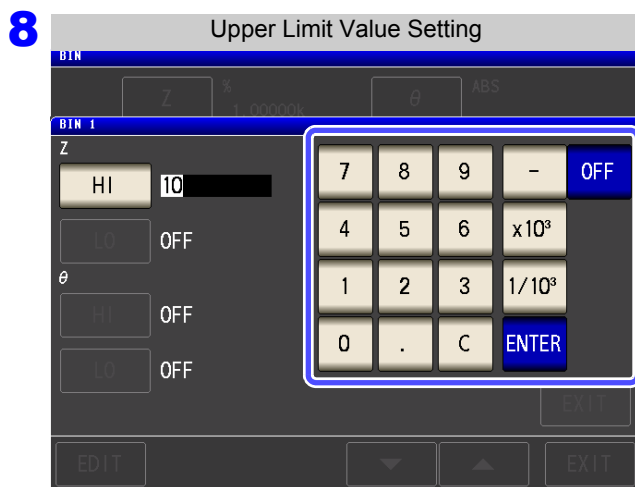

Use the numeric keypad to enter the upper limit value of the first parameter.

Settable range: -999.999% to 999.999%

Press  to confirm the upper limit value.

When you do not want to set the upper and lower limit values: Press .

9 Return to **step 7**, press , and use the numeric keypad to enter the lower limit value.

Settable range: -999.999% to 999.999%

10 Press  to confirm the lower limit value.

11 Return to **step 6**, and set the upper and lower limit values of the third parameter in the same way.

12 Press  to return to the BIN setting screen.

13 Press  to close the setting screen.

NOTE The set reference value and upper and lower limit values are common to percentage mode and percentage deviation mode.

3 Setting Upper and Lower Limit Values as ($\Delta\%$) Values Relative to the Offset from the Reference Value (Deviation Percentage Mode)

Procedure

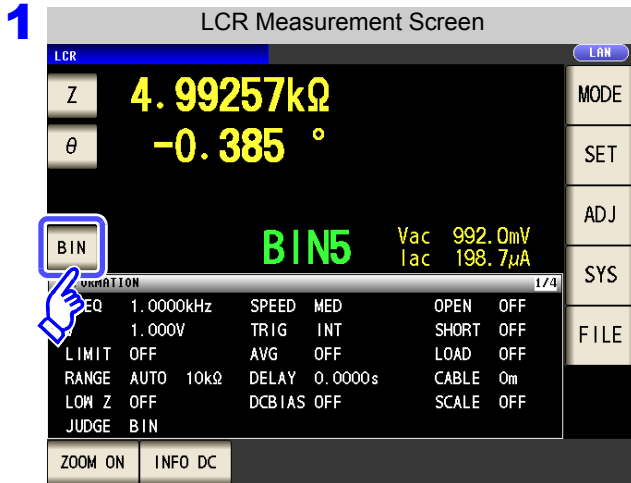

Press **BIN** .

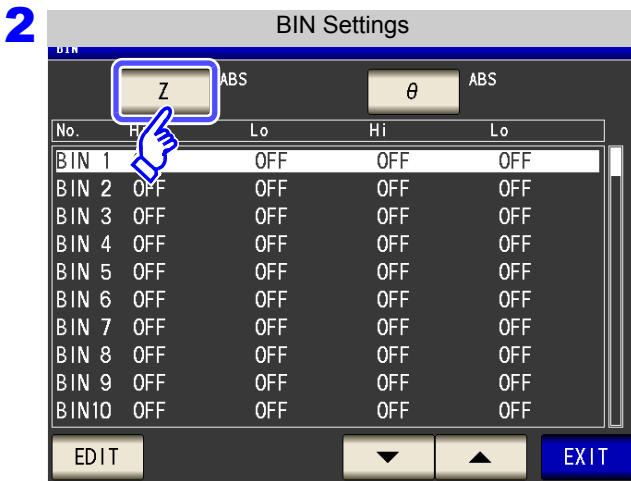

Press **Z** .

The button display differs depending on the measurement parameter.

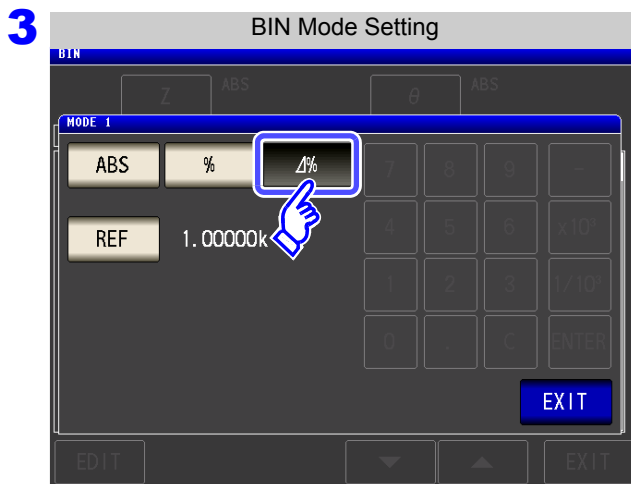

Press **Δ%** to select percentage mode.

4.4 Judging Measurement Results

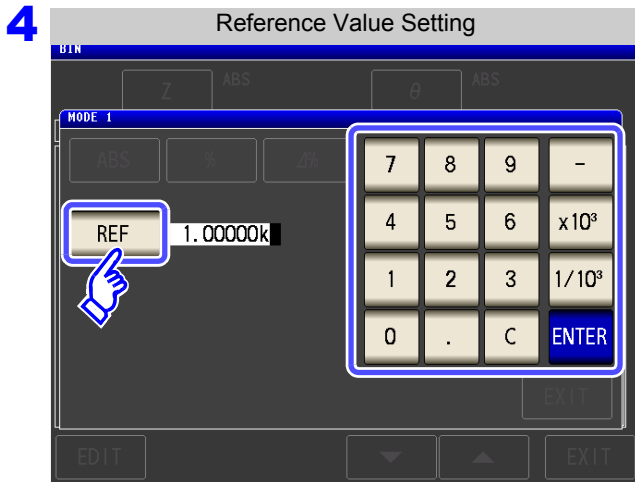

Press **REF** .

Use the numeric keypad to enter the reference value and press **ENTER** .

Settable range: -9.99999G to 9.99999G

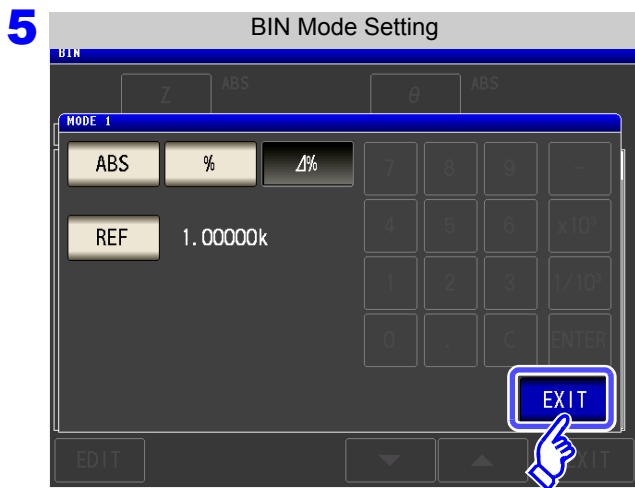

Press **EXIT** to return to the BIN setting screen.

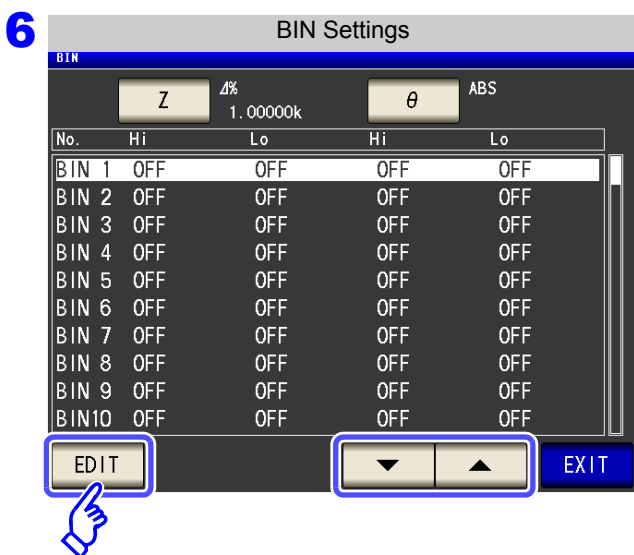

Use **▲** or **▼** to select the BIN number to set, and press **EDIT** .

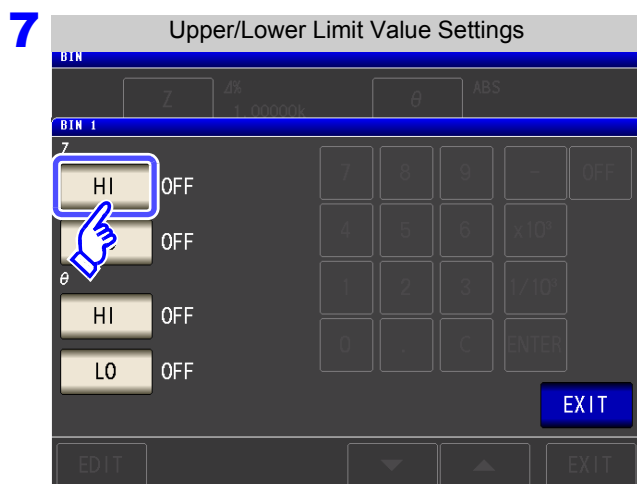

Press **HI** .

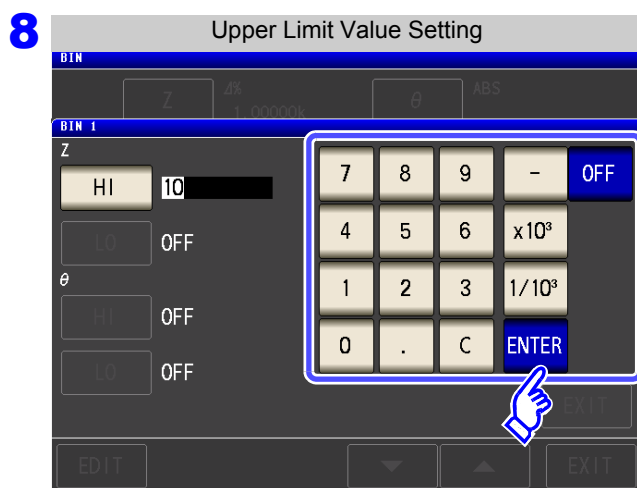

Use the numeric keypad to enter the upper limit value of the first parameter.

Settable range: -999.999% to 999.999%

Press **ENTER** to confirm the upper limit value.

When you do not want to set the upper and lower limit values: Press **OFF** .

9 Return to **step 7**, press **LO** , and use the numeric keypad to enter the lower limit value.

Settable range: -999.999% to 999.999%

10 Press **ENTER** to confirm the lower limit value.

11 Return to **step 6**, and set the upper and lower limit values of the third parameter in the same way.

12 Press **EXIT** to return to the BIN setting screen.

13 Press **EXIT** to close the setting screen.

NOTE The set reference value and upper and lower limit values are common to percentage mode and percentage deviation mode.

4.5 Setting Application Settings

4.5.1 Setting Measurement Conditions for Individual Measurement Ranges (Range Synchronization Function)

This section describes how to set measurement conditions for individual measurement ranges.

BASIC

Measurement speed (AC), averaging settings (AC), trigger delay, trigger synchronous output function

Rdc

Measurement speed (DC), averaging settings (DC)

NOTE

Settings are the same as those described in "4.2 Setting Basic Settings of Measurement Conditions" (p. 50).

Procedure

Enables the range synchronization function.

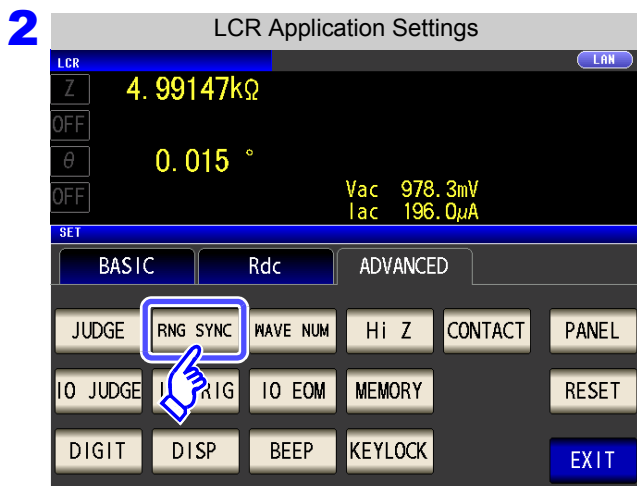
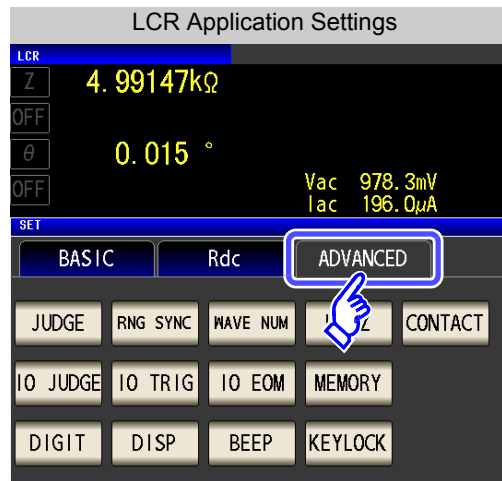
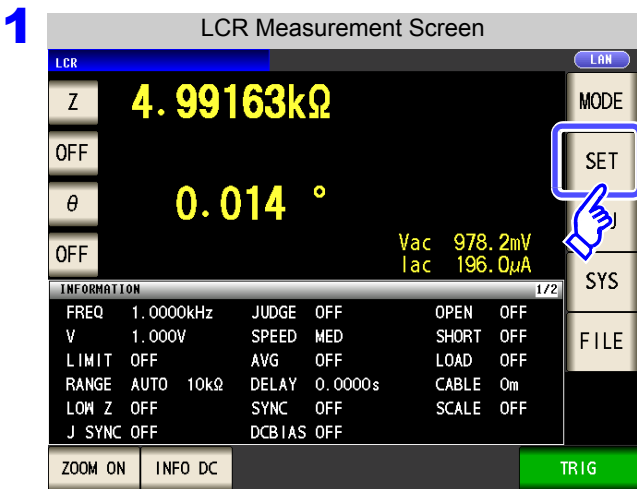

Press **RNG SYNC**

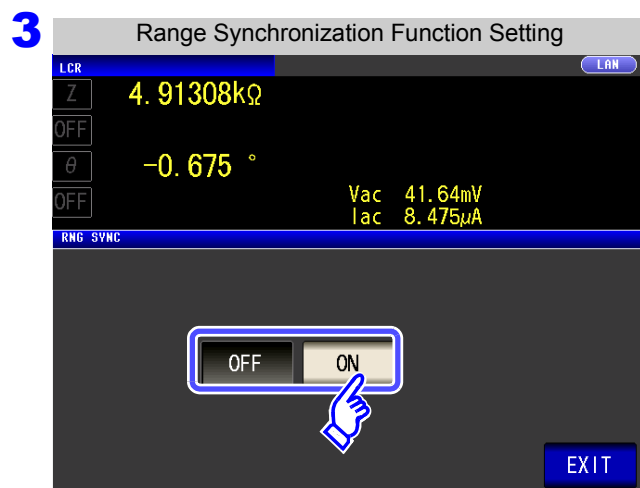

Turn the range synchronization function on or off.

OFF Disables the range synchronization function.

ON Enables the range synchronization function.

4 Press **EXIT** to close the setting screen.

4.5 Setting Application Settings

Range synchronization function settings (basic)

Procedure When the range synchronization function is enabled (p. 120)

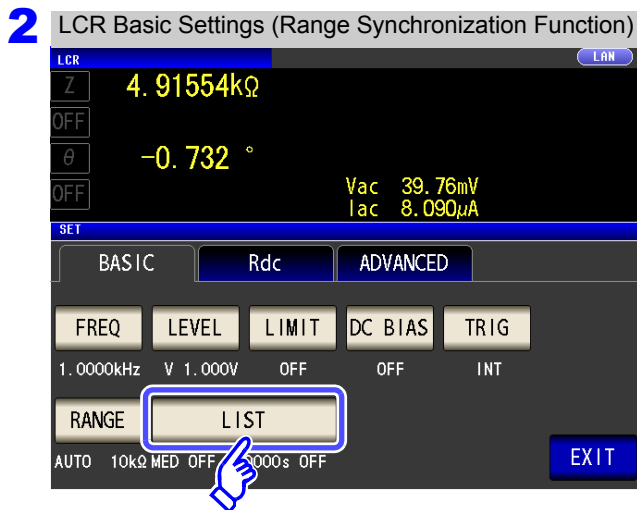
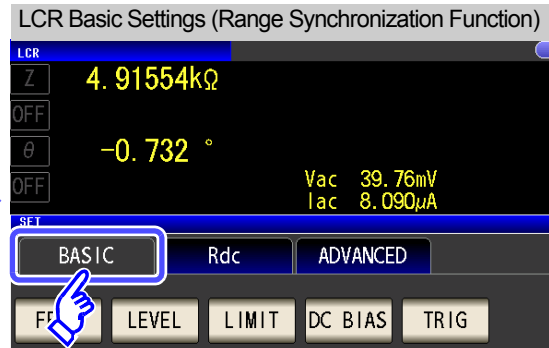
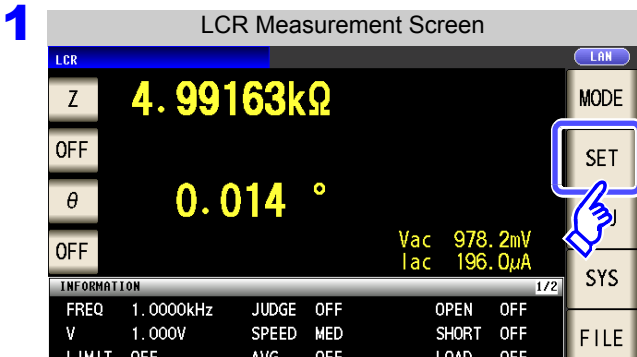

Press **LIST**.

Select the measurement range you wish to configure with **▲** and **▼** and configure the associated functions.

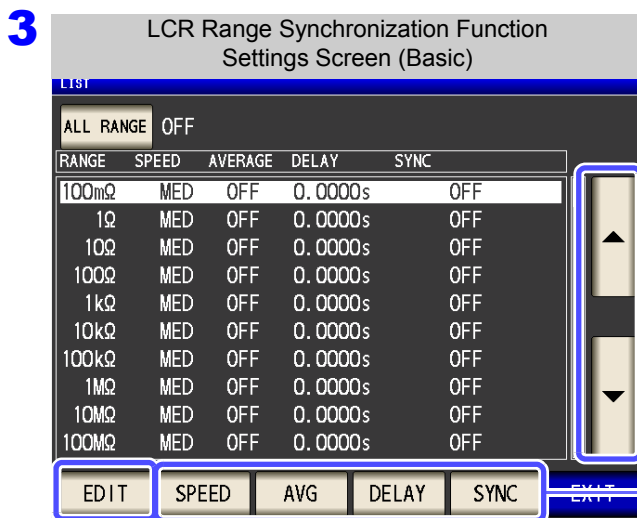

Allows you to configure functions on a single screen (p. 124).

Settings are the same as those described in "4.2 Setting Basic Settings of Measurement Conditions" (p. 50).

SPEED Sets the measurement speed (p. 73).

AVG Configures averaging (p. 74).

DELAY Sets the trigger delay (p. 76).

SYNC Configures the trigger synchronous output function (p. 77).

CANCEL Cancels the setting and returns to the previous screen.

4 Press **EXIT** to close the setting screen.

ALL RANGE To apply settings to all ranges

To apply the settings to all measurement ranges, enable **ALL RANGE** and touch individual settings keys or the **EDIT** key to configure function settings.

NOTE To configure settings for an individual measurement range, disable **ALL RANGE**.

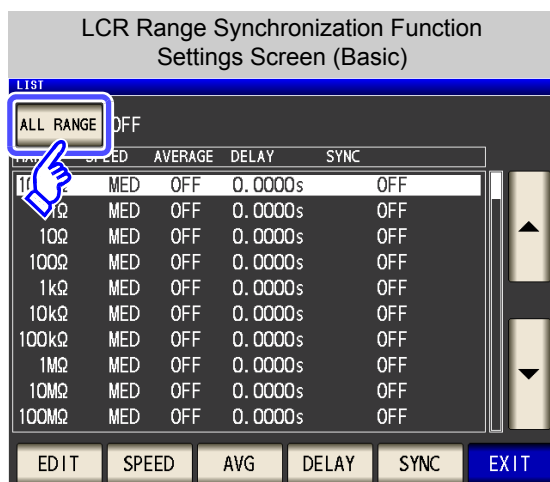

1. Press **ALL RANGE**.

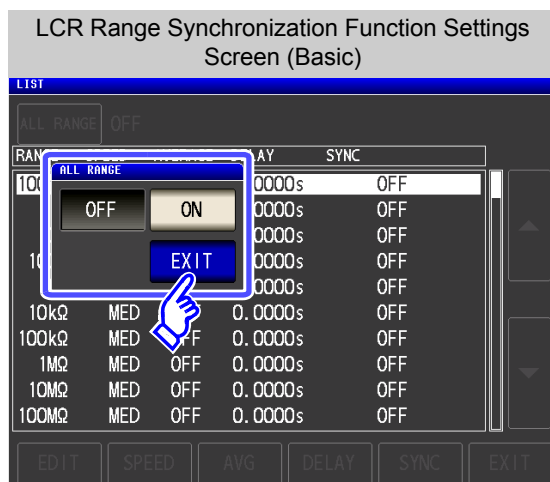

2. Turn on or off.

OFF Does not apply settings to all ranges.

ON Applies settings to all ranges.

3. Press **EXIT** to close the setting screen.

4.5 Setting Application Settings

EDIT

To configure all functions for a particular measurement range

This function allows you to configure measurement conditions (measurement speed, averaging settings, trigger delay, and the trigger synchronous output function) on a single screen.

NOTE

Settings are the same as those described in "4.2 Setting Basic Settings of Measurement Conditions" (p. 50).

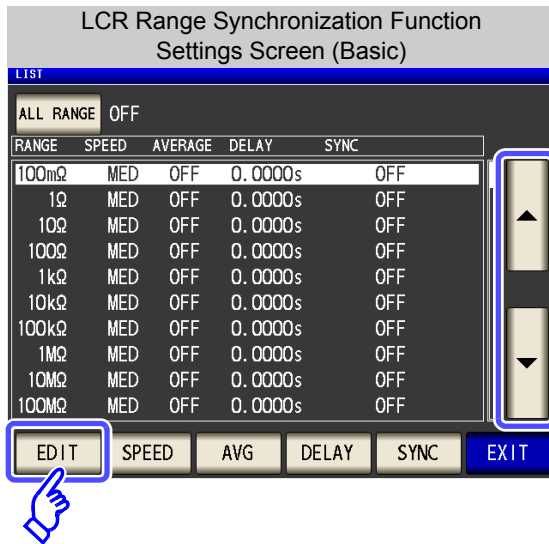

1. Select the measurement range you wish to configure with and and touch .

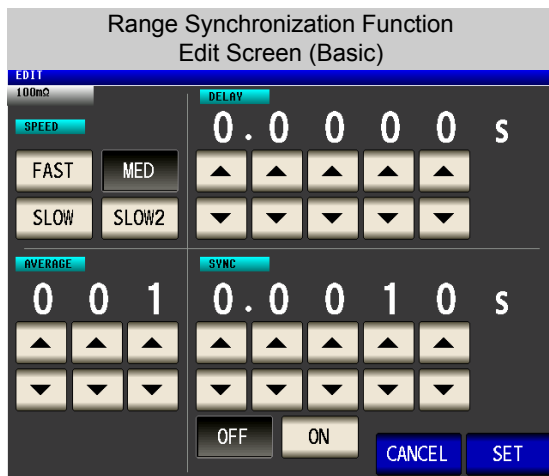

2. Configure the speed, averaging, trigger delay, and trigger synchronous output function settings.

See "4.2.7 Setting the Measurement speed" (p. 73)
 "4.2.8 Displaying Average Values (Averaging Set)" (p. 74)
 "4.2.9 Setting the Delay Time until Measurement Data is Captured (Trigger Delay)" (p. 76)
 "4.2.10 Applying the Signal to the Sample during Measurement Only (Trigger Synchronous Output Function)" (p. 77)

3. Press to close the setting screen.

When you want to cancel the setting and return to the previous screen:

Press .

Range synchronization function settings (Rdc)

Procedure When the range synchronization function is enabled (p. 120)

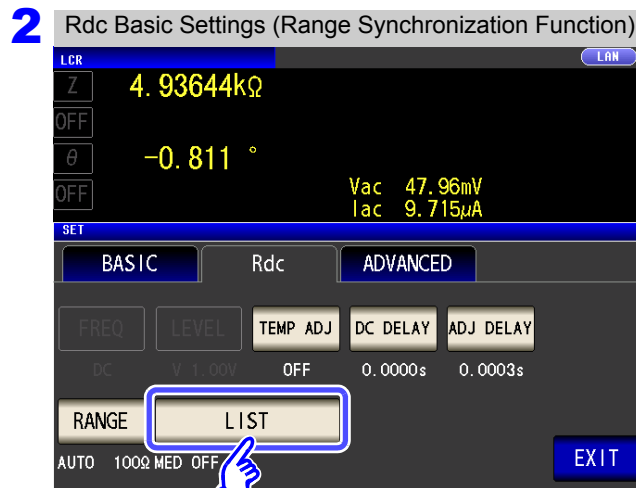
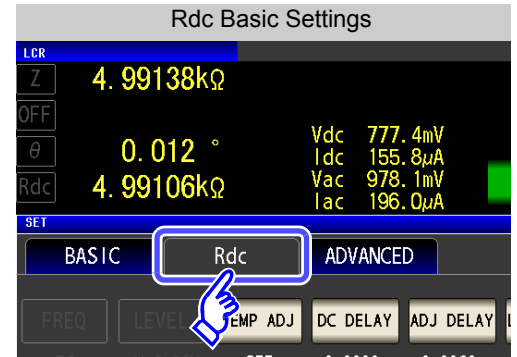
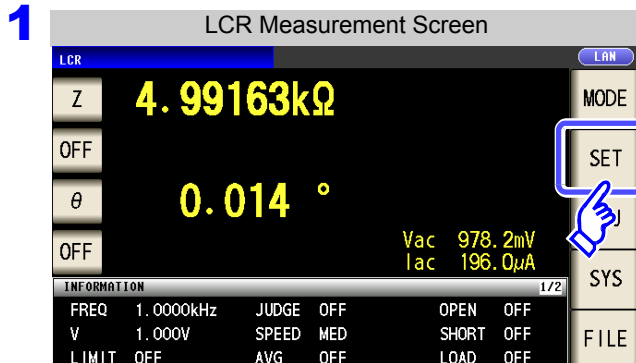

Press .

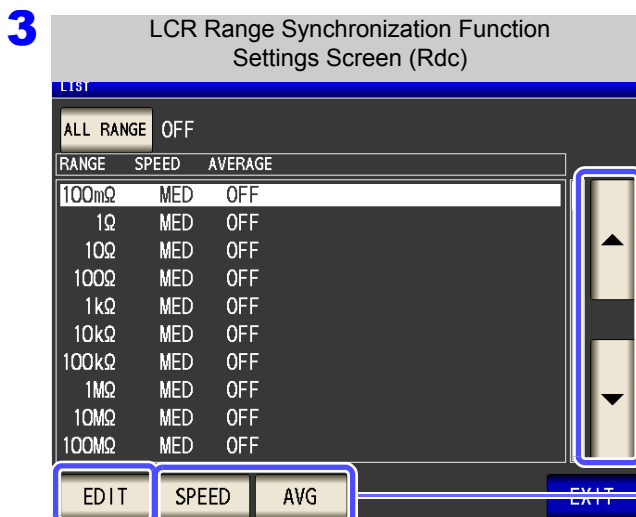

Select the measurement range you wish to configure with and and configure the associated functions.

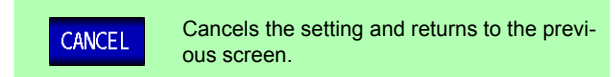
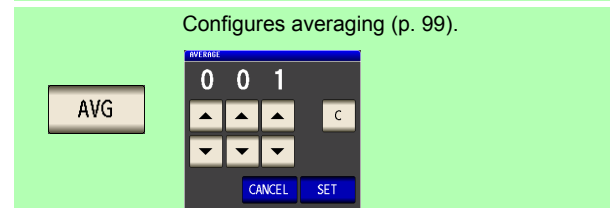
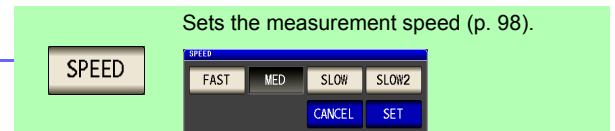

Allows you to configure functions on a single screen (p. 127).

Settings are the same as those described in "4.3 Setting DC Resistance Measurement" (p. 80).

4 Press to close the setting screen.

4.5 Setting Application Settings

ALL RANGE

To apply settings to all ranges

When applying the settings to all measurement ranges, enable **ALL RANGE** and use the settings keys or the **EDIT** key to configure the desired functionality.

NOTE

To apply settings to individual measurement ranges, disable **ALL RANGE**.

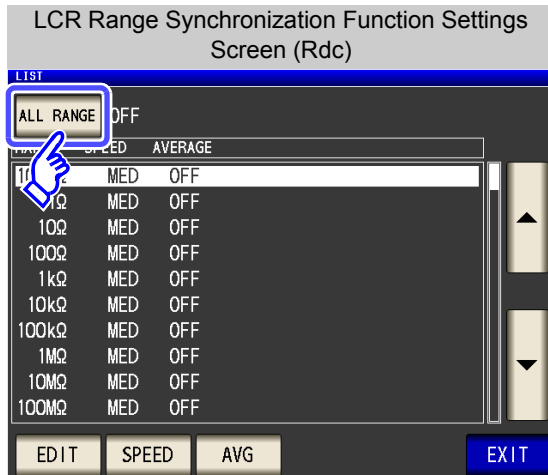

1. Press **ALL RANGE**.

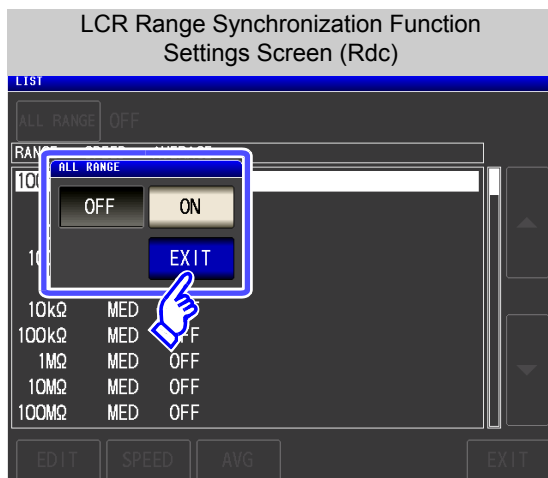

2. Turn on or off as desired.

OFF

Does not apply settings to all ranges.

ON

Applies settings to all ranges.

3. Press **EXIT** to close the setting screen.

EDIT



When configuring all functionality for a particular measurement range

This function allows you to set measurement conditions (measurement speed and averaging settings) on a single screen.

NOTE

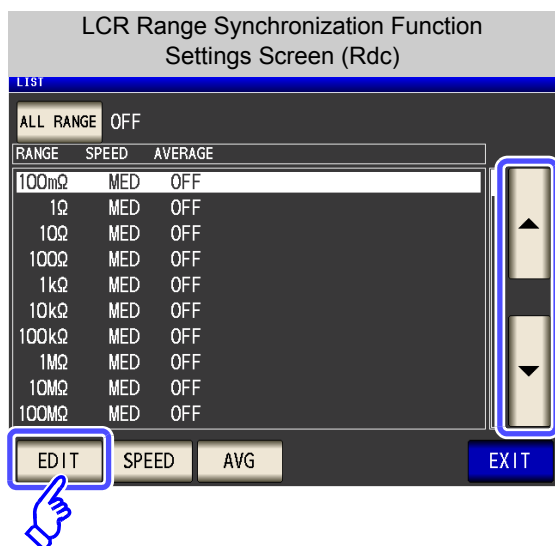
The settings are the same as described in "4.3 Setting DC Resistance Measurement" (p. 80).



1. Select the measurement range you wish to configure with  and  and touch .

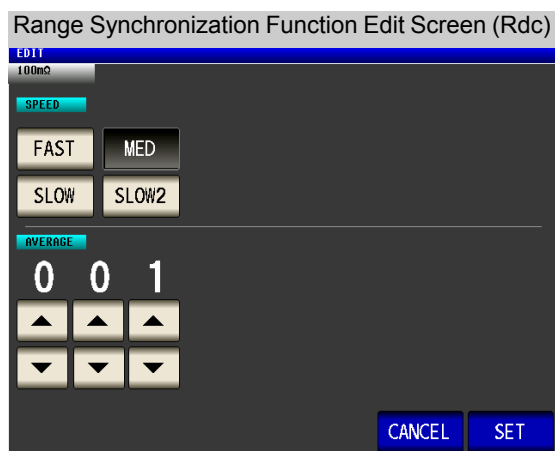

2. Configure the speed and averaging settings.
See "4.3.6 Setting the Measurement Speed" (p. 98)
 "4.3.7 Displaying Average Values (Average set)" (p. 99)
3. Press  to close the setting screen.

When you want to cancel the setting and return to the previous screen:

Press .

4.5 Setting Application Settings

4.5.2 Setting the Detection Signal Waveform Averaging Count (Waveform Averaging Function)

The number of measurement waveforms for each frequency band is set for the measurement speed settings (FAST, MED, SLOW, SLOW2), and this function allows you to set the number of measurement waveforms for each frequency band. Having more waveforms increases the measurement precision, while having fewer waveforms increases the measurement speed.

NOTE When the waveform averaging function is set, the measurement speed setting is unavailable. To set a measurement speed, first cancel the waveform averaging function setting.

Procedure

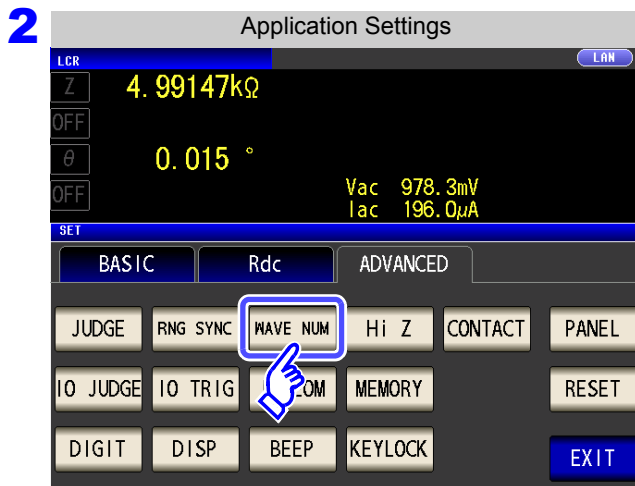
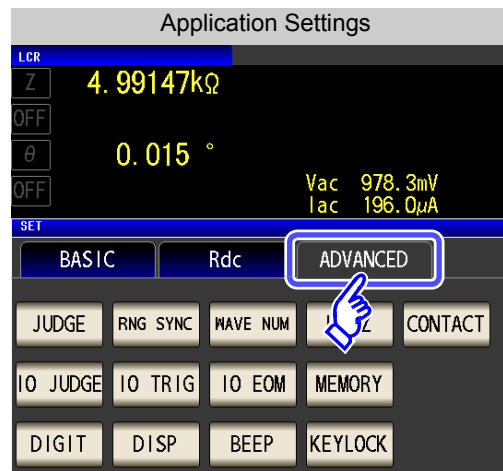
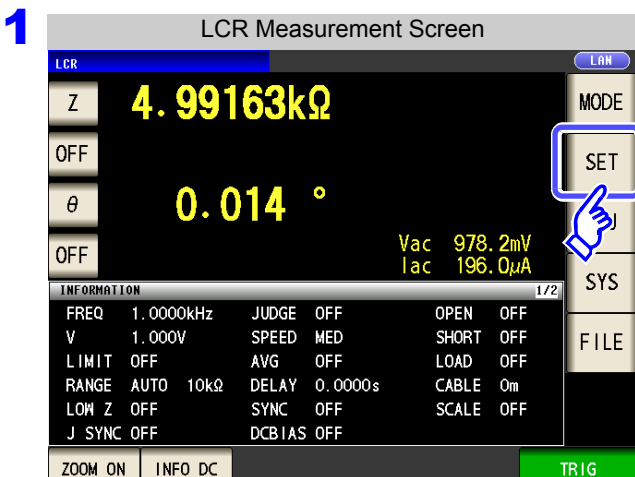

Press **WAVE NUM**.

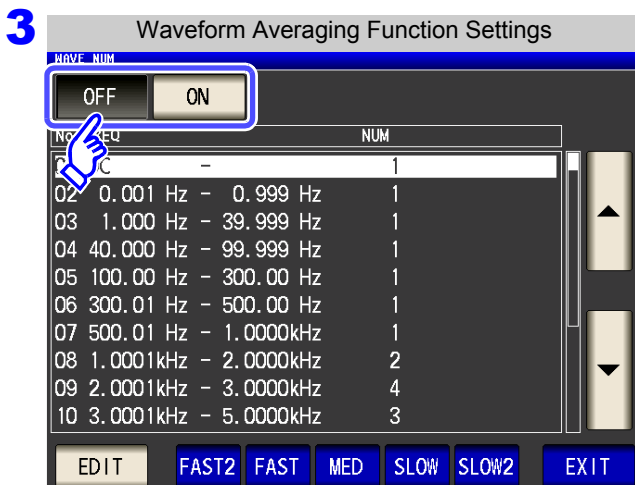

Turn the waveform averaging function on or off.

- OFF** Disables the waveform averaging function.
- ON** Enables the waveform averaging function.

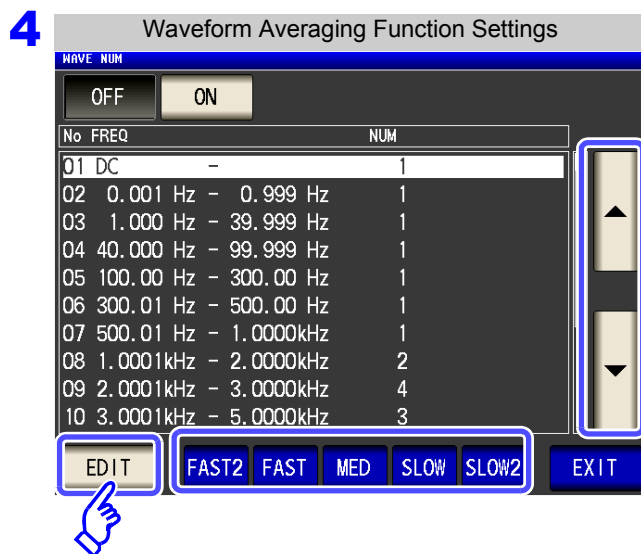

Select the frequency band for which you wish to change the number of measurement waveforms with and and touch .

Reset the number of measurement waveforms for each measurement speed.

FAST2

Sets the number of measurement waveforms to 1 for all frequency bands.

FAST

Sets to the number of measurement waveforms for FAST.

MED

Sets to the number of measurement waveforms for MED.

SLOW

Sets to the number of measurement waveforms for SLOW.

SLOW2

Sets to the number of measurement waveforms for SLOW2.

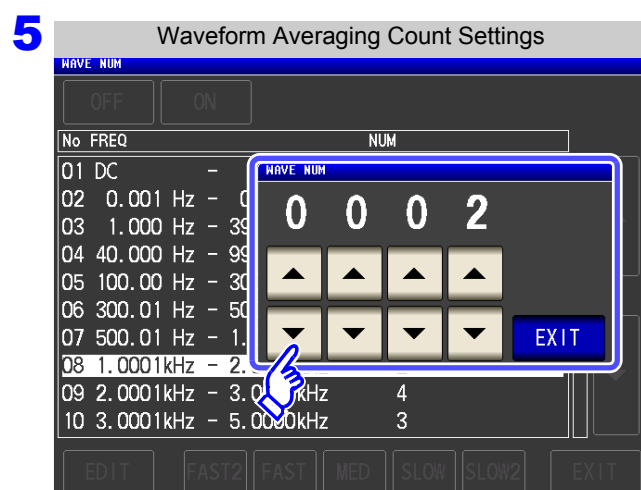

Set the waveform averaging count with and and touch .

No	Frequency band	Settable range
1	DC	1 to 24
2	0.001 Hz to 0.999 Hz	1
3	1.000 Hz to 10.000 Hz	1 to 4
4	10.001 Hz to 39.999 Hz	1 to 10
5	40.000 Hz to 99.999 Hz	1 to 40
6	100.00 Hz to 300.00 Hz	1 to 50
7	300.01 Hz to 500.00 Hz	1 to 200
8	500.01 Hz to 1.0000 kHz	1 to 300
9	1.0001 kHz to 2.0000 kHz	1 to 600
10	2.0001 kHz to 3.0000 kHz	1 to 1200
11	3.0001 kHz to 5.0000 kHz	1 to 2000
12	5.0001 kHz to 10.000 kHz	1 to 3000
13	10.001 kHz to 20.000 kHz	1 to 1200*
14	20.001 kHz to 30.000 kHz	1 to 480*
15	30.001 kHz to 50.000 kHz	1 to 800*
16	50.001 kHz to 100.00 kHz	1 to 1200*
17	100.01 kHz to 200.00 kHz	1 to 2400*

The No. 1 DC measurement waveform count performs waveform averaging using the set line frequency as one wave.

* When using No. 13, 5 times the number of waves set with the waveform averaging count are averaged, and when Nos. 14 to 17 are used, 25 times the number of waves set with the waveform averaging count are averaged.

6 Press to close the setting screen.

4.5 Setting Application Settings

4.5.3 Detecting OPEN during 2-terminal Measurement (HIGH-Z Reject Function)

This function is for outputting a measurement terminal connector error when the measurement result is high relative to the set judgment reference value. The setting value can be set as an absolute value, and the error is output via the Measurement Screen and EXT I/O. On the Measurement screen, this error is output as [Hi Z].
See "Chapter 12 External Control" (p. 309)

The judgment reference is calculated from the nominal value (range name) of the current measurement range and the judgment reference value as shown below.

Judgment reference = Nominal value of current measurement range × Judgment reference value (%)

Example Current measurement range nominal value: 10 kΩ
 Judgment reference value: 150%
 Judgment reference = 10 k × 1.50 = 15 k

Procedure

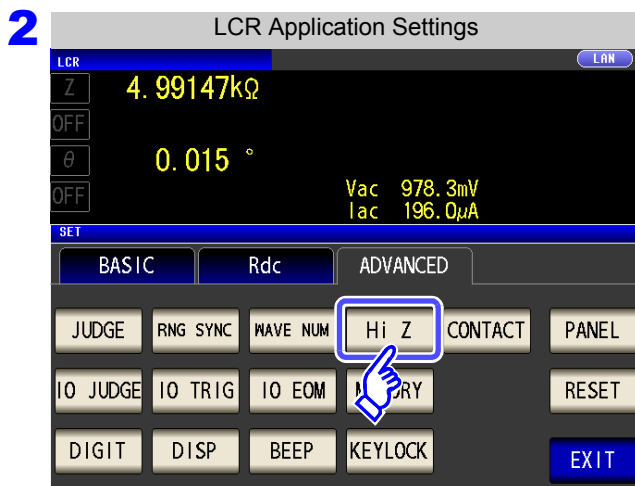
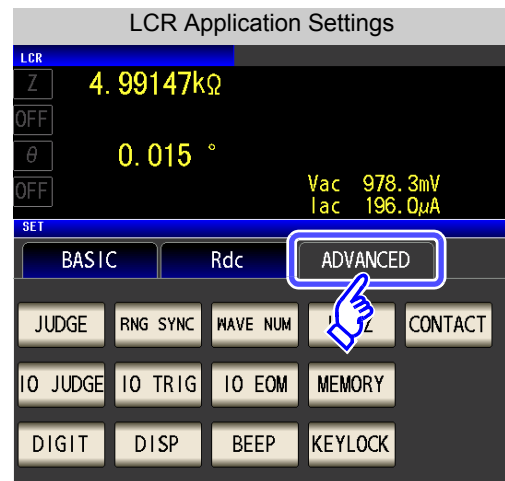
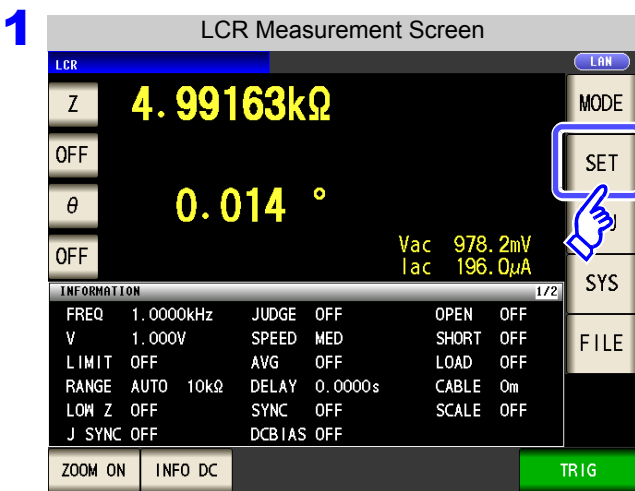

Press **Hi Z**.

4.5 Setting Application Settings

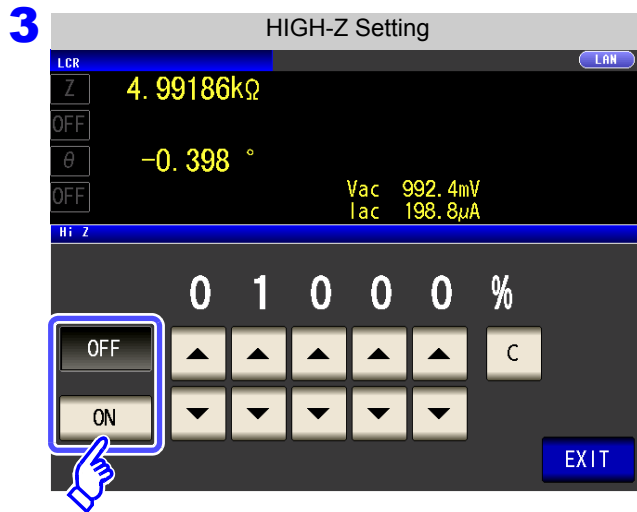

Select ON/OFF for the HIGH-Z reject function.

- Disables the HIGH-Z reject function.
- Enables the HIGH-Z reject function.

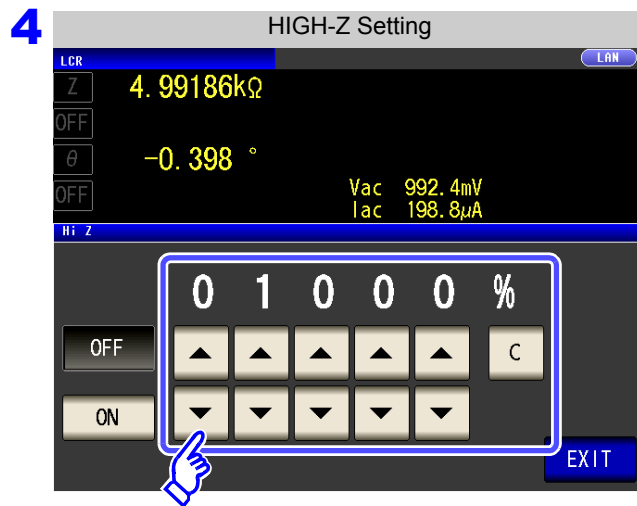

Use or to set the judgment reference value.

Settable range: 0% to 30000%

- A ratio is set using the range name as the reference value.
Example: When the 1 kΩ range is used:
A ratio to the value of 1 kΩ is set.
- If you make a mistake during input:
press to cancel the input and start again.

5 Press to close the setting screen.

4.5 Setting Application Settings

4.5.4 Checking Contact Defects and the Contact State (Contact Check Function)

This functionality allows you to detect contact defects between the terminals (H_{CUR}, H_{POT}, L_{CUR}, and L_{POT}) and the sample during 4-terminal measurement.

See Contact check error display (p. 362)

Procedure

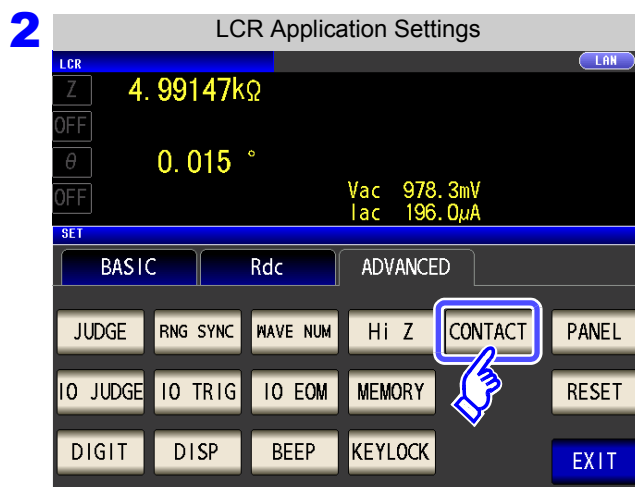
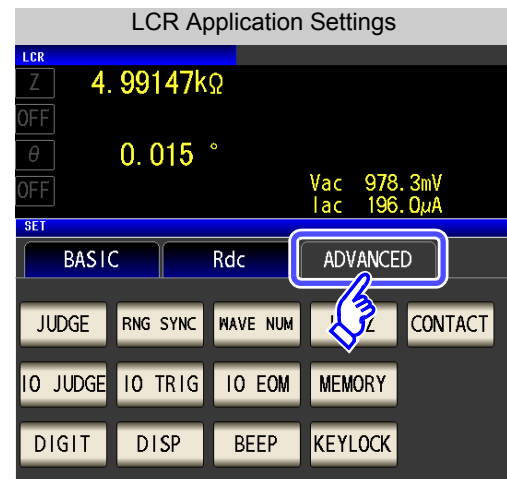
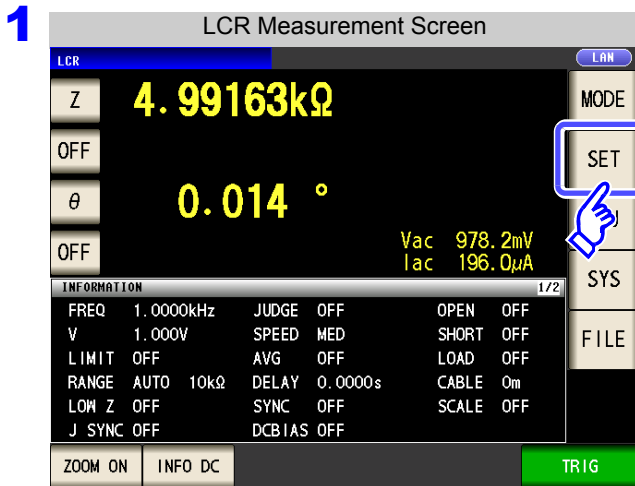

Press **CONTACT**.

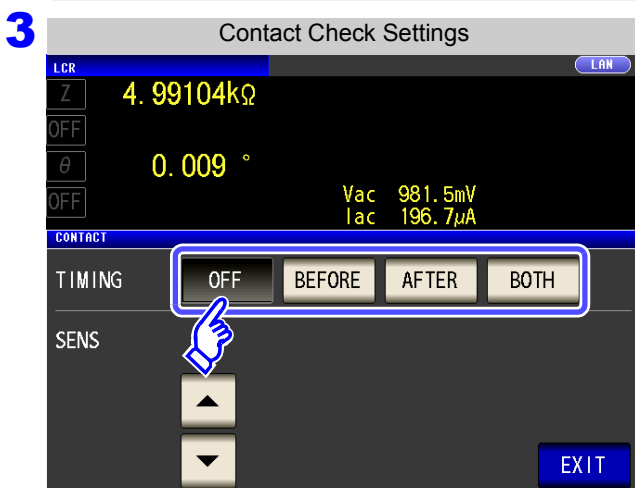

Select the timing at which to perform contact check operation.

- OFF** Disables the contact check function.
- BEFORE** Performs a contact check before measuring the sample.
- AFTER** Performs a contact check after measuring the sample.
- BOTH** Performs a contact check before and after measuring the sample.

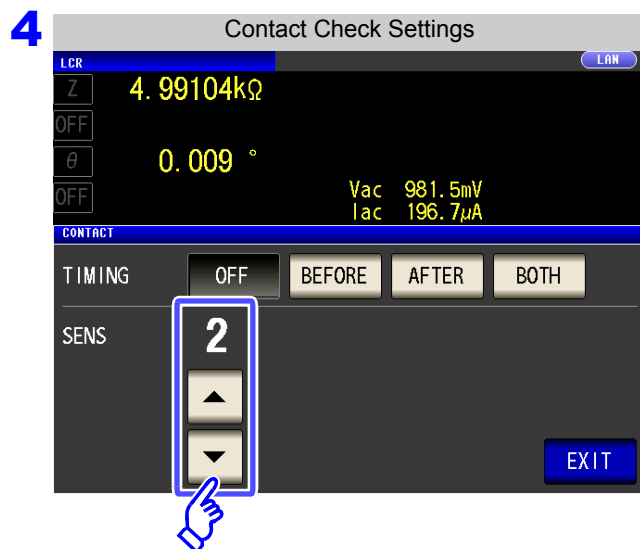

Set the contact check threshold with and .

Settable range : 1 to 5

Threshold	1	2	3	4	5
Permissible contact resistance [Ω]	Approx. 1000	Approx. 500	Approx. 100	Approx. 50	Approx. 10

5 Press to close the setting screen.

NOTE

- Selecting or as the contact check timing causes the trigger synchronous output function to be automatically turned on.
See "4.2.10 Applying the Signal to the Sample during Measurement Only (Trigger Synchronous Output Function)" (p. 77)
- When setting the contact check function, the $\overline{\text{INDEX}}$ time and $\overline{\text{EOM}}$ time will be delayed depending on the timing. (p. 354)
- The contact check function cannot be used during temperature measurement. However, if a contact error occurs at the timing, the temperature measurement will be shown as **DISP OUT** since the measurement will not have been performed at that point.
- The allowable contact resistance value may vary depending on the sample being measured.
- The measurement value will not be saved when all three of the following conditions apply:
 - When the memory function has been enabled
 - When the contact check timing is set to
 - When a contact check error has been displayed (see the error display) (p. 362)

4.5.5 Setting the Delay Time from the Output of Comparator and BIN Judgment Results until Output of EOM (LOW) and Resetting Judgment Results

You can set the delay time for the period from the output of the comparator and BIN judgment results until the output of EOM (LOW) from the EXT I/O.

You can also select whether to reset the comparator and BIN judgment results when the signal changes to EOM (HIGH).

See "12.2 Timing Chart" (p. 318)

Procedure

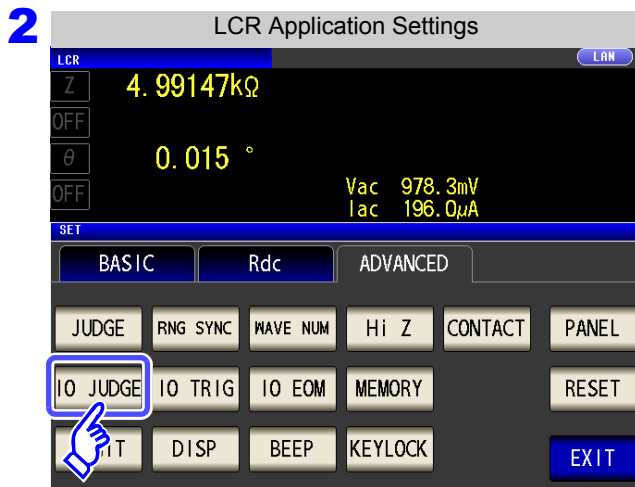
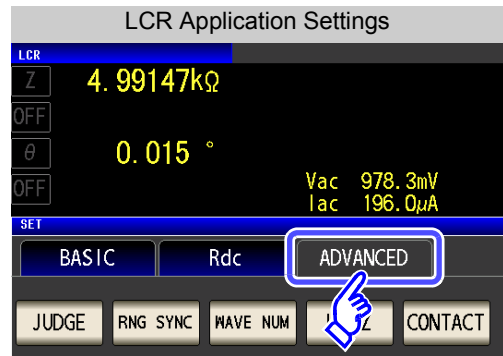
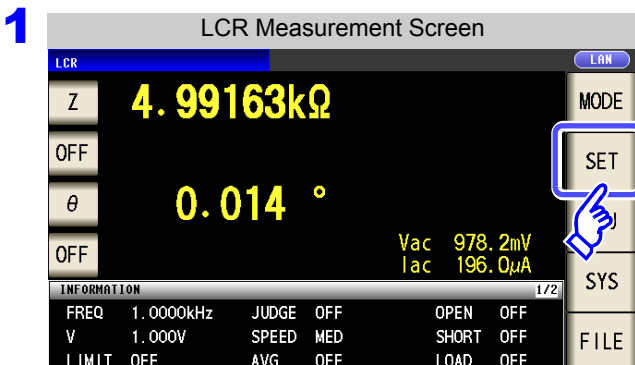

Press **IO JUDGE**.

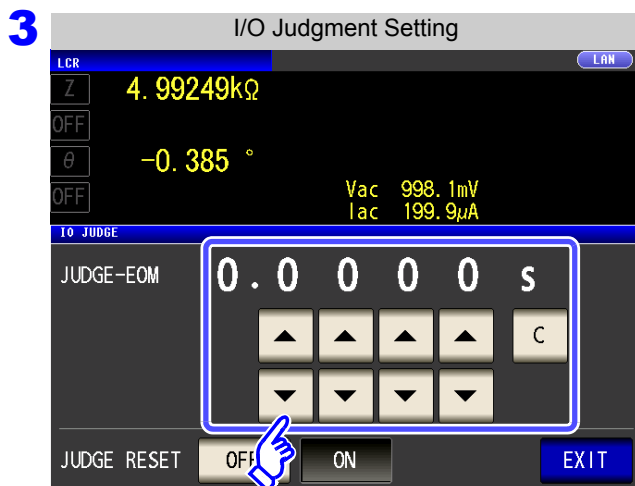

Use **▲** or **▼** to set the delay time for the period from the output of the comparator and BIN judgment results until the output of EOM (LOW).

- Settable range: 0.0000 s to 0.9999 s
- If you make a mistake during input: press **C** to cancel the input and start again.

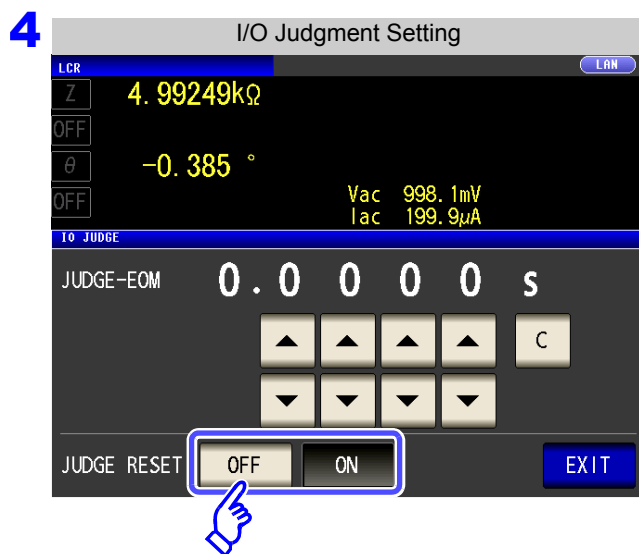

Select whether to reset the comparator and BIN judgment results when the signal changes to \overline{EOM} (HIGH).

OFF

Stores the last judgment results until the next judgment results are output.

ON

Resets the judgment results when the signal changes to \overline{EOM} (HIGH).

5 Press **EXIT** to close the setting screen.

4.5 Setting Application Settings

4.5.6 Enabling Trigger Input for during Measurement and Setting the Valid Edge of Trigger Input

You can select whether to enable or disable trigger input from the EXT I/O during measurement (while \overline{EOM} (HI) is being output after the trigger is received). Erroneous input due to chattering can be prevented by disabling trigger input during measurement. Furthermore, you can also select either the rising edge or falling edge as the valid edge of trigger input from the EXT I/O.

See "12.2 Timing Chart" (p. 318)

Procedure

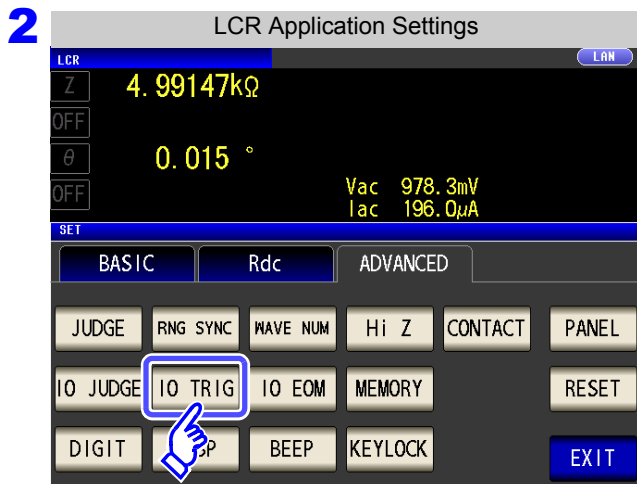
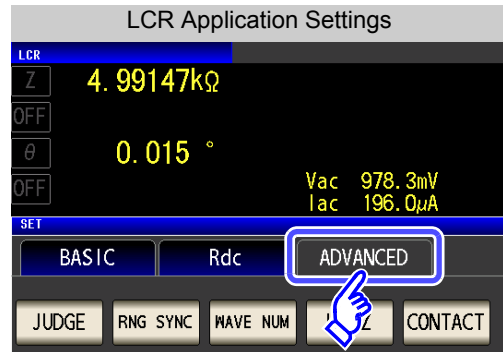
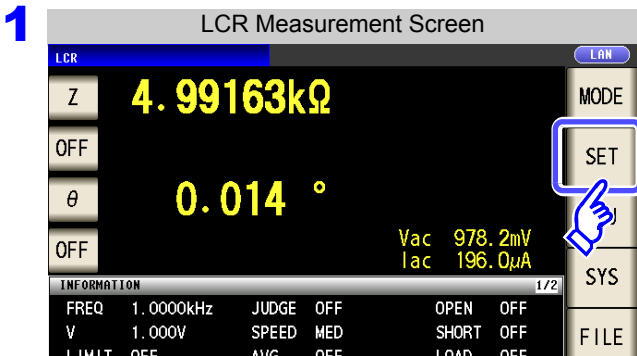

Press **IO TRIG**.

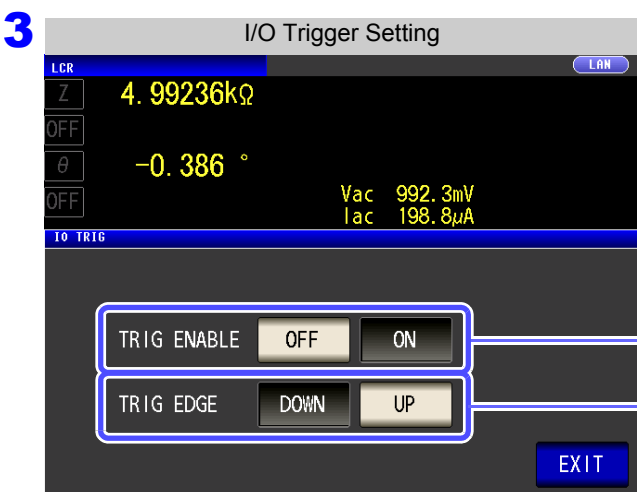

Select the I/O trigger function setting.

- OFF** Disables trigger input from the EXT I/O during measurement (while \overline{EOM} (HI) is being output after the trigger is received)
- ON** Enables trigger input from the EXT I/O during measurement (while \overline{EOM} (HI) is being output after the trigger is received)
- DOWN** Sets the falling edge as the valid edge of trigger input.
- UP** Sets the rising edge as the valid edge of trigger input.

4 Press **EXIT** to close the setting screen.

4.5.7 Setting the EOM Output Method

The higher the measurement frequency, the shorter the time that $\overline{\text{INDEX}}$ and $\overline{\text{EOM}}$ are high (off). When the high (off) time is too short due to characteristics of the input circuit, the instrument can be configured to maintain the low (on) state for a preset time once $\overline{\text{EOM}}$ changes to low (on) before reverting the signal to high (off) after the completion of measurement. The $\overline{\text{INDEX}}$ output method can be changed in the same manner.

See "Chapter 12 External Control" (p. 309)

Procedure

1

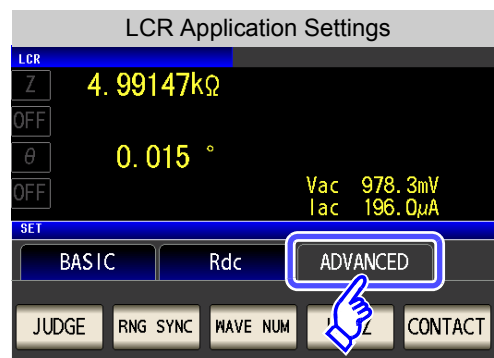
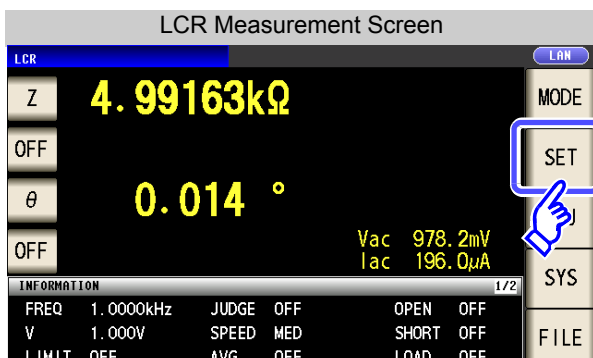

2

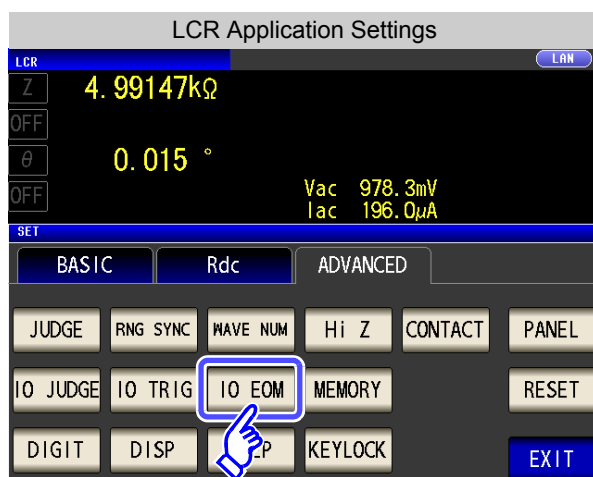

Press **IO EOM**.

3

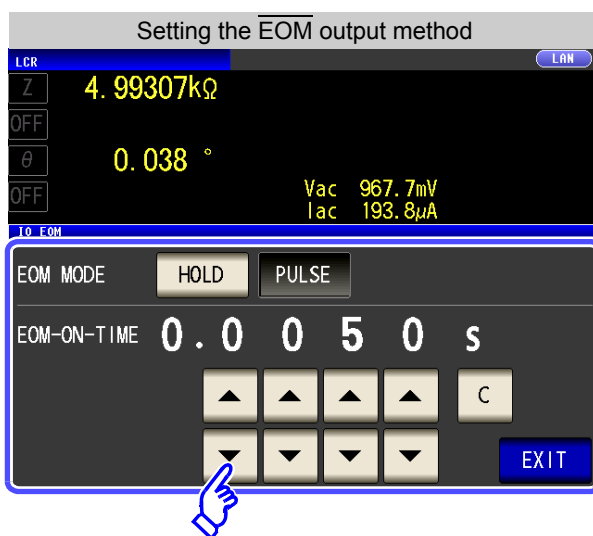

Setting the output method.

For HOLD and PULSE timing charts, see "Chapter 12 External Control" (p. 309).

Use **▲** or **▼** to set the $\overline{\text{EOM}}$ output time for the PULSE setting.

- Settable range: 0.0001 s to 0.9999 s
- If you make a mistake during input: press **C** to cancel the input and start again.
- The output time cannot be set unless the output method has been set to [PULSE].

4 Press **EXIT** to close the setting screen.

4

4.5 Setting Application Settings

4.5.8 Saving Measurement Results (Memory function)

You can save the measurement results inside the instrument (Up to 32,000 items). The saved measurement results can be saved to a USB flash drive. They can also be acquired using a communication command. The memory function setting is the same in **LCR** mode, **ANALYZER** mode, and **TRANSFORMER** mode.

The items saved to memory are in accordance with the **:MEASure:VALid** setting. For details on how to acquire the saved measurement results or set **:MEASure:VALid**, refer to LCR Application Disk (Communication Commands).

Saving Measurement Values

Procedure

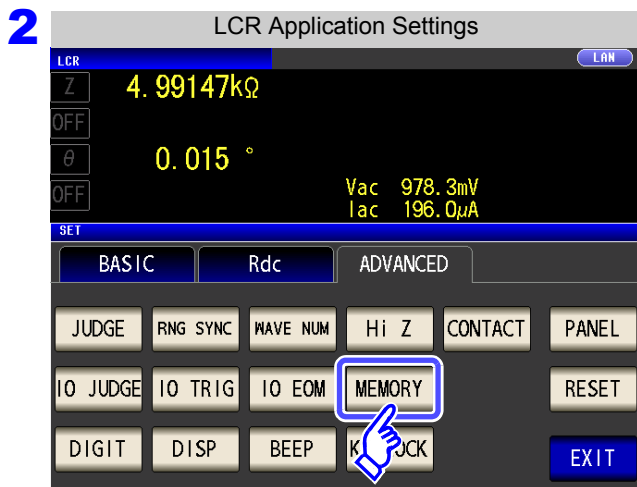
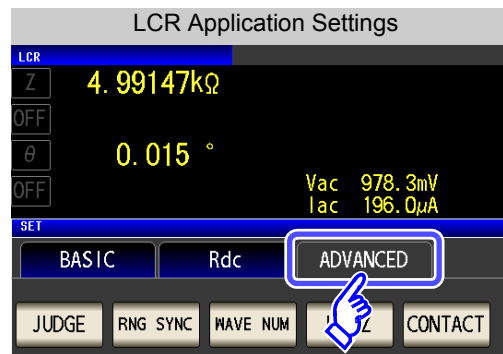
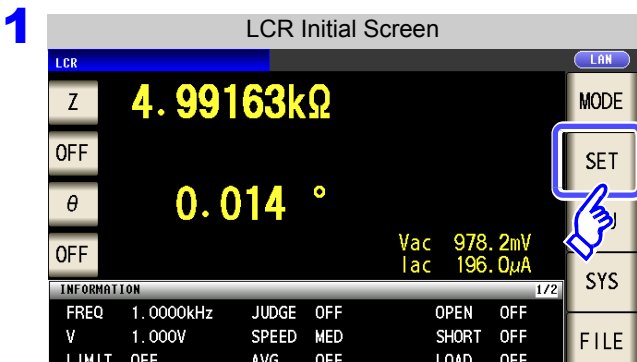

Press **MEMORY**.

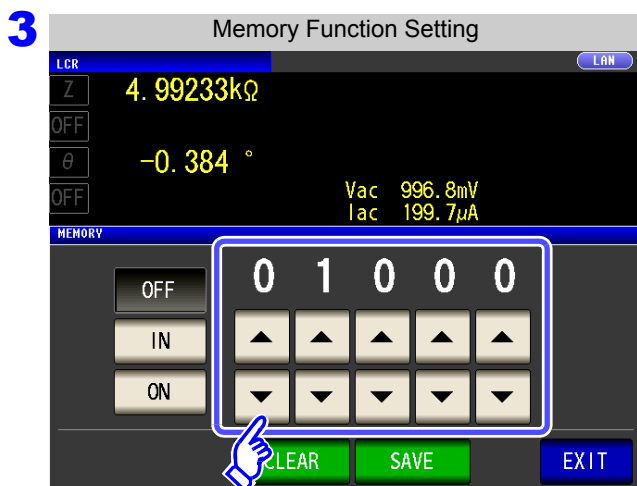

After touching **OFF** to disable the memory function, use **▲** or **▼** to set the number of measurement results.

Settable range: 1 to 32000
The number of measurement results cannot be changed while set to "OFF".

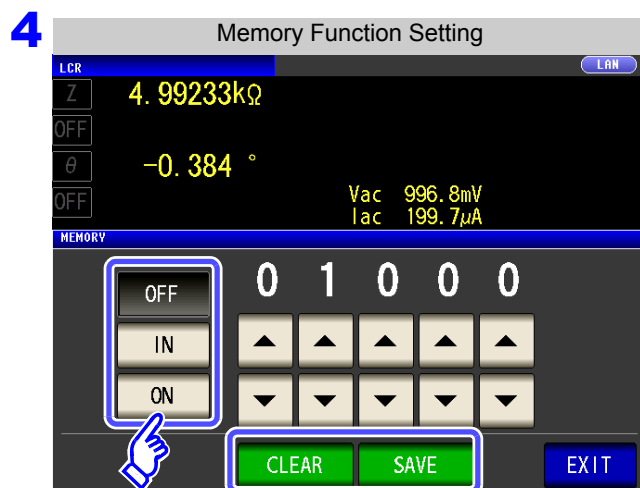

Select ON/IN/OFF for the memory function.

OFF Disables the memory function.

IN Saves the measurement results to memory only when a pass judgment is made for all of the parameters judged with the comparator and BIN functions. (The measurement results are not saved if even one of the comparator results is Hi or Lo or the BIN result is OUT-OF-BINS.)

ON Saves all measurement values to memory.

If the comparator and BIN functions are not set, the operation for **IN** is the same as that of **ON**.

5 Press **EXIT** to close the setting screen.

CLEAR Clears all of the saved measurement results from the instrument memory.

SAVE Saves the measurement values stored in the instrument memory to a USB flash drive and then clears the measurement values from the instrument memory. The measurement values are saved to the MEMORY folder in the USB flash drive. The file name is automatically assigned from the date and time (p. 285).

NOTE

- If the memory function is enabled, the number of memory items currently saved is displayed in the measurement screen.

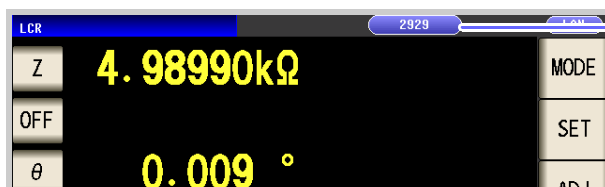

Indicates that the number of memory items currently saved is 2,929.

- Save the measurement results stored in the instrument to a USB flash drive or acquire them with the **:MEMory?** command.
- The internal data is lost when the memory function setting is changed.
- When the instrument memory becomes full, the following message appears on the measurement screen. If this message appears, subsequent measurement results will not be saved.

To resume saving, load or clear the measurement results from the instrument memory.

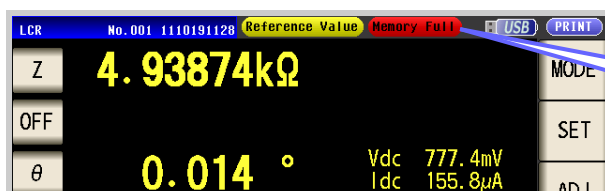

Memory Full

- When the contact check function has been set, the measurement value will not be saved when all three of the following conditions apply:
 - See "4.5.4 Checking Contact Defects and the Contact State (Contact Check Function)" (p. 132)
 - When the memory function has been enabled
 - When the contact check timing is set to **BEFORE**
 - When a contact check error has been displayed (see the error display) (p. 362)

4.5.9 Setting the Number of Display Digits

You can set the number of effective digits of the measurement value for each parameter.

Procedure

1

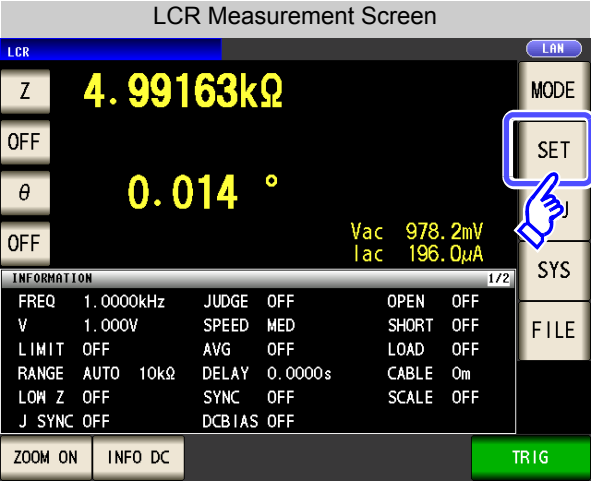

LCR Measurement Screen

Z 4.99163kΩ

θ 0.014°

Vac 978.2mV
Iac 196.0μA

INFORMATION

FREQ	1.0000kHz	JUDGE	OFF	OPEN	OFF
V	1.000V	SPEED	MED	SHORT	OFF
LIMIT	OFF	AVG	OFF	LOAD	OFF
RANGE	AUTO 10kΩ	DELAY	0.0000s	CABLE	0m
LOW Z	OFF	SYNC	OFF	SCALE	OFF
J SYNC	OFF	DCBIAS	OFF		

ZOOM ON INFO DC TRIG

2



LCR Application Settings

Z 4.99147kΩ

θ 0.015°

Vac 978.3mV
Iac 196.0μA

SET

BASIC Rdc ADVANCED

JUDGE RNG SYNC WAVE NUM Hi Z CONTACT PANEL

IO JUDGE IO TRIG IO EOM MEMORY RESET

DIGIT DISP BEEP KEYLOCK EXIT

Press **DIGIT**.

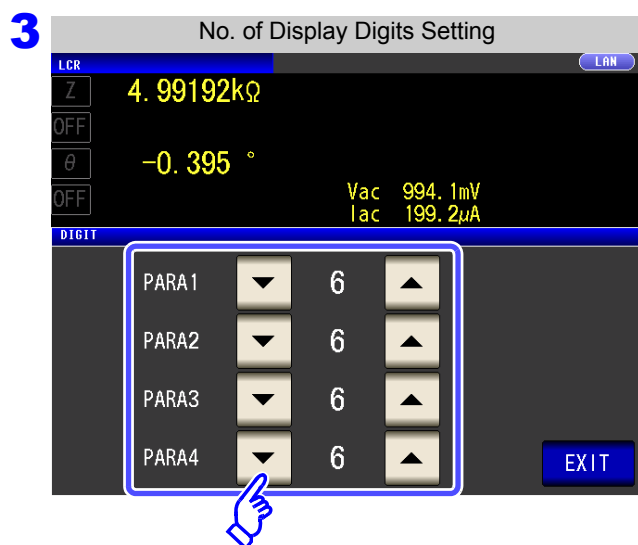

Use or to set the number of display digits. (For each parameter)

Settable range: 3 to 6 digits

Setting Value	Parameter				
	θ	D	Q	$\Delta\%$	Other
6	Up to three decimal places	Up to five decimal places	Up to second decimal place	Up to three decimal places	Up to 6 digits
5	Up to second decimal places	Up to four decimal places	Up to one decimal place	Up to second decimal place	Up to 5 digits
4	Up to one decimal place	Up to three decimal places	Up to zero decimal places	Up to one decimal place	Up to 4 digits
3	Up to zero decimal places	Up to second decimal place	Up to zero decimal places	Up to zero decimal places	Up to 3 digits

4 Press to close the setting screen.

NOTE The instrument may not be able to display minute values using the set number of display digits.

4.5 Setting Application Settings

4.5.10 Setting the LCD to ON/OFF

You can turn the LCD ON/OFF.

Setting the LCD to OFF saves power because the LCD turns off if the panel is not touched for 10 seconds.

Procedure

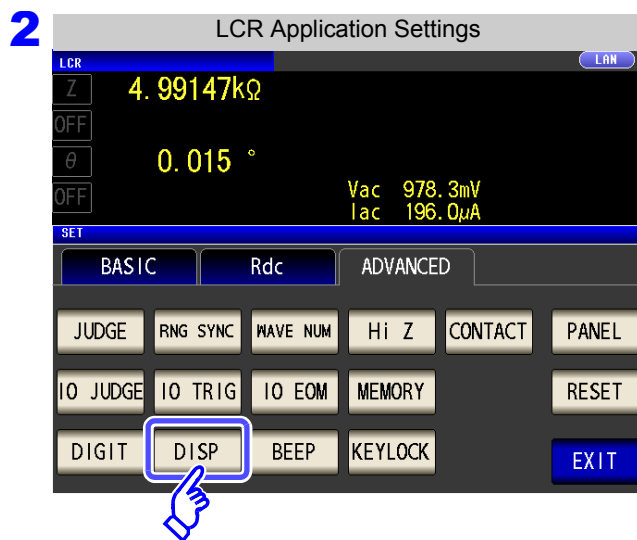
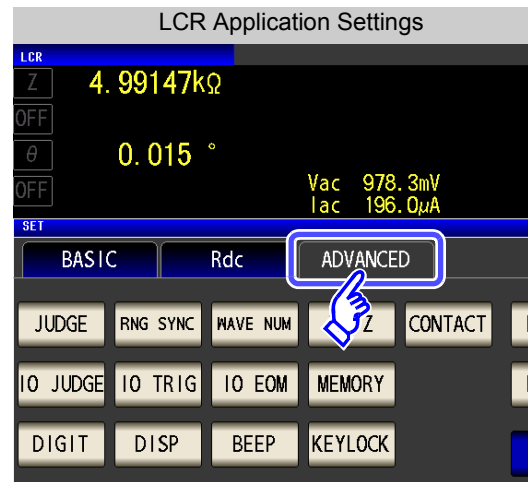
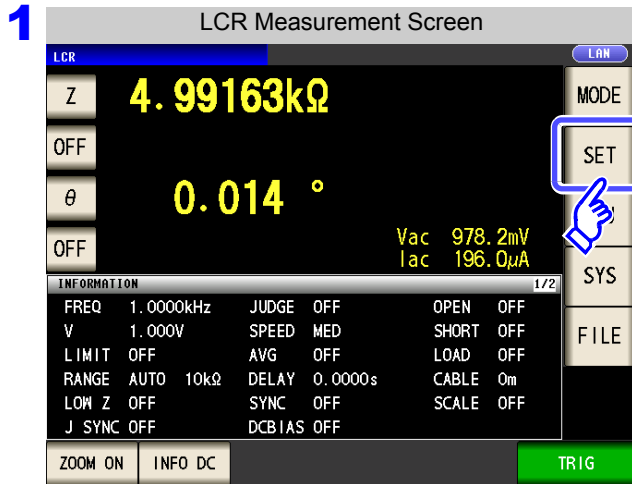

Press **DISP**.

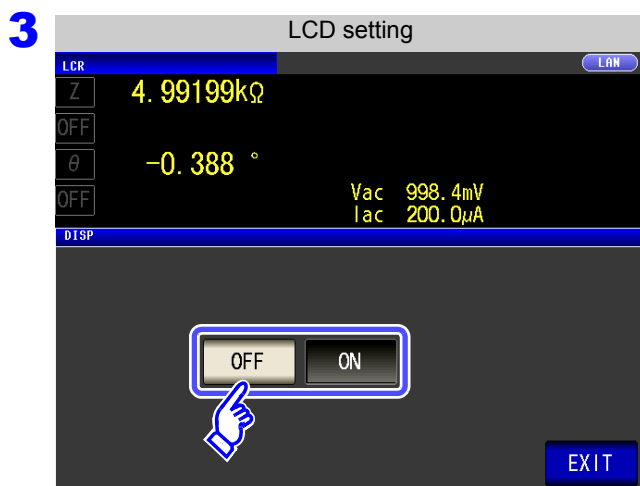

Select the LCD setting, and press **EXIT** to close the setting screen.

OFF Turns OFF the LCD.
The LCD turns off after approximately 10 seconds elapse since the touch panel was last touched.

ON Sets the LCD to always on.

When you want to turn the backlight on again:

If you touch the touch panel while the backlight is off, the backlight will turn on again.
The backlight will turn off again if you do not touch the touch panel for about 10 seconds.

4.5.11 Setting Operation Sounds (Beep Sounds)

You can set the operation sound and each of the beep sounds for judgment results.

Procedure

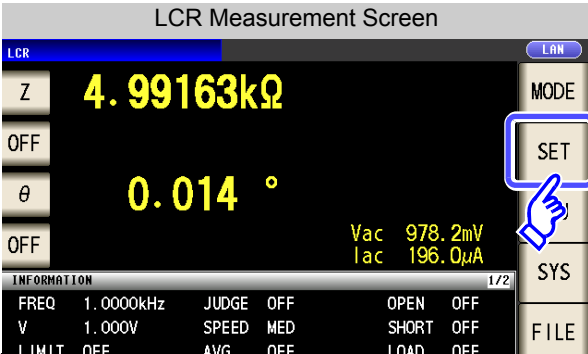
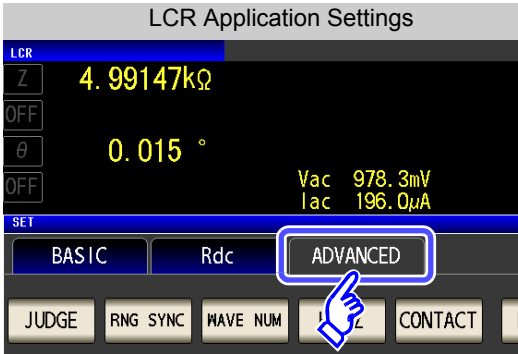
- 
- 

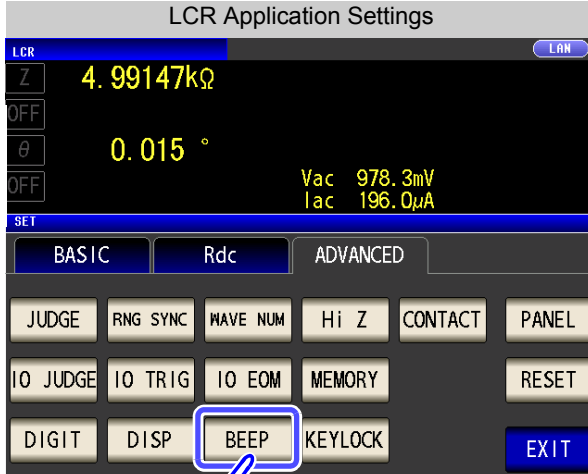
Press **BEEP**.
- 

Beep sound settings for when comparator judgment

OFF When a comparator judgment is made, no beep sound is emitted.

 - When judgment performed with 1 comparator

IN When the comparator result is IN, a beep sound is emitted.

NG When the comparator result is LO or HI, a beep sound is emitted.

 - When judgment performed with 2 comparators

IN When both of these comparator results are IN, a beep sound is emitted.

NG When either one is LO or HI, a beep sound is emitted.
- 

Beep sound setting for when key pressed

OFF When a key is pressed, no beep sound is emitted.

ON When a key is pressed, a beep sound is emitted.

Beep tone settings

You can select from four beep tones (**A** , **B** , **C** , and **D**).

4 Press **EXIT** to close the setting screen.

NOTE If an invalid key is pressed or an operation causes an error, an error tone will sound regardless of whether the beep tone is turned on or off.

4.5 Setting Application Settings

4.5.12 Disabling Key Operation (Key-lock Function)

When the key-lock function is enabled, all setting changes except canceling the key-lock are disabled to protect the settings.

You can also set a passcode (security code).

Procedure

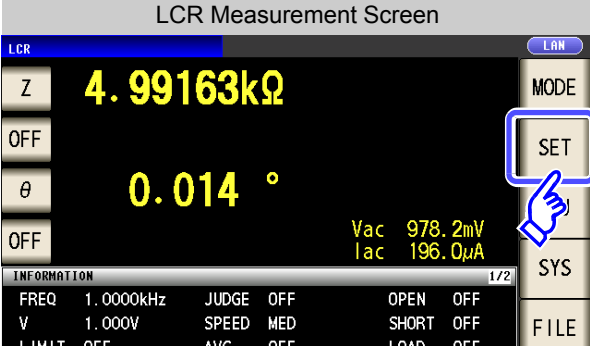
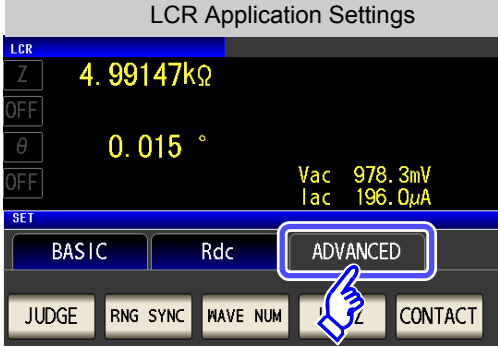
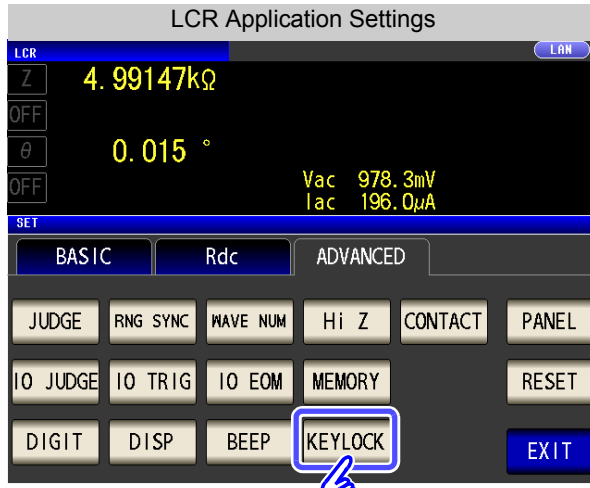
- 

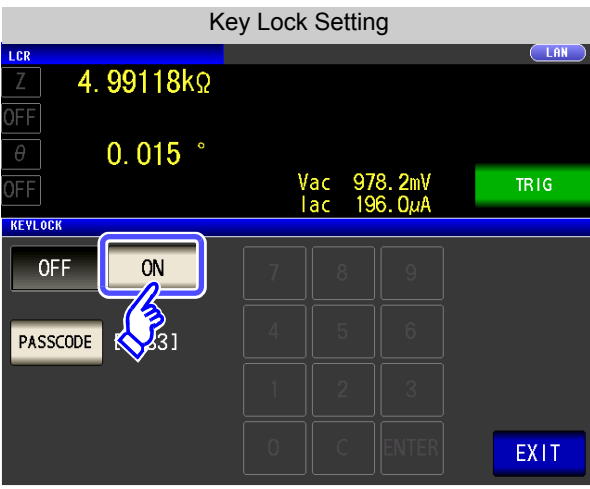
- 

Press **KEYLOCK**.
- 

Press **ON**.
- Press **EXIT** to close the setting screen.

NOTE

- In the case of an external trigger, the key lock is not enabled for **TRIG**.
- Turning off the power does not cancel the key-lock function.

Setting the Passcode of the Key-lock

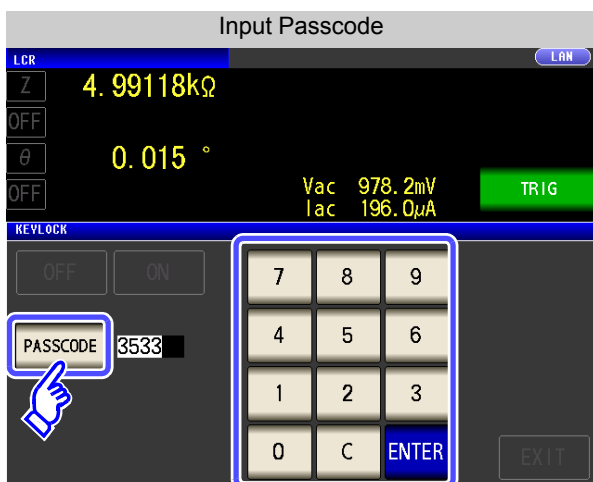

Press **PASSCODE** when the key-lock setting is **ON**.

Use the numerical keypad to enter the passcode, press **ENTER**, and then press **EXIT**.

Settable range: 1 to 4 digits
Initial passcode: 3533

NOTE If a passcode is set, it needs to be entered to disable the key-lock. Take care not to forget the set passcode.

Disabling the Key-lock

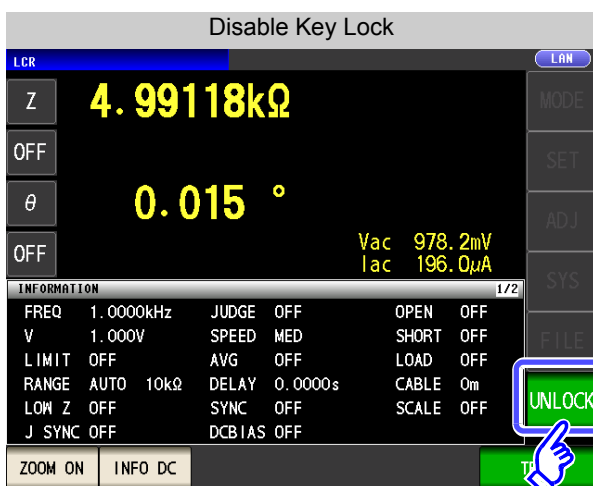

Press **UNLOCK** when the key-lock is enabled.

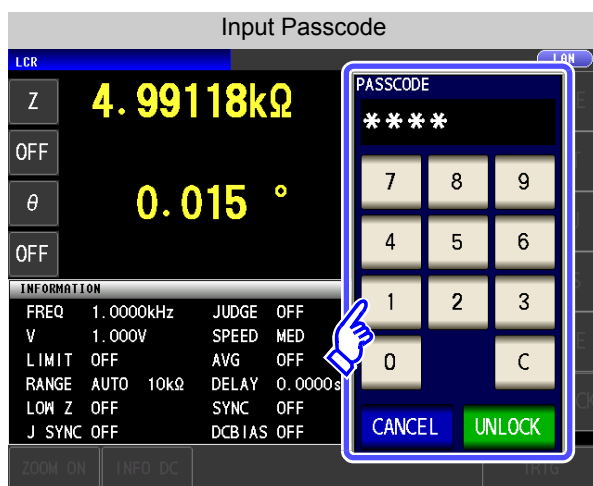

When a passcode is set

Enter the passcode and press **UNLOCK**.

The entered passcode is indicated as ***** on the screen.

(To cancel input: Press **C**.)

When a passcode is not set

Press **UNLOCK**.

When you want cancel the disabling of the key-lock: Press **CANCEL**.

NOTE If you forget the passcode, perform a full reset to restore the instrument to the factory default settings (p. 361).

146

4.5 Setting Application Settings

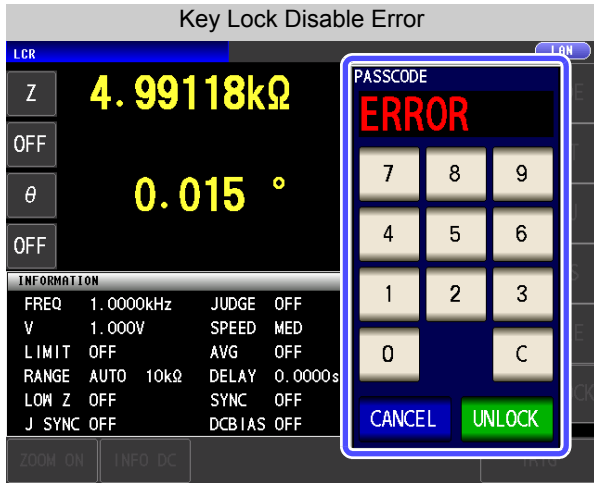

If the error indication shown on the left appears, check the following items.

Cause	Remedy
UNLOCK was pressed before you entered the passcode.	Press C and enter the passcode.
The entered passcode is incorrect.	Press C and enter the passcode again.

4.5.13 Initializing (System Reset)

In the event of the instrument malfunctioning, check "Before returning for repair" (p. 357).

If you do not know the cause of the problem, perform a system reset to restore the instrument to its factory default settings.

See "Appendix12 Initial Settings Table"(p. A18)

A system reset can also be performed with the *RST and :PRESet communication commands.

See Description of communications commands on the included LCR Application Disk. *RST, :PRESet

Procedure

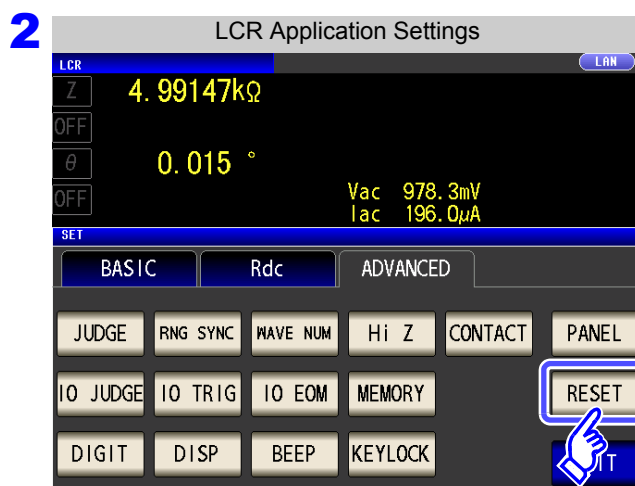
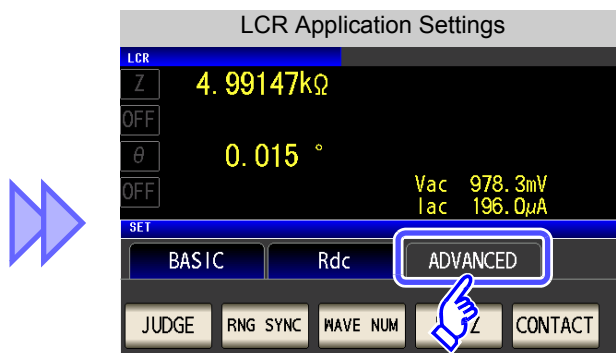
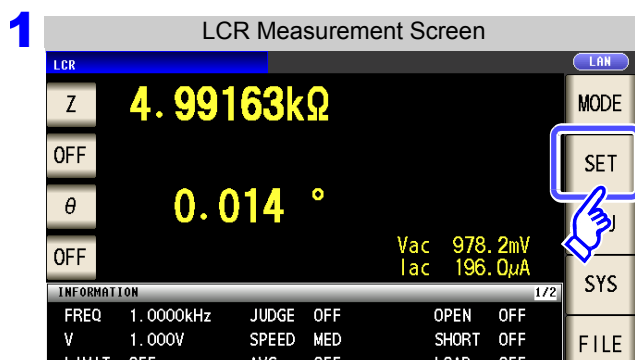

Press **RESET**.

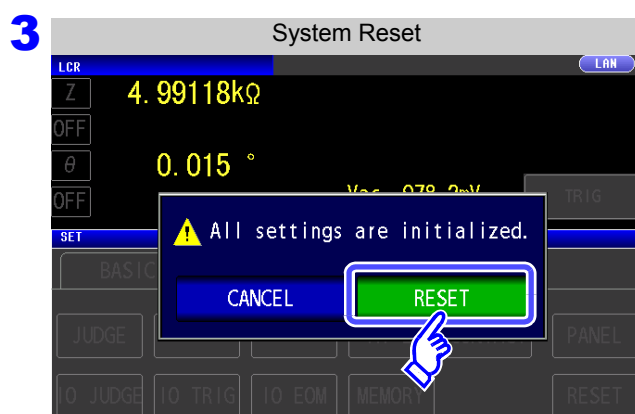

Press **RESET** to restore the factory default settings and automatically redisplay the measurement screen.

When you want to cancel the system reset:

Press **CANCEL**.

NOTE

- If the initialization screen cannot be displayed, perform a full reset (p. 361).
- Performing a system reset causes the instrument to return to its default factory settings. Disconnect the measurement sample before performing a system reset.

ANALYZER Function (IM3533-01) Chapter 5

5.1 About ANALYZER function

The ANALYZER function allows you to perform measurement while sweeping the measurement frequency. Use this function for measuring frequency characteristics.

NOTE

- The settings are synchronized between LCR mode, ANALYZER mode, and TRANS mode.
- DC resistance measurement is not supported in ANALYZER mode.

5.1.1 Measurement screen

When the instrument is turned back on, the screen will display the measurement mode in use when it was last turned off. For details on the screen configuration, refer to page 18.

If a HIGH-Z error, constant voltage measurement or constant current measurement error, or contact check error occurs, an error will be displayed.

Example: HIGH-Z error

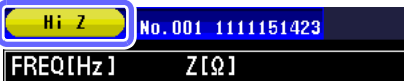

Indicates the name of the loaded panel (p. 256).

Indicates the usage status of internal memory (p. 138).

Indicates that a USB flash drive is connected (p. 273).

Indicates the interface that is currently set (p. 263).

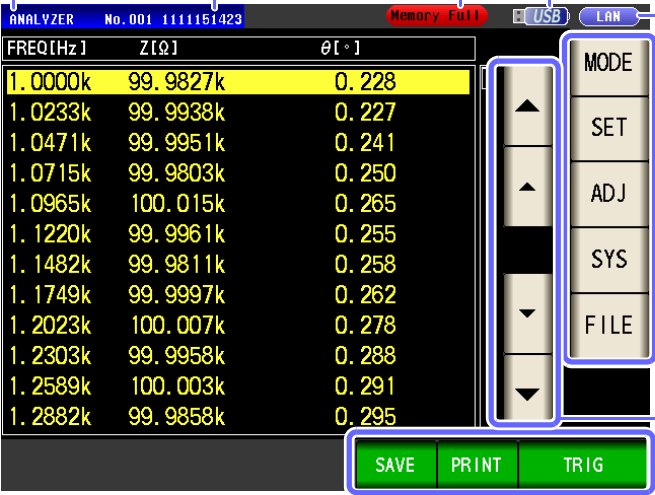

Menu keys

MODE	Select the measurement mode (p. 13).
SET	Set the details (p. 150).
ADJ	Set the compensation (p. 215).
SYS	Set the system (p. 263).
FILE	Set the save settings (p. 273).

The settings of **SET** differ depending on the measurement mode.

Scrolls through the list.

Operation keys An operation key is displayed depending on the situation.

SAVE Save the measurement data (p. 277).

PRINT Print the measurement data (p. 331).

TRIG Measurement starts (p. 151).
(This is displayed when **SEQ** or **STEP** is selected for the trigger setting.)

5.2 Setting Basic Settings of Measurement

5.2.1 Setting the measurement parameter

Set the measurement parameter for ANALYZER mode.

NOTE DC resistance measurement cannot be performed in ANALYZER mode.

Procedure

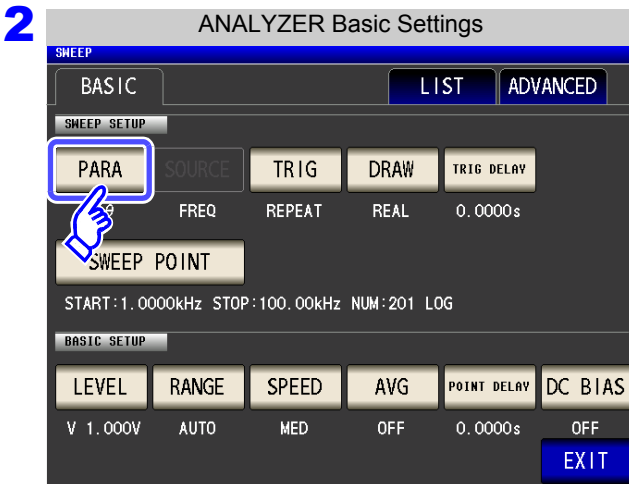
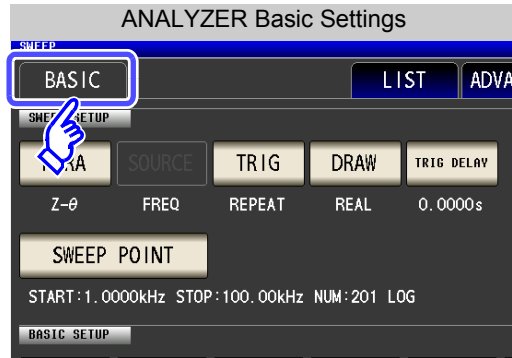
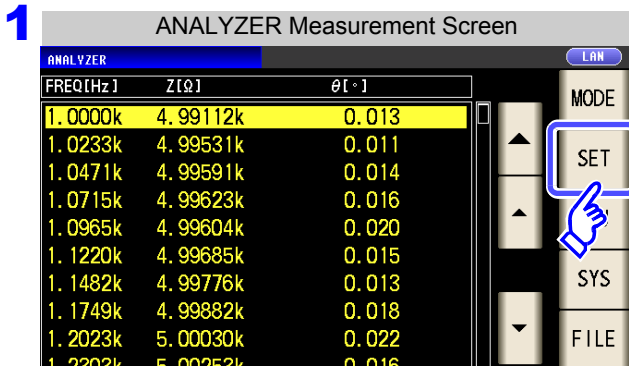

Press **PARA**.

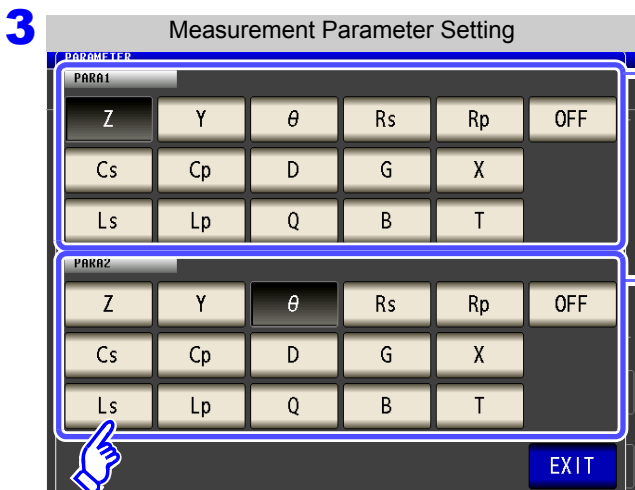

Select the first parameter.

Select the second parameter.

- In ANALYZER mode, two types of parameter measurement can be performed: PARA1 and PARA2.
- The parameter settings of LCR mode and parameter settings of ANALYZER mode are linked as shown below.

LCR mode	ANALYZER mode
PARA1	PARA1
PARA2	Unused
PARA3	PARA2
PARA4	Unused

4 Press **EXIT** to close the setting screen.

5.2.2 Setting the Trigger

Set the trigger. In ANALYZER mode, sweeping is performed in accordance with the trigger setting that is set for this item. The following three types of trigger can be set as the trigger setting.

- Sequential sweep
- Repeat sweep
- Step sweep

For details on each of the triggers, refer to **step 3**.

Procedure

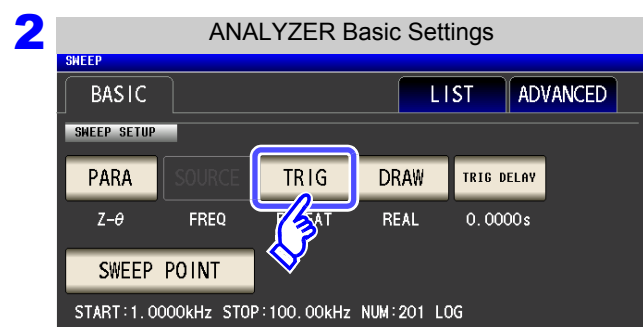
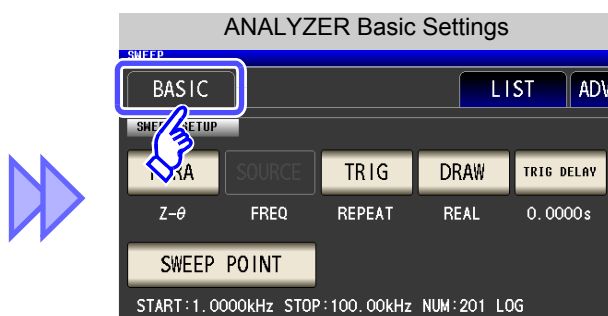
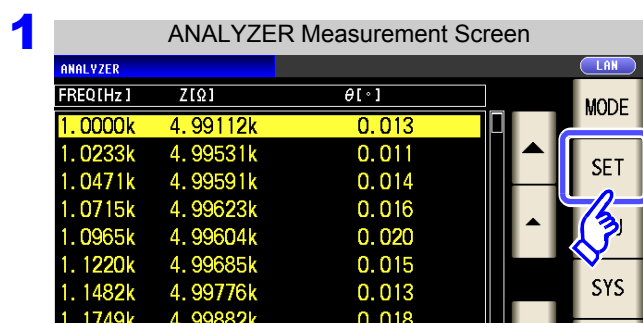

Press **TRIG**.

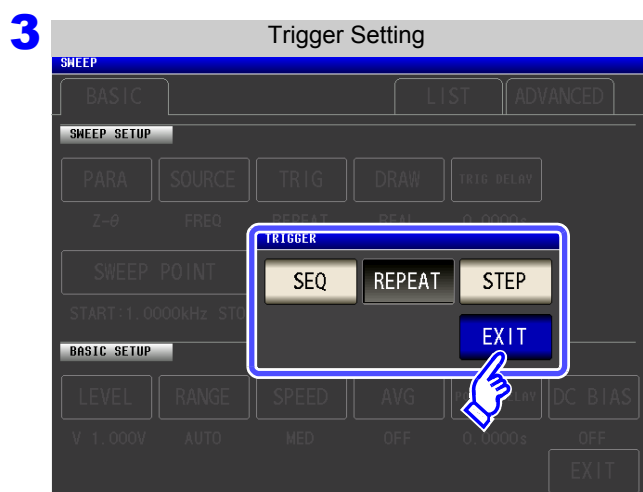

Select the trigger setting.

- | | |
|---------------|---|
| SEQ | Performs a sequential sweep. When an external trigger is input, sweep measurement is performed once only. |
| REPEAT | Performs a repeat sweep. An internal trigger results in a sweep being performed repeatedly. |
| STEP | Performs a step sweep. When an external trigger is input, measurement is performed at the current measurement point and then the process moves to the next measurement point. |

- If this is set to **SEQ** or **STEP**, **TRIG** is displayed in the measurement screen.
- Each time you press **TRIG**, a sequence sweep or step sweep is performed.

4 Press **EXIT** to close the setting screen.

NOTE The trigger setting that is set for this item differs from the trigger setting of LCR mode. (It does not influence the trigger setting of LCR mode.)

5.2 Setting Basic Settings of Measurement

5.2.3 Setting the Display Timing

Set the timing for drawing the list.

If the display timing is set to **REAL**, the time for one sweep becomes long because the screen is updated every time each sweep point is measured.

If it is set to **AFTER** to give priority to the measurement time, the screen update time becomes short.

Procedure

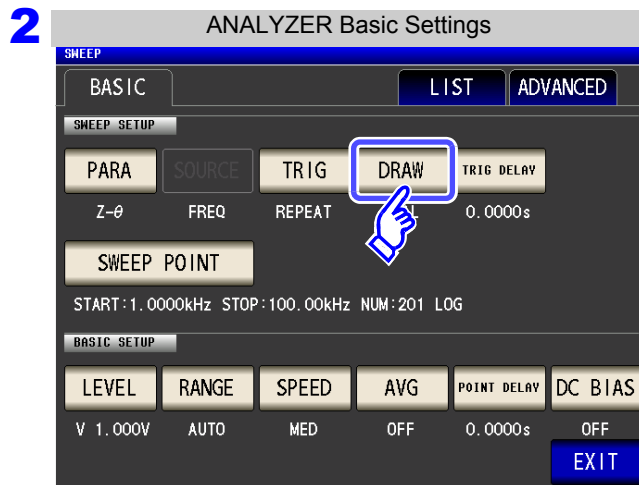
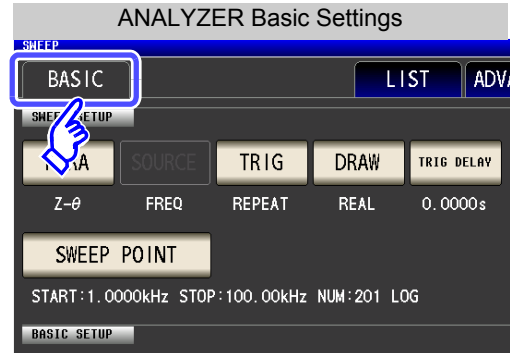
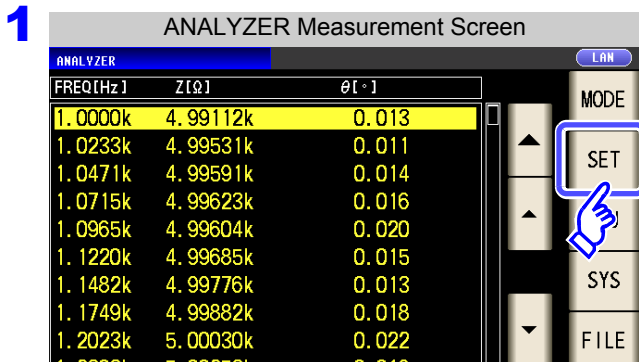

Press **DRAW**.

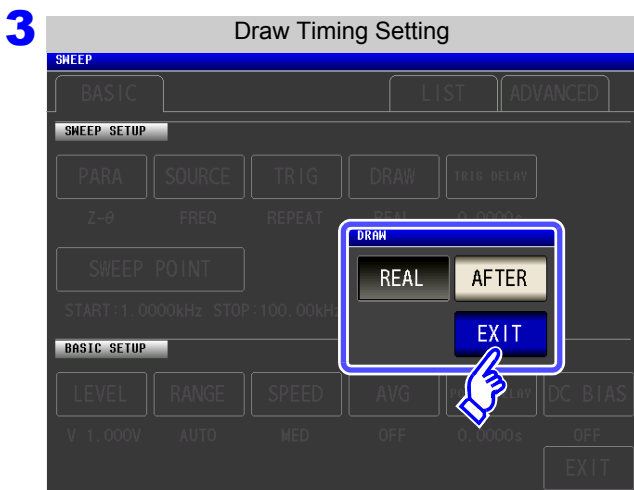

Set the timing for display.

REAL Sequentially draws after measurement of each sweep point.

AFTER Draws all after one sweep is finished.

4 Press **EXIT** to close the setting screen.

5.2.4 Setting the Trigger Delay

Set the delay time from the initial sweep point trigger input to the start of measurement.
There are two delay settings: "Trigger Delay" and "Point Delay."
With this item, only the setting for the trigger delay is configured.

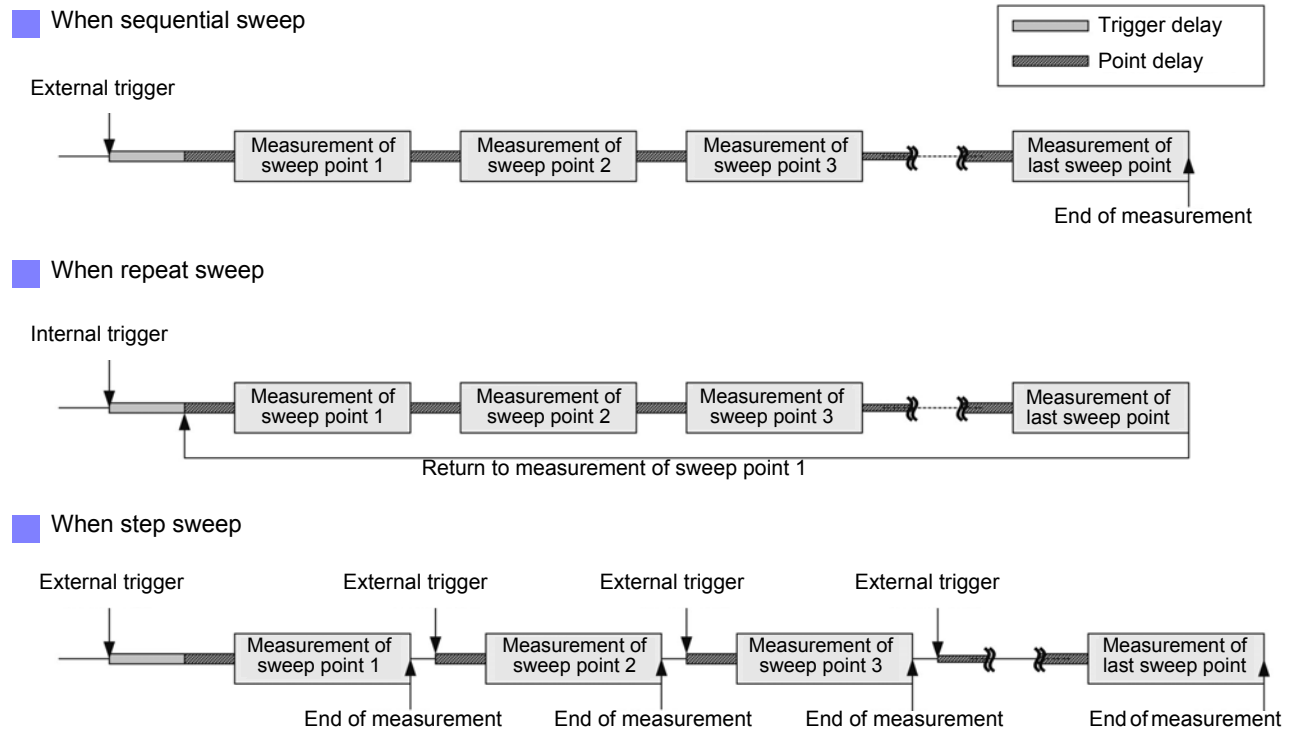

5.2 Setting Basic Settings of Measurement

Procedure

1

FREQ[Hz]	Z[Ω]	θ[°]
1.0000k	4.99112k	0.013
1.0233k	4.99531k	0.011
1.0471k	4.99591k	0.014
1.0715k	4.99623k	0.016
1.0965k	4.99604k	0.020
1.1220k	4.99685k	0.015
1.1482k	4.99776k	0.013
1.1749k	4.99882k	0.018
1.2023k	5.00030k	0.022
1.2303k	5.00253k	0.016
1.2589k	5.00546k	0.008
1.2882k	5.00738k	0.003

2

Press **TRIG DELAY**.

3

Use **▲** or **▼** to set the delay time.

- Settable range: 0 s to 9.9999 s with resolution of 0.1 ms
- If you make a mistake during input: press **C** to cancel the input and start again.

4 Press **EXIT** to close the setting screen.

5.2.5 Setting Sweep Points

Sets the start value and end value of the sweep.

Each sweep point is automatically calculated from the number of sweep points.

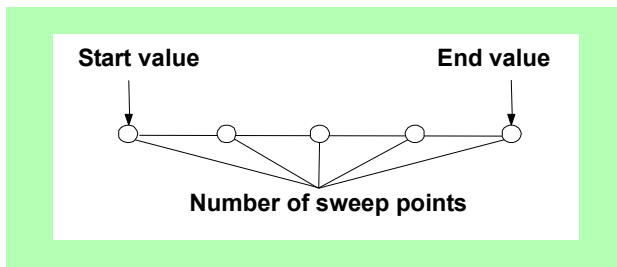

Procedure

1

ANALYZER Measurement Screen

FREQ[Hz]	Z[Ω]	θ [°]
1.0000k	4.99112k	0.013
1.0233k	4.99531k	0.011
1.0471k	4.99591k	0.014
1.0715k	4.99623k	0.016
1.0965k	4.99604k	0.020
1.1220k	4.99685k	0.015
1.1482k	4.99776k	0.013
1.1749k	4.99882k	0.018
1.2023k	5.00030k	0.022
1.2303k	5.00253k	0.016
1.2589k	5.00546k	0.008
1.2882k	5.00738k	0.003

MODE, SET, SYS, FILE, TRIG

ANALYZER Basic Settings

BASIC LIST ADV

SWEEP SETUP

PARAM SOURCE TRIG DRAW TRIG DELAY

Z- θ FREQ REPEAT REAL 0.0000s

SWEEP POINT

START:1.0000kHz STOP:100.00kHz NUM:201 LOG

BASIC SETUP

LEVEL RANGE SPEED AVG POINT DELAY

V 1.000V AUTO MED OFF 0.0000s

2

ANALYZER Basic Settings

SWEEP BASIC LIST ADVANCED

SWEEP SETUP

PARAM SOURCE TRIG DRAW TRIG DELAY

Z- θ FREQ REPEAT REAL 0.0000s

SWEEP POINT

START:1.0000kHz STOP:100.00kHz NUM:201 LOG

BASIC SETUP

LEVEL RANGE SPEED AVG POINT DELAY DC BIAS

V 1.000V AUTO MED OFF 0.0000s OFF

EXIT

Press SWEEP POINT .

5.2 Setting Basic Settings of Measurement



Press **START** and use the numeric keypad to set the start value of the sweep.

- Settable range: 1 mHz to 200 kHz
- If you make a mistake during input: press **C** to cancel the input and start again.
- When you want to cancel the setting: Press **CANCEL**.

Press **k**, **x1**, or **m** key to confirm the setting.

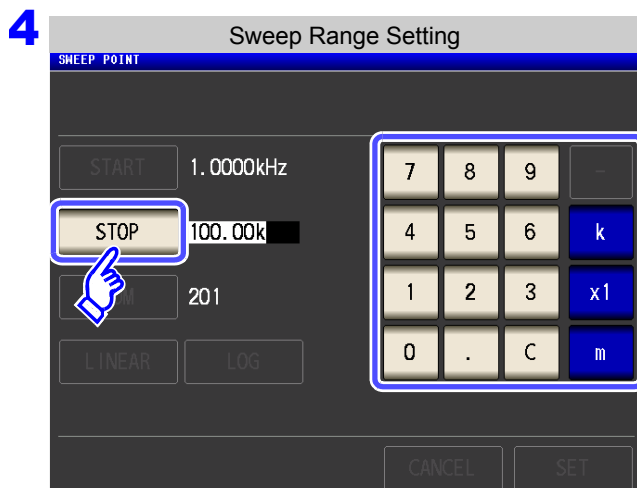

Press **STOP** and use the numeric keypad to set the end value of the sweep.

Settable range: 1 mHz to 200 kHz

Press **k**, **x1**, or **m** key to confirm the setting.

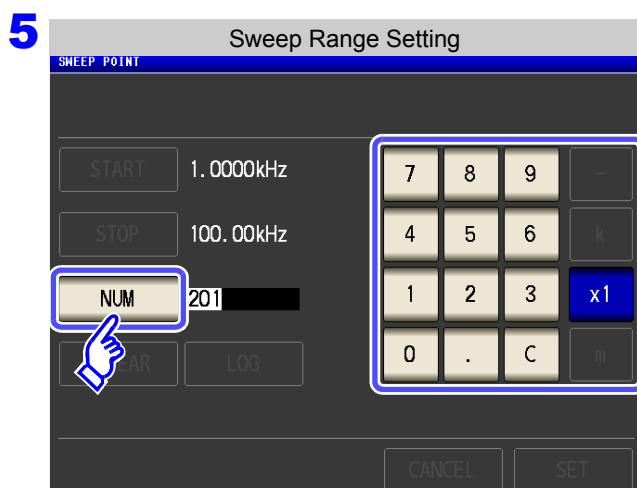

Press **NUM** and use the numeric keypad to enter the number of sweep points.

Settable range: 2 to 801

Press **x1** key to confirm the setting.

5.2 Setting Basic Settings of Measurement

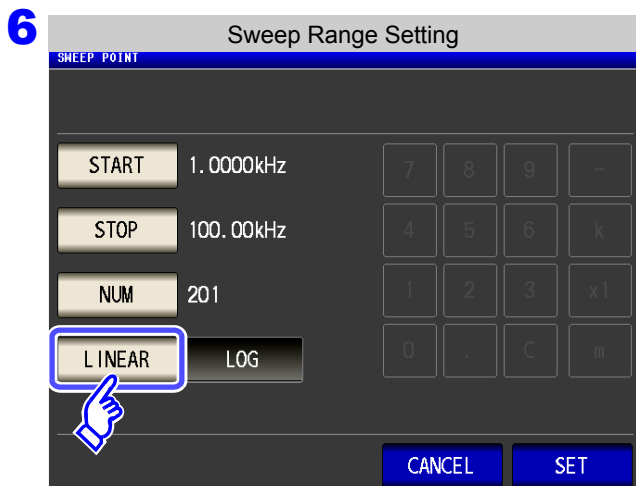

Select the setting method for sweep points.

LINEAR The sweep points are calculated linearly from the setting values of **START**, **STOP**, and **NUM**.

LOG The sweep points are calculated logarithmically from the setting values of **START**, **STOP**, and **NUM**.

CANCEL Reverts the number of sweep points to its original value and closes the Settings screen.

7 Press **SET** to confirm the setting.

How to Check the Set Sweep Points

You can check the sweep point setting values in the sweep parameter setting section of the Measurement screen as well as the [LIST] area of the Settings screen.

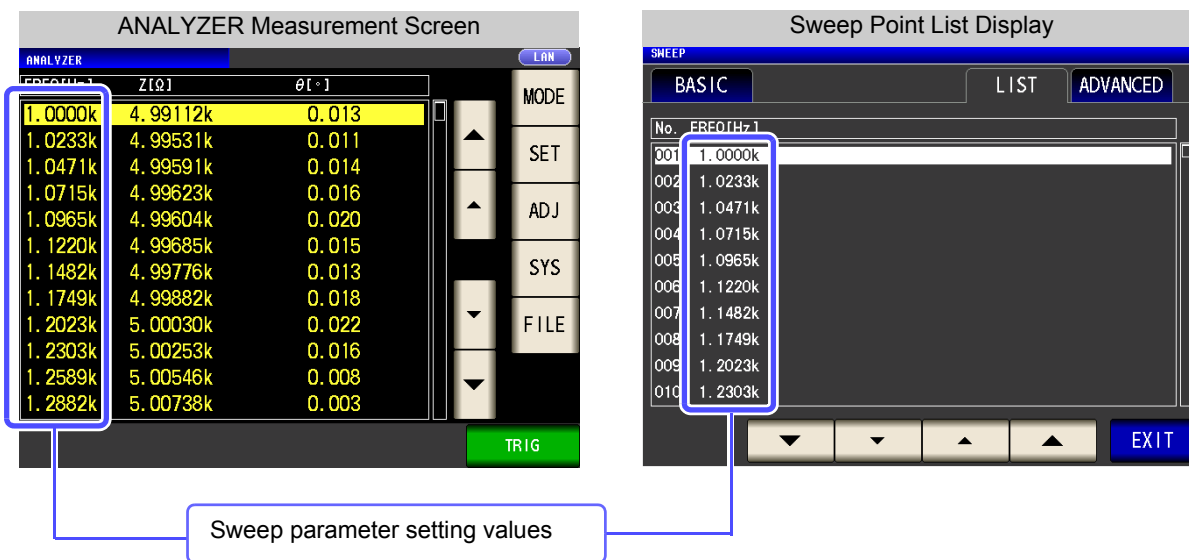

5.2 Setting Basic Settings of Measurement

5.2.6 Setting the Measurement Signal Level

The value of the test signal level may change according to the sample which is being tested. This instrument is possible to vary the level of the test signal applied to the object under test over a wide range using the following three methods. Selecting constant voltage or constant current mode will result in increased measurement times due to use of software feedback control.

Open circuit voltage (V) mode

The value of the open circuit voltage is set.

Constant voltage (CV) mode

The value of the voltage between the terminals of the object under test is set.

Constant current (CC) mode

The value of the current flowing through the object under test is set.

CAUTION Do not switch between V, CV and CC while the test sample is still connected to the measurement terminals because doing so may damage the test sample.

Procedure

1

FREQ[Hz]	Z[Ω]	θ[°]
1.0000k	4.99112k	0.013
1.0233k	4.99531k	0.011
1.0471k	4.99591k	0.014
1.0715k	4.99623k	0.016
1.0965k	4.99604k	0.020
1.1220k	4.99685k	0.015
1.1482k	4.99776k	0.013
1.1749k	4.99882k	0.018
1.2023k	5.00030k	0.022
1.2303k	5.00253k	0.016
1.2589k	5.00546k	0.008
1.2882k	5.00738k	0.003

2

Press **LEVEL**.

5.2 Setting Basic Settings of Measurement

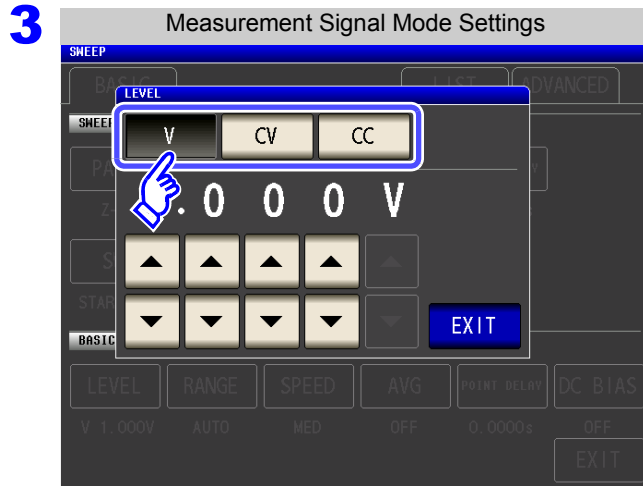

Select the measurement signal level.

- Open circuit voltage (V) mode (p. 54)
- Constant voltage (CV) mode (p. 54)
- Constant current (CC) mode (p. 55)

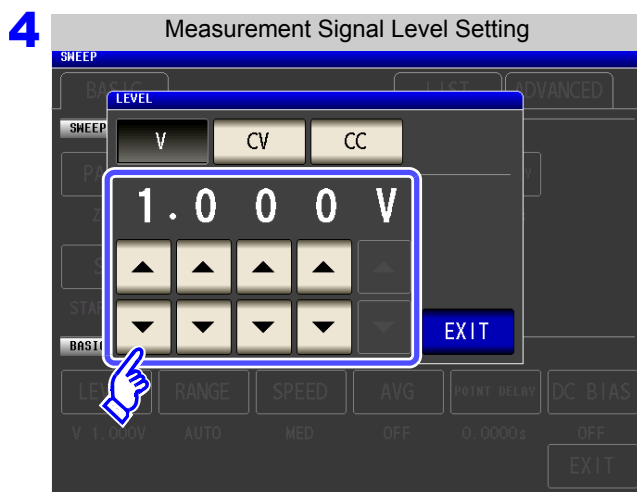

Use or to enter the voltage or current value.

Normal measurement mode

Measurement signal mode	Settable range
V, CV	0.005 V to 5.000 V
CC	0.01 mA to 50.00 mA

Low Z high accuracy mode

Measurement signal mode	Settable range
V, CV	0.005 V to 2.500 V
CC	0.01 mA to 100.00 mA

See "For setting range and accuracy" (p. 54)

The accuracy of testing varies according to the test signal level.

See "14.2 Measurement Range and Accuracy" (p. 343)

5 Press to close the setting screen.

5.2 Setting Basic Settings of Measurement

5.2.7 Setting the Measurement Range

When measuring a sample whose impedance varies greatly with frequency or a sample whose characteristics are unknown, you can have the instrument automatically select the optimal measurement range. Alternately, you can perform high-speed measurement by fixing the range with the HOLD function.

1 Setting the method for determining the measurement range (AUTO, HOLD)

AUTO

The most suitable test range is set automatically.

HOLD

The measurement range is fixed. The range is set manually.

NOTE

The ranges are all defined in terms of impedance. Therefore, for a parameter other than impedance, the value is obtained by calculating from the measured values of $|Z|$ and θ .
See "Appendix1 Measurement Parameters and Calculation Formula"(p. A1)

Setting AUTO Ranging

There are the following two methods for setting the measurement range.

Procedure

1

FREQ[Hz]	Z[Ω]	θ [°]
1.0000k	4.99112k	0.013
1.0233k	4.99531k	0.011
1.0471k	4.99591k	0.014
1.0715k	4.99623k	0.016
1.0965k	4.99604k	0.020
1.1220k	4.99685k	0.015
1.1482k	4.99776k	0.013
1.1749k	4.99882k	0.018
1.2023k	5.00030k	0.022
1.2303k	5.00253k	0.016
1.2589k	5.00546k	0.008
1.2882k	5.00738k	0.003

2

Press **RANGE**.

5.2 Setting Basic Settings of Measurement

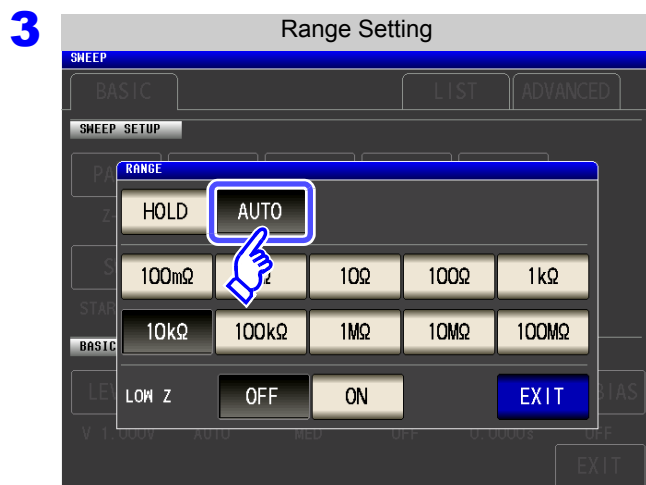

Press **AUTO**.

If the instrument is being used outside the limits of its specification, the suitable range may not be set in auto ranging function. In this case, check the accuracy assured ranges in "14.2 Measurement Range and Accuracy" (p. 343) and then change the test conditions.

4 Press **EXIT** to close the setting screen.

NOTE

- When an element other than a capacitor or a capacitor with a low DC resistance is measured while using DC bias, the AUTO range may not work properly and a range may not be able to be determined.
- When setting the sweep frequency, some ranges may not be available depending on the frequency range.
 - 10 M Ω range: Up to 100.00 kHz
 - 100 M Ω range: Up to 10.000 kHz
- The AUTO ranging range can be limited.
See: "5.3.6 AUTO Range Limit Function" (p. 182)

5.2 Setting Basic Settings of Measurement

Setting the Ranging to HOLD

Procedure

1

ANALYZER Measurement Screen

FREQ[Hz]	Z[Ω]	θ[°]
1.0000k	4.99112k	0.013
1.0233k	4.99531k	0.011
1.0471k	4.99591k	0.014
1.0715k	4.99623k	0.016
1.0965k	4.99604k	0.020
1.1220k	4.99685k	0.015
1.1482k	4.99776k	0.013
1.1749k	4.99882k	0.018
1.2023k	5.00030k	0.022
1.2303k	5.00253k	0.016
1.2589k	5.00546k	0.008
1.2882k	5.00738k	0.003

MODE
SET
SYS
FILE
TRIG

ANALYZER Basic Settings

SWEPT BASIC LIST ADV

SWEPT SETUP

PARA SOURCE TRIG DRAW TRIG DELAY

Z-θ FREQ REPEAT REAL 0.0000s

SWEPT POINT

START: 1.0000kHz STOP: 100.00kHz NUM: 201 LOG

BASIC SETUP

LEVEL RANGE SPEED AVG POINT DELAY

V 1.000V AUTO MED OFF 0.0000s

2

ANALYZER Basic Settings

SWEPT BASIC LIST ADVANCED

SWEPT SETUP

PARA SOURCE TRIG DRAW TRIG DELAY

Z-θ FREQ REPEAT REAL 0.0000s

SWEPT POINT

START: 1.0000kHz STOP: 100.00kHz NUM: 201 LOG

BASIC SETUP

LEVEL RANGE SPEED AVG POINT DELAY DC BIAS

V 1.000V 0 MED OFF 0.0000s OFF

EXIT

Press RANGE .

3

Measurement Range Selection

SWEPT BASIC LIST ADVANCED

SWEPT SETUP

RANGE

HOLD AUTO

mΩ 1Ω 10Ω 100Ω 1kΩ

10kΩ 100kΩ 1MΩ 10MΩ 100MΩ

LOW Z OFF ON

EXIT

Press HOLD .

5.2 Setting Basic Settings of Measurement

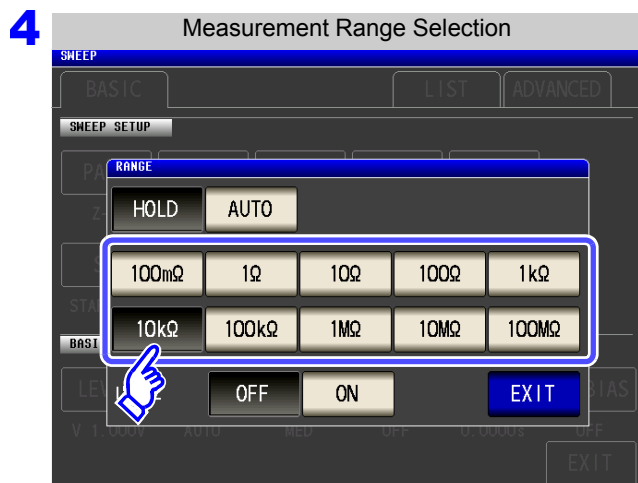

Set the test range according to the combined impedance value of the sample to be tested and the test cables.

To select the measurement range.

Test range	Accuracy guaranteed range	Auto ranging range
100 MΩ	8 MΩ to 200 MΩ	8 MΩ or more
10 MΩ	800kΩ to 100MΩ	800 kΩ to 10 MΩ
1 MΩ	80kΩ to 10MΩ	80 kΩ to 1 MΩ
100 kΩ	8 kΩ to 1MΩ	8 kΩ to 100kΩ
10 kΩ	800 Ω to 100 kΩ	800 Ω to 10 kΩ
1 kΩ	80 Ω to 10 kΩ	80 Ω to 1 kΩ
100 Ω	8 Ω to 100 Ω	8 Ω to 100 Ω
10 Ω	800 mΩ to 10 Ω	800 mΩ to 10 Ω
1 Ω	80 mΩ to 1Ω	80 mΩ to 1 Ω
100 mΩ	10 mΩ to 100 mΩ	0 Ω to 100 mΩ

NOTE

- The guaranteed accuracy range varies depending on the measurement conditions.
 - See:** Check the guaranteed accuracy range in "14.2 Measurement Range and Accuracy" (p. 343).
- The measurement range is determined according to the test range setting. If the display for the measured value shows "**OVER FLOW**" or "**UNDER FLOW**", that means that measurement cannot be performed using the currently set test range. Either you should set AUTO ranging so as to select the most suitable test range automatically, or you should set a more suitable test range manually.
- If the measurement range setting exceeds the range in the table above when the sweep frequency is set, it is automatically changed to the maximum setting.
- When setting the sweep frequency, some ranges cannot be used depending on the frequency range.
 - 10 MΩ range: Up to 100.00 kHz
 - 100 MΩ range: Up to 10.000 kHz

5 Press **EXIT** to close the setting screen.

NOTE

- With a test sample whose impedance varies with frequency, if the frequency is changed during measurement using HOLD, measurement within the same range may not be possible. When this happens, change the measurement range.
- The test range setting is made according to the combination of the impedances of the sample being tested and the test cables. Therefore it can happen that testing is not possible, if the test range is held with HOLD only upon the basis of the impedance of the sample under test. If this happens, you should change the test range, making reference to "8.1 Setting Open Circuit Compensation" (p. 215) and "8.2 Short Circuit Compensation" (p. 224).

5.2 Setting Basic Settings of Measurement

2 Low Z high accuracy mode

In low Z high accuracy mode, an output resistance of 25 Ω is used so that adequate current can flow to the measurement sample, allowing highly accurate measurement.

Procedure

1

FREQ[Hz]	Z[Ω]	θ [$^\circ$]
1.0000k	4.99112k	0.013
1.0233k	4.99531k	0.011
1.0471k	4.99591k	0.014
1.0715k	4.99623k	0.016
1.0965k	4.99604k	0.020
1.1220k	4.99685k	0.015
1.1482k	4.99776k	0.013
1.1749k	4.99882k	0.018
1.2023k	5.00030k	0.022
1.2303k	5.00253k	0.016
1.2589k	5.00546k	0.008
1.2882k	5.00738k	0.003

2

Press **RANGE**.

3

Select ON/OFF for the low Z high accuracy mode.

- OFF Disables low Z high accuracy mode.
- ON Enables low Z high accuracy mode.

4 Press **EXIT** to close the setting screen.

5.2 Setting Basic Settings of Measurement

NOTE

Low Z high accuracy mode is only available for the 100 mΩ and 1 Ω ranges.
See the following table:

No	Measurement range	
1	100 MΩ	Normal mode only (Low Z high accuracy mode setting disabled)
2	10 MΩ	
3	1 MΩ	
4	100 kΩ	
5	10 kΩ	
6	1 kΩ	
7	100 Ω	
8	10 Ω	
9	1 Ω	Low Z high accuracy mode/ normal mode
10	100 mΩ	

5.2.8 Setting the Measurement Speed

The testing speed can be set. The slower the testing speed is, the more accurate are the results.

Procedure

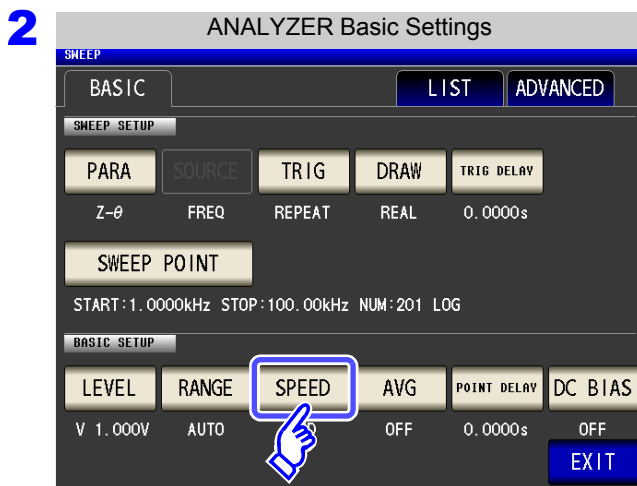
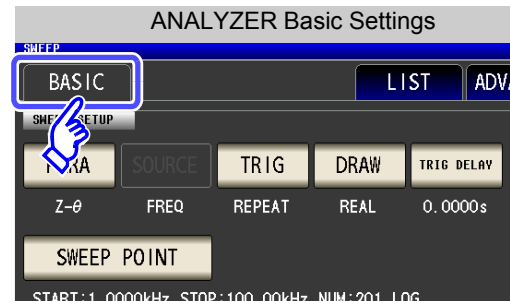
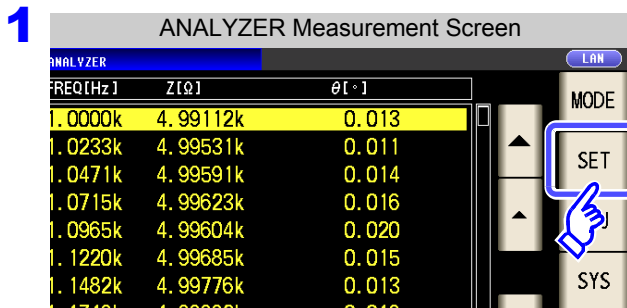

Press **SPEED**.

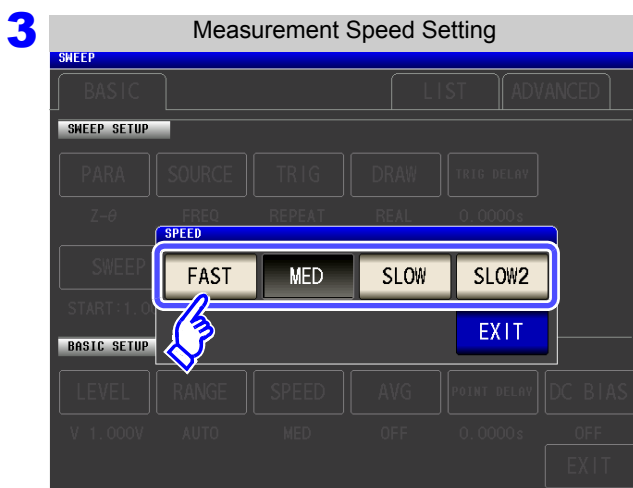

To select the measurement speed.

FAST	Performs high-speed measurement.
MED	This is the normal measurement speed.
SLOW	Measurement precision improves.
SLOW2	Measurement accuracy is better than SLOW.

4 Press **EXIT** to close the setting screen.

Measurement speed varies with the measurement conditions. The speeds given in the table relate to the case of $|Z|$ only being displayed.
 See "About Measurement Times and Measurement Speed" (p. 352)

NOTE

The waveform averaging function allows you to set the measurement speed at a higher level of detail. When the waveform averaging function is enabled, speed settings are not available. Disable the waveform averaging function before setting the speed.

See "5.3.2 Setting the Detection Signal Waveform Averaging Count (Waveform Averaging Function)" (p. 173)

5.2.9 Displaying as Average Values (Average set)

With the averaging function, the measured values can be averaged. Using this function, it is possible to reduce fluctuations in the measured value display.

NOTE

The measurement values are averaged by arithmetic mean during ANALYZER measurement regardless of the trigger setting (p. 74).

Procedure

1 ANALYZER Measurement Screen

FREQ[Hz]	Z[Ω]	θ [°]
1.0000k	4.99112k	0.013
1.0233k	4.99531k	0.011
1.0471k	4.99591k	0.014
1.0715k	4.99623k	0.016
1.0965k	4.99604k	0.020
1.1220k	4.99685k	0.015
1.1482k	4.99776k	0.013
1.1749k	4.99882k	0.018
1.2023k	5.00030k	0.022
1.2303k	5.00253k	0.016
1.2589k	5.00546k	0.008

MODE
SET
SYS
FILE

ANALYZER Basic Settings

BASIC LIST ADVANCED

SWEEP SETUP

PARAMETER SOURCE TRIG DRAW TRIG DELAY

Z- θ FREQ REPEAT REAL 0.0000s

SWEEP POINT

START: 1.0000kHz STOP: 100.00kHz NUM: 201 LOG

BASIC SETUP

LEVEL RANGE SPEED AVG POINT DELAY DC BIAS

V 1.000V AUTO MED 0.0000s OFF

EXIT

2 ANALYZER Basic Settings

SWEEP

BASIC LIST ADVANCED

SWEEP SETUP

PARAMETER SOURCE TRIG DRAW TRIG DELAY

Z- θ FREQ REPEAT REAL 0.0000s

SWEEP POINT

START: 1.0000kHz STOP: 100.00kHz NUM: 201 LOG

BASIC SETUP

LEVEL RANGE SPEED AVG POINT DELAY DC BIAS

V 1.000V AUTO MED 0.0000s OFF

EXIT

Press **AVG**.

3 Measurement Averaging Setting

SWEEP

BASIC LIST ADVANCED

SWEEP SETUP

PARAMETER SOURCE TRIG DRAW TRIG DELAY

Z- θ FREQ REPEAT REAL 0.0000s

SWEEP POINT

START: 1.0000kHz STOP: 100.00kHz NUM: 201 LOG

BASIC SETUP

LEVEL RANGE SPEED AVG POINT DELAY DC BIAS

V 1.000V AUTO MED 0.0000s OFF

EXIT

AVERAGE

0 0 1

EXIT

Use **▲** or **▼** to enter the number of averaging times.

Settable range: 1 to 256 times

When you want to cancel the averaging function: Press **C**.

The number of averaging times is set to 001.

4 Press **EXIT** to close the setting screen.

5.2 Setting Basic Settings of Measurement

5.2.10 Setting the Point Delay

For the point delay setting, set the delay time for each sweep point.

NOTE

In sweep measurement, some measurement samples may require time for the measured value to stabilize due to transient response. In this case, set a point delay time.

See "5.2.4 Setting the Trigger Delay" (p. 153)

Procedure

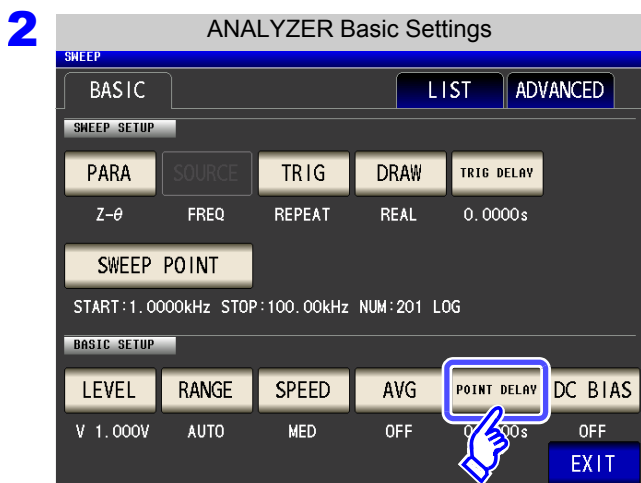
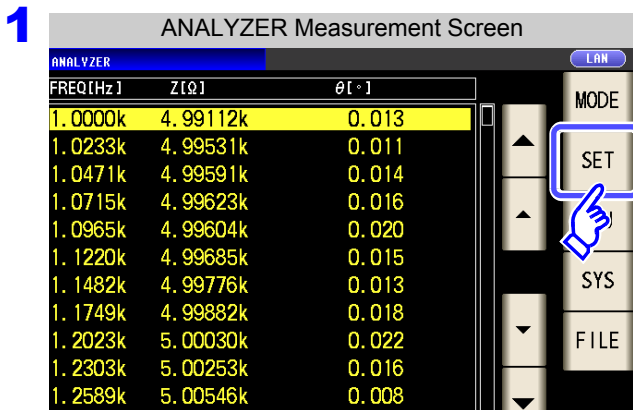

Press **POINT DELAY**.

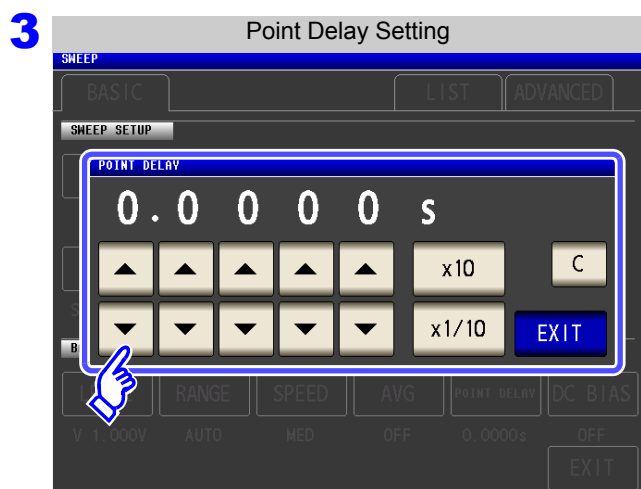

Use **▲** or **▼** to enter the delay time.

Settable range: 0.0000 s to 10000 s

When you want to cancel the point delay function: Press **C**.
The setting value is cleared to 0.

4 Press **EXIT** to close the setting screen.

5.2.11 Setting the DC Bias

For the DC bias setting, set the DC bias value for when sweep measurement is performed. If the DC bias is set, a DC signal can be superimposed on the measurement signal during capacitor measurement.

Procedure

1 ANALYZER Measurement Screen

FREQ[Hz]	Z[Ω]	θ[°]
1.0000k	4.99112k	0.013
1.0233k	4.99531k	0.011
1.0471k	4.99591k	0.014
1.0715k	4.99623k	0.016
1.0965k	4.99604k	0.020
1.1220k	4.99685k	0.015
1.1482k	4.99776k	0.013
1.1749k	4.99882k	0.018
1.2023k	5.00030k	0.022
1.2303k	5.00253k	0.016
1.2589k	5.00546k	0.008
1.2882k	5.00738k	0.003

MODE, SET, SYS, FILE, TRIG

ANALYZER Basic Settings

BASIC LIST ADVANCED

SWEEP SETUP

PARAM SOURCE TRIG DRAW TRIG DELAY

Z-θ FREQ REPEAT REAL 0.0000s

SWEEP POINT

START: 1.0000kHz STOP: 100.00kHz NUM: 201 LOG

BASIC SETUP

LEVEL RANGE SPEED AVG POINT DELAY

V 1.000V AUTO MED OFF 0.0000s

2 ANALYZER Basic Settings

BASIC LIST ADVANCED

SWEEP SETUP

PARAM SOURCE TRIG DRAW TRIG DELAY

Z-θ FREQ REPEAT REAL 0.0000s

SWEEP POINT

START: 1.0000kHz STOP: 100.00kHz NUM: 201 LOG

BASIC SETUP

LEVEL RANGE SPEED AVG POINT DELAY DC BIAS

V 1.000V AUTO MED OFF 0.0000s

Press DC BIAS.

3 DC Bias Setting

DC BIAS

OFF ON SET EXT

0.000V

EXIT

Select ON/OFF for the DC bias.

- OFF** Disables the DC bias setting.
- ON** Enables the DC bias setting.
- SET EXT** Press this button when using an external DC bias unit. The DC bias will be set to ON, and the bias value will be set to 0.00 V.

5.2 Setting Basic Settings of Measurement

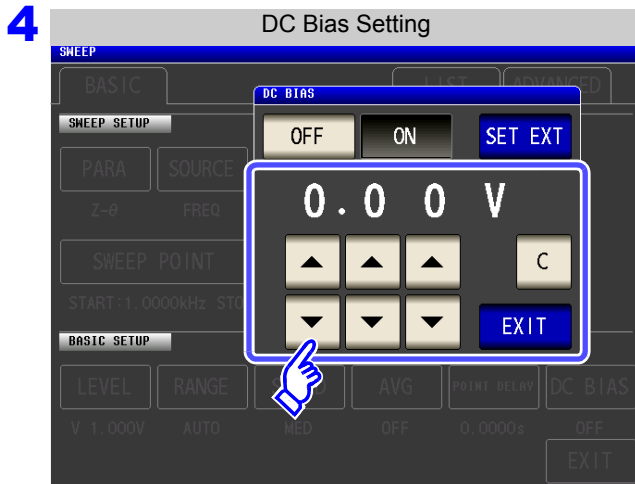

Use  or  to set the DC bias.

- Settable range:
 - 5.00 V to 5.00 V (Normal mode)
 - 2.50 V to 2.50 V (Low Z high accuracy mode)
- If you make a mistake during input:
 - press  to cancel the input and start again.

5 Press  to close the setting screen.

NOTE

- The DC bias function is specifically for capacitor measurement. If it is used for resistor, inductor, and other elements with low DC resistance, the following are likely.
 - Normal measurement is not possible
 - AUTO ranging is unable to determine a range.
- The DC bias function cannot be set during DC resistance measurement.
- The DC bias function cannot be set when **Rdc** measurement has been selected with the **:MEASure:ITEM** setting.
- When superimposing a DC voltage of ± 5 V (during low Z high accuracy mode operation, ± 2.5 V) or above, refer to "Appendix5.1 How to Supply a DC Bias Voltage"(p. A7).
- When superimposing a DC current on a coil or the like, refer to "Appendix5.2 How to Supply a DC Bias Current"(p. A9).
- If the total value for the measurement signal level (AC level setting value $\times \sqrt{2}$ + DC bias setting value) will become $> 5\sqrt{2}$ [V], the measurement signal cannot be raised any higher. Reduce the AC level or DC bias value, and then configure the setting. During low Z high accuracy mode operation, the AC level and DC bias value can be set such that the total value is less than or equal to $2.5\sqrt{2}$ [V].

5.3 Application Settings

5.3.1 Applying the Signal to the Sample Only during Measurement (Trigger Synchronous Output Function)

This function enables the measurement signal to be output after measurement is triggered for the initial sweep point only, ensuring that the signal is applied to the sample during measurement only. Thus reducing the generation of heat in the sample and decreasing electrode wear.

Procedure

- 

Hz	Z[Ω]	θ[°]
100k	4.99112k	0.013
133k	4.99531k	0.011
171k	4.99591k	0.014
215k	4.99623k	0.016
265k	4.99604k	0.020
320k	4.99685k	0.015
382k	4.99776k	0.013
449k	4.99882k	0.018
523k	5.00030k	0.022
603k	5.00253k	0.016
- 

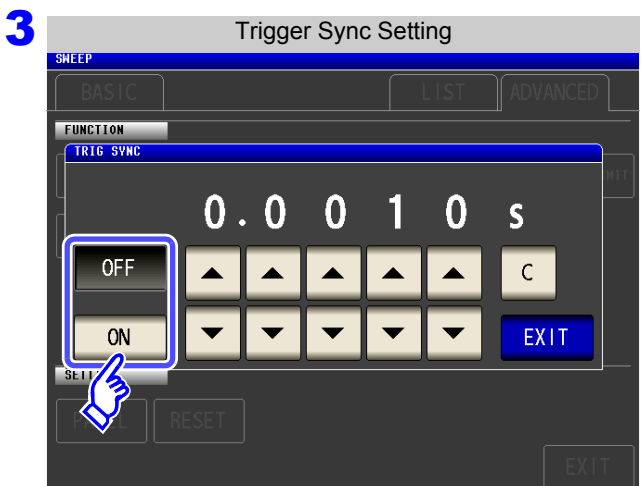
Press **SYNC**.
- 

Select **ON/OFF** for the trigger synchronous output function.

OFF	Disables the trigger synchronous output function.
ON	Enables the trigger synchronous output function.

5.3 Application Settings

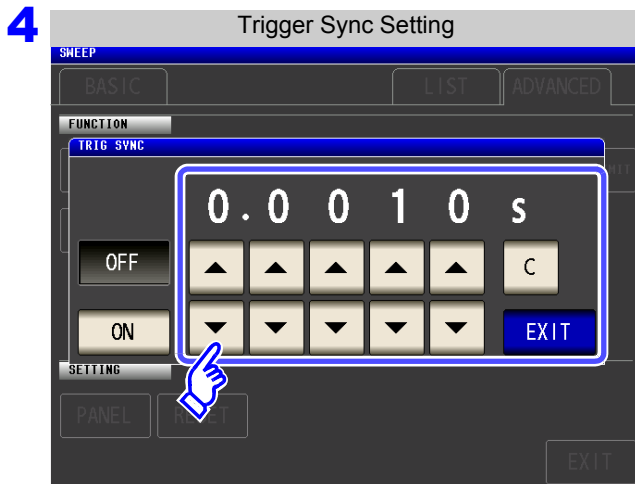

Use or to set the wait time from after the measurement signal is output by applying a trigger to the start of measurement.

Settable range: 0.0010 s to 9.9999 s

When you want to return the time to the initial state: Press .

The set time is set to 0.0010 s.

5 Press to close the setting screen.

NOTE

- When the trigger synchronous output function is set to ON, there is a measurement time delay because the instrument enters a wait time which spans from when the measurement signal is output to when measurement starts.
[See "14.3 About Measurement Times and Measurement Speed" \(p. 352\)](#)
- When the trigger synchronous output function is set to ON, the set DC level may be output if a measurement condition is changed. Also, output will stop when measurement is performed once.
- The measurement signal is output when the trigger signal is input and stops after measurement ends.
- Setting the contact check timing to either or for the contact check function will cause the trigger synchronous output functionality to be automatically turned on.
[See: "5.3.4 Checking Contact Defects and the Contact State \(Contact Check Function\)" \(p. 177\)](#)
- In CONTINUOUS measurement mode, the measurement signal stops after measurement of the last panel ends.

5.3.2 Setting the Detection Signal Waveform Averaging Count (Waveform Averaging Function)

The number of measurement waveforms for each frequency band is set for the measurement speed settings (FAST, MED, SLOW, SLOW2), and this function allows you to set the number of measurement waveforms for each frequency band. Having more waveforms increases the measurement precision, while having fewer waveforms increase the measurement speed. This function allows you to set the number of measurement waveforms for each frequency band as desired.

NOTE

When the waveform averaging function is set, the measurement speed setting is unavailable. To set a measurement speed, first cancel the waveform averaging function setting.

Procedure

- 

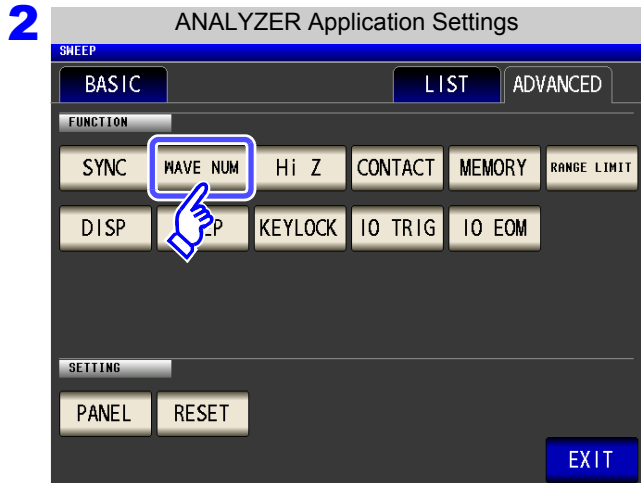
[Hz]	Z[Ω]	θ[°]
100k	4.99112k	0.013
133k	4.99531k	0.011
171k	4.99591k	0.014
215k	4.99623k	0.016
265k	4.99604k	0.020
320k	4.99685k	0.015
382k	4.99776k	0.013
449k	4.99882k	0.018
523k	5.00030k	0.022
603k	5.00253k	0.016
691k	5.00540k	0.022
- 

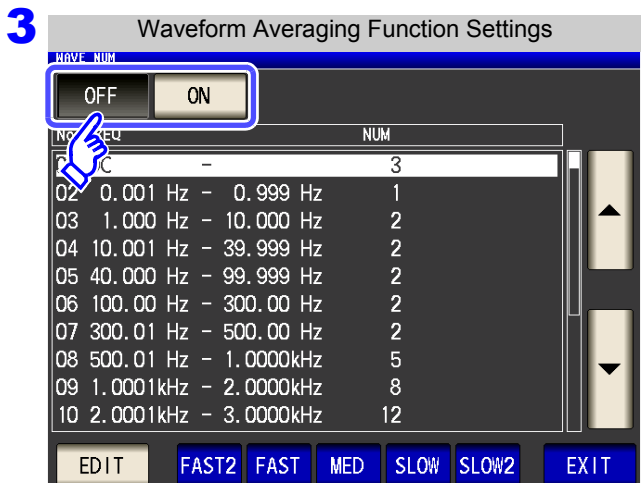
Press **WAVE NUM**.
- 

Turn the waveform averaging function on or off.

OFF	Disables the waveform averaging function.
ON	Enables the waveform averaging function.

5.3 Application Settings

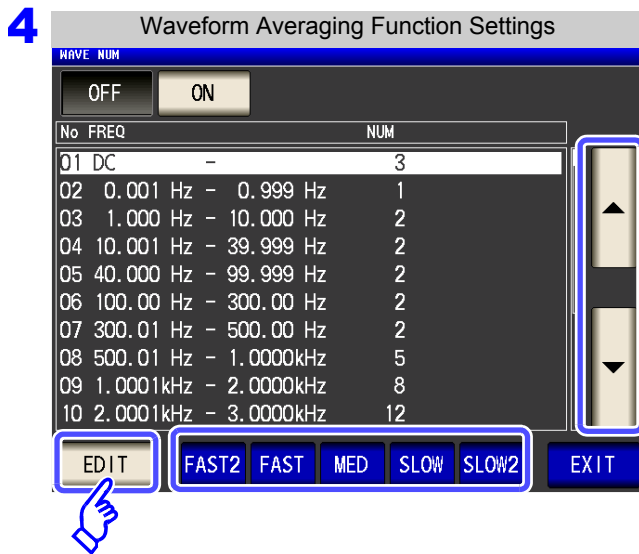

Select the frequency band for which you wish to change the number of measurement waveforms with and and touch .

Reset the number of measurement waveforms for each measurement speed.

FAST2

Sets the number of measurement waveforms to 1 for all frequency bands.

FAST

Sets to the number of measurement waveforms for FAST.

MED

Sets to the number of measurement waveforms for MED.

SLOW

Sets to the number of measurement waveforms for SLOW.

SLOW2

Sets to the number of measurement waveforms for SLOW2.

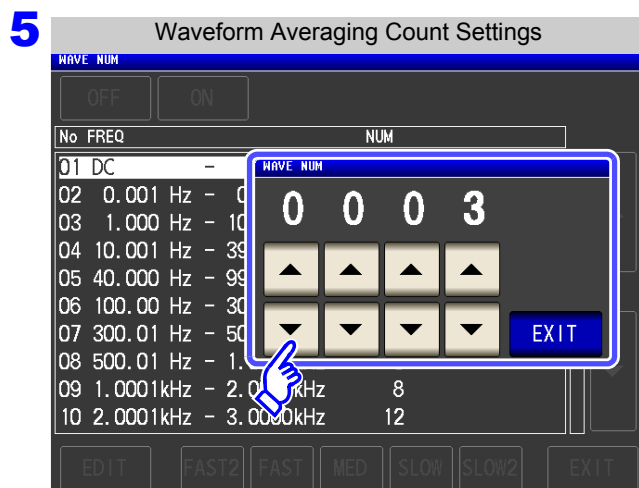

Set the waveform averaging count with and and touch .

No	Frequency band	Settable range
1	DC	1 to 24
2	0.001 Hz to 0.999 Hz	1 to 4
3	1.000 Hz to 10.000 Hz	1 to 4
4	10.001 Hz to 39.999 Hz	1 to 10
5	40.000 Hz to 99.999 Hz	1 to 40
6	100.00 Hz to 300.00 Hz	1 to 50
7	300.01 Hz to 500.00 Hz	1 to 200
8	500.01 Hz to 1.0000 kHz	1 to 300
9	1.0001 kHz to 2.0000 kHz	1 to 600
10	2.0001 kHz to 3.0000 kHz	1 to 1200
11	3.0001 kHz to 5.0000 kHz	1 to 2000
12	5.0001 kHz to 10.000 kHz	1 to 3000
13	10.001 kHz to 20.000 kHz	1 to 6000
14	20.001 kHz to 30.000 kHz	1 to 12000
15	30.001 kHz to 50.000 kHz	1 to 800
16	50.001 kHz to 100.00 kHz	1 to 1200
17	100.01 kHz to 200.00 kHz	1 to 2400

The No. 1 DC measurement waveform count performs waveform averaging using the set line frequency as one wave. When using No. 13, 5 times the number of waves set with the waveform averaging count are averaged, and when Nos. 14 to 17 are used, 25 times the number of waves set with the waveform averaging count are averaged.

6 Press to close the setting screen.

5.3.3 Detecting OPEN during 2-terminal Measurement (HIGH-Z Reject Function)

This function is for outputting a measurement terminal connector error when the measurement result is high relative to the set judgment reference value. The setting value can be set as an absolute value, and the error is output via the measurement screen and EXT I/O. On the Measurement screen, this error is output as [Hi Z]. See "Chapter 12 External Control" (p. 309)

The judgment reference is calculated from the nominal value (range name) of the current measurement range and the judgment reference value as shown below.

Judgment reference = Nominal value of current measurement range × Judgment reference value (%)

Example Current measurement range: 10 kΩ
 Judgment reference value: 150%
 Judgment reference = 10 k × 1.50 = 15 k

Procedure

1

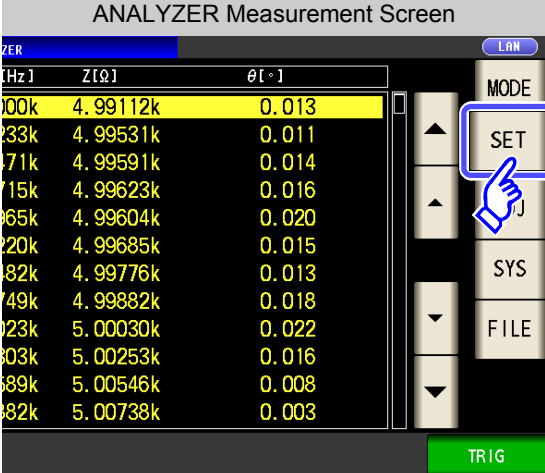

[Hz]	Z[Ω]	θ[°]
100k	4.99112k	0.013
233k	4.99531k	0.011
471k	4.99591k	0.014
715k	4.99623k	0.016
965k	4.99604k	0.020
120k	4.99685k	0.015
182k	4.99776k	0.013
249k	4.99882k	0.018
323k	5.00030k	0.022
403k	5.00253k	0.016
489k	5.00546k	0.008
582k	5.00738k	0.003

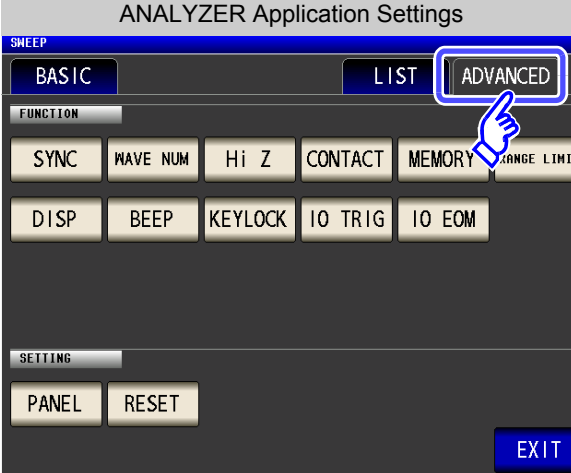

ANALYZER Application Settings

SNEEP

BASIC LIST **ADVANCED**

FUNCTION

SYNC WAVE NUM Hi Z CONTACT MEMORY RANGE LIMIT

DISP BEEP KEYLOCK IO TRIG IO EOM

SETTING

PANEL RESET

EXIT

2

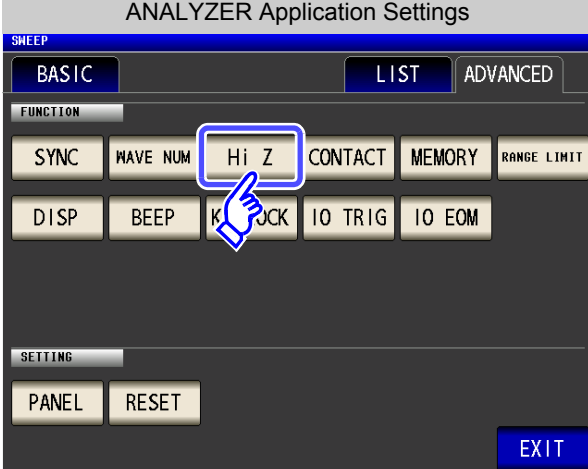

ANALYZER Application Settings

SNEEP

BASIC LIST ADVANCED

FUNCTION

SYNC WAVE NUM **Hi Z** CONTACT MEMORY RANGE LIMIT

DISP BEEP KEYLOCK IO TRIG IO EOM

SETTING

PANEL RESET

EXIT

Press **Hi Z**.

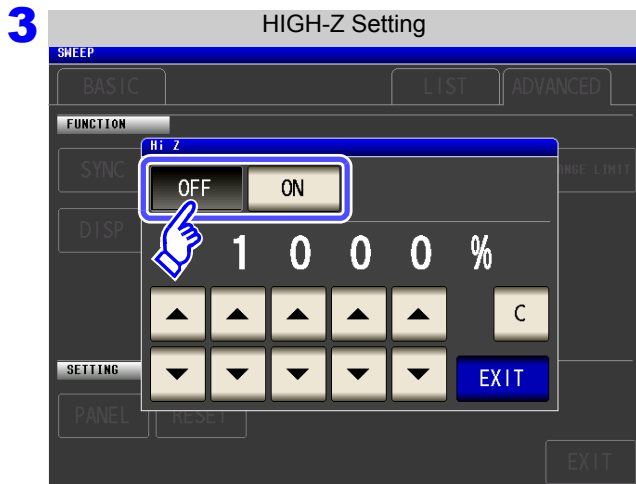

5.3 Application Settings

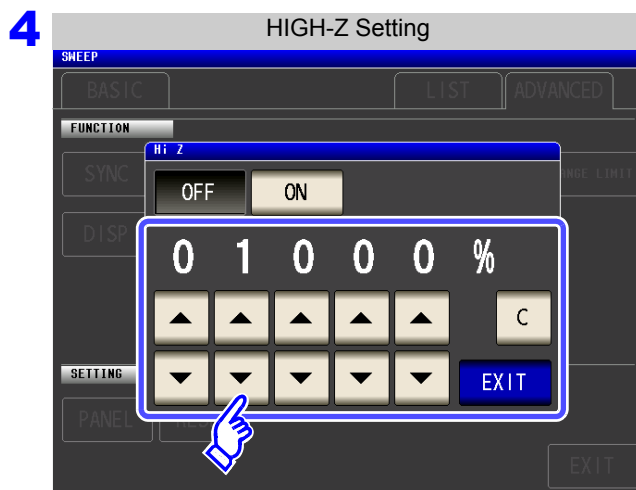

Select ON/ OFF for the HIGH-Z reject function.

- | | |
|-----|--------------------------------------|
| OFF | Disables the HIGH-Z reject function. |
| ON | Enables the HIGH-Z reject function. |



Use  or  to set the judgment reference value.

Settable range: 0% to 30000%

- A ratio is set using the range name as the reference value.
Example: When using the 1 k Ω range, a ratio to the value of 1 k Ω is set.
- If you make a mistake during input:
press  to cancel the input and start again.

5 Press  to close the setting screen.

5.3.4 Checking Contact Defects and the Contact State (Contact Check Function)

This functionality allows you to detect contact defects between the terminals (H_{CUR} , H_{POT} , L_{CUR} , and L_{POT}) and the sample during 4-terminal measurement.

Procedure

1

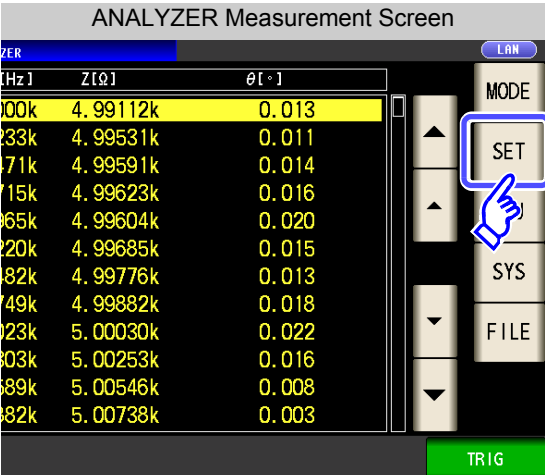

[Hz]	Z[Ω]	θ[°]
100k	4.99112k	0.013
233k	4.99531k	0.011
471k	4.99591k	0.014
715k	4.99623k	0.016
965k	4.99604k	0.020
120k	4.99685k	0.015
182k	4.99776k	0.013
249k	4.99882k	0.018
323k	5.00030k	0.022
403k	5.00253k	0.016
489k	5.00546k	0.008
582k	5.00738k	0.003

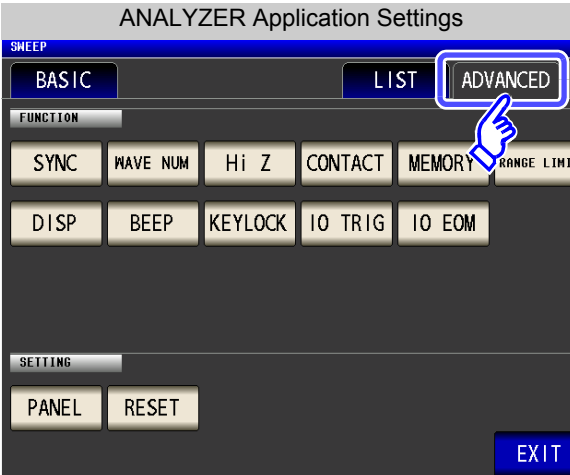

2

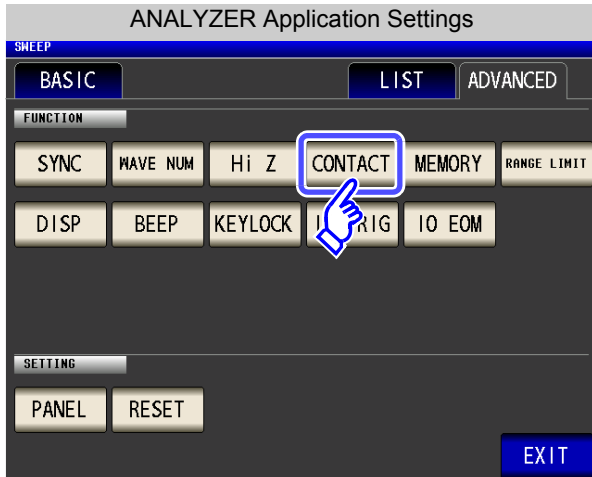

Press **CONTACT**.

3

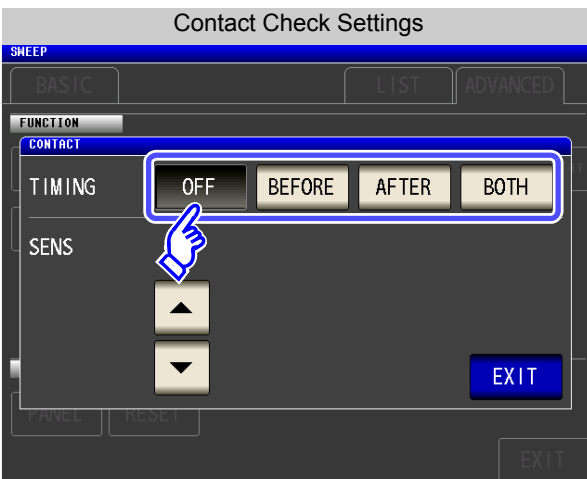

Select the timing at which to perform contact check operations.

- OFF** Disables the contact check function.
- BEFORE** Performs a contact check before measuring the sample.
- AFTER** Performs a contact check after measuring the sample.
- BOTH** Performs a contact check before and after measuring the sample.

5.3 Application Settings

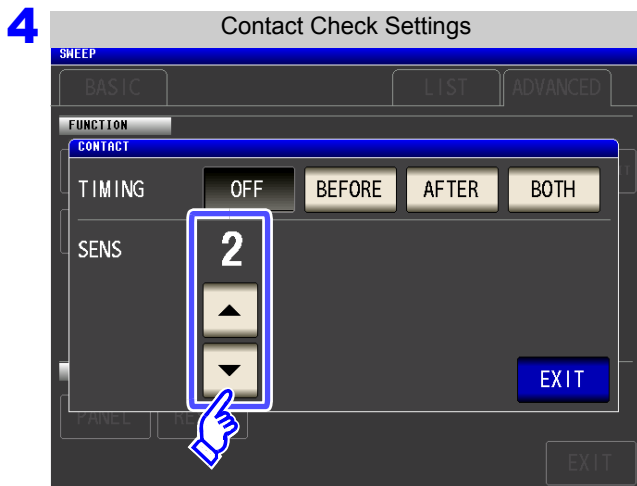

Set the contact check threshold with and .

Settable range : 1 to 5

Threshold	1	2	3	4	5
Permissible contact resistance [Ω]	Approx. 1000	Approx. 500	Approx. 100	Approx. 50	Approx. 10

5 Press **EXIT** to close the setting screen.

NOTE

- Selecting **BOTH** or **BEFORE** as the contact check timing causes the trigger synchronous output function to be automatically turned on.
 - See: "5.3.1 Applying the Signal to the Sample Only during Measurement (Trigger Synchronous Output Function)" (p. 171)
- When setting a contact check threshold, a wait time may occur depending on the timing. (p. 354)
- When the memory function has been enabled
 - When the contact check timing has been set to **BEFORE**
 - When a contact check error has been displayed (p. 362)
- No contact judgment can be made in the following circumstances:
 - When the instrument's memory becomes full partway through a series of frequency points (**Memory Full** will be displayed) (p. 179).
 - When the measurement mode is changed partway through a series of frequency points
- When the sample is a high-capacitance capacitor, the contact check function may not operate under some measurement conditions.
- If an error occurs during contact check operation, an error will be displayed at the top left of the screen, as shown in the following figure.

Example display when an error occurs during contact check operation

When the timing is set to **BEFORE**

When the timing is set to **AFTER**

5.3.5 Saving Measurement Results (Memory function)

You can save the measurement results inside the instrument. (Up to 32,000 items) The saved measurement results can be saved to a USB flash drive.

They can also be acquired using a communication command. Memory function settings apply to **LCR** mode, **ANALYZER** mode, and **TRANSFORMER** mode.

When the memory function is set to "IN" in **LCR** or **TRANSFORMER** mode, it will be set to "ON" in **ANALYZER** mode.

The items saved to memory are in accordance with the **:MEASure:VALid** setting.

For details on how to acquire the saved measurement results or set **:MEASure:VALid**, refer to the included LCR Application Disk.

Saving Measurement Values

Procedure

- | [Hz] | Z[Ω] | θ[°] |
|---------|----------|-------|
| 100k | 4.99112k | 0.013 |
| 233k | 4.99531k | 0.011 |
| 471k | 4.99591k | 0.014 |
| 915k | 4.99623k | 0.016 |
| 1865k | 4.99604k | 0.020 |
| 3720k | 4.99685k | 0.015 |
| 7482k | 4.99776k | 0.013 |
| 14949k | 4.99882k | 0.018 |
| 29903k | 5.00030k | 0.022 |
| 59803k | 5.00253k | 0.016 |
| 119689k | 5.00546k | 0.008 |
| 239382k | 5.00738k | 0.003 |
- Press **MEMORY**.

5.3 Application Settings

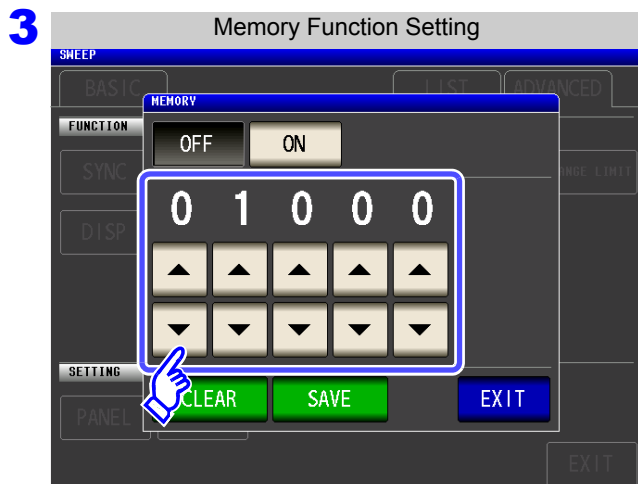

After touching **OFF** to disable the memory function, use **▲** or **▼** to set the number of measurement results.

Settable range: 1 to 32000

The number of measurement results can only be set when the memory function is set to OFF.

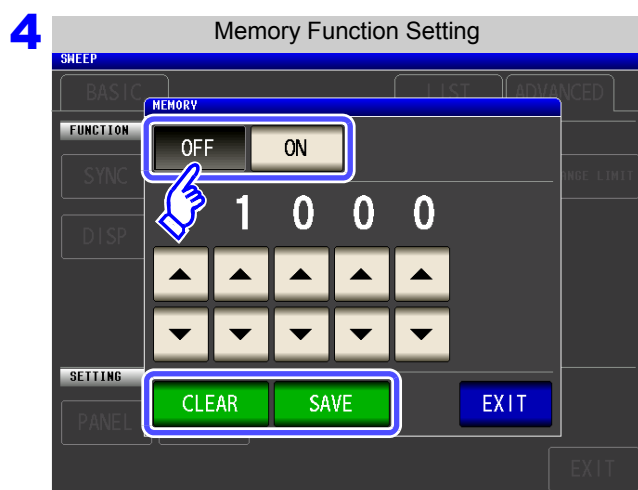

Select ON/OFF for the memory function.

OFF

Disables the memory function.

ON

Saves all measurement values to memory.

CLEAR

Clears all of the saved measurement values from the instrument memory.

SAVE

Saves the measurement values stored in the instrument memory to a USB flash drive and then clears the measurement values from the instrument memory.

The measurement values are saved to the MEMORY folder in the USB flash drive. The file name is automatically assigned from the date and time (p. 285).

5 Press **EXIT** to close the setting screen.

Clearing the Instrument Memory

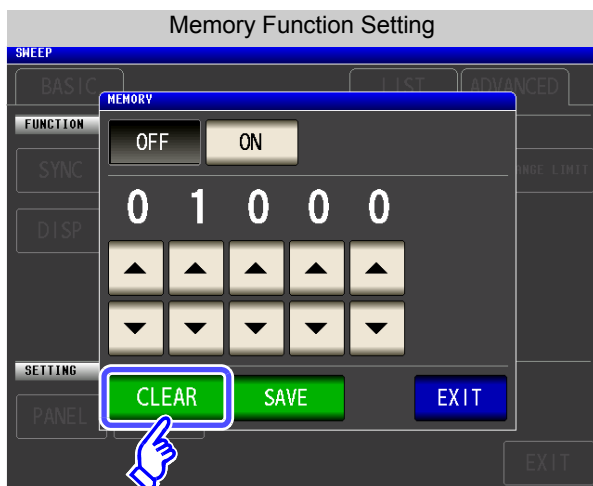

Press **CLEAR** to clear the instrument memory.

Saving Data in Instrument Memory to USB Flash Drive

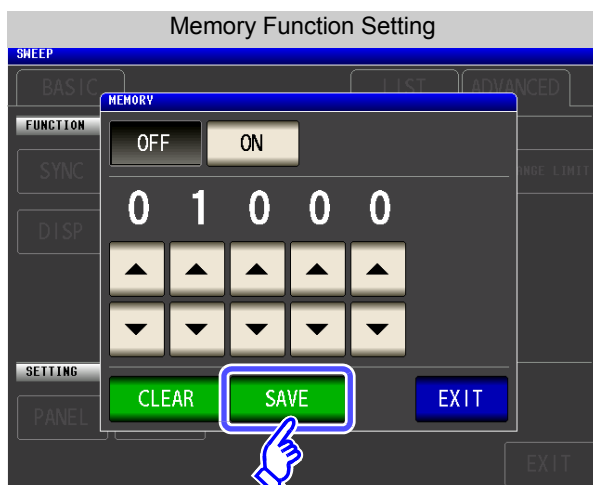

Connect a USB flash drive (p. 273).

Press **SAVE** to save the data in the instrument memory to a USB flash drive.

When this function is used to save the data in the instrument memory to a USB flash drive, the data is cleared from the instrument memory automatically.

NOTE

- If the memory function is enabled, the number of memory items currently saved is displayed in the measurement screen.

FREQ[Hz]	Z[Ω]	θ[°]
1.0000k	99.9731k	0.231
1.0233k	99.9892k	0.237
1.0471k	99.9807k	0.245
1.0715k	99.9931k	0.247

Indicates that the number of memory items currently saved is 1,144.

- In continuous measurement mode, only measurements for panels for which the memory function is enabled are saved.
- Save the data stored in the instrument to a USB flash drive or acquire it with the **:MEMory?** command.
- The data in the instrument memory is lost when the memory function setting is changed.
- When the instrument memory becomes full, the following message appears on the measurement screen.

If this message appears, subsequent measurement results will not be saved.

To resume saving, load or clear the measurement results from the instrument memory.

FREQ[Hz]	Z[Ω]	θ[°]
1.0000k	99.9827k	0.228
1.0233k	99.9938k	0.227
1.0471k	99.9951k	0.241
1.0715k	99.9803k	0.250

Memory Full

- When using the contact check function setting, measurement values cannot be saved when the following three conditions obtain:

See: "5.3.4 Checking Contact Defects and the Contact State (Contact Check Function)" (p. 177)

- When the memory function has been enabled
- When the contact check timing is set to **BEFORE**
- When a contact check error has been displayed (see the error display) (p. 362)

5.3.6 AUTO Range Limit Function

The AUTO range limit function allows you to limit the AUTO ranging range.

Procedure

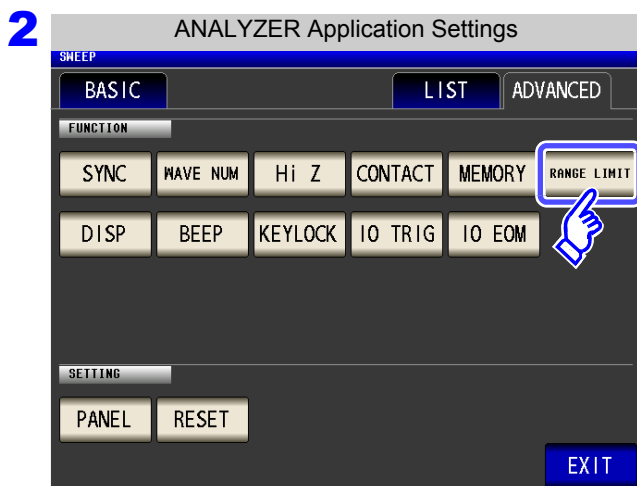
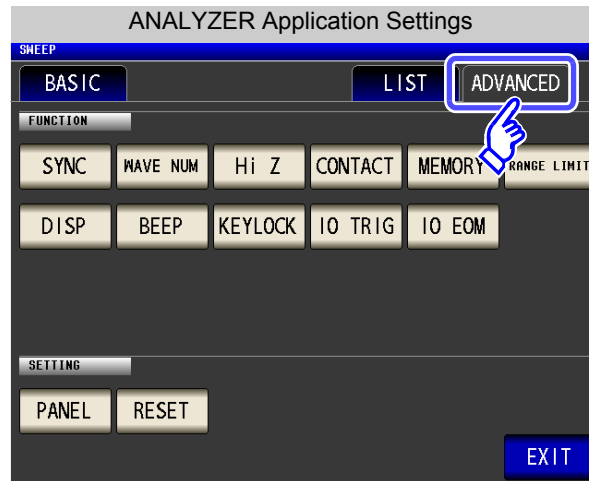
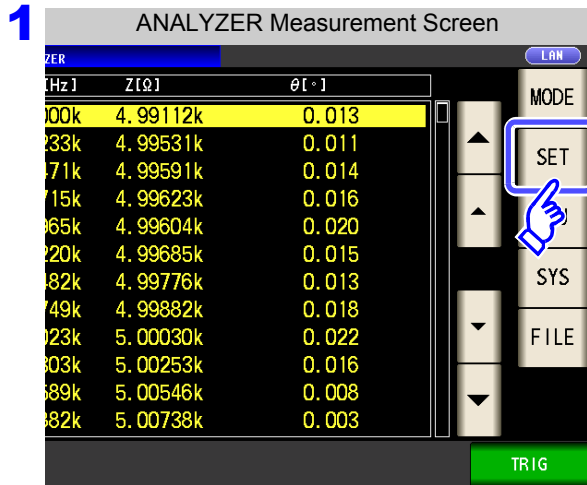

Press **RANGE LIMIT**.

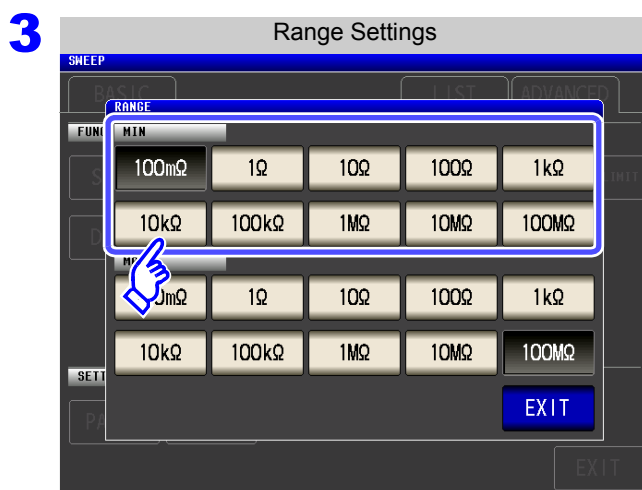

Select the lower limit range.

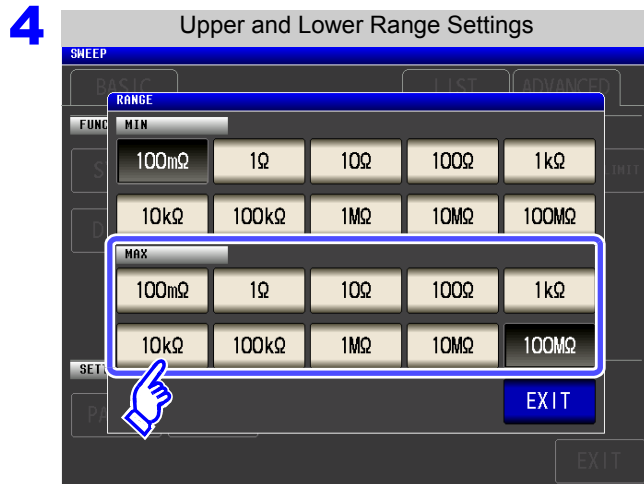

Select the upper limit range.

5 Press **EXIT** to close the setting screen.

Screen displayed when the AUTO range limit function has been enabled

Operation is only enabled within the set AUTO ranging range.
 Example: When the upper limit range is set to 1 kΩ and the lower limit range is set to 1 MΩ

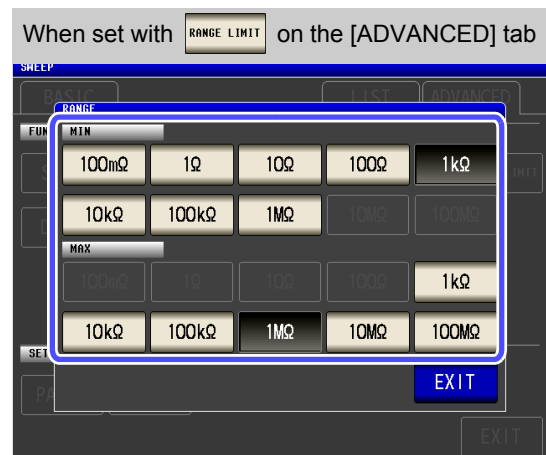
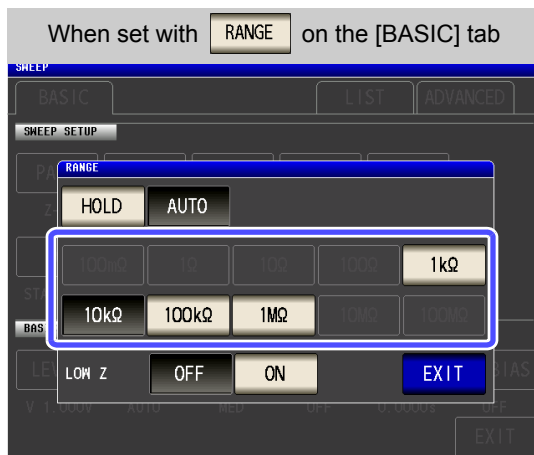

5.3.7 Setting the LCD to ON/OFF

You can turn the LCD ON/ OFF.

Setting the LCD to OFF saves power because the LCD turns off if the panel is not touched for 10 seconds.

Procedure

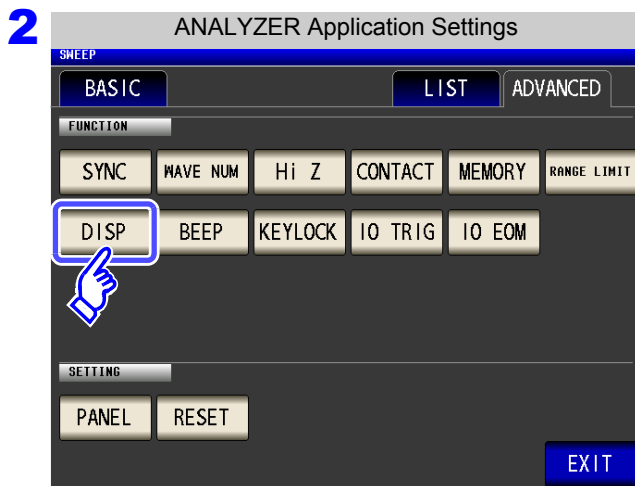
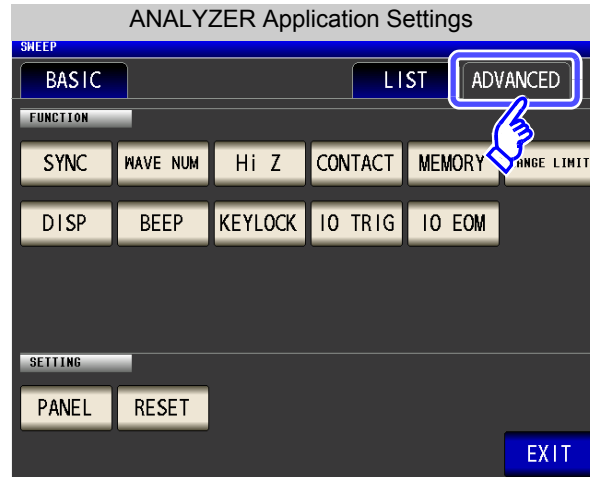
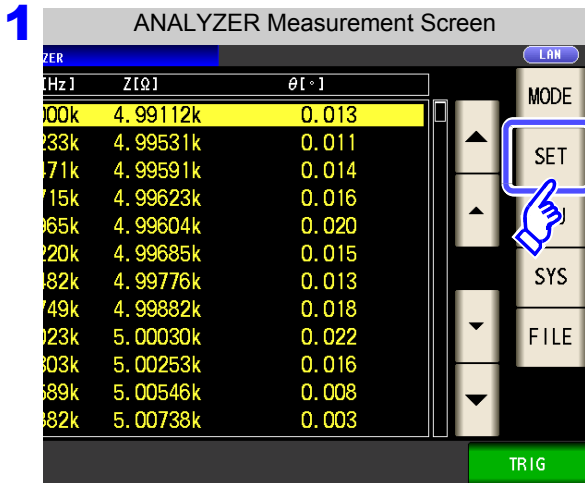

Press **DISP**.

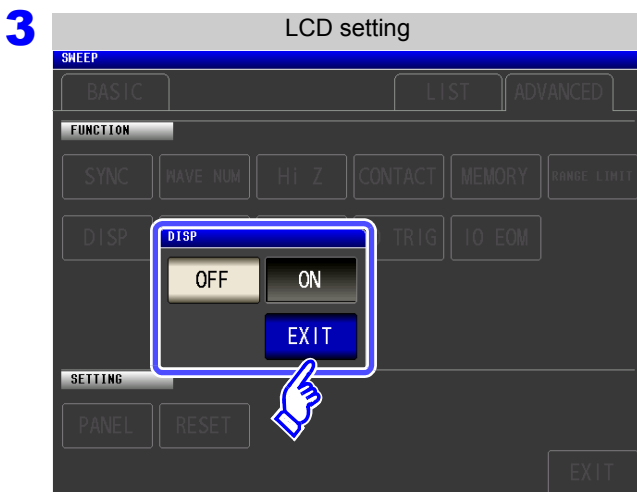

Select the LCD setting, and press **EXIT** to close the setting screen.

OFF Turns OFF the LCD. The LCD turns off after approximately 10 seconds elapse since the touch panel was last touched.

ON Sets the LCD to always on.

When you want to turn the backlight on again:

If you touch the touch panel while the backlight is off, the backlight will turn on again.

5.3.8 Setting Operation Sounds (Beep Sounds)

You can set the operation sound and each of the beep sounds for judgment results.

Procedure

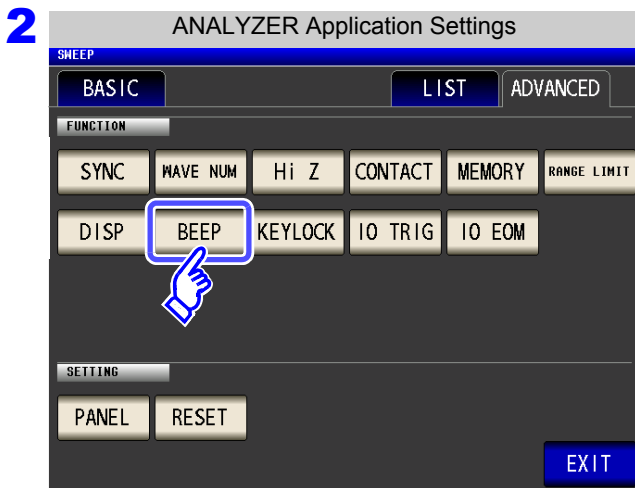
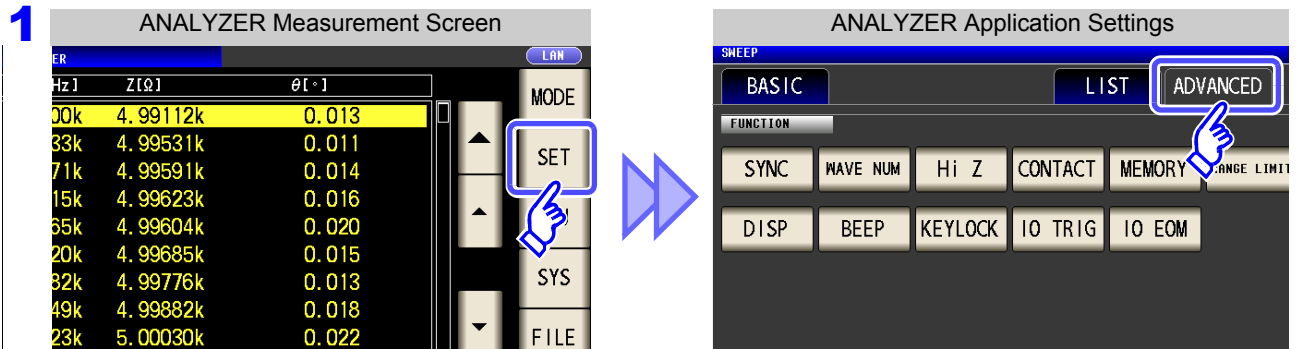

Press **BEEP**.

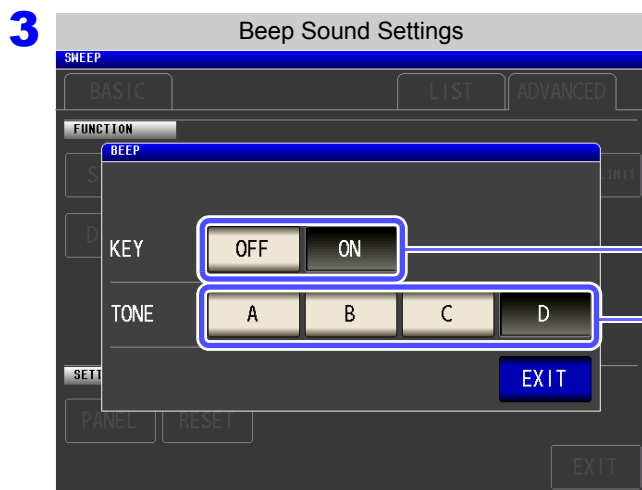

Beep sound setting for when key pressed

OFF When a key is pressed, no beep sound is emitted.

ON When a key is pressed, a beep sound is emitted.

Beep tone settings

You can select from four beep tones (**A** , **B** , **C** , and **D**).

4 Press **EXIT** to close the setting screen.

NOTE If an invalid key is pressed or an operation causes an error, an error tone will sound regardless of whether the beep tone is turned on or off.

5.3.9 Disabling Key Operation (Key-lock Function)

When the key-lock function is enabled, all setting changes except canceling the key-lock are disabled to protect the settings. You can also set a passcode (security code).

Procedure

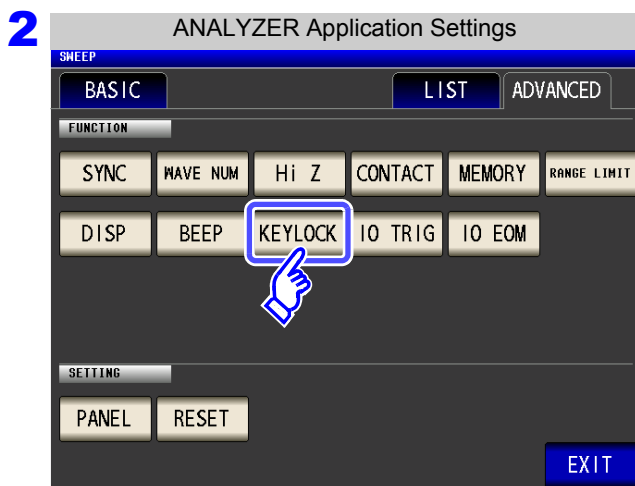
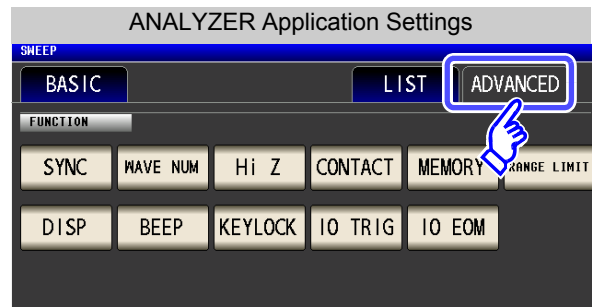
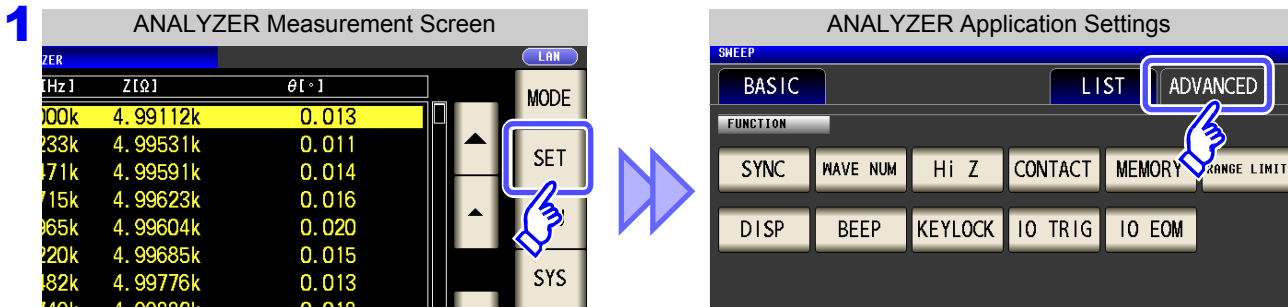

Press **KEYLOCK**.

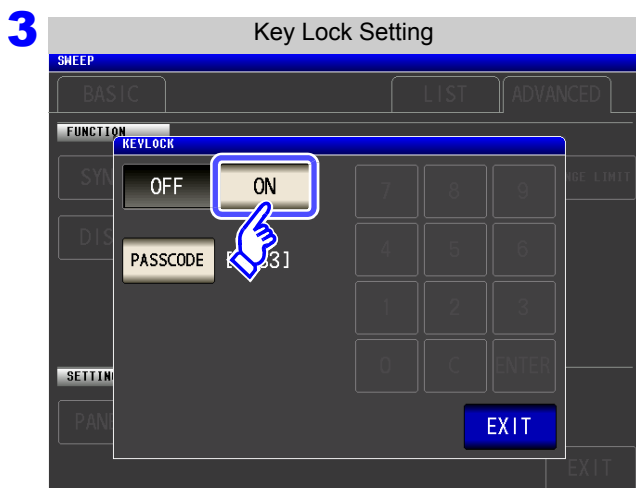

Press **ON**.

4 Press **EXIT** to close the setting screen.

NOTE

- In the case of an external trigger, the key lock is not enabled for **TRIG**.
- The measurement value zoom display (ZOOM) can be accessed, and measurement condition switching can be performed.
- Turning off the power does not cancel the key-lock function.

Setting the Passcode of the Key-lock

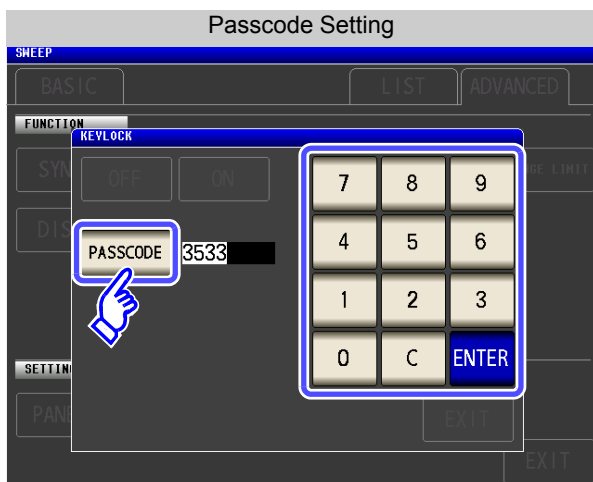

Press **PASSCODE** when the key-lock setting is **ON**.

Use the numerical keypad to enter the passcode, press **ENTER**, and then press **EXIT**.

Settable range: 1 to 4 digits
Default passcode: 3533

Disabling the Key-lock

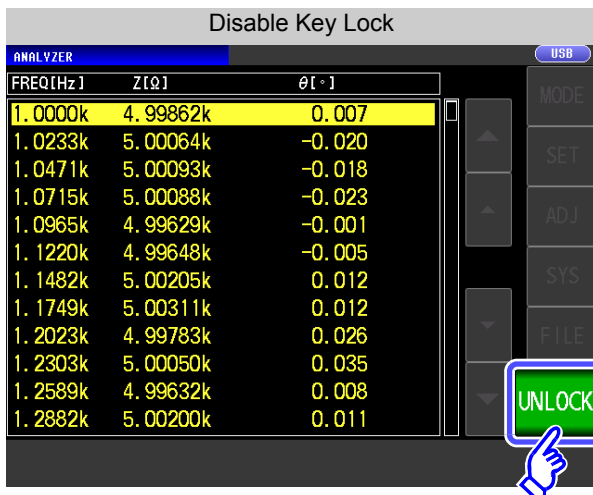

Press **UNLOCK** when the key-lock is enabled.

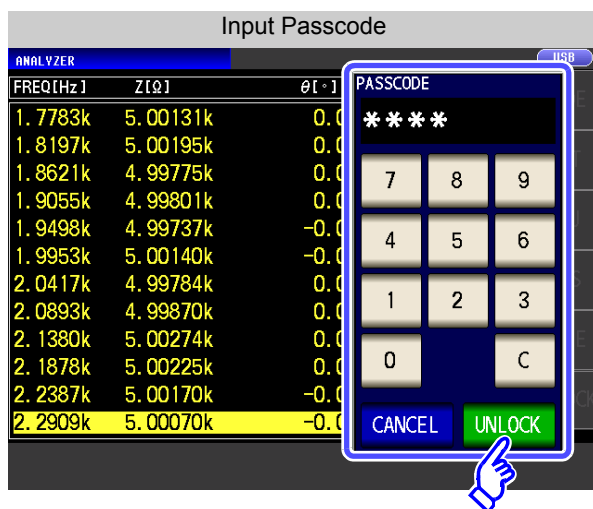

When a passcode is set

Enter the passcode and press **UNLOCK**.

The entered passcode is indicated as ***** on the screen.

(To cancel input: Press **C**.)

When a passcode is not set

Press **UNLOCK**.

When you want cancel the disabling of the key-lock: Press **CANCEL**.

NOTE If you forget the passcode, perform a full reset to restore the instrument to the factory default settings (p. 361).

5.3 Application Settings

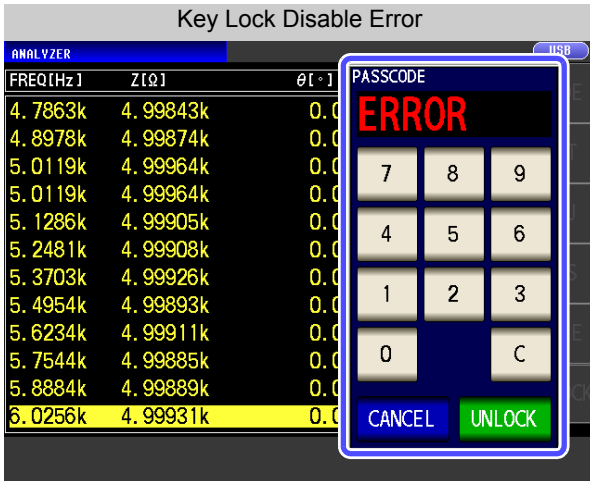

If the error indication shown on the left appears, check the following items.

Cause	Remedy
UNLOCK was pressed before you entered the passcode.	Press C and enter the passcode.
The entered passcode is incorrect.	Press C and enter the passcode again.

5.3.10 Enabling Trigger Input for during Measurement and Setting the Valid Edge of Trigger Input

You can select whether to enable or disable trigger input from the EXT I/O during measurement (during $\overline{\text{EOM}}$ (HI) output after trigger is received). Erroneous input due to chattering can be prevented by disabling trigger input during measurement. Furthermore, you can also select either the rising edge or falling edge as the valid edge of trigger input from the EXT I/O.

See "12.2 Timing Chart" (p. 318)

Procedure

1

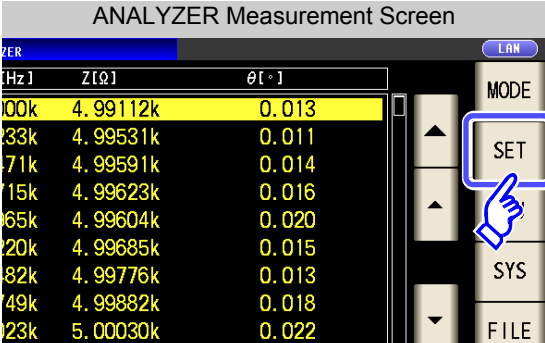

[Hz]	Z[Ω]	$\theta[^\circ]$
100k	4.99112k	0.013
133k	4.99531k	0.011
171k	4.99591k	0.014
215k	4.99623k	0.016
265k	4.99604k	0.020
320k	4.99685k	0.015
382k	4.99776k	0.013
449k	4.99882k	0.018
523k	5.00030k	0.022

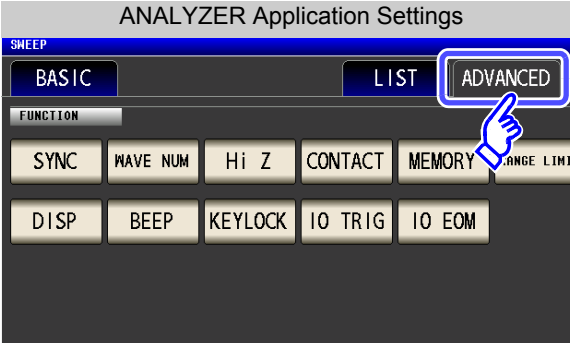

ANALYZER Application Settings

FUNCTION

SYNC WAVE NUM Hi Z CONTACT MEMORY RANGE LIMIT

DISP BEEP KEYLOCK IO TRIG IO EOM

2

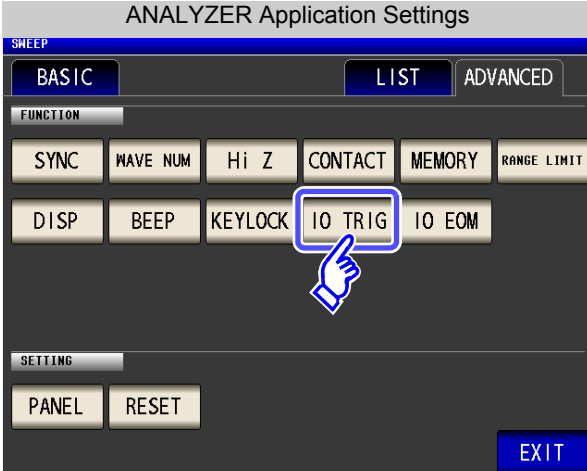

ANALYZER Application Settings

FUNCTION

SYNC WAVE NUM Hi Z CONTACT MEMORY RANGE LIMIT

DISP BEEP KEYLOCK IO TRIG IO EOM

SETTING

PANEL RESET

EXIT

Press **IO TRIG**.

3

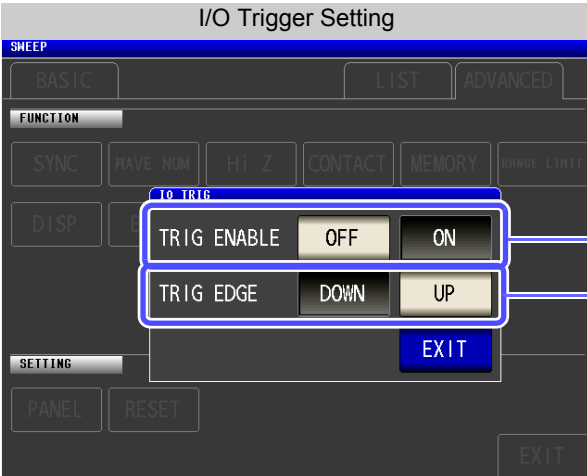

I/O Trigger Setting

FUNCTION

SYNC WAVE NUM Hi Z CONTACT MEMORY RANGE LIMIT

DISP BEEP KEYLOCK IO TRIG IO EOM

TRIG ENABLE OFF ON

TRIG EDGE DOWN UP

SETTING

PANEL RESET

EXIT

Select the I/O trigger function setting.

- OFF** Disables trigger input from the EXT I/O during measurement (during $\overline{\text{EOM}}$ (HI) output after trigger is received).
- ON** Enables trigger input from the EXT I/O during measurement (during $\overline{\text{EOM}}$ (HI) output after trigger is received).
- DOWN** Sets the falling edge as the valid edge of trigger input.
- UP** Sets the rising edge as the valid edge of trigger input.

4 Press **EXIT** to close the setting screen.

5.3.11 Setting the EOM Output Method

The higher the measurement frequency, the shorter the time that $\overline{\text{INDEX}}$ and $\overline{\text{EOM}}$ are high (off). When the high (off) time is too short due to characteristics of the input circuit, the instrument can be configured to maintain the low (on) state for a preset time once $\overline{\text{EOM}}$ changes to low (on) before reverting the signal to high (off) after the completion of measurement. The $\overline{\text{INDEX}}$ output method can be changed in the same manner.

See "Chapter 12 External Control" (p. 309)

Procedure

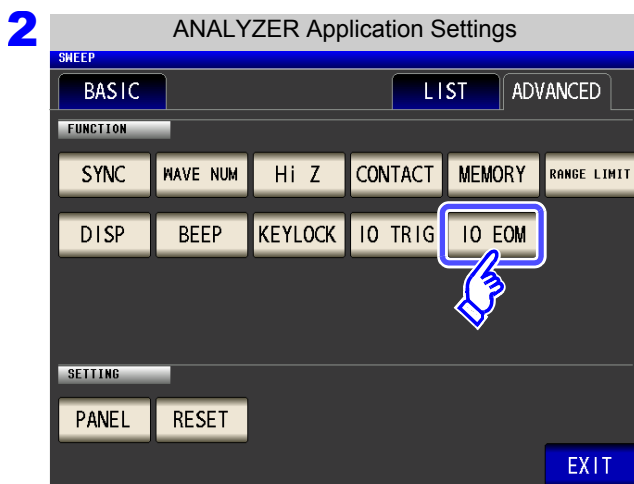
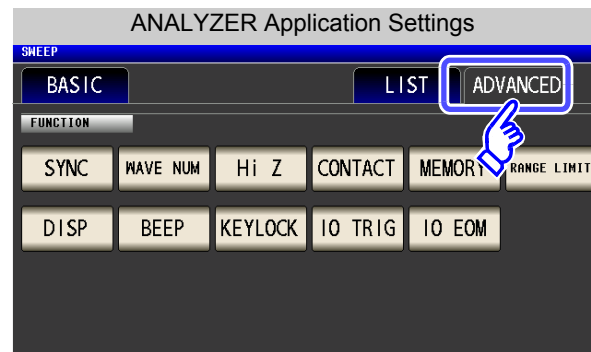
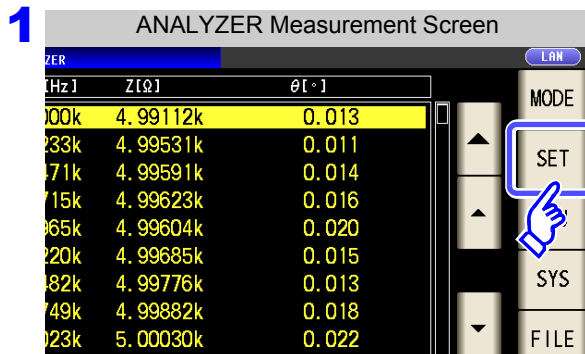

Press **IO EOM**.

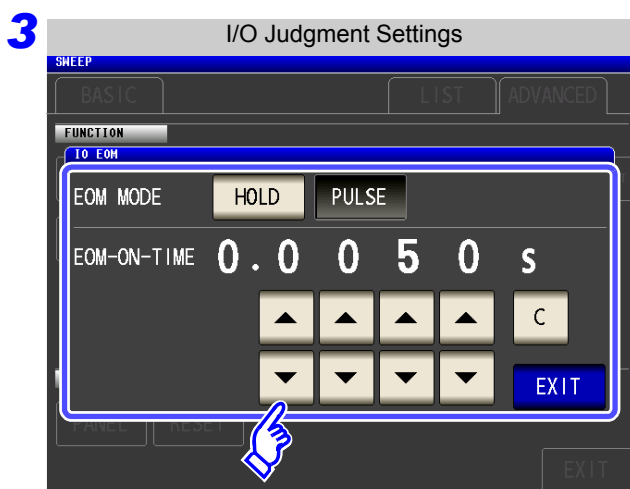

Setting the output method.

For HOLD and PULSE timing charts, see "Chapter 12 External Control" (p. 309).

Use **▲** or **▼** to set the $\overline{\text{EOM}}$ output time for the PULSE setting.

Settable range: 0.0001 s to 0.9999 s

4 Press **EXIT** to close the setting screen.

5.3.12 Initializing (System Reset)

In the event of the instrument malfunctioning, check "Before returning for repair" (p. 357).

If you do not know the cause of the problem, perform a system reset to restore the instrument to its factory default settings.

A system reset can also be performed with the ***RST** and **:RESet** communication commands.

See Description of communications commands on the included LCR Application Disk.

Procedure

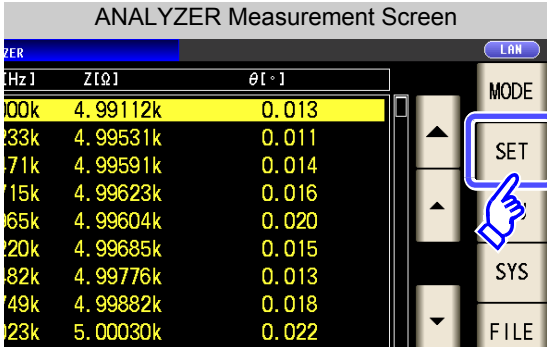
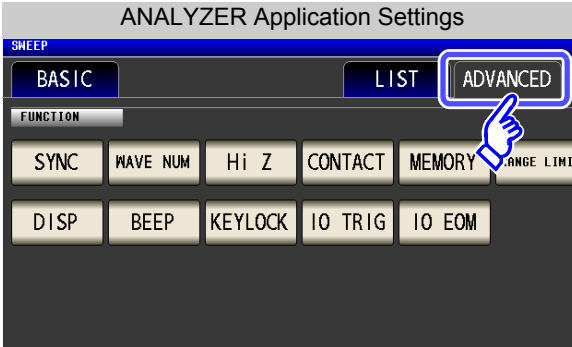
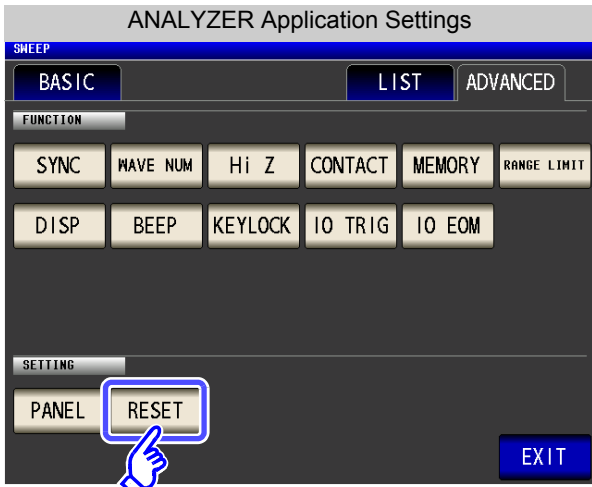
- 

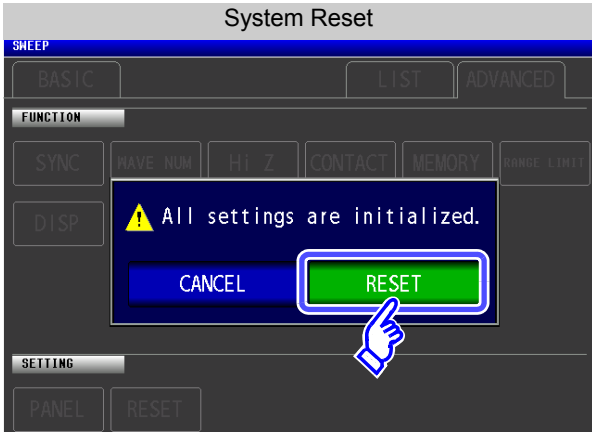
- 

Press **RESET**.
- 

Press **RESET** to restore the factory default settings and automatically redisplay the measurement screen.

When you want to cancel the system reset:
Press **CANCEL**.

NOTE

- If the initialization screen cannot be displayed, perform a full reset (p. 361).
- Performing a system reset causes the instrument to return to its default factory settings. Disconnect the measurement sample before performing a system reset.

TRANSFORMER Function

Chapter 6

6.1 About TRANSFORMER function

The TRANSFORMER function allows you to perform inductance measurement twice in order to calculate the winding ratio, mutual inductance, and inductance difference.

NOTE

Settings apply to LCR mode, ANALYZER mode, and TRANSFORMER mode.

6.1.1 Measurement screen

When the instrument is turned back on, the screen will display the measurement mode in use when it was last turned off. For more information about the screen layout, see (p. 20).

The screenshot shows the TRANSFORMER measurement screen with the following elements and callouts:

- Transformer Information:** TRANSFORMER No. 001 1110231226, Reference Value, Memory Full, USB, PRINT.
- Measurement Results:** Ls: 310.239 μ H, 310.209 μ H, 1.00005 IN.
- Measurement Conditions Table:**

FREQ	1.0000KHz	JUDGE	ON	OPEN	OFF
V	1.000V	SPEED	MED	SHORT	OFF
LIMIT	OFF	AVG	OFF	LOAD	OFF
RANGE	HOLD 100 Ω	DELAY	0.0000s	CABLE	0m
LOW Z	OFF	SYNC	OFF	SCALE	OFF
- Menu keys:** MODE, SET, ADJ, SYS, FILE.
- Operation keys:** ZOOM ON, INFO COMP, SAVE, PRINT, TRIG 1, TRIG 2.

Callouts:

- Indicates the name of the loaded panel (p. 256).
- Indicates error messages and other information (p. 362).
- Indicates the usage status of internal memory (p. 138).
- Indicates that a USB flash drive is connected (p. 273).
- Indicates the interface that is currently set (p. 263).
- A measurement condition is displayed.
- Displays the comparator measurement judgment results (p. 199).
- Calculation parameter key**
Sets calculation parameters (p. 197).
- Measurement parameter key**
Set each parameter (p. 196).

Menu keys

- MODE** Select the measurement mode (p. 13).
- SET** Set the details (p. 198).
- ADJ** Set the compensation (p. 215).
- SYS** Set the system (p. 263).
- FILE** Set the save settings (p. 273).

The settings of **SET** differ depending on the measurement mode.

Operation keys

An operation key is displayed depending on the situation.

- ZOOM ON** Enlarges the screen (p. 49).
- INFO AC** Displays the measurement conditions for AC measurement.
- INFO MODEL** Displays the transformer model.
- INFO COMP** Displays the comparator settings.
- SAVE** Saves the measurement data (p. 277).
- PRINT** Prints the measurement data (p. 331).

6.1 About TRANSFORMER function

6.1.2 Measurement Methods

Winding ratio and inductance difference

Touch **TRIG 1** after connecting the wiring to the coil's primary side. Then touch **TRIG 2** after connecting the wiring to the secondary side to display the wiring ratio and inductance difference.

Procedure

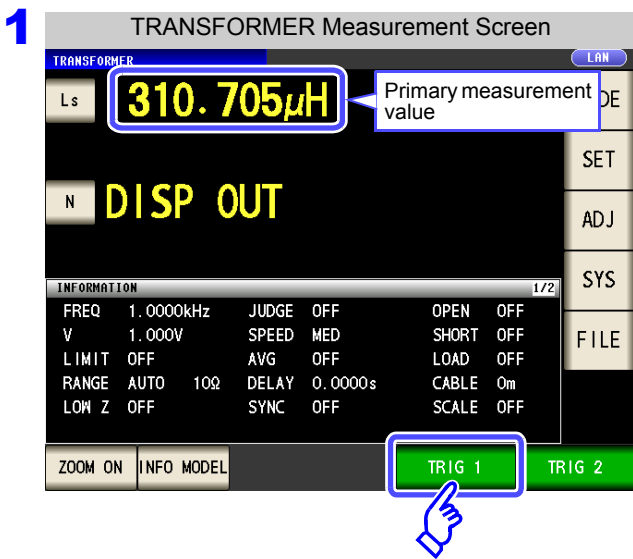

Measure the coil's primary side with **TRIG 1**.

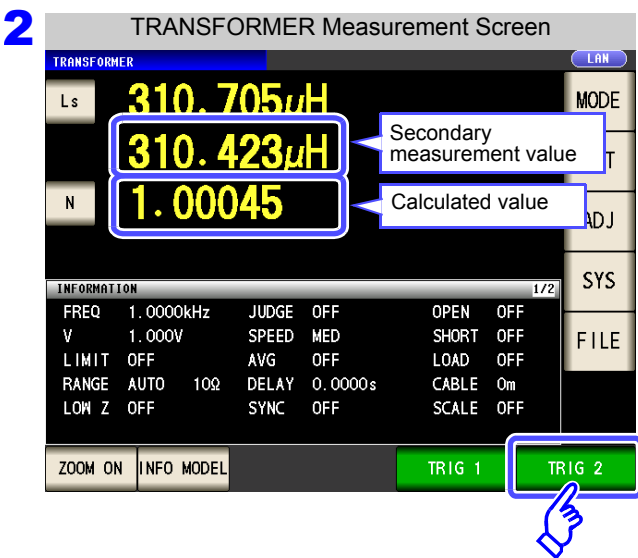
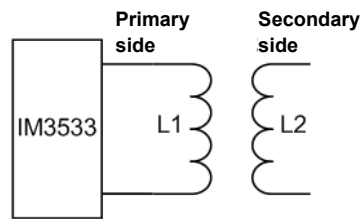

Measure the coil's secondary side with **TRIG 2**.

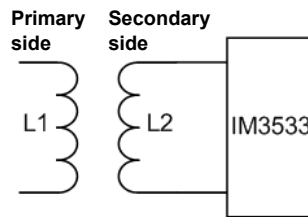

Mutual inductance

Connect the two sides in phase and in series and touch **TRIG 1**. Then connect them in reverse phase and in series and touch **TRIG 2** to display the mutual inductance.

Procedure

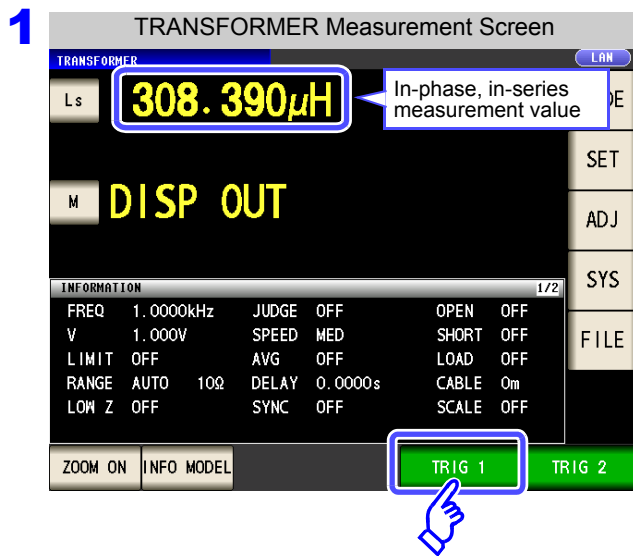

Connect the two sides in phase and in series as shown below and measure with **TRIG 1**.

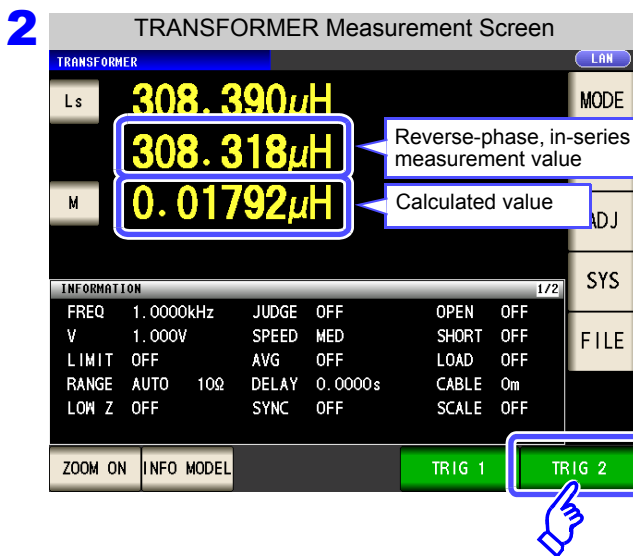
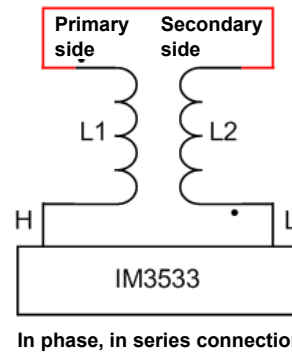

Connect the two sides in reverse phase and in series as shown below and measure with **TRIG 2**.

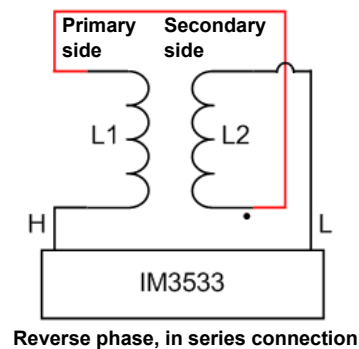

6.1 About TRANSFORMER function

6.1.3 Setting the measurement parameter

This section describes how to select Ls or Lp as the measurement parameter.

See "1.3.7 Parameter Settings Screen" (p. 28)

"Appendix1 Measurement Parameters and Calculation Formula"(p. A1)

"Appendix7 Series Equivalent Circuit Mode and Parallel Equivalent Circuit Mode"(p. A11)

Procedure

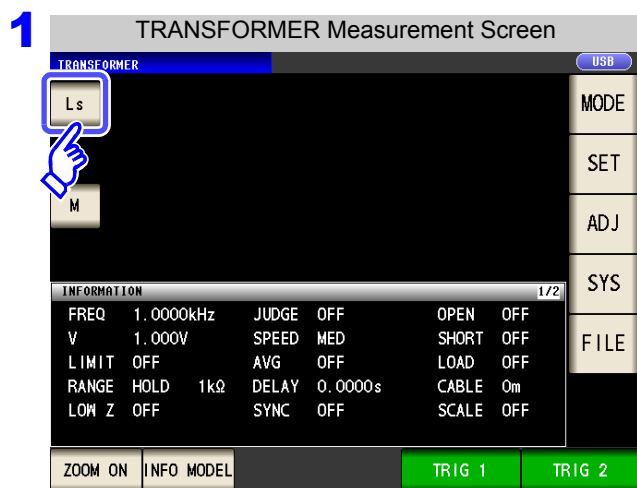

Touch the measurement parameter key on the measurement screen.

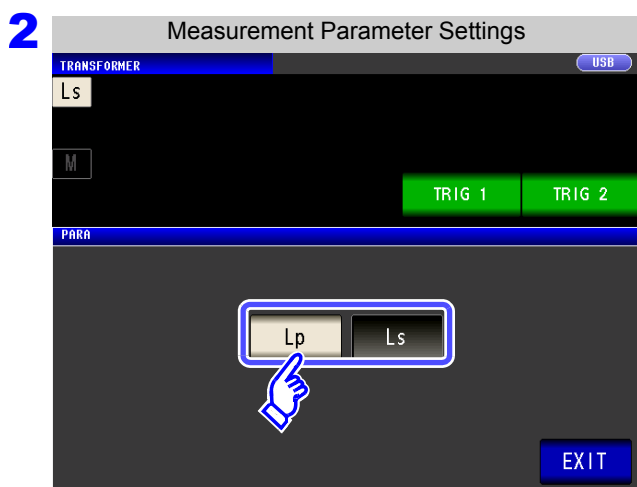

Select a measurement parameter.

Lp

Parallel equivalent circuit mode inductance (H)

Ls

Series equivalent circuit mode inductance (H)

3 Press **EXIT** to close the setting screen.

6.1.4 Setting Calculation Parameters

This section describes how to select winding ratio (N), mutual inductance (M), or inductance difference (ΔL) as the calculation parameter.

See "6.1.2 Measurement Methods" (p. 194)

Procedure

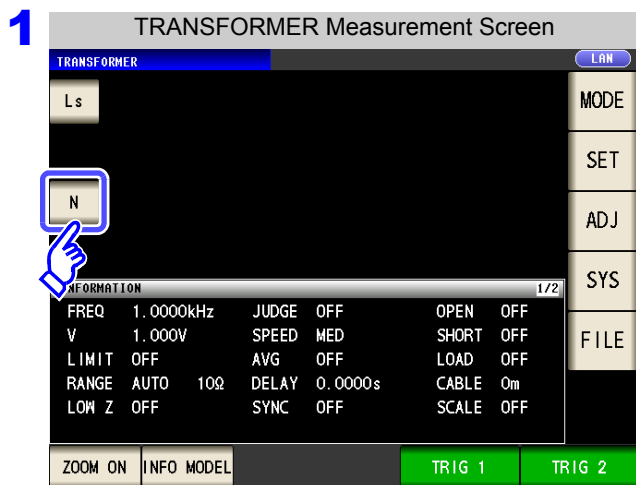

Touch the calculation parameter key on the measurement screen.

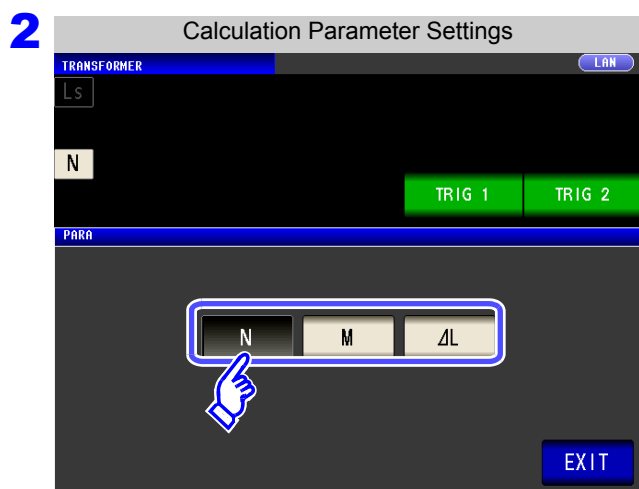

Select an calculation parameter.

Winding ratio $N = \sqrt{\frac{L1}{L2}}$

N

Mutual inductance $M = \frac{(La - Lb)}{4}$

M

Inductance difference $\Delta L = L1 - L2$

ΔL

3 Press **EXIT** to close the setting screen.

6.2 Setting Basic Settings of Measurement Conditions

NOTE Basic settings apply to LCR mode, ANALYZER mode, and TRANSFORMER mode.

Procedure

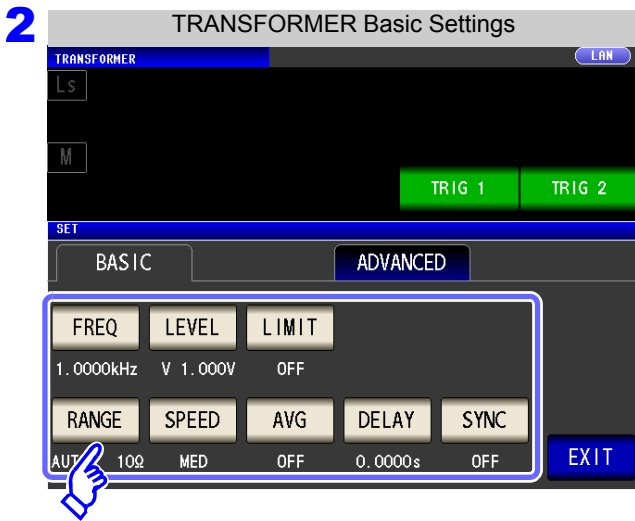
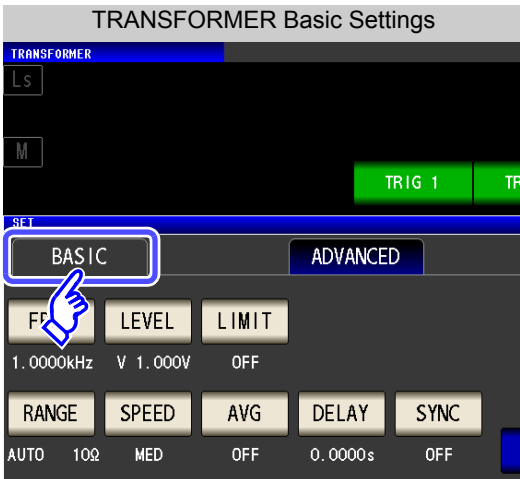
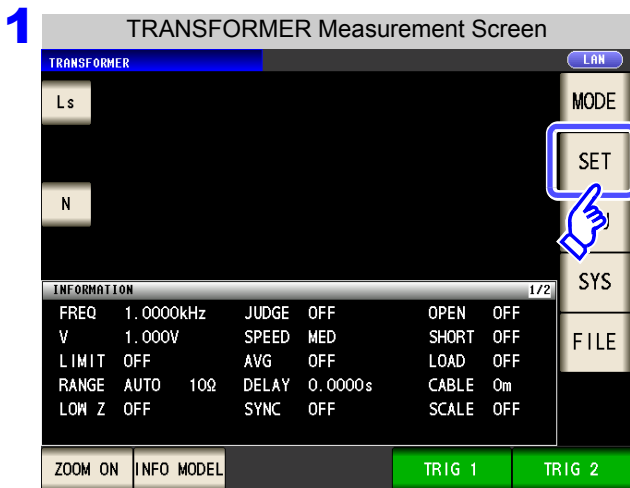

Select the setting you wish to configure.

- FREQ** Sets the measurement frequency (p. 50).
- LEVEL** Sets the measurement signal level (p. 52).
- LIMIT** Sets the voltage and current limits (p. 56).
- RANGE** Sets the measurement range (p. 62).
- SPEED** Sets the measurement speed (p. 73).
- AVG** Configures averaging (p. 74).
- DELAY** Sets the trigger delay (p. 76).
- SYNC** Configures the trigger synchronous output function (p. 77).

3 Press **EXIT** to close the setting screen.

6.3 Judging with Upper and Lower Limit Values (Comparator Measurement Mode)

6.3 Judging with Upper and Lower Limit Values (Comparator Measurement Mode)

This function compares calculation parameter calculation results to a user-specified reference and displays a judgment result.

In TRANSFORMER mode, only comparator measurement, which compares one judgment reference and the calculated values, is available.

- Preset a reference value and upper and lower limit values as the judgment reference, and display a calculation result as **HI** (higher than the upper limit value), **IN** (within the range set for the upper and lower limit values), or **LO** (lower than the lower limit value).
- Output the judgment results to an external device (via the EXT I/O connector).
- Be notified of judgment results by buzzer.
- Confirm the judgment result from the judgment result indication LEDs on the front panel of the instrument.

See "4.5.11 Setting Operation Sounds (Beep Sounds)" (p. 143)

See "Judgment Result Indication LEDs" (p. 10)

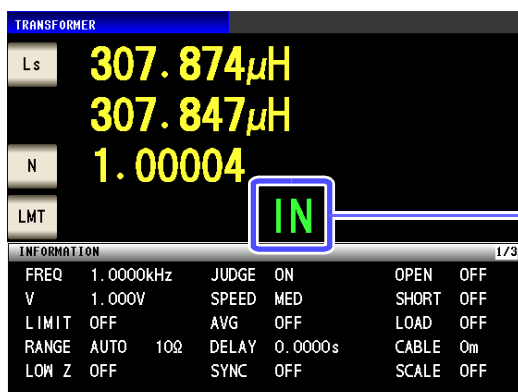
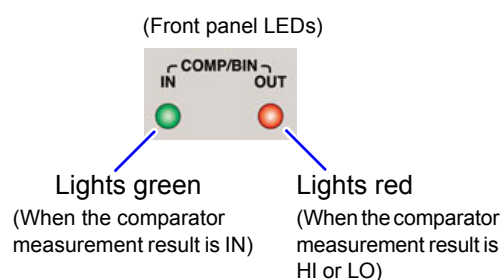

HI

The calculated value is above upper limit

IN

Upper limit value \geq calculated value \geq lower limit value

LO

The calculated value is below lower limit

If no judgment reference has been set

6.3 Judging with Upper and Lower Limit Values (Comparator Measurement Mode)

The following three judgment methods are available:

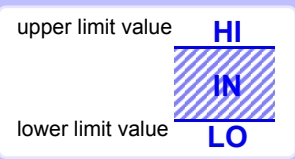
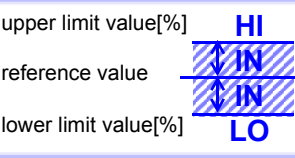
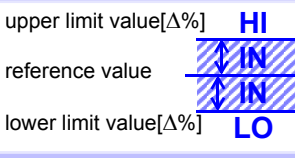
<p>Absolute value (ABS) setting (p. 202)</p> 	▶	<p>Set absolute values for the upper limit and lower limit values of the calculation parameter. The calculated values displayed are the same as those of the calculation parameter.</p>
<p>Percent (%) Setting (p. 203)</p> 	▶	<p>Enter reference values and then set percentages corresponding to the reference values as the upper limit and lower limit*1 values. The calculated values displayed are the same as those of the calculation parameter.</p>
<p>Deviation Percent (Δ%)*2 Setting (p. 205)</p> 	▶	<p>Enter reference values and then set percentages corresponding to the reference values as the upper limit and lower limit*1 values. The calculated values are displayed in deviations (Δ%) from the reference value.</p>

*1: The following equation is used to calculate the comparison upper limit value and comparison lower limit value. (In the case of the comparison lower limit value, if a value that is lower than the reference value is set, the minus (-) sign is required for the percentage setting value.)

$$\text{Upper limit comparison value (Lower limit comparison value)} = \text{reference value} + |\text{reference value}| \times \frac{\text{Percentage set value}}{100}$$

*2: The following equation is used to calculate the Δ% value.



$$\Delta\% = \frac{\text{measurement value} - \text{reference value}}{|\text{reference value}|} \times 100$$

NOTE

- The comparator judgment is made in the following order.
 1. If the calculated value is “DISP OUT”, **HI** is displayed.
 2. Whether the calculated value is higher than the lower limit value is judged, and **LO** is displayed if the judgment is NG.
 3. Whether the calculated value is lower than the upper limit value is judged, and **HI** is displayed if the judgment is NG.
 4. If other than 1, 2, or 3, **IN** is displayed.

No test is performed to ensure that the upper limit value is greater than the lower limit value, so no error message will be displayed if you set the upper limit value and lower limit value the wrong way around.

- If the power is turned off while the comparator measurement screen is displayed, the comparator measurement screen will be displayed when the instrument starts the next time you turn the power on.
- Comparator measurement can be used even if only the upper or lower limit value has been set.

<p>When only an upper limit value has been set</p> 	<p>When only a lower limit value has been set</p> 
---	---

6.3 Judging with Upper and Lower Limit Values (Comparator Measurement Mode)

Configuring comparator measurement

Procedure

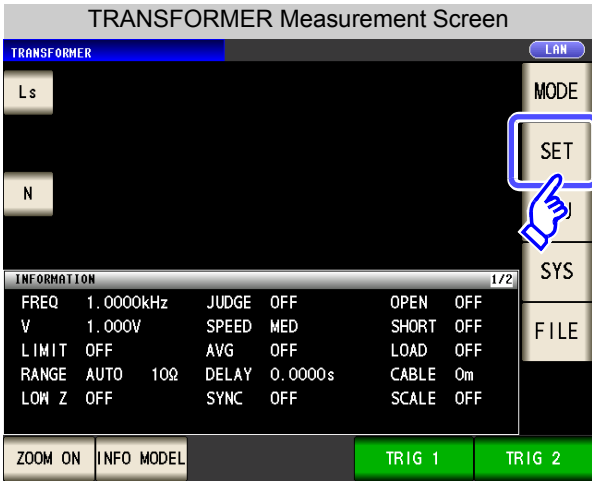
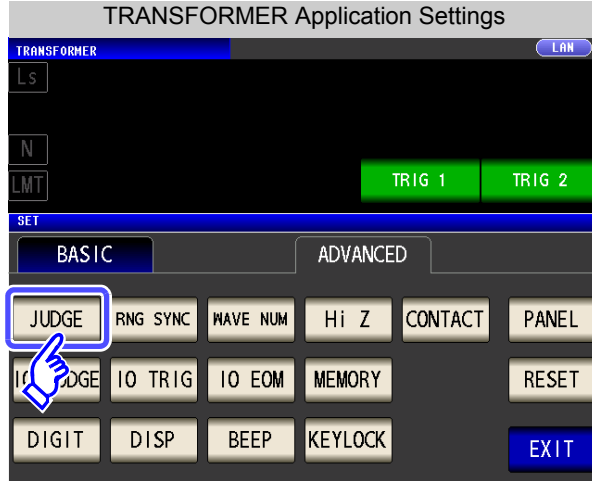
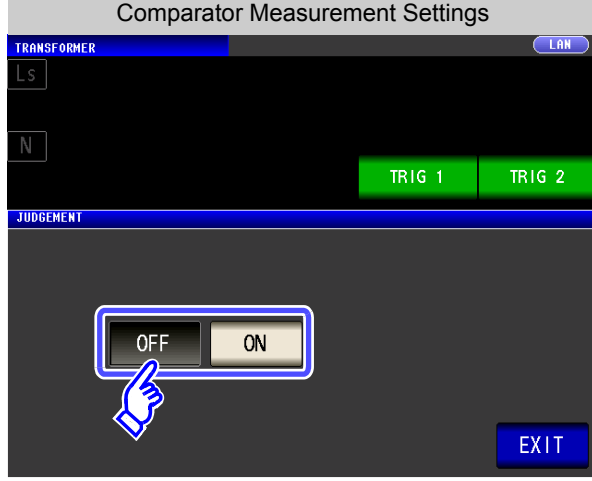
- 

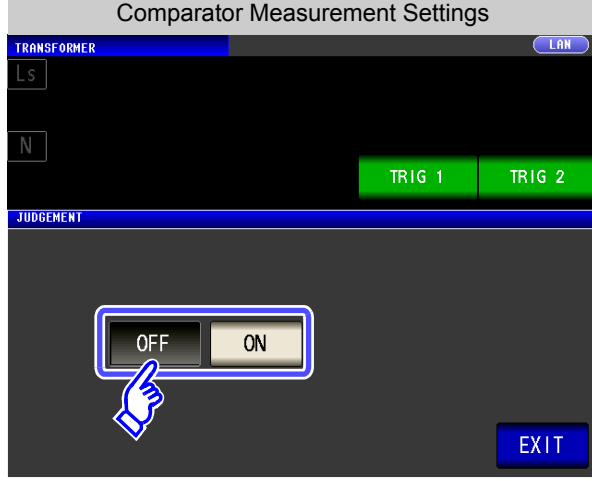
- 

Press **JUDGE**.
- 

Turn comparator measurement on or off.

 - OFF** Disables comparator measurement.
 - ON** Enables comparator measurement.
- Press **EXIT** to close the setting screen.

6.3 Judging with Upper and Lower Limit Values (Comparator Measurement Mode)

1 Setting the Upper or Lower Limit Value as an Absolute Value (ABS) (Absolute Value Mode)

Procedure

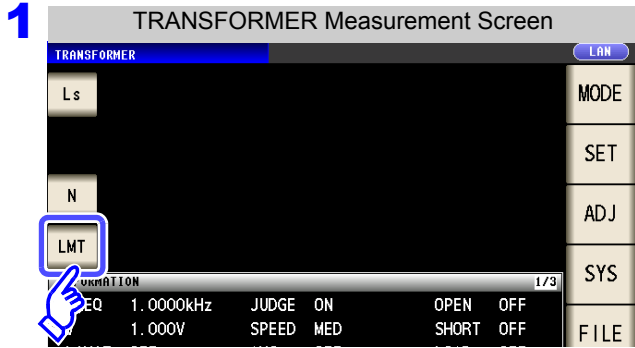

Press **LMT**.

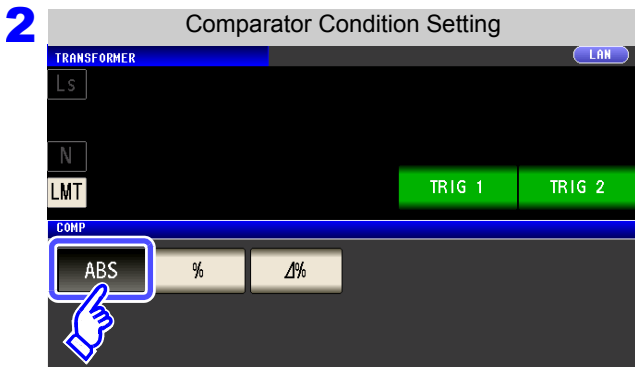

Press **ABS**.

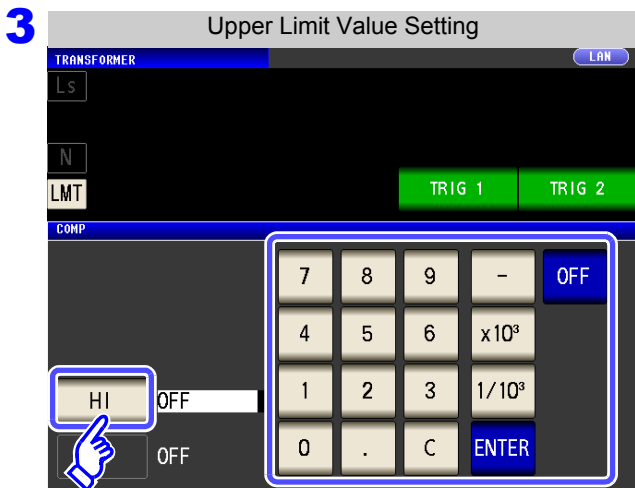

Press **HI** and use the numeric keypad to set the upper limit value.

Settable range: -9.99999 G to 9.99999 G

Changing the unit (a/ f/ p/ n/ μ/ m/ None/ k/ M/ G)

x10³ Step the units up.

1/10³ Step the units down.

When you do not want to set the upper and lower limit values: Press **OFF**.

4 Press **ENTER** to confirm the upper limit value.

5 Return to **step 2**, press **LO**, use the numeric keypad to set the lower limit value, and press **ENTER**.

Settable range: -9.99999 G to 9.99999 G

6 Press **EXIT** to close the setting screen.

6.3 Judging with Upper and Lower Limit Values (Comparator Measurement Mode)

2 Setting the Upper or Lower Limit Value as a Percentage (%) Relative to a Reference Value (Percentage Mode)

Procedure

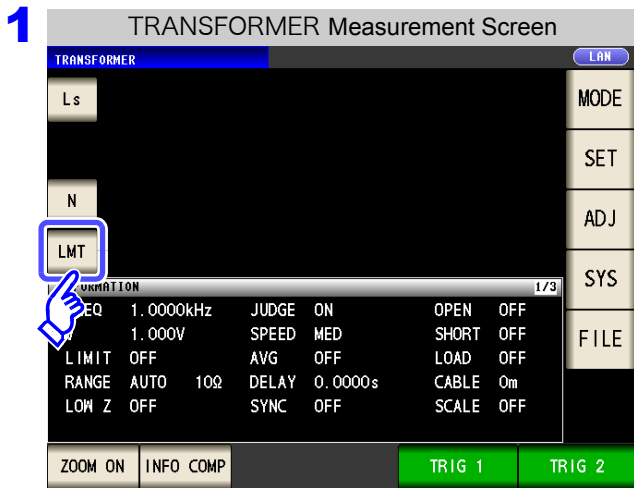

Press **LMT**.

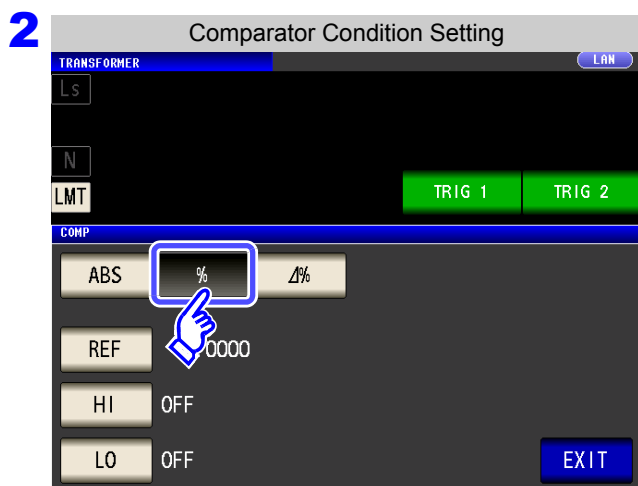

Press **%**.

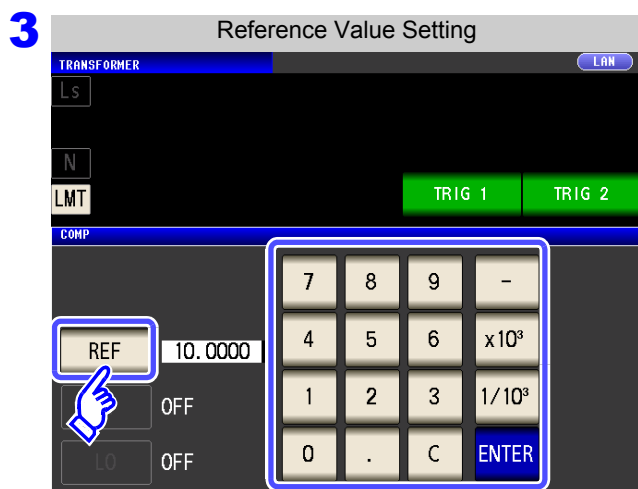

Press **REF** and use the numeric keypad to set the reference value.

Settable range: -9.99999G to 9.99999G

Changing the unit (a/ f/ p/ n/ μ/ m/ None/ k/ M/ G)

x10³ Step the units up.

1/10³ Step the units down.

4 Press **ENTER** to confirm the reference value.

6.3 Judging with Upper and Lower Limit Values (Comparator Measurement Mode)

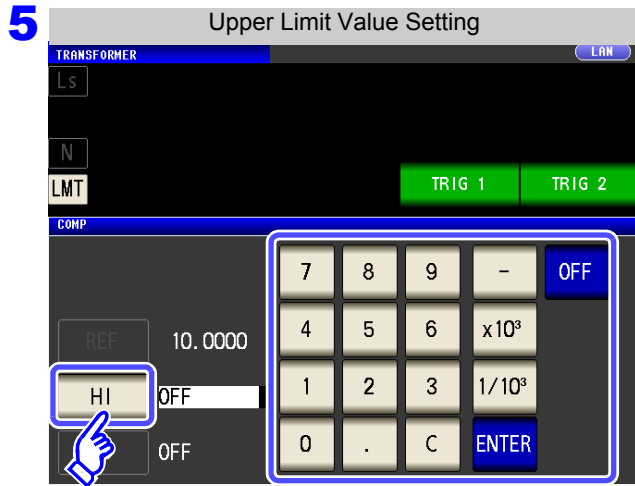

Press **HI** and use the numeric keypad to set the upper limit value.

Set the upper limit value as a percentage relative to the reference value.

When you do not want to set the upper limit: Press **OFF**.

- Settable range: -999.999% to 999.999%
 - The actual internal operation consists of calculating the upper-limit value of comparison using the equation given below, and comparing it to the calculated value to enable a decision to be made.
- $$\text{Upper limit comparison value} = \text{reference value} + |\text{reference value}| \times \frac{\text{Percentage set value}}{100}$$

6 Press **ENTER** to confirm the upper limit value.

7 Return to **step 2**, press **LO**, use the numeric keypad to enter the lower limit value, and press **ENTER**.

- Settable range: -999.999% to 999.999%
 - The actual internal operation calculates the lower limit comparison value with the following equation, and when a value that is lower than the reference value is set, the minus (-) sign is required for the percentage setting value.
- $$\text{Lower limit comparison value} = \text{reference value} + |\text{reference value}| \times \frac{\text{Percentage set value}}{100}$$

8 Press **EXIT** to close the setting screen.

NOTE The set reference value and upper and lower limit values are common to percentage mode and percentage deviation mode.

6.3 Judging with Upper and Lower Limit Values (Comparator Measurement Mode)

3 Setting Upper and Lower Limit Values as ($\Delta\%$) Values Relative to the Offset from the Reference Value (Deviation Percentage Mode)

Procedure

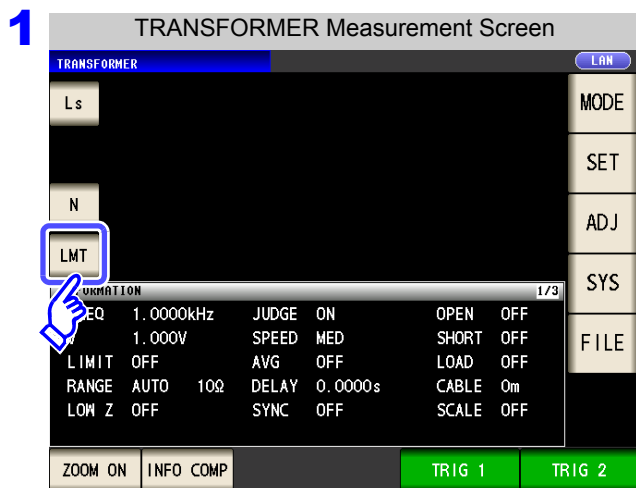

Press **LMT**.

- In the deviation percentage mode, the calculated value is displayed as a deviation ($\Delta\%$) from the reference value.
- The reference value and upper and lower limit values are set in the same manner as in the percentage mode.
 - See "Setting the Upper or Lower Limit Value as a Percentage (%) Relative to a Reference Value (Percentage Mode)" (p. 203)
- The settings of the reference value and the upper and lower limit values are common to both the percentage mode and deviation percentage mode.
- The $\Delta\%$ value is calculated using the following equation:

$$\Delta\% = \frac{\text{Calculated value} - \text{reference value}}{|\text{reference value}|} \times 100$$

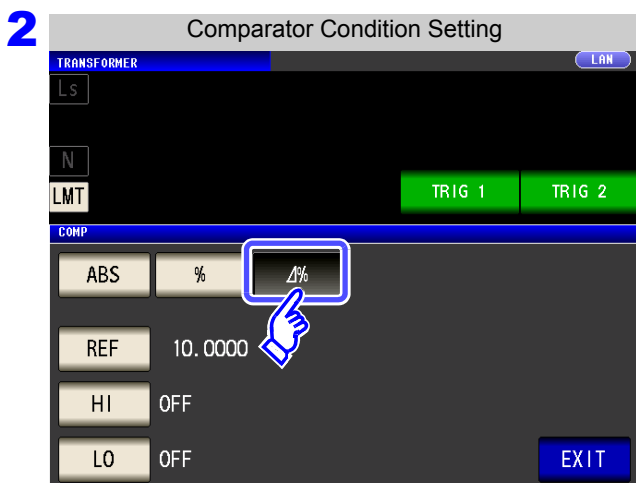

Press **$\Delta\%$** to select deviation percentage mode.

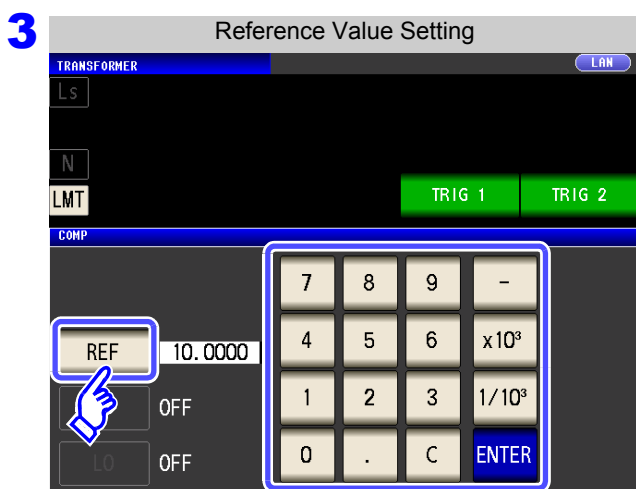

Press **REF** and use the numeric keypad to enter the reference value.

Settable range: -9.99999G to 9.99999G

- Changing the unit (a/ f/ p/ n/ μ / m/ None/ k/ M/ G)
- $\times 10^3$** Step the units up.
 - $1/10^3$** Step the units down.

4 Press **ENTER** to confirm the reference value.

6.3 Judging with Upper and Lower Limit Values (Comparator Measurement Mode)

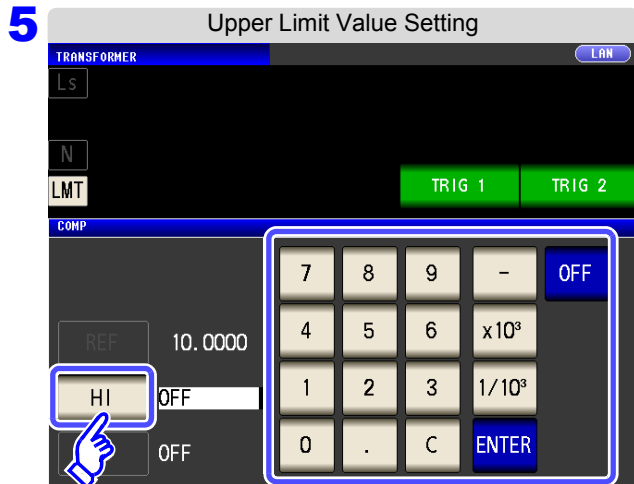

Press **HI** and use the numeric keypad to set the upper limit value.

Settable range: -999.999% to 999.999%

When you do not want to set the upper limit: Press **OFF**.

6 Press **ENTER** to confirm the upper limit value.

7 Return to **step 2**, press **LO**, and use the numeric keypad to enter the lower limit value.

Settable range: -999.999% to 999.999%

8 Press **EXIT** to close the setting screen.

NOTE

The set reference value and upper and lower limit values are common to percentage mode and percentage deviation mode.

6.4 Setting Application Settings

NOTE

Basic settings apply to LCR mode, ANALYZER mode, and TRANSFORMER mode.

Procedure

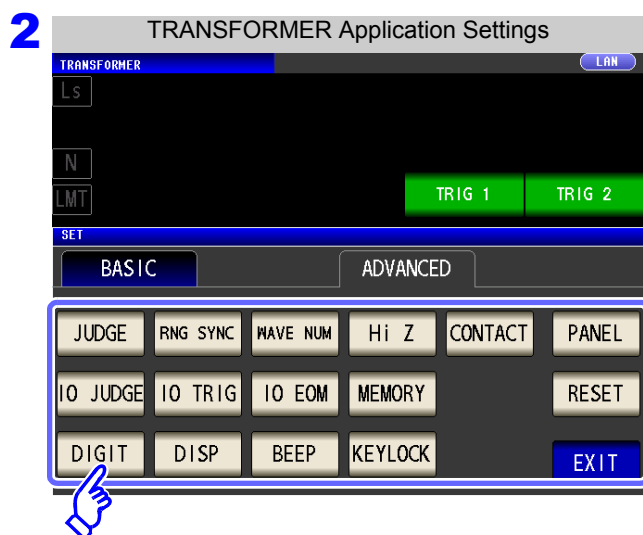
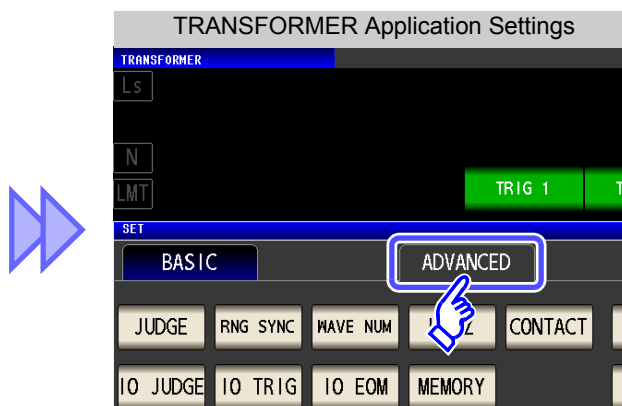
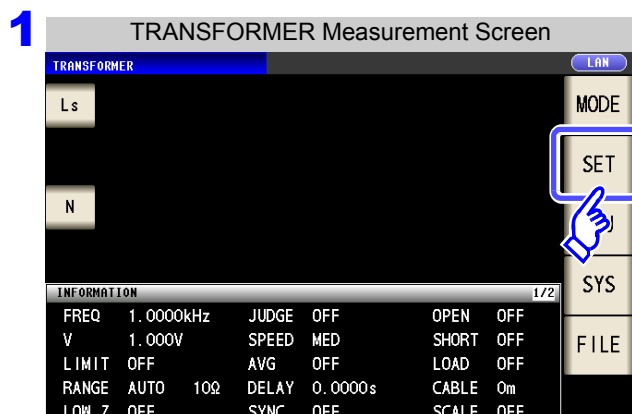

Select the setting you wish to configure.

JUDGE	Measurement result judgment setting (p. 199)
RNG SYNC	Range synchronization function setting (p. 120)
WAVE NUM	Waveform averaging function setting (p. 128)
Hi Z	HIGH-Z reject function setting (p. 130)
CONTACT	Contact check function setting (p. 132)
IO JUDGE	I/O output setting of judgment results (p. 134)
IO TRIG	I/O trigger setting (p. 136)
IO EOM	$\overline{\text{EOM}}$ Output method setting (p. 137)
MEMORY	Save settings of measurement results (p. 138)
DIGIT	Number of display digits setting for each parameter (p. 140)
DISP	LCD setting (p. 142)
BEEP	Beep sound setting (p. 143)
KEYLOCK	Key-lock setting (p. 144)
PANEL	Panel loading and saving (p. 249)
RESET	System reset (p. 147)

3 Press **EXIT** to close the setting screen.

CONTINUOUS Measurement Function Chapter 7

7.1 About CONTINUOUS Measurement Function

The CONTINUOUS measurement function loads measurement conditions saved using the panel save function in order and performs a series of measurements. LCR mode and ANALYZER mode (IM3533-01 only) measurement conditions can be mixed.

Up to 60 (IM3533-01: up to 62) continuous measurements can be performed.

7.1.1 Measurement screen

When the instrument is turned back on, the screen will display the measurement mode in use when it was last turned off. For details on the screen configuration (p. 23).

The screenshot shows the CONTINUOUS measurement screen. At the top, there are indicators for 'CONTINUOUS', 'USB', and 'LAN'. The main display area shows a table of measurement conditions:

No.	PARA1	PARA2	JUDGE
001	Z: 4.99086kΩ	θ: 0.005 °	-- --
002	Z: 4.99059kΩ	θ: 0.009 °	IN HI
003	Z: 4.99090kΩ	θ: 0.005 °	IN HI
005	Z: SWEEP	θ: SWEEP	-- --
007	Z: 4.99047kΩ	θ: 0.002 °	BIN5

Below the table is a 'NUMERIC' field and three buttons: 'SAVE', 'PRINT', and 'TRIG'. To the right of the table is a vertical menu with buttons: 'MODE', 'SET', 'ADJ', 'SYS', and 'FILE'. At the bottom right, there are callouts for 'Menu keys' and 'Operation keys'.

Menu keys

- MODE**: Select the measurement mode (p. 13).
- SET**: Set the continuous measurement settings (p. 210).
- FILE**: Set the save settings (p. 273).

Operation keys An operation key is displayed depending on the situation.

- SAVE**: Saves the measurement results (p. 277).
- TRIG**: Starts continuous measurement (p. 211).
- PRINT**: Prints the measurement data (p. 331).

Other callouts include: 'Displays a list of panels for which continuous measurement is to be performed.', 'Indicates that a USB flash drive is connected (p. 273).', 'Indicates the interface that is currently set (p. 263).', and 'Scrolls the list.'

NOTE

- Setting the measurement conditions so that the measurement frequency or measurement signal level differs for each panel allows you to simply evaluate the characteristics of the test sample.
- Continuous measurement can also be performed from the EXT I/O (p. 310).
- If the power is turned off when the [CONTINUOUS Measurement Screen] is displayed, the [CONTINUOUS Measurement Screen] will be displayed when the instrument starts the next time you turn the power on.
- CONTINUOUS measurement is not available in TRANSFORMER mode.
- ANALYZER mode is only available on the IM3533-01.

7.2 Configuring CONTINUOUS Measurement Basic Settings

Before you perform continuous measurement, set which panels are target for continuous measurement. Save the measurement conditions with the panel save function in LCR mode or ANALYZER mode (IM3533-01 only) in advance.

See "9.1 Saving Measurement Conditions (Panel Save Function)" (p. 251)

Procedure

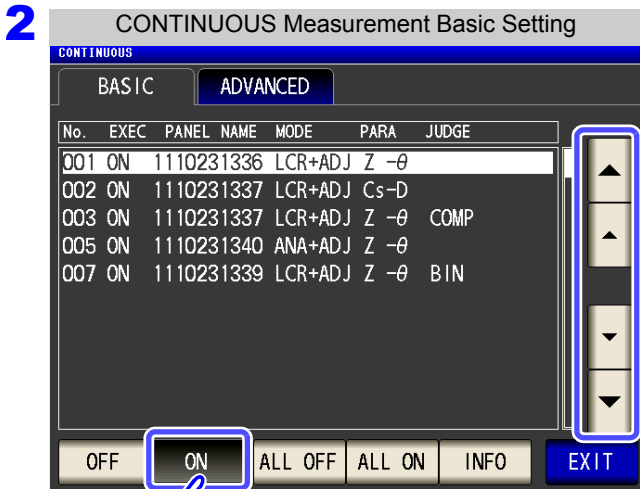
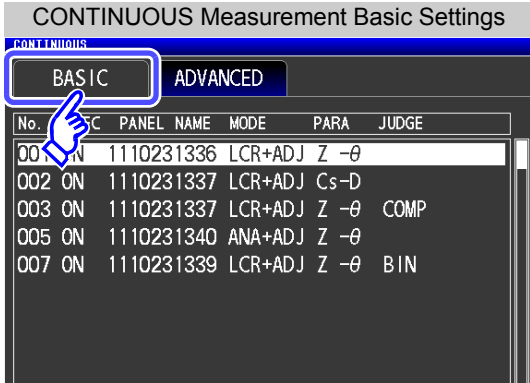
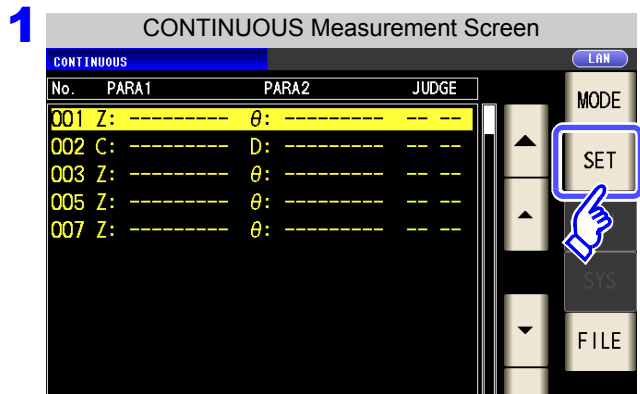

A list of the measurement conditions saved with LCR mode and ANALYZER mode appears.

Any panel for which only the compensation value (ADJ) was saved is not displayed.

Use or to select a panel for which to perform continuous measurement, and press .

- Removes the selected panel from the targets for continuous measurement.
- Sets the selected panel as a target for continuous measurement.
- Removes all panels from the targets for continuous measurement.
- Sets all panels as targets for continuous measurement.
- Display the panel information.

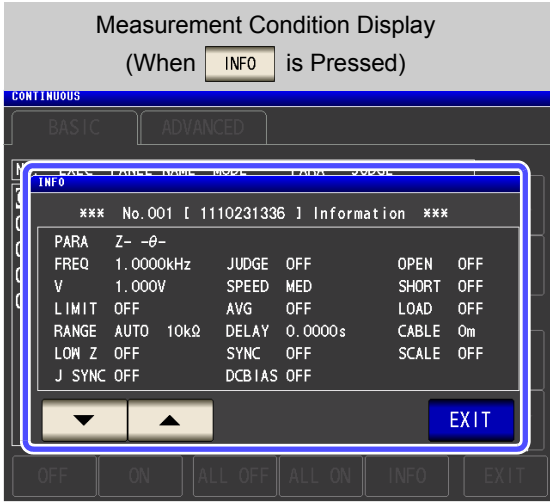

3 Press to close the setting screen.

7.3 Performing CONTINUOUS Measurement

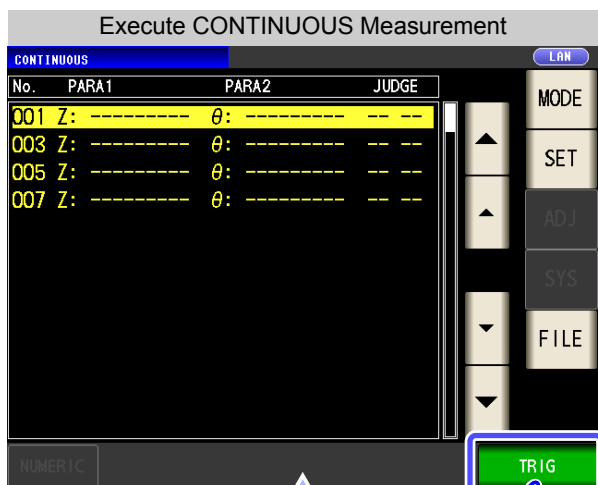

Panels that were set to **ON** in the setting screen are displayed in the list.

Press **TRIG**.

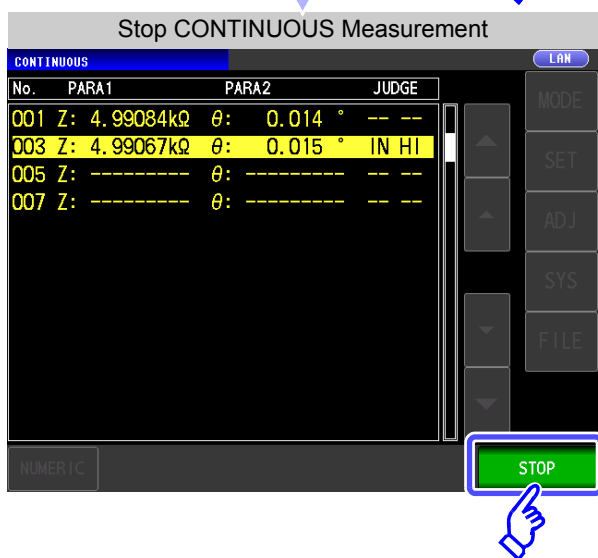

When you want to stop continuous measurement: Press **STOP**.

7.4 Checking CONTINUOUS Measurement Results

Indicates the panel number.

Displays the measurement value.

Displays the judgment result.
LCR mode: The first parameter, The third parameter

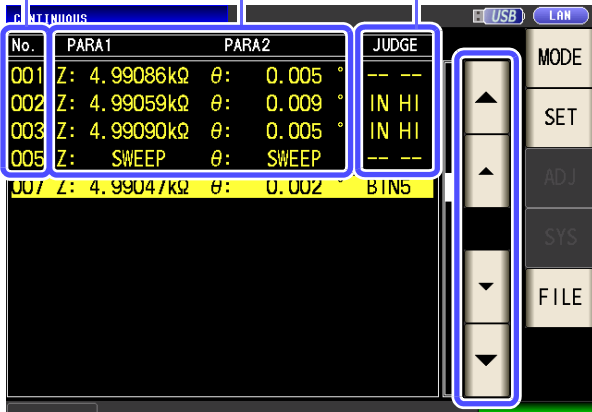

Example: To check measurement results in ANALYZER mode (IM3533-01 only)



Select the ANALYZER mode panel with

▲ and ▼ and touch **NUMERIC**.

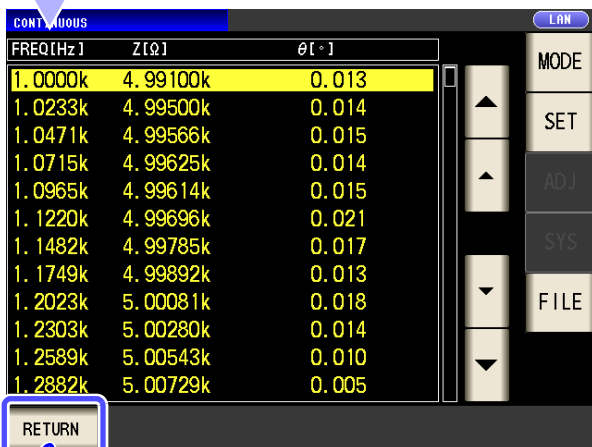

To return to the list of measurement results: Press **RETURN**.

NOTE

LCR mode measurement values are displayed for the first and third parameters only.

7.5 Configuring CONTINUOUS Measurement Application Settings

7.5.1 Setting the Display Timing

Set the display timing for during continuous measurement.

If the display timing is set to **REAL**, the time for continuous measurement becomes long because the screen is updated every time measurement is performed.

If it is set to **AFTER** to give priority to the measurement time, the screen update time becomes short.

Procedure

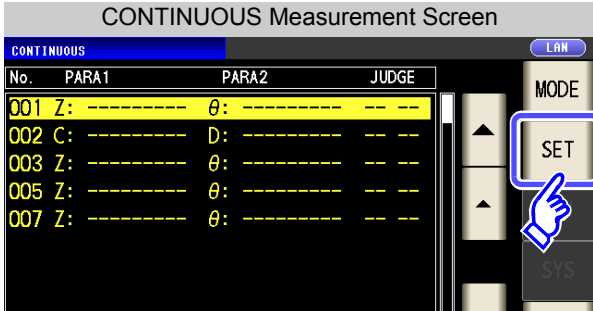
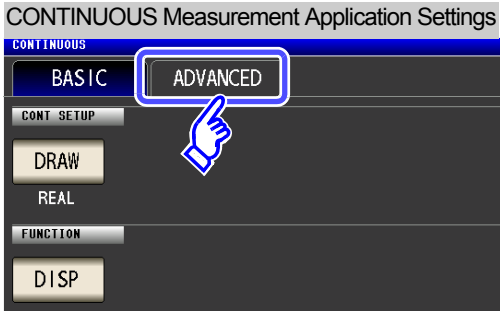
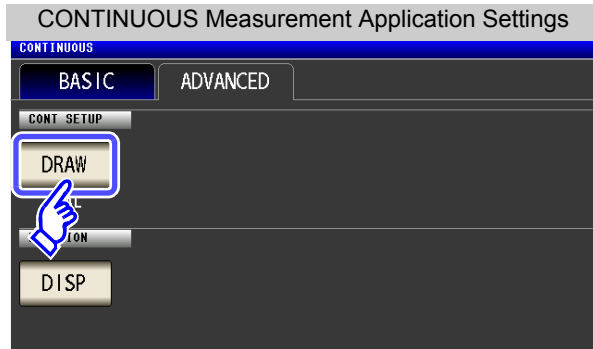
- 

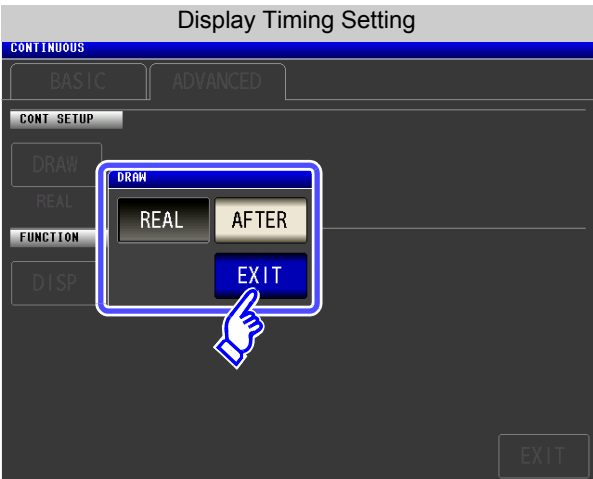
- 

Press **DRAW**.
- 

Set the timing for display.

REAL	Sequentially displays after measurement of each panel.
AFTER	Displays all after continuous measurement is finished.
- Press **EXIT** to close the setting screen.

7.5.2 Setting the LCD to ON/OFF

You can turn the LCD ON/OFF.

Setting the LCD to OFF saves power because the LCD turns off if the panel is not touched for 10 seconds.

Procedure

- 1** CONTINUOUS Measurement Screen

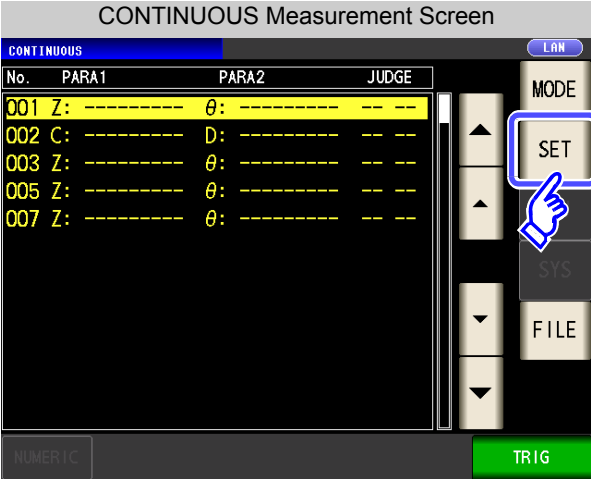

CONTINUOUS Measurement Application Settings

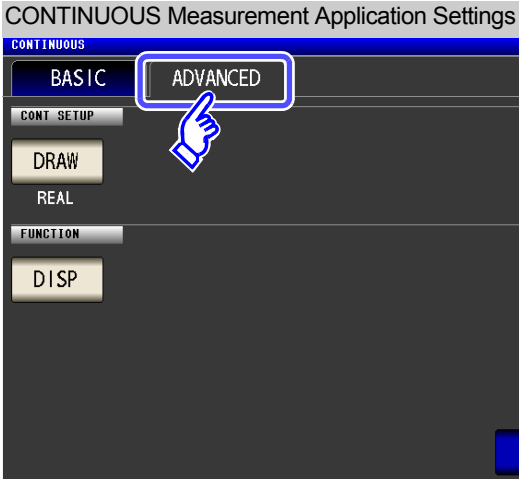
- 2** CONTINUOUS Measurement Application Settings

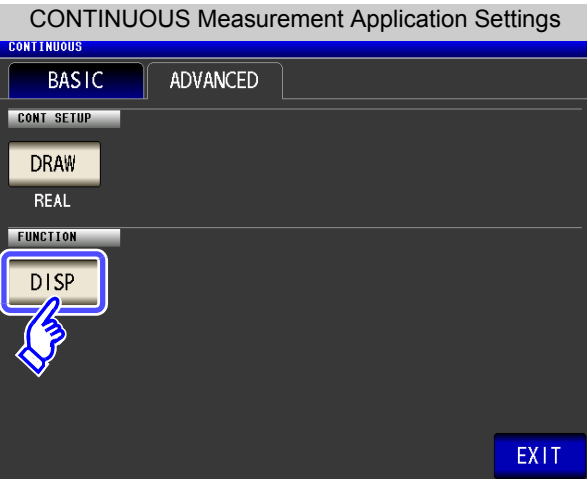

Press **DISP**.
- 3** LCD setting

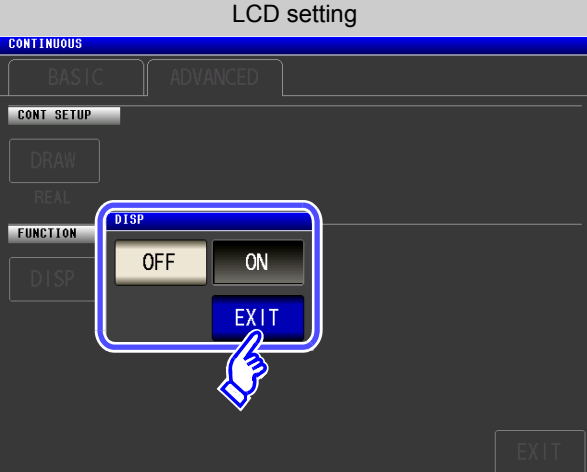

Select the LCD setting, and press **EXIT** to close the setting screen.

OFF Turns OFF the LCD. The LCD turns off after approximately 10 seconds elapse since the touch panel was last touched.

ON Sets the LCD to always on.

When you want to turn the backlight on again:
If you touch the touch panel while the backlight is off, the backlight will turn on again.

Error Compensation

Chapter 8

Compensate for errors caused by a fixture or measurement cable.

8.1 Setting Open Circuit Compensation

With open circuit compensation, it is possible to reduce the influence of the floating impedance of the test cables and thereby to enhance the accuracy of measurement. It is effective for test samples whose impedance is relatively high. The comparator decision mode can be set as one of the following:

All Compensation	▶	The compensation values are obtained for all test frequencies (p. 216). The range of measurement frequencies to compensate can be set. "Compensation range limitation function" (p. 218)
Spot Compensation	▶	The compensation values are obtained at the set measurement frequency only (p. 216).
OFF	▶	Open circuit compensation data becomes invalid (p. 223).

NOTE

- Before open circuit compensation, always set the cable length. [See](#) "8.4 Compensating Measurement Cable Errors (Cable Length Compensation)" (p. 245)
- The measurement accuracy values defined in the specifications are for when open circuit compensation and short circuit compensation are performed.
- Be sure to perform compensation again after replacing the measuring cable. You will be unable to obtain correct values if measurement is performed in the compensation state prior to replacement.
- For SPOT compensation, the open circuit compensation will be valid only when the measurement frequency agrees with the SPOT compensation frequency.
- When performing compensation, make sure that there is no noise source nearby. Noise may cause an error when performing compensation.
ex. Servo Motor, switching power source, high-voltage cable and etc.
- For SPOT compensation, the open circuit compensation will be valid only when the measurement frequency agrees with the SPOT compensation frequency.
- The compensated value is preserved in the memory of the main instrument even when power is turned off.
- If the setting of the low Z high accuracy mode is changed, the compensation value becomes invalid. Select the low Z high accuracy mode setting before compensation.

8.1 Setting Open Circuit Compensation

Before Performing Screen Operations

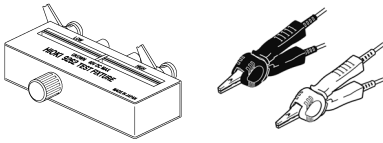

- Arrange the test leads as they will be when measurement will actually be performed. Changing the configuration of the leads may result in compensation not being performed properly.
- Create an open state between the HIGH terminals and LOW terminals of the probes or fixture in accordance with the width of the measurement object. (Connect H_{CUR} and H_{POT}, and connect L_{CUR} and L_{POT}.)
- In open compensation, be sure to perform guarding.
[See "Appendix2 Measurement of High Impedance Components"\(p. A3\)](#)

(When using optional 9500-10)

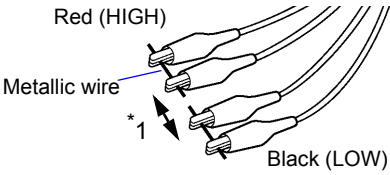

Short the probe's H_{CUR} and H_{POT} terminals (red) with one metallic wire and its L_{CUR} and L_{POT} terminals (black) with the other, so that there is no connection between the high and low terminals. Perform open correction.

*1: Leave the high and low terminals as far apart as they will be when connected to the measurement sample.

8.1.1 All Compensation

Simultaneously acquire the open compensation values for all measurement frequencies.

[See "To limit the compensation frequency range for all compensation" \(p. 218\)](#)

Procedure

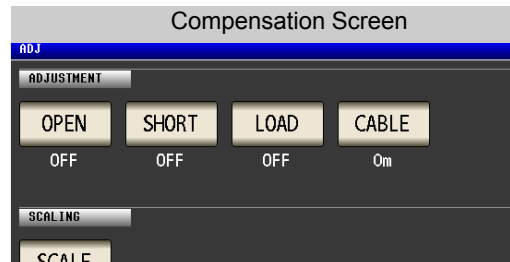
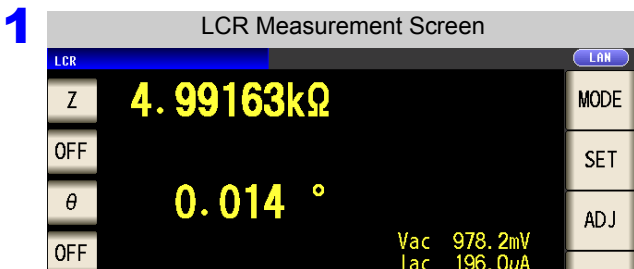

Press **ADJUST**.

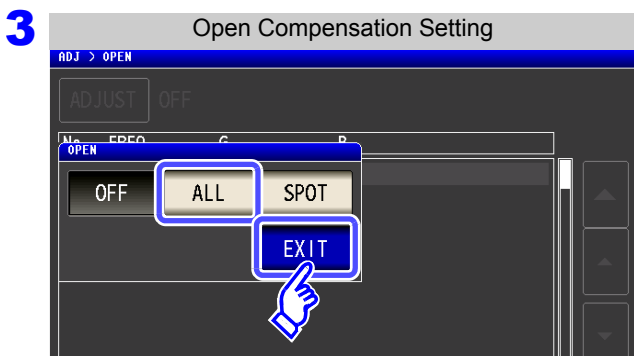

Select **ALL** and press **EXIT** to close the setting screen.

8.1 Setting Open Circuit Compensation

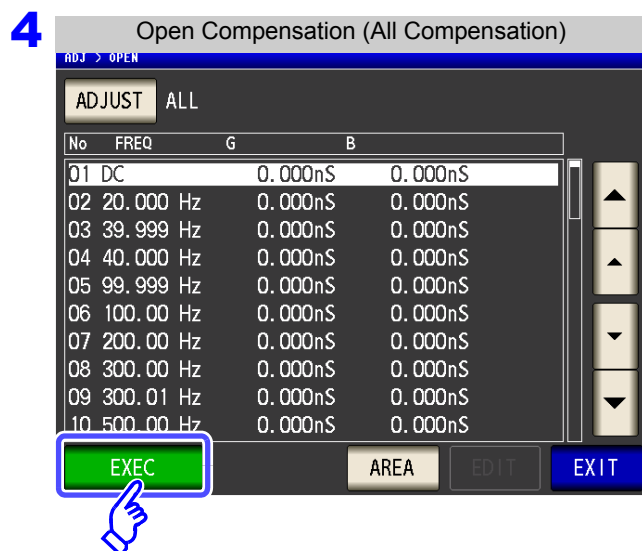

The compensation values from last time are displayed in a confirmation screen. (If compensation has never been performed, the compensation values become 0.)

Check that the measurement cable is in an open circuit state.

Press **EXEC**.

When you want to limit the compensation range: Press **AREA**.

See "Compensation range limitation function" (p. 218)

When you do not want to acquire the compensation values: Press **EXIT**.

The setting screen is redisplayed, and the compensation values from last time become valid.

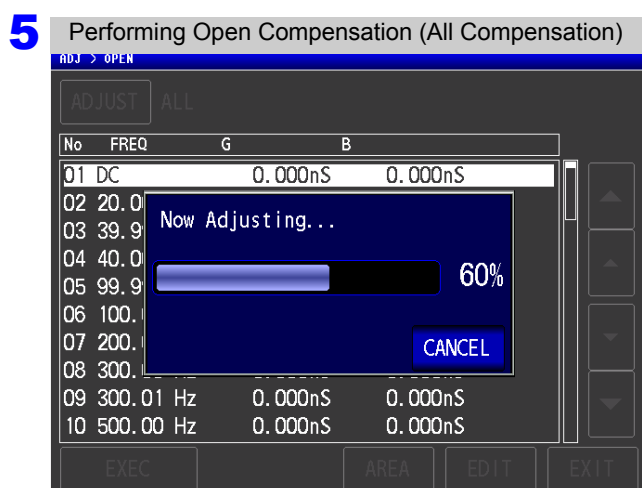

Compensation starts.

Compensation value acquisition time:
Approximately 45 seconds

When you want to cancel compensation:

Press **CANCEL**.

Compensation is cancelled and the compensation screen is redisplayed.

(The open circuit compensation value state from last time remains.)

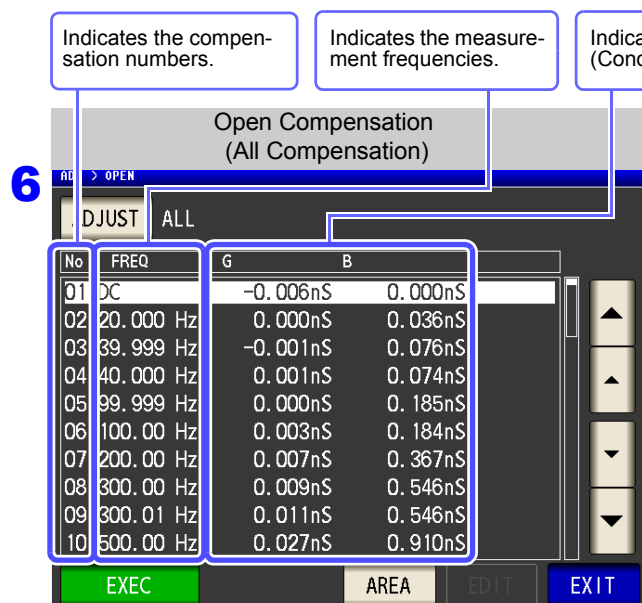

You can use **▲** and **▼** to check the Conductance, susceptance of each compensation point.

- If compensation ends normally, the conductance and susceptance are displayed.
- Compensation can be performed for impedances of at least 1 k Ω .

When unable to acquire normal compensation values: (p. 222)

When compensation failed: (p. 223)

When you want to disable open compensation data: (p. 223)

7 Press **EXIT** to close the setting screen.

8.1 Setting Open Circuit Compensation

Compensation range limitation function

In "ALL" compensation, compensation is performed for the entire frequency range. By setting the minimum and maximum compensation frequencies with this function, you can reduce the time required to perform the compensation process. The DC on/off setting as well as the compensation minimum and maximum frequency settings apply to both open and short compensation.

Procedure

1 Open Compensation (All Compensation)

No	FREQ	G	B
01	DC	0.000nS	0.000nS
02	20.000 Hz	0.000nS	0.000nS
03	39.999 Hz	0.000nS	0.000nS
04	40.000 Hz	0.000nS	0.000nS
05	99.999 Hz	0.000nS	0.000nS
06	100.00 Hz	0.000nS	0.000nS
07	200.00 Hz	0.000nS	0.000nS
08	300.00 Hz	0.000nS	0.000nS
09	300.01 Hz	0.000nS	0.000nS
10	500.00 Hz	0.000nS	0.000nS

Press **AREA** .

2 Compensation Range Limitation Setting

DC OFF ON

MIN MINIMUM

MAX MAXIMUM

RESET CANCEL SET

Turn DC open compensation on or off.

- OFF** Disables DC open compensation.
- ON** Enables DC open compensation.

When you want to revert settings to their default values: Press **RESET** .

When you want to cancel the setting: Press **CANCEL** .

3 Compensation Range Limitation Setting

DC OFF ON

MIN MINIMUM

MAX MAXIMUM

RESET CANCEL SET

Select the minimum and maximum compensation frequencies for open compensation.

- MIN** Sets the minimum compensation frequency for open compensation.
- MAX** Sets the maximum compensation frequency for open compensation.

8.1 Setting Open Circuit Compensation

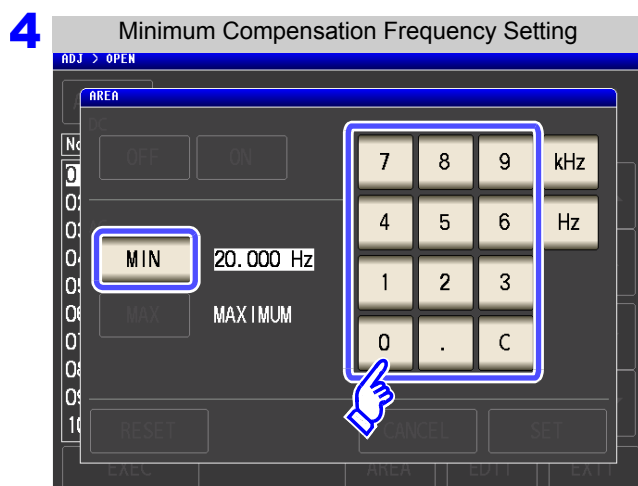

Press **MIN** .

- Settable range: 20.000 Hz to 200 kHz
- If you make a mistake during input: press **C** to cancel the input and start again.

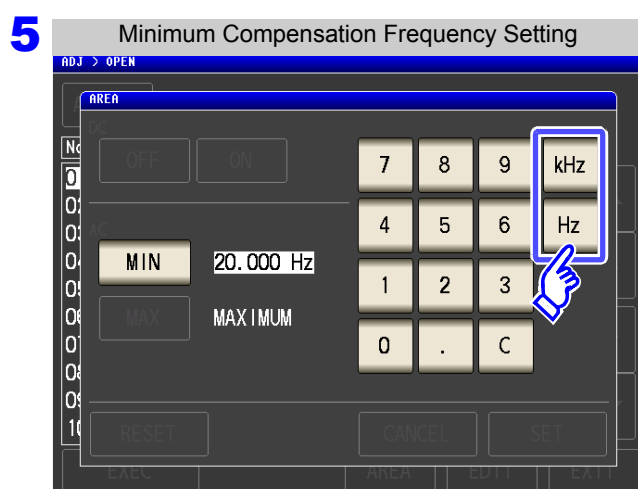

Press a instrument key to confirm the setting.

- The frequency is not confirmed until a instrument key is pressed.
- If you attempt to set a measurement frequency greater than 200 kHz, it will automatically be reduced to 200 kHz.
- If you attempt to set a measurement frequency lower than 20.000 Hz, it will automatically be increased to 20.000 Hz.

6 Return to **step 3**, touch **MAX** , and set the maximum compensation frequency.

7 Press **EXIT** to close the setting screen.

NOTE

- If the maximum compensation frequency is less than the minimum compensation frequency, the maximum and minimum compensation frequencies will be switched automatically.
- [MINIMUM] is displayed when the setting is 20.000 Hz, and [MAXIMUM] is displayed when the setting is 200 kHz.

8.1 Setting Open Circuit Compensation

8.1.2 Spot Compensation

Acquire the compensation values at the set measurement frequencies. Measurement frequencies can be set for up to five points.

Procedure

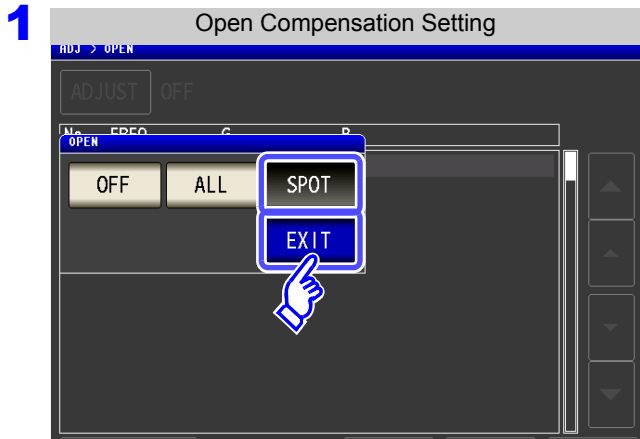

Select **SPOT** in the open circuit compensation screen, and press **EXIT** to confirm the selection.

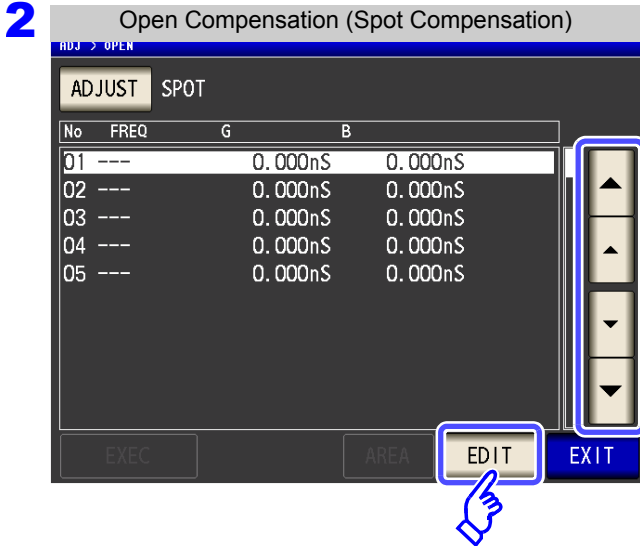

Use **▲** or **▼** to select the compensation point you want to set or edit, and press **EDIT**.

When you do not want to perform compensation: Press **EXIT**. Compensation is not performed and the compensation screen is redisplayed.

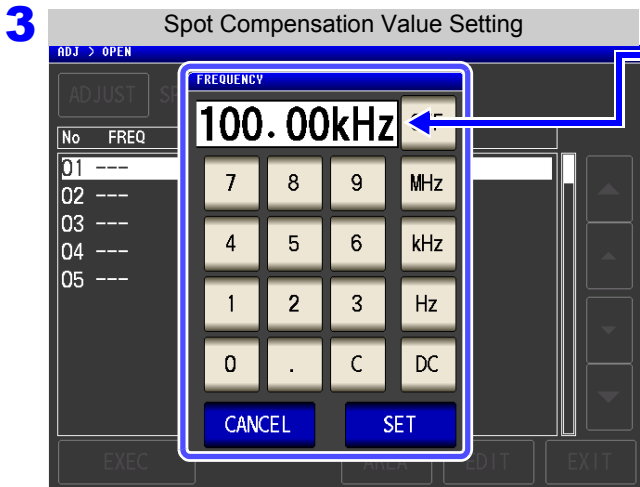

Until one of these keys is pressed for input of a numerical value, the previous frequency for which SPOT compensation was performed is displayed.

Use the numeric keypad to enter a frequency for compensation.

- Settable range: DC, 1 mHz to 200 kHz
- If a value in excess of 200 kHz is entered, the measurement frequency will automatically set to 200 kHz.
- If a frequency of less than 1 mHz is set, the value will be automatically changed to 1 mHz. However, very small values will cause the DC setting to be used.
- If you make a mistake during input: press **C** to cancel the input and start again.

4 Press **SET** to confirm the frequency for compensation.

8.1 Setting Open Circuit Compensation

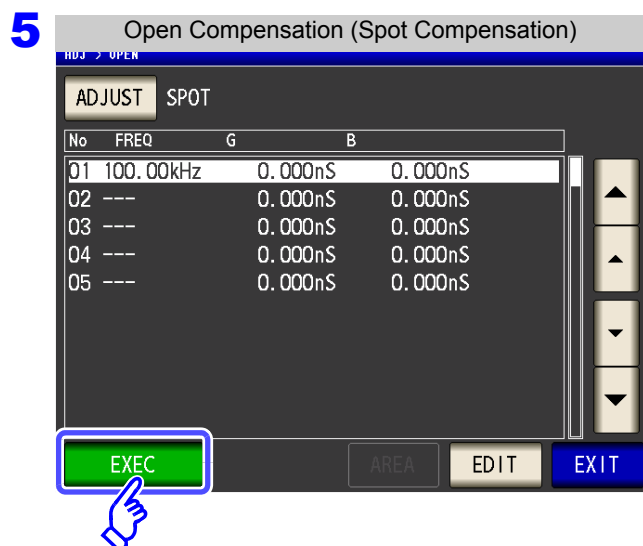

The compensation values from last time are displayed in a confirmation screen. (If compensation has never been performed, the compensation values become 0.)

Check that the measurement cable is in an open circuit state.

Press **EXEC**.

When you do not want to acquire the compensation values: Press **EXIT**.

The compensation screen is redisplayed, and the compensation values from last time become valid.

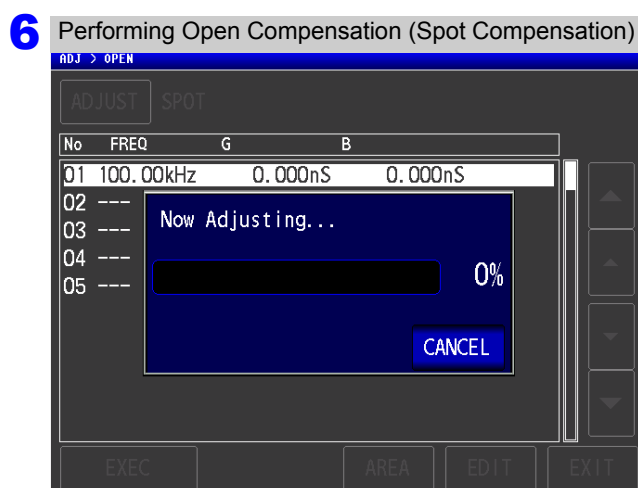

Compensation starts.

Compensation value acquisition time:
Varies with the measurement frequency and number of points.

When you want to cancel compensation:

Press **CANCEL**.

Compensation is cancelled and the compensation screen is redisplayed. (The open circuit compensation value state from last time remains.)

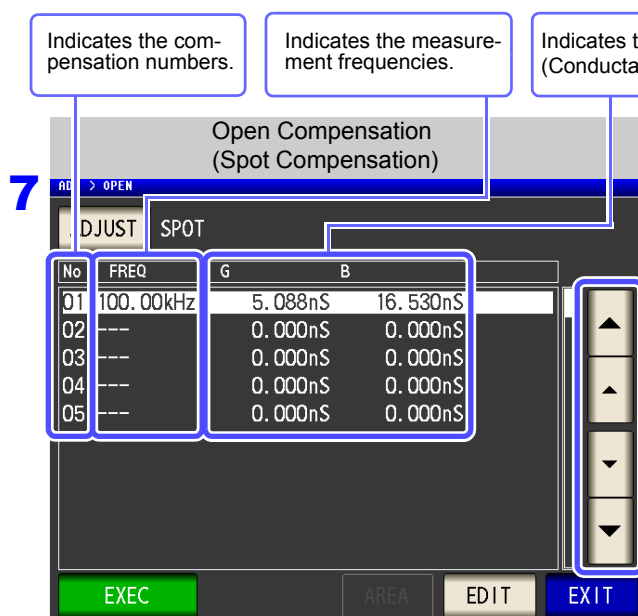

Indicates the compensation numbers.

Indicates the measurement frequencies.

Indicates the compensation results. (Conductance, susceptance)

You can use **▲** and **▼** to check the Conductance, susceptance of each compensation point.

- If compensation ends normally, the conductance and susceptance are displayed.
- Compensation can be performed for impedances of at least 1 k Ω .

When unable to acquire normal compensation values: (p. 222)

When compensation failed: (p. 223)

When you want to disable open compensation data: (p. 223)

8 Press **EXIT** to close the setting screen.

8.1 Setting Open Circuit Compensation

When Normal Compensation Values were Not Acquired

A window such as the following will be displayed if the instrument was unable to acquire normal compensation values. If this occurs, the acquired compensation values can be enabled by touching **EXIT**. However, those values are not guaranteed.

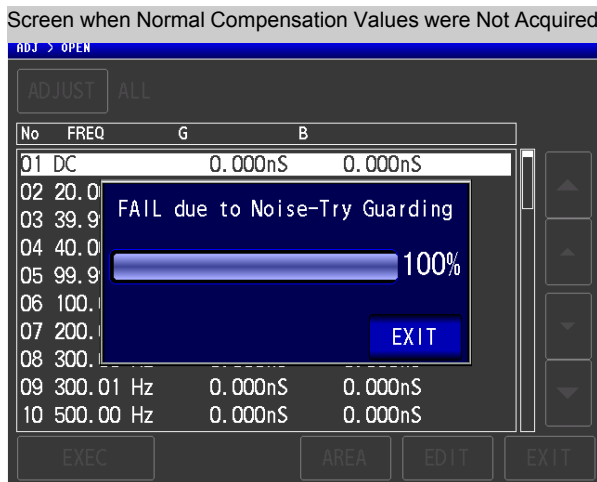

The open circuit compensation process is quite sensitive to noise - both noise originating externally and induced noise. Therefore, if open circuit compensation has been interrupted with a fault, you should check the following points before starting the compensation process again (p. 215):

- Check that the test cables are properly connected.
- Check that nothing is connected to the test cables. (Open circuit compensation cannot be performed while any test sample is connected to the test cables.)
- Check that the test leads are arranged as closely as possible to their configuration in which measurement will be performed.
- During the compensation process, be sure not to disturb the test cables or to move your hand near them.
- Execute the guarding process.

[See "Appendix2 Measurement of High Impedance Components"\(p. A3\)](#)

When Open Compensation Failed

A window such as the following will be displayed if the compensation process fails. If an error message is displayed and compensation canceled (if you touch **EXIT**), the instrument conditions revert to those before the compensation was attempted to be performed.

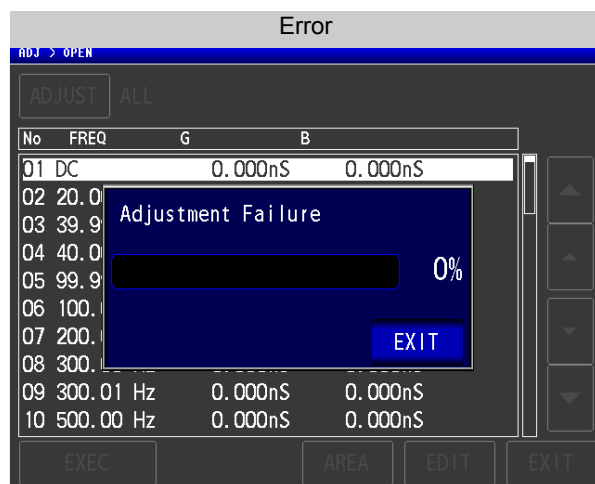

The open circuit compensation process is quite sensitive to noise - both noise originating externally and induced noise. Therefore, if open circuit compensation has been interrupted with a fault, you should check the following points before starting the compensation process again (p. 215):

- Check that the test cables are properly connected.
- Check that nothing is connected to the test cables. (Open circuit compensation cannot be performed while any test sample is connected to the test cables.)
- Check that the test leads are arranged as closely as possible to their configuration in which measurement will be performed.
- During the compensation process, be sure not to disturb the test cables or to move your hand near them.
- Execute the guarding process.
[See "Appendix2 Measurement of High Impedance Components"\(p. A3\)](#)

When You Want to Make Open Circuit Compensation Data Invalid

Select **OFF** in **step 3** of [Open Compensation Setting] (p. 216) and touch **EXIT** to disable the acquired compensation data.

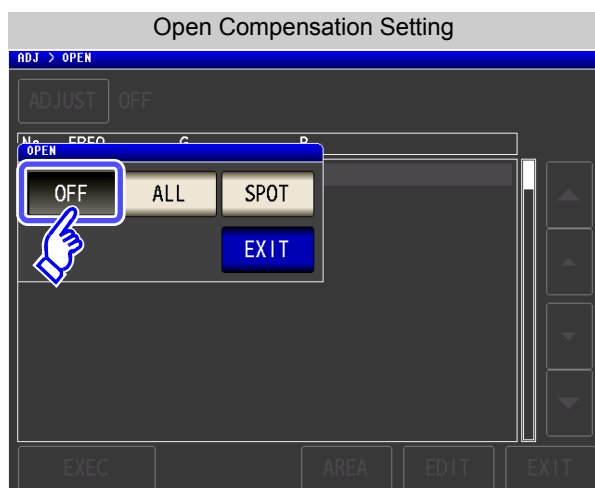

NOTE

The compensation values that are stored internally are not cleared by the operation described above. When ALL or SPOT is selected, the stored compensation values can be used.

8.2 Short Circuit Compensation

With short circuit compensation, it is possible to reduce the influence of the residual impedance of the test cables and thereby to enhance the accuracy of measurement.

It is effective for test samples whose impedance is relatively low.

The comparator decision mode can be set as one of the following:

All Compensation

Compensation values are obtained for all test frequencies (p. 226). The range of measurement frequencies to compensate can be set. "Compensation range limitation function" (p. 218)

Spot Compensation

Compensation values are obtained at the set measurement frequency only (p. 228).

OFF

Short circuit compensation data becomes invalid (p. 231).

NOTE

- Before short circuit compensation, always set the cable length.
See: "8.4 Compensating Measurement Cable Errors (Cable Length Compensation)" (p. 245)
- The measurement accuracy values defined in the specifications are for when open circuit compensation and short circuit compensation are performed.
- Be sure to perform compensation again after replacing the measuring cable.
 You will be unable to obtain correct values if measurement is performed in the compensation state prior to replacement.
- For spot compensation, short circuit compensation will be valid only when the measurement frequency and spot compensation frequency match.
- When performing compensation, make sure that there is no noise source nearby. Noise may cause an error when performing compensation.
 ex. Servo Motor, switching power source, high-voltage cable and etc.
- For SPOT compensation, the open circuit compensation will be valid only when the measurement frequency agrees with the SPOT compensation frequency.
- The compensated value is preserved in the memory of the main instrument even when power is turned off.
- If the setting of the low Z high accuracy mode is changed, the compensation value becomes invalid. Select the low Z high accuracy mode setting before compensation.

Before Performing Screen Operations

Necessary item: Shorting bar

This shorting bar is for short circuiting together the ends of the test leads. Use an object whose impedance is as low as possible.

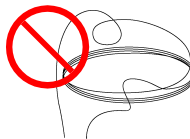
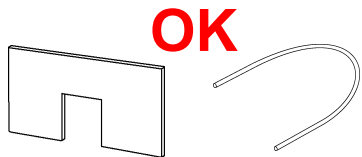

If you use a metallic wire or the like as a shorting bar, try to ensure that it is as thick and short as possible.

Usage example:

Arrange the test leads as closely as possible to their configuration in which measurement will be performed, and short circuit together the HIGH and LOW leads.

(When using the optional 9140-10)

If you intend to short circuit between the clamps at the ends of the test leads, clip both clamps onto a short piece of metallic wire as shown. When using the 9140-10, please pinch the short wire with both clips. A short circuit state can not be created by pinching clip each other.

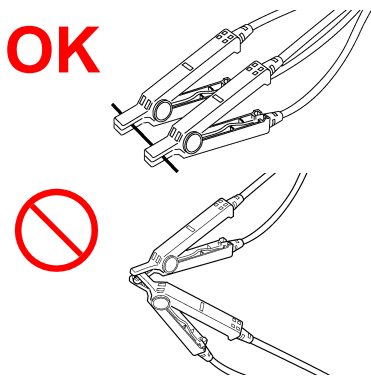

(When using a fixture)

In order to keep external influences as low as possible, be sure to thrust the shorting bar in all the way.

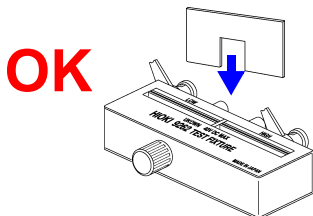

(When using optional L2000)

Short-circuit the tips with the **V** marks on the clips aligned as shown in the diagram, and then perform short compensation.

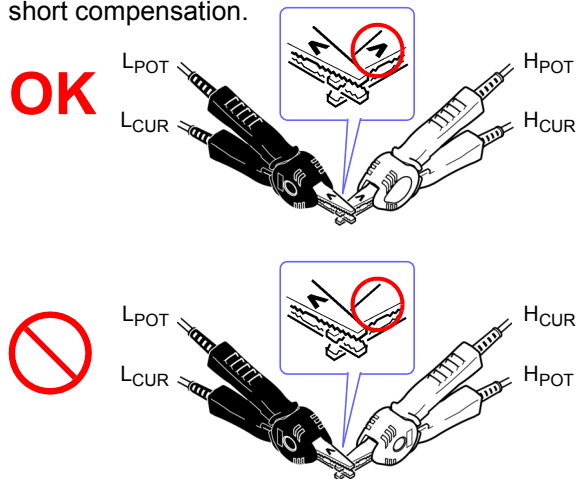

(When using optional 9500-10)

Pinch the clips onto a short metallic wire in the order of H_{CUR}, H_{POT}, L_{POT}, and L_{CUR} so that all the terminals are shorted, and then perform open correction.

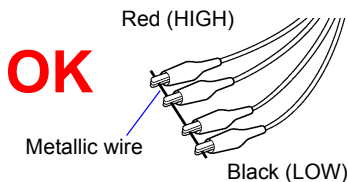

8.2.1 All Compensation

Simultaneously acquire the short compensation values for all measurement frequencies.

See "To limit the compensation frequency range for all compensation" (p. 218)

Procedure

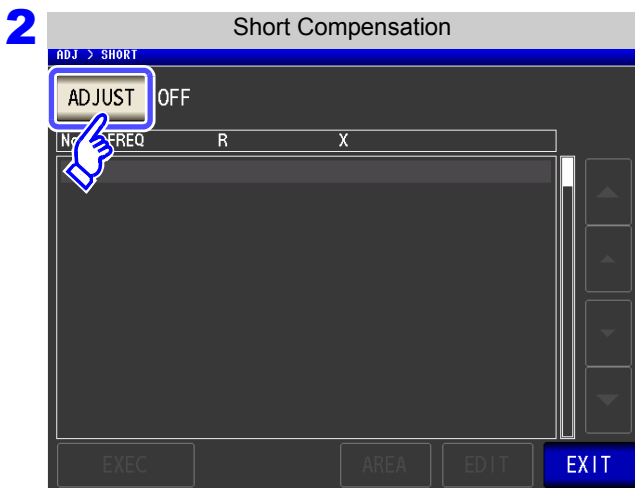
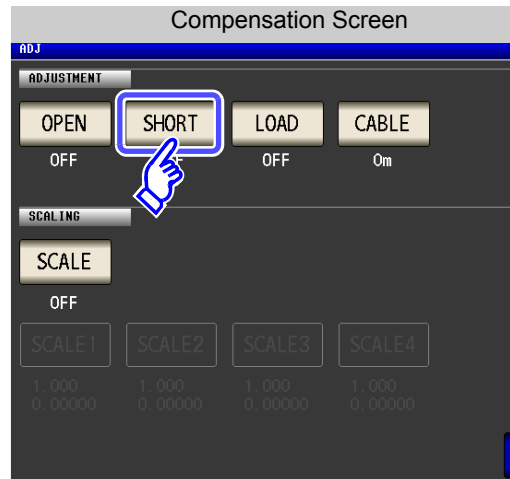
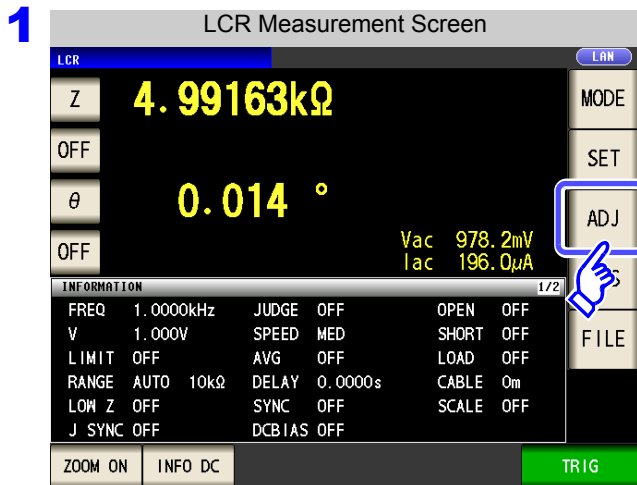

Press **ADJUST**.

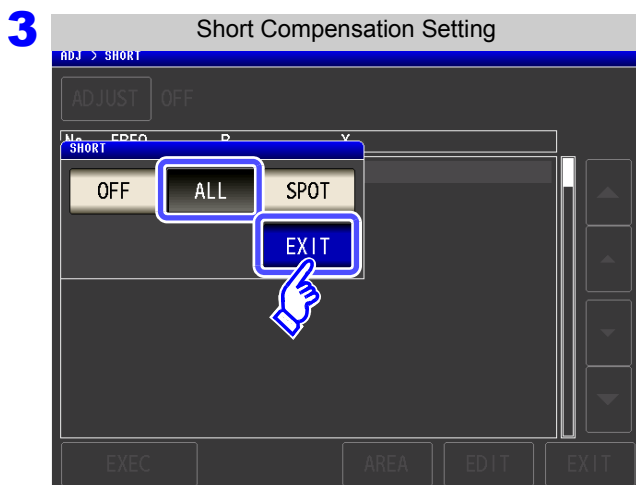

Select **ALL** and press **EXIT** to close the setting screen.

8.2 Short Circuit Compensation

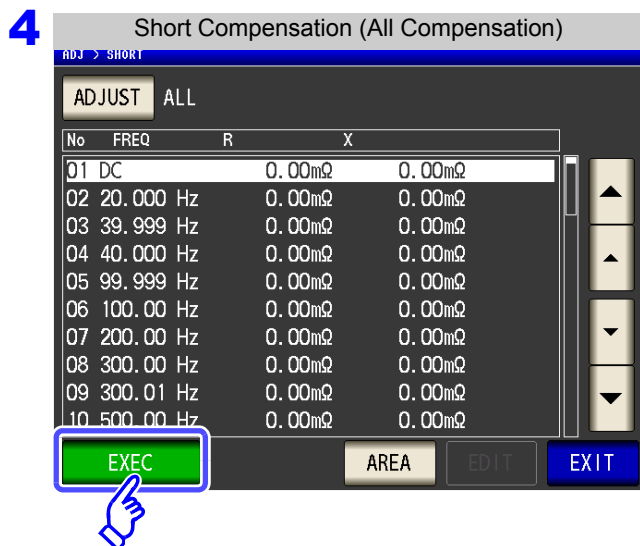

The compensation values from last time are displayed in a confirmation screen. (If compensation has never been performed, the compensation values become 0.)

Check that the measurement cable is in a short-circuit state.

Press **EXEC**.

When you want to limit the compensation range: Press **AREA**.

See "Compensation range limitation function" (p. 218)

When you do not want to acquire the compensation values: Press **EXIT**.

The setting screen is redisplayed, and the compensation values from last time become valid.

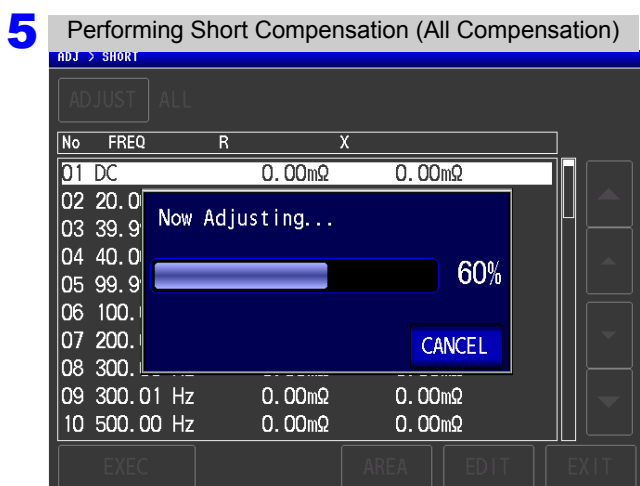

Compensation starts.

Compensation value acquisition time:
Approximately 45 seconds

When you want to cancel compensation:

Press **CANCEL**.

Compensation is cancelled and the compensation screen is redisplayed. (The short circuit compensation values from last time remain.)

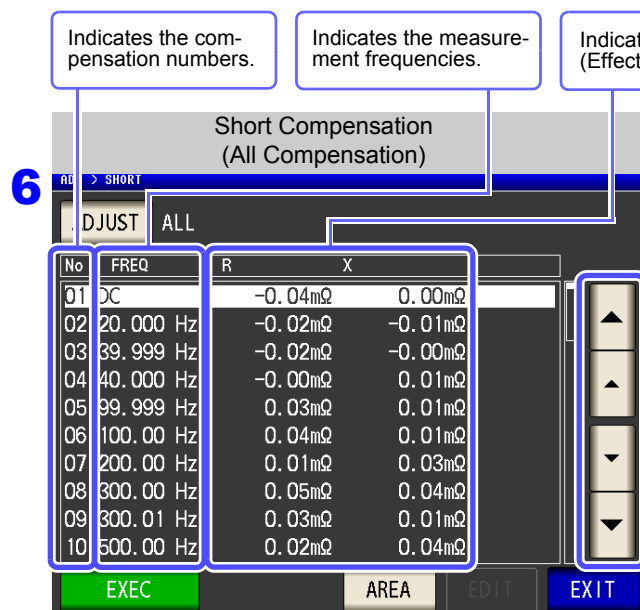

Indicates the compensation numbers.

Indicates the measurement frequencies.

Indicates the compensation results. (Effective resistance, reactance)

Use **▲** or **▼** to check the effective resistance and reactance of each compensation point.

- If compensation ends normally, the effective resistance and reactance are displayed.
- The possible compensation range is 1 kΩ or less for impedance.

When unable to acquire normal compensation values: (p. 230)

When compensation failed: (p. 230)

When you want to disable open compensation data: (p. 230)

7 Press **EXIT** to close the setting screen.

8.2 Short Circuit Compensation

8.2.2 Spot Compensation

Acquire the compensation values at the set measurement frequencies. Measurement frequencies can be set for up to five points.

Procedure

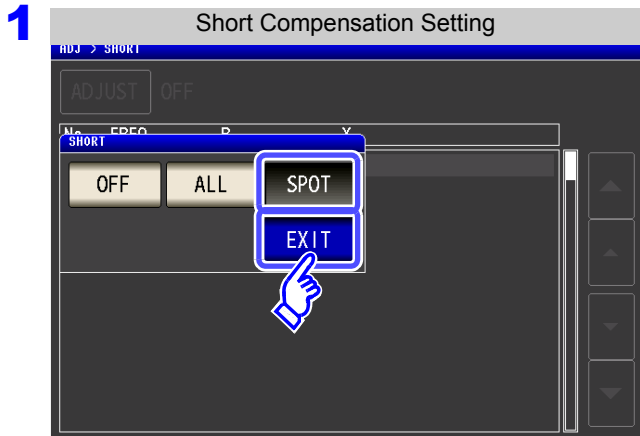

Select **SPOT** in the short circuit compensation screen, and press **EXIT** to confirm the selection.

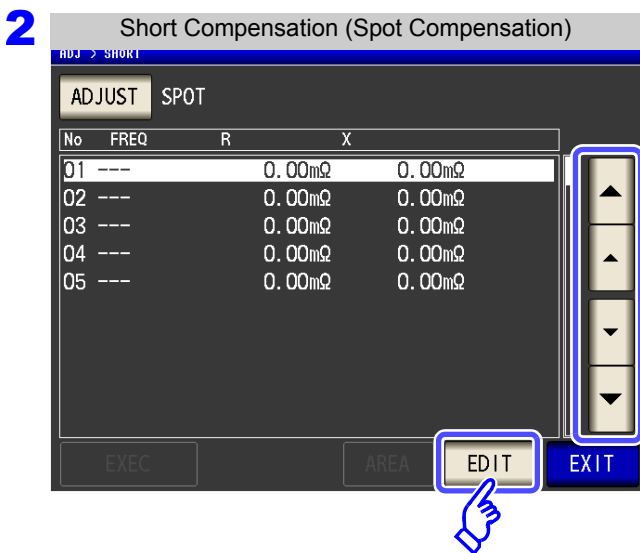

Use **▲** or **▼** to select the compensation point you want to set or edit, and then press **EDIT**.

When you do not want to perform compensation: Press **EXIT**. Compensation is not performed and the compensation screen is redisplayed.

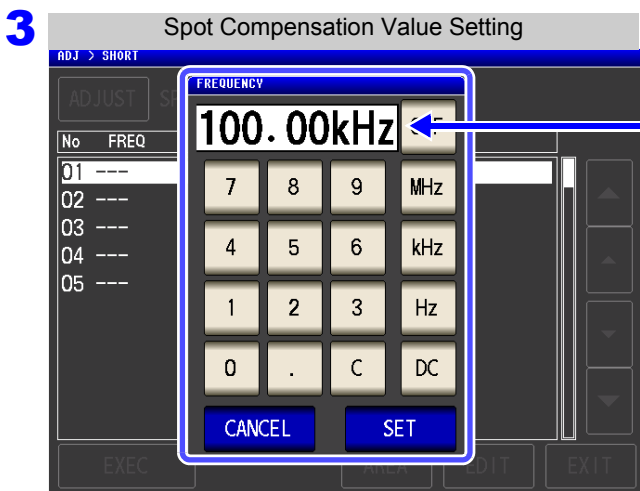

Until one of these keys is pressed for input of a numerical value, the previous frequency for which SPOT compensation was performed is displayed.

Use the numeric keypad to enter a frequency for compensation.

- Settable range: DC, 1 mHz to 200 kHz
- If a value in excess of 200 kHz is entered, the measurement frequency will automatically set to 200 kHz.
- If a frequency of less than 1 mHz is set, the value will be automatically changed to 1 mHz. However, very small values will cause the DC setting to be used.
- If you make a mistake during input: press **C** to cancel the input and start again.

4 Press **EXIT** to confirm the frequency for compensation.

8.2 Short Circuit Compensation

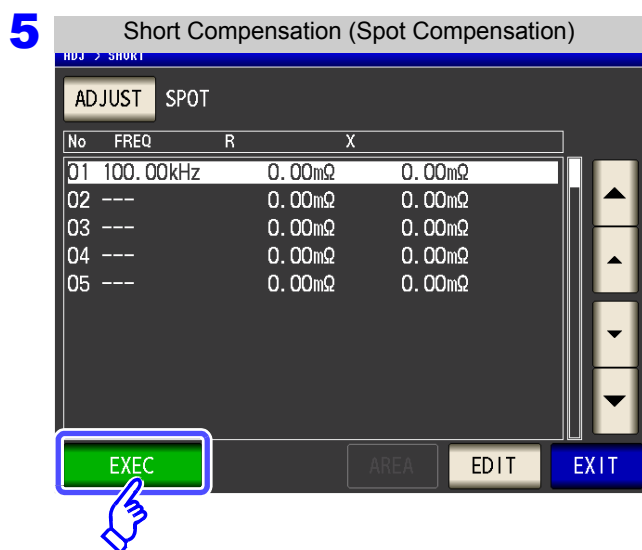

The compensation values from last time are displayed in a confirmation screen. (If compensation has never been performed, the compensation values become 0.)

Check that the measurement cable is in a short-circuit state.

Press **EXEC**.

When you do not want to acquire the compensation values: Press **EXIT**.

The compensation screen is redisplayed, and the compensation values from last time become valid.

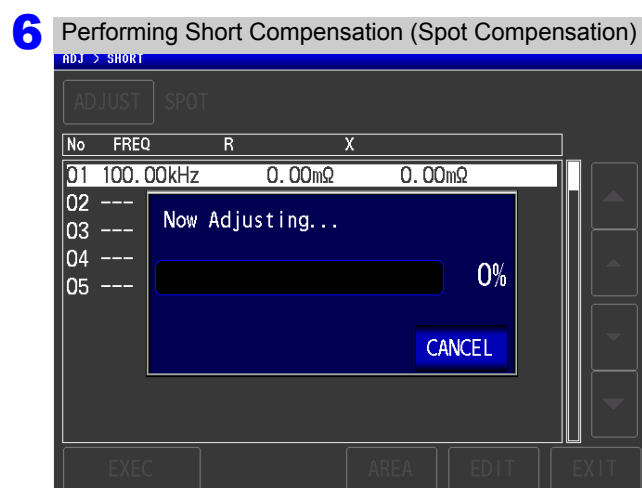

Compensation starts.

Compensation value acquisition time:
Varies with the measurement frequency and number of points.

When you want to cancel compensation:

Press **CANCEL**.

Compensation is cancelled and the compensation screen is redisplayed. (The short circuit compensation values from last time remain.)

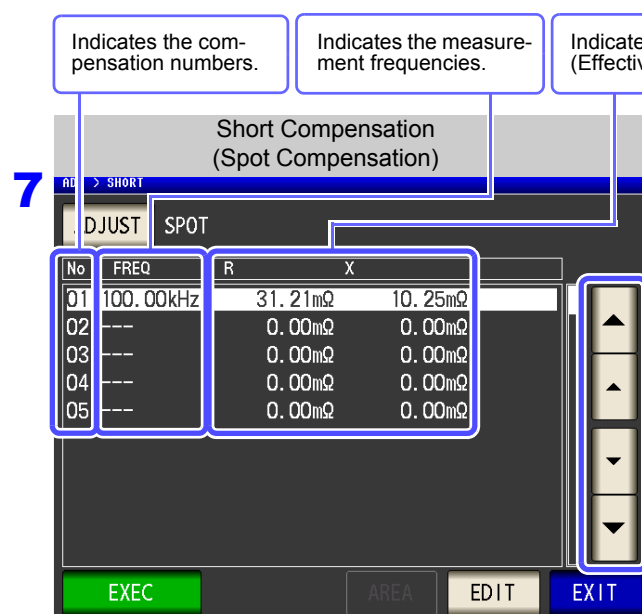

Indicates the compensation numbers.

Indicates the measurement frequencies.

Indicates the compensation results. (Effective resistance, reactance)

Use **▲** or **▼** to check the effective resistance and reactance of each compensation point.

- If compensation ends normally, the effective resistance and reactance are displayed.
- The valid compensation range for impedance is 1 kΩ or less.

When you want to disable open compensation data: (p. 230)

When compensation failed: (p. 230)

When you want to disable open compensation data: (p. 230)

8 Press **EXIT** to close the setting screen.

8.2 Short Circuit Compensation

When Normal Compensation Values were Not Acquired

A window such as the following will be displayed if the instrument was unable to acquire normal compensation values. If this occurs, the acquired compensation values can be enabled by touching **EXIT**. However, those values are not guaranteed.

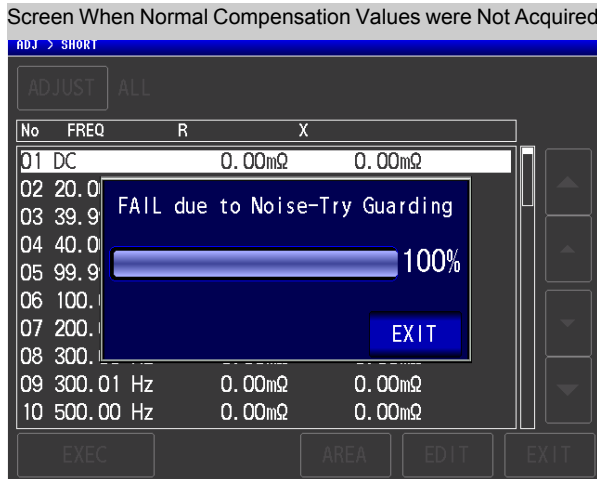

Check the following points before starting the short circuit compensation process again (p. 225):

- Check that the test cables are properly connected.
- Check that the test cables are properly shorted together with the shorting bar. (Short circuit compensation cannot be performed while any test sample is connected to the test cables.)
- Check that the test leads are arranged as closely as possible to their configuration in which measurement will be performed.
- During the compensation process, be sure not to disturb the test cables or to move your hand near them.

When Short Compensation Failed

A window such as the following will be displayed if the compensation process fails. If an error message is displayed and compensation canceled (if you touch **EXIT**), the instrument conditions revert to those before the compensation was attempted to be performed.

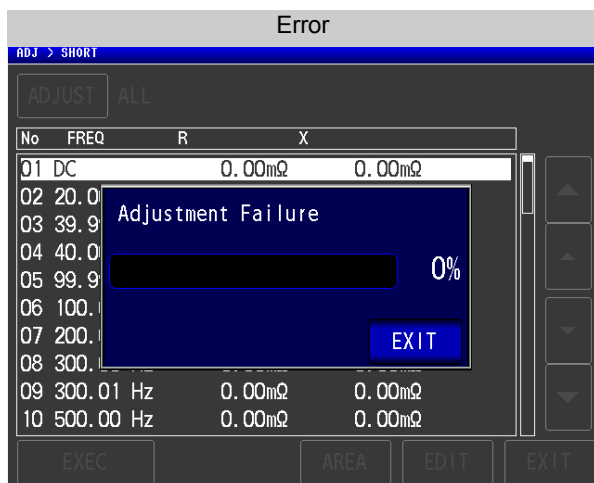

Check the following points before starting the short circuit compensation process again (p. 225):

- Check that the test cables are properly connected.
- Check that the test cables are properly shorted together with the shorting bar. (Short circuit compensation cannot be performed while any test sample is connected to the test cables.)
- Check that the test leads are arranged as closely as possible to their configuration in which measurement will be performed.
- During the compensation process, be sure not to disturb the test cables or to move your hand near them.

When You Want to Make Short Circuit Compensation Data Invalid

Select **OFF** in **step 3** of [Short Compensation Setting] (p. 226) and touch **EXIT** to disable the acquired compensation data.

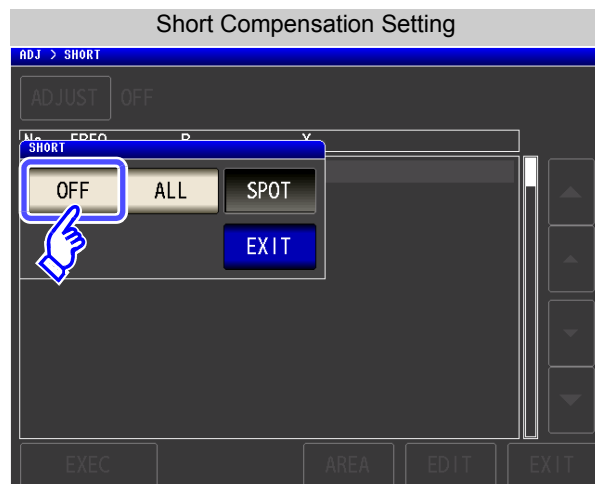

NOTE The compensation values that are stored internally are not cleared by the operation described above. When ALL or SPOT is selected, the stored compensation values can be used.

8.3 Compensating Values to Match Reference Values (Load Compensation)

Compensate measurement values to match the element that will be the reference. With load compensation it is possible to calculate the compensation coefficient by measuring a reference sample with known data and perform the compensation for the test data obtained from the target sample. The compensation coefficient can be acquired using up to five compensation conditions. The reference value of each compensation condition can be set independently.

The following seven items should be set for one compensation condition.

The screenshot shows the 'RDJ > LOAD > No. 1' menu with the following settings:

- CONDITION:** FREQ (1.0000kHz), RANGE (10kΩ), LEVEL (1.000V), DC BIAS (OFF)
- REFERENCE:** MODE (Z -θ), REF1 (---), REF2 (---)

Buttons at the bottom include RESET, GET, CANCEL, and SET.

Callouts for the settings:

- FREQ Compensation Frequency:** Define the measurement frequency used to measure and compensate the reference sample. (p. 237)
- RANGE Compensation Range:** Set the range to compensate. (p. 238)
- LEVEL Compensation Signal Level:** Set the type and value of the measurement signal mode to compensate. (p. 239)
- DC BIAS DC Bias:** Enable or disable DC bias and set the value. (p. 240)
- MODE Parameter Type:** Set the parameter to use as the reference value. (p. 241)
- REF1 Reference Value 1:** Set the Z/ Cs/ Cp/ Ls/ Lp/ Rs reference value selected for the parameter type (p. 242).
- REF2 Reference Value 2:** Set the θ/ D/ Rs/ Rp/ Q/ X reference value selected for the parameter type (p. 242).

Callouts for the buttons:

- RESET:** Deletes the compensation conditions (p. 243).
- GET:** Loads the current measurement conditions as compensation conditions (p. 243).

The compensation coefficient is computed from the reference values of Z and θ obtained from the set values and the actual data acquired from the reference sample at each of the compensation frequencies.

$$\text{Compensation coefficient of } Z = \frac{(\text{Reference value of } Z)}{(\text{Actual data of } Z)}$$

$$\text{Compensation value of } \theta = (\text{Reference value of } \theta) - (\text{Actual data of } \theta)$$

The measured values of Z and θ are first compensated using the following equations, and then individual parameters from the compensated Z and θ values are employed.

$$Z = (Z \text{ before compensation}) \times (\text{Compensation coefficient of } Z)$$

$$\theta = (\theta \text{ before compensation}) + (\text{Compensation value of } \theta)$$

8.3 Compensating Values to Match Reference Values (Load Compensation)

NOTE

- Be sure to set the cable length before performing load compensation. See "8.4 Compensating Measurement Cable Errors (Cable Length Compensation)" (p. 245)
- Set the compensation condition of the load compensation same as the present measurement condition. If they do not match, no load compensations are performed.
- If the current measurement frequency and compensation frequency do not match, an error such as the following will be displayed on the Measurement screen, and compensation will be canceled.

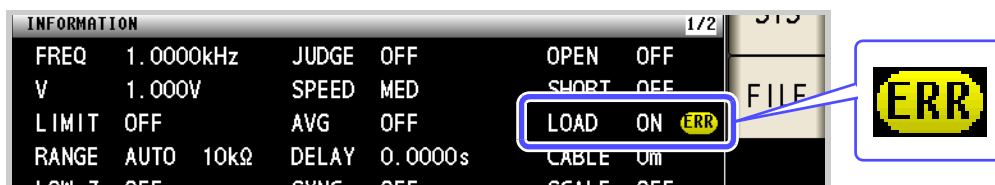

- If a condition other than the compensation frequency does not match, compensation is performed but an error like the following is displayed in the measurement screen.

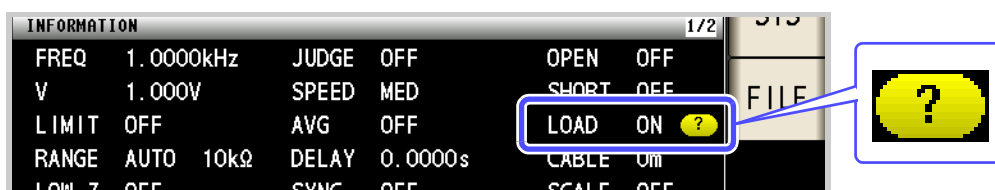

- When the OPEN or SHORT compensation is valid, the load compensation is performed for Z and θ processed by the OPEN or SHORT compensation.
- In acquiring load compensation data (i.e., reference sample measurement), the OPEN/SHORT compensation settings, that were defined before entry into the Load Compensation Screen, are valid.
- If the setting of the low Z high accuracy mode is changed, the compensation value becomes invalid.
- If the same compensation frequency is set for multiple compensation points, only the compensation point with the lowest number of the compensation conditions will become effective.
- No LOAD compensation can be executed in ANALYZER mode.

8.3 Compensating Values to Match Reference Values (Load Compensation)

Procedure

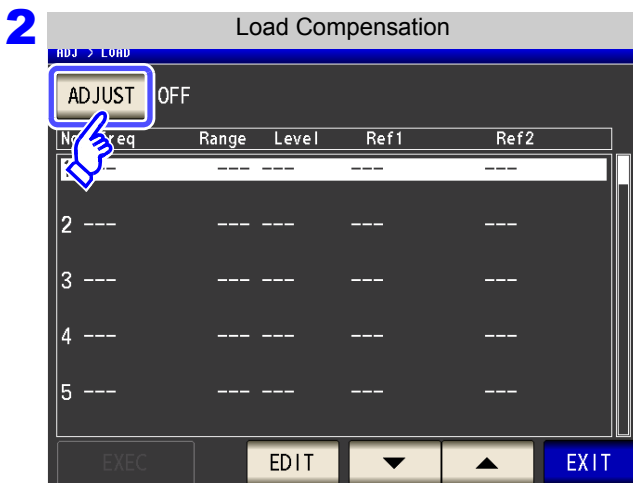
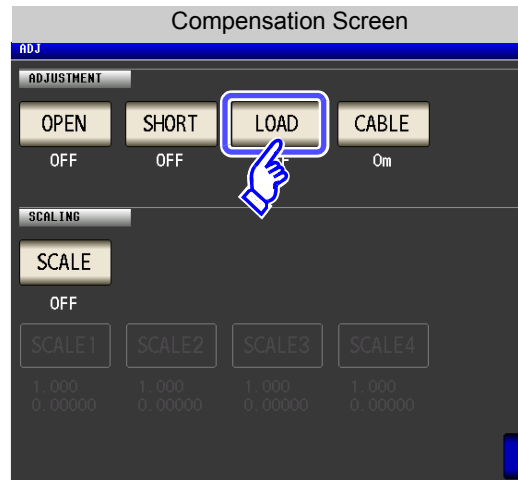
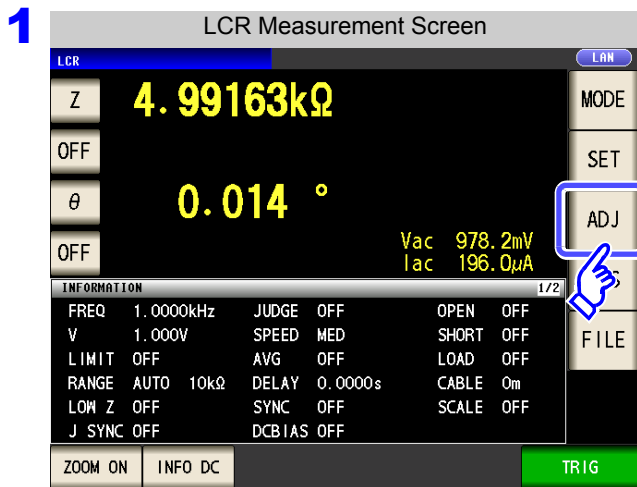

Press **ADJUST**.

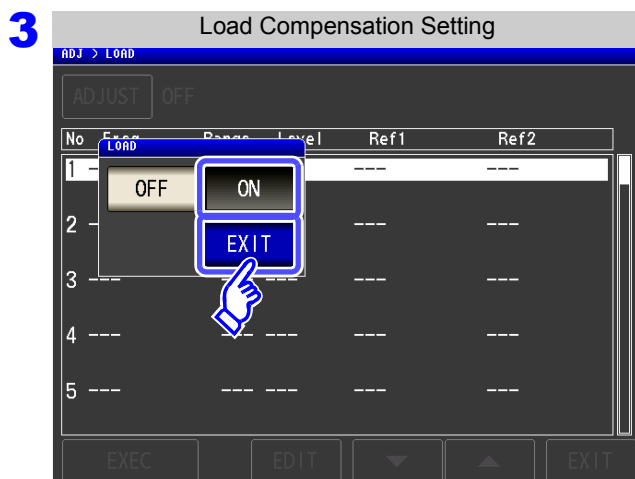

Select **ON**, and press **EXIT** to confirm the selection.

8.3 Compensating Values to Match Reference Values (Load Compensation)

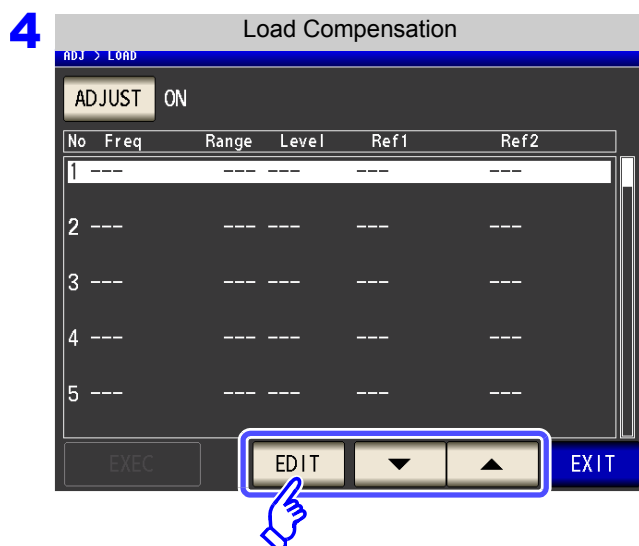

Use or to select the number of the load compensation condition to set.

Press .

5 Set the compensation condition.

- Compensation frequency (p. 237)
- Compensation range (p. 238)
- measurement signal mode and value of the compensation level (p. 239)
- DC bias (p. 240)
- Parameter to use for reference value (p. 241)
- Reference value (p. 242)

- Compensation cannot be performed if all settings have not been configured.
- When you want to use the current measurement conditions as the load compensation conditions: (p. 243)

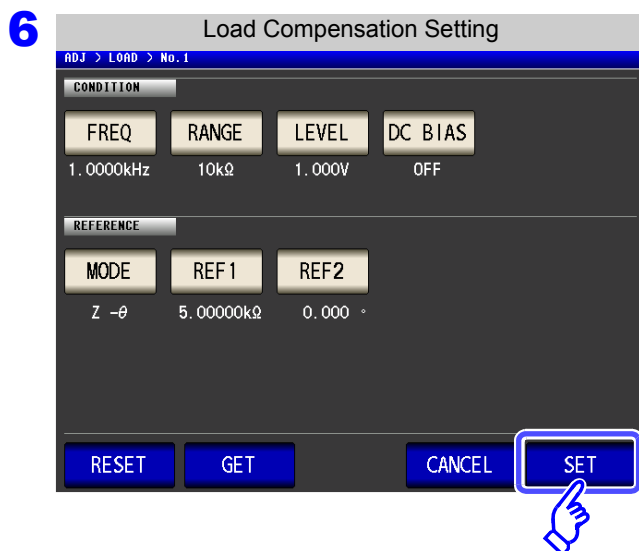

Press to confirm the compensation conditions.

The load compensation screen is redisplayed.

Attach the reference sample to the test fixtures and connect it to the measurement cables.

When you want to cancel compensation:

Press .

The compensation conditions are discarded and the load compensation screen is redisplayed.

8.3 Compensating Values to Match Reference Values (Load Compensation)

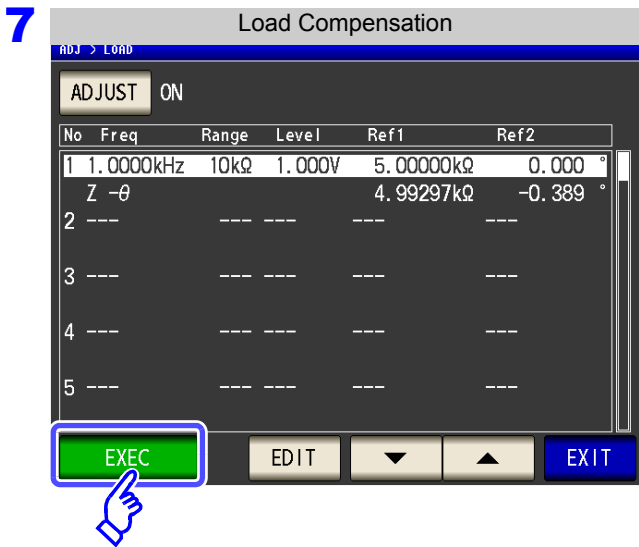

Press **EXEC**, the compensation values are acquired.

- When data acquisition is completed, the reference sample compensation data is displayed on the screen.
- When an error occurs during data acquisition, a “beep” sound is generated and the compensation data is invalidated (p. 244).
- If even one of the load compensation conditions is changed following data acquisition, the acquired compensation data is invalidated.

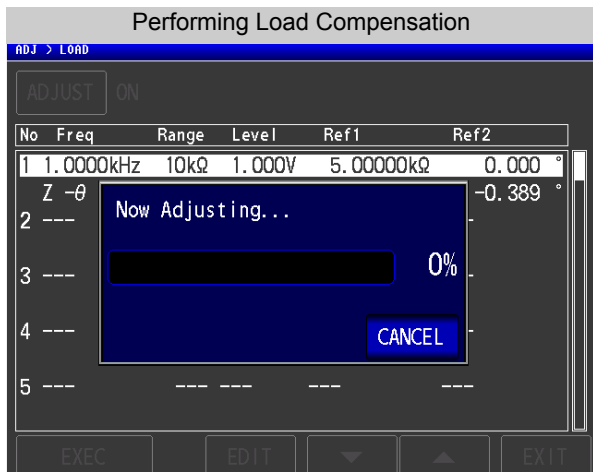

Compensation starts.

Compensation value acquisition time:
Varies with the measurement frequency and number of points.

When you want to cancel compensation data acquisition: Press **CANCEL**.

When compensation failed: (p. 244)

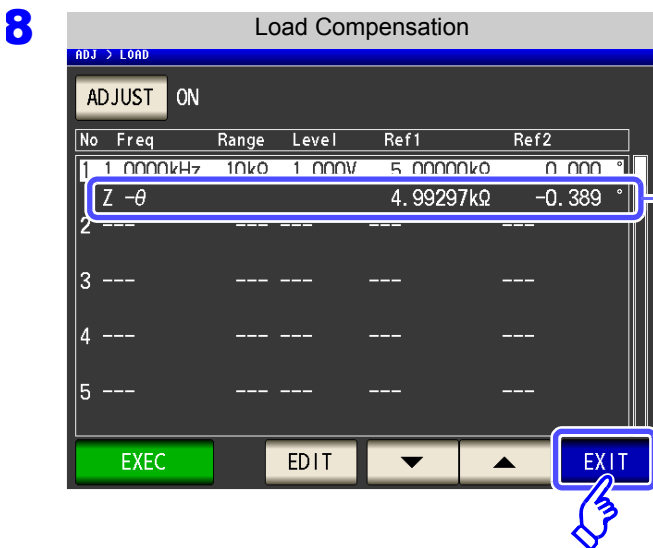

When acquisition of the compensation value is completed, the compensation value is displayed.

Press **EXIT** from the load compensation screen to return to the measurement screen.

When you want to disable load compensation: (p. 244)

8.3 Compensating Values to Match Reference Values (Load Compensation)

9

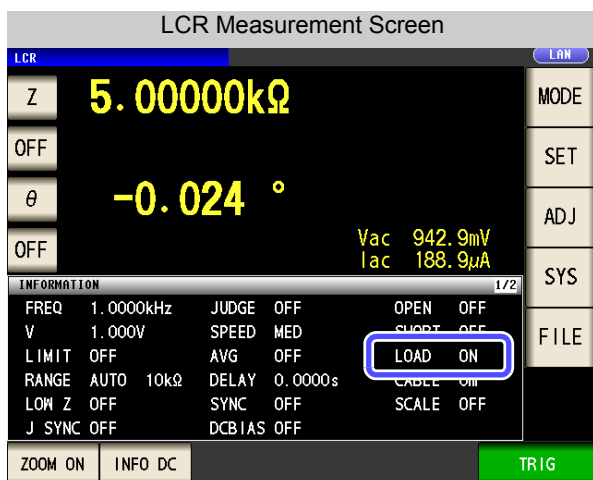

When the load compensation is valid for the set measurement conditions, ON appears on the LOAD parameter in the measurement Screen.

When the same compensation frequency has been set to multiple load compensation groups, only the group with the smallest number will be valid.

When the current measurement frequency does not agree with the load compensation frequency, the load compensation will be invalid and ON will not appear.

FREQ Set the compensation frequency.

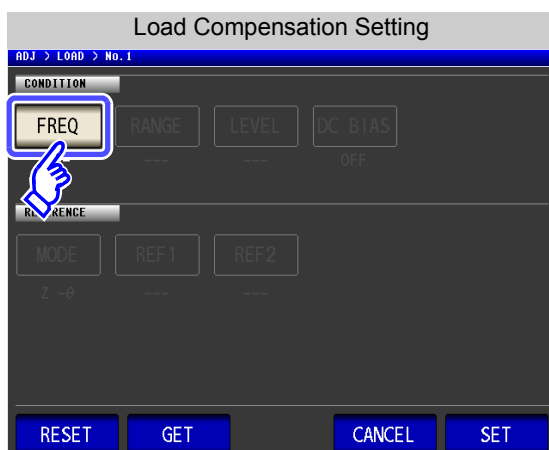

1. Press **FREQ**.

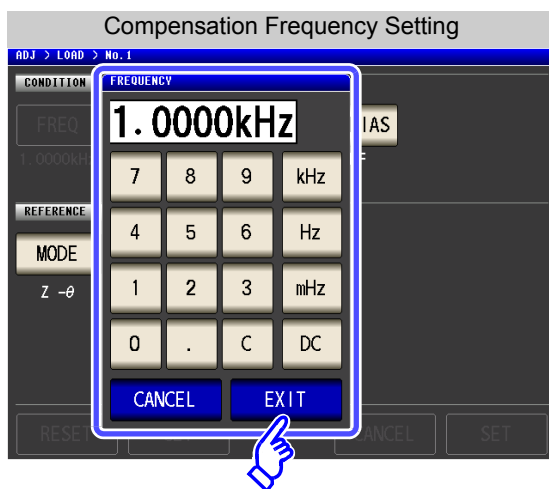

2. Use the numeric keypad to enter the compensation frequency.

Settable range: DC, 1 mHz to 200 kHz

3. Press a instrument key to confirm the setting.

4. Press **EXIT** to close the setting screen.

- When performing load compensation for DC resistance measurement: Press **DC**.
- If you make a mistake during input:
press **C** to cancel the input and start again.
- When you want to cancel input:
Press **CANCEL** to close the compensation frequency setting screen.

8.3 Compensating Values to Match Reference Values (Load Compensation)

RANGE

Setting the Compensation Range

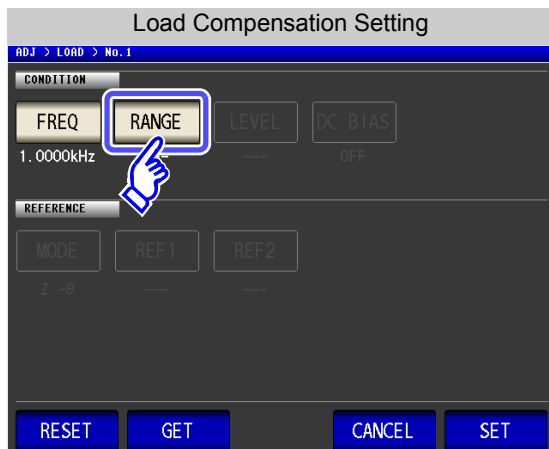
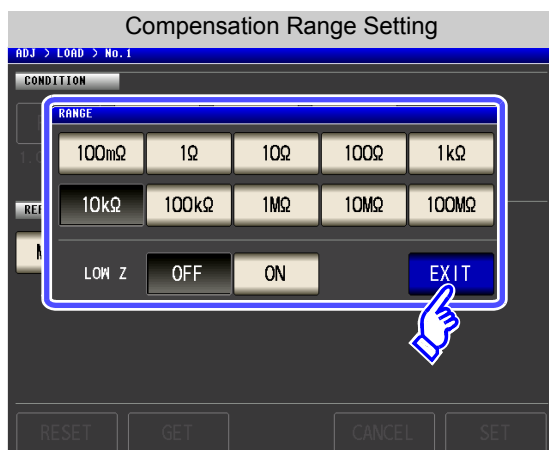
1. Press **RANGE**.

2. Select the range for compensation.

The range that can be set varies depending on the compensation frequency.

Frequency	Ranges that can be set	Range Settings screen
DC	Entire range	
0.001 Hz to 10.000 kHz		
10.001 kHz to 100.00 kHz	100 mΩ to 10 MΩ	
100.01 kHz to 200.00 kHz	100 mΩ to 1 MΩ	

3. Press **EXIT** to close the setting screen.**NOTE**

If the compensation frequency is not set, the compensation range cannot be set.

8.3 Compensating Values to Match Reference Values (Load Compensation)

LEVEL Setting the measurement signal mode and value for the compensation signal level

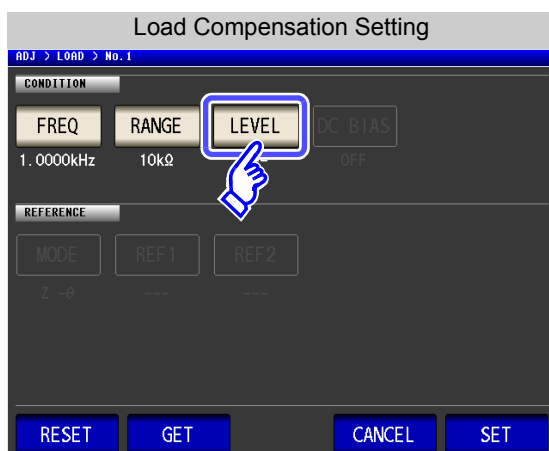

1. Press **LEVEL**.

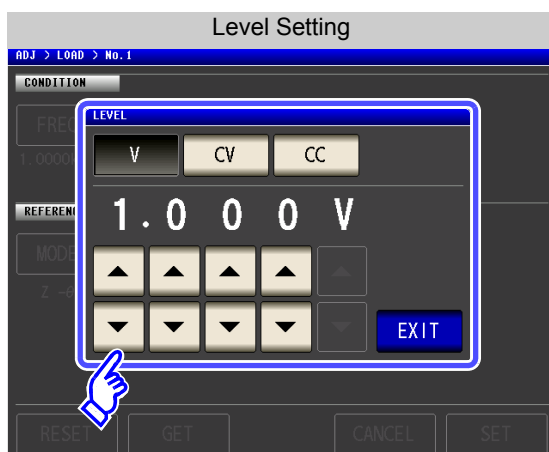

2. Select the measurement signal mode for the compensation signal level.

V Open circuit voltage (V) mode (p. 54)

CV Constant voltage (CV) mode (p. 54)

CC Constant current (CC) mode (p. 55)

3. Use **▲** or **▼** to enter the voltage or current value. For the compensation signal level setting ranges, see the following figures.

4. Press **EXIT** to close the setting screen.

AC Load Compensation

V, CV

LOW Z	Range	V, CV
OFF	Entire range	0.005 to 5.000 V
ON	Entire range	0.005 to 1.000 V

CC

LOW Z	Range	CC
OFF	Entire range	0.01 m to 50.00 mA
ON	Entire range	0.01 m to 100.00 mA

DC Load Compensation

V

LOW Z	Range	V
OFF	Entire range	2 V (fixed)
ON	Entire range	2 V (fixed)

NOTE

- If the compensation range is not set, you will be unable to set the measurement signal mode and value for the compensation signal level.
- Since only 2 V open circuit voltage (V) mode is supported for DC load compensation, this setting cannot be changed.

8.3 Compensating Values to Match Reference Values (Load Compensation)

DC BIAS

Setting the DC Bias

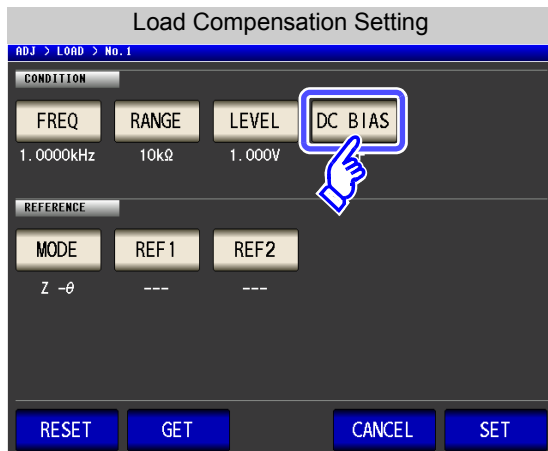

1. Press **DC BIAS**.

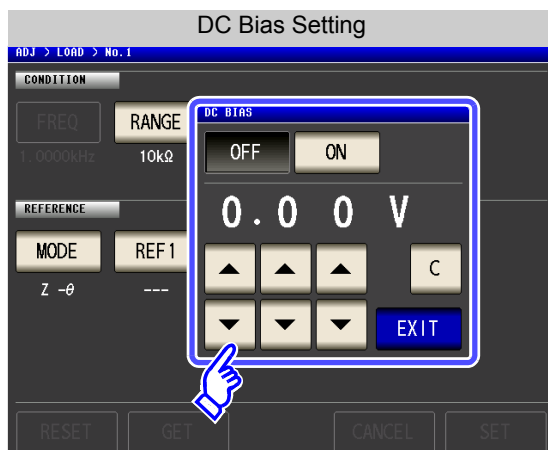

2. Select ON/OFF for the DC bias.

OFF Sets the DC bias to OFF.

ON Sets the DC bias to ON.

3. Use **▲** or **▼** to enter the DC bias value.

Settable range: -5.00 V to 5.00 V (Normal mode)
-2.50 V to 2.50 V (low Z high accuracy mode)

4. Press **EXIT** to close the setting screen.

If you make a mistake during input:
press **C** to cancel the input and start again.

NOTE

- If the compensation frequency, compensation range, and compensation signal level are not set, the DC bias setting cannot be set.
- When DC is selected for the compensation frequency setting, the DC bias setting cannot be set.

8.3 Compensating Values to Match Reference Values (Load Compensation)

MODE

Setting of Parameter to Use for Reference Value

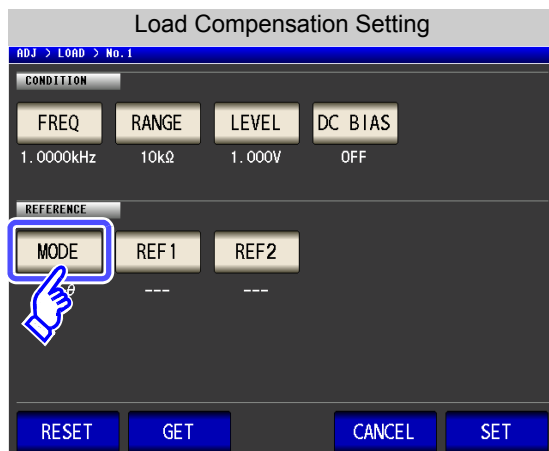

1. Press **MODE**.

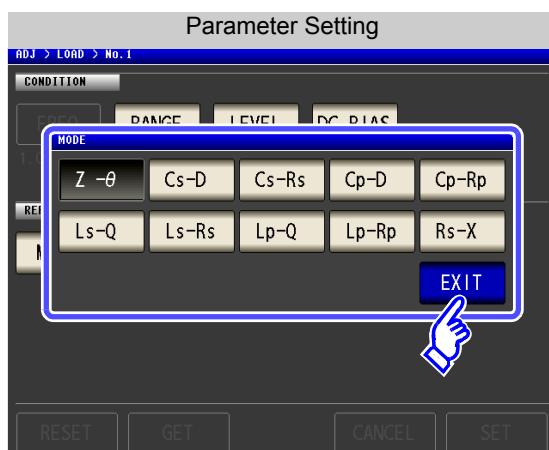

2. Select the parameter mode of the reference value to be set.

3. Press **EXIT** to close the setting screen.

See "1.3.7 Parameter Settings Screen" (p. 28)

NOTE

- If the compensation frequency, compensation range, and compensation signal level are not set, the parameter to use for the reference value setting cannot be set.
- When DC is selected for the compensation frequency setting, DC resistance measurement (R_{dc}) is selected automatically and the parameter to use for the reference value setting cannot be set.
- If you change the parameter to use as the reference value, the settings of reference value 1 and reference value 2 are cleared.

8.3 Compensating Values to Match Reference Values (Load Compensation)

REF1 and REF2 Reference Value Settings

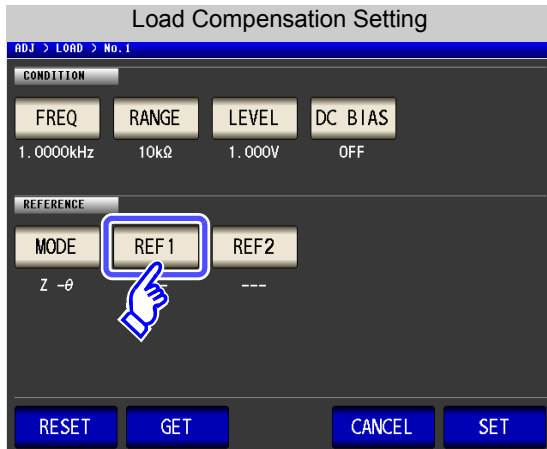

1. Press **REF1** (reference value1: the parameter reference value displayed on the left of the parameter mode).

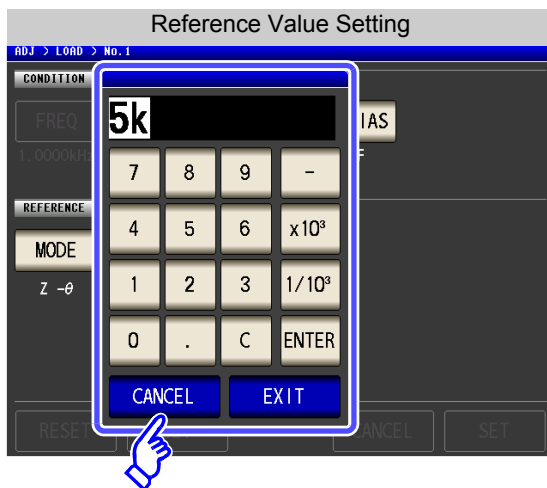

2. Use the numeric keypad to enter the reference value.

3. Press a instrument key to confirm the setting.

4. Press **EXIT** to confirm the setting.

5. Also set **REF2** (reference value2: the parameter reference value displayed on the right of the parameter mode) in the same way.

If you make a mistake during input:

press **C** to cancel the input and start again.

NOTE

- If the compensation frequency, compensation range, and compensation signal level are not set, the reference value setting cannot be set.
- When DC is selected for the compensation frequency setting, only reference value 1 can be set.

8.3 Compensating Values to Match Reference Values (Load Compensation)

When You Want to Reset All Settings

RESET

You can clear all settings and repeat the configuration process from the compensation frequency setting by touching **RESET**.

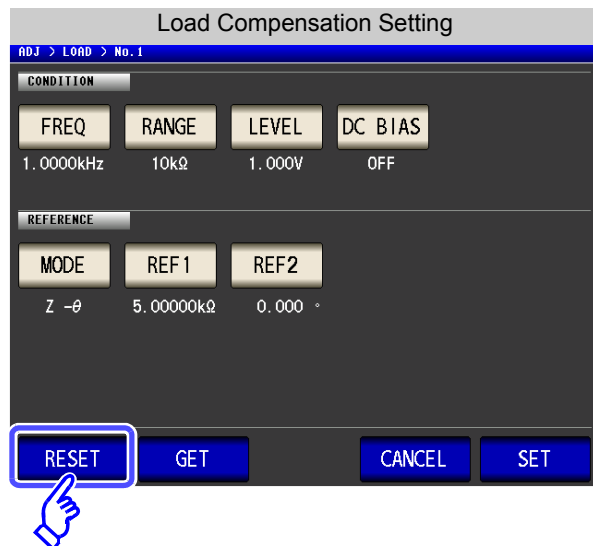

When You Want to Use the Current Measurement Conditions as the Load Compensation Conditions

GET

You can load the current measurement conditions (frequency, range, measurement signal mode and value for the measurement signal level, and DC bias setting) as the load compensation conditions by touching **GET**.

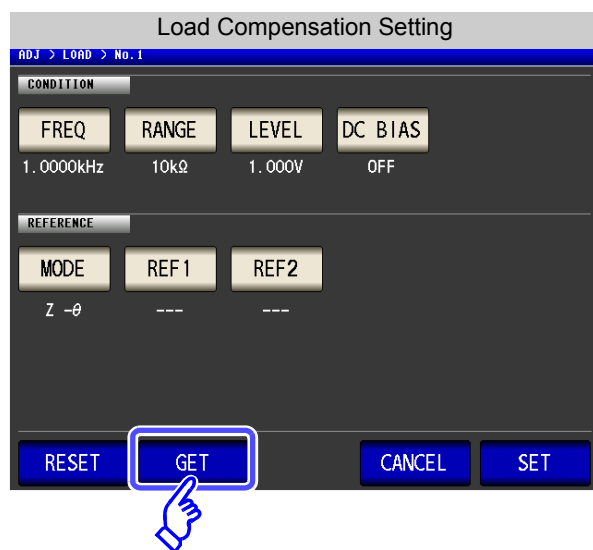

NOTE

When the measurement conditions are acquired with **GET**, **MODE** ("Setting of Parameter to Use for Reference Value" (p. 241)) is initialized to Z-θ.

8.3 Compensating Values to Match Reference Values (Load Compensation)

When Load Compensation Failed

If compensation fails, a window like the following appears.

Presses **EXIT** to close the window and set the compensation condition once again.

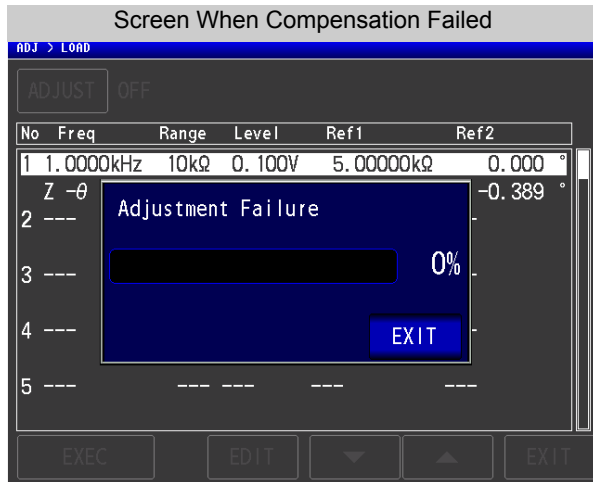

When You Want to Disable Load Compensation

Press **OFF** in the [Load Compensation Setting] to disable load compensation.

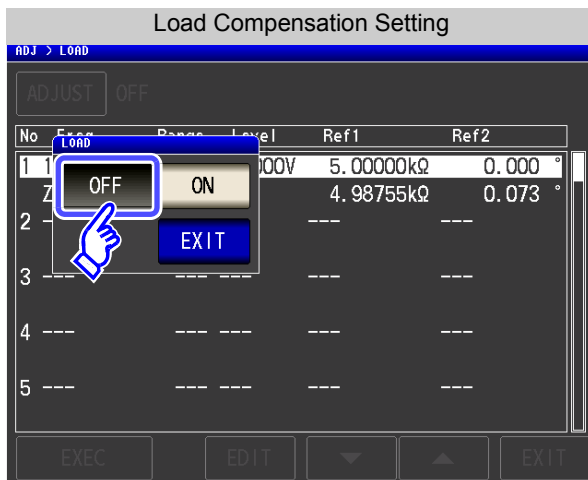

8.4 Compensating Measurement Cable Errors (Cable Length Compensation)

With high frequency measurement, the influence of the cable results in large measurement errors. Setting the cable length enables you to reduce the measurement errors. Use a coaxial cable with 50 Ω impedance.

Procedure

1

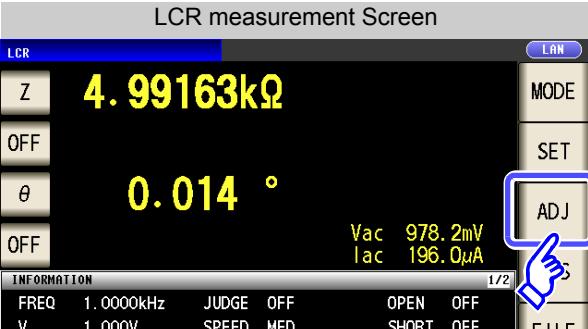

LCR measurement Screen

LCR

Z 4.99163k Ω

OFF

θ 0.014°

OFF

Vac 978.2mV
Iac 196.0 μ A

INFORMATION

FREQ 1.0000kHz JUDGE OFF OPEN OFF
V 1.000V SPEED MED SHORT OFF

MODE
SET
ADJ

Compensation Screen

ADJ

ADJUSTMENT

OPEN OFF SHORT OFF LOAD OFF CABLE

SCALING

SCALE OFF

2

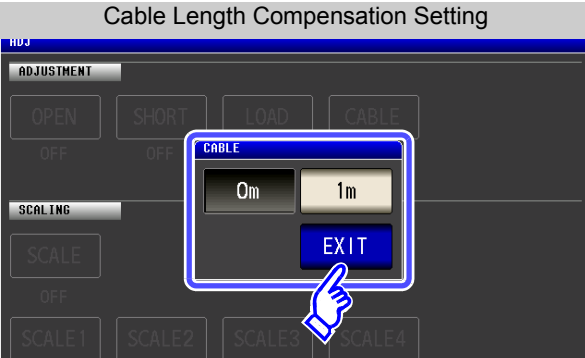

Cable Length Compensation Setting

ADJ

ADJUSTMENT

OPEN OFF SHORT OFF LOAD OFF CABLE

SCALING

SCALE OFF

SCALE1 SCALE2 SCALE3 SCALE4

CABLE

0m 1m

EXIT

Select the cable length to be used, and press **EXIT** to confirm the selection.

0m

Select this when using a direct-coupled fixture or the like.

1m

Select this when the cable length is 1 m, 2 m, or 4 m.

3 Press **EXIT** to close the setting screen.

NOTE

- If the cable length changes, repeat open, short, and load compensation.
- The guaranteed accuracy range varies with the cable length.
See: Cable length coefficient (p. 346)
- When manufacturing your own cables, make sure that the cable length matches the length set with the instrument. (IM3533: 1 m, IM3533-01: 1 m/ 2 m/ 4 m)
See: "Points to pay attention to when making your own probe" (p. 32)
- When using the L2000, set cable length compensation to 1 m.

The cable length settings for the IM3533-01 are as follows:

Cable Length Compensation Setting (IM3533-01only)

ADJ

ADJUSTMENT

OPEN OFF SHORT OFF LOAD OFF CABLE

SCALING

SCALE OFF

SCALE1 SCALE2 SCALE3 SCALE4

CABLE

0m 1m 2m 4m

EXIT

0m

Select this when using a direct-coupled fixture or the like.

1m

Select this when the cable length is 1 m.

2m

Select this when the cable length is 2 m.

4m

Select this when the cable length is 4 m.

8.5 Calculating Values (Scaling)

Scaling applies a compensation function to the measurement value. This function can be used to provide compatibility among measurement devices. Set the compensation coefficients a and b for the measurement values of the first to fourth parameters to compensate by the following expression.

In transformer mode, the compensation coefficients a and b are set relative to the calculation parameter calculated value, and compensation is applied using the following expression:

See "Appendix1 Measurement Parameters and Calculation Formula"(p. A1)

$$Y = a \times X + b$$

However, if the parameter corresponding to X is either D or Q, scaling is applied to θ as shown in the following expression, and then D or Q is obtained from θ' .

$$\theta' = a \times \theta + b$$

- X: the first or third parameter measurement value
- a: integration value of the measured value X
- Y: the last measurement value
- b: the value added to measured value X
- θ' : compensation value of θ

Procedure

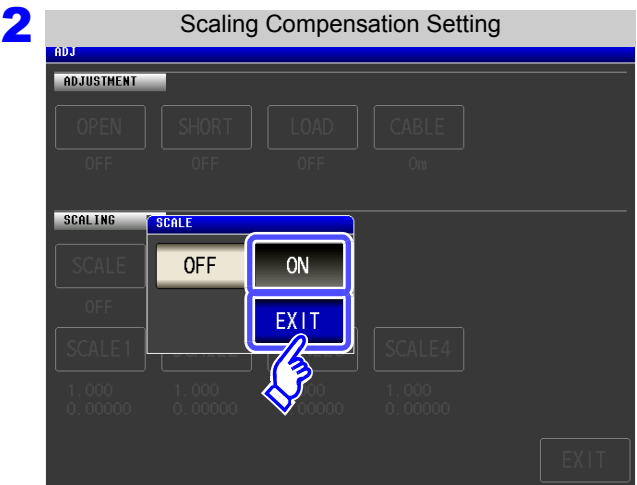
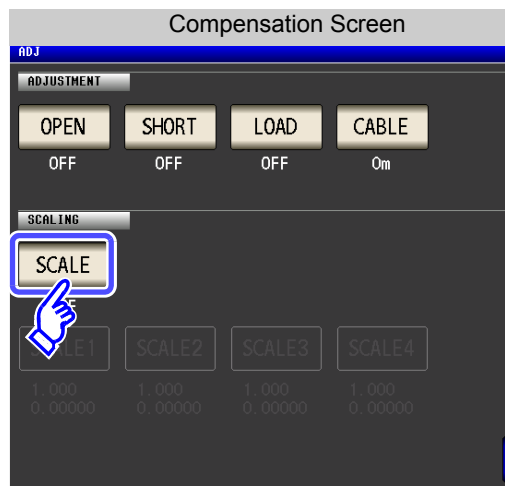
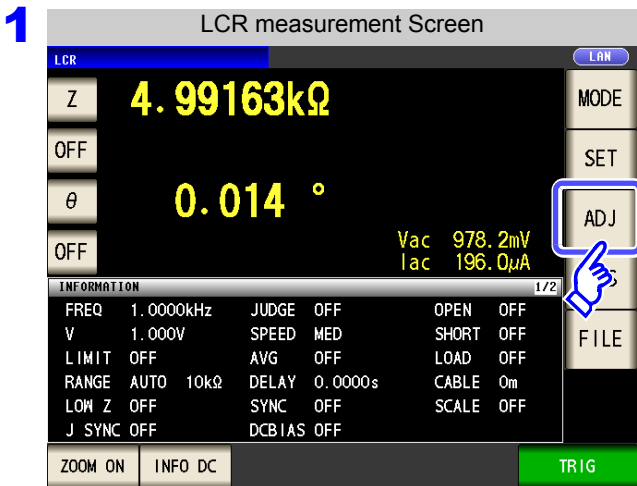

Select **ON**, and press **EXIT** to confirm the selection.

When you want to cancel scaling:

1. Press **ADJ** to switch to the [Compensation Screen].
2. Press **SCALE** and select **OFF**.
3. Press **EXIT** to confirm the setting.

8.5 Calculating Values (Scaling)

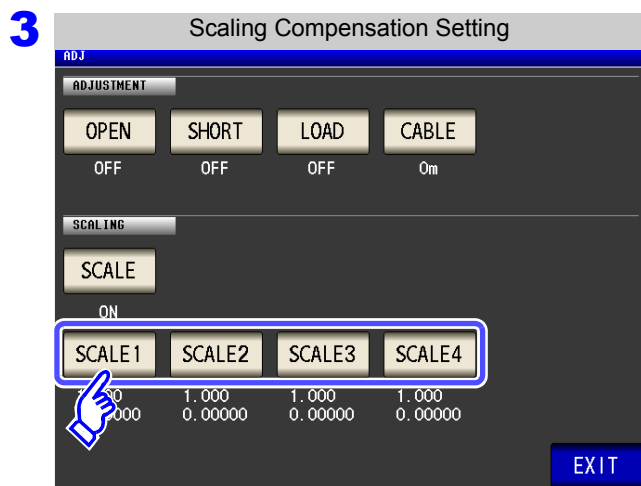

Select the compensation coefficient of the parameter you want to change.

The parameters and compensation coefficient numbers correspond as shown below.

SCALE1	Parameter 1
SCALE2	Parameter 2
SCALE3	Parameter 3
SCALE4	Parameter 4

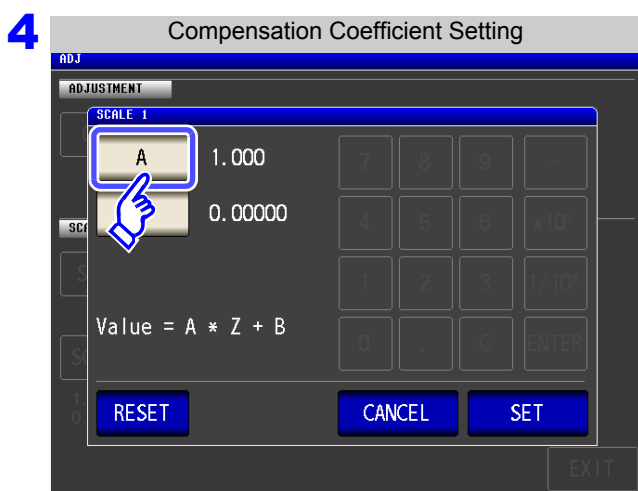

Press **A**.

When you want to revert the settings to their default values: Press **RESET**.

When you want to cancel the setting:

Press **CANCEL**.

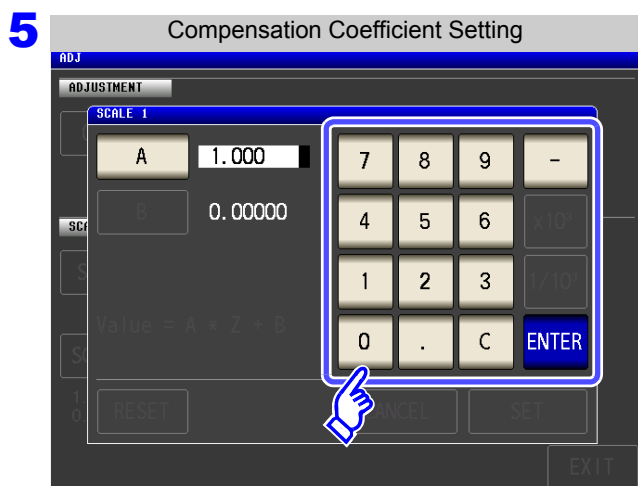

Use the numeric keypad to set compensation coefficient **A**.

- Settable range: -999.999 to 999.999
To return to the previous screen without making any change to the set value, press the **ENTER** key when the screen is in the state with nothing being displayed (the state after pressing the **C** key).
- If you make a mistake during input:
press **C** to cancel the input and start again.

Touch **ENTER** to accept compensation coefficient **A**.

8.5 Calculating Values (Scaling)

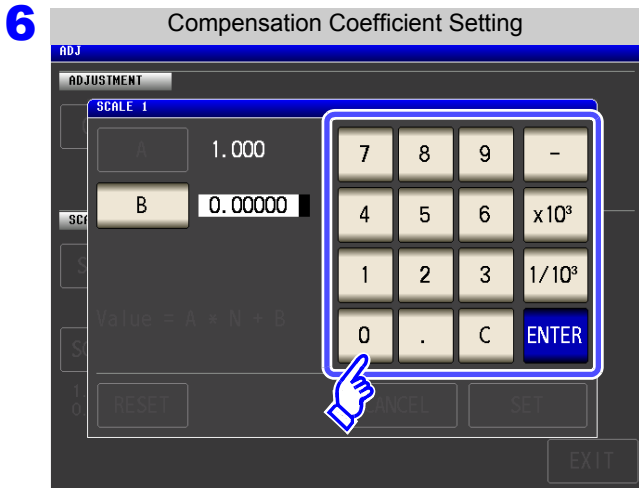

Touch **B** and use the numeric keypad to set compensation coefficient **B** in the same way as for **A**. Then touch **ENTER** to accept compensation coefficient **B**.

Settable range: -9.99999G to 9.99999G
 To return to the previous screen without making any change to the set value, press the **ENTER** key when the screen is in the state with nothing being displayed (the state after pressing the **C** key).

Changing the unit (*a/ f/ p/ n/ μ/ m/ None/ k/ M/ G*)

x10³ Step the units up.

1/10³ Step the units down.

7 Press **SET** to return to the [Scaling Compensation Setting].

NOTE

- If the same parameter is selected multiple times and a different compensation coefficient is set for each of them, the compensation coefficient of the parameter with the smallest number is used to perform scaling for all of the parameters of the parameter numbers. (The compensation coefficients of the other parameter numbers become invalid.)
- In the case of the following settings, scaling is performed using the compensation coefficient of parameter 1 for all Z of parameters 1, 2, and 4. (The compensation coefficients of parameters 2 and 4 are invalid.)

Reference value 1

Display Parameter Setting	Compensation Coefficient Setting
Parameter 1: Z	a = 1.500, b = 1.50000
Parameter 2: Z	a = 1.700, b = 2.50000
Parameter 3: θ	a = 0.700, b = 1.00000
Parameter 4: Z	a = 1.900, b = 3.50000

Saving and Loading Panel Information **Chapter 9**

This section describes how to save data (measurement conditions and compensation values) to the instrument's memory as well as how to subsequently load that data.

(Data for the point in time  is pressed is saved.)

These operations are possible in both  mode,  mode and  mode.

Saving Data	▶	<ul style="list-style-type: none"> • Measurement conditions and compensation values (p. 251)
Loading Data	▶	<ul style="list-style-type: none"> • Measurement conditions and compensation values (p. 256)
Editing Saved Data	▶	<ul style="list-style-type: none"> • Change panel name (p. 258) • Delete panel (p. 260)

- NOTE**
- The instrument contains a built-in backup lithium battery, which offers a service life of about ten years.
 - When the life of the built-in battery ends, the measurement conditions will no longer be able to be saved.
Ask the store (distributor) from which you purchased the instrument or the nearest HIOKI sales office to replace the instrument's battery.

About the Save Screen

Indicates the panel number. (001 to 128)

Indicates the panel name. **See** When you want to change a panel name (p. 258)

Indicates the number of panels currently saved (p. 251). The text color changes in accordance with the number of data items currently saved as shown in the table below.

MODE	White	Yellow	Red
LCR	0 to 29	30 to 59	60
ANALYZER	0	1	2
ADJ	0 to 63	64 to 127	128

Panels for both LCR and TRANSFORMER measurement modes are included under "LCR".

*Because this manual uses screenshots from the IM3533 in this description, "ANALYZER" is not shown.

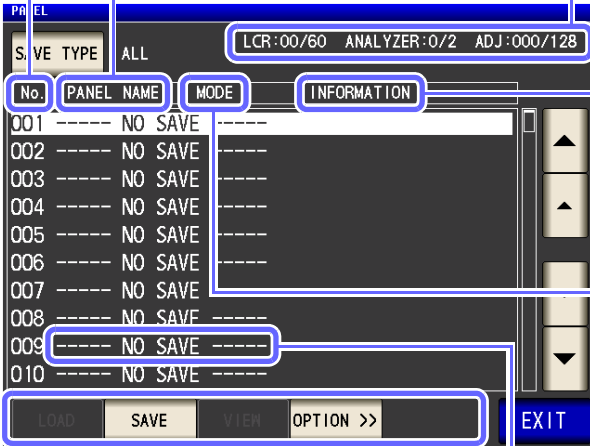

Indicates basic information on the saved panels. In order from the left

MODE	Measurement Parameters	Judgment Mode
LCR	[PARA1] - [PARA2] - [PARA3] - [PARA4]	[COMP] or [BIN]
ANALYZER	[PARA1] - [PARA2]	None
TRANSFORMER	[Measurement parameters] - [Calculation parameters]	[COMP]

Indicates the save type (p. 251).

When saving with **ALL** : [LCR+ADJ], [ANA+ADJ] or [TRN+ADJ]

When saving with **HARD** : [LCR], [ANA] or [TRN]

When saving with **ADJ** : [ADJ]

Indicates that nothing is saved.

Loads the save conditions (p. 256).

Saves the measurement conditions (p. 251).

Allows you to check the information of the selected panel (p. 254).



Allows you to changes the panel name (p. 258).

Deletes the panel (p. 260).

NOTE

ANALYZER mode settings are available only for the IM3533-01.

9.1 Saving Measurement Conditions (Panel Save Function)

You can save the measurement condition and compensation value.
The numbers of conditions and values that can be saved are as follows:

LCR and TRANSFORMER Measurement Condition	▶ Total of up to 60 items
ANALYER Measurement Condition (IM3533-01 only)	▶ Up to 2 items
Compensation Value	▶ Up to 128 items

Although only one panel is saved when the save type is set to **ALL**, that data counts as one measurement condition and one compensation value.

(Example: When saving is performed with **ALL** in **LCR** mode, LCR is counted as one item, and the compensation value as one item.)

Setting the Type to Save

Procedure

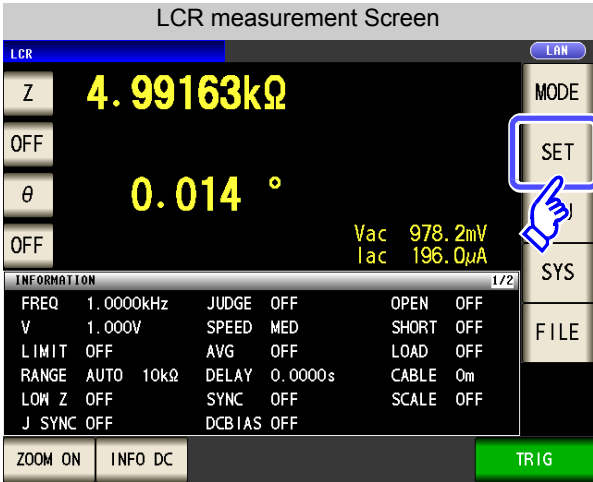
- 

LCR measurement Screen

LCR

Z 4.99163kΩ

OFF

θ 0.014 °

OFF

Vac 978.2mV
Iac 196.0μA

INFORMATION

FREQ	1.0000kHz	JUDGE	OFF	OPEN	OFF
V	1.000V	SPEED	MED	SHORT	OFF
LIMIT	OFF	AVG	OFF	LOAD	OFF
RANGE	AUTO 10kΩ	DELAY	0.0000s	CABLE	0m
LOW Z	OFF	SYNC	OFF	SCALE	OFF
J SYNC	OFF	DCBIAS	OFF		

ZOOM ON INFO DC TRIG

LAN

MODE

SET

SYN

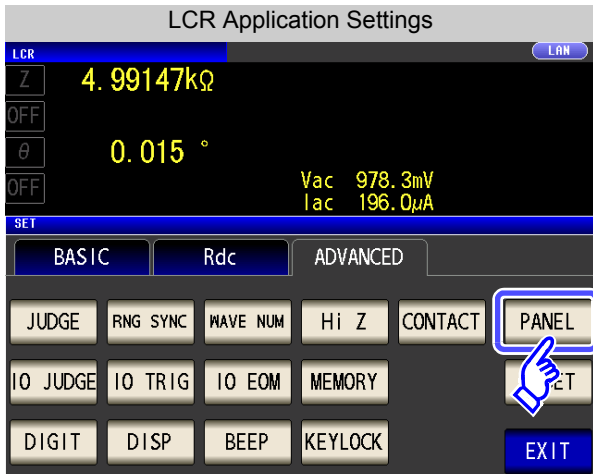
FILE
- 

LCR Application Settings

LCR

Z 4.99147kΩ

OFF

θ 0.015 °

OFF

Vac 978.3mV
Iac 196.0μA

SET

BASIC Rdc ADVANCED

JUDGE RNG SYNC WAVE NUM Hi Z CONTACT

IO JUDGE IO TRIG IO EOM MEMORY

DIGIT DISP BEEP KEYLOCK

PANEL

EXIT

Press **PANEL**.

9.1 Saving Measurement Conditions (Panel Save Function)

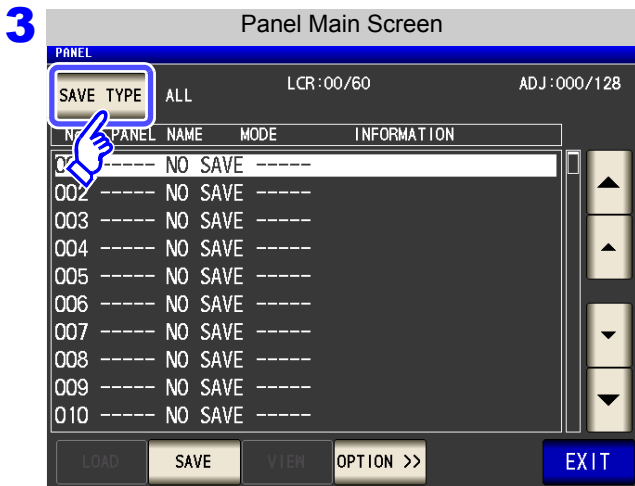

Press **SAVE TYPE**.

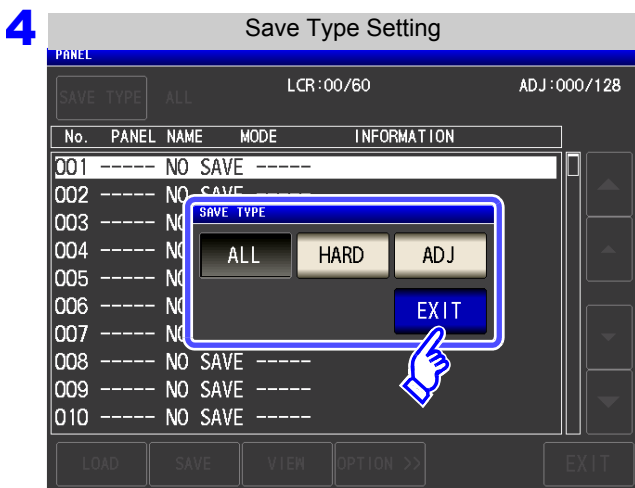

Select the save type.

- ALL** Saves both the measurement condition and compensation value.
- HARD** Saves only the measurement condition.
- ADJ** Saves only each of the setting values and compensation values of open compensation, short compensation, load compensation, cable length compensation, and scaling compensation.

5 Press **EXIT** to close the setting screen.

When ANALYZER mode (IM3533-01 only)
You can save a panel in the same way in ANALYZER mode.

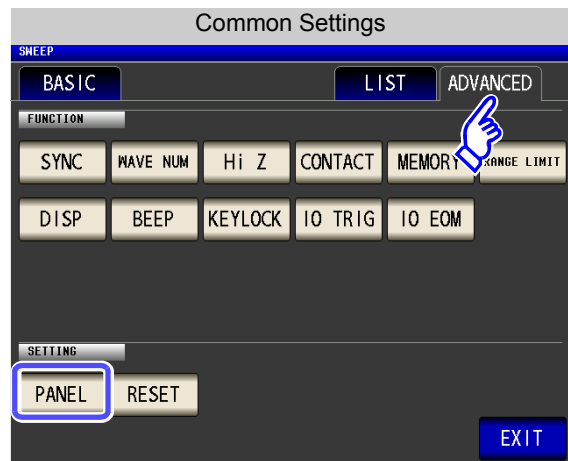
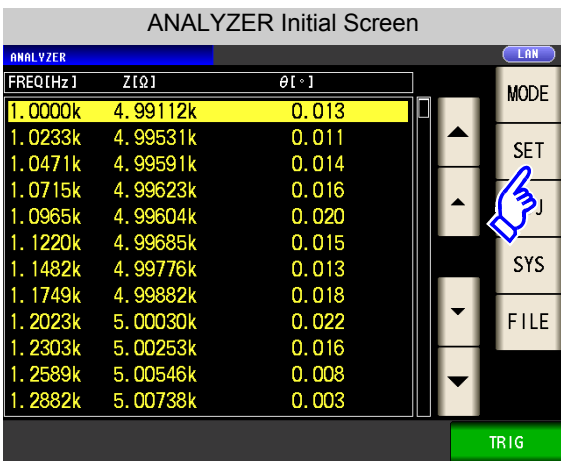

9.1 Saving Measurement Conditions (Panel Save Function)

Saving measurement conditions

Procedure

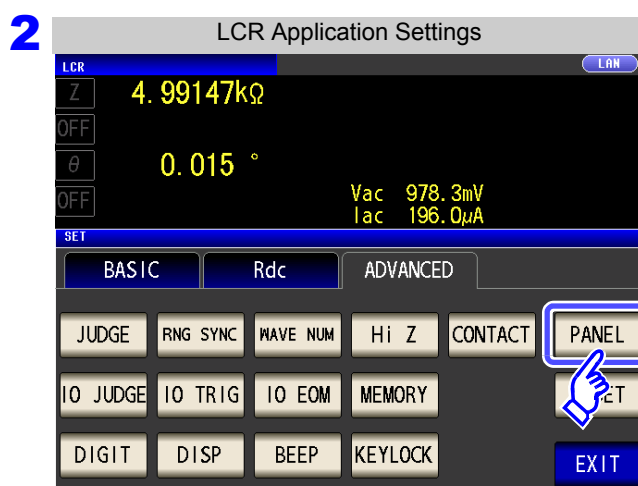
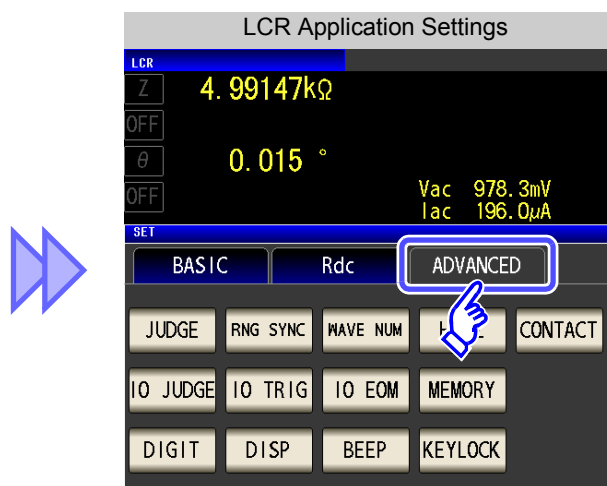
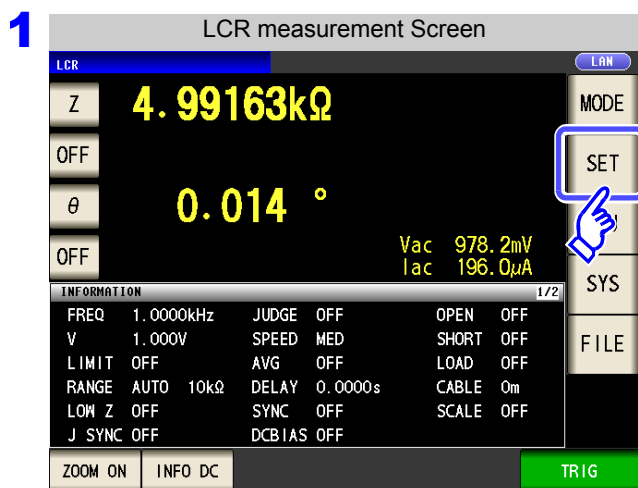

Press **PANEL** .

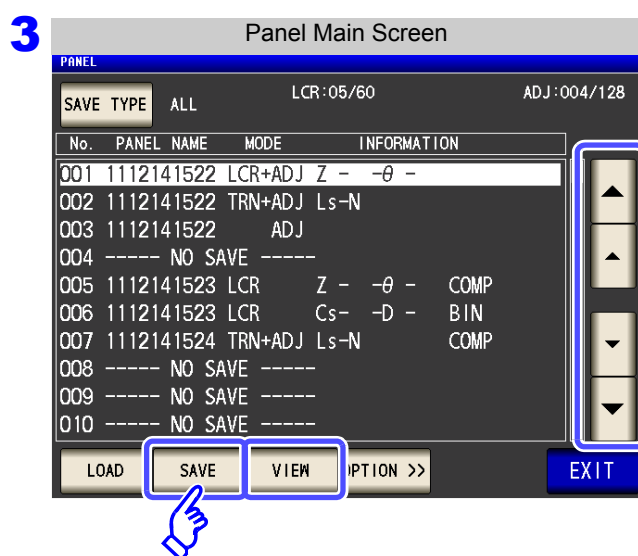

Use **▲** or **▼** to select the number of the panel to save.

- Display range: No. 001 to No. 128
- When you want to check the information of a saved panel:

Press **VIEW** .

Press **SAVE** .

When you want to cancel saving:

Press **EXIT** .

9.1 Saving Measurement Conditions (Panel Save Function)

When **VIEW** is selected

You can check the information of a saved panel:

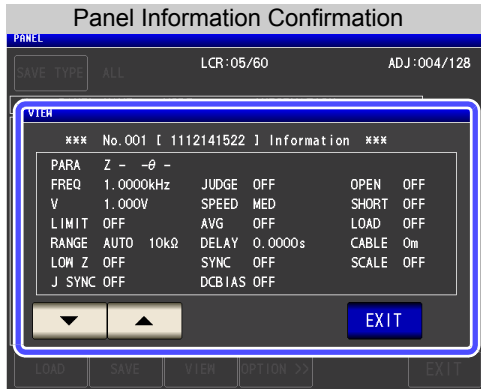

Use **▲** or **▼** to switch to the information of the previous or next panel.

When you want to return to the Panel Main screen:

Press **EXIT**.

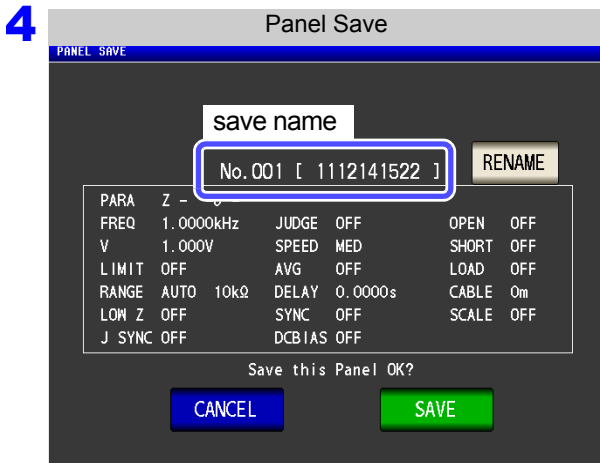

The save name and the measurement condition to be saved are displayed.

RENAME

Changes the save name.
See **step 5**

CANCEL

Returns to the previous screen.
Returns to the Panel Main screen.

SAVE

Saves the measurement condition under the displayed save name.
(The instrument automatically returns to the Panel Main screen.)

5 When **RENAME** is pressed

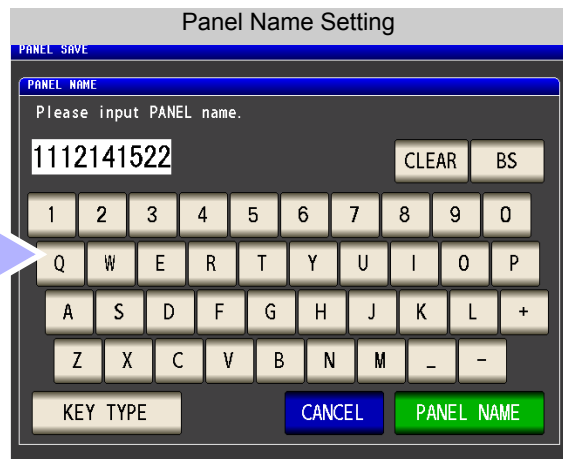
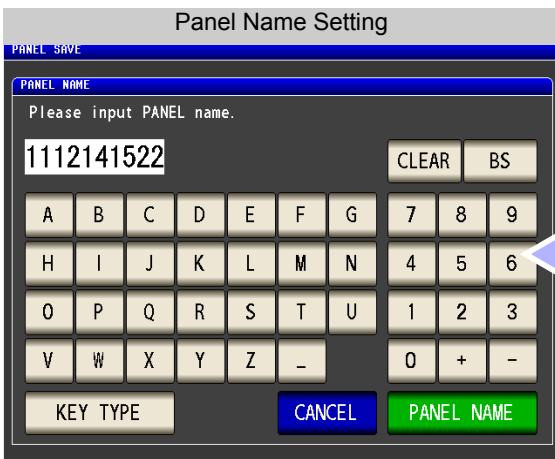

Enter the save name. (Up to 10 characters)

CLEAR

Deletes all input characters.

BS

Deletes the last character.

KEY TYPE

Changes the keyboard type.

9.1 Saving Measurement Conditions (Panel Save Function)

- 6 After you enter the save name, press **PANEL NAME** to return to **step 4**, and press **SAVE** to confirm saving.

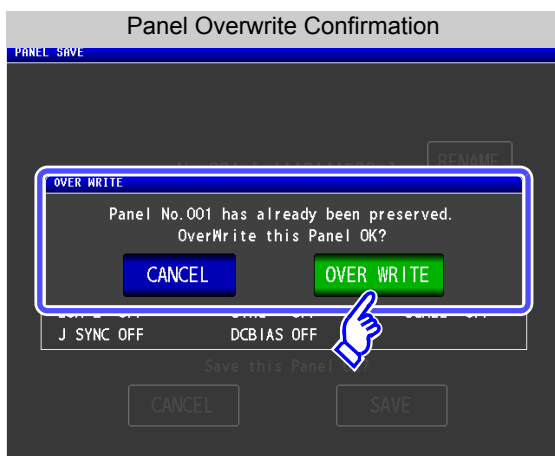

When saving to a panel that has already been saved, a window confirming that you wish to overwrite the existing data will be displayed.

To enter a different save name: Press **CANCEL**.

To overwrite the save name: Press **OVER WRITE**.

- 7 Press **EXIT** to close the setting screen.

9.2 Loading Measurement Conditions (Panel Load Function)

You can read saved measurement conditions with the panel load function.

Procedure

1

LCR measurement Screen

LCR

Z 4.99163kΩ

OFF

θ 0.014 °

OFF

Vac 978.2mV
Iac 196.0μA

INFORMATION

FREQ	1.0000kHz	JUDGE	OFF	OPEN	OFF
V	1.000V	SPEED	MED	SHORT	OFF
LIMIT	OFF	AVG	OFF	LOAD	OFF
RANGE	AUTO 10kΩ	DELAY	0.0000s	CABLE	0m
LOW Z	OFF	SYNC	OFF	SCALE	OFF
J SYNC	OFF	DCBIAS	OFF		

ZOOM ON INFO DC TRIG

LCR Application Settings

LCR

Z 4.99147kΩ

OFF

θ 0.015 °

OFF

Vac 978.3mV
Iac 196.0μA

SET

BASIC Rdc ADVANCED

JUDGE RNG SYNC WAVE NUM CONTACT

IO JUDGE IO TRIG IO EOM MEMORY

DIGIT DISP BEEP KEYLOCK

2

LCR Application Settings

LCR

Z 4.99147kΩ

OFF

θ 0.015 °

OFF

Vac 978.3mV
Iac 196.0μA

SET

BASIC Rdc ADVANCED

JUDGE RNG SYNC WAVE NUM Hi Z CONTACT PANEL

IO JUDGE IO TRIG IO EOM MEMORY

DIGIT DISP BEEP KEYLOCK

EXIT

Press **PANEL** .

3

Panel Main Screen

PANEL

SAVE TYPE ALL LCR:05/60 ADJ:004/128

No.	PANEL NAME	MODE	INFORMATION
001	1112141522	LCR+ADJ Z - -θ -	
002	1112141522	TRN+ADJ Ls-N	
003	1112141522	ADJ	
004	----	NO SAVE	----
005	1112141523	LCR Z - -θ -	COMP
006	1112141523	LCR Cs- -D -	BIN
007	1112141524	TRN+ADJ Ls-N	COMP
008	----	NO SAVE	----
009	----	NO SAVE	----
010	----	NO SAVE	----

LOAD SAVE VIEW OPTION >> EXIT

Use **▲** or **▼** to select the number of the panel to load.

- Display range: No. 001 to No. 128
- When you want to check the information of a saved panel: Press **VIEW** .

Press **LOAD** .

When you want to cancel the loading of the panel: Press **EXIT** .

9.2 Loading Measurement Conditions (Panel Load Function)

When **VIEW** is selected

You can check the information of a saved panel:

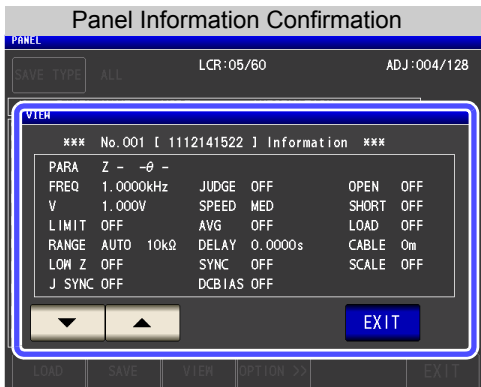

Use or to switch to the information of the previous or next panel.

When you want to return to the Panel Main screen: Press **EXIT**.

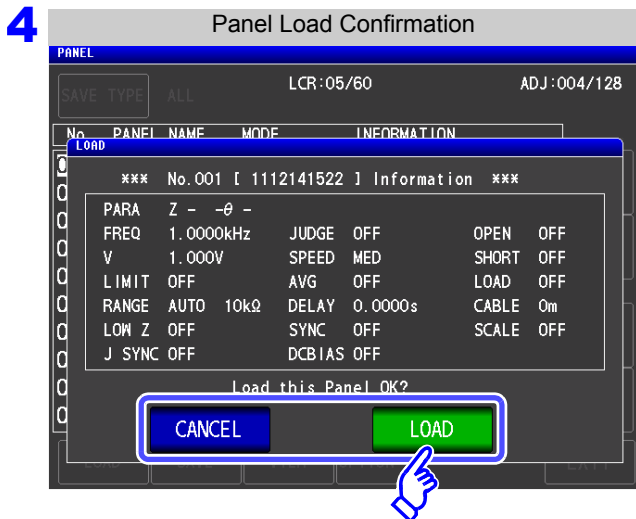

The read confirmation screen appears.

- CANCEL** Returns to the Panel Main screen.
- LOAD** Reads the measurement conditions of the selected panel number. (The [Measurement Screen] is redisplayed automatically.)

5 When reading of the measurement conditions is finished, the [Measurement Screen] is redisplayed automatically.

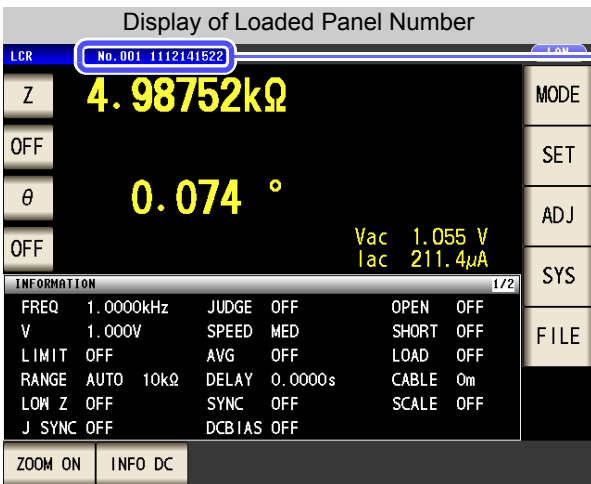

The loaded panel number is displayed in the measurement screen.

9.3 Changing a Panel Name

You can change the name of a panel saved to the instrument.

Procedure

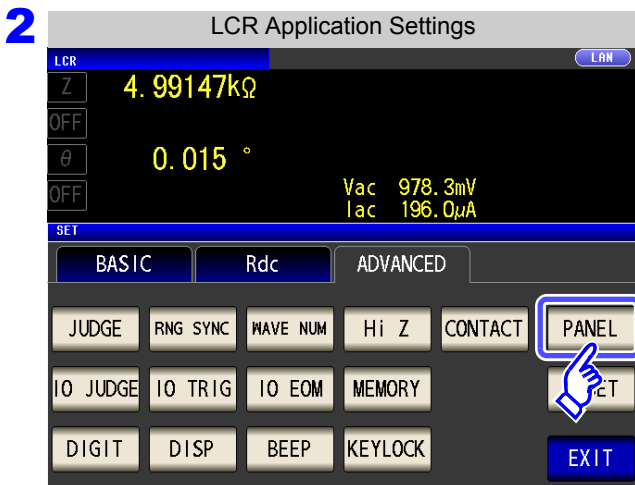
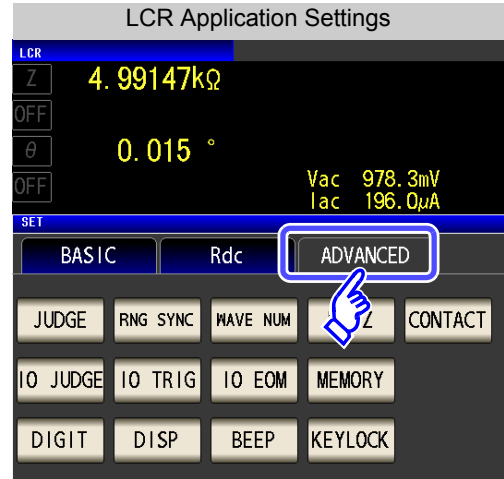
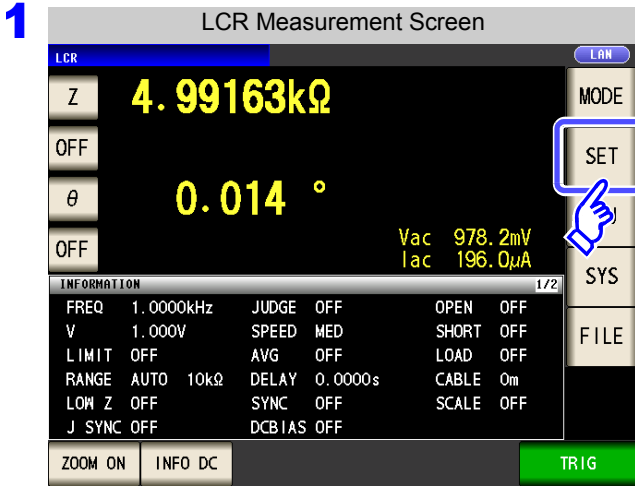

Press **PANEL**.

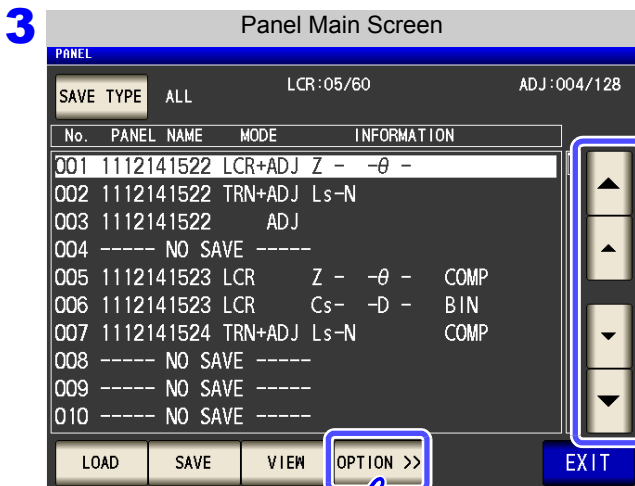

Use **▲** or **▼** to select the number of the panel to rename.

Press **OPTION >>**.

When you want to cancel the changing of the panel's name: Press **EXIT**.

9.3 Changing a Panel Name

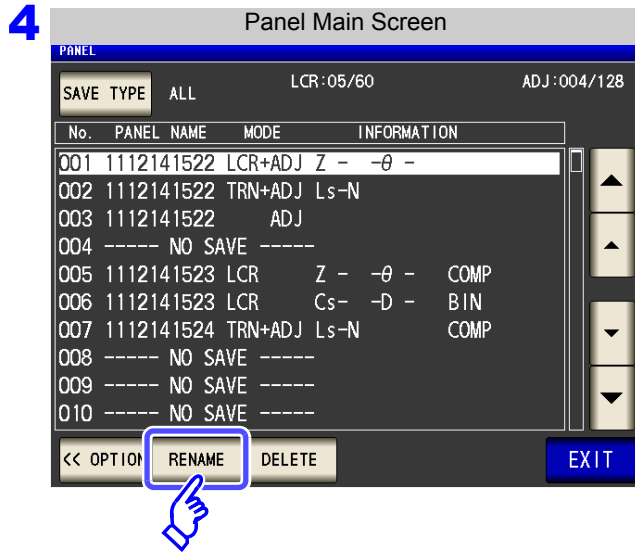

Press **RENAME**.

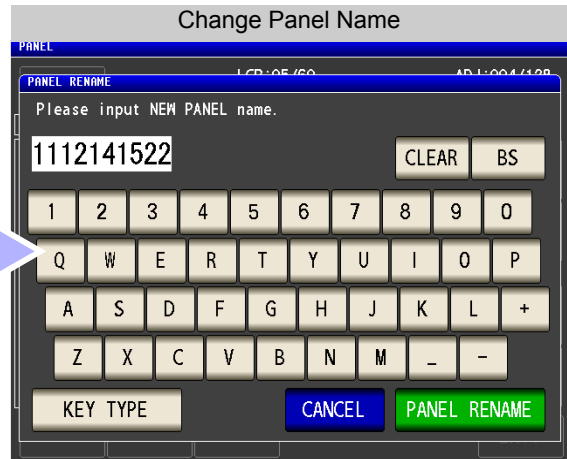
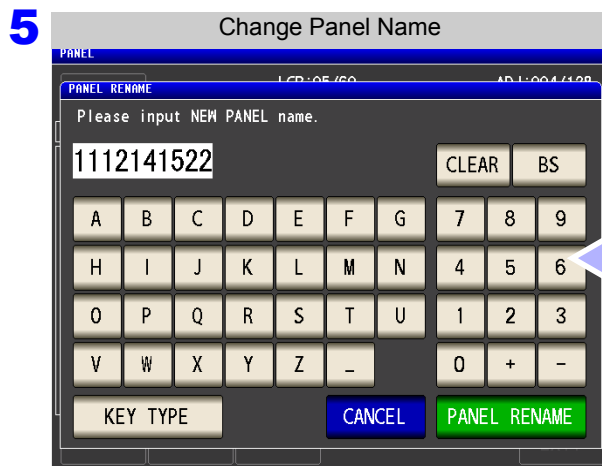

Enter the save name. (Up to 10 characters)

- CLEAR** Deletes all input characters.
- BS** Deletes the last character.
- KEY TYPE** Changes the keyboard type.

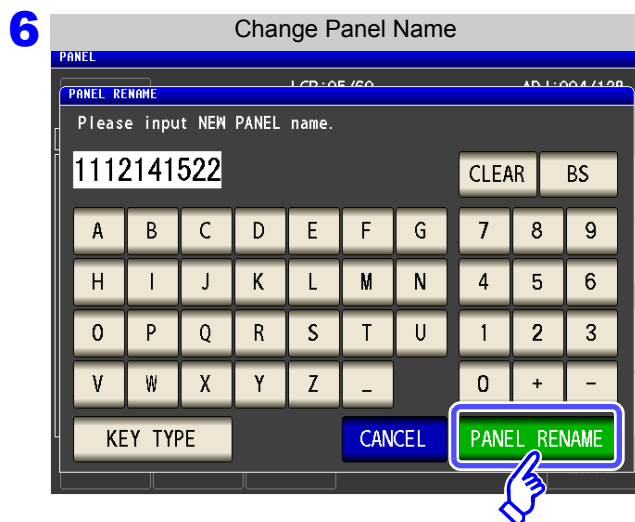

After you enter the new save name, press **PANEL RENAME** to confirm the name.

7 Press **EXIT** to close the setting screen.

9.4 Deleting a Panel

You can delete a panel saved to the instrument.

Procedure

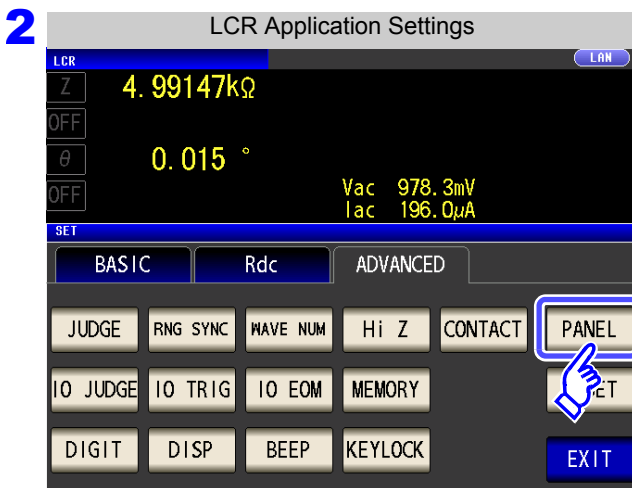
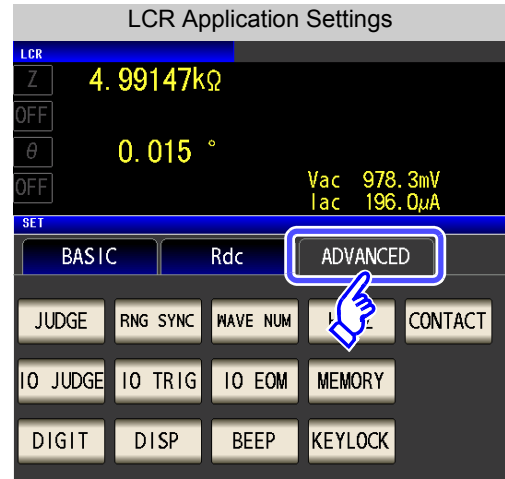
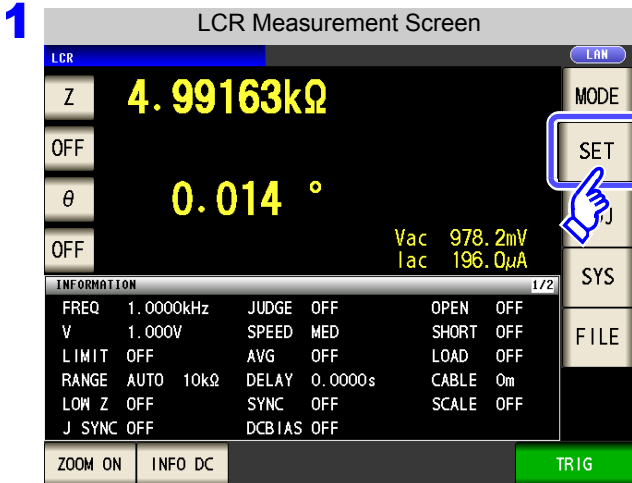

Press **PANEL** .

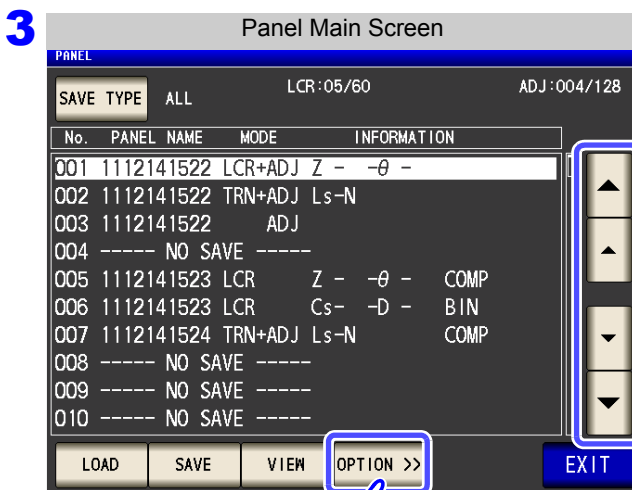

Use **▲** or **▼** to select the number of the panel to delete.

Press **OPTION >>** .

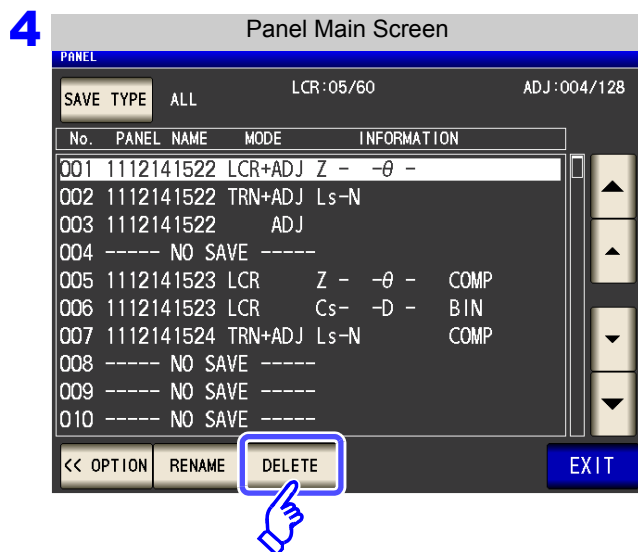

Press **DELETE** .

Some of the information saved to the panel is displayed.

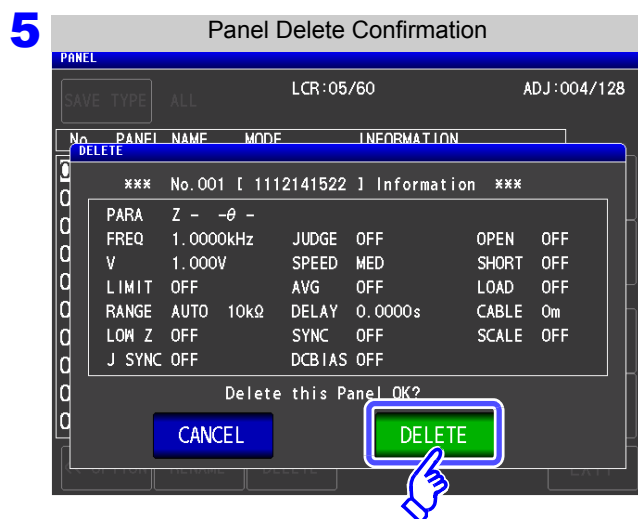

Check the information saved to the panel.

A panel cannot be restored once it is deleted.

When you want to cancel deletion:

Press **CANCEL** .

Press **DELETE** .

6 Press **EXIT** to close the setting screen.

Setting the SYSTEM

Chapter 10

10.1 Setting the Interface

You can control the instrument from a computer via the USB, GP-IB, RS-232C and LAN interfaces. Printing can also be performed with RS-232C printer.

NOTE

- The GP-IB, RS-232C, and LAN settings can only be configured when the optional Z3000 (GP-IB), Z3001 (RS-232C), or Z3002 (LAN) is installed.
- Printer settings are only available when the Z3001 is installed.

Procedure

This operation is possible in any of the **LCR** mode, **ANALYZER** mode and **TRANSFORMER** mode.

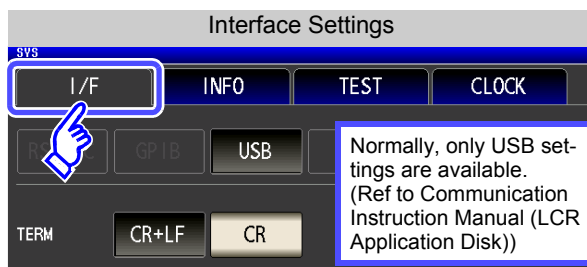
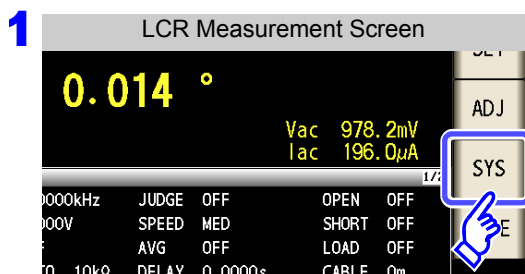

2 Select the interface type. (Only available when an optional interface is installed.)

See Printer Settings (p. 331)

For more information about settings other than the printer settings, see the Communication Instruction Manual (LCR Application Disk).

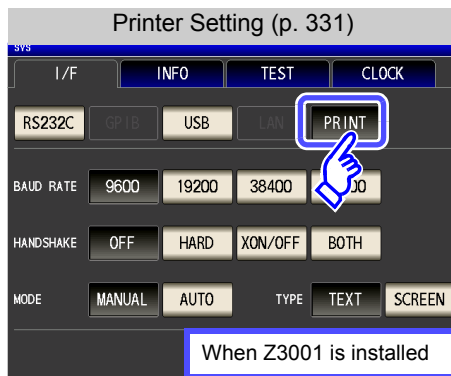
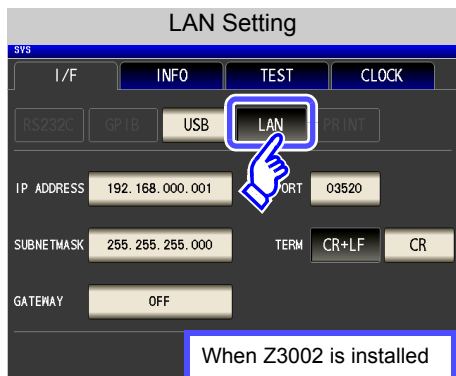
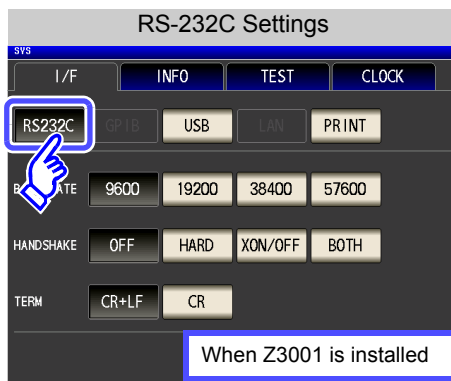
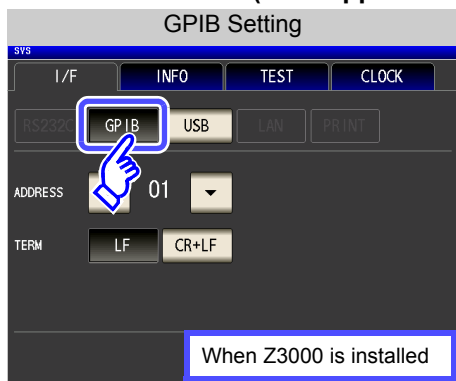

3 Press **EXIT** to close the setting screen.

10.2 Checking the Version of the Instrument

Procedure

You can check the version in **LCR** mode, **ANALYZER** mode, or **TRANSFORMER** mode.

1

LCR Measurement Screen

LCR

Z **4.99163kΩ**

OFF

θ **0.014 °**

OFF

Vac 978.2mV
Iac 196.0μA

MODE
SET
ADJ
SYS

INFORMATION

FREQ	1.0000kHz	JUDGE	OFF	OPEN	OFF
V	1.000V	SPEED	MED	SHORT	OFF
LIMIT	OFF	AVG	OFF	LOAD	OFF
RANGE	AUTO 10kΩ	DELAY	0.0000s	CABLE	0m
LOW Z	OFF	SYNC	OFF	SCALE	OFF
J SYNC	OFF	DCBIAS	OFF		

ZOOM ON INFO DC TRIG

Instrument Info

SVS

I/F INFO TEST CLOCK

IM3533 LCR METER

Serial No. 123456789
Software Version 1.00
FPGA Version 0x5
Board Version 0
MAC Address 00-01-67-03-26-39
USB ID 108f:0001
Interface Board Z3002 LAN INTERFACE

2

Instrument Info

SVS

I/F INFO TEST CLOCK

IM3533 LCR METER

Serial No. 123456789
Software Version 1.00
FPGA Version 0x5
Board Version 0
MAC Address 00-01-67-03-26-39
USB ID 108f:0001
Interface Board Z3002 LAN INTERFACE

EXIT

Check the version of the instrument.

3 Press **EXIT** to close the setting screen.

10.3 Self Checks (Self Diagnosis)

You can check the display screens of the instrument.

Panel Test

You can check the touch panel.

Procedure You can check the touch panel in **LCR** mode, **ANALYZER** mode, or **TRANSFORMER** mode.

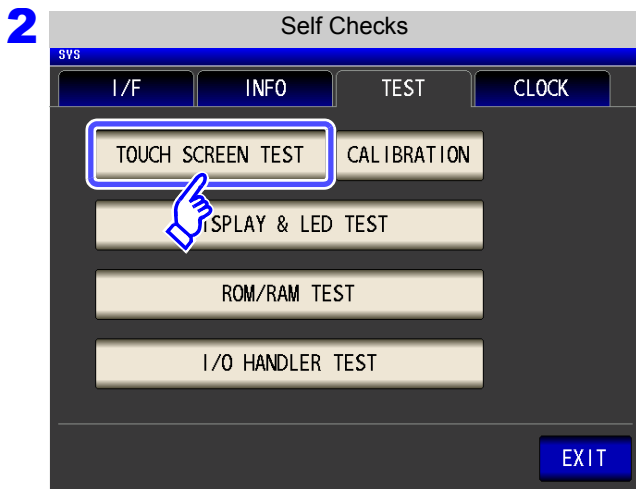
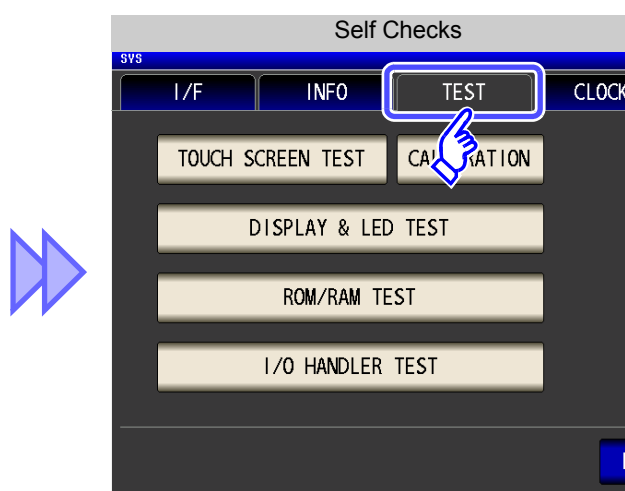
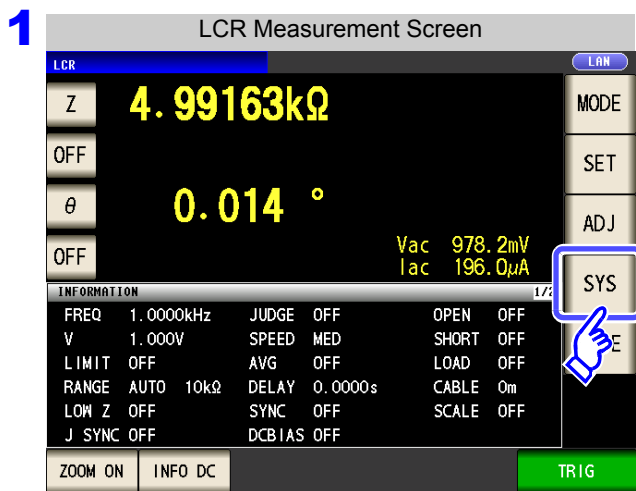

Press **TOUCH SCREEN TEST**.

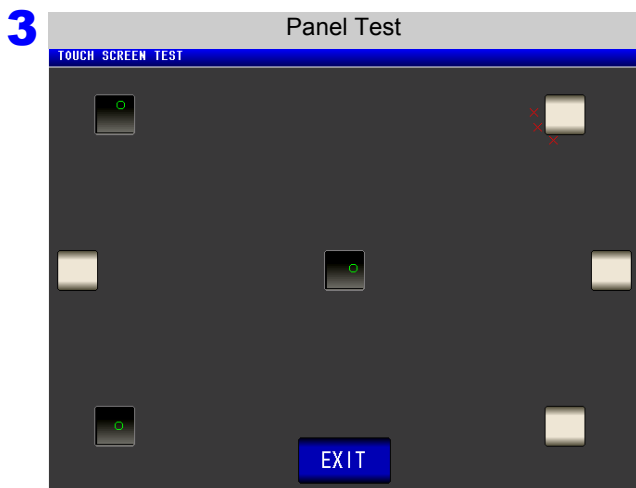

Press the keys displayed on the screen. If the pressed keys are highlighted and the green appears, the touch panel is working properly.

Perform panel compensation (p. 266) if they are not highlighted or the red **×** appears. If there is still problem after performing panel calibration, the panel may be malfunctioning. Contact your authorized Hioki distributor or reseller.

10.3 Self Checks (Self Diagnosis)

Panel Compensation

You can perform position compensation of the touch panel.

Procedure You can perform this compensation procedure in **LCR** mode, **ANALYZER** mode, or **TRANSFORMER** mode.

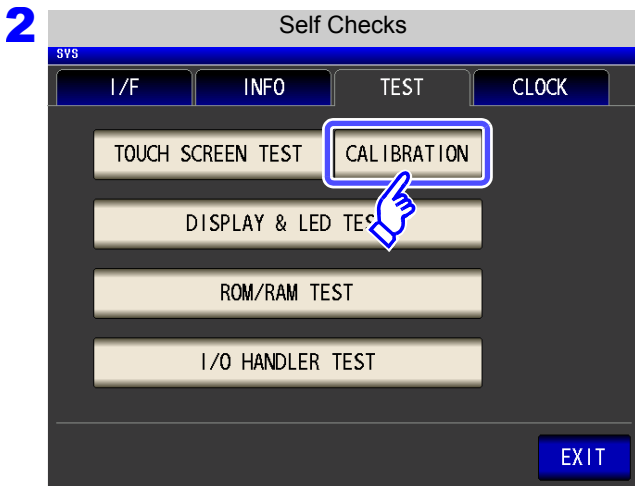
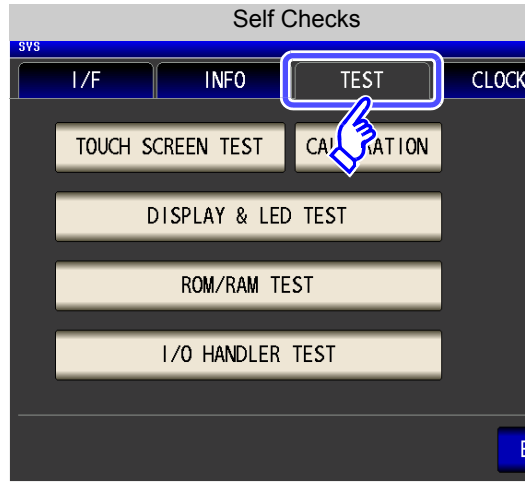
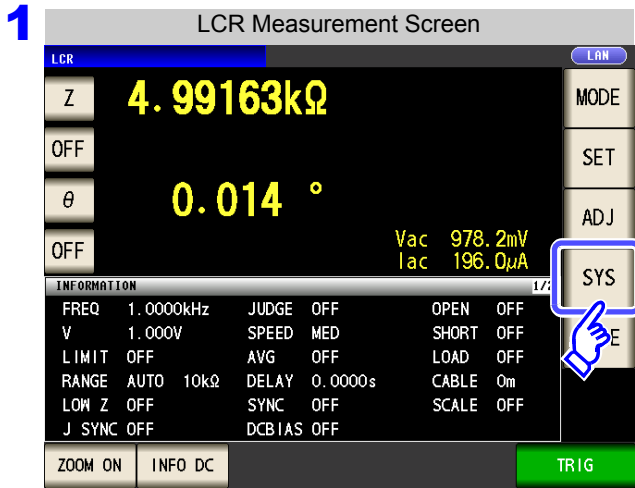

Press **CALIBRATION**.

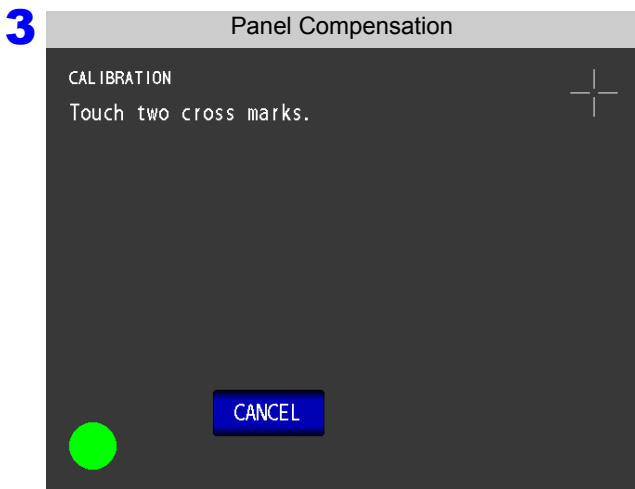

Press in the location of  continuously until the green  appears.

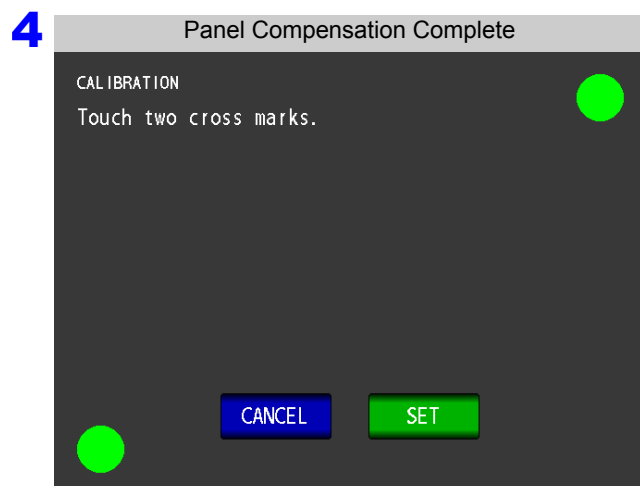

Press **SET** to close the setting screen.

Press **CANCEL** to start panel compensation from the beginning.

If the **SET** indication does not appear, the instrument needs to be repaired. Contact your authorized Hioki distributor or reseller.

10.3 Self Checks (Self Diagnosis)

Screen Display Test

Check the display state of the screen and lighting state of the LEDs.

Procedure



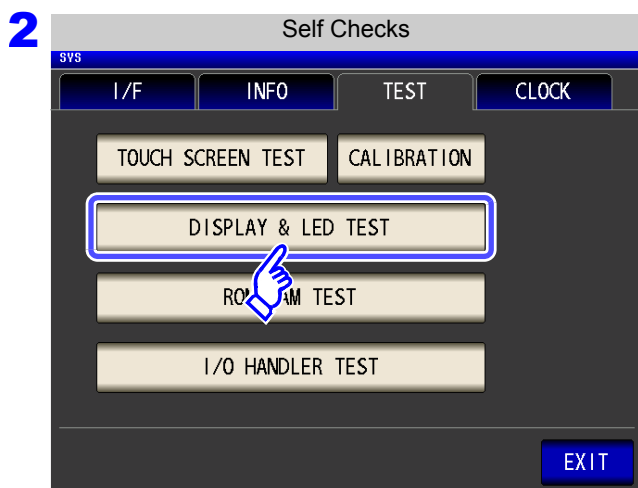
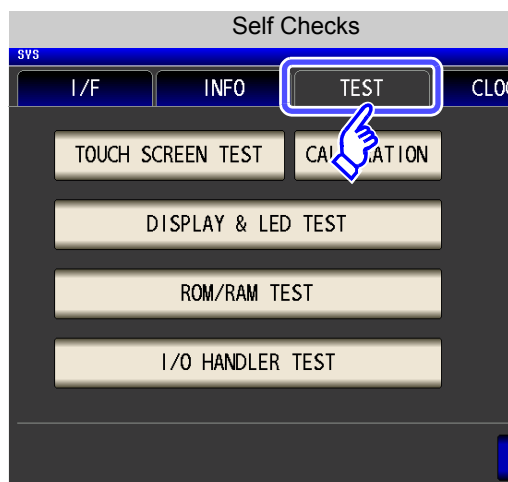
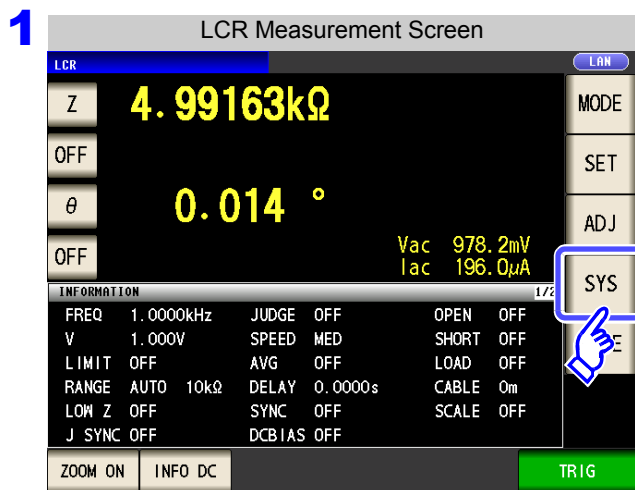







You can check the display state and lighting state in **LCR** mode, **ANALYZER** mode, or **TRANSFORMER** mode.

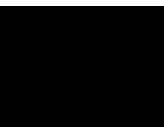

Press

DISPLAY & LED TEST

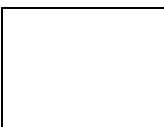
- 3** Each time you touch the screen, the screen color and front panel LEDs change as shown in the following table.

Screen Color	Front Panel LEDs
 Red	 All LEDs turn on
 Green	 All LEDs turn off
 Blue	 The [OUT] LED turns on
 Black	 The [IN] LED turns on
 White	 The [MEAS] LED turns on

If the entire screen does not appear to be the same color or if the LEDs do not turn on as shown in the figure on the left, the instrument needs to be repaired. Contact your authorized Hioki distributor or reseller.

- 4** Press **EXIT** to close the setting screen.

10.3 Self Checks (Self Diagnosis)

ROM/RAM Test

Check the internal memory (ROM and RAM) of the instrument.

Procedure You can check the internal memory in **LCR** mode, **ANALYZER** mode, or **TRANSFORMER** mode.

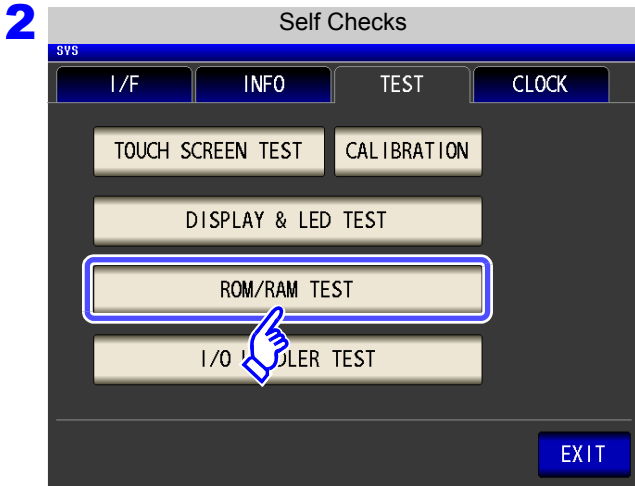
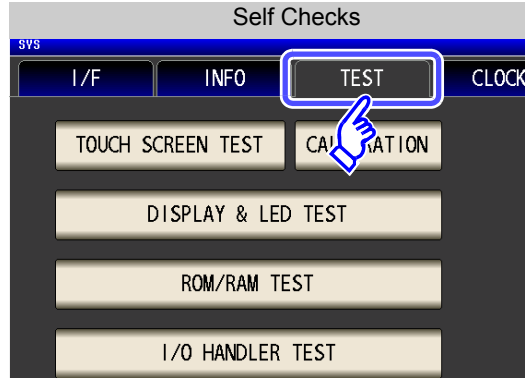
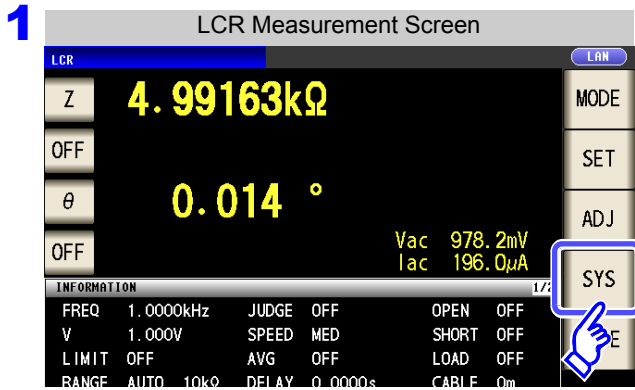

Press **ROM/RAM TEST**.

Never turn off the power during a test.

- Press the **ROM/RAM TEST** button to start the test automatically. (Approx. 40 seconds)
- No operation is possible during the ROM/RAM test.

3 If the overall judgment result indication is **[PASS]**, the test ended normally.

If the overall judgment result indication is **[NG]**, the instrument needs to be repaired. Contact your authorized Hioki distributor or reseller.

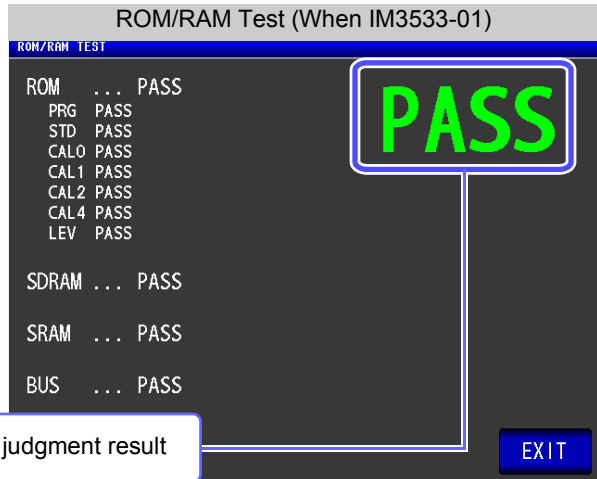
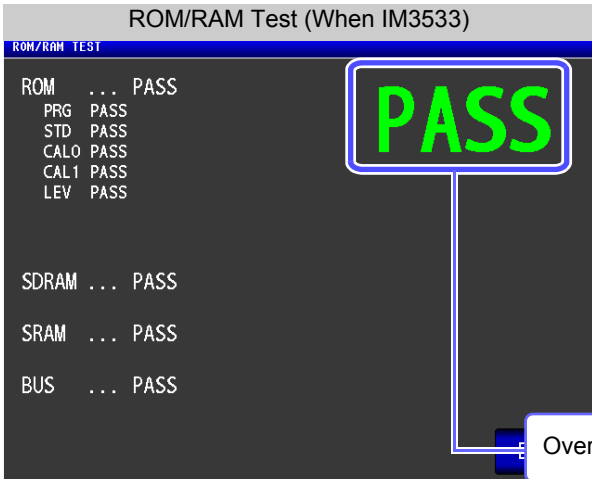

4 Press **EXIT** to close the setting screen.

I/O Test

Check whether an output signal is output normally from the EXT I/O, and whether an input signal is read normally.

Procedure You can perform the I/O test in **LCR** mode, **ANALYZER** mode, or **TRANSFORMER** mode.

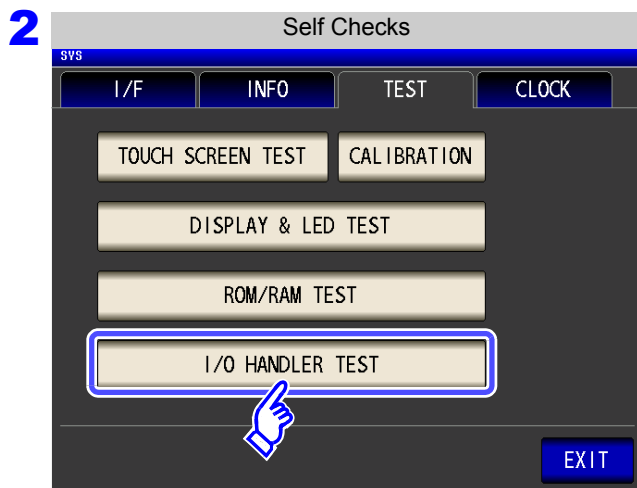
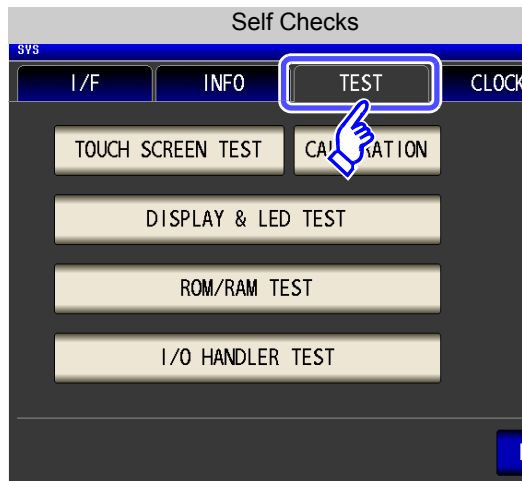
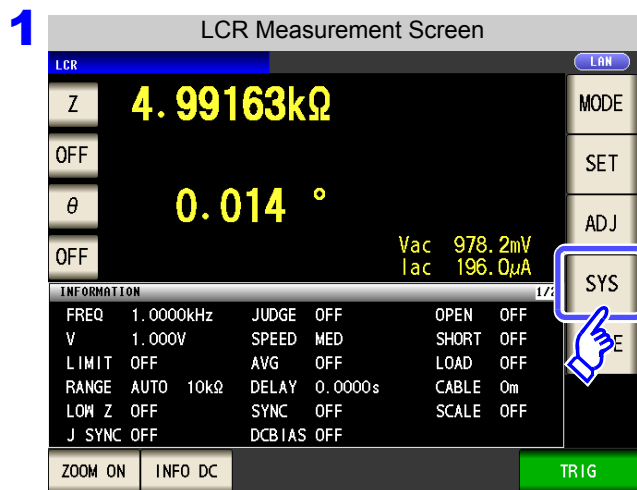

Press **I/O HANDLER TEST**.

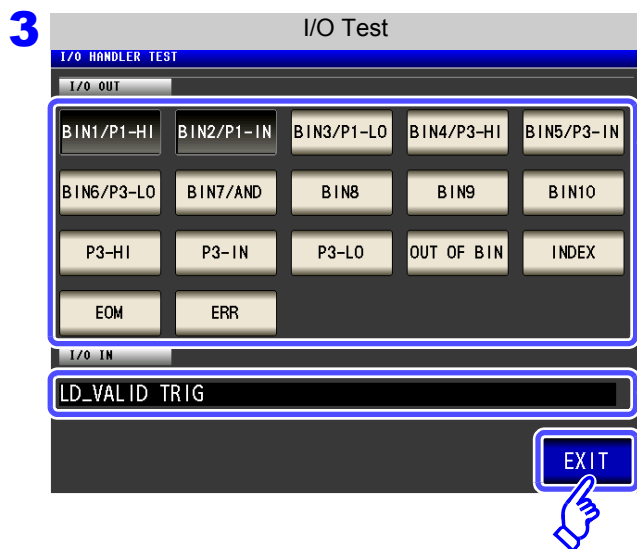

To perform an output signal test:
Press the button with the name of the signal for which you want to check the output.

To perform an input signal test:
The signal line name of the input signal being input (LOW) is displayed in the input signal test window.

To end the test:
Press **EXIT** to close the setting screen.

10.4 Setting the Date and Time

You can set the date and time of the instrument.
Data is recorded and managed based on the set date and time.

Procedure

You can set the date and time in **LCR** mode, **ANALYZER** mode, or **TRANSFORMER** mode.

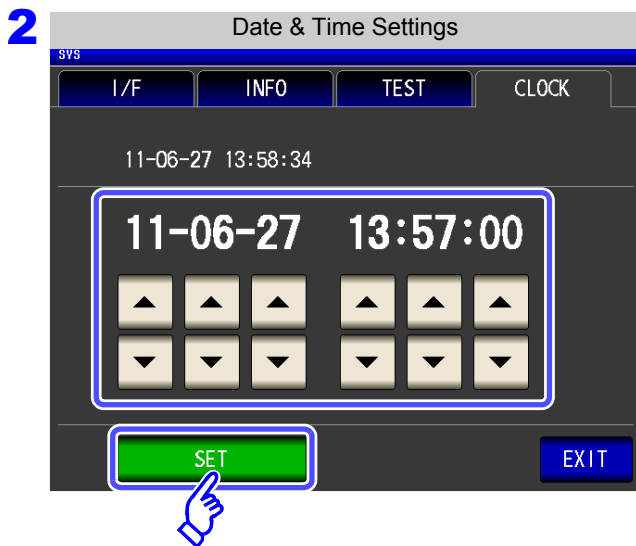
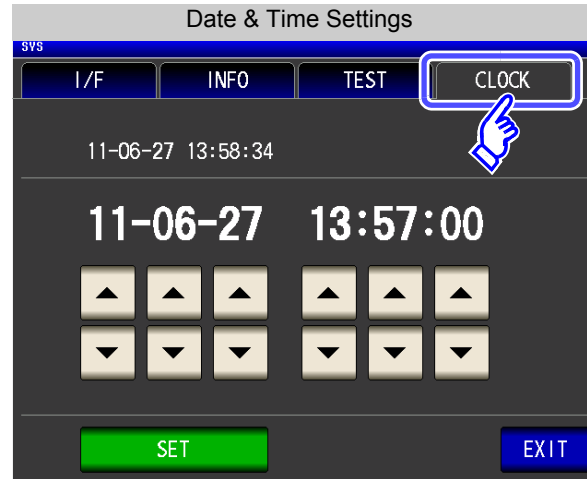
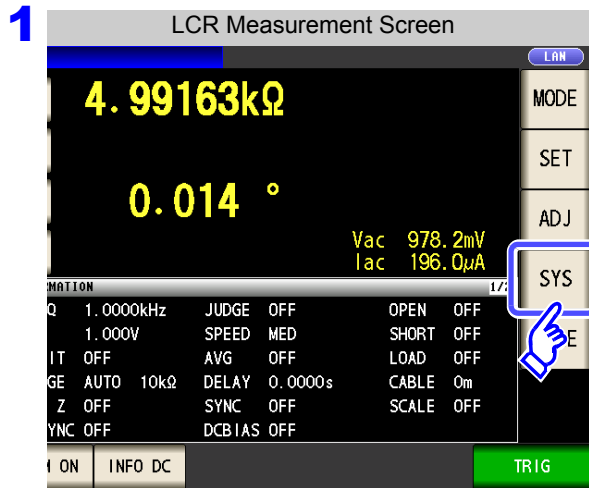

Use  or  to set the date and time.

(Year-Month-Day Hour-Minute-Second)

Settable range :
00:00:00, January 1, 2000, to
23:59:59, December 31, 2099

Press  to confirm the setting.

3 Press  to close the setting screen.

Using USB Flash Drive Chapter 11

You can save measurement values to a USB flash drive. The instrument settings can also be saved and read.

Saving Data

- Measurement values, measurement conditions, compensation values, instrument settings (p. 277)
- Currently displayed screen (p. 287)

Reading Data

- Measurement conditions, compensation values, measurement values, instrument settings (p. 297)
- Saved screen (p. 290)

File Operations

- Formatting a USB Flash Drive (Initializing) (p. 302)
- Create folders (p. 305)
- Delete files and folders (p. 304)

USB Specifications

Connector	USB type A
Electrical specification	USB2.0
Power supply	500 mA maximum
No. of ports	1
Compatible USB device	USB Mass Storage Class

CAUTION

- Hioki cannot recover data from damaged or faulty storage media resulting from abnormalities. We are also unable to provide compensation for such data loss, regardless of the contents or cause of the failure or damage. We recommend making a backup of all important data such as a computer.
- Avoid forcing insertion of storage media backwards or in the wrong orientation, as this could damage the media or instrument.
- When a USB flash drive is accessed, the color of the USB icon changes from blue to red. Do not turn off the power of the instrument while the USB flash drive is being accessed. Also, never remove the USB flash drive from the instrument. Doing so may result in the data in the USB flash drive being lost.
- When transporting the instrument, remove the USB flash drive. Failing to do so may result in the instrument or USB flash drive being damaged.
- Do not move the instrument with a USB flash drive installed. Otherwise, the instrument or media could be damaged.
- Some USB flash drives are easily affected by static electricity. Be careful handling the USB flash drive to avoid damage to the drive or instrument malfunctions due to static electricity.
- Some USB flash drives may prevent the instrument from turning on when inserted. In this case, turn the instrument on before inserting the USB flash drive.

NOTE

USB flash drives have a limited usable lifetime. After long-term use, data reading and writing will fail, at which time the USB flash drives must be replaced.

11.1 Inserting and Removing USB flash drive

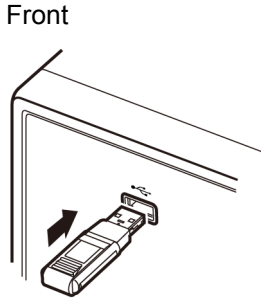

Inserting a USB flash drive

Insert the USB flash drive into the USB port on the front panel of the instrument.

- Do not insert a USB flash drive that is not Mass Storage Class compatible.
- Not all commercially available USB flash drives are compatible.
- If a USB flash drive is not recognized, try using another USB flash drive.

Removing a USB flash drive

Check that the USB flash drive is not being accessed (saving, reading, etc.) by the instrument, and then remove it.

(No remove operation needs to be performed on the instrument.)

Screen Display when Using USB

When a USB flash drive has been recognized properly, the USB flash drive icon is displayed at the top of the measurement screen.

The icon is red while the USB flash drive is being accessed.

 When the instrument recognizes the USB flash drive (Blue)

 When USB is being accessed (Red)

About File Types

The following files can be handled by the instrument.

Content	Type (file extension)	Indication on instrument
-	Folder	FDR
Measurement data	CSV file	CSV
Screen copy data	BMP file	BMP
Instrument settings data	Settings file	SET
Panel save data	Panel settings file	PNL

The instrument cannot display double-byte characters (Japanese, etc.). A double-byte characters is replaced by "??"

11.2 About the File Operation Screen

This screen displays a list of the files saved in the USB flash drive. It also allows you to perform file operations such as creating a folder and deleting a file. The instrument can recognize file names of up to 127 single-byte characters. File names that exceed that length are not recognized.

Procedure

1 Insert the USB flash drive into the USB port (front panel).

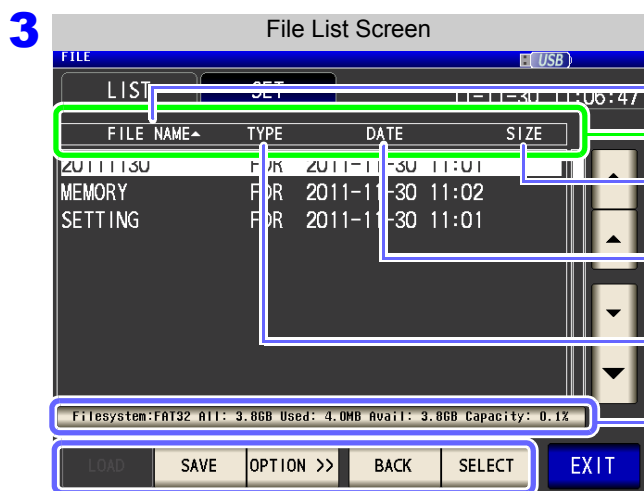
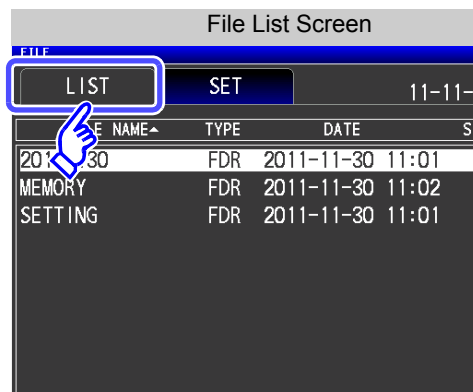
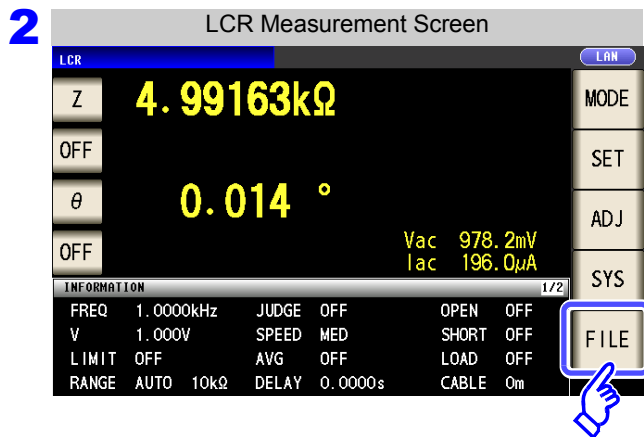

Indicates the file name.

You can press the **[FILE NAME]**, **[DATE]**, and **[SIZE]** parts to change the sorting order.

▲ : Sorts the files in ascending order.

▼ : Sorts the files in descending order.

Indicates the file size.

Indicates file save date and time.

Indicates the file type. (p. 274)

[FDR]: Folder

[BMP]: Screen copy data

[CSV]: Text data

[SET]: Instrument settings data

[PNL]: Panel save data

Indicates the information of the USB flash drive. Press the information indication portion to confirm details. (p. 307)

Loads the instrument settings. (p. 297)

Saves the instrument settings. (p. 293)

Moves to the level immediately above.



The indicated key varies depending on the type of the selected file.

• **[FDR]**: (p. 297), (p. 290)

• **[TXT]**, **[CSV]**, **[BMP]**: (p. 290)



Initializes the USB flash drive. (p. 302)

Deletes files and folders. (p. 304)

Creates a folder. (p. 305)

Saves all settings of the instrument. (p. 295)

11.3 About the File Save Setting Screen

You can configure settings such as the file save format, save destination, and text save format. Check the settings before using the file save function.

Procedure

1 Insert the USB flash drive into the USB port (front panel).

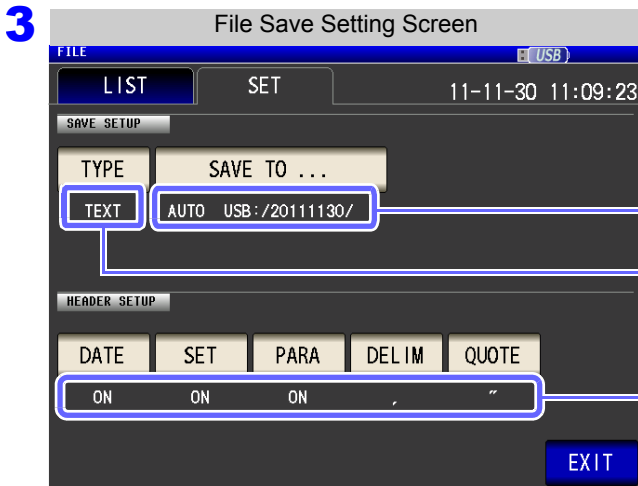
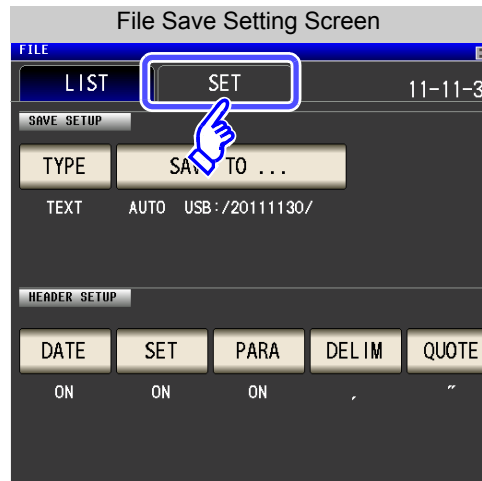
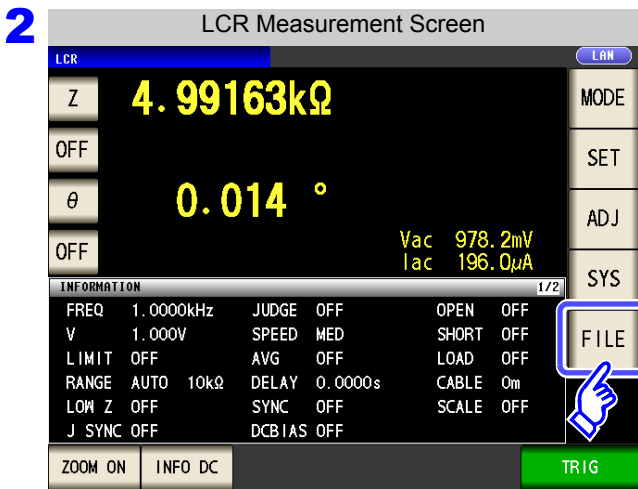

- Indicates the save destination folder.
- Indicates the save format.
- Indicates settings related to saving text. (Settings cannot be configured when BMP is selected for the file type.)

11.4 Saving Measurement Data

You can save the measurement data to a USB flash drive in CSV format.

LCR mode	▶	Saves the measurement values displayed in the current screen in CSV format.
ANALYZER mode (IM3533-01 only)	▶	Saves the measurement values of one sweep in CSV format.
TRANSFORMER mode	▶	Saves the measurement values shown on the current screen in CSV format.
CONTINUOUS measurement mode	▶	Saves the measurement result of each panel in CSV format.

1 Saving Measurement Data

Measurement results are saved in the following order: measuring instrument information, time and date, measurement conditions, measurement parameters, and measurement values. The text file's header (time and date, measurement conditions, measurement parameters, delimiter, and quotation mark type) can be configured as desired.

Example of screen copy

DATE: ON, SET: ON, PARA: ON, DELIM: " , " (comma),
QUOTE: " (double quotation mark)

When LCR mode

```
"HIOKI E.E. CORPORATION","IM3533","Ver. 1.00",
"Serial No. 123456789"

"DATE","11-11-30"
"TIME","10:10:06"

"FREQ","1.0000E+03","Hz"
"V","1.000","V"
"LIMIT","OFF"
"RANGE","AUTO","10k","ohm"
"LOW Z","OFF"
"JUDGE SYNC","OFF"
"JUDGE","OFF"
"SPEED","MED"
"TRIG","INT"
"AVG","OFF"
"DELAY","0.0000","s"
"TRIG SYNC","OFF"
"DCBIAS","OFF"
"OPEN","OFF"
"SHORT","OFF"
"LOAD","OFF"
"CABLE","0","m"
"SCALE","OFF"

"Z[ohm]","OFF","PHASE[deg]","OFF"
"4.983329E+03","","0.074",""
```

When ANALYZER mode (IM3533-01 only)

```
"HIOKI E.E. CORPORATION","IM3533-01","Ver. 1.00",
"Serial No. 123456789"

"DATE","11-11-30"
"TIME","17:21:31"

"SOURCE","FREQ"
"TRIG","REPEAT"
"DRAW","REAL"
"TRIG DELAY","0.0000","s"
"DCBIAS","OFF"
"V","1.000","V"
"RANGE","AUTO"
"SPEED","MED"
"AVG","OFF"
"POINT DELAY","0.0000","s"

"No.,"FREQUENCY(Hz),"Z[ohm]","PHASE[deg]"
"1","1.0000E+03","4.987525E+03","0.074"
"2","1.0233E+03","4.987028E+03","0.008"
"3","1.0471E+03","4.987108E+03","0.012"
"4","1.0715E+03","4.987147E+03","0.010"
"5","1.0965E+03","4.987112E+03","0.010"
"6","1.1220E+03","4.986926E+03","0.012"
"7","1.1482E+03","4.987031E+03","0.012"
```

When TRANSFORMER mode

```
"HIOKI E.E. CORPORATION","IM3533","Ver. 1.00",
"Serial No. 123456789"

"DATE","11-11-30"
"TIME","10:13:33"

"FREQ","1.0000E+03","Hz"
"V","1.000","V"
"LIMIT","OFF"
"RANGE","AUTO","10","ohm"
"LOW Z","OFF"
"JUDGE SYNC","OFF"
"JUDGE","OFF"
"SPEED","MED"
"AVG","OFF"
"DELAY","0.0000","s"
"TRIG SYNC","OFF"
"OPEN","OFF"
"SHORT","OFF"
"LOAD","OFF"
"CABLE","0","m"
"SCALE","OFF"

"LS1[H]","LS2[H]","NI[ ]"
"1.040480E-03","1.024376E-03","1.007830E+00"
```

11.4 Saving Measurement Data

Procedure

1 Insert the USB flash drive into the USB port (front panel).

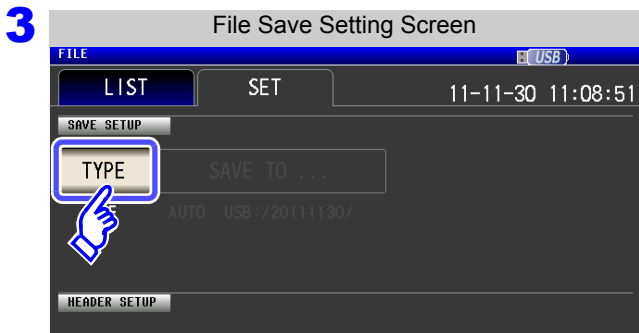
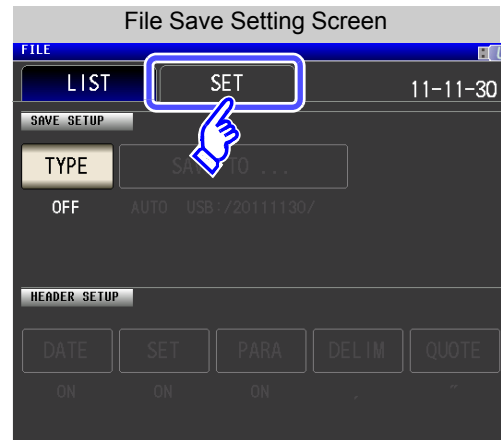
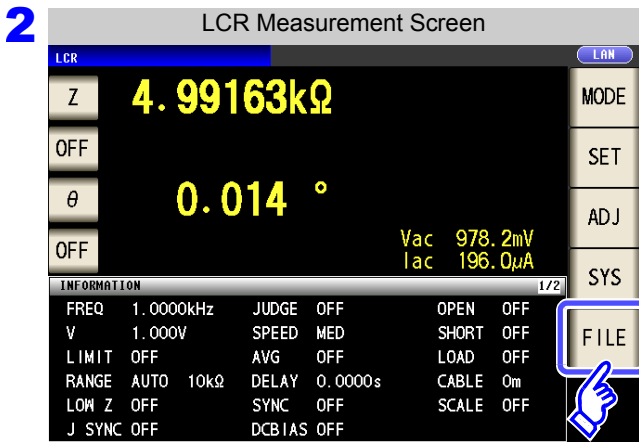

Press **TYPE**.

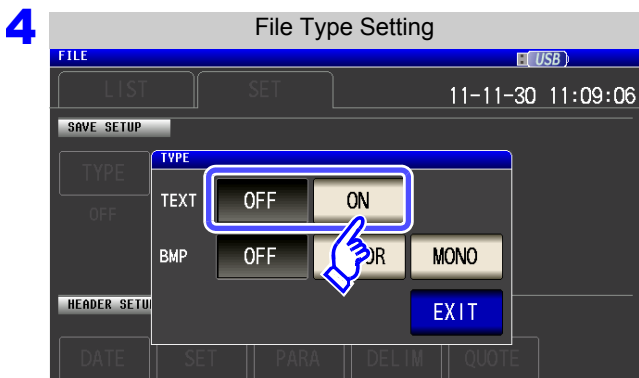

Enable the text file type.

OFF Disables the text file type.

ON Saves measurement values as text data.

Press **EXIT**.

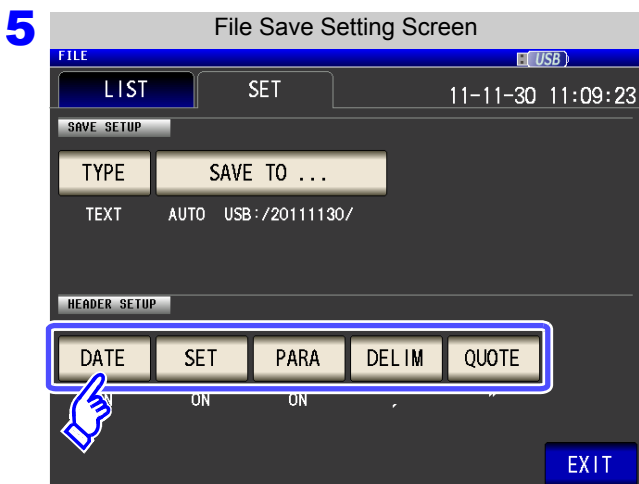

Set the header of the text file.

Select the header setting.

DATE Turns the save date and time ON/OFF.

SET Turns the measurement condition ON/OFF.

PARA Turns the measurement parameter ON/OFF.

DELIM Sets the delimiter type.

QUOTE Sets the quotation mark type.

DATE

Save Date and Time Setting

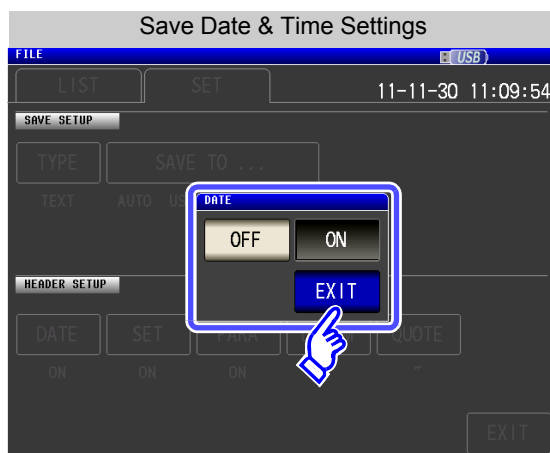

1. Select ON/OFF for the save date and time.

OFF Does not record the save date and time.

ON Records the save date and time.

2. Press **EXIT** to close the setting screen.

When ON

```
"HIOKI E.E. CORPORATION","IM3533","Ver. 1.00",
"Serial No. 123456789"
```

```
"DATE","11-11-30"
"TIME","10:10:06"
```

```
"FREQ","1.0000E+03","Hz"
"V","1.000","V"
"LIMIT","OFF"
"RANGE","AUTO","10k","ohm"
```

When OFF

```
"HIOKI E.E. CORPORATION","IM3533","Ver. 1.00",
"Serial No. 123456789"
```

```
"FREQ","1.0000E+03","Hz"
"V","1.000","V"
"LIMIT","OFF"
"RANGE","AUTO","10k","ohm"
```

SET

Measurement Condition Setting

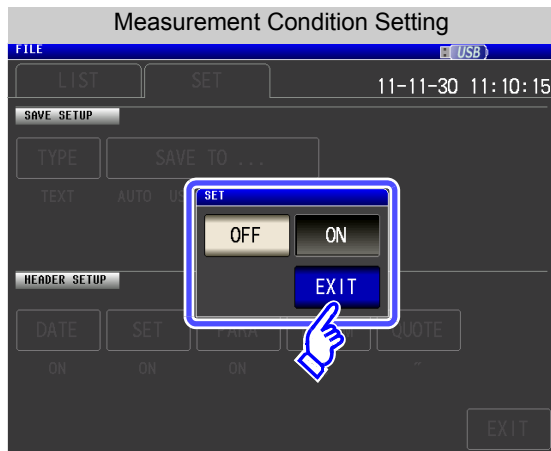

1. Select ON/OFF for the measurement condition setting.

OFF

Does not record the measurement condition.

ON

Records the measurement condition.

2. Press **EXIT** to close the setting screen.

When ON

```
"HIOKI E.E. CORPORATION","IM3533","Ver. 1.00",
"Serial No. 123456789"
```

```
"DATE","11-11-30"
```

```
"TIME","10:10:06"
```

```
"FREQ","1.0000E+03","Hz"
"V","1.000","V"
"LIMIT","OFF"
"RANGE","AUTO","10k","ohm"
"LOW Z","OFF"
"JUDGE SYNC","OFF"
"JUDGE","OFF"
"SPEED","MED"
"TRIG","INT"
"AVG","OFF"
"DELAY","0.0000","s"
"TRIG SYNC","OFF"
"DCBIAS","OFF"
"OPEN","OFF"
"SHORT","OFF"
"LOAD","OFF"
"CABLE","0","m"
"SCALE","OFF"
```

```
"Z[ohm]","OFF","PHASE[deg]","OFF"
"4.987600E+03","","0.074","
```

When OFF

```
"HIOKI E.E. CORPORATION","IM3533","Ver. 1.00",
"Serial No. 123456789"
```

```
"DATE","11-11-30"
```

```
"TIME","10:10:37"
```

```
"Z[ohm]","OFF","PHASE[deg]","OFF"
"4.987600E+03","","0.074","
```

PARA Measurement Parameter Setting

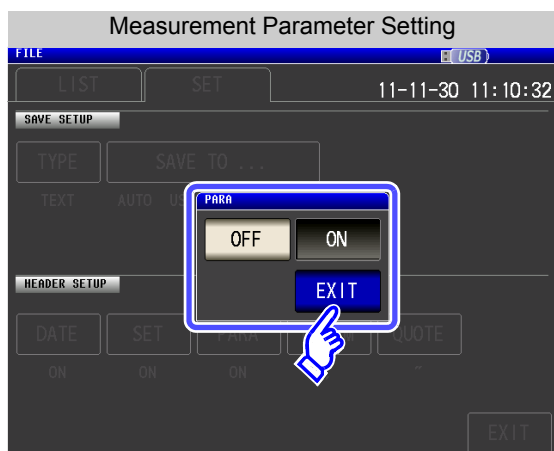

1. Select ON/OFF for measurement parameter recording.

OFF Does not record the measurement parameter.

ON Records the measurement parameter.

2. Press **EXIT** to close the setting screen.

When ON

```
"HIOKI E.E. CORPORATION","IM3533","Ver. 1.00",
"Serial No. 123456789"
```

```
"DATE","11-11-30"
"TIME","10:10:06"
```

```
"FREQ","1.0000E+03","Hz"
"V","1.000","V"
"LIMIT","OFF"
"RANGE","AUTO","10k","ohm"
"LOW Z","OFF"
"JUDGE SYNC","OFF"
"JUDGE","OFF"
"SPEED","MED"
"TRIG","INT"
"AVG","OFF"
"DELAY","0.0000","s"
"TRIG SYNC","OFF"
"DCBIAS","OFF"
"OPEN","OFF"
"SHORT","OFF"
"LOAD","OFF"
"CABLE","0","m"
"SCALE","OFF"
```

```
"Z[ohm]","OFF","PHASE[deg]","OFF"
4.987600E+03","",0.074"
```

When OFF

```
"HIOKI E.E. CORPORATION","IM3533","Ver. 1.00",
"Serial No. 123456789"
```

```
"DATE","11-11-30"
"TIME","10:10:53"
```

```
"FREQ","1.0000E+03","Hz"
"V","1.000","V"
"LIMIT","OFF"
"RANGE","AUTO","10k","ohm"
"LOW Z","OFF"
"JUDGE SYNC","OFF"
"JUDGE","OFF"
"SPEED","MED"
"TRIG","INT"
"AVG","OFF"
"DELAY","0.0000","s"
"TRIG SYNC","OFF"
"DCBIAS","OFF"
"OPEN","OFF"
"SHORT","OFF"
"LOAD","OFF"
"CABLE","0","m"
"SCALE","OFF"
```

```
"4.987600E+03","",0.074,""
```

DELIM

Delimiter Setting

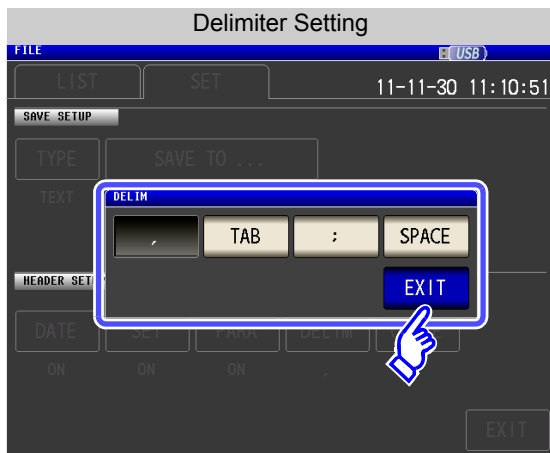

1. Select the delimiter setting.



Sets the delimiter to a comma (,).



Sets the delimiter to a tab.



Sets the delimiter to a semicolon (;).



Sets the delimiter to a space.

2. Press **EXIT** to close the setting screen.

When comma

```
"HIOKI E.E. CORPORATION","IM3533","Ver. 1.00",
"Serial No. 123456789"

"DATE","11-11-30"
"TIME","10:10:06"

"FREQ","1.0000E+03","Hz"
"V","1.000","V"
"LIMIT","OFF"
"RANGE","AUTO","10k","ohm"
"LOW Z","OFF"
"JUDGE SYNC","OFF"
"JUDGE","OFF"
"SPEED","MED"
"TRIG","INT"
"AVG","OFF"
```

When tab

```
"HIOKI E.E. CORPORATION" "IM3533" "Ver. 1.00"
"Serial No. 123456789"

"DATE" "11-11-30"
"TIME" "10:11:36"

"FREQ" "1.0000E+03" "Hz"
"V" "1.000" "V"
"LIMIT" "OFF"
"RANGE" "AUTO" "10k" "ohm"
"LOW Z" "OFF"
"JUDGE SYNC" "OFF"
"JUDGE" "OFF"
"SPEED" "MED"
"TRIG" "INT"
"AVG" "OFF"
```

When semicolon

```
"HIOKI E.E. CORPORATION";"IM3533";"Ver. 1.00";
"Serial No. 123456789"

"DATE";"11-11-30"
"TIME";"10:11:42"

"FREQ";"1.0000E+03";"Hz"
"V";"1.000";"V"
"LIMIT";"OFF"
"RANGE";"AUTO";"10k";"ohm"
"LOW Z";"OFF"
"JUDGE SYNC";"OFF"
"JUDGE";"OFF"
"SPEED";"MED"
"TRIG";"INT"
"AVG";"OFF"
```

When space

```
"HIOKI E.E. CORPORATION" "IM3533" "Ver. 1.00"
"Serial No. 123456789"

"DATE" "11-11-30"
"TIME" "10:11:48"

"FREQ" "1.0000E+03" "Hz"
"V" "1.000" "V"
"LIMIT" "OFF"
"RANGE" "AUTO" "10k" "ohm"
"LOW Z" "OFF"
"JUDGE SYNC" "OFF"
"JUDGE" "OFF"
"SPEED" "MED"
"TRIG" "INT"
"AVG" "OFF"
```

QUOTE Quotation Mark Setting

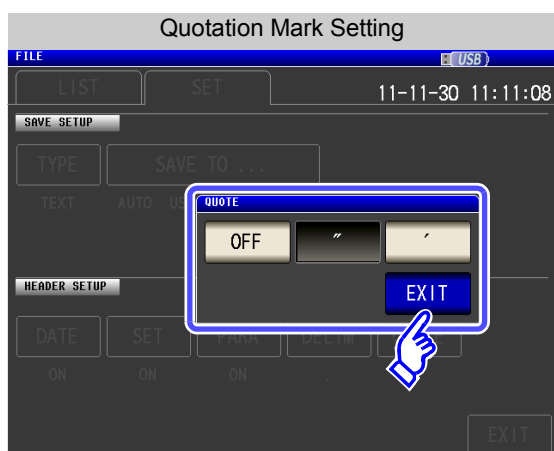

1. Select the quotation mark setting.

OFF	No quotation marks are added.
"	Sets the quotation mark to a double quotation mark (").
'	Sets the quotation mark to a single quotation mark (').

2. Press **EXIT** to close the setting screen.

When OFF

```
HIOKI E.E. CORPORATION,IM3533,Ver. 1.00,
Serial No. 123456789
```

```
DATE,11-11-30
TIME,10:12:05
```

```
FREQ,1.0000E+03,Hz
V,1.000,V
LIMIT,OFF
RANGE,AUTO,10k,ohm
LOW Z,OFF
JUDGE SYNC,OFF
JUDGE,OFF
SPEED,MED
TRIG,INT
AVG,OFF
```

When double quotation mark

```
"HIOKI E.E. CORPORATION","IM3533","Ver. 1.00",
"Serial No. 123456789"
```

```
"DATE","11-11-30"
"TIME","10:10:06"
```

```
"FREQ","1.0000E+03","Hz"
"V","1.000","V"
"LIMIT","OFF"
"RANGE","AUTO","10k","ohm"
"LOW Z","OFF"
"JUDGE SYNC","OFF"
"JUDGE","OFF"
"SPEED","MED"
"TRIG","INT"
"AVG","OFF"
```

When single quotation mark

```
'HIOKI E.E. CORPORATION','IM3533','Ver. 1.00',
'Serial No. 123456789'
```

```
'DATE','11-11-30'
'TIME','10:12:15'
```

```
'FREQ','1.0000E+03','Hz'
'V','1.000','V'
'LIMIT','OFF'
'RANGE','AUTO','10k','ohm'
'LOW Z','OFF'
'JUDGE SYNC','OFF'
'JUDGE','OFF'
'SPEED','MED'
'TRIG','INT'
'AVG','OFF'
```

11.4 Saving Measurement Data

6 Press **EXIT**.

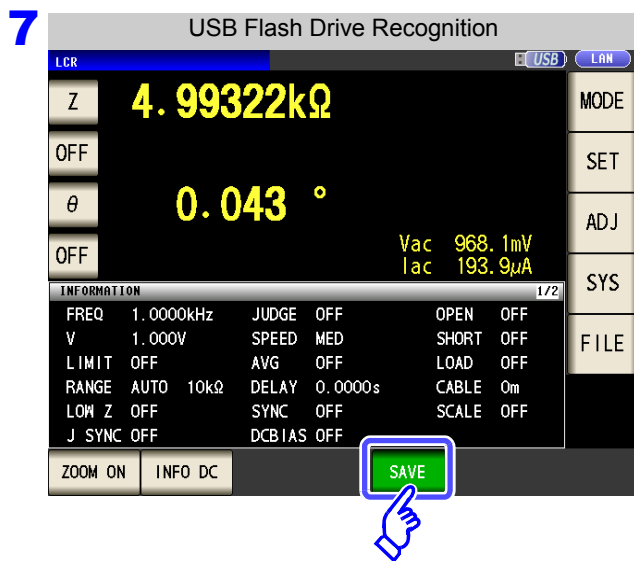

Press **SAVE** in the measurement screen.

The measurement data is saved.

When **SAVE** is pressed, a folder is automatically created in the USB flash drive and the file is saved.

- The date is used for the name of the folder created when you press **SAVE**.
- The date and time are automatically assigned to the file name.

See "Changing the Save Folder" (p. 291)

NOTE

When performing measurement in ANALYZER mode, do not save measurement data partway through the series of frequency points.

Error measurement results

When LCR mode, ANALYZER mode, CONTINUOUS measurement mode

Priority/Order	Measurement Error	Screen Indication	Measurement Status	Measurement Values (Upper Portion: When text save, the memory function (short Format), Lower Portion: When the memory function (Long Format))	When saved by the memory function		
					Comparator Measurement		BIN Measurement
					Logical Product	Each Parameter Judgment Result	BIN No
High ↑	Sampling error	SAMPLE ERR	9	999999E+28	0	1 ^{*1}	-1
				9999999999E+28			
	Overcurrent error	OVER CUR	19	999999E+28	0	1 ^{*1}	-1
				9999999999E+28			
	H side and L side contact error (AFTER)	NC A HL NC A HL	17	999999E+28	0	1 ^{*1}	-1
				9999999999E+28			
	L side contact error (AFTER)	NC A L NC A L	16	999999E+28	0	1 ^{*1}	-1
				9999999999E+28			
	H side contact error (AFTER)	NC A H NC A H	15	999999E+28	0	1 ^{*1}	-1
				9999999999E+28			
	H side and L side contact error (BEFORE)	NC B HL NC B HL	14	999999E+28	0	1 ^{*1}	-1
				9999999999E+28			
	L side contact error (BEFORE)	NC B L NC B L	13	999999E+28	0	1 ^{*1}	-1
				9999999999E+28			
H side contact error (BEFORE)	NC B H NC B H	12	999999E+28	0	1 ^{*1}	-1	
			9999999999E+28				
Underflow	UNDERFLOW	-7	-999999E+28	0	-1 ^{*1,2}	-1	
			-9999999999E+28				
Overflow	OVERFLOW	7	999999E+28	0	1 ^{*1,3}	-1	
			9999999999E+28				
Outside of HIGH-Z reject limit range	Hi Z	5	Normal Measurement Values	Normal judgment	Normal judgment	Normal judgment	
			Normal Measurement Values				
Outside of display range ^{*4}	DISP OUT	3	Normal Measurement Values	Normal judgment	Normal judgment	Normal judgment	
			Normal Measurement Values				
Temperature correction sensor error (temperature correction)	TC ERR	18	Normal Measurement Values	Normal judgment	1	Normal judgment	
			Normal Measurement Values				
Outside of guaranteed accuracy range	Reference Value	2	Normal Measurement Values	Normal judgment	Normal judgment	Normal judgment	
			Normal Measurement Values				
Normal	Measurement Values	0	Normal Measurement Values	Normal judgment	Normal judgment	Normal judgment	
			Normal Measurement Values				
Low ↓	No measurement after power turned on		1	999999E+28	0	2	-2
				9999999999E+28			

*1 The judgment result will be 2 when comparator judgment is not mode.

*2 The judgment result will be 1 when the parameters are Y, Cs, Cp, G, and B.

*3 The judgment result will be -1 when the parameters are Y, Cs, Cp, G, and B.

*4 For the outside of the display range to which a temperature sensor is not connected, "999999E+28" is returned as a short form and "9999999999E+28" is returned as a long form.

11.4 Saving Measurement Data

When TRANSFORMER mode

Priority Order	Measurement Error	Screen Indication	Measurement Status	Measurement Values (Upper Portion: When text save, the memory function (short Format), Lower Portion: When the memory function (Long Format))	When saved by the memory function
					Comparator Measurement
High	Outside of display range*1	DISP OUT	3	999999E+28	1/2 *2
				9999999999E+28	
	Outside of HIGH-Z reject limit range	Hi Z	5	Normal Measurement Values	Normal judgment
				Normal Measurement Values	
	Outside of guaran- teed accuracy range	Reference Value	2	Normal Measurement Values	Normal judgment
				Normal Measurement Values	
	Normal	Measurement Values	0	Normal Measurement Values	Normal judgment
				Normal Measurement Values	
Lo	No measurement af- ter power turned on	 	1	999999E+28	2
				9999999999E+28	

*1 When L1, L2 cannot be measured correctly.

*2 Returns 2 if either L1 or L2 has not been measured, or 1 if a measurement parameter is erroneous or calculation is impossible.

NOTE

The measurement status indicates the error response saved with the memory function by the **:MEASure:VALId** setting.

For more information about how to set **:MEASure:VALId**, see the Communications Command Instruction Manual (LCR Application Disk).

2 Saving a Copy of the Screen

You can save the screen currently displayed to the USB flash drive in bmp file format (256 colors or mono-chrome [2 colors]). The file extension is [.bmp].

Procedure

1 Insert the USB flash drive into the USB port (front panel).

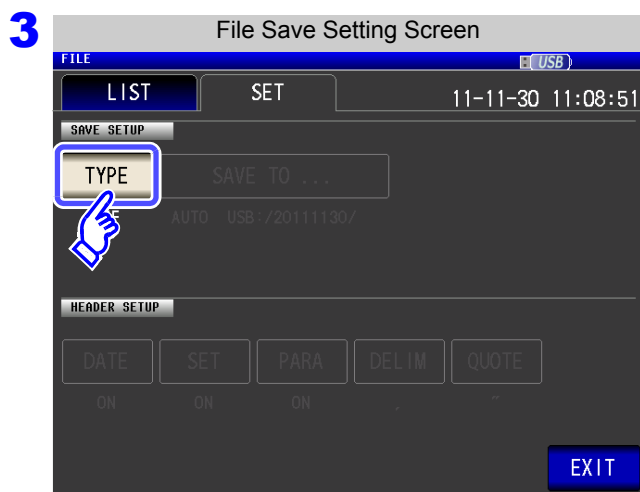
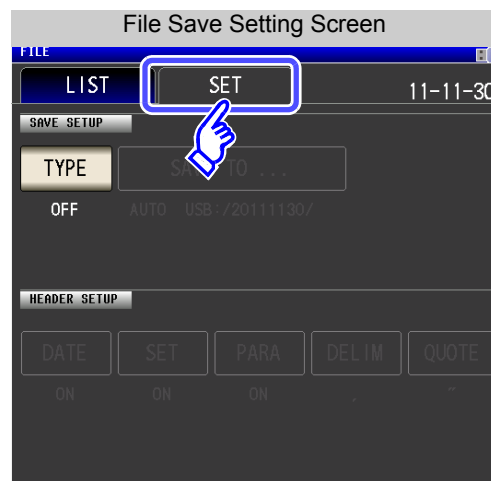
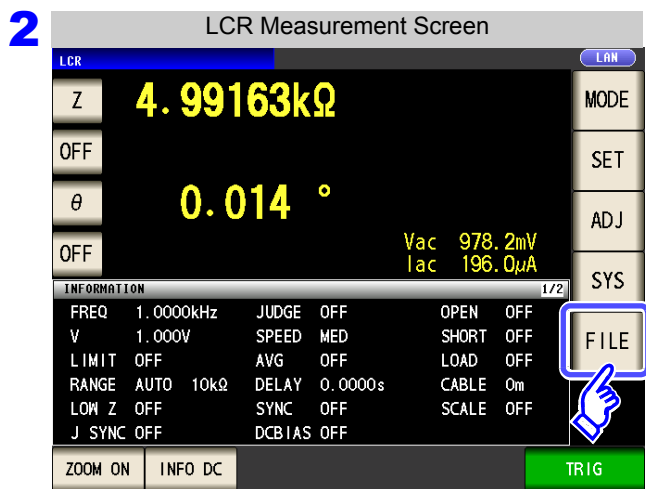

Press **TYPE**.

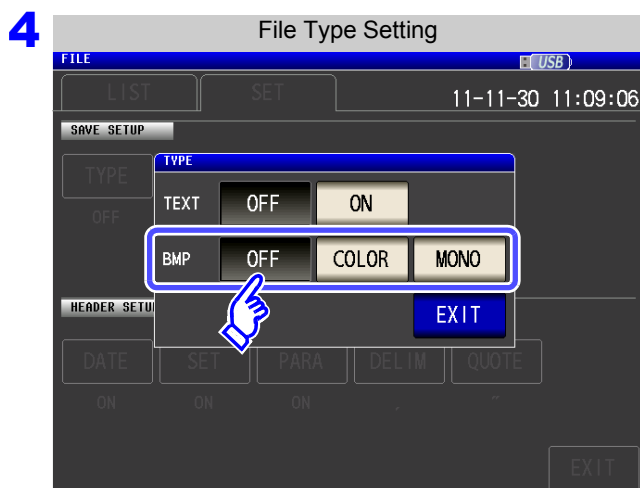

Select the BMP save setting.

- OFF** Disables the screen copy function.
- COLOR** Saves a copy of the screen as a 256-color BMP file.
- MONO** Saves a copy of the screen as a monochrome (2-color) BMP file.

Press **EXIT** to close the setting screen.

11.4 Saving Measurement Data

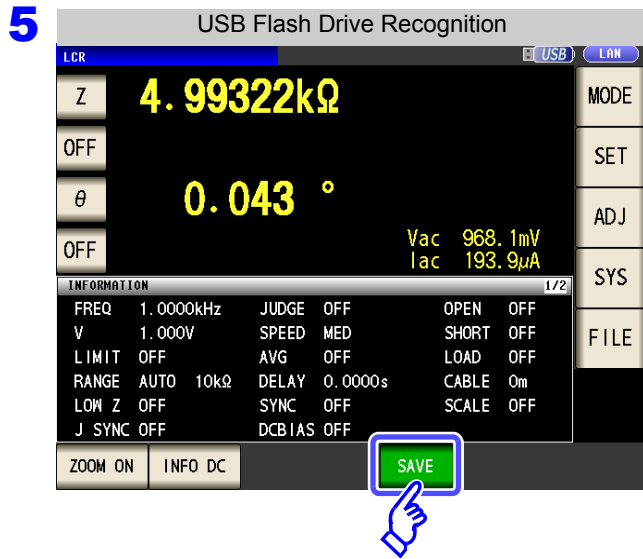

Press **SAVE** in the [Measurement Screen].

A copy of the screen is saved.

When **SAVE** is pressed, a folder is automatically created in the USB flash drive and the file is saved.

- The date is used for the name of the folder created when you press **SAVE**.
- The date and time are automatically assigned to the file name.

See "Changing the Save Folder" (p. 291)

Example of screen copy

When LCR mode

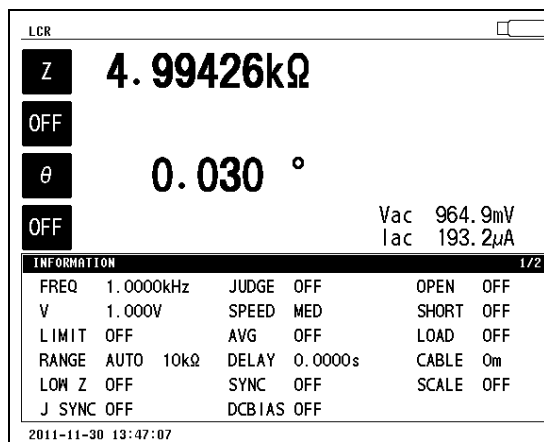

When ANALYZER mode (IM3533-01 only)

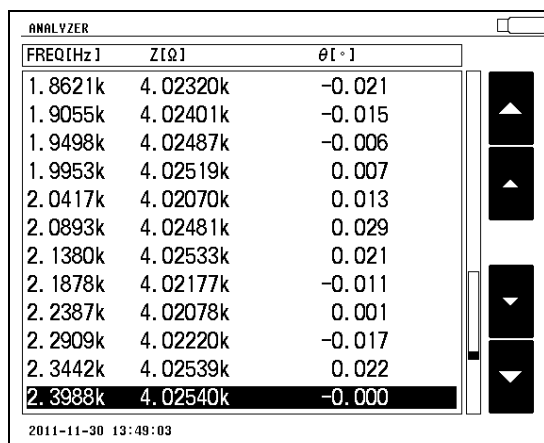

When TRANSFORMER mode

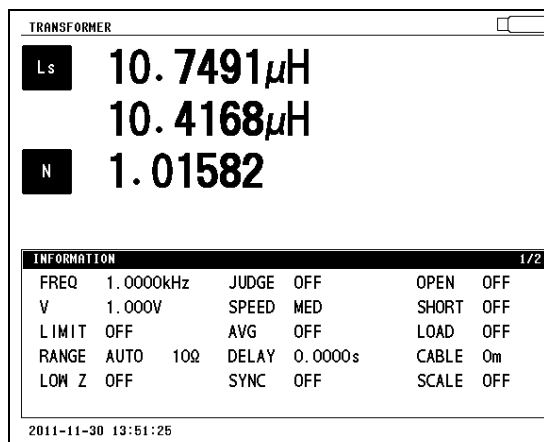

11.4 Saving Measurement Data

3 Checking the Contents of Files

You can check files saved to a USB flash drive in text format ([TXT], [CSV]) and BMP format on the screen.

Procedure

1 Insert the USB flash drive into the USB port (front panel).

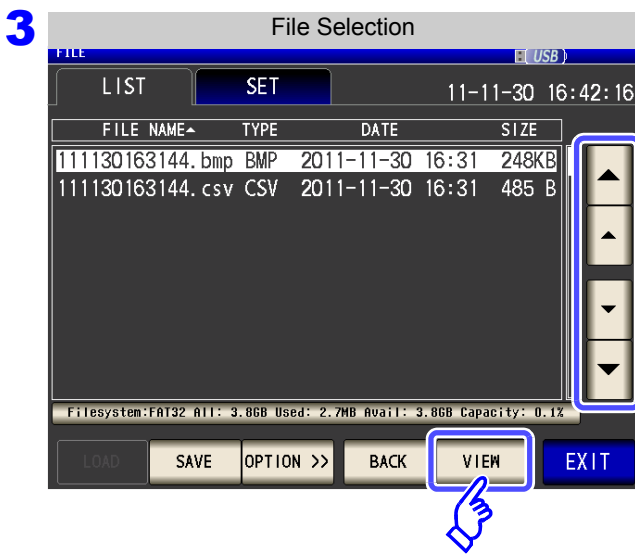
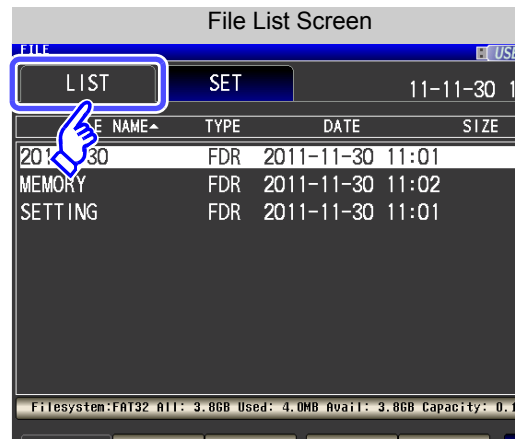
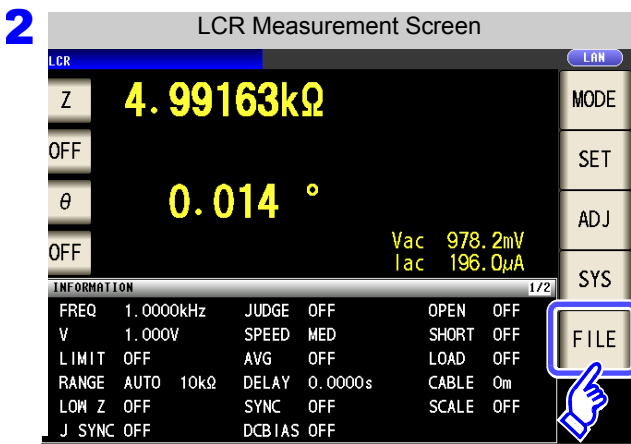

Use or to select the file to check.

Press to check the file.

The indicated key varies depending on the type of the selected file.

- When [FDR]:
- When [TXT], [CSV], or [BMP]:

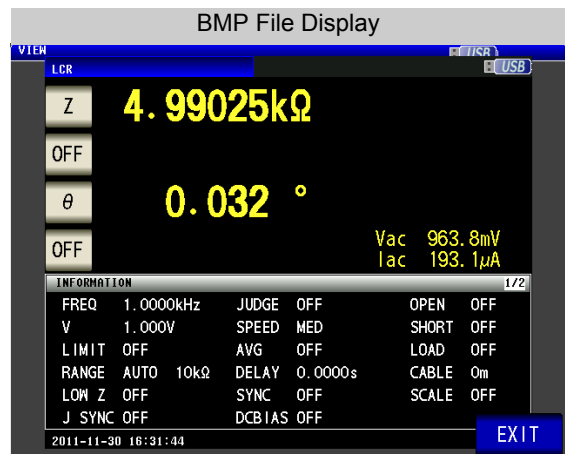
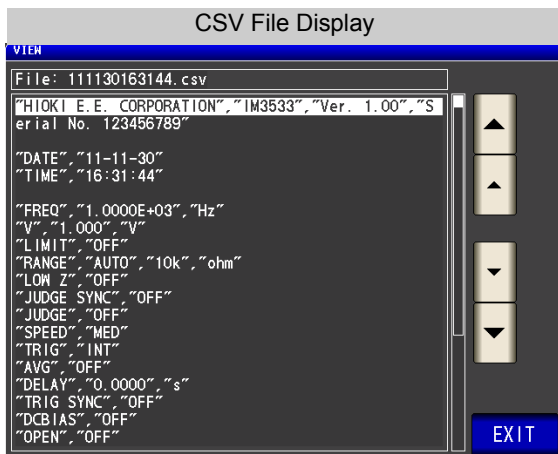

4 Press to close the setting screen.

4 Changing the Save Folder

You can set the save destination for data automatically or set the desired folder.

Procedure

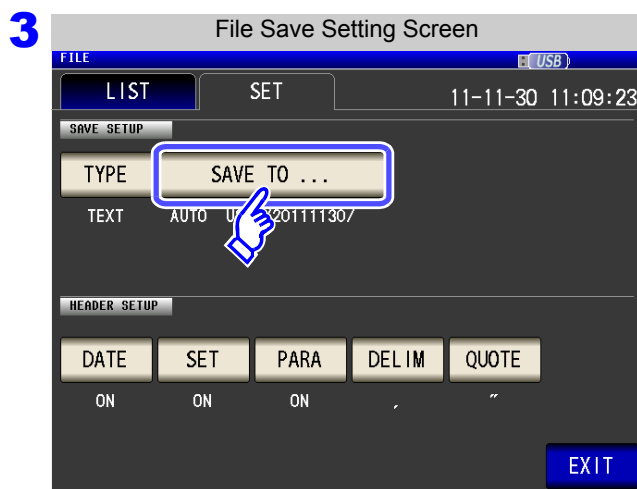
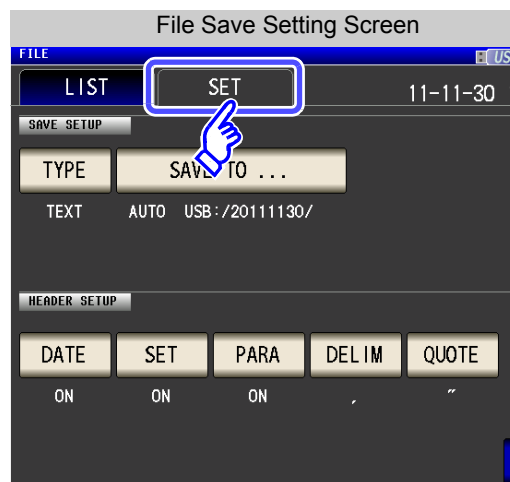
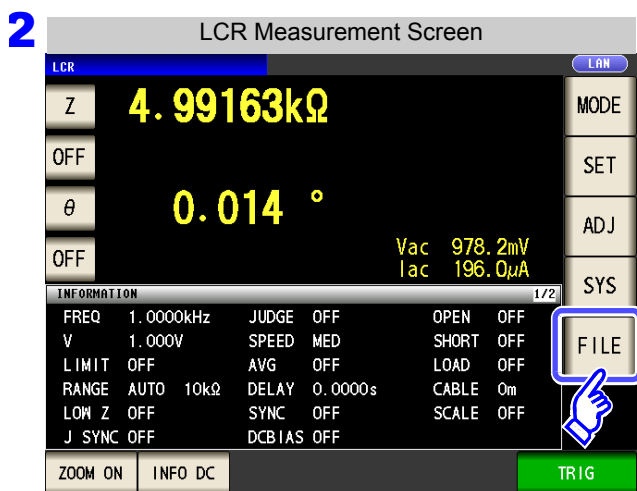

1 Insert the USB flash drive into the USB port (front panel).

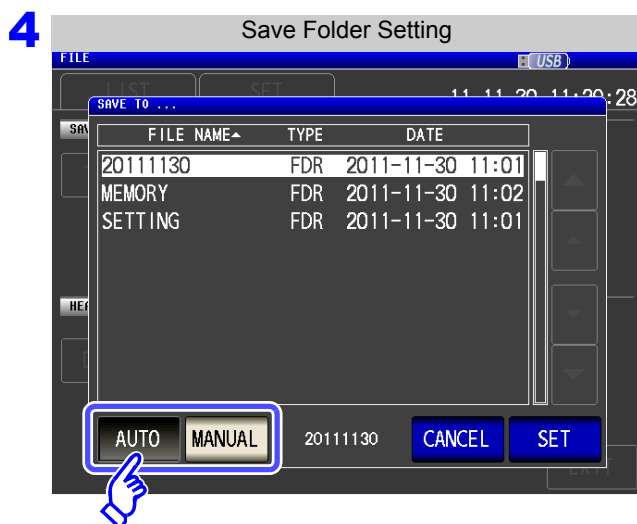

Press  .



Select the setting procedure of the save folder.

-  Automatically creates a folder for today's date, and saves the data in the folder.
-  Allows you to specify any folder and then save the data.

Press  to confirm the setting.

When you want to cancel the setting:
Press  .

11.4 Saving Measurement Data

NOTE

The following restrictions apply to the folder that can be selected with **MANUAL**.

- The folder name must be all single-byte characters (a folder name containing Japanese or other double-byte characters cannot be specified).
- The folder name must be no more than 12 characters.

5 Press **EXIT** to close the setting screen.

NOTE

- Only folders in the root directory of the USB flash drive can be selected with **MANUAL**.
- If the folder specified as the save destination folder has been deleted, create a folder when saving files.

What is the root directory?

The root directory refers to the top-most directory in the hierarchy of the USB flash drive.

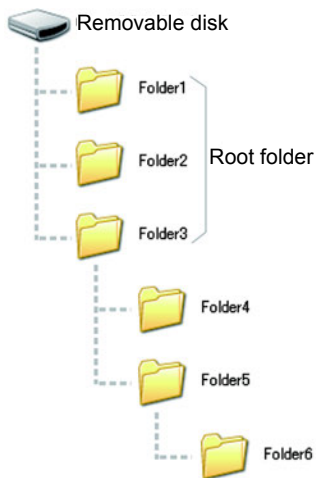

11.5 Saving Instrument Settings

1 Saving Instrument Settings

Save various setting information of the instrument as a setting file to the USB flash drive. The extension of the setting file is ".SET." This function is convenient for when you want to back up the setting state of the instrument. For the settings that are saved, refer to "Appendix12 Initial Settings Table"(p. A18).

Procedure

1 Insert the USB flash drive into the USB port (front panel).

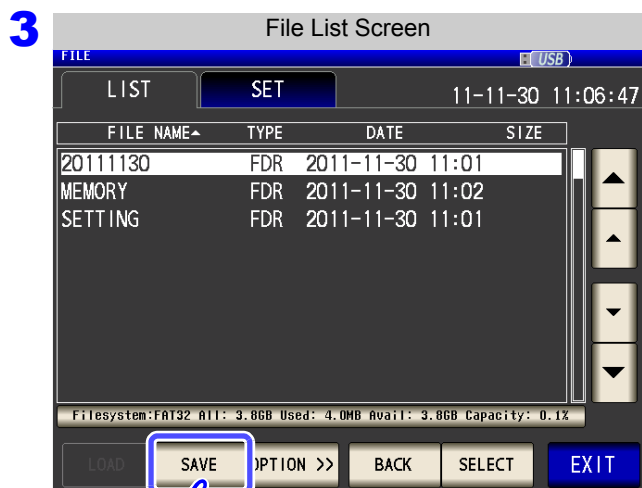
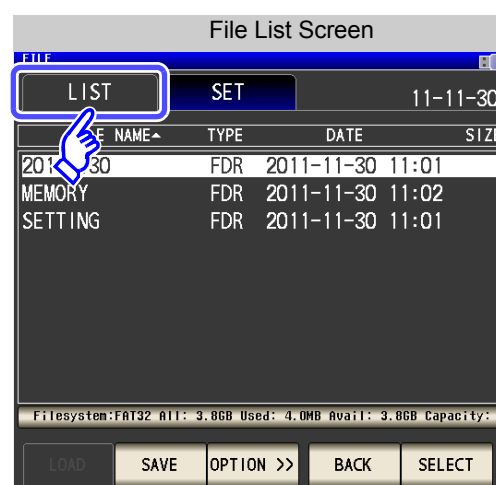
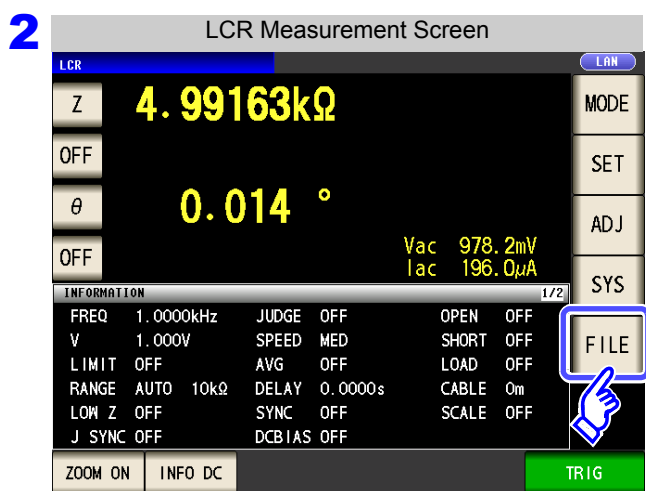

Press  .

11.5 Saving Instrument Settings

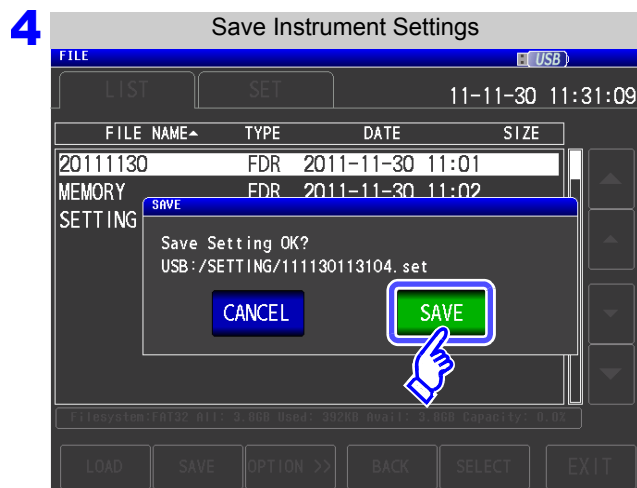

Press **SAVE** in the save confirmation screen.

The measurement data is saved.

- The setting file is saved to the **[SETTING]** folder in the USB flash drive.
- The date and time are automatically assigned to the file name.

When you want to cancel saving:

Press **CANCEL**.

2 Saving All Settings of Instrument (ALL SAVE Function)

Save various setting information of the instrument including the panel save information as a setting file to the USB flash drive.

The extension of the setting file is “.SET.” The extension of the panel save is “.PNL.” For the settings that are saved, refer to "Appendix12 Initial Settings Table"(p. A18).

Procedure

1 Insert the USB flash drive into the USB port (front panel).

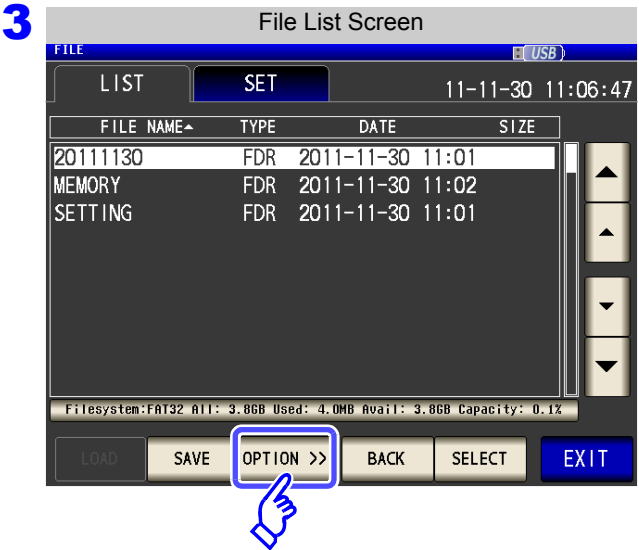
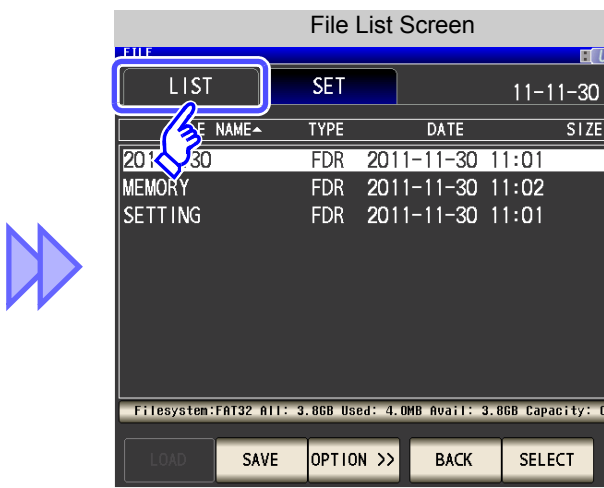
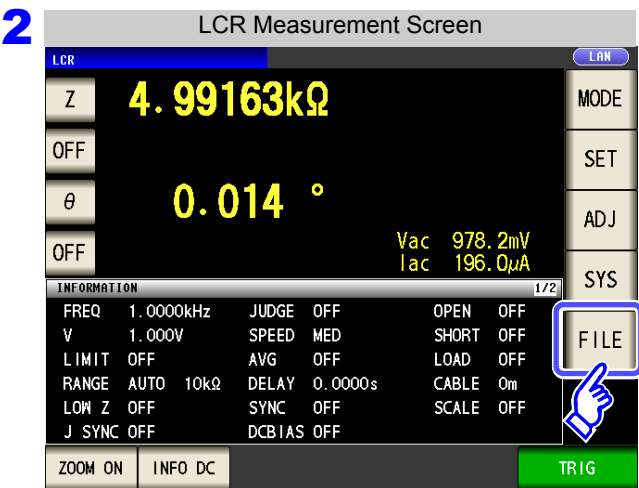

Press **OPTION >>**.

11.5 Saving Instrument Settings

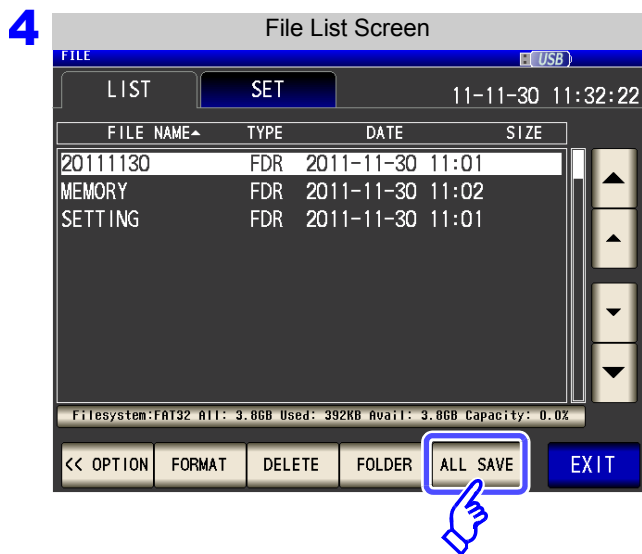

Press **ALL SAVE** .

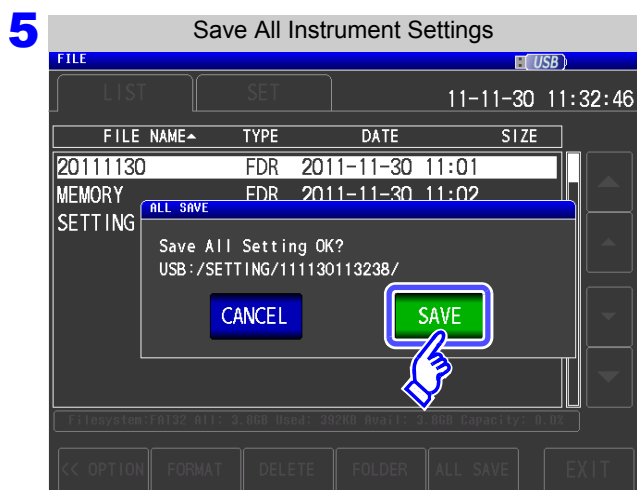

Press **SAVE** in the save confirmation screen.

The measurement data is saved.

- The setting file and panel save data are saved to a folder of the save date and time that is created automatically in the **[SETTING]** folder.
- The date and time are automatically assigned to the folder name and file name.

When you want to cancel saving:

Press **CANCEL** .

11.6 Loading Instrument Settings

1 Loading instrument settings

Read a setting file or panel save file that is saved to the USB flash drive, and restore the settings.

Procedure

1 Insert the USB flash drive into the USB port (front panel).

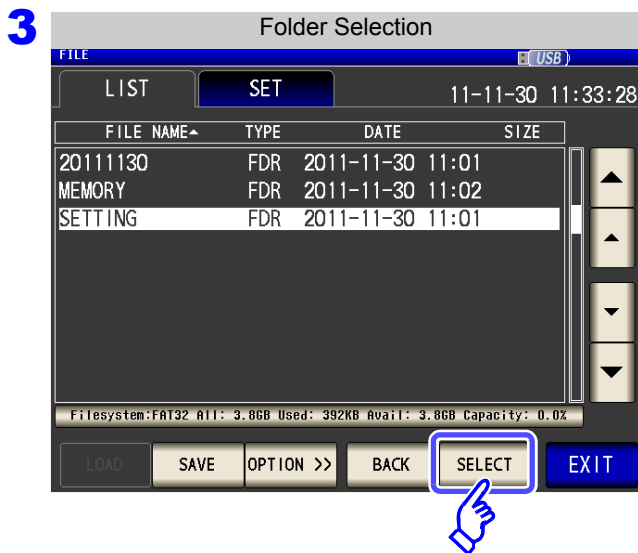
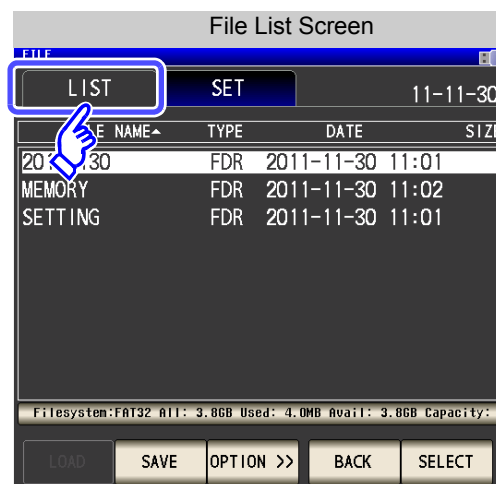
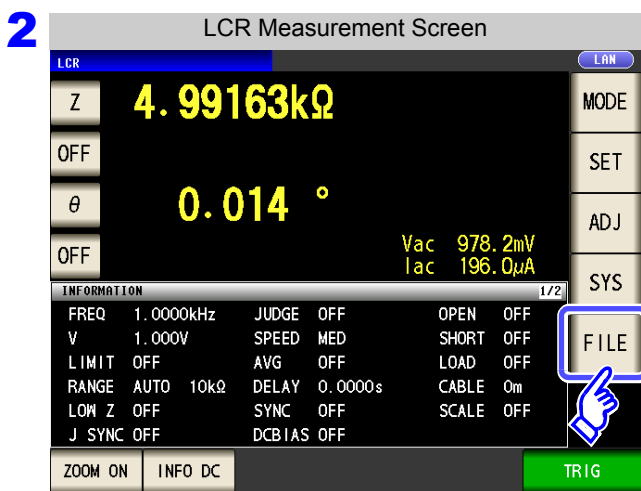

Use or to select the [SETTING] folder.

Press .

11.6 Loading Instrument Settings

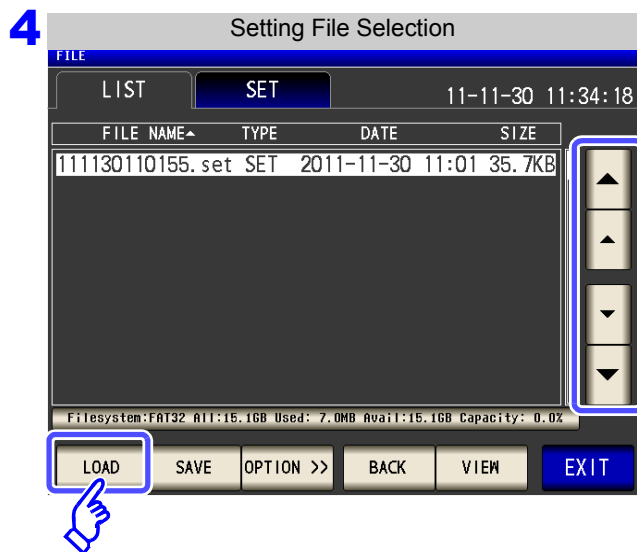

Use or to select the setting file or panel save file to read.

When you want to check a saved file's contents:

Press .

Press .

When is selected

You can check the contents of the file selected in **Step 4**.

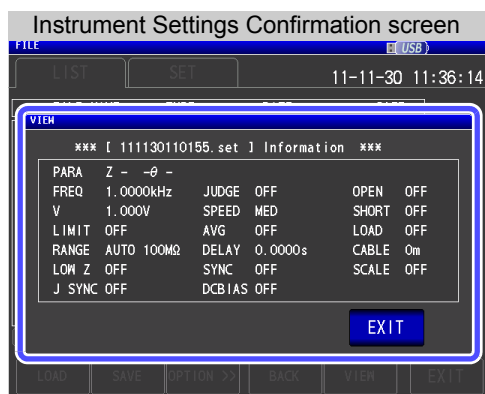

When you want to return to the Setting File Selection screen:

Press .

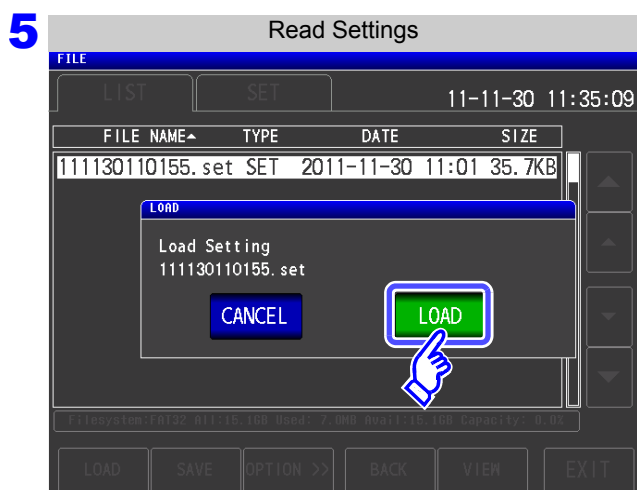

Press in the read confirmation screen.

The measurement data is read, and reflected as the current settings.

When you want to cancel reading:

Press .

When the Read Confirmation Screen Appears

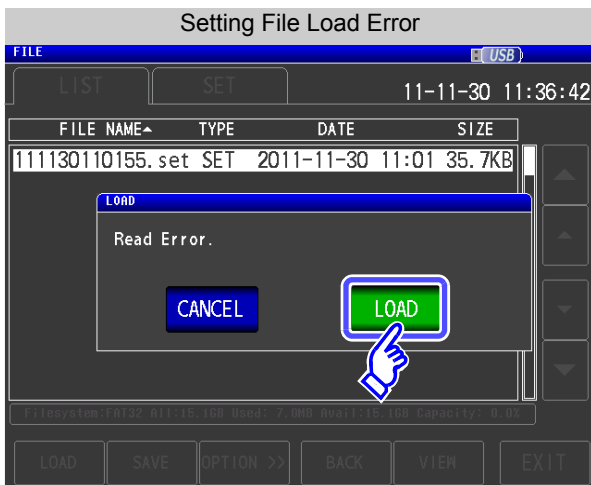

If an error appears when **LOAD** is pressed, one of the following are likely to be cause.

- The setting file is damaged.
- The file is not a setting file that can be read by the instrument.

When you want to cancel reading:

Press **CANCEL** .

11.6 Loading Instrument Settings

2 Loading all settings saved on a USB flash drive (ALL LOAD Function)

Load and restore instrument settings, including panels saved to USB memory using the all save function.
 See "Saving All Settings of Instrument (ALL SAVE Function)" (p. 295)

Procedure

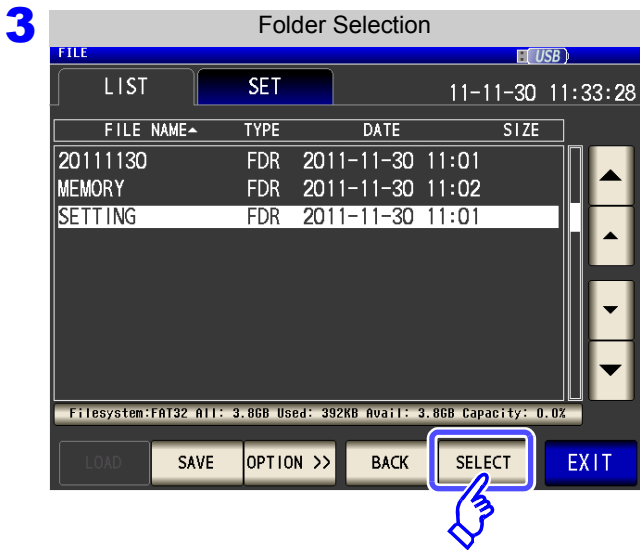
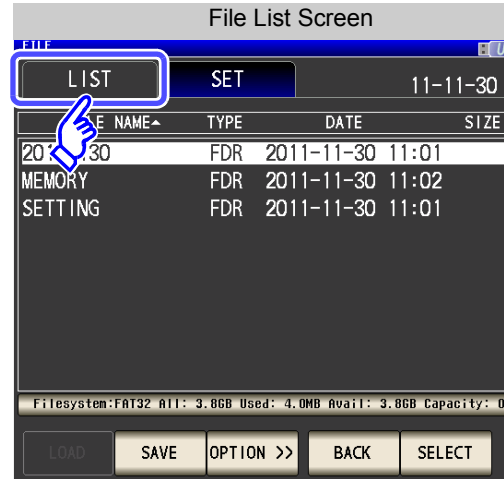
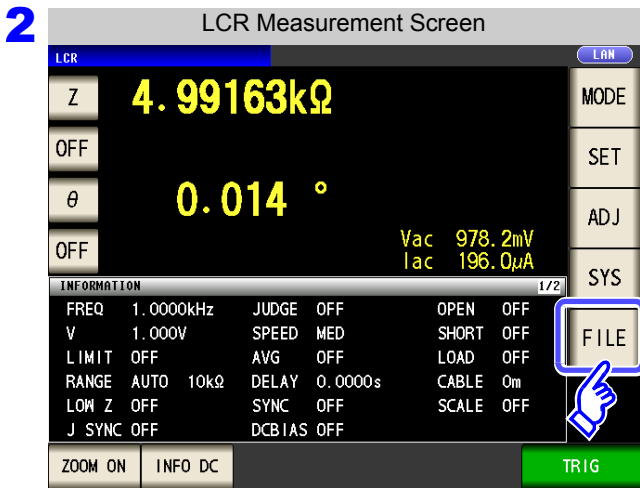

1 Insert the USB flash drive into the USB port (front panel).

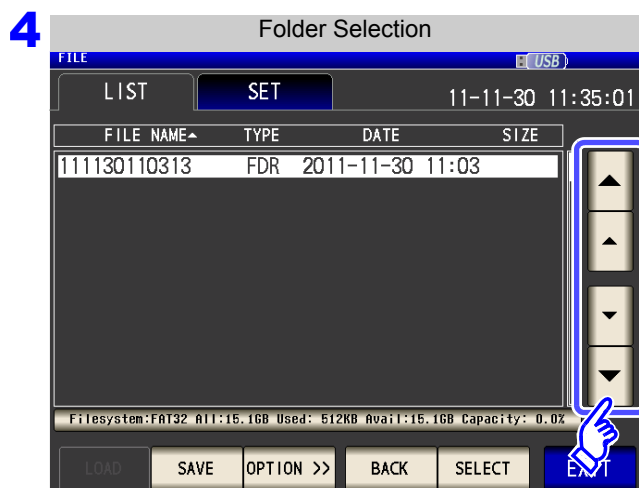

Use ▲ or ▼ to select the [SETTING] folder.

Press SELECT .



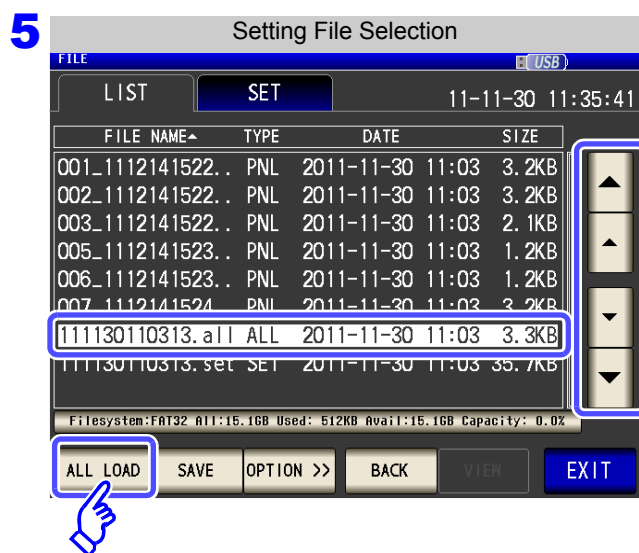

Using the  and  buttons, select the folder to which settings were saved with the all save function.

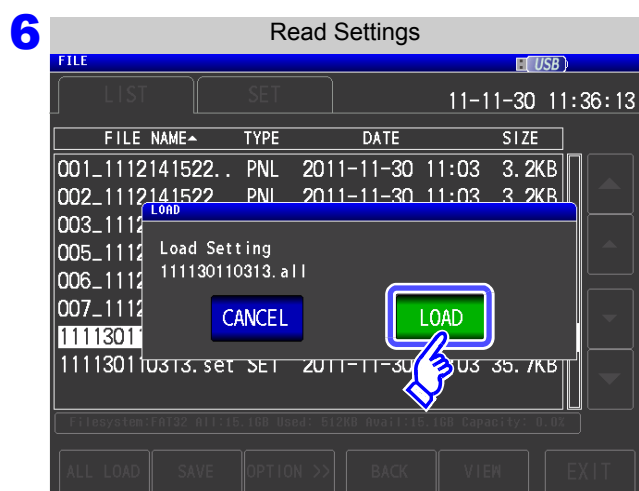

Using the  and  buttons, set [TYPE] to [ALL] files.

Press  .



Press  in the read confirmation screen.

All measurement data saved in the folder will be loaded and applied to the current settings.

When you want to cancel reading:

Press  .

NOTE

- Selecting [LOAD] will cause the instrument's current settings to be deleted.
- If the instrument is unable to load the settings file, a beep will sound.

11.7 File and Folder Operations

You can edit files and folders saved to the USB flash drive.

1 Formatting a USB Flash Drive

Perform this operation if the USB flash drive to be used is not formatted (initialized). Insert the USB flash drive to be formatted into the USB port (on the front panel) (p. 274) and start the format. The instrument formats drives in the FAT32 format.

Procedure

1 Insert the USB flash drive into the USB port (front panel).

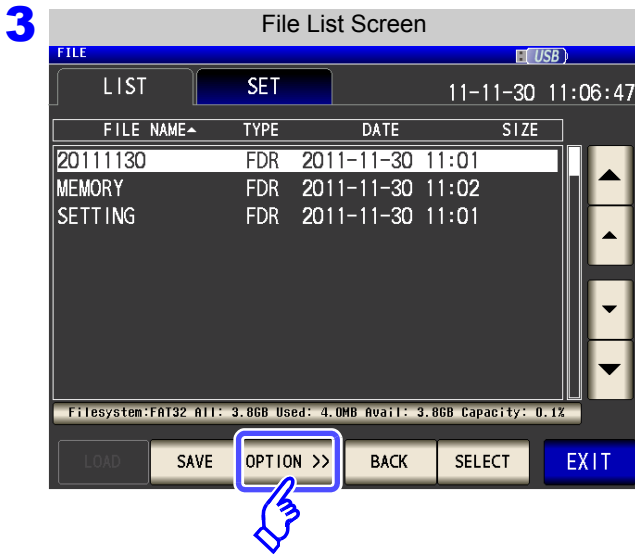
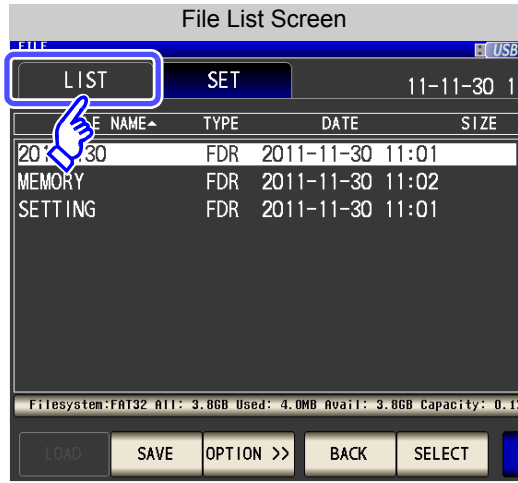
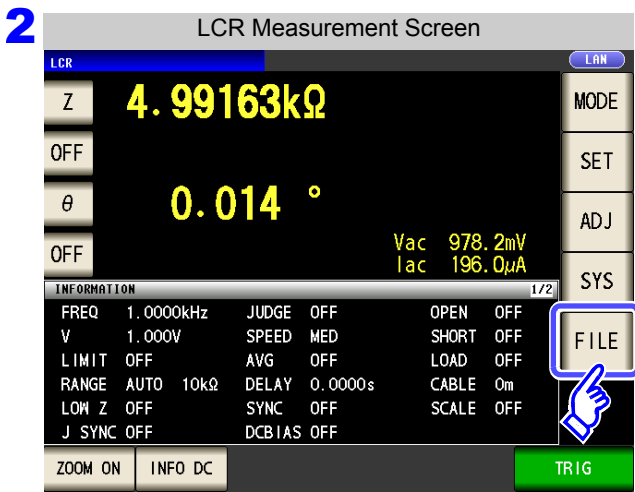

Press **OPTION >>**.

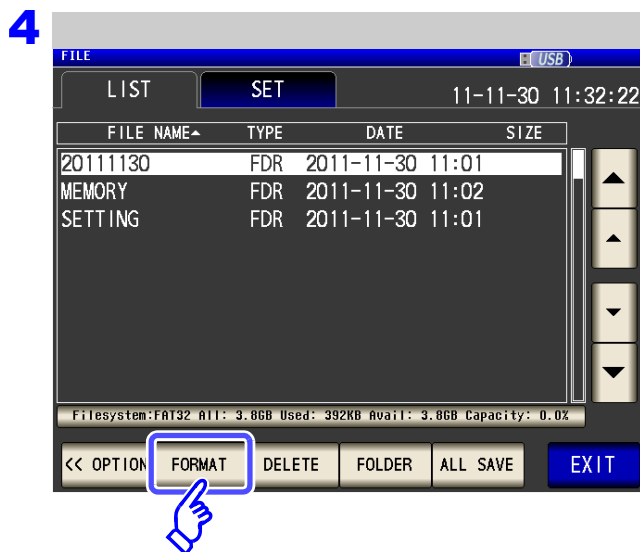

Press **FORMAT**.

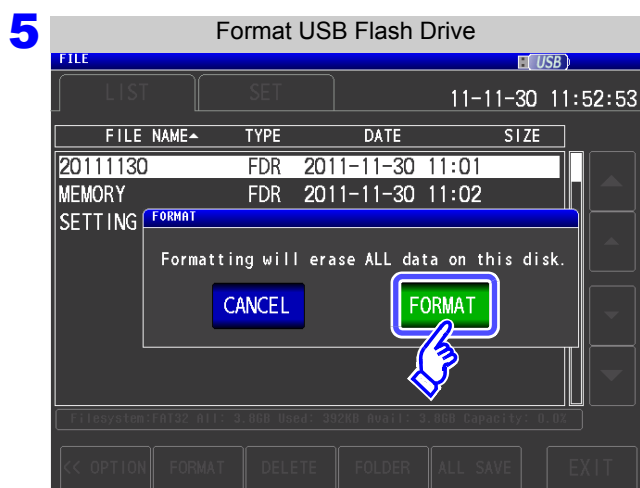

A confirmation screen appears.

Press **FORMAT**.

When you want to cancel the format:

Press **CANCEL**.

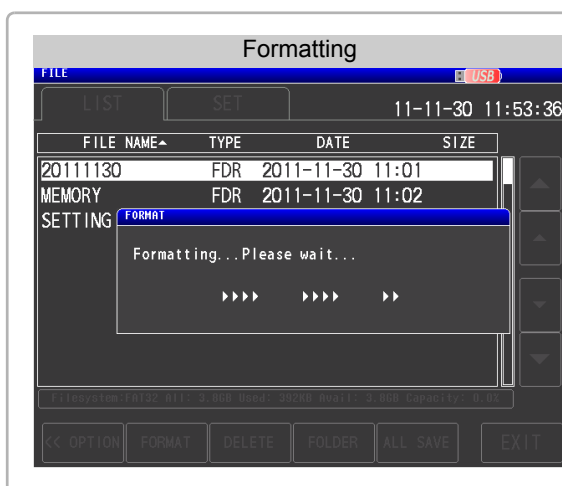

No operation is possible during formatting.

When formatting ends, the file list screen is redisplayed.

- NOTE**
- When you perform a format, all of the data saved to the USB flash drive is deleted and cannot be restored. Carefully check the contents before you perform a format.
 - We recommend making a backup of any important data on a USB flash drive.
 - When formatting is performed with the instrument, the volume label of the USB flash drive becomes **[NO NAME]**.

What is a Volume Label?

A name that is assigned to a drive such as a USB flash drive.

In Windows®, you can check the volume label of each drive in My Computer.

2 Deleting Files and Folders

You can delete a file or folder saved to the USB flash drive.

Procedure

1 Insert the USB flash drive into the USB port (front panel).

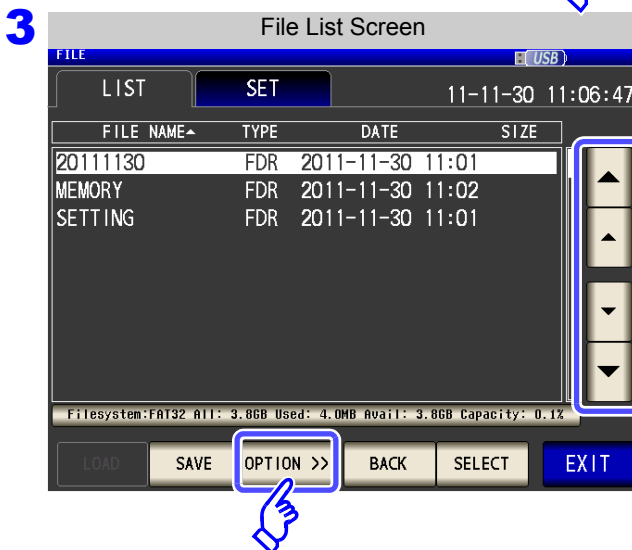
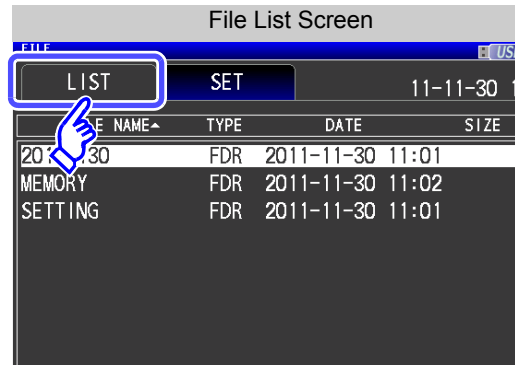
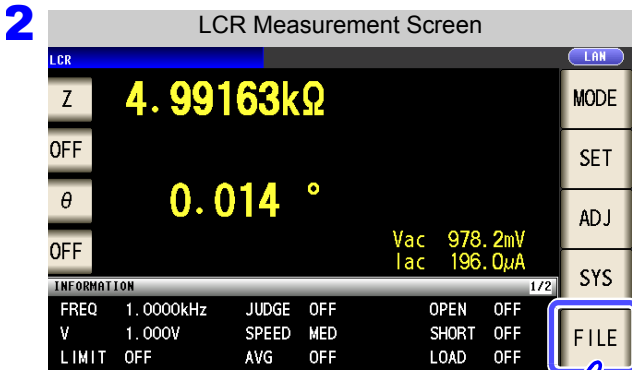

Select the file or folder you wish to delete with

and and touch .

Press .

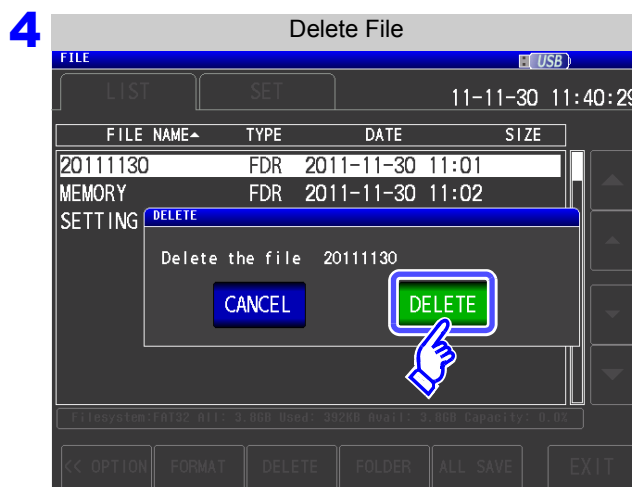

A deleted file or folder cannot be restored once it is deleted.

Confirm the file or folder to be deleted, and then press .

When you want to cancel deletion:

Press .

NOTE

If the folder to be deleted contains a file, it cannot be deleted. To delete the folder, delete all of the files in the folder.

3 Creating Folders

Procedure

1 Insert the USB flash drive into the USB port (front panel).

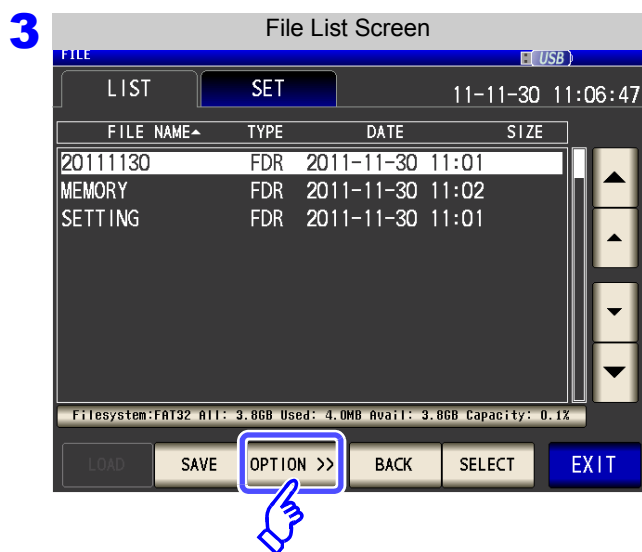
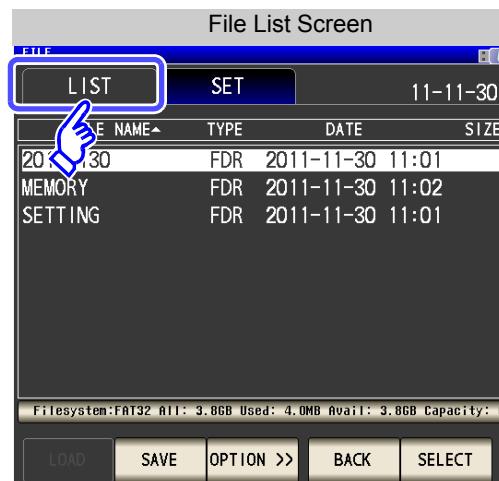
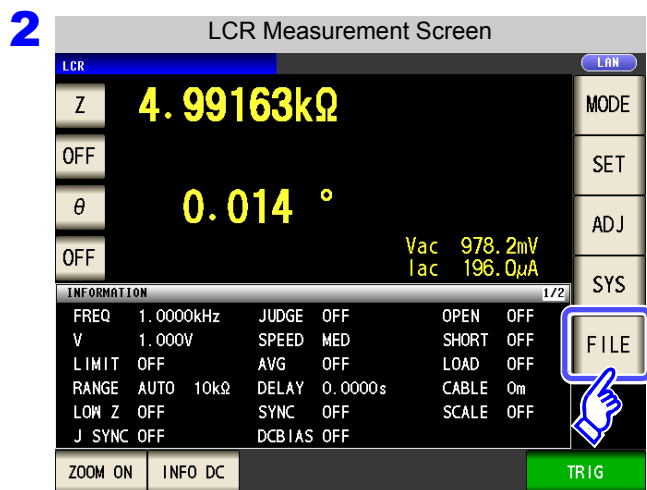

Press **OPTION >>** .

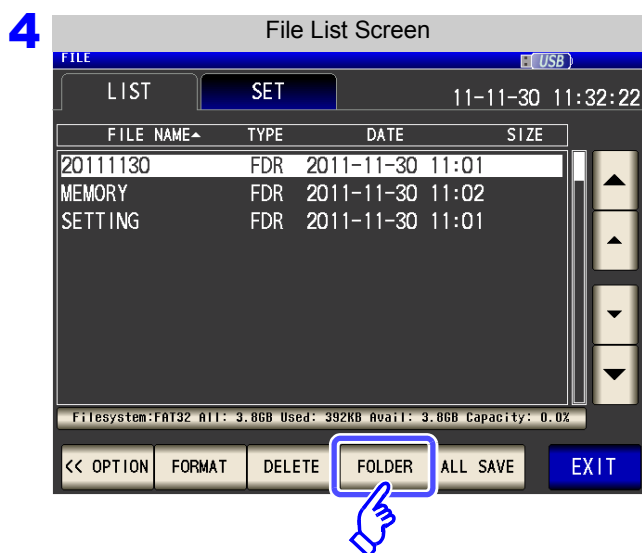

Press **FOLDER** .

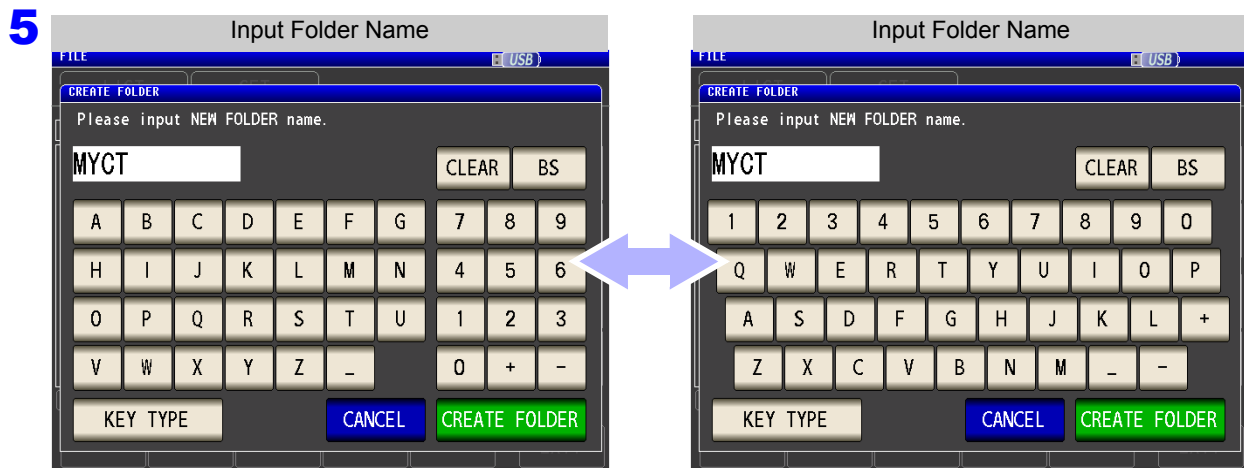

Enter the save name. (Up to 12 characters)

CLEAR

Deletes all input characters.

BS

Deletes the last character.

KEY TYPE

Changes the keyboard type.

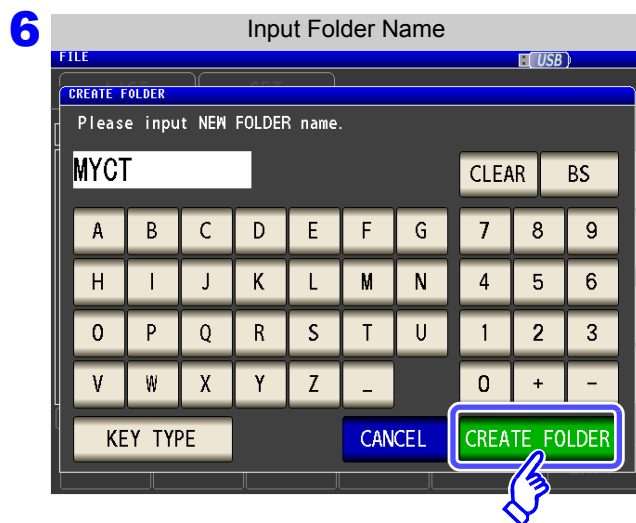

Press **CREATE FOLDER** to create a folder.

7 Press **EXIT** to close the setting screen.

4 Displaying the USB Flash Drive Information

You can check the usage rate and file system of the USB flash drive.

Procedure

1 Insert the USB flash drive into the USB port (front panel).

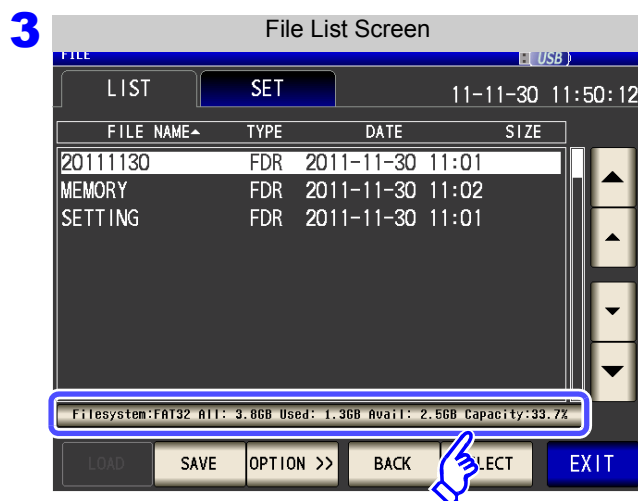
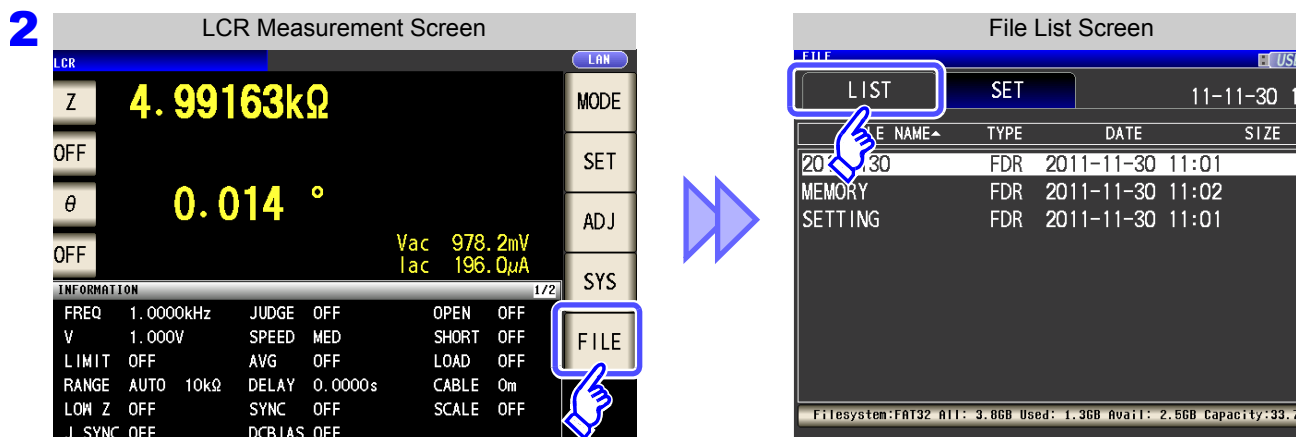

Press the part indicating the disc information.

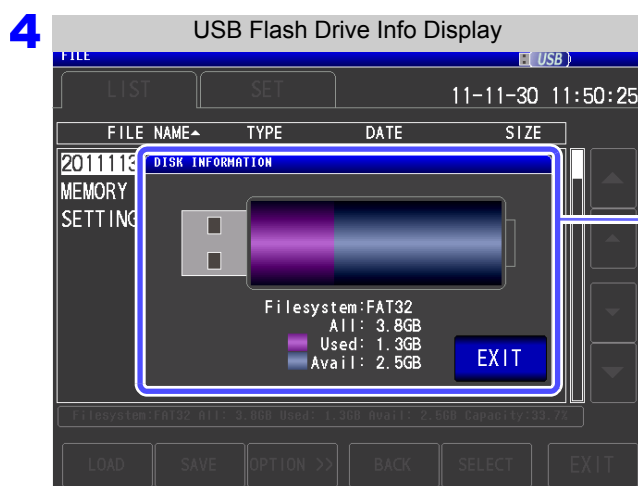

[Filesystem]: File system type
[All]: Total size
[Used]: Space used
[Avail]: Space free

5 Press **EXIT** to close the setting screen.

External Control Chapter 12

The EXT I/O connector on the rear of the instrument supports external control by providing output of the end-of-measurement and comparator decision signals, and accepting input of measurement trigger and panel load signals. All signals are isolated by optocouplers (inputs and outputs share a common signal ground (ISO_COM signal ground).)

Confirm input and output ratings, understand the safety precautions for connecting a control system, and use accordingly.

Connect the instrument's EXT I/O connector to the signal output or input device.

Make instrument settings

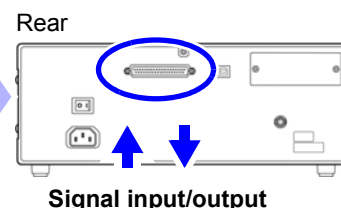

12.1 External Input/Output Connector and Signals



WARNING

To avoid electric shock or damage to the equipment, always observe the following precautions when connecting to the EXT I/O terminals.

- Always turn off the power to the instrument and to any devices to be connected before making connections.
- During operation, a wire becoming dislocated and contacting another conductive object can be serious hazard. Make sure that connections are secure and use screws to secure the external connectors.
- Ensure that devices and systems to be connected to the EXT I/O terminals/ are properly isolated.

CAUTION

To avoid damage to the instrument, observe the following cautions:

- Do not apply voltage or current to the EXT I/O terminals that exceeds their ratings.
- When driving relays, be sure to install diodes to absorb counter-electromotive force.
- Be careful not to short-circuit ISO_5V to ISO_COM.

See "Connector Type and Signal Pinouts" (p. 310)

Connector Type and Signal Pinouts

Rear

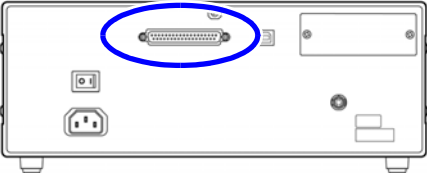

Connector: (Instrument Side)

- 37-pin D-sub female with #4-40 screws

Mating Connectors:

- DC-37P-ULR (solder type)
- DCSP-JB37PR (pressure weld type)
Japan Aviation Electronics Industry Ltd.

EXT I/O Connector (Instrument Side)

LCR mode (p. 318)

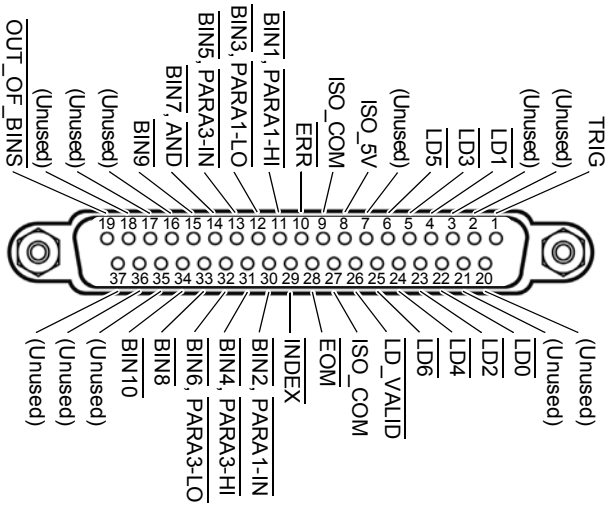

ANALYZER mode (IM3533-01 only) (p. 322)

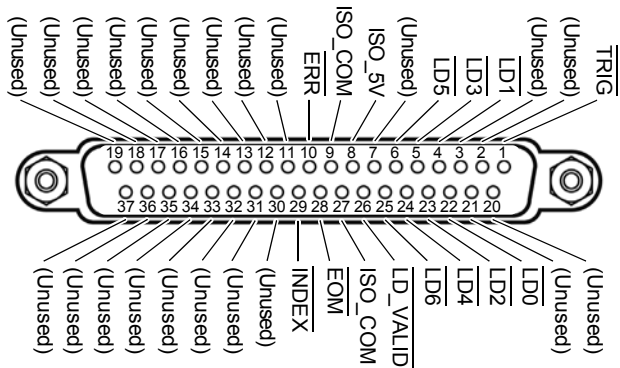

TRANSFORMER mode (p. 322)

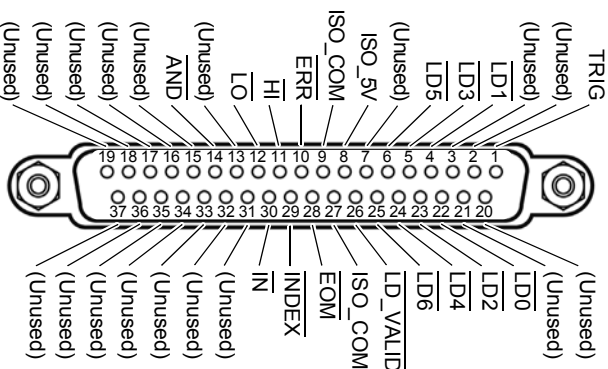

CONTINUOUS measurement mode (p. 323)

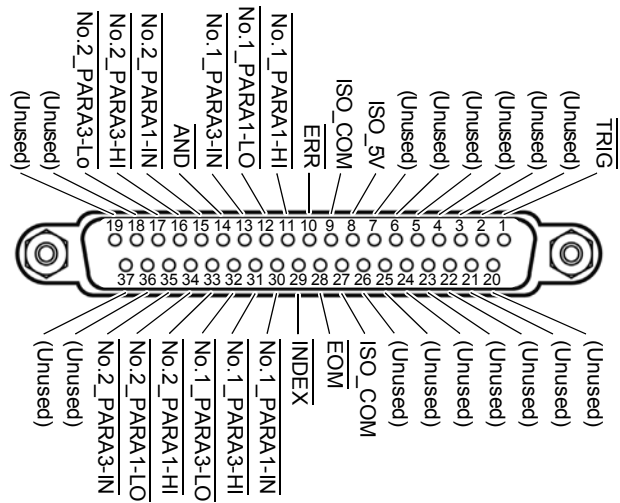

NOTE

The connector shell is conductively connected to the metal instrument chassis and the protective earth pin of the power plug. Be aware that it is not isolated from ground.

LCR mode

Pin	I/O	Signal name	Function	Logic	
				Pos/ Neg	Edge
1	IN	$\overline{\text{TRIG}}$	External trigger (p. 316)	Pos/ Neg	Edge
2	-	(Unused)	-	-	-
3	-	(Unused)	-	-	-
4	IN	$\overline{\text{LD1}}$	Select panel number (p. 316)	Neg	Level
5	IN	$\overline{\text{LD3}}$	Select panel number (p. 316)	Neg	Level
6	IN	$\overline{\text{LD5}}$	Select panel number (p. 316)	Neg	Level
7	-	(Unused)	-	-	-
8	-	ISO_5V	Isolated 5 V power output	-	-
9	-	ISO_COM	Isolated common signal ground	-	-
10	OUT	$\overline{\text{ERR}}$	Outputs when a sampling error, overcurrent error, contact error, HIGH-Z reject error, temperature sensor error, constant voltage/constant current error, or voltage/current limit value exceeded error occurs.	Neg	Level
11	OUT	$\overline{\text{BIN1, PARA1-HI}}$	Outputs BIN measurement results and HI comparator judgment results for the No. 1 parameter.	Neg	Level
12	OUT	$\overline{\text{BIN3, PARA1-LO}}$	Outputs BIN measurement results and LO comparator judgment results for the No. 1 parameter.	Neg	Level
13	OUT	$\overline{\text{BIN5, PARA3-IN}}$	Outputs BIN measurement results and IN comparator judgment results for the No. 3 parameter.	Neg	Level
14	OUT	$\overline{\text{BIN7 AND}}$	BIN judgment results Outputs results obtained by applying an AND operation to the judgment results for measurement results for two parameters. When both judgment results are IN or one of the No. 1 or No. 3 parameters has not been judged, outputs when the judgment result for the parameter that has been judged is IN.	Neg	Level
15	OUT	$\overline{\text{BIN9}}$	BIN judgment results	Neg	Level
16	-	(Unused)	-	-	-
17	-	(Unused)	-	-	-
18	-	(Unused)	-	-	-
19	OUT	$\overline{\text{OUT_OF_BINS}}$	BIN judgment results	Neg	Level
20	-	(Unused)	-	-	-
21	-	(Unused)	-	-	-
22	IN	$\overline{\text{LD0}}$	Select panel number (p. 316)	Neg	Level
23	IN	$\overline{\text{LD2}}$	Select panel number (p. 316)	Neg	Level
24	IN	$\overline{\text{LD4}}$	Select panel number (p. 316)	Neg	Level
25	IN	$\overline{\text{LD6}}$	Select panel number (p. 316)	Neg	Level
26	IN	$\overline{\text{LD_VALID}}$	Execute panel load (p. 316)	Neg	Level
27	-	ISO_COM	Isolated common signal ground	-	-
28	OUT	$\overline{\text{EOM}}$	Measurement complete signal: When this signal is output, the comparator judgment results have been finalized.	Neg	Edge
29	OUT	$\overline{\text{INDEX}}$	Signal indicating that A/D conversion for the measurement circuit has completed: When this signal changes from high (off) to low (on), the sample may be changed.	Neg	Edge
30	OUT	$\overline{\text{BIN2, PARA1-IN}}$	BIN judgment results. Outputs IN comparator judgment results for the No. 1 parameter.	Neg	Level
31	OUT	$\overline{\text{BIN4, PARA3-HI}}$	BIN judgment results. Outputs HI comparator judgment results for the No. 3 parameter.	Neg	Level

12.1 External Input/Output Connector and Signals

Pin	I/O	Signal name	Function	Logic	
32	OUT	$\overline{\text{BIN6}}, \overline{\text{PARA3-LO}}$	BIN judgment results. Outputs LO comparator judgment results for the No. 3 parameter.	Neg	Level
33	OUT	$\overline{\text{BIN8}}$	BIN judgment results	Neg	Level
34	OUT	$\overline{\text{BIN10}}$	BIN judgment results	Neg	Level
35	-	(Unused)	-	-	-
36	-	(Unused)	-	-	-
37	-	(Unused)	-	-	-

ANALYZER mode (IM3533-01 only)

Pin	I/O	Signal name	Function	Logic	
1	IN	$\overline{\text{TRIG}}$	External trigger (p. 316)	Pos/ Neg	Edge
2	-	(Unused)	-	-	-
3	-	(Unused)	-	-	-
4	IN	$\overline{\text{LD1}}$	Select panel number (p. 316)	Neg	Level
5	IN	$\overline{\text{LD3}}$	Select panel number (p. 316)	Neg	Level
6	IN	$\overline{\text{LD5}}$	Select panel number (p. 316)	Neg	Level
7	-	(Unused)	-	-	-
8	-	ISO_5V	Isolated 5 V power output	-	-
9	-	ISO_COM	Isolated common signal ground	-	-
10	OUT	$\overline{\text{ERR}}$	Outputs when a sampling error, overcurrent error, contact error, HIGH-Z reject error, or constant voltage/constant current error occurs.	Neg	Level
11	-	(Unused)	-	-	-
12	-	(Unused)	-	-	-
13	-	(Unused)	-	-	-
14	-	(Unused)	-	-	-
15	-	(Unused)	-	-	-
16	-	(Unused)	-	-	-
17	-	(Unused)	-	-	-
18	-	(Unused)	-	-	-
19	-	(Unused)	-	-	-
20	-	(Unused)	-	-	-
21	-	(Unused)	-	-	-
22	IN	$\overline{\text{LD0}}$	Select panel number (p. 316)	Neg	Level
23	IN	$\overline{\text{LD2}}$	Select panel number (p. 316)	Neg	Level
24	IN	$\overline{\text{LD4}}$	Select panel number (p. 316)	Neg	Level
25	IN	$\overline{\text{LD6}}$	Select panel number (p. 316)	Neg	Level
26	IN	$\overline{\text{LD_VALID}}$	Execute panel load (p. 316)	Neg	Level
27	-	ISO_COM	Isolated common signal ground	-	-
28	OUT	$\overline{\text{EOM}}$	Measurement complete signal: When this signal is output, the comparator judgment results have been finalized.	Neg	Edge

12.1 External Input/Output Connector and Signals

Pin	I/O	Signal name	Function	Logic	
29	OUT	$\overline{\text{INDEX}}$	Signal indicating that A/D conversion for the measurement circuit has completed: When this signal changes from high (off) to low (on), the sample may be changed.	Neg	Edge
30	-	(Unused)	-	-	-
31	-	(Unused)	-	-	-
32	-	(Unused)	-	-	-
33	-	(Unused)	-	-	-
34	-	(Unused)	-	-	-
35	-	(Unused)	-	-	-
36	-	(Unused)	-	-	-
37	-	(Unused)	-	-	-

TRANSFORMER mode

Pin	I/O	Signal name	Function	Logic	
1	IN	$\overline{\text{TRIG}}$	External trigger (p. 316)	Pos/ Neg	Edge
2	-	(Unused)	-	-	-
3	-	(Unused)	-	-	-
4	IN	$\overline{\text{LD1}}$	TRIG 2 (p. 316) Select panel number (p. 316)	Neg	Level
5	IN	$\overline{\text{LD3}}$	Select panel number (p. 316)	Neg	Level
6	IN	$\overline{\text{LD5}}$	Select panel number (p. 316)	Neg	Level
7	-	(Unused)	-	-	-
8	-	ISO_5V	Isolated 5 V power output	-	-
9	-	ISO_COM	Isolated common signal ground	-	-
10	OUT	$\overline{\text{ERR}}$	Outputs when a sampling error, contact error, HIGH-Z reject error, constant voltage/constant current error, or voltage/current limit value exceeded error occurs.	Neg	Level
11	OUT	$\overline{\text{HI}}$	Outputs HI comparator judgment results.	Neg	Level
12	OUT	$\overline{\text{LO}}$	Outputs LO comparator judgment results.	Neg	Level
13	-	(Unused)	-	-	-
14	OUT	$\overline{\text{AND}}$	Returns the result of an AND operation. Outputs only when the judgment results in TRANSFORMER mode are IN.	Neg	Level
15	-	(Unused)	-	-	-
16	-	(Unused)	-	-	-
17	-	(Unused)	-	-	-
18	-	(Unused)	-	-	-
19	-	(Unused)	-	-	-
20	-	(Unused)	-	-	-
21	-	(Unused)	-	-	-
22	IN	$\overline{\text{LD0}}$	TRIG 1 specification (p. 316) Select panel number (p. 316)	Neg	Level
23	IN	$\overline{\text{LD2}}$	Select panel number (p. 316)	Neg	Level
24	IN	$\overline{\text{LD4}}$	Select panel number (p. 316)	Neg	Level
25	IN	$\overline{\text{LD6}}$	Select panel number (p. 316)	Neg	Level

12.1 External Input/Output Connector and Signals

Pin	I/O	Signal name	Function	Logic	
26	IN	$\overline{\text{LD_VALID}}$	Execute panel load (p. 316)	Neg	Level
27	-	ISO_COM	Isolated common signal ground	-	-
28	OUT	$\overline{\text{EOM}}$	Measurement complete signal: When this signal is output, the comparator judgment results have been finalized.	Neg	Edge
29	OUT	$\overline{\text{INDEX}}$	Signal indicating that A/D conversion for the measurement circuit has completed: When this signal changes from high (off) to low (on), the sample may be changed.	Neg	Edge
30	OUT	$\overline{\text{IN}}$	Outputs IN comparator judgment results.	Neg	Level
31	-	(Unused)	-	-	-
32	-	(Unused)	-	-	-
33	-	(Unused)	-	-	-
34	-	(Unused)	-	-	-
35	-	(Unused)	-	-	-
36	-	(Unused)	-	-	-
37	-	(Unused)	-	-	-

CONTINUOUS measurement mode

Pin	I/O	Signal name	Function	Logic	
1	IN	TRIG	External trigger (p. 316)	Pos/ Neg	Edge
2	-	(Unused)	-	-	-
3	-	(Unused)	-	-	-
4	-	(Unused)	-	-	-
5	-	(Unused)	-	-	-
6	-	(Unused)	-	-	-
7	-	(Unused)	-	-	-
8	-	ISO_5V	Isolated 5 V power output	-	-
9	-	ISO_COM	Isolated common signal ground	-	-
10	OUT	$\overline{\text{ERR}}$	Outputs when a sampling error, overcurrent error, contact error, HIGH-Z reject error, temperature sensor error, constant voltage/constant current error, or voltage/current limit value exceeded error occurs.	Neg	Level
11	OUT	$\overline{\text{No.1_PARA1-HI}}$	Outputs HI comparator judgment results for the first No. 1 parameter.	Neg	Level
12	OUT	$\overline{\text{No.1_PARA1-LO}}$	Outputs LO comparator judgment results for the first No. 1 parameter.	Neg	Level
13	OUT	$\overline{\text{No.1_PARA3-IN}}$	Outputs IN comparator judgment results for the first No. 3 parameter.	Neg	Level
14	OUT	$\overline{\text{AND}}$	Outputs when all panel judgments are IN and the instrument is not OUT_OF_BINS.	Neg	Level
15	OUT	$\overline{\text{No.2_PARA1-IN}}$	Outputs IN comparator judgment results for the second No. 1 parameter.	Neg	Level
16	OUT	$\overline{\text{No.2_PARA3-HI}}$	Outputs HI comparator judgment results for the second No. 3 parameter.	Neg	Level
17	OUT	$\overline{\text{No.2_PARA3-LO}}$	Outputs LO comparator judgment results for the second No. 3 parameter.	Neg	Level
18	-	(Unused)	-	-	-
19	-	(Unused)	-	-	-

12.1 External Input/Output Connector and Signals

Pin	I/O	Signal name	Function	Logic	
20	-	(Unused)	-	-	-
21	-	(Unused)	-	-	-
22	-	(Unused)	-	-	-
23	-	(Unused)	-	-	-
24	-	(Unused)	-	-	-
25	-	(Unused)	-	-	-
26	-	(Unused)	-	-	-
27	-	ISO_COM	Isolated common signal ground	-	-
28	OUT	\overline{EOM}	Measurement complete signal: When this signal is output, the comparator judgment results have been finalized.	Neg	Edge
29	OUT	\overline{INDEX}	Signal indicating that A/D conversion for the measurement circuit has completed: When this signal changes from high (off) to low (on), the sample may be changed.	Neg	Edge
30	OUT	$\overline{No.1_PARA1-IN}$	Outputs IN comparator judgment results for the first No. 1 parameter.	Neg	Level
31	OUT	$\overline{No.1_PARA3-HI}$	Outputs HI comparator judgment results for the first No. 3 parameter.	Neg	Level
32	OUT	$\overline{No.1_PARA3-LO}$	Outputs LO comparator judgment results for the first No. 3 parameter.	Neg	Level
33	OUT	$\overline{No.2_PARA1-HI}$	Outputs HI comparator judgment results for the second No. 1 parameter.	Neg	Level
34	OUT	$\overline{No.2_PARA1-LO}$	Outputs LO comparator judgment results for the second No. 1 parameter.	Neg	Level
35	OUT	$\overline{No.2_PARA3-IN}$	Outputs IN comparator judgment results for the second No. 3 parameter.	Neg	Level
36	-	(Unused)	-	-	-
37	-	(Unused)	-	-	-

Signal function details

You can select rising or falling for the valid edge of a trigger.









See "Enabling Trigger Input for during Measurement and Setting the Valid Edge of Trigger Input" (p. 136)

Input

$\overline{\text{TRIG}}$	<ul style="list-style-type: none"> When the trigger setting is the external trigger <input type="checkbox"/> EXT , measurement is performed once with the falling (ON) or rising (OFF) edge of the TRIG signal. The edge direction can be set in the setting screen. (Initial value: Falling (ON)) See: "Enabling Trigger Input for during Measurement and Setting the Valid Edge of Trigger Input" (p. 136) When the trigger source is set to the internal trigger <input type="checkbox"/> INT , trigger measurement is not performed. You can set whether to enable or disable TRIG signal input during measurement (during output of the EOM signal (HI)). See: "Enabling Trigger Input for during Measurement and Setting the Valid Edge of Trigger Input" (p. 136) 																																																																																
$\overline{\text{LD0}}$ to $\overline{\text{LD6}}$	<p>Selects the number of the panel to load. To activate the selected panel, input the $\overline{\text{LD-VALID}}$ signal. If a trigger signal is input in external trigger mode, the selected panel is loaded and used for measurement.</p> <p>0: (HIGH: 5 V to 24 V), 1: (LOW: 0 V to 0.9 V)</p> <table border="1" data-bbox="427 1048 1193 1435"> <thead> <tr> <th>PIN No.</th> <th>$\overline{\text{LD6}}$</th> <th>$\overline{\text{LD5}}$</th> <th>$\overline{\text{LD4}}$</th> <th>$\overline{\text{LD3}}$</th> <th>$\overline{\text{LD2}}$</th> <th>$\overline{\text{LD1}}$</th> <th>$\overline{\text{LD0}}$</th> </tr> </thead> <tbody> <tr> <td>Panel 1</td> <td>0</td> <td>0</td> <td>0</td> <td>0</td> <td>0</td> <td>0</td> <td>1</td> </tr> <tr> <td>Panel 2</td> <td>0</td> <td>0</td> <td>0</td> <td>0</td> <td>0</td> <td>1</td> <td>0</td> </tr> <tr> <td>Panel 4</td> <td>0</td> <td>0</td> <td>0</td> <td>0</td> <td>1</td> <td>0</td> <td>0</td> </tr> <tr> <td>Panel 8</td> <td>0</td> <td>0</td> <td>0</td> <td>1</td> <td>0</td> <td>0</td> <td>0</td> </tr> <tr> <td>Panel 16</td> <td>0</td> <td>0</td> <td>1</td> <td>0</td> <td>0</td> <td>0</td> <td>0</td> </tr> <tr> <td>Panel 32</td> <td>0</td> <td>1</td> <td>0</td> <td>0</td> <td>0</td> <td>0</td> <td>0</td> </tr> <tr> <td>Panel 64</td> <td>1</td> <td>0</td> <td>0</td> <td>0</td> <td>0</td> <td>0</td> <td>0</td> </tr> <tr> <td>Panel 127</td> <td>1</td> <td>1</td> <td>1</td> <td>1</td> <td>1</td> <td>1</td> <td>1</td> </tr> <tr> <td>Panel128</td> <td>0</td> <td>0</td> <td>0</td> <td>0</td> <td>0</td> <td>0</td> <td>0</td> </tr> </tbody> </table>	PIN No.	$\overline{\text{LD6}}$	$\overline{\text{LD5}}$	$\overline{\text{LD4}}$	$\overline{\text{LD3}}$	$\overline{\text{LD2}}$	$\overline{\text{LD1}}$	$\overline{\text{LD0}}$	Panel 1	0	0	0	0	0	0	1	Panel 2	0	0	0	0	0	1	0	Panel 4	0	0	0	0	1	0	0	Panel 8	0	0	0	1	0	0	0	Panel 16	0	0	1	0	0	0	0	Panel 32	0	1	0	0	0	0	0	Panel 64	1	0	0	0	0	0	0	Panel 127	1	1	1	1	1	1	1	Panel128	0	0	0	0	0	0	0
PIN No.	$\overline{\text{LD6}}$	$\overline{\text{LD5}}$	$\overline{\text{LD4}}$	$\overline{\text{LD3}}$	$\overline{\text{LD2}}$	$\overline{\text{LD1}}$	$\overline{\text{LD0}}$																																																																										
Panel 1	0	0	0	0	0	0	1																																																																										
Panel 2	0	0	0	0	0	1	0																																																																										
Panel 4	0	0	0	0	1	0	0																																																																										
Panel 8	0	0	0	1	0	0	0																																																																										
Panel 16	0	0	1	0	0	0	0																																																																										
Panel 32	0	1	0	0	0	0	0																																																																										
Panel 64	1	0	0	0	0	0	0																																																																										
Panel 127	1	1	1	1	1	1	1																																																																										
Panel128	0	0	0	0	0	0	0																																																																										
$\overline{\text{LD0}}$, $\overline{\text{LD1}}$	<p>When performing <input type="checkbox"/> TRIG 1 measurement in TRANSFORMER mode, select $\overline{\text{LD0}}$ and input the trigger signal. When performing <input type="checkbox"/> TRIG 2 measurement, select $\overline{\text{LD1}}$ and input the trigger signal.</p>																																																																																
$\overline{\text{LD-VALID}}$	<p>Inputs a negative logic signal from an external device so that the selected panel number is recognized as valid. After $\overline{\text{TRIG}}$ input, maintain a Low level until $\overline{\text{INDEX}}$ is outputted.</p>																																																																																

12.1 External Input/Output Connector and Signals

Error output

Priority Order	Measurement Error	Error Display	ERR No. 10 Pin *4	Comparator Measurement		BIN Measurement	
				Logical Product AND No. 14 Pin	Each Parameter Judgment Result Pin Nos. 11, 12, 13, 30, 31, and 32	BIN1 to BIN10, Pin Nos. 11 to 15 and 30 to 34	OUT_OF_BINS Pin No. 19
High ↑	Sampling error	SAMPLE ERR	LOW	HI	HI	HI	LOW
	Overcurrent error	OVER CUR	LOW	HI	HI	HI	LOW
	Simultaneous H and L contact errors (after measurement)	NC A HL 	LOW	HI	LCR: 11, 31*1	HI	LOW
	L side contact error (after measurement)	NC A L 	LOW	HI	LCR: 11, 31*1	HI	LOW
	H side contact error (after measurement)	NC A H 	LOW	HI	LCR: 11, 31*1	HI	LOW
	Simultaneous H and L contact errors (before measurement)	NC B HL 	LOW	HI	LCR: 11, 31*1	HI	LOW
	L side contact error (before measurement)	NC B L 	LOW	HI	LCR: 11, 31*1	HI	LOW
	H side contact error (before measurement)	NC B H 	LOW	HI	LCR: 11, 31*1	HI	LOW
	Underflow	OVERFLOW	HI	HI	LCR: 12, 32*1, 2	HI	LOW
	Overflow	UNDERFLOW	HI	HI	LCR: 11, 31*1, 3	HI	LOW
	Outside of HIGH-Z reject limit range		LOW	Normal judgment	Normal judgment	Normal judgment	Normal judgment
	Outside of guaranteed accuracy range		HI	Normal judgment	Normal judgment	Normal judgment	Normal judgment
	Normal	Measurement Values	HI	Normal judgment	Normal judgment	Normal judgment	Normal judgment
	Low ↓	No measurement after power turned on		HI	HI	HI	HI

*1 Indicates the pin numbers that will be the LOW level.

*2 LCR 11 and 31 will be LOW when the parameters are Y, Cs, G, and B.

*3 LCR 12 and 32 will be LOW when the parameters are Y, Cs, G, and B.

*4 LOW will be output if even one error occurs.

12.2 Timing Chart

12.2.1 LCR Mode

If you set the judgment condition for the comparator (the trigger setting is external trigger) and then in that state a trigger signal is input from the EXT I/O or TRIG is pressed in the screen, the judgment result is output from the signal line for comparator result output of the EXT I/O after measurement ends. Furthermore, if the panel number is selected with the panel load signal when a trigger signal is input from the EXT I/O, the measurement condition of that panel number is loaded and then measurement is performed.

The following shows examples of the measurement timing.
(In the timing examples, the valid edge of the TRIG signal is set to falling (ON).)

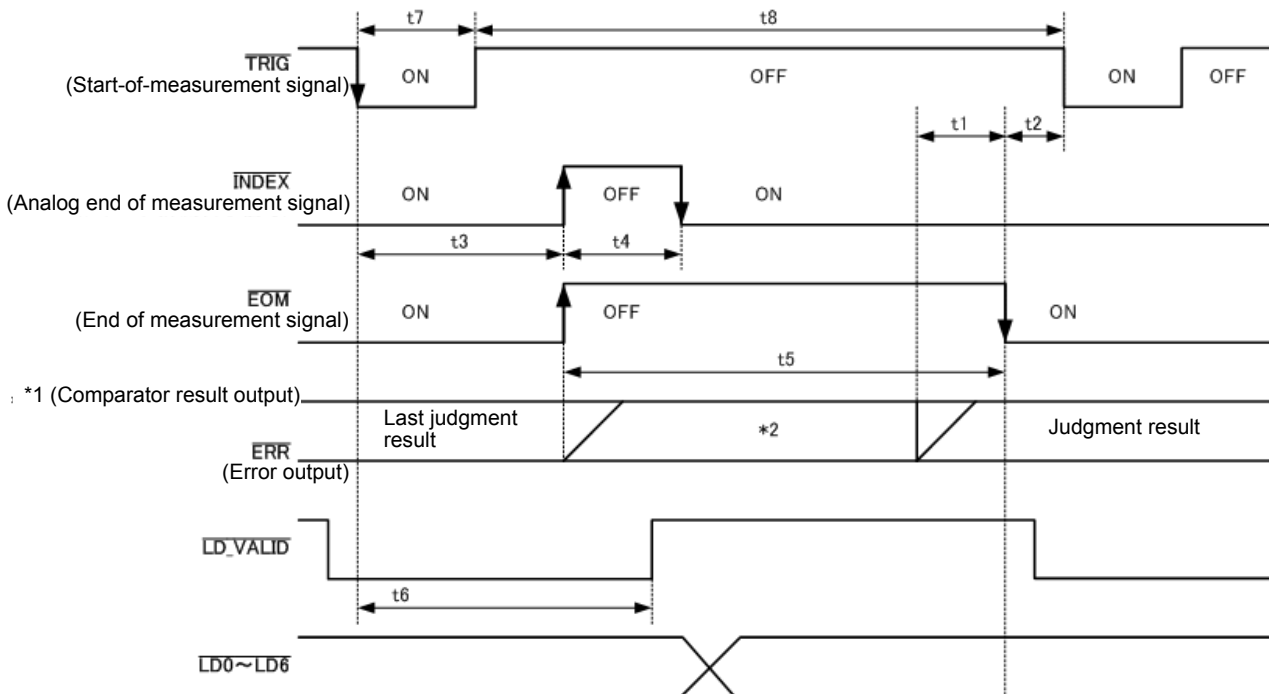

*1: PARAx-HI, PARAx-IN, PARAx-LO, AND, BINx, OUT_OF_BINS

*2: Reset when signal changes to $\overline{\text{EOM}}$ (HIGH): HIGH

Do not reset when signal changes to $\overline{\text{EOM}}$ (HIGH): Last judgment result remains

NOTE

Whether the comparator and BIN judgment results are reset when the signal changes to EOM (HIGH) or updated when measurement completes can be selected on the instrument or using a communication command.

See "4.5.5 Setting the Delay Time from the Output of Comparator and BIN Judgment Results until Output of EOM (LOW) and Resetting Judgment Results" (p. 134)

LCR Application Disk - communication commands (: IO:RESult:RESet)

Timing Chart Interval Descriptions

Interval	Description	Time (Approximate)
t1	From Comparator, BIN Judgement Result to $\overline{\text{EOM}}$ (LOW): Setting value for delay time *1	40 μs
t2	From $\overline{\text{EOM}}$ width (LOW) to $\overline{\text{TRIG}}$ (LOW): Minimum time from end of measurement to next trigger *2	400 μs
t3	From $\overline{\text{TRIG}}$ (LOW) to $\overline{\text{INDEX}}$ (HIGH): Time from trigger to circuit response *3	1 ms
t4	$\overline{\text{INDEX}}$ width (HIGH): Minimum chuck time, switching chuck with $\overline{\text{INDEX}}$ (LOW) is possible *4	1 ms
t5	$\overline{\text{EOM}}$ width (HIGH): Measurement time *4	2 ms
t6	From $\overline{\text{TRIG}}$ width (LOW) to $\overline{\text{LD-VALID}}$ (HIGH) : Time to recognize panel number	t3
t7	Trigger pulse width (LOW time)	At least 100 μs
t8	Trigger off (HI time)	At least 100 μs

*1: There is an approximate error of 100 μs in the delay time entered for Judgement Result \leftrightarrow $\overline{\text{EOM}}$ for the setting value. t1 is the reference value for when the setting value is 0.0000 s.

*2: t2 is the reference value for when trigger input for during measurement is disabled (p. 136).

*3: When the panel number is read by the panel load function, the response time is as shown in the table below.

Measurement mode	Load mode	Response time
LCR	LCR+ADJ	10 ms
	HARD	9 ms
	ADJ	4 ms
ANALYZER	ANA+ADJ	80 ms
	HARD	60 ms
	ADJ	6 ms

• When the trigger synchronous output function and trigger delay is enabled, wait times are included.

*4: Reference value for Measurement frequency: 1 kHz, Measurement speed: FAST, Measurement range: HOLD (p. 352)

NOTE

- Since the speed of the rise (LOW \rightarrow HIGH) of the comparator/BIN judgment result differs depending on the configuration of the circuit connected to the EXT I/O, there is the likelihood of an incorrect judgment if the level of the comparator/BIN judgment result acquired immediately after $\overline{\text{EOM}}$ output is used. To prevent this from happening, a delay time (t1) between the comparator/BIN judgment result and the $\overline{\text{EOM}}$ can be set. Furthermore, if the judgment result signal line of the EXT I/O is set to be reset simultaneously with the measurement start signal, and a forced transition to the HIGH level is performed at the same time as $\overline{\text{TRIG}}$, the transition from LOW to HIGH does not occur when the judgment result is output after measurement ends. As a result, the delay time between the judgment result and the $\overline{\text{EOM}}$ can be set to the minimum level. However, be careful because the judgment result confirmation interval is until the next trigger is accepted.
- During measurement, a trigger input from EXT I/O or communicating by interface may lead to a bigger dispersion of delay time between comparator or BIN judgement result output and $\overline{\text{EOM}}$. As far as possible, try not to control from external sources when carrying out measurement.

See "Setting the Delay Time from the Output of Comparator and BIN Judgment Results until Output of $\overline{\text{EOM}}$ (LOW) and Resetting Judgment Results" (p. 134)
LCR Application Disk - communication commands (: IO:OUTPut:DElay), (: IO:RE-Sult:RESet)

12.2 Timing Chart

NOTE

- The shorter the measurement time, the shorter the time that $\overline{\text{INDEX}}$ and $\overline{\text{EOM}}$ are high (off).
When the high (off) time is too short due to characteristics of the input circuit, the instrument can be configured to maintain the low (on) state for a preset time once $\overline{\text{EOM}}$ changes to low (on) before reverting the signal to high (off) after the completion of measurement.
- When trigger input is received at $\overline{\text{EOM}}:\text{LOW}$ and $\overline{\text{INDEX}}:\text{LOW}$, the signal transitions to high (off) when measurement starts.

Setting the $\overline{\text{INDEX}}$ and $\overline{\text{EOM}}$ output method

See "4.5.7 Setting the EOM Output Method" (p. 137)
LCR Application Disk - communication commands (: IO : EOM : MODE)

Setting the pulse width for which low (on) $\overline{\text{EOM}}$ is held

See "4.5.7 Setting the EOM Output Method" (p. 137)
LCR Application Disk - communication commands (: IO : EOM : PULSe)

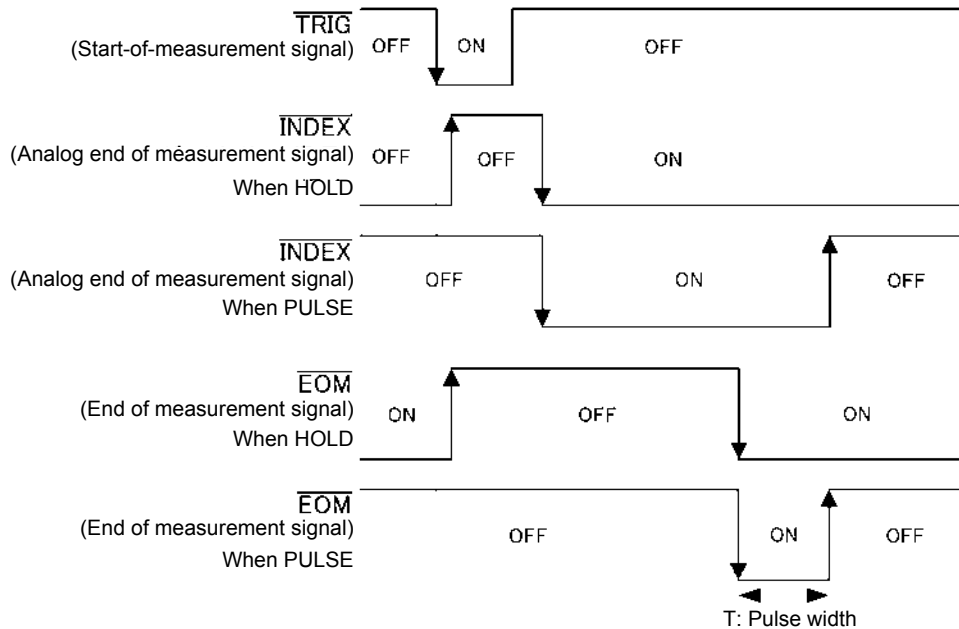

12.2.2 ANALYZER Mode (IM3533-01 only)

Touching **TRIG** on the screen asking whether to input the trigger signal from EXT I/O in ANALYZER mode will result in the following output.

Furthermore, if the panel number is selected with the panel load signal when a trigger signal is input from the EXT I/O, the measurement condition of that panel number is loaded and then measurement is performed.

The following shows examples of the measurement timing.

(In the timing examples, the valid edge of the $\overline{\text{TRIG}}$ signal is set to falling (ON).)

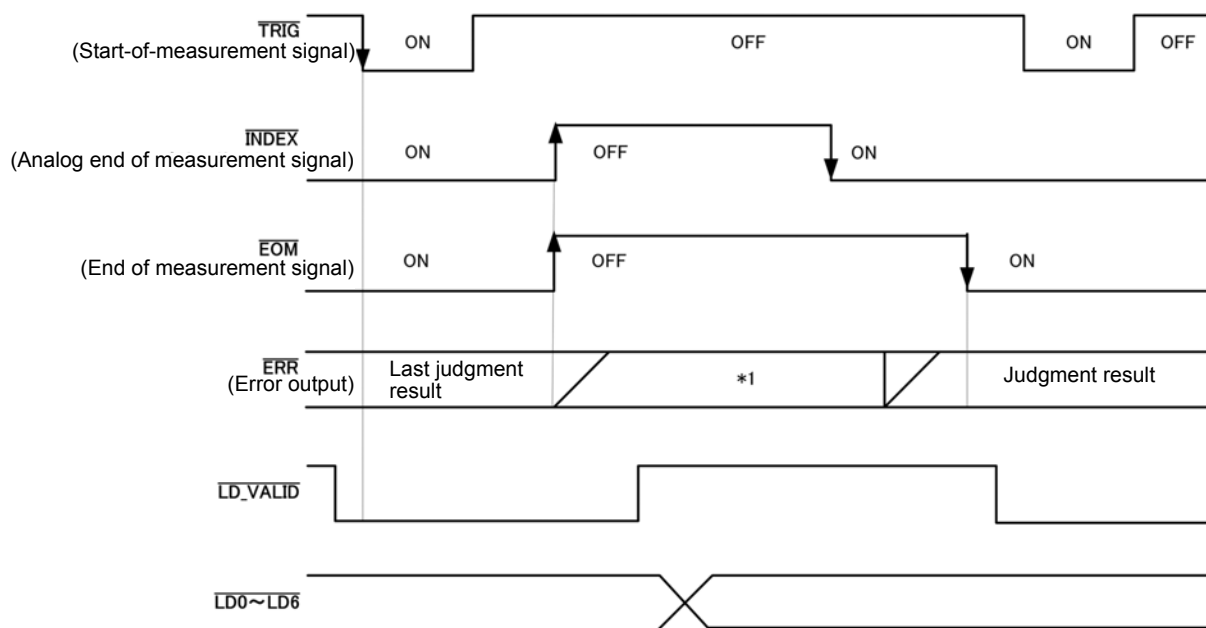

*1: Reset when signal changes to $\overline{\text{EOM}}$ (HIGH): HIGH

Do not reset when signal changes to $\overline{\text{EOM}}$ (HIGH): Last judgment result remains

Signal line	Description
$\overline{\text{INDEX}}$	The transition to HIGH is performed when measurement of the first sweep point starts after trigger signal input and the transition to LOW is performed when the analog measurement of the last sweep point ends. (The HIGH level is maintained during sweep measurement.)
$\overline{\text{EOM}}$	The transition to HIGH is performed when measurement of the first sweep point starts after trigger signal input. Measurement of the last sweep point ends and the transition to LOW is performed after judgment result output. (The HIGH level is maintained during sweep measurement.)

NOTE

- If the trigger setting is set to STEP, $\overline{\text{INDEX}}$ and $\overline{\text{EOM}}$ transition to LOW every time the measurement for each point ends, and then transition to HIGH when there is trigger input.
- For other timing chart times, refer to "12.2.1 LCR Mode" (p. 318).

12.2 Timing Chart

12.2.3 TRANSFORMER Mode

If you set the judgment condition for the comparator and then in that state a trigger signal is input from the EXT I/O or **TRIG** is pressed in the screen, the judgment result is output from the signal line for comparator result output of the EXT I/O after measurement ends.

Furthermore, if the panel number is selected with the panel load signal when a trigger signal is input from the EXT I/O, the measurement condition of that panel number is loaded and then measurement is performed.

The following shows examples of the measurement timing.

(In the timing examples, the valid edge of the TRIG signal is set to falling (ON). TRIG1 measurement is performed, followed by TRIG2 measurement.)

When TRIG1 and TRIG2 measurement are performed with the comparator set

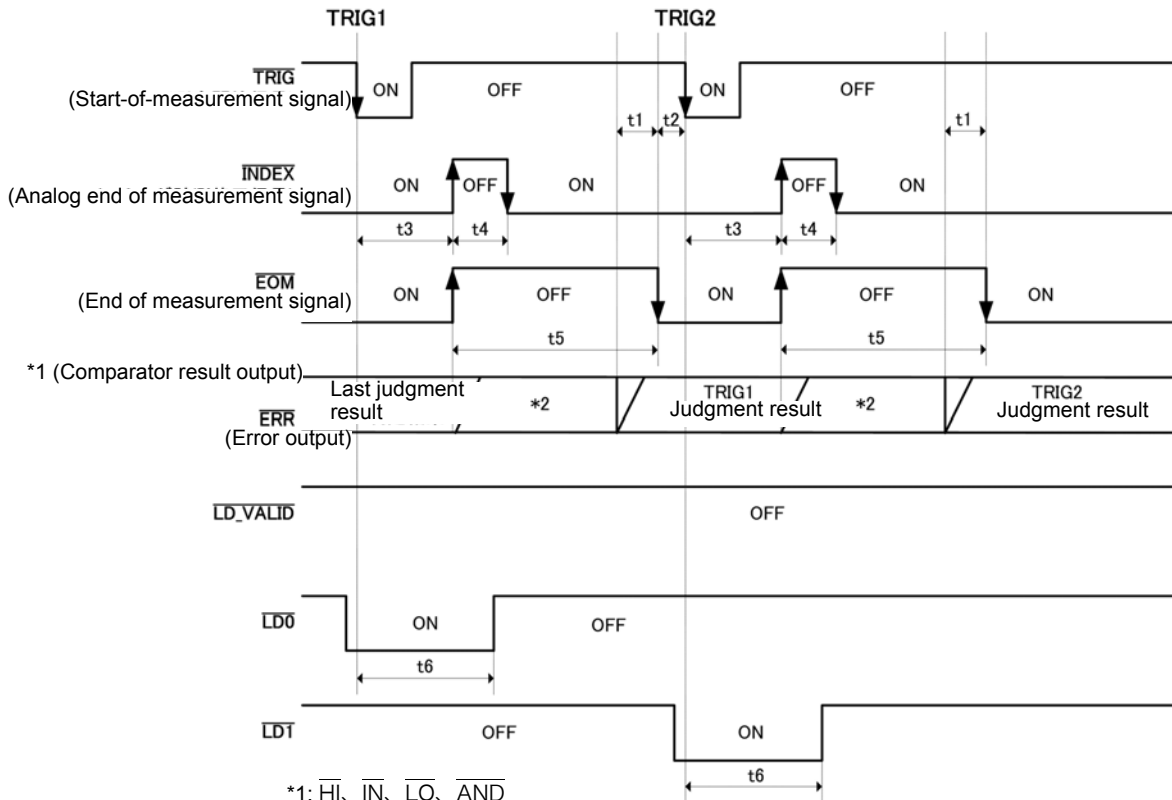

*1: \overline{HI} , \overline{IN} , \overline{LO} , \overline{AND}

*2: Reset when signal changes to \overline{EOM} (HIGH): HIGH

Do not reset when signal changes to \overline{EOM} (HIGH): Last judgment result remains

When a panel is loaded

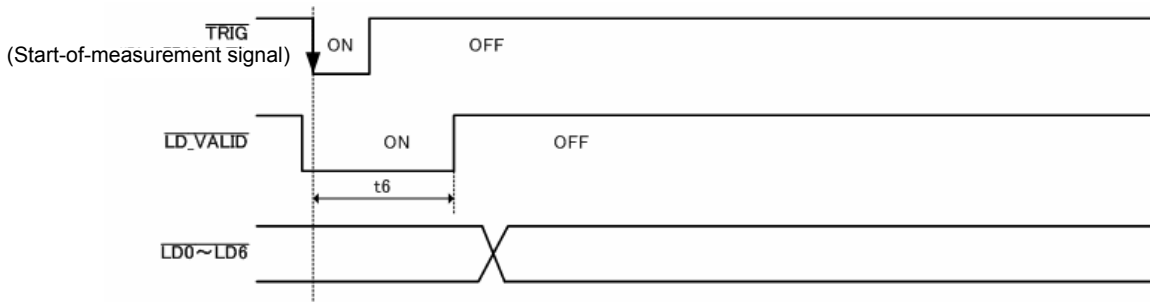

NOTE

Whether the comparator and BIN judgment results are reset when the signal changes to EOM (HIGH) or updated when measurement completes can be selected on the instrument or using a communication command.

See "4.5.5 Setting the Delay Time from the Output of Comparator and BIN Judgment Results until Output of EOM (LOW) and Resetting Judgment Results" (p. 134)

LCR Application Disk - communication commands (:IO:RESult:RESet)
 "Timing Chart Interval Descriptions" (p. 319)

12.2.4 CONTINUOUS Measurement Mode

Inputting a trigger signal from EXT I/O or touching **TRIG** on the screen in CONTINUOUS measurement mode will cause the No. 1 and No. 3 parameter judgment results for the first and second items to be output from the EXT I/O comparator result output signal lines after measurement of all panel numbers set to be executed on the screen. (Judgment results for the third and subsequent items are not output.)

The following shows examples of the measurement timing.

(In the timing examples, the valid edge of the TRIG signal is set to falling (ON).)

Example: Continuous measurement using panel numbers 1, 2, and 4

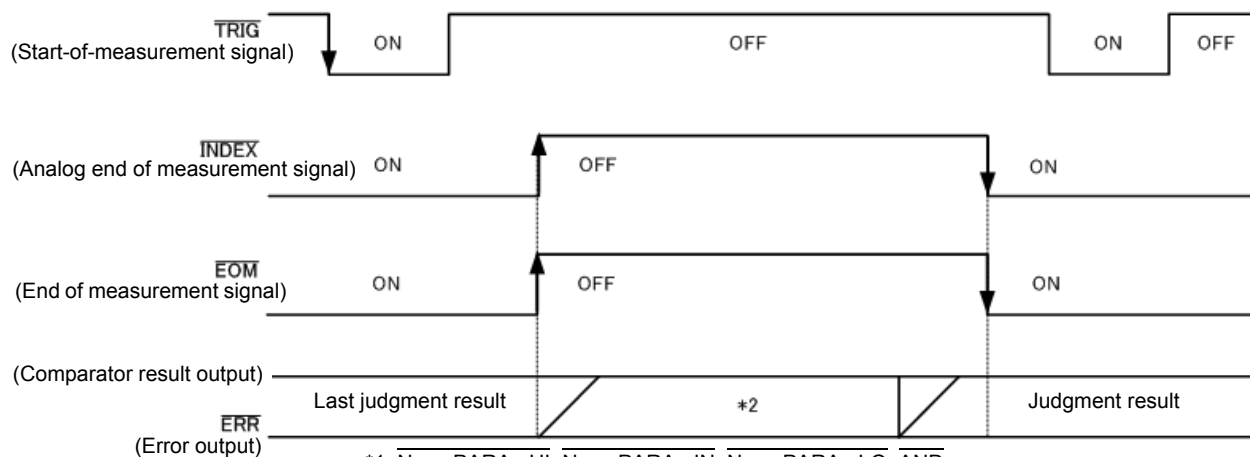
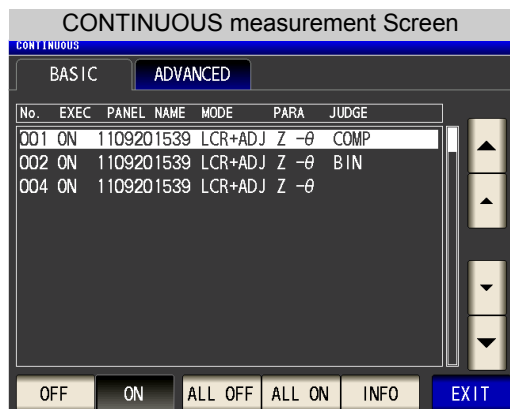

*1: No.x_PARAy-HI, No.x_PARAy-IN, No.x_PARAy-LO, AND

*2: Reset when signal changes to $\overline{\text{EOM}}$ (HIGH): HIGH

Do not reset when signal changes to $\overline{\text{EOM}}$ (HIGH): Last judgment result remains

Signal Line	Description
$\overline{\text{INDEX}}$, $\overline{\text{EOM}}$	For both $\overline{\text{INDEX}}$ and $\overline{\text{EOM}}$, a transition to HIGH is performed when the first panel measurement starts after the trigger signal is input, and a transition to LOW is performed after measurement of the last panel is finished and the judgment result has been output. (The HIGH level is maintained during continuous measurement.)
$\overline{\text{AND}}$	When the judgment results of all panels are IN, LOW is output.

12.2 Timing Chart

NOTE

- In the continuous measurement screen, panel load signals ($\overline{\text{LD-VALID}}$, $\overline{\text{LD0}}$ to $\overline{\text{LD6}}$) cannot be used.
See: "Chapter 7 CONTINUOUS Measurement Function" (p. 209)
 - Whether the comparator judgment results are reset when the signal changes to $\overline{\text{EOM}}$ (HIGH) or updated when measurement completes can be selected on the instrument or using a communication command.
See: "4.5.5 Setting the Delay Time from the Output of Comparator and BIN Judgment Results until Output of EOM (LOW) and Resetting Judgment Results" (p. 134)
LCR Application Disk - communication commands (**:IO:RESult:RESet**)
 - For other timing chart times, refer to "12.2.1 LCR Mode" (p. 318).
-

12.3 Internal Circuitry

Input Circuit

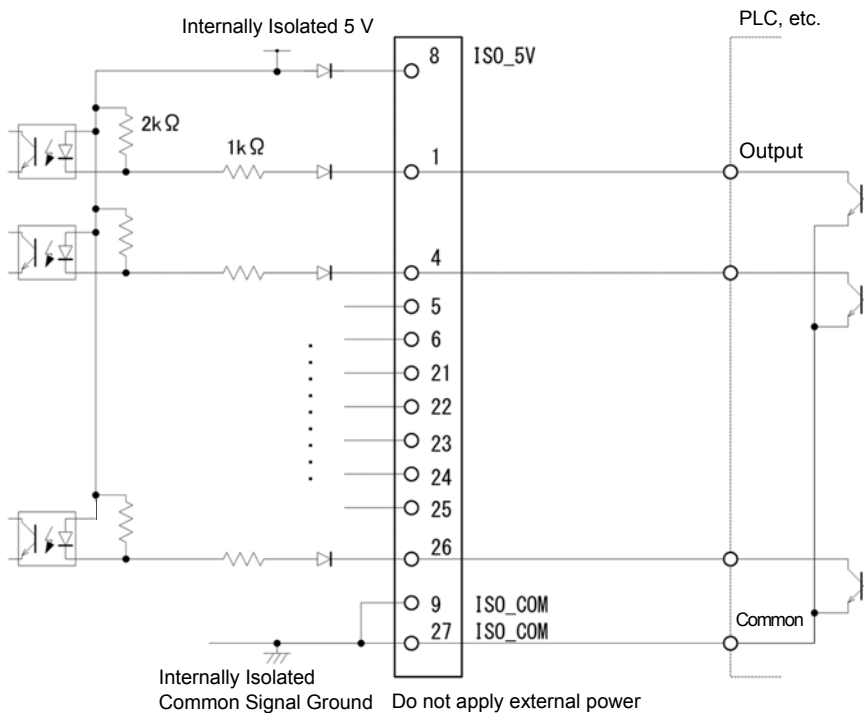

Output Circuit

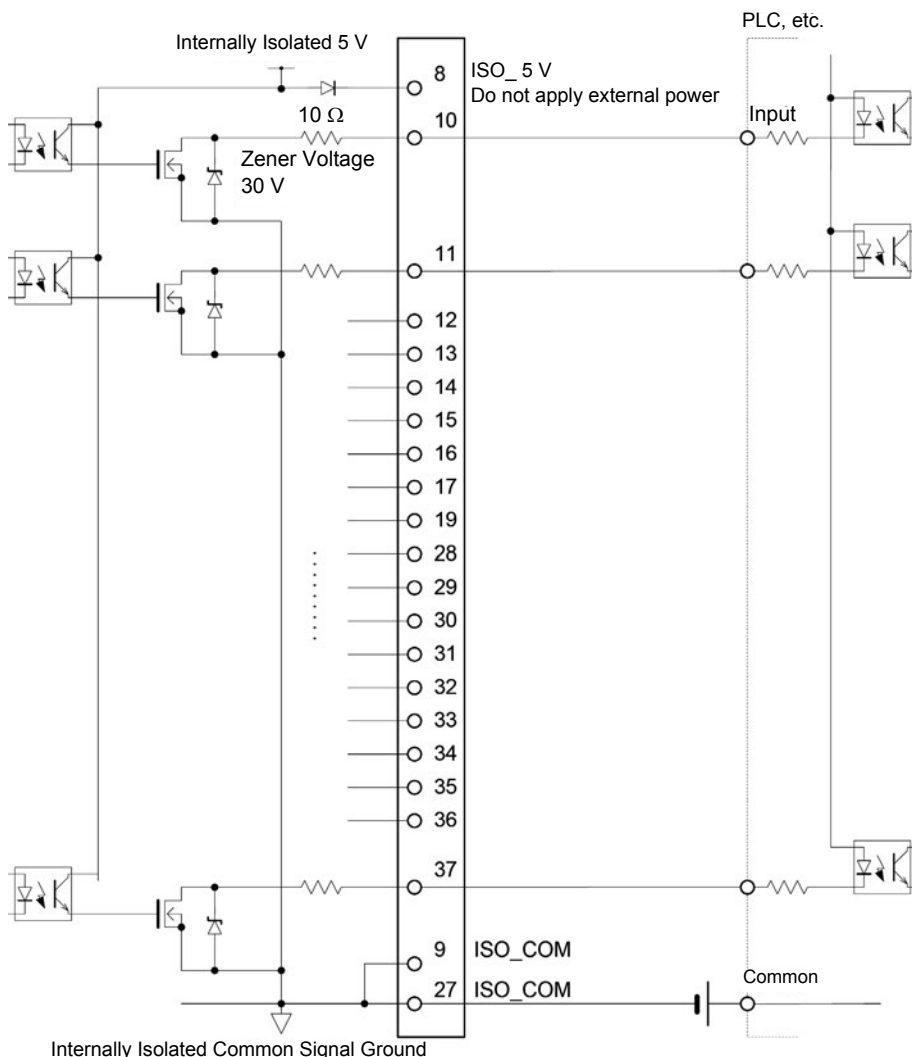

Electrical Specifications

Input Signals	Input type	Optocoupler-isolated, non-voltage contact inputs (source input, active-low)
	Input asserted (ON) voltage	1 V or less
	Input de-asserted (OFF) voltage	Open or 5 to 30 V
	Input asserted (ON) current	3 mA/ch
	Maximum applied voltage	30 V

Output Signals	Output type	Optocoupler-isolated Nch open drain outputs (current sink, active-low)
	Maximum load voltage	30 V
	Maximum output current	50 mA/ch
	Residual voltage	1 V or less (50 mA)

Internally Isolated	Power Output	4.5 V to 5.0 V
	Maximum output current	100 mA
	External power input	none

Connection Examples

Input Circuit Connection Examples

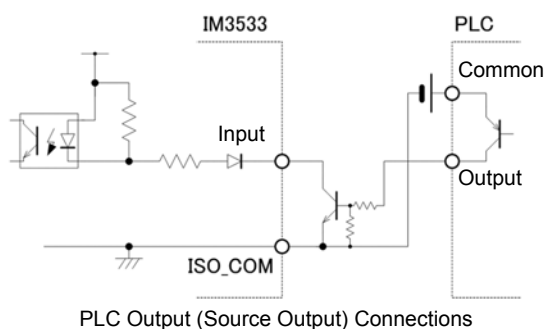
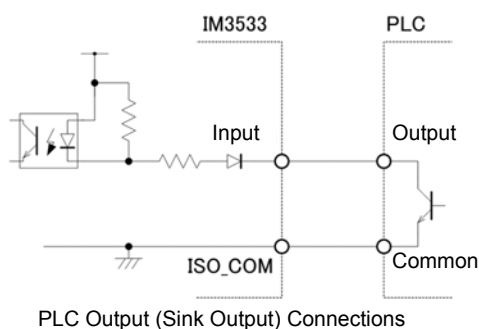
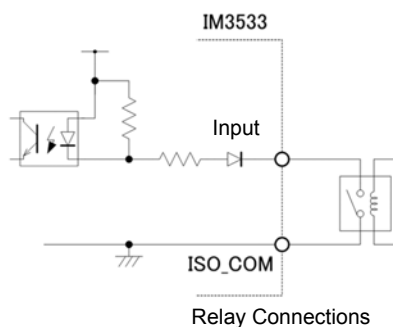
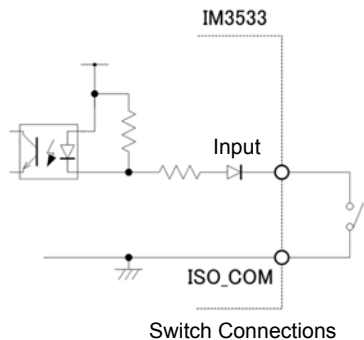

Output Circuit Connection Examples

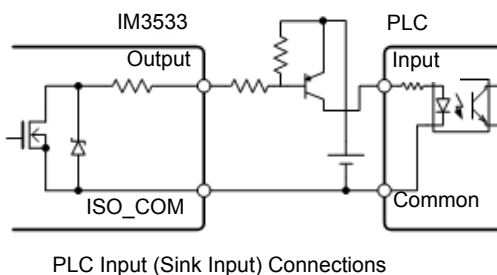
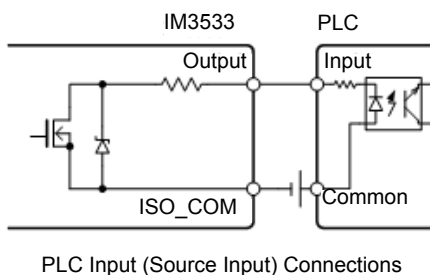
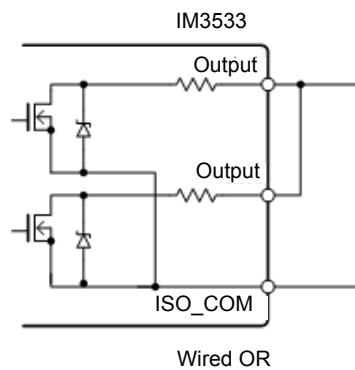
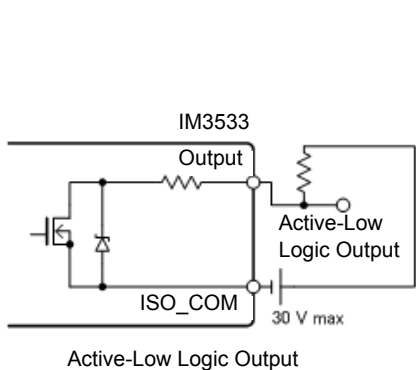
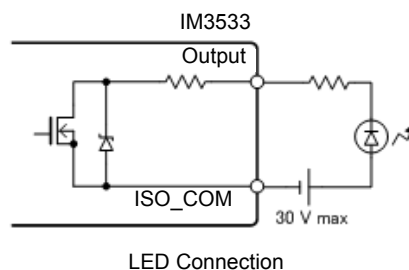
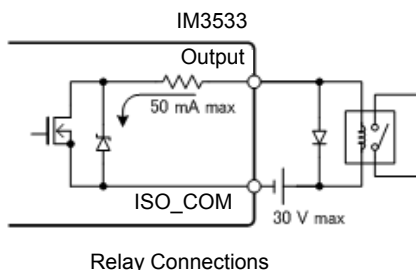

12.4 External I/O Settings

There are the following setting items for the output timing of the judgment result output signal and the logic of the trigger signal.

Setting Delay Time from Output of Comparator and BIN Judgment Results until Output of EOM (LOW)

The delay time for the period from the output of the comparator and BIN judgment results until the output of EOM (LOW) from the EXT I/O can be set on the instrument or by a communication command. For the setting procedure, refer to the following.

See "Setting the Delay Time from the Output of Comparator and BIN Judgment Results until Output of EOM (LOW) and Resetting Judgment Results" (p. 134)

LCR Application Disk - Communication Commands (**:IO:OUTPut:DElay**) .

Setting Reset of Judgment Results

Whether to reset the comparator and BIN judgment results simultaneously with the measurement start signal can be selected on the instrument or by a communication command.

For the setting procedure, refer to the following.

See "Setting the Delay Time from the Output of Comparator and BIN Judgment Results until Output of EOM (LOW) and Resetting Judgment Results" (p. 134)

LCR Application Disk - Communication Commands (**:IO:RESult:RESet**)

Enabling Trigger Input for during Measurement

Whether to enable or disable trigger input from the EXT I/O during measurement (during $\overline{\text{EOM}}$ (HI) output) can be selected on the instrument or by a communication command.

For the setting procedure, refer to the following.

See "Enabling Trigger Input for during Measurement and Setting the Valid Edge of Trigger Input" (p. 136)

LCR Application Disk - Communication Commands (**:IO:TRIGger:ENABle**)

Setting Valid Edge of Trigger Input

Either the rising edge or falling edge can be selected as the valid edge of trigger input from the EXT I/O. For the setting procedure, refer to the following.

See "Enabling Trigger Input for during Measurement and Setting the Valid Edge of Trigger Input" (p. 136)

LCR Application Disk - Communication Commands (**:IO:TRIGger:EDGE**)

12.5 External Control Q&A

Common Questions	Answers
How do I connect external trigger input?	Connect the (active low) $\overline{\text{TRIG}}$ input pin to an ISO_COM pin using a switch or open-collector output.
Which pins are common ground for input and output signals?	The ISO_COM pins.
Are the common (signal ground) pins shared by both inputs and outputs?	Both common ground pins can be shared by inputs and outputs.
How do I confirm output signals?	Confirm voltage waveforms with an memory recorder and oscilloscope. To do this, the output pins such as $\overline{\text{EOM}}$ and comparator decision outputs need to be pulled up (through several k Ω).
How do I troubleshoot input (control) signal issues?	For example, if triggering does not operate properly, bypass the PLC and short the $\overline{\text{TRIG}}$ pin directly to an ISO_COM pin. Be careful to avoid power shorts.
Are the comparator decision signals ($\overline{\text{HI}}$, $\overline{\text{IN}}$, $\overline{\text{LO}}$) retained during measurement (or can they be off)?	They are initially set to be confirmed at the end of measurement and turned OFF when measurement starts. However, it is possible to change the settings so that the judgment results from last time are also stored during measurement. See "Setting Reset of Judgment Results" (p. 328)
When are measurement error signals displayed?	An error is displayed in the following cases. <ul style="list-style-type: none"> • When sampling error • Overcurrent error • When contact error • When HIGH-Z reject error • Temperature sensor error • When constant voltage/constant current error • When voltage/current limit value exceeded error
Is a connector or flat cable for connection provided?	A connector and cable are not supplied, so you need to provide them yourself.
Is direct connection to a PLC possible?	Direct connection is supported for relay or open-collector outputs and positive-ground optocoupler inputs. (Before connecting, confirm that voltage and current ratings will not be exceeded.)
Can external I/O be used at the same time as RS-232C or other communications?	After setting up communications, it is possible to control measurement with the $\overline{\text{TRIG}}$ signal while acquiring measurement data via a communications interface.
How should external power be connected?	The instrument's external I/O input and output signals all operate from an internal isolated power source, so power must not be supplied from the PLC side.

12.6 Measurement Using a Computer

You can control the instrument with communication commands from a computer via the USB, GP-IB, RS-232C, LAN interfaces. To enable communication, the communication conditions need to be set on the instrument. For details on the communication condition settings, refer to "10.1 Setting the Interface" (p. 263). For the details on the communication control procedure, refer to the supplied Communication Instruction Manual (LCR Application Disk).

Printing

Chapter 13

Connecting the printer
to the instrument

Make instrument
settings (p. 333)

Make printer
settings

Printing (p. 334)

- Measurement values and comparator decisions
- Statistical calculation results

13.1 Connecting the Printer

Connecting the Printer



WARNING Because electric shock and instrument damage hazards are present, always follow the steps below when connecting the printer.

- Always turn off the instrument and the printer before connecting.
- A serious hazard can occur if a wire becomes dislocated and contacts another conductor during operation. Make certain connections are secure.

NOTE

The printer can be connected only when the Z3001 RS-232C interface is connected.

Recommended printer

The requirements for a printer to be connected to the instrument are as follows.

Confirm compatibility and make the appropriate settings on the printer before connecting it to the instrument.

See "13.2 Instrument and Printer Settings" (p. 333)

- Interface..... RS-232C
- Characters per line..... At least 45
- Communication speed . 9,600 bps (Initial value)
- Data bits..... 8bit (fixed)
- Parity..... none (fixed)
- Stop bits 1bit (fixed)
- Flow control..... none (Initial value)

NOTE

The communication speed and flow control can be changed with instrument settings. However, the instrument and printer must be configured with the same settings.

13.1 Connecting the Printer

Connecting the Printer to the Instrument

Procedure

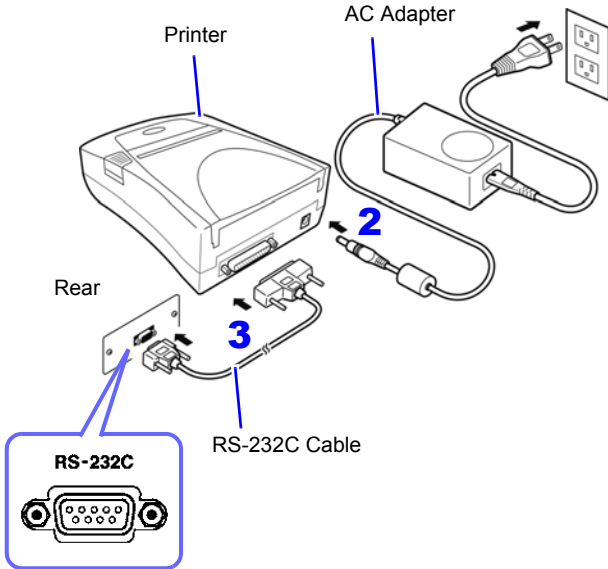

- 1** Confirm that the instrument and Printer are turned off.
- 2** Connect the AC Adapter to the Printer, and insert the power plug into an outlet.
- 3** Connect the RS-232C Cable to the RS-232C connectors on the instrument and printer.
- 4** Turn the instrument and printer on.

Connector pin assignments

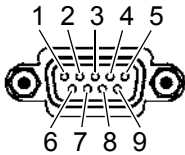

Z3001 RS-232C interface connector (9-pin)

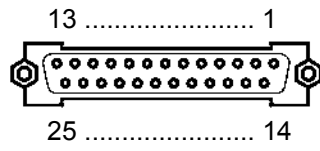

Printer Connector (25-pin)

Function	Signal Name	Pin
Receive Data	RxD	2
Transmit Data	TxD	3
Signal or Common Ground	GND	5
Request to Send	RTS	7
Clear to Send	CTS	8

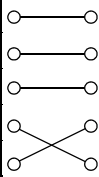

Pin	Signal Name	Function
2	TxD	Transmit Data
3	RxD	Receive Data
7	GND	Signal or Common Ground
4	RTS	Request to Send
5	CTS	Clear to Send

NOTE

- To use hardware flow control, you will need an RS-232C cable with RTS and CTS wires that are connected each other (7-pin at instrument to 5-pin at printer or 8-pin at instrument to 4-pin printer,) which is compatible with Interlink. Hardware flow control cannot be used with cables whose RTS and CTS wires are shorted together.
- When using a printer other than the recommended model, exercise care to choose a model with compatible connector pin assignments.

13.2 Instrument and Printer Settings

Make Instrument Settings

Procedure

This operation is possible in any of the **LCR** mode, **ANALYZER** mode and **TRANSFORMER** mode.

1

LCR Measurement Screen

➔

Interface Setting

2

Printer Settings

Press **PRINT** and select the printing method.

- BAUD RATE** Communication speed with the printer
- HANDSHAKE** Configuring flow control
- TEXT** Prints the measurement results as text.
- SCREEN** Prints the screen.
- Manual Print** Outputs the measurement values only when **PRINT** of the measurement screen is pressed.
- Auto Print** Outputs the measurement values after measurement finishes.

In ANALYZER mode (IM3533-01 only), **[TYPE]** cannot be selected. Only the screen can be printed.

3 Select **SET** and check each of the settings, and press **EXIT** to close the setting screen.

The printer's communication speed (baud rate) and flow control settings are the same as the RS-232C settings. If the communication speed is changed, you may need to increase the print speed. It is also necessary to change the printer's communication speed setting. When the communication speed is increased, the printer may be unable to keep up, preventing data from being printed properly. If this occurs, use hardware or software flow control. For more information, see the instruction manual that came with the printer.

13.3 Printing

Before Printing

Verify that the instrument and printer settings (p. 333) are correct.

When the Printing Method is Set to AUTO

- Prints automatically after measurement completes.
- Since measurement data is printed automatically, it is recommended to print using an external trigger.
- When set to use an external trigger, pressing TRIG causes the measurement data to be printed.

When the Printing Method is Set to MANUAL

Prints the state when PRINT is pressed in the measurement screen.

When LCR Mode

LCR PRINT

Z **4.99483kΩ**

OFF

θ **0.037 °**

OFF

Vac 955.9mV
Iac 191.4μA

INFORMATION 1/2

FREQ	1.0000kHz	JUDGE	OFF	OPEN	ALL
V	1.000V	SPEED	MED	SHORT	OFF
LIMIT	OFF	AVG	OFF	LOAD	OFF
RANGE	AUTO 10kΩ	DELAY	0.0000s	CABLE	0m
LOW Z	OFF	SYNC	OFF	SCALE	OFF
J SYNC	OFF	DCBIAS	OFF		

ZOOM ON INFO DC PRINT

When ANALYZER Mode (IM3533-01 only)

ANALYZER PRINT

FREQ[Hz]	Z[Ω]	θ[°]
1.0233k	4.99566k	0.013
1.0471k	4.99605k	0.016
1.0715k	4.99625k	0.015
1.0965k	4.99652k	0.016
1.1220k	4.99724k	0.013
1.1482k	4.99825k	0.020
1.1749k	4.99897k	0.016
1.2023k	5.00085k	0.019
1.2303k	5.00320k	0.016
1.2589k	5.00542k	0.011
1.2882k	5.00770k	0.002
1.3183k	5.00726k	0.004

MODE SET ADJ SYS FILE PRINT

When TRANSFORMER Mode

TRANS PRINT

Ls **10.4851μH**

10.1926μH

N **1.01425**

INFORMATION 1/2

FREQ	1.0000kHz	JUDGE	OFF	OPEN	ALL
V	1.000V	SPEED	MED	SHORT	OFF
LIMIT	OFF	AVG	OFF	LOAD	OFF
RANGE	AUTO 10Ω	DELAY	0.0000s	CABLE	0m
LOW Z	OFF	SYNC	OFF	SCALE	OFF
J SYNC	OFF				

ZOOM ON INFO MODEL PRINT TRIG 1 TRIG 2

Example Printouts

The print content varies depending on the printer settings of the instrument.

See "13.2 Instrument and Printer Settings" (p. 333)

When LCR Mode

When the [TYPE] setting is **TEXT**

Normal measurement

```
Z  4.99300kohm
PH  0.014 deg
```

Comparator measurement

```
Z  4.99254kohm IN
PH  0.013 deg HI
```

BIN measurement

```
Z  4.99188kohm
PH  0.015 deg
BIN3
```

When the [TYPE] setting is **SCREEN**

```
LCR
Z  4.99177kΩ
OFF
θ  0.012 °
OFF
Vac 978.0mV
Iac 195.9μA
INFORMATION 1/2
FREQ 1.0000kHz JUDGE OFF OPEN OFF
V 1.000V SPEED MED SHORT OFF
LIMIT OFF AVG OFF LOAD OFF
RANGE AUTO 10kΩ DELAY 0.0000s CABLE 0Ω
LOW Z OFF SYNC OFF SCALE OFF
J SYNC OFF DCBIAS OFF
```

NOTE

When the display is enlarged, the print type is text even when [TYPE] is set to **SCREEN**.

When ANALYZER Mode (IM3533-01 only)

In ANALYZER mode, the [TYPE] setting can only be set to a copy of the screen.

```
ANALYZER
FREQ[Hz] Z[R] θ[ ]
1.0000k 4.99170k 0.015
1.0233k 4.99544k 0.015
1.0471k 4.99617k 0.012
1.0715k 4.99597k 0.013
1.0965k 4.99643k 0.015
1.1220k 4.99733k 0.020
1.1482k 4.99776k 0.015
1.1749k 4.99901k 0.021
1.2023k 5.00038k 0.018
1.2303k 5.00260k 0.019
1.2589k 5.00526k 0.008
1.2882k 5.00750k 0.011
```

When TRANSFORMER Mode

13.3 Printing

When the [TYPE] setting is TEXT

Normal measurement

```
Ls  303.715uH  303.653uH  N  1.00010
```

Comparator measurement

```
Ls  303.755uH  303.718uH  N  1.00006  IN
```

When the [TYPE] setting is SCREEN

TRANSFORMER

Ls 301.702μH
301.625μH

N 1.00013

LWT IN

1/23

FREQ	1.0000kHz	JUDGE	ON	OPEN	OFF
V	1.000V	SPEED	MED	SHORT	OFF
LIMIT	OFF	AVG	OFF	LOAD	OFF
RANGE	AUTO 10Ω	DELAY	0.0000s	CABLE	On
LOW Z	OFF	SYNC	OFF	SCALE	OFF

NOTE When the display is enlarged, the print type is text even when [TYPE] is set to SCREEN.

CONTINUOUS measurement mode

When the [TYPE] setting is TEXT or SCREEN

When measurement values are being displayed, they are printed as text.

When ANALYZER (IM3533-01 only) results are being displayed, they are printed as a copy of the

Measurement value display

```
001 Z  4.99076kohm  PH  0.015 deg  -- --
002 Z  4.99066kohm  PH  0.015 deg  IN HI
004 Z  4.99048kohm  PH  0.012 deg  BIN3
005 Z      SWEEP      PH  SWEEP
```

ANALYZER result display

CONTINUOUS

FREQ[Hz]	Z[Ω]	θ[]
1.0000k	4.99147k	0.013
1.0233k	4.99602k	0.012
1.0471k	4.99619k	0.016
1.0715k	4.99632k	0.015
1.0965k	4.99679k	0.011
1.1220k	4.99728k	0.020
1.1482k	4.99761k	0.018
1.1749k	4.99886k	0.014
1.2023k	5.00076k	0.016
1.2303k	5.00289k	0.016
1.2589k	5.00527k	0.014
1.2882k	5.00789k	0.004

NOTE The printer cannot be configured in CONTINUOUS measurement mode. To change the printer settings, place the instrument in LCR mode, ANALYZER mode (IM3533-01 only), or TRANSFORMER mode.

Specifications Chapter 14

All of the AC voltage and AC current values shall be RMS values.

14.1 General Specifications

1. Basic Specifications

Measurement mode	<p>(1) LCR mode: Measurement with single condition</p> <p>(2) ANALYZER mode (IM3533-01 only): Measurement frequency sweep</p> <ul style="list-style-type: none"> • No. of measurement points: 2 to 801 • Sweep method: Normal sweep START-STOP • Display: List display <p>(3) TRANSFORMER mode: Measurement using a single condition</p> <p>(4) CONTINUOUS measurement mode: Continuous measurement of saved conditions</p> <ul style="list-style-type: none"> • LCR mode Up to 60 • ANALYZER mode Up to 2 (IM3533-01 only) <p>* Continuous measurement using mixed LCR mode and ANALYZER mode operation is also supported (IM3533-01 only).</p>
------------------	---

Measurement items	<p>(1) LCR mode, ANALYZER mode:</p> <p>Z (Impedance), Y (Admittance), θ (Phase angle), Rs (Equivalent series resistance (ESR)), Rp (Equivalent parallel resistance), X (Reactance), G (Conductance), B (Susceptance), Ls (Equivalent series inductance), Lp (Equivalent parallel inductance), Cs (Equivalent series capacitance), Cp (Equivalent parallel capacitance), Q (Q factor), D (Loss coefficient $\tan\delta$), Rdc (DC resistance), T (Temperature)</p> <p>(2) TRANSFORMER mode:</p> <p>N (winding ratio), M (mutual inductance), ΔL (inductance difference)</p>
-------------------	--

Display range

Parameters	Display range (6 digit)
Z	0.00m to 9.99999G Ω
Y	0.000n to 9.99999GS
θ	± 0.000 to 999.999°
Rs, Rp, X, Rdc	$\pm 0.00m$ to $9.99999G\Omega$
G, B	$\pm 0.000n$ to $9.99999GS$
Cs, Cp	$\pm 0.0000p$ to $9.99999GF$
Ls, Lp, M, ΔL	$\pm 0.00000\mu$ to $9.99999GH$
D	± 0.00000 to 9.99999
Q	± 0.00 to 9999.99
$\Delta\%$	± 0.000 to 999.999%
T	-10.0 to $+99.9^\circ C$
N	$0.00000f$ to $999.999G$

14.1 General Specifications

1. Basic Specifications

Measurement frequency	(1) Frequency range 1 mHz to 200 kHz (2) Setting resolution 0.001 Hz to 99.999 Hz.....1 mHz steps 100.00 Hz to 999.99 Hz.....10 mHz steps 1.000 kHz to 9.9999 kHz.....100 mHz steps 10.000 kHz to 99.999 kHz...1 Hz steps 100.00 kHz to 200.00 kHz...10 Hz steps (3) Frequency accuracy ±0.01% of setting or less
-----------------------	--

Output impedance (Hc terminal, when 1 kHz)	Normal mode: 100 Ω ±10 Ω Low impedance accuracy mode: 25 Ω ±5 Ω
---	--

Measurement signal level	(1) Open circuit terminal voltage (V) mode and constant voltage (CV) mode <ul style="list-style-type: none"> Level range Normal mode: 5 mV to 5 V, maximum 50 mA Low Z high accuracy mode: 5 mV to 2.5 V, maximum 100 mA Setting resolution 1 mV steps Setting accuracy ±10% of setting ±10 mV (2) Constant current (CC) mode <ul style="list-style-type: none"> Level range Normal mode: 10 μA to 50 mA, maximum 5 V Low Z high accuracy mode: 10 μA to 100 mA, maximum 2.5 V Setting resolution 10 μA steps Setting accuracy ±10% of setting ±10 μA
--------------------------	---

Measurement range The measurement range is determined according to impedance Z.
 The values of the other measurement items can be calculated.
 Ranges: 100 mΩ, 1 Ω, 10 Ω, 100 Ω, 1 kΩ, 10 kΩ, 100 kΩ, 1 MΩ, 10 MΩ, 100 MΩ (10 ranges)

Measurement range	Guaranteed Accuracy Range	AUTO Ranging Range
100 MΩ	8 MΩ to 200 MΩ	8 MΩ to
10 MΩ	800 kΩ to 100 MΩ	800 kΩ to 10 MΩ
1 MΩ	80 kΩ to 10 MΩ	80 kΩ to 1 MΩ
100 kΩ	8 kΩ to 1 MΩ	8 kΩ to 100kΩ
10 kΩ	800 Ω to 100 kΩ	800 Ω to 10 kΩ
1 kΩ	80 Ω to 10 kΩ	80 Ω to 1 kΩ
100 Ω	8 Ω to 100 Ω	8 Ω to 100 Ω
10 Ω	800 mΩ to 10 Ω	800 mΩ to 10 Ω
1 Ω	80 mΩ to 1Ω	80 mΩ to 1 Ω
100 mΩ	10 mΩ to 100 mΩ	0 Ω to 100 mΩ

- The guaranteed accuracy range differs depending on the measurement conditions (p.347).
- Out of guaranteed accuracy is displayed when out of the ranging range
 OVERFLOW or UNDERFLOW is displayed when out of the A/D input range

1. Basic Specifications

- Low Z High Accuracy Mode
- Improves measurement accuracy in the 100 mΩ and 1 Ω ranges. The measurement current is increased (maximum 100 mA, maximum applied voltage 2.5 V) and the measurement accuracy is improved by setting the output resistance to 25 Ω.
 - Low Z high accuracy mode is only available for the 100 mΩ and 1 Ω ranges.

Setting range of low Z high accuracy mode

No	Measurement range	to 1 kHz	to 10 kHz	to 100 kHz	to 200 kHz
1	100 MΩ	Normal mode only (low Z high accuracy mode setting disabled)			None
2	10 MΩ				
3	1 MΩ				
4	100 kΩ				
5	10 kΩ				
6	1 kΩ				
7	100 Ω				
8	10 Ω				
9	1 Ω	Low Z high accuracy mode/ normal mode			
10	100 mΩ				

Period of guaranteed accuracy	1 year
Warm-up time	At least 60 minutes
Measurement time	Approx. 2.0 ms (1 kHz, FAST, no screen display)
Measurement speed	FAST, MED, SLOW, SLOW2
Terminal structure	4-terminal structure
Backup battery life	Approx. 10 years (25°C (77°F) reference value)
Product warranty period	3 years

2. Function

Monitor functions	(1) Monitor voltage <ul style="list-style-type: none"> Monitor range 0.000 V to 5.000 V Monitor accuracy ±10% rdg. ±10 mV (2) Monitor current <ul style="list-style-type: none"> Monitor range 0.000 mA to 100.0 mA Monitor accuracy ±10% rdg. ±10 μA
Limit function	(1) Current limit (when V or CV) <ul style="list-style-type: none"> Limit range 0.01 mA to 100.0 mA Limit accuracy ±10% rdg. ±10 μA (2) Voltage limit (when CC set) <ul style="list-style-type: none"> Limit range 0.005 V to 5.000 V Limit accuracy ±10% rdg. ±10 mV
DC bias measurement	Superimposing a DC voltage and then performing measurement is possible. DC voltage Normal mode: -5.00 V to 5.00 V (10 mV resolution) Low Z high accuracy mode: -2.50 V to 2.50 V (10 mV resolution) Generation accuracy: ±10% of setting ±(VAC 0.01 + 30 mV) *VAC: AC signal voltage setting [V]

14.1 General Specifications

2.Function

DC resistance measurement	<p>Settable when setting the Rdc measurement item. The measurement condition when DC resistance measurement is settable to other than AC measurement</p> <ul style="list-style-type: none"> Measurement signal level: Normal mode: Fixed at 2 V Low Z high accuracy mode: Fixed at 2 V Occurrence accuracy: $\pm 10\%$ of setting $\pm 20\text{mV}$ Measurement range, measurement speed, average, Adjustment delay, line frequency Temperature correction function: Converts data to referen Reference temperature settings range -10.0°C to 99.9°C Temperature coefficient setting range $-99,999$ ppm to $99,999$ ppm
Temperature measurement function	<p>Temperature can be measured when the temperature T measurement parameter is set.</p> <ul style="list-style-type: none"> Dedicated temperature probe: 9478 (option) Measurement range: -10.0°C to 99.9°C Guaranteed accuracy range: -10.0°C to 99.9°C Measurement accuracy: $\pm 0.5\%$ rdg $\pm 1^{\circ}\text{C}$ Ambient temperature: From 0°C to 18°C and 28°C to 40°C, add $0.02^{\circ}\text{C}/^{\circ}\text{C}$ to the measurement accuracy. Sampling time: Approx. 640 ms
Average	1 to 256 (1 step)
Trigger function	An internal trigger or external trigger can be set.
Trigger delay	0 to 9.999 s (0.001s resolution)
BIN measurement	10 classifications for 2 items, OUT OF BINS Absolute value setting, $\Delta\%$ setting, % setting
Comparator	<ul style="list-style-type: none"> LCR mode: First item: HI/IN/LO Third item: HI/IN/LO Absolute value setting, $\Delta\%$ setting, % setting TRANSFORMER mode: HI/IN/LO relative to calculation items Absolute value setting, $\Delta\%$ setting, % setting
Compensation	<ul style="list-style-type: none"> Open and short circuit compensation Load circuit compensation Cable length compensation IM3533: 0 m, 1 m (Guaranteed accuracy up to 4 m) IM3533-01: 0 m, 1 m, 2 m, 4 m
Correlation compensation	Enter the compensation coefficients a and b of the following expression. [Measurement value after compensation] = a \times [measurement value] + b
Residual charge protection function (Provides protection against a discharge voltage from a charged capacitor)	$V = \sqrt{\frac{10}{C}}$ <p>C: Capacitance [F] of test sample However, V = maximum 400 V</p>
Magnification display function	The display of measurement values and comparator judgment results can be magnified.
CONTINUOUS measurement	Perform continuous measurement with saved conditions from the screen.
Display digits setting function	The number of display digits for measurement values can be set to 3, 4, 5, and 6. However, the setting differs depending on the parameter. (The initial value is 6 digits)
Display setting function	The LCD can be set to ON/OFF.
Key-lock function	Can be enabled and disabled by front panel key operation. Can be enabled and disabled by password input
Trigger synchronous output function	Applies a measurement signal during analog measurement only.
Panel save and load function	LCR mode, TRANSFORMER mode: A total of 60 measurement conditions can be saved. ANALYZER mode: Two measurement conditions can be saved. Compensation value only: 128 different measurement conditions can be saved. Any measurement condition can be read by key operation or a control signal via the EXT I/O.

2.Function

Memory function	32,000 measurement result items can be saved to the instrument. (Reading via USB, GP-IB, RS-232C and LAN is possible. GP-IB, RS-232C, and LAN interfaces are optional.)
Contact check	(1) 4-terminal contact check Performs a contact (disconnection) check between H_{CUR} and H_{POT} and between L_{CUR} and L_{POT} . The threshold can be changed: 1 to 5 (5: high sensitivity, low contact resistance value) (2) HIGH-Z reject function (detection of OPEN state during 2-terminal measurement) When the measurement value is higher than the judgment reference, a contact error is output. Judgment reference: Can be set to 0% to 30,000% (1% resolution) of range full-scale. Error output: An error is output from the EXT I/O.
Print function	The measurement values can be printed. *Requires Z3001 RS-232C Interface and RS-232C-compatible printer.
Buzzer sound	<ul style="list-style-type: none"> The buzzer for the comparator judgment result (IN or NG) can be set to ON/OFF. The buzzer sound for key input can be set to ON/OFF. Any of four buzzer tones can be selected.
TRANSFORMER	Winding ratio (N), mutual inductance (M), and inductance difference (ΔL) can be measured. Winding ratio $N = \sqrt{\frac{L1}{L2}}$ (L1: Primary-side L; L2: Secondary-side L) Mutual inductance $M = \frac{(La - Lb)}{4}$ (La: In-phase, in-series L; Lb: Reverse-phase, in-series L) Inductance difference $\Delta L = L1 - L2$ (L1: Primary-side L; L2: Secondary-side L)

3.Interface

Display	5.7-inch color TFT, touch panel
Handler interface	Equipped as standard
USB interface	Equipped as standard, full speed/hi speed compatible
USB memory	Measurement conditions, measurement values, and screens can be saved. Measurement conditions can be loaded. Supported operations: display of saved measurement values and screens, file deletion, folder creation, and formatting
Optional units	Model Z3000 GP-IB Interface (Option) Model Z3001 RS-232C Interface (Option) Model Z3002 LAN Interface (Option)

4.Environmental and Safety Specifications

Operating temperature and humidity	0 to 40°C (32 to 104°F), 80% RH or less (non-condensating)
Storage temperature and humidity	-10 to 55°C (14 to 131°F) 80% RH or less (non-condensating)
Operating environment	Indoors, pollution degree 2, altitude up to 2000 m (6562-ft.)
Rated supply voltage	AC100 V to 240 V
Rated supply frequency	50/ 60 Hz
Maximum rated power consumption	50 VA
Dimensions	Approx. 330 W × 119 H × 168 D mm (12.99" W × 4.69" H × 6.61" D) (excluding protrusions)
Mass	Approx. 3.1 kg (109.3 oz.)
Applicable Standards	Safety EN61010 EMC EN61326 Class A
Dielectric strength	Between the power wire and ground wire: 1.62 kV AC for 1 minutes

14.1 General Specifications

5. Accessories, Options

Accessories	Power Cord.....	1
	Instruction Manual	1
	LCR Application Disk	1
	(Communications instruction manual [PDF format], explanation of communications commands, USB driver, sample application)	
Options	Model 9262 Test Fixture	
	Model 9263 SMD Test Fixture	
	Model 9677 SMD Test Fixture	
	Model 9699 SMD Test Fixture	
	Model IM9100 SMD Test Fixture	
	Model IM9110 SMD Test Fixture	
	Model L2000 4-Terminal Probe	
	Model 9140-10 4-Terminal Probe	
	Model L2001 Pincher Probe	
	Model 9261-10 Test Fixture	
	Model 9500-10 4-Terminal Probe	
	Model Z3000 GP-IB Interface	
	Model Z3001 RS-232C Interface	
	Model Z3002 LAN Interface	
	Model 9478 Sheath Type Temperature Probe	
Model 9268-10 DC Bias Voltage Unit		
Model 9269-10 DC Bias Current Unit		

14.2 Measurement Range and Accuracy

Impedance measurement

The measurement accuracy is calculated from a basic accuracy, which is based on the accuracy for impedance Z (% rdg.) and phase angle θ ($^{\circ}$), and the following coefficients.

$$\text{Measurement accuracy} = \text{Basic accuracy} \times C \times D \times E \times F \times G$$

C: Level coefficient/ D: Measurement speed coefficient/ E: Cable length coefficient/
F:DC bias coefficient/ G: Temperature coefficient

Basic accuracy

Measurement conditions of basic accuracy coefficient table

- Using the Model 9262 Test Fixture
- Measurement speed: SLOW2
- Cable length: 0 m
- Operation 60 minutes after the power is turned on.
- Open circuit compensation and short circuit compensation both being performed.
- Temperature and humidity: $23 \pm 5^{\circ}\text{C}$, 80 %RH or less

When the measurement conditions differ from the above, multiply the level coefficient (C), measurement speed coefficient (D), cable length coefficient (E), DC bias coefficient (F), and temperature coefficient (G) by the basic accuracy.

The basic accuracy is calculated by determining coefficient A and B from the basic accuracy coefficient table in accordance with the measurement frequency and measurement range, and then using the following expression.

The basic accuracy becomes the accuracy [%] of Z and accuracy [$^{\circ}$] of θ .

Basic accuracy formula

$$\begin{array}{l} \text{1 k}\Omega \text{ range or more} \\ \text{Basic accuracy} = \pm \left(A + B \times \left| \frac{10 \times Z_x[\Omega]}{\text{Range}[\Omega]} - 1 \right| \right) \end{array}$$

$$\begin{array}{l} \text{100 }\Omega \text{ range or less} \\ \text{Basic accuracy} = \pm \left(A + B \times \left| \frac{\text{Range}[\Omega]}{Z_x[\Omega]} - 1 \right| \right) \end{array}$$

Z_x : Impedance (effective value or value obtained by the following expression) of the test sample

$$\begin{array}{l} Z_x[\Omega] = \omega L [\text{H}] \quad (\text{when } \theta = 90^{\circ}) \\ = \frac{1}{\omega C [\text{F}]} \quad (\text{when } \theta = -90^{\circ}) \\ = R[\Omega] \quad (\text{when } \theta = 0^{\circ}) \end{array}$$

NOTE

See "Example calculation of basic accuracy" (p. 348)

14.2 Measurement Range and Accuracy

Accuracy table (IM3533 and IM3533-01)

Upper portion: Impedance Z (Unit: %) Lower portion: Phase angle θ (Unit: °)

Range	DC	1 mHz to 99.999 Hz	100.00 Hz to 999.99 Hz	1.0000 kHz to 10.000 kHz	10.001 kHz to 100.00 kHz	100.01 kHz to 200.00 kHz
100 MΩ	A= 1 B= 1	A= 6 B= 5	A= 3 B= 2	A= 3 B= 2	- -	- -
		A= 5 B= 3	A= 2 B= 2	A= 2 B= 2	- -	- -
10 MΩ	A= 0.5 B= 0.3	A= 0.8 B= 1	A= 0.5 B= 0.3	A= 0.5 B= 0.3	A= 3 B= 2	- -
		A= 0.8 B= 0.5	A= 0.4 B= 0.2	A= 0.4 B= 0.2	A= 2 B= 2	- -
1 MΩ	A= 0.2 B= 0.1	A= 0.4 B= 0.08	A= 0.3 B= 0.05	A= 0.3 B= 0.05	A= 0.7 B= 0.08	A= 1 B= 0.5
		A= 0.3 B= 0.08	A= 0.2 B= 0.02	A= 0.2 B= 0.02	A= 1.5 B= 0.08	A= 3 B= 0.5
100 kΩ	A= 0.1 B= 0.01	A= 0.3 B= 0.03	A= 0.2 B= 0.03	A= 0.15 B= 0.02	A= 0.25 B= 0.04	A= 0.4 B= 0.3
		A= 0.3 B= 0.02	A= 0.1 B= 0.02	A= 0.1 B= 0.015	A= 0.4 B= 0.02	A= 1.2 B= 0.3
10 kΩ	A= 0.1 B= 0.01	A= 0.3 B= 0.025	A= 0.2 B= 0.025	A= 0.05 B= 0.02	A= 0.2 B= 0.025	A= 0.3 B= 0.03
		A= 0.3 B= 0.02	A= 0.1 B= 0.02	A= 0.03 B= 0.02	A= 0.4 B= 0.02	A= 0.6 B= 0.05
1 kΩ	A= 0.1 B= 0.01	A= 0.3 B= 0.02	A= 0.2 B= 0.02	A= 0.15 B= 0.02	A= 0.2 B= 0.02	A= 0.3 B= 0.02
		A= 0.2 B= 0.02	A= 0.1 B= 0.02	A= 0.08 B= 0.02	A= 0.4 B= 0.02	A= 0.6 B= 0.02
100 Ω	A= 0.1 B= 0.02	A= 0.4 B= 0.02	A= 0.3 B= 0.02	A= 0.15 B= 0.02	A= 0.2 B= 0.02	A= 0.3 B= 0.03
		A= 0.2 B= 0.01	A= 0.15 B= 0.01	A= 0.1 B= 0.01	A= 0.4 B= 0.02	A= 0.6 B= 0.02
10 Ω	A= 0.2 B= 0.15	A= 0.5 B= 0.2	A= 0.4 B= 0.05	A= 0.3 B= 0.05	A= 0.3 B= 0.05	A= 0.4 B= 0.2
		A= 0.3 B= 0.1	A= 0.3 B= 0.03	A= 0.15 B= 0.03	A= 0.75 B= 0.05	A= 1.5 B= 0.1
1 Ω	A= 0.3 B= 0.3	A= 2 B= 1	A= 0.6 B= 0.3	A= 0.4 B= 0.3	A= 0.4 B= 0.3	A= 1 B= 1
		A= 1 B= 0.6	A= 0.5 B= 0.2	A= 0.25 B= 0.2	A= 1 B= 0.2	A= 2 B= 0.5
100 mΩ	A= 3 B= 3	A= 10 B= 10	A= 3 B= 3	A= 3 B= 2	A= 2 B= 2	A= 4 B= 3
		A= 6 B= 6	A= 2 B= 2	A= 2 B= 1.5	A= 2 B= 1.5	A= 3 B= 4

The following value is added to the basic accuracy when performing temperature correction during DC resistance measurement:

$$\frac{-100\alpha_{t0}\Delta t}{1 + \alpha_{t0} \times (t + \Delta t - t_0)} \quad [\%]$$

t₀: Basic temperature [°C]

t: Current temperature [°C]

Δt: Temperature measurement accuracy

α_{t0}: Temperature coefficient at t₀ [1/°C]

C Level coefficient

The coefficient corresponding to the setting for measurement level is obtained from the measurement level coefficient table and then multiplied by the basic accuracy.

AC measurement

	0.005 V to 0.999 V	1 V	1.001 V to 5 V
Level coefficient	$1 + \frac{0.2}{V}$	1	$1 + \frac{2}{V}$

V: Setting value (equivalent to when V mode) [V]

DC resistance measurement

	2 V
Level coefficient	1

D Measurement speed coefficient

The coefficient corresponding to the setting for measurement speed is obtained from the measurement speed coefficient table and then multiplied by the basic accuracy.

When the measurement frequency is 0.001 Hz to 0.999 Hz, the SLOW2 coefficient is used, regardless of the measurement speed.

		FAST	MED	SLOW	SLOW2
speed coefficient	AC measurement	8	4	2	1
	DC resistance measurement	4	3	2	1

When the waveform averaging function is enabled, the coefficient corresponding to the set measurement waveform count is obtained from the measurement speed coefficient table at the time of waveform averaging and then multiplied by the basic accuracy.

Measurement speed coefficient table when the waveform averaging function is enabled

No	Frequency band	Settable range	Measurement speed coefficient			
			4	3	2	1
1	DC (line frequency: 50 Hz)	1 to 24	1 to 2	3 to 4	5 to 19	20 to 24
	DC (line frequency: 60 Hz)	1 to 24	1 to 2	3 to 5	6 to 23	24

No	Frequency band	Settable range	Outside guaranteed accuracy	Measurement speed coefficient			
				8	4	2	1
2	0.001 Hz to 0.999 Hz	1	-	-	-	-	1
3	1.000 Hz to 10.000 Hz	1 to 4	-	1	2	3	4
4	10.001 Hz to 39.999 Hz	1 to 10	-	1	2 to 4	5 to 9	10
5	40.000 Hz to 99.999 Hz	1 to 40	-	1	2 to 4	5 to 39	40
6	100.00 Hz to 300.00 Hz	1 to 50	-	1	2 to 4	5 to 49	50
7	300.01 Hz to 500.00 Hz	1 to 200	-	1	2 to 9	10 to 199	200
8	500.01 Hz to 1.0000 Hz	1 to 300	-	1 to 4	5 to 19	20 to 299	300
9	1.0001 kHz to 2.0000 kHz	1 to 600	1	2 to 7	8 to 39	40 to 599	600
10	2.0001 kHz to 3.0000 kHz	1 to 1200	1 to 3	4 to 11	12 to 59	60 to 1199	1200
11	3.0001 kHz to 5.0000 kHz	1 to 2000	1 to 5	6 to 19	20 to 99	100 to 1999	2000
12	5.0001 kHz to 10.000 kHz	1 to 3000	1 to 9	10 to 39	40 to 199	200 to 2999	3000
13	10.001 kHz to 20.000 kHz	1 to 1200	1 to 3	4 to 15	16 to 79	80 to 1199	1200
14	20.001 kHz to 30.000 kHz	1 to 480	1	2 to 5	6 to 23	24 to 479	480
15	30.001 kHz to 50.000 kHz	1 to 800	1	2 to 9	10 to 39	40 to 799	800
16	50.001 kHz to 100.00 kHz	1 to 1200	1 to 3	4 to 15	16 to 79	80 to 1199	1200
17	100.01 kHz to 200.00 kHz	1 to 2400	1 to 7	8 to 31	32 to 159	160 to 2399	2400

NOTE

When the measurement frequency falls outside the guaranteed accuracy, instrument operation is considered to be outside the guaranteed accuracy.

14.2 Measurement Range and Accuracy

E Cable length coefficient

The coefficient corresponding to the setting for measurement cable length is obtained from the measurement cable length table and then multiplied by the basic accuracy.

		0 m	1 m	2 m	4 m	
Cable length coefficient	IM3533	10 kΩ range or less	1	1.2	$1.5 + \frac{fm}{100}$	$2 + \frac{fm}{50}$
		100 kΩ range or greater	1	1.2	$1.5 + \frac{fm}{20}$	$2 + \frac{fm}{10}$
	IM3533-01	1	1.2	1.5	2	

fm: Measurement frequency [kHz]

* IM3533 guaranteed accuracy range (frequency)

	Cable length	10 kΩ range or less	100 kΩ range or greater
Guaranteed accuracy range (frequency)	0 m	Up to 200 kHz	
	1 m	Up to 200 kHz	
	2 m	Up to 200 kHz	Up to 100 kHz
	4 m	Up to 200 kHz	Up to 10 kHz

* IM3533-01 guaranteed accuracy range (frequency)

0 m / 1 m / 2 m / 4 m: Up to 200 kHz (no limit)

F DC bias coefficient

The coefficient corresponding to the setting for ON/OFF of DC bias is obtained from the DC bias coefficient table and then multiplied by the basic accuracy.

	DC Bias Setting OFF	DC Bias Setting ON
DC bias coefficient	1	2

G Temperature coefficient

The coefficient corresponding to the operating temperature is obtained from the operating temperature coefficient table and then added to the basic accuracy.

	$0^{\circ}\text{C} \leq t < 18^{\circ}\text{C}, 28^{\circ}\text{C} < t \leq 40^{\circ}\text{C}$	$18^{\circ}\text{C} \leq t \leq 28^{\circ}\text{C}$
Temperature coefficient	$1 + 0.1 \times t - 23 $	1

When the operating temperature (t) is $23^{\circ}\text{C} \pm 5^{\circ}\text{C}$, the coefficient is 1.

Guaranteed Accuracy Range

The guaranteed accuracy range is as follows. The guaranteed accuracy range varies with the sample's impedance.

Range	Sample impedance	0.001 Hz to 99.999 Hz	100.00 Hz to 999.99 Hz	1.0000 kHz to 10.000 kHz	10.001 kHz to 100.00 kHz	100.01 kHz to 200.00 kHz
100 M Ω	8 M Ω to 200 M Ω	0.101 V to 5 V				
10 M Ω	800 k Ω to 10 M Ω					
1 M Ω	80 k Ω to 1 M Ω	0.05 V to 5 V		0.101 V to 5 V	0.501 V to 5 V	
100 k Ω	8 k Ω to 100 k Ω	0.005 V to 5V			0.05 V to 5 V	0.101 V to 5 V
10 k Ω	800 Ω to 10 k Ω					
1 k Ω	80 Ω to 1 k Ω					
100 Ω	8 Ω to 100 Ω					
10 Ω	800 m Ω to 10 Ω	0.05 V to 5 V				
1 Ω	80 m Ω to 1 Ω	0.101 V to 5 V ^{*2}				
100 m Ω	10 m Ω to 100 m Ω	0.501 V to 5 V ^{*1}				

*1 The guaranteed accuracy range during DC bias operation is 1 V to 5 V.

*2 The guaranteed accuracy range during DC bias operation is 0.501 V to 5 V.

Range	Sample impedance	0.001 Hz to 99.999 Hz	100.00 Hz to 999.99 Hz	1.0000 kHz to 10.000 kHz	10.001 kHz to 100.00 kHz	100.01 kHz to 200.00 kHz
10 M Ω	10 M Ω to 100 M Ω	0.101 V to 5 V				
1 M Ω	1 M Ω to 10 M Ω					
100 k Ω	100 k Ω to 1 M Ω	0.05 V to 5 V		0.101 V to 5 V	0.501 V to 5 V	
10 k Ω	10 k Ω to 100 k Ω	0.005 V to 5V			0.05 V to 5 V	0.101 V to 5 V
1 k Ω	1 k Ω to 10 k Ω					

The above voltages are the voltage settings equivalent to when V mode.

The maximum measurement signal level value in low Z high accuracy mode is 2.5 V.

NOTE

- The above measurement specification was determined using a 1.5C-2 V coaxial cable with an established cable length for the instrument. Using a cable other than a 1.5C-2 V, or a cable that not an established length for the instrument in question increases the chance of measurement inaccuracy. A large capacitance between the H terminal and grounding capacitance (GND) or the L terminal and GND may result in measurement inaccuracy. Please set the GND to 10 pF or less.
- When measuring capacitors with an impedance of 100 k Ω or greater with a measurement frequency of 1 Hz or lower, the instrument may indicate **UNDERFLOW**, and you may experience significant variation in measurement values. If **UNDERFLOW** is indicated, you can lower the measurement range in order to measure the part. In this case, measurement values should be used for reference purposes only as the accuracy specifications may not be satisfied.

14.2 Measurement Range and Accuracy

Example calculation of basic accuracy

- Impedance ($Z=50\ \Omega$) basic accuracy
(For example) Measurement conditions: measurement frequency=10 kHz, measurement speed=SLOW2

Accuracy table (p.344)

range			1.0000 kHz to 10.000 kHz		
10 k Ω					
100 Ω			A= 0.15 B= 0.02		Z
			A= 0.1 B= 0.01		θ
10 Ω					

- Because Z is 50 Ω , the 100 Ω measurement range will be used.
- Obtain the Z coefficients A and B from the accuracy table (p.344) and then calculate the basic accuracy of Z.
In the 10 kHz/100 Ω range, the accuracy table (p.344) yields the values A = 0.15 and B = 0.02.

Using the basic accuracy formula (p.343) for 100 Ω or less ranges,

$$Z \text{ accuracy} = \pm \left(0.15 + 0.02 \times \left| \frac{100}{50} - 1 \right| \right) = \pm 0.17\%$$

- Similarly, calculate the basic accuracy of θ .
The accuracy table (p.344) yields the values A = 0.1 and B = 0.01

Using the basic accuracy formula (p.343) for 100 Ω and lower ranges,

$$\theta \text{ accuracy} = \pm \left(0.1 + 0.01 \times \left| \frac{100}{50} - 1 \right| \right) = \pm 0.11^\circ$$

- Capacitance ($C_s=160$ nF) basic accuracy

14.2 Measurement Range and Accuracy

(For example) Measurement conditions: measurement frequency=1 kHz, measurement speed=SLOW2

Accuracy table (p.344)

range				1.0000 kHz to 10.000 kHz		
100 kΩ						
10 kΩ				A= 0.05 B= 0.02		Z
				A= 0.03 B= 0.02		θ
1 kΩ						

1. Measure the sample's Z and θ values using auto-ranging.
2. Assume that the measured Z and θ values are as follows:

$$Z = 1.0144 \text{ k}\Omega, \theta = -78.69^\circ$$

Because Z is 1.0144 Ω, the 10 kΩ measurement range will be used.

3. Obtain the Z coefficients A and B from the accuracy table (p.344) and then calculate the basic accuracy of Z. In the 1 kHz/10 kΩ range, the accuracy table (p.344) yields the values A = 0.05 and B = 0.02.

Using the basic accuracy formula (p.343) for 1 kΩ or more ranges,

$$Z \text{ accuracy} = \pm \left(0.05 + 0.02 \times \left| \frac{10 \times 1.0144 \times 10^3}{10 \times 10^3} - 1 \right| \right) \cong \pm 0.05\%$$

4. Similarly, calculate the basic accuracy of θ.
The accuracy table (p.344) yields the values A = 0.03 and B = 0.002.
Using the basic accuracy formula (p.343) for 1 kΩ or more ranges,

$$\theta \text{ accuracy} = \pm \left(0.03 + 0.02 \times \left| \frac{10 \times 1.0144 \times 10^3}{10 \times 10^3} - 1 \right| \right) \cong \pm 0.03^\circ$$

5. Calculate the range within which Z and θ values can be acquired from the basic accuracy.

$$Z_{\min} = 1.0144 \text{ k}\Omega \times \left(1 - \frac{0.05}{100} \right) \cong 1.0139 \text{ k}\Omega$$

$$Z_{\max} = 1.0144 \text{ k}\Omega \times \left(1 + \frac{0.05}{100} \right) \cong 1.0149 \text{ k}\Omega$$

$$\theta_{\min} = -78.69 - 0.03 = -78.72^\circ$$

$$\theta_{\max} = -78.69 + 0.03 = -78.66^\circ$$

6. Calculate the range within which Z and θ values can be acquired from the basic accuracy.
(For more information about the Cs calculation formula, see "Appendix1 Measurement Parameters and Calculation Formula"(p. A1).)

$$C_{s\min} = - \frac{1}{\omega \times Z_{\max} \times \sin \theta_{\min}} \cong 159.90 \text{ nF} \quad \dots -0.0625\%$$

$$C_{s\max} = - \frac{1}{\omega \times Z_{\min} \times \sin \theta_{\max}} \cong 160.10 \text{ nF} \quad \dots 0.0625\%$$

$$\omega = 2 \times \pi \times f \quad f = \text{frequency [Hz]}$$

7. Consequently, the Cs basic accuracy is ±0.0625%.

Conversion table from C and L to |Z|

14

Chapter 14 Specifications

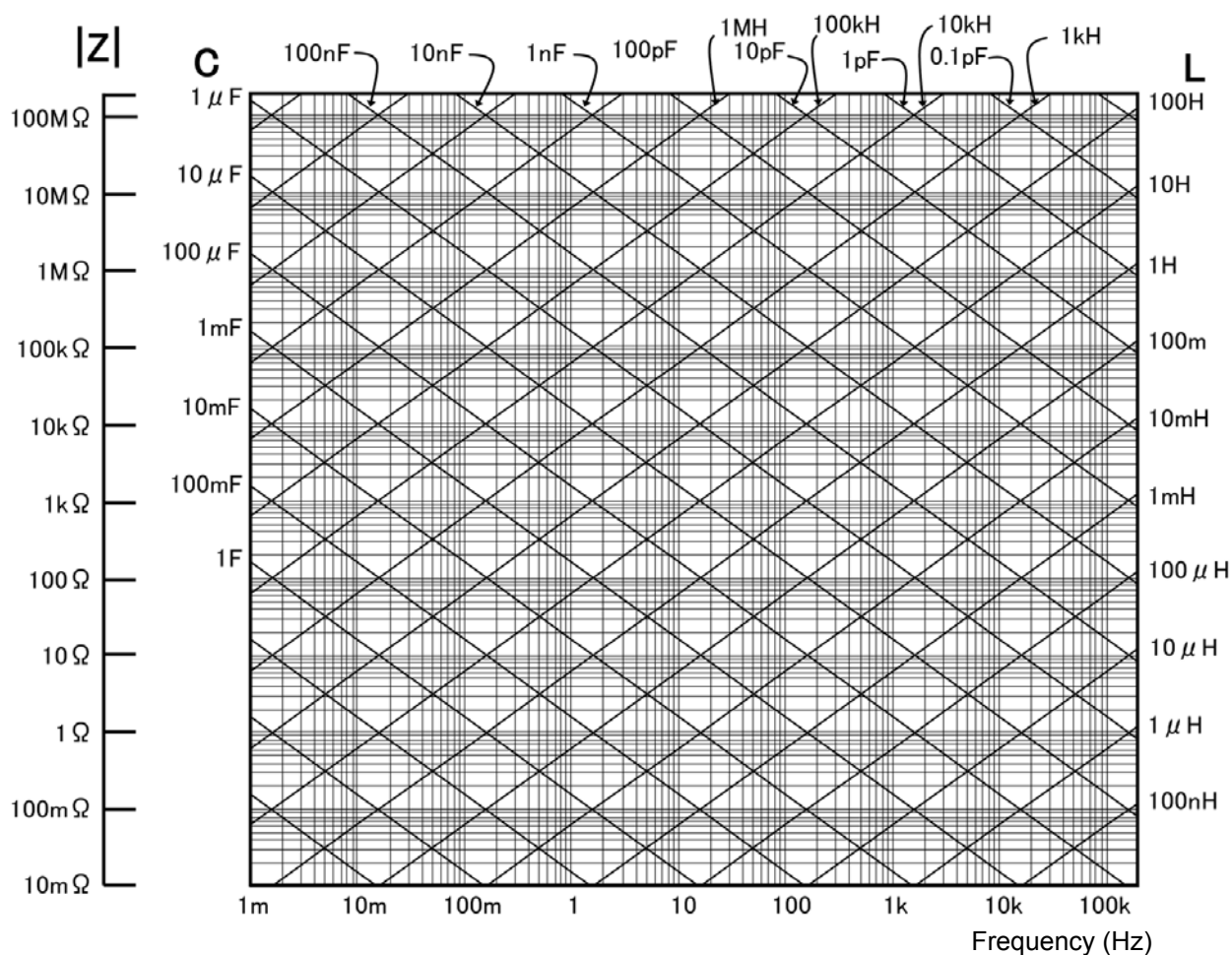

Temperature measurement

Pt sensor

Sheath-type temperature probe
HIOKI 9478

Measurement conditions

At least 60 min. after power supply activation
Temperature and humidity: $23 \pm 5^\circ\text{C}$, 80% rh or less

Accuracy

Guaranteed accuracy range	-10.0°C to 99.9°C
Accuracy	$\pm 0.5\% \text{rdg} \pm 1^\circ\text{C}^*1$
Sampling time	Approx. 640 ms

*1 Indicates the accuracy of the instrument used in combination with the 9478 Sheath Type Temperature Probe.
For ambient temperatures of 0°C to 18°C and 28°C to 40°C , add $0.02^\circ\text{C}/^\circ\text{C}$ to the measurement accuracy.

14.3 About Measurement Times and Measurement Speed

Measurement times differ depending on the measurement conditions. Refer to the following values.

NOTE All of the values are reference values. Note that they may differ depending on the conditions of use.

Analog measurement signal (INDEX)

	FAST	MED	SLOW	SLOW2
DC (line frequency: 50 Hz)	43 ms	123 ms	203 ms	803 ms
DC (line frequency: 60 Hz)	37 ms	103 ms	203 ms	803 ms
0.001 Hz to 0.999 Hz	Tf s + 3 ms	Tf s + 3 ms	Tf s + 3 ms	Tf s + 3 ms
1.000 Hz to 10.000 Hz	Tf s + 3 ms	2 × Tf s + 3 ms	3 × Tf s + 3 ms	4 × Tf s + 3 ms
10.001 Hz to 39.999 Hz	Tf s + 3 ms	2 × Tf s + 3 ms	5 × Tf s + 3 ms	10 × Tf s + 3 ms
40.000 Hz to 99.999 Hz	Tf s	2 × Tf s	5 × Tf s	40 × Tf s
100.00 Hz to 300.00 Hz	Tf s	2 × Tf s	5 × Tf s	50 × Tf s
300.01 Hz to 500.00 Hz	Tf s	2 × Tf s	10 × Tf s	200 × Tf s
500.01 Hz to 1.0000 kHz	Tf s	5 × Tf s	20 × Tf s	300 × Tf s
1.0001 kHz to 2.0000 kHz	2 × Tf s	8 × Tf s	40 × Tf s	600 × Tf s
2.0001 kHz to 3.0000 kHz	4 × Tf s	12 × Tf s	60 × Tf s	1200 × Tf s
3.0001 kHz to 5.0000 kHz	6 × Tf s	20 × Tf s	100 × Tf s	2000 × Tf s
5.0001 kHz to 10.000 kHz	10 × Tf s	40 × Tf s	200 × Tf s	3000 × Tf s
10.001 kHz to 20.000 kHz	20 × Tf s	80 × Tf s	400 × Tf s	6000 × Tf s
20.001 kHz to 30.000 kHz	50 × Tf s	150 × Tf s	600 × Tf s	12000 × Tf s
30.001 kHz to 50.000 kHz	50 × Tf s	250 × Tf s	1000 × Tf s	20000 × Tf s
50.001 kHz to 100.00 kHz	100 × Tf s	400 × Tf s	2000 × Tf s	30000 × Tf s
100.01 kHz to 200.00 kHz	200 × Tf s	800 × Tf s	4000 × Tf s	60000 × Tf s

Tf[s]=1 ÷ measurement frequency[Hz]

Tolerance: ±5% ±0.2 ms

- When the contact check function has been enabled, the following time will be added to INDEX depending on the contact check timing.

Contact check timing	
BEFORE	2.5 ms
AFTER	1.0 ms
BOTH	3.0 ms

- Use of the BEFORE or BOTH contact check settings will result in longer analog measurement times since the trigger synchronous output function's wait time is automatically allowed to elapse after the contact check before measurement is started.

The above values are reference values based on use of the initial value for the wait time setting.

Measurement times (EOM)

Measurement times= INDEX + A + B + C + D + E + F

A. Calculation time (no OPEN /SHORT/ LOAD compensation, HOLD range, no screen display, normal measurement)

	FAST	MED	SLOW	SLOW2
All frequencies	1.0 ms			

Tolerance: $\pm 10\% \pm 0.1$ ms

B. OPEN/ SHORT/ LOAD compensation

OPEN/ SHORT/ LOAD compensation	
No	0.0 ms
Yes	MAX 0.4 ms

C. Measurement mode

Measurement mode	
Normal measurement	0.0 ms
Comparator measurement	MAX 0.4 ms
BIN measurement	MAX 0.8 ms

E. Saving to memory

Saving to memory	
Memory function ON/IN	MAX 0.4 ms
Memory function OFF	0.0 ms

F. Contact check function

Contact check timing	
BEFORE	0.5 ms
AFTER	1.0 ms
BOTH	1.5 ms

Wait time

- **When the frequency is changed:**

When the frequency is changed, the wait time is 1 ms.

However, a 3 ms wait time will be used if the measurement frequency change spans the two ranges of (1 mHz to 39.999 Hz) and (40 Hz to 200 kHz).

- **When switching levels**

When the AC signal level is changed, the wait time is 1 ms.

- **When switching ranges**

When the range is changed, the wait time is 1 ms.

Also, when low Z impedance high accuracy mode is turned ON/OFF, the wait time is 1 ms.

- **When DC bias**

When DC bias is changed to ON/OFF and when the DC bias level is changed, the wait time is 1 ms.

- **When DC resistance measurement**

When switching from AC measurement to DC resistance measurement, the wait time is 3 ms.

- **When panel load**

After all changes have been made, the maximum applicable wait time listed above will be used.

Maintenance and Service

Chapter 15

15

Chapter 15 Maintenance and Service

15.1 Inspection, Repair and Cleaning

Before requesting instrument repair or inspection, please read "Before returning for repair" (p. 357) and Section "Error display" (p. 362).

Inspection and Repair

⚠ WARNING Do not attempt to modify, disassemble or repair the instrument; as fire, electric shock and injury could result.

NOTE

- If damage is suspected, check the "Before returning for repair" (p. 357) section before contacting your dealer or Hioki representative.
- If the fuse blows, do not attempt to replace the fuse or repair the instrument: contact your authorized Hioki distributor or reseller.
- If damage is suspected, check the "Before returning for repair" (p. 357) section before contacting your dealer or Hioki representative. However, in the following cases, immediately stop using the instrument, unplug the power cord and contact your authorized Hioki distributor or reseller.
 - When the nature of the damage is clearly evident
 - When measurement is impossible
 - After long-term storage in adverse conditions such as high temperature or humidity
 - After being subject to severe shock during transport
 - After severe exposure to water, oil, or dust (internal insulation can be degraded by oil or water, causing increase hazard of electric shock or fire)

Replaceable Parts

Certain parts require replacement periodically and at the end of their useful life: (Useful life depends on the operating environment and frequency of use. Operation cannot be guaranteed beyond the following periods)

Part	RemarksLife	Remarks
Electrolytic Capacitors	Approx. 10 years	The useful life of electrolytic capacitors depends on the operating environment. Periodic replacement is necessary.
Lithium battery	Approx. 10 years	The instrument incorporates a lithium battery for backup. The life of the backup battery is approximately 10 years. If the date and time greatly differ from the actual date and time when the power is turned on or a backup error appears at startup, it is time to replace the battery. Contact your authorized Hioki distributor or reseller.
LCD backlight (to half brightness)	Approx. 50,000 hours	Periodic replacement is necessary.

Transporting the instrument

- Pack the instrument so that it will not sustain damage during shipping, and include a description of existing damage. We do not take any responsibility for damage incurred during shipping.
- Use the original packing materials when transporting the instrument, if possible.

Cleaning

NOTE

- To clean the instrument, wipe it gently with a soft cloth moistened with water or mild detergent. Never use solvents such as benzene, alcohol, acetone, ether, ketones, thinners or gasoline, as they can deform and discolor the case.
 - Wipe the LCD gently with a soft, dry cloth.
 - Clean the vents periodically to avoid blockage.
If a vents becomes clogged, the instruments internal cooling is impeded, and damage may result.
-

15.2 Troubleshooting

Before returning for repair

In the event of the instrument malfunctioning, check the following items.

Symptom	Check Item, or Cause	Remedy and Reference
The display does not appear when you turn the power on.	Is the power cord unplugged? Is it properly connected?	Confirm that the power cord is properly connected. See (p. 31)
Keys do not work.	Are the keys locked?	Disable the key lock. See (p. 145), (p. 186)
	Is the instrument being remotely operated from an external device using the communication cable?	Switch to the local state. See Description of communications commands on the included LCR Application Disk. - [Remote mode]
A key other than the pressed one is pressed.	Have you performed panel compensation?	Perform panel compensation. See (p. 266)
The instrument doesn't work. You don't know how to use the instrument.	Did you check the Instruction Manual?	Check the appropriate section of the Instruction Manual.
	Are you using the instrument as part of an automated system?	Consult the administrator or manager of the instrument or the automated system containing the instrument.
Cannot print.	Is the recording paper loaded properly? Are the printer settings correct? (Communication speed, interface, etc.) Are the instrument and printer properly connected with a suitable cable?	See (p. 331)
Nothing is displayed on the screen.	The LCD may be set to automatically turn off after a set time. Is the instrument in the standby state?	Touch the screen. See (p. 49) Cancel the standby state. See (p. 36)
Key response and screen drawing are slow.	Is the measurement value automatic output function enabled?	When the measurement value automatic output function is enabled, key response and screen drawing may become slow in order to give priority to measurement and measurement value output. See LCR Application Disk - Communication Commands

15.2 Troubleshooting

Symptom	Check Item, or Cause	Remedy and Reference
The measurement values are exhibiting excessive variation.	Is the signal level setting too low?	Change the signal level setting. See (p. 52)
	Is an error from "15.3 Error display" (p. 362) being displayed?	Check the item indicated by the error display, address the cause, and then perform measurement. See (p. 362)
		If Reference Value is being displayed, check measurement conditions such as the frequency and signal level and select conditions for which Reference Value will not be displayed. See (p. 52)
	Are you using the instrument in a high-noise environment?	If you are using the instrument in a high-noise environment, consider taking the following measures: <ul style="list-style-type: none"> • Use guarding. • Implement anti-noise measures. • Separate the sample, measurement cables, and instrument from the source of the noise (motor, inverter, electromagnetic switch, power line, equipment generating sparks, etc.) or perform the measurement in a separate room. • Plug the instrument into a grounded outlet. • Use a separate power supply from the device that is generating the noise.
	Are you using a cable that you made yourself?	<ul style="list-style-type: none"> • Check the wiring method and correct it if necessary. • Use a designated cable of the same length as the cable length setting.
	Is the connection cable too long?	Use a designated cable of the same length as the cable length setting. See (p. 245)
	Are you using a 2-terminal connection to perform measurement?	Two-terminal connections are susceptible to the influence of contact resistance. When possible, use a 4-terminal connection to the sample's electrodes to perform measurement.
		Add a wait time to allow contact to stabilize before measurement.
Did you perform open and short compensation?	Perform open and short compensation properly. See (p. 215), (p. 224)	

Symptom	Check Item, or Cause	Remedy and Reference
You are unable to perform measurement properly.	Is an error from "15.3 Error display" (p. 362) being displayed?	Check the item indicated by the error display, address the cause, and then perform measurement. See (p. 362)
	Is OVERFLOW or UNDERFLOW being displayed? See "15.3 Error display" (p. 362)	If the range is not appropriate: Change to an appropriate range or perform measurement using auto ranging. See (p. 62), (p. 88), (p. 160)
		If there is a break or short in the wiring: Check the wiring and perform measurement with the correct wiring connections.
		Proper contact is not being made with the sample. Check the points of contact with the sample. Check the wiring for a break or defective contact. See (p. 32), (p. 132)
	Is an error such as NC A or NC B being displayed (contact error)? See "15.3 Error display" (p. 362)	If you are using the instrument in a high-noise environment, consider taking the following measures: <ul style="list-style-type: none"> • Use guarding. • Separate the sample, measurement cables, and instrument from the source of the noise (motor, inverter, electromagnetic switch, power line, equipment generating sparks, etc.) or perform the measurement in a separate room. • Plug the instrument into a grounded outlet. • Use a separate power supply from the device that is generating the noise.
	Are you measuring an element that generates voltage on its own, for example a battery?	If there is a high DC voltage, you may damage the instrument. Avoid measuring the sample.
	Are you measuring an element on a printed circuit board?	<ul style="list-style-type: none"> • You can measure an element on a printed circuit board if the target element is isolated from external connections. However, if the target element is connected to other components or external circuitry, you will not be able to obtain a proper measurement. • You may be unable to measure components in circuits that are generating a voltage or to which a voltage is being applied, for example because they are energized.
	Is a high-impedance element which is influenced by noise being measured?	Use guarding. See (p.A3)
Is an element of other than a capacitor being measured using the DC bias function?	Turn the DC bias function OFF. See (p. 58)	
The measurement values differ when a standard resistor, standard capacitor, or other known test sample is measured.	Do the measurement conditions of the known test sample and measurement conditions of the instrument match?	Make sure the measurement conditions match.
	Did you perform open and short compensation properly?	Perform open and short compensation again. See (p. 215), (p. 224)
	Is load compensation set?	Turn load compensation off. See (p. 232)
	Is the wait time for from connecting the test sample until performing measurement insufficient?	Ensure there is an appropriate trigger delay and trigger synchronization output wait time. See (p. 76), (p. 77)
	Is a test sample other than a capacitor being measured using the DC bias function?	Turn the DC bias function OFF. See (p. 58)

15.2 Troubleshooting

Symptom	Check Item, or Cause	Remedy and Reference
The LCD appears blurred.	Are you pressing the LCD screen too hard?	Press the LCD screen gently. Slight blurring may occur but this is normal.
AUTO ranging is unable to determine a range.	Is a high-impedance element which is influenced by noise being measured?	Use guarding. See (p.A3)
	Is an element of other than a capacitor being measured using the DC bias function?	Turn the DC bias function OFF. See (p. 58)
A contact error is generated even though the connections are correct.	Is an element of other than a capacitor being measured using the DC bias function?	Turn the DC bias function OFF. See (p. 58)
Open compensation or short compensation resulted in an error.	Is the open or short compensation wiring correct?	Perform open compensation or short compensation with the proper wiring. See (p. 215), (p. 224)
	Are you using the instrument in a high-noise environment?	If you are using the instrument in a high-noise environment, consider taking the following measures: <ul style="list-style-type: none"> • Use guarding. • Implement anti-noise measures. • Separate the sample, measurement cables, and instrument from the source of the noise (motor, inverter, electromagnetic switch, power line, equipment generating sparks, etc.) or perform the measurement in a separate room. • Plug the instrument into a grounded outlet. • Use a separate power supply from the device that is generating the noise.
An error beep sound is emitted continuously.	Is the measurement value automatic output function enabled?	When the measurement value automatic output function is enabled, a send error occurs on the measuring instrument side if the receive operation is not performed on the PC side, and a send error sound is emitted continuously when, for example, there is an internal trigger. Perform the receive operation on the PC side and then perform measurement on the measuring instrument side, or disable the measurement value automatic output function. See LCR Application Disk - Communication Commands
No EXT I/O output signal can be obtained.	You don't know what type of output circuit is being used.	The instrument's EXT I/O functionality generates open drain output. Connect the wiring properly to the open drain. See (p. 45)
You are unable to send and receive data using RS-232C.	Are you using a straight cable?	Use a cross cable.
	Are you using the wrong COM port?	Check whether the computer's settings match the connected COM port. Connect the cable to the proper COM port.
		Check the computer's settings. The COM port may be selected at the operating system, driver, or application level. Check all of these settings.
	The computer has no COM port.	Consider using a commercially available USB/RS-232C conversion cable.
	You don't know which command is wrong.	Using an application such as Windows [®] HyperTerminal, check commands using manual input.
	The instrument is unable to communicate with the application.	Check whether the instrument is turned on. Turn on the instrument and complete any interface connections before launching the computer application.

When no apparent cause can be established

Perform a system reset.
This will return all settings to their factory defaults.
See (p. 147), (p.A18)

Full Reset Procedure

Performing a full reset will restore all of the settings to the factory default settings (p.A18).
Only perform a full reset in the following cases.

- When the normal reset screen cannot be displayed because of a problem with the instrument.
(After the full reset, perform a self check to confirm that there are no problems (p. 265).)
- When you have forgotten the passcode for the key lock.

If the instrument still does not operate normally after the full reset, it needs to be repaired.
Contact your authorized Hioki distributor or reseller.

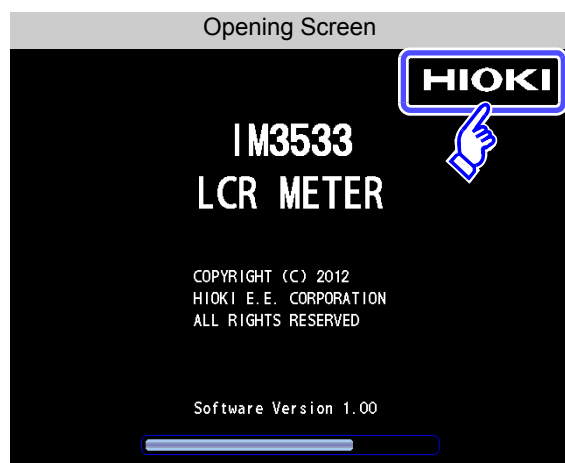











- 1** Connect the power cable.
- 2** Turn ON the switch on the back panel.
- 3** While the opening screen is displayed, press the top right of the screen continuously.
- 4** The full reset is complete when a beeping sound is emitted.

After the full reset, the panel calibration screen is displayed automatically (p. 266).

NOTE Disconnect the measurement sample before performing a full reset.

15.3 Error display

When any of the following indications appear on the screen, check the corresponding reference page.

Error display	Description	Remedy and Reference
	The life of the RAM backup battery has ended.	The instrument needs to be repaired. Contact your authorized Hioki distributor or reseller.
	This is displayed when a measurement value is outside of the guaranteed accuracy range.	Increase the measurement signal level or change the measurement range to one that matches the impedance of the element to be measured (p. 52), (p. 62).
	This is displayed when load compensation is enabled and the load compensation frequency does not match the current measurement frequency.	Match the current measurement frequency to the compensation frequency (p. 232).
When LCR mode:  When ANALYZER mode: 	This is displayed when constant voltage measurement and constant current measurement cannot be performed.	Reduce the constant voltage level or constant current level (p. 54).
	This is displayed when a signal level that is lower than the set value is applied to the test sample as a result of the voltage/current limit value setting.	Set the limit value again or change the measurement signal level so that the limit value is not exceeded (p. 56).
	This is displayed when load compensation is enabled and a load compensation condition other than the frequency does not match the current measurement condition.	Match the current measurement condition to the load compensation condition (p. 232).
	This is displayed when the set number of measurement results have been stored in the instrument's memory.	Load measurement values stored in the instrument's memory with the memory function or clear the memory. (p. 138)
	<ul style="list-style-type: none"> This is displayed when a measurement value is outside of the screen display range. This is displayed when no temperature probe is connected during temperature measurement. 	<ul style="list-style-type: none"> Change the measurement range to one that matches the impedance of the element to be measured (p. 62). Check the measurement probe connection. (p. 33)
	This is displayed when measurement does not end because of an internal circuit error.	The instrument needs to be repaired. Contact your authorized Hioki distributor or reseller.
	This is displayed when a measurement value is at or above the upper limit value of the auto ranging range.	Change the measurement range to a high-impedance range (p. 62).
	This is displayed when a measurement value is at or below the lower limit value of the auto ranging range.	Change the measurement range to a low-impedance range (p. 62).

Error display	Description	Remedy and Reference
OVER CUR	This is displayed when an overcurrent is detected while the DC bias setting is on.	<ul style="list-style-type: none"> Because the instrument's H_{CUR} terminal output switch has been turned off, no current will flow. To resume measurement, input a trigger. Check the DC bias setting or the sample's voltage and impedance (p. 58).
When LCR mode, TRANSFORMER mode, CONTINUOUS measurement mode: When ANALYZER mode:	NC A HL This is displayed when the H_{POT} , H_{CUR} , L_{POT} , or L_{CUR} terminal is not connected after measurement, for example due to a break in wiring.	Check the connection of each terminal (p. 32).
When LCR mode, TRANSFORMER mode, CONTINUOUS measurement mode: When ANALYZER mode:	NC A L This is displayed when the L_{POT} or L_{CUR} terminal is not connected after measurement, for example due to a break in wiring.	Check the connection of each terminal (p. 32).
When LCR mode, TRANSFORMER mode, CONTINUOUS measurement mode: When ANALYZER mode:	NC A H This is displayed when the H_{POT} or H_{CUR} terminal is not connected after measurement, for example due to a break in wiring.	Check the connection of each terminal (p. 32).
When LCR mode, TRANSFORMER mode, CONTINUOUS measurement mode: When ANALYZER mode:	NC B HL This is displayed when the H_{POT} , H_{CUR} , L_{POT} , or L_{CUR} terminal is not connected after measurement, for example due to a break in wiring.	Check the connection of each terminal (p. 32).
When LCR mode, TRANSFORMER mode, CONTINUOUS measurement mode: When ANALYZER mode:	NC B L This is displayed when the L_{POT} or L_{CUR} terminal is not connected prior to measurement, for example due to a break in wiring.	Check the connection of each terminal (p. 32).
When LCR mode, TRANSFORMER mode, CONTINUOUS measurement mode: When ANALYZER mode:	NC B H This is displayed when the H_{POT} or H_{CUR} terminal is not connected prior to measurement, for example due to a break in wiring.	Check the connection of each terminal (p. 32).
TC ERR	This is displayed when the instrument is unable to perform temperature correction.	<ul style="list-style-type: none"> Check the temperature probe connection (p. 33). Check the reference temperature and temperature coefficient settings (p. 81).
Hi Z	This is displayed when a measurement result is high in relation to the judgment reference set for the HIGH-Z reject function.	Check the connection of each terminal (p. 130).

NOTE

Since impedance is measured internally even when measuring only temperature, impedance error output may be encountered.

15.4 Discarding the Instrument

When disposing of this instrument, remove the lithium battery and dispose of battery and instrument in accordance with local regulations.



- **WARNING** To avoid electric shock, turn off the power switch and disconnect the power cord and measurement cables before removing the lithium battery.
- Battery may explode if mistreated. Do not short-circuit, recharge, disassemble or dispose of in fire.
- Keep batteries away from children to prevent accidental swallowing.



If the protective functions of the instrument are damaged, either remove it from service or mark it clearly so that others do not use it inadvertently.

Lithium Battery Removal

Required tools:

- One Philips screwdriver
- One wire cutter (to remove the lithium battery)

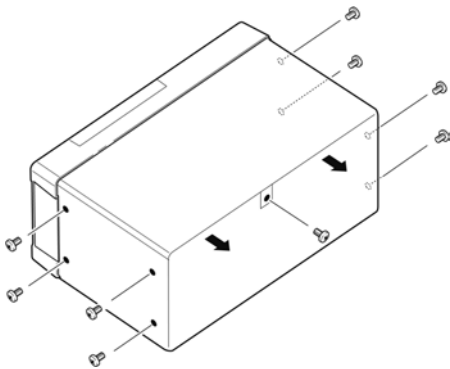

(Overhead View)

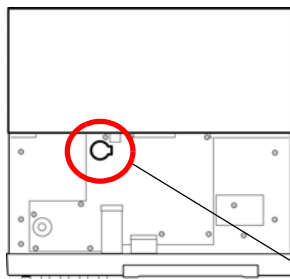

Lithium Battery

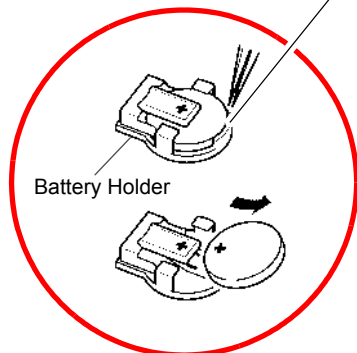

- 1** Verify that the power is off, and remove the connection cables and power cord.
- 2** Remove the six screws from the sides and one screw from the rear.
- 3** Remove the cover.
- 4** Insert the tweezers between the battery and battery holder as shown in the diagram below and lift up the battery.

CAUTION
 Take care not to short the + and -.
 Doing so may cause sparks.

CALIFORNIA, USA ONLY
 This product contains a CR Coin Lithium Battery which contains Perchlorate Material - special handling may apply.
 See www.dtsc.ca.gov/hazardouswaste/perchlorate

Appendix

Appendix1 Measurement Parameters and Calculation Formula

In general, impedance Z is used to evaluate the characteristics of, for example, circuit components. Measure voltage and current vectors for circuit components relative to AC measurement frequency signals. The instrument uses these values to obtain the impedance Z and phase difference θ . The following values can be obtained from impedance Z by rotating the impedance Z around the complex plane.

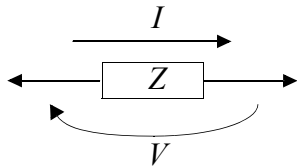

$$Z = R + jX$$

$$\theta = \tan^{-1} \frac{X}{R}$$

$$|Z| = \sqrt{R^2 + X^2}$$

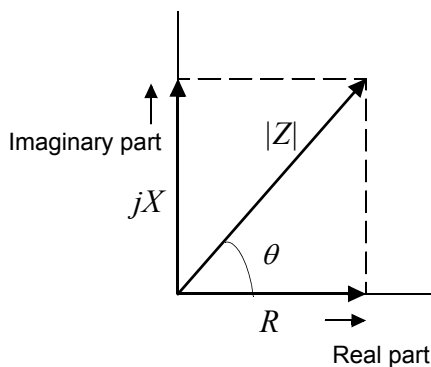

- Z : Impedance (Ω)
- θ : Phase angle (deg)
- R : Resistance (Ω)
- X : Reactance (Ω)
- $|Z|$: Absolute value of impedance (Ω)

Furthermore, admittance Y that is the reciprocal of impedance Z can also be used depending on the characteristics of circuit components. As in the case of impedance Z , the following values can also be obtained from admittance Y by rotating the admittance Y around the complex plane.

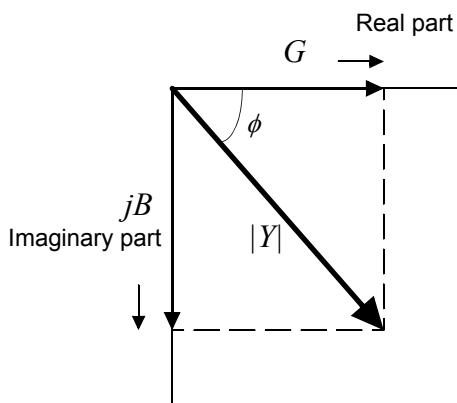

$$Y = G + jB$$

$$\phi = \tan^{-1} \frac{B}{G}$$

$$|Y| = \sqrt{G^2 + B^2}$$

- Y : Admittance (S)
- ϕ : Phase angle (deg) = $-\theta$
- G : Conductance (S)
- B : Susceptance (S)
- $|Y|$: Absolute value of admittance (S)

A2

Appendix1 Measurement Parameters and Calculation Formula

From the voltage V which is applied between the terminals of the sample under test, the current I which flows through the test sample at this time, the phase angle θ between this voltage V and this current I , and the angular velocity ω which corresponds to the measurement frequency.

NOTE The phase angle θ is shown based on the impedance Z . When measuring based on the admittance Y , the sign of the phase angle θ must be reversed.

Item	Series equivalent circuit mode	Parallel equivalent circuit mode
Z	$ Z = \frac{V}{I} (= \sqrt{R^2 + X^2})$	
Y	$ Y = \frac{I}{ Z } (= \sqrt{G^2 + B^2})$	
R	$R_S = ESR = Z \cos \theta$	$R_P = \frac{I}{ Y \cos \phi} (= \frac{I}{G})^*$
X	$X = Z \sin \theta$	_____
G	_____	$G = Y \cos \phi^*$
B	_____	$B = Y \sin \phi^*$
L	$L_S = \frac{X}{\omega}$	$L_P = -\frac{I}{\omega B}$
C	$C_S = -\frac{I}{\omega X}$	$C_P = \frac{B}{\omega}$
D	$D = \frac{\cos \theta}{ \sin \theta }$	
Q	$Q = \frac{ \sin \theta }{\cos \theta} (= \frac{I}{D})$	

* ϕ : phase angle of admittance Y ($\phi = -\theta$)

L_S, R_S, C_S : The measured values of $L, C,$ and R in series equivalent circuit mode.

L_P, R_P, C_P : The measured values of $L, C,$ and R in parallel equivalent circuit mode.

Appendix2 Measurement of High Impedance Components

The measured value obtained when testing a high impedance element (such as, for example, a resistor with resistance higher than 100 k Ω) is sometimes unreliable, because such an element is vulnerable to the effects of external interference and the like. In this case, reliable testing can be performed by the use of guarding, that is, connecting a metallic plate to the GUARD terminal and carrying out the measurement on the metallic plate.

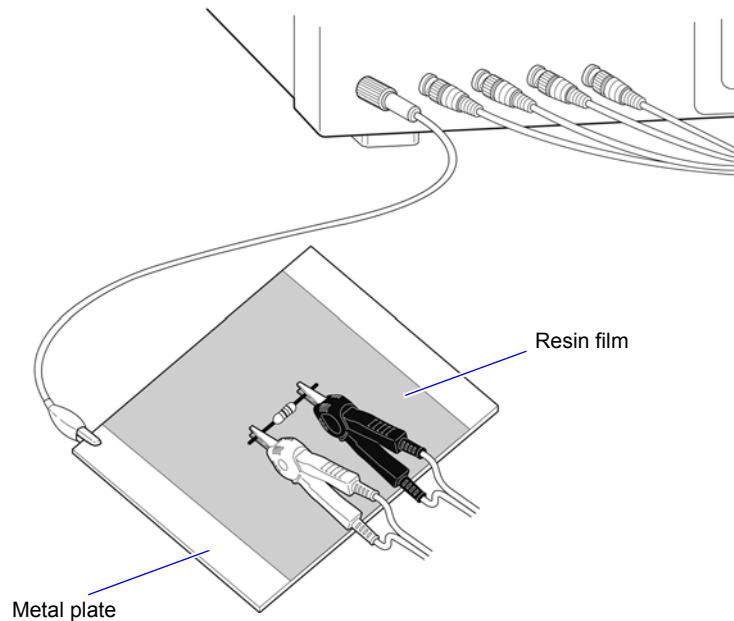

When measuring components on a metal plate, use, for example, resin film as insulation to ensure terminals and the like are not short-circuited.

NOTE Open circuit compensation is high impedance measurement, so be sure to use the shielding process. If it is not used, the compensation values may become unstable and affect the measurement values.

Appendix3 Measurement of In-circuit Components

Measure an in-circuit component after providing guarding.

$$R = R_2 \cdot \frac{R_3 + R_4}{R_2 + R_3 + R_4}$$

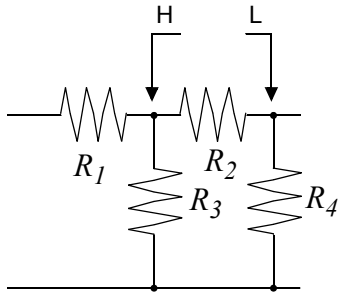

Referring to the following figure, when measuring a resistance value for the resistor R_2 , even if the tips of the two probes are contacted against the ends of the resistor R_2 , considering the sum of the current flowing through the resistor R_2 and the current flowing through the resistors R_3 and R_4 , what is obtained is the resistance value for the parallel combination:

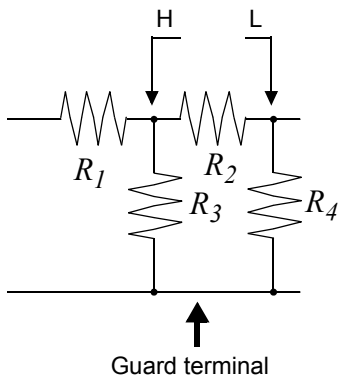

If as shown in the next figure a guard terminal is used, the current flowing through the resistors R_3 (not flowing through R_4) is absorbed by this guard terminal, so that the resistance value for the resistor R_2 is accurately measured.

NOTE

- The accuracy of measurement will not be improved in cases where for example $R_2 \gg R_3$ and R_3 is close to zero.
- As shown in the figure below, it is not possible to use this type of separation process for testing of the impedance values of two resistors or other elements of identical types which are connected in parallel, or for testing of the impedance values of a coil and a capacitor which are connected in parallel.

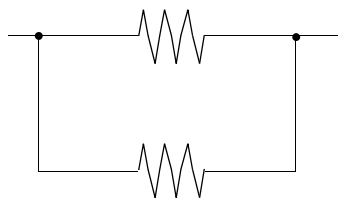

Two resistors in parallel

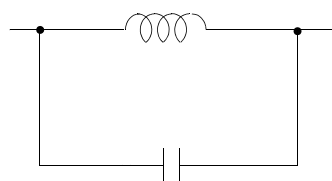

Coil and capacitor in parallel

Appendix4 Countermeasures Against Incorporation of External Noise

The unit is designed to be resistant to errors caused by interference from the test cables or the power supply line. However, if the level of the interference is particularly large, this can cause measurement errors or faulty operation.

Refer to the examples given below for examples of countermeasures which can be taken against interference which has caused faulty operation etc.

Appendix4.1 Countermeasures Against Incorporation of Noise from the Power Line

You can use the following countermeasures to reduce the effect of noise being incorporated from the power line.

Grounding Using a Protective Ground Wire

The unit is structured so that the ground wire of the power cable can be used as protective grounding for the unit. Protective grounding plays an important role in not only the prevention of electrical accidents but also the use of an internal filter to eliminate the incorporation of noise from the power line. Use the supplied power cord.

Attaching a Noise Filter to the Power Line

Connect a commercial plug-in noise filter to the power outlet and then connect the unit to the output of the noise filter in order to suppress the incorporation of noise from the power line. Plug-in noise filters are commercially available from various specialist manufacturers.

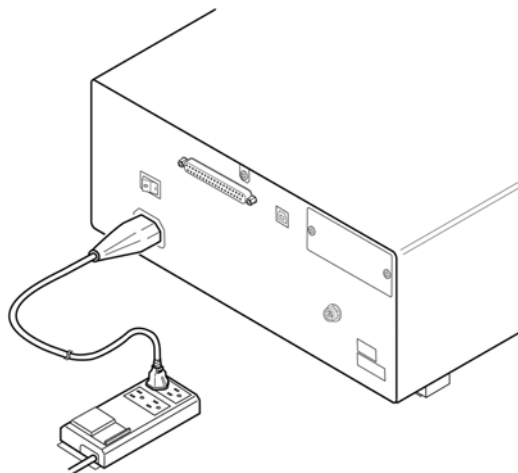

A6

Appendix4 Countermeasures Against Incorporation of External Noise

Attaching an EMI Suppression Ferrite Core to the Power Cord

Pass the power cord through a commercially available EMI suppression ferrite core and secure the core as close as possible to the AC power inlet of the unit in order to suppress the incorporation of noise from the power line.

Suppression is even more effective if you also attach an EMI suppression ferrite core close to the power plug of the power source.

If a toroidal ferrite core or split ferrite core with a large enough internal diameter is used, the amount of noise suppression can be increased by passing the power cord through the core several times.

EMI ferrite cores and ferrite beads are commercially available from various specialist manufacturers.

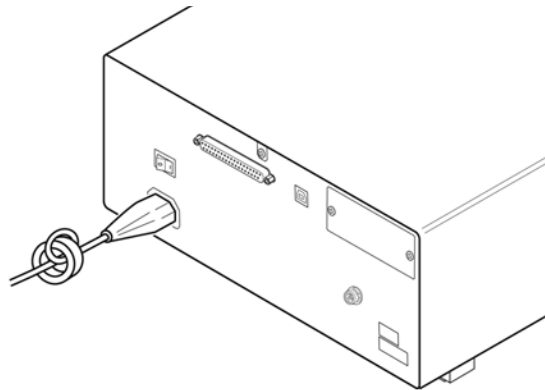

Appendix4.2 Countermeasures Against Noise from the measurement Cables

If interference is producing noise in the measurement cables, its influence can be moderated by the following countermeasure.

Fitting an anti-interference ferrite core on the measurement cables

Pass the test cables through a commercially available anti-interference ferrite core, and fix it close to the measurement terminals, so as to suppress noise from the measurement cables.

Moreover, if the internal diameter of the ferrite core allows, winding the measurement cables several times around the ferrite core (as with the power cord as described above) may further reduce the amount of noise.

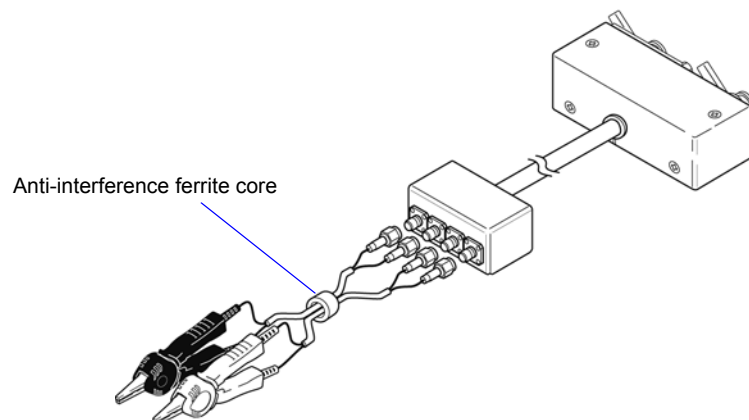

Appendix5 Supplying DC Bias

Supplying DC bias means that a DC voltage is supplied as a bias to a sample for test whose characteristics are voltage dependent, such as an electrolytic capacitor or a ceramic capacitor.

Further, a DC current can be supplied as a bias to a sample for test whose characteristics are current dependent, such as a choke coil.

This instrument does not provide a DC bias input terminal. DC bias should be applied using the method described below.



CAUTION A voltage must not be applied to the measurement terminals of the instrument from an external source.
If a voltage is applied from an external source, the instrument may be damaged.

Appendix5.1 How to Supply a DC Bias Voltage

When you want to apply a DC voltage bias, refer to the following explanation.

Apply a DC voltage bias to a capacitor or other test sample as shown below.

DC Bias Voltage Circuit

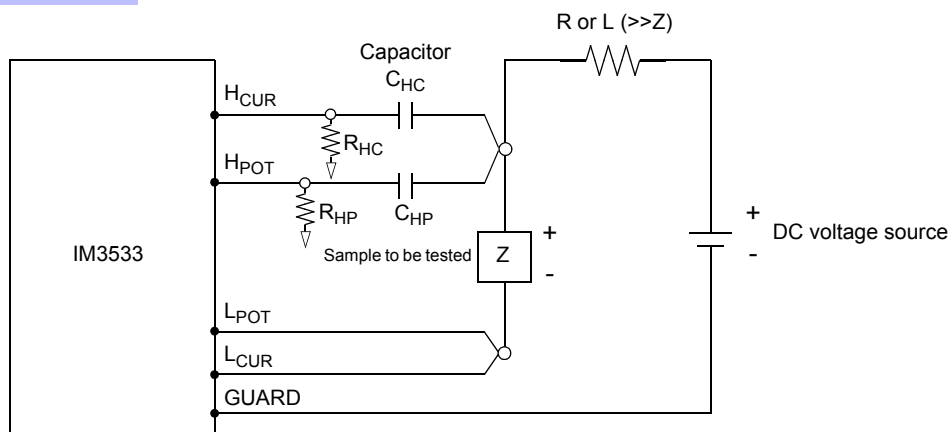

- Use a resistance (R) or inductance (L) which has a large enough impedance with reference to the sample under test (Z).
- A H_{CUR} side capacitor must have a small enough impedance (i.e. a large enough capacitance) relative to the output resistance (100Ω) while a H_{POT} capacitor must have a small enough impedance to the R_{HP} .
- Be careful about the polarity when connecting together the probes, the sample to be tested, and the DC voltage source.
- It takes a little time for the DC voltage which is being supplied to the sample under test to reach the set voltage, so you should wait for a certain stabilization time period (which depends upon the sample) before performing.
- After testing is completed, drop the voltage of the DC voltage source to zero, and remove the sample under test from the probes after having discharged any electric charge which may have built up.
- If you have removed the sample under test from the probes without first having discharged the accumulated electric charge, you should be careful to do so immediately.

A8

Appendix5 Supplying DC Bias

CAUTION

- In order to avoid electric shock accident, be absolutely sure not to touch the test terminals while the DC bias voltage is being supplied to them.
 - If you disconnect the sample under test from the test terminals with the DC bias voltage still being supplied, then the test sample is left charged, which is very dangerous. In order to avoid electric shock.
 - Do not short circuit between the clips of the test probes with the DC bias voltage still being supplied. Doing so may damage the probes or cause a short circuit accident.
 - When measuring the element whose DC resistance is not high enough, DC current will flow to the main unit and the measurement will not be performed properly.
-

Appendix5.2 How to Supply a DC Bias Current

When you want to apply a DC current bias, refer to the following explanation.

With regards to a DC current bias for a transformer, choke coil, or other test sample, configure the external bias circuit as shown below.

DC Bias Current Circuit

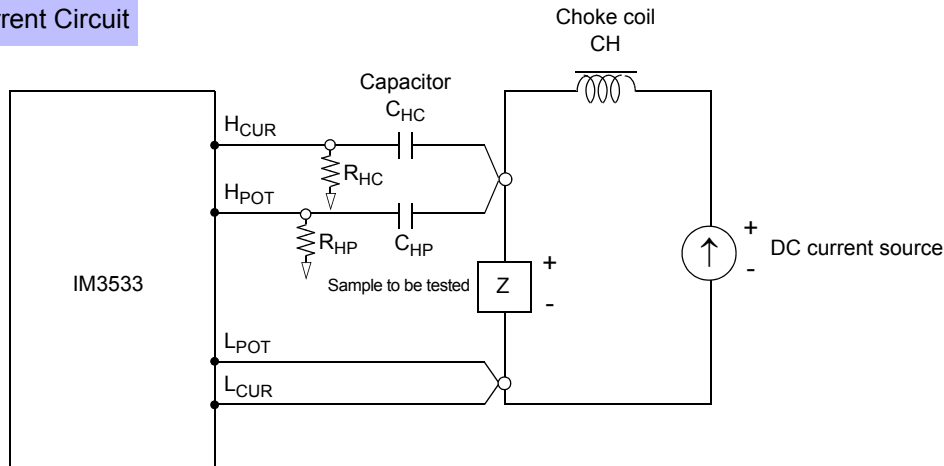

- Connect the sample to the measuring probe and then gradually raise the voltage of the DC source to the specified DC bias level. To disconnect the sample, gradually reduce the voltage of the DC source until the DC bias supplied to the sample is decreased to zero. You may disconnect the sample after this is achieved.
- Use a choke coil (CH) which has a large enough impedance with reference to the sample under test (Z).
- A H_{CUR} side capacitor must have a small enough impedance (i.e. a large enough capacitance) relative to the output resistance (100 Ω) while a H_{POT} capacitor must have a small enough impedance to the R_{HP}.
- Be careful about the polarity when connecting together the probes, the sample to be tested, and the DC current source.
- Be careful not to magnetically saturate the choke coil (CH) with the DC bias current.
- It takes a little time for the DC current which is being supplied to the sample under test to reach the set value, so you should wait for a certain stabilization time period (which depends upon the sample) before performing testing. Be careful, because if you perform testing before this stabilization time period has elapsed, the results will not be reliable.

CAUTION

- In order to avoid electric shock accident, be absolutely sure not to touch the test terminals while the DC bias is being supplied to them.
- Due to the inductance of the coil and the sample, counter electromotive force is generated when the sample is removed or inserted with the DC bias supplied. This may result in damage to the instrument or to the DC source.
- When measuring the element whose DC resistance is high (incl. open state), a high voltage occurred on the H side may cause damage on the main instrument.

Appendix6 The Residual Charge Protection Function

The instrument has been enhanced by the incorporation of a residual charge protection function. If by mistake a charged capacitor is connected to the measurement terminals, this function protects the internal circuitry of the instrument from discharge of such residual charge.

The maximum voltage from which the instrument can be protected by this function is determined from the capacitance value of the sample under test by the following equation:

$$V = \sqrt{\frac{10}{C}}$$

V: voltage (volts) (maximum 400 VDC)

C: capacitance (farads)



- The quoted maximum voltage from which the instrument can be protected by this function is for reference purposes only, and is not a guaranteed value. There may be danger of damage to the instrument, depending upon the operational circumstances and upon how often such charged capacitors are connected. In general, you should not rely upon this protection function; be sure to discharge charged capacitors properly before connecting them to the test terminals.
- The residual charge protection function is for protection of the instrument against the discharge of voltage present in charged capacitors, and is not capable of protecting the instrument against DC voltage which is constantly applied such as a superimposed DC voltage. If this is done, there is a danger of damage to the instrument.

See: Appendix5 Supplying DC Bias (p.A7)

Relationship of capacitance and residual voltage from which the LCR meter can be protected

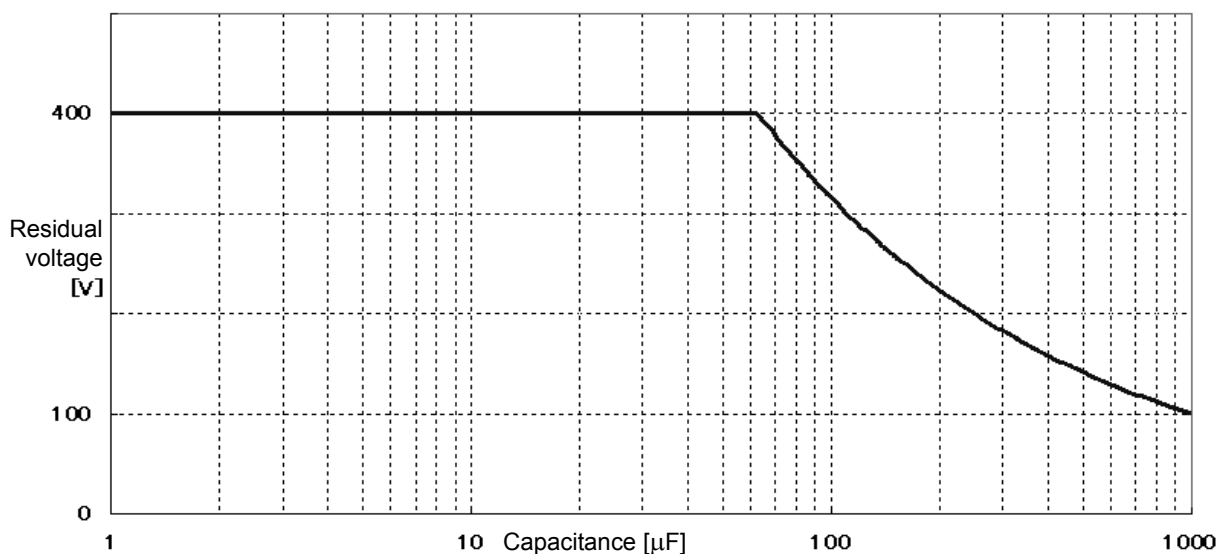

Appendix7 Series Equivalent Circuit Mode and Parallel Equivalent Circuit Mode

The instrument measures the current flowing to the test sample and the voltage at both ends of the test sample, and determines Z and θ . Other measurement items such as L , C , and R are calculated from Z and θ . At this time, the mode for calculation becomes series equivalent circuit mode if the resistance components for C (or L) are assumed to be in series, and the mode becomes parallel equivalent circuit mode if the resistance components for C (or L) are assumed to be in parallel. It is, therefore, necessary to select the correct equivalent circuit mode to reduce errors because the calculation formula differs for series equivalent circuit mode and parallel equivalent circuit mode.

Generally, for measurement of a low impedance device (approx. less than $100\ \Omega$) like a large capacitance capacitor or a low inductance, a series equivalent circuit mode will be selected. While, for a high impedance device (approx. more than $10\ \text{k}\Omega$) like a small capacitance capacitor or a high inductance, a parallel equivalent circuit mode will be selected. When you are not sure about selection of circuit mode, please ask the parts maker. (ex. a impedance approx. between $100\ \Omega$ and $10\ \text{k}\Omega$)

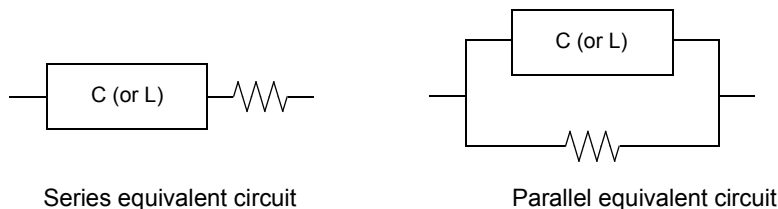

NOTE Because measurement value in each equivalent circuit mode is obtained through calculation, measurement values of both modes can be displayed. However, please note that the appropriate equivalent circuit depends on the test sample.

Appendix8 Open Circuit Compensation and Short Circuit Compensation

The residual impedance component of the test fixture can be considered in terms of an equivalent circuit as shown in the figure. Further, because the measured value Z_m for impedance includes this residual component, therefore, in order to obtain the genuine impedance value, it is necessary to compensate the measured value in terms of the open circuit impedance residual component and the short circuit residual component, which accordingly must be obtained.

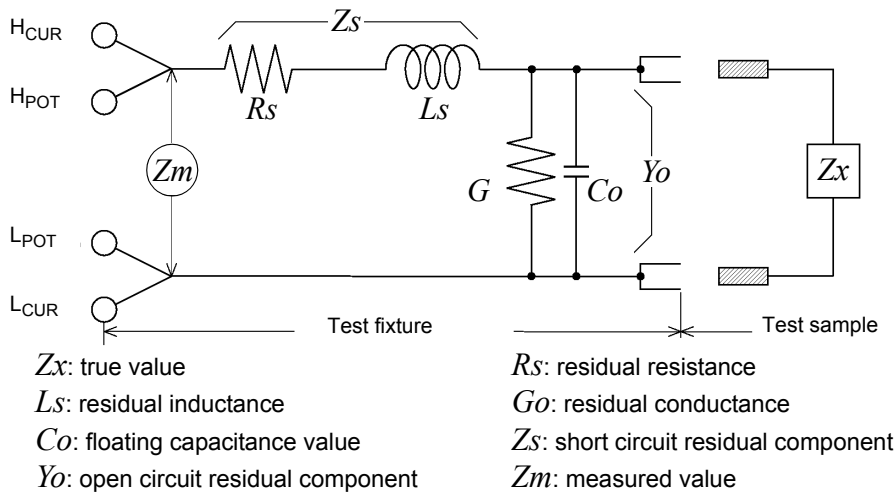

In this case, for the measured value Z_m :

$$Z_m = Z_s + \frac{1}{Y_o + \frac{1}{Z_x}}$$

The residual components can be determined in the following manner:

- **Open circuit compensation**

The terminals of the test fixture are left separated (open circuited). Because the short circuit residual component Z_s is now zero, therefore the open circuit residual component Y_o can be determined.

- **Short circuit compensation**

The terminals of the test fixture are connected together (short circuited).

Because the open circuit residual component Y_o is now zero, therefore the short circuit residual component Z_s can be determined.

These residual components thus obtained are recorded as compensation values, and the compensation process may then be performed by substituting them into the above equation.

NOTE The determination of test range is performed according to the measured value Z_m for impedance. Therefore it may happen that testing cannot be performed, when HOLD is on, if the test range is determined merely according to the value of impedance of the sample under test. In this case, you should set the test range in consideration both of the impedance of the test sample and also of the residual impedance components of the test fixture.

Deviations in the measured values can become comparatively large in the following cases:

- **If only short circuit compensation has been performed.**

With short circuit compensation only having been performed, since no compensation can be performed in terms of the open circuit residual component Y_o (which is not available), thereby deviation in the resultant values will become large if the value of that open circuit residual component Y_o is relatively large.

- **If only open circuit compensation has been performed.**

With open circuit compensation only having been performed, since no compensation can be performed in terms of the short circuit residual component Z_s (which is not available), thereby deviation in the resultant values will become large if the value of that short circuit residual component Z_s is relatively large.

In order to avoid this sort of thing, be sure always to perform both short circuit compensation and also open circuit compensation.

Appendix9 Temperature Correction Function (TC)

Temperature correction employs the temperature coefficient of a material to convert its resistance measured at one temperature to the value it would have at any other temperature, for display. Because resistance is fundamentally temperature-dependent, measuring it without considering the temperature can provide meaningless results.

Resistances R_t and R_{t0} below are the resistance values of the test object (having resistance temperature coefficient at t_0 °C of α_{t0}) at t °C and t_0 °C.

$$R_t = R_{t0} \times \{1 + \alpha_{t0} \times (t - t_0)\}$$

R_t : Actual measured resistance [Ω]

R_{t0} : Corrected resistance [Ω]

t_0 : Reference temperature [$^{\circ}\text{C}$]

t : Ambient temperature [$^{\circ}\text{C}$]

α_{t0} : Temperature coefficient at t_0 [$1/^{\circ}\text{C}$]

Example

If a copper test object (with resistance temperature coefficient of 3930 ppm) measures 100 Ω at 30°C, its resistance at 20°C is calculated as follows:

$$\begin{aligned} R_{t0} &= \frac{R_t}{1 + \alpha_{t0} \times (t - t_0)} \\ &= \frac{100}{1 + (3930 \times 10^{-6}) \times (30 - 20)} \\ &= 96.22 \end{aligned}$$

For more information about how to configure the temperature correction function, see below:

See "4.3.1 Configuring the Temperature Correction Function" (p. 81)

NOTE

- The temperature probe detects only ambient temperature; not surface temperature.
- Before measuring, allow the instrument and temperature probe to warm up completely, place the temperature probe as close to the test object as possible, and allow sufficient time for them to stabilize at ambient temperature.

A14

Appendix9 Temperature Correction Function (TC)

Reference

Conductive Properties of Metals and Alloys

Material	Content [%]	Density ($\times 10^3$) [kg/m ³]	Conductivity [%]	Temp. Coeff. (20°C) [ppm]
Annealed copper wire	Cu>99.9	8.89	1.00 to 1.02	3810 to 3970
Hard-drawn copper wire	Cu>99.9	8.89	0.96 to 0.98	3770 to 3850
Cadmium copper wire	Cd 0.7 to 1.2	8.94	0.85 to 0.88	3340 to 3460
Silver copper	Ag 0.03 to 0.1	8.89	0.96 to 0.98	3930
Chrome copper	Cr 0.4 to 0.8	8.89	0.40 to 0.50 0.80 to 0.85	2000 3000
Carlson alloy wire	Ni 2.5 to 4.0 Si 0.5 to 1.0		0.25 to 0.45	980 to 1770
Annealed aluminum wire	Al>99.5	2.7	0.63 to 0.64	4200
Hard-drawn aluminum wire	Al>99.5	2.7	0.60 to 0.62	4000
Aldrey wire	Si 0.4 to 0.6 Mg 0.4 to 0.5 Al remaining portion		0.50 to 0.55	3600

Copper Wire Conductivity

Diameter [mm]	Annealed copper wire	Tinned annealed copper wire	Hard-drawn copper wire
0.01 to less than 0.26	0.98	0.93	-
0.26 to less than 0.29	0.98	0.94	-
0.29 to less than 0.50	0.993	0.94	-
0.50 to less than 2.00	1.00	0.96	0.96
2.00 to less than 8.00	1.00	0.97	0.97

The temperature coefficient changes according to temperature and conductivity, so if the temperature coefficient at 20°C is α_{20} and the temperature coefficient for conductivity C at t °C is α_{ct} , α_{ct} is determined as follows near ambient temperature.

$$\alpha_{ct} = \frac{I}{\frac{I}{\alpha_{20} \times C} + (t - 20)}$$

For example, the temperature coefficient of international standard annealed copper is 3930 ppm @20°C. For tinned annealed copper wire (with diameter from 0.10 to less than 0.26 mm), the temperature coefficient α_{20} at 20°C is calculated as follows:

$$\alpha_{20} = \frac{I}{\frac{I}{0.00393 \times 0.93} + (20 - 20)} \approx 3650 \text{ ppm}$$

Appendix10 Rack Mounting

Rack mounting brackets can be attached to the instrument.



WARNING Observe the following precautions regarding the mounting screws to avoid instrument damage and electric shock accidents.

- When installing the Rack Mounting Plate, the screws must not intrude more than 6 mm into either side of the instrument.
- When removing the Rack Mounting Plate to return the instrument to stand-alone use, replace the same screws that were installed originally. (Feet: M3 × 8 mm, Sides: M4 × 6 mm)

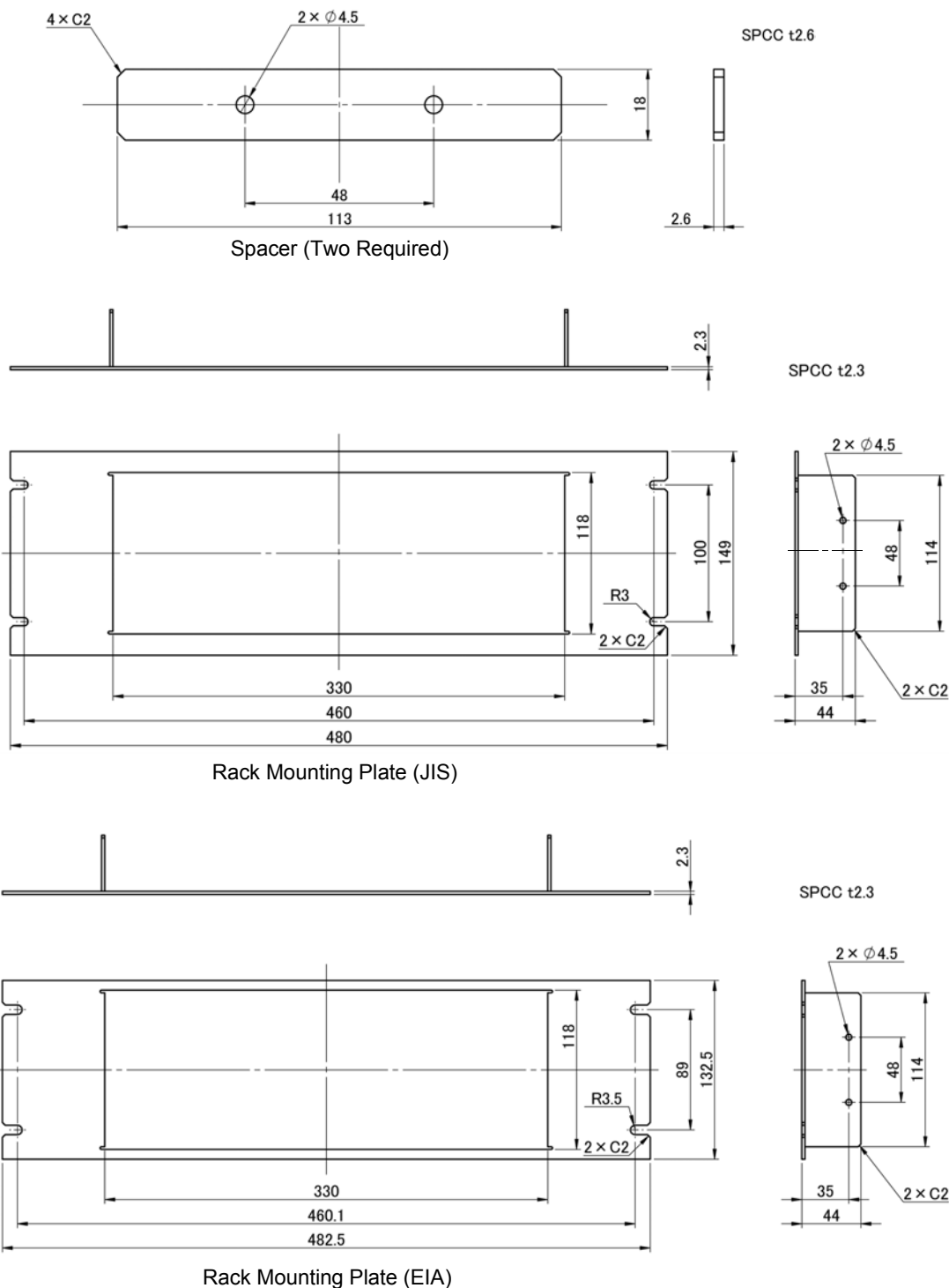

A16

Appendix10 Rack Mounting

Installation Procedure

- 1 Fold down the instrument's legs.

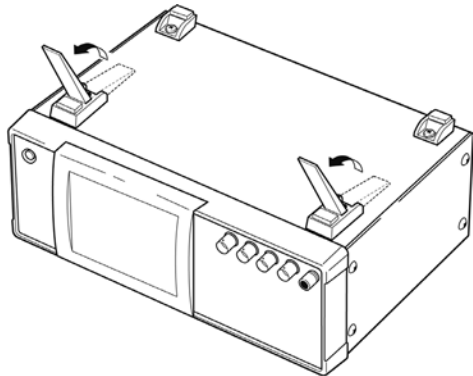

- 2 Remove the feed from the bottom of the instrument, and the screws from the sides (four near the front).

M3 x 8 mm

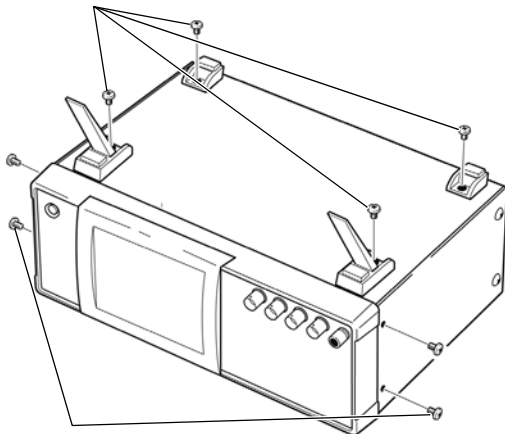

M4 x 6 mm

- 3 Installing the spacers on both sides of the instrument, affix the Rack Mounting Plate with the M4 x 12 mm screws.

When installing into the rack, reinforce the installation with a commercially available support stand.

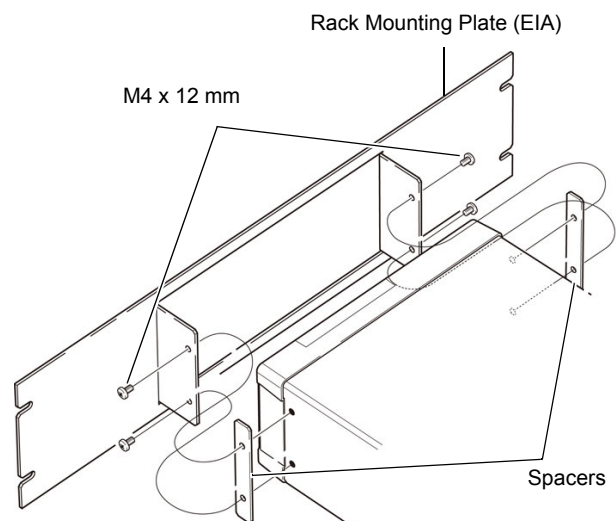
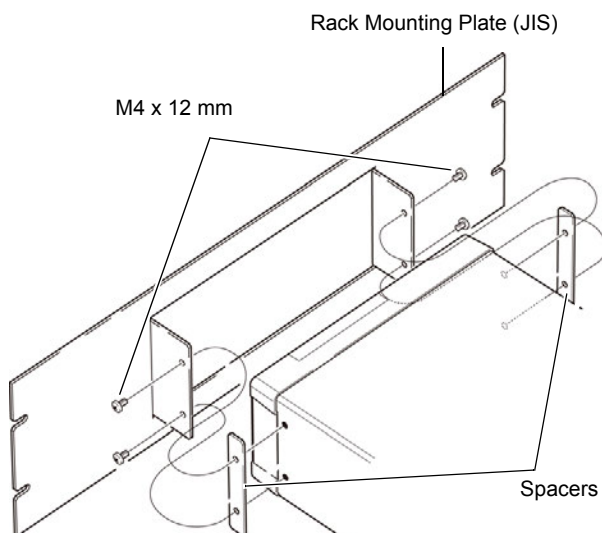

Appendix11 Dimensional Diagram

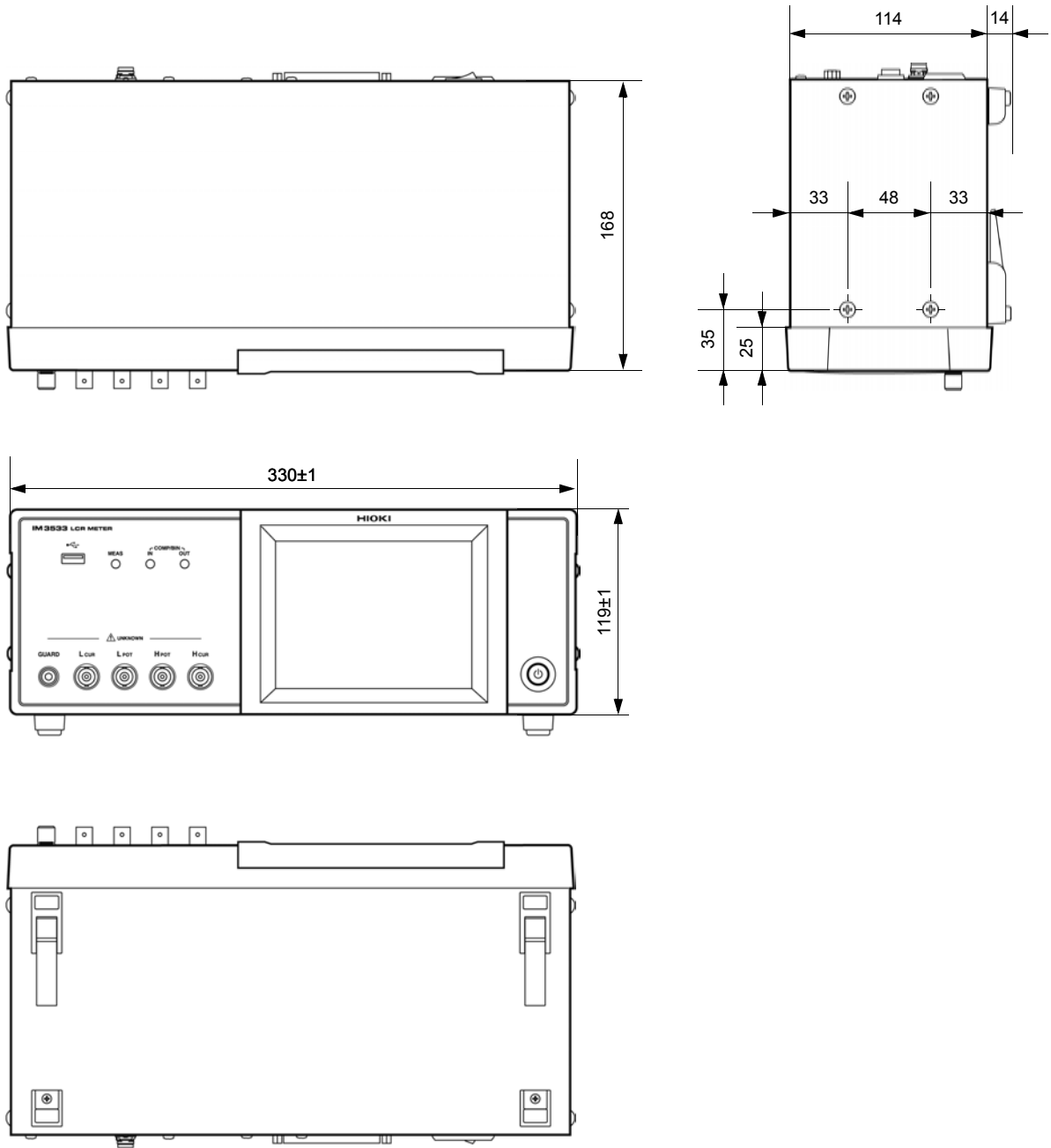

(Unit : mm)

A18

Appendix12 Initial Settings Table

Appendix12 Initial Settings Table

The following table shows the initial settings of the instrument.

Yes: Available/ No: Unavailable/ ←: The same as the initial settings

Setting Items		Initial setting	instru- ment RESET operati on full reset	*RST	:PRESet	Return to initial settings when power is turned on	Panel save/ Load ¹⁾			File save/ Load	
							LCR mode	ANALY ZER mode ²⁾	TRAN SFOR MER mode		
Measurement mode		LCR	←	←	←	No	Yes	Yes	Yes	Yes	
LCR mode measurement parameter		Z/OFF/θ/OFF	←	←	←	No	Yes	Yes	Yes	Yes	
Magnification display		OFF	←	←	←	No	No	No	No	Yes	
Basic settings (LCR mode/ TRANSFORMER mode)	Measurement frequency		1 kHz	←	←	←	No	Yes	Yes	Yes	Yes
	Measurement signal level	Mode	V	←	←	←	No	Yes	Yes	Yes	Yes
		V	1.000 V	←	←	←	No	Yes	Yes	Yes	Yes
		CV	1.000 V	←	←	←	No	Yes	Yes	Yes	Yes
		CC	10.00 mA	←	←	←	No	Yes	Yes	Yes	Yes
	Limit	ON/OFF	OFF	←	←	←	No	Yes	Yes	Yes	Yes
		Current limit value	100.00 mA	←	←	←	No	Yes	Yes	Yes	Yes
		Voltage limit value	5.00 V	←	←	←	No	Yes	Yes	Yes	Yes
	DC bias (TRANSFORMER mode: None)	ON/OFF	OFF	←	←	←	No	Yes	Yes	No	Yes
		Bias value	0.00 V	←	←	←	No	Yes	Yes	No	Yes
	Trigger mode (TRANSFORMER mode: None)		INT (Internal Trigger)	←	←	←	No	Yes	Yes	No	Yes
	Measurement range	Mode	AUTO	←	←	←	No	Yes	Yes	Yes	Yes
		AUTO range control function	100 mΩ/ 100 MΩ	←	←	←	No	Yes	Yes	Yes	Yes
		Range	100 Ω	←	←	←	No	Yes	Yes	Yes	Yes
		Judgment synchroni- zation setting	OFF	←	←	←	No	Yes	Yes	Yes	Yes
		LOW Z	OFF	←	←	←	No	Yes	Yes	Yes	Yes
	Measurement speed		MED	←	←	←	No	Yes	Yes	Yes	Yes
	Number of times for average		1	←	←	←	No	Yes	Yes	Yes	Yes
	Trigger delay		0.0000 s	←	←	←	No	Yes	Yes	Yes	Yes
	Trigger synchronous output	ON/OFF	OFF	←	←	←	No	Yes	Yes	Yes	Yes
Trigger time		0.0010 s	←	←	←	No	Yes	Yes	Yes	Yes	
AC range synchronization function *3	Measurement speed		MED	←	←	←	No	Yes	No	Yes	Yes
	Number of times for average		1	←	←	←	No	Yes	No	Yes	Yes
	Trigger delay		0.0000 s	←	←	←	No	Yes	No	Yes	Yes
	Trigger synchronous output	ON/OFF	OFF	←	←	←	No	Yes	No	Yes	Yes
		Trigger time	0.0010 s	←	←	←	No	Yes	No	Yes	Yes

Appendix12 Initial Settings Table

Yes: Available/ No: Unavailable/ ←: The same as the initial settings

Setting Items			Initial setting	instru- ment RESET operati on full reset	*RST	:PRESet	Return to initial settings when power is turned on	Panel save/ Load ^{*1}			File save/ Load	
								LCR mode	ANALY ZER mode ^{*2}	TRAN SFOR MER mode		
LCR mode DC resistance measurement	Temperature correction	ON/OFF	OFF	←	←	←	No	Yes	No	No	Yes	
		Reference temperature	20.0°C	←	←	←	No	Yes	No	No	Yes	
		Temperature coefficient	3930 ppm	←	←	←	No	Yes	No	No	Yes	
	DC delay		0.0000 s	←	←	←	No	Yes	No	No	Yes	
	ADJ delay		0.0030 s	←	←	←	No	Yes	No	No	Yes	
	Line frequency		60 Hz	←	←	←	No	Yes	No	No	Yes	
	Measurement range	Mode	AUTO	←	←	←	No	Yes	No	No	Yes	
		AUTO range limit function	100 mΩ/ 100 MΩ	←	←	←	No	Yes	No	No	Yes	
		Range	100 Ω	←	←	←	No	Yes	No	No	Yes	
		Judgment synchroni- zation setting	OFF	←	←	←	No	Yes	No	No	Yes	
		LOW Z	OFF	←	←	←	No	Yes	No	No	Yes	
	Measurement speed		MED	←	←	←	No	Yes	No	No	Yes	
	Number of times for average		1	←	←	←	No	Yes	No	No	Yes	
	DC range synchronization function ^{*3}	Measurement speed		MED	←	←	←	No	Yes	No	No	Yes
Number of times for average		1	←	←	←	No	Yes	No	No	Yes		
Application settings (for all modes)	Judgment mode		OFF	←	←	←	No	Yes	No	Yes	Yes	
	Memory	OFF/IN/ON	OFF	←	←	←	No	Yes	Yes	Yes	Yes	
		Number of memory items	1000	←	←	←	No	Yes	Yes	Yes	Yes	
	Range synchronization function		OFF	←	←	←	No	Yes	No	Yes	Yes	
	Waveform averaging function	ON/OFF	OFF	←	←	←	No	Yes	Yes	Yes	Yes	
		No. of waveform aver- ages for each frequen- cy band	No. of MED waveform averages	←	←	←	No	Yes	Yes	Yes	Yes	
	Judgment result	Delay between judg- ment results and EOM	0.0000 s	←	←	←	No	No	No	No	Yes	
		Reset	ON	←	←	←	No	No	No	No	Yes	
	IO trigger	ENABLE	ON	←	←	←	No	No	No	No	Yes	
		Edge	DOWN	←	←	←	No	No	No	No	Yes	
	IO EOM	Mode	HOLD	←	←	←	No	No	No	No	Yes	
		EOM output time	0.0050 s	←	←	←	No	No	No	No	Yes	
	HIGH-Z Reject	ON/OFF	OFF	←	←	←	No	Yes	Yes	Yes	Yes	
		Judgment reference value	1000%	←	←	←	No	Yes	Yes	Yes	Yes	
	Contact check	Timing	OFF	←	←	←	No	Yes	Yes	Yes	Yes	
		Threshold	2	←	←	←	No	Yes	Yes	Yes	Yes	
	Display digits		6/6/6/6	←	←	←	No	Yes	No	Yes	Yes	
	Backlight		ON/OFF	ON	←	←	←	No	No	No	No	Yes
	Beep sound	Judgment result	NG	←	←	←	No	Yes	Yes	Yes	Yes	
		Key	ON	←	←	←	No	No	No	No	Yes	
		Beep tone	C	←	←	←	No	No	No	No	Yes	
	Key-lock	ON/OFF	OFF	←	←	←	No	No	No	No	Yes	
Passcode		3533	←	←	←	No	No	No	No	Yes		
LCR mode comparator	Mode		ABS/ABS	←	←	←	No	Yes	No	No	Yes	
	Absolute value mode	Upper limit value	OFF/OFF	←	←	←	No	Yes	No	No	Yes	
		Lower limit value	OFF/OFF	←	←	←	No	Yes	No	No	Yes	
	Percent mode Deviation percent- age mode	Reference value	1.0000 k/ 10.0000	←	←	←	No	Yes	No	No	Yes	
		Upper limit value	OFF/OFF	←	←	←	No	Yes	No	No	Yes	
		Lower limit value	OFF/OFF	←	←	←	No	Yes	No	No	Yes	

Appendix12 Initial Settings Table

Yes: Available/ No: Unavailable/ ←: The same as the initial settings

Setting Items		Initial setting	instru- ment RESET operati on full reset	*RST	:PRESet	Return to initial settings when power is turned on	Panel save/ Load ¹			File save/ Load	
							LCR mode	ANALY ZER mode ²	TRAN SFOR MER mode		
BIN	Mode	ABS/ABS	←	←	←	No	Yes	No	No	Yes	
	Absolute value mode	Upper limit value	OFF/OFF	←	←	←	No	Yes	No	No	Yes
		Lower limit value	OFF/OFF	←	←	←	No	Yes	No	No	Yes
	Percent mode Deviation percent- age mode	Reference value	1.0000 k/ 10.0000	←	←	←	No	Yes	No	No	Yes
		Upper limit value	OFF/OFF	←	←	←	No	Yes	No	No	Yes
		Lower limit value	OFF/OFF	←	←	←	No	Yes	No	No	Yes
Basic settings (ANALYZER mode)	Sweep parameters		Z - θ	←	←	←	No	No	Yes	No	Yes
	Trigger		REPEAT	←	←	←	No	No	Yes	No	Yes
	Display timing		REAL	←	←	←	No	No	Yes	No	Yes
	Trigger delay		0.0000 s	←	←	←	No	No	Yes	No	Yes
	Normal sweep	Sweep start value	1.0000 kHz	←	←	←	No	No	Yes	No	Yes
		Sweep end value	100.00 kHz	←	←	←	No	No	Yes	No	Yes
		No. of points	201	←	←	←	No	No	Yes	No	Yes
		Measurement point setting method	LOG	←	←	←	No	No	Yes	No	Yes
	Sweep signal		1.000 V (V mode)	←	←	←	No	No	Yes	No	Yes
	Measurement range		AUTO	←	←	←	No	No	Yes	No	Yes
	Measurement speed		MED	←	←	←	No	No	Yes	No	Yes
	Averaging count		OFF	←	←	←	No	No	Yes	No	Yes
	Point delay		0.0000 s	←	←	←	No	No	Yes	No	Yes
	DC bias	ON/OFF	OFF	←	←	←	No	No	Yes	No	Yes
Bias value		0 V	←	←	←	No	No	Yes	No	Yes	
Measurement parameters (TRANSFORMER mode)		Ls	←	←	←	No	No	No	Yes	Yes	
Calculation parameters (TRANSFORMER mode)		N	←	←	←	No	No	No	Yes	Yes	
TRANSFORMER mode Comparator	Mode	ABS	←	←	←	No	No	No	Yes	Yes	
	Absolute value mode	Upper limit value	OFF	←	←	←	No	No	No	Yes	Yes
		Lower limit value	OFF	←	←	←	No	No	No	Yes	Yes
	Percent mode Deviation percent- age mode	Reference value	10.0000	←	←	←	No	No	No	Yes	Yes
		Upper limit value	OFF	←	←	←	No	No	No	Yes	Yes
		Lower limit value	OFF	←	←	←	No	No	No	Yes	Yes
CONTINUOUS measurement	Display timing	REAL	←	←	←	No	No	No	No	Yes	
Open circuit compensation	Compensation mode		OFF	←	←	No Change	No	Yes (ADJ)	Yes (ADJ)	Yes (ADJ)	Yes
	Correction value	G Correction value	0.000 ns	←	←	No Change	No	Yes (ADJ)	Yes (ADJ)	Yes (ADJ)	Yes
		B Correction value	0.000 ns	←	←	No Change	No	Yes (ADJ)	Yes (ADJ)	Yes (ADJ)	Yes
	Compensation range limit function	DC	ON	←	←	No Change	No	Yes (ADJ)	Yes (ADJ)	Yes (ADJ)	Yes
		MIN	20.000 Hz	←	←	No Change	No	Yes (ADJ)	Yes (ADJ)	Yes (ADJ)	Yes
		MAX	200.00 kHz	←	←	No Change	No	Yes (ADJ)	Yes (ADJ)	Yes (ADJ)	Yes
Short circuit compensation	Compensation mode		OFF	←	←	No Change	No	Yes (ADJ)	Yes (ADJ)	Yes (ADJ)	Yes
	Correction value	R Correction value	0.00 m Ω	←	←	No Change	No	Yes (ADJ)	Yes (ADJ)	Yes (ADJ)	Yes
		X Correction value	0.00 m Ω	←	←	No Change	No	Yes (ADJ)	Yes (ADJ)	Yes (ADJ)	Yes
	Compensation range limit function	DC	ON	←	←	No Change	No	Yes (ADJ)	Yes (ADJ)	Yes (ADJ)	Yes
		MIN	20.000 Hz	←	←	No Change	No	Yes (ADJ)	Yes (ADJ)	Yes (ADJ)	Yes
		MAX	200.00 kHz	←	←	No Change	No	Yes (ADJ)	Yes (ADJ)	Yes (ADJ)	Yes

Appendix12 Initial Settings Table

Yes: Available/ No: Unavailable/ ←: The same as the initial settings

Setting Items		Initial setting	instru- ment RESET operati on full reset	*RST	:PRESet	Return to initial settings when power is turned on	Panel save/ Load ^{*1}			File save/ Load	
							LCR mode	ANALY ZER mode ^{*2}	TRAN SFOR MER mode		
Load circuit compensation	ON/OFF		OFF	←	←	No Change	No	Yes (ADJ)	Yes (ADJ)	Yes (ADJ)	Yes
	Compensation mode		Z-θ	←	←	No Change	No	Yes (ADJ)	Yes (ADJ)	Yes (ADJ)	Yes
	Reference value	Impedance reference value	OFF	←	←	No Change	No	Yes (ADJ)	Yes (ADJ)	Yes (ADJ)	Yes
		Phase reference value	OFF	←	←	No Change	No	Yes (ADJ)	Yes (ADJ)	Yes (ADJ)	Yes
	Compensation frequency		OFF	←	←	No Change	No	Yes (ADJ)	Yes (ADJ)	Yes (ADJ)	Yes
	Compensation signal level	Mode	V	←	←	No Change	No	Yes (ADJ)	Yes (ADJ)	Yes (ADJ)	Yes
		V	OFF	←	←	No Change	No	Yes (ADJ)	Yes (ADJ)	Yes (ADJ)	Yes
		CV	OFF	←	←	No Change	No	Yes (ADJ)	Yes (ADJ)	Yes (ADJ)	Yes
		CC	OFF	←	←	No Change	No	Yes (ADJ)	Yes (ADJ)	Yes (ADJ)	Yes
	Compensation range	Range	OFF	←	←	No Change	No	Yes (ADJ)	Yes (ADJ)	Yes (ADJ)	Yes
		LOW Z	OFF	←	←	No Change	No	Yes (ADJ)	Yes (ADJ)	Yes (ADJ)	Yes
	Compensation DC bias	ON/OFF	OFF	←	←	No Change	No	Yes (ADJ)	Yes (ADJ)	Yes (ADJ)	Yes
		Bias value	0.00 V	←	←	No Change	No	Yes (ADJ)	Yes (ADJ)	Yes (ADJ)	Yes
	Compensation value	Impedance coefficient	OFF	←	←	No Change	No	Yes (ADJ)	Yes (ADJ)	Yes (ADJ)	Yes
		Phase coefficient	OFF	←	←	No Change	No	Yes (ADJ)	Yes (ADJ)	Yes (ADJ)	Yes
Cable length compensation		0 m	←	←	No Change	No	Yes (ADJ)	Yes (ADJ)	Yes (ADJ)	Yes	
Scaling compensation	ON/OFF		OFF	←	←	No Change	No	Yes (ADJ)	Yes (ADJ)	Yes (ADJ)	Yes
	Compensation value	A	1.000	←	←	No Change	No	Yes (ADJ)	Yes (ADJ)	Yes (ADJ)	Yes
		B	0.00000	←	←	No Change	No	Yes (ADJ)	Yes (ADJ)	Yes (ADJ)	Yes
Panel	Save type		ALL	←	←	No Change	No	No	No	No	Yes
	Panel		No registration	Clear all data	Clear all data	No Change	No	No	No	No	Only when ALL SAVE

Appendix12 Initial Settings Table

Yes: Available/ No: Unavailable/ ←: The same as the initial settings

Setting Items		Initial setting	instru- ment RESET operati on full reset	*RST	:PRESet	Return to initial settings when power is turned on	Panel save/ Load ¹			File save/ Load	
							LCR mode	ANALY ZER mode ²	TRAN SFOR MER mode		
Interface	USB	Terminator	CR+LF	←	No Change	No Change	No	No	No	No	Yes
	GP-IB	Address	01	←	No Change	No Change	No	No	No	No	Yes
		Terminator	LF	←	No Change	No Change	No	No	No	No	Yes
	RS-232C	Baud rate	9600	←	No Change	No Change	No	No	No	No	Yes
		Handshake	OFF	←	No Change	No Change	No	No	No	No	Yes
		Terminator	CR+LF	←	No Change	No Change	No	No	No	No	Yes
	LAN	IP address	192.168.000.001	←	No Change	No Change	No	No	No	No	Yes
		Subnet mask	255.255.255.000	←	No Change	No Change	No	No	No	No	Yes
		Gateway	OFF	←	No Change	No Change	No	No	No	No	Yes
		Port	3500	←	No Change	No Change	No	No	No	No	Yes
		Terminator	CR+LF	←	No Change	No Change	No	No	No	No	Yes
	Printer	Baud rate	9600		No Change	No Change	No	No	No	No	Yes
		Handshake	OFF		No Change	No Change	No	No	No	No	Yes
		Mode	MANUAL	←	No Change	No Change	No	No	No	No	Yes
		Type	TEXT	←	No Change	No Change	No	No	No	No	Yes
	Header		OFF	←	←	No Change	Yes	No	No	No	No
	Status Byte register		0	No Change	No Change	No Change	Yes	No	No	No	Yes
	Event register		0	No Change	No Change	No Change	Yes	No	No	No	Yes
	Enable register		0	No Change	No Change	No Change	Yes	No	No	No	Yes
	:MEASure:ITEM		0,0	←	←	←	No	Yes	Yes	Yes	Yes
	:MEASure:VALid	IM3533	10	←	←	←	No	Yes	Yes	Yes	Yes
		IM3533-01	14								
	Automatic output of measurement values		OFF	←	←	←	No	No	No	No	Yes
Transfer format		ASCII	←	←	←	No	No	No	No	Yes	
Long format		OFF	←	←	←	No	No	No	No	Yes	
File	Save Format		OFF	←	←	←	No	No	No	No	Yes
	Save folder		AUTO	←	←	←	No	No	No	No	Yes
	Header	Date and time	ON	←	←	←	No	No	No	No	Yes
		Measurement conditions	ON	←	←	←	No	No	No	No	Yes
		Measurement parameters	ON	←	←	←	No	No	No	No	Yes
		Delimiter	, (Comma)	←	←	←	No	No	No	No	Yes
Quote	" (Double quote)	←	←	←	No	No	No	No	Yes		
Touch panel compensation		No compensation	*4	No Change	No Change	No	No	No	No	No	
Clock		-	No Change	No Change	No Change	No	No	No	No	No	

*1 When TYPE=ALL is set, the items indicated by Yes (ADJ) are also saved.

*2 ANALYZER mode is only available on the IM3533-01.

*3 All 10 ranges are initialized as shown to right.

*4 Does not change with instrument reset; reverts to default value at full reset.

Appendix 13 Device Compliance Statement

"Information on compliance to standards" based on the IEEE 488.2 standard

Item	Description
1. IEEE 488.1 interface functions	See Description of Communication Instruction Manual on the included LCR Application Disk., "GP-IB specifications"
2. Operation with a device address other than 0 through 30	Such a setting is not possible.
3. Timing of changed device address recognition	A change of address is recognized immediately after changing.
4. Device settings at power on	The status information is cleared, and all other items are preserved. However, the header on/off setting, and response message separator and terminator are all reinitialized.
5. List of message exchange options	<ul style="list-style-type: none"> • Input buffer capacity and operation <p>See The included LCR Application Disk.</p> <p>Queries to which multiple response message instruments are returned</p> <pre> :BIN:FLIMit:ABSolute? 2 :BIN:FLIMit:DEViation? 2 :BIN:FLIMit:PERcent? 2 :BIN:SLIMit:ABSolute? 2 :BIN:SLIMit:DEViation? 2 :BIN:SLIMit:PERcent? 2 :COMParator:FLIMit:ABSolute? 2 :COMParator:FLIMit:DEViation? 3 :COMParator:FLIMit:PERcent? 3 :COMParator:SLIMit:ABSolute? 2 :COMParator:SLIMit:DEViation? 3 :COMParator:SLIMit:PERcent? 3 :CORRection:LIMit:POINt 2 :CORRection:OPEN:DATA:ALL * :CORRection:OPEN:DATA:SPOT * :CORRection:SHORT:DATA:ALL * :CORRection:SHORT:DATA:SPOT * :CORRection:LOAD:CONDition? 7 :CORRection:LOAD:DCResistance:CONDition? . 2 :CORRection:LOAD:REFerence? 3 :CORRection:SCALE:DATA? 2 :DCResistance:RANGE:AUTO:LIMit 2 :FILE:INFORMation? 5 :MEASure? * :MEASure:ITEM? 2 :MONItor? 4 :RANGE:AUTO:LIMit 2 :SYSTem:DATE? 3 :SYSTem:TIME? 3 </pre>

Appendix 13 Device Compliance Statement

Item	Description
	<p>* The number of response messages varies depending on the settings.</p> <ul style="list-style-type: none"> • Queries producing responses as syntax checking is performed: All queries produce responses when syntax checking is performed. • Whether any queries produce responses when read: There are no queries which produce response messages at the instant they are read in by the controller. • Whether any commands are coupled: There are no relevant commands.
<p>6. Summary of functional elements for use when constructing device specific commands, and whether compound commands or program headers can be used:</p>	<p>The followings can be used</p> <ul style="list-style-type: none"> • Program message • Program message terminator • Program message unit • Program message unit separator • Command message unit • Query message unit • Command program header • Query program header • Program data • Character program data • Decimal program data • Compound commands and program headers
<p>7. Buffer capacity limitations for block data</p>	<p>Block data is not used.</p>
<p>8. Summary of program data elements used in expressions, and deepest nesting level allowable in sub-expressions, including syntax restrictions imposed by the device.</p>	<p>Sub-expressions are not used. Character data and decimal data are the only program data elements used.</p>
<p>9. Response syntax for queries</p>	<p>See The included LCR Application Disk.</p>
<p>10. Transmission congestion relating to device-to-device messages which do not conform to the general principles for basic response messages</p>	<p>There are no device to device messages.</p>
<p>11. Response capacity for block data</p>	<p>Block data does not appear in responses.</p>
<p>12. Summary of standard commands and queries used</p>	<p>See The included LCR Application Disk.</p>
<p>13. Device state after a calibration query has been completed without any problem</p>	<p>The "*CAL?" query is not used.</p>
<p>14. Existence/nonexistence of "*DDT" command</p>	<p>The "*DDT" query is not used.</p>
<p>15. Existence/nonexistence of macro command</p>	<p>Macros are not used.</p>
<p>16. For queries related to identification, explanation of the response to the "*IDN?" query</p>	<p>See Description of communications commands on the included LCR Application Disk. "*IDN?"</p>

Appendix 13 Device Compliance Statement

Item	Description
17. Capacity of the user data storage area reserved for when the "*PUD" command and the "*PUD?" query are being executed	The "*PUD" command and the "*PUD?" query are not used. Further, there is no user data storage area.
18. Resources when the "*RDT" command and the "*RDT?" query are being used	The "*RDT" command and the "*RDT?" query are not used. Further, there is no user data storage area.
19. Conditions which are influenced when "*RST" , "*LRN?" , "*RCL?" , and "*SAV" are used	<p>"*LRN?", "*RCL?", and "*SAV" are not used. The "*RST" command returns the instrument to its initial state.</p> <p>See Description of communications commands on the included LCR Application Disk.-"*RST"</p>
20. Scope of the self-testing executed as a result of the "*TST?" query	See Description of communications commands on the included LCR Application Disk.- "*TST"
21. Additional organization of the status data used in a device status report	See The included LCR Application Disk.
22. Whether commands are overlap or sequential type	All commands except :MEASure? , :MEMory? , :CORRection:OPEN , :CORRection:SHORT , and :CORRection:LOAD are sequence commands.
23. Criterion relating to the functions required at the instant that the termination message is produced, as a response to each command	Termination occurs when the command has been parsed.

A26

Appendix 13 Device Compliance Statement

Index

A

Absolute Value Mode	202
Absolute Value mode	104, 111
Accuracy	343
Adjustment Delay	85
All Compensation	216, 226
ANALYZER measurement	149
AUTO	62, 88, 160
Average	74, 99, 167

B

Beep Sounds	143, 185
BIN	109

C

Cable Length Compensation	245
Calculation Formula	A1
CC	52, 158
Changing a Panel Name	258
Cleaning	355, 356
Comparator	102
Constant current	52, 158
Constant voltage	52, 158
Contact Check Function	132
CONTINUOUS Measurement	209
Conversion	351
Copy of the Screen	287
Current limit	56
CV	52, 158

D

Date	272
DC bias	58, A7
DC delay	83, 85
DC Resistance	80
Deleting a Panel	260
Deviation Percentage	117
Deviation Percentage Mode	107, 205
dgt.	4
Dimensional Diagram	17
Discarding	364
Display Timing	152, 213

E

EMI Suppression	6
Enlarging Display	49
Error display	362
EXT I/O	
Connection Examples	327
EXT I/O connector	310
External Control	309
Q&A	329
External Interference	A5
External trigger	60

F

f.s.	4
FAST	73, 98, 166
File Operation	275
Fixture	32
Folder	291, 305
Format	297, 302
Frequency	50
Full Reset	361

G

Guarding	3
----------------	---

H

High Impedance Components	A3
HIGH-Z Reject	130, 175
HOLD	62, 88, 160

I

In-circuit Components	A4
Initial Screen	12, 45, 149, 193, 209
Initial Settings	A18
Initializing	147, 191, A18
Inspection and Repair	355
Instrument Installation	5
Interface	263
Internal Circuitry	325
Internal Trigger	60

K

Key-lock Function	144, 186
-------------------------	----------

L

LCD	16, 21, 23, 142, 184, 214
LCR Application Disk	1
LCR	45
Limit value	56
Line Frequency	87
Load Compensation	232
Low Z High Accuracy Mode	71, 96

M

Measurement accuracy	343
Measurement Cable	32
Measurement categories	4
Measurement frequency	50
Measurement Mode	13
Measurement Range	62, 88, 343
Measurement signal level	52
Measurement speed	73, 98
Measurement Times	352
MED	73, 98, 166

N

Noise	A5
Number of Display Digits	140

O

Open Circuit Compensation	215, A12
Opening screen	30
Options	2

P

Panel Compensation	266
Panel Load	256
Panel Save	251
Panel Test	265
Parallel Equivalent Circuit Mode	A11
Parameter	47, 150
Percentage mode	105, 114, 203
Point Delay	168
Power Line	A5
Pre-Operation Inspection	30
Printer	331
Printing	334
Probe	32

R

Rack Mounting	15
Range	62, 88, 160
Range Synchronization Function	120
rdg.	4

Replaceable Parts	355
Residual Charge Protection	A10
ROM/RAM Test	270

S

Saving Measurement Results	138, 179
Scaling	246
Screen Display Test	268
Self Checks	265
Series Equivalent Circuit Mode	A11
Set the date and time	272
Setting	4
Setting CONTINUOUS Measurement	210
Short Circuit Compensation	224, A12
Signal	316
Signal level	52
Signal Pinouts	310
SLOW	73, 98, 166
SLOW2	73, 98, 166
Specifications	337
Spot Compensation	220, 228
Standby	36
Supply a DC Bias Current	A9
Supply a DC Bias Voltage	A7
Sweep Point	155
System Reset	147, 191
System Settings	25, 263

T

Temperature Correction	81
Timing Chart	318
EXT I/O	318
TRANS Measurement	193
TRANSFORMER Function	193
Trigger	60
Trigger Delay	76, 153
Trigger Measurement	60
Trigger Synchronous Output	77, 171

U

USB Flash Drive	273
-----------------------	-----

V

V	52, 158
Version	264
Voltage limit	56

W

Waveform Averaging	128
--------------------------	-----

Warranty Certificate

HIOKI

Model	Serial number	Warranty period Three (3) years from date of purchase (___ / ___)
-------	---------------	--

Customer name: _____
Customer address: _____

Important

- Please retain this warranty certificate. Duplicates cannot be reissued.
- Complete the certificate with the model number, serial number, and date of purchase, along with your name and address. The personal information you provide on this form will only be used to provide repair service and information about Hioki products and services.

This document certifies that the product has been inspected and verified to conform to Hioki's standards. Please contact the place of purchase in the event of a malfunction and provide this document, in which case Hioki will repair or replace the product subject to the warranty terms described below.

Warranty terms

1. The product is guaranteed to operate properly during the warranty period (three [3] years from the date of purchase).
If the date of purchase is unknown, the warranty period is defined as three (3) years from the date (month and year) of manufacture (as indicated by the first four digits of the serial number in YYMM format).
2. If the product came with an AC adapter, the adapter is warranted for one (1) year from the date of purchase.
3. The accuracy of measured values and other data generated by the product is guaranteed as described in the product specifications.
4. In the event that the product or AC adapter malfunctions during its respective warranty period due to a defect of workmanship or materials, Hioki will repair or replace the product or AC adapter free of charge.
5. The following malfunctions and issues are not covered by the warranty and as such are not subject to free repair or replacement:
 - 1. Malfunctions or damage of consumables, parts with a defined service life, etc.
 - 2. Malfunctions or damage of connectors, cables, etc.
 - 3. Malfunctions or damage caused by shipment, dropping, relocation, etc., after purchase of the product
 - 4. Malfunctions or damage caused by inappropriate handling that violates information found in the instruction manual or on precautionary labeling on the product itself
 - 5. Malfunctions or damage caused by a failure to perform maintenance or inspections as required by law or recommended in the instruction manual
 - 6. Malfunctions or damage caused by fire, storms or flooding, earthquakes, lightning, power anomalies (involving voltage, frequency, etc.), war or unrest, contamination with radiation, or other acts of God
 - 7. Damage that is limited to the product's appearance (cosmetic blemishes, deformation of enclosure shape, fading of color, etc.)
 - 8. Other malfunctions or damage for which Hioki is not responsible
6. The warranty will be considered invalidated in the following circumstances, in which case Hioki will be unable to perform service such as repair or calibration:
 - 1. If the product has been repaired or modified by a company, entity, or individual other than Hioki
 - 2. If the product has been embedded in another piece of equipment for use in a special application (aerospace, nuclear power, medical use, vehicle control, etc.) without Hioki's having received prior notice
7. If you experience a loss caused by use of the product and Hioki determines that it is responsible for the underlying issue, Hioki will provide compensation in an amount not to exceed the purchase price, with the following exceptions:
 - 1. Secondary damage arising from damage to a measured device or component that was caused by use of the product
 - 2. Damage arising from measurement results provided by the product
 - 3. Damage to a device other than the product that was sustained when connecting the device to the product (including via network connections)
8. Hioki reserves the right to decline to perform repair, calibration, or other service for products for which a certain amount of time has passed since their manufacture, products whose parts have been discontinued, and products that cannot be repaired due to unforeseen circumstances.

HIOKI E.E. CORPORATION

<http://www.hioki.com>

18-07 EN-3

HIOKI

<http://www.hioki.com>



**Our regional
contact
information**

HEADQUARTERS

81 Koizumi
Ueda, Nagano 386-1192 Japan

HIOKI EUROPE GmbH

Rudolf-Diesel-Strasse 5
65760 Eschborn, Germany
hioki@hioki.eu

1808EN

Edited and published by HIOKI E.E. CORPORATION

Printed in Japan

- CE declarations of conformity can be downloaded from our website.
- Contents subject to change without notice.
- This document contains copyrighted content.
- It is prohibited to copy, reproduce, or modify the content of this document without permission.
- Company names, product names, etc. mentioned in this document are trademarks or registered trademarks of their respective companies.