

MR8880-20

Instruction Manual

MEMORY HiCORDER



Video

Scan this code to watch an instructional video.
Carrier charges may apply.



! Be sure to read this manual before using the instrument

Safety information

▶ p.5

✓ When using the instrument for the first time

Names and Functions of Parts ▶ p.22

Measurement Preparations ▶ p.31

📖 Troubleshooting

Troubleshooting ▶ p.249

Error Messages and Remedial Actions ▶ p.A1

EN

July 2018 Revised edition 7
MR8880B980-07 18-07H



Contents

Procedure.....	1
Introduction.....	3
Confirming Package Contents.....	4
Safety Information	5
Operating Precautions.....	8

Chapter 1 Overview _____ 21

1.1 Product Overview and Features	21
1.2 Names and Functions of Parts	22
1.3 Screen Configuration and Display	24

Chapter 2 Measurement Preparations _____ 31

2.1 Using the Alkaline Battery Box (Accessory) or Battery Pack (Option)	32
■ Installing the Alkaline Battery Box and Replacing the Batteries ...	33
■ Install the Battery Pack	34
■ Charge the Battery Pack	36
2.2 Connecting the AC Adapter	37
2.3 Connecting Measurement Cables to the Memory HiCorder	38
■ Connecting Connection Cords (to record voltage waveforms) ..	38
■ Connecting a Clamp Sensor (to record current waveforms)	39
■ Connecting the Logic Probe (to record logic signals)	40
2.4 Connecting Printer and Loading Recording Paper (Options)	41
■ Connecting the Printer	41
■ Loading the Recording Paper	42
2.5 Attaching the Carrying Strap	44
2.6 Turning the Power On and Off	45
2.7 Using CF Card or USB Flash Drive (for Saving Data)	46
■ CF Card Insertion & Removal	47

■ USB Flash Drive Insertion & Removal	47
■ Formatting a CF Card/USB Flash Drive	48
2.8 Compensating for Input Circuit Offset (Zero Adjustment)	49

Chapter 3

Basic Operating Procedures _____ 51

3.1 Pre-Operation Inspection.....	51
3.2 Measurement Flow	52
3.3 Basic Operation	55
■ Checking Input State (Monitor)	55
■ Configuring Settings (Changing Settings)	57
■ Starting and Stopping Measurement	58
■ Viewing Measurement Results (Scrolling Waveforms & Displaying Measurement Values)	60
■ Saving Data	61
■ Printing Data	62
■ Disabling Key Operations (Key-Lock Function)	62
3.4 Measurement Using Setting Wizard (PRESETS key)	63
■ Configuring Settings by Following Instructions in Navigation (Basic Guide)	63
■ Selecting Application and Configure Settings (Measurement Guide)	64
■ Loading Setting Configuration Data	65

Chapter 4

Setting the Measurement Conditions (When you want to customize the settings) 67

4.1 Flow of Configuring Settings Individually	67
4.2 Recording Methods (Measurement Functions) ...	68
4.3 Using High-speed Function (Instantaneous Recording)	70
■ Selecting the Function (High-speed Function)	70
■ Setting the Horizontal Axis (Time Base Range)	71
■ Setting Recording Length (no. of divisions)	74
■ Set the Recording Length for Repeated or One-time Recording .	75
■ Configuring Settings Automatically (Auto Range)	76

4.4	Using Real-time Function (Fluctuation Recording)	.78
■	Selecting the Function (Real-time Function)	78
■	Setting the Interval for the Data to Record (Recording Interval)	79
■	Setting the Recording Time	81
■	Setting the Repeat Operation (Repeat Measurement or Single Measurement)	83
■	Retaining Records of Maximum and Minimum Values (Envelope)	84
4.5	Setting the Input Conditions	86
■	Setting the Input Channel (Instantaneous Value/Effective Value & Measurement Range)	86
■	Selecting a Low-Pass Filter (L.P.F.)	88
■	Selecting the Input Coupling Method	88
4.6	Setting the Screen Display	89
■	Expanding and Compressing in the Horizontal Axis (Time Axis) Direction	89
■	Setting Display Range in Vertical Axis Direction	91
■	Setting the Display Format (Screen Splitting/Synthesis/Graph Assignment)	94
■	Setting Waveform Display Colors & Turning On/Off Display	96
■	Converting Measurement Values (Scaling Function)	97
■	Setting Logic Channel Display Colors	100
■	Setting Logic Channel Display Positions	100
■	Setting the Recording Width of Logic Waveforms	101
4.7	Setting Automatic Saving	102
■	Replacing CF Card or USB Flash Drive during Saving ([Realtime] only)	106
4.8	Setting Automatic Printing	108
4.9	Recording Using Specific Conditions (Trigger Function)	110
■	What is a Trigger?	110
■	Enabling the Trigger Function	111
■	Setting the Trigger Timing	111
■	Setting AND/OR Trigger Application Conditions	113
■	Recording Data Before Trigger Applied (Pre-trigger)	115
■	Setting the Trigger Type for Analog Input Signals	116
■	Applying a Trigger at a Specified Value (Level Trigger)	117
■	Applying a Trigger Using Range Specified by Upper & Lower Limit Values (Window Trigger)	119

■ Detecting Instantaneous Power Failure of Commercial Power Supply (Voltage Drop Trigger) (High-speed Function only) ...	120
■ Monitoring Commercial Power Supply (Waveform Judgment Trigger) (High-speed Function only) ...	121
■ Applying Trigger with Logic Input Signal (Logic Trigger)	124
■ Applying Trigger at Fixed Time Interval (Interval Trigger)	126
■ Applying Trigger with External Input Signal (External Trigger)	127
4.10 Entering Comments and Titles	128
■ Setting the Title and Comments	128
■ Printing the Title and Comments	130

Chapter 5

Waveform Analysis _____ **131**

5.1 Observing Waveforms	131
■ Displaying Waveforms (Display Descriptions)	131
■ Scrolling Waveforms	132
■ Verifying Waveform Display Position	133
■ Displaying Gauges	134
■ Magnifying and Compressing Horizontally	135
■ Viewing Any Waveform Location (Jump Function)	137
■ Displaying Cursor Values	138
■ Specifying a Waveform Time Span	140
5.2 Marking Waveforms and Searching Marks (Search Function)	141
■ Inserting Event Marks While Viewing Waveforms	141
■ Inserting Event Marks Using External Input Signals	142
■ Searching Event Marks	143
■ Viewing Events in Text Format (CSV)	144
5.3 Synthesizing Waveforms (X-Y Synthesis)	145
■ Synthesizing All Acquired Data	145
■ Synthesizing Part of the Data	146

Chapter 6

Managing Data _____ **147**

6.1 Saving & Loading Data	147
■ About the File Hierarchy	147
■ About File Types & Saving/Loading	148

■ Preparations and Settings for Power Outages during Long-term Measurements	149
6.2 Saving Data	150
■ Selecting & Saving Data with the SAVE Key [Select&Save] ..	152
■ Saving immediately with the SAVE Key [Quick Save]	154
■ Saving Setting Configuration Data	156
6.3 Loading Data on the HiCorder	157
■ Loading a Setting Configuration	157
■ Loading Waveform Data and Screen Images	159
6.4 Data Management	160
■ Switching Removable Storage	160
■ Viewing Folder Contents and the Parent Folder	160
■ Deleting Data	161
■ Renaming Files and Folders	162
■ Sorting Files	163

Chapter 7

Printing _____ **165**

7.1 Printing Waveform after Measurement (Manual Print)	166
■ Printing Whole Waveform	166
■ Specifying the Range to Print (Partial Print)	167
7.2 Printing the Screen Display (Screen Hardcopy) .	168
7.3 Printing the Setting Information (List Print)	169
7.4 Print Examples	170
7.5 Various Print Settings	171
■ Printing the Channel Number or Comment (Channel Marker) ..	171
■ Setting the Grid Type	172
■ Setting the Print Density	173
■ Printing Setting List and Gauge (List & Gauge)	173
■ Specifying the Range to Print (Print Range)	174
7.6 Feeding	175
7.7 Performing a Printer Check	175

Chapter 8

Numerical Calculations _____ **177**

8.1 Calculation Methods	177
--------------------------------------	------------

8.2	Calculating Automatically (Auto Calculation)	179
■	Calculating at Specified Interval (Interval Calculation)	181
8.3	Calculating after Measurement (Manual Calculation)	182
■	Performing Calculation for All Data	182
■	Apply Calculations to a Specific Time Span	183
8.4	Numerical Value Calculation Expressions	184

Chapter 9

Scheduling Measurement **187**

9.1	Starting & Stopping Measurement on a Specified Day	187
9.2	Starting & Stopping Measurement Periodically	189
9.3	Canceling a Schedule	191
9.4	About Schedule Function Operation	193
9.5	Setting Examples	195

Chapter 10

System Environment Settings **197**

10.1	Operation Settings	198
■	Using the Auto-Resume Function (Resume After Power Restoration)	198
■	File Protection Level Setting	198
10.2	Screen Key Operation Settings	199
■	Enabling and Disabling the Backlight Saver	199
■	Adjust Backlight Brightness	199
■	Selecting Black or White Screen Background	200
■	Enabling or Disabling the Beeper	200
■	Selecting the Horizontal (Time) Axis Display	201
■	Display of Start/Stop Confirmation Messages	201
■	Setting the SAVE Key Action	202
■	Selecting the Display Language	202
10.3	CSV File Saving Settings	203
■	CSV File Data Decimal and Separator Characters	203
10.4	Making System Settings	204

- Setting the Date and Time204
- Initializing the HiCorder (System Reset)204
- Self-Test205

Chapter 11

Connection to a PC _____ **207**

- 11.1 USB Settings and Connections**207
- 11.2 Importing Data to a Computer**208
 - Select the USB Drive Mode208
 - Connecting the Instrument and Computer209
- 11.3 Communication Using Commands**210
 - Setting Communication210
 - Installing the USB Driver211
 - Connecting the Instrument and Computer214
 - Uninstalling the USB Driver215

Chapter 12

External Control _____ **217**

- 12.1 Connecting to the External Control Terminals** ...217
- 12.2 External Signal Input (External Trigger Input)**219
- 12.3 External Signal Output (Trigger Output)**221
- 12.4 Controlling Instrument Using External Inputs (START/IN1 and STOP/IN2)**223
- 12.5 Using External Outputs (ALM/OUT)**225
- 12.6 Synchronous Measurements with Multiple Instruments**226

Chapter 13

Specifications _____ **227**

- 13.1 MR8880-20 Specifications**227
- 13.2 High-speed Function**235
- 13.3 Real-time Function**236
- 13.4 Other Functions**239
- 13.5 Monitor Functions**243
- 13.6 Setting Wizard Function (PRESETS)**243

13

14

8

9

10

11

12

Appendix

Index

Chapter 14
Maintenance and Service _____ 245

- 14.1 Inspection, Repair, and Cleaning 245
- 14.2 Troubleshooting 249
- 14.3 Disposing of the Instrument 251

Appendix

- Appendix 1 Error Messages and Remedial ActionsA1
- Appendix 2 List of Default SettingsA7
- Appendix 3 File NamingA12
- Appendix 4 Text File (CSV File) Internal Format.....A13
- Appendix 5 Waveform File Size.....A15
- Appendix 6 Maximum Recordable TimeA16
- Appendix 7 Supplemental Technical Information.....A19
- Appendix 8 Frequently Asked QuestionsA21
- Appendix 9 OptionsA26
- Appendix 10 Installing Waveform Viewer.....A28

Index _____ Index 1

Procedure

Preparation (p. 31)

Inspection (p. 51)

Setup (p. 63)

You can customize the settings as necessary (p. 67).

Start of Measurement

View Input State (p. 55)

End of Measurement

Analyze with Instrument (p. 131)

Save (p. 147) and Print (p. 165)

You can also automatically save (p. 102) and print (p. 108) data.

Analyze with computer

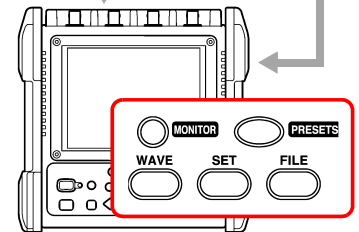
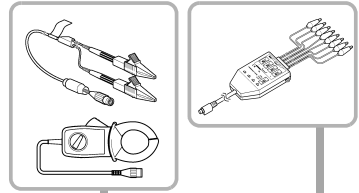

You can configure the settings easily with Setting Wizard.

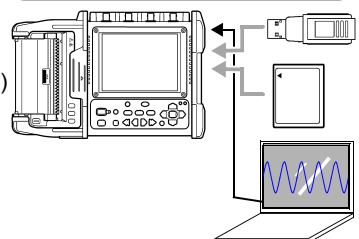
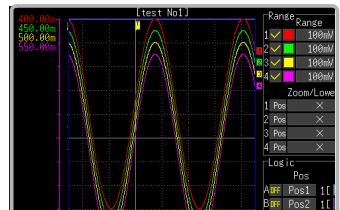
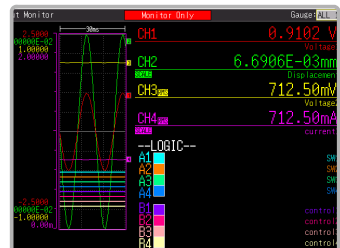

2

Procedure

Introduction

Thank you for purchasing the HIOKI Model MR8880-20 Memory HiCorder. To obtain maximum performance from the instrument, please read this manual first, and keep it handy for future reference.

The inputs of the instrument are specifically for voltage input.

An optional clamp-on probe is required for current measurement with the Memory HiCorder. In this manual, all models of these probes are collectively referred to as "clamp sensors." For details, refer to the instruction manual of the particular clamp sensor to be used.

Trademarks

- Microsoft and Windows, Microsoft Excel are either registered trademarks or trademarks of Microsoft Corporation in the United States and other countries.
 - CompactFlash is a registered trademark of Sandisk Corporation (USA).
-

Confirming Package Contents

When you receive the instrument, inspect it carefully to ensure that no damage occurred during shipping. In particular, check the accessories, panel switches, and connectors. If damage is evident, or if it fails to operate according to the specifications, contact your dealer or Hioki representative.

Confirm that these contents are provided.

- Model MR8880-20 Memory HiCorder **1**

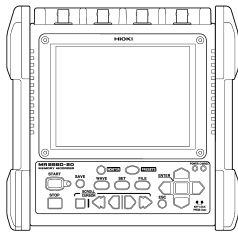

- Instruction Manual (This document) **1**



- USB cable..... **1**

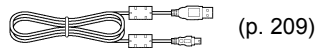

- Strap **1**

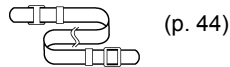

- Model Z1002 AC Adapter **1**
with supplied power cord



(p. 37)

- Application program CD
(Waveform Viewer (Wv),
Communication command) **1**



The latest version can be downloaded from our web site.

- Alkaline Battery Box..... **1**

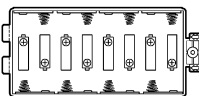

(p. 32)

Use the original packing materials when transporting the instrument, if possible.

For information about options: (p. A26)

Contact your dealer or Hioki representative for details.

Safety Information



DANGER

This instrument is designed to comply with IEC 61010 Safety Standards, and has been thoroughly tested for safety prior to shipment. However, mishandling during use could result in injury or death, as well as damage to the instrument. Using the instrument in a way not described in this manual may negate the provided safety features.



Be certain that you understand the instructions and precautions in the manual before use. We disclaim any responsibility for accidents or injuries not resulting directly from instrument defects.

This manual contains information and warnings essential for safe operation of the instrument and for maintaining it in safe operating condition. Before using it, be sure to carefully read the following safety precautions.

Safety Symbols



In the manual, the  symbol indicates particularly important information that the user should read before using the instrument.

The  symbol printed on the instrument indicates that the user should refer to a corresponding topic in the manual (marked with the  symbol) before using the relevant function.



Indicates a burn hazard if touched directly.



Indicates a double-insulated device.



Indicates a grounding terminal.



Indicates DC (Direct Current).



Indicates the ON side of the power switch.



Indicates the OFF side of the power switch.

Safety Information

The following symbols in this manual indicate the relative importance of cautions and warnings.



Indicates that incorrect operation presents an extreme hazard that could result in serious injury or death to the user.



Indicates that incorrect operation presents a significant hazard that could result in serious injury or death to the user.



Indicates that incorrect operation presents a possibility of injury to the user or damage to the instrument.



Indicates advisory items related to performance or correct operation of the instrument.

Symbols for Various Standards



Indicates that the product conforms to regulations set out by the EU Directive.



Ni-MH

This is a recycle mark established under the Resource Recycling Promotion Law (only for Japan).



WEEE marking:

This symbol indicates that the electrical and electronic appliance is put on the EU market after August 13, 2005, and producers of the Member States are required to display it on the appliance under Article 11.2 of Directive 2002/96/EC (WEEE).

Other Symbols



Indicates the prohibited action.

(p.)

Indicates the location of reference information.

*

Indicates that descriptive information is provided below.

[]

The names of setting objects and buttons on the screen are indicated by square brackets [].

SET

(Bold characters)

Bold characters within the text indicate operating key labels.

- Unless otherwise specified, "Windows" represents Windows 7, Windows 8, or Windows 10.
- Dialog box represents a Windows dialog box.
- Click: Press and quickly release the left button of the mouse.
- Double click: Quickly click the left button of the mouse twice.

Accuracy

We define measurement tolerances in terms of f.s. (full scale), rdg. (reading) and dgt. (digit) values, with the following meanings:

f.s.	(maximum display value or scale length) The maximum displayable value or scale length. In this instrument, the maximum displayable value is the range (V/div) times the number of divisions (10) on the vertical axis. Example: For the 1 V/div range, f.s. = 10 V
rdg.	(reading or displayed value) The value currently being measured and indicated on the measuring instrument.
dgt.	(resolution) The smallest displayable unit on a digital measuring instrument, i.e., the input value that causes the digital display to show a "1" as the least-significant digit.

Measurement categories

This instrument complies with CAT IV (300 V AC/DC), CAT III (600 V AC/DC) safety requirements.

To ensure safe operation of measurement instruments, IEC 61010 establishes safety standards for various electrical environments, categorized as CAT II to CAT IV, and called measurement categories.

CAT II	Primary electrical circuits in equipment connected to an AC electrical outlet by a power cord (portable tools, household appliances, etc.) CAT II covers directly measuring electrical outlet receptacles.
CAT III	Primary electrical circuits of heavy equipment (fixed installations) connected directly to the distribution panel, and feeders from the distribution panel to outlets.
CAT IV	The circuit from the service drop to the service entrance, and to the power meter and primary overcurrent protection device (distribution panel).

Using a measurement instrument in an environment designated with a higher-numbered category than that for which the instrument is rated could result in a severe accident, and must be carefully avoided.

Use of a measurement instrument that is not CAT-rated in CAT II to CAT IV measurement applications could result in a severe accident, and must be carefully avoided.

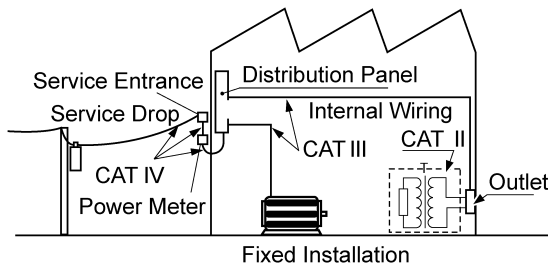

Operating Precautions



Follow these precautions to ensure safe operation and to obtain the full benefits of the various functions.

Before Use

Before using the instrument the first time, verify that it operates normally to ensure that no damage occurred during storage or shipping. If you find any damage, contact your dealer or Hioki representative.



Before using the instrument, make sure that the insulation on the probes, connection cords, and clamp sensor leads is undamaged and that no bare conductors are improperly exposed. Using the instrument in such conditions could cause an electric shock, so contact your dealer or Hioki representative for replacements.

Instrument Installation

Operating temperature and humidity

Temperature: -10°C to 50°C (14 to 122°F),

Humidity: -10°C to 40°C (14 to 104°F) at 80%RH or less (non-condensating)

40°C to 45°C (104 to 113°F) at 60%RH or less (non-condensating)

45°C to 50°C (113 to 122°F) at 50%RH or less (non-condensating)

- During battery operation: 0°C to 40°C (32 to 104°F) at 80% RH or less (non-condensating)
- During battery charging: 10°C to 40°C (50 to 104°F) at 80% RH or less (non-condensating)

Temperature and humidity range for guaranteed accuracy: 23±5°C (73±9°F), 80%RH or less (non-condensating)

Avoid the following locations that could cause an accident or damage to the instrument.



Exposed to direct sunlight
Exposed to high temperature



In the presence of corrosive or explosive gases



Exposed to water, oil, other chemicals, or solvents
Exposed to high humidity or condensation



Exposed to strong electromagnetic fields
Near electromagnetic radiators



Exposed to high levels of particulate dust



Near induction heating systems (e.g., high-frequency induction heating systems and IH cooking utensils)



Subject to vibration

Handling the Instrument



- Do not allow the instrument to get wet, and do not take measurements with wet hands. This may cause an electric shock.
- To avoid electric shock, do not remove the instrument's case. The internal components of the instrument carry high voltages and may become very hot during operation.



- Do not attempt to modify, disassemble or repair the instrument; as fire, electric shock and injury could result.
- Avoid obstructing the ventilation holes on the sides of the instrument, as it could overheat and be damaged, or cause a fire.

CAUTION

- The operating temperature range of the instrument is -10°C to 50°C. Do not use the instrument in an environment that is out of this range.
- To avoid damage to the instrument, protect it from physical shock when transporting and handling. Be especially careful to avoid physical shock from dropping.
- This instrument may cause interference if used in residential areas. Such use must be avoided unless the user takes special measures to reduce electromagnetic emissions to prevent interference to the reception of radio and television broadcasts.
- Before transporting the instrument, disconnect all cables and remove any CFcard, USB flash drive and recording paper.
- Do not slant the device or place it on top of an uneven surface. Dropping or knocking down the device can cause injury or damage to the device.
- The instrument is equipped with a protector. The physical shock protection provided by the protector does not fully prevent instrument failures. Be sufficiently careful when handling the instrument.

NOTE

Correct measurement may be impossible in the presence of strong magnetic fields, such as near transformers and high-current conductors, or in the presence of strong electromagnetic fields such as near radio transmitters.

Handling the Cords and Cables**WARNING**

To avoid electric shock, do not exceed the lower of the ratings shown on the instrument and test leads

CAUTION

- Avoid stepping on or pinching cables, which could damage the cable insulation.
- To avoid breaking the cables, do not bend or pull them.
- To avoid damaging the power cord, grasp the plug, not the cord, when unplugging it from the power outlet.
- When disconnecting the BNC connector, be sure to release the lock before pulling off the connector. Forcibly pulling the connector without releasing the lock, or pulling on the cable, can damage the connector.
- To prevent an electric shock accident, confirm that the white or red portion (insulation layer) inside the cable is not exposed. If a color inside the cable is exposed, do not use the cable.

NOTE

- Use only the specified connection cables. Using a non-specified cable may result in incorrect measurements due to poor connection or other reasons.
- Before using a clamp sensor or logic probe, read the instruction manual supplied with it.

Alkaline Battery Box (Accessory) and Battery Pack (Option)

About installation procedure: "2.1 Using the Alkaline Battery Box (Accessory) or Battery Pack (Option)" (p. 32)

⚠ WARNING

Be sure to observe the following precautions. Incorrect handling may result in liquid leaks, heat generation, ignition, bursting and other hazards.

- **For the battery pack, use the optional Z1000 Battery Pack. We do not take any responsibility for accidents or damage related to the use of any other batteries.**
- **When using the alkaline battery box, use commercially available eight LR6 alkaline batteries.**
- **To avoid the possibility of explosion, do not short circuit, disassemble or incinerate battery pack/battery. Handle and dispose of batteries in accordance with local regulations.**
- **When storing the instrument, make sure no objects that could short-circuit the connectors are placed near them.**
- **The battery pack and alkaline dry cell batteries contain lye, which can cause blindness if comes into contact with the eyes. Should battery liquid get into your eyes, do not rub your eyes but rinse them in plenty of water and seek the immediate attention of a physician.**
- **To avoid electric shock, turn off the power switch and disconnect the cables before replacing the batteries or battery pack.**
- **After installing or replacing the batteries or battery pack, replace the battery compartment cover and screws.**
- **Handle and dispose of batteries or battery pack in accordance with local regulations.**

About alkaline dry cell batteries

CAUTION

- Do not mix old and new batteries, or different types of batteries. Also, be careful to observe battery polarity during installation. Otherwise, poor performance or damage from battery leakage could result.
- Do not use LR6 alkaline batteries together with commercially available nickel hydride batteries or other types of batteries.
- To avoid corrosion and damage to this instrument from battery leakage, remove the batteries from the instrument if it is to be stored for a long time (several months or more).

When using battery pack

CAUTION**Observe the following to avoid damage to the instrument.**

- Use the battery pack in an ambient temperature range of 0 to 40°C and charge it in an ambient temperature range of 10 to 40°C.
- If the battery packs fails to complete charging within the stipulated time, disconnect the AC adapter from the pack to stop charging.
- Consult your dealer or nearest service station should liquid leaks, strange odor, heat, discoloration, deformation and other abnormal conditions occur during use, charging or storage. Should these conditions occur during use or charging, turn off and disconnect the instrument immediately.
- Do not expose the instrument to water and do not use it in excessively humid locations or locations exposed to rain.
- Do not expose the instrument to strong impacts and do not throw it around.

NOTE

- The battery pack is a consumable. If the battery capacity remains very low after correct recharging, the useful battery life is at an end.
 - When a battery pack that has not been used for a long time is used, charging may end before the battery pack is fully charged. In such a case, repeat charging and discharging a number of time before use. (A battery pack may also be in such a state immediately after purchase.)
 - The life of the battery pack (when capacity is 60% or more of initial capacity) is approximately 500 charge-discharge cycles. (The life differs depending on the conditions of use.)
 - To prevent battery pack deterioration when the battery will not be used for 1 month or longer, remove it and store it in a dry location with an ambient temperature range of between -20 to 30°C. Be sure to discharge and charge it every two months. Long-term storage when capacity has decreased will make charging impossible and reduce performance.
 - When a battery pack is used, the instrument turns off automatically when the capacity drops. Leaving the instrument in this state for a long time may lead to over discharge so be sure to turn off the power switch on the instrument.
 - The charging efficiency of the battery pack deteriorates at high and low temperatures.
-

Using the AC Adapter

⚠WARNING

- Use only the supplied Model Z1002 AC Adapter. AC adapter input voltage range is 100 to 240 V AC (with $\pm 10\%$ stability) at 50/60 Hz. To avoid electrical hazards and damage to the instrument, do not apply voltage outside of this range.
- Before connecting to a power supply, make sure the supply voltage matches that indicated on the AC adapter. Connection to an improper supply voltage may damage the instrument or AC adapter and present an electrical hazard.
- Turn the instrument off before connecting the AC adapter to the instrument and to AC power.
- To avoid electrical accidents and to maintain the safety specifications of this instrument, connect the power cord provided only to a 3-contact (two-conductor + ground) outlet.

⚠CAUTION

- If you wish to use a UPS (uninterruptible power supply) or DC-AC inverter to power the instrument, do not use a UPS or DC-AC inverter with square wave or pseudo sine wave output. Doing so may damage the instrument.
- To avoid damaging the power cord, grasp the plug, not the cord, when unplugging it from the power outlet.

NOTE

- After use, always turn OFF the power.
 - Brief power interruptions of 40 ms or less will not cause this instrument to malfunction. However, longer interruptions may cause the Memory HiCorder to shut itself off, so consider local power conditions before installing, as appropriate.
 - To ensure that recording is not interrupted by power outages, you can use the Z1002 AC Adapter and Z1000 Battery Pack together.
-

Connecting to the Terminals

Connecting to the Analog Input Terminals



- Note the following maximum input voltage and maximum rated voltage to earth.

600 V AC/DC (CAT III, II), 300 V AC/DC (CAT IV)

If their voltages are exceeded, this device will be damaged and personal injury will result. Therefore, do not perform measurement in this case.

The maximum allowable input voltage is the smaller of that of the instrument or of the measurement cables.

- The relationship between the maximum allowable input voltage and the maximum rated voltage to earth of the combined Memory HiCorder and measurement cables is as follows.

To avoid electric shock or damage to the instruments, do not apply input voltage above the lowest maximum.

The maximum rated voltage to earth in the table applies when measuring through input attenuators.

Measurement cables	Maximum input voltage	Maximum rated voltage to earth
Model 9197 Model L9197	600 V AC/DC	600 V AC/DC (CAT III, II) 300 V AC/DC (CAT IV)
Model L9198 Model L9217	300 V AC/DC	600 V AC/DC (CAT II)
Model L9790	600 V AC/DC	When using Model L9790-01 Alligator clip and Model 9790-03 Contact Pin 600 V AC/DC (CAT II) 300 V AC/DC (CAT III) When using Model 9790-02 Grabber clip 300 V AC/DC (CAT II) 150 V AC/DC (CAT III)
Model 9322	2000 V DC, 1000 V AC	When using the Grabber clip 1500 V AC/DC (CAT II) 600 V AC/DC (CAT III) When using the Alligator clip 1000 V AC/DC (CAT II) 600 V AC/DC (CAT III)

⚠ DANGER

Connect the clamp-on sensors or connection cords to the instrument first, and then to the active lines to be measured. Observe the following to avoid electric shock and short circuits.

- To avoid short circuits and potentially life-threatening hazards, never attach the clamp to a circuit that operates at more than the maximum rated voltage to earth, or over bare conductors.
- Do not allow the connection cord clips to touch two wires at the same time. Never touch the edge of the metal clips.
- When the clamp sensor is opened, do not allow the metal part of the clamp to touch any exposed metal, or to short between two lines, and do not use over bare conductors.
- Do not leave the Memory HiCorder connected to test objects in environments where a voltage surge might exceed the dielectric withstand voltage. Doing so could result in damage to the Memory HiCorder, bodily injury or fatal accident.

⚠ WARNING

- Do not connect a cable to the instrument while it is connected to the object to be measured. Otherwise, an electric shock accident may occur.
- To avoid short-circuit accidents, make certain that connections are secure.

⚠ CAUTION

To prevent damage to the instrument and sensor, never connect or disconnect a sensor while the power is on, or while the sensor is clamped around a conductor.

NOTE

- Lay the connection cords and various cables away from the power supply line and ground wire.
- Connecting the connection cords and various cables in a parallel configuration with the inputs of another device (see the figure below) may result in variations in measurement values and incorrect operation of the instrument. When connecting with another device in a parallel configuration, be sure to verify operation.

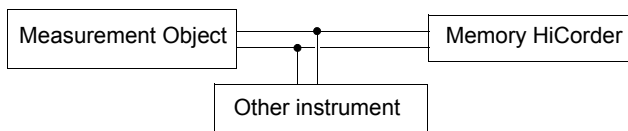

Connecting to the logic terminals

⚠ DANGER

To avoid electric shock and short circuit accidents or damage to the instrument, pay attention to the following:

- Maximum logic probe input voltages are as follows.
Do not measure if the maximum voltage would be exceeded, as damage to the instrument or personal injury may result.
Model 9320-01 Logic Probe: +50 V DC
Model MR9321-01 Logic Probe: 250 Vrms (HIGH range), 150 Vrms (LOW range)

- The ground terminal for the 9320-01 Logic Probe is not isolated from the Memory HiCorder's ground (chassis ground). Therefore, if the measurement object connect to AC, it should have a grounded, polarized plug, and be connected to the same power outlet as the Memory HiCorder's AC adapter.

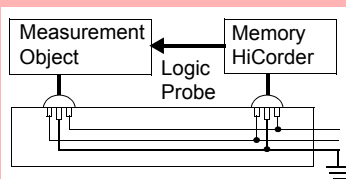

If the Memory HiCorder and measurement object are connected to different mains circuits, or if an ungrounded power cord is used, the potential difference between the different grounding paths may result in current flow through a logic probe that could damage the measurement object or Memory HiCorder.

- Do not allow the metal tip of a logic probe to cause a short between conductors on the measurement probe. Never touch the metal tip of a probe.

When connecting USB cable

⚠ CAUTION

- To prevent a malfunction, do not disconnect the USB cable during communication.
- The Memory HiCorder and computer should be connected to the same earth ground. If grounded separately, potential difference between the ground points can cause malfunctions or damage when connecting the USB cable.

NOTE

This instrument cannot be powered by the bus of a PC or USB hub. When using the instrument, connect the AC adapter or install batteries.

When connecting to external control terminals**⚠ WARNING**

To avoid electric shock or damage to the equipment, always observe the following precautions when connecting to external control terminals.

- Always turn off the power to the instrument and to any devices to be connected before making connections.
- Be careful to avoid exceeding the ratings of external control terminals.
- Ensure that devices and systems to be connected to the external control terminals are properly isolated.
- The ground of external control terminals and the ground of the instrument are common and not isolated.

To prevent damage to the instrument, use a grounded power cord for the device to be connected with the external control terminals and this instrument, and supply power from the same line. Using different lines or an ungrounded power cord may result in a potential difference between the grounds depending on the wiring state, and current flowing through the wiring material may lead to damage of the measurement object or instrument.

- To prevent an electrical accident, use wiring material that has more than enough dielectric strength and current-carrying capacity.

NOTE

If a cable of 3 meters or longer is connected, the instrument may be susceptible to the interference of external noise and other EMC environmental factors.

About the Printer



- The printer head and metal parts nearby become very hot. Be careful not to touch them because doing so may result in a burn.



- Be careful not to cut a finger with the paper cutter.



- To prevent a malfunction of the instrument, turn off the power when connecting the instrument and printer unit.
- Do not directly touch the printer head because there is the risk of it being damaged by static electricity.

NOTE

As much as possible, avoid printing in hot and humid environments. Otherwise, printer life may be severely shortened.

Using a CF Card/ USB Flash Drive

Measurement data (data captured to internal buffer memory) is cleared when new measurements are started. If you want to keep any data, be sure to save it to external media.



- Inserting a CF card/USB flash drive upside down, backwards or in the wrong direction may damage the CF card, USB flash drive, or instrument.
- Never remove a CF card or USB flash drive during measurement while the instrument is accessing the CF card or USB flash drive. The CF card or USB flash drive and/or the data on it may be damaged. (The icon of the CF card or USB flash drive on the bottom left of the screen is displayed in red during access.)
- Do not transport the instrument while a USB flash drive is connected. Damage could result.
- Some USB flash drives are susceptible to static electricity. Exercise care when using such products because static electricity could damage the USB flash drive or cause malfunction of the instrument.
- With some USB flash drives, the instrument may not start up if power is turned on while the USB flash drive is inserted. In such a case, turn power on first, and then insert the USB flash drive. It is recommended to try out operation with a USB flash drive before starting to use it for actual measurements.

NOTE

- The Flash memory in a CF card/USB flash drive has a limited operating life. After long-term usage, data storage and retrieval become difficult. In this case, replace the CF card/USB flash drive with a new one.
- We cannot provide compensation for data loss in a CF card/USB flash drive, regardless of content or cause of the damage. Furthermore, if a long time has elapsed since data was recorded to a file, the stored data may be lost. Always maintain a backup of important data stored on a CF card/USB flash drive.
- Perspective of data protection, we recommend using Hioki's optional CF card and USB flash drive. The operation of media other than Hioki's optional products is not guaranteed.

CD Handling**CAUTION**

- Always hold the disc by the edges, so as not to make fingerprints on the disc or scratch the printing.
 - Never touch the recorded side of the disc. Do not place the disc directly on anything hard.
 - Do not wet the disc with volatile alcohol or water, as there is a possibility of the label printing disappearing.
 - To write on the disc label surface, use a spirit-based felt pen. Do not use a ball-point pen or hard-tipped pen, because there is a danger of scratching the surface and corrupting the data. Do not use adhesive labels.
 - Do not expose the disc directly to the sun's rays, or keep it in conditions of high temperature or humidity, as there is a danger of warping, with consequent loss of data.
 - To remove dirt, dust, or fingerprints from the disc, wipe with a dry cloth, or use a CD cleaner. Always wipe from the inside to the outside, and do not wipe with circular movements. Never use abrasives or solvent cleaners.
 - Hioki shall not be held liable for any problems with a computer system that arises from the use of this CD, or for any problem related to the purchase of a Hioki product.
-

Overview

Chapter 1

1

Chapter 1 Overview

1.1 Product Overview and Features

This instrument is a waveform recorder that is easy to operate. It can be powered by batteries, making it quick to employ in the field in the event of trouble. The measurement data can be observed on the screen, calculated, and printed with a printer. You can also check saved data on a computer. The instrument can be connected to a computer and then controlled.

Measuring and Recording

Measure voltage and current waveforms

Optional connection cords and clamp sensors can be used to record the voltage and RMS value and measure the current of, for example, a commercial power supply.

Measure timing

Logic probes can be used to measure the timing of control signals.

Easy Setting Wizard Always Monitor Input State

Record anomalies

Abnormal events can be analyzed by recording with the trigger function (p. 110).



Schedule measurements

Measurements can be scheduled.

Saving, Reading, and File Management

Measurement data can be stored to and read from an optional CF card or USB flash drive (p. 147).

Printing

The optional printer allows you to keep the measurement results on paper (p. 165).

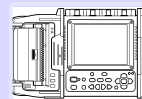

Analyzing



Gauge display (p. 134)

123.4V

Check (monitor) the current input state as a waveform and numerical values (p. 55)



Zoom in/out (p. 135)



Numerical Calculations (p. 177)



Event search (p. 141)

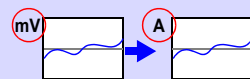

Unit conversion display (p. 97)



Cursor Measurements (p. 138)

The supplied USB cable can be used to transfer the data on a CF card or USB flash drive to a computer. The measurement data can also be analyzed in software (p. 207).



1.2 Names and Functions of Parts

Front Panel

Analog input terminals (BNC Jack)

Connect optional measurement cables or clamp sensors (p. 38).

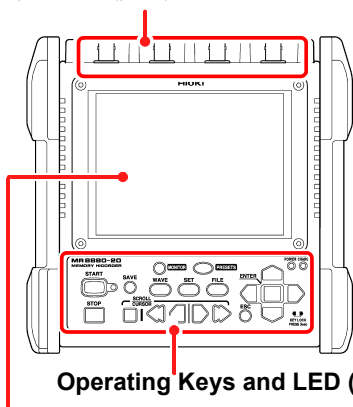

Operating Keys and LED (p. 23) **Battery Compartment Cover (p. 32)**

Display Screen (p. 24)

5.7-inch TFT color LCD

Rear Panel

Manufacturer's Serial Number

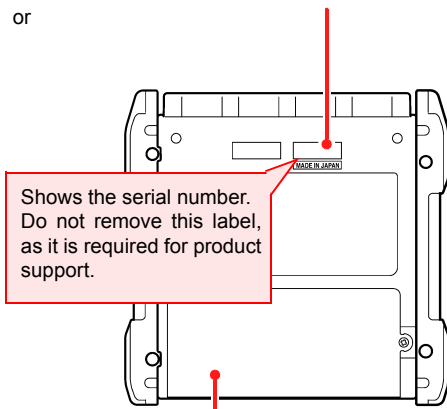

Install the supplied alkaline battery box or optional Z1000 Battery Pack in the instrument.

Right Side

AC Adapter Socket (p. 37)

Connect the supplied Model Z1002 AC Adapter.

POWER Switch

Turns the instrument on (I) and off (O) (p. 45)

USB Flash Drive Port (p. 46)

Used to save data to an USB flash drive. Insert an USB flash drive.

USB Port (p. 207) (USB 2.0 mini-B receptacle)

When you want to import the data to a computer, connect the supplied USB cable. The data saved on a CF card or USB flash drive can be transferred to a computer.

LOGIC Connector (p. 40)

Connect an optional logic probe.

External Control Terminals (p. 217)

Control signals can be received from and output to external devices.

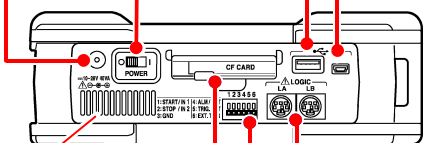

Ventilation holes
(Avoid obstructing the ventilation holes)

CF Card Slot (p. 46)

Used to save data to a CF card. Insert an optional CF card.

Operating Keys and LED

Start and stop measurement (p. 58)

■ START

Start measurement. The LED at the right lights green while measuring.

■ STOP

Stop measurement.

LED

■ POWER

Lights when the power is turned on (p. 45).

■ CHARGE

Lights when the Z1000 Battery Pack is charging (p. 36).

Saving operations

Press to save data manually

View input state

■ MONITOR

Displays the current input state as a waveform or numerical values. (The data is not recorded in internal buffer memory.)

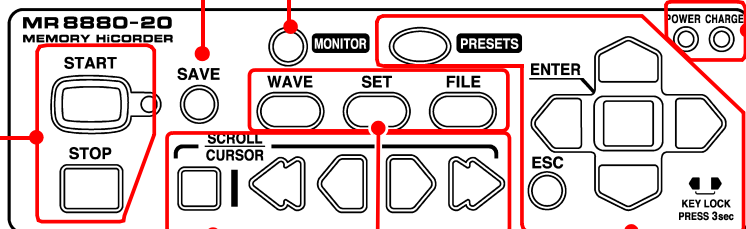

Choose a screen

■ WAVE

Switches the waveform screen display (p. 25).

■ SET

Displays the Settings screens, and switches among the screen tabs with each press (p. 26).

■ FILE

Displays file information (p. 160).

Setup and display

■ PRESETS

Allows you to set measurement conditions by following instructions on the screen.

■ ESC

Cancels changes to settings.

■ (Cursor Keys)

Moves the position of the cursor (blinking selection) on the screen.



■ ENTER

Accepts displayed settings.



■ KEY LOCK

To lock the keys, press and hold the left and right cursor keys for three seconds. Repeat to unlock (p. 62).



Scroll waveforms and read cursor values

■ SCROLL/CURSOR

Selects the application for the left and right scroll keys (waveform scrolling or cursor A/B movement).

■ (left/ right keys)

Scrolls the waveform or moves cursors A and B (p. 132).

1.3 Screen Configuration and Display

Monitor Screen

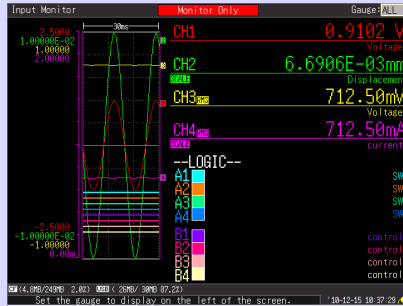

You can check the input state (p. 55).

PRESETS Screen (Setting Wizard)



Allows you to configure the settings by following instructions displayed on the screen (p. 63).

Waveform Screens

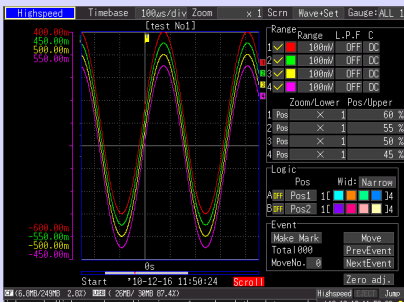

The screen switches each time you press the key (Five types) (p. 131).

[Wave+Set] Display

Check the waveform and setting information (p. 67).

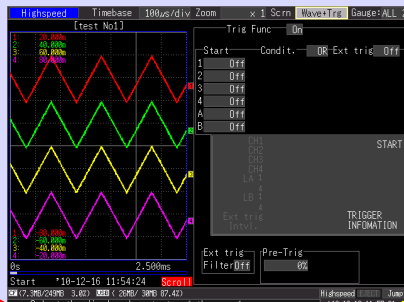

[Wave+Trg] Display

Check the waveform and trigger setting information (p. 110).

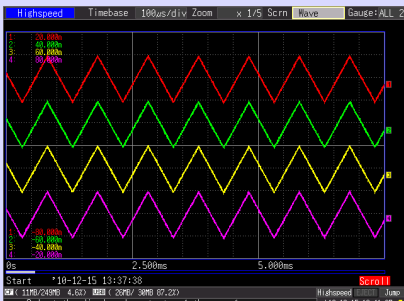

[Wave] Display

Check the waveform.

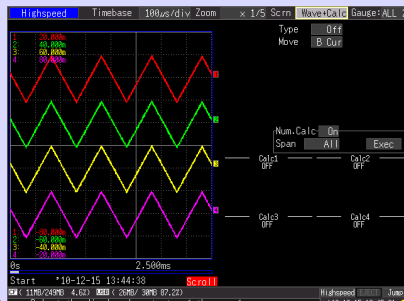

[Wave+Calc] Display

Check the waveform and calculation results (p. 177).

Operational information is displayed along the bottom of the screen.

1.3 Screen Configuration and Display

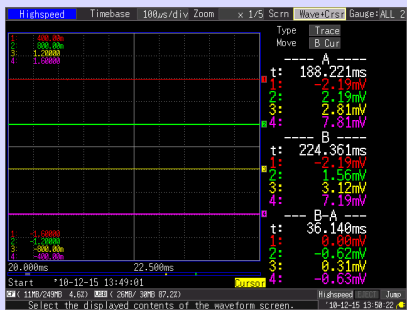

Operational information is displayed along the bottom of the screen.

[Wave+Crsr] Display

Check the waveform and cursor value. (p. 138)

Settings Screens



The screen switches each time you press the key. (Seven types)

- Setting
- CH
- ALL CH
- Trig
- Comment
- System
- Print

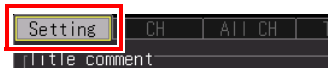

Press the left/right cursor keys to select between the Settings screens.

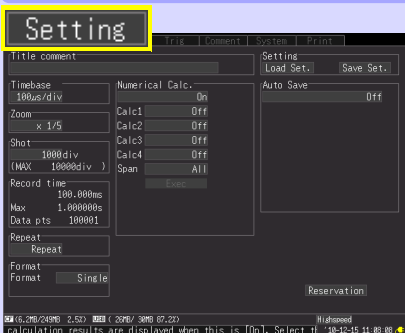

[Setting] Screen

Make settings for recording (p. 67). Set numerical calculation, auto-saving and timers.

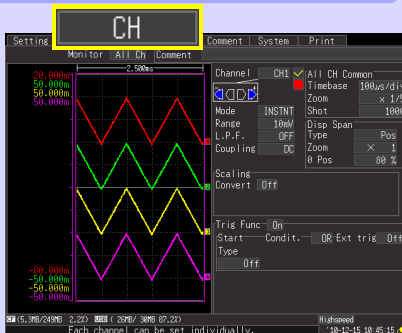

[CH] Screen

Make input channel settings while viewing the monitor display (p. 86).

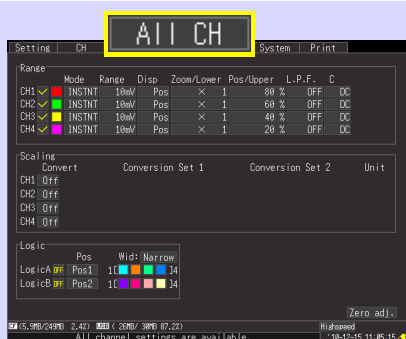
**[All CH] Screen**

Make settings while viewing all channel settings.

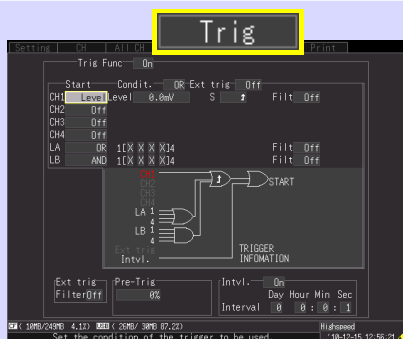
**[Trig] Screen**

Set the recording conditions (trigger function) for each input channel (p. 110).

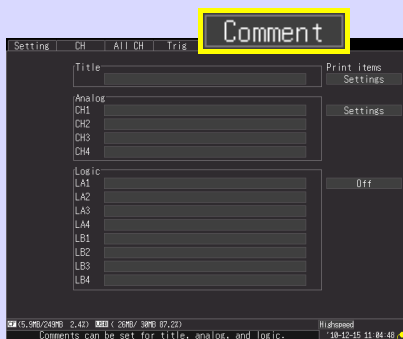
**[Comment] Screen**

Enter channel comments (p. 128).

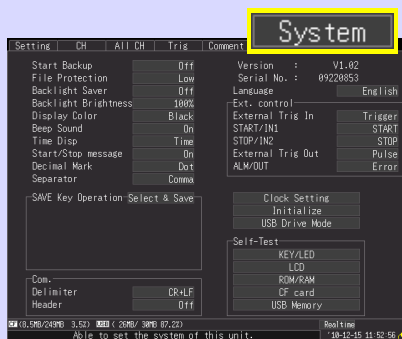
**[System] Screen**

Configure the system environment (p. 197).

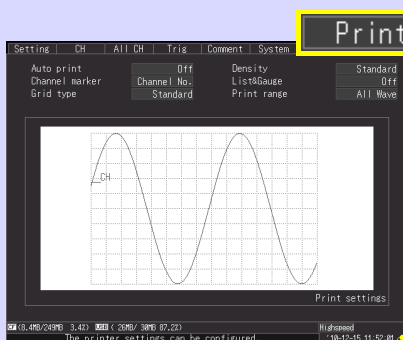
**[Print] Screen**

Set the printer settings (p. 165).

This is only displayed when an optional printer is connected.

File Screen



No.	NameA	Type	Size	Date
0001	CONFIG	Folder		*10-12-15 10:01:40
0002	DATA	Folder		*10-12-15 10:01:22
0003	MEASUREMENT	Folder		*10-12-15 10:02:12
0004	PICTURE	Folder		*10-12-15 09:46:38

Free Size 249.5MB

Back (Enter) Operating Panel Change folder

2548/2496 0.23

*10-12-15 10:19:46

File Screen

View and manage files on the CF card/USB flash drive (p. 147).

Drive name
A:/ CF Card
B:/ USB flash drive

No.	NameA	Type	Size	Date
0001	CONFIG	Folder		*10-12-15 10:01:40
0002	DATA	Folder		*10-12-15 10:01:22
0003	MEASUREMENT	Folder		*10-12-15 10:02:12
0004	PICTURE	Folder		*10-12-15 09:46:38

About the Icons

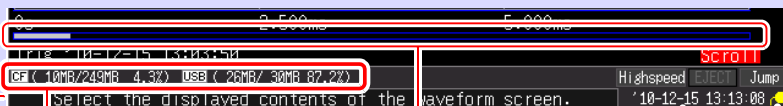
**CF card, USB flash drive**

Displayed when a CF card/USB flash drive is inserted. The icon appears red when accessing the CF card/USB flash drive.

CF (10MB/249MB 4.3%) USB (26MB/ 30MB 87.2%)

Indicates the name, space used, total size, and usage percentage of the storage media in order from the left.

State indication

Indicates the current instrument process state. Usually, displays help for the cursor item.

Storing...	
Waiting for trigger...	(Trigger wait state)
Waiting for pre-trigger...	(Before importing data. Only indicated when a trigger is set.)
Preparing...	
The reservation will be started soon.	(State when within 30 seconds before schedule starts)
Storing... (Display Past Data. 'Trace' to change Now Data)	(State in which past waveform displayed)
Storing... (Realtime Save)	
Storing... (Insert Media)	
Storing... (Change New Media)	
Storing... (Low Battery. Stopped Realtime Save)	
Calculating... Press the ESC key to abort.	
Saving waveform... Press the ESC key to abort.	
Saving calc...	
Drawing waveform... Hit ESC to stop.	(XY waveform drawing state)

Clock

"Setting the Date and Time"(p. 204)

Power source indicator

Indicates the Memory HiCorder's power source (p. 45).

	AC adapter operation
	Battery pack operation (Fully charged battery pack)
	Battery pack operation
	Battery pack operation (Low battery indicator)
	See "Battery replacement and charging timing" (p. 35)

Measurement Preparations

Chapter 2

2

Chapter 2 Measurement Preparations

- 1** Install the alkaline battery box (accessory) or battery pack (option) if necessary (p. 32).

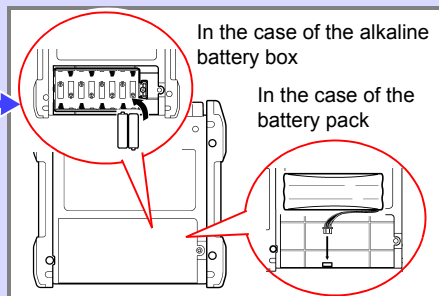

When using a printer (option) (p. 41)
Connect the printer.
Load the recording paper.

- 2** Connect the measurement cables (p. 38).

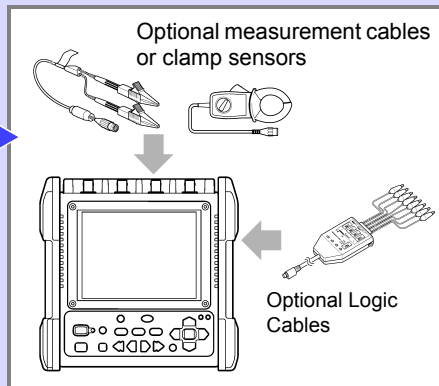

- 3** Connect the AC adapter (p. 37).

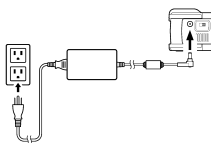

- 4** Turn the power on (p. 45).

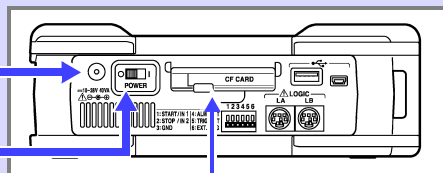

Correct the offset at the input terminals (zero adjustment) if necessary (p. 49).

To save data (p. 46)
Insert a CF card or USB flash drive

2.1 Using the Alkaline Battery Box (Accessory) or Battery Pack (Option)



When power cannot be supplied from a commercial power supply by connecting the AC adapter, the instrument can be powered by just the supplied alkaline battery box or optional Z1000 Battery Pack. Furthermore, when you are using a commercial power supply, the alkaline battery box or Z1000 Battery Pack can serve as a backup power supply in the event of a power failure.

Operating Precaution

Before installation, be sure to read "Alkaline Battery Box (Accessory) and Battery Pack (Option)" (p. 11).

When using the optional battery pack

Charge the battery pack fully before using it the first time (p. 36).

Installing the Alkaline Battery Box and Replacing the Batteries

To be required: One Phillips screwdriver (No.2), eight LR6 alkaline batteries

- 1** Turn off the instrument.
Disconnect the AC adapter and cables if they are connected.
- 2** Remove the screw from the back of the instrument, and then remove the battery compartment cover.
- 3** Connect the alkaline battery box to the connector.
Slide it toward the top the instrument until you hear a clicking sound.
- 4** Insert the alkaline battery box into the compartment.
- 5** Firmly fix the alkaline battery box in place with the screw.
- 6** Insert eight new LR6 alkaline batteries into the alkaline battery box.
- 7** Attach the battery compartment cover, and firmly fix it in place with the screw.
Make sure that the cables are not pinched.

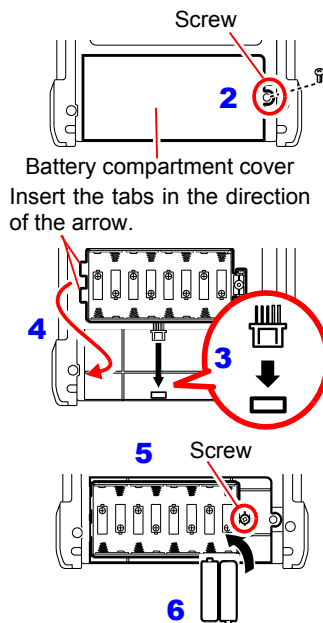

Do not mix new and old or different types of dry cell batteries.

Install the Battery Pack

To be required: One Phillips screwdriver (No.2), Z1000 Battery Pack

- 1** Turn off the instrument.
Disconnect the AC adapter and cables if they are connected.
- 2** Remove the screw from the back of the instrument, and then remove the battery compartment cover.
- 3** Connect the plug of the battery pack to the connector.
Slide it toward the top the instrument until you hear a clicking sound.
- 4** Insert the battery pack with the label surface facing up.
- 5** Attach the battery compartment cover, and firmly fix it in place with the screw.
Make sure that the cables are not pinched.

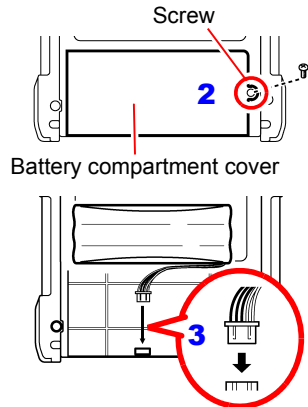

■ Approximate continuous battery-only operating time

When used at ambient temperature of 23°C after a full charge (when using battery pack) and when the LCD backlight power saving mode is OFF (initial setting)

See: "Enabling and Disabling the Backlight Saver" (p. 199)

Operation state	Alkaline Battery Box	Battery Pack
Trigger wait state, brightness 100%	Approx. 40 minutes	Approx. 3 hours
When printer operating	Not possible	Approx. 2 hours

- The above times vary depending on the type of batteries, ambient temperature, and ink coverage of the printer.
- When the printer is used, the brightness of the backlight is set automatically to **[40%]**.
- **The printer cannot be used with alkaline dry cell batteries.**
When you want to use the printer, use the Z1002 AC Adapter or Z1000 Battery Pack.

■ Battery replacement and charging timing

When the instrument is being used with batteries or a battery pack, the  mark (red) appears on the screen when the batteries are depleted or the battery power becomes low.

When using the alkaline battery box:

The batteries are depleted so replace them as soon as possible.

When using a battery pack:

Connect the Z1002 AC Adapter and charge the battery pack.

Charge the Battery Pack

Regardless of whether the Memory HiCorder is on or off, the battery pack recharges whenever the Z1002 AC Adapter is plugged in to a power source. Therefore, charging is provided by merely keeping the battery pack installed in the Memory HiCorder.

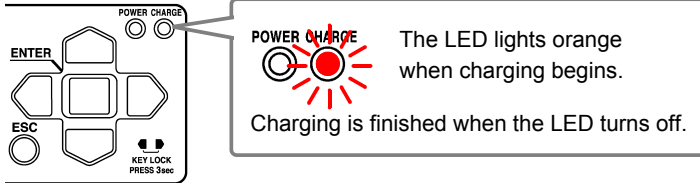

■ Approximate charging time

When charging a battery with not much remaining battery power:

Fast charge time: Approximately 3 hours

The charging LED turns off after an additional auxiliary charge of approximately 1 hour is complete.

2.2 Connecting the AC Adapter



Connect the power cord and the instrument to the supplied Model Z1002 AC Adapter, then plug the power cord into an outlet. When used with the battery pack installed, the battery serves as an operating backup supply in case of power failure, and the AC adapter otherwise has priority.

2

Chapter 2 Measurement Preparations

Operating Precaution

Before connecting the AC adapter, be sure to read "Using the AC Adapter" (p. 14) and "Handling the Cords and Cables" (p. 10).

Rated supply voltage is 100 to 240 V AC, and rated supply frequency is 50 or 60 Hz.

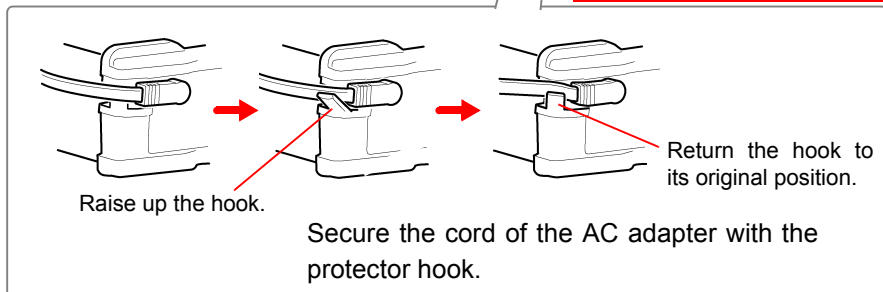
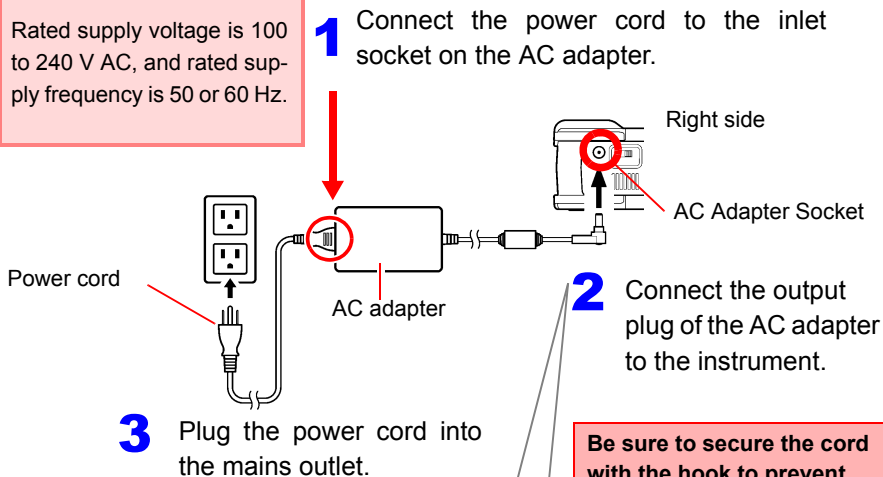

2.3 Connecting Measurement Cables to the Memory HiCorder



Connect the appropriate cables for the intended recording application.

Operating Precaution

Before connecting the cables, be sure to read "Handling the Cords and Cables" (p. 10) and "Connecting to the Terminals" (p. 15).

Connecting Connection Cords (to record voltage waveforms)

Connect an optional Hioki Connection Cord to the analog input terminals. Use the Hioki 9322 Differential Probe if the voltage of the measurement object may exceed the Memory HiCorder's maximum input voltage (p. 15).

Top of instrument

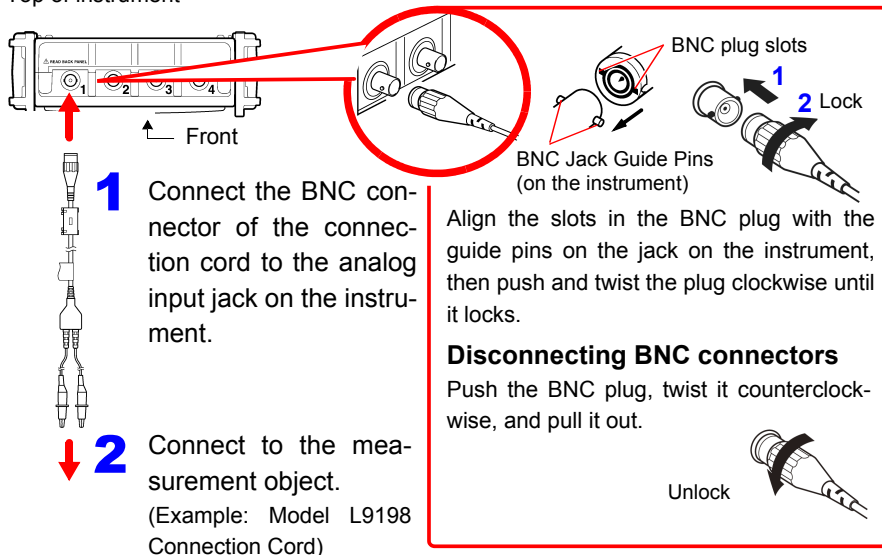

Connecting a Clamp Sensor (to record current waveforms)

Connect an optional Hioki clamp sensor to the analog input terminals. Refer to the instructions provided with the clamp sensor for usage instructions.

Top of instrument

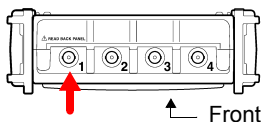

The scaling function needs to be set according to the clamp sensor model being used. Refer to "Converting Measurement Values (Scaling Function)" (p. 97) for details.

- 1 Connect the BNC plug on the clamp sensor to the analog input terminals (BNC jack) on the Memory HiCorder.

The connection method is the same as described for other Connection Cables.

(Example: Model 9018-50 Clamp-on Probe)



- 2 Clamp the sensor around the measurement object.

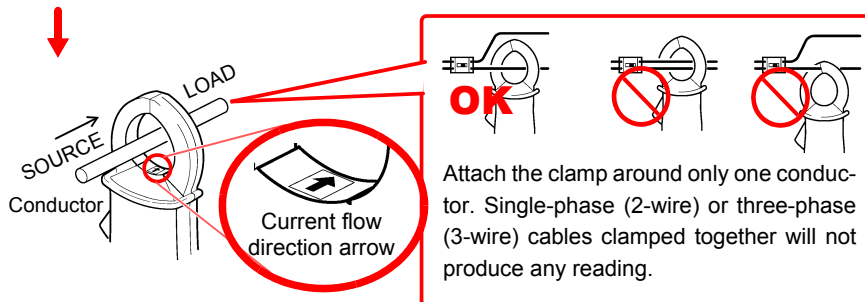

The arrows on the clamp indicating the direction of current flow should point toward the load side.

Connecting the Logic Probe (to record logic signals)

Connect the optional logic probe to the LOGIC Connector. Refer to the instructions provided with the probe.

Right Side

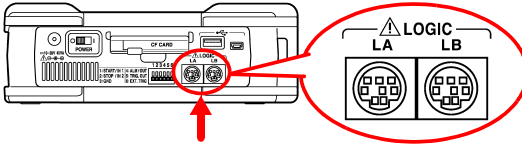

Take care to ensure the connector is oriented correctly.

- 1 Connect the logic probe by aligning the grooves on the plug and a LOGIC receptacle.

(Example: Model MR9321-01 Logic Probe)

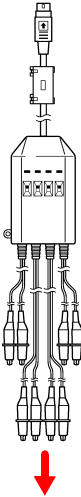

- 2 Connect to the measurement object.

When a logic probe is not connected, the corresponding logic waveform appears at HIGH level on the waveform screen.

2.4 Connecting Printer and Loading Recording Paper (Options)

Connect the optional MR9000 Printer Unit to the instrument. Usable recording paper: Hioki's optional 9234 Recording Paper (112 mm wide, 18 m roll)

See: "Loading the Recording Paper" (p. 42)

Operating Precaution

Before use, be sure to read "About the Printer" (p. 19).

Before connecting the printer

CAUTION

- Be sure to secure the printer with the screws to prevent it from dropping.
- To prevent damage to the printer cover, do not apply force to it while it is open.

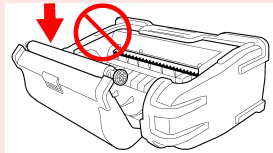

NOTE

The printer cannot be used with alkaline dry cell batteries.

When you want to use the printer, use the Z1002 AC Adapter or Z1000 Battery Pack.

Connecting the Printer

Connect the MR9000 Printer Unit to the instrument. When connecting and disconnecting the printer unit, be sure to turn the power switch OFF. Also, be sure to attach the protector when the printer is not connected.

Required items: Phillips screwdriver

Back of instrument

Printer connector

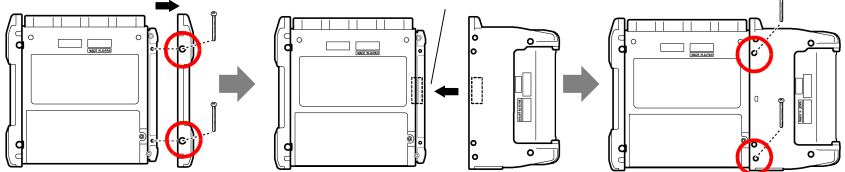

1 Use a Phillips screwdriver to remove the two screws securing the protector on the left side of the instrument, and then remove the protector.

2 Connect the printer unit.
Connect the printer to the connector properly.

3 Secure the printer in place at the back of the instrument with the two screws.

Loading the Recording Paper

Load the recording paper so that the print surface is on the underside.

Insert the rod so that it is protruding an equal amount from the left and right sides.

Press the **[LOCK]** mark in the center of the cover until you hear a clicking sound.

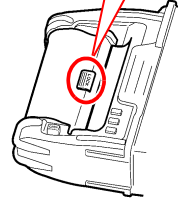
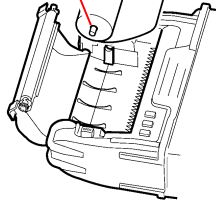
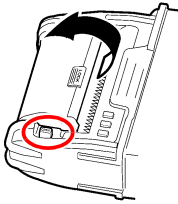

1 Press the OPEN button to open the printer cover.

2 Insert the rod through the center of the recording paper.

3 Pull the recording paper toward you, and then close the printer cover.

Tear off a section of recording paper

Paper cutter

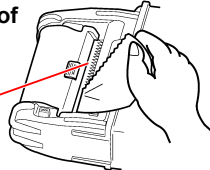

Remove any slack in the paper roll by pulling the paper straight. Slack may result in the paper becoming jammed.

About recording paper

NOTE

- Please use only the specified recording paper. Using non-specified paper may not only result in faulty printing, but printing may become impossible.
- If the recording paper is skewed on the roller, paper jams may result.
- Printing is not possible if the front and back of the recording paper are reversed.
- Make photocopies of recording printouts that are to be handled or stored for legal purposes.

Handling and Storing Recording Paper

The recording paper is thermally and chemically sensitized. Observe the following precautions to avoid paper discoloration and fading.

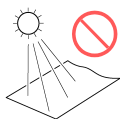

Avoid exposure to direct sunlight.



Avoid exposure to volatile organic solvents like alcohol, ethers and ketones.

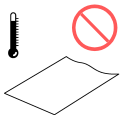

Do not store thermal paper above 40°C or 90% RH.



Avoid contact with adhesive tapes like soft vinyl chloride and cellophane tape.

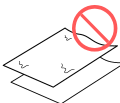

Avoid stacking with wet Diazo copy paper.

2.5 Attaching the Carrying Strap

Use the strap to avoid dropping the instrument while carrying, or when you need to hang it on a hook.

CAUTION Attach the strap securely to the strap holes in two places on the protector. If the strap is not sufficiently secure, the instrument may drop while being carried, resulting in damage.

When only instrument

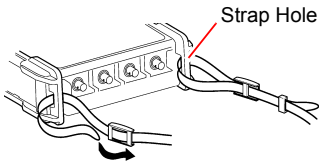

When printer attached

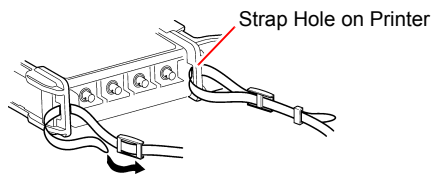

- 1 Push the strap through one of the strap holes on the instrument.

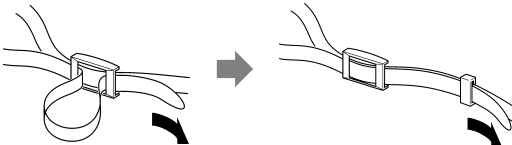

Feed the strap through the buckle so that it is tight and not twisted.

- 2 Feed the strap through the buckle.
- 3 Put the end of the strap under the retaining loop.
- 4 Repeat the same procedure with the other end of the strap and the other strap hole.

2.6 Turning the Power On and Off

Before turning on the power, be sure to read "Operating Precautions" (p. 8).

Turning Power On

Verify that the instrument and peripheral devices are correctly connected.

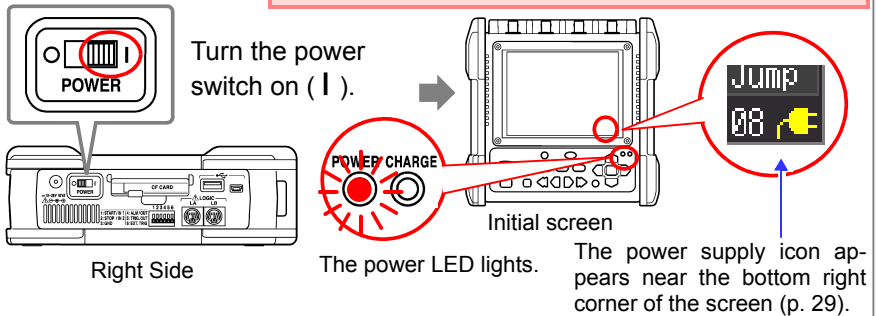

If the "  " indicator is not displayed, the instrument is not being powered from the AC line. In this state, the battery charge will be depleted if measuring for a long time, and measurement may be interrupted. Verify that the AC adapter is securely connected to an AC power source and to the instrument.

The accuracy of the instrument is guaranteed under the condition that the instrument has been warmed up for at least 30 minutes.

To ensure accuracy is met, execute zero adjustment approximately 30 minutes after turning the power on. (p. 49)

Turning Power Off

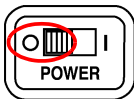

Turn the **POWER** switch off (O).

The installed battery pack is charged whenever the AC adapter is plugged into a power outlet, even when the Memory HiCorder is off. In addition, providing there is some remaining battery charge, waveform data and the setting configuration are memorized whenever the Memory HiCorder is turned off, so that when the Memory HiCorder is turned back on, the same operating state is displayed.

2.7 Using CF Card or USB Flash Drive (for Saving Data)

You can use an optional CF card (see below) and USB flash drive (see below) to save and read the data measured with the instrument.

Operating Precaution

Before using the CF card or USB flash drive, be sure to read "Using a CF Card/ USB Flash Drive" (p. 19).

Important

Use only CF cards and USB flash drive sold by Hioki. Compatibility and performance are not guaranteed for CF cards and USB flash drive made by other manufacturers. You may be unable to read from or save data to such cards.

Hioki option

(CF card + adapter) (The adapter cannot be used with the instrument.)

9727 PC Card 256M, 9728 PC Card 512M, 9729 PC Card 1G, 9830 PC Card 2G

(USB flash drive)

Z4006 USB Drive 16G

CAUTION

If the Eject button is in the released position, press it in first before inserting the CF card all the way in. Inserting the CF card when the Eject button is released may damage the instrument.

If the CF card does not go all the way in, do not force it in. Press the Eject button once to release it, then press it again and insert the CF card all the way in.

NOTE

- Perspective of data protection, we recommend using Hioki's optional CF card and USB flash drive.
- USB flash drive with security functions such as password and fingerprint authentication can not be used.
- See "6.4 Data Management" (p. 160) for details about managing data storage in the media.

CF Card Insertion & Removal

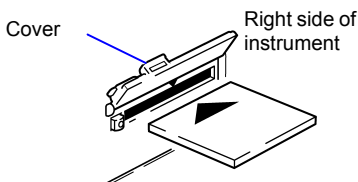

Inserting a CF card

- 1** Open the CF card slot cover.
- 2** Press the Eject button in if it is in the released position.
- 3** Face the CF card with the arrow mark on top (▲), and insert it in the direction of the arrow all the way in the slot.

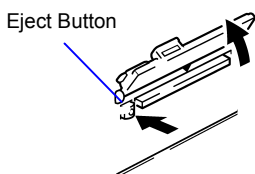

Removing a CF card

- 1** Open the CF card slot cover.
- 2** Press the Eject button (to release it).
- 3** Press the Eject button again and pull the card out.

USB Flash Drive Insertion & Removal

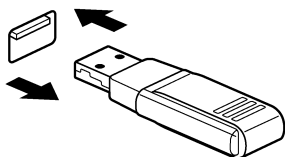

Inserting a USB flash drive

Confirm the orientation of the connection parts of the USB flash drive and USB flash drive port, and then insert the USB flash drive all the way in.

Removing a USB flash drive

Pull the USB flash drive out.

See: "Replacing CF Card or USB Flash Drive during Saving ([Realtime] only)" (p. 106)

NOTE The USB flash drive may not be recognized by the instrument depending on the USB flash drive used.

Formatting a CF Card/USB Flash Drive

This section describes how to format a CF card or USB flash drive with the instrument.

Format a new CF card of USB flash drive before use.

1  Select the File Screen.

2  Open the Control Dialog box

Control Dialog box

3  Select **[Format]**.
Apply

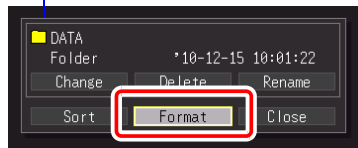

The Format Confirmation dialog appears.

4  Select **[Yes]**.
Apply

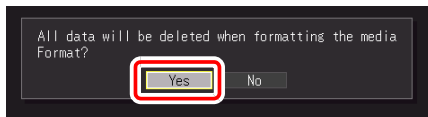

The Format Confirmation dialog appears again.

5  Select **[Yes]**.
Apply

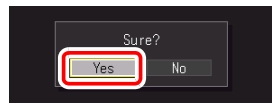

NOTE Formatting irretrievably erases all data on the CF card/USB flash drive. Always backup important data from the CF card/USB flash drive before formatting.

2.8 Compensating for Input Circuit Offset (Zero Adjustment)

Zero adjustment corrects for voltage offset at the input circuits, so that Memory HiCorder measurements are relative to zero volts.

Execute zero adjustment again after a sudden change in the ambient temperature.

- Turn on the power and wait for 30 minutes to stabilize the internal temperature of the Memory HiCorder.
- Execute the zero adjustment without any signal input. The zero adjustment with a signal input may not be executed correctly.

1  Display the Waveform screen.

2  Press and hold these keys simultaneously for one second. The Zero Adjust dialog appears.

3  Select **[Zero Adjust]**.

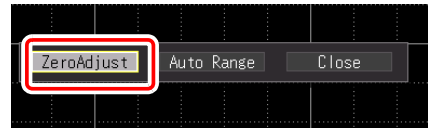

Waveform screen

Apply

Zero adjustment is executed.

Alternatively, zero adjustment can be executed from the setting items on the **[Wave+Set]** or **[All CH]** screen.

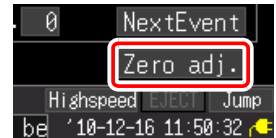

NOTE Any zero-adjust setting is cleared upon system reset (p. 204). Execute zero adjustment again after a system reset.

■ About zero position offset of analog input circuits

With this instrument, the zero position may be offset in a high sensitivity range (10-mV/div range, etc.). Furthermore, the accuracy of the instrument is guaranteed under the condition that the instrument has been warmed up for at least 30 minutes. The figure on the right shows the representative characteristics of zero position drift from immediately after the power is turned on. The changes in the zero position are relatively large for 30 minutes after the power is turned on. The existence of these characteristics means that zero adjustment must always be executed before measurements are taken. In particular, when you will take measurements for a long time or take high-precision measurements, we recommend 60 minutes of aging before executing zero adjustment.

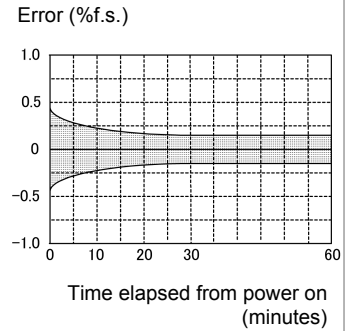

Basic Operating Procedures

Chapter 3

3.1 Pre-Operation Inspection



Before using the instrument the first time, verify that it operates normally to ensure that no damage occurred during storage or shipping. If you find any damage, contact your dealer or Hioki representative.

1 Peripheral Device Inspection

Is the insulation of the measurement cable to be used damaged, or is bare metal exposed?

Metal Exposed

No Metal Exposed
To **2**

Do not use if damage is present as you could receive an electric shock. Replace the damaged items.

2 Instrument Inspection

Is damage to the instrument evident?

Yes

If damage is evident, request repairs.

↓ No

When turning power on

Does the HIOKI logo appear on the screen?

No

The power cord may be damaged, or the instrument may be damaged internally. Request repairs.

↓ Yes

Is the Waveform screen or Setting screen displayed?
(When power is turned on the first time after purchase, the Setting screen should appear.)

Nothing appears, or the display is abnormal

The instrument may be damaged internally. Request repairs.

↓ Yes

Inspection complete

3.2 Measurement Flow

1. Preparations for Measurement (p. 31)

Before beginning the preparations, be sure to read "Operating Precautions" (p. 8) and "3.1 Pre-Operation Inspection" (p. 51).

1 Install the batteries or battery Pack (p. 32)

Rear Panel

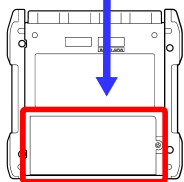

2 Connect the AC adapter (p. 37)

3 Connect the measurement cables (p. 38)

Front Panel

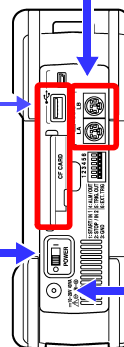
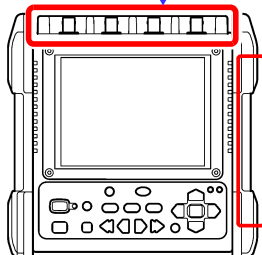

Connecting the optional Printer (p. 41)

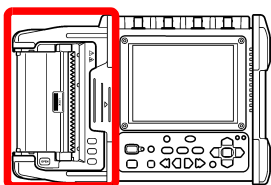

To save data

Insert a CF card/ USB flash drive (p. 46).

Right Side

Attaching the Carrying Strap (p. 44)

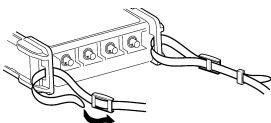

4 Turn the Power On (p. 45)



5 Connect the instrument to the measurement point

2. Viewing Input State (Monitor) (p. 55)

The current input state can be confirmed as a waveform and numerical values.

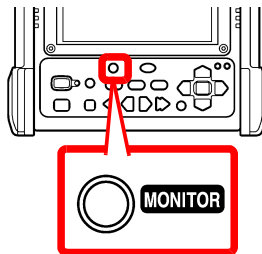
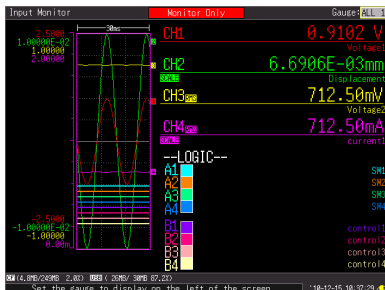

3. Settings(p. 67)

Configure the settings using the setting procedure that matches the purpose of measurement.

Configuring settings by following instructions on the screen (Easy Setup)



(p. 63)

You can configure settings by following instructions displayed on the screen.

Configuring settings individually



(p. 67)

You can configure settings by changing the values of desired setting items.

Loading setting configuration data

(p. 157)

You can configure settings by loading setting conditions saved in advance.

4. Starting and Stopping Measurement (p. 58)

Press the **START** key.



The start and stop operations differ depending on the set conditions.

See: "About Measuring Operation" (p. 59)

When recording measured data using arbitrary conditions (trigger function), measured data meeting the set conditions is recorded in the internal buffer memory so it is not displayed on the Waveform screen until the condition is met. When you want to view the current input state, you can check it on the Monitor screen (press the **MONITOR** key).

5. Data Analysis

View Measurement Data
(p. 131)

▶ Waveforms can be zoomed and numerical values confirmed.

Save Data (p. 147)

▶ Measurement data, waveform data, screen images and numerical calculation results can be saved.

Print Data (p. 165)

▶ Waveforms can be printed with the printer.

Calculate (p. 177)

▶ Numerical measurement data can be applied to calculations.

View on a Computer (p. 207)

▶ Measurement data can also be analyzed in the supplied software.

6. When Finished

Turn the Memory HiCorder Off
(p. 45)

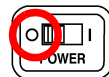

3.3 Basic Operation

Checking Input State (Monitor)

The current input state and display range can be checked on the Monitor screen regardless of whether or not measurement has started. However, the data will not be acquired to the internal buffer memory of the instrument if measurement has not started.

The Monitor screen displays the input state in accordance with the current setting conditions.

After measurement starts, the input state is not displayed on the Waveform screen until the set conditions are met (while waiting for the trigger) but you can check the input state in accordance with the current setting conditions if you switch to the Monitor screen.

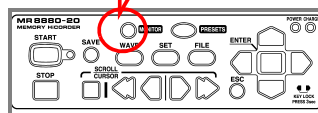

Gauge

The gauge of the channel you want to display can be selected from the setting options of **[Gauge]** on the top right of the screen.

The gauge is displayed in the set range on the CH Screen.

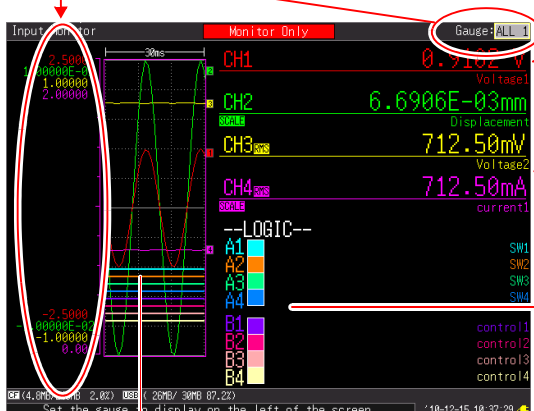

Numerical value of analog channel

Indicates the instantaneous value or effective value. (**[RMS]** is displayed beside CH only when the effective value is indicated.)

Channel comment

Instantaneous value of logic

(□ : 0, ■ : 1)

Signal currently being input

When the scaling function (conversion indication) is used, **[SCALE]** is indicated below the channel (CH) for which scaling is set.

NOTE

The input signal is displayed as follows when it exceeds the possible measurement range of the set measurement range.

- Measurement waveform: The data that exceeds the possible measurement range is displayed in white when the screen background is black, and in black when the screen background is white.
 - Measurement values: The data that exceeds the possible measurement range is indicated as "OVER."
-

Configuring Settings (Changing Settings)

The settings items can be changed.

Changing screen contents

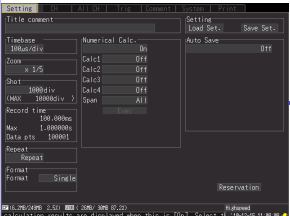

Setting Screen

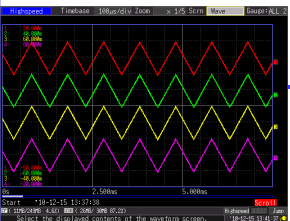

Waveform Screen

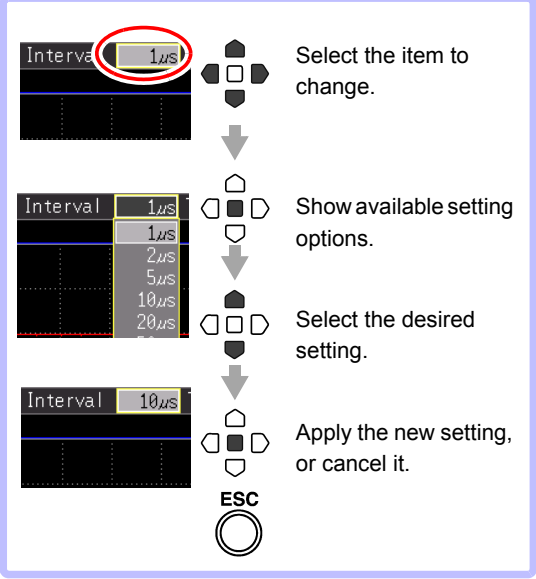

Select the item to change.

Show available setting options.

Select the desired setting.

Apply the new setting, or cancel it.

ESC

There are three procedures available for configuring the settings depending on the purpose of use.

For details, refer to each of the reference pages.

Configuring settings by following instructions on the screen (Easy Setup)



(p. 63)

Configuring settings individually



(p. 67)

Loading setting configuration data

(p. 157)

Setting configuration data can also be loaded from Setting Wizard.

Starting and Stopping Measurement

Start measurement so that the data is acquired to the internal buffer memory.

Start Measurement

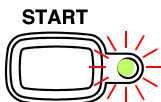

Press the **START** key.

(The green LED lights.)

[Storing...] is displayed on the screen during measurement.

When measuring using the trigger function, the timing for starting measurement and starting recording (starting acquiring of data to internal buffer memory) differs.

IMPORTANT

When the **START** key is pressed, the start confirmation message appears. (You can set the message not to be displayed (p. 201).)

If measurement is resumed after it has been stopped, the measurement data recorded to the internal buffer memory will be overwritten. Save any important data to a CF card or USB flash drive before you resume measurement.

When automatically saving data

When you want to save the data to storage media simultaneously with measurement, check the following items before you start recording.

- Are the auto save settings configured properly? (p. 102)
- Is the CF card or USB flash drive inserted properly? (p. 46)
- Is there sufficient free space on the CF card or USB flash drive? (p. A15)

Finish Measurement



When [Repeat] is set to [Single] (default setting), measurement finishes when the data is read once for the set recording length (or recording time portion).

When [Repeat] is set to [Repeat] or [Cont (Continuous Recording)] is set to [On] (Real-time Function only), press the **STOP** key to end measurement.

If you press the **STOP** key part way through measurement, the stop confirmation message appears. (You can set the message not to be displayed (p. 201).)

Select [Yes] to force measurement to stop.

About Measuring Operation

The operation differs depending on the measurement function (high speed or real time) and setting conditions.

- Press **START** key or wait until scheduled start time
- Press **STOP** key or wait until scheduled end time

Continuous Recording [Cont]	Repeat Recording [Repeat]	
	[Single]	[Repeat]
Specified *1 or Off *2		
Specified (*1 and when measurement stopped with in recording time) or Off*2		
On *2		

*1: When High-speed Function

*2: When Real-time Function

About Dead time

When **[Repeat (Repeat Recording)]** is set to **[Repeat]**: After measurement is performed for the recording length (recording time) portion, time is needed for internal processing before measurement can be resumed (dead time). Measurement is not performed during this dead time.

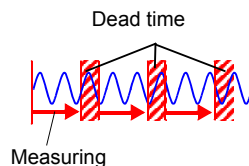

When you want to split the data into files at arbitrary times without losing any data, set **[Cont (Continuous Recording)]** to **[On]** and set **[Split Save]** of auto saving to **[On]**.

The dead time cannot be eliminated when measurement is performed with the High-speed Function. The measurement operation differs when measurement is performed using the trigger function.

Viewing Measurement Results (Scrolling Waveforms & Displaying Measurement Values)

Scrolling a waveform

- 1 Switch to **[Scroll]** display.



- 2 Scroll backward. Scroll forward.

See: "Scrolling Waveforms" (p. 132)

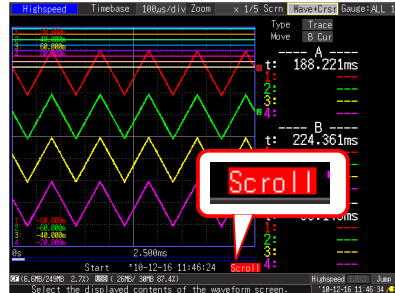

Reading values at cursors

- 1 Switch to **[Cursor]** display.



- 2 Move the A/B cursors.
Values at cursor positions can be read numerically.

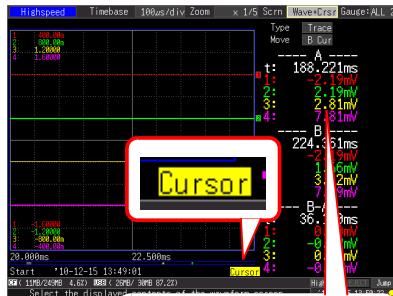

You can select the cursor display type and which cursor(s) to move (p. 138).

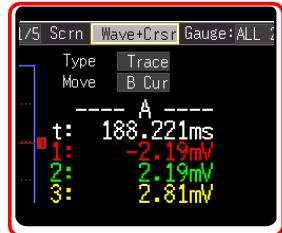

Saving Data

Measurement data, settings, screen images and numerical calculation results can be saved.

For details of the saving methods, see "Chapter 6 Managing Data" (p. 147).

(Default settings)

Saving Method: **[Select & Save]** (Press the **SAVE** key to select and save data.)

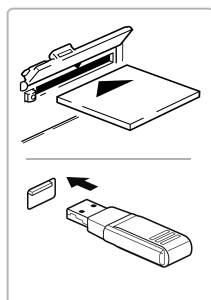

Insert a CF card (or USB flash drive).



Press the SAVE key.
(A dialog appears.)

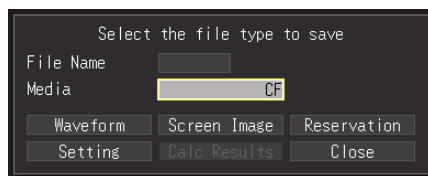

Select the items to be saved, and press the ENTER key.

Select **[Yes]** in the confirmation dialog, and press **ENTER** again.

(The data is saved to the set CF card or USB flash drive.)

Printing Data

The measurement data can be printed with an optional printer.

See: About connecting the printer and loading the recording paper
"2.4 Connecting Printer and Loading Recording Paper (Options)" (p. 41)
Various Printing Methods: "Chapter 7 Printing" (p. 165)

(When default settings)

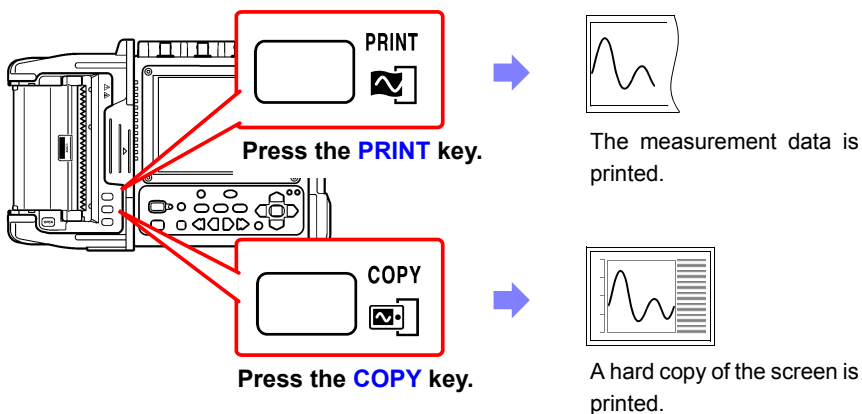

Disabling Key Operations (Key-Lock Function)

Keys can be disabled to avoid inadvertent operations.

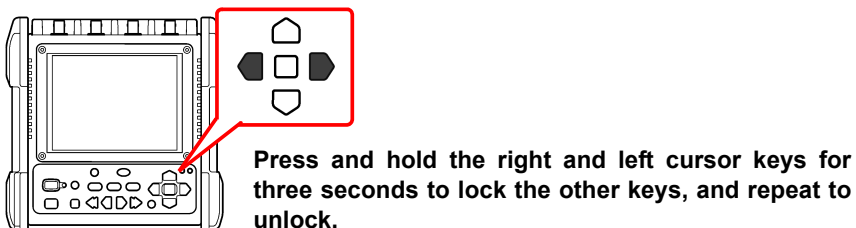

3.4 Measurement Using Setting Wizard (PRESETS key)

You can configure settings and perform measurement by following instructions displayed on the screen.

Basic Guide

Configuring settings by following instructions in Navi (p. 63)

Measurement Guide

Select application and configure settings (measurement example) (p. 64)

Loading Settings

Load setting configuration data (p. 65)

Configuring Settings by Following Instructions in Navigation (Basic Guide)

Configure the settings by following instructions displayed on the screen.

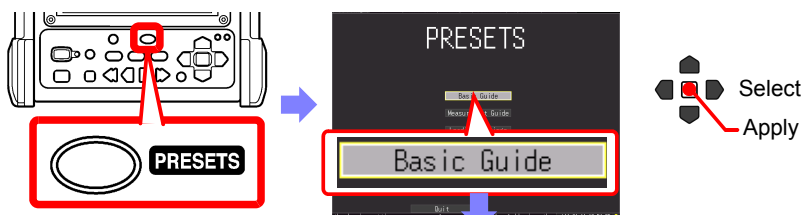

1 Set the function.

- [Highspeed]
- [Realtime]

You can check the difference between the functions on the right side of the screen.

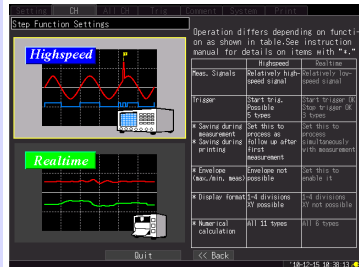

High-speed Function

Real-time function

2 Execute Auto Range.

3 Set the analog channel.

4 Set the time base range and recording length.

Set the recording interval and recording time.

3.4 Measurement Using Setting Wizard (PRESETS key)

High-speed Function

Real-time function

5 Set the trigger.

Set the start trigger.
Set the stop trigger.

6 Set the pre-trigger and repeat measurement.

Start measurement

Selecting Application and Configure Settings (Measurement Guide)

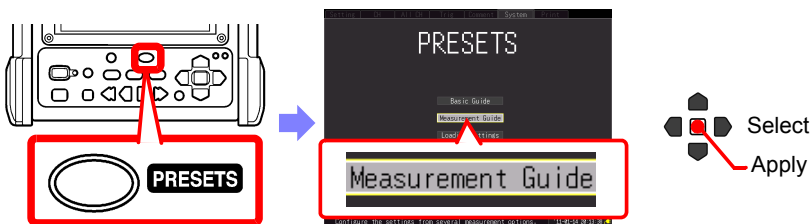

1 Select the purpose of use.

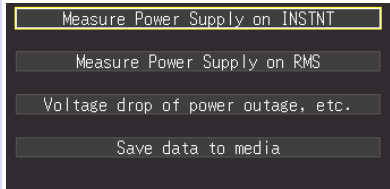

2 Configure the settings to match the setting items on the screen.

See: Other screens (p. 65)

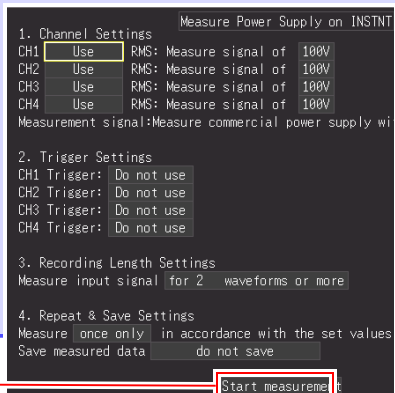

Start measurement

Examples of other settings screens [Measurement Guide]

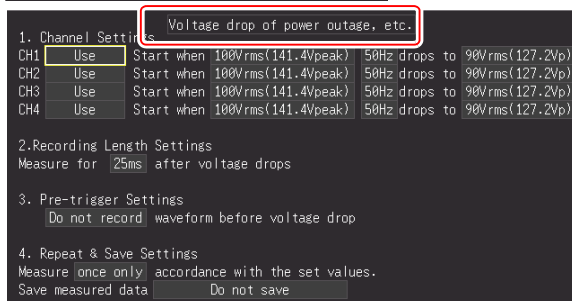
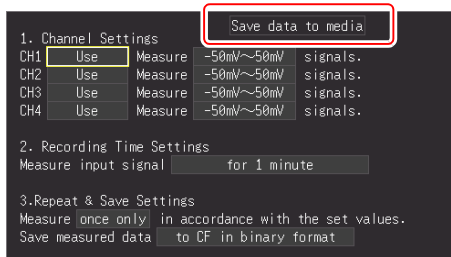
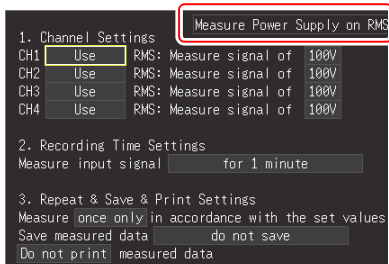

Loading Setting Configuration Data



1 Select the load destination.

2 Select the data to load from the list.

Load the data

- NOTE**
- With PRESETS, all settings are applied by performing a series of operations to the end.
 - Once you switch to the PRESETS screen, the settings of some items will be cleared if you cancel the setup procedure in the PRESETS screen part way through.

Setting the Measurement Conditions

(When you want to customize the settings)

Chapter 4

4.1 Flow of Configuring Settings Individually

Configuring settings individually



Load the setting configuration data (p. 157)

Setting configuration data that has been saved in advance to the instrument or a CF card/USB flash drive can be loaded.

Setting the Recording Conditions (p. 68)

Setting

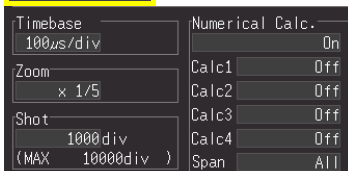

- Select the function (p. 68)
[High speed]: Instantaneous recording (p. 70)
[Real time]: Fluctuation recording (p. 78)
- Set the horizontal axis (data acquisition interval or recording interval).
- Set the length (or time) for recording.
- Select whether to repeat recording.

Setting the Input Channel (p. 86)

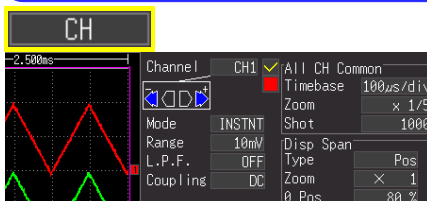

- Set the vertical axis (measurement range).
- Configure the other settings as necessary.

Setting Specific Conditions (p. 110)

Trig

When you want to use specific conditions to record, for example, abnormal phenomenon

Setting Saving (p. 147)

Setting

When you want to save automatically after measurement starts

4.2 Recording Methods (Measurement Functions)

As recording methods, the instrument has two measurement functions, high speed and real time. The internal processing for saving and printing and the setting items on the measurement screen differ depending on the function.

High-speed Function [Highspeed]

Select this function when you want to, for example, measure waveforms that change at high speed (instantaneous waveforms) and unexpected transient phenomena as you would with an oscilloscope.
Just the necessary measurement data can be saved and printed after measurement.

This measurement function is equivalent to the Memory Recorder function of previous Hioki Memory HiCorder models.

Real-time Function [Realtime]

Select this function when you want to, for example, measure fluctuations in low-speed phenomena and fluctuations in the effective value of a power supply over a long period of time as you would with a pen recorder or data logger.
Recording, saving, and printing can be performed simultaneously with measurement*.

This measurement function is equivalent to the Recorder function of previous Hioki Memory HiCorder models.

(*). Printing may not be possible at the same time depending on the setting for the horizontal axis.

The measurement function can be set on the Waveform screen and Setting screen of the instrument.

Waveform screen

[Setting] screen

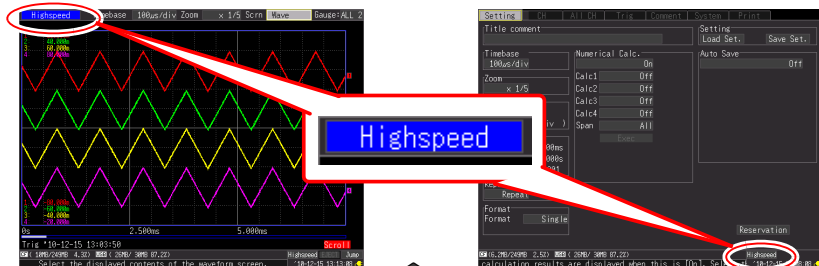

Change the function

(Open/confirm the setting information.)

Differences in operation by function

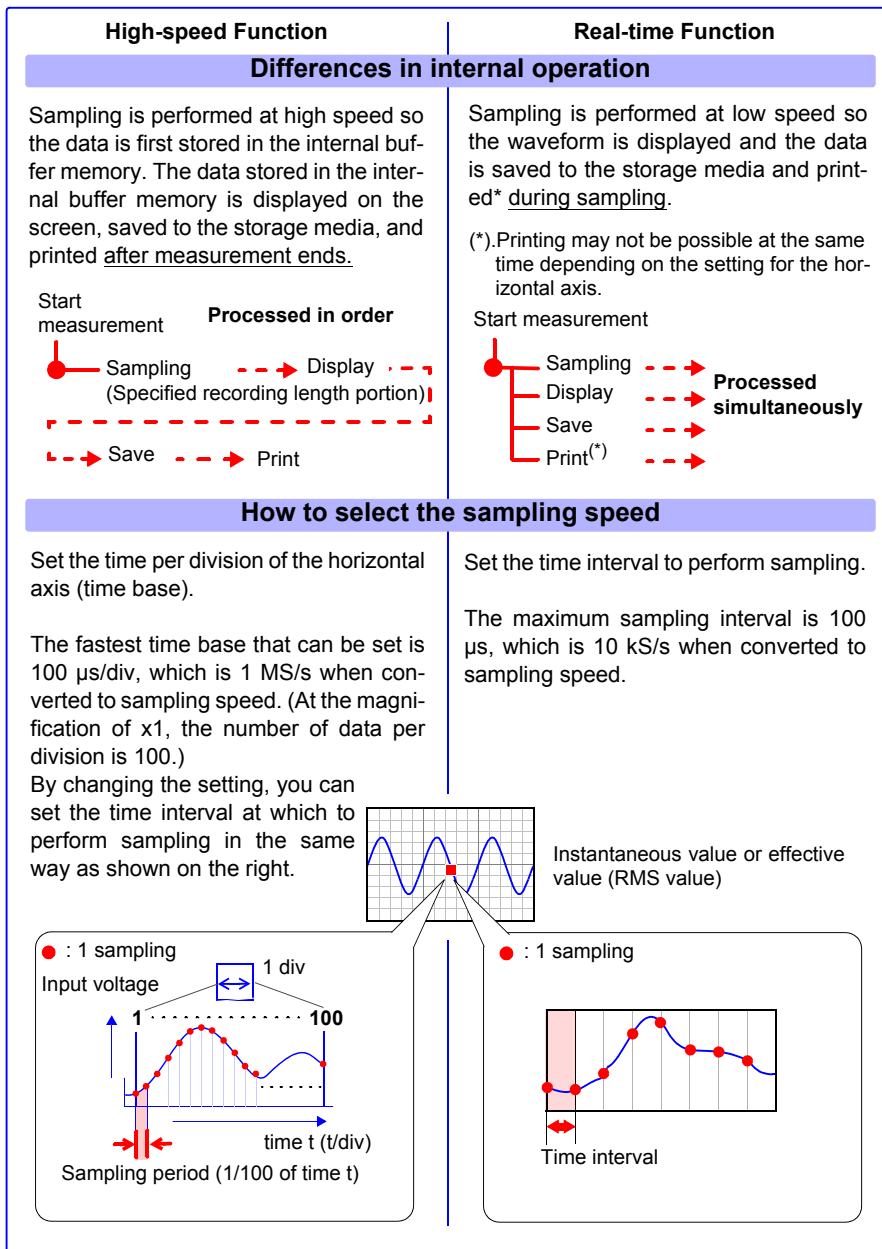

4.3 Using High-speed Function (Instantaneous Recording)

This function is suitable for recording, for example, instantaneous waveforms of a power supply and the starting current of a motor.

Set the recording conditions on the **[Setting]** screen.

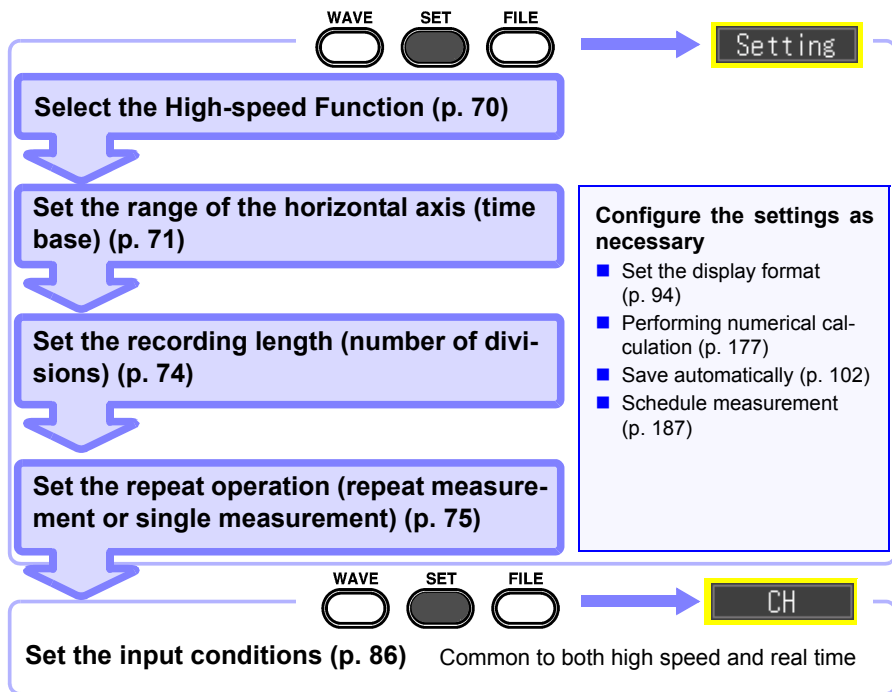

Selecting the Function (High-speed Function)

Display the setting screen for the High-speed Function.

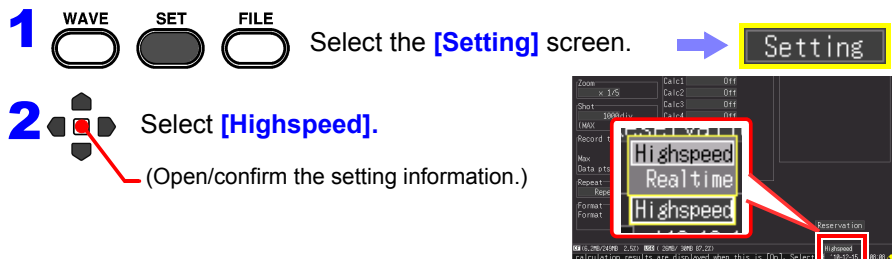

Setting the Horizontal Axis (Time Base Range)

Two setting procedures are available: setting the time per division of the horizontal axis and setting the data acquisition interval.

- When setting the time per division of the horizontal axis

The data of 100 samples is included in 1 division.
(When the magnification is x1)

Sampling rate = timebase (seconds/div)/100 (data samples/division)

- When setting the data acquisition interval (p. 72)
(It is possible to switch to the same setting procedure as for the Real-time Function.)

Select the recording interval that matches the measurement target. If a short recording interval is selected, the recording time for which data can be stored in the internal buffer memory will be short.

Time per division

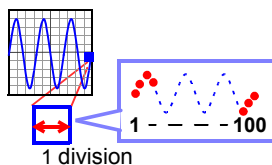

Data acquisition interval

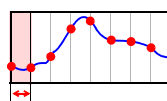

Set the time per division



Select the **[Setting]** screen. →



Select from the setting options of **[Timebase]**.

(Open/confirm the setting information.)

Setting options (*. default setting)

100*, 200, 500 μ s [div]
1, 2, 5, 10, 20, 50, 100 ms [div]

- Decreasing the timebase increases the resolution of data available for analysis.

See: "Selecting a Timebase (Horizontal Axis)" (p. A19)

- When the product of the timebase multiplied by the display magnification is greater than 50 ms, waveforms can be automatically scrolled on the display while measuring (the Roll Mode display function).

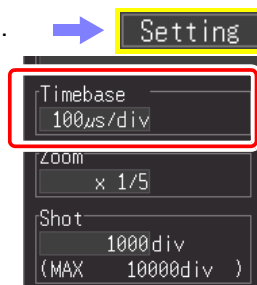

The setting can also be changed on the Waveform screen. ([Wave+Set] Display)





4.3 Using High-speed Function (Instantaneous Recording)

Set the data acquisition interval

1  Select the [Setting] screen. 

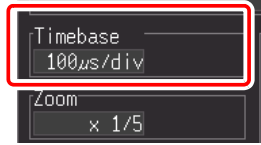
2  Press the **ENTER** key at the [Timebase] position. Select from the setting options of [Interval].



3  Select from the setting options of [Interval].
(Open/confirm the setting information.)

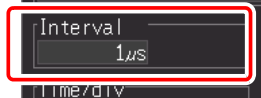

Setting options (*. default setting)

- 1µs*, 2µs, 5µs, 10µs, 20µs, 50µs, 100µs, 200µs, 500µs, 1ms

The setting can also be changed on the Waveform screen. ([Wave+Set] Display)



■ Recording Interval and Waveform Peak

The waveform peak may not be able to be recorded depending on the setting for the recording interval.

Example: When the recording interval is set to 1 ms, a state in which the waveform peak cannot be recorded is displayed.

The peak cannot be acquired.
Recording interval: 1ms

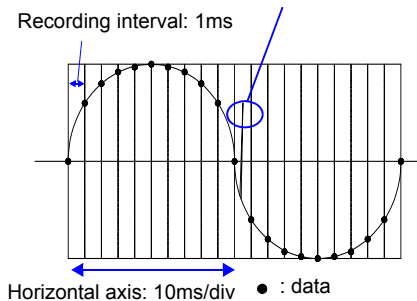

■ Recording Interval and Selection Range

●: Selectable, X: Not selectable

Horizontal axis (/div)	Interval									
	μs									ms
	1	2	5	10	20	50	100	200	500	1
10 μs	●	X	X	X	X	X	X	X	X	X
20 μs	●	●	X	X	X	X	X	X	X	X
50 μs	●	●	●	X	X	X	X	X	X	X
100 μs	●	●	●	●	X	X	X	X	X	X
200 μs	●	●	●	●	●	X	X	X	X	X
500 μs	●	●	●	●	●	●	X	X	X	X
1 ms	●	●	●	●	●	●	●	X	X	X
2 ms	●	●	●	●	●	●	●	●	X	X
5 ms	●	●	●	●	●	●	●	●	●	X
10 ms	●	●	●	●	●	●	●	●	●	●
20 ms	●	●	●	●	●	●	●	●	●	●
50 ms	●	●	●	●	●	●	●	●	●	●
100 ms	●	●	●	●	●	●	●	●	●	●
200 ms	●	●	●	●	●	●	●	●	●	●
500 ms	●	●	●	●	●	●	●	●	●	●
1 s	●	●	●	●	●	●	●	●	●	●
2 s	●	●	●	●	●	●	●	●	●	●
5 s	●	●	●	●	●	●	●	●	●	●
10 s	●	●	●	●	●	●	●	●	●	●
30 s	●	●	●	●	●	●	●	●	●	●
1 min	●	●	●	●	●	●	●	●	●	●
2 min	●	●	●	●	●	●	●	●	●	●
5 min	●	●	●	●	●	●	●	●	●	●
10 min	●	●	●	●	●	●	●	●	●	●

4.3 Using High-speed Function (Instantaneous Recording)

Setting Recording Length (no. of divisions)

Set the recording length in units of display divisions.

Recording time = timebase (s/div) x recording length (div)

An arbitrary value up to 10,000 can be set.

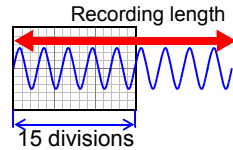

1 **WAVE** **SET** **FILE** Select the **[Setting]** screen.



2 Select from the setting options of **[Shot (recording length)]**.
(Open/confirm the setting information.)

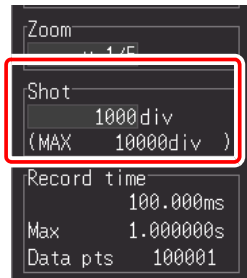

- **When the setting procedure for the horizontal axis is set to time per division:**

Set the recording length for acquiring the waveform.

Setting options

5 to 10,000 div (Settable in 5-division steps)
(default setting): 15



 Increases or decreases the value in increments of 5.  Increases or decreases the value in increments of 100.

- **When the setting procedure for the horizontal axis is set to data acquisition interval:**

Set the number of data for acquiring the waveform.

Setting options

500 to 1,000,000
(default setting): 1,500

 Increases or decreases the value in increments of 500.  Increases or decreases the value in increments of 10,000.

Set the Recording Length for Repeated or One-time Recording

Set recording to be performed once or repeatedly for the set recording length portion.

If you want to record only when the desired conditions are met, the trigger settings also need to be configured.

Repeated recording

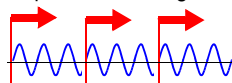

Recording only once

See: "4.9 Recording Using Specific Conditions (Trigger Function)" (p. 110)

1  Select the **[Setting]** screen. → 

2  Select from the setting options of **[Repeat]**.

(Open/confirm the setting information.)

Setting options (*. default setting):

Single *	Records once only and then ends.
Repeat	Records repeatedly until the STOP key is pressed. When a trigger is not applied, the waiting for trigger state will be restored. When the trigger is off, the next recording starts automatically. See: "About Measuring Operation" (p. 59)

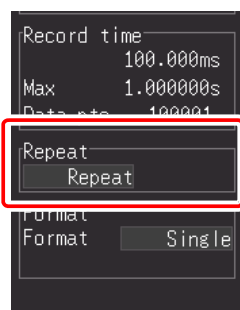

Configuring Settings Automatically (Auto Range)



Auto Range can only be set when the High-speed Function is used.

When you do not know how to determine the range for the input signal, you can set the range automatically (Auto Range) on the Waveform screen or [CH] screen or in Setting Wizard (using the **PRESETS** key).

Furthermore, the instrument can be set by loading setting configuration data saved to the instrument or a CF card (when inserted). (p. 157)

Auto Range from the Waveform Screen

- 

Select the Waveform Screen.
-  (Simultaneously)
 Press and hold together for one second.
 A dialog appears.
- 

Select **[Auto Range]**.
 Apply

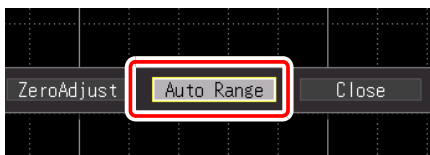



When [Auto Range failed] appears.

If the voltage level of the input signal is low, it may not be possible to determine a suitable range. In this case, configure the range settings manually from the Setting screen while watching the waveform monitor.

Selecting Auto Range on the Setting Screen

(Also Settable in Setting Wizard using the **PRESETS** key)

- 

Select the **[All CH]** screen. →
- 

Select **[Zero adj.]**.
 Apply
 A dialog appears.
- 

Select **[Auto Range]**.
 Apply



If you follow the instructions in the dialog box, the range will be set to match the input waveform.

Auto Range Settings

Setting Item		Settings
[Timebase](*)	Timebase	Auto setting value Automatically displays 1 to 2.5 cycles on the Waveform screen.
[Zoom]	Zoom (magnification)	x1
Settings for CH1 to CH4		
[Mode]		Instantaneous value
[Range]	Voltage-axis range	Auto setup value
[0 Pos]	Zero position	Auto setup value
[Zoom]	Zoom (magnification)	x1
[L.P.F.]	Low-pass filter	Off
[Coupling]	Input coupling	DC
Trigger Criteria		
[Repeat]	(Setting screen)	Repeat
[Condit.]		OR
[Pre-Trig]		(20%)
[Start](*)	Trigger	Level trigger
[S]	Slope	↑
[Level]	Trigger Level	Auto setup value
[Filt]	Filter	Off

(*): Check whether the difference between the maximum value and minimum value of the input signal is 3 divisions or more from CH1 while display is on, and set the time base range and trigger using the signal of the corresponding channel as the reference.

NOTE Executing Auto Range generates a trigger signal on the trigger output external control terminal. Bear this in mind when using the trigger output terminal and the Auto Range function.

4.4 Using Real-time Function (Fluctuation Recording)

This function is suitable for monitoring the control voltage, recording fluctuations in the effective value of a power line, etc. over a long period of time. Set the recording conditions on the **[Setting]** screen.

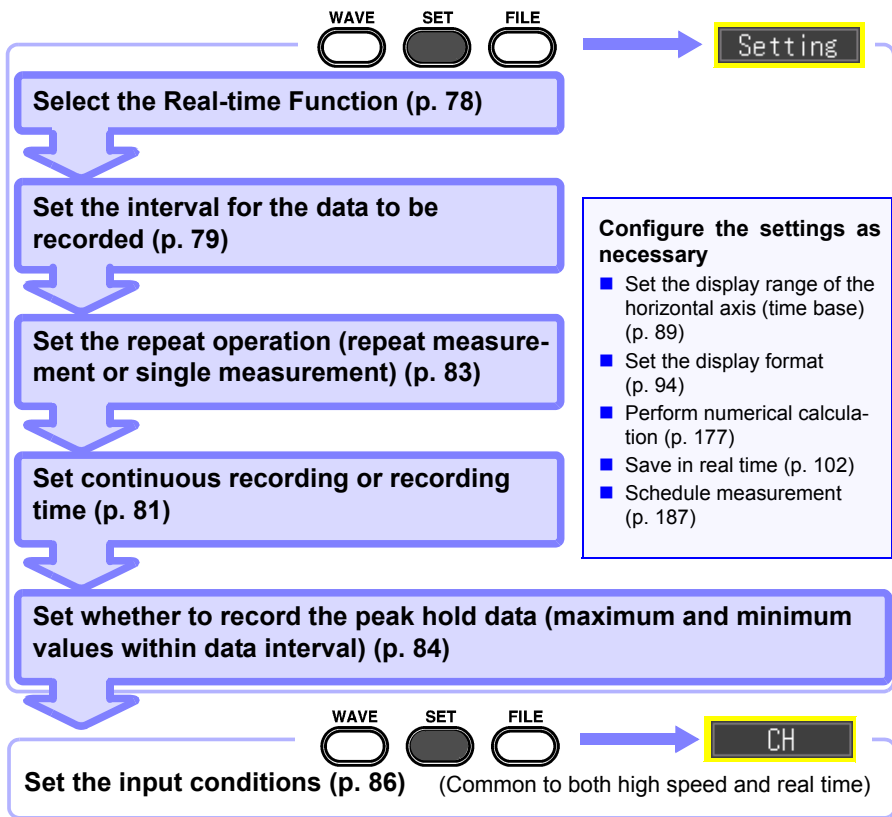

Selecting the Function (Real-time Function)

Display the setting screen for the Real-time Function.

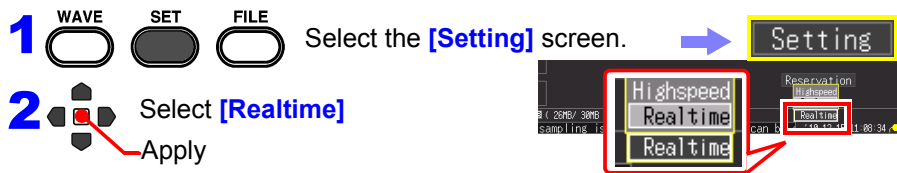

Setting the Interval for the Data to Record (Recording Interval)

Set the interval for acquiring data

Select the data acquisition interval to suit your measurement objectives.

If a short recording interval is selected, the recording time for which data can be stored in the internal buffer memory will be short. If you want to retain the data for a long period of time, we recommend setting continuous recording to **[On]** and saving in real time to external storage media.

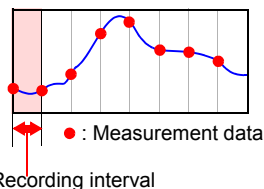

1 **WAVE** **SET** **FILE** Select the **[Setting]** screen.

2 Select from the setting options of **[Interval]**.
(Open/confirm the setting information.)

Setting options (*. default setting)

100 μ s*, 200 μ s, 500 μ s,
1ms, 2ms, 5ms, 10ms, 20ms, 50ms, 100ms, 200ms,
500ms, 1s, 2s, 5s, 10s, 20s, 30s, 1min

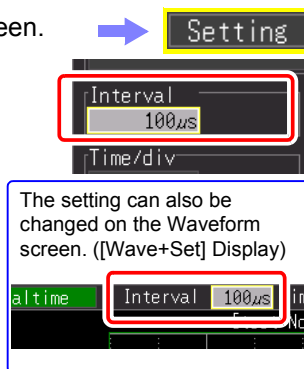

The setting can also be changed on the Waveform screen. ([Wave+Set] Display)

Recording Interval and Waveform Peak

Some waveform peaks may not be displayable with certain interval settings.

Example: When the recording interval is set to 1 s and the horizontal axis is set to 5 s/div, a state in which the waveform peak cannot be recorded is displayed.

To make sure the peak is recorded:

"Retaining Records of Maximum and Minimum Values (Envelope)" (p. 84)

Recording interval: 1s Peak

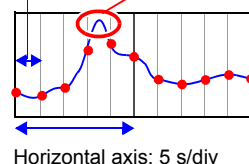

NOTE If real time saving, [Envelope] function, and [Numerical Calc.] are set at the same time, the recording interval cannot be set to 100 μ s and 200 μ s.

Setting the Recording Time

Specify how you want recording to start and stop. The following methods are available.

- Recording continuously:
Record continuously from when recording is started until when the **STOP** key is pressed or the stop condition is met.
- Recording for specified recording time:
Record for only the specified amount of time. Recording can also be repeated each time the specified time ends (p. 126).

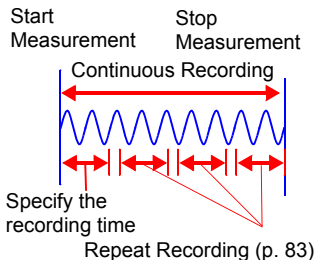

Recording continuously

1    Select the **[Setting]** screen.

2  Enable continuous recording (set **[Cont]** to **[On]**).
(Open/confirm the setting information.)

When measurement data is saved automatically, the save method will differ depending on the **[Deleting]** (Delete while Saving) and **[Split Save]** settings.

See: "4.7 Setting Automatic Saving" (p. 102)

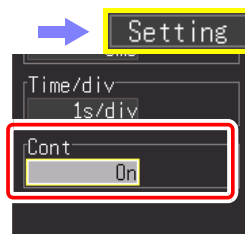

4.4 Using Real-time Function (Fluctuation Recording)

Recording for Specified Recording Time

1  Select the **[Setting]** screen. 

2  Set **[Cont]** to **[Off]**.
(Open/confirm the setting information.)

3 Specify the duration of one recording length (time span).

Setting options (*. default setting)

d (days) (0 to 694), h (hours)(0 to 23),
min (minutes) (0 to 59), s (seconds) (0 to 59)

- Recording proceeds for the specified length. Recording stops early if you press the **STOP** key before the recording length has elapsed, or if a "stop trigger" event occurs.
- When continuous recording OFF, the maximum recording time is limited by the capacity of the internal buffer memory.

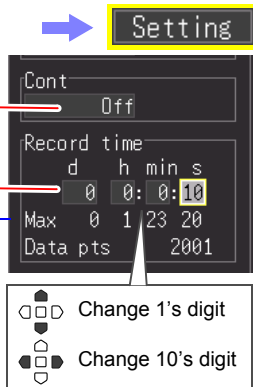

Maximum recording length and data samples

Indicates the maximum recording time to internal buffer memory, and the maximum number of data samples. These values are limited by the Recording Interval (p. A16).

Setting the Repeat Operation (Repeat Measurement or Single Measurement)

Set whether to resume recording after recording for the set recording time or when the condition for stopping recording using the trigger function is met (stop trigger condition is met).

This can only be set when **[Cont (Continuous Recording)]** is set to **[Off]**.

Repeated recording

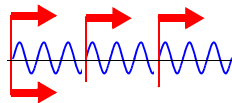

Records one time

1 **WAVE** **SET** **FILE** Select the **[Setting]** screen.

2 Select from the **[Repeat]** setting items.

(Open/confirm the setting information.)

Setting options (*. default setting)

Single*	Records one time and stops.
Repeat	Recording restarts after the specified recording length has elapsed or after recording is stopped by a "stop trigger" event. To manually stop recording, press the STOP key. See: "About Measuring Operation" (p. 59)

→ **Setting**



Retaining Records of Maximum and Minimum Values (Envelope)

The maximum and minimum values within the recording interval are calculated from data oversampled at maximum sampling speed (1 MS/s), and recorded for each recording interval. Therefore, recording without missing the peak of fluctuation will be possible even if a long recording interval is set.

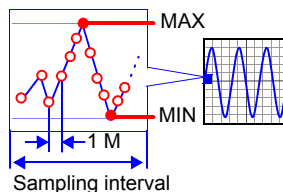

(*): Sampling is the acquiring of the data to be saved

to the internal buffer memory. Oversampling is the acquiring of data at a higher speed than when data is acquired to the internal buffer memory (sampling). Over-sampled data is not saved.

1 **WAVE** **SET** **FILE** Select the **[Setting]** screen. → **Setting**

2 Select from the setting options of **[Envelope]**.
(Open/confirm the setting information.)

Setting options (*. default setting)

On	Records the maximum value and minimum values within the sampling interval.
Off*	Records instantaneous data of each sampling interval.

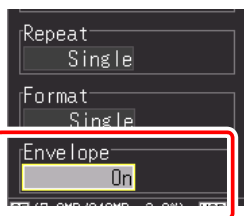

■ Envelope Values

One sampling data for during [Envelope] recording consists of two data items, the maximum value and minimum value, of the measurement values obtained as a result of performing oversampling during the set recording interval.

When displaying them on the screen or printing them with the printer, they will be displayed or printed as a shaded band.

When saved to external storage media, the two data items, the maximum value and minimum value, are saved for one measurement time.

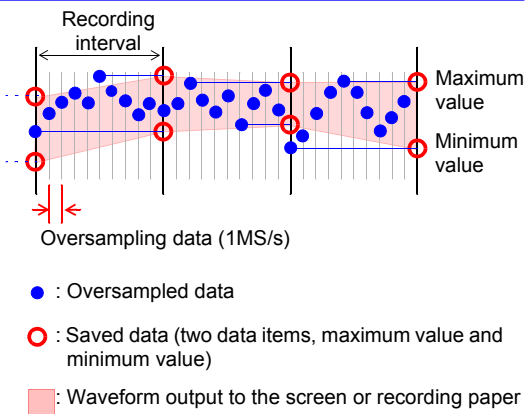

NOTE If real-time saving, [Envelope] function, and [Numerical Calc.] are set at the same time for the Real-time Function, the recording interval cannot be set to 100 μ s and 200 μ s.

4.5 Setting the Input Conditions

Configure the input channel settings on the [CH] screen. You can configure various settings while viewing the monitor display on the Setting screen.

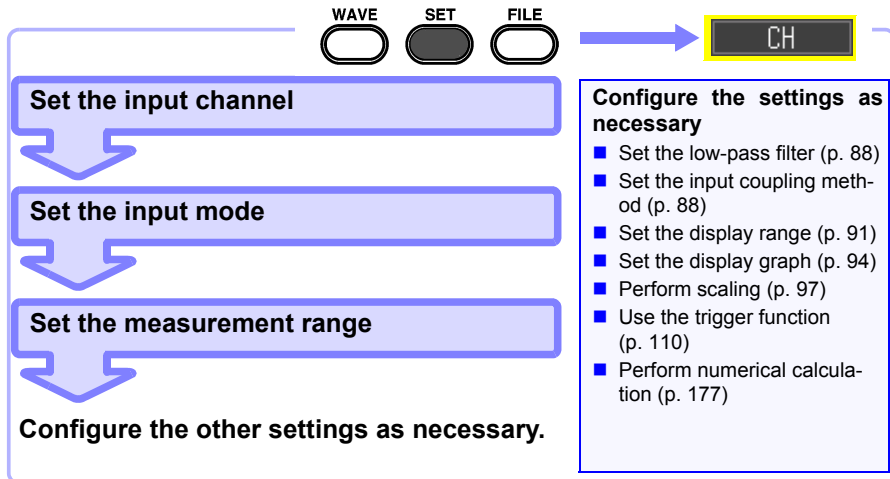

Setting the Input Channel (Instantaneous Value/Effective Value & Measurement Range)

This section describes the minimum required settings for measurement.

The input channel mode (instantaneous value/effective value recording) and measurement range need to be set before measurement. Change the settings of other setting items as necessary.

NOTE

- The frequency range for effective values that can be measured with the instrument is 30 Hz to 10 kHz. An effective value of a frequency that is out of this range cannot be measured correctly.
- When effective value measurement is performed, the response time becomes long if the input voltage is 10% f.s. or less. We recommend configuring the setting so that the input voltage becomes 10% f.s. or more.
- The input signal is displayed as follows when it exceeds the possible measurement range of the set measurement range.
Measurement waveform: The data that exceeds the possible measurement range is displayed in white when the screen background is black, and in black when the screen background is white.
Measurement values: The data that exceeds the possible measurement range is indicated as "OVER."

1  Select the [CH] screen.

2  Select the channel to set from [Channel].

(Open/confirm the setting information.)

In the following steps, use the same operation to configure settings.

3 Select the type of value to record from [Mode].

Setting options (*. default setting)

INSTNT*	Records instantaneous values.
RMS	Records effective values.

NOTE When an effective value is selected, the input coupling automatically becomes [AC]. ([DC] cannot be selected.)

4 Select the appropriate measurement amplitude range from [Range].

Setting options (*. default setting)

10*, 20, 50, 100, 200, 500 mV,
1, 2, 5, 10, 20, 50, 100 V [div]

The measurable effective range is up to ± 10 times of the range. (However, for 100 V/div, the maximum input voltage is up to 600 V AC/DC.)

When you want to view all of the channel setting information

You can check the information on the [All CH] screen.

When you do not want to display the waveform of a specific channel

Set the channel display setting to Off (clear the check).

If the channel setting is set to Off, the following items are not applicable. However, the trigger is accepted because measurement is performed.

Waveform display, printing, data saving, and data calculation

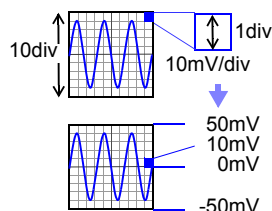
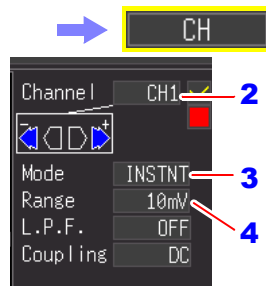

Voltage value per division in the vertical axis direction

The setting can also be changed on the Waveform screen. ([Wave+Set] Display)

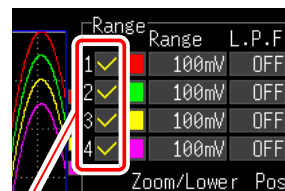

Selecting a Low-Pass Filter (L.P.F.)

When you want to eliminate excess high-frequency components such as frequencies higher than the waveform you want to measure, select a cut-off frequency.

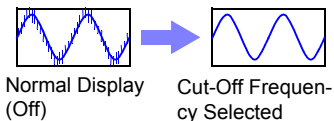

1 Select the **[CH]** screen.



2 Select from the setting options of **[L.P.F.]**.

(Open/confirm the setting information.)

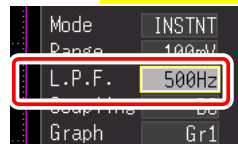

Setting options (*. default setting)

Off*, 5Hz, 50Hz, 500Hz, 5kHz, 50kHz

The setting can also be changed on the Waveform screen. ([Wave+Set] Display)

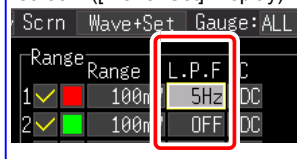

Selecting the Input Coupling Method

Select the coupling method for input signals.

1 Select the **[CH]** screen.

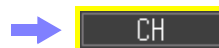

2 Select from the setting options of **[Coupling]**.

(Open/confirm the setting information.)

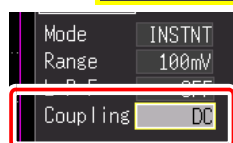

Setting options (*. default setting)

DC*	DC Coupling Select this to acquire both DC and AC components of an input signal.
GND	The input signal is disconnected. Zero position can be confirmed.

The setting can also be changed on the Waveform screen. ([Wave+Set] Display)

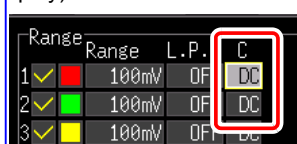

NOTE

When an effective value is selected in **[Mode]**, the input coupling automatically becomes **[AC]**.

4.6 Setting the Screen Display

The screen display of recording data can be changed. The screen display can also be changed for a recorded waveform before measurement.

Expanding and Compressing in the Horizontal Axis (Time Axis) Direction

The waveform display can be expanded and compressed in the horizontal axis direction. This setting can also be changed after the waveform has been acquired. The setting items differ depending on the function.

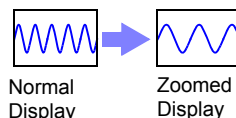

When High-speed Function (Time Base Setting)

Change the display magnification

1  Select the **[Setting]** screen.

2  Select from the setting options of **[Zoom]**.
(Open/confirm the setting information.)

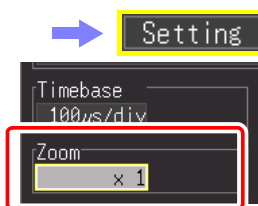

Setting options (*. default setting)

x10, x5, x2, x1*, x1/2, x1/5, x1/10, x1/20, x1/50, x1/100, x1/200, x1/500, x1/1000, x1/2000

Example: When the time base range is 100 µs/div
The value per division is as follows depending on the magnification.

- when x10: $100\mu\text{s}/\text{div} \div 10 = 10\mu\text{s}/\text{div}$
- when x1/100: $100\mu\text{s}/\text{div} \times 100 = 10\text{ms}/\text{div}$

The setting can also be changed on the Waveform screen.

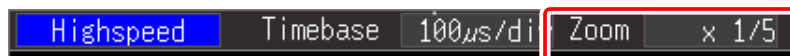

When High-speed Function (Interval Setting) and Real-time Function

Change the time per division of the horizontal axis

1  Select the [Setting] screen. → 

2  Select from the setting options of [Time/div].
(Open/confirm the setting information.)

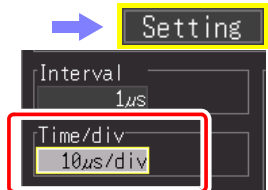

Setting options (*. default setting)

[Highspeed]	10 μ s, 20 μ s, 50 μ s, 100 μ s*, 200 μ s, 500 μ s, 10ms, 20ms, 50ms, 100ms, 200ms, 500ms, 1s, 2s, 5s, 10s, 30s, 1min, 2min, 5min, 10min [/div]
[Realtime]	10ms, 20ms, 50ms, 100ms, 200ms, 500ms, 1s*, 2s, 5s, 10s, 30s, 1min, 2min, 5min, 10min, 30min, 1h, 2h, 5h, 10h, 12h, 1day [/div]

The setting can also be changed on the Waveform screen. ([Wave+Set] Display)

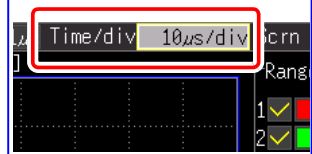

If the recording interval is changed after measurement, the selection range for the horizontal axis changes, but the horizontal axis settings which actually allow you to expand or compress the horizontal axis are those of the selection range that corresponds to the recording interval used during measurement.

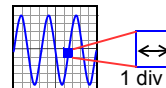

Selection Range of Horizontal Axis

The selection range of the horizontal axis differs depending on the function and [Envelope] function.

- High-speed Function: A value equivalent to the setting value of [Interval] multiplied by less than 10 cannot be set.
(Example: When the recording interval is 1 ms, the horizontal axis can be set from 10 ms.)
- Real-time Function when [Envelope] is [Off]:
A value equivalent to the setting value of [Interval] multiplied by less than 2 cannot be set.
(Example: When the recording interval is 10 ms, the horizontal axis can be set from 20 ms.)
- Real-time Function when [Envelope] is [Off]:
A value equivalent to the setting value of [Interval] multiplied by less than 100 cannot be set.
(Example: When the recording interval is 10 ms, the horizontal axis can be set from 1 s.)

NOTE Values of 1 s/div and above are displayed during real-time saving. If the setting value is less than 1 s/div, it is changed to 1 s/div simultaneously with the start of measurement.

Setting Display Range in Vertical Axis Direction

You can change the display range in the vertical axis direction of each waveform.

There are two ways to change the display range.

- Setting the display magnification and the display position of 0 V (zero position) of the waveform (p. 92).
- Setting the upper and lower limit values of the vertical axis (p. 93).

Setting the display magnification and the display position of 0 V (zero position) of the waveform

Display magnification

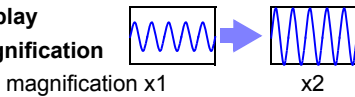

Display position

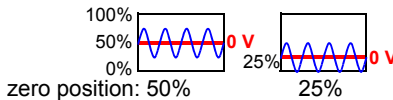

Setting the upper and lower limit values of the vertical axis

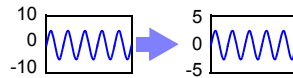

The range does not need to be set because the optimal range is set automatically in accordance with the upper and lower limit values. However, if the upper and lower limit values are changed on the Waveform screen, the range will not be changed to the optimal range.

4.6 Setting the Screen Display

Setting the Display Range of the Waveform with the Magnification and 0 V Position

1 **WAVE** **SET** **FILE** Select the [CH] screen. → CH

2 Select [Pos (Position)] from [Type] of the display range.
(Open/confirm the setting information.)

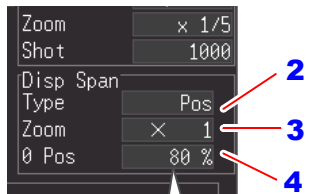

In the following steps, use the same operation to configure settings.

3 Select the magnification.

Setting options (*. default setting)

x20, x10, x5, x2, x1*, x1/2, x1/5, x1/10

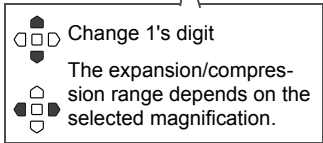

4 Set the desired zero position as a percentage of screen height.

Setting options (default setting: 50%)

-50 to 150% (in 1% increments, when the expansion/compression ratio [Zoom] in the vertical axis (voltage axis) direction is x1)

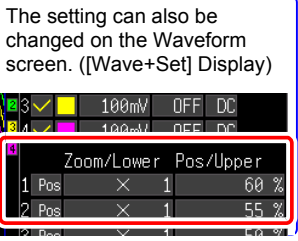

■ Display Magnification and Zero Position Setting Range

The voltage range displayed on the Waveform screen varies depending on the zero position and expansion/compression ratio of the vertical axis, but the measurement range does not change.

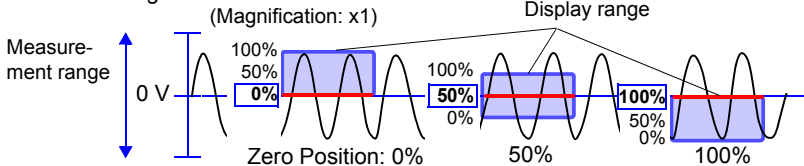

Zoom	Zero Position Setting Range	Zoom	Zero Position Setting Range
x1/10	-10 to 100%	x2	-150 to 250%
x1/5	-20 to 100%	x5	-450 to 550%
x1/2	-50 to 100%	x10	-950 to 1050%
x1	-50 to 150%	x20	-1950 to 2050%

Setting the Display Range of the Waveform with the Upper and Lower Limit Values

1  Select the [CH] screen.

2  Select [Up/Lwr] from [Type] of the display range (Disp Span).

(Open/confirm the setting information.)

In the following steps, use the same operation to configure settings.

3 Specify the [Upper] value for the top of the display.

Move the cursor to the numerical value input field, and then press the **ENTER** key to display the numerical value setting dialog box.

For how to enter numerical values, see below.

4 Specify the [Lower] value for the bottom of the display.

Set this in the same way as the upper limit value. The display range and scaling settings are inter-linked.

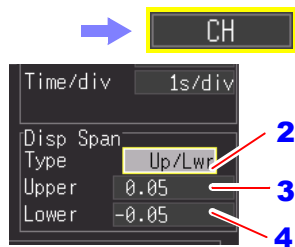

 Change 1's digit

 The expansion/compression range depends on the selected magnification.

The setting can also be changed on the Waveform screen. ([Wave+Set] Display)

Numerical Value Entry

1. Select a digit to change with the left/right cursor keys, and increment/decrement the digit with the up/down keys.

(The rightmost character is for an optional measurement unit symbol.

Pressing the up/down keys selects from among E - P - T - G - M - k - (blank) - m - u - n - p - f - a.

If no unit symbol is needed, it can be left "blank.")

2. When the desired value is selected, press **[OK]**.

Numerical value setting dialog box



Optional unit

 Select another digit

 Change 1's digit and +/-

Setting the Display Format (Screen Splitting/Synthesis/Graph Assignment)

You can split the screen into multiple graphs, and then assign the waveform to display in each graph. This setting can also be changed after the waveform has been acquired. The setting items differ depending on the function.

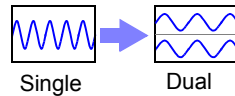

When High-speed Function: Screen Splitting and XY Synthesis

You can split the screen, and synthesize waveforms.

1    Select the **[Setting]** screen.

2  Select from the setting options of **[Format]**.
(Open/confirm the setting information.)

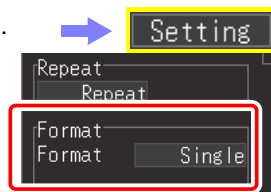

Setting options (*. default setting)

Single *, **Dual**, **Quad**, **X-Y Line**, **X-Y Dots**

Set each screen or X-Y assignment in the **[CH]** or **[All CH]** screen.

(When [X-Y Line] or [X-Y Dots] is selected)

Select from the setting options of **[ComboArea]**.

Setting options (*. default setting)

All*	Use the whole range for the composite waveform.
A-B	Use the range specified by the cursors. Procedure to specify a range with A/B cursors:(p. 140)



X-Y Dots

Linear interpolation is not performed.
The input signal (sampling data) is displayed and recorded as is.



X-Y Line

Linear interpolation is performed.
The display is easier to see, but the display speed is slow compared with dot display.

When [Dual] or [Quad] is selected in [Format]

3    Select the [CH] screen.

4  Select from the setting options of [Graph].

(Open/confirm the setting information.)

Setting options

Gr1, Gr2, Gr3, Gr4

The default setting varies depending on the display format and channel.

Dual: CH1 Gr1, CH2 Gr2, CH3 Gr1, CH4 Gr2

Quad: CH1 Gr1, CH2 Gr2, CH3 Gr3, CH4 Gr4

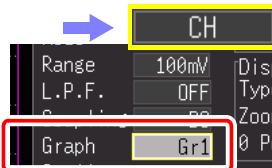

You can also select the [All CH] screen.

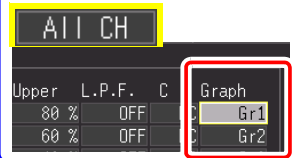

4.6 Setting the Screen Display

When Real-time Function: Screen Splitting

1 Select the [Setting] screen.



2 Select from the setting options of [Format].
(Open/confirm the setting information.)

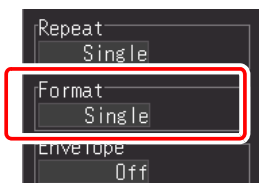

Setting options (*. default setting)

Single *, Dual, Quad

3 Select the [CH] screen.



4 Select from the setting options of [Graph].
(Open/confirm the setting information.)



Setting options

Gr1, Gr2, Gr3, Gr4

The default setting varies depending on the display format and channel.

Dual: CH1 Gr1, CH2 Gr2, CH3 Gr1, CH4 Gr2

Quad: CH1 Gr1, CH2 Gr2, CH3 Gr3, CH4 Gr4

You can also select the [All CH] screen.

Setting Waveform Display Colors & Turning On/Off Display

The waveform display color can be set for each input channel. You can also turn off the display for channels for which you do not want to display a waveform.

1 Select the [CH] screen.



2 Select from the setting options of waveform display colors.
(Open/confirm the setting information.)

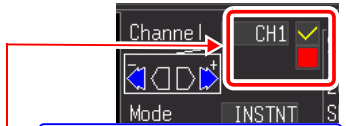

Setting options

1 to 24 colors (default setting CH1: red, CH2: green, CH3: yellow, CH4: pink)

Clear the check for any channel for which you do not want to display a waveform.

: Display On
 : Display Off

You can also select the [All CH] screen.

Converting Measurement Values (Scaling Function)

Input voltage values can be converted to physical units for display, such as by converting voltage to current. Preset scaling settings are provided for current measurement with the optional clamp sensor models.

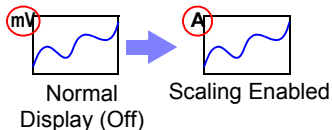

1    Select the [CH] screen. 

2  Select the display format for after scaling in [Scaling].

(Open/confirm the setting information.)

Setting options (*. default setting)

Off*	Scaling is not performed.
Dec	Displays values in decimal notation after scaling.
Exp	Displays values in exponential notation after scaling.

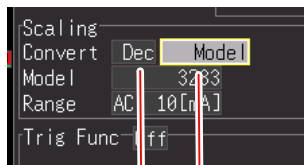

3  Select the conversion method for scaling.

(Open/confirm the setting information.)

Setting options (*. default setting)

Ratio*, 2-Point, Model, Rate

4.6 Setting the Screen Display

[Ratio]

Convert by specifying the ratio of physical units per volt of input signal (conversion ratio), offset, and the name of the units.
(The unit can be set with up to 7 single-byte characters.)

Units (eu)

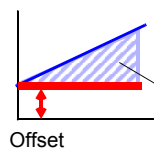

Slope (Conversion ratio: eu/v)

[2-Point]

Convert by specifying the input signal voltage at two points, the physical unit values at those points, and the name of the units.

Units: [A]

Cnv 1: V_H value \rightarrow A_H value

Cnv 2: V_L value \rightarrow A_L value

(The unit can be set with up to 7 single-byte characters.)

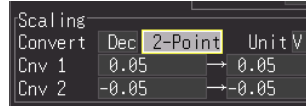
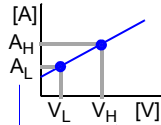

Actual measurement values (input value)

Converted unit values

[Model]

Select your clamp sensor or probe model from the Model list. Also set the measurement range to match the clamp.

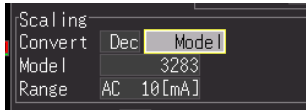

Setting options

Model	Measurement range
3283	AC 10 [mA], AC 100 [mA], AC 1 [A], AC 10 [A], AC 200 [A]
3284	AC 20 [A], AC 200 [A]
3285	AC 200 [A], AC 2000 [A]
9010-50	AC 10 [A], AC 20 [A], AC 50 [A], AC 100 [A], AC 200 [A], AC 500 [A]
9018-50	AC 10 [A], AC 20 [A], AC 50 [A], AC 100 [A], AC 200 [A], AC 500 [A]
9132-50	AC 20 [A], AC 50 [A], AC 100 [A], AC 200 [A], AC 500 [A], AC 1000 [A]
9322	
9657-10	AC 10 [A]
9675	AC 10 [A]
CT9691	AC 10 [A], AC 100 [A]
CT9692	AC 20 [A], AC 200 [A]
CT9693	AC 200 [A], AC 2000 [A]

[Rate]

Select the output rate (conversion ratio) of the clamp sensor or the voltage divider ratio of the voltage divider probe.

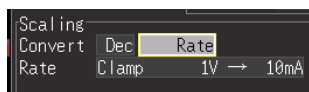

Setting options

Clamp 1V ->10mA	Clamp 1V -> 50A	Clamp 1V -> 1000A
Clamp 1V ->100mA	Clamp 1V -> 100A	Clamp 1V -> 2000A
Clamp 1V ->1A	Clamp 1V -> 200A	Clamp 1V -> 2500A
Clamp 1V ->10A	Clamp 1V -> 250A	Clamp 1V -> 5000A
Clamp 1V ->20A	Clamp 1V -> 500A	Clamp 1V -> 10000A
		Probe 1V -> 1000V

■ Conversion Ratio and Offset

$$Y = \underbrace{\frac{A_H - A_L}{V_H - V_L}}_{\text{Conversion Ratio}} \times X + \underbrace{\frac{V_H \times A_L - V_L \times A_H}{V_H - V_L}}_{\text{Offset}}$$

X: Voltage value
Y: Converted value

Valid setting ranges for conversion ratio and offset are as follows.

Note that the conversion ratio cannot be set to zero.

-9.9999E+9 ≤ (conversion ratio, offset) ≤ -1.0000E-9
(offset) = 0

+1.0000E-9 ≤ (conversion ratio, offset) ≤ +9.9999E+9

Values outside the above range cannot be set.

Scaled values (and cursor values when using the A/B cursors) can be verified in the waveform screen.

Setting Logic Channel Display Colors

You can select a display color for each logic channel waveform.

1 Select the **[All CH]** screen.

2 Select from the setting options of waveform display colors.
(Open/confirm the setting information.)

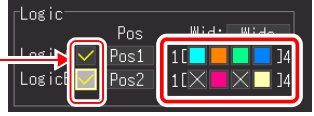

Setting options

Off, 1 to 24 colors
The default setting varies depending on the channel.

The setting can also be changed on the Waveform screen ([Wave+Set] display) and [CH] screen.

: Display On
 : Display Off

You can simultaneously turn on or off the display of four channels for each logic probe.

Setting Logic Channel Display Positions

You can select the display position of each logic waveform. Waveform overlap on the display can be minimized when recording simultaneously with an analog waveform.

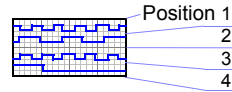

1 Select the **[All CH]** screen.

2 Select from the setting options of **[Pos]**.
(Open/confirm the setting information.)

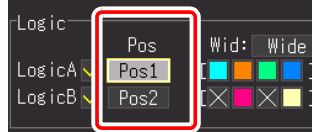

Setting options

Pos1, Pos2, Pos3, Pos4
Pos5*, Pos6*, Pos7*, Pos8*
*. This can only be selected when the logic recording width is **[Narrow]**.
(default setting): LogicA **Pos1**, LogicB **Pos2**

The setting can also be changed on the Waveform screen ([Wave+Set] display) and [CH] screen.

Setting the Recording Width of Logic Waveforms

You can change the display width in the vertical axis direction of logic waveforms.

When there are, for example, many waveforms, making the display width narrow makes them easier to see.



1    Select the **[All CH]** screen. 

All CH

2  Select from the setting options of **[Wid]** (recording width).
Apply

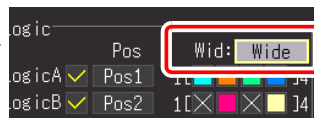

Setting options (*. default setting)

Wide, Narrow*

The setting can also be changed on the Waveform screen ([Wave+Set] display) and [CH] screen.

4.7 Setting Automatic Saving

Data can be automatically saved to external storage media (CF card or USB flash drive). The save operation differs depending on the function.

High-speed Function (Automatic saving)

Sampling is performed at high speed so the data is first stored in the internal buffer memory.

After measurement ends, the data stored in the internal buffer memory is saved automatically to the external storage media.

Real-time Function (Real-time saving)

Sampling is performed at low speed so the data is saved automatically to the external storage media during sampling.

See: "Recording Methods (Measurement Functions)" (p. 68)

After measurement, you can press the **SAVE** key and save the acquired recording data as desired. For details, refer to "6.2 Saving Data" (p. 150).

The default setting is **[Select & Save]**. For details, refer to "Chapter 6 Managing Data" (p. 147).

Types of measurement data that can be saved automatically

The display items differ depending on the function ([Highspeed] or [Realtime]).

- Waveform data (binary format or CSV format) (p. 103)
- Calculation results (CSV format) (p. 103)
- Waveform data and calculation results (binary format or CSV format) (p. 103)

CSV Format Data

- When other than **[Comma]** is selected in **[Separator]** (Delimiter Character) on the System screen, the extension is ".TXT."
- When a calculation result is saved, numerical calculation needs to be set before the start of measurement. (p. 177)
- When a CSV file is opened in a spreadsheet program, there is a limit to the number of rows that can be read at one time. (This differs depending on, for example, the version of the spreadsheet program.)
- When **[CSV (realtime)]** saving and **[CSV + Calc]** is selected, saving is possible when the recording interval is set to 5 ms or longer.

1. Waveform data

Function	Selection Option	File Extension	Description
Highspeed	Waveform (after meas.) *1	.MEM	After the specified recording length portion is acquired to the internal buffer, the waveform data is saved in binary format.
	CSV (after meas.) *2	.CSV	After the specified recording length portion is acquired to the internal buffer, the waveform data is saved in CSV (text) format. This is convenient when you want to open the data in a spreadsheet program such as Excel®.
Realtime	Waveform (real-time) *1	.REC	During measurement, the waveform data is saved in binary format.
	CSV(realtime)*2	.CSV	During measurement, the waveform data is saved in CSV (text) format. This is convenient when you want to open the data in a spreadsheet program such as Excel®.

2. Calculation results (requires setting numerical calculation before the start of measurement) (p. 177)

Function	Selection Option	File Extension	Description
Highspeed/ Realtime	CSV(after meas.) *2	.CSV	After measurement ends, the calculation results are saved. When [Repeat] is set to [Repeat], the calculation result for each measurement is added to the file. When [Split Calc] is set to [On], the calculation results are added at each split length.

3. Waveform data and calculation results (requires setting numerical calculation before the start of measurement) (p. 177))

Function	Selection Option	File Extension	Description
Highspeed	Waveform + Calc	.MEM .CSV	After measurement ends, the waveform data is saved in binary format, and then the calculation results are saved.
	CSV + Calc *2	.CSV	After measurement ends, the waveform data is saved in CSV (text) format, and then the calculation results are saved.
Realtime	Waveform + Calc	.REC .CSV	The waveform data is saved in binary format during measurement, and the calculation results are saved after measurement ends.
	CSV + Calc *2	.CSV	The waveform data is saved in CSV (text) format during measurement, and the calculation results are saved after measurement ends.

*1 The data can be converted to text format with the instrument or supplied software after measurement, so we recommend selecting [Waveform (after meas.)] for the High-speed Function and [Waveform (realtime)] for the Real-time Function when saving data automatically.

*2 The saved data cannot be read by the instrument or supplied software.

4.7 Setting Automatic Saving

1  Select the **[Setting]** screen.  

2  Select the data you want to save.
(Open/confirm the setting information.)

Setting options (*. default setting)

Off*, **Waveform(*1)**, **CSV(*1)**, **Calc(after meas.)**,
Waveform + Calc, **CSV + Calc**

(*1):After you select the data, "(after meas.)" is displayed for the High-speed Function and "(realtime)" is displayed for the Real-time Function. (If you select **[Off]**, proceed to step 8.)

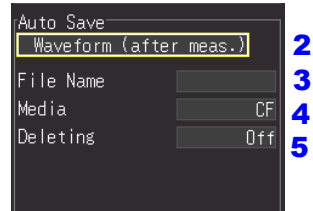

Approx. savable time
2 Hour 38 Min

For real-time saving, this field displays an approximate time of which in length the storage device inserted in the instrument can store data.

In the following steps, use the same operation to configure settings.

3 When you want to specify the name of the waveform file:
Specify a name in **[File Name]**.

See: "4.10 Entering Comments and Titles" (p. 128)

If left blank, file names are created automatically.

See: "Appendix 3 File Naming" (p. A12)

In the case of CSV (real time), saving is possible when the recording interval is set to 5 ms or longer.

4 When you want to use both a CF card and USB flash drive:
Set **[Media (Preferred Save Location)]**.
(default setting: CF)

If you selected **[Calc (after meas.)]** for the data to save, proceed to step **8**.

If the storage media set as the preferred save location becomes full, the data will be automatically saved to the other storage media.

5 Set **[Deleting (Delete while Saving)]**.

Select the desired operation when removable storage becomes full while saving.

Setting options (*. default setting)

Off* Saving ends when the removable storage is nearly full.

On When the free capacity of the removable storage reaches a certain minimum size, waveform files are deleted, oldest first. If deletion is not possible, saving stops.

A file other than a waveform file is not applicable for deletion. (Numerical calculation file, setting configuration file, file created with other than MR8880-20, etc.)

6 Select whether to save data into multiple files (Set **[Split Save]**) (Real-time Function only).

Select single (per measurement) or multiple (timed) file creation.

Setting options (*. default setting)

Off*	Creates a single file per measurement.
On	Specify the save timing (split time). A new data file is created for each split time (span).
Ref Time	Specify the reference time (Ref Time) and split time (Split Length). A file is created at the set interval from the first measurement data after the reference time.

- Even if split saving is set to Off, the file will be split and saved if the size of the file exceeds 500 MB.
- When you attempt to read files with the supplied Waveform Viewer, reading may not be possible due to the performance of the PC if the size of one file is large. We recommend performing split saving so that the size of each file is within 100 MB (p. A15).

7 When saving CSV data:

Set **[Thin out]**.

Setting options (*. default setting)

Off*, 1/2, 1/5, 1/10, 1/20, 1/50, 1/100, 1/200, 1/500, 1/1000

8 Press **START** to start measuring.

After measurement, the data is automatically saved to removable storage.

Before starting to measure, confirm that Auto Save is configured correctly, and that the removable storage is properly installed.

With **[Split Save]** set to **[On]**

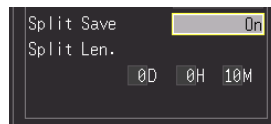

Also set the **[Split Len]** (length).
Days (0 to 30), Hours (0 to 23),
Minutes (0 to 59)

With **[Split Save]** set to **[Ref Time]**

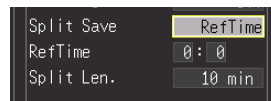

Also set the following items:

[Ref Time]: 0:0 to 23:59

[Split Len] (length): 1, 2, 5, 10, 15, 20, 30 minutes, 1, 2, 3, 4, 6, 8, 12 hours, 1 day

Replacing CF Card or USB Flash Drive during Saving ([Realtime] only)

When the Real-time Function is used, a CF card or USB flash drive can be replaced during real-time saving without stopping measurement. This section describes how to replace a CF card.

- 1**  Select **[EJECT]**.
Apply

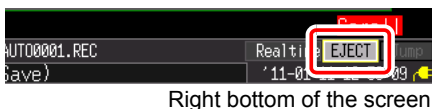

- 2**  Select **[Unmount CF]**.
Apply

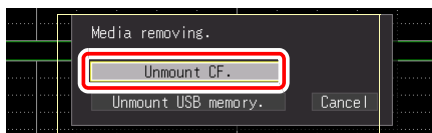

- 3**  Select **[Yes]**.
Apply

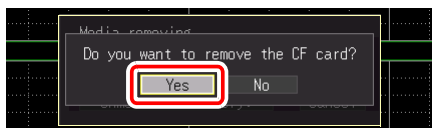

- 4**  Select **[Yes]**.
Apply
A "Replaceable" message appears

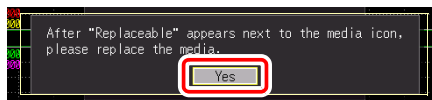

- 5** Remove the USB flash drive (p. 46).

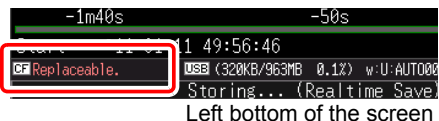

- 6** Insert a formatted removable storage.
Measurement data acquired while the device was removed is automatically written.

See: [How to format \(p. 48\)](#),
[How to insert \(p. 46\)](#)

When both a CF card and USB flash drive are installed and either is removed, the save destination automatically switches to the remaining media.

NOTE

- Data equivalent to half the internal buffer memory will be stored after "Yes" is selected in the "Do you want to remove the CF card/USB memory? message. Replace the CF card or USB flash memory within the time required to complete this action.
- If the recording interval is set to 100 μ s, media must be swapped out-within 20 seconds.
- If a storage device is replaced during real-time saving, data is saved to a new file.
- If measurement ends while the removable storage is ejected, even if a removal storage is then inserted, the remaining data is lost.

4.8 Setting Automatic Printing

Data can be printed automatically when you use the optional printer (auto print). The operation differs depending on the function (high speed/real time).

See: "Recording Methods (Measurement Functions)" (p. 68)

High-speed Function (Auto print)	Real-time Function (Real-time print)
<p>Sampling is performed at high speed so the data is first stored in the internal buffer memory.</p> <p>The data stored in the internal buffer memory is printed with the printer automatically <u>after measurement ends</u>.</p> <p>Set the [Auto print] item on the [Print] setting screen.</p>	<p>Sampling is performed at low speed so the data can be printed with the printer during sampling ^(*1).</p> <p>Set the [Realtime print] item on the [Print] setting screen.</p> <p>(*1): If a horizontal axis that is faster than 1 s/div is set, printing cannot be performed at the same time as sampling.</p>

To print automatically, you need to set the printer settings in advance.

For how to connect the printer and load the recording paper, refer to "2.4 Connecting Printer and Loading Recording Paper (Options)" (p. 41).

NOTE

- In the case of real-time printing with the Real-time Function, if the **[Interval]** setting is slower than 1/100 of the **[Time/div]** setting, paper is fed every 1 division.
Example: Recording interval of 200 ms and horizontal axis of 1 s/div
The recording interval is 1/5 of the horizontal axis (= 200 ms ÷ 1 s), so paper is fed every 1 division.
- When printing is performed automatically using cursors A and B, the operation differs depending on the measurement function.
 - High-speed Function:
You can set the print range with cursors A and B (print part of the data). However, cursors A and B cannot be moved if the measurement data is not displayed on the screen.
 - Real-time Function:
When printing in real time (Real-time Function), the entire waveform is printed regardless of the cursor positions. The print range cannot be selected.
- The printer cannot be used with alkaline dry cell batteries. When printing, use the Z1002 AC Adapter or Z1000 Battery Pack.

1    Select the [Print] screen.



This is displayed only when the printer is connected.
The item name differs depending on the function.

2  Select the print items from [Auto print] or [Realtime print].
(default setting: Off)

(Open/confirm the setting information.)

When High-speed Function [Auto print]

Setting options (*. default setting)

Off *	Not print
Wave-form	Print the waveform after the data for the recording length portion is acquired to the internal buffer.
Calc.	Perform numeric calculation and print the numeric calculation results after the data for the recording length portion is acquired to the internal buffer.
Wave+Calc	Perform numeric calculation after the data for the recording length portion is acquired to the internal buffer. After that, print the waveform then the numeric calculation results.



When Real-time Function [Realtime print]

Setting options (*. default setting)

Off *	Not print.
Wave-form	Print the waveform during measurement. If the horizontal axis setting is faster than 1 s/div, printing cannot be performed at the same time as measurement.
Calc.	Perform calculation during measurement. Print the numeric calculation results after measurement stops.
Wave+Calc	Print the waveform and perform calculation during measurement. Print the numeric calculation results after measurement stops. <ul style="list-style-type: none"> • If the horizontal axis setting is faster than 1 s/div, printing cannot be performed at the same time as measurement. • If continuous recording is set to [On], the calculation results are printed after measurement is stopped with the STOP key.

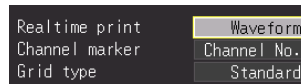

Configure the other settings as necessary.

See: "Chapter 7 Printing" (p. 165)

4.9 Recording Using Specific Conditions (Trigger Function)

You can apply specific conditions to start and stop measurement.

In the case of **[Highspeed]**, only the condition for starting measurement can be applied. When these specific conditions are applied for measurement, the trigger function is used.

What is a Trigger?

Triggering is the process of controlling the start and stop of recording by specific signals or conditions (criteria). When recording is started or stopped by a specific signal, we say the trigger is "applied" or "triggering occurs."

In this manual, **T** indicates a "trigger point", as the time at which a trigger is applied.

Signals that can be used for triggering (trigger sources) are as follows.

Trigger condition met

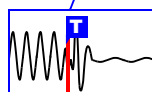

Trigger Source		Description	Ref.
Conditions such as measurement timing	Start trigger	Measurement starts at the point in time when a trigger is applied in accordance with the setting condition of the start trigger.	(p. 111)
	Stop trigger	Measurement stops at the point in time when a trigger is applied in accordance with the setting condition of the stop trigger. When [Repeat] is set to [Repeat] , measurement is resumed. ([Realtime] only)	(p. 111)
	Pre-trigger	Enables measurement that also includes phenomena before the measurement condition was met.	(p. 115)
	Trigger condition	Enables specifying the trigger application conditions (AND/OR) for measurement.	(p. 113)
	Interval	Enables measurement at the specified measurement interval.	(p. 126)
Trigger condition of each signal	Analog Trigger	Applies a trigger according to a signal input on an analog channel. (Level, In-Window, Out-of-Window, Voltage Sag trigger, Waveform Judgment Trigger)	(p. 116)
	Logic Trigger	Applies a trigger according to signals input on logic channels (Ch A to Ch D).	(p. 124)
	External Trigger	Applies a trigger according to an input signal at the EXT.TRIG terminal (External Trigger Input)	(p. 127)

You can set the condition for each channel on the **[CH]** screen, and the trigger settings for all channels on the **[Trig]** screen.

Enabling the Trigger Function

The trigger function is disabled (Off) when the instrument is shipped from the factory or the settings are restored to the default settings. Before setting trigger conditions, enable the trigger function (On).

The trigger can be enabled in the [Wave+Trg] display, [CH] screen, and [Trig] screen.

1  Select the [Trig] screen.

2  Select from the setting options of [Trig Func] ([Trig] screen).

(Open/confirm the setting information.)

Setting options (*. default setting)

Off*, On

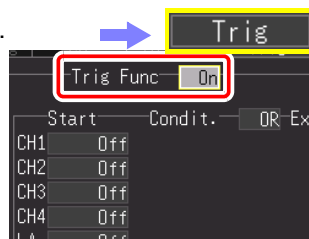

Setting the Trigger Timing

You can set the timing (starting and stopping of measurement) for enabling the trigger. This can be set only for the Real-time Function.

This can be set on the [Trig] screen and [Wave+Trg] display.

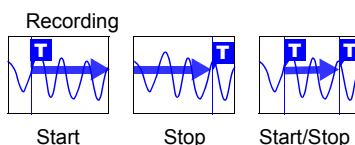

1  Select the [Trig] screen.

2  Select the trigger timing from the setting options of [Timing] ([Trig] screen).

(Open/confirm the setting information.)

Setting options (*. default setting)

Start*	Use a trigger as the condition for starting measurement.
Stop	Use a trigger as the condition for stopping measurement.
Start/Stop	Use a trigger as the condition for starting and stopping measurement.

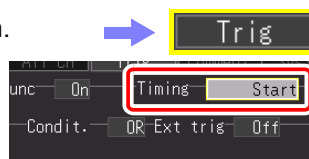

Set the start/stop condition for each input signal. Only the start/stop condition selected for the timing is enabled.

See: "Types of trigger for which [Timing] can be set" (p. 112)

NOTE

If you selected [Start & Stop] for the trigger timing, there will be a dead time from when the start trigger is accepted until when the stop trigger is accepted. The dead time will be whichever is the longer of 1 ms and a two sample portion.

4.9 Recording Using Specific Conditions (Trigger Function)

Types of trigger for which [Timing] can be set

●: Selectable, X: Not selectable

		Timing	
		Start	Stop
Analog input signal	CH1 to CH4	●	●
Logic input signal	LA1 to LA4, LB1 to LB4	●	●
External trigger	EXT.TRIG	●	●
Interval trigger	Fixed interval recording	●	X

NOTE

- The timing settings cannot be configured for the High-speed Function.
- If [Timing] is set to [Stop] (or [Start/Stop]) and the trigger is not applied during data acquisition for the set recording time portion after measurement starts, measurement ends at the point in time that the data for the recording time portion has been acquired.
- When [Timing] is set to [Stop] and [Repeat] is set to [Single], measurement ends after the stop condition is met. However, measurement will be resumed if [Repeat] is set to [Repeat].
- When [Timing] is set to [Start/Stop], the instrument first waits until the trigger of the [Start] condition is applied.

Setting AND/OR Trigger Application Conditions

The relation between each trigger source can be set. This is only valid for channels for which triggers have been set.

This can be set on the [Trig] screen and [Wave+Trg] display.

1  Select the [Trig] screen. ➔ 

2  Select the relation between trigger sources from the setting options of [Condit.].

(Open/confirm the setting information.)

Setting options (*. default setting)

OR* A trigger is applied at the change point (edge) when any one of the set trigger conditions changes from an unmet state to a met state. Therefore, even if a trigger condition is met at the start point in time, the trigger is not applied until the change point is detected.

Note: The "change point" indicates the point when the trigger condition changes from an unmet state to a met state.

AND A trigger is applied when all of the set trigger conditions are met. Therefore, if the trigger conditions are met at the start point in time, the trigger is applied immediately.

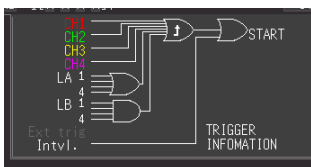
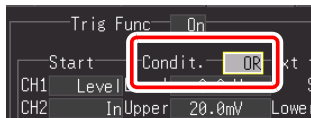

You can confirm the trigger application conditions between channels on the screen.

■ About Trigger Application Conditions

(Example) To apply a trigger when the upslope (↑) of the waveform crosses zero volts:

TriggerLevel
Level0 V
Slope.....↑

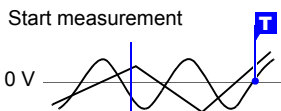

[AND]

One waveform has crossed above 0 V as the other crosses on the upslope

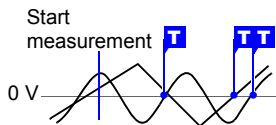

[OR]

Either waveform crosses 0 V on the upslope

4.9 Recording Using Specific Conditions (Trigger Function)

Block Diagrams of Trigger Application Conditions (AND/OR)

OR When the **[OR]** trigger application condition is selected, the change point (edge) when each trigger source changes from unmet to met is detected.

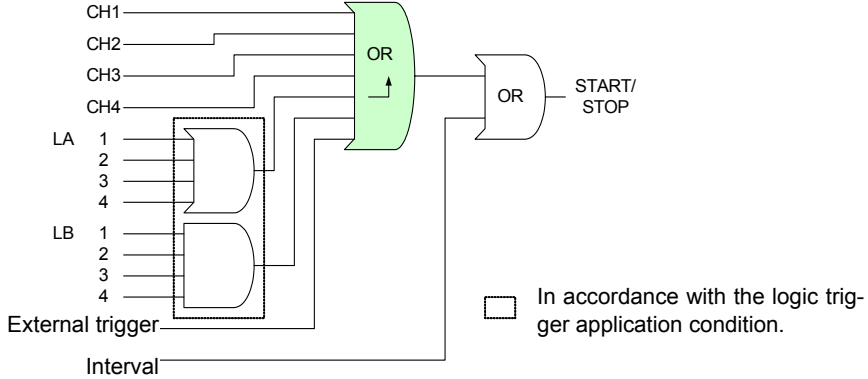

AND When the **[AND]** trigger application condition is selected, the state in which all of the trigger sources are met is detected.

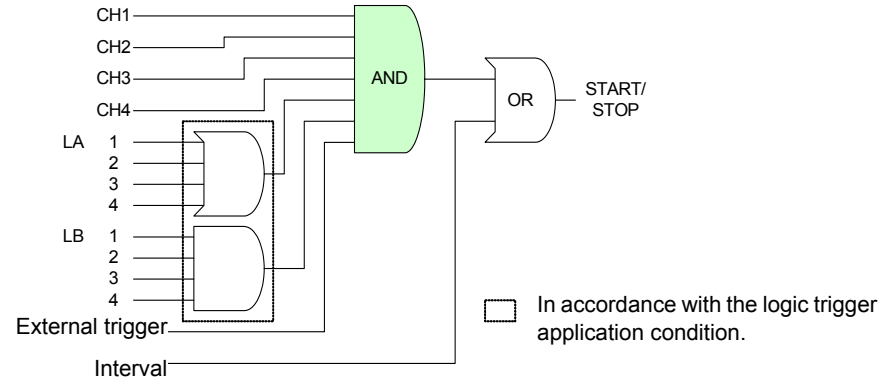

Recording Data Before Trigger Applied (Pre-trigger)

It is possible to record not only the waveform after the trigger is applied but also the waveform before the trigger is applied. The options that can be set differ depending on the function.

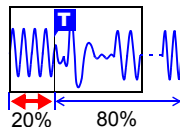

This can be set on the [Trig] screen and [Wave+Trg] display.

- 1 Select the [Trig] screen.
- 2 Select from the setting options of [Pre-Trig]
 Apply

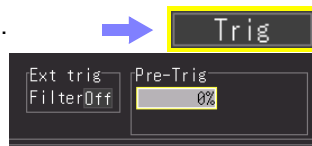

Setting options (*. default setting)

(When High-speed Function)
 0%, 5%, 10%, 20%, 30%, 40%, 50%, 60%, 70%, 80%, 90%, 95%, 100%

Set percentage in relation to entire recording length

(When Real-time Function)
 Hours, minutes, and seconds can be set (up to maximum recording time)
 Up to 1,000,000 data when continuous recording is set to [On] (however, up to 500,000 when envelope is set to On)

■ **Difference between [Waiting for pre-trigger] and [Waiting for trigger]**

When measurement is started, the specified pre-trigger length is recorded. This period is indicated as the [Waiting for pre-trigger]. After the specified pre-trigger length has been recorded, the period indicated as [Waiting for trigger] continues until a trigger occurs. During the [Waiting for pre-trigger] period, trigger events are not recognized even when the trigger criteria are met.

■ **Pre-Trigger vs. Recording Time (When Real-time Function)**

Recording Time shorter than Pre-Trigger Time

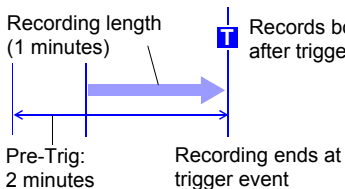

Recording Time longer than Pre-Trigger Time

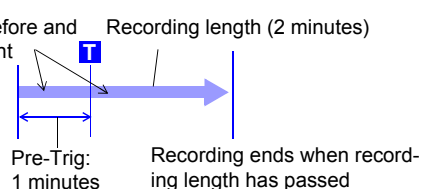

Pressing the **MONITOR** key when either [Waiting for pre-trigger...] or [Waiting for trigger...] is displayed allows you to confirm the waveform currently being input.

4.9 Recording Using Specific Conditions (Trigger Function)

Setting the Trigger Type for Analog Input Signals

Set the trigger type and conditions. The options that can be set differ depending on the trigger type.

This can be set on the [Trig] screen, [CH] screen, and [Wave+Trg] display.

1 **WAVE** **SET** **FILE** Select the **[Trig]** screen.

2  Select the trigger type from the setting options of **[Start]** (Start Trigger).
 (Open/confirm the setting information.)



Setting options (*. default setting)

Off*, **Level**, **In**, **Out**, **Drop**, **Judge**

If **[Stop]** or **[Start/Stop]** is selected for the trigger timing when using the Real-time Function, also set the setting column for the **[Stop]** (Stop Trigger).

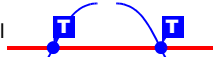
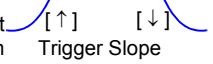
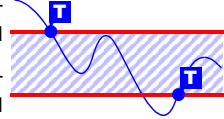
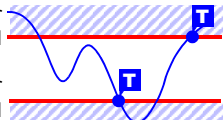
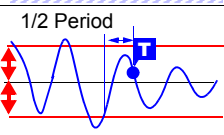
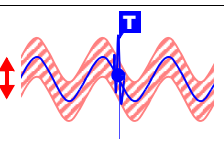
Type of Analog Trigger	Trigger Example	Description
Level Trigger [Level] (p. 117)	Trigger level  Input waveform  Trigger Slope	A trigger is applied when an input signal crosses the specified trigger level (threshold voltage).
In-Window Trigger [In] (p. 119)	Upper Threshold  Lower Threshold	A trigger is applied when the input signal enters a range defined by upper and lower thresholds.
Out-of-Window Trigger [Out] (p. 119)	Upper Threshold  Lower Threshold	A trigger is applied when the input signal exits a range defined by upper and lower thresholds.
Voltage Drop Trigger [Drop] (p. 120) (High-speed Function)	1/2 Period  Trigger Level	A trigger is applied when the amplitude of the input signal (at commercial mains frequency) dips below the specified trigger level. This is only selectable when the input mode is set to [INSTNT] .
Waveform Judgment Trigger [Judge] (p. 121) (High-speed Function)	Judgment range (Range) 	A trigger is applied when the set judgment range is exceeded. Target: Commercial power supply (50/60 Hz) This is only selectable when the input mode is set to [INST-NT] .

Even if the channel setting is set to Off, the trigger condition can be set because measurement is being performed. Also, the set trigger is enabled.

Applying a Trigger at a Specified Value (Level Trigger)

You can specify the desired signal level (level) and the direction (slope) of change of the input signal in order to apply a trigger. The options that can be set differ depending on the function.

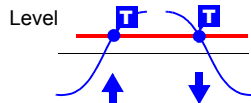

This can be set on the [Trig] screen, [CH] screen, and [Wave+Trg] display.

1 Select the [Trig] screen.

2 Select [Level] (level trigger) for the trigger type.

(Open/confirm the setting information.)

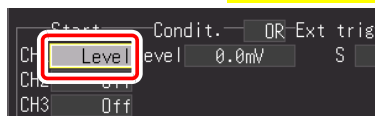

In the following steps, use the same operation to configure settings.

This can also be set for each channel on the [CH] screen.

3 Set a numerical value for the signal level you want to detect in [Level] (signal level)

Setting options (default setting: 0)

Settable range: - (minus) full scale value to + (plus) full scale value
 Full scale value = vertical axis (voltage axis) range [V/div] x 10 div
 Example: When the vertical axis (voltage axis) range is 20 V/div:
 $20 \text{ V/div} \times 10 \text{ div} = 200 \text{ V}$
 200 V becomes the full scale value.

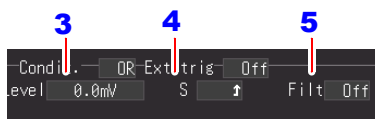

Set the value for each digit, and then select [OK] to confirm the setting.

4 Select the judgment item for the input signal from the setting options of [S] (slope).

The options that can be set differ depending on the trigger application condition (AND/OR).

Setting options (*. default setting)

Trigger Condition	Selection	Description of Operation
OR	↑	A trigger is applied when the input signal crosses the trigger level in the up direction (↑).
	↓	A trigger is applied when the input signal crosses the trigger level in the down direction (↓).
AND	HIGH	A trigger is applied when the input signal rises above the trigger level.
	LOW	A trigger is applied when the input signal falls below the trigger level.

4.9 Recording Using Specific Conditions (Trigger Function)

5 Set [Filt (filter)].

A trigger is applied when the application condition of the trigger is met in the period of the set [Filt].

This is effective for preventing incorrect operation caused by noise. The options that can be set differ depending on the function.



Setting options (*. default setting)

(When High-speed Function)

Set by number of samples

Off*, 10S, 20S, 50S, 100S, 200S, 500S, 1000S

(S= Number of samples)

(When Real-time Function)

Off*, On

(When this is On, the filter width is fixed to 10 ms.)

Note: The filter width is 2 samples when the recording interval is 10 ms or longer.

■ When Noise is a Concern

You can make sure fluctuations within the specified filter width (number of samples) do not cause the trigger to be applied even if the trigger condition is met. This prevents the trigger from being applied due to noise.

Example: When the number of samples is set to **[10S]**, the trigger is not applied if the trigger condition is not met in 10 consecutive samples.

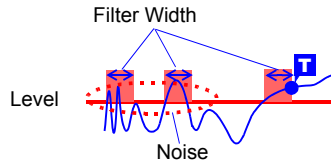

Applying a Trigger Using Range Specified by Upper & Lower Limit Values (Window Trigger)

Measurement starts or stops when the input signal enters (IN) or exits (OUT) a range defined by upper and lower limit values.

You can check the upper and lower limit values on the [CH] screen.

This can be set on the [Trig] screen, [CH] screen, and [Wave+Trg] display.

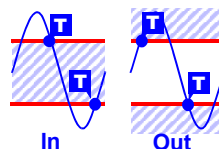

1 **WAVE** **SET** **FILE** Select the [Trig] screen. →

2 Select [In] or [Out] for the trigger type.
(Open/confirm the setting information.)

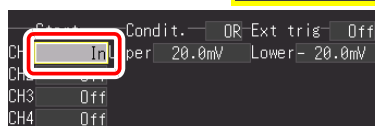

In the following steps, use the same operation to configure settings.

3 Select from the setting options of [Upper]/[Lower].

Setting options

- vertical axis (voltage axis) range x 10 to
- + vertical axis (voltage axis) range x 10

4 Set [Filt] (filter).

A trigger is applied when the application condition of the trigger is met in the period of the set [Filt] (Filter). This is effective for preventing incorrect operation caused by noise. The options that can be set differ depending on the function.

Setting options (*. default setting)

(When High-speed Function)

Set by number of samples

Off*, 10S, 20S, 50S, 100S, 200S, 500S, 1000S

(S = Number of samples)

(When Real-time Function)

Off*, On

(When this is On, the filter width is fixed to 10 ms.)

Note: The filter width is 2 samples when the recording interval is 10 ms or longer.

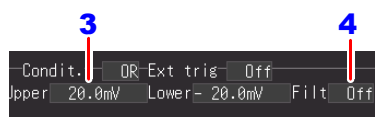

Set the value for each digit, and then select [OK] to confirm the setting.

Select another digit

 Change 1's digit and switch between + and -

When noise is a concern (p. 118)

4.9 Recording Using Specific Conditions (Trigger Function)

Detecting Instantaneous Power Failure of Commercial Power Supply (Voltage Drop Trigger) (High-speed Function only)

Detect an instantaneous voltage drop for the measurement target of a commercial power supply (50/60 Hz). A trigger is applied when the voltage peak is below the set level for 1/2 a cycle or more. This is only selectable when the input mode is set to [INSTNT]. This can be set on the [Trig] screen, [CH] screen, and [Wave+Trg] display.

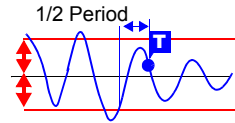

1 **WAVE** **SET** **FILE** Select the [Trig] screen.



2 Select [Drop (Voltage Drop)] for the trigger type.
Apply



The range of the time base for which the voltage drop trigger can be selected is 100 μs/div to 20 ms/div.

3 Set a numerical value for the signal level you want to detect in [Level] (signal level).

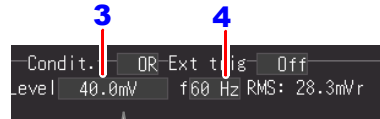

Setting options

Settable range
x1/10 to x10 of vertical axis (voltage axis) range
Example: When the vertical axis (voltage axis) range is 20 V/div: 2 V to 200 V

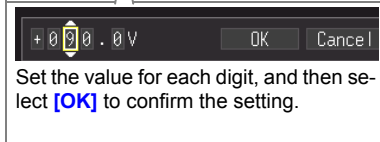

Set the value for each digit, and then select [OK] to confirm the setting.

The level to be set at this time is the instantaneous value level. Set this while referring to the value calculated for the effective value that is displayed at the same time.

The value calculated for the displayed effective value is a value calculated under the assumption that there is, for example, no distortion of the waveform for the commercial power supply that is the target for measurement. If the waveform is greatly distorted, consideration needs to be given to the value to be set.

Setting example

Applying a trigger when the voltage drops to 90 V rms (Vmax = 127 V) during the measurement of a 100 V rms (Vmax = 141 V) commercial power supply

Range (vertical axis): 20 V/div
Level: $90 \times \sqrt{2} \approx 127$ [V]
(Effective value 90 V [display only])
The settable trigger level range is limited by the voltage range setting.

4 Set the frequency of the target commercial power supply in [f] (frequency).

Setting options (*. default setting)

50Hz, 60Hz *

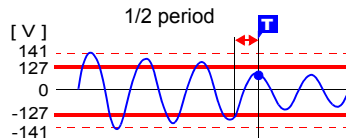

Monitoring Commercial Power Supply (Waveform Judgment Trigger) (High-speed Function only)

Apply a trigger when the measurement data goes out of the set judgment range for a measurement target that is a commercial power supply (50/60 Hz) (Waveform Judgment Trigger). This is only selectable when the input mode is set to **[INSTNT]**. This can be set on the **[Trig]** screen, **[CH]** screen, and **[Wave+Trg]** display.

Create a judgment range from a set reference waveform and control range in order to apply a trigger when the measurement data goes out of the judgment range.

The time base range that can be selected for the waveform judgment trigger is 100 $\mu\text{s}/\text{div}$ to 20 ms/div . The following shows the specifications for the waveform judgment trigger.

- Judgment period: 20 μs (with 100 $\mu\text{s}/\text{div}$ to 2 ms/div), sampling period (with 5 ms/div to 20 ms/div)
- Maximum sampling speed: 1 MS/s (with time base of 100 $\mu\text{s}/\text{div}$)

1 **WAVE** **SET** **FILE** Select the **[Trig]** screen. 

2  Select **[Judge]** for the start trigger condition.
Apply

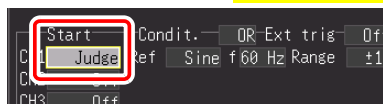
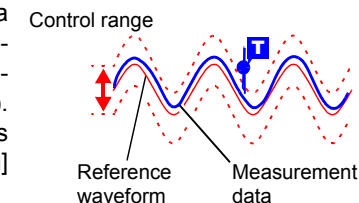

This can also be set for each channel on the **[CH]** screen.

In the following steps, use the same operation to configure settings.

4.9 Recording Using Specific Conditions (Trigger Function)

- 3** Select the waveform to be the judgment reference in [Ref].

Setting options (*. default setting)

- Sine*** Uses the ideal waveform based on the set frequency and reference voltage as the reference.
- Prev.** Uses the waveform one cycle before the input waveform as the reference. Use this when you do not want the trigger to be applied as a result of slight changes.

Judgment is started using the point at which the input signal crosses 0 V as the reference

- 4** Set the frequency of the target commercial power supply in [f] (frequency).

Setting options (*. default setting)

50Hz, 60Hz*

- 5** Set the control range to permit for the reference waveform in [Range].

Setting options

Settable range
x1/2 to x2.5 of vertical axis (voltage axis) range
Example: When the vertical axis (voltage axis) range is 20 V/div: 10 V to 50 V
(20 V/divX0.5 = 10 V, 20 V/divX2.5 = 50 V)

The level to be set at this time is the instantaneous value level.

- 6** When [Sine] was selected in [Ref]
Set the voltage to measure from the setting options of [Ref volt].

Setting options

Settable range
x1 to x7 of vertical axis (voltage axis) range

Example: When the vertical axis (voltage axis) range is 20 V/div: 20 V to 140 Vr

(20 V/divX1= 20 Vr, 20 V/divX7 = 140 Vr)

The level to be set at this time is the effective value level.

(The "r" of "Vr" indicates rms (effective value))

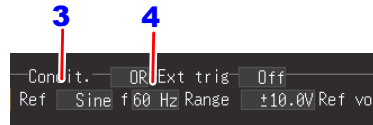

[Prev. (Previous waveform)]

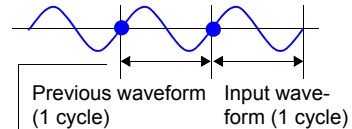

Judgment is made by comparing with the previous waveform.

The control range is set for this portion

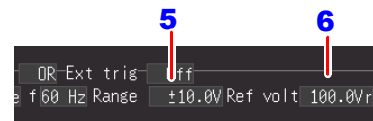

When the data of the measured waveform is printed, the judgment area of the one cycle portion in which the trigger was applied is also printed.

4.9 Recording Using Specific Conditions (Trigger Function)

NOTE The waveform judgment trigger is specialized for the application of monitoring commercial power supplies.

The comparison with the reference waveform begins from the point at which 0 V is crossed. Therefore, trigger judgment cannot be made correctly if, for example, a waveform for which 0 V is not crossed or a noise waveform is input. Furthermore, even if the frequency of the measurement target is a commercial frequency (50/60 Hz), trigger judgment cannot be made correctly when a rectangular waveform is input or the signal level is not appropriate.

■ About the Set Judgment Area

The set judgment area can be confirmed on the screen or on a printout.

The judgment area is displayed in gray.

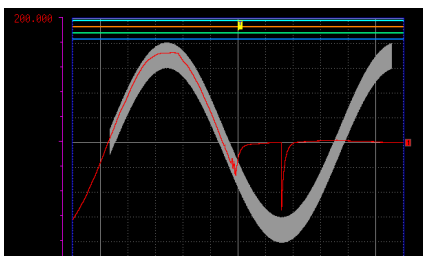

Waveform display

The judgment area is printed lightly.

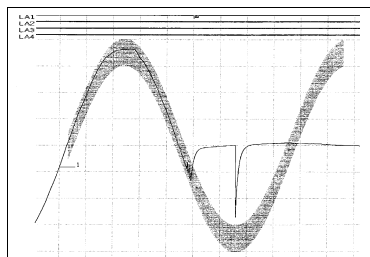

Print

4.9 Recording Using Specific Conditions (Trigger Function)

Applying Trigger with Logic Input Signal (Logic Trigger)

Specify a signal level (pattern) of the logic input signal in order to apply a trigger. The options that can be set differ depending on the function.

This can be set on the [Trig] screen, [CH] screen, and [Wave+Trg] display.

Type of Logic Trigger	Trigger Example	Description
[1]		Judge the pattern to be met when the HIGH level of the logic input signal is detected.
[0]		Judge the pattern to be met when the LOW level of the logic input signal is detected.
[X]		Ignore signal. Pattern judgment is not affected.

1 Select the [Trig] screen. →

2 Select the trigger condition.
 (Open/confirm the setting information.)

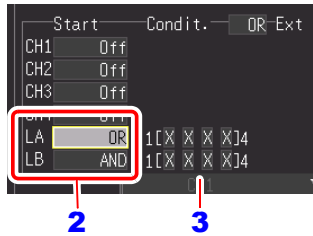

In the following steps, use the same operation to configure settings.

Setting options (*. default setting)

Off	A logic trigger is not used.
OR*	The pattern (trigger condition) is met at the point in time when even one of the logic signals matches the set logic level.
AND	The pattern (trigger condition) is met at the point in time when all of the logic signals match the set logic level.

3 Set the signal level you want to detect with the pattern.

Setting options (*. default setting)

X*	Ignore signal
0	Detect the low level.
1	Detect the high level.

4 Set [Filter (filter)].

A trigger is applied when the application condition of the trigger is met within the period of the set [Filter]. This is effective for preventing incorrect operation caused by noise.

The options that can be set differ depending on the function.

Setting options (*. default setting)

(When High-speed Function)

Set by number of samples

Off*, 10S, 20S, 50S, 100S, 200S, 500S, 1000S

(S = Number of samples)

(When Real-time Function)

Off, On (When this is On, the filter width is fixed to 10 ms.

Note: The filter width is 2 samples when the recording interval is 10 ms or longer.



4

4

The relation between a pattern being met and a trigger being applied for a logic trigger is as shown below.

OR

(Example 1)

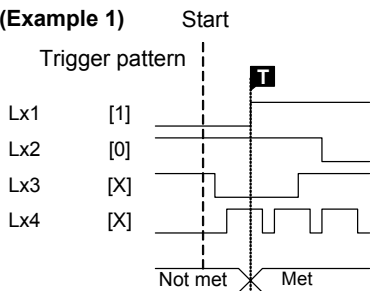

(Example 2)

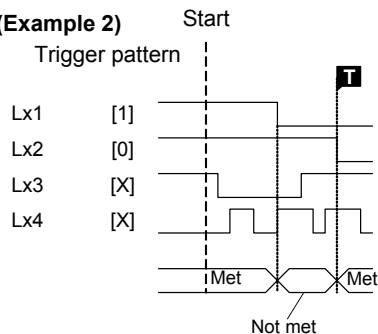

AND

(Example 1)

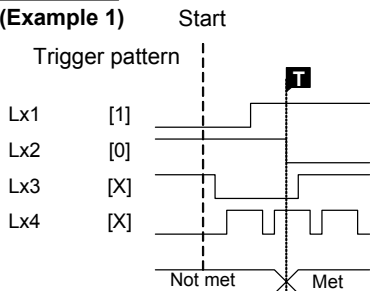

(Example 2)

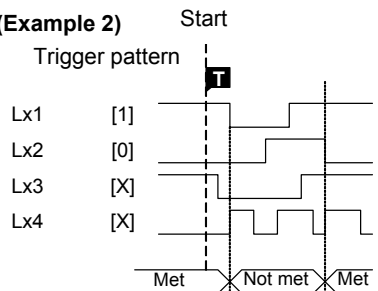

Applying Trigger at Fixed Time Interval (Interval Trigger)

You can apply a trigger at a fixed time interval. This can be set on the [Trig] screen.

1  Select the **[Trig]** screen.

2  Set **[Intvl. (interval)]** to **[On]**.
(Open/confirm the setting information.)

In the following steps, use the same operation to configure settings.

3 Set the time interval for repeat measurement.
[Day]/ [Hour]/ [Min]/ [Sec]

A trigger is applied simultaneously with the start of measurement, and then a trigger is subsequently applied at the specified measurement interval.

Combining this with the schedule function enables fixed interval measurement.

In the case of the Real-time Function, this functions as one start trigger.

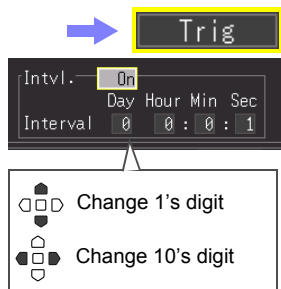

Applying Trigger with External Input Signal (External Trigger)

You can apply a trigger by inputting a signal from an external source. This also enables the synchronous operation of multiple instruments by parallel triggering (p. 226). When using an external trigger, be sure to set **[External Trig In]** to **[Trigger]** in the **[System]** screen.

- 1** Connect the external control terminals of the instrument and the external signal input destination with electrical wires.

See: "Chapter 12 External Control" (p. 217)

- 2**    Select the **[System]** screen. → 

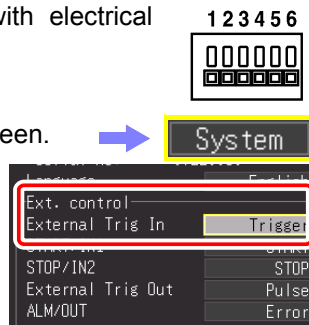
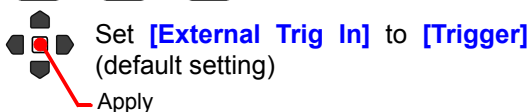

In the following steps, use the same operation to configure settings.

- 3**    Select the **[Trig]** screen. → 

- 4** Select the application condition of the external input signal in **[Ext Trig]**.

The options that can be set differ depending on the trigger application condition (AND/OR). You can set different application conditions for each of the start condition and stop condition.

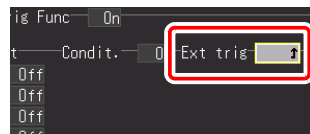

Setting options (*. default setting)

[OR]	Off*	An external trigger is not used.
	↑	A trigger is applied when the external input signal changes from low to high.
	↓	A trigger is applied when the external input signal changes from high to low.
[AND]	Off*	An external trigger is not used.
	HIGH	A trigger is applied when the external input signal is high level.
	LOW	A trigger is applied when the external input signal is low level.

- 5** Set **[Filter]**.

If **[Filter]** is set to On, a trigger is not applied if the fixed period trigger condition is not met.

This is effective for preventing incorrect operation caused by noise.

Setting options (*. default setting)

Off*, On

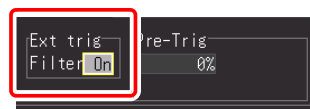

4.10 Entering Comments and Titles

Comments of up to 40 characters can be entered as a title for the measurement data, and as a label for each input waveform.

Titles and comments are displayed on the waveform screen.

They are also printed when the data is printed with an optional printer (p. 171). Comments can also be displayed when the data is viewed using software on a computer.



Setting the Title and Comments

The title comment and comment for each channel can be set on the following screen.



Title comment: [Setting]/[Comment] screens

Comment for each channel: [CH]/[Comment] screens

1 **WAVE** **SET** **FILE** Select the [CH] screen. 

2  Select the field to enter the comment.  Apply

The character entry screen appears.

3  Select the characters to enter.  To enter a space, select a blank character. 

 Apply
 The selected character appears in the entry field.

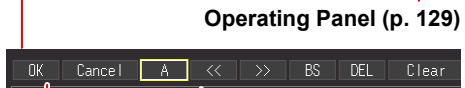

Finished with entry

Navigate the entry field

You can also select from the pick list

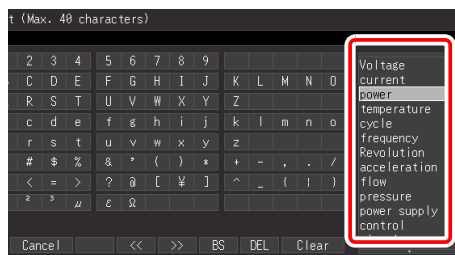
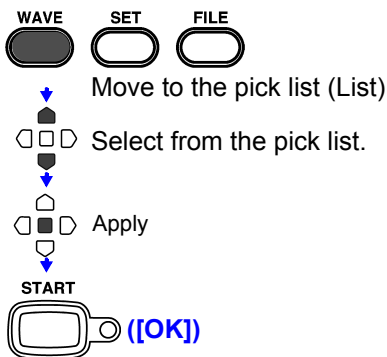

The control panel supports operation key input.

The input field is confirmed, and the previous setting screen reappears.

Operating Panel

The operating panel depicts the functions of Memory HiCorder's operating keys.:



List

Displays a pick list of registered phrases related to measurement.

Hist

Displays a pick list of previously entered phrases.

Clear

Clears all entered characters.

Char Input

Switches between the pick list and character selection frames.

OK

Accepts entry.

Cancel

Cancels entry.

4.10 Entering Comments and Titles

Printing the Title and Comments

You can print the set title and comments at the same time as the measurement waveform.

1 **WAVE** **SET** **FILE** Select the **[Comment]** screen. → **Comment**

2 Select the items you want to print in **[Print items]**.
(Open/confirm the setting information.)

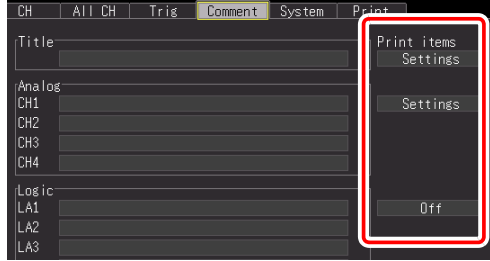

Setting options (*. default setting)

Off *	Do not print any items.
Settings (*1)	(Title comment) Print the function, horizontal axis setting, and start or trigger times. (Analog comment) Print the vertical axis setting and filter value.
Comment	Print the comments.
Setup/Comment (*1)	Print the settings and comments alternately. (Switched every 20 divisions.)

(*1): Logic comments cannot be set.

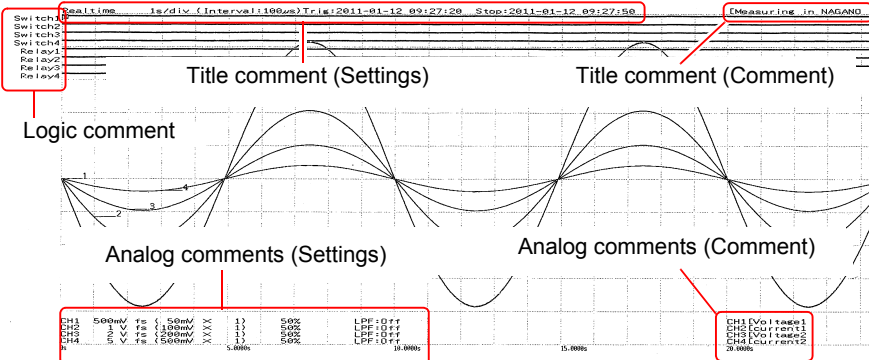

Waveform Analysis

Chapter 5

5.1 Observing Waveforms

View data during and after measuring on the Waveform Screen.

Displaying Waveforms (Display Descriptions)

Press the **WAVE** key to display the Waveform screen. Repeated key presses cycle the screen through seven types.

The settings can be changed. (The setting options are the same as on the Setting screen.)

- Function [**Highspeed**]/[**Realtime**]
- When [**Highspeed**]:
Setting time base range (p. 71) and magnification in the horizontal axis direction (p. 89)
- When [**Realtime**]:
Recording interval (data acquisition interval)(p. 79) and Display time base (time per horizontal division) (p. 90)

Waveform display type (default setting: [**Wave+Set**])

You can switch between five types of waveform display (p. 25).

- Viewing values of cursors on waveform (p. 138)
- Viewing numerical calculation result (p. 177)

In addition, you can switch the display, and confirm channel and trigger settings on the Waveform screen.

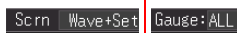

Analog and logic waveforms

Displays acquired data as waveforms.

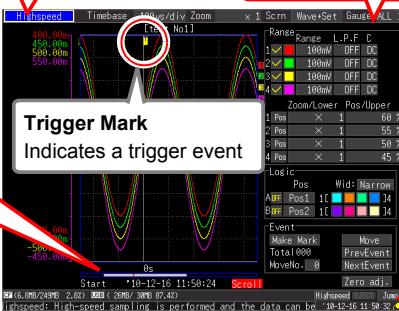

Changing the Gauge
You can display all of the gauges, and the gauge of the specified channel (p. 134).



Scroll Bar (p. 133)

Shows the range and position of the displayed waveform.

Information such as measurement start time and trigger times is displayed below the scroll bar.

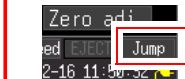

Jump Function (p. 137)

You can specify the position you want to display.

Setting Procedure

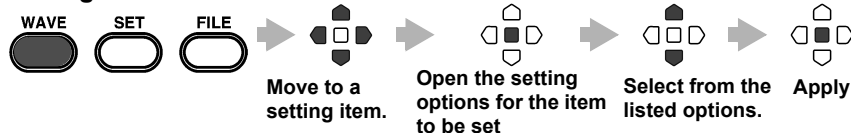

Scrolling Waveforms

When measuring or displaying an existing waveform, use the **SCROLL/CURSOR** keys to scroll.

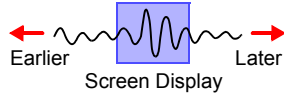

[Highspeed] During Roll Mode display,* manually scrolling a waveform terminates the Roll Mode, so you can freely view any part of the measured waveform. To return to Roll Mode, move the cursor to [Trace] near the bottom right corner of the display, and press the **ENTER** key. Alternatively, just scroll to the right end of the waveform to resume Roll Mode.

* About the Roll Mode display: When the timebase range divided by the display magnification results in a value greater than 50 ms, the screen scrolls automatically so that the newest part of the waveform is always displayed.

[Realtime] During measurement, you can freely view the waveform up until the current point of measurement.

1 Switch to **[Scroll]** display.



2 Fast scroll backward

Scroll backward

Scroll forward

Fast scroll forward

Jumps to the waveform beginning

Press both simultaneously.

Jumps to the latest waveform

Press both simultaneously.

While measuring, you can also put the cursor on **[Trace]** (near the lower right of the screen), and press **ENTER** to jump to the latest waveform.

When measuring with [Cont] set to [On] in Real-time Function

If internal buffer memory becomes full, recording continues by overwriting the oldest acquired data. Therefore, a deleted portion of a waveform cannot be displayed even if you scroll backward during measurement to display past portions of the waveform.

Internal buffer memory (max. recording length): scrollable viewing time span

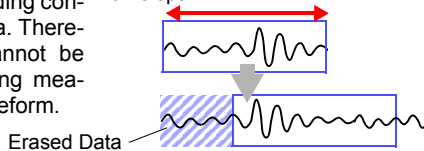

Verifying Waveform Display Position

From the scroll bar you can verify the relative position and size of the displayed portion of a waveform within the overall measured waveform.

Furthermore, the trigger time, trigger position, and positions of cursors A and B (when using the vertical cursors and trace cursors) are also displayed.

The width of the currently displayed time span indicator within the scroll bar depends on the time base (time per horizontal division) setting, even when the recording length is unchanged.

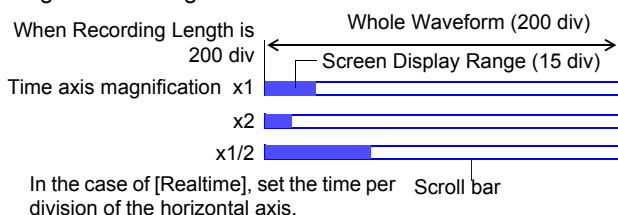

Whole Waveform

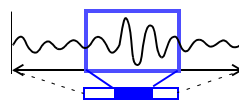

Screen Display Range

Even if the recording length (or recording time) is the same, the width of the scroll bar displayed on the screen differs depending on the magnification (expansion/compression) of the horizontal axis.

Displaying Gauges

A gauge corresponding to the measurement range of each channel can be displayed at the left side of the screen, for confirming measurement values.

The color of the gauge matches the waveform display color of its input channel.

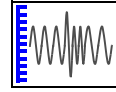

2 Select from the setting options of **[Gauge]**.

(Open/confirm the setting information.)

Setting options (*. default setting)

Off	The gauge is not displayed.
CH1, CH2, CH3, CH4	Display the gauge of the selected channel.
ALL1*	Display the upper and lower limit values of the gauges of all channels.
ALL2	Display the upper and lower limit values of the gauges of all channels on top of the waveform.

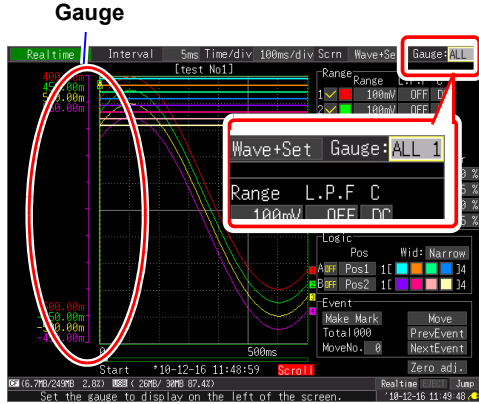

Set the gauge to display on the left of the screen.

Magnifying and Compressing Horizontally

Data details can be observed by magnifying the waveform along the time axis. Also, by compressing the time axis, overall waveform fluctuations can be readily seen.

When the A/B cursors are displayed in [Cursor] display, magnification can be set according to cursor position (but only when finished measuring).

The setting options for the expansion and compression method differ depending on the function.

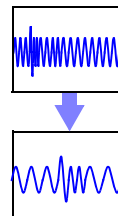

High-speed Function (when [Timebase] setting)

Change the display magnification



2 Select from the setting options of [Zoom].

(Open/confirm the setting information.)

Setting options (*. default setting)

x10, x5, x2, x1*, x1/2, x1/5, x1/10, x1/20, x1/50,
x1/100, x1/200, x1/500, x1/1000, x1/2000

Example: When the time base range is 100 $\mu\text{s}/\text{div}$
The value per division is as follows depending on the magnification.

- x10: $100\mu\text{s}/\text{div} \div 10 = 10\mu\text{s}/\text{div}$
- x1/100: $100\mu\text{s}/\text{div} \times 100 = 10\text{ms}/\text{div}$

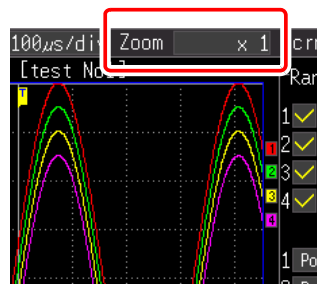

High-speed Function (when [Interval] setting)

Real-time Function

Change the time per division of the horizontal axis

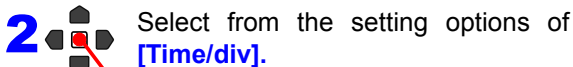

Select from the setting options of [Time/div].

(Open/confirm the setting information.)

Setting options (*. default setting)

[Highspeed]	10 μ s, 20 μ s, 50 μ s, 100 μ s*, 200 μ s, 500 μ s, 10ms, 20ms, 50ms, 100ms, 200ms, 500ms, 1s, 2s, 5s, 10s, 30s, 1min, 2min, 5min, 10min [/div]
[Realtime]	10ms, 20ms, 50ms, 100ms*, 200ms, 500ms, 1s, 2s, 5s, 10s, 30s, 1min, 2min, 5min, 10min, 30min, 1h, 2h, 5h, 10h, 12h, 1day [/div]

- If the recording interval is changed after measurement, the selection range for the horizontal axis changes, but the horizontal axis settings which actually allow you to expand or compress the horizontal axis are those of the selection range that corresponds to the recording interval used during measurement.

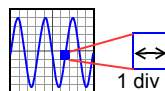

- The selection range of the horizontal axis differs depending on the function and [Envelope] function.

When you use the High-speed Function or use the Real-time Function with [Envelope] set to [Off]:

A value equivalent to the setting value of [Interval] multiplied by less than 10 cannot be set.

Example: When the recording interval is 1 ms, the horizontal axis can be recorded from 10 ms.

When you use the Real-time Function with [Envelope] set to [On]

A value equivalent to the setting value of [Interval] multiplied by less than 100 cannot be set.

Example: When the recording interval is 1 ms, the horizontal axis can be recorded from 100 ms.

Viewing Any Waveform Location (Jump Function)

When the recording length of a waveform is long, you can specify the portion to be displayed immediately.

This is only enabled when measurement is stopped.

[Jump] changes to [Trace] during measurement (p. 132).

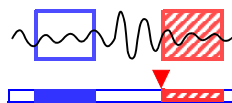

1  Select [Jump].

 Apply

The location of the currently displayed portion of the overall waveform is indicated by the ▼ mark on the scroll bar.

2  Move the ▼ mark to display a different portion of the waveform.

The portion of the waveform at the ▼ mark is displayed.

3  Apply

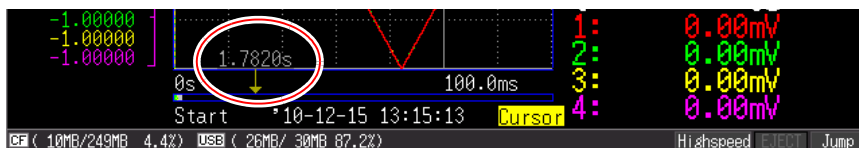
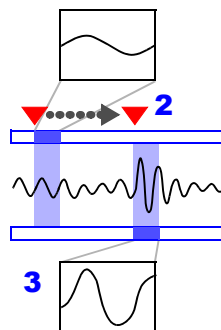

Displaying Cursor Values

Time difference and potential difference (and when scaling is enabled, scaling values) can be read as numerical values using the A/B cursors.

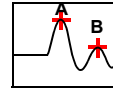

1 Switch to **[Cursor]** display.
(To hide the cursor items again, press the **SCROLL/CURSOR** key.)



2 Move a cursor with the left or right cursor key.
The numerical values along the waveform can be read.

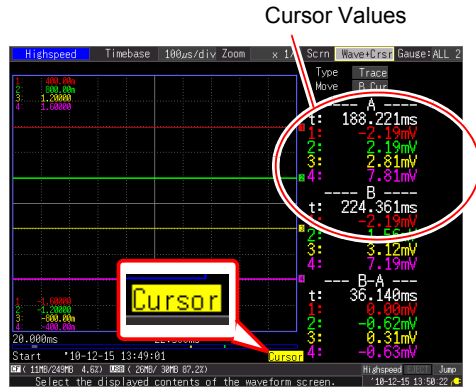

Cursor Values



Press the left or right **SCROLL/CURSOR** key (outer key) to increase the amount of movement.

Press **<** or **>** while pressing the **ESC** key to move a cursor one division at a time.
Press **<<** or **>>** while pressing the **ESC** key to move a cursor 10 divisions at a time.

Changing Cursor Type

Select from the **[Type]** setting options.

- Off
 - Trace*
 - Vert (Vertical)
 - Horz (Horizontal)
- (*: default setting)

High-speed Function

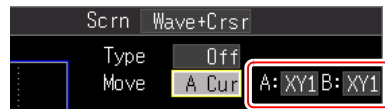

When XY display, you can select the waveform for each of cursor A and cursor B.
Setting options : **XY1, XY2, XY3, XY4**

To select which cursor to move

Select from the **[Move]** setting options.

- A Cur*
 - B Cur
 - AB Cur
- (*: default setting)

Real-time Function

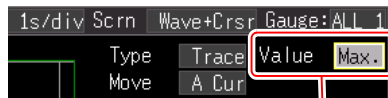

When the envelope function is on, select whether to acquire the maximum value or minimum value of the envelope data with the trace cursors.

About Cursor Values

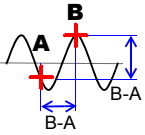
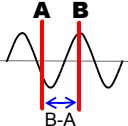
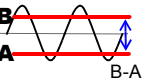
Cursor Type	Example	Cursor Value
Trace Cursors		Displays the time and measurement values at the A/B cursors, or the time and measurement differences between the A/B cursors. Displays the intersections (trace points) of cursors and waveforms. (the intersections of waveform traces of all channels) These cursors are used to specify the range for saving or numerical calculation.
Vertical Cursors		Displays the time and frequency values at the A/B cursors, or the time and frequency differences between the A/B cursors. During X-Y display, the measurement value at cursor A or B of the vertical axis and the difference of the measurement values between cursors A and B are displayed. These cursors are used to specify the range for saving or numerical calculation.
Horizontal Cursors		Displays the measurement values at the A and B cursors for the selected channel(s), or the difference between A/B cursor values. During X-Y display, the measurement value at cursor A or B of the vertical axis and the difference of the measurement values between cursors A and B are displayed. A/B cursors can be enabled for any channel.

NOTE

- The cursors can also be moved in the **[Wave+Calc]** display screen.
- If the number of digits of the time value displayed when using the cursors in the **[Wave+Calc]** display screen exceeds 11, the time value is indicated as "* + 10 digits."



Specifying a Waveform Time Span

Specify a waveform time span when saving a partial waveform or applying numerical calculations (Trace cursors or Vertical cursors).

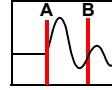

Switch to **[Cursor]** display.

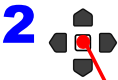

Select the cursor you want to move from **[Move]**.

(Open/confirm the setting information.)



Move cursors A and B to specify the range.

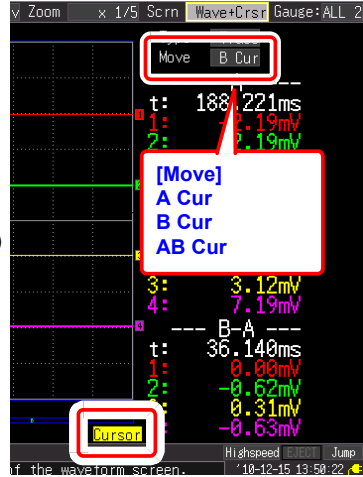

5.2 Marking Waveforms and Searching Marks (Search Function)

You can insert up to 100 event marks at any point while measuring, to help find them later.

See: "Searching Event Marks" (p. 143)

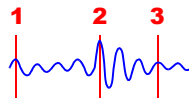

Event marks can be applied by the following methods.

- Method 1. Press the **START** key while measuring (see below).
- Method 2. Select **[Make Mark]** in the event setting display of the Waveform screen ([Wave+Set] display) (see below).
- Method 3. Input a signal from the EXT.TRIG terminal (external trigger input) (p. 142).

Inserting Event Marks While Viewing Waveforms

Insert a mark while viewing the data during measurement in the Waveform screen.

Method 1:

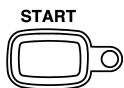

Press the **START** key when you want to insert a mark. When the **START** key is pressed, a mark is inserted in the waveform. Event marks are numbered in the sequence they are inserted.

Method 2:

Select **[Make Mark]** in the **[Wave+Set]** display screen of the Waveform screen.

1 **WAVE** **SET** **FILE** Select the **[Wave+Set]** display.



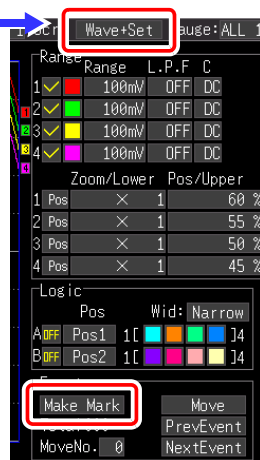

2 Move to **[Make Mark]**.



3 Press to insert an event mark. Event numbers appear on the waveform displayed when you select **[Make Mark]**.



Inserting Event Marks Using External Input Signals

Event marks can be inserted by applying external input signals.
Make this setting before starting measurements.

1    Select the **[System]** screen.  

2  Select **[Event]** from the selection options of **[External Trig In]**.
 (Open/confirm the setting information.)

3 Connect the external signal input (p. 217).

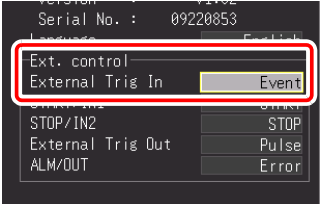

An event mark is inserted when the external trigger input (EXT TRIG external control terminal) switches from High to Low (falling edge) while measuring.



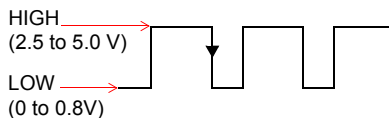

For input signal specifications:

See: "12.2 External Signal Input (External Trigger Input)" (p. 219)

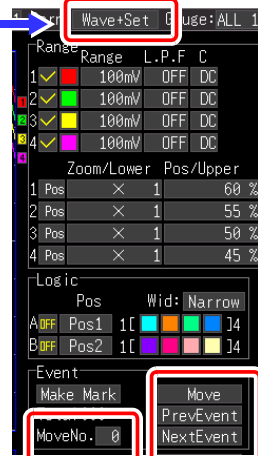

Searching Event Marks

Any event mark can be found by searching.

- 1    Select the **[Wave+Set]** display. 
- 2  For the **[MoveNo.]** setting, select the number of the event you want to find.
(Open/confirm the setting information.)
- 3  Select **[Move]**.
Apply
The waveform with the specified event number is displayed.

You can search by incrementing and decrementing the event number.

PrevEvent Search for the previous event mark.

NextEvent Search for the next event mark.

5.2 Marking Waveforms and Searching Marks (Search Function)

Viewing Events in Text Format (CSV)

If you save measurement data in text format, event numbers are inserted beside the measurement data. This enables you to extract only the data with marks when performing analysis on a computer.

Example

File name	WAVE0001.CSV	V1.00			
Title comment					
Trigger Time	'10/10/22 15:14				
CH	CH1	CH2	CH3	CH4	
Mode	DC	DC	DC	DC	
Range	500mV	2V	100V	500mV	
Comment					
Scaling	Off	Off	Off	Off	Event No.
Ratio	1.00E+00	1.00E+00	1.00E+00	1.00E+00	
Offset	0.00E+00	0.00E+00	0.00E+00	0.00E+00	
Time	CH1[V]	CH2[V]	CH3[V]	CH4[V]	Event
0.00E+00	1.16E+00	1.13E+01	5.47E+00	2.85E-01	0
5.00E-01	1.14E+00	1.13E+01	5.47E+00	2.87E-01	0
1.00E+00	1.11E+00	1.13E+01	5.63E+00	2.89E-01	0
1.50E+00	1.09E+00	1.13E+01	5.78E+00	2.95E-01	1
2.00E+00	1.06E+00	1.13E+01	5.78E+00	2.96E-01	0
2.50E+00	1.03E+00	1.13E+01	5.78E+00	2.98E-01	2
3.00E+00	1.01E+00	1.13E+01	5.47E+00	3.03E-01	0
3.50E+00	9.76E-01	1.13E+01	5.63E+00	3.05E-01	0
4.00E+00	9.48E-01	1.13E+01	5.63E+00	3.07E-01	0
4.50E+00	9.23E-01	1.13E+01	5.63E+00	3.10E-01	3
5.00E+00	8.89E-01	1.13E+01	5.63E+00	3.12E-01	4
5.50E+00	8.62E-01	1.13E+01	5.78E+00	3.19E-01	0
6.00E+00	8.34E-01	1.13E+01	5.78E+00	3.21E-01	0
6.50E+00	8.00E-01	1.13E+01	5.78E+00	3.23E-01	0
7.00E+00	7.71E-01	1.13E+01	5.78E+00	3.25E-01	5
7.50E+00	7.41E-01	1.13E+01	5.63E+00	3.32E-01	0
8.00E+00	7.05E-01	1.13E+01	5.63E+00	3.29E-01	0
8.50E+00	6.77E-01	1.13E+01	5.78E+00	3.34E-01	0
9.00E+00	6.44E-01	1.13E+01	5.63E+00	3.37E-01	0
9.50E+00	6.10E-01	1.13E+01	5.78E+00	3.39E-01	0
1.00E+01	5.80E-01	1.13E+01	5.63E+00	3.45E-01	0
1.05E+01	5.43E-01	1.13E+01	5.63E+00	3.43E-01	0

5.3 Synthesizing Waveforms (X-Y Synthesis)

Up to four measured waveform data can be synthesized in any channel combination ([Highspeed] only). You can also specify a waveform range and then perform synthesis (partial synthesis).

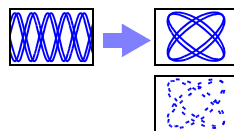

When you want to perform synthesis during measurement, configure the settings on the setting screen before measurement (p. 94).

Synthesizing All Acquired Data

1 Select the **[Setting]** screen.



2 Select **[X-Y Line]** or **[X-Y Dots]** from the setting options of **[Format]**.

Apply

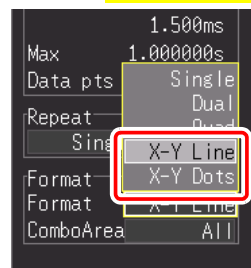

3 Select **[All]** from the setting options of **[ComboArea]**.

(Open/confirm the setting information.)

4 Select the **[Wave+Crsr]** display.

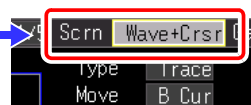

Synthesis example

If you select [X-Y Line] or [X-Y Dots] for the display format, the horizontal axis setting will automatically switch to [Interval] selection.

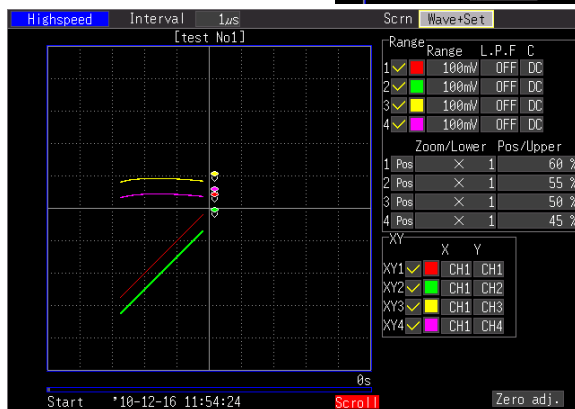

Synthesizing Part of the Data

1 Select the **[Setting]** screen.



2 Select **[Single]**, **[Dual]**, or **[Quad]** from the setting options of **[Format]**.
Apply

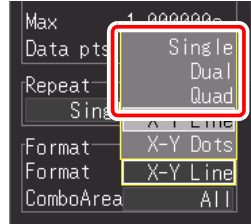

3 Select the **[Wave]** display.

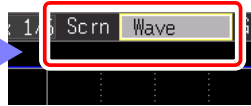

4 Switch to **[Cursor]** display.

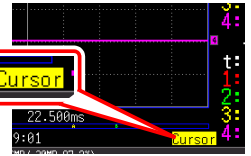

5 Select the range with cursors A and B (p. 140).
(Specify the range with the trace or vertical cursors.)
Specify the positions of the cursors in other than the XY screen.

6 Select the **[Setting]** screen.



7 Select **[X-Y Line]** or **[X-Y Dots]** from the setting options of **[Format]**.
Apply

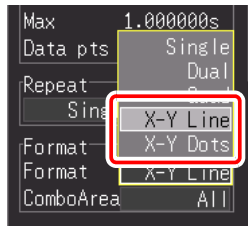

8 Select **[A-B]** from the setting options of **[ComboArea]**.
Apply

Managing Data

Chapter 6

The instrument measurement data can be saved to an optional CF card or USB flash drive.

See: "2.7 Using CF Card or USB Flash Drive (for Saving Data)" (p. 46)

Furthermore, the data saved to a CF card or USB flash drive can be loaded into the instrument. (Only data in binary format)

6.1 Saving & Loading Data

About the File Hierarchy

When saving data, a folder named HIOKI_MR8880 is created, and files are stored in the folder as follows.

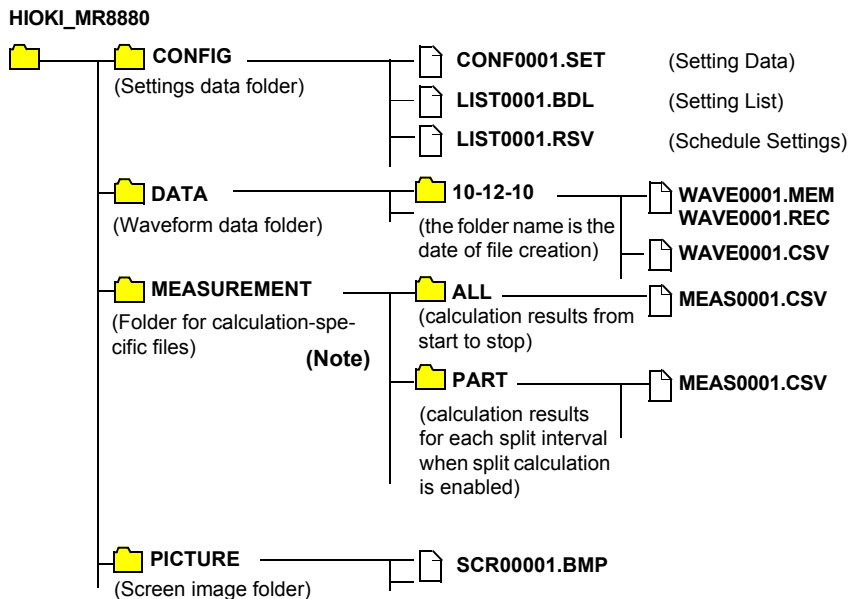

(Note) When split calculation is enabled, both ALL and PART folders are created, with calculation results from start to stop stored in the "ALL" folder, and calculation results for each split interval stored in the "PART" folder.

About File Types & Saving/Loading

●: Available/ X: Not Available

File Type	File Format	Folder Name	File Name*5 (Auto-numbered from 1)	Save		Load	
				Auto	Manual	MR880-20	PC
Setting Conditions (Setting list) (Schedule Settings)	Binary	CONFIG	CONF0001.SET	X	●	●	X
	Binary	CONFIG	LIST0001.BDL	X	●	●	X
	Binary	CONFIG	LIST0001.RSV	X	●	●	X
Waveform Data *1	Binary	DATA\date)*4 (e.g.:10-12-10)	WAVE0001.MEM WAVE0001.REC	●	●	●	●
	Text (CSV) *2	DATA\date)*4 (e.g.: 10-12-10)	WAVE0001.CSV *6	●	●	X	●
Numerical Calculation Results	Text *2	MEASUREMENT	MEAS0001.CSV	●	●	X	●
Captured Screen Image	BMP *3	PICTURE	SCR00001.BMP	X	●	●	●

*1: Save waveform data in binary format if you intend to view it later in the HiCorder or on a PC with the supplied program. Waveform data and some measurement-related settings data are saved. To save a waveform partially, specify a period by using A/B cursors before saving (p. 140).

*2: When opening a CSV file in a spreadsheet program, note that the number of rows that can be loaded at one time is limited (p. A12).

*3: BMP Format: This is a standard Windows® graphics format. These files can be handled by many graphics programs.

*4: Date (YY-MM-DD) folders are automatically created inside the DATA folder.

*5: When saved manually. See "Appendix 3 File Naming" (p. A12) for file naming details.

*6: The TXT file extension is applied except when [Separator:Comma] is selected on the [System] screen.

NOTE

Up to 1,000 files can be stored in one folder. Also, as more files are created, more time is needed to start and stop recording.

We recommend setting measurement conditions so that the number of files saved stays as low as possible. (For example, adjust the recording time so that the size of one file does not become too small.)

When the number of files saved in one folder exceeds 1000, a new folder will automatically be created and files continued to be saved in the new folder (except for real time saving).

Preparations and Settings for Power Outages during Long-term Measurements

Data in internal buffer memory is retained for about 30 minutes after power-off.

If power is off for more than 30 minutes, the data is lost.

Also, when Auto-Resume (p. 198) is enabled, measurement resumes automatically when power is restored, so previous measurement data is deleted.

To avoid data loss in such cases during long-term measurement, we recommend the following settings to prepare for power outages.

Measure 1

Combined Use with Battery Pack (Option) (p. 32)

Measurement can continue on battery power for a certain period of time if the commercial power supply fails.

Measure 2

Setting Automatic Saving (p. 102)

Data is periodically saved to removable storage. The HiCorder includes a large-value capacitor to provide power to save the most recent data and close the files when power fails.

CAUTION

- If power is lost within about three minutes after power-on, files on the removable storage may be corrupted, and the device could be damaged.
- If storage media that is not a genuine Hioki CF card or damaged storage media is used, files may fail to close within the allotted time, and data may be lost.
- Setting [File Protection] to [High] on the System screen enables the files to be protected in the event of a power outage. However, storage media is not recognized during the period of approximately three minutes after power-on in which files may be inaccessible and could become corrupted.

See: "File Protection Level Setting" (p. 198)

NOTE

Although [CSV(realtime)] saving is possible, data is saved only as text, so waveforms cannot be displayed later by reloading into the HiCorder or by application programs. Note that the recording interval setting is limited.

See: "CSV Format Data" (p. 102)

6.2 Saving Data

Basically, three methods are available for saving.

To save automatically while measuring

Auto Save (p. 102)

Set this before starting measurement. The operation differs depending on the function (p. 68). The measurement data is saved automatically after measurement starts.

Insert a removable storage (p. 46)

Setting

Set the Auto Save (p. 102)

Select what to save

- Waveform Data
- Numerical Calculation Results

Measurement

Auto save

- **[Highspeed]:** Data is saved automatically after the waveform is acquired.
- **[Realtime]:** Data is saved automatically while the waveform is acquired.

The calculation result is saved automatically when measurement ends.

To save immediately upon pressing the SAVE

Quick Save (p. 154)

Before saving, select the items to be saved on the **[System]** screen. These are saved immediately when you press **SAVE**. This is convenient for saving certain types of data, or when you want to save immediately while monitoring.

Insert a removable storage (p. 46)

System

Set the function of **SAVE** to **[Quick Save]**

Select what to save

- Waveform Data
- Screen Image
- Setting Data
- Numerical Calculation Results

Press **SAVE** after measuring

Save

To save selected contents

Select & Save (p. 152)

(default setting)
Press **SAVE** to select and save the selected contents. No settings are needed before saving this way.

Insert a removable storage (p. 46)

System

Set the function of **SAVE** to **[Select & Save]**

Press **SAVE** after measuring

Save Dialog

Select what to save.

- Waveform Data
- Screen Image
- Setting Data
- Numerical Calculation Results
- Schedule Settings

Press **ENTER**

Save

When [Quick Save] and [Select & Save] (Real-time Function)**NOTE**

- **[Quick Save]** and **[Select & Save]** can save the data remaining in the internal buffer memory (up to the last 1 Mword). If you want to save data that exceeds 1 Mword, set **[Cont (Continuous Recording)]** to **[On]** and **[Realtime Save]** to **[Waveform (Real time)]** before performing measurement.
- Data can only be saved with **[Quick Save]** and **[Select & Save]** when measurement is stopped. Saving is not possible during measurement. (Both waveform data and display images)

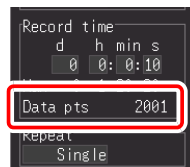

To save a waveform partially, specify a period by using A/B cursors. (Saving a waveform section is not available with Auto Save) (p. 140)

To save a screen image, display the desired screen before saving.

Selecting & Saving Data with the SAVE Key [Select&Save]

If you press the **SAVE** key, you can select save options and then save the data. This is enabled when the **SAVE** key setting is set to **[Select & Save]**.

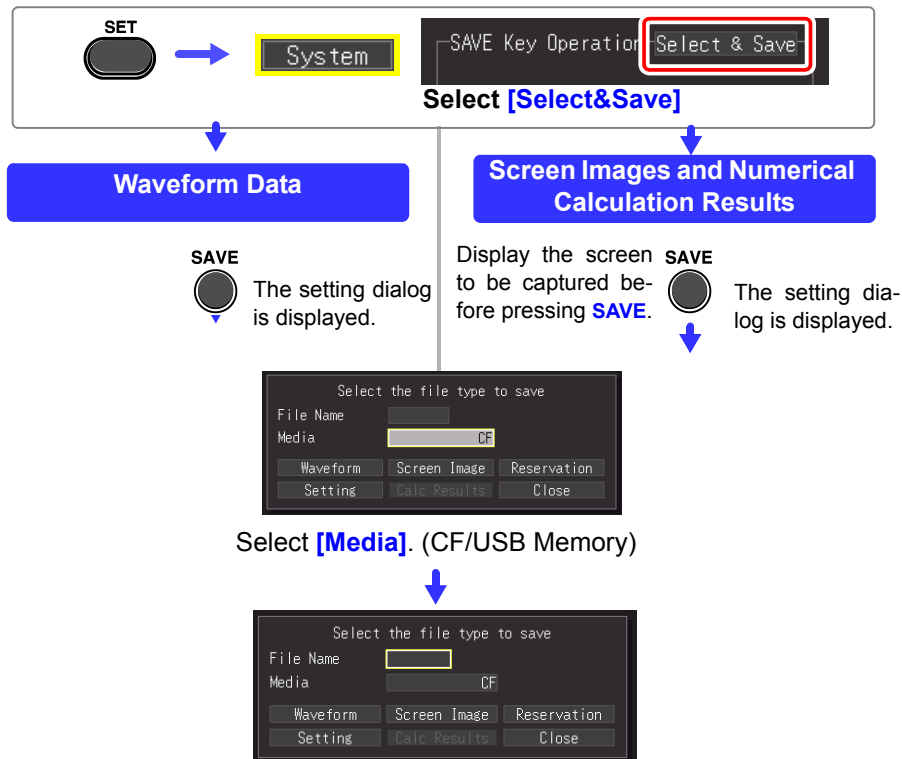

Enter **[File Name]**.

The operating procedure is the same as for entering comments. (Some characters and symbols cannot be selected because of file system restrictions.) (p. 128)

A confirmation dialog appears.

Select **[Yes]** and press the **ENTER** to apply the new name.



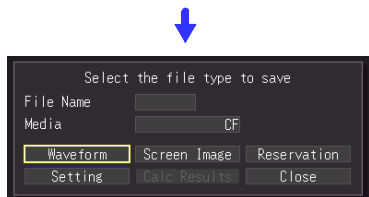

Select **[Waveform]**, and press the **ENTER** key.

Select the save format and range, select **[Save]**, and press the **ENTER** key.

Select **[Yes]** in the confirmation dialog, and press **ENTER**.

Before saving a partial waveform, specify the span to be saved (p. 140)

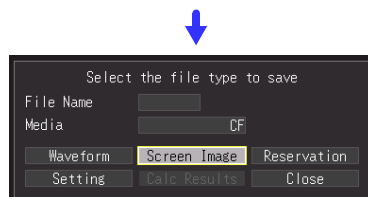



Select **[Screen Image]** or **[Calc Results]**, and press the **ENTER** key.

Select **[Yes]** in the confirmation dialog, and press **ENTER**.

- Numerical calculation must be configured in order to save calculation results (p. 177)
- When a save span is specified for calculation results, the results are saved for the specified span.

Saving immediately with the SAVE Key [Quick Save]

If you set the save options in advance, you will be able to save data quickly according to the preset save options when you press the **SAVE** key. This is enabled when the **SAVE** key setting is set to **[Quick Save]**.

1  Select the **[System]** screen.  

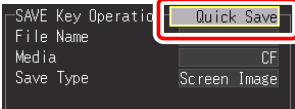
2  Select **[Quick Save]** from the setting options of **[SAVE Key Operation]**. 
 (Open/confirm the setting information.)

In the following steps, use the same operation to configure settings.

3 Select the storage media to which to save from **[Media (Preferred Save Location)]**.
 Setting options (*. default setting)

CF*	Save to the CF card first
USB Memory	Save to the USB flash drive first

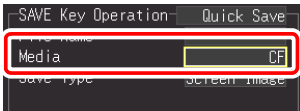

4 Select the item to save from **[Save Type]**.
 Setting options (*. default setting)

Waveform*	Save waveform data.
Screen Image	Save screen image.
Setup File	Save setting configuration data.
Calc Results	Save numerical calculation results.

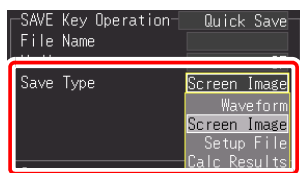

5 (When **[Waveform]** is selected for **[Save Type]**)

Select the file format for saving from **[Format]**.

Setting options (*. default setting)

Binary*	Select this when you want to be able to re-load the saved data into the instrument, or read it in the supplied software.
CSV	Select this when you want to save the data in text format. This is convenient when you want to open the data in a spreadsheet program such as Excel®.

Data saved with [CSV] cannot be read by the instrument or supplied software. Data saved with [Binary] can be later converted to text (CSV) format with the instrument or software.

Calculation must be configured before saving numerical calculation results (p. 177).

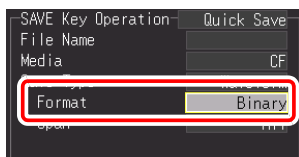

6 (When [Waveform] is selected for [Save Type])

Select the waveform range to save from **[Span]**.

Setting options (*. default setting)

All*	Save all measured waveform data.
A-B	Save waveform data between A/B cursors. (This is only enabled when cursors A and B are displayed on the screen.)

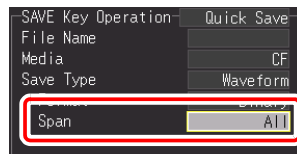

Before saving a partial waveform, specify the span to be saved (p. 140)

- When a save span is specified for calculation, the results are saved for the specified span.

7 (When [Waveform] is selected for [Save Type], and [CSV] is selected for [Format])

Select the amount of data thinning desired from the **[Thin out]**.

Setting options (*. default setting)

OFF*, 1/2, 1/5, 1/10, 1/20, 1/50, 1/100, 1/200, 1/500, 1/1000

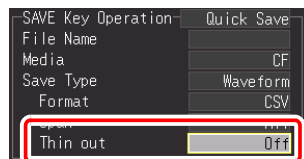

(Examples)

1/2: Saves every other data point

(●●●●●●●●●●)

1/5: Saves one of every five data points

(●●●●●●●●●●●●●●●●)

8 Enter [File Name].

The operating procedure is the same as for entering comments.

(Some characters and symbols cannot be selected because of file system restrictions.) (p. 128)

A confirmation dialog appears.

Select **[Yes]** and press the **ENTER** to apply the new name.

- Measurement data is automatically saved as the entered name.
 - When multiple files are saved in succession, numbers are appended to the file name.
 - If left blank, file names are created automatically.
- See:** "Appendix 3 File Naming" (p. A12)

9 **SAVE** Press **SAVE** to immediately save data according to current settings.





Saving Setting Configuration Data

Setting configurations can be saved as data files and later reloaded into the HiCorder when you need to make more measurements with the same settings.



Up to ten setting configurations can be saved to internal memory, and more can be stored on the removal storage device.

1  Select the **[Setting]** screen.  

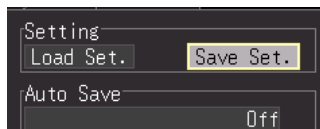

2  Select **[Save Set.]**
 Apply



The Save dialog appears.

3  Select whether to save to HiCorder memory, CF card, or USB flash drive.
 Apply



4 (When **[Memory]** is selected)
 Select **[Save]** for the configuration instance (No.) to save.
 Enter a comment as needed (p. 128)
 Apply

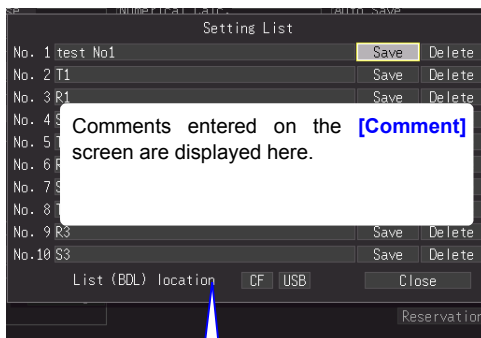

(When **[CF Card]**, or **[USB memory]** is selected)

Setting configuration files are automatically named CONFnnnn.SET in a folder named [HIOKI_MR8880]-[CONFIG] (p. 147)

When you want to simultaneously save all setting conditions stored in the instrument memory as a file

Select the CF card or USB flash drive as the save location in the **[List (BDL) location]** item.

The file is saved under the name [LIST+Automatically Assigned Number (0001).SET] in the [HIOKI_MR8880]-[CONFIG] folder.



See: To load the setting configuration data (p. 157)



6.3 Loading Data on the HiCorder

Previously stored binary waveform data, captured screen images and saved setting configurations can be reloaded into the HiCorder (p. 147).



Loading a Setting Configuration

Setting configurations saved in the HiCorder's memory or on a removable storage can be reloaded.



1  Select the **[Setting]** screen.  

2  Select **[Load Set.]**.
 Apply



The loading dialog appears.

3  Select whether to load from HiCorder memory, CF card, or USB flash drive.
 Apply

4 (When **[Memory]** is selected)

 Select **[Load]** for the setting configuration file to load.
 Apply

(When **[CF Card]**, or **[USB memory]** is selected)

 Select the configuration file to load.
(CONFnnnn.SET)
 Apply

HiCorder settings are reconfigured to those in the loaded configuration file.

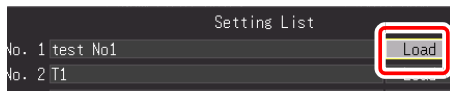
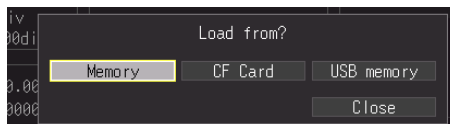
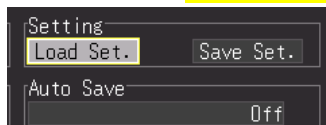

When Loading from HiCorder Memory

The list of configurations stored in HiCorder memory is displayed.

No.	NameA	Type	Size
0001	CONF0001.SET	Set	10.0
0002	CONF0002.SET	Set	10.0
0003	CONF0003.SET	Set	10.0

When Loading from removable storage

Configuration files stored in the [HIOKI_MR8880]-[CONFIG] folder on the removable storage are displayed.

Setting configurations saved to removable storage can be reloaded from the File screen

■ To load the setting configuration data automatically:

Method 1. Loading from instrument memory

1 Open the screen for loading the setting configuration.
(Up to step 3 on the previous page)

2 Specify the number of the setting configuration you want to load automatically and input it into **[Auto Load]**.
Setting options (*. default setting)

Off * Loading is not performed automatically.

No1 to No10 Select the file to load automatically.

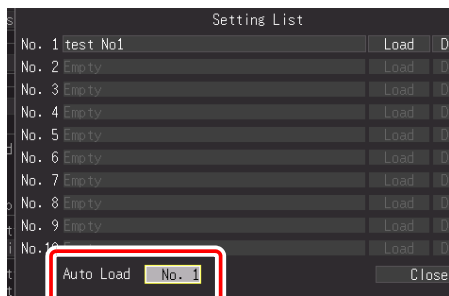

Method 2. Loading from external storage media

- Setting configuration data saved as a file named STARTUP.SET in the [HIOKI_MR8880] - [CONFIG] folder of the CF card is automatically loaded at power-on.
- When [File Protection] is set to [High] on the System screen, Auto Setup is not available.

Loading Waveform Data and Screen Images

Saved binary waveform data and screen images can be reloaded in the HiCorder.

1  Select the File screen.
The contents of the removable storage are displayed.

2  Select a file to load.

No.	NameA	Type	Size
0001	AUTO0001.MEM	Wave	20.7K
0002	AUTO0002.MEM	Wave	20.7K
0003	AUTO0003.MEM	Wave	20.7K
0004	AUTO0004.MEM	Wave	20.7K

 — Displays the child folder.
(Viewing folder contents)

 Displays the parent folder.

After selecting a folder by pressing **ENTER**, select **[Change]** in the displayed control dialog box.

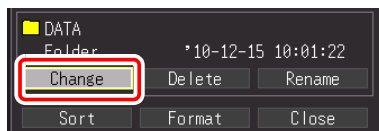

 Apply
The control dialog box appears.

3  Select **[Load]**.
Apply

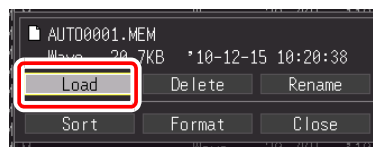

When loading waveforms

If the number of data items included in the file to be loaded exceeds the available space in the internal buffer memory, you can specify from what waveform data number to start loading. ([Top of data num])

The data portion indicated by [Readable data num] (number of data that can be loaded) is loaded from the set number. This settings does not need to be configured when the data will fit in internal buffer memory.

Select [OK] to load the data.

File name	AUTO0001.MEM
Trigger Time	*10-12-15 10:20:37
Data num	1501
Saved Ch	CH1 CH2 CH3 CH4 LA LB
Readable data num	1000001
Top of data num	(0 ~ 0) OK
Scope of data re	*10-12-15 10:20:37 ~ *10-12-15 10:20:37.001500

6.4 Data Management

You can manage data stored on a removable storage in the HiCorder

- Format removable storage (p. 48)
- Load a file (when the file is selected) (p. 157)
- Move displayed folders (when the folder is selected) (p. 160)
- Delete data (p. 161)
- Rename files and folders (p. 162)
- Sort files (p. 163)

Switching Removable Storage



Select the File screen.

CF card contents are displayed.

When only a USB flash drive is inserted in the HiCorder, its contents are displayed.

The drive cannot be switched.

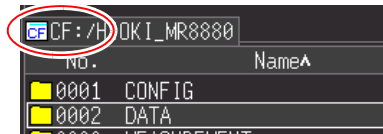

USB flash drive contents are displayed.

Press the **FILE** key to toggle between the CF card and USB flash drive.

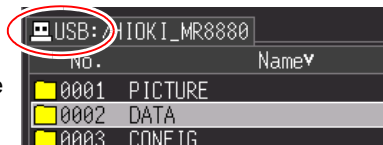

Viewing Folder Contents and the Parent Folder



Select the File screen.

CF card contents* are displayed.

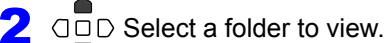

View child folder (view contents of the currently highlighted folder) (press **ENTER** and select **[Change]** in the displayed control dialog box)

Displays the parent folder.

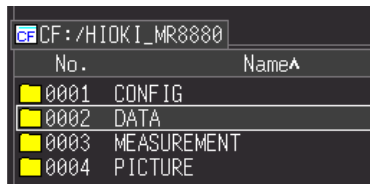



*: When only a USB flash drive is inserted in the HiCorder, its contents are displayed.

- Another drive can be selected when the root folder is displayed.
- The path name may have up to 128 characters.

Deleting Data

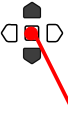
You can delete the files and folders on a CF card and USB flash drive.

- 1  Select the File screen.
- 2  Select a folder or a file to delete.
Apply
- 3  Select **[Delete]**.
Apply

When the file you want to delete is not displayed on the screen

See: "Switching Removable Storage" (p. 160)

See: "Viewing Folder Contents and the Parent Folder" (p. 160)



A confirmation dialog appears.
Select **[Yes]** and press **ENTER** to delete.

NOTE

- To protect against inadvertent data loss, the HIOKI_MR8880 and DATA folders cannot be deleted. If you need to delete one of these folders, rename it first.
- Read-only files can only be deleted with a PC.

Renaming Files and Folders

Folders and files on a removable storage can be renamed. File names may consist of up to 26 regular characters.

1  Select the File screen.

2  Select the file or folder to rename.
Apply

3  Select **[Rename]**.
Apply

When the file you want to rename is not displayed on the screen
See: "Switching Removable Storage" (p. 160)
See: "Viewing Folder Contents and the Parent Folder" (p. 160)

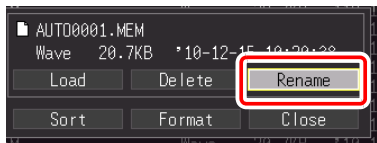



The character entry dialog appears.
Enter the new file name
The operating procedure is the same as for entering comments.
(Some characters and symbols cannot be selected because of file system restrictions.) (p. 128)

A confirmation dialog appears.
Select **[Yes]** and press the **ENTER** to apply the new name.

Sorting Files

Files can be sorted in ascending or descending order according to a selected sort key.

- 1**  Select the File screen.
- 2**  Apply
The control dialog box appears.

- 3**  Select [Sort].
Apply

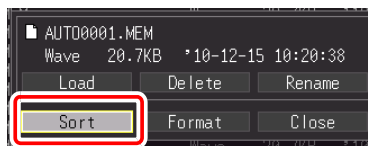

- 4**  Select the key on which to sort.
Apply

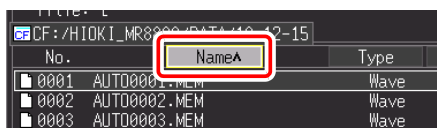

- 5**  Execute the sort.
Files are redisplayed sorted in ascending or descending order.
(Press to toggle ascending/descending order)
^ : Ascending order
v : Descending order

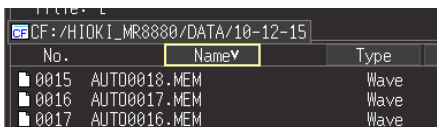

- 6**  Finish

File sorting is also applied to files that are not displayed on the screen. (In the figure above, all file names are displayed in descending order.)

Printing

Chapter 7

You can use the optional printer to print measurement data and display screens.

Auto print (p. 108)

Print the waveform during measurement. (The initial setting of auto print is [Off].)
Set this before measurement.

Manual print (after measurement) (p. 166)

Partial print. (p. 167)
Specify the range to print.

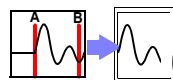

Screen hardcopy (p. 168)

Print the screen display.

List print (p. 169)

Print the setting information.

Before Printing

Set the print method and advanced settings of the printer on the **[Print]** screen.

1 **WAVE** **SET** **FILE** Select the **[Print]** screen.



2 Select from the setting options.



(Open/confirm the setting information.)

Time value display (p. 201)

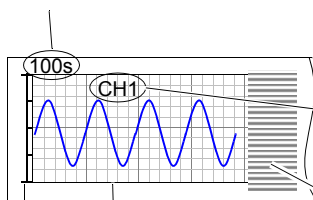

Grid (p. 172)

Gauge (p. 173)

Channel number or comment
(channel marker) (p. 171)

List (p. 173)

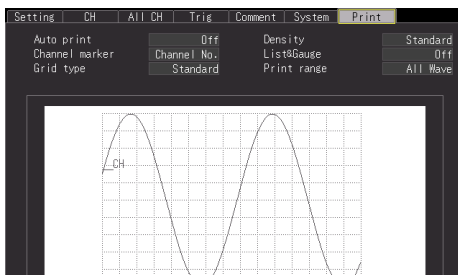

Before printing, connect the optional printer and load the recording paper.

See: "2.4 Connecting Printer and Loading Recording Paper (Options)" (p. 41)

If a problem occurs when using the printer:

See: "14.2 Troubleshooting"- "Printing problems" (p. 250)

7.1 Printing Waveform after Measurement (Manual Print)

Press the **PRINT** key while the waveform screen is displayed, select the print range and type, and then print the waveform.

Printable Waveforms

- Waveforms saved to the internal buffer memory after measurement
- Waveforms of data saved to media that has been read to the internal buffer memory of the instrument

Printing Whole Waveform

- Press the **WAVE** key to display the waveform display screen.

When you want to print a waveform that is saved to media, read the data to the instrument before pressing the **PRINT** key.

See: "Loading Waveform Data and Screen Images" (p. 159)
- Press the **PRINT** key on the printer.

The print range confirmation screen appears.
- Select [**All Wave**].

Printing of the waveform begins.

To force printing to end, press the **STOP** key.

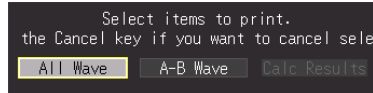
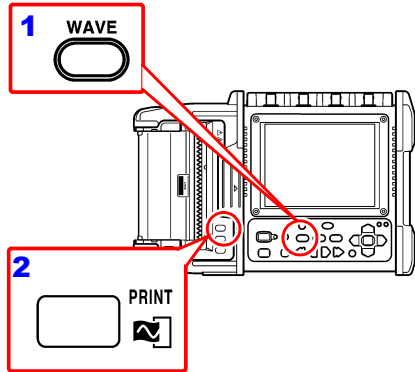

Print Example

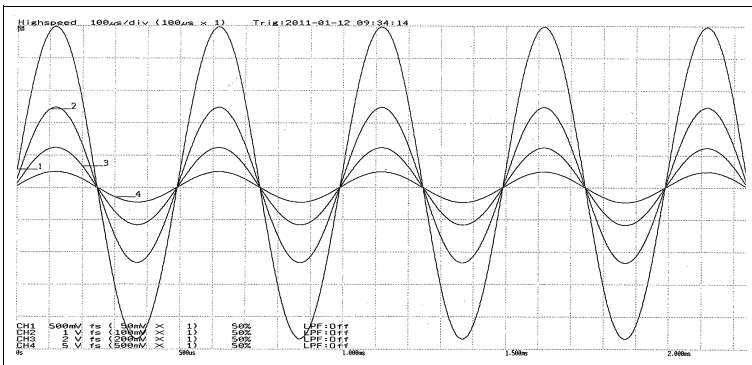

Specifying the Range to Print (Partial Print)

You can specify the range of the waveform to print with cursors A and B.

- 1 Press the **WAVE** key to display the waveform of the part you want to print in the waveform display screen.

When you want to print a waveform that is saved to media, read the data to the instrument before pressing the **PRINT** key.

See: "Loading Waveform Data and Screen Images" (p. 159)

- 2 Press the **SCROLL/CURSOR** key. Cursors A and B and the cursor values appear in the **[Wave+Crsr]** display screen.

- 3 Select **[A Cur]** for **[Move]**.

- 4 Use the left and right scroll keys to move cursor A to the location at which you want to start printing.

- 5 Select **[B Cur]** for **[Move]**.

- 6 Use the left and right scroll keys to move cursor B to the location at which you want to end printing.

- 7 Press the **PRINT** key on the printer. The print range confirmation screen appears.

- 8 Select **[A-B Wave]**.
The waveform between cursors A and B is printed. To force printing to end, press the **STOP** key.

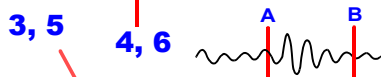
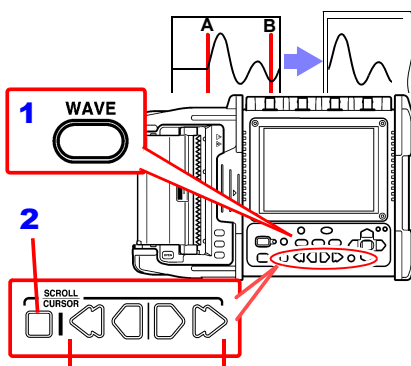

Set the type to **[Trace]** or **[Vertical]**.

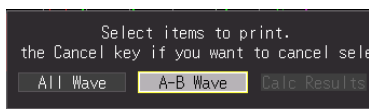
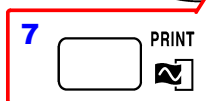
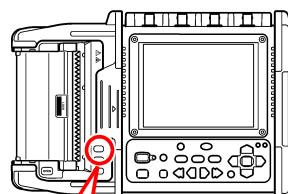

7.2 Printing the Screen Display (Screen Hardcopy)

You can print the information displayed on the screen.

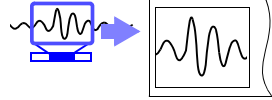

- 1 Display the information you want to print on the screen.
(Waveform screen, settings screen, file screen, monitor screen, PRESETS screen)

- 2 Press the **COPY** key on the printer. Printing of the displayed screen begins.
To force printing to end, press the **STOP** key.

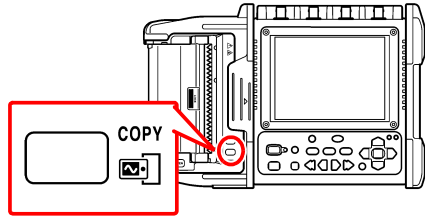

Print Example

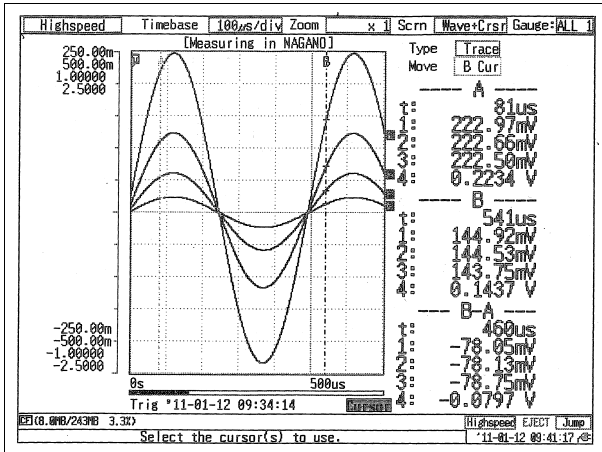

NOTE

When using the optional battery pack, the print density becomes thin automatically.

7.3 Printing the Setting Information (List Print)

You can print a list of the settings for the measurement data read to the internal buffer memory after measurement.

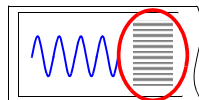

1 **WAVE** **SET** **FILE** Display a screen other than the waveform screen or file screen.

2 Press the **PRINT** key on the printer.
To force printing to end, press the **STOP** key.

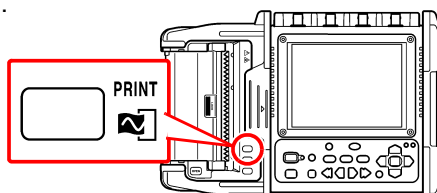

Print Example

HIOKI MR8880 MEMORY HI-CORDER		Trig: 2011-01-12 09:34:14	
Measuring in MAGAW			
Setting			
Function	Highspeed		
Timebase	100µs/div		
Time Mes	× 1		
Shot	30div		
Format	Single		
Hum.Calc	Off		
Auto Save	Off		
Channel			
Analog	Mode	Range	Disp
CH1	C1 INSTNT	50mV	Pos
CH2	C2 INSTNT	100mV	Pos
CH3	C3 INSTNT	200mV	Pos
CH4	C4 INSTNT	500mV	Pos
Logic		Color	Pos
LA	1C	—	Pos1
LB	1C	—	Pos2
Scaling			
ch.	Convert	Conversion Set 1	Conversion Set 2
CH1	Off		
CH2	Off		
CH3	Off		
CH4	Off		
Trigger			
Start	OK	Ext trig	Off
CH1 Level	Level	0.0mV	Slp. 2
CH2	Off		
CH3	Off		
CH4	Off		
LA	Off		
LB	Off		
Print			
Auto print	Off		
Channel marker	Channel No.		
Grid type	Standard		
Density	Dark		
List&Gauge	Off		
Print range	All Wave		
Ext trig Filter	Off		
Pre-Trig	8%		
Invtl.	Off		

■ If you want to print a list after printing a waveform

Select **[List]** or **[Both]** for the **[List & Gauge]** item on the **[Print]** screen.

NOTE The printed list of setting conditions is for the measurement data read to the internal buffer memory. Even if you change a setting after measurement, the items in the list will not change. Furthermore, a list cannot be printed if there is no waveform.

7.4 Print Examples

Function name Timebase Trigger date and time

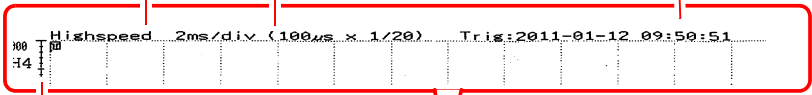

Gauge

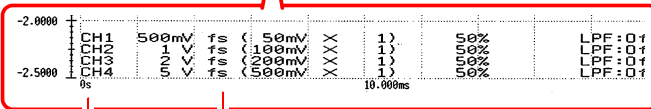
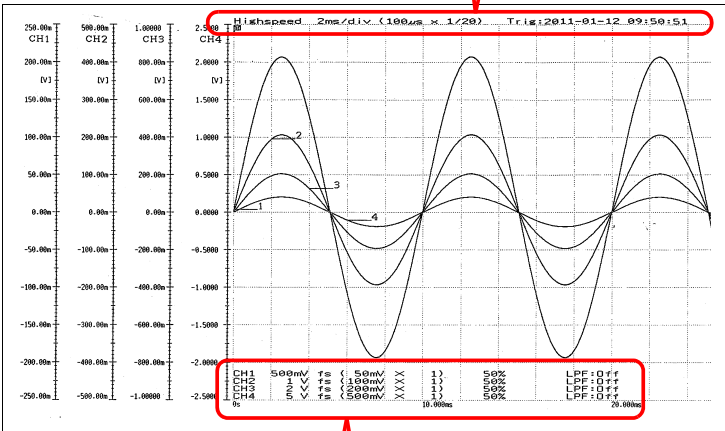

Time value Channel information

Indicates the timing at which the display settings were changed during measurement.

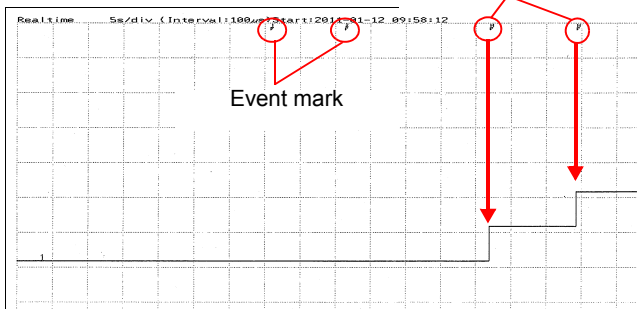

7.5 Various Print Settings

You can add a grid to a waveform and print the channel number or a comment and other information. The **[Print]** tab is added to the settings screen when you connect a printer.

The information printed for the horizontal axis is the same as that of the screen display (p. 201).

To print automatically after measurement, configure the setting before measurement.

See: "4.8 Setting Automatic Printing" (p. 108)

Printing the Channel Number or Comment (Channel Marker)

You print the channel number or a comment together with the waveform.

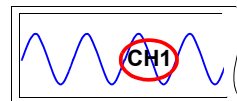

1 **WAVE** **SET** **FILE** Select the **[Print]** screen.



2  Select from the setting options of **[Channel marker]**.
(Open/confirm the setting information.)

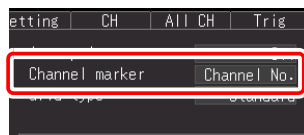

Setting options (*. default setting)

Off	Does not print a channel number and comment.
Channel No.*	Prints the channel number.
Comment	Prints a comment. Set a comment in the [CH] screen. See: "4.10 Entering Comments and Titles" (p. 128)

NOTE

- If the waveform to be printed is short, the comment may not be printed.
- In the case of X-Y display, the channel markers are not displayed.

Setting the Grid Type

You can set the type of grid to print on the recording paper.

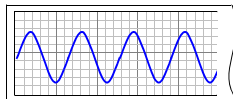

1 **WAVE** **SET** **FILE** Select the **[Print]** screen.



2 Select from the setting options of **[Grid type]**.

(Open/confirm the setting information.)

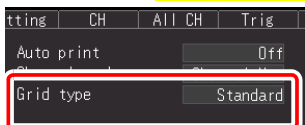

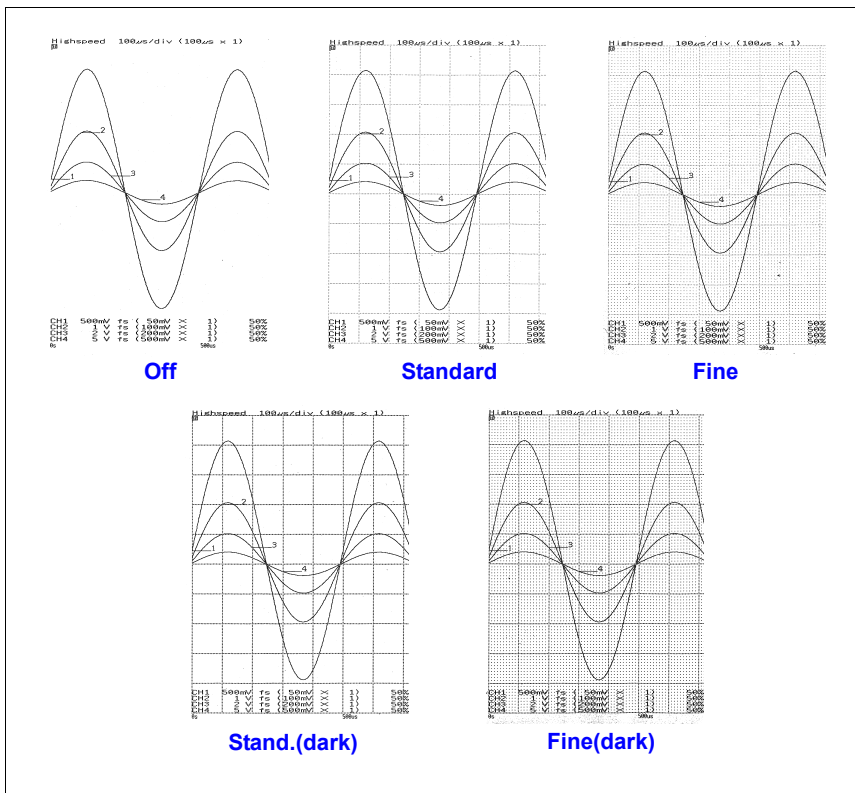

Setting options (*. default setting)

Off, Standard*, Fine, Stand.(dark), Fine(dark)



Setting the Print Density

You can set the density for printing to recording paper to one of three levels. Setting the print density to a low level will reduce power consumption and increase the length of time that the batteries can be used.

1  Select the **[Print]** screen. 

2  Select from the setting options of **[Density]**.
(Open/confirm the setting information.)

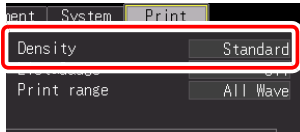



Setting options (*. default setting)

Light, Standard* Dark

Printing Setting List and Gauge (List & Gauge)

You can print a gauge before the waveform and a list after the printed waveform when printing a waveform (except when printing a screen hardcopy).

1  Select the **[Print]** screen. 

2  Select from the setting options of **[List&Gauge]**.
(Open/confirm the setting information.)

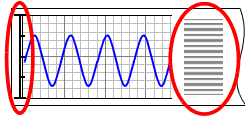
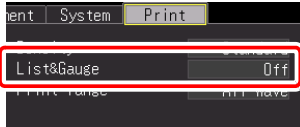
Setting options (*. default setting)

Off*	The list (settings list) and gauge are not printed.
List	Prints the list after the waveform.
Gauge	Prints the gauge before the waveform.
Both	Prints the list and gauge.

Specifying the Range to Print (Print Range)

You can set the print range. (High-speed Function only)

1    Select the **[Print]** screen. 

2  Select from the setting options of **[Print range]**.
(Open/confirm the setting information.)

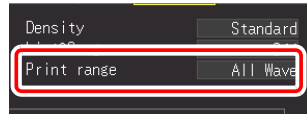

Setting options (*. default setting)

All Wave*	Prints all recorded data.
A-B Wave	Prints the data between cursors A and B.

7.6 Feeding

You can feed blank recording paper.

Press the **FEED** key on the printer.
Blank recording paper is fed, and then feeding stops automatically.

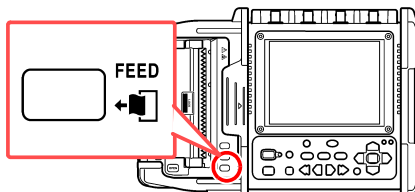

7.7 Performing a Printer Check

You can check the print operation of the printer.

A checkered pattern, vertical straight lines, horizontal straight lines, diagonal straight lines, and text are printed in order.

Press the **COPY** key while pressing the **FEED** key on the printer.

If you want to stop the check part way through, press the **STOP** key to force checking to end.

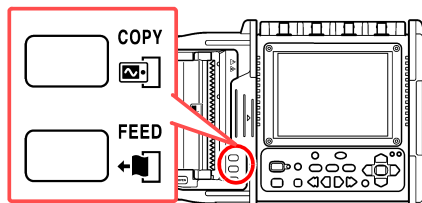

Print Example

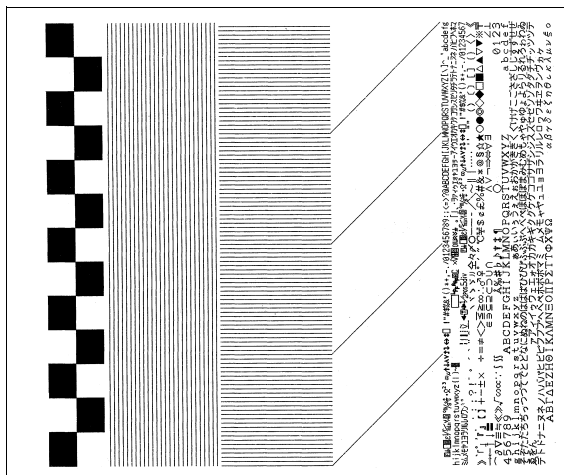

Numerical Calculations

Chapter 8

8.1 Calculation Methods

Calculations can be applied to measured data.

The operation differs depending on the function ([Highspeed]/[Realtime]). Up to four calculations can be performed at one time.

Types of calculations

Types		High-speed	Realtime
Average value	Average value of waveform data	●	● *
Peak value	Peak-to-peak value of waveform data	●	●
Maximum value	Maximum value of waveform data	●	●
Time to maximum value	Time elapsed from the start of measurement to the maximum value	●	●
Minimum value	Minimum value of waveform data	●	●
Time to minimum value	Time elapsed from the start of measurement to the minimum value	●	●
RMS value	RMS value of waveform data	●	—
Period	Period of signal waveform	●	—
Frequency	Frequency of signal waveform	●	—
Area value	Area enclosed by the zero position and signal waveform	●	—
X-Y area value	Area for X-Y synthesis	●	—

*. This cannot be set when [Envelope: On].

See: "8.4 Numerical Value Calculation Expressions" (p. 184)

Calculation Methods

Two methods are available for applying calculations, as follows.

When a calculation is applied automatically, the operation differs depending on the function.

Default setting: [Numerical Calc.: Off]

Calculating Automatically after Measurement Starts (Auto Calculation)

Configure numerical calculations before starting measurement.
The latest calculated values can be viewed on the [\[Wave+Calc\]](#) display.

Settings
(p. 179)



Numeric calculation: On
Select the calculation type.
Set automatic saving of calculation results (p. 102)
(If necessary)

Start of Measurement

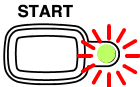

The operation differs depending on the function.

- [Highspeed]:
Calculates automatically after reading for specified recording length.
- [Realtime]:
Calculates in real time during measurement.

Analyze

[\[Wave+Calc\]](#) screen

Calculating after Measurement Ends (Manual Calculation)

Configure numerical calculations after measurement.

Measurement End



Settings (p. 182)
Numeric calculation: On
Select the calculation type.
(This can also be set from the [\[Settings\]](#) screen.)

Execute Calculations

(Waveform Screen)

Analyze

[\[Wave+Calc\]](#) screen

You can also specify the range for which to perform the calculation (p. 183).

NOTE If [Waveform (real time)] saving, [Envelope] function, and [Numerical calculation] are set at the same time for the Real-time Function, the recording interval cannot be set to 100 μ s and 200 μ s.



8.2 Calculating Automatically (Auto Calculation)

Perform calculation automatically after measurement starts. The operation differs depending on the function.

- Highspeed: Calculates automatically after reading for specified recording length.
- Realtime: Calculates in real time during measurement.

In the case of the Real-time Function, the calculation value can also be saved in text (CSV) format at a specified interval (p. 102).

Numerical calculations can also be saved automatically (p. 102).

1  Select the **[Setting]** screen.  

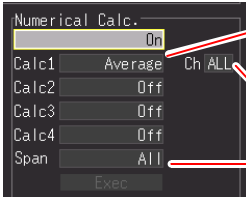
2  Set **[Numerical Calc.]** to **[On]**. **2** 

(Open/confirm the setting information.)

3 Select the calculation type for each of calculations 1 to 4.

Setting options (*. default setting)

[Highspeed] **Average, P-P, Maximum, Minimum, Time To Max, Time To Min, RMS, Period, Frequency, Area, X-Y Area, Off***

[Realtime] **Average(*1), P-P, Maximum, Minimum, Time To Max, Time To Min, Off***

(*1). This cannot be set when [Envelope: On].

4 Select each of the calculation targets for the **[Ch]** setting items.

Setting options (*. default setting)

Calculation item other than **CH1, CH2, CH3, CH4, ALL***

X-Y area value

X-Y area value In the case of calculating the X-Y area, you can set each of the X axis and Y axis.

X: **CH1*, CH2, CH3, CH4**, Y: **CH1*, CH2, CH3, CH4, ALL**

5 Select the calculation range from **[Span]**.

Setting options (*. default setting)

All*, A-B(*)

A-B: Calculates between A and B.
Specify the range to calculate in the waveform screen with cursors A and B.
When a waveform has not been read by the instrument, perform measurement once and then specify the range so that calculation will be performed within that range from the next measurement.

(*) In the case of automatic calculation, calculating between A and B is not possible when using the Real-time Function. To calculate between A and B when using the Real-time Function, perform the calculation again after measurement ends. (p. 183)

8.2 Calculating Automatically (Auto Calculation)

6 Set automatic saving to automatically save calculation results.

Select the type of automatic saving (p. 102).
 Select any of the following.

- [Calc(after meas.)]
- [Waveform + Calc]
- [CSV + Calc]

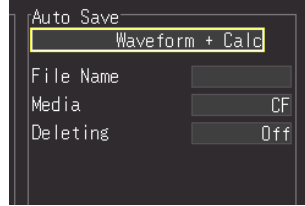

You can save the calculation values at the specified interval (p. 181).

7 Start measurement.

8 Select [Wave + Calc] display in the waveform screen.

The numerical calculation results appear.

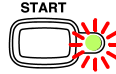

The results for the selected calculation number appear.

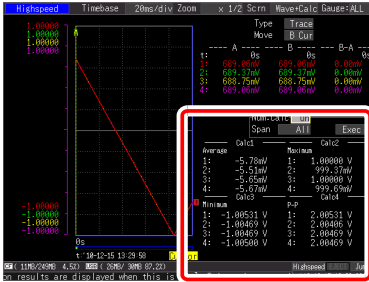

This is a close-up of the calculation results table, showing the 'Average' and 'Maximum' columns. The table is divided into two sections: 'Average' and 'Maximum'. The 'Average' section shows values for Calc1 and Calc2, and the 'Maximum' section shows values for Calc1 and Calc2.

Average		Maximum	
Calc1	Calc2	Calc1	Calc2
1: -5.78mV	1: 1.00000 V	1: 1.00000 V	
2: -5.51mV	2: 999.37mV	2: 999.37mV	
3: -5.65mV	3: 1.00000 V	3: 1.00000 V	
4: -5.67mV	4: 999.69mV	4: 999.69mV	

Calculating at Specified Interval (Interval Calculation)

You can save the calculation value at a specified interval. The setting procedure is the same as for auto calculation when other than interval calculation is set (p. 179). (Real-time Function only)

Set how to split the calculation values in **[Split Calc.]**.

Setting options (*. default setting)

Off*	Save only the last calculation results.
On	Save the calculation value at a specified interval. Set the interval at which to perform the calculation in [Split Len.]. (Day, hour, and minute can be set.)
RefTime	Save the calculation value at a specified interval. Set the reference time and time interval for calculation in [Split time] and [Split Len.].

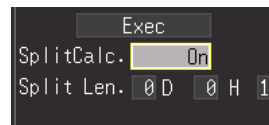

[On]

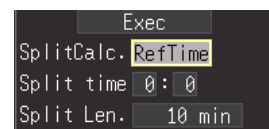

[RefTime]

When [On]

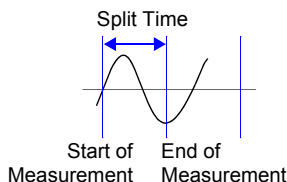

Calculation results for the specified time span are automatically saved.

When [Ref Time]

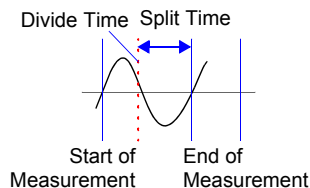

The calculation value for the specified split length portion is automatically saved from the specified divide time.

You can confirm the numerical calculation results on the [Wave+Calc] display of the Waveform screen. If you set the split save settings when using the Real-time Function, you can switch between the normal values and split values.

	Calc1	Maximum	Calc2
P-P	2.00637 V	1.00094 V	1.00031 V
1:	2.00531 V	1.00094 V	1.00031 V
2:	2.00531 V	1.00031 V	1.00031 V

[Usual] display

The calculation values from the start of measurement are displayed.

	Calc1	Maximum	Calc2
P-P	2.00750 V	1.00094 V	1.00062 V
1:	2.00750 V	1.00094 V	1.00062 V
2:	2.00562 V	1.00062 V	1.00062 V

[Split] display

The latest calculation value is displayed at a specified interval. If split save is not set (interval calculation), [---] is indicated for the split value.

8.3 Calculating after Measurement (Manual Calculation)

You can set the calculation and perform the numeric value calculation after measurement. You can perform the calculation for all of the waveform data, or specify the range for which to perform the calculation (p. 183).

Performing Calculation for All Data

1 Start and finish measuring.

2    Select the **[Setting]** screen. → 

3  Set **[Numerical Calc.]** to **[On]**.
(Open/confirm the setting information.)

In the following steps, use the cursor keys in the same way to configure settings.

4 Select the calculation type for each of calculations 1 to 4.
Setting options (*. default setting)

[Highspeed]	Average, P-P, Maximum, Minimum, Time To Max, Time To Min, RMS, Period, Frequency, Area, X-Y Area, Off*
[Realtime]	Average(*1), P-P, Maximum, Minimum, Time To Max, Time To Min, Off*

(*1). This cannot be set when [Envelope: On].

5 Select each of the calculation targets for the **[Ch]** setting items.

Setting options (*. default setting)

Calculation item other than X-Y area value	CH1, CH2, CH3, CH4, ALL*
X-Y area value	In the case of calculating the X-Y area, you can set each of the X axis and Y axis. X: CH1*, CH2, CH3, CH4 Y: CH1, CH2, CH3, CH4, ALL*

6 Select **[All]** from **[Range]**.

7 Select **[Exec]** to execute the calculation.
The numerical calculation results appear.

This can also be set in the waveform [Wave+Calc] screen. However, the items that can be set are limited.

Settable items

Numeric calculation: On/Off, Calculation range selection: All data/Between A and B, Execute calculation

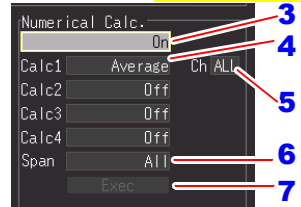

Apply Calculations to a Specific Time Span

1 Start and finish measuring.

2  Select the **[Setting]** screen. → 

3  Set **[Numerical Calc.]** to **[On]**.

(Open/confirm the setting information.)

In the following steps, use the cursor keys in the same way to configure settings.

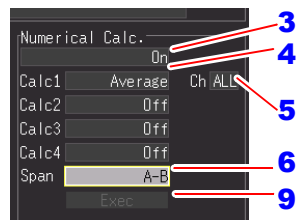

4 Select the calculation type for each of calculations 1 to 4.

Setting options (*. default setting)

[Highspeed]	Average, P-P, Maximum, Minimum, Time To Max, Time To Min, RMS, Period, Frequency, Area, X-Y Area, Off*
[Realtime]	Average (*1), P-P, Maximum, Minimum, Time To Max, Time To Min, Off*

(*1). This cannot be set when [Envelope: On].

5 Select each of the calculation targets for the **[Ch]** setting items.

Setting options (*. default setting)

Calculation item other than X-Y area value	CH1, CH2, CH3, CH4, ALL*
X-Y area value	In the case of calculating the X-Y area, you can set each of the X axis and Y axis. X: CH1*, CH2, CH3, CH4 Y: CH1, CH2, CH3, CH4, ALL*

6 Select **[A-B]** from **[Range]**.

7 Switch to **[Cursor]** display.

8 Use the left and right scroll keys to move cursor A or B to specify the range to calculate.

To select which cursor to move (p. 140)

9 Select **[Exec]** to execute the calculation.

The numerical calculation results appear.

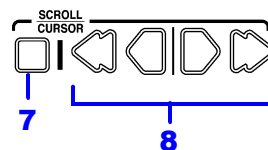

This can also be set in the waveform **[Wave+Calc]** screen. However, the items that can be set are limited.

Settable items:

Numeric calculation: On/Off, Calculation range selection: All data/Between A and B, Execute calculation

8.4 Numerical Value Calculation Expressions

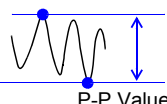
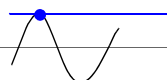
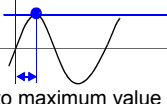
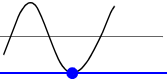
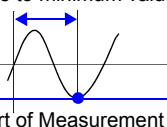
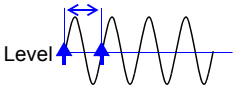
Average value	$AVE = \frac{1}{n} \sum_{i=1}^n di$	Obtains the average value of waveform data. <i>AVE</i> : Average value <i>n</i> : Data count <i>di</i> : Data on channel number <i>i</i>
Peak-to-Peak (P-P) Value	Maximum value  Minimum value	Obtains the value of the difference (peak-to-peak value) between maximum and minimum values of waveform data.
Maximum Value	Maximum value 	Obtains the maximum value of waveform data.
Time to maximum value	Start of Measurement* Maximum value  Time to maximum value	Acquires the time (s) elapsed from the start of recording* to maximum value. When there are two or more maxima, this value is the first to occur. *. Trigger position when using trigger
Minimum Value	Minimum value 	Obtains the minimum value of waveform data.
Time to minimum value	Time to minimum value  Minimum value Start of Measurement *	Acquires the time (s) elapsed from the start of recording* to minimum value. When there are two or more minima, this value is the first to occur. *. Trigger position when using trigger
RMS (Root-Mean-Square) value	$RMS = \sqrt{\frac{1}{n} \sum_{i=1}^n di^2}$	Obtains the RMS value of waveform data. If Scaling is enabled, calculations are applied to the waveform after scaling. <i>RMS</i> : effective value (Root-Mean-Square value) <i>n</i> : Data count <i>di</i> : Data on channel number <i>i</i>
Period and Frequency		Displays the period (in seconds) and frequency (Hz) of the signal waveform. Calculations are based on the interval between successive rising or falling transitions of the signal waveform through its amplitude midpoint in the same direction.

Area

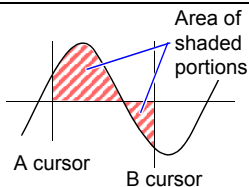

Obtains the area value ($V \cdot s$) enclosed by the zero position (point of zero potential) and the signal waveform. When calculation of the range specified by the A/B cursors is selected, the calculated area is constrained to the waveform between the cursors.

S:Area
 n:Data count
 di: Data on channel number i
 h= Δt : Sampling rate

$$S = \sum_{i=1}^n |di| \cdot h$$

X-Y Area

When the trace consists of multiple loops

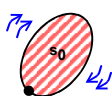

$S = n \times s_0$
 S:Area
 n:Number of loops

Start/end point

Obtains the area value (V^2) of an X-Y composite waveform. The areas within the lines are calculated as shown in the figures on the left. The calculation is available even if the X-Y composite waveform is not intended for display.

To enable area calculation, specify the calculation range using the A/B cursors (Voltage axis or Trace) on the waveform of each channel for X-Y composition. (The area cannot be specified directly by A/B cursors on the X-Y waveform.)

When the trace is an open curve



$S = s_0$
 S:Area
 (Area enclosed by the curve and line connecting start and end points)

Start point End point

When the trace is a figure-8



$S = |s_0 - s_1|$
 S: Area

Start point End point

When the trace is an open curve

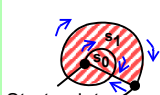

$S = s_0 \times 2 + s_1$
 S: Area
 (The number of overlapping regions increases with the number of loops)

Start point End point

Scheduling Measurement

Chapter 9

You can schedule measurement to start and stop at specific times. Before you configure these settings, confirm that the instrument clock is set to the correct time. If it is not, set the clock again on the System screen. (p. 204)

9.1 Starting & Stopping Measurement on a Specified Day

You can specify the desired days to start and stop measurement.

1 **WAVE** **SET** **FILE** Select the **[Setting]** screen. → **Setting**

2 Select **[Reservation]**.
Apply

3 4 5

No.	Type	Strt.Day	Strt.Tm	Stop Day	Stop Tm	Conditn.	Error.
1 ✓	Spc.Dt	2011-01-28	08:30	011-01-28	17:00	Current	
2 ✓	Reg	Mon.	17:30	-	23:00	Current	
3 ✓	Off						

- 3** Select (turn on) the check box of the number (No.) for which you want to configure the schedule settings.

- 4** Set **[Spc.Dt (Specified Date)]** in **[Type]** for the schedule.

- 5** Set the date and time you want to start and stop measurement. Set each of year-month-day, hour, and minute.

When you want to set the current time:

Select the clock mark (⌚), and then press the **ENTER** key.

Setting the date and time

20 11-01-28 08:30 ⌚ 2011-01-28 17

Select the setting field

Select

Apply

Change 1's digit

Change 10's digit

9.1 Starting & Stopping Measurement on a Specified Day

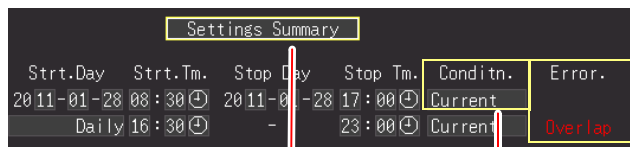

6 Select [Conditn. (Condition)].

Setting options (*. default setting)

Current Perform measurement using the instrument setting conditions configured at the time of scheduling.

Save No. 1 to Save No. 10 Select any conditions from 10 setting conditions saved to the internal memory of the instrument and perform measurement.

About error display

Red indication: Indicates the error item. The schedule conditions are not set correctly. Change the settings.

Green indication: Indicates that the schedule is set correctly.

Error

Stop<start	The stop time is set to a time that is before the start time.
Stop<cur.	The stop time is set to a time that is before the current time.
Overlap	The schedule times overlap those of another setting.

7 Select [Settings Summary].

The schedule confirmation screen appears.

8 Select [OK].

If you select [Cancel], the Schedule screen is redisplayed.

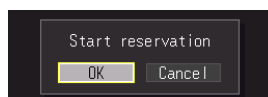

When the schedule settings are complete, the screen switches from the Measurement Schedule screen to the normal Setting screen.

At that time, the **[Reserved]** indication flashes green on the bottom right of the screen to indicate that the instrument has entered the schedule standby state.

Measurement starts automatically at the scheduled date and time.

The setting conditions of the enabled schedule cannot be changed.

■ When you want cancel a schedule while **[Reserved]** is displayed



Press the **ENTER** key to display the schedule cancellation dialog box.
Select **[OK]** to cancel the schedule.



9.2 Starting & Stopping Measurement Periodically

You can perform measurement periodically.

1  Select the **[Setting]** screen. → 

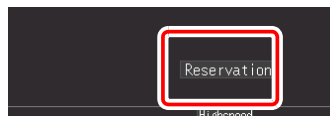
2  Select **[Reservation]**.



3  **4**  **5** 

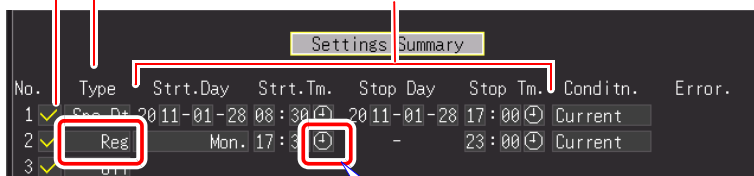

No.	Type	Strt.Day	Strt.Tm.	Stop Day	Stop Tm.	Conditn.	Error.
1	Reg	01-28	08:30	2011-01-28	17:00	Current	
2	Reg	Mon.	17:30	-	23:00	Current	
3	Reg						
4	Reg						

3 Select (turn on) the check box of the number (No.) for which you want to configure the schedule settings.

4 Set **[Reg]** in **[Type]** for the schedule.

5 Set the periodic measurement conditions.

You can set each of the start day and time.

When you want to set the current time:

Select the clock mark (⌚), and then press the **ENTER** key.

Setting the date and time

2011-01-28 08:30 2011-01-28 17:00

 Select the setting field

 Select  Change 1's digit

 Apply  Change 10's digit

Daily	Perform measurement from the set start time to the set stop time every day.
Mon. to Fri.	Perform measurement from the set start time to the set stop time every day from Monday to Friday.
Mon. to Sat.	Perform measurement from the set start time to the set stop time every day from Monday to Saturday.
Sun., Mon., Tue., Wed., Thur., Fri., Sat.	Perform measurement from the set start time to the set stop time on the selected days every week.

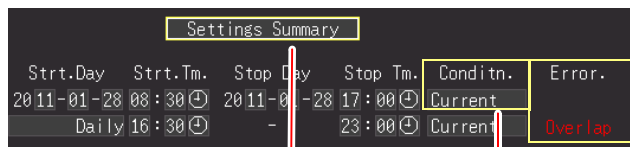

6 Select [Conditn. (Condition)].

Setting options (*, default setting)

Current	Perform measurement using the instrument setting conditions configured at the time of scheduling.
Save No. 1 to Save No. 10	Select any conditions from 10 setting conditions saved to the internal memory of the instrument and perform measurement.

7

6

About error display

Red indication: Indicates the error item. The schedule conditions are not set correctly. Change the settings.

Green indication: Indicates that the schedule is set correctly.

Error

Stop<start	The stop time is set to a time that is before the start time.
Stop<cur.	The stop time is set to a time that is before the current time.
Overlap	The schedule times overlap those of another setting.

7 Select [Settings Summary].

The schedule confirmation screen appears.

8 Select [OK].

If you select [Cancel], the Schedule screen is redisplayed.



When the schedule settings are complete, the screen switches from the Measurement Schedule screen to the normal Setting screen.

At that time, the [Reserved] indication flashes green on the bottom right of the screen to indicate that the instrument has entered the schedule standby state.

Measurement starts automatically at the scheduled date and time.

The setting conditions of the enabled schedule cannot be changed.

■ When you want cancel a schedule while [Reserved] is displayed



Press the **ENTER** key to display the schedule cancellation dialog box.
Select **[OK]** to cancel the schedule.

9.3 Canceling a Schedule

To cancel a schedule or change the settings of a schedule, [Reserved] (schedule standby state) needs to be cancelled first.

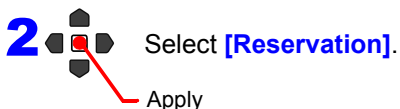

The schedule cancellation dialog box appears.



(To continue in the schedule standby state without canceling the schedule, select [Cancel].)

Select [OK] to cancel the schedule standby state and open the Schedule screen. Change the schedule as necessary.

See: "9.1 Starting & Stopping Measurement on a Specified Day" (p. 187), "9.2 Starting & Stopping Measurement Periodically" (p. 189)

If you do not want to change the schedule, press the **ESC** key. The instrument returns to normal operation.

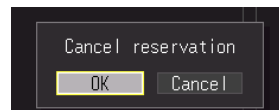

NOTE About operation restrictions while **[Reserved]** is displayed (standby state)

- Keys related to starting, stopping, files, saving, and printing do not work.
- To change a setting, first cancel the schedule. If you change a setting in the standby state, a dialog box to confirm canceling the schedule operation will appear.

About schedule start and stop operations

- If the first schedule start time has passed at the point in time that the schedule is set, the set measurement conditions are accessed and measurement starts immediately.
 - "The reservation will be started soon." is displayed 30 seconds before a schedule start time, and then measurement starts at the start time.
 - When repeat recording is set to **[Single]**, the schedule operation finishes when one measurement ends. When repeat recording is set to **[Repeat]**, measurement is performed repeatedly until the stop time.
 - When the state is **[Waiting for pre-trigger]** or **[Waiting for trigger]** at the stop time, measurement stops and the state switches to the waiting for next schedule (schedule standby) state. When the state is **[Storing]**, measurement is halted, calculation, saving, and printing is performed using the data up until that point in time, and then the state switches to the next schedule standby state.
 - If the next schedule start time has passed because of the time required for saving and printing, the measurement conditions are accessed and the next measurement starts immediately.
 - When all schedules are complete, the scheduled state is cancelled.
 - If the power is cut off when measurement is scheduled, the scheduled state is resumed when the power recovers and measurement is started if the time when the power recovers is between the schedule start time and schedule stop time, regardless of the Start Backup setting (On/Off).
 - When the scheduled state is cancelled, the settings are restored to the point in time that the schedule was enabled.
-

9.4 About Schedule Function Operation

The stop time setting is within the recording length

- Enable schedule ⊕ Start time or stop time ↔ Recording time
- ➡ Measuring T Trigger criteria match ▨ Deadtime

Trig-ger	[Repeat: Single] / [Cont: On]	[Repeat: Repeat]
Off	<p>Recording time</p> <p>Start time Stop time</p> <p> </p> <p>Start of measurement End of measurement</p>	<p>Recording time</p> <p>Start time Stop time</p> <p> </p> <p>Start of measurement End of measurement</p>
Start	<p>Recording time</p> <p>Start time Stop time</p> <p> </p> <p>Start of measurement End of measurement</p>	<p>Recording time</p> <p>Start time Stop time</p> <p> </p> <p>Start of measurement End of measurement</p>
Stop (*)	<p>Recording time</p> <p>Start time Stop time</p> <p> </p> <p>Start of measurement End of measurement</p>	<p>Recording time</p> <p>Start time Stop time</p> <p> </p> <p>Start of measurement End of measurement</p>
Start& Stop (*)	<p>Recording time</p> <p>Start time Stop time</p> <p> </p> <p>Start of measurement End of measurement</p>	<p>Recording time</p> <p>Start time Stop time</p> <p> </p> <p>Start of measurement End of measurement</p>

■ About Dead Time

After measurement is performed for the recording time portion, time is needed for internal processing before measurement can be resumed (dead time). Measurement is not performed during this dead time.

When you want to perform measurement without any loss of data, perform measurement with **[Cont]** set to [On].

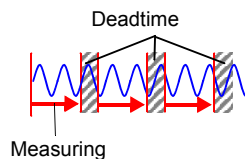

9.5 Setting Examples

This section introduces examples of setting measurement schedules. All of the examples are for when measurement is to be performed using the Real-time Function.

1	Record data to a CF card from 9:00 to 17:00 on December 10, 2010.
2	Record data periodically to a CF card for each 24 hours every day during a 1-month period from 9:00 on December 10, 2010.
3	Record data to a CF card for a 1-hour period every 6 hours (9:00, 15:00, 21:00 and 3:00) during a 1-month period from 9:00 on December 10, 2010.
4	Record data to a CF card from 9:00 to 17:00 every day from December 10, 2010, until the schedule is cancelled.
5	Record data to a CF card from when a trigger is met between 8:30 to 17:15 on Monday to Friday from December 10, 2010, until the schedule is cancelled.
6	Record data to a CF card from 9:00 to 12:00 and 13:00 to 17:30 on Thursday every week from December 10, 2010, until the schedule is cancelled.

9.5 Setting Examples

Measurement Schedule Screen [Reservation]				[Setting] screen				[Trig] screen
No	Type	Start Date Start time	Stop Date Stop time	Repeat Cont	Shot Record time	Realtime save Media	Split Save	Trig Func
1	SpC.Dt	2010-12-10 9:00	2010-12-10 17:00	On		Waveform (real-time) CF	Off	Off
2	SpC.Dt	2010-12-10 8:59	2011-01-10 9:01	On		Waveform (real-time) CF	RefTime RefTime: 00:00 Split Len: 1day	Off
3	Reg	2010-12-10 9:00	2011-1-10 4:01	Repeat Off	Record time: 1h	Waveform (real-time) CF	Off	On Interval trig- ger: 6:00
4	Reg (Daily)	9:00	17:00	On		Waveform (real-time) CF	Off	Off
5	Reg (Mon. to Fri.)	8:30	17:15	Repeat	Shot: desired settings	Waveform (after meas.) CF	Off	On Configure the de- sired settings.
6	Reg (Thur.)	9:00	12:00	On		Waveform (real-time) CF	Off	Off
2	Reg (Thur.)	13:00	17:30	On		Waveform (real-time) CF	Off	Off

System Environment Settings

Chapter 10

Settings affecting the clock, **SAVE** key operation and self testing are made from the **[System]** screen.

Setting Procedure

1 **WAVE** **SET** **FILE** Select the **[System]** screen.

2 Move to a setting item.

Open the setting options for the item to be set.

Select from the listed options.

Apply

System

Setting	CH	All CH	Trig	Comment	System	Print
Start Backup			Off	Version : V1.10		
File Protection			Low	Serial No. : 110226234		
Back light Saver			Off	Language	English	
Back light Brightness			100%	Ext. control		
Display Color			Black	External Trig In	Trigger	
Beeper Sound			On	START/INH	START	
Time Disp			Time	STOP/INH	STOP	
Start/Stop mess			On	External Trig Out	Pulse	
Decimal Mark			Dot	ALM/OUT	Error	

7 -SAVE Key Operation-Select & Save

5 Clock Setting

6 USB Drive Mode

Com: CRJLF
Beeper: Off

Setting

System Environment Settings

1 Operation Related Settings	<ul style="list-style-type: none"> Specify operating behavior when recovering from power outages (Auto-Resume) (p. 198) Set the file protection level (p. 198)
2 Screen and Key Related Settings	<ul style="list-style-type: none"> Set backlight power saving (p. 199) Set backlight brightness (p. 199) Select black or white screen background (p. 200) Enable or disable the beeper (p. 200) Set the horizontal axis (time value display) (p. 201) Select display language (p. 202) Set start/stop confirmation message display (p. 201)
3 CSV File Saving	<ul style="list-style-type: none"> Select CSV file data decimal and separator characters (p. 203)
4 External Trigger Input	<ul style="list-style-type: none"> Set function selection of external trigger input (p. 217)
5 System-Related Settings	<ul style="list-style-type: none"> Set the clock (p. 204) Reinitialize the HiCorder (p. 204)
6 Self Testing	<ul style="list-style-type: none"> KEY/LED test (p. 205) LCD test (p. 205) ROM/RAM test (p. 205) CF card test (p. 205) USB flash drive test (p. 205)
7 Others	<ul style="list-style-type: none"> Manual saving setting (p. 150) Communication setting (p. 210) USB drive mode setting (p. 208)

10.1 Operation Settings

Using the Auto-Resume Function (Resume After Power Restoration)

If a power outage or other power loss causes an interruption in recording (while the LED on the left side of **START** is lit), you can automatically resume recording when the power is restored. If you are using triggers, the triggers are restored to the **[Wait for trigger]** state.

NOTE When Auto-Resume is enabled, measurement data that was in internal buffer memory before the outage is lost when measurement resumes. To retain measurement data from before an outage, disable Auto-Resume (set to Off). To retain measurement data from before an outage and resume measuring automatically afterwards, enable Auto Save (p. 102).

Select from the setting options of **[Start Backup]**.

Setting options (*, default setting)

Off*	Do not use the Auto-Resume Function.
On	Use the Auto-Resume Function.



File Protection Level Setting

If power is lost within about three minutes after power-on, files on the removable storage may be corrupted, and the device could be damaged. These risks can be avoided by setting the file protection level to **[High]**.

Select from the setting options of **[File Protection]**.

Setting options (*, default setting)

Low*	Although removable storage is recognized and ready for recording immediately upon power-on, if power is lost within about three minutes after power-on, files on the removable storage may be corrupted, and the device could be damaged.
High	The CF card or USB flash drive cannot be accessed for about 3 minutes after power-on, but the files can be protected.

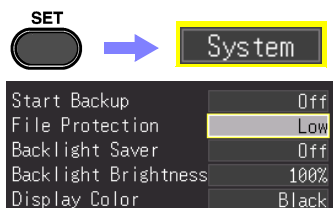

NOTE Auto-Setup is not available when **[High]** is selected (p. 158).

10.2 Screen Key Operation Settings

Enabling and Disabling the Backlight Saver

A backlight saver can be activated after a specified number of minutes during which no operation key is pressed. The backlight saver turns off the backlight of the LCD, prolonging the lifetime of the backlight by turning it off when not needed.

To deactivate the backlight saver, press any key. The operating screen appears again.

Select from the setting options of **[Backlight Saver]**.

Setting options (*. default setting)

Off*	Disables the backlight saver function. The operating screen is always displayed.
1min, 2min, 3min, 4min, 5min	The backlight saver is activated if the specified time is exceeded.



Start Backup	Off
File Protection	Low
Backlight Saver	Off
Backlight Brightness	100%
Display Color	Black

NOTE

- Be aware that power is still consumed even when the backlight is off, so be sure to turn the HiCorder power switch off when not in use.
- While the backlight saver is active, the HiCorder's measuring state is still indicated by the LED.

Adjust Backlight Brightness

Backlight brightness can be selected from four levels. Lower brightness settings provide longer battery operating time.

Select from the setting options of **[Backlight Brightness]**.

Each press of the **ENTER** key changes the brightness.

Setting options (*. default setting)

100%*, 70%, 40%, 25% (four-step brightness setting)



Start Backup	Off
File Protection	Low
Backlight Saver	Off
Backlight Brightness	100%
Display Color	Black

NOTE

The backlight brightness is reduced automatically when you print with the printer.

Selecting Black or White Screen Background

The screen background can be set to black or white.

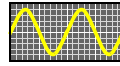

Black
Background

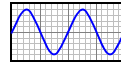

White
Background

Select from the setting options of
[Display Color].

Setting options (*. default setting)

Black* Make background black.

White Make background white.

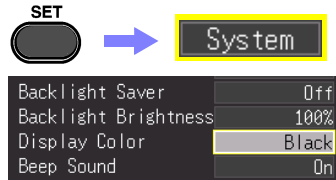

Enabling or Disabling the Beeper

The beeper can be set to sound when an error occurs.

Select from the setting options of
[Beep Sound].

Setting options (*. default setting)

On* Emit a beep sound on error messages (error and warning displays).

Off Do not emit beep sound.



Selecting the Horizontal (Time) Axis Display

Select the display method for the horizontal axis at the bottom of the screen. This setting also determines the time display for data saved in CSV format.

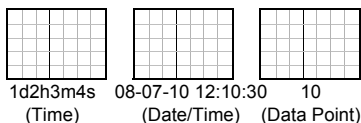

Select from the setting options of **[Time Disp]** (Time Value Display).

Setting options (*. default setting)

Time*	Displays the time span from the start of measurement. If triggering is enabled, the displayed time span is from the last trigger event.
Date	Displays the date and time every ten divisions.
Data Pts	Displays the number of data points from the start of measurement. If triggering is enabled, the displayed data points begin from the last trigger event.



Backlight Brightness	100%
Display Color	Black
Beep Sound	On
Time Disp	Time
Start/Stop message	On
Decimal Mark	Dot
Separator	Comma

Display of Start/Stop Confirmation Messages

To help avoid operator errors, confirmation messages can be displayed when measurement is manually started or stopped.

Select from the setting options of **[Start/Stop message]**.

Setting options (*. default setting)

Off	Confirmation messages are not displayed. Pressing START and STOP start and stop measurement immediately.
On*	Confirmation messages are displayed. To start or stop measurement, move the cursor to "Yes" and press ENTER .



Time Disp	Time
Start/Stop message	On
Decimal Mark	Dot
Separator	Comma
SAVE Key Operation Select & Save	

Setting the SAVE Key Action

Set the action for when the SAVE key is pressed.

Select from the setting options of **[SAVE Key Operation]**.

Setting options (*. default setting)

Select & Save*	Pressing the SAVE key displays the setting options for saving. (p. 152)
Quick Save	Select the setting options for saving on the [System] screen before pressing the SAVE key. (p. 154)

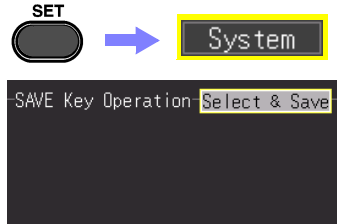

Selecting the Display Language

Select the display language.

Select from the setting options of **[Language]**.

Setting options (*. default setting)

English*	Display in English.
Chinese	Display in Chinese.
Japanese	Display in Japanese.

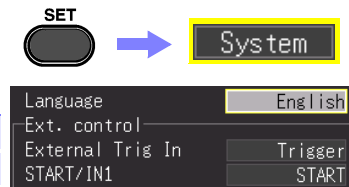

10.3 CSV File Saving Settings

CSV File Data Decimal and Separator Characters

Select decimal point and separator characters for CSV file data.

Select from the setting options of
[Decimal Mark].

Setting options (*. default setting)

Dot*	Select the period character.
Comma	Select the comma character.

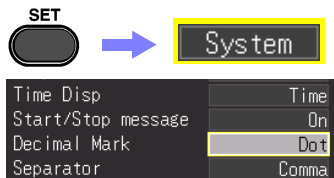

Select from the setting options of
[Separator].

Setting options (*. default setting)

Comma*	Select the comma character.
Space	Select the space character.
Tab	Select the tab character.
Semicolon	Select the semicolon character.

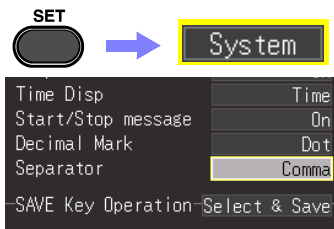

NOTE





- The comma character cannot be selected for both decimal point and separator at the same time. By default, comma is the separator character, so it is not available as the decimal character. To select comma as the decimal character, first select a different separator character.
- If the comma is selected for the separator character, the file extension is ".CSV." If other than the comma is selected, the file extension is ".TXT."

10.4 Making System Settings

Setting the Date and Time

The HiCorder is equipped with an auto-calendar, automatic leap year detection, and a 24-hour clock.

If the clock is not set to the correct time, measurement start time (start trigger time) and file date information will be incorrect. If this occurs, reset the clock.

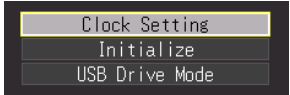
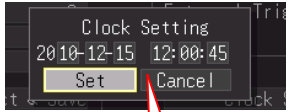
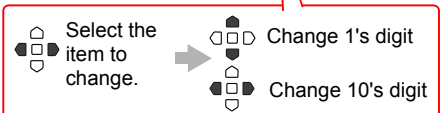



- 1  Select the **[System]** screen.  
- 2  Select **[Clock Setting]**.
 Apply
 The setting dialog appears. 
- 3 Select an item to change. (year, month, day, hour, minute or second)

- 4 Select **[Set]**.
 The clock is reset. 

Initializing the HiCorder (System Reset)

This procedure resets all settings to their factory defaults.

However, the setting conditions, language setting, and communication related settings saved to the instrument memory are not reset.

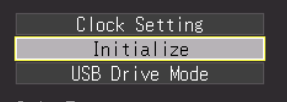
See: About the factory default settings, "Appendix 2 List of Default Settings" (p. A7)

- 1  Select the **[System]** screen.  
- 2  Select **[Initialize]**.
 Apply
 A confirmation dialog appears. 
- 3 Select **[Yes]**.
 Initialization proceeds.

Self-Test

The following self tests are available. Results are displayed on the screen.

If any faults are found, have the HiCorder repaired. Contact your dealer or Hioki representative.

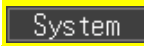
1  Select the **[System]** screen. → 

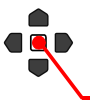
2  Select the self test to perform.

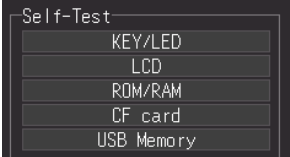

The Self-Test menu shows the following options: KEY/LED, LCD, ROM/RAM, CF card, and USB Memory.

Self-Test	Details
KEY/LED	<p>Tests the keys and LEDs for correct operation. After every key has been pressed, the KEY/LED check finishes. Pressing START also tests whether the LED lights.</p> <p>If you notice a malfunction, press START and STOP simultaneously to abort the test.</p>
LCD	<p>Tests the screen display (character test, gradation test, color test). The screen changes each time you press an operation key.</p> <p>If the display screen seems abnormal, request repairs.</p>
ROM/RAM	<p>Tests the HiCorder's internal memory (ROM and RAM).</p> <p>If "NG" appears, request repairs.</p>
CF	<p>Tests whether the inserted CF cards is recognized by the HiCorder. Use only Hioki optional CF cards. Non-Hioki CF cards may be unable to provide proper read/write performance, in which case HiCorder performance cannot be guaranteed.</p>
USB	<p>Tests whether the inserted USB flash drive is recognized by the HiCorder. Performs a simple read and write test.</p>

Connection to a PC

Chapter 11

11.1 USB Settings and Connections

Connecting the instrument to a computer via a USB cable allows you to import the data on a CF card or USB flash drive to the computer (p. 208), and perform command communication (p. 210).

Features enabled by USB settings and connection

Importing data from CF card or USB flash drive to computer (p. 208)

The data saved to a CF card or USB flash drive can be imported to a computer.

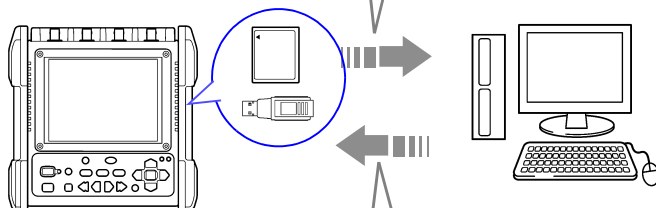

Communication using commands (p. 210)



For details on communication commands, see the instruction manual on the supplied CD.

11.2 Importing Data to a Computer

The supplied USB cable can be used to import the data saved on a CF card or USB flash drive to a computer. Before connecting the USB cable to the instrument, set USB Drive Mode on the [System] settings screen.

Select the USB Drive Mode

1  Select the [System] screen.  

2  Select [USB Drive Mode].
 Apply

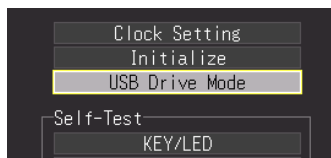

3 Select the media to be read.
CF, USB

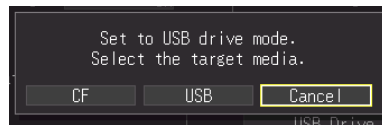

4 Connect the USB cable (p. 209).

If you select [EXIT], USB Drive Mode will be disabled.

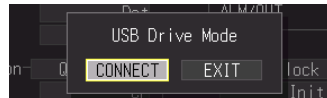

NOTE In USB Drive Mode, no operation other than disabling USB Drive Mode can be performed on the instrument.

Connecting the Instrument and Computer

Computer Requirements: A personal computer running Windows 7, Windows 8, Windows 10.

CAUTION

- Do not eject the CF card or pull out the USB cable during data transfer. Doing so would prevent proper data transfer.
- The Memory HiCorder and computer should be connected to the same earth ground. If grounded separately, potential difference between the ground points can cause malfunctions or damage when connecting the USB cable.

NOTE

Before connecting the USB cable to the HiCorder, select the USB Drive Mode on the [System] screen. If you connect the USB cable without setting USB Drive Mode, the data on the CF card or USB flash drive of the instrument are not able to be accessed.

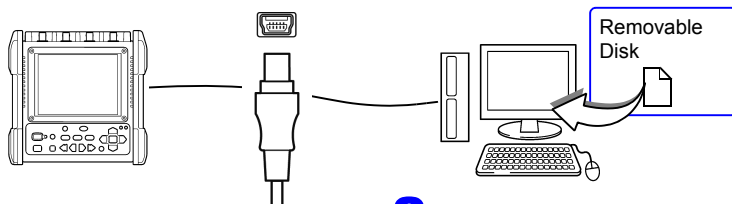

- 1 Connect one end of the USB cable to the USB port on the instrument while making sure the plug is oriented correctly.
- 2 Connect the other end of the cable to a USB port on the computer. The computer should recognize the Memory HiCorder as a removable disk when the cable is connected.

To exit USB Drive Mode

- 1 Click the Safely Remove Hardware (🗑️) icon in the Windows® notification area.
- 2 Click the appropriate line "Safely remove USB Mass Storage Device – Drive(H:)" where H is the drive letter that Windows assigned to the HiCorder.
- 3 When "Safe to remove hardware" appears, click [X] or [OK].
- 4 Disconnect the USB cable.



11.3 Communication Using Commands

If you use the supplied USB cable to connect the instrument to the computer, you can perform command communication using communication commands. The first time you perform communication between the instrument and computer, install the USB driver (p. 211).

NOTE

- If you connect the USB cable while both the instrument and the computer are off, be sure to turn on the computer first. If you turn them on in the wrong order, communication between the instrument and computer will not be possible.
- This instrument cannot be powered by the bus of a PC or USB hub. When using the instrument, connect the AC adapter or install batteries.

This instruction manual only describes the instrument settings. For details on communication commands, refer to the Communication Commands Instruction Manual (HTML format) on the supplied CD.

How to view the Communication Commands Instruction Manual

1. Insert the supplied CD into the CD drive of the computer.
2. Click index.htm in the MR8880 directory.

Setting Communication

Set the control by command communication and header.

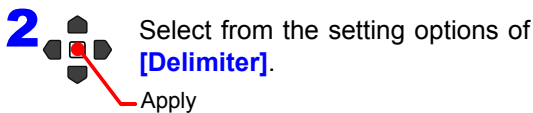

Setting options (*. default setting)

LF, CR+LF*

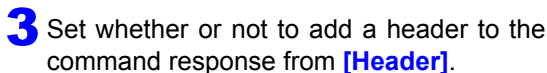

Setting options (*. default setting)

On Adds a header.

Off* Does not add a header.

NOTE

Communication using a communication command cannot be performed while you are operating Setting Wizard (p. 63).

Installing the USB Driver

Before connecting the instrument by USB, perform the following procedure to install the USB driver.

NOTE Perform the installation with administrator privileges.

Installing the Driver

- 1 Run [HiokiUsbCdcDriver.msi] in the CD-R X:\Driver folder.
([X] indicates the CD-ROM drive. The letter will differ depending on the computer.)

NOTE Depending on the environment, the dialog box may take some time to appear so please wait till it does so.

- 2 Click [Next].

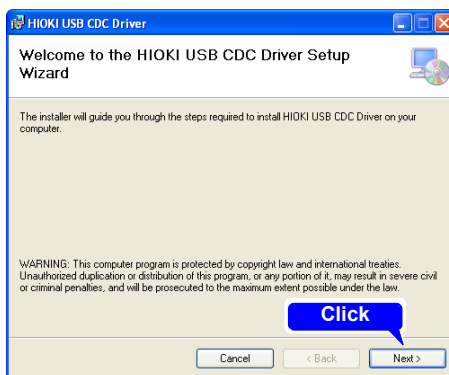

- 3 Click [Next].

When you want to change the installation destination

Click [Browse...] to change the folder to install into. Normally, there is no need to change.

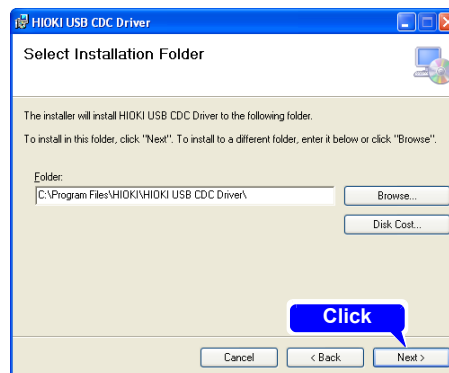

11.3 Communication Using Commands

4 Click **[Next]** to start installing.

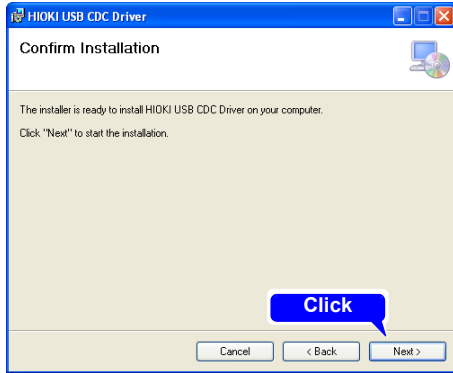

Installing

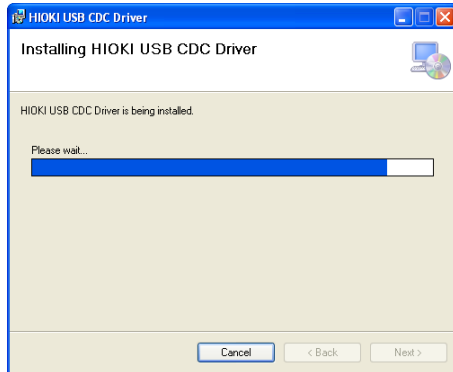

When a dialog box requesting your permission to continue the program appears, click **[Yes]**.

For Windows 8 and Windows 10, the display contents are slightly different, but proceed with the same procedure.

Sometimes another dialog box requesting your permission to install the software may appear. When it does, check **[Always trust software from "HIOKI E.E. CORPORATION"]** and click **[Install]** to continue.

5 When installation is completed and the dialog box appears, click **[Close]** to exit.

This completes the driver installation.

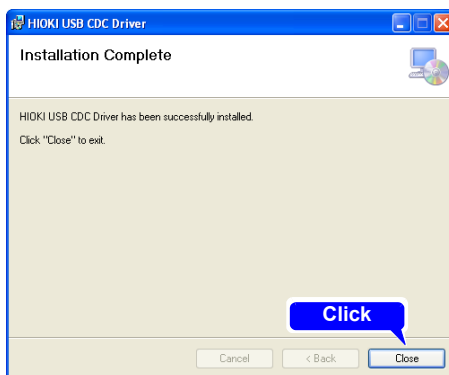
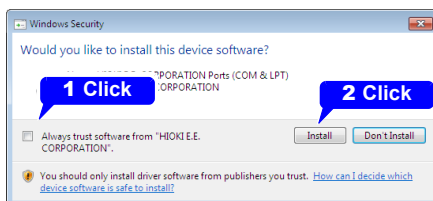
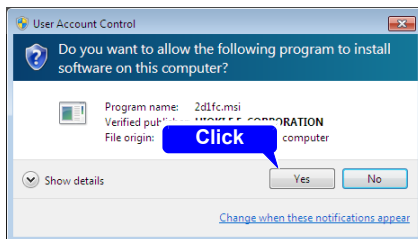

Connecting the Instrument and Computer

Computer Requirements: A personal computer running Windows 7, Windows 8, Windows 10.

CAUTION

- To prevent a malfunction, do not disconnect the USB cable during communication.
- The Memory HiCorder and computer should be connected to the same earth ground. If grounded separately, potential difference between the ground points can cause malfunctions or damage when connecting the USB cable.

NOTE

If you connect the USB cable while both the instrument and the computer are off, **be sure to turn on the computer first**. If you turn them on in the wrong order, communication between the instrument and computer will not be possible.

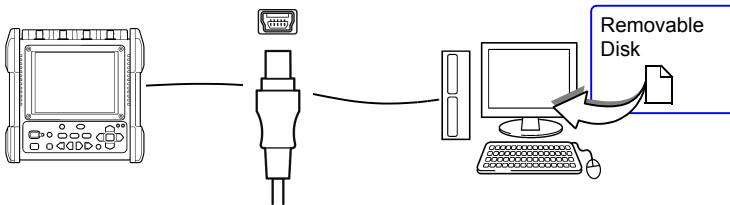

- 1** Connect one end of the USB cable to the USB port on the instrument while making sure the plug is oriented correctly.
- 2** Connect the other end of the cable to a USB port on the computer.

The instrument is recognized automatically, and the preparation to use the device completes.

Uninstalling the USB Driver

When the USB driver is no longer needed, uninstall it with the following procedure.

- 1 Click the Start button of Windows®, and click **[Control Panel]** on the Start menu. The Control Panel window is displayed. Click **[Uninstall a program]**.

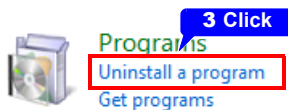
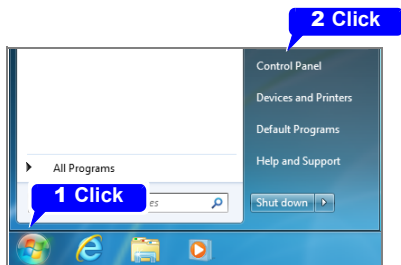

The **[Uninstall or change a program]** screen appears.

When Windows 10 is used, click the Start button and select **[Setting] - [System] - [Apps and Features]**.

- 2 From the list of installed programs, select **[HIOKI USB CDC Driver]**, and remove it.

External Control



Chapter 12

The external control terminals on the Memory HiCorder support trigger signal input and output.



External control terminals
(Right side)

1	START/IN1	Input signals for controlling the operation of the instrument. (Start, stop, abort, print)	Input
2	STOP/IN2		
3	GND	(common with instrument ground)	
4	ALM/OUT	Output signals for instrument status. (Printing, saving, instrument alarm)	Output
5	TRIG.OUT	Output signal when trigger applied.	Output
6	EXT.TRIG	(External trigger input) Input external signals.	Input

12.1 Connecting to the External Control Terminals



To avoid electrical hazards and damage to the instrument, do not apply voltage exceeding the rated maximum to the external control terminals.

	I/O terminals	Maximum input voltage
Input	EXT.TRIG	0 to 10 V DC
	START/IN1 STOP/IN2	
Output	ALM/OUT	0 to 50 V DC
	TRIG.OUT	

12.1 Connecting to the External Control Terminals



WARNING To prevent electric shock accidents and damage to the equipment, always observe the following precautions when making connections to external terminal blocks and external connectors.

- Before making connections, turn off the power on the instrument and the equipment to connect.
- Do not exceed the specified signal levels for signals supplied to external terminal blocks.
- Ensure that devices and systems to be connected to the external control terminals are properly isolated.



- The external control ground terminal is not isolated from the Memory HiCorder's chassis ground. Make certain that there will be no potential difference between the external control ground terminal and the ground of any connected device. Otherwise, the Memory HiCorder or device could be damaged.
- To avoid electric shock, use the recommended wire type to connect to the current input terminals, or otherwise ensure that the wire used has sufficient current handling capacity and insulation.

Terminal Connections

Required items:

Recommended cables:

- single strand diameter 0.65 mm (AWG22),
- multi-strand 0.32 mm² (AWG22)

Usable cables:

- Single strand diameter 0.32 to 0.65 mm (AWG28 to 22),
- Multi-strand 0.08 to 0.32 mm² (AWG28 to 22)
- Strand diameter 0.12 mm or greater (per wire)

Standard insulation stripping length: 9 to 10 mm

Button operation specified tool: Flat-blade screwdriver
(shaft diameter 3 mm, tip width 2.6 mm)

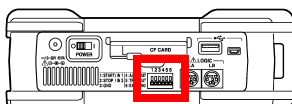
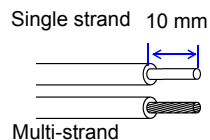

Right side

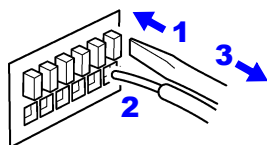

1 Press in the button of the terminal with a flat-blade screw driver or other tool.

2 While the button is depressed, insert the wire into the electric wire connection hole.

3 Release the button.
The electric wire is locked in place.

12.2 External Signal Input (External Trigger Input)

Triggering can be controlled by applying a signal from an external trigger source (p. 127). Furthermore, an event mark can be added by an input signal (p. 142). This allows synchronous operation of multiple Memory HiCorders by parallel triggering (p. 226).

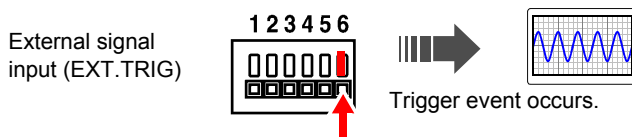

External Trigger Input Signals

Voltage range

HIGH level: 2.5 to 5.0 V, LOW level: 0 to 0.8 V

Pulse width

- Filter Off:
 - HIGH level: 1 ms or greater, LOW level: 2 μ s or greater
- Filter On:
 - HIGH level: 2.5 ms or greater, LOW level: 2.5 ms or greater

Maximum input voltage 0 to 10 V DC

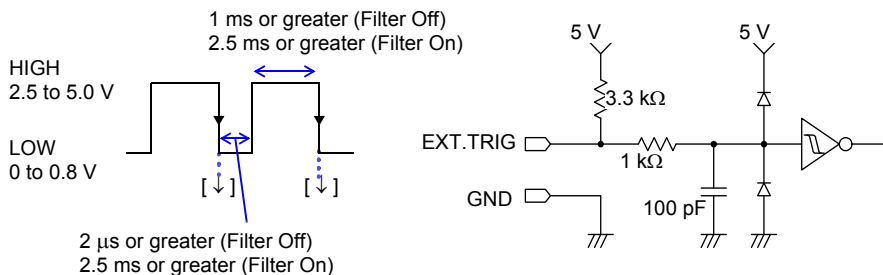

NOTE

When using an external trigger to synchronize multiple instruments, make sure you set **[Filter]** of the external trigger input to **[Off]**.

Signal Input Procedure

1 Connect the cables for the corresponding external input signals to the EXT.TRIG and GND terminals.

See p. 217 for the connection method.



2 Press the **SET** key to open the **[System]** screen.

3 Select an item from **[External Trig In]** of external control.

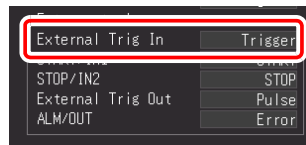

Trigger Applies a trigger with an input signal.
(p. 127)

Event Adds an event mark with an input signal.
(p. 142)

Select either rising or falling.

4 Short-circuit the EXT.TRIG terminal and GND, or leave the terminals open-circuited, and input a HIGH level (2.5 to 5.0 V) or LOW level (0 to 0.8 V) pulse wave or rectangular wave to the EXT.TRIG terminal.

12.3 External Signal Output (Trigger Output)

You can output a signal when a trigger event occurs. This allows synchronous operation of multiple Memory HiCorders by parallel triggering (p. 226).

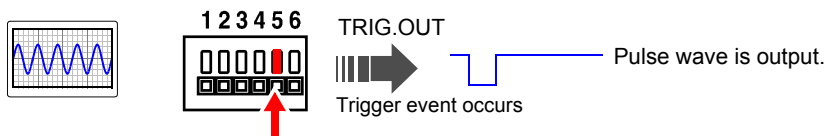

Trigger Output Signals

Output signal	Open drain output (with voltage output), Active Low
Output voltage range	HIGH level: 4.0 to 5.0 V, LOW level: 0 to 0.5 V
Pulse width	Level: Sampling period x (number of data since trigger – 1) or longer (2 μ s or longer) (for trigger synchronization operation) Pulse: 2 ms \pm 10% (for external synchronization)
Maximum switch rating	5 to 30 VDC, 200 mA

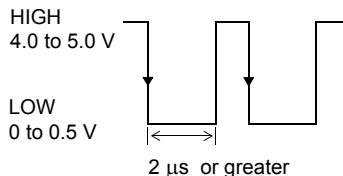
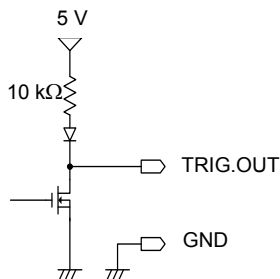

NOTE

- When triggering is not otherwise used, a trigger signal is output during measurement.
A trigger signal is also output when the Auto Range function is used, so be careful when using both Auto Range and the trigger output signal for triggering other devices.
- When using an external trigger to synchronize multiple instruments, make sure you set the external trigger output to **[Level]** on the System screen of the external trigger input.

For the external trigger setting procedure, see "Applying Trigger with External Input Signal (External Trigger)" (p. 127)

Signal Output Procedure

- 1 Connect the cables for the output signals to TRIG.OUT and GND terminals.
- 2 Press the **SET** key to open the **[System]** screen.
- 3 Select an item from **[External Trig Out]** of external control.

See p. 217 for the connection method.

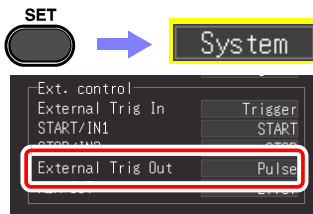

Pulse* After LOW level output, the signal goes HIGH after a specified interval.

Level After a trigger event has occurred, the signal remains LOW during waveform retrieval.

- 4 When trigger event occurs, a pulse wave changing from the HIGH level (4.0 to 5.0 V) to LOW level (0 to 0.5 V) is output from the TRIG.OUT terminal.

12.4 Controlling Instrument Using External Inputs (START/IN1 and STOP/IN2)

You can start and end measurement and print and save data by inputting signals from an external source.

External signal
input
START/IN1
STOP/IN2

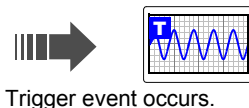
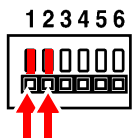

External Trigger Input Signals

Voltage range	HIGH level: 2.5 to 5.0 V, LOW level: 0 to 0.8 V
Pulse width	HIGH level: 20 ms or greater, LOW level: 30 ms or greater
Maximum input voltage	0 to 10 V DC

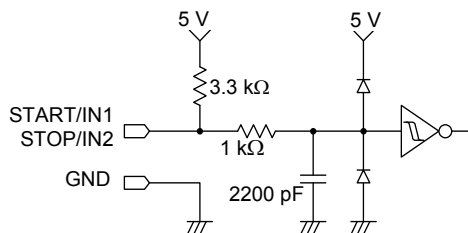
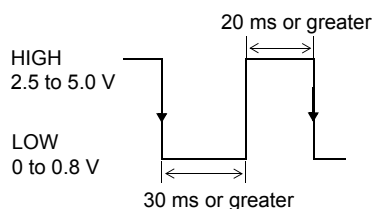

Signal Input Procedure

- 1 Connect each of the START terminal or STOP terminal and GND terminal to the external signal input destination with electrical wires.
- 2 Press the **SET** key to open the **[System]** screen.
- 3 Select the function for each of **[START/IN1]** and **[STOP/IN2]** of external control.

See p. 217 for the connection method.

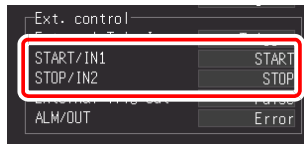

START	Start measurement.
STOP	Stop measurement. (Perform post-measurement processing such as numerical calculation, automatic saving, etc.)
START/STOP	Start measurement on LOW level, and stop measurement on HIGH level.
ABORT	Force end of measurement. (Do not perform post-measurement processing such as numerical calculation, automatic saving, etc.)
SAVE	Save to the media specified for the SAVE key, according to the specified conditions. (Selection is invalid during execution (p. 202).)
PRINT	Perform the same action as the PRINT key. (Selection is invalid during execution (p. 165).)

The initial settings (factory defaults) are shown below.

- START/IN1: START
- STOP/IN2: STOP

- 4 Short circuit the terminal and GND, or input a HIGH level (2.5 to 5.0 V) or LOW level (0 to 0.8 V) pulse wave or rectangular wave to the EXT.TRIG terminal.

The START/IN1 terminal and STOP/IN2 terminal are active LOW.

Furthermore, control can be performed by creating an open or short state between the START/IN1 terminal or STOP/IN2 terminal and the GND terminal.

An open state is equivalent to the HIGH level and the short state is equivalent to the LOW level.

12.5 Using External Outputs (ALM/OUT)

Signals can be output that indicate the instrument's judgment state.



Output Signals

Output signal	Open drain output (with voltage output, active LOW)
Output voltage range	HIGH level: 4.0 to 5.0 V, LOW level: 0 to 0.5 V
Maximum switch rating	5 to 30 VDC, 200 mA

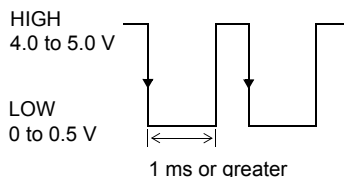
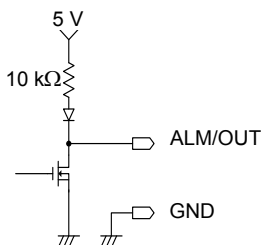

Signal Output Procedure

- 1 Connect each of the ALM/OUT terminal and GND terminal to the signal output destination with electrical wires.
- 2 Press the **SET** key to open the **[System]** screen.
- 3 Select an item for the **[ALM/OUT]** external terminal.

See p. 217 for the connection method.

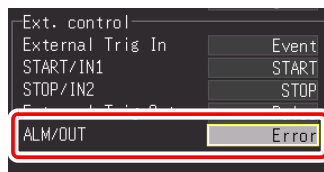

Error	Output a low level signal when some kind of error occurs. (While an error message is displayed on the screen.)
BUSY	Output a low level signal when no start action such as starting, saving, and printing has been accepted from an external source.
Waiting	Output a low level signal while waiting for a trigger.

The signal is output in accordance with the status of the instrument.

12.6 Synchronous Measurements with Multiple Instruments

- NOTE**
- This is for using an external trigger to synchronize the start time for measurements with multiple instruments, not for synchronizing sampling itself. When measurements are performed for a long time, differences in data acquisition times occur because of variations in the sampling clocks of individual instruments.
 - When using an external trigger to synchronize multiple instruments, make sure you set the following.
 - Set **[Filter]** of the external trigger input to **[Off]**
 - Set the external trigger output to **[Level]** on the System screen

Multiple instruments can be synchronized using the external control terminals. The following two methods are available for synchronous operation.

Daisy chain configuration

Set all instrument to master.

Setting procedure: (System screen, p. 127)

- Set external trigger to **[On]** for the all instruments.
- Set all instruments to **[External Trig In: Trigger]**.

When a trigger event occurs on any of the connected instruments, it also occurs on the others.

As more instruments are connected, the difference between trigger timing on different instruments becomes larger.

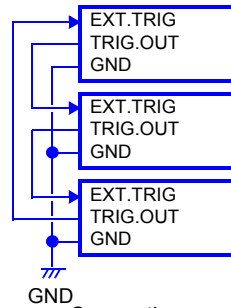

Connection example

Parallel synchronization

Set one instrument to master, and set the others to slave.

Setting procedure: (System screen, p. 127)

- Set external trigger to **[On]** for the slave instruments only. (p.129)
- Set all instruments to **[External Trig In: Trigger]**.

When using the master instrument as the trigger source, the other instruments start measuring simultaneously when a trigger event occurs.

This gives the least difference in trigger timing between instruments.

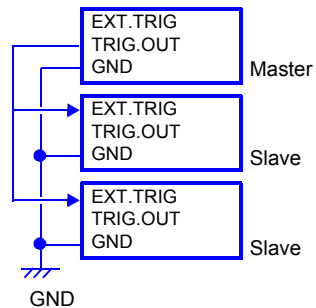

Connection example

Specifications Chapter 13

13.1 MR8880-20 Specifications

(1) Basic Specifications

Product warranty period	3 years AC adapter: 1 year Connector, cable, etc.: Not covered by the warranty
Measurement functions	<ul style="list-style-type: none"> • High-speed recording (previous Memory Recorder function) • Real-time recording (equivalent to Memory HiLogger and includes previous recorder function and effective value recorder)
No. of channels (max.)	4 analog channels + 8 logic channels (Equipped as standard, Logic ground is common with chassis ground)
External terminals	External Trigger Input, Trigger Output, External Start, External Stop, External Output and GND
Memory capacity	14-bit X 1M Words/Ch (1Word = 2 byte)
Maximum sampling rate	1MS/s (All channels simultaneously)
Timebase accuracy	±0.0005%
Clock functions	Auto calendar, auto leap year judgment, 24-hour timer
Clock accuracy	±3s/day (@23°C, 73°F)
Backup battery life	For clock and setting conditions, approx. ten years (@23°C, 77°F)
Waveform backup time	Approx. 30 minutes (@23°C, 73°F)
Operating temperature and humidity	Temperature: -10°C to 50°C (14 to 122°F), Humidity: -10°C to 40°C (14 to 104°F) 80%RH or less (non-condensating) 40°C to 45°C (104 to 113°F) 60%RH or less (non-condensating) 45°C to 50°C (113 to 122°F) 50%RH or less (non-condensating) <ul style="list-style-type: none"> • During operation with Z1000 Battery Pack Temperature: 0°C to 40°C (32 to 104°F), Humidity: 80%RH or less (non-condensating) • During charging of Z1000 Battery Pack Temperature: 10°C to 40°C (50 to 104°F), Humidity: 80%RH or less (non-condensating)
Period of guaranteed accuracy	1 year
Conditions of guaranteed accuracy	After 30 minutes warm-up

13.1 MR8880-20 Specifications

Temperature and humidity range for guaranteed accuracy Temperature: 23±5°C (73±9°F), humidity 80% RH or less (non-condensating)

Storage temperature and humidity

- Model MR8880-20, MR9000
 Temperature: -20°C to 60°C (-4 to 140°F),
 Humidity:
 -20°C to 40°C (-4 to 104°F) 80% RH or less (non-condensating)
 40°C to 45°C (104 to 113°F) 60% RH or less (non-condensating)
 45°C to 60°C (113 to 140°F) 50% RH or less (non-condensating)
- Model Z1000
 Temperature: -20°C to 40°C (-4 to 104°F),
 Humidity: 80% RH or less (non-condensating)

Operating environment Indoors, Pollution degree 2, up to 2000 m (6562-ft.) ASL

Dielectric strength, Insulation resistance 5.4 kV AC for 1 minute, 100 MΩ or more at 500 V DC (between inputs and instrument, and between each input)

Power source

1. Model Z1002 AC Adapter (12 V DC)
 Rated supply voltage 100 to 240 V AC (Voltage fluctuations of ±10% from the rated supply voltage are taken into account)
 Rated supply frequency 50/60 Hz
 Anticipated transient overvoltage 2500 V
2. Z1000 Battery Pack (when used in combination with the AC adapter, priority is given to the AC adapter.)
 Rated supply voltage 7.2 V DC
3. LR6 Alkaline batteries x 8 (when used in combination with the AC adapter, priority is given to the AC adapter)
4. DC power supply input: 10 to 28 V DC (input from the AC adapter jack is possible with a custom-ordered cable), the cable between the batteries and instrument must be within 3 m (charging voltage range: 12 V DC to 16 V DC)

Maximum rated power	Operating power supply	(*1)	(*2)	(*3)
	Z1002 AC Adapter (AC adapter included)	45 VA	38 VA	107VA
	External DC power supply	11 VA	10 VA	40 VA
	Z1000 Battery Pack	9 VA	8 VA	22 VA

(*1) Real-time saving and backlight on (reference value)
 (*2) Real-time saving and backlight off (reference value)
 (*3) Real-time saving, backlight on and optional printer connected

Continuous operating time	When using Model Z1000 Battery Pack (@23°C reference value) 1. Real-time measurement and backlight on: approx. 3 hours 2. Real-time measurement and backlight off: approx. 3.5 hours When using alkaline dry cell batteries (@23°C reference value) 1. Real-time measurement and backlight on: approx. 40 minutes 2. Real-time measurement and backlight off: approx. 50 minutes
Charging function	With the Z1000 Battery Pack installed and the AC Adapter connected Charging time: Approx. 3 hours (@23°C reference value)
Dimensions (sans protrusions)	<ul style="list-style-type: none"> Unit only Approx. 205W x 199H x 67D mm (8.07"W x 7.83"H x 2.64"D) When printer connected Approx. 303W x 199H x 67D mm (11.93"W x 7.83"H x 2.64"D)
Mass	<ul style="list-style-type: none"> Unit only Approx. 1.3 kg (45.9 oz) (not including batteries) When printer connected Approx. 1.8 kg (63.5 oz) (not including batteries)
Applicable Standards	Safety EN61010 EMC EN61326 Class A
Vibration endurance	JIS D 1601:1995 5.3(1), Category 1: Vehicle, Condition: Category A equiv. (45 m/s ² oscillating acceleration on X-axis for 4 h, and on Y- and Z-axes for 2 h)

(2) Display Section

Display type	5.7-in TFT Color LCD (640X480 dot)
Display resolution	Waveform: 15div (time axis) X 10div (voltage axis) (1div = 40dot (time axis) X 36dot (voltage axis))
Backlight lifespan	Approx. 50,000 hours (23°C reference value)
Display character	English/ Chinese/ Japanese selectable
Backlight power saver function	The backlight turns off when no key is pressed (Off, or 1 to 5 minutes)
Backlight brightness	Selectable from four levels (100%, 70%, 40%, 25%)
Waveform display colors	24
Screen color	Black or white selectable
Screen surface treatment	Hard coat

(3) Printer Interface

Connectable printer	MR9000 Printer Unit (for Model MR8880-20)
----------------------------	---

13.1 MR8880-20 Specifications

Recording width	Total recording width:104 mm (832-dot) Waveforms:100 mm f.s. (1div=10 mm, f.s.=10div)
Recording speed	Max. 1 cm/s However, printing is not possible while using alkaline batteries
Paper feed dimensions accuracy	±3% (25°C, 50%RH)

(4) External Storage**CF card**

PC card slot	One CompactFlash compliant slot
Supported cards	HIOKI 9727 (256MB), 9728 (512MB), 9729 (1GB), 9830 (2GB)
Data formats	FAT, FAT32

USB flash drive

Connector	Series A receptacle
------------------	---------------------

(5) Communications Functions**USB Interface**

USB standard	USB2.0 compliant High Speed
Connector	Series-mini B receptacle
USB Function	1. Setting and measurement by communications commands 2. USB Drive Mode (to transfer data from removable storage to a PC)

(6) Analog Input Section

Measurement ranges	10, 20, 50, 100, 200, 500 mV/div 1, 2, 5, 10, 20, 50, 100 V/div (Same for instantaneous values and effective values)
Analog measurement accuracy	±0.5% f.s. (after zero adjustment. with the filter set to 5Hz.)
Effective value measurement accuracy	±1.5% f.s. (30 Hz to less than 1 kHz), ±3% f.s. (1 kHz to 10 kHz) Crestfactor: 2 (*) (*) With sine wave input (up to 850 V peak voltage of instantaneous value)
Effective value measurement response time	300 ms (with low-pass filter Off) • Rising: Response time of up to 0% f.s. → 90% f.s. when 0% f.s.→100% f.s. input • Falling: Response time of up to 100% f.s. → 10% f.s. when 100% f.s.→0% f.s. input

Temperature characteristic	$\pm 0.1\%$ f.s./ $^{\circ}\text{C}$ (after zero adjustment)
Frequency characteristic	DC to 100kHz $\pm 3\text{dB}$
Common mode rejection ratio	-90dB minimum (sensitivity range, at 50/60Hz and with signal source resistance 100 Ω maximum)
Low-pass filter	Off, 5Hz, 50Hz, 500Hz, 5kHz, 50kHz $\pm 50\%$ (Hz) -3dB
Noise	2mVp-p typ. 3mVp-p max. (sensitivity range, with input shorted)
Input type	Unbalanced (input isolated from output)
Input resistance	1 M Ω $\pm 1\%$
Input capacitance	7 pF \pm 3 pF (at 100 kHz)
A/D converter used	14 bits (\pm f.s.= ± 6400 data)
Voltage axis resolution	640 data/div (x1)
Voltage axis measurement range	± 1 to ± 10 times measurement range (f.s. = 10div)
Maximum sampling rate	Analog measurement: 1MS/s
Input coupling	DC/GND *Automatically becomes AC coupling when measuring an effective value.
Input terminals	Insulated BNC terminal
Maximum rated voltage between terminals	600 V AC/DC(*). With sine wave input (up to 850 V peak voltage of instantaneous value)
Maximum rated voltage to earth	600 V AC, DC Measurement category III 300 V AC, DC Measurement category IV Anticipated transient overvoltage 6000 V (between each input channel and chassis, and between input channels)

(7) Miscellaneous

Accessories	<ul style="list-style-type: none"> • Instruction Manual (1) • Z1002 AC Adapter (1) • Alkaline Battery Box (1) • Strap (1) • USB Cable (1) • Application disc (CD) (Waveform Viewer [Wv], Communication Commands) (1)
--------------------	--

Accessories sold separately

Standard options	<ul style="list-style-type: none"> • Model Z1002 AC Adapter (12 V DC, 5.25 A) • Model MR9000 Printer Unit (for Model MR8880-20) • Model Z1000 Battery Pack (NiMH, 7.2 V, 4500 mAh) • Model C1003 Carrying Case (with space for storing options) • Model 9234 Recording Paper (112 mm wide, 18 m roll) • Model Z4006 USB Drive (16GB) • Model 9727 PC Card (256MB) • Model 9728 PC Card (512MB) • Model 9729 PC Card (1GB) • Model 9830 PC Card (2GB)
Measurement probes, etc.	<ul style="list-style-type: none"> • Model L9197 Connection Cord (Maximum input voltage 600 V AC/DC, Isolated BNC, Alligator Clip) • Model 9197 Connection Cord (Maximum input voltage 600 V AC/DC, Isolated BNC, Alligator Clip) • Model L9198 Connection Cord (Maximum input voltage 300 V AC/DC, Isolated BNC, Alligator Clip) • Model 9199 Conversion Adaptor (Isolated BNC, Banana jack with rigid insulating sleeve) • Model L9217 Connection Cord (Maximum input voltage 300 V AC/DC, Isolated BNC-BNC) • Model L9790 Connection Cord (Maximum input voltage 600 V AC/DC, Isolated BNC, Banana Plug with rigid insulating sleeve) • Model L9790-01 Alligator Clip (for Model L9790) • Model 9790-02 Grabber Clip (for Model L9790) • Model 9790-03 Contact Pin (for Model L9790) • Model 9322 Differential Probe • Model 9418-15 AC Adapter (for Model 9322)
Logic probes	<ul style="list-style-type: none"> • Model 9320-01 Logic Probe (Four channels, for detecting voltage and closed/open contact points) • Model MR9321-01 Logic Probe (Four isolated channels, for detecting AC/DC voltage on/off) • Model 9323 Conversion Cable (for connecting Model 9320 or 9321)
Current measurement probes, etc.	<ul style="list-style-type: none"> • Model 9018-50 Clamp-On Probe (10 A to 500A AC, 40 Hz to 3 kHz) • Model 9132-50 Clamp-On Probe (10 A to 500A AC, 40 Hz to 1 kHz) • Model 9675 Clamp-On Leak Sensor (10 A AC, 40 Hz to 5 kHz) • Model 9657-10 Clamp-On Leak Sensor (10 A AC, 40 Hz to 5 kHz)
PC application program	<ul style="list-style-type: none"> • Model 9335 Wave Processor (PC application programs)

(8) Trigger Function

Trigger method	Digital comparison
Repeat recording	Single, Repeat
Trigger timing	<ul style="list-style-type: none"> • High-speed function: Start • Real-time function: Start, stop, start&stop (conditions can be set for each of start and stop)
Trigger criteria	AND or OR possible between all trigger sources
Trigger source	<p>Trigger source selectable for each channel Free-running when all trigger sources are Off</p> <ol style="list-style-type: none"> 1. Analog inputs: CH1 to CH4 2. Logic inputs: LA1 to LA4, LB1 to LB4 (4 channels x 2 probes) 3. External trigger: Input signal to external trigger terminal
Interval trigger	<p>Fixed interval recording at specified measurement interval (day, hour, minute, second) is possible. A trigger is applied simultaneously with start of measurement, and then a trigger is subsequently applied at the set measurement interval. (Use the schedule function to specify the start time.)</p>
Trigger types (analog)	<ol style="list-style-type: none"> 1. Level trigger A trigger is applied when rise or fall to set voltage value. 2. Window trigger Set the upper and lower limits of trigger level 3. Voltage drop trigger ([Highspeed] only) A trigger is applied when the voltage peak falls below the set level. (Dedicated for commercial power supply of 50/60 Hz. The trigger can not be set with the time base range of 50 ms/div and 100 ms/div.) 4. Waveform judgment trigger ([Highspeed] only) A trigger for performing waveform judgment in real time. (Dedicated for commercial power supply. The trigger can not be set with the time base range of 50 ms/div and 100 ms/div.) Comparison targets: Sine wave and previous waveform Judgment period: 20 μs (with 100 μs to 2 ms/div), sampling period (with 5 ms to 20 ms/div) Maximum sampling speed: 1 MS/s (with time base of 100 μs/div)
Trigger types (logic)	<p>Pattern trigger: Settable to 1/0/x for each input (ignore x)</p> <ul style="list-style-type: none"> • Configure the pattern setting for each probe. • The trigger condition (AND/OR) can be set between logic input channels in each probe. • The trigger condition between probes is in accordance with overall trigger condition (AND/OR).

Trigger types (external trigger)	<p>Rising and falling selectable</p> <ul style="list-style-type: none"> • Rising A trigger is applied when rise from low (0 to 0.8 V) to high (2.5 to 5 V). • Falling A trigger is applied when fall from high (2.5 to 5 V) to low (0 to 0.8 V), or terminal short. <p>Input voltage range: 0 V to 10 V DC External trigger filter: On/Off selectable Response pulse width: H period 1 ms or greater, L period 2 μs or greater (when external trigger filter Off) H period 2.5 ms or greater, L period 2.5 ms or greater (when external trigger filter On)</p>
	<ul style="list-style-type: none"> • High-speed function: Set by number of samples (Off, 10, 20, 50, 100, 200, 500, 1000) • Real time function: On/Off selectable(*) (*) Operation with the Real-time Function differs depending on whether envelope mode is On/Off.
Trigger filter	<p>(Envelope mode Off) The filter differs depending on setting of recording interval. Recording interval 100 μs to 10 ms: Filter fixed to 10 ms 20 ms to 1 min: Filter for 2 consecutive data portions (Envelope mode On) The filter is fixed to 10 ms regardless of the recording interval.</p>
Trigger level resolution	<p>0.1% f.s. (f.s. = 10div)</p>
Pre-trigger	<ul style="list-style-type: none"> • [Highspeed]: Set percentage in relation to entire recording length (0, 5, 10, 20, 30, 40, 50, 60, 70, 80, 90, 95, 100%) • [Realtime]: Set by hour, minute, and second (Settable up to same value as recording length (*)) (*) When continuous recording is [On], settable up to the following corresponding value. whether envelope mode is [Off]: upto 1,000,000 data whether envelope mode is [On]: upto 500,000 data
Trigger output	<p>Open-drain output (with 5 V output, Active Low) Output voltage level HIGH: 4.0 to 5.0 V, Low: 0 to 0.5 V Output pulse width: Level/ Pulse selectable</p> <ul style="list-style-type: none"> • Level: Sampling period x (number of data since trigger -1) or longer (2 μs or longer) • Pulse: 2 ms\pm10%
Trigger input and output terminals	<p>Terminal block</p>

13.2 High-speed Function

Basic Specifications

Timebase	100, 200, 500 μ s/div 1, 2, 5, 10, 20, 50, 100 ms/div
Time axis resolution	100 points/div (80 points/div when printing with printer/div)
Sampling period	1/100th of timebase
Recording length	5 to 10000div Settable in 5-division steps (Also stores one previous measurement after measurement starts)
Data types	Selectable from instantaneous values and effective values
Display Screen	Waveform display Simultaneous waveform and trigger setting display Simultaneous waveform and setting display Simultaneous waveforms and numerical calculation results display Waveform and A/B cursor values displayed at the same time
Screen settings	Single, Dual, Quad, X-Y Dots, X-Y Line
Waveform compression and magnification	Horizontal axis (time axis): x10, x5, x2, x1, x1/2, x1/5, x1/10, x1/20, x1/50, x1/100, x1/200, x1/500, x1/1000, x1/2000 Vertical axis (voltage axis): Differs depending on display method setting. <ul style="list-style-type: none"> When set by position: Magnification: x20, x10, x5, x2, x1, x1/2, x1/5, x1/10 Position: Set -50 to 150% (when magnification x1) When set by upper and lower limits: Set the upper and lower limits. The display is as follows when the measurement value is over the set range. <ul style="list-style-type: none"> "OVER" when over on + side "-OVER" when over on - side
Waveform scrolling	Scrolling possible in time axis direction only for data portion stored in internal buffer memory (Possible both during measurement and after measurement) <</ >> These keys make large jumps
Auto save	Selectable from Off, waveform, CSV, numerical calculation, waveform + numerical calculation, and CSV + numerical calculation When data has been acquired for the specified recording length portion, all data is saved simultaneously.

Overwriting save	Selectable Off or On <ul style="list-style-type: none"> • On: When there is not much space left on the storage media, the oldest waveform file with the same extension is deleted and a new file is created. • Off: Data is saved until the storage media is full and then measurement ends.
Auto print	Selectable from On and Off (after measurement) When measurement data has been acquired for the specified recording length portion, it is printed in accordance with the settings.
Manual print	Printing with the printer is performed in the measurement stop state each time the PRINT key on the MR9000 Printer Unit is pressed. (Only measurement data stored in internal buffer memory is printed.)
Print range	Selectable from entire waveform and waveform between A and B <ul style="list-style-type: none"> • When using auto print, set the print range before measurement. • When the PRINT key on the MR9000 Printer Unit is pressed after measurement, a screen for selecting printing of all data or part of data is displayed to enable the print range to be selected.

13.3 Real-time Function

Basic Specifications

Recording interval	100, 200, 500 μ s 1, 2, 5, 10, 20, 50, 100, 200, 500 ms 1, 2, 5, 10, 20, 30 s 1 min Note: Data is stored at the interval set here.
Recording length (Continuous recording)	Continuous measurement can be set to On/Off <ul style="list-style-type: none"> • On: Continuous recording from start to end of measurement* 1 M Words from before measurement was stopped are stored in internal buffer memory. (500,000 Words when envelope mode is On) *: When a 2 GB CF card is used, saving for approx. 11 hours at recording interval of 100 μs is possible. • Off: Set the recording time (Variable by recording interval, up to 694 days, 10 hours, and 40 minutes when recording interval of 1 min.)
Data types	Selectable from instantaneous values and effective values
Envelope mode	On/Off The sampling clock for acquiring peak data is fixed to 1 MS/s. Sampling data used for acquiring peak data is not retained.

Screen settings	Single, Dual, Quad
Waveform compression and magnification	<p>Horizontal axis (time axis): 10ms, 20ms, 50ms, 100ms, 200ms, 500ms, 1s, 2s, 5s, 10s, 30s/div, 1min, 2min, 5min, 10min, 30min, 1h, 2h, 5h, 10h, 12h, 1day/div</p> <p>Vertical axis (voltage axis): Differs depending on display method setting.</p> <ul style="list-style-type: none"> When set by position: Magnification: x20, x10, x5, x2, x1, x1/2, x1/5, x1/10 Position: Set -50 to 150% (when magnification x1) When set by upper and lower limits: Set the upper and lower limits. <p>The display is as follows when the measurement value is over the set range.</p> <ul style="list-style-type: none"> "OVER" when over on + side "-OVER" when over on - side
Display screen	<p>Waveform display Simultaneous waveform and trigger setting display Simultaneous waveform and setting display Simultaneous waveforms and numerical calculation results display Waveform and A/B cursor values displayed at the same time</p>
Waveform scrolling	<p>Scrolling possible in time axis direction only for data portion stored in internal buffer memory (Possible both during measurement and after measurement) <</ >> These keys make large jumps</p>
Jump function	<p>Specifying and jumping to waveform display position possible. (Specify a jump position in the waveform position display bar, and then jump to the specified location.)</p>
Real-time saving	<p>Selectable from off, Waveform (realtime), CSV (realtime), Calc (after meas.), Waveform + Calc, CSV + Calc Saving simultaneously with measuring, drawing, and printing is possible (limited by time axis).</p>
Split save	<p>Selectable Off, On or Periodic</p> <ul style="list-style-type: none"> On: Saves data split into separate files from measurement start, at the set interval. Periodic: Saves data split into separate files from a set reference time (within 24 hours), at the set interval. <p>*Even if split saving is set to Off, the file will automatically be split if its size is expected to exceed 500 MB.</p>
Overwriting save	<p>Selectable Off or On</p> <ul style="list-style-type: none"> On: When there is not much space left on the storage media, the oldest waveform file with the same extension is deleted and a new file is created. Off: Data is saved until the storage media is full and then measurement ends.

Remove external media	<p>The storage media can be removed during real-time saving. (When replacing external storage media, replace it within 20 seconds when the recording interval is set to 100 μs.) (Removal procedure) Press the storage media eject button on the screen. A message appears when the storage media becomes able to be ejected. When reinserting the storage media, save the data retained in internal buffer memory while the storage media was not inserted to a separate file.</p>
Real-time printing	<p>Selectable from Off and On (limited by time base, no trace printing) Printing simultaneously with acquiring of waveforms possible. However, only when the time base is slower than 1 s/div. Partial printing using cursors A and B is not possible during real-time printing.</p>
Manual print	<p>Printing with the printer is performed in the measurement stop state each time the PRINT key on the MR9000 Printer Unit is pressed. (Only measurement data stored in internal buffer memory is printed.)</p>
Partial printing	<p>Part between cursors A and B printable (When the PRINT key on the MR9000 Printer Unit is pressed, a screen for selecting printing of all data or part of data is displayed to enable the print range to be selected.)</p>

13.4 Other Functions

Zero adjustment function	<p>The effect of temperature drift of the analog circuit of the input section can be cancelled.</p> <p>Possible with zero adjustment item on the Settings screen (Also possible by pressing the up and down cursor keys simultaneously for at least 1 second)</p>
Logic recording width	<p>The display width in the vertical axis direction of logic waveforms can be set.</p> <ul style="list-style-type: none"> • Wide: Wide logic recording width for displaying and printing. • Narrow: Narrow logic recording width for displaying and printing.
Numerical calculations	Four calculations are available at the same time
Calculation target	Selectable from CH1, CH2, CH3, CH4, and ALL (all channels target).
Calculation range	Selectable from all measurement data and between cursors A and B.
Calculation type	<ul style="list-style-type: none"> • [Highspeed]: Average value, peak value, maximum value, maximum value time, minimum value, minimum value time, RMS value, period, frequency, area value, and X-Y area value • [Real time]: Average value^(*), peak value, maximum value, maximum value time, minimum value, and minimum value time <p>(*) This cannot be set when envelope mode is On.</p>
Split calculation	<p>Selectable from Off, On, and Reference time (Real-time Function only)</p> <ul style="list-style-type: none"> • Off: Split calculation is not performed. • On: Specify the split length (day, hour, minute). Calculation is performed at each split length from the start. • Ref time (Reference value): Specify the divide time (hour, minute) and split length (1 minute to 1 day). Calculation is performed from the divide time. After that, calculation is performed at each split length.
Automatic saving of calculation results	<p>Calculates the final calculation value automatically after measurement stops, and then saves it in text format to the CF card or USB flash drive.</p> <p>However, if split calculation is selected when using the Real-time Function, the calculation result is saved for each specified split length.</p>

Event mark function	
Event mark insertion	<p>Event input under the following conditions is possible (max. 100 marks).</p> <ol style="list-style-type: none"> 1. When pressing START while measuring 2. When pressing the on-screen [Make Mark] button. 3. When a signal is applied to the external trigger input terminal (External Trigger and Exclusive settings on the System screen)
Search function	Displays the waveform before and after a specified event mark. (Searchable events only exist in internal buffer memory)
Cursor measurement functions	Select trace, vertical, or horizontal
Measurement items	<p>Cursor A/cursor B: Potential, time from trigger</p> <p>Between cursors A and B: Time difference, potential difference, frequency</p>
Cursor movement	Select A, B, or Both (simultaneous)
Scaling functions	<p>The display format for after scaling is selectable for each channel.</p> <ul style="list-style-type: none"> • Off: Scaling is not performed. • Decimal: Displays values in decimal notation after conversion. • Exponential: Displays values in exponential notation after conversion. <p>When decimal or exponential is selected, the scaling conversion method can be selected.</p> <ul style="list-style-type: none"> • Conversion ratio: Set the physical quantity (conversion ratio) per 1 V, offset, and unit. (Default values: conversion = 1, offset = 0) • Setting at 2 points: Set the voltage of the two-point portion and the value and unit for after conversion. (Default values: Conversion 1 = 0.05 → 0.05, conversion 2 = -0.05 → -0.05) • Model: Select from the clamp model and setting range of the clamp or 9322 Differential Probe. (Default values: Model = 3283, measurement range = 10 mA AC) • Output rate: Select the conversion value per 1 V from a list. (Default value: Clamp 1 V → 10 mA)
Data protection	<p>In the event of a power outage during saving to storage media, the file is closed and then the power is shut down.</p> <p>When the instrument is operating on batteries during saving, the file is closed and access to storage media is stopped when there is not much power remaining in order to protect the file.</p> <p>Note: This function is enabled 3 minutes after the power is turned on.</p>

Manual saving	Data can be saved by pressing the SAVE key while measurement is stopped. Save types: Setting conditions, waveform data (binary format), waveform data (CSV format), numerical calculation results, and screen data (compressed bitmap format) Able to set the desired file name.
SAVE key operation setting	The operation for when the SAVE key is pressed is selectable from Select & Save and Quick Save. When Quick Save is selected, set the save type, format, and range.
Reloading data	A position can be specified in data saved in binary format, and then up to 1M data points per channel can be loaded at one time.
Comment entry	A title or a comment for each channel can be entered (up to 40 single-byte characters). Numerical values, alphabet letters, symbols
Comment printing	Prints function, used channels, input range, zero adjustment, trigger time, etc.
Setting condition printing	Selectable from Off, List, Gauge, and List & Gauge.
Gauge	Gauges can be displayed on the Waveform screen Off: Gauges are not displayed. CH1, CH2, CH3, and CH4: Displays gauges for only the specified channels. ALL1: Displays gauges for all channels not on top of the waveform display. ALL2: Displays gauges for all channels on top of the waveform display.
Retain start condition function	Provided
Auto setup function	Setting conditions in the instrument or storage media can be loaded automatically at power-on.
Setting configuration saving function	Up to 10 setting configurations can be stored in HiCorder memory.
Measurement data backup	Backs up the measurement data for a period of approx. 30 minutes after the power is turned off. Note: However, measurement data is not backed up under the following conditions. <ul style="list-style-type: none"> • When the power is turned off during writing to external storage media • When the power is turned off within 3 minutes of the power being turned on
Inadvertent START/STOP prevention	Displays a confirmation message when pressing START or STOP keys. Confirmation message: Select enable/disable (Default: enabled)

External trigger terminal functions	The external trigger terminal function is selectable from trigger and event.
External trigger filter	Selectable from On and Off.
External input terminal functions	Any of the following functions can be set for each of terminal 1 and terminal 2. Start, stop, abort, save, print
External output terminal functions	Any of the following functions can be set for the terminal. Error, BUSY, Waiting (waiting for trigger) Open-drain output (with 5 V output, Active Low) Output voltage level HIGH: 4.0 to 5.0 V, LOW: 0 to 0.5 V
Time value display	Select from time, date, and number of data for the horizontal axis display. The time, date, or number of data from the start of measurement is displayed. <ul style="list-style-type: none"> • Time: Displays the time (in hours, minutes, and seconds) from the start of measurement. However, if a trigger is set, the time from the trigger point is displayed. • Date: Displays the date and time that the data was acquired. • Number of data: Display the number of data from the start of measurement. However, if a trigger is set, the number of data from the trigger point is displayed. This setting is reflected in the values saved in CSV format.
Key-Lock function	Disables key operations (Hold cursor left and right keys for three second to enable/disable.)
System reset	All setting items can be restored to their factory defaults.
Beeper	On/Off
Auto range	Available (The most suitable time axis and voltage axis for the input waveform are selected automatically.)
Screen hard copy	The screen image can be printed by pressing the COPY key on the MR9000 Printer Unit.
List print	Outputs the setting conditions after the waveform data is printed. (When List or List & Gauge is selected for the print setting condition) In addition to from the display screen, output can be performed by pressing the PRINT key on the MR9000 Printer Unit.
Printing density	Print density selectable from the following. Dark, standard, and fine
Grid types	Type of grid to draw on the recording paper selectable from the following. Off, normal, fine, normal (dark) or fine (dark)
Self-Test function	KEY/LED, LCD, ROM/RAM, and USB checks are possible.

Schedule function	<p>Up to 10 measurement start and stop conditions can be set.</p> <ol style="list-style-type: none"> Specified day <ul style="list-style-type: none"> The start time and stop time (year/month/day/hour/minute) can be set. The setting conditions for performing a scheduled operation can be set. Fixed time <ul style="list-style-type: none"> The start day (specify daily, Monday to Friday, Monday to Saturday, or days every week) can be set. The start time and stop time (hour/minute) can be set. The setting conditions for performing a scheduled operation can be set.
--------------------------	---

13.5 Monitor Functions

Refresh rate	0.5 s
Display items	<p>Numerical values and measurement waveform of instantaneous values or effective values (The number of divisions of the displayed waveform differs depending on the gauge setting. The number of divisions is five for Off or ALL2, and three for a setting other than that.) The Monitor screen is displayed when the MONITOR key is pressed. The Monitor screen can also be displayed when the instrument is waiting for a trigger</p>
No. of display digits	5
Range used	Same as measurement range
Accuracy	<ul style="list-style-type: none"> Instantaneous value measurement: $\pm 0.5\%$ f.s. (after zero adjustment) Effective value measurement: $\pm 1.5\%$ f.s. (30 Hz to 1 kHz), $\pm 3\%$ f.s. (1 kHz to 10 kHz) <p>(Guaranteed accuracy range: 10% to 100% of full scale)</p>
Print function	The values shown in numerical display can be printed by pressing the PRINT key

13.6 Setting Wizard Function (PRESETS)

Selection options	<ol style="list-style-type: none"> Basic Measurement Guide Measurement Example Guide Load Settings from Memory
--------------------------	---

Maintenance and Service

Chapter 14

14

Chapter 14 Maintenance and Service

14.1 Inspection, Repair, and Cleaning

**WARNING**

Do not attempt to modify, disassemble or repair the instrument; as fire, electric shock and injury could result.

Transporting

- Use the original packing materials when transporting the instrument, if possible.
- Pack the instrument so that it will not sustain damage during shipping, and include a description of existing damage. We do not take any responsibility for damage incurred during shipping.
- Remove any CF card, USB flash drive, recording paper, or the like from the instrument to prevent damage to the instrument.
- Do not transport the instrument while recording paper is installed. The parts supporting the recording paper may be damaged by vibration.

Replaceable Parts and Operating Lifetimes

Useful life depends on the operating environment and frequency of use. Operation cannot be guaranteed beyond the following periods.

For replacement parts, contact your dealer or Hioki representative.

Part	Life
LCD (to half brightness)	Approx. 50,000 hours
Z1000 Battery Pack	60% of initial battery capacity can be expected to remain after 500 complete charge/discharge cycles.
Electrolytic Capacitors	Approx. 10 years
Lithium battery	Approx. 10 years The instrument has a built-in lithium battery for backing up the settings and clock. If the date and time deviate substantially when the instrument is switched on, it is the time to replace that battery. Contact your dealer or Hioki representative.
Electrical double layer capacitor	Approx. 3 years The instrument has a built-in electrical double layer capacitor for protecting data and backing up measurement data. When the backup time of measurement data becomes remarkably short, it is time to replace the capacitor. Contact your dealer or Hioki representative.
Battery pack connectors	Disconnection/connection times: 30 (the number of times that provides stable connection)

In particular, the life span is likely to become remarkably short when the instrument is used in a very hot environment.

Fuse

The fuse is housed in the power unit of the instrument. If the power does not turn on, the fuse may be blown. If this occurs, a replacement or repair cannot be performed by customers. Please contact your dealer or Hioki representative.

Cleaning

■ Instrument and printer (option)

- To clean the instrument, wipe it gently with a soft cloth moistened with water or mild detergent. Never use solvents such as benzene, alcohol, acetone, ether, ketones, thinners or gasoline, as they can deform and discolor the case.
- Wipe the LCD gently with a soft, dry cloth.

■ Printer head



CAUTION Do not directly touch the printer head because there is the risk of it being damaged by static electricity.

The MR9000 Printer Unit (option) does not normally require maintenance. However, depending on the conditions of use, the life of the head and platen roller may be reduced due to paper dust and foreign matter adhering to them as the printer is used for a long time.

In such a case, perform the following procedure to clean the head.

Required items: Ethyl alcohol, cotton buds

Wear an anti-static wristband when performing this work to protect against static electricity.

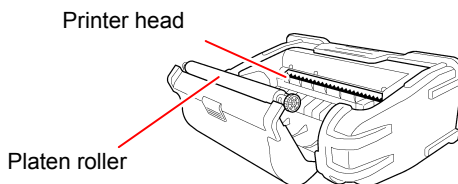
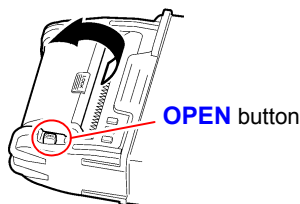

1 Press the **OPEN** button to open the cover so that you can see the head.

2 Use a cotton bud moistened with ethyl alcohol to gently wipe the heating elements on the head surface.

NOTE

- During cleaning, do not apply excessive force to the thermal head or bang the head surface with a hard object.
 - Do not use sandpaper or the like because doing so may result in damage to the heating elements.
 - After cleaning, wait until the ethyl alcohol is completely evaporated, and then close the cover and perform an operation check.
 - Do not use thinner, benzene, or the like because doing so may cause discoloration and deformation of the instrument.
 - Prolonged use may result in paper dust and other white particles adhering to the surface of the roller. Small amounts of particles will not affect the printer but if you are worried you can use a commercially available blower brush for cameras or similar device to remove them.
-



14.2 Troubleshooting

If damage is suspected, check the “Troubleshooting” section before contacting your dealer or Hioki representative.

Before Returning for Repair

If abnormal operation occurs, check the following items.

Power, operation, and display problems

Symptom	Check Items	Solution
The display does not appear when you turn the power on.	<ul style="list-style-type: none"> Is the power cord disconnected? Are connections made correctly? Is the battery pack installed correctly? 	Verify that the power cord is connected properly (p. 37). Verify that the batteries or battery pack is correctly installed (p. 32).
Keys do not work.	<ul style="list-style-type: none"> Is any key being held down? Is the key-lock state active? (A message appears when a key is pressed while key-lock is active.) 	Verify key operation. Cancel key-lock: (Hold the   cursor keys for three seconds)
Power does not turn on.	<ul style="list-style-type: none"> Is the AC adapter disconnected? A power protection component may be damaged. 	Contact your dealer or Hioki representative for service. Customers should not attempt to perform parts replacement and repair. Contact your dealer or Hioki representative for service.
A waveform does not appear when you press the START key.	<ul style="list-style-type: none"> Is the "Waiting for pre-trigger" message displayed? Is the "Waiting for trigger" message displayed? Is the waveform display color selection box selected ()? 	When pre-triggering is enabled, triggering is ignored until the pre-trigger portion of the waveform has been acquired. Recording starts when a trigger occurs.
No changes occur in the displayed waveform.	<ul style="list-style-type: none"> Is the clamp sensor or connection cable connected correctly? Is the measurement range set properly? Is a low-pass filter being applied? 	Check that the clamp sensor and connection cord are connected correctly (p. 38). Check the input channel settings (p. 86).
The display turns off or the display does not appear while the power LED lights.	<ul style="list-style-type: none"> Is the backlight power saver set? 	Press any of the keys. To disable the backlight power saver, set it to Off (System screen) (p. 199).
The data is displayed with a frequency that is much lower than the actual frequency during measurement.	<ul style="list-style-type: none"> An aliasing error (p. A20) may have occurred. 	Change the time axis range to a fast sampling speed (p. 71).

Printing problems

Symptom	Check Items	Solution
Nothing prints on the paper.	<ul style="list-style-type: none"> • Is the paper reversed (back to front)? • Is the printer connected correctly? 	Verify that the recording paper is loaded correctly.
Printout is too light.	<ul style="list-style-type: none"> • Is the specified recording paper being used? • Is the print density setting correct? • Is the print head dirty? 	Try changing the print density setting (p. 173). Clean the print head (p. 247).
Recording traces are too wide.	<ul style="list-style-type: none"> • The input signal may have a ripple component. 	Set the low-pass filter.
Paper is not output.	<ul style="list-style-type: none"> • Is there a paper jam? 	Open the printer cover, and re-load the recording paper.

Saving problems

Symptom	Check Items	Solution
Data cannot be saved to the CF card/USB flash drive.	<ul style="list-style-type: none"> • Is the CF card/USB flash drive inserted properly? • Is the CF card/USB flash drive formatted? • Is the remaining capacity of the CF card/USB flash drive too low? 	Using a CF Card/USB flash drive (p. 46)

Others

Symptom	Check Items	Solution
The USB driver cannot be installed.	<ul style="list-style-type: none"> • Did installation of the driver fail? 	Uninstall the driver, and then re-install it (p. 215). Install the driver from an account with administrator privileges.

If the cause is unknown

<ul style="list-style-type: none"> • Try performing a system reset (p. 204) • All settings are returned to their factory defaults (p. A7) However, the setting conditions and communication related settings saved to the instrument memory are not reset.
--

14.3 Disposing of the Instrument

The instrument contains a lithium battery for memory backup.

When disposing of this instrument, remove the lithium battery and dispose of battery and instrument in accordance with local regulations.

Removing the Lithium Battery



WARNING To avoid electric shock, turn off the power switch and disconnect the power cord and measurement cables before removing the lithium battery.

Required tools:

- One Phillips screwdriver (No.1)
- One wire cutter (to remove the lithium battery)
- One box wrench or spanner (5.5 mm) (for removing the hexagonal standoffs)

1 Verify that the power is off, and remove the measurement cables and power cord.

2 Turn the instrument upside down, and then remove the screw (1) from the battery compartment cover.

3 Remove the battery compartment cover.

4 Remove the batteries or battery box.

5 Remove the screws (4) securing the protector, and then remove the protector.

6 Remove the screws (4) securing the bottom of the case, and then remove the bottom of the case.

7 Remove the screws (2) securing the board, and then remove the board.

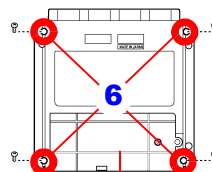
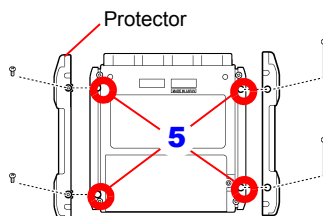
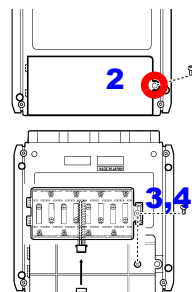

Bottom of the case

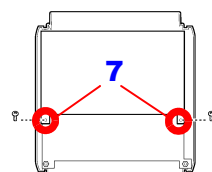

14.3 Disposing of the Instrument

- 8** Remove the screws (2) securing the circuit board and the hexagonal standoffs (5).
- 9** Remove the circuit board to which the lithium battery (back surface) is attached.
- 10** Lift up the lithium battery on the circuit board, and then cut both the + and - leads with a pair of wire cutters.

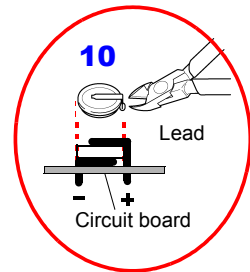
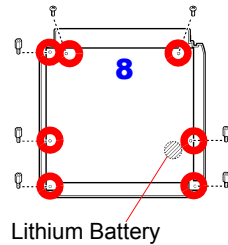
**CALIFORNIA, USA ONLY**

This product contains a CR Coin Lithium Battery which contains Perchlorate Material - special handling may apply.

See www.dtsc.ca.gov/hazardouswaste/perchlorate

Appendix

Appendix 1 Error Messages and Remedial Actions

Error messages consist of either "Error" or "Warning" displays.

A screen message appears whenever an error occurs. In either case, take the remedial action indicated.

Error Messages



To clear an error message, press the **ENTER** key.

Message	Remedial Action
001 The internal buffer memory has been cleared. (Cause: Possible buffering time exceeded)	The internal buffer memory can only be backed up more than five minutes after turning on the power. Do not turn off the power for five minutes after it is turned on. Once the back-up function is activated, the internal buffer memory can be backed up for approximately 30 minutes even after the power is turned off.
004 Battery low. Cannot access to the waveform backup and media.	Low battery charge: recharge or replace with a fresh battery pack.
005 FPGA error	Incompatible FPGA firmware version. Try updating the firmware, and if the error persists, submit the Memory HiCorder for repair.
007 Failed to update ROM.	Try updating the firmware, and if the error persists, submit the Memory HiCorder for repair.
008 FPGA PLL error. Turn off and on the power.	The instrument has malfunctioned. Turn the power off and then back on. If the error message appears after turning the power off and then back on, the instrument needs to be repaired.
010 The amp adjustment value is abnormal. This unit needs to be repaired.	There is a problem with the input section. If the error message appears after turning the power off and then back on, the instrument needs to be repaired.
012 Internal memory error.	The instrument has malfunctioned. Turn the power off and then back on. If the error message appears after turning the power off and then back on, the instrument needs to be repaired.

Appendix 1 Error Messages and Remedial Actions

Message	Remedial Action
015 The possible zero-adjustment range has been exceeded. INSTNT error: RMS error:	There is a problem with the input section. If the error message appears after turning the power off and then back on, the instrument needs to be repaired.
030 The printer has been stopped because a head temperature error was detected.	Wait until the temperature of the printer falls before using the printer
031 The printer has been stopped because a motor temperature error was detected.	Wait until the temperature of the printer falls before using the printer
032 The printer was stopped for an error of the motor.	There is a problem with the printer motor. If the error message appears after turning the power off and then back on, the printer needs to be repaired.

Warning Messages

When there is a warning, a warning message will appear just once and then disappear after a few seconds. A displayed warning message can be closed by pressing any key.

Message	Remedial Action
101 Invalid key.	Keys are disabled while measuring. Try operating again when measurement is finished.
102 Cannot start measurement.	The START and STOP keys are disabled when the current screen is displayed.
103 Cannot change while measuring.	Press STOP to stop measuring before changing the setting.
104 Voltage drop and wave comparison triggers cannot be modified. (The effective time axis range is 100 μ s/div to 20ms/div and the effective recording interval is 1 μ s to 200 μ s.)	Set the time base range or recording interval to a valid range.
105 Voltage drop and wave comparison triggers have already been set and cannot be modified. (The effective time axis range is 100 μ s/div to 20ms/div and the effective recording interval is 1 μ s to 200 μ s.)	Disable the voltage drop and waveform judgment triggers.
106 This cannot be used in RMS mode (voltage drop and wave comparison trigger).	Change the measurement mode of the corresponding channels to instantaneous value.
201 Exceeding the setting range.	The entered numerical value exceeds the setting range. Enter an appropriate value.

Appendix 1 Error Messages and Remedial Actions

Message		Remedial Action
203	Voltage drop trigger will be disabled.	Voltage sag triggering is disabled when the timebase is outside of the range 100 μ s to 50 ms/div. Change the timebase so that it is within this range. The trigger cannot be set when the input mode is effective value.
204	Measurement range changed.	When [Type]-[Upper/ Lower] is selected, the measurement range is automatically changed to match the upper and lower limits.
230	Recording time has been changed due to memory limit.	Increasing the number of measurement channels has decreased internal buffer memory waveform data capacity.
231	Pre-Trigger span changed.	If the recording interval and recording time are changed, a warning may appear because the time that can be set for the pre-trigger changes.
232	Recording and Pre-Trigger spans changed due to waveform memory limit.	If the recording interval is changed, a warning may appear because the recording time and the time that can be set for the pre-trigger changes.
236	File partition period was changed.	The segment time span has been changed in response to changing the recording interval.
237	File partition time was changed.	The segment time span has been changed in response to changing the recording interval.
238	Unable to set CSV auto-save with the current record interval.	If you select [CSV(realtime)] or [CSV + Calc] for automatic saving, set the recording interval to 5 ms or longer.
239	CSV auto save has been set. Unable to set the specified record interval.	To perform measurement at the specified recording interval, set auto save to other than CSV saving.
245	The reservation settings are incorrect.	Confirm the schedule settings.
246	When using real-time save, enveloping, and numerical calculations simultaneously, the recording interval cannot be set to 100 μ s or 200 μ s.	Set the recording interval to 500 μ s or longer.
301	No waveform data.	No waveform data is preset, so data saving and calculations cannot be performed. Press START to start acquiring measurement data.
302	Confirm the A-B cursor position.	The A/B cursor positions are invalid (out of waveform range). Check the cursor positions.
303	No numerical calculation data.	Execute numerical calculation (p. 177)
304	Invalid event mark.	Try moving to an event mark that is not in memory.
401	File processing error.	An unexpected fault occurred while processing a file on the removal storage. Turn the power off and back on.

Appendix 1 Error Messages and Remedial Actions

Message	Remedial Action
402 Cannot load this file.	The format of the file is incompatible with the HiCorder, or the file is corrupt. Refer to "6.1 Saving & Loading Data" (p. 147) for loadable file formats.
403 Insert a Media.	A CF card or USB flash drive is not present. Insert storage media.
404 Directory full.	<ol style="list-style-type: none"> 1. Reduce the number of files by moving files in the directory to other storage media. 2. If you set [Deleting] to [On] when using automatic saving, the most recent file will be saved normally when the directory becomes full because the oldest file will be deleted.
405 Not enough capacity.	The removal storage as insufficient space to save the file. Delete files to increase free space, or replace the removal storage.
406 Process interrupted (not enough battery capacity).	The file cannot be processed because there is insufficient battery power. Charge the battery or connect the AC adapter.
407 Insert CF card or USB memory.	A CF card or USB flash drive is not present. Insert storage media.
408 Preparing to protect file. Do not access the storage media for about 3 minutes after turning on the device.	Allow about three minutes for the capacitor to charge.
410 This file may be corrupted.	<p>Check or perform the following:</p> <ol style="list-style-type: none"> 1. Verify that the CF card is specified by Hioki (p. 46) 2. Reformat the CF card (p. 48) <p>If the message persists after performing the above, either the CF card or Memory HiCorder may be damaged. Contact your dealer or Hioki representative.</p>
430 Unsaved data present.	The cause is likely to be that a CF card or USB flash drive is not inserted or there is insufficient free space. Insert a CF card or USB flash drive, and then manually save any necessary data.
431 Insert media to save waveform data.	Insert a removal storage.
432 Change media.	Removable storage cannot be accessed. Replace the CF card or USB flash drive.
434 Media is full or cannot delete oldest wave file.	<p>This may appear while measuring using waveform auto save.</p> <p>A file could not be saved: Not enough space on the removable storage.</p>
435 Media is nearly full.	Not enough space on the removal storage. Replace with a new removal storage.
436 Saving interrupted (Low battery).	Battery charge is too low to save. Recharge, or connect the AC adapter.

Appendix 1 Error Messages and Remedial Actions

Message	Remedial Action
437 Saving wave data.Wait for a moment.	Some key operations are disabled because of the increased load during real-time saving. Minimize key operations as much as possible during real-time saving.
438 This folder is protected. Rename for deleting.	This message is displayed to prevent accidental deletion of data folders. To delete a folder, first rename it.
441 Insert the recording media. Un-saved data will be lost soon.	A CF card or USB flash drive is not present. Insert storage media.
501 File system error (I/O error).	An I/O error occurred while accessing the removal storage. Reformat the removal storage. If the error persists, try a different removal storage.If this error occurs while using a good removal storage, the HiCorder may be damaged, in which case contact your dealer or Hioki representative.
502 File system error (Incorrect file handle).	Turn the HiCorder off and back on. If the fault persists, perform system reset (p. 204).
503 File system error (system configuration).	
504 File system error (not enough memory).	
505 File system error (incompleted information).	The removable storage could not be recognized. Reformat the removable storage on a PC. If the error persists, try a different removable storage. If this error occurs while using a good removable storage, the HiCorder may be damaged, in which case contact your dealer or Hioki representative.
506 File system error (incorrect device).	Turn the HiCorder off and back on. If the fault persists, perform system reset (p. 204).
507 File system error (file protected).	The requested write process (including deletion) could not be performed because the file attribute is read-only. Use a PC to cancel the read-only setting.
508 File system error (failed to recognize the format).	The removable storage could not be recognized. Reformat the removable storage on a PC. If the error persists, try a different removable storage. If this error occurs while using a good removable storage, the HiCorder may be damaged, in which case contact your dealer or Hioki representative.
509 File system error (limit of the number of files).	The number of files to be processed exceeds the limit, so processing cannot be performed. Delete files to increase free space, or try another removable storage.
510 File system error (same name file).	An attempt was made to create a file with the same name as an existing file. Change the name of the file to be created (p. 162).

Appendix 1 Error Messages and Remedial Actions

Message	Remedial Action
511 File system error (system busy).	Processing could not be performed because files are in use by another executing process. Wait for the current process to finish. If there is no other executing process, turn the HiCorder off and back on.
512 File system error (too long path name).	The specified path name is too long. Re-enter the name of a removable storage folder from the PC.
513 File system error (no file).	Turn the HiCorder off and back on. If the fault persists, perform system reset (p. 204).
514 File system error (mode error).	
515 File system error (invalid file handle).	
516 File system error (file offset error).	
517 File system error (not enough capacity).	Insufficient free space is available on the removable storage for the process to execute. Delete files to increase free space, or try another removable storage.
518 File system error (invalid file name).	The file name contains an invalid character. Rename the file (p. 162).
519 File system error (directory error).	Turn the HiCorder off and back on. If the fault persists, perform system reset (p. 204).
520 File system error (invalid file type).	
521 File system error (file rename error).	
522 File system error (internal parameter error).	
523 File system error (block size error).	
524 File system error (semaphore error).	
525 File system error (not supported action).	
550 The printer has run out of paper.	Replace the recording paper.
551 The printer cover is open.	Close the printer cover properly.
552 The temperature of the printer head is abnormal.	Reduce the ink coverage (reduce the number of black shaded portions).
553 The temperature of the printer motor is abnormal.	The ambient temperature in the location of use may be high. Use the printer in a location that is within the range described in the specifications.
554 The recording length is set to continuous.	
555 Real-time printing is not possible with a horizontal axis of 10 to 500 ms.	Set the horizontal axis (time base) so that it is slower than 500 ms/div.

Appendix 2 List of Default Settings

When shipped from the factory or initialized to factory defaults, the settings are as follows.

(*1). High-speed Function, (*2). Real-time Function

■ Setting Screen (Status)

●: Setting available, X: Setting not available

Setting Items	Initial settings	(*1)	(*2)
Function	Highspeed	●	●
Repeat	Single	●	●
Sampling period (Recording interval)	1 μs (*1) 100 μs (*2)	●	●
Timebase	100 μs	●	X
Zoom (in the Horizontal axis direction) for 1 div time	100μs/div (*1) 1s/div (*2)	●	●
Zoom (in the Horizontal axis direction) for magnification	X1	●	X
Continuous recording	Off	X	●
Shot (div)	15	●	X
Recording length	15	●	X
Recording time (d/h/m) * Specifically for screen settings	0	X	●
Recording time [s] * Specifically for screen settings	10	X	●
Format	Single	●	X
ComboArea	All	●	X
Envelope	Off	X	●

■ Setting Screen (Setting save)

●: Setting available, X: Setting not available

Setting Items	Initial settings	(*1)	(*2)
Setting save state	–	●	●
Setting comment	–	●	●
Auto load target	Off	●	●

■ Setting Screen (Numerical calculation)

●: Setting available, X: Setting not available

Setting Items	Initial settings	(*1)	(*2)
Numerical Calc. On/Off	Off	●	●
Types of calculations	Off	●	●
Target channels for numerical calculation	All	●	●
X axis channel (when XY area)	CH1	●	X
Y axis channel (when XY area)	All	●	X
Span	All	●	●
Display of the Numerical calculation value	Normal value	X	●
Split Save Off/On/RefTime	Off	X	●
Split Len	0D0H10M	X	●
Ref Time	0:0	X	●
Split Len	10M	X	●

■ Setting Screen (File)

●: Setting available, X: Setting not available

Setting Items	Initial settings	(*1)	(*2)
Autosave (Realtime)	Off	●	●
Autosave file name	–	●	●
Split Save	Off	X	●
Deleting	Off	●	●
Time (minutes) of length split for split saving	0D0H10M	X	●
Time (minutes) of periodic split for split saving	10M	X	●
Ref Time (minutes)	0:0	X	●
Media	CF	●	●
Thin out text saved with auto save	Off	●	●

Appendix 2 List of Default Settings

(*1). High-speed Function, (*2). Real-time Function

■ Setting Screen (Scheduling)

●: Setting available, X: Setting not available

Settings Items	Initial settings	(*1)	(*2)
On/Off	Off	●	●
Enable/Disable	Off (check box)	●	●
Type	Off	●	●
Conditn.	Current	●	●
Strt.Day	Daily	●	●
Strt.Day/ Stop Day (year)	00	●	●
Strt.Day/ Stop Day (day)	01	●	●
Strt.Tm./Stop Tm. (time)	00	●	●

■ Setting Screen (Graph)

●: Setting available, X: Setting not available

Setting Items	Initial settings	(*1)	(*2)
Single	All channel Gr1	●	●
Dual	Channel 1 Gr1 Channel 2 Gr2 Channel 3 Gr1 Channel 4 Gr2	●	●
Quad	Channel 1 Gr1 Channel 2 Gr2 Channel 3 Gr3 Channel 4 Gr4 XY Line XY Dots	●	●
Logic display	Logic A Off Logic B Off	●	X

■ CH/All CH Screen (channels)

●: Setting available, X: Setting not available

●: Setting available, X: Setting not available

Setting Items	Initial settings	(*1)	(*2)
Channel	CH1	●	●
Range	10mV	●	●
Mode	INSTNT	●	●
L.P.F.	Off	●	●
Coupling	DC	●	●
Zoom	X1	●	●
Waveform display position	50%	●	●
Waveform color (analog)	Ch1: red, Ch2: green, Ch3: yellow, Ch4: pink		
Waveform color (logic)	LOGIC A Bit1: light blue, Bit2: orange, Bit3: light green, Bit4: blue LOGIC B Bit 1: dark purple, Bit 2: light purple, Bit 3: very light purple, Bit 4: cream		

Setting Items	Initial settings	(*1)	(*2)
Logic display position	Logic A: Pos1 Logic B: Pos2	●	●
Logic display width	Narrow	●	●
Monitor display specification of Channel Settings screen	All CH	●	●
XY display color	XY1: red, XY2: green, XY3: yellow XY4: pink	●	X
X-Y plot X-axis channel	XY1 to 4: CH1	●	X
X-Y plot Y-axis channel	XY1: CH1, XY2: CH2, XY3: CH3, XY4: CH4	●	X

(*1). High-speed Function, (*2). Real-time Function

■ CH/ All CH Screen (Upper/lower limit)

●: Setting available, X: Setting not available

Setting Items	Initial settings	(*1)	(*2)
Disp Span - Type	Pos	●	●
Upper	0.05	●	●
Lower	-0.05	●	●

■ CH/ All CH Screen (Scaling)

●: Setting available, X: Setting not available

Setting Items	Initial settings	(*1)	(*2)
Scaling	Off	●	●
Scaling setting	Ratio	●	●
Ratio	1	●	●
Offset	0	●	●
Voltage coefficient 1 Cnv1 (2-point)	0.05	●	●
Voltage coefficient 2 Cnv2 (2-point)	-0.05	●	●
Scaling coefficient 1 (Unit1) (2-point)	0.05	●	●
Scaling coefficient 2 (Unit2) (2-point)	-0.05	●	●
Unit	-	●	●

■ Comment Screen

●: Setting available, X: Setting not available

Setting Items	Initial settings	(*1)	(*2)
Title	-	●	●
Analog CH1 to CH4	-	●	●
Logic LA1 to LB4	-	●	●
Print items-Title	Settings	●	●
Print items-Analog	Settings	●	●
Print items-Logic	Off	●	●

■ Waveform Screen

●: Setting available, X: Setting not available

Setting Items	Initial settings	(*1)	(*2)
Screen display	Wave+Set	●	●
Gauge	ALL 1	●	●

■ Wave+Crsr Screen (A/B cursor)

●: Setting available, X: Setting not available

Setting Items	Initial settings	(*1)	(*2)
Type	Trace	●	●
Type (when XY display)	Trace	●	X
Move	A Cur	●	●
A, B: (when XY display)	XY1	●	X

■ System Screen (Communications)

●: Setting available, X: Setting not available

Setting Items	Initial settings	(*1)	(*2)
Delimiter	CR+LF (*)	●	●
Header	Off (*)	●	●

(*). This setting value is not reset when the instrument is initialized.

Appendix 2 List of Default Settings

(*1). High-speed Function, (*2). Real-time Function

■ Trig Screen (Trigger)

●: Setting available, X: Setting not available

●: Setting available, X: Setting not available

Setting Items	Initial settings	(*1)	(*2)
Trig Func	Off	●	●
Timing	Start	X	●
Ext trig			
(Start)	Off	●	●
(Stop)	Off	X	●
Filt (filter for external trigger)	Off	●	●
Trigger Condit.(AND/OR)			
(Start)	OR	●	●
(Stop)	OR	X	●
Pre-Trig (%)	0	●	X
(d/h/m/s)	0	X	●
Start trigger			
Trigger type	Off	●	●
Level	0.0mV	●	●
Drop level	40.0mV	●	X
Drop frequency(f)	60Hz	●	X
Trigger slope (S)	↑	●	●
Window-In/Out trigger Level	Upper 20.0mV Lower -20.0mV	●	●
Trigger filter (Filt)	Off	●	●
Judge frequency (f)	60Hz	●	X
Judge Ref	Sine	●	X
Judge Range	±5.0mV	●	X
Judge Ref volt	20.0mVr	●	X
Stop trigger			
Trigger type	Off	X	●
Trigger level	0.0mV	X	●
Trigger slope	↑	X	●
Window trigger	Upper 20.0mV Lower -20.0mV	X	●
Trigger filter (Filt)	Off	X	●

Setting Items	Initial settings	(*1)	(*2)
Logic (Start)			
Trigger source	Off	●	●
Trigger bit pattern bit 1- bit 4	X (Off)	●	●
Trigger filter	Off	●	●
Logic (Stop)			
Trigger source	Off	X	●
Trigger bit pattern bit 1- bit 4	X (Off)	X	●
Trigger filter	Off	●	●
Interval trigger	Off	●	●
Interval (Intvl.) d/h/m/s	0Day 0Hour 0Min 1Sec	●	●

(*1). High-speed Function, (*2). Real-time Function

■ System Screen

●: Setting available, X: Setting not available

Setting Items	Initial settings	(*1)	(*2)
Start Backup	Off	●	●
File Protection	Low	●	●
Backlight Saver	Off	●	●
Backlight Brightness	100%	●	●
Display Color	Black	●	●
Beep Sound	On	●	●
Time Disp	Time	●	●
Language	English	●	●
Separator	Comma	●	●
Decimal Mark	Dot	●	●
Start/Stop message	On	●	●
External Trig In	Trigger	●	●
START/IN1	START	●	●
STOP/IN2	STOP	●	●
External Trig Out	Pulse	●	●
ALM/OUT	Error	●	●
SAVE Key Operation	Select & Save	●	●
Media	CF	●	●
Save Type	Waveform	●	●
Format	Binary	●	●
Thin out	Off	●	●
Span	All	●	●

■ Print Screen

●: Setting available, X: Setting not available

Setting Items	Initial settings	(*1)	(*2)
Auto print	Off	●	X
Realtime print	Off	X	●
Channel marker	Channel No.	●	●
Grid type	Standard	●	●
Density	Standard	●	●
List&Gauge	List	●	●
Print range	All Wave	●	●

Appendix 3 File Naming

File names are constructed as follows (must be exactly eight characters, not including extension).

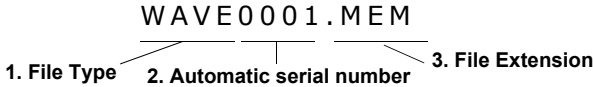

File Type	Folder Name	1. File Type	2. Automatic serial number	3. File Extension
Settings Data	CONFIG	CONF	0001,...99999999	.SET
Waveform Data	DATA (Folders named by date are automatically created) *2	Manual Save: WAVE Auto Save: (specified name) or AUTO	0001, ... 99999999 *1	.MEM (Binary) .CSV (Text) *3, *4
Numerical Calculation Results (calculation results from start to stop)	MEASURE- MENT/ALL	Manual Save: MEAS Auto Save: (specified name) or AUTO	0001, ... 99999999	.CSV *3, *4
Numerical Calculation Results (calculation results for each split interval when split calculation is enabled)	MEASURE- MENT/PART			.CSV *3, *4
Captured Screen Image	PICTURE	SCR	00001... 99999999	.BMP
Setting list	CONFIG	LIST	0001...99999999	.BDL
Schedule Settings	CONFIG	LIST	0001...99999999	.RSV

*1 When auto saving waveform data and calculation results, automatically generated serial numbers (up to eight digits) are appended to the specified file name. If no file name is specified, AUTO is automatically entered. (XXXX0001.MEM, XXX00001.MEM, XX000001.MEM, X0000001.MEM)
When auto numbering exceeds 9999, the file name characters are overwritten (right to left) until all eight digits are used for serial numbers. (Example: WAVE9999.MEM, WAV10000.MEM, ..)

*2 When **[Deleting]** is enabled with auto save:
The oldest waveform file with the same extension is deleted. When all waveform files within a date folder have been deleted, the folder name (date) is automatically updated.
(Example:) Before updating: 08-07-17, After updating: 08_07_17_080719_101113 (*old date_new date_new day and time*), Hyphens (-) are changed to underbars (_) and the date when the folder name was last changed is appended. (The example shows a new date and time of July 19th 2008, 10:11:13.)

*3 The TXT file extension is applied except when **[Separator:Comma]** is selected on the **[System]** screen.

*4 Before loading data into a spreadsheet program such as Excel®, note that the number of rows that can be loaded at one time is limited (to 60,000 rows in Excel 97 – 2003, and to one million rows in Excel 2007). Larger CSV files can be split by the following methods:

- Use a CSV file-splitting program (downloadable for free from Hioki’s website).
- Before saving, select the **[Split Save]** saving method in the HiCorder.

Note: The number of rows recorded per minute with 10 ms recording interval is:
100 (data points per second) x 60 (seconds) = 6,000 rows

Appendix 5 Waveform File Size

The file size can be obtained with the following formula.

File size = text header size + binary header size + data size

Each of these sizes differs depending on the function and envelope setting.

High-speed Function

- Text header:
 $512 \text{ (bytes)} * (\text{number of analog channels} * 2 + \text{number of logic channels} + 2) * (\text{number of headers}) = 4096 \text{ (bytes)}$
- Binary header:
 $512 \text{ (bytes)} * 12 \text{ (number of headers)} = 6144 \text{ (bytes)}$
- Data portion: $[(\text{number of analog channels}) + (\text{logic data})] * \text{number of data} * 2 \text{ (bytes)}$
- Waveform Judgment data portion: 4608 (bytes)

Example:

When saving the waveforms of 15 divisions (1,501 data) on all channels

$$4096 + 6144 + (4+1) * 1501 * 2 = 25250 \text{ (bytes)}$$

When saving the waveforms of 15 divisions (1,501 data) on all channels (Waveform Judgment Trigger)

$$4096 + 6144 + (4+1) * 1501 * 2 + 4608 = 29858 \text{ (bytes)}$$

Real-time Function

- Text header:
 $512 \text{ (bytes)} * (\text{number of analog channels} * 2 + \text{number of logic channels} + 2) * (\text{number of headers}) = 6144 \text{ (bytes)}$
- Binary header:
 $512 \text{ (bytes)} * 12 \text{ (number of headers)} = 6144 \text{ (bytes)}$
- Data portion (When Envelope is set to Off)
 $[(\text{number of analog channels}) + (\text{logic data})] * \text{number of data} * 2 \text{ (bytes)}$
- Data portion (When Envelope is set to On)
 $[(\text{number of analog channels}) + (\text{logic data})] * \text{number of data} * 2 \text{ (bytes)} * 2$

Example:

When saving in envelope On format for 10,001 data on all channels.

$$6144 + 6144 + (4+1) * 10001 * 2 * 2 = 212308 \text{ (bytes)}$$

Appendix 6 Maximum Recordable Time

High-speed Function

The maximum available recording time depends on the selected timebase.

The maximum recording time can be obtained by the following formula.

Recordable Time = Timebase x Recording Length

The possible recording time is displayed for the recording time indication on the Setting screen.

Timebase	Sampling rate	Recording interval	Maximum recording time
100 $\mu\text{s}/\text{div}$	1 MS/s	1 μs	1 s
200 $\mu\text{s}/\text{div}$	500 kS/s	2 μs	2 s
500 $\mu\text{s}/\text{div}$	200 kS/s	5 μs	5 s
1 ms/div	100 kS/s	10 μs	10 s
2 ms/div	50 kS/s	20 μs	20 s
5 ms/div	20 kS/s	50 μs	50 s
10 ms/div	10 kS/s	100 μs	100 s
20 ms/div	5 kS/s	200 μs	200 s
50 ms/div	2 kS/s	500 μs	500 s
100 ms/div	1 kS/s	1 ms	1000 s

Real-time Function

The maximum recording time when saving waveform files to a CF card is as follows. The recording times when all channels (4 Analog channels and 8 Logic channels) are recorded are shown.

(The following table does not include a number of days that is 365 or more.)

The maximum recording time increases as the number of channels to be recorded is reduced. (When using logic channels, the number of logic channels in use does not affect the maximum recording time.)

$$\text{Max. recording time} = \frac{([\text{Storage capacity}^{(*1)}] - [\text{Size of header portion}^{(*2)}]) (\text{byte}) \times \text{recording interval (seconds)}}{\text{Number of recording channels}^{(*3)} \times 2}$$

*1. Storage capacity: The following examples show the calculations for the respective cards in use:

Model 9727 (256MB) : 256,000,000 bytes (256 x 1000 x 1000)

Model 9830(2GB) : 2,000,000,000 bytes (2 x 1000 x 1000 x 1000)

Internal Buffer Memory : 8,000,000 bytes (8 x 1000 x 1000)

*2. Size of header portion: Maximum 12288 bytes (0 byte when internal memory is in use)

Capacity = (14 + number of analog channels in use x 2 + number of logic terminals in use) x 512 (bytes)

3. Number of recording channels: number of analog channels + logic^()

(*) Logic is considered as follows regardless of the number of bits in use.

All channels OFF: 0 channel, At least 1 bit ON: 1 channel

When internal memory is used, logic is considered as 0 channel regardless of whether it is ON or OFF.

Setting a slow timebase may result in a very long recording time (over a year) which may exceed the guarantee period or product life, in which case we cannot guarantee operation.

Appendix 6 Maximum Recordable Time

The recordable times when 4 Analog channels and 8 Logic channels are used

day, h: hours, min: minutes, s: seconds, ■: 1 year or longer

Interval	Storage capacity					
	HiCorder's internal memory (8MB)	Model 9726 (128MB)	Model 9727 (256MB)	Model 9728 (512MB)	Model 9729 (1GB)	Model 9830 (2GB)
100 μs	1min40s	21min20s	42min40s	1h25min20s	2h46min40s	5h33min20s
200 μs	3min20s	42min40s	1h25min20s	2h50min40s	5h33min20s	11h6min40s
500 μs	8min20s	1h46min39s	3h33min19s	7h6min39s	13h53min19s	1day3h46min39s
1 ms	16min40s	3h33min19s	7h6min39s	14h13min19s	1day3h46min39s	2day7h33min19s
2 ms	33min20s	7h6min38s	14h13min18s	1day4h26min38s	2day7h33min18s	4day15h6min38s
5 ms	1h23min20s	17h46min34s	1day11h33min14s	2day23h6min34s	5day18h53min14s	11day13h46min34s
10 ms	2h46min40s	1day11h33min8s	2day23h6min28s	5day22h13min8s	11day13h46min28s	23day3h33min8s
20 ms	5h33min20s	2day23h6min15s	5day22h12min55s	11day20h26min15s	23day3h32min55s	46day7h6min15s
50 ms	13h53min20s	7day9h45min39s	14day19h32min19s	29day15h5min39s	57day20h52min19s	115day17h45min39s
100 ms	1day3h46min40s	14day19h31min17s	29day15h4min37s	59day6h11min17s	115day17h44min37s	231day11h31min17s
200 ms	2day7h33min20s	29day15h2min34s	59day6h9min14s	118day12h22min34s	231day11h29min14s	-
500 ms	5day18h53min20s	74day1h36min26s	148day3h23min6s	296day6h56min26s	-	-
1 s	11day13h46min40s	148day3h12min51s	296day6h46min11s	-	-	-
2 s	23day3h33min20s	296day6h25min42s	-	-	-	-
5 s	57day20h53min20s	-	-	-	-	-
1 s	115day17h46min40s	-	-	-	-	-
20 s	231day11h33min20s	-	-	-	-	-
30 s	347day5h20min0s	-	-	-	-	-
60 s	-	-	-	-	-	-

As the actual capacity of the CF card is lower than the capacity indicated, expect recording time to be about 90% of the above recordable time.

Appendix 7 Supplemental Technical Information

Selecting a Timebase (Horizontal Axis)

Timebase: with 1 div = 5 ms

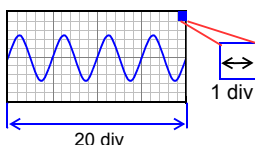

Timebase: with 1 div = 10 ms

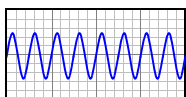

The input signal acquisition rate corresponds to time per division on the horizontal axis.

Determining the timebase: Calculate from the frequency and period.

$$f [\text{Hz}] = 1/t [\text{s}] \quad (\text{f: frequency, t: period})$$

Example: If the measurement frequency is 50 Hz

$$50 [\text{Hz}] = 1/t [\text{s}] \quad t = 1/50 [\text{s}] = 0.02 [\text{s}] = 20 [\text{ms}]$$

To enable 1 period to be displayed with 10 divisions, the timebase becomes $20 [\text{ms}]/10 [\text{div}] = 2 \text{ ms/div}$.

To display multiple periods, set a timebase range that is slower than 2 ms/div.

From the selection ranges for the timebase range, select a range that is close to the calculated value.

To measure phenomena with relatively fast signals such as instantaneous waveforms, we suggest setting a small value (if the frequency is 50 Hz, the timebase should be set faster than 5 ms/div).

During and after measurement, waveforms can be expanded and compressed along the time axis.

Timebase and Sampling

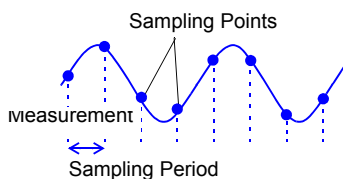

This instrument converts analog input signals into digital values which are then processed internally as digital (numerical) values. This A/D conversion process is called sampling. Sampling repeatedly measures the size of the input signal at a specific interval (the sampling period).

The rate of measurement is called the sampling rate. Sampling units are [S/s] (read as samples-per-second)

This is the number of samples taken each second, and is the inverse of the sampling period. ($1/T$)

Aliasing

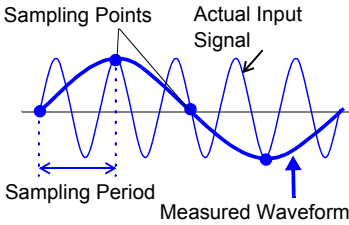

Aliasing occurs when the sampling period is longer than half of the input signal period.

If the signal to be measured changes too fast relative to the sampling period, beginning at a certain frequency, non-existent slow signal fluctuations are recorded. This phenomena is aliasing.

With the Memory function, the sampling period can be significantly affected by the timebase setting, so care is necessary to avoid aliasing when selecting the timebase.

Because the timebase determines the measurement frequency limit, the fastest possible timebase setting should be used.

When the signal can be recorded repeatedly, the auto-ranging function (p. 76) may be used to select the optimum timebase.

Measurement Frequency Limit

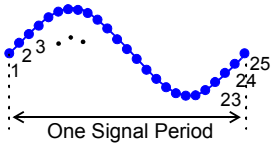

Displaying waveforms by their sampled values with adequate resolution of characteristics such as sine wave peaks requires a minimum of about 25 samples per waveform period.

The measurement frequency limit is determined by the timebase.

Timebase [div]	Sampling period	Measurement limit frequency	Timebase [div]	Sampling period	Measurement limit frequency	Timebase [div]	Sampling period	Measurement limit frequency
100 μ s	1 μ s	40 kHz	10 ms	100 μ s	400 Hz	1 s	10 ms	4 Hz
200 μ s	2 μ s	20 kHz	20 ms	200 μ s	200 Hz	2 s	20 ms	2 Hz
500 μ s	5 μ s	8 kHz	50 ms	500 μ s	80 Hz	5 s	50 ms	0.8 Hz
1 ms	10 μ s	4 kHz	100 ms	1 ms	40 Hz	10 s	100 ms	0.4 Hz
2 ms	20 μ s	2 kHz	200 ms	2 ms	20 Hz	30 s	300 ms	0.13 Hz
5 ms	50 μ s	800 Hz	500 ms	5 ms	8 Hz	1 min	600 ms	0.067 Hz
						2 min	1.2 s	0.033 Hz
						5 min	3 s	0.013 Hz

Appendix 8 Frequently Asked Questions

Here are some common questions and answers about the HiCorder.

Installation and Settings

Question	Remedial Action	Reference page
<p>Can the HiCorder be installed at an angle?</p> <p>Can it be mounted on a wall?</p>	<p>This is possible if you place a special order for a fixed stand. However, if the MR9000 printer unit is connected to the instrument, printing with the printer will not be possible. (There is a risk of the data not being printed straight.)</p>	
<p>How long can the instrument take measurements when using the battery pack or dry batteries?</p>	<p>Approx. 4 hours when using the battery pack, and approx. 50 minutes when using dry batteries (the reference value for both is 23°C).</p>	<p>"2.1 Using the Alkaline Battery Box (Accessory) or Battery Pack (Option)" (p. 32)</p>
<p>Can recording resume automatically after a power outage?</p>	<p>Enable Auto Resume. Recording will automatically resume after a power outage. Because data measured before the outage is not retained in internal buffer memory, we recommend enabling auto saving to removable storage.</p>	<p>"Using the Auto-Resume Function (Resume After Power Restoration)" (p. 198)</p>
<p>How can I acquire maximum, minimum, and average values every hour?</p>	<p>"Split Calc" calculates and displays the latest results after each interval. TXT format data can be saved to removable storage in real time.</p>	<p>"8.2 Calculating Automatically (Auto Calculation)" (p. 179)</p>

Triggering

Question	Remedial Action	Reference page
<p>Why does measurement not start when "Waiting for trigger" is displayed?</p>	<p>A trigger is set. If you want to start recording immediately with the START key, set all trigger conditions to Off.</p>	<p>"Enabling the Trigger Function" (p. 111)</p>
<p>How to acquire data before a trigger?</p>	<p>Enable pre-triggering to acquire data before trigger events.</p>	<p>"Recording Data Before Trigger Applied (Pre-trigger)" (p. 115)</p>

Appendix 8 Frequently Asked Questions

Question	Remedial Action	Reference page
How do I acquire data only when the external signal is in the HIGH period?	This is only possible with the Real-time Function. Input an external signal to the EXT.TRIG terminal, and configure the settings as follows. [Ext trig]-[Start: ↑ (Rising)], [Stop: ↓ (Falling)] This will enable data to be acquired only when the external signal is in the HIGH period.	"Applying Trigger with External Input Signal (External Trigger)" (p. 127)
Can I use two instruments and synchronize the measurement?	The start of measurement can be synchronized using an external trigger. It is not possible to synchronize sampling itself.	"12.6 Synchronous Measurements with Multiple Instruments" (p. 226)

Measuring

Question	Remedial Action	Reference page
What should I do about zero offset when the input is shorted?	Execute zero adjustment to compensate for offset when the inputs are shorted.	"2.8 Compensating for Input Circuit Offset (Zero Adjustment)" (p. 49)
Even though a signal is only input on CH1, why do similar waveforms appear on unused channels?	An open-circuit input terminal can be affected by signals on other channels. By closing the input terminal circuit, normal measurement is possible. If you want to turn off the waveforms, set the display of unused channels to Off or short between the + and – terminals.	"Setting Waveform Display Colors & Turning On/Off Display" (p. 96)
How to display numerical data values?	Press the MONITOR key to confirm the input channels. Cursors A and B can be used to read the numerical values of specified places.	"Checking Input State (Monitor)" (p. 55) "Displaying Cursor Values" (p. 138)
How can I apply markers while measuring for easy searching later?	An event mark can be inserted.	"5.2 Marking Waveforms and Searching Marks (Search Function)" (p. 141)

Data Saving

Question	Remedial Action	Reference page
Can after-market CF cards be used?	Operation is not guaranteed. Furthermore, compatibility problems may result in the operation of the instrument becoming unstable. To ensure stable operation of the instrument, use genuine Hioki products.	"2.7 Using CF Card or USB Flash Drive (for Saving Data)" (p. 46)
Can after-market USB flash drives be used?	They can be used, although for real-time saving, we recommend using a Hioki-specified CF card and USB flash drive option for data protection. Operation can only be guaranteed for Hioki CF card and USB flash drive options. Also, USB flash drive security features such as fingerprint authentication are not supported.	"2.7 Using CF Card or USB Flash Drive (for Saving Data)" (p. 46)
Can removable media be replaced while measuring?	Yes. Put the cursor on the [EJECT] button at the lower right of the screen, press ENTER, and remove the media following the displayed message.	"Replacing CF Card or USB Flash Drive during Saving ([Realtime] only)" (p. 106)
How much recording space is available?	This will differ depending on the setting conditions (number of measurement channels and recording interval) When recording to 1 GB storage media at a recording interval of 1 s, you can record for a period of approx. 1,500 days.	"Appendix 6 Maximum Recordable Time" (p. A16)
Can I process saved data in Excel®?	If files that have been automatically saved with [Waveform (realtime)] to a CF card or USB flash drive are converted to text (CSV) format files using the supplied Waveform Viewer, they will be able to be opened in Excel®. Auto-saved files recorded in [CSV(realtime)] mode can be directly loaded into a spreadsheet program, but note that the data cannot be reloaded into the HiCorder.	"About File Types & Saving/Loading" (p. 148)
How can I load data from a CF card onto the PC when it has no CF card slot?	Data can be transferred to a PC using the supplied USB cable and the USB Drive mode.	"11.2 Importing Data to a Computer" (p. 208)

Question	Remedial Action	Reference page
<p>How can I create files every hour, from 0:00 (ideal split time)?</p>	<p>Set the start time of the measurement schedule to 0:00 (ideal split time). At the same time, set [Split Save] to [Ref Time] for automatic saving.</p>	<p>"Setting Automatic Saving" (p. 102)</p>
<p>What is the file limit when auto saving to removable storage?</p>	<p>Up to 1,000 files can be stored in one folder. Also, as more files are created, more time is needed to start and stop recording. We recommend setting measurement conditions so that the number of files saved stays as low as possible. (For example, adjust the recording time so that the size of one file does not become too small.) When the number of files saved in one folder exceeds 1000, a new folder will automatically be created and files continued to be saved in the new folder (except for real time saving). (When saving, a folder named "HIOKI_MR8880" is created, and files with different data types are saved in subfolders within it.)</p>	<p>"6.1 Saving & Loading Data" (p. 147)</p>
<p>Is data retained in internal buffer memory when I turn the power off after measuring? I did not use auto saving to removable storage.</p>	<p>If waveforms are displayed when power is turned on, the data has been retained. Data in internal buffer memory is retained for about 30 minutes after power-off. However, if power is off for more than 30 minutes, the data is lost. We recommend making preparations and settings for power outages during long-term measurements, such as combined use with a battery pack and setting automatic saving.</p>	<p>"Preparations and Settings for Power Outages during Long-term Measurements" (p. 149)</p>
<p>Why is only part of the data saved when saving to removable storage after measuring?</p>	<p>When A/B cursors are set to specify a save time span, only data within that span is saved. Also, internal buffer memory capacity limits saving of measurement data to the most recent 4M data points (1M data points/Ch * 4ch). If you need to save more data points, enable real-time auto saving beforehand.</p>	<p>"Specifying a Waveform Time Span" (p. 140) "4.7 Setting Automatic Saving" (p. 102)</p>

Question	Remedial Action	Reference page
After starting measurement with real-time auto saving, can I still acquire data if I neglected to insert removable storage media until later?	As long as storage media is inserted before internal buffer memory overflows, data from the start of measurement will be saved to the removable storage.	"Replacing CF Card or USB Flash Drive during Saving ([Realtme] only)" (p. 106)
Why does "Saving" continue to be displayed and saving not finish when saving internal buffer memory data as text after measurement?	When all of the data in the internal buffer memory is saved as text to the storage media after measurement, it takes about 1 hour. To stop the save process, press and hold the STOP key. After data is saved in binary format, you can use the supplied Waveform Viewer to convert it to text in just a few seconds.	
How to view data saved in binary format on a PC?	The WaveViewer PC application program is included on the supplied CD. Install it on the PC and use it to open the file.	"Appendix 10 Installing Waveform Viewer" (p. 28)
When opened in Excel®, the time displayed is elapsed time from start. How can I display real time?	When data is saved in CSV format, the time display is linked to [Time Disp] on the System screen. To display the real time, select [Date] .	"6.2 Saving Data" (p. 150)
How are event marks handled when converting data to text (CSV)?	When converting to text with the instrument: Event numbers are inserted beside the measurement data. This is convenient for extracting only the data with marks at a later time. When converting to text with Waveform Viewer: The event numbers and times are retained as information in the headers.	"5.2 Marking Waveforms and Searching Marks (Search Function)" (p. 141)

Appendix 9 Options

For the details, contact your supplier or Hioki representative for details.

Input cables for voltage measurement

Model 9197 Connection Cord

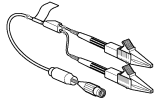

Maximum input voltage 600 V AC/DC

Model L9197 Connection Cord

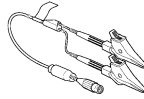

Maximum input voltage 600 V AC/DC

Model L9198 Connection Cord



Maximum input voltage 300 V AC/DC

Model L9217 Connection Cord

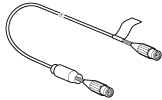

Maximum input voltage 300 V AC/DC (for BNC output)

Model L9790 Connection Cord

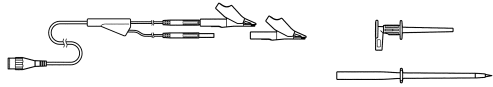

Maximum input voltage 600 V AC/DC (Select the end clip separately.)
 Model L9790-01 Alligator Clip
 Model 9790-02 Grabber Clip
 Model 9790-03 Contact Pin

Model 9322 Differential Probe

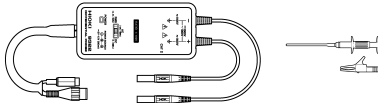

Requires the 9418-15 AC Adapter (power cannot be supplied from the LOGIC connector)
 For high voltage, maximum input voltage: 2000 V DC, 1000 V AC

When connecting to the sensor with banana plug: Model 9199 Conversion Adapter (BNC-to-Banana)

Logic Signal Measurement Logic Probes

Model 9320-01 Logic Probe

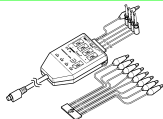

Measures digital signals and on/off switching of non-voltage contacts.

Model MR9321-01 Logic Probe

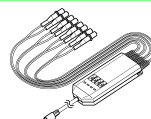

Detects the presence of AC and DC voltages. Measures activation timing of relay sequencing circuits.
 Maximum input voltage: 250 Vrms (HIGH range)

For users of the following legacy products:
 Models 9306, 9307, 9320, 9321 Logic Probes
 Usable with this instrument by connecting the Model 9323 Conversion Cable.

Clamp-On Probes

Model 9018-50

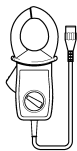

10 to 500 A AC,
40 Hz to 3 kHz
Outputs 0.2 V AC waveform of commercial power line current.

Model 9132-50

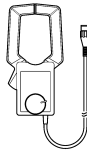

10 to 500 A AC,
40 Hz to 1 kHz

For users of the following legacy products:
Model 9018 or 9132 Clamp-On Probe
Usable with this instrument by connecting the Model 9199 Conversion Adapter.

Model 9675

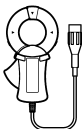

10A AC, 40 Hz to 5 kHz

Model 9657-10

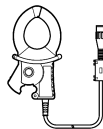

10A AC, 40 Hz to 5 kHz

For leakage
current mea-
surement

Software

- Model 9335 Wave Processor (PC application programs)
Provides analysis of measurement data on a computer.

Power Sources

- Model Z1000 Battery Pack
- Model Z1002 AC Adapter

Storage media

- Model 9727 PC Card (256MB)
- Model 9728 PC Card (512MB)
- Model 9729 PC Card (1GB)
- Model 9830 PC Card (2GB)

Printer related

- Model MR9000 Printer Unit
- Model 9234 Recording Paper

Others

- Model C1003 Carrying Case

Appendix 10 Installing Waveform Viewer

About Waveform Viewer (Wv)

The viewer has a CSV conversion function. Converted files may be read by a spreadsheet program.

This section only describes how to install, uninstall, start, and end Waveform Viewer. For details on how to use the software, read the explanation (Read.me.txt) on the CD.

The latest version can be downloaded from our web site.

System requirements

For a PC running Windows 7, Windows 8, Windows 10

Installation

- 1** When you insert the Application Disk (CD) into the CD-ROM drive, the opening page should appear automatically.
If it does not appear, open the "index.htm" file with your Web browser.
 - 2** Select the language to display (click the English icon).
 - 3** Click the **[Wave viewer (Wv)]** icon to view Wv specifications and revision history.
 - 4** Click the **[Install]** icon at the top right of the page to open the [File Download] dialog.
 - 5** Click **[Open]** to display the confirmation dialog to proceed with installation.
 - 6** Click **[Next]** to open the installation destination selection window.
Click the [Browse] button to change the installation folder.
 - 7** Click **[Next]** to start installation.
The program is now installed.
-

Starting & Ending

Starting

Before use, read the READ ME text file.

In the Windows® Start menu, select **[Programs]-[HIOKI]-[Wv.]** This starts the waveform viewer application.

Ending

Select **[Exit]** from the File menu of Waveform Viewer. You can also end the software by clicking the close button at the top right of the window.

Uninstall Procedure

- 1** Click the Start button of Windows®, and click **[Control Panel]** on the Start menu. The Control Panel window is displayed. Click **[Add or Remove Program]**.
When Windows 10 is used, click the Start button and select **[Setting] - [System] - [Apps and Features]**.
- 2** Select and remove **[HIOKI Waveform Viewer (Wv)]**.
When updating Wave viewer to the latest version, uninstall the earlier version before installing the latest version.

Index

A

A/B cursors	138
Aliasing	A20
Alkaline Battery Box	32
Analog input terminals	22
AND/OR Trigger	113
Apply Calculations to a Specific Time Span	183
Area	185
Area value	177
Assign the waveform to display in each graph	94
Auto Calculation	178, 179
Auto Range	76
Auto Save	150
Automatic Printing	108
Automatic Saving	102, 150
Average value	177, 184

B

Backlight Brightness	199
Backlight Saver	199
Battery Pack	32
Beep Sound	200
Before Returning for Repair	249
Binary	148

C

Calculating after Measurement	182
Calculation Expressions	184
Canceling a Schedule	191
CF	205
CF card	46
Change	160
Delete	161
Load	157
Rename	162
Sort	163
Channel Marker	171
Charging time	36
Charging timing	35
Cleaning	247
Clock Setting	204
Comments	128
Printing	171

Communication commands	210
Communication Setting	210
Connecting a Clamp Sensor	39
Connecting Measurement Cables	38
Connecting the Logic Probe	40
Connecting the Printer	41
Cont (Recording continuously)	81
Continuous battery-only operating time	35
Coupling	88
CSV file	203
CSV format	102
Current flow direction arrow	39
Cursor	
Move	138
Type	138
Cursor Type	139
Cursor Values	138

D

Daisy chain configuration	226
DC	88
Decimal Mark	203
Default Settings	A7
Delete while saving	104
Deleting (Delete while Saving)	104
Deleting Data	161
Density	173
Display Colors	96, 100
Display Language	202
Display Positions	100
Display problems	249
Display Range	91
Disposing of the Instrument	251
divisions	74
Drop	116

E

Effective Value	86
Envelope	84
Error Messages	A1
Event Marks	141
EXT.TRIG	219
External control terminals	217
External Inputs (start/ stop/ print)	223
External Outputs	225
External Trigger	110, 127, 219

Index 2

Index

F	
Feeding	175
File	
File Name	104, 148, A12
File Protection	198
File Size	A15
File Type	148
Hierarchy	147
Rename	162
Sorting	163
Filt (Filter)	119
Filter (filter)	118, 119, 125
Filter Width	118
Fluctuation Recording	78
Folder	
Contents	160
Folder Name	148
Rename	162
Format	48
Frequency	177, 184
Fuse	246
G	
Gauge	134, 173
GND	88
Graph	94
Grid type	172
H	
Horizontal Axis (timebase)	71, 89, 135
Horizontal Cursors	139
I	
Icons	29
Initialize	204
Input Conditions	86
Input Coupling	88
Input State (Monitor)	55
Inspection	245
Installation	8
Instantaneous Recording	70
Instantaneous Value	86
Internal buffer memory	149
Internal Format	A13
Interval	72
Interval Trigger	126
J	
Judgment Area	123
Jump	137
K	
Key problems	249
KEY/LED	205
L	
L.P.F	88
Language	202
LCD	199, 205
Level	116, 117, 120
Level Trigger	116, 117
Lifetimes	246
List	173
List Print	169
List&Gauge	173
Load Set	157
Loading a Setting Configuration	157
Loading the Recording Paper	42
Loading Waveform Data and Screen Images	159
Loading waveforms	159
Logic Channel	100
Logic Trigger	124
Long-term Measurements	149
Low-Pass Filter (L.P.F.)	88
M	
Maintenance	245
Manual Calculation	178, 182
Manual Print	166
Maximum Recordable Time	A16
Maximum value	177
Measurement Frequency Limit	A20
Measurement Functions	68
Measurement on a Specified Day	187
Measurement Periodically	189
Measurement Range	86
Measuring Operation	59
Media (Preferred Save Location)	104
Memory	156, 157
Minimum value	177
Mode	87
Model	98
Monitor	55
N	
no. of divisions	74
Numerical Calculation Results	
Save	150
Numerical Calculations	177
Numerical Value Entry	93

O

Offset	99
Operation problems	249
Options	A26
OR	113
Oversampling	84

P

Parallel synchronization	226
Partial Print	167
Pattern (trigger condition)	124
Peak value	177
Period	177, 184
Pos (display position)	100
Pre-Operation Inspection	51
Preparations and Settings for Power Outages 149	
PRESETS	63
Pre-Trig	115
Print Density	173
Print Range	174
Printer Check	175
Printing	165

Q

Quick Save	154
------------------	-----

R

Range (control range to permit for the refer- ence waveform)	122
Ratio (conversion ratio)	98
Reading value	60
Real-time Function	78
Realttime print	109
Recording Interval	72, 79
Recording Length	74
Recording Time	81
Recording Width	101
Ref (judgment reference)	122
Ref Time	105
Rename	162
Repair	245
Repeat	83
Replaceable Parts	246
Replacing	
Batteries	33
CF card, USB flash drive	106
Reservation	187
Reserved	192
RMS	87, 184
RMS value	177
Roll Mode	132

ROM/RAM	205
---------------	-----

S

Safety Information	5
Sampling	69, A19
Save	
Calc Results	153
Screen Image	153
Waveform data	152
SAVE Key Action	202
Saving	
Auto Save	150
File Type	148
Memory	156, 157
Numerical Calculation Results	152
Quick Save	150
Save Set	156
Screen Images	153
Select & Save	150
Waveform	153
Saving Setting Configuration Data	156
Scaling	97
2-Point	98
Model	98
Rate	99
Ratio	98
Scheduling Measurement	187
Screen Background	200
Screen Configuration	24
Screen Display	89
Screen Hardcopy	168
Screen Splitting	94
Scroll bar	133
Scrolling Waveforms	132
Select&Save	152
Selecting a Timebase	A19
Self-Test	205
Separator	203
Service	245
Setting Wizard	63
Shot	74
Single	75, 83
Slope (S)	117
Specifications	227
Split	181
Split Calc.	181
Split Length	105
Split Save	105
Standby state	192
Start Backup	198
Start Trigger	116
Start/Stop Confirmation Messages	201
Strap	44
Synchronous Measurements	226

Index 4

Index

Synthesizing Part of the Data	146
System Environment Settings	197
System Reset	204
System screen	197

T

Text	148
Time Disp	201
Time per division	71
Time to maximum value	177
Time to minimum value	177
Time Value Display	201
Timebase	71, 72
Timing	111
Titles	128
Trace	132
Trace Cursors	139
TRIG.OUT	221
Trigger	110
Drop	116
IN	116
Level	116
OUT	116
Trigger Output	221
Two-Point Setting	98

U

Upper and Lower Limit Values	93
USB	205
USB Drive Mode	208
USB driver	
Install	211
Uninstall	215
USB Flash Drive	46
Delete	161
Load	157
Rename	162
Sort	163

V

Vertical Cursors	139
Viewing Folder	160
Voltage Drop Trigger	116

W

Warning Messages	A2
Waveform display colors	96
Waveform Peak	72, 79
Waveform screen	131
Waveform Viewer	A28
Window Trigger	116

X

X-Y area	185
X-Y area value	177
X-Y Dots	94
X-Y Line	94
XY Synthesis	94, 145

Z

Zero Adjustment	49
Zero position offset	50
Zoom	89, 135

Warranty Certificate

HIOKI

Model	Serial number	Warranty period Three (3) years from date of purchase (___ / ___)
-------	---------------	--

Customer name: _____

Customer address: _____

Important

- Please retain this warranty certificate. Duplicates cannot be reissued.
- Complete the certificate with the model number, serial number, and date of purchase, along with your name and address. The personal information you provide on this form will only be used to provide repair service and information about Hioki products and services.

This document certifies that the product has been inspected and verified to conform to Hioki's standards.

Please contact the place of purchase in the event of a malfunction and provide this document, in which case Hioki will repair or replace the product subject to the warranty terms described below.

Warranty terms

1. The product is guaranteed to operate properly during the warranty period (three [3] years from the date of purchase).
If the date of purchase is unknown, the warranty period is defined as three (3) years from the date (month and year) of manufacture (as indicated by the first four digits of the serial number in YYMM format).
2. If the product came with an AC adapter, the adapter is warranted for one (1) year from the date of purchase.
3. The accuracy of measured values and other data generated by the product is guaranteed as described in the product specifications.
4. In the event that the product or AC adapter malfunctions during its respective warranty period due to a defect of workmanship or materials, Hioki will repair or replace the product or AC adapter free of charge.
5. The following malfunctions and issues are not covered by the warranty and as such are not subject to free repair or replacement:
 - 1. Malfunctions or damage of consumables, parts with a defined service life, etc.
 - 2. Malfunctions or damage of connectors, cables, etc.
 - 3. Malfunctions or damage caused by shipment, dropping, relocation, etc., after purchase of the product
 - 4. Malfunctions or damage caused by inappropriate handling that violates information found in the instruction manual or on precautionary labeling on the product itself
 - 5. Malfunctions or damage caused by a failure to perform maintenance or inspections as required by law or recommended in the instruction manual
 - 6. Malfunctions or damage caused by fire, storms or flooding, earthquakes, lightning, power anomalies (involving voltage, frequency, etc.), war or unrest, contamination with radiation, or other acts of God
 - 7. Damage that is limited to the product's appearance (cosmetic blemishes, deformation of enclosure shape, fading of color, etc.)
 - 8. Other malfunctions or damage for which Hioki is not responsible
6. The warranty will be considered invalidated in the following circumstances, in which case Hioki will be unable to perform service such as repair or calibration:
 - 1. If the product has been repaired or modified by a company, entity, or individual other than Hioki
 - 2. If the product has been embedded in another piece of equipment for use in a special application (aerospace, nuclear power, medical use, vehicle control, etc.) without Hioki's having received prior notice
7. If you experience a loss caused by use of the product and Hioki determines that it is responsible for the underlying issue, Hioki will provide compensation in an amount not to exceed the purchase price, with the following exceptions:
 - 1. Secondary damage arising from damage to a measured device or component that was caused by use of the product
 - 2. Damage arising from measurement results provided by the product
 - 3. Damage to a device other than the product that was sustained when connecting the device to the product (including via network connections)
8. Hioki reserves the right to decline to perform repair, calibration, or other service for products for which a certain amount of time has passed since their manufacture, products whose parts have been discontinued, and products that cannot be repaired due to unforeseen circumstances.

HIOKI E.E. CORPORATION

<http://www.hioki.com>

18-07 EN-3

HIOKI

<http://www.hioki.com>



**Our regional
contact
information**

HEADQUARTERS

81 Koizumi, Ueda, Nagano 386-1192 Japan

HIOKI USA CORPORATION

<http://www.hiokiusa.com/> hioki@hiokiusa.com

HIOKI (Shanghai) SALES & TRADING CO., LTD.

<http://www.hioki.cn/> info@hioki.com.cn

HIOKI SINGAPORE PTE.LTD.

www.hioki.com.sg/ info-sg@hioki.com.sg
info-indo@hioki.com.sg (Indonesia)
info-thai@hioki.com.sg (Thailand)
info-vn@hioki.com.sg (Vietnam)

HIOKI KOREA CO., LTD.

<http://www.hiokikorea.com/> info-kr@hioki.co.jp

HIOKI EUROPE GmbH

<http://www.hioki.com/> hioki@hioki.eu

Taiwan Representative Office

<http://www.hioki.com/> info-tw@hioki.com.tw

MEA Representative Office

<http://www.hioki.com/> hioki@hiokimea.ae

1804EN

Edited and published by HIOKI E.E. CORPORATION

Printed in Japan

- CE declarations of conformity can be downloaded from our website.
- Contents subject to change without notice.
- This document contains copyrighted content.
- It is prohibited to copy, reproduce, or modify the content of this document without permission.
- Company names, product names, etc. mentioned in this document are trademarks or registered trademarks of their respective companies.