

# IM3536

Instruction Manual

# LCR METER



**Read carefully before use.  
Keep for future reference.**

**✓ When using the instrument for the first time**

- Safety Information ▶ p.12
- Names and Functions of Parts ▶ p.20
- Screen Layout and Operation ▶ p.22



**Troubleshooting**

- Maintenance and Service ▶ p.229
- Error Message and Error Display ▶ p.238

**EN**



# Contents

Introduction.....	1
Verifying Package Contents .....	2
Measurement Process .....	8
Safety Information .....	12
Operating Precautions .....	14

## 1 Overview 19

1.1 Product Overview and Features .....	19
1.2 Names and Functions of Parts .....	20
1.3 Screen Layout and Operation .....	22
■ Screen transition diagram .....	22
■ Viewing measured values (Measurement screen).....	24
■ Select the measurement mode (MODE screen).....	26
■ Setting detailed settings such as measurement conditions (SET screen) .....	27
■ Checking measurement condition settings information.....	28
■ Configuring correction functionality (ADJ screen).....	29
■ Configuring the instrument's interfaces, setting the time and date, and checking the system (SYS screen).....	30
■ Displaying and manipulating files on the USB flash drive (FILE screen) .....	31

## 2 Measurement Preparations 33

2.1 Preparation Flowchart .....	33
2.2 Pre-operation Inspection.....	35
2.3 Connecting the Power Cord.....	36
2.4 Connecting the Measurement Cables, Probes, or Fixture.....	37
2.5 Turning the Instrument On and Off .....	38
2.6 Setting the Date and Time .....	40

## 3 Performing Measurements in LCR Mode 41

3.1 Setting Display Parameters.....	41
■ To perform DC measurement (DC resistance measurement).....	42
3.2 Viewing Measured Values.....	44
3.3 Enlarging Display of Measurement Values.....	45

3.4 Setting Measurement Conditions (Basic Settings) .....	46
■ Required settings .....	47
■ User-configurable settings .....	58
■ Measurement and data acquisition timing .....	69
■ When measuring conductivity and permittivity.....	71
3.5 Judging Measurement Results .....	72
■ Setting the judgment mode.....	73
■ Configuring comparator function settings (judging measurement results based on one judgment standard) .....	73
■ Configuring BIN function settings (judging measured values based on multiple judgment standards).....	78
3.6 Setting Application Settings .....	83
■ Range synchronization (setting measurement conditions for individual measurement ranges).....	83
■ Waveform averaging function (increasing measurement precision or measurement speed).....	86
■ High-Z reject function (detecting contact errors during 2-terminal measurement).....	88
■ Contact check function (detecting poor contact with the sample during 4-terminal measurement).....	89
■ Memory function (saving measurement results) .....	91
■ Number of effective digits of the measurement value .....	94
■ LCD display auto-off (power-saving mode).....	95
■ Key tones and judgment tones .....	96
■ Key-lock function (disabling key operation).....	97

## 4 Using Continuous Measurement Mode 99

4.1 Setting Which Panels to Use in Continuous Measurement.....	99
4.2 Performing Continuous Measurement .....	100
4.3 Checking Continuous Measurement Results .....	100
4.4 Changing the Display Timing Setting (When You Wish to Shorten the Screen Update Interval) .....	101

**4.5 Setting the LCD Display Auto-Off (When You Wish to Save the Power) ..... 102**

**5 Error Correction 103**

**5.1 Setting the Cable Length (Cable Length Correction)..... 104**

**5.2 Open Correction..... 105**

- Before performing open correction ..... 105
- All correction ..... 106
- Spot correction..... 110

**5.3 Short Correction.....112**

- Before performing open correction ..... 112
- All correction ..... 113
- Spot correction..... 114

**5.4 If Open or Short Correction Fails to Complete Normally .....116**

**5.5 Disabling Open and Short Correction Values.....118**

**5.6 Load Correction (Correcting Values to Match Reference Values) .....119**

- Procedures for the load correction..... 120
- To reset the correction condition settings ..... 127
- When load correction fails to complete normally ..... 127
- Disabling load correction ..... 128

**5.7 Correcting Measured Values with a User-Specified Correction Coefficient (Correlation Correction) ..... 129**

**6 Saving and Loading Measurement Condition and Correction Value Data 131**

**6.1 Saving Measurement Conditions and Correction Values (Panel Save Function)..... 132**

**6.2 Loading Measurement Conditions and Correction Values (Panel Load Function) ..... 136**

**6.3 Changing a Panel Name ..... 137**

**6.4 Deleting a Panel ..... 138**

**7 Setting the System 139**

**7.1 Setting the Interface (Controlling the Instrument from a Computer) ..... 140**

**7.2 Checking the Version of the Instrument..... 140**

**7.3 Testing the System (Self Diagnosis) ..... 141**

- Panel test..... 141
- Panel calibration ..... 142
- Testing the screen display status and LED status ..... 142
- ROM/RAM test..... 143
- Testing EXT I/O input/output signals..... 143

**8 Using USB Flash Drive (Saving and Loading Data) 145**

**8.1 Inserting and Removing a USB Flash Drive ..... 146**

**8.2 Checking the Contents of Files on a USB Flash Drive ..... 147**

**8.3 Formatting a USB Flash Drive .... 148**

**8.4 Saving Measurement Data ..... 149**

- Saving measurement data in text ..... 149
- Saving a copy of the screen ..... 158
- To specify the save folder ..... 160

**8.5 Saving Settings Data ..... 161**

- Saving instrument settings other than panels ..... 161
- Save all instrument settings including panels (ALL SAVE function)..... 162

**8.6 Loading Instrument Settings ..... 163**

- Loading settings files or panel files..... 163
- Loading settings files including panel files (ALL LOAD function) ..... 164

**8.7 Checking the Contents of a File . 165**

**8.8 Deleting Files and Folders ..... 166**

**8.9 Creating Folders..... 167**

**8.10 Displaying the USB Flash Drive Information ..... 168**

**9 External Control 169**

**9.1 External Input/Output Connector and Signals ..... 170**

- Instrument connector and supported connectors ..... 170
- Instrument connector signal assignments 170
- Input (IN) signal function details ..... 175

■ BCD mode function details .....	176
■ Output signals when errors occur .....	178
<b>9.2 Example Measurement Timing (Timing Charts).....</b>	<b>179</b>
<b>9.3 Internal Circuitry .....</b>	<b>184</b>
■ Circuit diagrams .....	184
■ Electrical specifications.....	186
■ Connection examples .....	186
<b>9.4 External I/O Settings .....</b>	<b>188</b>
■ Setting the delay time (from judgment result output to EOM output) and judgment result reset operation .....	189
■ Disabling the trigger input during measurement and setting the trigger input effective edge.....	190
■ Setting the EOM output method and output time .....	191
■ Outputting measured values (switching to BCD mode) (LCR mode only).....	192
<b>9.5 External Control Q&amp;A .....</b>	<b>193</b>
<b>9.6 Measurement Using a Computer</b>	<b>194</b>

## **10 Specifications** **195**

<b>10.1 General Specifications .....</b>	<b>195</b>
<b>10.2 Environmental and Safety Specifications .....</b>	<b>200</b>
<b>10.3 Accessories and Options .....</b>	<b>201</b>
<b>10.4 Function Specifications.....</b>	<b>201</b>
<b>10.5 Interfaces .....</b>	<b>213</b>
<b>10.6 Measurement Range and Accuracy .....</b>	<b>215</b>
<b>10.7 About Measurement Times and Measurement Speed .....</b>	<b>225</b>

## **11 Maintenance and Service** **229**

<b>11.1 Calibration, Inspection, Repair, and Cleaning.....</b>	<b>229</b>
■ Calibrations.....	229
■ Inspection and repair .....	229
■ Replaceable parts and operating lifetimes.....	229
■ Transporting the instrument.....	230
■ Cleaning.....	230
<b>11.2 Troubleshooting .....</b>	<b>231</b>
■ Before returning for repair.....	231
■ Initializing (system reset) .....	236
■ Performing a full reset (If you are unable to perform a system reset).....	237
<b>11.3 Error Message and Error Display .....</b>	<b>238</b>

<b>11.4 Discarding the Instrument.....</b>	<b>243</b>
--	------------

## **Appendix** **Appx.1**

<b>Appx. 1 Measurement Parameters and Calculation Formula .....</b>	<b>Appx.1</b>
<b>Appx. 2 Measurement of High Impedance Components.....</b>	<b>Appx.3</b>
<b>Appx. 3 Measurement of In-circuit Components .....</b>	<b>Appx.4</b>
<b>Appx. 4 Countermeasures Against Incorporation of External Noise.....</b>	<b>Appx.5</b>
■ Countermeasures against incorporation of noise from the power line.....	Appx.5
■ Countermeasures against noise from the measurement cables .....	Appx.6
<b>Appx. 5 Supplying DC Bias.....</b>	<b>Appx.6</b>
■ How to supply a DC bias voltage.....	Appx.7
■ How to supply a DC bias current .....	Appx.8
<b>Appx. 6 The Residual Charge Protection Function.....</b>	<b>Appx.9</b>
<b>Appx. 7 Series Equivalent Circuit Mode and Parallel Equivalent Circuit Mode .....</b>	<b>Appx.10</b>
<b>Appx. 8 Open Correction and Short Correction .....</b>	<b>Appx.11</b>
<b>Appx. 9 Attaching Rack-Mounting Hardware to the Instrument.....</b>	<b>Appx.12</b>
<b>Appx. 10 Dimensional Diagram ....</b>	<b>Appx.14</b>
<b>Appx. 11 Initial Settings Table .....</b>	<b>Appx.15</b>
<b>Appx. 12 Device Compliance Statement .....</b>	<b>Appx.23</b>

## **Index** **Ind.1**

11

5

6

7

8

9

10

Appx.

Ind.



# Introduction

Thank you for purchasing the Hioki IM3536 LCR Meter. To obtain maximum performance from the instrument, please read this manual first, and keep it handy for future reference.

## Latest instruction manual

The contents of this manual are subject to change, for example as a result of product improvements or changes to specifications.

The latest edition can be downloaded from Hioki's website.

<https://www.hioki.com/global/support/download>



This instrument comes with the following documentation. Please refer to these resources as necessary in light of your specific application.

Type	Manual contents	Printed edition	CD edition
Instruction Manual (this document)	Detailed information about functionality and operation; specifications	✓	–
Communication Instruction Manual	Explanation of communications commands for controlling the instrument	–	✓

## Product registration

Register your product in order to receive important product information.

<https://www.hioki.com/global/support/myhioki/registration>



## Target audience

This manual has been written for use by individuals who use the product in question or who teach others to do so. It is assumed that the reader possesses basic electrical knowledge (equivalent to that of someone who graduated from the electrical program at a technical high school).

## Trademarks

Microsoft and Windows are either registered trademarks or trademarks of Microsoft Corporation in the United States and other countries.

## Verifying Package Contents

When you receive the instrument, inspect it carefully to ensure that no damage occurred during shipping. In particular, check the accessories, panel switch, button, and connectors. If damage is evident, or if it fails to operate according to the specifications, contact your authorized Hioki distributor or reseller.

Confirm that these contents are provided.

- IM3536 LCR Meter ×1

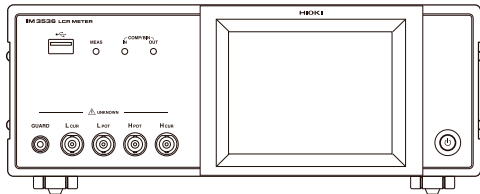

### Accessories

- LCR Application Disc ×1

(including the PDF edition of Communications Instruction Manual, explanations of communications commands, and the USB driver)



The latest version can be downloaded from our website

- Instruction Manual (This document) ×1

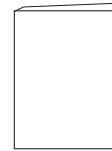

- Power cord ×1

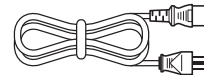



- Measurement cable and fixture are not supplied with the instrument as standard equipment. You should order them separately, according to requirements. See “Options (reference: open and short correction states)” (p. 3).
- The instrument ships from the factory configured as described in “Appx. 11 Initial Settings Table” (p. Appx.15).

### Precautions when transporting the instrument

Store the packaging in which the instrument was delivered, as you will need it when transporting the instrument.

### Options (reference: open and short correction states)

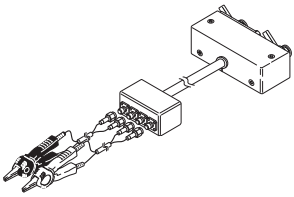
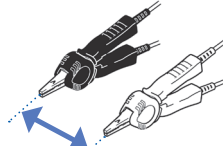
The following options are available for the instrument. Contact your authorized Hioki distributor or reseller when ordering. Options are subject to change. Check Hioki's website for the latest information.

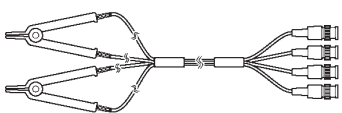
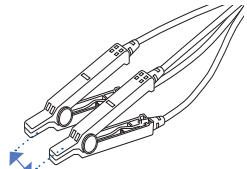
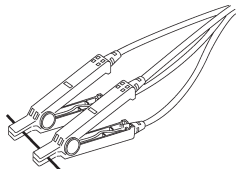
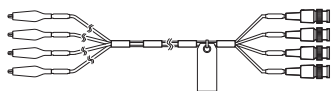
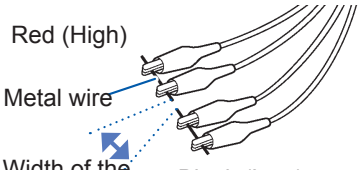
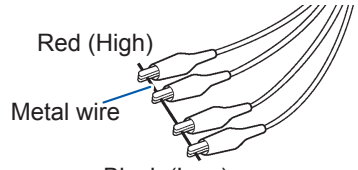
Probe type (cord length: 1 m)	Open state during open correction	Shorted state during short correction
<p><input type="checkbox"/> L2000 4-Terminal Probe</p>  <p>Measurable range: DC to 8 MHz                      Maximum applied voltage: <math>\pm 42</math> V peak (AC+DC)                      Maximum applied current: <math>\pm 1</math> A peak (AC+DC)                      Measurement terminal hole diameter: 0.3 mm to 5 mm                      Alligator-clip-type measurement cables. These general-purpose dual-electrode clips fit a wide range of conductor thicknesses.</p>	 <p>Width of the measurement sample</p> <p>Close the tips of the probes and place the probes so that they are as far apart as the width of the measurement sample.</p>	 <p>Clamp the probe tips together with the V mark facing up.</p>
<p><input type="checkbox"/> 9140-10 4-Terminal Probe</p>  <p>Measurable range: DC to 200 kHz                      Maximum applied voltage: <math>\pm 42</math> V peak (AC+DC)                      Maximum applied current: <math>\pm 1</math> A peak (AC+DC)                      Measurement terminal hole diameter: 0.3 mm to 5 mm</p>	 <p>Width of the measurement sample</p> <p>Close the tips of the probes and place the probes so that they are as far apart as the width of the measurement sample.</p>	 <p>Clamp the probes on the short bar.</p>
<p><input type="checkbox"/> 9500-10 4-Terminal Probe</p>  <p>Measurable range: DC to 200 kHz                      Maximum applied voltage: DC<math>\pm 40</math> [42 V peak (Measurement signal + bias voltage)]                      Maximum applied current: 1 A peak (Measurement signal + bias voltage)                      Measurement terminal hole diameter: 0.3 mm to 2 mm                      Rubber-sheathed alligator clip type</p>	 <p>Red (High) Metal wire</p> <p>Width of the measurement sample</p> <p>Black (Low)</p> <p>Clamp a short piece of metal wire with the H<sub>CUR</sub> and H<sub>POT</sub> terminals (red) and the L<sub>CUR</sub> and L<sub>POT</sub> terminals (black) of the probes so that they are as far apart as the width of the measurement sample.</p>	 <p>Red (High) Metal wire</p> <p>Black (Low)</p> <p>Clamp a short piece of metal wire in the following probe terminal order: H<sub>CUR</sub>, H<sub>POT</sub>, L<sub>POT</sub>, L<sub>CUR</sub>.</p>

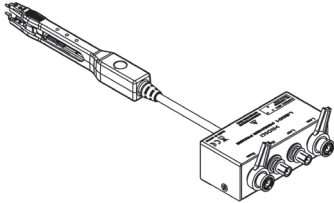
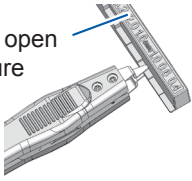
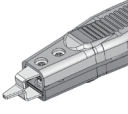
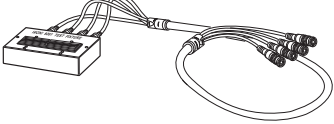
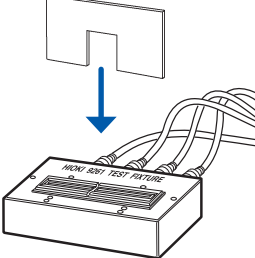
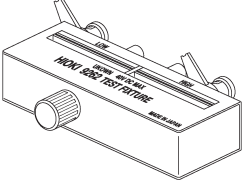
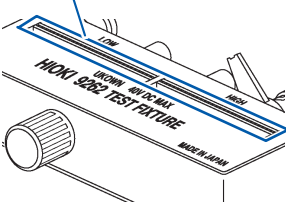
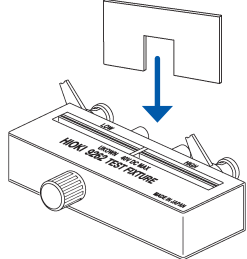

Probe type (cord length: 1 m)	Open state during open correction	Shorted state during short correction
<p><input type="checkbox"/> L2001 Pincher Probe<sup>*1</sup></p>  <p>Measurable range: DC to 8 MHz                      Maximum applied voltage: ±30 V DC                      Space between tip electrodes: 0 mm to approx. 6 mm                      Pincer type</p>	<p>Gradations on open correction fixture</p>  <p>Clamp the tip of the pincers at the open correction fixture gradation (using the same value as the length of the measurement sample), taking care to insert the pincers all the way.                      (For sample 1005, the length is 1.0 mm.)</p>	 <p>Close the tip of the pincers.</p>
Test fixture types	Open state during open correction	Shorted state during short correction
<p><input type="checkbox"/> 9261-10 Test Fixture</p>  <p>Measurable range: DC to 8 MHz                      Maximum applied voltage: ±40 V DC                      Measurement terminal hole diameter: 0.3 mm to 1.5 mm                      Cord length: 1 m</p>	<p>Connect the 9261-10 and the instrument with the connection cable (do not clamp anything to the fixture).</p>	 <p>Insert the short bar all the way into the sample mounting area.</p>
<p><input type="checkbox"/> 9262 Test Fixture<sup>*1</sup></p>  <p>Measurable range: DC to 8 MHz                      Maximum applied voltage: ±40 V DC                      Measurable sample dimensions:                      Lead diameter of φ0.3 mm to φ2 mm                      Lead pitch of 5 mm or more                      This fixture is for measuring lead components. (less than 10 mΩ residual resistance after zero adjustment)</p>	<p>In contact</p>  <p>Turn the knob clockwise to tighten the sample mounting area.</p>	 <p>Insert the short bar all the way into the sample mounting area.</p>

\*1: Although the test fixture appears to use a four-terminal setup, two terminals provide contact with the sample since H<sub>POT</sub> and H<sub>CUR</sub> as well as L<sub>POT</sub> and L<sub>CUR</sub> are connected inside the fixture and probe.

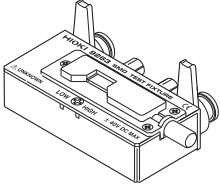
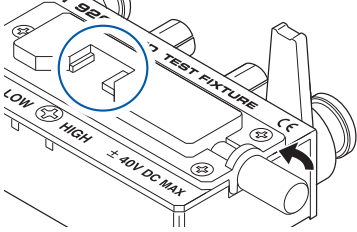
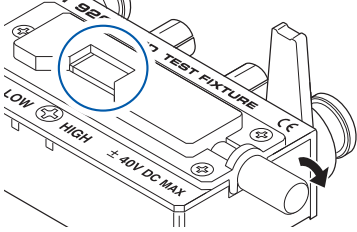
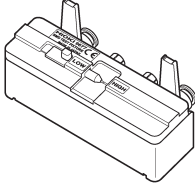
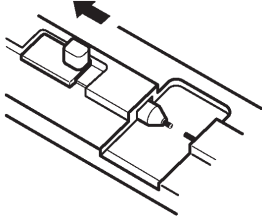
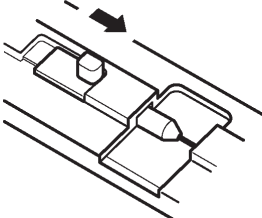
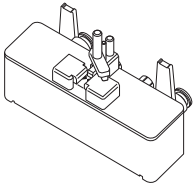
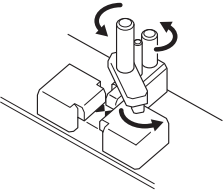
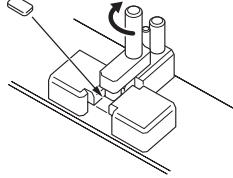
Test fixture types	Open state during open correction	Shorted state during short correction
<p><input type="checkbox"/> 9263 SMD Test Fixture<sup>*1</sup></p>  <p>Measurable range: DC to 8 MHz                      Maximum applied voltage: ±40 V DC                      Measurable sample dimensions: Test sample width of 1 mm to 10 mm                      This fixture is for measuring chip components. (less than 10 mΩ residual resistance after zero adjustment)</p>	 <p>Turn the knob counterclockwise to open the high and low electrodes (use the width of the measurement sample as the open spacing).</p>	 <p>Turn the knob clockwise to tighten the high and low electrodes.</p>
<p><input type="checkbox"/> 9677 SMD Test Fixture<sup>*1</sup></p>  <p>Measurable range: DC to 120 MHz                      Maximum applied voltage: ±40 V DC                      Measurable sample dimensions: Test sample width of 3.5±0.5 mm or less</p>	 <p>Move the knob to open the high and low electrodes (use the width of the measurement sample as the open spacing).</p>	 <p>Move the knob to close the high and low electrodes.</p>
<p><input type="checkbox"/> 9699 SMD Test Fixture<sup>*1</sup></p>  <p>Measurable range: DC to 120 MHz                      Maximum applied voltage: ±42 V peak (AC+DC)                      Measurable sample dimensions: Test sample width of 1 mm to 4 mm                      Test sample height of 1.5 mm or less                      This fixture is for the lower electrode.</p>	 <p>Turn both knobs counterclockwise to loosen them (do not place anything in the sample mounting area).</p>	 <p>Position the included short bar in the sample mounting area and turn the knobs clockwise to secure the measurement sample in place.</p>

\*1: Although the test fixture appears to use a four-terminal setup, two terminals provide contact with the sample since  $H_{POT}$  and  $H_{CUR}$  as well as  $L_{POT}$  and  $L_{CUR}$  are connected inside the fixture and probe.

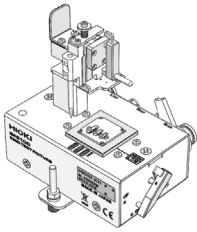
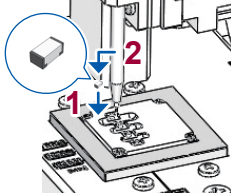
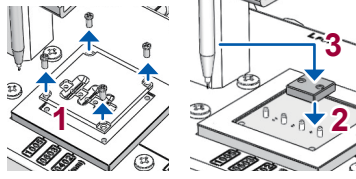
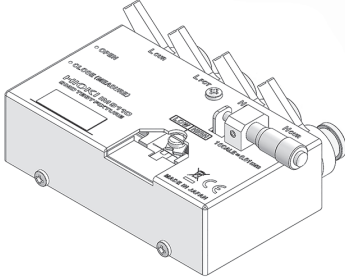
Test fixture types	Open state during open correction	Shorted state during short correction
<p><input type="checkbox"/> IM9100 SMD Test Fixture</p>  <p>Measurable range: DC to 8 MHz                      Maximum applied voltage: <math>\pm 40</math> V DC                      Maximum applied current: 0.15 A rms (<math>\pm 0.15</math> A DC)                      Measurable sample dimensions:                      JIS (EIA): L mm <math>\times</math> W mm                      0402 (01005) : 0.4 mm <math>\times</math> 0.2 mm                      0603 (0201) : 0.6 mm <math>\times</math> 0.3 mm                      1005 (0402) : 1.0 mm <math>\times</math> 0.5 mm                      For use with SMD components</p>	 <p>Mount the open correction fixture for the 1005 in the test head measurement area with a pair of pincers.</p>	 <ol style="list-style-type: none"> <li>1. Remove the template.</li> <li>2. Mount the short correction fixture in the test head measurement area, passing the guide pins through the holes on the fixture.</li> <li>3. Push the tip of the tip pin gradually into the short correction fixture.</li> </ol>
<p><input type="checkbox"/> IM9110 SMD Test Fixture</p>  <p>Measurable range: DC to 1 MHz                      Maximum applied voltage: <math>\pm 42</math> V peak (AC+DC)                      Maximum applied current: 0.15 A rms (<math>\pm 0.15</math> A DC)                      Measurable sample dimensions:  <math>0.25 \pm 20\% \times 0.125 \pm 10\% \times 0.125 \pm 10\%</math> mm (notation base on JIS: 0201)</p>	<ol style="list-style-type: none"> <li>1. Move the operating lever toward CLOSE (MEASURE).</li> <li>2. Find the position where the measurement probes switch between an open state and a short state.</li> <li>3. From that position, rotate the micrometer clockwise by 0.25 mm (a half turn) for correction.</li> </ol> <p>See the IM9110 SMD Test Fixture Instruction Manual to perform open correction using samples.</p>	<ol style="list-style-type: none"> <li>1. Move the operating lever toward CLOSE (MEASURE).</li> <li>2. Find the position where the measurement probes switch between open and short states.</li> <li>3. From that position, rotate the micrometer counterclockwise by 0.1 mm for correction.</li> </ol> <p>See the IM9110 SMD Test Fixture Instruction Manual to use the short-compensation jig, which came with the IM9110.</p>

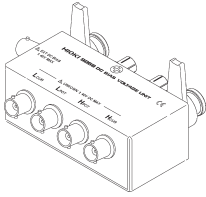
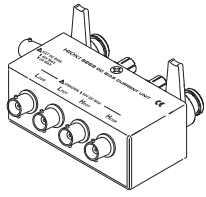
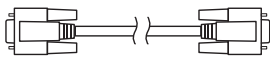
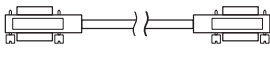
DC Bias Unit <sup>*2</sup>		Open state during open correction	Shorted state during short correction
<input type="checkbox"/> 9268-10 DC Bias Voltage Unit  Measurable range: 40 Hz to 8 MHz Maximum applied voltage: ±40 V DC	Connect the following items to the 9268-10: <ul style="list-style-type: none"> <li>• Measurement cables and fixture or probe (in the open correction state)</li> <li>• Bias application cable</li> <li>• External DC bias power supply (with the 0 V output setting on)</li> </ul>	Connect the following items to the 9268-10: <ul style="list-style-type: none"> <li>• Measurement cables and fixture or probe (in the short correction state)</li> <li>• Bias application cable</li> <li>• External DC bias power supply (with the 0 V output setting on)</li> </ul>	
<input type="checkbox"/> 9269-10 DC Bias Current Unit  Measurable range: 40 Hz to 2 MHz (The upper-limit frequency decreases to 1 MHz for extended measurement cables.) Maximum applied current: 2 A DC	Connect the following items to the 9269-10: <ul style="list-style-type: none"> <li>• Measurement cables and fixture or probe (in the open correction state)</li> <li>• Bias application cable</li> <li>• External DC bias power supply (setting off)</li> </ul> (Do not connect the bias application cable.)	Connect the following items to the 9269-10: <ul style="list-style-type: none"> <li>• Measurement cables and fixture or probe (in the short correction state)</li> <li>• Bias application cable</li> <li>• External DC bias power supply (setting off)</li> </ul> (Do not connect the bias application cable.)	
<p>*2: When using the DC Bias Unit to perform short correction for ALL, use the instrument to turn off the DC measurement.                      When using the DC Bias Unit, use the instrument to turn on the DC bias function and set the voltage at 0.00 V. (p. 63)</p>			
Connection cords			
<input type="checkbox"/> 9637 RS-232C Cable  9-pin to 9-pin cross type, Cord length: 1.8 m	<input type="checkbox"/> 9151-02 GP-IB Connector Cable  Cord length: 2 m		

# Measurement Process

This section uses AC measurement of a laminated ceramic capacitor as an example to provide an overview of the instrument's functionality.

Items to be prepared:

9263 SMD Test Fixture, Laminated ceramic capacity you want to measure

- 1** Inspect the instrument before measurement. (p. 35)
- 2** Connect the power cord to the instrument. (p. 36)
- 3** Turn on the instrument. (p. 38)  
(A 60-minute warm-up period is necessary before performing the correction process described in Step 9.)
- 4** Set the date and time. (p. 40)
- 5** Connect the 9263 SMD test fixture to the measurement terminals.

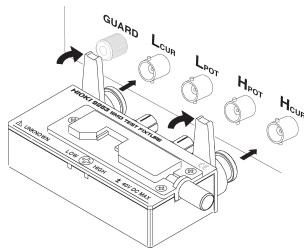

- Overview of connections: p. 37  
(The connection method varies with the probes and fixture being used. For more information, see each product's user manual.)
- Optional probes and fixtures: p. 3

**6** Set the measurement mode to LCR. (Default setting: LCR)

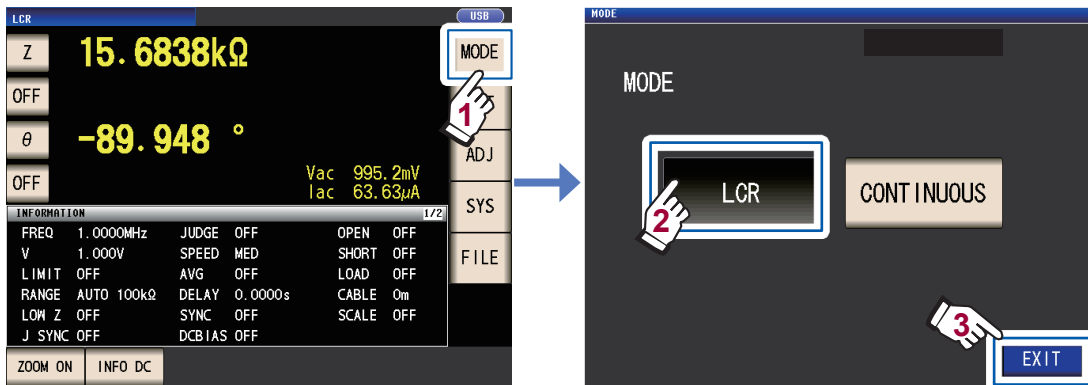

Use the **CONTINUOUS** setting if you wish to take continuous measurements under multiple sets of conditions. (In LCR mode, you must first set and save the measurement conditions.)  
See "4 Using Continuous Measurement Mode" (p. 99).

## 7 Set the first parameter to Cs and the third parameter to D. (p. 41)

Example: Set the first parameter to Cs

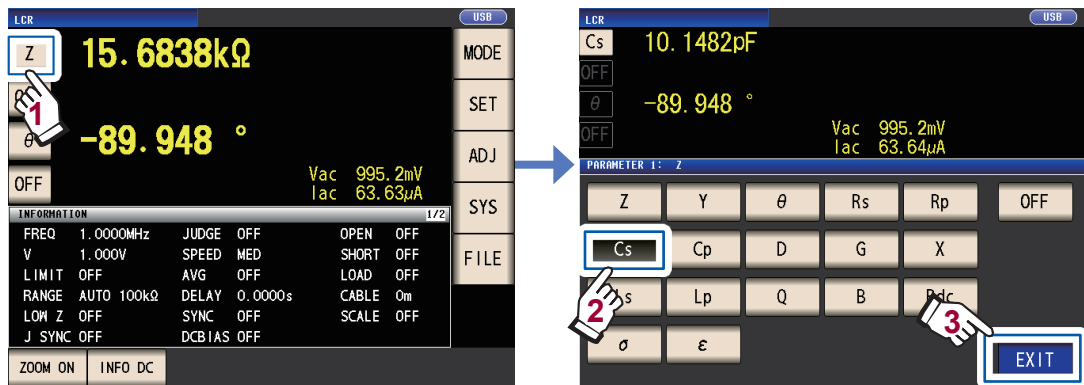

When you wish to perform DC in addition to AC measurement, set the parameter to **Rdc**: “To perform DC measurement (DC resistance measurement)” (p. 42)

## 8 Set the measurement conditions.

Press the **SET** key, select the **BASIC** tab, and configure the settings as desired. (The numbers underneath the buttons indicate the default settings.)

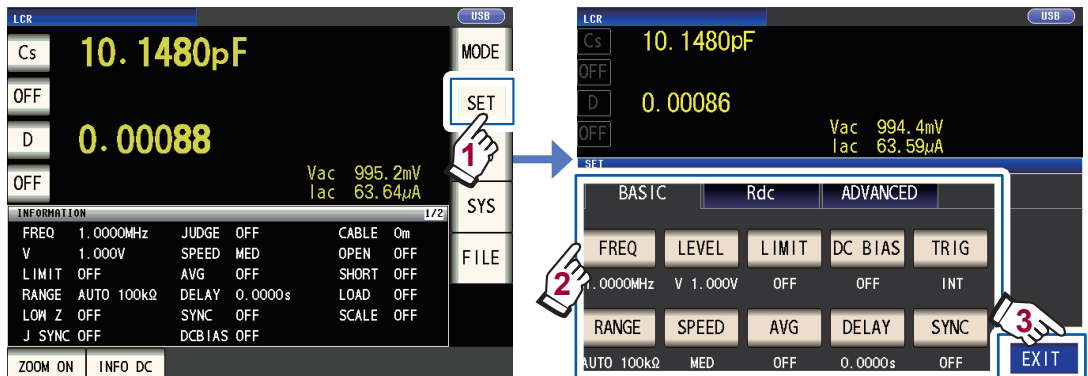

<b>FREQ</b>	Measurement frequency: 1.0000 kHz (p. 47) (Required: configure based on the measurement sample.)	<b>AVG</b>	Average: OFF (p. 60) (Optional: Set to ON when you wish to prevent instability in the display value.)
<b>RANGE</b>	Measurement range: AUTO (p. 48) (Required: configure based on the measurement sample.)	<b>DC BIAS</b>	DC bias: OFF (p. 63) (Optional: Set to ON when you wish to superimpose the DC voltage on the measurement signal during capacitance measurement.)
<b>LEVEL</b>	Measurement signal mode: Open circuit voltage (V) mode Measurement signal level: 1.000 V (p. 52) (Required: configure based on the measurement sample.)	<b>DELAY</b>	Trigger delay: 0.0000 s (p. 67) (Optional: If the trigger synchronous output function is enabled, set to a large enough value that measurement can stabilize.)
<b>SPEED</b>	Measurement speed: MED (p. 58) (Optional: Change this setting when you wish to perform measurement more quickly or at a higher level of precision.)	<b>TRIG</b>	Trigger: INT (p. 66) (Optional: Set to <b>EXT</b> when you wish to input the trigger manually, using EXT I/O, or using the interface.)
<b>LIMIT</b>	Voltage and current limit: OFF (p. 62) (Optional: Set to ON when you wish to limit the voltage or current that is applied to the sample.)	<b>SYNC</b>	Trigger synchronous output function: OFF (p. 68) (Optional: Change the setting when you wish to apply the signal to the sample during measurement only.)

- To save measurement conditions internally or load previously saved measurement conditions: “6 Saving and Loading Measurement Condition and Correction Value Data” (p. 131)
- To perform DC (DC resistance) measurement: “3.4 Setting Measurement Conditions (Basic Settings)” (p. 46)

**9 Wait at least 60 minutes after turning on the instrument and then perform correction.**

1. Press the **ADJ** key.

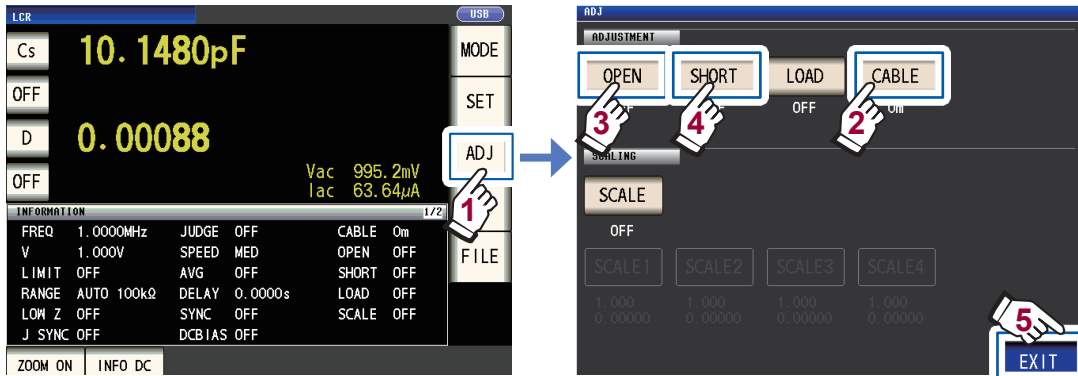

- CABLE** “5.1 Setting the Cable Length (Cable Length Correction)” (p. 104)
- OPEN** “5.2 Open Correction” (p. 105)
- SHORT** “5.3 Short Correction” (p. 112)

2. Set the cable length (for the 9263, use a setting of 0 m).
3. Place the 9263 SMD Test Fixture in the open state and perform open correction.

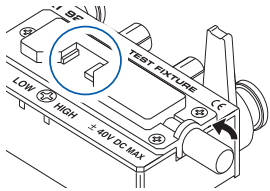

4. Place the 9263 SMD Test Fixture in the shorted state and perform short correction.

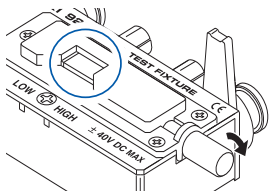

- To save measurement conditions internally or load previously saved measurement conditions: “6 Saving and Loading Measurement Condition and Correction Value Data” (p. 131)
- The open state and shorted state vary with the probe or fixture being used. (p. 3)  
For more information, see each component’s user manual.

**10 Connect the test sample to the 9263 SMD test fixture.**

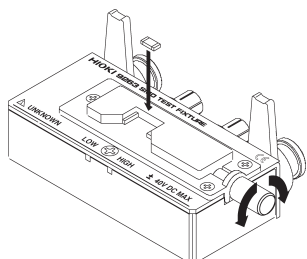

The method used to connect to the sample varies with the probe or fixture being used. See each component’s user manual for details.

# 11 Check the measurement results. (p. 44)



- To enlarge the measured value display: p. 45
- To change the number of digits used to display measured values: p. 94
- When you want to judge the measurement results:  
To perform comparator measurement (p. 73),  
To perform BIN measurement (p. 78)
- When you want to save the measurement results:  
To save the desired number of measurement data points (p. 91)  
To save one measurement data point before the save was performed to the USB flash drive in the CSV format (p. 149)

An error message or error display will be shown:

**Error message**  
**Reference Value:** No measured value accuracy guarantee  
**Memory Full:** Memory full  
**Hi Z:** Hi Z reject error

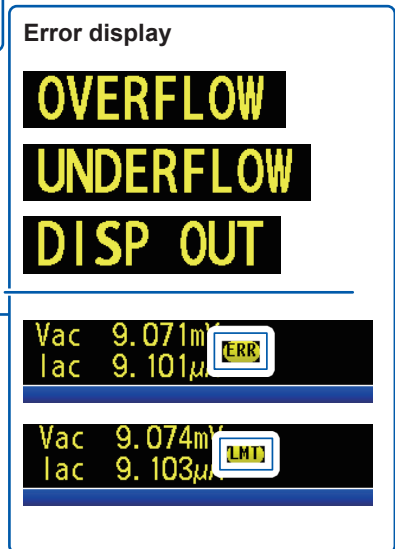

See “11.3 Error Message and Error Display” (p. 238).

The following functionality is also available

Measuring conductivity and permittivity	▶	p. 71
Measuring at a high level of precision	▶	p. 59
Limiting instability of display values	▶	p. 60
Setting measurement conditions for each measurement range	▶	p. 83
Increasing the measurement precision or measurement speed	▶	p. 86
Detecting contact errors during two-terminal measurement	▶	p. 88
Detecting poor contact with the sample during four-terminal measurement	▶	p. 89
Changing the key tone or judgment tone	▶	p. 96
Disabling key operation (key lock function)	▶	p. 97
Performing measurement by outputting a signal from an external device to the instrument	▶	p. 66, p. 169
Controlling the instrument by sending commands from a computer	▶	p. 140
Saving settings data to the USB flash drive	▶	p. 161
Loading settings data from the USB flash drive	▶	p. 163



# Safety Information

This instrument is designed to conform to IEC 61010 Safety Standards, and has been thoroughly tested for safety prior to shipment. However, using the instrument in a way not described in this manual may negate the provided safety features.

Before using the instrument, be certain to carefully read the following safety notes.

## **DANGER**



**Mishandling during use could result in injury or death, as well as damage to the instrument. Be certain that you understand the instructions and precautions in the manual before use.**







## **WARNING**







**With regard to the electricity supply, there are risks of electric shock, heat generation, fire, and arc discharge due to short circuits. If persons unfamiliar with electricity measuring instrument are to use the instrument, another person familiar with such instruments must supervise operations.**

### Notation



In this manual, the risk seriousness and the hazard levels are classified as follows.

 <b>DANGER</b>	Indicates an imminently hazardous situation that will result in death or serious injury to the operator.
 <b>WARNING</b>	Indicates a potentially hazardous situation that may result in death or serious injury to the operator.
 <b>CAUTION</b>	Indicates a potentially hazardous situation that may result in minor or moderate injury to the operator or damage to the instrument or malfunction.
<b>IMPORTANT</b>	Indicates information related to the operation of the instrument or maintenance tasks with which the operators must be fully familiar.
	Indicates a high voltage hazard. If a particular safety check is not performed or the instrument is mishandled, this may give rise to a hazardous situation; the operator may receive an electric shock, may get burnt or may even be fatally injured.
	Indicates the prohibited action.
	Indicates the action which must be performed.
*	Additional information is presented below.
<b>Bold</b>	Names and keys on the screen are indicated in boldface.
<b>Windows</b>	Unless otherwise specified, "Windows" represent Windows 7, Windows 8 and Windows 10.

## Symbols on the instrument

	Indicates cautions and hazards. When the symbol is printed on the instrument, refer to a corresponding topic in the Instruction Manual.
	Indicates a grounding terminal.
	Indicates AC (Alternating Current).
	Indicates the ON side of the power switch.
	Indicates the OFF side of the power switch.

## Symbols for Various Standards

	Indicates the Waste Electrical and Electronic Equipment Directive (WEEE Directive) in EU member states.
	Indicates that the product conforms to regulations set out by the EU Directive.

## Accuracy

We define measurement tolerances in terms of f.s. (full scale), rdg. (reading) and dgt. (digit) values, with the following meanings:

<b>f.s.</b>	(maximum display value) The maximum displayable value. This is usually the name of the currently selected range.
<b>rdg.</b>	(reading or displayed value) The value currently being measured and indicated on the measuring instrument.
<b>dgt.</b>	(resolution) The smallest displayable unit on a digital measuring instrument, i.e., the input value that causes the digital display to show a "1" as the least-significant digit.

## Measurement categories

To ensure safe operation of measuring instruments, IEC 61010 establishes safety standards for various electrical environments, categorized as CAT II to CAT IV, and called measurement categories.

### DANGER



- **Using a measuring instrument in an environment designated with a higher-numbered category than that for which the instrument is rated could result in a severe accident, and must be carefully avoided.**
- **Never use a measuring product that lacks category labeling in a CAT II to CAT IV measurement environment. Doing so could result in a serious accident.**

- CAT II: When directly measuring the electrical outlet receptacles of the primary electrical circuits in equipment connected to an AC electrical outlet by a power cord (portable tools, household appliances, etc.)
- CAT III: When measuring the primary electrical circuits of heavy equipment (fixed installations) connected directly to the distribution panel, and feeders from the distribution panel to outlets
- CAT IV: When measuring the circuit from the service drop to the service entrance, and to the power meter and primary overcurrent protection device (distribution panel)

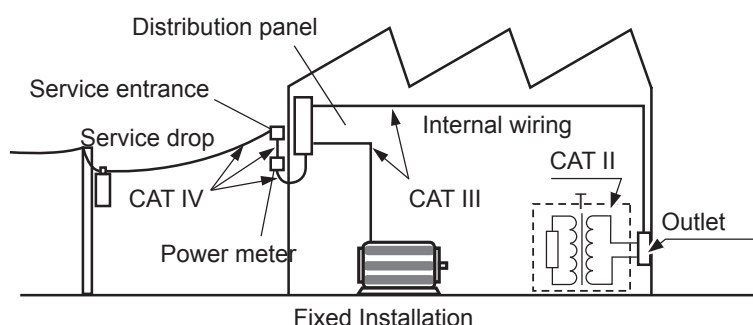

## Operating Precautions

Follow these precautions to ensure safe operation and to obtain the full benefits of the various functions. Use of the instrument should conform not only to its specifications, but also to the specifications of all accessories, options, and other equipment in use.

### DANGER



If the probes, cords or the instrument is damaged, there is a risk of electric shock. Before using the instrument, perform the following inspection.

- Before using the instrument, check that the coating of the probes or cords are neither ripped nor torn and that no metal parts are exposed. Using the instrument under such conditions could result in electric shock. Replace the probes or cords with those specified by our company.
- Verify that the instrument operates normally to ensure that no damage occurred during storage or shipping. If you find any damage, contact your authorized Hioki distributor or reseller.

### Installing the instrument

#### Installation environment

### WARNING

Installing the instrument in inappropriate locations may cause a malfunction of instrument or may give rise to an accident. Avoid the following locations.



- Exposed to direct sunlight or high temperature
- Exposed to corrosive or combustible gases
- Exposed to a strong electromagnetic field or electrostatic charge
- Near induction heating systems (such as high-frequency induction heating systems and IH cooking equipment)
- Susceptible to vibration
- Exposed to water, oil, chemicals, or solvents
- Exposed to high humidity or condensation
- Exposed to high quantities of dust particles

#### Installation instructions

### CAUTION



- Do not place the device on an unstable table or an inclined place. Dropping or knocking down the device can cause injury or damage to the device.
- Leave sufficient space around the instrument when positioning it. Failure to do so may result in damage to the instrument or fire.

- Install with the bottom surface facing downward.
- Vents must not be obstructed.

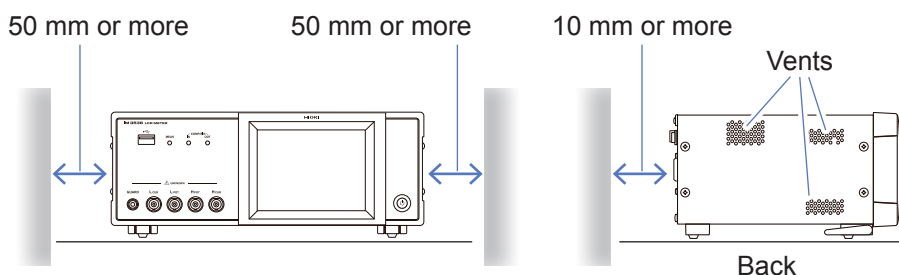

The instrument can be used with the stand (p. 20).  
It can also be rack-mounted (p. Appx.12).

### Shipping precautions

Hioki disclaims responsibility for any direct or indirect damages that may occur when this instrument has been combined with other devices by a systems integrator prior to sale, or when it is resold.

### Handling the instrument

This instrument complies with EN 61326 Class A. This instrument may cause interference if used in residential areas. Such use must be avoided unless the user takes special measures to reduce electromagnetic emissions to prevent interference to the reception of radio and television broadcasts.

#### **DANGER**



**To avoid electric shock, do not remove the instrument's case. The internal components of the instrument carry high voltages and may become very hot during operation.**

#### **CAUTION**



- Note that the instrument may be damaged if the applied voltage or current exceeds the measurement range.
- Do not use excessive force on the touch panel, and do not use sharp objects that could damage the touch screen.
- Do not apply heavy downward pressure with the stand extended. The stand could be damaged.



- If the instrument exhibits abnormal operation or display during use, review the information in “11.2 Troubleshooting” (p. 231) and “11.3 Error Message and Error Display” (p. 238) before contacting your dealer or Hioki representative.
- To avoid damage to the instrument, protect it from physical shock when transporting and handling. Be especially careful to avoid physical shock from dropping.
- After use, always turn off the instrument.

### Before turning on the instrument

#### **WARNING**



- **Before turning the instrument on, make sure the supply voltage matches that indicated on its power connector. Connection to an improper supply voltage may damage the instrument and present an electrical hazard.**
- **To avoid electrical accidents and to maintain the safety specifications of this instrument, connect the power cord provided only to a 3-contact (two-conductor + ground) outlet.**
- **Be sure to ground the power cord. Failure to do so will cause the enclosure to have a voltage equal to half the supply voltage, resulting in electric shock.**
- **To avoid shock and short circuits, turn off all power before connecting probes or cords.**

#### **CAUTION**



**Do not connect the supply voltage improperly. Doing so may destroy the instrument's internal circuitry.**

**DC resistance measurement only**

To suppress noise, the instrument needs to be set to match the frequency of the power source. Before operating, set the instrument to the frequency of your commercial power. If the supply frequency is not set properly, measurements will be unstable. See "Line frequency (DC)" (p. 57).

**Handling the cords, fixtures, and probes**

 **WARNING**



**If the insulation on a cord melts, the metal conductor may be exposed. Do not use any cord whose metal conductor is exposed. Doing so could result in electric shock, burns, or other hazard.**

 **CAUTION**



- To avoid breaking the cords or probes, do not bend or pull them.
- Avoid stepping on or pinching cords, which could damage the cord insulation.
- Keep in mind that, in some cases, conductors to be measured may be hot.
- To avoid damage to the instrument, do not short-circuit the measurement terminals and do not input voltage to the measurement terminals.



- For safety reasons, disconnect the power cord when the instrument is not used.
- To avoid damaging the power cord, grasp the plug, not the cord, when unplugging it from the power outlet.
- To prevent damage to the BNC connector or junction, be sure to release the locking mechanism, grip the head of the connector (not the cord), and pull it out.
- Put the protective cap back on the connector when not in use. If the protective cap is not properly inserted, dust or other foreign matter may enter the connector and cause damage.

**IMPORTANT**

- Use only the specified connection cords. Using a non-specified cable may result in incorrect measurements due to poor connection or other reasons.

Before using a fixture or the like, read the instruction manual supplied with the product to be used.

**Before using the USB flash drive**

 **CAUTION**



- Do not transport the instrument while a USB flash drive is connected. Damage could result.
- Inserting a USB flash drive upside down, backwards or in the wrong direction may damage the USB flash drive and/or the instrument.



- Some USB flash drives are susceptible to static electricity. Exercise care when using such products because static electricity could damage the USB flash drive or cause malfunction of the instrument.

**IMPORTANT**

- USB flash drives have a limited usable lifetime. After long-term use, data reading and writing will fail, at which time the USB flash drives must be replaced.
- When a USB flash drive is accessed, the color of the USB icon changes from blue to red. Do not turn off the instrument while the USB flash drive is being accessed. Also, never remove the USB flash drive from the instrument. Doing so may result in the data in the USB flash drive being lost.
- Hioki cannot recover data from damaged or faulty storage media resulting from abnormalities. We are also unable to provide compensation for such data loss, regardless of the contents or cause of the failure or damage. We recommend making a backup of all important data on a computer or other storage devices..

With some USB flash drives, the instrument may not start up if it is turned on while the USB flash drive is inserted. In such a case, turn the instrument on first, and then insert the USB flash drive. It is recommended to try out operation with a USB flash drive before starting to use it for actual measurements.

**Before connecting external I/O**** WARNING**

- The ISO\_5V pin of the EXT I/O connector is a 5 V power output. Do not apply external power to this pin.

To avoid electric shock or damage to the equipment, always observe the following precautions when connecting to EXT I/O connectors.



- Always turn off the power to the instrument and to any devices to be connected before making connections.
- Be careful to avoid exceeding the ratings of EXT I/O connectors. (p. 186)
- During operation, a wire becoming dislocated and contacting another conductive object can be serious hazard. Use screws to secure the external connectors.
- Ensure that devices and systems to be connected to the EXT I/O terminals are properly isolated.

** CAUTION**

To avoid damage to the instrument, observe the following cautions:

- Do not apply voltage or current to the EXT I/O terminals that exceeds their ratings.
- Do not short the ISO\_5V and ISO\_COM EXT I/O connectors.  
See “Instrument connector signal assignments” (p. 170).



- When driving relays, be sure to install diodes to absorb counter-electromotive force.

**Handling the LCR application disc**

- Exercise care to keep the recorded side of discs free of dirt and scratches. When writing text on a disc's label, use a pen or marker with a soft tip.
- Keep discs inside a protective case and do not expose to direct sunlight, high temperature, or high humidity.
- Hioki is not liable for any issues your computer system experiences in the course of using this disc.



## 1.1 Product Overview and Features

The HIOKI IM3536 LCR Meter is an impedance measuring instrument which achieves high speed and high accuracy.

It can be used in a wide range of applications thanks to its broad range of measurement frequencies and its ability to set measurement conditions based on measurement signal levels.

### Wide range of measurement conditions

Measurement frequencies: 4 Hz to 8 MHz  
Measurement signal levels: 10 mV to 5 V

### Continuous measurement mode

Allows measurements to be performed continuously using preconfigured measurement conditions. This function enables, for example, making pass/fail judgment with different measurement conditions.

(Example: Performing C-D measurement with 120 Hz and Rs measurement with 100 kHz in succession)

### Comparator function (p. 73)

Makes HI/IN/LO judgments based on measured values and two preconfigured parameters.

### Low impedance can be measured with high degree of accuracy

Allows you to configure the instrument to measure low impedance values at a high level of precision. (p. 59)

### Capable of high-speed measurement

Up to 1 ms (typical values)

### Various interfaces supported

Supports the most suitable EXT I/O (handler interface) for production lines, USB, GP-IB, RS-232C and LAN.

### BIN function (p. 78)

Ranks measured values in up to 10 categories based on 2 preconfigured parameters.

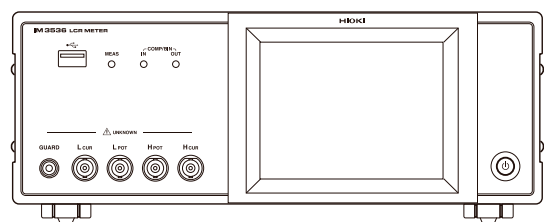



# 1.2 Names and Functions of Parts

## Front

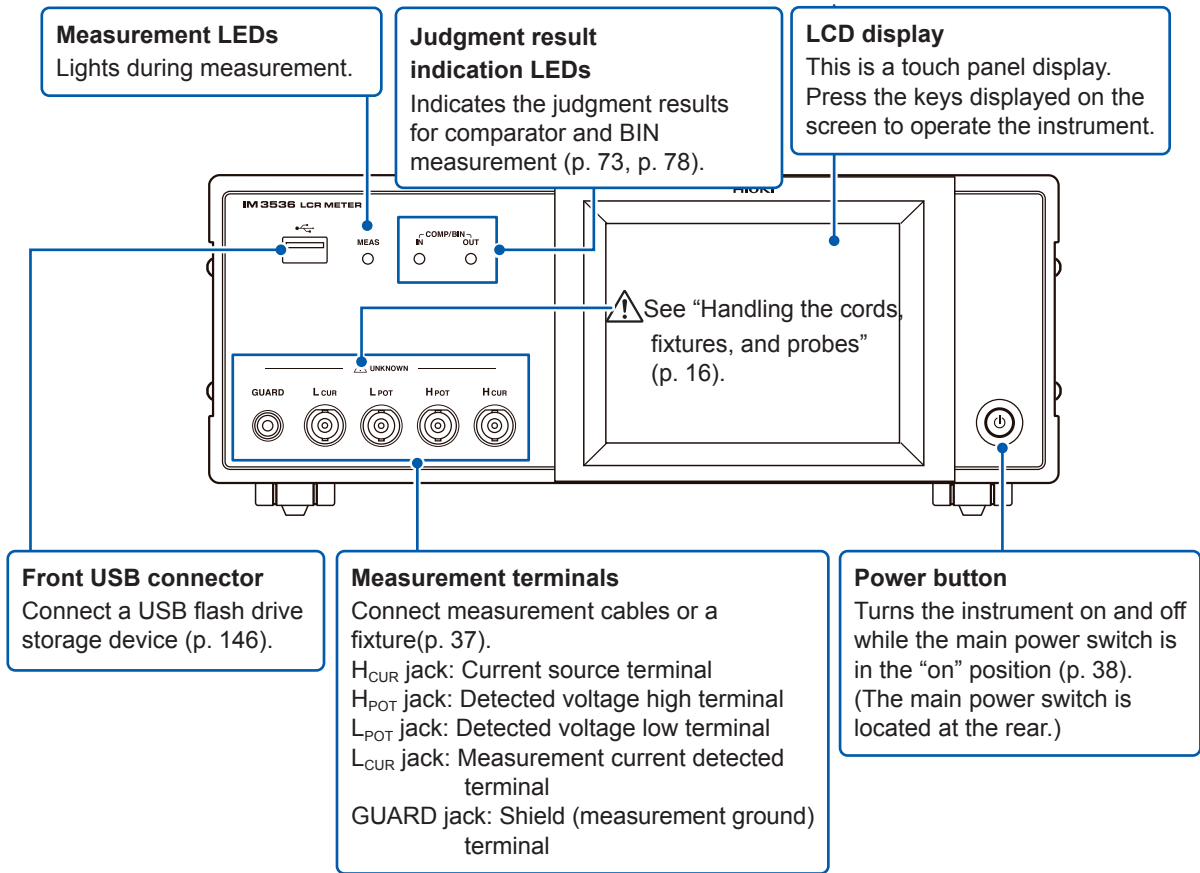

## Left side

## Right side

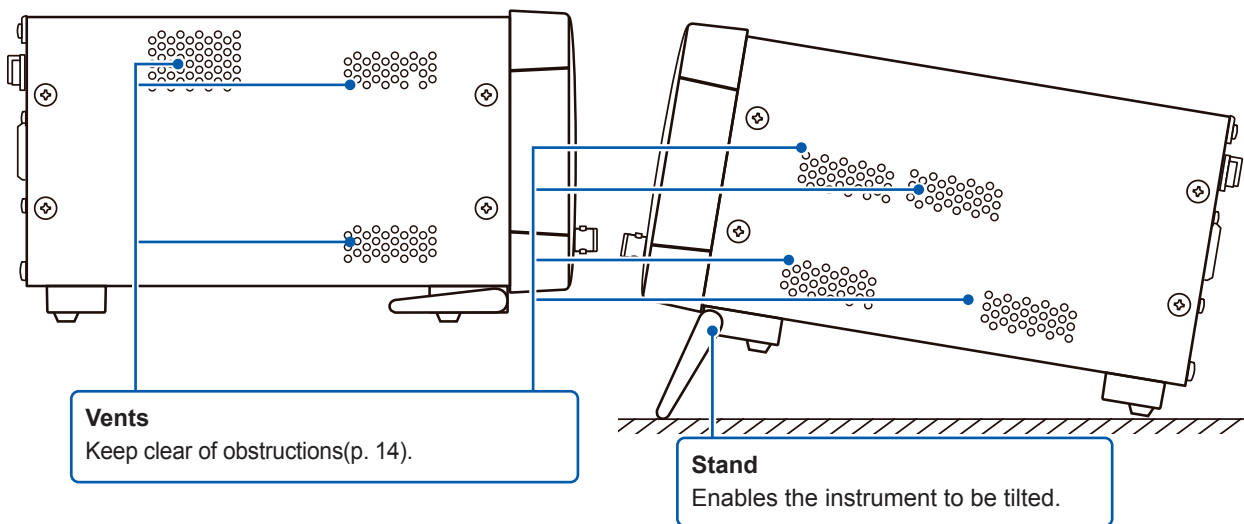

## ⚠ CAUTION



Do not apply heavy downward pressure with the stand extended. The stand could be damaged.

**Rear**

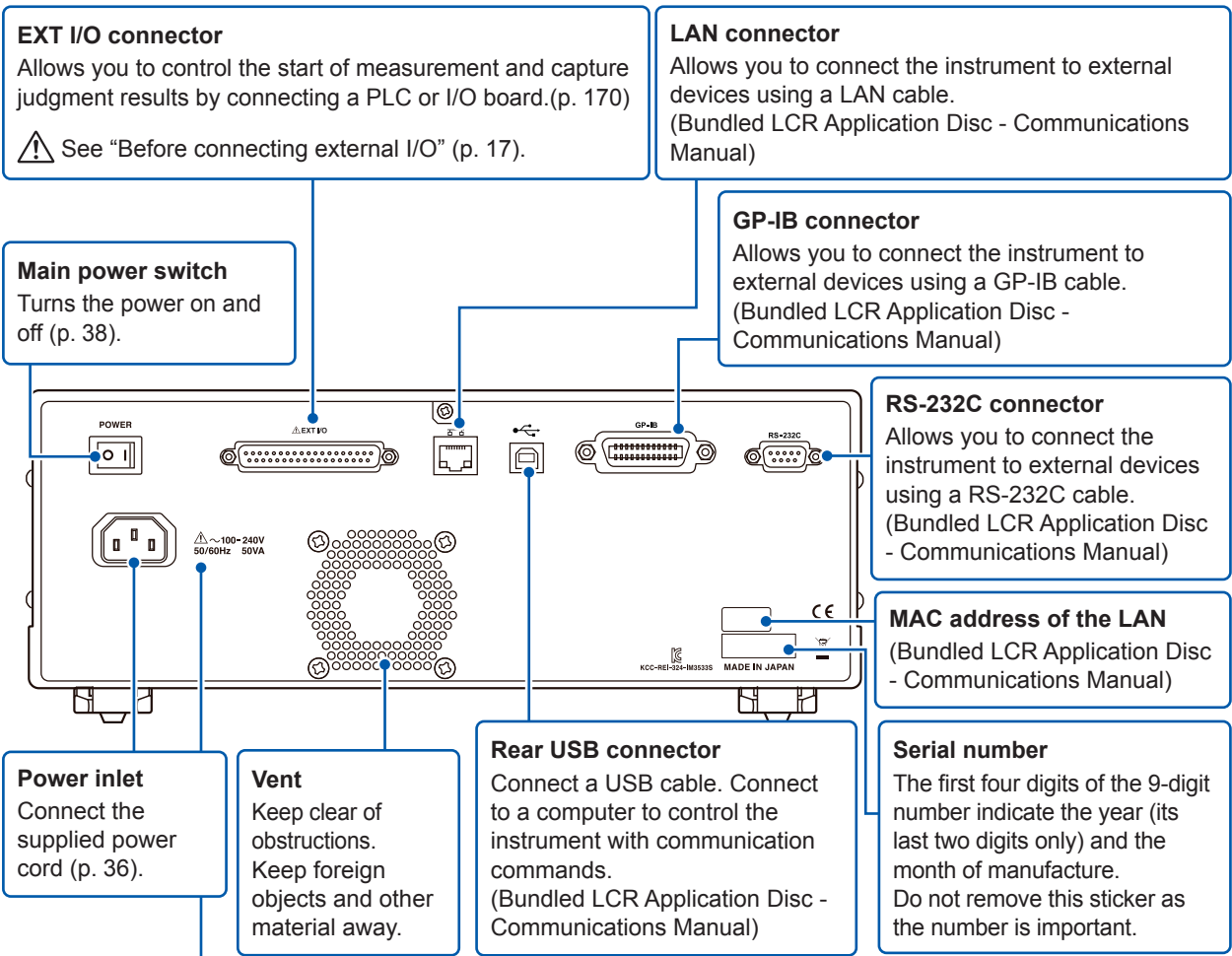

⚠ See “Before turning on the instrument” (p. 15), and “Handling the cords, fixtures, and probes” (p. 16).

**Bottom**

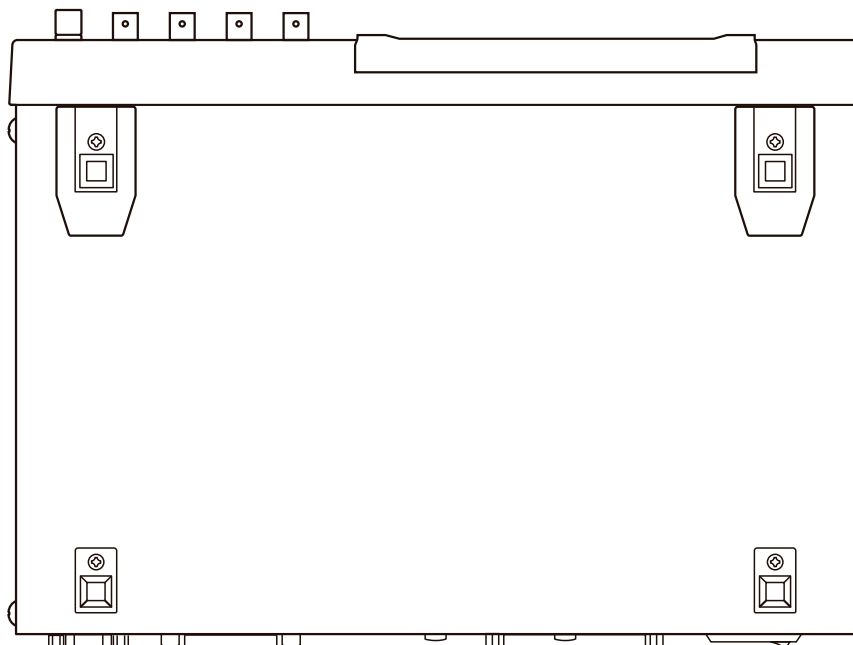

This instrument can be rack mounted.

See “Appx. 9 Attaching Rack-Mounting Hardware to the Instrument” (p. Appx.12).

## 1.3 Screen Layout and Operation

This instrument allows you to use a touch panel to set and change all measurement conditions. Gently touch a key on the screen to select the item or numerical value set for that key. A selected key turns black.

This manual refers to the act of lightly placing your finger on the screen as “touching” it, and a finger  mark is used on the screen to represent this action.

### CAUTION



Do not use excessive force on the touch panel, and do not use sharp objects that could damage the touch screen.

## Screen transition diagram

### Continuous measurement mode

No.	PARA	PARA	JUDGE
001	Z: 373.89mΩ	θ: 1.004 °	-- --
002	Z: 373.89mΩ	θ: 1.004 °	LO HI
003	L: 1.03121μH	Q: 98.38	IN LO
004	L: 1.03084μH	Q: 100.69	BIN1
005	L: 1.03083μH	Q: 100.55	BIN1
006	L: 1.03082μH	Q: 100.46	-- --

Measurement screen

This screen is used to view continuous measurement results (p. 24).

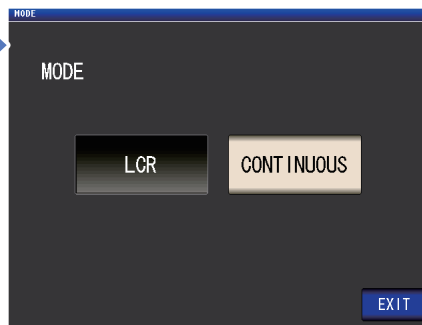

MODE screen

This screen is used to select the measurement mode (p. 26).

No.	EXEC	PANEL NAME	MODE	PARA	JUDGE
001	ON	1407141346	LCR+ADJ	Z -θ	
002	ON	1407141347	LCR+ADJ	Z -θ	COMP
003	ON	1407141349	LCR+ADJ	Ls-Q	COMP
004	ON	1407141351	LCR+ADJ	Ls-Q	BIN
005	ON	1407141352	LCR+ADJ	Ls-Q	BIN
006	ON	1407141352	LCR+ADJ	Ls-Q	BIN

SET screen

This screen is used to configure continuous measurement (p. 27).

FILE NAME	TYPE	DATE	SIZE
20111130	FDR	2011-11-30	11:01
MEMORY	FDR	2011-11-30	11:02
SETTING	FDR	2011-11-30	11:01

FILE screen

This screen is used to check and manipulate files on the USB flash drive (p. 31).

Return to the Measurement screen with the **EXIT** key.

LCR mode

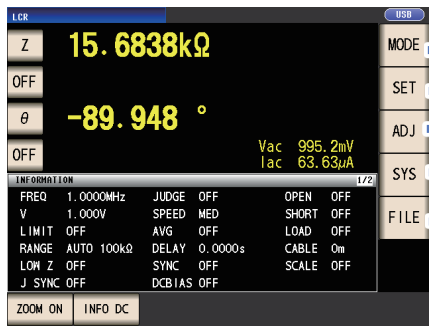

Measurement screen

This screen is used to view measured values and measurement condition settings information. (p. 24,p. 28)

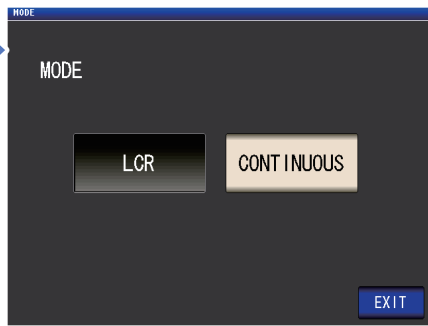

MODE screen

This screen is used to select the measurement mode (p. 26).



SET screen

This screen is used to configure detailed settings such as measurement conditions (p. 27).

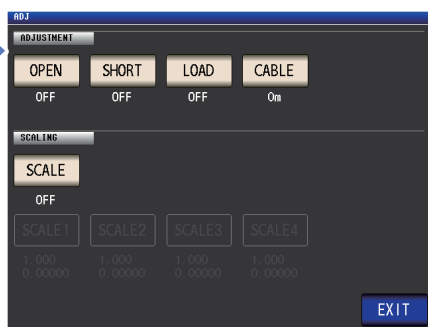

ADJ screen

This screen is used to configure correction functionality (p. 29).

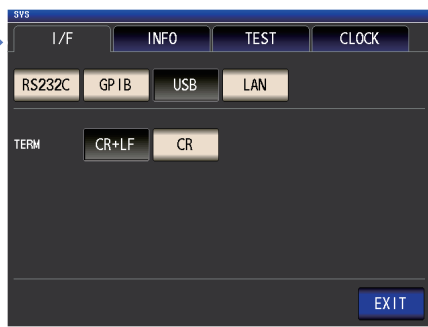

SYS screen

This screen is used to configure the instrument's interfaces, to set the time and date, and to check the system (p. 30).

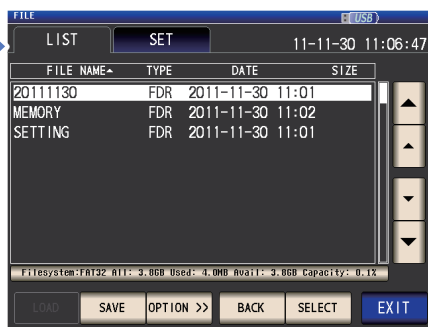

FILE screen

This screen is used to check and manipulate files on the USB flash drive (p. 31).

Return to the Measurement screen with the EXIT key.

## Viewing measured values (Measurement screen)

This is the first screen displayed when the instrument is turned on.  
 Touch the **EXIT** key to return to the measurement screen from another screen.

### Displaying elements used in both LCR mode and continuous measurement mode

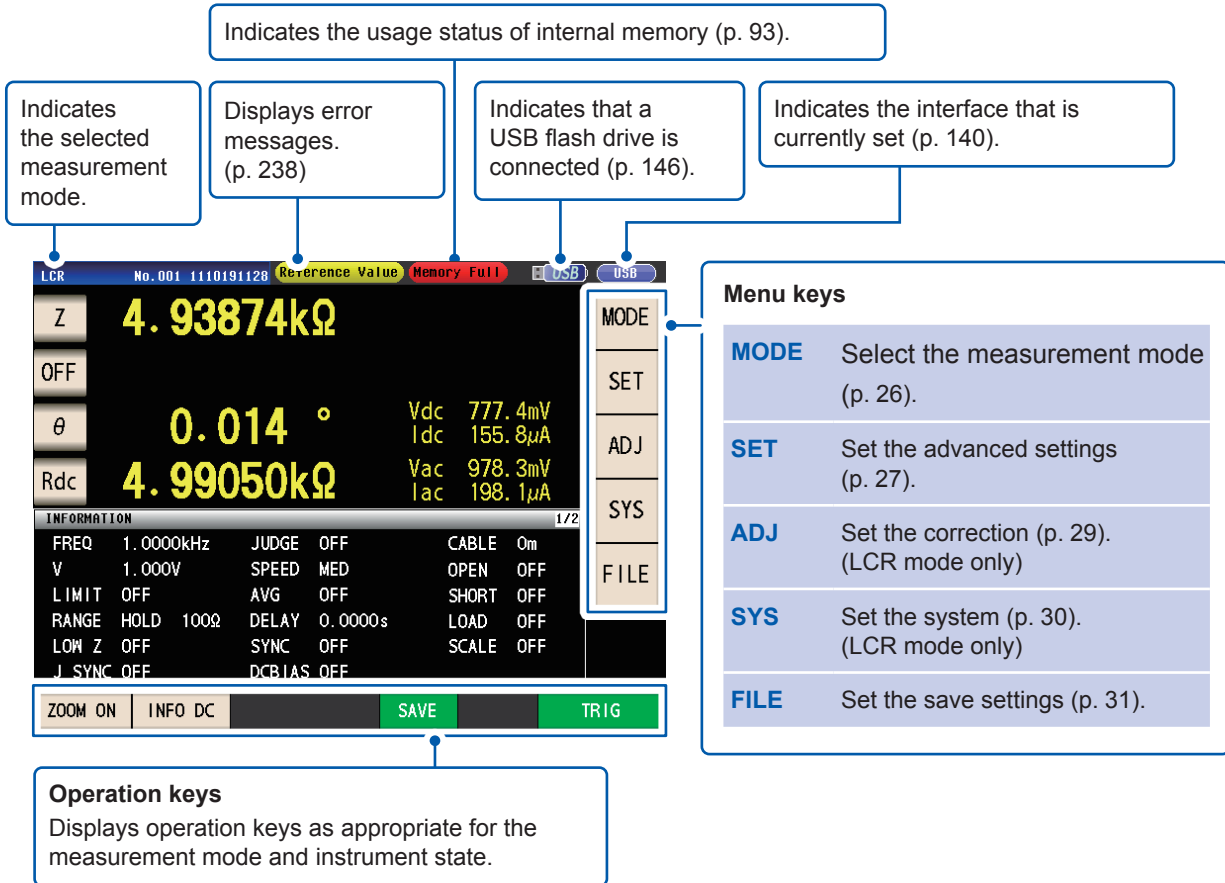

Measurement screen in LCR mode

**Indicates the name of the loaded panel (p. 136).**

**Measured values\***  
Displays measured values for various parameters.

**Parameter keys**  
Sets which parameters to display on the measurement screen (p. 41).

**Monitor values**  
Vac, Vdc: Voltage between the sample terminals  
Iac, Idc: Current passing through the sample

**Displays measurement condition settings information.**

**Enlarges the display of measured values and comparator judgment results. (p. 45)**

**Displays measurement condition settings information. (p. 28)**

**When the external trigger is selected, activates the trigger manually.(p. 67)**

**Switches measurement condition settings information (p. 28).**

**Saves the measurement data (p. 151).**

**Displays measurement condition settings information. (p. 28)**

**When the external trigger is selected, activates the trigger manually.(p. 67)**

\*How to view measured values: See “3.2 Viewing Measured Values” (p. 44).

Measurement screen in continuous measurement mode

**Panel No.**

**Measured value\***

**Judgment result\***

**Displays a list of the panels being used to perform continuous measurement.**

**Scrolls the screen.**

**Starts continuous measurement (p. 100).**

**Saves the measurement data (p. 151).**

\*How to view measured value and judgment result: See “4.3 Checking Continuous Measurement Results” (p. 100).

## Select the measurement mode (MODE screen)

This screen is used to select the measurement mode.

### 1 Touch the **MODE** key.

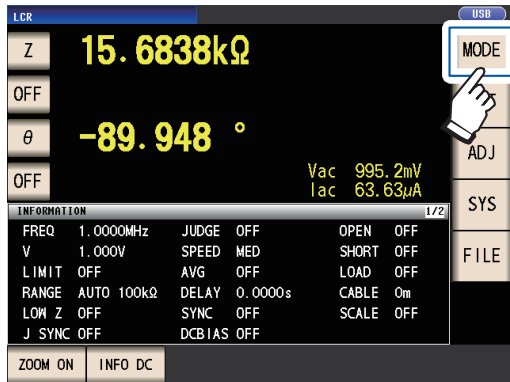

### 2 Select the measurement mode.

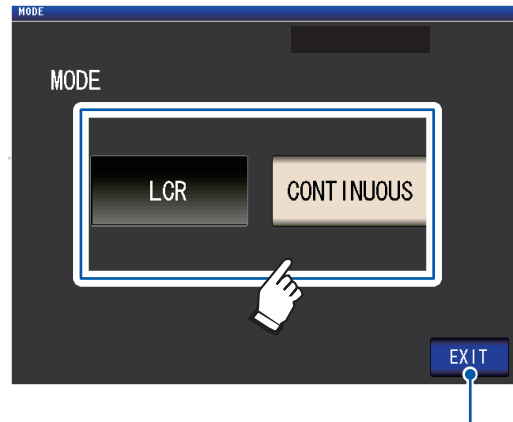

Displays the measurement screen for the selected mode.

**LCR** LCR mode (p. 41)

**CONTINUOUS** Continuous measurement mode (p. 99)

After changing the measurement mode, check all settings (including correction) before performing measurement.  
(Correction values will be deleted, so you will need to repeat the correction process.)

## Setting detailed settings such as measurement conditions (SET screen)

This screen is for configuring the measurement conditions you want to change and other advanced settings.

Select the measurement mode (p. 26) before configuring the advanced settings.

(Example screen: LCR mode)

For more information about the continuous measurement (CONTINUOUS) mode screen, see “4 Using Continuous Measurement Mode” (p. 99)

### 1 Touch the SET key.

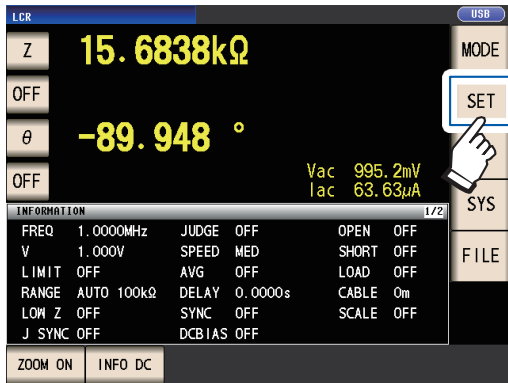

### 2 Touch a tab.



<b>BASIC</b>	Basic setting
<b>Rdc</b>	DC resistance measurement setting (shown during LCR mode operation only)
<b>ADVANCED</b>	Application settings

### 3 Touch the key for the parameter you wish to set.



The settings screen for the parameter will be displayed.

### 4 Configure settings for LCR mode and continuous measurement mode.

See “3 Performing Measurements in LCR Mode” (p. 41), and “4 Using Continuous Measurement Mode” (p. 99).



## Checking measurement condition settings information

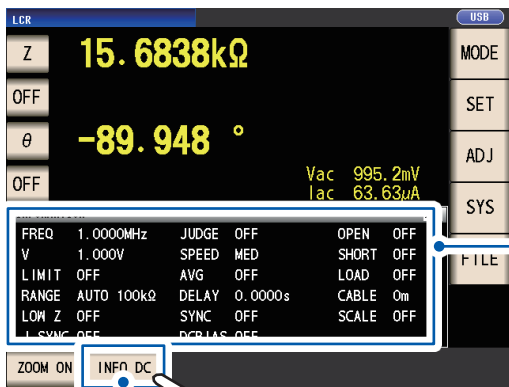

You can check settings information on the Measurement screen during LCR mode operation.

Current measurement conditions (This information is not shown when using the zoom display (p. 45)).

### INFO AC

Information related to AC measurement is displayed.

INFORMATION				1/2	STS
FREQ	1.0000MHz	JUDGE	OFF	OPEN	OFF
V	1.000V	SPEED	MED	SHORT	OFF
LIMIT	OFF	AVG	OFF	LOAD	OFF
RANGE	AUTO 100kΩ	DELAY	0.0000s	CABLE	0m
LOW Z	OFF	SYNC	OFF	SCALE	OFF
J SYNC	OFF	DCBIAS	OFF		

ZOOM ON INFO DC

Touching the **INFO** key switches the displayed information. (The **INFO** key display will vary depending on what type of information is being displayed.)

### INFO DC

Information related to DC measurement is displayed.

INFORMATION				2/3	STS
FREQ	DC	SPEED	MED		
V	1.00V	AVG	OFF		
RANGE	AUTO 100Ω	DC ADJ	ON		
LOW Z	OFF	DCR OFFSET	XX-XX-XX XX:XX:XX		
J SYNC	OFF	DC DELAY	0.0000s		
L FREQ	60Hz	ADJ DELAY	0.0030s		

ZOOM ON INFO COMP

### INFO COMP

(When comparator function has been set)  
Displays information about comparator measurement judgment standards.

INFORMATION				3/3	STS
Z	%	θ	ABS		
REF	1.0000k				
HI	1.000%	HI	100.000m		
LO	-1.000%	LO	-100.000m		

ZOOM ON INFO AC

### INFO BIN

(When BIN function has been set)  
Displays information about BIN measurement judgment standards.

INFORMATION				3/4	SYS
Z ABS		θ ABS			
BIN 1	5.00001k	4.99999k	80.0000m	70.0000m	
BIN 2	5.00010k	4.99990k	80.0000m	70.0000m	
BIN 3	5.00100k	4.99900k	80.0000m	70.0000m	
BIN 4	5.01000k	4.99000k	80.0000m	70.0000m	
BIN 5	5.10000k	4.90000k	80.0000m	70.0000m	

ZOOM ON INFO BIN

Touch again to display information for BIN 6 to BIN 10. (When display information is for BIN 6 to BIN 10, this key is **INFO AC** key.)

The following information can be displayed:

Display	Description	Remarks
FREQ	Measurement frequency	For AC and DC
RANGE	Measurement range	
LOW Z	Low Z high accuracy mode <sup>*1</sup>	
J SYNC	JUDGE synchronization setting for the measurement range	
SPEED	Measurement speed	
AVG	Average	
V	Measurement signal level	AC: Setting DC: Fixed to 1.00 V
DELAY	Trigger delay	Used for both AC and DC. (Displayed for <b>INFO AC</b> only)
SYNC	Trigger synchronous output	
JUDGE	Measurement result judgment	
OPEN	Open correction	
SHORT	Short correction	
LOAD	Load correction	
CABLE	Cable correction	
SCALE	Scale correction (Correlation Correction)	
LIMIT	Limit	AC only
DC BIAS	DC bias	DC only
L FREQ	Line frequency	
DCR OFFSET	DC adjustment value acquisition time <sup>*2</sup>	
DC DELAY	DC delay	
ADJ DELAY	Adjustment delay	

\*1: When set to ON, the display will show **ON\*** if set to a measurement range or measurement frequency for which the output resistance will be 100 Ω. (See “Low Z High Accuracy Mode” (p. 59))

\*2: The acquisition time will not be displayed if DC adjustment is ON. When DC adjustment is OFF, the display will show **RESERVED** after DC offset acquisition, and the acquisition time will be displayed once acquisition is complete.

## Configuring correction functionality (ADJ screen)

This screen is used to configure correction functionality (LCR mode only).

### 1 Touch the **ADJ** key.

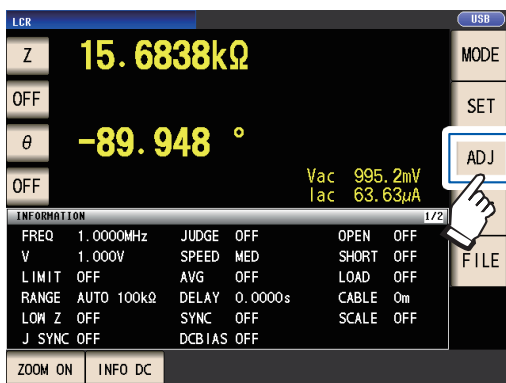

### 2 Touch the key for the parameter you wish to set.

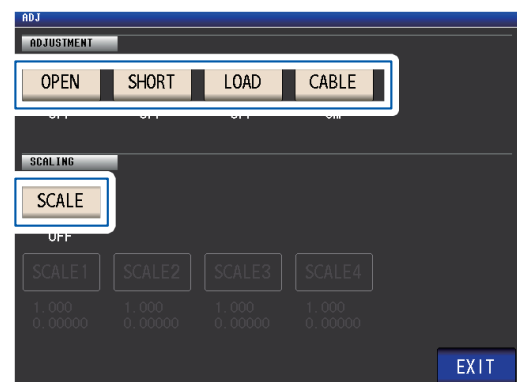

The settings screen for the parameter will be displayed.

### 3 Configure the settings.

See “5 Error Correction” (p. 103).

## Configuring the instrument's interfaces, setting the time and date, and checking the system (SYS screen)

This screen is used to configure the instrument's interfaces, to set the time and date, and to check the system. (LCR mode only)

- 1 Touch the **SYS** key.

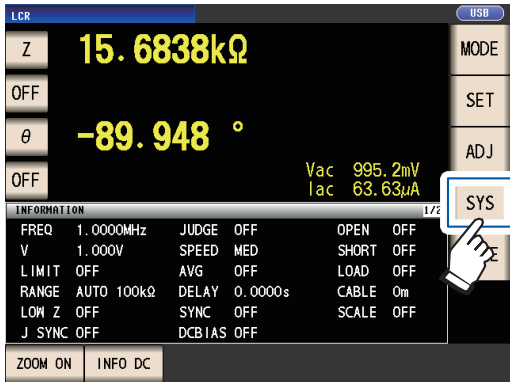

- 2 Touch a tab.



<b>I/F</b>	Configure interface settings
<b>INFO</b>	Check the version and other system information
<b>TEST</b>	Check the system
<b>CLOCK</b>	Set the time

- 3 Touch the key for the parameter you wish to set.



The settings screen for the parameter will be displayed.

- 4 Check the settings and version number or perform a test measurement.  
See "7 Setting the System" (p. 139).

## Displaying and manipulating files on the USB flash drive (FILE screen)

This screen is used to display files saved on the USB flash drive and to configure and edit file-related settings. It is displayed after the USB flash drive is inserted into the instrument's receptacle.

### 1 Touch the **FILE** key.

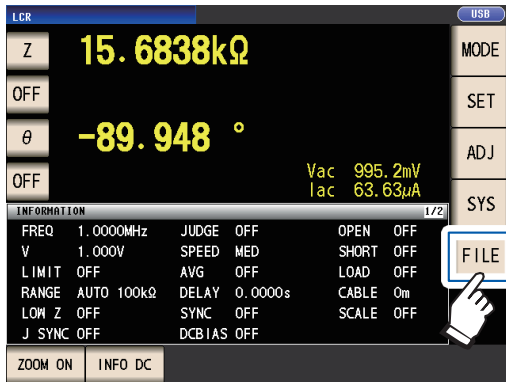

### 2 Touch a tab.

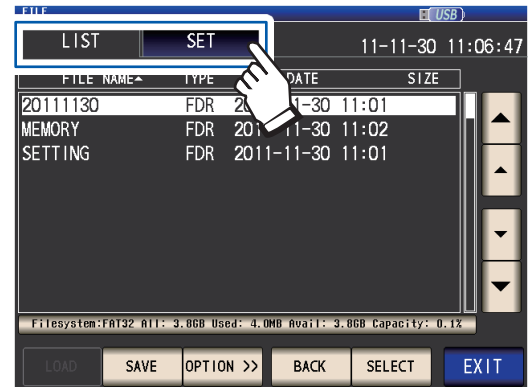

- LIST**
- Display files
  - Load, save, or delete (initialize) files

**SET** Configure file-saving operation

### 3 Configure file-saving settings, display files, and manipulate files.

See “8 Using USB Flash Drive (Saving and Loading Data)” (p. 145).



# 2

# Measurement Preparations

## 2.1 Preparation Flowchart

Before preparing for measurement, be sure to read “Operating Precautions” (p. 14). Refer to “Appx. 9 Attaching Rack-Mounting Hardware to the Instrument” (p. Appx.12) for rack mounting.

(1) Installing the instrument (p. 14)

(2) Connecting the power cord (p. 36)

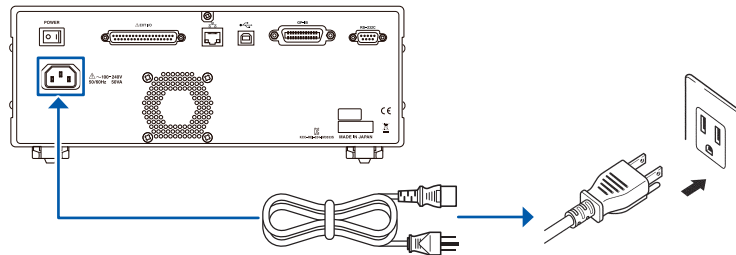

(3) Connecting the measurement cables, optional Hioki probes, or test fixture to the measurement connectors (p. 37)

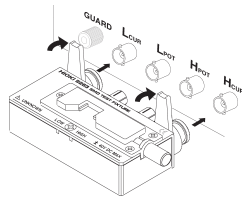

Check that the instrument's power switch is set to the off position.

(4) Connecting the external interface (as needed)

For more information about making RS-232C, GP-IB, USB, and LAN connections, see the Communications Instruction Manual on the bundled LCR Application Disc.

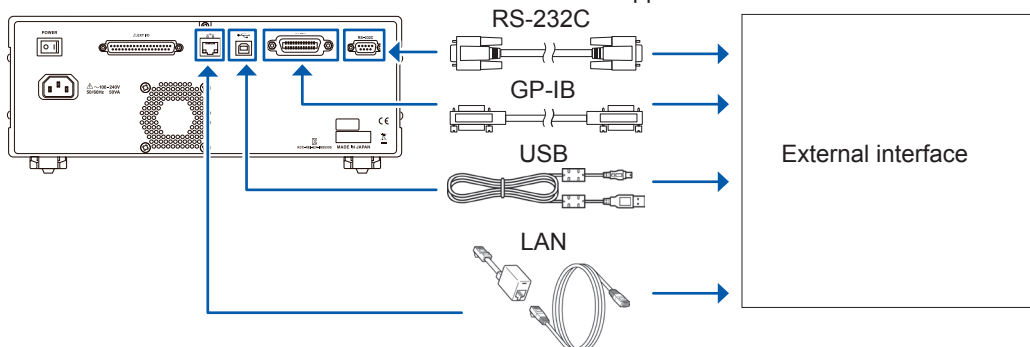

(5) Turning on the instrument (p. 38)

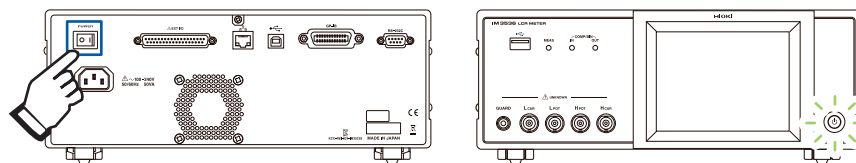

**(6) Making instrument settings**

- First, set the time and date (p. 40).
- When measuring DC resistance, be sure to set the line frequency before performing measurement (p. 57).

After allowing the instrument to warm up for at least 60 minutes, perform open correction and short correction and connect the instrument to the sample (p. 38).

## 2.2 Pre-operation Inspection

Please read the “Operating Precautions” (p. 14) before use.

Before using the instrument, verify that it operates normally to ensure that no damage occurred during storage or shipping. If you find any damage, contact your authorized Hioki distributor or reseller.

### 1

#### Peripheral device inspection

The power cord insulation is not torn, or any metal is not exposed.

↓ No metal exposed

→ Metal exposed

Do not use the instrument if damage is found, as electric shock or shortcircuit accidents could result. Contact your authorized Hioki distributor or reseller.

The insulation on a cables is not torn, or any metal is not exposed.

↓ No metal exposed

→ Metal exposed

If there is any damage, measured values may be unstable and measurement errors may occur. Replace the cable with an undamaged one.

### 2

#### Instrument inspection

The instrument is not damaged.

↓ Not damaged

→ Damaged

If damage is evident, request repairs.

**When the instrument is turned on**

The splash screen (model no., version no.) is displayed.

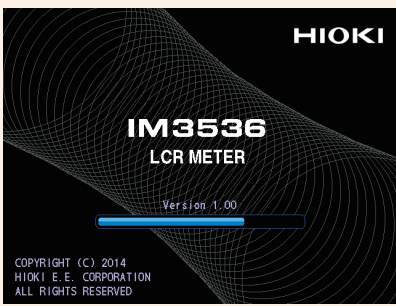

↓ Displayed

→ Not displayed

The power cord may be damaged, or the instrument may be damaged internally. Request repairs. “11.2 Troubleshooting” (p. 231)

No error is displayed on the splash screen.

↓ No error displayed

→ An error indication occurs (Err)

The instrument may be damaged internally. Request repairs. See “Transporting the instrument” (p. 230).

**Inspection complete**

## 2

Measurement Preparations



## 2.3 Connecting the Power Cord

Be sure to read the “Before turning on the instrument” (p. 15), and “Handling the cords, fixtures, and probes” (p. 16) before connecting the power cord.

Connect the power cord to the power inlet on the instrument, and plug it into an outlet.

- 1 Check that the main power switch is set to the off position.

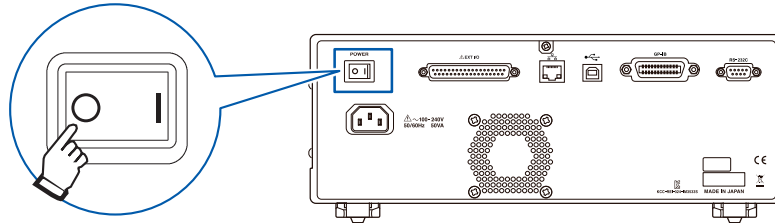

- 2 Connect a power cord that matches the line voltage to the power inlet on the instrument. (100 V AC to 240 V AC)

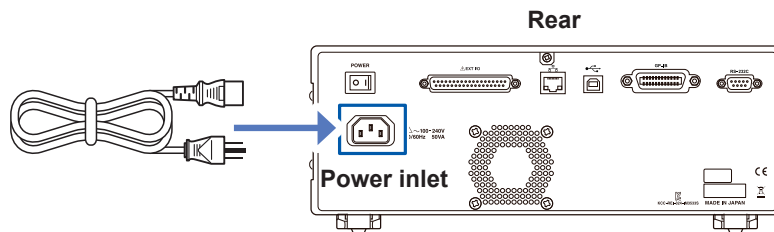

- 3 Plug the other end of the power cord into an outlet.

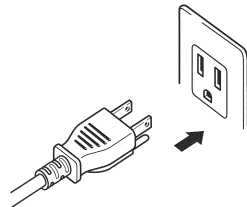

## 2.4 Connecting the Measurement Cables, Probes, or Fixture

Be sure to read the “Handling the cords, fixtures, and probes” (p. 16) before connecting measurement cables, probes or test fixture.

Connect your measurement cables, optional Hioki probes or test fixture to the measurement terminals. Refer to “Options (reference: open and short correction states)” (p. 3) for details. See the instructions provided with the fixture for operating details.

### Example: Hioki optional test fixture

Connect directly to the measurement jacks with the label side up, and affix with the levers on the left and right.

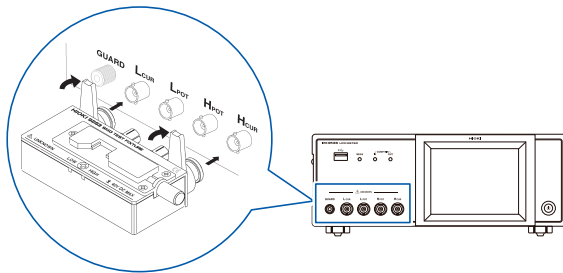

### Example: Hioki optional Model 9140-10

Connect the red plugs to the  $H_{CUR}$  and  $H_{POT}$  jacks, and the black plugs to the  $L_{CUR}$  and  $L_{POT}$  jacks.

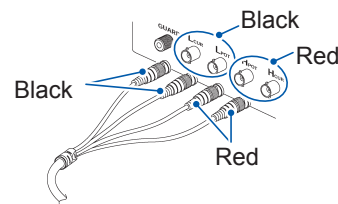

### Example: Hioki optional Model 9500-10

Connect the  $H_{CUR}$ ,  $H_{POT}$ ,  $L_{CUR}$ , and  $L_{POT}$  BNC plugs to the corresponding terminals on the instrument.

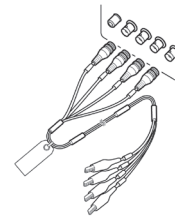

### Points to pay attention to when making your own probe

- Use  $50\ \Omega$  coaxial cable for the measurement cable.
- When it ships from the factory, the instrument has been adjusted for the length of its cable. Since use of a cable with a different capacitance value between the coaxial cable's core wire and the shielding will introduce a measurement error, use a cable whose capacitance value is as close as possible to that used when adjusting the instrument prior to its shipment (1 m: 111 pF/cable; 2 m: 215 pF/cable; 4 m: 424 pF/cable).
- Make the portion of the core wire that is exposed as short as possible.
- Connect the  $H_{CUR}$ ,  $L_{CUR}$ ,  $H_{POT}$ , and  $L_{POT}$  shield pairs at the measurement sample side. (Ensure that a shield is not connected to a core wire.)
- In general, Hioki optional parts (p. 3) should be used for measurement cables and fixtures. If you use a probe yourself, it may not be able to satisfy the specifications of this instrument.
- If all four terminals are disconnected, a meaningless number may be displayed on the unit.

### Measurement Terminal Configuration

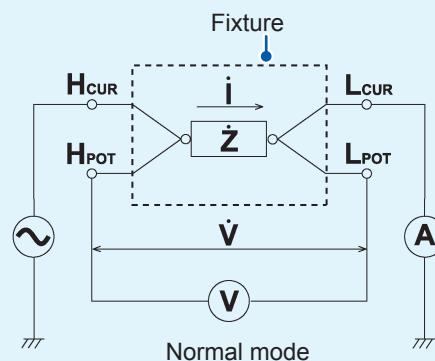

## 2.5 Turning the Instrument On and Off

Before turning on the instrument, be sure to read “Before turning on the instrument” (p. 15).

Once you have connected measurement cables or an optional Hioki probe or test fixture, set the instrument’s main power switch to the on position. Once the main power switch has been set to the on position, the instrument can be turned on and off using the power button on the front panel.

This feature is convenient when embedding the instrument in an automated tester or on a production line. (If the main power switch is set to the off position in the suspended state, the instrument will be turned on in the suspended state when the main power switch is next set to the on position.)

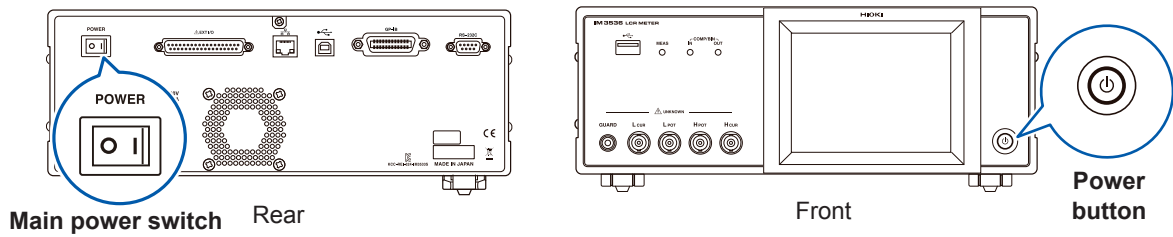

### Turning on the instrument

Place the main power switch in the “on” (I).

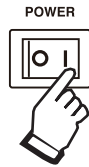

The power button's green indicator will light up.



### Turning off the instrument

Place the main power switch in the “off” (O).



The power button's indicator will be turned off.



- When the power supply is interrupted by a power failure or the like, the instrument recovers in the measurement mode used before the power failure.
- Instrument settings will be retained (backed up) even if the main power switch is set to the off position.

### Placing the instrument in the suspended state

ON the main power in the state, hold down the front Standby Key 2 seconds approximately.

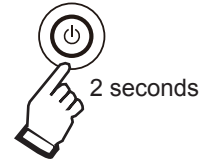

The power button's red indicator will light up.



#### What is the suspended state?

The instrument is turned off in the suspended state. (Only the circuit needed to light up the power button's indicator will operate.)

### To cancel the suspended state

The instrument is in suspended state, press the power button on the front.

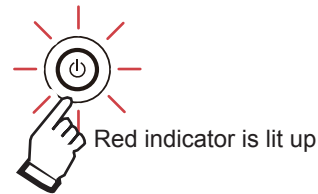

The power button's green indicator will light up.



To perform measurements at the level of accuracy indicated in the instrument's specifications, allow it to warm up for at least 60 minutes after setting the main power switch to the on position or canceling the suspended state.

## 2.6 Setting the Date and Time

Set the instrument's date and time.

Data is recorded and managed based on the set date and time.

- 1 Press the **SYS** key.

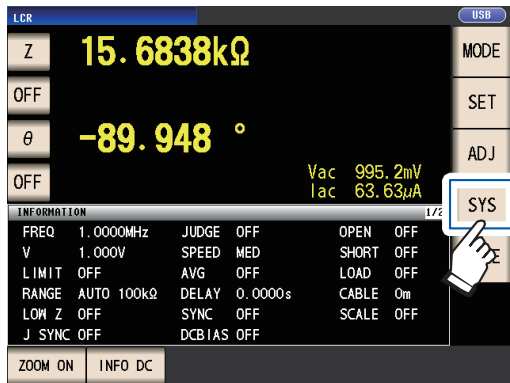

- 2 Touch the **CLOCK** tab, and set the date and time with the **▲▼** key.  
(Year-Month-Day Hour-Minute-Second)

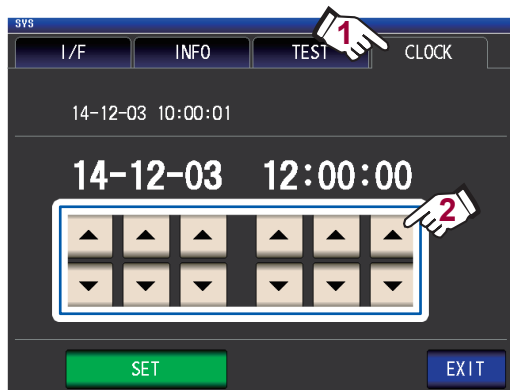

Settable range :

00:00:00, January 1, 2000, to  
23:59:59, December 31, 2099

- 3 Press the **SET** key to accept the setting.

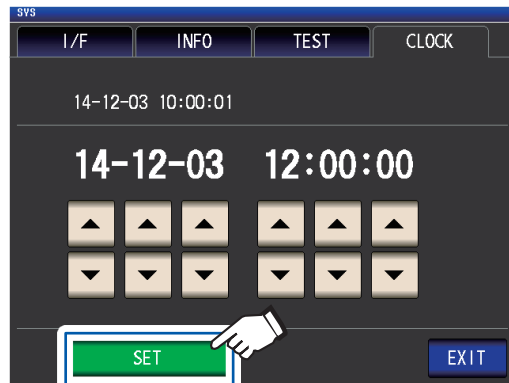

- 4 Press the **EXIT** key.  
The measurement screen will be displayed.

# 3

## Performing Measurements in LCR Mode

The LCR mode allows you to measure the impedance, phase angle, and other items by applying any frequency or level (effective value) signal to the element you want to measure. This function is suitable for evaluating the passive element of a capacitor, coil, or the like.

**First, set the measurement mode to LCR mode (p. 26).**

### 3.1 Setting Display Parameters

You can select up to 4 of the 16 measurement parameters to display on the measurement screen. These parameters are set on the measurement screen.

<Example> No. 1 parameter: Cs, No. 3 parameter: D (See “Parameters” (p. 42).)

**1** Touch the No. 1 parameter key.

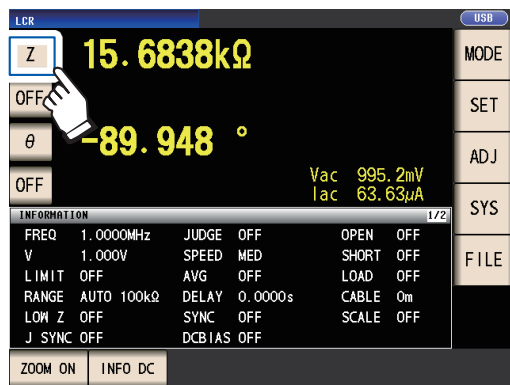

**2** Touch the Cs key and then the EXIT key to accept the settings.



**3** Touch the No. 3 parameter key.

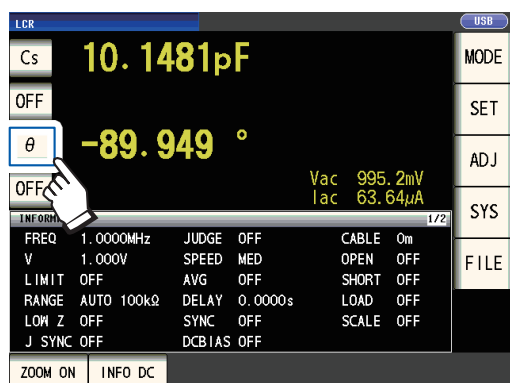

**4** Touch the D key and then the EXIT key to accept the setting.



Cs and D are set as the parameters.



If OFF is selected in the parameter setting, a measurement value is not displayed.

# 3

**Parameters**

The following parameters are available:

Parameters	Description
<b>Z</b>	Impedance ( $\Omega$ )
<b>Y</b>	Admittance (S)
$\theta$	Impedance phase angle ( $^{\circ}$ ) <sup>*1</sup>
<b>Rs</b>	Effective resistance= ESR ( $\Omega$ ) (Equivalent series resistance)
<b>Rp</b>	Effective resistance ( $\Omega$ ) (Equivalent parallel resistance)
<b>X</b>	Reactance ( $\Omega$ )
<b>G</b>	Conductance (S)
<b>B</b>	Susceptance (S)
<b>Ls</b>	Inductance (H) (Equivalent series inductance)
<b>Lp</b>	Inductance (H) (Equivalent parallel inductance)

Parameters	Description
<b>Cs</b>	Capacitance (F) (Equivalent series capacitance)
<b>Cp</b>	Capacitance (F) (Equivalent parallel capacitance)
<b>Q</b>	Q-factor
<b>D</b>	Loss factor= $\tan\delta$
<b>Rdc</b>	DC resistance ( $\Omega$ )
$\sigma$	Conductivity (See p. 71.) <sup>*2</sup>
$\epsilon$	Permittivity (See p. 71.) <sup>*2</sup>
<b>OFF</b>	No display

- Parameters other than **Rdc** are measured using an AC signal (AC measurement).
- **Rdc** measures DC resistance (DC measurement).
- For more information about series equivalent circuit mode and parallel equivalent circuit mode, see p. Appx.10.

\*1: The phase angle  $\theta$  is shown based on the impedance Z.

\*2: The following message will be displayed when you select either  $\sigma$  or  $\epsilon$  as a parameter: **“Please set the area and length of DUT.”** Touch the **EXIT** key to clear the message.

**To perform DC measurement (DC resistance measurement)**

When **Rdc** is set as a parameter, you can measure the DC resistance **Rdc**.

For more information about measurement condition settings, see “3.4 Setting Measurement Conditions (Basic Settings)” (p. 46).

When **Rdc** is set as a parameter along with other parameters, DC resistance is measured (DC measurement) after other parameters are measured using an AC signal (AC measurement).

DC measurement is performed automatically using the following series of operations:

Example: When the number of average iterations is 1

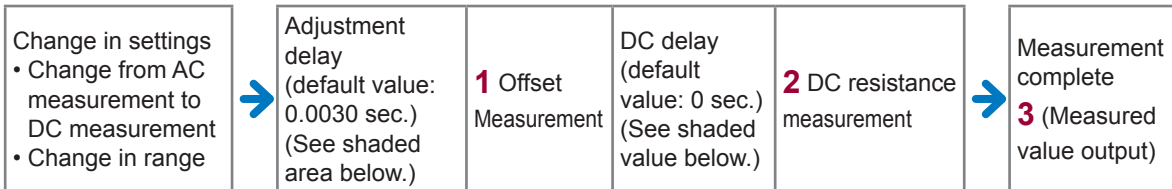

**1** The DC resistance is measured after setting the generated voltage to 0 V, and the result is used as the offset value. (See “DC adjustment (reducing measurement error) (DC)” (p. 64).)

**2** The DC resistance is measured after outputting 1.0 V.

**3** The measurement error is reduced using the offset value, and the **Rdc** measured value is output.

- When the sample is a capacitor, it may not be possible to perform DC resistance measurement normally.
- The time required until the DC signal level stabilizes differs depending on the test sample to be measured. To facilitate more accurate measurement, observe the measurement waveform in advance and set delay times (adjustment delay and DC delay) to allow the DC signal level to stabilize adequately. (See “Measurement and data acquisition timing” (p. 69).)



## 3.2 Viewing Measured Values

Measured values for each parameter are shown next to the corresponding parameter key. The measured values shown in the screenshot below are as follows:

No. 1 parameter Z (impedance)	: 4.93874 k $\Omega$
No. 2 parameter	: No display
No. 3 parameter $\theta$ (Impedance phase angle)	: 0.014°
No. 4 parameter Rdc (DC resistance)	: 4.99050 k $\Omega$

Monitor values are displayed next to the measured values. The monitor values shown in the screenshot below are as follows:

Vdc (Sample terminal voltage during DC measurement)	: 777.4 mV
Idc (Current flowing to sample during DC measurement)	: 155.8 $\mu$ A
Vac (Sample terminal voltage during AC measurement)	: 978.3 mV
Iac (Current flowing to sample during AC measurement)	: 198.1 $\mu$ A

For more detailed information about the screen layout, see “Viewing measured values (Measurement screen)” (p. 24).

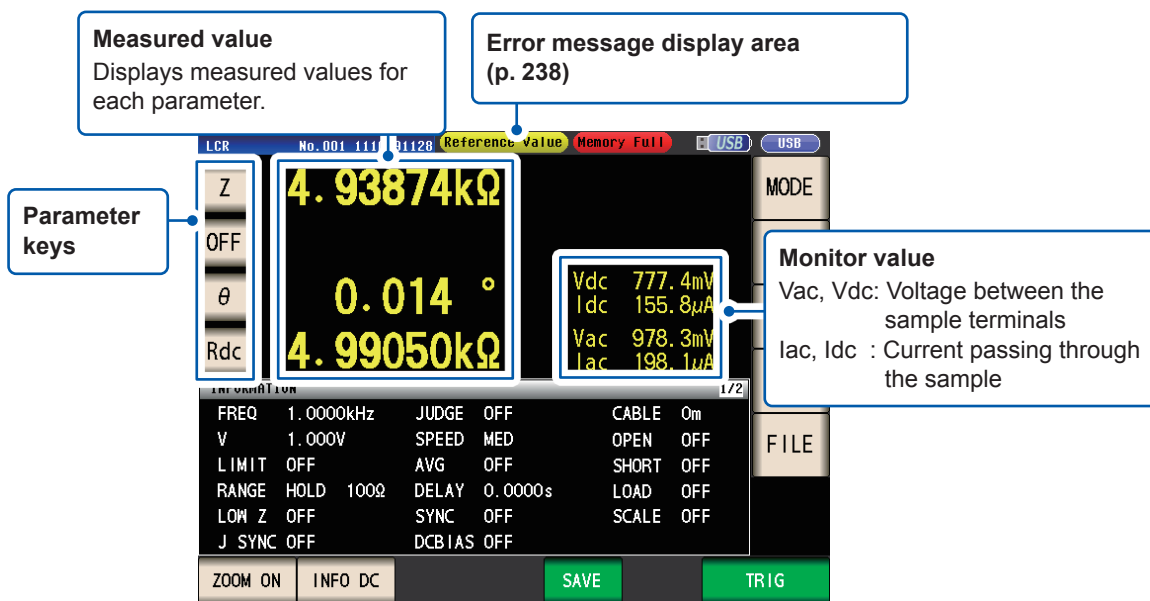

### 3.3 Enlarging Display of Measurement Values

The measurement values and comparator judgment results can be displayed in enlarged form. This functionality provides a convenient way to make measured values easier to view.

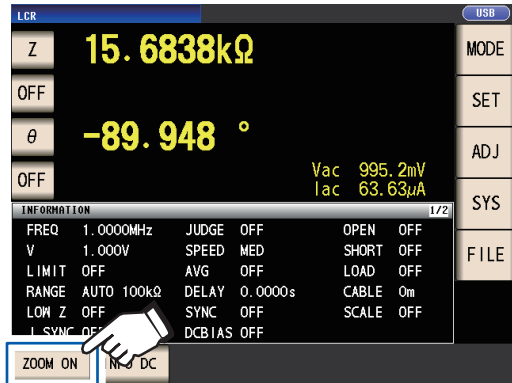

Touch the **ZOOM ON** key.

#### Magnification Display Screen

Normal measurement

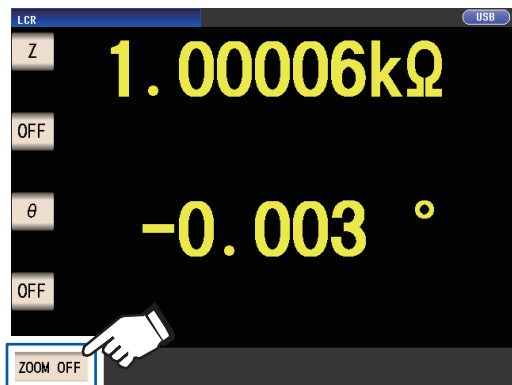

To cancel the zoom display:

Touch the **ZOOM OFF** key.

Comparator measurement



BIN measurement



- Indicates the position of the measurement value relative to the comparator thresholds with a bar.
- The bars will not be displayed unless both upper and lower limit values have been set.

If the instrument is turned off while using the zoom display, the zoom display will remain activated when the instrument is next turned on.

## 3.4 Setting Measurement Conditions (Basic Settings)

(There are two types of measurement: AC measurement and DC measurement (p. 42).

The measurement conditions set for AC measurement and DC measurement differ.

Required: Be sure to set.

Optional: Change setting as necessary.

Setting	During AC measurement (When the parameter is other than Rdc)	During DC measurement (When the parameter is other than Rdc)	Ref.	Overview
Measurement frequency	Required	-	p. 47	Configure based on the measurement sample.
Measurement range	Required	Required	p. 48	
Measurement signal level	Required	-	p. 52	
Line frequency	-	Required	p. 57	Set to the power supply's frequency.
Measurement speed	Optional	Optional	p. 58	When you wish to perform measurement more quickly: <b>FAST</b> When you wish to perform measurement at a higher level of precision: <b>SLOW</b> , or <b>SLOW2</b>
Low Z high accuracy mode	Optional (default value: <b>OFF</b> )	Optional (default value: <b>OFF</b> )	p. 59	To perform high-precision measurement, set to <b>ON</b> . To measure at high speed: <b>OFF</b>
Average	Optional (default value: <b>OFF</b> )	Optional (default value: <b>OFF</b> )	p. 60	To limit variability of displayed values, set to <b>ON</b> .
Limit	Optional (default value: <b>OFF</b> )	-	p. 62	To limit the voltage or current that is applied to the sample, set to <b>ON</b> .
DC bias	Optional (default value: <b>OFF</b> )	-	p. 63	To superimpose a DC voltage on the measurement signal during measurement, set to <b>ON</b> .
DC adjust	-	Optional (default value: <b>OFF</b> )	p. 64	To reduce measurement error: <b>ON</b> To measure at high speed: <b>OFF</b>
Trigger Synchronous Output	Optional (default value: <b>OFF</b> , default value: 0.0010 s)		p. 68	To apply the signal during measurement only, set to <b>ON</b> .
Trigger Synchronous delay*	Optional (default value: 0.0010 s)			
DC delay*	-	Optional (default value: 0 s)	p. 65	Set to a sufficiently large value when you wish to stabilize measurement.
Adjustment delay*	-	Optional (default value: 0.0030 s)	p. 66	
Trigger	Optional (Default setting: <b>INT</b> ) Measurement is repeated automatically.		p. 66	To input signals and commands from an external source, set to <b>EXT</b> .
Trigger delay*	Optional (default value: 0 s)		p. 67	If the trigger function is enabled, set to a large enough value that measurement can stabilize.

\*Delay time (For more information about delay timing, see "Measurement and data acquisition timing" (p. 69).

Refer to the “AC,” “DC,” “AC/DC,” and “Common” notation next to settings.

(AC)	▶ Set when performing AC measurement.
(DC)	▶ Set when performing DC measurement.
(AC/DC)	<ul style="list-style-type: none"> <li>• Set when performing AC or DC measurement. Set on the <b>BASIC</b> tab screen for AC measurement and on the [Rdc] tab screen for DC measurement. (This explanation uses the [Basic] screen to explain the setting method, which is the same for both.)</li> <li>• AC measurement settings do not apply to DC measurement.</li> <li>• DC measurement settings do not apply to AC measurement.</li> </ul>
(Common)	▶ The setting applies to both AC and DC measurement and is set on the [Basic] tab screen.

## Required settings

### Measurement frequency (AC)

Set the frequency of the signal to apply to the test sample.  
Changing the measurement frequency setting may cause measured values to vary for some samples.

Screen display method (For more information, see p. 26.)  
(Measurement screen) **SET** key>(SET screen) **BASIC** tab>**FREQ** key

- 1 Enter each digit of the frequency with the ▲▼ buttons.

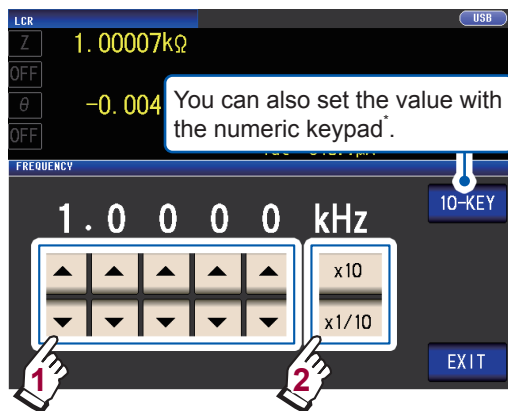

(Settable range :4 Hz to 8 MHz)

Set the decimal point and unit with the **×10** and **×1/10** keys.

<b>×10</b>	Sets the measurement frequency to ×10.
<b>×1/10</b>	Sets the measurement frequency to ×1/10.

- 2 Touch the **EXIT** key twice.  
Displays the measurement screen.

\*Use the numeric keypad to enter the frequency.

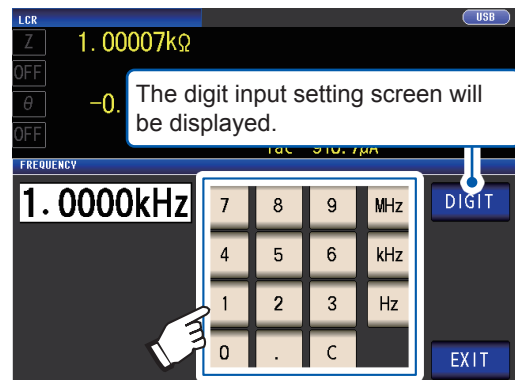

If you make a mistake, touch the **C** key to reenter the value.

- The frequency is not confirmed until a unit key is pressed. (During numeric keypad entry only)
- The unit keys are disabled until a number is entered. (During numeric keypad entry only)
- If you set a value in excess of 8 MHz, the value will be automatically set to 8 MHz.
- If you set a value less than 4 Hz, the value will be automatically set to 4 Hz.

## Measurement range (AC/DC)

There are the following three methods for setting the measurement range.

<b>AUTO (p. 49)</b>	▶ The most suitable test range is set automatically. (This setting is useful when measuring a sample whose impedance varies greatly with measurement frequency or when measuring an unknown sample.)
<b>HOLD (p. 50)</b>	▶ The measurement range is fixed. The range is set manually. (High-speed measurement is possible.)
<b>JUDGE SYNC (JUDGE synchronization) (p. 51)</b>	▶ The optimal range is set automatically based on the comparator or BIN measurement judgment standard. (This setting is useful when measuring a sample whose impedance varies greatly with measurement frequency.)

- Ranges consist of impedance values. Consequently, values for measurement parameters other than impedance are calculated based on the measured  $|Z|$  and  $\theta$  values.  
See “Appx. 1 Measurement Parameters and Calculation Formula” (p. Appx.1).
- Enabling the HOLD setting or AUTO setting while the JUDGE SYNC setting is on will cause the JUDGE SYNC setting to be turned off.
- The selection of ranges that can be set during AC measurement varies with the measurement frequency, DC bias on/off setting, and cable length setting. For more information, see p. 219 of “10.6 Measurement Range and Accuracy”.
- The guaranteed accuracy range varies depending on the measurement conditions. Check the accuracy assured ranges in “Guaranteed accuracy measurement level range” (p. 221).
- The range of impedance for each range for which accuracy is guaranteed refers to the total impedance for the sample and measurement cables (probe and fixture) (p. 198).
- When the measurement value is outside the guaranteed accuracy range, the following icon appears at the top of the screen.



This issue may be the result of the following causes. Check the guaranteed accuracy range as described in “Guaranteed accuracy measurement level range” (p. 221) and either change the measurement signal level and measurement range or use the measured value for reference purposes only.

- The test signal level is too low: Increase the test signal level.
- The current measurement range is not appropriate: Either change the measurement range or change to the AUTO setting so that the instrument can select an optimal range automatically.

## Setting AUTO ranging

Screen display method (For more information, see p. 26.):

AC measurement: (Measurement screen) **SET** key>(SET screen) **BASIC** tab>**RANGE** key

DC measurement: (Measurement screen) **SET** key>(SET screen) **Rdc** tab>**RANGE** key

### 1 Touch the **AUTO** key.



### 2 Touch the **EXIT** key twice.

Displays the measurement screen.

- If the instrument is being used outside the limits of its specification, the suitable range may not be set in auto ranging function. Check the accuracy assured ranges in “Guaranteed accuracy measurement level range” (p. 221) and then change the test conditions.
- Manually changing the set range while using the **AUTO** setting will cause the instrument to switch to the **HOLD** setting.

The AUTO range limit function allows you to limit the AUTO ranging range.

### 1 Touch the **MIN** key.



### 2 Select the AUTO range lower limit range.



### 3 Touch the **EXIT** key.

The display will return to the screen shown in step 1.

### 4 Touch the **MAX** key, and select the AUTO range upper limit range.

### 5 Touch the **EXIT** key twice.

Displays the measurement screen.

The AUTO range scope is the selection of ranges within which the AUTO range is selected. If the AUTO range scope has been limited, the instrument will not select a range that lies outside that scope. For more information about the AUTO range scope, see “Measurement range” (p. 198).

- When canceling the AUTO range limit function, set the lower limit range to 100 mΩ and the upper limit range to 100 MΩ.  
**Range selection screen when the AUTO range scope has been limited**

Example: When the lower limit range is set to 1 kΩ and the upper limit range is set to 1 MΩ

Ranges that fall outside the AUTO range scope will not be shown.



## Setting the ranging to HOLD

Screen display method (For more information, see p. 26.):

AC measurement: (Measurement screen) **SET** key>(SET screen) **BASIC** tab>**RANGE** key

DC measurement: (Measurement screen) **SET** key>(SET screen) **Rdc** tab>**RANGE** key

### 1 Touch the **HOLD** key and then select the measurement range.

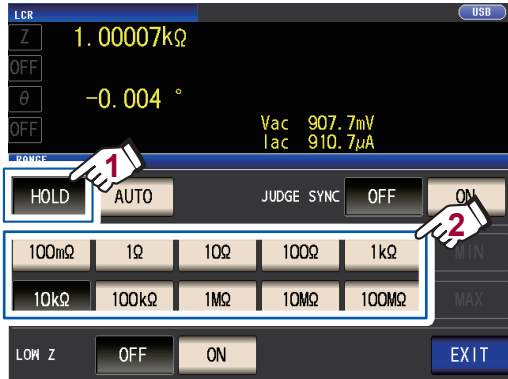

The measurement range is set based on the total impedance of the sample, measurement cable, and probe or test fixture.

### 2 Touch the **EXIT** key twice.

Displays the measurement screen. For more information about the guaranteed accuracy range for each measurement range, see "Measurement range" (p. 198).

- If you change the measurement frequency during AC measurement using the HOLD setting of a sample whose impedance varies with frequency, you may not be able to perform measurement using the same range. In this case, change the measurement range setting.
- If **OVER FLOW (UNDER FLOW)** is indicated as the measured value, measurement cannot be performed with the current measurement range. Change the measurement range or change to the AUTO setting so that the instrument can select an optimal range automatically.
- The measurement range is set based on the total impedance of the sample and measurement cable. Consequently, you may not be able to perform measurement if you set the measurement range using the HOLD setting based solely on the sample's impedance (for example, if the measurement cable's parasitic Z [Y] value is large, as it is in long cables). In this case, perform correction, check the sample's impedance and the fixture's residual component, and determine the measurement range based on those values. (See "5.2 Open Correction" (p. 105), "5.3 Short Correction" (p. 112), and "Appx. 8 Open Correction and Short Correction" (p. Appx.11).)
- Available range settings are limited based on the measurement frequency and cable length settings. (See p. 219 of "10.6 Measurement Range and Accuracy"..)

**Judgment synchronization setting**

When the JUDGE SYNC setting is turned on, the instrument will select the optimal range automatically based on the comparator measurement or BIN measurement judgment standard. (See “Judging Measurement Results” (p. 72).)

This setting is useful when performing comparator measurement or BIN measurement of a variety of impedance samples, including samples whose impedance varies greatly with frequency.

Screen display method (For more information, see p. 26.):

AC measurement: (Measurement screen) **SET** key>(SET screen) **BASIC** tab>**RANGE** key

DC measurement: (Measurement screen) **SET** key>(SET screen) **Rdc** tab>**RANGE** key

(Example: Comparator)

**1 Touch the JUDGE SYNC ON key.**

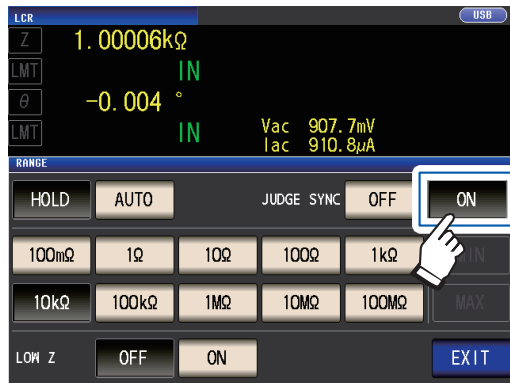

**2 Touch the EXIT key twice.**

Displays the measurement screen.

- This setting is only available when the judgment standards have been set for comparator and BIN measurement
- When the comparator and BIN measurement judgment standards have been set with this setting enabled, the instrument will automatically switch to the optimal range. If no judgment standard has been set, the instrument will function the same as when the AUTO setting is enabled.
- If only the  $\theta$ , D, or Q measurement parameter has been set, the instrument will function the same as when the AUTO setting is enabled.
- During AC measurement, because the phase angle cannot be calculated for some combinations of parameters, the range is determined from ideal values. For more information, see the table below. (See also “Appx. 1 Measurement Parameters and Calculation Formula” (p. Appx.1)).
- Set the range based on the maximum value for the comparator measurement or BIN measurement judgment standard. Depending on the judgment standard setting, measured values may fall outside the guaranteed accuracy range.

**3**

Performing Measurements in LCR Mode

**Parameter combination conditions for the judgment synchronization setting**

You may be unable to enable the JUDGE SYNC setting for certain combinations of No. 1 and No. 3 parameters.

**(1) AC measurement**

		No. 3 parameter																		
		AC	OFF	Z	Y	Rs	Rp	X	G	B	Ls	Lp	Cs	Cp	$\theta$	D	Q	$\sigma$	$\epsilon$	
No. 1 parameter	OFF	x	●	●	●	●	●	●	●	●	●	●	●	●	x	x	x	x	x	
	Z	●	●	●	●	△	△	△	△	△	△	△	△	△	△	●	●	●	△	△
	Y	●	●	●	●	△	△	△	△	△	△	△	△	△	△	●	●	●	△	△
	Rs	△	△	△	△	△	△	△	△	△	△	△	△	△	△	●	●	●	△	△
	Rp	△	△	△	△	△	△	△	△	△	△	△	△	△	△	●	●	●	△	△
	X	△	△	△	△	△	△	△	△	△	△	△	△	△	△	●	●	●	△	△
	G	△	△	△	△	△	△	△	△	△	△	△	△	△	△	●	●	●	△	△
	B	△	△	△	△	△	△	△	△	△	△	△	△	△	△	●	●	●	△	△
	Ls	△	△	△	△	△	△	△	△	△	△	△	△	△	△	●	●	●	△	△
	Lp	△	△	△	△	△	△	△	△	△	△	△	△	△	△	●	●	●	△	△
	Cs	△	△	△	△	△	△	△	△	△	△	△	△	△	△	●	●	●	△	△
	Cp	△	△	△	△	△	△	△	△	△	△	△	△	△	△	●	●	●	△	△
	$\theta$	x	●	●	●	●	●	●	●	●	●	●	●	●	●	x	x	x	x	x
	D	x	●	●	●	●	●	●	●	●	●	●	●	●	●	x	x	x	x	x
	Q	x	●	●	●	●	●	●	●	●	●	●	●	●	●	x	x	x	x	x
	$\sigma$	x	△	△	△	△	△	△	△	△	△	△	△	△	△	x	x	x	x	x
	$\epsilon$	x	△	△	△	△	△	△	△	△	△	△	△	△	△	x	x	x	x	x

x: Invalid setting (Same operation as AUTO setting),

△: Set from ideal value since phase angle cannot be calculated., ●: Configurable



(2) DC measurement

		No. 3 parameter	
		OFF	Rdc
No. 1 parameter	OFF	×	●
	Rdc	●	●

×: Invalid setting (Same operation as AUTO setting), ●: Configurable

**Measurement signal level (AC)**

Sets the measurement signal level to apply to the sample.

The measurement signal level applied to the sample can be set using the following three modes: (See “About the measurement signal mode” (p. 56).)

<b>Open circuit voltage (V) mode</b>	▶	The value of the open circuit voltage is set.
<b>Constant voltage (CV) mode</b>	▶	The value of the voltage between the terminals of the object under test is set.
<b>Constant current (CC) mode</b>	▶	The value of the current flowing through the object under test is set.

Selecting constant-voltage or constant-current mode will result in longer measurement times (due to the use of software feedback control).

For some samples, changing the measurement signal level setting will cause measured values to vary.

**⚠ CAUTION**



Do not switch between V, CV and CC while the test sample is still connected to the measurement terminals because doing so may damage the test sample.

Screen display method (For more information, see p. 26.):  
 (Measurement screen) **SET** key>(SET screen) **BASIC** tab>**LEVEL** key

**1** Select the measurement signal mode.

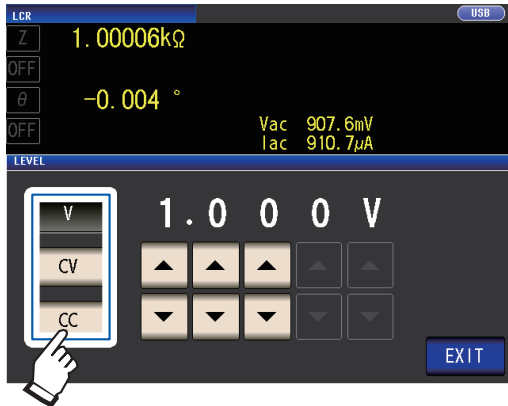

- V** Open circuit voltage (V) mode
- CV** Constant voltage (CV) mode
- CC** Constant current (CC) mode

**2** Use the ▲▼ key to enter voltage level or current level.

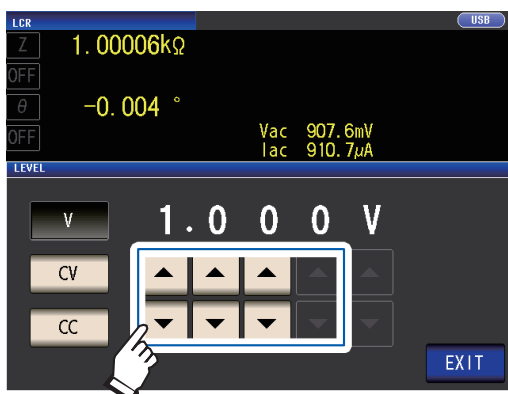

Measurement signal mode	Settable range
V, CV	4 Hz to 1.0000 MHz: 0.010 V to 5.000 V 1.0001 MHz to 8 MHz: 0.010 V to 1.000 V
CC	4 Hz to 1.0000 MHz: 0.01 mA to 50.00 mA 1.0001 MHz to 8 MHz: 0.01 mA to 10.00 mA

**3** Touch the EXIT key twice.  
Displays the measurement screen.

• When low Z high accuracy mode (p. 59) is on, the valid setting range will vary.

Measurement signal mode	Settable range
V, CV	0.010 V to 1.000 V
CC	<ul style="list-style-type: none"> <li>• When the output impedance is 10 Ω: 0.01 mA to 100.00 mA</li> <li>• When the output impedance is 100 Ω: 0.01 mA to 10.00 mA</li> </ul>

See: “For setting range and accuracy” (p. 54)  
 • The accuracy of testing varies according to the test signal level.  
 See: “Guaranteed accuracy measurement level range” (p. 221)

**For setting range and accuracy**

**Open circuit voltage (V) mode and Constant voltage (CV) mode setting**

	Normal operation	When low Z high accuracy mode (p. 59) is on
<b>Open circuit voltage setting range</b>	0.010 V to 5.000 V	0.010 V to 1.000 V
<b>Open circuit voltage accuracy</b>	1 MHz or less: ±10% rdg. ±10 mV, 1.0001 MHz or more: ±20% rdg. ±10 mV	
<b>Output impedance</b>	100 Ω ±10 Ω	10 Ω ±2 Ω

For some samples, you may not be able to perform constant-voltage measurement (measurement in constant-voltage mode) In this situation, the following error will be displayed:

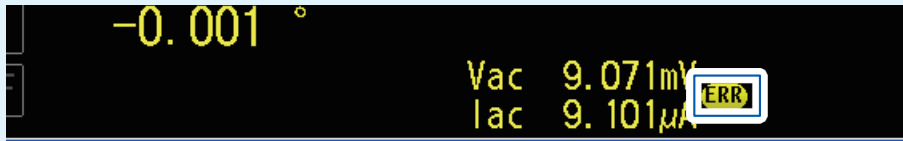

Constant voltage measurement will not be performed. Change the constant-voltage value to a value that is less than or equal to the value displayed for **Vac**.

(Example: Constant-voltage measurable range when measuring a C value of 1 µF at 10 kHz)  
The sample impedance  $Z_m$  is as follows:

$$Z_m = R_m + jX_m = 0 [\Omega] - j15.9 [\Omega] \quad X_m = \frac{-1}{(2\pi fC)}$$

The impedance  $Z_m'$  as seen from the instrument's voltage generator is as follows:  
 $Z_m' = R_o + Z_m = 100[\Omega] - j15.9 [\Omega]$   $R_o$ : Output resistance (100 [Ω])

Accordingly, the voltage  $V_m$  across both leads of the sample is as follows:

$$V_m = \frac{|Z_m| \times V_o}{|Z_m'|} = \frac{15.9 [\Omega] \times V_o}{101.3 [\Omega]} \quad V_o: \text{generator output}$$

Since the instrument's voltage generator output range is 10 [mV] to 5 [V] as per the above table, the constant-voltage measurable range is  $V_m = 1.6$  [mV] to 0.78 [V] based on the above formula.

When low Z high accuracy mode is enabled, the output resistance  $R_o$  will be 10 [Ω].

**Constant current (CC) mode setting**

	Low Z high accuracy mode (p. 59) is set to OFF	Low Z high accuracy mode (p. 59) is set to ON
Constant current setting range	0.01 mA to 50.00 mA	0.01 mA to 100.00 mA
Constant current accuracy	±1%±10 μA	
Output impedance	100 Ω ±10 Ω	10 Ω ±2 Ω

For some samples, you may not be able to perform constant-current measurement (measurement in constant-current mode). In this case, the following error will be displayed:

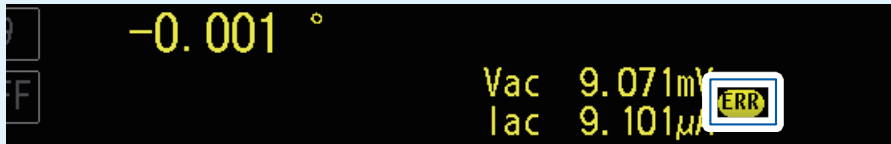

Constant current measurement will not be performed. Change the constant-current value to a value that is less than or equal to the value displayed for Iac.

(Example: Constant-current measurable range when measuring an L value of 1 mH at 1 kHz)  
Sample impedance  $Z_m$  becomes as follows:

$$Z_m = R_m + jX_m = 0 [\Omega] - j6.28 [\Omega] \quad X_m = 2\pi fL$$

The impedance  $Z_m'$  as seen from the instrument's voltage generator is as follows:

$$Z_m' = R_o + Z_m = 100 [\Omega] - j6.28 [\Omega] \quad R_o: \text{Output resistance (100 } [\Omega])$$

Accordingly, the current  $I_m$  across both leads of the sample is as follows:

$$I_m = \frac{V_o}{|Z_m'|} = \frac{V_o}{100.2 [\Omega]} \quad V_o: \text{generator output}$$

Since the instrument's voltage generator output range is 10 [mV] to 5 [V] as per the above table, the constant-voltage measurable range is  $I_m = 0.10$  [mA] to 49.9 [mA] based on the above formula.

When low Z high accuracy mode is enabled, the output resistance  $R_o$  will be 10 [Ω].

- When the measurement value is outside the guaranteed accuracy range, the following error message appears at the top of the screen.

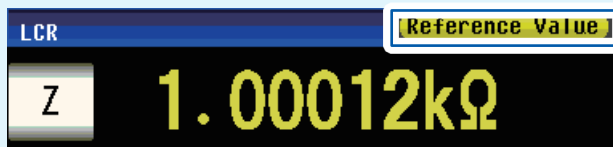

In this case, you should consider the following possible causes, and you should either change the measurement signal level and measurement range while checking the accuracy assured ranges "Guaranteed accuracy measurement level range" (p. 221), or you should consider the measured values as values for reference.

- Measurement signal level is too low: Increase the test signal level.
- The current measurement range is inappropriate (when using the HOLD setting): set again in the AUTO range, or change the range by manual.

**About the measurement signal mode**

Relationship between the measurement signal mode of the instrument and the sample is as follows.

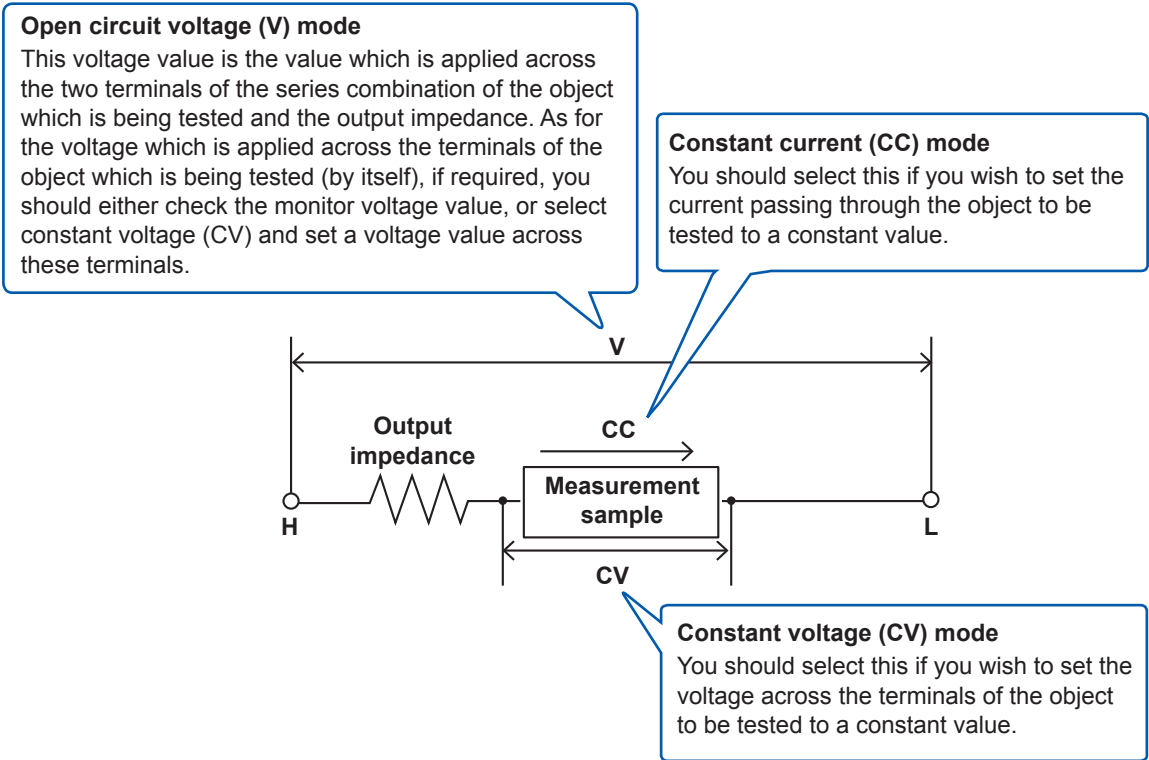

**Constant-voltage (CV) mode operation**  
 When the sample's impedance is higher than the previous measurement, a voltage that is greater than the set voltage level will be applied, and this may damage the sample. This is due to the fact that the output voltage is controlled, and the set voltage level applied, by means of a software feedback process that observes the voltage across the sample's terminals when the same voltage level is applied as during the previous measurement.

**Constant-current (CC) mode operation**  
 When the sample's impedance is less than the previous measurement, a current that is greater than the set current level may be applied. This is due to the fact that the output voltage is controlled, and the set current level applied, by means of a software feedback process that observes the voltage across the sample's terminals when the same voltage level is applied as during the previous measurement.

## Line frequency (DC)

When performing DC measurement, be sure to set the line frequency of the power supply being used.

Screen display method (For more information, see p. 26.):  
(Measurement screen) **SET** key>(SET screen) **Rdc** tab>**LINE FREQ** key

### 1 Select the line frequency.



**50 Hz** Sets the line frequency to 50 Hz.

**60 Hz** Sets the line frequency to 60 Hz.

### 2 Touch the **EXIT** key twice.

Displays the measurement screen.

To suppress noise, the instrument needs to be set to match the frequency of the power source. Before operating, set the instrument to the frequency of your commercial power. If the supply frequency is not set properly, measurements will be unstable.

## User-configurable settings

### Measurement speed (AC/DC)

The measurement speed can be set. The slower the measurement speed is, the more accurate are the results.

Screen display method (For more information, see p. 26.):

AC measurement (Measurement screen) **SET** key>(SET screen) **BASIC** tab>**SPEED** key

DC measurement (Measurement screen) **SET** key>(SET screen) **Rdc** tab>**SPEED** key

#### 1 Select the measurement speed.



Measurement speed	Measurement time	Measurement accuracy
<b>FAST</b>	Short	Low
<b>MED</b>	↓	↓
<b>SLOW</b>		
<b>SLOW2</b>	Long	High

#### 2 Touch the **EXIT** key twice.

Displays the measurement screen.

- Measurement time varies with the measurement conditions. (See “10.7 About Measurement Times and Measurement Speed” (p. 225).)
- The waveform averaging function allows you to set the measurement speed at a higher level of detail.
- The measurement speed cannot be set using the **SPEED** key when the waveform averaging function is enabled.  
(See “Waveform averaging function (increasing measurement precision or measurement speed)” (p. 86).)

### Low Z High Accuracy Mode (high-precision measurement) (AC/DC)

Enabling low Z high accuracy mode will switch the output resistance to 10 Ω, enabling high-precision measurement by allowing an adequate amount of current to flow to the measurement sample.

Screen display method (For more information, see p. 26.):

AC measurement (Measurement screen) **SET** key>(SET screen) **BASIC** tab>**RANGE** key

DC measurement (Measurement screen) **SET** key>(SET screen) **Rdc** tab>**RANGE** key

#### 1 Touch the **LOW Z ON** key.

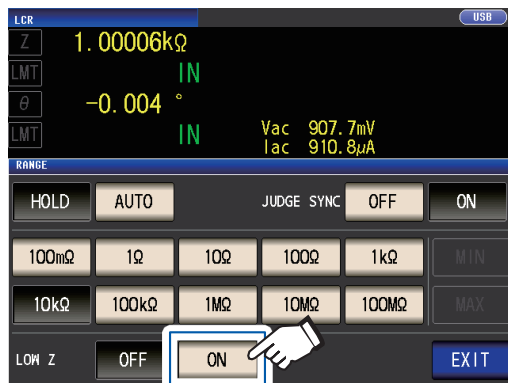

- In low Z high accuracy mode, the measurement signal level setting range changes. (p. 54)
- Changing the low Z high accuracy mode setting while open correction, short correction, or load correction is enabled causes the correction values to be disabled.
- Low Z high accuracy mode can only be enabled while using the 100 mΩ, 1 Ω, or 10 Ω range. See the table below.

#### 2 Touch the **EXIT** key twice.

Displays the measurement screen.

Measurement range	DC measurement	AC measurement (measurement frequency)					
		to 1 kHz	to 10 kHz	to 100 kHz	to 1 MHz	to 5 MHz	to 8 MHz
100 MΩ							
10 MΩ							
1 MΩ							
100 kΩ							
10 kΩ							
1 kΩ							
100 Ω							
10 Ω							
1 Ω							
100 mΩ							

Even if low Z high accuracy mode is set to **ON**, the output resistance will remain 100 Ω. (The measurement signal level will be limited to 1 V or less.)

Low Z high accuracy mode is enabled. (When low Z high accuracy mode is off, the output resistance will be 100 Ω.)



## Averaging (limiting display value instability) (AC/DC)

With the averaging function, the measured values can be averaged. This function can be used to limit instability of displayed measured values.

### AC measurement

With internal trigger

A rolling average of the tested values over the set number of times for averaging is always calculated backwards from the present.  
(When the sample to be tested is changed over, it takes a little time for a certain stabilization time period until the results is reliable.)

With external trigger

Average over the number of averaging times based on trigger input.

### DC measurement

Averaging processing during DC measurement calculated an arithmetic average regardless of the trigger setting.

Screen display method (For more information, see p. 26.):

AC measurement (Measurement screen) **SET** key>(SET screen) **BASIC** tab>**AVG** key

DC measurement (Measurement screen) **SET** key>(SET screen) **Rdc** tab>**AVG** key

- 1 Use **▲▼** key to enter the number of averaging times.

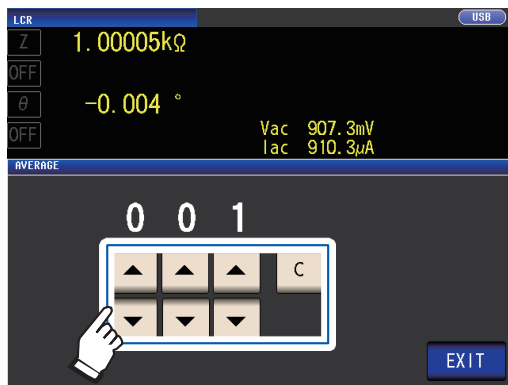

Settable range: 1 to 256

To disable the averaging function, touch the **C** key.

(The setting will be set to 001.)

- 2 Touch the **EXIT** key twice.

Displays the measurement screen.

When the range is changed, including by auto-range operation, averaging processing up to that point is cleared and then resumed.

Example: If the number of averaging iterations is set to 4 (measurement count, measured value output points, and method for calculating measured values at output)

**(1) Moving average**

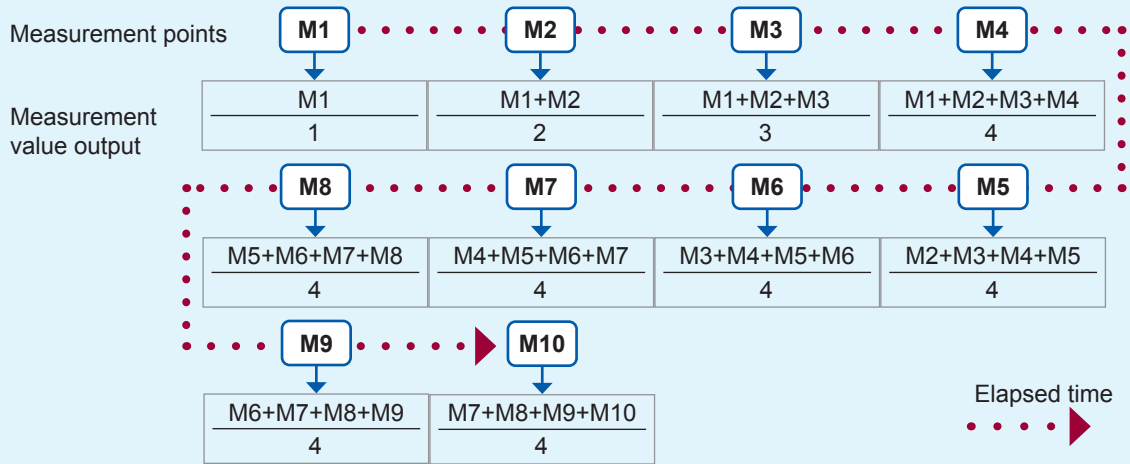

**(2) Arithmetic mean**

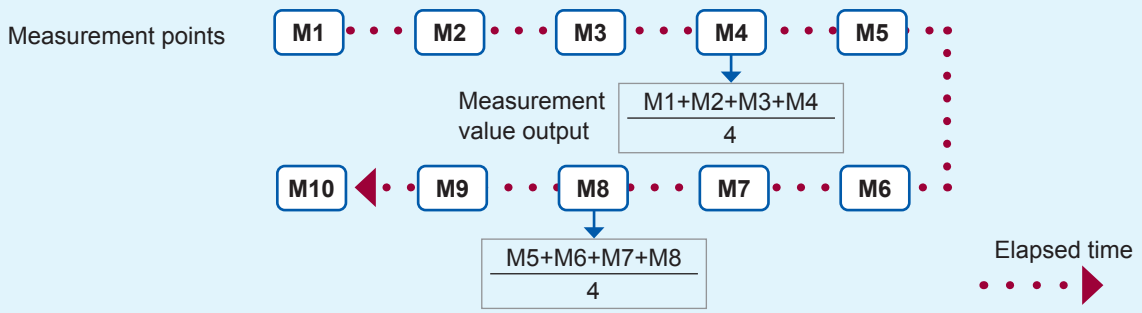

## Limit (limiting the voltage and current applied to the sample) (AC)

Depending on the measurement signal level, in some cases it is possible to damage the sample which is being measured by applying to it a voltage or a current greater than its rated value. (See “Constant voltage (CV) mode” (p. 56), and “Constant-current (CC) mode operation” (p. 56).)

To prevent such damage, you can set limits on the voltage that will be applied to the sample or the current that will flow to the sample.

Enabling the limit function increases the measurement time (due to the use of software feedback control).

When open circuit voltage (V) mode or constant voltage (CV) mode is set

▶ Set the current limit.

When constant current (CC) mode is set

▶ Set the voltage limit.

Screen display method (For more information, see p. 26.):  
(Measurement screen) **SET** key>(SET screen) **BASIC** tab>**LIMIT** key

### 1 Touch the **ON** key.

(Example screen: When the measurement signal mode is V or CV)

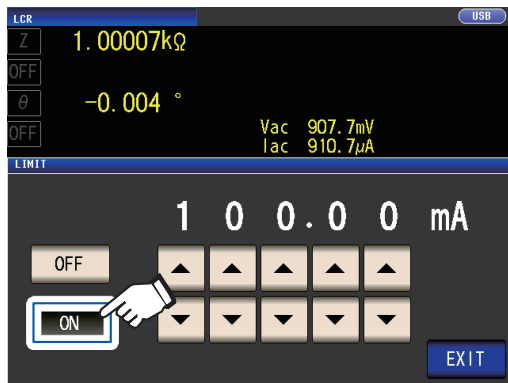

### 2 Use the **▲▼** key to enter the limit value.

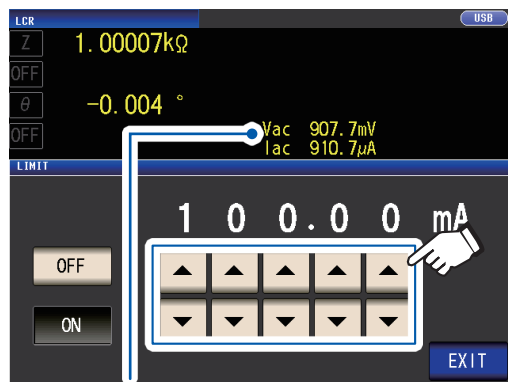

You can check the voltage and current between the sample terminals using monitor values. Monitor values differ depending on the measurement signal mode setting (V, CV, CC).

Measurement signal mode	Limit set	Settable range
V, CV	Current limit	0.01 mA to 100.00 mA
CC	Voltage limit	0.01 V to 5 V

Current limit accuracy:  $\pm 1\% \pm 10 \mu\text{A}$   
Voltage limit accuracy:  $\pm 1\% \pm 10 \text{mV}$

### 3 Touch the **EXIT** key twice.

Displays the measurement screen.

- First set the measurement signal level, and thereafter set the voltage or current limit.
- The screen used to set the limit function varies depending on the measurement signal mode that has been selected (V, CV mode: current limit; CC mode: voltage limit). See “Measurement signal level (AC)” (p. 52).

When the limit function is **ON**, you may encounter a display such as the following. (Example: When constant voltage (CV) setting)



**ERR:** If the voltage or current which is applied to the sample under test exceeds the limit value (the current exceeding the limit value flows through the sample even when the open-circuit voltage is set to minimum value.)

Lower the measurement signal level so that the limit value is not exceeded.



**LMT:** When a lower signal level than the setting is being applied to the sample due to the voltage limit or current limit value setting

At this time, the voltage or current which exceeds the limit value is not being applied to the sample under test. You should change the test signal level so that it does not exceed the limit value.

## DC bias (superimposing a DC voltage on the measurement signal)(AC)

You can superimpose a DC voltage on the measurement signal during capacitor measurement.

Screen display method (For more information, see p. 26.):

(Measurement screen) **SET** key>(SET screen) **BASIC** tab>**DC BIAS** key

### 1 Touch the **ON** key.

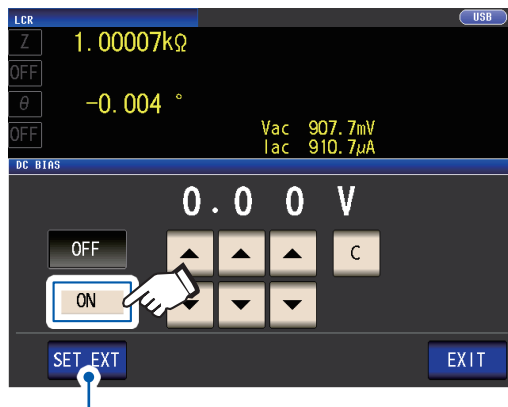

Touch this button when using an external DC bias unit (option).

The DC bias will be set to ON, and the bias value will be set to 0.00 V.

### 2 Set the DC voltage value to superimpose with the **▲▼** keys.

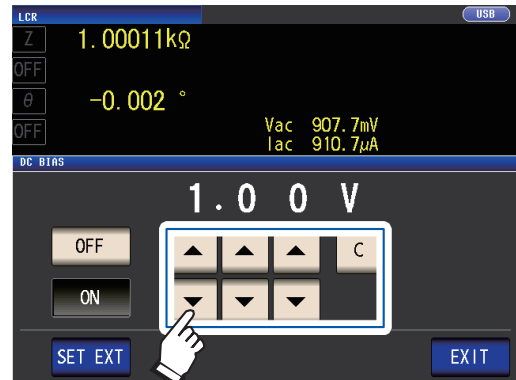

Settable range 0 V to 2.5 V

If you make a mistake, touch the **C** key and reenter the value.

### 3 Touch the **EXIT** key twice.

Displays the measurement screen.

If low Z high accuracy mode (p. 59) is enabled, the valid setting range will differ. (0 V to 1.0 V)

- The DC bias function is specifically for capacitor measurement. If it is used for resistor, inductor, and other elements with low DC resistance, the following are likely.
  - Normal measurement is not possible.
  - AUTO ranging is unable to determine a range.
- If the parameter has been set to **Rdc**, you will not be able to enable the DC bias function.
- When superimposing a DC voltage that falls outside the valid setting range for the DC bias function, refer to “How to supply a DC bias voltage” (p. Appx.7).
- When superimposing a DC voltage on a coil or the like, refer to “How to supply a DC bias current” (p. Appx.8).
- If the total value for the measurement signal level (AC level setting value  $\times \sqrt{2}$  + DC bias setting value) will become  $>5\sqrt{2}$  [V], the measurement signal and DC bias value cannot be raised any higher. Reduce the measurement signal level or DC bias value, and then configure the setting. In low Z high accuracy mode, the measurement signal level and DC bias value can be set when the total value is in the range of  $\sqrt{2}$  [V] or below.
- The selection of ranges that can be set varies depending on whether the DC bias function is enabled or disabled. For more information, see p. 219 of “10.6 Measurement Range and Accuracy”.

## DC adjustment (reducing measurement error) (DC)

Enabling the DC adjustment function causes the instrument to set the generated voltage to 0 V and acquire the offset value generated by its internal circuitry in order to reduce measurement error. (Default setting: ON)

Disabling the DC adjustment function allows high-speed DC resistance measurement since the offset value is not acquired before each measurement is performed.

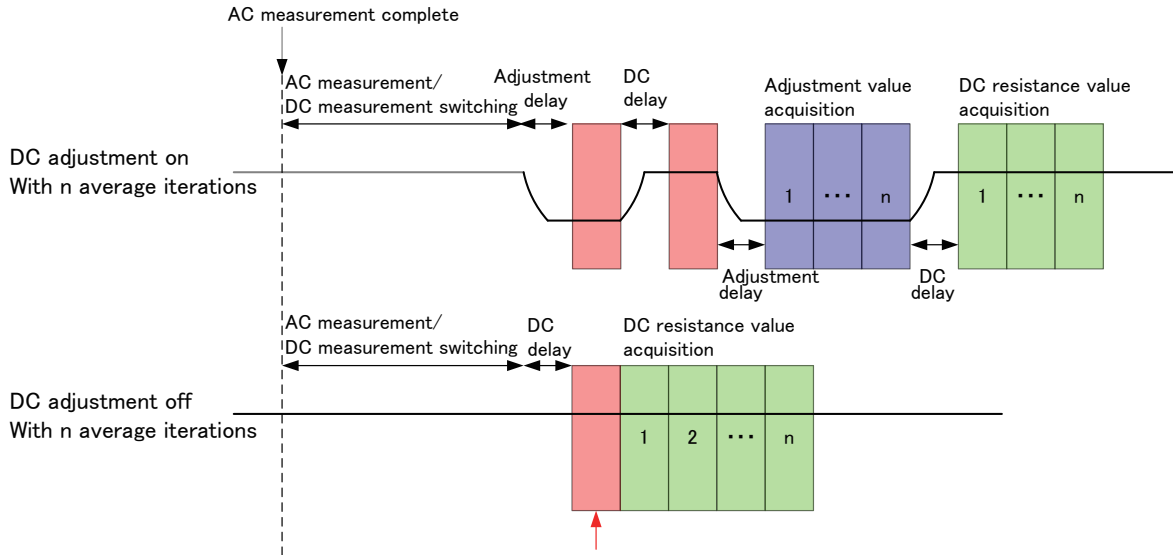

During auto-range operation, the instrument performs measurement to determine the range (the result is not applied to measured values).

- Disabling DC adjustment may cause the measurement error to increase.
- When using the instrument with DC adjustment disabled, acquire the adjustment value with the sample (or a circuit with equivalent DC resistance [Rdc]) connected.
- Because the adjustment value will vary when the sample's Rdc or ambient temperature changes, disabling DC adjustment will prevent accurate measurement.

Screen display method (For more information, see p. 26.):  
 (Measurement screen) **SET** key>(SET screen) **Rdc** tab>**DC ADJ** key

### 1 Touch the **ON** key.



- OFF** Acquires the offset value at the time shown below.
- ON** Obtains the offset value for each measurement.
- GET DCR OFFSET** Acquires the DC adjustment value. (Valid only when the DC ADJ setting is disabled.)

Selecting **OFF** will cause the following message to be displayed.

**"Please Get DCR Offset."** (Acquire the DCR offset value.)

Touching **EXIT** will close the message.

### 2 Touch the **EXIT** key twice.

Displays the measurement screen.

- Measurement is switched between 1 V and 0 V to acquire the offset value. Set the DC delay (p. 65) and adjustment delay (p. 66) so that the measurement sample's inductance does not affect measured values. Start with a long value for both and gradually shorten it while observing measured values.
- When the DC adjustment function is enabled, measurement will include both the normal measurement time and the offset measurement time, resulting in measurement times that are about twice as long as when the DC adjustment function is disabled.
- Offset measurement is performed as follows when the DC function setting is off (once the first trigger signal is received under the following conditions, the offset value is acquired when output reaches 0 V and the adjustment delay is in effect):
  - When changing the Rdc measurement range (including the AUTO range)
  - When enabling or disabling Rdc low Z high accuracy mode (for ranges from 100 mΩ to 10 Ω)
  - When changing the adjustment delay time (See "Measurement and data acquisition timing" (p. 69).)
  - When the **GET DCR OFFSET** key is touched (Touching the **GET DCR OFFSET** key again before the trigger signal is received will cancel offset measurement.)
  - When the CALIB signal is input from an external device to the EXT I/O connector (p. 170)
  - When the **:DCResistance:ADJust:DEMAND** interface communications command is sent from an external device
- If the parameter has not been set to **Rdc**, the **GET DCR OFFSET** key will be disabled.

## DC delay (setting the DC measurement delay time) (DC)

Sets the time allowed to elapse before starting DC measurement after AC measurement. This delay time is used to delay measurement until the DC signal level stabilizes.

For more information about DC delay timing, see the figures in "Measurement and data acquisition timing" (p. 69).

Screen display method (For more information, see p. 26.):

(Measurement screen) **SET** key>(SET screen) **Rdc** tab>**DC DELAY** key

- 1 Use the **▲▼** key to enter the DC delay time.

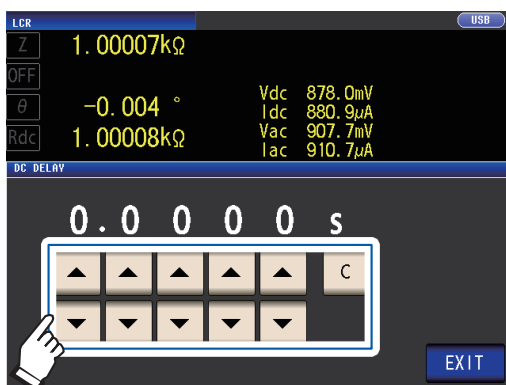

Settable range: 0 s to 9.9999 s

To disable the DC delay setting, touch the **C** key.

(The delay will be set to 0 sec.)

- 2 Touch the **EXIT** key twice.  
Displays the measurement screen.

The time required until the DC signal level stabilizes differs depending on the test sample to be measured. To ensure measurement is performed accurately, observe the measurement waveform in advance and then set the delay time required until the DC signal level stabilizes.

## Adjustment delay (setting the offset measurement delay time) (DC)

This delay time serves to delay measurement until offset measurement (0 V DC) stabilizes. For more information about adjustment delay timing, see the figures in "Measurement and data acquisition timing" (p. 69).

Screen display method (For more information, see p. 26.):

(Measurement screen) **SET** key>(SET screen) **Rdc** tab>**ADJ DELAY** key

### 1 Change the adjustment delay time with the ▲▼ keys.

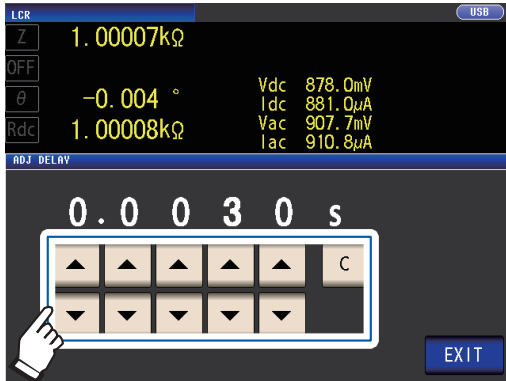

Settable range: 0.0030 s to 9.9999 s

To revert the setting to the default value, touch the **C** key. (The set time is set to 0.0030 s.)

### 2 Touch the **EXIT** key twice.

Displays the measurement screen.

The time required until the DC signal level stabilizes differs depending on the test sample to be measured. To ensure measurement is performed accurately, observe the measurement waveform in advance and then set the delay time required until the DC signal level stabilizes.

## Trigger (perform measurements with user-defined timing) (Common)

Trigger functionality allows you to start and stop recording based on a particular signal. When recording is started or stopped by a specific signal, we say the trigger is "applied" or "triggering occurs".

With this instrument, you can select the following two types of trigger.

<b>Internal Trigger</b>	Generates the trigger signal internally and repeats measurement automatically.
<b>External trigger</b>	Accepts input of signals and commands from an external source to control measurement. You can also apply the trigger manually on the instrument's screen.

This setting applies to both AC and DC measurement.

Screen display method (For more information, see p. 26.):

(Measurement screen) **SET** key>(SET screen) **BASIC** tab>**TRIG** key

### 1 Select the trigger type.

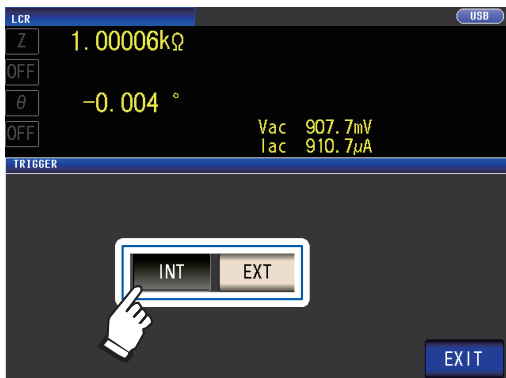

<b>INT</b>	Internal trigger Automatically repeats measurement.
<b>EXT</b>	External trigger Input the trigger manually via EXT I/O or from the interface.

### 2 Touch the **EXIT** key twice.

Displays the measurement screen.

**External trigger input method**

There are the following three types of input method for a trigger.

- Touching the **TRIG** key on the screen to manually apply the trigger causes the instrument to perform one measurement.

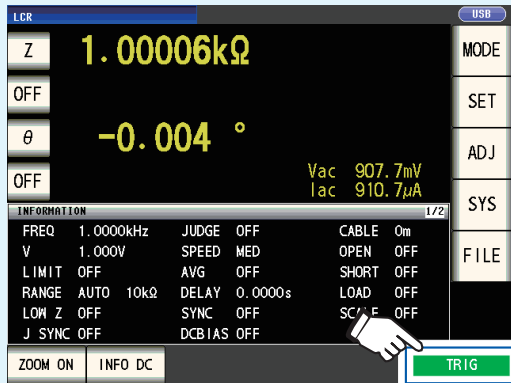

Measurement screen

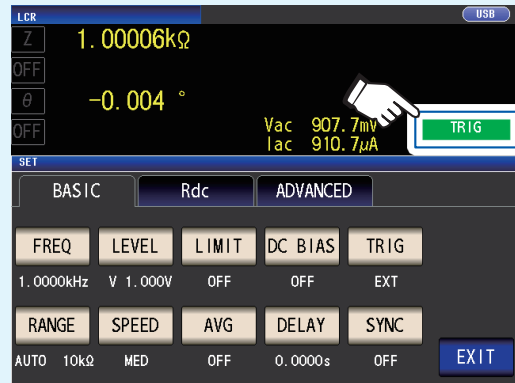

SET screen

- Input via EXT I/O: Measurement is performed once each time a negative logic pulse signal is applied. See “9.1 External Input/Output Connector and Signals” (p. 170).
- Input from interface: Measurement is performed once when \*TRG is transmitted. Refer to the Communications Instruction Manual on the bundled LCR Application Disc.

**Trigger delay (inserting a delay between the trigger and measurement)(Common)**

The delay time period from input of the trigger signal to measurement can be set.

With this function it is possible to ensure that testing is started after the connection condition of the object being tested and the test cables has stabilized.

The setting applies to both AC and DC measurement.

See “Trigger delay and Trigger synchronous output” (p. 68).

For more information about trigger delay timing, see the figures in “Measurement and data acquisition timing” (p. 69).

Screen display method (For more information, see p. 26.):

(Measurement screen) **SET** key>(SET screen) **BASIC** tab>**DELAY** key

- 1 Use the **▲▼** key to enter the trigger delay time.

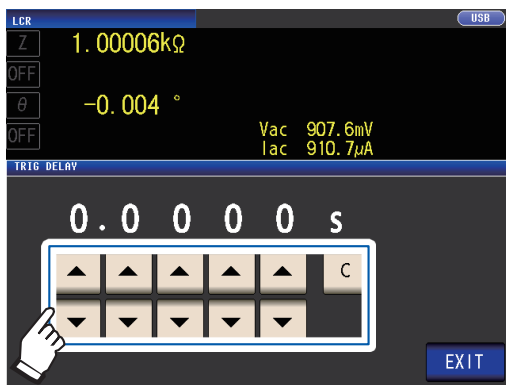

Settable range: 0 s to 9.9999 s with resolution of 0.1 ms

When you want to turn off the trigger delay setting, touch the **C** key.

(The set time is set to 0 s.)

- 2 Touch the **EXIT** key twice.  
Displays the measurement screen.

When a trigger delay has been set, the measurement LED will light up from the time trigger input is received until measurement completes.



## Trigger synchronous output (Applying the signal to the sample during measurement only) (Common)

After outputting the measurement signal at trigger input, applies the signal to the sample during measurement only. You can also set a delay time (Trigger synchronous delay) to ensure that data is acquired after the sample stabilizes.

Thus reducing the generation of heat in the sample and decreasing electrode wear.

The setting applies to both AC and DC measurement

See “Trigger delay and Trigger synchronous output” (p. 68).

For more information about trigger synchronous delay timing, see the figures in “Measurement and data acquisition timing” (p. 69).

Screen display method (For more information, see p. 26):

(Measurement screen) **SET** key>(SET screen) **BASIC** tab>**SYNC** key

### 1 Touch the **ON** key.



### 2 Use the **▲▼** key to change the trigger synchronous delay time.



Settable range: 0.0010 s to 9.9999 s

When you want to return the time to the initial state, touch the **C** key.

(The set time is set to 0.0010 s.)

### 3 Touch the **EXIT** key twice.

Displays the measurement screen.

- When the trigger synchronous output function is set to **ON**, the measurement time will increase due to the incorporation of a delay time between output of the measurement signal and data acquisition. (See “10.7 About Measurement Times and Measurement Speed” (p. 225).)
- When the trigger synchronous output function is set to **ON**, the set level may be output momentarily if a measurement condition is changed.
- The measurement signal is output when the trigger signal is input and stops after measurement ends.
- When the contact check (p. 89) timing is set to either **BOTH** or **BEFORE** for the contact check function, the trigger synchronous output function is automatically turned on. Set the trigger synchronous delay time.
- To continue to apply the measurement signal until measurement of the last panel is complete in continuous measurement mode, set trigger synchronization for all panels other than the final panel to OFF.

#### Trigger delay and Trigger synchronous output

When the range synchronization feature is enabled, the ranges for which the trigger delay function and trigger synchronization output function will be enabled will vary depending on the parameter setting.

Parameters	Ranges for which the trigger delay function and trigger synchronization output function are enabled
Parameters other than Rdc only (AC measurement)	Range for AC measurement
Combination of Rdc and other parameters (AC measurement+DC measurement)	Range for AC measurement
Rdc only (DC measurement)	Range for DC measurement

## Measurement and data acquisition timing

Measurement and data acquisition timing varies with the following settings:  
 Trigger synchronous output (p. 68), Trigger delay (p. 67), Trigger synchronous delay (p. 68),  
 DC delay (p. 65), Adjustment delay (p. 66)

### When the trigger synchronization function is on

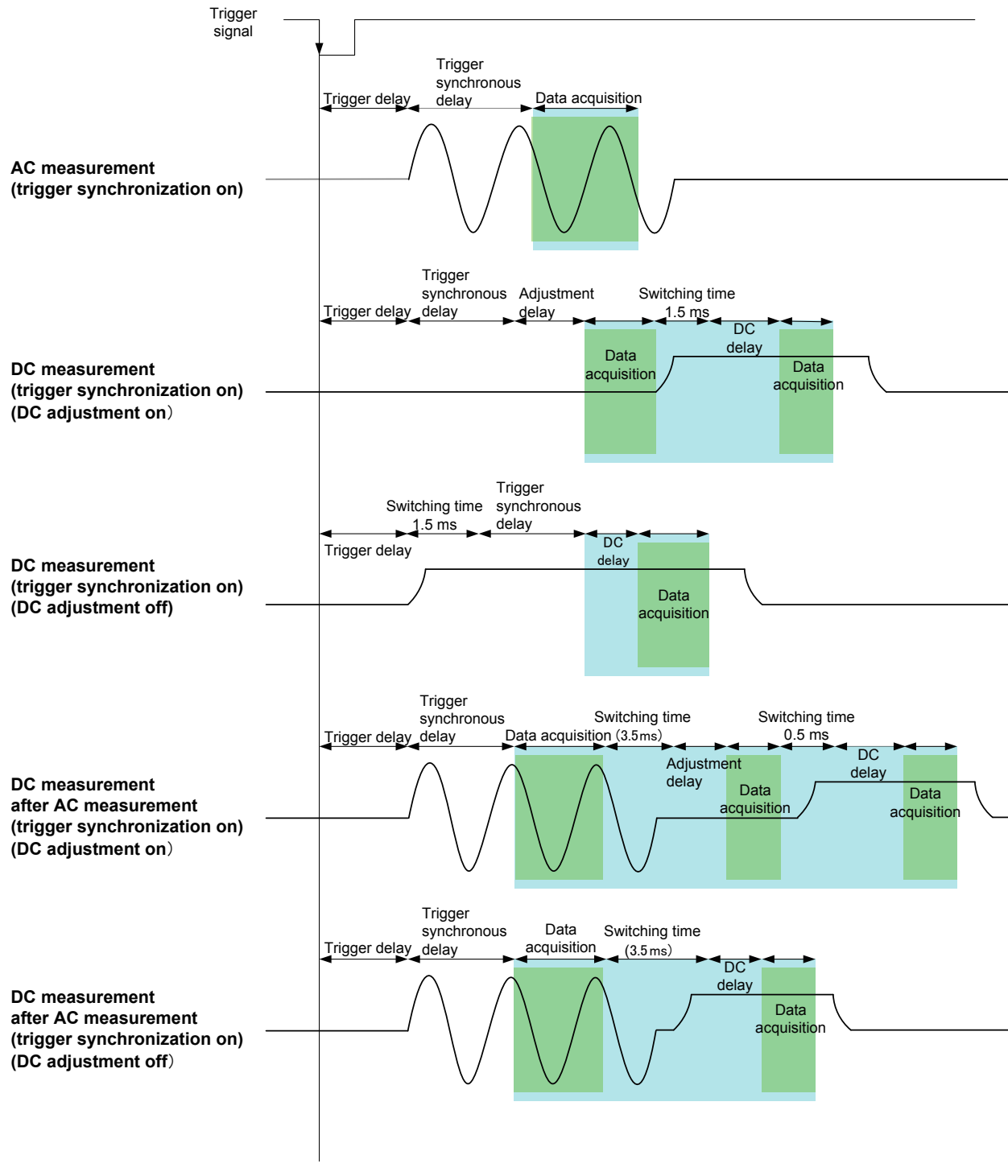

### When the trigger synchronization function is off

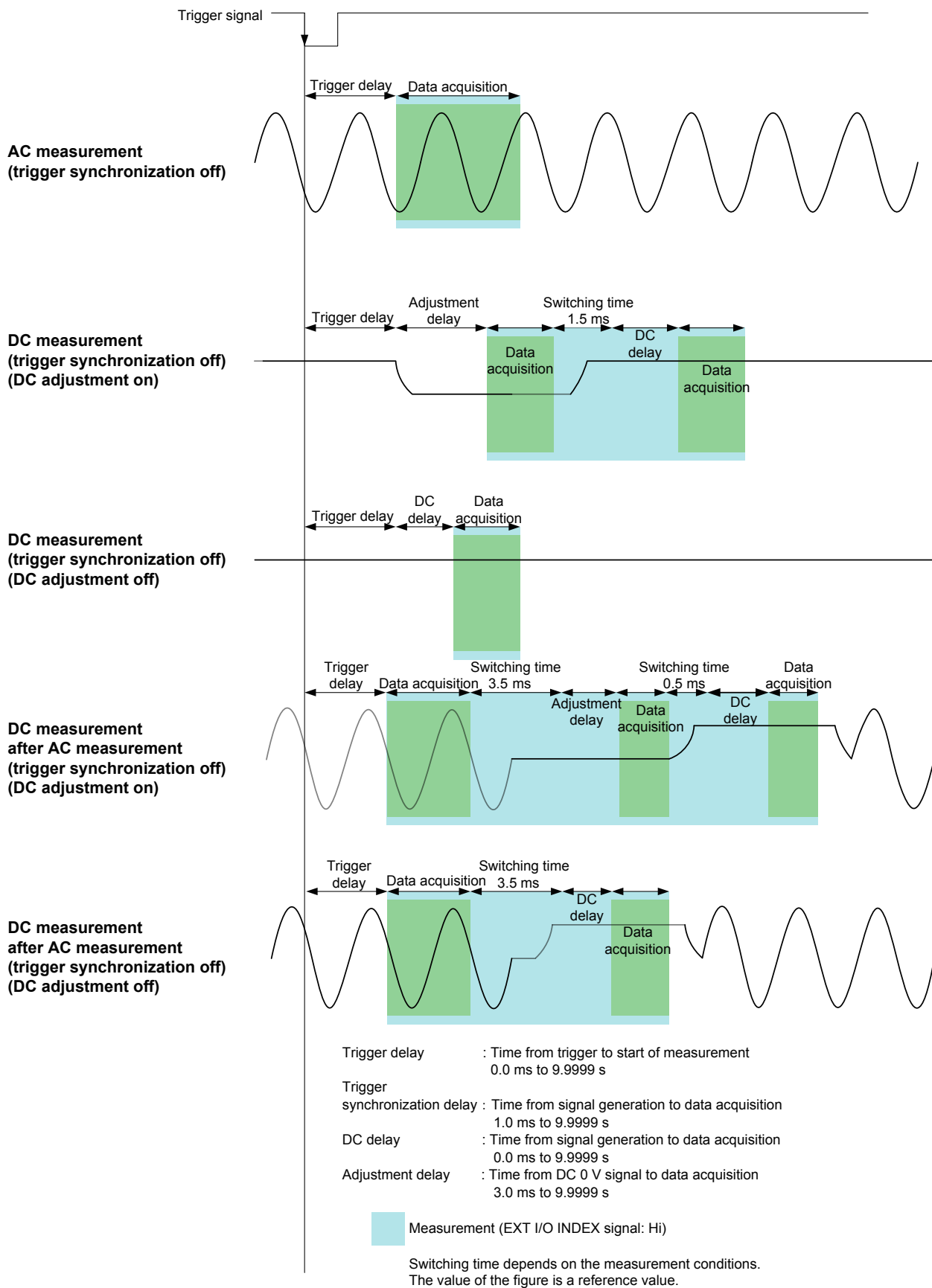

## When measuring conductivity and permittivity

Set the parameters to  $\sigma$  (conductivity) and  $\epsilon$  (permittivity) (p. 41) and set the conditions used to calculate conductivity and permittivity. The instrument cannot measure relative permittivity.

- Conductivity** ▶ Value indicating the ease with which electricity is conducted by a substance
- Permittivity** ▶ Value indicating the ease with which an electric field can be formed in a substance (dielectric material)

Screen display method (For more information, see p. 26):  
(Measurement screen) **SET** key>(SET screen) **ADVANCED** tab> $\sigma\epsilon$  key

- Select the capacitance to use when calculating the permittivity.**

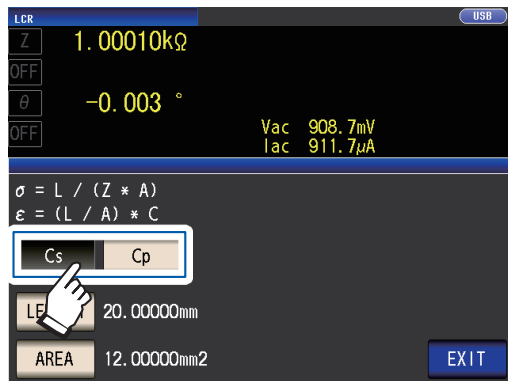

- Cs** Series equivalent circuit mode capacitance (F)
- Cp** Parallel equivalent circuit mode capacitance (F)

- Touch the **LENGTH** key.**



- Enter the length of the measurement sample and touch the **ENTER** key.**



Settable range:  
0.000001 mm to 1000000 mm

- Touch the **AREA** key.**

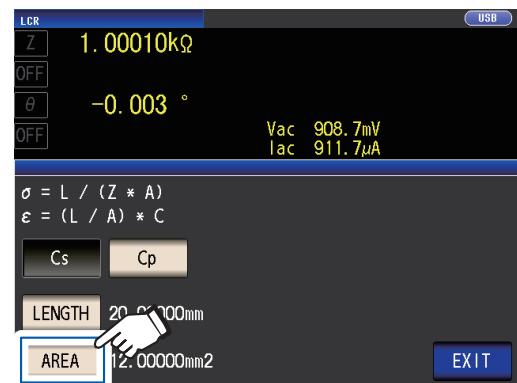

- Enter the crosssectional area of the measurement sample and touch the **ENTER** key.**

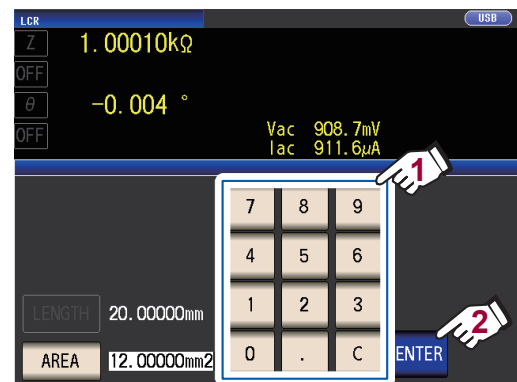

Settable range:  
0.000001 mm<sup>2</sup> to 1000000 mm<sup>2</sup>)

- Touch the **EXIT** key twice.**  
Displays the measurement screen.

## 3.5 Judging Measurement Results

The measurement results are compared to an arbitrarily set reference and then the judgment results are displayed.

This function is useful for quality evaluation and the like.

There is comparator measurement which compares one judgment reference and the measurement values, and BIN measurement which compares multiple judgment reference values (up to 10) and the measurement values.

Judgment by comparator measurement and BIN measurement is performed for the No. 1 parameter and No. 3 parameter.

Therefore, set the measurement values you want to judge for the No. 1 parameter and No. 3 parameter in advance.

See “3.1 Setting Display Parameters” (p. 41).

### Comparator measurement



Judgment Target	Result Display
No. 1 parameter	No. 2 parameter
No. 3 parameter	No. 4 parameter

### BIN measurement



Judgment Target	Result Display
No. 1 parameter	No. 4 parameter
No. 3 parameter (The No. 2 parameter area is shown.)	

## Setting the judgment mode

Select a judgment mode as described below and configure the settings.

Screen display method (For more information, see p. 26):

(Measurement screen) **SET** key>(SET screen) **ADVANCED** tab>**JUDGE** key

### 1 Select the judgment mode.



<b>OFF</b>	Disables comparator and BIN function.
<b>COMP</b>	Enables comparator function. Configure the comparator function settings (p. 73).
<b>BIN</b>	Enables BIN function. Configure the BIN function settings (p. 78).

### 2 Touch the **EXIT** key twice. Displays the measurement screen.

- When comparator measurement and BIN measurement are performed, only the first and third parameters can be set. (During BIN measurement, the No. 3 parameter will be displayed in the No. 2 parameter area.)
- During comparator measurement, the No. 2 and No. 4 parameter displays will indicate [**LMT**].
- During BIN measurement, the No. 4 parameter display will indicate [**BIN**].

## Configuring comparator function settings (judging measurement results based on one judgment standard)

The comparator function allows you to do the following.

Preset a reference value and upper and lower limit values as the judgment reference, and display a judgment result as **HI** (higher than the upper limit value), **IN** (within the range set for the upper and lower limit values), or **LO** (lower than the lower limit value).

- Output the judgment results to an external device (via the EXT I/O connector).
- Select different settings and perform judgment for up to two parameters.
- Be notified of judgment results by buzzer. See “Key tones and judgment tones” (p. 96).
- Confirm the judgment result from the judgment result indication LEDs on the front panel of the instrument.

(Judgment result indication LEDs)

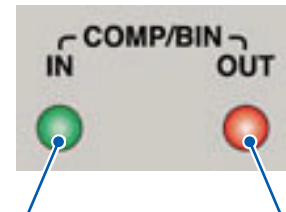

When the comparator measurement result is **IN**, the green indicator will light up.

When the comparator measurement result is **HI** or **LO**, the red indicator will light up.



<b>HI</b>	Measured value is above upper limit
<b>IN</b>	Upper limit value ≥ calculated value ≥ lower limit value
<b>LO</b>	Measured value is below lower limit
---	When no reference standards have been set

The comparator decision mode can be set as one of the following:

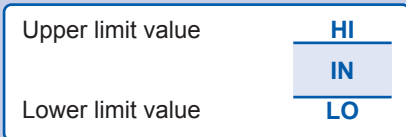
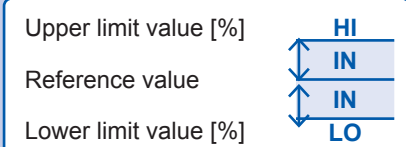
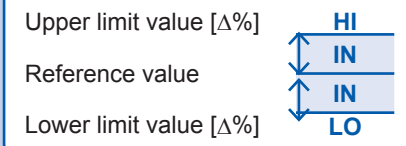
<p><b>Absolute value (ABS) setting (p. 75)</b></p> 	<p>Set absolute values for the upper limit and lower limit values of the measurement parameters. The measurement values displayed are the same as those of the measurement parameters.</p>
<p><b>Percent (%) Setting (p. 76)</b></p> 	<p>Enter reference values and then set percentages corresponding to the reference values as the upper limit and lower limit<sup>*1</sup> values. The measurement values displayed are the same as those of the measurement parameters.</p>
<p><b>Deviation Percent (Δ%)<sup>*2</sup> Setting(p. 76)</b></p> 	<p>Enter reference values and then set percentages corresponding to the reference values as the upper limit and lower limit<sup>*1</sup> values. The measurement values are displayed in deviations (Δ%) from the reference value.</p>

\*1: The following equation is used to calculate the comparison upper limit value and comparison lower limit value. (In the case of the comparison lower limit value, if a value that is lower than the reference value is set, the minus (-) sign is required for the percentage setting value.)

$$\text{Upper limit comparison value (Lower limit comparison value)} = \text{reference value} + |\text{reference value}| \times \frac{\text{Percentage set value}}{100}$$

\*2: The following equation is used to calculate the Δ% value.

$$\Delta\% = \frac{\text{measurement value} - \text{reference value}}{|\text{reference value}|} \times 100$$

The comparator and BIN judgment is made in the following order.

Judgment order	State	Judgment display
1	When the measurement value is <b>OVER FLOW</b> (However, <b>LO</b> is displayed when the parameters are <b>Y, Cs, Cp, G,</b> and <b>B.</b> )	<b>HI</b>
	When the measurement value is <b>UNDER FLOW</b> (However, <b>HI</b> is displayed when the parameters are <b>Y, Cs, Cp, G,</b> and <b>B.</b> )	<b>LO</b>
	When the measurement value is <b>SAMPLE ERR</b> or a contact error	<b>HI</b>
2	When measured value < lower limit value	<b>LO</b>
3	When measured value > upper limit value	<b>HI</b>
4	Other than 1, 2, 3	<b>IN</b>

**No test is performed to ensure that the upper limit value is greater than the lower limit value, so no error message will be displayed if you set the upper limit value and lower limit value the wrong way around.**

- If the instrument is turned off while set up for comparator measurement, it will start up in the same state the next time it is turned on.
- Comparator measurement can be used even if only the upper or lower limit value has been set.

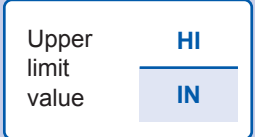
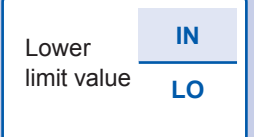
<p><b>When only an upper limit value has been set</b></p> 	<p><b>When only a lower limit value has been set</b></p> 
---	--

### Absolute value setting

Set the value after setting the judgment mode (p. 73) to **COMP**.

This explanation uses the example of setting the measurement conditions for the No. 1 parameter.

- 1 Touch the **LMT** key on the measurement screen.



- 2 Touch the **ABS** key.

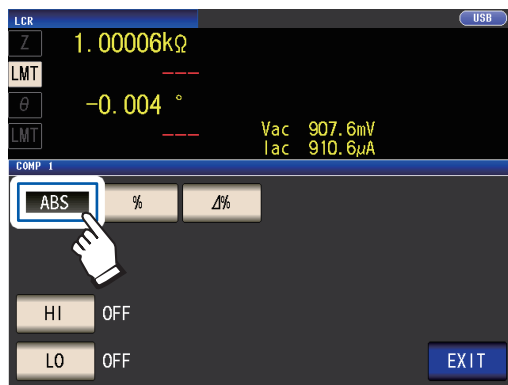

- 3 Touch the **HI** key, and set the upper limit value with the numeric keypad.



$\times 10^3$  Step the units up.

$\times 1/10^3$  Step the units down.

Units: a/ f/ p/ n/ μ/ m/ none/ k/ M/ G

Settable range: -9.99999 G to 9.99999 G

If you do not wish to set an upper limit value, touch the **OFF** key.

- 4 Touch the **ENTER** key to confirm the upper limit value.

The display will return to the screen shown in step 2.

- 5 Touch the **LO** key, set the lower limit value with the numeric keypad, and touch the **ENTER** key.

Settable range: -9.99999 G to 9.99999 G

If you do not wish to set a lower limit value, touch the **OFF** key.

- 6 Touch the **EXIT** key.

Displays the measurement screen.

# 3

Performing Measurements in LCR Mode



Percentage setting and deviation percentage setting

Set the value after setting the judgment mode (p. 73) to **COMP**.

This explanation uses the example of setting the measurement conditions for the No. 1 parameter.

- 1 Touch the **LMT** key on the measurement screen.



- 2 Touch the **%** key (percentage setting) or **Δ%** key (deviation percentage setting)

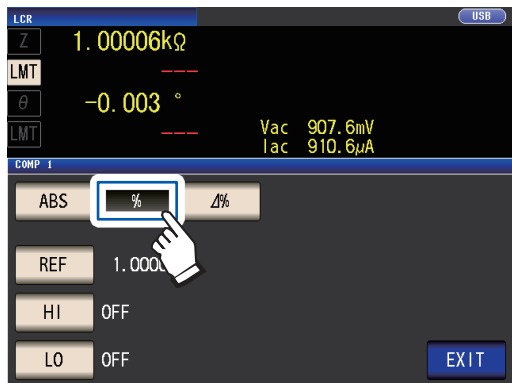

- 3 Touch the **REF** key, and set the reference value with the numeric keypad.

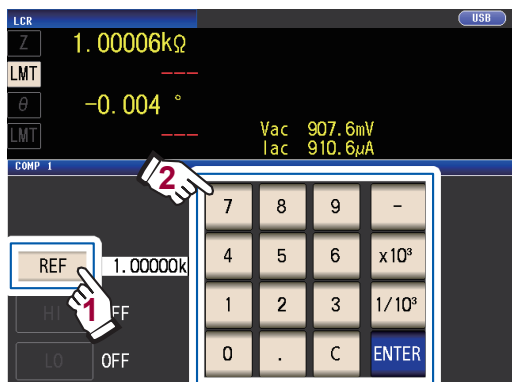

**×10<sup>3</sup>** Step the units up.

**×1/10<sup>3</sup>** Step the units down.

Units: a/ f/ p/ n/ m/ m/ none/ k/ M/ G  
 Settable range -9.99999 G to 9.99999 G

- 4 Touch the **ENTER** key to confirm the reference value.
- 5 Touch the **HI** key, and set the upper limit value with the numeric keypad.

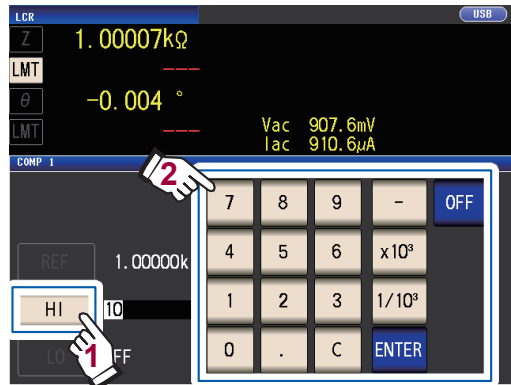

Settable range: -999.999% to 999.999%  
 Set the upper limit value as a percentage relative to the reference value.  
 If you do not wish to set an upper limit value, touch the **OFF** key.

- 6 Touch the **ENTER** key to confirm the upper limit value.

The display will return to the screen shown in step 2.

- 7 Touch the **LO** key, set the lower limit value with the numeric keypad, and touch the **ENTER** key.

Settable range: -999.999% to 999.999%  
 Set the lower limit value as a percentage relative to the reference value.  
 If you do not wish to set a lower limit value, touch the **OFF** key.

- 8 Touch the **EXIT** key.

Displays the measurement screen.

The set reference value and upper and lower limit values are common to percentage setting and percentage deviation setting.

**Percentage setting**

- The actual operation performed internally is to calculate the upper limit comparison value (or lower limit comparison value) using the following formula and then compare it to the measured value to make a judgment. To set an upper limit comparison value (or lower limit comparison value) that is less than the reference value, give the percent setting a negative sign.

$$\text{Upper limit comparison value} = \text{reference value} + |\text{reference value}| \times \frac{\text{Percentage set value}}{100}$$

$$\text{Lower limit comparison value} = \text{reference value} + |\text{reference value}| \times \frac{\text{Percentage set value}}{100}$$

**Deviation percent setting**

- The measurement values are displayed in deviations ( $\Delta\%$ ) from the reference value.
- The following equation is used to calculate the  $\Delta\%$  value.

$$\Delta\% = \frac{\text{measurement value} - \text{reference value}}{|\text{reference value}|} \times 100$$

## Configuring BIN function settings (judging measured values based on multiple judgment standards)

Set the upper and lower limit values for two parameters and display up to 10 classifications of judgment results. You can also output the judgment results to an external device.

(Measurement screen)

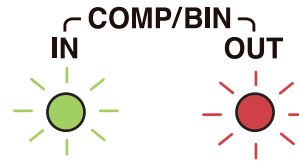

(Judgment result indication LEDs)

When the measurement result falls within the BIN category, the green indicator will light up.

When the measurement result is **OUT OF BINS**, the red indicator will light up.

<b>BIN2 (numeral)</b>	When BIN judgment
---	When BIN is not set
<b>OUT OF BINS</b>	When does not match any BIN

### About BIN measurement

Bin measurement is performed using a process such as the example shown below.

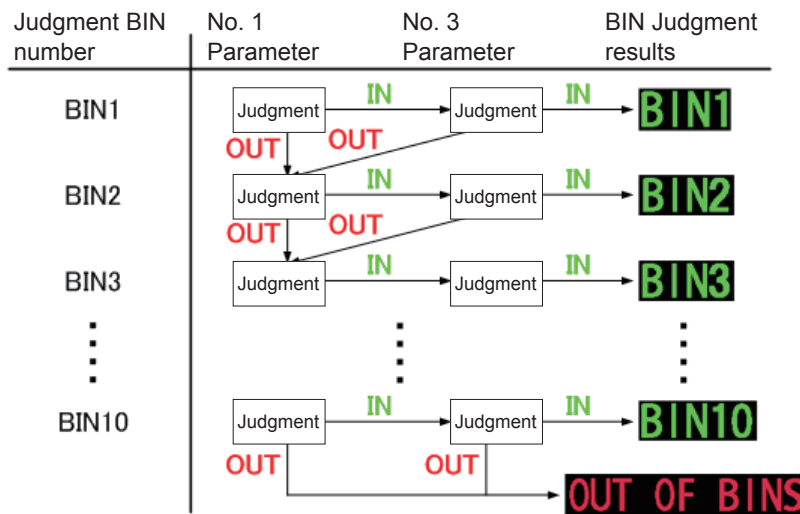

The instrument will display the first BIN number for which the measurement value is judged to be within the set judgment standard.

If none of the BIN judgments is determined to apply, **OUT OF BINS** will be displayed.

The BIN number for which the measured value was first judged to be within the set judgment standards will be displayed as the judgment result.

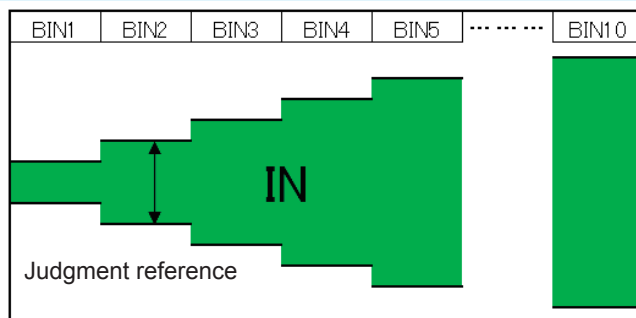

The BIN decision mode can be set as one of the following:

<p><b>Absolute value (ABS) setting (p. 80)</b></p> <table border="1"> <tr> <td>Upper limit value</td> <td>HI</td> </tr> <tr> <td></td> <td>IN</td> </tr> <tr> <td>Lower limit value</td> <td>LO</td> </tr> </table>	Upper limit value	HI		IN	Lower limit value	LO	<p>Set absolute values for the upper limit and lower limit values of the measurement parameters. The measurement values displayed are the same as those of the measurement parameters.</p>		
Upper limit value	HI								
	IN								
Lower limit value	LO								
<p><b>Percent (%) Setting (p. 81)</b></p> <table border="1"> <tr> <td>Upper limit value [%]</td> <td>HI</td> </tr> <tr> <td>Reference value</td> <td>IN</td> </tr> <tr> <td>Lower limit value [%]</td> <td>IN</td> </tr> <tr> <td></td> <td>LO</td> </tr> </table>	Upper limit value [%]	HI	Reference value	IN	Lower limit value [%]	IN		LO	<p>Enter reference values and then set percentages corresponding to the reference values as the upper limit and lower limit<sup>*1</sup> values. The measurement values displayed are the same as those of the measurement parameters.</p>
Upper limit value [%]	HI								
Reference value	IN								
Lower limit value [%]	IN								
	LO								
<p><b>Deviation Percent (Δ%)<sup>*2</sup> Setting (p. 81)</b></p> <table border="1"> <tr> <td>Upper limit value [Δ%]</td> <td>HI</td> </tr> <tr> <td>Reference value</td> <td>IN</td> </tr> <tr> <td>Lower limit value [Δ%]</td> <td>IN</td> </tr> <tr> <td></td> <td>LO</td> </tr> </table>	Upper limit value [Δ%]	HI	Reference value	IN	Lower limit value [Δ%]	IN		LO	<p>Enter reference values and then set percentages corresponding to the reference values as the upper limit and lower limit<sup>*1</sup> values. The measurement values are displayed in deviations (Δ%) from the reference value.</p>
Upper limit value [Δ%]	HI								
Reference value	IN								
Lower limit value [Δ%]	IN								
	LO								

\*1: The following equation is used to calculate the comparison upper limit value and comparison lower limit value.  
 (In the case of the comparison lower limit value, if a value that is lower than the reference value is set, the minus (-) sign is required for the percentage setting value.)

$$\begin{matrix} \text{Upper limit comparison value} \\ \text{(Lower limit comparison value)} \end{matrix} = \text{reference value} + |\text{reference value}| \times \frac{\text{Percentage set value}}{100}$$

\*2: The following equation is used to calculate the Δ% value.

$$\Delta\% = \frac{\text{measurement value} - \text{reference value}}{|\text{reference value}|} \times 100$$

- For more information about HI/IN/LO judgment procedures, see p. 74.
- By starting with a restrictive standard and setting a series of judgment standards that grow progressively more permissive, as shown in the figure to the right, you can rank measured elements.
- For a BIN number that does not require a BIN judgment, set the upper and lower limit values to **OFF**.
- The measurement conditions that are used when normal measurement<sup>\*</sup> is performed are inherited as is for the measurement conditions when BIN is performed.
- BIN measurement can be used even if only the upper or lower limit value has been set.

**When only an upper limit value has been set**

Upper limit value	HI
	IN

**When only a lower limit value has been set**

Lower limit value	IN
	LO

\*: Indicates measurement when not using the comparator function or BIN measurement function.

**Absolute value setting**

Set the value after setting the judgment mode (p. 73) to **BIN**.

- 1 Touch the **BIN** key on the measurement screen.



- 2 Touch the **Z** key.

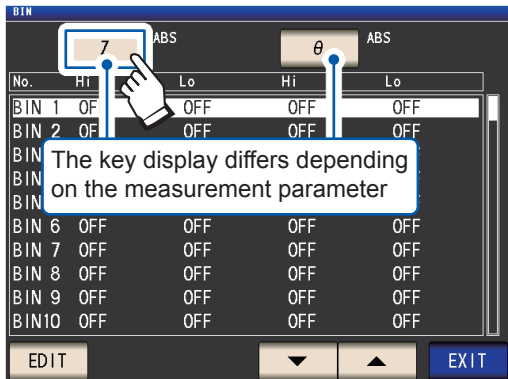

- 3 Touch the **ABS** key and then touch the **EXIT** key.

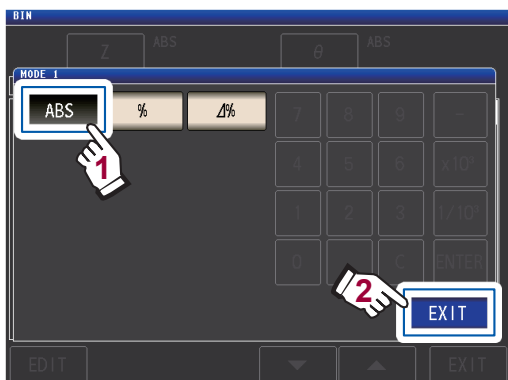

- 4 Use the **▲▼** key to select the BIN number to set, and touch the **EDIT** key.

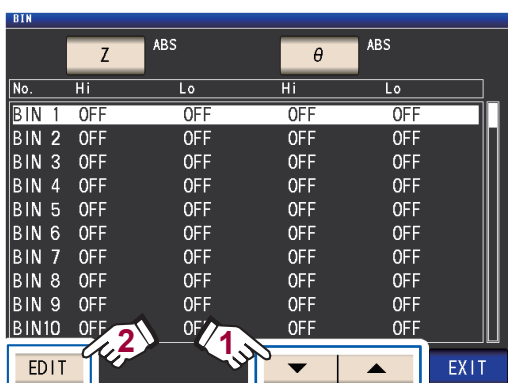

- 5 Touch the **HI** key for the No. 1 parameter.

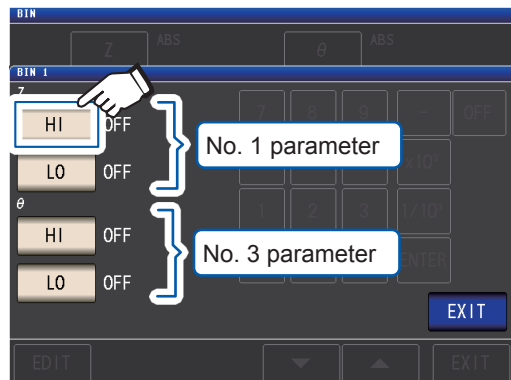

- 6 Enter the upper limit value with the numeric keypad.

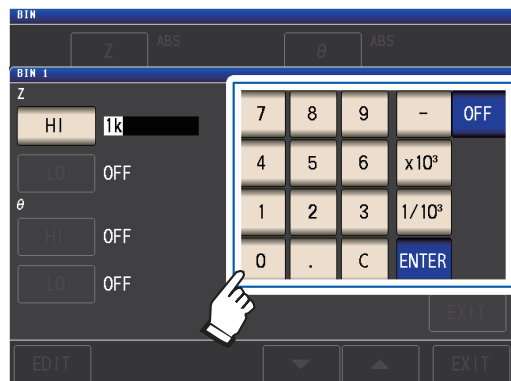

Settable range: -9.99999 G to 9.99999 G  
When you do not want to set the upper and lower limit values, touch the **OFF** key.

- 7 Touch the **ENTER** key to confirm the upper limit value.

The display will return to the screen shown in step 5.

- 8 Touch the **LO** key for the No. 1 parameter, set the lower limit value with the numeric keypad, and then touch the **ENTER** key.

Settable range: -9.99999 G to 9.99999 G  
The display will return to the screen shown in step 5.

- 9 Using the same procedure, set the upper and lower limit values for the No. 3 parameter.

- 10 Touch the **EXIT** key twice.

Displays the measurement screen.

Percentage setting and deviation percentage setting

Set the value after setting the judgment mode (p. 73) to **BIN**.

- 1 Touch the **BIN** key on the measurement screen.



- 2 Touch the **Z** key.

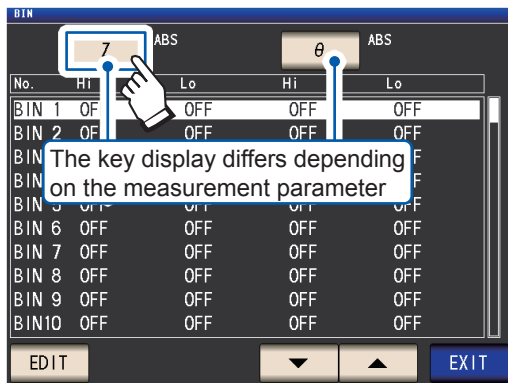

- 3 Touch the **%** key (percentage setting) or **Δ%** key (deviation percentage setting)

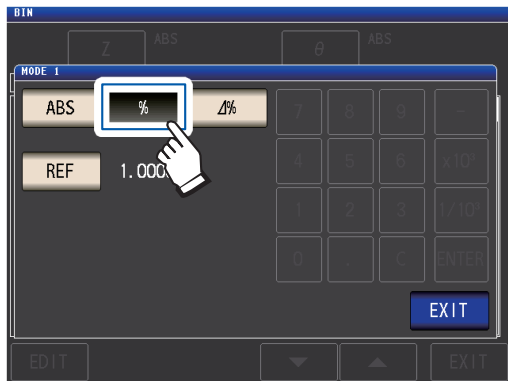

- 4 Touch the **REF** key, and enter the reference value with the numeric keypad.

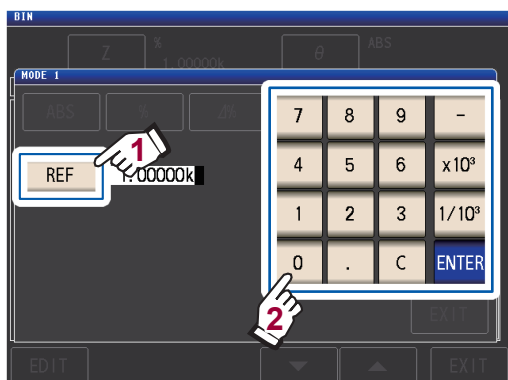

Settable range: -9.99999 G to 9.99999 G

- 5 Touch the **ENTER** key to confirm the reference value.

- 6 Touch the **EXIT** key.

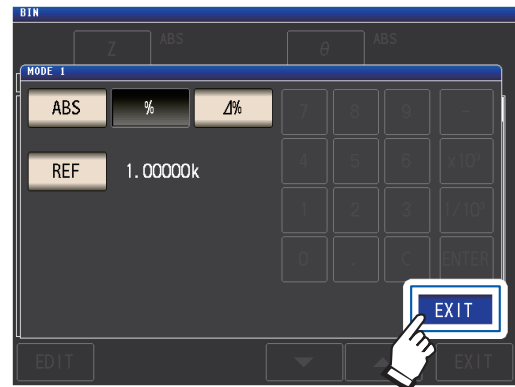

- 7 Use the **▲▼** key to select the BIN number to set, and touch **EDIT** key.

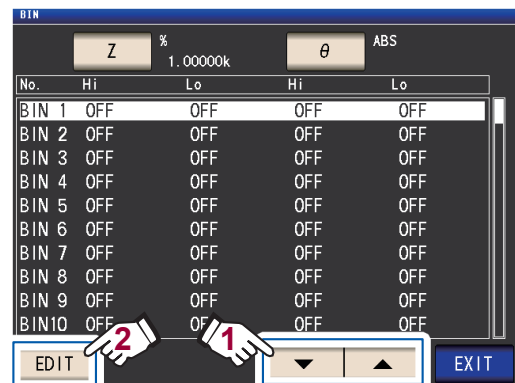

- 8 Touch the **HI** key for the No. 1 parameter.

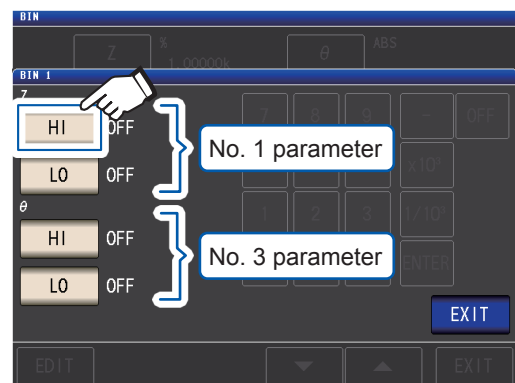

3

Performing Measurements in LCR Mode

**9** Enter the upper limit value with the numeric keypad.

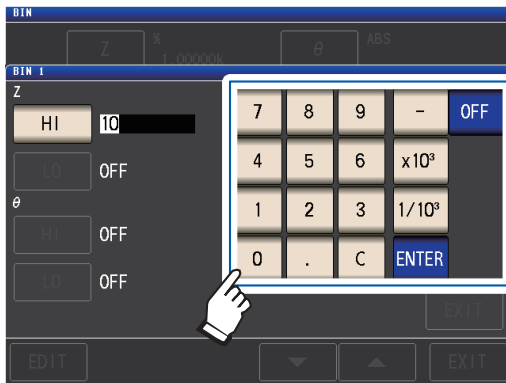

Settable range -999.999% to 999.999%  
 When you do not want to set the upper and lower limit values, touch the **OFF** key.

**10** Touch the **ENTER** key to confirm the upper limit value.

The display will return to the screen shown in step 8.

**11** Touch the **LO** key for the No. 1 parameter, set the lower limit value with the numeric keypad, and then touch the **ENTER** key.

Settable range: -999.999% to 999.999%  
 The display will return to the screen shown in step 8.

**12** Using the same procedure, set the upper and lower limit values for the No. 3 parameter.

**13** Touch the **EXIT** key twice.

Displays the measurement screen.

The set reference value and upper and lower limit values are common to percentage setting and percentage deviation setting.

## 3.6 Setting Application Settings

### Range synchronization (setting measurement conditions for individual measurement ranges)

This section describes how to set measurement conditions for individual measurement ranges.

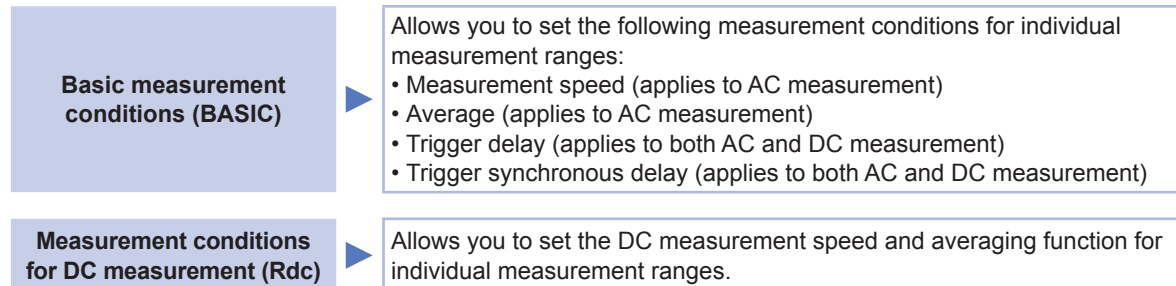

#### (1) Turn on the range synchronization function.

Screen display method (For more information, see p. 26):

(Measurement screen) **SET** key > (**SET** screen) **ADVANCED** tab > **RNG SYNC** key

#### 1 Touch the **ON** key.

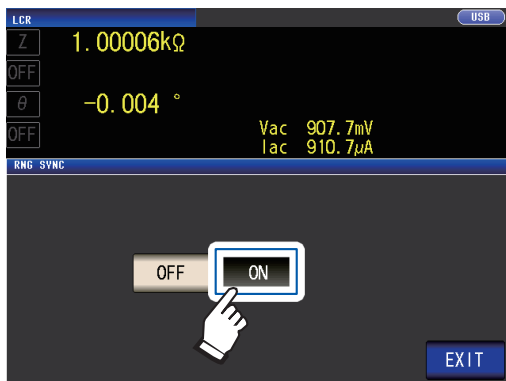

#### 2 Touch the **EXIT** key.

The instrument will return to the **SET** screen.

Set the measurement conditions as described in “(2) Setting measurement conditions on individual dialog boxes” (p. 84) and “(3) Setting measurement conditions on a single screen” (p. 85).



**(2) Setting measurement conditions on individual dialog boxes**

Screen display method (For more information, see p. 26):  
 AC measurement: (SET screen) **BASIC** tab>**LIST** key  
 DC measurement: (SET screen) **Rdc** tab>**LIST** key

**1** Select the measurement range you wish to configure with the ▲▼ keys.

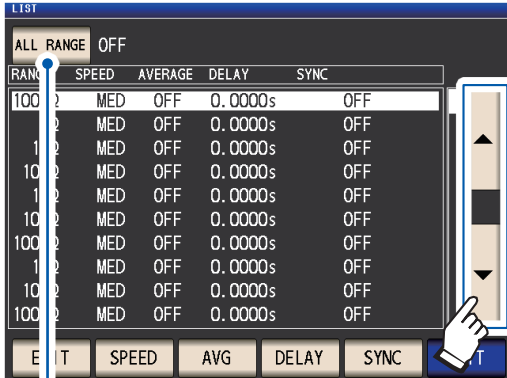

To apply the settings to all measurement ranges, turn this setting on and then configure the settings. (To configure measurement ranges individually, turn it off.)  
 \*Touch **EXIT** to return to the previous screen.

**2** Select the setting you wish to configure.

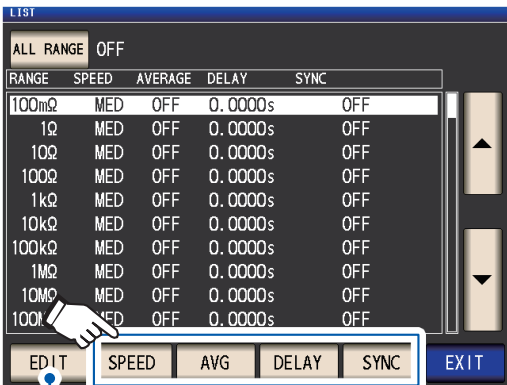

“Setting measurement conditions on a single screen” (p. 85)

**3** Set the conditions and touch the **SET** key.

**SPEED** Sets the measurement speed (p. 58).



**AVG** Configures averaging (p. 60).



**DELAY** Sets the trigger delay (p. 67). (BASIC tab screen only)

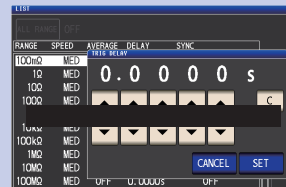

**SYNC** Configures the trigger synchronous output (p. 68) (BASIC tab screen only)

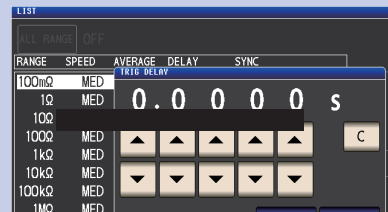

Touch the **CANCEL** key to cancel the settings and close the dialog box.

**4** Touch the **EXIT** key twice.

Displays the measurement screen.

Settings are the same as those described in “3.4 Setting Measurement Conditions (Basic Settings)” (p. 46).

**(3) Setting measurement conditions on a single screen**

Screen display method (For more information, see p. 26):  
 AC measurement: (SET screen) **BASIC** tab>**LIST** key  
 DC measurement: (SET screen) **Rdc** tab>**LIST** key

**1** Select the measurement range you wish to configure with ▲▼ key, and touch the **EDIT** key.

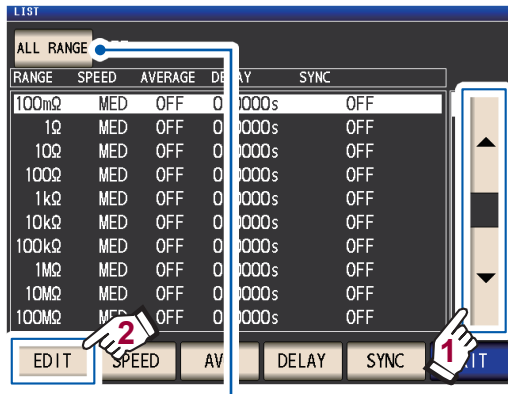

To apply the settings to all measurement ranges, set **ALL RANGE** to **ON**, then configure each settings. (To configure settings for an individual measurement range, set to **OFF**)  
 Touch the **EXIT** key to return to the previous screen.

**2** Set conditions.

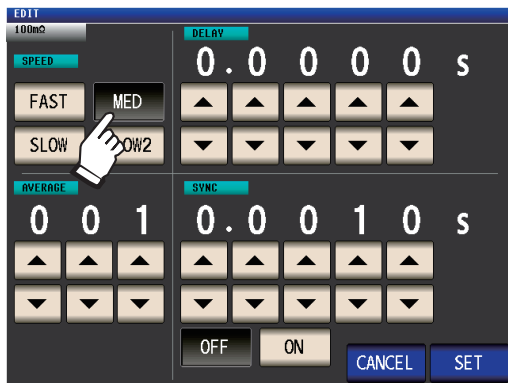

- SPEED** Set measurement speed (p. 58).
- AVERAGE** Configures averaging (p. 60).
- DELAY** Sets the trigger delay (p. 67). (BASIC tab screen only)
- SYNC** Configures the trigger synchronous output (p. 68) (BASIC tab screen only)

**3** Touch the **SET** key to accept the settings.

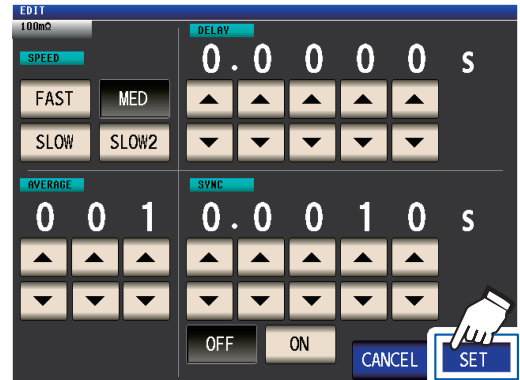

Touch the **CANCEL** key to cancel the settings and close the dialog box.

**4** Touch the **EXIT** key twice.  
 Displays the measurement screen.

Settings are the same as those described in “3.4 Setting Measurement Conditions (Basic Settings)” (p. 46).

**3** Performing Measurements in LCR Mode

## Waveform averaging function (increasing measurement precision or measurement speed)

The number of measurement waveforms for each frequency band is set for the measurement speed settings (**FAST**, **MED**, **SLOW**, **SLOW2**), and this function allows you to set the number of measurement waveforms for each frequency band. Having more waveforms increases the measurement precision, while having fewer waveforms increases the measurement speed.

Screen display method (For more information, see p. 26):  
 (Measurement screen) **SET** key>(SET screen) **ADVANCED** tab>**WAVE NUM** key

### 1 Touch the **ON** key.

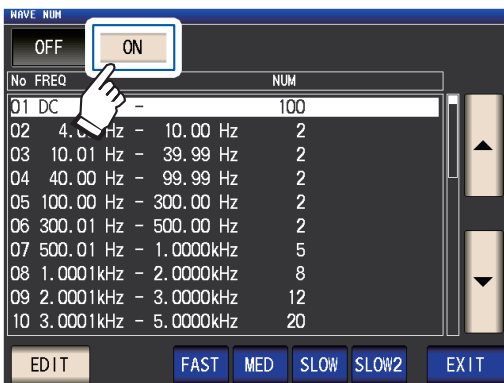

### 2 Select the frequency band for which you wish to change the number of measurement waveforms with the ▲▼ key, and touch the **EDIT** key.

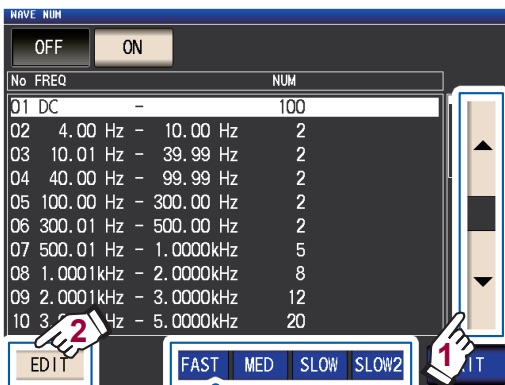

Reverts to the number of measurement waveforms for each measurement speed.

### 3 Select the number of measurement waveforms with ▲▼ key and touch the **EXIT** key.

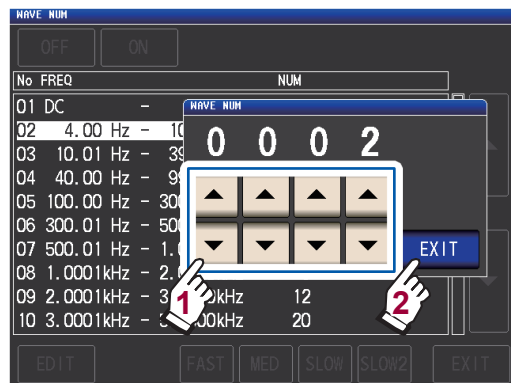

(For more information about the valid setting range, see the table on the following page.)

### 4 Touch the **EXIT** key twice.

Displays the measurement screen.

When the waveform averaging function is enabled, the measurement speed cannot be set with the **SPEED** key.

No.	Frequency band	Settable range
1	DC (Line frequency 50 Hz)	1 to 2000
1	DC (Line frequency 60 Hz)	1 to 2400
2	4.00 Hz to 10.00 Hz	1 to 4
3	10.01 Hz to 39.99 Hz	1 to 10
4	40.00 Hz to 99.99 Hz	1 to 40
5	100.00 Hz to 300.00 Hz	1 to 50
6	300.01 Hz to 500.00 Hz	1 to 200
7	500.01 Hz to 1.0000 kHz	1 to 300
8	1.0001 kHz to 2.0000 kHz	1 to 600
9	2.0001 kHz to 3.0000 kHz	1 to 1200
10	3.0001 kHz to 5.0000 kHz	1 to 2000
11	5.0001 kHz to 10.000 kHz	1 to 3000
12	10.001 kHz to 20.000 kHz	1 to 1200
13	20.001 kHz to 30.000 kHz	1 to 480
14	30.001 kHz to 50.000 kHz	1 to 800
15	50.001 kHz to 100.00 kHz	1 to 1200
16	100.01 kHz to 140.00 kHz	1 to 2400
17	140.01 kHz to 200.00 kHz	1 to 2400
18	200.01 kHz to 300.00 kHz	1 to 960
19	300.01 kHz to 400.00 kHz	1 to 1600
20	400.01 kHz to 500.00 kHz	1 to 1600
21	500.01 kHz to 700.00 MHz	1 to 2400
22	700.01 kHz to 1.0000 MHz	1 to 2400
23	1.0001 MHz to 1.4000 MHz	1 to 960
24	1.4001 MHz to 2.0000 MHz	1 to 960
25	2.0001 MHz to 3.0000 MHz	1 to 1440
26	3.0001 MHz to 4.0000 MHz	1 to 2400
27	4.0001 MHz to 5.0000 MHz	1 to 2400
28	5.0001 MHz to 6.0000 MHz	1 to 4000
29	6.0001 MHz to 8.0000 MHz	1 to 4000

DC measurement waveform count performs waveform averaging using 1/100 of the set line frequency as one wave.

5 times the number of waves set with the waveform averaging count are averaged.

25 times the number of waves set with the waveform averaging count are averaged.

125 times the number of waves set with the waveform averaging count are averaged.

625 times the number of waves set with the waveform averaging count are averaged.

## High-Z reject function (detecting contact errors during 2-terminal measurement)

This functionality outputs an error when the measurement results exceed a set judgment standard, allowing poor contact to be detected when using a 2-terminal fixture to perform measurement. Errors are shown on the measurement screen and output to EXT I/O. **Hi Z** and the error message will be shown at the top of the measurement screen. (See “11.3 Error Message and Error Display” (p. 238).)

The judgment reference is calculated from the nominal value (range name) of the current measurement range and the judgment reference value as shown below.

Judgment reference = Nominal value of current measurement range × Judgment reference value (%)

Example Current measurement range nominal value: 10 kΩ,

Judgment reference value: 150%, Judgment reference = 10 kΩ × 1.50 = 15 kΩ)

Screen display method (For more information, see p. 26):

(Measurement screen) **SET** key > (SET screen) **ADVANCED** tab > **Hi Z** key

### 1 Touch the **ON** key.



### 2 Use the **▲▼** key to set the judgment reference value.

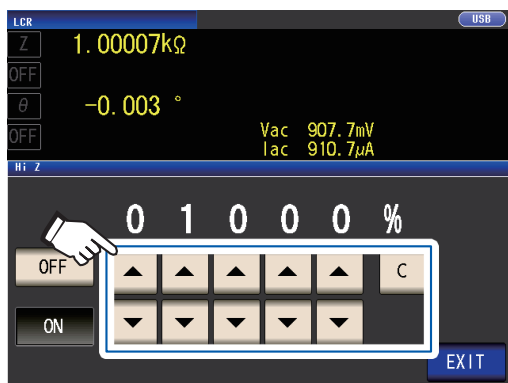

Settable range: 0% to 30000%

If you make a mistake during input, touch the **C** key to cancel the input and start again.

A ratio is set using the range name as the reference value.  
Example: When the 1 kΩ range is used:  
A ratio to the value of 1 kΩ is set.

### 3 Touch the **EXIT** key twice.

Displays the measurement screen.

## Contact check function (detecting poor contact with the sample during 4-terminal measurement)

---

This functionality allows you to detect contact defects between the terminals ( $H_{CUR}$ ,  $H_{POT}$ ,  $L_{CUR}$ , and  $L_{POT}$ ) and the sample during 4-terminal measurement.

Set the contact resistance between  $L_{POT}$  and  $L_{CUR}$  and between  $H_{POT}$  and  $H_{CUR}$ . If the measured value is greater than or equal to the set threshold, an error message will be displayed.

An error message will be displayed in the measured value display area on the measurement screen. (See "Contact error" in the "11.3 Error Message and Error Display" (p. 238).)

Screen display method (For more information, see p. 26):

(Measurement screen) **SET** key>(SET screen) **ADVANCED** tab>**CONTACT** key

**1** Select the timing at which to perform contact check operation.

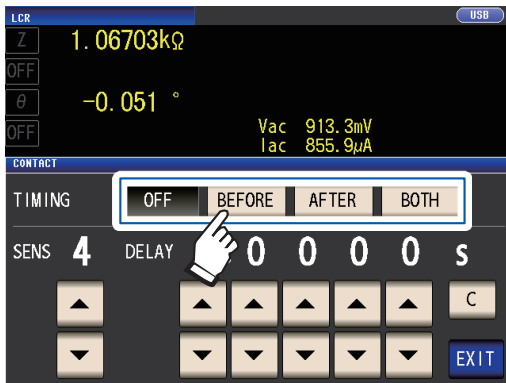

- OFF** Disables the contact check function.
- BEFORE** Performs a contact check before measuring the sample.
- AFTER** Performs a contact check after measuring the sample.
- BOTH** Performs a contact check before and after measuring the sample.

Selecting **BOTH** or **BEFORE** as the contact check timing causes the trigger synchronous output function (p. 68) to be automatically turned on.

**2** Set the contact check threshold with the ▲▼ key.

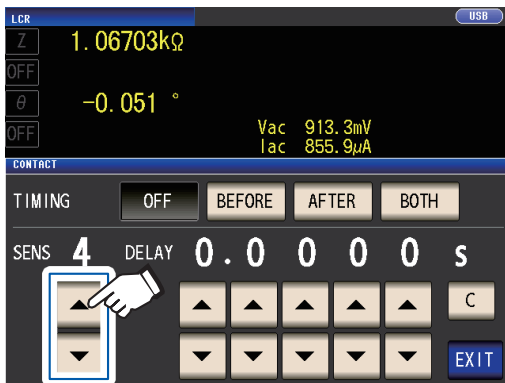

Settable range: 1 to 5

Threshold (SENS)	Permissible contact resistance [ $\Omega$ ]
1	Approx. 1000
2	Approx. 500
3	Approx. 100
4	Approx. 50
5	Approx. 20

**3** (Set only when the contact check function does not operate correctly.) Set the contact check delay time with the ▲▼ key.



Settable range: 100  $\mu$ s to 1 s  
Touching the **C** key causes the value to be set to 0 s.

- When the sample is a high-capacitance capacitor, the contact check function may not operate normally under some measurement conditions.
- Contact check measurements are made in the following order: (1) between L<sub>POT</sub> and L<sub>CUR</sub> and then (2) between H<sub>POT</sub> and H<sub>CUR</sub>. Measurement (2) will be delayed by the set delay time.

**4** Touch the **EXIT** key twice. Displays the measurement screen.

- When setting the contact check function, the INDEX time and EOM time will be delayed depending on the timing (p. 226).
- The allowable contact resistance value may vary depending on the sample being measured.
- The measurement value will not be saved when all three of the following conditions apply: the memory function (p. 91) is set to **ON**, the timing is set to **BEFORE**, a contact error has been displayed

## Memory function (saving measurement results)

You can save the measurement results inside the instrument (Up to 32,000 items). This function allows you to save previously saved measurement results to the USB flash drive and to acquire them from a computer using the **:MEMory?** communications command.

When using communications commands, the information saved to memory reflects the **:MEASure:VALid**.

For more information about acquiring measurement results stored in memory and how to configure the **:MEASure:VALid** setting, see the LCR application disc (communications commands).

### IMPORTANT

Changing the memory function setting will cause data stored in the instrument's memory to be deleted.

Screen display method (For more information, see p. 26):

(Measurement screen) **SET** key > (**SET** screen) **ADVANCED** tab > **MEMORY** key



- 1 After touching the **OFF** key to disable the memory function, use the **▲▼** keys to set the number of measurement results.



Settable range: 1 to 32000

The number of measurement results can only be set when the memory function is set to **OFF**.

- 2 Touch the **IN** key or **ON** key.



Clears all of the saved measurement values from the instrument memory.

Measured values in the instrument's memory are deleted once they have been saved to the USB flash drive. The measurement values are saved to the **MEMORY** folder in the USB flash drive. The file name is automatically assigned from the date and time.

Example

If saved at 16:00:44, September 30, 2014, the file is named "140930163144.txt."

**IN** Measured values are stored in memory only when all parameters judged by the comparator and BIN measurement yield a pass result. (If even one HI or LO comparator result is received or if the BIN result is OUT OF BINS, the value will not be saved.)

**ON** Saves all measurement values to memory.

If the comparator and BIN functions have not been configured, the **IN** and **ON** keys result in the same operation.

- 3 Touch the **EXIT** key twice.

Displays the measurement screen.

#### File type

Contents	Measured values of the memory function
Type	CSV file
Filename extension	.txt
On-screen test (TYPE)	TXT

- If the memory function is enabled (**ON** or **IN**), the number of memory items currently saved is displayed in the measurement screen.

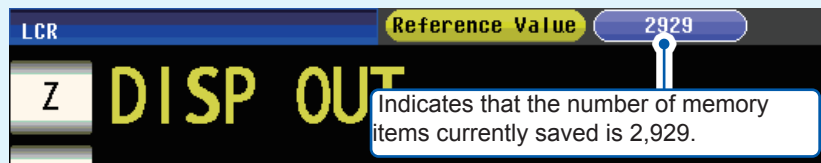

- Save the data stored in the instrument to a USB flash drive or acquire it with the **:MEMory?** command. When the instrument memory becomes full, the following message appears on the measurement screen. If this message appears, subsequent measurement results will not be saved. To resume saving, load or clear the measurement results from the instrument memory (See previous page.).



- When the contact check function (p. 89) is enabled, measured values cannot be saved if all of the following three conditions apply:
  - When the memory function is enabled (**ON** or **IN**)
  - When the contact check timing is set to **BEFORE**
  - When a contact check error has been displayed (p. 241)

## Number of effective digits of the measurement value

You can set the number of effective digits of the measurement value for each parameter.

Screen display method (For more information, see p. 26):

(Measurement screen) **SET** key > (**SET** screen) **ADVANCED** tab > **DIGIT** key

- 1 Use the **▲▼** key to set the number of display digits. (For each parameter)



Settable range: 3 to 6

- 2 Touch the **EXIT** key twice.  
Displays the measurement screen.

Setting Value	Parameter				
	θ	D	Q	Δ%	Other
6	Up to 3rd decimal places	Up to 5th decimal places	Up to 2nd decimal places	Up to 3rd decimal places	Up to 6 digits
5	Up to 2nd decimal places	Up to 4th decimal places	Up to 1st decimal places	Up to 2nd decimal places	Up to 5 digits
4	Up to 1st decimal places	Up to 3rd decimal places	Up to zero decimal places	Up to 1st decimal places	Up to 4 digits
3	Up to zero decimal places	Up to 2nd decimal places	Up to zero decimal places	Up to zero decimal places	Up to 3 digits

The instrument may not be able to display minute values using the set number of display digits.

## LCD display auto-off (power-saving mode)

You can set whether the LCD display remains on continuously or turns off automatically. Setting the LCD display to **OFF** causes the LCD display to automatically turn off after there is no panel use for 10 seconds, thereby reducing power consumption. The default setting is **ON** (i.e., the LCD display remains on continuously). (This setting is linked to the auto-off setting for continuous measurement mode (p. 102).)

Screen display method (For more information, see p. 26):  
 (Measurement screen) **SET** key>(SET screen) **ADVANCED** tab>**DISP** key

### 1 Touch the **OFF** key or **ON** key.

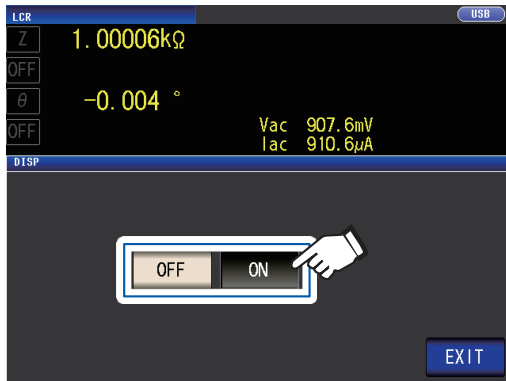

**OFF** Turns off the LCD.  
 The LCD is turned off after approximately 10 seconds elapse since the touch panel was last touched.

**ON** Sets the LCD to always on.

### 2 Touch the **EXIT** key twice.

Displays the measurement screen.

#### When you want to turn the backlight on again

If you touch the touch panel while the backlight is off, the backlight will be turned on again.

The backlight will be turned off again if you do not touch the touch panel for about 10 seconds.

## 3

Performing Measurements in LCR Mode

## Key tones and judgment tones

You can set the operation sound and each of the beep sounds for judgment results.

Screen display method (For more information, see p. 26):

(Measurement screen) **SET** key > (SET screen) **ADVANCED** tab > **BEEP** key

### 1 Configure beep tones.

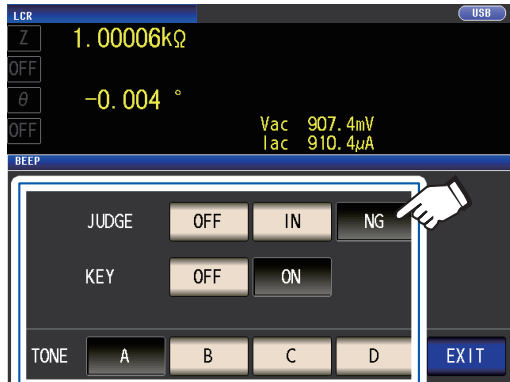

#### JUDGE: Beep sound settings for when comparator judgment

**OFF** When a comparator judgment is made, no beep sound is emitted.

#### When judgment performed with 1 comparator

**IN** When the comparator result is IN, a beep sound is emitted.

**NG** When the comparator result is LO or HI, a beep sound is emitted.

#### When judgment performed with 2 comparators

**IN** When both of these comparator results are IN, a beep sound is emitted.

**NG** When either one is LO or HI, a beep sound is emitted.

#### KEY: Beep sound setting for when key pressed

**OFF** When a key is pressed, no beep sound is emitted.

**ON** When a key is pressed, a beep sound is emitted.

#### TONE: Beep tone type

You can select from four types (A, B, C, and D).

### 2 Touch the EXIT key twice.

Displays the measurement screen.

If an invalid key is pressed or an operation causes an error, an error tone will sound regardless of whether the beep tone is turned on or off.

## Key-lock function (disabling key operation)

When the key-lock function is enabled, all setting changes except canceling the key-lock are disabled to protect the settings.

You can also set a passcode (security code).

Screen display method (For more information, see p. 26):

(Measurement screen) **SET** key>(SET screen) **ADVANCED** tab>**KEYLOCK** key

### 1 Touch the **ON** key.

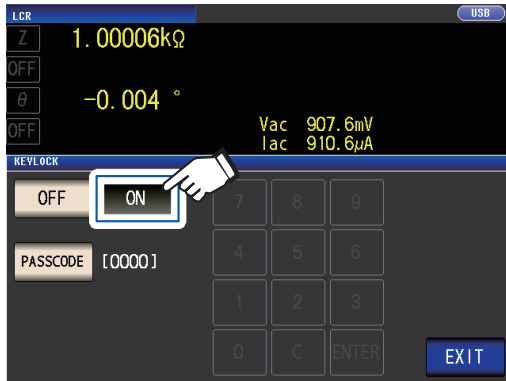

(When setting the passcode)

#### 1. Touch the **PASSCODE** key when the key-lock setting is **ON**.



#### 2. Use the numerical keypad to enter the passcode, and touch the **ENTER** key.

Settable range: 1 to 4 digits

Initial passcode: 3536

If a passcode is set, it needs to be entered to disable the key-lock.  
Take care not to forget the set passcode.

### 2 Touch the **EXIT** key twice.

Displays the measurement screen.

## 3

Performing Measurements in LCR Mode

- The key lock is disabled from the time the **EXIT** key is touched until the measurement screen is displayed.
- When using an external trigger, the key lock function does not apply to the **TRIG** key.
- Turning off the instrument will not cancel the key lock function.

## Disabling the Key-lock

- 1 Touch the **UNLOCK** key when the key-lock is enabled.



- 2 (When a passcode is set)  
Enter the passcode and touch the **UNLOCK** key.

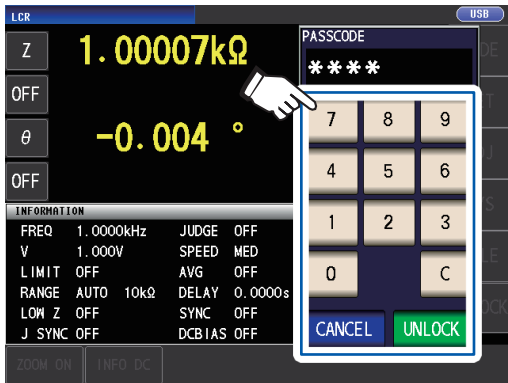

The entered passcode is indicated as \* on the screen.

To cancel input, touch the **C** key.

When you want cancel the disabling of the key-lock, touch the **CANCEL** key.

If the error indication shown below, check the following items.

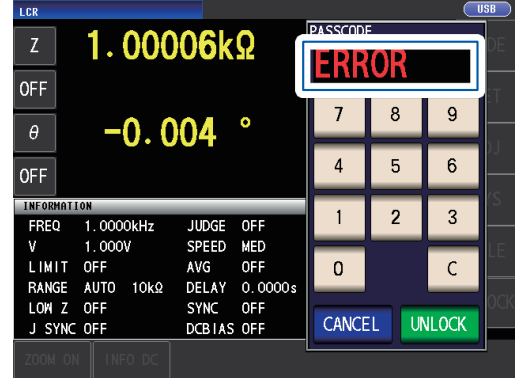

Cause	Remedy
The <b>UNLOCK</b> key was touched before you entered the passcode.	Touch the <b>C</b> key and enter the passcode.
The entered passcode is incorrect.	Touch the <b>C</b> key and enter the passcode again.

If you forget the passcode, perform a full reset to restore the instrument to the factory default settings (See "Performing a full reset (If you are unable to perform a system reset)" (p. 237).)

# 4

## Using Continuous Measurement Mode

In continuous measurement mode, a series of measurement conditions saved using the panel save function (p. 132) are loaded in order, and measurement is performed continuously using multiple different sets of conditions. Measurement can be performed using up to 60 sets of conditions. Continuous measurement mode measures the No. 1 and No. 3 parameters of the selected panel and makes judgments. The mode does not measure the No. 2 and No. 4 parameters. Their judgments are also performed if the comparator function and BIN function are set for the selected panel. For the measurement screen in continuous measurement mode, see “4.3 Checking Continuous Measurement Results” (p. 100).

**First, set the measurement mode to continuous measurement mode (p. 26).**

- Setting the measurement conditions so that the measurement frequency or measurement signal level differs for each panel allows you to simply evaluate the characteristics of the test sample.
- Continuous measurement can also be performed from the EXT I/O (p. 173).

# 4

### 4.1 Setting Which Panels to Use in Continuous Measurement

Before performing continuous measurement, set which panels to use.

Save the measurement conditions with the panel save function in advance.

See “6.1 Saving Measurement Conditions and Correction Values (Panel Save Function)” (p. 132).

Screen display method (For more information, see p. 26):  
(Measurement screen) **SET** key > (SET screen) **BASIC** tab

A list of the measurement conditions saved appears.

Any panel for which only the compensation value (ADJ) was saved is not displayed.

- 1 Use the **▲▼** key to select a panel for which to perform continuous measurement, and touch the **ON** key.

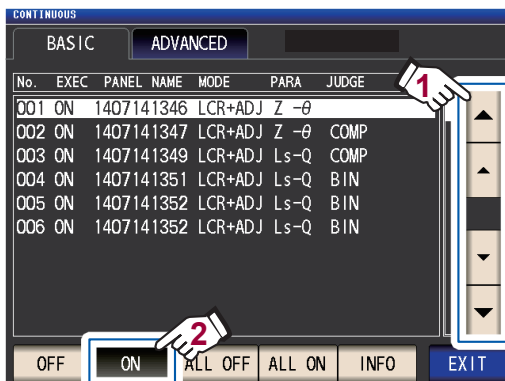

<b>OFF</b>	Removes the selected panel from the targets for continuous measurement.
<b>ON</b>	Sets the selected panel as a target for continuous measurement.
<b>ALL OFF</b>	Removes all panels from the targets for continuous measurement.
<b>ALL ON</b>	Sets all panels as targets for continuous measurement.
<b>INFO</b>	Display the panel information.

- 2 Touch the **EXIT** key.  
Displays the measurement screen.



## 4.2 Performing Continuous Measurement

Perform continuous measurement.

On the measurement screen, a list of the panels selected for use in continuous measurement will be shown on the **SET** screen (**BASIC** tab).

Touch the **TRIG** key.

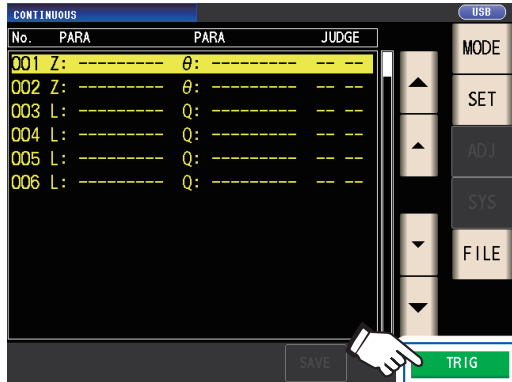

Continuous measurement will start.

To cancel continuous measurement, touch the **STOP** key.



## 4.3 Checking Continuous Measurement Results

Measurement results can be checked on the measurement screen. If another screen is being displayed, touch the **EXIT** key.

Measured values for the selected No. 1 parameter and No. 3 parameter will be displayed.

### Measurement screen

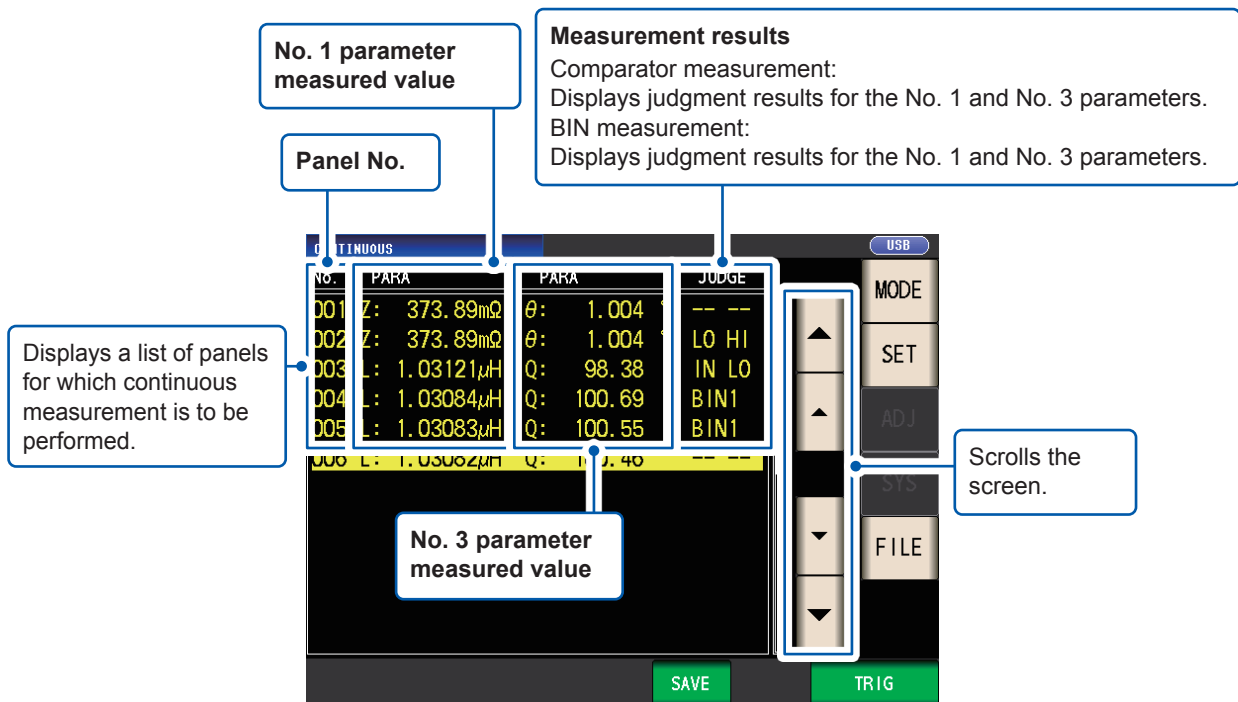

## 4.4 Changing the Display Timing Setting (When You Wish to Shorten the Screen Update Interval)

You can set the display timing during continuous measurement as desired.

If the display timing is set to **REAL**, the time for continuous measurement becomes long because the screen is updated every time measurement is performed.

If it is set to **AFTER** to give priority to the measurement time, the screen update time becomes short. (This is because the screen is updated once after all measurements are complete.)

The default setting is **REAL**.

Screen display method (For more information, see p. 26):

(Measurement screen) **SET** key > (SET screen) **ADVANCED** tab > **DRAW** key

### 1 Touch the **AFTER** key.

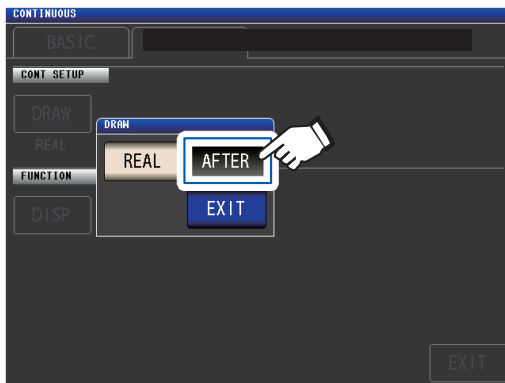

**REAL** Updates the screen after measurement of each panel.

**AFTER** Displays all after all continuous measurements are finished.

### 2 Touch the **EXIT** key twice.

Displays the measurement screen.

## 4.5 Setting the LCD Display Auto-Off (When You Wish to Save the Power)

You can set whether the LCD display remains on continuously or is turned off automatically. Setting the LCD display to **OFF** causes the LCD display to automatically turn off after there is no panel use for 10 seconds, thereby reducing power consumption. The default setting is **ON** (i.e., the LCD display remains on continuously). (This setting is linked to the auto-off setting for LCD mode [p. 95].)

Screen display method (For more information, see p. 26):  
(Measurement screen) **SET** key>(SET screen) **ADVANCED** tab>**DISP** key

### 1 Touch the **OFF** key.

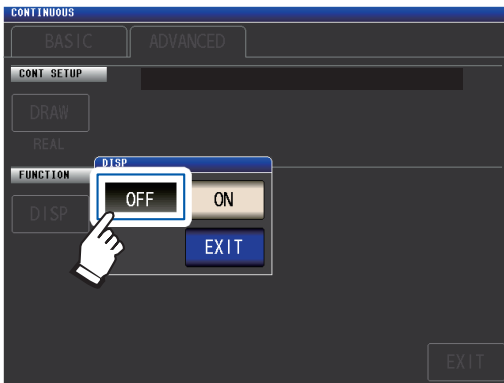

**OFF** Turns the LCD off after approximately 10 seconds elapse since the touch panel was last touched.

**ON** Sets the LCD to always on.

### 2 Touch the **EXIT** key twice.

Displays the measurement screen.

When you want to turn the backlight on again, touch the touch panel.

# 5 Error Correction

Measurement cables, probes, and fixtures have stray admittance and residual impedance. Since these characteristics influence measured values, measurement accuracy can be increased by correcting for them.

**First, set the measurement mode to LCR mode (p. 26).**

Settings are configured on the **ADJ** screen.

## **Check the following before performing correction:**

- Turn on the instrument and allow it to warm up for at least 60 min. before performing correction.
- The measurement accuracy values defined in the specifications are for when open circuit correction and short circuit correction are performed. Before performing measurement, be sure to perform open correction and short correction.
- Be sure to repeat the correction process after changing measurement cables, probes, or fixtures. You will be unable to obtain correct values if measurement is performed in the correction state prior to replacement.
- When performing correction, make sure that there is no noise source nearby. Noise may cause an error when performing correction.  
ex. Servo Motor, switching power source, high-voltage cable and etc.
- Perform correction under conditions that are similar to the environment in which the sample actually will be measured.
- The corrected value is preserved in the memory of the main instrument even when the instrument is turned off.
- Before performing correction, configure the low Z high accuracy mode, cable length, and DC bias settings. Changing any of these settings will invalidate the correction values.  
(See "Low Z High Accuracy Mode (high-precision measurement) (AC/DC)" (p. 59), "5.1 Setting the Cable Length (Cable Length Correction)" (p. 104), and "DC bias (superimposing a DC voltage on the measurement signal)(AC)" (p. 63).)

## 5.1 Setting the Cable Length (Cable Length Correction)

With high frequency measurement, the influence of the cable results in large measurement errors. Setting the cable length enables you to reduce the measurement errors. Use a coaxial cable with 50  $\Omega$  impedance.

Before performing correction, be sure to set the cable length.

Screen display method (For more information, see p. 29):  
(Measurement screen) **ADJ** key>(ADJ screen) **CABLE** key

### 1 Select the cable length to be used.

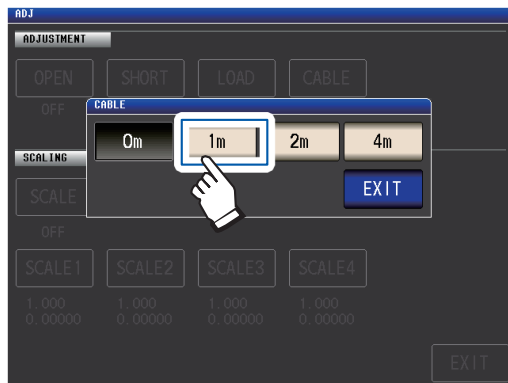

- 0 m** Select this when using a direct-coupled fixture or the like.
- 1 m** Select this when the cable length is 1 m.
- 2 m** Select this when the cable length is 2 m.
- 4 m** Select this when the cable length is 4 m.

### 2 Touch the **EXIT** key twice.

Displays the measurement screen.

- If the cable length changes, repeat open, short, and load correction.
- The guaranteed accuracy range varies with the cable length. (See "E: Coefficient of the measurement cable's length" (p. 223).)
- When manufacturing your own cables, make sure that the cable length matches the length set with the instrument. (See "Points to pay attention to when making your own probe" (p. 37).)
- When using the L2000, 9140-10, 9500-10, L2001, and 9261-10, set cable length compensation to **1 m**.
- Available range settings vary with the cable length setting. For more information, see p. 219 of "10.6 Measurement Range and Accuracy".

## 5.2 Open Correction

With open correction, it is possible to reduce the influence of the floating impedance of the measurement cables and thereby to enhance the accuracy of measurement. It is effective for measurement samples whose impedance is relatively high.

There are the following three methods for setting the open correction.

<b>All correction</b>	<ul style="list-style-type: none"> <li>• The correction values are obtained for all measurement frequencies (p. 106).</li> <li>• The range of measurement frequencies to correct can be set. See "Correction range limitation function (to shorten the correction time)" (p. 108).</li> </ul>
<b>Spot correction</b>	The correction values are obtained at the set measurement frequency only (p. 110).
<b>Off</b>	Open correction data becomes invalid (p. 118).

### Before performing open correction

- 1** Review the information shown under "Check the following before performing correction:" (p. 103).
- 2** Follow the instructions in "5.1 Setting the Cable Length (Cable Length Correction)" (p. 104).
- 3** Arrange the measurement cables, probes, and fixtures as they will be when measurement will actually be performed.

Changing the configuration of them may result in correction not being performed properly.

For more information about how to connect the instrument, see "2.4 Connecting the Measurement Cables, Probes, or Fixture" (p. 37).

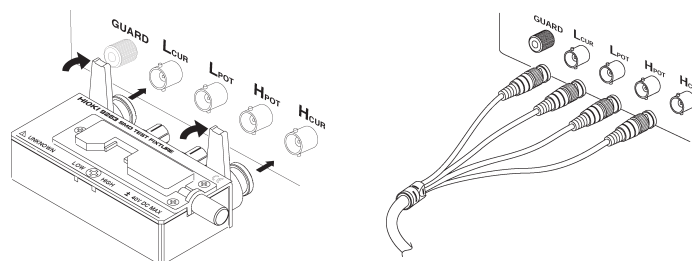

- 4** Adjust the distance between the HI and LO terminals of the measurement cable or Hioki optional probe or fixture to the width of the measurement sample and place them in the open state\*.

(What constitutes the open state varies with the measurement cable, probe, or fixture being used [p. 3 to p. 7]. For more information, review the appropriate user manual.)

\*: Defined as when the  $H_{CUR}$  terminal and  $H_{POT}$  terminal, as well as the  $L_{CUR}$  terminal and the  $L_{POT}$  terminal, are connected while the HIGH terminal and LOW terminal are not connected.

- 5** Perform guarding.  
(See "Appx. 2 Measurement of High Impedance Components" (p. Appx.3).)

Perform open correction after completing the above procedure.

See "All correction" (p. 106), and "Spot correction" (p. 110).

## All correction

Simultaneously acquire the open correction values for all measurement frequencies.

Screen display method (For more information, see p. 29):  
 (Measurement screen) **ADJ** key>(ADJ screen) **OPEN** key

### 1 Touch the **ADJUST** key.

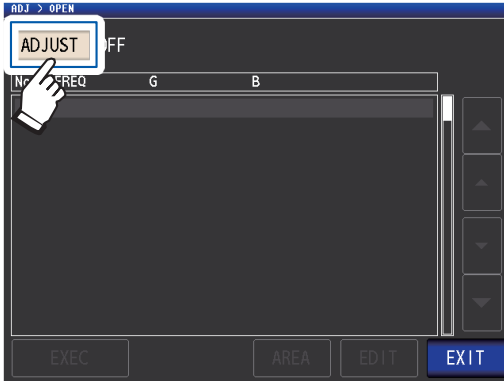

### 2 Touch the **ALL** key and then touch the **EXIT** key.

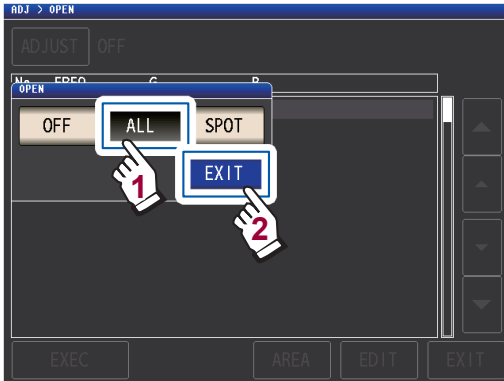

The **OPEN** dialog box will be closed, and the previous correction value will be displayed. (If correction has never been performed, the correction values become 0.)

Check that the measurement cable is in an open circuit state.

### 3 Touch the **EXEC** key.

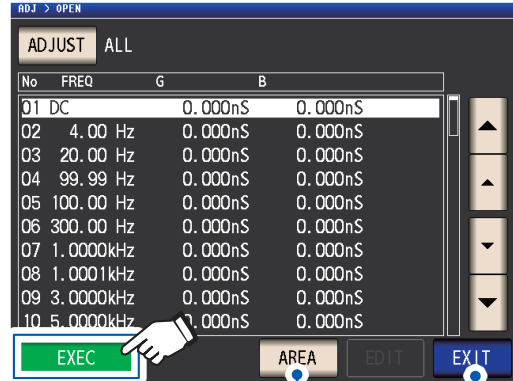

The correction range can be limited. (See p. 108)

Touch when you wish to cancel correction. (The display will return to the screen shown in Step 2 of the process, and the open correction value will remain unchanged.)

Correction will start.  
 Correction value acquisition time:  
 Approx. 50 seconds

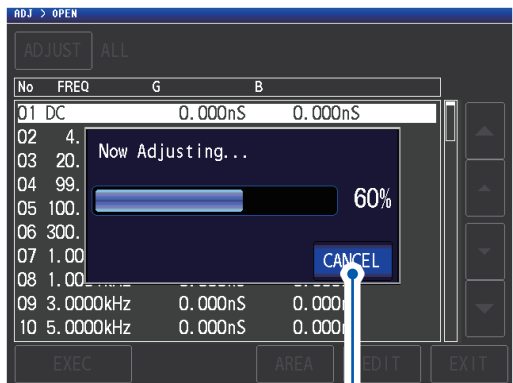

Touch when you wish to cancel correction. (The display will return to the screen shown in step 2, and the open correction value will remain unchanged.)

The next screen will be displayed once correction has completed normally.

**Correction results  
(Conductance, susceptance)**

No	FREQ	G	B
01	DC	0.001nS	0.000nS
02	4.00 Hz	0.006nS	-0.003nS
03	20.00 Hz	0.004nS	-0.000nS
04	99.99 Hz	0.004nS	0.001nS
05	100.00 Hz	0.005nS	-0.000nS
06	300.00 Hz	0.004nS	0.003nS
07	1.0000kHz	0.008nS	0.002nS
08	1.0001kHz	0.006nS	0.002nS
09	3.0000kHz	0.010nS	-0.003nS
10	5.0000kHz	0.006nS	-0.007nS

**Correction No.**

**Measurement frequencies**

- You can scroll the screen with the ▲▼ keys.
- Correction can be performed for impedances of at least 1 k $\Omega$ . If the impedance in the open state is less than 1 k $\Omega$ , an error will result.

#### 4 Touch the **EXIT** key twice.

Displays the measurement screen.

- If correction does not complete normally: (p. 116)
- To disable the correction value: (p. 118)



### Correction range limitation function (to shorten the correction time)

In All correction, correction is performed for the entire frequency range. By setting the minimum and maximum correction frequencies with this function, you can reduce the time required to perform the correction process. The DC on/off setting as well as the correction minimum and maximum frequency settings apply to both open and short correction.

For more information about the sequence of screens until the **AREA** key is displayed, see "All correction" (p. 106), and (p. 113).

**1** Touch the **AREA** key.

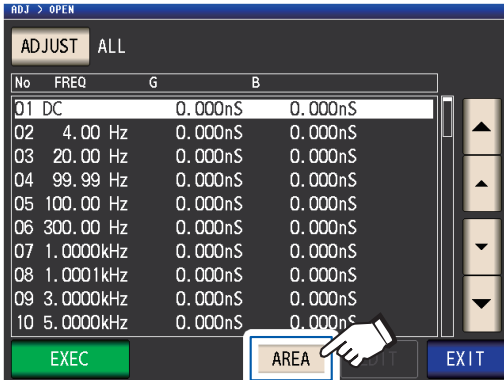

**2** Select DC correction.

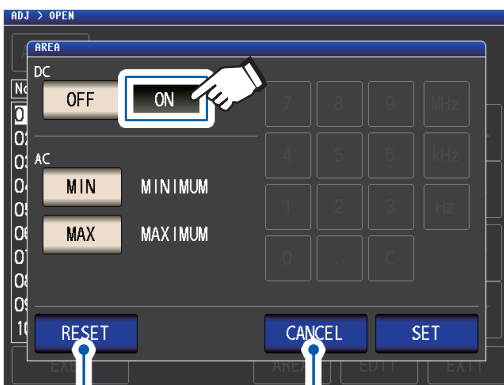

Touch when you wish to revert the settings to their default values.

Touch when you wish to cancel the configuration process.

**ON** Performs correction for AC measurement and DC measurement.

**OFF** Performs correction for AC measurement only.

**3** Touch the **MIN** key and enter the correction minimum frequency with the numeric keypad.

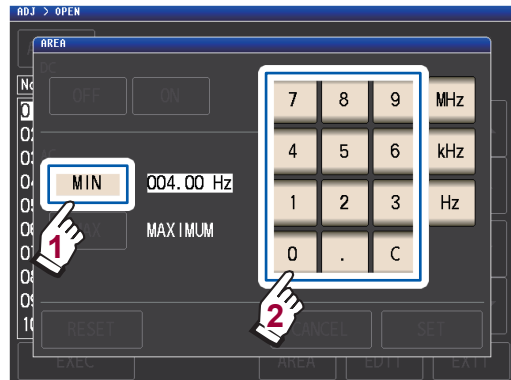

Settable range: 4 Hz to 8 MHz  
(default setting: 4 Hz)

If you make a mistake, touch the **C** key to reenter the value.

Touch the **MIN** key to return to the previous screen without changing the settings.

**4** Press a unit key to confirm the setting.

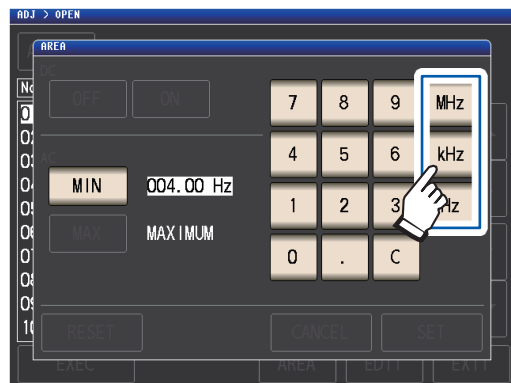

- The frequency is not confirmed until a unit key is pressed.
- If you attempt to set a measurement frequency greater than 8 MHz, it will automatically be reduced to 8 MHz.
- If you attempt to set a measurement frequency lower than 4 Hz, it will automatically be increased to 4 Hz.

The display will return to the screen shown in step 2.

**5** Touch the **MAX** key and enter the correction maximum frequency with the numeric keypad.

Settable range: 4 Hz to 8 MHz  
(default setting: 8 MHz)

Correction cannot be performed if limits are applied using a range that exceeds the maximum valid frequency setting (see p. 223) for each cable length. Correction will be performed up to the maximum valid frequency setting for the set cable length if limits are applied using a range that exceeds the maximum valid frequency setting (see p. 223) for each cable length.

**6** Touch the **SET** key.

The display will return from the **ADJ>OPEN** screen.

- If the maximum correction frequency is less than the minimum correction frequency, the maximum and minimum correction frequencies will be switched automatically.
- If the default settings are being used, the instrument will display **MINIMUM** and **MAXIMUM**.

**7** Touch the **EXEC** key.

Correction will be performed. Please wait for the process to complete.

**8** Touch the **EXIT** key twice.

Displays the measurement screen.

## Spot correction

Acquire the correction values at the set measurement frequencies. Measurement frequencies can be set for up to five points.

Screen display method (For more information, see p. 29):  
(Measurement screen) **ADJ** key > (**ADJ** screen) **OPEN** key

### 1 Touch the **ADJUST** key.

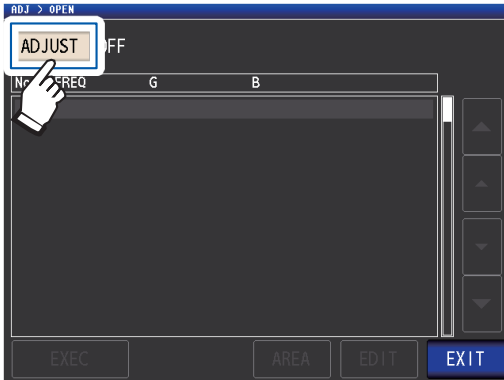

### 2 Touch the **SPOT** key and then touch the **EXIT** key.

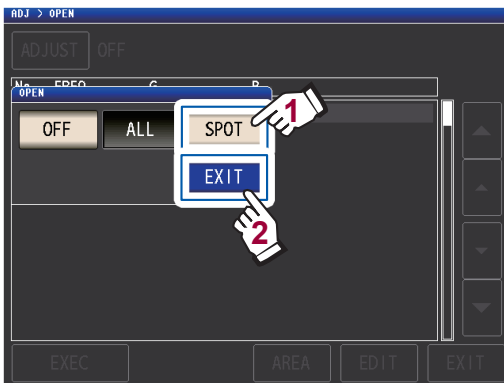

### 3 Select the correction point you want to set or edit with the ▲▼ key, and touch the **EDIT** key.

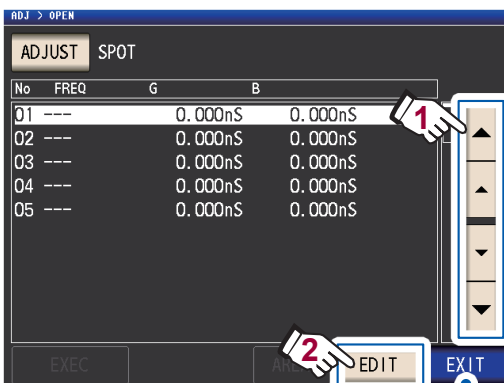

Touch when you wish to cancel correction.  
(The instrument will return to the screen shown in step 2.)

### 4 Enter the frequency to correct with the numeric keypad and touch the **SET** key to accept the setting.

The previous value will be displayed until you enter a value.

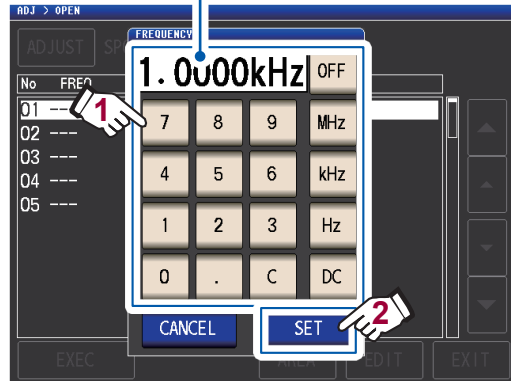

- Settable range: DC, 4 Hz to 8 MHz\*
- \*: The maximum frequency varies with the cable length (p. 223).
- Touch the **C** key to cancel input.

- If you attempt to set a measurement frequency greater than the maximum frequency for each cable length setting, it will automatically be reduced to the maximum frequency for each cable length setting.
- If you attempt to set a measurement frequency lower than 4 Hz, it will automatically be increased to 4 Hz.

The correction values from last time are displayed in a confirmation screen.

Check that the measurement cable is in an open circuit state.

## 5 Touch the EXEC key.

If correction has never been performed, the correction values become 0.

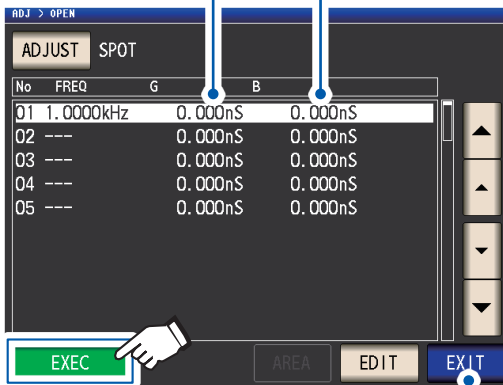

Touch when you wish to cancel correction. (The display will return to the screen shown in step 2, and the open correction value will remain unchanged.)

Correction starts.

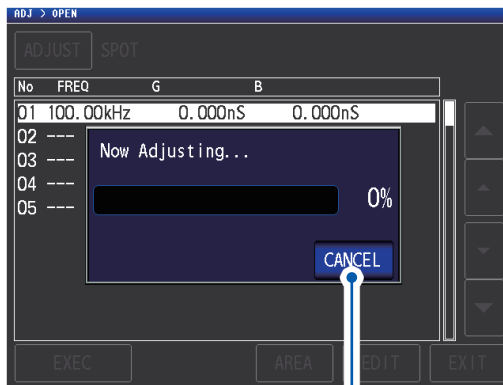

Touch when you wish to cancel correction. (The display will return to the screen shown in step 2, and the open correction value will remain unchanged.)

The time required to acquire correction values varies with the measurement frequency and the number of points.

For spot correction, the correction is valid when the measurement frequency and the spot correction frequency match.

The next screen will be displayed once correction has completed normally.

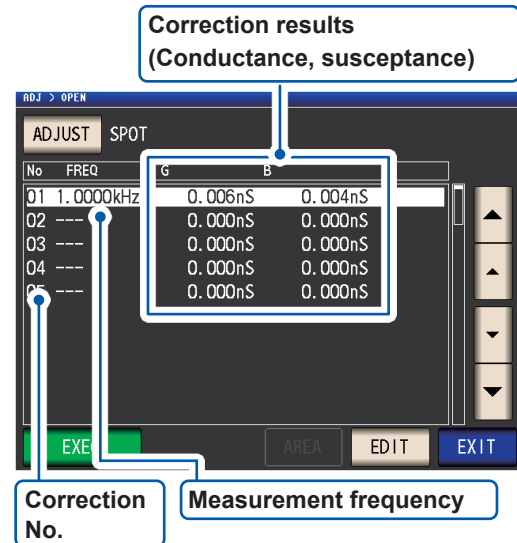

- You can check the conductance and susceptance for each correction point with the ▲▼ keys.
- Correction can be performed for impedances of at least 1 kΩ. If the impedance in the open state is less than 1 kΩ, an error will result.

## 6 Touch the EXIT key twice.

Displays the measurement screen.

- If correction does not complete normally: (p. 116)
- To disable the correction value: (p. 118)

## 5.3 Short Correction

With short correction, it is possible to reduce the influence of the residual impedance of the measurement cables and thereby to enhance the accuracy of measurement.

It is effective for measurement samples whose impedance is relatively low.

There are the following three methods for setting the open correction.

<b>All correction</b>	<ul style="list-style-type: none"> <li>• Correction values are obtained for all test frequencies (p. 113).</li> <li>• The range of measurement frequencies to correct can be set. See "Correction range limitation function (to shorten the correction time)" (p. 108).</li> </ul>
<b>Spot correction</b>	Correction values are obtained at the set measurement frequency only (p. 114).
<b>Off</b>	Short correction data becomes invalid (p. 118).

### Before performing open correction

- 1** Review the information shown under "Check the following before performing correction:" (p. 103).
- 2** Follow the instructions in "5.1 Setting the Cable Length (Cable Length Correction)" (p. 104).
- 3** Short the measurement cable terminals.  
(The shorted state varies with the measurement cable, probe, or fixture being used. [p. 3 to p. 7].  
For more information, review the appropriate user manual.)

**Necessary item: Shorting bar**

This shorting bar is for short circuiting together the ends of the test leads. Use an object whose impedance is as low as possible.



If you use a metallic wire or the like as a shorting bar, try to ensure that it is as thick and short as possible.

**Shorting method: Short the HI and LO terminals under conditions that are as close to the measurement conditions as possible.**

**(When using a fixture)**

In order to keep external influences as low as possible, be sure to thrust the shorting bar in all the way.

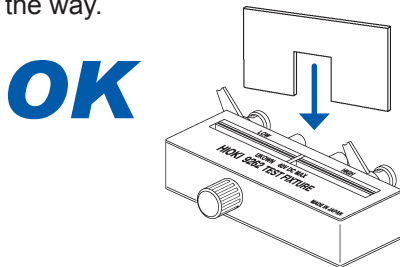

**(When using optional 9500-10)**

Pinch the clips onto a short metallic wire in the order of H<sub>CUR</sub>, H<sub>POT</sub>, L<sub>POT</sub>, and L<sub>CUR</sub> so that all the terminals are shorted.

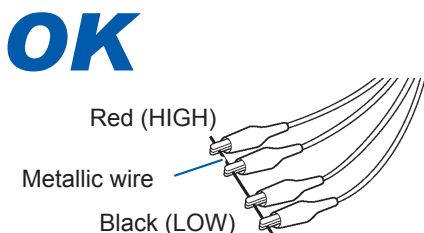

**(When using optional L2000)**

Short-circuit the tips with the V marks on the clips aligned as shown in the diagram.

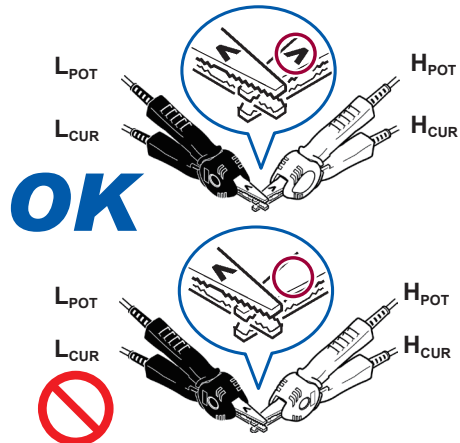

**(When using the optional 9140-10)**

Clip both clamps onto a shorting bar as shown.

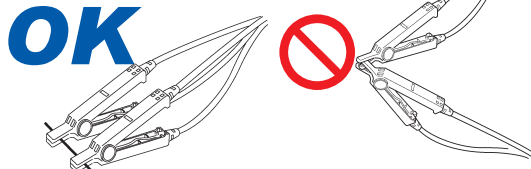

After completing the above procedure, perform short correction. See "All correction" (p. 113), and "Spot correction" (p. 114).

## All correction

Simultaneously acquire the short correction values for all measurement frequencies.

Screen display method (For more information, see p. 29):  
(Measurement screen) **ADJ** key > (**ADJ** screen) **SHORT** key

### 1 Touch the **ADJUST** key.

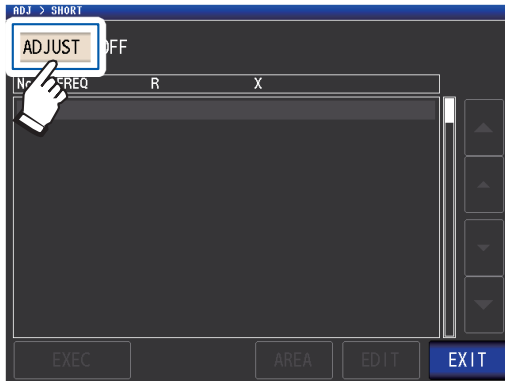

### 2 Touch the **ALL** key, and then touch the **EXIT** key.

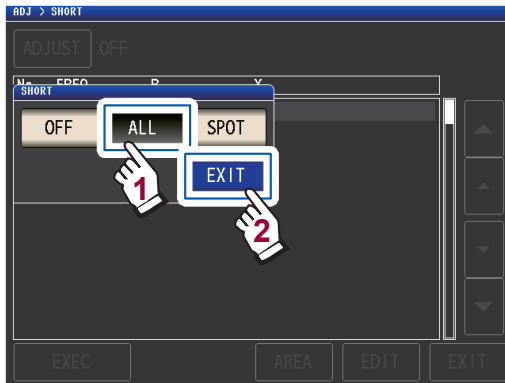

The correction values from last time are displayed in a confirmation screen.  
(If correction has never been performed, the correction values become 0.)

Check that the measurement cable is in an short circuit state.

### 3 Touch the **EXEC** key.

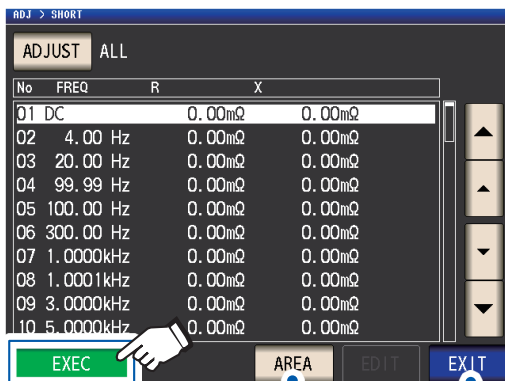

The correction range can be limited. (p. 108)

Touch when you wish to cancel correction. (The display will return to the screen shown in step 2, and the short correction value will remain unchanged.)

Correction starts.

Compensation value acquisition time:

Approx. 50 seconds

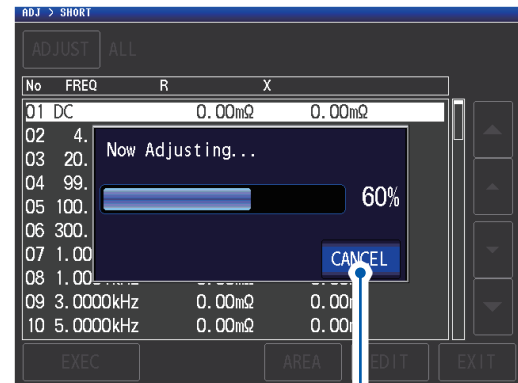

Touch when you wish to cancel correction.  
(The display will return to the screen shown in step 2, and the short correction value will remain unchanged.)

The next screen will be displayed once correction has completed normally.

### Correction results (Effective resistance, reactance)

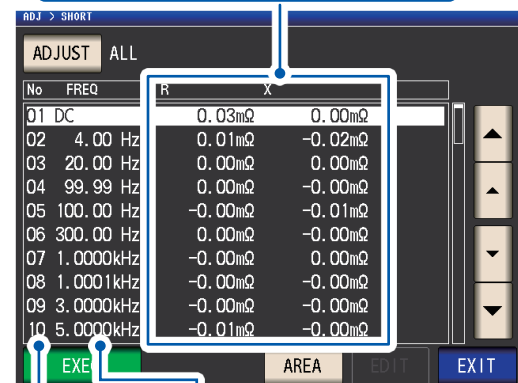

Correction No.

Measurement frequency

- You can check the effective resistance and reactance at each correction point with the ▲▼ keys.
- The possible correction range is 1 kΩ or less for impedance. Correction cannot be performed if the measured value (cable or fixture residual impedance) is 1 kΩ or greater.

### 4 Touch the **EXIT** key twice.

Displays the measurement screen.

- If correction does not complete normally: (p. 116)
- To disable the correction value: (p. 118)

## Spot correction

Acquire the correction values at the set measurement frequencies. Measurement frequencies can be set for up to five points.

Screen display method (For more information, see p. 29):  
(Measurement screen) **ADJ** key > (**ADJ** screen) **SHORT** key

### 1 Touch the **ADJUST** key.

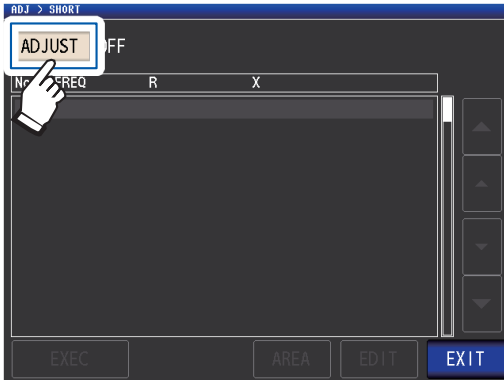

### 2 Touch the **SPOT** key, and then touch the **EXIT** key.

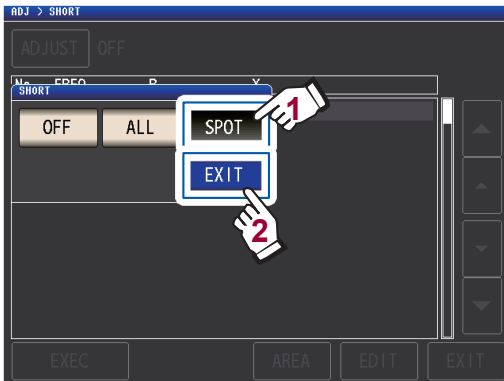

### 3 Select the correction point you want to set or edit with the ▲▼ key, and touch the **EDIT** key.

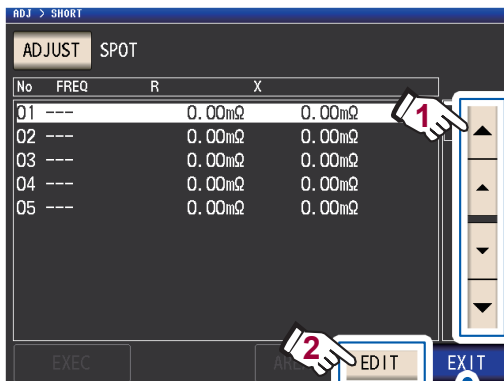

Touch when you wish to cancel correction.  
(The instrument will return to the screen shown in step 2)

### 4 Enter a frequency for correction, and touch the **SET** key to confirm it.

Until one of these keys is pressed for input of a numerical value, the previous frequency for which Spot correction was performed is displayed.

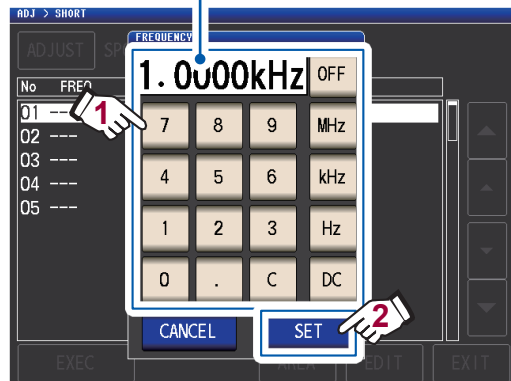

- Settable range: DC, 4 Hz to 8 MHz\*
- \*: The maximum frequency varies with the cable length (p. 223).
- Touch the **C** key to cancel input.

- If you attempt to set a measurement frequency greater than the maximum frequency for each cable length setting, it will automatically be reduced to the maximum frequency for each cable length setting.
- If you attempt to set a measurement frequency lower than 4 Hz, it will automatically be increased to 4 Hz.

The correction values from last time are displayed in a confirmation screen.

Check that the measurement cable is in an short circuit state.

## 5 Touch the EXEC key.

If correction has never been performed, the correction values become 0.

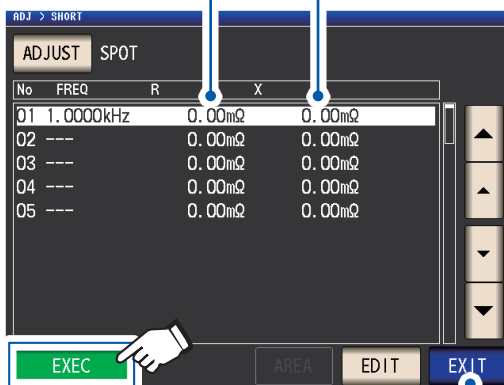

Touch when you wish to cancel correction. (The display will return to the screen shown in step 2, and the short correction value will remain unchanged.)

Correction starts.

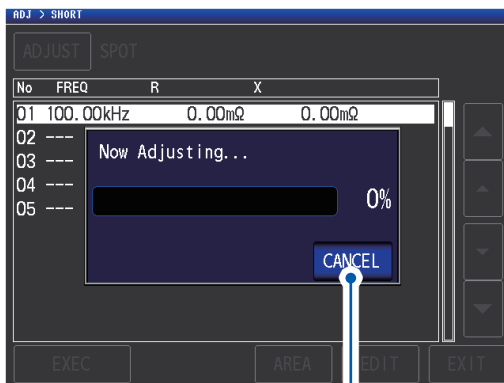

Touch when you wish to cancel correction. (The display will return to the screen shown in step 2, and the short correction value will remain unchanged.)

Compensation value acquisition time varies with the measurement frequency and number of points.

For spot compensation, correction will be valid only when the measurement frequency and spot correction frequency match.

The next screen will be displayed once correction has completed normally.

**Correction results  
(Effective resistance, reactance)**

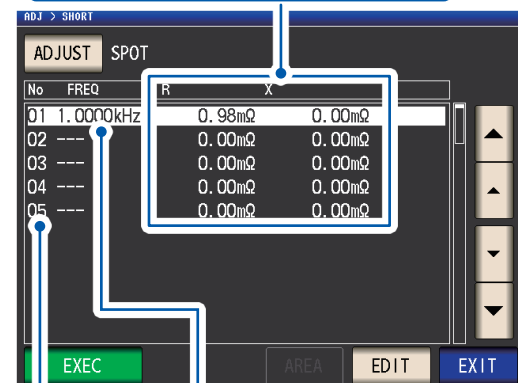

**Correction No.**

**Measurement frequency**

- You can check the effective resistance and reactance for each correction point with the ▲▼ keys.
- The valid correction range for impedance is 1 kΩ or less. Correction cannot be performed if the measured value (cable or fixture residual impedance) is 1 kΩ or greater.

## 6 Touch the EXIT key twice.

Displays the measurement screen.

- If correction does not complete normally: (p. 116)
- To disable the correction value: (p. 118)



## 5.4 If Open or Short Correction Fails to Complete Normally

A window such as the following will be displayed.

### (1) When correction failed

A window such as the following will be displayed. If this window is displayed and correction canceled (if you touch **EXIT** key), the instrument will revert to its state prior to correction.

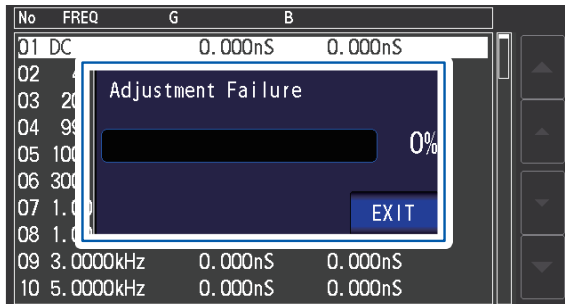

### Solution

#### Both open correction and short correction

- Check the correction status of the measurement cables (probe and fixture) (p. 3).
- Check the cable length correction setting. (If the setting is incorrect, it may not be possible to perform correction at high frequencies.)
- Verify that the sample is not connected. (Correction cannot be performed while the sample is being measured.)
- Check the correction range limitation function (p. 108) and the DC bias unit. (When DC correction is on, DC correction cannot be performed while the DC bias unit is connected.)
- Verify contact between  $L_{POT}$  and  $L_{CUR}$  and between  $H_{POT}$  and  $H_{CUR}$ .

#### Open correction

- Check that nothing is connected to the measurement cables. (Correction cannot be performed if the open correction value impedance is  $1\text{ k}\Omega$  or less.)

#### Short correction

- Check that the measurement cables are properly shorted together with the shorting bar. (Correction cannot be performed if the short correction value impedance is  $1\text{ k}\Omega$  or greater.)

(2) A window such as the following will be displayed if the cable length setting does not match the length of the connected cable (during open correction only).

A window such as the following will be displayed.

Adjusting

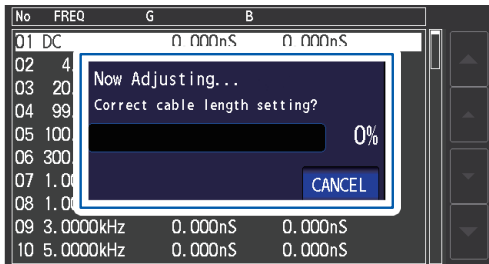

To change the cable length setting, touch the **CANCEL** key.

Completed

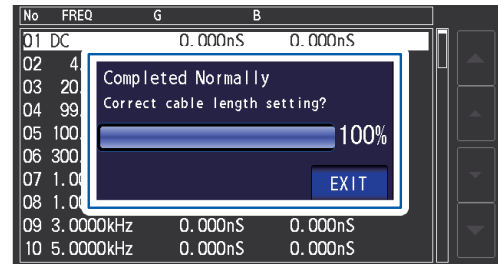

Touching the **EXIT** key will enable the acquired correction value.

### Solution

- Verify that the length of the connected cable and the cable length setting match (p. 104).
- The connected cable length is detected based on the voltage monitor value. It may not be possible to properly detect the cable length depending on the cable type and length and the impedance value at the time of open correction.

## 5.5 Disabling Open and Short Correction Values

Turning off the correction setting will disable the correction values you have acquired.

Screen display method (For more information, see p. 29):

To disable open correction: (Measurement screen) **ADJ** key>(ADJ screen) **OPEN** key

To disable short correction: (Measurement screen) **ADJ** key>(ADJ screen) **SHORT** key

### 1 Touch the **ADJUST** key.

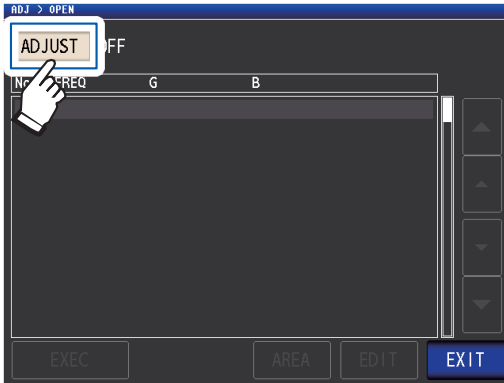

### 2 Touch the **OFF** key and then touch the **EXIT** key.

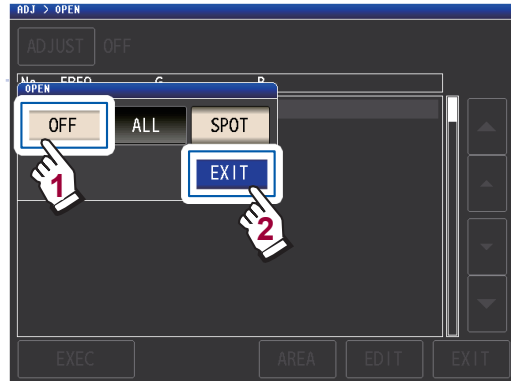

### 3 Touch the **EXIT** key twice.

Displays the measurement screen.

The correction values that are stored internally are not cleared by the operation described above. When **ALL** or **SPOT** is selected, the stored correction values can be used.

## 5.6 Load Correction (Correcting Values to Match Reference Values)

This section describes how to correct measured values based on a reference sample. A sample with a known measured value is measured. Then a correction coefficient is calculated and used to correct future measured values. The correction coefficient can be acquired using up to five compensation conditions. Up to five sets of correction conditions can be saved.

You can configure the following seven settings (in order) for each set of correction conditions:

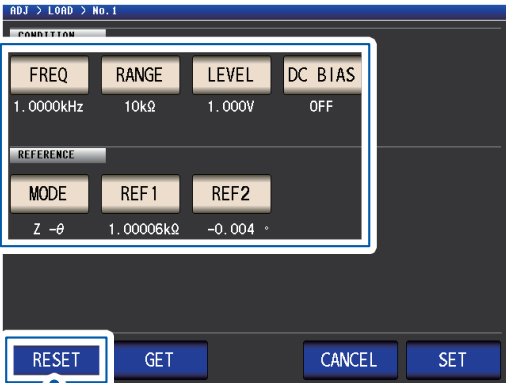
<p><b>Correction</b> 1. <b>frequency</b> <b>FREQ</b> (p. 122)</p>	<p>Define the measurement frequency used to measure and correct the reference sample.</p>	 <p>Resets the correction conditions (p. 127).</p>
<p>2. <b>Correction range</b> <b>RANGE</b> (p. 123)</p>	<p>Set the range to correct.</p>	
<p>3. <b>Correction signal level</b> <b>LEVEL</b> (p. 124)</p>	<p>Set the type and value of the measurement signal mode to correct.</p>	
<p>4. <b>DC bias</b> <b>DC BIAS</b> (p. 125)</p>	<p>Enable or disable DC bias and set the value.</p>	
<p>5. <b>Parameter type</b> <b>MODE</b> (p. 125)</p>	<p>Set the parameter to use as the reference value.</p>	
<p>6. <b>Reference value 1</b> <b>REF1</b> (p. 126)</p>	<p>Set the Z/ Cs/ Cp/ Ls/ Lp/ Rs reference value selected for the parameter type.</p>	
<p>7. <b>Reference value 2</b> <b>REF2</b> (p. 126)</p>	<p>Set the <math>\theta</math>/ D/ Rs/ Rp/ Q/ X reference value selected for the parameter type.</p>	

The correction coefficient is computed from the reference values of Z and  $\theta$  obtained from the set values and the actual data acquired from the reference sample at each of the correction frequencies.

$$\text{Correction coefficient of Z} = \frac{(\text{Reference value of Z})}{(\text{Actual data of Z})}$$

$$\text{Correction value of } \theta = (\text{Reference value of } \theta) - (\text{Actual data of } \theta)$$

The measured values of Z and  $\theta$  are first compensated using the following equations, and then individual parameters from the compensated Z and  $\theta$  values are employed.

$$Z = (Z \text{ before correction}) \times (\text{Correction coefficient of Z})$$

$$\theta = (\theta \text{ before correction}) + (\text{Correction value of } \theta)$$

## Procedures for the load correction

Once you have set the measurement cable length, use the following procedure to configure the load correction conditions and perform correction.

(See “5.1 Setting the Cable Length (Cable Length Correction)” (p. 104).)

Screen display method (For more information, see p. 29):

(Measurement screen) **ADJ** key>(ADJ screen) **LOAD** key

### 1 Touch the **ADJUST** key.

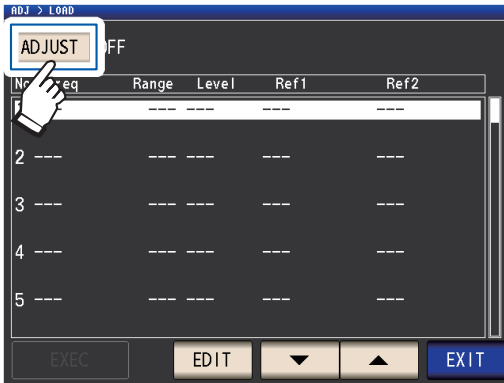

### 2 Touch the **ON** key, and then touch the **EXIT** key.

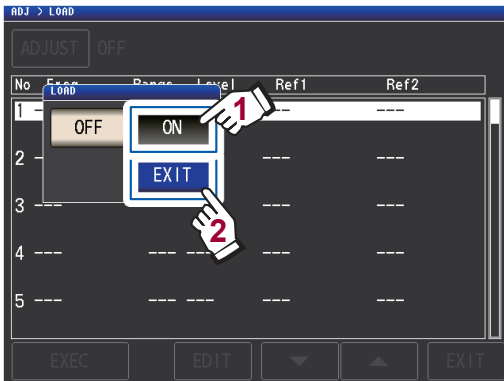

### 3 Select the correction point to configure with the **▲▼** keys and then touch the **EDIT** key.

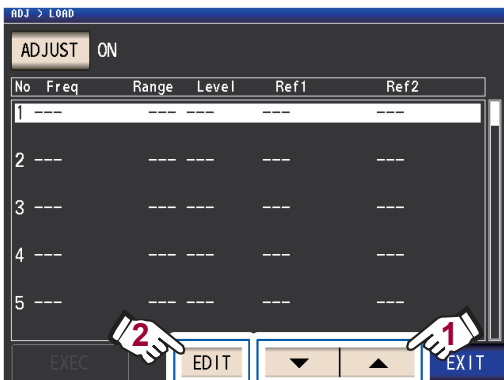

### 4 Set the correction conditions in the following order and then touch the **SET** key:

1. **FREQ**(p. 122)
2. **RANGE**(p. 123)
3. **LEVEL**(p. 124)
4. **DC BIAS**: (p. 125)
5. **MODE**: (p. 125)
6. **REF1, REF2**: (p. 126)

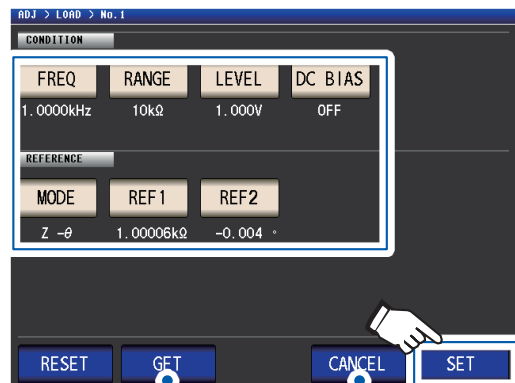

Allows you to set the current measurement conditions as the load correction conditions. (After touching the **GET** key, touch the **SET** key to accept the settings.)

Touch to cancel configuration of the correction conditions. (The display will return to the screen shown in step 3, and the correction conditions will remain unchanged.)

- You cannot skip ahead in the order of settings.
- Correction cannot be performed if all settings have not been configured.
- When you acquire measurement conditions with the **GET** key, the parameters used as reference values (p. 126) will be initialized to  $Z - \theta$ , and the reference values (**REF1** and **REF2**) will be cleared.

### 5 Connect the reference sample to the measurement cable.

**6** Touch the **EXEC** key, the correction values are acquired.



- A beep will sound if an error occurs while acquiring correction values. In this case, the correction values will be invalid (p. 127).
- After acquiring correction values, the acquired values will become invalid if any correction condition is changed.

Correction starts.  
Correction value acquisition time varies with the measurement frequency and number of points.

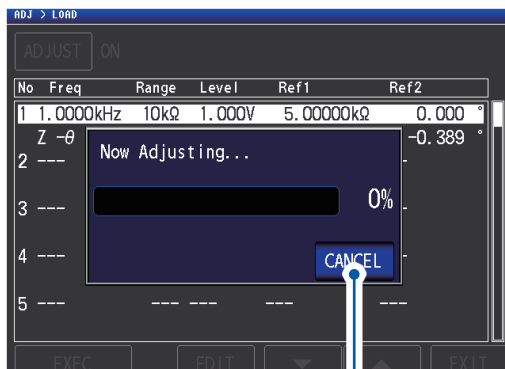

Touch when you wish to cancel correction. (The display will return to the screen shown in step 5, and the correction conditions will remain unchanged.)

**7** Touch the **EXIT** key.

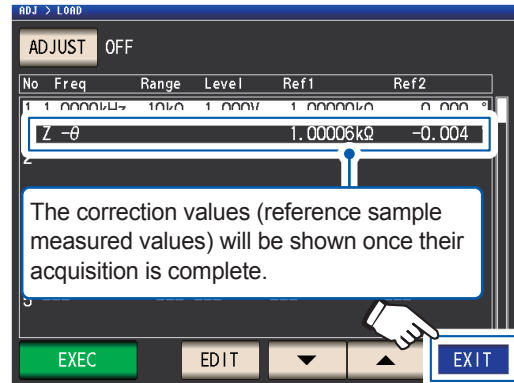

The instrument will return to the **ADJ** screen.

If correction does not complete normally: (p. 127)

**8** Touch the **EXIT** key.

Displays the measurement screen.

To disable the correction value: (p. 128)

When the load compensation is valid for the set measurement conditions, **ON** appears on the **LOAD** parameter in the measurement Screen.



**5** Error Correction

- Use the same correction conditions for load correction as the measurement conditions when correction is performed. Use of different conditions will prevent load correction from being performed. If the current measurement frequency and correction frequency do not match, an error such as the following will be displayed on the measurement screen.

INFORMATION						1/2
FREQ	10.000kHz	JUDGE	OFF	CABLE	0m	
V	1.000V	SPEED	SLOW2	OPEN	OFF	
LIMIT	OFF	AVG	OFF	SHORT	OFF	
RANGE	AUTO 10kΩ	DELAY	0.0000s	LOAD	ON	ERR

If the current measurement conditions and correction conditions other than correction frequency do not match, correction will be performed, but an error such as the following will be displayed on the measurement screen.

INFORMATION						1/2
FREQ	1.0000kHz	JUDGE	OFF	CABLE	0m	
V	0.100V	SPEED	SLOW2	OPEN	OFF	
LIMIT	OFF	AVG	OFF	SHORT	OFF	
RANGE	HOLD 10kΩ	DELAY	0.0000s	LOAD	ON	?

- When the same correction frequency has been set to multiple load correction groups, only the group with the smallest number will be valid.
- If open and short correction are enabled, the Z and  $\theta$  values after open and short correction will be corrected during load correction.
- When acquiring load correction values (when performing reference sample measurement), the open and short correction settings that were in effect before switching to the load correction screen will be enabled.
- Changing the low Z high accuracy mode setting will invalidate correction values.

## Setting the correction frequency

### 1 Touch the **FREQ** key.

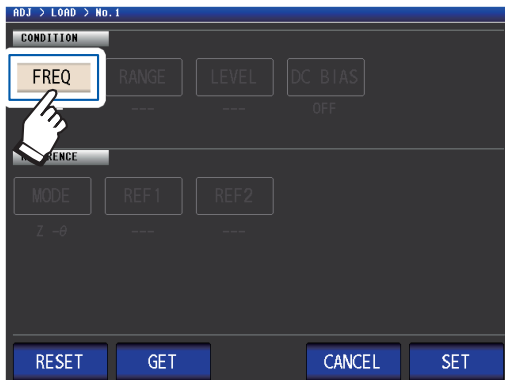

### 2 Enter the correction frequency with the numeric keypad, and touch the unit key to confirm the setting.

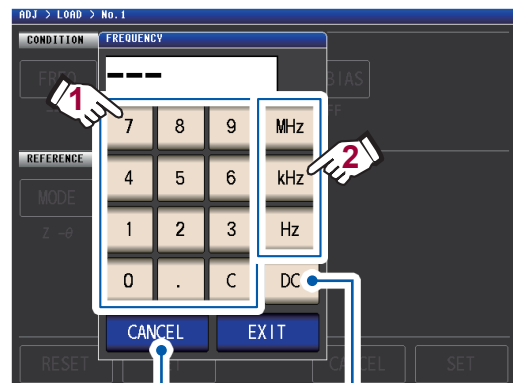

Touch when you wish to cancel input. (This dialog box will be closed.)

Touch when you wish to perform load correction during DC measurement.

Settable range: DC, 4 Hz to 8 MHz\*

\*: The maximum frequency varies with the cable length (p. 223).

If you make a mistake, touch the **C** key to reenter the value.

### 3 Touch the **EXIT** key.

The dialog box will be closed.

## Selecting the correction range

### 1 Touch the **RANGE** key.



### 2 Select the range for correction.

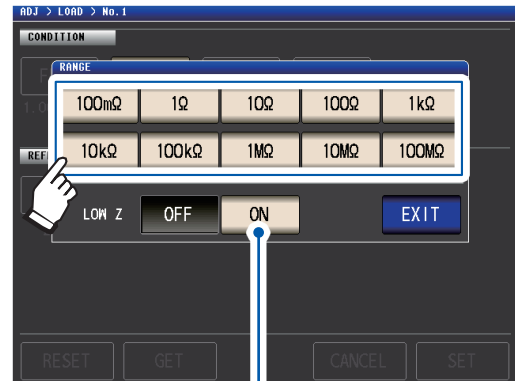

Touch when you wish to enable LOW Z operation.

### 3 Touch the **EXIT** key.

The dialog box will be closed.

The selection of available ranges will vary with the correction frequency. For more information, see p. 219 of "10.6 Measurement Range and Accuracy".



**Setting the measurement signal mode and level value for the correction signal level**

**1** Touch the **LEVEL** key.



**2** Select the correction signal level measurement signal mode.

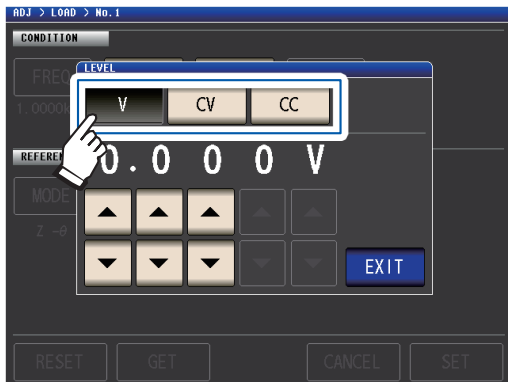

- V** Open circuit voltage (V) mode (p. 54)
- CV** Constant voltage (CV) mode (p. 54)
- CC** Constant current (CC) mode (p. 55)

**3** Enter the voltage level or current level with the **▲▼** keys.

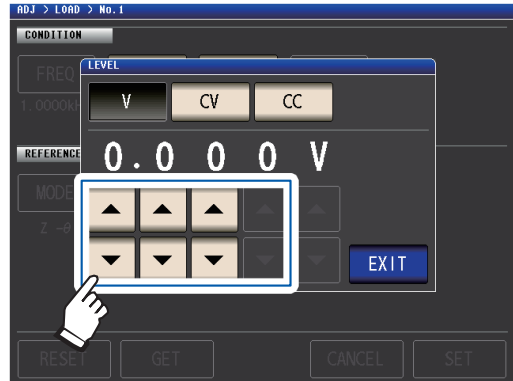

For settable range, see the following table.

**4** Touch the **EXIT** key.  
The dialog box will be closed.

Since load correction when the frequency is set to DC is fixed to 1 V in open voltage (V) mode, the correction signal level cannot be set.

LOW Z	Range	V, CV
OFF	All range	1 V (fixed)
ON	All range	1 V (fixed)

**Valid voltage level and current level setting range (load correction during AC measurement)**

V, CV			CC		
LOW Z	Range	V, CV	LOW Z	Range	CC
OFF	All range	4 Hz to 1.0000 MHz: 0.010 V to 5.000 V 1.0001 MHz to 8 MHz: 0.010 V to 1.000 V	OFF	All range	4 Hz to 1.0000 MHz: 0.01 mA to 50.00 mA 1.0001 MHz to 8 MHz: 0.01 mA to 10.00 mA
ON	All range	0.010 V to 1.000 V	ON	All range	0.01 mA to 100.00 mA

## Setting the DC bias

### 1 Touch the **DC BIAS** key.

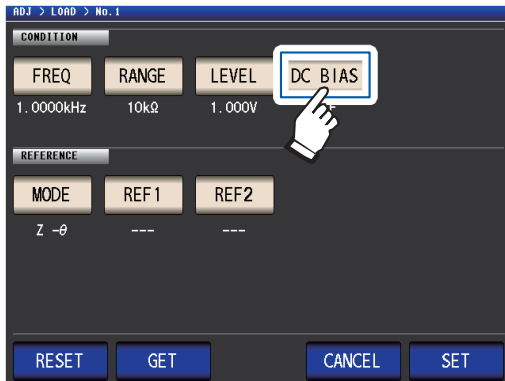

### 2 Touch the **ON** key and enter the DC bias value with the **▲▼** keys.

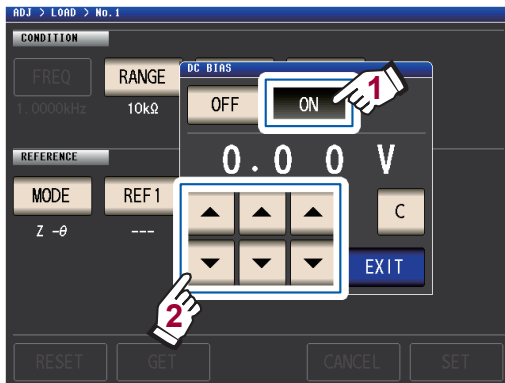

Settable range: 0 V to 2.5 V

If you make a mistake, touch the **C** key to reenter the value.

### 3 Touch the **EXIT** key.

The dialog box will be closed.

When low Z high accuracy mode (p. 59) is enabled, the valid setting range will differ (from 0 V to 1 V).

When **DC** is selected for the compensation frequency setting, the DC bias setting cannot be set.

## Selecting the parameters to use as reference values

### 1 Touch the **MODE** key.



### 2 Select the parameter mode of the reference value to be set.

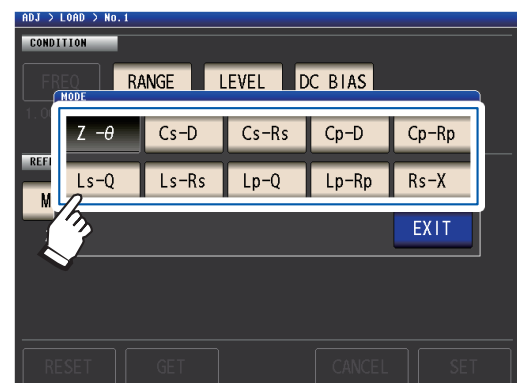

### 3 Touch the **EXIT** key.

The dialog box will be closed.

See "Parameters" (p. 42).

- When **DC** is selected for the correction frequency setting, DC measurement (Rdc) is selected automatically and the parameter to use for the reference value setting cannot be set.
- If you change the parameter to use as the reference value, the settings of reference value 1 and reference value 2 are cleared. (See "Setting reference values" (p. 126).)

**Setting reference values**

Enter the reference value for the parameter displayed to the left of the parameter mode for **REF1** and the reference value for the parameter displayed to the right of the parameter mode for **REF2**.

- 1 Touch the REF1 key.**

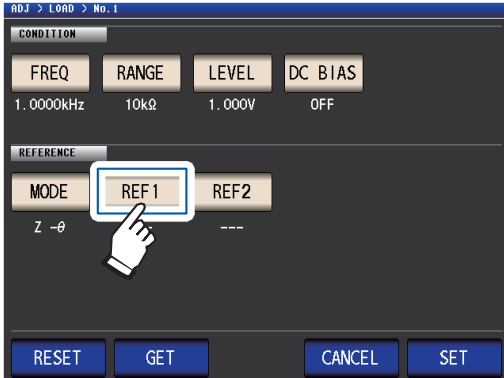

- 2 Enter the reference value with the numeric keypad and touch a unit key to accept the setting.**

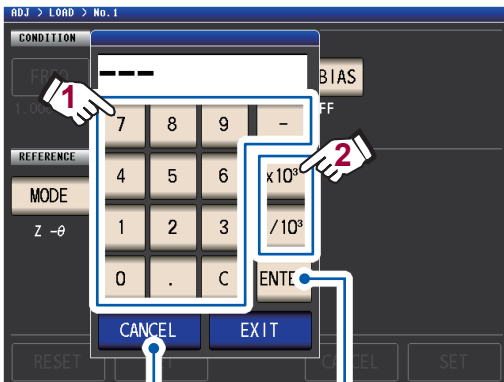

Touch when you wish to cancel input. (This dialog box will be closed.)

Uses a multiple of  $\times 1$ . (Touching **EXIT** without touching a unit key will also cause a multiple of  $\times 1$  to be used.)

Settable range:

Same as the maximum display range for the selected parameter.

(See “10.1 General Specifications” (p. 195))

If you make a mistake, touch the **C** key to reenter the value.

- 3 Touch the EXIT key.**

The dialog box will be closed.

- 4 Touch the REF2 key and set the reference value in the same manner.**

When **DC** is selected for the correction frequency setting, only reference value 1 can be set.

## To reset the correction condition settings

This section describes how to clear all settings for the selected correction condition number.

Screen display method (For more information, see p. 29):  
(Measurement screen) **ADJ** key>(ADJ screen) **LOAD** key

- 1 Select the correction condition number to reset with the **▲▼** keys and then touch the **EDIT** key.

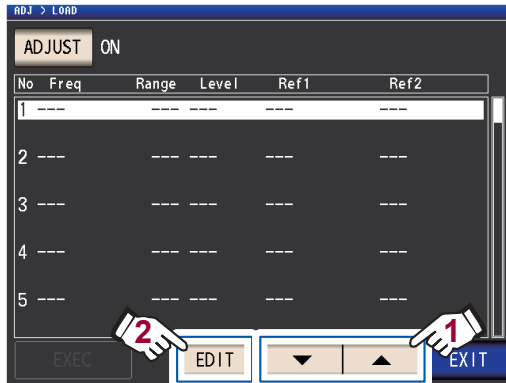

- 2 Touch the **RESET** key and then touch the **SET** key.

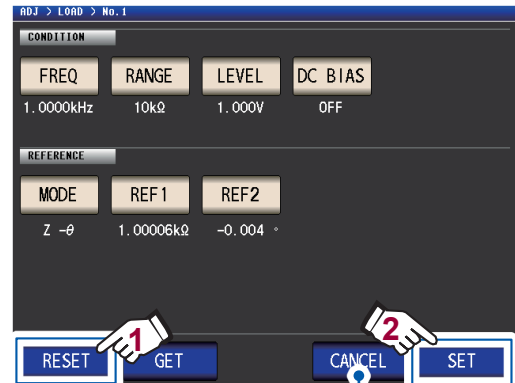

Touch when you wish to cancel the reset.  
(This dialog box will be closed.)

- 3 Touch the **EXIT** key twice.  
Displays the measurement screen.

5

Error Correction

## When load correction fails to complete normally

If correction fails, a window like the following appears. Touch **EXIT** to close the window and then configure the correction conditions again.

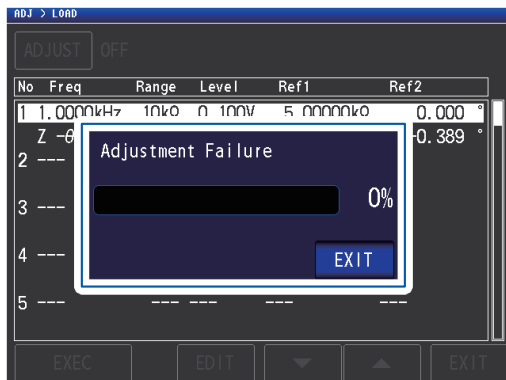

## Disabling load correction

You can disable correction by setting the correction setting to **OFF**.

Screen display method (For more information, see p. 29):  
(Measurement screen) **ADJ** key>(ADJ screen) **LOAD** key

- 1 Touch the **ADJUST** key.

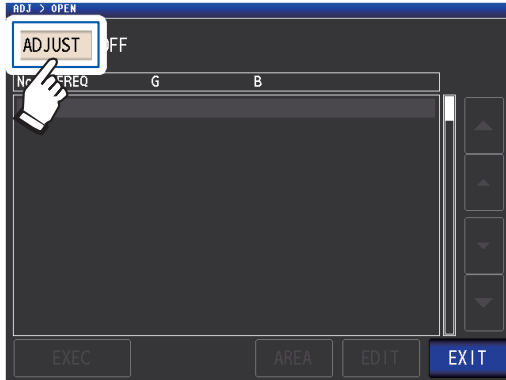

- 2 Touch the **OFF** key, and then touch the **EXIT** key.

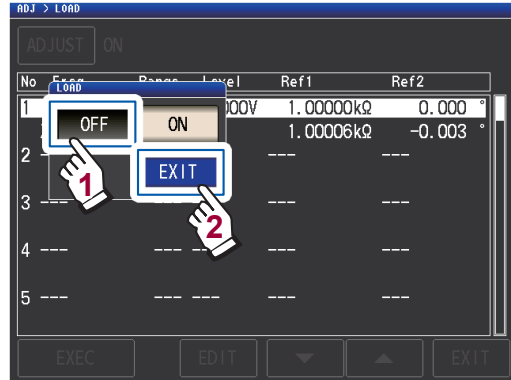

- 3 Touch the **EXIT** key twice.  
Displays the measurement screen.

## 5.7 Correcting Measured Values with a User-Specified Correction Coefficient (Correlation Correction)

This functionality enables you to correct measured values using a user-specified correction coefficient. This function can be used to provide compatibility among measurement devices.

Set the correction coefficients A and B for the measurement values of No. 1 to No. 4 parameters to correct by the expression on the right.  
(See “Appx. 1 Measurement Parameters and Calculation Formula” (p. Appx.1).)

$$Y = A \times X + B$$

However, if the parameter corresponding to X is either D or Q, scaling is applied to  $\theta$  as shown in the expression on the right, and then D or Q is obtained from  $\theta'$ .

$$\theta' = A \times \theta + B$$

X: No. 1 or No. 3 parameter measurement value    Y: the last measurement value     $\theta'$ : correction value of  $\theta$   
A: integration value of the measured value X    B: the value added to measured value X

Screen display method (For more information, see p. 29):  
(Measurement screen) **ADJ** key > (**ADJ** screen) **SCALE** key

- 1 Touch the **ON** key, and then touch the **EXIT** key.

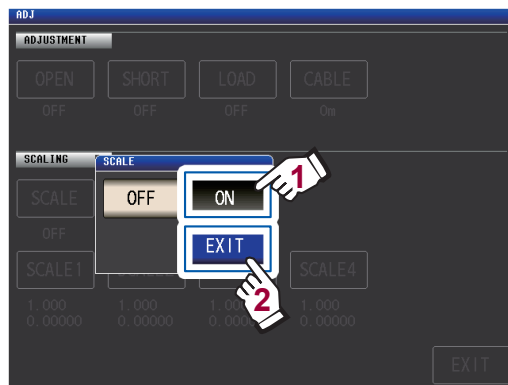

When you wish to cancel scaling  
Touch **OFF**.

- 2 Select the correction coefficient of the parameter you want to change.

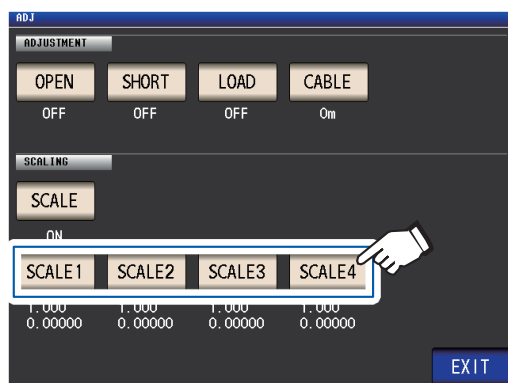

The parameters and correction coefficient numbers correspond as shown below.

<b>SCALE1</b>	No. 1 parameter
<b>SCALE2</b>	No. 2 parameter
<b>SCALE3</b>	No. 3 parameter
<b>SCALE4</b>	No. 4 parameter

- 3 Touch the **A** key.

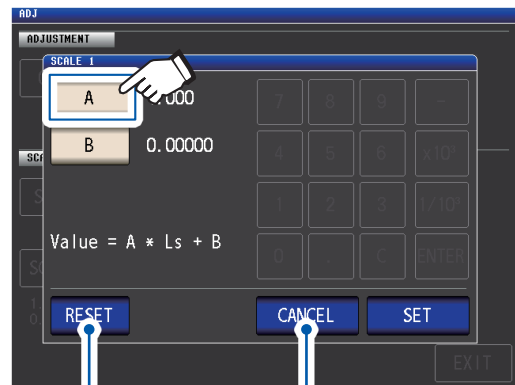

Touch when you wish to revert the setting to the default value.

Touch when you wish to cancel the setting.

- 4 Set correction coefficient A with the numeric keypad and then touch the **ENTER** key.

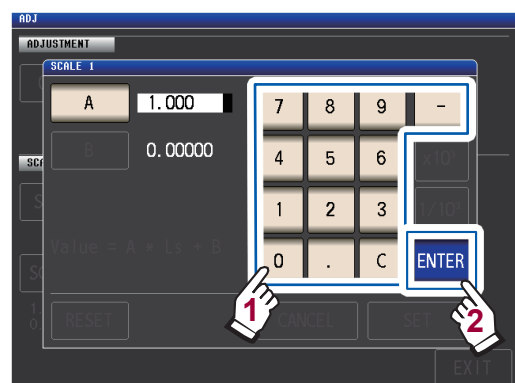

Settable range: -999.999 to 999.999

If you make a mistake, touch the **C** key to reenter the value.

Touching **ENTER** while nothing is being displayed (while touching the **C** key) will close the dialog box without changing the setting.

The display will return to the screen shown in step 3.

**5** Touch the **B** key.

**6** Enter the correction coefficient **B** with the numeric keypad, and touch the **ENTER** key to accept the value.

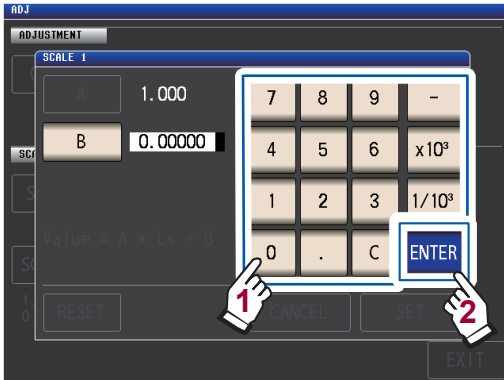

$\times 10^3$  Step the units up.

$1/10^3$  Step the units down.

Units: a/ f/ p/ n/  $\mu$ / m/ none/ k/ M/ G

Settable range: -9.99999G to 9.99999G

If you make a mistake, touch the **C** key to reenter the value.

To close the dialog box without making any change to the set value, press the **ENTER** key when the screen is in the state with nothing being displayed (the state after touching the **C** key).

**7** Touch the **SET** key.

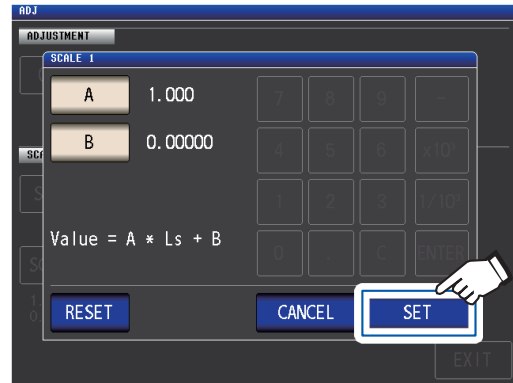

**8** Touch the **EXIT** key.

Displays the measurement screen.

If you select the same parameter multiple times and set a different correction coefficient for each, scaling will be performed using the correction coefficient for the parameter with the lowest number. (The correction coefficients of the other parameter numbers become invalid.)

Example: In the case of the following settings, scaling is performed using the correction coefficient of No. 1 parameter for all Z of No. 1, 2, and 4 parameters. (The correction coefficients of No. 2 and 4 parameters are invalid.)

Display Parameter Setting	Correction Coefficient Setting
No. 1 Parameter: Z	A = 1.500, B = 1.50000
No. 2 Parameter: Z	A = 1.700, B = 2.50000
No. 3 Parameter: $\theta$	A = 0.700, B = 1.00000
No. 4 Parameter: Z	A = 1.900, B = 3.50000

# 6

## Saving and Loading Measurement Condition and Correction Value Data

This section describes how to save measurement condition data and correction value data in the instrument's memory as well as how to load that data.

(Measurement conditions and correction values at the time the green **SAVE** key on the measurement screen is touched will be saved.)

Data is saved as a panel.

On the screen, measurement condition data is displayed as **LCR**, while correction value data is displayed as **ADJ**.

No.	PANEL NAME	MODE	INFORMATION
001	1412031000	LCR+ADJ	
002	1412031000	LCR+ADJ	Ls- -Q -Rd
003	1412031200	ADJ	
004	1412031201	LCR	Z - -θ -
005	1412031202	LCR	
006	----	NO SAVE	----
007	----	NO SAVE	----
008	----	NO SAVE	----
009	----	NO SAVE	----
010	----	NO SAVE	----

Example:

Measurement conditions and correction values have been saved as panel No. 1.

Correction values have been saved as panel No. 3.

Measurement conditions have been saved as panel No. 5.

**First, set the measurement mode to LCR mode (p. 26).**

Settings can be configured on the **SET** screen.

<b>Panel save function (p. 132)</b>	Saves measurement conditions and correction values as a panel.
<b>Panel load function (p. 136)</b>	Loads a panel.
<b>Editing panel data</b>	<ul style="list-style-type: none"> <li>Changes the panel name (p. 137).</li> <li>Deletes the panel (p. 138).</li> </ul>

- The instrument contains a built-in backup lithium battery which offers a service life of about ten years.
- When the life of the built-in lithium battery ends, the measurement conditions will no longer be able to be saved. Contact your authorized Hioki distributor or reseller.



# 6.1 Saving Measurement Conditions and Correction Values (Panel Save Function)

This section describes how to save measurement condition data and correction value data in the instrument's memory. The following number of data sets can be saved:  
 (Measurement condition: Up to 60 items, Correction value: Up to 128 items)

First, select the data type you wish to save. You can select from three types (see procedure below). Then, save the selected type of data to a panel (See p. 134).

## Setting the type of data to save

Screen display method (For more information, see p. 26.)  
 (Measurement screen) **SET** key>(SET screen) **ADVANCED** tab>**PANEL** key

**1** Touch the **SAVE TYPE** key.

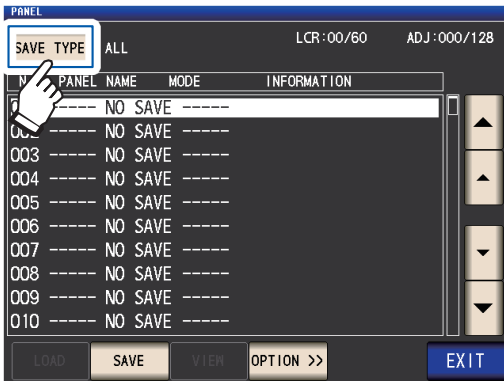

**2** Select the type of data to save and touch the **EXIT** key.

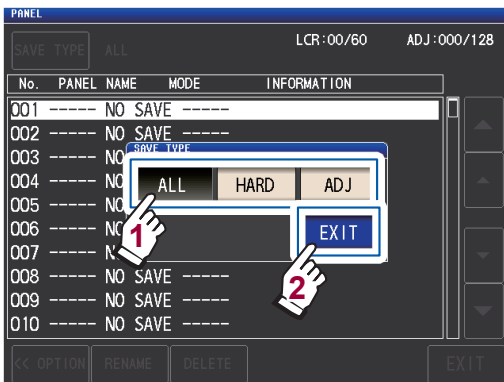

<b>ALL</b>	Saves all <b>HARD</b> and <b>ADJ</b> content. (Indication on screen: <b>LCR+ADJ</b> )
<b>HARD</b>	Saves the measurement condition and cable length correction setting value. (Indication on screen: <b>LCR</b> )
<b>ADJ</b>	Saves only each of the setting values and correction values of open correction, short correction, load correction, and correlation (scaling) correction. (Indication on screen: <b>ADJ</b> )

**3** Touch the **EXIT** key twice.  
 Displays the measurement screen.

When the type of data to save is set to **ALL**, data is saved to one panel but counted as one set of measurement conditions and one set of correction values.

(Example: When data is saved after setting the type of data to save to **ALL**, the panel is counted as 1 **LCR** [measurement conditions] data set and 1 **ADJ** [correction values] data set.)

Each count will increase by 1.

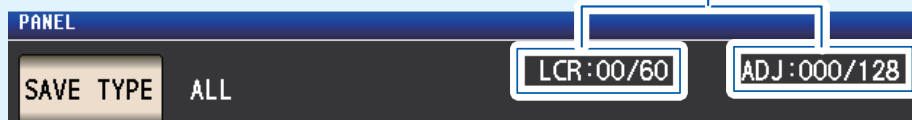

## PANEL screen layout

### Number of data sets saved

The text color changes in accordance with the number of data items currently saved as shown in the table below.

Text colors:	White	Yellow	Red
<b>LCR</b> (LCR mode measurement conditions)	0 to 29	30 to 59	60
<b>ADJ</b> (correction values)	0 to 63	64 to 127	128

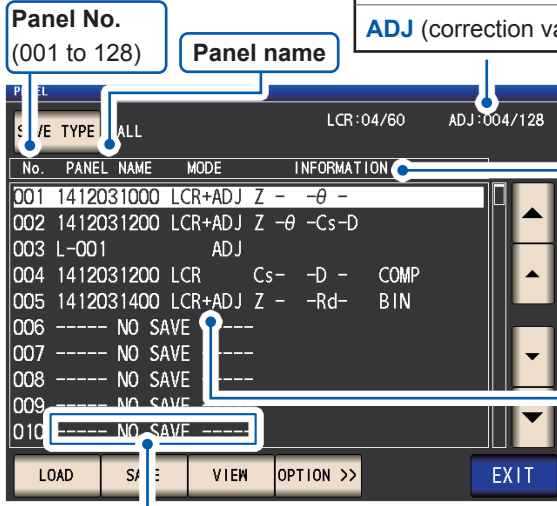

Indicates that nothing is saved.

### Information

In order from left

Measurement parameters	Judgment mode
PARA1 - PARA2 - PARA3 - PARA4	<b>COMP</b> or <b>BIN</b>

### Mode (Type of saved data)

Notation	Meaning
<b>LCR+ADJ</b>	All <b>LCR</b> and <b>ADJ</b> content
<b>LCR</b>	LCR measurement conditions and cable length correction setting value
<b>ADJ</b>	Only each of the setting values and correction values of open correction, short correction, load correction, and correlation (scaling) correction

## Saving measurement conditions and correction values

Screen display method (For more information, see p. 26.)  
 (Measurement screen) **SET** key>(SET screen) **ADVANCED** tab>**PANEL** key

- 1 Select the panel number to save with the **▲▼** keys and then touch the **SAVE** key.

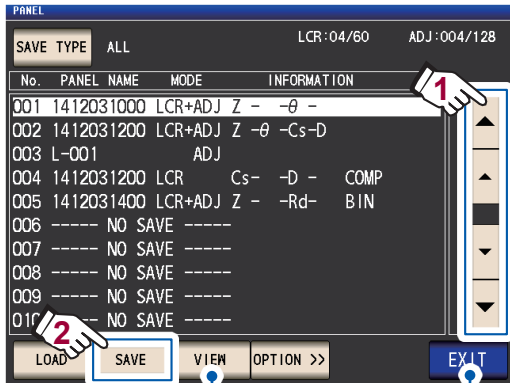

Touch when you wish to check the contents of saved panels. (See p. 135)

Touch when you wish to cancel the save operation.

Panel number display range:  
 No. 001 to No. 128

See "PANEL screen layout" (p. 133).

- 2 (To change the panel name)  
**If you do not wish to change the panel name, proceed to step 5.**  
 Touch the **RENAME** key.

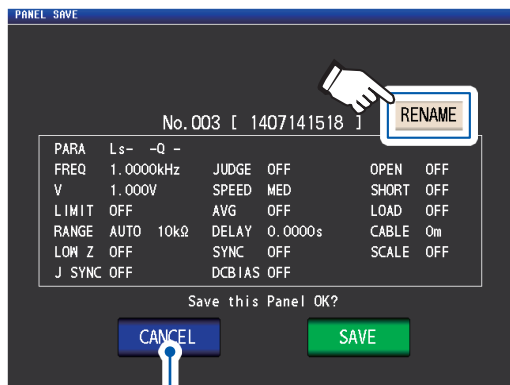

Cancels the save operation and displays the **PANEL** screen.

- 3 Enter the panel name with the numeric keypad and touch the **PANEL NAME** key.

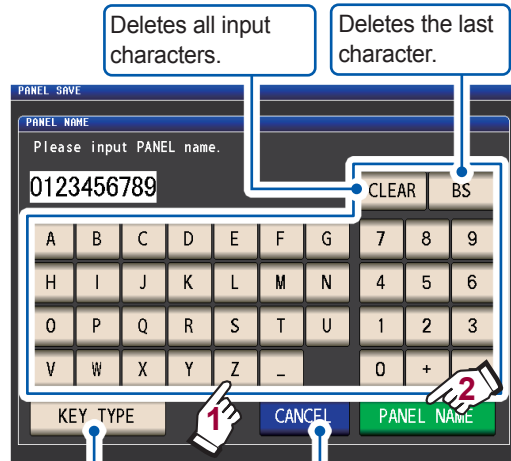

Changes the keyboard type.

Cancels the operation to change the panel name and closes the dialog box.

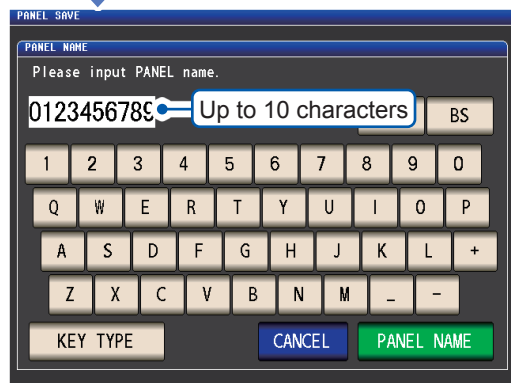

- 4 Touch the **SAVE** key to save the panel.

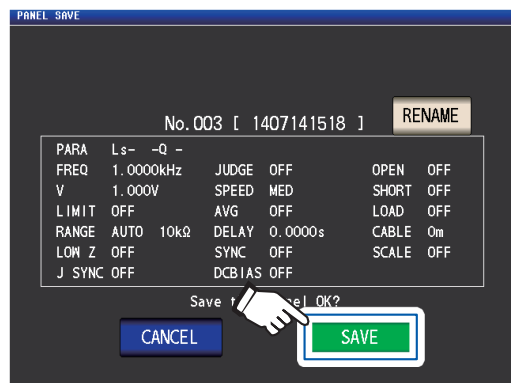

- 5** (To overwrite an existing panel)  
The **OVER WRITE** dialog box will be displayed.  
Touch the **OVER WRITE** key.

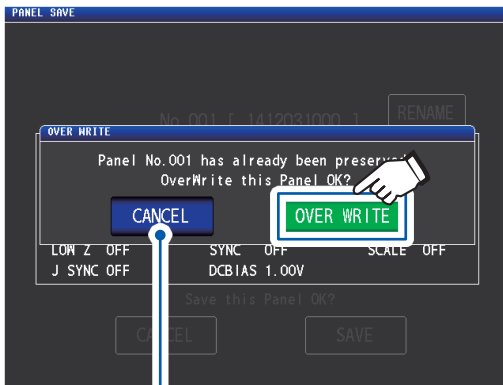

Touch when you wish to cancel the save (overwrite) operation.

- 6** Touch the **EXIT** key twice.  
Displays the measurement screen.

When you touch the **VIEW** key (**VIEW** dialog box)

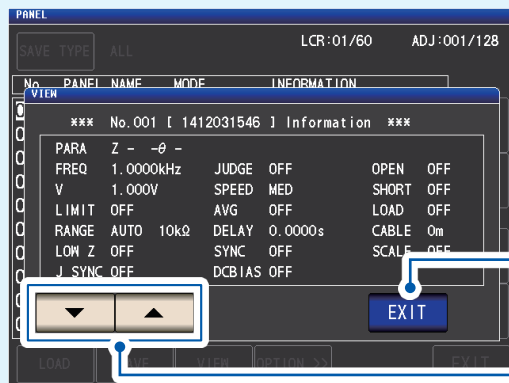

Closes the **VIEW** dialog box.

Allows you to view the contents of the previous and next dialog boxes.

## 6.2 Loading Measurement Conditions and Correction Values (Panel Load Function)

This section describes how to load panel data that has been saved in the instrument's memory. The instrument's settings will be replaced with the loaded data settings.

Screen display method (For more information, see p. 26.)  
 (Measurement screen) **SET** key>(SET screen) **ADVANCED** tab>**PANEL** key

- 1 Select the panel number to load with the ▲▼ keys and then touch the **LOAD** key.

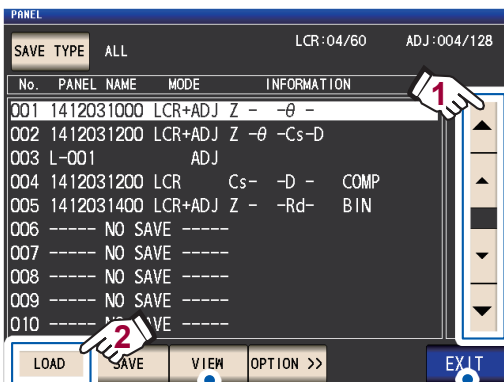

Touch when you wish to check the contents of saved panels. (See p. 135)

Touch when you wish to cancel the load operation.

Panel number display range:  
 No. 001 to No. 128

See "PANEL screen layout" (p. 133).

- 2 Touch the **LOAD** key.

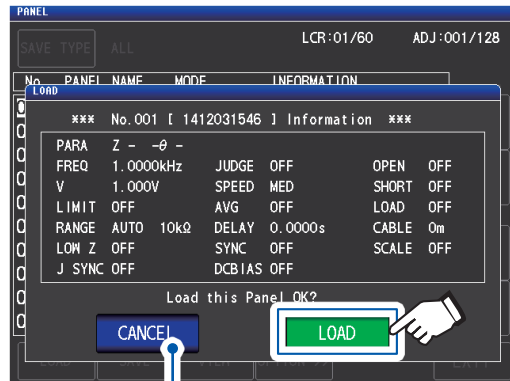

Cancels the load operation and closes the dialog box.

The data will start to load. Once the load operation has completed, the measurement screen will be displayed.

Displays the panel number that was loaded.



# 6.3 Changing a Panel Name

This section describes how to change the name of a panel saved in the instrument's memory.

Screen display method (For more information, see p. 26.)

(Measurement screen) **SET** key>(SET screen) **ADVANCED** tab>**PANEL** key

- 1 Select the panel number whose name you wish to change with the **▲▼** keys and then touch the **OPTION>>** key.

Touch when you wish to check the information of the selected panel (p. 135).

Touch when you wish to cancel the operation to change the panel name.

- 2 Touch the **RENAME** key.

- 3 Enter a panel name with the numeric keypad, and touch the **PANEL RENAME** key.

Deletes all input characters.

Deletes the last character.

Changes the keyboard type.

1

2

Cancels to change the panel name and closes the dialog box.

- 4 Touch the **EXIT** key twice.  
Displays the measurement screen.

Up to 10 characters

# 6

Saving and Loading Measurement Condition and Correction Value Data

## 6.4 Deleting a Panel

This section describes how to delete a panel that has been saved in the instrument's memory.

Screen display method (For more information, see p. 26.)

(Measurement screen) **SET** key>(SET screen) **ADVANCED** tab>**PANEL** key

- 1 Select the panel number you wish to delete with the **▲▼** keys and then touch the **OPTION>>** key.

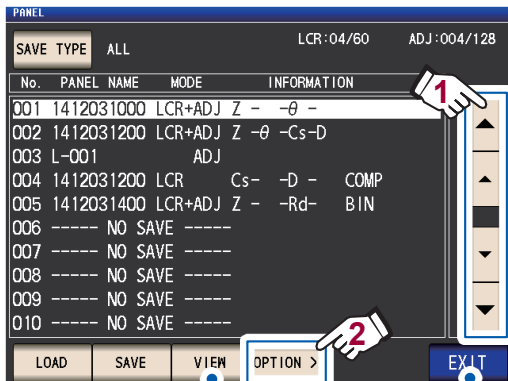

Touch when you wish to check the information of the selected panel (p. 135).

Touch when you wish to cancel the operation to delete the panel.

- 2 Touch the **DELETE** key.

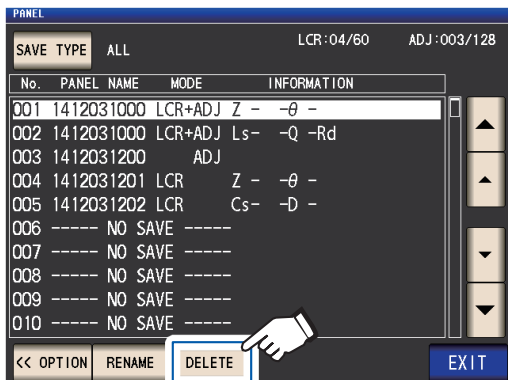

The **DELETE** dialog box will be displayed.

(You will be able to check some of the contents saved in the panel.)

- 3 Touch the **DELETE** key.

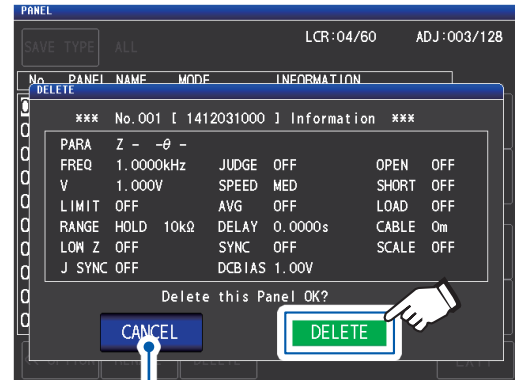

Touch when you wish to cancel the delete operation. The dialog box will be closed.

A panel cannot be restored once it is deleted.

- 4 Touch the **EXIT** key twice.

Displays the measurement screen.

# 7

## Setting the System

This chapter describes how to configure the instrument's system settings.

**First, set the measurement mode to LCR mode (p. 26).**

Settings are configured on the **SYS** screen.

<b>Configuring interface settings</b> (p. 140)	▶ Allows you to configure settings used to control the instrument from a computer via its USB, GP-IB, RS-232C, or LAN interface.
<b>Checking the instrument's version</b> (p. 140)	▶ Allows you to check the instrument's version and other information. (Serial number, version, MAC address, USB ID, and interfaces)
<b>Testing the system (Self diagnosis)</b> (p. 141)	▶ Allows you to check the instrument's screen, internal memory, and EXT I/O status. <ul style="list-style-type: none"><li>• Panel test</li><li>• Panel calibration</li><li>• Testing the screen display status and LED status</li><li>• ROM/RAM test</li><li>• Testing EXT I/O input and output signals</li></ul>
<b>Setting the date and time</b> (p. 40)	▶ Set the instrument's time and date.



## 7.1 Setting the Interface (Controlling the Instrument from a Computer)

This section describes how to configure the settings that are used to control the instrument via its USB, GP-IB, RS-232C, or LAN interface.

Screen display method (For more information, see p. 30.):  
(Measurement screen) **SYS** key>(SYS screen) **I/F** tab

- 1 **Select the interface you wish to configure.**

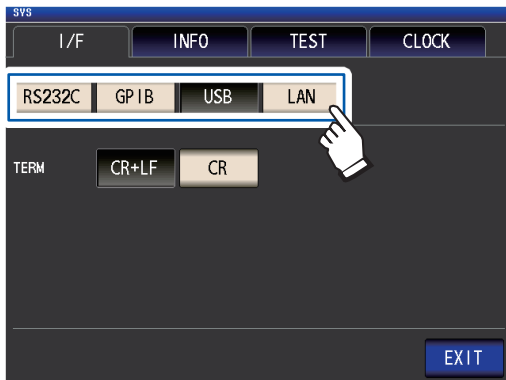

- 2 **Configure the selected interface.**

USB, RS-232C, GP-IB, and LAN settings:  
Refer to the Communications Instruction Manual on the bundled LCR Application Disc.

- 3 **Touch the EXIT key.**  
Displays the measurement screen.

## 7.2 Checking the Version of the Instrument

This section describes how to check the instrument's serial number, version, MAC address, USB ID, and interfaces.

Screen display method (For more information, see p. 30.):  
(Measurement screen) **SYS** key>(SYS screen) **INFO** tab

- 1 **Check the instrument's version and other information.**

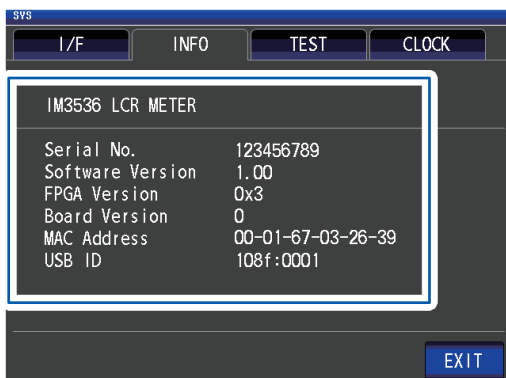

- 2 **Touch the EXIT key.**  
Displays the measurement screen.

## 7.3 Testing the System (Self Diagnosis)

Allows you to check the instrument's screen, internal memory, and EXT I/O status.

<b>Panel test (p. 141)</b>	▶ Allows you to check for touch panel errors.
<b>Panel calibration (p. 142)</b>	▶ Allows you to calibrate the touch panel.
<b>Testing the screen display status and LED status (p. 142)</b>	▶ Allows you to check the screen display status and LED status.
<b>ROM/RAM test (p. 143)</b>	▶ Allows you to check the instrument's internal memory (ROM and RAM) for errors.
<b>Testing EXT I/O input and output signals (p. 143)</b>	▶ Allows you to verify that output signals are output normally from EXT I/O and that input signals can be read properly.

### Panel test

Allows you to check for touch panel errors.

Screen display method (For more information, see p. 30.):  
(Measurement screen) **SYS** key>(SYS screen) **TEST** tab>**TOUCH SCREEN TEST** key

- 1 Touch the  key displayed of the screen.

If the pressed keys are highlighted and the green  appears, the touch panel is working properly.

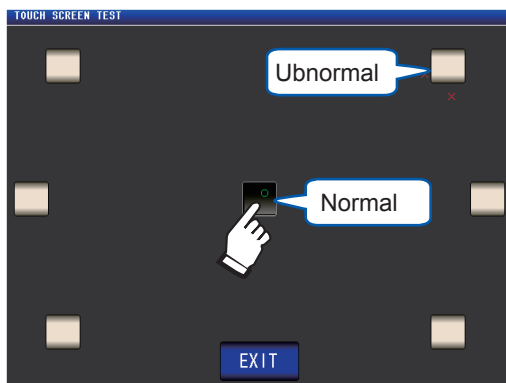



Perform panel calibration (p. 142) if they are not highlighted or the red **X** appears.  
If there is still problem after performing panel calibration, the panel may be malfunctioning. Contact your authorized Hioki distributor or reseller.

- 2 Touch the **EXIT** key twice.  
Displays the measurement screen.

## Panel calibration

Allows you to calibrate the touch panel.

Screen display method (For more information, see p. 30.):  
 (Measurement screen) **SYS** key>(SYS screen) **TEST** tab>**CALIBRATION** key

- 1 Touch in the location of  continuously until the green  appears.



- 2 Touch the **SET** key to confirm the calibration.

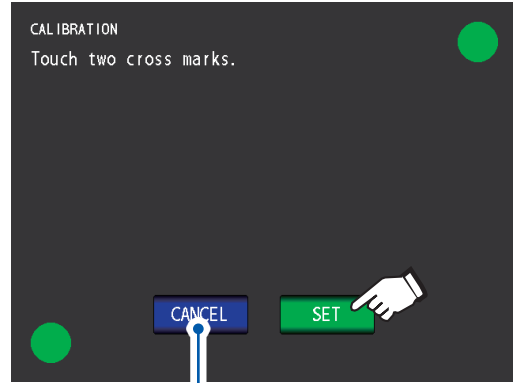

Touch when you wish to repeat panel correction from the beginning.

If the **SET** key does not appear, the instrument needs to be repaired. Contact your authorized Hioki distributor or reseller.

- 3 Touch the **EXIT** key.  
Displays the measurement screen.



## Testing the screen display status and LED status



Allows you to check the screen display status and LED status.

Screen display method (For more information, see p. 30.):  
 (Measurement screen) **SYS** key>(SYS screen) **TEST** tab>**DISPLAY & LED TEST** key

- 1 Touch the screen and check for switching on and off of screen colors and the LEDs on the front of the instrument.

The screen and LED status should change each time you touch the screen.

Front panel LEDs	Screen color
 All lit up	Red
 All turned off	Green
 OUT lit up	Blue

Front panel LEDs	Screen color
 IN lit up	Black
 MEAS lit up	White

If the entire screen does not appear to be the same color or if the LEDs do not turn on as shown in the figure on the left, the instrument needs to be repaired. Contact your authorized Hioki distributor or reseller.

The instrument will return to the **SYS** screen.

- 2 Touch the **EXIT** key.  
Displays the measurement screen.

## ROM/RAM test

Allows you to check the instrument's internal memory (ROM and RAM) for errors.

Screen display method (For more information, see p. 30.):  
(Measurement screen) **SYS** key>(SYS screen) **TEST** tab

### 1 Touch the **ROM/RAM TEST** key.

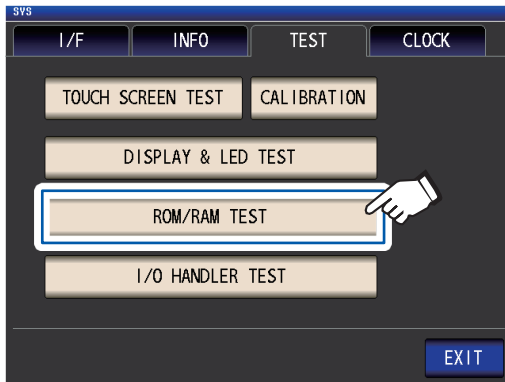

Starts the test. (Approx. 40 seconds)  
No operation is possible during the ROM/RAM test.

Never turn off the instrument during a test.

If the overall judgment result indication is **PASS**, the test ended normally.

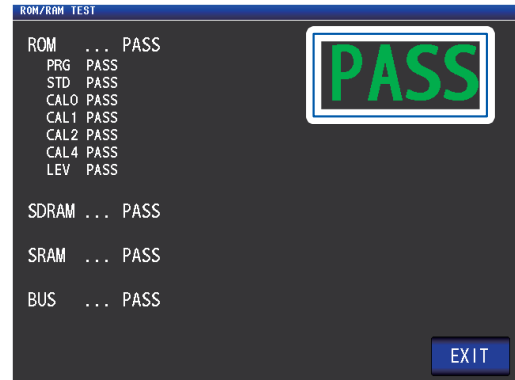

If the overall judgment result indication is **NG**, the instrument needs to be repaired. Contact your authorized Hioki distributor or reseller.

### 2 Touch the **EXIT** key twice.

Displays the measurement screen.

## Testing EXT I/O input/output signals

Allows you to verify that output signals are output normally from EXT I/O and that input signals can be read properly.

Screen display method (For more information, see p. 30.):  
(Measurement screen) **SYS** key>(SYS screen) **TEST** tab>**I/O HANDLER TEST** key

### 1 (To perform an output signal test)

Touch the button with the name of the signal for which you want to check the output.

(To perform an input signal test)

Input a signal and verify that the signal line name\* is displayed in the window.

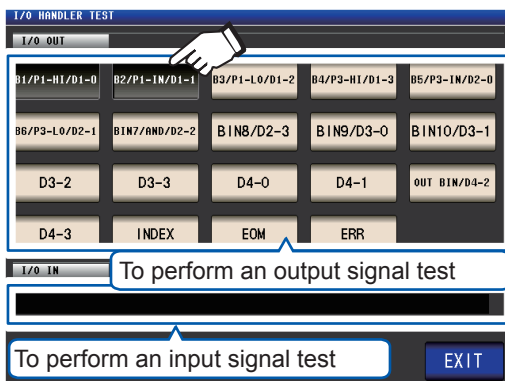

\*: Names of signals that are being input (LO)

### 2 Touch the **EXIT** key twice.

Displays the measurement screen.

On the test screen, an input signal does not cause the trigger to be enabled or panel to be loaded.



## 8

# Using USB Flash Drive (Saving and Loading Data)

Before using this functionality, be sure to read “Before using the USB flash drive” (p. 16). This section describes how to save measurement data, instrument settings, and other data on a USB flash drive as well as how to load data that has been saved on a USB flash drive.

<b>Checking the Contents of Files</b>	▶ Allows you to check the contents of files saved on a USB flash drive.
<b>Saving data</b>	▶ Allows you to save data from the instrument to a USB flash drive. <ul style="list-style-type: none"> <li>• Measurement results (p. 149)</li> <li>• Screen copy (p. 158)</li> <li>• Panel (measurement conditions and correction values), and instrument settings (p. 161)</li> </ul>
<b>Loading settings data</b>	▶ Allows you to load settings data from a USB flash drive into the instrument. <ul style="list-style-type: none"> <li>• Panel (measurement conditions and correction values), and instrument settings (p. 163)</li> </ul>
<b>Other</b>	▶ <ul style="list-style-type: none"> <li>• Allows you to format (initialize) a USB flash drive (p. 148).</li> <li>• Allows you to check the contents of files on a USB flash drive (p. 165).</li> <li>• Allows you to delete files and folders from a USB flash drive (p. 166)</li> <li>• This section describes how to create a folder on a USB flash drive (p. 167).</li> <li>• Allows you to check the usage rate and file system of the USB flash drive (p. 168).</li> </ul>

## File format

The following files can be handled by the instrument.

Content	Format	Extension	Screen display (TYPE)
-	Folder	-	FDR
Measurement data	CSV file	.csv	CSV
Screen copy data	BMP file	.bmp	BMP
Instrument settings data	Setting file	.SET	SET
Panel (measurement conditions and correction values)	Panel file	.PNL	PNL

The instrument cannot display double-byte characters (Japanese, etc.). A double-byte characters is replaced by "??.

## Supported USB flash drive specifications

<b>Connector</b>	USB type A
<b>Electrical specification</b>	USB2.0
<b>Power supply</b>	500 mA maximum
<b>No. of ports</b>	1
<b>Compatible USB device</b>	USB Mass Storage Class

# 8.1 Inserting and Removing a USB Flash Drive

## Inserting a USB flash drive

Insert the USB flash drive into the USB receptacle on the front of the instrument.

- Do not insert a USB flash drive that is not Mass Storage Class compatible.
- Not all commercially available USB flash drives are compatible.
- If a USB flash drive is not recognized, try using another USB flash drive.

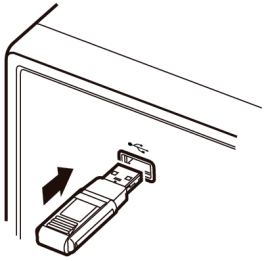

## Removing a USB flash drive

Check that the USB flash drive is not being accessed (saving, reading, etc.) by the instrument, and then remove it.

No remove operation needs to be performed on the instrument.

## Screen display when using USB

When a USB flash drive has been recognized properly, the USB flash drive icon is displayed at the top of the measurement screen.

The icon is red while the USB flash drive is being accessed.

The screenshot shows the LCR measurement screen with the following data:

- Measurement:  $4.99322k\Omega$
- Phase:  $0.043^\circ$
- Vac: 968.1mV
- Iac: 193.9μA

The information table at the bottom is as follows:

INFORMATION			
FREQ	1.0000kHz	JUDGE	OFF
V	1.000V	SPEED	MED
LIMIT	OFF	AVG	OFF
RANGE	AUTO 10kΩ	DELAY	0.0000s
LOW Z	OFF	SYNC	OFF
J SYNC	OFF	DCBIAS	OFF
CABLE	0m	OPEN	OFF
SHORT	OFF	LOAD	OFF
SCALE	OFF		

Navigation buttons: ZOOM ON, INFO DC, SAVE.

Callout box details:

- (Blue) When the instrument recognizes the USB flash drive
- (Red) When USB is being accessed

## 8.2 Checking the Contents of Files on a USB Flash Drive

This section describes how to display files and check their contents.

Screen display method (For more information, see p. 31.):  
 (Measurement screen) **FILE** key>(FILE screen) **LIST** tab

The screenshot shows the instrument's file list screen. At the top, there are three callouts: 'File name' pointing to the 'FILE NAME' column header, 'File save date and time' pointing to the 'DATE' column header, and 'File size' pointing to the 'SIZE' column header. A hand icon is shown touching the 'SET' button. Below the table, there are callouts for 'Recognizing the USB flash drive: blue USB is being accessed : red p. 146', 'Allows you to change the sorting order by touching the FILE NAME, DATE, or SIZE.' (with icons for ascending and descending order), 'File format' (with definitions for FDR, CSV, BMP, SET, and PNL), 'Information of the USB flash drive.' (pointing to the filesystem info at the bottom), and 'Displays the measurement screen.' (pointing to the 'EXIT' button).

FILE NAME	TYPE	DATE	SIZE
20111130	FDR	2011-11-30 11:01	
MEMORY	FDR	2011-11-30 11:02	
SETTING	FDR	2011-11-30 11:01	

Filesystem: FAT32 RT1: 3.8GB Used: 4.0MB Avail: 3.8GB Capacity: 0.1%

The instrument can recognize file names of up to 127 single-byte characters.



## 8.3 Formatting a USB Flash Drive

The USB flash drive must be formatted (initialized) before it can be used. The instrument formats drives in the FAT32 format. Formatting is necessary since files on the USB flash drive can only be recognized when stored using the FAT32 file system.

Screen display method (For more information, see p. 31.):  
 (Measurement screen) **FILE** key>(FILE screen) **LIST** tab

**1** Insert the USB flash drive into the front USB connector (p. 146).

**2** Touch the **OPTION>>** key.

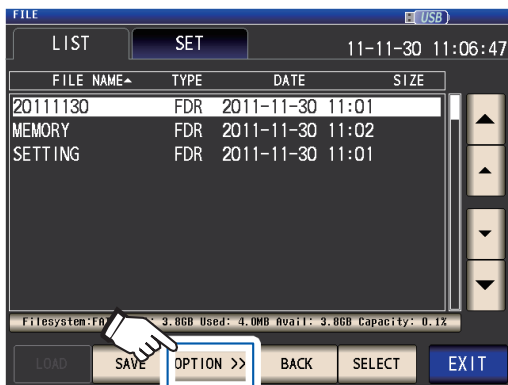

**3** Touch the **FORMAT** key.

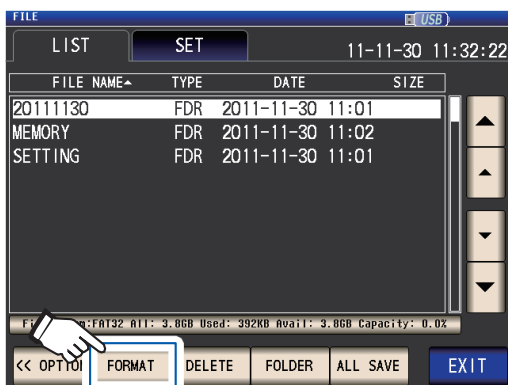

**4** Touch the **FORMAT** key.

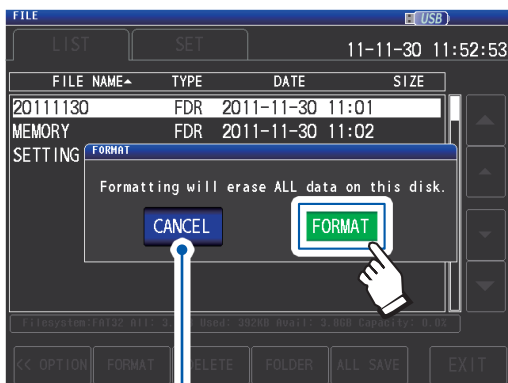

Touch when you wish to cancel the format operation. (The dialog box will be closed.)

Formatting of the USB flash drive will begin.

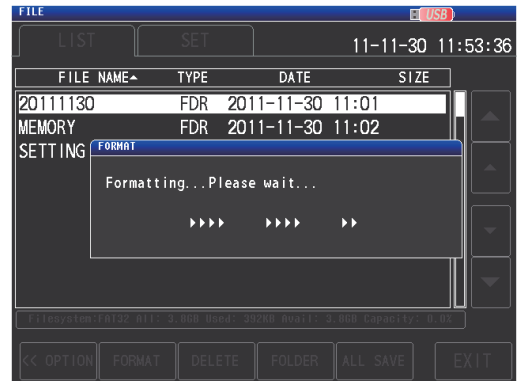

No operation is possible during formatting. When formatting ends, the dialog is closed.

- When you perform a format, all of the data saved to the USB flash drive is deleted and cannot be restored. Carefully check the contents before you perform a format.
- We recommend making a backup of any important data on a USB flash drive.
- When formatting is performed with the instrument, the volume label\* of the USB flash drive becomes **NO NAME**.

\*: A volume label is a name given to a disk drive on a USB flash drive or other media.

Volume labels for each drive can be verified in Windows® by going to **Computer** or this **PC**.

**5** Touch the **EXIT** key.

Displays the measurement screen.

## 8.4 Saving Measurement Data

### Saving measurement data in text

Measurement data<sup>\*</sup> can be saved to a USB flash drive in the CSV format. (\*: Refers to one piece of data measured before the **SAVE** key is touched. To save all measurement data stored in the instrument's memory, see "Memory function (saving measurement results)" (p. 91).) The file extension is ".csv."

#### LCR mode

Saves the measurement values displayed in the current screen in CSV format.

#### Continuous measurement mode

Saves the measurement result of each panel in CSV format.  
Saves all measurement conditions and measurement data for each panel in a single file.

Measurement results are saved in the following order: measuring instrument information, time and date, measurement conditions, measurement parameters, and measurement values. The header (time and date, measurement conditions, measurement parameters, delimiter, and quotation mark type) can be configured as desired.

**CSV file sample**

Example of saving DATE (save date and time): ON, SET (measurement conditions) ON, PARA (measurement parameters): ON, DELIM (delimiter): , (comma), QUOTE (quotation mark) " (double quotation)

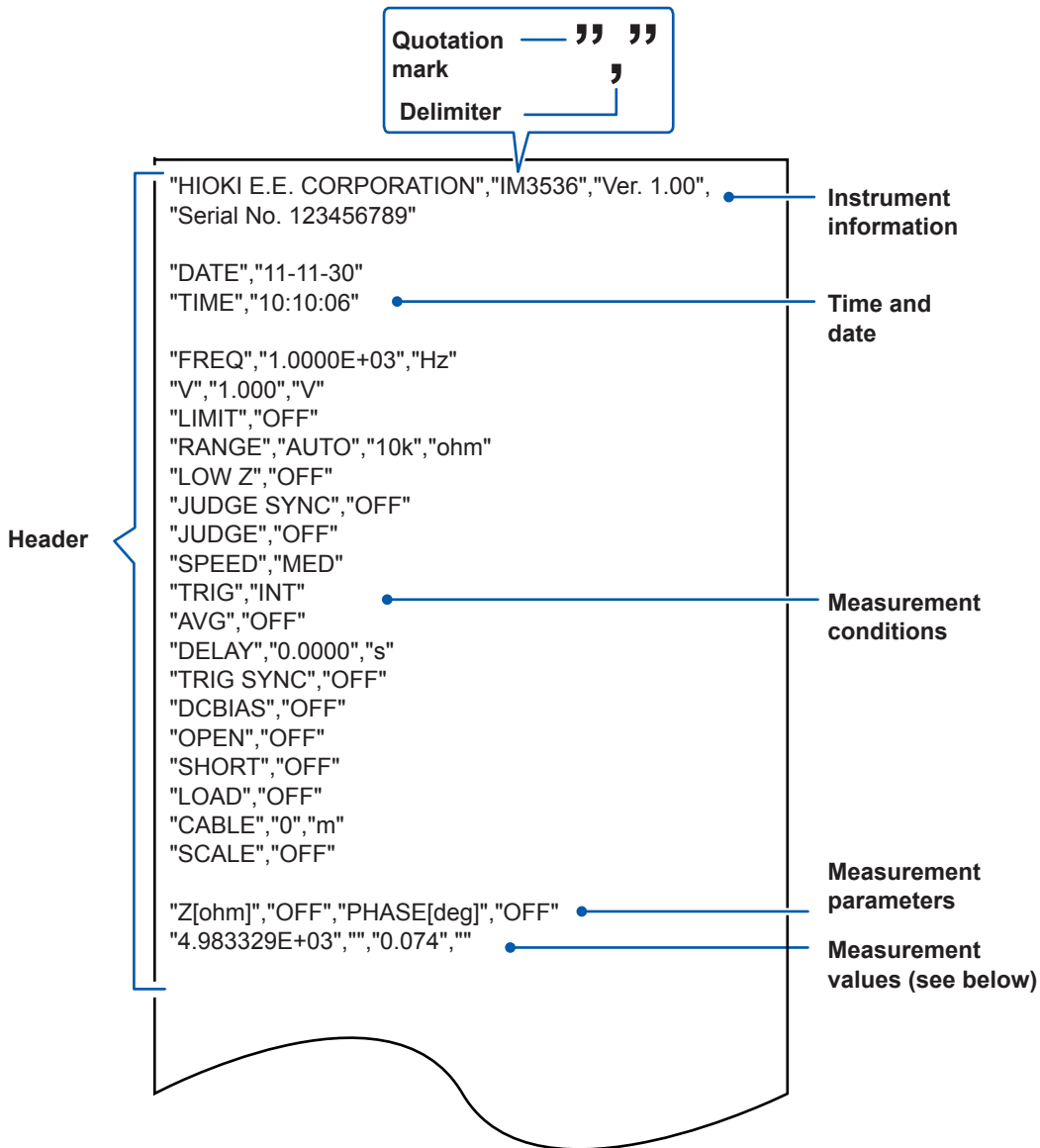

**How to interpret measured values**

Example: No. 1 parameter: Z (impedance [ $\Omega$ ]); No. 2 parameter: OFF;  
 No. 3 parameter:  $\theta$  (impedance phase angle [ $^\circ$ ]); No. 4 parameter: OFF

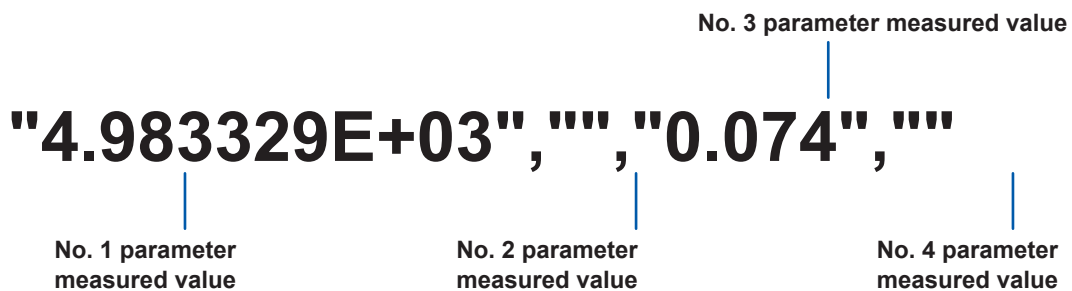

The No. 1 parameter is 4.983329 k $\Omega$ , and the No. 3 parameter is 0.074 $^\circ$ . No measured values are shown for the No. 4 or No. 4 parameter since they are set to OFF.

## Procedures

Screen display method (For more information, see p. 31.):  
(Measurement screen) **FILE** key>(FILE screen) **SET** tab

- 1** Insert the USB flash drive into the front USB connector (p. 146).
- 2** Touch the **TYPE** key.

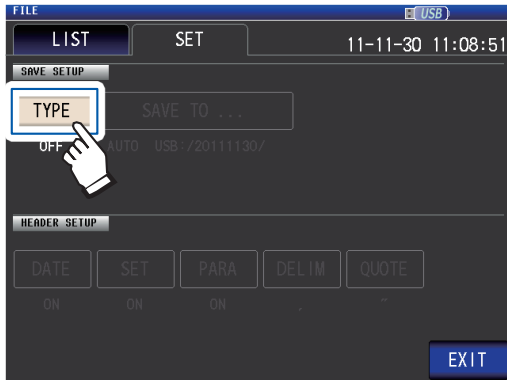

- 3** Touch the **TEXT ON** key and then touch the **EXIT** key.

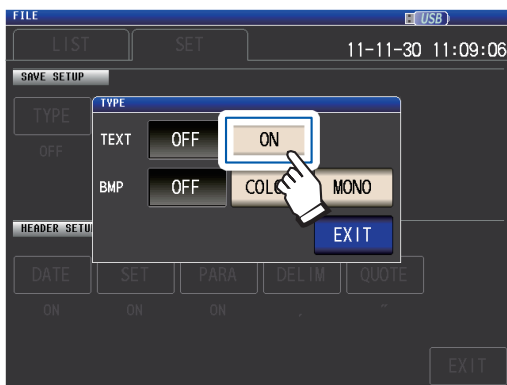

- 4** Set the header, delimiter, and quotation mark character.

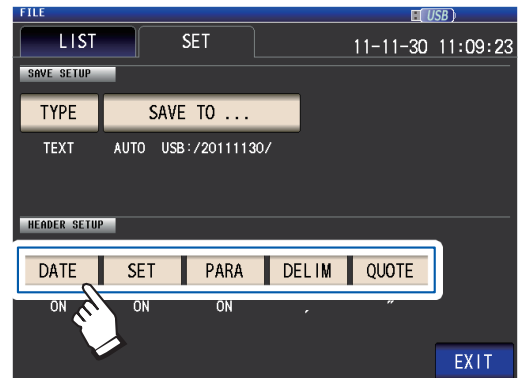

**DATE** Sets whether to use the save date and time as the header (p. 152).

**SET** Sets whether to use the measurement condition as the header (p. 153).

**PARA** Sets whether to use the save measurement parameters as the header (p. 154).

**DELIM** Sets the delimiter type. (p. 156)

**QUOTE** Sets the quotation mark character. (p. 157)

- 5** Touch the **EXIT** key.  
Displays the measurement screen.

- 6** Touch the **SAVE** key.



The measurement data will be saved.

- Touching **SAVE** automatically creates a folder on the USB flash drive and saves the file there.  
The date is used for the name of the folder created when you press **SAVE** key.  
Example: Saved on September 30, 2014 → 20140930
- “To specify the save folder” (p. 160)
- A filename will be assigned automatically based on the date and time.  
(Example: Saved at 16:31:44 on September 30, 2014 → 140930163144.csv)

Setting the header, delimiter, and quotation mark character

(1) **DATE** (save date and time)

Sets whether to use the save date and time as the text file's header.

**1** Select either the **ON** key (save as the header) or the **OFF** key (do not save as the header).

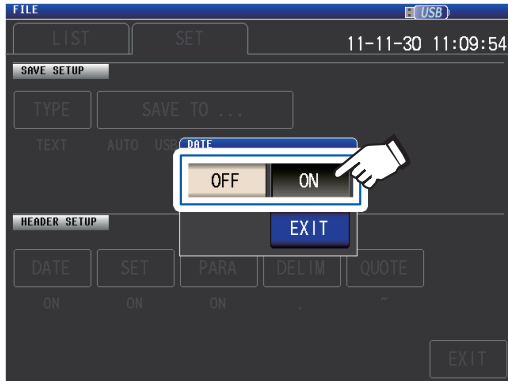

**2** Touch the **EXIT** key.

The dialog box will be closed.

When ON

"HIOKI E.E. CORPORATION","IM3536","Ver. 1.00",  
"Serial No. 123456789"

"DATE","11-11-30"  
"TIME","10:10:06"

"FREQ","1.0000E+03","Hz"  
"V","1.000","V"  
"LIMIT","OFF"  
"RANGE","AUTO","10k","ohm"

When OFF

"HIOKI E.E. CORPORATION","IM3536","Ver. 1.00",  
"Serial No. 123456789"

"FREQ","1.0000E+03","Hz"  
"V","1.000","V"  
"LIMIT","OFF"  
"RANGE","AUTO","10k","ohm"

**Display when ON:**

Save date: November 30, 2011; save time: 10:10:06

**(2) SET (measurement conditions)**

Sets whether to use the save measurement conditions as the text file's header.

- 1** Select either the **ON** key (save as the header) or the **OFF** key (do not save as the header).

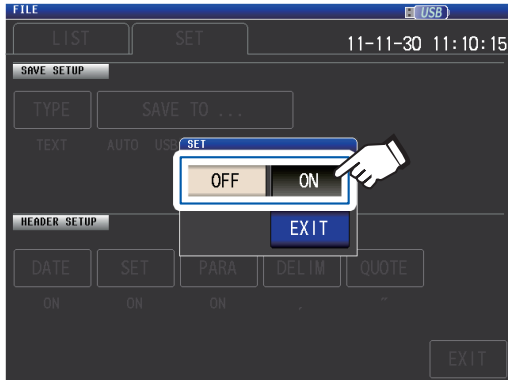

- 2** Touch the **EXIT** key.  
The dialog box will be closed.

**When ON**

```
"HIOKI E.E. CORPORATION","IM3536","Ver. 1.00",
"Serial No. 123456789"
```

```
"DATE","11-11-30"
"TIME","10:10:06"
```

```
"FREQ","1.0000E+03","Hz"
"V","1.000","V"
"LIMIT","OFF"
"RANGE","AUTO","10k","ohm"
"LOW Z","OFF"
"JUDGE SYNC","OFF"
"JUDGE","OFF"
"SPEED","MED"
"TRIG","INT"
"AVG","OFF"
"DELAY","0.0000","s"
"TRIG SYNC","OFF"
"DCBIAS","OFF"
"OPEN","OFF"
"SHORT","OFF"
"LOAD","OFF"
"CABLE","0","m"
"SCALE","OFF"
```

```
"Z[ohm]","OFF","PHASE[deg]","OFF"
"4.983329E+03","","0.074",""
```

**When OFF**

```
"HIOKI E.E. CORPORATION","IM3536","Ver. 1.00",
"Serial No. 123456789"
```

```
"DATE","11-11-30"
"TIME","10:10:06"
```

```
"Z[ohm]","OFF","PHASE[deg]","OFF"
"4.983329E+03","","0.074",""
```

**Display when ON:**

Measurement frequency: 1.0000 kHz, measurement signal mode: V, measurement signal level: 1.000 V, current limit: OFF, measurement range: AUTO (10 kΩ), low Z high accuracy mode: OFF, JUDGE synchronous setting: OFF, judgment mode: OFF, measurement speed: MED, trigger: INT, average: OFF, trigger delay: 0.0000 s, trigger synchronous output: OFF, DC bias: OFF, open correction: OFF, short correction: OFF, load correction: OFF, cable length correction: 0 m, scaling (correlation correction): OFF

**(3) PARA (measurement parameters)**

Sets whether to use the save measurement parameters as the text file's header.

**1** Select either the **ON** key (save as the header) or the **OFF** key (do not save as the header).

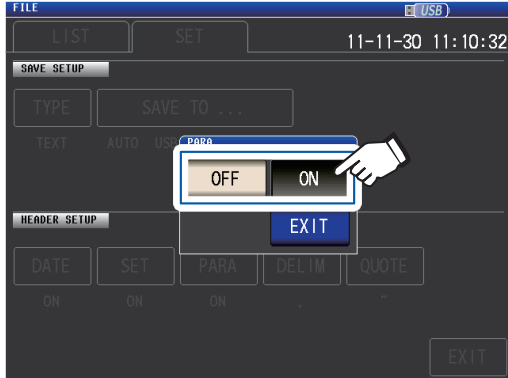

**2** Touch the **EXIT** key.  
The dialog box will be closed.

**When ON**

```
"HIOKI E.E. CORPORATION","IM3536","Ver. 1.00",
"Serial No. 123456789"

"DATE","11-11-30"
"TIME","10:10:06"

"FREQ","1.0000E+03","Hz"
"V","1.000","V"
"LIMIT","OFF"
"RANGE","AUTO","10k","ohm"
"LOW Z","OFF"
"JUDGE SYNC","OFF"
"JUDGE","OFF"
"SPEED","MED"
"TRIG","INT"
"AVG","OFF"
"DELAY","0.0000","s"
"TRIG SYNC","OFF"
"DCBIAS","OFF"
"OPEN","OFF"
"SHORT","OFF"
"LOAD","OFF"
"CABLE","0","m"
"SCALE","OFF"

"Z[ohm]","OFF","PHASE[deg]","OFF"
"4.983329E+03","","0.074","
```

**Display when ON:**

No. 1 parameter: Z (impedance [ $\Omega$ ]), No. 2 parameter: OFF,  
No. 3 parameter:  $\theta$  (impedance phase angle [ $^\circ$ ]), No. 4 parameter: OFF

**When OFF**

```
"HIOKI E.E. CORPORATION","IM3536","Ver. 1.00",
"Serial No. 123456789"

"DATE","11-11-30"
"TIME","10:10:06"

"FREQ","1.0000E+03","Hz"
"V","1.000","V"
"LIMIT","OFF"
"RANGE","AUTO","10k","ohm"
"LOW Z","OFF"
"JUDGE SYNC","OFF"
"JUDGE","OFF"
"SPEED","MED"
"TRIG","INT"
"AVG","OFF"
"DELAY","0.0000","s"
"TRIG SYNC","OFF"
"DCBIAS","OFF"
"OPEN","OFF"
"SHORT","OFF"
"LOAD","OFF"
"CABLE","0","m"
"SCALE","OFF"

"4.983329E+03","","0.074","
```

The following parameter symbols are used when saving text files:

Parameters	Description	Symbol used when saving text files
Z	Impedance ( $\Omega$ )	Z [ohm]
Y	Admittance (S)	Y [S]
$\theta$	Impedance phase angle ( $^{\circ}$ )	PHASE [deg]
Rs	Effective resistance= ESR ( $\Omega$ )(Equivalent series resistance)	RS [ohm]
Rp	Effective resistance ( $\Omega$ ) (Equivalent parallel resistance)	RP [ohm]
Cs	Capacitance (F) (Equivalent series capacitance)	CS [F]
Cp	Capacitance (F) (Equivalent parallel capacitance)	CP [F]
D	Loss factor= $\tan\delta$	D
G	Conductance (S)	G[S]
X	Reactance ( $\Omega$ )	X [ohm]
Ls	Inductance (H) (Equivalent series inductance)	LS [H]
Lp	Inductance (H) (Equivalent parallel inductance)	LP [H]
Q	Q-factor	Q
B	Susceptance (S)	B [S]
OFF	No display	No symbol



**(4) DELIM (delimiter)**

Selects the delimiter to use in text files.

**1 Select one of the available delimiters.**

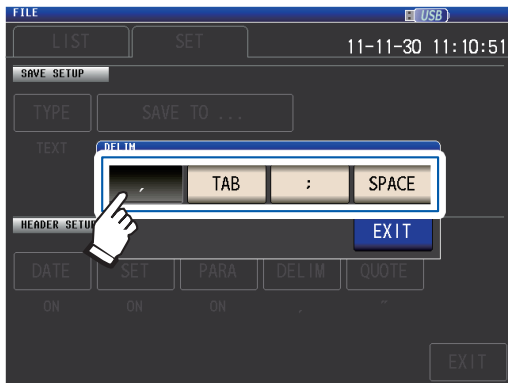

,	Sets the delimiter to a comma (,).
<b>TAB</b>	Sets the delimiter to a tab.
;	Sets the delimiter to a semicolon (;).
<b>SPACE</b>	Sets the delimiter to a space.

**2 Touch the EXIT key.**

The dialog box will be closed.

**When comma**

```
"HIOKI E.E. CORPORATION","IM3536","Ver. 1.00",
"Serial No. 123456789"

"DATE","11-11-30"
"TIME","10:10:06"

"FREQ","1.0000E+03","Hz"
"V","1.000","V"
"LIMIT","OFF"
"RANGE","AUTO","10k","ohm"
"LOW Z","OFF"
"JUDGE SYNC","OFF"
"JUDGE","OFF"
"SPEED","MED"
"TRIG","INT"
"AVG","OFF"
```

**When tab**

```
"HIOKI E.E. CORPORATION"  "IM3536"  "Ver. 1.00"
"Serial No. 123456789"

"DATE"      "11-11-30"
"TIME"      "10:11:36"

"FREQ"      "1.0000E+03"      "Hz"
"V"         "1.000"      "V"
"LIMIT"     "OFF"
"RANGE"     "AUTO"      "10k"      "ohm"
"LOW Z"     "OFF"
"JUDGE SYNC"      "OFF"
"JUDGE"     "OFF"
"SPEED"     "MED"
"TRIG"      "INT"
"AVG"       "OFF"
```

**When semicolon**

```
"HIOKI E.E. CORPORATION";"IM3536";"Ver. 1.00";
"Serial No. 123456789"

"DATE";"11-11-30"
"TIME";"10:11:42"

"FREQ";"1.0000E+03";"Hz"
"V";"1.000";"V"
"LIMIT";"OFF"
"RANGE";"AUTO";"10k";"ohm"
"LOW Z";"OFF"
"JUDGE SYNC";"OFF"
"JUDGE";"OFF"
"SPEED";"MED"
"TRIG";"INT"
"AVG";"OFF"
```

**When space**

```
"HIOKI E.E. CORPORATION" "IM3536" "Ver. 1.00"
"Serial No. 123456789"

"DATE" "11-11-30"
"TIME" "10:11:48"

"FREQ" "1.0000E+03" "Hz"
"V" "1.000" "V"
"LIMIT" "OFF"
"RANGE" "AUTO" "10k" "ohm"
"LOW Z" "OFF"
"JUDGE SYNC" "OFF"
"JUDGE" "OFF"
"SPEED" "MED"
"TRIG" "INT"
"AVG" "OFF"
```

**(5) QUOTE (quotation mark)**

Selects the quotation mark character to use in text files.

**1 Select one of the available quotations.**

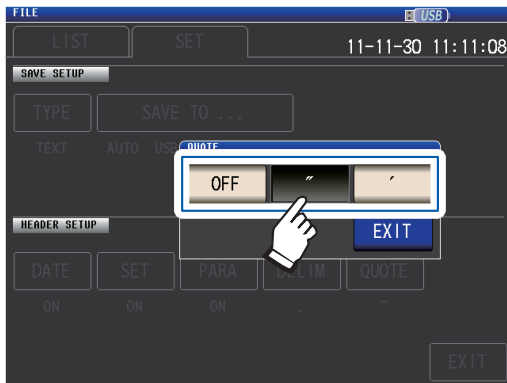

<b>OFF</b>	No quotation marks are added.
<b>"</b>	Sets the quotation mark to a double quotation mark (").
<b>'</b>	Sets the quotation mark to a single quotation mark (').

**2 Touch the EXIT key.**  
The dialog box will be closed.

**When OFF**

```
HIOKI E.E. CORPORATION,IM3536,Ver. 1.00,
Serial No. 123456789

DATE,11-11-30
TIME,10:12:05

FREQ,1.0000E+03,Hz
V,1.000,V
LIMIT,OFF
RANGE,AUTO,10k,ohm
LOW Z,OFF
JUDGE SYNC,OFF
JUDGE,OFF
SPEED,MED
TRIG,INT
AVG,OFF
```

**When double quotation mark**

```
"HIOKI E.E. CORPORATION","IM3536","Ver. 1.00",
"Serial No. 123456789"

"DATE","11-11-30"
"TIME","10:10:06"

"FREQ","1.0000E+03","Hz"
"V","1.000","V"
"LIMIT","OFF"
"RANGE","AUTO","10k","ohm"
"LOW Z","OFF"
"JUDGE SYNC","OFF"
"JUDGE","OFF"
"SPEED","MED"
"TRIG","INT"
"AVG","OFF"
```

**When single quotation mark**

```
'HIOKI E.E. CORPORATION','IM3536','Ver. 1.00',
'Serial No. 123456789'

'DATE','11-11-30'
'TIME','10:12:15'

'FREQ','1.0000E+03','Hz'
'V','1.000','V'
'LIMIT','OFF'
'RANGE','AUTO','10k','ohm'
'LOW Z','OFF'
'JUDGE SYNC','OFF'
'JUDGE','OFF'
'SPEED','MED'
'TRIG','INT'
'AVG','OFF'
```

## Saving a copy of the screen

Allows you to save the screen currently displayed to the USB flash drive in bmp file format (256 colors or monochrome [2 colors]). The file extension is ".bmp".

### BMP file sample

#### Color

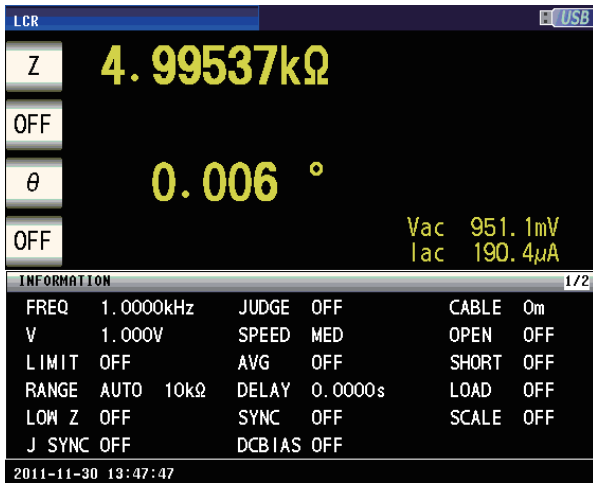

#### Monochrome

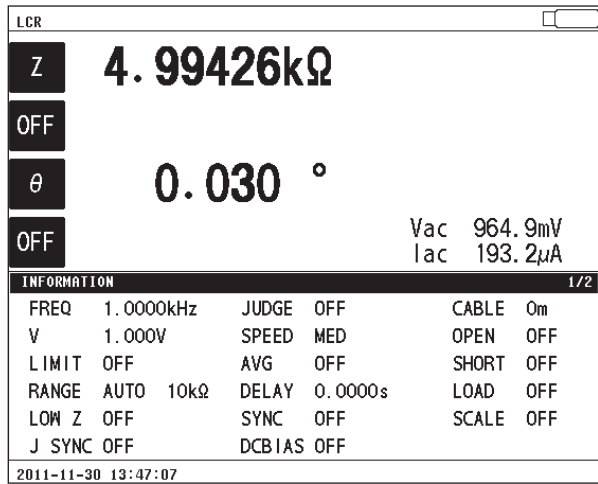

## Procedures

Screen display method (For more information, see p. 31.):  
(Measurement screen) **FILE** key>(FILE screen) **SET** tab

- 1** Insert the USB flash drive into the front USB connector (p. 146).
- 2** Touch the **TYPE** key.

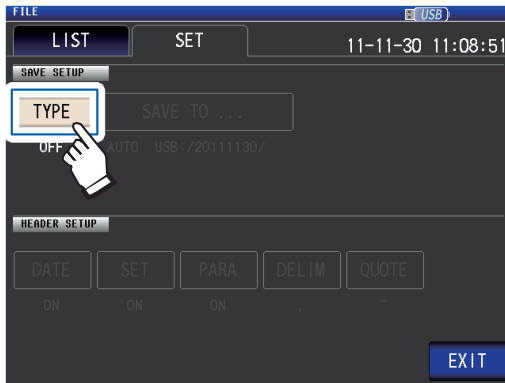

- 3** Touch the **BMP COLOR** or **MONO** key.

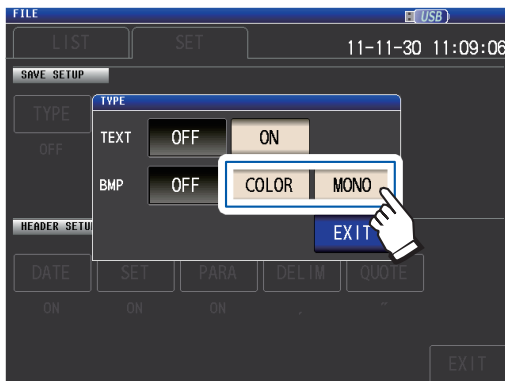

**OFF** Disables saving of screen copies.

**COLOR** Saves a copy of the screen as a 256-color BMP file.

**MONO** Saves a copy of the screen as a monochrome (2-color) BMP file.

- 4** Touch the **EXIT** key twice.  
Displays the measurement screen.

- 5** Touch the **SAVE** key.

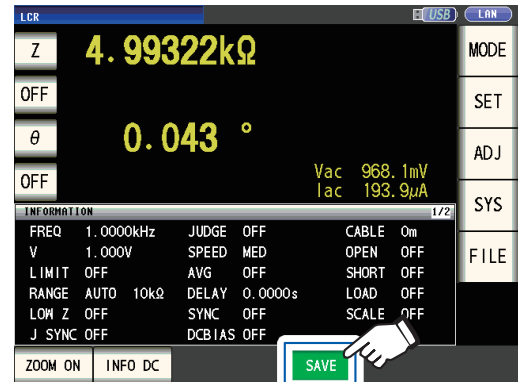

A copy of the measurement screen will be saved.

- When the **SAVE** key is pressed, a folder is automatically created in the USB flash drive and the file is saved.  
The date is used for the name of the folder created when you press **SAVE** key.  
Example: Saved on September 30, 2014 → 20140930
- “To specify the save folder” (p. 160)
- A filename will be assigned automatically based on the date and time.  
(Example: Saved at 16:31:44 on September 30, 2014 → 140930163144.csv)

## To specify the save folder

This section describes how to set the desired folder as the data save destination.

Screen display method (For more information, see p. 31.):  
 (Measurement screen) **FILE** key>(FILE screen) **SET** tab

- 1 Insert the USB flash drive into the front USB connector (p. 146).
- 2 Touch the **SAVE TO...** key.

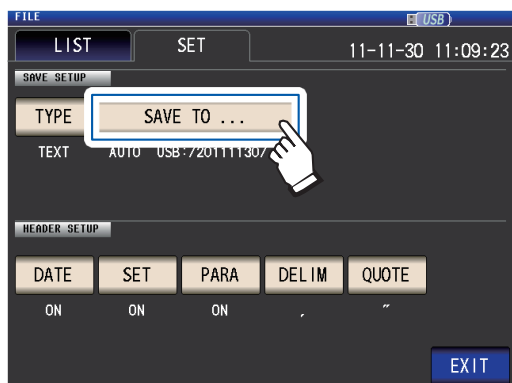

- 3 Touch the **MANUAL** key.

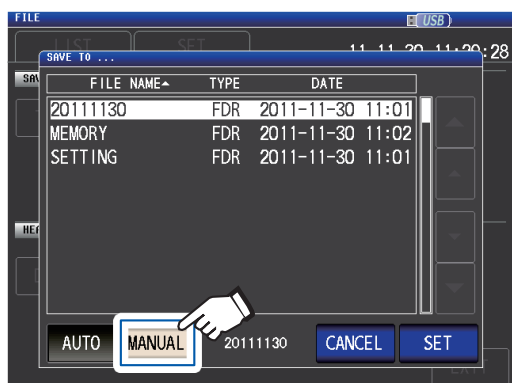

- AUTO** Automatically creates a folder named based on the save date and saves data in that folder.
- MANUAL** Allows you to specify any folder and then save the data.

- 4 Select the folder in which you wish to save data with the ▲▼ keys and then touch the **SET** key.

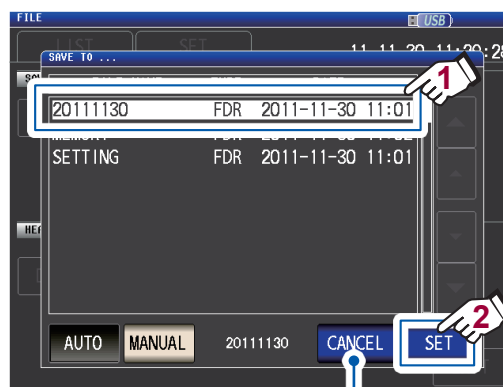

Touch to cancel the configuration process. (The dialog box will be closed.)

- 5 Touch the **EXIT** key.  
Displays the measurement screen.

- The following folders can be specified:
  - The root\* directory of the USB flash drive
  - The folder name is all single-byte characters (A folder name containing Japanese or other double-byte characters cannot be specified.)
  - The folder name is no more than 12 characters
- If the folder specified as the save destination is deleted, a folder of the same name will be created when saving data.

\*: "Root" refers to the uppermost level on the USB flash drive.

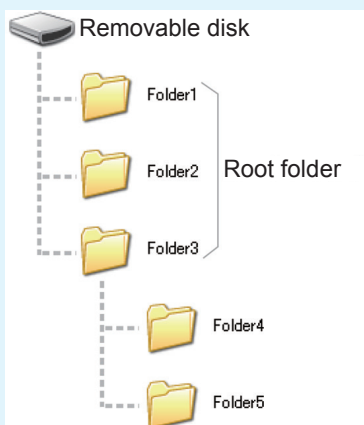

## 8.5 Saving Settings Data

### Saving instrument settings other than panels

This section describes how to save instrument settings other than panels on a USB flash drive. The extension of the setting file is “.SET.” This function is convenient for when you want to back up the setting state of the instrument.

For the settings that are saved, refer to “Appx. 11 Initial Settings Table” (p. Appx.15).

Screen display method (For more information, see p. 31.):  
(Measurement screen) **FILE** key>(FILE screen) **LIST** tab

**1** Insert the USB flash drive into the front USB connector (p. 146).

**2** Touch the **SAVE** key.

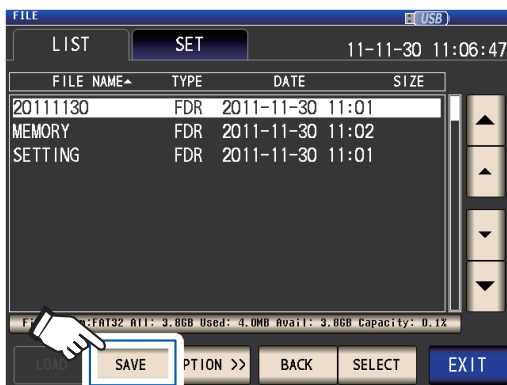

**3** Touch the **SAVE** key.

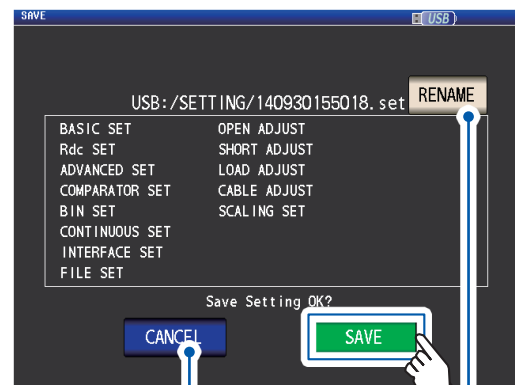

Touch when you wish to cancel the save operation.(The dialog box will be closed.)

Touch when you wish to change the filename of the setting file.  
(A filename entry dialog box will be displayed.)

The measurement data is saved.

**4** Touch the **EXIT** key.

Displays the measurement screen.

- Touching the **SAVE** key will cause a **SETTING** folder to be automatically created on the USB flash drive, and setting files will be saved there.
- Filenames are automatically assigned based on the time and date by default, but they can be changed by touching the **RENAME** key.  
(Example:Saved at 16:31:44 on September 30, 2014→140930163144.SET)
- If a setting file with the same name already exists, a dialog box confirming whether you wish to overwrite the file will be displayed.

## Save all instrument settings including panels (ALL SAVE function)

This section describes how to save instrument settings including panels as settings files on the USB flash drive. The file extension will be “.ALL.” At this time, settings files (extension “.SET”) and panel files (extension “.PNL”) will also be saved separately in the same folder.

For the settings that are saved, refer to “Appx. 11 Initial Settings Table” (p. Appx.15).

Screen display method (For more information, see p. 31.):  
(Measurement screen) **FILE** key>(FILE screen) **LIST** tab

**1** Insert the USB flash drive into the front USB connector (p. 146).

**2** Touch the **OPTION>>** key.

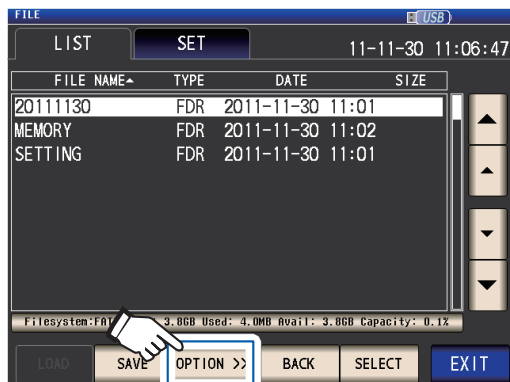

**3** Touch the **ALL SAVE** key.



**4** Touch the **SAVE** key.

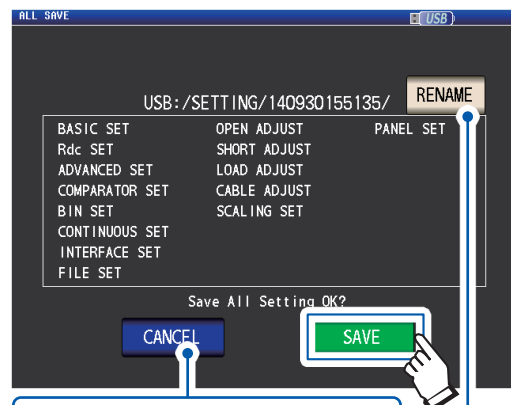

Touch when you wish to cancel the save operation. (The dialog box will be closed.)

Touch when you wish to change the folder name of the setting file. (A folder name entry dialog box will be displayed.)

Settings data including panels will be saved.

**5** Touch the **EXIT** key.

Displays the measurement screen.

- Touching the **SAVE** key will cause a **SETTING** folder to be automatically created on the USB flash drive, and setting files will be saved there.
- Folder names are automatically assigned based on the time and date by default, but they can be changed by touching the **RENAME** key.  
(Example: Saved at 16:31:44 on September 30, 2014→140930163144.ALL, 140930163144.SET, and 140930163144.PNL files are saved in the 140930163144 folder.)
- If a setting folder with the same name already exists, a dialog box confirming whether you wish to overwrite the folder will be displayed.

## 8.6 Loading Instrument Settings

### Loading settings files or panel files

This section describes how to load a setting file (**SET**) or panel file (**PNL**) that is saved to the USB flash drive, and to restore the settings.

Screen display method (For more information, see p. 31.):  
(Measurement screen) **FILE** key>(FILE screen) **LIST** tab

- 1 Insert the USB flash drive into the front USB connector (p. 146).
- 2 Select the **SETTING** folder with the **▲▼** keys and touch the **SELECT** key.



- 3 Select the setting file (**SET**) or panel file (**PNL**) to load with the **▲▼** keys and touch the **LOAD** key.

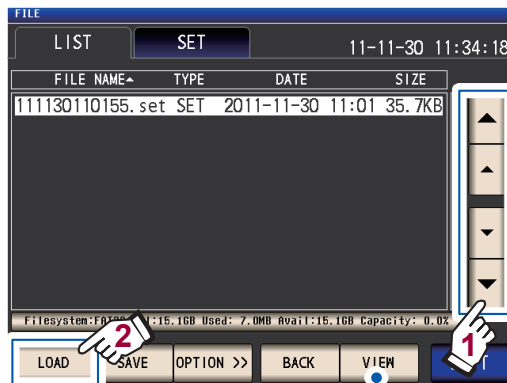

Touch when you wish to check the contents of a file. (See p. 165)

- 4 Touch the **LOAD** key.

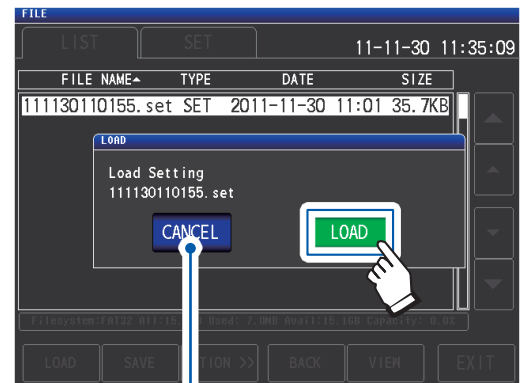

Touch when you wish to cancel the load operation. (The dialog box will be closed.)

The file will be loaded and applied as the current settings.

- 5 Touch the **EXIT** key.

Displays the measurement screen.

#### If a load error is displayed

If an error is displayed, the following causes may be to blame:

- The setting file is damaged.
- The file is not a setting file that can be read by the instrument.

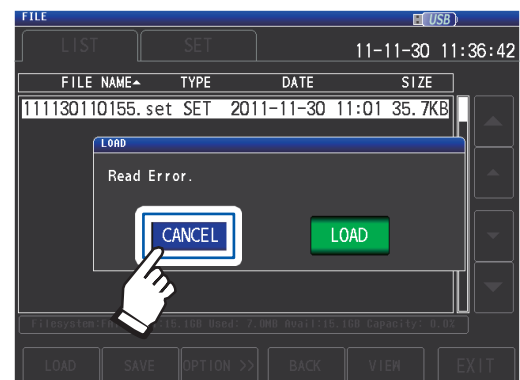

Touch the **CANCEL** key.

The load operation will be canceled, and the dialog box will be closed.



## Loading settings files including panel files (ALL LOAD function)

This section describes how to load settings files (**ALL**) including panel files saved on the USB flash drive with the ALL SAVE function and restore the stored settings.

Screen display method (For more information, see p. 31.):  
(Measurement screen) **FILE** key>(FILE screen) **LIST** tab

- 1 Insert the USB flash drive into the front USB connector (p. 146).
- 2 Select the **SETTING** folder with the **▲▼** keys and touch the **SELECT** key.

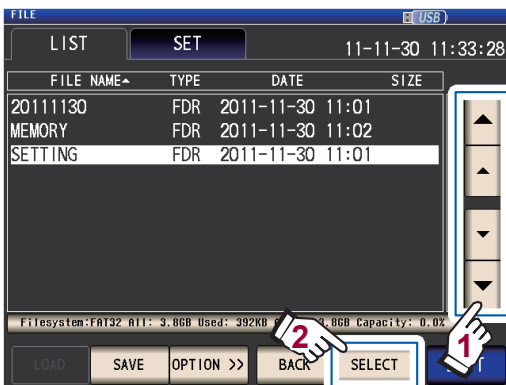

- 3 Using the **▲▼** keys, select the folder which settings were saved with the all save function and touch the **SELECT** key.

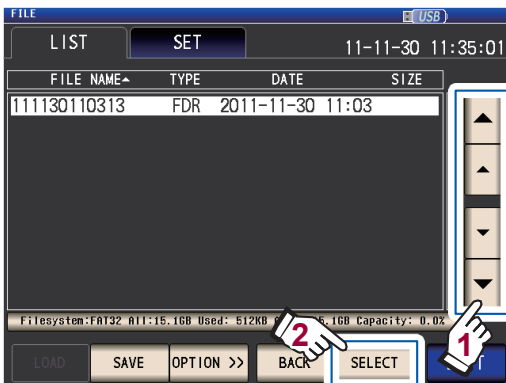

- 4 Using the **▲▼** keys, select the file which **TYPE** is **ALL** and touch the **ALL LOAD** key.

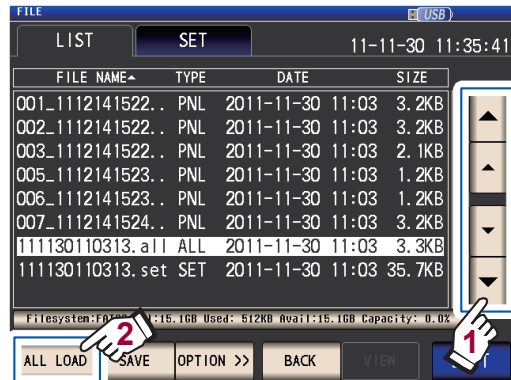

- 5 Touch the **LOAD** key.

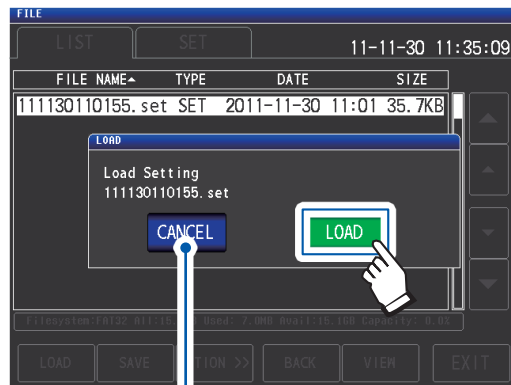

When you want to cancel loading, touch this key. (The dialog box will be closed.)

All files saved in the folder will be loaded and applied as the current settings.

- 6 Touch the **EXIT** key.

Displays the measurement screen.

- When the load operation is performed, all current instrument settings will be deleted.
- If the instrument is unable to load the settings file, a beep will sound.
- Refer to "If a load error is displayed" (p. 163).

# 8.7 Checking the Contents of a File

This section describes how to check measurement data files (**CSV**), screen copy files (**BMP**), settings files (**SET**), and panel save files (**PNL**) saved on a USB flash drive on the instrument's screen.

Screen display method (For more information, see p. 31.):  
 (Measurement screen) **FILE** key>(FILE screen) **LIST** tab

- 1 Insert the USB flash drive into the front USB connector (p. 146).
- 2 Select a file with the ▲▼ keys and touch the **VIEW** key.



If the selected file is a folder (**FDR**), the **SELECT** key will be displayed. Touching this key will display the files in the folder.

The file's contents will be displayed.

### CSV file

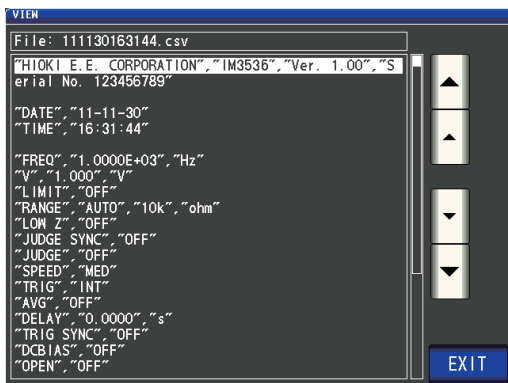

### BMP file



### SET file

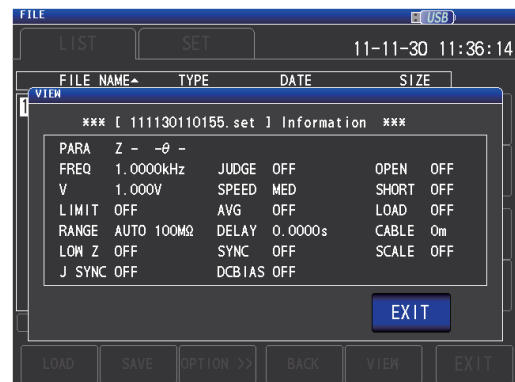

### PNL file

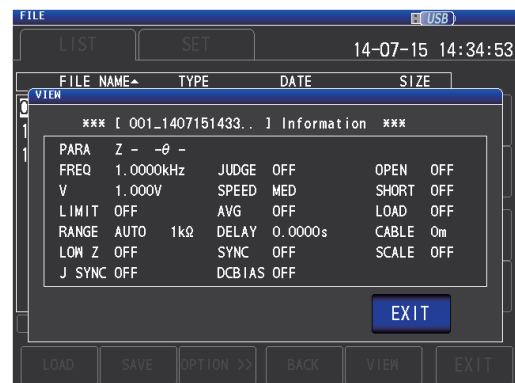

- 3 Touch the **EXIT** key twice.  
 Displays the measurement screen.

## 8.8 Deleting Files and Folders

This section describes how to delete files and folders saved on a USB flash drive.

Screen display method (For more information, see p. 31.):  
 (Measurement screen) **FILE** key>(FILE screen) **LIST** tab

- 1** Insert the USB flash drive into the front USB connector (p. 146).
- 2** Select the file or folder you wish to delete with the ▲▼ keys and touch the **OPTION>>** key.

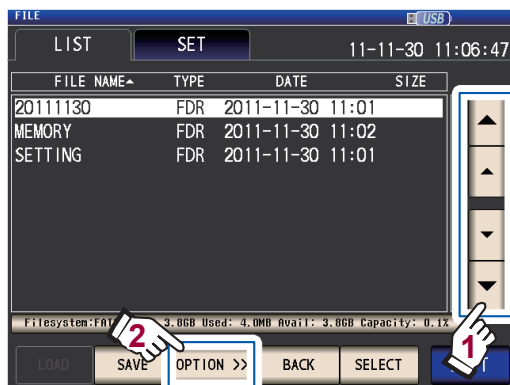

- 3** Touch the **DELETE** key.

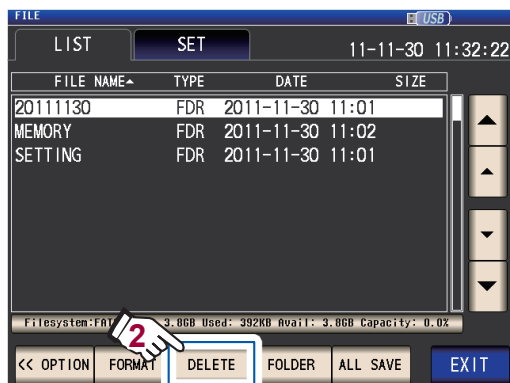

- 4** Touch the **DELETE** key.

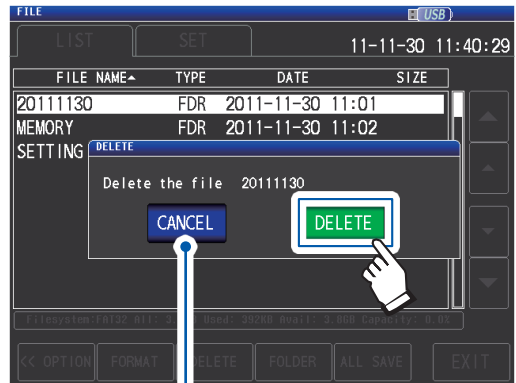

Touch when you wish to cancel the delete operation. (The dialog box will be closed.)

The selected file or folder will be deleted.

A deleted file or folder cannot be restored once it is deleted.

- 5** Touch the **EXIT** key.

Displays the measurement screen.

If the folder to be deleted contains a file, it cannot be deleted. To delete the folder, delete all of the files in the folder.

# 8.9 Creating Folders

This section describes how to create a folder on a USB flash drive.

Screen display method (For more information, see p. 31.):  
 (Measurement screen) **FILE** key>(FILE screen) **LIST** tab

- 1 Insert the USB flash drive into the front USB connector (p. 146).
- 2 Touch the **OPTION>>** key.

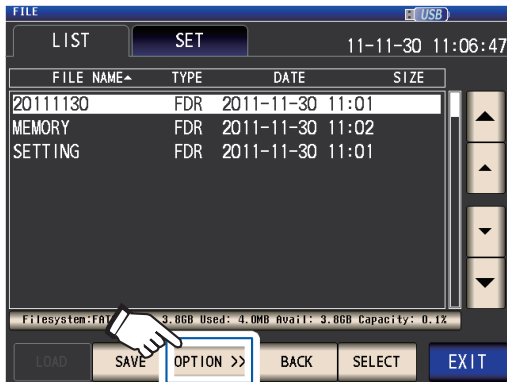

- 3 Touch the **FOLDER** key.

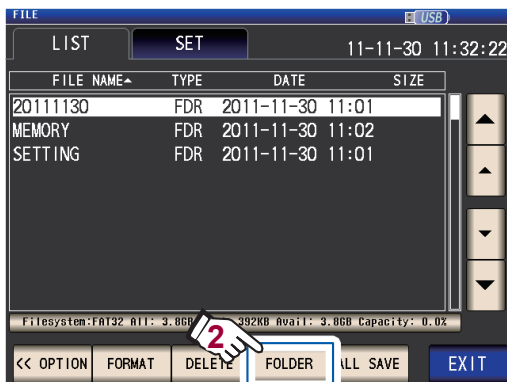

Enter the save name. (Up to 12 characters)

Deletes all input characters.      Deletes the last character.



Changes the keyboard type.

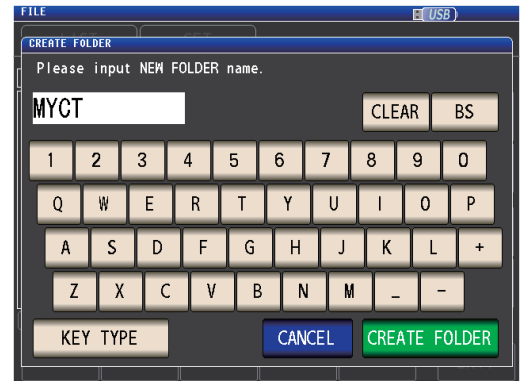

- 4 Touch the **CREATE FOLDER** key.

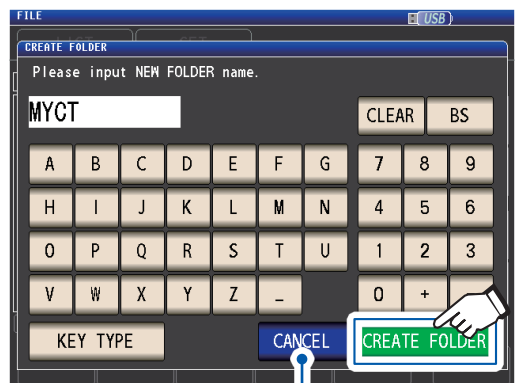

Touch when you wish to cancel the creation operation. (The dialog box will be closed.)

- 5 Touch the **EXIT** key.  
 Displays the measurement screen.

## 8.10 Displaying the USB Flash Drive Information

Allows you to check the usage rate and file system of the USB flash drive.

Screen display method (For more information, see p. 31.):  
 (Measurement screen) **FILE** key>(FILE screen) **LIST** tab

- 1** Insert the USB flash drive into the front USB connector (p. 146).
- 2** Touch the part indicating the disc information.

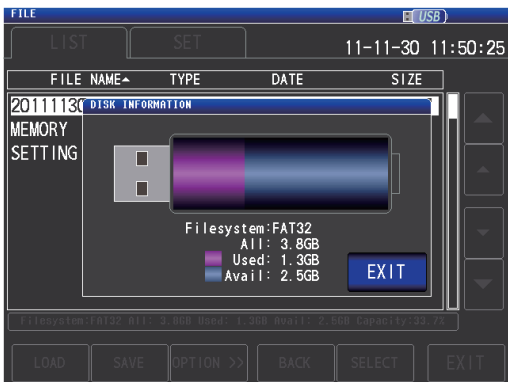
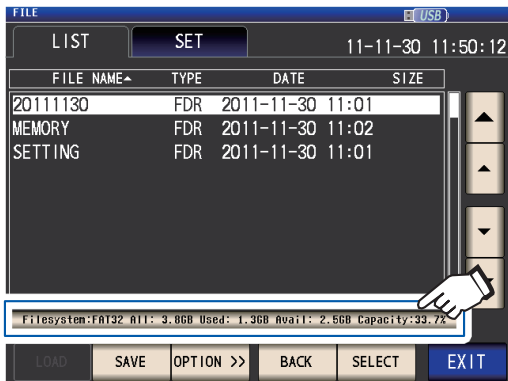

- File system** : File system type
- All** : Total size
- Used** : Space used
- Avail** : Space free

- 3** Touch the **EXIT** key.  
The dialog box will be closed.
- 4** Touch the **EXIT** key.  
Displays the measurement screen.

# 9

# External Control

This chapter describes how to connect the EXT I/O connector on the rear of the instrument to an external device and how to control the instrument using the following methods:

- Outputting signals from the instrument to the external device (measurement complete signal, judgment results signal, etc.)
- Inputting signals from the external device to the instrument (measurement start/stop trigger signal, panel load signal, etc.)

All signals are isolated by photocouplers (inputs and outputs share a common signal ground (ISO\_COM signal ground).)

## (1) Connecting the instrument's EXT I/O connector to the control system (See p. 170 to p. 187)

Confirm input and output ratings, understand the safety precautions for connecting a control system, and use accordingly.

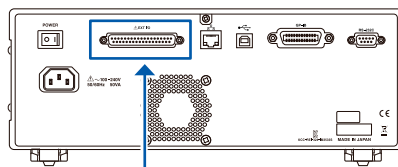

Control system  
(Signal output destination or signal input source)

## (2) Configuring the instrument (See p. 188)

To input a signal from the external device to the instrument to start and stop measurement (external trigger)	p. 66
To output contact errors during 2-terminal measurement (Hi Z reject function)	p. 88
<ul style="list-style-type: none"> <li>• To set the delay time from comparator/BIN judgment result output to measurement complete signal output (EOM [LO])</li> <li>• To reset the comparator/BIN judgment results when measurement starts</li> </ul>	p. 189
To enable trigger input during measurement and set the trigger input effective edge	p. 190
To set the EOM signal's LO and HI times so that they are sufficiently long	p. 191

## 9.1 External Input/Output Connector and Signals

Before connecting the terminals, be sure to read “Before connecting external I/O” (p. 17). This section describes the instrument’s EXT I/O connectors, compatible connectors, connector signal assignments, input (IN) signal functionality, and output signals when errors occur.

Signal input or output is indicated as “LO (ON),” while the absence of signal input or output is indicated as “HI (OFF).” (Please note that this usage differs in meaning from “HI” and “LO” as used for judgment results.)

### Instrument connector and supported connectors

The instrument provides the following EXT I/O connector and supports use of the following types of connectors:

<b>Instrument side connector</b>	37-pin D-sub female with #4-40 screws
<b>Mating connectors</b>	<ul style="list-style-type: none"> <li>• DC-37P-ULR (solder type)</li> <li>• DCSP-JB37PR (pressure weld type)</li> <li>Japan Aviation Electronics Industry Ltd.</li> </ul>

### Instrument connector signal assignments

Signal assignments vary with the measurement mode. Signal logic is 0 V to 0.9 V for LO level and 5 V to 24 V for HI level.

**LCR mode (LCR) operation**

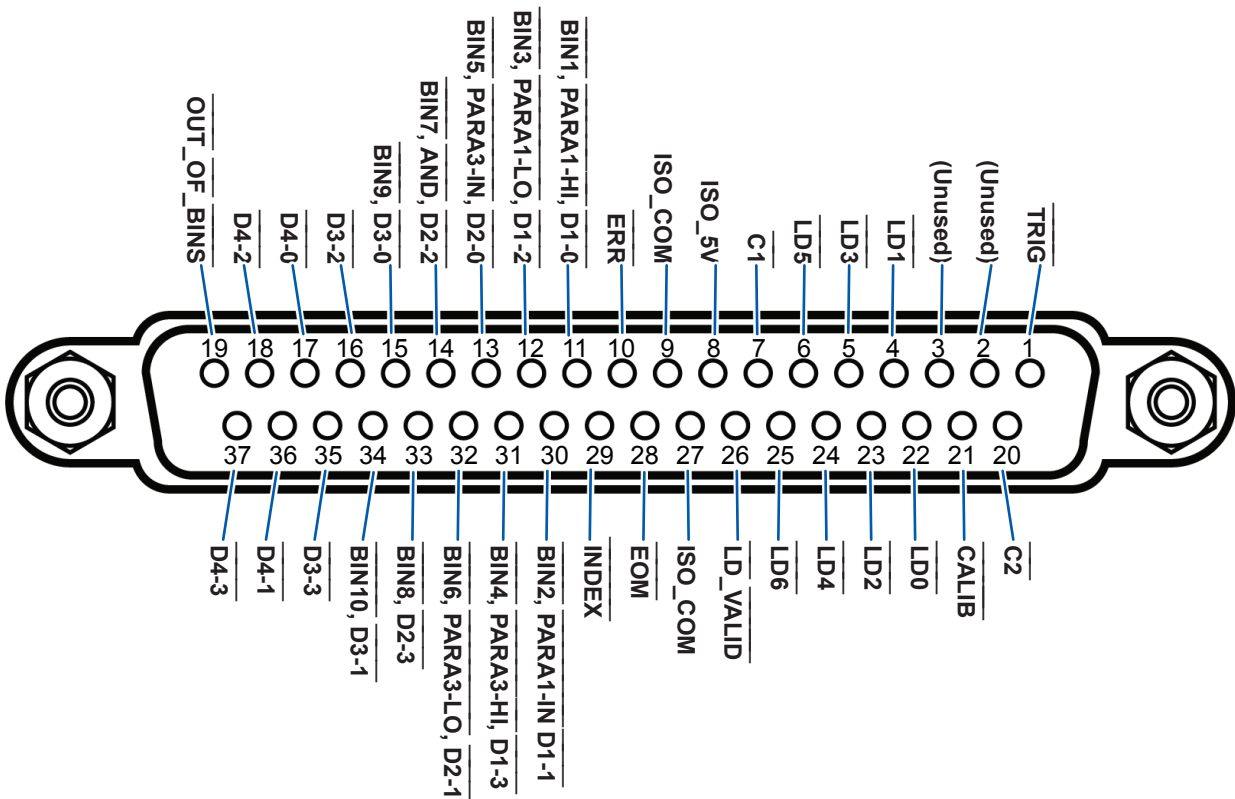

Pin	I/O <sup>1</sup>	Signal name	Function	Logic	
1	IN	TRIG	External trigger (See "Input (IN) signal function details" (p. 175).)	Rising/ falling	Edge
2	-	(Unused)	-	-	-
3	-	(Unused)	-	-	-
4	IN	LD1	Select panel number (See "Input (IN) signal function details" (p. 175).)	Negative	Level
5	IN	LD3	Select panel number (See "Input (IN) signal function details" (p. 175).)	Negative	Level
6	IN	LD5	Select panel number (See "Input (IN) signal function details" (p. 175).)	Negative	Level
7	IN	C1	Switches between the high-order digit and low-order digit during BCD output.	Negative	Level
8	-	ISO_5V	Isolated 5 V power output	-	-
9	-	ISO_COM	Isolated common signal ground	-	-
10	OUT	ERR	Outputs when a sampling error, overcurrent error, contact error, High-Z reject error, constant voltage/constant current error, or voltage/current limit value exceeded error occurs.	Negative	Level
11 <sup>2</sup>	OUT	BIN1	Generates output when the BIN measurement result is BIN1.	Negative	Level
		PARA1-HI	Generates output when the comparator judgment result is HI for the No. 1 parameter.		
		D1-0	BCD output signal		
12 <sup>2</sup>	OUT	BIN3	Generates output when the BIN measurement result is BIN3.	Negative	Level
		PARA1-LO	Generates output when the comparator judgment result is LO for the No. 1 parameter.		
		D1-2	BCD output signal		
13 <sup>2</sup>	OUT	BIN5	Generates output when the BIN measurement result is BIN5.	Negative	Level
		PARA3-IN	Generates output when the comparator judgment result is IN for the No. 3 parameter.		
		D2-0	BCD output signal		
14 <sup>2</sup>	OUT	BIN7	Generates output when the BIN measurement result is BIN7.	Negative	Level
		AND	Outputs judgment results for two parameter measured values (the result of a logical AND operation). Generates output when both judgment results are IN. Additionally, generates output when either of the No. 1 or No. 3 parameters is IN and the other is undetermined.		
		D2-2	BCD output signal		
15	OUT	BIN9	Generates output when the BIN measurement result is BIN9.	Negative	Level
		D3-0	BCD output signal		
16	OUT	D3-2	BCD output signal	Negative	Level
17	OUT	D4-0	BCD output signal	Negative	Level
18	OUT	D4-2	BCD output signal	Negative	Level
19	OUT	OUT_OF_BINS	Generates output when the BIN judgment result does not match any BIN.	Negative	Level
20	IN	C2	Switches between the No. 1 parameter and No. 3 parameter during BCD output.	Negative	Level
21	IN	CALIB	DC adjustment request (See "Input (IN) signal function details" (p. 175))	Negative	Level
22	IN	LD0	Select panel number (See "Input (IN) signal function details" (p. 175).)	Negative	Level



Pin	I/O <sup>*1</sup>	Signal name	Function	Logic	
23	IN	LD2	Select panel number (See "Input (IN) signal function details" (p. 175).)	Negative	Level
24	IN	LD4	Select panel number (See "Input (IN) signal function details" (p. 175).)	Negative	Level
25	IN	LD6	Select panel number (See "Input (IN) signal function details" (p. 175).)	Negative	Level
26	IN	LD_VALID	Execute panel load (See "Input (IN) signal function details" (p. 175).)	Negative	Level
27	-	ISO_COM	Isolated common signal ground	-	-
28	OUT	EOM	This signal indicates that measurement is complete. "HI (OFF)" indicates that measurement is in progress, while "LO (ON)" indicates that measurement is complete. When LO (ON), the comparator judgment results have been finalized.	Falling	Edge
29	OUT	INDEX	Signal indicating that A/D conversion for the measurement circuit has completed: When this signal changes from HI (OFF) to LO (ON), the sample may be changed.	Falling	Edge
30 <sup>*2</sup>	OUT	BIN2	Generates output when the BIN measurement result is BIN2.	Negative	Level
		PARA1-IN	Generates output when the comparator judgment result is IN for the No. 1 parameter.		
		D1-1	BCD output signal		
31 <sup>*2</sup>	OUT	BIN4	Generates output when the BIN measurement result is BIN4.	Negative	Level
		PARA3-HI	Generates output when the comparator judgment result is HI for the No. 3 parameter.		
		D1-3	BCD output signal		
32 <sup>*2</sup>	OUT	BIN6	Generates output when the BIN measurement result is BIN6.	Negative	Level
		PARA3-LO	Generates output when the comparator judgment result is LO for the No. 3 parameter.		
		D2-1	BCD output signal		
33	OUT	BIN8	Generates output when the BIN measurement result is BIN8.	Negative	Level
		D2-3	BCD output signal		
34	OUT	BIN10	Generates output when the BIN measurement result is BIN10.	Negative	Level
		D3-1	BCD output signal		
35	OUT	D3-3	BCD output signal	Negative	Level
36	OUT	D4-1	BCD output signal	Negative	Level
37	OUT	D4-3	BCD output signal	Negative	Level

\*1: IN indicates signal input to the instrument, while OUT indicates signal output from the instrument.

\*2: When BIN measurement is selected, refer to the top cell. When comparator measurement is selected, refer to the middle cell. When BCD mode is selected, refer to the bottom cell.

Continuous measurement mode (CONTINUOUS) operation

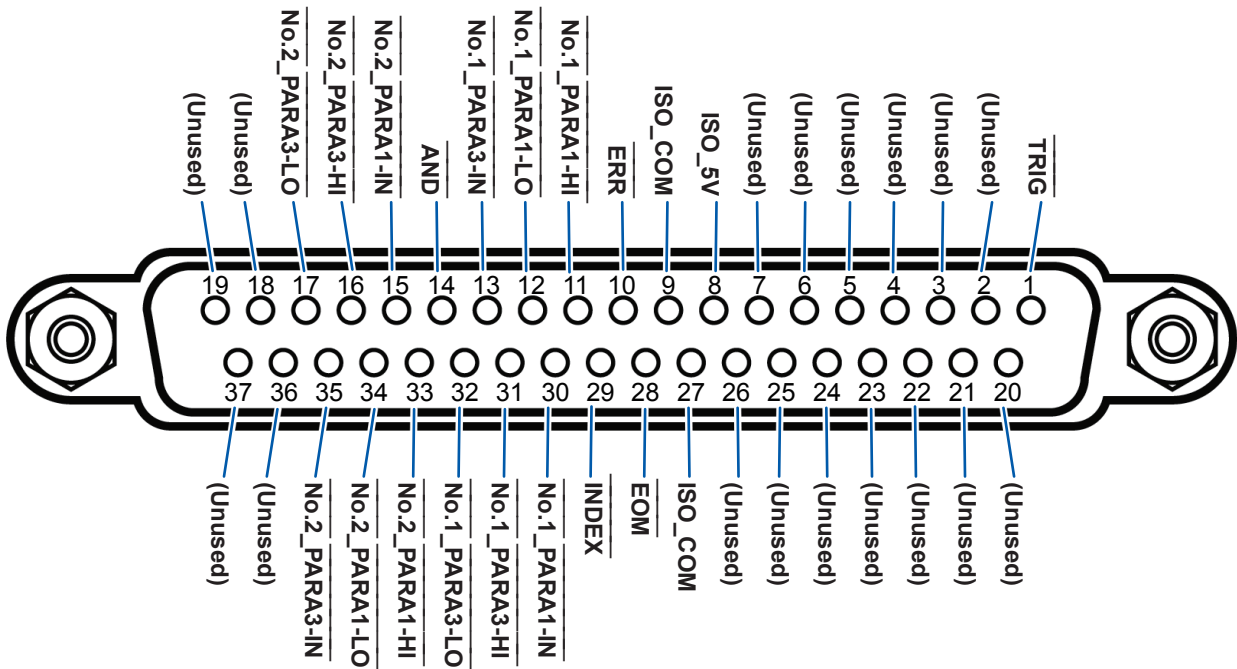

Pin	I/O*	Signal name	Function	Logic	
1	IN	TRIG	External trigger (See "Input (IN) signal function details" (p. 175).)	Rising/ falling	Edge
2	-	(Unused)	-	-	-
3	-	(Unused)	-	-	-
4	-	(Unused)	-	-	-
5	-	(Unused)	-	-	-
6	-	(Unused)	-	-	-
7	-	(Unused)	-	-	-
8	-	ISO_5V	Isolated 5 V power output	-	-
9	-	ISO_COM	Isolated common signal ground	-	-
10	OUT	ERR	Outputs when a sampling error, overcurrent error, contact error, High-Z reject error, constant voltage/ constant current error, or voltage/current limit value exceeded error occurs.	Negative	Level
11	OUT	No.1_PARA1-HI	Outputs HI comparator judgment results for the first No. 1 parameter.	Negative	Level
12	OUT	No.1_PARA1-LO	Outputs LO comparator judgment results for the first No. 1 parameter.	Negative	Level
13	OUT	No.1_PARA3-IN	Outputs IN comparator judgment results for the first No. 3 parameter.	Negative	Level
14	OUT	AND	Outputs when all panel judgments are IN and the instrument is not OUT_OF_BINS.	Negative	Level
15	OUT	No.2_PARA1-IN	Outputs IN comparator judgment results for the second No. 1 parameter.	Negative	Level
16	OUT	No.2_PARA3-HI	Outputs HI comparator judgment results for the second No. 3 parameter.	Negative	Level
17	OUT	No.2_PARA3-LO	Outputs LO comparator judgment results for the second No. 3 parameter.	Negative	Level
18	-	(Unused)	-	-	-

Pin	I/O*	Signal name	Function	Logic	
19	-	(Unused)	-	-	-
20	-	(Unused)	-	-	-
21	-	(Unused)	-	-	-
22	-	(Unused)	-	-	-
23	-	(Unused)	-	-	-
24	-	(Unused)	-	-	-
25	-	(Unused)	-	-	-
26	-	(Unused)	-	-	-
27	-	ISO_COM	Isolated common signal ground	-	-
28	OUT	EOM	This signal indicates that measurement is complete. "HI (OFF)" indicates that measurement is in progress, while "LO (ON)" indicates that measurement is complete. When LO (ON), the comparator judgment results have been finalized.	Falling	Edge
29	OUT	INDEX	Signal indicating that A/D conversion for the measurement circuit has completed: When this signal changes from HI (OFF) to LO (ON), the sample may be changed.	Falling	Edge
30	OUT	No.1_PARA1-IN	Outputs IN comparator judgment results for the first No. 1 parameter.	Negative	Level
31	OUT	No.1_PARA3-HI	Outputs HI comparator judgment results for the first No. 3 parameter.	Negative	Level
32	OUT	No.1_PARA3-LO	Outputs LO comparator judgment results for the first No. 3 parameter.	Negative	Level
33	OUT	No.2_PARA1-HI	Outputs HI comparator judgment results for the second No. 1 parameter.	Negative	Level
34	OUT	No.2_PARA1-LO	Outputs LO comparator judgment results for the second No. 1 parameter.	Negative	Level
35	OUT	No.2_PARA3-IN	Outputs IN comparator judgment results for the second No. 3 parameter.	Negative	Level
36	-	(Unused)	-	-	-
37	-	(Unused)	-	-	-

\*: IN indicates signal input to the instrument, while OUT indicates signal output from the instrument.

## Input (IN) signal function details

This section describes input (IN) signals.

Input (IN) signal	Detailed description																																																																																																																
TRIG	<ul style="list-style-type: none"> <li>When the trigger setting is the external trigger (<b>EXT</b>), measurement is performed once with the falling (<b>DOWN</b>) or rising (<b>UP</b>) edge of the TRIG. The edge direction can be set in the <b>SET</b> screen. (Initial value: Falling [<b>DOWN</b>]) See “Disabling the trigger input during measurement and setting the trigger input effective edge” (p. 190). (Falling: HI→LO, rising: LO→HI)</li> <li>The TRIG signal is invalid when the trigger source is set to the internal trigger (<b>INT</b>). See “Trigger (perform measurements with user-defined timing) (Common)” (p. 66).</li> <li>You can set whether to enable or disable TRIG input during measurement (during output of the EOM (HI)). “Disabling the trigger input during measurement and setting the trigger input effective edge” (p. 190).</li> </ul>																																																																																																																
LD0 to LD6	<p>Selects the number of the panel to load. If a trigger signal is input in external trigger mode, the selected panel is loaded and used for measurement. Input the panel value as a binary value to LD0 to LD6.</p> <p>&lt;Example&gt; OFF: HI (5 V to 24 V), ON: LO (0 V to 0.9 V)</p> <table border="1"> <thead> <tr> <th>Pin No.</th> <th>LD6</th> <th>LD5</th> <th>LD4</th> <th>LD3</th> <th>LD2</th> <th>LD1</th> <th>LD0</th> </tr> </thead> <tbody> <tr><td>Panel 1</td><td>OFF</td><td>OFF</td><td>OFF</td><td>OFF</td><td>OFF</td><td>OFF</td><td>ON</td></tr> <tr><td>Panel 2</td><td>OFF</td><td>OFF</td><td>OFF</td><td>OFF</td><td>OFF</td><td>ON</td><td>OFF</td></tr> <tr><td>Panel 3</td><td>OFF</td><td>OFF</td><td>OFF</td><td>OFF</td><td>OFF</td><td>ON</td><td>ON</td></tr> <tr><td>Panel 4</td><td>OFF</td><td>OFF</td><td>OFF</td><td>OFF</td><td>ON</td><td>OFF</td><td>OFF</td></tr> <tr><td>Panel 5</td><td>OFF</td><td>OFF</td><td>OFF</td><td>OFF</td><td>ON</td><td>OFF</td><td>ON</td></tr> <tr><td>Panel 6</td><td>OFF</td><td>OFF</td><td>OFF</td><td>OFF</td><td>ON</td><td>ON</td><td></td></tr> <tr><td>Panel 7</td><td>OFF</td><td>OFF</td><td>OFF</td><td>OFF</td><td>ON</td><td>ON</td><td>ON</td></tr> <tr><td>Panel 8</td><td>OFF</td><td>OFF</td><td>OFF</td><td>ON</td><td>OFF</td><td>OFF</td><td>OFF</td></tr> <tr><td>⋮</td><td></td><td></td><td></td><td></td><td></td><td></td><td></td></tr> <tr><td>Panel 32</td><td>OFF</td><td>ON</td><td>OFF</td><td>OFF</td><td>OFF</td><td>OFF</td><td>OFF</td></tr> <tr><td>⋮</td><td></td><td></td><td></td><td></td><td></td><td></td><td></td></tr> <tr><td>Panel 127</td><td>ON</td><td>ON</td><td>ON</td><td>ON</td><td>ON</td><td>ON</td><td>ON</td></tr> <tr><td>Panel 128</td><td>OFF</td><td>OFF</td><td>OFF</td><td>OFF</td><td>OFF</td><td>OFF</td><td>OFF</td></tr> </tbody> </table>	Pin No.	LD6	LD5	LD4	LD3	LD2	LD1	LD0	Panel 1	OFF	OFF	OFF	OFF	OFF	OFF	ON	Panel 2	OFF	OFF	OFF	OFF	OFF	ON	OFF	Panel 3	OFF	OFF	OFF	OFF	OFF	ON	ON	Panel 4	OFF	OFF	OFF	OFF	ON	OFF	OFF	Panel 5	OFF	OFF	OFF	OFF	ON	OFF	ON	Panel 6	OFF	OFF	OFF	OFF	ON	ON		Panel 7	OFF	OFF	OFF	OFF	ON	ON	ON	Panel 8	OFF	OFF	OFF	ON	OFF	OFF	OFF	⋮								Panel 32	OFF	ON	OFF	OFF	OFF	OFF	OFF	⋮								Panel 127	ON	ON	ON	ON	ON	ON	ON	Panel 128	OFF	OFF	OFF	OFF	OFF	OFF	OFF
Pin No.	LD6	LD5	LD4	LD3	LD2	LD1	LD0																																																																																																										
Panel 1	OFF	OFF	OFF	OFF	OFF	OFF	ON																																																																																																										
Panel 2	OFF	OFF	OFF	OFF	OFF	ON	OFF																																																																																																										
Panel 3	OFF	OFF	OFF	OFF	OFF	ON	ON																																																																																																										
Panel 4	OFF	OFF	OFF	OFF	ON	OFF	OFF																																																																																																										
Panel 5	OFF	OFF	OFF	OFF	ON	OFF	ON																																																																																																										
Panel 6	OFF	OFF	OFF	OFF	ON	ON																																																																																																											
Panel 7	OFF	OFF	OFF	OFF	ON	ON	ON																																																																																																										
Panel 8	OFF	OFF	OFF	ON	OFF	OFF	OFF																																																																																																										
⋮																																																																																																																	
Panel 32	OFF	ON	OFF	OFF	OFF	OFF	OFF																																																																																																										
⋮																																																																																																																	
Panel 127	ON	ON	ON	ON	ON	ON	ON																																																																																																										
Panel 128	OFF	OFF	OFF	OFF	OFF	OFF	OFF																																																																																																										
C1, C2	<ul style="list-style-type: none"> <li>C1: Switches between the high-order digit and the low-order digit (exponent or decimal point) in BCD mode. OFF: High-order digit output; ON: low-order digit output (polarity, ERR)</li> <li>C2: Switches between the No. 1 parameter and the No. 3 parameter in BCD mode. OFF: No. 1 parameter; ON: No. 3 parameter</li> <li>For more information about BCD mode, see “BCD mode function details” (p. 176).</li> </ul>																																																																																																																
LD_VALID	<ul style="list-style-type: none"> <li>Input a negative logic signal from an external source when performing a panel load operation.</li> <li>Maintain LO level after TRIG input until INDEX is output.</li> </ul>																																																																																																																
CALIB	<ul style="list-style-type: none"> <li>When the DC adjustment function is set to OFF during DC resistance measurement, acquires the offset value generated by the internal circuitry at the user-defined timing.</li> <li>Maintain LO level after TRIG input until INDEX is output.</li> </ul>																																																																																																																

## BCD mode function details

LCD mode output signals operate in two modes: judgment mode and BCD mode. In BCD mode, measured values for the No. 1 parameter and the No. 3 parameter are output using the BCD signals.

See “Outputting measured values (switching to BCD mode) (LCR mode only)” (p. 192).

The BCD high-order digit and low-order digit (polarity and ERR information) can be switched with the C1 signal.

C1	D4	D3	D2	D1
HI (high-order)	No. 6 digit data	No. 5 digit data	No. 4 digit data	No. 3 digit data
LO (low-order)	No. 2 digit data	No. 1 digit data	Polarity	ERR

### Signal correspondence table

Dm-3	Dm-2	Dm-1	Dm-0	Measured value
OFF	OFF	OFF	OFF	0
OFF	OFF	OFF	ON	1
OFF	OFF	ON	OFF	2
OFF	OFF	ON	ON	3
OFF	ON	OFF	OFF	4
OFF	ON	OFF	ON	5
OFF	ON	ON	OFF	6
OFF	ON	ON	ON	7
ON	OFF	OFF	OFF	8
ON	OFF	OFF	ON	9

(m: 4 to 1)

	Output				Description
	D4-n	D3-n	D2-n	D1-n	
Polarity	OFF	OFF	OFF	OFF	Plus
	OFF	OFF	OFF	ON	Minus
ERR*	OFF	OFF	OFF	OFF	Normal data
	OFF	OFF	OFF	ON	OVERFLOW
	OFF	OFF	ON	OFF	UNDERFLOW
	OFF	OFF	ON	ON	NC (Contact error)
	OFF	ON	OFF	OFF	Error

\*: When other than normal data, the value 9 will be output for numerical data.

The C2 signal is used to switch between the No. 1 parameter and the No. 3 parameter.

### Relationship between BCD signals and the instrument display

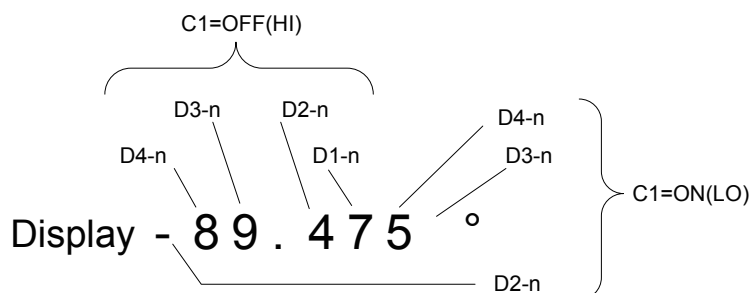

### Example output

The decimal point is set to an appropriate position.

**12.3456  $\mu$ F** Decimal point: 99.9999  $\mu$

$\overline{C1}$		$\overline{D4}$				$\overline{D3}$				$\overline{D2}$				$\overline{D1}$			
		3	2	1	0	3	2	1	0	3	2	1	0	3	2	1	0
OFF (High-order)	Decimal display	1				2				3				4			
	BCD output	OFF	OFF	OFF	ON	OFF	OFF	ON	OFF	OFF	OFF	ON	ON	OFF	ON	OFF	OFF
ON (Low-order)	Decimal display	5				6				Polarity: 0				ERR: 0			
	BCD output	OFF	ON	OFF	ON	OFF	ON	ON	OFF	OFF	OFF	OFF	OFF	OFF	OFF	OFF	OFF

**-12.345°** Decimal point: 99.9999

$\overline{C1}$		$\overline{D4}$				$\overline{D3}$				$\overline{D2}$				$\overline{D1}$			
		3	2	1	0	3	2	1	0	3	2	1	0	3	2	1	0
OFF (High-order)	Decimal display	1				2				3				4			
	BCD output	OFF	OFF	OFF	ON	OFF	OFF	ON	OFF	OFF	OFF	ON	ON	OFF	ON	OFF	OFF
ON (Low-order)	Decimal display	5				0				Polarity: 1				ERR: 0			
	BCD output	OFF	ON	OFF	ON	OFF	OFF	OFF	OFF	OFF	OFF	OFF	ON	OFF	OFF	OFF	OFF

**NC (Contact error)**

$\overline{C1}$		$\overline{D4}$				$\overline{D3}$				$\overline{D2}$				$\overline{D1}$			
		3	2	1	0	3	2	1	0	3	2	1	0	3	2	1	0
OFF (High-order)	Decimal display	9				9				9				9			
	BCD output	ON	OFF	OFF	ON	ON	OFF	OFF	ON	ON	OFF	OFF	ON	ON	OFF	OFF	ON
ON (Low-order)	Decimal display	9				9				Polarity: 0 or 1				ERR: 3			
	BCD output	ON	OFF	OFF	ON	ON	OFF	OFF	ON	OFF	OFF	OFF	OFF	OFF	OFF	ON	ON

## Output signals when errors occur

When an error occurs, the signals are as follows. When multiple errors occur, the signal with the highest precedence is output.

See “11.3 Error Message and Error Display” (p. 238).

Error	Screen error display	ERR No. 10 Pin <sup>*1</sup>	During comparator measurement		During BIN measurement		Priority Order
			Logical product and No. 14 Pin	Each Parameter Judgment Result Pin Nos. 11 to 13 and 30 to 32	BIN1 to BIN10 Pin Nos. 11 to 15 and 30 to 34	OUT_OF_BINS Pin No. 19	
Sampling error	<b>SAMPLE ERR</b>	LO	HI	HI	HI	LO	High
Simultaneous H and L contact errors (after measurement)	<b>NC A HL</b>			Pin Nos. 11 and 31: LO <sup>*2</sup> (LCR mode only)			
L side contact error (after measurement)	<b>NC A L</b>						
H side contact error (after measurement)	<b>NC A H</b>						
Simultaneous H and L contact errors (before measurement)	<b>NC B HL</b>						
L side contact error (before measurement)	<b>NC B L</b>						
H side contact error (before measurement)	<b>NC B H</b>						
Underflow	<b>UNDERFLOW</b>	HI	HI	Pin Nos. 12 and 32: LO <sup>*2,3</sup> (LCR mode only)	HI	LO	High
Overflow	<b>OVERFLOW</b>			Pin Nos. 11 and 31: LO <sup>*2,4</sup> (LCR mode only)			
Outside of High-Z reject limit range	<b>Hi Z</b>	LO	Normal judgment	Normal judgment	Normal judgment	Normal judgment	High
Constant voltage/constant current error	<b>9.071mV</b> <b>9.101μA</b> <b>ERR</b>						
Voltage/current limit value exceeded error	<b>9.074mV</b> <b>9.103μA</b> <b>LMI</b>						
Outside of guaranteed accuracy range	<b>Reference Value</b>	HI	Normal judgment	Normal judgment	Normal judgment	Normal judgment	High
Normal	Measured value						
No measurement is performed after the instrument is turned on	<b>■■■■■</b>						

\*1: LO output is generated if even one error for which output changes to LO occurs.

\*2: Pin numbers that change to LO level are shown.

\*3: Pin Nos. 11 and 31 will be LO when the parameters are Y, Cs, G, and B. (LCR mode only)

\*4: Pin Nos. 12 and 32 will be LO when the parameters are Y, Cs, G, and B. (LCR mode only)

## 9.2 Example Measurement Timing (Timing Charts)

This section describes an example of measurement timing in each measurement mode using timing charts.

### LCR mode (LCR)

First, set the trigger to **EXT** (external trigger) and set the comparator judgment conditions. In that state a trigger signal ( $\overline{\text{TRIG}}$ ) is input from the EXT I/O or is pressed **TRIG** key in the screen, the judgment result is output from the signal line for comparator result output of the EXT I/O after measurement ends.

Additionally, when the panel number ( $\overline{\text{LD0}}$  to  $\overline{\text{LD6}}$ ) and the panel load execution ( $\overline{\text{LD\_VALID}}$ ) are input, inputting the trigger signal from EXT I/O causes the measurement conditions for that panel number to be loaded and measurement to be performed.

The following shows examples of the measurement timing.

(In the timing examples, the valid edge of the TRIG signal is set to falling (**DOWN**)).

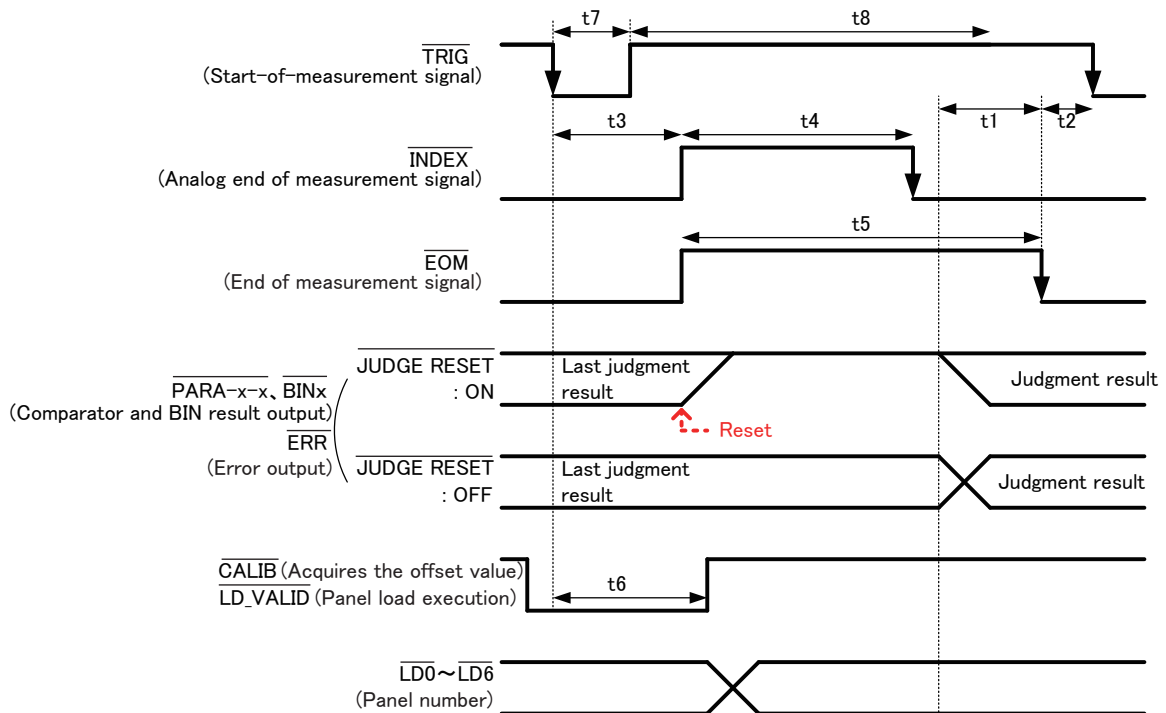

\*:  $\overline{\text{PARAx-HI}}$ ,  $\overline{\text{PARAx-IN}}$ ,  $\overline{\text{PARAx-LO}}$ , AND,  $\overline{\text{BINx}}$ ,  $\overline{\text{OUT\_OF\_BINS}}$

You can select whether to reset the comparator and BIN measurement judgment results when  $\overline{\text{EOM}}$  changes to HI (measurement in progress) or update the results when  $\overline{\text{EOM}}$  changes to LO (measurement complete) on the instrument or with a communications command.

Setting on the instrument:  
See "Setting the delay time (from judgment result output to  $\overline{\text{EOM}}$  output) and judgment result reset operation" (p. 189).

Setting with a communications command:  
See LCR Application Disc - Communications Command (`:IO:RESult:RESet`).



### Timing chart interval descriptions

Interval	Description	Time (Approx.)
t1	From Comparator, BIN Judgement Result to EOM (LO): Setting value for delay time <sup>*1</sup> (p. 189.)	40 μs
t2	From EOM width (LO) to TRIG (LO): Minimum time from end of measurement to next trigger <sup>*2</sup>	400 μs
t3	From TRIG (LO) to INDEX (HI): Time from trigger to circuit response <sup>*3</sup>	400 μs
t4	INDEX width (HI): Analog measurement time (=Minimum chuck time), switching chuck with INDEX (LO) is possible <sup>*4</sup>	1 ms
t5	EOM width (HI): Measurement time*4	1.7 ms
t6	From TRIG width (LO) to LD-VALID (HI), CALIB (HI): Time to panel load execution and DC adjustment request signal detection	At least t3
t7	Trigger pulse width (LO time)	At least 100 μs
t8	Trigger off (HI time)	At least 100 μs

\*1: There is an approximate error of 100 μs in the delay time entered for Judgement Result→EOM for the setting value. t1 is the reference value for when the setting value is 0.0000 s.

\*2: t2 is the reference value for when trigger input for during measurement is disabled (p. 190).

\*3: When the panel number is read by the panel load function, the response time is as shown in the table below.

Measurement mode	Save type for loaded data	Content of loaded data	Response time
LCR	LCR+ADJ	Both measurement conditions and correction values	Approx. 6.5 ms
	LCR	Measurement conditions and cable length correction setting	Approx. 5 ms
	ADJ	Open correction, short correction, load correction, and correlation correction (scaling) settings and correction values only	Approx. 1.5 ms

The trigger synchronization delay, trigger delay, and DC delay times are added to t3. When using the “External trigger” (p. 226) condition, 500 μs is added to t3.

\*4: Reference value for Measurement frequency: 1 kHz, Measurement speed: FAST, Range: HOLD (p. 225)

- Because the speed with which the comparator and BIN judgment results rise (LO → HI) varies with the architecture of the circuit connected to EXT I/O, using the judgment results level immediately after EOM output may result in an erroneous detection. To prevent this phenomenon, set a delay time (t1) between judgment result output and EOM output.  
In addition, by configuring the instrument so that the judgment result signal at EXT I/O is reset at the same time as the measurement start signal (thereby forcing the judgment results to transition to HI at the same time as TRIG input [EOM {HI}]), the transition from LO to HI when the judgment results are output after the completion of measurement can be eliminated. As a result, the delay time set between judgment result output and EOM output can be minimized. However, be careful because the judgment result confirmation interval is until the next trigger is accepted.
- When inputting the trigger from EXT I/O or communicating using one of the instrument’s interfaces during measurement, variability in the delay time between output of comparator and BIN judgment results and EOM output may increase. Consequently, control of the instrument from an external device should be avoided during measurement to the greatest extent possible.  
Setting on the instrument:  
See “Setting the delay time (from judgment result output to EOM output) and judgment result reset operation” (p. 189).  
Setting with a communications command:  
See LCR Application Disc - Communications Command (:IO:OUTPut:DElay), (:IO:RESult:RESet).

- The shorter the measurement time, the shorter the time that INDEX and EOM are HI (off). The HI (OFF) time when receiving the INDEX and EOM signals may be too short depending on the input circuit. By setting the EOM output method to **PULSE**, an adequately long HI (OFF) time can be configured. The instrument can be configured to maintain the low (on) state for a preset time once EOM changes to LO (on) before reverting the signal to HI (off) after the completion of measurement. When trigger input is received at EOM: LO (on) and INDEX: LO (on), the signal transitions to HI (off) when measurement starts.

**Setting the INDEX and EOM output method**

Setting on the instrument:

See “Setting the EOM output method and output time” (p. 191).

Setting with a communications command:

See LCR Application Disc - Communications Command (: IO: EOM: MODE).

**Setting the pulse width for which LO (on) EOM is held**

Setting on the instrument:

See “Setting the EOM output method and output time” (p. 191).

Setting with a communications command:

See LCR Application Disc - Communications Command (: IO: EOM: PULSE).

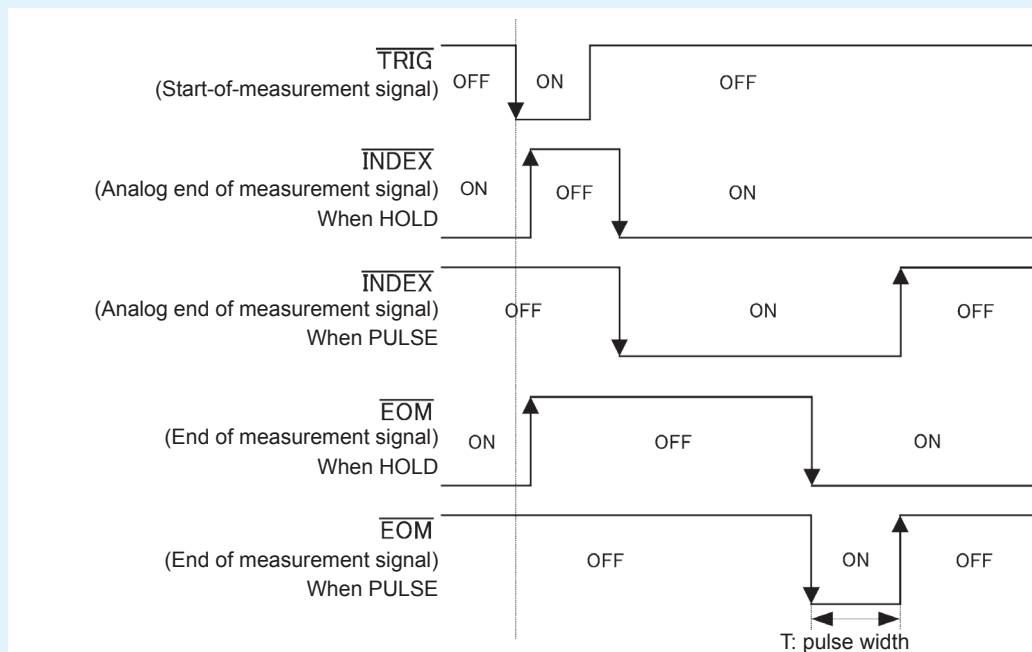

In the above figure, “ON” indicates signal input and output, while “OFF” indicates the absence of signal input or output.

(ON: HI, OFF:LO)

**BCD signal timing**

BCD single DM-n transition time based on the C1 and C2 signals

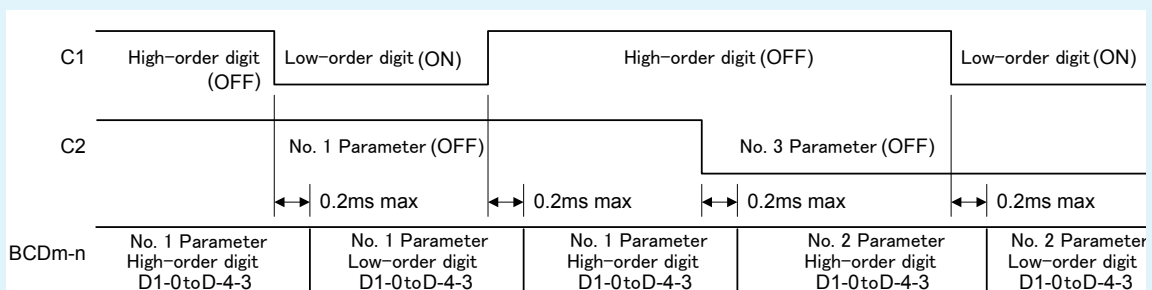

**Acquisition of measured values (BCD) using an external trigger**

With BCD output, it is necessary to acquire the No. 1 parameter and the No. 3 parameter as well as the high-order digit and the low-order digit separately. The No. 1 parameter and the No. 3 parameter and the high-order digit and the low-order digit can be acquired in any order. In the following example, the high-order digit of the No. 1 parameter is acquired first. A wait of at least 0.2 ms is required after controlling the C1 and C2 signals.

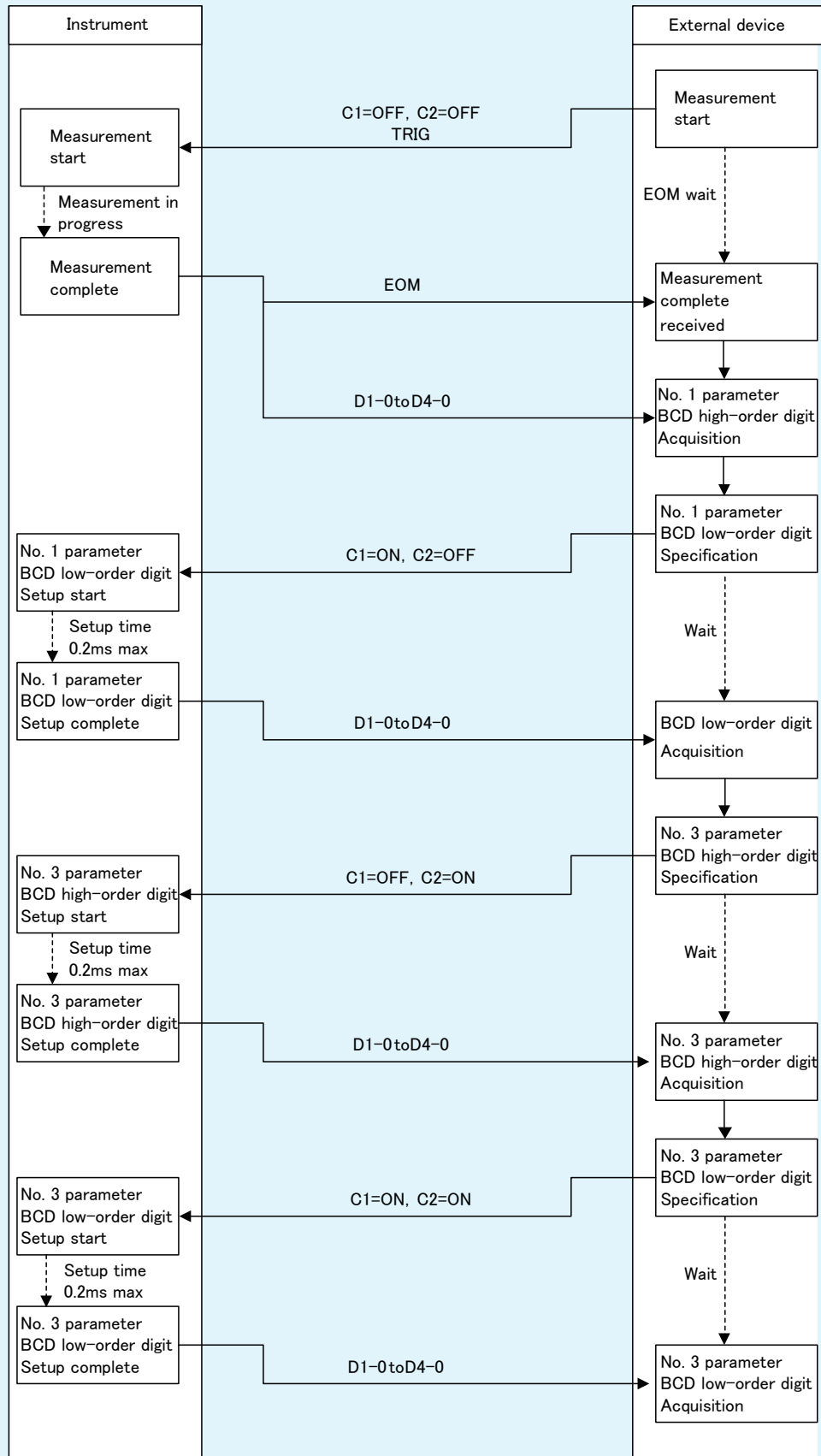

**Continuous measurement mode (CONTINUOUS)**

When the trigger signal is input from EXT I/O or **TRIG** key is touched on the screen in continuous measurement mode, measurement will be performed for all panel numbers that have been enabled on the screen. Once those measurements are complete, the respective judgment results measured first and second for the No. 1 and No. 3 parameters will be output from the EXT I/O comparator result output signal lines. (Judgment results for the third and subsequent items are not output.)

The following shows examples of the measurement timing.

(In the timing examples, the valid edge of the TRIG signal is set to falling (**DOWN**).)

Example: Continuous measurement using panel numbers 1, 3, and 4

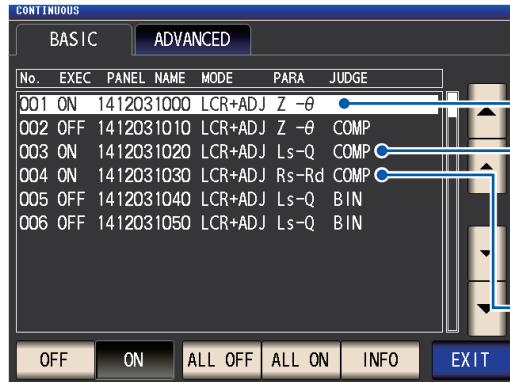

The first judgment result will not be output since comparator is not set.

Since No. 2 is OFF, measurement will be performed using the No. 3 conditions, and the second judgment result will be output.

The judgment result will not be output from EXT I/O since this will be the third measurement.

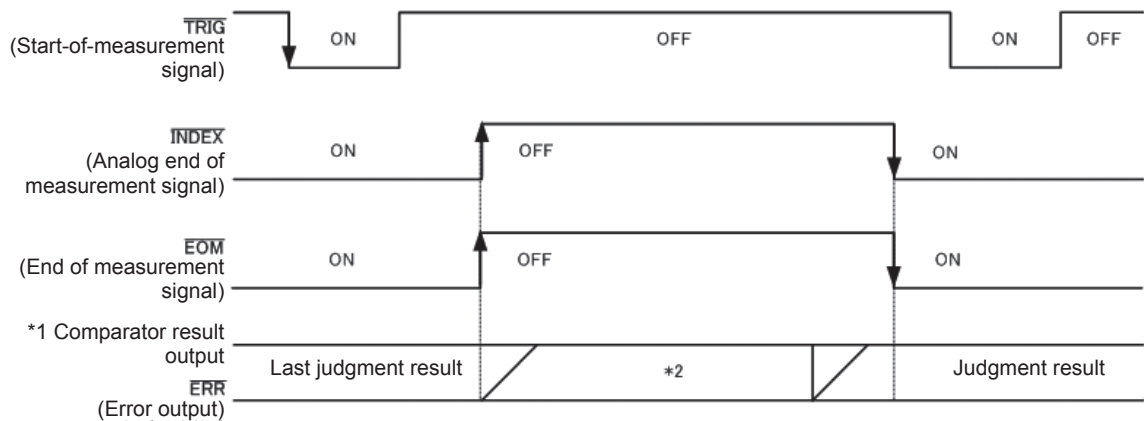

In the above figure, “ON” indicates signal input and output, while “OFF” indicates the absence of signal input or output. (ON: HI, OFF: LO)

\*1 No.x\_PARAy-HI, No.x\_PARAy-IN, No.x\_PARAy-LO, AND

\*2 Reset when signal changes to EOM (HI) (measurement in progress): ON

Do not reset when signal changes to EOM (HI) (measurement in progress): Last judgment result remains

Signal line	Description
INDEX, EOM	For both INDEX and EOM, a transition to Hi (off) is performed when the first panel measurement starts after the trigger signal is input, and a transition to LO (on) is performed after measurement of the last panel is finished and the judgment result has been output. (The HI level is maintained during continuous measurement.)
AND	When the judgment results of all panels are IN, LO is output.

- In the continuous measurement screen, comparator result output signals (however, other than AND, the first panel, or the second panel) and panel load signals (LD-VALID, LD0 to LD6) cannot be used. (See “Using Continuous Measurement Mode” (p. 99).)
- You can select whether to reset the comparator and BIN measurement judgment results when EOM changes to HI (measurement in progress) or update the results when EOM changes to LO (measurement complete) on the instrument or with a communications command.  
Setting on the instrument:  
See “Setting the delay time (from judgment result output to EOM output) and judgment result reset operation” (p. 189).  
Setting with a communications command:  
See LCR Application Disc - Communications Command (:IO:REsult:RESet).
- For other timing chart times, refer to “LCR mode (LCR)” (p. 179).

## 9.3 Internal Circuitry

This section provides I/O circuit diagrams, electrical specifications, and example connections for the instrument.

### Circuit diagrams

#### Input circuit

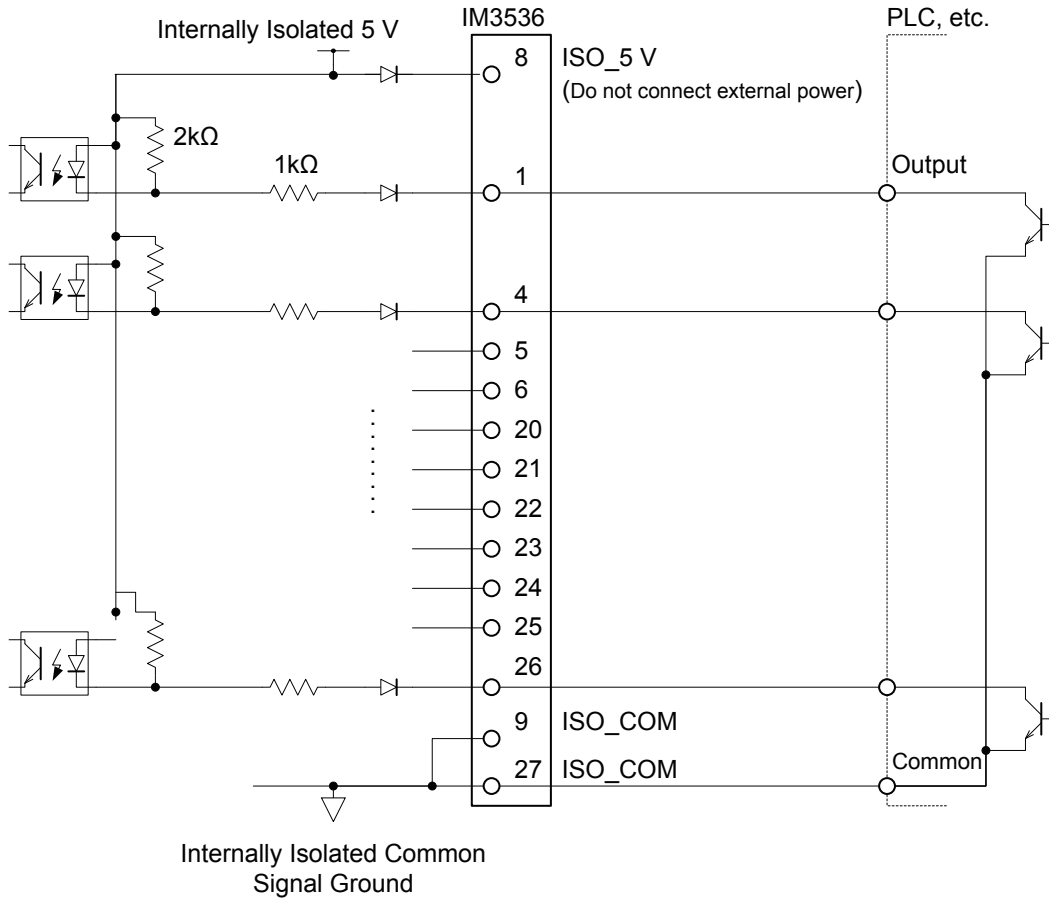

Output circuit

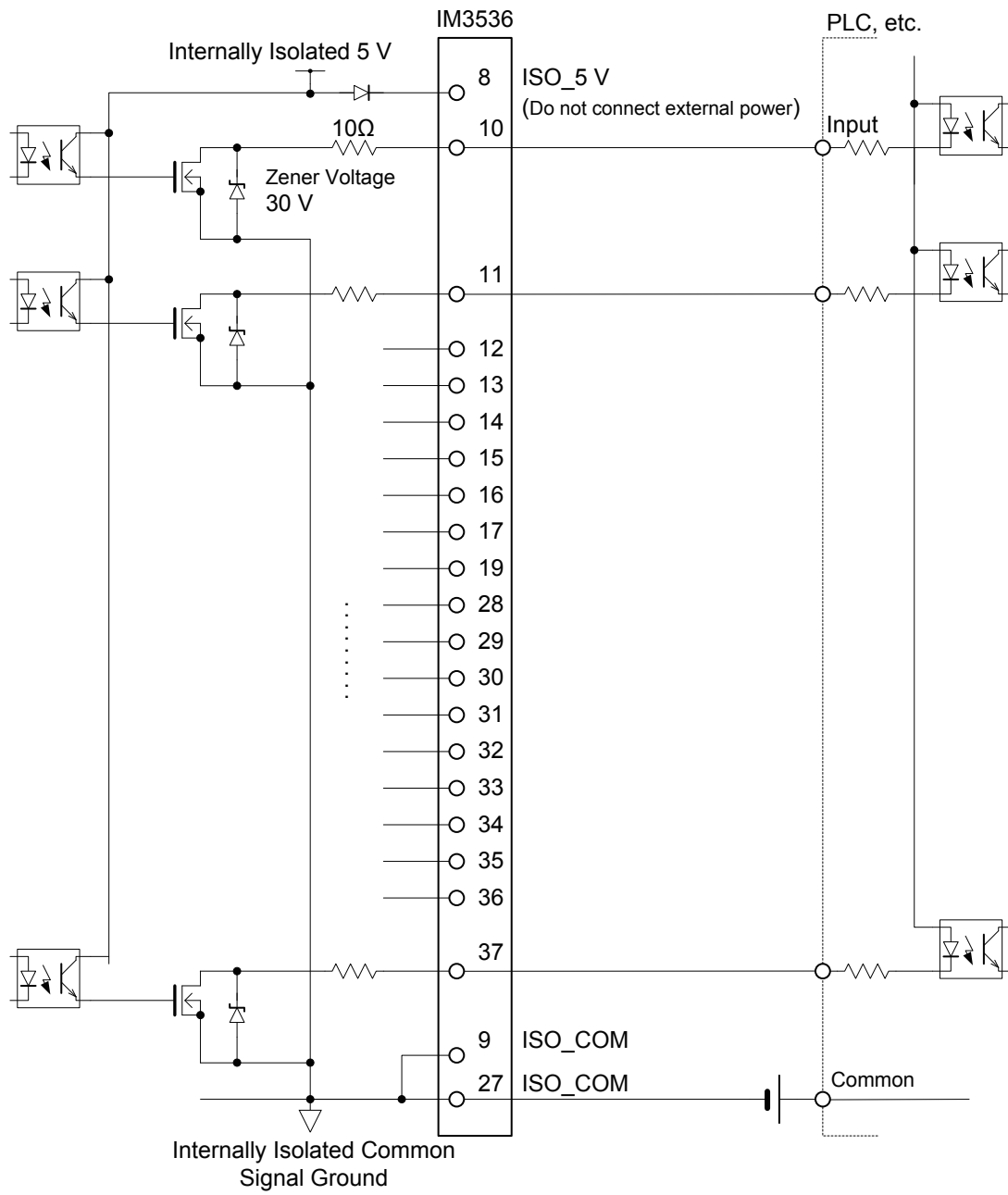

## Electrical specifications

<b>Input signals</b>	Input type	Optocoupler-isolated, non-voltage contact inputs (current sink, active-low)
	Input asserted (on) voltage	0.9 V or less
	Input de-asserted (off) voltage	Open or 5 V to 24 V
	Input asserted (on) current	3 mA/ch
	Maximum applied voltage	30 V
<b>Output signals</b>	Output type	Isolated by photo-couplers, Nch open drain output (current sink, active-low)
	Maximum load voltage	30 V
	Maximum output current	50 mA/ch
	Residual voltage	1 V or less (50 mA)
<b>Internally isolated power supply</b>	Output voltage	4.5 V to 5.0 V
	Maximum output current	100 mA
	External power input	none

## Connection examples

### Input circuit connection examples

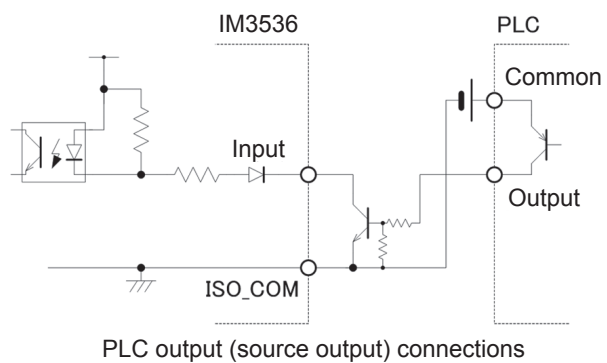
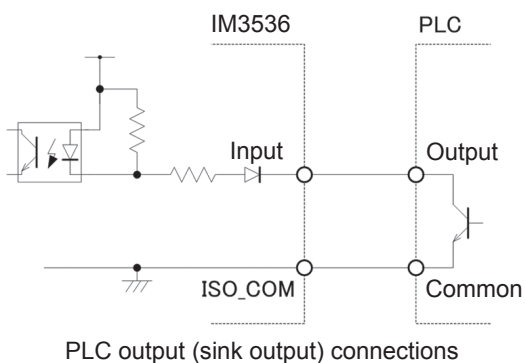
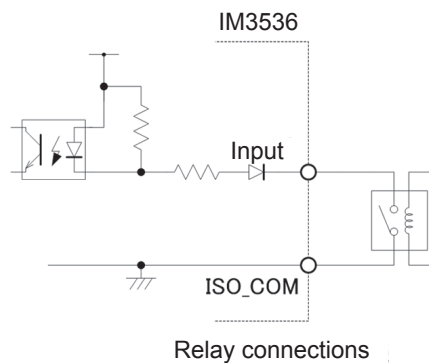
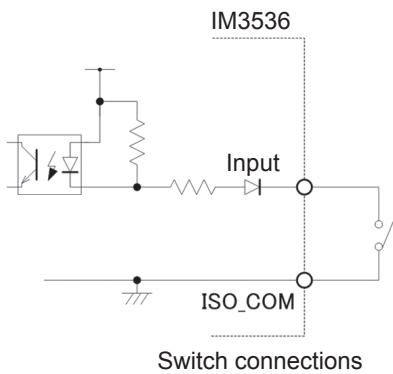

**Output Circuit connection examples**

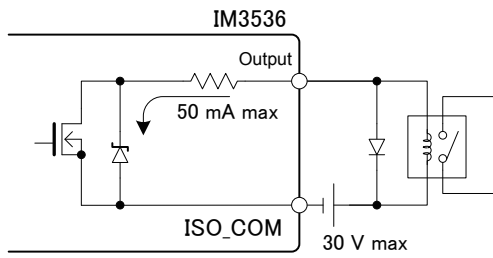

Connection to relay

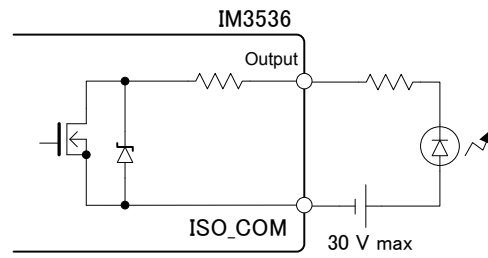

Connection to LED

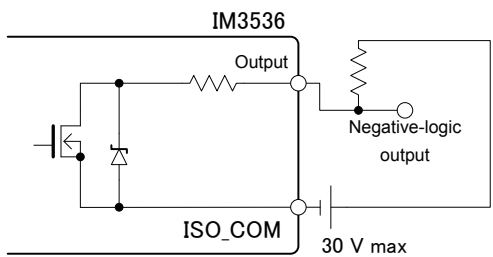

Negative-logic output

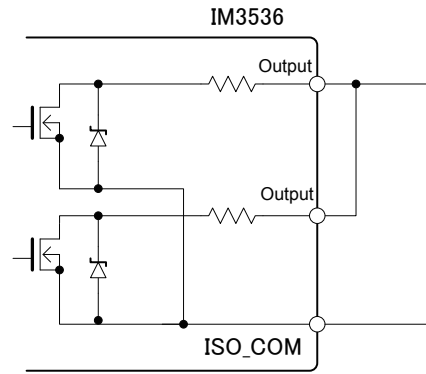

Wired or

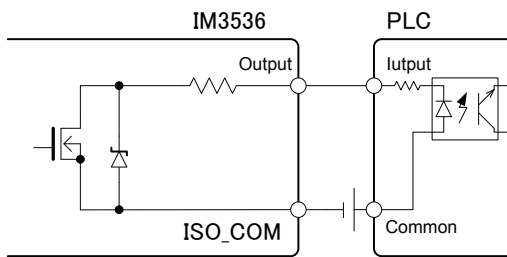

Connection to programmable controller  
(plus common input)

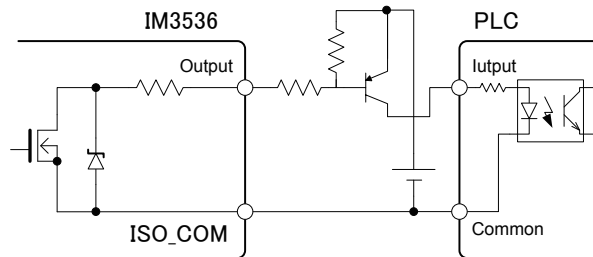

Connection to programmable controller  
(negative common input)



## 9.4 External I/O Settings

The following settings govern EXT I/O. They can be set on the instrument and with communications commands.

<p><b>Setting the external trigger</b></p>	<p>You can control (start and stop) recording by inputting a specific signal from an external device to the instrument.</p> <p>Setting on the instrument: See p. 66. Setting with a communications command: See LCR application dkc - Communications command (: <b>TRIGger</b>).</p>
<p><b>Setting the Hi Z reject function</b></p>	<p>You can output a measurement terminal contact error when the measurement results exceed a set judgment standard during 2-terminal measurement.</p> <p>Setting on the instrument: See p. 88. Setting with a communications command: See LCR application dkc - Communications command "Hi Z reject function".</p>
<p><b>Setting the delay time from judgment results output to EOM output</b></p>	<p>You can set the delay time from <u>output</u> of comparator and BIN judgment results from EXT I/O to EOM output.</p> <p>Setting on the instrument: See p. 189. Setting with a communications command: See LCR application dkc - Communications command (: <b>IO:OUTPut:DElay</b>).</p>
<p><b>Setting reset of judgment results</b></p>	<p>You can reset comparator and BIN judgment results at the same time as the measurement start signal.</p> <p>Setting on the instrument: See p. 189. See LCR application dkc - Communications command (: <b>IO:RESult:RESet</b>).</p>
<p><b>Enabling trigger input for during measurement</b></p>	<p>Whether to enable or disable <u>trigger</u> input from the EXT I/O during measurement (during EOM (HI)) can be selected on the instrument or by a communication command.</p> <p>Setting on the instrument: See p. 190. See LCR application dkc - Communications command (: <b>IO:TRIGger:ENABle</b>).</p>
<p><b>Setting valid edge of trigger input</b></p>	<p>Either the rising edge or falling edge can be selected as the valid edge of trigger input from the EXT I/O.</p> <p>Setting on the instrument: See p. 190. See LCR application dkc - Communications command (: <b>IO:TRIGger:EDGe</b>).</p>
<p><b>Setting the EOM output method and output time</b></p>	<p>You can set the output method for the <u>EOM</u> measurement complete signal. You can <u>also</u> set the time for which EOM is held in the LO state before the EOM measurement complete signal is output.</p> <p>Setting on the instrument: See p. 191. See LCR application dkc - Communications command (<b>IO:EOM:MODE</b>).</p>
<p><b>Outputting measured values (Switching to BCD mode)</b></p>	<p>During LCR mode operation, you can switch the output mode from judgment mode to BCD mode so that measured values are output instead of judgment results.</p> <p>Setting on the instrument: See p. 192. Setting with a communications command: See LCR application dkc - Communications command (<b>IO:BCD</b>).</p>

## Setting the delay time (from judgment result output to EOM output) and judgment result reset operation

The delay time for the period from the output of the comparator and BIN judgment results until the output of EOM from the EXT I/O can be set.

You can also select whether to reset comparator and BIN judgment results when EOM output changes to HI (indicating that measurement is in progress).

(See "9.2 Example Measurement Timing (Timing Charts)" (p. 179).)

Screen display method (For more information, see p. 26.):

(Measurement screen) **SET** key > (SET screen) **ADVANCED** tab > **IO JUDGE** key

### 1 Set the delay time with the ▲▼ key.



Settable range: 0.0000 s to 0.9999 s

If you make a mistake, touch the **C** key to reenter the value.

### 2 Select the judgment result hold/reset setting.



**OFF** Stores the last judgment results until the next judgment results are output.

**ON** Resets the judgment results when the EOM signal change to HI.

### 3 Touch the **EXIT** key twice.

Displays the measurement screen.

## Disabling the trigger input during measurement and setting the trigger input effective edge

This section describes how to select whether to enable or disable trigger input from EXT I/O during measurement. Erroneous input due to chattering can be prevented by disabling trigger input during measurement.

Furthermore, you can also select either the rising edge or falling edge as the valid edge of trigger input from the EXT I/O.

(“9.2 Example Measurement Timing (Timing Charts)” (p. 179).)

Screen display method (For more information, see p. 26.):

(Measurement screen) **SET** key>(SET screen) **ADVANCED** tab>**IO TRIG** key

### 1 Select the I/O trigger function setting.

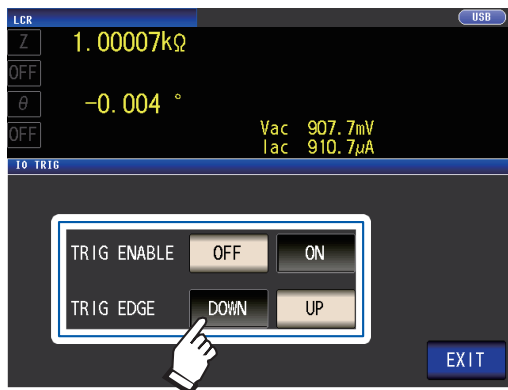

<b>OFF</b>	Disables trigger input from the EXT I/O during measurement.
<b>ON</b>	Enables trigger input from the EXT I/O during measurement.
<b>DOWN</b>	Sets the falling edge as the valid edge of trigger input.
<b>UP</b>	Sets the rising edge as the valid edge of trigger input.

### 2 Touch the **EXIT** key twice.

Displays the measurement screen.

## Setting the EOM output method and output time

The higher the measurement frequency, the shorter the time that INDEX and EOM are HI (during measurement).

If the HI time when receiving the INDEX and EOM signals is too short for reasons related to the input circuit, you can configure the instrument so that the LO signal is held (i.e., so that EOM output is continued) after EOM changes to LO when measurement completes before reverting to HI.

The INDEX output method can be changed in the same manner.

Screen display method (For more information, see p. 26.):

(Measurement screen) **SET** key > (SET screen) **ADVANCED** tab > **IO EOM** key

### 1 Select the EOM output method.

**HOLD** EOM will be in the HI state for (analog measurement time + calculation time + delay time t1) (see “9.2 Example Measurement Timing (Timing Charts)” (p. 179)).

**PULSE** EOM will be in the HI state except during the set pulse width time. Once the measurement is completed, EOM turns LO (ON) and HI (OFF) after the set time elapses.



### 2 Set the EOM output time during PULSE operation with the ▲▼ keys.

Settable range: 0.0001 s to 0.9999 s

If you make a mistake, touch the **C** key to reenter the value.

- For a timing chart illustrating operation when using the **HOLD** and **PULSE** settings, see p. 181.
- The output time can only be set when using the **PULSE** output method.

### 3 Touch the EXIT key twice.

Displays the measurement screen.

## Outputting measured values (switching to BCD mode) (LCR mode only)

This section describes how to switch the output mode (between judgment mode and BCD mode) during LCR mode operation. The default setting is judgment mode, in which case judgment results are output. Changing the mode to BCD mode causes measured values to be output.

Screen display method (For more information, see p. 26.):

(Measurement screen) **SET** key>(SET screen) **ADVANCED** tab>**IO BCD** key

### 1 Touch the **ON** key.



**OFF** Sets the output mode to judgment mode. (Judgment results will be output.)

**ON** Sets the output mode to BCD mode. (Measured values will be output.)

### 2 Set the decimal point position with the **▲▼** keys.

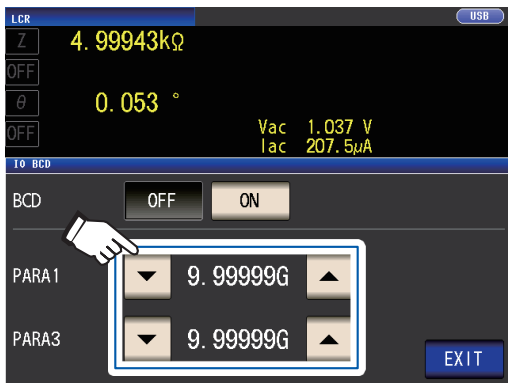

**PARA1** Sets the decimal point position for the No. 1 parameter.

**PARA3** Sets the decimal point position for the No. 3 parameter.

(Select: 9.99999G/  
999.999M/ 99.9999M/ 9.99999M/  
999.999k/ 99.9999k/ 9.99999k/  
999.999/ 99.9999/ 9.99999/  
999.999m/ 99.9999m/ 9.99999m/  
999.999μ/ 99.9999μ/ 9.99999μ/  
999.999n/ 99.9999n/ 9.99999n/  
999.999p/ 99.9999p)

Example:

To display the No. 1 parameter measured value as 12.3456 μF and the No. 3 parameter measured value as -80.567°, use the following settings:

**PARA1: 99.9999μ**

**PARA3: 99.9999**

### 3 Touch the **EXIT** key twice.

Displays the measurement screen.

## 9.5 External Control Q&A

This section presents a list of frequently asked questions about external control for your reference.

Common Questions	Answers
How do I connect external trigger input?	Connect the TRIG input pin to an ISO_COM pin using a switch or open-collector output.
Which pins are common ground for input and output signals?	The ISO_COM pins.
Are the common (signal ground) pins shared by both inputs and outputs?	Both common ground pins can be shared by inputs and outputs.
How do I confirm output signals?	Confirm voltage waveforms with a memory recorder and oscilloscope. To do this, the output pins such as EOM and comparator decision outputs need to be pulled up (through several k $\Omega$ ).
How do I troubleshoot input (control) signal issues?	For example, if triggering does not operate properly, bypass the PLC and short the TRIG pin directly to an ISO_COM pin. Be careful to avoid power shorts.
Are the comparator decision signals (HI, IN, LO) retained during measurement (or can they be off)?	They are initially set to be confirmed at the end of measurement and turned off when measurement starts. However, it is possible to change the settings so that the judgment results from last time are also stored during measurement. (See “Setting the delay time (from judgment result output to EOM output) and judgment result reset operation” (p. 189).)
When are measurement error signals displayed?	The ERR signal will be output in the following circumstances: <ul style="list-style-type: none"> <li>• When sampling error</li> <li>• When contact error</li> <li>• When High-Z reject error</li> <li>• When constant voltage/constant current error</li> <li>• When voltage/current limit value exceeded error</li> </ul> See “Output signals when errors occur” (p. 178).
Is a connector or flat cable for connection provided?	A connector and cable are not supplied, so you need to provide them yourself.
Is direct connection to a PLC possible?	Direct connection is supported for relay or open-collector outputs and positive-ground optocoupler inputs. (Before connecting, confirm that voltage and current ratings will not be exceeded.)
Can external I/O be used at the same time as RS-232C or other communications?	After setting up communications, it is possible to control measurement with the TRIG signal while acquiring measurement data via a communications interface.
How should external power be connected?	All of the instrument’s EXT I/O connector’s input and output signals are driven by the instrument’s internal isolated power supply. If the power supply needed to acquire output signals satisfies the internal isolated power supply’s specifications requirements (4.5 to 5 V, 100 mA), use the internal isolated power supply (No. 8 pin). If not, supply power from an external source such that the maximum load voltage (30 V) is not exceeded. Do not connect the power supply to the internal isolated power supply (No. 8 pin).
I can’t acquire the EXT I/O output signal. (I don’t know what type the output circuit is.)	EXT I/O output is open-drain output. Please connect wiring properly for open-drain output. (see p. 184.)

## 9.6 Measurement Using a Computer

You can control the instrument with communication commands from a computer via the USB, GPIB, RS-232C, LAN interfaces. To enable communication, the communication conditions need to be set on the instrument.

For details on the communication condition settings, refer to “Setting the Interface (Controlling the Instrument from a Computer)” (p. 140).

For more detailed information about control methods, see the Communications Instruction Manual on the bundled LCR Application Disc.

### CAUTION



- To avoid damage, do not disconnect the communications cable while the instrument is sending or receiving data.



- Use a common ground for both the instrument and the computer. Using different ground circuits will result in a potential difference between the instrument's ground and the computer's ground. If the communications cable is connected while such a potential difference exists, it may result in equipment malfunction or failure.
- Before connecting or disconnecting any communications cable, always turn off the instrument and the computer. Failure to do so could result in equipment malfunction or damage.
- After connecting the communications cable, tighten the screws on the connector securely. Failure to secure the connector could result in equipment malfunction or damage.
- When connecting the instrument to your LAN using a LAN cable of more than 30 m or with the cable laid outdoors, take appropriate countermeasures that include installing a surge protector for LANs. Such signal wiring is susceptible to induced lightning, which can cause damage to the instrument.

# 10 Specifications

These specifications apply to the IM3536 LCR Meter.  
All AC voltage and AC current values are RMS values.

## 10.1 General Specifications

### Measurement mode

<b>LCR mode</b>	Measurement under a single set of conditions
<b>Continuous measurement mode</b>	Continuous measurement using saved conditions; measure using up to 60 sets of conditions

### Measurement items

**Parameters: Select up to 4 out of 17 measurement parameters.**

Parameters	Description	Parameters	Description
Z	Impedance	Ls	Equivalent series inductance
Y	Admittance	Lp	Equivalent parallel inductance
$\theta$	Phase angle	Cs	Equivalent series capacitance
Rs	Equivalent series resistance (ESR)	Cp	Equivalent parallel capacitance
Rp	Equivalent parallel resistance	Q	Q factor
X	Reactance	D	Loss coefficient $\tan\delta$
G	Conductance	Rdc	DC resistance
B	Susceptance	$\sigma$	Conductivity
		$\epsilon$	Permittivity

### Display range

Parameters	Display range (6 digits)
Z	0.00 m to 9.99999 G $\Omega$
Y	0.000 n to 9.99999 GS
$\theta$	$\pm(0.000^\circ$ to $180.000^\circ)$
Rs, Rp, X, Rdc	$\pm(0.00$ m to $9.99999$ G $\Omega$ )
G, B	$\pm(0.000$ n to $9.99999$ GS)
Cs, Cp	$\pm(0.0000$ p to $9.99999$ GF)
Ls, Lp	$\pm(0.00000$ $\mu$ to $9.99999$ GH)
D	$\pm(0.00000$ to $9.99999)$
Q	$\pm(0.00$ to $9999.99)$
$\Delta\%$	$\pm(0.000\%$ to $999.999\%)$
$\sigma, \epsilon$	$\pm(0.00000$ f to $999.999$ G)

The screen will indicate **DISP OUT** if the upper limit is exceeded.

### Default settings

No. 1 Parameter	Z	No. 2 and No. 4 Parameter	OFF
No. 3 Parameter	$\theta$		



## Measurement frequency

<b>Setting range</b>	4 Hz to 8 MHz
<b>Setting resolution</b>	4.00 Hz to 999.99 Hz : 10 mHz steps 1.0000 kHz to 9.9999 kHz : 100 mHz steps 10.000 kHz to 99.999 kHz : 1 Hz steps 100.00 kHz to 999.99 kHz : 10 Hz steps 1.0000 MHz to 8.0000 MHz: 100 Hz steps
<b>Frequency accuracy</b>	±0.01% of setting or less
<b>Default setting</b>	1.0000 kHz

## Measurement signal level

### Open-terminal voltage (V) mode and constant-voltage (CV) mode

<b>Setting range</b>	<ul style="list-style-type: none"> <li>Normal mode 4 Hz to 1.0000 MHz : 10 mV to 5 V, maximum 50 mA 1.0001 MHz to 8 MHz: 10 mV to 1 V, maximum 10 mA</li> <li>Low Z high accuracy mode: 10 mV to 1 V , maximum 100 mA</li> </ul>
<b>Setting resolution</b>	10 mV to 1.000 V: 1 mV steps 1.01 V to 5 V : 10 mV steps
<b>Level accuracy</b>	<ul style="list-style-type: none"> <li>V mode 1 MHz or less: ±10% rdg. ±10 mV 1.0001 MHz or more: ±20% rdg. ±10 mV</li> <li>CV mode Monitor voltage accuracy specifications and software control range (±1% ±10 mV)</li> </ul>
<b>Default setting</b>	1.000 V (default mode: V mode)

### Constant-current (CC) mode

<b>Setting range</b>	<ul style="list-style-type: none"> <li>Normal mode 4 Hz to 1.0000 MHz : 10 µA to 50 mA, maximum 5 V 1.0001 MHz to 8 MHz : 10 µA to 10 mA, maximum 1 V</li> <li>Low Z high accuracy mode: When the output resistance is 100 Ω: 10 µA to 10 mA, maximum 1 V When the output resistance is 10 Ω : 10 µA to 100 mA, maximum 1 V</li> </ul>
<b>Setting resolution</b>	10 µA steps
<b>Level accuracy</b>	Monitor current accuracy specifications and software control range (±1%±10 µA)
<b>Default setting</b>	10.00 mA

### Monitor functions

<b>Function</b>	The voltage across the sample's terminals (Vac, Vdc) and the current flowing to the sample (Iac, Idc) are displayed on the screen.
<b>Monitor voltage</b>	Monitor range: 0.000 V to 5.000 V Monitor accuracy: ±10% rdg. ±10 mV (less than 1.0000 MHz) ±20% rdg. ±10 mV (1.0001 MHz or more)
<b>Monitor current</b>	Monitor range: 0.000 mA to 100.0 mA Monitor accuracy: ±10% rdg.±10 µA (less than 1.0000 MHz) ±20% rdg.±10 µA (1.0001 MHz or more)

## Limit function

<b>Function</b>	Sets limits (limit values) on the voltage that can be applied to the sample or the current that can flow to the sample.
<b>Operating mode</b>	OFF/ON
<b>Current limit</b>	During open-terminal voltage mode or constant-voltage mode operation Limit range: 0.01 mA to 100.00 mA Limit accuracy: Monitor current accuracy specifications and software control range ( $\pm 1\% \pm 10 \mu\text{A}$ )
<b>Voltage limit</b>	During constant-current mode operation Limit range: 0.01 V to 5.000 V Limit accuracy: Monitor current accuracy specifications and software control range ( $\pm 1\% \pm 10 \text{mV}$ )
<b>Default setting</b>	OFF

## Output impedance ( $H_{\text{CUR}}$ terminal, measurement frequency 1 kHz)

<b>Normal mode</b>	$100 \Omega \pm 10 \Omega^*$
<b>Low impedance high accuracy mode</b>	$10 \Omega \pm 2 \Omega$

\*: The output resistance and termination resistance will be set to  $50 \Omega$  (The output resistance is the resistance connected to the  $H_{\text{CUR}}$  terminal, and the termination resistance is the resistance connected to the  $L_{\text{CUR}}$  terminal) when measuring under the following conditions with the cable length set to 1 m, 2 m, or 4 m:  
All measurement frequencies for the 10 k $\Omega$  range to the 100 M $\Omega$  range  
Measurement frequencies from 1.0001 MHz to 8 MHz for the 100 m $\Omega$  range to the 1 k $\Omega$  range

## Measurement range

<b>Measurement range</b>	10 ranges (100 mΩ, 1 Ω, 10 Ω, 100 Ω, 1 kΩ, 10 kΩ, 100 kΩ, 1 MΩ, 10 MΩ, 100 MΩ) <ul style="list-style-type: none"> <li>• Defined for impedance Z.</li> <li>• Other measurement parameters are calculated from Z and θ values. See “Appx. 1 Measurement Parameters and Calculation Formula” (p. Appx.1).</li> <li>• See the table below for the accuracy guaranteed range and the selection of auto ranges for each range.</li> </ul>
<b>Range selection method</b>	Selected with the HOLD setting, AUTO setting, or judgment synchronization setting.
<b>HOLD setting</b>	The range is set manually. The measurement range is fixed.
<b>AUTO setting</b>	The optimal range is set automatically.
<b>Judgment synchronization setting</b>	The optimal range for the judgment standards being used for comparator or BIN measurement is set automatically.
<b>Default setting</b>	AUTO, judgment synchronization OFF

Range	Guaranteed accuracy range	AUTO ranging range
100 MΩ	8 MΩ to 200 MΩ	8 MΩ or more
10 MΩ	800 kΩ to 100 MΩ	800 kΩ to 10 MΩ
1 MΩ	80 kΩ to 10 MΩ	80 kΩ to 1 MΩ
100 kΩ	8 kΩ to 1 MΩ	8 kΩ to 100 kΩ
10 kΩ	800 Ω to 100 kΩ	800 Ω to 10 kΩ
1 kΩ	80 Ω to 10 kΩ	80 Ω to 1 kΩ
100 Ω	8 Ω to 100 Ω	8 Ω to 100 Ω
10 Ω	800 mΩ to 10 Ω	800 mΩ to 10 Ω
1 Ω	80 mΩ to 1 Ω	80 mΩ to 1 Ω
100 mΩ	1 mΩ to 100 mΩ	0 Ω to 100 mΩ

- The guaranteed accuracy range differs depending on the measurement conditions (See p. 221.)
- Outside the selection of ranges, measured values whose accuracy is not guaranteed are displayed on the screen.
- Outside the A/D input range, **OVERFLOW** or **UNDERFLOW** is displayed on the screen.

## Low Z high accuracy mode

<b>Function</b>	Increases the measurement current using 10 Ω output resistance (to a maximum of 100 mA and a maximum applied voltage of 1 V). As a result, the measurement precision increases.
<b>Operation mode</b>	OFF/ON
<b>Target ranges</b>	100 mΩ, 1 Ω, 10 Ω range
<b>Frequency range</b>	4 Hz to 1.0000 MHz
<b>Default setting</b>	OFF

## DC resistance measurement

<b>Function</b>	Measures DC resistance (when the measurement parameter is set to Rdc). The measurement conditions are set separately from those for AC measurement. (Measurement conditions: Measurement range, measurement speed, average, judgment synchronization setting, DC delay, adjustment delay, line frequency)
<b>Measurement signal level</b>	Fixed at 1 V
<b>Generating accuracy</b>	±10% of setting ±20 mV

## DC bias function

<b>Function</b>	Allows superposition of a DC voltage for measurement.
<b>Operation mode</b>	OFF/ON
<b>Generating range</b>	DC voltage : 0 V to 2.50 V (10 mV resolution) When low Z high accuracy mode: 0 V to 1 V (10 mV resolution)
<b>Generating accuracy</b>	±10% of setting ± (V <sub>AC</sub> ×0.01+30 mV) V <sub>AC</sub> refers to the AC signal voltage setting (V).
<b>Default setting</b>	OFF

## Residual charge protection function

<b>Function</b>	Protects the instrument from discharge voltage in the event that it is connected to a charged capacitor. <ul style="list-style-type: none"> <li>Discharge voltage reference value: At 400 V DC or less, 5 J or less; at 1,000 V DC or less, 0.5 J or less</li> <li>The energy W [J] stored in capacitance C [F] at voltage V [V] can be determined using the following equation: <math display="block">W = \frac{1}{2} CV^2</math> </li> <li>See “Appx. 6 The Residual Charge Protection Function” (p. Appx.9)</li> </ul>
-----------------	---

## Terminal structure

4-terminal pair structure

## Backup battery life

Approx. 10 years (at 25°C)  
Used to back up the clock and settings (lithium battery).

## Accuracy

<b>Basic accuracy</b>	Z: ±0.05% rdg., θ: ±0.03° (representative value)
<b>Guaranteed accuracy period</b>	1 year
<b>Warm-up time</b>	60 minutes
<b>Temperature and humidity for guaranteed accuracy</b>	0°C to 40°C (32°F to 104°F), 80% RH or less (no condensation)

## Measurement time

Approx. 1 ms (measurement frequency: 1 MHz; measurement speed: FAST; no screen display)

## Measurement speed

FAST, MED, SLOW, SLOW2 (Default setting: MED)

## 10.2 Environmental and Safety Specifications

<b>Operating temperature and humidity</b>	0°C to 40°C (32°F to 104°F), 80% RH or less (no condensation)
<b>Storage temperature and humidity</b>	-10°C to 50°C (14°F to 122°F), 80% RH or less (no condensation)
<b>Operating environment</b>	Indoors, Pollution Degree 2, altitude up to 2000 m (6562 ft.)
<b>Rated supply voltage</b>	100 V AC to 240 V AC (Voltage fluctuations of $\pm 10\%$ from the rated supply voltage are taken into account.)
<b>Rated power supply frequency</b>	50 Hz/ 60 Hz
<b>Maximum rated power</b>	50 VA
<b>Dimensions</b>	Approx. 330W×119H×230D mm (12.99" W ×4.69" H ×9.06" D) (excluding protrusions)
<b>Mass</b>	Approx. 4.2 kg (148.1 oz.)
<b>Standards</b>	EMC EN61326 Class A Safety EN61010
<b>Effect of radiated radio-frequency electromagnetic field</b>	Z: $\pm 5\%$ rdg., $\theta$ : $\pm 5^\circ$ at 10 V/m
<b>Effect of conducted radio-frequency electromagnetic field</b>	Z: $\pm 5\%$ rdg., $\theta$ : $\pm 5^\circ$ at 3 V
<b>Dielectric strength</b>	Between the power wire and ground wire: 1.62 kV AC for 1 minute, cutoff current 10 mA
<b>Product warranty period</b>	3 years

## 10.3 Accessories and Options

Accessories: Refer to “Accessories” (p. 2).

Options: Refer to “Options (reference: open and short correction states)” (p. 3).

## 10.4 Function Specifications

### DC measurement (DC resistance measurement)

#### DC adjustment

<b>Function</b>	Functionality for measuring and canceling the circuit offset ON/OFF selectable When ON : Acquires the offset value at each measurement. When OFF: Uses the offset value acquired initially in subsequent measurements.
<b>Offset value acquisition methods (When set to “off”)</b>	<ul style="list-style-type: none"> <li>• Change the Rdc range (the offset is acquired automatically when the range is changed).</li> <li>• Change the Rdc low Z high accuracy mode setting (ON/OFF) while using a range from 100 mΩ to 10 Ω (value acquisition will be performed automatically when the setting is changed).</li> <li>• Change the adjust delay time (value acquisition will be performed automatically when the delay time is changed).</li> <li>• Touch the <b>GET DCR OFFSET</b> key on the screen.</li> <li>• Input a signal from an external device to the instrument’s EXT I/O connector.</li> <li>• Send a communications command from an external device to the instrument’s interface.</li> </ul>
<b>Default setting</b>	ON

#### DC delay

<b>Function</b>	Sets the time until DC resistance measurement starts.
<b>Setting range</b>	0.0000 s to 9.9999 s (0.0001 s resolution)
<b>Default setting</b>	0.0000 s

#### Adjustment delay

<b>Function</b>	Sets the time to wait before starting offset measurement so that a stable measured value can be obtained.
<b>Setting range</b>	0.0030 s to 9.9999 s (0.0001 s resolution)
<b>Default setting</b>	0.0030 s

#### Power supply frequency setting

<b>Function</b>	Sets the frequency of the power supply being used.
<b>Setting value</b>	50 Hz/ 60 Hz
<b>Default setting</b>	60 Hz

#### Average

<b>Function</b>	Performs processing to average measured values.
<b>Setting range</b>	1 to 256 (1 step)
<b>Averaging method</b>	Arithmetic average
<b>Default setting</b>	1 (Average OFF)

## Trigger

<b>Function</b>	Uses a specific signal to time the start of measurement.
<b>Trigger types</b>	Internal trigger: Automatically generates a trigger signal internally to repeat measurement. External trigger: Allows you to control the instrument's measurement operation by inputting a trigger signal from an external device. Trigger source: Manual, communication command, EXT I/O
<b>Default setting</b>	Internal trigger

## Average

<b>Function</b>	The measured values can be averaged.
<b>Setting range</b>	1 to 256 (1 step)
<b>Average method</b>	Internal trigger: Moving average from the current value to the set number of averaging iterations in the past External trigger: Arithmetic average of the set number of averaging iterations from trigger input
<b>Default setting</b>	1 (Average OFF)

## Trigger delay

<b>Function</b>	Sets the delay time from trigger input to measurement.
<b>Setting range</b>	0.0000 s to 9.9999 s (0.0001 s resolution)
<b>Default setting</b>	0.0000 s

## Trigger synchronous output

<b>Function</b>	Outputs the measurement signal after trigger input and applies it to the sample during measurement only. Allows you to set a wait time until data is acquired.
<b>Operation mode</b>	OFF/ON
<b>Setting range</b>	0.0010 s to 9.9999 s (0.0001 s resolution)
<b>Default setting</b>	OFF (setting: 0.0010 s)

## AUTO range limit

<b>Function</b>	Allows you to limit the auto range selection (by setting lower limit and upper limit ranges).
<b>Default setting</b>	Lower limit range: 100 m $\Omega$ , Upper limit range: 100 M $\Omega$

## Range synchronization function

<b>Function</b>	<ul style="list-style-type: none"> <li>Allows you to set measurement conditions for each measurement range.</li> <li>The following measurement conditions can be set: AC measurement: Speed, Average, Trigger delay, and trigger synchronization DC measurement: Speed, and Average</li> </ul>
<b>Operation mode</b>	OFF/ON
<b>Default setting</b>	OFF

## BIN measurement

<b>Function</b>	<ul style="list-style-type: none"> <li>Displays up to 10 judgment results for two parameters (the No. 1 parameter and No. 3 parameter) (BIN1 to BIN10, OUT OF BINS).</li> <li>Allows you to output judgment results to an external device from EXT I/O.</li> </ul>
<b>Judgment method</b>	<ul style="list-style-type: none"> <li>Set as absolute values: Set the upper and lower limits for the measurement parameters as absolute values.</li> <li>Set as percentage: Enter the reference value and set the upper and lower limits as percentages of the reference value. (Measured values for the measurement parameters will be displayed as they are.)</li> <li>Set as deviation percentage: Enter the reference value and set the upper and lower limits as percentages of the reference value. (Measured values will be displayed in terms of their deviation from the reference value.)</li> </ul>
<b>Valid setting range</b>	<ul style="list-style-type: none"> <li>Set as absolute values : -9.99999 G to 9.99999 G</li> <li>Set as percentage : -999.999% to 999.999%</li> <li>Set as deviation percentage : -999.999% to 999.999%</li> </ul>
<b>Default setting</b>	OFF

## Comparator

<b>Function</b>	<ul style="list-style-type: none"> <li>Displays measurement results for two parameters (the No. 1 parameter and the No. 3 parameter) as a HI/IN/LO result.</li> <li>Allows you to output judgment results to an external device from EXT I/O.</li> </ul>
<b>Judgment method</b>	<ul style="list-style-type: none"> <li>Set as absolute values: Set the upper and lower limits for the measurement parameters as absolute values.</li> <li>Set as percentage: Enter the reference value and set the upper and lower limits as percentages of the reference value. (Measured values for the measurement parameters will be displayed as they are.)</li> <li>Set as deviation percentage: Enter the reference value and set the upper and lower limits as percentages of the reference value. (Measured values will be displayed in terms of their deviation from the reference value.)</li> </ul>
<b>Valid setting range</b>	<ul style="list-style-type: none"> <li>Set as absolute values : -9.99999 G to 9.99999 G</li> <li>Set as percentage : -999.999% to 999.999%</li> <li>Set as deviation percentage : -999.999% to 999.999%</li> </ul>
<b>Default setting</b>	OFF

## Conductivity and permittivity calculations

<b>Function</b>	Measures conductivity and permittivity after the user sets conditions used in calculating conductivity and permittivity.
<b>Settings</b>	<ul style="list-style-type: none"> <li>L: Sample length (mm)</li> <li>A: Sample cross-sectional area (mm<sup>2</sup>)</li> <li>C: Selection of whether to use Cs (equivalent series capacitance) or Cp (equivalent parallel capacitance) in calculations (default setting: Cs)</li> </ul>
<b>Valid setting range</b>	<ul style="list-style-type: none"> <li>L: 0.000001 mm to 1000000 mm (default setting: 20.00000 mm)</li> <li>A: 0.000001 mm<sup>2</sup> to 1000000 mm<sup>2</sup> (default setting: 12.00000 mm<sup>2</sup>)</li> </ul>
<b>Equation</b>	Conductivity $\sigma = \frac{L}{Z \times A}$ (Z: Impedance value), permittivity $\varepsilon = \frac{L}{A} \times C$



## Contact check

### 4-terminal contact check

<b>Function</b>	Performs a contact (disconnection) check between $H_{CUR}$ and $H_{POT}$ and between $L_{CUR}$ and $L_{POT}$ .												
<b>Check timing</b>	Variable <ul style="list-style-type: none"> <li>• BEFORE: Checks contact before measurement.</li> <li>• AFTER : Checks contact after measurement.</li> <li>• BOTH : Checks contact before and after measurement.</li> </ul>												
<b>Threshold setting</b>	Variable Settings: 1 to 5, with larger values indicating greater sensitivity (low contact resistance values) Default setting: 4 (50 $\Omega$ ) <table border="1" data-bbox="580 631 1311 757"> <thead> <tr> <th>Setting value</th> <th>1</th> <th>2</th> <th>3</th> <th>4</th> <th>5</th> </tr> </thead> <tbody> <tr> <td>Threshold values of the contact resistance (<math>\Omega</math>)</td> <td>1000</td> <td>500</td> <td>100</td> <td>50</td> <td>20</td> </tr> </tbody> </table>	Setting value	1	2	3	4	5	Threshold values of the contact resistance ( $\Omega$ )	1000	500	100	50	20
Setting value	1	2	3	4	5								
Threshold values of the contact resistance ( $\Omega$ )	1000	500	100	50	20								
<b>Delay time setting</b>	A user-specified delay time may be set since the contact check may not function properly if the sample is a charged capacitor. Settable time: 0.0000 s to 1.0000 s (0.0001 s resolution) Default setting: 0.0000 s												
<b>Default setting</b>	OFF												

### High-Z reject function (detection of OPEN state during 2-terminal measurement)

<b>Function</b>	When the measurement value is higher than the judgment reference, a contact error is output.
<b>Judgment reference</b>	Can be set to 0% to 30000% (1% resolution) of range full-scale.
<b>Error output</b>	<ul style="list-style-type: none"> <li>• Displays errors on the measurement screen.</li> <li>• Outputs errors to an external device from the EXT I/O connector.</li> </ul>
<b>Default setting</b>	OFF

## Memory

<b>Function</b>	<ul style="list-style-type: none"> <li>• Measurement result items (maximum 32000 items) can be saved to the instrument.</li> <li>• Memory can be read using communications commands or a USB flash drive.</li> </ul>
<b>Number of measurement results setting range</b>	• 1 to 32000
<b>Operation mode</b>	OFF/ IN/ ON <ul style="list-style-type: none"> <li>• OFF: Memory function disabled</li> <li>• IN : Saves measured values in memory only when all measurement parameters that are being judged using the comparator or BIN function yield a "PASS" result.</li> <li>• ON : Saves all measured values.</li> </ul>
<b>Default setting</b>	OFF

## Number of display digits setting

<b>Function</b>	Allows you to set the number of display digits for measured values for each measurement parameter.
<b>Valid setting range</b>	3 to 6 digits
<b>Default setting</b>	6 digits

## Display setting

<b>Function</b>	Allows you to turn the instrument's LCD display on or off. (When the display is off, the screen will not be updated.)
<b>Operation mode</b>	OFF/ON <ul style="list-style-type: none"> <li>• OFF: Turns off the LCD display 10 sec. after the last use of the touch panel. Touching the touch panel after it goes out will reenables it.</li> <li>• ON : Keeps the LCD display on at all times.</li> </ul>
<b>Default setting</b>	ON

## Key-lock

<b>Function</b>	<ul style="list-style-type: none"> <li>• Protects settings by disabling all setting changes (except cancellation of key lock).</li> <li>• Allows you to set a passcode for use when canceling key lock.</li> </ul>
<b>Operation mode</b>	OFF/ON
<b>Valid passcode setting range</b>	1 to 4 digits (default setting: 3536)
<b>Default setting</b>	OFF

## Magnification display

<b>Function</b>	The display of measurement values and comparator judgment results can be magnified.
<b>Operation mode</b>	Zoom off/zoom on
<b>Default setting</b>	Zoom off

## Waveform averaging

<b>Function</b>	<ul style="list-style-type: none"> <li>Allows you to set the number of measurement waveforms for each measurement frequency band as desired.</li> <li>Measurement precision increases as the number of waveforms increases, while measurement speed increases as the number of waveforms decreases.</li> </ul>
<b>Operation mode</b>	OFF/ON
<b>Valid setting range</b>	See table below.
<b>Default setting</b>	OFF

Measurement frequency	Waveform averaging function ON	Waveform averaging function OFF			
	Valid setting range	FAST	MED	SLOW	SLOW2
DC (Power supply frequency 50 Hz)	1 to 2000	5	100	500	2000
DC (Power supply frequency 60 Hz)	1 to 2400	6	100	600	2400
4.00 Hz to 10.00 Hz	1 to 4	1	2	3	4
10.01 Hz to 39.99 Hz	1 to 10	1	2	5	10
40.00 Hz to 99.99 Hz	1 to 40	1	2	5	40
100.00 Hz to 300.00 Hz	1 to 50	1	2	5	50
300.01 Hz to 500.00 Hz	1 to 200	1	2	10	200
500.01 Hz to 1.0000 kHz	1 to 300	1	5	20	300
1.0001 kHz to 2.0000 kHz	1 to 600	1	8	40	600
2.0001 kHz to 3.0000 kHz	1 to 1200	2	12	60	1200
3.0001 kHz to 5.0000 kHz	1 to 2000	3	20	100	2000
5.0001 kHz to 10.000 kHz	1 to 3000	5	40	200	3000
10.001 kHz to 20.000 kHz	1 to 1200	2	16	80	1200
20.001 kHz to 30.000 kHz	1 to 480	1	6	24	480
30.001 kHz to 50.000 kHz	1 to 800	1	10	40	800
50.001 kHz to 100.00 kHz	1 to 1200	2	16	80	1200
100.01 kHz to 140.00 kHz	1 to 2400	4	32	160	2400
140.01 kHz to 200.00 kHz	1 to 2400	4	32	160	2400
200.01 kHz to 300.00 kHz	1 to 960	2	12	48	960
300.01 kHz to 400.00 kHz	1 to 1600	2	20	80	1600
400.01 kHz to 500.00 kHz	1 to 1600	2	20	80	1600
500.01 kHz to 700.00 kHz	1 to 2400	4	32	160	2400
700.01 kHz to 1.0000 MHz	1 to 2400	4	32	160	2400
1.0001 MHz to 1.4000 MHz	1 to 960	2	14	64	960
1.4001 MHz to 2.0000 MHz	1 to 960	2	14	64	960
2.0001 MHz to 3.0000 MHz	1 to 1440	3	24	96	1440
3.0001 MHz to 4.0000 MHz	1 to 2400	4	40	160	2400
4.0001 MHz to 5.0000 MHz	1 to 2400	4	40	160	2400
5.0001 MHz to 6.0000 MHz	1 to 4000	8	64	250	4000
6.0001 MHz to 8.0000 MHz	1 to 4000	8	64	250	4000

## Continuous measurement

<b>Function</b>	Performs continuous measurement using measurement conditions that have been saved using the panel save function. Measurement is started by an external trigger (any of the three types described below). <ul style="list-style-type: none"> <li>• Touch the TRIG key on the screen.</li> <li>• Input a signal from an external device to the instrument's EXT I/O connector.</li> <li>• Send a communications command from an external device to the USB connector, LAN connector, RS-232C connector, or GP-IB connector on the rear of the instrument.</li> </ul>
<b>Maximum number of measurements</b>	60
<b>Display timing setting</b>	REAL/AFTER (Default setting: REAL) <ul style="list-style-type: none"> <li>• REAL: Displays results one at a time after measurement under each set of conditions.</li> <li>• AFTER: Displays all results together after continuous measurement is complete.</li> </ul>
<b>Display setting</b>	The LCD can be turned on or off (default: ON). <ul style="list-style-type: none"> <li>• OFF: Turns off the LCD display 10 sec. after the last use of the touch panel. Touching the touch panel after it goes out will reenable it.</li> <li>• ON: Keeps the LCD display on at all times.</li> </ul>
<b>Judgment results output</b>	Allows you to output up to two sets of judgment results simultaneously from the instrument's EXT I/O.

## Correction

**Open correction: Increases measurement precision by eliminating the effects of the measurement cable's stray admittance.**

- All correction

<b>Function</b>	<ul style="list-style-type: none"> <li>• Acquires correction values for all measurement frequencies.</li> <li>• Allows you to limit the correction range (by setting the minimum and maximum correction frequencies).</li> </ul>
-----------------	--

- Spot correction

<b>Function</b>	Acquires correction values for the set measurement frequencies.
-----------------	---

<b>Maximum number of settings</b>	5 points
-----------------------------------	----------

<b>Valid frequency setting range</b>	DC, 4 Hz to 8 MHz
--------------------------------------	-------------------

- OFF (Default setting)

<b>Function</b>	Disables open correction data.
-----------------	--------------------------------

**Short correction: Increases measurement precision by eliminating the effects of the measurement cable's residual impedance.**

- All correction

<b>Function</b>	<ul style="list-style-type: none"> <li>• Acquires correction values for all measurement frequencies.</li> <li>• Allows you to limit the correction range (by setting the minimum and maximum correction frequencies).</li> </ul>
-----------------	--

- Spot correction

<b>Function</b>	Acquires correction values for the set measurement frequencies.
<b>Maximum number of settings</b>	5 points
<b>Valid frequency setting range</b>	DC, 4 Hz to 8 MHz

- OFF (Default setting)

<b>Function</b>	Disables short correction data.
-----------------	---------------------------------

### Load correction

<b>Function</b>	Measures a reference sample whose measured value is known and then calculates the correction coefficient. The coefficient is used to correct measured values.
<b>Number of sets of correction conditions</b>	Up to 5
<b>Correction correction settings</b>	Correction frequency, correction range, correction signal level, DC bias, parameter type, reference value 1, reference value 2 Seven settings can be configured for each set of correction conditions.
<b>Calculation equation</b>	$Z = (Z \text{ before correction}) \times (Z \text{ correction coefficient})$ $\theta = (\theta \text{ before correction}) + (\theta \text{ correction value})$ $Z \text{ correction coefficient} = \frac{(Z \text{ reference value})}{(\text{accutual data of } Z)}$ $\theta \text{ correction value} = (\theta \text{ reference value}) - (\text{accutual data of } \theta)$
<b>Operation mode</b>	OFF/ON
<b>Default setting</b>	OFF

### Cable length correction

<b>Function</b>	Corrects measurement errors caused by the effects of the measurement cable.
<b>Cable length settings</b>	0 m, 1 m, 2 m, 4 m
<b>Default setting</b>	0 m

### Correlation correction

<b>Function</b>	<ul style="list-style-type: none"> <li>• Corrects measured values using user-configured correction coefficients (using user-configured correction coefficient A and correction coefficient B).</li> <li>• Corrected measured values are calculated using the following equation: (Measured value after correction) = A × (measured value) + B</li> </ul>
<b>Operation mode</b>	OFF/ON
<b>Correction coefficient A setting range</b>	-999.999 to 999.999
<b>Correction coefficient B setting range</b>	-9.99999 G to 9.99999 G
<b>Default setting</b>	OFF (Correction coefficient A: 1.000, Correction coefficient B: 0.00000)

## Panel save and load

<b>Function</b>	Saves measurement conditions and correction values in the instrument's internal memory and loads saved data. The desired measurement conditions may be loaded using the following methods: <ul style="list-style-type: none"> <li>• Using the keys on the instrument</li> <li>• Sending communications commands from an external device to the USB connector, LAN connector, RS-232C connector, or GP-IB connector on the rear of the instrument</li> <li>• Inputting a signal from an external device to the instrument's EXT I/O connector</li> </ul>
<b>Save types</b>	ALL/HARD/ADJ <ul style="list-style-type: none"> <li>• ALL : Saves all HARD and ADJ content.</li> <li>• HARD: Saves measurement conditions and cable length correction setting.</li> <li>• ADJ : Saves settings for open correction, short correction, load correction, and correlation correction and correction values only.</li> </ul>
<b>Number of data points that can be saved</b>	Measurement conditions: Up to 60 Correction values : Up to 128
<b>Default setting</b>	ALL

## Beep tone setting

<b>Function</b>	Allows you to set the key tone and judgment result beep tone.
<b>Comparator judgment setting</b>	OFF/ IN/ NG (Default setting: NG) <ul style="list-style-type: none"> <li>• OFF: Does not sound a beep for comparator judgments.</li> <li>• IN : Sounds a beep when the result is an IN judgment.</li> <li>• NG : Sounds a beep when the result is LO or HI.</li> </ul>
<b>Key input setting</b>	OFF/ON (Default setting: ON) <ul style="list-style-type: none"> <li>• OFF: Does not sound a beep when a key is touched.</li> <li>• ON : Sounds a beep when a key is touched.</li> </ul>
<b>Tone setting</b>	Allows you to select any of four beep tones (A, B, C, or D). (Default setting: A)

## Internal temperature monitoring

<b>Function</b>	<ul style="list-style-type: none"> <li>• Monitors the temperature inside the instrument.</li> <li>• Monitors whether the fan is operating.</li> <li>• Displays a warning on the screen in the event of a malfunction.</li> </ul>
<b>Error display temperature threshold</b>	Ambient temperature 50°C
<b>Fan stoppage monitoring threshold</b>	30% of the rated speed of rotation (4,100 r/min.) or less

## USB flash drive operation

### Saving measurement data

<b>Function</b>	<ul style="list-style-type: none"> <li>• LCR mode: The SAVE key saves measured values shown on the current screen.</li> <li>• Continuous measurement mode: The SAVE key saves measurement results for the each panel.</li> </ul>
<b>Saved data</b>	Measuring instrument information, time and date, measurement conditions, measurement parameters, and measurement values
<b>Data format</b>	CSV file format
<b>File name</b>	Generated automatically based on the time and date and given the extension "CSV."

### Saving screenshots

<b>Function</b>	The SAVE key saves the currently displayed screen.
<b>Data format</b>	BMP file format (256 colors or 2-color monochrome)
<b>File name</b>	Generated automatically based on the time and date and given the extension "BMP."

### Saving instrument settings

<b>Function</b>	<ul style="list-style-type: none"> <li>• Saves settings information as a settings file on the FILE screen.</li> <li>• Allows you to load previously saved settings files and restore their settings on the FILE screen.</li> </ul>
<b>File name</b>	Generated automatically based on the time and date and given the extension "SET."

### Saving all settings (All save function)

<b>Function</b>	<ul style="list-style-type: none"> <li>• Saves settings information including panel save content as a settings file on the FILE screen.</li> <li>• Allows you to load settings files including panel save content that were saved using the all save function and restore their settings on the FILE screen.</li> </ul>
<b>File name</b>	Generated automatically based on the time and date and given the extension "SET" for setting files (panel save extension is "PNL").

## External control (using the EXT I/O connector)

### Input and output signals

<b>Function</b>	<ul style="list-style-type: none"> <li>• Switches between judgment mode and BCD mode.</li> <li>• In BCD mode, comparator/BIN judgment results are not output.</li> <li>• BCD output is only enabled in LCR mode.</li> <li>• BCD output includes the No. 1 and No. 3 parameters.</li> </ul>
-----------------	--

### Judgment mode

<b>Function</b>	Outputs comparator/BIN judgment results.
<b>Input signal</b>	TRIG, LD0 to LD6, LD_VALID
<b>Output signal</b>	EOM, INDEX, ERR, HI, IN, LO, AND, BIN1 to BIN10

### BCD mode

<b>Function</b>	Generates BCD output for the No. 1 and No. 3 parameter measured values.
<b>Input signal</b>	TRIG, LD0 to LD6, LD_VALID, C1, C2
<b>Output signal</b>	EOM, INDEX, ERR, D4-3 to D4-0, D3-3 to D3-0, D2-3 to D2-0, D1-3 to D1-0

### Trigger enable function

<b>Function</b>	Allows you to set whether to enable trigger input from EXT I/O during measurement (starting when the trigger is received and while EOM is being output as HI).
<b>Operation mode</b>	OFF/ON OFF: Disabled; ON: Enabled
<b>Default setting</b>	ON

**Trigger active edge selection function**

<b>Function</b>	Allows you to select the active edge for trigger input from the EXT I/O (rising or falling).
<b>Operation mode</b>	DOWN/UP DOWN: falling, UP: raising
<b>Default setting</b>	DOWN

**EOM output method setting**

<b>Function</b>	Allows you to configure the instrument to hold the signal in the LO state for the set amount of time after EOM changes to LO and then restore it to the HI state.
<b>Operation mode</b>	HOLD/PULSE • HOLD : Holds the signal in the HI state for the period defined by (analog measurement time and calculation time, and delay time). • PULSE: Holds the signal in the LO state for the set amount of time after EOM changes to LO and then restores it to the HI state.
<b>Valid setting range</b>	0.0001 s to 0.9999 s
<b>Default setting</b>	HOLD, 0.0050 s

**Delay setting from judgment result output to EOM output**

<b>Function</b>	Allows you to set the delay time for EOM (LO) output from judgment result output.
<b>Valid setting range</b>	0.0000 s to 0.9999 s
<b>Default setting</b>	0.0000 s

**Resetting judgment results**

<b>Function</b>	Allows you to set whether to reset the judgment results after EOM changes to HI.
<b>Operation mode</b>	OFF/ON OFF: Holds the judgment results until the next judgment; ON : Resets the judgment results once EOM changes to HI.
<b>Default setting</b>	ON

**System settings****Interface settings**

- RS-232C

<b>Communications speed</b>	9600 bps / 19200 bps / 38400 bps / 57600 bps (Default setting: 9600 bps)
<b>Flow control</b>	OFF/ Hardware/ Software (Default setting: OFF)
<b>Terminator</b>	CR+LF, CR (Default setting: CR+LF)

- GP-IB

<b>Address</b>	00 to 30 (Default setting: 01)
<b>Terminator</b>	LF, CR+LF (Default setting: LF)



- USB

<b>Terminator</b>	CR+LF, CR (Default setting: CR+LF)
-------------------	------------------------------------

- LAN

<b>IP address</b>	Four 3-digit values (from 0 to 255 each) (Default setting: 192.168.000.001)
<b>Subnet mask</b>	Four 3-digit values (from 0 to 255 each) (Default setting: 255.255.255.000)
<b>Default gateway</b>	Four 3-digit values (from 0 to 255 each) (Default setting: OFF)
<b>Port number</b>	1024 to 65535 (Default setting: 3500)
<b>Terminator</b>	CR+LF, CR (Default setting: CR+LF)

**Instrument information**

<b>Serial number information</b>	Displays the serial number.
<b>Version information</b>	Displays the software version and the FPGA version.
<b>MAC address</b>	Displays the MAC address.
<b>USB ID</b>	Displays the USB ID.

**Self-check function**

<b>Panel test</b>	Allows you to check for touch panel errors.
<b>Panel calibration</b>	Allows you to calibrate the touch panel.
<b>Display status test</b>	Allows you to check the screen display status and LED status.
<b>ROM/RAM test</b>	Allows you to check the instrument's internal memory (ROM and RAM) for errors.
<b>EXT I/O test</b>	Allows you to verify that output signals are output normally from EXT I/O and that input signals can be read properly.

**Time setting**

<b>Time and date setting</b>	Sets the year, month, day, hour, minute, and second.
------------------------------	--

## 10.5 Interfaces

### Display

<b>Display</b>	5.7-inch VGA color TFT LCD (640 × 480 dots)
<b>Dot pitch</b>	0.06(W)mm×0.18(H)mm
<b>Touch panel</b>	Analog resistive film type

### EXT I/O connector

<b>Connector</b>	D-sub 37-pin female #4-40 inch thread
<b>Input signal</b>	Photocoupler-isolated, no-voltage contact input Input ON voltage : 0 V to 0.9 V Input OFF voltage : OPEN, or 5 V to 24 V Maximum input voltage: 30 V
<b>Output signal</b>	Photocoupler-isolated, Nch open drain output Maximum load voltage : 30 V Maximum output current: 50 mA/CH Residual voltage : 1 V or less (50 mA)
<b>Built-in isolated power supply</b>	Voltage : 4.5 V to 5 V Maximum output current: 100 mA Floating relative to protective ground potential and measurement circuit
<b>Pin and signal assignments</b>	See "Instrument connector signal assignments" (p. 170).

### Rear USB connector

<b>Connector</b>	USB Type B receptacle
<b>Electrical specifications</b>	USB2.0 (High Speed)
<b>Number of receptacles</b>	1

### Front USB connector

<b>Connector</b>	USB type A
<b>Electrical specification</b>	USB2.0 (High Speed)
<b>Bus power</b>	Max. 500 mA
<b>Number of ports</b>	1
<b>Supported USB flash drives</b>	USB Mass Storage Class compatible
<b>Functions</b>	<ul style="list-style-type: none"> <li>• Saves measured values, measurement conditions, correction values, instrument settings, and screen data.</li> <li>• Loads previously saved measurement conditions, correction values, measured values, instrument settings, and screen data.</li> </ul>

**RS-232C connector**

<b>Connector</b>	D-sub 9-pin connector
<b>Data length</b>	8
<b>Parity</b>	None
<b>Stop bit</b>	1
<b>Flow control</b>	Hardware/ Software
<b>Terminator</b>	CR+LF, CR
<b>Communication speed</b>	9600 bps, 19200 bps, 38400 bps, 57600 bps

**GP-IB connector**

<b>Connector</b>	24-pin Centronics type connector
<b>Standards</b>	IEEE-488.1 1987, IEEE-488.2 1987

**LAN connector**

<b>Connector</b>	RJ-45 connector
<b>Transmission method</b>	10Base-T/100Base-T automatic detection
<b>Protocol</b>	TCP/IP

## 10.6 Measurement Range and Accuracy

Measurement accuracy equation: Measurement accuracy is calculated using the following equation.

$$\text{Measurement accuracy} = \text{Basic accuracy} \times C \times D \times E \times F \times G$$

C: Level coefficient, D: Measurement speed coefficient, E: Cable length coefficient, F: DC bias coefficient, G: Temperature coefficient (operating temperature coefficient)

### Basic accuracy

Accuracy is calculated based on coefficients A and B from the basic accuracy chart shown below. (See "Example calculation of basic accuracy" (p. 217).)

$$\text{1 k}\Omega \text{ range or higher} \quad \text{Basic accuracy} = \pm \left( A + B \times \left| \frac{10 \times Z_x}{\text{Range}} - 1 \right| \right)$$

$$\text{100 }\Omega \text{ range or lower} \quad \text{Basic accuracy} = \pm \left( A + B \times \left| \frac{\text{Range}}{Z_x} - 1 \right| \right)$$

Z<sub>x</sub>: Impedance of the measurement sample

A and B: Noted in basic accuracy chart. (Upper value: Z accuracy [% rdg.]; lower value: θ accuracy [°])

- From 1.0001 MHz to 5 MHz, multiple basic accuracy by (fm [MHz]+3)/4.\*
- From 5.0001 MHz to 8 MHz, multiple basic accuracy by fm [MHz]/2.\*

\*: "fm" is measurement frequency [MHz].

### Basic accuracy chart

Range	For DC measurement		For AC measurement (measurement frequency)					
			4 Hz to 99.99 Hz		100.00 Hz to 999.99 Hz		1.0000 kHz to 10.000 kHz	
100 MΩ	A=1	B=1	A=6	B=5	A=3	B=2	A=3	B=2
			A=5	B=3	A=2	B=2	A=2	B=2
10 MΩ	A=0.5	B=0.3	A=0.8	B=1	A=0.5	B=0.3	A=0.5	B=0.3
			A=0.8	B=0.5	A=0.4	B=0.2	A=0.4	B=0.2
1 MΩ	A=0.2	B=0.1	A=0.4	B=0.08	A=0.3	B=0.05	A=0.3	B=0.05
			A=0.3	B=0.08	A=0.2	B=0.02	A=0.2	B=0.02
100 kΩ	A=0.1	B=0.01	A=0.3	B=0.03	A=0.2	B=0.03	A=0.2	B=0.03
			A=0.2	B=0.02	A=0.1	B=0.02	A=0.1	B=0.02
10 kΩ	A=0.1	B=0.01	A=0.3	B=0.03	A=0.2	B=0.02	A=0.05	B=0.02
			A=0.2	B=0.02	A=0.1	B=0.02	A=0.03	B=0.02
1 kΩ	A=0.1	B=0.01	A=0.3	B=0.02	A=0.2	B=0.02	A=0.2	B=0.02
			A=0.2	B=0.01	A=0.1	B=0.02	A=0.1	B=0.02
100 Ω	A=0.1	B=0.02	A=0.3	B=0.02	A=0.2	B=0.02	A=0.2	B=0.02
			A=0.2	B=0.01	A=0.15	B=0.01	A=0.1	B=0.01
10 Ω	A=0.2	B=0.15	A=0.5	B=0.1	A=0.4	B=0.05	A=0.4	B=0.05
			A=0.3	B=0.1	A=0.3	B=0.03	A=0.3	B=0.03
1 Ω	A=0.3	B=0.3	A=1.5	B=1	A=1	B=0.3	A=1	B=0.3
			A=0.8	B=0.5	A=0.5	B=0.2	A=0.5	B=0.2
100 mΩ	A=1	B=1	A=8	B=8	A=5	B=4	A=3	B=2
			A=5	B=4	A=3	B=2	A=2	B=1.5

Range	For AC measurement (measurement frequency)					
	10.001 kHz to 100.00 kHz		100.01 kHz to 1 MHz		1.0001 MHz to 8 MHz	
100 MΩ	-	-	-	-	-	-
	-	-	-	-	-	-
10 MΩ	A=2	B=1	-	-	-	-
	A=2	B=1	-	-	-	-
1 MΩ	A=0.5	B=0.1	A=3	B=0.5	-	-
	A=0.6	B=0.1	A=3	B=0.5	-	-
100 kΩ	A=0.25	B=0.04	A=1	B=0.3	A=2	B=0.5
	A=0.2	B=0.02	A=1	B=0.3	A=2	B=0.3
10 kΩ	A=0.3	B=0.02	A=0.5	B=0.05	A=2	B=0.5
	A=0.2	B=0.02	A=0.5	B=0.05	A=1.5	B=0.3
1 kΩ	A=0.2	B=0.02	A=0.4	B=0.02	A=1.5	B=0.2
	A=0.15	B=0.02	A=0.4	B=0.02	A=1.5	B=0.2
100 Ω	A=0.2	B=0.02	A=0.5	B=0.03	A=1.5	B=0.2
	A=0.15	B=0.02	A=0.5	B=0.03	A=1.5	B=0.2
10 Ω	A=0.4	B=0.05	A=0.8	B=0.1	A=2	B=1.5
	A=0.3	B=0.03	A=0.5	B=0.05	A=2	B=1
1 Ω	A=1	B=0.3	A=1.5	B=1	A=3	B=3
	A=0.5	B=0.2	A=0.7	B=0.5	A=3	B=2
100 mΩ	A=2	B=2	A=4	B=3	-	-
	A=2	B=1.5	A=3	B=4	-	-

### Example calculation of basic accuracy

**(1) Calculate the basic accuracy for impedance  $Z=50\ \Omega$ .**

(If the measurement conditions are a measurement frequency of 10 kHz and a measurement speed of SLOW2)

Excerpted from the "Basic accuracy" (p. 215).

Range				1.0000 kHz to 10.000 kHz			
1 k $\Omega$							
100 $\Omega$				A = 0.2    B = 0.02			$Z$
				A = 0.1    B = 0.01			$\theta$
10 $\Omega$							

**1** Find the cell at the intersection of the row for the 100  $\Omega$  range (since  $Z$  is 50  $\Omega$ , the 100  $\Omega$  measurement range is used) and the 1.0000 kHz to 10.000 kHz column (since the measurement frequency is 10 kHz) in the "Basic accuracy" (p. 215).

**2** Calculate the basic accuracy for  $Z$  using the  $Z$  coefficients A and B.

Based on the accuracy table, coefficient A = 0.2 and coefficient B = 0.02.

Plug in the values for the 100  $\Omega$  range in the "Basic accuracy" (p. 215) into the following equation:

$$Z \text{ accuracy} = \pm \left[ 0.2 + 0.02 \times \left| \frac{100\Omega}{50\Omega} - 1 \right| \right] = \pm 0.22\% \text{ rdg.}$$

**3** Similarly, calculate the basic accuracy of  $\theta$ .

The accuracy table yields the values A=0.1 and B=0.01

Using the basic accuracy formula of "Basic accuracy" (p. 215) for "100  $\Omega$  or less".

$$\theta \text{ accuracy} = \pm \left[ 0.1 + 0.01 \times \left| \frac{100\Omega}{50\Omega} - 1 \right| \right] = \pm 0.11^\circ$$

**(2) Calculate the basic accuracy for capacitance Cs=160 nF.**

(If the measurement conditions are a measurement frequency of 1 kHz and a measurement speed of SLOW2)

Excerpted from the “Basic accuracy” (p. 215).

Range				1.0000 kHz to 10.000 kHz		
100 kΩ						
10 kΩ				A= 0.05    B= 0.02	→ Z	
				A= 0.03    B= 0.02	→ θ	
1 kΩ						

**1** Measure the sample’s  $Z$  and  $\theta$  values using auto-ranging.

Assume that the measured  $Z$  and  $\theta$  values are as follows:

$$Z=1.0144 \text{ k}\Omega, \theta=-78.69^\circ$$

Because  $Z$  is 1.0144 kΩ, 10 kΩ measurement range will be used.

**2** Find the cell at the intersection of the row for the 10 kΩ range and the 1.0000 kHz to 10.000 kHz column (since the measurement frequency is 1 kHz) in the “Basic accuracy” (p. 215).

**3** Calculate the basic accuracy for  $Z$  using the  $Z$  coefficients A and B.

Based on the accuracy table, coefficient A = 0.05 and coefficient B = 0.02

Plug in the values for the 1 kΩ range in the “Basic accuracy” (p. 215) into the following equation:

$$Z \text{ accuracy} = \pm \left[ 0.05 + 0.02 \times \left| \frac{10 \times 10.144 \text{ k}\Omega}{10 \text{ k}\Omega} - 1 \right| \right] \doteq 0.05\% \text{ rdg.}$$

**4** Similarly, calculate the basic accuracy of  $\theta$ .

The accuracy table yields the values A=0.03 and B=0.02

Using the basic accuracy formula of “Basic accuracy” (p. 215) for “1 k± or more”.

$$\theta \text{ accuracy} = \pm \left[ 0.03 + 0.02 \times \left| \frac{10 \times 10.144 \text{ k}\Omega}{10 \text{ k}\Omega} - 1 \right| \right] \doteq \pm 0.03^\circ$$

**5** Calculate the range within which  $Z$  and  $\theta$  values can be acquired from the basic accuracy.

$$Z \text{ min} = 1.0144 \text{ k}\Omega \times \left( 1 - \frac{0.05}{100} \right) \doteq 1.0139 \text{ k}\Omega$$

$$Z \text{ max} = 1.0144 \text{ k}\Omega \times \left( 1 + \frac{0.05}{100} \right) \doteq 1.0149 \text{ k}\Omega$$

$$\theta \text{ min} = -78.69 - 0.03 = -78.72^\circ$$

$$\theta \text{ max} = -78.69 + 0.03 = -78.66^\circ$$

**6** Calculate the range within which  $C_s$  values can be acquired based on the  $Z$  and  $\theta$  ranges. (For more information about the  $C_s$  calculation formula, see “Appx. 1 Measurement Parameters and Calculation Formula” (p. Appx.1).)

$$C_s \text{ min} = \frac{1}{\omega \times Z \text{ max} \times \sin \theta \text{ min}} \doteq 159.90 \text{ nF} \quad \dots -0.0625\% \text{ rdg.}$$

$$C_s \text{ max} = \frac{1}{\omega \times Z \text{ min} \times \sin \theta \text{ max}} \doteq 160.10 \text{ nF} \quad \dots 0.0625\% \text{ rdg.}$$

$$\omega = 2 \times \pi \times f$$

$f$  is frequency [Hz].

Consequently, the  $C_s$  basic accuracy is  $\pm 0.0625\%$  rdg.

Whether a given range is available varies with settings (cable length setting and DC bias setting).

**[Cable length 0 m]**

Range	Measurement frequency							
	DC	4 Hz to 99.99 Hz	100 Hz to 999.99 Hz	1 kHz to 10 kHz	10.001 kHz to 100 kHz	100.01 kHz to 1 MHz	1.0001 MHz to 5 MHz	5.0001 MHz to 8 MHz
100 MΩ	Available				Not available			
10 MΩ	Available				Not available			
1 MΩ	Available				Not available			
100 kΩ	Available				Not available			
10 kΩ	Available				Not available			
1 kΩ	Available				Not available			
100 Ω	Available				Not available			
10 Ω	Available				Not available			
1 Ω	Available				Not available			
100 mΩ	Available				Unavailable when DC bias is ON but may be set when DC bias is OFF		Not available	

: Unavailable when DC bias is ON but may be set when DC bias is OFF.

**[Cable length 1 m]**

Range	Measurement frequency							
	DC	4 Hz to 99.99 Hz	100 Hz to 999.99 Hz	1 kHz to 10 kHz	10.001 kHz to 100 kHz	100.01 kHz to 1 MHz	1.0001 MHz to 5 MHz	5.0001 MHz to 8 MHz
100 MΩ	Available				Not available			
10 MΩ	Available				Not available			
1 MΩ	Available				Not available			
100 kΩ	Available				Not available			
10 kΩ	Available				Not available			
1 kΩ	Available				Not available			
100 Ω	Available				Not available			
10 Ω	Available				Not available			
1 Ω	Available				Not available			
100 mΩ	Available				Unavailable when DC bias is ON but may be set when DC bias is OFF		Not available	

: Unavailable when DC bias is ON but may be set when DC bias is OFF.



**[Cable length 2 m]**

Range	Measurement frequency							
	DC	4 Hz to 99.99 Hz	100 Hz to 999.99 Hz	1 kHz to 10 kHz	10.001 kHz to 100 kHz	100.01 kHz to 1 MHz	1.0001 MHz to 2 MHz	2.0001 MHz to 8 MHz
100 MΩ	Available					Not available		
10 MΩ								
1 MΩ								
100 kΩ								
10 kΩ								
1 kΩ								
100 Ω								
10 Ω								
1 Ω								
100 mΩ								

: Unavailable when DC bias is ON but may be set when DC bias is OFF.

**[Cable length 4 m]**

Range	Measurement frequency							
	DC	4 Hz to 99.99 Hz	100 Hz to 999.99 Hz	1 kHz to 10 kHz	10.001 kHz to 100 kHz	100.01 kHz to 1 MHz	1.0001 MHz to 5 MHz	5.0001 MHz to 8 MHz
100 MΩ	Available					Not available		
10 MΩ								
1 MΩ								
100 kΩ								
10 kΩ								
1 kΩ								
100 Ω								
10 Ω								
1 Ω								
100 mΩ								

The range of measurement levels for which accuracy is guaranteed varies with the setting conditions.

### Guaranteed accuracy measurement level range

Range	Sample's impedance	Measurement frequency								
		DC	4 Hz to 99.99 Hz	100 Hz to 999.99 Hz	1 kHz to 10 kHz	10.001 kHz to 100 kHz	100.01 kHz to 1 MHz	1.0001 MHz to 5 MHz	5.0001 MHz to 8 MHz	
100 MΩ	8 MΩ to 200 MΩ	1 V (fixed)	0.101 V to 5 V							
10 MΩ	10 MΩ to 100 MΩ		0.101 V to 5 V							
	800 kΩ to 10 MΩ		0.101 V to 5 V		0.501 V to 5 V					
1 MΩ	1 MΩ to 10 MΩ		0.101 V to 5 V		0.501 V to 5 V					
	80 kΩ to 1 MΩ		0.050 V to 5 V		0.101 V to 5 V		0.501 V to 5 V			
100 kΩ	100 kΩ to 1 MΩ		0.050 V to 5 V		0.101 V to 5 V		0.501 V to 5 V			
	8 kΩ to 100 kΩ		0.010 V to 5 V				0.050 V to 5 V		0.101 V to 1 V	
10 kΩ	10 kΩ to 100 kΩ		0.010 V to 5 V				0.050 V to 5 V		0.101 V to 1 V	
	800 Ω to 10 kΩ		0.010 V to 5 V				0.050 V to 5 V		0.050 V to 1 V	
1 kΩ	1 kΩ to 10 kΩ		0.010 V to 5 V				0.050 V to 5 V		0.050 V to 1 V	
	80 Ω to 1 kΩ		0.010 V to 5 V						0.050 V to 1 V	
100 Ω	8 Ω to 100 Ω		0.010 V to 5 V						0.050 V to 1 V	
10 Ω	800 mΩ to 10 Ω		0.050 V to 5 V						0.101 V to 1 V	
1 Ω	80 mΩ to 1 Ω		0.050 V to 5 V				0.101 V to 5 V		0.501 V to 1 V	
100 mΩ	1 mΩ to 100 mΩ		0.101 V to 5 V				0.501 V to 5 V			

The accuracy guarantee range during DC bias operation is 10 mΩ or greater.

The accuracy for DC resistance (R<sub>dc</sub>) measurement is guaranteed only when offset values are acquired.

The guaranteed accuracy range varies with the sample's impedance.

### C: Measurement level coefficient

The measurement level coefficient is shown in the table below.

- DC measurement (DC resistance measurement)

Measurement level	1 V
Coefficient	1

- AC measurement

Measurement level	0.010 V to 0.999 V	1 V	1.01 V to 5 V
Coefficient	$1+0.2/V^*$	1	$1+2/V^*$

\*: V is measurement level setting value (open voltage (V) mode equivalent).

### D: Measurement speed coefficient

The measurement speed coefficient is shown in the table below.

Measurement speed	FAST	MED	SLOW	SLOW2
Coefficient during DC measurement (DC resistance measurement)	4	3	2	1
Coefficient during AC measurement	8	4	2	1
Coefficient during waveform averaging function operation	(See table below.)			

No.	Frequency band	Measurement speed coefficient				
		5	4	3	2	1
1	DC (line frequency 50 Hz)	1 to 4	5 to 99	100 to 499	500 to 1999	2000
1	DC (line frequency 60 Hz)	1 to 5	6 to 99	100 to 599	600 to 2499	2400

No.	Frequency band	Measurement speed coefficient				
		16	8	4	2	1
2	4.00 Hz to 10.00 Hz	-	1	2	3	4
3	10.01 Hz to 39.99 Hz	-	1	2 to 4	5 to 9	10
4	40.00 Hz to 99.99 Hz	-	1	2 to 4	5 to 39	40
5	100.00 Hz to 300.00 Hz	-	1	2 to 4	5 to 49	50
6	300.01 Hz to 500.00 Hz	-	1	2 to 9	10 to 199	200
7	500.01 Hz to 1.0000 kHz	-	1 to 4	5 to 19	20 to 299	300
8	1.0001 kHz to 2.0000 kHz	-	1 to 7	8 to 39	40 to 599	600
9	2.0001 kHz to 3.0000 kHz	1	2 to 11	12 to 59	60 to 1199	1200
10	3.0001 kHz to 5.0000 kHz	1 to 2	3 to 19	20 to 99	100 to 1999	2000
11	5.0001 kHz to 10.000 kHz	1 to 4	5 to 39	40 to 199	200 to 2999	3000
12	10.001 kHz to 20.000 kHz	1	2 to 15	16 to 79	80 to 1199	1200
13	20.001 kHz to 30.000 kHz	-	1 to 5	6 to 23	24 to 479	480
14	30.001 kHz to 50.000 kHz	-	1 to 9	10 to 39	40 to 799	800
15	50.001 kHz to 100.00 kHz	1	2 to 15	16 to 79	80 to 1199	1200
16	100.01 kHz to 140.00 kHz	1 to 3	4 to 31	32 to 159	160 to 2399	2400
17	140.01 kHz to 200.00 kHz	1 to 3	4 to 31	32 to 159	160 to 2399	2400
18	200.01 kHz to 300.00 kHz	1	2 to 11	12 to 47	48 to 959	960

No.	Frequency band	Measurement speed coefficient				
		16	8	4	2	1
19	300.01 kHz to 400.00 kHz	1	2 to 19	20 to 79	80 to 1599	1600
20	400.01 kHz to 500.00 kHz	1	2 to 19	20 to 79	80 to 1599	1600
21	500.01 kHz to 700.00 MHz	1 to 3	4 to 31	32 to 159	160 to 2399	2400
22	700.01 kHz to 1.0000 MHz	1 to 3	4 to 31	32 to 159	160 to 2399	2400
23	1.0001 MHz to 1.4000 MHz	1	2 to 13	14 to 63	64 to 959	960
24	1.4001 MHz to 2.0000 MHz	1	2 to 13	14 to 63	64 to 959	960
25	2.0001 MHz to 3.0000 MHz	1 to 2	3 to 23	24 to 95	96 to 1439	1440
26	3.0001 MHz to 4.0000 MHz	1 to 3	4 to 39	40 to 159	160 to 2399	2400
27	4.0001 MHz to 5.0000 MHz	1 to 3	4 to 39	40 to 159	160 to 2399	2400
28	5.0001 MHz to 6.0000 MHz	1 to 7	8 to 63	64 to 249	250 to 3999	4000
29	6.0001 MHz to 8.0000 MHz	1 to 7	8 to 63	64 to 249	250 to 3999	4000

### E: Coefficient of the measurement cable's length

The coefficient of the measurement cable's length is shown in the table below.

Measurement cable's length	0 m	1 m	2 m	4 m
Coefficient	1	1.5	2	3

The settable range for frequency varies with the measurement cable's length.

Cable length	Settable range for frequency
0 m	Up to 8 MHz
1 m	Up to 8 MHz
2 m	Up to 2 MHz
4 m	Up to 1 MHz

### F: DC bias coefficient

The DC bias coefficient is shown in the table below.

DC bias coefficient	OFF	ON
Coefficient	1	2

### G: Temperature coefficient

The operating temperature coefficient is shown in the table below.  
(When the operating temperature (t) is 23°C±5°C, use a coefficient of 1.)

Operating temperature	t [°C]
Coefficient	$1+0.1 \times  t-23 $

**Measurable range for L and C**

**Measurable range for L**

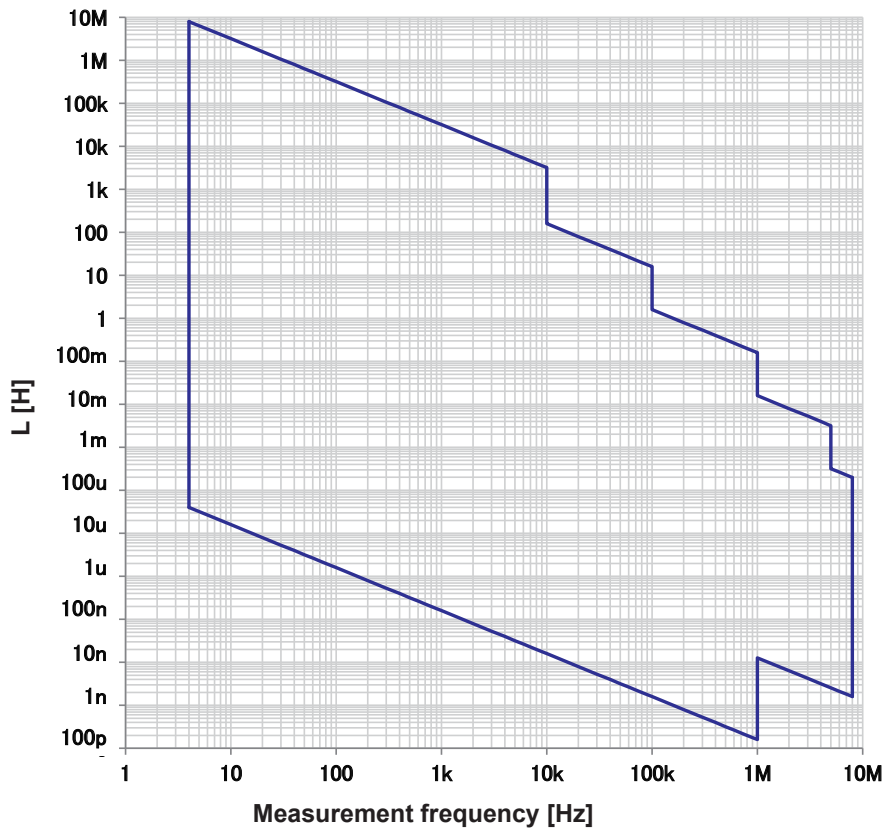

**Measurable range for C**

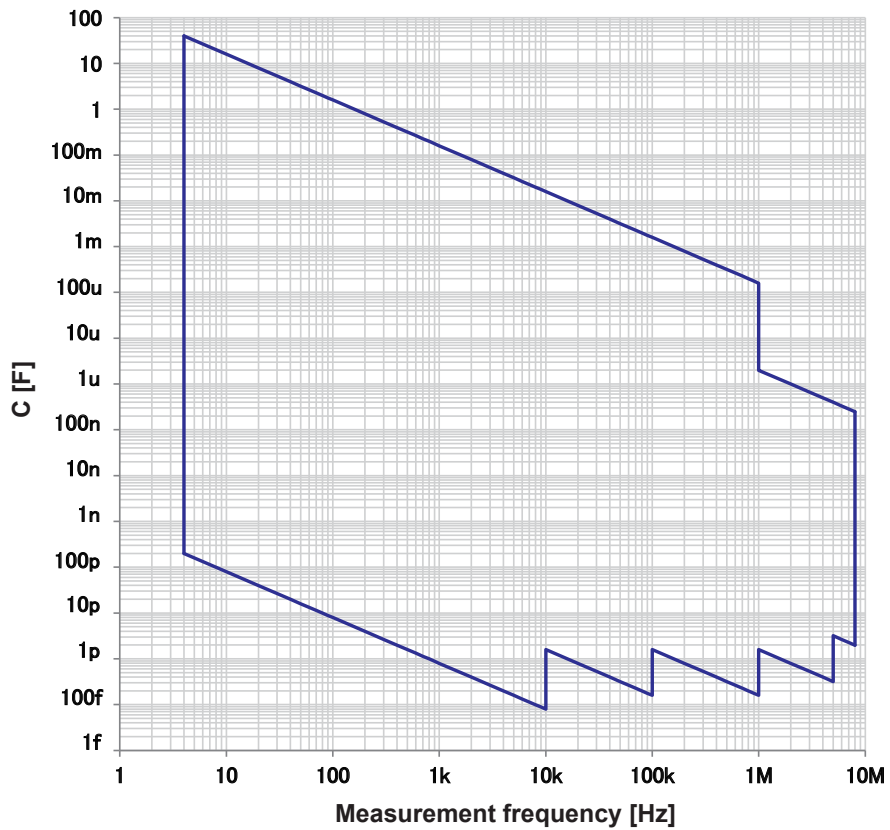

## 10.7 About Measurement Times and Measurement Speed

Measurement times vary with the measurement conditions (see the table below). Values are all provided for reference purposes only (and vary with operating conditions).

### Analog measurement signal (INDEX)

Measurement speed \ Measurement frequency	FAST	MED	SLOW	SLOW2
DC (line frequency 50 Hz)	1 ms	20 ms	100 ms	400 ms
DC (line frequency 60 Hz)	1 ms	16.67 ms	100 ms	400 ms
4.00 Hz to 10.00 Hz	Tf	2×Tf	3×Tf	4×Tf
10.01 Hz to 39.99 Hz	Tf	2×Tf	5×Tf	10×Tf
40.00 Hz to 99.99 Hz	Tf	2×Tf	5×Tf	40×Tf
100.00 Hz to 300.00 Hz	Tf	2×Tf	5×Tf	50×Tf
300.01 Hz to 500.00 Hz	Tf	2×Tf	10×Tf	200×Tf
500.01 Hz to 1.0000 kHz	Tf	5×Tf	20×Tf	300×Tf
1.0001 kHz to 2.0000 kHz	Tf	8×Tf	40×Tf	600×Tf
2.0001 kHz to 3.0000 kHz	2×Tf	12×Tf	60×Tf	1200×Tf
3.0001 kHz to 5.0000 kHz	3×Tf	20×Tf	100×Tf	2000×Tf
5.0001 kHz to 10.000 kHz	5×Tf	40×Tf	200×Tf	3000×Tf
10.001 kHz to 20.000 kHz	10×Tf	80×Tf	400×Tf	6000×Tf
20.001 kHz to 30.000 kHz	25×Tf	150×Tf	600×Tf	12000×Tf
30.001 kHz to 50.000 kHz	25×Tf	250×Tf	1000×Tf	20000×Tf
50.001 kHz to 100.00 kHz	50×Tf	400×Tf	2000×Tf	30000×Tf
100.01 kHz to 140.00 kHz	100×Tf	800×Tf	4000×Tf	60000×Tf
140.01 kHz to 200.00 kHz	100×Tf	800×Tf	4000×Tf	60000×Tf
200.01 kHz to 300.00 kHz	250×Tf	1500×Tf	6000×Tf	120000×Tf
300.01 kHz to 400.00 kHz	250×Tf	2500×Tf	10000×Tf	200000×Tf
400.01 kHz to 500.00 kHz	250×Tf	2500×Tf	10000×Tf	200000×Tf
500.01 kHz to 700.00 kHz	500×Tf	4000×Tf	20000×Tf	300000×Tf
700.01 kHz to 1.0000 MHz	500×Tf	4000×Tf	20000×Tf	300000×Tf
1.0001 MHz to 1.4000 MHz	1250×Tf	8750×Tf	40000×Tf	600000×Tf
1.4001 MHz to 2.0000 MHz	1250×Tf	8750×Tf	40000×Tf	600000×Tf
2.0001 MHz to 3.0000 MHz	1875×Tf	15000×Tf	60000×Tf	900000×Tf
3.0001 MHz to 4.0000 MHz	2500×Tf	25000×Tf	100000×Tf	1500000×Tf
4.0001 MHz to 5.0000 MHz	2500×Tf	25000×Tf	100000×Tf	1500000×Tf
5.0001 MHz to 6.0000 MHz	5000×Tf	40000×Tf	156250×Tf	2500000×Tf
6.0001 MHz to 8.0000 MHz	5000×Tf	40000×Tf	156250×Tf	2500000×Tf

- Tf [sec]: 1/measurement frequency [Hz]
- The above DC measurement times apply to operation with DC adjustment off. To calculate times for operation with DC adjustment on, multiply the above times by 2 and add 0.5 ms.

When the contact check is enabled, the contact check time will be added to the analog measurement times listed on the previous page.

**Contact check**

Contact check timing	Contact check time
BEFORE	5.5 ms
AFTER	5.5 ms
BOTH	10 ms

• When using the external trigger setting, 500 μs is added to the “Analog measurement signal (INDEX)” (p. 225) when the conditions outlined in the following table apply:

**External trigger**

Range	Low Z high accuracy mode	Measurement level	Measurement frequency	DC bias	Added time
100 mΩ, 1 Ω	OFF	All level	DC, all frequency	OFF	500 μs
100 mΩ, 1 Ω	ON	0.01 to 1 V	DC, all frequency	OFF	500 μs
10 Ω	OFF	0.01 to 1 V	DC, 4 Hz to 1 MHz	OFF	500 μs

**Measurement times (EOM)**

**Measurement times= INDEX+A+B+C+D+E**

A: Calculation time (no OPEN/SHORT/LOAD correction, HOLD range, no screen display, normal measurement\*)

Measurement speed	Calculation time
FAST	All frequencies 0.5 ms
MED	
SLOW	
SLOW2	

\*: Times are given for measurement while not using the comparator function or BIN function.

**B: OPEN/SHORT/LOAD correction time**

OPEN/SHORT/LOAD correction	Correction time
Disabled	0.0 ms
Enabled	MAX 0.4 ms

**C: Judgment time**

Judgment mode	Judgment time
Disabled (normal measurement*)	0.0 ms
Comparator measurement	MAX 0.4 ms
BIN measurement	MAX 0.8 ms

\*: Times are given for measurement while not using the comparator function or BIN function.

**D: Screen display time**

Screen display	Screen display time
No display	0.0 ms
Display	MAX 0.3 ms

**E: Memory save time**

Memory function	Memory save time
ON, or IN	MAX 0.4 ms
OFF	0.0 ms

**Wait time****(1) When the measurement frequency is changed**

When the measurement frequency is changed, the wait time is 1.5 ms.

However, the measurement frequency is divided into the following eight frequency ranges. When changing the frequency such that the old frequency was in one of these ranges and the new frequency is in another, a wait of 2 ms is added.

Frequency range
4 Hz to 99.99 Hz
100.00 Hz to 1.0000 kHz
1.0001 kHz to 5.0000 kHz
5.0001 kHz to 10.000 kHz
10.001 kHz to 100.00 kHz
100.01 kHz to 1.0000 MHz
1.0001 MHz to 2.0000 MHz
2.0001 MHz to 8.0000 MHz

**(2) When the measurement range or low Z high accuracy mode is changed**

When changing the measurement range or switching low Z high accuracy mode on or off, a wait of 4 ms is added.

**(3) When the measurement signal level is changed**

When changing the AC measurement signal level, a 4 ms wait is added.

**(4) When the DC bias is changed**

A 1.5 ms wait is inserted when switching the DC bias on or off.

In addition, when changing the applied DC bias value, a 1 ms wait is added.

**(5) When the cable length is changed**

When changing the cable length between 0 m and 1 m (or 2 m or 4 m), a 2.5 ms wait is added.

**(6) When switching to DC measurement (DC resistance measurement)**

A 3.5 ms wait is inserted when switching from AC measurement to DC measurement.

**(7) When changing multiple measurement conditions simultaneously**

When changing multiple measurement conditions simultaneously, a wait of up to 6.5 ms is added.





## 11.1 Calibration, Inspection, Repair, and Cleaning

Before requesting instrument repair or inspection, please read “Before returning for repair” (p. 231) and “11.3 Error Message and Error Display” (p. 238).

### Calibrations

#### IMPORTANT

Periodic calibration is necessary in order to ensure that the instrument provides correct measurement results of the specified accuracy.

The calibration frequency varies depending on the status of the instrument or installation environment. We recommend that the calibration frequency is determined in accordance with the status of the instrument or installation environment and that you request that calibration be performed periodically.

### Inspection and repair

#### WARNING



Customers are not allowed to modify, disassemble, or repair the instrument. Doing so may cause fire, electric shock, or injury.

### Replaceable parts and operating lifetimes

The characteristics of some of the parts used in the product may deteriorate with extended use. To ensure the product can be used over the long term, it is recommended to replace these parts on a periodic basis. When replacing parts, please contact your Hioki distributor. The service life of parts varies with the operating environment and frequency of use. Parts are not guaranteed to operate throughout the recommended replacement cycle.

Part	Recommended replacement cycle	Remarks/conditions
Electrolytic Capacitors	Approx. 5 years	A PCB on which a part concerned is mounted must be replaced. The board on which the parts in question are mounted should be replaced.
LCD backlight (Brightness reduced by half)	Approx. 5 years	If used for 24 hours per day at 25°C
Fan motor	Approx. 10 years	When used for 24 hours per day
Backup battery	Approx. 10 years	When turning on the instrument, if the date or time is not substantially accurate, the battery should be replaced. Replace if the time and date are significantly off when the product is turned on.

## Transporting the instrument

---

- Be sure to observe the following precautions:
- To avoid damage to the instrument, remove the accessories and optional equipment from the instrument. Moreover, use the original packing materials in which it was shipped, and be sure to pack in a double carton. Damage occurring during transportation is not covered by the warranty.
- When sending the instrument for repair, be sure to include details of the problem.

## Cleaning

---

- To clean the instrument, wipe it gently with a soft cloth moistened with water or mild detergent.

### IMPORTANT

Never use solvents such as benzene, alcohol, acetone, ether, ketones, thinners or gasoline, as they can deform and discolor the case.

- Wipe the LCD display gently with a soft, drycloth.

### CAUTION



Clean the vents periodically to avoid blockage. If a vents becomes clogged, the instruments internal cooling is impeded, and damage may result.

## 11.2 Troubleshooting

- If no measured value is displayed even when the probes are shorted together, internal damage may have occurred. Contact your authorized Hioki distributor or reseller.
- If damage is suspected, check the "Before returning for repair" section before contacting your dealer or Hioki representative. However, in the following cases, immediately stop using the instrument, unplug the power cord and contact your authorized Hioki distributor or reseller.
  - When the nature of the damage is clearly evident
  - When measurement is impossible
  - After long-term storage in adverse conditions such as high temperature or humidity
  - After being subject to severe shock during transport

After severe exposure to water, oil, or dust (internal insulation can be degraded by oil or water, causing increase hazard of electric shock or fire)

### Before returning for repair

#### Improper operation

Symptom	Cause	Remedy and Reference
<b>Keys and screens</b>		
The display does not appear when you turn the instrument on.	<ul style="list-style-type: none"> <li>• When power cord is disconnected.</li> <li>• The power cord is not connected properly.</li> </ul>	Check the power cord connection. "2.3 Connecting the Power Cord" (p. 36)
Keys do not work.	The instrument is in the key lock state.	Disable the key lock. See "Key-lock function (disabling key operation)" (p. 97).
	The instrument is being controlled by an external device using the communications cable.	Cancel remote mode.
A key other than the pressed one is pressed.	Panel correction has not been performed.	Perform panel calibration. "Panel calibration" (p. 142)
Nothing is displayed on the screen.	The instrument has been configured so that the LCD display turns off automatically once a certain amount of time elapses.	Touch the screen. See "LCD display auto-off (power-saving mode)" (p. 95).
	The instrument is in the suspended state.	Cancel the suspended state. See "To cancel the suspended state" (p. 39).
Key response and screen drawing are slow.	The measured value automatic output function has been enabled.	When the measurement value automatic output function is enabled, key response and screen drawing may become slow in order to give priority to measurement and measurement value output. Refer to the Communications Instruction Manual on the bundled LCR Application Disc.

Symptom	Cause	Remedy and Reference
The LCD display appears blurred.	You are pushing on the LCD display with too much force.	Touch the LCD display lightly. Although some degree of blurring may occur depending on how you touch the display, this is normal and does not pose a problem with the instrument's functionality.
<b>Operation methods</b>		
<ul style="list-style-type: none"> <li>The instrument doesn't work.</li> <li>You don't know how to use the instrument.</li> </ul>	You have not reviewed the user manual.	Check the appropriate section of this manual.
	The instrument is being used in an automated system.	Consult the administrator or manager of the instrument or the automated system containing the instrument.
<b>Measurement</b>		
The measurement values are exhibiting excessive variation.	The measurement signal level setting is too small.	Change the signal level setting. See "Measurement signal level (AC)" (p. 52).
	An error is being displayed.	Check items corresponding to the error display, correct the issue, and then perform measurement. See "11.3 Error Message and Error Display" (p. 238).
		If <b>Reference Value</b> message is being displayed, check measurement conditions such as the measurement frequency and measurement signal level and select conditions for which <b>Reference Value</b> message will not be displayed. See "Guaranteed accuracy measurement level range" (p. 221), "Measurement frequency (AC)" (p. 47), and "Measurement signal level (AC)" (p. 52).
	The instrument is being used in an environment with a large amount of noise.	<p>If you are using the instrument in a high-noise environment, consider taking the following measures:</p> <ul style="list-style-type: none"> <li>Use guarding. See "Appx. 2 Measurement of High Impedance Components" (p. Appx.3).</li> <li>Implement anti-external noise measures. See "Appx. 4 Countermeasures Against Incorporation of External Noise" (p. Appx.5).</li> <li>Separate the sample, measurement cables, and instrument from the source of the noise (motor, inverter, electromagnetic switch, power line, equipment generating sparks, etc.) or perform the measurement in a separate room.</li> <li>Plug the instrument into a grounded outlet.</li> <li>Use a separate power supply from the device that is generating the noise.</li> </ul>
	A homemade cable is being used.	<ul style="list-style-type: none"> <li>Check the wiring method and correct it if necessary.</li> <li>Use a Hioki-designated cable and configure the instrument with the length of the cable See "5.1 Setting the Cable Length (Cable Length Correction)" (p. 104).</li> </ul>
The connection cable is too long.	Use a Hioki-designated cable and configure the instrument with the length of the cable being used. See "5.1 Setting the Cable Length (Cable Length Correction)" (p. 104).	

Symptom	Cause	Remedy and Reference
The measurement values are exhibiting excessive variation.	Measurement is being performed using a 2-terminal connection.	<ul style="list-style-type: none"> <li>Two-terminal connections are susceptible to the influence of contact resistance. When possible, use a 4-terminal connection to the sample's electrodes to perform measurement.</li> <li>Add a wait time to allow contact to stabilize before measurement.</li> </ul>
	Open and short correction has not been performed.	Perform open and short correction properly. See "5.2 Open Correction" (p. 105) and "5.3 Short Correction" (p. 112).
	Rdc measurement is being performed before the voltage stabilizes.	Include an adequate DC delay and adjustment delay. See "DC delay (setting the DC measurement delay time) (DC)" (p. 65) and "Adjustment delay (setting the offset measurement delay time) (DC)" (p. 66).
	Multiple IM3536 instruments are being used in close proximity to each other.	Separate instruments and measurement cables before use.
You are unable to perform measurement properly.	An error is being displayed.	Check the item indicated by the error display, address the cause, and then perform measurement. See "11.3 Error Message and Error Display" (p. 238).
	An <b>OVERFLOW</b> or <b>UNDERFLOW</b> message is being displayed. (Measured value greater than upper limit/less than lower limit error)  See "11.3 Error Message and Error Display" (p. 238).	<ul style="list-style-type: none"> <li>If the range is not appropriate: Change to an appropriate range or perform measurement using auto ranging. It is necessary to set both the AC measurement and DC measurement ranges. See "Measurement range (AC/DC)" (p. 48).</li> <li>If there is a break or short in the wiring: Check the wiring and perform measurement with the correct wiring connections.</li> </ul>
	An error such as an <b>NC A L</b> or <b>NC B L</b> message is being displayed. (Contact error)  See "11.3 Error Message and Error Display" (p. 238).	<ul style="list-style-type: none"> <li>The sample has not been properly secured in the fixture. Verify that the sample has been properly secured. Refer to the instruction manual of the fixture.</li> <li>Check the measurement cable and fixture for broken wires or poor contact. See "2.4 Connecting the Measurement Cables, Probes, or Fixture" (p. 37).</li> </ul> <p>If you are using the instrument in a high-noise environment, consider taking the following measures:</p> <ul style="list-style-type: none"> <li>Use guarding. See "Appx. 2 Measurement of High Impedance Components" (p. Appx.3).</li> <li>Implement anti-external noise measures. See "Appx. 4 Countermeasures Against Incorporation of External Noise" (p. Appx.5).</li> <li>Separate the sample, measurement cables, and instrument from the source of the noise (motor, inverter, electromagnetic switch, power line, equipment generating sparks, etc.) or perform the measurement in a separate room.</li> <li>Plug the instrument into a grounded outlet.</li> <li>Use a separate power supply from the device that is generating the noise.</li> </ul>

Symptom	Cause	Remedy and Reference
You are unable to perform measurement properly.	An element with its own voltage, for example a battery, is being measured.	If there is a high DC voltage, you may damage the instrument. Avoid measuring the sample.
	An element on a circuit board is being measured.	<ul style="list-style-type: none"> <li>You can measure an element on a printed circuit board if the target element is isolated from external connections. However, if the target element is connected to other components or external circuitry, you will not be able to obtain a proper measurement.</li> <li>You may be unable to measure components in circuits that are generating a voltage or to which a voltage is being applied, for example because they are energized.</li> </ul>
	A high-impedance element is being measured in a noisy environment.	Use guarding. See "Appx. 2 Measurement of High Impedance Components" (p. Appx.3).
	The DC bias function is being used for a sample other than a capacitor.	Set the DC bias function OFF. See "DC bias (superimposing a DC voltage on the measurement signal)(AC)" (p. 63).
The measurement values differ when a standard resistor, standard capacitor, or other known test sample is measured.	The known sample measurement conditions and the instrument's measurement conditions do not match.	Make sure the measurement conditions match.
	The open or short correction method is wrong.	Perform open and short correction properly. To perform short correction for the 9140-10, use a short bar without directly shorting the tips. See "5.2 Open Correction" (p. 105), and "5.3 Short Correction" (p. 112).
	Load correction has been enabled.	Set the load correction off. See "5.6 Load Correction (Correcting Values to Match Reference Values)" (p. 119).
	The delay time from connection of the sample to measurement is not long enough.	Ensure there is an appropriate trigger delay and trigger synchronous output wait time. See "Trigger (perform measurements with user-defined timing) (Common)" (p. 66) and "Trigger synchronous output (Applying the signal to the sample during measurement only) (Common)" (p. 68).
	The DC bias function is being used while measuring an element other than a capacitor.	Set the DC bias function off. See "DC bias (superimposing a DC voltage on the measurement signal)(AC)" (p. 63).
AUTO ranging is unable to determine a range.	A high-impedance element is being measured in a noisy environment.	Use guarding. See "Appx. 2 Measurement of High Impedance Components" (p. Appx.3).
AUTO ranging is unable to determine a range.	The DC bias function is being used while measuring an element other than a capacitor.	Set the DC bias function off. Set "DC bias (superimposing a DC voltage on the measurement signal)(AC)" (p. 63).
<b>Errors</b>		
A contact error is generated even though the connections are correct.	The DC bias function is being used while measuring an element other than a capacitor.	Set the DC bias function off. See "DC bias (superimposing a DC voltage on the measurement signal)(AC)" (p. 63).

Symptom	Cause	Remedy and Reference
Open correction or short correction resulted in an error.	The wrong connection method is being used for open correction or short correction.	Perform open correction or short correction with the proper wiring. See “5.2 Open Correction” (p. 105) and “5.3 Short Correction” (p. 112).
Open correction or short correction resulted in an error.	The instrument is being used in an environment characterized by a large amount of noise.	If you are using the instrument in a high-noise environment, consider taking the following measures: <ul style="list-style-type: none"> <li>• Use guarding. See “Appx. 2 Measurement of High Impedance Components” (p. Appx.3).</li> <li>• Implement anti-external noise measures. See “Appx. 4 Countermeasures Against Incorporation of External Noise” (p. Appx.5).</li> <li>• Separate the sample, measurement cables, and instrument from the source of the noise (motor, inverter, electromagnetic switch, power line, equipment generating sparks, etc.) or perform the measurement in a separate room.</li> <li>• Plug the instrument into a grounded outlet.</li> <li>• Use a separate power supply from the device that is generating the noise.</li> </ul>
An error beep sound is emitted continuously.	The measured value automatic output function has been enabled.	When the measurement value automatic output function is enabled, perform the receive operation on the computer side. Failure to do so will result in a transmission error on the measuring instrument, and the transmission error tone will continue to sound in the event of an internal trigger, etc. Perform the receive operation on the computer side and then perform measurement on the measuring instrument side, or disable the measurement value automatic output function. Refer to the Communications Instruction Manual on the bundled LCR Application Disc.
<b>Communications</b>		
You are unable to send and receive data.	The computer is in sleep mode.	Have the computer exit sleep mode.
You are unable to send and receive data using RS-232C.	A straight cable is being used.	Use a cross cable.
	The wrong COM port is being used.	Check whether the computer's settings match the connected COM port. Connect the cable to the proper COM port.  Check the computer's settings. The COM port may be selected at the operating system, driver, or application level. Check all of these settings.
	The computer has no COM port.	Consider using a commercially available USB/RS-232C conversion cable.
	The instrument is unable to communicate with the application.	Check whether the instrument is turned on. Turn on the instrument and complete any interface connections before launching the computer application.

For more information about external control, see “9.5 External Control Q&A” (p. 193).



## When no apparent cause can be established

Perform a system reset.

Most settings will revert to their default values at the time the instrument was shipped from the factory.

(Some settings will not revert to their default values. See “Appx. 11 Initial Settings Table” (p. Appx.15).)

A system reset can also be performed with the **\*RST** and **:PRESet** communications commands.

For more information, see the descriptions of the **\*RST** and **:PRESet** communications commands on the bundled LCR Application Disc.

## Initializing (system reset)

Screen display method (For more information, see p. 26):

(Measurement screen) **SET** key>(SET screen) **ADVANCED** tab>**RESET** key

**1** Disconnect the measurement sample.

**2** Touch the **RESET** key.

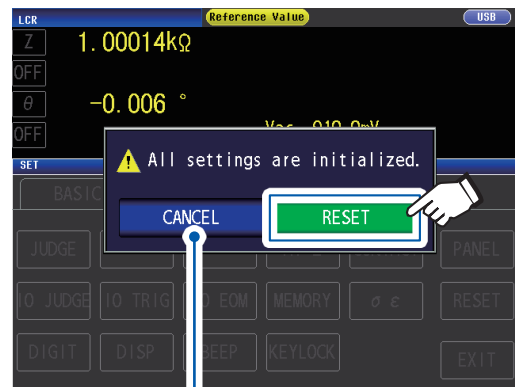

Touch to cancel the system reset. (The measurement screen will be displayed.)

Settings will revert to their factory defaults, and the measurement screen will be displayed.

If you are unable to display the initialization screen or perform a system reset, perform a full reset. (See p. 237)

## Performing a full reset (If you are unable to perform a system reset)

### IMPORTANT

If the instrument still does not operate normally after the full reset, it needs to be repaired. Contact your dealer, or a Hioki representative if you are not sure where the instrument was purchased.

When you perform a full reset, almost all settings\* will be reverted to their default values at the time of shipment from the factory.

\*: The status byte register, event register, enable register, and clock settings will not change. (See “Appx. 11 Initial Settings Table” (p. Appx.15).)

Perform a full reset only in the following circumstances:

- When the normal reset screen cannot be displayed because of a problem with the instrument. (After the full reset, perform a self check to confirm that there are no problems) See “7.3 Testing the System (Self Diagnosis)” (p. 141).
- When you have forgotten the passcode for the key lock.

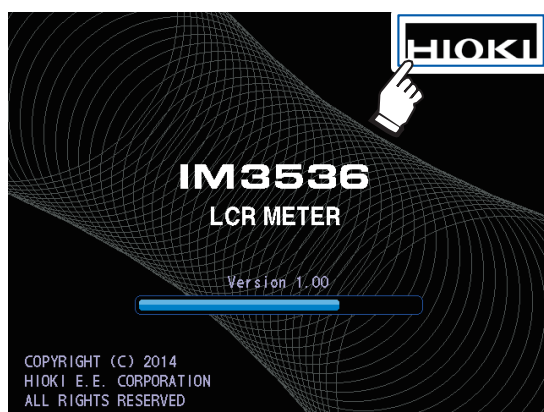

- 1** Disconnect the measurement sample.
- 2** Connect the power cord.
- 3** Set the main switch to the on position on the rear panel.
- 4** While the splash screen is displayed, press the top right of the screen continuously.





The full reset is complete when a beeping sound is emitted.



After the full reset, the panel calibration screen will be displayed.

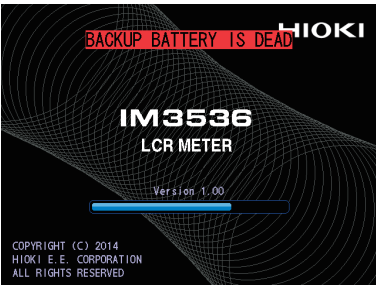





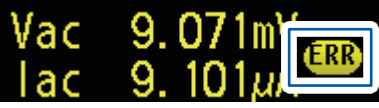
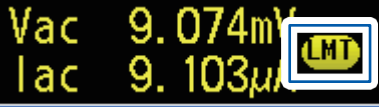
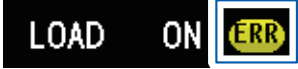

See “Panel calibration” (p. 142).



# 11.3 Error Message and Error Display

If a message or display such as those shown below is displayed on the screen, refer to the indicated section for more information.

Error overview	Error	Description	Solution and reference
Backup battery low		<p>The life of the RAM backup battery has ended.</p>	<p>The instrument needs to be repaired. Contact your authorized Hioki distributor or reseller.</p>
Memory full		<p>This message will be shown on the top of the screen if the set number of measurement results has been stored in the instrument's internal memory. Once this message has been displayed, you will not be able to save any more measured values.</p>	<p>Load measurement values stored in the instrument's memory with the memory function or clear the memory. See "Memory function (saving measurement results)" (p. 91).</p>
No measured value accuracy guarantee		<p>This message will be shown on the top of the screen if the accuracy of the measured value is not guaranteed.</p>	<p>Increase the measurement signal level or change the measurement range to one that matches the impedance of the element to be measured. See "Measurement signal level (AC)" (p. 52), and "Measurement range (AC/DC)" (p. 48).</p>
Hi Z reject error		<p>This message will be shown on the top of the screen if the measurement results are higher than the judgment standard that was set with the Hi Z reject function.</p>	<ul style="list-style-type: none"> <li>• Check the connection of each terminal. See "2.4 Connecting the Measurement Cables, Probes, or Fixture" (p. 37).</li> <li>• Check the Hi Z reject function settings. See "High-Z reject function (detecting contact errors during 2-terminal measurement)" (p. 88).</li> </ul>

Error overview	Error	Description	Solution and reference
Constant-voltage measurement or constant-current measurement not possible		<p>This message will be displayed to the right of the monitor value when it is not possible to perform constant-voltage measurement or constant-current measurement.</p> <p>It will also be displayed if the voltage applied to the sample or the current flowing to the sample exceeds the limit value (including, for example, if a current in excess of the limit value flows to the sample when the open voltage has been set to the lowest possible value).</p>	<p>Reduce the voltage level or current level. See “Measurement signal level (AC)” (p. 52).</p>
Less than voltage limit or current limit		<p>This message will be displayed if the set constant voltage (or constant current) is not reached because a signal that is greater than or equal to the current (or voltage) limit value is not being applied.</p>	<p>Set the limit value again or change the measurement signal level so that the limit value is not exceeded See “Measurement signal level (AC)” (p. 52) and “Limit (limiting the voltage and current applied to the sample) (AC)” (p. 62).</p>
Load correction frequency mismatch		<p>This message will be displayed in the settings information if the load correction frequency does not match the current measurement frequency when load correction is enabled.</p>	<p>Perform load correction at the same frequency as the measurement frequency. See “Measurement frequency (AC)” (p. 47), and “5.6 Load Correction (Correcting Values to Match Reference Values)” (p. 119).</p>
Load correction condition mismatch		<p>This message will be displayed in the settings information if load correction conditions other than the frequency do not match the current measurement conditions when load correction is enabled.</p>	<p>Perform load correction using the same conditions as the measurement conditions. See “3.4 Setting Measurement Conditions (Basic Settings)” (p. 46), and “5.6 Load Correction (Correcting Values to Match Reference Values)” (p. 119).</p>

Error overview	Error	Description	Solution and reference
Measured value out of display range		<p>This message will be displayed in the measured value display area if the measured value falls outside the screen display range.</p>	<p>This error may result from the following causes:</p> <ul style="list-style-type: none"> <li>• The sample has not been connected properly.</li> <li>• The display range has been exceeded due to a user-specified correction coefficient (p. 129).</li> <li>• Open correction, short correction, or load correction is being performed with an erroneous value (p. 105, p. 112, and p. 119).</li> </ul> <p>If you suspect any of the above causes, reconfigure the settings.</p> <p>If use of properly configured settings does not eliminate the error, measurement is not possible because the measured value exceeds the instrument's display range.</p>
Internal circuit error		<p>This message will be displayed in the measured value display area if an internal circuit error prevents measurement from completing.</p>	<p>The instrument needs to be repaired. Contact your authorized Hioki distributor or reseller.</p>
Greater than the measured value upper limit	  	<p>This message will be displayed in the measured value display area if the measured value is greater than to the range upper limit value.</p>	<ul style="list-style-type: none"> <li>• Change the measurement range to a high-impedance range. See "Measurement range (AC/DC)" (p. 48).</li> <li>• If applying a DC bias to perform resistance measurement, turn off the DC bias. See "DC bias (superimposing a DC voltage on the measurement signal)(AC)" (p. 63)</li> </ul>
Less than the measured value lower limit	  	<p>This message will be displayed in the measured value display area if the measured value is less than the range lower limit value.</p>	<ul style="list-style-type: none"> <li>• Change the measurement range to a low-impedance range. See "Measurement range (AC/DC)" (p. 48).</li> <li>• If applying a DC bias to perform resistance measurement, turn off the DC bias. See "DC bias (superimposing a DC voltage on the measurement signal)(AC)" (p. 63)</li> </ul>

Error overview	Error	Description	Solution and reference
<p style="writing-mode: vertical-rl; transform: rotate(180deg);">Contact check error</p>	<div style="text-align: center;">  </div> <p>The unconnected terminals will be indicated.</p> <p>HL : H<sub>POT</sub>, H<sub>CUR</sub>, L<sub>POT</sub>, L<sub>CUR</sub>                      L : L<sub>POT</sub>, L<sub>CUR</sub>                      H : H<sub>POT</sub>, H<sub>CUR</sub></p> <div style="text-align: center;">  </div> <p>The letter A (“after”) will be shown if the contact check error occurred after measurement, while the letter B (“before”) will be shown if the contact check error occurred before measurement.</p>	<ul style="list-style-type: none"> <li>This message will be displayed in the measured value display area if one of the terminals is found to be disconnected, for example due to a broken wire, after measurement.</li> <li>The sample has not been secured properly in the measurement cable, probe, or fixture.</li> <li>This message will also be displayed when using the instrument in an environment characterized by a large amount of noise.</li> </ul>	<p>Check the connection of each terminal. See “2.4 Connecting the Measurement Cables, Probes, or Fixture” (p. 37).</p> <p>Check the manner in which the sample has been secured. Check the wiring for wiring breaks or poor contact. See the probe or fixture’s user manual as well as “Contact check function (detecting poor contact with the sample during 4-terminal measurement)” (p. 89).</p> <p>Consider taking the following measures:</p> <ul style="list-style-type: none"> <li>Use guarding. See “Appx. 2 Measurement of High Impedance Components” (p. Appx.3).</li> <li>Implement anti-external noise measures. See “Appx. 4 Countermeasures Against Incorporation of External Noise” (p. Appx.5).</li> <li>Separate the sample, measurement cables, and instrument from the source of the noise (motor, inverter, electromagnetic switch, power line, equipment generating sparks, etc.) or perform the measurement in a separate room.</li> <li>Plug the instrument into a grounded outlet.</li> <li>Use a separate power supply from the device that is generating the noise.</li> </ul>
	<p style="writing-mode: vertical-rl; transform: rotate(180deg);">Fan motor error</p>	<div style="background-color: black; color: white; padding: 5px;">                         Error: 5 FAN attention                     </div>	<ul style="list-style-type: none"> <li>The fan motor has stopped or is operating at low speed.</li> </ul>

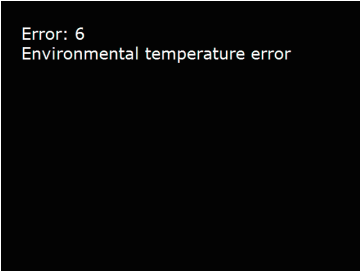
Error overview	Error	Description	Solution and reference
<p style="writing-mode: vertical-rl; transform: rotate(180deg);">Operating temperature error</p>		<ul style="list-style-type: none"> <li>The ambient temperature has exceeded the instrument's operating temperature range.</li> </ul>	<ul style="list-style-type: none"> <li>Cycle the instrument's power and use the instrument within its operating temperature range. See "10.2 Environmental and Safety Specifications" (p. 200).</li> <li>If this error is displayed even though the instrument is being used within its operating temperature range, the instrument needs to be repaired. Contact your authorized Hioki distributor or reseller.</li> </ul>

## 11.4 Discarding the Instrument

The instrument uses a lithium-ion battery as a power supply for saving the measurement conditions. When disposing of this instrument, remove the lithium battery and dispose of battery and instrument in accordance with local regulations.

### ! WARNING



- To avoid electric shock, set the power switch to the off position and disconnect the power cord and measurement cable, probe, or fixture before removing the lithium battery.



- Battery may explode if mistreated. Do not short-circuit, recharge, disassemble or dispose of in fire.



- Keep batteries away from children to prevent accidental swallowing.

### Lithium Battery Removal

Required tools: One Philips screwdriver (No.1), One tweezers (to remove the lithium battery)

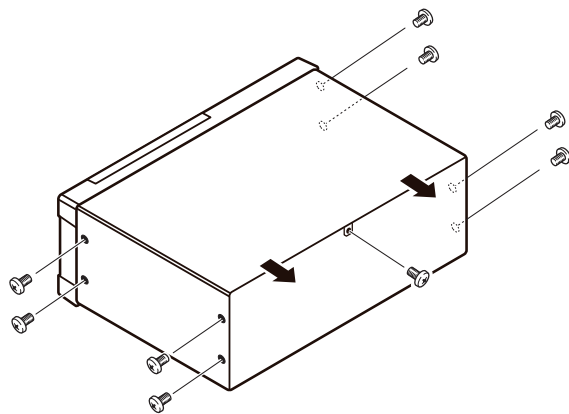

- 1 Verify that the power is off, and remove the connection cables and power cord.
- 2 Remove the eight screws from the sides and one screw from the rear.

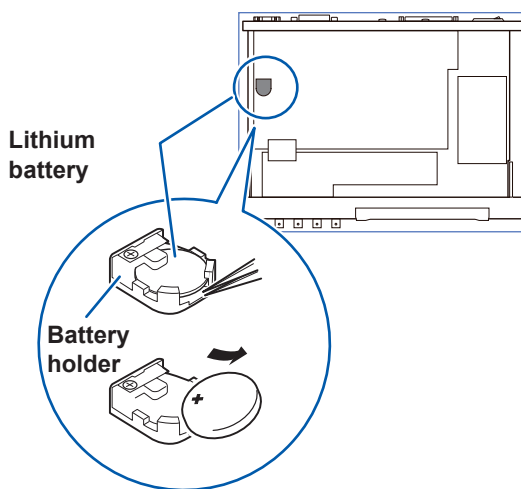

- 3 Remove the cover.
- 4 Insert the tweezers between the battery and battery holder as shown in the diagram below and lift up the battery.

### ! CAUTION



- Take care not to short the positive and negative terminals. Doing so may cause sparks.

#### CALIFORNIA, USA ONLY

This product contains a CR Coin Lithium Battery which contains Perchlorate Material - special handling may apply.

See [www.dtsc.ca.gov/hazardouswaste/perchlorate](http://www.dtsc.ca.gov/hazardouswaste/perchlorate)





# Appendix

## Appx. 1 Measurement Parameters and Calculation Formula

In general, impedance  $Z$  is used to evaluate the characteristics of, for example, circuit components. Measure voltage and current vectors for circuit components relative to AC measurement frequency signals.

The instrument uses these values to obtain the impedance  $Z$  and phase difference  $\theta$ . The following values can be obtained from impedance  $Z$  by rotating the impedance  $Z$  around the complex plane.

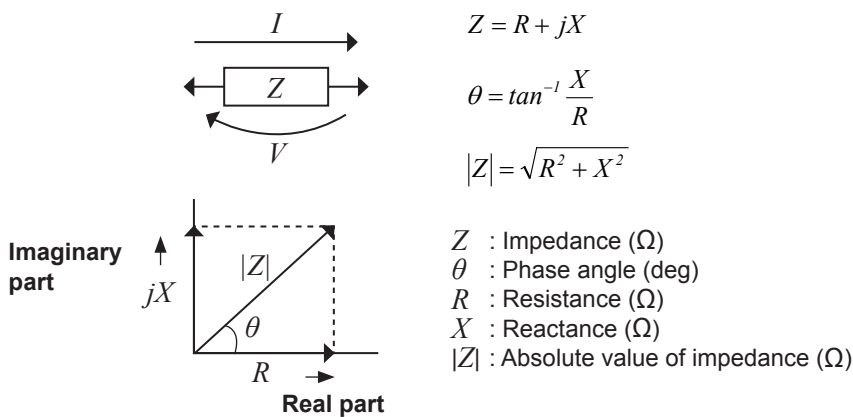

Furthermore, admittance  $Y$  that is the reciprocal of impedance  $Z$  can also be used depending on the characteristics of circuit components. As in the case of impedance  $Z$ , the following values can also be obtained from admittance  $Y$  by rotating the admittance  $Y$  around the complex plane.

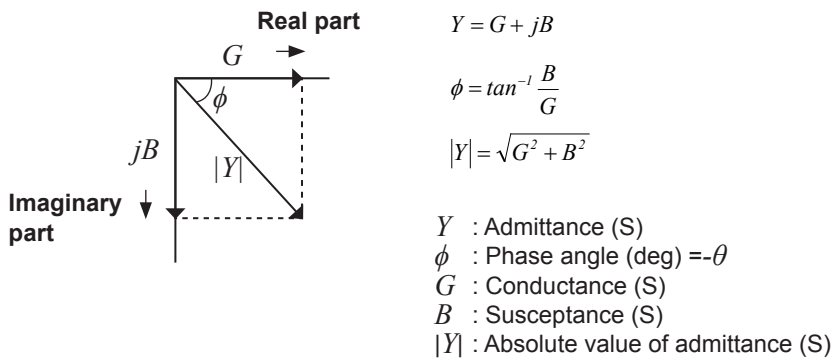

From the voltage  $V$  which is applied between the terminals of the sample under test, the current  $I$  which flows through the test sample at this time, the phase angle  $\theta$  between this voltage  $V$  and this current  $I$ , and the angular velocity  $\omega$  which corresponds to the measurement frequency.

The phase angle  $\theta$  is shown based on the impedance  $Z$ . When measuring based on the admittance  $Y$ , the sign of the phase angle  $\theta$  must be reversed.

Item	Series equivalent circuit mode	Parallel equivalent circuit mode
$Z$	$ Z  = \frac{V}{I} (= \sqrt{R^2 + X^2})$	
$Y$	$ Y  = \frac{I}{ Z } (= \sqrt{G^2 + B^2})$	
$R$	$R_s = ESR =  Z  \cos \theta$	$R_p = \frac{I}{ Y  \cos \phi} (= \frac{I}{G})^{*1}$
$X$	$X =  Z  \sin \theta$	$G =  Y  \cos \phi^{*1}$
$G$	$L_s = \frac{X}{\omega}^{*2}$	$B =  Y  \sin \phi^{*1}$
$B$	$C_s = -\frac{I}{\omega X}^{*2}$	$L_p = -\frac{I}{\omega B}^{*2}$
$L$	$C_p = \frac{B}{\omega}^{*2}$	$D = \frac{\cos \theta}{ \sin \theta }$
$C$	$Q = \frac{ \sin \theta }{\cos \theta} (= \frac{I}{D})$	
$D$		
$Q$		

\*1:  $\phi$  is a symbol for the phase angle of admittance  $Y$  ( $\phi = -\theta$ ).

\*2:  $\omega = 2\pi f$ ,  $\pi \approx 3.14$ ,  $f$  is a symbol for the measurement frequency.

$L_s, C_s, R_s$ : The measured values of  $L, C$ , and  $R$  in series equivalent circuit mode.

$L_p, C_p, R_p$ : The measured values of  $L, C$ , and  $R$  in parallel equivalent circuit mode.

## Appx. 2 Measurement of High Impedance Components

The measured value obtained when testing a high impedance element (such as, for example, a resistor with resistance higher than 100 k $\Omega$ ) is sometimes unreliable, because such an element is vulnerable to the effects of external interference and the like. In this case, reliable testing can be performed by the use of guarding, that is, connecting a metallic plate to the GUARD terminal and carrying out the measurement on the metallic plate.

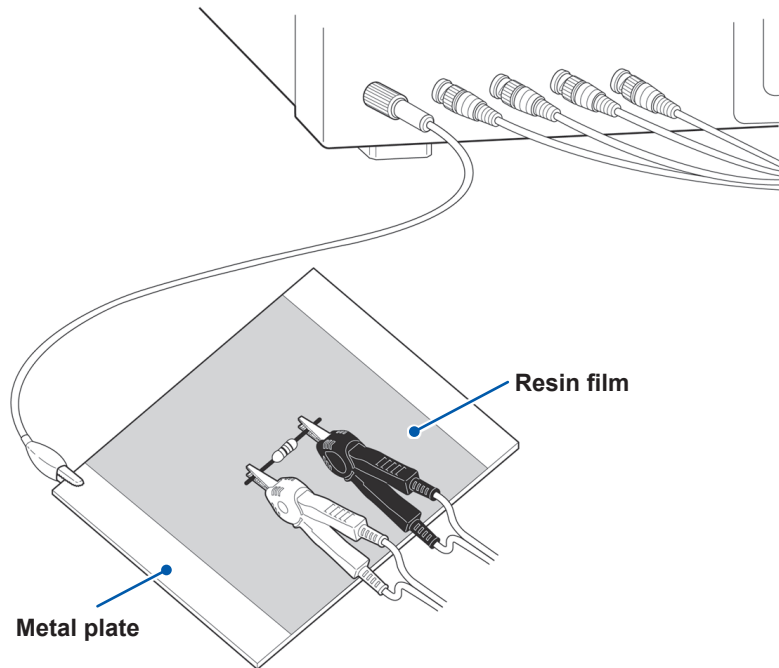

When measuring components on a metal plate, use, for example, resin film as insulation to ensure terminals and the like are not short-circuited.

Open circuit compensation is high impedance measurement, so be sure to use the shielding process. If it is not used, the compensation values may become unstable and affect the measurement values.

# Appx. 3 Measurement of In-circuit Components

Measure an in-circuit component after providing guarding.

$$R = R_2 \cdot \frac{R_3 + R_4}{R_2 + R_3 + R_4}$$

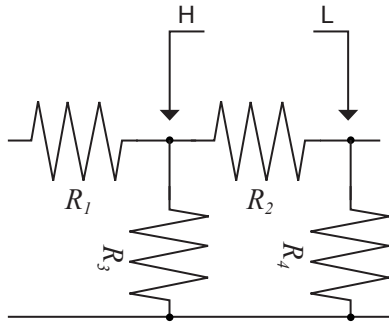

Referring to the following figure, when measuring a resistance value for the resistor  $R_2$ , even if the tips of the two probes are contacted against the ends of the resistor  $R_2$ , considering the sum of the current flowing through the resistor  $R_2$  and the current flowing through the resistors  $R_3$  and  $R_4$  what is obtained is the resistance value for the parallel combination:

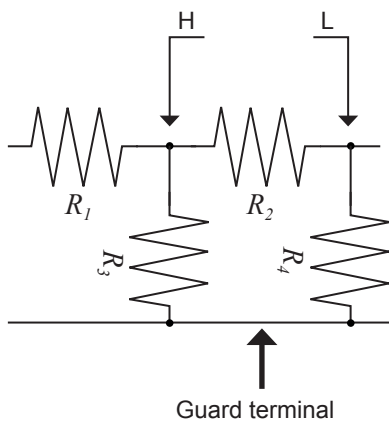

If as shown in the next figure a guard terminal is used, the current flowing through the resistors  $R_3$  (not flowing through  $R_4$ ) is absorbed by this guard terminal, so that the resistance value for the resistor  $R_2$  is accurately measured.

- The accuracy of measurement will not be improved in cases where for example  $R_2 \gg R_3$  and  $R_3$  is close to zero.
- As shown in the figure below, it is not possible to use this type of separation process for testing of the impedance values of two resistors or other elements of identical types which are connected in parallel, or for testing of the impedance values of a coil and a capacitor which are connected in parallel.

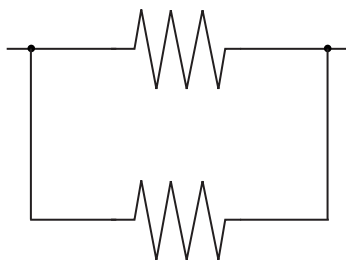

Two resistors in parallel

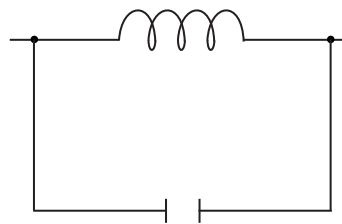

Coil and capacitor in parallel

## Appx. 4 Countermeasures Against Incorporation of External Noise

The instrument is designed to be resistant to errors caused by interference from the test cables or the power supply line. However, if the level of the interference is particularly large, this can cause measurement errors or faulty operation.

Refer to the examples given below for examples of countermeasures which can be taken against interference which has caused faulty operation etc.

### Countermeasures against incorporation of noise from the power line

You can use the following countermeasures to reduce the effect of noise being incorporated from the power line.

#### (1) Ground the protective ground wire.

The instrument is structured so that the ground wire of the power cord can be used as protective grounding for the instrument. Protective grounding plays an important role in not only the prevention of electrical accidents but also the use of an internal filter to eliminate the incorporation of noise from the power line. Use the supplied power cord.

#### (2) Insert a noise filter into the power line.

Connect a commercial plug-in noise filter to the power outlet and then connect the instrument to the output of the noise filter in order to suppress the incorporation of noise from the power line.

Plug-in noise filters are commercially available from various specialist manufacturers.

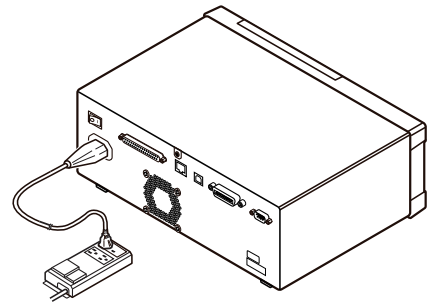

#### (3) Attach an EMI ferrite-core filter to the power cord.

Pass the power cord through a commercially available EMI suppression ferrite core and secure the core as close as possible to the AC power inlet of the instrument in order to suppress the incorporation of noise from the power line.

Suppression is even more effective if you also attach an EMI suppression ferrite core close to the power plug of the power source.

If a toroidal ferrite core or split ferrite core with a large enough internal diameter is used, the amount of noise can be decreased by passing the power cord through the core several times. EMI ferrite cores and ferrite beads are commercially available from various specialist manufacturers.

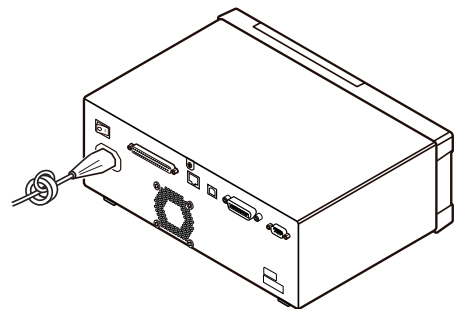

## Countermeasures against noise from the measurement cables

If interference is producing noise in the measurement cables, its influence can be moderated by the following countermeasure.

### Attach an EMI ferrite-core filter to the commercial cable.

Pass the test cables through a commercially available anti-interference ferrite core, and fix it close to the measurement terminals, so as to suppress noise from the measurement cables.

Moreover, if the internal diameter of the ferrite core allows, winding the measurement cables several times around the ferrite core (as with the power cord as described above) may further reduce the amount of noise.

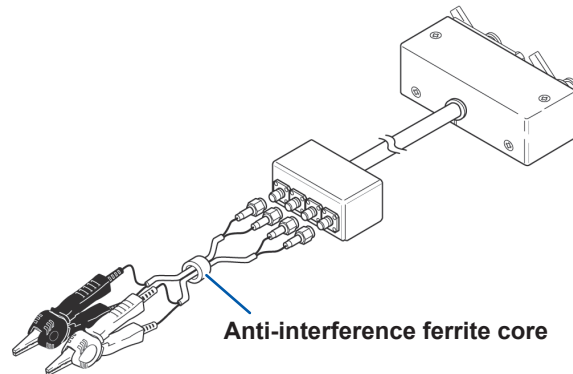

## Appx. 5 Supplying DC Bias

### ⚠ CAUTION



A voltage must not be applied to the measurement terminals of the instrument from an external source.

If a voltage is applied from an external source, the instrument may be damaged.

Supplying DC bias means that a DC voltage is supplied as a bias to a sample for test whose characteristics are voltage dependent, such as an electrolytic capacitor or a ceramic capacitor. Further, a DC current can be supplied as a bias to a sample for test whose characteristics are current dependent, such as a choke coil.

This instrument does not provide a DC bias input terminal. DC bias should be applied using the method described below.

- When applying DC bias during measurement, enable the internal DC bias setting and set the voltage to 0.00 V. (See “DC bias (superimposing a DC voltage on the measurement signal)(AC)” (p. 63))
- Rdc measurement cannot be performed when applying DC bias since a DC-cut capacitor is included in the circuit.
- The DC bias setting cannot be enabled when a parameter has been set to **Rdc**. Do not set any parameter to **Rdc**.

## How to supply a DC bias voltage

### ⚠ WARNING



- In order to avoid electric shock accident, be absolutely sure not to touch the test terminals while the DC bias voltage is being supplied to them.
- Do not short circuit between the H and L of the measurement cable, probe, or fixture with the DC bias voltage still being supplied. Doing so may damage the measurement cable, probe, or fixture or cause a short circuit accident.



- If you disconnect the sample under test from the test terminals with the DC bias voltage still being supplied, then the test sample is left charged, which is very dangerous. In order to avoid electric shock.

### ⚠ CAUTION



- When measuring the element whose DC resistance is not high enough, DC current will flow to the main unit and the measurement will not be performed properly.

When you want to apply a DC voltage bias, refer to the following explanation.  
Example: When applying a DC voltage bias to a capacitor or other test sample

#### DC Bias Voltage Circuit

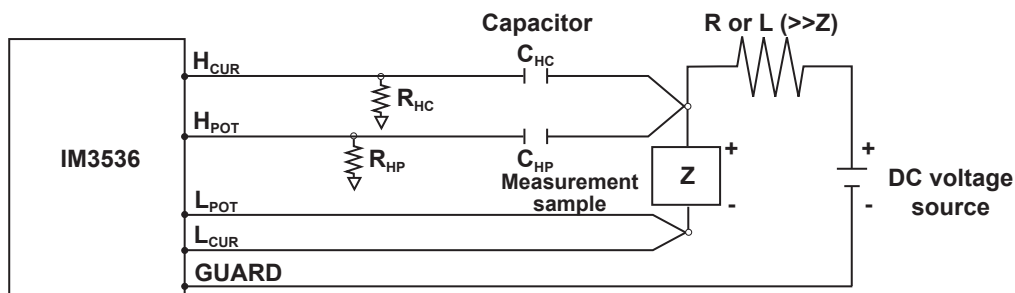

- Use a resistance (R) or inductance (L) which has a large enough impedance with reference to the sample under test (Z).
- A  $H_{CUR}$  side capacitor must have a small enough impedance (i.e. a large enough capacitance) relative to the output resistance ( $100\ \Omega$ ) while a  $H_{POT}$  capacitor must have a small enough impedance to the  $R_{HP}$ .
- Be careful about the polarity when connecting together the measurement cables, probes, or fixtures the sample to be tested, and the DC voltage source.
- It takes a little time for the DC voltage which is being supplied to the sample under test to reach the set voltage, so you should wait for a certain stabilization time period (which depends upon the sample) before performing.
- After testing is completed, drop the voltage of the DC voltage source to zero, and remove the sample under test from the measurement cables, probes or fixtures after having discharged any electric charge which may have built up.
- If you have removed the sample under test from the measurement cables, probes or fixtures without first having discharged the accumulated electric charge, you should be careful to do so immediately.



## How to supply a DC bias current

### ⚠ WARNING



In order to avoid electric shock accident, be absolutely sure not to touch the test terminals while the DC bias is being supplied to them.

### ⚠ CAUTION



- Due to the inductance of the coil and the sample, counter electromotive force is generated when the sample is removed or inserted with the DC bias supplied. This may result in damage to the instrument or to the DC source.
- When measuring the element whose DC resistance is high (incl. open state), a high voltage occurred on the H side may cause damage on the main instrument.
- Use a DC current supply whose output is isolated from ground. Failure to do so could enable DC current to flow into the instrument, damaging the instrument.

When you want to apply a DC current bias, refer to the following explanation.

With regards to a DC current bias for a transformer, choke coil, or other test sample, configure the external bias circuit as shown below.

#### DC Bias Current Circuit

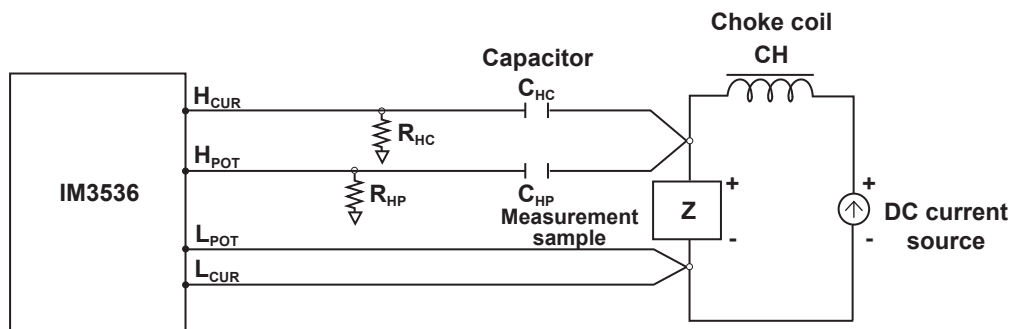

- Connect the sample to the measuring cable, probe, or fixture and then gradually raise the voltage of the DC source to the specified DC bias level. To disconnect the sample, gradually reduce the voltage of the DC source until the DC bias supplied to the sample is decreased to zero. You may disconnect the sample after this is achieved.
- Use a choke coil (CH) which has a large enough impedance with reference to the sample under test (Z).
- A  $H_{CUR}$  side capacitor must have a small enough impedance (i.e. a large enough capacitance) relative to the output resistance ( $100 \Omega$ ) while a  $H_{POT}$  capacitor must have a small enough impedance to the  $R_{HP}$ .
- Be careful about the polarity when connecting together the measurement cables, probes, or fixture, the sample to be tested, and the DC current source.
- Be careful not to magnetically saturate the choke coil (CH) with the DC bias current.
- It takes a little time for the DC current which is being supplied to the sample under test to reach the set value, so you should wait for a certain stabilization time period (which depends upon the sample) before performing testing. Be careful, because if you perform testing before this stabilization time period has elapsed, the results will not be reliable.

## Appx. 6 The Residual Charge Protection Function

### ⚠ CAUTION



- The quoted maximum voltage from which the instrument can be protected by this function is for reference purposes only, and is not a guaranteed value. The instrument may be damaged depending on operating conditions, for example the frequency at which charged capacitors are connected and whether a series of charged capacitors has been connected. In general, you should not rely upon this protection function; be sure to discharge charged capacitors properly before connecting them to the test terminals.
- The residual charge protection function is for protection of the instrument against the discharge of voltage present in charged capacitors, and is not capable of protecting the instrument against DC voltage which is constantly applied such as a superimposed DC voltage. If this is done, there is a danger of damage to the instrument.  
See “Appx. 5 Supplying DC Bias” (p. Appx.6).

The residual load protection function, which protects the instrument’s internal circuitry from the capacitor’s discharge voltage in the event a charged capacitor is inadvertently connected to a measurement terminal, has been enhanced.

The maximum voltage from which the instrument can be protected by this function is determined from the capacitance value of the sample under test by the following equation:

$$\begin{aligned}
 V &= 1000 \text{ V} && (C < 1 \text{ } \mu\text{F}) \\
 V &= \sqrt{1/C} \text{ V} && (1 \text{ } \mu\text{F} \leq C < 6.25 \text{ } \mu\text{F}) \\
 V &= 400 \text{ V} && (6.25 \text{ } \mu\text{F} \leq C < 62.5 \text{ } \mu\text{F}) \\
 V &= \sqrt{10/C} \text{ V} && (62.5 \text{ } \mu\text{F} \leq C)
 \end{aligned}$$

C: Capacitance of the measurement sample[F]

#### Relationship of capacitance and residual voltage from which the LCR meter can be protected

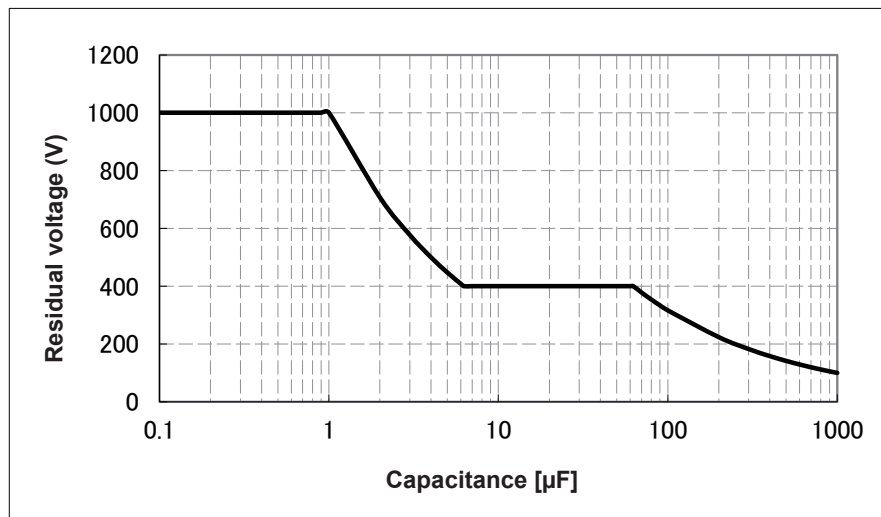

## Appx. 7 Series Equivalent Circuit Mode and Parallel Equivalent Circuit Mode

The instrument measures the current flowing to the test sample and the voltage at both ends of the test sample, and determines  $Z$  and  $\theta$ . Other measurement items such as  $L$ ,  $C$ , and  $R$  are calculated from  $Z$  and  $\theta$ .

At this time, the mode for calculation becomes series equivalent circuit mode if the resistance components for  $C$  (or  $L$ ) are assumed to be in series, and the mode becomes parallel equivalent circuit mode if the resistance components for  $C$  (or  $L$ ) are assumed to be in parallel. It is, therefore, necessary to select the parameter of the correct equivalent circuit mode to reduce errors because the calculation formula differs for series equivalent circuit mode and parallel equivalent circuit mode.

Generally, for measurement of a low impedance device (approx. less than  $100\ \Omega$ ) like a large capacitance capacitor or a low inductance, a series equivalent circuit mode will be selected. While, for a high impedance device (approx. more than  $10\ \text{k}\Omega$ ) like a small capacitance capacitor or a high inductance, a parallel-equivalent circuit mode will be selected. When you are not sure about selection of circuit mode, please ask the parts maker. (ex. a impedance approx. between  $100\ \Omega$  and  $10\ \text{k}\Omega$ )

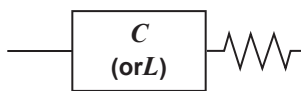

Series equivalent circuit

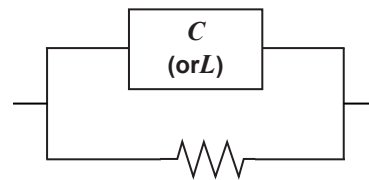

Parallel equivalent circuit

Although both values can be displayed since measured values in equivalent circuit modes are calculated, the appropriate equivalent circuit will vary with the sample.

## Appx. 8 Open Correction and Short Correction

The residual impedance component of the test fixture can be considered in terms of an equivalent circuit as shown in the figure. Further, because the measured value  $Z_m$  for impedance includes this residual component, therefore, in order to obtain the genuine impedance value, it is necessary to compensate the measured value in terms of the open circuit impedance residual component and the short circuit residual component, which accordingly must be obtained.

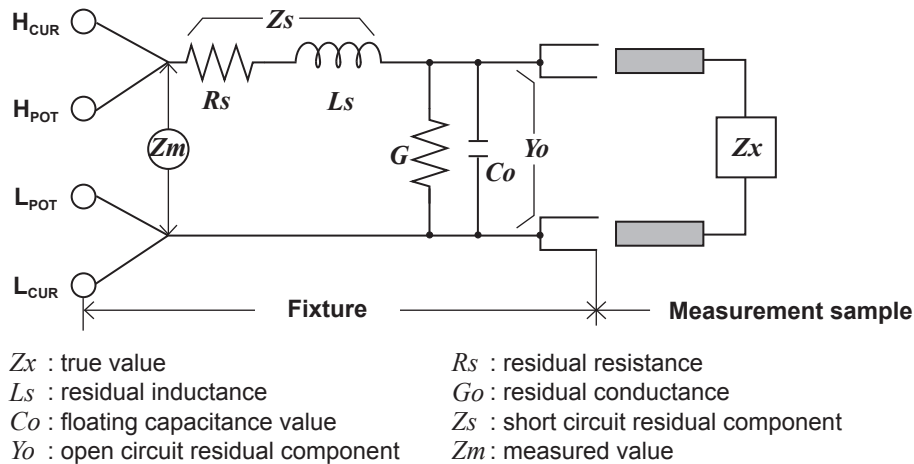

In this case, for the measured value  $Z_m$ :

$$Z_m = Z_s + \frac{1}{Y_o + \frac{1}{Z_x}}$$

The residual components can be determined in the following manner:

### Open correction:

The terminals of the test fixture are left separated (open circuited). Because the short circuit residual component  $Z_s$  is now zero, therefore the open circuit residual component  $Y_o$  can be determined.

### Short correction:

The terminals of the test fixture are connected together (short circuited).

Because the open circuit residual component  $Y_o$  is now zero, therefore the short circuit residual component  $Z_s$  can be determined.

These residual components thus obtained are recorded as compensation values, and the compensation process may then be performed by substituting them into the above equation.

The determination of test range is performed according to the measured value  $Z_m$  for impedance. Therefore it may happen that testing cannot be performed, when **HOLD** is on, if the test range is determined merely according to the value of impedance of the sample under test. In this case, you should set the test range in consideration both of the impedance of the test sample and also of the residual impedance components of the test fixture.

Deviations in the measured values can become comparatively large in the following cases:

### If only open correction has been performed.:

With open correction only having been performed, since no correction can be performed in terms of the short circuit residual component  $Z_s$  (which is not available), thereby deviation in the resultant values will become large if the value of that short circuit residual component  $Z_s$  is relatively large.

### If only short correction has been performed.:

With short correction only having been performed, since no correction can be performed in terms of the open circuit residual component  $Y_o$  (which is not available), thereby deviation in the resultant values will become large if the value of that open circuit residual component  $Y_o$  is relatively large.

Be sure to perform both types of correction to avoid this situation.

# Appx. 9 Attaching Rack-Mounting Hardware to the Instrument

## ⚠ WARNING

Observe the following precautions regarding the mounting screws to avoid instrument damage and electric shock accidents.



- When installing the rack mounting plate, the screws must not intrude more than 6 mm into either side of the instrument.
- When removing the rack mounting plate to return the instrument to stand-alone use, replace the same screws that were installed originally. (Feet: M3 × 6 mm, Sides: M4 × 6 mm)

Parts removed from this instrument should be stored in a safe place to enable future reuse. See "Installation instructions" (p. 14) also. Rack mounting brackets can be attached to the instrument.

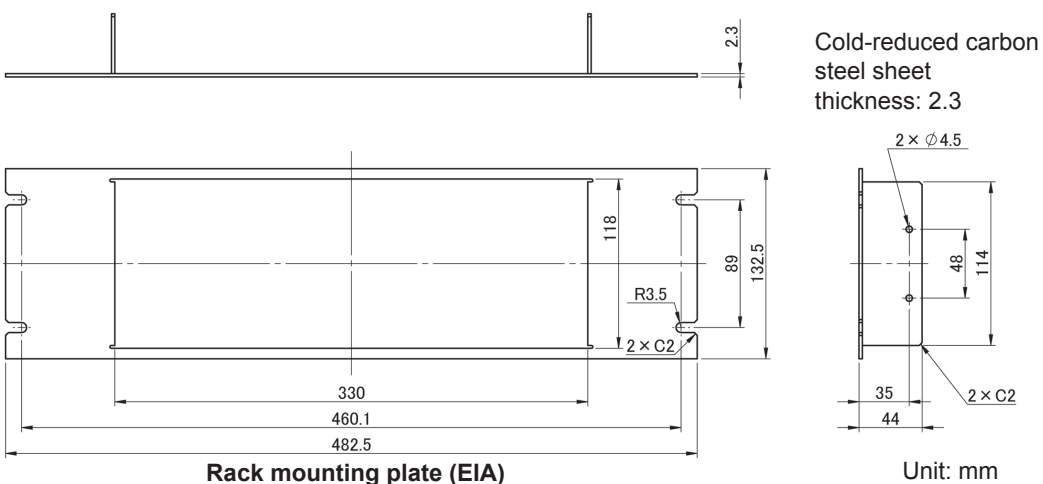
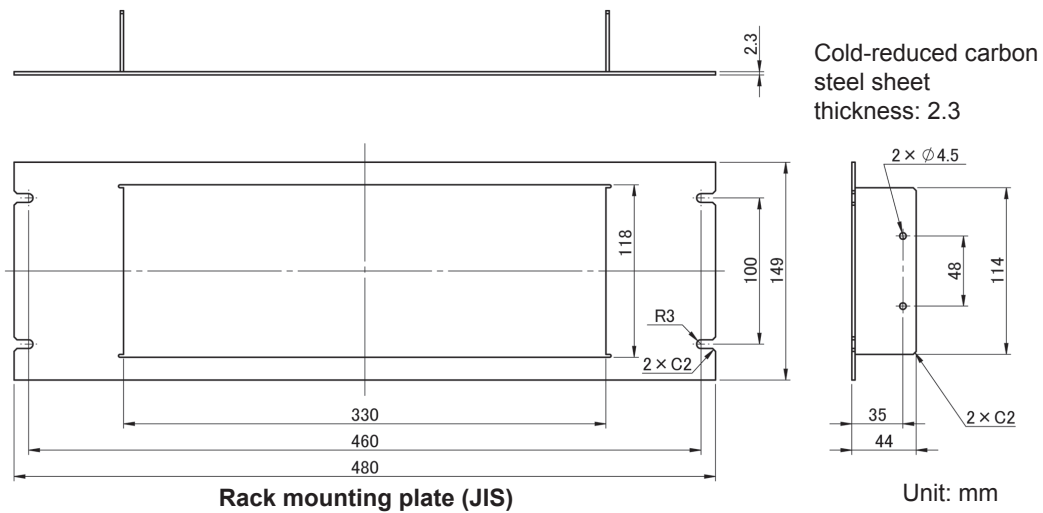
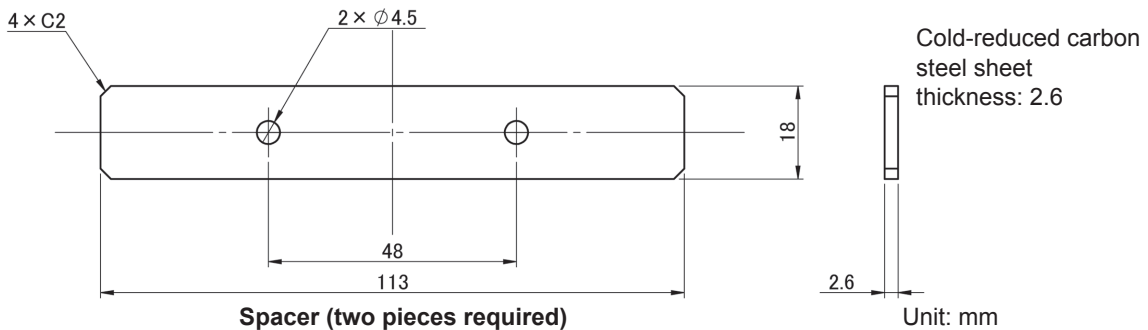

## Installation procedure

- 1** Remove the feet from the bottom of the instrument, and the screws from the sides (four near the front).

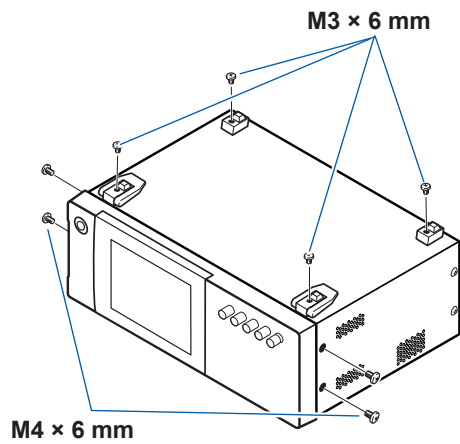

- 2** Installing the spacers on both sides of the instrument, affix the Rack Mounting Plate with the M4 × 12 mm screws.

When installing into the rack, reinforce the installation with a commercially available support stand.

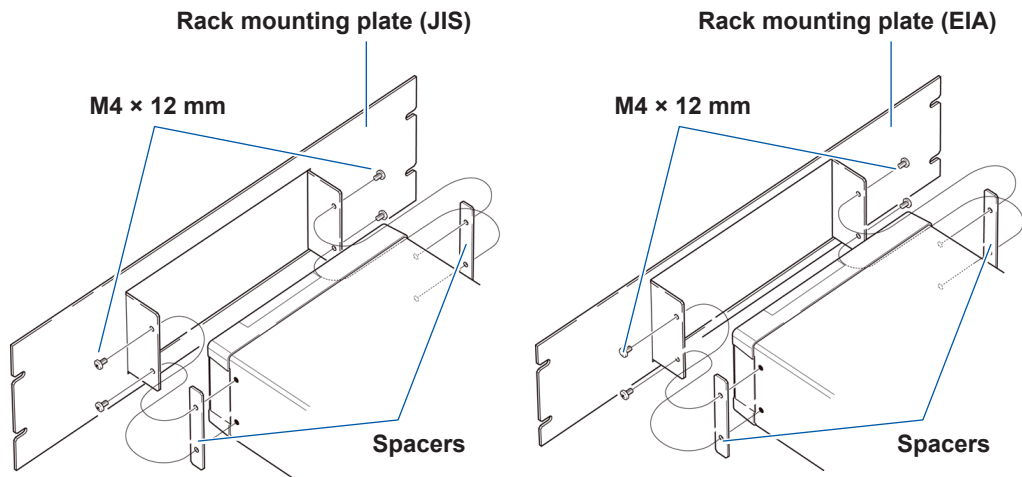

# Appx. 10 Dimensional Diagram

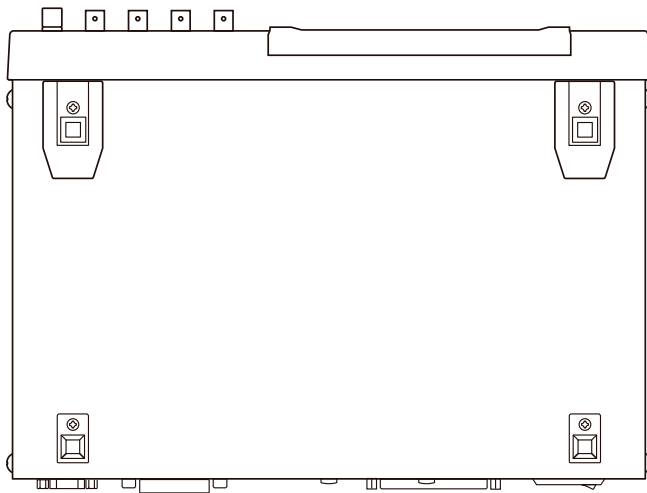
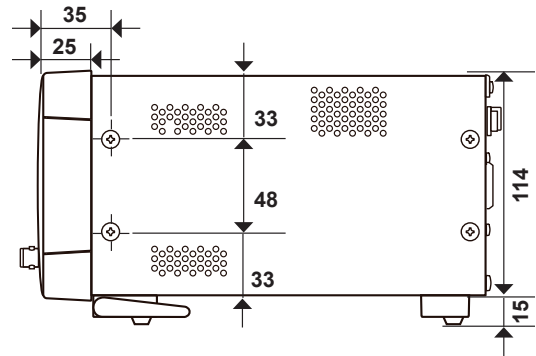
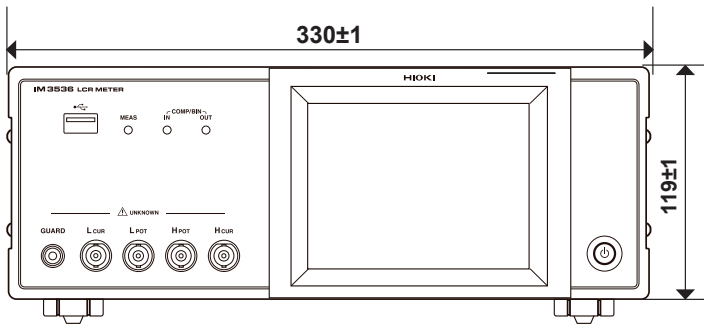
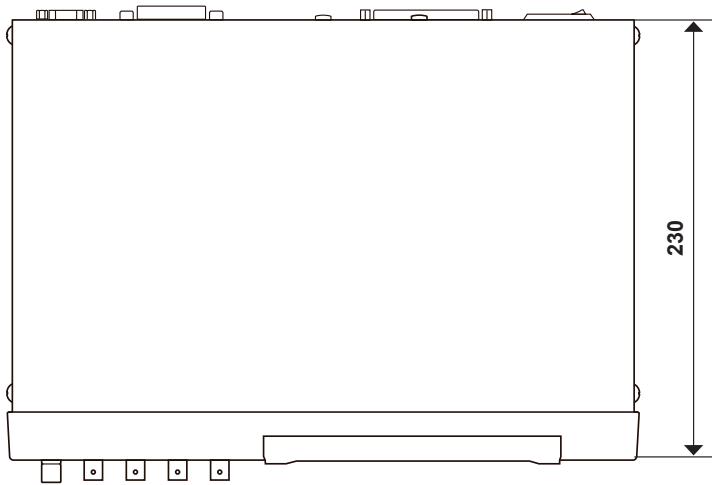

(Unit: mm)

## Appx. 11 Initial Settings Table

The following table shows the initial settings of the instrument.

This following information is also included:

- Setting status after initialization
- Whether the setting reverts to its default value when the instrument is turned on
- Whether the setting is included in panel save/load operation
- Whether the setting is included in file save/load operation

For more information about initialization, see the following sections:

- System reset initiated on the instrument : See “Initializing (system reset)” (p. 236).
- Full reset initiated on the instrument : See “Performing a full reset (If you are unable to perform a system reset)” (p. 237).
- Initialization initiated with a command (\*RST, :PRESet) : See the descriptions of the \*RST and :PRESet commands in the Communications Command User Manual on the bundled LCR Application Disc.

Yes: Available, No: Unavailable, ←: The same as the initial setting

Setting Items	Default setting	Initialized initiated on instrument	Initialization initiated with command		Reverts to default value at power-on	Panel save/ Load	File save/ Load
			*RST	:PRESet			
Measurement mode	LCR	←	←	←	No	Yes	Yes
Measurement parameter	Z/OFF/θ/OFF	←	←	←	No	Yes	Yes
Magnification display	OFF	←	←	←	No	No	Yes



Initial Settings Table

Setting Items		Default setting	Initialized initiated on instrument	Initialization initiated with command		Reverts to default value at power-on	Panel save/ Load	File save/ Load		
				*RST	:PRESet					
Basic settings	Measurement frequency		1 kHz	←	←	←	No	Yes	Yes	
	Measurement signal level	Mode	V	←	←	←	No	Yes	Yes	
		V	1.000 V	←	←	←	No	Yes	Yes	
		CV	1.000 V	←	←	←	No	Yes	Yes	
		CC	10.00 mA	←	←	←	No	Yes	Yes	
	Limit	ON/OFF		OFF	←	←	←	No	Yes	Yes
		Current limit value		100.00 mA	←	←	←	No	Yes	Yes
		Voltage limit value		5.00 V	←	←	←	No	Yes	Yes
	DC bias	ON/OFF		OFF	←	←	←	No	Yes	Yes
		Bias value		0.00 V	←	←	←	No	Yes	Yes
	Trigger mode		INT (Internal Trigger)	←	←	←	No	Yes	Yes	
	Measurement range	Mode		AUTO	←	←	←	No	Yes	Yes
		AUTO range control function		100 mΩ/100 MΩ	←	←	←	No	Yes	Yes
		Range		100Ω	←	←	←	No	Yes	Yes
		Judgment synchronization setting		OFF	←	←	←	No	Yes	Yes
		LOW Z		OFF	←	←	←	No	Yes	Yes
	Measurement speed		MED	←	←	←	No	Yes	Yes	
	Number of times for average		1	←	←	←	No	Yes	Yes	
	Trigger delay		0.0000 s	←	←	←	No	Yes	Yes	
	Trigger synchronous output	ON/OFF		OFF	←	←	←	No	Yes	Yes
Trigger time		0.0010 s	←	←	←	No	Yes	Yes		
AC range synchronization function <sup>1)</sup>	Measurement speed		MED	←	←	←	No	Yes	Yes	
	Number of times for average		1	←	←	←	No	Yes	Yes	
	Trigger delay		0.0000 s	←	←	←	No	Yes	Yes	
	Trigger synchronous output	ON/OFF		OFF	←	←	←	No	Yes	Yes
		Trigger time		0.0010 s	←	←	←	No	Yes	Yes

Setting Items		Default setting	Initialized initiated on instrument	Initialization initiated with command		Reverts to default value at power-on	Panel save/ Load	File save/ Load		
				*RST	:PRESet					
DC measurement (LCR mode)	DC adjustment		ON	←	←	←	No	Yes	Yes	
	DC delay		0.0000 s	←	←	←	No	Yes	Yes	
	Adjustment delay		0.0030 s	←	←	←	No	Yes	Yes	
	Line frequency		60 Hz	←	←	←	No	Yes	Yes	
	Measurement range	Mode		AUTO	←	←	←	No	Yes	Yes
		AUTO range control function		100 mΩ/100 MΩ	←	←	←	No	Yes	Yes
		Range		100 Ω	←	←	←	No	Yes	Yes
		Judgment synchronization setting		OFF	←	←	←	No	Yes	Yes
		LOW Z		OFF	←	←	←	No	Yes	Yes
	Measurement speed		MED	←	←	←	No	Yes	Yes	
Number of times for average		1	←	←	←	No	Yes	Yes		
DC range synchronization function <sup>*1</sup>	Measurement speed		MED	←	←	←	No	Yes	Yes	
	Number of times for average		1	←	←	←	No	Yes	Yes	
Application settings	Judgment mode		OFF	←	←	←	No	Yes	Yes	
	Memory	OFF/IN/ON	OFF	←	←	←	No	No	Yes	
		Number of memory items	1000	←	←	←	No	No	Yes	
	Range synchronization function		OFF	←	←	←	No	Yes	Yes	
	Waveform averaging function	ON/OFF	OFF	←	←	←	No	Yes	Yes	
No. of waveform averages for each frequency band		Number of MED waveform averages	←	←	←	No	Yes	Yes		

Setting Items		Default setting	Initialized initiated on instrument	Initialization initiated with command		Reverts to default value at power-on	Panel save/ Load	File save/ Load	
				*RST	:PRESet				
Application settings	Conductivity/ permittivity	Capacitance	Cs	←	←	←	No	Yes	Yes
		Sample length	20.00000 mm	←	←	←	No	Yes	Yes
		Sample cross-sectional area	12.00000 mm <sup>2</sup>	←	←	←	No	Yes	Yes
	Judgment result	Delay between judgment results and EOM	0.0000 s	←	←	←	No	No	Yes
		Reset	ON	←	←	←	No	No	Yes
	IO trigger	ENABLE	ON	←	←	←	No	No	Yes
		Edge	DOWN	←	←	←	No	No	Yes
	IO EOM	Mode	HOLD	←	←	←	No	No	Yes
		EOM output time	0.0050 s	←	←	←	No	No	Yes
	IO BCD	ON/OFF	OFF	←	←	←	No	No	Yes
		Position of the decimal point	9.99999G/ 9.99999G	←	←	←	No	No	Yes
	High-Z reject	ON/OFF	OFF	←	←	←	No	Yes	Yes
		Judgment reference value	1000%	←	←	←	No	Yes	Yes
	Contact check	Timing	OFF	←	←	←	No	Yes	Yes
		Threshold	4	←	←	←	No	Yes	Yes
		Delay time	0.0000	←	←	←	No	Yes	Yes
	Display digits		6/6/6/6	←	←	←	No	Yes	Yes
	LCD Display	ON/OFF	ON	←	←	←	No	No	Yes
	Beep sound	Judgment result	NG	←	←	←	No	Yes	Yes
		Key	ON	←	←	←	No	No	Yes
Beep tone		A	←	←	←	No	No	Yes	
Key-lock	ON/OFF	OFF	←	←	←	No	No	Yes	
	Passcode	3536	←	←	←	No	No	Yes	
Comparator (LCR mode)	Mode		ABS/ABS	←	←	←	No	Yes	Yes
	Absolute value mode	Upper limit value	OFF/OFF	←	←	←	No	Yes	Yes
		Lower limit value	OFF/OFF	←	←	←	No	Yes	Yes
	Percent mode Deviation percentage mode	Reference value	1.0000 k /10.0000	←	←	←	No	Yes	Yes
		Upper limit value	OFF/OFF	←	←	←	No	Yes	Yes
		Lower limit value	OFF/OFF	←	←	←	No	Yes	Yes

Setting Items		Default setting	Initialized initiated on instrument	Initialization initiated with command		Reverts to default value at power-on	Panel save/ Load	File save/ Load	
				*RST	:PRESet				
BIN	Mode		ABS/ABS	←	←	←	No	Yes	Yes
	Absolute value mode	Upper limit value	OFF/OFF	←	←	←	No	Yes	Yes
		Lower limit value	OFF/OFF	←	←	←	No	Yes	Yes
	Percent mode Deviation percentage mode	Reference value	1.0000 k/10.0000	←	←	←	No	Yes	Yes
		Upper limit value	OFF/OFF	←	←	←	No	Yes	Yes
		Lower limit value	OFF/OFF	←	←	←	No	Yes	Yes
Continuous measurement	Display timing		REAL	←	←	←	No	No	Yes
Open correction	Correction mode		OFF	←	←	No Change	No	Yes <sup>*2</sup>	Yes
	Correction value	G Correction value	0.000 ns	←	←	No Change	No	Yes <sup>*2</sup>	Yes
		B Correction value	0.000 ns	←	←	No Change	No	Yes <sup>*2</sup>	Yes
	Correction range limit function	DC	ON	←	←	No Change	No	Yes <sup>*2</sup>	Yes
		MIN	4 Hz	←	←	No Change	No	Yes <sup>*2</sup>	Yes
		MAX	8 MHz	←	←	No Change	No	Yes <sup>*2</sup>	Yes
Short correction	Correction mode		OFF	←	←	No Change	No	Yes <sup>*2</sup>	Yes
	Correction value	R Correction value	0.00 mΩ	←	←	No Change	No	Yes <sup>*2</sup>	Yes
		X Correction value	0.00 mΩ	←	←	No Change	No	Yes <sup>*2</sup>	Yes
	Correction range limit function	DC	ON	←	←	No Change	No	Yes <sup>*2</sup>	Yes
		MIN	4 Hz	←	←	No Change	No	Yes <sup>*2</sup>	Yes
		MAX	8 MHz	←	←	No Change	No	Yes <sup>*2</sup>	Yes

Setting Items		Default setting	Initialized initiated on instrument	Initialization initiated with command		Reverts to default value at power-on	Panel save/ Load	File save/ Load	
				*RST	:PRESET				
Load correction	ON/OFF		OFF	←	←	No Change	No	Yes <sup>2</sup>	Yes
	Correction mode		Z-θ	←	←	No Change	No	Yes <sup>2</sup>	Yes
	Reference value	Z Reference value	OFF	←	←	No Change	No	Yes <sup>2</sup>	Yes
		θ Reference value	OFF	←	←	No Change	No	Yes <sup>2</sup>	Yes
	Correction frequency		OFF	←	←	No Change	No	Yes <sup>2</sup>	Yes
	Correction signal level	Mode	V	←	←	No Change	No	Yes <sup>2</sup>	Yes
		V	OFF	←	←	No Change	No	Yes <sup>2</sup>	Yes
		CV	OFF	←	←	No Change	No	Yes <sup>2</sup>	Yes
		CC	OFF	←	←	No Change	No	Yes <sup>2</sup>	Yes
	Correction range	Range	OFF	←	←	No Change	No	Yes <sup>2</sup>	Yes
		LOW Z	OFF	←	←	No Change	No	Yes <sup>2</sup>	Yes
	Correction DC bias	ON/OFF	OFF	←	←	No Change	No	Yes <sup>2</sup>	Yes
		Bias value	0.00 V	←	←	No Change	No	Yes <sup>2</sup>	Yes
	Correction value	Z coefficient	OFF	←	←	No Change	No	Yes <sup>2</sup>	Yes
		θ coefficient	OFF	←	←	No Change	No	Yes <sup>2</sup>	Yes
Cable length correction		0 m	←	←	No Change	No	Yes	Yes	
Scaling correction (Correlation Correction)	ON/OFF		OFF	←	←	No Change	No	Yes <sup>2</sup>	Yes
	Correction value	A	1.000	←	←	No Change	No	Yes <sup>2</sup>	Yes
		B	0.00000	←	←	No Change	No	Yes <sup>2</sup>	Yes

Setting Items		Default setting	Initialized initiated on instrument	Initialization initiated with command		Reverts to default value at power-on	Panel save/ Load	File save/ Load	
				*RST	:PRESet				
Panel	Save type		ALL	←	←	←	No	No	Yes
	Panel registration		None	Clear all data	Clear all data	No Change	No	No	Only when ALL SAVE
Interfaces	USB	Terminator	CR+LF	←	No Change	No Change	No	No	Yes
	GP-IB	Address	01	←	No Change	No Change	No	No	Yes
		Terminator	LF	←	No Change	No Change	No	No	Yes
	RS-232C	Baud rate	9600	←	No Change	No Change	No	No	Yes
		Handshake	OFF	←	No Change	No Change	No	No	Yes
		Terminator	CR+LF	←	No Change	No Change	No	No	Yes
	LAN	IP address	192.168.000.001	←	No Change	No Change	No	No	Yes
		Subnet mask	255.255.255.000	←	No Change	No Change	No	No	Yes
		Gateway	OFF	←	No Change	No Change	No	No	Yes
		Port	3500	←	No Change	No Change	No	No	Yes
		Terminator	CR+LF	←	No Change	No Change	No	No	Yes
	Header		OFF	←	←	No Change	Yes	No	No
	Status Byte register <sup>*3</sup>		0	No Change <sup>*4</sup>	No Change	No Change	Yes	No	No
	Event register <sup>*3</sup>		0	No Change <sup>*4</sup>	No Change	No Change	Yes	No	No
	Enable register <sup>*3</sup>		0	No Change <sup>*4</sup>	No Change	No Change	Yes	No	No
Measurement parameter <sup>*3</sup> (:MEASure:ITEM)		0,0,0	←	←	←	No	No	Yes	

Initial Settings Table

Setting Items		Default setting	Initialized initiated on instrument	Initialization initiated with command		Reverts to default value at power-on	Panel save/ Load	File save/ Load	
				*RST	:PRESet				
Interface	Response data to measured value acquisition query <sup>*3</sup> (:MEASure:VALid)	10	←	←	←	No	No	Yes	
	Measured value automatic output <sup>*3</sup> (:MEASure:OUTPut:AUTO)	OFF	←	←	←	No	No	Yes	
	Transfer format <sup>*3</sup> (:FORMat:DATA)	ASCII	←	←	←	No	No	Yes	
	Long format <sup>*3</sup> (:FORMat:LONG)	OFF	←	←	←	No	No	Yes	
File	Save Format	OFF	←	←	←	No	No	Yes	
	Save folder	AUTO	←	←	←	No	No	Yes	
	Header	Date and time	ON	←	←	←	No	No	Yes
		Measurement conditions	ON	←	←	←	No	No	Yes
		Measurement parameters	ON	←	←	←	No	No	Yes
		Delimiter	,(Comma)	←	←	←	No	No	Yes
Quote	"(Double quote)	←	←	←	No	No	Yes		
Touch panel calibration		No calibration	No Change <sup>*5</sup>	No Change	No Change	No	No	No	
Clock		No setting	No Change <sup>*4</sup>	No Change	No Change	No	No	No	

\*1: All 10 ranges will be initialized as described.

\*2: The panel's save type (**SAVE TYPE**) is not saved in **HARD** mode.

\*3: Setting can only be changed using commands.

\*4: Setting will not change, even during a full reset.

\*5: Setting reverts to its factory default during a full reset.

# Appx. 12 Device Compliance Statement

"Information on compliance to standards" based on the IEEE 488.2 standard

	Item	Description
1	IEEE 488.1 interface functions	See "GP-IB specifications" in the Communications Instruction Manual on the bundled LCR Application Disc.
2	Operation with a device address other than 0 through 30	Such a setting is not possible.
3	Timing of changed device address recognition	A change of address is recognized immediately after changing.
4	Device settings at power on	The explanatory status information for hardware settings will be cleared when the instrument is turned on. Otherwise, data is backed up. However, the header on/off setting, and response message separator and terminator are all reinitialized.
5	List of message exchange options	<ul style="list-style-type: none"> <li>• Input buffer capacity and operation (See the bundled LCR Application Disc.)</li> <li>Queries to which multiple response message instruments are returned</li> </ul> <pre> :BIN:FLIMit:ABSolute? .....2 :BIN:FLIMit:DEVIation? .....2 :BIN:FLIMit:PERcent? .....2 :BIN:SLIMit:ABSolute? .....2 :BIN:SLIMit:DEVIation? .....2 :BIN:SLIMit:PERcent? .....2 :COMParator:FLIMit:ABSolute? .....2 :COMParator:FLIMit:DEVIation? .....3 :COMParator:FLIMit:PERcent? .....3 :COMParator:SLIMit:ABSolute? .....2 :COMParator:SLIMit:DEVIation? .....3 :COMParator:SLIMit:PERcent? .....3 :CORRection:LIMit:POINt .....2 :CORRection:OPEN:DATA:ALL .....* :CORRection:OPEN:DATA:SPOT .....* :CORRection:SHORT:DATA:ALL .....* :CORRection:SHORT:DATA:SPOT .....* :CORRection:LOAD:CONDition? .....7 :CORRection:LOAD:DCResistance:CONDition? .....2 :CORRection:LOAD:REFerence? .....3 :CORRection:SCALE:DATA? .....2 :DCResistance:RANGE:AUTO:LIMit .....2 :FILE:INFORMation? .....5 :MEASure? .....* :MEASure:ITEM? .....3 :MONItor? .....4 :RANGE:AUTO:LIMit .....2 :SAVE:MODE? .....2 :SIGMa? .....2 :SYSTem:DATE? .....3 :SYSTem:TIME? .....3 </pre> <ul style="list-style-type: none"> <li>* The number of response messages varies depending on the settings.</li> <li>• Queries producing responses as syntax checking is performed: All queries produce responses when syntax checking is performed.</li> <li>• Whether any queries produce responses when read: There are no queries which produce response messages at the instant they are read in by the controller.</li> <li>• Whether any commands are coupled: There are no relevant commands.</li> </ul>



Item		Description
6	Summary of functional elements for use when constructing device specific commands, and whether compound commands or program headers can be used:	The followings can be used <ul style="list-style-type: none"> <li>• Program message</li> <li>• Program message terminator</li> <li>• Program message unit</li> <li>• Program message unit separator</li> <li>• Command message unit</li> <li>• Query message unit</li> <li>• Command program header</li> <li>• Query program header</li> <li>• Program data</li> <li>• Character program data</li> <li>• Decimal program data</li> <li>• Compound commands and program headers</li> </ul>
7	Buffer capacity limitations for block data	Block data is not used.
8	Summary of program data elements used in expressions, and deepest nesting level allowable in sub-expressions, including syntax restrictions imposed by the device.	Sub-expressions are not used. Character data and decimal data are the only program data elements used.
9	Response syntax for queries	See the bundled LCR Application Disc.
10	Transmission congestion relating to device-to device messages which do not conform to the general principles for basic response messages	There are no device to device messages.
11	Response capacity for block data	Block data does not appear in responses.
12	Summary of standard commands and queries used	See the bundled LCR Application Disc.
13	Device state after a calibration query has been completed without any problem	The <b>*CAL?</b> query is not used.
14	Existence/nonexistence of the <b>*DDT</b> command	The <b>*DDT</b> query is not used.
15	Existence/nonexistence of macro command	Macros are not used.
16	For queries related to identification, explanation of the response to the <b>*IDN?</b> query	See the <b>*IDN?</b> query in the Communications Instruction Manual on the bundled LCR Application Disc.
17	Capacity of the user data storage area reserved for when the <b>*PUD</b> command and the <b>*PUD?</b> query are being executed	The <b>*PUD</b> command and the <b>*PUD?</b> query are not used. Further, there is no user data storage area.
18	Resources when the <b>*RDT</b> command and the <b>*RDT?</b> query are being used	The <b>*RDT</b> command and the <b>*RDT?</b> query are not used. Further, there is no user data storage area.
19	Conditions which are influenced when the <b>*RST</b> command and the <b>*LRN?</b> and <b>*RCL?</b> queries, and the <b>*SAV</b> command are used	The <b>*LRN?</b> and <b>*RCL?</b> queries and the <b>*SAV</b> command are not used. The <b>*RST</b> command returns the instrument to its initial state. See the <b>*RST</b> command in the Communications Instruction Manual on the bundled LCR Application Disc.
20	Scope of the self-testing executed as a result of the <b>*TST?</b> query	See the <b>*TST?</b> query in the Communications Instruction Manual on the bundled LCR Application Disc.
21	Additional organization of the status data used in a device status report	See the Communications Instruction Manual on the bundled LCR Application Disc
22	Whether commands are overlap or sequential type	All commands except the <b>:MEASure?</b> and <b>:MEMory?</b> queries and the <b>:CORRection:OPEN</b> , <b>:CORRection:SHORT</b> , and <b>:CORRection:LOAD</b> commands are sequence commands.
23	Criterion relating to the functions required at the instant that the termination message is produced, as a response to each command	Termination occurs when the command has been parsed.

# Index

## Symbol

$\sigma\epsilon$  key ..... 71

## Numbers

2-terminal measurement  
  Detecting contact errors ..... 88  
4-terminal measurement  
  Detecting poor contact ..... 89

## A

Absolute value setting ..... 75, 80  
Accessories ..... 2  
Accuracy ..... 199, 215  
  Calculation example ..... 217–218  
AC measurement ..... 42, 46  
ADJ DELAY key ..... 66  
ADJ screen ..... 29  
Adjustment delay ..... 66, 69–70  
Admittance ..... 42  
All correction (Open correction) ..... 106  
All correction (Short correction) ..... 113  
ALL LOAD key ..... 164  
Application settings ..... 83  
Applying the signal to the measurement sample  
  during measurement only ..... 68  
AREA key ..... 108  
AUTO range ..... 48  
  Limiting the range ..... 49  
  Unable to determine ..... 234  
Averaging ..... 60  
AVG key ..... 60

## B

Backup battery life ..... 199  
Basic settings ..... 46  
BCD mode ..... 176–177, 192  
BEEP key ..... 96  
Beep sound ..... 96  
Beep sound is emitted continuously ..... 235  
BIN function ..... 78  
  Settings ..... 78–82  
BIN measurement ..... 72

## C

CABLE key ..... 104  
Cable length correction ..... 104  
CALIBRATION key ..... 142  
Capacitance ..... 42  
Capacitor measurement ..... 63  
CC ..... 52  
Changing a panel name ..... 137

Circuit ..... Appx.4  
Circuit diagrams ..... 184  
Cleaning ..... 230  
Clean the instrument ..... 230  
Communication commands ..... 194  
Comparator function  
  Settings ..... 73–77  
Comparator measurement ..... 72  
Conditions/correction values  
  Load ..... 136  
Conductance ..... 42  
Conductivity ..... 42, 71  
Connection examples ..... 186–187  
Connector ..... 20–21  
Constant current ..... 52  
Constant voltage ..... 52  
Contact check function ..... 89  
CONTACT key ..... 89  
Continuous measurement ..... 99  
Correction ..... 29, 103  
  Disabling (Load correction) ..... 128  
  Disabling (Open/Short correction) ..... 118  
  Fails (Load correction) ..... 127  
  Fails (Open or Short Correction) ..... 116  
  User specified correction coefficient ..... 129–130  
Correction value data ..... 131  
  Save ..... 131  
Current limit ..... 62  
CV ..... 52

## D

DC ADJ key ..... 64  
DC adjustment function ..... 64–65  
DC bias ..... Appx.6  
DC bias current ..... Appx.8  
DC bias function ..... 63, 199  
DC BIAS key ..... 63  
DC bias voltage ..... Appx.7  
DC delay ..... 65, 69–70  
DC DELAY key ..... 65  
DC measurement ..... 42, 46  
DC resistance measurement ..... 42, 46, 199  
DELAY key ..... 67  
Delay time  
  Between the trigger and measurement ..... 67  
  DC measurement ..... 65  
  From judgment result output to EOM signal  
  output ..... 189  
  Offset measurement ..... 66  
DELETE key ..... 166  
Deleting a panel ..... 138  
Detecting poor contact ..... 89  
Deviation percentage setting ..... 76, 81  
dgt ..... 13  
Dielectric strength ..... 200  
DIGIT key ..... 94  
Dimensional diagram ..... Appx.14

Dimensions.....	200
Disc.....	2, 17
Discarding.....	243
DISP key.....	95, 102
Display.....	20
Auto-off.....	95, 102
does not appear.....	231
Shorten the screen update interval.....	101
DISPLAY & LED TEST key.....	142
Display parameters.....	41
Display timing.....	101
DRAW key.....	101

## E

---

Effective resistance.....	42
EMI ferrite-core.....	Appx.5
Enlarging display.....	45
Environment.....	200
EOM signal output method and output time.....	191
Equivalent parallel capacitance.....	42
Equivalent parallel resistance.....	42
Equivalent series capacitance.....	42
Equivalent series resistance.....	42
Error	
Output signals.....	178
Error display.....	11, 238
Error message.....	11, 44, 238
Exhibiting excessive variation of the measurement value.....	232–233
External control.....	169
Q&A.....	193
External noise.....	Appx.5
External trigger.....	66
EXT I/O.....	143
Connector.....	17, 21, 170, 213
Example connections.....	184

## F

---

Features.....	19
File.....	31
Delete.....	166
FILE screen.....	31
Fixture.....	37
Folder	
Create.....	167
Delete.....	166
Specify the data save destination.....	160
FOLDER key.....	167
Format	
USB flash drive.....	148
FORMAT key.....	148
FREQ key.....	47
Frequency.....	47
f.s.....	13
Full reset.....	237

Functions.....	20
Function specifications.....	201–212

## G

---

GP-IB connector.....	21, 214
Guaranteed accuracy range.....	221
Guarding.....	Appx.4

## H

---

High impedance components.....	Appx.3
High-precision measurement.....	59
High-Z reject function.....	88
Hi Z key.....	88
HOLD.....	48

## I

---

Iac.....	44
I <sub>dc</sub> .....	44
I/F tab.....	140
Impedance.....	42
Increasing measurement precision.....	86
Increasing measurement speed.....	86
Inductance.....	42
INFORMATION.....	28
INFO tab.....	140
Initialization.....	Appx.15
Initializing.....	236
Initial settings.....	Appx.15
Input (IN) signal.....	175
Input/output signals test.....	143
Inspection.....	35, 229
Instrument installation.....	14
Interface.....	30, 140
Specifications.....	213–214
Internal circuitry.....	184
Internal memory errors.....	143
Internal trigger.....	66
IO BCD key.....	192
IO EOM key.....	191
I/O HANDLER TEST key.....	143
IO JUDGE key.....	189
IO TRIG key.....	190

## J

---

JUDGE key.....	73
Judgement.....	72
Judgement results	
Output.....	192
JUDGE SYNC.....	48
Judgment mode.....	73
Judgment result	
Reset.....	189

Judgment tones ..... 96

## K

Key-lock ..... 97  
 Disable ..... 98  
 KEYLOCK key ..... 97  
 Keys do not work ..... 231  
 Key tones ..... 96

## L

LAN connector ..... 21, 214  
 LCD display  
 Auto-off ..... 95, 102  
 LCR application disc ..... 17  
 LCR Application disc ..... 2  
 LCR mode ..... 41  
 LED ..... 20  
 Status test ..... 142  
 Level ..... 52, 196  
 LEVEL key ..... 52  
 Lifetimes ..... 229  
 Limit ..... 62  
 Limit function ..... 197  
 Limiting display value instability ..... 60  
 Limiting the voltage and current applied to the sample ..... 62  
 LIMIT key ..... 62  
 LINE FREQ key ..... 57  
 Line frequency ..... 57  
 LIST key ..... 84–85  
 LIST tab ..... 147  
 Lithium battery ..... 243  
 Load correction ..... 119  
 Correction frequency ..... 122  
 Correction range ..... 123  
 Correction signal level ..... 124  
 DC bias ..... 125  
 Parameter ..... 125  
 Reference values ..... 126  
 Reset the correction condition ..... 127  
 Loading settings ..... 163–164  
 LOAD key ..... 120, 127, 128, 163  
 Loss factor ..... 42  
 Low Z high accuracy mode ..... 59, 198

## M

Manufacturer's serial number ..... 21  
 Mass ..... 200  
 Measurable range for C ..... 224  
 Measurable range for L ..... 224  
 Measured values ..... 44  
 Output ..... 192  
 Measurement accuracy ..... 215  
 Calculation example ..... 217–218

Measurement cables ..... 37  
 Measurement categories ..... 13  
 Measurement conditions ..... 28, 46, 131  
 For individual measurement ranges ..... 83–85  
 Measurement conditions/Correction values  
 Save ..... 132–135  
 Measurement error ..... 64  
 Measurement frequency ..... 47, 196  
 Measurement items ..... 195  
 Measurement mode ..... 26  
 Measurement range ..... 48–51, 198, 215  
 Measurement results  
 Continuous measurement ..... 100  
 Judgment ..... 72  
 Save ..... 91  
 Measurement screen ..... 24–25  
 Measurement signal level ..... 52–54, 196  
 Measurement speed ..... 58, 225  
 Measurement time ..... 199  
 Measurement times ..... 225  
 Measurement timing ..... 179–183  
 Memory function ..... 91–92  
 MEMORY key ..... 91  
 MODE screen ..... 26  
 Monitor value ..... 44

## N

Names of parts ..... 20  
 Noise ..... Appx.5  
 Number of effective digits ..... 94

## O

Open circuit voltage ..... 52  
 Open correction ..... 3–5, 105, Appx.11  
 OPEN key ..... 106, 110, 118  
 Operating temperature and humidity ..... 200  
 Options ..... 3  
 Output  
 Judgement result/Measured values ..... 192  
 Output impedance ..... 197  
 Output signals  
 When errors occur ..... 178  
 Outputting measured values ..... 192

## P

Panel ..... 131  
 Panel calibration ..... 142  
 PANEL key ..... 132, 134, 136, 137, 138  
 Panel load ..... 136  
 Panel save ..... 132  
 Panel test ..... 141  
 Parallel equivalent circuit ..... Appx.10  
 Parameters ..... 42  
 Passcode ..... 97–98

PASSCODE key .....	97
Percentage setting.....	76, 81
Permittivity .....	42, 71
Phase angle.....	42
Power cord .....	36
Power line.....	Appx.5
Power-saving.....	95
Power supply .....	20–21
Pre-operation inspection.....	35
Preparations .....	33
Probes .....	37

## Q

---

Q&A.....	231
External control.....	193
Q factor.....	42

## R

---

Rack-mounting .....	Appx.12
Range.....	48, 198
RANGE key .....	49, 50, 51, 59
Range synchronization function .....	83
rdg. ....	13
Reactance .....	42
Repair.....	229, 231
Repair and Inspection.....	229
Replaceable parts.....	229
Replaceable Parts and Operating Lifetimes.....	229
Residual charge protection.....	199, Appx.9
RNG SYNC key .....	83
ROM/RAM test .....	143
ROM/RAM TEST key .....	143
RS-232C connector.....	21, 214

## S

---

SAVE key.....	161
SAVE TO... key.....	160
Saving measurement data.....	149
Saving settings data .....	161–162
SCALE key .....	129
Scaling.....	129–130
Screen .....	22
Screen copy.....	158–159
Screen display status test.....	142
SELECT key .....	163
Self diagnosis .....	141
Series equivalent circuit.....	Appx.10
SET screen.....	27
Settings.....	26
External I/O settings.....	188
Optional.....	46
Required.....	46
Shipping precautions .....	15
Short correction .....	3–5, 112, Appx.11

Shorten the correction time .....	108
SHORT key .....	113, 114, 118
Signal assignments .....	170
Signal level .....	52
Specifications .....	195
Speed .....	58, 225
SPEED key.....	58
Splash screen.....	35, 237
Spot correction (Open correction) .....	110
Spot correction (Short correction).....	114
Standards .....	200
Storage temperature and humidity .....	200
Superimpose a DC voltage.....	63
Susceptance.....	42
Suspended state.....	39
Symbols.....	13
SYS screen.....	30
System.....	30
Test.....	141
System reset.....	236, 237
System settings .....	30, 139

## T

---

Terminals .....	20
Text saving.....	149
The instrument doesn't work. ....	232
Timing.....	69
Timing charts .....	179–183
EXT I/O .....	179
To specify the save folder .....	160
Touch screen .....	22
TOUCH SCREEN TEST key .....	141
Transport .....	2, 230
Trigger .....	66–67
Trigger delay.....	67, 69–70
Trigger input	
Disabled .....	190
Effective edge .....	190
Trigger synchronous delay .....	68, 69–70
Trigger synchronous output.....	68, 69–70
TRIG key .....	66–67, 100
Turning the instrument on.....	15, 38
TYPE key.....	151, 159

## U

---

Unable to communicate with RS-232C.....	235
Unable to perform measurement properly (Unusual measurement value).....	233–234
UNLOCK key .....	98
USB connector .....	21, 213
USB flash drive.....	16–17, 145
Checking the contents of a file .....	165
Checking the contents of files .....	147
Creating folders.....	167
Deleting files and folders.....	166

Format.....	148
Information .....	168
Insert .....	146
Loading instrument settings .....	163–164
Saving settings data.....	161–162
Using a computer .....	194

## V

---

V .....	52
Vac.....	44
Vdc .....	44
Version.....	140
VIEW key.....	165
Voltage limit .....	62

## W

---

Wait time.....	227
Waveform averaging .....	86
WAVE NUM key.....	86



# Warranty Certificate

# HIOKI

Model	Serial number	Warranty period Three (3) years from date of purchase ( ___ / ___ )
-------	---------------	--

Customer name: \_\_\_\_\_  
Customer address: \_\_\_\_\_

## Important

- Please retain this warranty certificate. Duplicates cannot be reissued.
- Complete the certificate with the model number, serial number, and date of purchase, along with your name and address. The personal information you provide on this form will only be used to provide repair service and information about Hioki products and services.

This document certifies that the product has been inspected and verified to conform to Hioki's standards. Please contact the place of purchase in the event of a malfunction and provide this document, in which case Hioki will repair or replace the product subject to the warranty terms described below.

## Warranty terms

1. The product is guaranteed to operate properly during the warranty period (three [3] years from the date of purchase).  
If the date of purchase is unknown, the warranty period is defined as three (3) years from the date (month and year) of manufacture (as indicated by the first four digits of the serial number in YYMM format).
2. If the product came with an AC adapter, the adapter is warranted for one (1) year from the date of purchase.
3. The accuracy of measured values and other data generated by the product is guaranteed as described in the product specifications.
4. In the event that the product or AC adapter malfunctions during its respective warranty period due to a defect of workmanship or materials, Hioki will repair or replace the product or AC adapter free of charge.
5. The following malfunctions and issues are not covered by the warranty and as such are not subject to free repair or replacement:
  - 1. Malfunctions or damage of consumables, parts with a defined service life, etc.
  - 2. Malfunctions or damage of connectors, cables, etc.
  - 3. Malfunctions or damage caused by shipment, dropping, relocation, etc., after purchase of the product
  - 4. Malfunctions or damage caused by inappropriate handling that violates information found in the instruction manual or on precautionary labeling on the product itself
  - 5. Malfunctions or damage caused by a failure to perform maintenance or inspections as required by law or recommended in the instruction manual
  - 6. Malfunctions or damage caused by fire, storms or flooding, earthquakes, lightning, power anomalies (involving voltage, frequency, etc.), war or unrest, contamination with radiation, or other acts of God
  - 7. Damage that is limited to the product's appearance (cosmetic blemishes, deformation of enclosure shape, fading of color, etc.)
  - 8. Other malfunctions or damage for which Hioki is not responsible
6. The warranty will be considered invalidated in the following circumstances, in which case Hioki will be unable to perform service such as repair or calibration:
  - 1. If the product has been repaired or modified by a company, entity, or individual other than Hioki
  - 2. If the product has been embedded in another piece of equipment for use in a special application (aerospace, nuclear power, medical use, vehicle control, etc.) without Hioki's having received prior notice
7. If you experience a loss caused by use of the product and Hioki determines that it is responsible for the underlying issue, Hioki will provide compensation in an amount not to exceed the purchase price, with the following exceptions:
  - 1. Secondary damage arising from damage to a measured device or component that was caused by use of the product
  - 2. Damage arising from measurement results provided by the product
  - 3. Damage to a device other than the product that was sustained when connecting the device to the product (including via network connections)
8. Hioki reserves the right to decline to perform repair, calibration, or other service for products for which a certain amount of time has passed since their manufacture, products whose parts have been discontinued, and products that cannot be repaired due to unforeseen circumstances.

**HIOKI E.E. CORPORATION**

<http://www.hioki.com>

18-07 EN-3



**HIOKI**  
**www.hioki.com/**



**All regional  
contact  
information**

**HEADQUARTERS**

81 Koizumi  
Ueda, Nagano 386-1192 Japan

**HIOKI EUROPE GmbH**

Helfmann-Park 2  
65760 Eschborn, Germany  
hioki@hioki.eu

2111 EN

Edited and published by HIOKI E.E. CORPORATION

Printed in Japan

- CE declarations of conformity can be downloaded from our website.
- Contents subject to change without notice.
- This document contains copyrighted content.
- It is prohibited to copy, reproduce, or modify the content of this document without permission.
- Company names, product names, etc. mentioned in this document are trademarks or registered trademarks of their respective companies.