

**HIOKI**

**9333**

Instruction Manual

# **LAN COMMUNICATOR**

**EN**

Jan. 2016 Revised edition 9  
9333A981-09 16-01H





# Contents

|   |           |
|---|-----------|
| <b>Introduction</b> .....                               | <b>i</b>  |
| <b>Notes on Use</b> .....                               | <b>i</b>  |
| <b>Chapter 1 Overview</b> .....                         | <b>1</b>  |
| 1.1 Product Overview .....                              | 1         |
| 1.2 Specifications .....                                | 2         |
| <b>Chapter 2 Setup</b> .....                            | <b>3</b>  |
| 2.1 System Configuration Required .....                 | 3         |
| 2.2 Installing and Uninstalling the Software .....      | 4         |
| 2.3 Checking the Memory HiCorder Version .....          | 5         |
| 2.4 LAN Settings .....                                  | 6         |
| <b>Chapter 3 Remote Control (RmtCtrl)</b> .....         | <b>9</b>  |
| 3.1 Starting the Remote Control Application .....       | 9         |
| 3.2 Remote Control Menus .....                          | 10        |
| 3.3 Connecting to the Memory HiCorder .....             | 11        |
| 3.4 Memory HiCorder Operations .....                    | 12        |
| 3.5 Receiving Waveform Data .....                       | 14        |
| 3.6 Printing Waveform Data .....                        | 16        |
| 3.7 Other Functions .....                               | 17        |
| 3.7.1 Changing the Connection Timeout Setting .....     | 17        |
| 3.7.2 Changing the Screen Image Transfer Interval ..... | 18        |
| 3.7.3 Changing the Key Repeat Interval .....            | 18        |
| 3.7.4 Saving the Screen Image .....                     | 19        |
| 3.7.5 Printing a Screen Image .....                     | 19        |
| 3.7.6 Changing the Printing Settings .....              | 19        |
| 3.7.7 Comment Transmission Function .....               | 20        |
| 3.7.8 Escaping from the Key Check Screen .....          | 20        |
| 3.7.9 Send Print Key .....                              | 21        |
| 3.7.10 Version Information .....                        | 21        |
| <b>Chapter 4 Data Collection (Accumulator)</b> .....    | <b>23</b> |
| 4.1 Starting the Data Collection Application .....      | 24        |
| 4.2 Data Collection Menus .....                         | 25        |
| 4.3 Preparation for Data Collection .....               | 26        |
| 4.3.1 Selecting the Port to Go on Standby .....         | 26        |
| 4.3.2 Making Save Settings .....                        | 27        |
| 4.3.3 Selecting the Print Image Color .....             | 28        |
| 4.3.4 Printer Settings .....                            | 28        |
| 4.3.5 Memory HiCorder Settings .....                    | 29        |

|                  |   |           |
|------------------|---|-----------|
| 4.4              | Starting Data Collection .....                          | 31        |
| 4.5              | Location of Saved Files .....                           | 32        |
| <b>Chapter 5</b> | <b>Waveform Viewer (Wv) .....</b>                       | <b>35</b> |
| 5.1              | Starting the Waveform Viewer .....                      | 36        |
| 5.2              | Waveform Viewer Menus .....                             | 37        |
| 5.3              | Using the Waveform Viewer .....                         | 39        |
| 5.4              | Conversion to CSV Format .....                          | 42        |
| 5.5              | Converting Multiple Waveform Files into CSV Files ..... | 44        |

---

# User's License Agreement

## Important

Please read the following agreement carefully. This user's license agreement (hereafter referred to as Agreement) is a legal contract between the software user (individual or institution) and HIOKI E. E. CORPORATION (hereafter referred to as HIOKI). The term "software" includes any related electronic documentation and computer software and media, as well as any printed matter (such as the Instruction Manual).

By installing, reproducing, or using the software, you, the Licensee, agree to accept the license terms set forth in this Agreement.

---

This software is protected by copyright laws, international copyright agreements, as well as non-corporate laws. The software is a licensed product, and is not sold to the user.

### 1. License

This Agreement grants you, the Licensee, a license to install a single copy of the software on a specified computer system.

### 2. Explanation of other rights and restrictions

-1. Restrictions on reverse engineering, decompiling, and disassembling:

You may not reverse engineer, decompile, or disassemble the software.

-2. Separation of components:

This software is licensed for use as a single product. You may not separate the components for use on multiple computer systems.

-3. Loaning:

You may not loan or lease the software.

-4. Transfer of software:

You may transfer full rights in accordance with this Agreement. However, if you do so, you may not retain any copy of the software, but must transfer the software in its entirety (all components, media, related documentation such as the Instruction Manual, and this Agreement), and must ensure that the receiver of the software agrees with the terms set forth in this Agreement.

-5. Cancellation:

In the event that the terms and conditions set forth in this Agreement are violated, HIOKI retains the right to cancel this Agreement without compromise of any of its other rights. In this event, you must destroy all copies of the software and its components.

### 3. Copyright

The title and copyright rights concerning the software's related documentation, such as the Instruction Manual and copies of the software, are the property of HIOKI and other licensors, and are protected by copyright laws and international agreement regulations. Accordingly, you must treat the software as you would any other copyrighted document. However, you are permitted to make copies as indicated in (A) and (B) below provided such copies are not intended for use other than back-up purposes.

(A) You may make a single copy of the software.

(B) You may install this software on a single computer.

However, you may not reproduce the documentation supplied with the software, such as the Instruction Manual.

---

---

#### **4. Dual media software**

You may receive the same software on more than one type of media. However, regardless of the type and size of media provided, you may only use one media type and only on a single computer. You must not use or install the other media on any other computer. Furthermore, except when transferring the software as stipulated above, you may not loan, lease, or transfer the other media to any other user.

#### **5. Warranty**

- 1. HIOKI reserves the right to make changes to the software specifications without any prior warning.
  - 2. If the software does not operate in accordance with the supplied Instruction Manual, or the software media or Instruction Manual are damaged in any way, you have one year from the date of purchase to apply for either an exchange or repair at HIOKI's discretion.
  - 3. In no event will HIOKI be liable for any damages resulting from fire, earthquake, or actions of a third party under the conditions stated in item number 2 above, or for any damage caused as a result of your using the software incorrectly or under unusual circumstances. Further, the warranty is invalid if the following occurs:
    - (A) Damage incurred through transport, moving, droppage, or any other kind of impact after you purchased the software.
    - (B) Damage incurred through any form of alteration, unwarranted servicing, or any other type of mistreatment.
  - 4. In the event that the software is exchanged or repaired, the period of warranty expires on the latest occurring date out of the day stated in the original warranty, and exactly 6 months from the day the exchanged/repaired software is returned to you.
  - 5. Regardless of the grounds for making a legal claim, HIOKI and its licensors will not be liable for any damage incurred (including, but not limited to: lost profits, suspension of business, loss of data or lost savings) unstated in the warranty terms for the use of this software. This is true even if HIOKI is notified of the possibility of such damages. In any event, HIOKI's liability shall be limited only to replacing defective software with software that is not defective.
-

---

## Introduction

Thank you for purchasing this HIOKI "9333 LAN COMMUNICATOR."  
To get the maximum performance from the unit, please read this manual first, and keep this at hand.

### Trademarks

- Pentium is a registered trademark of Intel Corporation.
- Windows is a registered trademark of Microsoft Corporation.



---

## Notes on Use

In order to ensure safe operation and to obtain maximum performance from the unit, observe the cautions listed below.

- Always hold the disc by the edges, so as not to make fingerprints on the label side or scratch the printing.
- Never touch the recorded side of the disc. Do not place the disc directly on anything hard.
- Do not wet the disc with volatile alcohol or water, as there is a possibility of the label printing disappearing.
- To write on the disc label surface, use a spirit-based felt pen. Do not use a ball-point pen or hard-tipped pen, because there is a danger of scratching the surface and corrupting the data. Do not use adhesive labels.
- Do not expose the disc directly to the sun's rays, or keep it in conditions of high temperature or humidity, as there is a danger of warping, with consequent loss of data.
- To remove dirt, dust, or fingerprints from the disc, wipe with a dry cloth, or use a CD cleaner. Always wipe radially from the inside to the outside, and do no wipe with circular movements. Never use abrasives or solvent cleaners.
- In the interests of ongoing product developments, there may be minor discrepancies between screen displays and the operating instructions, and in the data conversion process.
- HIOKI cannot accept any responsibility for the results of using this product.

The following symbols are used in this Instruction Manual to indicate the relative importance of cautions and warnings.

|  |   |
|--|---|
|  <b>CAUTION</b> | Indicates that incorrect operation presents possibility of injury to the user or damage to the equipment. |
|  <b>NOTE</b>    | Denotes items of advice related to performance of the equipment or to its correct operation.              |





---

# Chapter 1

## Overview

---

---

### 1.1 Product Overview

The 9333 LAN COMMUNICATOR comprises the following three software applications.

#### 1. Remote control (RmtCtrl)

This application provides remote control of the Memory HiCorder from a computer, through a LAN. This allows you to make settings on the Memory HiCorder and carry out simple monitoring.

You can transfer waveform data from the Memory HiCorder to the computer, and print reports on the computer.

#### 2. Data collection (Accumulator)

This software provides Memory HiCorder auto save and auto print functions on the computer.

A single computer can collect data from multiple Memory HiCorders, for centralized handling of Memory HiCorder measurement data on the computer, or printing of waveform data using the computer's printer.

#### 3. Waveform viewer (Wv)

This provides a simple viewing facility for waveform files transferred from the Memory HiCorder being used for remote control and data collection.

You can convert binary data to CSV format: CSV files are convenient because they can be read into spreadsheets and other software.

#### NOTE

- When not using a LAN (when no LAN card is installed), and the memory recorder function time axis setting is 10 ms/division or above, the waveform is displayed sequentially. However, when a LAN is used, the waveform is only displayed sequentially if the setting is 100 ms/division or above.\* Similarly, in roll mode the minimum setting is 100 ms/division.
- It can not be monitored by Remote control application while it is measured with X-Y CONT recorder.
- When the Recorder function time axis setting is 20 ms/DIV, it can not be monitored by 8826 with the Remote control application during the measurement.

\*: except MR8827, MR8847A, MR8847, 8847, MR8740, MR8741 (These models follow the "roll mode" settings)

## 1.2 Specifications

### General specification

|                       |  |
|-----------------------|--|
| Supplied medium       | One CD-R   |
| Supported recorders   | HIOKI MR8827, MR8847A, MR8847, 8847, MR8740, MR8741, 8730, 8731, 8826, 8835-01, 8841, 8842, 8855, 8720 |
| Operating environment | Windows 10/ 8/ 7/ Vista/ XP<br>(with LAN installed and TCP/ IP available)                              |
| Communications        | Ethernet, TCP/ IP  |

### Functional specifications

- (1) Remote control application (RmtCtrl)
  - Memory HiCorder remote control function  
Control carried out by sending key codes and receiving screen image
  - Report printing
  - Screen shot printing
  - Receiving waveform data files  
Same format as the Memory HiCorder waveform save function, but binary only, and if the cursors are shown, only the interval between the cursors.
- (2) Data collection application (Accumulator)
  - Receiving Memory HiCorder auto save files  
Same format as the Memory HiCorder auto save function, but waveform data is binary only (text format can be selected in MR8827, MR8847A, MR8847, 8847, MR8740, MR8741, 8730, 8731, 8855), and if the cursors are shown, only the interval between the cursors. (MR8827, MR8847A, MR8847, 8847, MR8740, MR8741, 8855 are depending on the format that you set in the Memory HiCorder)
  - Memory HiCorder auto print function, printing on the computer
  - Memory HiCorder screen hard copy function, printing on the computer (MR8827, MR8847A, MR8847, 8847, MR8740, MR8741, 8855 are not supported)
  - Memory HiCorder PRINT key, printing on the computer
- (3) Waveform viewer (Wv)
  - Waveform file display (support for binary files in MEM, REC, RMS, and POW format)
  - Conversion to CSV format (can thin, or specify section)
  - Display format settings (scroll function, zoom display, display channel setting)

---

# Chapter 2

## Setup

---

---

### 2.1 System Configuration Required

Using the 9333 requires the following hardware and software.

#### Computer

- Free hard disk capacity: 5 MB

#### Operating system

Microsoft Windows 10, Windows 8, Windows 7, Windows Vista, or Windows XP

#### LAN

Hardware for network connection installed  
TCP/IP available on the network

#### CD-ROM drive

Used for installation.

#### Printer

Required for printing Memory HiCorder data on the computer.  
Either a color or monochrome printer can be used, but as far as possible a high-speed printer is recommended.



Note that in data collection, when transferring large quantities of waveform data from the Memory HiCorder, a corresponding amount of hard disk space is required. The hard disk capacity provided should be in line with expected volumes of data.

## 2.2 Installing and Uninstalling the Software

### Installation

Use the following procedure to install the software.

1. Shut down all currently running applications.
2. Insert the supplied CD-R disc into the CD-ROM drive.
3. Execute the setup file on the CD-R.  
Supposing the drive letter for the CD-ROM drive is R (if another letter, substitute before the colon) then in the Windows Start menu, select Run, and enter R:\english\setup.exe, then click OK.
4. The 9333 installer start: follow the directions on the screen to complete the installation.

#### NOTE

- When installing, if other application are running it may not be possible to complete the installation. As far as possible, close all other applications before beginning the installation. In particular, if any anti-virus software is running, it may prevent the installation, even though it is not a virus. In this case, make the appropriate settings in the anti-virus software to allow the installation to proceed.
- When upgrading versions, uninstall the old version of 9333 before installing the new version of 9333. After installation, confirm the version information on the "Help" menu.

### Uninstallation

Use the following procedure to uninstall the software.

1. Shut down all currently running applications.
2. Insert the supplied CD-R disc into the CD-ROM drive.
3. Execute the setup file on the CD-R.  
Supposing the drive letter for the CD-ROM drive is R (if another letter, substitute before the colon) then in the Windows Start menu, select Run, and enter R:\english\setup.exe, then click OK.
4. The 9333 uninstaller start: follow the directions on the screen to complete the uninstallation.

All transferred data files remain, but can be removed manually when no longer required.

---

## 2.3 Checking the Memory HiCorder Version

To use the 9333 LAN Communicator, the software in the Memory HiCorder must have 9333 support. First check the Memory HiCorder version number: you can find this on the System screen of the Memory HiCorder.

For more details, refer to the Instruction Manuals for the Memory HiCorder.

Versions compatible to 9333 are ver 2.30 or later for 8826, 8841, 8842, ver 1.10 or later for 8835-01, ver 5.10 or later for 8835-01 High performance model (9540-01), ver 2.00 or later for 8720, ver 1.00 or later for 8855, ver 1.10 or later for 8730, 8731, and ver 3.07 or later for MR8847, 8847, and ver 3.12 or later for MR8740, and ver 2.12 or later for MR8741.

When Memory HiCorder is not compatible with 9333, upgrade the unit application software. According to the version-up instructions for each model contained in the CD-R, please be upgraded.



Depending on the version of your Memory HiCorder, the software may be an enhanced version in place of the normal version. The CD-R includes only normal versions, so in this case a separate upgrade is required. Consult your HIOKI service representative.

## 2.4 LAN Settings



Before connecting to the LAN for the first time, it is important to complete the Interface settings. If the unit is connected to the LAN without making these settings, there may be IP address conflicts with other devices on the network or other problems.

### Preparations for the settings

First, when connecting to an existing network, it is necessary to obtain the settings from the network system administrator. You will need to obtain the following from your network administrator.

- Host name  
This is the name of the Memory HiCorder in the network. It must be distinct from the host names of all other devices in the network.
- IP address  
This is the identifying address for the Memory HiCorder. It must be distinct from the addresses of all other devices in the network.
- Subnet mask  
This specifies the class (size) of the network.
- Default gateway  
Specify a gateway if communications from the Memory HiCorder to the computer pass through one.
- TCP/IP port number  
This is the port used for TCP/IP communications between the Memory HiCorder and the computer. Normally the default 880x ports can be used, but if these ports are already used by a different program on the computer, specify different ports.

When the port number is specified as "880x" the ports used are as follows:

- Port 8800: for remote control application
- Port 8801: for data collection application
- Port 8802: for control by GP-IB commands
- Ports 8803 to 8809: reserved

Use ports on the computer running the 9333 software that are unused.

Note that the ports are mapped to IP addresses, and do not have any relation to the ports used by other devices in the LAN.

Host Name (up to 12 characters) : \_\_\_\_\_

IP Address : \_\_\_\_\_.\_\_\_\_.\_\_\_\_.\_\_\_\_

Subnet Mask : \_\_\_\_\_.\_\_\_\_.\_\_\_\_.\_\_\_\_

Default Gateway (present or not present, when present)

: \_\_\_\_\_.\_\_\_\_.\_\_\_\_.\_\_\_\_

TCP/IP Port Number : \_\_\_\_X

You can set the upper three decimal digits of the port address (the rightmost digit is set internally by this device).

---

Of course, if assembling a stand-alone network with no connection to an existing network, you can still obtain the address information from the administrator, or if there is no administrator, you can assign the setup values yourself.

An IP address within the following range is recommended when setting up such a stand-alone network: 192.168.0.0 to 192.168.255.255.

However, the rightmost number may not be 0 or 255, so we recommend setting the controller device (PC, etc.) to 192.168.0.1, and setting this unit to 192.168.0.2. If several Memory HiCORDERS are to be connected, the last number should be incremented by one for each unit (e.g., the next unit would be 192.168.0.3).

The Host Name should be carefully selected to be unique among the Host Names assigned to all other devices.

Otherwise, the following settings should be satisfactory:

Subnet Mask : 255.255.255.0

Default Gateway : OFF

Port Number : 880X

## Settings on the Memory HiCorder

Carry out the Memory HiCorder settings in the System screen.

Do not change the settings during a communications session.

The settings take effect when you press the Confirm function key. In other words, do not press Confirm for each individual setting, but only after completing all the settings.

SYSTEM 4      INTERFACE      MEM      '00-02-06  
16:41:50

COPY OUTPUT      INTERFACE      MONO

PRINT OUTPUT      INTERNAL PRINTER

BMP file name      IMAGE

interface

IP Address      192.168. 0. 2

Subnet Mask      255.255.255. 0

Host Name      h8841a

Gateway      OFF      192.168. 0. 10

Port Number      880X

Data Server      192.168. 0. 1

Delimiter      LF

Header      OFF

SCSI ID      8841      7

target      5

MD Drive      controled by PC      OFF

unit  
gpid  
SET UP

EU  
SCALING

HIOKI MEM  
COMMENT

INTERFACE

2 of 2  
(etc)

This is required for the data collection function.  
For details see Section 4.3.5.

**Example: 8841/42**

- The delimiter and header settings are used for control by GP-IB commands.

### NOTE

- Using the 8841, 8842, 8826, 8835-01 and 8720  
If no LAN card is inserted, the Settings screen does not appear, so be sure to insert the LAN card before making the settings.  
For details of the settings, refer to the Instruction Manuals supplied with the 9578 10 BASE-T LAN CARD.
- Using the MR8827, MR8847A, MR8847, 8847, MR8740, MR8741, 8730, 8731, 8855  
For details of the settings, refer to the Instruction Manuals supplied.

## Settings on the computer

Using this software requires the computer to have a LAN connection installed. For details of the LAN settings, consult the Windows "Help" files, or the documentation supplied with the computer's LAN card. The TCP/IP protocol must be available for use.



---

# Chapter 3

## Remote Control (RmtCtrl)

---

### 3.1 Starting the Remote Control Application

In the Windows Start menu, select Programs, HIOKI 9333 LAN Communicator, and Remote Control. This starts the remote control application.

To close the remote control application, in the Connection menu select Exit. You can also click the Close button at the top right corner of the window.

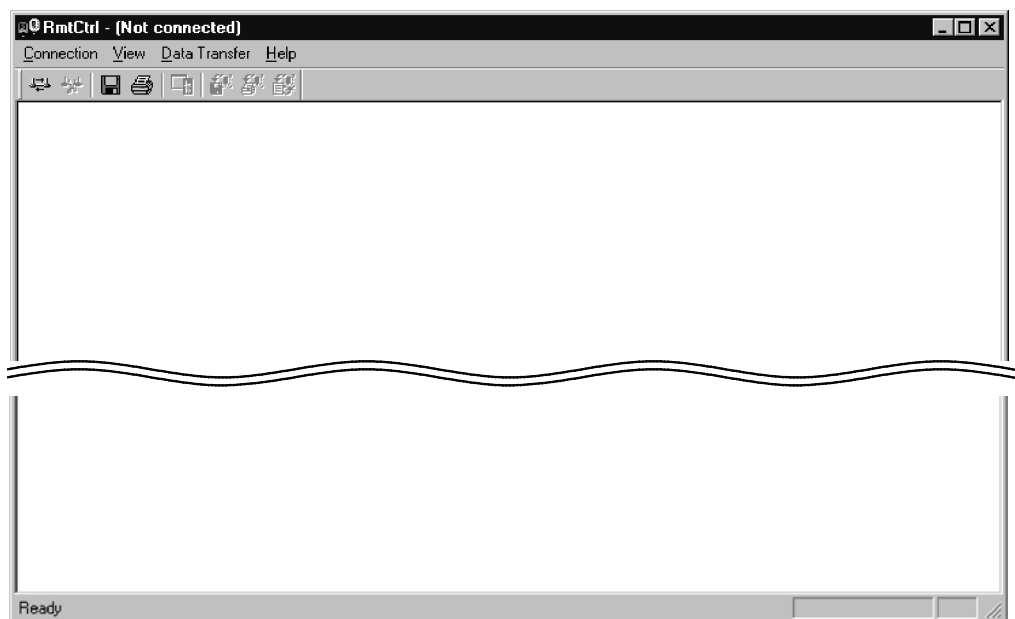

#### Toolbar

Click the icons in the toolbar for the respective functions.

From the left, these are: Connect, Disconnect, Save Screen, Print Screen, Toggle Key Dialog Bar, Get/Save Waveform Data, Get/Print Report Image, and Get/Send Comments.

For details of these operations, see the descriptions of the corresponding menu items.

#### Status bar

The status bar shows, from the right, the model name and its operating status.

---

## 3.2 Remote Control Menus

The following is the complete menu tree of the remote control application.

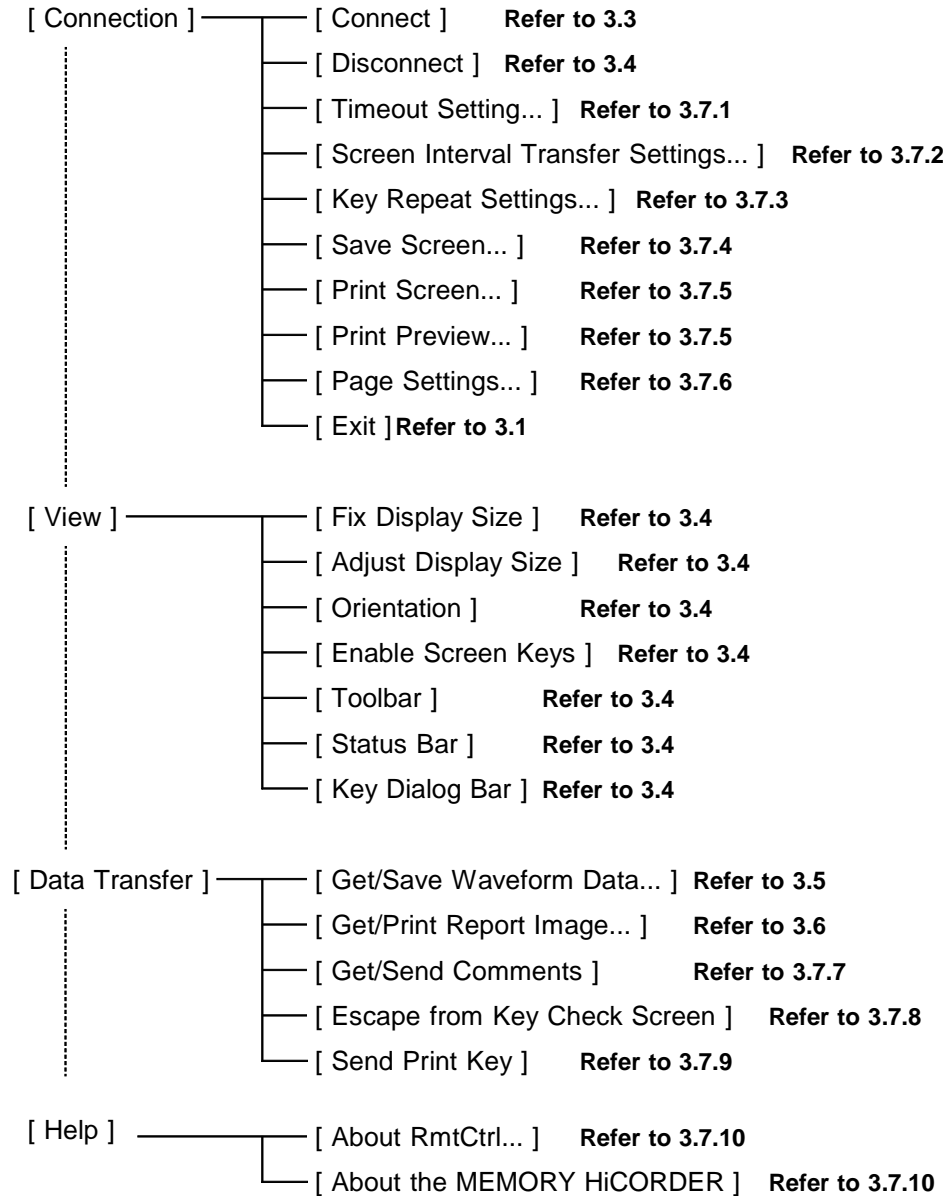

---

## 3.3 Connecting to the Memory HiCorder

In the remote control application Connection menu, select Connect. This displays the following Connection dialog box: enter the recorder's IP address and port number.

The IP address is the IP address set on the Memory HiCorder System screen. The port number is also set on the System screen, and in the example show, when "880x" was set, enter "8800" here.

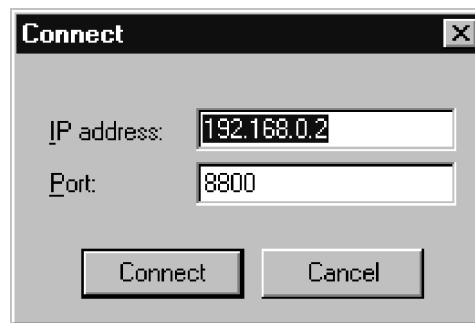

Next click the Connect button to connect to the Memory HiCorder.

## 3.4 Memory HiCorder Operations

Once connected to the Memory HiCorder, the following Screen image and key panel appear in the window.

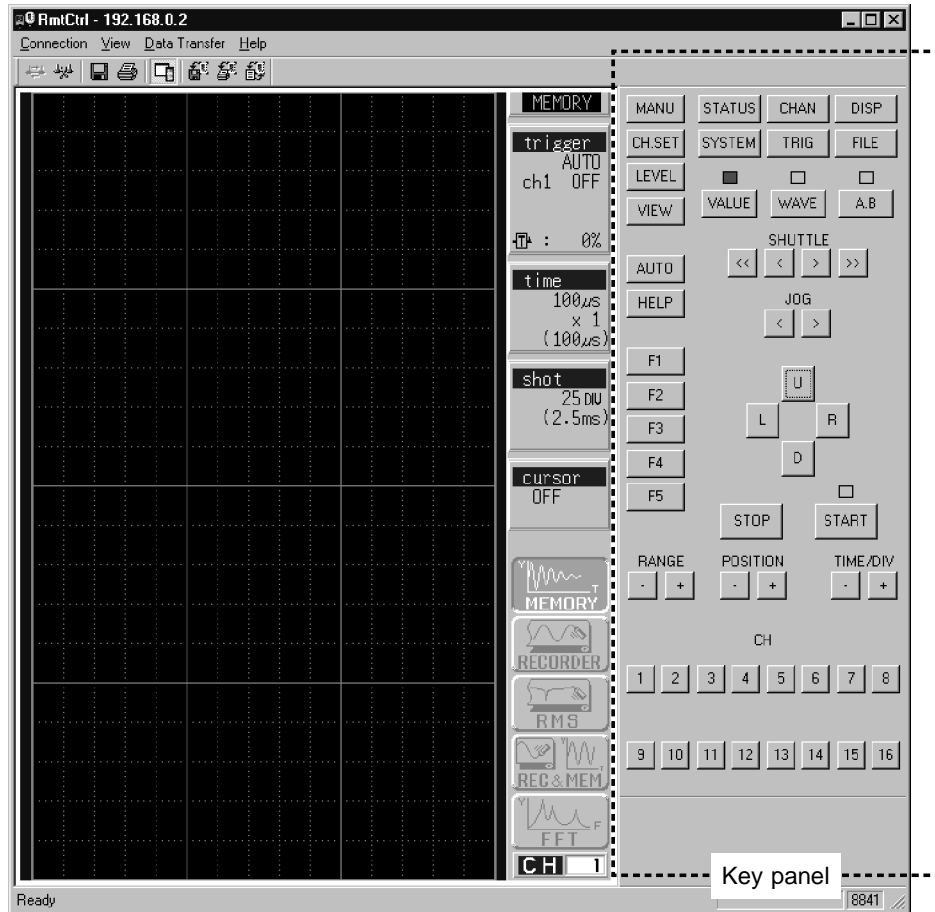

Example: 8841/42

Clicking a key button in the key panel with the mouse has the same effect as pressing the corresponding button on the Memory HiCorder.

In MR8827, MR8847A, MR8847, 8847, MR8740, MR8741, it can be manipulated by clicking directly on the screen. If you want to change the settings, click the Settings item you want to change first, and then click the GUI buttons next.

During measurement, the response from the Memory HiCorder is somewhat slower, but the software can be used for simple monitoring.

To end the connection to the Memory HiCorder, in the Connection menu select Disconnect.

You can change the size and orientation of the screen image display.

In the menus:

View > Select [Fix display size] to display the same display resolution as Memory HiCorder display. When the entire display cannot be viewed, scroll to view it.

View > Select [Adjust display size] to reduce or enlarge the Memory HiCorder display to fit and display the entire view in the window.

View > Orientation > Landscape (8841/42, 8720 only)

View > Orientation > Portrait (default) (8841/42, 8720 only)

When [Adjust display size] is selected and the window is reduced, the display with letters and waveforms becomes less readable. Use it only during monitoring.

In the View menu, if Enable Screen Keys is checked, you can also press the keys (GUI) on the Memory HiCorder screen.

Places where it is not possible to make settings are shown by a mark (⊙).

### Keyboard operations

In the View menu, select Key Dialog Bar, and set the key panel display to OFF in order to use the keyboard. The key allocations are as shown below.

|                                       |              |                   |               |
|---------------------------------------|--------------|-------------------|---------------|
| <b>STATUS</b>                         | Ten-key of 7 | <b>Shuttle</b>    | 0 , - , ^ , \ |
| <b>CHAN</b>                           | Ten-key of 8 | <b>Jog</b>        | @ , ⌈         |
| <b>DISP</b>                           | Ten-key of 9 | <b>START</b>      | Enter         |
| <b>SYSTEM</b>                         | Ten-key of 4 | <b>STOP</b>       | Space         |
| <b>TRIG</b>                           | Ten-key of 5 | <b>MANU TRIG</b>  | m             |
| <b>FILE</b>                           | Ten-key of 6 | <b>CH.SET</b>     | c             |
| <b>VALUE</b>                          | Ten-key of 1 | <b>LEVEL MONI</b> | l             |
| <b>WAVE</b>                           | Ten-key of 2 | <b>VIEW</b>       | v             |
| <b>A.B CSR</b>                        | Ten-key of 3 | <b>AUTO</b>       | a             |
| <b>Up and down<br/>Right and left</b> | Cursor key   | <b>HELP</b>       | h             |
| <b>F1 to F10</b>                      | 1 to 9, o    |                   |               |

#### NOTE

- The response is slower than when operating on the Memory HiCorder itself, and after pressing a key you should wait a moment for the effect to appear on the screen. This is because the key code and new screen image have to be transferred over the LAN.
- It is possible to make settings such as the LAN address by remote control, but as the setting takes effect, the connection is lost. Such operations should therefore be avoided.
- When the recorder function display format is X-Y, during measurement the display cannot be updated.

---

## 3.5 Receiving Waveform Data

You can transfer waveform data from memory in the Memory HiCorder to the computer. The data is transferred as a file in the same format as in a binary save to recording media on the Memory HiCorder.

Select Data Transfer, then Get/Save Waveform Data.

When the dialog box appears, enter the location (directory) to save the file and the file name.

Next click Start, to start receiving the waveform data from the Memory HiCorder.

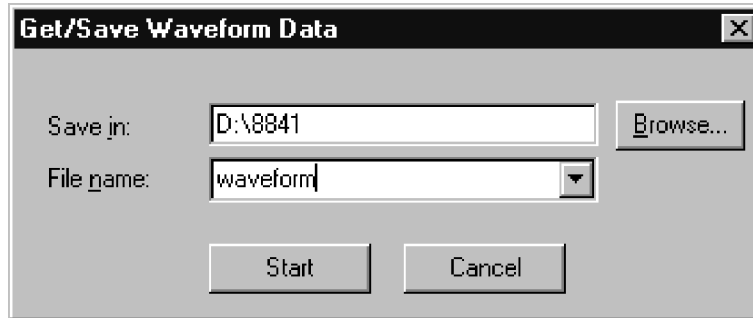

While the data is being transferred, the progress is shown at the lower right corner of the application window. When this bar reaches the right edge the transfer is complete. (When transferring more than one file, the progress bar wipes across for each set of waveform data.)

When the A/B cursors are present on the screen, only the section between the cursors is transferred. When the cursors are not shown the whole of the data is transferred: always check the cursors before sending.



After completing data transfer, the following dialog appears. Double click the displayed file name or select the file name and click [Wv] button to start up waveform view to display the waveform file. Also click [Explorer] button to start up Explorer and see the folder that contains the saved files. Transferred files can be converted to ASCII data and be used in EXCEL, copied to floppy disk and be loaded in Memory HiCorder.

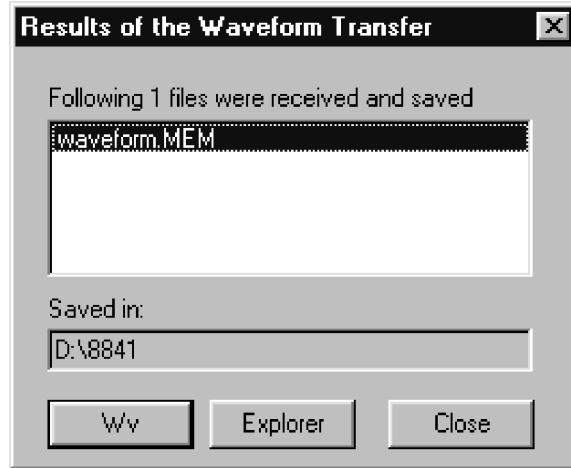

## 3.6 Printing Waveform Data

You can print waveform data from the Memory HiCorder on a printer connected to the computer, in place of the internal printer of the Memory HiCorder.

Go to [Data Transfer] and select [Get/Print Report Image] to display the following dialog. Select print data (color/black&white) to be received and click [Get] button to start receiving data.

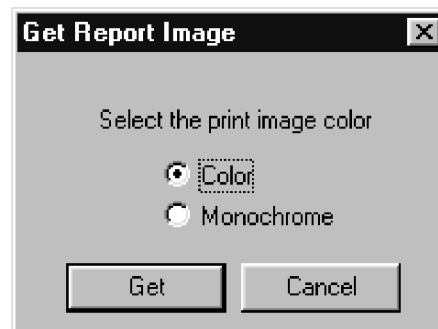

During receiving, progress is displayed on the bottom right in the application window. When the bar reaches the right end, data transfer is complete.

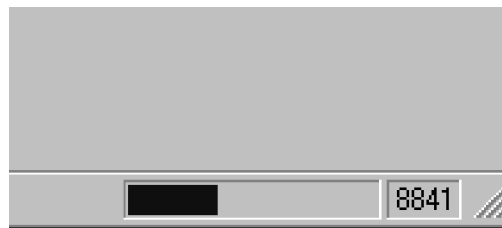

The following dialog box then appears.



- Print : Print the data. Note that this is in report print format.
- Print Preview : Preview the printing image on the screen.
- Page settings : Set the printing layout.
- Cancel : Cancel printing.
- Save to File : Save the data in bitmap file format.

When you select Print here, the report print image is output to the computer's printer.



- The print image color selection feature (Color/Monochrome) is disabled on the MR8827, MR8847A, MR8847, 8847, MR8740, MR8741, 8855. This is always set to monochrome. This feature is disabled on the 8730, 8731.



---

## 3.7 Other Functions

---

### 3.7.1 Changing the Connection Timeout Setting

The remote control application carries out various data transactions with the Memory HiCorder. If the LAN is busy, responses may be delayed, and if the delay with no response exceeds a preset limit, a timeout occurs, and the network is disconnected. You can change the setting of this timeout limit, increasing it if a busy network causes frequent timeouts. If the network connection is functioning normally, there is no need to change this setting. In the Connection menu, select Timeout Settings, to display the dialog box. Enter the new time limit here.

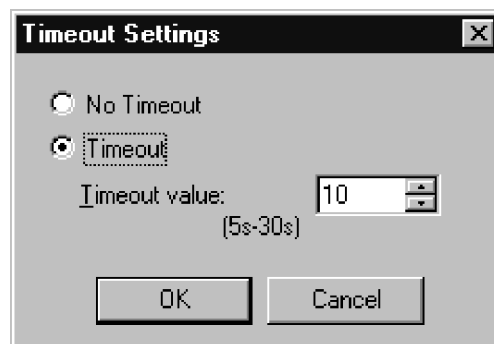
**NOTE**

When the remote control application and data collection application are used simultaneously, while the data collection application is transferring data, remote control of the Memory HiCorder is not possible. Since in this case the remote control could time out, select "No Timeout."

---

## 3.7.2 Changing the Screen Image Transfer Interval

The screen image display is normally updated each time there is a key panel press, directly after measurement ends (or at the measurement interval when the trigger mode is continuous or auto), and at regular intervals.

You can change this regular interval for the update. Making it shorter improves the screen image display response, but increases the load on the LAN and the Memory HiCorder. Making it longer decreases the screen image display response, but also lightens the load.

You can also stop the interval transfer, but in this case only the screen image immediately following the last key panel press will appear, so when carrying out processing that takes a significant time it will not be possible to determine when the operation has completed, because the screen image is not updated.

Normally the default setting should not require changing, but if the Memory HiCorder appears to be under a heavy load, or to reduce the load on the LAN, increase the setting.

In the Connection menu, select Screen Interval Transfer Settings to display the dialog box. Enter the new setting as required.

The transfer interval depends on the load state of the Memory HiCorder, and may be longer than the set value.

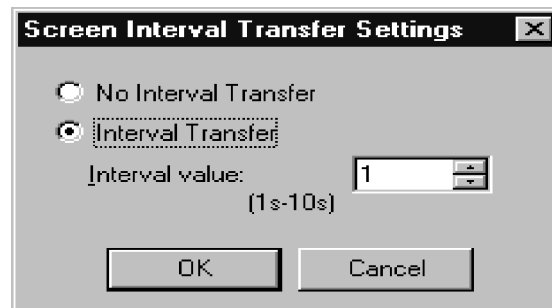

---

## 3.7.3 Changing the Key Repeat Interval

When you hold down a key panel button, the key information is sent repeatedly to the Memory HiCorder. This setting determines the repeat interval; it is best to adjust the setting after using the current setting. Since the response of the Memory HiCorder varies according to the current task, even if adjusted for operation on one screen, this may not necessarily be the best setting for all screens.

In the Connection menu, select Set Key Repeat Settings, to display the dialog box. Enter the new setting as required.

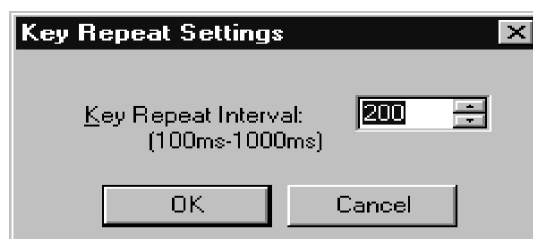

---

### 3.7.4 Saving the Screen Image

You can save the Memory HiCorder screen image displayed in the window of the remote control application as a bitmap file in the computer's file system.

This is convenient for saving a measured waveform as a screen image, or to copy a settings screen for documentation purposes.

In the Connection menu, select Save Screen. A dialog box asks where you want to put the screen image. Click Save to save the screen image as a bitmap file.

---

### 3.7.5 Printing a Screen Image

You can print the Memory HiCorder screen image displayed in the window of the remote control application on the computer's printer.

This is convenient for printing a measured waveform as a screen image, or when printing a settings screen for documentation purposes.

In the Connection menu, select Print Screen. The printing dialog box appears: click OK to print.

To change the printer settings, click Properties. The printer settings depend on the particular printer: refer to the documentation supplied with the printer for details.

You can also preview the effect of the printing. To do this, in the Connect menu select Print Preview.

---

### 3.7.6 Changing the Printing Settings

When printing a screen image or report print on the printer, you can change the printing settings on the fly, or you can make the settings here in advance.

In the Connection menu, select Page Settings. A dialog box appears: make the printing settings in it as required.

When you exit the application, the printing settings are not saved, and thus when the application starts, they revert to the Windows default printer settings.

Set the Windows printer settings by clicking the "My Computer" icon on the Windows desktop, selecting Printer, and in the dialog box selecting Properties.

For more details, see the Windows Help or the printer documentation.

### 3.7.7 Comment Transmission Function

Using the comment transmission function, you can conveniently prepare comments on the computer, and transfer them to the Memory HiCorder. In the Data Transfer menu, select Get/Send Comments. This displays a table of the comments stored in the Memory HiCorder.

| Send Comments   |                      |
|---|----------------------|
| Title:  | <input type="text"/> |
| <b>Analog</b>   |                      |
| ch1:  | LINE1                |
| ch2:  | LINE2                |
| ch3:  | <input type="text"/> |
| ch4:  | <input type="text"/> |
| ch5:  | <input type="text"/> |
| ch6:  | <input type="text"/> |
| ch7:  | <input type="text"/> |
| ch8:  | <input type="text"/> |
| ch9:  | <input type="text"/> |
| ch10:   | <input type="text"/> |
| ch11:   | <input type="text"/> |
| ch12:   | <input type="text"/> |
| ch13:   | <input type="text"/> |
| ch14:   | <input type="text"/> |
| ch15:   | <input type="text"/> |
| ch16:   | <input type="text"/> |
| <b>Logic</b>  |                      |
| A1:   | START SIGNAL A       |
| A2:   | START SIGNAL B       |
| A3:   | START SIGNAL C       |
| A4:   | START SIGNAL D       |
| B1:   | <input type="text"/> |
| B2:   | <input type="text"/> |
| B3:   | <input type="text"/> |
| B4:   | <input type="text"/> |
| C1:   | <input type="text"/> |
| C2:   | <input type="text"/> |
| C3:   | <input type="text"/> |
| D1:   | <input type="text"/> |
| D2:   | <input type="text"/> |
| D3:   | <input type="text"/> |
| D4:   | <input type="text"/> |
| <input type="button" value="Send"/> <input type="button" value="Cancel"/> |                      |

Example: 8841/42

Click with the mouse on the channel where you want to change the comment, and enter the new comment. After setting the comments, click the Send button to transfer them to the Memory HiCorder.

### 3.7.8 Escaping from the Key Check Screen

There are some keys which are present on the Memory HiCorder itself, but not on the key panel of the remote control application. Therefore, if you enter the Memory HiCorder key check screen under remote control (System screen, self-check), it will not be possible to complete the key Check. In this case, in the Data Transfer menu, select Escape from Key Check Screen. This has the effect of pressing the Memory HiCorder START and STOP keys simultaneously, and exits the key check screen.

---

### 3.7.9 Send Print Key

Selecting Send/Receive Data and Send Print Key on the Menu bar has the same effect as pressing the PRINT key on the Memory HiCorder. When you specify "Interface" for the "PRINT Output" of the Memory HiCorder and select the "Send Print Key" while waiting for the data collection (Accumulator), you can output the data to the printer connected to the computer.



This feature is disabled on the 8730, 8731.

---

### 3.7.10 Version Information

When making inquiries, the version number will be required. To check the software version number, in the Help menu select About RmCtrl. To check the version number of the Memory HiCorder, select About the Memory HiCorder.



---

## Chapter 4

# Data Collection (Accumulator)

---

By starting the data collection application (Accumulator) on the computer, you can use the following functions.

- Saving Memory HiCorder auto save files to the computer
- Using the computer printer for a Memory HiCorder auto print
- Using the computer printer for a Memory HiCorder screen hard copy
- Using the computer printer for the Memory HiCorder PRINT key function

With these functions, you can collect data from a number of Memory HiCorders on a single computer, constantly save the measurement data to the computer, print in color using a color printer with the computer, print on plain paper for archiving, and access data on the computer regardless of the physical location of the Memory HiCorder.

When the Memory HiCorder auto save function is used to transfer a file, when the Memory HiCorder A/B cursors are present, only the section between the cursors is saved. In other cases all of the data is saved. The waveform file is in binary format only (text format can be selected in MR8827, MR8847A, MR8847, 8847, MR8740, MR8741, 8730, 8731, 8855).

---

---

## 4.1 Starting the Data Collection Application

In the Windows Start menu, select Programs, HIOKI, 9333 LAN Communicator, and Data Collection. This starts the data collection application.

To close the data collection application, in the Server menu select Exit. You can also click the Close button at the top right corner of the window.

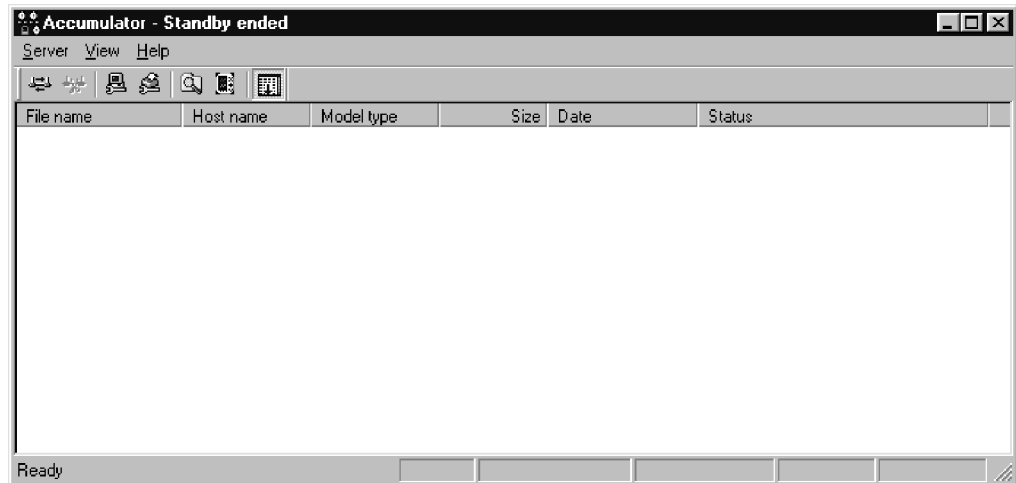

### Toolbar

Click the icons in the toolbar for the respective functions.

From the left, these are: Start Standby, End Standby, Server Settings, Printer Settings, Start Explorer, Start Waveform Viewer, Auto Scroll.

For details of these operations, see the descriptions of the corresponding menu items.

### Status bar

The status bar shows, from the right, the current number of connections, total size of files received, free disk space, the root path, and the port number.

### Version information

When making inquiries, the version number will be required.

To check the software version number, in the Help menu select About Accumulator.



## 4.2 Data Collection Menus

The following is the complete menu tree of the data collection application.

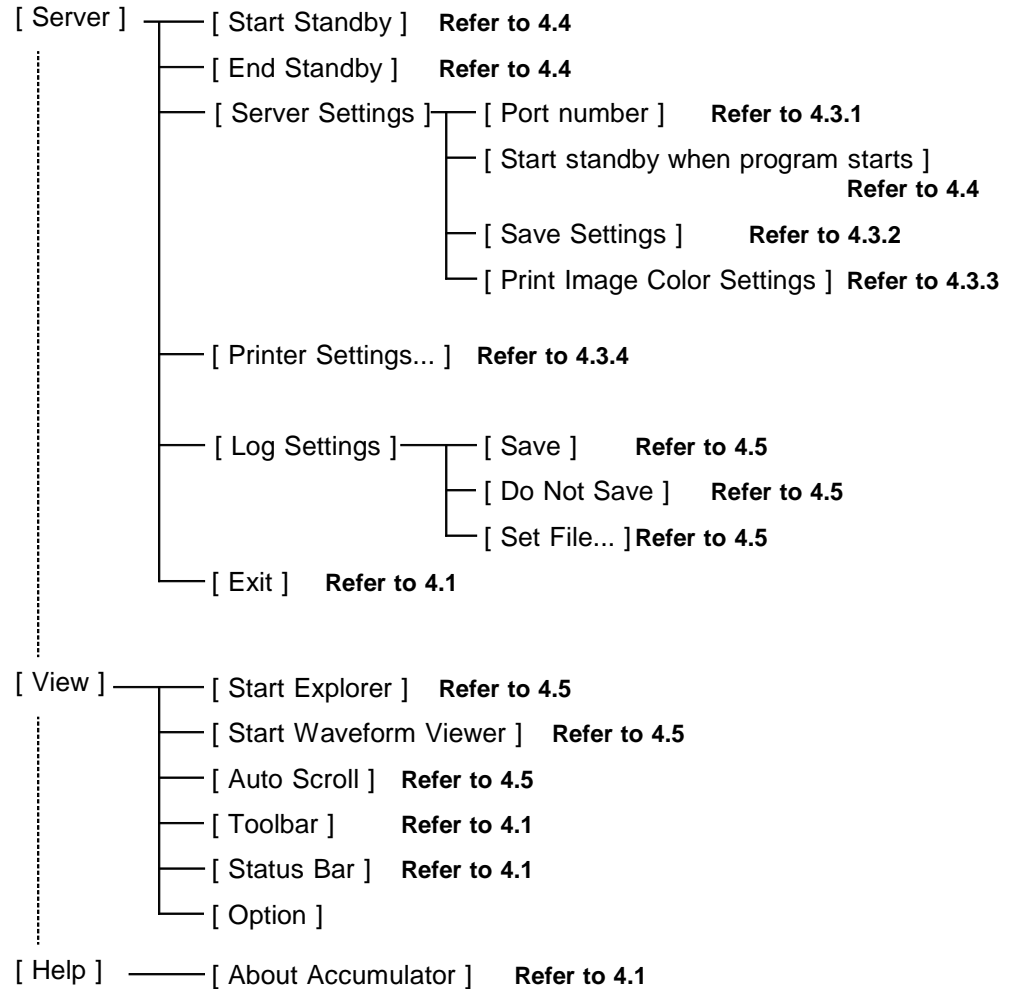

---

## 4.3 Preparation for Data Collection

Before beginning data collection, the following preparations are necessary.

1. Selecting the port to go on standby
2. Making save settings
3. Selecting the print image color
4. Printer settings
5. Memory HiCorder settings

---

### 4.3.1 Selecting the Port to Go on Standby

Before beginning data collection, it is necessary to select the port to go on standby. This is indicated by the TCP/IP port number.

Set to the TCP/IP port number of the Memory HiCorder. (See Section 2.4) In the menu bar, select Server, then Server Settings to display the Server Settings dialog box.

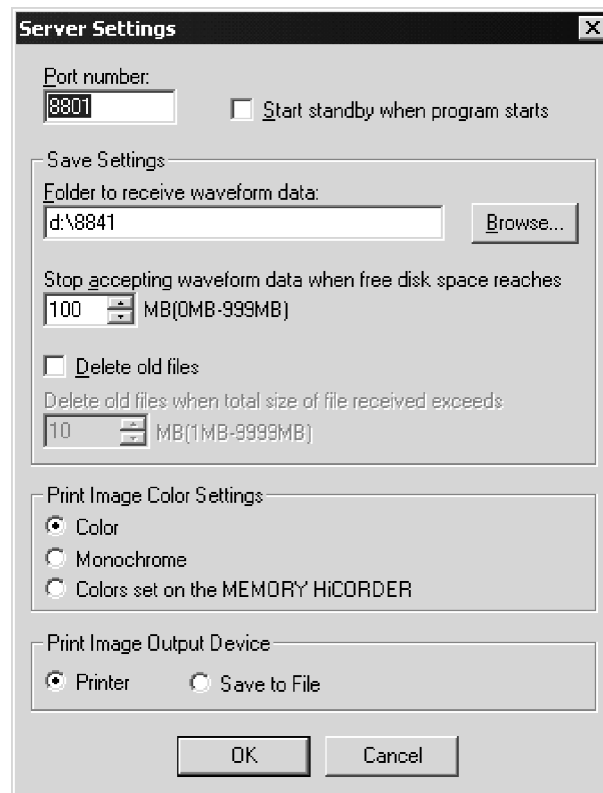

If the Memory HiCorder setting is "880x", here enter "8801", replacing the "x" by "1". For example, for "987x" enter "9871".

If you check the Start Standby when Program Starts box, then the data collection application starts data collection as soon as you launch it. (See Section 4.4.)

## 4.3.2 Making Save Settings

In the menu bar, select Server, then Server Settings, to display the Server Settings dialog box.

In the Folder to Receive Waveform Data box, specify where to save data received from the Memory HiCorder. (See Section 4.5.)

In the Stop Accepting Waveform Data when Free Disk Space Reaches box enter the minimum required free disk space.

Especially when important Windows files such as a swap file, temporary directory are placed on the same disk, use caution because Windows operation may possibly become unstable due to insufficient free disk space. Check [Delete old files] check box to automatically delete old files (only during waiting period) after starting up data collection application software and total size of file received exceeds the size set for saving in this setting. It deletes from the oldest file displayed in the list on the display chronologically. When data collection application software is restarted, the file previously collected is not displayed in the list and so cannot be selected for deleting.

When a large volume of waveform data files are transferred and deleting is not fast enough filling up specified free disk space, data collection stops.

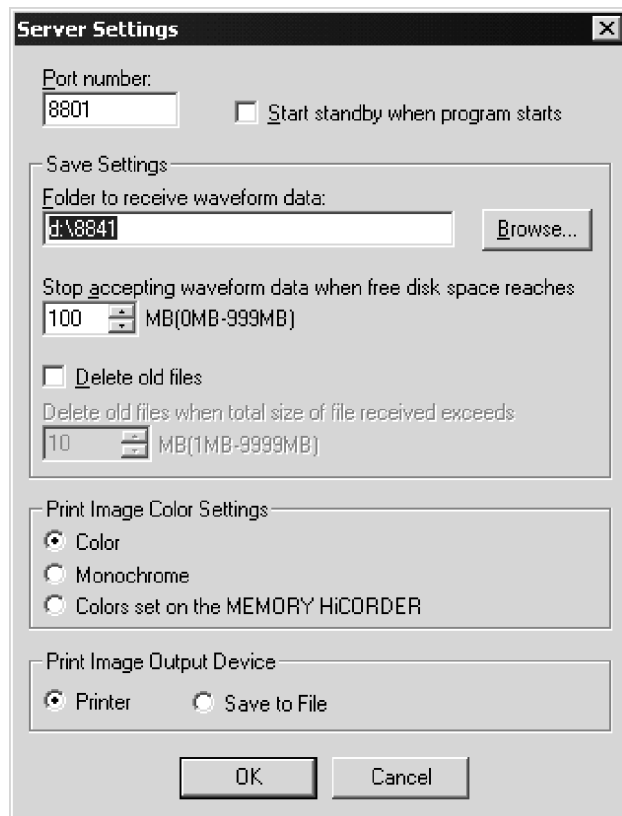

### 4.3.3 Selecting the Print Image Color

In the menu bar, select Server, then Server Settings, to display the Server Settings dialog box.

In this dialog box you can select the color used to print data received from the Memory HiCorder. You can select color, monochrome, or the colors set on the Memory HiCorder. The color/monochrome setting takes precedence over the Memory HiCorder setting (on the System screen).



- With the 8720, you cannot specify colors on the Memory HiCorder. Colors are automatically selected when you select the Memory HiCorder setting.
- This is always set to monochrome for the MR8827, MR8847A, MR8847, 8847, MR8740, MR8741, 8855.

---

### 4.3.4 Printer Settings

You can make settings as required for printing from the data collection application.

In the Server menu, select Printer Settings. A dialog box appears: make the printing settings in it as required.

When you exit the application, the printing settings are not saved, and thus when the application starts, they revert to the Windows default printer settings.

Set the Windows printer settings by clicking the "My Computer" icon on the Windows desktop, selecting Printer, and in the dialog box selecting Properties.

For more details, see the Windows Help or the printer documentation.

---

## 4.3.5 Memory HiCorder Settings

This section describes the settings on the Memory HiCorder for using the data collection application.

By starting the data collection application (Accumulator) on the computer, you can use the auto save and auto print functions of the Memory HiCorder on the computer disk or printer.

### Setting the data collection server IP address

It is necessary first to set the IP address for the data collection server, in the System screen. This is part of the Memory HiCorder System screen interface settings.

Move the flashing cursor to Data Collection Server, and use the function keys or jog dial to set the same IP address as on the computer.

### Auto save setting

You can use the Memory HiCorder auto save function on the computer running the data collection application.

To do this, in the Memory HiCorder Status screen, set the auto save destination to Communications (LAN). Note that in this function the waveform data is transferred in binary (text format can be selected in MR8827, MR8847A, MR8847, 8847, MR8740, MR8741, 8730, 8731, 8855).

### Auto print setting

You can use the Memory HiCorder auto print function on the computer running the data collection application.

To do this, in the Memory HiCorder Status screen, set the auto print destination to Communications (LAN).

### Hard copy destination setting

You can use the Memory HiCorder screen hard copy function on the computer running the data collection application. To do this, in the System screen set the COPY key output to Communications.

You can select color or monochrome output.

Now when you press the Memory HiCorder COPY key, the screen image will be printed on the computer.

### Print destination setting

You can print whatever is printed by pressing the Memory HiCorder PRINT key on the computer running the data collection application.

To do this, in the System screen set the PRINT key output to Communications.

You can select color or monochrome output.

Now when you press the Memory HiCorder PRINT key, the printing will appear on the printer connected to the computer.

**NOTE**

- Using the 8720  
Specify Communications (LAN) as the auto-save destination in the Memory HiCorder Status screen. This allows you to send the measured waveform, screen shot, and printed waveform to the 9333 simply by pressing the SAVE/COPY key. To specify desired colors, see "Selecting the Print Image Color" in Section 4.3.3 for more details. If you select the Memory HiCorder setting, colors are selected automatically on the 8720.
- Using the 8855  
To specify the IP address, select System and Interface.  
To specify auto-save, select System and File Save.  
After selecting System, File Save, Set SAVE key Setting, and Save Media, and specifying LAN as the destination, you can send the measured waveforms, screen shot (hard copy data), and printed waveform to the 9333 by pressing the SAVE key. For information on specifying colors, see "Selecting the Print Image Color" in Section 4.3.3
- Using the MR8827, MR8847A, MR8847, 8847, MR8740, MR8741.  
To specify the IP address, select System screen - [Interface] sheet.  
To specify auto-save, select System screen - [File Save] sheet.  
After specifying LAN as the destination of SAVE key, you can send the measured waveforms, screen shot (hard copy data), and printed waveform to the 9333 by pressing the SAVE key. For information on specifying colors, see "Selecting the Print Image Color" in Section 4.3.3

## 4.4 Starting Data Collection

In the Windows Start menu, select Programs, HIOKI, 9333 LAN Communicator, and Data Collection. This starts the data collection application.

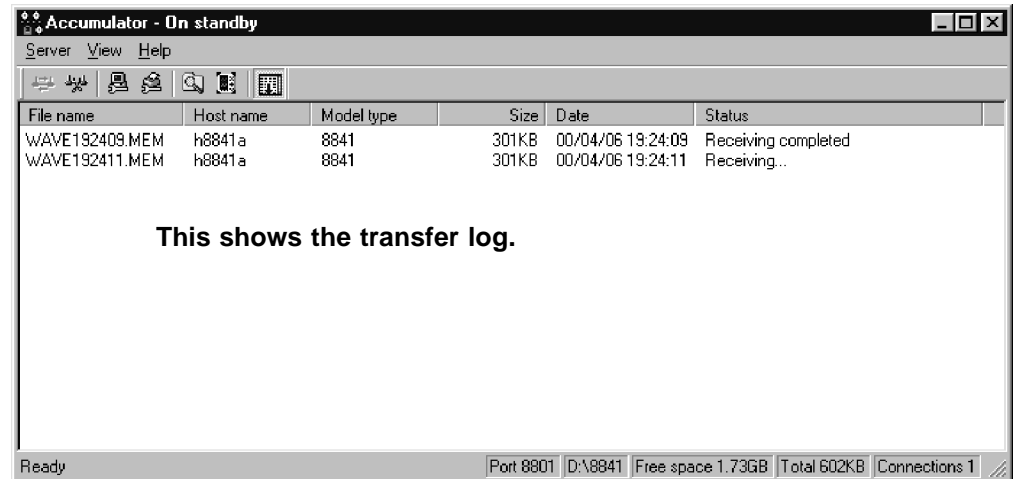

This shows the current status.  
(Port number, path, free disk space, total size of files received, current number of connections)

### Starting standby

After completing the server settings, in the Server menu, select Start Standby: this puts the application on standby.

Now when save data is transferred from the Memory HiCorder it is accepted and saved on the computer. When print data is transferred from the Memory HiCorder, it is printed on the computer.

To start the application automatically when the computer is started up  
When a computer is dedicated to the data collection task, you can have the computer start data collection as soon as it is started up. To do this, add this application to the Windows Startup. (For more details, refer to the Windows help.)

In the directory in which the 9333 software is installed, the program is the file "Accumulator.exe": add a shortcut to this file to Startup.

Next, in the data collection application settings, check the Start Standby when Program Starts box. (See Section 4.3.1.)

## 4.5 Location of Saved Files

Files obtained by data collection are saved as follows.

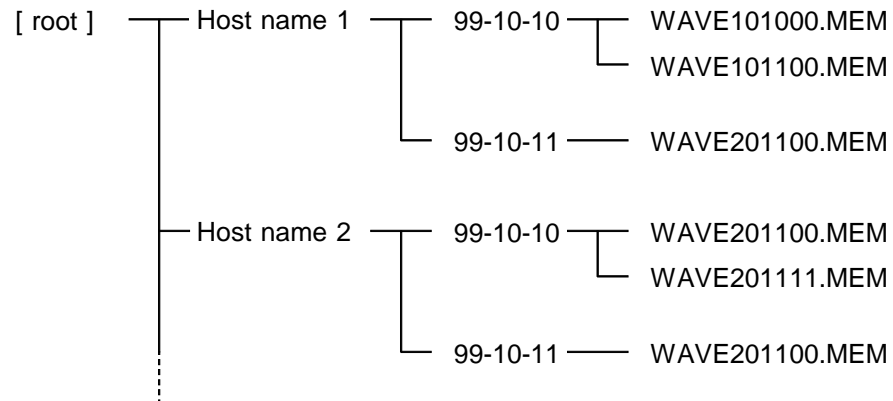

The root directory for the files is the directory set in the data collection application as Folder to Receive Waveform Data.

Within this directory, there is a directory name after the Host Name, as set on the Memory HiCorder.

Further below this directory, there are subdirectories named by the date. The files are saved in the directory with today's date.

The files are saved as "PARAMETER.TXT" if a parameter calculation file, or "WAVEHHMMSS.[extension]" if a waveform data file.

Here the "HHMMSS" is the time in hours, minutes, and seconds. If two file names would otherwise be the same, a numeric suffix is attached.

### Starting Explorer

In the View menu, select Start Explorer, or in the display list, right-click on an item, and select Browse with Explorer. Either method starts Explorer.

### Using the waveform viewer

For saved waveform files, double-click an item in the display list, or right-click and select View with Waveform Viewer, and display the waveform.

Once a file has disappeared from the display list, use the waveform viewer to open the corresponding file to display it. You can also start the waveform viewer by selecting Start Waveform Viewer in the View menu.

- You can select the waveform viewer to start in the setup screen displayed by selecting Display with Setup from the menu.

### Display auto scrolling

In the View menu, check Auto Scroll to scroll the display automatically so that when a new item is added to the list it is always within view.



**Transfer log**

You can save a log of the collected data transfers (when, from where, and what was transferred). You can check this file to find out what transfers have occurred.

In the Server menu, select Log Settings, then Set File, to display the File Settings dialog box.

Once you enter a file name here, logging starts.

In the Server menu, select Log Settings, then Save/Do Not Save to toggle the logging on and off.

**Organizing saved data**

Collected data is saved in sequence as it is received. If the settings are such that a very large volume of data will be saved, the free disk space may be rapidly used up. When the free disk space falls below the set level, data collection stops. Use the following methods to ensure that this does not happen.

- Expand the computer's hard disk capacity.
- Manage the files frequently, deleting any that are not required, or transferring them to other media. Note that moving files to the Recycle Bin does not of itself increase the free disk space: you also need to empty the Recycle Bin.



---

## **Chapter 5**

# **Waveform Viewer (Wv)**

---

This provides simple viewing of data transferred to the computer using the remote control and data collection applications. It also has a function to convert to CSV file format, after which you can load the data into a spreadsheet or other software.

---

---

## 5.1 Starting the Waveform Viewer

In the Windows Start menu, select Programs, HIOKI, 9333 LAN Communicator, and Waveform Viewer. This starts the waveform viewer application.

To close the waveform viewer application, in the File menu select Exit. You can also click the Close button at the top right corner of the window.

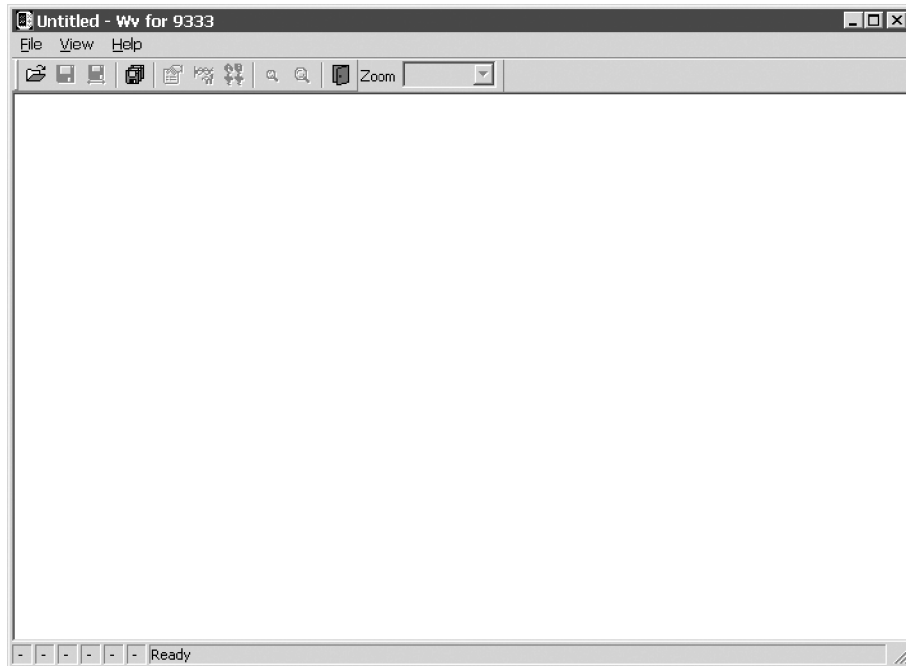

### Toolbar

Click the icons in the toolbar for the respective functions.

From the left, these are: Open, Save Whole Data, Save Between Cursors, Batch Conversion, Properties, Waveform Control Panel, Trace, Zoom Out, Zoom In, and Exit.

For details of these operations, see the descriptions of the corresponding menu items.

You can also select the magnification factor for the time axis by selecting on the toolbar.

### Status bar

The status bar shows, from the left, the model name, function, recording length, time axis, trigger time, pre-trigger, and judgment result.

### Version information

When making inquiries, the version number will be required.

To check the software version number, in the Help menu select About Wv.

## 5.2 Waveform Viewer Menus

The following is the complete menu tree of the waveform viewer application.

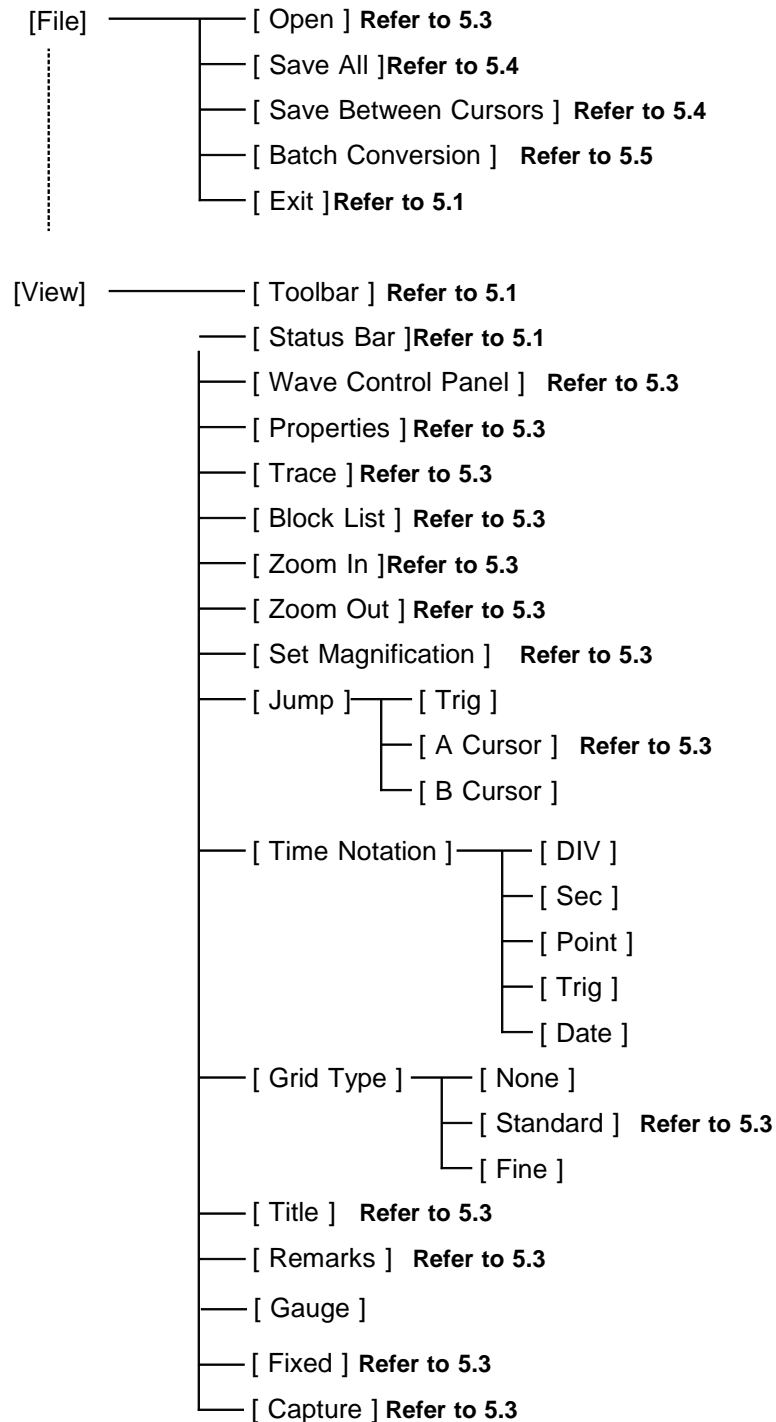

Right-click with the mouse in the waveform display screen for the following functions.

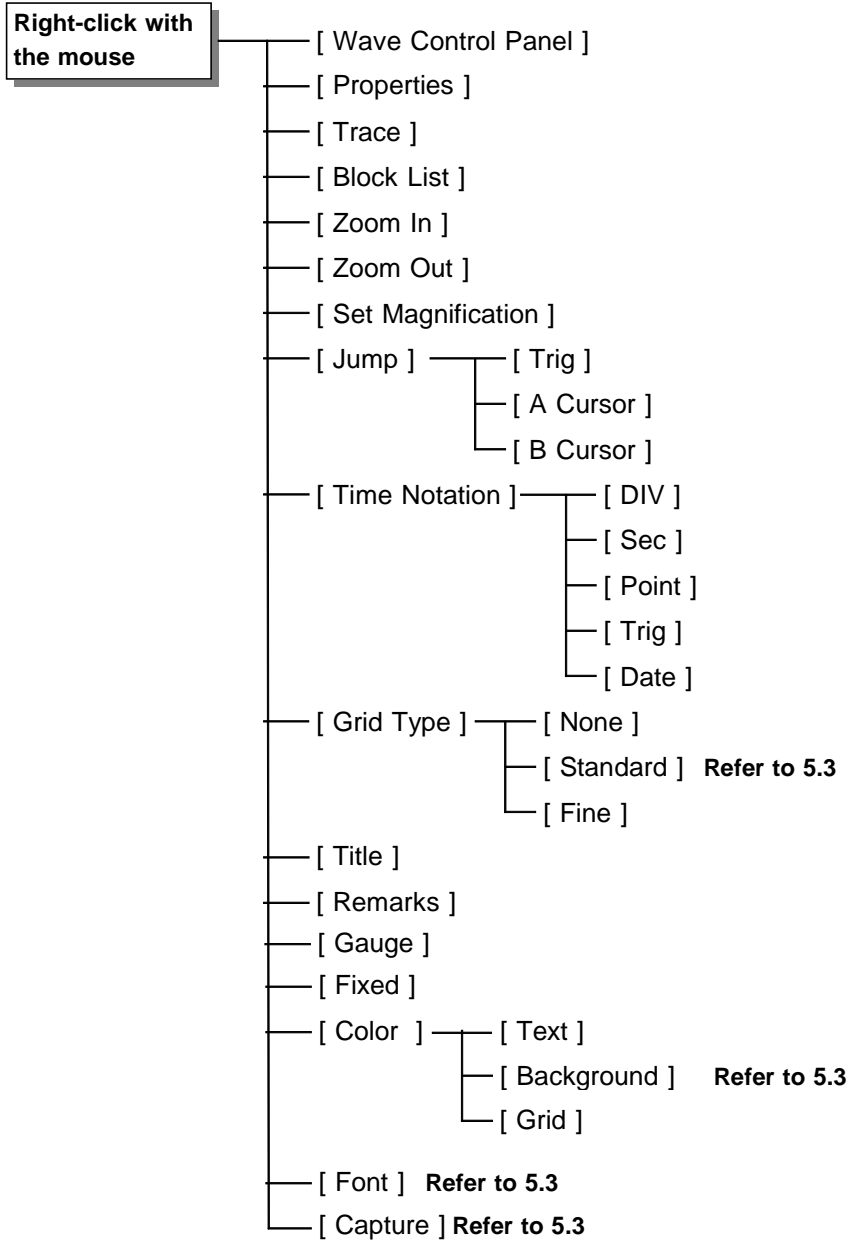

## 5.3 Using the Waveform Viewer

### Waveform display

To display a waveform it is first necessary to select the file to be displayed. In the [File] menu, select [Open], to display the file selection dialog box. Select a waveform file, and click Open to read in the file, and display the waveform.

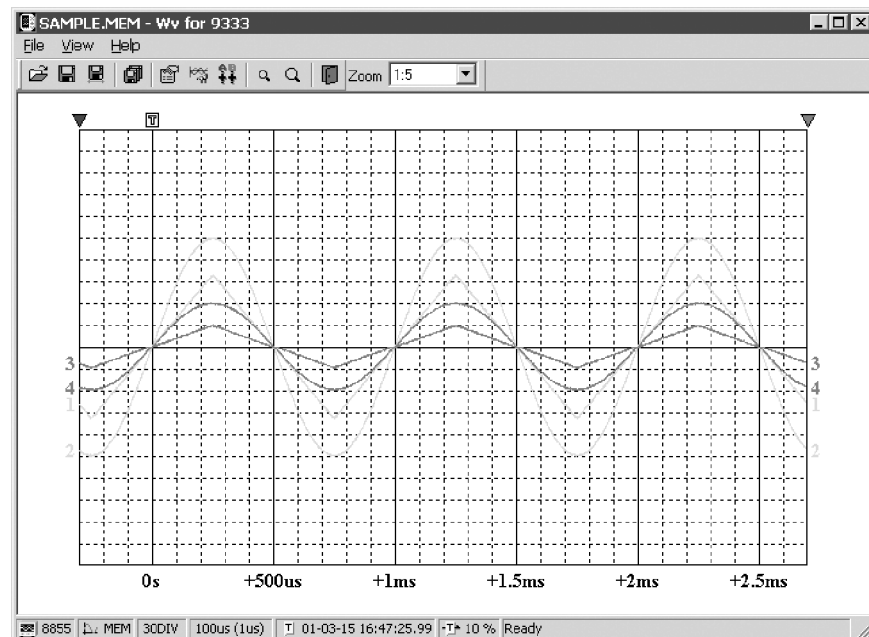

### Changing the time axis scale (zoom function)

You can change the time axis scale in the display using the menus or toolbar.

In the toolbar, click the Magnification box, to display the possible zoom factors: you can then select any desired value.

### Changing waveform scale and position (Waveform Control Panel)

You can adjust the display for each channel separately. In the [View] menu, select [Waveform Control Panel] to display a dialog box.

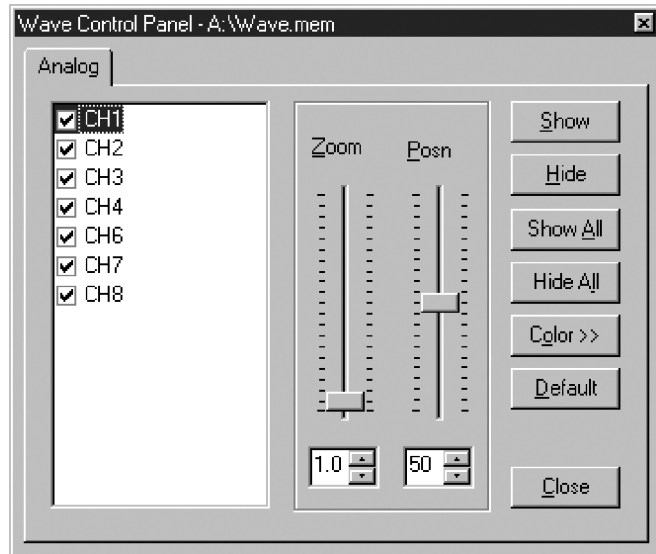

|                       |  |
|-----------------------|--|
| <b>CH</b>             | This indicate the list of channel.<br>When a check mark is present the corresponding channel is displayed. |
| <b>Zoom</b>           | Set the magnification on the voltage axis for the specified channel.                                       |
| <b>Posn</b>           | Set the position of the specified channel.   |
| <b>Show</b>           | Display the specified channel(s).  |
| <b>Hide</b>           | Do not display the specified channel(s).   |
| <b>Show All</b>       | Display all channels.  |
| <b>Hide All</b>       | Do not display all channels.   |
| <b>Color &gt;&gt;</b> | Change the color of the specified channel(s).  |
| <b>Default</b>        | Set all values of the specified channel(s) back to their default values.                                   |
| <b>Close</b>          | Close the Waveform Control Panel.  |

### Checking the waveform measurement conditions (Properties)

Select [View], then [Properties] from the menu to display the measurement settings on the MEMORY HiCORDER.

### Checking voltage values (Trace)

Select [View], then [Trace] from the menu to check the time value and difference of the two cursors (A and B) and the voltage values and differences of all channels.

### File list in index file

Select [View], then [Block List] to check the file list (block number, filename, time axis range, trigger time) in the index file.

Double-click a file in the list opens a new window in which you can check waveform in that file.

\* This is effective only when reading Sequential, Multi-block, REC&MEM index files.



---

**Waveform jump function**

Select [View], then [Jump] to jump to the trigger position or the positions of the A or B cursors.

**Time Notation**

Select [View], then [Time Notation] to change the time notation on the waveform screen.

**Grid Type**

Select [View], then [Grid Type] to change the grid type.

**Title comment display**

Select [View], then [Title] to display title comments in the top of the waveform screen.

**Waveform legend view**

Select [View], then [Remarks] to view the unit type of each channel, the measurement mode, measurement range, filters, comments, scaling, display position and magnification on the portion below the waveform screen.

**Fixing waveform view conditions**

Select [View], then [Fixed] to always view waveforms with the same color, display position and magnification.

When this item is enabled, the file view settings are disabled.

The standard values for display conditions are automatically saved when the application is terminated or when the check mark is removed from [Fixed] menu.

**Setting the display colors**

Right-click on the waveform display screen, and select [Color], then [Text]/[Background]/[Grid] to display a dialog box for setting the respective colors.

**Font settings (character size)**

Right-click on the waveform display screen, and select [Font], to display the font setting dialog box. You can then select the font for text on the waveform display screen.

**Waveform display snaps (capture)**

Select [View], then [Capture] to capture waveform display and copy to clipboard as a bit image. You can paste it into other applications.

## 5.4 Conversion to CSV Format

You can convert displayed waveform data to a CSV format file. Once in CSV format, the file can be loaded into spreadsheet or other software for further processing. You can either convert the whole data file or a range selected with the cursors.

If selecting a range, first set the cursors to the required positions. These are indicated at the top of the waveform screen by inverted blue and red triangles: drag these triangles with the mouse to set the range.

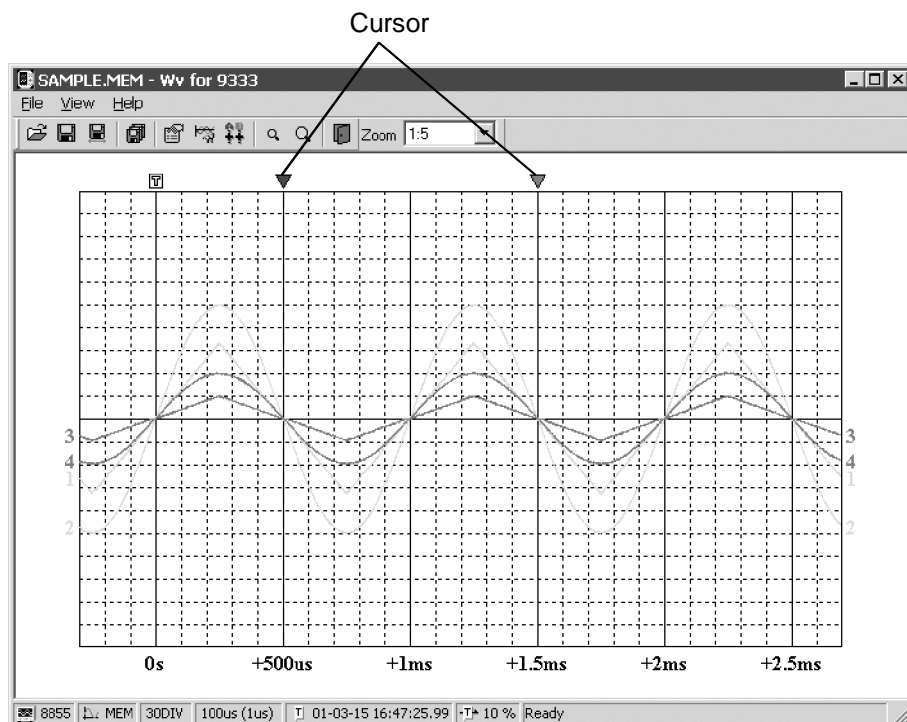

Then to save all of the data, in the [File] menu, select [Save All]; to save the range only, in the [File] menu, select [Save Between Cursors].

A dialog box appears for setting the file to be saved, and the thinning.

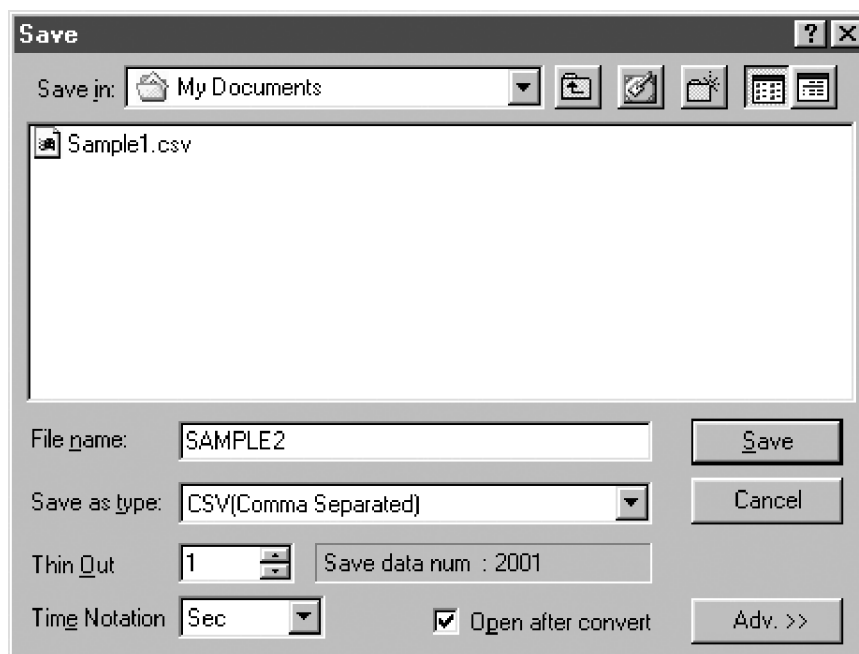

To save in text formats other than CSV (space delimited or tab delimited), select the desired format from the [Save as type] list.

In the Thinning box, enter the number of original samples corresponding to one converted value.

Use this when data over a large range (long time interval) is required, but the whole set of sampled data is not required.

In the Time Notation box, select the appropriate time notation from Sec, Date, Trig, Point.

Enter the name of the file to be saved, and click the Save button to convert the data to CSV format and save the file.

---

## 5.5 Converting Multiple Waveform Files into CSV Files

You can convert multiple waveform files into CSV files.

1. Select [File] from the menu bar, then select [Batch Conversion] from the File menu.

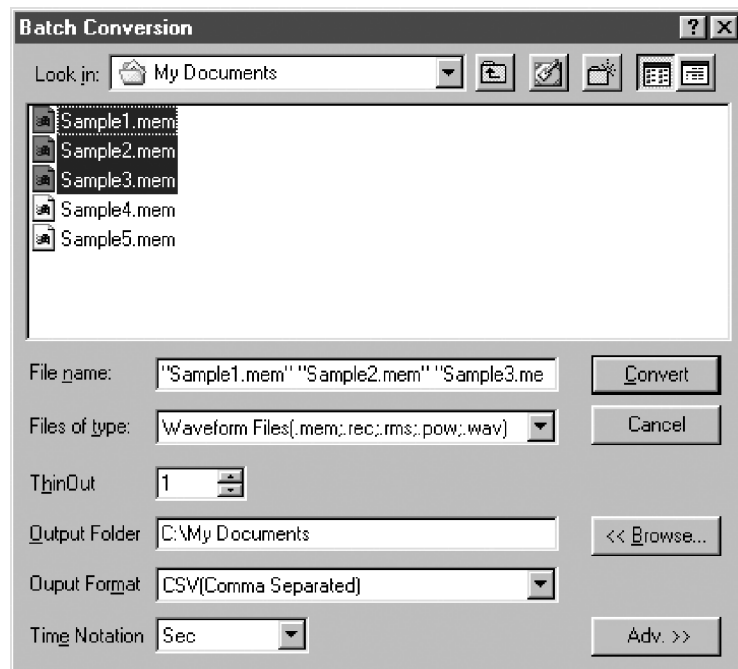

2. Select the desired files from the file list. To select two or more files, left-click on the desired files while holding down the Shift or Control key.
3. If required, specify the sampling intervals at which data is to be converted. Remember that not all data needs to be converted. This setting is useful when you need data over a broad time span.
4. In the Output, specify the folder in which to save the CSV files converted from waveform files. You can specify the desired folder without typing simply by clicking on the Ref button and selecting the desired folder from the list.
5. To save in text formats other than CSV (space delimited or tab delimited), select the desired format from the [Save as type] list.
6. In the Time Notation box, select the appropriate time notation from Sec, Date, Trig, Point.
7. Click the Convert button. All selected waveform files are converted to CSV files and saved in the specified folder.

---

- memo -

---

---

- memo -

---



- Please visit our website at [www.hioki.com](http://www.hioki.com) for the following:
  - Regional contact information
  - The latest revisions of instruction manuals and manuals in other languages.
  - Declarations of Conformity for instruments that comply with CE mark requirements.
- All reasonable care has been taken in the production of this manual, but if you find any points which are unclear or in error, please contact your supplier or the International Sales and Marketing Department at Hioki headquarters.
- In the interests of product development, the contents of this manual are subject to revision without prior notice.
- The content of this manual is protected by copyright.  
No reproduction, duplication or modification of the content is permitted without the authorization of Hioki E.E. Corporation.

# HIOKI

---

HIOKI E. E. CORPORATION

## HEADQUARTERS

81 Koizumi, Ueda, Nagano 386-1192, Japan  
TEL +81-268-28-0562 FAX +81-268-28-0568  
[os-com@hioki.co.jp](mailto:os-com@hioki.co.jp)  
(International Sales Department)

**[www.hioki.com](http://www.hioki.com)**

## HIOKI USA CORPORATION

[hioki@hiokiusa.com](mailto:hioki@hiokiusa.com) [www.hiokiusa.com](http://www.hiokiusa.com)

## HIOKI (Shanghai) SALES & TRADING CO., LTD.

[info@hioki.com.cn](mailto:info@hioki.com.cn) [www.hioki.cn](http://www.hioki.cn)

## HIOKI INDIA PRIVATE LIMITED

[hioki@hioki.in](mailto:hioki@hioki.in) [www.hioki.in](http://www.hioki.in)

## HIOKI SINGAPORE PTE. LTD.

[info@hioki.com.sg](mailto:info@hioki.com.sg)

1601EN